

POPULAR MECHANICS

MAGAZINE

WRITTEN SO YOU CAN UNDERSTAND IT



REG'D. TRADE MARK, GREAT BRITAIN, NO. 410224

REG. U.S. PAT. OFF.

DECEMBER
1946 25c



NEW RIVERS FOR THE WEST
PAGE 98

Doyle



FREE Flashlight
If—



RAY-O-VAC

Leakproof Flashlight Batteries

* Yes, a free flashlight if yours is ever damaged by Ray-O-Vac Leakproof Batteries. Ordinary batteries often ruin valuable flashlights by swelling, sticking or corrosion . . . you will protect your flashlight if you use Ray-O-Vac Leakproofs. Read the steel-clad guarantee. Ray-O-Vac Leakproofs make sure your flashlight works when you need light.

RAY-O-VAC COMPANY, MADISON, WISCONSIN

BUY SPARES—They Stay Fresh!

**READ THIS
GUARANTEE**

We will give you FREE a new comparable flashlight if yours is ever damaged by corrosion, leakage, or swelling of this cell.

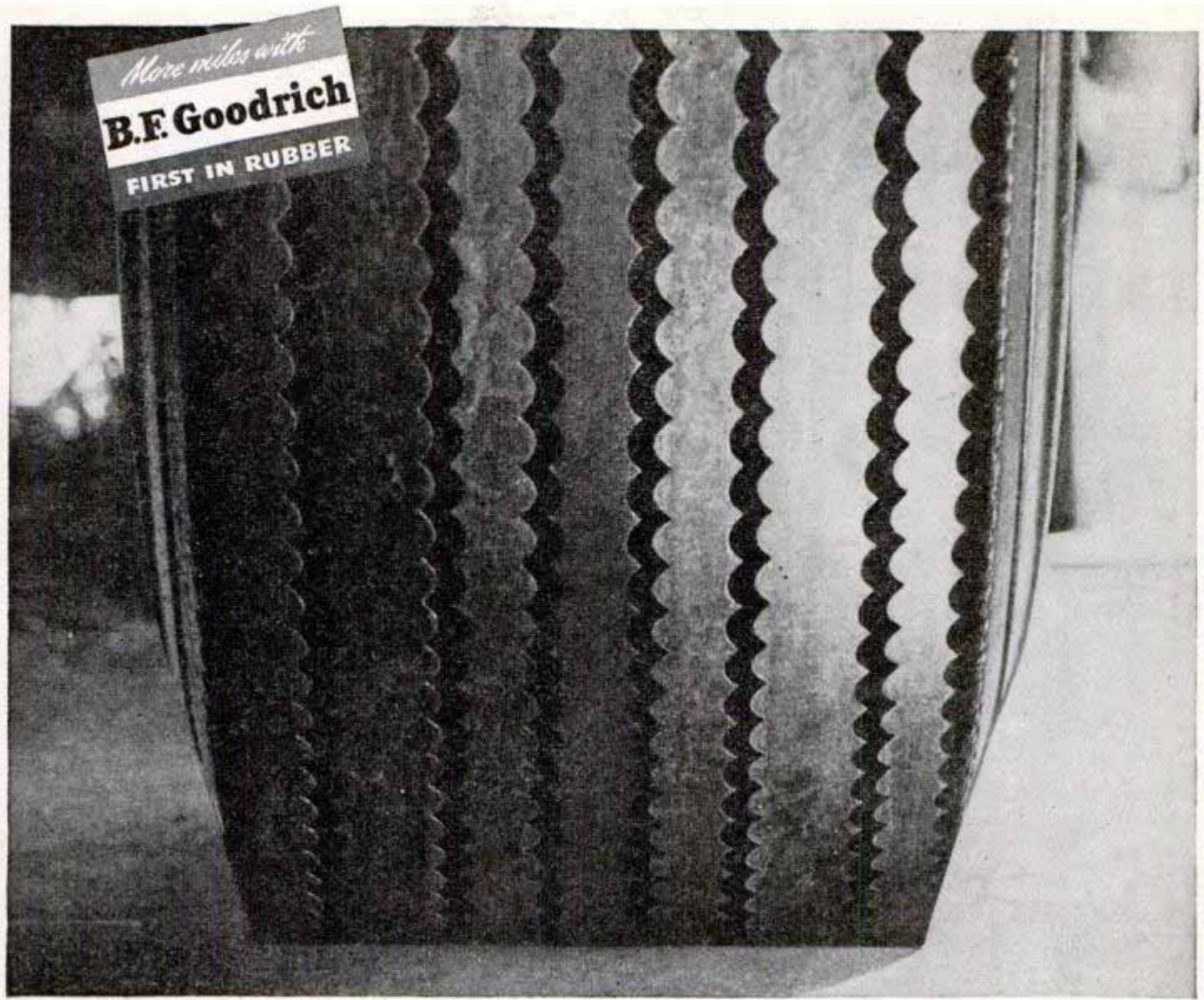

THE NEW B. F. GOODRICH TIRE OUTWEARS PREWAR TIRES

ON ANY KIND of road and in all kinds of climates, the new B. F. Goodrich tire outwears prewar tires. It has proved itself in millions of miles of driving on taxi fleets, police cars, and special test cars. Reports are coming in telling how much better the new B. F. Goodrich passenger car tires stand up than the tires of prewar days.

One reason for this exceptional durability is the wider, flatter tread that wears longer because it wears more evenly. Another is the stronger tire body, made that

way by using more cords and stronger cords.

This combination of thick, tough, longer-wearing tread and more rugged tire body gives you a tire that can take the pounding of bumpy roads as well as the steady grind of high-speed driving on smooth concrete.

Of course, supplies of tires are still limited. In spite of greatly

increased production, demand is even greater. This is especially true of the B. F. Goodrich Silver-town tire that outwears prewar tires. Please check your needs well in advance. Talk to your B. F. Goodrich dealer. He'll do his best to keep you rolling until he can get the new tires for you. *The B. F. Goodrich Company, Akron, Ohio.*

B.F. Goodrich

FIRST IN RUBBER



PREPARE your car for winter driving by having your dealer check your spark plugs now. If they have lost their efficiency, insist on new Champion Spark Plugs. They will insure instant starts in coldest weather, faster warm-ups and smoother engine performance. Champion dealers everywhere will serve you with the correct size and type for your car to insure maximum efficiency and economy. Snap into winter with dependable Champion Spark Plugs.



FOLLOW THE EXPERTS

DEMAND DEPENDABLE CHAMPIONS FOR YOUR CAR

POPULAR MECHANICS

***Snap into
winter...***



**with dependable
CHAMPION
SPARK PLUGS**

Popular Mechanics Magazine

Registered in U. S. Patent Office and Canada

H. H. WINDSOR, Founder

H. H. WINDSOR, Jr., Editor and Publisher



COMMANDER
Walter S. Reid,
copilot and en-
gineering officer
on the Truculent
Turtle, tells his
story of the rec-
ord-breaking 11,-
236-mile flight

from Perth, Australia, to Colum-
bus, Ohio, in this issue. "I Rode
the Turtle" is the real inside story
of an amazing flight that accom-
plished two important missions.

NEXT MONTH a front-row seat
awaits you for our own "European
Auto Show"—a five-page picture
layout of some postwar cars that
should make Detroit sit up and
take notice. Europe is fighting for
export business in automobiles.
Another January feature tells how
electrically operated machines are
becoming the right hand of medi-
cal science. Then there's an article
on America's most dangerous busi-
ness which takes a toll of 45 lives
every 24 hours. This business—
surprisingly enough—is farming.

FIVE-SECOND sequence, "injec-
tor" cooling, electric shutter and
"eyewink" speed of slide chang-
ing—these are the top features of
a new-type color-slide projector
fully described with how-to-build
plans in the January Craftsman
section. Another story tells how
to make an incubator for the biol-
ogy lab. If it is built in the school
woodworking shop every student
will have an opportunity to under-
stand its construction and operat-
ing principles. And of course you'll
want to read the article on tree
pruning so that you'll be ready
for the work when dormant-prun-
ing time rolls around.

BEGINNERS will find a 1-tube
dual-regenerative a.c. loud-speak-
er set in the Radio and Electronics
section next month, also simple
diagrams for individually con-
trolled extension speakers for any
receiver.

Volume 86 DECEMBER 1946 Number 6

Managing Editor..... Roderick M. Grant
Assistant Managing Editor..... Wayne Whittaker
Shop Notes and Crafts Editor..... James R. Ward
Radio and Electronics Editor..... Frank L. Brittin
Aviation Editor..... Aubrey O. Cookman, Jr.
Associate Editor..... John R. Kinsey
Eastern Editor..... Bill Reiche
Western Editor..... Thomas E. Stimson, Jr.
Art Director..... Frank Beatty

Assistant Editors

Donald R. Brooks Clifford B. Hicks Maston M. Jacks Virgil T. Swanson

Assistant Editors, Shop Notes and Crafts

W. Clyde Lamme Wayne C. Leckey John F. Shrock A. E. Youngquist

In This Issue

I Rode the Turtle	
<i>By Comdr. Walter S. Reid, USN</i>	89
New Rivers for the West	98
Narrow Gauge Movies	105
Designed for Junior Engineers	116
Hummingbird Cafeteria	123
Inside the "Atom City"	131
Harvest From the Sea	138
Bootmaker for the Stars	146
Home Town Circus	153
Special Delivery House	164
How Good a Driver Are You?	171

For the Craftsman

Her Own Chest of Drawers	178
Stage Your Own Marionette Show	188
Vacuum Cleaner Checkup and Repair	201
Shooting Single-Column Pictures	206
Synchronous Current Rectifier	219
"Heat-Forming" Plastics	223
Radio and Electronics	229

Table of Contents Continued on Page 8

Published monthly by POPULAR MECHANICS COMPANY, 200 East Ontario Street, Chicago 11, Ill. H. H. Windsor, Jr., president; Paul H. Dunakin, vice president and general manager; D. F. Windsor, vice president and secretary-treasurer; William Harrison Fetridge, vice president and assistant to the publisher; Clover L. Perkins, advertising manager; Alan M. Deyoe, circulation manager. Single copy in the United States and Canada, 25 cents; subscription rates in United States and possessions, Canada, and countries of the Pan-American Postal Union, 1 year, \$2.50; 2 years, \$4.50; 3 years, \$6.00. To all other countries add \$1.00 a year over United States prices for overseas postage. If you plan to move, notify us at least 60 days in advance so you will not miss an issue. Give both old and new addresses. Entered as Second Class Matter, September 15, 1903, at the Post Office at Chicago, Illinois, under Act of March 3, 1879. Entered as Second Class Matter at Post Office Dept., Canada. Copyright 1946, by Popular Mechanics Company, Copyright under International Copyright Union. Copyright in France. All rights reserved under Pan-American Copyright Union. Printed in the United States of America.

Ingenious New Technical Methods

To Help You with Your
Reconversion Problems

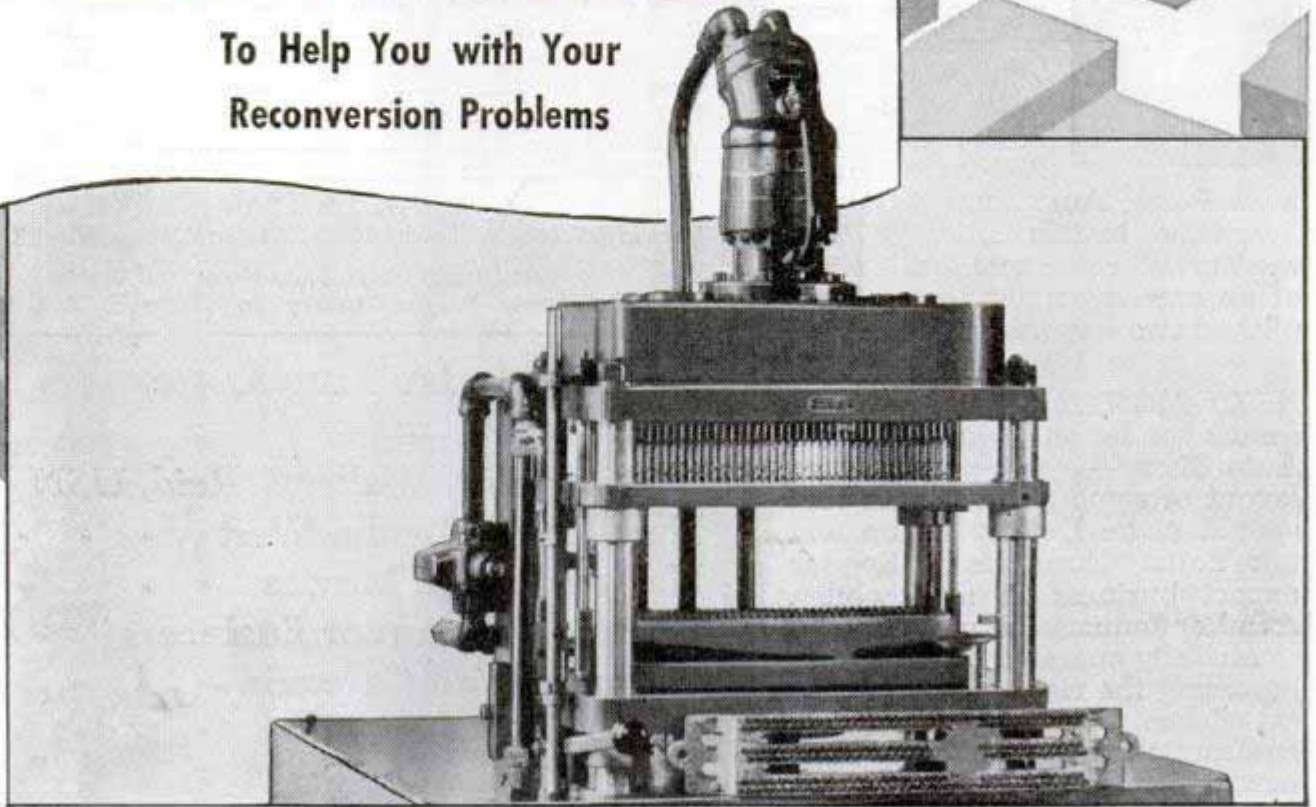

12,000 Holes per Hour! With New Gearless Multiple Spindle Drillhead!

The **Zagar Gearless Drillhead** can accommodate up to 400 drills in one head—drill up to 400 holes at one time! This revolutionary unit runs noiselessly and vibration-free on needle, tapered roller and precision ball bearings, and is lubricated by a patented automatic oiling system to insure trouble-free operation.

With this unit all holes are drilled at one pass, and valuable time is saved by the elimination of indexing and extra handling. It may be used on standard drill presses, or furnished as a complete hydraulic machine by the factory.

Another time saver, as well as a help on a tedious job, is chewing gum. The simple act of chewing seems to make the work go faster, easier—helping to relieve worker's fatigue—so that a better piece of work can be turned out with greater safety. Wrigley's Spearmint Gum may be used even when both hands are busy—right where the work is being produced.

*You can get complete information from Zagar Tool, Inc.
23881 Lakeland Blvd., Cleveland 17, Ohio*

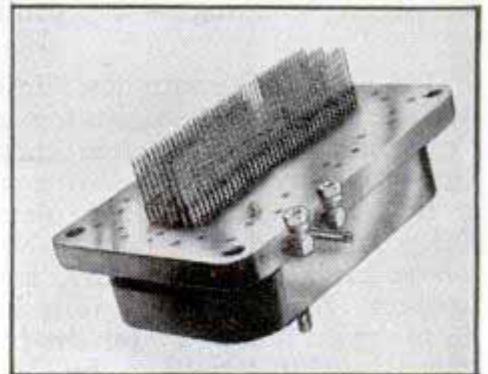

Zagar 220 Spindle Gearless Drillhead



AA-202



**THE SEASONED TRAVELER
GOES BY TRAIN
... IN ALL SEASONS**



***In cold or heat or snow or rain
You get there when you go by train***

Dependability! That's one big advantage of traveling by train—by Union Pacific. Furthermore... the air-conditioned comfort, restful sleep, room to roam, delightful meals... all these and other features go to make your train trip a vacation in itself. Going to or from the West—go as the seasoned traveler goes. Take the road of relaxation... Union Pacific.

**be Specific -
say "Union Pacific"**

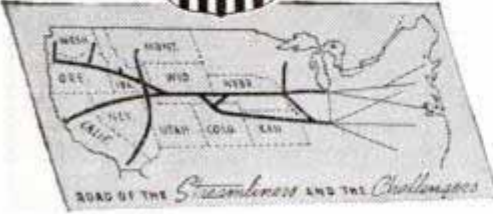

UNION PACIFIC RAILROAD



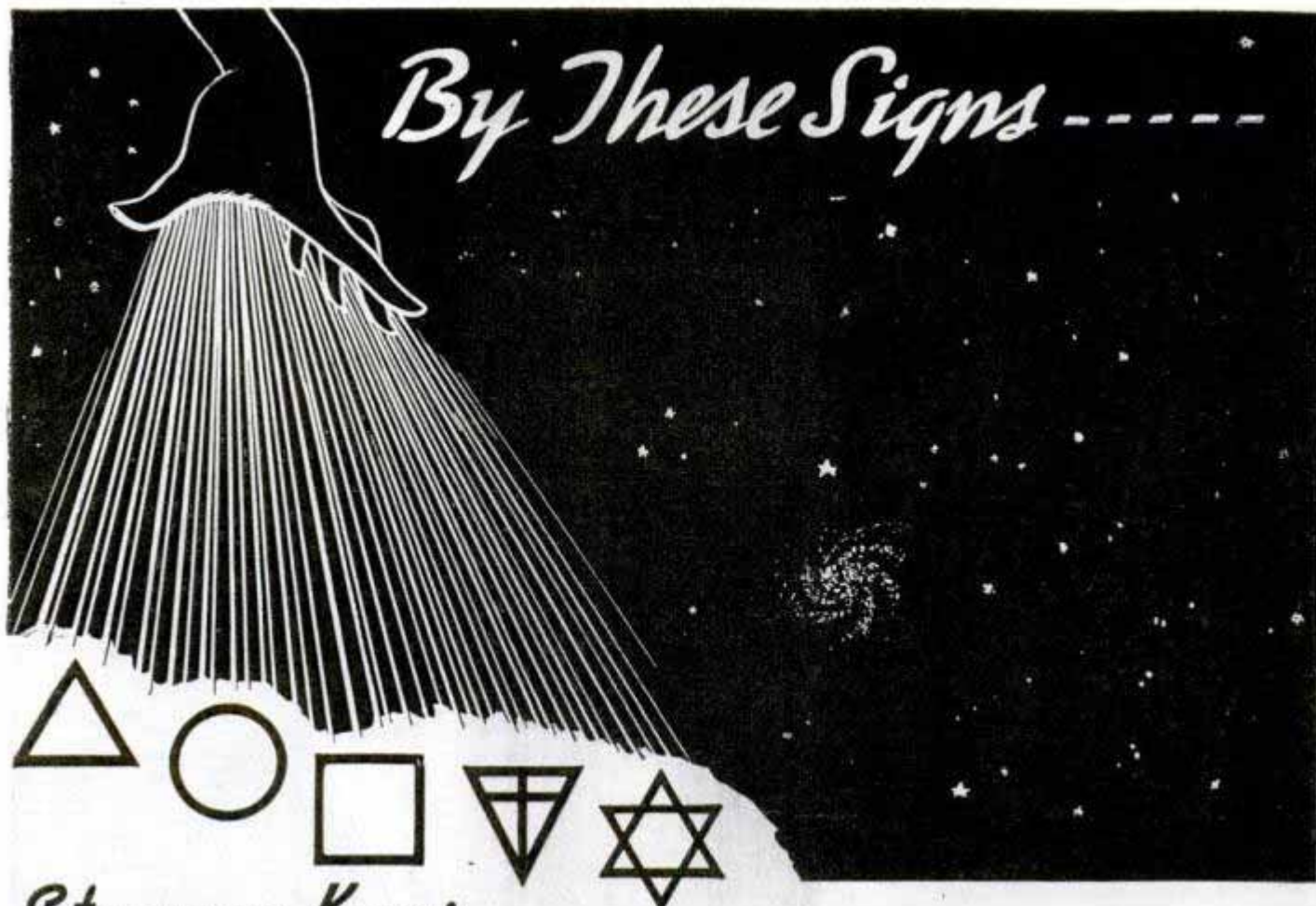

By These Signs -----

Strange Keys

to the Powers of the Universe

"GOD GEOMETRIZES," said an ancient sage. Within the straight line, curve, and angle—and their combinations—exist the forces of creation. These *secret symbols* contain the mysterious laws of the universe. Upon their right use—or the neglect of them—the success or failure of every human enterprise depends.

Have you a desire, something you wish to accomplish in life? Put your finger on a dot. In whatever direction you move your finger from the dot, you have made a beginning. Thus a dot is the symbol of *one*—or a beginning. Your desire then is also symbolized by *one*. If you follow the *proper method* or way to accomplish what you want, you have arrived at point *two*. Whenever these two symbols are brought together—the idea and the right way—you produce point *three*—the success of your plan. Success, therefore, is symbolized by the three equal sides of a triangle.

In planning your personal affairs—business, domestic, or the welfare of your family—do you use a *Cosmic formula*? Do you determine whether your acts are in accord with Divine truths eternally expressed in symbols? Why does the circle represent completion? Why is it said that a man is on the square? These

symbols are used by astronomers and scientists to prove the physical laws of the universe—why don't you apply them to the problems of your everyday world? Learn what symbols, as powers and forces of nature, you can simply and intelligently use in directing the course of your life.

Let the Rosicrucians (not a religious organization), a world-wide brotherhood of learning, reveal to you the *symbolism of successful living*.

Let this GIFT BOOK Explain

If you want to prepare yourself through understanding for the greater rewards of life, write for the fascinating *free Sealed Book*. It explains how you may receive this age-old wisdom. Use the coupon below.

Scribe E. Z. W.
THE ROSICRUCIANS, AMORC
San Jose, California, U. S. A.

Please send me the Free, Sealed Book. I am interested in knowing how I may obtain the masterful Rosicrucian teachings.

Name.....

Address.....

.....



THE ROSICRUCIANS, AMORC - SAN JOSE, CALIFORNIA, U. S. A.



To the man who wants
an ACCOUNTANT'S

to enjoy
CAREER



IF you're that man, here's something that will interest you.

Not a magic formula—not a get-rich-quick scheme—but something more substantial, more practical.

Of course, you need something more than just the desire to be an accountant. You've got to pay the price—be willing to study earnestly, thoroughly.

Still, wouldn't it be worth your while to sacrifice some of your leisure in favor of interesting home study—over a comparatively brief period in your life? Always provided that the rewards were good—a salary of \$3,000 to \$10,000?

An accountant's duties are interesting, varied and of real worth to his employers. He has *standing!*

Do you feel that such things aren't for you? Well, don't be too sure. Very possibly they *can* be!

Why not, like so many before you, investigate LaSalle's modern Problem Method of training for an accountancy position?

Just suppose you were permitted to work in a large accounting house under the personal supervision of an expert accountant. Suppose, with his aid, you studied accounting principles and solved problems day by day—easy ones at first—then the more difficult ones. If you could do this—and if you could turn to him for advice as the problems became complex—soon you'd master them all.

That's the training you follow in principle under the LaSalle Problem Method.

You cover accountancy from the basic Principles right up through Accountancy Systems and Income Tax Procedure. Then you add C. P. A. Training and prepare for the C. P. A. examinations.

As you go along, you absorb the principles of Auditing, Cost Accounting, Business Law, Statistical Control, Organization, Management and Finance.

Your progress is as speedy as you care to make it—depending on your own eagerness to learn and the time you spend in study.

Will recognition come? The only answer, as you know, is that success *does* come to the man who is really *trained*. It's possible your employers will notice your improvement in a very few weeks or months. Indeed, many LaSalle graduates have paid for their training—with increased earnings—before they have completed it! For accountants, who are trained in organization and management, are the executives of the future.

Write For This Free Book

For your own good, don't put off investigation of *all* the facts. Write for our free 48-page book, "Accountancy, The Profession That Pays." It'll prove that accountancy offers brilliant futures to those who aren't afraid of serious home study. Send us the coupon *now*.

Over 2300 Certified
 Public Accountants among
 LaSalle alumni

G. I. APPROVED

LASALLE EXTENSION UNIVERSITY

A CORRESPONDENCE INSTITUTION

417 South Dearborn Street, Dept. 1264-H, Chicago 5, Illinois

I want to be an accountant. Send me, without cost or obligation, the 48-page book, "Accountancy, The Profession That Pays," and full information about your accountancy training program.

Name.....

Address..... City.....

Position.....

This One



KK6G-77Y-XL9D



PROTECT YOUR NEW '46 or lengthen the life of your '38 '39 '40 '41 or '42 with PYROIL

Pyroil adds life to your car by providing oil with the property of clinging to metal surfaces. Dry starts cause wear that leads to breakdown. Pyroil also reduces battery drain, removes carbon formations and sludge. Ask your gas station attendant to add Pyroil . . . he has it and recommends it.

PYROIL FOR AIRCRAFT ENGINES

Use Aircraft Pyroil B for lubricating oil, Aircraft Pyroil A for gasoline.

Manufactured and Guaranteed by Pyroil Company, W. V. Kidder, Founder, 62 Pyroil Bldg., La Crosse, Wisconsin.

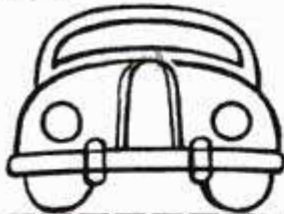

PYROIL COMPANY

62 Pyroil Bldg., La Crosse, Wisconsin

I want my car to last and run properly. Please tell me more about Pyroil and how it can accomplish this for me.

Name.....

Address.....

City or Town..... State.....



Jerry, the talking dog, is entertaining hospitalized veterans, by courtesy of the PYROIL Company. Picture of Jerry, sent on request.

TABLE OF CONTENTS (Continued)

AUTOMOTIVE

Rain and ice test British cars.....	110
Vacuum control valve stops carbon.....	130
"Electric" windshield keeps ice away.....	136
Electronic balancer for wheel senses slightest wobble.....	149
Dashboard light flashes red if emergency brake is not released.....	152
Jack removes valves quickly with no danger of breaking.....	167

AVIATION

Navy's pilot ejector tested on tower track.....	110
Nonflammable hydraulic fluid.....	115
Test sweptback wing on modified fighter.....	127
V-tailed four-place plane has low flying cost.....	145
Single "steering wheel" guides plane's flight.....	149
Motorless observation kite gives "eyes" to submarines.....	151
Musical note adjusts plane's altimeter to avert crashes.....	152
Electronic trainer for pilots simulates flight problems.....	159
How new light planes are tested.....	160
Helicopter with hoist used for sea rescues.....	163
V-2 tests cosmic rays 40 miles from earth.....	163
Versatile twin-engine Mustang has range of 5000 miles.....	169
Radar aims airborne cannon for hits at 5000 yards.....	176

BOATS AND TRAILERS

Boat won't sink or capsize and accommodates 80 people.....	127
Aluminum house-on-wheels accommodates six persons.....	130
Self-loading truck trailer.....	162
House trailer projects above coupling to make room for double bed.....	162
Surveyors' "amphib" crosses marshland.....	163
Glass boats.....	168

HOUSE AND HOME

Self-adjusting all-steel stand supports Christmas tree.....	111
Prefabricated plastic "igloo" featured at Berlin show.....	115
Fold-away kitchen table pulls out of wall cabinet to seat five persons.....	128
Six gelatin molds can be stacked vertically in refrigerator rack.....	128
Tent-shaped clothes drier fits over bathtub.....	129
Pump-type catsup dispenser eliminates shaking the bottle.....	129
Special cutter slices potatoes right size for French frying.....	129
Aluminum frame for bottom half of window holds screen in summer and storm window in winter.....	129
Hot pans, canning jars and cans are picked up easily with aluminum tongs.....	129
Valance hanger has slots to hold drapery in graceful, sweeping curves.....	129
Lamp kills refrigerator "bugs" with ultraviolet rays.....	130
Automatic lock on flexible cable makes drain cleaning easier.....	130
Nonkink synthetic clothesline can be cleaned with damp cloth.....	151
"Step-chest" ladder has drawer space.....	159
"Clothespin" clips place Christmas tree lights where needed.....	169
"Steam percolator" warms air in electric heating unit for homes.....	170
Trunk-size oil-burning furnace heats five-room house.....	170

INDUSTRY

Hard rubber spurs on climbers grip "H" or "I" beams.....	115
"Leather" coating for work gloves.....	122
Movie breeze-maker keeps actors cool.....	136
Snow "eater" clears tracks.....	151
Acetylene for welding made from coal gas.....	167

PHOTOGRAPHY

Round edge on darkroom tongs prevents damage to film.....	121
Electronic photo retoucher.....	122
Elastic photo frame fits most pictures.....	150
"Gunstock" camera support cures picture blurs.....	150

RADIO AND ELECTRICAL

Self-powered recording unit turned by spring motor.....	136
Horn-type antennas sharpen weak television signals.....	137
Plastic cover of fluorescent tube changes glare to soft color.....	150

RECREATION

Basketball sign language.....	112
Seats are attached to folding table.....	149
Snow cycle glides down mountain slopes on carved wood runners.....	158

TOOLS

Wheel-mounted snowplow clears 20-inch path.....	114
Straight-shank expansive bit fits electric drill.....	121
Slight move opens speed chuck without stopping motor.....	122
Engraving machine for the unskilled.....	176

MISCELLANEOUS

Colored poison grain kills rodent pests.....	110
Airplane metal in hand truck cuts weight to 26.6 pounds.....	111
"Silver mushroom" water tank holds 300,000 gallons.....	111
Pocket size shoe shine outfit.....	114
X-ray counter checks radiation.....	114
Future farm tractor.....	115
Stairstep-type gathering rack speeds assembly of book pages.....	121
Plastic and metal packing for pumps withstands 900° heat.....	121
"Accordion" rack files papers in 12 expandable compartments.....	122
Coil toy made of spring steel walks slowly down steps.....	127
How the Geiger counter works.....	135
Two-section bus seats 63.....	137
Station M-O-O-N.....	144
Water fills tires used on tractor.....	145
"Ice tong" clamps hold swing or bar.....	158
Road-striping vehicle does job of 90 men.....	167
Weather stations roll on trucks.....	167

(Continued to page 10)

GATEWAY TO OPPORTUNITY!

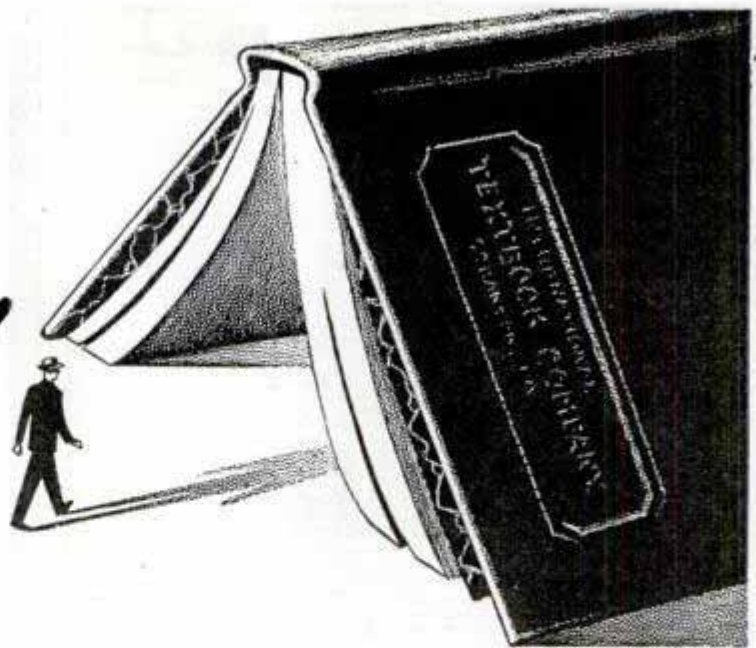

I.C.S. textbooks have been just such a gateway for thousands of men now established as leaders in American industry and business. They include the presidents, production chiefs and top technical men of some of the largest railroads, airlines, car manufacturers, publishing enterprises and steel, chemical and electric companies.

The same route they took is open to you. You study I. C. S. Courses in your spare time . . . Learn as you Earn . . . prepare

yourself for the advancements that go to *trained* men and women.

Business management or accountancy . . . aviation or plastics . . . drafting or engineering . . . whatever your interest, there's an I. C. S. Course covering it.

Mark and mail the coupon *right now*. The records of I. C. S. graduates show that today's I. C. S. student is tomorrow's leader. This is *your* today. Don't miss out on the rewards of tomorrow!

INTERNATIONAL CORRESPONDENCE SCHOOLS



BOX 5593-K, SCRANTON 9, PENNA.

Without cost or obligation, please send me full particulars about the course *before* which I have marked X:

- Air Conditioning and Plumbing Courses**
- Air Conditioning
- Heating Plumbing
- Refrigeration Steam Fitting
- Chemistry Courses**
- Chemical Engineering
- Chemistry, Analytical
- Chemistry, Industrial
- Chemistry, Mfg. Iron & Steel
- Petroleum Refining Plastics
- Pulp and Paper Making
- Civil Engineering, Architectural and Mining Courses**
- Architectural Drafting
- Architecture
- Bridge and Building Foreman
- Building Estimating
- Civil Engineering
- Coal Mining
- Contracting and Building
- Highway Engineering
- Lumber Dealer
- Reading Structural Blueprints
- Sanitary Engineering
- Structural Drafting

- Structural Engineering
- Surveying and Mapping
- Communications Courses**
- Electronics
- Practical Telephony
- Radio, General
- Radio Operating
- Radio Servicing
- Telegraph Engineering
- Electrical Courses**
- Electrical Drafting
- Electrical Engineering
- Electric Light and Power
- Lighting Technician
- Practical Electrician
- Internal Combustion Engines Courses**
- Auto Technician Aviation
- Diesel-Electric
- Diesel Engines Gas Engines
- Mechanical Courses**
- Aeronautical Engineering
- Aircraft Drafting
- Flight Engineer
- Foundry Work
- Heat Treatment of Metals

- Industrial Engineering
- Industrial Metallurgy
- Machine Shop
- Mechanical Drafting
- Mechanical Engineering
- Mold-Loft Work
- Patternmaking—Wood, Metal
- Reading Shop Blueprints
- Sheet-Metal Drafting
- Sheet-Metal Worker
- Ship Drafting Ship Fitting
- Tool Designing
- Toolmaking
- Welding—Gas and Electric
- Railroad Courses**
- Air Brake Car Inspector
- Diesel Locomotive
- Locomotive Engineer
- Locomotive Fireman
- Railroad Section Foreman
- Steam Engineering Courses**
- Boilermaking
- Combustion Engineering
- Engine Running
- Marine Engineering
- Steam Electric Steam Engines

- Textile Courses**
- Cotton Manufacturing
- Rayon Weaving
- Textile Designing
- Woolen Manufacturing
- Business and Academic Courses**
- Accounting Advertising
- Arithmetic Bookkeeping
- Business Correspondence
- Business Management
- Certified Public Accounting
- Commercial
- Cost Accounting
- Federal Tax
- First Year College
- Foremanship French
- Good English High School
- Higher Mathematics
- Illustrating Motor Traffic
- Postal Service
- Salesmanship Secretarial
- Sign Lettering
- Spanish Stenography
- Traffic Management

Name _____ Age _____ Home Address _____

City _____ State _____ Present Position _____

Working Hours _____ A.M. to _____ P.M. Length of Service in World War II _____

Special tuition rates to members of the Armed Forces. Enrollment under the G.I. Bill of Rights approved for War II Veterans. Canadian residents send coupon to International Correspondence Schools Canadian, Ltd., Montreal, Canada.

Craftsman and Shop Notes Index**AUTOMOTIVE**

Rear-view mirror aids motorist when parking auto.....	198
Balancing rubber-blade fan.....	200
Altered wheel nuts and wrench foil tire thieves.....	214

FARM

Boiler contains reserve supply for poultry waterer.....	218
Tops of fence posts cut evenly with saw guide.....	222
Spring water piped to covered stock tank will not freeze easily.....	228

HOUSE AND HOME

Solving home problems.....	182
Painted hangers prevent mixup.....	184
This door key can't slip out.....	186
Rubber hose attached to faucet with crutch-tip connector.....	187
Eggshells clean narrow vases.....	193
Light shows location of keyhole when push-button is operated.....	195
Easy way to clean plaster objects.....	198
Method of retrieving door key.....	198
Artistic spark screen.....	199
Doorknobs on garbage-can lid provide handle and hanger.....	200
Children can't pull this phone off its stand.....	200
Repairing leaky water faucet.....	200
Spare fuses kept beneath box.....	200
Braces attached to baby's swing will prevent tipping.....	204
Martin house built into chimney is cast from concrete.....	212
Storage cabinet for bed patient keeps accessories handy.....	214

LAWN AND GARDEN

Old stumps removed from lawn with saltpeter solution.....	181
Twin bird bath cut from can.....	186
Sturdy yard gate constructed from metal bed.....	212

PHOTOGRAPHY

Better use of monotone filter.....	211
Moving-picture title library.....	211
Paper extension focusing hood sharpens ground-glass image.....	211

RADIO AND ELECTRONICS

Getting started on the VHF bands.....	229
Fifty-watt ten-meter transmitter for beginners.....	230
Radio hints for today.....	232

RECREATION

Discarded dart game renewed by using Bristol board.....	184
Ice planer to surface skating pond.....	193
Chessmen in Staunton pattern.....	196

STORE AND OFFICE

Drawer fastened to typewriter holds writing supplies.....	195
Displaying samples of calcimine.....	218
Balance suspended from pulleys makes weighing easy.....	222

TOOLS

Trowel drives and pulls nails.....	181
Adjustable bench planing stop is built of plywood.....	184
Method of etching your name on steel tools.....	185
Tightening small brush bristles.....	186
Threading die for wood or plastic made from steel nut.....	204
Box holds grinder accessories.....	204
Stick attached to fence on saw reminds operator of its use.....	212
Rubber heel holds small work and prevents damage.....	212
Craft quiz.....	213
Lacquer glues bristles in brush.....	214
Surface-plate checking.....	215
Cutting round tenons.....	217
Chalked block marks high spots on newly sanded floors.....	218
Brushes clean chips from holes.....	218
Suction cup holds pivot point.....	222
C-clamp brazed to trouble light can be fastened on joists.....	222

TOYS AND NOVELTIES

Carrying case for toothpicks keeps them clean.....	181
Personalized child's penny bank made from alarm clock.....	184
These shadow boxes enhance your knickknacks.....	187
Amusing toy rises from knees.....	204

WOODWORKING

Bas-relief carving simplified with scrollsaw.....	185
Round corners for plywood box.....	198
Rest your feet.....	205

MISCELLANEOUS

Lighter fluid helps loosen bolts.....	181
Child's walker has plywood side guards.....	181
Nonslip tips for crutches.....	184
Tape spool stores rubber bands.....	186
Front hitch helps park trailer.....	186
Handy self-feeder for rabbits.....	193
Gift package glamour.....	194
Front-wheel tire is recapped with blown-out casing.....	198
Novel designs on flat surfaces.....	204
Sewing patches on canvas tent.....	214
Back of wrist watch protected by plastic shield.....	214
Self-anchoring stake driven without using a mallet.....	218
Extension for workshop table.....	222

IMPORTANT NOTICE—It is the intention of this magazine to provide its readers with information regarding the latest developments in the mechanical arts. We take no responsibility as to whether the disclosures contained in our articles are covered by patents and advise readers to investigate this subject before making, using, or selling any of the products, machines, or processes described in order to avoid possible liability for patent infringements.

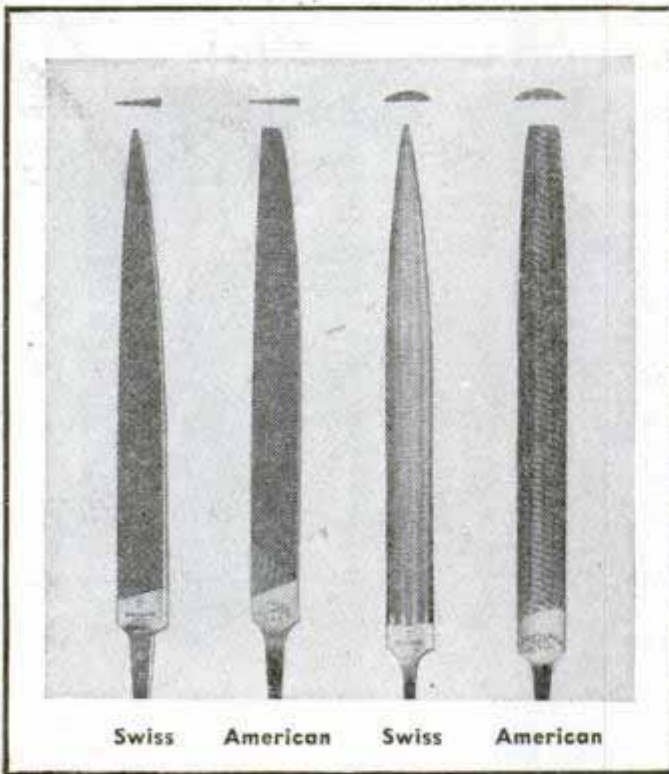

Swiss American Swiss American

HAVE YOU FOUND IT HARD TO OBTAIN SWISS PATTERN FILES?

JUST SAY "X.F." and get them



X.F. means *Extra Fine* and is part of the trade-mark which distinguishes the Swiss Pattern Files made by

Nicholson and sold in greater quantities than any other Swiss or Swiss Type brand.

These widely preferred Swiss Pattern Files are now again available in nearly all kinds, through industrial hardware distributors.

Nicholson X.F. Swiss Pattern Files are made for every one who does extra-fine filing: for tool and die makers, delicate instrument-parts finishers, model makers, hobbyists—precision craftsmen in general.

More exacting measurements—smaller points and longer tapers . . . these are features that distinguish X.F. Swiss Pattern Files from American Pattern (see examples in above illustrations). Highest quality—uniformity in each detail of manufacture—and the sweeping guarantee of *Twelve perfect files in every dozen* . . . these are factors that make them the first choice of most precision-file users.



NICHOLSON FILE CO.

22 Acorn St., Providence 1, R. I.

(In Canada, Port Hope, Ont.)



NICHOLSON
FILES FOR EVERY PURPOSE

AUDELS REFRIGERATION & AIR CONDITIONING GUIDE.....\$4

New from Cover to Cover—1280 Pages, Fully illus., Covering basic principles, servicing, operation & repair of household, commercial & industrial refrigeration & air conditioning. A gold mine of essential important facts for engineers, servicemen, users.

AUDELS CARPENTERS & BUILDERS GUIDES—4 Vols.\$6

A practical illustrated trade assistant on modern construction for carpenters, joiners, builders, mechanics and all woodworkers. 4 vols., 1600 pages, 3700 illustrations, flexible covers. Pocket size. Each volume sold separately \$1.50 a vol.

AUDELS AUTOMOBILE GUIDE.....\$4

A practical quick ready reference book for auto mechanics, service men, operators & owners. Explains theory, construction & servicing of modern motor cars, trucks, buses & auto type Diesel engines. 1540 pages, fully illustrated, 55 chapters. Indexed. A standard book for mechanics. New fluid drive covered.

AUDELS DIESEL ENGINE MANUAL.\$2

A practical, concise treatise with questions and answers on the theory, operation and maintenance of modern diesel engines including General Motors 2 cycle Diesel. 384 pages, fully illus., flexible binding, pocket size. All details plainly brought out, this book is of extreme value to engineers, operators & students.

AUDELS WIRING DIAGRAMS.....\$1

210 Pages. Illustrated. Gives practical facts on wiring of electrical apparatus. It shows clearly how to wire apparatus for practically all fields of electricity. Each diagram is complete & self-explanatory. Highly Endorsed Pocket Companion.

AUDELS PLUMBERS & STEAMFITTERS GUIDES—4 Vols.\$6

A Practical Trade Assistant & Ready Reference. Explains in plain language & by clear illustrations, diagrams, charts, graphs, pictures principles of modern plumbing practice including Marine Pipe Fitting and Air Conditioning. 4 Vols.—1670 Pages—3642 Diagrams. Pocket size. Each Vol. Sold Separately \$1.50 a Vol.

AUDELS SHEETMETAL WORKERS HANDY BOOK.....\$1

Practical inside information. Fundamentals of Sheet Metal Work. 388 pages. Illustrated. 11 sections. Clearly written. Essential & important facts, figures, pointers in everyday language. Ref. Index.

AUDELS SHEETMETAL PATTERN LAYOUTS.....\$4

Developed by Experts for Sheet Metal Workers, Layout Men & Mechanics. A Practical Encyclopedia in 10 Sections, size 7 x 10 x 2—1125 Pages—350 Layouts—1600 Illustrations. 1001 Key Facts. Fully indexed for ready reference in answering your layout problems. Covers all phases of sheet metal work including Pattern Cutting, Pattern Development & Shop Procedure.

AUDELS ANSWERS ON BLUE PRINT READING.....\$2

For Mechanics & Builders. Covers all types of blue print reading including ship & airplane. 376 pages, fully illustrated.

AUDELS NEW MACHINIST & TOOLMAKERS HANDY BOOK...\$4

Covers modern machine shop practice in all its branches. 5 practical books in 1. New from cover to cover. Tells how to set up & operate lathes, screw and milling machines, shapers, drill presses and all other machine tools. 1600 pages, fully illustrated, 5 x 6 1/2 x 2. Indexed. 5 sections. 1—Modern Machine Shop Practice. 2—Blue Print Reading & How to Draw. 3—Calculations & Mathematics for Machinists. 4—Shop Physics. 5—How to Use the Slide Rule. 60 chapters. Easy to read and understand. A shop companion that answers your questions.

AUDELS MATHEMATICS & CALCULATIONS FOR MECHANICS \$2

Mathematics for home study or reference. 700 pages, 550 illus. Practical mathematics from beginning. How to figure correctly. Easy, correct methods covering a complete review. Ill. & Indexed.

AUDELS HANDY BOOK OF PRACTICAL ELECTRICITY.....\$4

For maintenance engineers, electricians & all electrical workers. 1440 Pages, 2600 illus. Covers important electrical information in handy form—including Marine Wiring, Radio Principles, Welding. Indexed. A Key to a practical understanding of electricity.

AUDELS RADIOMANS GUIDE.....\$4

A key to the practical understanding of radio including Frequency Modulation, Television, etc., Aircraft & Marine Radio. For radio engineers, servicemen, amateurs. 772 pages. 400 Illustrations & Diagrams. Photos. Review Questions & Answers, Reference Index. Authentic, clear, concise.

AUDELS ELECTRONIC DEVICES...\$2

Tells What You Want to Know About Electric Eye. Easily Understood. Covers photo-electric cells & their applications. Amplifiers, illumination, frequencies, voltage, photocell, tubes, Ohm's Law, wiring diagrams, etc.

AUDELS WELDERS GUIDE.....\$1

A concise, practical text on operation & maintenance of all welding machines for all mechanics. Over 400 pages, illustrated. Covers all methods of electric and acetylene welding including airplanes work.

AUDEL, Publishers, 49 W. 23 St., N. Y. 10

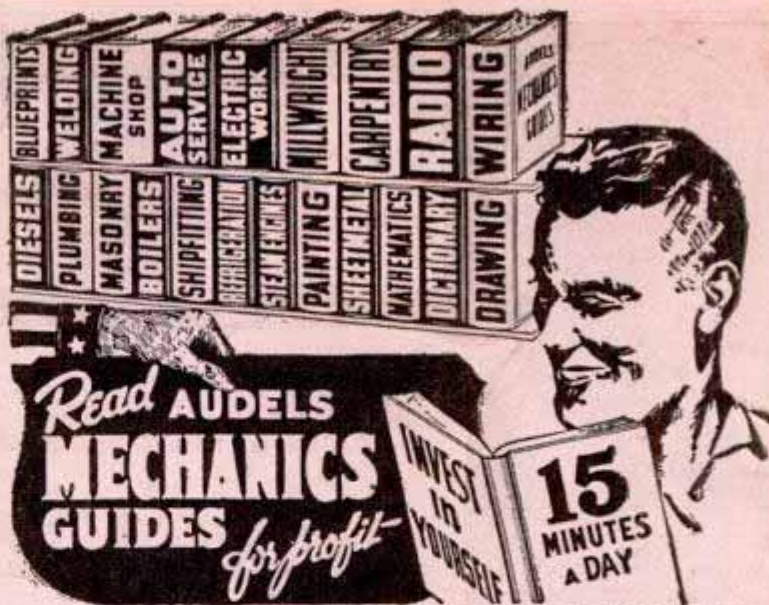

AN AUDEL GUIDE IS A GOOD FRIEND!

Use the brains and experience of others in these Guides of the Trades. Save time and money with right methods, short cuts, labor saving ideas. CHECK NOW! You can look over any Audel Guide in your home. Start the Easy Payments if satisfied.

CUT HERE MAIL ORDER

THEO. AUDEL & CO., 49 W. 23 St., New York 10, N. Y.

Please mail me for 7 days' free examination the books marked (X) below. I agree to mail \$1 in 7 days on each book or set ordered, and to further mail \$1 a month on each book or set ordered until I have paid purchase price.

If I am not satisfied with Guides I will return them.

- Audels OIL BURNER GUIDE \$1.
- Audels REFRIGERATION & Air Conditioning Guide 4.
- Audels POWER PLANT ENGINEERS GUIDE 4.
- Audels PUMPS, HYDRAULICS & AIR COMPRESSORS 4.
- Audels WELDERS GUIDE 1.
- Audels BLUE PRINT READING 2.
- Audels SHEET METAL WORKERS Handy Book 1.
- Audels SHEET METAL PATTERN LAYOUTS 4.
- Audels AIRCRAFT WORKER 1.
- Audels MATHEMATICS and CALCULATIONS 2.
- Audels MACHINISTS & TOOLMAKERS Handy Book 4.
- Audels MECHANICAL Dictionary 4.
- Audels AUTOMOBILE GUIDE 4.
- Audels DIESEL ENGINE MANUAL 2.
- Audels MARINE ENGINEERS Handy Book 4.
- Audels SHIPFITTERS Handy Book 1.
- Gueths MECHANICAL DRAWING COURSE 1.
- Rogers DRAWING and DESIGN 2.
- Audels MILLWRIGHTS and Mechanics Guide 4.
- Audels CARPENTERS and Builders Guides (4 vols.) 6.
- Audels PLUMBERS and Steamfitters Guides (4 vols.) 6.
- Audels MASONS and Builders Guides (4 vols.) 6.
- Master PAINTER and DECORATOR 2.
- Audels GARDENERS & GROWERS GUIDES (4 vols.) 6.
- Audels ENGINEERS & FIREMANS EXAMINATIONS 1.
- Audels ENGINEERS and Mechanics Guides 12.
- Nos. 1, 2, 3, 4, 5, 6, 7 and 8 complete 12.
- Audels Answers on Practical ENGINEERING 1.
- Audels ELECTRICIANS EXAMINATIONS 1.
- Audels WIRING DIAGRAMS 1.
- Audels Handy Book of PRACTICAL ELECTRICITY 4.
- Audels ELECTRICAL POWER CALCULATIONS 2.
- Audels ELECTRONIC DEVICES 2.
- Audels ELECTRONIC Dictionary 2.
- Audels RADIOMANS GUIDE 4.
- Audels NEW ELECTRIC LIBRARY at \$1.50 a Volume 4.
- Vols. I, II, III, IV, V, VI, VII, VIII, IX, X, XI, XII

Name _____

Address _____

Occupation _____

Employed by _____ PM



**J. E. SMITH, President
National Radio Institute**
The man who has directed the Home Study Training of more men for the Radio Industry than any other man in America.

BE YOUR

*I will show you how to start
a Radio Service Business
Full Time or Spare Time without capital*

I Trained These Men



\$35 - \$45 A Week in Own Shop
"Previous to enrolling for your Radio training I made \$12 per week in a hardware store. Now I operate my own repair shop, and often clear \$35 to \$45 a week."—**FREDERICK BELL**, 76 Golf Ave., St. Johns, Newfoundland.

\$250 A Month in Own Shop

"I am now operating a radio shop for myself and own all my equipment. Right now repairing radios pays me an average of about \$250 a month."—**J. M. SCRIVENER, JR.**, Aberdeen, Miss.



Averages Over \$60 A Week
"Not long ago I was working 16 hours a day in a filling station at \$10 a week. Now I have my own Radio business and average over \$60 a week. The N. R. I. course is fine."—**ALBERT C. CHRISTENSEN**, 1116 Tenth Ave., Sidney, Neb.

\$50 A Week From Own Shop

"Am making over \$50 a week profit from my own shop. Have another N. R. I. graduate working for me. I like to hire N. R. I. men because they know Radio."—**NORMAN MILLER**, Hebron, Neb.



\$50 A Month in Spare Time
"I have a spare time Radio and Electrical business of my own which has been very profitable, due to the efficient training I received from your Course. Last year I averaged over \$50 a month."—**FRED H. GRIFFIE**, Rt. 3, Newville, Pa.

Fixing Radios Profitable Hobby

"I am doing Radio work in my spare time and find it a profitable hobby. My extra earnings run about \$10 a week. I certainly am glad I took your N. R. I. Course."—**FERDINAND ZIRBEL**, Chaseley, N. Dak.



SAMPLE LESSON FREE SEE OPPOSITE PAGE

Do you want a good-pay job in Radio—or your own money-making Radio Shop? Mail Coupon for a **FREE Sample Lesson** and my **FREE 64-page book**, "Win Rich Rewards in Radio." See how N. R. I. gives you practical Radio experience at home—building, testing, repairing Radios with **6 BIG KITS OF PARTS** I send!

Many Beginners Soon Make Good Extra Money In Spare Time While Learning

The day you enroll I start sending **EXTRA MONEY JOB SHEETS**. You **LEARN** Radio principles from my easy-to-grasp, illustrated lessons—**PRACTICE** what you learn with parts I send—**USE** your knowledge to make **EXTRA** money fixing neighbors' Radios in spare time while still learning! From here it's a short step to your own **full-time Radio Shop** or a good Radio job!

Future for Trained Men is Bright in Radio, Television, Electronics

It's probably easier to get started in Radio now than ever before because the Radio Repair business is booming. Trained Radio Technicians also find profitable opportunities in Police, Aviation, Marine Radio, Broadcasting, Radio Manufacturing, Public Address work. Think of even **greater** opportunities as Television and Electronics become available to the public! Send for free books now!

Find Out What N. R. I. Can Do For You

Mail Coupon for Sample Lesson and my 64-page book. Read the details about my Course. Read letters from men I trained, telling what they are doing, earning. See how quickly, easily you can get started. No obligation! Just **MAIL COUPON NOW** in an envelope or paste it on a penny postal. **J. E. SMITH, President, Dept. 6NP, National Radio Institute, Pioneer Home Study Radio School, Washington 9, D. C.**

Our 32nd Year of Training Men for Success in Radio

**MY COURSE INCLUDES
TELEVISION
ELECTRONICS
FREQUENCY MODULATION**

A TESTED WAY

OWN BOSS

LEARN RADIO BY PRACTICING IN SPARE TIME
with 6 Big Kits of Radio Parts I Send You!

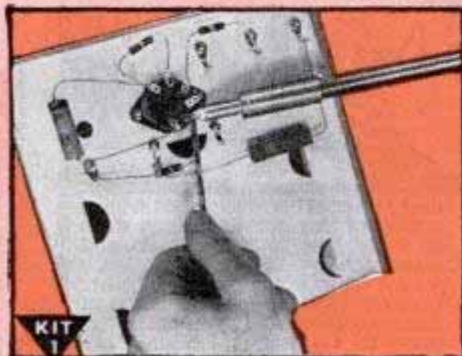

KIT 1

I send you Soldering Equipment and Radio Parts; show you how to do Radio soldering; how to mount and connect Radio parts; give you practical experience.



KIT 2

Early in my Course I show you how to build this N.R.I. Tester with parts I send. It soon helps you fix neighborhood Radios and earn EXTRA money in spare time.

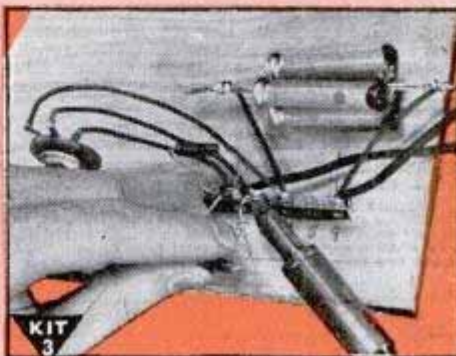

KIT 3

You get parts to build Radio Circuits; then test them; see how they work; learn how to design special circuits; how to locate and repair circuit defects.

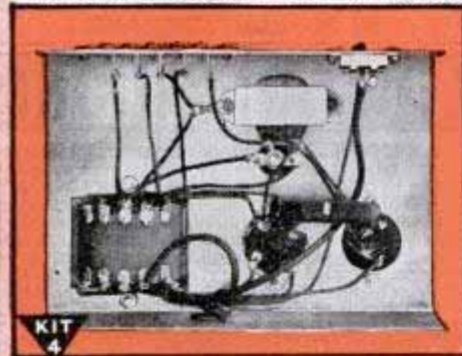

KIT 4

You get parts to build this Vacuum Tube Power Pack; make changes which give you experience with packs of many kinds; learn to correct power pack troubles.

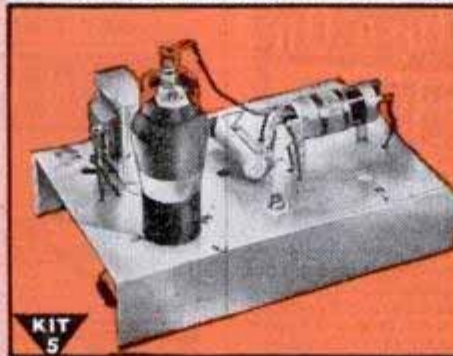

KIT 5

Building this A. M. Signal Generator gives you more valuable experience. It provides amplitude-modulated signals for many tests and experiments.



KIT 6

You build this Superheterodyne Receiver which brings in local and distant stations—and gives you more experience to help you win success in Radio.

SAMPLE LESSON

FREE

I will send you a FREE Lesson, "Getting Acquainted with Receiver Servicing," to show you how practical it is to train for Radio at home in spare time. It's a valuable lesson. Study it—keep it—use it—without obligation! Tells how Superheterodyne Circuits work, gives hints on Receiver Servicing, Locating Defects, Repair of Loudspeaker, I.F. Transformer, Gang Tuning, Condenser, etc. Thirty-one illustrations.



MAIL COUPON FOR FREE LESSON AND 64-PAGE BOOK

Good for Both FREE

Mr. J. E. SMITH, President, Dept. 6NP
 National Radio Institute, Washington 9, D. C.
 Mail me FREE, without obligation, Sample Lesson and 64-page book about how to win success in Radio and Television—Electronics. (No salesman will call. Please write plainly.)

Age.....
 Name.....
 Address.....
 City..... Zone..... State.....

APPROVED FOR TRAINING UNDER GI BILL



TO GOOD PAY →

8 BIG BUILDING BOOKS

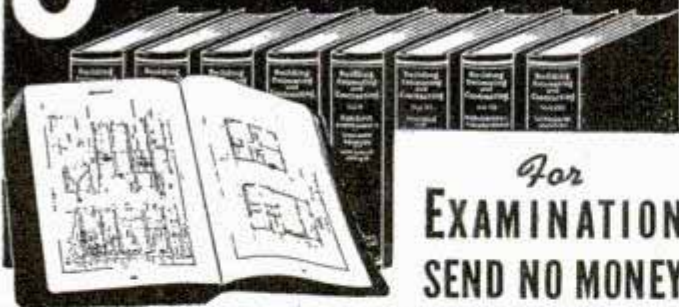

For
EXAMINATION
SEND NO MONEY

Learn to draw plans, estimate, be a live-wire builder, do remodeling, take contracting jobs. These 8 practical, profusely illustrated books cover subjects that will help you to get more work and make more money. Architectural design and drawing, estimating, steel square, roof framing, construction, painting and decorating, heating, air-conditioning, concrete forms and many other subjects are included.

BETTER JOBS — BETTER PAY

The postwar building boom is in full swing and trained men are needed. Big opportunities are always for **MEN WHO KNOW HOW**. These books supply quick, easily understood training and handy, permanent reference information that helps solve building problems.

UP-TO-DATE EDITION

These books are the most up-to-date and complete we have ever published on these many subjects.

Coupon Brings Eight Big Books For Examination

AMERICAN TECHNICAL SOCIETY Vocational Publishers since 1898
Dept. G919 Drexel at 58th Street Chicago 37, Ill.

You may ship me the Up-to-Date edition of your eight big books, "Building, Estimating and Contracting," without any obligation to buy. I will pay the delivery charges only, and if fully satisfied in ten days, I will send you \$2.00, and after that only \$3.00 a month, until the total price of only \$34.80 is paid. I am not obligated in any way unless I keep the books.

Name

Address

City.....State.....

Please attach a letter stating your age, occupation, employer's name and address, and name and address of at least one business man as a reference. Men in service, also please give home address.

NOW! Build Your Future On



DIESEL Opportunities

LOOK around you. See the way tractors, trucks, buses, railroads, ships, power plants and equipment of many kinds are "going Diesel." Every day new opportunities are opening—in industrial and farming communities—for trained men who can install, maintain, operate and repair Diesel engines. Plan now to build your future in this growing field.

Diesel Knowledge is Earning Power

You don't have to give up your present job. Now, you can begin learning DIESEL in spare time at home. UEI practical training teaches you, step by step, how Diesel engines operate, how fuel systems work, repairs, accessories and auxiliary equipment; a world of Diesel "know how." Includes actual practice on Diesel equipment in our shop under expert guidance. UEI training methods are successful. For 20 years they have helped mechanically inclined men better themselves.

NOW IT'S UP TO YOU!

Coupon below brings you all the facts without cost or obligation. Get going today! MAIL COUPON NOW.

UTILITIES ENGINEERING INSTITUTE Diesel Division
1314 W. Belden Dept. 312-D Chicago 14, Ill.

Founded 1927

UTILITIES ENGINEERING INSTITUTE, Diesel Division
1314 W. Belden Ave., Dept. 312-D Chicago 14, Ill.
Please send me Free Facts about Diesel opportunities and training.

NAME Age

ADDRESS

CITY Zone or County STATE

Check here for special information if you are under 17.
 Check here if Veteran of World War II.

"YOU ARE UNDER ARREST!"



There's a Thrill in Bringing a Crook to Justice Through Scientific

CRIME DETECTION!

I have taught thousands this exciting, profitable, pleasant profession. Let me teach you, too, in your own home. Learn Finger Printing, Fire Arms Identification, Police Photography and Criminal Investigation thoroughly, quickly and at small cost.

Be A
FINGER PRINT Expert

53% of All American Bureaus of Identification employ students or graduates of I. A. S. You, too, can fit yourself to fill a responsible crime detection job with good pay and steady employment. But don't delay—get the details now. Let me show you how easily and completely I can prepare you for this fascinating work, during spare time, in your own home. You may pay as you learn. Write today . . . Now . . . Be sure to state age.

FREE!!!
Send for Thrilling "BLUE BOOK OF CRIME"

INSTITUTE OF APPLIED SCIENCE
1920 Sunnyside Ave., Dept. 1359, Chicago 40, Ill.

SEND FOR THIS FREE!

Make money with horses. Every farmer, every lover of horseflesh should have a copy of this booklet. If you want to know how to break, train and make money with horses, write today for full information FREE, together with my special offer of a course in Animal Breeding. If you are interested in Galting and Riding the saddle horse check here. Do it today—now. You'll never regret it.

BEERY SCHOOL OF HORSEMANSHIP
Dept. 11012-D Pleasant Hill, Ohio

SAY YOU SAW IT IN POPULAR MECHANICS

LEARN WATCH REPAIRING



AT HOME. By our modern and original system of instruction you can learn every part of the **WATCH REPAIRING TRADE AT HOME.** Prepare yourself for a well-paying position or start in business after completing our course of instruction. Good watch repairers are in demand and generally earn very good salaries. For particulars apply to the **Wisconsin School of Watch Repairing** 759 North Milwaukee St., Milwaukee 2, Wis.

LEARN MASTER MACHINIST MECHANICAL DRAFTING

Expert training on Lathes, Milling Machines, Shapers, Grinders, etc.—Mechanical Drafting, Blueprint Reading and Designing. Allied shops are completely equipped and modern. Approved for G. I. Training Days, Evenings.

ALLIED SCHOOL OF MECHANICAL TRADES
1330 South Michigan Avenue Chicago 5, Illinois

LEARN INCREASE YOUR EARNINGS

Streamlined Home Study Course Now Available — Prepared by Successful Accountant
Penny post card brings full information
ACCOUNTING WESTERN HOME STUDY INSTITUTE
P.O. Box 2506, San Francisco 26, Calif.

PLAY GUITAR LIKE THE COWBOYS DO... 8 1/3¢ A LESSON

Just out—very latest guaranteed, simple, easy method. Play cowboy songs the Western way in a few minutes by ear. Surprise and amaze your friends. Be in big demand at parties, camps, public entertainments, on the radio, etc. 12 Complete Lessons. **SEND NO MONEY.** Pay postman only \$1.00 plus postage and C.O.D. charges, or send \$1.00 and get EXTRA SONGS all postpaid. (Canada, \$1.25 money order only.) Nothing else to buy. Positive money back guarantee. *Rush order today.*
WESTERN RANGER STUDIOS, Dept. 1512, Hutchinson, Kans.

INVENTORS

The patent laws provide that any new and useful art, machine, article of manufacture, composition of matter, or design, or any new and useful improvement thereof, may be patented if the act of invention is involved. Therefore, every inventor with a valuable invention should take advantage of the patent laws and proceed for patent protection in order to safeguard his rights.

A patent gives the inventor the exclusive right to prevent others from making, using, or selling the invention claimed in the patent for a period of 17 years.

The patent laws were enacted for the benefit of the inventor to give him protection for the features of his invention which are patentable. These features must be properly and concisely set forth and claimed in a formal application for patent in order to comply with the requirements of the U. S. Patent Office. For that reason, the Patent Office advises the inventor to engage a competent registered patent attorney to prepare his application for patent and represent him before the U. S. Patent Office Examiner.

A specially prepared booklet containing detailed information with respect to patent protection and procedure will be forwarded to you without obligation upon request.

Patents
Trademarks
Copyrights

Registered Patent Attorneys

CLARENCE A. O'BRIEN
& HARVEY B. JACOBSON

61-M Adams Building + Washington 4, D. C.

CLARENCE A. O'BRIEN & HARVEY B. JACOBSON
Registered Patent Attorneys
61-M Adams Building, Washington 4, D. C.

Please send me booklet containing information regarding patent protection and procedure. This request does not obligate me.

Name _____

Address _____

City _____ State _____

(Please write or print plainly.)

NOW

SPRAYBERRY RADIO TRAINING

GIVES YOU

8 BIG KITS OF RADIO EQUIPMENT

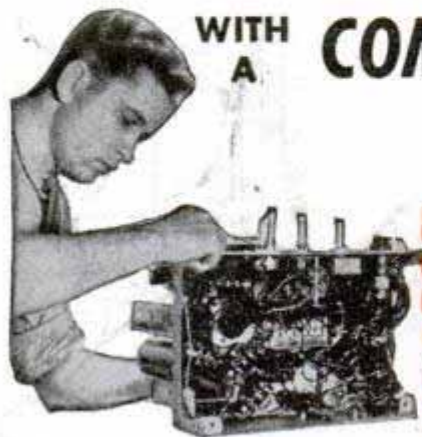

WITH A COMPLETE 6 TUBE SUPER-HETERODYNE RECEIVER

YOU LEARN RADIO SERVICING THROUGH INTENSIVE "SHOP-BENCH" PRACTICE

YOU DO EXPERIMENTS, CONSTRUCTION, TROUBLE-SHOOTING

I'll show you how to perform over 175 instructive Experiments—how to build countless Radio Circuits. You'll learn a new, fast way to test Radio Sets without mfg. Equipment.



I give you a fine, moving-coil type Meter Instrument on Jewel Bearings—with parts for a complete Analyzer Circuit Continuity Tester. You learn how to check and correct Receiver defects with professional accuracy and speed.

You'll get valuable experience and practice building this Signal Generator and multi-purpose Tester. Makes a breeze out of fixing Radios and you don't have to spend money on an outside, ready-made equipment.



Soldering, wiring, connecting Radio parts . . . building circuits with your own hands—you can't beat this method of learning. When you construct this Rectifier and Filter, Resistor and Condenser Tester, etc., you get a really practical slant on Radio that leads to a money-making future.



HERE'S THE LATEST, SIMPLEST WAY TO TRAIN at HOME for a GOOD LIVING in RADIO-ELECTRONICS & TELEVISION

I train your mind by putting you to work with your hands on a big 6-Tube Superheterodyne Receiver. And, believe me, when you get busy with real Radio Parts—8 big Kits of them—you really LEARN Radio and learn it RIGHT! You get the practical stuff you need to be useful in Radio, and that's what it takes to make money. You don't have to worry about what to do with these 8 Kits of Parts. Step by step, I show you how to build circuits, test, experiment, trouble-shoot. And you don't need any previous experience. The Sprayberry Course starts right at the beginning of Radio! You can't get lost! Simplified lessons, coupled

with real "Shop" practice, makes every subject plain and easy to understand and remember.

A BUSINESS OF YOUR OWN . . . OR A GOOD RADIO JOB

Soon after you begin Sprayberry Training, I'll send you my sensational BUSINESS BUILDERS. You'll find out how to get and do neighborhood Radio repair jobs for nice profits and rich experience while learning. This sort of work can easily pave the way for a Radio Service business of your own. But with Sprayberry Training, you're not limited. You can swing into any one of the swiftly expanding branches of Radio-Electronics INCLUDING Radio, Television, FM, Radar, Industrial Electronics. Be wise! Decide now to become a fully qualified RADIO-ELECTRONICIAN. Get full details about my Training at once! Mail coupon below for my 2 big FREE Books.

SEND FOR THESE FREE BOOKS



"How to Read Radio Diagrams and Symbols"

Here's a valuable and wonderfully complete new book which explains in simple English how to read and understand any Radio Set Diagram. Includes translation of all Radio symbols. Send for this volume at once! It's free! Along with it, I will send you another Big Free book describing in detail my Radio-Electronic Training.

SPRAYBERRY ACADEMY OF RADIO

F. L. Sprayberry, President, Room 10126, Pueblo, Colorado

Please rush my FREE copies of "How to MAKE MONEY in RADIO, ELECTRONICS and TELEVISION," and "HOW TO READ RADIO DIAGRAMS and SYMBOLS."

Name Age

Address

City State

(Mail in envelope or paste on penny postcard)

MAIL COUPON TODAY!

How to Make YOUR Body Bring You **FAME**

... Instead of **SHAME!**

**ARE YOU
Skinny?
Weak?
Flabby?**

**Will You Let Me
Prove I Can Make You
a New Man?**

I KNOW what it means to have the kind of body that people pity! Of course, you wouldn't know it to look at me now, but I was once a skinny weakling who weighed only 97 lbs.! I was ashamed to strip for sports or undress for a swim. I was such a poor specimen of physical development that I was constantly self-conscious and embarrassed. And I felt only HALF-ALIVE.

But later I discovered the secret that turned me into "The World's Most Perfectly Developed Man." And now I'd like to prove to you that the same system can make a NEW MAN of YOU!

What "Dynamic Tension" Will Do For You

I don't care how old or young you are or how ashamed of your present physical condition you may be. If you can simply raise your arm and flex it I can add SOLID MUSCLE to your biceps—yes, on each arm—in double-quick time! Only 15 minutes a day—right in your own home—is all the time I ask of you! And there's no cost if I fail.

I can broaden your shoulders, strengthen your back, develop your whole muscular system INSIDE and OUTSIDE! I can add inches to your chest, give you a viselike grip, make those legs of yours lithe and powerful. I can shoot new strength into your old backbone, exercise those inner organs, help you cram your body so full of pep, vigor and red-blooded vitality that you won't feel there's even "standing room" left for weakness and that lazy feeling! Before I get through with you I'll have your whole frame "measured" to a nice new, beautiful suit of muscle!

Only 15 Minutes A Day

No "ifs," "ands" or "maybes." Just tell me where you want handsome, powerful muscles. Are you fat and flabby? Or skinny and gawky? Are you short-winded, peppy? Do you hold back and let others walk off with the prettiest girls, best jobs, etc.? Then write for details about "Dynamic Tension" and learn how I can make you a healthy, confident, powerful HE-MAN.

"Dynamic Tension" is an entirely NATURAL method. Only 15 minutes of your spare time daily is enough to show amazing results—and it's actually fun. "Dynamic Tension" does the work.

"Dynamic Tension!" That's the ticket! The identical natural method that I myself developed to change my body from the scrawny, skinny chested weakling I was at 17 to my present super-man physique! Thousands of other fellows are becoming marvelous physical specimens—my way. I give you no gadgets or contraptions to fool with. When you have learned to develop your strength through "Dynamic Tension," you can laugh at artificial muscle-makers. You simply utilize the dormant muscle-power in your own body—watch it increase and multiply into real, solid LIVE MUSCLE.

My method—"Dynamic Tension"—will turn the trick for you. No theory—every exercise is practical. And, man, so easy! Spend only 15 minutes a day in your own home. From the very start you'll be using my method of "Dynamic Tension" almost unconsciously every minute of the day—walking, bending over, etc.—to BUILD MUSCLE and VITALITY!

FREE BOOK "Everlasting Health and Strength"

In it I talk to you in straight-from-the-shoulder language. Packed with inspirational pictures of myself and pupils—fellows who became NEW MEN in strength, my way. Let me show you what I helped THEM do. See what I can do for YOU! For a real thrill, send for this book today, AT ONCE. CHARLES ATLAS, Dept. 8M, 115 East 23rd Street, New York 10, N. Y.



*Charles
Atlas*

Holder of title, "The World's Most Perfectly Developed Man." This actual snapshot is not retouched in any way.

**Mail Coupon
For My
FREE Book**

**CHARLES ATLAS, Dept. 8M,
115 East 23rd Street, New York 10, N. Y.**

I want the proof that your system of "Dynamic Tension" will help make a New Man of me—give me a healthy, husky body and big muscle development. Send me your free book, "Everlasting Health and Strength."

Name.....
(Please print or write plainly)

Address.....

City.....State.....

Check here if under 16 for Booklet A.

INVENTORS

• **T**he Rules of Practice of U. S. Patent Office advises—unless the inventor is qualified to handle such matters—that he employ the services of a competent Patent Attorney in the preparation of his Patent Application. We are Registered Patent Attorneys fully qualified to represent you at the Patent Office. Our long and varied experience in patent practice, we believe, enables us readily to understand inventors' disclosures, to advise what is probably patentable, after conducting preliminary patentability investigation of prior U. S. patents, and to draw your specifications and claims in such manner as to present clearly the novel features.

Patent Laws Favor the Inventor Who Acts Promptly

Remember, the details of your invention do not have to be 100% perfect before you can obtain patent. Unwise inventors often

devote considerable unnecessary time working on unimportant details of their devices. This is expensive, hazardous and unnecessary. First step is to have us conduct search for the prior U.S. patents and render a report as to its patentability. Our Search Report is very valuable to you in that it clears up the course you should take in regard to your invention. If our Report is favorable, this report of the patentability of your device shows that your chances of patent protection are in your favor.

Have Patent Protection First

Unless you safeguard your invention by obtaining a patent, thereby securing a monopoly on same, it may become "public property," free to be made, used and sold by anyone, or it may be patented by some other person.

McMORROW, BERMAN & DAVIDSON

Registered Patent Attorneys

135-Z Victor Building, Washington 1, D. C.

McMORROW, BERMAN & DAVIDSON

Registered Patent Attorneys

135-Z Victor Building, Washington 1, D. C.

Send me further particulars on how to protect my invention and "Invention Record" form at once. I understand that this request does not obligate me.

Name.....

Address.....

City.....State.....

(Write or print name clearly)

•
COPYRIGHTS

PATENTS

TRADE MARKS
•

G.I.'s

CORRESPONDENCE SCHOOL



*You learn while you **EARN!***

I. C. S. COURSES free to you! They're available now to honorably discharged World War II Veterans under the G. I. Bill of Rights. The U. S. Government pays for this training . . . and it is NOT to be deducted from any future bonus payments.

This is *your* personal reconversion program if you want to earn as you learn . . . to master a trade or profession and qualify for promotions and pay raises on the job!

Here, for your choosing, is famous I. C. S. education in any one of more than 400 technical and business vocations. Courses are

practical, authoritative, easy to understand. You study in your spare time. At work you prove and apply what you learn.

Thousands of successful students have demonstrated that today's I. C. S. student is tomorrow's leader. Here's your chance to join them — at no cost to you.

Act *now!* When you mark and mail the coupon on this page you've taken the first step to Success. We send you full details of the Course in which you're interested — and complete instructions on how to enroll with us under the G. I. Bill of Rights.

INTERNATIONAL CORRESPONDENCE SCHOOLS



BOX 5594-K, SCRANTON 9, PENNA.

Without cost or obligation, please send me full particulars about the course *before* which I have marked X:

<p>Air Conditioning and Plumbing Courses</p> <p><input type="checkbox"/> Air Conditioning <input type="checkbox"/> Heating <input type="checkbox"/> Plumbing <input type="checkbox"/> Refrigeration <input type="checkbox"/> Steam Fitting</p> <p>Chemistry Courses</p> <p><input type="checkbox"/> Chemical Engineering <input type="checkbox"/> Chemistry, Analytical <input type="checkbox"/> Chemistry, Industrial <input type="checkbox"/> Chemistry, Mfg. Iron & Steel <input type="checkbox"/> Petroleum Refining <input type="checkbox"/> Plastics <input type="checkbox"/> Pulp and Paper Making</p> <p>Civil Engineering, Architectural and Mining Courses</p> <p><input type="checkbox"/> Architectural Drafting <input type="checkbox"/> Architecture <input type="checkbox"/> Bridge and Building Foreman <input type="checkbox"/> Building Estimating <input type="checkbox"/> Civil Engineering <input type="checkbox"/> Coal Mining <input type="checkbox"/> Contracting and Building <input type="checkbox"/> Highway Engineering <input type="checkbox"/> Lumber Dealer <input type="checkbox"/> Reading Structural Blueprints <input type="checkbox"/> Sanitary Engineering <input type="checkbox"/> Structural Drafting</p>	<p><input type="checkbox"/> Structural Engineering <input type="checkbox"/> Surveying and Mapping</p> <p>Communications Courses</p> <p><input type="checkbox"/> Electronics <input type="checkbox"/> Practical Telephony <input type="checkbox"/> Radio, General <input type="checkbox"/> Radio Operating <input type="checkbox"/> Radio Servicing <input type="checkbox"/> Telegraph Engineering</p> <p>Electrical Courses</p> <p><input type="checkbox"/> Electrical Drafting <input type="checkbox"/> Electrical Engineering <input type="checkbox"/> Electric Light and Power <input type="checkbox"/> Lighting Technician <input type="checkbox"/> Practical Electrician</p> <p>Internal Combustion Engines Courses</p> <p><input type="checkbox"/> Auto Technician <input type="checkbox"/> Aviation <input type="checkbox"/> Diesel-Electric <input type="checkbox"/> Diesel Engines <input type="checkbox"/> Gas Engines</p> <p>Mechanical Courses</p> <p><input type="checkbox"/> Aeronautical Engineering <input type="checkbox"/> Aircraft Drafting <input type="checkbox"/> Flight Engineer <input type="checkbox"/> Foundry Work <input type="checkbox"/> Heat Treatment of Metals</p>	<p><input type="checkbox"/> Industrial Engineering <input type="checkbox"/> Industrial Metallurgy <input type="checkbox"/> Machine Shop <input type="checkbox"/> Mechanical Drafting <input type="checkbox"/> Mechanical Engineering <input type="checkbox"/> Mold-Loft Work <input type="checkbox"/> Patternmaking—Wood, Metal <input type="checkbox"/> Reading Shop Blueprints <input type="checkbox"/> Sheet-Metal Drafting <input type="checkbox"/> Sheet-Metal Worker <input type="checkbox"/> Ship Drafting <input type="checkbox"/> Shipfitting <input type="checkbox"/> Tool Designing <input type="checkbox"/> Toolmaking <input type="checkbox"/> Welding—Gas and Electric</p> <p>Railroad Courses</p> <p><input type="checkbox"/> Air Brake <input type="checkbox"/> Car Inspector <input type="checkbox"/> Diesel Locomotive <input type="checkbox"/> Locomotive Engineer <input type="checkbox"/> Locomotive Fireman <input type="checkbox"/> Railroad Section Foreman</p> <p>Steam Engineering Courses</p> <p><input type="checkbox"/> Boilermaking <input type="checkbox"/> Combustion Engineering <input type="checkbox"/> Engine Running <input type="checkbox"/> Marine Engineering <input type="checkbox"/> Steam Electric <input type="checkbox"/> Steam Engines</p>	<p>Textile Courses</p> <p><input type="checkbox"/> Cotton Manufacturing <input type="checkbox"/> Rayon Weaving <input type="checkbox"/> Textile Designing <input type="checkbox"/> Woolen Manufacturing</p> <p>Business and Academic Courses</p> <p><input type="checkbox"/> Accounting <input type="checkbox"/> Advertising <input type="checkbox"/> Arithmetic <input type="checkbox"/> Bookkeeping <input type="checkbox"/> Business Correspondence <input type="checkbox"/> Business Management <input type="checkbox"/> Certified Public Accounting <input type="checkbox"/> Commercial <input type="checkbox"/> Cost Accounting <input type="checkbox"/> Federal Tax <input type="checkbox"/> First Year College <input type="checkbox"/> Foremanship <input type="checkbox"/> French <input type="checkbox"/> Good English <input type="checkbox"/> High School <input type="checkbox"/> Higher Mathematics <input type="checkbox"/> Illustrating <input type="checkbox"/> Motor Traffic <input type="checkbox"/> Postal Service <input type="checkbox"/> Salesmanship <input type="checkbox"/> Secretarial <input type="checkbox"/> Sign Lettering <input type="checkbox"/> Spanish <input type="checkbox"/> Stenography <input type="checkbox"/> Traffic Management</p>
---	---	---	---

Name _____ Age _____ Address _____
 City _____ State _____ Present Position _____
 Working Hours _____ A.M. to _____ P.M. Length of Service in World War II _____

Special tuition rates to members of the Armed Forces. Enrollment under the G.I. Bill of Rights approved for War II Veterans, Canadian residents send coupon to International Correspondence Schools Canadian, Ltd., Montreal, Canada.

PATENT PROTECTION *for* INVENTORS

A PATENT IS A VALUABLE RIGHT

On the basis of a constitutional provision Congress has established a system under which inventors may secure the exclusive right to prevent the unauthorized use, manufacture and sale of their inventions for periods of seventeen years. The inventor secures this protection by obtaining a patent from the United States Patent Office.

The United States Patent Office
RECOMMENDS

In its Rules of Practice that "an applicant is advised, unless familiar with such matters to employ a competent registered patent attorney or registered patent agent, as the value of patents depends largely upon the skillful preparation of the specifications and claims."

We
RECOMMEND

that you authorize us to conduct a search through the U. S. Patents pertinent to your invention and submit a report setting forth our opinion regarding its patentability.

VICTOR J. EVANS & CO., has a staff of experienced registered patent attorneys, available to represent inventors in the preparation and prosecution of their cases before the Patent Office. Detailed information and the steps to be taken in obtaining patent protection will be furnished upon request.

FORM BELOW FOR MAILING CONVENIENCE

**VICTOR J.
EVANS & Co.**

Merlin M. Evans

REGISTERED PATENT ATTORNEY

Main Office: 130-P Merlin Building, Washington 6, D. C.

Pittsburgh Office: 521-N Empire Building

Los Angeles Office: 738-N Security Building

Please forward to me detailed information regarding procedure to obtain Patent Protection, together with your convenient "Evidence of Invention" form.

Name.....

Address.....

City and State.....

PATENTS

TRADEMARKS

COPYRIGHTS

MEN! Whether You're 16 or ^{up} to 40..

Learn ELECTRICITY

Get Ready quickly
for the Field that offers
**STEADY WORK and
A REAL FUTURE!**

FREE BOOK shows how you can
prepare for a **GOOD JOB NOW**

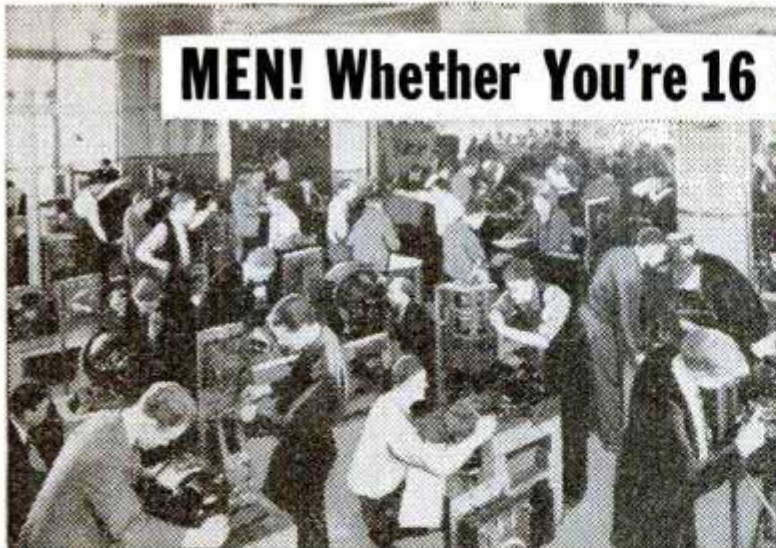

A partial view of one of the Training Departments at Coyne

"LEARN-BY-DOING" IN COYNE SHOPS

Start now to prepare for a Lifetime of Success. Get into Electricity, the essential field that will continue to offer good pay and a real future all through the years. Coyne trains you, NOT by correspondence, but by actual shop work right here in the Coyne Shops in Chicago on real electrical machinery. You get necessary theory in a practical way by lectures, blackboard illustrations and equipment demonstrations.

In the Big Coyne Shops you get practical "all-around" training... wiring, installing, operating, testing, repairing and servicing various types of Electrical and Electronic equipment... you work on real armatures, motors, generators, refrigerators, electronic controls, etc. No advanced education or previous electrical experience needed. Many of our students had no previous experience. Others had experience in one or two branches but realized they needed all-around training for the better jobs and advancement.

Student Finance Plan

Don't let lack of money hold you back. Our "Pay-Tuition-after-Graduation" plan has helped thousands. Coupon brings details.

Earn While Learning

Many earn while learning, to help take care of living expenses while here. When you have graduated, our Employment Department will give you Lifetime Employment Service.



PREPARE FOR PERMANENT JOBS LIKE THESE

Light and Power Wiring
Power Plant Work
Armature Winding
Substation Operator
Maintenance Electrician
Electrical Testing and Repair
Signal Maintenance
Industrial Electronics
Electric Refrigeration
and many others
Our Employment Bureau for graduates gives FREE lifetime employment service.

OUR GRADUATE EMPLOYMENT SERVICE HAS LETTERS FROM DOZENS OF FIRMS ASKING FOR COYNE TRAINED MEN FOR GOOD JOBS WITH A REAL FUTURE.

Industrial Electronics and Electric Refrigeration Training Now Included

Added training in these two great fields is now included with our Electrical Course. Industrial Electronics and Electric Refrigeration offer big opportunities. Get BOTH at Coyne!



B. W. Cooke

MEN WITH PHYSICAL DISABILITIES —

We also have facilities for men with physical disabilities whether due to war or other causes. Check coupon for particulars if you have a physical disability of any nature.

GET THE FACTS

Don't let lack of money keep you from sending in the Coupon now. Our Big FREE Book is full of facts and photographs which tell you about Coyne training. It also gives you the details of our "Student Finance" Plan, Part Time Employment Plan, Graduate Employment Service, Lifetime Membership, etc.



This modern fireproof building is occupied entirely by the Coyne Electrical School.

VETERANS

Coyne is also equipped to train those who qualify for training under the G. I. Bill of Rights. Check coupon for special G.I. Bulletin

ADDED TRAINING IN INDUSTRIAL ELECTRONICS AND ELECTRIC REFRIGERATION Now Included!

B. W. COOKE, Director

COYNE ELECTRICAL SCHOOL
500 S. Paulina St., Dept. 96-72, Chicago, 12

Send Today for this FREE Book!

B. W. COOKE, Director
COYNE ELECTRICAL SCHOOL,
500 S. Paulina St., Dept. 96-72, Chicago 12, Ill.

Without obligation send big free illustrated book with facts about Coyne and details of "Student Finance" Plan and added training in Industrial Electronics and Electric Refrigeration you are now including.

- Send special G. I. Bulletin.
- Send physical disability details.

Name.....

Address.....

City.....State.....



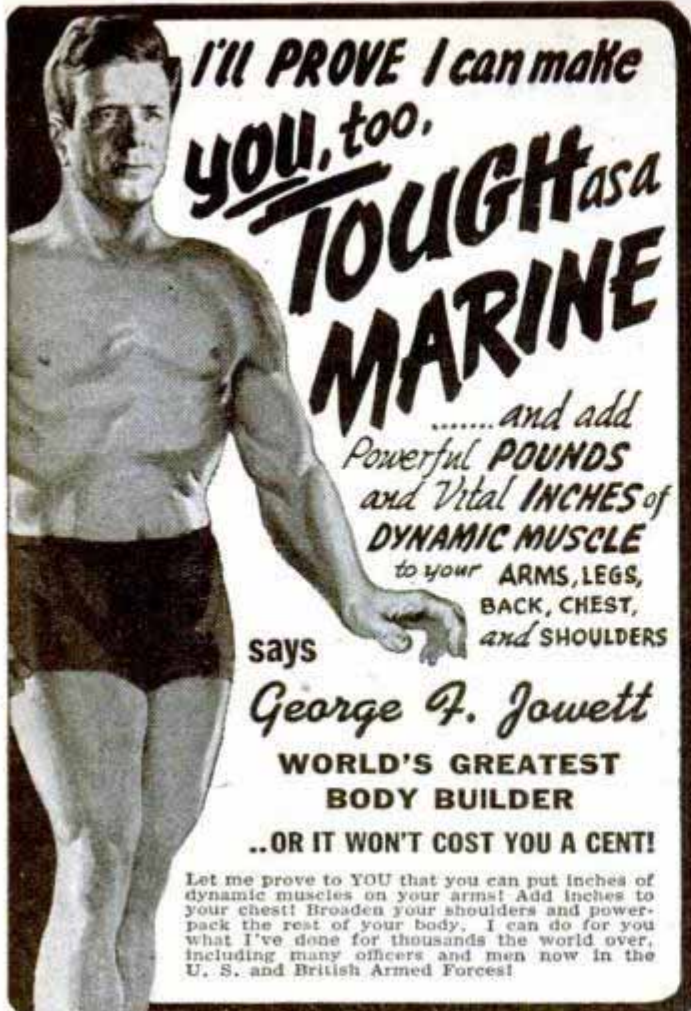

I'll PROVE I can make
you, too,
**TOUGH as a
MARINE**

.....and add
Powerful **POUNDS**
and Vital **INCHES** of
DYNAMIC MUSCLE
to your **ARMS, LEGS,
BACK, CHEST,
and SHOULDERS**

says
George F. Jowett
**WORLD'S GREATEST
BODY BUILDER**

..OR IT WON'T COST YOU A CENT!

Let me prove to YOU that you can put inches of dynamic muscles on your arms! Add inches to your chest! Broaden your shoulders and power-pack the rest of your body. I can do for you what I've done for thousands the world over, including many officers and men now in the U. S. and British Armed Forces!

**GIVE ME 10 MINUTES A DAY!
I'll Show You My Secrets Of Body Building**

I'll help you learn the "Progressive Power Method" through which I rebuilt myself from a physical wreck to the holder of more strength records than any other living athlete or teacher! No matter how skinny or flabby you are, you can learn my methods right in your own home. Through my proved secrets I show you how to develop your power, inside and out, until YOU are fully satisfied that you are the man you want to be. "The Jowett System," says R. F. Kelly, Physical Director of the YMCA, Atlantic City, "is the greatest in the world!" If you want a physique that will inspire respect from men, and admiration from women... **ACT LIKE**

A HE-MAN! Decide at once! The famous book, "Nerves of Steel—Muscles Like Iron" will be included FREE! Priceless for the strength fan! Full of photos of marvelous power-bodied men who will show you what Jowett has done for them and how he can do the same for you. Reach out... Grasp this Special Offer today!

**PROVE TO YOURSELF
IN ONE NIGHT!**

Send only 25c for test Course, "Molding a Mighty Arm." Read it the evening it arrives—learn from experience the thrill you can give your muscles!

**SEND FOR THESE FIVE FAMOUS
COURSES IN BOOK FORM
ONLY 25c EACH
or ALL 5 for \$1.00**

**Jowett Institute of Physical
Culture**
230 Fifth Avenue
Dept. PM-612
New York 1, N. Y.

*This
Book
Free!*



**BOOK WITH PHOTOS OF FAMOUS STRONG MEN
MAIL COUPON NOW**

FREE



Jowett Institute of Physical Culture
230 Fifth Avenue, Dept. PM-612, New York 1, N. Y.
George F. Jowett: Your proposition looks good to me. Send by return mail, prepaid, the courses checked below, for which I enclose (). Include FREE book of PHOTOS.

- George F. Jowett
Champion of Champions
- All 5 courses for... \$1
 - Molding a Mighty Arm 25c
 - Molding a Mighty Back 25c
 - Molding a Mighty Grip 25c
 - Molding a Mighty Chest 25c
 - Molding a Mighty Leg 25c
 - Send all 5 C.O.D. (\$1 plus postage.) No orders less than \$1 sent C.O.D.

NAME **Age**

(Please print plainly. Include Zone Number.)

ADDRESS

Learn PHOTOGRAPHY at Home Now—Portraiture, Press,



Commercial or Hobby

Whether it's for a full-time career or just plain fun, you'll enjoy learning photography this new, easy way. Every phase of photography is carefully covered, with the latest techniques and methods fully explained. There are thousands of opportunities in photography as a career, and hours of pleasure as a hobby, so make the most of them today.

12-Month Home Study Course

Written and directed by expert photographers with years of teaching experience at one of America's leading educational institutions. A really THOROUGH education in photography, taught in easy steps and simple terms. Write today for complete information.

MOODY EDUCATIONAL INSTITUTE, Inc.
208 E. Wisconsin Ave. Dept. 11-B6 Milwaukee 2, Wis.

LEARN MONEY- MAKING CARTOONING

IN SPARE TIME — by Easy Picture Chart Method
Same Simplified Method that has helped train creators of "Terry & Pirates," "Freckles," "Out Our Way," "Winnie Winkle," "Reg'lar Fellers," "Strange As It Seems," "The Neighbors," and many others. Earn while learning. Send 10c for Picture Chart (to test your ability), and full details. (State age.)
Landon School of Cartooning, Dept. 4612 Philadelphia 1, Pa.



LEARN Accounting AT HOME — IN SPARE TIME

Bookkeepers, accountants, and secretaries are in great demand. Now is the time to prepare for the many opportunities open to business-trained men and women.

Write today for FREE copy of interesting new booklet, "Through Hill's To Success," which tells where the best positions are found and how you may train for them quickly at home in your spare time or in resident school.

Hill's is rated as one of America's leading business schools. Thousands of successful graduates. Nationwide Employment Service.

Hill's EXTENSION SCHOOL And Business University

619 West Main St., Oklahoma City 2, Okla.

HOME STUDY OR SHOP TRAINING

Learn Plastics, Refrigeration or Diesel. Study at home, shop work later. Also shop courses in Body and Fender, Machine Shop, Tool and Die. 41,000 graduates. Established 1902. Free booklet. Specify trade.
GREER SHOP TRAINING, Dept. 1126, 460 S. State St., Chicago



CALLING ALL BOYS!

Yes, we're CALLING ALL BOYS, and we're calling YOU, too. Tune in on an interesting hobby that pays big returns in fun and interest. Even helps to prepare you for a career in radio. Learn how to make your own simple, tubeless, batteryless crystal radio. Just send 25c. We will send you postpaid by return mail a genuine Melomite crystal with complete illustrated instructions for making your very own set. Then you will enjoy competing with others for long-distant reception. With crystal and instructions we send The Magic Crystal, our own publication chock-full of news, diagrams, questions and answers of interest. Don't delay! Send 25c today!

ALLEN RADIO, Dept. PM-12 Clinton, Missouri

WHICH OF THESE *Opportunities* INTERESTS *You* MOST?

Accounting
Air Conditioning
Architecture & Building
Automotive Engineering
Aviation—Practical
Aviation Drafting & Design
Better Foremanship
Bookkeeping
Business Management

Contracting
Diesel Engineering
Drafting & Design
Electrical Engineering
Electricity—Practical
Electronics, Industrial
High School Courses
Machine Shop Operations
Mechanical Engineering

Plastics Engineering
Plumbing—Practical
Private Secretary
Radio Operating & Servicing
Railway Training
Refrigeration
Sheet Metal Pattern Drafting
Shop Management
Tool Making

THINK! LOOK FORWARD!

Business is making big, new plans

Men and Women are preparing for the future

WHAT ARE YOU DOING ABOUT YOUR TOMORROWS?

● *Today*, choose the job you want—and prepare for it. Or if you are already engaged in the work you like best, start training *now* for quicker promotion. Acquire the knowledge that will help you to get ahead faster, make more money and have greater security.

Invest part of your spare time in more rapid progress. Start training now, in spare time in your own home. Be ready to grasp your opportunity and step out ahead of those who lack the ability you have attained.

American School, founded in 1897 as an educational institution *not for profit*, can help you to reach your goal just as it has helped others during the past forty-nine years. Give serious thought to the list above. Pick one or more subjects that interest you. Then check the coupon at right, add your name and address and mail it at once. The school will send you details on its training plan and outline of study prepared by specialists. There is no charge, no obligation, so send the coupon immediately.

PRACTICAL, EFFECTIVE HOME - STUDY TRAINING SINCE 1897.

Take This First Easy Step

CHECK, CLIP AND MAIL COUPON NOW

AMERICAN SCHOOL, Dept. G945, Drexel at 58th, Chicago 37, Ill.
Without obligation, Please send FREE and postpaid, bulletin and details of the Subject checked.

- | | | |
|--|--|--|
| <input type="checkbox"/> PLASTICS ENG'R | <input type="checkbox"/> Accounting | <input type="checkbox"/> Drafting and Design for Men and Women |
| <input type="checkbox"/> Refrigeration | <input type="checkbox"/> Electrical Engr. | <input type="checkbox"/> Radio |
| <input type="checkbox"/> Architecture and Building | <input type="checkbox"/> Electricity-Pract. | <input type="checkbox"/> High School |
| <input type="checkbox"/> Contracting | <input type="checkbox"/> Electronics, Industr. | <input type="checkbox"/> Air Conditioning |
| <input type="checkbox"/> Practical Plumbing | <input type="checkbox"/> Bookkeeping | <input type="checkbox"/> Mechanical Eng. |
| <input type="checkbox"/> Automotive Engineering | <input type="checkbox"/> Private Secretary | <input type="checkbox"/> Shop Management |
| <input type="checkbox"/> Aviation Drafting | <input type="checkbox"/> Diesel Engineering | <input type="checkbox"/> Tool Making |
| <input type="checkbox"/> Aviation | <input type="checkbox"/> Sheet Metal | <input type="checkbox"/> Better Foremanship |
| <input type="checkbox"/> Business Mgmt | <input type="checkbox"/> Pattern Drafting | <input type="checkbox"/> Machine Shop Operations |
| <input type="checkbox"/> Railway Training | | |

Name.....Occupation.....
Address.....Age.....
City.....State.....

AMERICAN SCHOOL

Dept. G945, Drexel at 58th Street, Chicago 37

OIL BURNER

INFORMATION IN A HANDY FORM

JUST OUT!



A POCKET COMPANION THAT ANSWERS YOUR QUESTIONS!

AUDELS OIL BURNER GUIDE

- A new practical, concise treatise, 384 pages-31 Chapters - 321 Diagrams and Illustrations - covering Domestic and Industrial Oil Burners.

New from Cover to Cover, for mechanics interested in Oil Burners. Gives practical inside working knowledge of theory, construction, installation, operation, testing, servicing and repair of all types of oil burners. Includes electrical hook-ups and wiring diagrams of automatic control systems.

PRICE \$1 POSTPAID

Get this information for yourself. Mail coupon today. No obligation unless satisfied.

ASK TO SEE IT

AUDEL, Publishers, 49 W. 23rd St., New York 10, N.Y.

Please mail AUDELS OIL BURNER GUIDE (Price \$1). If satisfactory, I will remit \$1 on its safe arrival, otherwise I will return the book.

Name _____

Address _____

Occupation _____

Employed by _____ PM

OPPORTUNITIES AHEAD

For Men Who are Trained in

AUTO BODY & FENDER WORK

Men 18 to 60. Want a future with good pay, perhaps a business of your own later? If you are mechanically inclined, start now to learn to become an auto body mechanic and fender repair man. This fast growing field has great possibilities for trained men with experience. U. E. I. spare time, home-study training combined with actual shop practice gives you sound, basic knowledge of latest, best methods so you may get the experience which may bring you big pay. Capable instructors supervise your studies and actual practice. Course includes acetylene welding, spray painting, use of hand and power tools, etc.

THOROUGH, RELIABLE TRAINING

U. E. I. has trained men for new opportunity fields since 1927 and many students are now making good. Auto body and fender repairing is one of the best profit-makers in any garage or service station. Little capital required for mechanically inclined men to get into this business. Free employment placement service, or we will show you how to start your own shop. Get the facts FREE, without obligation. Write today.

UTILITIES ENGINEERING INSTITUTE

AUTO-CRAFTS DIVISION

1314 Belden Avenue, Dept. 1126X, Chicago 14, Ill.

Gentlemen: -YES! I want to get into profitable Auto Body and Fender Repair Work. Please send me FREE FACTS at once. This inquiry does not obligate me in any way.

Name _____ Age _____

Address _____

City _____ Zone _____ State _____

STUDY AT HOME

With An Educational Institution

Men with specialized training win higher positions, insure larger earnings, and are bigger successes in business and public life. Opportunities NOW greater than ever before. Send for our Catalog.

ARTS and SCIENCES

Courses in Philosophy; Education; Letters; Public Health; Medical Jurisprudence; Psychology; Sociology; Physics; Chemistry; Plastics; Geology; Political Science; Theology; Business and Commerce; Accounting; Mathematics; Statistics; Agriculture.

ENGINEERING

Courses in Electrical, Civil, Mechanical, Drafting, Architectural, Steam, Aeronautical, Radio, Structural, Mining, Industrial, Petroleum, Marine, Chemical, Diesel, Automobile, Refrigeration, and Air Conditioning Engineering.

LAW

Complete Professional Law Course includes 18 Hornbook Series college grade textbooks. Courses also in Commercial Law, Patent Law and Medical Jurisprudence. McKinley-Roosevelt Incorporated, 4610-K, Sheridan Rd., Chicago 40, Ill.



Beautiful brass Social Security plates (illustrated 1/2 actual size), priced at only 50c. Please print your name & number plainly.

ACME

Stamping Service
Box 836
Davenport, Iowa

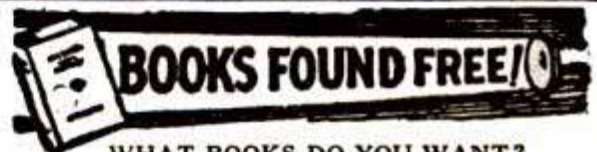

WHAT BOOKS DO YOU WANT?

We quote the lowest market prices. No charge for locating Hard-to-Find and Out-of-Print Books. All books, OLD or NEW, mailed POST-FREE.

SEARCHLIGHT BOOK CLUB, 22 East 17th St., New York City

THERE'S MONEY IN CARTOONS!

RAYE BURNS will teach you HOW to CREATE ORIGINAL CARTOONS at home that you may SELL! Course contains 26 lessons and over 600 illustrations. All for Only \$2.85

Send name and address for free details.

RAYE BURNS SCHOOL, Dept. M, Box 3583, CLEVELAND, OHIO



Begin today. Write now for our Free Book, "How to Become a Good Penman." It contains specimens and tells how others learned to write in spare time. Enclose 10¢ for your name beautifully written and a pen point suitable for shaded writing. Write today.

THE TAMBLYN SCHOOL OF PENMANSHIP
N-441 Ridge Building, Kansas City, Mo.

INDIANA TECHNICAL COLLEGE

B. S. degree in 27 mos. Aeronautical, Chemical, Civil, Electrical, Mechanical and Radio Engineering. 2-yr. diploma, Air Cond., Refrigeration. GI approved. Low rate. Earn board. Demand for grads. Enter March, June, Sept., Dec. Catalogue. 5126 E. Washington Blvd., Ft. Wayne 2, Ind.

MAKE MONEY AT HOME



Amazing rubber mold-making outfit makes perfect flexible molds of plaques, ash trays, bookends, etc. Molds cost 6¢ to 25¢ each. Each mold makes hundreds of novelties and gifts to sell for \$1.00 apiece and more! No experience necessary. Everything furnished. Quick and easy. Start profitable business in your home--sell to stores, gift shops, friends, resorts, road stands, by mail. Full or spare time. Write for complete FREE details and easy instructions.

SO-LO WORKS, Inc., Dept. N-800, Loveland, Ohio

Now IN YOUR OWN HOME Learn

RADIO ELECTRONICS

The Practical
"HOME-TESTED"
Modern "A-B-C" Way



YOU USE ALL OF THESE RADIO PARTS
TO BUILD
AND OPERATE
7
DIFFERENT RADIO
RECEIVING CIRCUITS

NO PREVIOUS RADIO OR ELECTRICAL EXPERIENCE NECESSARY

DeForest's Training, Inc. provides every major home study aid to help you learn Radio-Electronics rapidly and thoroughly . . . to give you the *experience and confidence* needed for a responsible, Good-Pay Job, or to Start a Business of Your Own! Here is a REAL opportunity field for YOU . . . when you are a trained Radio-Electronics man! Just think of the tremendously exciting future ahead of FM Radio, Aviation and Broadcast Radio, Sound Motion Picture Equipment, Servicing and Sales of Radio Equipment, etc. Put yourself in this picture . . . See how you can benefit from a PRACTICAL training in this fascinating work! Think, too, of the coming possibilities ahead of Radar, Facsimile and Television. Send TODAY for the interesting, opportunity-revealing book, "Victory for You!" See how others probably no more talented or ambitious than you, have advanced in earning power after this training . . . how YOU can do it too! Mail the coupon NOW!

INCLUDING:

1. Simple Receiver
2. Two Tube Receiver
3. Tuned Radio-Frequency Receiver
4. Short Wave Receiver
5. Aviation Band Receiver
6. 4-Tube Superheterodyne
7. 5-Tube Superheterodyne with Magic Tuning Eye

••• PLUS SCORES OF OTHER FASCINATING, INSTRUCTIVE RADIO-ELECTRONIC EXPERIMENTS

WITH THE HELP OF

A EIGHT Big Kits of Actual "Learn-by-Doing" Radio Parts and Assemblies with which you make 133 fascinating SHOP METHOD EXPERIMENTS in your own home! Imagine building 7 different Radio Receivers that operate!

B A 16 mm Home Movie Projector and Twelve Reels of "Learn-by-Seeing" Home Movie Films . . . for picture-clear, fast understanding of Radio Fundamentals!

C Modern, well-illustrated, Loose-leaf Lessons, prepared in clear, simple, understandable language . . . to guide you throughout your training!

THEN GET THE HELP OF OUR EFFECTIVE EMPLOYMENT SERVICE

16 MM MOVIE PROJECTOR
YOU USE "LEARN-BY-SEEING" MOVIES



DEFOREST'S TRAINING, INC. INCLUDES INSTRUCTION IN MOTION PICTURE SOUND EQUIPMENT, FM RADIO AND TELEVISION . . . RESIDENTIAL TRAINING IN OUR MODERN CHICAGO LABORATORIES ALSO AVAILABLE—ASK US FOR INFORMATION!

VETERANS!

Big things are happening at DeForest's Training, Inc. for veterans! See how you can prepare yourself WITHOUT COST for a GOOD JOB or a BUSINESS OF YOUR OWN in the vast Radio-Electronic opportunity field.



E. B. DEVRY, President
DeFOREST'S TRAINING, INC.
2535-41 North Ashland Ave., Dept. PM-C12
Chicago 14, Illinois, U.S.A.

Send FREE "VICTORY FOR YOU!" BOOK, showing how I may make my start in Radio Electronics.

Name _____ Age _____

Address _____ Apt. _____

City _____ Zone _____ State _____

If under 16, check here for special information.

If a discharged Veteran of World War II, check here.

DeFOREST'S TRAINING, INC.
CHICAGO 14, ILLINOIS



SO IT NEEDS FIXING

By S. T. CHRISTENSEN

the "Fix-it Man"

WELL, I guess I'm the fellow to see, for I've repaired thousands of refrigerators (home and commercial both), vacuum cleaners, radios, washing machines, irons, fans, lamps, mangles, motors, etc. In fact, many of my customers call me their "electrical appliance doctor." And, "doctoring," I might add, has paid me a good substantial income for quite a few years. Funny, in a way, how I got started. Always liked to tinker and by experimenting around I found that most electrical appliances had many things in common. That, regardless of what the appliance was used for, or who the manufacturer was, the basic principles were much the same. From fixing my own appliances to fixing friends' and then for strangers at a fee, seems now to have been but a small step.

What to Charge?

At first, I let the owner decide the charge and, frankly, I was amazed at what I earned per hour. But then, when one figures what initial costs are involved in buying most electrical appliances, one can readily see that spending extra dollars for repairs is well worth while. Before long I was making more in my spare time repairing than from my regular job. The result . . . I went into business for myself. When war came, business boomed, for new appliances were not available.

For a while, repair parts (needed on some

jobs) were a little difficult to get. But that situation quickly adjusted itself and many repair parts were given the high priority rating of AA2. After all, we had to provide for the health and well-being of our civilian population.

The Future Offers

Friends ask me about my future. And, I think I've got a grand one. Age is no handicap in repairing. I have in my files enthusiastic letters from repairmen ranging in age from 18 to 79 years. Now the war is over we are certain to see hundreds of new products on the market . . . products that the average person never dreamt of. These new products and our old appliances are all going to need at some time or other "fixing." Well, I'll still be the fellow to do it. The field open for appliance repairmen is unlimited. I don't worry at all about too much competition.

If You Are Ambitious

To the contrary, I've prepared a complete course, chuck full of simple, easy to understand photos and drawings and written in the same non-technical language as this article. I know the course is good, because I have hundreds of men all over the country writing to me telling me how the course has helped swell their pockets with cash. If you too want to prepare now for your future, I suggest you read the next page and send me the handy coupon."

Advertisement



**BIG MONEY
INDEPENDENCE**

*A PROFITABLE
LIFETIME
BUSINESS
OF
YOUR OWN!*

LEARN ELECTRICAL APPLIANCE REPAIRING

PREPARE NOW FOR THE FUTURE

If now employed, start your home appliance repair business NOW in your spare time and be set with a business of your own no matter what happens. You don't need elaborate fixtures or expensive equipment to be a successful repairman. Operate from your garage, basement, vacant store, etc. Work as many hours as you wish—the home appliance repairman is his own boss. It is a profitable occupation for on many types of repairs it is not unusual for a repairman to charge on the basis of \$5.00 to \$6.00 per hour. Don't gamble with your future—learn a trade that will always support you. Remember, as long as electrical appliances are used, there will be a need for electrical appliance repairmen.

If you are at all mechanically inclined—can hold and use tools—then you have all of the qualifications required for becoming a big money earning home appliance repairman. It does not matter if you have not had a great deal of schooling or had previous experience along these lines—**WE WILL TEACH YOU.** Age should be no barrier—nor should any minor physical handicap.

New Course Tells All

Profusely illustrated, our new course shows you in simple, easy to understand language and drawings how to make each repair on refrigerators, vacuum cleaners, washing machines, motors, etc. Explains and gives you a working knowledge of electricity, welding, nickel plating, etc. Shows you how to build the power tools you need and how to solicit and keep business coming to you. Not a theory course but an honest to goodness course written by and used by repairmen the country over. Price of course is so low that the savings on your own household appliance repairs will quickly pay for it. Act now! Mail the handy coupon below today.

----- Read What Our Students Say About Course -----

I really believe your course the best investment a mechanically minded man can make.—Claude E. Allen, Indianapolis, Ind.

I have received your Course in Appliance Repairing and I must say I am well pleased with same. I am only sorry I did not have said Course some years ago. I have learned so much more through this course I would not part with it.—Charles Schwarz, Hamilton, Ohio.

The Course in Appliance Servicing arrived a few days ago. Want to take out a few minutes of my valuable time to let you know that this is just what I have been looking for ever since I opened up my Fix-It shop. I must admit that you told the truth when you said that it contains quite a bit more information than I bargained for.—P. J. Bretl, Sebring, Ohio.

I am a mechanic for the Western Union Telegraph Co. Three days after receiving the lessons in refrigeration I earned the exact cost of the course.—Henry S. Lee, Washington, D. C.

I work day times at the shipyard and after 4:00 P.M. I operate from my cellar and garage. I average \$10.00 to \$15.00 clear every day.—Walter Hanby, Brockton, Mass.

GET STARTED TODAY — MAIL THIS COUPON

CHRISTY SUPPLY CO.
2835 N. Central Ave., Dept. D-4003
Chicago 34, Illinois

Please send me free illustrated literature about America's Fastest Growing Industry — ELECTRICAL APPLIANCE REPAIRING.

Name.....

Address.....

City..... State.....

Do you want

- ..to go to College?
- ..or to enter a Profession?

(Such as Accounting, Architecture, Nursing, Dentistry; Teaching, Social Work, Osteopathy, Beauty Culture, Optometry, Embalming, Chiropody, Law, Medicine, etc.)

- ..or get an Office Position?

To get anywhere, you practically **MUST** finish High School **FIRST**. You can complete our simplified High School Course in **SPARE** time at home, as **FAST** as your time and abilities permit. Equivalent to resident school work—prepares you for college, pre-professional examinations, business, industry. Standard texts furnished. Diploma. Credit for H. S. subjects already completed. Single subjects if desired. Low tuition, easy terms. American School, Chicago, est. 1897—endorsed by educators. Finish your high school education **NOW**, Write **TODAY!**

High School Course at Home

Many Finish in 2 Years

American School, Dept. H-945, Drexel Ave. at 58th St., Chicago 37, Ill.

Gentlemen: Send me **FREE** information covering special training in subjects checked below. No obligation on my part.

- | | |
|--|--|
| <input type="checkbox"/> High School Course | <input type="checkbox"/> Diesel Engineering |
| <input type="checkbox"/> Architecture and Building | <input type="checkbox"/> Drafting and Design for Men & Women |
| <input type="checkbox"/> Automotive Engineering | <input type="checkbox"/> Plastics |
| <input type="checkbox"/> Business Management | <input type="checkbox"/> Private Secretary |
| <input type="checkbox"/> Electrical Engineering | <input type="checkbox"/> Mechanical Engineering |
| <input type="checkbox"/> Elec. and Gas Refrigeration | <input type="checkbox"/> Aviation |
| <input type="checkbox"/> Air Conditioning | <input type="checkbox"/> Salesmanship |
| <input type="checkbox"/> Railway Training | <input type="checkbox"/> Radio |
| <input type="checkbox"/> Electronics, Industrial | |

Name.....

Address.....

AUDELS Carpenters and Builders Guides

4 vols. \$6



Inside Trade Information for Carpenters, Builders, Joiners, Building Mechanics and all Woodworkers. These Guides give you the short-cut instructions that you want—including new methods, ideas, solutions, plans, systems and money saving suggestions. An easy progressive course for the apprentice and student. A practical daily helper and Quick Reference for the master worker. Carpenters everywhere are using these Guides as a Helping Hand to Easier Work, Better Work and Better Pay. To get this assistance for yourself, simply fill in and mail the **FREE COUPON** below.

Inside Trade Information On:

How to use the steel square—How to file and set saws—How to build furniture—How to use a mitre box—How to use the chalk line—How to use rules and scales—How to make joints—Carpenters arithmetic—Solving mensuration problems—Estimating strength of timbers—How to set girders and sills—How to frame houses and roofs—How to estimate costs—How to build houses, barns, garages, bungalows, etc.—How to read and draw plans—Drawing up specifications—How to excavate—How to use settings 12, 13 and 17 on the steel square—How to build hoists and scaffolds—skylights—How to build stairs—How to put on interior trim—How to hang doors—How to lath—lay floors—How to paint



THEO. AUDEL & CO., 49 W. 23rd St., New York City

Mail Audels Carpenters and Builders Guides, 4 vols., on 7 days' free trial. If O.K. I will remit \$1 in 7 days, and \$1 monthly until \$6 is paid. Otherwise I will return them. No obligation unless I am satisfied.

Name.....

Address.....

Occupation.....

Reference..... PM

EASY to PLAY

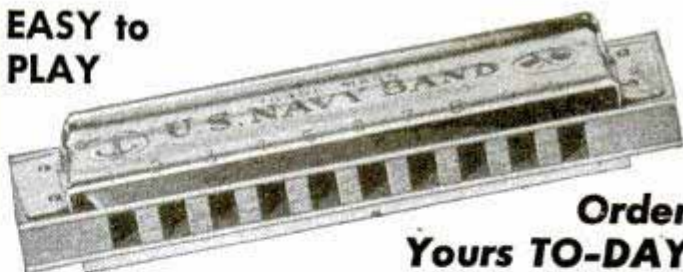

Order Yours TO-DAY

The New Luellen HARMONICA

Most wonderful pocket instrument ever made is the harmonica. Easy to master, fun for Everyone. The Luellen has 10 holes, 20 notes. Key of C. Beautiful tone. Now ready. Postpaid Only..... **\$2.35**

INSTRUCTION BOOK. Simple for youngest child. No notes, scales nor exercises. Ten lesson charts show everything. Includes 75 popular songs. Price \$1.00. Here's our special introductory offer: The Instructor and the Harmonica, both postpaid, both for \$2.85. Send Check or Money Order Today.

JOHN LUELLEN & CO., 17034 Page Ave., Dept. 1203, Hazelcrest, Ill.

Learn Penmanship

You can learn plain, rapid writing or fancy ornamental writing for social and business advancement, right in your own home during spare time by my Simplified Method. Write for my free book, "How to Become an Expert Penman," which shows what others have accomplished by taking my Courses. Send 10c for one of my favorite Pen Points and your name with a beautiful flourished bird written on a card. Write today. T. M. Tevis, Box 25K, Chillicothe, Mo.

LAW...

STUDY AT HOME Legally trained men win higher positions and bigger success in business and public life. Greater opportunities now than ever before.

More Ability: More Prestige: More Money We guide you step by step. You can train at home during spare time. Degree of LL.B. We furnish all text material, including 14-volume Law Library. Low cost, easy terms. Get our valuable 48-page "Law Training for Leadership" and "Evidence" books **FREE**. Send **NOW, G. I. APPROVED, LASALLE EXTENSION UNIVERSITY, 417 South Dearborn Street A Correspondence Institution Dept. 1264-L Chicago 5, Ill.**

TRAIN Your VOICE!

Results GUARANTEED

We build, strengthen the vocal organs—not with singing lessons—but by sound, scientifically correct silent and vocal exercises and absolutely guarantee complete satisfaction with results. Write for Voice Book. **FREE**. Sent to no one under 17 years old unless signed by parent.

Perfect Voice Studios, Studio 1359, Kimball Hall Bldg., Chicago 4, Ill.

CODE-RECEIVING SPEED

Learn to send and receive Radio Code with greater speed. Stop nervous tension. Have confidence. Be proficient. Same system used by radiotelegraph specialists. Thousands of operators needed. Rush name for **FREE** book.

CANDLER SYSTEM CO.
Dept. 5-0, Box 928, Denver 1, Colo., U. S. A.

SAVE MONEY

PARAMOUNT ADJUSTABLE

BAR BELLS

DUMB BELLS \$9.95
at Factory Prices AND UP

WRITE FOR FREE BOOKLET WITH HINTS ON MUSCLE BUILDING

INDEPENDENT IRON WORKS
2416-40 E. 23rd St., L. A. 11, CALIF. DEPT. 11

TOMORROW'S LEADERS ARE TRAINING

**NOW IS THE TIME TO GET
READY FOR A KEY JOB OR
BUSINESS OF YOUR OWN**

IN

**REFRIGERATION and
AIR CONDITIONING**

Today

**AMERICA'S FOREMOST
SCHOOL OF
PRACTICAL TRAINING
FOR INDUSTRY**

Here is an industry that offers every opportunity you could ask for. Good jobs—security—plenty of chance for advancement—a business of your own.

And here is a school equipped in every way to train you for Refrigeration and Air Conditioning work—one of the largest and most completely equipped schools of its kind in America—a school that already has trained thousands of men for just such opportunities.

GET READY NOW!

Learn Refrigeration and Air Conditioning—now, while the time is ripe. You don't need any advanced schooling or previous experience. If you are at all mechanically inclined and have gone to high school for at least one year or have an equivalent education, we can teach you Refrigeration and Air Conditioning.

LEARN AT HOME OR COME TO OUR SCHOOL

You can take most of your training at home, in your spare time—or you can come to Chicago and take your entire training in our completely equipped shops and laboratories. Either way you quickly acquire the fine points, practical skill, and broad, technical "know how" that makes the expert Refrigeration and Air Conditioning Technician.

Get all the facts about the opportunities in this interesting field of work, and about the I. T. I. system of training that has helped so many men into key jobs in this industry. Fill out the information coupon below and mail it TODAY. You will be under no obligation whatsoever.

AUTHORIZED TO ACCEPT VETERANS FOR G. I. TRAINING

FACTS ABOUT THE INDUSTRIAL TRAINING INSTITUTE

Founded in 1916. Has trained more than 400,000 men for practical work in industrial fields. From 1942 through 1945 trained specialized technicians, exclusively, for the Army, Navy and Marine Corps. Now training thousands of veterans under the G. I. Bill, both in its Residence Schools and by home-study. Occupies five buildings of its own. Has over \$500,000 invested in training facilities, with an instruction staff of more than 100 men. Known everywhere as America's foremost school of practical training for industry.



**INDUSTRIAL TRAINING
INSTITUTE WILL TRAIN
YOU**

**SEND FOR THIS BIG
FREE BOOK**



**REGISTRAR P1M
INDUSTRIAL TRAINING INSTITUTE**

2150 Lawrence Ave. • Chicago, 25, Ill.

Please send me, FREE, your "Camera Visit" booklet and information about the opportunities for trained men in Refrigeration and Air Conditioning. It is understood that I will be under no obligation.

Name.....

Address.....

City.....State.....

Are you a veteran?.....

GET THE FACTS TODAY!

Now A DYNAMIC HEAVY DUTY INDUSTRIAL WELDER

FOR ONLY
\$23.50
COMPLETE...

IDEAL FOR AUTO - HOME APPLIANCE AND FARM REPAIRS

DESIGNED TO DO HIGH GRADE WELDING INEXPENSIVELY—Maintenance Men; Farmers; Mechanics; Machine Shops; Foundries; Auto, General Repair and Job Welding Shops; all using the DYNAMIC find it so indispensable and useful that they cannot afford to be without it. If inexperienced, you can easily learn to do a variety of high grade welding jobs by following the practical, simplified operating and welding instructions furnished. Once you see a DYNAMIC in operation, you won't want to be without it. Its simplicity will amaze you. In a year the DYNAMIC only costs you about 6¢ a day. Helmet, rods, cables, holder and operating instructions, etc., furnished.

SAVES YOU VALUABLE TIME AND MONEY!

This portable DYNAMIC WELDER—easily carried to the job—can be operated from any convenient, properly wired 110 volt, 60 cycle line. Can also be supplied for 220 volt, 60 cycle operation and for other voltages and cycles at slight additional cost. Works on IRON, STEEL, BRASS, BRONZE, AND OTHER METALS—has 8 metallic and carbon arc welding heat stages—does work you would think only possible with larger more expensive machine.

DYNAMIC WELDER CO. • 13 East 23rd St., FN, Chicago 16, Ill.

IDEAL AND PRACTICAL GIFT FOR ANY MAN

Get details on our 10 day trial offer.

Member Chicago Association of Commerce



Learn this Profitable Profession



IN 90 DAYS AT HOME

Money-Making Career Open to Men and Women, 18 to 50

Hundreds of men and women between 18 and 50 make \$10 to \$20 in a single day giving scientific Swedish Massage and Hydro-Therapy treatments. There is big demand from doctors, hospitals, sanatoriums and clubs. Graduates earn large full time incomes from these or in private practice in their own offices. Others make good money from home treatments given in spare time. Learn this interesting, money-making profession in your own home, through our home study course. Same instructors as in our nationally known resident school. You can win independence and prepare for future security by qualifying for your Diploma. Course can be completed in 3 to 4 months. Many earn while they learn. Begin your training at once.

Anatomy Charts & Booklet FREE

Enroll now and we will include, at no extra cost, many needed supplies. Fit yourself to help meet growing demand for Scientific Swedish Massage. Send the coupon at once for complete details. Anatomy Charts and 32-Page Illustrated Booklet, FREE, postpaid.



THE COLLEGE OF SWEDISH MASSAGE
Dept. 664-R, 100 East Ohio St., Chicago 11, Illinois

Please send me FREE and postpaid, Anatomy Charts, 32-page Booklet and complete details on Home Training.

Name.....
Address.....
City..... State.....

"How to Make Money With Simple Cartoons"

A book everyone who likes to draw should have. It is free; no obligations. Simply address
CARTOONISTS' EXCHANGE

Dept. 912-D

Pleasant Hill, Ohio

LEARN MEAT CUTTING At Home—In Spare Time



Get into the vital meat industry. Concise, practical Home Training based on 25 years proven instruction methods used at National's famous resident school. Prepares you for bigger pay as Meat Cutter, Supervisor, market manager or more money in your own store. Go as rapidly as your spare time permits. Diploma. Start NOW to turn your spare hours into money. Send for FREE bulletin today. No obligation.

National School of Meat Cutting, Inc., Dept. U-76, Toledo 4, Ohio



STUDY AT HOME FOR PERSONAL SUCCESS and LARGER EARNINGS. 38 years expert instruction—over 108,000 students enrolled. LL. B. Degree awarded. All texts furnished. Easy payments. Send for FREE BOOK—"Law and Executive Guidance."

AMERICAN EXTENSION SCHOOL OF LAW
Dept. 72-M, 646 N. Michigan Ave., Chicago 11, Ill.



Thrilling Work COLORING PHOTOS

Fascinating vocation learned at home by those with aptitude. Thrilling pastime. National method brings out life-like colors. Free booklet.

NATIONAL PHOTO COLORING SCHOOL
1315 S. Michigan, Dept. 1359, Chicago 5



OZMENT'S INVENTION, corrects poor penmanship in few hours. Guaranteed. Write, Ozment, 72, St. Louis, Mo.

★ GET ON "UNCLE SAM'S" PAYROLL ★

\$1,756 TO \$3,021 FIRST YEAR

Veterans Get Special Preference

Railway Postal Clerks—Mail Carriers—Mail Clerks — Patrol Inspectors — Storekeeper Gaugers—Positions at Washington, D. C. — Etc. Mail Coupon immediately — 32-Page Civil Service Book—FREE

FRANKLIN INST., Dept. C86, Rochester 4, N. Y.

Gentlemen: Rush to me, without charge, 32 page book with list of U. S. Government big paid positions. Advise me also regarding salaries, hours, work, vacations, etc. Tell me how to prepare for a position.

Name.....
Address..... Vet?.....



GET INTO RADIO TELEVISION ELECTRONICS... NOW

SAMPLE LESSON Free!



Get Ready — at Home — in Spare Time For Opportunities of Peacetime Industrial Expansion

PREPARE NOW—With Shop Method Home Training BY A REAL ESTABLISHED RESIDENT SCHOOL

No doubt about it! — Radio, Television and Electronics is a dynamic, growing industry that offers opportunity TODAY for the Trained Radio Technician. It is a field with a proved future. Good jobs, interesting and profitable jobs are available in Radio Service, Broadcasting, Marine and Police Radio, Manufacturing, Public Address, and other specialized phases. Untold Radio sets are in use—they need maintenance and repair. Many, many more must be built to satisfy even normal demand. Trained men are constantly needed to keep this pulsating industry moving ahead. If you are mechanically inclined, if you are sincere and will follow instructions, you too can find your opportunity in Radio, Television and Electronics—either in business for yourself or in a responsible position in industry. TAKE THE FIRST STEP TODAY! FOR FACTS PACKED WITH OPPORTUNITY FOR YOU JUST MAIL THE COUPON BELOW.

Learn By Doing Right At Home

The secret of the success of this practical training method is the experience of working with actual full size, standard equipment during your training. Here's a fully tested and approved method—simple and direct, easy to understand and put into PRACTICE! You check what you know as you go along. You can see progress right from the start.

It will only take a moment to fill out and send the coupon for a sample trial lesson. PROVE TO YOURSELF HOW MUCH YOU CAN ACCOMPLISH IN A SHORT TIME.

National Training Is More Than Book Theory

National Schools can furnish you this modern, complete, up-to-date training in Radio, Television and Electronics for National has the Shops and Laboratories where instructors work with students and technicians to bring you—right in your own home—in your spare time—the kind of practical in-

struction, practice and experience that assures definite progress—step-by-step through the entire field.

Rush Coupon Today For Full Details

See what definite practical progress YOU YOURSELF CAN MAKE WITH JUST A SINGLE LESSON, sent to you with no obligation. No salesman will call on you from National. YOU make up your own mind. IT COSTS YOU NOTHING TO READ THE INTERESTING FACTS.

VETERANS

—if you qualify for training under the G.I. Bill of Rights check the coupon for a Special Bulletin.

41 Years Experience Training Men for Success!

NATIONAL SCHOOLS

LOS ANGELES 37, CALIFORNIA EST. 1905



ALSO THIS BIG OPPORTUNITY BOOK FREE!
Tells of the many fine, good-pay jobs in Radio, Television and Electronics — How to start your own life-time business. FILL OUT AND SEND THIS COUPON — NOW!

A BIG, POWERFUL RADIO AND EXPERIMENTAL EQUIPMENT ARE INCLUDED WITH YOUR TRAINING

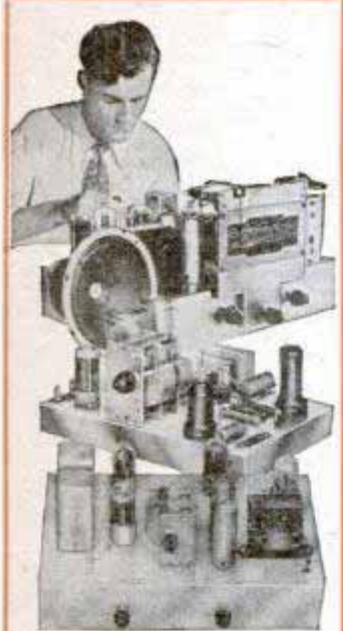

Here is some of the Radio equipment that is furnished you at no extra cost with National's Shop Method Home Training. BUILD A BIG, SEVEN TUBE, LONG DISTANCE SUPERHETERODYNE, an audio oscillator, a signal generator (low powered Radio transmitter) and many other units. Really Learn by Doing! Earn money early in the Course doing spare time Radio work.

THESE MEN KNOW

For over 40 years National training has given ambitious men their start in life and helped them win success and security. National graduates everywhere gratefully admit that they owe their success to National Training. They all started the same—by investigating what National has to offer.



Joseph Michel, Jr., Granite City, Illinois, says: "I am enclosing a letter I received very shortly after enrolling . . . I shall receive a salary advance of \$225 per month with an increase of \$300 shortly. Had I not taken advantage of the work National Schools sent me I would not have been able to interest this employer."



Clifford Hannah, Portage LaPrairie, Manitoba, Canada, writes: "My training has brought results as I'm in line for another raise, thanks to National's encouragement and thorough training. You can count on me as a real National booster."

MAIL OPPORTUNITY COUPON FOR QUICK ACTION

National Schools, Dept. PM-12
4000 South Figueroa Street
Los Angeles 37, California

(Mail in envelope or paste on penny post card)

Mail me FREE the books mentioned in your ad including a sample lesson of your course. I understand no salesman will call on me.

NAME.....AGE.....

ADDRESS.....

CITY.....ZONE.....STATE.....

Check here if veteran of World War II

Give yourself the Backing of a
GREAT GROWING INDUSTRY



REFRIGERATION AIR CONDITIONING

Refrigeration and Air Conditioning have leading place in fast growing fields of our time. Trained men paid well to service, install, maintain, repair, rebuild household and commercial refrigerators. Important new developments such as Frozen Foods and many new industrial uses. Demand for commercial installations in restaurants, butcher shops, taverns, florists, bakeries, etc. — air conditioning in homes, offices, shops.



START NOW—Full and Part Time Earnings

There may never again be such opportunities for men who want better jobs or business of their own to get in on ground floor and go up fast!



Many started with small investment who built good, growing business. If over 17 and under 60 learn how you can get started. CONSULTATION AND PLACEMENT SERVICE WHETHER YOU ARE INTERESTED IN WORTHWHILE JOB OR SETTING UP YOUR OWN BUSINESS.

Begin Training at Home or Come Directly to Shops

Begin your training at home in spare time, finish in our big, modern shops, or come directly to shops. At home you get C.T.I.'s SHOP PROVED HOME STUDY instruction—actual shop experience has gone into the practical lesson assignments. That is why it is easy for mechanically inclined men to learn by our Home Study training and start on actual refrigeration work.



A NATIONALLY KNOWN INSTITUTION

C.T.I. was only civilian school selected by Army to train service men for refrigeration. Same quality training available to you now. The method that has made rapid progress possible. Commercial Trades Institute has established its place in Air Conditioning and Refrigeration industries, and that is important to you in making your start.

VETERANS

Veterans qualifying under "G.I. Bill" have all expenses paid by Government plus monthly subsistence allowance. Just mail coupon, we will handle all details. (LOW TUITION, EASY TERMS if you are not a veteran.)



COMMERCIAL TRADES INSTITUTE
Dept. A-212

1400 W. Greenleaf Ave., Chicago 26, Ill.

FREE — Important Information Telling How to Get Started

CUT OUT COUPON BELOW

Fill Out, Cut Out, Mail Today

FACTS FREE for Men Who Want to Get Ahead
COMMERCIAL TRADES INSTITUTE, Dept. A-212
1400 W. Greenleaf, Chicago 26, Ill.

Send free illustrated Brochures and other information about Refrigeration and Air Conditioning.

Veteran Non Veteran

Name

Address

City State



Show Donald Duck

CARTOON FILMS

Every DONALD DUCK Home Movie a laugh riot from start to finish.

Get These Features

100 Ft. 8MM \$3.00
200 Ft. 16MM \$6.00

Fast & Furious 1452-B
The Fireman 1453-B
Donald's Day Off 1454-B
The Flying Trapeze 1455-B

Show also a Mickey Mouse, and a Walter Lantz, 3 Monkeys, and Oswald Rabbit feature for grand entertainment.

See at your Photo Dealers, or order direct. Catalog and prices on request. Write to:

HOLLYWOOD FILM ENTERPRISES, INC.

6060 Sunset Blvd. Dept. 115 Hollywood 28, Calif.

ELECTRICAL TRAINING

Intensive 32 weeks residence course in fundamentals of industrial electrical engineering, including radio, electronics. Prepares for technician, engineering aides. Approved for veteran training. 54th year. Catalog.

BLISS ELECTRICAL SCHOOL
7646 Takoma Ave., Wash. 12, D. C.



BUILDING



Millions of homes needed. Nation wide call for builders. Big opportunities. Learn now in spare time. — at home. Practical training with blue prints. No books. Send for FREE Trial Lesson and blue print plans.

CHICAGO TECHNICAL COLLEGE

S-150 Tech. Bldg., 2000 S. Mich. Ave.
Chicago 16, Ill.

SAY YOU SAW IT IN POPULAR MECHANICS

INVENTING

—FOR PROFIT! If you have an inventive turn of mind, write for free 28-page booklet explaining how the Institute of American Inventors is helping inventors pre-test the profit possibilities of proposed devices to fill today's unprecedented demand for useful new inventions.

INSTITUTE of AMERICAN INVENTORS

Dept. 4, 1926 Eye St., NW, Washington 6, D. C.

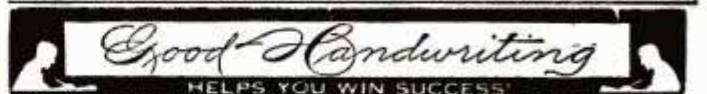

HELPS YOU WIN SUCCESS

It's so important to write a good hand for business and social advancement. Poor illegible penmanship often causes costly errors and marks you for failure. Why write a poor hand? It's so easy to learn at home in spare time. Write for our new free booklet today. If you wish, send 10c for a penpoint suitable for shaded writing and your name beautifully written.

THE TAMBLYN SCHOOL OF PENMANSHIP

In Business Since 1895 H-441 Ridge Bldg., Kansas City, Mo., U. S. A.

RUPTURED?

Get Relief This Proven Way

Why try to worry along with trusses that gouge your flesh—press heavily on hips and spine—enlarge opening—fail to hold rupture? You need the Cluthe. No leg-straps or cutting belts. Automatic adjustable pad holds at real opening—follows every body movement with instant increased support in case of strain. Cannot slip whether at work or play. Light. Waterproof. Can be worn in bath. Send for amazing FREE book, "Advice To Ruptured," and details of liberal truthful 60-day trial offer. Also endorsements from grateful users in your neighborhood. Write:

CLUTHE SONS, Dept. 31, Bloomfield, New Jersey



No, that's not necessarily wishful thinking. You possibly can be taller. "BUILDING HUMAN STATURE" tells how in 368 pages of non-technical language, thoroughly illustrated for complete understanding.

Why the 8-foot Watussi and the 3-foot Bushman? There's a reason. What made the New Zealander average 5½ inches taller than the Indian? General Emmons reports many 6-foot tall Hawaiian Japanese whose forbears averaged only 5 feet 2 inches, and Professor Borsook tells you why. Some Russian-Jewish men in U. S. grew 5 inches taller than their parents. What did they do? Did you know that from 1½ to 6 inches increase in height may, in some cases, be obtainable from gland treatments?

HERE ARE THE SECRETS

In simple words this book, "BUILDING HUMAN STATURE," outlines the work of the world's greatest authorities—physicians, biologists, and physical culture experts—explaining the response of bones to stimuli, as well as other factors which these authorities affirm may increase height.

This is the only book published in which you will find simple and explicit instructions for making the Stretching and Suspension Apparatus from which some have claimed remarkable results.

Dr. H. LaChance, M.D., the distinguished orthopaedic surgeon, said: "Very comprehensive and very well written." Capt. Cano, Commander, Spanish Loyalist Army Health Services: "If a young man apply himself . . . it should make considerable difference in his ultimate height."



FATHER and SON
Son exceeds father's height by nearly a head. This young man grew almost 6 inches during a year that he followed instructions in "BUILDING HUMAN STATURE."

WISH YOU WERE TALLER?

SOME HEADINGS

Foreword by Capt. Juan Cano, of the "Health Service," Spanish Loyalist Army. — Discussion of Student Height Increase by head of Barnard College. — The Truth About Heredity in Height Increase. — Food for Stature Building. — U. S. Surgeon General's Dietary Advice. — Natural and Artificial Bone Growth. — How the Ductless Glands Affect Growth; "Gains in Height Varying from 1½ to 6 inches." — A Famous Dwarf: Doubled His Height at 39. — Advice of U. S. Director of Physical Fitness. — Improved Stature in Women Brings Easier and Better Child Bearing. — Stretching Exercises Which Cure Painful Menstruation. — Stature Gaining Factors According to Dr. Krogman. — Use of Weights for Stretching. — Body Suspension. — His Height Increased 6 inches in 12 Months. — Instructions for Making Suspension Apparatus. — Jobs as Instructors. 368 pages. Thoroughly illustrated by Photographs and Sketches. Most Practical, Mailed in Plain Wrapper.

You owe it to yourself, and to those who one day may be dependent upon you, to know how maximum stature may be built. This book is a must if you are not to miss opportunities, for the taller person has many advantages. Turn wishing into action. Write at once, on this no risk 5 day free trial basis.

MONEY BACK GUARANTEE

CARILLON BOOKS
Dept. 83, Boerne, Texas

Please send at once "BUILDING HUMAN STATURE." I will pay postman \$3.50 plus C.O.D. charges on its arrival. It is understood that I may return the book in five days for refund if I am not completely satisfied.

Name

Address

NOTE: To get quickest action send check, money order, postal note, stamps or cash with order and pay only \$3.50.

MUFFLERS

STEELS and ALUMINUMS
with a motorboat tone

SINGLES, Chev. V-8, Plymouth, Steels \$5.50, Aluminum \$6.50. Chry., Olds., Buicks, etc., Steels \$7.50, Aluminum \$8.50. V-8 and MERCURY DUALS, Steel \$17.50, Aluminum \$20.00. Aluminums are guaranteed for life of your car.

DEALERS WANTED

**V-8
DUALS
& SINGLES**



SANDEE MUFFLER CO.
7523 S. WESTERN AVE., LOS ANGELES 44, CALIF.

VIDEO

Amazing Television Handbook. How to construct, install, operate, service, sight and sound receivers. How video is growing. How a modern transmitting station works. How receiver works. How to build receiver. How to erect antenna. How

to install. Trouble shooting. Video dictionary. Three separate 15" x 16" assembly stage diagrams. Written by a master, in simple language. 96 pages, 71 illustrations, heavy glossy paper, spiral binding lies flat. Only \$1. Your money back in 10 days if not delighted. HURRY. Write Norman W. Henley Publishing Co., Dept. PM12, 17 West 45th St., New York 19, N. Y.



SAMPLES FOR AGENTS Sample offer sent immediately to all who send name at once. A penny postal will do. SEND NO MONEY—just your name. KRISTEE CO., 688 Bar Street, AKRON, OHIO.

VETERANS Learn WATCHMAKING

A Lifetime Profession

Regardless of Conditions, Age, Sex, or Physical Limitations
Veterans—Civilians!
Your Opportunity—
LEARN WATCHMAKING



Approved
G. I. Training

Lift yourself from a futureless job into a position paying better than your present work. Fit yourself for the job that will permit you to establish your own shop, or be employed in a pleasant environment.

Watch Repairing—Jewelry—Engraving will always be in ever greater demand. Our graduates wanted everywhere. Dignified positions \$50-\$75-\$100 per week. Veterans write today for latest FREE enrollment requirements.

Kansas City School of Watchmaking
Largest Horological School in America
617-621 Wyandotte St. Kansas City 6, Mo.



Individual instruction is necessary in teaching television. Here an instructor helps a student. Each student must build 7 radio sets before he is allowed to start on a television set.

Expert Television Technician, Bob Cohen, using \$625.00 RCA Sweep Generator to check television set for engineering inaccuracies. It is expected that television test equipment will be reduced in cost as the television industry gets into its stride.

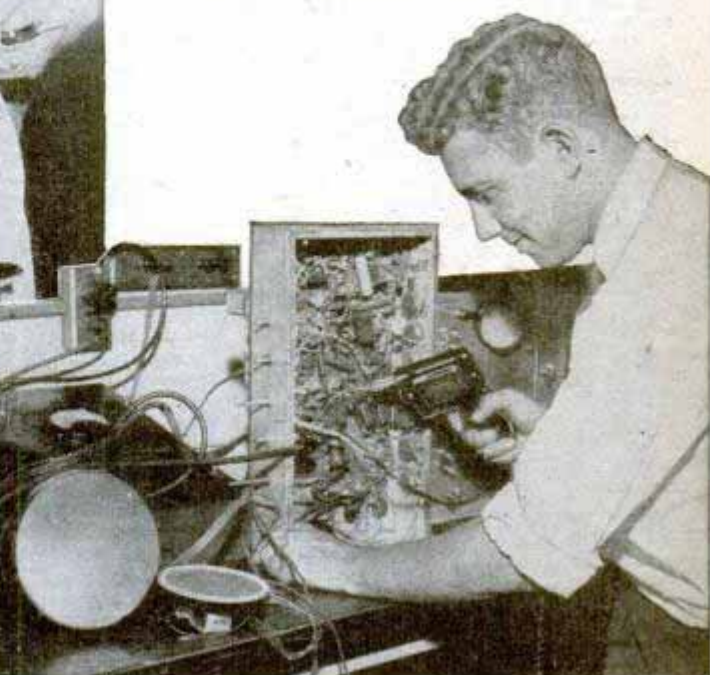

THEY BUILT THEIR OWN

MANY veteran students are now attending N.Y.T.I. of N.J. under the generous provisions of the G.I. Bill of Rights, which allows any approved school of the veteran's choice to charge the Veterans Administration up to \$500 a school year against the educational expenses of qualified veteran students. Full-time students, with dependents, are also paid a sub-

Student Walter E. Stevens, making engineering checks with \$395.00 United States Television Sweep Generator. The school is lavishly equipped with the most advanced test equipment.

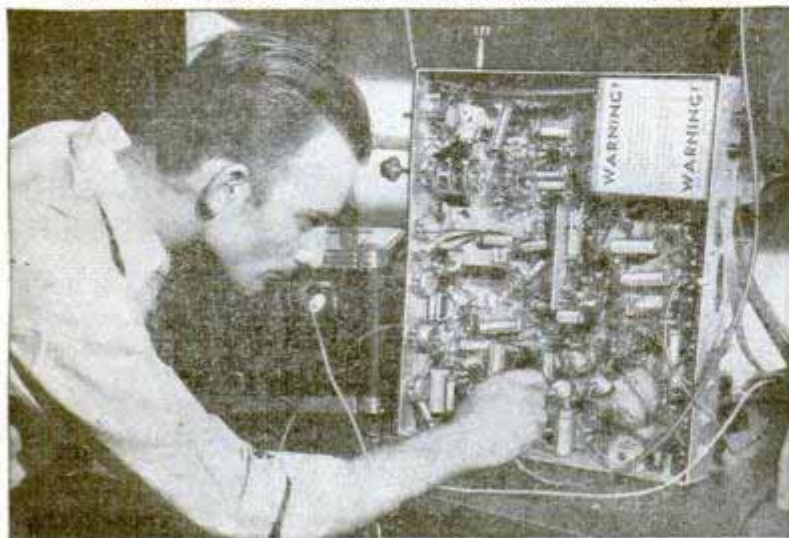

sistence allowance of \$90 monthly by the VA, and those without dependents, \$65. Many students hold part-time jobs, thus augmenting their monthly payments. However, you do not have to be a veteran to be accepted as a student.

A considerable number of out-of-state students attend the school because of its excellent, practical type of radio and television courses,

so difficult to get anywhere else in the world today. Living quarters are obtainable by single students, but married students report considerable difficulty in finding quarters for their families.

No high-school diplomas are required. Every student must have at least a grammar-school education, however. And the school requires that a student be earnest, sincere and technically inclined. Students without proper mathematical backgrounds are taught the radio and television mathematics they need.

You probably have been wondering what N.Y.T.I. of N.J. means. It stands for the New York Technical Institute of

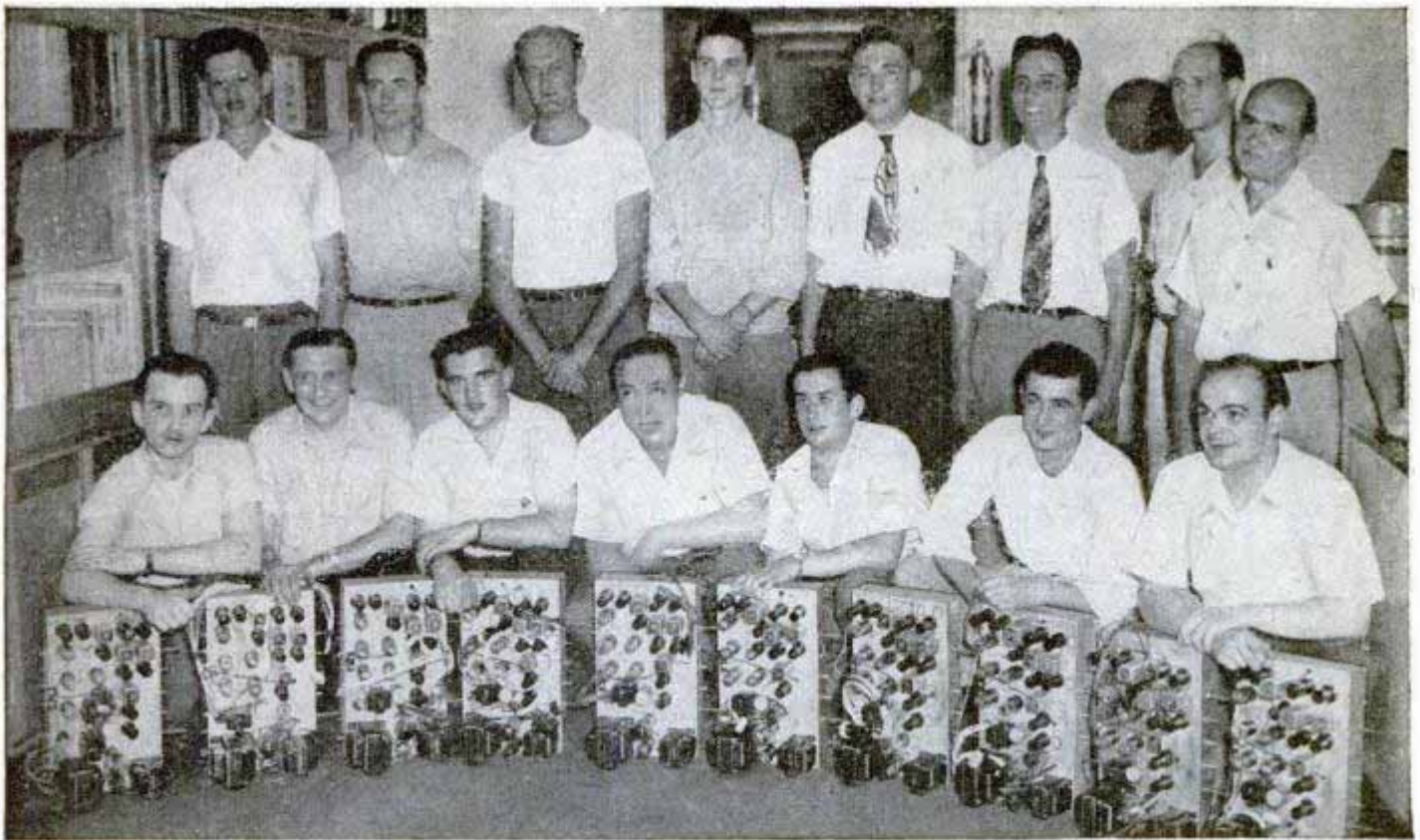

An Advanced Class in Television at N.Y.T.I. of N.J., famous television school, and the 17-tube television sets they built. Students at this school have been building television sets as part of their courses since 1939, when television programs were first broadcast regularly. School officials

found that this practical method of instruction is productive of very satisfactory results. Each student may build a set and keep it to use in his own home laboratory, if he chooses to. The school is located in the heart of the radio, television, electronics industry.

TELEVISION RECEIVERS!

New Jersey, a resident school located in Newark, N. J., just across the river from New York City (Only 20 minutes from Broadway by subway or train). The school is located in the heart of America's great radio and electronics industry. Such leading television, radio and electronics manufacturers as Western Electric, Du Mont, Federal and Edison are nearby. Newark also is near Radio Stations WJZ, WEA, WABC and WOR; each a leader in broadcasts going on networks all over the country. This means that the school offers numerous advantages, as it is in touch with most recent developments in radio and television. This also means that qualified radio and television engineers are available to the school for teaching purposes.

During the war N.Y.T.I. of N.J. was approved for the training of Signal Corps personnel by the Army. When the war ended the enrollment increased because of the influx of veterans desirous of getting practical television training. At the present time, there are

120 openings for new students for the several classes beginning in October & November 1946.

The school issues a special Bulletin, Numbered 212, which illustrates and describes its facilities and equipment and shows students using its varied laboratory equipment. Bulletin 212 also describes classes that may be attended, housing conditions, costs, hours, etc. To get complete information write for Bulletin 212 (for which no charge is made) to the New York Technical Institute of New Jersey, 158 Market Street, Newark, New Jersey.

A line of RCA television receivers used for comparative test purposes at N.Y.T.I. of N.J.

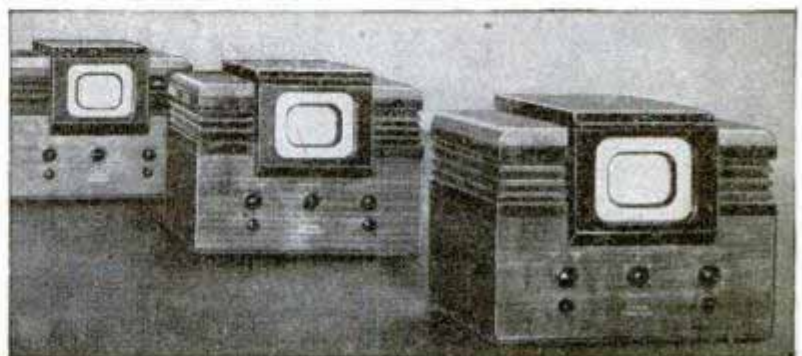

If you are between 15 and 55

\$200
a month

is all you have to pay for
Old Line, Legal Reserve
LIFE INSURANCE

This is half the Permanent Rate, payable until the 6th year. You get \$1,754 of Protection all your life if you are now 20, \$1,460 if you are 30, \$1,142 if 40, etc. Proportionate amounts at other ages. Budget your Insurance like Rent.

YOUR POLICY WILL BE FULLY PAID-UP IN 30 YEARS

with no more premiums to pay and all benefits continued. Send Coupon at once! for full details and amount of life long Protection offered at your age!

MAIL COUPON NOW FOR FREE BOOKLET

Postal Life Insurance Company
511 Fifth Ave., Dept. D-651
New York, 17, N. Y.

Mail me complete information about your new "\$2.00-per-month", 30-Payment Modified 5 Whole Life Policy at my age.

Name _____
Occupation _____ Date of Birth _____
Address _____

Include P. O. District Number, if any

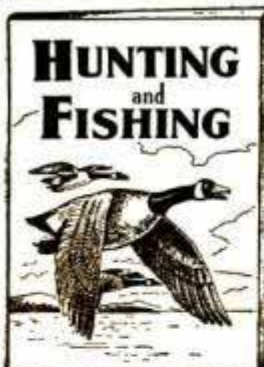

HUNTING and FISHING

is a monthly magazine crammed full of hunting, fishing, camping, dog and boating stories and pictures, invaluable information about guns, fishing tackle, game law changes, best places to fish and hunt—countless ideas that will add more fun to your days afield.

Special Trial Offer

Send 25c in stamps or coin and we will send you Hunting & Fishing for six months.

HUNTING & FISHING MAGAZINE

251 Sportsmen's Bldg., Boston, Massachusetts

Walt Disney Films

Your Own Little Theatre



MICKEY MOUSE VIEWER and No. 1 Film Strip... \$1

This beautiful plastic Mickey Mouse Viewer and Walt Disney's world famous "Brave Little Tailor" in an exciting condensed version FULL color 16mm film strip. 16 actual scenes from the original film. The Special Gift Set includes the Mickey Mouse Viewer and 13 thrilling full color condensed version 16mm film strips, each strip showing 16 scenes from Walt Disney's world famous pictures, 3 Academy Award Winners!

- PLEASE SEND ME A SPECIAL GIFT SET FOR ONLY \$3.95
- PLEASE SEND ME A MICKEY MOUSE VIEWER AND "BRAVE LITTLE TAILOR" FOR ONLY \$1.00

AT YOUR DEALER'S
CRAFTSMEN'S GUILD

6916 Romaine St Dept PM12 Hollywood 38, Calif

FREE! 32-PAGE ILLUSTRATED BOOKLET ABOUT WORLD'S MOST FASCINATING HOBBY



You're invited to hours of satisfaction with skilled tradesmen, business and professional men. Build your own scale model railroad—easy, inexpensive—looks and performs like the real thing. **Get started now!** Send for our **FREE** illustrated booklet—"Model Railroading For You." Send us your name and address **TODAY!**

MODEL RAILROADER MAGAZINE
DEPT. 624-R • MILWAUKEE 3, WISCONSIN



Are you "**PUSHED AROUND**" by Nerves, Fears, Inferiority, Poor Health? We offer you personal help with a money-back guarantee of results in your case. Our **Home Study Course** is a "**Must**" for those who want **New Powers** to meet life's demands. Write today for **FREE LECTURE. No obligation.**

SCHOOL OF PERSONAL PSYCHOLOGY, INC.
1008-1009 Washington Bldg., Louisville 2, Ky.

Train Your Own HORSES!

Colts — Stock Horses — Circus Horses
Gait Show Horses — Write for **FREE BOOK**
ANIMAL LOVERS' ASSOCIATION
Box KA-111, Tarzana, Calif.



RAISE CHIN-CHINS

No experience needed. Just a few minutes daily and a few feet of backyard, garage or barn space. Several females and a male starts a large, profitable herd. **WE FURNISH FREE INSTRUCTIONS. TREMENDOUS DEMAND** for breeding and laboratory stock, meat, and world's most beautiful rabbit fur. Brokers, cut off from imported rabbit pelts by world famine. **NEED CHIN-CHIN FURS NOW**, and for years to come! Write for free illustrated catalog today.
WILLOW BROOK FARM • R-64, SELLERSVILLE, PENNA.

"The Book They're Talking About"

Contains over 350 illustrations, charts and notes

ART ANATOMY OF THE HUMAN FIGURE

For the amateur and professional artist and sculptor. Giving detailed study of every part of the body.

MALE AND FEMALE, POSED AND IN ACTION

(Sent in plain wrapper.) Canada send \$1.25.

MAJOR BOOK CO., Dept. 320-C, 241 East Broadway, New York 2, N. Y.

ONLY \$100





Have you
considered a
career in
PLASTICS?

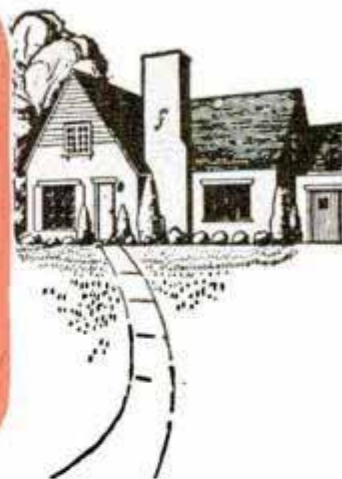

A job with a promising future goes a long way toward making you happy —at work and at home.

Do you know of the fine opportunities for advancement that are available in the plastics industry? Do you want to share in the development of a great new plastics era? *Trained men*, who have plastics know-how, will fill the well-paying positions in the industry. If YOU want to be one of them act NOW to prepare yourself.

Every day you can read glowing descriptions of how plastics are improving old products and creating new ones. Learn the hundreds of interesting phases of the plastics industry and be ready for the position that will give you the security and satisfaction you want.

LEARN AT HOME—Continue your present job and learn plastics in your spare time! The thorough, easy-to-understand Home Training Course presented by Plastics Institute requires no previous technical experience.

A COMPLETE COURSE—Everything you should know about plastics is included... materials, de-

signing, molding, fabricating, laminating and testing. You will acquire a basic knowledge of plastics that can be invaluable in getting you a fine position in this great, new industry.

YOU MAKE THINGS—To give you practical experience in working with plastics, we supply handsome, colorful, rods, sheets and tubes of plastics from which you can if you wish, make useful, attractive creations. You cement, saw, buff, form, dye, decorate, cast and laminate various types of plastics. You design plastic articles—develop your own ideas. You may earn money while learning.

START YOUR FUTURE TODAY—Mail the coupon below, now! You will get an interesting, illustrated, free booklet with valuable information about plastics. You will see how, at small cost you can prepare for a bright future in the expanding plastics industry. Clip the coupon and mail it TODAY!

Write Dept. PM6-12, 1601 S. Western Ave., Los Angeles 6, California
Home Training Courses and Resident School APPROVED FOR VETERANS

Plastics

INDUSTRIES TECHNICAL INSTITUTE
NEW YORK CHICAGO LOS ANGELES



FREE BOOKLET
Send For It Today!

Plastics Industries Technical Institute
Dept. PM6-12, 1601 S. Western Ave., Los Angeles 6, Calif.
Gentlemen: Please send me the booklet "World of Plastics" and information on your training. I understand there is absolutely no obligation.

Name (PRINT) Occupation.....
Street (PRINT) Age.....
City..... Zone..... State.....

Important: Please fill out coupon *completely*. If Veteran, please check.

Keep that "TICKING" Car

7 DAYS FREE TRIAL

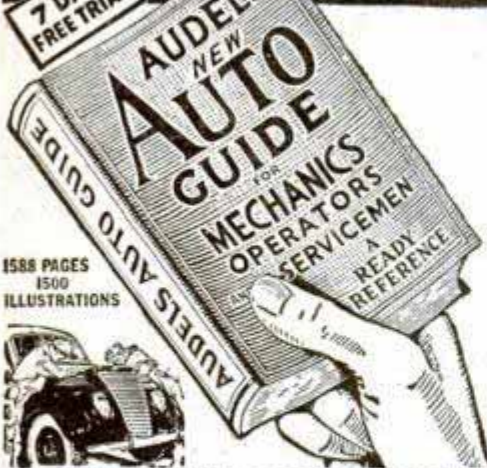

1588 PAGES
1500 ILLUSTRATIONS



Every operator and mechanic needs AUDELS AUTO GUIDE.

This book saves time, money and worry. Highly endorsed. It presents the whole subject of auto mechanics:

- 1—Basic principles
 - 2—Construction
 - 3—Operation
 - 4—Service
 - 5—Repair
- Handy Size, Easily understood.

NEW FLUID DRIVE, HYDRAULIC SHIFT AND DIESEL ENGINES FULLY COVERED

Over 1500 pages—1540 illustrations showing inside views of modern cars, trucks and buses with instructions for all service jobs.

4 COMPLETE • PAY ONLY \$1. A MONTH ←
ASK TO SEE IT!—To Get This Assistance for Yourself Simply Fill in and Mail Coupon Today.

AUDEL, Publishers, 49 West 23rd St., New York
MAIL AUDELS NEW AUTO GUIDE for free examination. If O. K. I will send you \$1 in 7 days; then remit \$1 monthly until price of \$4 is paid. Otherwise I will return it.

Name.....
Address.....
Occupation.....
Employed by..... PM

Become A Practical WELDING TECHNICIAN In 6 Months!

ARC WELDING

presents one of today's most outstanding opportunities for steady income and future success.



WELDING has grown rapidly, replacing large and intricate castings, rivets, nuts, bolts, screws. It is commonly used in assembling cranes, hoists, bridges, structural steel work, ships, trains, airplanes, etc.

WELDING is used extensively in manufacturing farm machinery, new automobiles, refrigerators, air conditioning systems, etc. There is no limit to the application of welding in industry, increasing durability and reducing manufacturing costs.

GREAT DEMAND. There is a decided shortage of properly trained Arc and Gas Welders, Welding Technicians. For full information and catalog, send coupon TODAY.

MILWAUKEE SCHOOL of ENGINEERING
Institute of Electrotechnics

44th Year

Milwaukee School of Engineering, Dept. PM-1246
N. Broadway and E. State, Milwaukee, Wis.
Without obligation send Free Booklet "The Dawn of a Gigantic Industry and its Outstanding Opportunities."

Name.....Age.....
Address.....
City.....State.....

ANALYZE HANDWRITING

Quality for Certified Grapho Analyst Degree at home, spare time. Credit, Employment, Personnel Managers, Business, Professional men, women use grapho-analysis in their work, earn substantial fees in spare time. Many study solely for personal benefit, no desire to earn money, find it so fascinating they start using it to add to their incomes. Entertainment field pays well, up to \$100 in a week reported. Others establishing profitable practices as Vocational and Family Problem Counselors, Personality Teachers, and lecturers.



GROWING—UNCROWDED PROFESSION

More and more police use grapho analysis handling suspects and criminals. They understand how criminals think. Their handwriting tells. Men like Hugh Dunlap, university student, Harry Allen, retired preacher, use it in court, win cases, earn fees even before graduation. Only school in world devoted to teaching grapho analysis offers thorough training to earnest, ambitious men and women regardless of where you live, small town, farm or city. Send for GRAPHO ANALYST, illustrated lesson, personal handwriting analysis offer, ALL FREE. Must be 21 or over. Address A. I. G. A. Inc., 120 Noel, Missouri.



Learn to Repair ELECTRIC APPLIANCES

WRITE TODAY for FREE BOOK

Prepare now for a permanent future, independence and security with a business of your own. Our practical, easy-to-learn home course teaches you, during your spare time, how to repair washing machines, vacuum cleaners, electric ranges, lamps, motors, irons, etc., and do house wiring. Also how to get started on little capital. Write today for FREE BOOKLET. No obligation.

PACIFIC TRAINING SCHOOL

7217 S. Broadway, Dept. P-12, Los Angeles 3

PRACTICAL SHOP TRAINING in AIR CONDITIONING

Domestic - Commercial - Industrial

REFRIGERATION
SERVICE-MAINTENANCE
INSTALLATION

Approved for G. I. Training

Write for Details

COMMERCIAL TRADES INSTITUTE
202 So. 20th St. BIRMINGHAM, ALABAMA

Train in the Magic City of the South

SAY YOU SAW IT IN POPULAR MECHANICS

ARTISTS MAKE MONEY

Do you like to draw? Send name, address, age and occupation for FREE ART TEST, to find out your ability.

ART INSTRUCTION, Inc.

12136 ART INSTRUCTION BLDG., MINNEAPOLIS 15, MINN.

"MAGIC VANISHING CARD"

THROW IT INTO THE AIR — It completely disappears. Reproduce it later from spectator's pocket. It amuses and confuses all. Easy to do — 25c with Amazing Catalog of 300 Tricks.

THE MAGICIAN, Dept. 5, 2463 Kensington Ave., Philadelphia 25, Pa.



RADIO TRAINER

Learn to design larger radios by building this simplified battery tube set model. Sensitive circuit brings in distant and local stations. Covers broadcast and short wave bands. Compact and portable. Uses no electricity. All parts furnished, including Tube, Batteries, Double Earphones, Aerial, Ground Wire and Easy-to-follow illustrated instructions. No soldering required. Complete, postpaid only \$9.95. Or send \$1.00—shipped C.O.D. for balance plus postage. Money-back guarantee. Order today! An Ideal Gift.

B. G. FLEMING MFG. CO.
Dept. 12-A, 906 Main St., Cincinnati 2, O.

LEARN TO MOUNT BIRDS and ANIMALS



SPORTSMEN • MEN, BOYS—

Here is something **NEW** — something **MARVELOUS**. Act **NOW**.
Learn **TAXIDERM**y at home. Save your wild-game trophies.

HAVE A HOME MUSEUM

Here is the **GRANDEST HOBBY** in the world for **HUNTERS, ANGLERS, SPORTSMEN**. **DOUBLE** your interest in hunting and fishing. Save your marvelous trophies. Mount **BIRDS, ANIMALS, HEADS, FISH**, all kinds of beautiful specimens, wild or tame. Tan leathers and fine furs. It is grand to be a **TAXIDERMIST**. You become well known and famous.



WILD-GAME NOT NEEDED

Mount common specimens, squirrels, crows, fish, frogs, pigeons. Make useful and humorous groups. A highly interesting hobby. You will be amazed and delighted.

TAN SKINS

Learn easily, fine **KROME-TAN METHODS**. Make sole, rawhide, harness leather, and **TAN SKINS** and furs. Create beautiful rugs. Decorate your home, and **MAKE FINE PROFITS** doing work for others.

CRAFT-TAXIDERM

y!

Make wild-game and domestic specimens into alluring **CRAFT-ART**, like the lamp shown above. You can devise a vast variety of alluring creations. **Easily learned**. Decorate with mounted specimens, **book-ends, door-stops, hat-racks, match and pen-holders**, and scores of delightful and **USEFUL** home articles and gifts. We teach you so easily, both **wild-game** and also **craft Taxidermy**. Investigate **NOW**.

Rush Coupon TODAY!

The beautiful book will go to you by **RETURN MAIL**. Nothing like its strange and amazing art ever seen before. It is **FOR SPORTSMEN** and **NATURE-LOVERS**, and it is **FREE** if you send the **COUPON NOW**. Hunters, Men, Boys. Mail the coupon **this MINUTE**. You will **WIN**, new interests.

NORTHWESTERN SCHOOL OF TAXIDERMy
3379 Elwood Bldg., Omaha 2, Nebr.

FUN • PROFITS

THINK of the fun and joy of mounting and saving your own hunting trophies. Right in your home, will be the prizes of your fine hunting and outing trips. It's simply great!

SPARE-TIME PROFITS

All of your sportsmen friends will be proud of you and your work. **THEY WILL URGE YOU TO MOUNT THEIR SPECIMENS**. They will be delighted to pay you liberally. Many students earn splendid profits while learning. **YOU can now be a Taxidermist, for pleasure and profits.**

300,000 Students

Many of our vast number of students are employed in the **BIGGEST AND FINEST MUSEUMS**, which endorse our school. No higher recommendation can be had in America. **WE CAN TEACH TAXIDERM**y TO YOU, men, boys, and women. Yes, more than 300,000 are members of this fine school, and endorse it enthusiastically. Here is your opportunity, long awaited. Send the **COUPON** without fail.

GET THE FREE BOOK

This new, strange, unique **FREE BOOK** will open a new world of fine pleasure to you. Write for it **NOW**. **IT TELLS THE WHOLE STORY**, 44 pages, over 100 photos of wild-game, and stories of success that will thrill you. Shoot fewer specimens, double your fun, and help conserve the wild-game.

Send the **COUPON THIS MINUTE**. State your **AGE**

Send
for
Free
Book

Mail Coupon Now

Northwestern School of Taxidermy,
3379 Elwood Building, Omaha 2, Nebr.

Please **Rush the FREE BOOK** to Me. I am interested. Please send the **FREE BOOK ON TAXIDERM**y and tell me about how I can **BECOME A FINE TAXIDERMIST**.

Without obligation on my part, explain how I can **double my interest** and fun in hunting, outdoor life.

Name.....

Address..... Age.....

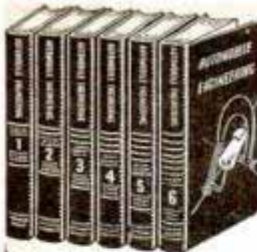

AUTO BOOKS ON APPROVAL



CAN YOU FIX IT?

These wonder books tell step by step HOW to make difficult repairs and adjustments, how to keep a car at maximum efficiency, including latest improvements in car design and operation. Engine troubles and how to correct them well covered.

6 BIG VOLUMES
2800 pages, 2000 illustrations, wiring diagrams, etc., including Diesel engines. Beautiful modernistic, washable cloth binding.

SEND NO MONEY. Just mail the coupon for a complete set of Six Big Auto Books, 20th Edition. Whether you are a mechanic or helper, expert or apprentice, auto owner or driver, take immediate advantage of this FREE EXAMINATION OFFER.

MAKE GOOD MONEY NOW HOLD A PERMANENT JOB

America wants its automobiles kept in good repair. Men with "know how" are in demand, at big pay. These books will help you get and hold an important job, or give you a chance to go into business for yourself now or later. Any man who half tries to improve himself can learn auto servicing and repairing by this quick reference method. Use the JIFFY INDEX to find easily understood answer to any auto problem. These wonder books prepared by eleven of America's great automobile engineers. Many hundreds of valuable illustrations. Send the coupon TODAY.

[A year's consulting privileges with our engineers now given with these books without extra charge.]

Vocational Publishers Since 1898

AMERICAN TECHNICAL SOCIETY, Dept. A919

Drexel Ave. at 58th St., Chicago 37, Ill.

I would like to examine your Six-Volume Set of Auto Books. I will pay the delivery charges only, but if I choose I may return them express collect. If after 10 days' use I prefer to keep them, I will send you \$2 and pay the balance at the rate of only \$3 a month until \$24.80 has been paid. Please include consulting service as offered above.

Name

Address

City State

Please attach letter stating age, occupation, employer's name and address and name and address of at least one business man as reference. Men in service, also please give home address.

Electricity at your finger ends

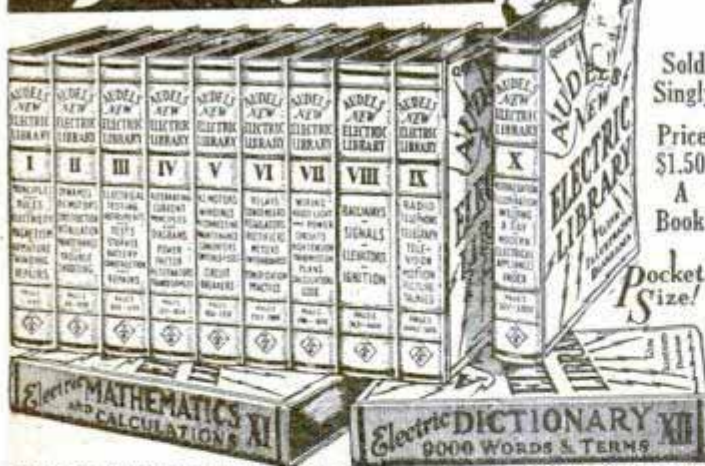

Sold Singly
Price \$1.50
A Book
Pocket Size!

AUDE'S NEW ELECTRIC LIBRARY—A progressive Home Study and Reference Course in applied electricity. Easy to understand. Questions and answers plainly written for a complete working knowledge of modern electrical practice, necessary to every electrician, engineer, mechanic and student.

LEARN THE AUDEL WAY! You ask the question—Aude's New Electric Library gives the answer—3500 simplified outlines, graphic illustrations and precise explanations covering Construction, Operation and Machine Maintenance.

BOOK A MONTH PLAN—Order the volume that interests you—today! We will send that volume on 7 days' free trial. If the book helps you, send us \$1.50. If it does not help you, mail book back to us. On receipt of your first payment, we will send your second book. We allow 30 days to pay for this and for each following book until you complete the Series.

If you are not satisfied, you may cancel your subscription at any time.

FREE EXAMINATION COUPON

Theo. Audel & Co., 49 W. 23rd St., New York City
Mail Vol. I, Electric Library on 7 days' free trial. If O. K. I will remit \$1.50, otherwise I will return it. I also request you to mail one book each month on same terms. No obligation unless I am satisfied.

Name

Address

Occupation PM

BE A

LANDSCAPE ARCHITECT

WORK OUTDOORS



Healthful, pleasant outdoor work in an uncrowded field.

The field of Landscape Gardening offers unusual opportunities for trained men... greatly augmented by the huge home-building and modernizing program ahead. We provide thorough, interesting home-training during your spare time... adapted to your regional conditions.

APPROVED for VETERANS

BE YOUR OWN BOSS

A graduate says, "I finished the course about two months ago and now I average about \$2.00 per hour net for my time."

There are many employment opportunities in this profitable, uncrowded field or you can easily start your own business. Write today.

Service from Coast to Coast

NATIONAL LANDSCAPE INSTITUTE

DEPARTMENT P 756 SOUTH BROADWAY — LOS ANGELES 14

Learn NOVELTY MANUFACTURING!!



Today's best bet for a business of your own starting with little money is the Casting of Wall Plaques, Book Ends and other Novelties. Large orders and profits waiting. Start in garage or basement, quickly learned. **NO EXPENSIVE MOLDS TO BUY.** Our system has started many on the road to a splendid financial future. Write today for free particulars.

PLASTEX PRODUCTS, 127 Clement St. San Francisco (18), Calif.

LEARN MOVIE PROJECTION THEATRE MANAGEMENT



The Motion Picture Theatre Business offers big opportunities for trained men. Get into a fascinating field with a post-war future. Train at home in spare time. Free Catalog. Established 18 years.

THEATRE INSTITUTE, 370 Washington St., Elmira, New York

Be our book representative in your plant and

EARN \$5-\$10 EXTRA EACH WEEK

In your sparetime recommend our helpful books to fellow workers. 2300 books—how how to do jobs better, easier; advance faster. Every worker a prospect. Join the hundreds now earning big commissions. Write for details: Dept. PM, McGraw-Hill, 33 W. 42 St., N. Y. C. 18.

So You Think You're Living?

Yes, you're going through the motion, all right—eating, sleeping, working and all that. But are you really LIVING? And how do you KNOW you are living? To find out read "Life Unlimited," a message for immortals. Your copy mailed free on request.

LIFE UNLIMITED, Dept PM-12

3227 Indiana Ave.

St. Louis 18, Mo.

Be Your Own Boss — In Your Own Business

Start at home... small capital needed... prepare for exciting plastics jobs or Your Own Plastics Business. We teach you Fabrication and Casting right in your own home. All materials furnished. Send ad with name and address for information. **VETERANS:** Eligible for resident training under G. I. bill, Check here

LEARN

PLASTICS

PLASTICS TECH

School of America, Inc.

5200 Euclid Avenue

Dept. M-12, Cleveland 3, Ohio

They're Back! **BETTER THAN EVER BEFORE!**

The New
1947

MIDWEST POST-WAR ENGINEERED RADIOS

Featuring this Powerful
SERIES 16*
AM-FM
CHASSIS

AT SENSATIONAL
**FACTORY-TO-YOU
PRICES**

ONCE again Midwest demonstrates its 27 years of leadership with this powerful Super De Luxe Series 16* 5-band world-ranging radio that brings you noise-free FM reception plus Standard Broadcast and 3 short wave bands. You'll be thrilled by its marvelous tone...its wealth of new post-war features...its world-ranging performance that brings you the finest programs with amazing clarity and strength. Send today for the new FREE 1947 Midwest Catalog before you buy any radio. Take advantage of our sensational Factory-to-you values and liberal 30 days Trial Offer.



***SERIES 16 CHASSIS USES ALL OF THESE LATEST TYPE TUBES**

Now Offering
FREQUENCY MODULATION

PUT THIS WORLD RANGING CHASSIS IN YOUR PRESENT CABINET OR SELECT A NEW **MIDWEST** FROM

30 DAYS TRIAL



THE MAGNIFICENT LINE OF BRILLIANT NEW CONSOLE AND TABLE MODEL RADIOS AND RADIO-PHONOGRAPHS

The **SYMPHONY GRAND SERIES 16*** AM-FM RADIO-PHONOGRAPH CONSOLE with **NEW AUTOMATIC RECORD-CHANGER**

A REAL masterpiece of cabinet design and radio engineering... a luxurious musical instrument that brings you the newest marvels of radio science, including static free FM, automatic record changing, 5 wave bands and scores of new features and improvements for your listening pleasure. For complete details of this and other Midwest Radio models send for your copy of the 1947 Midwest Catalog today.

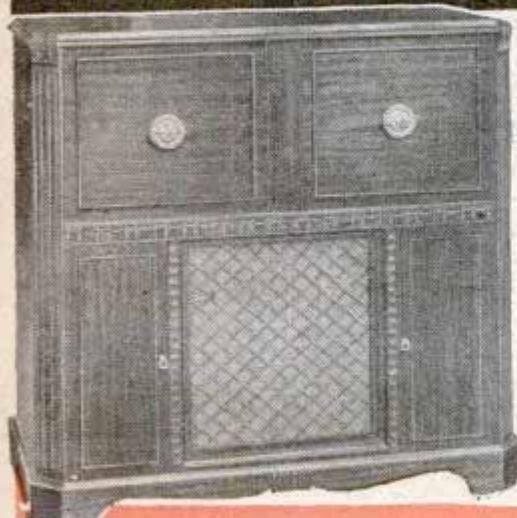

EASY TERMS

Rush for Free Catalog!

FILL IN COUPON AND MAIL TODAY OR JUST SEND YOUR NAME AND ADDRESS ON 1c POSTCARD

MIDWEST RADIO CORP.
Dept. 25-B, 909 Broadway
Cincinnati 2, Ohio

Gentlemen: Please send me your new FREE catalog and details of your liberal 30 Days Trial.

Name _____ Zone _____ State _____
Address _____
City _____

MIDWEST RADIO CORP.
Dept. 25-B • 909 BROADWAY • CINCINNATI 2, OHIO

LOANS *by* MAIL

\$50 to \$300 IN A HURRY

CONFIDENTIAL

Salaried people, men or women, married or single, loans on your own signature, or your own security. **NO** personal interview. **NO** co-signers needed. **NO** wage assignments. You mail the application to us... we mail the money to you.

FOR A LOAN OF	YOU CAN REPAY MONTHLY			
	IN 15 PAYMENTS	IN 12 PAYMENTS	IN 9 PAYMENTS	IN 6 PAYMENTS
\$ 50	8.40	\$ 5.03	\$ 6.43	\$ 9.24
100	16.75	10.07	12.87	18.48
150	20.85	15.10	19.30	27.73
200	24.93	20.09	25.68	36.91
250		25.02	32.02	46.05
300		29.94	38.33	55.17

The above payments made at regular monthly intervals will repay the entire loan and all charges in the time indicated. Charges are based on the monthly rate of three per cent on unpaid principal balances to \$150.00 and two and one-half per cent on that portion of unpaid balances in excess of \$150.00 but not exceeding \$300.00. "Loans by Mail" may be repaid in larger amounts, more frequent payments or repaid in full at further savings to you.

CONVENIENT

Just write us how much money you need and how you wish to repay... there's no charge or obligation. Whatever your needs for cash now or in the future, write for your "Loans by Mail" plan, today.

MERCHANTS INVESTMENT CO.

819-G 1st Nat'l Bldg., Omaha, Nebr.

Without obligation, rush complete details and all papers necessary for a loan of \$_____ to be repaid at \$_____ on the _____ day of each month.

Name _____

Address _____

City _____ State _____

Occupation _____

LAW

STUDY AT HOME FOR PERSONAL SUCCESS and LARGER EARNINGS. 38 years expert instruction—over 108,000 students enrolled. LL.B. Degree awarded. All texts furnished. Easy payments. Send for FREE BOOK—"Law and Executive Guidance."

AMERICAN EXTENSION SCHOOL OF LAW
Dept. 72-N, 646 N. Michigan Ave., Chicago 11, Ill.

AN IDEAL XMAS GIFT FOR MEN

Buy a whole year's pleasure for yourself and your sportsmen friends—a subscription for FUR-FISH-GAME. Gift card enclosed free. Twelve monthly copies packed with fascinating stories of the outdoors, adventure, nature experiences, valuable articles, text and photos taking you instantly where sportsmen's dreams come true. Hunting, fishing, camping, trapping, coon hunting, fur farming, boats, woodcraft, dogs, guns and ammunition, fur markets and prices.

Get a copy (20c) at the newsstand or save by sending for

SPECIAL CHRISTMAS OFFER Nine Months \$1.00 (Saves 80c)

Or write for full year's subscription \$1.50.

FUR-FISH-GAME, 307 Standard Bldg., Columbus 15, Ohio

Send Subscription 9 mo. \$1.00; also gift card to 1 yr. \$1.50;

Name _____

Address _____

From _____



MODERN SHOP TRAINING APPLIANCES

**SERVICE
REPAIR • INSTALL**

Active and growing field for men who want good jobs or business of their own. Practical shop training on all kinds of appliances—washers, ironers, mixers, heaters, vacuum cleaners, stoves. Learn polishing, plating, motor rewinding, welding, how to use precision and necessary power tools. Good pay for repairing, maintaining, servicing, installing, selling electric appliances. Chance to get in on ground floor, go up fast! If over 17 and under 60 learn how you can get started. Write for FREE FACTS today. If a Veteran we'll take care of all details if you qualify under G.I. Bill.

APPLIANCE TRAINING SCHOOL, Dept. C-212
6312 N. Broadway, Chicago 40, Illinois

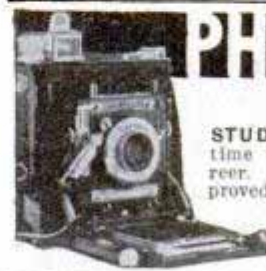

PHOTOGRAPHY

FOR FUN OR PROFIT

STUDY AT HOME—Photography offers leisure time enjoyment and well-paid, fascinating career. Ever-increasing opportunities! Successful N.Y.L. training qualifies you at home. Also resident courses. Details FREE! NEW YORK INSTITUTE OF PHOTOGRAPHY, (37th Year), Dept. 49, 10 West 33 St., New York 1, N. Y.

What Every Mason Wants



We have important Masonic books for Blue Lodge, Chapter, Commandery, Scottish Rite, and Shrine.

Our Rituals Are Used the World Over. Send for free catalog of books and rituals for Masons, Odd Fellows, Knights of Pythias, Knights of Columbus, etc. EZRA A. COOK, Publisher, P. O. Box 796, PD, Chicago 90, Ill.

SHORTHAND in 6 Weeks at Home

Famous Speedwriting system. No signs or symbols; uses ABC's. Easy to learn; easy to write and transcribe. Fast preparation for a job. Surprisingly low cost. 100,000 taught by mail. Used in leading offices and Civil Service. Write for free booklet. **SPEDWRITING, Dept. 1512-6, 55 West 42 St., N. Y. 18**

SIGNS EASILY AND EXPERTLY AND PAINTED WITH LETTER PATTERNS SHOWCARDS AND MANY SIZES & STYLES WRITE FOR FOLDER!

JOHN F. RAHN
1330-31 N. Central Ave.
CHICAGO 51, ILL.

SUPER YOUR GREATEST ASSET! FACTS - FIGURES - FACES MEMORY

at your command through the new improved SUPERMEMORY course

THOR BOOKS, Z-3, Box 1210, Chicago

Get U.S. Gov't Job

Splendid salaries, vacations, pension when retired. My low-priced, home-study practice tests help one make higher grade in Gov't Exam. Write today, OZMENT SCHOOL, 80, St. Louis, Mo. (Veterans given preference)



WHY WEAR DIAMONDS

When diamond-dazzling Zircons from the mines of far-away mystic Siam are so effective and inexpensive! Thrilling beauty, stand acid, true backs, full of FIRE! Exquisite mountings. See before you buy. Write for FREE catalog.

National Zircon Co., Dept. 20
Wheeling, W. Va.

Catalog
FREE!

Learn RADIO- ELECTRONICS- TELEVISION



RADIO TESTING AND SERVICING—Students learning to locate troubles with modern radio analyzers.



ELECTRONIC CIRCUIT TESTING — Instructor showing students use of large Cathode Ray Oscilloscope.

**TRAIN FOR A GOOD
JOB NOW** one that
offers **STEADY WORK**
with a **REAL FUTURE**

Don't be caught napping. Prepare for a good job now that will still be a good job with a real future when conditions change. If you are not a trained man you may have to compete with millions of other untrained men. Get into a field that offers real opportunities in good-times and bad-times. Tremendous expansion in **Frequency Modulation and Television** is predicted because of war time discoveries now being re-converted to civilian use. **Radio-Electronics** trained men are needed today—they will be needed in the years ahead!

Real Opportunities for the Radio Trained Man

Prepare for jobs as assembler, inspector and tester—Radio sales or service and installation work, electronics, television, sound work, aircraft-radio, auto-radio, etc. Many opportunities in the vast **Radio-Electronics** field.

GET OUR BIG NEW BOOK

It tells all about our big Chicago shops and our plans to help you get ahead. Packed with facts and pictures of students at work in our shops. Mail coupon for this **Big New Book** now! Coupon will also bring details on how we'll finance most of your tuition...facts on how we help you "Earn-While-Learning"...information on **FREE EMPLOYMENT SERVICE FOR LIFE...** and other plans to help you. **ACT NOW TO MAKE SURE YOU GET OUR GENEROUS OFFER.** Sending for this interesting free book can be your first big step to success. No obligation. No salesman will call. Mail coupon today. **B. W. Cooke**



"Learn by Doing"

RIGHT HERE in the SHOPS of COYNE — in a Few Weeks
Student Finance Plan

We train you on real Radio, Television and Sound equipment—RIGHT HERE IN THE COYNE SHOPS IN CHICAGO. Necessary theory is given in a practical way by practical lectures, blackboard illustrations and equipment demonstrations. Whether or not you have had Radio experience you need Coyne all-around Radio Electronics training. Many of our students had no previous experience. Others had experience in one or two branches but realized they needed all-around training for better jobs and advancement.

EARN WHILE LEARNING

If you need part-time work to help pay living expenses while at school, we will help you get it. Coyne graduates also receive a Life Membership with Life-time Employment Service.

MEN WITH PHYSICAL DISABILITIES—whether due to war or other causes—we also have facilities for you. Check coupon for particulars if you have a physical disability of any nature.

PREPARE FOR JOBS LIKE THESE

Frequency Modulation (FM)
Radio Manufacturing
Radio Set Serviceman
Television Servicing
Electronics Maintenance
Public Address Systems, etc.
Your Own Radio Shop
**Electric Refrigeration
Now Included**

**ADDED
TRAINING**

This training included to help you get ready for the better jobs in this great field

VETERANS!
Coyne is also equipped to train those who qualify for training under the **G. I. Bill of Rights**. Check coupon for special G. I. Bulletin.

THE HOME OF
COYNE



B. W. COOKE, Dir. **Founded 1899**
COYNE ELECTRICAL SCHOOL
RADIO-ELECTRONICS DIV.
500 So. Paulina Street Dept. 96-3H CHICAGO 12, ILLINOIS

**B. W. COOKE, Dir., Radio-Electronics Div.,
COYNE ELECTRICAL SCHOOL,
500 S. Paulina St., Dept. 96-3H,
Chicago 12, Ill.**

Dear Mr. Cooke, Send me your Big Free Radio-Electronics Book and all the facts... also full details of your "Student Finance" plan. Send special G.I. Bulletin. Send physical disability details.

NAME.....

ADDRESS.....

CITY.....STATE.....

NOW! You Can Learn ELECTRIC MOTOR REPAIR!



Easily—Quickly—at Home FOR ONLY \$5

Many fields of technical work are crowded, and becoming more so every day. Electric motor repair is one that IS NOT—chiefly because there has been no easy, inexpensive way for beginners to learn it at home in spare time. Now comes **ELECTRIC MOTOR REPAIR**, the big new book for only \$5 that teaches you quickly—completely—easily. Specially written for beginners. Explains every detail of motor trouble diagnosing, repair and re-winding. Invaluable for actual shop use.

TRAIN FOR BIG PAY IN A FIELD THAT ISN'T CROWDED!

Covers alternating—and direct-current motors, synchronous motors and generators and BOTH mechanical and electronic control systems. Quick-reference guides show step by step how to handle specific jobs. Based on this big book alone, you can equip yourself for profitable service on almost any motor. **AND YOU DON'T RISK A CENT!** Our 5-Day-Money-Back Guarantee is your absolute protection! 900 illustrations, 580 pages.

BUILT TO BE USED AS A TOOL!

Every step is demonstrated **VISUALLY!** Unique Duo-Spiral binding permits both text and related illustration to be seen **AT THE SAME TIME.** Teaches fast—teaches right. Amazingly easy for beginners to understand.

FIX RADIOS FOR FUN AND PROFIT!

NO COSTLY EQUIPMENT NEEDED... TELLS EXACTLY WHAT TO DO

Want to repair almost ANY popular home or auto radio? Just look up data on that particular make and model in A. A. Ghirardi's giant-size **RADIO TROUBLESHOOTER'S HANDBOOK**. Tells how to diagnose specific trouble symptoms. Explains **WHAT** repairs are needed and exactly **HOW** to make them. Eliminates tedious testing. Covers over 4800 different models. Hundreds of additional pages contain invaluable service data, charts, diagrams and "tips." Only \$5 complete.



5-DAY MONEY-BACK GUARANTEE on both books!

Dept. PM-126, Murray Hill Books, Inc.
232 Madison Ave., New York 16, N. Y.

Enclosed find \$..... for book(s) checked below; or send C.O.D. (in U.S.A. only) for this amount, plus postage. If not satisfied, I may return books in 5 days for refund of my money.

ELECTRIC MOTOR REPAIR \$5 (\$5.50 foreign) **RADIO TROUBLESHOOTER'S HANDBOOK, \$5 (\$5.50 foreign)**

Name.....

Address.....

City & Dist. No..... State.....

NEW MIDGET ELECTRIC ARC WELDER

FULLY GUARANTEED

RETAILS ONLY \$3.95



Plugs into Light Socket—AC or DC

It's new! It's handy! It's efficient! Use the Midget Electric Arc Welder for hundreds of light-metal jobs. Does comparable welding work with a 1/16 inch welding rod on thin metal as that of larger and higher priced welders. Operates on 15 ampere fuse, 110 volt 60 cycle A.C. or D.C. current, by use of our special standard-coated 1/16-inch welding rods. Generous supply of rods supplied with machine. Recommended for all light welding like automobile fenders, etc. Take the Midget Arc anywhere to the job. Sturdily built and fully guaranteed. Comes complete—ready to use. Nothing else to buy. No previous welding experience needed to strike an arc. In a short time, anyone mechanically inclined can learn to weld with this machine.

You'll find hundreds of money-saving, time-saving uses for the Midget Arc around your home, garage, or workshop. Also in garages, factories, repair shops, tin shops, mechanics, farmers, inventors, etc. Order a Midget Electric Arc Welder now! **SEND NO MONEY.** We'll rush one to you, complete with rods and helmet (equipped with APPROVED welding glass). Pay postman only \$3.95 plus postage charges. If not satisfied, return Midget Arc in 5 days from receipt and we'll refund your money immediately. **RUSH YOUR ORDER NOW.**

MIDGET ARC WELDER CO., Strader Ave., Dept. R-202, Cincinnati 26, Ohio

PRINTING PAYS BIG

"Make your future secure. Prepare for a highly paid position or a print shop of your own. Students throughout the world are enthusiastic in their praise of our training program and the personal attention given each student. Rush name today for free literature and sample lesson. No salesman will call. Write Dept. M-106.

International School of Printing, Box 334, Dayton, Ohio

INVENTORS

WITH GOOD INVENTIONS

Should write us without delay for **FREE BOOKLET**, Protective Disclosure Form and facts about The Inventor's Most Logical Markets. Patented, Unpatented inventions, all kinds, Cash, Royalty, needed by specific manufacturers. If your invention is for sale, write today for full particulars. A Post-Card will do! Address:

THE INVENTION REPORTER
5C-11106 South Longwood Drive Chicago 43, Illinois

SAY YOU SAW IT IN POPULAR MECHANICS

CHAPMAN CHINCHILLAS

The originator of the first Chinchilla Farm in the United States. For information on purchasing the finest, selected breeding stock of these aristocratic animals that were virtually trapped to extinction write or visit—

Established 1919

Chapman Chinchilla Farm
4957 West 104th Street
Inglewood, California

MAGIC LIQUID MAKES PHOTOS APPEAR On Scarfs, Ties, Stationery, Etc.

Reproduce any snapshot or negative on Scarfs, Ties, Stationery, etc., on Wood, Leather, Cloth, Cards or almost any other surface. Simply apply liquid. Photo appears like magic within 2 minutes in broad daylight. Harmless to negative. Won't wash off. Easy to use. Complete kit and instructions for 100 or more photos now only \$1.50. Send no money, just name. Pay postman \$1.50 plus few cents postage on delivery. (Foreign \$2.00 money order only). Order today.

STYLE-ARTS, Inc., Dept. 1-B, 4649 Broadway, Chicago 40, Ill.

DO ANY JOB.. EASIER.. QUICKER
MAKE MORE MONEY in the
BIG OPPORTUNITY
FIELDS

SEND NO MONEY
 Select the Books
YOU Need Now!
 We Ship **C.O.D.**
 Anywhere in U. S.
 and Will Refund
 Amount Paid if
 Not Satisfactory.

AIR CONDITIONING

Big air conditioning boom interrupted by war will be bigger than ever. It's ready to GO now! Get this non-technical book by international authority and be ready for your share of millions to be spent. Covers whole field. 450 pages. Illustrated. \$4.00.

AIRPLANE WELDING

All metal airplane building offers big peacetime opportunities. New 2nd edition of this famous book by J. B. Johnson, Materials Division, Wright Field. The authoritative and practical book on Airplane welding and materials brought right up to date. 420 pages, 193 pictures. \$3.50.



MODERN WELDING PRACTICE

Newest book on all types of welding and heat treatment of metals. Written by recognized specialists in training men for production jobs. Practical and Non-Technical.

430 Pages
 277 Illus.
 Practical and Non-Technical

Covers everything you need to know. Prepare for best pay jobs now. Price \$4.00.



REFRIGERATION—Book of the Hour!
Biggest Opportunity in Many Years!

NEW PRINTING—ALMOST 1000 PAGES

408 Pictures—17 Diagrams in Colors Makes All Refrigerator Service Maintenance, Repairs Simple as A. B. C.

Thousands of Refrigerators need repairs! Owners will pay big for competent service which will be needed more and more. Get MODERN GAS AND ELECTRIC REFRIGERATION, the non-technical guide to all types of refrigerators and get your share of this new profit. Get a job or start your own service business. This book will help you make money anywhere. Price \$5.00.

BODY & FENDER REPAIR

Owners will spend big money to keep their good older cars looking like the new ones coming out. This is a practical money-making guide, ideal for shop owners and every man who wants a share of the millions to be spent in keeping old cars looking new. Tells how to get a good job or start business of your own with small capital. 325 pages, 232 illustrations. \$3.50.

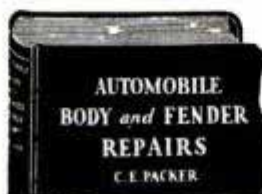

DYKE'S FAMOUS CARBURETOR BOOK

This famous book has been the standard guide in the best paying auto work for a generation. It has helped thousands of men make money. New edition covers engine tune-up, compression, ignition, carburetion, fuel pump valves, etc. Use this book to specialize in this big field. 244 pages, 549 illustrations. \$3.50.

HOUSE WIRING
NEW EDITION

Get this new sixth edition of this standard and practical electrical wiring book. It gives complete practical instruction on every phase of house wiring in one handy volume. Goes further than most books on subject. Hand-book style. Gives National Electric Code, 400 pages, 669 illustrations. Electrical work will reach a new high with millions of new homes to be built. Get started now. \$3.00.

15 Million Refrigerators
Need Service and Repairs

Here's the Help You Need
For Best Paying Jobs
Right NOW!

FREE TRIAL
IN YOUR OWN HOME

Used by Army, Navy, Other Government Depts., 200 Schools and Industrial Firms.

Do it now! Get the better pay that goes to men with specialized knowledge. Get into one of these big opportunity fields. Big money and many other advantages await you if you prepare now. Here is the help you need—EASY—QUICK—AT LOW COST. Thousands of men have already used these famous books. Beginners and experienced men alike have doubled and tripled their earnings with this help. You too, can now get the special knowledge you need for top pay, better jobs, or a business of your own. This is your GOLDEN OPPORTUNITY.

NEW
20th
 EDITION
Leading
Auto
Book
for Over
32 Years

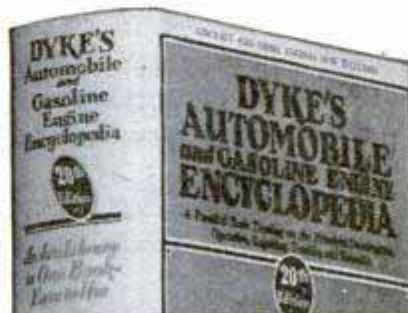

World's Greatest AUTO BOOK

New Material on Transmissions, Trucks, Tractors, Diesels, Aircraft and Auto Engines

Now with millions of cars needing repairs and thousands of men needed to do the work, you need the famous DYKE Auto Book more than ever before. Brand new 20th Edition covers all principles, construction, repair, adjustments, testing, troubles and remedies of all cars. Over a half million copies of 20 editions of Dyke's have been sold. Gives specifications of old and newer cars. World's biggest book value, \$7.00. This big book, a complete auto library in one volume, has 1483 pages—4600 illustrations and diagrams—weighs 6 lbs.—equal to 4 ordinary books.

ENGINEERS HANDBOOK

World famous Bailey's handbook of universal questions and answers for Stationary, Marine and DIESEL engineers and firemen. Prepares for any license examination. This is the one book that men should have if they want to reach the top in installation, maintenance and operation of Diesel and steam plants. Pocket size, \$2.00.

Goodheart-Willcox Co., Inc.
 209 S. Michigan Ave., Dept. 112, Chicago 16, Ill.

SEND NO MONEY! Mail Coupon

GOODHEART-WILLCOX CO.,
 209 S. Michigan Ave., Dept. 112, Chicago 16, Ill.
 Send books checked, C.O.D. I will pay postman, plus few cents charges. If not satisfactory I will return books in 5 days and you will refund money paid. (Outside U.S. or possessions remit with order.)

- Gas & Electric Refrigeration \$5.00
- Dyke's Auto Book \$7.00
- Dyke's Carburetor Book \$3.50
- Modern Welding \$4.00
- Airplane Welding \$3.50
- Sheet Metal Layout \$3.50
- Air Conditioning \$4.00
- Engineers Handbook \$2.00
- Body and Fender Repair \$3.50
- House Wiring \$3.00
- Shop Math. (2 vols.) \$3.00
- A.C. Power Wiring \$4.00
- D.C. Power Wiring \$4.00

If remittance accompanies order we will pay all postage charges under same return privilege.

Name
 Address
 City State

INVENTORS

The inventor who believes he has a new and useful invention, and finds himself in need of advice, should consult a competent registered patent attorney.

The question as to whether a subject matter is patentable can be substantially determined by a search of the United States Patent records.

Without obligation, write us for information as to what steps an inventor should take to secure a Patent.

RANDOLPH & BEAVERS

Registered Patent Attorneys
11-D Columbian Bldg., Washington 1, D. C.

RANDOLPH & BEAVERS

11-D Columbian Bldg., Washington 1, D. C.

Please send me full information on how to secure Patents & Trademarks.

Name.....
Street.....
City.....State.....

AIR RIFLES

BENJAMIN

AIR PISTOLS

ARE IN PRODUCTION

ORDER BENJAMIN AIR RIFLES & BENJAMIN AIR PISTOLS from your DEALER. Send for our FREE FOLDER and Complete Specifications TODAY. Both Calibre Benjamin H-C Pellets are available now.
BENJAMIN AIR RIFLE CO., 812 MARION ST., ST. LOUIS 4, MO.



Be an ARTIST!

Learn at home in your spare time

Prepare now for a fascinating and profitable Art career. Our practical method has trained men and women since 1914. COMMERCIAL ART, CARTOONING, and DESIGNING all in one complete course. Trained Artists are capable of earning \$40, \$60, \$75 a week. No previous Art experience necessary. FREE BOOK, "Art for Pleasure and Profit" describes course, commercial opportunities. TWO ART OUTFITS included with training. VETERANS! Course approved under G.I. Bill.

FREE BOOK gives details!

Washington School of Art, Studio 1212C
1115—15th St. N.W., Washington 5, D. C.

Please send me full information and your Free Book, "Art for Pleasure and Profit."

Name.....AGE.....
Street.....
City.....Zone.....State.....

PATENTS AND TRADE MARKS

C. A. SNOW & CO.

Registered Patent Attorneys Since 1875
Write for Free Book and "Certification of Invention" form
427 SNOW BUILDING, WASHINGTON 1, D. C.

PATENTS

Free preliminary advice
E. E. VROOMAN, Patent Lawyer
Registered Patent Attorney Since 1902
871 Woodward Building, Washington 5, D. C.

REFRIGERATION AND AIR CONDITIONING

SERVICE MECHANICS COURSE

Learn at home—how to start your own repair shop on little capital. No previous experience needed. Common school education sufficient. Splendid opportunity for older men. Prepare now for your future. FREE illustrated booklet.

MECHANICS TRAINING SCHOOL
7217 So. Broadway, Dept. P-12, Los Angeles 3, Calif.

Please Mention Popular Mechanics When Answering Ads

FREE BARGAIN CATALOG of BOOKS

25,000 books of all publishers listed in our 52nd Annual Bargain Catalog of 320 pages. Old-time favorites—latest "best sellers." Reference, Fiction, Juvenile, History, Scientific, etc. Supplying schools, colleges, libraries and thousands of individual customers. Send postcard today for our new 1947 catalog, "Bargains in Books."

THE BOOK SUPPLY COMPANY, Dept. 135
564-566 West Monroe Street Chicago 6, Illinois

Correspondence Courses in RADIO and ELECTRICAL ENGINEERING

LOW AS \$25

ELECTRICAL ENGINEERING. Get good grasp of wide electrical field. Modern. Very understandable. Theory made easy.
RADIO ENGINEERING. Extra fine course in radio, public address, photo-electric work. Trains you to be super-service man, real vacuum tube technician. Tuition ONLY \$25, either course. Deferred payment plan. Services needed badly.
FREE Write for free copies of school catalogs, student magazines, etc.
LINCOLN ENGINEERING SCHOOL, Box 931-P96, Lincoln, Nebr.

5¢ EACH LITTLE BLUE BOOKS

Send postcard for our FREE CATALOGUE. Thousands of bargains. Address:
HALDEMAN-JULIUS CO., Catalogue Dept., Desk M-2418, GIRARD, KANSAS

Optical Illusion makes any view or object you wish to draw appear on the drawing paper in rich detail. Low-cost invention makes drawing simple tracing. Educates and amuses children and adults. Practical for artists. Free details.
Dept. 21-M, BEELER ENTERPRISES, No. Hollywood, Calif.

ACCOUNTING

STUDY AT HOME for C.P.A. and BIG PAY Accounting opportunities with 42 year old school. No previous training needed. Texts furnished. EASY PAYMENTS. Send for FREE BOOK.
Mac CORMAC EXTENSION SCHOOL
Dept. 12-B, 1170 East 63rd St., Chicago 37, Ill.

PEPSI-COLA HITS THE SPOT

WATCHES WANTED Broken or Usable

All kinds. Highest Prices paid for jewelry, rings, spectacles, gold teeth, diamonds, Sterling Silver, etc. Cash mailed promptly. Write for free shipping container.
LOWE'S, Dept. PM, Holland Bldg., St. Louis 1, Mo.

RADIO ENGINEERING

Broadcasting, Servicing, Electronics, Aviation, Marine & Police Radio taught thoroughly. 48 weeks' Engineering course equivalent to 3 years' college radio work. Approved Veteran Training. Co-educational. Catalog free.
VALPARAISO TECHNICAL INSTITUTE, Dept. D, Valparaiso, Ind.



Three months after taking your course
I STARTED TO PLAY FOR DANCES

"Before I took it I didn't know a note of music"

writes Miss Rosie Montemurro of Vancouver, B. C., Canada

"Words cannot express my feelings to the U. S. School of Music. Before I took your course I didn't know one note of music. Three months later I started to play for dances. It has a clear explanation in every lesson." Miss Rosie Montemurro.

You, too, can learn your favorite instrument quickly, easily,
 for ONLY 7c A DAY

This letter is typical of many we have from pupils. Thousands who didn't know a note are now playing their favorite instruments—thanks to this simple home study way to learn music for only 7c a day. Learning music this famous "Print and Picture" way is easy as A-B-C! No long-winded explanations. No tiresome exercises. You play real tunes by note right from the start. If interested, send for Free Booklet and "Print and Picture" Sample. Mail coupon today, to U. S. School of Music, 712 Brunswick Bldg., New York 10, N. Y.

See how easy it is!

"My country 'tis of thee, sweet land of liberty"

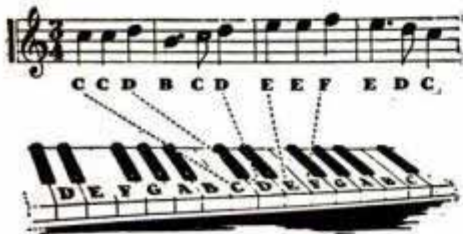

★
 Look at the music. The first note is "C." Follow the dotted line to the keyboard and locate "C" on the piano. Find other notes the same way. Strike the notes as indicated and you'll play the melody of America.



FREE! Print and Picture Sample

U. S. School of Music
 712 Brunswick Bldg., New York 10, N. Y.

Please send me Free Booklet and Print and Picture Sample. I would like to play instrument checked below.

- | | | |
|-----------------|-----------------|----------------|
| Piano | Saxophone | Clarinet |
| Guitar | Trumpet, Cornet | Tenor Banjo |
| Hawaiian Guitar | Modern | Mandolin |
| Violin | Elementary | Practical |
| Piano Accordion | Harmony | Finger Control |

Name..... Have You Instrument?.....

Address.....

City..... State.....

Save 2c—Stick Coupon on Penny Postcard

MAKE YOUR OWN COSTUME JEWELRY
BIG EARNINGS AT HOME

SPLENDID HOBBY OR VOCATION

- | | | | |
|---------------|---------------|-----------|-----------|
| Sea Shells | Ear Clips | Wire | Catches |
| Pin Backs | Floral Stones | Boxes | Plexiglas |
| Ear Screws | Jump Rings | Bracelets | Cements |
| Screw Eyes | Chains | Parts | Dyes |
| Plastic Discs | Clasps | Bow Knots | |

WRITE FOR FREE CATALOGUE

PHILADELPHIA BADGE, 1007 FILBERT ST., PHILA. 7, PA.

Learn Public Speaking

Learn theory and fundamentals at home—in spare time. Then acquire actual experience and practice. Send for FREE booklet "Power of Effective Speech."

North American School, Dept. 1359
 1315 S. Michigan Ave., Chicago 5, Illinois

Photography
 for

PLEASURE or PROFIT



Learn at home. Spare time. Practical basic training. Long-established school. Many have earned while learning. Send coupon below for free booklet, "Opportunities in Modern Photography" and full particulars.

AMERICAN SCHOOL OF PHOTOGRAPHY

1315 Michigan Avenue Dept. 1359 Chicago 5, Illinois
 Send booklet, "Opportunities in Modern Photography," full particulars and requirements.

Name..... Age.....
 Address.....
 City..... Zone..... State.....

AVIATION
Career

MAXIMUM TRAINING IN MINIMUM TIME

CAL-AERO TECH TRAINING will add dollars to your pay check all the rest of your life. Specializing in AERONAUTICAL ENGINEERING and MASTER AVIATION MECHANICS since 1929, Cal-Aero Tech training is carefully designed for just one thing—TO MAKE MORE MONEY FOR YOU. An alumni of over 6000 successful graduates proves our career training is unsurpassed.

VETERANS —Write us about Aviation Training, as provided under "G.I. Bill of Rights."



CAL-AERO TECHNICAL INSTITUTE
 MAJOR C. C. MOSLEY PRES. SINCE 1929
 FORMERLY CURTIS-WRIGHT TECHNICAL INSTITUTE

GRAND CENTRAL AIR TERMINAL
 GLENDALE 1, CALIFORNIA
 LOS ANGELES COUNTY

MAIL THIS COUPON TODAY!

Cal-Aero Technical Institute, Grand Central Airport, Glendale 1, California
 Please send full information on Aviation Training FREE—without obligation, Dept. PSE-12

Name..... Birth Date.....

Street.....

City..... State.....

**"What's he got
that I haven't got?"**

LOOK at the successful men you know. "What have they got" that you haven't?

Very little, probably. In most ways these men are no brighter or naturally more capable than average. Many of them probably have no more formal education or better natural aptitudes than you.

But that little extra they have is important. They have the special knowledge and ability for which business is glad to pay well—they know the what, why and how of business. They have also the confidence and aggressiveness which come from knowing that they know and can apply their knowledge.

You may add that extra—may get that same profitable knowledge and ability—that same confidence and aggressiveness—if you are willing to pay the price in earnest, necessary study. For LaSalle has spent 38 years developing, testing and proving, with over a million student members, spare-time success training in certain specialized business fields. What scores of thousands of men and women—many just like you—have done, you should be able to do.

You need not leave your home or interrupt your job; you need pay comparatively little money. But you must be ambitious and willing to study seriously. And soon after you start training, the results will begin to show up in your own confidence and in your work. For what you learn at home tonight is so practical that often you can apply it on the job tomorrow.

How much do you want success—more money, a promotion or a new job, prestige and responsibility? If you really want it, you will use the coupon below to find out what LaSalle training can do for you. It costs only a postage stamp, but a coupon like it has been the starting point to real success for scores of thousands—and can be for you.



G. I. APPROVED

LA SALLE Extension University
A Correspondence Institution
Dept. 1264-R • 417 S. Dearborn • Chicago 5, Ill.

I want to know how LaSalle can help me win success in the field I have checked below. Please send me your free 48-page booklet about that field and your success training in it.

- | | |
|--|--|
| <input type="checkbox"/> Accountancy | <input type="checkbox"/> Salesmanship |
| <input type="checkbox"/> Bookkeeping | <input type="checkbox"/> Effective Speaking |
| <input type="checkbox"/> C.P.A. Coaching | <input type="checkbox"/> Executive Management |
| <input type="checkbox"/> Business English | <input type="checkbox"/> Industrial Management |
| <input type="checkbox"/> Law: LL.B. degree | <input type="checkbox"/> Traffic Management |
| <input type="checkbox"/> Foremanship | <input type="checkbox"/> Stenotypy (Machine Shorthand) |

Name.....Age.....

Position.....

Address.....

City, Zone and State.....

LA SALLE **EXTENSION UNIVERSITY**
A Correspondence Institution

**WORLD'S
BEST
WANT AD
MEDIUM**

CLASSIFIED Advertisements



Advertisements in this section 60 cents per word, each insertion, minimum 10 words, payable in advance
To be inserted under proper classification in January issue, copy should be in our office November 25th

January issue on sale January 1st

F. W. Johnson, Manager, Classified Advertising

Popular Mechanics Magazine, 200 East Ontario Street, Chicago 11, Illinois

1580 CLASSIFIED ADVERTISEMENTS 1580 OPPORTUNITIES FOR YOU

AUTOMOBILES, MIDGET CARS

INDIANAPOLIS Model race car. Polished cast aluminum. Free running wheels. Looks like models selling for \$12.00. A beautiful Christmas gift. Send \$2.98 postpaid. Dealers' inquiries invited. S. and P. Merchandise, 12199 Flanders, Detroit 5, Mich.

CHRISTMAS Gift books: Power & Speed, \$2.50—Motor Racing With Mercedes-Benz, \$2.00—Motor History of America, \$3.00—Speed, How to Obtain It, \$1.50—Ab Jenkins' Racing Book, \$1.50—Fastest on Earth racing book, \$2.00—Clymer's Motor Scrapbooks (old cars) Editions 1, 2, & 3 each different, \$1.50 each—Steam Automobile Book, \$2.00—Motorcycling Manual, \$2.00—Motorcycles, How to Manage Them, \$1.50—Pull Throttle, \$3.50—Indianapolis Race History Book 1909-1946, \$3.50—1946 Indianapolis Racing Book, \$1.00; postpaid. Motorbook catalog free. See our ad Motorcycles classification. Clymer, Dept. A-121, 2125 W. Pico, Los Angeles 6, Calif.

NEW Racing hobby. Miniature racing car, 16," driven by model gasoline engines 80-100 miles per hour. Car less engine, \$45. Circular on request. Dooling Bros., 5452 W. Adams Blvd., Los Angeles 16, Calif.

HENRY Ford, His life—His Work, book, 384 pages, 50 photographs. Complete, detailed history book of Ford Motor Company and founder, genius Henry Ford. Revised to date, \$3.00; De Luxe Clothbound, \$4.00, postpaid. Clymer, Dept. A-125, 2125 W. Pico, Los Angeles 6, Calif.

SENSATIONAL. Exciting, new, fully enameled any color, numbered chrome plated, durable, non-tarnishing miniature, midget racing car pins, tie holder, belt buckles. Get yours. Write Hook-Fast, Box 1425, Providence, R. I.

"CUSTOM Styling" manual—Easily make any car look ultra-beautiful, streamlined, custom built! Newest beautifying suggestions, restyling instructions, illustrations, refinishing, custom accessory plans, mufflers, simplified model conversions—sport, Hollywood, speed, jeeps, etc., \$2.00. Alquist Engineering (T), 447-64 Street, Brooklyn 20.

NEW Racing books. Dick Seaman, Racing Motorist, \$3.50. Road Racing, \$3.50. Wheels at Speed, \$3.50. Wheelspin, \$3.50. Midget Automobile 1946 Racing Year Book, \$1.10. All postpaid. Clymer, Dept. A-122, 2125 W. Pico, Los Angeles 6, Calif.

SPEED & Mileage Manual—Easily obtain greater speed, mileage, racing performance from any car! Includes tuneup, maintenance, gas saving tips, speed tuning—instructions on building speed equipment, economizers, mufflers, superchargers, fast conversions. Postpaid \$1.98. Alquist Engineering, (T) 447-64 Street, Brooklyn 20.

FREE Catalog describes racing, historical, automobile, motorcycle books, 25 titles. Write Clymer, Dept. A-123, 2125 W. Pico, Los Angeles 6, Calif.

SCOOTER-CAR Runabout! Two passenger, three wheeled, motorized, speedy. More than a motorscooter! Simple construction from available second hand parts. Detailed plans \$1.00. Plans for midget "jeep" included free. Universal, 2671 Algonquin, Toledo 6, Ohio.

BUILD Tractors from second hand automobiles. Convert horse drawn farm equipment into tractor hook-up. Tractor plans—\$1.50. Mowing machine and plow hook-up plans \$1.00. Nolan's Garage, East Wareham, Mass.

INDIANAPOLIS 1946 Race History, including 80 illustrations, charts, drawings. World famous car, driver data. Highlights George Robson career; \$1.00. Complete Indianapolis Race History every Speedway race since 1909, including 1946, 1100 illustrations, 352 pages, \$3.50 postpaid. Clymer, Dept. A-120, 2125 W. Pico, Los Angeles 6, Calif.

RACING Fuels: six tested guaranteed auto racing formulas, \$1.00 postpaid. Formula Research, 481 Pacific, San Luis Obispo, Calif.

GOGGLES, Heavy duty Aero, \$4.50 pair. Summer helmets \$1.50 each. Winter leather helmets slightly used \$3.00 ea. New \$5.00 ea. Send payment with order. Western Aircraft, Hawthorne, California.

CLYMER-Tone finest California style dual mufflers, V-8 Ford, Mercury. Increases power, reduces back pressure. \$20.00 complete with pipes. Fast installation. Specify model car. Clymer, Dept. A-127, 2125 W. Pico, Los Angeles 6, Calif.

HOLLYWOOD Supertone dual muffler sets for Ford and Mercury's. Easily installed parts and simple instructions \$18.75. Chrome tail pipe extensions \$3.00. New stabilizer spring for Ford, Mercury and Zephyr. Give your Ford that knee action ride. Eliminates sway, restores arch to spring. '35 to '42, \$12.00. State whether front or rear. Supertone Mufflers, 2470 E. Slauson Ave., Huntington Park, Calif.

PHOTOGRAPHS, World's finest automobiles. List 10c. Box 1028, Minneapolis, Minnesota.

1947 SUPER Ignitioniter \$5.50. Atomic starting, pep, mileage. EG Mfg., 355A East 149th, New York 55.

RACING Car performance for all cars. Increase power, speed. Special "custom-built" equipment. Free literature. Write Lee Motorcraft, 1412-A Great Northern Bldg., Chicago 4, Illinois.

DUALTONE Twin muffler sets for Fords and Mercurys. Instructions included \$20. Replacement mufflers, all automobiles. Prices quoted on request. Designed to eliminate back pressure, giving increased gas mileage and horsepower. Has deep mellow tones. Three inch chrome tailpipe extension \$3.00. Dualtone Mufflers, 2636C India Street, San Diego (1), Calif.

CUSTOMIZE Your automobile. Illustrated, new restyling ideas, instructions, suggestions, specific model changes by simple methods. Postpaid \$1. Speedwheel, Box 723-E, Arcadia, California.

BUILD Speedy midget track racer from castoff parts! Plans, specifications, construction information, \$1.00. Motor Supply, Box 1682-CS, Toledo, Ohio.

"FASTEST On Earth" history book every World's Straightaway Speed Record, 200 pages, 70 illustrations world famous drivers, cars, \$2.00 postpaid. Clymer, Dept. A-124, 2125 W. Pico, Los Angeles 6, Calif.

500 DIFFERENT Photos, race cars, drivers. List, sample 10c. Frank Smith, Midland Park, N. J.

"STREAMLINED Roadster"—Speedy, small, two passenger automobile! Custom sport style. Easily constructed from available, inexpensive material—small motor. Complete instructions, drawings \$1.98. Alquist Engineering, (T) 447-64 Street, Brooklyn 20.

MUFFLER Manual. Convert easily to Hollywood, Laguna, Westwood, duals, etc. Includes construction details, regulations, diagrams. Postpaid \$1. Mellotone, Box 723E, Arcadia, California.

MIDGET Automobile Racing Book, 45 photos. Complete history 1946 California racing. \$1.10 postpaid. Clymer, Dept. A-126, 2125 W. Pico, Los Angeles 6, Calif.

PROFESSIONAL Midget racer, motorscooter, midget roadster, and midget motorcycle. Plans, specifications for all four contained in illustrated handbook, 25c. Big list bargain priced used motors, motorscooters, servicycles, etc., included free! Midwest, 3839 Drummond, Toledo, Ohio.

R & R Mfg. Co., marine and auto division, Anderson, Indiana, Robert M. Roof, \$1.00 for our new 1946 speed and power equipment catalogue with price sheet—showing racing cars, midgets, speed boats with recommendations how to rebuild your motors for racing. Dual ignition racing cylinder heads for V-60-100 and Mercury Ford engines. Dual intake manifolds, racing pistons, camshafts, compound valve springs, Lynite flywheels, quick change gear boxes and numerous other supplies.

AUTOMOBILE Racing book, fifth edition, well illustrated. Instructions on building bodies, frames, engines. Ford A and B conversions. Plans. AAA rules, specifications. Roadster racing. Indianapolis cars. \$1.00 postpaid, \$1.30 C.O.D. Ray Kuns, Dept. 47, Madisonville, Cincinnati 27, Ohio.

AUTO SUPPLIES AND EQUIPMENT

PATENTED Gasoline saving vacuum supercharger uses gasoline motors waste, manufacturers now using same principle high priced motors only, price \$7.90. Self-addressed stamped envelope for pamphlet. McDowell Co., 2000 NE. Union, Portland 12, Ore.

BURN Water in your car with the Vandervoel water injecting carburetor. More power, faster pickup, cleaner, cooler, smoother motor, \$22.25 complete with tank and fittings. State make and year of car. Ralph A. Shade, 563 Lake Road, Webster, N. Y.

NEW Auto parts. Write needs, Eddy, 1516 169th, Hammond, Ind.

FORGET Storage battery troubles. Build your own a.c. charger. For details write Garland Enterprises, Box 186, Windsor, Ontario, Canada.

NEUTRAL Anti-glare stops glare of wild headlights. Stops snow and road sun glare. Essential to safe driving. Restful to eyes. Place anywhere on windshield with tiny vacuum cups. Set of 3 shields \$1.00. Export invited. Gabe's, Box 615-a, North Hollywood, Calif.

BELTS—For automobiles, trucks, refrigerators, farm machines. Order your belt now! Immediate delivery! Belt Center, 1908 South Broadway, St. Louis, Mo.

33 MILES Per gallon. Center Flow carburetor throttle. Walert Company, 3429 North Tenth St., Milwaukee 6, Wisconsin.

BUILD Your own car supercharger and motor boat tone mufflers. (California). Cost only a few cents to build. Hand tools only needed. Three plans, illustrated, \$1.00 postpaid. Columbia Publications, Aberdeen, Idaho.

ELECTRIC Flares—(War surplus) non-deteriorating, approved by Electric Underwriters Laboratory. Up to 16 hour flare intensity. \$5.20 value (1 pair) \$1.98. Quantity discounts. Ideal for truck fleets; motorists; barricades; excavations, etc. Midwest Surplus Sales, 1515 Locust, Kansas City, Mo.

85 H. P. Ford transmission installed in Ford "60." Complete plans \$1.00. Wallace Crandall, Hutchinson, Minnesota.

CONDENSER Analyzer kit, light socket operated, \$4.87. Diagram 25c. Bursma, Route 5, Grand Rapids 4, Mich.

PLATINUM Ignition points for the nerve center of your car. Fast cold weather starting, smooth powerful performance, fuel economy. Complete set, \$5.69. State model and year. Jacon Industries, 3 Seaside Terr., E. Lynn, Mass.

START Your car instantly this winter, and cut your costs with a Redispark Coil Booster. Produces powerful ignition for easy starting, gas and oil economy, long dependable service. Easy to install by any one in a jiffy. Fits all automobiles (Fords prior to 1942 excepted). Redispark applies a practical scientific principle to correct electrical leaks. Is of durable construction and different. That difference is important to you. Accept no substitute. Guaranteed satisfaction or money refunded. Send \$2.00 now with make and year of car for your Redispark by return mail. Limited supply. Electronic Products Co., 4026 Clifton Avenue, Baltimore 16, Md.

FIBER Seat covers with leatherette trim. Sedan and coaches, \$15.75; coupes, \$11.50. 10% deposit required. Satisfaction guaranteed. Grilles for most cars. Meyers Auto Parts, 820 Dryades St., New Orleans, La.

RECLAIM And save on motor oil! Inexpensive, clean, easy method. Guaranteed instructions and plans \$1.00. Oil Reclaimers, 233A North Kenneth, Chicago 24.

MONOGRAMMED Automobile seat covers personalized with your initials in gold. Fit your car perfectly. Finest pre-war quality leatherette in 18 beautiful combinations with fibre, sail cloth or mercerized cotton. Priced low. Mono Auto Seat Cover Co. of Hollywood, 608 South Hill Street, Los Angeles 14, California.

AIR Compressor outfits, complete with quart size spray guns, less motors. Use your own 1/4 horse power motor. Limited quantity. Write for details. Box 172, North End Station, Detroit 2, Michigan.

HAVING Car trouble? New, used, guaranteed auto, truck parts save money. Transmission specialists. Describe needs; immediate reply. Victory, 2930 1/2 Northwestern, Chicago 18.

AUTO Parts for all autos and trucks. Trans., motors, differentials, fenders, carburetors. Also body parts. Security Auto and Truck Parts, 1941 BJ Eddy, Chicago 13.

PLATING Outfits for auto parts. Connect to a battery. No tanks used. Free particulars and proofs. Gunmetal Co., Ave. J, Decatur, Ill.

AUTO TRAILERS

TRAILER, 17 Foot Streamliner has everything. Large manual, drawings, instructions, parts list \$1.00. Illustrated circular 10c. Tudor Tandem 24 foot 3 room trailer. Large 24x36" six views floor plans giving principal dimensions \$1.00. Craftsmann Books, Box 1153-P3, Milwaukee 1, Wis.

TRAILERCOACHES—Learn about all types—sports, living or travel. Over 72 pages monthly—magazine tells all. Special \$1 year. Trail-R-News, Box 431, Glendale, Calif.

BUILD Your own trailer! Save money! Have every feature you want! Plans for house, sport, camp and utility trailers. Catalog describing 9 models 10c. 15c in Canada and overseas. Jim Dandy, Box 125-A, Wausau, Wisconsin.

MOTORCYCLES, BICYCLES, MOTOR-SCOOTERS AND SUPPLIES

LAUSON Motors (1 1/2 H.P.) for scooters, stationary and marine use. Specially built for Government. Perfect condition, slightly used. Immediate delivery. Arthur Gershel, 51 Chambers Street, New York 7.

HARLEY-DAVIDSON Parts. 24 hour service. Rebore \$2.50 per cylinder. Special rubber mask clear goggles with extra polaroid green lens \$1.29 prepaid. Philadelphia Harley-Davidson Company, 857 North Broad Street, Philadelphia 23, Pa.

1500, 8" METAL Disc wheels. Bargain. Universal, 4713 Virginia, St. Louis, Mo.

MOTORBIKE Manual containing easy to build motorbike and scooter plans, motor tune up information \$1.00. Veco Aids, Box 124, Evansville 5, Indiana.

BICYCLES. Balloon tires, boys, girls and accessories. Send dime for list. Also used bicycles. Good condition. Balloon tires. Thirty dollars. Century Cycle, 3447 Lawrence Avenue, Chicago 25, Illinois.

BUILD Scooter, midgets, Diesel conversion, motorcycle trailers, etc. Illustrated circular dime. Craftsmann Books, Box 1153-P2, Milwaukee 1, Wis.

FACTORY Built midget racer chassis \$35 less motor; Clipper motorscooter \$30; Cushman less motor \$15; motors \$4.50 up; 49 army surplus Briggs & Stratton and Lauson motors; more than 5000 small balloon tires, 10 to 20 inches high, \$1.50 up. Mailorder only. Send 25c for Big War-Bargain catalog Number 16 listing these and hundreds of other bargains in new and used motorscooters, small cars, parts, plans, etc. (35c by first class mail). Midget Motors Directory, Athens, Ohio.

CUSHMAN Motorscooter \$40. Briggs motor \$5, tires \$1.00! Send 25c for new bargain catalog packed with money saving buys in motorscooters, motorbikes, midget cars, motors, wheels, tires and parts. Gail and Company, 538 Erie, Toledo, Ohio.

MOTORCYCLE Parts, new and used. List 10c. Ballak, 811 N. 9th, St. Louis 1, Mo.

GOGGLES, Heavy duty Aero, \$4.50 pair. Summer helmets \$1.50 each. Winter leather helmets slightly used \$3.00 ea. New \$5.00 ea. Send payment with order. Western Aircraft, Hawthorne, California.

MOTOR Powered scooter, plans and instructions, 50c. Box 726, Terre Haute, Indiana.

BICYCLE Motors \$88, f.o.b. complete with all attachments. Fine Xmas gift. Send stamp for literature. Gerald Baughman, Rd. 2, Wadsworth, Ohio.

STEERING Wheels for midget autos, soap box racers. 8" \$1.00, other sizes and parts, send for list. Anderson, Bristol Road, Ivyland, Penna.

"ULTRA-Streamlined" motor scooter. Amazingly simple, inexpensive to build! Gas or electric. Both plans, \$1.50. "Speedster" electric bicycle plans (inexpensive motorcycle style hookup), \$1. Almuist Engineering, 447-64 Street, Brooklyn 20.

FLOYD Clymer publications—Book of Ariel, BSA, Norton, Triumph, Villiers Engine. Complete authentic service manuals, \$1.50 each, postpaid. Specify title wanted. Motorcycle Speedway Racing, 256 pages, \$2.00 postpaid. Clymer, Dept. A-128, 2125 W. Pico, Los Angeles 6, Calif.

NEW Bicycle engines. 120 miles gallon. Easy installation any bicycle. Send dime for folder. Clymer, Desk A-120, 2125 W. Pico, Los Angeles 6, Calif.

MOTORCYCLE Racing books: Speedway History, 256 pages, 50 photos, world famous riders, machines, \$2.00—Stenner's Motorcycle Speedway Annual, 46 photos, complete history English, Australian racing, \$1.00 postpaid. Clymer, Desk A-121, 2125 W. Pico, Los Angeles 6, Calif.

FLOYD Clymer's popular motorcycle books: Motorcycles, How to Manage Them, \$1.50—Motorcycling Manual, \$2.00—English Motorcycle Service Manual, \$1.50—Speed, How to Obtain It, \$1.50—Sample English Motorcycle Magazine, 50c—Plans build attractive motor scooter, \$2.00—Plans Electric Bicycle, \$1.50. Prices postpaid. See our classified advertisement under "Automobiles." Motorbook catalog free. Clymer, Dept. A-129, 2125 W. Pico, Los Angeles 6, Calif.

DISTRIBUTORS Of English motorcycles. Preston Motors, Inc., 1327 South Calhoun St., Fort Wayne, Indiana. Complete accessory line for all makes and models. Write for free list. New streamlined chrome mufflers, fit all makes and models of motorcycles, removable insides, complete with mounting brackets, \$9.50 chrome, \$7.50 black.

BUILD The first five passenger half-ton, three wheeled motorcycle in your locality, from Ford parts. Show your genius. Easy built, useful, handy. Nothing like it. Instructions \$1.00. Motorcycle Wizard, 73-A South Shirley, Pontiac 20, Mich.

MOTORSCOOTER \$10. Motor \$3, tires \$2! Send 25c for big new catalog Number 934 listing scores of other sensational bargains in motors, wheels, motorscooters, motorbikes, Servicycles, tires, etc. Associated, Box CS-1764, Toledo, Ohio.

LARGE Stock Indian parts. Expert motor rebuilding. New and rebuilt Chief motorcycle, motors only. Indian Motorcycle Sales, Kansas City 1, Mo.

GENUINE Moto-Scoot parts. Amsco centrifugal clutch. Windshields, sidecars. All other parts and accessories. Write for parts list. Also genuine engine parts for Briggs and Stratton, Lauson. American Moto-Scoot Co., 1313-23 Carroll Ave., Chicago 7, Ill.

WHEELS! Build wagons, scooters, mowers, trailers, wheelbarrows, grocery carts, baby carts, play pens, baby carriages. 4" to 16". Free list. Trulsen Mfg. Co., 811 E. 31, Kansas City, Mo.

HARLEY-DAVIDSON New and used 45" motors, service, parts, accessories. Send \$2.25 for army motorcycle manual, 10c for bulletins. Knuth's (Harley-Davidson factory dealer), 2491 Fondulac, Milwaukee, Wis.

MOTORCYCLE Cams ground for speed and power, carburetion. For information write Harold Schaller, 247 West Main, Turlock, Calif.

BICYCLE Book, how to buy, rebuild, sell used bicycles 50c. John Collett, Handley, Texas.

TIRES, Inner tubes, wheels, for small trucks, wheelbarrows, midget cars, power scooters, farm equipment, carts, etc. Sizes 8" to 18" o.d. in 2, 4, and 6 ply first-line quality tires, with removable inner tubes and heavy duty demountable wheels. Also caster forks, straight or swivel types. Free circular and prices. Experienced tire engineers to advise on your special equipment problems. Jahant Co., 626 East Exchange Street, Akron 6, Ohio.

TIRES And industrial wheels, suitable for scooters, wheelbarrows, farm equipment, etc. All sizes. Bicycles and accessories. Largest assortment in America. Send dime for list. Cycle Transport Company, 1241 So. Michigan Ave., Chicago 5, Illinois.

BUILD America's lowest priced motor-scooter speedster! Complete plans, specifications, \$1.00. Big list bargain priced used motors, etc., included free! Motor Supply, Box 1682-CS, Toledo, Ohio.

BOYS, Illustrated "Bicycle Repair Manual" teaches brake repairing, re-spoking wheels, etc. Dealers wanted, 65c. Robt. Klausner, Shelbyville, Ill.

AVIATION

PROPELLERS—Exclusive manufacturers Airliner 3 blade, all metal, fine quality, needs no tipping, also wooden 2 blades, fit any motor. Aircoo motor diagram 50c. Standard Aircraft, Ft. Worth, Texas.

LIGHTPLANES, All about them. Large manual \$1.00. Illustrated circulars on Scout, Eaglet, Seaplanes, etc., 20c. Craftsmann Books, Box 1153-P1, Milwaukee 1, Wis.

NEW 6 Ft. propellers, your price \$14.95. All crated, plus postage. Waterloo Aviation Co., Waterloo, New York.

B-29 COMPUTERS, Dynamotors, amplidyne, auto pilots, amplidyne servo-amplifiers, compressors, gun chargers, turret drives, generators, starters, Plexiglas domes, oxygen cylinders, sighting stations, etc. Write for details and prices. Ereco, 1006 Hewitt, Everett, Wash.

JET Propulsion—Easy ways to make experimental jet engine shells—25c coin. Circulars free. Rush order. Maupin, Tipp City 6, Ohio.

ENGINES Surplus, propellers, accessories, instruments, trainers, hardware. Write for literature. Varney, Tipp City, Ohio.

VETERANS: Flight training under G.I. bill. Private, commercial, and flight instructor ratings. Write for information. Gottschalk School of Aeronautics, Adrian, Michigan.

VOLTAGE Regulator, 24 volts, aeroplane generator Automatic by Westinghouse. \$3.95 each, 3 for \$10.00. Postpaid. Lyell Hdw. Co., Box 5, Rochester, N. Y.

CUBS, Wacos, Taylorcrafts, Aeronacs. Big catalog, 25c, lists these and thousands of other sensational airplane bargains. Some are "easy to repair" crackups. National, Box 1682-CS, Toledo, Ohio.

ELECTRICAL SUPPLIES—EQUIPMENT

ELECTRIC Meters, prompt shipments, any quantity, all sizes, D.C. or A.C. New and used. Ditto Pyrometers, Thermocouples. Service on all types. Write Cleveland Electric Laboratories, 1988 E. 66 St., Cleveland 3, Ohio.

LAMPS—If you build or repair and have trouble finding parts—your search is ended! We carry practically every part necessary. Harps, finials, vase caps, bases, etc. Illustrated catalog 10c. Gyro Lamps, 5416 Clark, Chicago 40.

ELEMENTS, Irons, toasters, 65 cents postpaid. Claudio, 67 West 101 Street, New York.

CHRISTMAS Tree lites, radios, heaters, toasters, automatic irons, broilers, etc. Jeannette Electric, 159 W. 23rd St., New York 11, N. Y.

AMAZING Value. New 110 volt-sixty cycle ball bearing precision motors. Operate grinders, fans, etc. Cost government, \$48.75. Sent express prepaid. Only \$3.69. Leco Engineering Company, 908-PM12, Lincoln, Nebraska.

ELECTRICIANS Attention: Make BX and Romax connectors for profit. Full details \$1.00 cash or \$1.10 check. Box 146, Salida, Colo.

STARTER Relay solenoids, 6, 12, 24 and 32 VDC. 1000 A. Silver contacts, \$2. New. Postpaid. Quantity discounts. Ereco, 1006 Hewitt, Everett, Washington.

FLUORESCENT Tubes burned-out? You can relight and use indefinitely. Complete instructions \$1.00. Wallingford, 121 Burlington, York, Nebr.

AUTOMOBILE Electric heater, a.c. current. Makes starting easier. Satisfaction guaranteed. \$1.95 postpaid. Harris Machinery, Minneapolis 14, Minn.

TOASTERS; Clocks; mixers; irons; other appliances. Immediate delivery. Price list. Mail Order Electric, 713 South Dearborn, Chicago.

5 POWERFUL Alnico magnets \$1.00. Ronald Eyrich, Box 849, Milwaukee 1.

ELECTRIC Fan assemblies. Make your own. Ted Riseman, 425 East Jefferson, Springfield, Illinois.

ELECTRIC Pencil—6 volt. Engraves all metal. \$1.00 postpaid. Beyer Mfg., 4515-H Cottage Grove, Chicago 15.

PRACTICAL Winding of a.c. motors. A course of instruction on winding, connecting, and testing single, two, and three phase motors. Clearly written in everyday non-technical language. Illustrated throughout. This book is recommended for beginners interested in learning motor rewinding and repair. Satisfaction guaranteed or remittance refunded. \$2.00 prepaid. Educational Advancement Co., Dept. Y, Lakewood, New York.

NOW—Repair your own electrical appliances with Chanite Self-welding Electrical Heating Element Flux. Instructions delivered, price \$1.00. Stick form 25c ea., \$2.00 doz. Chanite Sales Company, 914 South Main, Fort Worth, Texas.

WELDING, SOLDERING, PLATING

ELECTROPLATING By battery. Illustrated instructions. \$1.00. Alvin, 553 William, Winnipeg, Manitoba.

MAKE 400 Amp. a.c. welder from burned-out pole transformer. 6 plans. Various sizes \$1.00. Information dime. Hi-Point Electric, Box 539, Leesburg, Fla.

NEW Model electric welder 110 volt a.c.-d.c.; will weld all metals; easy to use; full directions. Complete with power unit, flame and metallic arc attachments, carbons, fluxes, rods, mask; all for \$19.95. Used by the navy. Magic Welder Mfg. Co., 239-MP12 Canal St., New York City.

ACETYLENE Welding outfits like new. Arcwelders, weldersbook \$1.75. Eagle Welding, Dept. PM, 5085 Broadway, Chicago 40, Ill.

WELDERS—Govt. surplus tested gasoline driven and motor generator sets. Save up to 50%. Iowa Machinery Co., Des Moines.

NEW Electronic a.c. welder. Welds radio parts, models and other small items. Blueprints, instructions, dollar. P. Johnson, Box 1171, Minneapolis, Minn.

NEW Atlas heavy duty transformer welder 110 v. a.c., 6 heat stages, complete with metallic arc and flame attachments. Supplies and illustrated simple instructions. Really 2 welders in one; including carrying case. Only \$34.50. Guaranteed one year. Magic Welder Mfg. Co., 241 GP Canal St., New York City.

HEAVY Duty 110/220 volt a.c. welders, \$68.00 to \$245.00 complete with supplies. Details free. Williams Sales Co., Box 4100, Portland 8, Oregon.

BUILD D.C. arcwelder without rewinding armature. Plans \$1.00 each. 25 to 600 amperes from automotive d.c. motors, light plant generators, automobile starter-generators. Welders Club, AB-3432, Chicago 54.

WELDING. Cutting, aircraft welding and soldering equipment. Electric arc welders. Superior Oxy-Acetylene Co., Hamilton, Ohio.

MACHINERY, TOOLS AND SUPPLIES

RIVET Guns—aluminum, air driven. Perfect condition. Famous makes. Limited quantity. Immediate delivery. \$9.95 postpaid. Free bargain catalog. Art's Surplus Mart, 1329 W. Florence Ave., Dept. M, Los Angeles 44, California.

TAPS And dies direct from manufacturer. Equip your shop at small cost. Write for free price list. King Tap & Tool Co., Inc., North Attleboro, Mass.

SPECIAL Dies, jigs, fixtures, tools, designed, manufactured. Free estimates. Colman Company, 204 North Buchanan, Amarillo, Texas.

TOOL Post grinder castings including frame, motor-mount, guard, and drawings \$7.50. Other machine tool accessories castings available. T-P Manufacturing Company, Box 7024, Dallas, Texas.

HARDNESS Tester: portable type reading Rockwell B & C scales. Free literature. Amity Products Company, Box 207C, Waltham 54, Mass.

BUILD Quickchange gear box. Craftsman 12". Atlas 10". adaptable to others. No castings required. Complete drawings \$3.00. Stevens Engineering, 2604 Military, Los Angeles 34.

ALUMINUM 8" Disc sanding wheel, 1/2" bore \$3.00 prepaid. Carles Oles, 2628-35 Ave. So., Minneapolis 6, Minn.

MAGNETIC Chucks, indicator bases, \$3.45! Unbelievable? Write, Eyrich, Box 849-B, Milwaukee 1.

OIL Heater conversion (pot burners) units. Cement mixers, block, brick machines. Blue Squarem, Excelsior, Minn.

DRILLS—1-45 H.S. with stand \$9.95. Surplus H.S. drills at big savings. Write for list. V-B Sales, Roselle, Ill.

CONCRETE Mixers—world's best! They mix faster and better. 3 1/2 cubic foot capacity \$41.50. All the advantages of big mixers. Immediate shipments made. Folder free. Wettschuracks Warehouse, Montmorenci, Indiana.

HOBBYISTS! You can equip your workshop at a fraction usual cost by building your own mill, shaper, drillpress and other shop tools for metal and woodworking from Lewis castings, materials and blueprints. Easy to complete, and ideal for home use. Send 10c to cover cost of mailing latest catalog describing 21 items. Lewis Machine Tool Co., 3217 Union Pacific Ave., Dept. M, Los Angeles 23, Calif.

GEARS For inventors, experimenters, model makers, schools, work shops, laboratories, etc. Government surplus made of brass, bronze, dural steel and stainless steel. 12 matched pairs; 24 gears, bevel, spur and ratchet. List price \$12.00, our price \$2.50. 25 matched pairs, 50 gears, includes larger gears, also sets of worm gears. List price \$30.00, our price \$5.00. 50 matched pairs; 100 gears better assortment, including worm sets. List price \$75.00, our price \$10.00. Limited quantity. Order now. Write for our bulletins on ball bearings, rectifiers, relays, selsyns, horns and government surplus materials. MET Exchange, 323 Canal Street, New York.

WAR Surplus in small tools for machine shop. Send 10c for bulletin. Travers Tool Company, Dept P, 5 Court Square, Long Island City, N. Y.

BARGAIN Assortments—48-pitch gears, assemblies. Fifty pieces \$4.75; hundred \$8.50, postpaid. Scientific Construction Co., Box 438, Hackensack, New Jersey.

SPECIAL Motor hand tool with 21 accessories \$18.50. Surplus mill cutters, large drills, tools, half price. List free. Colman, 3103 Jackson, Amarillo, Texas.

BLUE Prints and instructions to make new type lathe collet system, range 1/4" to 3/4" any steps desired. Not complicated. Ideal for home shops. Blue prints \$3.00. Prints and material \$15.00. Harry Smith, P.O. Box 623, South Gate, Calif.

CASE Hardening and coloring steel—Beautifully printed booklet of fast, sure and inexpensive methods, \$1.00 postpaid. Miles-Southeastern Machinery Co., Box 302, Bedford, Va.

LABEL Your cigar boxes, drawers, cans, jars, bottles. Increase storage space and save hours of time. A necessity in every small shop, 100 assorted labels of excellent quality, printed in extra large type with all necessary titles including all classes of tools, hardware, liquids, electrical supplies, machine screws, etc. Most titles printed on index cards for durability. \$1.00 postpaid. Dept. 12, Hinds Manufacturing Company, 223 Second Street, Niagara Falls, N. Y.

ANGLE Plate, 4" x 3" x 3" C.I. ribbed, machine finished (4) sides, \$2.00; unfinished 75c. V-blocks, surface plates, vises, etc. Free catalog. Model Tool Service, 202 Wood Ave., Rock Falls, Ill.

SHARPEN Dull pipe wrenches with new patent grinder. No competition. One operator made \$321 in one week. J. C. Moore Industries, Box 234, Fredonia, Penna.

AIR Compressors—27 volt a.c. d.c. new—3 stage. Weight 28 lbs. Cost government over \$200.00—convert with transformer or 4-1000 watt heating elements. Precision built—hook up furnished. 1500 pound pressure to square inch—motor 4500 r.p.m. Real buy—\$15.00. General Surplus Stores, 1439 Grand Avenue, Kansas City, Mo.

"PEPY" Governors make automobile motors power unit. Enclosed type. \$12.00. Circular. Harris Machinery, Minneapolis 14, Minn.

UNIVERSAL Tools dandy 10 piece set: Rigid pipe wrench, channellock pliers, adjustable wrench, Ceetee pliers, diagonal cutter, ballpen hammer, plastic screw-driver, waterpump pliers, hacksaw and blade, cold chisel, \$19.85. Universal Tool Company, 1527 Grand, PM-12, Kansas City, Missouri.

BENCH Saws, \$17.00, post drills, \$9.00. Motors, arbors, blades, jig saws. Circular 3c. Sunshine, Berkshire Heights, Penna.

HUNDREDS of tools, equipment, materials for metal, plastic workers. 70% stocked. New illustrated catalog (E), 15c. Metiplas Supply, 1420 South 16th, Maywood, Illinois.

HARDWARE. Tools, saw mandrels, model and pattern supplies, drills, taps, drill rod, steel, brass. Catalog 10c. Terek, 6304 Patterson, Chicago 34.

HOISTS For roofers, contractors. Mitchell Engineering, 6430 Evans, Chicago 37.

TWELVE-IN-ONE Precision tool. Fine tempered steel. Fits pocket. All one unit includes: adjustable nut wrench, alligator wrench, screw driver, file, glass cutter, wire stripper, staple and tack puller, straight edge, magnet, rule, knife sharpener, bottle opener. \$1.00 postpaid; guaranteed. Bishop Tools, 111 W. Washington, Chicago 2.

BALL-BEARINGS. One-fourth list price. Free list. Burgess, Box 168, Ferguson, Mo.

CONCRETE Building block machines and molds. Catalog free. Concrete Machine Co., 5129 South Compton Ave., St. Louis 11, Mo.

INDEX Heads for sale. Very inexpensive. Sixty-two different divisions. Used on small lathes, drill press, milling machines, etc. Make gears, hobbs, cutters, etc. Very accurate, and durable. Not a toy. Used by defense schools and hobbyists. Write for free folder. Long's Index Heads, 2117 East B St., Torrington, Wyo.

DRILL Grinder for twist drills \$2.95. See ad on page 271.

BOATS, OUTBOARD MOTORS, ETC.

CONVERSION Kits for Willys Jeep motors, and marine reverse gears. Arthur Gershel, 51 Chambers St., New York 7.

KEEP New or old fishing rowboat dry indefinitely. No paint, waterrot, deterioration, waiting. Inexpensive. Guaranteed instructions \$1.00. CRSA, Box 8, Nanticoke, Penna.

PLYWOOD Boat kits! Complete materials for building "Deltacraft," "Junior Dinghy," "Tadpole Skiff." Mahogany marine plywood and oak construction! Send 10c today for illustrated folder featuring these boat kits and other marine materials and supplies. Carmen-Bronson, Marine Department, Mount Vernon, N. Y.

NOISELESS Oarlocks for fishing and hunting. Aluminum with plastic bearing, smooth bearing action, fits any boat. \$4.50 per pair complete, postpaid. Forward money with order. Aluminum Marine Hardware Co., Inc., Auburn, N. Y.

REBUILT Tachometers 0-5000 and 0-8000 r.p.m. 3/8" diameter face. \$10.00 each, specify rotation. Zakarian Engineering, Box 416, East San Diego, Calif.

KAYAK Blueprints, deluxe models—catalogue 10c. Viking Canoes, Merrick, N. Y.

MARINE Power—Easily convert any Ford and Jeep motor (domestic and foreign) with Osco parts and kits. Complete catalogue 25c (coin). Osco Motors Corp., 2020 East Orleans Street, Dept. M, Philadelphia 34, Penna.

OUTBOARD Motor parts, new and used, for all makes. Our stock of used parts is too large to list. Write giving us the model and motor no. New parts for Waterwitch, Seaking, Mercury, Wizard, Lauson, Neptune, etc. New standard and over-size outboard pistons. Outboard motor cylinders honed and re-bored. Outboard Motor Mart, Inc., 309 Atlantic Ave., Boston 10, Mass.

ALL Copper water jacketed exhaust manifolds for marine conversions of automobile and aviation engines and marine engine replacements; any make, model or age. Joseph Van Blerck & Son, 397 Woodcleft Avenue, Freeport, N. Y.

BOATS And all about them. How to select, build, repair and operate. For 40 years the leading practical boating magazine. Half price trial subscription. 12 issues for \$1.00. Motor Boat, 62 Gold Street, New York 7.

TWENTY Plywood boat plans \$1.00. Catalog boat building plans 10c. The Rudder, 15 Murray Street, New York.

FORD-Mercury-Zephyr marine conversions. Catalog 10c. Lehman Manufacturing Company, Dept. D, Newark 2, N. J.

BOAT Designers are highly paid professionals. Complete course by mail. Catalog. Westlawn, Montville, N. J.

FULL Size, cut to shape boat patterns, blueprints. 7½ - 38 feet. Illustrated "Build a Boat" catalog, 10c (coin). "How to Build Boats" book, \$1.00. Cleveland Boat Blueprints Co., Dept. A-66, Cleveland, Ohio.

USED Marine motors, propellers, marine fittings, conversion manifolds. Stokes Marine Supply, Coldwater, Michigan.

ENGINES, MOTORS, DYNAMOS

WILLYS Jeep motors, rebuilt with 60 day factory guarantee. Also new motors both complete for Willys auto, marine conversion or stationary use. Arthur Gershel, 51 Chambers St., New York 7.

WIZZ Electric motor (large size.) Flashlight cell operates. Parts complete, plus illustrated instructions 35c. Eltro, 171 E. Deer Park, N. Y.

SIMPLEX Water motors. Fractional h. p. sizes: Duplex universal motors for water, oil, air, steam pressures, 250 lbs. or less, ½ to 3 h. p. Larger sizes and specials built to order. Duplex Motors, Burlington, Iowa.

150 AMPERE Generator for welding \$47.50. Extra flexible cable, 8 ft. lengths \$2.75. Other bargains. Butler Electric Company, 1885 Milwaukee, Chicago 47.

½ H.P. Motors D.C., 27 volts—easily changed to A.C. 110 volts. Only \$4.95 each. Also 1½ H.P., \$9.95 each, 1/5 H.P., \$2.50 each. All postpaid. Buy all three for \$15.00. Best buy in the world. Lyell Hdw. Co., Box 5, Rochester, N. Y.

"BUILD Your Own" gas drive arc welder easily with Hobart Generator. Save \$300 to \$500, and need only add used auto engine and chassis to build portable gas drive welder that goes everywhere after profitable construction and repair jobs. Write for free instruction book, further details. Hobart Brothers Co., Box M-1066, Troy, Ohio.

WINDING Data, listing 225 motors, single and three phase, \$1.00. Motor Data Co., Box 7631, Kansas City 3, Mo.

ATHLETIC EQUIPMENT, BODY BUILDING COURSES

BARBELLS. Specializing true olympic type. Stamp for folders. Jackson Barbells, Springfield, N. J.

BARBELLS. Exercise equipment. Courses. Special offers! Free booklet! Good Barbell Co., Reading, Penna.

DEADLY Judo—Fiercest fighting technique. Trick knockouts. (200 photographs—plus illustrations). Expert instructions. Three volumes. Complete \$2.25. Variety House, Box 46-BL, Wall Station, New York 5.

BARBELLS. Plates, solid dumbbells, 265 lb. barbell \$29.95, stainless steel bars \$6.00, revolving bars \$7.00. Texas Barbell Co., 201 Pine, Palestine, Texas.

SPORTING GOODS, GUNS, FISHING TACKLE, ARCHERY, TRAPPING

AUTOMATIC Bait—positively weedless. Greatest invention in ages. Nothing like it. Circular free. Babcock Reel Co., Oak Harbor, Ohio.

BARBELLS—Dumbbells. Factory direct. \$9.95 up. Send for catalog. Independent Iron Works, Dept. 15, 2416 East 23rd St., Los Angeles.

STREAMERS. Hair flies, leaders at wholesale, also material and hooks. One Black Ghost of Dark Tiger Streamer with catalog 25c. Bernitt's, Box 471-A, Duluth, Minn.

FISHING Poles: Native canes, bamboos, tonkins. Sample jointed native cane \$2.50. Dealers only. Bob Pace, Combs, Arkansas.

ARCHERY Catalog, ten pages. Write Chas. T. Schneider, Whitehall, Michigan.

HOWDY, Podnah! If you drink warm milk at the bar and wear lace on your shorts, you won't like Western Sportsman. It's a he-man's magazine about the new West—charging grizzlies, havalinas on the warpath, wily bucks of the high crags, fighting mountain trout, real western humor. Head a buck our way for 7 issues. Western Sportsman, 3303 Bridle Path, Austin, Texas.

CARTRIDGES. Shells, ammunition, guns, rifles, list 25c. Frank Parish, Vicksburg, Mississippi.

12 GAUGE, 00 Buckshot shotgun shells, 75 rounds \$5.00. Money order. Rudolphs, Atchison, Kansas.

FINEST Glass eyes; taxidermy supplies. Catalog free. Elwood Supply Company, Dept. 234, Omaha 2, Nebr.

BOWS, Arrows for recreation, hunting, fishing. Beautiful Archery Instruction Book. 70 pages, 50 illustrations, only 50c. Illustrated catalogue 10c. Archery Sales Service, 617 So. State, Chicago.

3000 BARGAINS, Firearms, binoculars, war relics, catalog 30c. Smith Firearms, Rummene, New Jersey.

"AMMUNITION"—New and used "shot-guns," "rifles," "handarms." List 10c. Rudolph's, Atchison, Kansas.

FIELD GLASSES, MICROSCOPES, TELESCOPES, MAGNIFIERS

TELESCOPES, Microscopes, binoculars, barometers, books. Bought, sold, repaired. All lists 10c. Rasmussen and Reece, 41 Market, Amsterdam, N. Y.

60 POWER Telescope, \$2.95. 250 power microscope, \$2.45. Send for free catalog of telescopes, binoculars and microscopes. Brownscope Company, 24 West 45th Street New York.

TELESCOPES 17 Power, 3 lenses, \$2.50. 7 power plastic \$1.49, luminous wrist compass \$2.50. Karl Gruenewald, 3837P Coolidge, Oakland 2, Calif.

EXTREMELY Clear 100X and 300X astronomical telescope easily made. Instructions 10c. Full set perfect lenses and instructions \$2.00. Carl Jamer, Manorville, N. Y.

REFLECTING Telescopes, complete. 3½" diameter, equatorially mounted. View planets, stars. \$19.75. Write Sky-scope Company, 475-P 5th Ave., New York.

FIELD Glasses. High powered, case, \$35.00 cash. Frank Payne, Route 5, Kansas City 3, Kansas.

TELESCOPES—36 Inch, 3 section, 17 power, precision ground and polished lenses, including carrying case \$2.50 postpaid. Microscope, 50 power, complete with specimen slides \$2.98 postpaid. Dept. PM, Criterion Co., 438 Asylum St., Hartford, Conn.

BUILD Your own reflecting telescope. Copy of instructions 10 cents. Catalogue free. Mayfloor, Katonah, N. Y.

BINOCULARS, Telescopes, watches. Buy, sell, trade. Paul Schweer, Donnellson, Iowa.

DOGS, PETS, BIRDS, RABBITS

HUNTING Hounds: Straight Cooners, Combination Hunters. Foxhounds, Beagles, Blueticks, Redbones, Blacktans. Reasonable. Trial. Free list. Echo Valley Kennels, Herrick, Illinois.

FOR Sale — Coonhounds, Foxhounds, Rabbithounds, Combination Hunters, Blacktans, Redbones, Blueticks, Spotted. Reasonable. Trial allowed. Literature free. Wildwood Kennels, Herrick, Illinois.

PIGEON Bargains! Genuine racing homers \$3.00 pair—6 pairs \$12.00. Franklin Morris, Batavia, Ill.

60 VARIETIES Pigeons, etc. Catalogue 10c. Jim Houck, Tiffin, Ohio.

MEAT Shortage troubles? Raise rabbits for meat and profit. Send \$2.00 for fine 250 page instruction book and sample kit of supplies. Nadri, Cleveland 16, Ohio.

SMALL Animal and fowl magazine, Badaxe, Michigan. Three years, \$1.00, sample 10c.

ANGORA Wool spinners, shearing tables, breeding stock. Write, House of Angora, Springfield, Illinois.

POLICE Puppies, blacks, whites. Ansonia Kennels, Mose, N. Dak.

ZOOLOGICAL And pet animals for sale. Illustrated catalogue, literature, 25c. Trails End Zoo-5, St. Stephen, S. C.

BUY Diamond seal rabbits. We pay up to \$50.00 each for the offspring. Continuous market price guaranteed. Prefabricated hutches, \$5.50 each. Illustrated booklet 25c with hatch plans, \$1.00. Completely automatic. Hansens Rabbitry, 1347 Miller Ave., Salt Lake City 5, Utah.

CAVIES—Best quality breeders for sale, booklet on care, 10c. L. M. Landis, Doylestown RD-1, Penna.

\$2000 PER Year raising Angora rabbits. We buy your output. Contract particulars free. Wilsons, 1065 Shryer, St. Paul 8, Minn.

BEAUTIFUL, Useful collies, collie-shepherds. Pups \$12. Paul Schultetus, New Liberty, Illinois.

RAISE Guinea pigs. Make money at home. Big demand. Booklet free. Taylors Guinea Pig Farm, Hapeville, Georgia.

RAISE Moneymaking Angora rabbits. Also New Zealand Whites. Wool \$15 pound. Plenty cash markets. Particulars free. White's Rabbitry, Lawrence, Kansas.

RAISING Rabbits, Cavies, Hamsters, Chinchillas is a growing and profitable industry. Magazine 10c. Descriptive book and magazine 25c. Book and magazine (monthly) one year \$1.00. Address Small Stock Farmer, Pearl River 15, N. Y.

RAISE Giant Chinchilla rabbits, Year round income. Ideal occupation. Tremendous demand for gorgeous furs, delicious meat. Great scarcity means large profits. We buy your youngsters. Willow Farm, R15, Sellersville, Penna.

ANGORAS, Chinchillas, giant rabbits—finest, pedigreed! Catalogue free. Book "Profitable Rabbit Raising" tells everything \$1.00; scientific self-cleaning hutch plans \$1.00; automatic feeder plans \$1.00. All three \$2.50. Grinsteeds, Dept. 15-E, Edwardsville, Illinois.

SPORTSMEN: 200 Pointers, setters, straight cooners, combination hunters, rabbit and fox hounds. Reasonable. List free. Ramsey Creek Kennels, Ramsey 1, Illinois.

RAISE Guinea pigs. Profitable, low-cost feeding, small space required, small investment. Complete details 25c. Guinea Pig Farms, 3456 West 116th St., Chicago 43.

ST. BERNARD Pups: Champion sired beauties. Franklin Young, R4, Riverhead, Long Island, New York.

STANDARD Rabbit Journal, Milton, Pa. 3 years \$1.00, sample dime.

FARMS, FARM LANDS, REAL ESTATE

HOMESITES \$450—Convenient payments. California's finest garden section. On Morro Bay's scenic shores. Wonderful fishing, hunting, boating, bathing. Fertile soil, softest water, temperate climate, congenial community. Free literature. Richard M. Otto, 6560 Hollywood Blvd., Hollywood 28, California.

WEST'S Fall catalogue: hundred pages of farm and business bargains. Free copy write West's Farm Agency, HE-3, Pittsburgh 16, Pa.

GOVERNMENT Lands \$1.00 acre up. Information all states 25 cents. National Tax Service Bureau, Majestic Building, Detroit.

WANT To be your own boss? A good farm in Canada is your answer. Low prices. Favorable terms. Drop a postal today, giving your preference as to size and kind of farm, and province in which you are interested. Address H. S. Cresswell, Canadian Pacific, Montreal.

PREFABRICATED Homes. Order at once, from \$300 up. Get our report with list of over 200 manufacturers now producing, only \$1. Nash reports, Box 1310, Glendale, California.

OZARK Lands for all purposes. Actual river frontages, 5 acres \$90.00 and upwards. Free list and literature. Hubbard, 424-I, Minnesota Ave., Kansas City 4, Kansas.

STROUT'S Blue farm catalog—27 states—coast to coast—over 1300 bargains, money-makers—132 pages. Write today. Mailed free. Strout Realty, 255-P 4th Ave., New York 10, N. Y. 7 So. Dearborn St., Chicago 3, Ill. 453 So. Spring, Los Angeles 13, Calif.

\$5.00 MONTHLY Buys 40 acres near town: price \$200.00. Free list. Box 425-P, Carthage, Mo.

OZARK Magazine, Eureka Springs, Arkansas. For homeseekers, sportsmen. Year, \$1.00.

CALIFORNIA Motels. Pay well. For circulars write Frank Dykema, 813 Gretna Green Way, Los Angeles 24, Calif.

FARMS, Ranches. All kinds, sizes. Reasonable prices, terms. Wide variety locations, climates, recreational facilities. Free descriptive folders, price lists. Milwaukee Railroad territory; Washington, Idaho, Montana, the Dakotas, Minnesota, Iowa, Missouri, Indiana, Illinois, Wisconsin Upper Michigan, R. W. Reynolds, 914, Union Station, Chicago 6, Illinois.

OZARK Farm bargains. 5 to 5000 acres. Frank, Mountain View, Mo.

GOOD Farms—ranches. Washington, Minnesota, Montana, Idaho, Oregon, North Dakota. Dependable crops, favorable climate. Write for literature, lists describing typical postwar farm opportunities. Specify which state. J. W. Haw, 119 Northern Pacific Ry., St. Paul 1, Minn.

POULTRY AND FARM SUPPLIES

BABY Chicks, champion mated. 52 varieties, 6 Hybrids, licensed inspected, blood-tested. Rush postal, large colored book free, low prices. Berry's Farm, Route 12, Clarinda, Iowa.

PRACTICAL Money-making poultry raising helps from experimental farm for only 25c per year. Five years, \$1.00. Subscribe today! Poultry Tribune, Dept. 41, Mount Morris, Ill.

EARN Spare-time dollars! Raise turkeys. Experimental farm advice and America's leading all-turkey magazine for whole year, both only \$2.00. Mail today! Turkey World, Dept. 92, Mount Morris, Ill.

YOUR Greatest poultry problem will look simple when you read American Poultry Journal regularly. 500,000 poultrymen do, why not you? 2 years 50c. 5 years \$1.00. American Poultry Journal, 534 So. Clark, Chicago.

INVESTIGATE—Osborne strain Australorps carrying the concentrated bloodlines of eight consecutive world champion egg layers. Free educational catalog shows customers profits. Osborne Farm, Holland, Michigan.

I MADE \$1000 From 1000 tomatoes using my unique methods. Detailed instructions, \$1.00. (Refundable). Alfred Dinmore, Marlborough, Mass.

BUILD Your own poultry picker. We furnish parts or complete product. Scalding tanks, gas burners, thermostatic controls, shackles, thermometers, rubber aprons, knives, etc. Bradley Mfg. Co., 15 W. Magnolia Ave., Burbank, Calif.

REVOLUTIONARY Tractor — Works anywhere, explanatory working model for 25c. Land Gear, 211-82nd St., Niagara Falls, N. Y.

RAISE Turkeys the new way. Write for free information explaining how to make up to \$3000 in your own backyard. Address National Turkey Institute, Dept. 3, Columbus, Kans.

PROFITABLE OCCUPATIONS

PAINT Plaster plaques for Christmas! Sell locally. Beautiful, clear detail. Strong, hard castings. Fascinating fun! Paying profits! Popular prices! Molding rubber, artists' brushes, paints, instruction books available. List free. Pioneer, 394AZ, Austin, Minnesota.

PHOTO Stamps. Illustrated instructions, \$1.00. Alvin, 553 William, Winnipeg, Manitoba.

SHELL Jewelry—Profitable hobby! Samples and instruction \$1.00. Shell Packages, 10c and 50c. For folder write Sarasota Shell Shop, Box 2046, Sarasota, Fla.

SCRAP Metal costing 5c pound brings dollars in finished castings. Lifetime profits. Information. Fritz Foundry & Supply, 622 N. Fulton, Allentown, Pa.

MUSHROOMS Grown. Boxes, Barrels. Illustrated instructions 50c. Spawn \$1.00. Gordons, 553 William, Winnipeg, Manitoba.

MECHANICALLY Inclined men — Own and operate general appliance repair shop. Complete, illustrated course shows you how. Welding, refrigeration, motor repair, how to get business, etc., all phases covered. Free literature. Christy Supply, Dept. 471, 2835 N. Central Ave., Chicago.

ANALYSESER; (Wisdomer; "Occupation-Tester") (Publication-serial.) Postpaid 7c. Box 6, Syracuse 10, N. Y.

IMMEDIATE Earnings, independence! Learn exclusive, non-crowded, best-paying "insect-pest control" business. We teach you how and back you up with personal guidance. Details free. Manufacturers Advisory Service (Insecticide Div.), 325 Wallabout Street, Brooklyn 6, N. Y.

ELECTROPLATE With sponge, using charger or battery. Instructions \$1.00. Mintel, Box 921, Pawtucket, R. I.

PROFITABLE Mail selling business. Write, Parcell, 2701 Main, Elkhart, Indiana.

\$3000 A YEAR—Your own business, no boss, no time clock, independence. Complete details \$1.00. Satisfaction guaranteed. Home Industries, B1354 Hollywood, Columbus, Ohio.

STORY Writing simplified. Home study. Ideal Christmas gift. Free circular. New Simple Segment System, Box 834, Spokane, Washington.

RAISE Fishworms, quick. Course \$1. Details, stamp. Stoner's, Chattanooga 6, Tenn.

PANNING Gold—Learn how. Illustrated booklet and catalogue of mining books, supplies. Free. Old Prospector, A14, Dutch Flat, Calif.

REFRIGERATION: Big profits. Easy to learn servicing, selling, buying at home. Send dime for lists of wholesale suppliers, manuals, circulars. Myers Electric, Manitowoc, Wis.

MAKE Money with signs, watches, electrical lines. Information, 25c. Grant's Service, Ola, Arkansas.

BEAUTIFUL Mirrors from ordinary glass. Complete instructions, \$1.00. Tes-Co., PM-3 P.O. Box 189, Wilkes Barre, Penna.

RAISE Domestic rabbits—Interesting. Pleasant. Profitable. Instruction folio, \$1.00. Odette Rabbitry, PO Box 5642-MP, Dallas 2, Texas.

"LATIN America opportunities" \$1.00 brings copyrighted 1947 research report listing specific firms and explaining how-when-where to apply for potential opportunities in oil, mining, aviation, etc., Pan Americana, 1663 N. Highland Ave., Hollywood 28, Calif.

\$1400.00 MONTHLY. Details, stamp. National Business Service, 3439 Michigan, Chicago 16.

SHELL-O-CRAFT Kit. All materials furnished. For ear bobs, brooches, etc. \$2.60. Also \$1.00 kit. Postpaid with free instructions. Wonderful Christmas gifts. Shell-O-Craft Co., Box 365 Station A, St. Petersburg, Fla.

"LOS Angeles boom." Post-war industrial expansion creates thousands of job opportunities at good pay. Los Angeles workers enjoy year-round delightful climate near the ocean, mountains and desert. Our copyrighted booklet lists over 300 firms. Gives data on expansion programs. Includes sample application letter telling how and where to apply. Also up-to-the-minute bulletin listing best job chances, newest projects, housing tips, \$1.00. Refund if not satisfied. Los Angeles Research Services, 507 N. Windsor Blvd., Los Angeles 4, Calif.

BIG Money making rubber stamps. Easy to learn! Small investment. Home, office, or by mail! Complete instructions—\$2.00, postpaid. Steele, 296-PM New Main, Yonkers, N. Y.

HOMEMAKER Art Craft, 155½ W. Kellogg Blvd., St. Paul 1, Minn. Seasonal novelties, plaques, painted, unpainted. Free list.

NO \$5000 Yearly profession can be mastered as quickly, inexpensively, as piano tuning. Write, Western Music, Box 931, Post, Texas.

SOAPMAKING. Easy instructions. Twenty formulas. No machinery needed. 50c. C-B, 9111 S. Hoyne, Chicago.

OUR Foreign employment report contains list of 300 firms, how to apply information, plus actual work projects in Alaska, South America and overseas. With this information it's hard to miss. Only 50c. Nash Reports, Box 1310, Glendale, Calif.

LOCKSMITHING — Profitable business or hobby! New course teaches you lock secrets and how to fit keys, de-code, masterkey, etc. Easy self-instruction lessons. Bargain price. Fascinating 100-page illustrated catalog free! Nelson Company, Dept. 2-02, Chicago 5.

ALASKA Opportunities. The Last Frontier offers many job and business opportunities. \$1.00 brings 1947 register explaining how-when-where to apply in commercial fishing, mining, aviation, timber, fur-farming, etc. Government homestead lands and free official map of Alaska. Alcan Pub. Co., 1663 N. Highland Ave., Hollywood 28, Calif.

FOR An extremely profitable lifetime business, operate a collection agency-credit bureau. Easily learned. Write: Cole & Associates, Syracuse 2, New York.

LEARN Gagwriting. Profitable new field. Free particulars. Frankel, 1508 South Homan, Chicago 23.

MINDREADING And ventriloquism. Instructions \$1.00. Alvin, 553 William, Winnipeg, Manitoba.

FORTUNE. From yard or basement. Information 25c. Dillard, Box 2807, Kansas City 13, Mo.

RAISE Earthworms, complete instructions \$1.00. W. L. Huffman, 391 Pleasant Lake, Rives Junction, Mich.

BIG Profits, full- or sparetime, anywhere. Catalog free. Polesi, 232 East 165th, New York 56, N. Y.

TYPEWRITER Repairing instructions, standard typewriters. Webers', Box 1008, Canton, Ohio.

LEATHERCRAFT Supplies. Catalog 10c. Art Craft Supply Company, 1205 Throckmorton, Fort Worth, Texas.

\$40.00 WEEKLY Made growing mushrooms, fresh, dried. Dominion patent 331583. Free spawn. North American, 169P Yonge, Toronto, Canada.

SHELL Jewelry, novelties. Easy to make at home as hobby or to sell. Beginners kit \$1.00. Catalog 5c. Burton, Box 27, Station A, St. Petersburg, Fla.

TADPOLES Make frogs, tremendous demand. Both make you money. 25c brings tell-how information. Chariton Corporation, Century Building, Chicago 4.

RAISE Profitable giant Chinchilla rabbits. Great scarcity means large profits for gorgeous furs and delicious meat. Little space. Pleasant occupation. Contact world's largest breeder. Willow Farm, R15-B, Sellersville, Penna.

WELDING—Electric arc. Learn profitable trade quickly through actual practice. Individual welder instructions at bare cost of materials. Full particulars free. Valuable welding lessons book 50c. Hobart Welding School, Box M-1064, Troy, Ohio.

WOULD You pay 3%—first \$350 made? Color-illustrated book "505 Odd, Successful Enterprises" free! Some offer occasional "day off". Start at home, office. Expect something odd! Pacific, 2207½ Cloverfield, Santa Monica, Calif.

ELECTRIC Clocks are every where you go, buildings, homes, parking lots, factories. Repairs increasing. Our easy to learn course with pictures and drawings teach you how to repair these clocks. Electronic Supply Co., P.O. Box 2350A, Houston 1, Texas.

TYPEWRITER Repairmen urgently needed. Earn \$40 to \$50 weekly spare time. Our easy to learn home study course teaches how to repair typewriters. Write for free information. Houston Typewriter Repair Service, P.O. Box 5357A, Houston 12, Texas.

ANNOUNCING Home study course in commercial baking. Practical basic training. Good field for those with aptitude. Nearly depression proof. Send for free booklet, "Opportunities in the Baking Industry." National Baking School, 1315 Michigan Ave., Dept. 3432, Chicago 5, Ill.

BOOKS, PERIODICALS, PICTURES, POSTCARDS

MAGAZINES—Business, vocational, professional. Profit by being informed on developments, opportunities, etc., in your line. Current single copies—choice of over 800 publications—all fields. Free price-list. Directory 3342 publications with addresses and subscription rates, \$1.00. Commercial Engraving Publishing Company, 34C North Ritter, Indianapolis 1, Indiana.

CAPTURED Photos. S.S. troopers. Maneuvers, parades, reviews, combat. Panzers, blitzkrieg, destroyed towns. Artillery, cavalry, mountain fighters, tiger tanks, infantry, the Dreaded "88". Six sets of ten postcard size photos. \$2.00 per set. E. Carey, 427 E. 77 St., New York 21, N. Y.

READ Nick Carter's magic story. \$1.00. Book list free. Buskett, Joplin, Missouri.

AMAZING New book gives instant solutions to 100,000 practical problems. Details free. Columbia Graphs, Columbia, Conn.

WHAT Every Mason wants. We have Masonic books for Blue Lodge, Chapter, Commandery, Scottish Rite and Shrine. Our rituals are used the world over. Send for free catalog of books and rituals for Masons, Odd Fellows, Knights of Columbus, etc. Ezra A. Cook, Publisher, P.O. Box 796-PD, Chicago 90, Ill.

FREE Books—A Guide to Good Reading, is the best book selection and buying catalog published. Contains 6,000 titles for all ages, described and classified. Our free book offer is explained in detail on page 3 of our catalog. Send for your copy today! Absolutely free! Follett Book Co., Dept. 643 - 1255 So. Wabash, Chicago 5, Ill.

CASH In on our national advertising campaign. Fastest dollar seller ever offered. Marshall Adrian Company, 371 Colorado Building, Denver, Colorado.

BOOKLOVERS! Our members save on every book in print. Plan new and different. Write for interesting particulars and free copy of "Books Current." Center Book Club, 243 Market, Newark 2, N. J.

BOOKS For busy people help solve your problems. Seven Cures for a Lean Purse, Successful Home Treatments for Troubled Feet, How to Write Stories That Sell, How to Read Character at a Glance, \$1.00 each, literature free. Books by mail, 3820 Grand Ave., Des Moines, Iowa.

UNUSUAL Merchandise, novelties, literature, swap offers. Latest "Hows" for mail dealers, homecrafters in MMM magazine. Dime brings copy. AC' Chervence, Box 791, Chicago 90.

VETERANS—Beautiful South Sea Island photographs, tropical scenes, native life. Twelve 4x6 hi-gloss, \$1.00. Fifty \$4.00. Kinnicutt's International Foto Service, 3537 Fruitvale Ave., Oakland, California.

FREE Book offer—Re-vitalize your life. Fascinating instructional books on unusual topics of keenest interest. Write for illustrated literature. Kester Brothers, 149-A Broadway, Newark 4, N. J.

SIMPLE Lessons in astrology. \$1.00 postpaid. Kelton, 4724-14th, Detroit 8, Mich.

HORATIO Alger books. Bought, sold, exchanged. Send wants. Clifton, Box 1377, Beverly Hills, Calif.

PLAY Piano accompaniments, chart, self instructions, 50c postpaid U. S. Wrightway, 26 Garrison St., Paterson, N. J.

OFFICIAL Nuremberg war trial, Bikini atom bomb test pictures. 20-4x5 glossy prints, \$1.50. Other sets available. Official War Pictures Co., Dept. PR, 64-40 98th St., Forest Hills, L. I., N. Y.

TECHNICAL, Religious, information books. New, used, fit your needs. Edwards, 324 North 18th, Quincy, Illinois.

IF You want more income, health and happiness order Callahan's "Success" book. It will certainly increase your ability, develop constructive thinking and better your condition. Now selling coast to coast. Prepaid to you, \$1.00. Mission Village, Los Angeles, Calif.

STRANGE, Interesting and unusual books, write for free catalogue. Fallor Company, 201 Dewey Street, Newark 8, New Jersey.

BOOKS! (Out-of-print, scarce): Quickly supplied. Send wants. Spotlight, 141 Broadway, New York.

BOOKS! All kinds! Stamp brings list. Monica Lake, 815-A East Fourteenth Street, Brooklyn 30, N. Y.

ATOM Bombed Nagasaki, 15 photos \$1.00, 12 Aleutian photos \$1.00. Makins Pictures, 538 1/2 Washington, Bremerton, Wash.

YOU Too can read handwriting! Ten lessons, beautifully illustrated, \$1.00. Astonish your friends, make money. Satisfaction guaranteed. \$1.00 analysis of your handwriting free. St. John, Noel, Missouri.

MAGAZINE Export Sales Company, 2084 First Avenue, New York 29, N. Y. U. S. A. Over-issue popular American magazines and pocket-size novels. Comics, fashions, pictorials, romances, screens, pulps, many others. Export only.

BOOKFINDERS! (Scarce, out-of-print unusual books.) Quickly supplied. Send wants. Clifton, Box 1377PM, Beverly Hills, Calif.

BOOKS, (Out-of-print, new, used) quickly supplied. Many 35c bargains. Catalogue. Mid-West Book Service, 18870 Marx Ave., Detroit 3, Mich.

BIG Profits taking subscriptions for all magazines. Agents' confidential catalog listing over 2500 periodicals and complete starting supplies free. Pines Subscription Agency, Flushing, New York.

SELF-EXPLAINING Bible: Illustrated circular free. Box 446-P, Minneapolis, Minn.

GOOD "Used" self-instruction educational books on all subjects bought, sold, rented, exchanged. Satisfaction guaranteed. Complete information and 100-page illustrated bargain catalog free! Write—Nelson Company, Chicago 5.

MAGAZINES (Back dated)—foreign, domestic, arts. Books, booklets, subscriptions, etc. Catalog 10c (refunded). Cicero's, 863 First Ave., New York 17, N. Y.

"TRUE Christian Religion." To obtain a free copy of an 80-page digest of this remarkable work by the famous scientist, philosopher and theologian, Emanuel Swedenborg, send your name and address to Swedenborg Foundation, Inc., Room 1649, 51 East 42 Street, New York 17.

GAMES AND ENTERTAINMENT

NEW—Rig-a-Jig the wonder toy from Hollywood. Builds anything from steam shovel to doll furniture. Small size, \$1.25, large \$1.95. Graff, Box 1386, Milwaukee, Wis.

JIGGERS, Dandy table game, 25c. Nice for gift or party. Distributor, 2921 N. 2nd St., Milwaukee 12, Wis.

PLAY Pool professionally. Complete course \$2.00. Pamphlet sent free. Box 268, Hindsboro, Ill.

A CHRISTMAS Gift which brings lasting enjoyment and benefits to your child. Fascinating game. Children 2-7. Free literature. Graff, 1943 N. 37th St., Milwaukee, Wis.

"84 CARD Tricks," 25c! Free; "Money-making Opportunities!" Hirsch's, Spring Valley, N. Y.

PLAY Football on checkered 15" x 26" matboard field. Adjustable goals, 23 characterized wood counters. 50 pages of instructions, games, plays, diagrams. \$1.65 post paid. Nat'l Scrimmage Club, 2220 North 33rd Avenue, Omaha 10, Nebraska.

"INTERPLANETARY": Sensational new game. Astronomy. Educational, fascinating. Beautiful board, eight colors. 100 plastic, interlocking poker chips in five colors. Catalin dice, kasaloid space ships. \$2.50. Interplanetary, 211 Utica Street, Fulton, N. Y.

MAGIC TRICKS, PUZZLES, JOKER NOVELTIES

MAGIC Trix—New, different. Sample trick and literature 25c. Industrial, Box 1726, Portland 7, Oregon.

VENTRILOQUISM Taught. 3c stamp brings particulars. Smith, 801 Bigelow, Peoria, Ill.

SEND 50c And we will send you our 84 page catalog. Also 50c trick free to get you started. The Mystery Mart, Dept. PM-1, 737 N. Jackson St., Milwaukee 2, Wis.

HAVE Fun! Tell fortunes with egg whites! Send \$1.00. Shirley, 810 1/2 Wayne Place, Fremont, Ohio.

ATTRACTIVE Magic kit of 10 tricks (\$2.50 value) \$1.00. Playing cards containing over 12,000 secret marks, \$1.00. Kogel's Magic Novelty Co., 6751-A Colbert St., New Orleans 19, La.

BE A magician. Large professional magic catalogue of latest tricks 25c. Ireland, C-109 North Dearborn, Chicago 2.

JUMPING Candy—"It's a joke, son!" Watch 'em jump when they open this wrapped candy you give them! Send 25c to Wynn Novelty House, Dept. RS126, 3232 Lorain, Cleveland 13, Ohio.

STARTLING, Bewildering Hindu mystic trick 10c. Postways, Box 5325, Philadelphia 42.

TRUE Secret of ventriloquism. Complete information free. Quackenbus, Big Flats, N. Y.

MAGIC Playing cards. Easy directions explain secret code on back of each card. Can do many kinds of magic tricks. Only \$1.50. M & N Card Co., P.O. Box 1463, New Haven, Conn.

BIG Mail! Magic and hobby magazines. All postpaid 25c. Magic, Box 35A, Irvington 11, N. J.

WORLD'S Largest professional magic shop, keeps you in touch with latest tricks. To receive mailings, send 35c for new catalog. Holden's, M220 West 42nd St., New York.

NEW Simplified card tricks amazing self-working bafflers, \$1.00 postpaid. The Roundtree Agency, 529 Elliott St., River Rouge 18, Mich.

MAGIC! Big illustrated lists and three baffling new pocket tricks! 25c. Modern Magic Shop, Woodbury, Conn.

ENTERTAINING Card deck routine The Auction, \$1.00. Ehbör, Box 6837, Philadelphia 32, Penna.

NEW! Exciting! Sensational! Gigantic joker novelty and magic trick assortment, \$1.00. Samples, 10c. Harley Steele, Maumee, Ohio.

AT Wholesale, jokes, tricks, puzzles. Gross lots. Ventrillos \$5.40. Famous T puzzle, jockey puzzle, sneeze powder, \$3.60. Luminous paint, \$7.50. Three hundred other items. 1/3 cash, balance c.o.d. P. Schwamm, 237 East Ninth St., New York 3, N. Y.

I'LL Bet you can't! Sure-fire challenge tricks with pocket objects. You can do them, but the other fellow can't! No skill, no make-ready, 120 show-how pictures. At leading bookstores, or \$1.00 postpaid. Lewis Kohrs Company, 2208-M Stuart Street, Berkeley 5, California.

"MAGIC Vanishing card." Throw it into air, it completely disappears, reproduce it later from spectators pocket. Easy to do. Complete, 25c with magic catalog. The Magician, 2463-C Kensington Ave., Philadelphia 25, Penna.

200 ELECTRIC Stunts, 110 volts, \$1. Kutting Sons, Campbell, Calif.

TWISTED, Tangled wire puzzle, 10c. Scheetz, Branch Ave., Sellersville, Penna.

CUT-RATE On magic tricks. Send stamped envelope. Sandell's, 66 W. 71, New York City.

UNTIE Knot in human hair. Instructions, 50c. Details, listings, free. Newton Company, Bonham, Texas.

VENTRILOQUISM, Ten lesson course only \$1. LeSueur, 77 Wellesley, Toronto, Canada.

500 TRICKS! New 1946-7 edition Douglas famous catalog now ready, only 10c. Brand new magic for pocket, parlor, club, stage, professional, amateur. America's fastest service to magicians everywhere for over 25 years. Send 10c today. Douglas Magicland, Dept. 1, Dallas, Texas.

EARN Money in any crowd. Call names of strangers, tell unspoken questions. Professional course mind reading, faked spiritualism, etc., \$1. Henderson, Box 341, San Bernardino, Calif.

AMAZE And mystify your friends with highest quality magic. New catalogue 25c coin. Mazda Magic Co., 1135 Westgate Ave., Oak Park, Ill.

LARGE Illustrated professional catalog 10c. Williams, 900 Plymouth, Ellwood City, Penna.

NEW Vanishing key and catalog 25c. Sterling Magic, Box 191, Royal Oak, Mich.

FREE! Large catalog of magical apparatus if you remit 25c for "Magic Is Fun" magazine. Robbins Co., 152-F West 42nd Street, New York.

ENTERTAIN! Mystify! New, bigger magic catalog and 4 secret tricks 25c. Herbert, P-192 N. Clark, Chicago 1.

MAGIC: Big 160 page Illustrated Catalog Latest Magic Goods, 25c. For over 1/3 century we have supplied Professional as well as Beginner. Chicago Magic Co., 2300 N. Mason, Chicago 39.

MAGIC Tricks, puzzles, books, cards, punch boards. Catalog 10c. Specialty, Box 671, St. Louis 1, Mo.

COINS, TOKENS, CURRENCY

WILL Pay \$10.00 each for certain Lincoln pennies! Indianheads \$50.00; dimes \$1,000. Catalogue 10c. Federal Coin Exchange, 12-PM, Columbus, Ohio.

OLD Money wanted. Will pay fifty dollars for nickel of 1913 with Liberty head (no buffalo). We pay cash premiums for all rare coins. Send 4c for large coin folder. May mean much profit to you. Numismatic Co., Dept. 20, Fort Worth, Texas.

COINS, Minerals, glass, Indian relics. Catalogue 5c. Cowboy Lemley, Las Cruces, New Mexico.

FREE List coins wanted. Highest prices. Clint Kellogg, Burbank, Calif.

INDIAN Head penny with list 10c. Charles Banker, Salina, Kansas.

WE Pay \$2.00 to \$500 each for hundreds of old or odd coins. Indian-Head, Lincoln and foreign coins wanted. Keep all until posted. Send 20 cents for new illustrated coin value book, 4x6. Buying and selling prices. 40 years in business. Coin Exchange, (2), LeRoy, N. Y.

FIFTEEN Different uncirculated Lincoln pennies \$1.00. Olson, 434 North Menard, Chicago 44.

BARGAINS' \$1.00. Collection contains large cent before 1857, Indian cent before 1880, 1890 cent, 1909 V. D. B. cent, 1923-S cent, 2c piece, foreign coin, foreign bill, and complete buying and selling catalogue. Catalogue alone 25c. Worthy Coin Corporation, 152-B Washington, Boston, Mass.

NEW Coin buying list 10c. 209 South Church, Rockford 27, Ill.

START An Indianhead penny collection, 18 different dates mounted in Whitman board and price list \$1.00 postpaid. John Handy, 1403 Tenth Avenue, Greeley, Colo.

FIFTEEN Different coins and bills 25c. Oddehon, Box 482, St. Louis, Mo.

LINCOLN Pennies—1910S, 1912S, 1913S, 1914S, 1915S, 1921S, 1923S, 1924S, 1926S, 1931D, 1932D, 1933D, 10c each. Complete price lists 3c. Reynolds, 1118 Mathews, Flint 3, Michigan.

FOR Sale: 1893 Columbian half dollar, 60c; 50 assorted Indian head cents, \$1.00; 50 foreign coins, \$2.00; large coin price list, 10c. Ben's Coin Company, 72 West Washington, Chicago 2, Illinois.

GET Profit and pleasure in collecting old coins. Send 10c for 56-page illustrated coin catalog. You'll be delighted with it. Send for it now. B. Max Mehl, 370 Mehl Building, Fort Worth, Texas. Largest rare coin establishment in U. S. Established 46 years.

FOREIGN Coins, paper money. Worldwide selection twelve different odd unusual only 25c. Richard Webb, Box 843, San Bruno, Calif.

WORLD Coins—List free. Harry Elsholz, Box 9014, Pittsburgh 24, Penna.

COMMEMORATIVE 1/2, Oregon, Texas, Kentucky, Cleveland, Long Island, \$2.00 ea. Illustrated catalogue 25c. Norman Shultz, Salt Lake 9, Utah.

FREE! Foreign coin, banknote and coin collectors illustrated catalog to approval service applicants. Send 3c postage. Tat-ham Coinco, Springfield-125, Mass.

OLD STAMPS WANTED

I WILL Pay \$100.00 each for 1924 1c green Franklin stamps, rotary perforated eleven (up to 1,000.00 each unused). Send 6c today for large illustrated folder showing amazing prices paid. Vernon Baker, (PM612), Elyria, Ohio.

STAMP COLLECTING

COMPLETE Mint sets of Yugoslavia, Hungary, Italy, former Italian Colonies and the Vatican on approval. Reasonable prices. Henry Connor, 1842 Seyber Street, Philadelphia, Penna.

500 DIFFERENT, 50 Countries, \$2. 1000 different, 50 countries, \$6. 3000 mixture, \$3. Approvals. Griest, 623 W. 4th, Davenport, Iowa.

25 BEAUTIFUL Stamps from 25 French colonies and our price lists. One silver dime. Stamp Sales, Box 1649-P, Oakland 4, California.

UNITED States collection. 104 different commemoratives including Columbians, Pan Americans, Pan Pacific, bicentennials, parks, famous Americans. Price \$1.00. Approval applicants only. Orange Stamp Company, Albany, New York.

MIXED 125 China, Mexico, Argentina. \$1.03. Hannafin, 121 1/2 S. Rocheblane, New Orleans 19, La.

EGYPT 20 Different—10c with U. S. and foreign approvals. Arnold Herman, 539B East 54th Street, Brooklyn 3, N. Y.

CARIBBEAN Stamp and Exchange Club, world-wide membership. Swap stamps, coins, etc. Year \$1.00. Raymond, 1616 Anthony, Columbia, Missouri.

FREE—Commemoratives, airmails, pictorials. Approvals. H. P. Wischart, Frankfurt 1, Ohio.

CANADIAN And general approvals. Lists. London Stamp House, London, Canada.

FREE. Irish commemorative collection, including dramatic Easter Rebellion issue with approvals. Raymax, 123-Z William St., New York City.

WE Specialize in 1c to 10c approvals. Let us send you a trial selection. Russell Holcombe, Canton, Georgia.

FORTY Stamps from forty countries 6c; approvals. I. Tesmer, 218 Carlton St., Buffalo 4, N. Y.

FREE! Fifty different stamps to applicants for our United States approvals. Send postage. Mr. Thompson, 392 Chelmsford, Lowell, Massachusetts.

ROOSEVELT Memorials. Two beautiful sets. Nicaragua 10c. Greece 20c with world wide approvals. G. A. Hegenbarth, 1545 Ardmore Ave., Chicago.

PRESIDENT Roosevelt issues. Attractive Nicaragua, Argentine, Greece. Approval applicants 10c. Oak Stamp Service, 137 Oak, Gardner, Mass.

"HITLER Stamps" 12 different unused 25c. Hartunian, 1625 Laguna, Santa Barbara, Calif.

JAPANESE Invasion money and 100 different foreign stamps, 10 cents. Nagle, 1101 Marion, Reading, Penna.

EXCHANGE Stamps the modern way. Send 50 different and dime, receive 50. Modern Exchange, Box 995, New Haven 4, Conn.

10 DIFFERENT U. S. over 40 years old, 5c. Foreign, U. S. approvals. Scott, 30 Baker Ave., Lexington 6, Mass.

TWO Pounds U. S. mixture \$1.00. Stephan Schrod, Box 3140, Route 4, Tampa, Florida.

INDIA Mission mixture! 500 \$1.00. Satisfaction guaranteed. Super-Exchange, Cranford, New Jersey.

100 DIFFERENT Stamps for 5c and approvals. Gottardo, 1226 Rossell, Oak Park, Ill.

MEXICO 400 Mixed \$1.00. Numerous pictorials and commemoratives. Biel's, Apatado 2887, Mexico City, D.F.

AROUND The World—30 different countries—Includes Basutoland, Nyassaland, Tangier, Cyprus, Ascension. All for 10c to approval applicants. Excello Stamps, P.O. Box #95, Hackensack, N. J.

FREE—Mint complete Argentina Roosevelt with foreign approvals. 20th Century, P.O.B. 3413, Philadelphia 22, Penna.

ILLUSTRATED Stamp Magazine, 26 weeks 25c. Stamp Journal, Kalamazoo, Michigan.

MONTENEGRO Colorful pictorial set, 10c with approvals. Vargo Stamps, 6044 South Fairfield, Chicago 29, Ill.

105 DIFFERENT Including Vatican Cardinal set. 10c to approval applicants. Quality Stamp Company, Department M, Box 202, Sta. F, Buffalo 12, N. Y.

POSITIVELY Greatest free offer—Lat-est Scott's International \$5.00 stamp album, covering entire world, contains 36,000 illustrated descriptive spaces; Scott's 1947 Standard \$6.00 catalogues "Philately's Encyclopedia"—absolutely free to applicants for foreign approvals becoming customers. Plymouth Specialty Company, Dept. A-9, Bell, California.

50 DIFFERENT—Including Seychelles, Caymans, Ceylon, triangle, giant, midget, diamond, odd, queer stamps. Everything 5c with approvals. Free albums, sets, supplies to customers. Regent, 316 Flatbush Ave., Brooklyn 17, N. Y. Dept. 25.

SPAIN'S "Nude Goya" set complete 30c. Approvals. Royal Stamp Company, Tamaqua 1, Penna.

WILL Rogers Nicaragua complete air mail set of five. 3c to approval applicants. Murray, 2152 Vogel Road, Evansville 14, Indiana.

HUNGARY. 100 Different. Many recent. 15c with approvals. Franciscan, 376 Oak St., San Francisco 2, Calif.

U. S. COLLECTION—Thirty different fine unused commemoratives before 1939 including Columbians, bicentennials, parks price \$1.00 approval applicants only. Fort Orange Stamps, Albany 7, New York.

\$1.00, \$5.00 U. S. Postage dues—3c with approvals. 211 U. S. commemoratives—50c. Riffle, 211 Jefferson, York, Penna.

300 DIFFERENT Given free with approvals. Postage 3c. Windsor Stamps, 1435 East 6th Place, Chicago 37.

WHAT Have you to offer? A collection? A "shoe box" accumulation? Anything in stamps. We urgently need them. Spot cash paid. Cosmopolitan Stamp Co., 1457 Broadway, Dept. 12-E, New York.

STAMPS 100 Years old. It is now 106 years since the world's first stamp was issued. Every collector should have at least a few stamps 100 years old or nearly so, but have you? Probably not because most early stamps are hard to get and are therefore not often offered. Nevertheless, we have prepared a selection of 12 all 19th century stamps. Very old, everyone of them, even if not fully 100 years old. We will send these for only 10c to sincere approval applicants. Write for them today, and kindly state whether approvals shall consist of United States or foreign stamps, or both. Approval Headquarters, Globus Stamp Company, 268 Fourth Ave., New York City 10, Dept. 201.

FLAGS! Flags! Flags! Beautiful collection flag stamps (value 25c). Manchukuo census set (value 8c). Packet 25 countries (value 57c) including scarce Macao, Morocco, etc. Perforation gauge (value 10c). Total value \$1.00. All—10c to approval applicants. Odd Stamps Co., Dept. A-4, 5391 Metropolitan Station, Los Angeles 55.

COLLECTION Builders! 750 mixed \$2.00. You'll re-order! Bob Harris, Box 144, Colorado Springs, Colorado.

31 DIFFERENT With George Washington stamps from Brazil and Ecuador; Pirate Island; victory issue; medical set; others—all 4c with approvals. Grayson Company, Sherman, Texas.

UNITED Nations, scarce 5c U. S. commemorative and packet 30 different U. S., including airmail, commemoratives, revenues, etc. Catalogs 65c—to approval applicants for 5c. Curhan Stamp Company, Dept. H, Gloucester, Mass.

BRITISH, Spanish, French Colonies, Vatican, Hitler heads, and airmail packet. Free with approvals. Pan-American Stamp Co., Box 145, New York 33, N. Y.

100 DIFFERENT—Mint, used, 10c with approvals. CM Stamps, Lewiston, Maine.

25 DIFFERENT Australia, Canada. Free. Approvals. Central Stamp Company, New Providence 1, New Jersey.

XMAS Greetings! Free gifts to customers. Send for list and United States approvals. Jarr Stamps, Box 217-D, Madison Square, New York 10.

FREE Illustrated price list. John Gerlach, 1427 South 12th, Sheboygan, Wis.

THIRD Philatelic exhibition sheet 25 cents. Approvals sent. Louis Merrill, 1623 5th, Portsmouth, Ohio.

FINE Stamps on approval. References appreciated. Chadakoin Stamps, Box 495-M, Jamestown, N. Y.

FREE Greek occupations to approval applicants. Seiden, 1331 Intervale, New York 59.

FREE—Beautiful new issues. Chinese, Hungarian, Italian, triangle to approval applicants. Green and Company, Norwood 12, Ohio.

U. S. COMMEMORATIVES, 20 different 5c. Henderson, 962M 72nd St., Brooklyn 28, N. Y.

\$1.00 WILSON—5 Airmails—Approvals—5c. O. Burgett, Lima, Ohio.

LESS Than 300 U. S. in your collection? You need my progressive U. S. approvals. Precancel selections also available. Cole, 43 Rinewalt, Williamsville, N. Y.

ADULTS Only, Honduras Roosevelt free. Approvals. Davis, 810 North 31st, Waco 2, Texas.

SET Of twelve. 1940 centennial postal stamps. Gummed, unperforated. Price 15 cents sheet. 7 sheets dollar. Postage paid. H. Madigan, Box 862, Dunedin, New Zealand.

WHAT A Bargain! 10 different Vatican including Cardinals, 10 different San Marino and beautiful large pictorial set Italy Polish Corp all for 10c with approvals. Aldee, Tremont Station, Box 38, Bronx 57, N. Y.

LIBERAL Offer! Rhodes, Libia, Eritrea, Guiana, Djibouti, Rhodesia, etc. Everything 10c to approval applicants. Sovereign Stamp, 57 Casot, Quebec, Canada.

\$3.35 CATALOGUE Value for only 10c. Gorgeous bicolored issue depicting Greece Glories (12 values). Send dime today for this outstanding offer. Imperial Stamp Co., P.O. Box 1491, Tampa 2, Florida.

FREE Premium to approval applicants. Stamps, 1267 Tutwiler, Memphis 7, Tennessee.

UNITED States souvenir sheet to approval applicants sending dime. Pomeroy, Minnetonka Beach, Minnesota.

25 DIFFERENT Peru 10c with approvals. Batch Stamp Service, Box 294, Elmhurst 1, Illinois.

HAWAII #35 (scarce) 10c. Approvals. Millhiser, 7724 Abbott, Pittsburgh 21, Pa.

FRANCE Bi-color Coat of Arms set 10c to approval applicants. Irving Solomon, 3716 Kings Highway, Brooklyn 10, N. Y.

BERLIN Bears, complete set of eight and 100 different stamps only 10c to approval applicants. Reich Stamp Co., 4647 Kenmore, Chicago 40, Ill. Dept. M11.

100 DIFFERENT Hungary, or 50 different Finland, 10c with approvals. Paul Rawden, Box 2920, Westville, New Haven, Conn.

100 U. S. COMMEMORATIVES, Airm etc., 10c, 300—25c. P.O. Box 457, Newark 1, N. J.

FREE—French "Coat of Arms" set to approval applicants. Wolf, 3202 Columbia Ave., Philadelphia 21, Pa.

25 GUARANTEED Stamps—10c with approvals. Midwest Stamp Company, 3303 Paseo, Rm. 24, Kansas City 3, Missouri.

25 DIFFERENT U. S. free to popular approvals. References please. Stanley Rumont, P.O. Box 996, Mobile, Ala.

8 DIFFERENT Triangle and diamond beauties, 10c to approval applicants. U. S. and foreign price lists on request. West Stamp Co., Box 154, La Mesa, Calif.

UNITED States Mint. #487A, #496, #627, #655, #670, #671, #687. Send 65c. Approvals accompany. Whiton-Stamps, Westport 4, Connecticut.

FREE 110 Different stamps to approval applicants. Postage appreciated. Barwis, 4748A Umbria, Philadelphia 27, Penna.

NETHERLANDS War set 10c with interesting approvals. Rheume, 8949 Routhier, Montreal, Canada.

EXCHANGE Your duplicates! Write for details. Robert Tromp, Danville, Calif.

ATTENTION! 5-5c sets—5c with approvals. Lawrence, Box 1616, Hartford 1, Conn.

50 DIFFERENT U. S. & foreign 3c. Budwitz, P.O. Box 108, Meriden, Conn.

FREE Monthly illustrated new issue stamp guide. Extra—new Burma Java set. 40c. Economical Suppliers, Box 758, Bridgeport, Connecticut.

FREE Sensational offer! U. S. \$1.00, \$2.00, \$4.00, \$5.00, \$10.00 stamps all for 3c postage with approvals! Thrifty Stamps, 727 Silver, Silver Spring, Md.

\$2,000 IN Stamps free to contest winners. Particulars, entry blank, to approval applicants enclosing only 10c for scarce Roosevelt Mourning stamps from Nicaragua, Greece and Argentina, plus photograph of "Roosevelt Collecting Stamps." National Stamp Sales, 276A West 43rd Street, New York 18, N. Y.

100 DIFFERENT Foreign stamps—15c; 150, 25c; 200, 35c; postpaid. No approvals. Gregoire, 507 Montgomery, Manchester, N. H.

20,000 VARIETIES 1c-5c each! Gordon Davison, Box 1019B, Manchester, N. H.

RARE Miami Cachet cover free with approvals! Miami Stamp Company, Box 2437, Miami, Florida.

FREE Hitler head, French Colonial, air mail, Vatican City packet to approval applicants. Nitta Yuma Stamp Co., Harrods Creek, Kentucky.

50 DIFFERENT Cuba, 35c; 50 different Colombia, 50c; 20 different Mauritius, 65c; 100 different Uruguay, 75c; 100 different Ecuador, \$1.00; 125 different Sweden, \$1.25; 100 different Costa Rica, \$3.00; 500 different French Colonies, \$6.50. Mission Mart, Washington 17, D. C.

UNPICKED: 5000 U. S., \$1.00; 2000 foreign, \$1.00; 500 mint new issues, \$3.00. Satisfaction guaranteed. Kuhn, 3315 80th, Jackson Heights, N. Y.

80 DIFFERENT U. S. commemoratives, \$1.00. Wonderful Christmas gift. Robert Gallup, Albany 3, N. Y.

SEND Today for: "The most beautiful stamps of 1946!" It's the new Belgium Crusader issue! They are giants, standing 2" high and superbly engraved. This outstanding set only 15c with our "honest-value" approvals. "Stanley the Stamp Man," 4232-A South Pine Ave., Milwaukee 7, Wisconsin.

75 DIFFERENT Free to approval buyers. References appreciated. Dunnebacke, 617 Genesee, Lansing 15, Mich.

1200 MARVELOUS Mix, \$1.00. Flying Mail, 1543 High, Utica 3, N. Y.

ST. Lucia, Ceylon, South Seas, Levant, Caucasus, all 3c with approvals. Hall, 610 Brackenridge, Corpus Christi, Texas.

BREAKING Up large foreign collection. Approvals by countries. Lion, 200 W. 81 St., New York 24.

WORLDWIDE, 100 Different stamps, 5c with approvals. Boerger Stamps, 206 Main, Toledo 5, Ohio.

JAP Occupied Philippines 5 different 10c. 10 different 30c. 15 Vatican City 10c. U. S. flag set (13) 99c. Approvals. Al. Johnson, 727 North Foote, Colorado Springs, Colorado.

ARGENTINA Roosevelt, 5c to approval applicants. Wm. O'Kane, 1246 Draper, Chicago, Ill.

FREE! Philippines—Japanese occupation pictorials. Approvals. Stampco, Miami Springs, Florida.

WORLDWIDE Packet from Pacific Islands, Asia, Africa, West Indies, South America, etc. 50 different 10c. Approvals. Stamps bought, Worldwide, 219P Nassau, Oshawa, Canada.

ROOSEVELTS Nicaragua (2), 5c to approval applicants. Collins', 71 Coleridge, San Francisco 10, Calif.

RICH Man's approvals, poor man's prices. Grand value packet containing five foreign sets, free with approvals. Stoll Stamp Service, 2630B West Burnett, Louisville 10, Kentucky.

BREAKING Up good sized collection. Have made early issues packets containing 19th century exclusively. Many countries represented. 100 different including mint items, \$2.00 Other bargains also. What do you collect? Alatalo, 14-N Marlboro, Maynard, Mass.

GERMAN Semi postals two different used, 5c with approvals. Demordy, 911 Shelmire, Philadelphia, Penna. 11.

WOW! \$10.00 Worth of fun only 10c. What a treasure hunt! Big package 500 foreign stamps—just as received from foreign missions other sources. Includes stamps from Africa, South America, Philippines, Free French, Cape Juby, Palestine, etc., including airmails, commemoratives, and stamps worth up to 50c and 75c. This amazing offer is given for 10c to serious approval applicants only. One to a customer, money back if not more than delighted. Jamestown Stamp Co., Dept. 22, Jamestown, New York.

EXCHANGE Stamps universe. Particulars free. "Exchangers," Bry 126, Seine, France.

BEAUTIFUL Collections wholesale \$1.00, \$2.00, \$5.00; approvals. Ehde, Amiret, Minnesota.

500 DIFFERENT Foreign, \$1.00. 50 countries represented. F. & J. Service, Box 434, Bellmore, N. Y.

100 DIFFERENT Hungary. New material 50c. Jem Stamps, Port Jefferson, N. Y.

NEW Mint Paraguay flag set (3) 15c with approvals. Clouse, 430 Glessner, Mansfield, Ohio.

ROOSEVELT, Churchill, Stalin, Hitler and Vatican City stamps free to approval applicants. Elliot Stampco, 86-31 Elliot Avenue, Rego Park, N. Y.

FREE. Two New Zealand mint triangles plus New Zealand centennial with approvals. Veteran Stamp Co., 169 Kensington Ave., North Hamilton, Canada.

WORLD'S Largest triangle stamp, included in rare Russian set of picturesque designs, mammoth stamps. This complete set including giant triangle retails for \$3.00 but only 10c to approval applicants. West Coast Stamp Service, Box 344, Hollywood Station, Hollywood 28, California.

200 DIFFERENT 25c Includes triangles, approvals. Husak, 342 Liberty, Syracuse 4, N. Y.

MEMO Pad and lists free. Johnston's of Conshohocken 2, Penna.

PHILATELIC Printing — stockforms. Samples. Acmeprint, Box 245, East Flat Rock, N. Car.

CANADIAN Stamps, 500 well mixed \$1.00. Approvals if desired. T. Johnstone, 421 Mt. Pleasant R.D., Toronto 12, Can.

ATTRACTIVE Packet free to approval applicants. Rare Stamp Service, P.O. Box 4077, Miami, Fla.

55 DIFFERENT United States 10c to approval applicants. Standard, 3817 Sackett, Cleveland 9, Ohio.

UNITED States flag stamps of occupied nations used set \$1.00. Steger, 1165 Downing, Denver 3, Colorado.

SUPERVISED Exchange collection packets, new issues. Details, lists free. Shoto Stamp Shop, Two Rivers, Wisconsin.

MEDIUM Priced foreign approvals. Streiner, 898 East 75, Cleveland 3, Ohio.

FREE! Airmail packet with approvals. Deane Stamp Co., Box 1002, Miami Beach 39, Florida.

AMAZING! South Orkneys, Bechuanaland, triangle, Lebanon, Luxembourg, Monaco, etc. Also 25 different Finland as extra prize. Everything 5c to approval applicants. Shaw, Box 819-W, Imperial Beach, Calif.

We Buy desirable stamp collections, and accumulations. Top prices. National Stamp Sales, 276 West 43rd St., New York City.

AIRMAILS, 100 Different \$1.00. John MacDonald, 30-M Seaman Ave., New York 34.

FREE! 10 Different Peru to approval applicants enclosing postage. Ranson, 721 West Maple, Compton, Calif.

MINTS Famous Americans, etc. Get list. Marion Slikes, 1831 E. Allegheny, Philadelphia 34, Penna.

FIVE Vatican City stamps free to approval applicants. Florida Stamp Company, Box 807, Miami 5, Florida.

SOLOMON Islands, Grenada, Turks Caicos, Caymans, Dominica—everything 2c with approvals. Viking, 130-Z Clinton St., Brooklyn, N. Y.

PENNY Approvals by country. M. H. Hoerning, 115 Farmington, Ark.

STAMP Collections wanted. Complete collections, duplicate lots, surplus stock, mint and used. Prefer trade for printing or other items, buy outright if priced right. What have you, what's wanted? Vanroy Shirk, Lebanon, Penna.

FREE Persia packet to approval applicants. Foreign only. Everglades Stamps, Box 3222, Sta. F. Atlanta, Georgia.

MAGNIFYING Glass, all plastic, non breakable. 50 different Italy, 50 different Sweden. All for 30c with approvals. Bradford, Box 636, G.P.O., Brooklyn 1, N. Y.

VATICAN City set catalogs 46c. 10c with approvals. Jefferson Stamps, 1300 Jefferson St. N.W., Washington 11, D. C.

1000 MIXED U. S. old and new—25c; 2 lb. \$1.25. Weatherby, Medina, Ohio.

30 BEAUTIFUL Airmails, 10c. Selected approvals. Louis Morrison, Milmont Park 1, Penna.

SWITZERLAND: Air mails C 37-39 25c with stamps in sets on approval. Mutual, 6316 Wellsmar, St. Louis, Mo.

PACKETS—List of 200 different countries free on request. Subway Stamp, 87 Nassau, New York.

NEW Zealand, 60 varieties plus Airmail, Coronation, and Health sets. \$1.00. Lovell, Taupiri, New Zealand.

FREE Premium to new foreign approval applicants. Wesken Stamp Company, Box 66M, Queens Village, N. Y.

YOUR Money's worth! Seychelles, Djibouti, Angola, Chinese hunger stamps and over 100 different other stamps. Everything 10c to approval applicants. Atlas Stamps, 4220 West 16th, Dep't L, Little Rock, Ark.

BRITISH Empire. Fifty different flashy stamps plus unique mystery stamp. 10c to penny approval applicants. Litsch, Box 535, Middletown, Ohio.

GUARANTEED Job lots U. S., foreign, precancelled. Each \$1.03. Pound old mixture \$1.15. Blackmon, Corcoran, Calif.

FREE! Stamp wallet, sincere approval buyers. These, 9320 San Juan Ave., South Gate, California.

FREE! Rhodesian bi-colored waterfall; old El Salvador issues; plus 25 different worldwide stamps. All free to approval applicants. Pladon Stamps, 1717-M Idaho, Toledo 5, Ohio.

MIXTURES. Worldwide accumulations 1,500 for \$1. Missions Outlet, Rev. Marshall, Paterson 1, N. J.

FREE — Abyssinia, Cayman Islands, Tuna triangle, Indochina, Syria, Ivoire, Philippines (Jap "shame" issue), Turkish harem, Damascus, Cambodia, African "beauty," Pirate Islands, Colonials, others—All free for 3c postage with approvals. Belmont Stamps, Washington 10, D. C.

EXCELLENT Pictorial approvals. Reasonably priced. Crown Stamp Company, Box 331, Toronto, Canada.

AMAZING Offer! Assortment each of giant stamps, midget stamps, flag stamps, airmail stamps, Free French Colonies, U. S. commemoratives and numerous others. Everything only 10c to approval applicants. Simon, Box 608, Iranan, Texas.

TRIANGLE Set 3c. Beginners approvals. Mallo, 767 Leith, Flint 5, Mich.

25 JAPANESE Stamps 5c with approvals. Frank Stamps, 177 Elmcroft, Rochester 9, N. Y.

SPECIALIZE In U. S. \$1 174 different, \$1.00; 254 different, \$2.00; 324 different, \$3.00. Veteran's Stamps, 4714 N. Albany, Chicago.

PORTUGUESE Colonies. 25 different 5c with approvals. Lorane Brown, Marion, Michigan.

GORGEOUS Colors, scarce airmail, surcharges, charities, sets, etc. All in our big premium packet only 3c to approval buyers. Dixie Stamp Company, Dept. M, Milwaukee 3, Wisconsin.

ADEN To Zanzibar! 40 different British Empire, including Cyprus, Malta, Dominica; 5c with approvals. Lyman Company, 95 Nassau Street, New York City 7.

U. S. Price list. Send postage. State Stamp Service, 1225 Park Building, Pittsburgh 22, Penna.

25 DIFFERENT Swiss 10c—with ¼, ½, 1c approvals. Carroll's, 4357A S. Hoover, Los Angeles 37, Calif.

OLD Scarce U. S. seconds on approval. Slightly defective, nice appearance, bargain prices. Hernfield, 551 Clinton, Newark 8, N. J.

ONE, Two, four, five dollar U. S. stamps free to approval applicants. United Stamp Service, Box 1789-M, Miami 10, Florida.

ZANZIBAR, Palestine, Manchukuo, Azerbaijan, Haiti, Iraq, Siam, Victoria, Hitler stamp 5c. Approvals. Postzegel, Windham, New York.

U. S. Price list. Send postage. Stanley Gibbons, 38-P Park Row, New York.

PENNY Approvals, that satisfy. Neil Gronberg, Box 5441-P, Philadelphia 43, Penna.

MINT Pictorials free to approval applicants. Surf Stamp Co., Box 2296, Miami Beach 40, Florida.

APPROVAL Sheets, Frederick B. Driver, 909 Finance Building, Philadelphia 2, Pa.

ZOWIE! A barrel of fun for only a dime. 500 United States stamps—absolutely unpicked and unsorted—just as received from church missions. Many varieties, including large commemoratives, airmails, high denominations up to \$5.00! Stampdom's biggest package of fun—and you might find something really valuable! Price only 10c to serious approval service applicants. Money back if not delighted. Illustrated bargain lists with each order. Mystic Stamp Company, Dept. 80, Camden, New York.

50 DIFFERENT United States, 10c. Price-list free. Seidenberg, Cassopolis, Mich.

CANADA—75c Diff. 25c. Approvals, Lists. Victoria Stamp Co., London 4, Canada.

FINE Approvals, freshly mounted. Fast, personal service. Tell me what countries you prefer and I'll send their stamps. Skinner, 438 Locust, Long Beach 2, Calif.

FREE! Negro Triangle; Turks Islands "Cactus"; Dakar; Guinea; Palestine; "Fairy Tale," Pirate Chart, Map, Ship, Sea Lion and Snake stamps; French, British, Portuguese Colonies, etc. Free for 3c postage. Approvals. Potomac Stamps, Washington 10, D. C.

FREE! Leeward Is., Cayman Is., Turks and Caicos plus 54 different mint World's Fair poster stamps, to approval service applicants sending 3c postage. Tatham Stamp Co., Springfield 30, Mass.

UNITED States approvals complete coverage, fine quality, attractive prices. Seminole Stamps, Box 378, Coconut Grove, Florida.

50 DIFFERENT Including scarce diamond-shaped airmail 3c to approval service applicants. Avalon Stamp Co., Dept. M, Springfield 8, Mass.

1000 GRABAGS 15c Each. Super bags 25c. Zandy, 630 Bingham, Reading, Pa.

BOX Stamps containing hundreds all different, cataloging up to 25c each. Everything \$1.00. Longacre Shop, 108 West 42nd, New York City.

COMPLETE "United States" catalog with 1000 illustrations! Send 10c for mailing. Harris & Co., 137 Transit Building, Boston, Mass.

SCARCE "Pole to Pole" packet! Stamps from strange, mysterious countries only—Greenland (North Pole), Solomons, Spanish Morocco, Bhopal, Patiala, Siberia, Grahamsland (South Pole), Djibouti, Zanzibar, etc., and including stamps cataloging up to 25c each! Our price only 5c to approval applicants. Big dime packet list free! Methuen Stamp Service, Inc., Dept. 136, Lawrence, Mass.

FREE U. S. price list. Postage 3c. Mark Hanna, 335 - 5th Avenue, Pittsburgh 22, Penna.

FREE—Pick 25c worth of stamps from our first U. S. approval selection. Approximately 100 stamps to choose from. Excellent value. No obligation to buy. Lists illustrating the most popular U. S. stamps—at prices you can afford—will be included. Don't miss this opportunity! Write today. S. C. Engel Co., 38 Park Row, New York City.

FREE! Canadian sets, royal visit, George VI, George V, coronation, jubilee, others, to approval applicants. Ensign, Box 118-M, South Orange, N. J.

WORLD'S Largest diamond and triangle stamps, free stamp magazine, stamps from fighting Free French, 20 stamps from 20 different countries, pictorials, airmails, big bargain 5c with approvals. Capital Stamps, Dept. 2, Little Rock, Ark.

DEALERS—Wholesale list. Postage 3c. Frank, 5031 Queensberry, Baltimore 15, Md.

118 DIFFERENT Stamps including commemoratives, charities, airmail sets, etc., only 3c to approval buyers. We buy collections. Badger Stamp Co., Milwaukee 3, Wis.

VICTORY Packet free—Includes stamps from Tanganyika, British Cayman Islands, animal, scarce babyhead, coronation, early Victorian, airmail, map stamps, with big catalogue—all free. Send 5c for postage. Gray Stamp Company, Dept. PM, Toronto, Canada.

FREE! The Stamp Finder! Send today for the big new edition, fully illustrated, enabling you instantly to identify all difficult stamps! Also fine packet strange, fascinating stamps from Bosnia-Herzegovina, Monaco, Patiala, Cyprus, etc., including maps, ships, animals and strange scenes. All free to approval applicants enclosing 3c postage. Garcelon Stamp Company, Box 900, Calais, Maine.

MINT George VI eight crown colony pictorials including bi-colors 10c to serious approval applicants. Mutual Stamp Service, 5145P Village Green, Los Angeles 16, California.

HOBBIES AND COLLECTIONS

MAKE Money with hobbies. Details free. Southern Specialty Service, 210 North E, Lake Worth, Florida.

"GEM Cutting." Profitable, interesting hobby. Instructive illustrated booklet, one dollar. Mineral Specimens Company, Box 1191, Santa Monica, California.

INTRODUCTORY Offers—10 officers insignias 25c; 22 different American or 15 different foreign, \$1.00. Illustrated catalog 10c. Hobbyguild, 35P West 32nd St., New York.

LET's Swap! What'cha got? What'cher hobby? Dime trial. Swappers' Hobbie, Royal Oak, Mich.

CAMPAIGN Buttons—Collectors—if you want to start or enlarge your collection, communicate with Irwin Russell, 815 Union Ave., Bronx 55, N. Y.

EXCHANGE Your duplicate stamps, match covers, post cards, or any hobby, with collectors everywhere! Exchange register listing swappers, 10c. (Mention hobby). World Hobby House, Box 721-A, Olympia, Wash.

KLONDIKE! For hobby jewelry makers! Novelty jewelry findings from tables of large manufacturers, parts for bracelets, pins, earrings, etc. Unfinished. Chains, rings, pins, stones, clips, beads, many other items—1 lb. bags \$2.00 per bag in 5 bag lots. Sample bag \$3.00, prepaid only. Mdse. Distributing Co., 19 E. 16th St., New York 13.

CAMPAIGN Ribbons—Beginner's package. Introductory price 50c. Contains assorted ribbons. Collectors desiring special ribbons specify your requirements. Mdse. Distributing Co., 19 E. 16 St., New York 13.

WANTED: Old cigarette cards. Write Charles Bray, East Bangor, Penna.

UNIQUE Gift items! Hobby Catalogue 10c. Reptile list 5c. Quivira Specialties, Topeka, Kansas.

FOREIGN Medal ribbon packet, United Nations, Axis, \$1.00, sample 20c. Insignia-craft, 236 28th Avenue N.W., Calgary, Canada.

SWAPPER? Collector? Send 10c for sample copy Hobbyswap Contacts. 1326 South 27th, Omaha, Nebraska.

INVENTING Can be an interesting and profitable hobby. Write for complete particulars. Institute of American Inventors, Dept. 40-E, 1926-Eye St. N. W., Washington 6, D. C.

COLLECTING Hobbyists. Exchange duplicates. Swappers directory 10c. C. Bishop, Route 8, Kalamazoo 88, Michigan.

COLLECT Colorful Army patches. Pictures, prices and sample patch only 10c. Insignia Mart, 703 Broadway, N. Y.

UNUSED Match book covers. 100 all different \$1.00. 35 Royal Flash covers \$1.00. Free list. Charles Edelmann, 1311C East 84, Cleveland 3, Ohio.

JEWELRY Stones removed from rings, etc., 100 assorted \$2.40; 50 large ones \$2.40. B. Lowe, Holland Bldg., St. Louis 1, Mo.

ANTIQUES, RELICS, INDIAN GOODS, CURIOS

25 ASSORTED Arrows, spears, knives, scrapers, \$2.00. Catalog free. Nirscher, 27 South 10th, Belleville, Illinois.

SOUVENIRS Of any state. 50c each, postpaid. Tapp, Box 2593, Little Rock, Ark.

50,000 INDIAN Arrows, tools, rainbow variations. Don McKillip, Regina, Sask.

500 RARE Guns for sale. Catalogue 25c. Gil Hebard, Knoxville, Illinois.

20 ARROWHEADS Or 20" string old Indian beads \$1 each. Lynn Crandall, Box 697, Idaho Falls, Idaho.

MUSEUM Specimens. Indian relics, curios, den decorations. Illustrated catalogue, identification chart 25c. We also buy. Museum Supplies, 6601 Oshkosh, Chicago 31, Illinois.

SWORDS, Rapiers, daggers, pistols, armor. Illustrated catalog 50c. Robert Abels, 860-A Lexington Ave., New York.

4 FINE Ancient arrowheads, \$1.00. Stone Tomahawk, \$1.00. Flint knife, 50c. List free. Lear's, Box 569, Galveston, Texas.

MINERALS—PRECIOUS STONES

METAL Detectors. We have the latest in circuit and mechanical design plus the know how. Free literature. Hedden Metal Detectors, 221 Hemlock St., Pittsburgh 12, Penna.

ASSORTMENT Of local minerals for cutting or specimens \$1.00. State which. Plummer, 5068 Brighton, San Diego 7, Calif.

CAMERAS AND PHOTO SUPPLIES

REPAIRS Made on all cameras and other photographic equipment. Free estimates. Dept. PM, Northwest Camera Repair Co., 209 Loeb Arcade, Minneapolis 2, Minn.

BUILD Your own contact printer with brand new Ansoco air cushioned platen, size 12x12, new live rubber gives perfect contact. Send prepaid anywhere on receipt of \$6.75. Mayfair Camera Shop, 4011 Shelburne St., Philadelphia 36, Penna.

SCOOP For Christmas. Reflex type camera. 57.5mm. Maester lens. Precision shutter. Postpaid \$5.95. Davis Service, 32J-W Randolph St., Chicago, Ill.

FILM. The welcome Christmas gift! High speed Panax. Four rolls, eight exposures, postpaid: No. 127—\$1.20, 120—\$1.45, 620—\$1.45, 116—\$1.65, 616—\$1.65. Artex, Union, New Jersey.

VIEWER For Kodachromes, streamlined plastic "Da-Scope" folds to vest-pocket. \$1.95 value, new, postpaid \$1.25. R. Dennis, Box 5, Pelham, N. Y.

AMATEUR Photographers. Your knowledge of photography can pay big dividends. For particulars write New Enterprise Studios, Box 1716, Miami, Arizona.

ELIMINATE Middleman. Surplus directory 25c. "Camera," 126-M Lexington Avenue, New York.

FILM, 35mm. Cartridges, fresh stock, all types Eastman and Ansoco; 36 exposures, 65c each; bulk film, 27½ ft., \$1.98; 100 ft., \$5.98, cash or c.o.d. Imperial Foto, 122 Sharon, Glendale, Ohio.

SPEED-O-COPY Ground-glass focusing attachment for Leica, Contax, Argus C-2 and C-3. Send for literature. D. Paul Shull, Dept. PM-12, 240 S. Union, Los Angeles, Calif.

PRINT Your own pictures, kit \$1.00. Spada Enterprises, 10 Lexington, Wethersfield 9, Conn.

LEARN About photography. Kit of pin-hole camera, plates, print paper, hypo, developer instructions. \$1.35. Guaranteed. Saturn, Box 262, St. Louis, Mo.

NOW Available! Kodascope 8mm. model #33 projector 500 watt, ideal for home, \$53.50. 10" photoflood clamp on reflectors, \$3.25; 40x40 screen radiant tripod model, \$21.50. Skan photo electric meter with case, \$4.50. Conway Camera Co., 34 N. Clark, Chicago 2, Ill.

BUILD Your own contact printer. Designed for the critical darkroom worker. Takes 35mm. to 4x5" negatives. Complete assembly kit, \$6.95. Free circular. Harvey Specialties, 3318 North Cramer Street, Milwaukee 11, Wisconsin.

ENLARGER Kit—For candid shots. Complete with lens. Ready for assembling. Hours of fascinating entertainment. Only \$10.95, postpaid. Barbarr Sales, 3828 Grenshaw, Chicago 24.

200 POWER Telephoto camera easily made. Instructions 10c. Perfect telephoto lens and instructions, \$2.00. Carl Jamer, Manorville, N. Y.

FOOTSWITCH—Only eighth inch thick. Incorporates precision, snap action. Underwriter's approved. Micro Switch. For enlarging; power tools. \$4.95 postpaid. Complete satisfaction or money refunded. Ped Eaz, 1220 S. Rotzler, Freeport, Ill.

BELLOWS, 127 To 116 \$4.00 inserted. Enlarger and portrait, estimate free. Mail cameras to Presto Camera Repair, 130 Ferguson Rd., Dallas 10, Texas. T. I. Hodges (owner).

CAMERAS, Enlargers, projectors. Lowest prices. Free catalog. Cavalier Camera, 1822 Center, Pittsburgh 19, Penna.

CASH! Spot cash for cameras, lenses, binoculars, movie and still equipment. Send full description for prompt cash offer. Over 36 years of dependability. Bass Camera Company, Dept. AG, 179 W. Madison St., Chicago 2.

BASS Says: Trade cameras? For 36 years Bass has satisfied thousands everywhere! Finest equipment available. Always satisfaction guaranteed or your money back! Bass buys 'em, sells 'em, trades 'em. Bass Camera Company, Dept. AG, 179 W. Madison St., Chicago 2.

USED Camera Directory, Box 1031-M, Canton, Ohio—lists hundreds of war-bargain used cameras—35mm., Speed Graphics, Kodaks, Rollei-flex—many others. Send 25c for latest issue.

HAVE You a camera? Improve your hobby of photography and learn how to make better pictures. Write today for our latest book catalog and sample copy of American Photography, containing articles and pictures by the world's foremost writers and photographers. Camera House, 601, 353 Newbury St., Boston 15, Mass.

PHOTOGRAPHY For pleasure or profit. Learn at home. Practical basic training. Long established school. Write for booklet. American School of Photography, 1315 Michigan, Dept. 3432, Chicago 5.

PHOTO FINISHING

AT Last: We have films: 116 and 616—38c ea., 120 and 620—33c ea., 127—27c ea. 8 exposure roll developed, all your snapshots hand-colored as beautiful as most actual colored photography—50c. Hand-colored reprints—6c each. 8 exposure roll developed and black and white prints—35c. Reprints—4c each. Midwest Photo, Janesville 26, Wis.

ROLL Developed and 8 beautiful enlargements 2 to 6 times larger. Deckled edge—high gloss. Any 8 exposure roll 25c coin. 12 ex. 35c—16 ex. 50c—36 ex. \$1.00. Reprint enlargements 3c each. Alden Photos, 94-3 Astor Sta., Boston, Mass.

QUALITY And service; rolls developed and printed 25c, with jumbo enlarged prints 30c. Skrudland, 6444-Z Diversey, Chicago.

100 MINIATURE Reprints 1x1½ \$1.00. Send photo (returned). Super-Exchange, Cranford, N. J.

BEAUTIFUL Double-size pictures 3½c each, from 116 and 120 negatives, 3¼x4½ from all other sizes. All work guaranteed. Overnight service. Roll developed and 8 pictures 30c. Roll 12 pictures 45c. Roll 16 pictures 60c. Enlargements on double weight portrait paper 5x7—30c, 8x10—50c. Copies made from any picture 75c. Pacific Photo Service, Box 666, San Francisco, Calif.

8"x10" **HAND** Colored framed enlargement from negative or photograph, \$1.50. Promenade Photos, Sta. D, Box 198-P, New York 3, N. Y.

DOUBLE Weight enlargements, 8x10's, 30c. Four \$1.00, 5x7's, 20c. Six \$1.00. Either size colored, \$1.00 each extra. Send negatives. Photos copied, 50c. Empire Photos, Adams Center, N. Y.

ROLL 6 or 8 Exposure, 1 print each, 30c. James V. Johnson, Fremont, Mich.

CASH For your pictures! Invaluable folio lists over 100 markets for your photographs. Tells where, how to sell. \$1 postpaid. Picmarts, 3 Park Row, New York 7, N. Y.

COLOR Prints, low price. Sherman Color Laboratory, 11541 Barman Street, Culver City, California.

8 HOUR Service. Your 8 exposure roll printed jumbo or regular size, 25c; 12 exposures, 35c; 16 exposures, 50c; 36 exposures, \$1.00. Reprints jumbo or regular, 3c. Regular prints deckled. Fine grain developing. Send for free mailers. Quality Photo Service, Box 468, San Francisco 1, Calif.

DELUXE Finishing. Film developed with double size prints, 8 exposures 30c, 12—45c. Kensey, B-25, 211 W. 145th, New York 30.

FREE Price list on quality developing, printing, enlarging. Write for it today. Roy Photo Service, G.P.O. Box 644, New York (1), N. Y., Dept. M.

BEAUTIFUL 4"x6" Enlargements. A 75c value for 30c a complete roll. Photo Service, 107 Dewey St., Newark, N. J.

GORGEOUS Color prints from your transparencies, 4x5, \$1.00; 5x7, \$1.98; 8x10, \$2.98. Broad Camera, 953 Broad St., Newark, N. J.

OVERNIGHT Service. Roll developed and 8 prints 30c. Finest quality guaranteed. Our 13th year. Tri-Plex Photo Service, Box 375-B, San Francisco 1, Calif.

ENLARGEMENTS From negatives 5x7, 25c; 8x10, 50c; from picture 50c extra. Cropping and small retouching, no charge. Finishing for kidnapers and studios a specialty. Photo Shop, 20 N. Broadway, Lake Orion, Mich.

SPECIALIZING 35MM, fine grain developed, 36 big 3x4 enlargements, \$1.25. Photoshop, Linton, Indiana.

FILM 127 Surplus \$3.59 dozen fast pan. Other sizes. We buy anything. "Camera-man," 542P 5th Ave., New York 19.

FIVE Beautiful 5x7 enlargements \$1. Photocraft, 110 Harris, LaGrange, Ill.

DE LUXE 8x10 Enlargement from your photo or negative 50c. Original returned unharmed. Photo Lab, 3122 N. Clark, Chicago 14.

CHRISTMAS Greeting cards from your own snapshots, send negative and \$1.00 for 18, (including envelopes). Rolls developed, 8 prints 25c, over 8 exposures 40c. Reprints 3c. Fred D. Eastman, Bode, Iowa.

25 BILLFOLD Size black and white copies from your favorite portrait. \$2.00. J. G. Jacob, 125 N. 4th Ave., Morton, Ill.

ROLLS Developed, 8 brilliant fadeproof Velox prints and two professional enlargements 25c. Overnight service. Young Photo Service, 405-C, Albany 2, N. Y.

FREE—Set of filters for names and addresses of four camera owners. Photocraft, Canton 1, Ohio.

8 PRINTS, All enlarged to nearly postcard size, from your roll or negative, 25c. Willard Studios, Box 3535A, Cleveland 18, Ohio.

SPECIAL—50 Reprints \$1. Suburban Studio, 1410 Bond, Rockford, Illinois.

SAVE \$1.00. Order 100 reprints at 3c each and receive an 8x10 tinted enlargement in a beautiful mount (value \$4.75) for \$3.75. Fred D. Eastman, Bode, Iowa.

CENTURY Delivers work and service that can't be beat. Sixteen famous Century-Tone prints each 8-exp. roll 30c. Free mailers. Century Photo Service, LaCrosse, Wis.

2 BEAUTIFUL Hi-Gloss prints each good negative and enlarging coupon with each 6 or 8 exposure roll developed 28c. Owlphoto Co., Weatherford, Oklahoma.

BIGGEST \$1.00 Value in 35mm. finishing today. 36 exposure fine grain 3¼x4½ enlargements; deckled, embossed margin and date. Eighteen exposures 75c; 16 exposure splits 55c; 36 exposure reloads 50c. Special: return this ad with \$2.00 and we will send five 36 exposure reloads. Free mailers. 8 exposure rolls in beautiful, deckled contact finish with embossed wide margin, 25c. Mailbag Film Service, Box 5440A, Chicago 80, Ill.

GLOSS Finish enlargements, 4 5x7 from negative 50c, 3 5x7 from photo 50c. Robert Renshaw, Jr., P.O. Box 478, Chester, Penna.

PHOTOGRAPHY For pleasure or profit. Learn at home. Practical basic training. Long established school. Write for booklet. American School of Photography, 1315 Michigan, Dept. 3451, Chicago 5.

EVERY Picture an enlargement! 8 sparkling deckle-edge enlargements and roll developed 25c coin; 116 size or smaller; enlarge reprints 3c. Enlarge Photo, Box 791D, Boston, Mass.

SENSATIONAL Introductory offer! Send snapshot or negative, this ad, and 3c. We'll send you a beautiful 7"x5" enlargement! Or, Kodak roll developed with 16 guaranteed deckle-edge velox fade-proof prints or 8 double-size prints, 25c! Special! From your negatives, 16 regular-size or 8 double-size reprints, 25c! Candid rolls—36 exp. 35mm. developed, vaporated, enlarged to 3x4, \$1.00! 18 exp. 50c. Reprints, 3x4, 3c each. We have new, perfect 35mm. film. Low prices. Free mailers, details on request. American Studios, Dept. 279, LaCrosse, Wis.

MOTION PICTURES AND SOUND EQUIPMENT

8MM-16MM, Films, equipment. Bargains! Towers, 935 North Fortieth, Philadelphia 4.

16MM, Sound projectors. Films, new, used. Bargain catalogue. Myron Osborn, Lebanon, Ohio.

LATEST Movies, 8mm., 16mm. S.O.F.! Save! 1947 projectors, cameras! Free catalogs! Charlie Poorman, Dep't PM2, Schuylkill Haven, Penna.

35MM, Sound features \$12.50 up. Reisinger, 2909 Whitney, Baltimore, Maryland.

16MM, Sound films. Complete subjects, good condition, \$1.95 per 400' reel, up. Write for list of over 100 available titles. Blackhawk Films, Dept. PM30, Davenport, Iowa.

RENT 8MM—16mm. and sound films by week. New catalogs. Lowest rates. Dayton Film, 2227 Heppburn, Dayton 6, Ohio.

16MM, Films. Lists. Sam's Electric Shop, 35 Monroe Street, Passaic, New Jersey.

COLOR Movie film! Guaranteed fresh stock for Univex 8mm, \$2.25! Double 8mm., \$3.70! Postpaid. Tilco, 1814 West 41st St., Kansas City 2, Missouri.

TALKIES: Convert your silent 16mm. projector into sound with our guaranteed parts kit. Plays all 16mm. sound films. Quickly assembled at home. Special introductory offer: Send this ad now with \$19.95, check or money order, and we will include sound test film, instruction manual and full information on how to use with your radio. Kit includes photocell, exciter lamp, optic, which makes a sound head complete. Or send \$1.50 for complete blue prints showing how to make adapter yourself. Sound Tech, Box 3071, Hollywood 28, California.

UNUSUAL Home movies: Travel, adventure, sports, comedies. Silent-Sound. Many film bargains. Big illustrated 1947 catalog, sample—dime. Audet, Box 6520BG, Philadelphia 38, Penna.

PROJECTORS—35 mm. Sound Silent. Nusslock, 4614 Green Tree, Milwaukee 9, Wis.

NEW 400 Ft. 16mm. motor driven projectors, \$25.95, \$40.95 postpaid. Sterling's, 679 Northampton, Easton, Pennsylvania.

FREE Catalog; movies, cameras, projectors; sample films, 10c. Photographic supplies. Goodwill Company, Jackson, Tennessee.

8-16MM, Silent-sound films. Complete rental library. All latest subjects. Free catalogue (sample film 10c). Garden Film, 317 W. 50th, New York 19.

NEW 1600' Reels \$1.75. Cans \$1.25. Combination \$2.50. 8-16mm. films bought, sold, exchanged. Literature, end title 10c. International (M), 2120 Strauss, Brooklyn, N. Y.

MOVIE Projector owners. Project outstanding home movie productions. Free. Send postal card immediately. Preferred Movies, Hamilton 1, Ohio.

FILM—Movetone is back. It's Weston 12, nonhalation. Free processing—100 ft. 16mm. \$3.25; 25 ft. Double 88, \$1.50. Bulk film without processing—100 ft. 16mm. \$2.25; Double 88, \$2.45. Free circulars. Fromader Genera, Davenport 7, Iowa.

TITLES Of quality give your movies that professional touch. Write for prices. Title Technicians, 3964 Ames St. N.E., Washington 19, D. C.

35MM, Sound features, Westerns, projectors. C. Rogers, Box 26, East Atlanta, Georgia.

KODACHROME Movies, 8-16mm. Color sample, lists—dime. Projection length color or sample—dollar. Also slides. Campus Films, 668-F, Ithaca, N. Y.

HOME Movies, 16mm., 100' subjects. Sound and silent. Write for list. Ultra Pictures, Box 319, No. Hollywood, Calif.

16-35MM, Silent, sound films, projectors. Bedner, 5300 So. Talman, Chicago.

CLUB Plan 16 mm. sound rentals. Lowest rates. Details dime. R. A. Dechene, 90 State St., Albany 7, N. Y.

EXCITING Films — bullfights, movie stunts. Unusual subjects. Send only dime for sample film and special list. Exciting Films, 1071-F El Centro, Hollywood, Calif.

16MM, And 35mm. projectors, film. A. Savarese, Woodcliff Lake, New Jersey.

RENT 16mm. sound films 50c reel. Large selection; free catalog. Film Service, 128 Chestnut St., Roselle Park, N. J.

"THE World's Greatest Passion Play," all sizes sound and silent. Write Hemenway Film, 33-F Melrose St., Boston 16, Mass.

FINEST Movie screens, inexpensive, make them yourself. Free literature. Snow White Screen Company, Danville, Illinois.

GUARANTEED Fresh movie film! Dalite loading! Processing free! Three spools double 8mm., \$3.45! Six single 8mm. for Univex, \$3.50! Postpaid. Eso-S, 828-B West 39th, Kansas City 2, Missouri.

LEARN Professional motion picture technique at home. Approved for veteran training under G.I. Bill. Free catalog. Motion Picture Institute, Birmingham 4, Mich.

UNUSUAL 8-16 mm. Film subjects. Big catalog with sample film, 10c. National Film Exchange, Broadway, Sta. E, Toledo 9, Ohio.

FRESH Movie camera films 100'—16mm. \$2.25, three rolls \$6.00, 25' double 8mm. \$1.25 developing included. Ambassador, 479-A Quincy Street, Brooklyn, N. Y.

COMPLETE Stocks always of Castle, Official, Pictorial films, 8mm., 16mm., sound, Musicals, soundies, free catalogs. We exchange your films and equipment, or buy them for cash. Frank Lane, 5 Little Bldg., Boston, Mass.

HOME Movies. Rent, buy, swap 8mm.-16mm. silent and sound at money-saving rates. Details for a dime. Midland, Box 429, Oak Park 4, Ill.

BASS Says: 36 years of leadership in the motion picture equipment field. Sound projectors, 8 and 16mm. equipment, finest accessories. Bass buys 'em, sells 'em, trades 'em. Always satisfaction guaranteed or money refunded! Bass Camera Company, Dept. A, 179 W. Madison St., Chicago 2.

I BUY, Sell, swap, rent s.o.f., 8 and 16mm. films. List free. Harvey Iris, Box 539, Brockton, Mass.

MAKE \$8 To \$10 net profit daily with your 8mm. or 16mm. projector. Details free. Metcalf, 10806 Glenroy Ave., Chicago 43, Ill.

LEARN Movie projection, management. Free catalog. Theatre Institute, Elmira, N. Y.

MOVIE Camera films, 100' 16mm. \$2.50, 25' double 8mm. \$1.25. Free developing. Better Films, 742 NewLots, Brooklyn 7, N. Y.

MUSIC AND MUSICAL INSTRUMENTS

SONGWRITERS! Amazing, ethical offer. Hibbeier, C5, 2157 N. Avers, Chicago.

SEND Lyric and \$3.00 for professional overhauling. Moneyback guarantee! Magdalene Kuhlman, Woodville, Ohio.

FUNNY Book with crazy song, 10c. 4 books 35c, 12 books \$1. None alike. Wood Publisher, 921 Jackson, Tulsa 5, Okla.

SONGWRITERS, Submit songs for free analysis. Only worthy material accepted for development. Tommy Kilbourne, Box 1253, Bakersfield, Calif.

HAVE Professional songwriter help complete and commercialize your songs. Latest composition "Kilroy Was Here." Write Dick Dixon, 634 Common, New Orleans, La.

WE Want song poems and lyrics on all subjects. We offer the services of a noted Hollywood motion picture composer and arranger. Send your poem today for consideration and our liberal offer. Hollywood Melodies, P.O. Box 2168PM, Hollywood 28, California.

SWISS Musical movements \$4.50. Swiss musical boxes. Lucite photo albums. Novelties of Distinction, 131 W. 42, New York City.

ACCORDIONS, New or used, wholesale and retail, cash or terms. Our 57th year in business. Del Principe, 307 So. Wabash, Chicago, Ill.

SONGWRITERS—Send poems for immediate examination and free book, "Your Future in Songwriting," Radio City Music Academy, 1674 Broadway, New York City 19.

PLAY Piano by ear in twenty easy lessons. Send for free literature. Whitworth Specialty, 4517 S. 137, Seattle 88, Wash.

ACCORDIONISTS Dream charts: Amazing set chord charts enables accordionists master all modern chords; all keys; both hands; with, without music. \$1.00. Charts, Box 21, Lefferts, Brooklyn 25, N. Y.

PIANISTS—Have fun swinging the scales. Acquire professional technic without drudgery. Three enjoyable lessons, \$1.00. Wehner, 25 Fulda, Roxbury 19, Massachusetts.

TELL Us your musical needs, we will supply them. Send for catalog. Full of hard to get items, lower prices too. Harden & Son, Musical Merchandisers, Marion, Ohio.

PIANO Play at site. All principal bass chords in all keys at a glance. No notes, no study. \$1.00. Teachers write. P. H. Kaufman, 6019 Hollywood Blvd., Hollywood 28, Calif.

PLAY The piano in one week, write. Box 202, Overlands, Independence, Iowa.

LEARN To play the piano by ear in one week. The quick easy way. Write. E. Morrison, Box 9312-N, Station S, Los Angeles 5, Calif.

POEMS Wanted! Send poem for immediate consideration. Eliot Wright, Master Composer, 107 Rivoli Theater Building, Portland, Oregon.

SONGWRITERS Outstanding proposition. Ed. Madden, G.P.O. Box 1226, Syracuse, N. Y.

POEMS Wanted for musical setting. Many of our songs have been published by ASCAP and BMI publishers and broadcast. Send poem for immediate consideration. Five Star Music Masters, 630 Beacon Building, Boston.

SONGWRITING — Publishing, liberal plan. Barnhart, 1320 48th, Des Moines, Iowa.

SONGWRITERS — Free explanatory booklet, attractive offer. Song Service, 331-C West 46th, New York.

MUSIC Printed from manuscript. Music composed. Reginald Belcher, Florham Park, New Jersey.

ACCORDIONS, Wholesale prices. Request circular. New streamline accordions. All sizes and makes. Monarch Accordion Co., 44 N. Albany Ave., Chicago, Ill.

MUSIC Arranged. Songs printed. Frank Wildt, Music Publisher, Lancaster, Penna.

"GUITARS"—"Band and orchestra instruments"—"harmonicas." List free. Rudolph's, Atchison, Kansas.

WANTED! Lyrics, melodies for songs. We arrange, publish, sell. Superior Song Studios, Passaic, N. J.

SONG Poems wanted. Free examination. McNeil, Master of Music, 510-PM South Alexandria, Los Angeles, Calif.

WRITE Songs. Big money and reputation. Write for information. J. Gordon Pub Co., 201 N. Hoyne Ave., Chicago.

SONG Writer's attention! The amazing demand for phonograph records, accelerated by more than 300,000 juke boxes and the hits popularized warrants your immediate consideration. We are offering song-poem writers the rare opportunity of having established composers collaborate on appealing material received this month. Recola Records, Box 987P, Hollywood 28, Calif.

POEMS Wanted for musical setting. Send poem for immediate consideration and free rhyming dictionary. Richard Brothers, 24 Woods Building, Chicago.

RADIOS, SUPPLIES AND INSTRUCTION

PLASTIC Radio. Safe, easy to build, no electricity, plays clearly, hours of fun. Complete kit includes clear lucite plastic, all necessary radio parts, aerial kit and headphone. Easy instructions. Only \$6.98 money order or c.o.d. to Hobby Sales Co., 1143 South St., Wrentham, Mass.

HEAD Phones: Finest quality, adaptable for use in making crystal sets. Used sets without head bands \$1.25. With head bands \$2.50. New sets without head bands \$1.75. New sets with head bands \$3.75. Add 25c for mailing, send check or money order—quantity limited. Department C, Nico Supply Co., 540 N. 17th St., Philadelphia 30, Penna.

KITS. Television, amplifier, record changers, receivers, crystals. Engineering products. Anyone can build. Free list MP, Electronics Laboratories of America, P.O. Box 394, New York 8, N. Y.

IT'S New! More powerful, simpler crystal set just developed. Instructions, 20c. "All About Crystal Sets," booklet, 45c. Amorose Radio, Route Four, Richmond, Virginia.

"RADIOBUILDER"—Parts, data. Sample free. Laboratories, Box I-c, San Carlos, California.

WIRERECORDERS — Limited quantity precision built Navy equipment—New and in original boxes. Records one-half hour continuously, has level wind, erasing head, minute and second indicators, automatic stops, etc., but less amplifier, motor and drive. \$87.50 f.o.b. Detroit. Photographs on request. Full money order remittance must accompany all orders. Richard H. Wann, 3000 East Jefferson Avenue, Detroit 7, Michigan.

FREE New radio catalog is ready! Radionic's catalog lists hard-to-get radio parts, books, amateur, test and P.A. equipment. All available for immediate shipment. Send today to: Radionic Equipment Co., Dept. SS-12, 170 Nassau St., New York 7, N. Y.

ASSEMBLE Your own radio! Latest complete crystal set, earphone and diagrams included. Educational, interesting, thrilling results. \$4.00 postage pd. T. & T. Merchandise Company, 98 North 13th, Kansas City, Kansas.

NEW FM radio. Build your own. New, simple, easily built. Parts cost less than \$5.00. Use separately or as converter on your broadcast receiver. Complete plans and instructions, \$1.00. FM-2, 26 Rixey Drive, Alexandria, Va.

BUILD And hear your own radio crystal detector set. Easily assembled. All parts included with ear phones and antenna. Illustrated instructions and 40-page radio beginners booklet free. Only \$3.45 postpaid or \$1.00 deposit, balance c.o.d. plus charges. Al Hawkins and Company, Box 1285, Sioux City 7, Iowa.

RADIOS: New or used. Combinations, portables, record-changers. Scarce tubes. Re-Ampliphone, 2345 Hopkins, Milwaukee 6, Wisconsin.

AMAZING One tube radio. New Dynaflex circuit (warborne development) makes loudspeaker operation possible. No batteries, ac-dc. Easy to construct. Complete plans, \$1.00. Dynaflex-1, 26 Rixey Drive Alexandria, Va.

QUALITY Record players, \$16 postpaid. Attaches to any radio. Wonderful tone. R. Carson, 505 Norman, Portsmouth, Va.

TUBELESS, Batteryless, razor blade radio. Plans 35c. N. W. C. Radio, Lohrville, Iowa.

SELSYN Beam rotation kit complete, 110 VAC operated. Includes pair selsyns, motor, drive gears, switches, etc. \$22.50. Postpaid. Ereco, 1006 Hewitt, Everett, Washington.

SPECIAL \$7.00 Complete ready to operate crystal radio in plastic case, station selector, crystal, official A & N headphones 8,000 ohm, 100 feet 7 x 22 aerial wire, 50 feet rubber covered lead-in and ground wire, insulator and ground strap. Postpaid \$7.00. Radio City, Fifth and Ash, San Diego 1, Calif.

XMAS Present. U. S. Government release famous No. 23-26 Western Electric fixed crystals, originally \$6.00 each, new special \$1.29 each. Both \$2.00 plus eleven cents charges. Make double detector. Marvelous for crystal set; loud, steady; no adjusting. Act now. Free list. C. R., John Barron, Box 128, Ft. Hamilton Station, Brooklyn 9, N. Y.

ELECTRIC Phonograph players \$10.00, other bargains. Sootin's, 230 Northwest Second Avenue, Miami, Florida.

"RADIO Announcing." A new book of instruction designed to teach beginners and aid professional radio announcers. Book contains pictures, quotations, and biographies of many top ranking announcers. \$2.00 post paid. Hollywood Radio Publishers, 5855 Hollywood Blvd., Hollywood, Calif.

FAMOUS "Allen" midget semi-fixed crystal detector. Set building plans and 100 late crystal set distance reports all for 50c postpaid. Allen, 427-2, Clinton, Mo.

NEVADIUM Super crystal. Write for details. Box 764, Elko, Nev.

NEW FM Radio. Build your own. New, simple, easily built. Parts cost less than \$5.00. Use separately or as converter on your broadcast receiver. Complete plans and instructions \$1.00. FM-2, 26 Rixey Drive, Alexandria, Va.

ELECTRONIC Organ easily constructed from radio parts. Plans \$1.00. Quaker Radio, Box 68, Salem, Ohio.

BUILD Your own radio. 5 tube super kit complete with tubes and cabinet using 50L6, 35Z5, 12SA7, 12SK7, 12SQ7. Easy to wire. Your cost \$16.95. McGee Radio Co., 1330 Broadway, Denver, Colorado.

RADIO Service men and experimenters send stamp for our giant radio catalogue. Save dollars. United Radio Co., (1000-V) Newark 1, N. J.

LOUD Speaking crystal radio, improved design. Illustrated plans 25c. Radio Clinic, 10631-C Euclid, Cleveland 6, Ohio.

FLAT Rate schedules improve profits. Compiled from 500,000 jobs. Write for information. Radio Equipment Co., 1415 W. Franklin Ave., Minneapolis 5, Minn.

RADIO, Electronic parts and equipment. New and used. Write for free list. Highbridge, 340 Canal Street, New York 13, New York.

MAKE Simple, tubeless, batteryless, distance-getting crystal radios. Crystal and illustrated instructions 25c postpaid. Allen, 427-P, Clinton, Missouri.

RADIO Technician and radio service courses. Training for federal licenses. American Radio Institute, 101 W. 63 St., New York City. Approved under G. I. Bill of Rights.

LEARN Radio at home. Earn money. Have fun building our "Educational Radio Kits." We teach you every step. Simple, easy to understand instructions. Free literature. See our ad, page 271. Write immediately. Chapin Electronics, Inc., Dept. A., 134 W. Onondaga, Syracuse, New York.

BUSINESS OPPORTUNITIES

DISTRIBUTORS (Gasol-Unit) the water and oil injector for all gasoline engines. Gives added power, dissolves carbon, lubricates upper cylinders, gives greater mileage, adds to length of motor life. Same principle used on airplanes. Now available for cars, trucks and buses. Write Frank Tatar, Gasol-Unit Sales Co., 11 Niagara Street, Buffalo 2, New York.

SURPLUS Reprocessed AC and Champion spark plugs. Cadmium plated, polished and neatly boxed. 75% discount, guaranteed. Dealers buy on sight and reorder steadily. Investigate this permanent profitable business. Carl's Supply Co., 7927 Paseo, Kansas City, Mo.

MECHANICALLY Inclined men — Own and operate general appliance repair shop. Complete, illustrated course shows you how. Welding, refrigeration, motor repair, how to get business, etc., all phases covered. Free literature. Christy Supply, Dept. 171, 2835 N. Central Ave., Chicago.

\$7.95 "MADE-TO-ORDER" Store signs cost you \$2.95. Also desk, lawn, business signs. Big profits. Box 526, Jamaica, N. Y.

WILL Manufacture and merchandise practical automotive invention on royalty. Power Products Co., 23 W. Grand Ave., Detroit 3, Mich.

PEARL Lustre, gives plaques beautiful finish. \$2.50 pint. Kents Studio, Worthington, Ohio.

MECHANICALLY Inclined? Here's a real opportunity! Your own profitable interesting business. Full information dime. River Workshop, 170 East 51st Street, New York 22.

ATTENTION Mail buyers! Your name on our mailing list free and a gift with every purchase. Tom Bowman's Service, 4600 Elkins, Nashville 9, Tenn.

OPERATE Profitable mail order business. Exceptional opportunity. For details write: Loshen Supply House, 5927 Euclid Ave., Rm. 24, Cleveland 3, Ohio.

"SECURITY Acres." Sensational new book tells how to create fine income in your own back-yard, city-lot, five-acre-plot. Presents scores of novel, moneymaking plans, ideas. No guesswork, no experimenting. You'll like booklet "Money Grows on Trees." Both \$1.00. Makes ideal gift. Money-back guarantee. Lightning Speed, Box 115-P.M., Streator, Illinois.

START Home manufacturing business making Cleaning Compounds, Soaps, Insecticides (DDT), Cosmetics, Polishes. No machinery. Literature free. Kemix, Park Ridge, Ill.

CONCRETE Blocks—Your own plant, low investment—5000 blocks per day. Expert advice. Booklet \$1.00. John Moen, 70 Minerva, Tiffin, Ohio.

MAKE Money at home. Small capital. No canvassing. Free details. Superior Distributors, 916 Hayes Street, San Francisco, Calif.

MAIL Order item, fast seller, repeat orders, big profits, free details. Victor Suarez Service, 833c Jefferson St., Gary, Indiana.

MAKE Liquid marble, flexible molds, statuary, art goods, novelties, artificial marble flooring. Literature free. Kemico, Park Ridge 50, Ill.

MAKE Money selling watches. Box 18—93 Fourth Ave., New York.

OPERATE Profitable business selling, packaging products under your own name. Lyle Products, 5 E. Spaulding, Willoughby, Ohio.

START A home business in spare time. Make extra money. Experience not essential. Literature free. Williams, P.O. Box 5319, Washington, D. C.

"FIFTY Prize-winning plans for mail order operation." Guides you to a profitable business. Free details. Deeley Business Service, 126 Lexington Ave., New York 16.

OVER 10,000 Modernized formulas. Everything; beauty preparations, cleaners, remedies, antiseptics, polishes. Write Helle, 11714 E. Jefferson, Detroit 14, Mich.

SELL By mail—Amazing new book tells how. Literature free. M. E. Egan, 205 D-W, Cherry Street, Shenandoah, Pennsylvania.

WORK In South America! Amazing opportunities. Write D. Macfarlan, Hanover, N. H.

MAKE Soap at home. No machinery. Profitable. Literature free. Kemico, Park Ridge 60, Ill.

CLEAN Up \$5000 yearly selling specialties, just like I do. Write me. Carylton, Bethany, Okla.

OPERATE Profitable mail order business. Tremendous profits. Patrick Service, Box 1322, Cleveland 3, Ohio.

GROW. Sell potted flowers, vegetable plants. Write: Bowers, Loyalton, Penna.

MAIL Order beginners! "Business Development Plan," "Profitable Mail Selling Idea," "Pointers Along the Mail Order Trail." Noted mail sales specialist's, three-in-one, 10,000-word treatise shows—step-by-step—"how," on small-capital-start. From idea to mailbag. 25c postpaid. Satisfaction guaranteed. Maupin & Maupin, Lafayette 3, Indiana.

BRONZING And metalizing baby shoes! Gold, silver, copper, nickel, bronze, pearl, ivory and "luminous glow" colors. Big profits! New field! Details free! Write, R. O. Morgan, Box 349, Long Beach 2, Calif.

SOUTH America! Business propositions translated, forwarded interested parties. Trade lists. Business information. Opportunities. Interamerican Service, 6411 Hollywood Blvd., Los Angeles 28, Calif.

FILLED Christmas stockings, seven tops plus candy 59c wholesale. Balloons, Ellswood Balloon Headquarters, LaJunta, Colorado.

MAKE Plaster novelties! Special molding rubber. Free sample. Quart \$3.00, gallon \$10.50. Free instructions. Universal Sales, Box 1076-A, Peoria, Ill.

GOT \$24,500 Using schemes from "Schemer" Magazine, Alliance, Ohio. 48th year, \$1.00; 3 samples, 25c.

OPERATE Profitable mail order business. Splendid opportunity. For details write: Wm. F. Liska, Box 337, Cranford, N. J.

LIQUID Marble—Make in any color. Soundproof plastic flooring. Flexible molds. Cast novelties, plaques, statuary. Big money—your own business. Catalog free. Write—Bing Products, 88-A2D Broad Street, Boston 10, Mass.

IF You would like to make \$5,000 yearly in an easily learned office business of your own, send for free details immediately. G. H. Cole, Pres., Syracuse 2, New York.

BRAND New proposition. Extra money spare time. No selling. No canvassing. Absolutely different. You do it. Full particulars free. R. H. Callaway Specialty Co., P.O. Box 341, Fort Smith, Ark.

PRINT Colorful signs and posters. Experience unnecessary. Simple home-made equipment. Complete instructions \$1.00. Signographer, 1 Benson Avenue, Elmout, N. Y.

PROFITABLE, Mailing, merchandising business. Write Strauss, 1211 So. 114 St., Milwaukee 14, Wis.

UNPAINTED Wall plaques 2½¢ up. Beautiful designs. Easily painted. Illustrated list free. Write today. Omman, 642-M Broadway, St. Paul 1, Minnesota.

FIFTY Tested mail order ideas for profitable, fascinating sparetime home operation. Send 3c stamp for complete details. Manhattan House, 126-D Lexington, New York 16.

LEARN Shell jewelry manufacturing. No tools or experience needed. Learn—earn within a week! Complete home instruction course, beautifully photographed, shows how to make 75 styles of pins, earrings, brooches, hair ornaments, dress clips, necklaces, bracelets, candy dishes, wall plaques, ash trays, candle sticks, etc. Includes pearlizing, golding, dyeing, luminous methods. Illustrates 55 species of sea shells. Lists hundreds of raw materials with wholesale prices. Complete course \$1.00, postpaid. Beginner's kit, \$3.00. (\$3.50 in Canada). House of Gifts, Box 4550-RF, Coral Gables, Fla.

OPERATE Profitable mail order business. Write Robert L. Brill, 647 E. Frederick St., Lancaster, Penna.

EARN \$2000 Or more during March 15th tax period. Be a tax consultant. Bookkeepers, etc. can qualify quickly. Details free. Edw. H. Smith, 17 Rockland Ave., Yonkers, N. Y.

ASTOUNDING Proposition mailed free. Make \$30 daily. United, Box 862, Johnstown, Penna.

DO It with sea shells. Attractive jewelry. Big profits. Free instructions. Werts, 1429 56th Avenue, Oakland 3, Calif.

PLASTER Hardener—See and hear it harden in four minutes. \$3.00 box. Valance Art Products, 1873 E. 70 St., Cleveland, Ohio.

MAKE A hobby into a profitable business. Build miniature structures for architects, builders and realtors. Min-A-Model Homes furnishes a complete line of model home supplies and instructions. Write Min-A-Model Homes, 1204 18th Street, San Diego, California.

"HOW To Start a Successful Mail Order Business". The guide to sound, profitable mail merchandising only 25c. Manhattan House, 126-B Lexington, New York 16.

EARN Up to \$500 month part or full time keeping books for small firms. Simplified system. Write Tax-Saver System, Dept. H, Ft. Worth, Texas.

OPERATE Profitable mail order business. Good opportunity. Write, Walter Service, A4159 East 112th, Cleveland 5, O.

\$100.00 WEEKLY Possible selling books by mail! Start small in spare time. Expand rapidly! Experience unnecessary. Free literature. Johnson Distributors, P.O. Box 449, Dodge City, Kansas.

\$565.00 PROFIT From every \$15.00 invested. Standard Service System, La Grange 1, Indiana.

QUICK Money! "Repairing car batteries." At home! Easy too! Write. Batteryman, Grand Junction 5, Colorado.

"HOW To Make Simple Molds and Plaster Plaques". Profitable business or hobby! Instructive booklet 25c. Plastercraft Supply Company, 1406 East 43rd Street, Cleveland 3, Ohio.

137 WAYS To make money, in home or office, business of your own. Full particulars free. Elite Co., 220-A Grand St., New York 13.

SELL Religious goods by mail. Make your own items. Universal Sales, Box 1076-A, Peoria, Ill.

REAL Big money opportunity! Details stamp. MacCormack, C-12, Madeira, Ohio.

AT Home—Your own manufacturing business, making popular \$1.00 novelties. Cost you 3c to 15c. Everything supplied. Write So-Lo Works, Dept. M-600, Cincinnati, Ohio.

SIX Mail order magazines, all different. 16 to 72 pages each. Full of money-making information. 25c. Kraft, Aurora 11, Mo.

EXTRA Dollars. Manufacturing statuary, plaques. Instructions and quart molding, \$2.95—gallon \$7.00. Wetzel's Products, 1223 Franklin Ave, Columbus, Ohio.

METALIZING Baby shoes instructions, \$1.00. Wilborn, 706-P Judson Rives Bldg., Los Angeles 13.

LEARN Piano tuning, repairing, at home. Tremendous field! Piano parts, tools furnished. Established 1935. Empire School of Piano Tuning, 606-B East University Ave., Champaign, Ill.

YES, You too can mail a 32 page catalog, your name, address printed. Other supplies. All free particulars. Manning, 3259 Decatur Ave., Bronx, N. Y.

ANYONE Can learn. Tune pianos by my system. \$1 2 lessons and chart. Oscar Fylling, 841 Robinson, Oroville, Calif.

MAIL Order profit maker. Beginners, dealers, no matter what you've tried or are selling by mail now, get next to this new, different, fast seller. 25c brings sample, plans, details. Pass judgment on this fast selling profit maker. Money back if you say so. L. Mallory, Neillsville, Wisconsin.

SIGNS Made easily. Instructions and ten sets modern alphabets, numerals, patterns. Sizes up to eight inches. All for \$1.00. Co-operative Business, 7 West Madison, Chicago, (2).

START Home business! Manufacture plaster novelties! Free details! H. Tooker, 63-M Chestnut, Hamilton, Ohio.

YOUR Own mail order business at home, spare time. Details dime. Midwest, Box 4001 Station A, Kansas City 7, Mo.

BOOKKEEPERS: General ledger and tax report experience. Operate permanent, profitable accounting service for the smaller business. Part or full time. Simplified method. Write now! L. A. Bell, 1404 West 25th Street, Cleveland 13, Ohio.

OPERATE Profitable appliance and building repair business. Information free. Cline-Porter, Box 6346D, Pittsburgh 12, Penna.

OPERATE profitable mail order business. Splendid opportunity. For details write Albert Tayes, Zolfo Springs, Fla.

UPHOLSTERING—Do your own, free details. Lyle, Box 385-A, Lombard, Illinois.

AMAZING Information. Outstanding opportunities. Investigation invited. Enterprises, 578F Prospect, New York 55.

START Your own advertising agency, in spare time at home. Opportunity for big earnings and permanent business. Complete operation revealed. No stock or equipment needed. Folder and proof free. P. Snyder, Box 4907-A, Philadelphia 19, Penna.

SELL By mail!—Books and novelties! 35 different items! Large profits! Catalog free! Elfo, 432 N. Wells, Chicago 10.

40 MAIL Order publications, magazines, ad-sheets and circulars. A barrel of opportunity for 25c. Theodore Gordon, Box 1223, New Haven, Conn.

PROFITABLE Home sparetime business, making wallets, belts, other fast-selling leather novelties. Simple to make. Tools not necessary. Amazing opportunity. Send for free catalog. Gold Leathercraft, 632 Desplaines, Forest Park, Ill.

WORLD'S Shortest complete bookkeeping and income tax record; copyrighted; \$2.00 postpaid; boon to small businesses; book-keeper's aid; vest pocket income tax digest included free. Mixon, Postoffice Box 2048, Los Angeles 53, California.

STOP—Be your own boss. Operate fifty profitable mail order business plans. Free details. Star, Box 41, Brooklyn 14, N. Y.

WHOLESALE Catalog, directory 10c. Thousands of articles. Stafford, 961½ N. Jefferson, Indianapolis 1, Ind.

EARN Money with textile painting course. Free details. George Gundrum, LeRoy, Michigan.

FREE Details—How to operate a profitable mail order business. Beier's, 837-A North Hoffer, Bethlehem, Penna.

"A BUSINESS Of My Own." Arthur E. Morgan. Select your business carefully. Hundreds of successful small enterprises described. Second, enlarged edition. 185 pages. \$2.00 (paper, \$1.00). Community Service, Yellow Springs, Ohio.

START Your own candy business. Wholesale. Retail. Small investment. Good profit. Complete course. \$1.00 postpaid. Sokola, 8751 Portland, Detroit 17, Mich.

ESTABLISH Profitable mail order business in spare time. Operate anywhere. Free details. Kelley Service Bureau, 215-K South Monroe, Kansas City 1, Mo.

MEN—Women who can sew. Write, Lyle, Box 385-A, Lombard, Illinois.

SOAP Powder for mechanic, factory, printing trades. Ample supplies. Big opportunity. Profits selling users, retail stores. Schultz Laboratories, Boone, Iowa.

FORTUNES In formulas and trade secrets. Practical, authentic, reliable. Details free. Stillman, 555 Kingston Ave., Brooklyn 3, N. Y.

SUPER X liquid molding rubber. Sample jar 25c, quart \$3.00, gallon \$10.00. Free sample. W. Wooley, 115-A Donald, Peoria, Ill.

MAILING List! 5000 women mailorder buyers. \$25.00; 3000, \$15.00; 1000, \$6.00. Guaranteed accurate! Try them! Woods Remnants, Bedford, Penna.

500% PROFIT. Cast our fastest sellers. Magic rubber liquid for 20 rubber molds, model, instructions, \$3. Hugue, 571 Central Avenue, Brooklyn 7, N. Y. Established 1902.

YOUR Own cleaning and pressing shop. Small capital. Good returns. Complete course. \$1.00 postpaid. John Sokola, 8751 Portland, Detroit 17, Mich.

ORGANIZE Wholesale-retail-popcorn, potato chip shops. We sell beginner's outfits. Long-Eakins, 4760 Hi St., Springfield, Ohio.

BABY Shoes preserved. Formulas, instructions, \$1.00. Novelty Bronzing, Box 56, Hyde Park 36, Mass.

WHY Financial worry? Manufacture fast-selling novelties at home. Low cost. Big profit. Everything supplied. Particulars free. Modern Products, 1216-M Park Row Bldg., New York 7.

SNO-WITE Bleach for snow white laundry. New, handy, powder form bleach. Scarcity of soap makes sales boom. Use of trade name. Formula and sales plan, \$1. Box 1182, Rochester 3, N. Y.

GO Into business for yourself. We have open territory for crunchy chips. Sample sent. No obligation. Write, Crunchy Chips, P.O. Box 310, Binghamton, New York.

"KEMO-PLASTIK"—Amazing new rubber molding liquid. Dries quickly. Easy to apply. Quart \$3.00. Gallon \$6.95. Mold-making instruction included free. B. Belfort, Engineering Bldg., Chicago.

PLASTIC—Liquid glass; China glazes, protects plaster objects, seals wood. Pint \$1.00, gallon \$3.00. New Era Products, 1321-N Belmont, Chicago.

OPERATE Profitable mail order business. Splendid opportunity. Free details. Johnson, Box 93, Lansdowne, Penna.

MAIL Order procedure. 13,000 words, 25c. Stav, 936 North Harvey, Oak Park, Illinois.

"BULK Vending" machines make easy steady income. Have you considered or would you like to learn this fascinating business. Post card brings free booklet. Vending, 1051 "L" St., San Bernadino, Calif.

MAKE Money at home by mail. 137 real moneymakers! Free information. Heydt, 827 E. 233 Street, Dept B1246, New York 66.

FAST-SELLING Patriotic book, just published; with free deal \$1, 100% profit. Portent, Box 62, New York 67.

\$46 FROM Square foot plywood. Jigsaw necessary. Write, Woodarts, X-33, Bridgewater, Mass.

BIG Money daily making beautiful braided leather belts, no tools, materials furnished. You assemble by hand. Leatherlinx, Dept. M, 610 N. Bishop St., Chicago 22, Ill.

NEW Type latex for flexible mold making. Not synthetic. Illustrated simple mold making instructions, 50c. Advanced instructions, \$1.00. Apex Plastic Products, 1915 Lunt, Chicago 26.

COMPLETE Blue prints for power-operated concrete tile machine, capacity 2500 per day; materials cost less than \$100. Send \$10 for plans. Designers, Box 222, Gainesville, Texas.

LIQUID Marble—Colorful, glazed! Molded, brushed, sprayed! Composition floors. Rubberlastic molds. Particulars free. Marbleizing Service, Edwardsville, Ill.

DO You want to learn the how, what, and where of the mail selling business? Details free. Harold Eisert, 218 Beach 81st Street, Rockaway Beach, New York.

USED Battery business, start in your home, no equipment needed, send postal. Pioneers, 2012 Clement, Alameda, Calif.

OPERATE Profitable mail order business, splendid opportunity. For details write, J. M. Watson, 758 Royal St., Baton Rouge 10, La.

START Profitable business, sell merchandise under your name, mail—local. Sample 25c. Linnell Co., Box 1720A, Cleveland, Ohio.

SELL By mail to huge Negro market. This is over-prosperous field of prospects. Details free. Fredericks Books and Supplies, Box 1810-P, Houston, Texas.

\$500 SALES Every business; \$500 month mail orders. "Skip" Tracers-Collector's Manual tells secrets. Sample directives. Supplies \$1. School of Credits, 424 S. Broadway, Room 900, Los Angeles 13, Calif.

IDEAS—Going into business for yourself? Wondering what field to enter? Are you looking for an idea? Mail \$1.00 to Dranichak & King, P.O. Box 310, Binghamton, New York for your copy of Ideas Starting to Choose Your Own Business.

RUBBER-AIRLASTEX Mold making li-quid; extra heavy "pre-war," quality. Sample pint with instructions, \$1.25. New Era Products, 1321-N Belmont, Chicago.

CASTONE—Hardest coldcasting composition on earth, any mold. White and colors, 10 pounds assorted colors, \$2.00; hundred pounds, \$6.00. New Era Products, 1321-N Belmont, Chicago.

VENDING Machines. Be independent. Own a big money business operating coin machines. Earn as high as \$7.00 weekly on machines costing as low as \$11.75 each. Car and experience unnecessary. Routes can be operated either in your spare or full time. Act quickly. Write for details and catalogue showing our amusement games, postage machines, candy-gum-nut vendor and scales. Parkway Machine Co., 623J W. North Ave., Baltimore 17, Md.

RUBBER Molds. Make big money duplicating hundreds of items, own your own business, start in spare time, make your own genuine rubber production molds, duplicate expensive molds for only a few dollars cost, latest factory and shop methods. Information free. Write Shop Technician, 1832 E-9th Street, Kansas City, Mo.

YOUR Town is ripe for a profitable Collection Agency. \$5,000 first year easily possible. We train you, coach you, get you started and help develop your business. Send \$1.00 for Starter Course, or ask for facts. American Collection Associates, 226 State Street, Schenectady 5, New York.

OPERATE Profitable business at home by mail. Write F. Webster, Box 1553B, Sacramento, Calif.

\$10 STARTS Well paying business. Complete course in shellcraftsmanship. Materials and instructions. Write Brace Mail Shop, Dept. 11-a, 528 White Bldg., Buffalo 2, N. Y.

A MAN, an idea, and \$5 builds profitable business. Folio price \$1. M. K. Service Bureau, 710 South Main St., Orrville, O.

"FIFTY Plans for Mail Order Operation" guide you to a profitable business. Free details. Leroy Harris, 310 W. 14th Street, Cincinnati, Ohio.

FELLOW Hustlers—Salute two aristocrats that bring cash instead of promises. Particulars including "free" copy. Additional money maker 10c. Word Products, 2742 Boulevard, Jersey City, New Jersey.

OWN Your own medical company. Operate from home. Employ agents, big profits. Quaker Medical Company, 220 George St., Cincinnati 2, Ohio.

SPECIAL—New, different. Money, Jobs, Honest, dignified. Information for stamp. Empire Distributing Agency, Box 67, Sebastopol, Calif.

EVERYBODY'S Feet hurt. Sell guaranteed cream. Excellent repeater. Free advertising. Write IDI, Quakertown, Penna.

FREE Weekly lists new government, civilian surplus and closeouts. Toys, hardware, jewelry, household items, clothing, novelties, etc. Sell to stores and users. Small quantities available at fraction of original prices. Royalee, 5210 3rd Ave., Brooklyn 20, N. Y.

MORE Power to you! Success—money, whatever needed, soon yours. Simply follow compelling, startling idea just published in Victor Tooley's amazing new book, "Yours is the Power," 50c postpaid. Author's special individual personal advice privilege to each purchaser. Liberal quantity discount for distribution to handicapped or discouraged. Dulco, Box 5259M, Pittsburgh 6, Penna.

PROFITABLE Business of your own. Spare or full time. Write Tes-Co Enterprises, Wilkes Barre, Penna., Box 189-PM.

OWN A mail-order paper products business. Sell envelopes, tags, bags, boxes by mail, wholesale. Tremendous demand. Steady profits. No capital necessary. Write Omaha Envelope Service, Dept. 177, 4721 California, Omaha 3, Nebr.

METALLIZE Baby shoes! Learn this money making business from nationally recognized consultant. Get "know how" from outstanding authority! See Kushner ad, page 271.

METALLIZE Baby shoes and plaster casts! New, easily followed complete step by step instructions. Written by a plating engineer. Electroplating by brush included. Make own equipment. Complete instructions \$2.00. H. C. Pedrick, 1419 West Ontario Street, Philadelphia 40, Penna.

BOOKKEEPERS. Cost clerks, accountants, time study men. Earn \$10 hour installing cost reduction programs. Learn direct from successful firm of management engineers through ten sets instructions at \$10 each. Unusual opportunity. Suite 665, 120 S. La Salle, Chicago 5.

WHOLESALE Distributors: Turn to page 271, read important display ad. Millen Mfg.

EARN \$10-\$25 Weekly spare time. No canvassing. Experience unnecessary. Unique Service, Box 851P, Minneapolis, Minn.

START Home business making statuary, plaques, novelties, garden furniture, artificial marble flooring, liquid marble. Make your own flexible molds. Amazing profits. Folder free. Creative Publishers, Box 236-L, Winnetka, Illinois.

315 GOLDEN Money-making opportunities now ready for you, selling by mail. Details free! Mailway Agency, 10-620P William, Winnipeg, Manitoba, Canada.

START Selling costume jewelry, pearls, wholesale, retail, wonderful Xmas gifts. Costume Jewelers, 264 - 5th Ave., New York.

WORLD'S Best floor wax, 40c gallon. Use in your own home. Resell others. Big profits. Lifetime business. Write Westholz, Box 7324, New Orleans, La.

CASH In now with tested profit maker, Advertising Tips on Selling by Mail. Circular free. Winkelpost, Box 517, Grand Central Annex, New York 17.

MAKE Strange, plastic Rub-R-Slate—1c pound. Makes durable, attractive floors, walls, roofs. Build for half. Bays Laboratory, Oklahoma City 9.

COLOR Concrete with chemicals. Make Hollywood style pottery; home or shop. Marbling, water-paints, 10c brings sample, pictures. Hollywood Cementcraft, 8527 Wonderland, Hollywood 46, Calif.

MAIL Order beginners! How to start, create and develop a profitable mail order business of your own with small capital! Instruction guide 25c. Send for it today. Kraft, Aurora 5, Mo.

MOLD—Model, mold making liquid, material supply catalogue free. Novelty manufacturing instructions, sales outlets. Aircure, 3873A California, San Diego, California.

START Profitable concrete block business. Details free. Wm. Horne, 206 West Wilder, Tampa 3, Florida.

DOLLARS Daily! Cleared \$1900.00 in two months. Details. Duffy, J56, Covington, Ky.

ADVERTISEMENT Writer. Long, successful experience creating powerful mail-order letters, literature, campaigns. Investigate! Les Finkle Advertising, 408 South Spring, Los Angeles 13, California.

START Profitable mail business, booklet 25c. Colin Couch, Elkin, N. C.

20th CENTURY "business opportunities book." 144 pages of formulas, mailorder, homeworkers plans. \$1.00 postpaid or c.o.d. plus postage. Money back guarantee. Silver Crest Products, Dept. 1A, 3040 North Ave., Chicago 47.

ARE You "fed up" working for a boss? Own a permanent mail order business. Write: Gordon Crompton, P.O. Box 2567, Hollywood 28, Calif.

INVESTIGATE Mail selling! What's the one best thing to sell, happily, honestly, profitably? We know! Get free particulars. Free samples. What-to-Do Shop, Box 1082, Tacoma, Wash.

BUILD Your own independent, fascinat-ing and very profitable business at home, spare, or full time, \$75.00 and upwards weekly easily possible making beautiful brilliant, sparkling novelties and religious figures. Fast sellers through you, salesmen, stores. Quickly learned and few dollars starts you making real money. Successful manufacturer can tell you how and furnish everything. Start small, grow big. Write for full information and "amazing story of my success" at once, Inghram Company, 2845 Sixth Street, Detroit 1, Michigan.

BECOME A finance man. Particulars free. George Lenhoff, Lincoln 8, Nebr.

AIRCURE: Liquid latex for flexible molds. Directions. 22 ounces \$2.50. Gallon \$9.00. Rubbercoat, 3873A California, San Diego, California.

EARN Up to \$400.00 monthly. Details free to mail order beginners only. F. C. Bradford, P.O. Box 246, Morenci, Arizona.

INTERESTED In immediate mail order cash? Read "Advance"—Voice of mail order. Offers money-making opportunities. Personal guidance and benefits to all. Sample copy 25c. American Mail Trade Association, 313 East 21st Street, Dept. 400, New York 10, N. Y.

WHY Job worry? Learn electroplating. Highly paid, uncrowded, interesting business. Gold, silver, nickel, chromium, etc. Send postcard for free booklet and proof. Plater Hyde, Dept. MC, P.O. Box 176, National City, Calif.

COPUBLISH Leading m.o. paper. Latest copy Mail Sale Advertiser and proposition, commemorative stamp. Vanroy Shirk, Lebanon, Penna.

GO INTO the mail order business. My 32 years' experience tells how. Send 25 cents for instructions. Mail Order Institute, Box 1902, Cleveland 6, Ohio.

PLASTIC Flooring offers profitable lifetime business! Write Palmer Company, Station A, Berkeley, California.

START Profitable mail order business, write Harry Punch, 1329 Grace, Cincinnati 8, Ohio.

PARATOL—Amazing new rubber latex moulding compound for perfect detail castings of all kinds tested and approved in long service. No worries—easy to apply, quick drying, maximum strength and long life. Why pay more—buy direct! Quarts—\$1.60, 1 gal.—\$4.90, 5 gals. \$4.45 gal. 4 oz. samples on request. Send 25c to cover mailing and handling charges. Full instructions sent with each order. Testworth Laboratories, Inc., Manufacturers of coating and adhesive products of all kinds, 407 S. Dearborn Street, Chicago 5, Illinois.

START Your own business! Free information. Reim, 3931 Bayo, Oakland 2, California.

REAL Opportunity! Start clean, legitimate mail order business with only \$80.00 capital. May not make you rich, but should bring \$30 weekly or more—in spare time. Details free. Opportunity Press, 5015 Lake Park, Chicago 15, Illinois.

START Profitable mail order business. PMT lists new propositions available; products, sources, accurate methods. Covers ad writing, letter logic, trade information. Send 10c for copy and get free instruction folio offer. Progressive Magazine, Sheboygan, Wisconsin.

MERCHANTISE At half the standard advertised price. Ken Solomon Company, 813 Broadway, New York 3, N. Y.

BOOKKEEPERS. Cost clerks, accountants may earn fees of \$500 to \$5,000 as cost consultants installing modern cost control systems. Learn direct from successful firm of industrial analysts and cost consultants, through ten sets instructions at \$10.00 each. Unusual opportunity, territory limited. Room 1504, Fidelity-Philadelphia Building, Philadelphia 9, Pa.

FLASH. Classic novelty. Big business for you. Hurry, dime. Robert Martin, PM 57 Hart, New Britain, Connecticut.

LOOKING For new opportunities? Mail order and others? Get "The Practical Idea." Write: Veteran, Charleston 6, Ill.

MAKE Extra money now. Build to financial independence. Sell office supplies by mail from your home. I tell you how. Jo Troutwine, 8654 S.W. Ninth, Portland 1, Oregon.

ESTABLISH Own specialized, profitable advertising business. Make big money practically giving away advertising. E. J. Matteson, P.O. Box 580, Hanford, Calif.

WORK Evenings at home collecting names and addresses. Sell them by mail. Details free. MacAndrews, 8 Buick Street, Calais, Maine.

SELL By mail. Part or full time. Free details. Write Glenn Heck, Box 81, Russell, Kentucky.

OPERATE Profitable home business selling merchandise by mail. Fast sellers. Large profits. Powell Service, 5713 Euclid, Cleveland 3, Ohio.

START A home business in spare time. Make extra money. Experience unnecessary. Literature free. Elmar Services, Muncy, Penna.

LIQUID Rubber, for making flexible molds, literature and sample free. H. Chaney, 1130 E. 16th St., Jacksonville 6, Fla.

HOW And where to obtain capital. Fully explained. Particulars free. Star Service, Wapakoneta, Ohio.

ASTOUNDING Modern mailorder plans bring quick profits. Darrah, Orono, Maine.

DON'T Waste time! Get the newest and best offers without searching. New, unique service brings complete ready to start offers at low cost. Particulars free. American Enterprises, Box 595-B Grand Central Station, New York 17.

AMAZE Others. Add faster than adding machine. Free details. Math Institute, Box 633, Mobile 4, Ala.

1946 GIGANTIC Directory of opportunities, advertisers supplies, sources, trade information, mail order ideas, products, wholesalers, valuable tips—just published! Descriptive literature free. Wilkin & Co., 118-AP East Main St., Hillsboro, Ohio.

INVITATION To income. Contact Mib Associates, Fitzsimmons Building, Pittsburgh 22, Penna.

BIG Paying jobs in welding. Complete welding lessons and reference books, 516 pages, 41 lessons, \$2.00 copy. Money-back guarantee. Hobartweld, Box M-1065, Troy, Ohio.

BELTS! Make'm and make money. No tools! Sample 50c. Artinic Leather, 411 Joseph Ave., Rochester 5, N. Y.

START A clock shop. Fascinating, easily learned profitable business requiring little capital. We teach you how to repair all kinds of clocks. Information free. Houston Clock Shop, P.O. Box 5086A, Houston 12, Texas.

START Home manufacturing business making Cleaning Compounds, Soaps, Insecticides (DDT), Cosmetics, Polishes. No machinery. Literature free. Kemix, Park Ridge, Ill.

MEN, Women, "Everybody Likes Candy." Learn to manufacture professionally at home. (Our 36th year.) Ragsdale Candies, East Orange 2, N. J.

SYNTHETIC Latex with Neoprene base for making flexible molds! Quick drying! Safe! For home, classroom, or industry. Quart \$2.00. Gallon \$5.95. Full instructions. Plastercraft Supply Company, 1406 East 43rd Street, Cleveland 3, Ohio.

10c BRINGS You hundreds of money-making propositions, plans, ideas, tips, wholesale supply sources, magazines. Gardenville Publishers, Gardenville 4, N. Y.

200 MONEY Making deals, Plans. Rare formulas. Schemes. Folio free. Formico Mart, Box 572, Dayton, Ohio.

WOULD You pay 3%—first \$350 made? Color-illustrated book "505 Odd, Successful Enterprises" free! Some plans offer occasional "day off." Start at home, office. Expect something odd! Pacific, 2207 1/2 Cloverfield, Santa Monica, Calif.

RAISING Canaries pays good profits. Valuable bird book—"Its Care, Breeding and Training." Price \$1.00. American Canary, 2839 N. Halsted, Chicago.

INCORPORATE Your business. Delaware laws. Many advantages, free details. Tax Research Bureau, Inc., Delaware Trust Building, Wilmington, Delaware.

SPECIALTY Manufacturing, the big money business that can be operated anywhere, start on a very small capital; we supply dependable formulas and complete instructions; get interesting free booklet, "Money-making Opportunities in Specialty Manufacturing." Howard Robinson, Ph.G., 1300-A South Ohio Street, Sedalia, Mo.

FELLOW Workers—Down with bosses—Start own business—Be independent—Booklet describing 137 tested plans, free. P. Padney, 307 York St., Jersey City, N. J.

MINK Raising, information free. Complete. Lake Superior Mink Farm, Superior, EE, Wisconsin.

PROFITABLE Mailing merchandising business. Write Riegel, 1111 Harrison, Phila. (24), Penna.

TADPOLES Make frogs, tremendous demand. Both make you money. 25c brings tell-how information. Chariton Corporation, Century Building, Chicago 4.

COPPERIZE Baby-shoes, complete instructions, tested sales plan. Metalloids, Box 8087-b, Pittsburgh 16, Penna.

MAKE "DDT" Products. My ten master formulas show how. Literature free. Howard Robinson, Ph. G., 1302-A So. Ohio, Sedalia, Missouri.

MAKE Flexible molds! Few cents each! Cast plaques, novelties, bookends! Free sample! H. Tooker, 630-A Chestnut, Hamilton, Ohio.

WE Start you in business, at home, sparetime, earning \$10-\$30 weekly selling by mail. Stamp appreciated but not necessary. Driscoll Sales Service, Box 2771-A, Denver, Colo.

COLORGLAZED Concrete pottery made without molds. New, low cost, patented method. Cemetery products, novelties, tiles, floors, etc. Basement leaksealing. Other money-making projects. Booklet, details free. Men only. National Potteries Company, Fergus Falls, Minnesota.

ELITE Collection contains 137 practical money-making plans; local and mail order. New edition. Particulars free. Elite Co., 220-A Grand St., New York 13.

PLASTIC Homes—Build yourself! Re-surface old buildings! Wonderful building material. Particulars free. Marbleizing Service, Edwardsville, Illinois.

YOUR Own business. Big profits, very small capital. National organization teaches, helps, supplies everything. Interesting service business. Big demand everywhere. Americlean, 211 North 7th Street, St. Louis 1, Mo.

HANDY Men—Earn money home operating Community "Fix-It" Shop. Write Stafford, 708 Rawlings, Carbondale, Ill.

MAIL Order business course shows you how to make money, spare or fulltime. Teaches professional mail order technique—not penny-snatching schemes. Fascinating 100-page illustrated success-catalog free! Write—Nelson Company, Dept. 4-02, Chicago 5.

BUILD Miracle homes. Yours. Others. Chamberlain, Fitzsimmons Building, Pittsburgh 22, Penna.

BOOKKEEPERS—Operate your own "Dollar-A-Week" bookkeeping and tax service. Full or spare time. Details free. Ellis, Box 200, Cedar Grove, No. Carolina.

RECAST Old batteries into new. Latest achievements. Battery Laboratories, Minneapolis.

START Mailorder bookshop—Everything furnished; publisher cooperation. 25c brings booklet, exclusive setup, samples, exciting ideas. General Publications, Ossining, N. Y.

\$25 WEEKLY Working two hours daily. No canvassing. No manufacturing. Lycke, Box 2471, Cleveland 12, Ohio.

BRUSH Plating outfits connect to a battery. No tanks necessary. Good paying business at home plating autoparts, bathroom fixtures, bicycles, reflectors, silvering mirrors. No shop or experience required. Outfits furnished. Free booklet. Gunmetal Co., Ave. H, Decatur, Ill.

BUILD Neon signs and neon lighting. Easy to learn. Very small capital required. McMaster Sign Co., 730 State St., Bellingham, Wash.

BABY Shoes preserved. Complete instructions. Exclusive rights. M. E. Watson, Bellefontaine, Ohio.

EARN Money sparetime mailing circulars for others. Our folio tells how. Write Pioneer, 404-P, Yonkers 1, N. Y.

MONEYMAKING OPPORTUNITIES

SELL Personalized jewelry by mail. Danbros Jewelers, Dept. M, 3530 South Hanover, Baltimore, Maryland.

CARNIVAL Ride plans: Kiddie auto, \$5; Toonerville trolleys \$8. Brill, 228-M North University, Peoria, Illinois.

SILVOGOLD, America's finest 1000 signature embossing \$1.00 kit. Glass packed, two toned. Proposition free. Bender Products, Mastic 2, N. Y.

MECHANICALLY Inclined men—Own and operate general appliance repair shop. Complete, illustrated course shows you how. Welding, refrigeration, motor repair, how to get business, etc., all phases covered. Free literature. Christy Supply, Dept. 1171, 2835 N. Central Ave., Chicago.

THOUSANDS Articles wholesale. "Supply Source Directory" 10c. Ideal Service, Park Ridge 40, Illinois.

THREE Mail order magazines free. Thompson, Box 133-ZB10, Tonawanda, N. Y.

EARN Up to \$2,000 year, inventing simple items for special cash markets. Ideas only. No patents. Hendrickson, Argyle (7), Wisconsin.

HAVE More—Be more! "The Magic Story" tells all. Details free. Southern Specialty Service, 210 North E, Lake Worth, Florida.

BE A magician! Have fun! Make money! Send 25c for large professional magic apparatus catalog. "Magic" magazine included free. Robbins Co., 152-P West 42nd Street, New York.

THERE'S Big money in junk." and repairing batteries. Write, Batteryman, Grand Junction 5, Colorado.

START A spare time mail order business. Make extra money. Big profits. Experience unnecessary. (Dealership available). Richard Ponto, Elkton 1, S. D.

START Your own business! Big money manufacturing novelties, plaques, statuary. Free catalog. Write Bing Products, 88-A2F Broad Street, Boston 10, Mass.

EARN Money evenings, copying and duplicating comic cartoons for advertisers. Adservice, Argyle (1), Wisconsin.

EARN Money at home! Thousands do! "Home Worker Magazine" tells how. Sample, 25c (coin). Six issues, \$1.00. Arthur Sizemore, Pub., Box 870-M, St. Petersburg, Fla.

MANUFACTURE Artificial fishing baits. Immense demand; good profits. Write Goff, 5017 22nd, Cicero 50, Illinois.

IMPRINT Circulars. New 2-color samples free. Fowl Printing Co., Muncie 2, Indiana.

\$5 IN Mail orders! Start now. Free particulars. Stillman Taylor, Cologne, N. J.

\$246.50 MAKING Unusual secret device without skill, machinery, from former war material costing \$1.50! Simple, baffling invention, unbelievably profitable! Illustrated proofs free. Rolls Enterprises, 115-D West 16th, New York 11.

SELL Books by mail. Large profits! Details free. Cline-Porter (Publisher), Box 6346-H, Pittsburgh 13, Penna.

CO-PUBLISH Magazine. Many profits. 16-page booklet 10c (refundable). Goldenberg, 5209-G Lindsay, Houston 3, Texas.

EARN While you learn clock repairing. With our method your income can start immediately. Write Akron Clock Clinic, 964 Wye Drive, Akron 3, Ohio.

ENTER Profitable export field. Send \$2.00 for list over 100 oriental firms urgently desiring all types American merchandise. Box 2183, San Francisco 26, Calif.

NYLONS—Supply sources, 50 manufacturers. \$1.00. Bonafide information. Enterprises, 578N Prospect, New York 55.

UNUSUAL Mail order opportunities. Guthrie, 3215 Brest Ave., Norfolk 2, Virginia.

256 PLANS, Formulas, tips, ideas, publications 25c. Dancer, Mansfield, Ohio.

NEW Money making opportunity ready now. Write, Sharp, 904 Pennsylvania, Kansas City 6P, Missouri.

DOLLARS Daily! Learn how. Read "Timely Tips Magazine." Paulding 2, Ohio. 19th year, \$1.00. Three copies, 25c.

OPPORTUNITY Knocks. \$50 weekly in your spare time. Complete exclusive plans and details for Xmas novelty. Send 50c. Novelty, Box 1278, Middletown, Conn.

"LUMINOUS Paint." Soap, weed killer, antifreeze, fly spray, etc. One hundred and fifty moneymaking formulas. \$1.00 postpaid. Columbia Publications, Aberdeen, Idaho.

"GOLDEN Magic" raised effect ink transforms handwriting into matchless beauty. Dollar item with wide profit margin. Rotex, 216 Degraw, Brooklyn 2, N. Y.

MAKE Popular, fast-selling stainless steel bracelets at home, full or spare time. Easy profit. Special introductory kit makes work quick, easy. Facts free. Ar-Clo Products, 2055 West Summerdale, Chicago 25, Ill.

OPERATE Profitable mail order business. Splendid opportunity. Z. J. Wass, 3802 W. Chicago Ave., Chicago 51, Ill.

EMBOSS Christmas cards, letterheads yourself. "Embosso," gold, silver, \$1.00. Dexter, 45 Pleasant, Battle Creek, Mich.

SMALL Capital "moneymaker." New. Unusual. Write, Jones, Bethany 2, Okla.

OPERATE Profitable part time business in your own home. Free details. General Mail Trade Service, 2272M-Andrews Avenue, New York 53, New York.

EARN Money at home, make seashell brooch and earring sets. Kits include materials, actual photographs, instructions for one set \$1.00—6 sets \$5.00. Black's Shells, 601 S. Newport Ave., Tampa 6, Fla.

MAKE Sell over 100 fast repeating products under your name without machinery. Kohen, 506 W. 45th St., Chicago 9.

EARN Extra cash—full time or spare time—selling Pines' 1947 Greetings. Profits over 100% for producers. These sensational easy-selling boxed assortments must be seen to be fully appreciated. The complete line includes over 100 different moneymaking assortments for all occasions—birthday, anniversary, convalescent, congratulations, announcements, invitations, gifts, special occasion and holiday cards; distinctive social stationery for men and women. Climb this big-profit band wagon by sending \$3.00 now for your saleable samples (value \$6.00) of six different current feature dollar box assortments together with full details of our no-risk money back guarantee on our complete line. Just print your name and address, attach \$3.00, and mail to: Pines, Box 32, Flushing 1, New York.

ADVERTISING Offers you interesting profitable career. Start your own advertising business immediately. Others do the work; you collect your profits immediately. No merchandise to sell. Information free. Robert Theis, Rydal, Pennsylvania.

SELL By mail! Mail order business is shortest cut to profitable sales. Inspiring, constructive, instructive literature sent without obligation. Earl Cratty, 385 Lenzen Ave., San Jose 11, California.

"LUMINOUS Paint." Resilvering Mirror formulas 25c each. "50 Single Ingredient Formulas" \$1.00. Ideal Service, 300, Park Ridge, Ill.

RAISE Own capital, start own business! Copyrighted method. 25c brings proven money making offers. McCann, Ravine, Nutley 10, N. J.

MAKE Big money selling top quality, artistic chenille bed spreads. Sample \$7.95—big profit. Order today and get full details. Michigan Brokerage Co., 123 N. Baum Street, Saginaw, Mich.

WANTED Agents, advertisers, co-publishers. Sample and details 25c. J. W. Arthur, Box 4, Montgomery, W. Va. Member N.M.D.A.

MAKE Big money preserving baby shoes in metal, bronze, pearl, gold and silver! Kiktavi Company, 6820 South Ruthelen, Los Angeles 44, California.

STOP Looking for work! Here is something you can put your hands on. Good paying jobs available in Florida. Send for free booklet, "Florida Opportunities." Florida Businessmen's Service, Box 767-B, Panama City, Florida.

ASSEMBLE Fast-selling jewelry with colorful plastic and metal parts. Profitable hobby; simple—inexpensive—fascinating! Free details. Hughes, 712 Kimball, Danville 3, Illinois.

UNPAINTED Figurines, plaques. List. Progress Company, 4033 Chowen, Minneapolis 10, Minn.

\$25 WEEKLY Working two hours daily. No canvassing or manufacturing. Lycke, Box 2471, Cleveland 12, Ohio.

EARN Money at home—steady income. Write Successful Income Builders, 508-A, Hollywood 28, California.

LEARN Metascience. Remarkable drugless healing. No manipulation. No apparatus. Unbelievable simplicity and results. Inexpensive correspondence course. Write Metascience, De Land, Florida.

RAISE Giant Chinchilla rabbits. Tremendous profits from gorgeous fur, delicious meat. Ideal business. Willow Farm, R15A, Sellersville, Penna.

LEARN Battery repairing, rebuilding. Engineer offers money making methods. Battery Bureau, 2225 North 44th St., Milwaukee, Wis.

WIN Contest money. General contest bulletin shows how. 16 big pages of help. Many current contests listed. Sample 25c. General Contest Bulletin, 1609 1/2 East 5th, Duluth 5, Minn.

FREE "Prize Contest Bulletin" describes many contests. Money making opportunity. Cash Register-G, 210 Fifth Ave., New York 10.

200 MONEY Making deals, plans, rare formulas. Schemes, Folio free. Formico-Eng., Box 572, Dayton, Ohio.

WOULD You pay 3%—first \$350 made? Color-illustrated book "505 Odd, Successful Enterprises" free! Proven by "Little Fellows." Start at home, office. Expect something odd! Pacific, 2207 1/2 Cloverfield, Santa Monica, Calif.

FORTIFY The future! Start own business; home, office. Booklet describing "Collection of 137 Tested Plans" free. Elite Co., 220-A Grand St., New York 13.

PUBLISH Your own magazine. Handsome 52 page format, well edited, illustrated. Cost low as \$1.00 month. Brings you prestige, profits. 25c brings sample details. National, Ord, Nebr.

I MAKE Big money in the mail-order business. You can do the same at home with my copyrighted system. Write me. I'll tell you how. F. Little, Box 8, Glenshaw P.O., Pittsburgh, Penna.

FORMULAS, PLANS, ETC.

21 POPCORN, Candy apple, etc. formulas. All money-makers, \$1.00. We can supply equipment. Concession Supply Co., Dept. "A," Box 133 Sta. "B," Toledo, O.

CHEMISTS—Chemical questions answered. Formulas, analyses. Lewitsky, 26 Erwin Place, New Britain, Conn.

MANUFACTURE Cleaners, flavors, cosmetics. Formula catalog 10c. Kemico, Park Ridge 20, Illinois.

FORMULAS Are fortunes. Send 25c. May be turning point of your life! Write! CPB, 540 Amity, Muskegon, Michigan.

NEED Chemists? Formulas? Analyses? Technical services? Consulting Scientific Company, Swarthmore, Pennsylvania.

SOAPLESS Soap! Easily, cheaply made-sold. Formula, 25c. Duffy, L52, Covington, Ky.

FORMULAS Guaranteed manufacturing. Expert chemist. Lists free. Riviere, 521 Provident Bank Building, Cincinnati, Ohio.

10,000 FORMULAS And trade secrets. Free literature. Stillman, 555 Kingston Ave., Brooklyn 3, N. Y.

MAKE Toilet, laundry and liquid soap. 5 formulas \$1. M. Elsbury, 717 N. Dearborn, Chicago 10.

REAL Manufacturing formulas. Lists free. Cummings, Chemist, Gordon Ave., Syracuse 4, N. Y.

MAKE 25 Pounds soap for 25c in about 25 minutes. Three ingredients. No lye or grease. (Original). Also bubble liquid, Carpet cleaner, Soap substitute, Garment cleaning soap. All 25c coin. Smart circular free. Teycer, Chemist, Box 1287 1/4, Chicago 90.

MECHANIC'S Soap powder and 109 other money making formulas for 50 cents. K. Reeves, 3226 Tularosa Street, El Paso, Texas.

FORMULAS—Latest, best. Analysis. Giant formula catalog and chemical instruction sheet 10c. Refunded first order. Belfort, Engineering Building, Chicago 6.

MANUFACTURE Cleaners, flavors, cosmetics. Formula catalog free. Kemico, Park Ridge 16, Illinois.

PLASTICS

ACETATE Plastic 3/000 transparent. Two 20"x50" sheets \$1.00; dozen \$4.95; 100—\$34.75. Two dozen 5"x20" \$1.00. Daniels Press, Statesville, N. Car.

PLEXIGLAS Sheets. 10"x12"x15" —85c; 1/8"x11 1/2"x12"—60c; 3/16"x12"x16"—\$1.35. Plastic rod assortment, 9 colors and phosphorescent, \$4.00. Julian Rhodes Muench Co., 1527 W. Alabama, Houston 6, Texas.

PLEXIGLAS, Clear masked: 12"x12" 1/16"—\$1.25; 1/8"—\$1.60; 3/16"—\$2.00; 1/4"—\$2.30. Also thicker and colored sheets. Cement 4 oz.—60c. Free instructions and complete price list. Postpaid. Money orders only. Plasteco, 1800 Stuart, Houston 4, Texas.

PLEXIGLAS, Clear, masked. Prices per square foot. 1/16"—\$1.17, 1/8"—\$1.46, 3/16"—\$1.77, 1/4"—\$2.09, 3/8"—\$3.10, plus 10% postage. M. Raffel, Rethel Plastics, 15 Walnut Street, Steelton, Penna.

PLASTICS And supplies—new Plexiglas, Lucite, Catalin sheets, rods, tubes, etc. Exceptional kits, \$2.00, \$5.00, \$8.00. Attractive prices. We pay postage. Free list. Plas-met Sales and Engineering, 4648 Shirley Pl., St. Louis 15, Mo.

PLEXIGLAS—Everything for the plastic craftsman. Free catalogue. Novalte Plastic, P.O. Box 106, Brooklyn 19, N. Y.

LUCITE—Special offer, catalog 10c. Midwest Plastic, 1717 No. 66, Omaha 4, Nebr.

MAKE Money assembling our pre-fabricated plastic kits. Sample kit 50c. Catalog free. Fabros, Box 156 Station F-1, Buffalo 12, N. Y.

SENSATIONAL Plastic injection molding machine. Low price Plexiglas, dyes, cements, shellcraft kits; molding sets, polystyrene rods. Free literature. G. Baker Company, River Edge, New Jersey.

PLASTIC Craftsmen—Plasticast liquid plastic kits are again available. Cast your novelties, book ends, jewelry. Kit contains one pint of plastic, accelerator, mold material, mold parting compounds, complete instructions. \$5.00 prepaid. Alexandria Brass and Plastics, Box 221, Silver Spring, Maryland.

NEW Liquid plastic. Clear colors. Cast without heat. Embed flowers, insects, coins. Saw, drill, carve. Manual tells how. Send \$2.95 plus 20c postage for complete kit including one pound liquid Castolite. Castolite, Box B211, Kenilworth, Ill.

LUCITE Sheets—\$1.00 per lb. postpaid. Sizes available (inches)—1x2, 1x4, 2x2, 2x3. Send order with payment to Bellite Company, 173 Utica Ave., Brooklyn 13, N. Y.

LUCITE, Plexiglas. Prices you can't beat. Prime grades. Masked sheets 12"x12" 1/16"—\$1.00; 1/8"—\$1.25; 3/16"—\$1.55; 1/4"—\$1.85; 10% postage. Jewelry findings, shells, accessories. Free listings. Craft Plastics, Box 129M, Somerville, N. J.

PLEXIGLAS Lucite slashed, free listings. Douglas Home Craftsman, Dept. M, Stamford, Conn.

PLASTICS, Material and supplies. Information folio, list free. Art Plastics of Calif., 8127 East 14th St., Oakland 3, Calif.

PLEXIGLAS, Lucite, Cellulose Acetate for hobbies, money-making opportunities. Sheets, rods, tubes, clear or colored. Full range of sizes. Cements, dyes, polishing compounds, buffs. Free price list. Plastic Parts & Sales, 1157 S. Kingshighway, Dept. H-2, St. Louis 10, Mo.

PLASTIC Gifts—Assembled from pre-fabricated kits. Ideal Xmas gifts. Catalog 10c. Plastic Products Co., Box 384-T, Massillon, Ohio.

PLASTICS—10c Brings illustrated 1947 catalog containing kits, bulk assortments, plastics and national contest. Write Dept. D12, Bellico Plastics, 147 W. Sidney, Mt. Vernon, New York.

WRITE Today for generous free samples "Lucy-Plex" and "Coty-Bak" fast action; dustless, greaseless, non-burning, optical polish plastic buffing compounds. 5000 plastic hobbyists now use them. Enclose 12c postage. Plastic Masterpieces, 529 West Manchester Ave., Los Angeles 44, Calif.

PLASTIC Discs, shapes, metal findings, wholesale, free catalog. "Secors," Bradenton Beach, Florida.

MAKE Plastic novelties with Hollywood kit containing 2 lbs. of Lucite and Plexiglas; 3 colors of dye, bottle of cement and complete instructions. Postpaid \$3.25. Hollywood Items Co., Box 1151, Hollywood 28, Calif.

PLASTICS; Sheets, rods, tubes. Free list. Plastic Supply Co., 2618 St. Louis Ave., St. Louis 6, Mo.

GUARANTEED! We are America's lowest priced plastic supply house. Write for free price lists. Allcraft Products, Box 212, Hempstead, N. Y.

WRITE Today for generous free samples "Lucy-Plex" and "Coty-Bak" fast action; dustless, greaseless, non-burning, optical polish plastic buffing compounds. 5000 plastic hobbyists now use them. Enclose 12c postage. Plastic Masterpieces, 529 West Manchester Ave., Los Angeles 44, Calif.

PLEXIGLAS And Lucite liquid cementing dye kit. Full color range. Excellent for cementing or dipping. \$2.00 postpaid in United States. Money orders only. Handicraft Supply, 409 N. Akard, Dallas, Texas.

\$100 CASH. Plus up to \$1000 "royalties." Enter "Allcraft Products Contest." Write immediately: Allcraft Products, Box 212, Hempstead, N. Y.

PLASTICOR Injection molding press produces 100 1/4 oz. Tenite moldings per hour! Mechanical pressure, electric heat, sixteen colors, 2 1/2"x2"x1" molds. Commercial results! Magazine featured! Money-back guarantee! \$34.95 complete! Limited supply! Technicraft, 1156 Commonwealth, Boston 34, Mass.

MONEY In plastics! Lucite plastic hobby kit. Two pounds Lucite materials, coloring dye, cement. Instructions. Send \$2.50 to Plastic Specialty Co., (Dept. M), 192 Lexington Ave., New York 16. Also Swiss music movements, \$3.50 each.

LUCITE—Complete illustrated fabricating instructions, used in craft classes throughout the world, price list on lucite, dyes, complete supplies. Booklet 10c, with sample, 35c. "Gem-O-Lite," P.O. Box 686-B North Hollywood, California.

LEARN At home "Working With Plastics." Full information on sheets, blocks, rods, tubes. Trade names, sizes, colors for fabrication. Designing, tooling, bending, cementing, polishing. Also for homework-shop. Only \$1.25 postpaid. Money back guarantee. Modern Technical Book Co., Dept. MMC, 55 West 42nd St., New York 18.

PLASTICS. Make yours at home. Formula and moulding instructions \$1.00. Forester, Zone 84, Station K, Toronto, Canada.

CHEMISTRY

THE House of Winn, home of supplies for amateur chemists. See Winn's New Idea chemical kits and apparatus outfits for home experimenting. Send 10c for retail catalog. Established 1931. John H. Winn, Dept. 512, 124 West 23rd St., New York 11, N. Y.

BUY Laboratory supplies at big savings direct from the manufacturer. Catalogue 10c. Est. 1916. National Scientific Co., 2204 W. North Ave., Chicago 47, Ill.

HYDROGEN! 10 Charges \$1.00. Inflate balloons, etc. Miles Specialties, Kokomo, Indiana.

HANDBOOK For chemical experimenters, illustrated, hundreds of experiments, 50c. Experiment booklet 15c. Supply catalog 5c. Reading Scientific Company, Reading, Penna.

STUDENTS' Laboratory supplies. Send 5c for catalog. Mel-Glo Chemical Co., 258 Fourth Ave., Brooklyn, N. Y.

APPARATUS. Chemicals, ounce quantities, catalog 5c. Fleischer's Laboratories, Everett 49, Mass.

CHEMICALS And apparatus for industrial, analytical, and private laboratories. Complete supply service for correspondence school students. Send 3c for catalog. Dept. M-43, Biological Supply Co., 1176 Mt. Hope Ave., Rochester 7, New York.

FREE Catalog. Chemistry, mineralogy, biology, optics. Tracey Laboratories, Evanston, Illinois.

LABORATORY Supplies. Chemicals and apparatus all descriptions. 36 page book 10c. Standard Science Supply Co., 1232 N. Paulina St., Chicago 22, Illinois.

HELP WANTED

"LATIN America Opportunities." \$1.00 brings copyrighted 1947 research report listing specific firms and tells how-when-where to apply for opportunities in mining, oil, aviation, etc. Many men have secured lucrative jobs through this research report. Pan Americana, 1663 N. Highland Ave., Hollywood 28, Calif.

AGENTS WANTED

AGENTS. Substantial profits. Repeat order product. Not mere "job" but opportunity establish steady income. Additive lubricant. Limitless field. Factories, autoists, service stations, fleet owners buy in huge quantities. Write Kidder Oil Company, LaCrosse 1, Wis.

ODOR "Mufflers" finest refrigerator deodorizer for ice boxes, closets, kitchens. Retail \$2.00. Sell consumer and retailer. Big profits, exclusive territory. Write L. A. Muller, Continental Bldg., Los Angeles.

FREE Illustrated catalog—hard to get merchandise. Get it now! American Merchandising, Dept. PM-WC, 12 Adams, Montgomery, Alabama.

JOBBER. Distributors for high-grade line of tropical feather bird pictures native to Mexico; birds made entirely of "genuine feathers," artistically framed. Feather-craft Studios, 220 South State Street, Chicago 4, Illinois.

MAKE Up to \$50 a week in spare time selling greatly in demand kitchen oil burners. Write: Oil Burner Supply Outlet, P.O. Box 327, Cambridge, Mass.

AGENTS—Co-publish, world's largest mail-trade magazines. Complete details. 25c in coin. Briggs & Garberina Co., 3446 Cottman Ave., Philadelphia, Penna.

2 PROFITABLE Sellers: Silver Plating Liquid (NuSilver—RePlateO—trademarks). Simply apply with a cloth and polish-up, or immerse article in Liquid 1 minute and polish-up. This is a method of chemically applying silverplating in 1 minute to certain affinitive metal surfaces, like Sterling and silverplated ware, nickel-silver, german-silver, brass, copper, bronze, zinc, and some other metal compositions. Deposits genuine pure silver 1000 Fine. Gives a durable and lasting finish. Formula perfected in 1926-27 and sold successfully now for over 19 years. Has over a thousand uses. A very profitable seller at about 4 for 1. Lectrik Silver Kleener Atomic Metal Electrode Plates, for de-tarnishing silverware (and other metals, too) quick. As many as 100 pieces of tableware can be de-tarnished in 1 minute. This is the original metal de-tarnishing Plate invented in 1907, and now sold successfully for over 39 years. This is a demonstrating money-maker with a margin of 5 for 1. Both of these items are thrilling demonstrators. To any one who will get out and cover territory and demonstrate and sell, real money can be made. Exclusive territory demonstrating sales—distributors are wanted in all territory not being worked now. Wholesale and retail. Men and women. Work yourself and appoint agents and dealers throughout territory. This work is permanent if you will do the job. Complete details free by letter mail. Nu-Process Products Laboratories, Dept. 260, Aurora, Illinois.

\$1 STARTS You in business. Sell De-Luxe ties, 100% wool interlining. Costs you only \$7 per dozen, you make \$5.00 dozen. Send \$1.00 for special introductory offer two DeLux ties. Catalog complete line free. Philip's Neckwear, 20 West 22nd St., Dept. K-6, New York 10.

PLASTONE—Amazing new polishes for floors, furniture, autos. Beautifully packaged. Low priced. Whirlwind seller to stores, gas stations, homes. Fast repeater. Big profits. Unconditional money back guarantee. Write for free samples offer now! Plastone Company, 2207-A West Chicago Ave., Chicago 22, Ill.

\$1.44 PROFIT On \$2.00 sale to dealers. Klisem Baits, Painesville, Ohio.

BALLOONS. Available now in all colors and sizes. Write for prices. Unger Novelty, 506 South Canal St., Chicago, Illinois.

STRANGE "Dry" window cleaner. Sells like wild. Replaces messy rags, liquids. Simply glide over glass. Samples sent on trial. Kristee 129, Akron, Ohio.

SELL Fast moving punch board premium deals to taverns, roadhouses, drug stores, cigar stores, etc. Send for big profit deal. Howard Machine Products Company, 2754 Diversey Blvd., Chicago 47, Ill.

100% PROFIT. History World War II. Tremendous seller. Schlake, Box 813, Cincinnati 1, Ohio.

GREETING Card money-makers. Write for folder. Greenport Art Company (Dept. 128), Brooklyn 15, New York.

AGENTS—Big money for men, women, boys, girls—selling gorgeous night-glowing orchids, gardenias; perfect imitation real flowers, last for years, all the rage for wear on hair or clothes. Write for wholesale prices. Marney's, Dept. M-5, P.O. Box 581, Ogden, Utah.

CASH In on OPA restaurant price removals. Sell menu display signs, banners. We ship hand painted to order. Thirty dollars daily easy. Juanita Mitchell, La Verne, California.

SELL Personalized soap. Name on every cake. Ideal for gifts. Get sample offer. Dunbar Soap, New Brunswick, N. J.

AGENTS—Cash in on this amazing new Xmas gift item—"The Champ" Giant Piggy Bank, holds \$1000 in coin, large as a watermelon, hand-painted decorations. \$3.98 retailer, samples are \$2, f.o.b. Chicago, refund if not satisfied. Act now! Nation-Wide Merchandise Co., 64 W. Randolph St., Chicago 1, Ill.

100% PROFIT! \$20.00 Worth polishes, etc., \$10.00. Renschler's, Carrollton (2), Kentucky.

NEWLY Patented attachable pipe device. Cooler, cleaner, drier smoking. Less re-lighting. 50c each, three for \$1.00. Agents free demonstrator, profitable. Morris Sales, P.O. Box 1136, Atlanta 1, Ga.

WONDER Rat boards. A new type trap made of special glue. No poisons, no disagreeable odors. "Like catching flies on flypaper." Cost \$4.00 dozen, \$45.00 gross. Resell at \$9.00 dozen, \$100.00 gross. Star Exterminating Co., 2958 Nostrand Ave., Brooklyn 29, New York City.

SELL Reflective name plates. Business signs. Elmer Vandrey, Truman, Minnesota.

RUBERLYKE Plastic foneholder. New, novel, fast selling. Retail, 60c. Fair-traded. Everybody a prospect. You also sell retail outlets. Fits all phones. Telephone rests on shoulder. Leaves hands free. Sample 50c. Reyam Plastic Co., Dept. P-12, 1525-A-East 53rd St., Chicago 15.

SENSATIONAL. Exciting, new, fully enameled any color, chrome-plated, durable, non-tarnishing miniature midget racing car pins, tie holders, belt buckles. Write Hook-Fast, Box 425, Providence, R. I.

MEXICAN Curiosities. Biggest line. Lowest prices. Prompt delivery. List free. I.I.E.A. Lucerna 63-8, Mexico City.

MAKE \$15.00 Daily in plastics. How? Send your favorite snap shot and \$1.00 for sample and complete details. Plexart, Box 1976, San Antonio, Texas.

SILVER Plating liquid (contains pure silver). Simply apply with a cloth. Silver plates permanently onto silver, copper, brass, bronze and zinc. Once applied it is there to stay. Shines to a brilliant lustre. Sample free. Nu-Lustre Products, 88 Paterson Ave., Paterson 2, New Jersey.

BIG Profits operating as our exclusive distributor your territory. State agencies open. Quaker Medicine Co., 220 George St., Cincinnati 2, Ohio.

FREE—Mexican novelty curiosities. Fastest selling items. Biggest profits. "Productos," Apartado 9218, Mexico City.

WONDER Cleaner, new bubble bath, Glasklean—three profits. Fast sellers, homes and stores. Circulars free. Courier, 3829-I Delmore, Cleveland Heights 21, O.

SELL Full, part time individualized belts, buckles, cap badges, tie holders, 2,000 emblems to choose. Fast profits. Repeats. Write today special outfit offer. Hookfast Specialties, Box 1425, Providence, Rhode Island.

SELL Superb line personal printed stationery. High quality items, year 'round sales. Attractive sample book, supplies free. Writewell Stationery, Dept. 113, 108 Massachusetts Avenue, Boston.

LOOK: Agents. Golden rays kit. New, different. Fast seller, big profits. Sample kit \$1.00. Clinton Sales Co., 237 So. 4th St., Hamburg, Penna.

MEXICAN Feather pictures. Christmas novelty. 50c (stamps) bring \$2.00 worth samples, details. Refunded if unsatisfied. Aztec Art, Apartado 762, Mexico City.

NO Money or experience required. Spare or full time writing orders for guaranteed men's hosiery. We deliver and collect. Advance profit and 33% cash bonus. Huge demand everywhere. Steady repeat business. Write for free sales outfit including everything needed to make money. Kentcraft, 44 Court St., Dept. KM, Brooklyn 2, N. Y.

SELLING To housewives? Double your sales with inexpensive premiums. Postal brings interesting details. A. Kinford, Wayne, Penna.

EXCELLENT Sideline for printing and advertising salesmen. Decalcomania name plates in small quantities. Great demand. Also make money applying initials on automobiles. Free samples. "Ralco" XL-Roxbury, Boston 19, Mass.

HOUSE Numbers that glow in the dark. Luminous pictures, etc. Large mfr. wants factory representative. Wonderful new product. Fast seller. Free samples. Madison Mills, 303 4th Ave., New York City.

AGENTS: Do you want \$50 per week? Selling a profitable line of fibre brooms, mops and floor dusters. Write, Burtz Fibre Broom Co., Columbia, Pa., Dept. A.

AGENTS—Big line including food products. Fast selling premium and bargain deals. Low prices. Send card for big profit offer with gift. Ho-Ro-Co, 2796 Dodier, St. Louis 7, Mo.

SELL Books by mail. Mammoth sales and huge profits. Everything furnished. Send 10c for complete details. Business Plans Foundation, Box 56-R, New York 10.

AMAZING Seller: "Soilless Garden Chemical." Grow plants, vegetables, fruits, flowers all year round without soil. In or outdoors. Tremendous demand. Excellent profits. Literature free. Nega & Co., 1824 W. Dickens, Chicago 14.

SCHOOL Seniors—Sell classmates America's most beautiful, distinctive graduation name cards. 40% commission. Largest selection. Lowest prices. Free cards and sample kit. Printcraft, 1425 E. Elm Street, Scranton 5, Penna.

JUST Out! History of World War II. Huge volume. Popular price. Authentic text. Official photographs. Big profits. Riverside Book Company, Iowa Falls, Iowa.

SCHOOL Seniors! Your postal will bring our wonder, Kwick-Sell Cardalog of popular graduation name cards. Biggest profits! Only firm giving free souvenir chest and card case. Don't miss out! Hurry that postal! Craftcards, Box 235(L), Pittsburgh 30, Pennsylvania.

AGENTS—300% Profit selling genuine gold window letters; stores and offices. Free samples. Metallic Letter Co., 438-B North Clark, Chicago.

BIG Bargains for big profits. Over 100 sensational values. Men's used suits \$2.00, pants 35c, topcoats \$1.25, overcoats \$2.00, shoes 20c. Experience unnecessary. Free wholesale catalog. Superior, 1250-FB Jefferson, Chicago 7.

200 MONEY Making deals. Plans, rare formulas. Schemes. Folio free. Formico Service, Box 572, Dayton, Ohio.

137 COMPLETE Plans for starting own business: local—mail order. Particulars free. Elite Co., 220-A Grand St., New York 13.

AGENTS: Stamping names on pocket-key protectors. Sample check with your name, address, 25c. Stamping outfits. Emblem checks, check-fobs, name plates. Hart Mfg. Co., 303 Degraw St., Brooklyn, N. Y.

\$3 FIRE Extinguisher; quick sales, wholesale or direct; liberal profits. "Fire-Killer," 109 N. Franklin, Syracuse 1, N. Y.

PLATING Outfits for autoparts, reflectors. Connect to a battery. No tanks necessary. Free booklet and particulars. Gunmetal Co., Ave. N, Decatur, Ill.

FREE Water and our concentrates, makes flavors, lotions, shampoos. 72 products, labels, bottles furnished. Qualco, E-20030 Russell, Detroit.

"OUR Flag"—famous picture. Four colors. 500,000 sold. Sample print—free. Our Flag Sales Corp., Dept. C1076, Excelsior Springs, Mo.

GOLD Lacquered window sign letters. Large sizes penny each. New foils. Absolutely beautiful. Free samples. Atlas, 544 W. 79th, Chicago 20.

HIGH-GRADE SALESMEN

SELL Gift shops, department stores, etc. Write Kimley, 103 Highland, Williamsville, N. Y.

POCKET Pal: The all-purpose cutting tool. Wagon jobbers-salesmen. Sell to retailers and jobbers. 50c seller. Steady repeat item. Exceptional profit. Sample 25c. Nelson Mfg. Co., 222 W. Kellogg, St. Paul 2, Minn.

"WORLD'S Latest" Since advertising specialty and calendar samples ready for high grade representatives. Effective as atomic power! Inquire by letter. Postcard applications not considered. The H. W. Singleton Co., Dept. P.M., Salt Lake City, Utah.

LARGE Earnings! Your own business supplying household food and drug necessities to consumers! Free details. Hollenbush Products, Dept. PM, Pottsville, Penna.

START Your own business on our capital. Always your own boss. Hundreds average \$6,000 to \$25,000 annual sales year after year. We supply stocks, equipment on credit. 200 home necessities. Selling experience unnecessary to start. Wonderful opportunity to own pleasant, profitable business backed by world wide industry. Write Rawleigh Co., Dept. L-U-PPM, Freeport, Illinois.

BIG Commissions—selling to stores celluloid pricing tickets, metal shelf moulding—to restaurants, menu covers, signs. Pricing Press, 124 White St., Dept. P, New York 13, N. Y.

SALES Representative to call on radio, music, appliance dealers, servicemen with nationally advertised line of test equipment. Generous commission. Metropolitan Electronics, 6 Murray St., New York City.

ADVERTISING Calendar. New, 12-in-one! Entirely different. Samples 25c. Simplex, 225 Second, Lombard, Illinois.

COALOID—The chemical saves fuel, money, labor. Unconditionally guaranteed. 1945-46 no refunds, dissatisfaction. 10 ton treatment \$2.00. Sample 18c postage. Coaloid Company, Waterloo 2, Iowa.

WAGON—Jobbers, agents! Big profits selling stores, individuals sensational ball point pen. \$2.98 retailer. Free details; also list hundreds fast sellers. Salesmanager, Box 27, Atlanta, Georgia.

TAX Law forces merchants keep records, sell Green's; every merchant your prospect; big commissions; yearly repeat business. Mill-Green Publishing Company, 370 Seventh Avenue, New York.

GOOD Income, spare or full time, selling large selection national woolen mills fabrics by the yard for men's, women's tailoring. Natural opportunity. Write samples, information. Western Fabrics, 832 S. Spring, Los Angeles 14, Calif.

SALESMANAGERS Needed every city. Make surveys for management engineering firm. (See our ad under Special Services.) Valuable training available. Gerald E. Sims & Associates, 120 S. La Salle, Chicago 3.

TIRE Reliners. Every filling-station a prospect. Hottest item in years. Allied Rubber Company, East St. Louis, Illinois.

SELL Record of Service certificates. All data from discharge paper may be copied on certificate for framing. Sales made easily. Sample \$1. Wilbur Sales Company, Box 451, Plymouth, Mass.

ORANGES, Most delicious, bursting full with health giving juice and vitamins, from our famous Indian River groves direct to consumers. Employers are placing now Christmas gift orders for employees and customers. Salesmen earn over \$100.00 commission weekly. Sunset Valley, Oak Hill 7, Florida.

QUICK Profits with individualized belts, buckles, cap badges, tie holders, uniforms. Choice of thousand emblems. Sure repeat orders. Easy-selling outfit offer. Write Hook-Fast Company, Dept. 12, Roanoke, Virginia.

EXCELLENT Sideline for printing salesmen. 300% profit. Samples 25c. "Acme," Oblong, Illinois.

WAGON Salesman—Fast moving carded goods and 10c line. Long profit. Free facts. Peerless, 2717 Dodier, St. Louis 7, Mo.

FREE! Latest issue Opportunity Magazine. Salesman's Guide. Inspiring, constructive. Shows how to earn money selling for others or in your own business. Hundreds postwar opportunities. Send name and describe what you have sold or are selling. Illustrated copy sent free. Opportunity Magazine, 620 N. Michigan, Dept. 17, Chicago 11, Ill.

EDUCATIONAL AND INSTRUCTION

ACCOUNTANTS Make big pay. We will train you for one of these good paying positions at home in your spare time. No previous knowledge or experience necessary. Write today for free information and aptitude test. Modern School of Accounting, Dept. PM, 735 No. Throop St., Chicago 22, Ill. A correspondence institution.

WRITERS! Want to sell? Lessons, collaborative criticism for beginners. Experienced editor, author, teacher is instructor. Cash, terms. Studio Story Method, Dept. PM, P.O. Box 1046, Spokane 4, Wash.

ANALYZE Handwriting for fun, knowledge, and profits! Full instructions. \$1.98. Details free. N. W. Oliver, Box CB, Mansfield, Tenn.

BE A pedopractor (foot correctionist). Extension, Degree, Alaska-Foot Institute, Box 2894, Juneau, Alaska.

MAIL Order beginners! "Business Development Plan," "Profitable Mail Selling Idea," "Pointers Along the Mail Order Trail." Noted mail sales specialist's three-in-one, 10,000-word treatise shows—step by step—"How," on small capital-start. From idea to mailbag. 25c, postpaid. Satisfaction guaranteed. Maupin & Maupin, Lafayette 4, Indiana.

GOOD Jobs and a sound, substantial future await you in hotel and institutional field. Men and women—all ages—needed for well-paid positions that offer color, excitement, ever-new and fascinating duties. Record-breaking travel means even greater opportunities for trained men and women in hotels, clubs and institutions. Lewis School receiving calls for managers, assistant managers, stewards, hostesses, purchasing agents and 55 other types of important positions! From coast to coast there are important positions that offer splendid opportunities for advancement in a business where you are not dropped because you are over 40. Previous experience proved unnecessary! No need to leave your job to qualify. A good grade school education, plus Lewis Training qualifies you at home, in spare time. Our National Placement Bureau helps to place you—and our amazing Certified Job Plan—actually certifies you will "make good" when placed. Write today for free book! Veterans: This course approved for veterans' training. Lewis Hotel Training School, Room HX-368, Washington 7, D. C. (First and only school of its kind—now in its 31st year.)

SELL Real estate. We teach you. R. J. Anderson, 551 Dickinson E., Grand Rapids 7, Mich.

"UNCLE SAM" Jobs! Start \$1756-\$3021 year. Paid vacations. Men-women. Prepare immediately for next examinations. Thousands of permanent appointments expected soon. Particulars free. Franklin Institute, Dept. C24, Rochester, N. Y.

LEARN Trigonometry better than others. Master method instructions \$1. Guaranteed. J. Ziemba, 6123 Orchard, Dearborn, Mich.

A SUPER Memory is yours; new, improved, simple course available to you now! Write! Z-C3 Thor Books, Box 1210, Chicago.

LEARN Landscaping. Profitable, healthful career—absorbing hobby, for men, women. Thorough 45-lesson home-study course takes 8-12 months spare time. Hundreds of successful graduates. 31st year. Send for free catalog. American Landscape School, 6392 Grand Ave., Des Moines, Iowa.

"HOW To Break and Train Horses"—a book every farmer and horseman should have. It is free; no obligation. Simply address Beery School of Horsemanship, Dept. 11012C, Pleasant Hill, Ohio.

CHIROPODY. Evans Natural Therapeutics Home Study Course. Foot Correction Massage Supports. General Knowledge of Feet. Excellent for Shoe Salesmen, Assistants, etc. P.O. Box 1195, San Antonio 6, Texas.

CIVIL Service jobs. Men-women. Examinations coming. Valuable information free. Columbian Correspondence College, Washington 2, D. C.

29 LANGUAGES By Linguaphone. Russian, Spanish, Portuguese—Direct conversational method for mastering any language quickly, easily, correctly at home. Available under G.I. Bill of Rights. Send for free book. Linguaphone Institute, 83 RCA Bldg., New York 20.

LEARN Appliance and building repair business. Simplified. Free literature. Cline-Porter, Box 6346F, Pittsburgh 12, Penna.

MASSO-PHYSIO-THERAPY Home study course. Massage, diet, baths, etc. Dignified profession. Evans Nat'l Therapeutics Courses, P.O. Box 1195, San Antonio 6, Tex.

TYPEWRITING Learned in 10 lessons guaranteed (your home); Also: shorthand, bookkeeping including accounting—ninety hours each; low rates (Osborne-Chilcoat "Psycho-Methods") Secret (first lesson) either course \$2. Osborne College of Short System, 212 West Third Street, Los Angeles 13, California.

USED Educational and technical books bought, sold, rented. Free catalog. Educational Exchange, Henagar, Ala.

PAINT Original pictures without previous experience. Unusual discovery. Colorful details free. Weidner, 1321 Wellesley, Los Angeles 25, California.

"ASTROLOGY Course"—Very easy to learn. Send \$1.00 for introductory lesson and details. Box 867, Grand Central Annex, New York City.

A New home study course—Lesson No. One of Accounts Delineator is important to anyone interested in studying Double Entry Bookkeeping. It may be all you need. Save time and money. No contract to sign. Mail check or money order for \$10.00 (refunded if you are not satisfied). International Ideal School of Accountancy, 4610 Drexel, Chicago 15.

PREPARE For civil service examination. Pay for course after securing position. Write Free School, Dept. PM-2, Kokomo, Ind.

WANT A beautiful home? A fine car? Respect and admiration of friends? Everything, in short, that money can buy? Then get "Building Your Fortune through Salesmanship" by Fred Elgin. Written by a top-notch salesman, this twenty-three thousand word brochure reveals facts you should know about this big moneymaking field. Warning! This is not a get-rich-quick scheme. Only honest, sincere hard workers will reap rich rewards in cash. Only \$2.00 postpaid. Cash, check or money order. Money back guarantee. Copeland House, Publishers, 46 Park St., Framingham, Mass.

EXPERT, 40 Years experience offers over 100 questions and answers to practical automotive and electrical problems. Business opportunities included. \$1. Send check or money order—no stamps. WJC Publishers, 127 Franklin St., Dept. C, Jersey City 7, N. J.

HOW To tri-sect an angle by geometry. Copyrighted instruction and geometric proof \$1.00. Novel Products, 60 E. Marion, Youngstown 2, Ohio.

HAVE An office. Many earn up to \$5,000-\$15,000 annually. Learn credit-collection agency business by home study course. Write for free bulletin. Franklin Credit School, Dept. 202N, Roanoke 7, Virginia.

USED Correspondence courses, books, bought and sold. Free catalogue! Spotlight, 141 Broadway, New York.

MASTER Success secret revealed. Magnetic, compelling speech gets you what you want. Guaranteed instructions now yours, only \$2. Exciting details free. Trissell-Heymann, Box 896, Mason City, Iowa.

TECHNICAL, Religious, information books. New, used, fit your needs. Edwards, 324 North 18th, Quincy, Illinois.

STUDY Real estate at home. Free bulletin. DeVoto Realty Schools, 35 Vicente, San Francisco 16, Calif.

LEARN Shoe repairing—Own your shop. G.I. apprv'd. Low tuition. Modern Shoe Rebuilding School, 2935 W. Belmont, Chicago 18.

BRIEFSRIPT—Simple, speedy, ABC shorthand, 50c. Eastern Book Co., 203 E. 18 St., New York.

STUTTERING And stammering can be eliminated. 20 years successful experience. Send for free literature now. Frank Teurfs, 25-D East Jackson, Chicago, Ill.

APTITUDE Testing \$1.00 complete. J. H. P., Box 112, Station P, Brooklyn 12, N. Y.

MODERN Welding school gives thorough training for one of industry's best paid jobs. Experienced instructors. Individual attention. Non-profit institution. Qualified under G.I. Bill. Write for literature and details. Hobart Brothers Co., Box M-1067, Troy, Ohio.

HOME Bible course. Simple, helpful, instructive. Total cost \$3.00 includes textbooks, stationery, examinations, certificate. \$1.00 starts you, or simply request prospectus. The Bible Study School, Reverend Leslie Marshall, Secretary, 382 Van Houten Street, Paterson 1, N. J.

INVESTIGATOR Training, Phillips Secret Service, 1917B North Kenneth, Chicago 39, Illinois.

HOME Study course, drugless therapy. Free literature. Institute of Drugless Therapy, Tama, Iowa.

GOOD "Used" self-instruction educational books on all subjects bought, sold, rented, exchanged. Satisfaction guaranteed. Complete information and 100-page illustrated bargain catalog free! Write—Nelson Company, Chicago 5.

LEARN Photo-engraving at home or in oldest, largest school in America. Work for newspaper or establish own profitable business. New Tasope' Photo-Engraving equipment available soon. Write for information. Veterans ask about G.I. training. The Aurora School of Photo-Engraving, Tasope' Bldg., Aurora, Mo.

MEDICAL Laboratory technicians in great demand. We train you in your spare time, in your own home. You can practice while studying. Write for free catalogue. Imperial Technical Institute, Box 973-E, Austin, Texas.

SECRET Investigation. Experience unnecessary. Investigators particulars free. George Wagner, M 125 West 86th, New York.

USED Educational books on all subjects sold, rented, also bought and exchanged. Moneyback guarantee. Write today for free catalog and details. Lee Mountain, Pisgah, Alabama.

PLAYS, STORIES, MANUSCRIPTS

"AUTHOR Beware!" Expose of literary rackets. \$1.00 postpaid. Colzar Publishers, 621 Dickinson, Springfield, Mass.

POETS, We want your poems for publication consideration. Details free: J. Barnes Publisher, Box 490, Times Sq. Station, New York 18, N. Y.

LEARN To write stories (The Short Line Way). Complete instructions, \$1.00. Mastercrafter, Box 2667, New Orleans, La.

EVERY Help for writers, low cost. National Writers Club, 1835 Champa, Denver 2, Colo.

I WANT New writers to cash hundreds of checks for \$1 to \$100, offered each month. The easiest way to write for pay. No previous experience necessary. Send for free details. No obligation. Saunders M. Cummings, 467-M Independence Bldg., Colorado Springs, Colo.

NEW Writers needed to rewrite ideas in newspapers, magazines and books. Splendid opportunity to "break into" fascinating writing field. May bring you up to \$5.00 per hour spare time. Experience unnecessary. Write today for free details. No obligation. Postcard will do. Comfort Press, Inc., 210-P South Seventh St., St. Louis 2, Missouri.

WIN Fame, success, security writing short stories, newspaper features. New, easy plan shows you how. Write today for exclusive details. Writer's Institute, 4-M So. 15th St., Philadelphia 2, Penna.

BUSINESS SERVICE

YOUR Bookkeeping, accounting, taxes questions answered. \$1.00. Box 526, Jamaica, N. Y.

NEW York mail address (or branch office). Complete service. Lowest rates. Multiservices, 3-B Park Row, New York 7, N. Y.

RAZOR Blades sharpened free. Send two and three cents. R. E. Reese, Emmaus, Penna.

PERSONAL Or business representation, collections, investigations, purchases. Chicago Personal Service, Box 145, Chicago 90.

NEW York mail address. Your mail received and forwarded. Arlington, 131-H West 42nd Street, New York 18, N. Y.

\$2.00 MONTHLY Maintains Washington, D. C., "Capital Address." Your business, personal mail forwarded when wanted. "Hawkins," (Established 1917), 1300-B Taylor.

TO Whom it may concern: We will represent you in all principal cities of the world. Personal or business assignments \$1 per hour. James W. Farley, Citizens Bldg., Cleveland 14, Ohio. Note: Would appreciate hearing from someone who wishes to enter this business in your city. Will send you assignments immediately. References exchanged. State qualifications.

SPECIAL SERVICES

NEED Personal secretary? Inexpensive! Free trial! Personal Service, Woodville, Ohio.

GLOBAL Mail—Travel on beggar's pittance. Confidential information 3c postage. Travelpost, Box 1449, Palm Springs, Calif.

\$100.00 WORTH Of shortcuts in refrigeration service and motor repairs, \$1.00. Your refrigeration service problems analyzed, \$1.00. Frenchy's Refrigeration Service, 219 E. Standley, Ukiah, Calif.

BAG Your limit: Visit pheasant capital of world. Mail forwarded: 3 post cards, attractive stickers, 25c; letters 25c each, airmailed. Personal or business assignments transacted efficiently and confidentially. Reliable. Mashek's Service, Box 1192, Aberdeen, S. Dakota.

SURPRISE Your friends from Miami Beach; 3 beautiful picture cards, 25c. You address and return, we mail. Letter mailing service \$2.00 monthly, 25c each. Title or tax search anywhere South Florida, reasonably done. "Raymond for Service," Box 2733, Miami 17, Fla.

HAND Engraving—Prompt service. Initials 15c per letter, all others 10c per letter. Royal Engraving Service, P.O. Box 311, Fond du Lac, Wis.

MAIL Forwarded, 25c each letter. Charles W. Garrison, 81 Blake St., San Francisco 18, Calif.

MANUFACTURERS, Wholesalers, retailers. More production, sales, profits through management engineering—the science of determining with engineering exactitude the most profitable utilization of personnel, capital, facilities, time, and materials (or merchandise). Cost reduction programs installed by your personnel under guidance our specialists. Fees amazingly low. Write on letterhead for functional analysis chart enabling you to evaluate your own conditions. Gerald E. Sims & Associates, 120 S. La Salle, Chicago 3.

MANUFACTURERS! Increase production. Reduce costs. Write for details Moore's Modern Production Control, and Wage Incentive Plans. Installations anywhere in United States. Fees reasonable. Moore and Company, Industrial Analysts and Consultants, Fidelity-Philadelphia Trust Building, Philadelphia 9, Penna.

GOOD "Used" self-instruction educational books on all subjects bought, sold, rented, exchanged. Satisfaction guaranteed. Complete information and 100-page illustrated bargain catalog free! Write—Nelson Company, Chicago 5.

CARTOONING, COMMERCIAL ART, SHOWCARD WRITING, SIGN PAINTING

LEARN Showcard writing at home. Spare time. Fascinating lifetime business of your own. No special skill needed. Free information. Sherwood Publishing Co., Irvington 41, N. J.

EARN Money evenings, copying and duplicating comic cartoons for advertisers. Adservice, Argyle (1-B), Wisconsin.

AMAZING Bargains—Quick landscape painting, poster art-letting, art studies. Free literature. Art Book Shop, Arnold 2N, Mo.

"HOW To Make Money With Simple Cartoons"—a book everyone who likes to draw should have. It is free; no obligation. Simply address Cartoonists' Exchange, Dept. 912-C, Pleasant Hill, Ohio.

NOW Paint signs in six months. Instructions \$1.00. Including "how to make" paints, bronzes, cardboards. Ideal Xmas gift. Jantzen, 252 West New York, New Jersey.

MAKE Signs. 9 complete alphabet pattern sets. 3 complete numeral pattern sets and catalog \$1.00. Sign Letter Distributors, P.O. Box 101, Mineola, N. Y.

31 LESSON Art course. Cartooning and drawing with over 600 illustrations. Complete: \$1.00. Dorba Service, D-PM, Cashton, Wisconsin.

ARTISTS—Students: Auto-scale saves half time copying, enlarging, reducing drawings. Guaranteed. \$3. Particulars free. Disco, Box 761, Glendale 5, Calif.

CHALK Talks. Laugh producing program, \$1.00. Catalog 10c. Balda The Cartoonist, Oshkosh, Wisconsin.

CARTOON Course—22 easy lessons. 200 figure sketches. 25c coin postpaid. Snack-Pack Co., 32 E. Georgia, Indianapolis 4.

ADVERTISING AGENCIES, LETTER WRITERS, FOR ADVERTISERS

GUARD Your advertising dollars. Newspapers, radio, magazine. Advertise in any newspaper or magazine, no matter where. Send us your needs, we will quote you prices by return mail. No obligation. Write today. Whaling City Advertising Agency, P.O. Box 17, New Bedford, Mass.

PROVED Sales programs—letters. Preliminary report free. References. Smith Adv. Agency, Excelsior Springs, Mo.

ADVERTISERS! Reach nearly 18,000,000 readers. 25 Sunday national key newspapers, 18 words, \$42.25. "Terrific pullers." 20 popular newspapers, \$8.50. "Free booklet." Special—One inch display 2,600,000 circulation, \$32.90. Newmark's Advertising Agency, (Established 1893) 217-7th Ave., New York 11.

AMERICAN Advertisers—Your 24 words ad in 140 Canadian Weeklies once \$8.00, three times \$16.00. Circulation over million. Proofs sent. J. M. Lever, P.O. Box 38, Dept. PM, Baie Comeau, Que., Can.

ADVERTISING Placed everywhere lowest rates. Reliable guidance on publications, expert assistance on ads without charge. Newspaper, magazine, mailing-list ratebook free. Chicago Advertising Agency, 20-P West Jackson, Chicago 4.

MAKE Much more money through classified advertising. We show you how. 19 years mail-order experience. Booklet free. Machen & Co., Station "F," Toledo, Ohio.

SPECIAL Inch display advertisement, Mail Order World, year \$24. Wood's Popular Advertising Service, Atlantic City, (N. J.)

MAILING Lists, accurate, productive, mdse. buyers trial 250—\$2.00. Zech, 7532 Buist, Philadelphia 42, Penna.

ORDER-Pulling sales letters written, \$2 page. Twenty years' experience. Satisfaction guaranteed. Dudley Bunn, 126-PM Lexington Avenue, New York 16.

ADVERTISING, Art work, sales letters. C. F. Sanford, 5029 Maple Ave., St. Louis.

MAILING Lists, certified, productive, inexpensive, \$5.00 1000. Homeworkers, agents, buyers, etc. Write Dixie Service, King, N. C.

FREE! 1946 Advertisers Rate & Data Directory. 52 pages! E. H. Brown Advertising Agency, 20 N. Wacker, Chicago 6.

ADVERTISE: 24 Words, 40 newspapers \$3.50. List free. Advertising Bureau, 4515-C Cottage Grove, Chicago 15.

24 WORDS in 64 weeklies \$4.96. H. J. Darnell, 730 Hays, Jackson, Tenn.

ADS Placed in out of town newspapers and magazines. Low rates. Catalogue free. Ideas that pay. Baker Advertising Agency, Successors Ankrum Agency, 189 W. Madison, Chicago 2.

TYPEWRITERS, DUPLICATORS, OFFICE DEVICES

ADDING Machines available now for immediate delivery, send for free literature. National Enterprise, 1412-13 Great Northern Bldg., Chicago 4, Illinois.

STENCIL Duplicators. Descriptive literature free. Monarch, 38-M Jefferson, Auburn, New York.

"PRINTOMATIC" Selffeeding post card stencil printing duplicators \$9.50 up. Office size duplicators, Speedoprints, Hilcos, Excellographs \$33.41 up. Literature free. Pittsburgh Typewriter Supply, 339-WK Fourth Avenue, Pittsburgh 22, Penna.

RECONDITIONED Typewriters, mimeograph, multigraph printing devices, appliances, supplies. Catalog. Dixiegraph Service, King, N. Carolina.

RUBBER STAMPS, OFFICE SUPPLIES

FAST Service on rubber stamps. Send for literature. Lee-Vall Press, Box 1242, Indianapolis 6, Indiana.

3 LINES 40c; Signatures \$1.75; pads 25c. 35 personalized pencils \$1.50. Stamprite, Wauwatosa 13, Wis.

LEAD Pencil, the office friend. 3 dozen \$2.50; 1 gross \$4.80. The Roundtree Agency, 529 Elliott St., River Rouge 18, Mich.

RUBBER Stamps. All types. Free catalogue. Print & Stamp Co., Box 172 Back Bay Annex, Boston, Mass.

RUBBER Stamps, all kinds. Send for catalogue. Excello, Box 500, Shreveport, Louisiana.

PRINTING, MULTIGRAPHING, MIMEOGRAPHING, GUMMED LABELS

100 MIMEOGRAPHED Letters \$1.75 (like typewriting) additional hundreds, 60c. Accurate, speedy. Multico, Nine Cornhill, Boston 8.

FOLDERS, Ruled forms, color work, circulars, labels, business stationery. Davidson & Klotter, 110 Sudbury Street, Boston 14, Mass.

SEASON'S Greetings to all. Mango Printing Company, 555-A South 20th Street, Newark 3, N. J.

REPRODUCTIONS—Line drawings, printed matter, newspaper clippings, documents. Actual sizes, within 8x10—50c. (2 for 75c) larger sizes quoted. Alo, 148 Anderson, Cliffside, N. J.

MIMEOGRAPHING. Multigraphing. Highest quality. Reasonable. Letter Service, Box 1849, Chicago 90, Illinois.

HAMMERMILL Letterheads 250, \$2.00; 500, \$3.75; price list; fine printing. Benneville Printing, Box 1931, Pittsburgh 30, Penna.

REASONABLY Priced printing. Samples. Parker Press, 479 Main, Groveland, Mass.

2 1/2 x 1 1/4 GUMMED Labels 1,000—\$1.50 postpaid. 20 word limit. Schultheis, Box 449, Irwin, Penna.

"RESULT Producing printing." Samples free. Mail Printing, M93, Danvers, Mass.

SEND 10c Now, for our 36-page 1947 pricelist—refunded first order. McCall Press, 1326 South 27th, Omaha, Nebraska.

1,000 6 3/4 ENVELOPES Or letterheads, \$4.50 postpaid. Modern Print, Box 34, Hyattsville, Maryland.

QUALITY Printing, reasonable prices. Cline Printing Service, 615 South Birchwood, Davenport, Iowa.

PERSONALIZED—50 Envelopes, 100 sheets 6 1/2 x 9 1/2, Chieftain Bond, \$1 postpaid. Eiland, 5874 N. 14th St., Arlington, Va.

MIMEOGRAPHING—24 Hour service. N. R. Everitt, 370 Whittemore St., Pontiac 20, Michigan.

5000 ELEGANT Envelope slips \$4.75; circulars, folders, imitation letters at low prices. Goodprint, Harrisonburg, Virginia.

100 ENVELOPES, 100 Letterheads and 100 airmail stickers, \$1.50 postpaid. Keena, 1312 Jefferson, Grand Rapids, Mich.

2000 DODGERS \$6.50. List free. Kent, 3414 Spring, Dallas 10, Texas.

MIMEOGRAPHING Specialists—Any copy. Reasonable. Mailers Service, Box 606-A, Chicago 90, Ill.

350 BUSINESS Cards \$1.00 postpaid. Artcraft, 40-06 97th, Corona 1, N. Y.

150—8 1/2 x 11 HAMMERMILL Letterheads \$1.00 postpaid. Envelopes same. Race Printing, Hudson, New York.

200 MIMEOED Letters with printed letterheads, \$2.50; 500, \$5.00. Horace Mohler, R-10, Dayton 9, Ohio.

MIMEOGRAPHING—Get the best. Free price list, samples. Bull Letter Co., 109 East Ninth, Ft. Worth, Texas.

PRINTING, Mimeographing. Best and cheapest in the country. Imprint, Emporia, Kansas.

1000 FOUR Line stickers, \$1.00. Imprint, Box 361, Emporia, Kansas.

QUALITY Printing, embossing, planographing. Lowest cost. Samples free. Adams, 30 West Washington, Chicago 2.

250 LETTERHEADS, Envelopes \$3.00. Mallo Press, 767 Leith, Flint 5, Mich.

QUALITY Printing: Business, personal stationery. Prepaid delivery. Samples free. Mero Products, 100 Morrison, Punxsutawney, Penna.

BETTER Printing, attractively priced! Letterheads, envelopes, booklets, cards, labels. Samples, estimate free. Lonelm Publishers, Paulding, Ohio.

BETTER Grade printing reasonable. Estimates on anything. Economic Press, Leonia, N. J.

500 3/4 x 2 1/4 FOUR Line gummed stickers, 25c. Moritz Printery, Saginaw, Mich.

MIMEOGRAPHING—Letters, pricelists, formulas, instructions. Lowest prices. Lem's Letter Shop, 5710 Stanton, Detroit 8.

PRINTING OUTFITS AND SUPPLIES

MAKE Your own printing press, cuts, halftones easily. Pilgrim, Box 194, Springfield, Mass.

NUMBERING Machines, press or hand, bought, sold, repaired. Numbering Machine Service, 90 Baxter Street, New York 13.

BARGAINS—Presses, type, supplies. Send stamp. 8 Walden, Cambridge, Mass.

MAKE Cuts from photos and drawings. Simple. Inexpensive. Both processes \$1.00. Lucius Dawson, Box 20-A Sta. "J," New York.

PRESSES, Type, cabinets, supplies. List for stamp. Lincoln Press Co., 220E Hartwell, Fall River, Mass.

PRINTERS, Make a quick-etch etcher for cuts, halftones. Details, Charles Medlock, Box 256C, Goodland, Indiana.

PRINT At home—Send 10c for catalogue—presses, type, supplies. Barnhard Co., 6 Columbia St., Newark 5, N. J.

HOME-MADE Presses. Proofs free. Riegel, 1111 Harrison, Phila. (24), Penna.

CUTS—Make real halftones, line cuts yourself! Samples 25c. Particulars free. Rapid Chemical Service, Edwardsville, Ill.

INEXPENSIVE Home-made printing press. Details free. Novelty Shop, Downs-ville, Louisiana.

PATENT ATTORNEYS

INVENTORS. Have patent protection first. Remember, the details of your invention do not have to be 100% perfect before you can obtain patent. First step is to have us conduct search of prior U. S. patents and render a report as to its patentability. Send at once for further particulars and "Invention Record" form. Request does not obligate you. McMor-row, Berman & Davidson, Registered Patent Attorneys, 1346 Atlantic Building, Washington 1, D. C.

INVENTOR'S Guide free on request. Frank Ledermann, Registered Patent Attorney, 154 Nassau St., New York 7, N. Y.

PATENT Protection—The U. S. Patent Office recommends—"an applicant is advised, unless familiar with such matters, to employ a competent registered Patent Attorney, as the value of patents depends largely upon the skillful preparation of the specifications and claims." Steps to be taken in obtaining patent protection will be sent upon request. Victor J. Evans & Co., 131-P Merlin Building, Washington 6, D. C.

REGISTERED Patent Attorney offers services. Sanders, 6430 Evans, Chicago 37.

INVENTORS: Learn how to protect your invention. The patent laws were enacted for the benefit of the inventor to give him protection for the features of his invention which are patentable. The United States Patent Office advises the inventor to engage a competent, registered patent attorney to represent him. We offer the inventor experienced, conscientious counsel and prompt, confidential service. A specially prepared booklet containing detailed information concerning patent protection and procedure with "Record of Invention" form will be forwarded to you upon request—without obligation. Clarence A. O'Brien & Harvey Jacobson, Registered Patent Attorneys, 61B-L Adams Building, Washington, D. C.

INVENTORS: Write for free brochure "Evidence of Invention." Labiner, World Building, New York 7.

C. A. SNOW & Co., M-427 Snow Bldg., Washington 1, D. C. Registered patent attorneys. Established 1875. Literature mailed on request.

PATENTS—U. S. and foreign patents secured. Trade-marks and copyrights registered. Searches made to determine patentability and validity. Patent, trademark and unfair competition causes. Lancaster, Allwine & Rommel, Registered Patent Attorneys, Suite 411, 815-15th St., N. W., Washington 5, D. C.

INVENTORS: Without obligation, write us for information as to what steps an inventor should take to secure a patent. Randolph & Beavers, Registered Patent Attorneys, 21-C Columbian Bldg., Washington 1, D. C.

PATENTS. Free preliminary advice. E. E. Vrooman, Patent Lawyer, Registered Patent Attorney, 871 Woodward Building, Washington 5, D. C.

PATENTS—Trade marks. Irving L. McCathran, 315 McLachlen Bldg., Washington 1, D. C. Registered Patent Attorney.

FOR INVENTORS

MANUFACTURING. Stamping, designing, developing and experimental work; tools, dies, jigs, fixtures. Models made by experts. A complete service available once again following interruption by war work. Technical Development Co., 157 Chambers St., New York City 7. (Dept. M-12).

INVENTORS. Have patent protection first. Remember, the details of your invention do not have to be 100% perfect before you can obtain patent. First step is to have us conduct search of prior U. S. patents and render a report as to its patentability. Send at once for further particulars and "Invention Record" form. Request does not obligate you. McMor-row, Berman & Davidson, Registered Patent Attorneys, 1347 Atlantic Building, Washington 1, D. C.

PATENTED. Unpatented inventions promoted. M. Joyce Humphries, 1424 Land-tite, Philadelphia 10, Penna.

RELIABLE Patent Office searches \$10.00. Invention Protection Form free upon request. Mail sketch and description to M. P. Bell, Patent Searcher, 920—19th St. N. W., Washington 6, D. C.

INVENTORS: You save up to 300% when dealing with your patent searcher direct. Complete search with patent copies \$6.00. Reports mailed in 5 days. Invention protection forms free. Write Raymond L. Smith, Patent Searcher, 703-M Albee Building, Washington 5, D. C.

INVENTORS—If you consider your invention to be something of importance, you may take steps to protect it with a U. S. Patent which gives you the right to exclude others from making, using and selling the invention as claimed. Detailed information and steps to take to secure Patent Protection will be mailed to you promptly without obligation. Victor J. Evans & Co., Merlin M. Evans, Registered Patent Attorney, 132-P Merlin Building, Washington 6, D. C.

INVENTOR'S Guide free on request. Frank Ledermann, Registered Patent Attorney, 154 Nassau St., New York 7, N. Y.

INVENTION Selling, patented or unpatented depends on reaching right manufacturers. Find out "how it's done." Will have preparation, filing your invention by Registered Patent Attorney including drawings, investigation, analysis on monthly payments. Details free. Charles R. Morton, Patent Broker, 11 West 42nd St., New York.

INVENTIONS Wanted — Development and Production. Zschau Service, 5312 Grace, Chicago.

PATENT Searching in electronics by expert. \$25.00. N. Wasser, 6301 16th Street N.W., Washington 11, D. C.

READ "Pitfalls For Inventors" \$1.50. Inventors Hobby Club, St. Louis 1, Mo., Box 827.

INVENTORS—Don't fail to read Carson Consultant advertisement on page 271.

CASH For your idea. 100 manufacturers need inventions, patented or unpatented. List free. Inventors Bureau, 208 Clinton, Oak Park, Illinois.

INVENTORS: Learn how to protect your invention. The patent laws were enacted for the benefit of the inventor to give him protection for the features of his invention which are patentable. The United States Patent Office advises the inventor to engage a competent, registered patent attorney to represent him. We offer the inventor experienced, conscientious counsel and prompt, confidential service. A specially prepared booklet containing detailed information concerning patent protection and procedure with "Record of Invention" form will be forwarded to you upon request—without obligation. Clarence A. O'Brien & Harvey Jacobson, Registered Patent Attorneys, 61A-L Adams Building, Washington, D. C.

INVENTORS Get free bulletin and full information on proved 12 step plan for making money from inventions, either patented or unpatented. National Merchandisers, 28 East Huron Street, Chicago 11, Illinois.

INVENTORS—Your commercially valuable invention, any kind, patented, unpatented, may have cash, royalty possibilities in today's markets. Write today. Explanatory booklet, disclosure form, references, free. Invention Reporter, 5A-11106 So. Longwood Drive, Chicago 43.

DRAWINGS Of your ideas—inventions, by college draftsmen. Drawings approved by patent attorneys. Chrisman, College Box 375, Manhattan, Kansas.

I SELL Patents. Established in 1900. Charles A. Scott, 773PM Garson Ave., Rochester, N. Y.

THE Inventor who believes he has a new and useful invention, and needs advice, should consult a competent registered patent attorney. Without obligation, write for full information on how to secure patents and trademarks. Randolph & Beavers, Registered Patent Attorneys, 11-E-Columbian Bldg., Washington 1, D. C.

INVENTORS: Avoid unnecessary expense. Write for free booklet explaining how our consulting and advisory service can assist you in deriving greatest profit from inventing. Institute of American Inventors, Dept. 40-A, 1926-Eye St. N.W., Washington 6, D. C.

INVENTIONS Developed from idea stage. Circular free. Aye and Dee Technical Corp., 743 Carroll Street, Brooklyn, N. Y.

INVENTIONS WANTED

PATENTS Solicited. Preliminary searches conducted. Metzler, 11 West 42nd, New York.

EARN Up to \$2,000 year, inventing simple items for special cash markets. Ideas only. No patents. Hendrickson, Argyle (7-B), Wisconsin.

WANTED: Practical inventions of all kinds by manufacturers. Patented or unpatented. Write:—John D. & Son, 285 Howard Ave., Box 3213, Bridgeport 5, Conn.

SELL Your idea or invention. We help you. Hundreds of buyers waiting. Our unique method gets results. Details free. Burvid, 100 Vine, Lynn, Massachusetts.

WANTED: Practical inventions for marketing through chain, drug, and cigar stores. Particularly desire lighters, smoker's articles, etc., in plastic, wood or metal. Write Matt, 1412-DN Great Northern Bldg., Chicago 4.

NEW Product? New idea? Have you a new product or idea for improved product which could be profitably sold to farmers through hardware and implement dealers? If so, send copies of patents, blueprints or just sketch and description. We have engineers and designers capable of working up your ideas for manufacture. Also modern, well-equipped plant producing precision instruments and high-grade farm tools. We need more products for salesmen covering farm trade. If you have something practical, preferably patented or patentable, we will consider it for manufacture and sale on royalty basis. Interview arranged if product seems acceptable. American Gage & Mfg. Co., 127 Bayard St., Dayton 1, Ohio.

WE Are looking for new practical inventions. We market and sell your inventions to manufacturers and distributors on a royalty basis. We will finance models, and legal matters. All subject matter treated strictly confidential. Large Chicago bank our reference. Patent Development and Marketing Co., 228 N. LaSalle St., Chicago 1, Illinois.

INVENTIONS Wanted. Patented or pending. Inventors Exchange, Dept. B, Hartford 1, Connecticut.

CASH For inventions, patented, unpatented. Mr. Ball, A-9441 Pleasant, Chicago.

INVENTORS: Hundreds of manufacturers have requested our assistance in locating marketable new products. Complete information, free. Institute of American Inventors, Dept. 40-D, 1926-Eye St. N.W., Washington 6, D. C.

WANTED—Patented, unpatented inventions having profit possibilities, all kinds. If will sell, reply immediately. Descriptive booklet, references, free. Invention Reporter, 5B-11106 So. Longwood Drive, Chicago 43.

PATENTS FOR SALE

SILENT Central switching system. Multiple control with low voltage single push buttons. Eliminates threeway switches. Light continues while you leave room. Production designed. Application filed. Royalty desired. Balletric, Milton, Washington.

AUTOMATIC Conveyor lubricator, patented. Write S. Tuhy, 11747 So. Union, Chicago 28, Ill.

FOR Sale patent on reel for clothesline. H. Nilsen, 1725 E. Minnehaha Ave., St. Paul 6, Minn.

GARMENT Hanger—Patent pending, no wrinkling of garments, goes in at the neck of any garment. Cash or royalty. Loyd Valentine, Atlantic, Iowa.

NOVELTY Toothbrush holder, of plastic, simple and cheap to make. Patent pending. J. Lynch, 361 Irving Avenue, Brooklyn 27, N. Y.

"SUPER" Nail puller. Combination sprinker and hose nozzle. Leather punch. Patents applied for. An investigation will reveal their great possibilities. Emmett Seifert, 124 E. Chestnut, San Gabriel, California.

JUST Patented. Card game for chain store business. Royalty basis. Information to manufacturers only. Oh-Kay Games, Box 127, Wilkes-Barre, Penna.

CAPTURED German and Jap patents. 18,000 enemy alien formulas, patents, ideas, plans, drawings. Use immediately; royalty free. Bishop Tools, 111 W. Washington, Chicago 2.

INVENTORS—Your patented, unpatented invention, if practical, may have specific cash, royalty value in correct markets. Find out now. Explanatory booklet free. Invention Reporter, 5D-11106 So. Longwood Drive, Chicago 43.

INVENTORS: Test the commercial value of your patented or unpatented inventions, quickly and inexpensively. Write for free information. Institute of American Inventors, Dept. 40-B, 1926-Eye St. N.W., Washington 6, D. C.

MANUFACTURING

SEND Item or drawing for estimates. Machinists, 114-111-PM 229th, St. Albans 11, N. Y.

MANUFACTURING Inventions successfully fifty years. Models, machines. Baum's Metal Specialties, Kansas City, Mo.

PARTS Bottleneck holding down production? Write for quotation on your delivery schedule. Practically anything in wood, metal or rubber. Desire orders requiring volume production on long term basis, however will handle small orders. Please list all pertinent data in initial correspondence. Triangle Industries, Box 59, Mendon, Ohio.

MODELS—Small lot manufacturing. Metals, plastics, etc. Milburn, Burlington, Kentucky.

NAME Plates for manufactured products. Any quantity. Ad-Craft, LaCrosse, Wis.

INVENTORS—Market study; developing; manufacturing models. J-M, Burlington, Kentucky.

MODELS AND MODEL SUPPLIES

SHIP Models, coaches, covered wagons, blueprints, supplies, catalog 25c coin. R. E. Hancock, 323 Douglas Ave., Portsmouth, Virginia.

U CONTROL Plane inc. motor \$18.75. Racing cars, power ice sleds, engines. Bargain list. Ridgway's Model Hobbies, 3312 Monroe Ave., Kansas City, Mo.

SCENEX—You will like this new mineral pulp. In sheets ready to mold mountains, tunnels anything easy. Instructions. 10 sq. ft. \$2.50. Trial package \$1.00. Hardnite Company, Box 352, Springfield, Illinois.

LANDLOCKED Sailors! Here's a beautiful, richly illustrated, fully descriptive catalogue of famous model ships—whalers, slavers, corvettes, etc., authentic in every detail. Send for it today. Only 10c. Halesite Yacht Service, Inc., Halesite, Huntington, N. Y.

SHIP and Yacht model fittings; blueprints. Send 25c for illustrated catalog No. 20—listing hundreds of items. A. J. Fisher, 1002-1 Etowah Ave., Royal Oak, Mich.

"MIDGET 1" Motor, runs on top of flashlight cell! Parts, instructions, 35c. Arthur Ponskov, 655-K Amboy Ave., Perth Amboy, N. J.

STEAM Engines, boilers, castings. Catalog 25c. Anton Bohaboy, 2297 Price, Rahway, New Jersey.

HOME Builders: Beautiful California ranch home, two bedrooms, cement block exterior, plaster interior, brown shingle roof. 1/2" scale kit for home planning and enjoyment. \$6.75, check or money order. Min-A-Model Homes, 1204 18th St., San Diego 2, California.

BALSA Wood. Ideal for modelers, craftsmen. Sample carving block, 25c. List free. Sanlader, Manitowoc, Wis.

MAGNESIUM Dowmetal for light weight construction now available in miniature extrusion structural shapes and .032" and .064" flat stock. If your dealer or jobber cannot supply you, write for size and prices to Sims & Associates, 464 Neff Road, Grosse Pointe, Michigan.

MIDGET Magnetic motor; flashlight cell operates. Parts plus instructions, 30c. Electro, 171B, Deer Park, N. Y.

JUNIORS And dads—Easily assembled miniature street, railroad or station lamp kit, stands 8 1/2" high, brass and copper, kit \$1.00. Assembled \$1.10. Check or m.o. Inquiries invited from hobby dealers. Minilamp Co., Box 13, East Station, Yonkers 4, N. Y.

MIDGET Electric motors. 145 or 250 r.p.m., 27 v. d.c. Reversible. \$2.35. With gear reduction to 2 r.p.m., \$5. Postpaid. Eresco, 1006 Hewitt, Everett, Washington.

MIDGET Steam engines \$2.98, boilers \$2.65. Stamp for literature. R. Looker, Box 105, Michigan City, Indiana.

REMEMBER. When selecting model equipment at GMCO, you will find a complete stock of model airplanes, gas engines, ship models, railroads, race cars, supplies and tools. Chances are we have just what you want in stock. Send 25c for your copy of our new catalogue to GMCO Modelcraft Hobbies, 91-17 (M11) 173rd St., Jamaica 3, New York.

3/4" SCALE Steam locomotive, cheap. Simonson, 3054 N. Greenview, Chicago, Illinois.

BRASS Gears and model supplies for the inventors. Send 10c for catalog. Pierce Model Works, Tinley Park, Ill.

FREE Catalog of model trains, airplanes, ships, accessories and tools. Ben's Hobby Company, 72 West Washington, Chicago 2, Illinois.

BUILD Model ships, airplanes, railroads. Catalog 10c. Ideal, 21 West 18th Street, New York 11, N. Y.

ENGINE Castings, Supplies. Catalogue 10c. Howard A3, 2417 N. Ashland, Chicago, Ill.

RAILWAY Models, complete line, 128 page catalog. HO and O gauge 25c. Walthers, 247 Erie, Milwaukee 2, Wis.

DYNA—Jet famous miniature jet gasoline engine for planes, boats, cars. Guaranteed deliver 3 pounds thrust. \$24.50 ready to run. Aeromarine, 5201 Old Springfield Pike, Dayton, Ohio.

BIG Illustrated model engine catalog 10c. Active Products & Supply Co., 53 W. Jackson, Chicago 4.

SHIP Model kits and fittings. Complete line Fisher model yacht equipment. All Boucher, Fisher, Marine Model and Ideal kits, fittings and blueprints at standard prices. Most complete stock in New England. Send 10c for price list. James Bliss & Co., Inc., 220 State St., Boston, Mass.

MINIATURE Steam locomotives, 1/4", 1/2", 3/4" scales. Castings, parts, rail! Thorough drawings with instructions. Catalog 25c. Little Engines, Wilmington, Cal.

CATALOGS (Illustrated) for modellers! Airplanes, 60 page book on solids. Features construction data, specifications, camouflaging, 15c; railroads: 128 page "HO" guide. Equipment, accessories, fittings, 25c (includes refund coupon). Send coin or stamps for each profusely illustrated catalog desired. Polk's, "Nation's Leading Hobby House," 314-PM Fifth Ave., New York City 1.

HOME CRAFTSMEN

ATTENTION: Woodworkers and home-craftsmen. If you have 100 or 10,000 ft. of hardwood suitable for milling into small furniture parts and desire profitable part or full-time work, have good proposition for right parties. Make your home workshop pay! Contact W. F. Devore, 506 S. 9th St., Cambridge, O., for details and complete information.

WHEELS, Cast aluminum, roller bearings, for 4x8, 3 1/2x6 tires. Utility Products Co., Auburn, Indiana.

BABY Rocker. Full size plan 25c. Frieders, 609 North Root, Aurora, Illinois.

MONEY And fun from scrap. New, amazing idea book, 400 pages. Make useful articles from plastics, leather, felt, paper, wood, metal and 68 other scrap materials. Literature free. Craft Service, 2024 Sedgwick, Chicago 14.

YOUR Dollar brings shell material for butterfly brooch, bracelet, floral spray. Illustrated catalogue free. Dixie Shell Service, Lakeland, Fla.

FREE. Descriptive circular on toy plans. Production Engineering, 403-C City Hall Bldg., Rockford, Illinois.

WOODWORKERS: "Rotary Files" make carving, shaping easy. 3 ground shapes (reconditioned) \$2.00, 1/4" shank. (New value \$8.00.) Muller Equipment Company, 1235 Main, Hartford 3, Conn.

LEATHERCRAFTERS! Send for free catalog listing leather, kits, supplies. Kit Kraft, 1607 S. Western, Los Angeles 6, California.

RARE Wood—Selected buris and sections from rare Myrtlewood. Grows only in Oregon and bush form in Palestine. Ideal for lathe work and carving. A hardwood which takes a glass like finish. Make jewel boxes, candlesticks, plaques, lamps, of rich and fine appearance. All pieces have good pattern and color. Piece suitable for lamp or pedestal, \$2.00. Larger sizes up to \$10.00. State approximate size desired. Oregon Myrtlewood Company, 112 SW Pine Street, Portland 4, Oregon.

LUMINOUS Paint kit—Make any object glow at night! Lasts indefinitely. Everything you need, \$1.00. Gadgeteers, Inc., 160 Fulton St., Brooklyn, N. Y.

HOMECRAFTSMEN—Lucite will create a superior article for you. Samples in color and working manual 50c. Write for new low prices. Discount to schools and clubs. Ready-cut projects, trimming for leather-crafts and jewelry making. Creative Plastics, 423 E. 147th Street, Cleveland 10, Ohio.

25 ORIGINAL Plans, detailed instructions. Furniture novelties, best sellers, \$2.00. Also fine woods list, 10c. Hillcraft, Eureka Springs, Ark.

CRAFTSMEN—Make your hobby pay. Fascinating game for two to eight players, all ages, easily made from plywood. You'll want to keep first one but others will sell at huge profit. Clear, detailed plans and instructions, \$1.00. Valuable bonus free with first 100 orders this month. Money back guarantee. Write now—what can you lose? Plancraft, Box 372, Danville, Illinois.

CHRISTMAS Gifts. Give plating kits, \$2.95 up plus postage. Anchor Sales, 3519 Texas Ave., Washington 20, D. C.

SCRATCH-PIX Makes it fun to draw! No skill needed! Fascinating! Let us show you how to make ten handsome Christmas gifts for one dollar. Rose Tree Craftsmen, Media, Penna.

MAKE Your own saw depth gauge out of scrap material for dados, rabbets, grooving, inlaying; hand or back saws. Complete instructions 25c coin. Fixit Shop, 3635 Bruckner Boulevard, 61, New York, N. Y.

KIL-RUST! Renew rusty metal surfaces to original sparkle. Send 35c for trial bottle. Gadgeteers, Inc., 160 Fulton St., Brooklyn, N. Y.

WHITE Enamelled plywood sleigh for Xmas centerpiece. Holds candy, cookies, fruit. Complete drawings, templates 50c. Returnable. Alpha Co., 241 Orange, Suite 8, New Haven, Conn.

SHELLCRAFTERS! We are the wholesale firm you've been looking for. A wide selection of seashells, plastic and jewelry findings. Prices right. Beachcomber Novelty Co., Box 551, Fort Myers, Florida.

ENLARGE Workshop drawings automatically. Eliminate graphsquares. \$2.50 postpaid. Illustrated literature free. Pantograph, Munising 1, Michigan.

ATTENTION—35 Clever new lawn figure patterns designed especially for 12" lumber, all for \$2.50. 100 delightful brooch and lapel pin patterns, quickly cut from scrapwood, \$1.00. All patterns \$3.00. Sure to please. Catherine Schilder, Cresbard, S. Dak.

PREFABRICATED Plexiglas hobby kits with illustrated instructions for assembly, by beginners, without tools: Corner wall shelf \$1.95, cigarette cart \$2.00, jewel box \$2.95, tissue box \$3.95. Bow-E Plastics, 2170 Amsterdam Ave., New York City.

BIG Craft kits—25c complete. Textile paint or copper. Make gorgeous pictures! Liberal materials, tools, instructions, patterns. Vin's, 305 West 8th Street, Los Angeles 14, Calif.

BARGAIN Box jewelry findings, parts, novelties for making all types metal, plastic jewelry. Included are gold plated, brass, plastic chain, catches, shapes, pins, ear screws, stones, beads, pearls, combs, charms, etc. \$2 for large box full. Royale, 5210 3rd Ave., Brooklyn 20, N. Y.

HAG'S Leathercraft: Christmas special: Complete leathercraft book, instructions, designs, \$1.50. Also kits, tools. 7532 22nd N.E., Seattle 5, Washington.

BEAUTIFUL Mirrors from ordinary glass. Complete instructions \$1.00. Tes-Co, PM-4 P.O. Box 189, Wilkes-Barre, Penna.

EXPERIMENTERS! Interested in electrical, mechanical devices from war surplus? List free. F. Siefke, Box 18, Station E, Buffalo 11, N. Y.

WOODWORKING Outfit—Includes lumber, designs, tools, equipment, instructions. Make many fine toys, novelties, gifts for fun and profit! Only \$2.00 postpaid. Handicraft Creators, 1734 President Street, Brooklyn 13, N. Y.

ANYONE Can learn carving figures with penknife. Write Carv-It Projects, 343 Division, East Lansing, Michigan.

LEATHER Craftsmen—Hand engraved plastic transfers imprint design instantly for tooling. Sample 10c. Introductory set \$1.00. Lampkin Artcrafts, Box 641-M, Culver City, Calif.

HOBBYISTS! Join "Allcraft Club." Free, no obligations. Fun, profits galore! Write immediately: Allcraft Products, Box 212, Hempstead, N. Y.

CERAMIC Jewelry supplies, bar pins, ear screws, for ceramic and woodworkers; also glass and seashell assemblers. Free catalog. Philadelphia Badge Co., 1007 Filbert St., Philadelphia, Penna.

FINISHES For any type material. Electroplating chemicals and supplies, wood and metal finishes; shop chemicals; industrial and novelty finishes. Write for price list now being prepared. Craft-Finishes, Box 467 M, Arlington, Virginia.

LEATHER Scraps for hobbyist. Six pounds \$2.00. Hobby books "Applied Leathercraft" \$3.00, "Art of Whittling" \$2.00, "Wooden Toymaking" \$2.25. Hobby books catalog free. Northern Supply Co., Dept. A, Sheboygan, Wis.

CRAFTSMEN—Lawn furniture plans, beautiful jigsaw designs—large selection—free folders. Summercraft Studio, 42 Vernon St., Newton 58, Mass.

30 FULL Size toy patterns 50c. 40 novelty and lawn ornament patterns 50c. Other patterns; craft supplies; lists 10c. Lynds, Medway, Mass.

MASONITE Mill ends 10 lbs. \$1.00 plus postage. Carl Sign Co., Wooster, Ohio.

WHITTLES'S Supplies, readicut blanks, special woods, knives. Old Whittler, 1402 Charles, LaCrosse, Wis.

MAKE Shell jewelry—for gifts, as a hobby or start a business. Free catalogue and price list. Complete illustrated book of instructions 75c. Florida Shellcraft Company, Box 1840, Sarasota, Florida.

SHELLCRAFT Kits for beginners—shells and complete supplies for making pins, earrings, combs and novelties. Instructions free. Kits \$2.00 and \$5.00. Herbert Diamond & Co., 1121 North East First Avenue, Miami 36, Florida.

35 PATTERNS Of action pull toys, trucks, carts, toy furniture, etc., \$1.00. Continental Homecrafter, 907 Birch, Eau Claire, Wisconsin.

SHELL Jewelry supplies. Wholesale only. McFarland Plastic Co., Sarasota, Fla.

CATALOG: Patterns plywood novelty furniture, letters, numerals, plaques, frames, weathervanes, silhouettes, lawn ornaments, 100 books and booklets on crafts and hobbies, picture frame mouldings, tools, large line decal transfers. Other lines. Hundreds articles finely illustrated. Write Wo-Met Shop, Ashburn, Ga.

KNOCKDOWN Cedar chest lumber veneers. Free price list. Giles-Kendall, Huntsville, Ala.

TURNING Squares and lumber—Honduras mahogany and Spanish cedar, plywood and veneers. Sedlo Company, P.O. Box 7161, New Orleans, La.

MAKE IT YOURSELF

MAKE Your own combination table saw. Crosscuts, rips and miters. Easily made of inexpensive material. Blueprints, instructions \$1.00. Practiplans, Box 1231, Rochester, N. Y.

10 1/2" OR 15" Folding Kayak boat plans \$1.00 apiece. General Mail Service, Box 601, North Platte, Nebr.

BUILD Berberic chairs for comfort and profit. Easy plans \$1.00. H. M. Hardy, Box 644, San Francisco, Calif.

HOT Water free—From sunlight. System efficient any locality year 'round. Standard materials—easily built—low cost. Facts free. Solar Water Co., Box 175, Dept. V, Coral Gables, Florida.

BUILD Your own camp, cottage or cabin. Complete step by step illustrated instructions, detailed blueprints, material lists. Send \$2.00 for year 'round twosome, foursome or sextet size. Leisure Bilt, West Henrietta, New York.

FLUORESCENT Lights. How to make your own 20 watt lights for less than \$1.00 each. Materials available. Complete guaranteed, detailed instructions, \$1.00 cash or money order. Checks \$1.10. Specialty Sales, Box 1086, Muncie, Indiana.

BUILD Heavy duty machines using our production tested plans. 30" bandsaw, 12" lathe, farm type sawmill, planer, concrete block machines. Dozens other machines for shop, farm, home. Free catalog. Nichols Equipment Co., Purvis, Miss.

BUILD Powerful, compact garden tractor. Different principle. Instructions \$2.00. Chas. Garber, Box 508, Far Hills Branch, Dayton, Ohio.

BUILD Concrete mixer. Power driven, simple, inexpensive. Details free. Horne, 206 West Wilder, Tampa 3, Florida.

BUILD A Famous Norwood Direct Positive Camera. Plans \$1.50. E. Poch, 2858 S. Lawndale, Chicago 23, Ill.

RACE Horse cribbage. Colored design, 12"x12". Round track, four lanes. Advances, novel features. Easy to make. Send 25c. Box 163, Point Richmond, Calif.

PLANES, Gliders, autogiros, helicopters made of paper, toothpicks, pins and glue. Easily assembled by anyone in ten minutes. Fly in living room, cannot harm furniture. Fun for grown ups and kids alike. Plans can be used many times. Booklet containing twenty plans and complete instructions, \$1.00 postpaid. Dent, Box 262, Starkville, Mississippi.

CAST Your own copper novelties electrolytically without heat. Duplicate expensive pieces cheaply. This closely guarded industrial process explained in our booklet "Electroforming for Beginners." Price, including limited consultation service, \$5.00. Opti-Phonetics, Inc., Box 155, Tuckahoe 7, New York.

BUILD Your home of concrete blocks, easily made. Complete instructions \$2.00. MacLaughlan, 415 So. 4th Ave., Puente, Calif.

GRANDFATHER Clock building system, simple, shoptested, thousands built, with weight movements pictured in production \$1. Kuempel Clock Engineers, Minneapolis 16, Minn.

MINIATURE Electric switch lights closet when door is opened, sounds alarm when window is opened, turns radio on and off; many other uses. Instruction booklet included free. Send \$1.00 to R. H. Lee & Co., 147-10 14th Ave., Whitestone, N. Y.

CONSTRUCTION Plans make good Christmas gifts. Order now. Backyard railroad, \$1.50; toy farm wagon, 50c; log cart, 25c; streamline train, \$1.00; many others. Specials for December only. G. P. Padrick, 1535 S.W. 9th St., Miami, Fla.

BLUEPRINTS For a 7 room concrete block house. \$20.00. Bowman, 2117 No. Main Street, Santa Ana, California.

BUILD Powerful, compact, garden tractor. Different principle. Plans \$2.00. Chas. Garber, Box 508, Far Hills Branch, Dayton, Ohio.

BUILD Concrete block machine. Vibration and hand operated types. 100 blocks per hour. Easy, inexpensive. Sell blocks, build home, garage, barn at low cost. Details free. Horne, 206 West Wilder, Tampa 3, Florida.

AIRPLANE Jettison gasoline tanks, streamlined, ten foot six inches by two foot four inches, 165 gallon, twenty gauge terne coated steel. Ideal for making boats, bob sleds, midget auto, etc. Price \$10.00 per tank, \$7.50 per tank quantities of five or more. General Truck Sales, Inc., 205 Market S.W., Grand Rapids, Michigan.

CONCRETE Block homes, 24 page booklet: drawings and instructions, how to build, \$1.00. H. C. Lightfoot, Civil Engineer, Richboro 1, Penna.

BUILD Your home as a hobby. No rent. No mortgage, save 50%. Use spare time. No special skill required. Amazing facts sent free. H. C. Lightfoot, Civil Engineer, Richboro 1, Penna.

BLUEPRINTS AND PLANS

DESIGNING. Remodeling home? Complete set latest illustrations on interior development. Special Christmas offer \$5 postpaid. The C. F. Engineering Board, 303 Herald Place, Syracuse 4, N. Y.

FORGET Storage battery troubles. Build your own A. C. charger. For details write Garland Enterprises, Box 186, Windsor, Ontario, Canada.

WATCHES, OLD GOLD, JEWELRY, ETC.

GOLD Plated expansion men's watch bands, \$3. Bands for ladies' watches, \$4.50. Postpaid. William Speece, Urbana, Ohio.

GUARANTEED Watch repairing, all types, 8-day service. Mail to Rite-Time, 1112 West 79th Street, Chicago, Illinois.

OLD Gold in any form: highest price. Mail old or broken jewelry, rings, watches, gold teeth. Receive cash by return mail. 100% satisfaction or your articles returned. Old Gold Specialist, Robert Wyndham, 1035 East A Street, Ontario 1, Calif.

WANTED—Old, broken jewelry. Cash paid immediately. Mail gold teeth, watches, rings, silverware, diamonds, spectacles. Satisfaction guaranteed. Information free. Rose Smelting Co., 29-A East Madison, Chicago.

"JEWELRY, Gem Cutting, Metalcraft." Fascinating designs for hobbies and money-making opportunities. New, complete illustrated book covers cutting, polishing, mounting gems, metal, jewelry work, etc. 287 pages, \$3.25 postpaid. Money back guarantee. We supply tools, materials at lowest cost. Modern Technical Book Co., Dept. MMC, 55 West 42nd St., New York 18.

GOLD \$35.00 Ounce—Mail old gold teeth, diamonds, jewelry, watches—receive cash by return mail. Satisfaction guaranteed. Free information. Dr. Weisberg's Gold Refining Company, 1500-Q Hennepin, Minneapolis, Minn.

GEMS, Precious and semi-precious, all genuine, from world wide sources. Deal direct, no overhead, save money. Catalog 10c. Hill Co., Route 7, Salem, Oregon.

WATCH Repairing easy learned by our home study course. Watch repairers are in demand and are among the highest paid craftsmen today. Write for free information. Houston Chronometer & Watch Co., P.O. Box 1140A, Houston 1, Texas.

WATCH And clock repairing—complete practical course in modern horology. 66 illustrated self-instruction lessons. Just out! Low price. Fascinating 100-page illustrated catalog free! Write—Nelson Company, Dept. 8-02, Chicago 5.

TOBACCO, SMOKERS' SUPPLIES

CIGARETTES—Popular brands. Minimum 3 cartons. Price \$1.46 per carton, postpaid. Send check or money order. Ace Mail Order Co., East Orange 84, N. J.

ENJOY Carving and smoking fine imported briar pipe. Complete kit with instructions, \$1.00. Carvape, 2829 Dixie, Hamilton, Ohio.

PIPE Smokers! Monthly pipe magazine! Pictures, articles, gadgets, ideas. Sample 10c. Literature free. Cushman, 532P Pine, Long Beach 2, California.

MAKE Smoking pipes, briar blocks and stems. Send for circular. Michelson & Sternberg, 67 West 44th St., New York 18.

RAZORS, BLADES, SHARPENING

BLADES Last a lifetime same as old razors did if you use Razorlife as instructed. Send \$2.00. L. G. Eggers, Box 2406, Sarasota, Florida.

SURVEYING INSTRUMENTS

GUARANTEED Factory rebuilt transits and levels for sale (cash or terms) or rent (with purchase option). We will repair, trade, or buy old instruments. Ship prepaid for estimate and valuation. For complete information, write for list M-212, Warren-Knight Co., (Manufacturers of Transits and Levels), 136 N. 12th St., Philadelphia 7, Penna.

FOR THE HOME

MAKE Rich looking gilt house numbers. Pattern your number and full instructions 50c. The Pebble Shop, Box 1383, Chattanooga, Tenn.

FIREPLACE Owners: Are you proud of your fireplace? Add beauty with Sunset Glow, exclusive fire color, \$1.00 per box. Free sample. Amity Products Co., Box 207A, Waltham 54, Mass.

BED-BUG, Cockroach killer. Positive death, harmless, with instructions, \$1.00. Box 98, New Hyde Park, N. Y.

UNPAINTED Bookcases in a variety of sizes and kitchen units. Write for prices and information. Joe's Fix-It Shop, 61 Lincoln Street, Exeter, New Hampshire.

REPLACEMENTS. Stoves, furnaces. Grates, firepots, linings. Craxmend, Majprudax, Royal Oak, Mich.

FOR SALE—MISCELLANEOUS

MECHANICAL Drawing instruments—Veeco, 4 piece, compact, precision set, brand new in lined case, value \$12.50, special, \$7.25, \$10.00—Charvos 9 piece set, \$8.50. Army surplus slide rules, slightly used, 75c each. Hull automobile compass, for accurate road direction, brand new, \$2.50. Brand new folding valise knapsacks made of heavy olive green duck, heavily bound and reinforced, repellent to fire or water. Inside 3 large snap fastened pockets, heavy webbed straps, hand and shoulder handles, size opened 22" x 54", closed 22" rolled. Useful to hunters, boy scouts, hikers and for all traveling use. A \$7.50 value, special \$2.25 postpaid. Prisms for 6 x 30 or 8 x 30 binoculars brand new \$1.50 each. Offset prisms to be attached to 7 x 50 B. & L. binoculars gives double the field of the ordinary 7 x 50 binocular. Cost \$98.00, special \$25.00. Green sunshades for binoculars size 6 x 30 and 7 x 50 snap on type value \$7.50, special \$1.25 per pair. Forward money order. No C.O.D. shipments. Public Sport Shops, 13 S. 16th, Philadelphia, Penna.

BUY! Sell! Swap! On our capital! We make your deals on commission basis only. Swap ads. free! Listing forms, details, on request. Contact Brokers, 610-C Kirby Street, Raleigh, North Carolina.

WOODEN Spools 4" dia. heads 2" x 6" barrel 1/2" bore. 10 cents each. Thomas, 2407 Heard Street, Columbus, Georgia.

AIRPLANE Oxygen tanks (used—good condition.) Up to 400 lbs. pressure. Non-rusting, stainless steel. Weighs 5 lbs.—24" long x 6" diameter. \$3.49 each. Same specifications 24" long x 12" diameter, \$4.98. Suitable for air; any bottled gas or liquids. Ideal for house trailers. Midwest Surplus Sales, 1515 Locust, Kansas City, Mo.

EVERY One can use assorted aluminum rivets. Half pound 25c p.p. Arizona Mfg. Co., 20th and Jackson, Phoenix, Ariz.

40MM. Shell solid brass table lamp. 15" high, 1 1/2" round, \$5.00. P.O. Box 64, Newton Centre 59, Mass.

FLYING Boots, leather, shearing lined. Used, large sizes only, \$4.95. 15 Alnico twenty power magnets \$1.10 prepaid. Aviator's helmet 95c prepaid. Headphones, army, \$1.10 postpaid. Aero Parts Supply, Municipal Airport, Houston, Texas.

ELECTROPLATER; Binoculars; expansion watch bands. Mailing lists. Ramsey, Monticello, Ky.

WANTED MISCELLANEOUS

WANTED Floor mat making equipment. Alvin, 3704 Gordon, Ft. Worth 4, Texas.

WANTED. Shop or office work. J. L. Dodson, Stamford, Texas.

WANTED—Oldfashioned music boxes and parlor lamps. Write; Barnes, 1534 Walnut, Kansas City 8, Mo.

MERCHANDISE Of any kind. Paul, 425 E. Jefferson, Springfield, Illinois.

HAVE You a product? Well financed sales organization with national distributing facilities is desirous to purchase the factory output of a meritorious product for resale to automotive or hardware jobbers. Will also consider the purchase of patent or patent pending rights on salable item and provide outside manufacturing facilities. Write Goslin Advertising Agency, Battle Creek, Mich.

WANT To swap-buy-sell anything? Send 25c for National Swapper's Guide. It's full eager swappers-buyers-sellers coast to coast and opportunities to swap-buy-sell almost anything under sun. National Swapper's Guide, P. O. Box 415, Evansville, Indiana.

MERCURY—Highest prices. Free containers. Write. Wholesale Terminal, Norwood, Mass.

MERCURY (Quicksilver). Write for quotation stating quantity. Metallurgical Products Co., 35th and Moore Sts., Philadelphia, Penna.

PERSONAL

VISIT Portland, City of Roses, by proxy. 25c for 3 postcards. Address, return for free remailing. Letters forwarded 25c. Box 2225, Portland 14, Oregon.

VISIT Miami Beach. Send 25c for three scenic cards. You write message, address and return. I remail. Letters 15c. Box 1465, Miami Beach, Fla.

LIVE Longer, feel better, enjoy life. Free information. Fairchild Company, Mt. Vernon, Ohio.

HAIR Falling out? Use scalp stimulator. Amazing new method helps promote hair growth. Particulars free. L. Shields, 1024 Cavalry, Detroit 9, Mich.

VISIT MIAMI Beach, "Millionaires Playground" by mail. 3 romantic colorful postcard views 25c. You address, return, I remail free. Letters forwarded, 25c ea. Duran, Box 1547, Miami 9, Florida.

MAIL Friends postal cards from Niagara Falls, 3 for 25c. Address, stamp, return for mailing. Letters 25c. Lake, 115-67 Street, Niagara Falls, N. Y.

"GOLDEN Rays Process" embosses in gold, silver and copper. Personalize your greeting cards. Kit \$1.00. Circular free. "Sunshine Line" de luxe Christmas folders, with or without scripture texts—21 for \$1.00. A.M.N., Box 288, Filer, Idaho.

SWAPPERS! Traders! Free list "Swappers' Gazette," 2836-PM Slevin, Louisville 12, Kentucky.

THREE Beautiful St. Louis postcards 25c. Address, return, we remail. Letters forwarded 25c each. Clyde Price, 2331 Albion Place, St. Louis, Mo.

GOT Words for a song? I'll write music! Ahlstrand, Box 1056, Port Orchard, Washington.

NYLONS! Want six pair for Xmas? "Service," 418 Gregory, Rockford, Illinois.

PHOTOSTAMPS. Details free. Pera, 165 Chattanooga, Dept. A1, San Francisco 14, Calif.

POWERFUL Prescription for achieving personal and business success; works without expense or guesswork. You can use it. Write for free literature. Menders, 15857-A Coram Ave., Detroit 5, Michigan.

FOOL Your friends. Make believe you're in Hollywood. Send 25c for two scenic cards. After receiving them, write message, address and return for mailing. E. McCarty, 923 So. Sherbourne Drive, Los Angeles 35, California.

FALSE Teeth wearers. If your dental plate is loose and uncomfortable I have good news for you. Send name on postcard. No obligation. Dr. Reese, Dentist, Box 268-X, Winnetka, Illinois.

FALLING Hair, its cause and prevention. An informative and educational pamphlet entitled "How To Keep Your Hair Till Ninety" mailed free. James Hilton, 4819 A Fourth Ave., Brooklyn 20, N.Y.

RUPTURED? Positive comfort, no understraps, no steel, no elastic. Write Smith Manufacturing Company, Preston, Ontario.

HAVE Fun! Pretend visiting California. 3 postcard views 20c. Address, return. I remail. Letters mailed 15c. Free information. Ira Smith, 708 Ellis, San Francisco 9, California.

HOW You can find out! Information discreetly developed, any matter, person, problem, anywhere. Personal-business assignments, representations, undertaken. Nation-wide. Officially licensed and bonded service established 1922. Reasonable. All inquiries confidential. William Herman, 170 Broadway, New York.

HAIR Falling? Dandruff? Write Trichologist, 137 Lewis St., Phillipsburg, N. J.

MISCELLANEOUS

FOODS And fruit cakes, direct also board deals. Samples \$4.00. Retail \$7.50. Northwestern Food Sales, Merchandise Mart, Box 3402, Chicago 54, Illinois.

A.A.F. Target propellers 24" \$3.95, 26" \$4.95, 32" \$9.95. Clear lacquer finish, 4" diameter hubs. Suitable for mounting clocks. Ideal for den or mantel. \$1.00 deposit on C.O.D. orders. Queen Prop Shop, 2159 N. Magnolia Avenue, Chicago 14, Ill.

HAWAIIAN Photos, curios, novelties. Send stamp for list. Hickam Photo Studio, Hickam Housing, Honolulu, T. H.

PHILIPPINE Products. Carved wooden shoes for ladies', pair; \$2.75 ordinary painted or polished; \$3.75 dress style polished, upper glasstex, fabric, leather, other materials; \$12.00 socialite style elaborately carved, upper fabric, leather, glasstex, other materials. Sleepers: hemp nicely woven, \$.75 & \$1.25; weed nicely woven, \$.75 & \$1.25. Shopping bags: net woven hemp with comfort grip handle, small \$.85; big size \$1.50. Famous Manila rope, three strands factory made: diameter 3/16" \$0.0125 per ft.; 1/4" \$0.0165 per ft.; 5/16" \$0.021 per ft.; 3/8" \$0.03 per ft.; 7/16" \$0.0375 per ft.; 1/2" \$0.045 per ft.; 9/16" \$0.075 per ft.; 5/8" \$0.085 per ft.; 3/4" \$0.105 per ft.; 13/16" \$0.115 per ft.; 7/8" \$0.145 per ft.; 1" \$0.1625 per ft. Maximum length 720 feet or 20 pounds weight. Prices postpaid, good in U. S. and Possessions and subject to change. Payment Postal check. Big orders; other Philippine Products; other countries—prices upon request. Gifts in double packing \$0.30 extra per package. Mention sizes. Jose V. Dizon, 1138C Bambang, Manila, Philippines. Cable Address: Vedizon.

WISE Nut cracker. Patented steel construction. Shells all pecans in halves. Guaranteed. \$1.00 postpaid; C.O.D. plus postage. Wise Nut Cracker Co., Box 5524, Fort Worth, Texas.

"RECEIVE Mail." Moneymaking offers, opportunities, catalogs. Name listed 10c. Ideal Service, 100, Park Ridge, Ill.

FOR Laundered curtains—use a modern and easy roll-on curtain pinner for attaching curtains to the stretchers. Complete with instructions 25c postpaid. Yarger Tool & Manufacturing Co., Dept. PM, Morgantown, West Virginia.

PAINT Crackles forming designs. Samples 25c. Circular free. Mapco, Hasbrouck Heights, New Jersey.

MAGNET, "Alnico" 4 oz. horseshoe; powerful (lifts and pulls up to 10 lbs.). \$1.00 postpaid. Ross, 66 W. Broadway, New York 7, N. Y.

PHOTO Cards. Books. Pictures. Mail service. Samples postage. List free. Nu-Art, 436 New York Ave., Brooklyn 25, N. Y.

GET Your copy of the "Surplus News Letter" for photographic "plus-values." No charge—from Sterling Howard, Dept. CM, 1900 Monterey Avenue, New York 57.

METAL Locator. A/H dipping needle locates buried minerals and metals. Only \$17.50. Allen-Howe Electronics Corp., Peabody, Massachusetts.

MAIL Order magazines, moneymaking opportunities 10c. Listing in big mail directory 25c. Box 1386, Milwaukee, Wis.

VETERAN'S Discharge papers photocopied. \$1.00. Each copy notarized. Baltimore Photocopy Service, 2859-D2 W. North Ave., Baltimore 16, Maryland.

NEW Edition simplified bookkeeping and income tax record for small business, postpaid \$3.75. S&A Bookkeeping Systems, 8858 Ladue, St. Louis 5, Mo.

SEND Dollar, receive prepaid, choice assorted 15 wrenches, or 10 gears, or 6 used muslin buffs. Mechanical, 150-06 Liberty Ave., Jamaica, N. Y.

8 ALNICO Magnets plus 100 experiments, \$2.00. Eljay, Box 891, Newark 1, N. J.

GIGANTIC Mails, opportunities, magazines, samples. Name listed 10c. Press, Box 1302-B, Detroit 31.

AMAZING Bubble blowing novelty. Nothing like it before. Scented liquid makes many beautifully colored, long lasting bubbles. Fancy box 2 bottles and wands 50c postpaid. Seafoam, Box 973, Charlotte, N. C.

SOUVENIR! Japanese barbaric invasion. Send \$1.00 registered. Teachers Exchange, Manila, P. I.

IRREGULAR (Seamless) nylons, all sizes. Full length and very light weight. Defect only slight, hardly noticeable. Six pairs \$6.60 postpaid in U. S. only. Carl Bohman, Saratoga Springs, N. Y.

DISCHARGES — Valuable documents—20 wallet size reductions both sides, 5 sealed in plastic. \$4.00. Originals returned registered mail. Hansen Engineers, 7216 Dunglein Court, Baltimore 22, Maryland.

50 BEAUTIFUL 1946 Christmas cards. Assorted box \$1.00 postpaid. Circular free. Shipp Greeting Card Co., 625 N.W. 19 St., Oklahoma City 3, Oklahoma.

FAMOUS Fire gun thaws, heats water in stock tanks, disinfects, burns weeds, destroys tree stumps, 100 uses. Valuable literature free. Sine Equipment 16M, Quakertown, Penna.

EXQUISITE Sea shell earrings or brooch \$1.00. Federal tax included. United States only. Ann Spence, Fine Gifts, Box 311, Seaside Heights, N. J.

MEXICAN Feather pictures framed 4x7" \$1.00; 5x9" \$1.35; 6x14" \$2.15. Hobby catalogue 10c. Quivira Specialties, Topeka, Kansas.

LADIES Beautiful alligator skin handbags, shoes, bedroom slippers \$8.00 up. extra sheer nylon like stockings \$2.50 pair. up. Unique merchandise for gifts, cigars, Panama hats, embroideries, souvenirs, Yarey straw reticules, bags. Free particulars. Export, 656 Enna, Havana, Cuba.

EMBOSSING Ink outfits \$1.00 postpaid. Feole, Box 708, Huntington Park, Calif.

MAKE Your own plastoplate printing cuts. Simple, easy process. Plastoservice, Argyle 1, Wisconsin.

FIREWORKS—Any time—any quantity—newest ideas—highest quality—best values. Giant salutes, aerial bombs, skyscreamers, battle-in-the clouds, new jet-propulsion plane rocket, 150-piece combination offer \$4.95. Satisfaction guaranteed. Write for big new catalog. Banner Fireworks, Dept 36, Toledo, Ohio.

METAL. Mineral locators latest 1946 electronic type ready for immediate shipment. Fisher Research Laboratory manufactured 2 million dollars worth of electronic equipment for the U. S. Army, including some of the finest metal-locators. Experience gained is yours in the best metal, mineral locator. Free 16 page booklet upon request. Fisher Research Laboratory, Palo Alto, California.

NEW Powerful Goldak locators for minerals and metals and with wartime improvements now available. Screen grid and beam power tubes. Moneyback guaranteed detect buried gold and silver at greater depths than any competitive device. Write Goldak Co., 1544 W. Glenoaks Blvd., Glendale 1, Calif.

LARGE Hand tooled leather purses. Zipper style. Made by hand the slow, sure way. A product of the great southwest. Wonderful selection. Scores of styles. Last a lifetime. Free catalog. Star Drug, 619 N. Fillmore, Amarillo, Tex.

GOLDEN Rays process kit engraves in gold, silver and copper \$1. Mrs. J. M. Watson, 758 Royal St., Baton Rouge 10, La.

NEW Free catalog, selected farm bargains, 16 midwest states, sent to you free! Many equipped. Many illustrated with picture. Special service to those stating general location desired, and payment plan. Write today! United Farm Agency, 1684 Arcade Bldg. 1, St. Louis, Mo.

NEW Retail merchandise catalog. Write for yours. Herman Neely, Box 230, Somerset, Kentucky.

YOUR Name on sports, photo, hobby, office, lab., shop equipment and products with Personal I-D-Cals. Decal transfers with name in gold letters 1/8 inch high. Like gold leaf. For wood, metal, glass, plastic. Set of fifty, one name (middle initial only); \$2.00. Remit with order. I-D-Cal Company, 451A West Fairview Blvd., Inglewood, California.

PERFUMES, 1 Dram bottle, metal cap, American Beauty rose, \$1.00 plus federal tax 20c. Lincoln Laboratories, 7528 Sheridan Road, Chicago 26, Ill.

WASHING Powder (ten pounds)—bill-folds, \$2.50. Christmas cards—fountain pens, \$1.10. Grabbags, \$5.00. Renschler's Carrollton 2, Kentucky.

EASY Mend while you iron. Enough for 100 mendings \$1.00. Box 6682, Cleveland, Ohio.

FIX Alarm clocks. Instructions 50c. Jones, 1210P Dudley, Utica, N. Y.

GENUINE Souvenir luggage labels. Five diff.—25c. 25—\$1.00. Distributors wanted. View cards, 50—\$1.00. Nabers Distributor, 242-ML Gordon, Laurens, S. C.

SOMETHING To Swap? Advertise in Green Mountain Trader. National circulation. Sample, dime. Henshaw, Bondville 13, Vermont.

CARPENTERS—50c Vestpocket calculator! Simplifies everything! Free particulars. Box 1414, Great Falls, Montana.

MAKE Delicious caramels, marshmallows, caramcorn; three confectioners secret formulas, \$1.00. Frank Shilling, 1017-C Dueber, Canton 6, Ohio.

RESURRECTION Plants — Hundred \$6.00. Sample 35c. Mexican Products Co., 126 N. Main, Tulsa 3, Okla.

PERSONALIZED Pencils. Individual or firm name. Dozen 60c. 2 dozen \$1.00. 100 up 3c each. Same imprint. Cash. Delivered. Pencil Market, 611-15th St., Knoxville 16, Tenn.

UNPAINTED Religious statues and novelties. Free list. Bill N. Varner, Picher, Oklahoma.

BOOKFINDERS! (Scarce, out-of-print unusual books.) Quickly supplied. Send wants. Clifton, Box 1377PMM, Beverly Hills, Calif.

TATTOOING Outfits—engraving outfits. Circulars free. Write, Zels Studio, 728 Lesley, Rockford, Illinois.

HOLIDAY Gift packages. Tangerines half bushel package \$3.50. Prepaid express. O. L. Stroman, Mission, Texas.

LOTS Of mail from everywhere! Receive free samples, magazines, catalogues, literature, moneymaking opportunities! Mails galore! Your name listed in over 15,000 "surefire" directories, \$1.00. 5,000 listings, 50c; 2,000, 25c. Stanford, 6220-M 16th, Philadelphia 41.

A THOUSAND Laughs. Unique jackass cigarette dispenser. Holds 10 cigarettes. Simply press donkey's head down, tail rises—presto—out slips cigarette. Satisfaction guaranteed. Sent postpaid for \$1.00 with order or \$1.10 c.o.d. Ideal for Christmas gifts. Sanimo Industries, Dept. C-11, Spencer, Ind.

SQUARE Dance calls, instructions, illustrated. \$1.00. Guide, Eureka Springs, Arkansas.

NYLONS! 50c brings supply source. (Guaranteed legitimate.) Renschler's, Carrollton 2, Kentucky.

SOILLESS Culture. Grow plants without soil. See the amazing results you can achieve with a few drops of "Ready Grow" the wonder plantfood, added to water or soil. 65c or two for \$1.00 postpaid or C.O.D. plus postage. Alfred Kittel, 1601 Nostrand Avenue, Brooklyn 26, N. Y.

MERCHANTS Bookkeeping system \$3.50 postpaid. James Lamont, Distributor, Beacon, New York.

SWAPPERS, Buyers, sellers, advertise 2c word. Royal Swapper, 209 1/2 Elm St., Amesbury, Mass. Sample copy dime.

FREE—"Amazing New Book"—"Profits From Classified Advertising." Tells how and what to advertise. Be sure to read this book before you invest one cent in advertising. Remember—it's free! Write for your copy now. F. W. Johnson, Classified Advertising Manager, 200 East Ontario Street, Chicago 11, Illinois.

THE Lord's coming! Get free undeniable proofs today. Write International Evangelism, Box 263, Duluth, Minn.

WANTED—1000 Foot sufferers to test Custom Made Research Foot Balancers at our risk. Amazing foot relief awaits you. Rush name and address for free trial offer. Kindschi Foot Appliances, Dept. A4, 321 W. Jefferson, Dallas 8, Texas.

MEXICAN-AZTEC Featherwork tropical bird picture cards. Samples 25c. Bulletin free. Mexican Products Co., 126 N. Main, Tulsa 3, Okla.

RECEIVE Moneymaking opportunities, mails, samples, catalogs, magazines. Your name in thousand mailing lists, 25c. Glassmine, 1654-MX Amsterdam Avenue, New York 31.

CALENDAR 1753 to 2152. 35 cents postpaid. Tracy Newton, Decatur, Georgia.

LUMINOUS Paint. Best quality. Glows bright blue in dark. 1 oz. each paint and sealer only \$1.59 f.o.b. Chicago. Black Light Products, 67 E. Lake St., Chicago 1, Ill.

GOOD "Used" self-instruction educational books on all subjects bought, sold, rented, exchanged. Satisfaction guaranteed. Complete information and 100-page illustrated bargain catalog free! Write—Nelson Company, Chicago 5.

"BIBLE Studies" 70 lessons 25c. Bulletin, Box 87, Station H, New York 25.

MEDICAL Laboratory technicians in great demand. We train you in your spare time, in your own home. You can practice while studying. Write for free catalogue. Imperial Technical Institute, Box 973-J, Austin, Texas.

JEEP Hats 10c, meskits 35c, canteens 50c, covers, cups 15c, leggings 25c, holsters 50c, gunslings 75c, pistol cartridge belts 75c, field bags 95c, tool box, steel helmets, raincoats \$1.00, wading boots \$3. Catalogue. New York Salvage Co., 144 Chambers St., New York City.

DIAMOND Dust—20 beautiful Christmas cards and envelopes in gift box \$1.00 postpaid. Davis Specialty Shoppe, Box 213, Venice, Calif.

It ROARS! MOVES! ROLLS! BANKS! TURNS!

**PROPELLER REVOLVES ON ITS OWN POWER!
MOVES AND ROARS LIKE A REAL PLANE!**

Educational? Yes! It's the first Toy Plane ever built on the Gyroscopic principle. Just pull the string and watch it Roar, Move, Turn, Bank, and travel across the floor. Any child can operate it!

\$1.95

(Dealer's Inquiries Invited)

HURRY! DON'T DELAY! GET YOURS TODAY!

SEND FOR OUR FREE GENERAL CATALOG Dept. MM-7

UTILITY STORES

117 S. Wabash Ave., Dept. MM-7, Chicago 3, Ill.

Enclosed find \$..... for which ship at once

Gyro-Planes at \$1.95 each 'complete.

Name.....

Address.....

City..... Zone..... State.....

Make UTILITY STORES your Mail Order Shopping Headquarters.

Established 1906



Plane Balances on Special Stand, and Roars Like a Plane!

Plane Moves! And Sounds Like a Real Plane!

SPECIALIZED TECHNICAL TRAINING

Prepare in 6 months to 3 years for specific technical occupations. Select the course that interests you most.

- * **Institute of Electrotechnics**
Applied Electricity—Electrotechnics—Radio and Electronics
- * **Welding Institute**
Gas, Aircraft and Arc Welding
- * **Refrigeration, Heating and Air Conditioning Division**
Service—or Technician
- * **College of Electrical Engineering**
B.S. Degree With Major in Machinery—or Electronics

WRITE FOR MORE DETAILS AND FREE BOOKLET

MILWAUKEE SCHOOL of ENGINEERING
Institute of Electrotechnics

"Has Served Industry 44 Years"

Milwaukee School of Engineering, Dept. PM-1246A
N. Broadway and E. State, Milwaukee, Wis.
Without obligation, send me free booklet "Career Building" and more details on course in.....

Name..... Age.....

Address.....

City..... State.....

48 PLANS

\$1.00

48 complete plans of toys, ash trays, garden ornaments, Dutch boys and girls, what-not shelves, and many other interesting projects. Finest selection available. Novel method allows you to make finished project any size desired. **PLUS FREE De-Luxe Plan of corner shelves.** Send only \$1 to

Jackson, Dept. PM-5440 N. Shoreland Ave., Milwaukee 11, Wis.



FENCING

EXCITING FUN HARMLESS



Just Out! Two 3 ft. Spring Steel Foils with Safety Rubber Buttons. Complete Outfit 2 foils (swords) with hand guards and Free Instruction Book **NOW ONLY \$1.98** Postpaid. A Healthy and Clean Sport makes you Strong and Alert. Instruction Book teaches Quickly—Easily. **MAIL CHECK or M.O. today for \$1.98.** Add 28c for Foreign Postage.

LEE PRODUCTS CO.

Dept. 18—1613 First Ave., New York 28, N. Y.



SAY YOU SAW IT IN POPULAR MECHANICS

LIQUID MARBLE COLORED POTTERY



Different! Marvelous! Color-glazed, Brush, spray, mold tiles, table-tops, ornamental **SANITARY COMPOSITION FLOORING**—Dustless, noiseless; put on like plaster, plain or tile designs; yielding as cork, tasting as stone. **RUBBERLASTIC Mold Compound**—For plaster casting, novelties, statuary, toys, plaques, dolls. **TILEX Colored Roofing.** Build Modern **PLASTIC HOMES.** Illustrated literature free. **RAPID MARBLEIZING SERVICE, Dept. 10-A, Edwardsville, Illinois**

SUIT YOURS AS A BONUS

And Big Money in Spare Time, Too
We want you to wear this fine made-to-measure suit! Make it yours by sending a few orders, and earn **BIG CASH PROFITS** in spare time. Your suit will help you get more orders with scores of rich, quality fabrics, tailored-to-measure to newest styles. Also Ladies' Tailored Suits—complete line. Write today for **FREE SAMPLES.** No experience, no money needed. For quick action tell us about yourself. **J. C. FIELD & SON, Inc.**
Harrison and Throop Sts., Dept. M-1716, Chicago 7, Ill.



How to Start YOUR OWN BUSINESS

Amazing Postwar Development Now Gives
You the Opportunity to Make Money Fast!

Startling scientific discovery, just now becoming available for general use, will enable you to start your own business and reap great profits! Plastics, one of the most revolutionizing and rapidly expanding industries, offers a great opportunity to all enterprising men and women. This is one of the few industries in which home manufacturers thrive and prosper. You can start even on a spare time basis in your own home, and expand rapidly into a full time business, paying good profits.

LIQUID MARBLE

Make LIQUID MARBLE the amazing Plastic, with a thousand uses. LIQUID MARBLE can be poured into FLEXIBLE MOLDS for casting all kinds of artistic and serviceable articles such as: ornaments, novelties, desk sets, paper weights, book-ends, souvenirs, statuary, toys, etc.

FLEXIBLE MOLDS

Make your own FLEXIBLE MOLDS. The cost is low—in fact, a large sized mold costs but a few cents. Hundreds of casts can be taken from a single mold.

NO EXPERIENCE NEEDED!

No skill or previous knowledge is necessary. All you do is follow our easy-to-understand instructions.

UNLIMITED MARKET

The market is literally unlimited. You will find steady year-round demand in your own community. Your problem will not be in selling but in supplying the huge pent-up demand. Moreover, we supply you with names of big buyers for your finished products.

WRITE TODAY

Bing Products will show you how to start with a small investment and build a permanent, independent, profitable business! Don't fail to grasp this opportunity! Write today for FREE CATALOG.

BING PRODUCTS

Dept. A-13, 88 Broad Street BOSTON 10, MASS.



Get Started in Radio

TEN "HOW-TO-DO-IT" BOOKS

Get a solid foundation in radio by means of these 10c timely text books. Each clearly written, profusely illustrated, contains over 15,000 words. You'll be amazed at the wealth of information packed into these handy books. Excellent for reference—ideal for technical library. Your money back if not satisfied.

5 Books for 50c - 10 Books for \$1
SENT TO YOU POSTPAID

- | | |
|--|-------------------------------------|
| No. 1—How to Make Four Doerle Short Wave Sets | No. 4—All About Aerials |
| No. 2—How to Make The Most Popular All-Wave 1 and 2 Tube Receivers | No. 5—Beginners' Radio Dictionary |
| No. 3—Alternating Current for Beginners | No. 6—How To Have Fun With Radio |
| | No. 7—How To Read Radio Diagrams |
| | No. 8—Radio for Beginners |
| | No. 9—Simple Electrical Experiments |
| | No. 10—Television |
- Remit by check or money order—register letter if you send cash or stamps.
RADIO PUBLICATIONS, 23-R West Broadway, New York (7)

PLAY LIKE YOU'VE ALWAYS WANTED TO!



Harmony made easy. Learn quickly at home! It's fun! Brand new simple method. For **Guitar, Piano, Accordion**, etc. Helps you learn your favorite musical instrument. Makes any instrument easier to play. Learn harmony. Play for **self, friends, entertainments**, etc. Prepare for **radio, stage, orchestra** playing. Fine for songwriters, too. Harmony for **hill-billy, western** and **sacred** songs is extra easy! Get this **quick, simple** method now. Sent anywhere for only **\$1**, postpaid, **guaranteed. Play like YOU'VE always wanted to!**

Rush dollar for your simple home harmony method today!
Ahstrand Music Studio, Box 1056, Port Orchard, Wash.

LEARN TRIG QUICKLY—EASILY

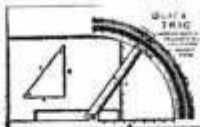

WITH QUICK TRIG, BY COMPETITIVE TESTS, it was found that QUICK TRIG gave answers faster to one with a slight knowledge of trig than to an expert on trig with a slide rule. Simply set the slides and read the answers for all three sides and angles of a triangle. Also gives degrees, sines, cosines and tangents of angles. Entirely automatic. Easy instructions included. We mail C.O.D. plus postage or enclose \$1.00, the full price, and we will mail postpaid. Send now for your QUICK TRIG, to
REED MFG. CO., 124-M W. 4th St., Los Angeles 13, Calif.

FIGURE DRAWING WITHOUT A MODEL

This book brings famous art schools right to your home! Over 300 "real-life" drawings in this new Cliff Young book. Copy from them to guide your Art Career. Only \$1 postpaid. Order Now; Art Books list included FREE.
HOUSE OF LITTLE BOOKS, 80-A East 11th St., New York 3



LEARN PORTRAIT PAINTING AT HOME



● Previous art training or talent NOT necessary. This new Stuart System teaches you, in 11 simple, easy-to-follow lessons, to make exact charcoal and oil likenesses. Guidance for your every step. Send for free book today.

STUART STUDIOS.

121 Monument Circle, Room 612, Indianapolis 9, Ind.
Please send me free book and outline of lessons.

Name.....
Street.....
City..... State.....

Now! The ONE-UNIT HEARING AID

Thousands Have Waited For

THE NEW ONE-UNIT
Beltone
MONO-PAC
HEARING AID

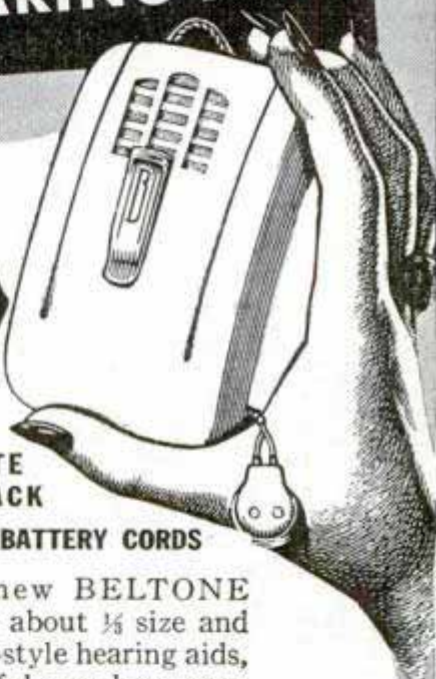

THIS IS
ALL YOU
WEAR

NO SEPARATE
BATTERY PACK
NO DANGLING BATTERY CORDS

The tiny new BELTONE Mono-Pac is about 1/8 size and weight of old-style hearing aids, yet so powerful you hear even *whispers!* Get helpful facts about this new "MIRACLE" aid in valuable FREE book about deafness.

BELTONE HEARING AID CO.
1450 W. 19th St., Chicago 8, Ill.



FREE BOOKLET

Beltone Hearing Aid Co.
Dept PM-12, 1450 W. 19th St., Chicago 8, Ill.
Please send me FREE booklet about deafness and what can be done to overcome it.

Name.....
Address.....
Town..... Zone..... State.....

102 Booklets filled with Money and Time-Saving Helps

Little Library of Useful INFORMATION

5 for \$1.00
12 for \$2.00
25¢ Each

Here at amazingly low cost is the practical help and information you have always wanted. Articles in previous issues of Popular Mechanics have been classified according to subject and are now available in these handy reprint booklets. Check Titles wanted, clip ad and mail today.

BOOKLETS ON WORKSHOP EQUIPMENT

Power-Driven Saws—74: Complete details on scrollsaw, two circular saws, sliding cut-off saw, bandsaw.
Drill Presses, Plane, Grinders—79.
Sanders—80: Complete constructional details on 8 useful machines.
Wood & Metal-Turning Lathes—81: Two wood lathes, small metal-turning lathe.
Filing Machine, Hacksaw, Cutoff Wheel, Shaper—82.
Metal Lathe Tools You Can Make—101.
Workbenches & Tool Cabinets—47.
Spray Painting—94: Constructing spray guns, compressor, using spray gun.
From Pattern to Casting—91: How to make your own patterns and small castings.

BOOKLETS ON SHARPENING—USING TOOLS

Correct Measurement—106: How to use micrometers, gauges, calipers, etc.
Tool and Saw Sharpening—92.
Using & Sharpening Drills & Wood Bits—90.
Successful Wood Turning—32: All the information you need to master this art.
How to Read Blueprints—71: Tells you how to understand signs, symbols, and lines.
Metal Turning Lathe Kinks—99: Simple homemade tools, time and labor-saving shortcuts you can use.
Operating a Metal Turning Lathe—100.
Heat Treating & Case Hardening—102.
Working with Glass—103: Cutting, drilling, etching, blowing.

ELECTRICAL BOOKLETS

Rewinding & Servicing Electric Motors—75: Repairing and rewinding a.c. and d.c. motors. Locating trouble. Converting auto generators into 110 v. a. c. motors.
House Wiring—89: All the information you need to do a complete wiring job or install extra outlets.
Electromagnets & Solenoids—44: Designing and building.
Transformer Construction—41: Easy-to-understand instructions for all kinds of transformers.
The Boy Electrician—43: Easy-to-build motors, experiments.
Soldering & Brazing—17.
Arc & Spot Welders—5: Building and operating 110 v. a. c. arc and spot welders.
Treasure Finders—13: Build your own treasure finder and metal locator. Details for both large and small radio types.

ELECTROPLATING BOOKLETS

Electroplating with Copper, Nickel, Chromium, Lead, Zinc, Cadmium—86.
Plating Leather & Other Non-Metallic Objects—Plating with Gold, Silver, Alloys—87.

HOME IMPROVEMENT BOOKLETS

Simple Home Improvements—104: Modernizing; making storm sash, ironing boards, etc.
Building Extra Rooms in Attic—23.
Attractive Basement Playrooms—24.
Lower Your Fuel Cost—31: Practical kinks that will save you hundreds of dollars.
Hanging Wallpaper—38: Tricks of hanging wallpaper, removing old paper, etc.
Curing Leaky Basements—45.
Fitting Home Game Room—55: Construct own game & tennis tables, shuffleboard court, action game, portable playrooms.

Ridding the Home of Insect Pests—107: Exterminating and protecting against moths, flies, termites, mosquitoes, etc.
Built-in Fixtures—78: Step and space-saving kitchen units, built-in beds, corner cabinets, vanities, linen chest.
Constructing Indoor & Outdoor Fireplaces—88: Stone fireplaces, portable mantels, garden fireplaces.

GARDENING BOOKLETS

Backyard Gardening—39: Selecting, planning and getting the best results.
Lawn & Garden Novelties—72: Jig-sawed ornaments, parkway numbers, sundials, flower boxes.
Trellises, Pergolas, Fences—76.
Lawn & Garden Furniture—77: Modern bent-tube furniture, arbor and seat combinations, swings, lawn chairs.
Playground Equipment—73: Two play-houses, ferris wheel, roller coaster, treadmill, play store, slide, two merry-go-rounds.
Colored Concrete Garden Furniture—6: Garden benches, pottery, flower boxes, bird baths and sundial pedestals in colored concrete. How to build small concrete mixer.
Bird Houses—7: Easy to build homes for all kinds of birds.
Farm & Garden Tractors—8: Two tractors you can build from old automobile parts.

CRAFT WORK—HOBBY BOOKLETS

Complete how-to-make-it instructions for hundreds of practical projects.

Working with Plastics—61: Using brilliantly-colored plastics in craftwork.
Magazine Racks—49: Ten attractive racks.
Clock Cases—50: Large Hall, Colonial wall and mantel, ship's wheel, miniature grandfather, desk, Spanish style banjo.
Serving Trays for Every Occasion—53: Fourteen different designs.
Children's Room Furniture—51: Twelve attractive pieces.
Book Ends—52: Ten designs offer good selection.
Small Tables—54: Modern and colonial styling.
Smoking Stands—56: Seven designs given.
Jigsawed Novelties—57: Sewing kits, string holders, place-card holders, plywood kitchen-ware, plant and flower holders, coin banks, door stops, drawer pulls.
Desks—58: Colonial writing desk, two modern-type desks, student's study desk of plywood, combined chest and writing desk.
Book Cases—59: Eight designs.
Doll House & Doll Furniture—60.
25 Shelves You Can Make—64.
Novelties Turned on Lathe—62.
Inlay Pictures—Veneering—63.
Whittling and Wood & Soap Carving—65.
Action Toys—66: 21 easy-to-make toys.
High Flying Kites—67.
Windmills & Weathervanes—68.
Lamps in Wood, Metal, Plastic—69: Selection of 14 designs.
Metal Craft—28: Brass tapping and making of novelties both decorative and useful.
Small Looms—37: Building hand looms for weaving rugs, etc.; leather novelties.
Plain & Novelty Wood Finishing—40.
Gem Cutting—42: How to cut and polish semi-precious stones.
Rustic Furniture—18: How to build chairs, benches, tables, gates, summer house, etc.

BOAT BUILDING BOOKLETS

Build a boat at home—you can do it

14 Ft. Outboard Runabout—2: Here is a fast 14 foot V-bottom boat. Suitable for motors of 4 to 24 hp., estimated cost, \$30 to \$40.
14 Ft. Sailing Dinghy—26: This 14-foot boat combines strength and light weight. It carries 140 sq. ft. of canvas and weighs about 350 pounds. Actual photographs and diagrams illustrate every detail.
21 Ft. Sloop—46: Every fact needed by the amateur boat builder to construct this craft which carries eight to ten persons.
Rowboats, Bicycle Boat, Small Dinghy—83: All the information you need to construct four low-cost boats.
Small Sail Boats—84: 12-ft. sailing dinghy, 8-ft. "training ship" for young sailors, how to sail a boat.
Two Outboard Runabouts—85: 14-Ft. family outboard weighs about 400 lbs. and 12-ft. plywood outboard weighs about 110 lbs. Both are V-bottom type.
Build Your Own Canoe, Kayak, Surfboard—30: Complete details on 16-ft. Canadian-type canoe, 17-ft. kayak, and 12-ft. hollow surfboard.
Fast Class-E Ice Yacht—22: Build your own Class-E ice yacht. Every detail of construction carefully explained.

AUTOMOBILE BOOKLETS

Automobile Kinks and Shortcuts—10: Money-saving hints on upkeep, operation.
Building Trailers—27: Small Streamlined house trailer; several utility trailers.
Motor-Driven Midget Car & Scooter—34: Both use gas engine of washing machine type.
Curing Auto Electrical Troubles—95.

PHOTOGRAPHY BOOKLETS

Save Money by constructing your own photo equipment.
Photo Enlargers—1: Condenser lens type; simple vertical; horizontal.
Photo Printers and Dryer—25: Describes three practical printers, timer and negative dryer.
Photo Darkroom Equipment—96: Cabinets, light-tight box, timer, agitator, washer.
Picture Projector, Trick & Table Top Photography—97: Projectors that enlarge magazine illustrations and shop drawings. Tips for table toppers, photomontages, tricks.
Photo Kinks—98: 63 time and money-saving ideas you can use.

FORMULA BOOKLETS

Cleaning Preparations—11: Easy-to-make cleaners for walls, glass, etc. Removing fabric stains.
Cosmetic Formulas—12: Hand lotions, creams, rouge, bath salts, beauty clay, lipsticks, etc.
Re-Silvering Mirrors—70: Formulas for silvering and coloring.

MISCELLANEOUS BOOKLETS

Knots and Ropework—105.
Chemical Experiments—93: Easy-to-perform experiments. Inexpensive lab.
Taxidermy—9: How to prepare skins and obtain life-like poses.
Log Cabins & Tourists Cottages—14: Year-round log cabins; inexpensive tourists' cabin.
Magic for Everybody—29: Simple tricks to puzzle your friends.
Trapping Small Animals—33: How to lure fur bearers, prepare bait and traps, dress skins.
Tricks of Training Your Dog—35.
Small Furnaces—36: Build own gas or electric.
Telescopes—20: Design and construction.
Poultry Houses—108: Structures, brooders and incubators.
Guns and Decoys—109: Cleaning, shooting; making decoys.

POPULAR MECHANICS PRESS, 200 E. Ontario St., Chicago 11, Ill.

I enclose (U. S. bills may be mailed if carefully wrapped) for "Little Library" booklets numbers: *

.....
 Name
 Address Zone
 City State

MAKE UP TO \$5⁰⁰ AN HOUR

In Your Own YEAR ROUND Business!

ONLY A FEW DOLLARS PUTS YOU IN BUSINESS!

Many Clearing as High as \$20 to \$30 a Day NET Renewing Rugs, Carpets, Upholstery. New Method Now Used for Auto Upholstery. Write for Facts About Quick, Easy Way to Get Started

Here is the chance you've been looking for to step into a pleasant, dignified, big-pay business of your own that offers you a steady, year 'round income. Start on "a shoe-string," full or spare time, right from your own home. Equal opportunities for men and women, young or old, in small towns or big cities. No experience needed. Many making big money with new American System just cleaning auto upholstery. Easy to learn. We send you complete instructions and quick-cleaning supplies so you can start making money the very first day! Quick method cleans upholstery, rugs and carpets like new without taking off floor! Tremendous demand in homes, apartments, hotels, stores, office and public buildings. Steady repeat business. Territories going fast. Write today for full FREE facts. No cost or obligation. Rush letter or postcard now to AMERICLEAN CO., Dept. G-2, St. Louis 1, Missouri.

WRITE FOR FREE DETAILS NOW!

AUTOMOTIVE MECHANICS BODY & FENDER REBUILDING

Pay is good in both these big branches of the Automobile Industry. Learn in few weeks in our big, modern training shops. Good pay for men who learn to service, repair, install all mechanical and electrical parts of autos. Learn to make used cars look like new—training in welding, aligning, mixing and matching colors, spray painting, power and hand tools. CONSULTATION AND PLACEMENT SERVICE WHETHER YOU ARE INTERESTED IN WORTHWHILE JOB OR SETTING UP YOUR OWN BUSINESS for men who learn to service, repair, install all mechanical and Mechanics for U. S. Army. If over 17 and under 60 learn how you can get started. Write for FREE FACTS today. If you are a veteran, we'll take care of all details if you qualify under G.I. Bill.

MOTIVE TRADES INSTITUTE, Dept. B-212

1400 Greenleaf Chicago 26, Illinois

MAKE MONEY CASTING AT HOME FREE FACTS SENT



Make hundreds of Plaster Casts, quick, easy. Sell output to stores, novelty shops, etc. Enormous profits. No experience. Very little capital needed. Start in basement, garage or workshop. Complete, simple instructions anyone can follow. Start now while merchants are begging for merchandise to sell. Rush.

PLASTIC ARTS STUDIOS, R. R. 5, Dept. 29, Muncie, Ind.

Learn CARTOONING



HAVE FUN! MAKE MONEY! Cash in on your sense of humor AT HOME—BY MAIL. No experience needed to start. Write today! Send 10c for TRIAL LESSON and full particulars. Moon Gag Cartoon School, Dept. A, Fall Creek, Wis.

do you WORRY?

Why worry and suffer any longer if we can help you? Try a Brooks Patented Air Cushion. This marvelous appliance for most forms of reducible rupture is GUARANTEED to bring YOU heavenly comfort and security—day and night—at work and play—or it costs you NOTHING. Thousands happy. Light, neat-fitting. No hard pads or springs. For men, women, and children. Durable, cheap. Sent on trial to prove it. Not sold in stores. Beware of imitations. Write for Free Book on Rupture, no-risk trial order plan, and proof of results. All Correspondence Confidential.



Brooks Company, 359-D State St., Marshall, Mich.

WAR BARGAINS in LENSES and PRISMS

MAKE YOUR OWN BINOCULARS!



View of 7X 50 Binoculars

ATTENTION!

Coming About

JANUARY 30th!!

Complete Optics and Metal Parts for Army's 7X 50 Binoculars and Army's 6X 30 Binoculars

A rare opportunity to pick up a really fine expensive, precision set of Binoculars, either the 7X 50 or 6X 30, at under 1/2 their normal retail cost. We will furnish complete assembly instructions. Send your name and address, and request Bulletin #14-H which will give you complete details of this offer the moment it is ready.

POLARIZING VARIABLE DENSITY ATTACHMENT FOR 7X 50 BINOCULARS—An amazingly effective unit for controlling amount of light reaching your eyes. Cuts down glare in sky and overwater observations. Easily snapped on and off over the eye cups of American-made 7X 50 Binoculars. Govt. cost \$8.30 each.

Stock #20,000-H \$2.00 Postpaid

CARRYING CASE WITH STRAPS FOR 7X 50 BINOCULARS—Modern synthetic rubber construction—brand new—a regular \$12.00 value.

Stock #44-H (Price includes tax)..... \$4.80 Postpaid

SPECTROSCOPE SETS . . . These sets contain all Lenses and Prisms you need to make a Spectroscope plus FREE 15-page Instruction Booklet.

Stock #1500-H Hand Type Spectroscope... \$3.45 Postpaid

Stock #1501-H Laboratory Type Spectroscope \$6.50 Postpaid

PRISM TELESCOPE—All the Lenses You Need to build your own 20 power Telescope! No mounts. Has wide field of view.

Stock #5012-H \$7.25 Postpaid

MAGNIFIER SET—5 Magnifying Lenses . . . powers from 1 to 10. Various diam. for many uses. Free Booklet on Home-made magnifiers included.

Stock #1026-H \$2.00 Postpaid

35 MM. KODACHROME PROJECTING LENS SET—Consists of Achromatic Lens for projecting, plus a Condensing Lens and piece of Heat Absorbing Glass with directions.

Stock #4025-H \$1.95 Postpaid

AIR FORCES GUN SIGHT

With Polarizing Variable Density Attachment

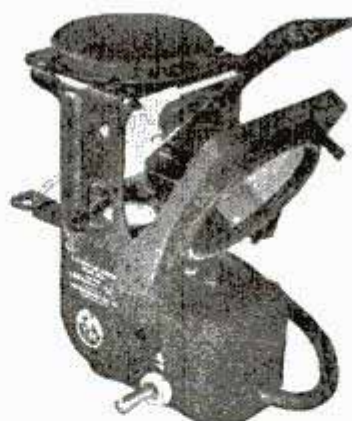

Can be used as Slide Viewer, or take it apart and you can get Polarizing Variable Density Attachment, Mangin Concave Mirror, Reflector Plate, Metal Reticule, Window, Lamp Housing, Ring and Bead Sight. The Polarizing attachment alone is worth many times the price of entire unit. Consists of 2 Polarizing Filters mounted with small handle which rotates one around the other. May be used in Photography, Research, Experiments, as Light Dimmer, etc.

Stock #908-H..... \$5.00 Postpaid

Same Unit Without Polarizing Attachment

Stock #916-H..... \$2.50 Postpaid

BOMBER SIGHTING STATION—A double end Periscope Type Instrument of highest precision. 6 ft. tall, shipping wt. 360 lbs. Orig. cost \$9.850. Consists of numerous Lenses, Prisms, Mirrors, Gears, Motors, Metal Parts and Electrical Gadgets.

Stock #914-H..... \$50 F.O.B. Oklahoma

TANK PRISMS—90-45-45 deg., 5 3/4" long, 2 1/2" wide, finely ground and polished.

Stock #3004-H Silvered Prism (new & perfect) \$2.00 Postpaid

Stock #3005-H Plain Prism (new & perfect)..... \$2.00 Postpaid

Stock #3100-H Silvered Prism (Second)..... \$1.00 Postpaid

Stock #3101-H Plain Prism (Second)..... \$1.00 Postpaid

We have literally millions of war surplus lenses and prisms for sale at bargain prices. Write for Catalog "H"—Sent Free!

Satisfaction Guaranteed

Order by Stock No.

EDMUND SALVAGE COMPANY

P. O. AUDUBON, NEW JERSEY

Opportunities and Advancement Get Started QUICK in DRAFTING



I Will Train You Until You Get
a GOOD PAY JOB! — *Engineer Dobe*

Act Now! Get ready for a better job, advancement, more pay and security. Drafting is the field of big opportunities and now bigger than ever before. Thousands of draftsmen and designers must come first—before any kind of production can begin. Get into Drafting. Engineer Dobe will train you at home in your spare time. You'll get experience on actual work—the same kind of jobs you will do for the best paying firms. You will be trained until you are competent, experienced, and are actually holding a position that will bring advancement and pay raises as deserved. Write today for details.

**Previous Experience
Not Needed**

I train you through practical jobs and give your experience as a reference to employers when you become competent. Lack of starting experience or higher education won't hold you back. Low cost—and monthly payments, if desired. Write today for illustrated book and all details. No salesman will call. Give your age to get reply.

WORKING TOOLS FURNISHED
Professional instruments, drawing table and other tools included and sent when you start.



Engineer Dobe, Div. 19, Libertyville, Ill.

Send me the Vital Facts on Drafting and Industrial Designing, your FREE BOOK and advertised list of positions for Draftsmen and Designers wanted.

Name..... Age.....

Address.....

City..... Zone..... State.....

★ TRAIN for SUCCESS in the Poultry Business



Study at home in spare time. Earn extra while learning...

YOU CAN MAKE A Good, Sure, Comfortable LIVING WITH POULTRY

Enjoy country life—grow your own food—and let poultry pay expenses

Get ready now—the easy, scientific, inexpensive way! For 25 years, we've been helping thousands to greater success. During 25 years we have trained thousands of students, showing them how to establish poultry farms—how to avoid mistakes—how to cut losses—how to increase profits on established plants—how to have their own small profitable breeding plant and make a good living at it.

Proper management and "know-how" makes profits ANY season, for life. Our courses cover all phases of poultry raising, including plans for buildings, breeding, hatching, culling, sexing, caponizing, marketing, judging, exhibiting, and many others, etc., as planned by Harry M. Lamon, former Senior Poultryman for the United States Dept. of Agriculture. Endorsed by leading colleges, poultrymen everywhere. Write today for this Free Catalog "How to Raise Poultry for Profit." It fully describes courses, methods, service, opportunities, and easy payment plan.

National Poultry Institute
Dept. 50, Adams Center, N. Y.



**YOU CAN SUCCEED....
Send For this Book Today**

LEARN WATCH REPAIRING AT HOME



Construction, repair, adjustment. New complete "PRACTICAL COURSE" for beginners and professional repairmen. All essential steps. Theory, operation. Many test cases. Full coverage of tools, materials. Fully illustrated. **\$2.95** Only (If C.O.D. plus C.O.D. fee.)
Money Back Guarantee Post Paid

We Supply Tools, Materials at Lowest Cost
Illustrated catalogue of tools and materials, 50 cents, credited to your first order.
We specialize in all books on Watchmaking, Jewelry, Metalcraft, Gem Cutting, Optics.

MODERN TECHNICAL BOOK CO., Dept. MMC
55 WEST 42ND ST. NEW YORK 18, N. Y.

JOIN our new TECHNICAL BOOK CLUB—free

Members receive current literature, guidance on all book problems, premiums. No obligation. **ALL BOOKS:** Technics, Chemistry, Physics, Plastics, Refrigeration, Air-conditioning, Building, Construction, Electricity, Radio, Television, Electronics, Automotives, Mathematics, Woodworking, Homecraft, Business, Languages, Farming, Sports, Photography, etc.—Write for free literature, please specify subject.

BE A BUILDING CONTRACTOR

FREE FACTS: Use Our Training Plan to Learn at Home in Spare Time

Do you want to be on the inside in the building boom—where big money is made? Learn about opportunities for Building Contractors whether or not you have previous experience in this field. Millions of dollars are going to be made in home and farm buildings, in construction of stores, garages, small industrial buildings. The building industry uses men with organizing ability by thousands in construction, supervision, management, sales. Properly trained men needed in production, distribution, finance, installation, marketing. Government estimates housing demand at 40 billion dollars. Others are preparing to get in now! Act immediately—get the facts! Mail postcard today—no obligation.

HOME BUILDERS TRAINING INSTITUTE, Dept. D-212
7050 No. Glenwood Chicago 26, Illinois

WANTED DISTRICT PURCHASING AGENTS

No experience or money required. Exceptional opportunity for those who want to establish themselves in a steady, year 'round, well paying business.

For details: Write **DEPT. C**
PURCHASING MANAGER
2719 LAWRENCE AVE. CHICAGO 25, ILL.

SAY YOU SAW IT IN POPULAR MECHANICS

START HOME NOVELTY MFG. BUSINESS

New course tells in simple language how to make plaster novelties of many kinds at home. Descriptive folder free.

W. BELFORT Chicago 6, Illinois
Engineering Building

Stromberg WINTER LAYERS

BABY CHICKS! Our breeders are U. S. APPROVED and U. S. PULLORUM TESTED. Specializing in Large Type **WHITE LEGHORNS** and High Production **WHITE ROCKS**. 20 other leading varieties and crosses. Sold under 15-Day Replacement Guarantee. Also **STARTED CHICKS**. **FREE**, Big, New **RECORD-CATALOG**. Write **STROMBERG HATCHERY, Dept. 813, FT. DODGE, IOWA**



COLLECT U. S. ARMY Shoulder Patches

Send \$1 for sample selection of patches and PATCH CATALOGUE.

SPRINGER'S

EL PASO, TEX.

20 for \$1

GRASP THIS OPPORTUNITY

TO TRAIN YOURSELF
FOR A WELL PAID JOB IN **ELECTRICITY**

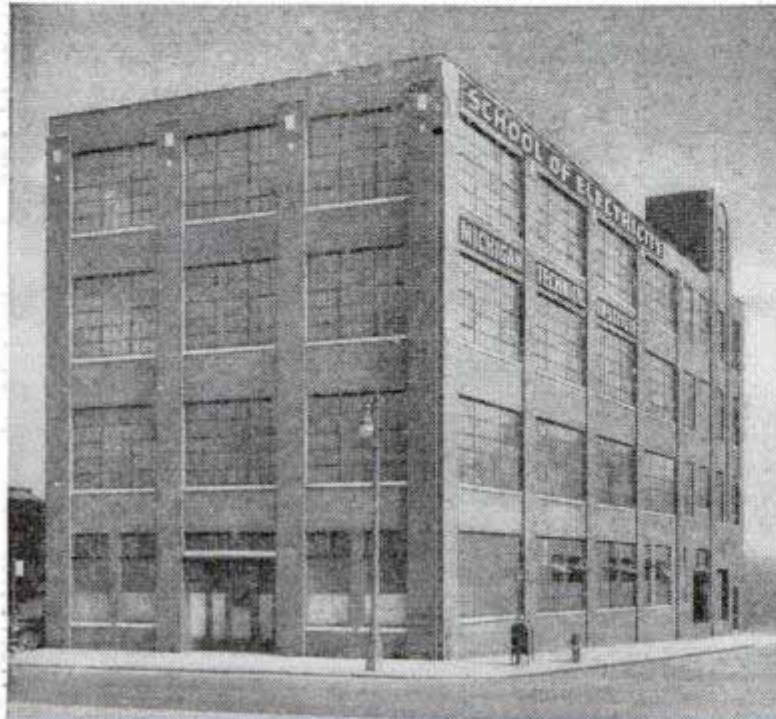

This large, four-story building completely equipped with first class electrical equipment for *on-the-job, up-to-the-minute* methods of training in Armature and Motor Winding, Factory Wiring, House Wiring, Electrical Maintenance, Appliance Repair. Entire building—4 floors devoted exclusively to this one course. No crowding, plenty of space and light. Well staffed with instructors to give individual attention to students. Living quarters arranged for if desired.

Pay after you graduate . . . Lack of money need not hold you back. We will finance your training. After you graduate you can pay us back in small monthly payments.

VETERANS!!!

School approved for training under the GI Bill. Take this course at no cost to you, and receive \$65 to \$90 per month while training. Complete details furnished.

—MAIL COUPON TODAY—

MICHIGAN TECHNICAL INSTITUTE, Dept. P-12
2281 W. Fort St., Detroit 16, Michigan

- Please send me literature about your training.
 I am a G.I.

NAME

ADDRESS

CITY STATE

MAIL COUPON *today*

DOUBLE your INCOME IN YOUR SPARE TIME

LEARN SILK SCREEN PROCESS

Jealously Guarded Trade Secrets NOW
Available to You

Develop a Profitable Business of
Your Own . . . or a Hobby

Prepare yourself for an interesting top paying position. Thousands of jobs open. Silk Screen Process signs, displays, Xmas cards, toys, etc. IN GREAT DEMAND THE WORLD OVER. You may make enough the second week to pay for the entire course. EASY TO DO . . . EASY TO LEARN. No education or mechanical knowledge required. BOOKLET with 3-color Silk Screen Processed cover and *Samples* sent FREE. Write NOW!

CALIFORNIA SCHOOL OF SCREEN PROCESS
Dept. PM-126 2710 So. Spaulding Avenue, Los Angeles 16, California



**COURSE
INCLUDES
A COMPLETE
KIT OF
SUPPLIES**

SAY YOU SAW IT IN POPULAR MECHANICS

TRI-STATE COLLEGE

B. S. Degree in 27 months in Engineering (all branches); Bus. Admin., Acc't and Sec. Science. 63rd year. School now filled to capacity. No applications can be accepted until further notice.
4126 College Ave., Angola, Ind.

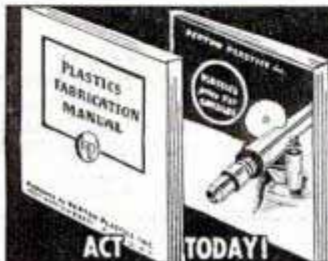

BIG MONEY FOR YOU IN PLASTICS

SEND **10¢** Offer includes 2 books: New Fabrication Manual & Giant Catalog, listing the most complete stock of Plastic Materials, Accessories, Tools.

BERTON PLASTICS, INC.
19 W. 21st St., N. Y. 10, N. Y.

The Handy-Sized Merriam-Webster

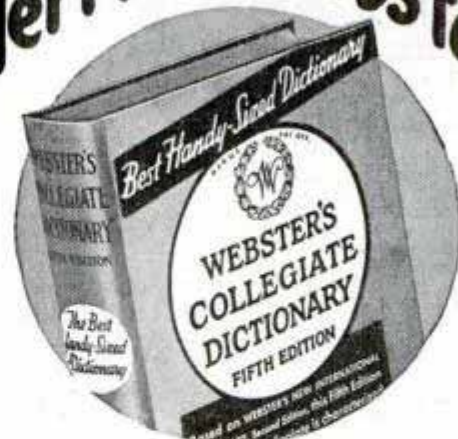

Best Because It Is Based On "The Supreme Authority"

WEBSTER'S COLLEGIATE is the most dependable handy dictionary for home and office because it is a compact abridgment of the famous Webster's New International Dictionary, Second Edition—"The Supreme Authority." Defines all the words most commonly used. 1,300 pages; 110,000 entries. \$5 to \$10.00, depending on binding. If your dealer happens to be out of stock, try him again—we are delivering more WEBSTER'S COLLEGIATES than ever before in our history, to supply the unprecedented demand. G. & C. Merriam Co., Springfield 2, Mass.

Floyd Clymer's Popular MOTOR BOOKS

1946 INDIANAPOLIS "500" RACING BOOK \$1.00
80 ILLUSTRATIONS, drawings, charts. World famous driver, car data on 1946 race and highlights George Robson racing career. \$1.00. Large 320-page Indianapolis Race History every race since 1909, 1000 illustrations. Includes 1946 book. \$3.50.

FASTEST ON EARTH, by George Eyston, a racing history book of all world's straightaway land speed records since 1898. \$2.00. **MERCEDES-BENZ Grand Prix** race book, 176 pages, 93 photos. \$2.00.

Famous Motor Scrapbooks
Nos. 1, 2 & 3 available, \$1.50 each; cloth-bound, \$2.50 each. Power & Speed, \$2.50. Ab Jenkins' Race History Book, \$1.50. Speed—How to Obtain It, \$1.50. All books postpaid. See our ad under Autos, Classified section.

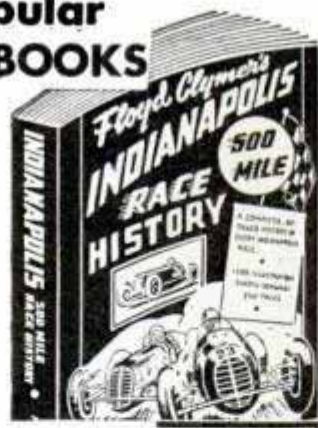

Send for FREE Motor Book Catalog

CLYMER MOTORS, Dept. A-12
2125 W. Pico St. LOS ANGELES 6, CALIF.

LEARN TO WRITE PRODUCTIVE Sales Letters

Step up your earning power in your job or own business! Complete Home Study Courses in Advertising and Business Correspondence. New, simplified, scientific training method based on real sales psychology. Easy to learn in spare time. Earn more as you learn. The knack of making sales by mail pays big dividends. Write today for free illustrated folder.

BUSINESS LETTER INSTITUTE

803 MANHATTAN BLDG. CHICAGO 5, ILL.



Learn modern watch and clock repairing

At home, spare time. Good field now... security and contentment in future. Start part-time business and **EARN while you learn**. Horology is precision instrument work... a great and growing field, sensational opportunities. Easy self-instruction course. Low price. **Money-back guarantee**. Write today for **FREE Success-Catalog!**

NELSON CO., 1139 S. Wabash Ave. Dept. 1M02 Chicago 5, Illinois

GENUINE U.S. BARGAINS

- Army O. D. Wool Blankets, 5 lbs. \$5.95
 - Army Pocket Knife, Scout Style, \$2.50
 - Pup Tents, Poles and Pegs, Used, \$4.85
 - Mess Kit — Knife, Fork and Spoon, Used \$.50
- Thousands of Other Bargains in Military, Outdoor & Sport Goods for Hunter, Farmer, Scout. Send 10c for 32-page catalog returned with first order.

A and N SUPPLY CO.

EST. 1868 4720 LESTER ST. RICHMOND, VA.

REFRIGERATION

Repair and adjust all refrigerators. New manual tells how. Charts and pictures to help you. Price only \$1.00, postpaid. Money back guarantee. Supreme Publications, 9 S. Kedzie Ave., Chicago 12, Illinois.

CARTOON TO SUCCESS!

Learn to cartoon! Big pay! Easy, enjoyable work! Cartoon course, gag course, anatomy course and business course full of plans, markets, ideas. Drawing set and criticisms. All one low price! Rush card for details! **HARTMAN SCHOOL**, 2776 California Court, Lincoln 8, Nebraska

The great **SUCCESS** instruction for men and women now in business... or planning to get into **PRODUCTIVE** work... **THE PROFITABLE, EASY, SURE** method... Get it **NOW**

HOW TO MAKE MONEY BY MAIL

ENLARGED to 640 pages, 15th edition

Down-to-earth facts, directions (illustrated) for running business profitably, using expertly for **YOUR** good fortune the employees, trains, planes which Gov't places at your disposal **CHEAP**. Get orders by mail, ship by express or freight or mail, get out of the kindergarten... 15th edition, enlarged to 640 pages, now selling. It's **YOUR** winner. Make this year and the following years worth more. **THIS** knowledge really **PAYS OFF**.

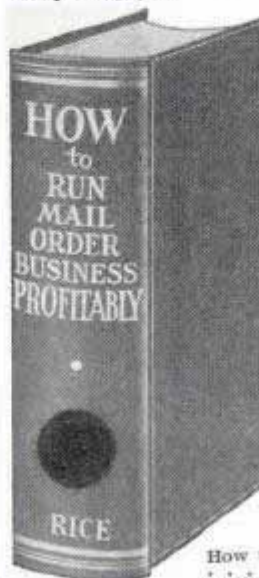

THE EASY WAY to start new or expand your present occupation. Do it **NOW**. Extraordinary plain, simple skill, know-how. **No theory**. Fact story of rich experience of author E. Rice day-by-day. How many times have we heard: "I wish I had some money, this patent would earn me a fortune," or "why can't my crop pay better?" or "I wish I knew how to sell this gadget myself," or "why should my boss alone do this when I too know how the money is made?" . . . **Listen, YOU DO NOT NEED MONEY TO START THIS RICE WAY**. His method automatically pays all bills same day rendered, no bank loans, pay as you go, no borrowing from relatives or friends, no salesmen. Also no worry, quickly a home of your own all paid for. Rice paid off \$5000 in mortgages a year after using this skillful idea.

46 Years of PROOF

Sounds fishy? Sure, but this has been done steadily for 46 years, depression or no depression, by the author; that is why he wrote this book, to pass the good word along. Make it go with anything you have which is salable, or with what you are now doing. Rice made his pay plan go from the start when living in one room in a city lodging house. Turn your city or country home, your work, your hobby, into money. How to get orders coming steadily at cost of only \$4 for each \$100 taken in. The popular error to avoid in trying for sales. Business won free while others have to pay for it. How to conceive the money-getting advertisement. . . . Profitable changes from ordinary ideas and methods. Not usual cut-and-dried pattern, 250 adventures, a dictated book in everyday talk by Rice doing day by day what he discloses in his book can be done by his method. No dictionary writing. . . . Read how others are profiting big.

Take a chance on this book being worth a fortune to you and yours and send \$2.95. Book mailed same day order is received. Hundreds of buyers whose letters we show you declare emphatically its superlative goodness. Follow its easy pattern for success. Cloth-bound, 640 pages, 8 1/2 by 12. Best-seller, 15th edition now selling. Cut out the \$2.95 **HOW BOX** here, pin or stick it to sheet of paper bearing your name and address, mail in envelope with money order or check for \$2.95 to

HOW
640 PAGES
\$2.95

HOWARD ST. HOUSE, Melrose 76d, Massachusetts



MAKE MORE MONEY BE YOUR OWN BOSS!

\$1.00 VALUE
25¢
40,000
WORDS
IN TEXT

In "CASH IN" you now get **THE** real money-makers—dozens of profitable tested mail order plans, confidential business secrets, dozens of practical tested formulas, successful tested schemes—actual experiences of men who have started on a shoestring—with less than \$10 capital.

25c a copy postpaid. Send U. S. stamps, money order, or coin. **MONEY BACK GUARANTEE**

NATIONAL PLANS COMPANY
P. O. Box 26D, Station N. New York 23, N. Y.

SAY YOU SAW IT IN POPULAR MECHANICS

TRAVEL - for 'UNCLE SAM'

RAILWAY POSTAL CLERKS

\$2,300 First year regular

MANY OTHER GOVERNMENT JOBS

Postoffice Clerks—Mail Carriers—Stenographers—Typists. Statistical Clerks, etc. 32 Page Civil Service Book—FREE.

MEN - WOMEN

Veterans Get Preference

Mail Coupon immediately—today sure.

\$1,756 to \$3,021

FIRST YEAR

COUPON

FRANKLIN INST., Dept. C79, Rochester 4, N. Y.

Gentlemen: Rush to me, without charge, 32 page book with list of U. S. Government big paid positions. Advise me also regarding salaries, hours, work, vacation, etc. Tell me how to prepare for a position.

Name.....

Address..... Vet?.....

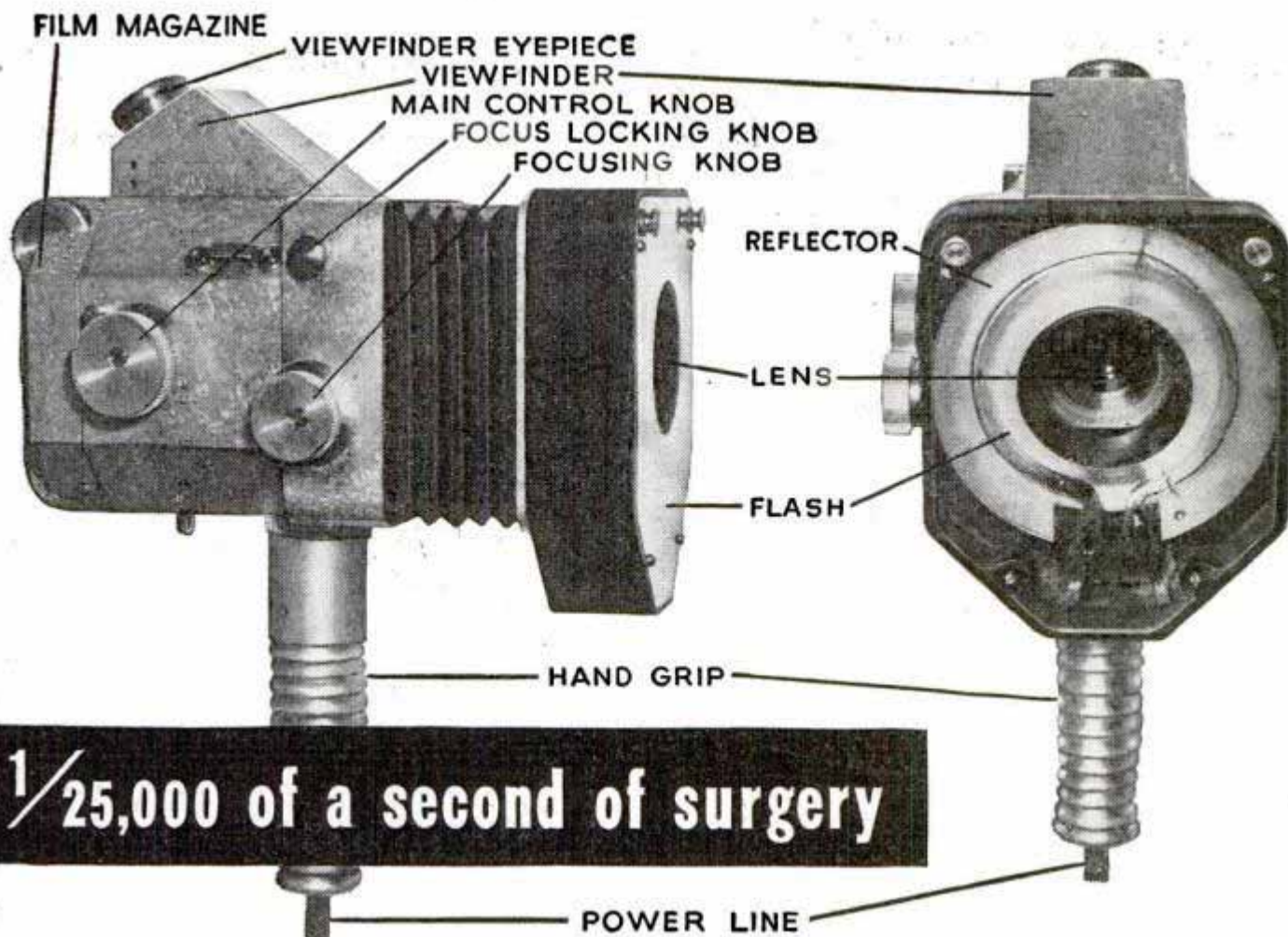

HERE IT IS . . . the clinical recording camera. Developed by the Army Signal Corps for the surgeons of the Medical Department, it can "stop" an intricate operation with a silent, built-in flash lasting 1/25,000 of a second!

Best of all, it can take a consecutive stream of stills without interfering with the progress of the surgeons. Successful solutions of unique surgical problems can now be preserved in picture-story form — in color — for medical personnel throughout the Army, and for civilians as well. The importance of this camera to the future of surgery and the saving of lives can hardly be overestimated.

This is but one post-war stride of the new Regular Army. The civilian fields of tomorrow—such as Radar, Nuclear Energy,

**YOUR REGULAR ARMY SERVES THE NATION
AND MANKIND IN WAR AND PEACE**

Supersonic Aviation, Advanced Electronics, Jet Propulsion — are the fields of *today* in the Army!

Combine exciting opportunities in these fields with the merits of an Army career, and you've an education that's hard to beat. New higher pay, liberal leave and retirement benefits, and the chance to choose your branch of service from those still open (on 3-year enlistments) make this a job you can't afford to miss! See your nearest Army Recruiting Officer for full details.

• Listen to: "Sound Off," "Warriors of Peace," "Voice of the Army," and "Proudly We Hail" on your radio.

A GOOD JOB FOR YOU

U. S. Army

CHOOSE THIS

FINE PROFESSION NOW!

No Waiting to LEARN

START NOW TO EARN!

This BIG BOOK SHOWS HOW



IF IT'S RESULTS YOU WANT—GET ACTION QUICKLY WITH THESE PRACTICAL IDEAS

Never before has a more helpful book been printed for those planning a business of their own. Gathered in this large illustrated volume are the formulas, recipes, facts and secrets that have contributed so largely to America's great industrial progress. Capitalize on this information for making most any conceivable product without experience, special equipment or previous knowledge of chemistry. Start at home, expand with profits—build for a profitable independence.

The experts who compiled this book are authorities, and present this information in simple, understandable language. They also give you wholesale supply sources for needed materials, short cuts and economy methods for the most profitable results. Hundreds of good paying businesses have been built on a product made from a simple

recipe. Opportunities in this field exist everywhere. Choose from any of the 162,000 facts and 10,000 formulas of which the following are only a very few: Adhesives, Alloys, Anti-Freeze Solutions, Cosmetics, Beverages and Liquors, Candy, Gum, Casein, Celluloid, Ceramics, Cheese, Cleaning Preparations, Concrete, Copper, Cotton, Dentifrices, Depilatories, Dyes, Embalming Fluids, Enameling, Glass, Glazes, Household Formulas, Inks, Insecticides, Iron, Jewelers' Formulas, Lacquers, Laundry Preparations, Leather, Linoleum, Lubricants, Manicure Preparations, Marble (artificial), Metals, Mirrors,

Sell by Mail!

You will profit by the ideas contained in this big book for setting up a mail business you can easily run from your home in your spare time.

Oil and Ointments, Powders, Remedies for Man, Beast or Fowl, Rubber Products, Refrigerants, Soaps, Solder and Soldering, Tooth Cements, Transfers, Transparencies, Varnishes and Thousands of others for making all sorts of profitable and practical things.

FORTUNES MADE FROM A SINGLE IDEA!

This comprehensive book is an accepted authority by chemists, schools, industry, etc. and is the largest and most comprehensive book of its kind ever issued. Nothing else like it in existence. A single formula has been worth a thousand times this book's small cost to countless owners. Crammed with money-making ideas. Invaluable for reference. Ideal for Factory, Home, Farm, Office or Workshop. As necessary as the dictionary and more useful for manufacturers, chemists and salesmen who put up products for profit.

\$3.50 postpaid. Canada or Foreign, **\$3.85** U. S. Funds. (C.O.D. shipments U.S.A. only.) Immediate Shipment—Safe Delivery Guaranteed.
ADAMS BROWN COMPANY BOOKS OF APPLIED SCIENCE
Dept. 162, Chestnut Hill 67, Massachusetts, U. S. A.

POSTPAID!
\$3.50
U.S.A.
\$3.85
FOREIGN

Every BUILDING TRADESMAN NEEDS THIS BOOK Only \$3.00

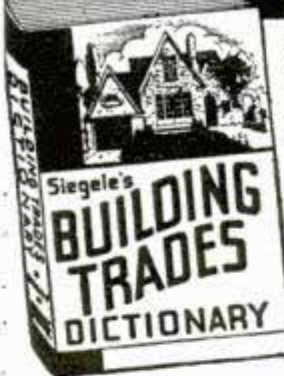

Siegele's new BUILDING TRADES DICTIONARY

Contains more than 6800 definitions of words and terms used in building trades. 380 value-packed pages. 670 illustrations. Hundreds of helpful suggestions based on author's experience as building tradesman and contractor. Get your copy today. Check No. 1 on the coupon.

ALSO—these other Siegele books give practical solutions for all kinds of building problems.

- | | | |
|---|---|--|
| No. 2—CARPENTRY (Craft Problems) 302 pages. Over 700 illust. Only \$2.50. | No. 3—BUILDING (Forms, Stairs, Roofs) 210 pages. 495 illust. Only \$2.50. | No. 4—QUICK CONSTRUCTION (Practical Building Problems) 250 pages. 670 illust. Only \$2.50. |
|---|---|--|

—DRAKE BOOKS SOLD BY LEADING BOOKSELLERS

USE THE COUPON — MAIL TODAY

Fred'k J. Drake & Co., Dept. A-1, 600 W. Van Buren St., Chicago 7, Ill. Please send me the books checked below. If not satisfied I will return them in 5 days and money will be refunded.

1 2 3 4 (Circle numbers wanted)

Check or money order enclosed \$..... Send books postpaid.
 Send C.O.D. plus postage.

Name

Address

City

State

Wanted: Salesmen by National Manufacturer

We are building up our sales force to the prewar quota. Products available again after six years pent-up demand. Present scarcities of building materials and labor make fire protection devices essential. Sell direct to schools, factories, service stations, warehouses, hotels, restaurants, public institutions, truck and bus companies, grain elevators, house trailers, autos, farms, homes, etc. We set no limit on your earnings. Profit checks mailed weekly. Sales now 100% higher than prewar period. Nationally advertised. Established 30 years. Millions will be sold. Write today for our original "Be Your Own Boss" sales plan. You take the orders and we ship direct from the factory.



Dept. 90-24 FYR-FYTER CO., Dayton 1, Ohio

PLASTIC KITS

Complete line of kits with full scale lay-outs for making your own items. Picture Frames, Jewelry and Cigarette Boxes, Tie Racks and numerous other articles from Sparkling Lucite and Plexiglas. Send today for free catalog of kits and supplies. Home Craftsman Plastics, 1945 W. Harrison St., Chicago 12, Ill.

HIGHWAY ENGINEERING

PRACTICAL TRAINING IN HIGHWAY DESIGN AND PRACTICE. HOME STUDY — BY MAIL ONLY — WRITE US NOW!
SCHOOL OF HIGHWAY PRACTICE
DEPT. A, 2161 SHATTUCK AVE. BERKELEY 4, CALIF.

STAMMER ?

This new 128-page book, "Stammering, Its Cause and Correction," describes the Bogue Unit Method for scientific correction of stammering and stuttering—successful for 45 years. Benj. N. Bogue, Dept. 1843, Circle Tower, Indianapolis 4, Ind.

GET THIS FREE BOOK!

Beautiful Modern

SIGN LETTERS

Signs anywhere, quickly, easily... Write for money making-saving plan... Samples
PINNACLE SIGN LETTERS, Mound City, Ill.

AMAZING

New book gives instant solutions to 100,000 practical problems. Greatest mathematical aid since the invention of the slide-rule. Details free.
COLUMBIA GRAPHS, Columbia 5, Connecticut

Say you saw it in POPULAR MECHANICS

SELL MERCHANDISE BY MAIL

Operate profitable home business selling merchandise by mail. 75c profit on fast selling \$1 items. Write TODAY.
POWELL CO., Dept. A, Sampliner Bldg., Cleveland 3, Ohio

BOWS & ARROWS

Write for 94 page Illustrated Instruction Hand Book 50c; 20 page catalog 5c; stamps or coin.
LE.STEMMLER-CO-QUEENS VILLAGE L.I.N.Y.

MONEY MEN ALL FREE

THE PLASTEX Industry needs manufacturers on small scale and for big production of Lamp and Clock Stands, Art Goods and Novelties in Plastex and Marble imitation. Experience unnecessary. 1/2c material makes regular 10c store sellers. Rubber moulds furnished for speed production. Small investment brings good returns. Big chain store orders now being placed. Ambitious men have chance for real prosperity. Our Free booklet will interest and benefit you.

PLASTEX INDUSTRIES, Dept. P, 1035 Washington Ave., New York, N.Y.

Handy Mail Order List

Little Library of Useful INFORMATION

5 for \$1.00
12 for \$2.00
25¢ Each

Here at amazingly low cost is the practical help and information you have always wanted. Articles in previous issues of Popular Mechanics have been classified according to subject and are now available in these handy reprint booklets.

How to Use Measuring Tools—
Micrometers, Calipers, etc.—
106.

Power Driven Saws—74.
Drill Presses, Grinders, Etc.—79.
Wood, Metal Turning—Lathes—81.
Filing Machine, Hacksaw, Cutoff
Wheel, Shaper—82.

Lathe Tools You Can Make—101.
Workbenches—Tool Cabinets—47.
Spray Painting—94.
From Pattern to Casting—91.
Tool and Saw Sharpening—92.
Sharpening Drills, Wood Bits—
90.

Successful Wood Turning—32.
How to Read Blueprint—71.
Metal Turning Lathe Kinks—99.

Operating a Metal Lathe—100.
Heat Treating, Hardening—102.
Working With Glass—103.

Servicing Elec. Motors—75.
Electromagnets & Solenoids—44.
Transformer Construction—41.

The Boy Electrician—43.
Soldering and Brazing—17.
Arc and Spot Welders—5.

**Electroplating With Nickel, Chro-
mium, Cadmium, Etc.—86.**
Plating Leather, Wood, etc.—87.

Lower Your Fuel Costs—31.
Curing Leaky Basements—45.
Fitting Home Game Room—55.

Indoor & Outdoor Fireplaces—88.
Backyard Gardening—39.
Lawn and Garden Novelties—72.

Trellises, Pergolas, Fences—76.
Lawn and Garden Furniture—77.
Playground Equipment—73.

Concrete Garden Furniture—6.
Making Serving Trays—53.

Sanders—80.
House Wiring—89.
Treasure Finders—13.
Hanging Wallpaper—
38.

Built-in Fixtures—78.
Bird Houses—7.
Magazine Racks—49.
Clock Cases—50.

Book Ends—52.
Small Tables—54.
Smoking Stands—56.
Desks—58.
Book Cases—59.
Action Toys—66.
High Flying Kites—
67.

Telescopes—20.
Metal Craft—28.

Small Looms—37.
Gem Cutting—42.
Photo Enlargers—1.
Photo Kinks—98.
Cleaning Formulas—
11.

Faxidermy—9.
Magic—29.
Training Dogs—35.
Small Furnaces—36.

Knots and Ropework—105.
Working With Plastics—61.
Simple Home Improvements—104.
Ridding Home of Insect Pests—107.
Children's Room Furniture—51.
Jigsawed Novelties—57.
Doll House & Doll Furniture—60.
25 Shelves You Can Make—64.
Novelties Turned on Lathe—62.
Inlay Pictures—Veneering—63.
Wood, Soap Carving—65.
Windmills & Weather-vanes—68.
Lamps from Wood, Metal—69.
Rustic Furniture—18.
Wood Finishing—40.
Boats—14 ft. Outboard—2.
Boats—14 ft. Sail Dinghy—26.
Boats—21 ft. Sloop—46.
Rowboats, Small Dinghy—83.
Small Sail Boats—84.
Two Outboard Runabouts—85.
Build Own Canoe, Kayak—30.
Build Class-E Ice Yacht—22.
Auto Kinks, Shortcuts—10.
Building Trailers—27.
Motor-Driven Midget Cars—34.
Stop Auto Elect. Troubles—95.
Photo Printers and Dryers—25.
Photo Darkroom Equipment—96.
Trick and Table Top Photos—97.
Cosmetic Formulas—12.
Poultry Houses—108.
Guns and Decoys—109.
Re-Silvering Mirrors—70.
Chemical Experiments—93.
Log Cabins, Tourist Houses—14.
Trapping Small Animals—33.
Farm and Garden Tractors—8.
Building Extra Attic Rooms—23.
Attractive Basement Rooms—24.

Check Titles Wanted, Clip, Mail with Remittance to

POPULAR MECHANICS PRESS, Dept. 635, 200 E. Ontario, Chicago 11

★ ★ ★

MAKE YOUR OWN
POWER TOOLS
at Low Cost
from old Auto Parts, etc.



A New Edition
Featuring TOOLS of WOOD

Now you can have a good lathe, drill press, circular and band saw and other power tools in your home workshop, at a cost of only a few dollars each. Make them yourself from old auto parts, discarded sewing machines and other odds and ends that cost little or nothing. Get this new book—"Forty Power Tools You Can Make." Costs only \$1.25 postpaid. This book gives every detail in plain language you can understand and follow. Hundreds of pictures and plans show every step to follow in making the power tools you want. Actual photographs of finished machines included. Send \$1.25 today. Money back if not satisfied.

FORTY POWER TOOLS
YOU CAN MAKE



MAKE EVERY POWER TOOL NEEDED IN YOUR HOME WORKSHOP

Some of the power tools you can make are:

- | | |
|--------------------|------------------------------|
| 2 Band Saws | 2 Drill Presses |
| 9 Sanding Machines | 1 Scroll Saw |
| 2 Circular Saws | 2 Wood Turning Lathes |
| 1 Metal Lathe | 3 Grinders |
| 1 Power Hack Saw | 1 Shaper or Moulding Machine |
| 1 Jig Shears | 1 Vibrating Pencil |
| 1 Cut-Off Wheel | and others |

Information too, about pulleys, belts, motors and drive methods. Just published. No other book like it. Order today.

POPULAR MECHANICS PRESS

Dept. 621

200 E. Ontario Street, Chicago 11



Earn Big Money
Arc Welding
with a
HOBART



welds faster

more economical

easier to operate

heavy duty

cooler running

Own a profitable business with a minimum investment? It's easy if you establish a welding shop with Hobart Arc Welders. People bring repair work to you—automotive, farm equipment, etc. There's profit in every job—and plenty of jobs to keep you busy.

WELDING WITH HOBART IS EASIER! Only with Hobart do you get operation and convenience features that let you complete a job faster while producing better quality, more profitable welds. Write for details on the Electric Drive Welder—ideal for job welding shops. **"BUILD YOUR OWN" AND SAVE!** With the Hobart Generator Only, a used auto engine and chassis, you can build your own portable gasoline drive arc welder and save hundreds of dollars. This equipment goes everywhere to handle welding jobs. Send coupon.

COMPLETE HOBART LINE. You'll find every type and size of arc welder in the Hobart line—electric or gasoline drive, stationary or portable, AC or DC.

HOBART WELDING SCHOOL. Instruction in all phases of welding in short, intensive course. Modern building, individual instruction. Qualified under G. I. Bill. A non-profit institution. Hobart Bros. Co., Box M-126, Troy, Ohio



Hobart Stationary Electric Drive Shaft Extension



Hobart "Build Your Own" Generator



Hobart AC Model for Single Phase



Hobart

"One of the World's Largest Builders of arc welders"



Free!

Vest Pocket Welders' Guide Full of welding tables, charts and data.

HOBART BROS. CO., BOX M-126, TROY, OHIO

I'm interested in the profit-making possibilities of Hobart Arc Welders. Send me free book, and details on items checked.

- | | |
|---|---|
| <input type="checkbox"/> Electric Drive | <input type="checkbox"/> A.C. Welder |
| <input type="checkbox"/> "Build Your Own" | <input type="checkbox"/> Welding School |

NAME

ADDRESS

NEW AUTOMOBILE ENGINE MANUAL



JUST OFF THE PRESS

Drake's Automobile Manual helps you keep your own car running smoothly or qualifies you to earn big money as an automobile engine expert. 300 pages of sound information and instruction. Over 200 illustrations. Teaches you how to service all types of auto engines. Covers ignition, carburetion, etc. Order today. No. 1 on coupon.

ALSO—note these other big value books:

- No. 2—Drake's CYCLOPEDIA OF RADIO and ELECTRONICS—NEW 12th Edition. 764 pages. 1400 headings. 90 illust. Only \$6.00.
 - No. 3—HOUSE WIRING MADE EASY. 96 pages. Over 100 illust. Only \$1.50.
 - No. 4—Drake's REFRIGERATION SERVICE MANUAL. 317 pages. 148 illust. Only \$2.00.
 - No. 5—Drake's HEATING, COOLING, and AIR CONDITIONING HANDBOOK. 700 pages. 64 tables and charts. 350 illust. Only \$4.00.
- DRAKE BOOKS ARE SOLD BY LEADING BOOKSELLERS
USE THE COUPON — MAIL TODAY

Fred'k J. Drake & Co., Dept. A-1, 600 W. Van Buren St., Chicago 7, Ill. Please send me the books checked below. If not satisfied I will return them in 5 days and my money will be refunded.

1 2 3 4 5 (Circle numbers wanted)

Check or money order enclosed \$..... Send books postpaid.
 Send C.O.D. plus postage.

Name.....

Address.....

City.....State.....

PARTS FOR MODEL MAKERS

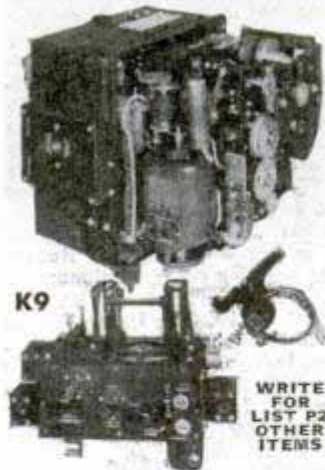

ELECTRICAL "BUGS" INVENTORS AND MECHANICAL WIZARDS K3 AND K9 GUN-SIGHTS

TEST YOUR WITS! Create gadgets, electrical devices, etc. Great gifts for budding geniuses, mechanics, shut-ins, schools, etc. Perfect war souvenirs!

HUNDREDS OF PARTS
K3 GUN-SIGHT UNIT contains fascinating array of parts usable in 1001 ways! Amazing 1/50th H.P. 24 V. D.C. High-Speed Motor. Many wires, connectors, etc. Original cost approx. \$3000.00. You pay only..... **\$17.50**

SEE
ADV.
PAGE
295

EXCITING INVENTIVE CHALLENGERS

Countless gears, shafts, miniature bearings, lenses, dials, knobs, switches, clutches, electrical components, etc. Veritable Tinkers Paradise!
K9 GUN-SIGHT — comprises 3-1/50th H.P. 24 V. D.C. Motors, computer, sighting head, range pedal and connecting cables. A BIG "BUY." Regular and bevel gears, switches, shafts, bearings, electrical parts, etc. Shipment includes (1) computer, (2) sighting head, (3) range pedal, (4) cables. War price about \$4000.00. Yours for only..... **\$27.50**



K3

SHIPPED PREPAID ANYWHERE IN CONTINENTAL U.S.A.
CASH WITH ORDER 24 V. quilted electric Bomb-Sight heating pad, 5 ft. cord, twist-lock connector, thermostat, 20" zipper, No. HP 10, only **\$1.49**

WARSHAWSKY & LAZAR
2126 S. Michigan, Chicago 16

Build and Fly CLEVELAND MODELS



NEW! De Luxe Tether Sharpie

Gas Model Super Value, now with landing gear. Kit \$2
GPL-5023b

P-47 Thunderbolt
3084" Scale Flying Model. MPM Kit SF-81

Cleveland Model & Supply Co.

4512M21 LORAIN AVE. ★ CLEVELAND 2, OHIO, U.S.A.

Black Widow NEW!



49 1/2" model of the largest fighter built—the famous P-61 night fighter. Model may be easily converted to a gas powered flying model. Master Flying Model Com-plete Kit SF-155.. **\$1450**

36" Industrial Training Model Dry Kit T-155

SEE your dealer first. In ordering direct, include 20c extra for packing-postage. Get our jumbo folder (Kits 25c to \$15.00)—send stamp **3c**

WIN \$100.00

A Christmas Present

to the boy or girl who writes the best 100 word letter, beginning with—"I like my plastic scale model of the 1946 Indianapolis winner because"—Contest closes December 21st... Judges decision will be final. Refer to page 291 of the November issue Popular Mechanics, for details on this amazing racer.

**BAND
INSTRUMENT
REPAIR
MANUAL
Only \$2.00**

Learn quickly to become a band instrument repairman by our original simplified method. Write for yours today. Send money order only. Address

ALBERT ROBERTSON 768 N. Water St. Milwaukee 2, Wis.

FIVE ACRES AND INDEPENDENCE

A Practical Guide to the Selection and Management of the Small Farm

By M. G. Kains



This book is a complete, practical guide to the selection and management of a small farm. It explains how a small farm can be self-supporting. What farms not to buy. How to choose the right farm, based on proper soil, location, irrigation, elevation, climate, etc. Then a detailed explanation of what crops to plant and how to make them yield results, sure-fire methods of grafting, rotation, transplanting, etc. Finally, how to make a profit by selling your excess crops, livestock and preserves. Written by an expert who has made a real success with many small farms. Revised, enlarged edition. 413 pages, profusely illustrated. Price **\$2.50**

Only \$2.50, Postpaid in U.S.A. (Outside U.S. \$2.75). Order Today

POPULAR MECHANICS PRESS Room 490 • 200 East Ontario St., Chicago

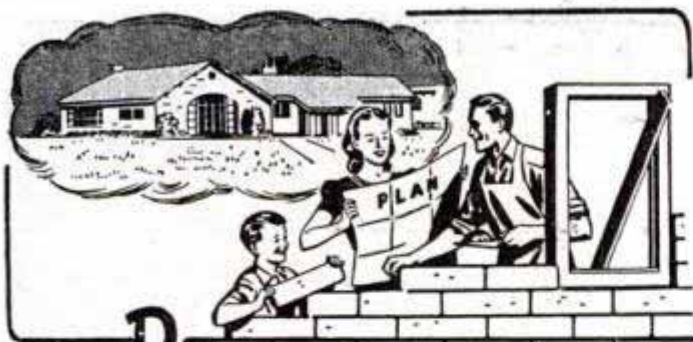

Build it Yourself

Send for booklet showing how to make your own bricks of Cemadobe and build an attractive low cost home yourself. Amazing discovery in soil stabilization. Bricks of earth and cement. Attractive; heat and cold resisting. Easy to make. A Godsend to anyone who needs a home. Now being used by hundreds of satisfied home builders. Acceptable to loan agencies. Complete instructions in attractive, easy-to-understand booklet entitled "Cemadobe". 50 illustrations and 40 chapters. Money back guarantee of satisfaction. Send \$1.00 to **Cem-Adobe Company, Box 81, Dept. PM-126, West Los Angeles Station, Los Angeles 25, California.**

GOV'T JOBS!

VALUABLE INFORMATION FREE
Columbian Correspondence College, Dept. 7, Washington 2, D. C.

APTITUDE TESTS for men, women, boys, girls, discover the kind of work or studies best for your success! You get a personal report—a guide for life—more happiness—more prosperity. Write for complete facts.

VOCATIONAL COUNSELING INSTITUTE
956 Maccabees Bldg., Detroit 2, Michigan



ITALIAN ACCORDIONS

Hand Made. Very best. Lowest prices. Buy Direct from Factory Representative and Save Money. Send name and Address for FREE catalog.

ITALIAN ACCORDION CO.
323 W. POLK ST., DEPT. PM-12, CHICAGO 7, ILL.



FIBRE ARMS AND LEGS!

Light, correctly fitted, strong and comfortable. Natural appearance. Braces for all deformities. Scientific design. Fair Terms.

BUCHSTEIN-MEDCALF

223 S. 6th St., Minneapolis, Minn.

SHAW and "Peppy-Pal" GARDEN TRACTORS

1 to 9 H.P. Circulars on request. Building more now. We supply repairs for all SHAW Tractors sold in our 42 years in business.

BUILD YOUR OWN RIDING TRACTOR—"WAR HORSE"

using old auto parts, powered by 2 H.P. or larger air-cooled engine; or walking type Garden Tractor 1/2 to 3 H.P. or convert truck or auto into Farm Tractor. Each with steel or rubber tires; will plow, cultivate. Plans for building, in few hours, any one of above, postpaid for \$1.00 (state which wanted) or all 3 for \$2.00. Money Back Guarantee.

SHAW MFG. CO., 4512 Front St.
Galesburg, Kansas

668G North 4th St., Columbus, Ohio

DECEMBER 1946

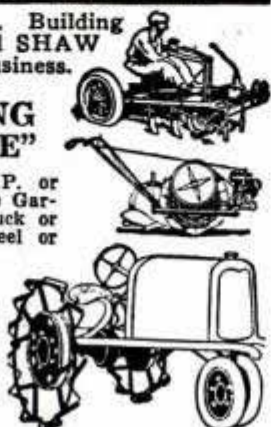

USE AC'S FOR UTMOST RELIABILITY

"The mail must go through"—and does, with the help of today's AC's in thousands of mail cars and trucks. You can enjoy utmost reliability in spark plug performance by having your spark plugs checked to be sure they are right for today's driving and fuels.



Look for this sign



Spark Plugs cleaned and adjusted "By the AC Method" may save as much gas as 1 gallon in 10



SPARK PLUGS

AC SPARK PLUG DIVISION • GENERAL MOTORS CORPORATION

SAY YOU SAW IT IN POPULAR MECHANICS

BE YOUR OWN BOSS

This REFERENCE SET
Helps You to Success in

ELECTRICITY

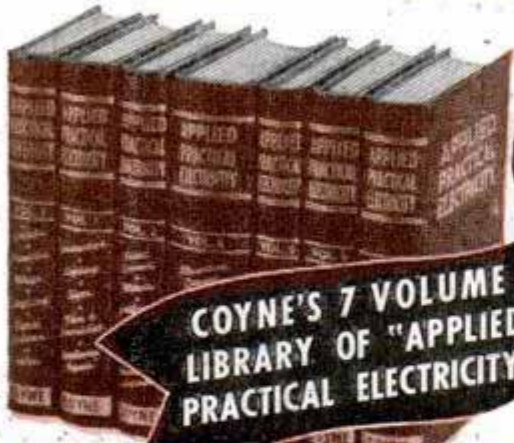

COYNE'S 7 VOLUME
LIBRARY OF "APPLIED
PRACTICAL ELECTRICITY"

Here, in 7 handy-sized volumes, is the information that will help you to be a better electrician — to get higher pay if you work for the "other fellow" — or to give you the knowledge you need to open your own full time or part time shop! This amazing set completely covers the electrical field, gives you data that every successful electrician and radioman must know. 3,360 pages containing 10,000 facts on 3,000 subjects such as D.C.-A.C. Motors, Refrigeration, Air Conditioning, Automotive, Diesel, and thousands of others! Hundreds of diagrams, charts, tables, fully explain everything.

7 DAYS FREE TRIAL

We're so strongly convinced that this is the set you need for progress on the job or in your own business, that we want you to try it for 7 days FREE! Furthermore, we'll give you the brand new Coyne Book, "Starting Your Own Electrical and Radio Business", just for asking to see this set! This book will give you the information you need to become your own boss in a shop of your own. Examine the 7 volumes for 7 days—use them—then if you're not completely satisfied return them — keep the free book—AND YOU OWE US NOTHING.

Don't miss this opportunity—Rush Coupon

FREE
"Starting Your Own
Electrical & Radio Shop"
— Just for Asking
to See Coyne's
7 Volume Set for
7 Days FREE!



FREE TRIAL COUPON

Educational Book Publishing Division
COYNE ELECTRICAL SCHOOL, Dept. 96-R6,
500 S. Paulina St., Chicago 12, Illinois
Send me Coyne's 7 volume set, plus free gift book, for 7 days free trial. If I am not 100% satisfied after 7 days I'll return the 7 volume set, keep the free book, and owe nothing. If I decide to keep the books I'll send you \$3.00 down and \$3.00 a month until \$21.00 is paid. (Cash price, \$19.75). 1 year of Free Consultation Service and Technical Bulletins will be included with 7 Vol. Set.

Name _____

Address _____

City _____ Zone _____ State _____

CHECK HERE if you want books sent C. O. D. You pay post-man Cash Price—save \$1.25. SAME TRIAL and FREE BOOK OFFER and MONEY BACK GUARANTEE.

Educational Book Publishing Division
COYNE ELECTRICAL SCHOOL
500 S. Paulina St., Dept. 96-R6, Chicago 12, Ill.



TRELLIS



FENCES
GATES



LAWN
FURNITURE



PLAY HOUSES

Let the Popular Mechanics
Garden Book Help You!

MAKE YOUR OWN GARDEN FURNISHINGS

Here is the practical and handy guide that thousands of home owners are using to improve their yards and gardens and save money. It shows how you can make, at small cost, easily and quickly, attractive outdoor furniture, fences, trellises, fireplaces, pools, lawn ornaments, playthings for children, window boxes, etc., plus helpful and vital information on the making of lawns and flower and vegetable gardens. A most unusual book. Suitable for all localities and climates.

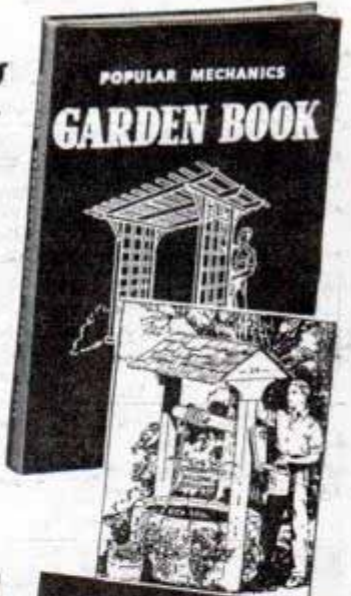

OUTDOOR FIREPLACES

BIRD HOUSES

How to Make Lawn Furniture . . . Trellises . . . Gates . . .
Fences . . . Outdoor Fireplaces . . . Bird Houses . . . Etc.

PARTIAL CONTENTS: Window Boxes—Bar-B-Q Fireplaces—Fencing for the Home Grounds—Pergolas to Beautify Your Garden—Backyard Screens and Trellises—Porch Furniture—Colonial Lawn Chair—Hammock on Wheels—Barrow Chair—Single and Colony Bird Houses—Bird Baths and Sun Dials from Colored Concrete—Concrete Garden Furniture—Swimming Pool for Youngsters—Playhouses—Portable Screened Porch—Outdoor Living Rooms—Weathervanes—Ornaments—Etc. **OTHER FEATURES:** Secrets of Backyard Vegetable Gardening—Better Gardens With Better Watering—Lighting Gardens at Night—Landscaping—Growing Creeping Bent—Growing Roses—and other articles. HUNDREDS OF PHOTOS, DIAGRAMS, PLANS.

Order from
POPULAR MECHANICS PRESS . . . \$1.00

Make Your Own
RUBBER MOLDS
with RED LATEX
MOLDING COMPOUND

Earn money, have fun; make your own molds for plater objects. Produce novelties and gifts for home and to sell to friends. RED LATEX MOLDING COMPOUND (60% density) now available in quart and gallon quantities. Gives perfect results, easy to apply. Send for complete information and prices.

FRANCIS SUPPLY CO., Dept. P-2, 1836 E. Fulton St., Columbus 9, O.

FREE *Bikini Crossroads Patch*



Send only \$1.00 for our beautiful selection of 20 different Flight Squadron and Shoulder Insignia and receive the **MIKE BIKINI BOMBER** leatherette breast patch absolutely FREE. Tremendous value. Colored insignia book with your order at no cost. Send to-day. Offer limited.

THE INSIGNIA MART, Dept. CC
703 Broadway, New York 3, N. Y.



MIKE Jr.
NOW ONLY \$1.39

SING—TALK—AMUSE YOUR FRIENDS— through your own radio set. Practice to become an announcer. Simple to install—Not a Toy. **SEND NO MONEY—WRITE TODAY** Just send your name and address and when your MIKE Jr. arrives, pay postman \$1.39 plus few cents postage. Sent postpaid if check or money order accompanies your order. No stamps.

MART DISTRIBUTORS, Dept. M-3, P. O. Box 6, Evanston, Ill.

● **Earn HIGH SCHOOL DIPLOMA at Home** ●

Guided study permits you to complete High School education in shortest possible time. Modern methods make it interesting, easier. Prepare for better jobs, pre-professional, college entrance exams. Recognition for H.S. credits already earned. Books supplied, low tuition, easy terms. Write for FREE information. HOME STUDY INSTITUTE, Dept. 112, 209 Vine Ave., Park Ridge, Illinois

Learn BAKING At Home

Baking is one of America's high industries in wages. Nearly depression-proof. Thorough basic home course lays sound foundation. If you have aptitude, write for FREE BOOKLET, "Opportunities in Commercial Baking." National Baking School, 1315 Mich. Ave., Dept. 1359, Chicago 5

FREE CATALOG OF TOOLS, BOOKS, DEVICES, CHARTS

of great value to Mechanics, Pipe Workers, Welders, Sheet Metal Workers, Foremen, Layout men, etc. Angle Meter for pipe layouts \$2.00; slide rules \$1.00. Other great values. Write for complete free catalog. Agents also invited. INTERSTATE SALES CO., 1121 Broadway, New York 10, N. Y.

Become a Doctor of PSYCHOLOGY

Win the degree of Ph.D. Teach the secret of contentment, happiness. Solve mental worries. Experience the revelation of truth. Chartered college. Individual help. Write for FREE book. COLLEGE OF UNIVERSAL TRUTH, 5153-B North Clark St., Chicago.

Say You Saw It in POPULAR MECHANICS

Radio Parts BARGAIN

Amazing war-surplus radio parts bargain, with new Coils, Condensers, Transformers, Resistors, Controls, others. \$13 to \$25 value. Ideal for experimenters, amateurs, home shop men. Now only \$3.98. MARKO SUPPLY, Dept. PM-12a, 2924 Logan Blvd., Chicago 47, Ill.

ENSHRINE THEIR MEMORIES WITH U.S. MONUMENTS \$14. UP
Freight Paid

There is none better. Our free catalog is ready for you. Write today. A-18 U. S. Marble & Granite Co., Oneco, Fla.



LANGUAGE IS POWER

... Forge ahead, win special assignments, promotion, better job in global peace time opportunities through ability to speak a foreign language.

MASTER A NEW LANGUAGE quickly, easily, correctly by

LINGUAPHONE

The world-famous Linguaphone Conversational Method brings voices of native teachers INTO YOUR OWN HOME. You learn the new language by LISTENING. It's amazingly simple; thousands have succeeded.

HOME-STUDY COURSES IN 29 LANGUAGES

Send for FREE book—

LINGUAPHONE INSTITUTE

98 RCA Building, New York 20, N.Y. • Circle 7-0830

Available under
GI BILL OF RIGHTS

Send for Information
State of GI

LINGUAPHONE INSTITUTE,
98 RCA Bldg., New York 20, N.Y.
Send me the FREE Linguaphone Book.

Name

Address..... City.....

Language Interested.....

THERMOPLASTIC RING KIT



Contains complete material equipment for making 10 photo or signet rings valued at \$10.00; Assembled in an attractive Christmas carton. Ideal gift in the home, for camps, clubs, scouts and servicemen. Only \$1 Postpaid or COD. Refundable. PLAST-O-CRAFT PRODUCTS, 13401 Cerise Ave., Hawthorne, Calif.



FREE NEW HOBBY HANDBOOK

A Gold Mine of Information on Newest Equipment,

Materials, Tools for HOME CRAFTSMEN AND MECHANICS

If you work in metals, woods, plastics or glass, you need this Big, FREE Source Book of equipment, tools, parts and materials... including dozens of hard-to-get items you can't find in stores. Many things you must have for your home hobby or shop. Just loaded with ideas and illustrations.

A WAREHOUSE OF THINGS YOU WANT

More than 100 items including: Portable Welder; Bench Tools; Plastic Molder; Telephone System; Chemical Sets; Spray Guns; Electroplater; Drills; Grinders; Tool Chests; Model Tools; Key Maker... everything you need for your hobby or craft. Send for this Big, FREE Book TODAY. Mail postcard or coupon below.

WARNER ELECTRIC CO., 1512 Jarvis, Chicago 26, Dept. K-106

WARNER ELECTRIC CO., 1512 Jarvis, Chicago 26, Dept. K-106
PLEASE SEND BIG, FREE BOOK

NAME.....

ADDRESS.....

CITY..... ZONE..... STATE.....

Learn AUTOMOBILE STYLING at Home

- ✓ Auto Enthusiasts
- ✓ Art Students
- ✓ Designers
- ✓ Engineers
- ✓ Draftsmen



QUALIFY FOR TRAINING IN THIS HIGHLY PAID FIELD NOW!

THIS is the correspondence course you have been waiting for. Those with sufficient aptitude who have heretofore been unable to secure instruction in this fascinating subject can now be admitted for basic training. Lessons are packed with inside information, illustrations and blueprints to help you express your ideas on postwar car design. Our staff, directed by Harley J. Earl, designer of twenty million cars here and abroad, gives each student sincere and detailed evaluation of his work.

DETROIT INSTITUTE OF AUTOMOBILE STYLING

Operated by Harley Earl Corporation

Dept. 12-P, 5533 Woodward Avenue • Detroit 2, Michigan

Please send me full particulars of your free trial qualification offer and easy payment plan.

NAME _____ AGE _____
 OCCUPATION _____
 ADDRESS _____
 CITY _____ ZONE _____ STATE _____

HOW TO CUT RAFTERS

New vest pocket book gives lengths, Side cuts, Plumb cuts, Deductions. For all rafters for any building from one inch to forty feet wide. Gives numbers to cut on square. Also degrees for same cuts for Radial Saws. All standard pitches from 1/4 to 3/4. Just open book to pitch page and there are your lengths, side cuts, etc. Anyone who knows what a jack rafter is can frame a roof if he has this great book. Price one dollar prepaid. BUILDERS' TOPICS, Dept. M, Lock Box 828, Seattle, Washington. Original teachers of the square in five easy lessons by mail. SEND FOR FREE LIST OF TECHNICAL BOOKS. Learn to read blueprints, etc.

Say You Saw It in POPULAR MECHANICS



NOW! EASY-TO-MAKE HOMECRAFT NOVELTIES FOR PLEASURE AND PROFIT!

FREE! NEW 40-PAGE CATALOG

Our new book is crammed with money-making facts about Leather Craft, Wood Carving, Clay Modeling, Lacing and Braiding, Wood Burning (Pyrography), Showcard Lettering, Ready-to-Finish Woodcraft, Plastics, Marblite Molding, etc., mailed FREE with order. Or send 10c for book only.

SPECIAL! EASY MONEY-MAKER!

Newest fashion idea. Leather Link Belts. Very smart for both men and women. Kit including everything for six easy-to-make belts (2 white, 2 black, 1 brown, 1 natural) to sell at \$2 each (\$12 total) sent to you complete for only \$3.50 postpaid. Or C.O.D., you pay postage. (No Canadian C.O.D.'s and no foreign shipments made.) Money back if not delighted. Sample Kit (1 belt) \$1.

- Make BEAUTIFUL Hand-Tooled
- CLAY MODELS
 - WOOD CARVINGS
 - POTTERY
 - SPATTER CRAFT
 - BOOK ENDS
 - BRACELETS

DWINNELL CRAFT SHOP, Dept. P-612, Elm Grove, Wheeling, W. Va.

PRESTO! ANYONE CAN MASTER GLAZE

- LEAVES HARD GLASS-LIKE FINISH
- EASY TO APPLY
- PROTECTS THE SURFACE
- NO SMEAR OR STREAKS AS WITH WAX
- LASTS SIX MONTHS TO A YEAR
- SEALS THE PORES OF THE SURFACE
- WILL NOT FINGER-MARK
- EASY TO KEEP CLEAN
- NO OILY FILM AS WITH POLISH



SAVES YOU MONEY

Car Owners! Meet Master Glaze—the sensationally different luster for new and used cars! Not a wax—not an oil polish—not a paint!—nothing that “smears” over the surface.

MASTER GLAZE is a unique discovery—a creamy liquid—quick and easy to apply! Gives a hard, glass-like surface. Even gasoline cannot dull it! Lasts six months to a year! Amazing luster—beautiful, sparkling clean and brilliant! Doesn't finger-mark—doesn't smear! A match box full glazes an entire car. Seals the pores—protects! NOTHING LIKE IT!

AGENTS
 An unusual opportunity! Quick, flashy demonstrator. Big profits. Good territory. Write today!

FREE SAMPLE

Just send your name and address today to

MASTER GLAZE CO., 7720-565 W. Harwood Ave., Milwaukee, Wis.



59c

COMB-A-TRIM THE NEW QUICK TRIMMER

Something New! Trim your hair without any experience. It's easy! The excess hair comes off smoothly and easily by just pulling-trimmer through hair like an ordinary comb. Also removes hair from legs—armpits. Save on hair-cut bills... Trim your own hair or the whole family's. Send 59c and your Comb-A-Trim will be sent at once.

SPECIAL OFFER
 Send \$1.00 for 2 Comb-A-Trims and save 18c. **2 for \$1**

5 Extra Blades (Year's Supply) 25c

COMB-A-TRIM CO. Cincinnati, O.

1734 Carew Tower

Dept. R-14

TEACH HIM HOW TO SHAVE WITH MY UNUSUAL BELLO

hollow grinding abrasive strap sharpener. Gives 50plus. CONSTANT COMFORT. fast clean shaves per double edge blade. HE-MAN'S GIFT. SERVICEMAN'S GODSEND. Col. J. Joy, Texas, says: "I blades 15 years in my Bello."

Or Write Bel-lid, Gardner 23, Mass. & Stores like Macy; any jewelry store; Jordan; Bannberger; Abham; Strauss; W. & J. Burns; Hart; E. Kern; Higbee; A.M.A. Frink; Nelson; Frink; Hunter.

12 lbs .SURPLUS RADIO PARTS...\$2.00

A gold mine of parts for repairmen, amateurs, and experimenters... relays, condensers, resistors, transformers, coils, hardware, wire, etc., etc. An outstanding bargain in usable parts! Send cash, check or M.O. today!

ELECTRONIC PARTS, Inc. Dept. M, 622 W. Randolph St. CHICAGO 6, ILL.

NEW CHEAP OIL BURNER

FOR COOKING & HEATING STOVES-FURNACES HEAT YOUR HOME, COOK YOUR MEALS WITH CHEAP FURNACE OIL

NO MORE SHOVELING COAL OR ASHES. A New Fuelizer Starter Vaporizing System turns Cheap 130 Flash Furnace Oil, Distillate, Kerosene etc. into Oil Gas heat without clogging up. LIFETIME GUARANTEE against defects. \$1.00 Bonus Offer for Testing. We will let you try it in your own stove or furnace for one month. Get yours for introducing. Big Profits QUICK. Be first. Send in your name TODAY.

NORTHWEST MFG. CO., 561-P 5th, Mitchell, So. Dakota

★ BRAND NEW WAR SURPLUS

POSTPAID WITHIN THE U.S.A.



100% WEATHER PROOF 2 PIECE STORM SUIT

#751 Double textured fabric. Parka jacket. Bib style pants with zipper fly, button flap. Small, med., lge.

#647 U.S. Navy Alarm Siren **7⁰⁰**

2 P.C. Cook-Eat Messkit #518. **1⁰⁰**

#597 Metal Tank Periscope **1⁰⁰**

ZIPPER Carryall-Pac #743 **4⁰⁰**
May be worn on back or carried by hand. Canvas.

#587 Small med. lge. O.C.D. Gas Masks **1⁰⁰**

6 pk't Apron Tool Kit #634 **75c**

#557 2 1/2 Gallon Canteens **2⁰⁰**

100% Wool Sleeping Bag #522 **7⁰⁰**

BRAND NEW! G.I. Type 100% wool. Heavy-duty 30" zipper front

2 Man Mountain Tent #753 **10⁰⁰**

Regulation Army type. NYLON, reinforced seams! Complete with poles, guy ropes.

Rucksacks #520—U.S. Army duck. Steel frame. Add 2.0% Tax. **5⁰⁰**

Air Inflating Rubber Boat #544 **20⁰⁰**

Holds 1 or 2 people

U.S.N. Emergency Fish Kit #726 **5⁰⁰**

Can contains 7 drop lines, hooks, lines, gloves, bait, knife, gaff, apron, etc.

Nylon Net Jungle Hammock #752 **10⁰⁰**

Insectproof! Army style. Waterproof roof. Complete with nylon ropes, rings, etc.

Army Training Rifles #561 **4⁰⁰**

Made of wood and metal. Won't shoot!

Signal Corps Jack Knife #660 **2⁰⁰**

2 1/2" Blade

BAYONET TYPE KNIFE #611—Polished 6 1/4" blade. Metal and plastic guard handle, case. **3⁷⁵**

U. S. ARMY CANTEENS #688—All metal regulation. Plastic cap. One quart size. **1²⁵**

FOX-HOLE SPADE #517—Steel blade 6" wide, red finish, hardwood handle, 24" long. **75c**

G. I. PISTOL BELTS #687—Khaki 2 1/4" web, non-rust hardware. Adjust to 42". (White belts \$2.00) **1⁷⁵**

ALCOHOL STOVE #632—All metal. Burners have caps. 9" x 3 1/2" w. x 1 1/2" h. **75c**

SIGNALING MIRROR #683—Metal with cord. Size 4" x 5". **35c**

COLEMAN G. I. STOVE #632—Sensational! Metal telescoping case. Burns gasoline. 8 1/2" h. x 4 1/2" dia. **10⁹⁵**

TOBACCO POUCH #651—Rollup style. O. D. Poplin fabric. Moistureproof lining. **35c**

CANTEEN CASE #689—O. D. Cloth. Shoulder strap. Will hold qt. size canteen. **60c**

COLLAPSIBLE BUCKET #671—Heavy waterproof white canvas. Rope carrying handle. 12 1/2" diameter. **3⁰⁰**

WRIST COMPASSES #596—Liquid type. Plastic case. Adjustable strap. **1⁵⁰**

TARGET BALLOONS #681—Red rubber target balloons that blow up to 7 feet. **75c**

25 P.C. Camp-Scout Kits #514 **3⁵⁰**

#514—Plastic case. Has scout knife, safety razor, blades, plastic oil can, whistle, fire tabs.

Army Angle Flashlights #700 **1⁷⁵**

#700—Plastic case. Metal clip. 2 bulbs (1 in cap), 2 batteries included.

Pocket Size Heatlab Stove #639 **1⁰⁰**

Metal. folds flat. Comp. with 10 Heatabs. 3" x 4"

Waltham Jewelled Compass #507 **2⁵⁰** O.P.A. 3.95

Sprayer Pump #543 **1⁵⁰**

543 Sprays pumps, bails! 27" high 10ft. hose.

14-pc. Sait Gaff Set #579 **1⁰⁰**

Navy Ships Bell #502 **8⁵⁰**

Steel 10" X 9 3/4" dia. O.P.A. 12.50

U.S.N. Sheath Knife #703 **2⁵⁰**

#703—Parkerized no-glare 6" blade. Leather washer handle. Genuine leather sheath.

FEDERAL SURPLUS CORP. 3 EAST 4th ST. NEW YORK 3. HOW TO ORDER: Order by number. Remit by money order or bank draft. Send 30% deposit on C.O.D. orders. No C.O.D. orders for less than \$3.00 total.

PRINCE ALBERT

SMOKING TOBACCO

Whether he smokes a pipe—or rolls his own cigarettes—a gift of Prince Albert is sure to please

Dealers everywhere are featuring this 16-ounce tin of Prince Albert for Christmas gifts. It's all ready to give—gay Christmas wrapping—even space for your own greeting.

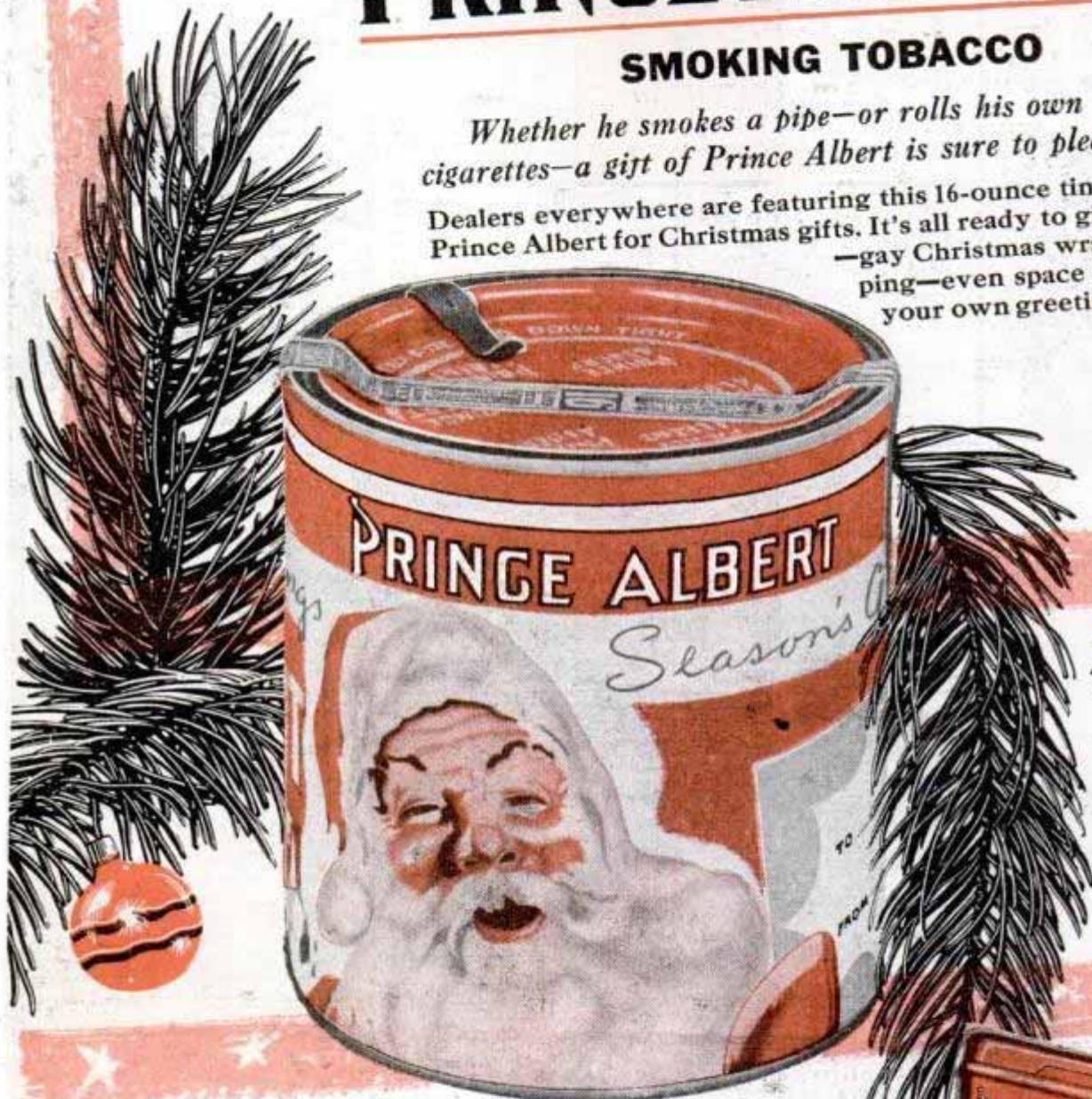

16-OZ. TIN
Also available
in 1/2-lb. size

ALSO IN
POCKET SIZE

★ For pipes or roll-your-own cigarettes, there's no other tobacco quite like Prince Albert. It's crimp cut to pack better in a pipe—or to roll up fast in a "makin's" cigarette. And P. A. is specially treated to remove bite...to smoke cool, rich, and tasty.

FOR PIPES OR ROLL-YOUR-OWNS
THE NATIONAL JOY SMOKE

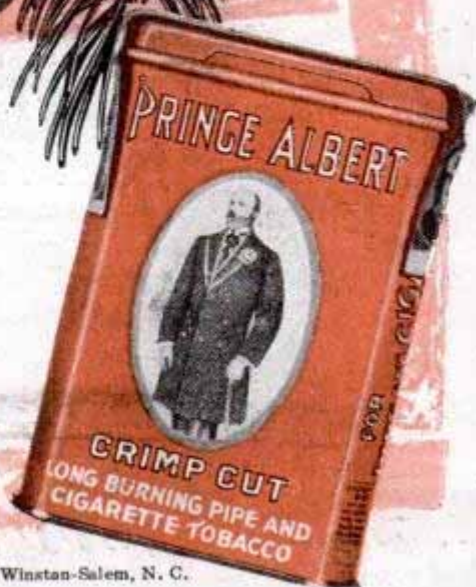

R. J. Reynolds Tob. Co., Winston-Salem, N. C.



By Commander Walter S. Reid, USN

OUR RECORD FLIGHT nearly half-way around the world was not done for melodrama. It did have its thrilling moments, probably the greatest of which was that uncertain moment of takeoff.

The 11,236-mile nonstop flight from Perth, Australia, to Columbus, Ohio, in the "Truculent Turtle" was carefully planned to accomplish two main missions: First, to test standard equipment for long flights and, second, to observe the physical and psychological reactions of personnel on long flights and learn at what point dangerous fatigue sets in.

For the most part our airplane utilized standard equipment and we practiced standard operating flying techniques during the 55 hours and 5 minutes we were in the air. We relied entirely on celestial navigation across the Pacific. With the exception of extra fuel capacity, everything on the flight was normal, even to the feeding and sleeping arrangements.

We took off from a 6000-foot macadam runway at Pearce Airdrome (RAAF airfield), 35 miles north of Perth, into an estimated seven-knot wind. The Turtle,

Copilot and engineer of the "Truculent Turtle" on her record-making 11,236-mile flight, the author, right, had his most trying moment at takeoff, with 8450 gallons of high-test gasoline against his back. Above is the plane's insignia and, top, JATO units boosting the huge "flying gas tank" into the air

I RODE

THE TURTLE





U. S. Navy photo

Attaching a jet-assist takeoff bottle to the fuselage

with her 8450 gallons of fuel and 220 gallons of oil, weighed more than 85,000 pounds, the greatest weight ever lifted by a two-engine airplane. While high wing loadings are common in high-speed aircraft, the

wing loading in excess of 85 pounds per square inch, which the Turtle had at takeoff, was one of the highest ever attempted for this type and size of aircraft.

My position during the takeoff was the fuel dumping station, which is next to the aft fuselage tanks. If we crashed during takeoff I would have been in for a hot time with all the high-test gasoline against my back. As the Turtle roared down the runway I was mentally calculating the time it would take me to crawl out the aft emergency hatch.

The technique for takeoff consisted of the pilot's holding the brakes and running up the engines to full power. Upon reaching full power, the brakes were released and the benefit of full power realized immediately as the Turtle began to roll. Acceleration of the heavy load was slow and gradual. At about 3500 feet, 85 knots (93 miles per hour) was reached and the four JATO (jet-assisted takeoff) units were fired. This burst of extra power gave the Turtle the kick in the pants she needed. She left the runway at the 4700-foot mark, indicating 110 knots (127 miles per hour).

The wheels were pulled up immediately and were almost fully retracted by the time the end of the runway was reached. Flaps had been set at 20 degrees and were retracted by small stages after the airplane had reached 140 knots and 300 feet.

The flaps are designed to form a contin-

U. S. Navy map showing weather conditions encountered en route during the 55-hour trip from Perth to Columbus

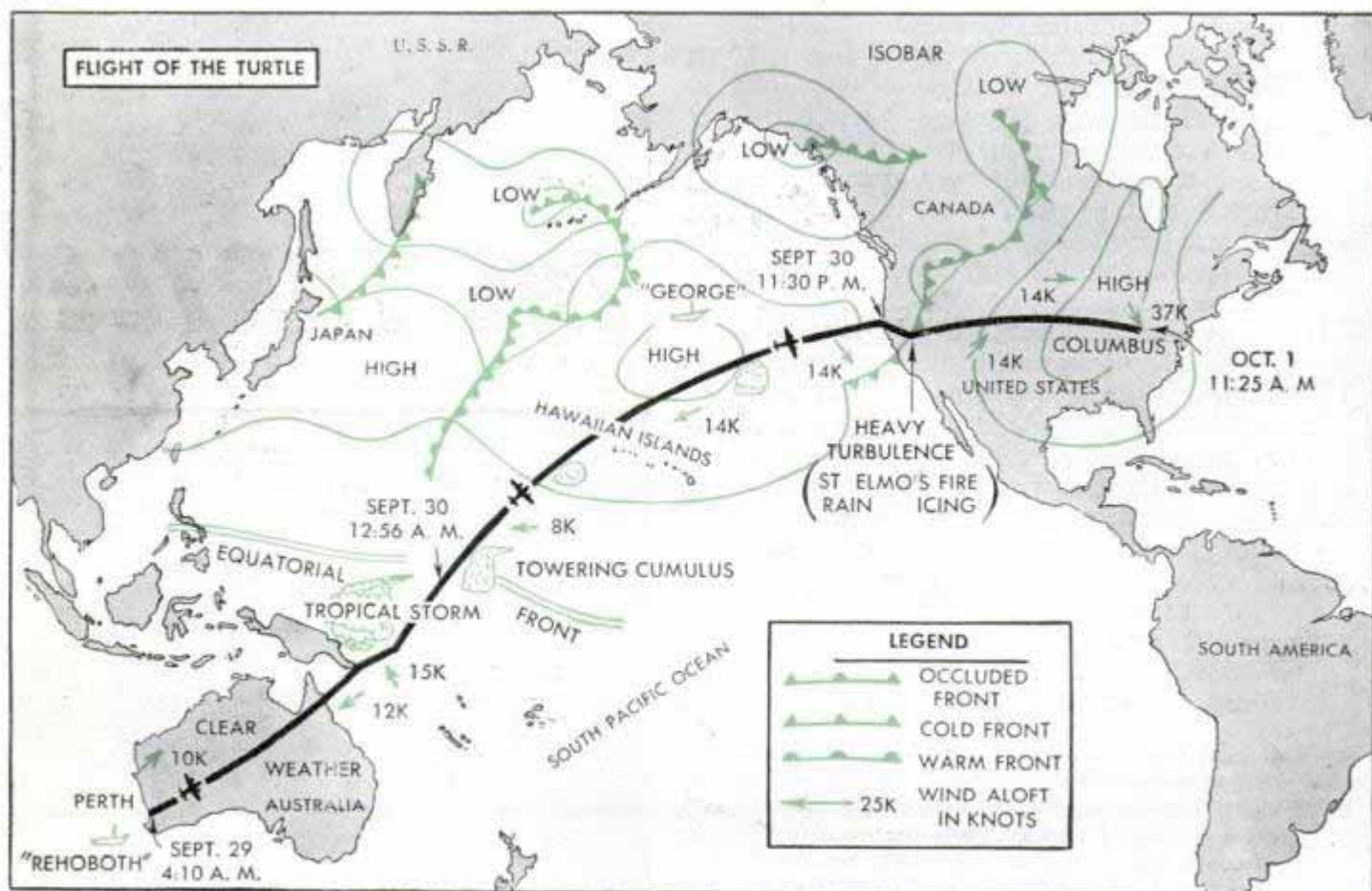

uation of the trailing edge of the wing when they are partially or fully extended. The top side of the flaps is smooth and unbroken. The underside is broken only at the screw jacks. The flaps retract along the underside of the wing in the typical Fowler flap fashion.

While the main gear tires were changed from 16-ply to 18-ply for the flight, no other alterations were made to the landing gear or retracting mechanism. The landing gear can be handled by either the main hydraulic or emergency hydraulic systems. These systems can be operated electrically or manually, giving the airplane four separate systems for raising or lowering the landing gear.

The fuel system consisted of the normal inboard and outboard wing fuel tanks, extra outboard wing cells (nylon), a bomb-bay tank, a nose tank, an aft fuselage tank and a wing-tip tank on each wing. The engines took suction only from the main right and left inboard service tanks. The

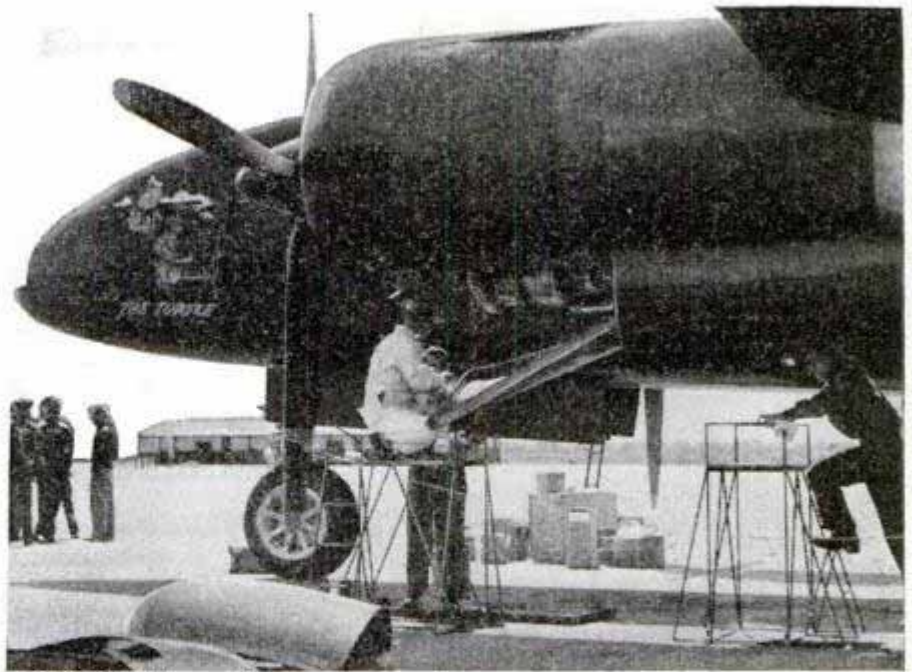

U. S. Navy photo

Lockheed technicians giving engines a last-minute check before takeoff

fuel from other tanks was transferred into the main inboard tanks from time to time to augment the main supply.

The transfer was regulated to maintain a minimum shift of the center of gravity of the airplane. Transfers were made from the fuselage tanks first, in order to keep the weight properly distributed throughout the wings. The shifts were made in 400 to 500-gallon lots which were evenly

Cutaway diagram of crew stations in combat version of the Lockheed P2V Neptune. Its wing span is 100 feet and length 75 feet 6 inches. Its height of 28 feet 1 inch is equivalent to that of a three-story building

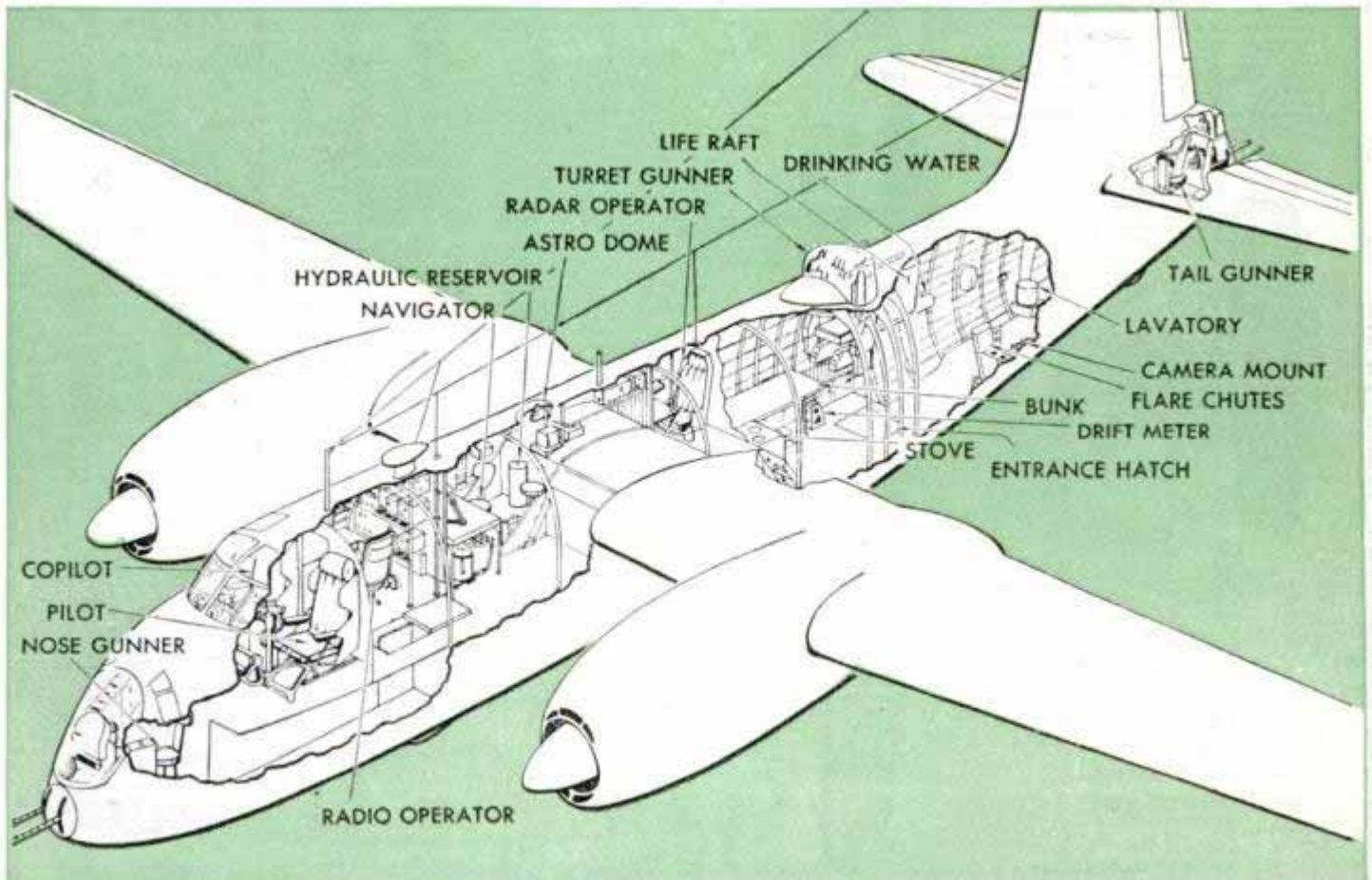

Aerodynamically one of the cleanest airplanes ever built, the long-range Neptune is driven by two 2500-horsepower Curtiss-Wright engines



distributed between the two service tanks.

Through a system of piping, valves and pumps, the fuel from all auxiliary tanks except the wing-tip tanks passed by the fuel transfer station from which all pumps and valves were controlled. The fuel transferred registered on electrical flow meter counters.

A positive fuel transfer indicating system was set up to indicate, by means of a light, everything that passed through the fuel lines. If air was passing in the line a bulb would light; if a combination of air and fuel was passing, the light would blink; if only fuel was passing the light was out.

Each wing-tip tank had its own submerged electric pump controlled from the fuel transfer station. After the wing-tip tanks were emptied they were dropped off their bomb shackles, electrically, in the same manner that auxiliary fuel tanks are dropped off carrier airplanes.

The electric fuel transfer pump at the fuel transfer station was augmented by a high-capacity hand transfer pump. Fortunately it was not necessary to use it. Also as a positive means of getting the fuel from the outboard wing tanks into the main fuel tanks, if the normal inlet lines to the pumps clogged or topside tank connections broke, a gravity flow line into the bomb-bay tank was provided.

Each engine was provided with its normal lubricating oil tank of 90-gallon capacity. Extra oil was carried in an auxiliary tank located in the nose wheel well, and a hand transfer pump was located on the flight deck to transfer oil to either engine's oil tank.

At the takeoff weight, our 2500-horsepower Curtiss-Wright 3350 engines gave us a rate of climb of over 400 feet per minute at sea level at normal rated power. Naturally, as the altitude increased the rate of climb fell off slowly. In case of an engine failure at takeoff, or shortly thereafter, the Turtle's rate of descent could be held to 200 feet per minute at

Tank	Capacity (Gals.)	Total (Gals.)
WING, CENTER (2)	730	1460
WING, OUTER (2)	771	1541
NOSE	926	926
DROP (2)	200	400
BOMB-BAY	2132	2132
TAIL	2082	2082
GRAND TOTAL		8541

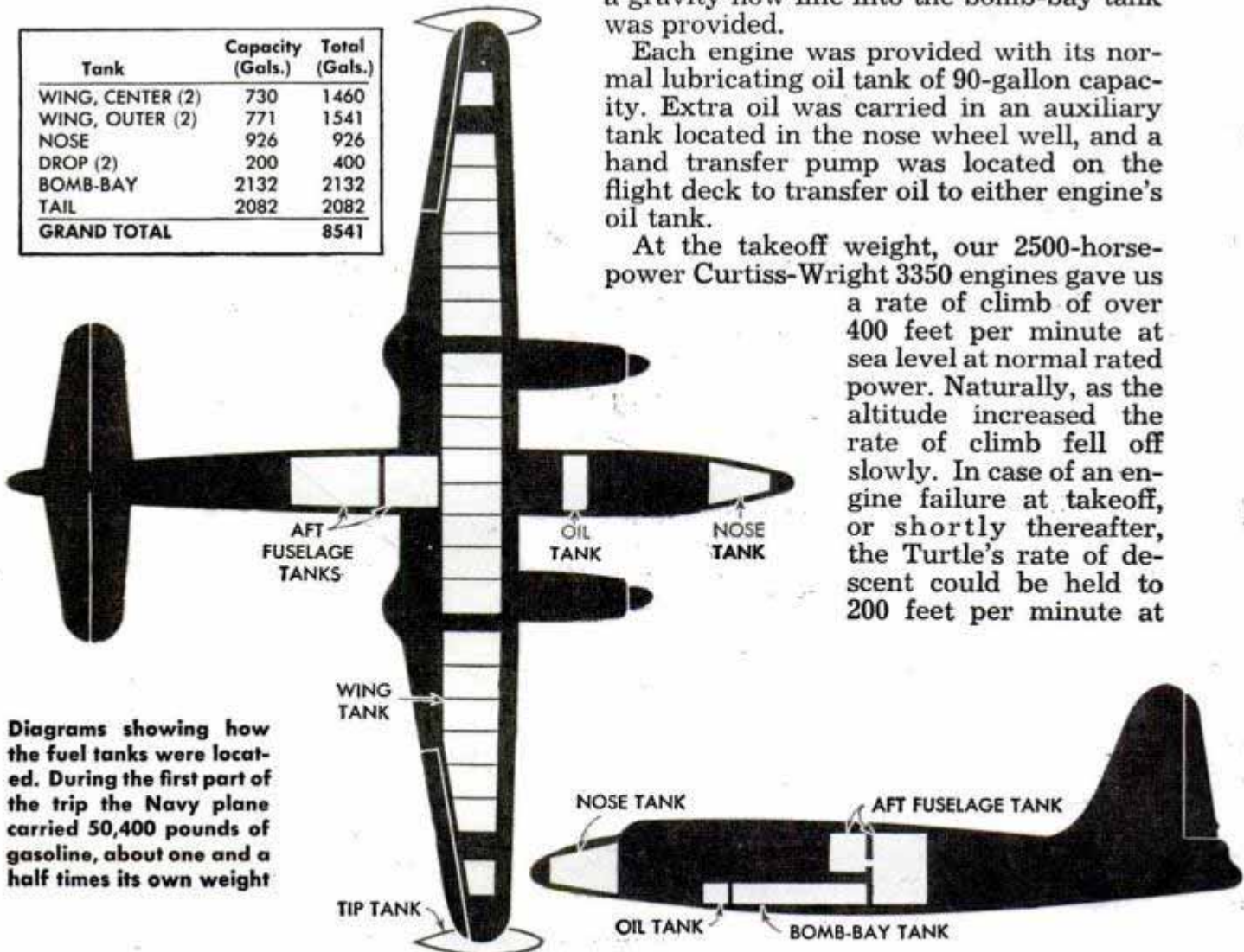

Diagrams showing how the fuel tanks were located. During the first part of the trip the Navy plane carried 50,400 pounds of gasoline, about one and a half times its own weight

military power (which would be used) on one engine. It was felt by us, the pilots, that at an altitude of a thousand feet or more we could save the airplane—and ourselves—by dumping fuel.

The Turtle was equipped with a fairly simple, easy, quick-operating fuel dumping system connecting the fuselage tanks and located at the fuel transfer station. A vertical dump chute which was almost completely retracted at takeoff—its rigged stowage position—could be lowered by one man and connected ready for dumping operations in about 1½ minutes. Just forward of the dump chute connection were located three quick-opening, handle-operated gate valves connecting the nose tank, the bomb-bay tank and the aft fuselage tank in a common joint.

Great care would have to be exercised by whoever manned the dump valves to dump tanks in a certain sequence in order not to pull the center of gravity of the air-

plane off the flyable limits. The bomb-bay tank, being located at the center of gravity, generally could be dumped completely and quickly. The nose tank and the aft fuselage tank would have to be alternated to keep the center of gravity centrally located.

Tests conducted prior to "the big jump" indicated that all the fuselage tanks could be completely dumped in six to eight minutes. The wing-tip tanks, of course, would be dropped immediately at engine failure, thus lightening the plane by 2600 pounds. By dumping the nose, bomb-bay and aft fuselage tanks, another 29,000 pounds of fuel could be released overboard.

In broad terms, the Turtle had approximately 37,500 pounds of immediately dropable weight. In 10 minutes the weight at takeoff could be down to an entirely feasible single engine weight and safe landing weight. From an engine failure at one thousand feet shortly after takeoff, we felt

(Continued to page 268)

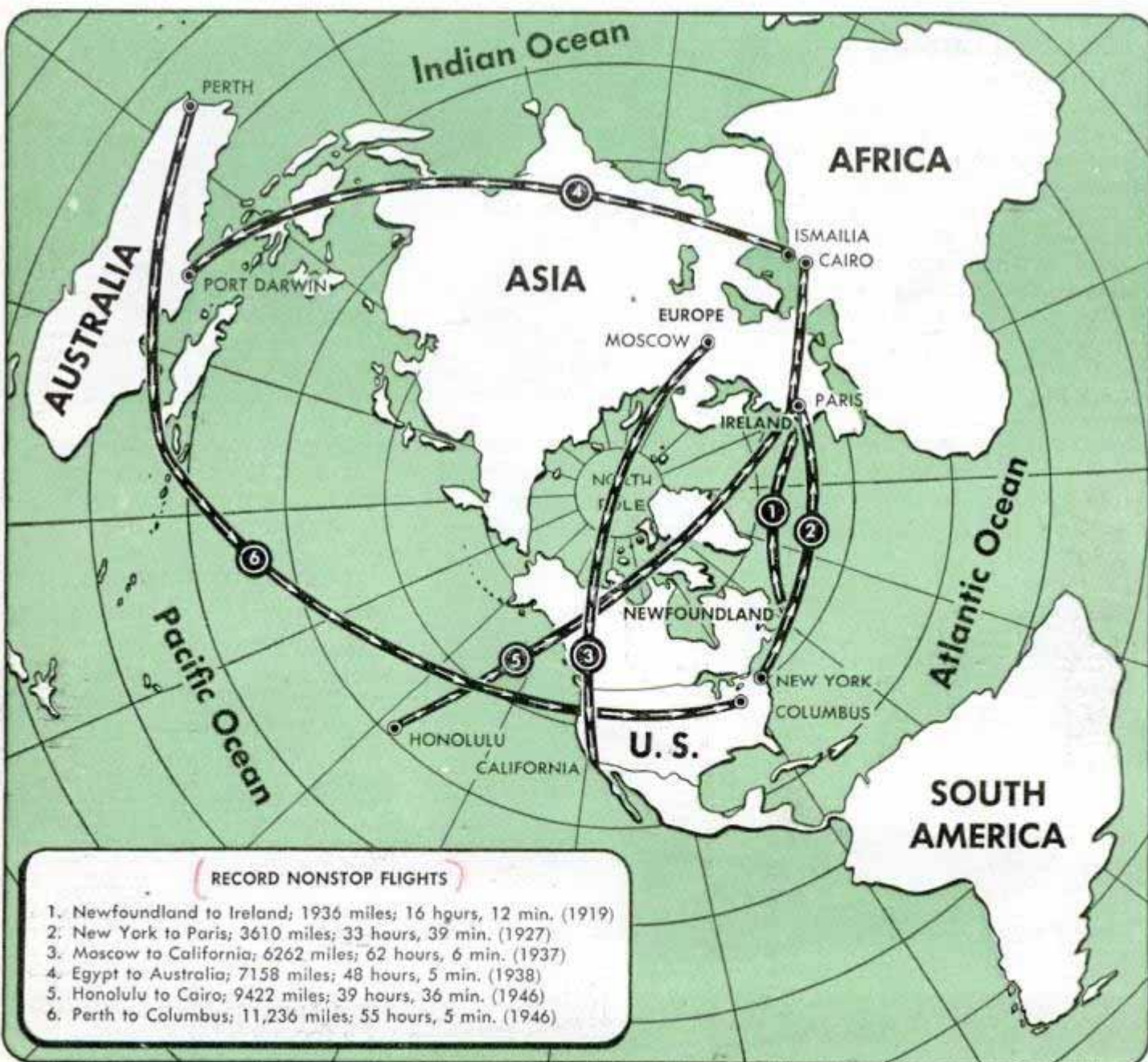

Snowplow Built From Garden Tractor Clears Sidewalks



Sidewalks at Coulee Dam, Washington, the town occupied by employees of the big dam, are cleared of snow by an efficient snowplow converted from a garden tractor by U. S. Bureau of Reclamation mechanics. The plow blades were improvised from light steel plates. The ingenious mechanics riveted scraps from an old belt conveyor to the continuous tractor treads to prevent damage to the sidewalks and to lessen noise. The snowplow is powered by a two-cylinder motor.

Heart-Shaped Plane Flies Fast or Slow

Two-speed engines permit an experimental fighter plane built for the Navy to fly fast or slow. Speeds up to 460 miles an hour or as slow as 20 miles an hour are possible. The new plane, designated the XF5U1, is patterned after an earlier low-powered flying model of wood and fabric construction. The structure of the new heart-shaped plane is stronger than that of conventional aircraft. It is powered by twin engines which, through a transmission system, turn the two propellers at approx-

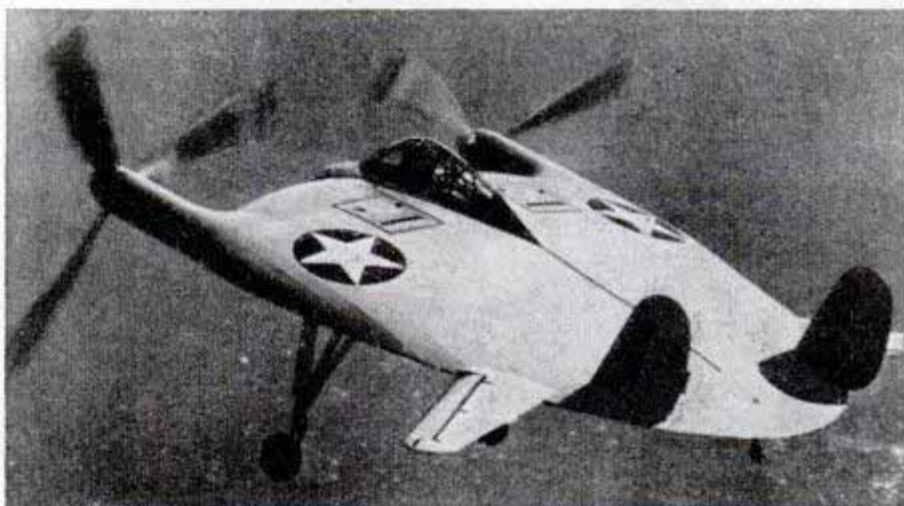

imately one fifth the number of revolutions per minute of the engines. In case one engine fails, the other can drive both propellers through the transmission system.



Largest Helicopter Carries 1½ Tons

World's largest and first twin-engine helicopter, the Navy's XHJD-1 will cruise over 100 miles per hour carrying a useful load of more than 3000 pounds. The big 40 or 46-foot blade rotors turn in opposite directions, intermeshing when the latter are used. Either of the two 450-horsepower engines can be hooked up to drive both rotors. The twin-rotor system does away with the need for an anti-torque rotor at the tail.

Hot Wing and Tail on C-82 Melt Path Through Icy Storm

Leading edges of wing and tail surfaces heated hot enough to fry an egg prevent formation of ice on the Fairchild Packet. The first cargo plane with a built-in wing-heating system, the Packet can be made so hot it literally melts a path through icy storms. The thermal anti-icing system extracts heat from engine exhausts and forces hot air through ducts into the wings and tail. To reach the tail surfaces, the ducts pass through the twin booms. Air scoops bring the air in and feed it to four crossflow-type heat exchangers, two for each engine, that are installed in the nacelles. The heat exchangers warm the air to 350 degrees Fahrenheit. The hot air is released through small holes in the ducts to heat the leading edges of the wings and tail to 130 degrees. The system keeps the entire wing free of ice although the heated area includes only 15 percent of the wing chord. It also supplies heat for the pilot's cabin.

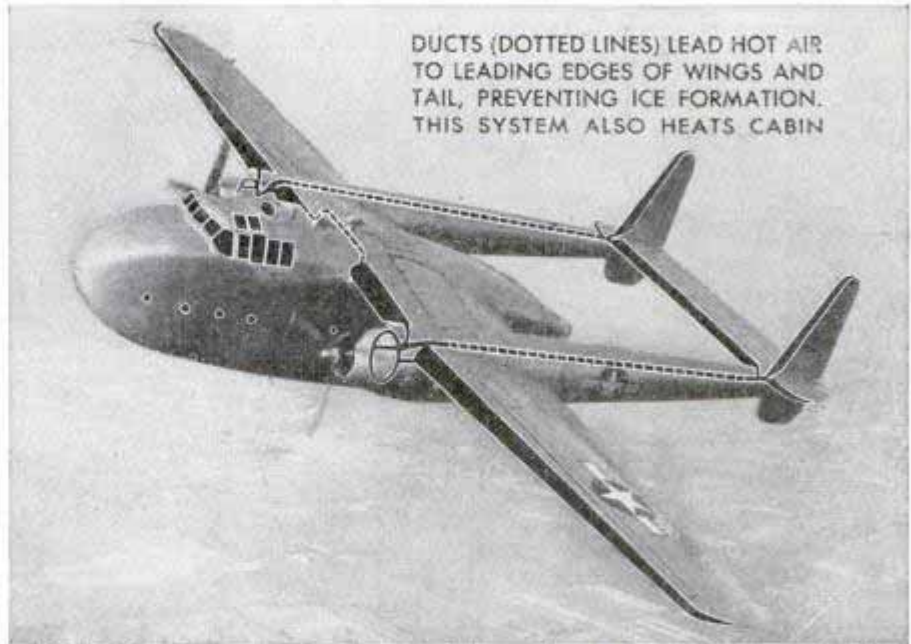

Drinking Fountain Attachment on Pump Gives Constant Water Flow



For safer drinking in areas outside the reach of public water systems, a pump designed for use as a drinking fountain makes it possible to discard the old tin cup with its rust and dirt. Sustained pressure provides a constant flow of water from a well through the fountain-pump. A few strokes with the handle build up enough pressure so that the user can take a drink without more pumping. A step for children is built on one side of the bubbler. A basin below can be used as a watering place for dogs, birds or other pets.

You may wish to obtain additional information about the new products described each month in Popular Mechanics. If you want to know the name and address of the manufacturer or distributor, just write to Bureau of Information, Popular Mechanics Magazine, 200 East Ontario Street, Chicago 11, Illinois. Your letter will be answered promptly.

Bowling Markers Provide "Rifle Sight" Aim

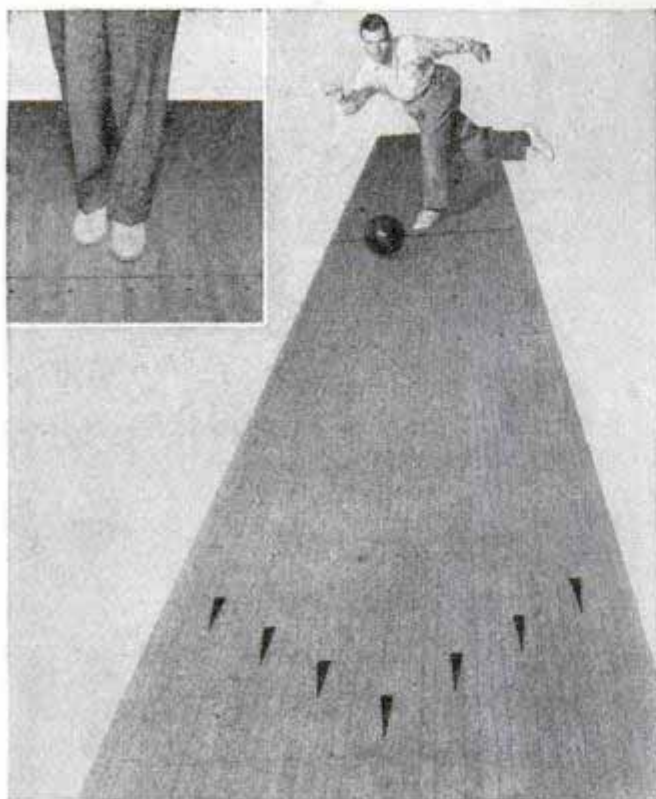

Crack bowler Buddy Bomar keeps his eye on new type alley marker to improve his aim. Dots on runway (inset photo) enable bowler to check starting position

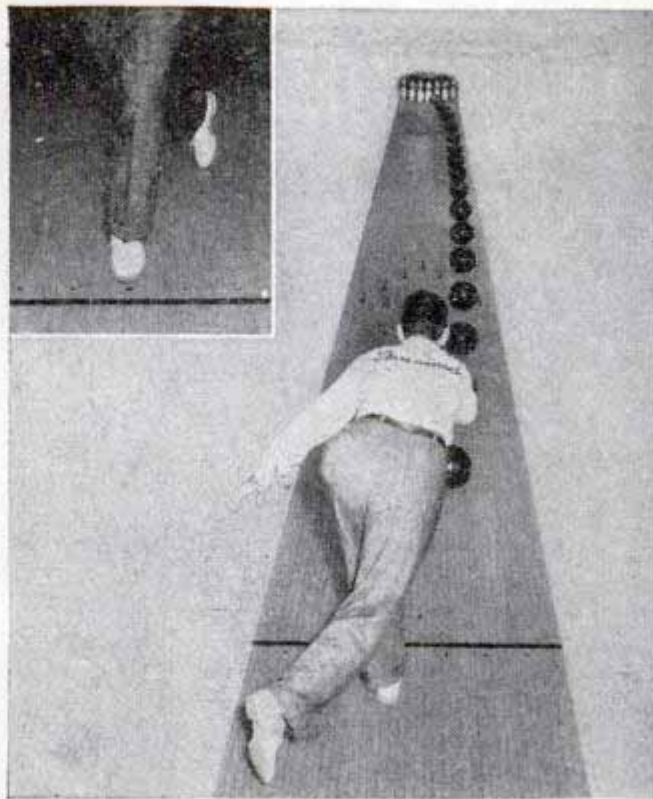

String of bowling balls duplicates path of a Bomar strike hit and shows how he aims at second marker from right. Inset, position of foot at the foul line

Thousands of bowlers would improve their game if they did *not* look at the pins. The explanation is this: By drawing an imaginary line from the foul line to the head pin and aiming at a spot on that line, five to 15 feet from the foul line, a bowler increases his accuracy.

Spot bowling enables him to come closer to keeping the ball on the imaginary line than if he looks at the pins as he approaches the foul line. In the past, spot bowlers have sighted on a light or dark board in the alley when throwing their first ball and aiming at the "one-three pocket" for a strike hit slightly to the right of center of the head pin.

Recently the American Bowling Congress approved the idea of putting special markings on the alley as a guide to bowlers. This will make spot bowling as simple as aiming through the sights on a rifle.

The Brunswick-Balke-Collender Company has designed what it calls "Range-Finder" marking for bowling alleys. The photographs above show the spots and arrowhead markings used on these new alleys to help bowlers aim.

The markings consist of 10 fiber dowels (dots) in a line across the alley seven feet from the foul line, and seven arrowhead inlays—called darts—erected in the shape of a giant arrowhead with the point 15 feet 10 inches from the foul line. In aiming,

the bowler can use a dot or a dart or he can sight on both dot and dart in the manner of a hunter looking through rear and front sights on a rifle. Hook bowlers have to take into consideration the amount of hook they put on a ball. By experience they learn how far to the right of a marker they must aim to make allowance for the curve.

In addition to the alley markings, Range-Finder alleys are equipped with three rows of dowels, or dots, on the runway to guide the bowler as he approaches the foul line. Many bowlers unconsciously fail to keep on a straight line as they run toward the foul line. They veer to the right or left and spoil their chances for a strike or spare.

To eliminate this tendency Range-Finder alleys have seven dots 15 feet back from the foul line, seven dots 12 from the foul line, and seven dots at the foul line. By noting the position he takes at the 15 or 12-foot line, the bowler can check his position at the foul line and find out if his approach is on a straight line.

Main purpose of all these markers is to help the bowler get a strike. However, the same system can be applied to shooting spares. For a spare, the bowler takes the proper position, draws the imaginary line, sights and shoots.

A number of Range-Finder, or "rifle shot" alleys, were installed at Army camps and naval stations during the war.

Electric-Eye Trap Fools Baboons

Harassed keepers at Chicago's Brookfield Zoo have solved the annual problem of catching apes on "monkey island" with a homemade electronically operated trap. The picturesque island of towering rocks and sharp drops was not designed for the convenience of keepers corralling baboons for winter quarters. The two-room trap attracts the wary baboons with food and strategically arranged mirrors. As an ape walks across the first chamber he intercepts an electric eye beam. This closes the front door and opens another door leading to a short tunnel. At the end of the tunnel is a swinging Plexiglas door through which the baboon can see his image in a mirror on the back wall of the inner chamber. As the ape kicks this door open and leaps ahead, a switch is tripped which resets the entire mechanism, closing the middle door and opening the front door. As the inner chamber fills up, a cage is pulled to a back door and the baboons are removed. The trap was built by Ralph Graham and Holly

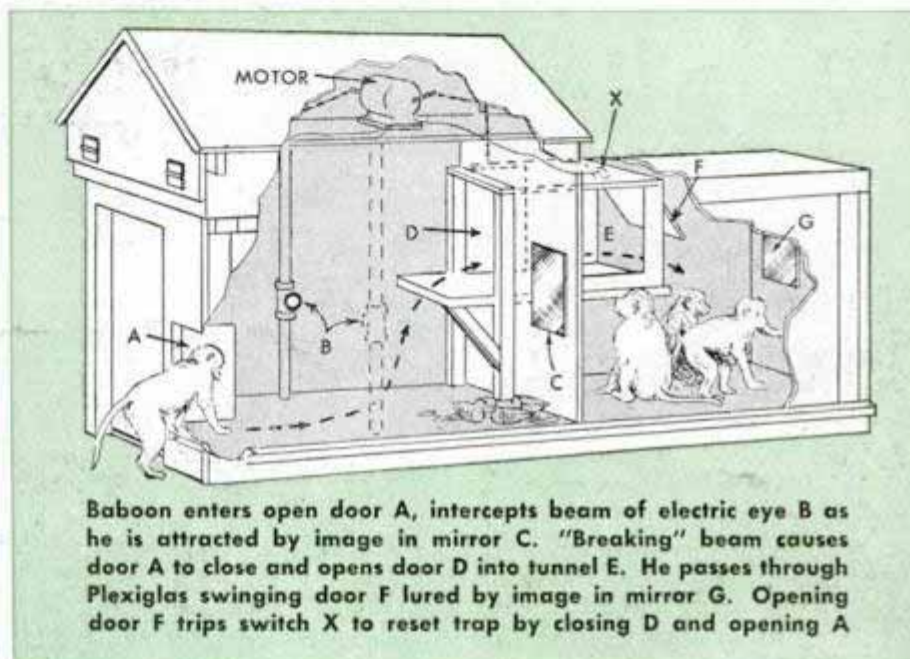
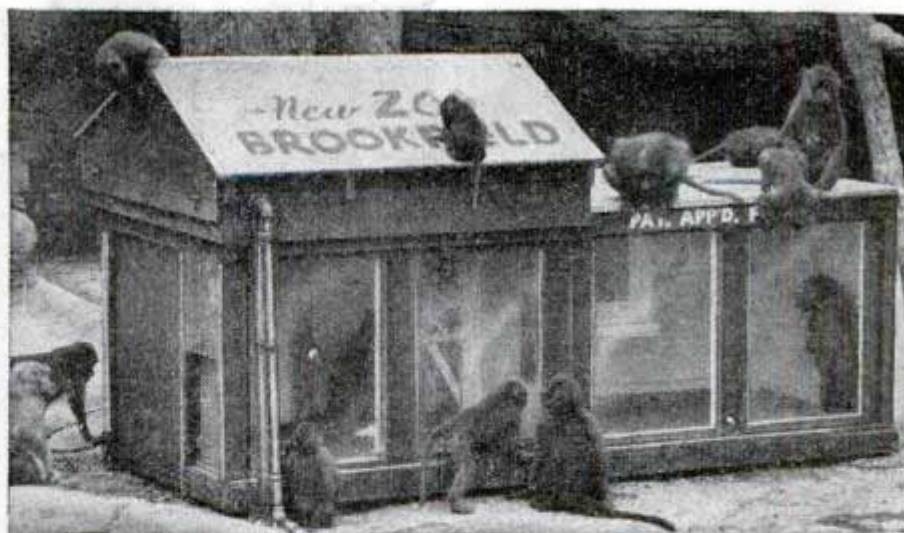

Jeffries. Robert Bean, director of the zoo, believes it has possibilities for catching wild animals in the jungle.



Fountain Brush With Felt Point Writes on Glass or Fabric

Resembling a fountain pen even to the pocket clip, a fountain brush writes on any surface, including glass, Cellophane, plastic, wood and fabrics. Suitable for writing, drawing and marking, it writes in colors that dry instantly. When dry, the writing can be removed only by a special cleanser. Three types of felt nibs provide variety in the size of writing. A valve control adjusts the flow of the coloring. In addition to marking packages, the pen brush can be used for sketching, drawing, painting window signs and marking laundry.

☐ To make electrical conductors for atom bomb production during the war, 14,000 tons of silver worth \$400,000,000 were withdrawn from the U. S. Treasury to substitute for copper needed for ammunition.

Ditches 16½ feet wide are dug in a jiffy by this giant canal-digging machine in the Gila irrigation project in southwest Arizona

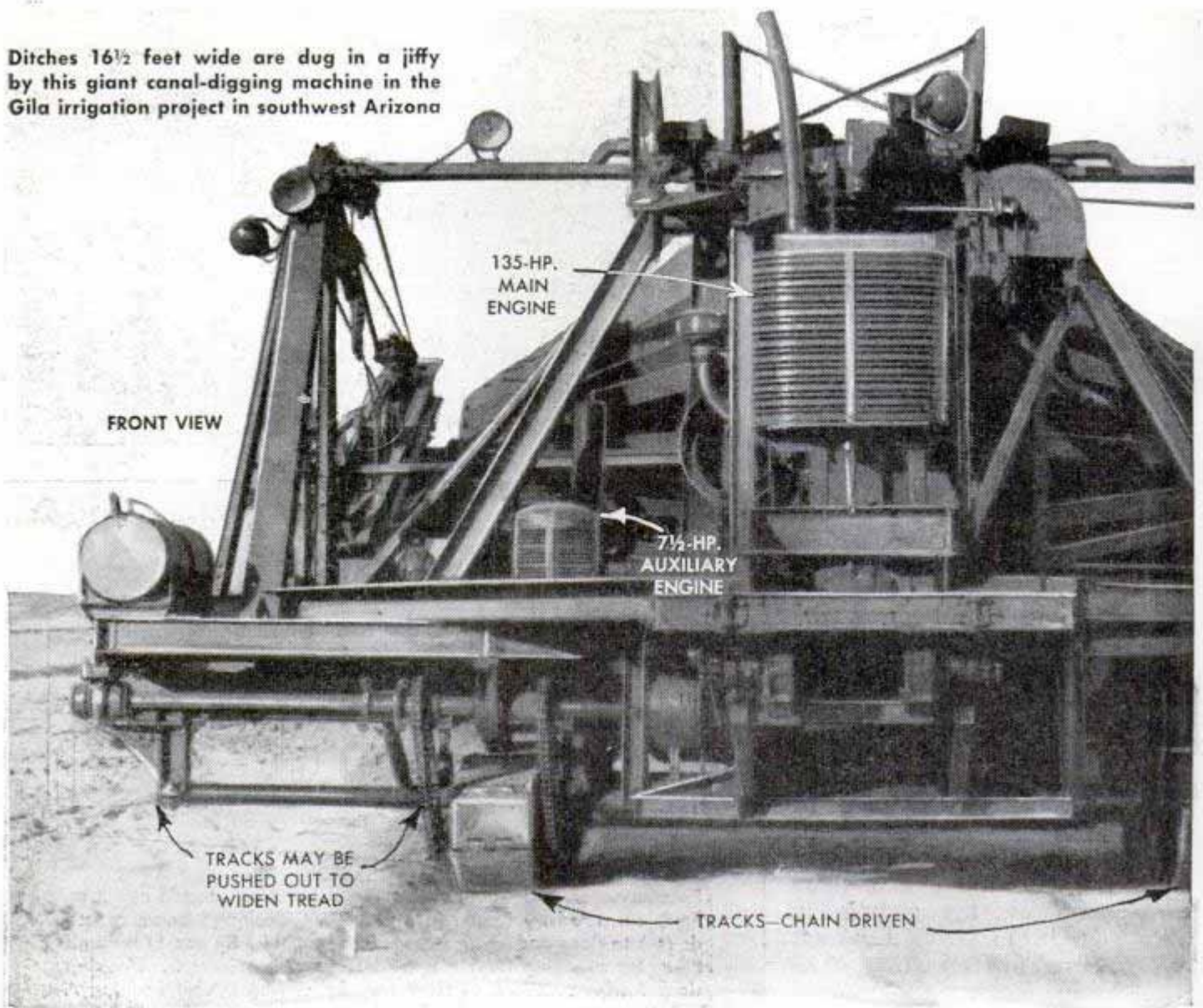

NEW RIVERS FOR THE

TREMENDOUS canal-digging machines that leave miles of open channel behind them as they move ponderously across country are being used in the West to speed up the nation's program of utilizing excess river waters for irrigation.

On the new Gila project in southwest Arizona where half a million thirsty desert acres are to be watered by the Colorado, a big canal digger is scooping out an entire canal at the rate of one foot per minute. The wide rotating blades of the machine take a succession of never-ending bites and create a channel 16½ feet wide at the top, 3 feet wide at the bottom, and 4½ or 5 feet deep.

Behind the machine a crew of men smooths down the sides of the canal, lays steel reinforcing mesh and applies liquid concrete to the floor and walls. The finished canal, ready for use, is completed in the one operation.

Invented by the engineers of the Macco

Construction Company, the canal digger operates on the same principle as a ditch digger. Dirt scooped up by the blades falls onto endless belts inside the digging cone and is transported outward to be discharged at each side of the canal. The digging machine is powered by a 135-horsepower main engine that operates the digging cone and also moves the machine ahead on its track-type treads. An auxiliary 7½-horsepower gasoline engine spins a generator that supplies electricity to the motors that move the endless belts and also furnishes current for seven powerful lamps that are used after dark.

In all, thousands of miles of artificial rivers and streams are under construction west of the 100th meridian today. Before the war the U. S. Bureau of Reclamation had started numerous vast irrigation projects. Now work is progressing at top speed both night and day in a hurry-up program

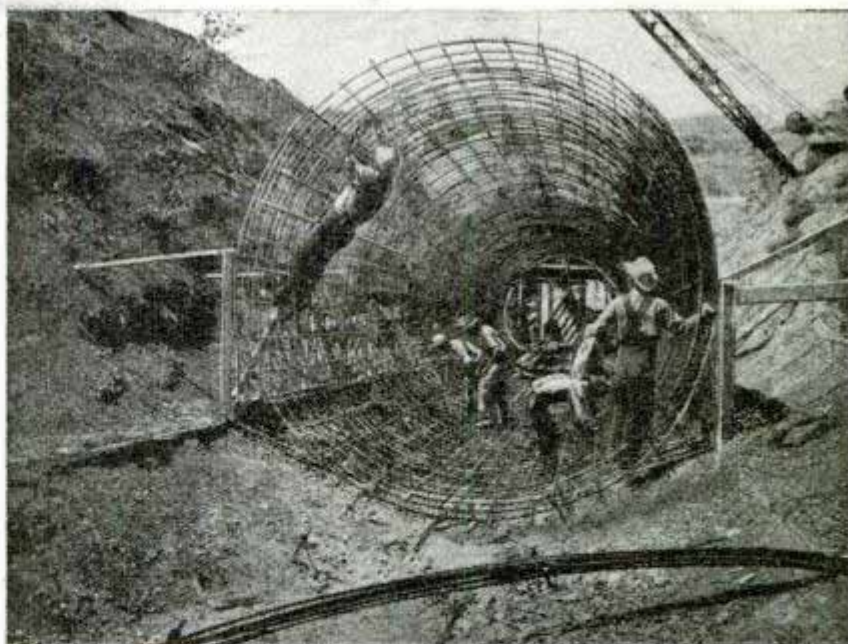
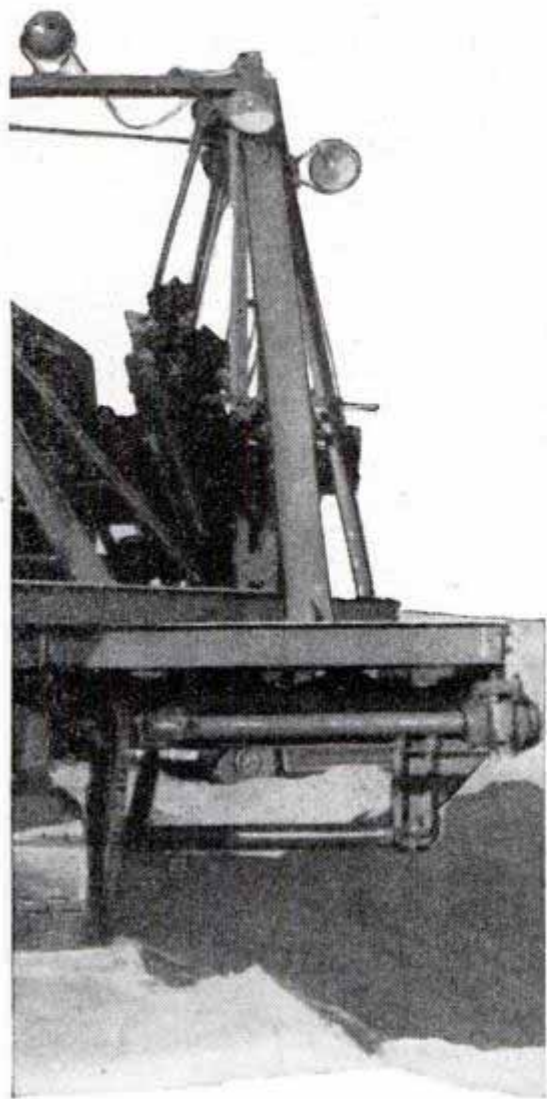

↑ Steel reinforcing bars are installed to hold concrete for siphons to carry the big Conchas irrigation canal across the bed of a stream

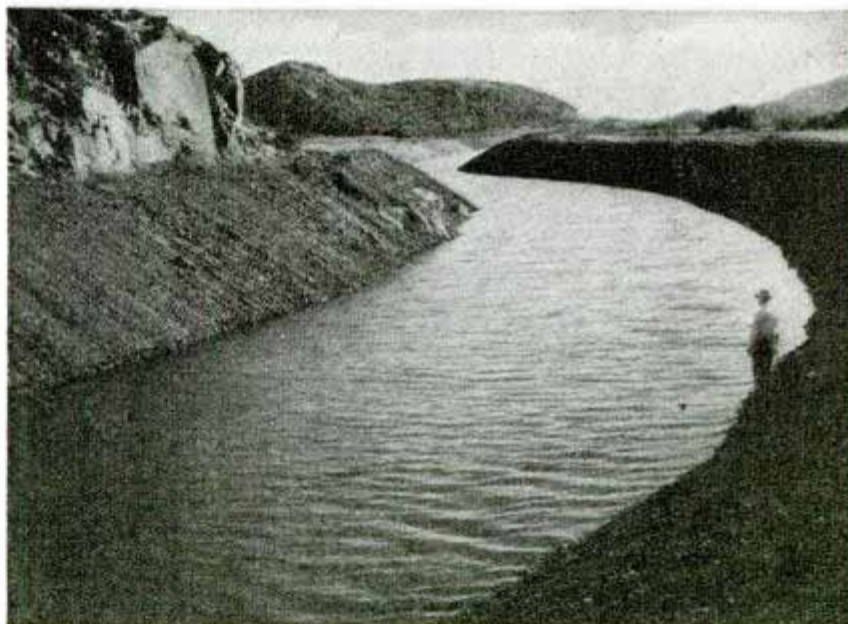

↑ Altus Canal in Oklahoma carries water for irrigating 70,000 acres
↓ Butte Dam, New Mexico, feeds canals to irrigate 155,000 acres

WEST

to get the projects completed.

Representative of the larger developments is the huge Central Valley project in California, encompassing two thirds of the state's agricultural acreage. Some of the valley now receives more water than it can use while other parts can't be farmed for lack of water.

To provide a more even distribution of life-giving moisture, much of the flow of one great river is being diverted from the area it now irrigates and transported to the arid portion of the valley by a new canal system. Meanwhile, excess water from a second river is being rerouted in order to serve the tracts from which

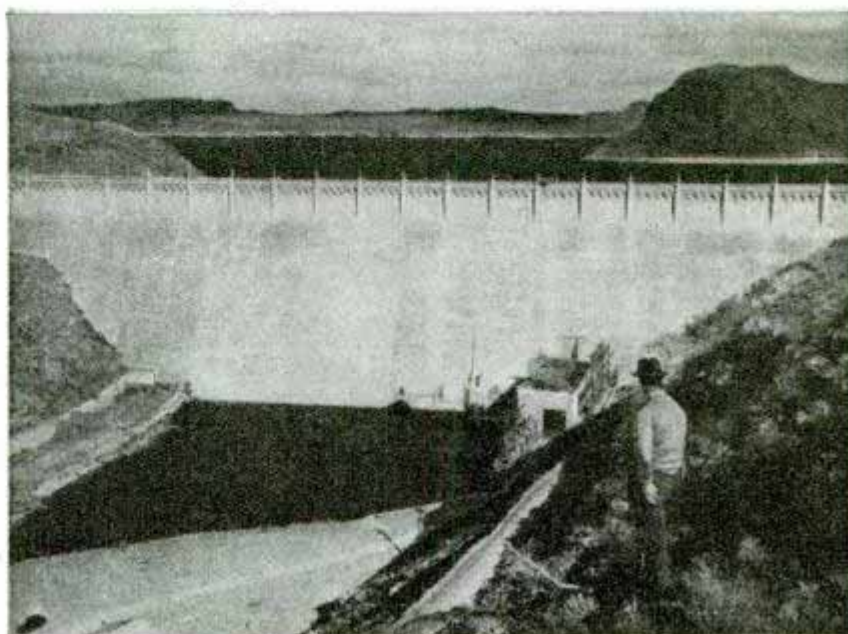



Dragline hauls five cubic yards of earth in one scoop. Below, side view of mechanical ditch digger

the water of the first river was diverted.

The first step in this project was to build two great dams. Shasta Dam in the northern end of the valley now controls the flow of the Sacramento River and Friant Dam east of Fresno now stems the San Joaquin River. The two dams are, respectively, the second and fourth largest concrete structures in the world.

Water from the San Joaquin will be taken from behind Friant Dam by means of the new Friant-Kern Canal, now under construction, to the arid southern end of the valley 160 miles away. The initial section of the canal is 15 feet deep, 15 feet across the bottom, and 70 feet wide at the top of its concrete lining.

Much too large to be excavated by one of the new canal-digging machines, the channel is being scooped out by giant draglines and in some places blasted out of solid rock. It is conducted under existing cross-streams by means of reinforced concrete siphons. A companion canal, the Madera, diverts 1000 cubic feet of water per second from behind Friant Dam to an irrigation district 40 miles north of the dam.

These diversions rob thousands of acres along the lower San Joaquin of the water to which they are entitled. In compensation a "cross delta" canal taps the Sacramento River in the north and carries its excess flow across country to the depleted area. This water must be raised 200 feet uphill during its journey and this is done "free" by power transmitted from Shasta Dam, 200 miles north. In all, some 350 miles of major canals are included in the project.

Already under heavy bondage, the Colorado River that runs from the west slope of

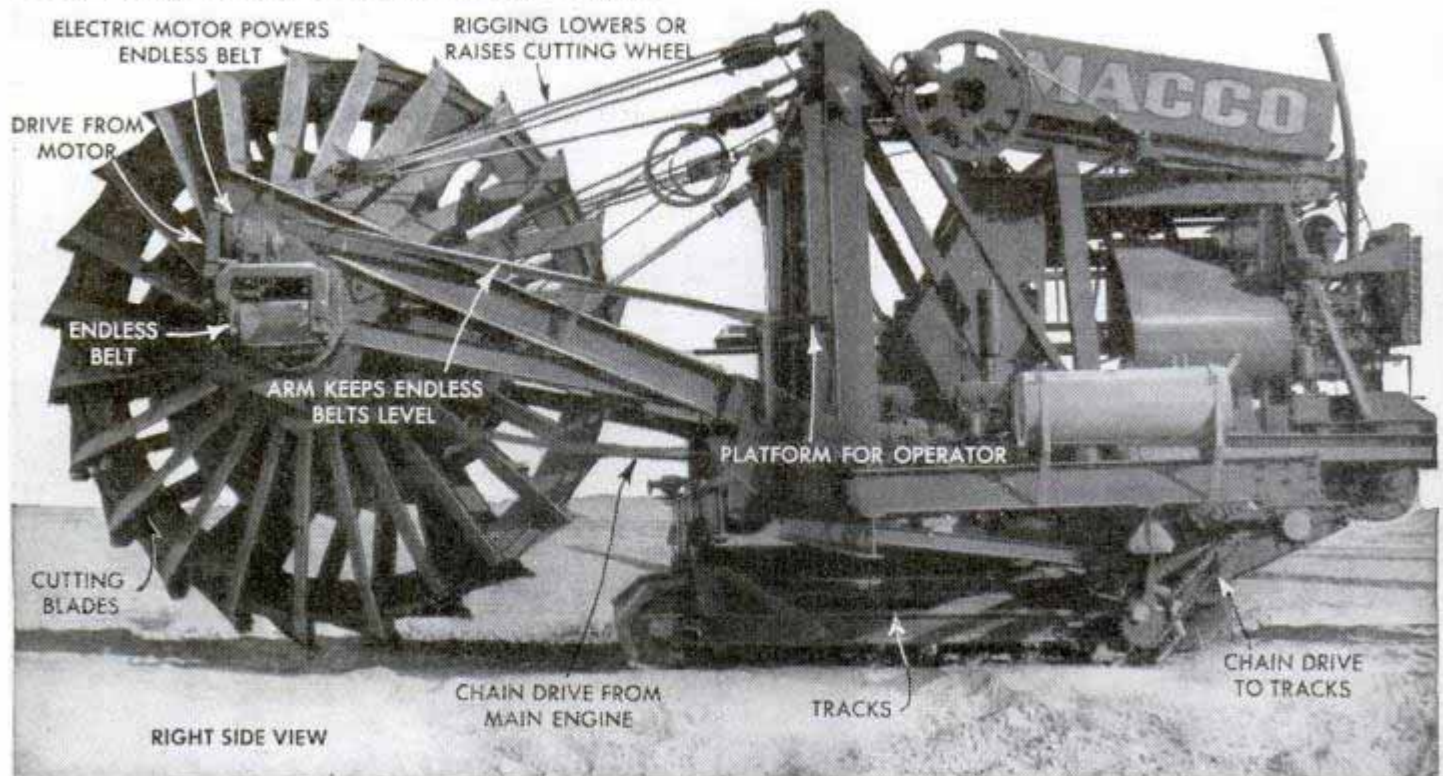

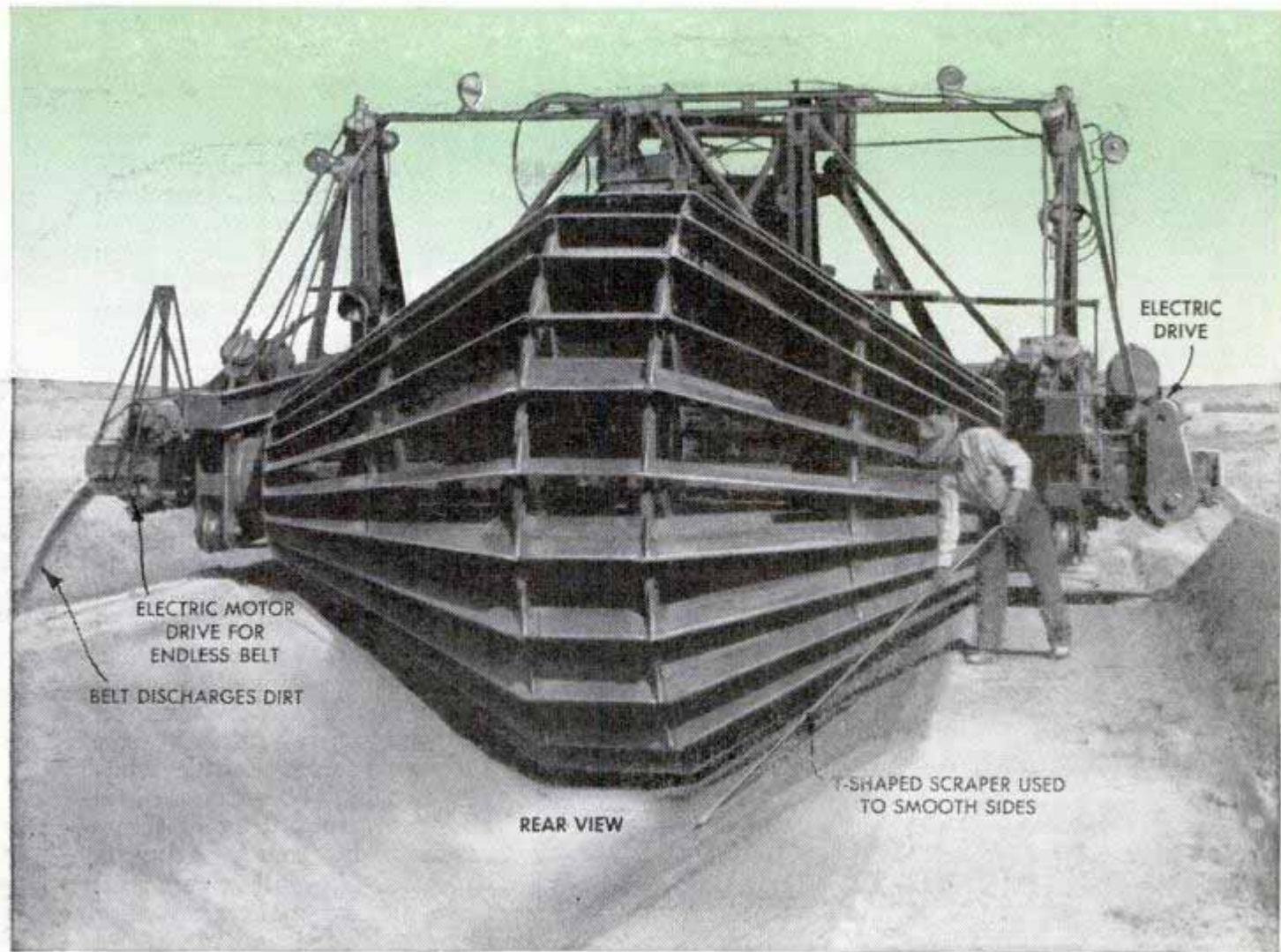

With mathematical precision the "paddle-wheel" digger carves out a canal at the rate of one foot per minute

the Rockies to the Gulf of California is to be made to contribute still more of its moisture and hydroelectric strength to civilization. New chains being forged will make this useful river perform more work than ever. Up near the headwaters of the river, work is well along on the Colorado-Big Thompson project by which Colorado River water will flow under the Continental Divide to the east slope of the Rockies, making use of the 13-mile Adams tunnel through the mountains. After completion of more tunnels and canals, 615,000 acres in northeastern Colorado will receive the benefit of water that otherwise would make its way down to the Pacific.

Far to the south, the Colorado is being tapped again at Imperial Dam for water for the Gila project. Seventy thousand acres in Yuma County, Arizona, are to be irrigated first. Ultimately the plan is to provide water for

half a million acres on which can be grown alfalfa, cotton, flax, cantaloupes, winter vegetables, citrus fruits and dates. About 15,000 acres of the initial development consist of public lands that are to be opened for homesteading, with preference given to veterans of World War II. Temperatures in the Gila Valley range from slightly be-

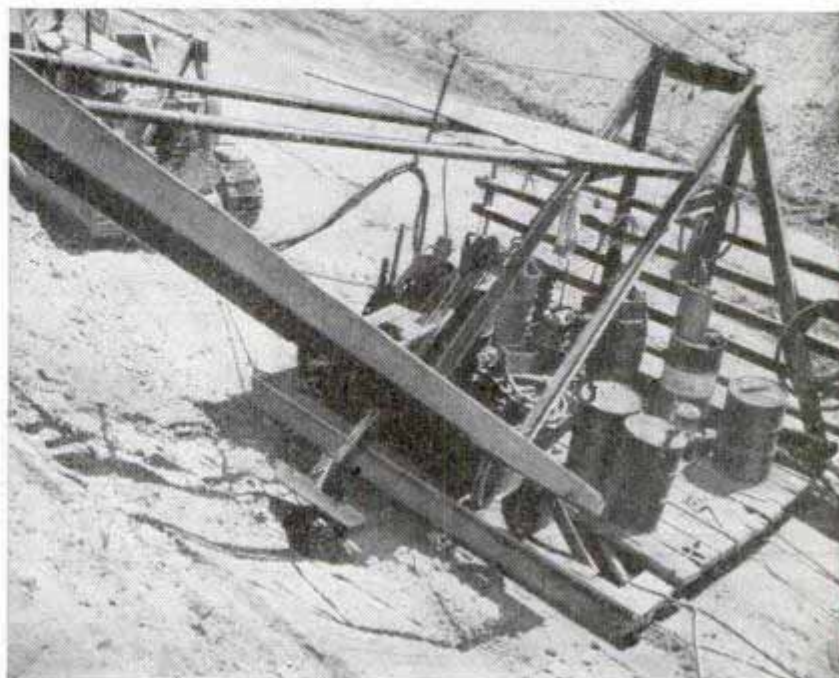

Sides of canal are hammered firm by machine similar to ordinary pile driver

DETAILS FROM: DIRECTOR, BUREAU OF LAND MANAGEMENT, WASHINGTON 25, DC.

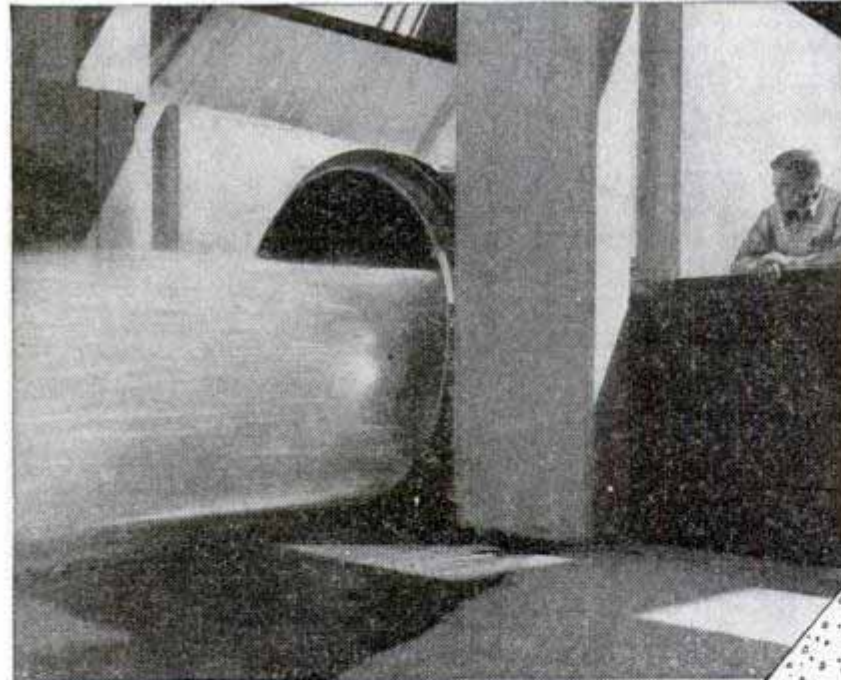
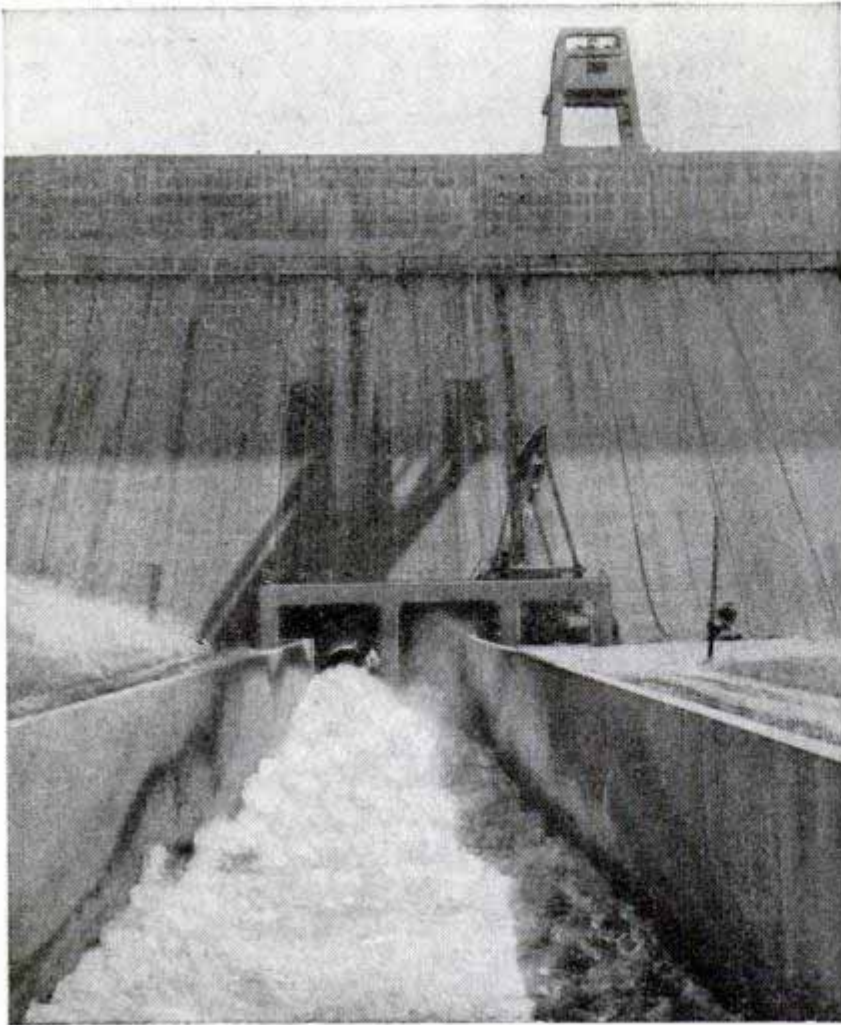

Approximately 280 cubic feet of water per second is discharged through Friant Dam (above pictures) into 37-mile Madera Canal. Right, how the action of the water is slowed

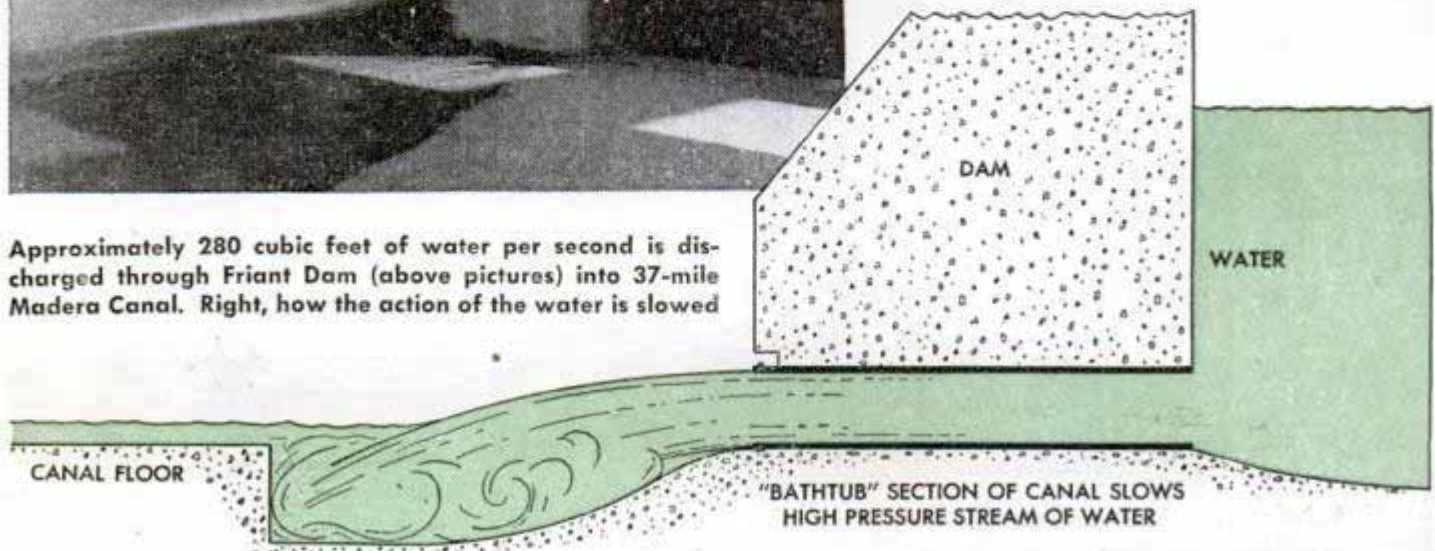

low freezing to 120 degrees Fahrenheit, with an average annual precipitation of only 3.5 inches.

Water from behind Imperial Dam is supplying the present 80-mile All-American Canal that leads to California's Imperial Valley. This canal has a capacity of 15,155 second-feet, greater than the flow of some rivers, and can furnish water for the irrigation of more than a million acres of ground. From the All-American Canal a 130-mile branch is being constructed to Coachella Valley.

Water from the Colorado is so heavily loaded with silt and mud that the All-American Canal would be clogged up in a short time except for a desilting operation at the head of the canal. Water intended for the canal flows first through a series of settling basins in which 80 percent of its silt load, amounting to thousands of dry tons per day, is dropped. The silt is removed from the basins by rotating scraper blades and is sluiced back into the Colorado below the dam. Similar desilting works will be constructed at the head of the new Gila irrigation system.

Forty-five thousand acres in New Mexico will receive water when the Tucumcari project, now under way, is finished, and in Oklahoma water from behind the new Altus Dam is to be used to irrigate 70,000 acres of land.

(Continued to page 276)

Push of Helicopter Tail Jet Balances Torque Thrust

Jet thrust from its right-angle tail keeps an experimental British helicopter, nicknamed the "Flying Drainpipe," from turning in the opposite direction to its lifting rotor. In some helicopters a tail propeller has been used to overcome this torque thrust. A 200-horsepower engine mounted behind the cabin drives a three-blade rotor and its exhaust gas feeds the jet orifice. The pilot's compartment has no doors and is entered through two large holes in either side of the canopy, resembling eyes in the head of a giant dragonfly.

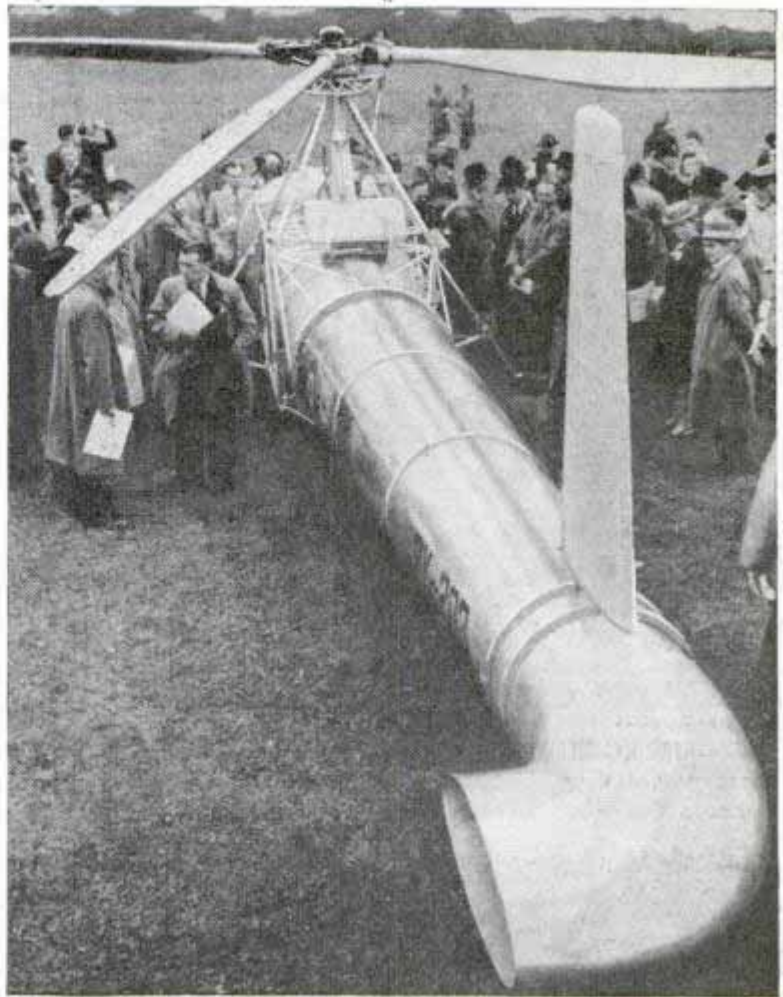

'Memory Circuits' in Mines Strangled Jap Shipping

Air-dropped magnetic mines with "memory circuits" had almost completely severed Japanese shipping lanes when the war ended, the U. S. Navy reveals. The mine fuses, developed by Bell Telephone Laboratories, could be set to permit one ship or several ships to pass over them before exploding. Their magnetic action caused them to blow up at the closest point of the designated victim's approach. Thus the Japs never knew when a waterway was safe. The mine had an attachment that rendered the weapon impotent after a predetermined period to elim-

inate the chance of blasting an Allied ship. With all these complex magnetic and electronic controls, the fuses were small, lightweight and practically indestructible. One mine fell 10,000 feet from a plane and hit solid ground, but the fuse was undamaged.

Auger Bores Holes in Thick Ice With Bit-Brace Action

← Cutting through 12 to 16 inches of ice per minute, an ice auger is a handy tool for a winter fisherman. It is four feet tall and made like a brace and bit so the operator does not have to stoop over. Blades on the cutting head, cast of aluminum to prevent freezing or clogging, may be replaced when worn. It weighs only three pounds.



Pierce Interstellar Dust Cloud

Using infrared light, astronomers have pierced the interstellar dust cloud for the first time and observed the center region of the Milky Way galaxy. The light's effect was the same as using a color screen and red-sensitive plates to photograph distant landscapes more clearly. A 60-inch telescope was attached to a photocell and filter glass giving greater sensitivity than that of the human eye. Apparently less than 1/1000 of the ordinary blue photographic light penetrates the interstellar dust cloud.



Douglas Aircraft photo

AIRBORNE ROCKET POWER with an explosive wallop more potent than the guns of a light cruiser hangs beneath the wings of a Navy attack-type Skyraider

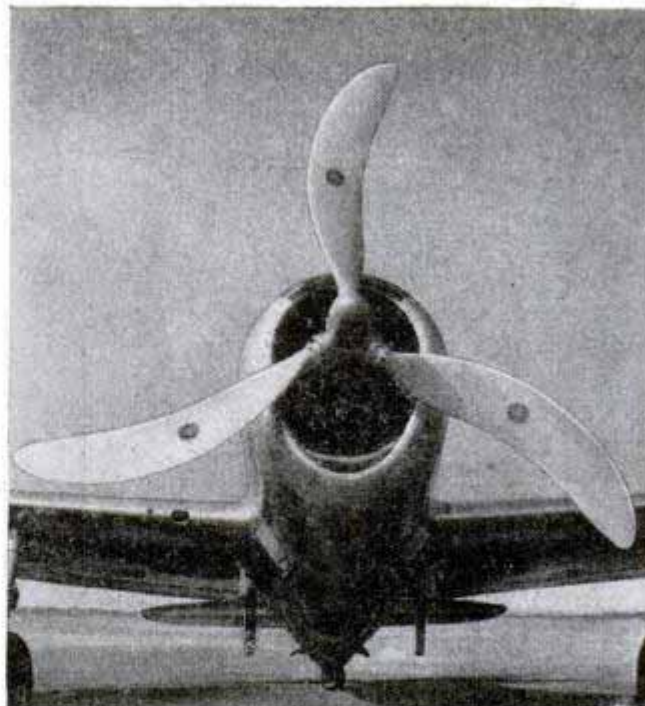

Curtiss-Wright photo

SWEPT-BACK BLADES are now being tested to boost propeller efficiency into the 700-mile-an-hour class to keep pace with the newest turbo-jet developments



AIR TRIP INSURANCE contracts are dispensed in a few minutes by an automatic vending machine



SPEEDS OVER 600 miles an hour are anticipated from the new British Supermarine fighter, powered by a Rolls-Royce Nene turbo-jet. Below, a Lancaster flies experimentally with both jet and conventional engines





NARROW GAUGE MOVIES

Sixteen-millimeter movies, long a tool of industry, are finding a new niche in television and small theaters

WHEN television really gets going, one of its most popular programs will be the nightly "news views" of events of the last few hours. Collisions at sea, spectacular fires and all the other happenings of public interest will appear on your home video screen to the accompaniment of sound picked up at the spots.

The machinery that will provide these up-to-the-minute broadcast news reels already has been perfected and tried out. Movies of blazing oil wells, for instance, have been made on 16-millimeter film, rushed to a television studio for automatic 20-minute processing, and put on the air a few minutes later. The handy 16-mm. camera is ideal for gathering television news shots.

Most television stations broadcast 16-mm. films as a regular entertainment feature. Their crews are being trained in the operation of 16-mm. cameras and most of the stations plan to keep one of the cameras on hand for making visual transcriptions. When a station is televising a local program that

shouldn't be interrupted, the camera will be used to record important scenes that happen to come in over the network's "pipe." The film can be processed in plenty of time for use as soon as the local program ends. At a dinner recently, 16-mm. movies that were made of the guests while they were enjoying their soup were projected on a wall screen in the dining room a short time later just as the guests were finishing dessert.

Narrow gauge movies have grown up in the last few years and their employment in television is only one of their important uses. Ten years ago 16-mm. cameras were used mostly by amateur movie makers, by the manufacturers of educational films for classroom use, and by explorers and others who couldn't lug a full-size 35-mm. camera around with them. To the professional the "16" was a toy that couldn't begin to compete with the big cameras.

Mitchell professional "16," small version of 35-mm. studio camera, operates on 110 volts





↑ In preliminary step to making 16-mm. sound-on-film master prints, picture reels must be matched and synchronized with three sound-track reels

Telefilm photo

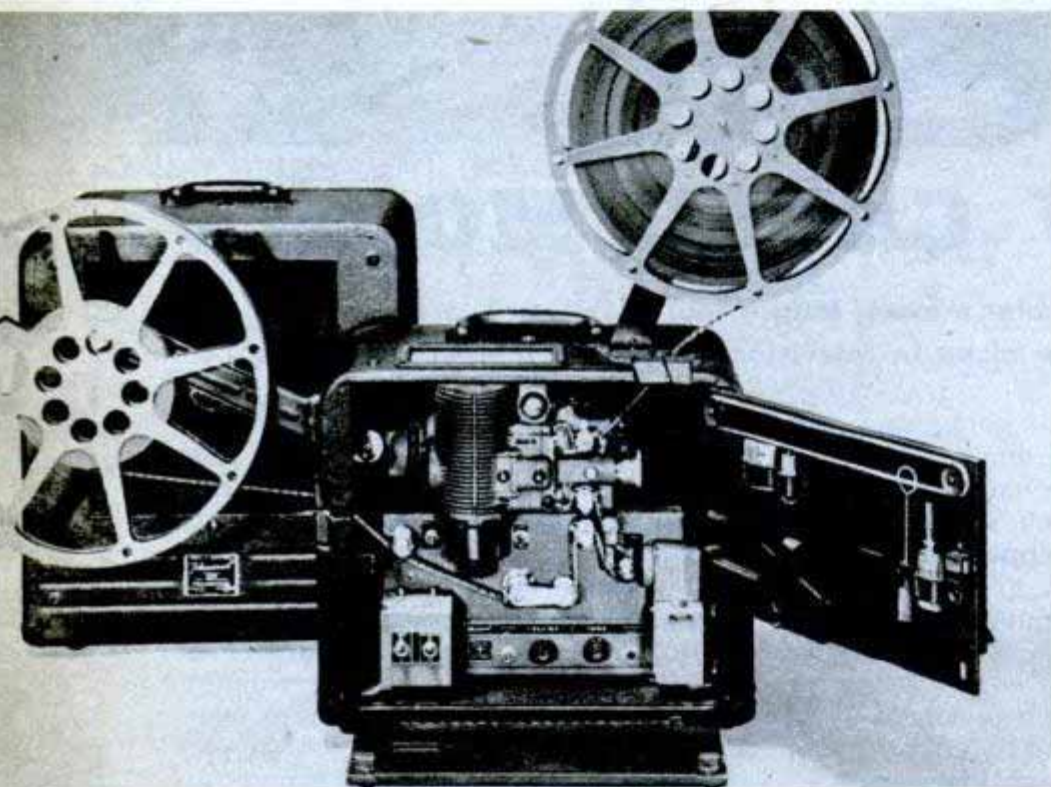

↑ One big advantage of modern 16-mm. sound-movie projectors is that they are portable. This Bell & Howell machine folds inside carrying case

↓ Shooting an educational film in the kitchen with 16-mm. equipment

Telefilm photo



The portability of 16-mm. equipment, its relative cheapness and the increasing demand for motion pictures that would instruct special audiences all combined to increase the popularity of the small-size film. Now precision types of cameras and projectors are being built. Manufacturers of the Mitchell movie camera in Hollywood, for instance, are introducing a new "16" that virtually is a duplicate of their big studio camera. Intended for the mushrooming 16-mm. professional field, its cost is beyond the average amateur pocketbook. To assist in making time-motion studies, Bell & Howell has developed a new electrically driven 16-mm. speed camera that can operate at up to 4000 frames per minute. Other recent improvements in narrow gauge movies include better fine grain development, a tiny but adequate sound track alongside the image on the film, mono-pack color film and new arc-type projection lamps.

On several occasions theater audiences have watched full-color movies, with sound, projected on full-size theater screens with perfect satisfaction, unaware that they were being entertained by 16-mm. movies. Arc lamps that deliver about three times the illumination of standard 1000-watt projection lamps made this possible.

Eastman Kodak is fitting 16-mm. projectors with Lumenized lenses, coated with a microscopically thin layer of magnesium fluoride. This permits screen area to be enlarged one third without using projector bulbs of higher wattage and at the same time increases screen brilliance one third.

Black-and-white 16-mm. movies as used in the average projector can cover a 12 by 16-foot projection screen but more often are shown on portable screens up to 8 by 12 feet in size.

Today in hundreds of communities that are too small to support regular motion picture theaters, modern 16-mm. sound movies are being shown to audiences of several hundred people. These so-called movie road shows are a new development in entertainment. An operator purchases a projector, arranges for the leasing of 16-mm. films and news reels, and exhibits in a different community each night. Each show is held in an empty store building, schoolhouse or tent. His portable projector uses fireproof film, hence no special projection booth is needed. His film rentals cost possibly \$20 per night and he charges from a quarter to a half dollar per head for admission. Each night he tacks up adver-

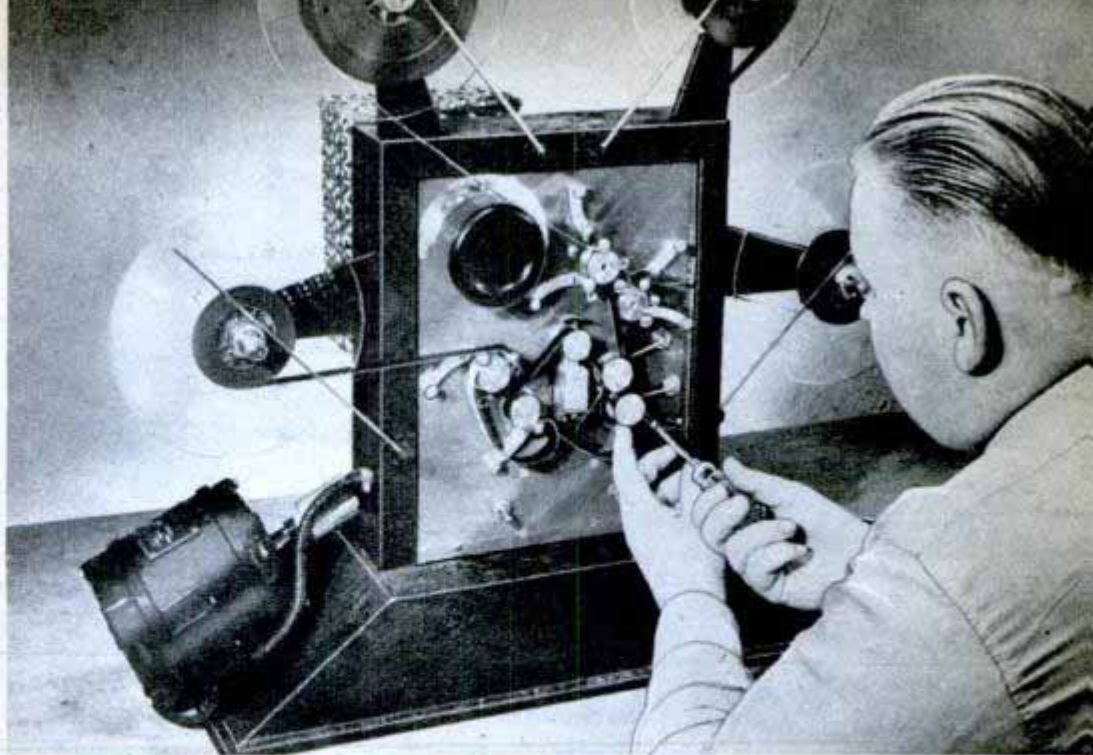

Electrically driven precision sound printer puts the reversed sound track on a 16-mm. color film. Printer's reels are made of transparent plastic

tising placards that describe the films he will exhibit the following week.

So important has this new field become that the major studios are optically reducing their full-length feature pictures of several years ago and are releasing 16-mm. prints. Some of them, in fact, are printing their latest releases on 16 as well as on 35

Operator threads film through sound head of projector and television camera so sound is transmitted over air simultaneously with the picture. Scanning tube of camera is located inside housing to avoid extraneous light

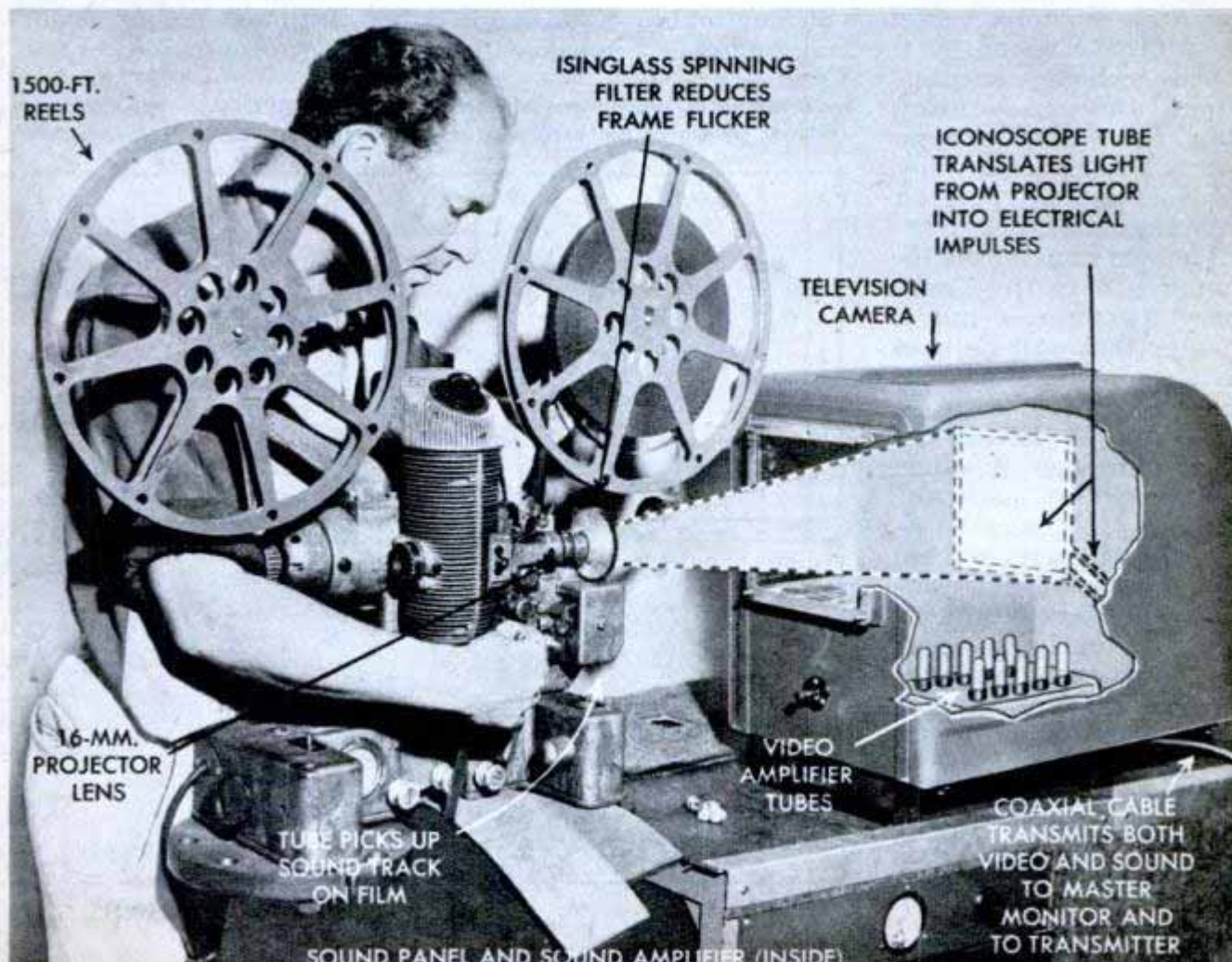



Narrator supplies voice accompaniment to the film as he watches screening in the studio. Mixer handles the controls that record voice on film

movie enthusiasts own 16-mm. projectors and many of them, now that they can rent films on nearly every subject from the film libraries, are holding movie shows at home for their own entertainment. Rentals start at \$1.50 for short black-and-white silent subjects. Grade A Hollywood features can be rented for \$17.50. Too, there are hundreds of "message" films that can be borrowed. The only costs are postage and insurance. Railroads are one of many large industries which have numerous full-length movies that describe their functions. Government departments

for distribution abroad. Today several companies in Hollywood and elsewhere are producing entertainment pictures solely for this 16-mm. market. Planet Pictures, started several years ago by a group of Lockheed employees, plans to release 104 first-run full-length melodramas, mysteries, musicals, westerns and other subjects in 1947. With them will be 104 short subjects including comedies, news reviews and animated cartoons.

In addition, operators of the 16-mm. theaters can draw upon the tens of thousands of subjects stocked by the major film libraries, which have representatives in every state. Films of every type and on practically any subject can be rented from these libraries.

Planned soon for the 16-mm. field is the "one-man" automatic movie theater that will be sold on a percentage basis to those who wish to open small movie houses in store buildings or other locations. The "package" will include several hundred theater seats, screen, automatic reloading projector, an untended coin-operated entrance gate, air-conditioning apparatus and cardboard baffles for installation along the walls of the theater to balance the sound and prevent echoes.

Thousands of amateur

such as the Department of Agriculture have spent thousands in telling the story of their work on 16-mm. educational reels. Other government agencies also have films ready for use. The camera store at which you bought your movie equipment can tell you how to borrow these films.

Most high-grade modern projectors come complete with sound attachment. Older silent projectors that can't take advantage of the sound track can be fitted with an attachment that scans the track and plays it through your ordinary home radio speaker. The sound head is attached to the

Six strategically located movie cameras, top, film entire horse race. Bottom, diagram compares the projection areas covered by 16 and 35-mm. film

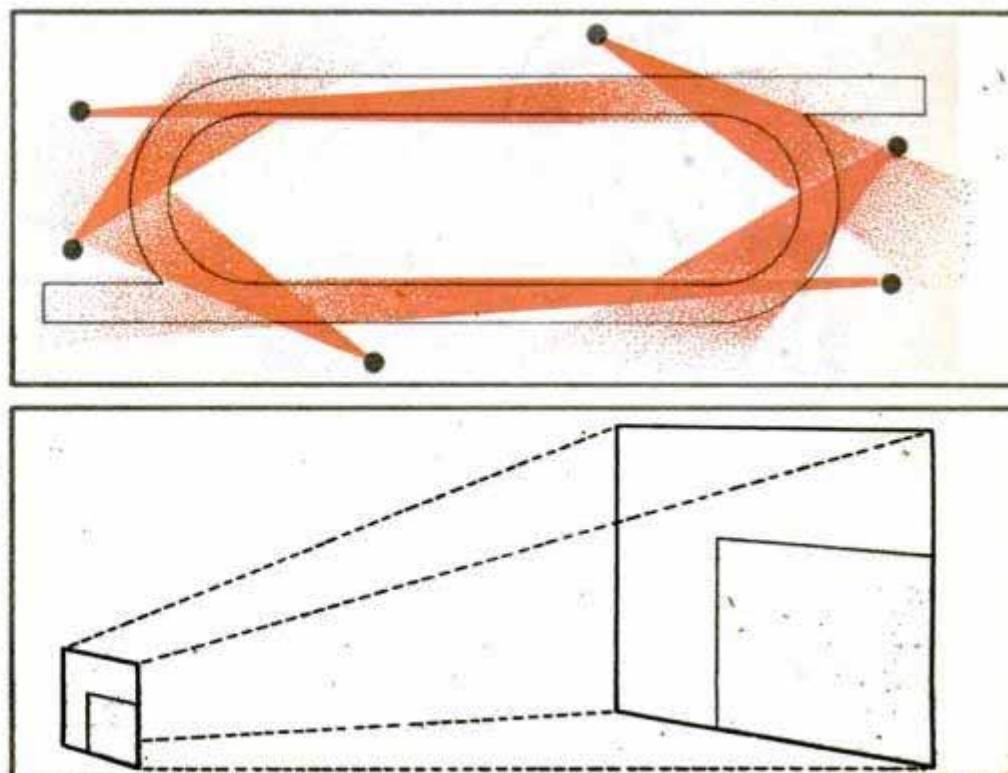

projector by means of a bracket and the film is threaded through both the projector and the sound head. A photocell tube in the sound head scans the sound track and relays the impulses to an electrical adapter that in turn is hooked to any radio broadcast receiver. Theaterlike sound that can be varied in volume and tone is produced. The adapter costs about \$100 and can be fitted to any silent projector. Another accessory on the market is an extension arm that enables most projectors to make use of reels up to 2000 feet in capacity.

Narrow gauge film came into its own for mass instruction during the war, when it was used to instruct millions of war workers, from aircraft pilots to munitions factory employees, in their particular jobs. There are many examples. One, a 30-minute picture titled "Starting the engines of the B-29," speeded the transition of pilots who were learning to fly the big bombers. The picture outlined the cockpit controls that were used to start the engines, the sequence in which they should be operated, the action of each control at the engines and remedial measures to be taken if a control balked.

Telefilm, Inc., of Hollywood, producers

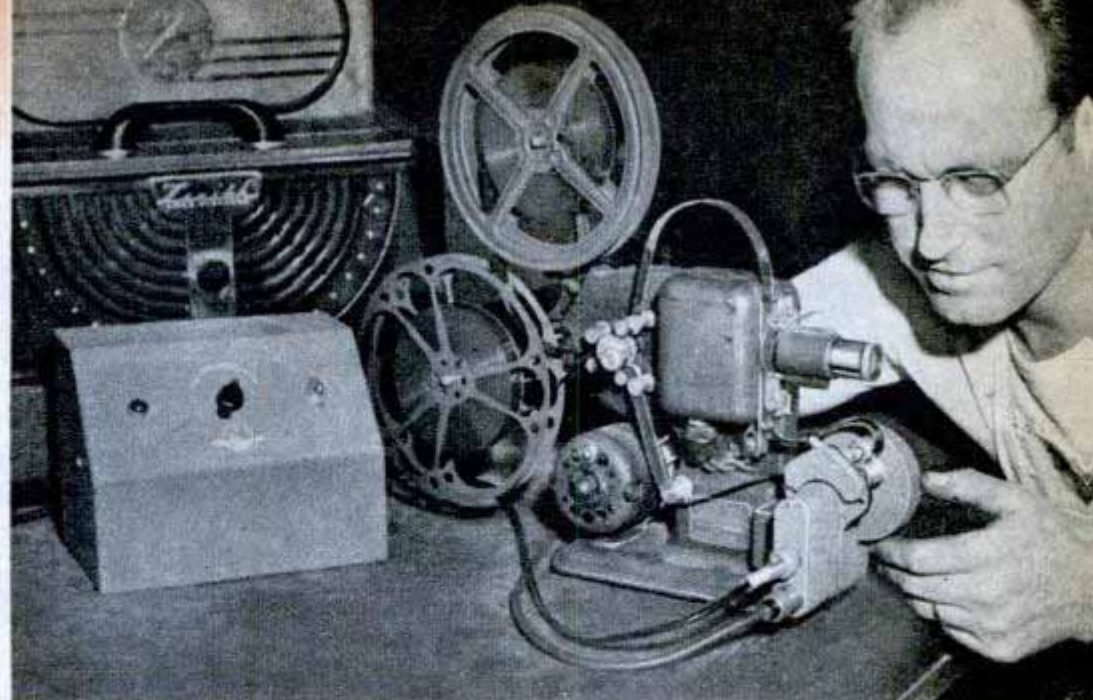

If sound head (at left hand) is attached to silent 16-mm. projector, sound movies can be shown. Sound is played through speaker of radio receiver

When equipped with a hood, 16-mm. projector can show clear movies in ordinary light. Top of the hood is one side of the projector carrying case



of the B-29 picture, developed the technique of making movies of horse races to help the judges settle any questions as soon as a race is over. In the telefilm system now used at a number of tracks, six 16-mm. cameras are mounted on towers so that each camera commands a portion of the track. Each camera is operated until the horses pass that post, then the cameraman unloads the film and sends it down a slanting wire to the ground where it is immediately picked up by a station wagon. The collected reels are processed in seven minutes or less and, when a question is raised,

are projected on a screen in front of the judges. On a number of occasions jockeys have been relieved of their racing privileges or have been vindicated of suspicious riding because of the movie records.

One of the major producers of 16-mm. pictures makes upwards of a dozen commercial films per year for use in public relations by large national concerns. Nearly all the bigger pictures are in color with sound and some of them cost \$50,000 each.

Such is the quality of a modern 16-mm. movie that, aside from the smaller screen usually used, you can't tell it from a release by one of the big studios.

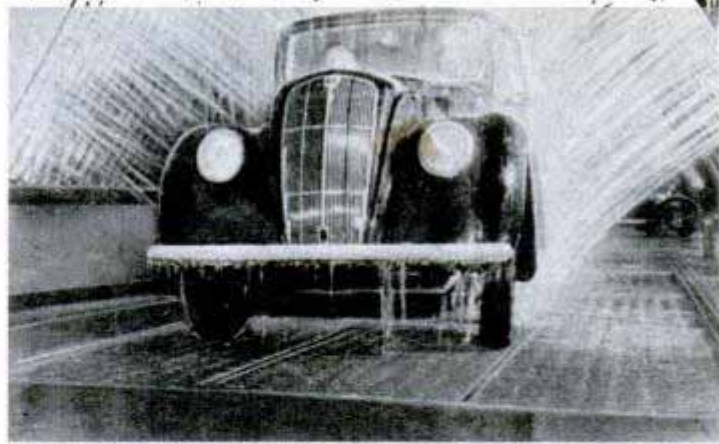

Automobile builders in England are exporting 1000 cars a week to overseas buyers. Since the cars will be subjected to every kind of climate on roads in all parts of the world, exhaustive weather tests are being made at the factories. Two weeks in the weather laboratories equal two years on the road. Heat lamps brighter than

Rain and Ice Test British Cars

the most brilliant sunlight check resistance of paint, rubber and exterior finishing material. Next an artificial downpour tests waterproofing of doors, windows and windshields. In the cold room, cars are exposed to subzero temperature for three days to check ignition systems and ability of engines to start in cold weather.

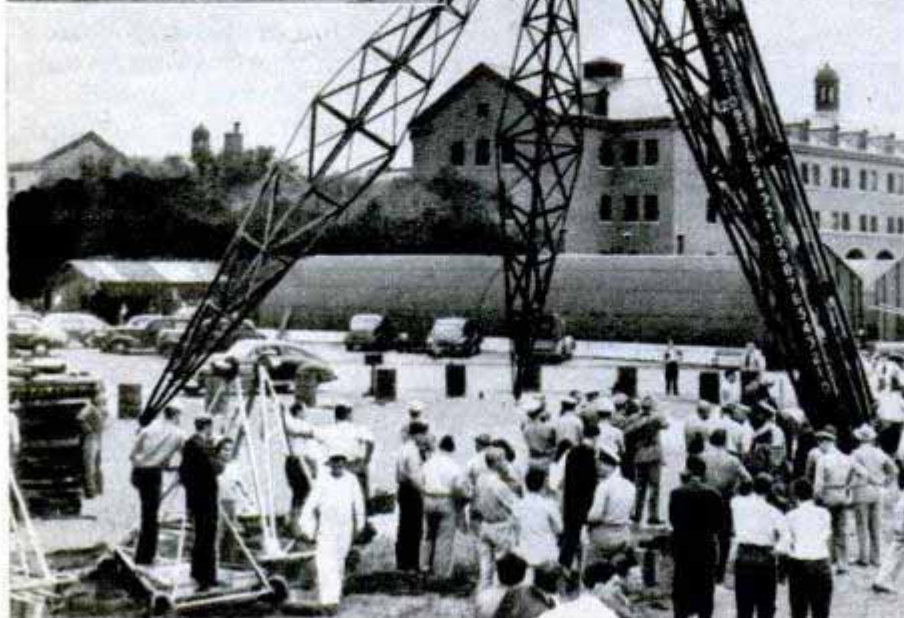

Navy's Pilot Ejector Tested on Tower Track

Tests of the Navy's explosive seat-ejection unit are made with a 110-foot track on a steel tower to guide the pilot seat. The apparatus, operated by a self-fired charge, is designed to throw the pilot 60 to 100 feet clear of a plane flying at supersonic speed. After being "ejected" on the test equipment, pilot and seat slide safely down the track.

Colored Poison Grain Kills Rodent Pests

Because they apparently are color-blind, rodents eat poison grain dyed yellow or green but birds reject the deadly bait. The discovery was made by the U. S. Fish and Wildlife Service during a search for a method to prevent birds from eating bait intended for rodent pests. The birds seemingly are repelled by the bright colors.

Airplane Metal in Hand Truck Cuts Weight to 26.6 Pounds

So light that a child can lift it, a new 26.6-pound hand truck is made of cast magnesium alloy—a metal widely used in airplane parts. The truck body is cast in one piece except for a nose of rustproof steel. All stress points are reinforced, and edges and corners are curved to eliminate snags. The wheels, also of magnesium, are equipped with ball bearings and rubber treads. The truck is balanced to tip forward automatically when unloaded.

"Silver Mushroom" Water Tank Holds 300,000 Gallons

Landmark at Shakopee, Minnesota, is an unusual water tower shaped like a giant mushroom that rises 130 feet into the air. The shining ball atop the steel shaft is 43

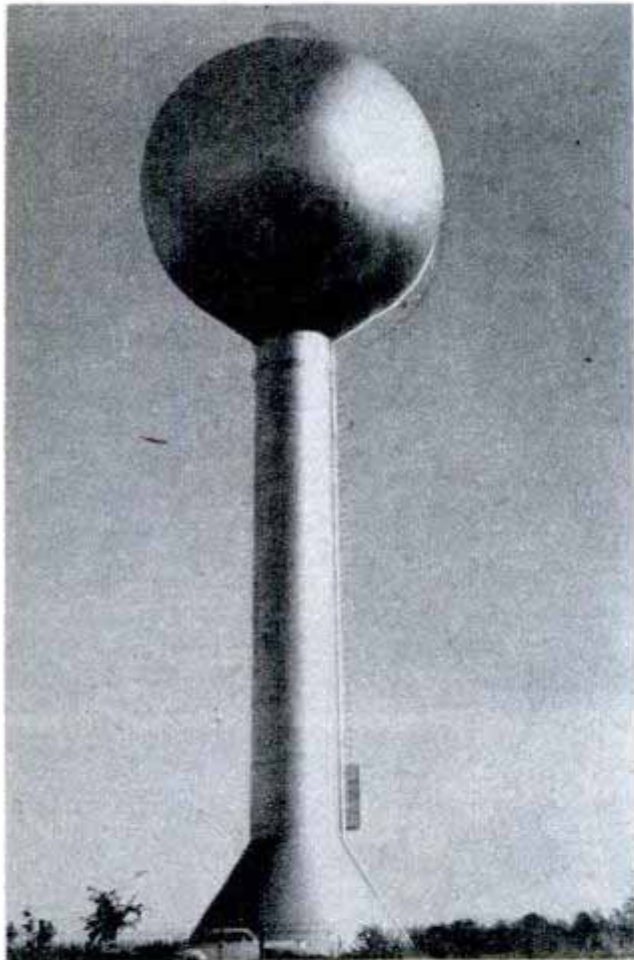

feet in diameter and has a capacity of 300,000 gallons. The conical support for the tower is smaller than the ball, measuring approximately 30 feet in diameter.

Popular Mechanics is always ready to supply further information to readers about various products described in any issue. Just write to Bureau of Information, Popular Mechanics, 200 East Ontario Street, Chicago 11, Ill., for a prompt reply.



Self-Adjusting All-Steel Stand Supports Christmas Tree

It's easy to set up a Christmas tree with a self-adjusting all-steel stand operated by the weight of the tree itself. The base of the tree is placed in an inverted cone cup on the tripod stand. Angle-clamp legs grip it, center it in the stand and hold it perpendicular. The stand holds trees from one to four inches in diameter at the base and from five to nine feet high.

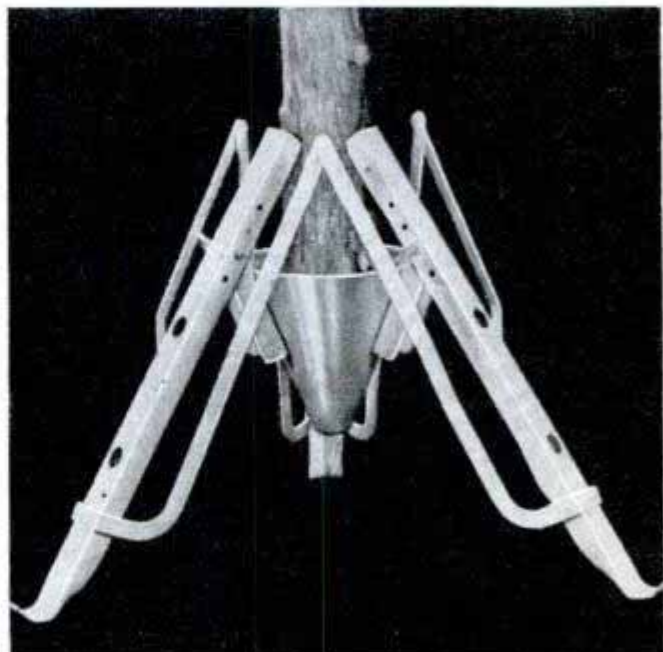



ILLEGAL DRIBBLE. Opposing team gets ball to put into play from out-of-bounds



CANCEL SCORE because ball entered basket after a rules violation



INDICATING NUMBER of player committing foul to scorers at officials' table

Basketball's Sign Language

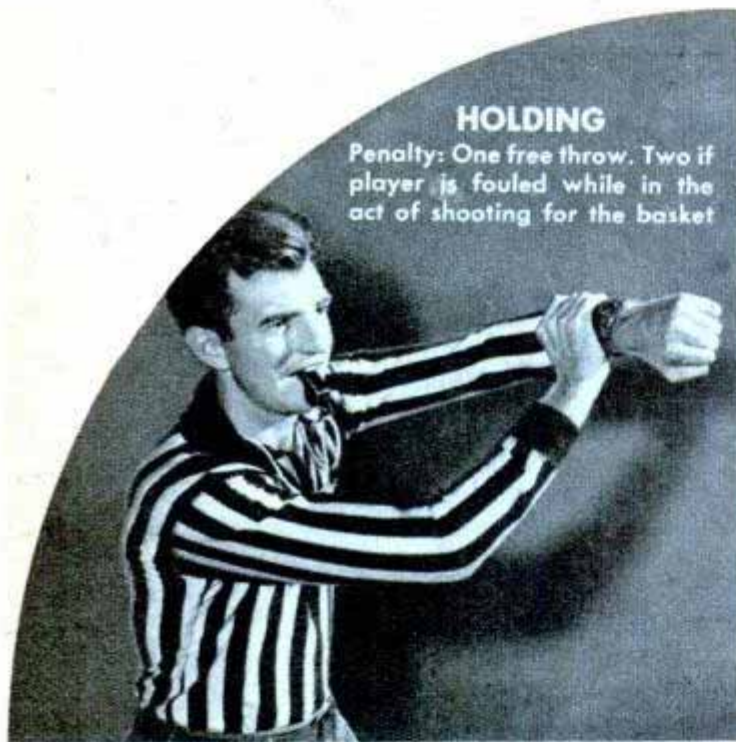

HOLDING

Penalty: One free throw. Two if player is fouled while in the act of shooting for the basket

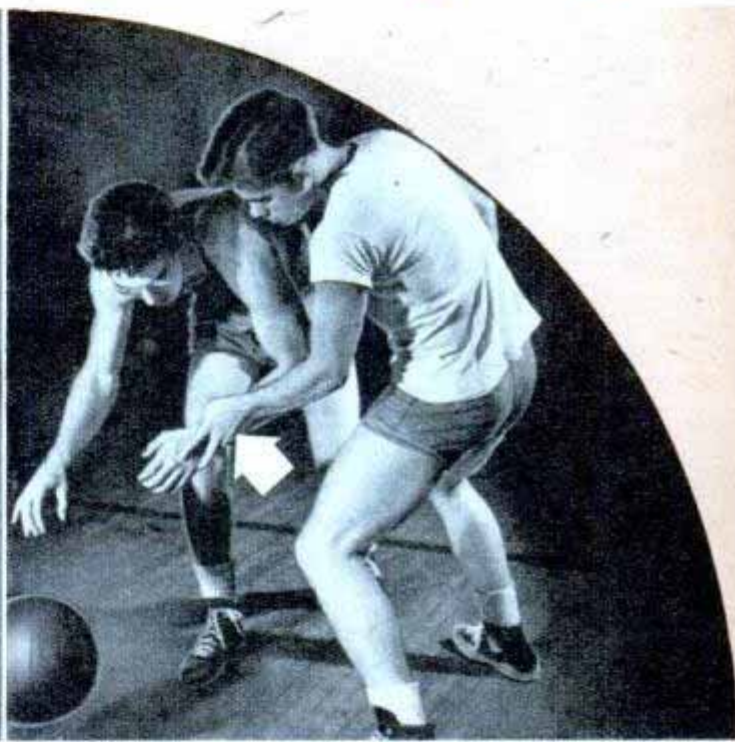

ILLEGAL USE OF HANDS

Penalty: One free throw. Two if player is fouled shooting for the basket



PUSHING OR CHARGING

Penalty: One free throw.
Two if player is fouled shooting for the basket

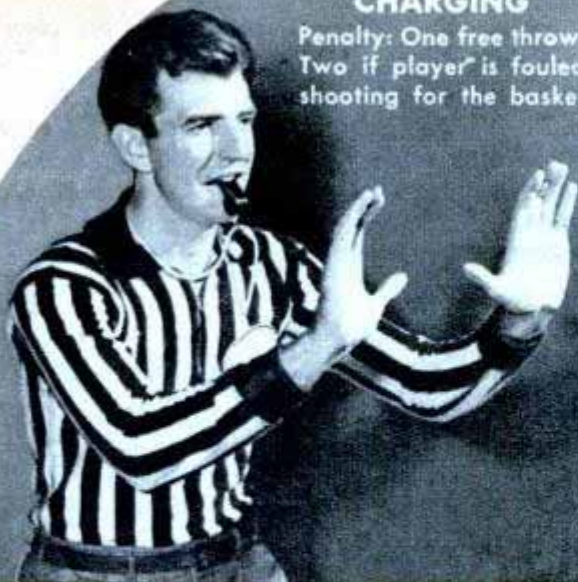

A. SCORE COUNTS

Number of fingers raised indicates points scored

B. NUMBER OF FREE THROWS

Shown by fingers extended

C. OUT OF BOUNDS

Official waves arm laterally

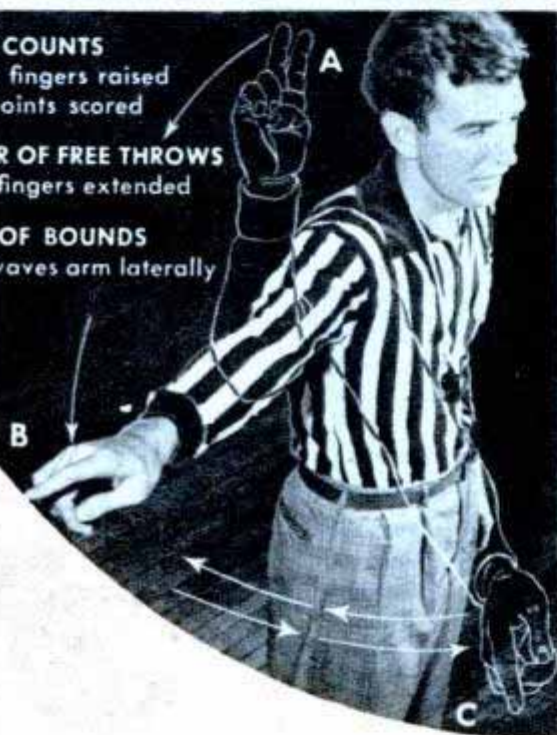

TIME OUT (With foul)

Palm open if play is halted for substitution or any other reason



Basketball spectators, unaided by running commentaries, have to understand the official's pantomime to know exactly what happened. An average of 31 fouls, many not

easily discerned, are called in a game. Some of the more common signals and their meanings are shown, posed by Bob Neu, assistant coach, DePaul University, Chicago.

RUNNING with ball. Opponent puts ball into play from out-of-bounds

JUMP BALL. Generally called when opposing players have one or both hands firmly on ball

TECHNICAL FOUL for a rules violation, not for illegal contact





Wheel-Mounted Snowplow Clears 20-Inch Path

Snow five inches deep can be cleared from a sidewalk with a single-wheel snowplow as fast as a person can push it. With blades set in line, the plow clears a path 20 inches wide. The blades can be set in a V-shape to clear 16-inch paths for auto driveways. When the bottoms of the blades become worn they can be reversed, doubling their life.

X-Ray Counter Checks Radiation

X-rays of widely varying intensities are measured and recorded in a fraction of a second by an instrument which gives science its first all-purpose tool for this task. Developed by Dr. Fitz-Hugh Marshall and Dr. John W. Coltman of the Westing-

Pocket-Size Shoeshine Outfit Applies Polish From Buttons

Folding to the size of a billfold, a shoe-shining outfit has 32 "wax buttons" attached to a pad used as a mitt to apply the polish. A wool buffer adds the gloss. The buttons are available in brown or black, or brown on one side of the mitt and black on the other. Each set of buttons provides approximately 100 shines.



house Research Laboratories, the X-ray "detective" is expected to be useful for both scientists and manufacturers. The counter is an adaptation of an electronic photomultiplier tube used in the past to measure light output. About the size of a radio tube, the photomultiplier tube is converted into an X-ray counter by wrapping it in a sheet of fluorescent screen which is itself wrapped in black paper. While the black paper blocks out all room light, X-rays penetrate to the fluorescent screen. Measurement of the fluorescence by the photomultiplier tube provides a record of the X-ray intensity.

Prefabricated Plastic "Igloo" Featured at Berlin Show

National tastes and needs in housing are reflected in a Berlin exhibition of model prefabricated one-family units made entirely of plastics. They were made from plans submitted by the four occupying powers as representative of the type of homes suitable for export by Germany to their countries. A round house is suggested as the French home and the English model is flat-roofed and oblong. Plumbing, washbowls, bathtubs and other fixtures will also be of plastics wherever practical.

Interest at Berlin centered on model of round house to be built for the French. Below, English selection

Future Farm Tractor

What the farmer needs is a two-way tractor with the same speeds forward and reverse, according to agricultural engineers. It should be able to handle all farm machines. Plowing and cultivating implements must be quickly interchangeable, perhaps through a power hoist operated by the engine. It should have proper tread and clearance for easy steering and minimum crop damage. These ideas were advanced in response to a survey conducted by the Department of Agriculture.

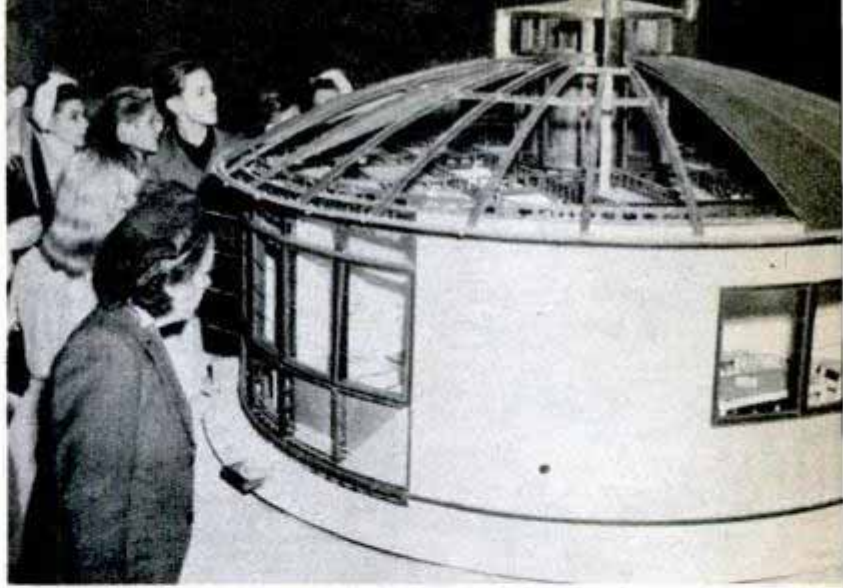

Hard Rubber Spurs on Climbers Grip "H" or "I" Beams

Hard rubber spurs on steel climbers keep workers from slipping from vertical "H" or "I" beams. Strapped over a worker's shoes, the spurs grip the beam section firmly when the wearer rests his weight on the climbers. They support both ball and heel of the foot so that the worker's feet are parallel with the ground in a normal standing position.



Nonflammable Hydraulic Fluid

Airplane fire hazards have been lessened by the development of a hydraulic fluid for aircraft which will not burn. The fluid is used under high pressure to operate brakes, landing flaps, landing gear, controls and automatic pilots. The mixture was concocted in the Navy research laboratory. It is composed of a water base and other liquids which can be used in hydraulic pumps without corrosion at temperatures as low as 50 degrees below zero Fahrenheit. Petroleum oil now used as hydraulic fluid is flammable. The formula for the mixture has been released to all airplane manufacturers and air lines.



1



2



3

- 1** Power from toy electric motor drives colorful Airplane Whirl
- 2** Worm gears control azimuth, elevation of Long Tom cannon
- 3** Bucket loader, dump truck are scale models of big machines
- 4** Electronic doll dances to beat of music from radio or piano
- 5** Electric steam engine shuts off automatically if boiler is dry
- 6** In Foto-Electric football, player can see ball carrier moving



4

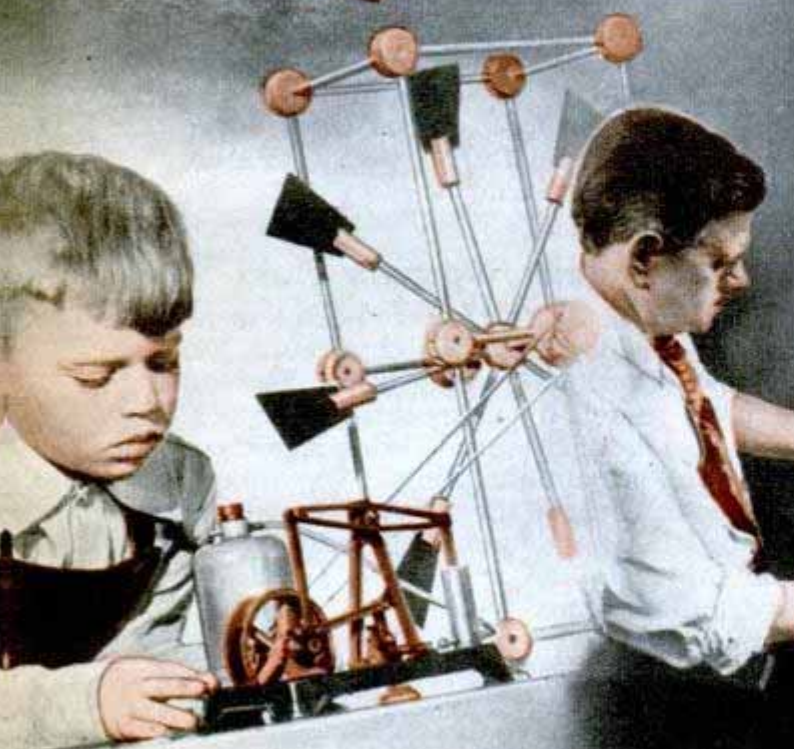

5



6

Designed for Junior Engineers



By Maston M. Jacks

THE Junior Engineer of the great American partnership of Father & Son right now is inspecting critically a vast assortment of new equipment he thinks the firm should acquire.

There is a large reconversion program under way in the basement workshop and recreation room and playroom. Wartime "substitutes" are being replaced by post-war equipment—things that work: miniature trains operated by electronic controls, building construction sets with girders locked by tiny rivets, casting sets for plastics and metals, electric tools for the young



↑ Miniature pulse-jet engines develop over two pounds of thrust to drive model racing boats, cars or planes

↓ Precision attachments on Handee tool help Junior Engineer control depth of cut when routing or shaping





↑ Electric pistol will shoot table tennis balls 20 feet
← Handee drill press table raises workpiece to tool

craftsman, and jet-driven boats and planes.

Father, of course, is the firm's purchasing agent and this Christmas he has some half billion dollars' worth of American-made playthings to choose from.

When Dad himself was a kid, a good percentage of his toys were marked "Made in Switzerland" or "Made in Czechoslovakia." Long before the war, the trend was toward the growing American toy industry, and today there is little representation of foreign

playthings in the department store aisles.

Being a "sidewalk superintendent" himself, Dad is likely to be influenced by his own unconfessed longing for electric trains and model airplanes and miniature steam shovels that work—rather than by the Junior Engineer's own desires, which might be as simple as a pencil set or an empty cigar box for filing away marbles.

Most toys, as a matter of fact, are designed to appeal to the Purchasing Agent. And a big percentage are designed to teach as well as amuse. Many a chemical genius got his start with a toy outfit that intrigued Father & Son together, if it did frighten the feminine part of the family with thoughts of tear gas and TNT in the basement. Many an electrical wizard got his first impulse

Small magnetized metal pellets replace pointed darts in modern version of dart game. Scoring board is metal

Front wheels automatically turn in the desired direction when the body of this toy car is tilted slightly



Carbon dioxide cartridges supply propelling charge for miniature V-2 rocket



toward his career by tinkering with a battery telephone set or an electric motor kit.

During the war, at least 150 manufacturers stopped making toys and went to work on \$100,000,000 worth of contracts for such things as rocket motors, bomb cases, parachute flares and proximity fuses. Other toy makers substituted paper and wood for scarce metal and rubber and kept turning out toys. As a result of war production experience and the finding of new materials, many of the 35,000,000 children under nine this year will be running durable electric trains that puff real smoke, pushing buzzing vacuum cleaners that actually pick up lint and playing with plastic dolls covered with lifelike synthetic rubber skin. One manufacturer is making scale models of heavy earthmoving equipment. To go with a dump truck there will be a chain-drive bucket loader which fills a working model earthmover with sand for a toy concrete mixer that mixes real concrete.

A firm that once made kitchen utensils is building an all-metal car that parks itself, backs up or turns corners. Another is mak-

Lead soldiers are formed in Cast-Rite molds, below. Chemical action and evaporation change weight distribution in thirsty penguin, right, causing it to drink

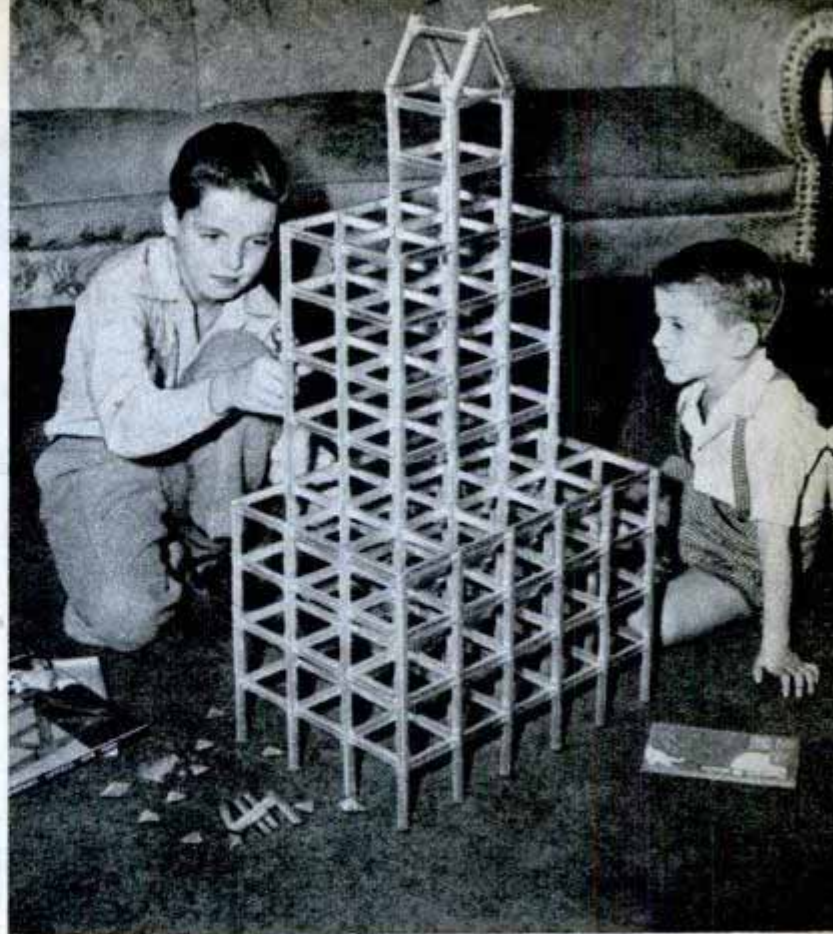

Steel beams in playroom skyscrapers are riveted together. Same tool, below, is used to remove rivets

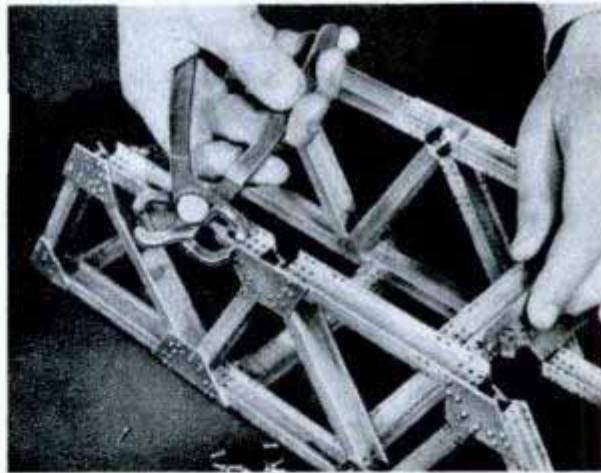



↑ Geared cable drums operate booms of toy derrick

↓ Tiny Diesel engines are available for model planes



ing a plastic car with front wheels that turn when the body is tilted.

So far children haven't demanded toy atomic bombs. But most of the other weapons of World War II are available as playthings, including a V-2 rocket powered by small carbon dioxide cylinders of the type used in charged-water siphons and aviator's life jackets.

Although many parents and educators deplore warlike toys for children, youngsters keep right on playing soldier. Today the Junior Engineer can make his own soldiers of plastics, formed at home in an electrically heated toy injection mold. There are also cannon resembling the 155-millimeter Long Tom. One fires 10 wooden shells when an electric switch is depressed. An electric mortar fires table tennis balls as fast as they are dropped into the barrel. A spring operated cannon, with worm drive gears controlling elevation and azimuth, shoots marbles. The old fashioned water pistol has become an atomic rocket weapon. It has a long brass barrel with plastic grip and water cylinder. On one filling, it will fire 25 to 30 bursts of

water up to 50 feet, enough to wet down all the opposition in back-yard battles.

Materials shortages forced some manufacturers to switch to plastics and their use is continuing. Dolls, doll houses and furniture are of plastics. Water flows in a plastic doll-house sink, part of a toy kitchen set.

(Continued to page 264)

New version of battleship game is played on red opaque Plexiglas board so players can't see opponent

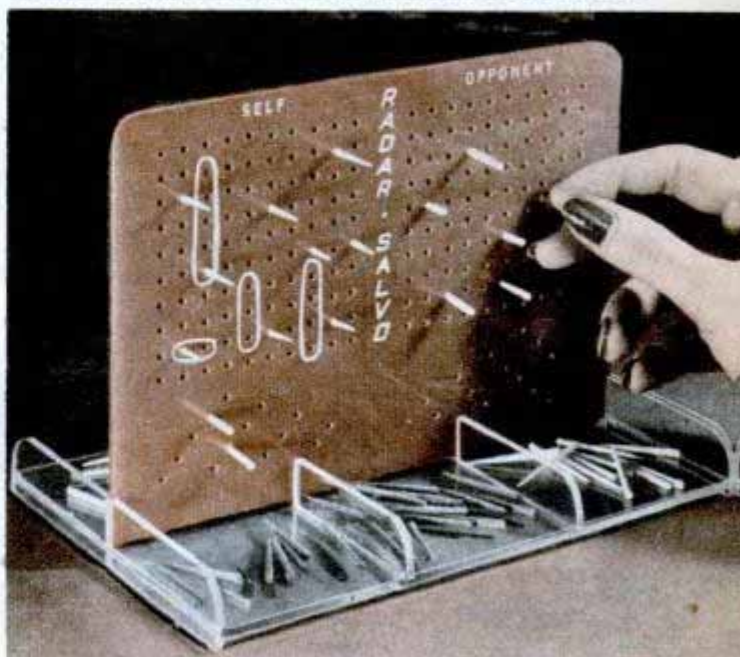

Straight-Shank Expansive Bit Fits Electric Drill

Made with a straight shank for use in an electric drill or drill press, an expansive bit bores holes from 1½ to 3½ inches

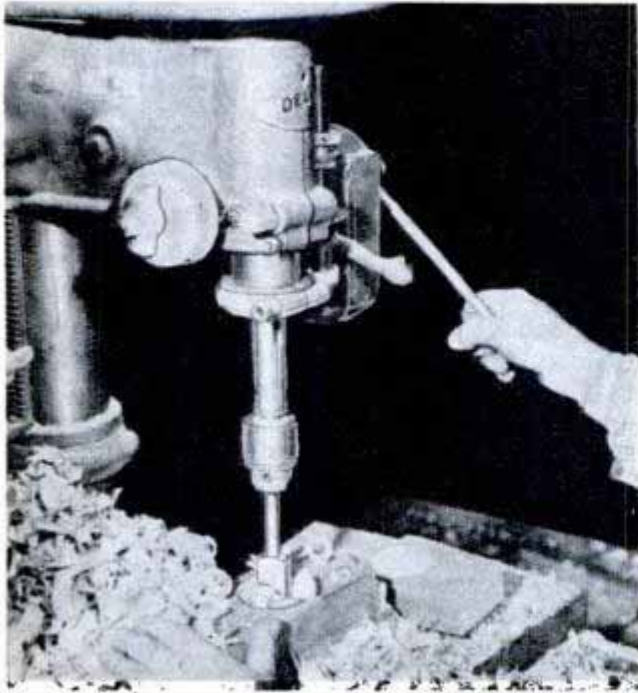

in diameter in wood. Sturdily constructed, the center lip of the bit extends back to form a clamp which holds the adjustable blade at the diameter set. The clamp is locked tight by a screw. The screw point is extra-long and finely threaded for greater efficiency.

Stairstep-Type Gathering Rack Speeds Assembly of Book Pages



Pages to go in booklets can be gathered in sequence at the rate of 3500 sheets per hour with a sectional gathering rack. Permitting the operator to stand or sit, the rack fits on a table, bench or desk. It consists of six sections, and other units can be added to permit the handling of a greater number of pages.



Round Edge on Darkroom Tongs Prevents Damage to Film

Rounded edges on the long lips of photographer's tongs made for darkroom use speed the handling of film and prevent damage to film or paper. A spring mechanism causes the stainless tongs to grasp the paper firmly. The user opens them easily with finger pressure. A hole is provided in one arm so the tongs may be hung up.

Plastic and Metal Packing for Pumps Withstands 900° Heat

Metal and plastic are combined with lubricated asbestos fibers to form a resilient packing made as either spirals and rings. It conforms easily to any shape and is used in standard stuffing boxes of pumps, agitators, mixers and valves. Impervious to steam, acids, oils or caustics, one type of the packing withstands temperatures to 450 degrees Fahrenheit and another to 900.

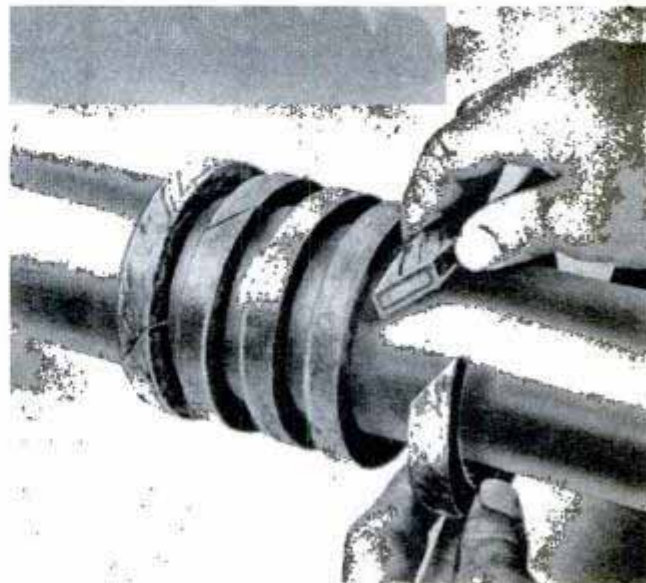

"Accordion" Rack Files Papers In 12 Expandable Compartments



Sorting mail and office papers is simplified by an expanding rack equipped with alphabetical or numerical file guides. Twelve compartments hold up to 100 folders, with a minimum opening of 25 inches and a maximum of four feet. When not in use, the rack collapses for easy storage.

Electronic Photo Retoucher Cuts Work Time to One Third

Electronic control is embodied in a photo retouching machine to produce finer work and in approximately one third the time required with former methods. By making a single line with a standard retouching pencil, the operator gets a correctly

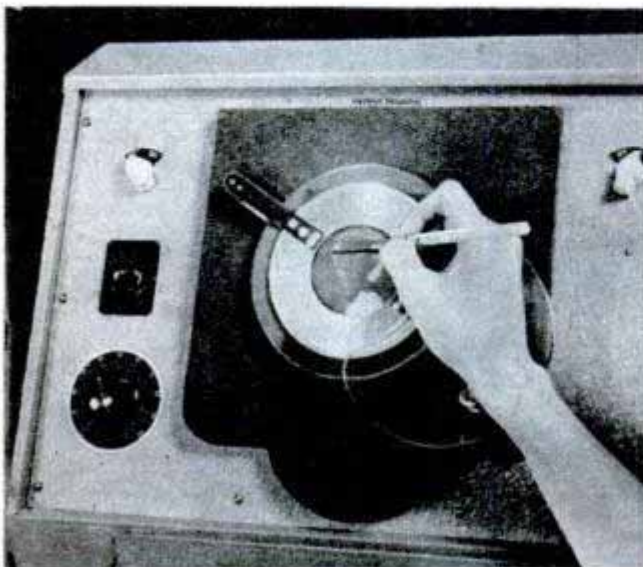

diffused pattern of strokes at the rate of 2000 per minute, with no visible motion of the negative. An adjustable rheostat knob governs fineness of diffusion, and fingertip control regulates cool fluorescent light to provide proper illumination for any negative intensity. Housed in an all-metal case, the instrument weighs 18 pounds, is 12 by 18 inches in size and operates on 110-volt alternating current.

Slight Move Opens Speed Chuck Without Stopping Motor

For any turning operation, a high-speed chuck is designed so that it can be opened or closed by slight movement of a handle without stopping the motor or spindle. If desirable to stop the spindle, the handle can be used as a brake. For facing, thread-

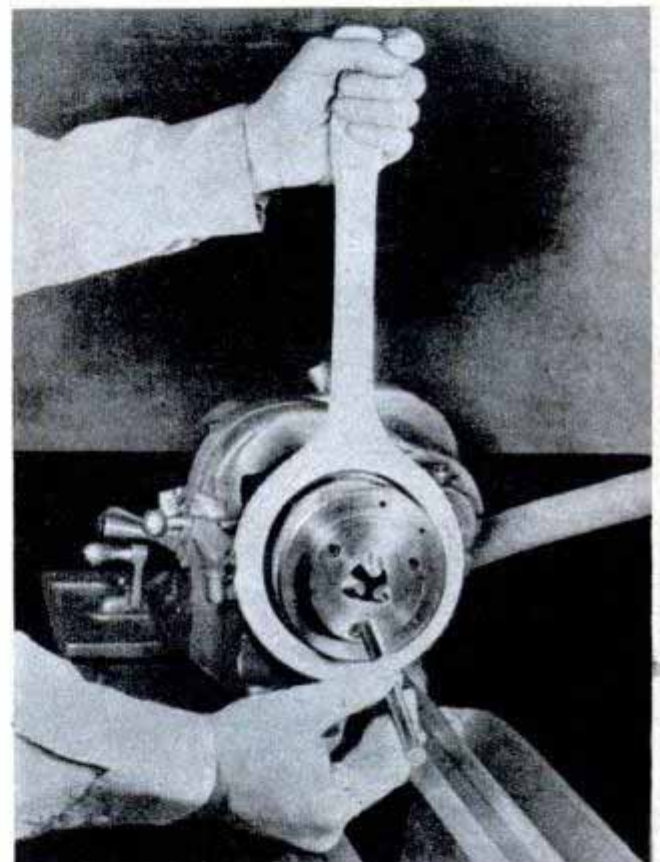

ing, centering or drilling, an adjustable stop accessory may be installed and used as part of the chuck. The jaws can be adjusted for close-tolerance concentric or eccentric turning operations. The chuck will hold any size or shape of bar stock in its size range.

"Leather" Coating for Work Gloves

Cloth work gloves will soon be coated with a tough, flexible plastic called vinyl butyral, affording protection similar to leather. The plastic coating is washable and grease, oil and grime can be removed with a solvent. It has demonstrated good wearing qualities and an excellent grip.



HUMMINGBIRD CAFETERIA

By Richard W. Emery

Photos by H. S. Melvin

FOR a ringside seat at a spectacular air circus, build a hummingbird cafeteria. That may sound pretty tame. After all, a hummingbird is no bigger than your thumb. But oh, brother, what a pilot he is!

He's got the bravest heart under feathers. He has a power plant which, by ratio of weight to speed, makes mankind's latest and best look clumsy. He's good for 3600 r.p.m., so to speak—60 wingbeats a second.

When he turns on full power for a brief burst, he can cover a quarter mile at 150 miles per hour. But he's good for a steady 100 miles per hour for seven or eight hours. Twice a year he zips across the Gulf of Mexico, traveling 700 miles in seven hours.

For acrobatics in the air, he's matchless! He can fly straight up or straight down, stop as if he'd hit a brick wall, zigzag like a ricocheting bullet or hang in midair, motionless except for his whirring wings. He can fly sidewise and he can fly backward.

He knows every trick of combat flying



Up to 6000 hummingbird guests per day have hovered over the serving beakers at the Tucker supercafeteria near Orange, Calif. In return for a little sugar water, the winged acrobats will put on a great air show

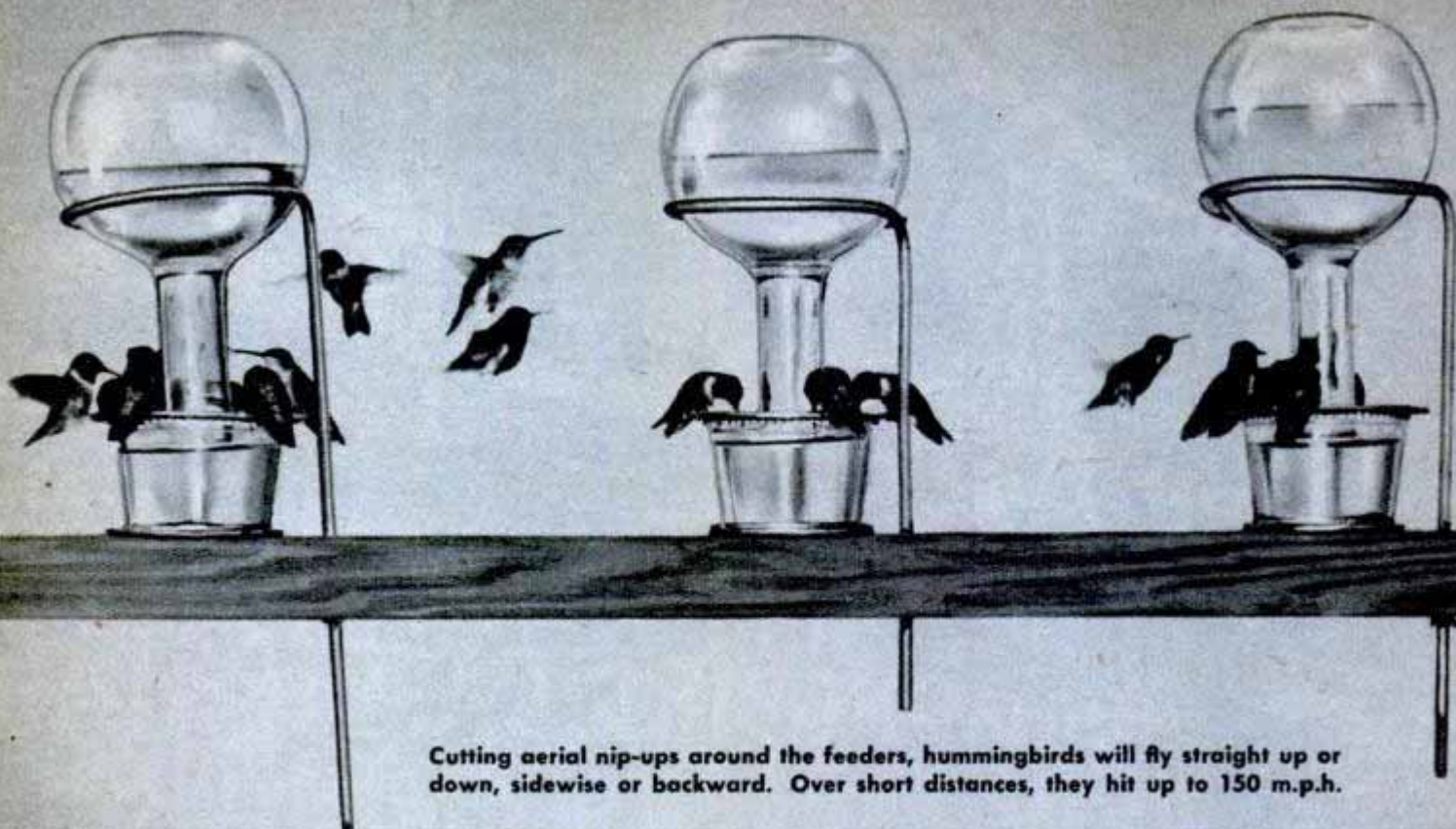

Cutting aerial nip-ups around the feeders, hummingbirds will fly straight up or down, sidewise or backward. Over short distances, they hit up to 150 m.p.h.

and aerobatics. With a needlelike bill as his only weapon, he'll tackle a sharp-shinned hawk and send the hawk screeching for help. The big tough boys of the air have great respect for the needle that blinds them in flight!

Flying is so easy for a hummingbird that he'll fly one inch, instead of hopping. He uses his feet only to perch, not to hop or walk. He's an aerialist all the way, cocky and self-assured, a joyous acrobat who looks at you with beady eyes as if to challenge you to come out and fly with him.

You can't watch hummingbirds without catching some of that gay confidence. They

radiate spunk. They're not the least down-hearted at being so peanut-sized. If their size matched their spirit, they'd look eye-to-eye with the mighty eagle!

If you want them to perform for you, the birds will meet you halfway. If you do your part, they'll do theirs.

It's a matter of eating. The hummingbird likes a balanced diet—half meat and half nectar. Left to himself, he'll search for a neighborhood where he can find both. If the flowers dry up, although there are still lots of tiny insects, he'll leave. Or if the flowers are blooming, but there's a bug shortage, he'll leave.

SYRUP FEEDERS ATTRACT HUMMINGBIRDS AND REPEL ANT!

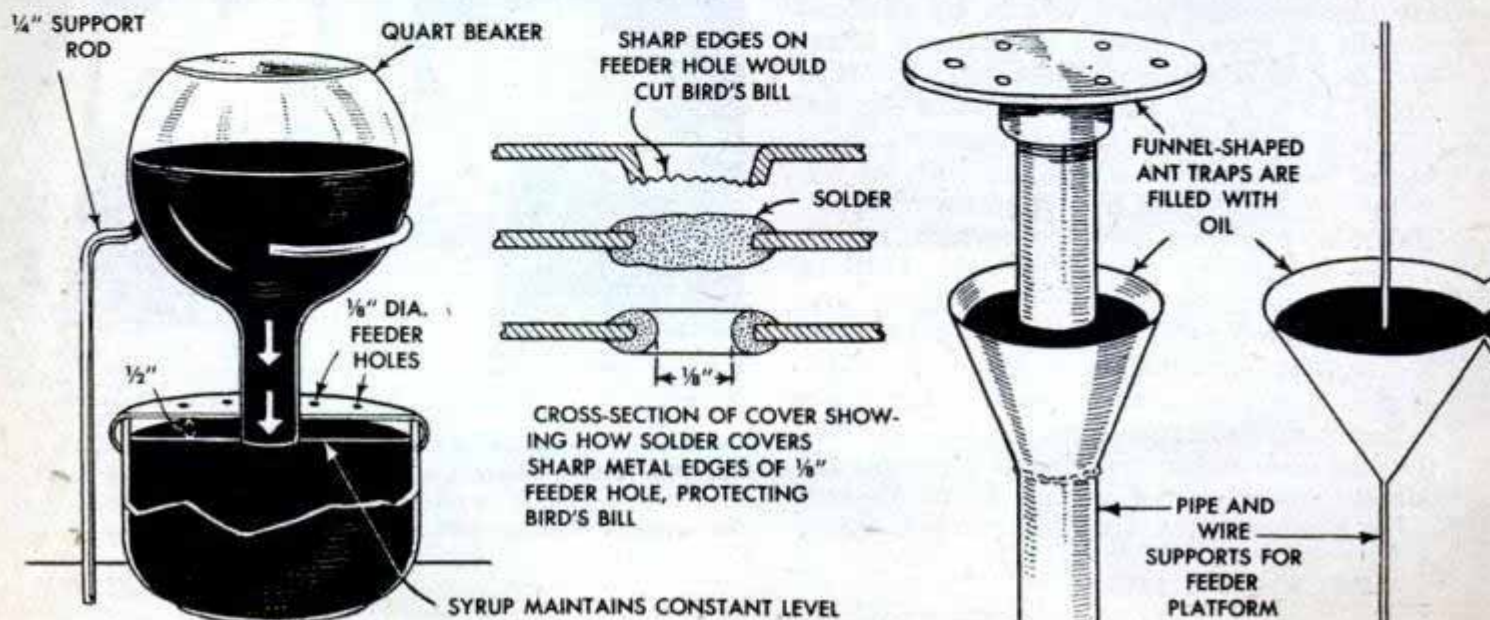

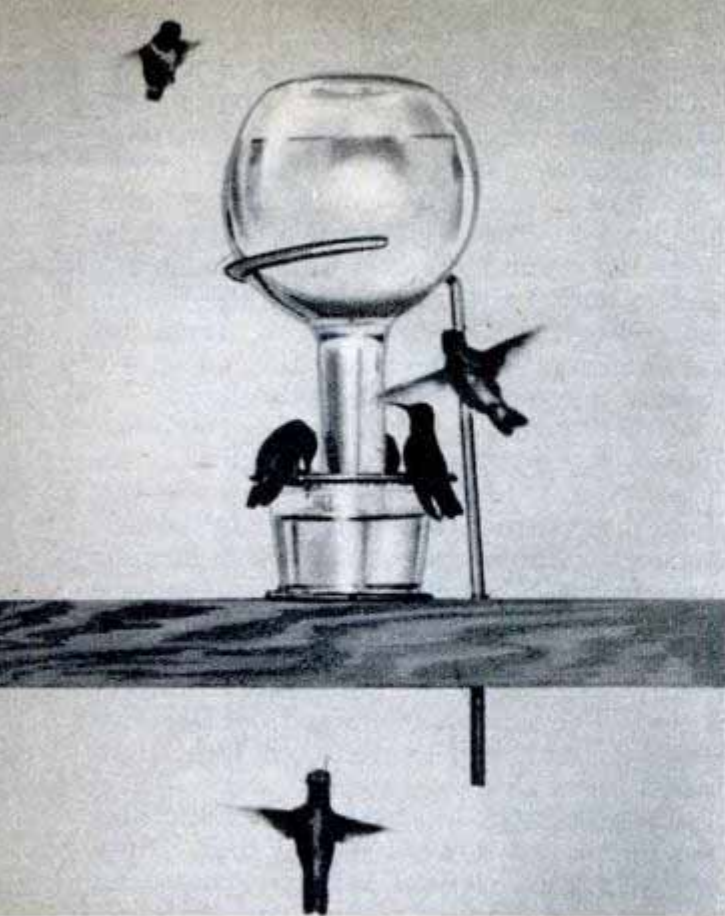

If you supply artificial nectar—half water and half sugar—he'll stay long after flower blooming time and he'll eat tiny insect pests to pay for his keep.

He and his pals will perform aerial nips right in front of your window. That's where you'll place the permanent cafeteria. But first you must make some preparations.

You start out with a test tube or similar small bottle, enough sugar syrup to fill it, a two-foot piece of wire, and a flower. Choose a flower from a patch you've seen a hummingbird visit—a deep-throated flower, preferably red.

Nip off the deep end of the flower, where

Benjamin F. Tucker, above, founded the sanctuary. He warns visitors that quick movements frighten the birds

the nectar lies. Stick this open end down into the test tube. The idea is that the hummingbird will look for nectar and find, instead, a Thanksgiving dinner.

Twist one end of the wire around the test tube so that the tube will be held upright. Place the free end prominently in the same flower patch your flower came from.

With any luck at all, eventually you'll find a taker. He'll return frequently. Once he's sampled the syrup, he's yours. After a few days he'll drink from the test tube without the flower.

When you have "captured" a bird by the test tube and flower method, you can bring him over to your ringside seat at the window by moving the test tube a few feet closer every day. Choose a spot above reach of children and cats.

Perhaps you'll decide that one test tube on a wire stem is enough. If you keep it full of syrup, it will have visitors aplenty.

But if you want a bigger show you'll provide a multiple feeder or two. You won't have a great many customers in the first year, but your fame will spread mysteriously in hummingbird society, and year by year your cafeteria will grow in popularity.

Twenty years ago a California businessman started playing host to hummingbirds at his foothill cabin. He used a cactus flower and a test tube to win the first bird. It took two weeks for the bird to decide to follow the source of free nectar, as the tube was

LOWER LURES BIRD TO TUBE

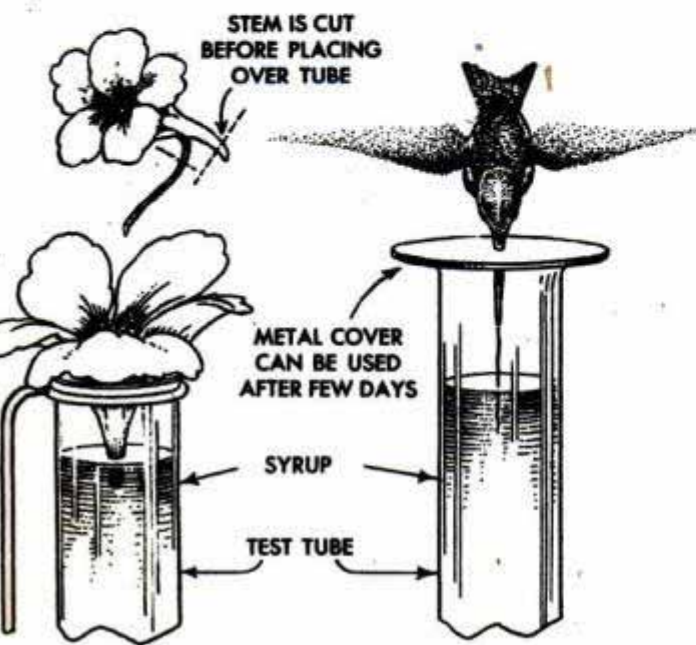



Make nectar half sugar and half water. Hummingbirds repay you for it by killing insect pests. Fill the beaker through a funnel; after filling it slip the perforated metal cover over neck. Then place cup upside down over open end of beaker. If you spill the nectar, wash it up because it also attracts bees and ants

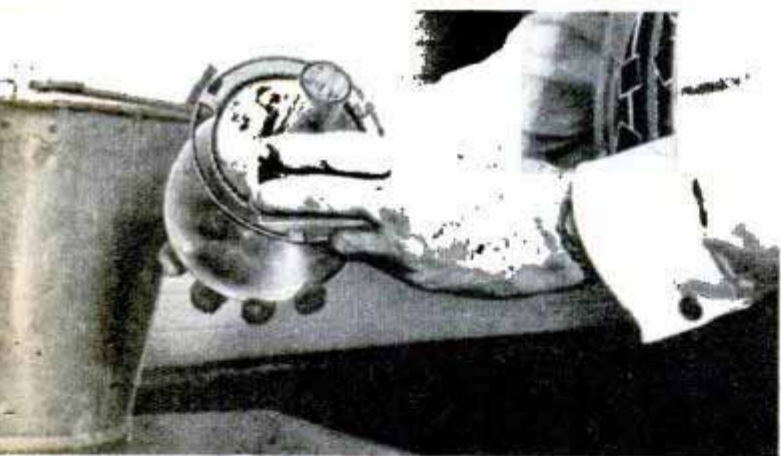
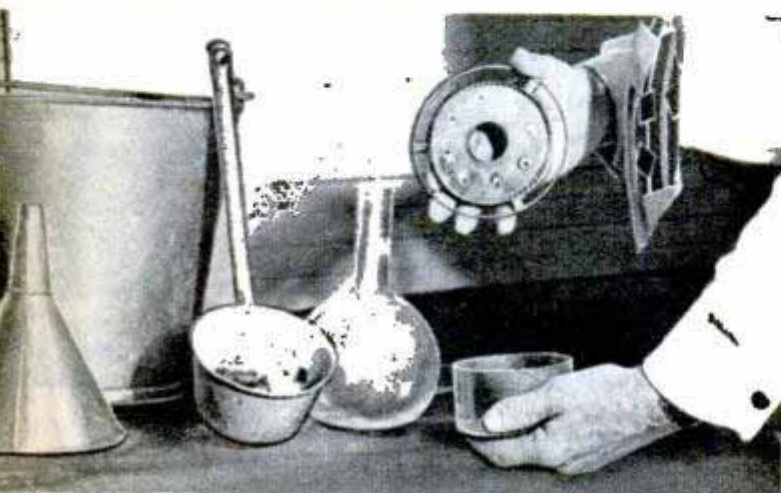

After turning beaker upside down, below, regulate level of liquid by adjusting height of beaker support

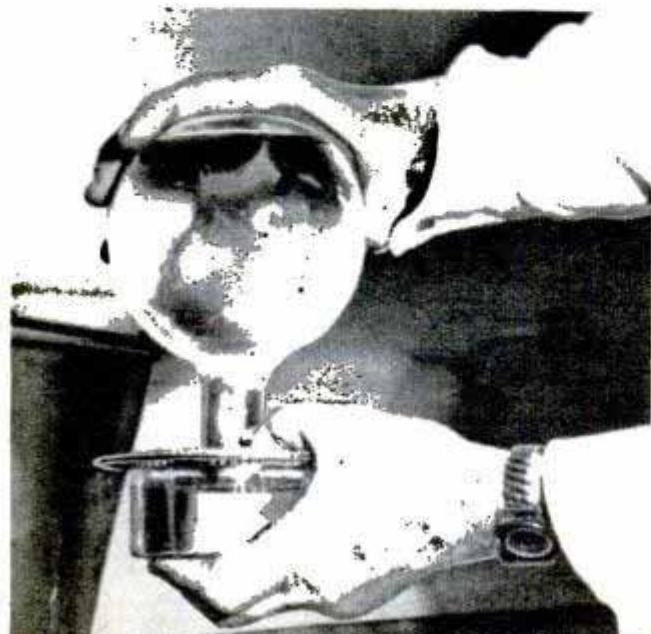

moved a little nearer the cabin each day.

The first year, three birds were regular visitors; the next year, six or eight. The third year, 30 or 40 birds arrived and stayed.

Curious to see what would happen, and delighted by the aerial antics of the tiny birds, Benjamin F. Tucker built a dozen big feeders and got them ready for the fourth year. When the birds began to arrive, he was amazed. More than 100 swarmed around, joyously doing loop-the-loops.

After 10 years, the cabin had become nationally famous for its hummingbirds. As many as 6000 of the wee flyers made the place their spring, summer and fall headquarters. Hummingbird nests were located everywhere, in the oaks and sycamores, under the eaves of the cabin, even on telephone wires. Several years ago Mr. Tucker deeded the place to the California Audubon Society. The sanctuary, named the Dorothy May Tucker Bird Sanctuary, is located 16 miles east of Orange, Calif.

Hummingbirds like red flowers best and orange-colored flowers second best. They dip their long, slender bills into the deep tubes of such flowers as larkspur, trumpet vine, honeysuckle, petunias and verbenas, and hoist up nectar through an extensible split tongue which forms two tubes. They capture insects on the wing and also in flowers and in the bark of trees.

Hummingbirds are found only in the Americas. Most of them migrate southward when cold weather comes, winging away for some South American retreat. They return in spring. West of the Rockies, a species known as the Annas loyally stays through the winter season.

You can lure hummingbirds to eat from feeders, but you'll never succeed in luring a hummingbird to use a man-made nest. Within five minutes after mating, the hen hummingbird starts to build her own nest of cobwebs and tree sap. She always builds her own nest and she won't use it a second time. If disaster takes her first brood of one or two nestlings, she grieves for a day and then mates again and builds another nest.

The male hummingbird is a gay and dazzling fellow, but he's no help to his bride when time comes to take care of the baby birds. From the domestic point of view, he's a tramp. He abandons his bride when she starts to build the nest. She lays one or two tiny white eggs. Two weeks later they hatch. The infants look like black bugs. They have neither feathers nor bill. Mama Bird works hard to feed them and she'll appreciate your syrup cafeteria! When the young birds are 21 days old, they already have grown bills and feathers and they fly out of the nest like arrows zipping from a bowstring. They seem to know, right from the start, that they're aerial acrobats.

Boat Won't Sink or Capsize And Holds 80 Persons

Two-in-one lifeboats that are said to be unsinkable, noncapsizable and self-emptying have been approved by the British Board of Trade and tested by American authorities. The new craft looks like two boats fastened bottom-to-bottom. Regardless of which section is uppermost, the bottom section furnishes an air cushion beneath the craft to make it unsinkable, according to inventor H. A. Gaskin of London. The Diesel engine that powers the boat will work either side up, and nonreturn valves empty the boat of any water that is shipped in, making bailing unnecessary. The lifeboat is 45 feet long and 10 feet broad with a capacity of 75 passengers and a crew of five. Compartments in the boat hold six months' supply of food and water.

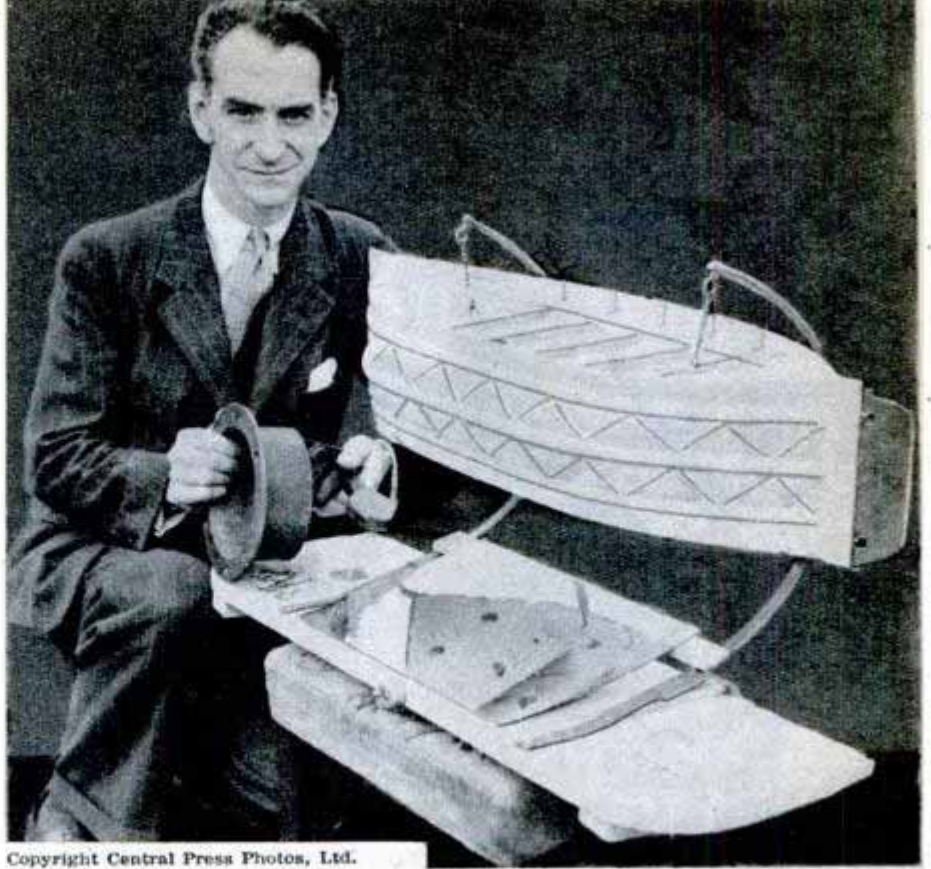

Copyright Central Press Photos, Ltd.

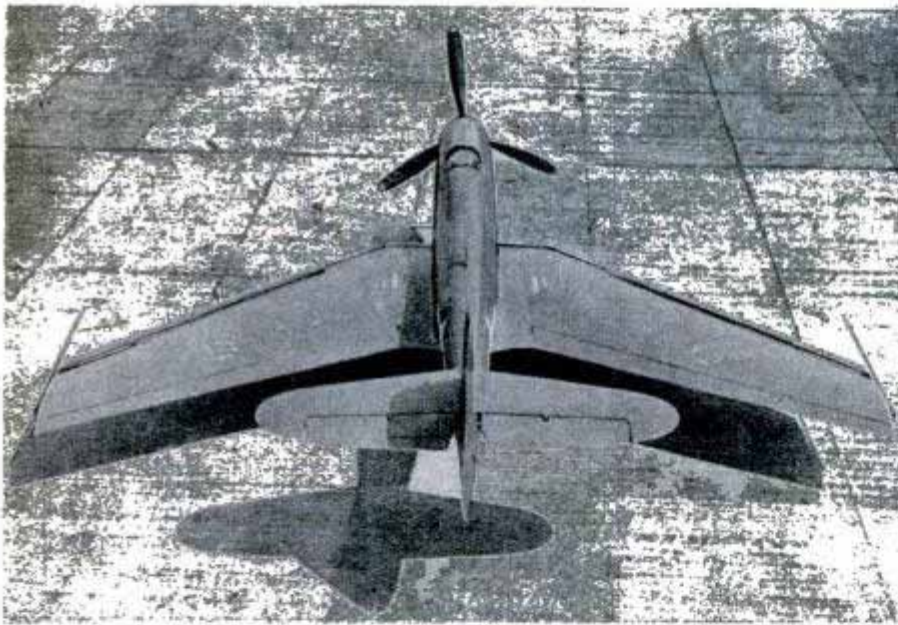

Test Swept-back Wing On Modified Fighter

Possibilities of the swept-back wing in the quest for supersonic plane speeds are now being tested in the Navy's L-39. A modified version of the P-63 Kingcobra, also built by Bell Aircraft, the L-39's wings have a rearward angle of 35 degrees. It is believed to be the first conventional American craft to be equipped with swept-back wings. Swept-forward wings are also being tested.

Coil Toy Made of Spring Steel Walks Slowly Down Steps

Made of Swedish steel, a spring coil toy vibrates as though it's alive and walks down a slanting surface, end over end. When placed on a flight of stairs with the two ends on different steps, the coil walks slowly down the stairs, coiling and uncoiling by its own action. It is made of about 100 turns of the tempered steel.

Using a diamond drill, a tiny machine tool developed by the Russians can bore holes as small as .0001 inch in diameter.

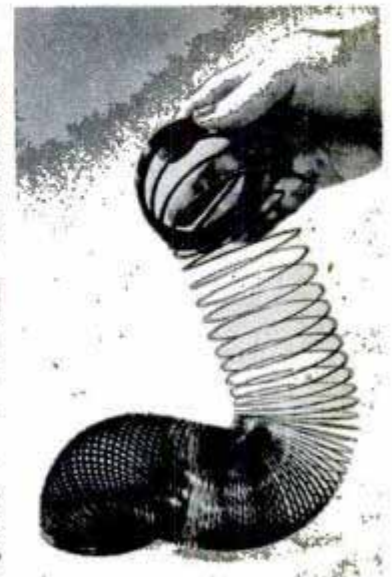
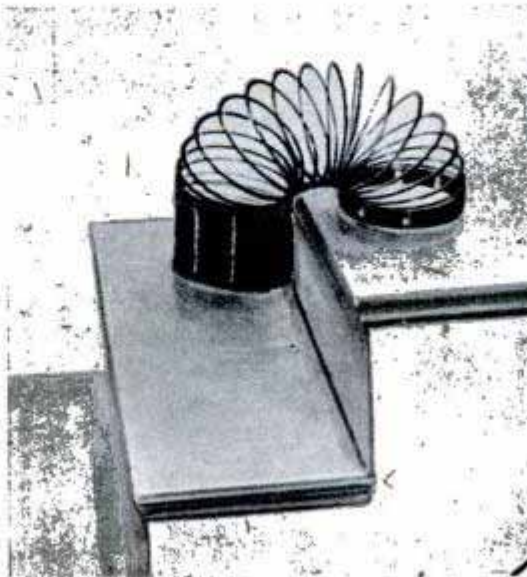



Slide-away kitchen table pulls out of a wall cabinet or sink to seat five persons. Below, six gelatin molds can be stacked vertically in rack for refrigerator.

*"Inside
Stubb"*

for
Your Home

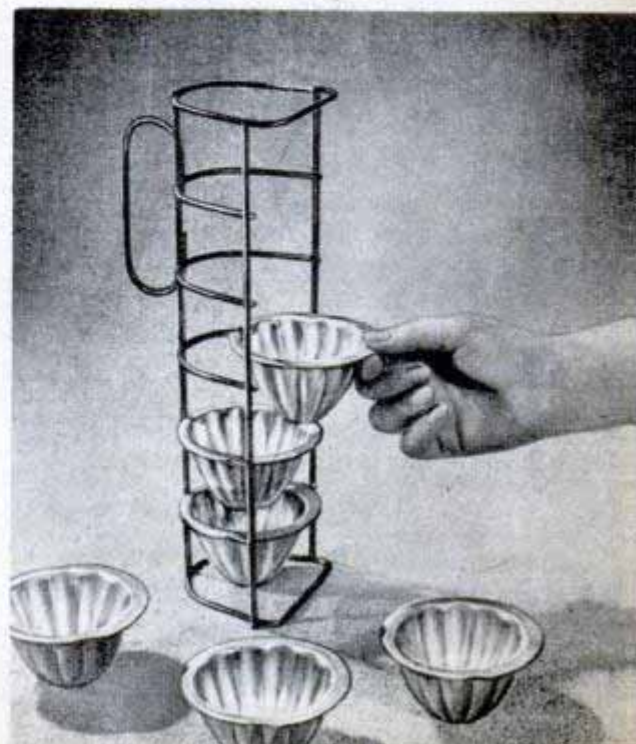

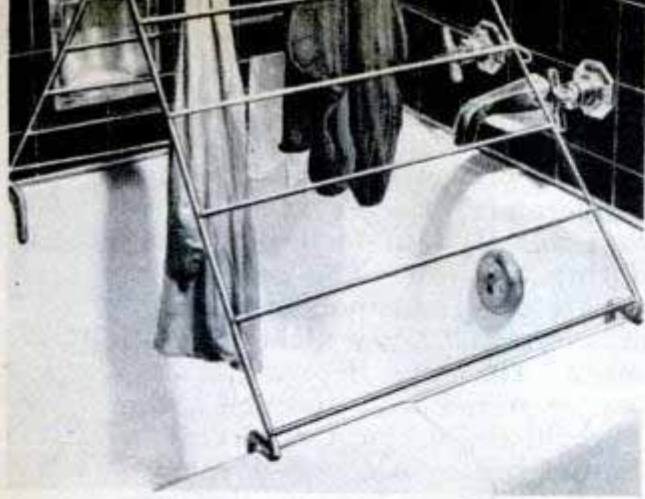

Tent-shaped clothes drier fits over bathtub which catches water drops from laundered lingerie, hosiery and baby garments. Below, pump-type catsup dispenser eliminates shaking or pounding the bottle



Four or five potato slices the right size for French frying can be cut with one movement of the hand when a special cutter is used. Made of aluminum, it has a series of small sharp blades that do the job



Aluminum frame for bottom half of window holds the screen in summer and storm window in winter season



Hot pans, canning jars and cans are picked up easily with the assistance of aluminum tongs. Below, valance hanger has slots to hold drapery in graceful, sweeping curves

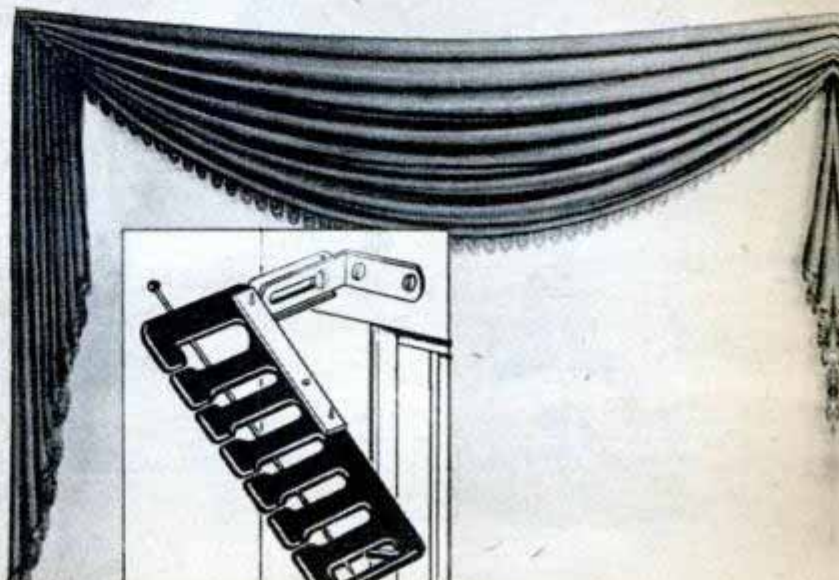



Lamp Kills Refrigerator "Bugs" With Ultraviolet Rays

Rays that deal death to bacteria are emitted from a midget lamp designed for home refrigerators. Larger sterilizing lamps were installed in food processing plants during the war. The new lamp, about the size of an automobile headlight bulb, can be screwed into a niche in small refrigerators. The rays improve sanitation, preserve stored food and check the growth of mold and bacteria, according to Westinghouse engineers who developed the bulb. In addition to the rays the lamp produces ozone, a form of oxygen that purifies the air. Ozone retards the "swapping" of odors that can affect the taste of fresh foods stored in refrigerators. The lamp operates at a cost of about a nickel a month.

Aluminum House-on-Wheels Accommodates Six Persons

When Mr. and Mrs. Max Ranney and their four children, of Wichita, Kan., take a trip, their house goes with them. It's a combination automobile and cabin. The living quarters, designed and built by Ranney, are in an aluminum structure 7½ feet wide and 24 feet long mounted on a six-wheel Franklin chassis. Interior walls are lined with plywood. The house-on-wheels has a kitchen, 24 square feet of window space, sleeping accommodations for six, and its own lighting system.



Automatic Lock on Flexible Cable Makes Drain Cleaning Easier

For easier cleaning of stopped drains, a flexible cable type drain cleaner has an automatic cable lock built into the lower swivel handle. When the handle is moved up, the lock releases its grip. When the handle is moved down, the cable is locked in place for rotating by hand or by an electric drill attached to the T-handle. The aluminum shell holds 25 feet of cable.

Vacuum Control Valve Stops Carbon

Through a special valve, controlled quantities of air are admitted into an automobile engine to reduce the vacuum pressure which builds up on deceleration. The valve permits air to enter only when the throttle is closed. This prevents suction of gasoline and oil into the motor where it forms carbon or blows out of the exhaust in smoke or fumes.

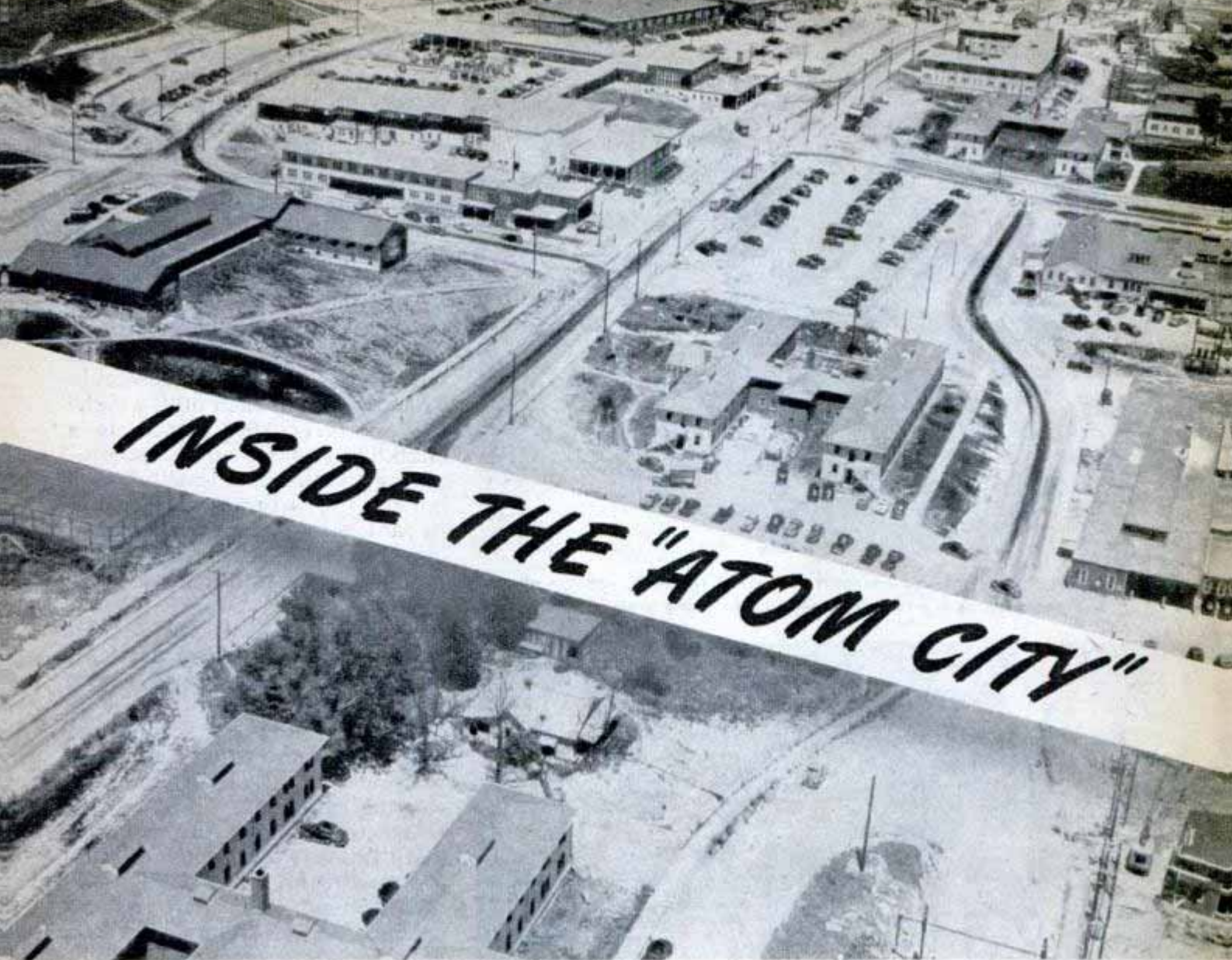

By Chester B. Farnham

STRANGE SIGHTS greet the visitor to the "Atom City" of Oak Ridge, Tenn. As a member of the first group of writers permitted to enter this fabulous place, I saw scientists "canning" atomic energy; researchers producing "RI," medicine's sensational new A-weapon; men peering into periscopes; physicists creating the kind of "capped" energy that blotted out Hiroshima but which may some day help retard the effects of old age in humans.

Standing near the spot where materials for the atom bomb were made, I observed scientists handling by remote control the deadliest substances the world has ever known.

Daily they work with amounts as small as $1/500,000,000$ pound. Many of these by-products of the atomic bomb are in units too small to be seen with the naked eye; some are in liquid form, while others, weighing an ounce or so, are solids. Some are not dangerous at all, while others emit rays able to snuff out a life in less than a minute.

Top, air view of Oak Ridge.
Right, measuring activity of
radio-isotope in Geiger counter



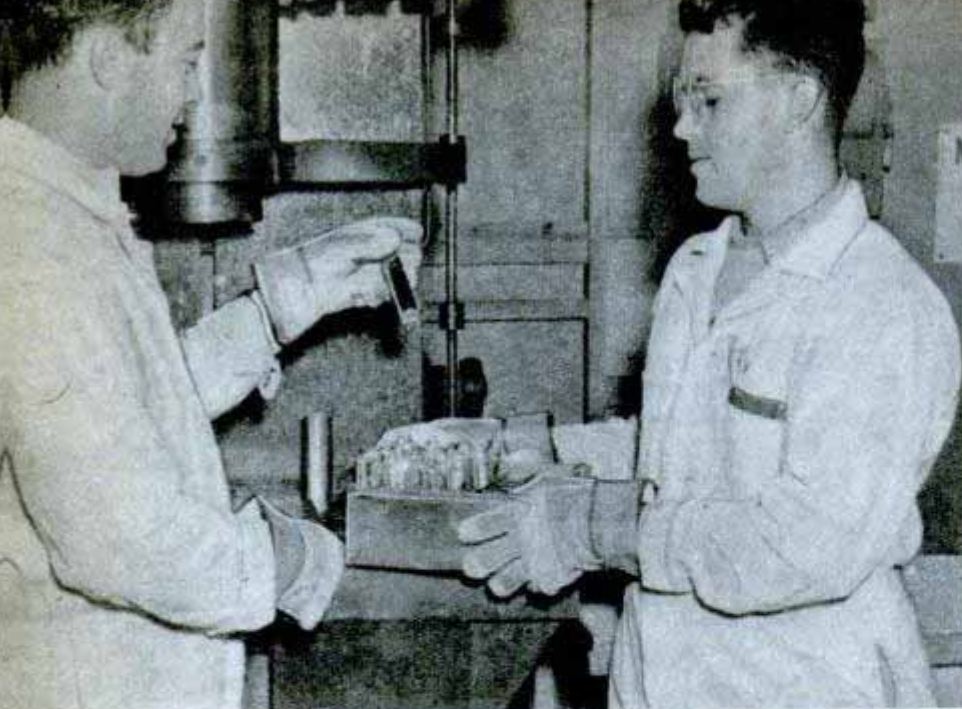

In "canning" atomic energy for medical research, calcium nitrate is measured as a powdered solid before being pressed into pellets

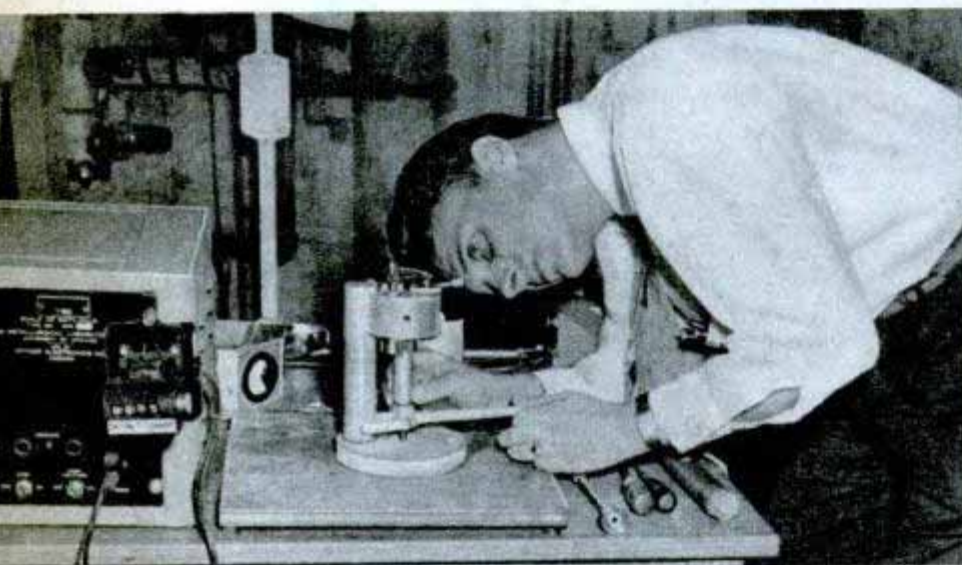

Isotope can is sealed prior to being inserted in atomic pile. Below, removing shielding plugs from uranium pile before freeing isotope. Uranium is bombarded behind protective walls of concrete



The occasion was the official reconversion of the atom bomb factory to peacetime, when the government turned over to research institutions the first "canned" products of atomic energy made in the Clinton Laboratories at Oak Ridge, research center operated for Uncle Sam by Monsanto Chemical Company.

Directors of five medical research institutions received the first units of Carbon 14, which will be used in cancer research. The material in each unit, weighing about 1/10,000 ounce, is a chalklike powder made by combining two kinds of barium carbonate, the ordinary variety and its radioactive type. It was placed in a tiny bottle set in a steel container housed in a six-inch rectangular wooden box.

This strange substance will emit beta (atomic ray) particles for many thousands of years, starting at the rate of about 37 million particles a second. In 10,000 years the rate of emission will decline to about half the starting rate.

Greatest hope of the research institutions is to discover whether some of the radioactive materials (50 all told) that can be produced in an atomic pile will help find a means of preventing cancer. Furthermore, ray-emitting forms of various common elements will be used as "tracers" in studying other diseases.

RI is the scientific nickname for radio-isotope, medicine's new atom weapon. Radio-isotopes (of which Carbon 14 seems the most promising) are radioactive forms of elements with the same chemical properties as the stable element but having a different atomic weight. Their structure is complicated but it is possible, by man-made devices such as an atomic pile or other nucleus-bombarding instrument like the cyclotron, to make RIs which do not occur in nature and which are radioactive.

An RI is made by placing in the pile a stable element, which may be a metal, salt, liquid or gas, and leaving it there for a given length of time. This is the basic process and it applies regardless of whether the material inserted is fissionable, such as

uranium, a common salt like sodium chloride, or an ordinary metal like iron.

Some RIs can be made in a few days while others require several months. Care must be taken to protect the material put into the pile from the temperatures it will meet (hence liquids and gases are not usually used) and from the action of oxygen and water vapor in the air. Not only for these reasons must the material be enclosed in a container but also for purposes of handling.

Furthermore, the form and purity of the material exposed, as well as the material of which the exposure can is made, must be such as to minimize neutron loss. That is, the drain on the power of the atomic pile must be kept to a minimum. These conditions usually are met by carefully selecting the form of the element to be exposed and by using aluminum for the can in which it is enclosed.

A major consideration is the subsequent separation of the newly created radioactive species from the "parent" element or compound put into the pile. Such separation may be very complex, as in the case of the extraction of the individual fission products from the parent uranium. It may be relatively simple, as in the extraction of radioactive iodine from the parent tellurium. Or it may be skipped altogether, as in the case of radioactive phosphorus, produced by the exposure of phosphorus itself.

In "canning" atomic energy, Oak Ridge scientists use two types of aluminum cans to enclose material for isotope production in the pile. One is a welded, tight-fitting aluminum jacket for uranium and calcium nitrate salt. Parent materials for all the other RIs produced in the Clinton pile are placed in aluminum cans about the size and shape of a man's index finger. These cans then are set into holes in a graphite block running into the center of the pile. When the graphite block, containing a number of cans, is loaded, it is pushed into the pile and left there during the period of irradiation.

While the pile is being loaded or unloaded, the control rods



Remote control device—out of range of dangerous radiation—is used to remove atomic energy (radio-isotopes) from uranium pile



Can of radio-isotopes (above) removed from the pile is placed in a lead shipping container. Below, physicist (right) uses radiation-measuring device to be sure no dangerous rays are emitted



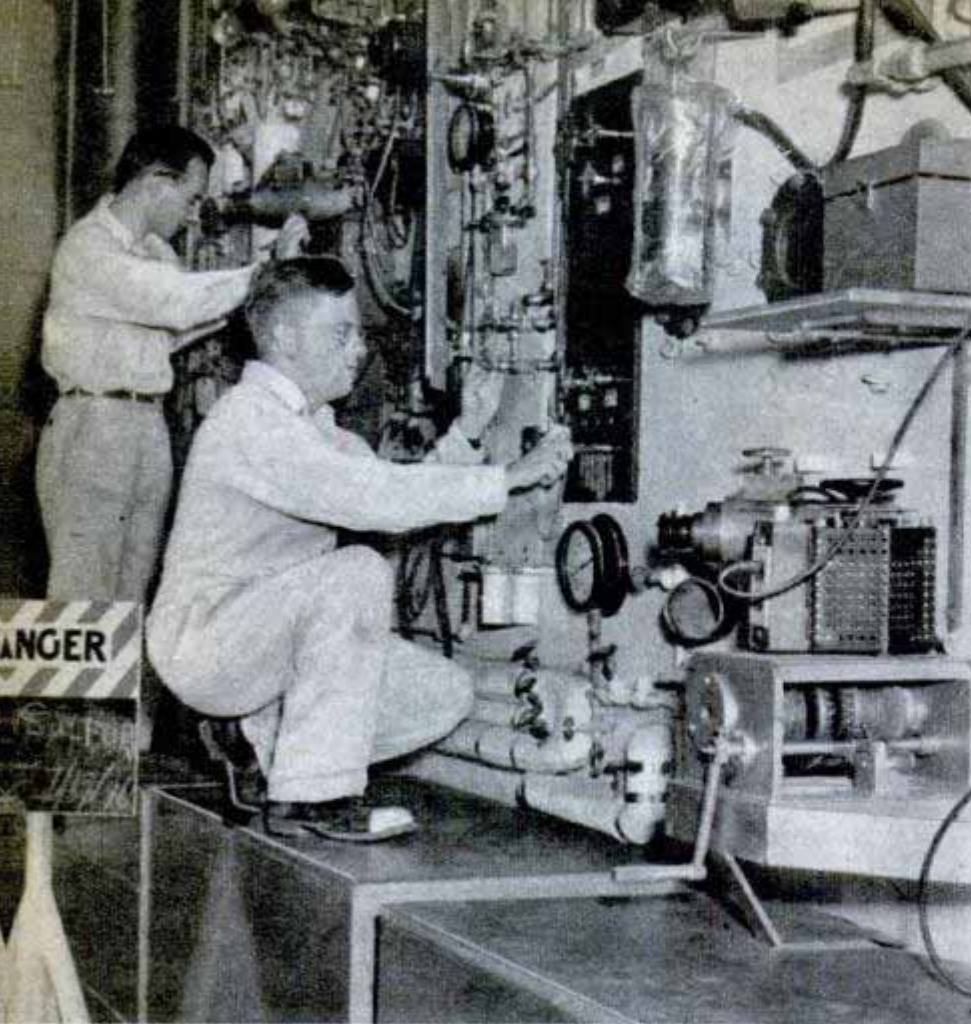

Atomic chemists operate remote control apparatus, including periscope, to peer behind concrete walls during separation of uranium

which stop the chain reaction are in place. This is to prevent the escape of dangerous neutrons from the pile during loading.

After the loading has been accomplished and the loading hole has been blocked so that neutrons cannot escape, the pile is started up. Usually the material is left in the pile from one to several weeks.

When it's time to remove the batch of

Remote control device measures out tiny portions of radioactive products in solution. Sample, shielded by lead, is viewed in mirror

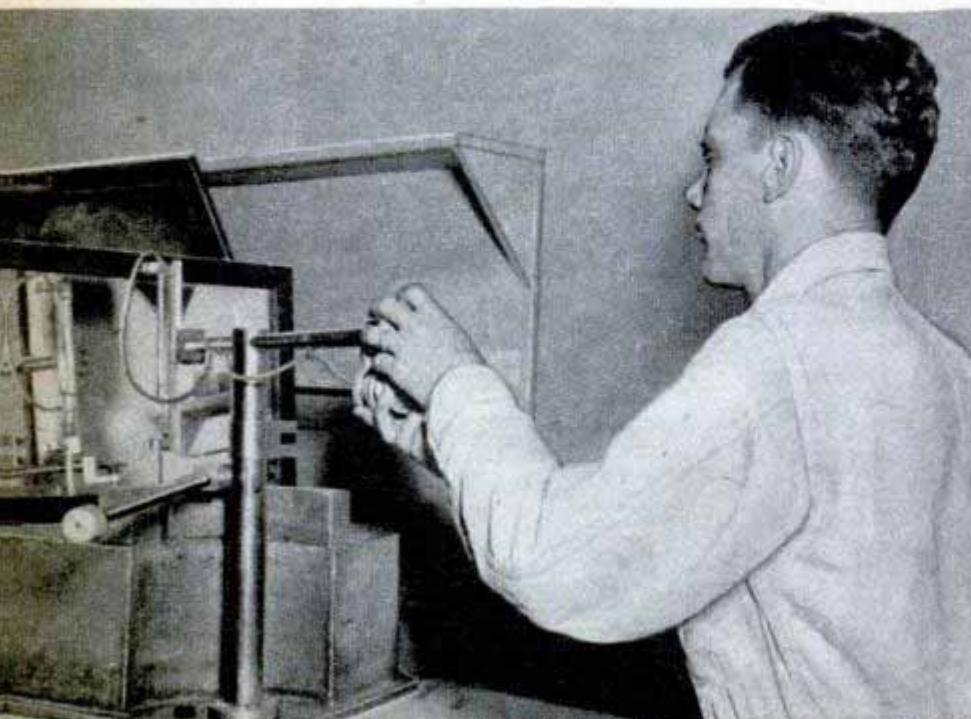

ner and see the material with which he is working.

Where low intensities of radiation are encountered, the operator may use tongs and work behind shields within one or two feet of the radioactive species. For the separation of high-intensity fission products, however, a cell 4 by 6 by 8 feet is placed inside a larger room with all controls on the outside. By means

of air pressure, vacuum processes, rods and grappling devices, the operator is able to put the radioactive material through the required chemical and physical steps without entering the cell or removing the "hot" material from it.

Instruments to measure radiation are needed not only for the scientists who work with radiation but also for the success of the chemical work. Devices are built right into certain parts of the apparatus so the operator always knows how much of a radioactive material is at a given point.

Almost infinite are the potential uses of radio-isotopes. With a unit of Carbon 14 the

(Continued to page 260)

samples the pile is shut down and left long enough to permit the gamma radiation, which would come from the open hole, to die off to a relatively low intensity. Then the hole is opened and the graphite block is pulled out into a lead "coffin." This precaution is necessary because of the radiations being emitted by the exposed material and by the containers.

Technicians stand by with radiation-measuring devices to insure that no person exposes himself unduly. The samples are removed from the block by means of long tongs, examined with instruments and then placed in a lead safe for temporary storage.

Manufacturing RIs on a large scale, which involves working with radiations of the most dangerous types, requires a special type of large research chamber known as a "hot" laboratory. Here the operating chemist uses heavy shielding of concrete and lead, besides periscopes which allow him to look around a cor-

HOW THE GEIGER COUNTER WORKS



Types of counters reacting to different kinds of rays

The Geiger counter tube was developed in 1908 to detect single ionizing particles from radioactive elements, ultraviolet rays, X-ray generators, X-ray sources and cosmic rays.

What it consists of: A conducting cylinder (usually copper) down the axis of which is stretched a fine insulated wire attached at either end with small springs. The cylinder and wire inside it are surrounded by a thin glass shell, forming a tube in which gas (usually hydrogen or argon) is contained at a few centimeters of pressure. The wire is frequently

five mils tungsten. Though the tubes vary, they are generally less than an inch in diameter and about five inches long.

Operation: A voltage of 300 to 5000 is introduced (depending on the gas used in the tube, its pressure and the geometry of the counter). This voltage must be just less than enough to break down the wire-to-cylinder gap. When an ionizing particle—for instance a beta ray—enters the space between the wire and the cylinder, the electrons produced in the gas will be speeded toward the wire with increasing kinetic energy and, in the strong electric field near the wire, obtain sufficient energy to ionize the gas, producing more electrons. These in turn are accelerated, and an avalanche of electrical charges is initiated. In addition, the recombination of the positive ions produces light quanta which eject photoelectrons from the metal cylinder.

Results of action: The avalanche sets up a flow of current in the external circuit which may be electronically amplified to produce a click in a loud-speaker. It also can be fed to various radio instruments that record both number and intensity of the ionizing particles.

Extinguishing of action: When a discharge is started, it has to be extinguished rapidly so the tube may be sensitive to the next ionizing particle. After the short is extinguished, the circuit is ready to act again. In general it may be said that the action in a Geiger counter is such that the incident particle causes the counter tube to break down electrically once for each particle entering the counter tube.

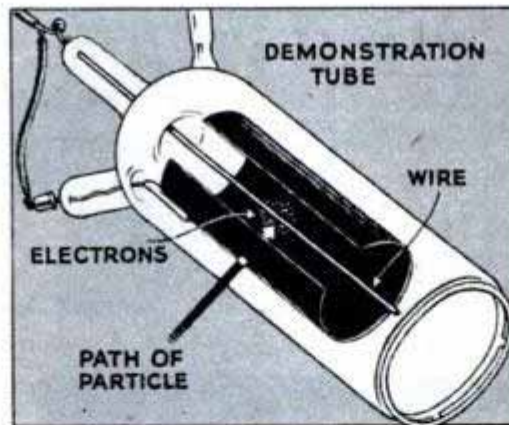

Heavy metal bar blocks less than half the gamma rays

Thin brass sheet halts less penetrating beta radiation

Westinghouse photos

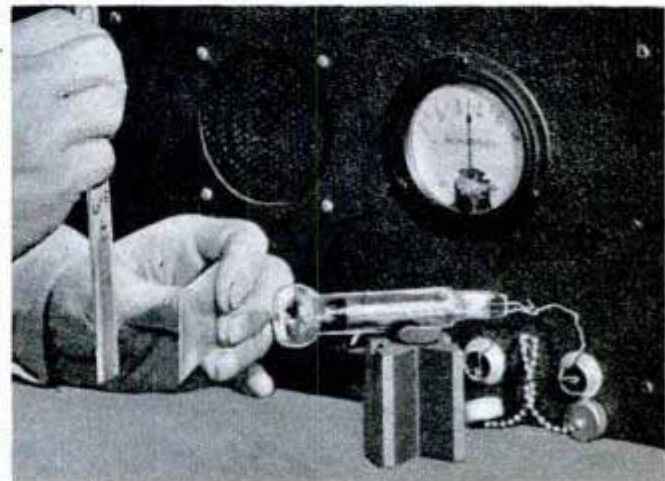
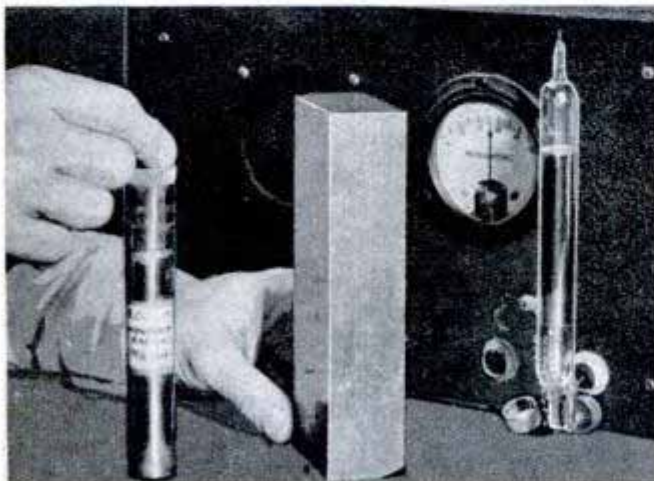

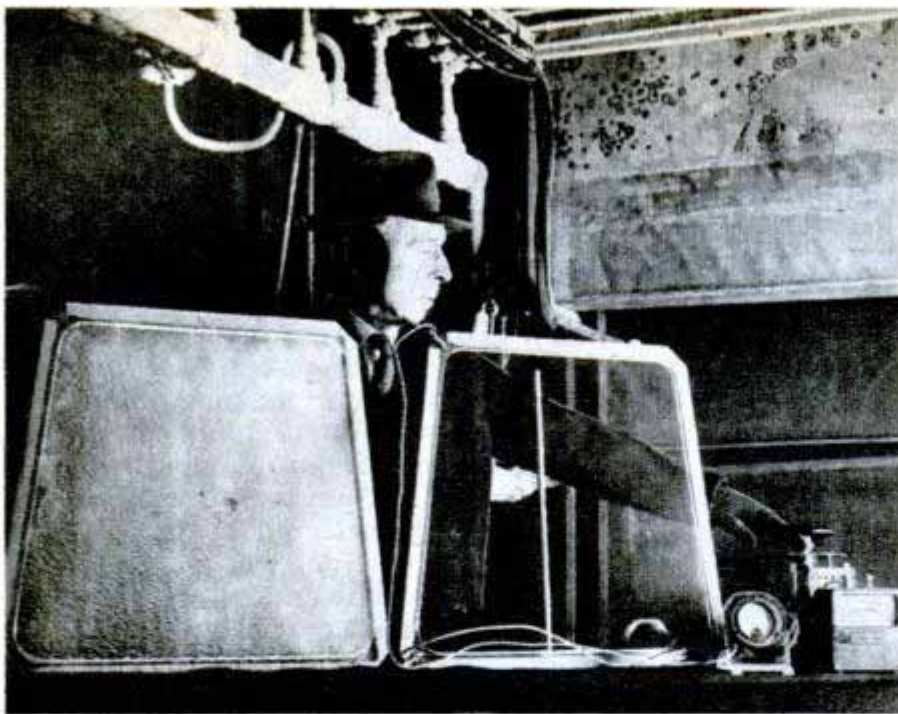

'Electric' Windshield Keeps Ice Away

Ice formations on airplane windshields are eliminated by a transparent coating for glass that conducts an electric current to keep the windshield at above-freezing temperatures. The coating also eliminates interior fogging. Electrical resistance of the coating is relatively low and converts the electric energy into heat. The coating does not distort vision through the glass. Metal bars on the edges provide electrical contact.

Self-Powered Recording Unit Turned by Spring Motor

No outside power of any kind is needed by a new portable recording machine imported from England for on-the-spot broadcasts of special events. Power is supplied by a spring-wound motor similar to the type used in old-fashioned phonographs but modern in construction. The unit weighs only 34 pounds. Long-range pickup without amplification and a microphone that hooks to the coat lapel are additional features. The unit, imported by Station WOR of New York, records three minutes on each platter at 78 r.p.m. The quality of the recording is claimed to equal that of conventional portable units.

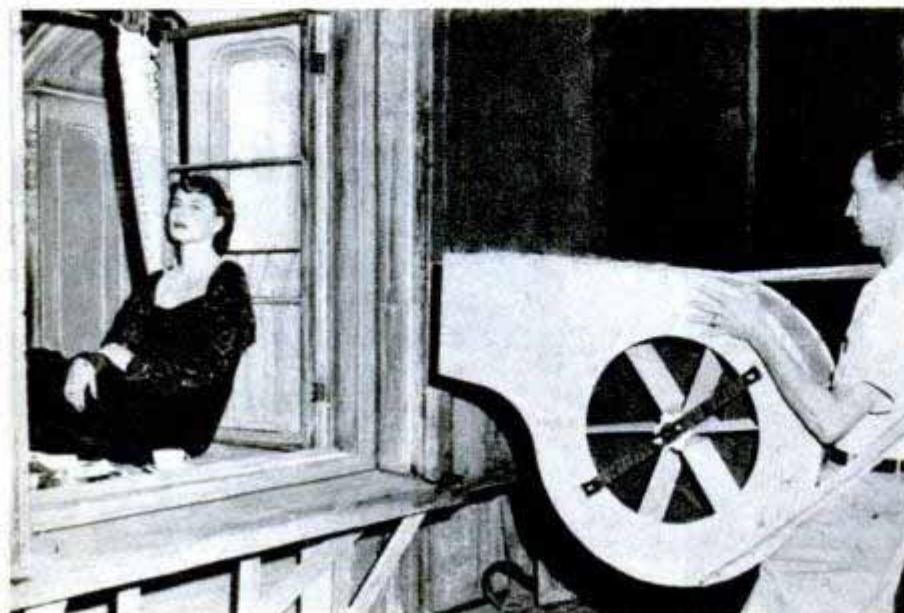

Movie Breeze-Maker Keeps Actors Cool

Cool air is dispensed from a portable air conditioner to keep movie stars comfortable while they are acting under the heat of floodlights. When Ingrid Bergman was making interior scenes for "The Arch of Triumph," Hank McCleed, a special effects technician, devised the portable blower. It was also used to stir up breezes for special photographic effects.

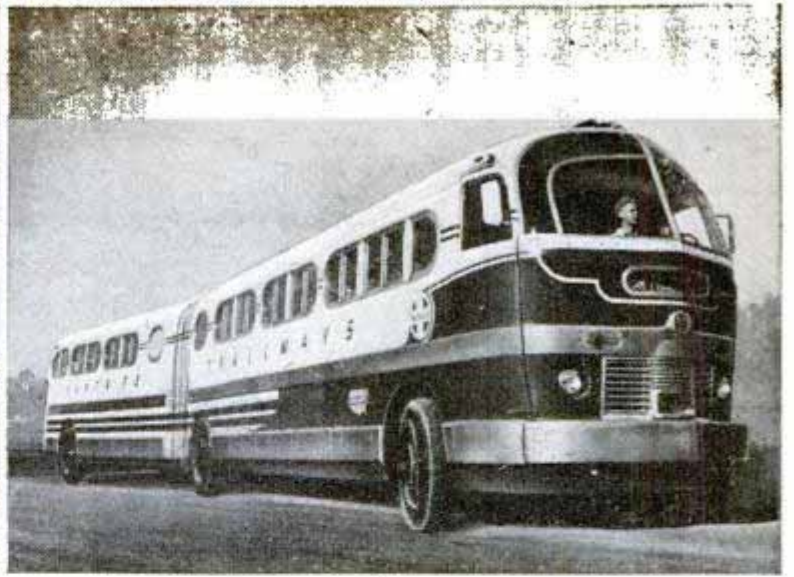

Standard buses are dwarfed by a huge 60-foot bus built in two sections for greater maneuverability. The bus is 25 feet longer than most standard buses and carries 63 passengers, 26 more than other buses operated by the same line. It has a pay load of 28,000 pounds, 4000 pounds greater than the older buses. The rear section rolls on

Two-Section Bus Seats 63

only two wheels with part of its weight supported on the double rear wheels of the front section. Passengers are seated three abreast. The vehicle, built of magnesium-aluminum alloy, is powered by a 275-horsepower Diesel engine. It was built by Henry J. Kaiser's Permanente Metals Corporation for Santa Fe Trailways.

Horn-Type Antennas Sharpen Weak Television Signals

Huge metal horns focus television signals into a sharp beam in a video system now under development for the Los Angeles area. The horns, developed by the Southern California Telephone Company and the Bell System, transmit programs from Hollywood studios to Mt. Wilson, 17 miles away, where they are picked up and re-broadcast over the Los Angeles area. Focusing "lenses" for the horns are parallel metal plates spaced half a wave length apart. Only four tenths of a watt of power, concentrated into a very sharp beam by the antenna, will produce strong, clear reception at the mountain. The television band is four million cycles wide at a frequency of about 4000 megacycles. The pictures received on the mountain are transmitted back to Hollywood by a "dishpan" antenna to be checked for clarity.

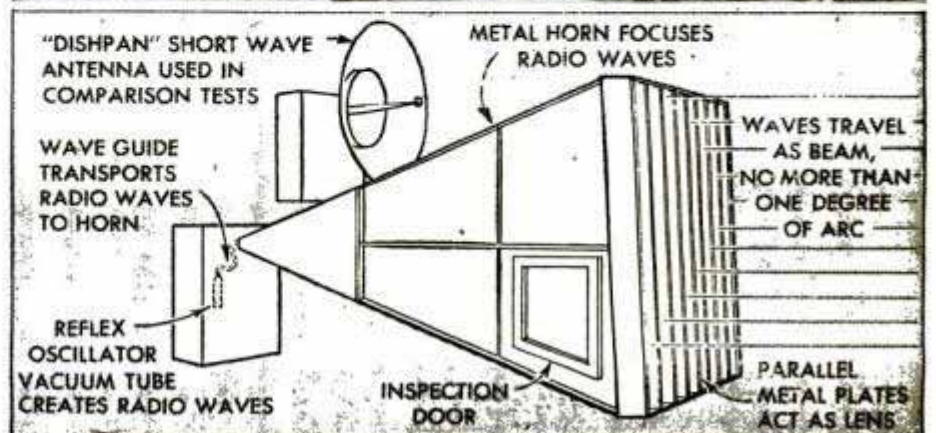
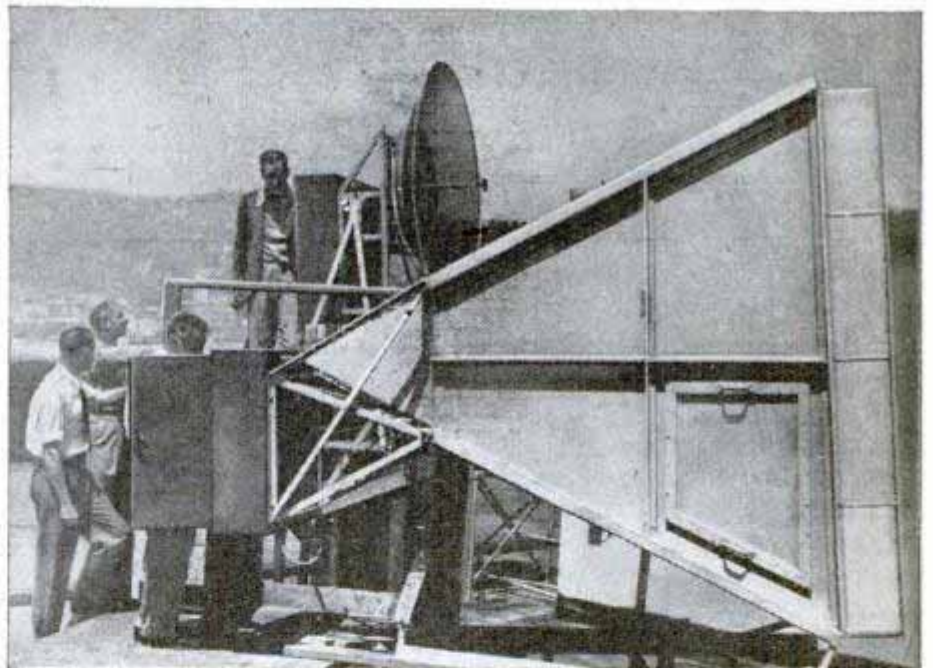

As Told to Andrew Hamilton

AN ESTIMATED \$30,000,000,000,000 in gold beneath the sea awaits anyone who will take it. Not pirate treasure, but tiny particles of the yellow metal held in suspension in the water. This represents about \$15,000 apiece for every man, woman and child in the entire world.

But it would cost more to extract this gold than it is worth at the present market value. And besides, the ocean holds even greater wealth in animal, vegetable and mineral resources that can be used advantageously by man.

Approximately 200,000 species of animals and 8000 species of plants grow in the ocean, many of which are edible. Almost every known mineral element has been found and some exist in commercial quantities. The continental shelf may be our last source of petroleum and man's ingenuity some day may be



able to harness the enormous power of the tides, now going to waste.

Before the war a few thickly populated nations, such as Japan, Belgium, Holland and the Scandinavian countries, were profitably practicing aquiculture or the cultivation of shellfish and seaweeds for food. Scientists say that aquiculture can be as productive as agriculture and may offer a solution to the present world-wide shortages of food, clothing, building materials, fuel and medicinal drugs.

Sea water contains an average of 3.5 percent of mineral matter. Most of it is sodium chloride, or common table salt, but traces of almost every other mineral known to science have been found as well.

Large quantities of salt are reclaimed each year from the sea, solar salterns in California yielding more than 2,000,000 barrels annually. The Pacific Ocean contains enough salt to cover the continental United States to a depth of about a mile. In spite of the fact that the rivers of the world carry 5,000,000,000,000 tons of salt into the ocean yearly, its salinity is not rising perceptibly.

In addition to salt, other important minerals are mined from the sea. Magnesium, which teamed up with aluminum to make the United States a leader in the light metals field during the war, is processed in great quantities in the Dow Chemical plants at Freeport, Texas, and Cape Fear, North Carolina.

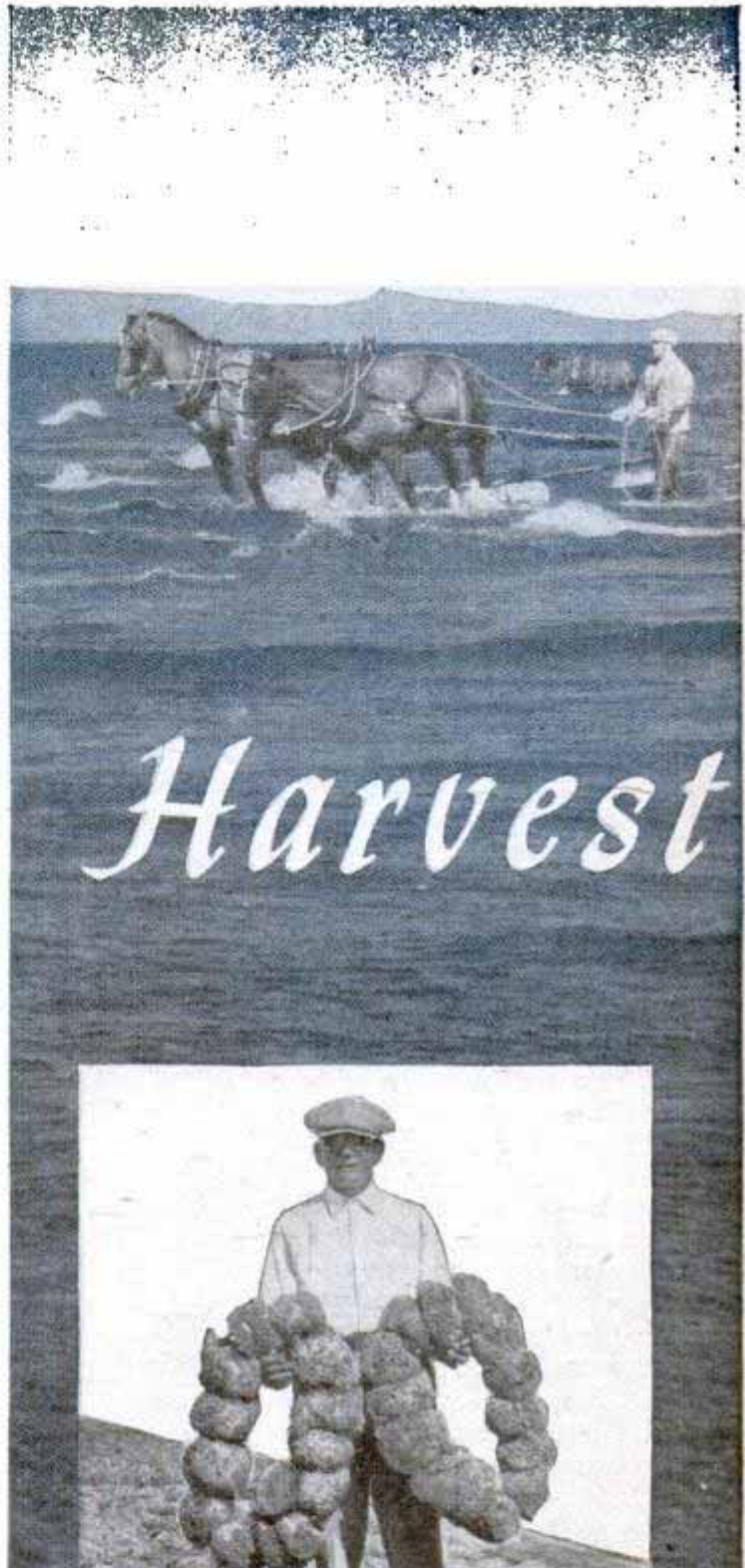

Fish and Wildlife Service photo

Inspecting sponges at Tarpon Springs, Florida, center of the U. S. sponge fishing industry

In the shallow waters of the Columbia River horses are used to drag in nets of salmon, one of the richest of fish crops

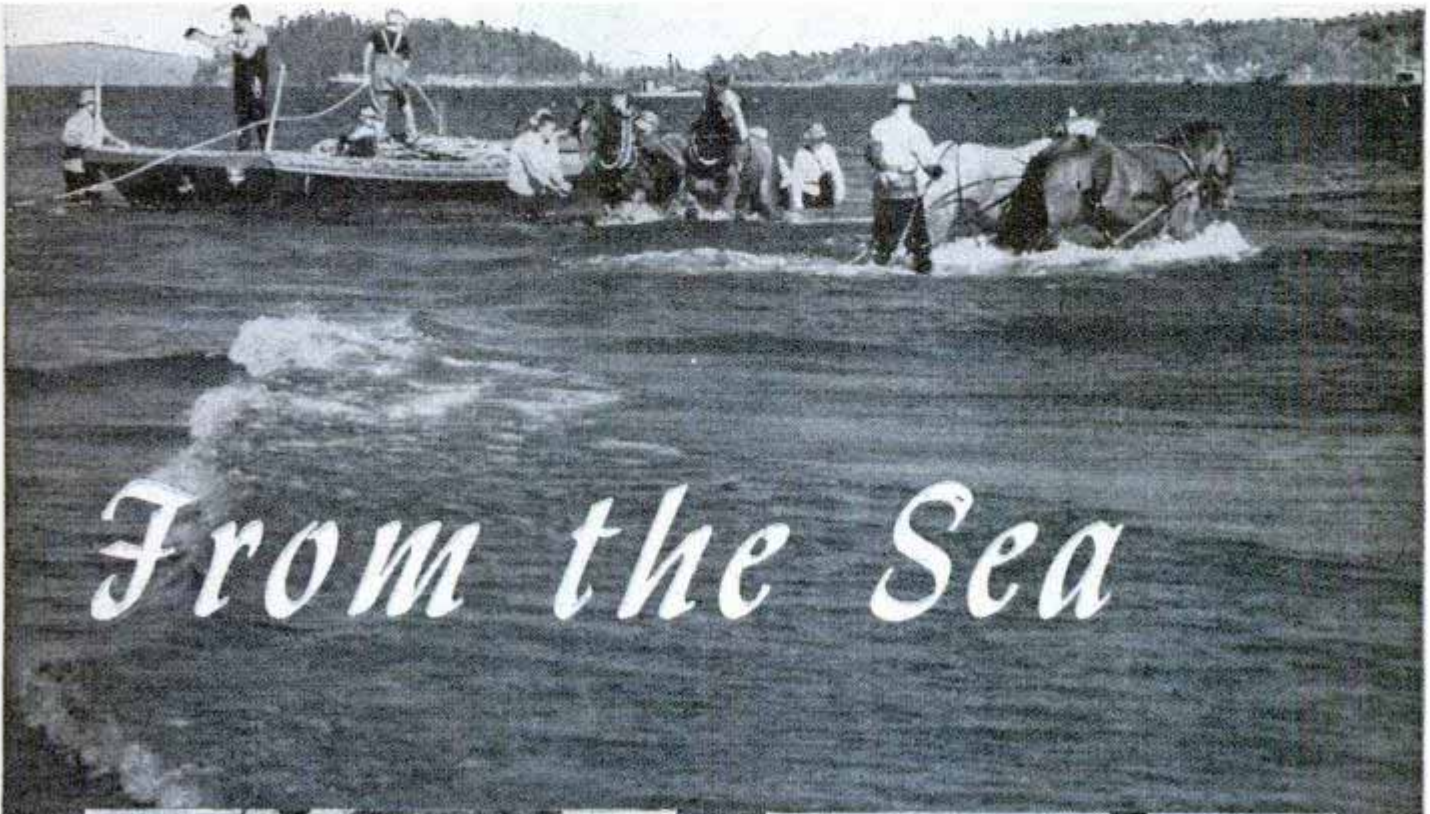

From the Sea

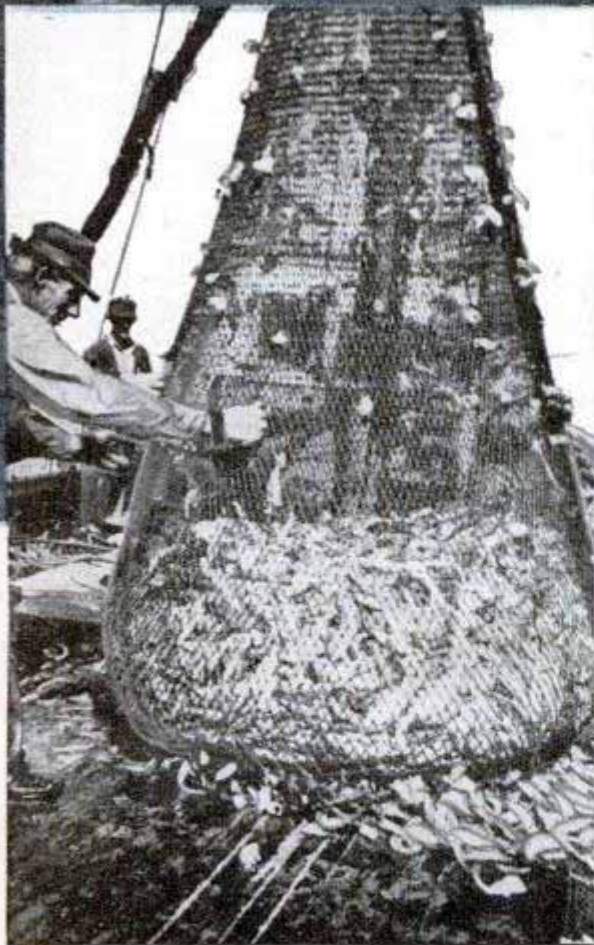

Pulling the "purse string" at the bottom of a loaded trawl sends the catch flopping on deck

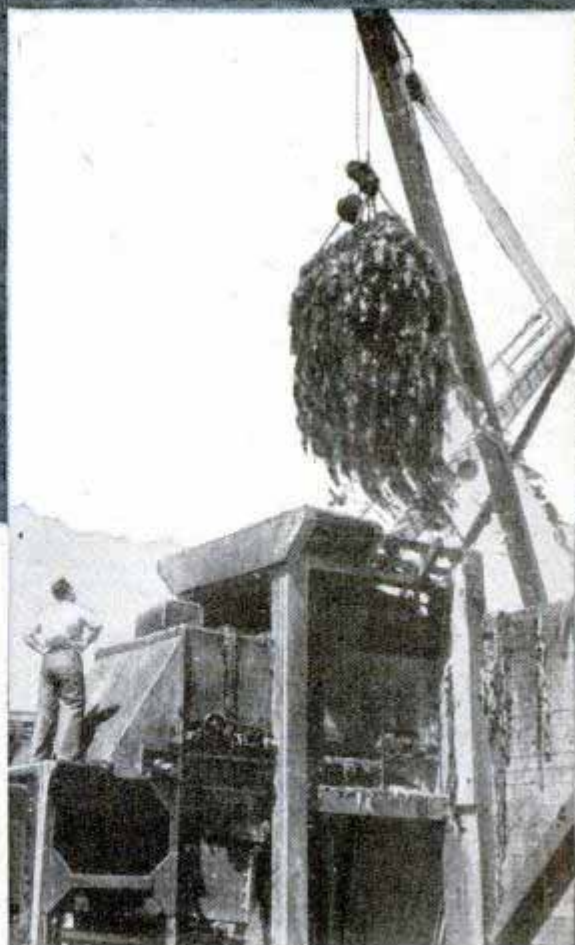

Barge loads of harvested seaweed begin the conversion process in this mechanical chopper

Bromine, necessary in preparing lead tetraethyl used in high-compression motor fuels, is found in sea water in concentrations of .0065 percent. However, there should be no appreciable shortage in this essential material for many years as a cubic mile of sea water contains 250,000 tons of bromine and methods of its extraction are being steadily improved.

Tremendous quantities of chlorine, used in chemical industries and manufacturing, are being extracted from the sea.

Accumulating evidence indicates that, acre for acre, the sea is more productive than the land. The primary production (production of organic matter by photosynthetic organisms) of certain marine areas, such as the Gulf of California, appears to compare favorably with that of fertile garden soil.

Aquiculture would seem to offer these advantages over agriculture: (1) there is



never any drought in the sea, (2) even temperatures prevail, (3) sea water is a perfectly balanced salt solution with only nitrates, phosphates and silicates as factors which might limit plant growth, (4) instead of a growing area of the few top inches of soil, the sea is productive to the limit of sunlight, 200 to 800 feet, and (5) it has fewer barren acres than land, with even the arctic and antarctic waters fertile.

We have already made a good start. More than \$500,000 worth of kelp is harvested each year for fertilizer, cattle feed, solvents, tars and alginic acids.

Algin has become one of the most important of our kelp products. It is used as a dispersing agent in lacquers, in sulfa and burn ointments, in latex insulation for wires, in a variety of food products such as ice cream, bakery goods, jams and jellies, and as a coating for paper containers.

Seaweeds concentrate potassium and io-

Seaweeds are used in many ways: (A) young specimen of the California giant kelp, a source of acetone and potash; (B) purple laver, used in soups and eaten raw; (C) California agarweed, a basis for microbiological culture media; (D) Irish moss from Massachusetts, which produces carrageenin, used in candy, jellies and salad dressing; (E) East Coast broadleaf kelp, producing algin used in ice cream, cake icings and dental impressions

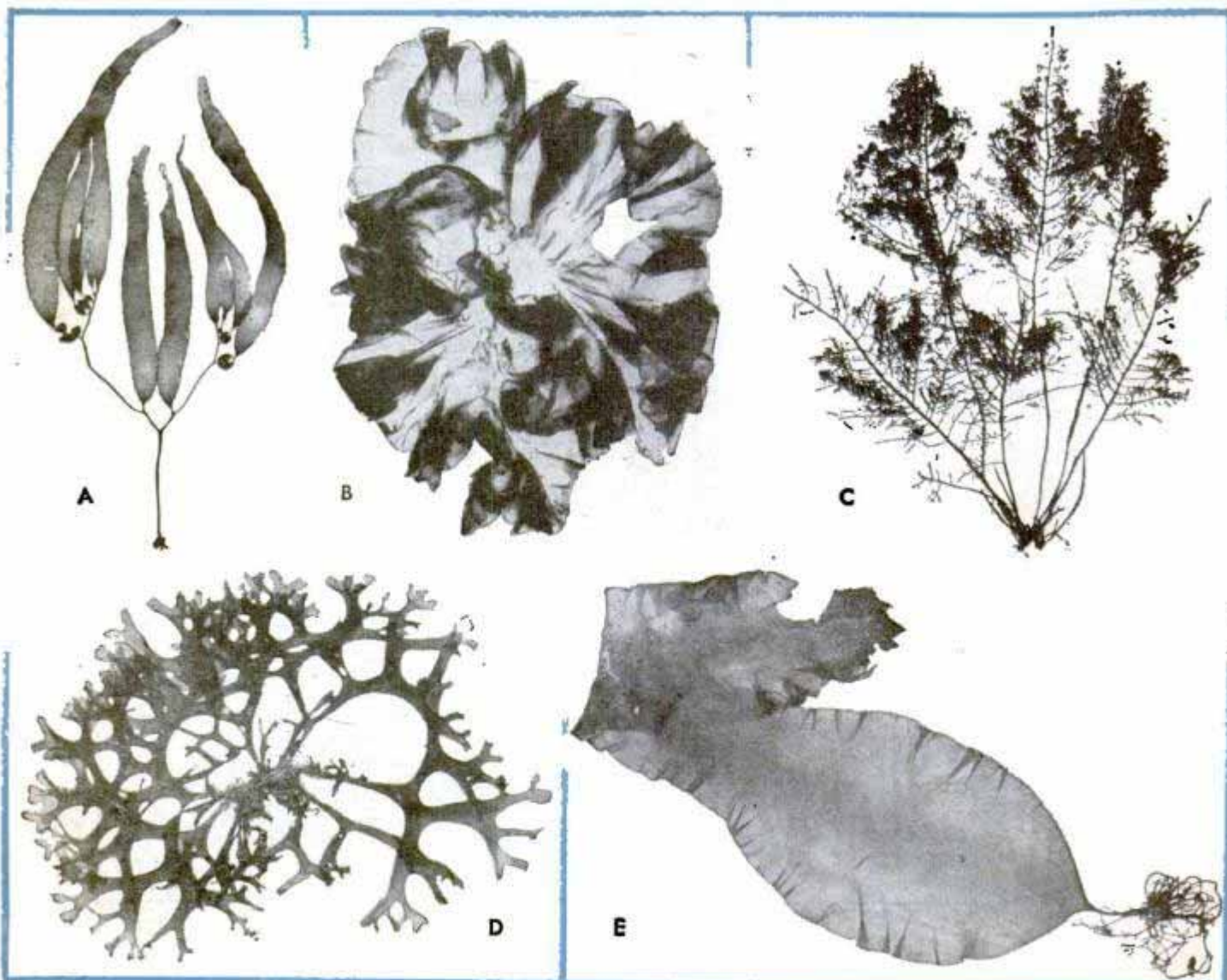

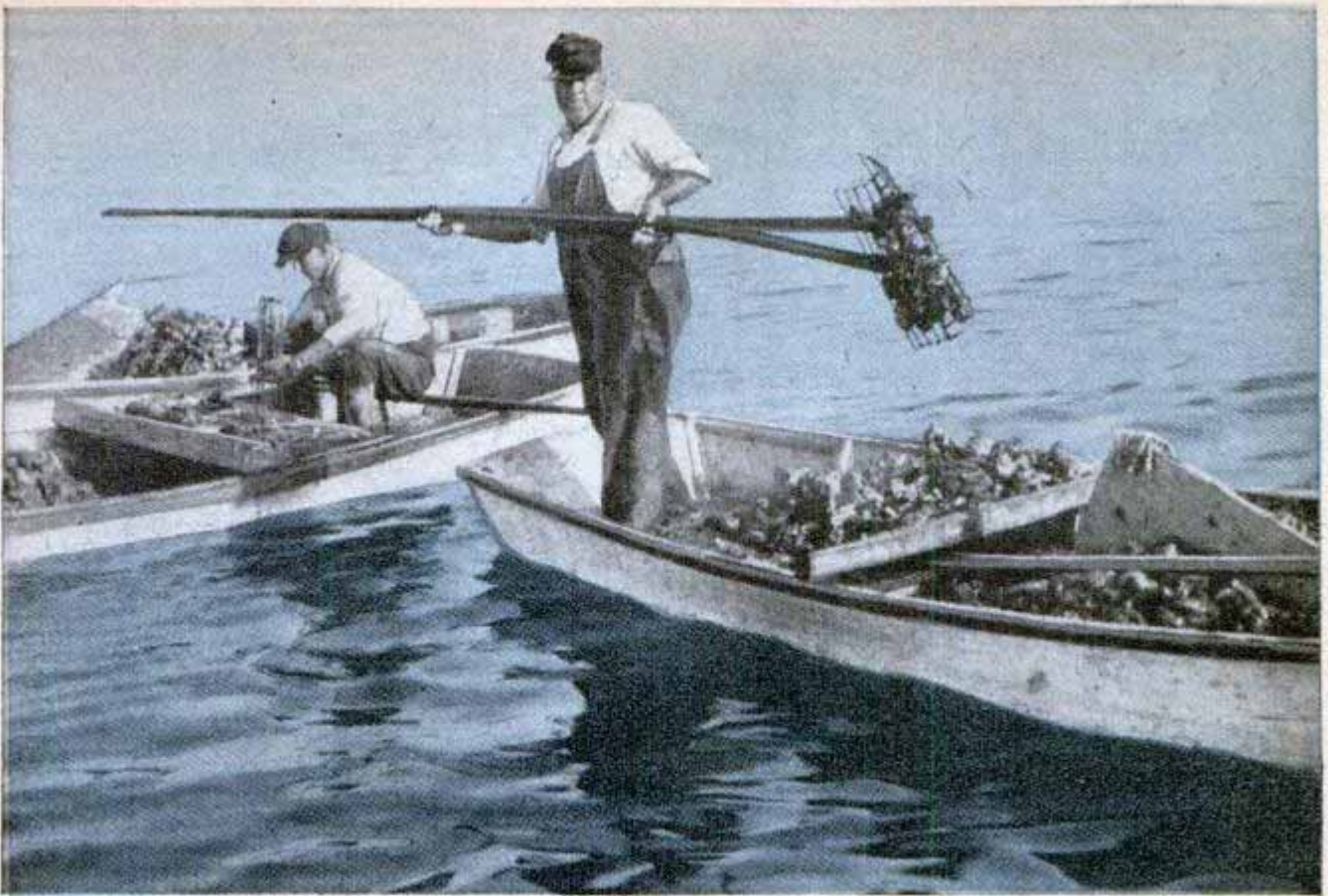

Fish and Wildlife Service photo

East Coast fishermen "tonging" for oysters, the most common method of collecting this popular shellfish

dine so that they can be extracted profitably. Sea water itself contains only .037 percent of potassium, while dried kelp contains from 10 to 14 percent. Similarly, there is only .0000005 percent of iodine in sea water while certain seaweeds contain .2 to .5 percent when dried.

Certain red algae produce agar, or vege-

table gelatine, which is used medicinally, as a medium for bacteria culture and in several kinds of confections and desserts. Before the war the United States was using agar at the rate of 600,000 tons a year, mostly imported from Japan. Since 1941, however, we have gathered our own supply along the California and Mexican coasts.

Crane at a coastal chemical plant moving filter leaves so that valuable magnesium hydrate may be blasted off

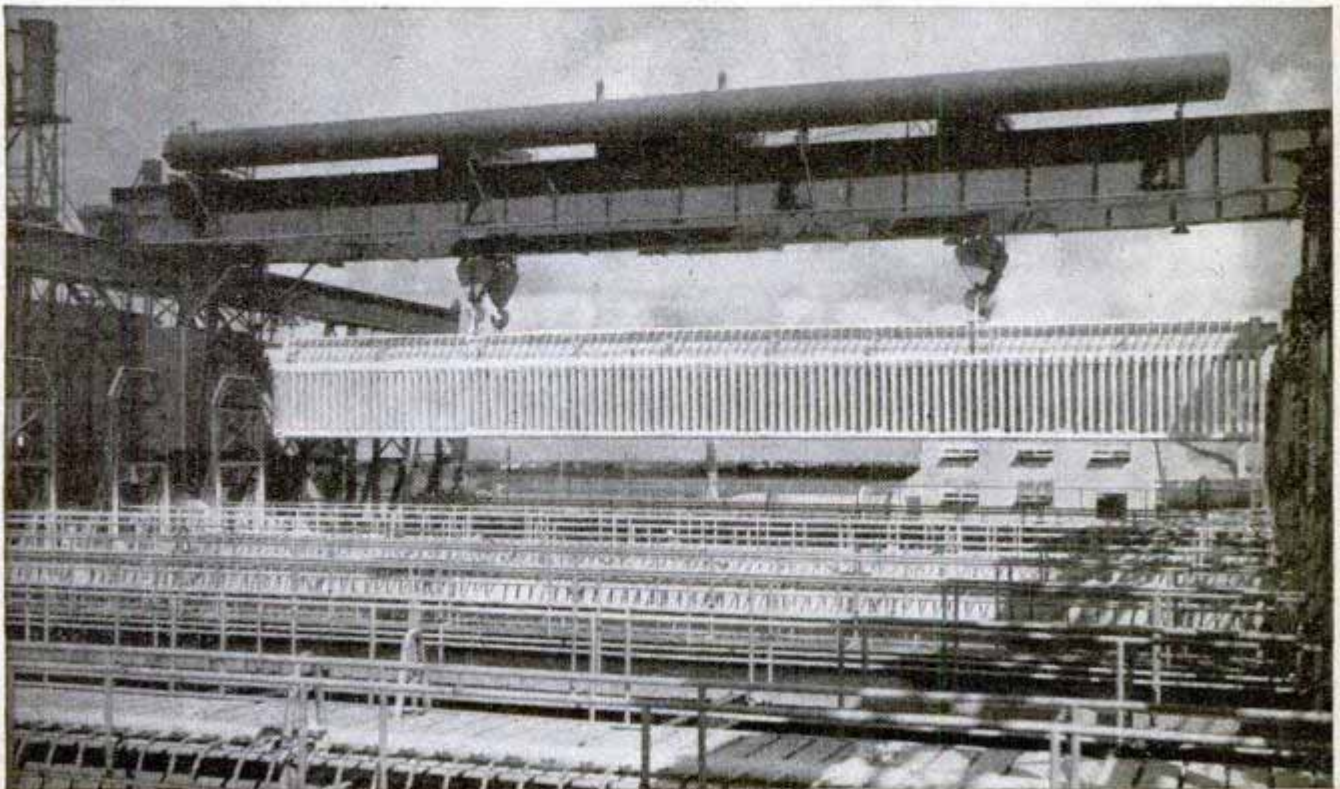

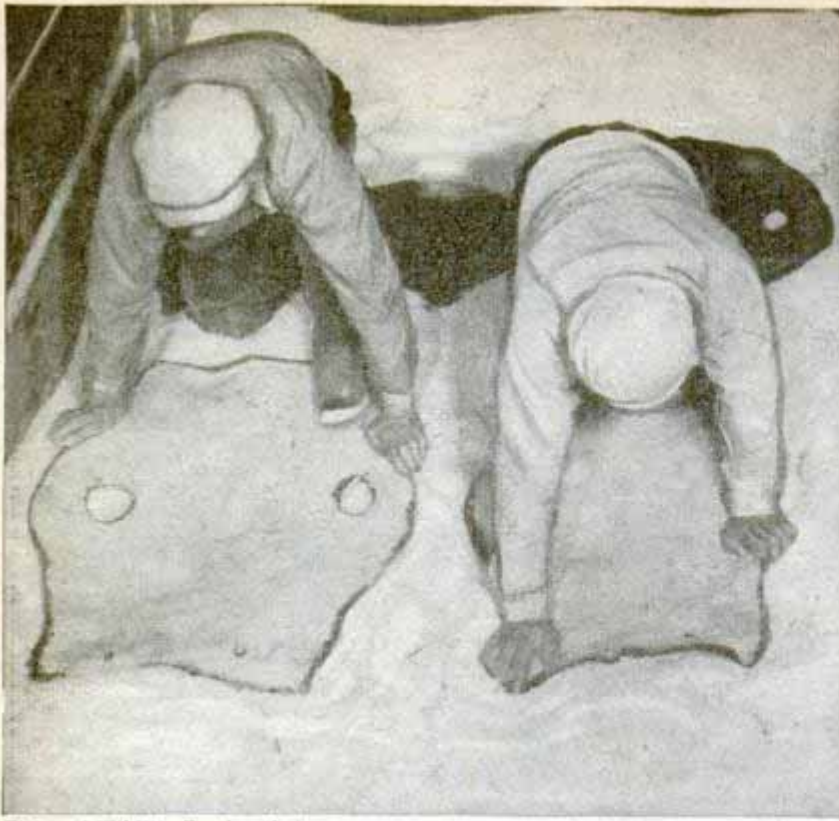

Fish and Wildlife Service photo

"Kenching" or salting down sealskins to improve their preservation

Many seaweeds make palatable and nutritious foods. For example, in the Hawaiian Islands more than 70 species of marine plants are eaten, while the Chinese and Japanese make use of nearly as many. Irish moss, purple laver, dulse, seatron, kombu, amonori, kijiki, arame or murlins harvested from the sea make dishes which are really more palatable than the term

pollock, flounders and rosefish, as well as clams, lobsters and scallops. The Middle Atlantic coast is known for its oysters, crabs, shad and striped bass. The Gulf of Mexico produces tons of shrimp each year. Along the California coast, tuna and sardines represent the largest catches, while the waters of the Northwest are a source of fish-liver oils. Alaska both catches and

"seaweed" suggests. Some are eaten fresh, as in a salad, while others are dried.

Although many large, easily harvested plants grow in the sea, it is principally the microscopic plants called phytoplankton which are most important. The phytoplankton is to the grazing animals of the sea what grass is to those on land. It is often called "ocean pasturage" because it is eaten by smaller sea animals which, in turn, are eaten by fish.

Marine animal products worth \$30,000,000,000 annually are harvested from the oceans of the world and give employment to between 15,000,000 and 20,000,000 men in the northern hemisphere.

The United States is especially rich in its fisheries resources. The New England coast and the Newfoundland banks produce cod, haddock,

Fish are dumped into this trough of flowing water and carried into the cannery untouched by human hands

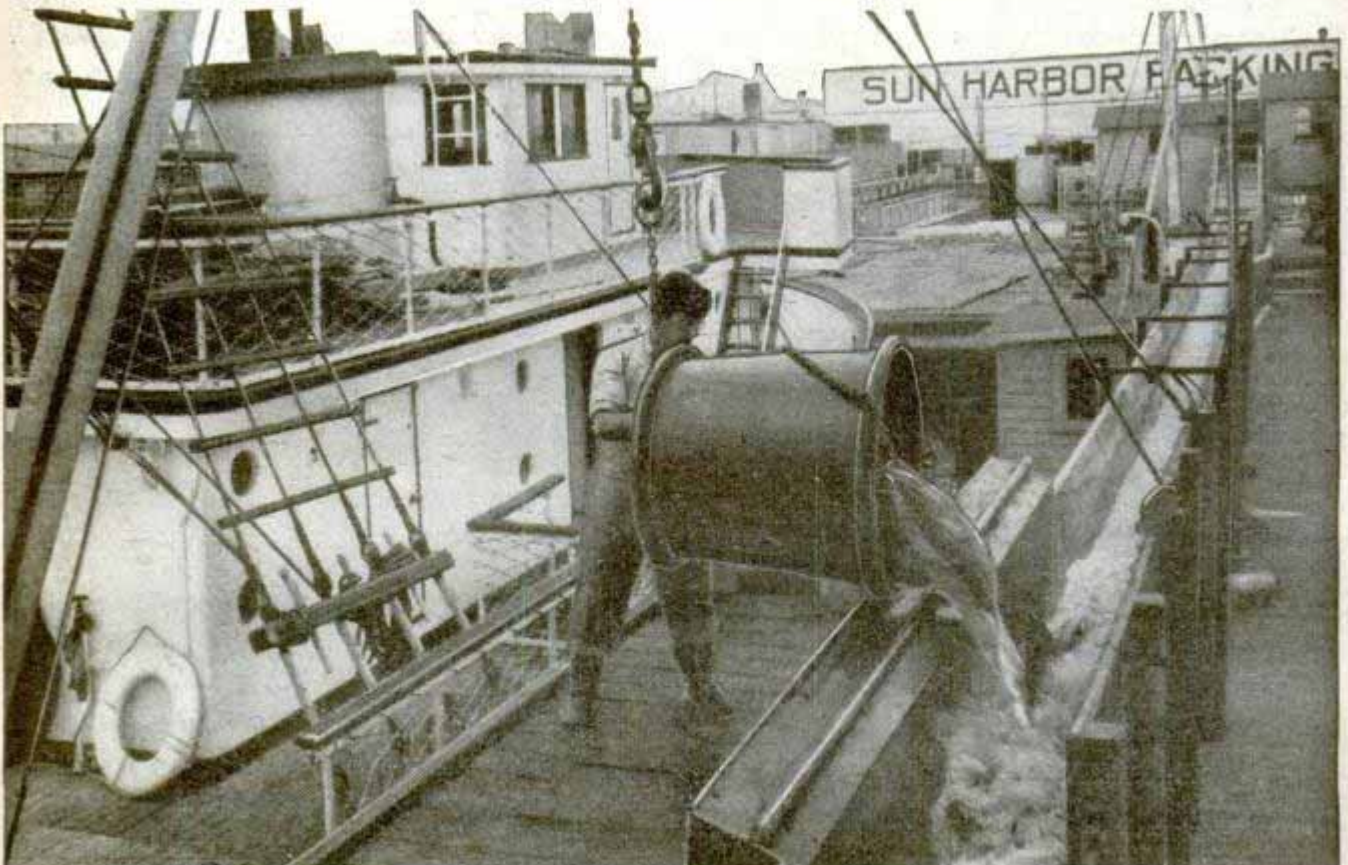



Tightly packed cluster of males, females and young seals in harem at Zapadni Rookery, St. Paul Island

packs 90 percent of North America's most valuable fish product—salmon.

Judging from the vast quantities of fish taken from the sea, it would seem that marine resources are unlimited. However, the ruthless slaughter of whales and sea otter proves that unlimited exploitation can lead to disaster. If the world is to profit from the wealth its oceans produce, there must be an international program of cooperation and conservation.

With the United States using 5,600,000 barrels of petroleum a day, and with little or no slackening of production, the world may have to explore the sea for new petroleum and power resources.

It is generally believed that buried organic matter is the source of petroleum, although the exact transformation of it is not well understood. Since

(Continued to page 244)



Upper, American Can Co. photo
Lower, Morton Salt Co. photo

Releasing salmon from a trap on the Columbia River, and, right, another product of the sea, salt, being moved by a small scoop

Station

M-O-O-N

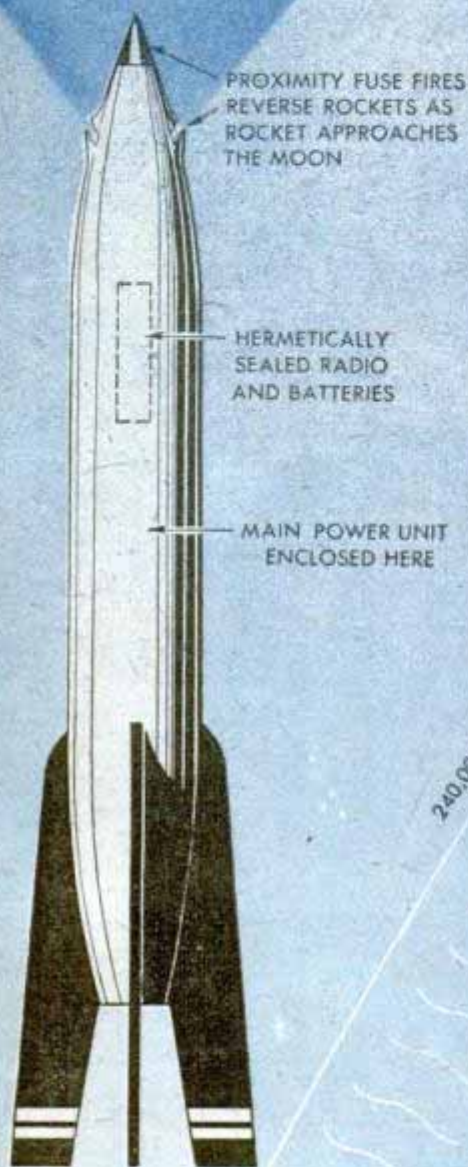

ROCKET SPEED
4000 M.P.H.

240,000 MILES TO MOON

IT'S possible to shoot a 100-pound radio weather station to the moon and land it undamaged, according to Dr. A. J. Hutcheson of Westinghouse Research Laboratories, commenting on moon-bound rockets the Army plans to build within 15 months. The meteorological findings of sensitive instruments carried in the rocket could be transmitted 240,000 miles to earth by ultrashort waves. Resistance of wire changes according to temperature and this change, for example, could be made to vary the frequency modulation and tone of the earthbound signal. A "soft" landing could be achieved by reverse rockets set off by a tiny radio set, in the manner of a proximity fuse, when the missile neared the moon. The 100-watt transmitter, weighing under 50 pounds, and small storage batteries of about the same weight, would fit in a cabinet three feet long and a foot in depth and width. It would be hermetically sealed for operation in the near vacuum of the ionosphere and on the surface of the moon itself.

ULTRA SHORT
WAVE BROADCAST
EVERY HOUR

104 MILES—
NEW MEXICO V-2

165 MILES—
GERMAN A-10

IONOSPHERE

STRATOSPHERE

TROPOSPHERE

12 MILES—FUTURE AIRPLANE CEILING

7.5 MILES—B-29

RECORD MANNED BALLOON
ASCENT 13.7 MILES



V-Tailed 4-Place Plane Has Low Flying Cost

Full rudder control without a vertical tail fin is provided by the V tail of the new low-wing four-place Beechcraft Bonanza. The tail assembly is said to reduce drag and weight and add stability. Although handled by both elevator and rudder controls, use of the rudder is unnecessary except for crosswind landings and takeoffs. The Bonanza, which costs \$7345, can be operated for 1½ cents per passenger mile when used 100 hours a month, according to the manufacturer. It is powered by a six-cylinder 165-horsepower Continental engine, less than half the horsepower previously required for the same size plane with comparable performance characteristics. Top speed is 184 miles an hour. With full load of four people of 170 pounds each plus 100 pounds of baggage, the Bonanza has a cruising range of 750 miles at 165 miles an hour. Large tires and a long



wheelbase between nose wheel and the two main wheels permit landing safely on soft or rough fields without damage. The cabin is soundproof. The interior is comfortably furnished and all protruding knobs, switches, levers and sharp corners have been eliminated. Landing speed is approximately 45 miles per hour. It is equipped with a complete set of flight instruments for night and day flying and necessary radio accessories.

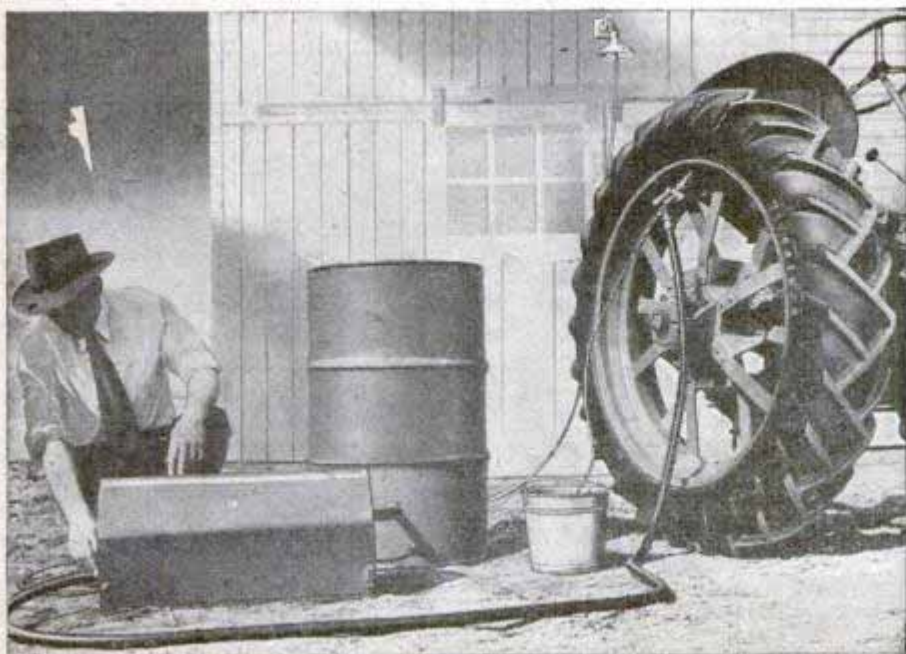

Water Fills Tires Used on a Tractor

Extra weight and traction are added to tractor wheels by inflating the tires with water forced into them, in nonfreezing weather, by a special electric pump in 8½ minutes. The nozzle has a bleeder tube which allows air from the tire to escape as water is pumped in.

☐ Because of its great weight—81,120 tons—the George Washington Monument is sinking into the ground ¼₄₀ inch a year.

Bootmaker for the Stars



Wooden lasts shaped exactly like the feet of film stars guide Joe Napoli in making movie boots and shoes

IF YOU were a movie star, it's a good bet you'd know Joe Napoli. His story is another version of the classic mousetrap yarn. Only Joe didn't build better mousetraps. He built better boots, slippers, gaiters and moccasins — and the stars beat a path to his door right down Hollywood Boulevard.

Joe Napoli, the Hollywood bootmaker, was born in Sicily. At 16 he came to America with his father, who taught him the bootmaker's craft. Joe got a job working in a shoe repair shop in Hollywood.

One day, nine years later, the boss handed Joe a funny looking pair of old shoes

covered with patches. "Put on some more patches," the boss told Joe. "The more patches you put on, the better he likes it. Those are Charlie Chaplin's shoes!"

After that, Joe got to thinking about the shoes worn by movie actors and actresses. The shoes had to be comfortable. They had to look right. Most of them weren't even modern shoes; they were something out of a history book. Movie producers were fussy about having shoes right so people wouldn't write letters poking fun at a mistake. Joe thought it would be fun to work all the time on shoes for the movies.

Two-tone high lace shoe of 1900 vintage (left) is placed on a last. Right, "library" of movie stars' lasts





So he went to work for a costume supply house which did a big business with the studios. For four years he put soles and heels on "period" shoes worn in costume, or historical, pictures. Then the foreman died, jobs were shuffled, and Joe became a shoe designer for the company.

In October 1941 he decided to try boot-making on his own. He bought a shop on

Harpo Marx ordered that big black number—a combination shoe and dustpan. Boots are Gary Cooper's

Hollywood Boulevard and announced that he specialized in theatrical and movie shoes.

Two days after he opened the door, Metro-Goldwyn-Mayer asked him to make a pair of Roman sandals for Jeanette MacDonald. He measured her feet very carefully and made the sandals of fine leather.

Napoli prepares to add cork build-up to increase height in a pair of modern French oxfords for Charles Boyer





Strips of leather for movie costume shoes are trimmed carefully

Miss MacDonald liked them; so did M-G-M.

From then on, the stars "moved in" on Joe's little shop. The studios found him. He worked long hours. His wife, Carmela, helped him. He hired many shoemakers. Orders began to come for 100 period boots, or 200, or even more, for a single motion picture. He'd get a phone call at 6 p.m. for four pairs of period boots for a certain star, to be delivered next morning.

Those boots couldn't be just ordinary boots; they had to be the best boots that human skill could put together, and they had to fit the star's feet as comfortably as if the star had been wearing them for years.

Joe developed a library of data on movie stars' feet. He made wooden models of the left and right foot of many actors and actresses. If the star had a bunion, Joe allowed extra space there. If the star had a corn, Joe allowed for that. If the ends of the actor's toes turned up, Joe turned up the toes on the wooden last.

He did it by gluing strips of leather over a wooden last which came nearest to duplicating the foot. He built up a "rough" and then made fine adjustments by shaving the leather down. He started his library of foot statistics by placing each pair of lasts in a shoe box labeled with the star's name.

Row on row, the names look like Hollywood's Blue Book—Joe E. Brown, Eddie Cantor, Don Ameche, Clark Gable, Bing Crosby, Bob Hope, Fay Bainter, Binnie Barnes, Bette Davis, Loretta Young, Robert Taylor, Grace Moore, Joan Crawford, Nelson Eddy, Sonja Henie, Rita Hayworth, Paulette Goddard and many others.

He makes period shoes for all the major studios except one, which makes its own. A week's orders may call for 20 pairs, or 200, no two pairs alike.

(Continued to page 236)

From 1000 wooden lasts Napoli selects one which nearly duplicates an actor's foot; then the last is altered to conform to the foot. Right, foot outline (with measurements noted) serves as the bootmaker's guide



Electronic Balancer for Wheel Senses Slightest Wobble

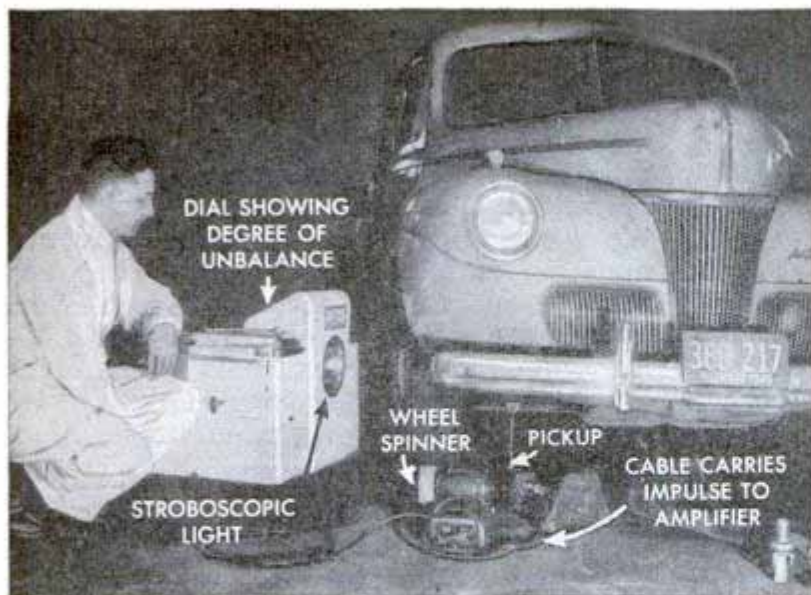

Auto and truck wheels are checked for balance with an electronic instrument that senses vibrations as minute as two thousandths of an inch. A magnetic pickup unit transmits electrical impulses to a meter which transforms the vibrations into dial readings revealing the amount of unbal-

ance. The electronic amplifier, similar to a four-tube radio, furnishes power for a stroboscopic light which, when directed toward a spinning wheel, gives the visual effect of stopping it. This shows the exact spot at which the wheel is out of balance and where weights must be placed.

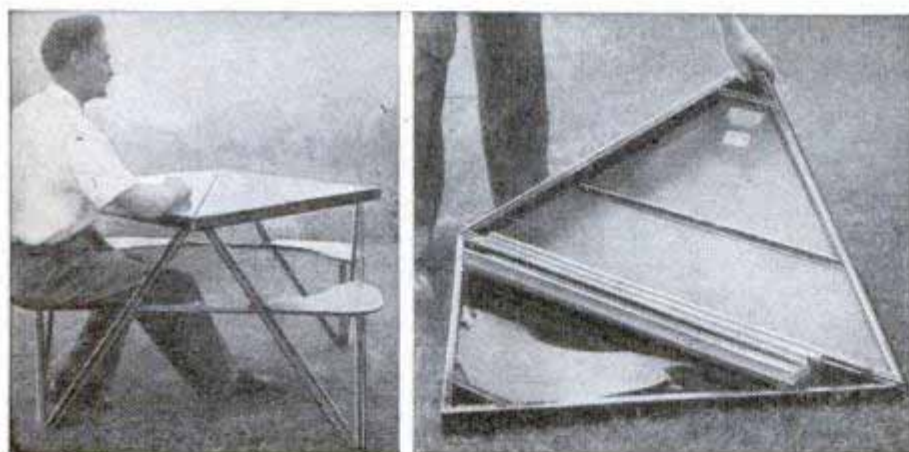

Seats Are Attached To a Folding Table

Four seats are attached to an all-metal square table which folds into a triangular package for storage in the rear compartment of an automobile. Suitable for campers and picnickers, the table is so designed that it cannot collapse or fold up when in use.

Single 'Steering Wheel' Guides Plane's Flight

All controls are coordinated into one wheel in the Waco Aristocrat, a four-place monoplane with a new-type tail propeller. The plane steers like an automobile, with turn and bank coordinated, and pulling the wheel toward the pilot sends it into a climb. There are no rudder pedals. Advantages of the tail propeller are reduced cabin noise, elimination of drag from prop wash and less danger of passengers and airport personnel being struck by the whirling blade. Equipped with a 215-horsepower Franklin aircooled engine, it can cruise 657 miles at 152 miles an hour at 5000 feet. Further

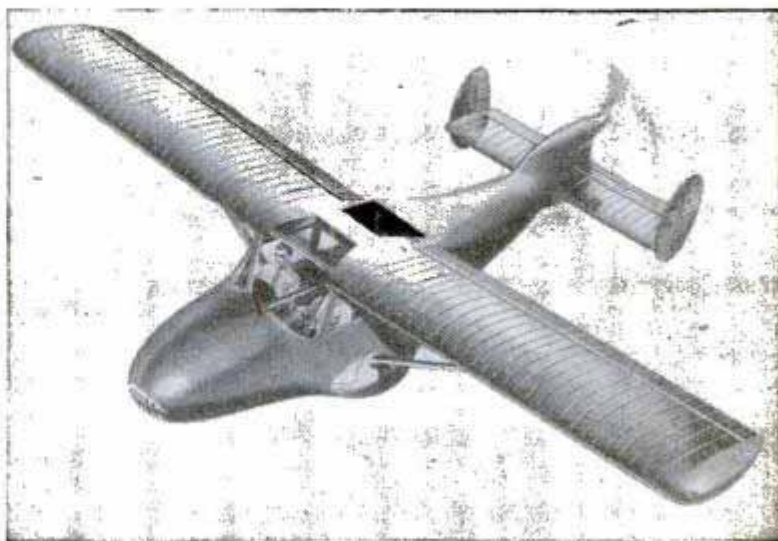

safety changes are the extra-long wheel base of its tricycle landing gear and a steerable nose wheel.



Plastic Cover of Fluorescent Tube Changes Glare to Soft Color

Plastic covers fit over fluorescent tubes to reduce glare and allow a wide range of colors. The covers permit wider use of fluorescent light for display and decorative purposes, producing soft colors that reduce eyestrain. Designed to fit a 24-inch tube, the covers slip easily into place and are nonflammable and washable. They are durable and can be used over and over. Two of the shields can be fitted over a 48-inch tube. Only a small part of the light output is lost with the covers in place. They are available in ivory, rose beige, blue, pink, maize and green.

Elastic Photo Frame Fits Most Pictures

"Elastic" picture frames can be made smaller or larger by a system of springs and overlapping corners. The frames can be pulled in or pushed out to fit any size photographs from 4 by 6 to 8 by 10 inches. The plastic frames, made in several parts that slide along each other to permit exact adjustment to the picture's size, are mounted on attractive easels. They may be purchased in ivory, jade green, Chinese red or dark turquoise colors to harmonize with the other decorations of the room.

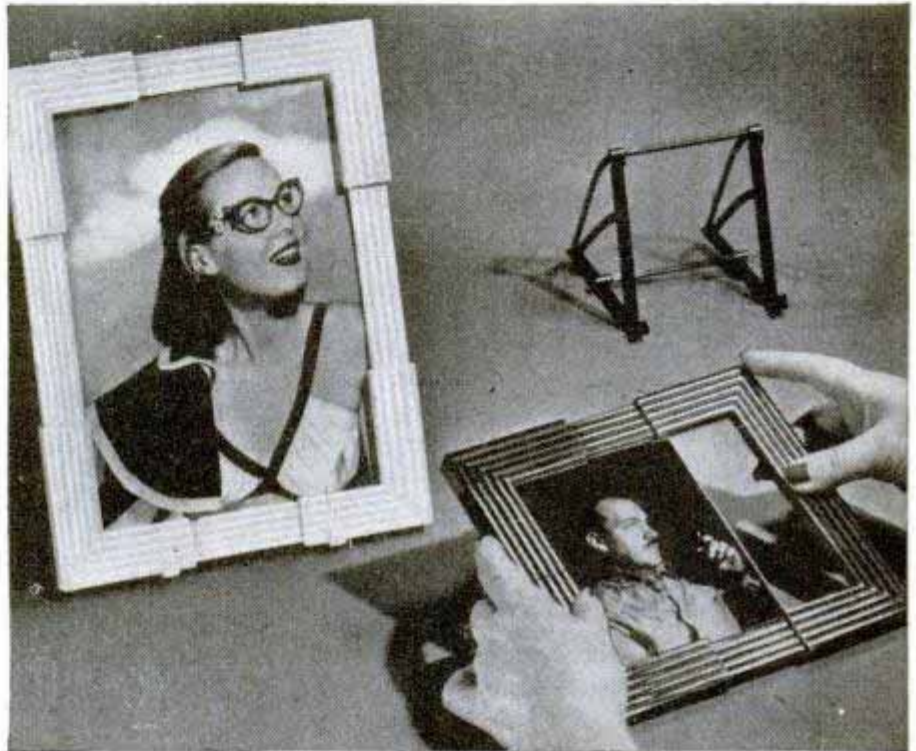

"Gunstock" Camera Support Cures Picture Blurs

Photographic buck fever is cured with a shoulder camera mount which simulates a gunstock to help the picture maker hold his camera steady. It is made of tubular aluminum and weighs only 4½ ounces. It holds the camera at eye level, free to follow rapidly moving objects. The mount is suitable for use with 8, 16 and 35-mm. movie cameras and with still cameras up to 4 by 5 negative size. The support is helpful in shooting sports action scenes.

You may wish to obtain additional information about the new products that are described each month in *Popular Mechanics*. If you want to know the name and address of the manufacturer or the distributor, just write to Bureau of Information, *Popular Mechanics*, 200 East Ontario Street, Chicago 11, Ill. Your letter will be answered promptly.

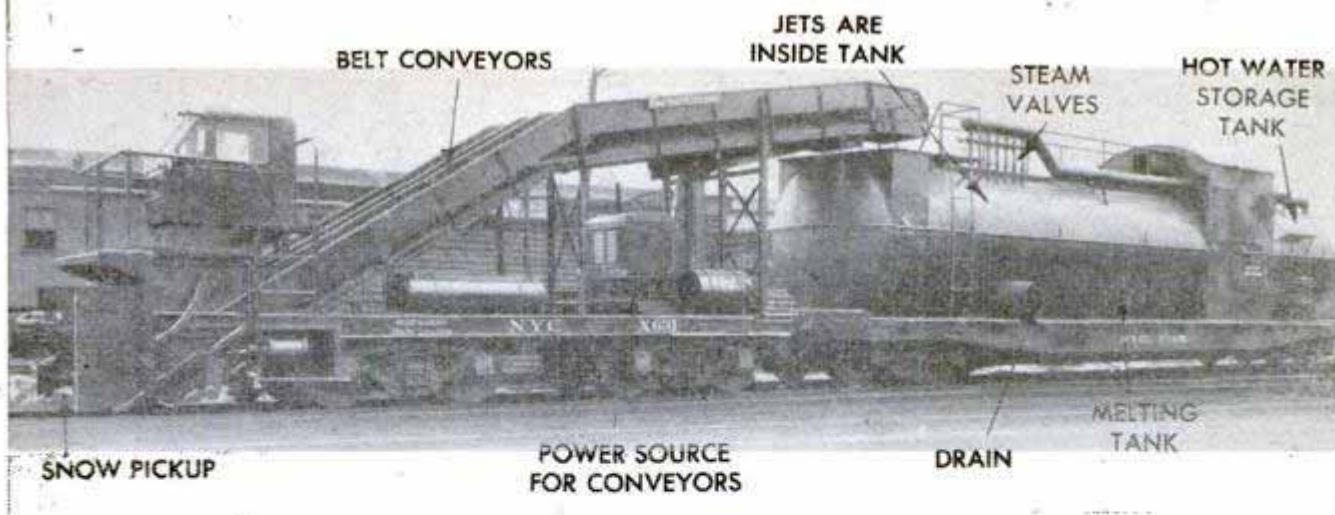

Capable of removing and melting 810 square feet of snow per minute, a giant snow removal machine on the New York Central System can clear the right of way at speeds of from two to six miles an hour. The device is in two units, a snow loader and a snow melter; it weighs 66 tons and is propelled by a powerful freight locomotive. Snow is scooped up by the loader, powered by a 52-horsepower gasoline mo-

Snow "Eater" Clears Tracks

tor, moved by two continuous belt conveyors and dumped into a melting tank of 16,000-gallon capacity. This tank contains a foot of boiling water which has been heated by steam from the locomotive. Fourteen steam jets hasten the melting and when the tank is full it is dumped in a catch basin or drain. The device was designed by the Barber-Greene Company with the cooperation of System engineers.

Motorless Observation Kite Gives "Eyes" to Submarines



In an effort to devise "eyes" for their submarines, the Germans developed a combination helicopter-kite. Weighing only 180 pounds, the motorless craft carries a pilot and is lifted into the air and kept aloft by air pressure on its three-blade rotor. It is towed by a submarine on a cable 200 to 500

feet long. For stowage aboard a sub, it is folded into a compact package. The craft has no gear for landing on water. Descent is accomplished by releasing the rotor, causing the machine to come apart and allowing the pilot to descend by parachute. Helicopter pilots say it is easy to fly.

Nonkink Synthetic Clothesline Can Be Cleaned With Damp Cloth

Clotheslines and other lightweight cords are being made of a flexible synthetic that won't kink or twist and can be wiped clean with a damp cloth. Nineteen strands of low-stretch rayon are jacketed with a coating of Koroseal, the elastic synthetic, to pro-

duce a smooth-surface rope. The clothesline has a tensile strength of 150 to 200 pounds, is not affected by the heat and will withstand subzero weather if not abruptly kinked. Standard clothespins fit the line, which is available in 50-foot lengths.

Musical Note Adjusts Plane's Altimeter to Avert Crashes

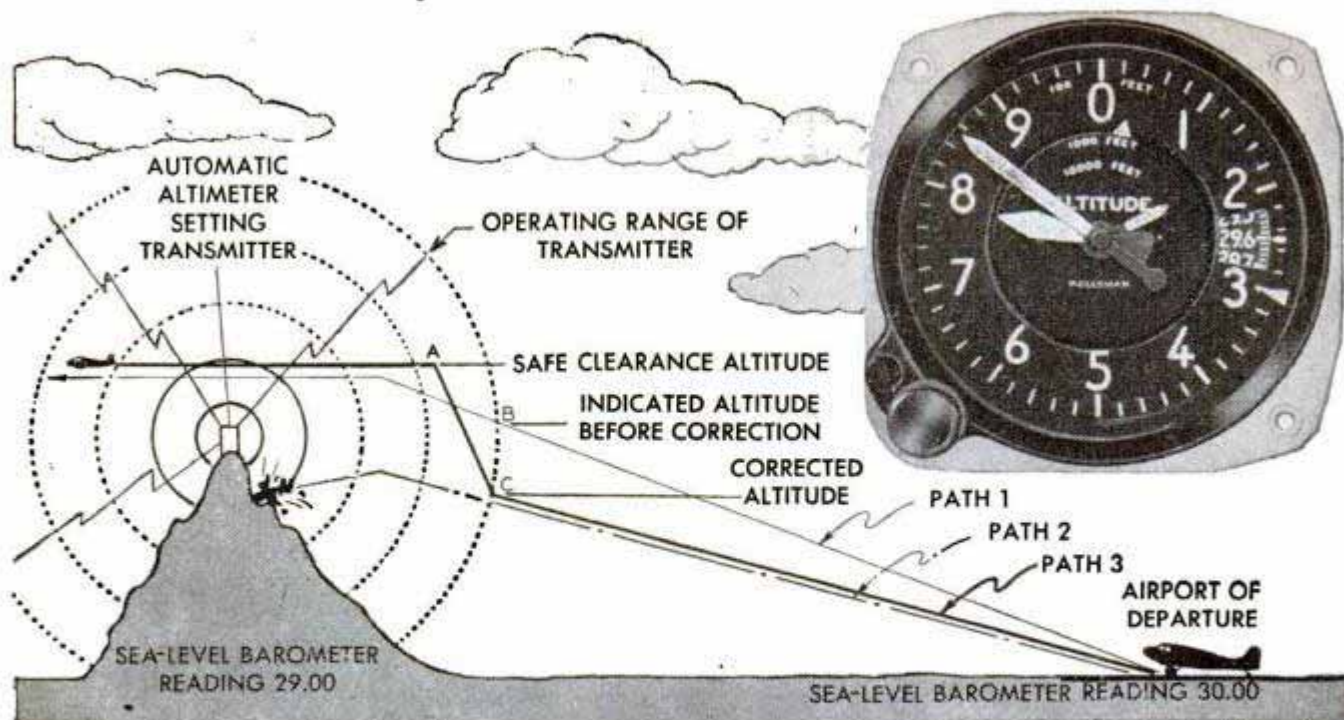

Musical notes, tuned to an exact pitch, transmitted from mountain tops by automatic radio "broadcasting" stations can adjust airplane altimeters to the correct barometric pressure and in this way help to prevent accidents. The pitch or frequency of the constant signal indicates the barometer reading at the point of transmission. Previously the information as to ground barometer reading was given to the pilot as a matter of routine in all ground-to-plane messages and the pilot adjusted his altimeter manually. But an error of one inch in barometric pressure will cause the altimeter to err by 1000 feet, in addition to which the pressure at 15,000 feet may vary considerably from that on the ground. The pilot would intend to follow Path 1, based on a sea-level barometer reading at the takeoff point of 30.00, one inch higher than

at the mountain site. Basing his calculations on the higher reading, he would actually fly Path 2 and crash into the mountain. With the new device he would follow Path 2 until coming within range of the automatic transmitter, which would correct his altimeter setting by means of a radio signal in time for him to adjust his course to Path 3, a safe clearance altitude over the mountain. The transmitters, developed by the Kollsman Instrument Division of the Square D Company, can be installed at radio range stations or independently and have a 50-mile range. They require no operational or maintenance personnel and can be powered by batteries, gasoline engines or windmills. The device may be tested by the pilot manually setting it to a false barometer reading or by transmitting to it a false reading.

Dashboard Light Flashes Red If Emergency Brake Is Not Released

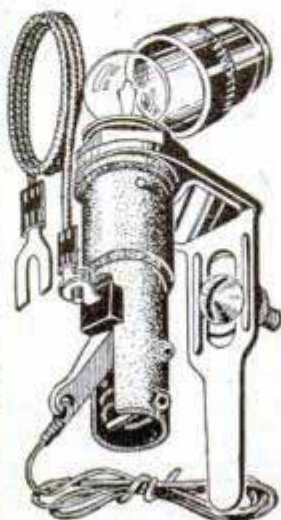

Some cars and trucks are now equipped with an extra dashboard light which flashes a fiery red warning if the driver starts to drive away without first releasing his emergency brake. The light will not turn on with the ignition off, eliminating any danger of running the battery down when a vehicle is parked.

☞ Birds that swooped too near a giant radar antenna used to jam enemy search equipment during the war were stunned and cooked instantly by the powerful beam of high-frequency radar waves.

NONE OF THE KIDS in Gainesville, Texas, ever runs away to join a circus.

They have their own circus right at home, with relatives and neighbors billed as stars. Any youngster with talent has a chance to perform but he must be good, for this amateur assemblage has its own big top and can compete on even terms with professional circus groups. The Gainesville Community Circus travels thousands of miles and puts on scores of performances every season.

Watching one of the shows, you gasp when a pretty Gainesville girl makes a breath-taking "slide for life" from high in the air. You marvel at the "educated equines ridden by masterful trainers" and chuckle over the "comic capers of irresistible clowns."

Graceful and daring queens of the air, peerless tightrope artists, Texas peace officers in displays

HOME TOWN CIRCUS

By

THOMAS E. STIMSON, JR.

Pretty troupers on white horses lead parade of the Gainesville, Texas, Community Circus—"only show of its kind in the world"

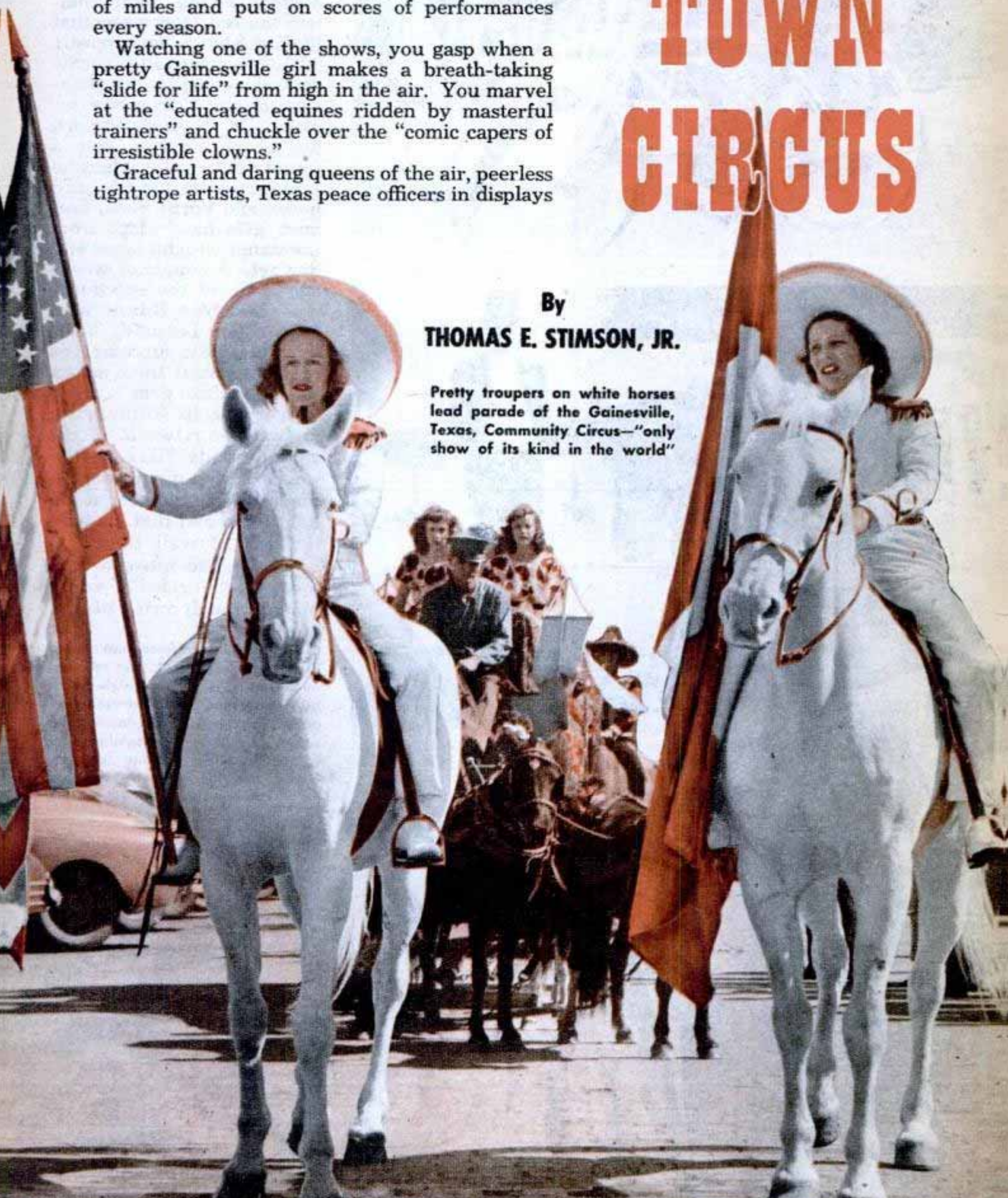



of marksmanship, and acrobats with contortionist acts—the community circus has them all.

The circus presents all the pageantry and thrills of the big time and yet home-towners in the audience recognize the slack-wire performer as Johnny Young, soda fountain worker. They know that the Roy Stamps who appears with five ponies in intricate drills is actually the manager of the Gainesville ice plant. Dr. A. A. Davenport, the chiropractor, gets a round of applause when he appears with his trained horse, and Portis Sims, fireman, gets hand claps from the stands with his horse and dog act. A couple of weeks ago some of the spectators watched Sue Roane and Mary Ellen Leonard, "feminine aerialists supreme," as they rehearsed their act in the high school gym.

Everyone in Gainesville knows that Alex Murrell who presents "Dexter, the smallest high-diving dog in the world," is engineer at the light plant and that his wife is Gerry Murrell, the tight-rope star and intrepid performer who rides a white horse through a ring of fire.

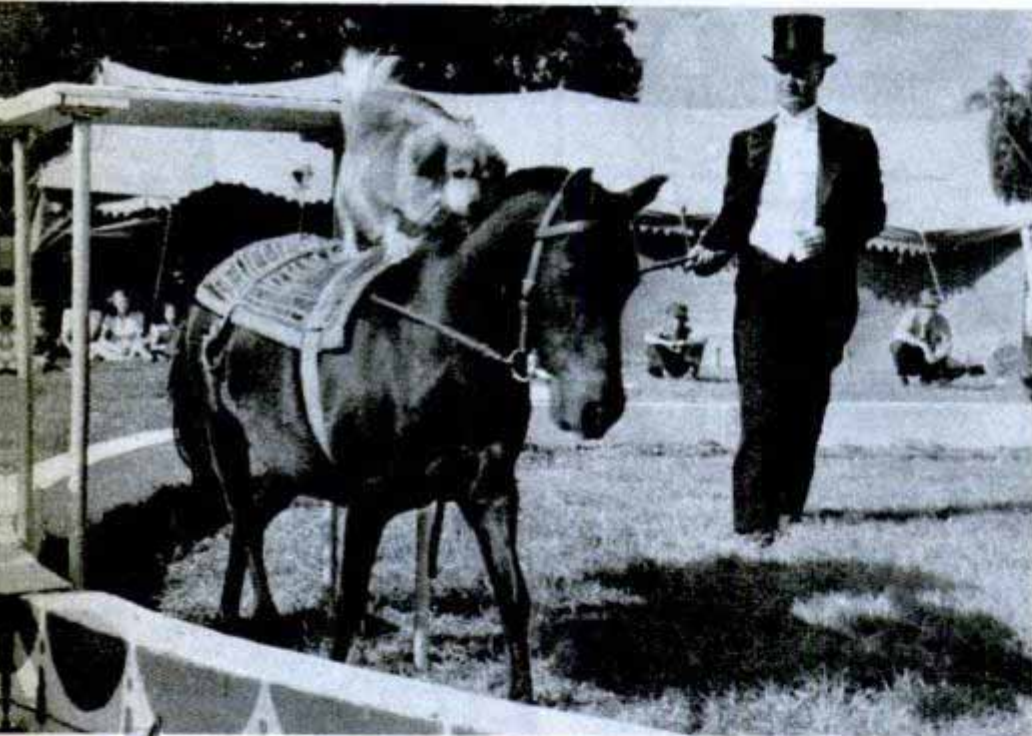

Clown (top) is a businessman during working hours. Left, taking rehearsal seriously is Dexter, high-diving dog who jumps from platform to the pony's back. Having fun down in the corner is clown band containing some of Gainesville's leading citizens. Below, aerialist helps paint clown



POPULAR MECHANICS

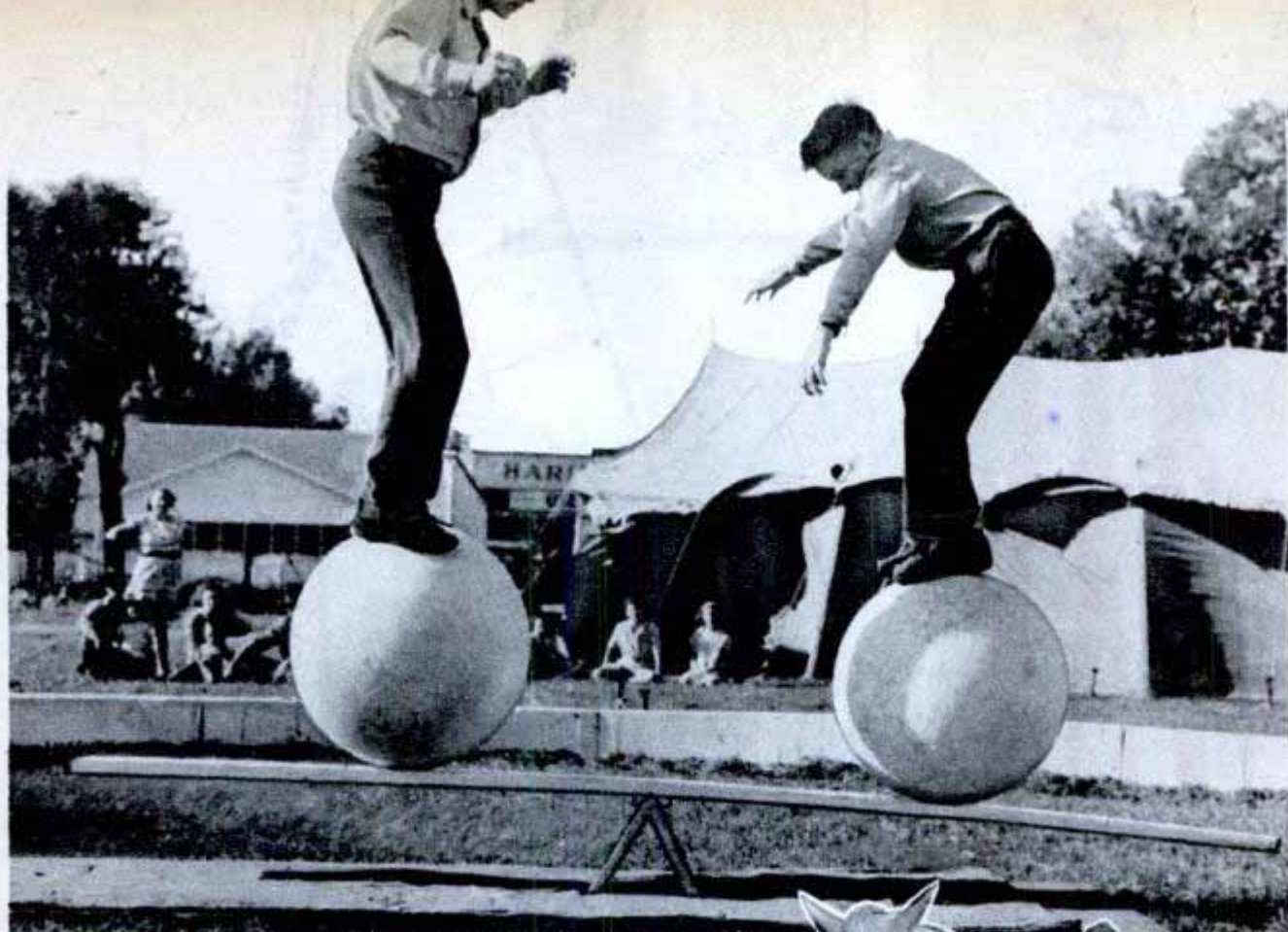

This teeter-totter act requires balancing on rolling globes

Not so easily recognized in their absurd clown costumes are J. B. Saylor, accountant, A. W. Wells, mathematics teacher, Dr. S. M. Yarbrough, physician, and Cecil Farr, automobile dealer. There are 15 clowns.

The Gainesville performers attract crowds wherever they appear and have turned down high-priced offers for professional tours. They exhibited before 11,000 spectators in College Station, 7500 in Austin, 52,000 in Fort Worth and 30,000 in Houston. In all, the circus has played to more than half a million spectators.

Some of their acts are adaptations of

Right, taking final bow just like in the big time. Gerry Murrell (below) takes time out from her housework to rehearse two white horses for feature act

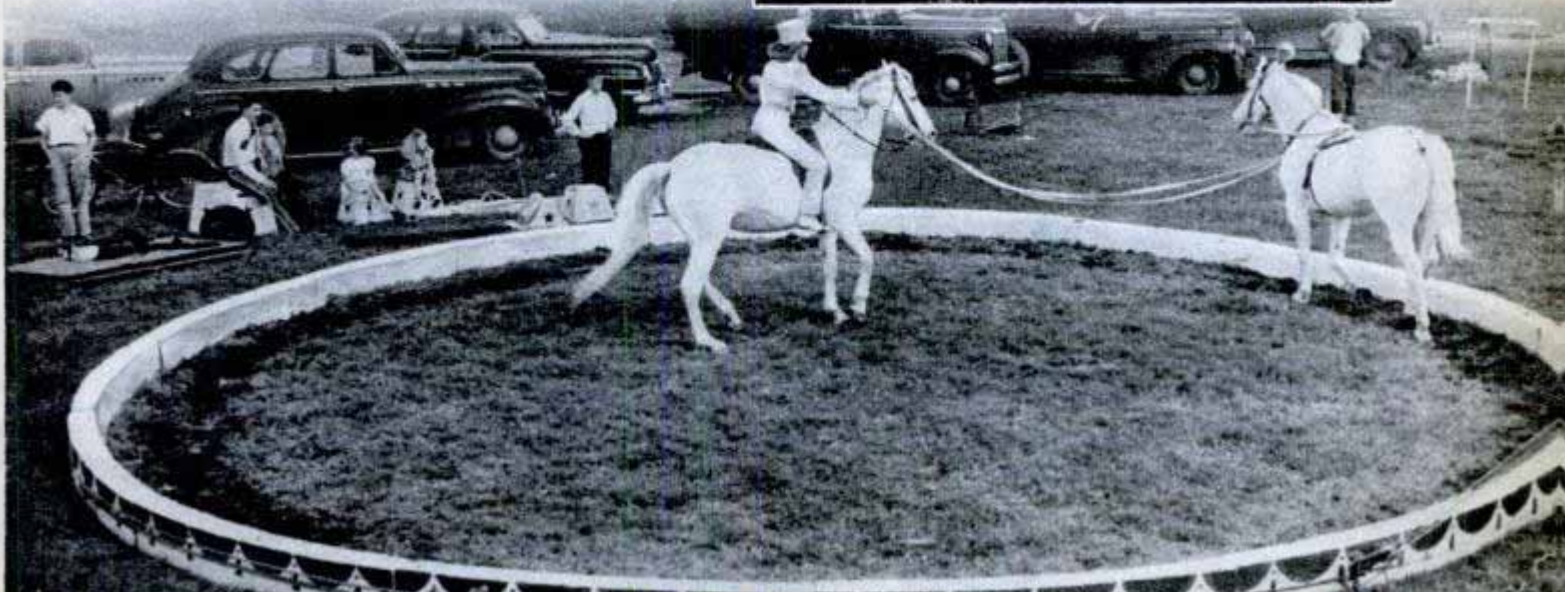



Two high school girls rehearse tricky act on double aerial ladder

standard circus routines, others are their own innovations. Any resident of Gainesville can try out for the community circus. With the proper training almost anyone can perform difficult aerial feats—so the performers say. The circus usually employs a big top expert for part of the spring training period. He advises them on new stunts, makes suggestions on properties and costumes and shows them how to polish up the acts.

This instruction is augmented by a special gym class at the Gainesville high school. Students who desire

Stilt-walking clown towers 15 feet high. Below, aerial view of tent

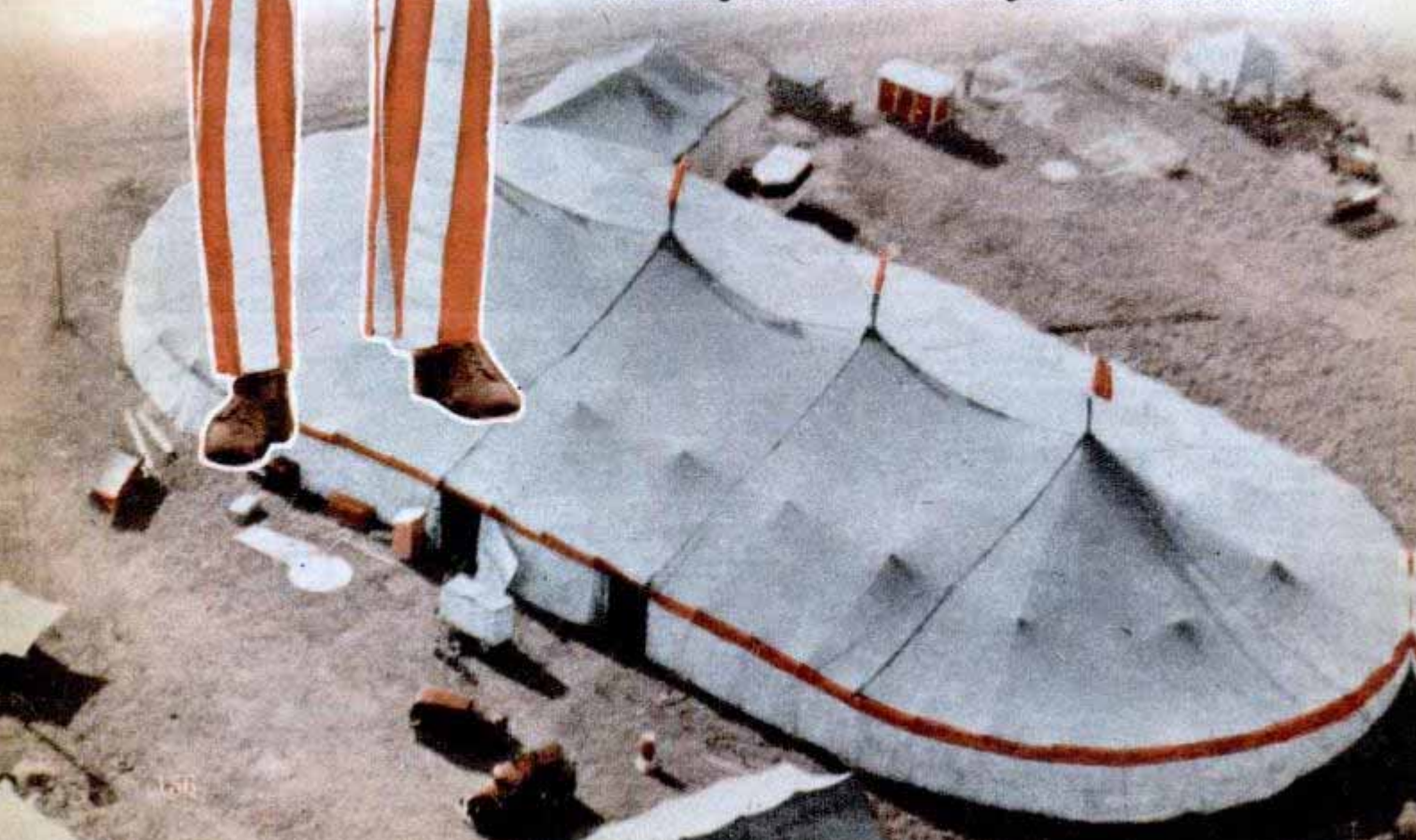



Aerialist rehearses for act to thrill crowd

may spend their gym periods working on aerial ladders, Spanish webs, rolling globes, Roman rings and other pieces of circus equipment. At least 25 percent of the students become good enough to participate in the circus. The best of them are selected at the annual spring tryouts.

At the tryouts, too, the officers pick the other features and the animal acts. The group has no wild animals. Horses and dogs are the most popular four-legged performers. One of the new acts last summer, for instance, was an eight-horse act performed by matched chocolate-colored equines and presented by Vern Brewer. None of the horses was even halterbroken when Brewer started to train them early last spring.

Other Gainesville citizens work up spe-

(Continued to page 252)



Amateur tightrope walker is climbing a ladder while he balances with only one arm

High school girls in spangled costumes ride wagon built in local shop

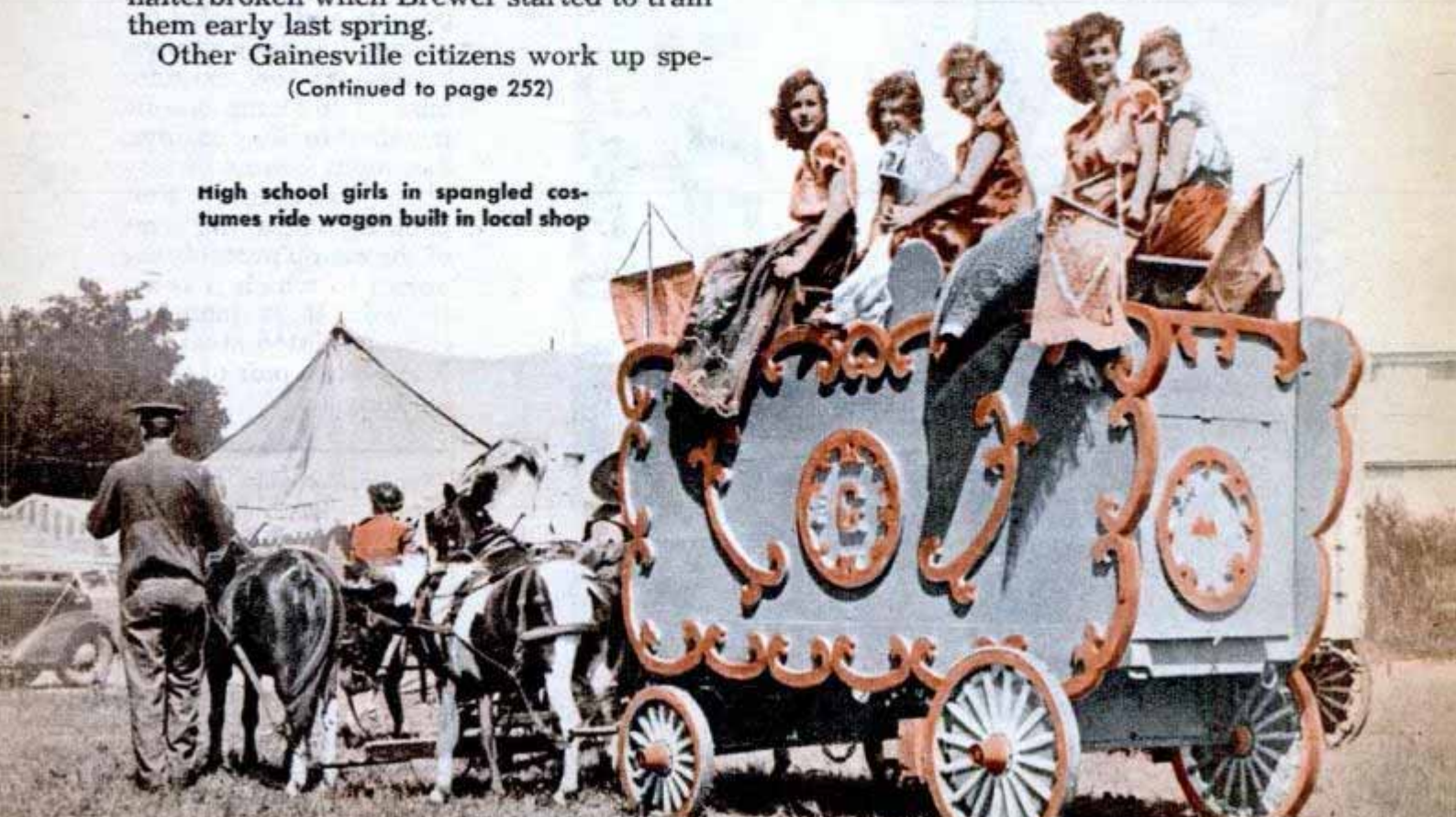

Snow Cycle Glides Down Mountain Slopes on Carved Wood Runners



Swiss mountains, slippery with ice and snow, are taken in stride by a "schnee-velo"—snow cycle—invented by a 74-year-old resident of Schwandi, Switzerland. Christian Buhlmann, whose right

leg has been paralyzed since childhood and who lost his left arm in the sawmill he operates, invented the snow cycle to help him move around the village. The runners that substitute for wheels are hand carved.



"Ice Tong" Clamps Hold Swing or Bar

Weighing only 1½ pounds, a clamp support holds up to 250 pounds and is useful for supporting baby swings, hammocks or exercise bars. The clamp can be fastened to door casings, basement beams or any sturdy structure. Felt padding within the arms of the clamp protects the object to which it is attached. It is made of chrome-plated steel and looks like a pair of shiny ice tongs.

Popular Mechanics is always ready to supply further information to readers about various products described in any issue. Just write to Bureau of Information, Popular Mechanics, 200 East Ontario Street, Chicago 11, Illinois, for a prompt reply.

Electronic Trainer for Pilots Simulates Flight Problems

Any kind of flying condition, from the smooth "on the beam" variety to emergencies such as icing or engine failures, is duplicated in an electronic pilot trainer built by the Curtiss-Wright Corporation. Previous trainers reproduced only routine flights.

Approximately nine feet long, the trainer resembles an enclosed airplane fuselage minus wings and tail section. It has a pilot's seat, aircraft controls and lighted instrument panel. The device is made stationary so that the pilot gets no assistance in "flying by the seat of his pants" and is wholly dependent on his instruments.

An amplifier produces various engine noises such as those occurring in actual flight. Built into the tail is an instrument panel on which the instructor can create changing weather conditions.

When the controls are operated, all the interacting effects of lift, drag, thrust and other factors that cause the plane to maneuver, spin or stall are developed as electrical voltages. These voltages are sent as signals to the electronic computing system of the trainer which gives the correct answers promptly as voltages or shaft rotations representing air speed, rate of turn and climb, pitch and roll. These answers are continuously translated into meter indications in the trainer's cockpit.

All of the radio signals of a navigational range and blind landing system, together with visual and audible markers, are provided. A flight path recorder permanently charts the trainee's maneuvers.

The initial model duplicates the instruments and flight characteristics of an AT-6

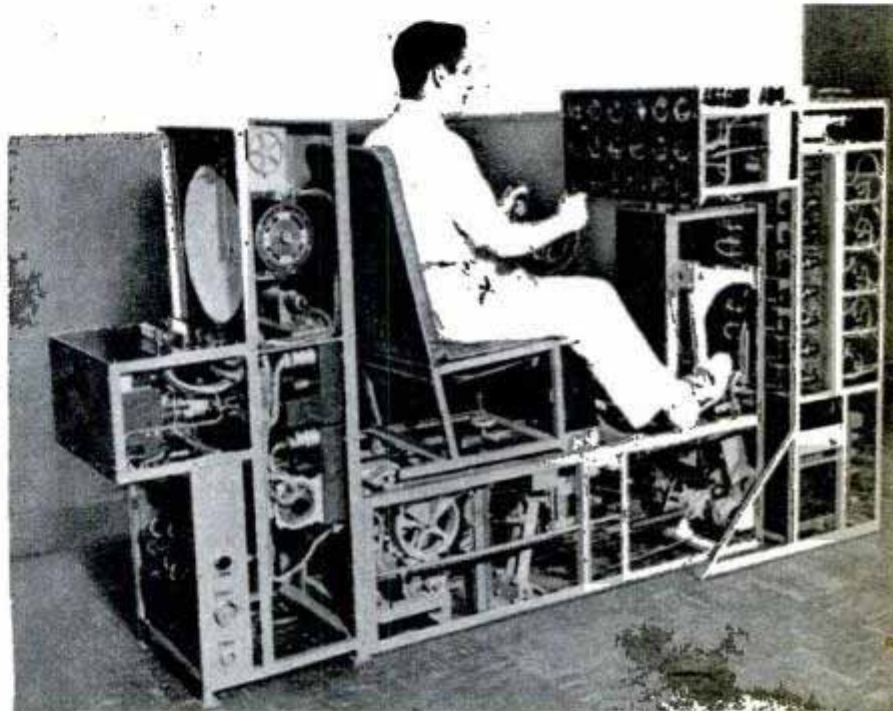
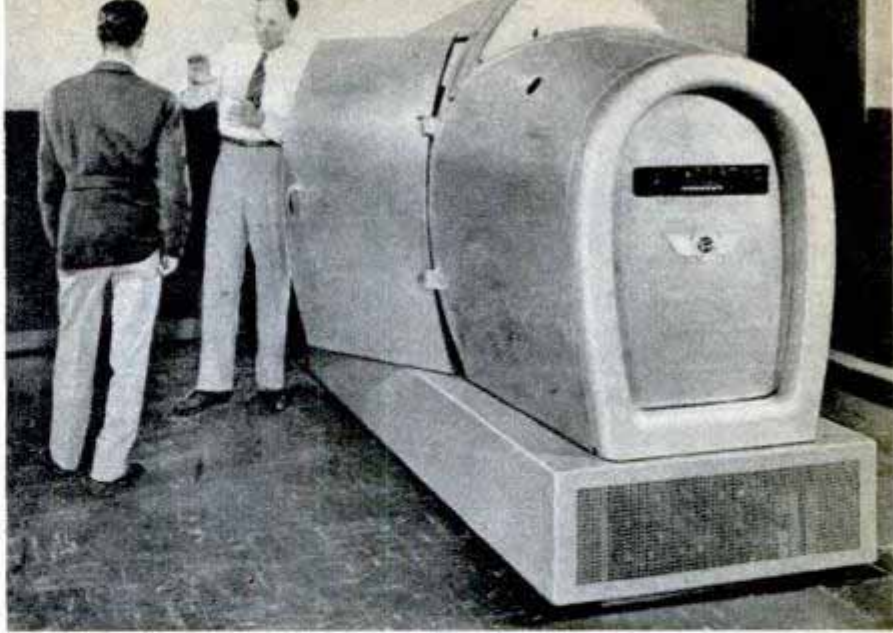

airplane, but they can easily be modified to any type. It is expected to be especially valuable to the armed forces and air lines in training pilots to fly new model planes. Some air lines have estimated the cost alone for such transitional training at \$20,000 a pilot.

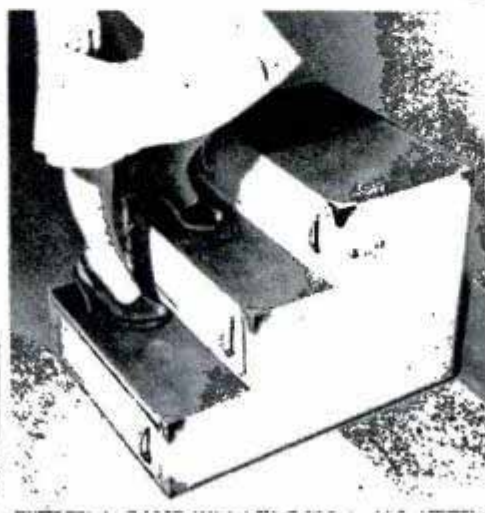

"Step-Chest" Ladder Has Drawer Space

Called a "step-chest" because it combines the functions of a small stepladder and chest of drawers, an aluminum unit has three roomy drawers—one for each step. The legs are equipped with domes which make it easy to slide across floors, yet they move upward into the legs to insure steady support when a person stands on the ladder.

TESTING A NEW LIGHTWEIGHT



By pressing button at his left thumb pilot photographically records instrument readings that show forces acting against control surfaces

BECAUSE it's too late to call a mechanic when something goes wrong aloft, newly designed planes probably get the most thorough "going over" of any means of transportation. For this job aeronautical engineers and pilots rely on dozens of sensitive instruments, automatic recording cameras and completely equipped laboratories. The experimental craft is put through its paces by flyers trained to observe every flight characteristic. Here are some of the ways North American, for example, spent over 5000 hours in the engineering test flight department alone before producing its new four-place private plane, the Navion

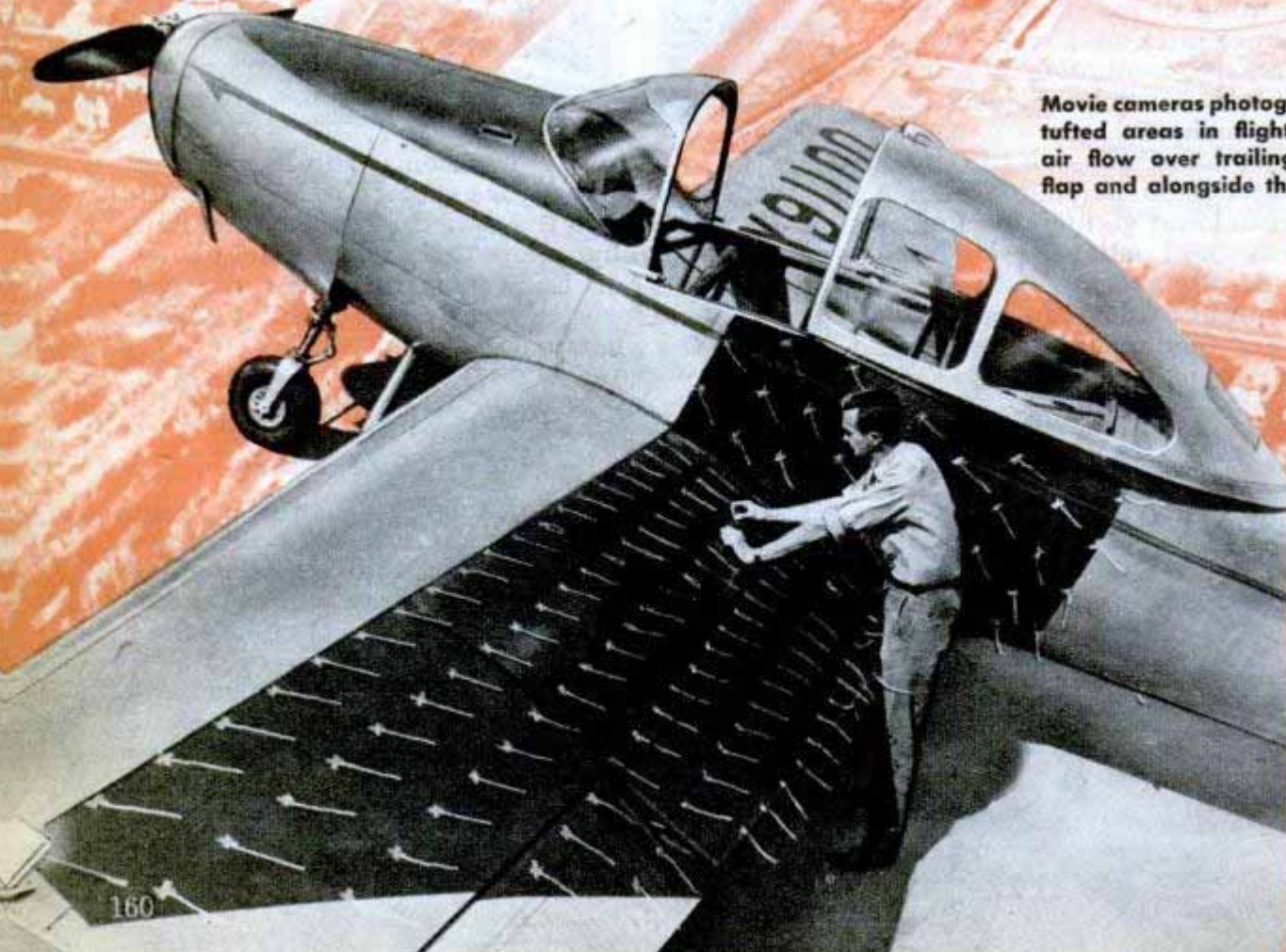

Movie cameras photograph black tufted areas in flight to study air flow over trailing edge of flap and alongside the fuselage

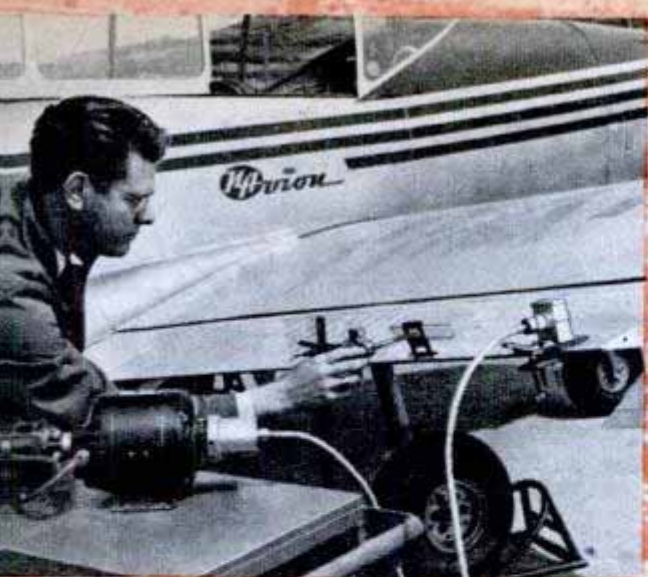

Flap tests (above) detect unwanted vibration. Right, angle-of-attack vane shows plane's heading relative to forward flight

Equipment at left tests wearing qualities of control cables. Bottom, removing camera recording unit after flight. To guard test pilot, tail chute at right can stop a spin



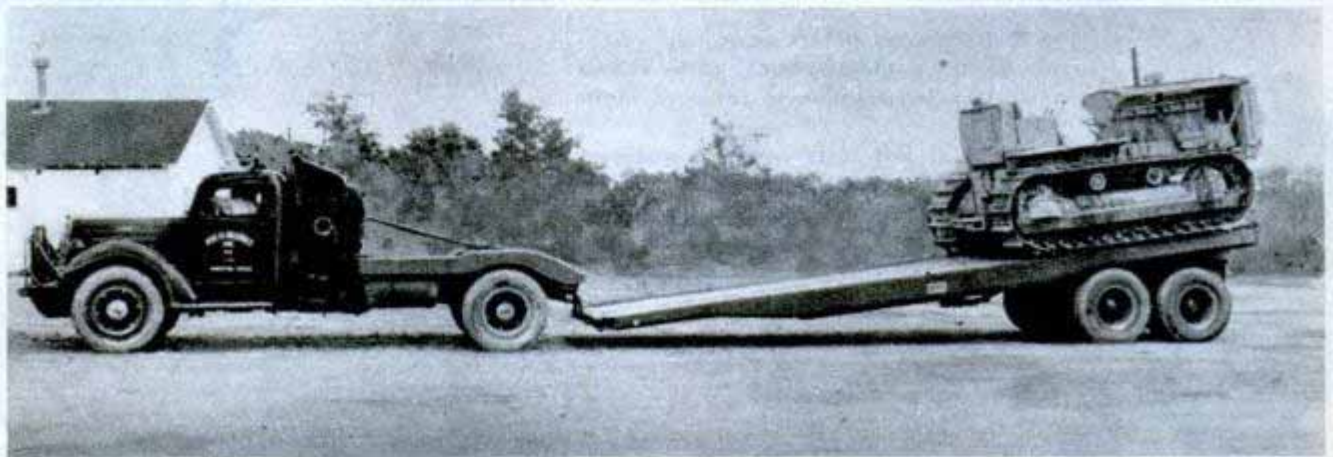
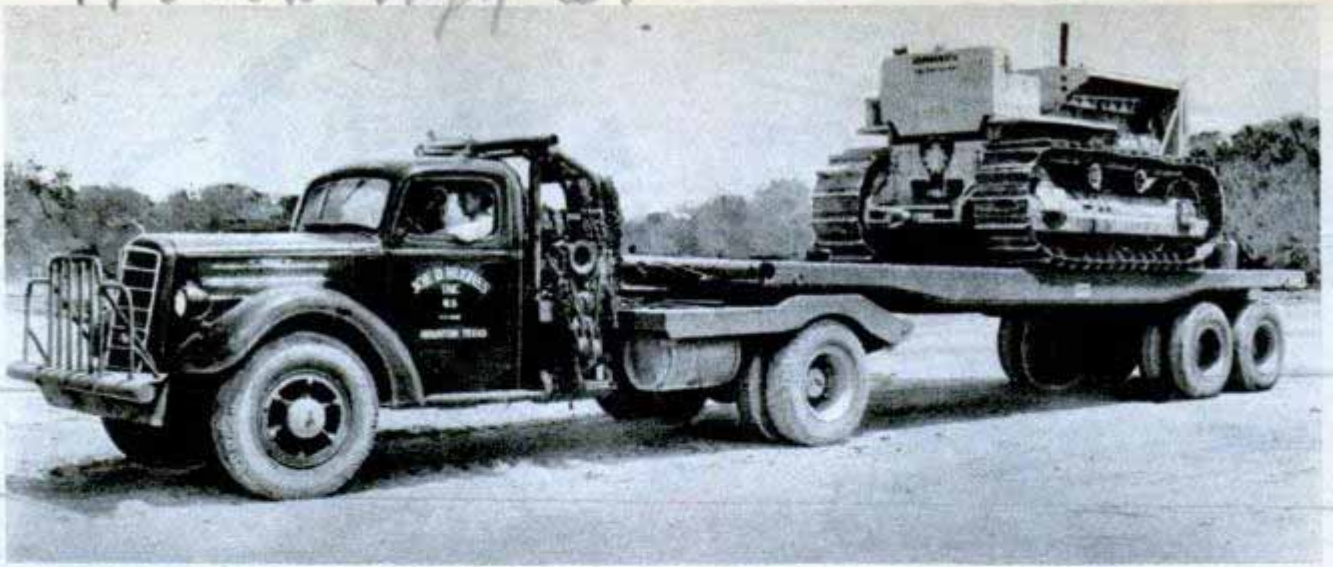

Power from a tow truck makes it easy to load or unload a trailer. To load it with a tractor or other heavy equipment, the front of the trailer is lowered to the ground. When the loading is completed, the front end is hauled by a power winch up over the rear end of the truck and onto the towing wheel plate. It was designed by Meck Trucks.

Self-Loading Truck Trailer

House Trailer Projects Above Coupling to Make Room for Double Bed

Extra space for living quarters is provided in a house trailer that extends above the coupling to utilize the space between the automobile and trailer. A large double bed is mounted in the extension. Close coupling makes the trailer easier to handle.



Helicopter With Hoist Used for Sea Rescues

Using a helicopter equipped with a power hoist, the Navy is experimenting with new sea rescue techniques. While the helicopter hovers overhead the victim hooks a line dropped from the hoist to his life jacket and is reeled up into the craft.

Cosmic Rays Tested 40 Miles From Earth

Cosmic rays 20 times more frequent, and stronger than those on earth, were found by a Nazi V-2 rocket soaring 40 miles above the desert at White Sands, New Mexico. Practically all were "hard count" rays that can penetrate six inches of lead, while scientists estimate only 70 percent of those reaching earth are in that class. Radio interference blacked out reception of much of the data.



Surveyors' "Amphib" Crosses Marshland

Veterans of rough action in the southwest Pacific, Navy LVT-III amphibian tanks are now carrying Bureau of Reclamation engineers through the marshlands along the Colorado River between Needles and Topock, California, to conduct river control surveys. The armor-plated tanks plow through areas that formerly required days of trail hacking to cross. Another war development, two-way walkie-talkie radio sets, are also used.

☐ For the past 20 years the Atlantic Ocean has been rising at the rate of 1½ feet per century, according to the U. S. Coast and Geodetic Survey.

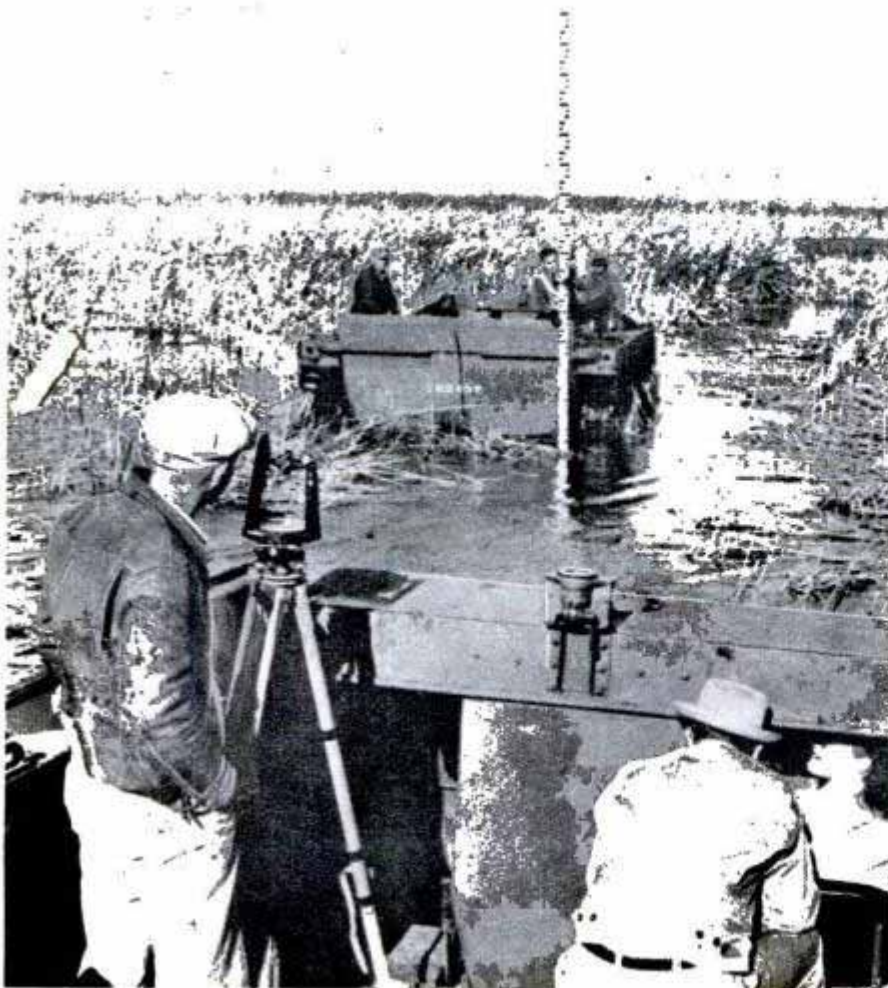

U. S. Bureau of Reclamation photo

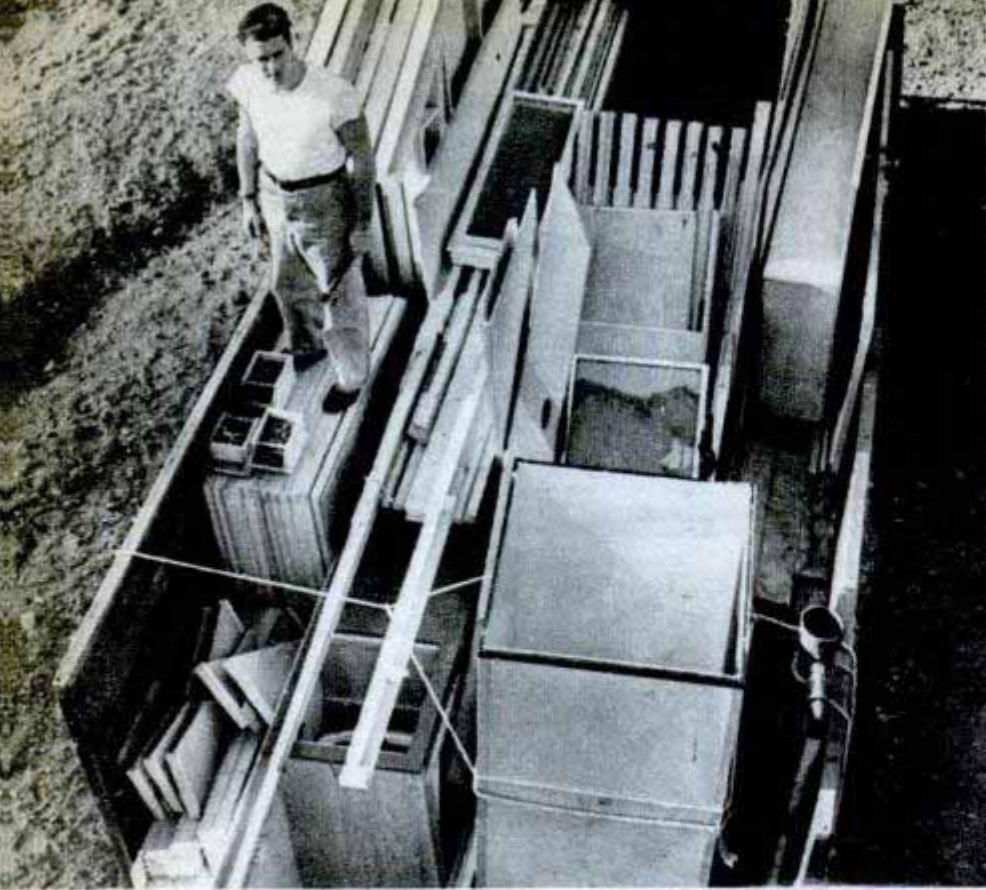

Truck hauls knocked-down house to site in one load. Home will be ready for occupancy in about 56 hours



Door from living room leads into kitchen. Beyond kitchen extra bedroom can be seen

Special Delivery House

Assembled cottage makes an inexpensive mountain cabin with lots of light and air





Right, with one of the end walls and part of an interior partition in place, the builder assembles the roof trusses

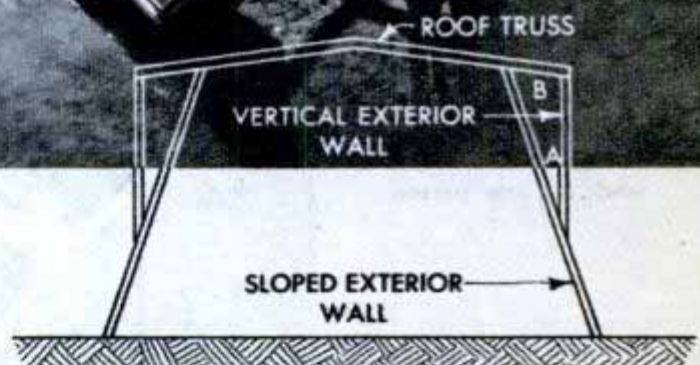
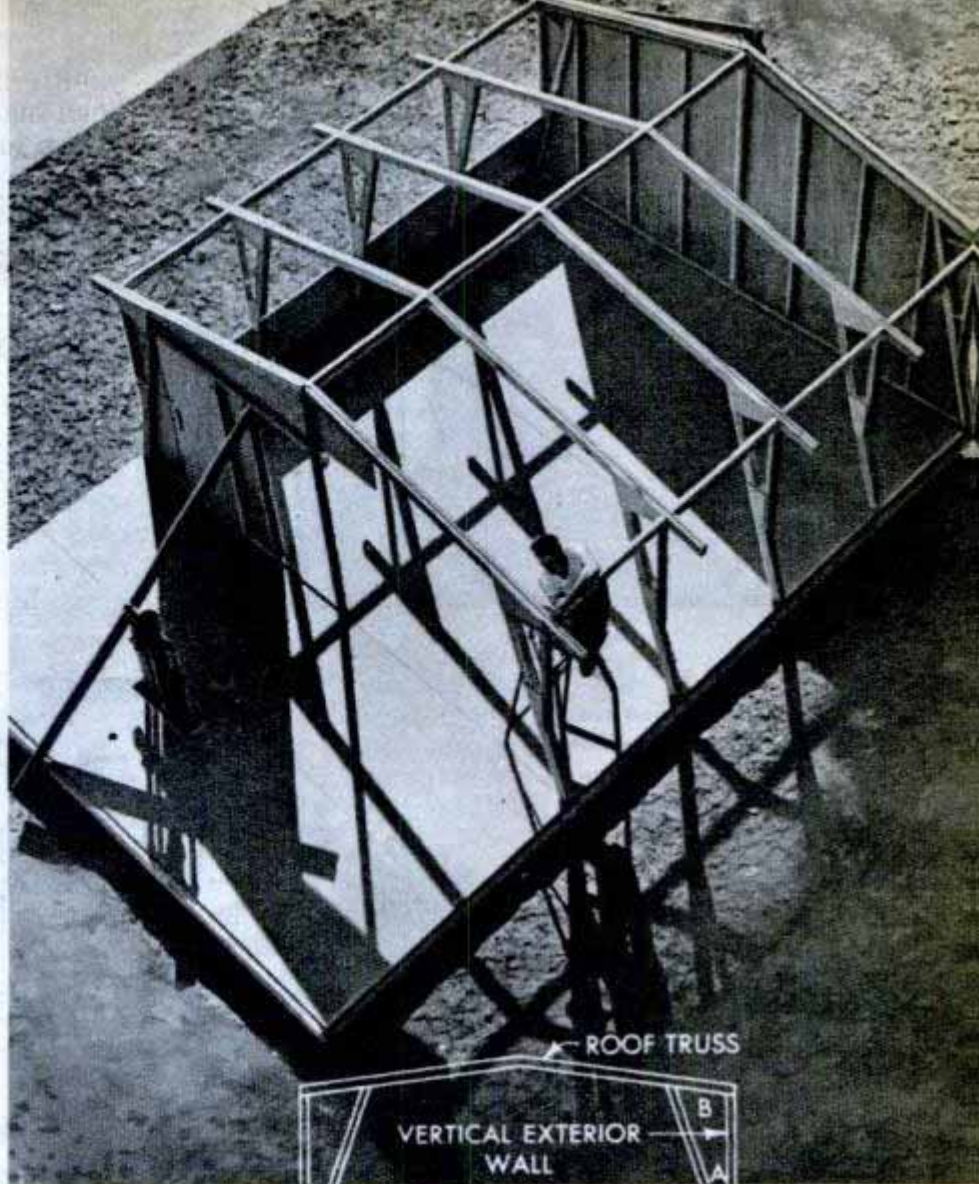

Roof and side wall detail shows sloping exterior walls. Plywood reinforcing gussets are fastened at A and B as in photo above

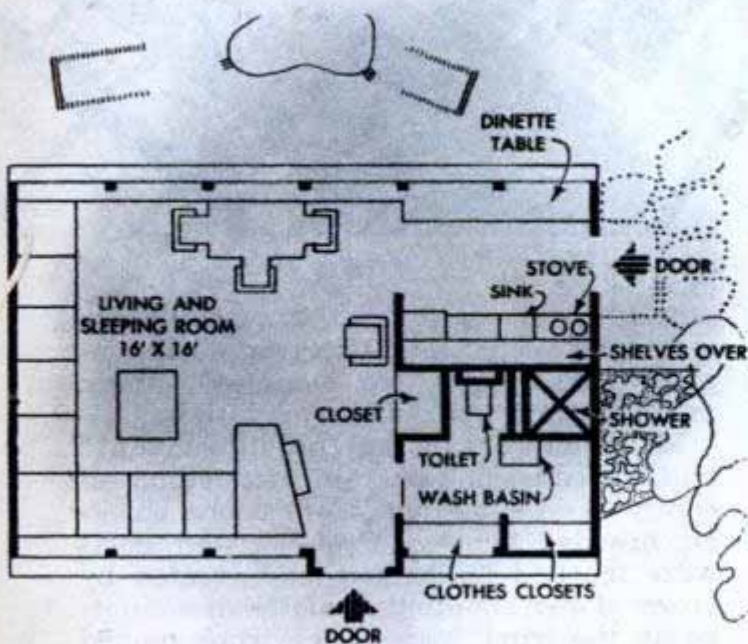

Plan shows space-saving arrangement of rooms. Front door can be placed anywhere in side wall

ONE man can erect a new "production line" cottage-type dwelling in 36 hours, wire it in 10 hours and install the prefabricated plumbing in another 10 hours.

The 16 by 24-foot home contains a combination living and sleeping room, a kitchen with a dinette, and a bath complete with stall shower. All the material used in the basic unit is delivered in one truckload to the site. Additional units may be added at either end to serve as separate bedrooms.

Priced at about one third less than conventional homes, the house has a unique "trussed modular" system of roof support that has been tested to 60,000 pounds per square foot, four times the requirements of stringent building codes. About 150 of the "packaged" houses are prefabricated per



↑
Compact kitchen has a dinette table beneath expanse of windows. Note the cupboards above stove and sink

House is completed and occupied (roof is left off so you can see → inside) after 56 hours' work by one person

Spacious living room has row of windows on each side, storage space beneath. Note the novel roof trusses ↓



month in California and deliveries have been made to other states and Hawaii.

The long walls of the house are paneled in glass windows. The lower side walls, end walls, flooring, interior partitions and roof are built up from 4 by 8-foot weather-resistant plywood panels. Bathroom and kitchen are placed back to back for economy. Plywood panels may be used to cover window areas and doors may be placed anywhere along the side walls.

Entirely prefabricated at the mill, the parts of each house are assembled without special fitting or cutting at the site. A hammer and a pipe wrench are the only tools required. The electrical system is pre-assembled into a complete unit of wiring,

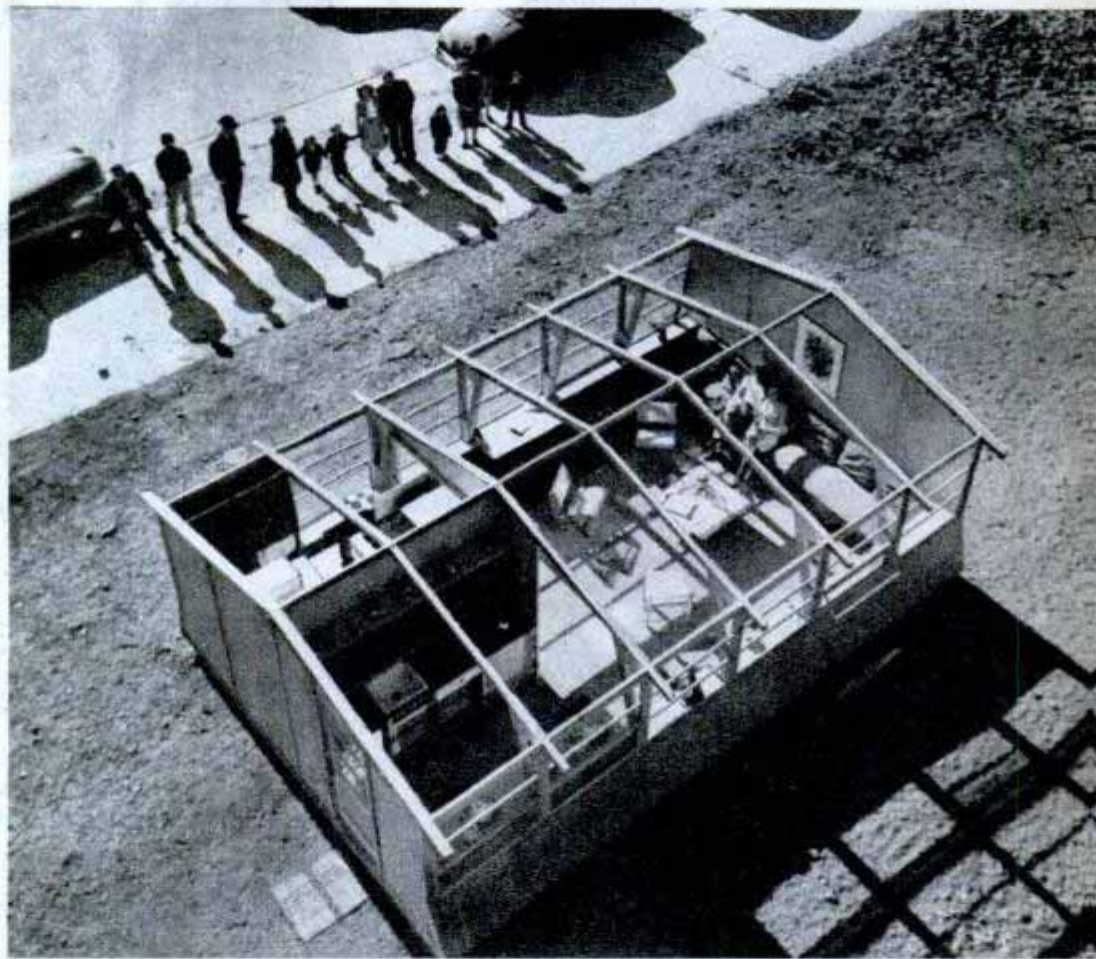

outlets and fixtures, ready for installation.

The completed buildings can be used as guest houses, beach or mountain cabins, motels and camp or classroom buildings.

Manufacturers of the "production line" house used a somewhat similar method recently in erecting five 500-foot-long chicken brooder houses. Prefabricated parts were trucked to the site and erected by crews of men standing on platforms mounted on the truck beds. Each truck moved forward at the rate of 24 feet per hour while the men erected the sidewalls, roof trusses and roofing.

Road-Striper Does Job of 90 Men

White lines are painted on the many miles of highways at Camp Pendleton Marine Base, Oceanside, Calif., by a mechanical road-striper built of spare parts at the base machine shop. The machine paints a stripe on 30 miles of road in eight hours, a job that formerly required the work of 90 men. One man operates the machine, sighting down an extension bar to follow a guide line marked on the highway. The striper is pushed by a truck. It was developed by Lieutenant E. N. Nelson.

Acetylene Made From Natural Gas

Acetylene gas, used in welding and as a base for making some types of plastics, soon may be produced commercially from natural or coal gas instead of calcium carbide as at present. The process, developed by German scientists, was discovered by American investigators searching through chemical secrets of former enemies, and is said to be more efficient than American processes. The United States has large quantities of

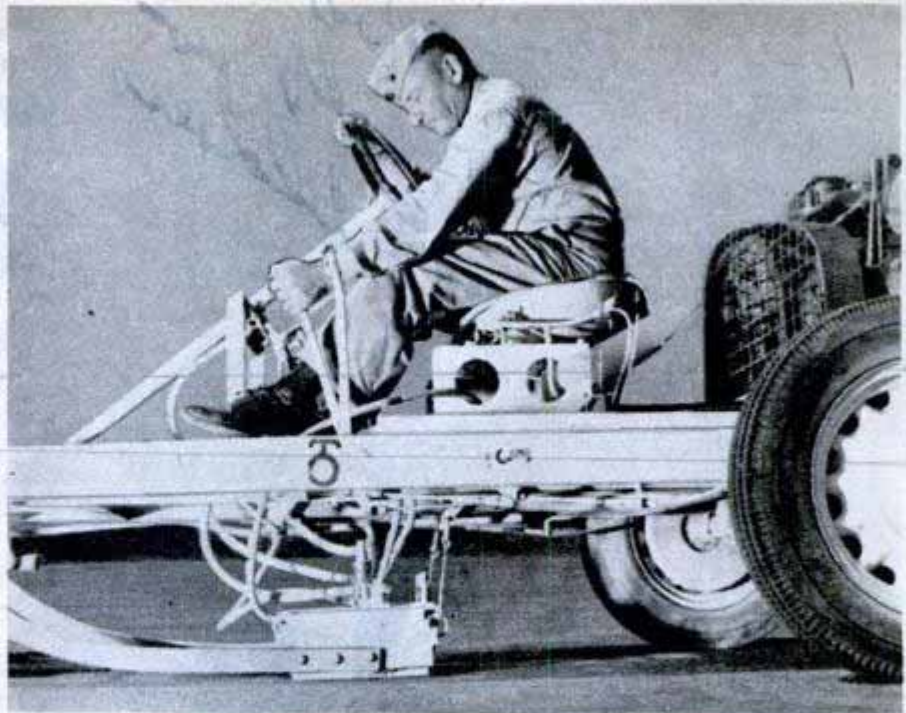

U. S. Marine Corps photos

natural gas, a relatively small amount of which is used in production of chemicals. The process may give America another source for an important basic chemical.

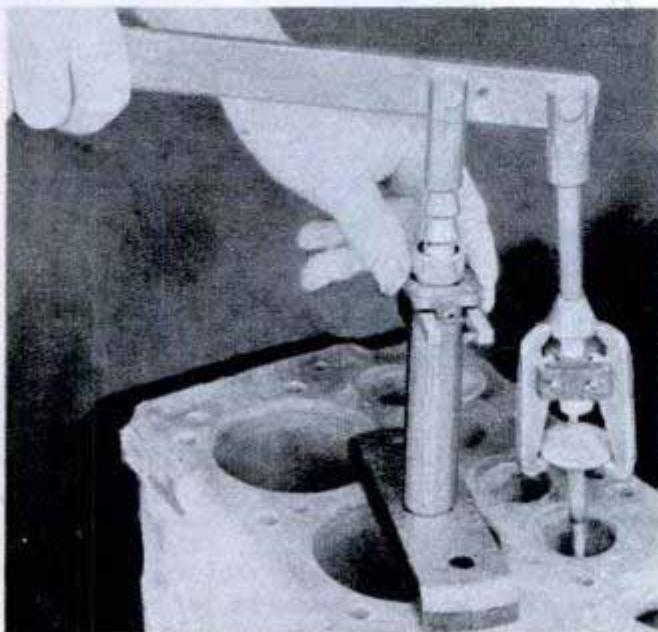

Jack Removes Valves Quickly With No Danger of Breaking

Removal of valves is accomplished easily and quickly with a jack which eliminates prying out valves, a bothersome procedure that often bends the stems. The jack has a long handle which permits the exertion of full power on the valve with no danger of breaking the guides. The position of the jack's fulcrum insures a straight pull.

Weather Stations Roll on Trucks

Mounted on Army 2½-ton trucks, mobile weather stations developed by the Signal Corps carry all the instruments necessary for meteorological observation. They were used during the war to facilitate collection of weather data in combat areas.

GLASS BOATS

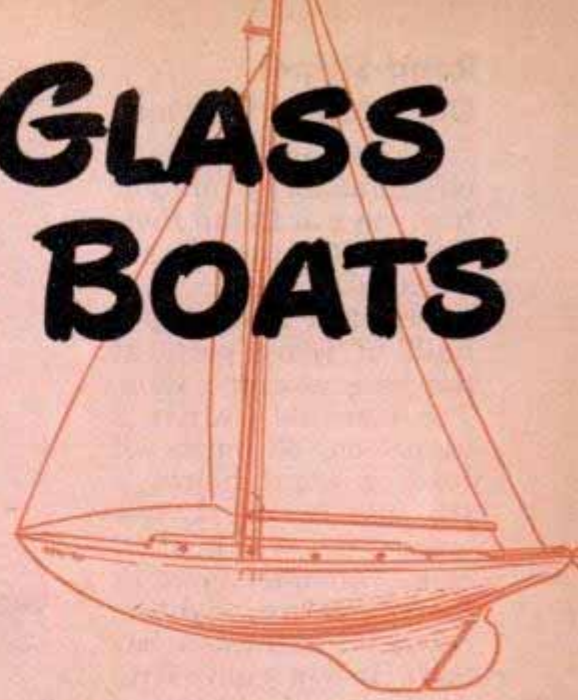

Power boats, runabouts and sloops made by a new technique have glass hulls that are virtually unbreakable and won't open up or absorb water. The boats are built by laminating layers of glass fabric and plastic over a wooden form. The 167-pound runabouts with a tensile strength of 65,000 pounds per square inch have been run at full speed over jagged rocks without harming their hulls



↑ Sloop patterned after this scale model will have Fiberglas sails
↓ Laminated hull is pried from the form. Bottom, excess fabric is trimmed from old wooden hull that has been given a new glass "skin"

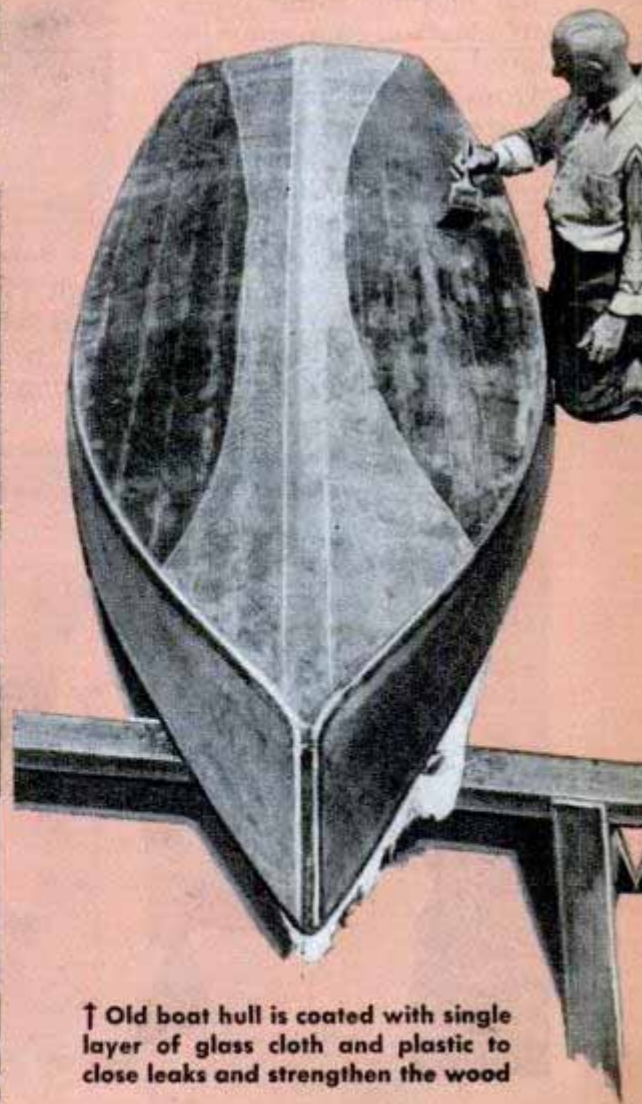
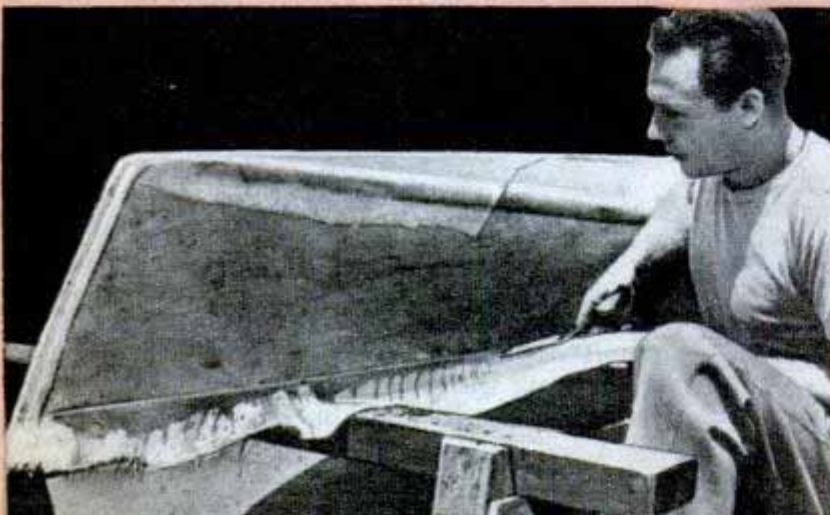
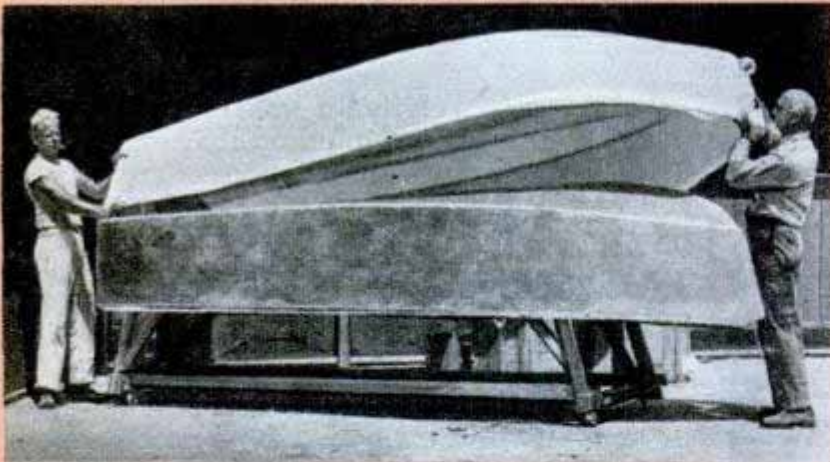

↑ Old boat hull is coated with single layer of glass cloth and plastic to close leaks and strengthen the wood

Versatile Twin-Engine Mustang Has Range of 5000 Miles

As a single-engine AAF fighter the P-51 Mustang had an outstanding war record. Now as a P-82 Twin Mustang it is considered one of the most versatile warplanes of its type ever built. Powered by two Packard-built Rolls-Royce engines developing 2300 horsepower each, the Twin Mustang approaches 500 miles per hour and can climb 7000 feet a minute. It can be used as interceptor, fighter-bomber, long-range escort, photographic reconnaissance ship, night fighter or rocket-fighter. To adapt it to varying missions, different nacelles containing guns, rockets or photographic equipment are fitted to the center wing section. When used as a fighter-bomber it packs 14 forward firing .50-caliber guns with 400 rounds for each one. Range is 1900 miles. Or it can carry two 2000-pound bombs over 1500 miles without external fuel tanks. As an escort, equipped with two 310-gallon external fuel tanks, it has a range of nearly 5000 miles at 240 miles per hour. An extra-long-range version car-

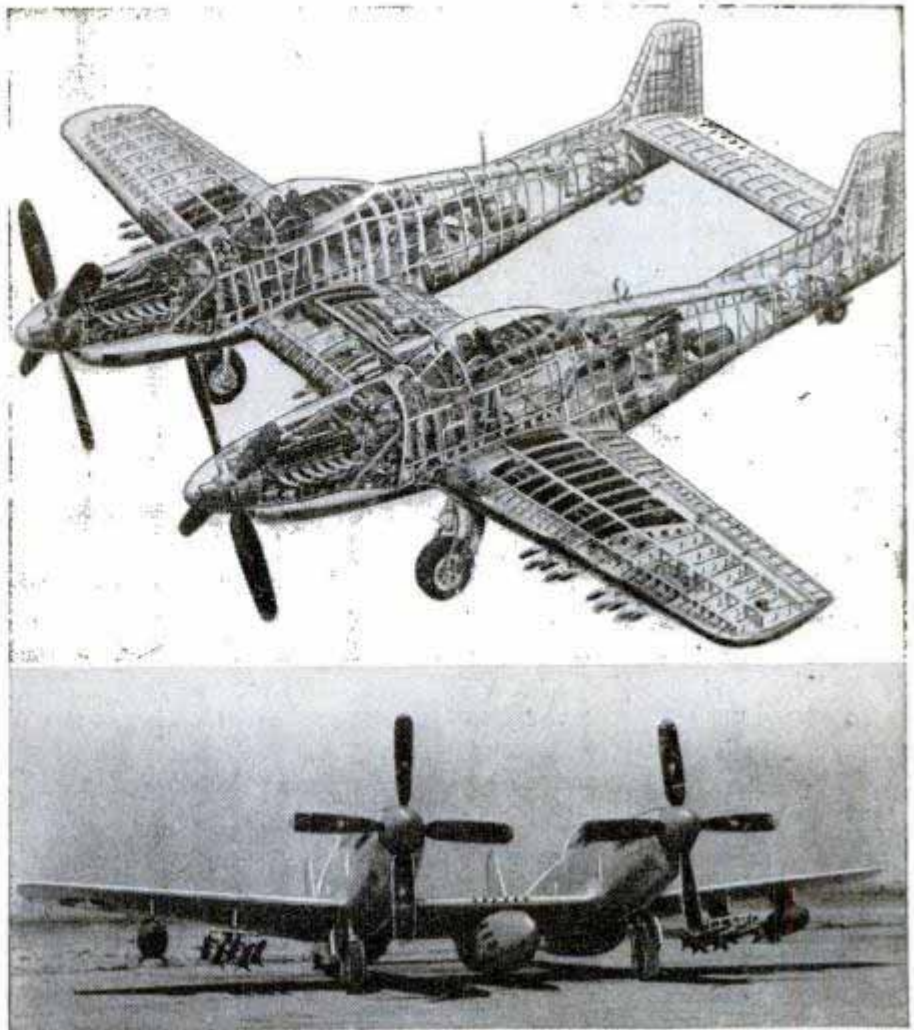

rying additional fuel has been suggested for a range of 7000 miles. As a rocket-fighter it packs 25 five-inch rockets. For reconnaissance, North American has designed a center wing nacelle to accommodate cameras.

"Clothespin" Clips Place Each Christmas Tree Light Where Needed

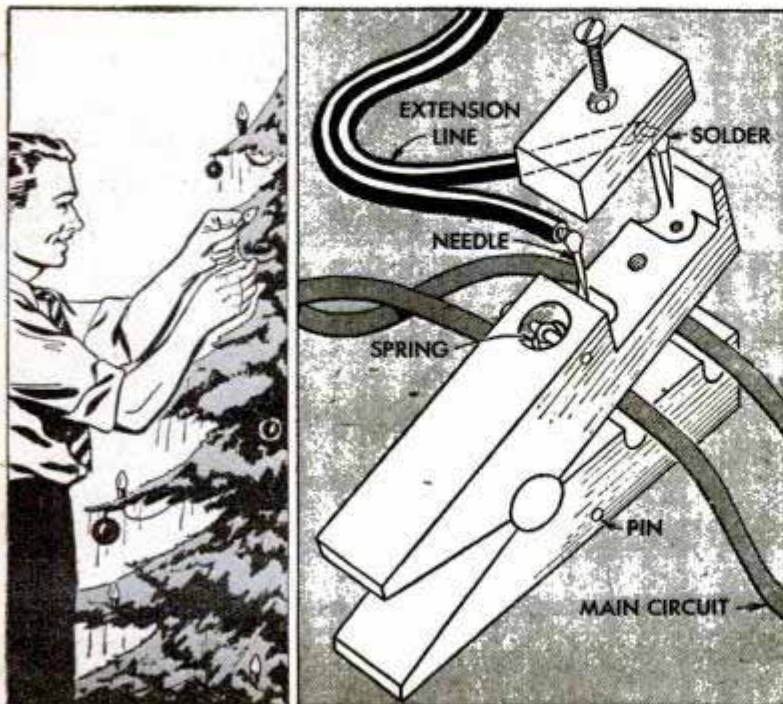

Christmas tree lights can be placed exactly where they are needed with a new wiring system. Each of the bulbs is on an individual extension that can be clipped to a main wire at any point. This current-carrying wire is attached to the trunk of the tree with one bulb on the end for the top branch. The individual wires are fastened to the main wire with a clip that looks like a miniature spring-action clothespin. The clip has two sharp pins that penetrate the insulation of the main wire to establish contact.

☐ Durable Nylon sheeting which can be made in any thickness in various colors has been developed by Du Pont as a substitute for leather in wallets and handbags.

Trunk-Size Oil-Burning Furnace Heats Five-Room House



Circulating fan in oil-fired furnace changes air six times per hour. Dust and dirt are kept out by filter

It requires only three minutes for a 187-pound oil-fired, forced warm air furnace to heat a five-room house. Measuring only 21 by 27 by 44 inches, the furnace delivers 55,000 B.T.U. A circulating fan provides six complete changes of air per hour, and a filter tray removes dirt and dust from the

air and automatically controls humidity. A larger furnace—thermostatically controlled like the smaller one—is 29 by 41 by 44 inches in size, and has double the capacity, or 110,000 B.T.U. An oil-level-control valve meters the correct amount of fuel to the burner.

"Steam Percolator" Warms Air in Electric Heating Unit for Homes

Steam generated in a sealed copper "percolator" warms the air circulated by a compact electric heating unit for the home. It is completely automatic and desired room temperatures can be selected by adjusting a wall control. Fresh air is drawn into the unit through filters. It is channeled through

multispined copper fins which warm the air and release it into the air ducts of the house. The copper fins are heated by the "percolator" heart of the system. This consists of a copper tank containing water under reduced pressure. Low voltage immersion-type heating elements are encased in

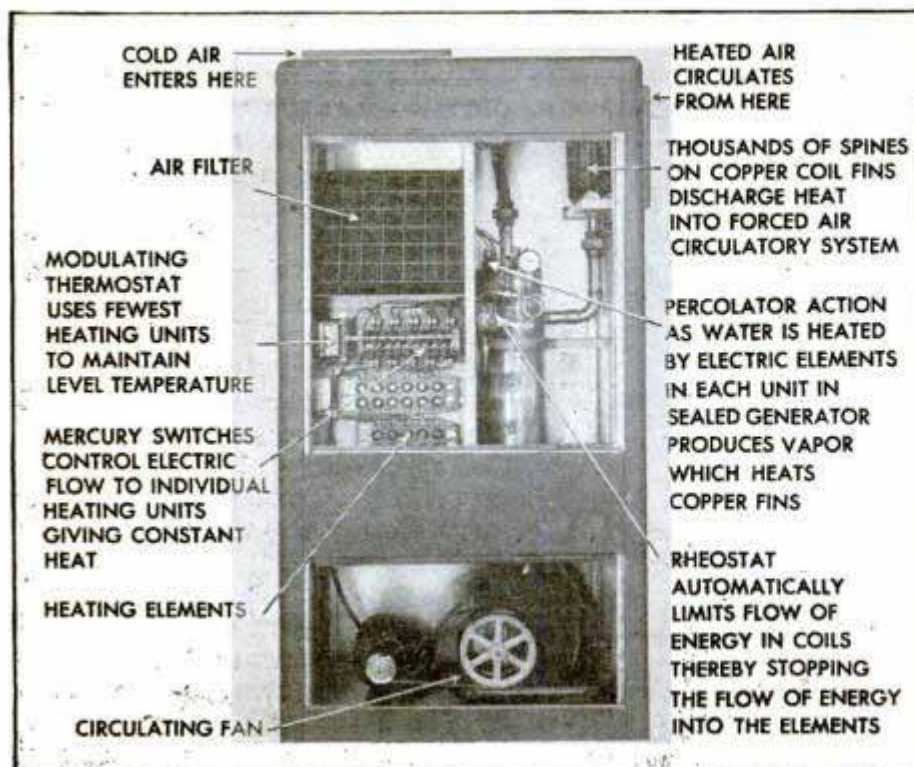

copper tubes inside the tank. Percolating action draws water into orifices at the bottom of the tubes. In the tubes it is heated enough to change into steam vapor. The steam vapor is discharged from the top of the tubes to circulate inside the spines on the copper fins. As the steam loses its heat to the air on the outside of the fins it is condensed and returned to the tank.

☐ New tools for electronic scientists include instruments that record weights within 100,000ths of an ounce and thicknesses as minute as 100,000,000ths of an inch.

HOW GOOD A DRIVER ARE YOU?

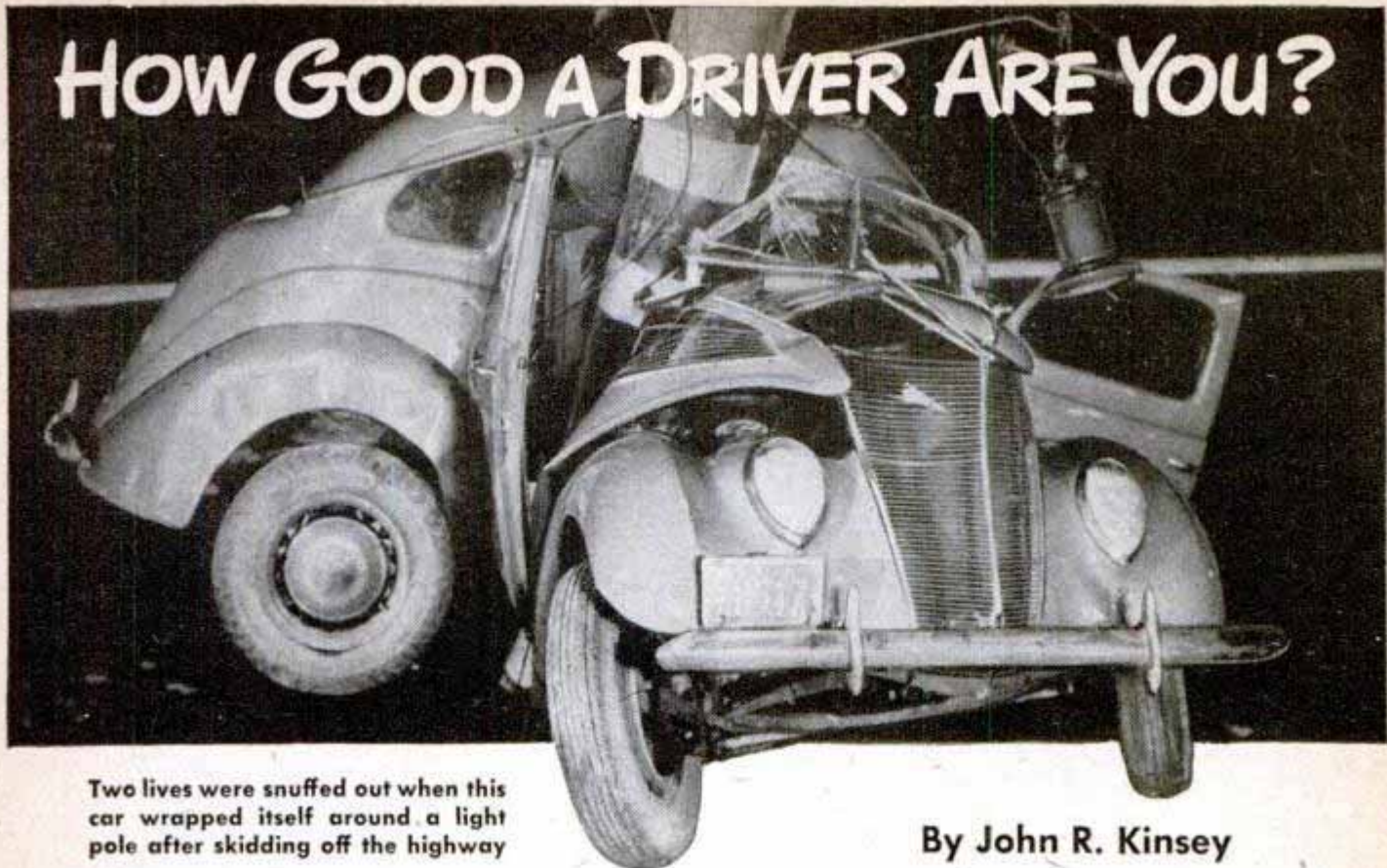

Two lives were snuffed out when this car wrapped itself around a light pole after skidding off the highway

By John R. Kinsey

"HEY, YOU! Doncha know how to drive?"

Many an indignant automobile driver has smoldered under this familiar bit of insolence from an irate pedestrian or a hard-boiled cop.

Few drivers have ever stopped to take such a question seriously. Of course, you'll admit that the fellow in the convertible who just zipped by is a lousy driver, and that old woman in the Reo sedan ought to be home, knitting. But me? Why I'm a natural behind the wheel.

Could it possibly be that you're a bit weak on some of the essentials that make up, not necessarily an expert driver, but just an average motorist who keeps his car and himself out of crashes?

Judging by the fast-mounting auto accident toll, quite a few men and women are not fit to drive a car. Inefficient eyes, hands, feet and minds are partly responsible for the fact that probably 40,000 persons will be killed and 1,350,000 injured this year in motor vehicle accidents—an all-time high.

The average car on the road today is

ON GUARD AGAINST ACCIDENTS



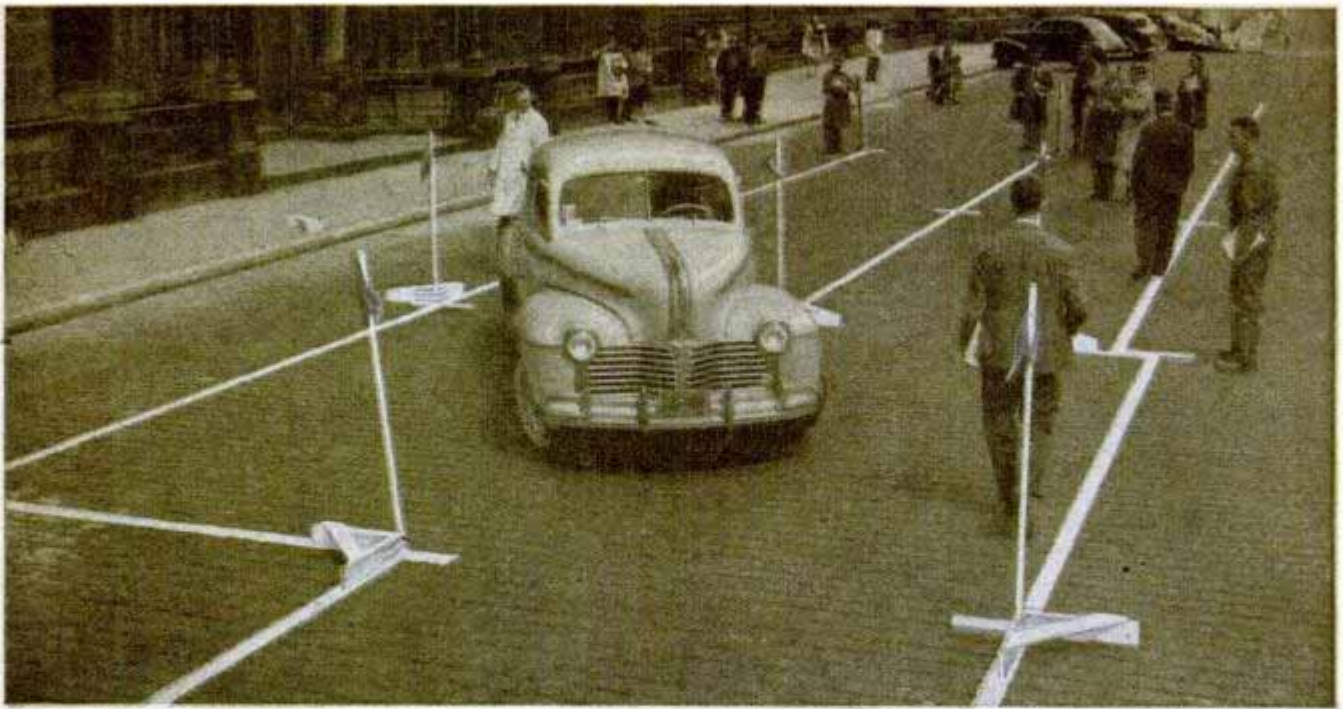

White lanes dotted with posts marked the boundaries for safe driving tests conducted at Columbia University

about eight years old, and one out of three is dangerously defective mechanically. A nation-wide police traffic checkup proved this. But what about the drivers? Too many handle automobiles in such a way that the cars become lethal weapons, and state licensing laws are so variable that there is no way of tabulating the safe drivers as against the unsafe.

So serious is the climbing auto death rate that President Truman summoned the nation's top safety experts to Washington to draw up a course of action to stop the needless killing, maiming and loss of property.

In the past 10 years, 322,100 Americans have been killed in motor vehicle traffic accidents, 11,000,000 have been injured, and the damage loss exceeds 15 billion dollars.

Auto crashes are occurring at such an increased tempo, since the war's end, that collision insurance rates are up about 50

percent and liability and property damage insurance costs about 25 percent more.

One recommendation made at the President's Highway Safety Conference was that all states adopt a sound driver licensing plan which should include:

1. Adoption of minimum standards for driver examination — as recommended by the American Association of Motor Vehicle Administrators—by those states where the standards are lower. If possible, standards

Reaction speed of motorists is tested by clocking time required to press key after red light flashes. Right, California test for driver's glare resistance



Small Child's Walker Has Plywood Side Guards

Fashioned of plywood, this walker for a small child has side guards that will keep his feet off the wheels and prevent him from dragging his shoes on the ground. The guards are cut to the general shape shown and then bolted to the frame. The walker can be carried in the car also where it will serve as a seat for the child. The back of the walker rests on the seat and the front is fastened to the instrument panel by means of snap hooks. The hook arrangement will vary with different makes and models of cars.

LeRoy Ryan, Quincy, Mass.

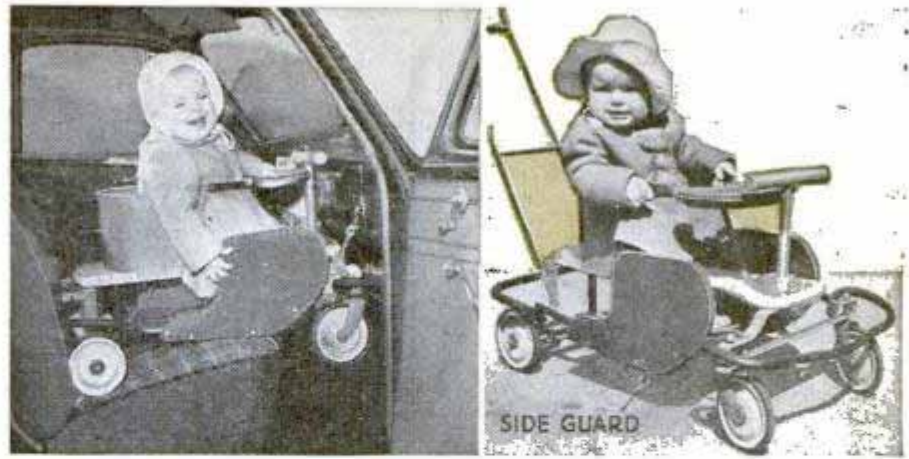

Carrying Case for Toothpicks Keeps Them Clean



Easily made, this carrying case will keep toothpicks clean. It's cut from light, pliable leather and holes are punched in the sides for stitching. A leather of contrasting color is used for the lacing. If desired, initials or a design can be tooled in the cover and back for decoration.

August E. Wasco, Cleveland, Ohio.

Lighter Fluid Helps Loosen Bolts

A bottle of cigarette lighter fluid kept on the workbench will be handy in loosening rusted or tight bolts and nuts, especially the small ones on electrical appliances that have been "burned on" by the heat. Usually a few drops will loosen most threads.

E. W. Moses, Jr., Blacksburg, Va.

Trowel Drives and Pulls Nails

Making a three-in-one tool of his trowel, one mason fitted a metal head on the handle and slotted the heel of the trowel. The head is used to drive nails and the slot, of course, to pull them. This tool is excellent for small nails.

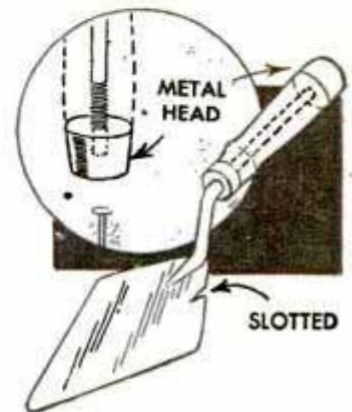

Old Stump Removed From Lawn With Saltpeter Solution

If it is inconvenient to chop or blast that old stump from the front lawn, try using a solution of saltpeter. Bore a series of holes in the top and sides of the stump and fill them with the solution. In a short time the wood will rot away. As much saltpeter as can be dissolved in the water should be used in order to make a saturated solution.



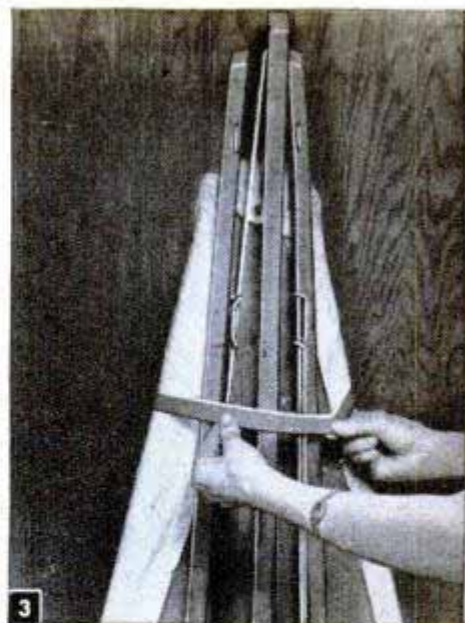
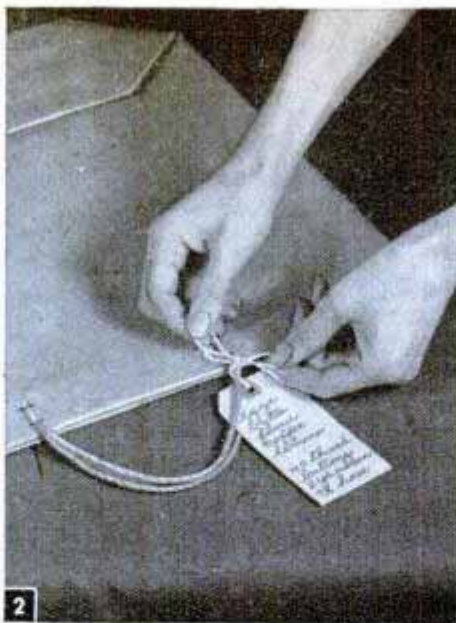
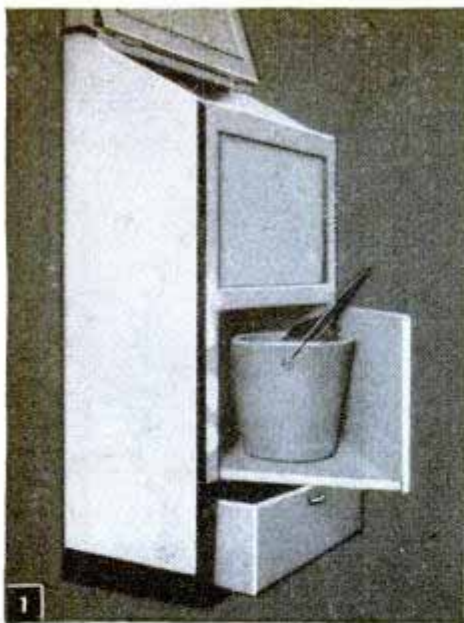

Solving Home Problems

1 If you have a wood or coal-burning stove, and it's necessary to store fuel in your kitchen, this bin is ideal for wood, coal and kindling

2 You won't have to waste much time hunting for a shopping list if you write it on a tag and then tie it to the handle of your shopping bag

3 Cut from an inner tube and slipped over the small end of an ironing board, a rubber band will hold the legs of the board securely

4 When new, reinforce the finger tips of rubber gloves with adhesive tape to make them last longer. Reinforcing is done on the inside

5 Toothpicks are easier to remove from a flat-bottom holder if a shallow paper cone is placed in the base of the container as indicated

6 Where the walls of a room are finished in a light color, extension cords will harmonize if painted with white-sidewall-tire coating

7 Keep embroidery floss between notebook pages. Glue edges together, bring ends through top sheet. Put identifying label on same page

8 Long seams can be ripped easily if the material is held under the presser foot of a sewing machine. This will serve as a third hand

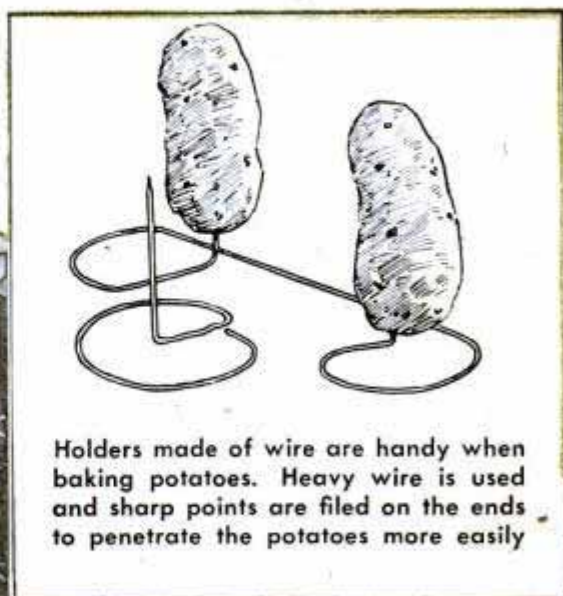

8 Holders made of wire are handy when baking potatoes. Heavy wire is used and sharp points are filed on the ends to penetrate the potatoes more easily

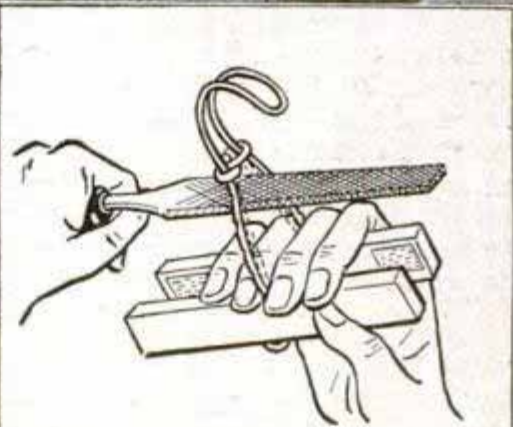
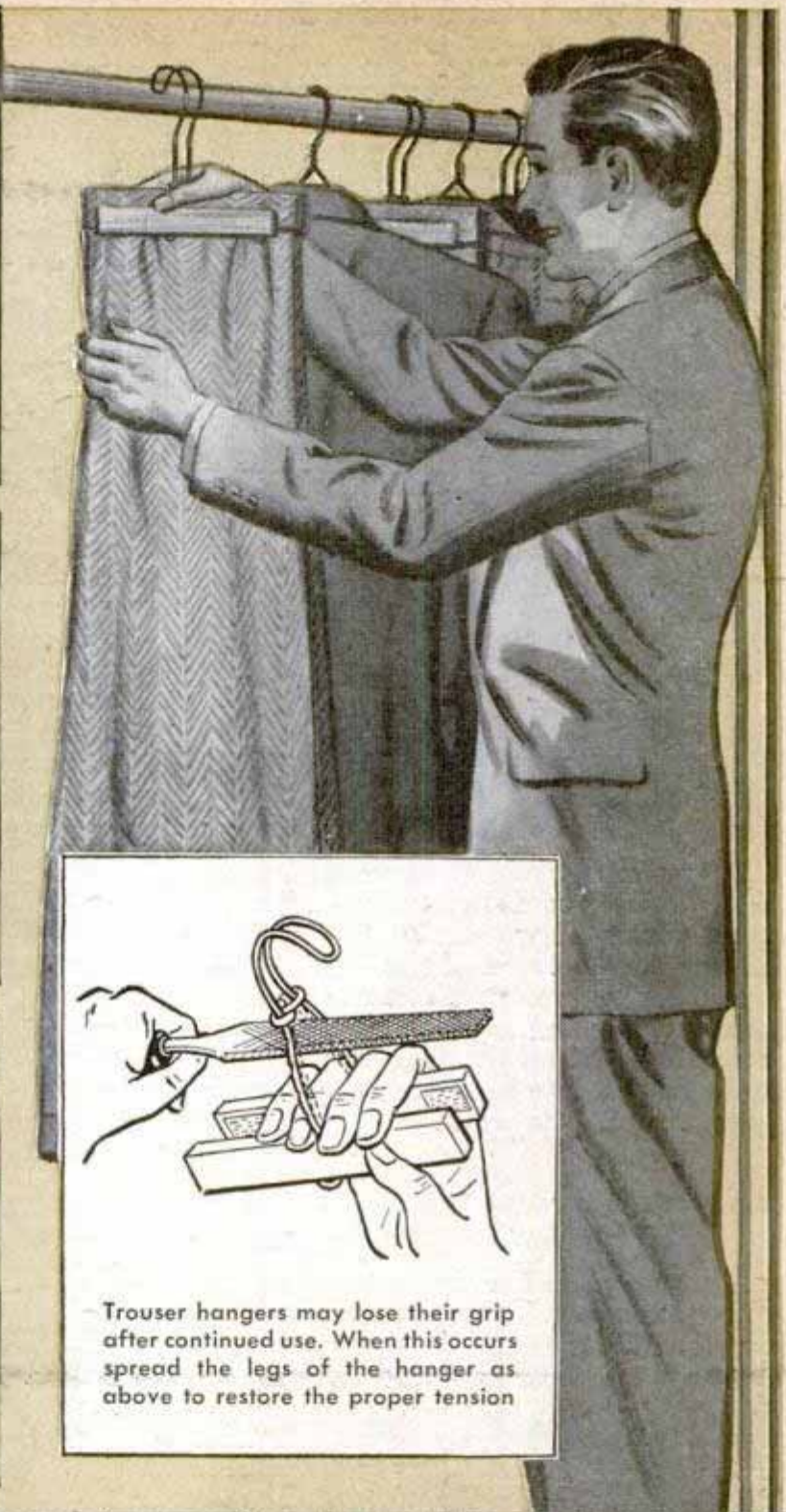
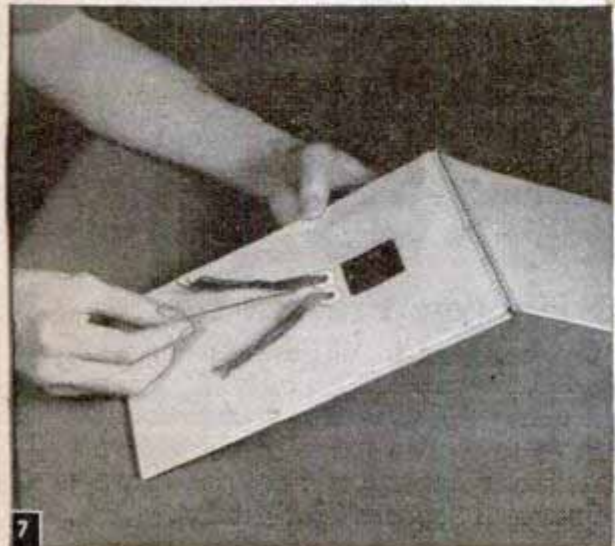

Trouser hangers may lose their grip after continued use. When this occurs spread the legs of the hanger as above to restore the proper tension

Bas-Relief Carving Simplified With Scrollsaw



Much of the painstaking work involved in carving a figure in bas-relief, such as shown in Fig. 1, can be eliminated by first sawing the work roughly in outline. In this way, the waste stock is cut away quickly, leaving the rough outline of the figure to guide you in carving. From here on it's simply a job of rounding the edges and making the necessary body cuts to give the proper contour as in Fig. 2. The final carving then is sanded as in Fig. 3. Finishing may be done in several colors of enamel or bronze paint. An antique-ivory finish looks especially well on a background of dark wood. To antique the finish, apply two coats of ivory enamel. When thoroughly dry, fill all the depressions with brown enamel, using a small brush. Then, with a soft cloth moistened with turpentine, wipe across the work as in Fig. 4. This blends the brown into the ivory and highlights the dark depressions.

Elma Waltner, Hurley, S. Dak.

Satisfactory Method of Etching Your Name or Initials on Steel Tools

To secure satisfactory results when etching your initials on steel tools, use a solution of commercial nitric acid, one part, and muriatic acid, one part, mixed in a glass container. Mix with extreme care and wear rubber gloves to avoid acid burns. Cover exposed skin areas. Coat the metal with asphaltum and scratch the letters in after the coating is dry. Apply the acid with a cotton swab until the desired depth is obtained and remove the asphaltum with

either lacquer thinner or kerosene. Raised letters are produced by writing or printing the name and then etching around it. You can also etch your name by using a rubber stamp. First clean the metal with a dry abrasive and then prepare the "stamp pad." With a camel's-hair brush paint a thin coat of asphaltum over the surface of a piece of glass. Press the stamp on the glass to coat the letters, then press the stamp firmly on the metal. Let dry and apply the acid.

Tape Spool Stores Rubber Bands

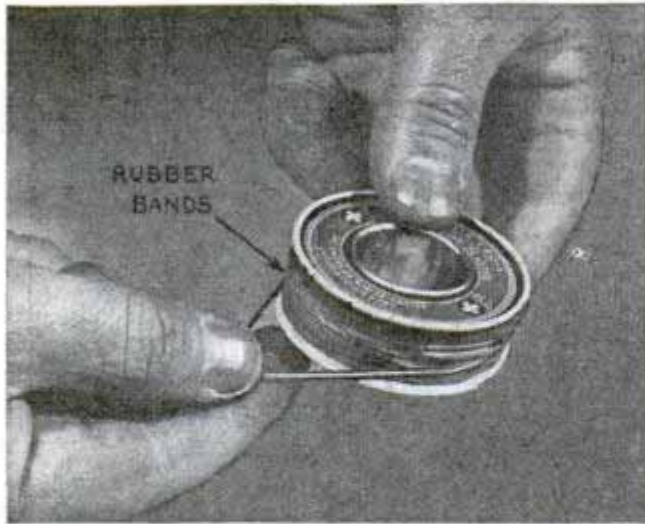

To store rubber bands and keep them from the light until used, slip them over a spool of the kind used to dispense adhesive tape. After the cover is slipped on, it serves as a protection against the deterioration of the rubber. The container can be suspended from a convenient nail.

Kenneth Murray, Colon, Mich.

Twin Bird Bath Cut From Can

Easily and quickly constructed at low cost, this bath will accommodate two birds at a time, and it can be made in practically



any size you wish. An oil can is suitable as it has only the small triangular hole in one end and this is easily soldered shut. Cut the can lengthwise, bend the sides apart and turn over the sharp edges with a pair of pliers.

Front Hitch Helps Park Trailer

If you experience difficulty in maneuvering a trailer into tight places when backing it into a parking space, try the idea I use. Just put a hitch on the front bumper so that the trailer can be attached at this

end. Then you can either push it into place, or back the car and pull it into place. You will find it much easier to spot the trailer when you can see in the direction in which you are driving.

G. P. Shutack, Nesquehoning, Pa.

Tightening Small Brush Bristles

When you have need for a small artist's brush and only the inexpensive kind is available, the brush can be prepared before use so the bristles will not loosen and fall out. Using a pair of small-nose pliers, pinch the metal ferrule as tightly as possible. This will flatten the ferrule so that the bristles will be held firmly.

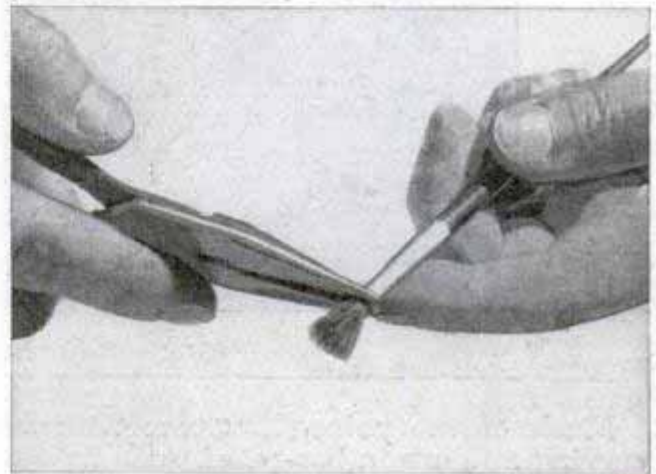

This Door Key Can't Slip Out

One neat way to prevent a key from falling out of a lock when the door is closed sharply is to put a piece of slit rubber underneath the escutcheon plate to help retain the key. Most plates are flanged around the edge, which rests against the door, so there is enough space under them for the rubber. Two holes are cut in the rubber in alignment with the screw holes on the plate. The slit in the rubber should be as long as the keyhole. An advantage of this arrangement is that it is more difficult for intruders to work the key out from the outside of the door.

H. N. Durham, Jr., New York City.

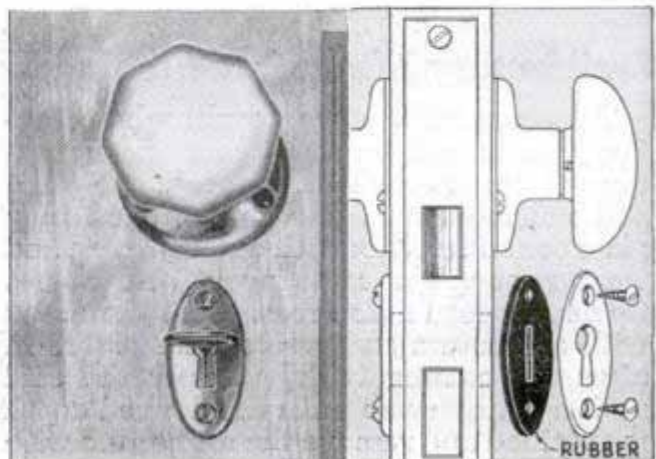

These Shadow Boxes Enhance Your Knickknacks

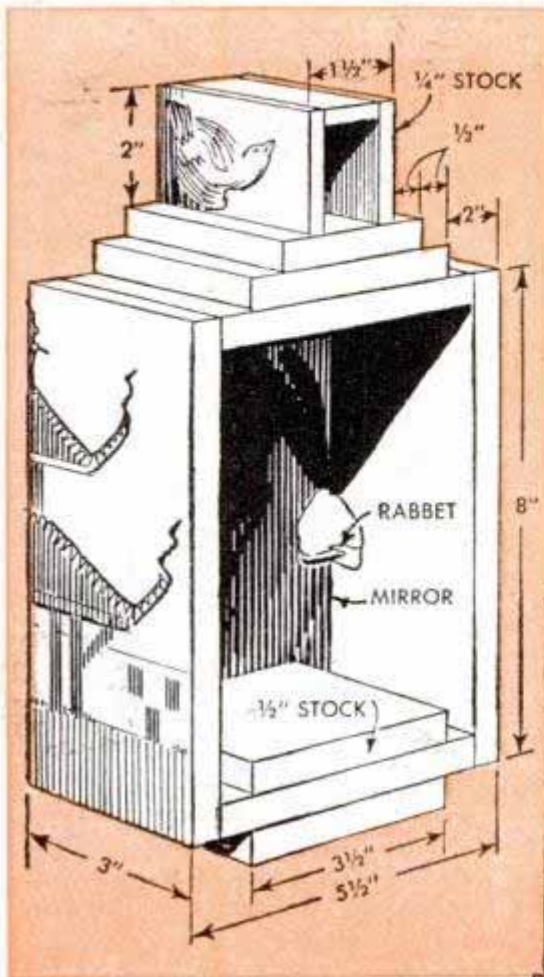

Adapted from an ancient Chinese design, these shadow boxes provide a dramatic means of displaying your most cherished knickknacks. The boxes are especially effective when suspended at each side of a fireplace. With the exception of the handle at the top, which is made of 1/4-in. material, the box is formed of 1/2-in. stock, preferably white oak. Since the sides are nailed to the top and bottom pieces and the nails countersunk, no joinery is necessary. This does not detract from the appearance of the box, but merely heightens its provincial quaintness. The back may be nailed in place, although you will get a better job by rabbeting it into the sides and top. The decorative pieces above and below the bottom piece will be more effective

if they are glued on, although they can be nailed, too. The handle is glued together and then assembled to the blocks on which it rests with screws driven up through the blocks. When assembled, the unit is glued in its proper place. If desired, a mirror may be glued to the inside of the back to heighten the effect.

If the wood used is a good grade, an oil finish is best. In any event, natural finish without stain is advised. Use silk cords to hang the boxes. Long tassels hanging from the suspension hook and the bottom of each box add to the appearance of the finished project.—Allan C. Carpenter, Chicago.

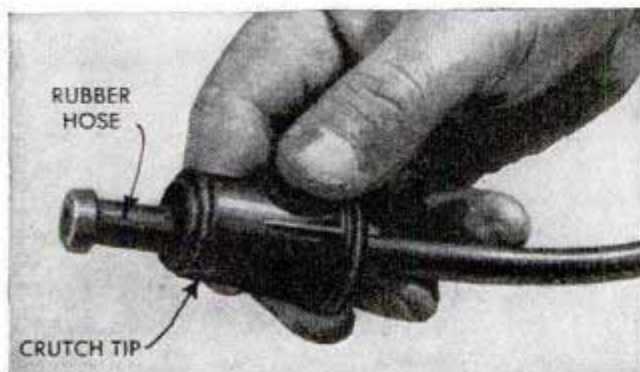

Rubber Hose Attached to Faucet With Crutch-Tip Connector

Usually it's a difficult matter to find a connector to attach a small hose or rubber tubing to a water faucet. A rubber crutch tip will serve this purpose very nicely. Cut a hole in the bottom of the tip for the hose, which is pushed through and folded back as shown. Then secure the hose to the tip with rubber cement and slip it over the faucet.

Puppets, says the dictionary, are small images in human form—but Martin and Olga Stevens, leading puppeteers, make them talk and act like living people. Here's how they do it

STAGE



PART I

By Kenneth Murray

A MARIONETTE show, skillfully handled, is real entertainment—with all the dramatic atmosphere, costuming and dialogue of the professional stage, and the character and individuality of adult performers. In fact, so realistic are the shows put on by the Stevens Marionette Team, top-ranking puppeteers, that children have asked to be introduced to the "actors" after the performance. Except for the controlling strings which, with the small size of the stage, are the only "give-aways" of the puppeteer, marionettes can be made to go through a complete dramatic performance with an illusion so perfect that the audience is hardly aware of it. And Martin and Olga Stevens, who make their own marionettes, have revealed the reason is that the figures are copied, to a rough but close scale, directly from human models. Movements of the models are studied carefully so that the marionettes may have the same limitations, balance and dissimilarities as the prototypes.

Preparing rough blanks. In making a puppet, front and side profile sketches are first made on a 15 by 24-in. sheet of brown wrapping paper pinned to a smooth surface. General dimensions of the professional-type marionette figure can be determined from Fig. 16. Many professional puppeteers choose a model from life, using a scale of 4 in. to 1 ft. And, as already mentioned, they include all variations from the normal to give the completed figure character and individuality. Be particular in meas-

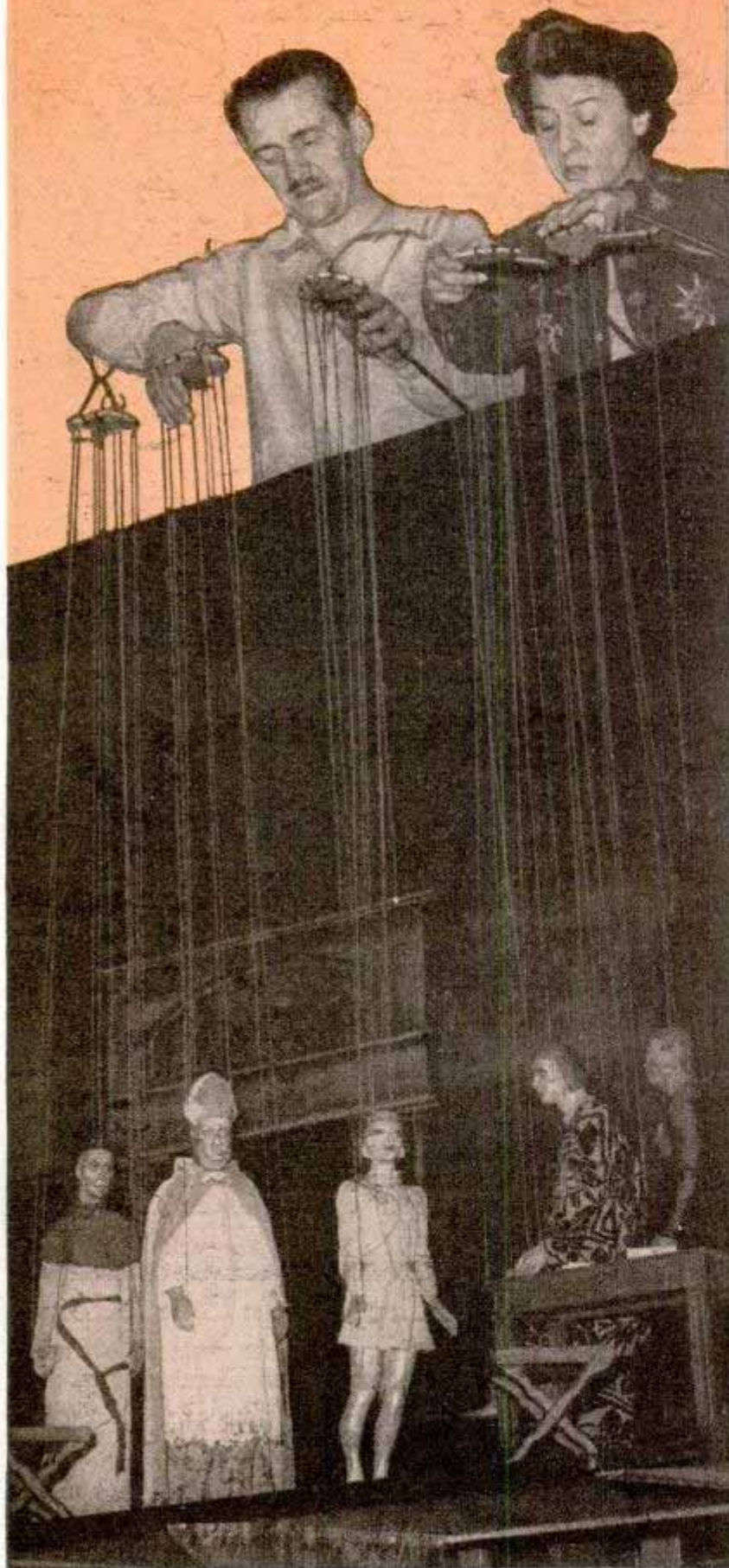

YOUR OWN SHOW with these marionettes

uring and locating knee and other joints so that naturalness will be built directly into the figure and will not be entirely dependent on skill in handling the controller. The location of the center line, passing through shoulder, hip and knee joints, is important because the correct position, Figs. 15 and 16, assures natural balance. If you make the figure without proper balance, special strings will be necessary for control during performances. Correctly balanced, the figures will assume characteristic poses quite naturally when merely supported by the controller strings.

Cardboard templates are next made from each view of head, torso, arms, legs, hips and feet. Carefully mark the center line on each template, Figs. 1, 2, 3 and 16. Then square up the stock from which the parts are to be cut and mark center lines on the wood as a guide in locating templates. White pine of the grade and quality commonly known as sugar pine is the best material to use, with poplar or basswood a

fairly good second choice. Front and side profiles are marked carefully from the templates on each piece. Saw out one profile, then the other, as in Fig. 6. In sawing the head, Fig. 9, notice that it is slightly heavy in front of the center line as in Fig. 16. This location of the center line allows the head to nod easily and without tipping inward when the figure is performing.

Hand carving. Carving the sawed blanks to the required contours may look difficult but actually it's quite simple once you get into it. With the exception of the head, the job is merely that of whittling off the sharp corners of the pieces and scraping and sanding the rounded surfaces to a smooth finish. Use regular carving tools or a sharp carving knife. Make the chipping cuts across the grain and control the tool by bracing it with the thumb of the left hand so that it cannot slip. On the head, Fig. 10, a little more patience is required to shape the features, and a photo of the model from which the profile drawings were made can

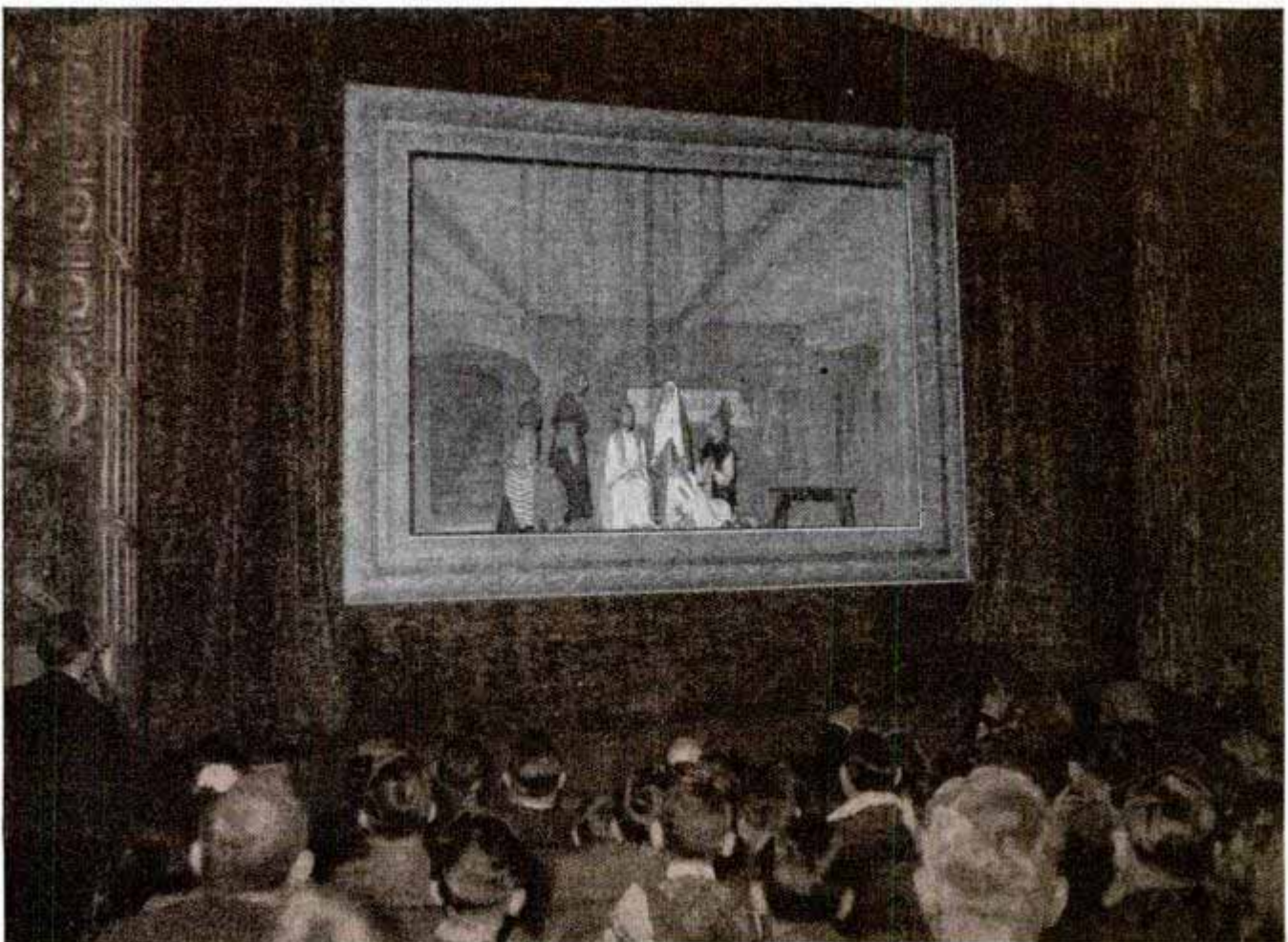

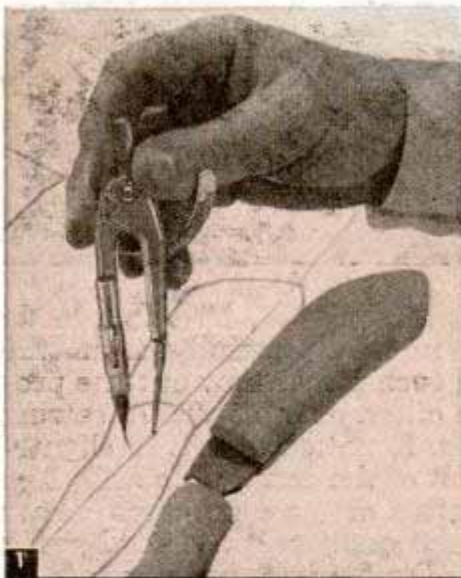

1 Lay out the knee joint with compass and make cut outside line

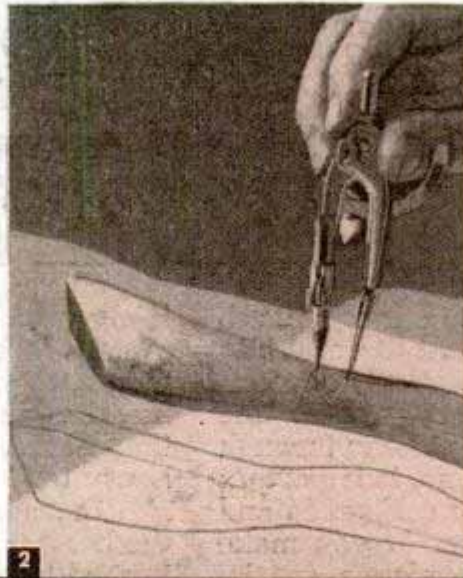

2 Transfer to the wood, locating circular cut carefully to assure fit



3 Trial fit of the parts comes next. Joints should work without binding



7 Toothpick holds end of cord, and notches are made to receive knots



8 Rough-carved figure with two-piece arm. One-piece arm also is used



9 Bandsawing the head to the rough shape makes carving much easier

be most helpful. Don't bother to include details that cannot be seen beyond the first row of the audience.

Joints. Various types of joints have been devised by puppeteers but the simple string-and-fiber-hinge joints are so completely satisfactory that many continue to use them. Position of strings in the hip joints is indicated in Fig. 16. Ordinary cotton chalk line is used. A notch is made in the leg to receive the knotted beginning end of the cord, which passes diagonally upward, through the lower part of the torso and back to pass out the side of the hip, Fig. 7. Round toothpicks are driven into the exit holes to secure ends of the cords and to permit later adjustment, as the legs must be of exactly the same length.

Use a compass to mark a circle equal to the diameter of the leg at the knee, Fig. 1. Draw a line across the leg immediately above the circle, and saw the leg into two parts. Slots for the hinge are cut as in Fig.

4, using a keyhole saw with a blade of the same thickness as the fiber from which the hinge pieces are cut. Holes for the hinge pins are made by using brads in a hand drill rather than hammering them into place. Note that the fiber is shaped to strike a stop pin, Fig. 17, so that the leg cannot double up in a forward position.

As the first step in forming a ball-and-socket knee joint, round off the upper end of the leg and, after wetting the ball portion so that wood putty will not adhere, shape the socket as in Fig. 5 by applying the wood putty to the adjoining part. The completed joint is shown in Figs. 3 and 12, the latter also showing finished ankle joints which are made in a similar manner but without the use of wood putty. The ankle hinge, which is self-stopping in both directions, is shown in Fig. 18. It is important to round the heels and toes so that the figure will walk in a natural manner.

Simplest way of making the shoulder



4

Slotting for the fiber hinge piece. Be sure the slot is wide enough



5

Wood putty forms the knee socket. Make an allowance for shrinkage



6

Nearly all parts of figures can be bandsawed to the rough shape



10

Carving is no trick if you use a sharp blade of the right shape



11

Use a fine brush and artists' oil colors to paint on the features

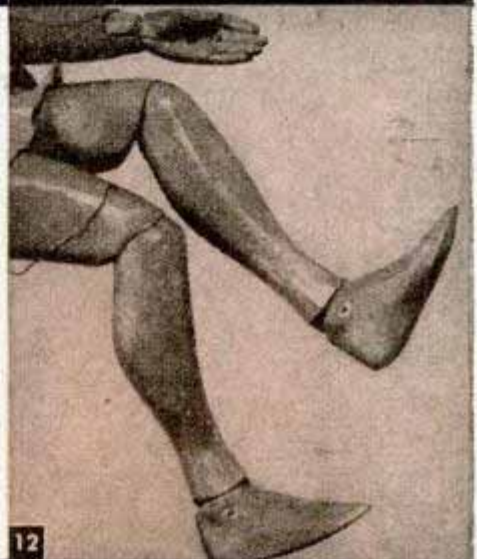

12

Here are the finished leg joints. A trial fit assures free movement

joint is with a chalk line, Fig. 8, the end of the cord being secured with a toothpick as in joining the hips. Despite its simplicity, this joint gives a perfectly natural action. It will be noticed that the elbow in Fig. 8 also is hinged. However, this requires additional control strings and is not necessary except in more detailed acts. Elbow and wrist joints may be added at any time.

Head movements. Ordinarily, puppeteers use the very practical screw-eye joint in which the neck extends into the shoulders, like a ball and socket. This simple head coupling, shown in Fig. 16, is recommended for both amateur and professional use. One of the screw eyes is wrapped with cord, in half-hitches, to eliminate operational noise. Slacking of the head-control strings permits the head to nod and turn in either direction.

Painting and clothing. Homemade wigs or ready-made doll wigs provide natural-appearing hair when the head is to be un-

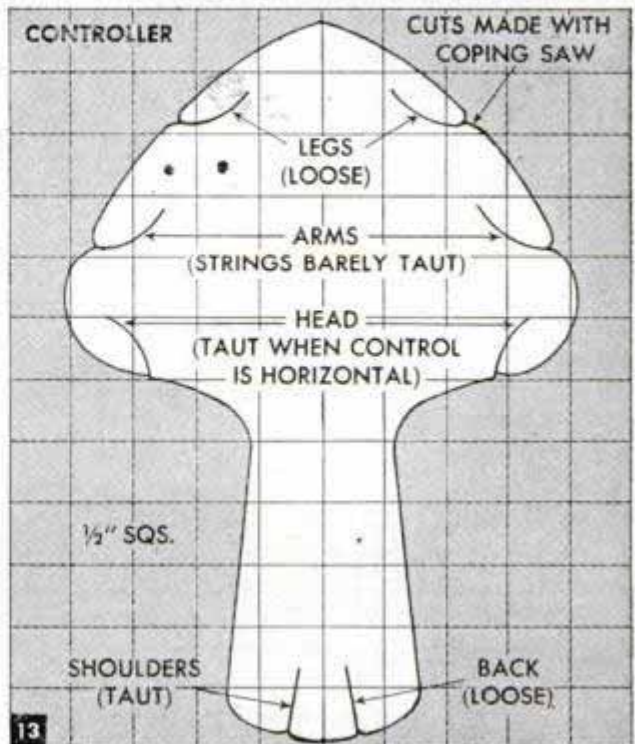

13

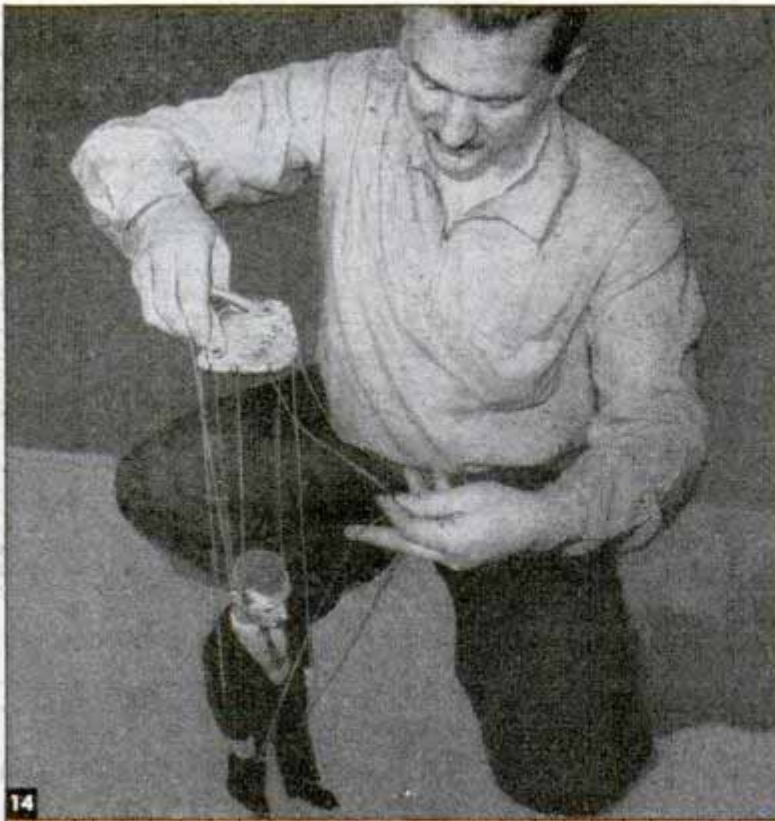

14

NOTE—
IN CUTTING
BLANKS OF
SIDE PRO-
FILE, DRAW
LINE DOWN
MIDDLE AND
SQUARE
WITH THE
STOCK TO
INDICATE
POSITION
OF SUPPORT-
ING JOINTS

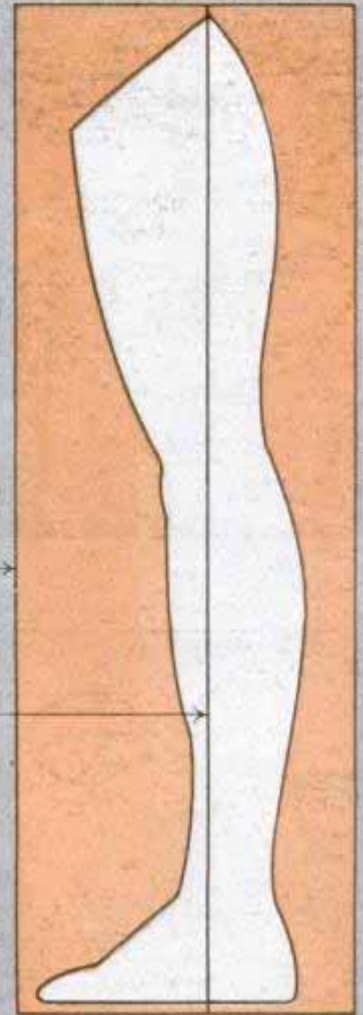

OUTLINE OF
WOOD STOCK

CENTER
LINE

15

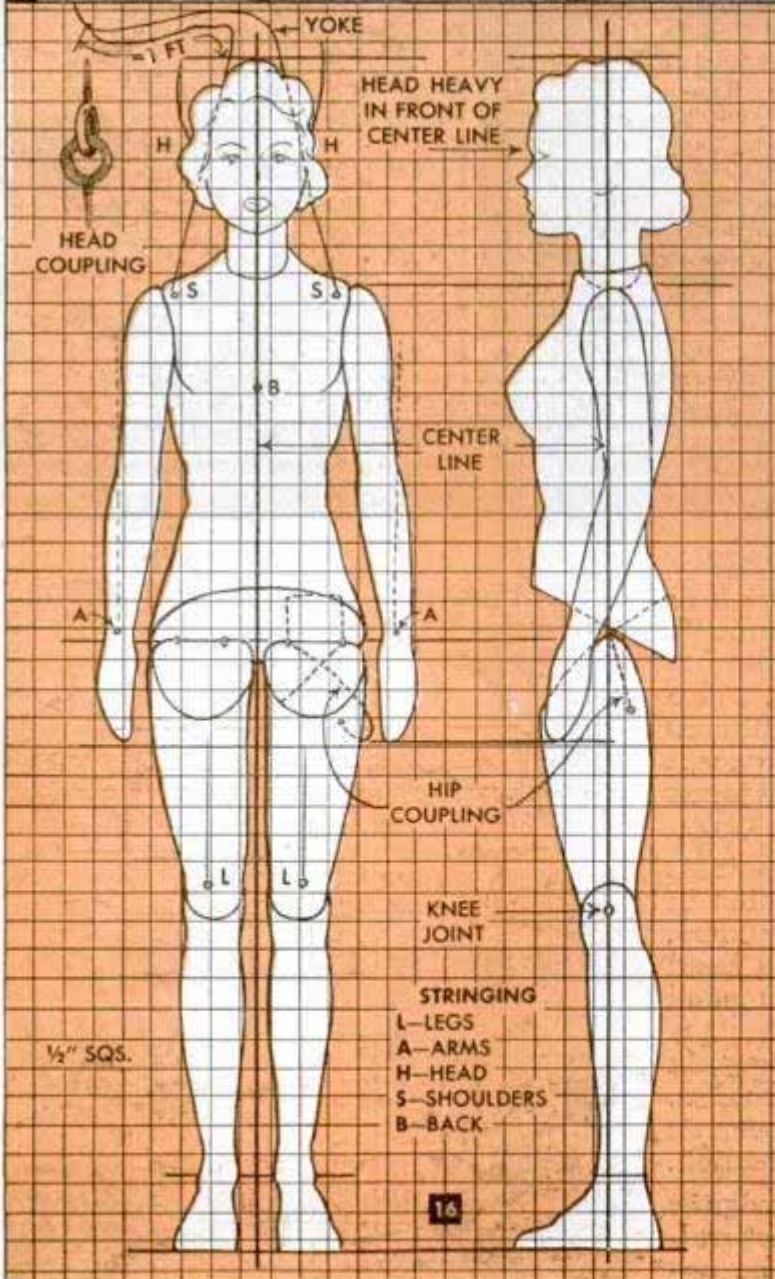

1/2" SQS.

STRINGING
L—LEGS
A—ARMS
H—HEAD
S—SHOULDERS
B—BACK

16

KNEE JOINT
DOTTED LINE
INDICATES POSI-
TION AND SIZE
OF FIBER HINGE
PIECE

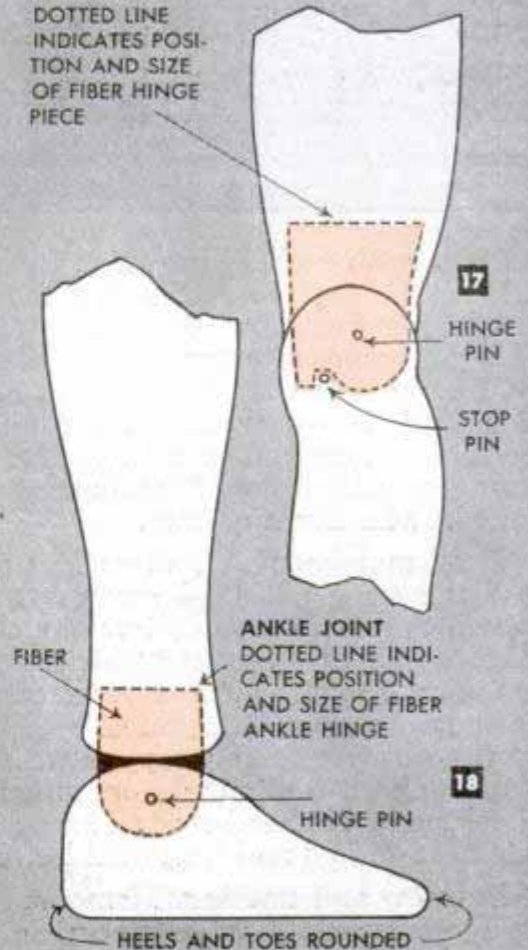

17

HINGE
PIN
STOP
PIN

ANKLE JOINT
DOTTED LINE INDI-
CATES POSI-
TION AND SIZE OF
FIBER ANKLE HINGE

18

HEELS AND TOES ROUNDED

covered, but ordinarily hair simulated with paint will be adequate. Finishing of the head is done with artists' oil colors, Fig. 11, the features being painted in with a fine brush after the ground coat of flesh-colored paint has thoroughly dried. The latter also is used for the body. Characterization and personality, developed by the use of paints, is important for a professional performance. Costumes can be as simple or as elaborate as you wish, of your own design or reduced to scale from regular patterns. It is important to note that, for these small actors and actresses, clothing must be reduced in weight and texture by several times, as nothing could be more unnatural than to use cloth of standard weight which will not drape properly. As an example, to simulate the appearance of a velvet robe, use silk jersey; for a fur coat, use velvet. Clothing is attached with an adhesive or with very small tacks.

Stringing and controlling. Use fine black fishline for stringing the marionettes, attaching ends to parts of each figure with small tacks. Avoid loose string ends at the figure and replace broken strings rather than knot them together. The controller is convenient to handle and does not require separate controls as used with the customary airplane type. It is cut from 1/4-in. plywood with coping-saw cuts for the strings as in Fig. 13. Surplus string ends are wound around the handle. Use of the controller is shown in Fig. 14, with the strings shortened to include the figure in the photograph. In this illustration Mr. Stevens is demonstrating how the loose leg strings are grasped in the left hand to control walking movements. Entire support of the figure is by the shoulder strings, which form a yoke ending 1 ft. above the head with a single string connecting the yoke with the controller. To maintain natural balance, it is important that the center of the yoke be exactly above the center line of the figure. Head strings are taut when the controller is horizontal. The head turns when controller is tilted to either side and with the controller tilted forward the head nods. The back string is loose to permit it to be caught with the little finger. This causes the figure to bow naturally.

(TO BE CONTINUED)

Eggshells Clean Narrow Vases

When narrow-neck crystal vases and bottles need cleaning and a bottle brush won't do the work, break several eggshells into the bottle or vase, add a little water and shake until all film and dust disappear from the glass. After rinsing, the vase will be crystal clear.

Ruth C. Buck, Jackson, Miss.

Harrow Disks Make Ice Planer To Surface Skating Pond



For removing skate marks or other roughness from the surface of a skating pond, one ice enthusiast found that a number of discarded harrow disks, bolted to a heavy plank, made a planer that would do the work. The device can be pulled by hand or towed behind an automobile.

Handy Self-Feeder for Rabbits

Made from a tall can and a cake tin, this self-feeder for rabbits is anchored to the hutch but can be removed for cleaning. The top of the can is cut away, and a portion of the side is removed to provide access to the food. Wire hold-downs are at each corner and cross wires are run through these.—E. Y. Wormuth, El Cajon, Calif.

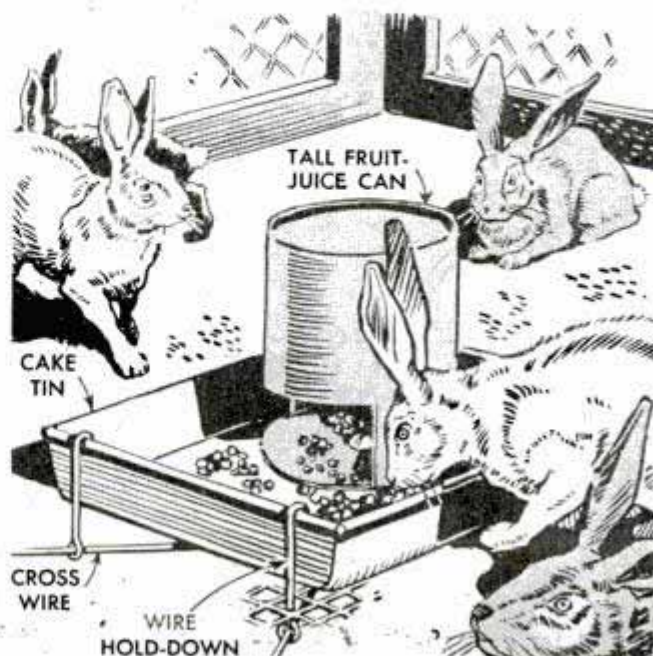

Gift Package *Glamour*

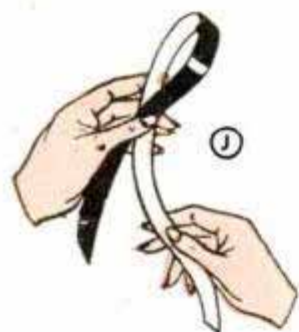
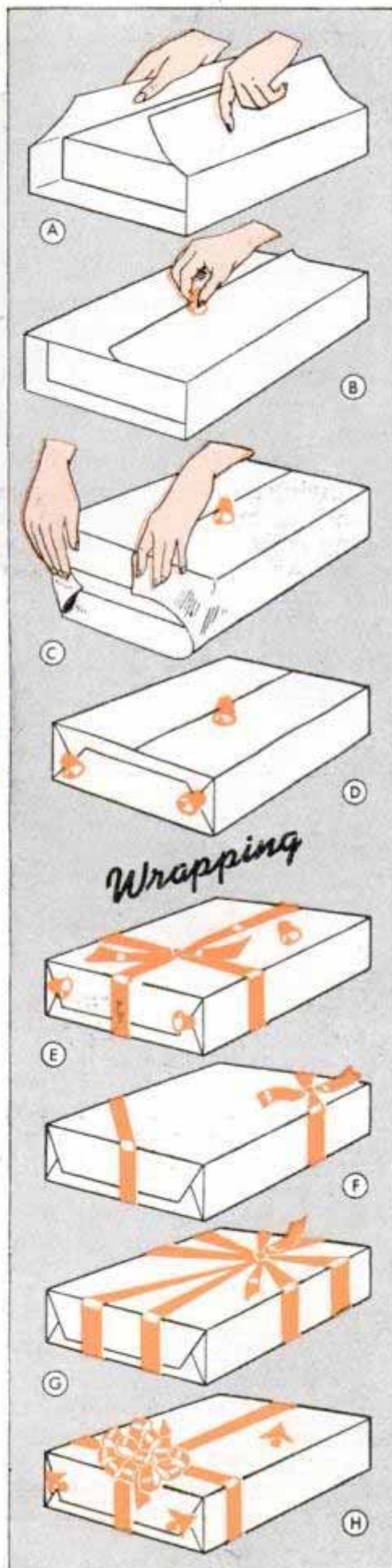

IRREGULAR LOOP



CARNATION BOW

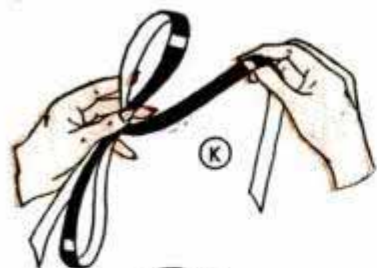

FLAT BOW



Tying Bows



FRENCH BOW

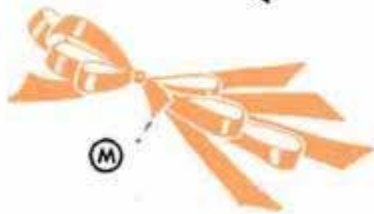

ELONGATED BOW



DAHLIA BOW

Wrapping

By Mildred Anderson

IT'S what's in the gift package that counts, of course, but there's no getting away from it—the wrapping leaves the first impression. Nothing takes the edge off lively anticipation quite so much as a messy, hard-to-undo package. Colorful ribbon, suitable paper in gay shades, glue, seals and a little time are all you need to turn out a neat, attractive job. The first important step is to get the paper wrapping cut to exactly the right size. Details A and B show the proper procedure. Use glue or a seal to hold the center seam, B. Glue usually is best as it makes a hidden seam which is especially effective on lined, checked or plaid papers. However, be careful not to use too much as it has a tendency to penetrate the paper. Glue or seal-fasten the flaps as at D, first making sure that the folds are neat and sharp and without wrinkles.

Details E to H inclusive suggest four package ties which are most effective on flat, rectangular boxes, although with slight variations they can be used on packages which are more nearly square. For best results, bows are made separately. The attractiveness of a bow depends on the number of loops and the way they are arranged. How to begin a loop is shown at the left in detail J, while details K, L and M outline the successive steps.

After sufficient loops have been formed for the type of bow desired, excess ribbon is cut off and the bow is laid on top of the package and tied securely. Ends of the ribbon tie need not be knotted over the bow unless the ribbon used has a tendency to slip. The irregular loop bow is easily made by varying the lengths of the loops and tying them in the center with loose ends of ribbon, which are left for this purpose. This method also can be used for an elongated bow except that the loose ends, instead of being fastened in the center, are tied nearer to one end of the group of loops. The dahlia bow consists of loops which have only slight variations in length. After the bow is tied to the package, the loops are cut diagonally to produce a petal-like effect. The French bow has loops of identical lengths, but they are placed sidewise and tied to obtain a fanlike effect. The carnation bow is composed of two separate bows with the bottom loops longer than those on top. Each unit is tied with thread before placing on the package. Besides using tricky bows like those described above, professional wrappers call further attention to packages by using ribbon that contrasts with the decorative paper wrapping and ornaments appropriate to the occasion of the gift. These are inserted in the fastening of the bow.

Light Shows Location of Keyhole When Pushbutton Is Operated

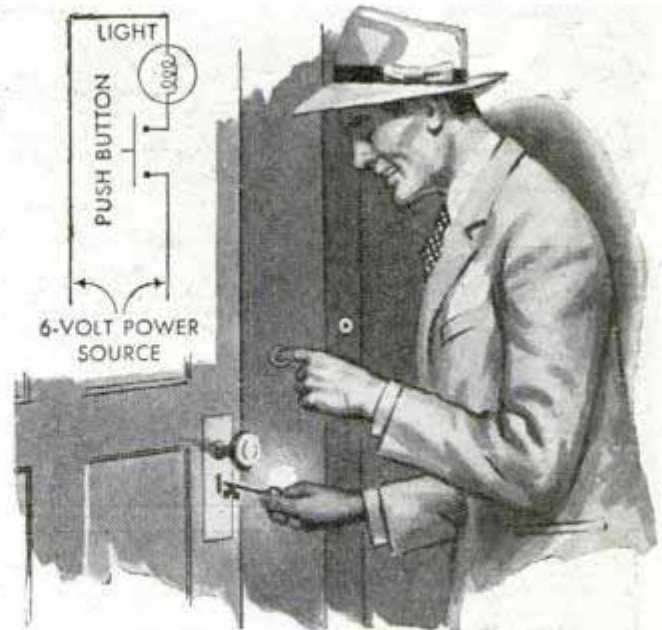

The difficulty of locating a keyhole at night is overcome by this light which directs its beam at the hole when a pushbutton is operated. A 6-volt light and receptacle from the dashboard of a car are recessed into one side of the door frame at the same height as the keyhole. Above the light a doorbell pushbutton is mounted and connected in series with the light. The power source is a transformer or batteries.

George M. Singer, Erie, Pa.

Drawer Fastened to Typewriter Holds Writing Supplies

Of help to all who use a portable typewriter, this cabinet and drawer are attached to the bottom of a typewriter case and will hold most of your supplies. The cabinet is finished flush with all sides of the case and does not mar its appearance. The drawer and cabinet are plywood.



CHESSMEN IN

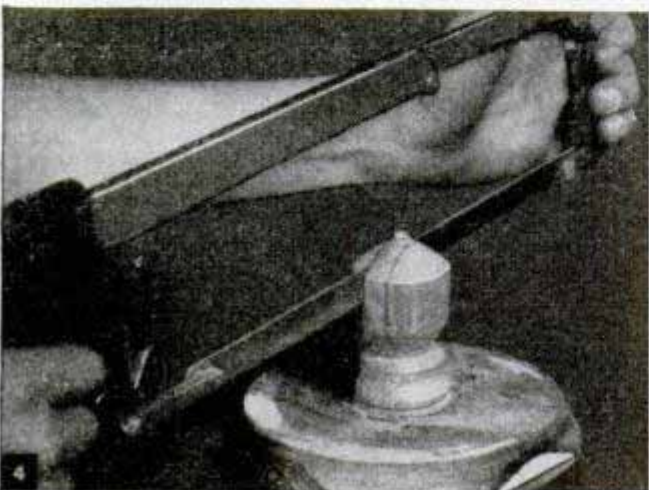
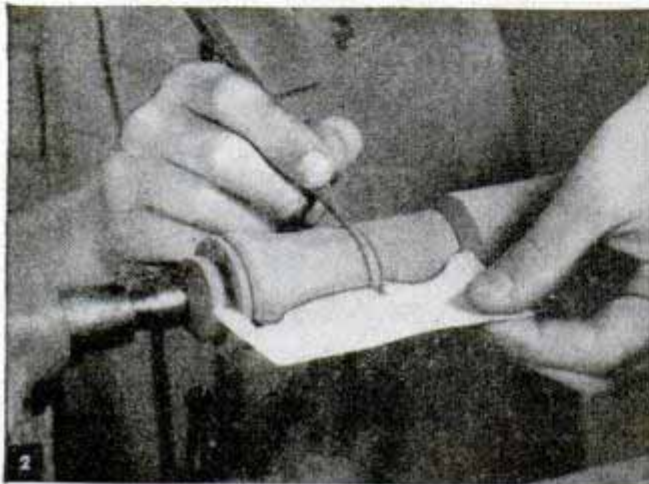
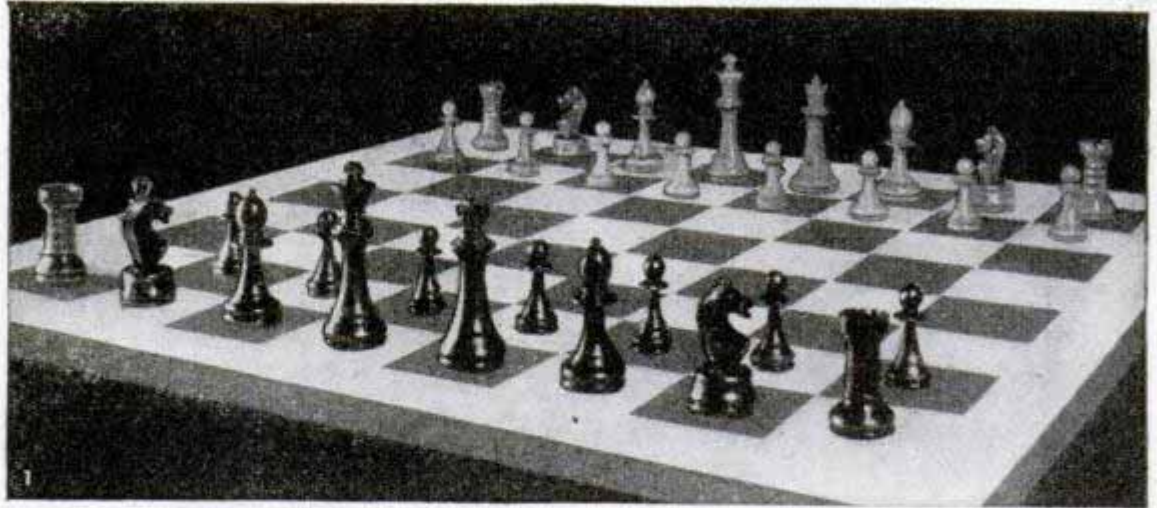

Chessmen in the Staunton pattern are familiar to all players and turning a set in the tournament size from fancy hardwood stock is wood turning at its best

By Willard Allphin

FANCY hardwoods of natural contrast are the thing for turning this set in the larger tournament size where the king is 4 in. high. Black ebony for the dark-colored men and boxwood for those that are light colored make the best combination, Fig. 1. Walnut and maple also are suitable but compared to the finer woods they are only a compromise. Careful work with sharp tools on both ebony and boxwood produces a glass-smooth surface that needs no finishing or polishing whatever.

Begin by making a template from cardboard for each man, following the cross-hatched patterns in Fig. 9. You need only a half profile. Then, after turning the work

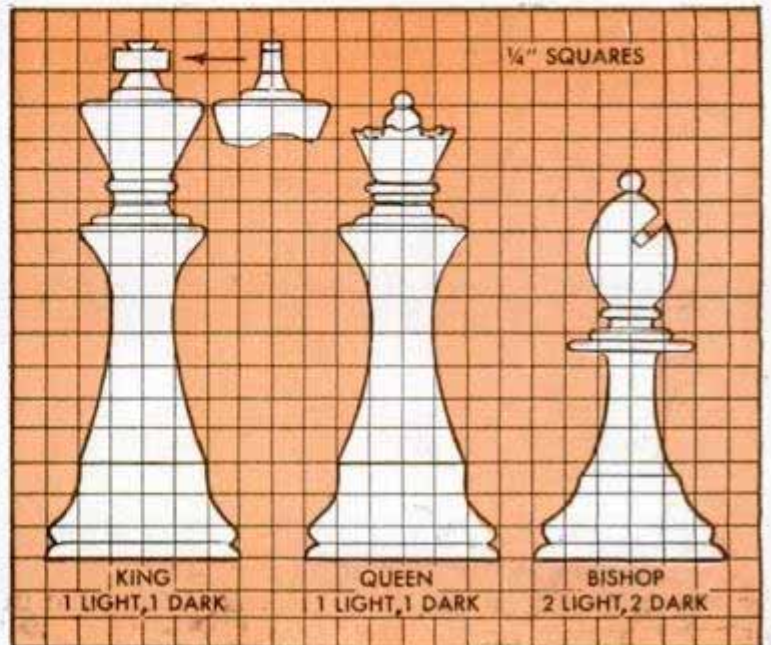

STAUNTON PATTERN

to round, use the template to lay off the exact location of shoulders, grooves and beads as in Fig. 2. After turning down the work to diameters which are near the finished dimensions, use the templates in conjunction with calipers to determine the accuracy of the profiles and diameters. If necessary you can make a screw center easily by turning an ordinary screw through a wood disk. Screw the disk to the lathe faceplate as in Fig. 3. Turn the knight to the shape shown in Fig. 4, then slot with a hacksaw—a hacksaw is best because of the fine teeth and stiff blade—and carefully cut away the waste on each side. Then, using a coping saw with a fine blade, saw the profile of the horse's head, Fig. 5. The rest is a handcarving job, but as you can see it's quite simple. Use a fine-tooth saw to slot the bishop and notice that this slot is made in two separate cuts, Fig. 9. To hollow the bases make a jig as in Fig. 6. Begin with the pawns and enlarge the hole in the jig as needed. Cut a recess in each base $\frac{1}{2}$ in. in diameter by $\frac{1}{4}$ in., fill with lead wool and wood putty to hold the "ballast," Fig. 8. Finish by gluing felt disks to the bases.

If you use any contrasting woods other than ebony and boxwood, these will need sanding and finishing as you go along. Sand as in Fig. 7. On open-grained woods such as walnut follow sanding with a filler colored to suit. Then apply a coat of sealer and finish with several coats of wax. Aside from the carving on the knight, the only other hand work is squaring the cross on the king's crown, scalloping the edges of the queen's crown, notching the rim of the castle and carving the stonework on the column of the castle.

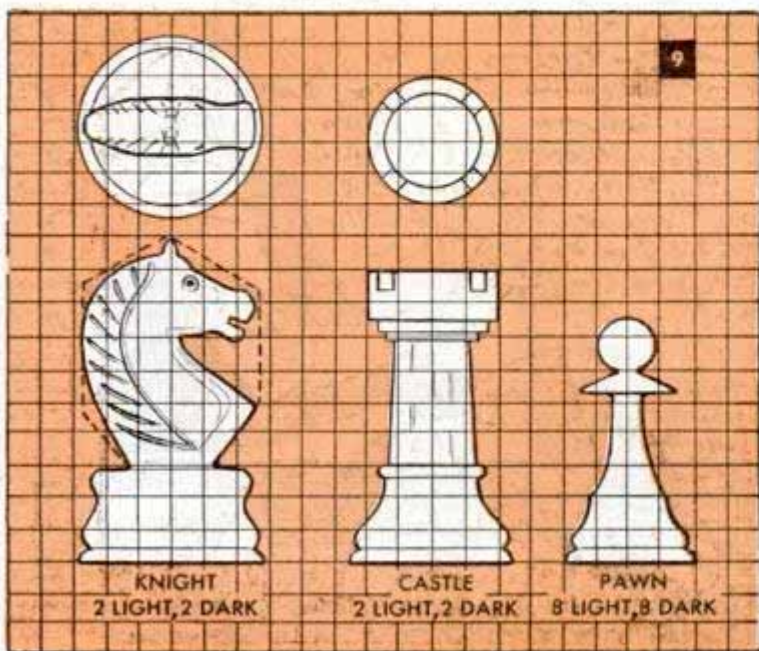
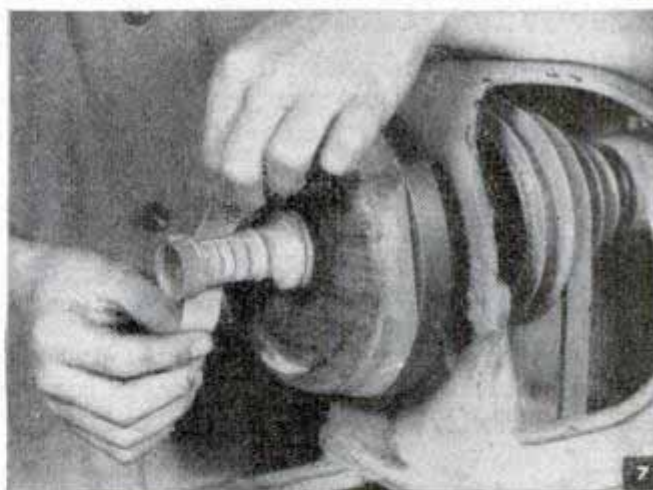
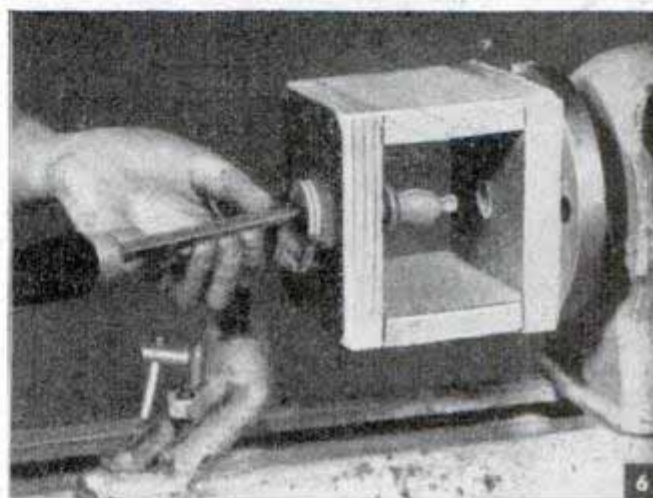
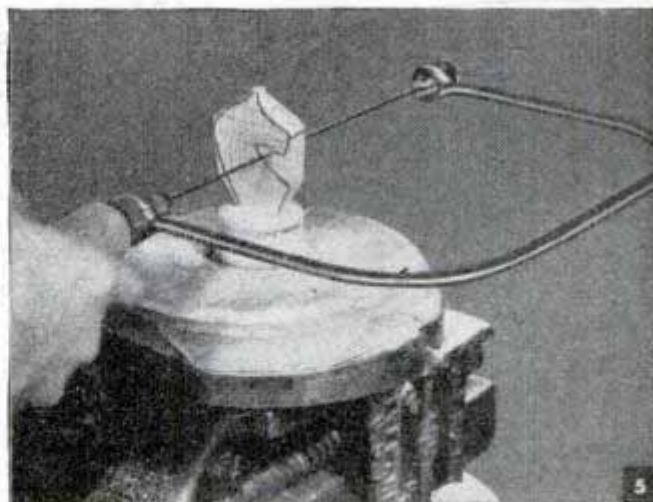

Rear-View Mirror Aids Motorist When Parking Automobile

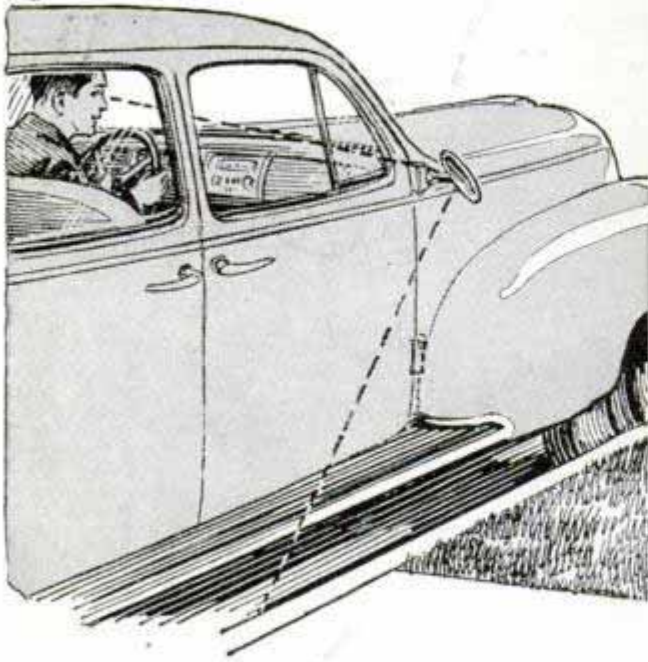

If it's difficult to avoid scraping the side-walls of your tires when parking a car, a rear-view truck mirror may be the solution to the problem. The mirror should have an arm that is long enough to extend beyond the running board so that it can be adjusted properly. Before mounting the mirror, try it in several positions to see which one is the most satisfactory.

Easy Way to Clean Plaster Objects

After a time almost all plaster objects, such as statuettes, plaques, etc., collect dust that cannot be removed with a cloth. To clean such bric-a-brac, make a thick paste of white powdered starch and hot water. Brush the paste over the plaster and allow it to dry. Then scale the starch from the object and the dirt will be removed with it. Before using this starch paste, make sure it will not mar the finish of the plaster by applying a small amount on a test area.

Wilford Leach, Williamsburg, Va.

Method of Retrieving Door Key

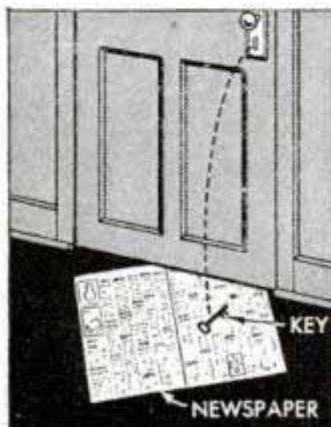

When a small child has locked himself in a room and is unable to open the door, here's a trick that may make it unnecessary for you to climb through a window and open the door from the inside. Slip a newspaper under the

door to cover as much area as possible on the floor beneath the keyhole. Gently work the key from the lock so it will fall on the paper. Then withdraw the paper and key, and you can open the door from the outside.

Round Corners for Plywood Box

When making a plywood box or other rectangular object, the corners may be rounded by assembling the plywood pieces to form a joint as indicated and then inserting a strip of quarter-round molding into the joint. Both the plywood and molding, of course, must be nailed or screwed to a corner strip.

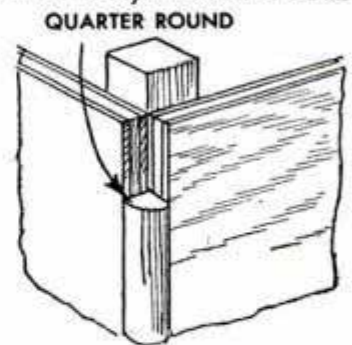

Front-Wheel Tire Is Recapped With Blown-Out Casing

After the tread wore off the front-wheel tire on his bicycle, one boy produced a satisfactory repair by cementing a blown-out casing over it as a "recap." The blowout was repaired and the bead and part of the sidewall were cut away, detail 1. Then the inside of the recap and the outside of the other tire were cleaned with a wire brush, detail 2, to remove dirt and roughen the surfaces so they would adhere better. Rubber cement was applied to these surfaces, detail 3, and allowed to dry for about 5 minutes. Then a second coat was applied and the recap was slipped over the tire.

James J. Yerges, Reeseville, Wis.



Artistic SPARK SCREEN

By H. Skalla

POSSESSING utility as well as being ornamental, the spark screen suggested here is presented in a variety of designs that can be adapted to almost any home. The frame is basically the same for all screens, but the scrollwork and the scenes can be altered to suit your scheme of decoration. A single length of angle iron is used to form the frame. When laying it out, allow about 1 in. on all sides to overlap the fireplace opening. Cut V-grooves in one leg of the angle at each corner to permit bending. Then reinforce each corner and the ends by riveting a triangular piece to the inside. Drill $\frac{5}{32}$ -in. holes on 4-in. centers and rivet the wire cloth to the frame, Fig. 1. The scrolls should be formed in pairs in a vise so that the halves will be symmetrical. Of course, the length of the flat iron will vary with the size of the screen, but it's a good practice to form the smaller curves first and then trim any excess length from the

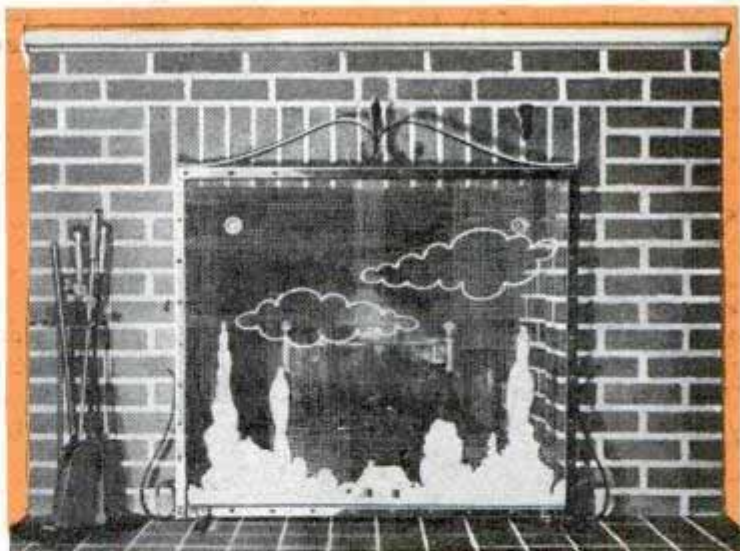

other end. After the scrolls are shaped, lay them on the frame and mark the holes for drilling and riveting. All rivet heads, both for the scrolls and the screen, should be on the outside with a washer on the inside. The feet are made of flat iron reinforced with angle-iron knees.

Character is given to the screen by the silhouette decoration. In addition to the design in Fig. 1, alternate suggestions are made in Figs. 2, 3 and 4. The silhouettes are cut of light sheet metal, with the ends slipped between the frame and the screen and tacked on with solder. Clouds are outlined with wire, Fig. 1, and smoke from the house, Fig. 2, is represented by fine-mesh screen. The entire screen is painted a dull black, but if desired, touches of color can be added. Colors that are not affected by heat should be used.

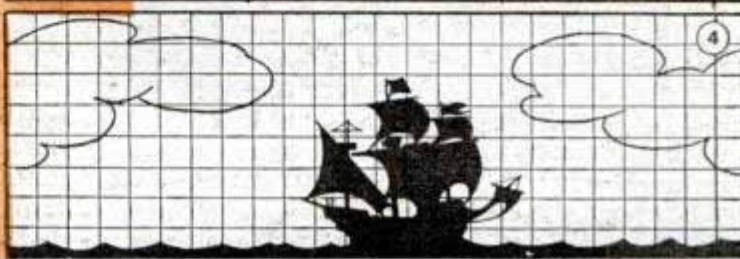
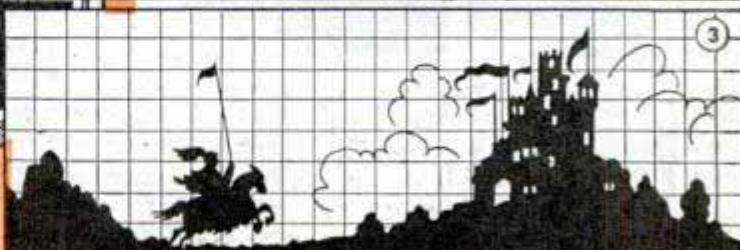
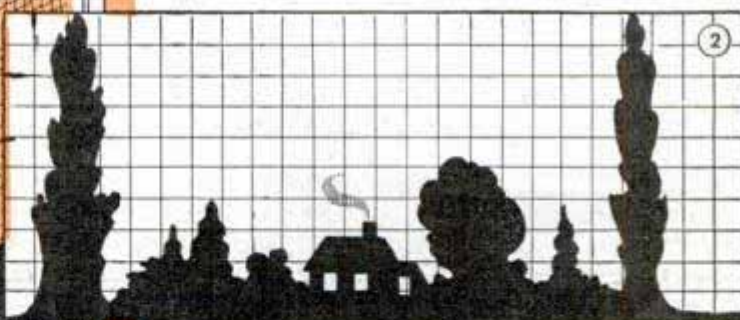
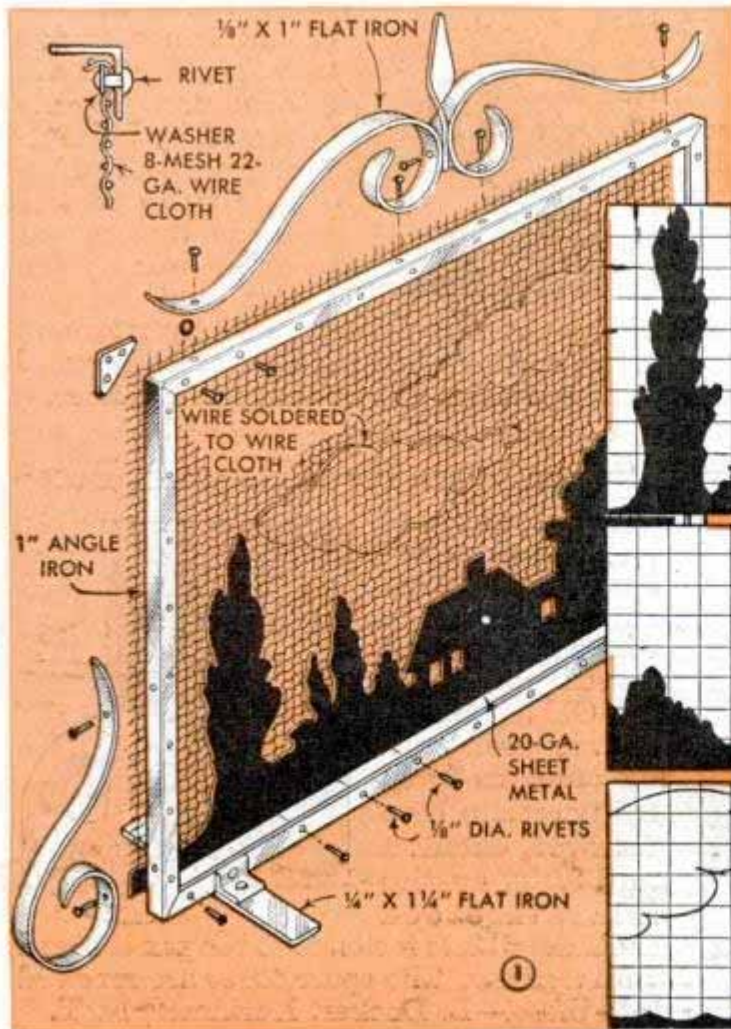

Doorknobs on Garbage-Can Lid Provide Handle and Hanger



If two discarded porcelain doorknobs are attached to the lid of a garbage can in the manner illustrated, they will act both as a handle and a hanger. The knob on top is grasped to remove the lid and the knob on the underside is used to hook it over the edge. This leaves both hands free to handle the container in which the garbage is carried to the can.

Peter B. Horsley, Brandon, Man., Can.

Children Can't Pull This Phone Off Its Stand

In homes having a desk-type phone, there is always danger that small children will pull it off the stand and injure themselves or damage the instrument. This can be pre-

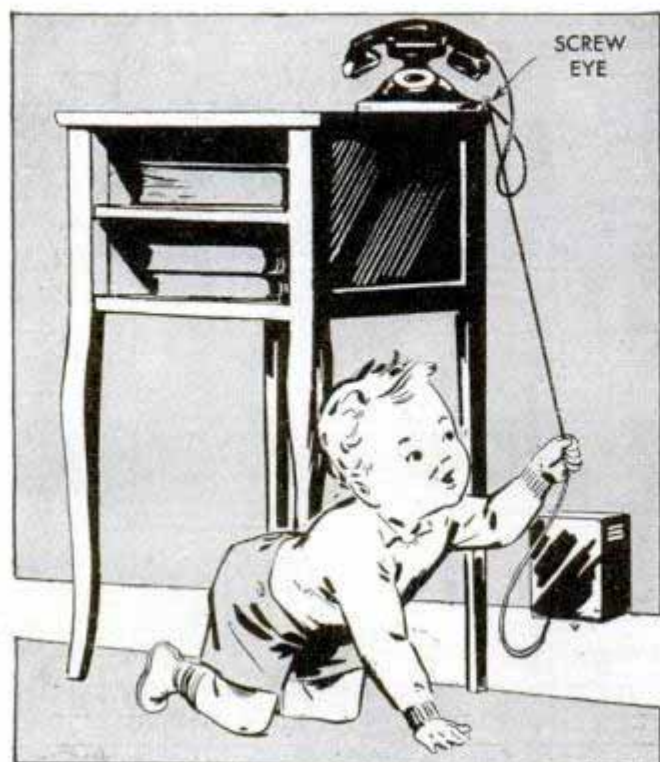

vented by fastening a screw eye on the back of the stand and running the phone cord through it. Then a child tugging on the cord could only pull the phone to the edge of the table since the screw eye would prevent further movement.

Richard C. Hare, Grafton, Mass.

Repairing Leaky Water Faucet

After refacing the damaged seat, A, of a water faucet, one man found that he was unable to stop the leak that resulted. A composition washer, D, was selected that would fit the disk holder, C, and serve as a valve disk. This was drilled to fit a bushing, B, cut from 1/4-in. o. d. brass tubing. The assembly was fastened in the disk holder with the screw, E, and stopped the leak.

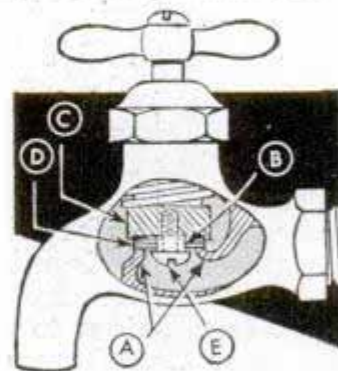

P. L. Schmidt, Kenmore, N. Y.

Balancing Rubber-Blade Fan

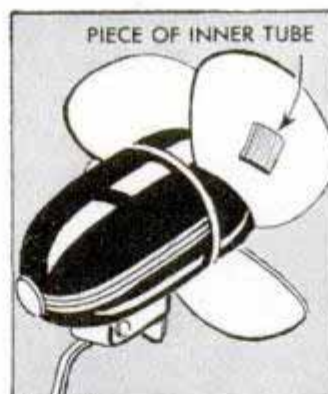

Some defrosting fans have rubber blades that may get out of balance and cause undue vibration. This condition is corrected by cementing a patch of inner tube to the blade that is out of balance. The size and location

of the patch are determined by trial and error, so the piece should not be secured until operation shows that fan balances.

Spare Fuses Kept Beneath Box

When mounted on the panel beneath the fuse box, spare fuses are available without needless searching. Old light sockets are used with the outer shell and the porcelain base removed, details 1 and 2. Then the inner, threaded shell, detail 3, is fastened to the panel board with a screw. The spare fuses are screwed into these.—L. Decker, Herkimer, N. Y.

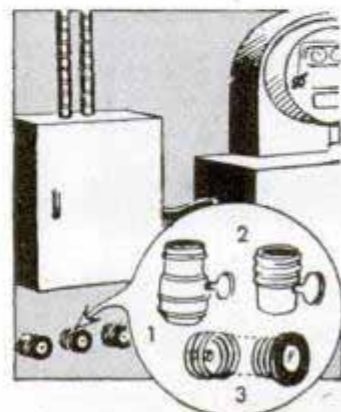

VACUUM CLEANER

Check-up and Repair

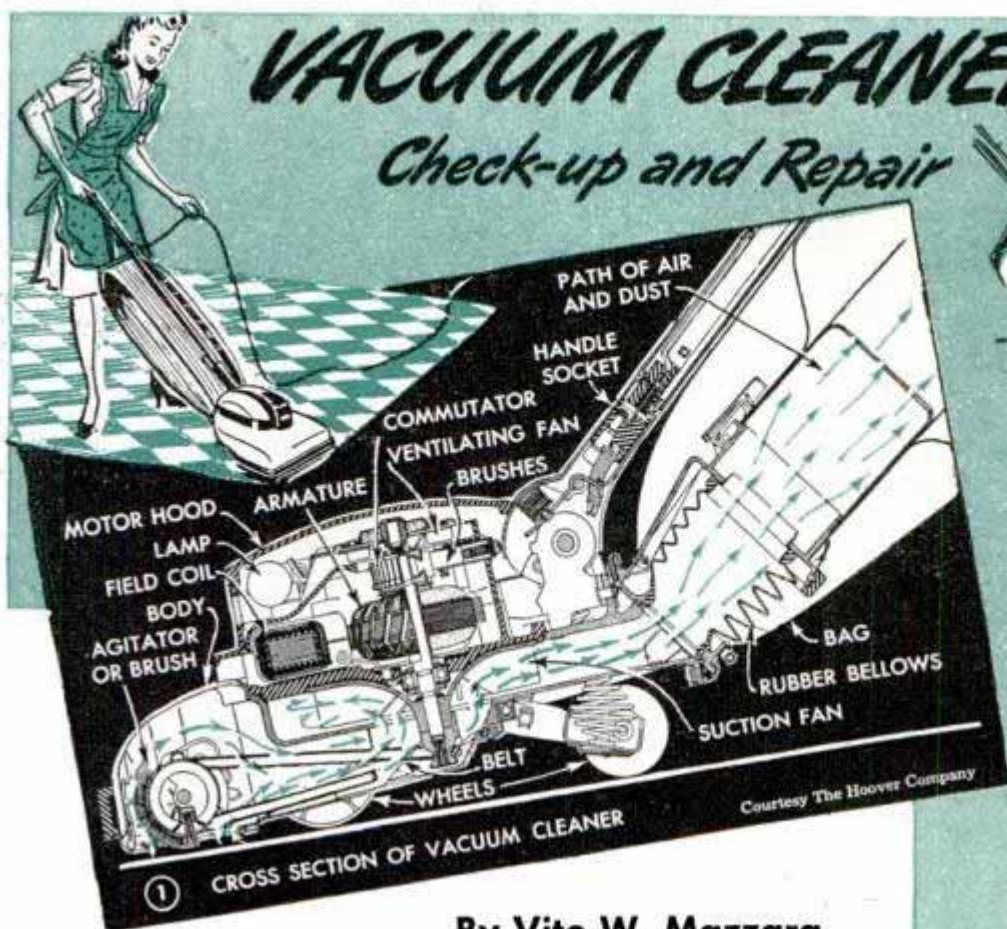

By Vito W. Mazzara

ALTHOUGH a vacuum cleaner is one of the most reliable mechanical devices in the home, there comes a time when it needs servicing and minor repairs—if for no other reason than to keep it in top-notch working condition. In doing its job of collecting dirt in the dust container, certain parts of the cleaner take plenty of punishment. Cut a cleaner in half, as in Fig. 1, so you can view it “in section,” as the draftsman calls it, and it looks like a complicated piece of machinery. But in reality its operation and its parts are quite simple. Essentially it consists of a centrifugal suction fan, a dust bag or container, a suction nozzle and a small electric motor which drives the fan. And that’s all, except a handle perhaps, a light to illuminate dark corners and, on certain types such as that in Fig. 1, small wheels and casters for easy maneuverability. Most cleaners of this particular type also are fitted with an agitator brush, its purpose being to loosen embedded dirt so that it can be picked up by the air stream. This brush and the dust bag or container are the two parts requiring the most frequent attention. When emptying the bag, the directions furnished by the manufacturer of the cleaner should be carefully followed, of course, but a common procedure is to hold the bag over a sheet of paper with the open end down, place your feet on the corners of the frame and shake the bag vigorously, as in Fig. 2. Turn the bag inside out occasionally and carefully brush off the accumulated film of fine dust. Never wash the bag as this will likely destroy its properties of dust retention.

The agitator brush should be removed occasionally and thoroughly cleaned. Lint, thread and string often wind so tightly on this brush that it’s impossible to untangle the mass. But you can cut through the strands with shears and remove them with a comb as in Fig. 4. Be careful not to break the bristles of the brush. Check the length of

② EMPTY THE BAG AFTER EVERY CLEANING



③ IF PLUG DOES NOT MAKE CONTACT, BEND PRONGS OUTWARD SLIGHTLY



④ CUT TANGLED THREAD WITH SHEARS AND REMOVE WITH COMB

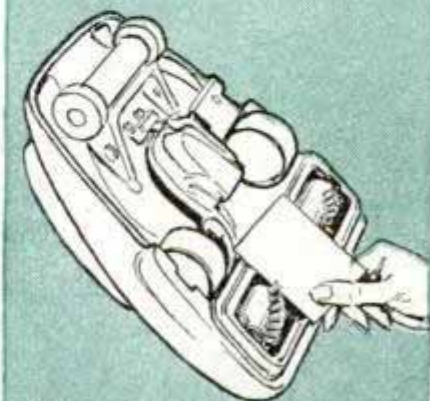

⑤ CHECK LENGTH OF BRISTLES BY LAYING CARD ACROSS NOZZLE

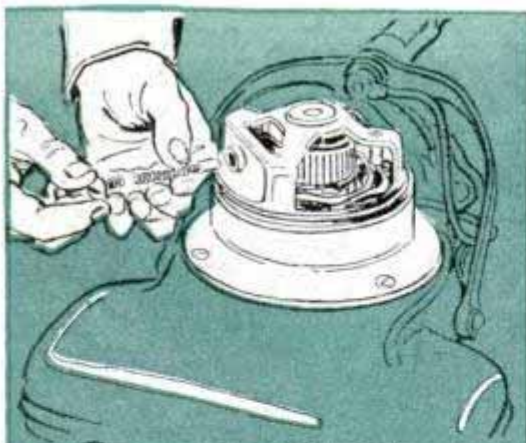

6 INSPECT MOTOR BRUSHES.
IF WORN THEY SHOULD BE RENEWED



7 EXAMINE THE COMMUTATOR AND
CLEAN WITH FINE (8-0) SANDPAPER

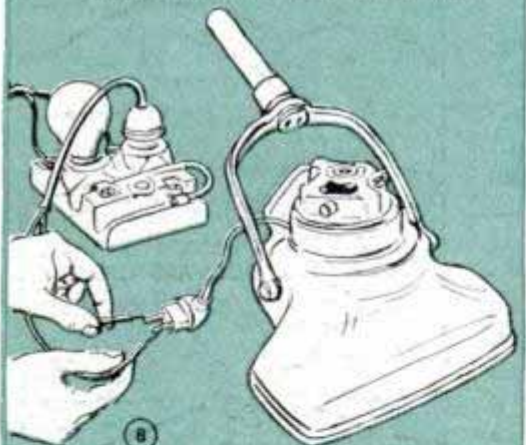

8 A TEST LAMP IS USED TO CHECK FOR "OPEN"
CIRCUIT IN FIELD OR ARMATURE COILS

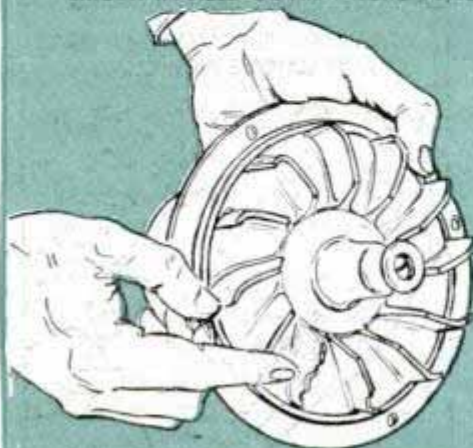

9 BROKEN FAN BLADES WILL CAUSE
VIBRATION AND WEAR ON MOTOR BEARINGS

the bristles occasionally as in Fig. 5. Also check the agitator belt tension to see that there is no slippage.

Sometimes a cleaner will start and stop at intervals when the switch is turned on, or it may simply refuse to run. When this happens the first part to examine is the plug, Fig. 3. Usually you'll find that the plug is loose in the receptacle and this means that the prongs are making only intermittent contact. The remedy is to bend the prongs outward slightly, or if the prongs are unusually loose when inserted in the receptacle it often helps to bend the ends of the prongs with pliers.

At long intervals it will be necessary to replace worn motor brushes, Fig. 6. Unscrew the brush caps and examine the brushes occasionally. Handle brushes carefully and be sure to return them to the sockets exactly as they were taken out. Don't turn the brush over. A commutator in good condition should be reasonably clean with the brush track somewhat darker in color. If the track is pitted, burned or coated, the brushes are not making proper contact. This causes arcing and results in a rough commutator surface, which of course grows worse with continued use. The remedy depends on the condition of the parts. Sometimes merely cleaning the commutator surface with fine sandpaper as in Fig. 7 will be sufficient. However, if it is rough and pitted or grooved, then, if tests show the motor otherwise in good condition, it will pay to have the commutator trued up and the mica undercut by a competent service shop. Whenever you have the cleaner apart for any reason, give the fan a thorough going over. There might be a cracked or bent blade or maybe a piece broken out as in Fig. 9. This will cause vibration which in turn greatly accelerates wear. If any of the blades are cracked or broken, a new fan is the surest remedy.

If you suspect there's need to check over the cleaner electrically, then make up the simple circuit tester detailed in Fig. 10. Begin by plugging the cleaner cord into the tester and turning the switch to the "off" position. If the lamp lights there's a short somewhere in the cleaner. Check switch cords and leads to the motor to locate it. If, on the other hand, the lamp does not light with the switch in the "off" position, snap it to the "on" position. If the lamp still does not light, there's a short somewhere along the line of the electrical circuit. Check the plug for breakage or loose wire connections, also

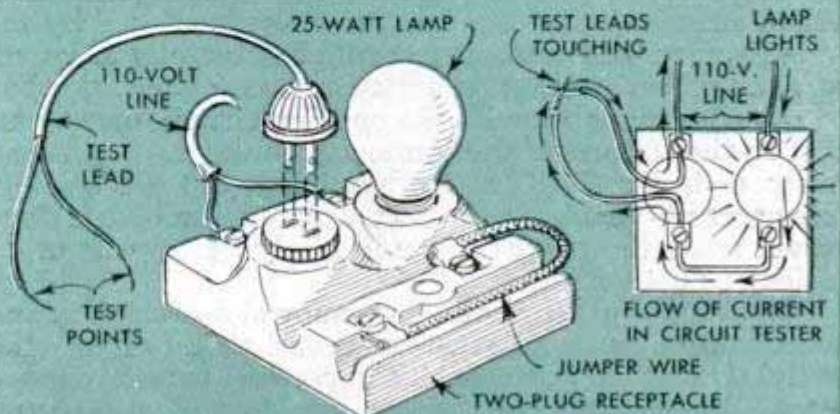

10 A SIMPLE CIRCUIT TESTER FOR CHECKING
CIRCUITS IN ANY ELECTRICAL APPLIANCE

the wires to the cleaner switch plate. Shake the cord all along its length and note if the lamp flickers at any point. If nothing happens, disconnect the cord from the motor, twist the wires together and plug the cord into the circuit tester. The lamp will light if the cord and switch are intact.

To test for open circuit in field or armature coils proceed as in Figs. 8 and 12. The lamp will light unless there is a burned or open field coil. If turning the fan slowly, Fig. 12, produces a uniform flicker of the light, everything is okay. But if the flicker is unsteady, turn slowly to find a point where the lamp goes out. Ordinarily this will indicate an opened commutator segment.

To test field coils proceed as in Fig. 14, connecting the complete set in series across the line voltage and measuring the voltage drop across each coil. A low reading indicates a short in the coil being tested. Fig. 15 shows the circuit of a universal motor, a common type in vacuum cleaners. Fig. 11 illustrates tests B and C, shown diagrammatically in Fig. 15. Although a light shows that the coil being tested is continuous, the insulation may be burned off. Test D, Figs. 12 and 15, checks coils of the rotor or armature. If the lamp does not light then test each adjacent pair of commutator segments as at E, Fig. 15. No light indicates that the coil is burned out between those two segments. The motor will not start if it should stop when a brush is in contact with the dead coil. If the test lamp lights when making the test F in Fig. 15, illustrated in Fig. 13, insulation has been scraped or burned from the armature coil, or coils, and the armature is grounded to the shaft.

If the test lamp fails to respond when it should light, make a careful inspection of the particular circuit you are testing. Unless the motor is burned out or otherwise damaged, making replacement of the whole unit necessary, breaks usually will be found near the ends of the wires where it is easy to make a lasting repair. Generally the cord is the first offender. When you coil or uncoil it from the cord brackets on the cleaner be careful not to kink it. If you should happen to pull out a sharp kink you may break the strands of one or both the wires as well as the insulation. Other than the cord, most repairs are necessary only after a long period of hard service, unless of course the cleaner is damaged. Often it's a question of deciding which to do, repair the damaged part or renew it entirely.

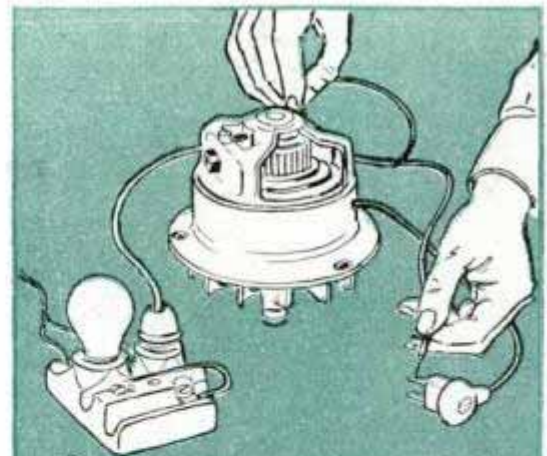

11 LIGHT SHOWS THIS FIELD COIL IS CONTINUOUS ALTHOUGH IT MAY BE SHORTED

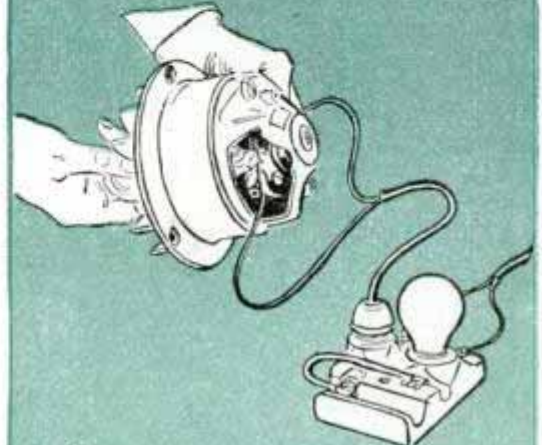

12 TURN FAN SLOWLY TO CHECK ARMATURE COILS FOR "OPEN" CIRCUIT

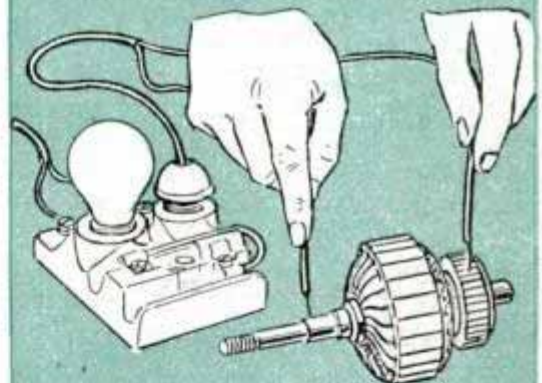

13 LIGHT HERE INDICATES THE ARMATURE COIL IS GROUND TO THE SHAFT

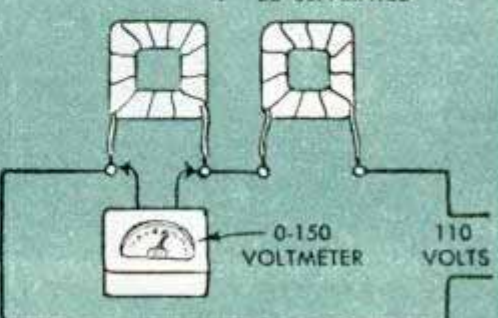
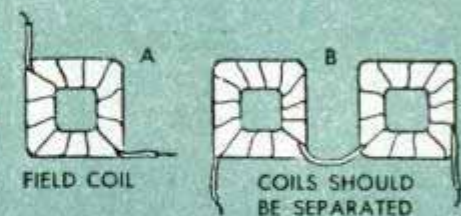

14 A LOW VOLTMETER READING INDICATES A SHORT CIRCUIT IN THE FIELD COIL

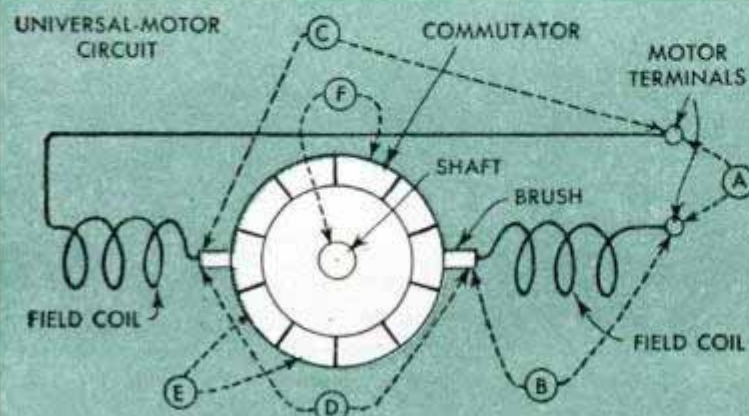

15 TEST LAMP SHOULD LIGHT AT ALL LETTERED POINTS EXCEPT (F)

Braces Attached to Baby's Swing Will Prevent Tipping



Baby swings of the type that have a seat suspended from four cords may tip over if the infant leans forward too far. To prevent this, one housewife attached diagonal braces from the front of the seat to the rear cord where it joins the spreader. This counterbalances any forward movement.

Threading Die for Wood or Plastic Made From Steel Nut

Here's a set of emergency dies you can make from ordinary steel nuts. As many sizes as are needed can be made. Slots are

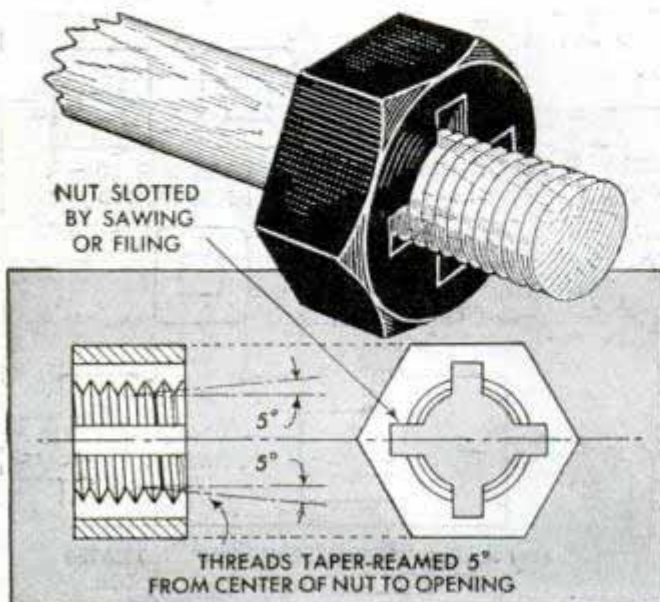

cut across the threads which are taper-reamed 5 deg. from the center to the opening of the nut. In the smaller sizes, only two slots may be required. An adjustable wrench is used to turn the nuts when threading. Cutting threads in wood should be accomplished with a "rocking" back-and-forth motion.

Box Holds Grinder Accessories

If hand grinder accessories are kept in a box, they are less likely to become damaged or lost. A metal box about 2 1/4 in. high is required, length and width being determined by the number of tools you have. A block of hardwood about 3/4 in. thick is cut to fit inside the box. In this block drill holes 5/8 in. deep, spacing the holes so that the tools do not touch. An eyebolt fastened to the block will simplify lifting it out of the box.

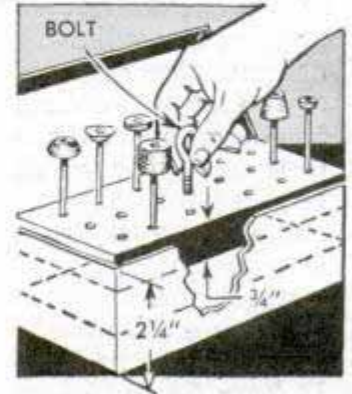

D. E. Horn, River Forest, Ill.

Novel Designs on Flat Surfaces

It's possible to ornament most flat surfaces impervious to alcohol with an all-over design of small floral forms much like that of cut glass. Make a solution of clear gelatin, 1 part, and water, 49 parts. Filter the solution and pour the liquid over the surface you desire to embellish. Drain off any excess water and place the object where it will freeze. Once it has frozen, pour absolute alcohol over it to dissolve the water and leave a network of gelatin forming graceful designs. After the gelatin has dried, the surface is varnished.

Amusing Toy Rises From Knees

This amusing toy is made from a few matches and a walnut shell. The head of the animal is formed from any small nut; a hazelnut, for example, will serve the purpose. Holes are drilled for the head, tail and legs—the jointed members being wooden matchsticks. When drops of water are placed on the joints of the legs, the animal rises in a lifelike manner.



Nathan Bogoch, Winnipeg, Man., Can.

REST YOUR FEET

YOU get experience in wood turning, veneering, upholstering and finishing all in one when building this simple footstool. The base is formed of two $\frac{3}{4}$ -in. walnut boards half-lapped at the center. The top is built up of two plywood disks, the center being cut from one to provide the cushion base. Glue and screw the ring to the bottom disk, then true the edge in a lathe. Next, face the edge with straight-grained veneer, using the improvised clamp shown, and, when dry, trim off the surplus veneer flush at the top and bottom. Then veneer the top of the ring and attach to the base with screws. The slip-in cushion is padded in the manner given to fit snugly in the recessed top.

N. R. Hacken, North Sacramento, Calif.

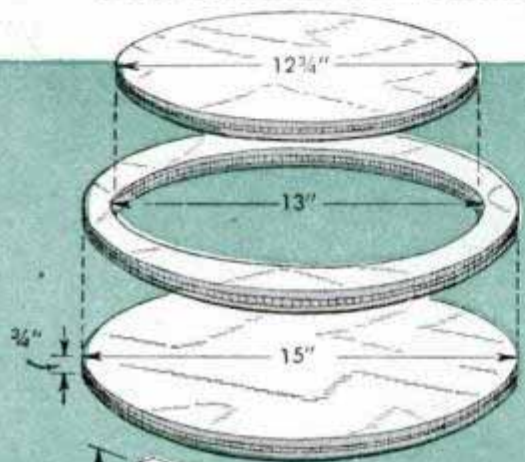

- EXTERIOR UPHOLSTERY COVERING
- MUSLIN OR BURLAP COVERING
- WOOL OR COTTON BATTING
- MOSS OR HAIR
- PLYWOOD BASE



CROSS SECTION OF CUSHION

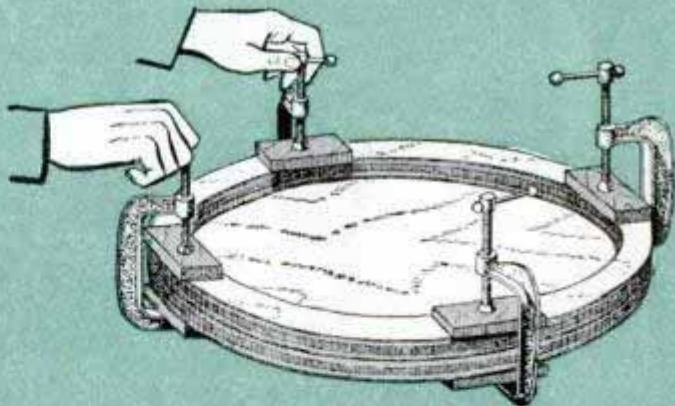
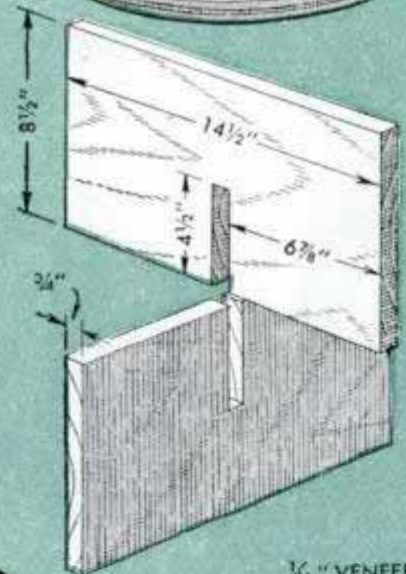

FIRST, PLYWOOD RING IS GLUED TO TOP DISK



THEN, VENEER BAND COVERS EDGE TO CONCEAL PLYS...

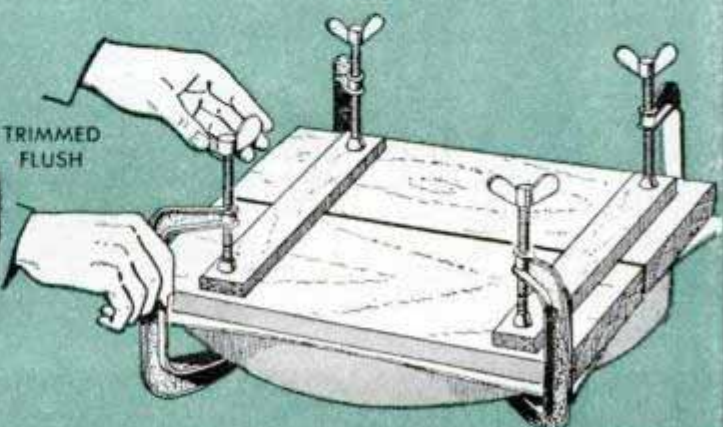

AFTER WHICH TOP IS VENEERED AND TRIMMED

SHOOTING

By Richard W. Emery

Photos by Ray Chapin



To keep a picture within single-column proportions, center the subject between two cardboard "masks" held as shown

TO BREAK up the grayness of solid printed matter, news editors use bright, cheerful, one-column cuts. Knowing how to make those slim, snappy pictures is a valuable aid to any photographer who wants to pay for his photo equipment. Good single-column shots can help you put over home-town newspaper publicity for your camera club, golf tournament or after-dinner speakers' club. If the small space given your picture seems



In the picture at the left it's necessary to crop one foot and part of the racket. Right, essentially the same picture but a slight shift in the camera position not only has improved modeling of the figure but both racket and foot are kept well within the single-column width you're after



Likewise, you can't pose the girl fisherman as shown above and then crop the print to single-column proportions without cutting

SINGLE-COLUMN PICTURES

Eye-catching single-column pictures find a ready market in newspapers and photo services, but you have to compete with crack photographers. Here's how it's done

too little reward for all your work, just remember that the trim one-column picture has a high attention value. And once in a while your eye-catching narrow picture will surprise you by blossoming out in the newspaper as a two-column or even a three-column cut, maybe half a page deep. It has happened!

A good single-column shot finds a ready market in metropolitan newspapers and the various news-photo syndicates. It's handy for illustrating your own feature articles for newspapers and for news-service

markets. And every single-column picture can be made to "tell a story." It can have pictorial value in its own right. It pleases the eye. It's alive. It expresses a mood which the reader easily recognizes. It looks easy. But the job calls for imagination, careful planning and, above all, resourceful photography. Unless these narrow pictures are planned and then executed according to plan, they're almost sure to be duds with uninteresting "clothespin" lines—arms, legs and features lining up parallel with the edges of the narrow print.



off parts of the hat, boots and rod. Rather, the lady should pose as in the view you see above. She'll be happier about it and so will you

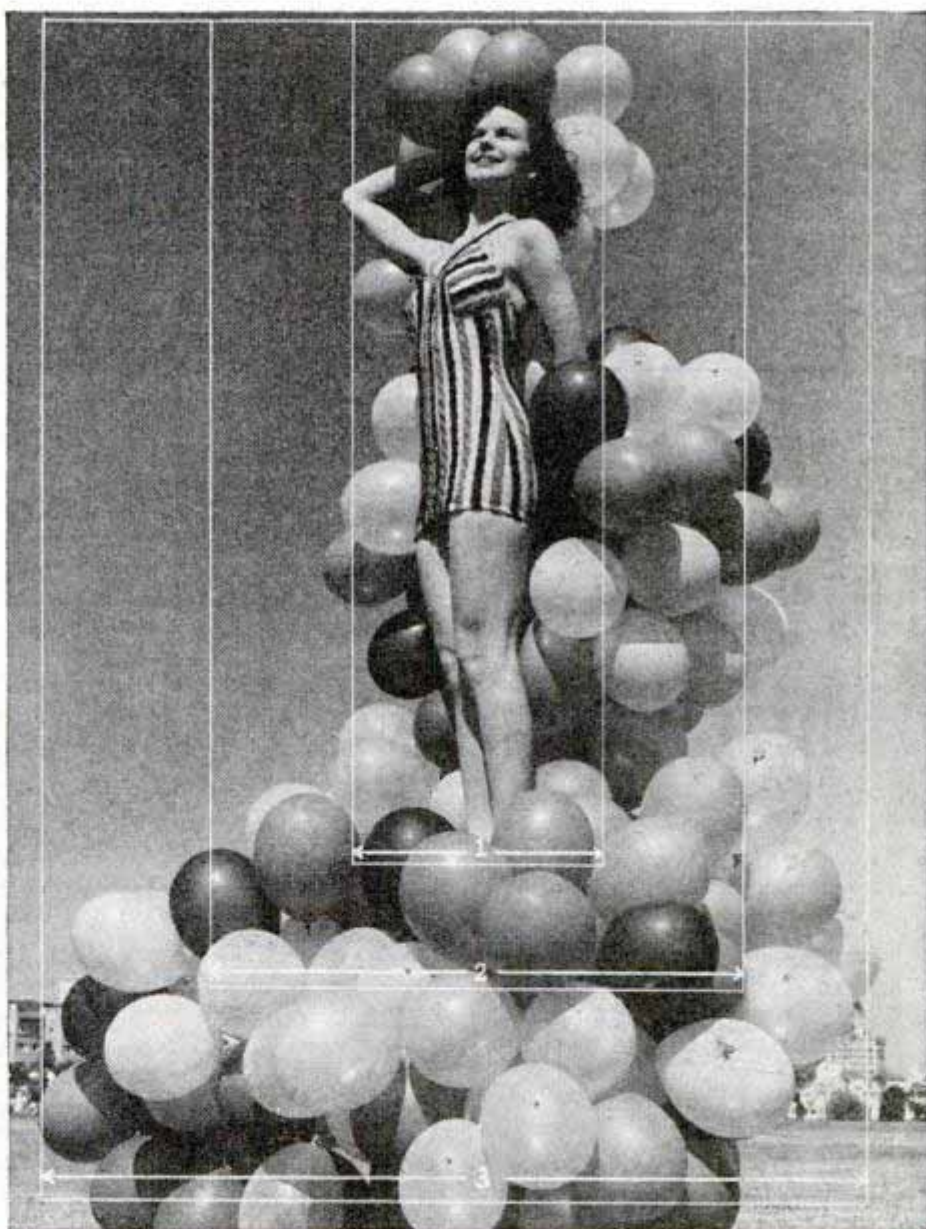

Here white lines show how you can crop the print to three possible proportions, all distinctly different pictures. News editors have used all three, and you will see at once that the pose of the figure and the placing of the props have been arranged with this thought in mind. Take your pick



The usual single-column photo of this type is merely an identification picture with no atmosphere to suggest a theme. But introduce simple props, arrange camera and subject with close attention to every detail, and in the case of an outdoor shot make the best use of sunlight. As a result you have a picture with a story, plus character and expression



Looks like a publicity shot, and of course it is, but the photographer knew his trade. Four persons and props have been posed within single-column width. The girls are standing on a stepladder, and elevating the camera at a rather steep angle reduced the depth of field to bring the whole group into sharp focus

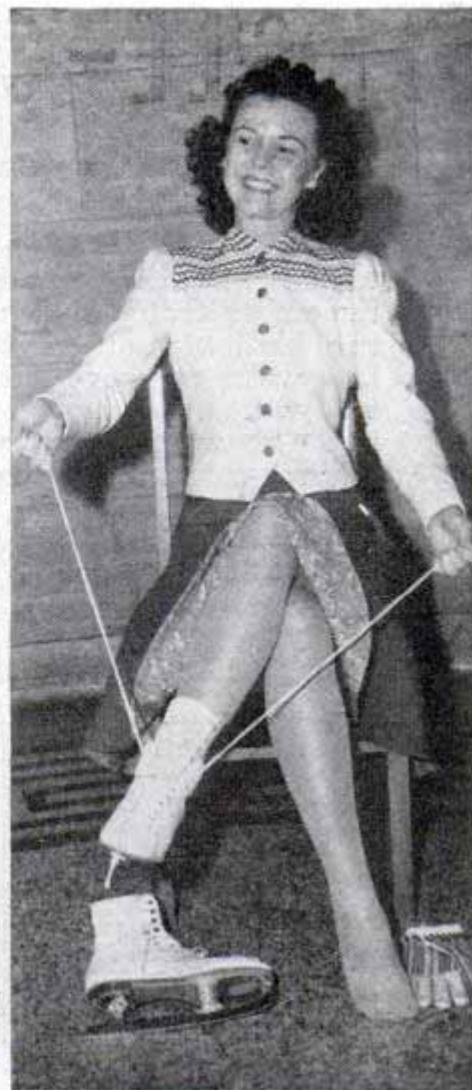

Even persons who are somewhat camera-shy pose more naturally when you give them something to do. This occupies the attention of the subject and gives the pose the quality of action. In the shot above this thought is carried out by the simple act of lacing the skate shoes



So here comes rule one: Break up parallel lines.

One sure way to break lines is to shoot an action pose rather than a stand-still pose. Have the subject of your picture walk toward you, or perhaps do some kind of work. Or changing your camera angle may be the solution. Watch out for straight, vertical lines in the subject's clothing. Maybe you can cover them up with props—something the subject carries or works with. But remember that in your effort to avoid parallel lines, it's easy to forget about the limitations of one-column art.

And out of that you get rule two: Keep all essential parts of the picture inside single-column limits.

You'll be disappointed if you have to lop off the subject's hands or arms or ears or his pipe. The ordinary newspaper column is about 2 in. wide. A single-column cut may be anywhere

Where your camera is in relation to the subject is important. Here the photographer has found it necessary to lie almost flat on the ground to get just the angle he wants



Here the girl in the uniform of a drum majorette, the marching arrangement of the trophies and the baton make you think immediately of a parade and all the colorful fanfare which goes with it. That's what the picture is intended to do



This photo tells a story to the air-minded reader. The partial view of the plane and the pilot's uniform and helmet supply the theme. The shot is taken at a low angle. Wind action on clothing gives movement



A real action shot, this one, and an example of what you can do by skillful posing and careful timing. Just enough background is included to identify the location completely

from 4 in. to 6 or 8 in. deep with 6 in. the average. Freak pictures often require an even deeper cut—the city's new fire ladder in action, for example, or a telephone pole full length with such props as spectators around its base, a lineman and maybe a stranded tomcat on top. Within those proportions you must confine everything vital to the sense of your picture. If you let some part of the picture wander out of bounds, the column-rule will whack it off. Arms usually are the worst problem. Sometimes you can nip an elbow and then bring the hand back into the picture. If the subject is carrying anything, don't let it stick out sideways. You'll be surprised at how bulky or lengthy an object can be neatly tucked into a one-column picture, if you study camera angles and pose the subject carefully. If you have to take a picture of something that simply can't

To determine single-column width lay the print on a table and place rulers or pieces of paper on each side. Three parts length to one part width is about the right proportion





The best camera angle may require you to perch atop a high ladder and shoot down on the subject. High-angle camera positions enable you to get a number of objects in sharp focus and make all of equal size

be stuffed into one-column slimness use backgrounds to suggest oversize objects.

Rule three in one-column shooting is to use the background to round out the idea in the picture.

You can use only a touch of background but that always helps. You may have to fit the pieces of background jigsaw-puzzle fashion into the crook of your subject's elbow and a half-moon area behind his neck. And that may take some fancy maneuvering, but usually it's worth it.

People are the best subjects for single-column pictures. That's rule four.

The majority of newspaper pictures are pictures of people. You need concentrated subject matter and people supply just that. You can squeeze a fat man into a one-column, if you try, and a thin man is simply made to order. If your subject is one person, your problem is to pose him so that he won't look "stiff-collared" and posed, and generally uncomfortable, and at the same time keep his arms, legs, cigar, dog, shotgun, surfboard or wheelbarrow from sticking out of the imaginary boundaries.

So, you search for a camera angle. That's rule five.

Ground level may give you the best view. Eye level may be the answer. Or you may need the tallest stepladder in town, but no matter how skillfully you pack the scene into a one-column picture, you'll have a pretty dull one unless it has either action or an unusual, attractive pose.

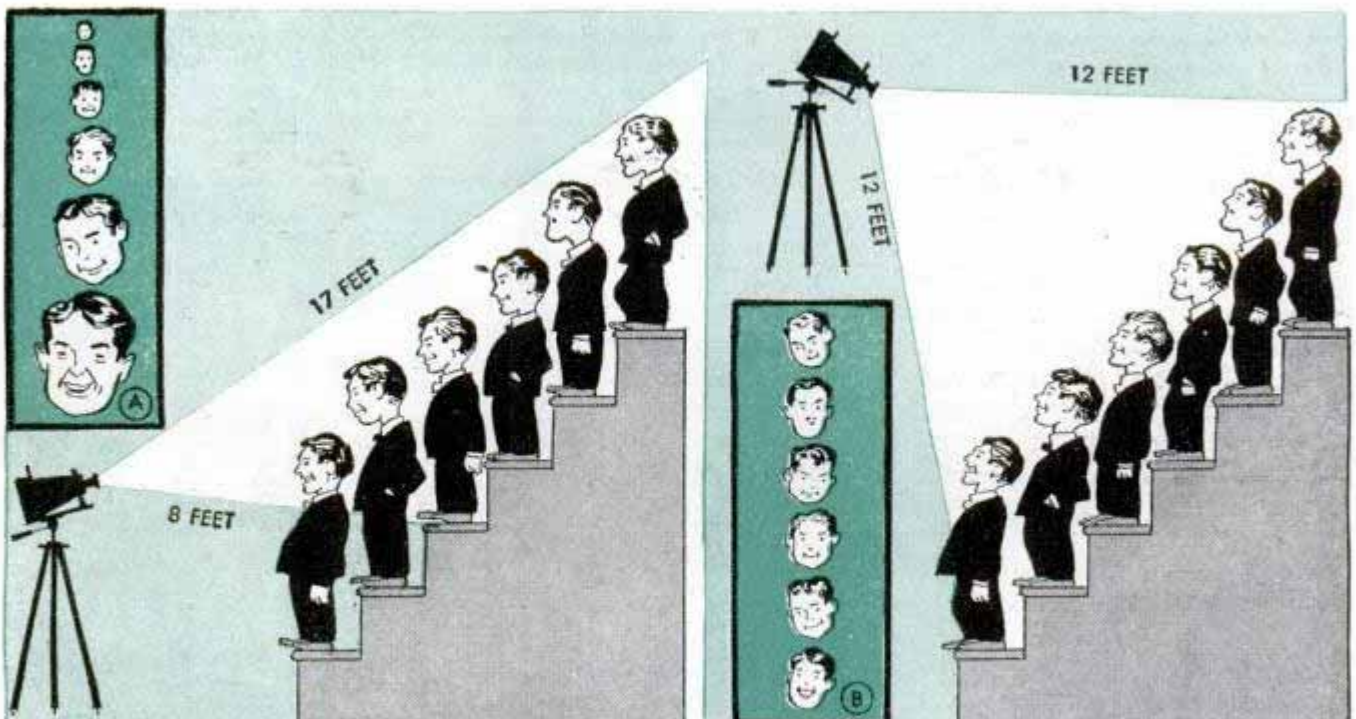

Detail A above shows what you get when you shoot from a low angle and include objects at varying distances from the camera. Objects in the foreground often are so greatly foreshortened they appear distorted, while those farther back are difficult to bring into proper focus. Such subjects should be taken at a high angle as at B above. Here all members of the group will appear about the same size on the print

Mark down rule six: Get action, in some form.

Confining action in a single-column is like trying to get an elephant to turn a somersault in a darkroom. But it can be done, and done well. To provide some reason for the action, you use props. Give the subject something to carry, something to do.

Use props to enliven the picture. That's good enough for rule seven.

If you have more than one person in the picture, you face the job of lining them up so they will appear in the picture one above the other. Resourcefulness will give you a catchy shot. Maybe a ladder or stairway or chair can serve to raise one person. You may be able to arrange a group in vertical order on a stairway and then shoot from a high enough perch to put them all in focus. Add it up and it amounts to the same thing—you have to do some advance engineering if the picture is to have any action or prop arrangement to give it a kick.

The final rule should be obvious to all hands who try single-column illustration, but many photographers muff it—and miss the picture.

Rule eight requires that you shoot the same action several times, just to make sure.

Why? Well, try to break up parallels, tuck in some background, catch action and show interesting props all without stepping over the one-column boundary lines. Shooting several times over may give you one good negative on which everything turns up just where you hoped it would be. And in the tricky business of shooting salable single-column pictures, that's the one you're after.

Paper Extension Focusing Hood Sharpens Ground-Glass Image

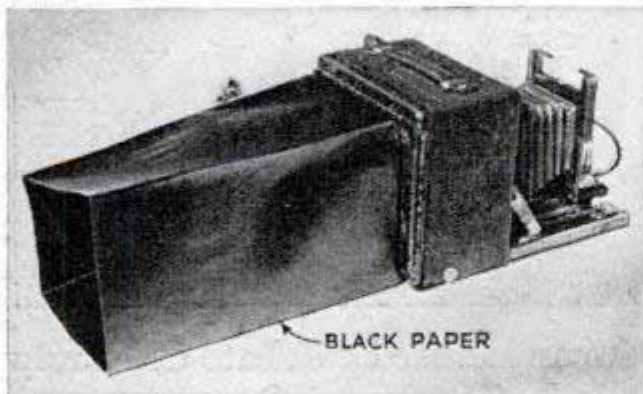

When focusing on the ground glass in brilliant sunlight, reflections sometimes hinder accuracy, even though the camera has a built-in focusing hood. A large piece of black opaque paper can be folded to fit over the hood and form an extension that will minimize reflections greatly.

Better Use of Monotone Filter



Used to view a scene before photographing it, a monotone filter can be improved if it has two densities, either of which may be used according to the strength of the light. One half of the filter may be given added density by covering it with several strips of Cellophane of the same color as the filter. After you have experimented with the unit, you will know which half to use as a viewer, depending upon the light.

Moving-Picture Title Library

A file of several sizes and types of letters and numbers for movie titles can be made by copying different kinds of lettering with a still camera. Calendars can be used to start the file. Cut out the letters of the month and the numbers. Then mount them on a sheet of white paper and copy. Enlarge to the size wanted and make contact prints for smaller titles. In this way you will build up a file of many types and styles of letters that are used to make pasteups for your moving picture titles.

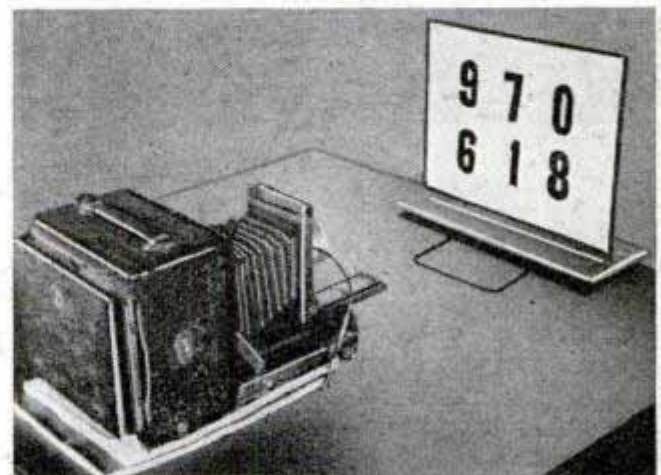

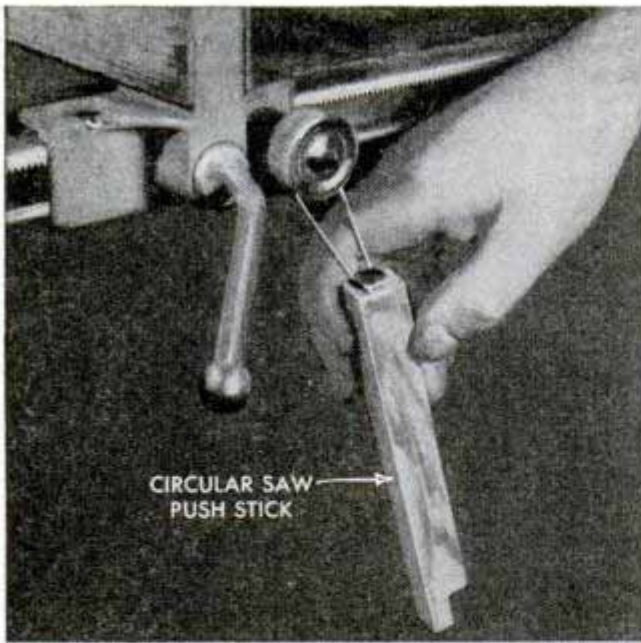

Stick Attached to Fence on Saw Reminds Operator of Its Use

Many accidents would be avoided if a push stick were used whenever practical in operating a circular saw. One way to jog your memory so the push stick is not forgotten is to attach it to a loop of cord with a thumbtack and suspend it from the locking knob of the rip fence. This method has proved successful where formerly use of the stick was neglected.

Rubber Heel Holds Small Work And Prevents Damage

Small and delicate parts often may be ruined when working on a drill press because the piece is twisted from your fingers. Such parts can be held very easily, however, if a rubber heel is placed underneath the piece to act as a drill pad. Pressure of the heel against the work prevents the latter from turning.



Sturdy Yard Gate Constructed With Part From Metal Bed

If of the right width and height, the head of a discarded metal bed will make a strong and attractive yard gate. The legs are sawed off and hinges are attached to one side with a latch on the other. Flat iron is used in the construction of the hinges and latch.—Glenn Adams, Tecopa, Calif.

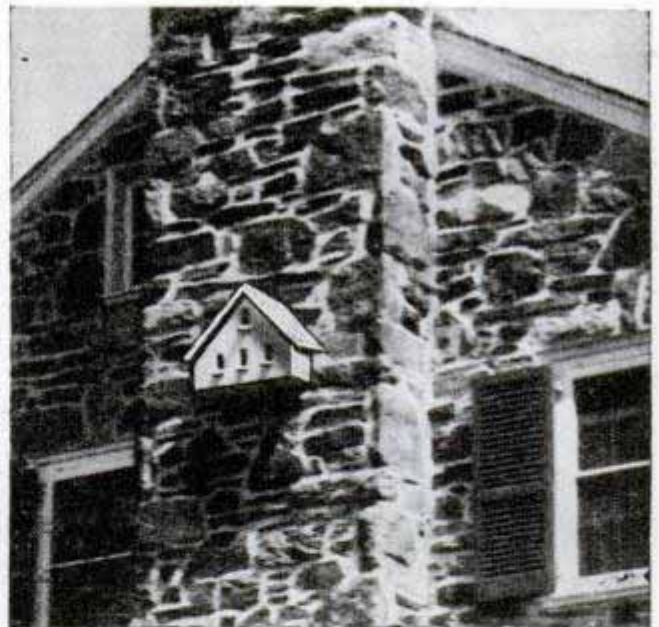
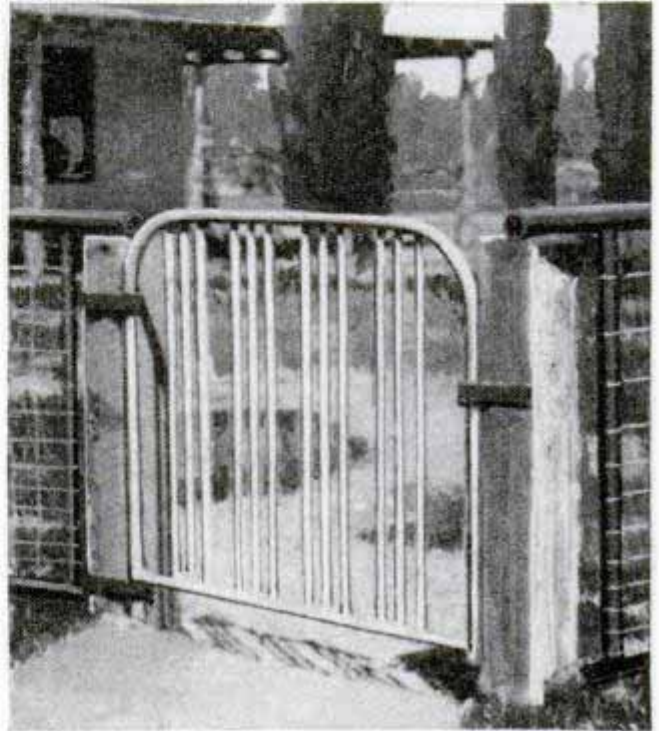

Martin House Built Into Chimney Is Cast From Concrete

Made of concrete and set in place during the building of the stone chimney, this martin house is a novel decoration. Painting the house white makes it distinguishable. Because it is made of concrete, its construction is as permanent as that of the chimney.—Paul Hadley, Philadelphia, Pa.

CRAFT QUIZ



1. Plane he is using is—
 (a) Jack (c) Jointer
 (b) Block (d) Smoothing



2. What is wrong here?
 (a) Kind of socket (c) Wire loop
 (b) Kind of wire (d) Screwdriver



3. These gem stones are cut—
 (a) Brilliant (c) Rose
 (b) Cabochon (d) Step

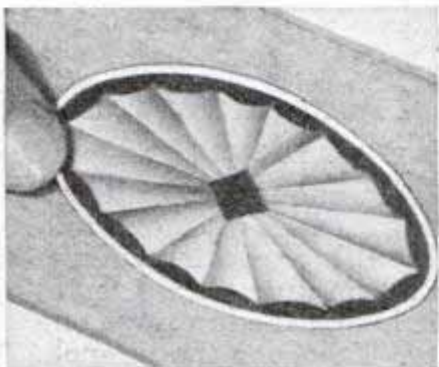

4. This inlay is a—
 (a) Sunburst (c) Anthemion
 (b) Cornflower (d) Urn

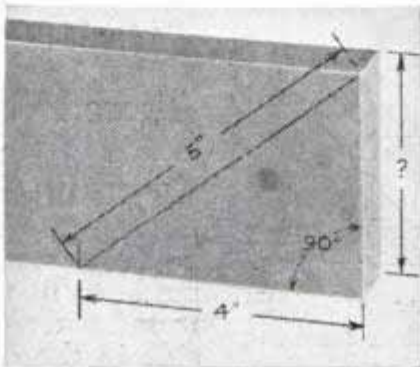

5. This board is—
 (a) 3" wide (c) 2 7/8" wide
 (b) 3 1/8" wide (d) 1" thick



6. Best wood for boat is—
 (a) Pine (c) American mahogany
 (b) Oak (d) Philippine mahogany

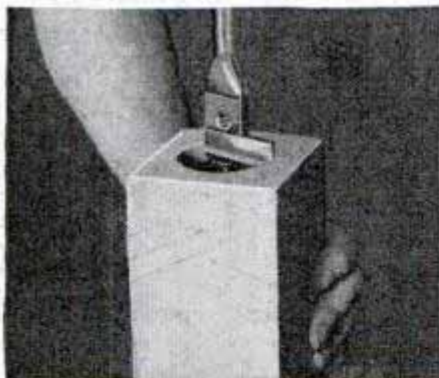

7. Boring is done with—
 (a) Boring bit (c) Forstner bit
 (b) Expansive bit (d) Gimlet bit



8. This boat plank is called—
 (a) Garboard (c) Gunwale
 (b) Sheer strake (d) Shutter

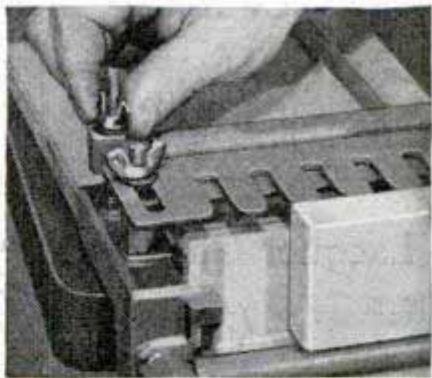

9. Getting set to do—
 (a) Dovetailing (c) Box joint
 (b) Mortising (d) Cogged joint



ANSWERS: 1—b; 2—c (loop should curl clockwise); 3—b (a rounded or plain surface, not faceted); 4—c; 5—o (from 3-4-5 rule used to test right angle); 6—c; 7—b; 8—d; 9—c; 10—c; 11—b



10. This metal spinning tool is—
 (a) Bead (c) Diamond
 (b) Flat (d) Point

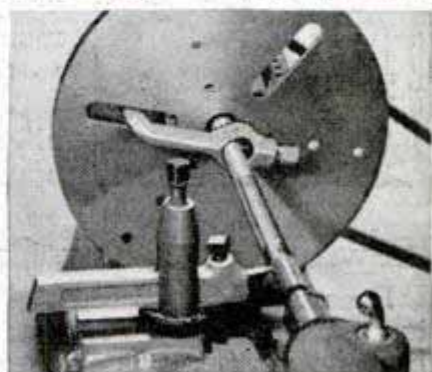

11. Work holding device is a—
 (a) Cat (c) Clamp
 (b) Dog (d) Tail

Storage Cabinet for Bed Patient Keeps Accessories Handy

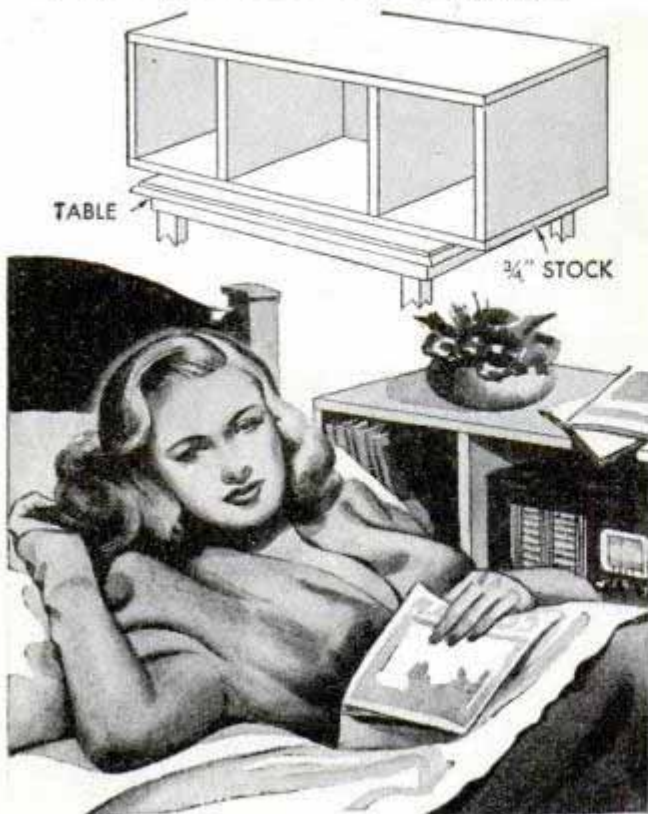

A patient confined to a bed for any length of time will find this combination cabinet and storage box a great convenience. One compartment will house a small radio and the other compartments can be used for writing materials, books and records, all of which are kept in neat order and within easy reach. The cabinet also saves work for the person who keeps the room in order as it can be moved about when cleaning. It is made of $\frac{3}{4}$ -in. stock and will set on an ordinary card table.

Lacquer Glues Bristles in Brush

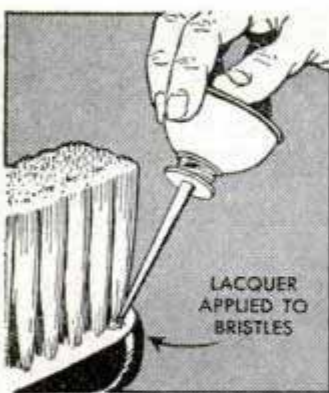

Lacquer is used by one craftsman to stop old brushes from shedding. The lacquer is applied at the base and serves to cement the bristles to the brush. For this purpose, an oilcan is an ideal applicator.

Sewing Patches on Canvas Tent

Because of the stiffness of the cloth, sewing patches on canvas tents, tarpaulins and hunting garments is often a difficult task. One woodsman found that by soaking the area to be patched and then rubbing in soap, the needle will slip through the ma-

terial easily and the possibility of breaking the needle will be lessened.

R. A. Jenkins, St. Louis, Mo.

Back of Wrist Watch Protected By Plastic Shield

If you want to prevent the back of a wrist watch from corroding, try using a protective shield of plastic. The plastic is cut to fit the contour of the watch and the ends are bent and slit for the strap to pass through. After cutting and forming, the shield should be sanded. —Frank Shore, New York.

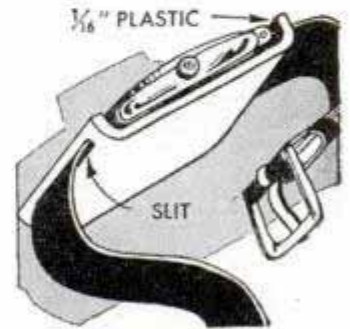

Altered Wheel Nuts and Wrench Foil Tire Thieves

To foil tire thieves, one motorist altered the lug nuts on his car wheels so they could be removed only with a special wrench made to fit them. The nuts were ground round and a $\frac{1}{4}$ -in. hole drilled through one side in the center. Then, for the wrench, he used a piece of pipe that would just slip over the nut. One end was fitted with a T-handle and the other drilled to take a short $\frac{1}{4}$ -in. bolt. The bolt, with head removed, is held in position by a spring riveted to the pipe. In use, the pipe is slipped over the nut and the bolt engaged in the hole in the nut.

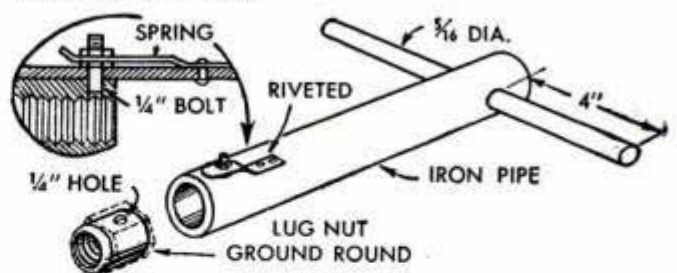



SURFACE-PLATE CHECKING

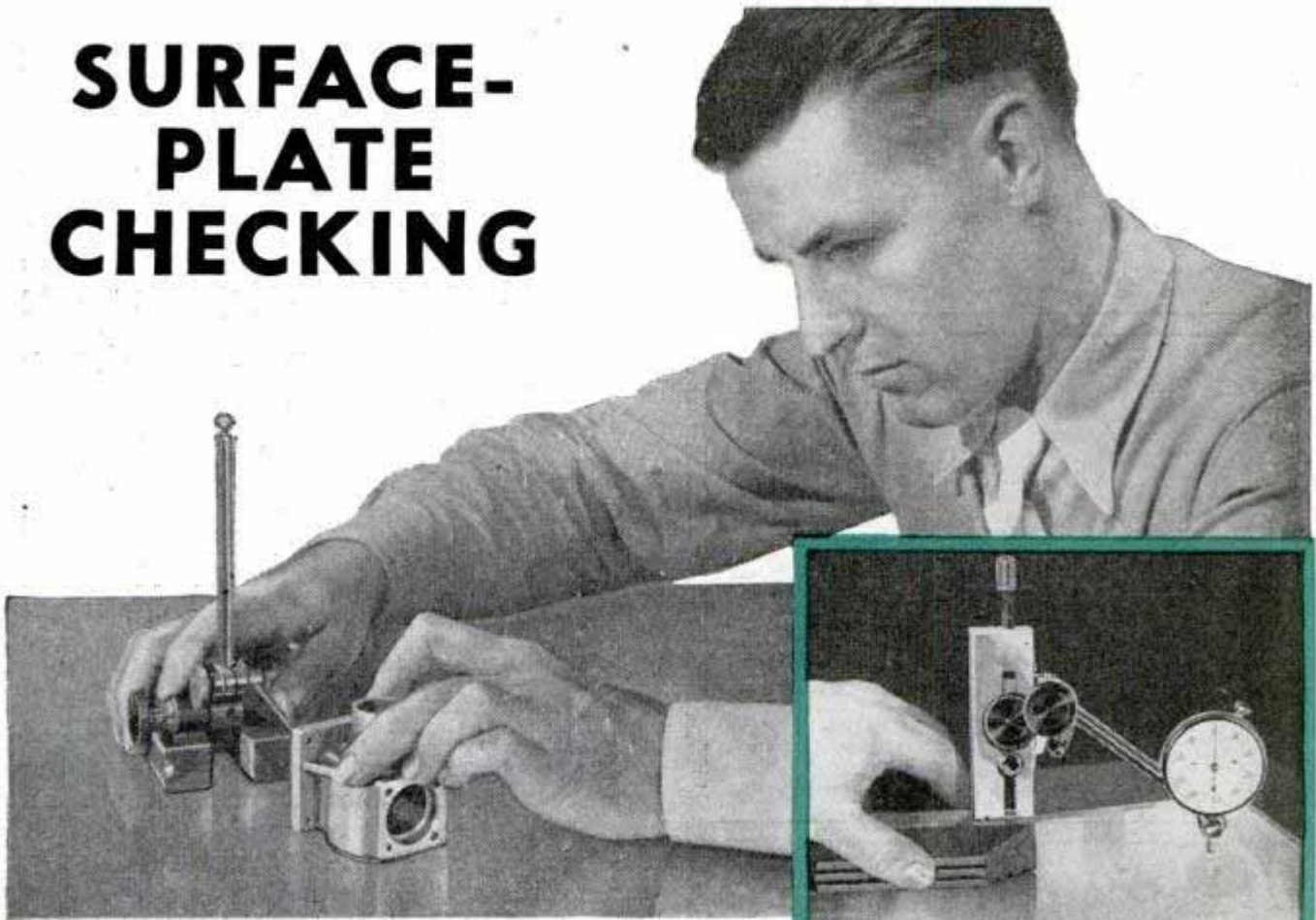

AROUND good shops a surface plate is used for close-limit inspection and layout work, and the reputation of the firm as well as the individual may depend on its accuracy. For this excellent reason every top-notch mechanic guards his surface plate with a jealous eye—there must be no dirt, no metal chips, no digs, dents or scratches and no rust anywhere on its surface if he is to do accurate work. And if the plate is to retain the fine accuracy that was built into it, it can't be used for just any rough job that comes along.

For this reason many shops handling a variety of work use a piece of heavy plate glass as a surface plate for both routine and incidental operations where the allowable error permits it. In most cases ordinary commercial plate glass provides a satisfactory and economical working surface. Glass has the one disadvantage that it will bend under a fairly heavy weight, but if care is used in placing the plate on a flat surface, the deflection caused by light to medium-weight work is not sufficient to affect ordinary measurements. The glass plate does not rust, hence there's no need to oil it after use. It is easily wiped dry with a cloth and if the surface is scratched, even quite deeply, there is no burr to hone down. When you lay the glass plate down ready for work, it is always a good idea to go over it with the dial indicator, Fig. 1, to check for deflection. Often merely relo-

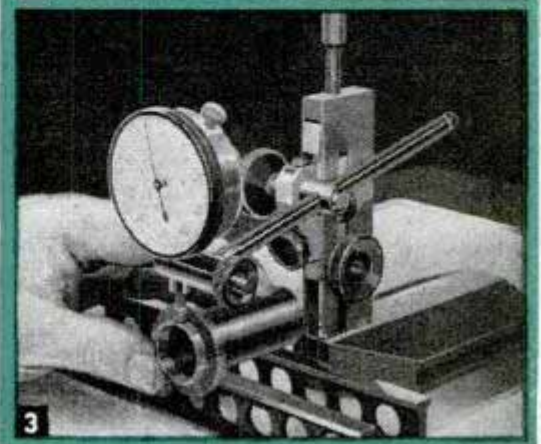
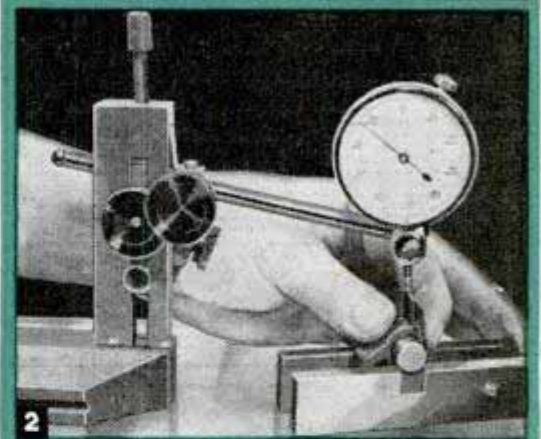
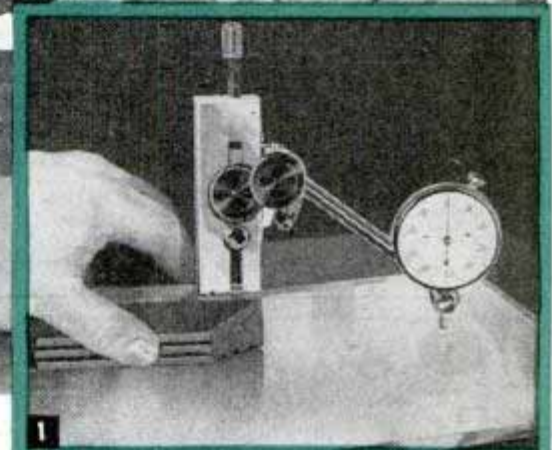

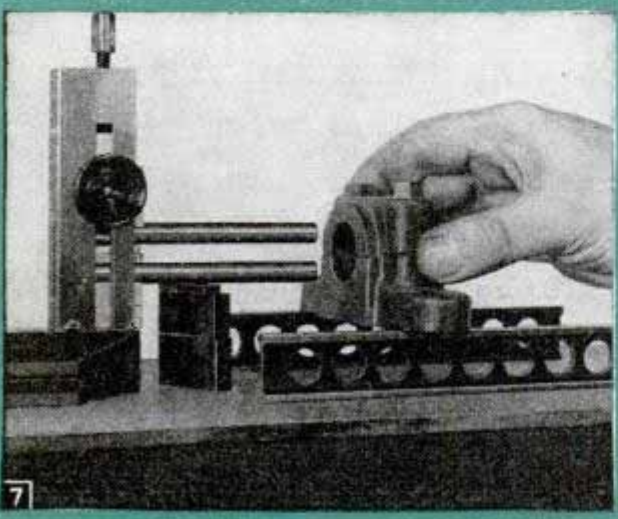
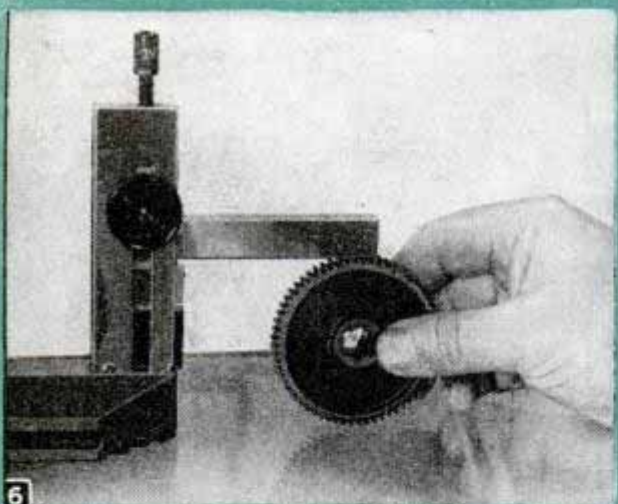
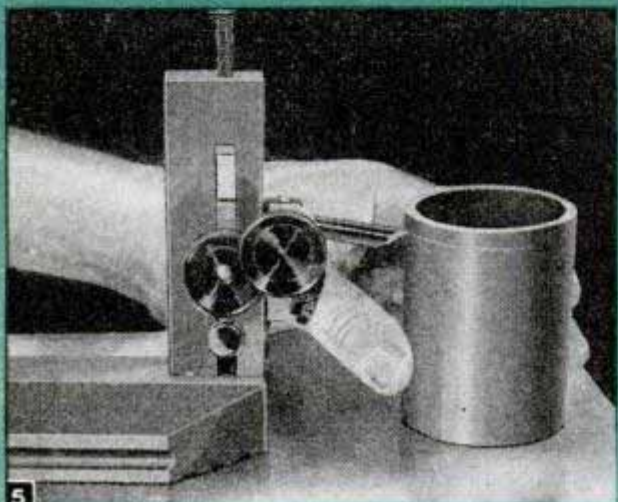
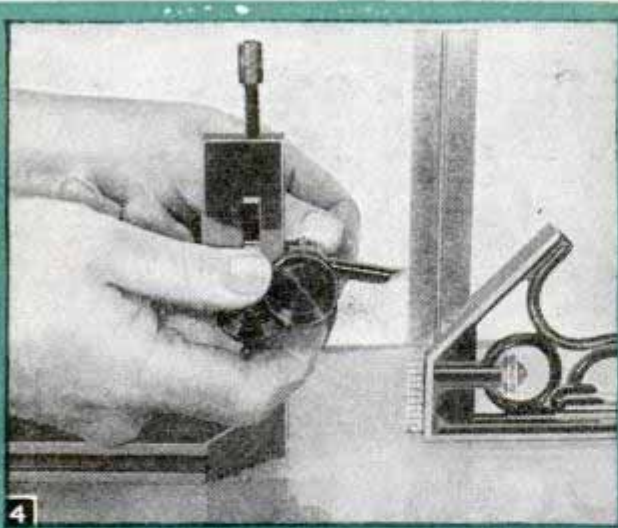

cating the glass on the bench will correct slight bends due to any unevenness of the surface on which it is resting.

Only a few examples of the many jobs which can be handled satisfactorily on a glass surface plate are given. The sharpening of shaper cutters, Fig. 2, requires a check to determine the length of each blade. Slide the cutter over a shaft resting in agate V-blocks and bring each blade to bear on the dial indicator button as shown. When inspecting shouldered or collared objects, Fig. 3, which cannot be rested on the plate, use a pair of parallels. Be sure the dust is wiped from the bottom of the parallels before using. It is good practice to have a pad of cheesecloth handy and make a habit of wiping all contacting surfaces frequently.

In addition to simple inspecting, the actual layout of profile and center lines is an important operation. Starting with only a known base line, all the measurements desired can be obtained as in Fig. 4 and laid down as in Fig. 5. The same base block and standard used with the dial gauge is retained. The tool is a hardened scriber point. For simple measurements it is set against a steel rule. For extreme accuracy the point is brought to bear on a stack of gauge blocks. In laying down the lines, the scriber is held still and the work rotated or pushed past, the sharp point scoring a clean and visible line, Fig. 5. For higher visibility on complex layouts purple ink is first applied to the surface to be scribed. With a scriber all guesswork is eliminated.

When inspecting a large production run make up a limit gauge, Fig. 6. It can be maximum or be minimum or both, side by side. The gear is slid under the overhanging caliper bar and over or undersize rejects are quickly caught. In Fig. 7 one pass of the pillow block will show the inspector if the bore is the correct height above the base line, if the bore is the correct diameter, and if it is bored parallel with the base line. Making the inspection fixture requires the use of gauge blocks. As the pillow block is too low to be measured while resting on the plate, the parallels are used. The height of the bore above base is added to the parallels and gauge blocks equaling the total are wrung together. A precision ground caliper bar is secured in the standard at the correct height. As the diameter of the bars is known, .350 in., the diameter of the bore is easily obtained by inserting gauge blocks between a pair of bars until the total adds up to the bore diameter. Clamped rigidly in the standard, the caliper bars project parallel with the surface plate. All the inspector has to do is lay the pillow blocks on the ways, one at a time, and slide them along.

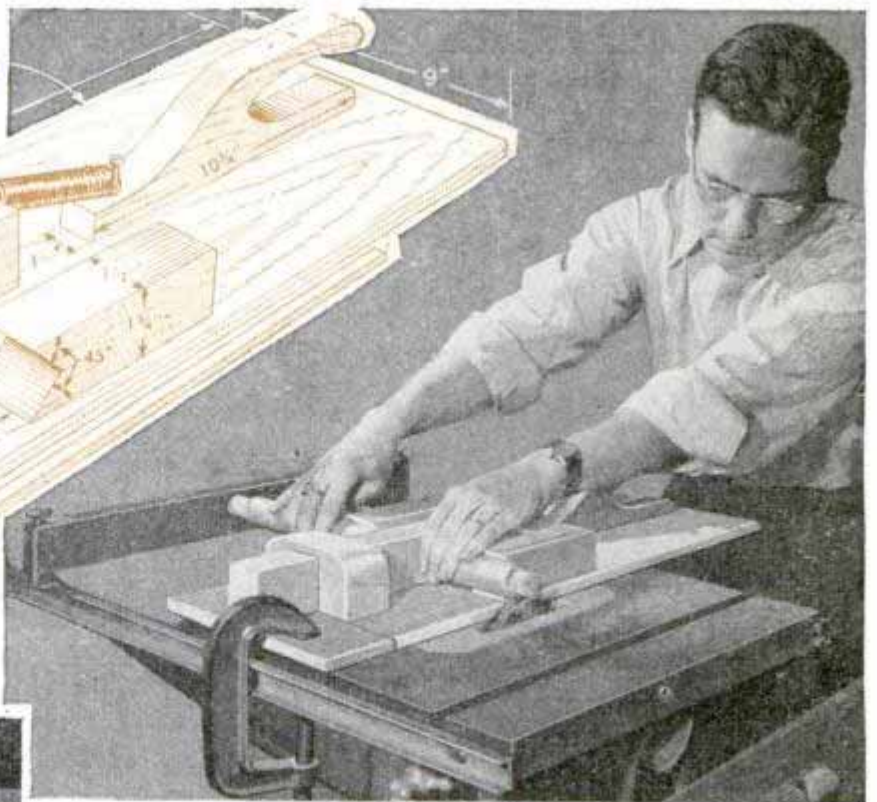
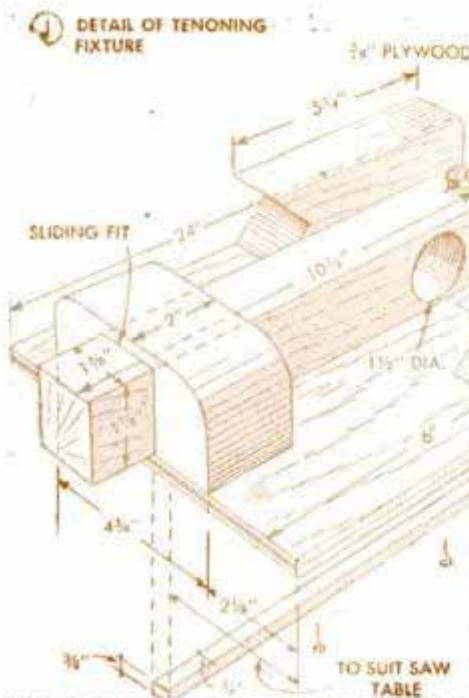

CUTTING ROUND TENONS

By Frank Skalla

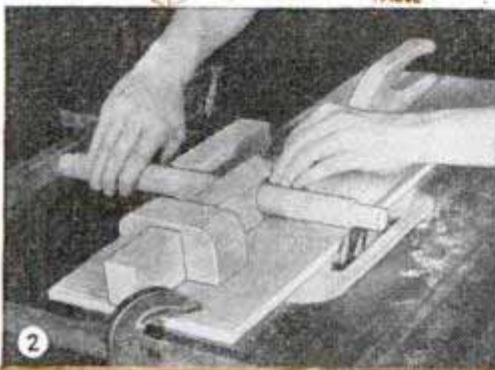

A dado head is used for cutting straight round tenons on dowels

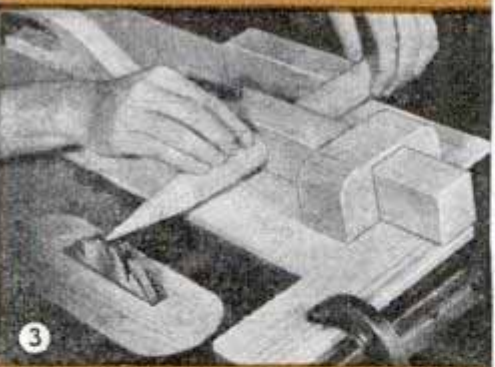

The saw table, or arbor, is tilted to point or taper ends of dowels

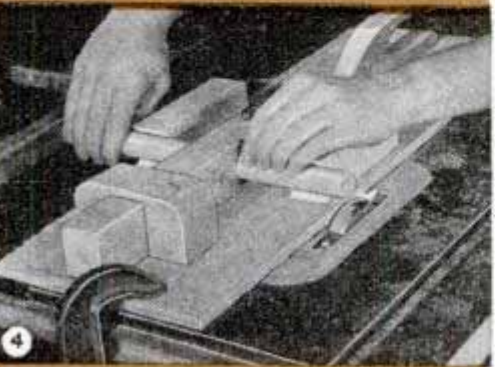

For rounding the ends of dowels a molding-head cutter is used

SHAPING a neat, square-shouldered tenon on ordinary flat stock can be done easily with common hand tools and of course it's only a matter of a few one-second passes on the circular saw. But shaping a round or tapered tenon on round stock without a lathe—that is something. Here's a quick, precise way to do it on a power saw. Make up a jig as in Fig. 1, using 3/8-in. plywood for the base and hardwood for the fixtures and handle. Fig. 2 shows how this jig works in making a straight tenon. The sliding member of the jig, which is spring-tensioned as shown, acts as a clamp to hold the work firmly against the V-blocks. Simply slide the work into place, locate it over the dado head, raise the latter to the proper height to give the diameter you want and slide the jig against the stop clamped to the saw table. Then turn the work one complete revolution and there you are, letter-perfect. Or maybe you need a number of stakes with one end tapered so that they can be easily driven into the ground. Tilt the saw table, or the arbor, and make the cuts in several passes. You finish up with a neatly tapered end like that shown in Fig. 3. The trick in this is in the depth setting of the head for each pass of the work. With a little care you can get a perfect taper. Then, should you wish to round the other end of the pointed stakes, you can do it quite as easily by using a molding cutter head as in Fig. 4. Select molding cutters of the proper radius and locate the work so that the squared end is over the curved section of the cutter. Turn the work one complete revolution, holding it firmly so that it does not slide to the right or left. Here again a careful depth setting determines the accuracy and neatness of the finished job.

Chalked Block Marks High Spots On Newly Sanded Floors

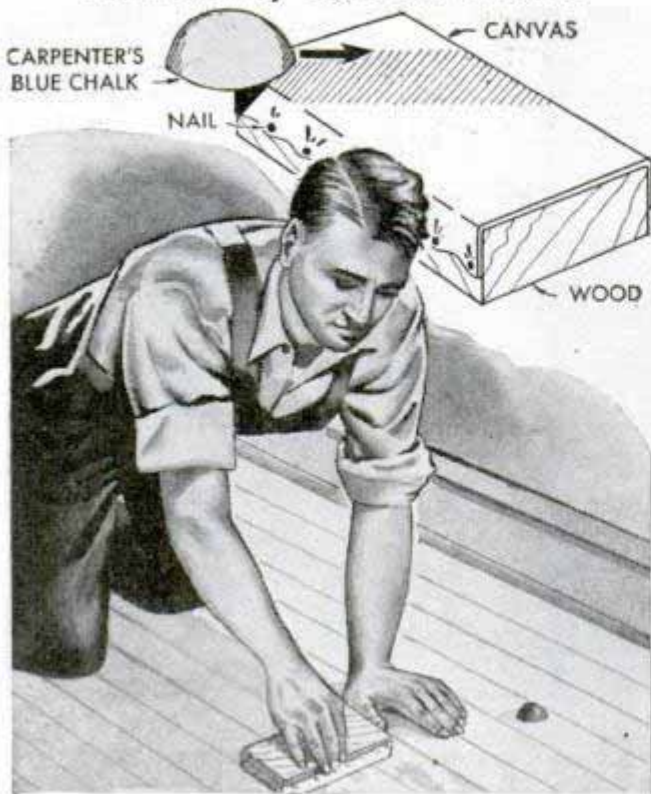

When checking a newly sanded floor for high and low spots, one workman uses a canvas-faced block that is coated with carpenter's chalk, preferably colored. By rubbing the block over the floor, uneven areas are marked for further sanding.

Self-Anchoring Stake Driven Without Using a Mallet

To facilitate driving stakes that support a chalk line, one workman screwed a galvanized sheet-metal plate, which has a triangular shape, to each one. The stakes are pushed easily with the foot. In addition to speeding the operation, once the stakes are in the ground, they will not twist and allow the line to loosen or to become slack.

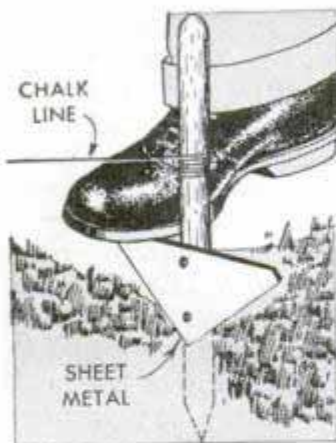

Brushes Clean Chips From Holes

Cleaning chips from holes, particularly blind ones, is a difficult job and especially so when cutting oil has been used as it tends to make the chips stick to the walls. One way to get the chips out is to use a set of rifle and shotgun brushes of appropriate diameters. The brush is "threaded" into

the hole and then withdrawn without twisting it. These brushes are made principally of steel, brass, bronze and fiber.

F. E. Averill, Jr., Santa Ysabel, Calif.

Displaying Samples of Calcimine

One paint dealer uses small glass bottles to display colors of calcimine that he has in stock. The bottle covers are nailed to the bottom of a shelf and the bottles are screwed into the covers.

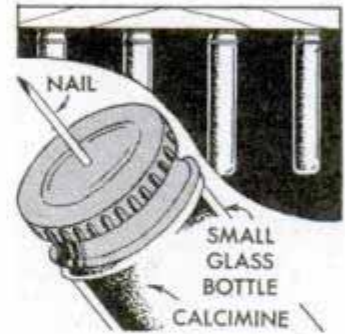

Care should be taken to locate the display at the proper height, which should be eye level.—E. J. Wiczorek, Chicago.

Boiler Contains Reserve Supply For Poultry Waterer

In order to provide a reserve supply of water for his poultry, one farmer mounted an unused range boiler on a concrete base and connected it to an automatic waterer in the poultry house. Although the waterer maintains the proper level as long as the openings in the tank are plugged, a valve is provided for further control of the flow.

A. M. Wettach, Mt. Pleasant, Iowa.

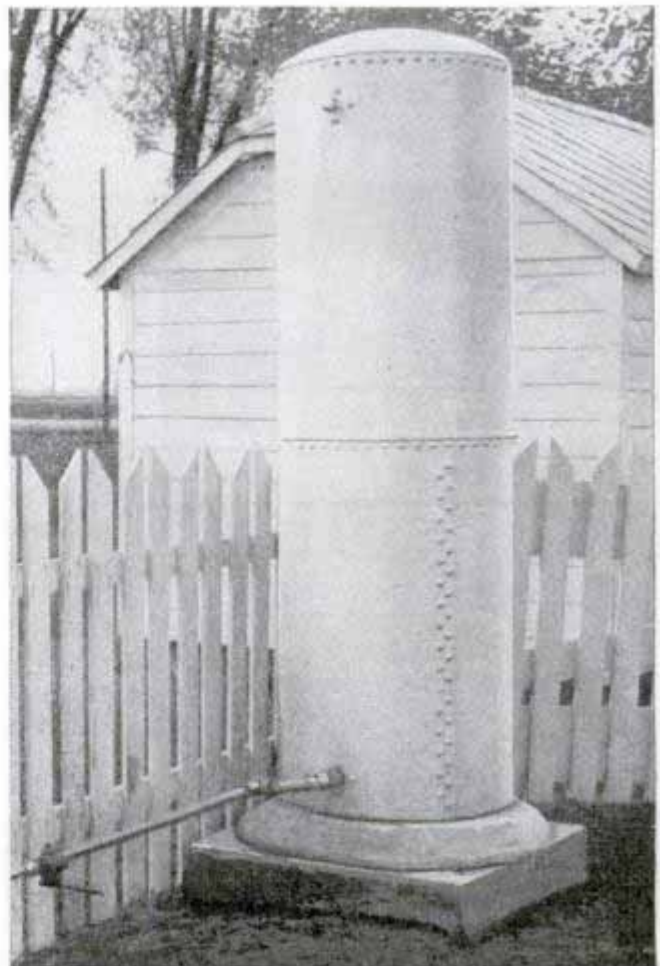

SYNCHRONOUS CURRENT RECTIFIER

By Alexander Maxwell

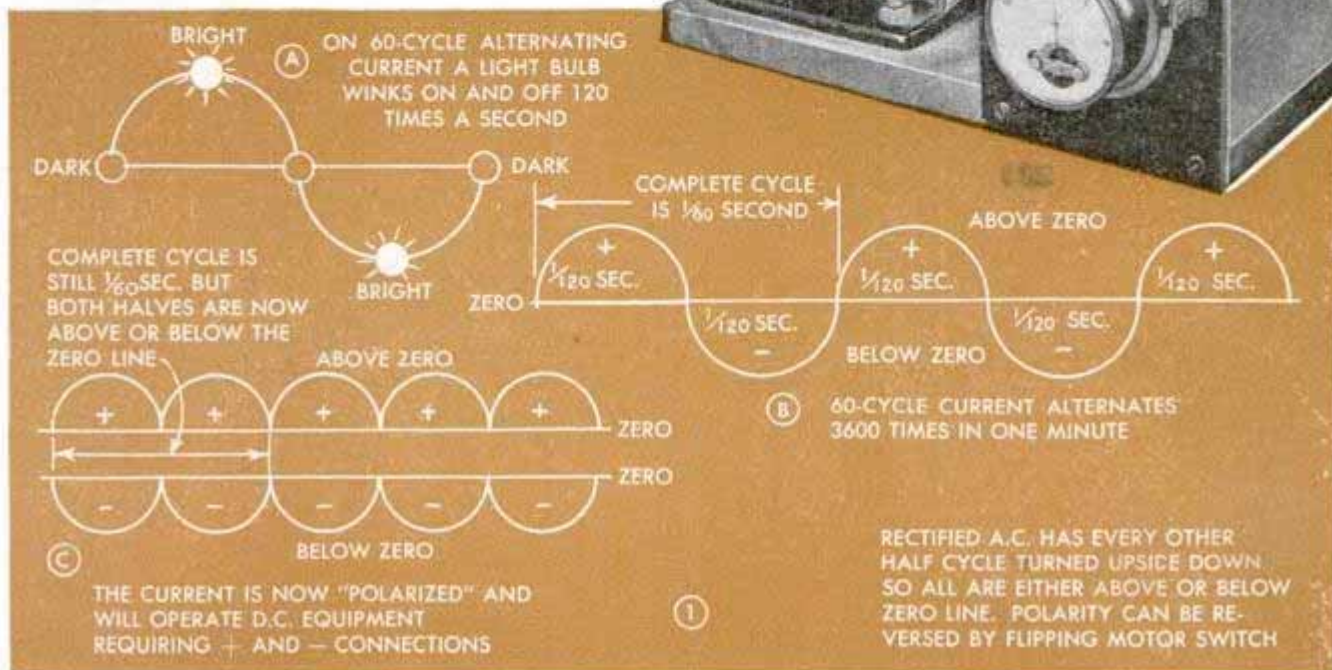
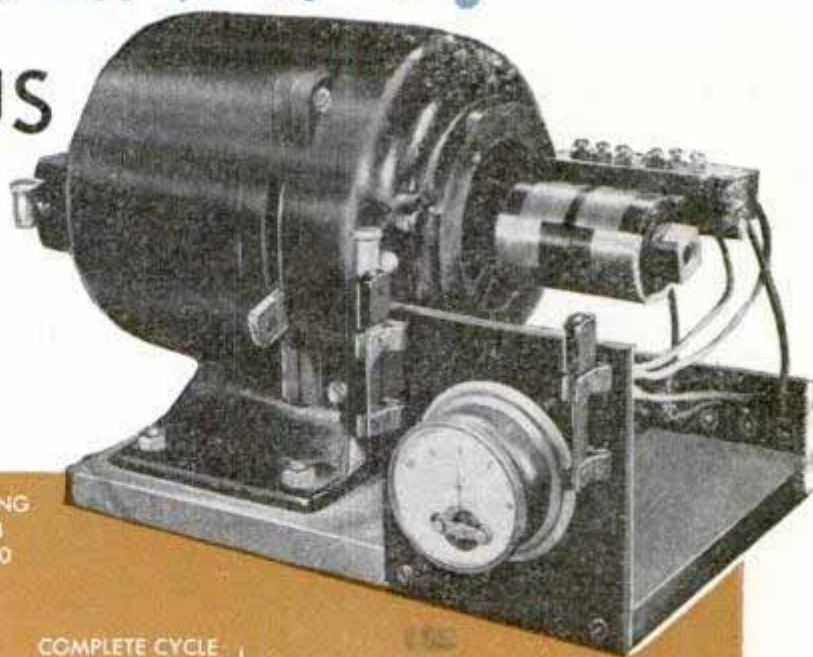

One of the simplest and most convenient ways to obtain a source of direct current is first to transform alternating current to the desired voltage, and then rectify it. This synchronous rectifier will handle high and low voltages equally well, the capacity in amperes being limited only by the size of the commutator and brushes

MANY are the applications for this synchronous rectifier, which is one of the most economical methods of rectifying electric current. Model railroaders will find that it will carry their entire system—polarized relays, block signals and permanent-magnet locomotives—delivering a reliable source of power necessary for smooth performance. It also can be used in electroplating, battery charging, operating electric-eye mechanisms, polarized relay control systems, arc lights and other electrical equipment requiring a d.c. source of current, the exception being radio.

The heart of the rectifier is a 3600-r.p.m. single-phase 60-cycle motor. It need not be powerful, for a $\frac{1}{8}$ -hp. motor will handle a commutator capable of carrying a 2-kilowatt load. The synchronous speed is necessary to agree with the frequency of the generating station. In Fig. 1, details A and B, the manner in which alternating current functions is shown. The current goes from peak voltage to zero twice during the cycle. When the current is rectified it becomes

polarized and will operate equipment requiring positive and negative connections. When the rectifier motor is rotating in exact synchronization with the power-station generator, a commutator with make-and-break switches will divide the cycles as shown in detail C of Fig. 1. Then positive current is delivered at one terminal and negative at the other. To get full efficiency, the break must come as the cycle starts. At this instant the line is dead and there will be little or no tendency to arc. Should the change come at the peak of the cycle, enough arcing might result to melt the brushes. To adjust the commutator, rotate it on the motor shaft until the point is found where arcing is at the minimum, then tighten the locknut. Use only a 6-volt power source when making this adjustment.

Since most synchronous motors are intended for direct connection to the devices they operate, they usually have long shafts and are centered so the entire armature may be placed in a lathe and the shaft turned down to specifications, Fig. 3. Bake-

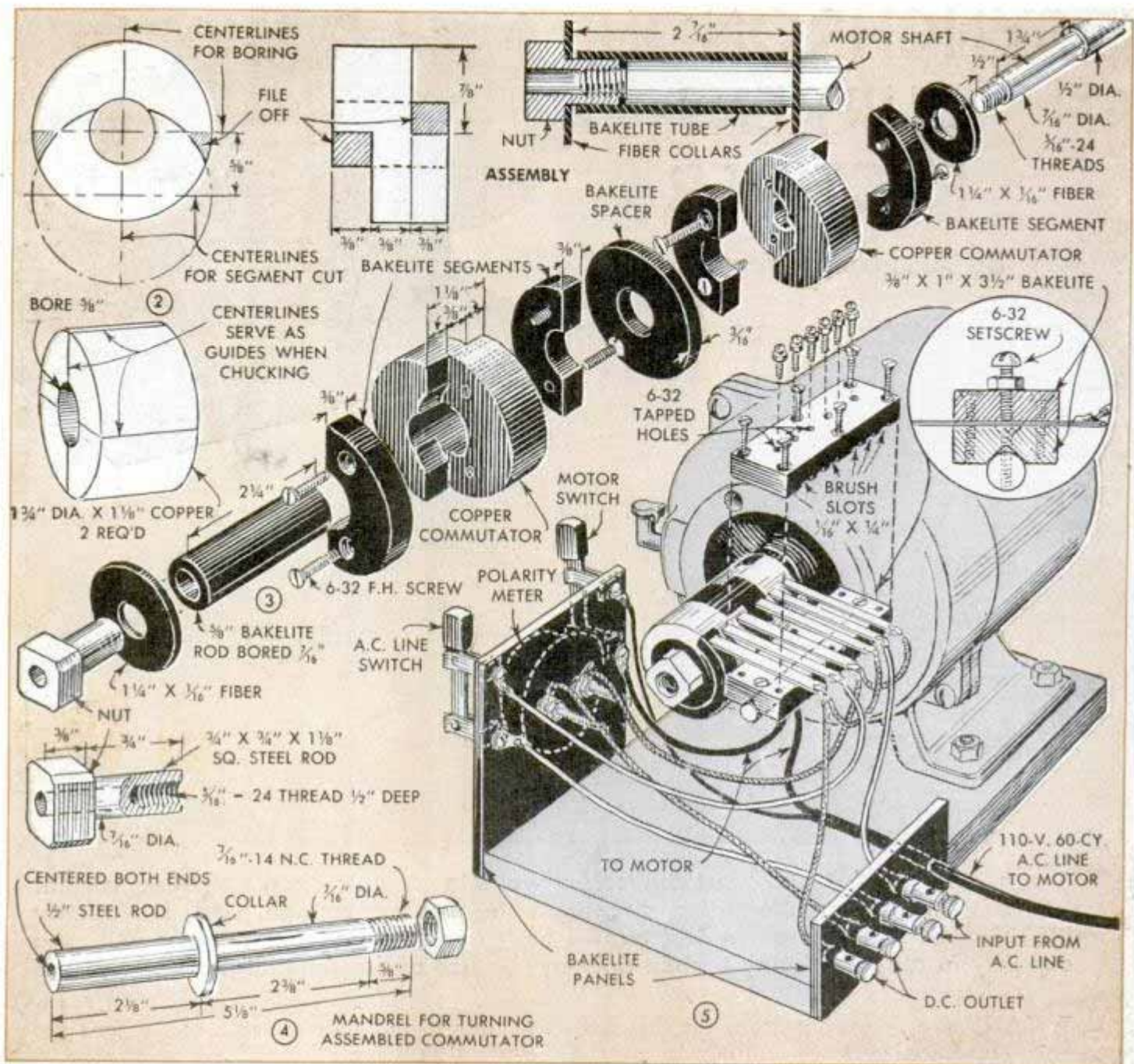

lite is used for the insulating material on the commutator, Fig. 3, which is rough cut to the dimensions given with allowances for finishing. The Bakelite tube should be made from a piece of molded rod, although it can be cut from molded sheets. Bore first, then turn to size while on the motor armature. This tube should be a snug fit.

One of the most difficult steps is building up the copper commutator segments. After boring and rough finishing, the segment is cut as indicated in Fig. 7 and the portion that is shaded is filed flat, Fig. 2. The rough-cut Bakelite segments are secured to the copper commutators with flathead machine screws, Fig. 3, and the unit is slipped over the tube. It should be an easy press fit; if it binds it will throw the commutator out of line when the locknut is tightened. This assembly is slipped on a special mandrel, Figs. 4 and 6, and turned down until all lines disappear. Then the commutator is

placed on the armature which is chucked in the lathe and a series of light finishing cuts are taken, Fig. 8. All cuts should be light, and sufficient oil should be used.

The brush assembly is supported on a bolt or rod which screws into the end bell of the motor. It will be necessary to drill and thread a hole at the proper location. Or a wooden pedestal can be screwed to the base as a support. The brushes are held between two Bakelite plates, the lower one resting on the support rod. Since the lower plate rests on the rod, a V-groove is cut down the center for a better fit. Bore mounting holes at each end of the plate, and drill and tap two similar holes in the support rod. Mount with flathead screws.

The upper plate has six shallow slots cut in it to take the brushes, Fig. 5, and it also must be drilled and tapped for the six setscrews and locknuts. Six assembly bolts are used to hold the two plates together.

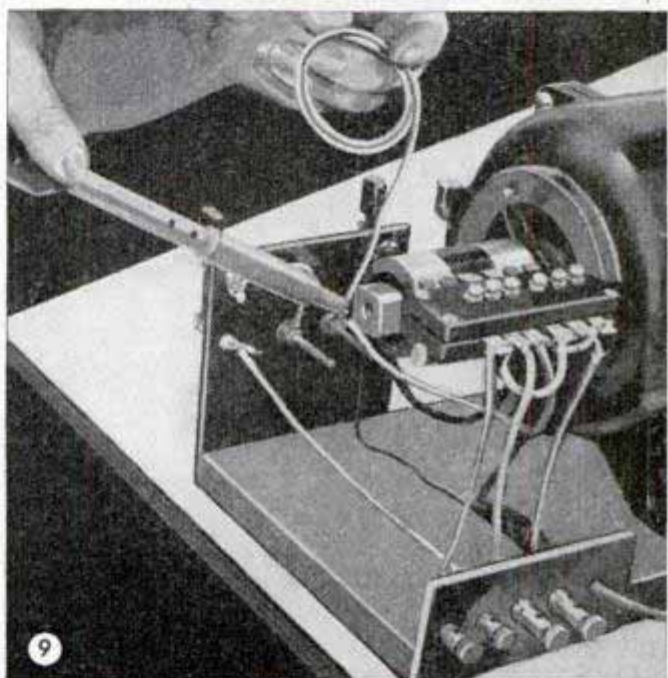
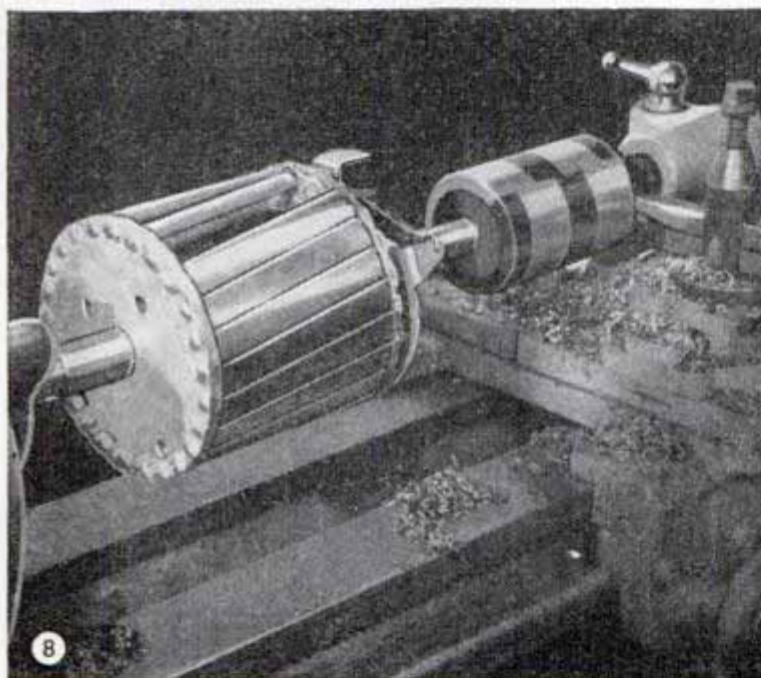
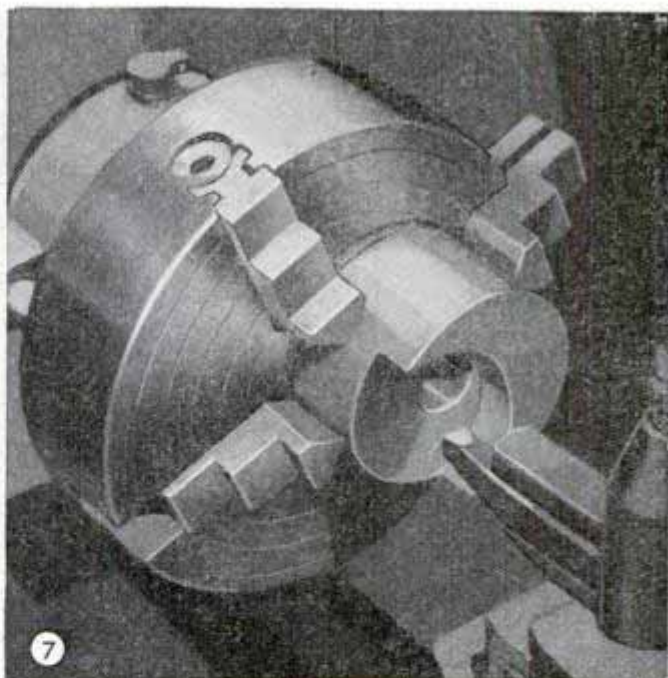
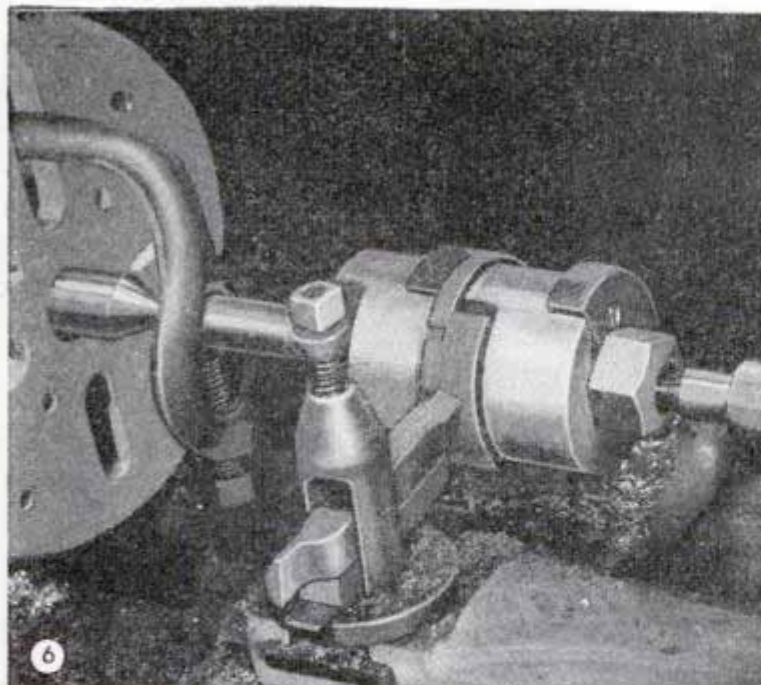

The brushes are made of thin strips of phosphor-bronze spring stock built up to a thickness of $\frac{1}{16}$ in. The ends to which the wires are connected are soldered together. File the contacting end to fit the curvature of the commutator. When adjusting the brushes, remember that the pressure need be only enough to assure contact.

Fig. 5 shows the wiring connections and Fig. 9 shows one of the connections being made. Use stranded insulated wire heavy enough to carry the load. To secure the proper operation, the two halves of the commutator must register so the make-and-break lines are in perfect alignment. Also, to secure the correct connections, the two outside brushes should ride on the copper when the two inside brushes ride on the Bakelite and vice versa.

The polarity meter, Fig. 5, is required because a synchronous rectifier will pro-

duce positive or negative current at either d.c. outlet terminal, depending upon which half of the cycle it starts. To reverse polarity, quickly open and close the motor switch, repeating this if necessary until correct polarity is obtained. The meter is an ordinary charge-discharge ammeter of sufficient capacity to carry the load. In addition to the motor switch, there is another one which connects to the a.c. input. The terminals for this switch are connected to the line directly or through a transformer, depending upon the voltage that is desired.

When starting the unit, always turn the motor switch on first and the line switch after the motor has been operating at full speed for 10 seconds. When stopping the rectifier, always open the line switch first. Doing this avoids serious arcing. There should never be any load on the commutator when the motor is not in operation.

Tops of Fence Posts Cut Evenly With This Saw Guide

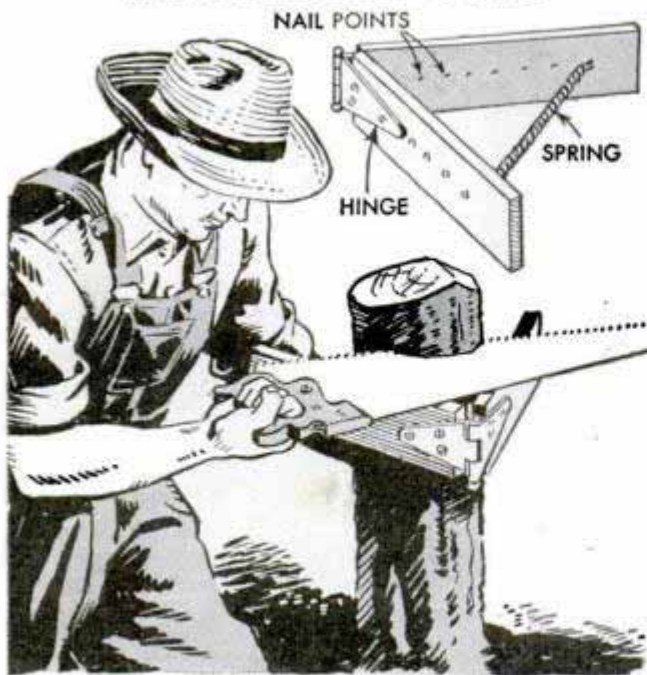

Fence posts are cut straight across when you use this guide. The two arms are held together by a strap hinge and a spring is fastened near the two ends so the guide will grip the post firmly. Nails are driven through the arms from the outside to provide additional purchase.

Balance Suspended From Pulleys Makes Weighing Easy

With a double pulley and bracket arrangement similar to the one illustrated, weighing a number of heavy bundles with a spring balance is made a lot easier. Instead of lifting the bundle onto the spring



balance, the latter is lowered and hooked to the object to be weighed. Then, by means of the rope, the bundle is lifted free of the ground so the weight can be read. A cleat fastened to the wall will secure the rope so the balance can be held at any convenient height.—A. H. Waychoff, Phoenix, Ariz.

Suction Cup Holds Pivot Point

When you don't want pin holes, caused by the use of a compass, to show on a drawing, a rubber suction cup can be used to hold the pivot point of the compass when drawing a circle or an arc. Should the cup have a metal stud on the top, as many of them do, drill a small hole to hold the point of the compass.

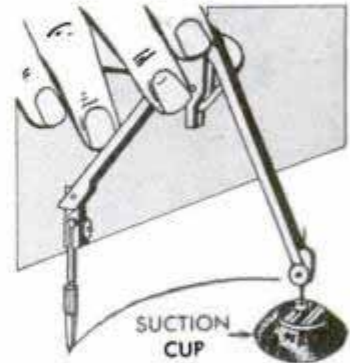

Herman Klein, Pittsburgh, Pa.

C-Clamp Brazed to Trouble Light Can Be Fastened on Joists

If a C-clamp is brazed to the cage on a trouble light, the latter can be fastened to overhead joists, beams, and exposed studding where it is undesirable to drive nails for the hook on the lamp. Only a small clamp is used.—Opie Read, Jr., Chicago.



Extension for Workshop Table

Occasionally work comes through the shop that is too long for any of the tables and, in such a case, this extension solves the problem. The top of the extension is flush with the table top and the two rods which support it slide in pipes that are fastened to the underside of the bench with pipe hangers.—Elmer Vandrey, Truman, Minn.

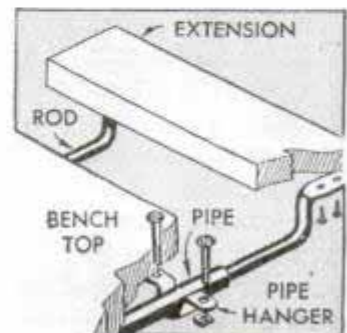

☐ An oilcan filled with paint can be used as a "fountain pen" to write names on sacks.



"HEAT-FORMING" PLASTICS

By Sam Brown

First plastics available to craftsmen were phenolic resins, such as Traf-ford, Catalin, Bakelite, etc. These are thermosetting—they set by heat and cannot be reshaped by bending. Recent trends in crafting have been toward the thermoplastic materials which, when heated, can be bent to almost any shape. There are various types of thermoplastics, the group most commonly available being the acrylics. Acrylics or methyl methacrylate resins are represented by such products as Plexiglas and Lucite, and are available in sheet, rod or tube form in a variety of colors

AT a temperature slightly higher than boiling water, thermo-plastic materials become almost as flexible as a sheet of rubber and can be bent or twisted by hand to almost any shape. After cooling for a few minutes, the plastic will retain its new shape. This pliability of thermoplastics permits them to be used in making many attractive articles which would be difficult or impossible to do otherwise.

Heating: The kitchen oven is an ideal heater. The tempera-ture should be held to between 220 and 300 deg. F. Many stoves are equipped with thermostatic gas control, but it's not advisable to depend on this. Best practice is to turn the gas as low as it will go, which usually will give an oven temperature of about 250 deg. The plastic sheet or strip can be placed directly on the oven grid, as shown in Fig. 1. Very small pieces can be support-ed on a sheet of asbestos paper, wood or other material. The protective masking tape is removed from the plastic before placing it in the oven. The work should be kept clean—any dirt or an undried film of water will tend to bake into the plas-tic. Heating requires 5 to 10 minutes, depending on the thick-ness of the plastic and the nature of the work.

Peg forming: One of the simplest methods of forming is to bend the heated plastic over a suitable arrangement of wood pegs, as shown in Fig. 4. Soft cotton gloves should be worn for hand comfort and also to prevent finger marking the hot plastic. The hotter the plastic is, the more pliable it will be, but it also will pick up marks more readily from any rough surface. It is good practice to wave the hot plastic sheet in the air for a sec-ond or two after removal from the oven. This will give it a



PICTURE FRAME



NIGHT LAMP



CIGARETTE HOPPER



PLANT SHELF



TRAY



TIE RACK

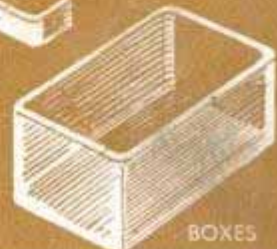

BOXES

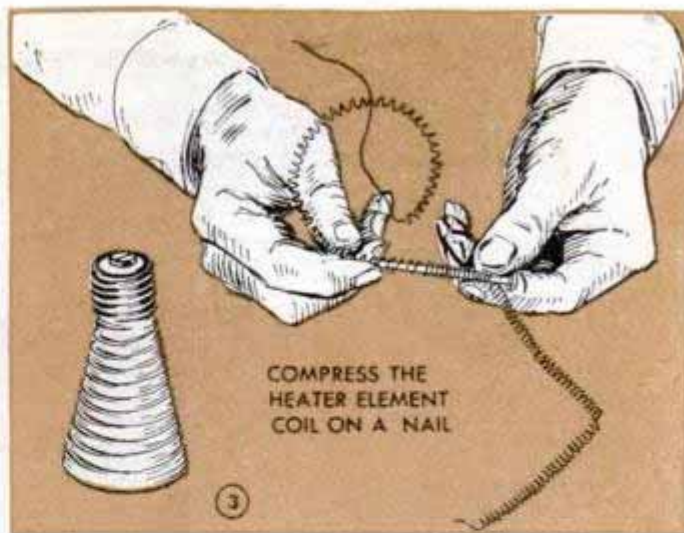

measure of surface hardness to withstand marring during handling but will not decrease its flexibility to any great extent. Whenever practical the pegs should be covered with felt or linoleum to provide smooth contact.

Strip heater: Some articles require heating only at certain points, the remainder of the plastic being retained in its original sheet form. For work of this kind, some type of strip heater is required. Fairly good results can be obtained with a heater element, as shown in Fig. 6. A better device, shown in Figs. 7 and 8, can be made from an asbestos shingle and a heater element. The heater element is unwound from its original core and then compressed on a nail, as shown in Fig. 3. It will be a bit long after compressing, making it necessary to jog two of the porcelain tubes through which it is fitted, as in Fig. 7. Of course, the heater could be made longer, but the one here is based on construction from a single 12 by 24-in. asbestos shingle. It is not practical to make the element shorter, as it will become too hot.

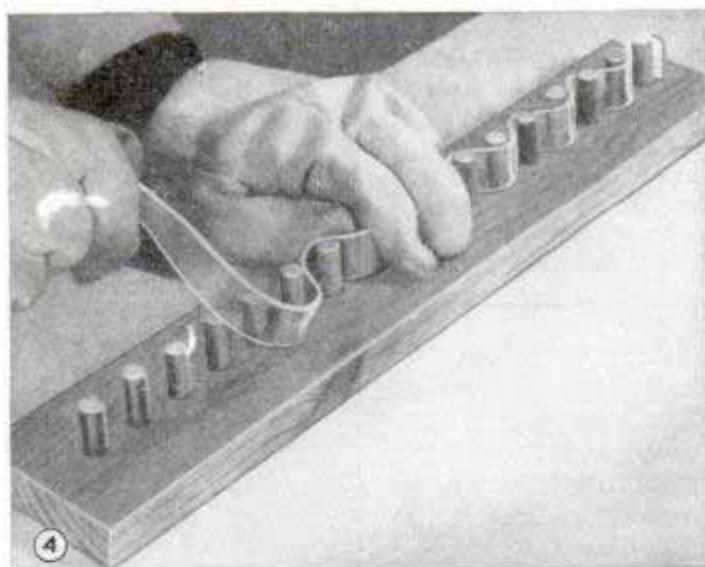

Soft cotton work gloves should be worn to protect hands and prevent finger marks when handling the hot plastic

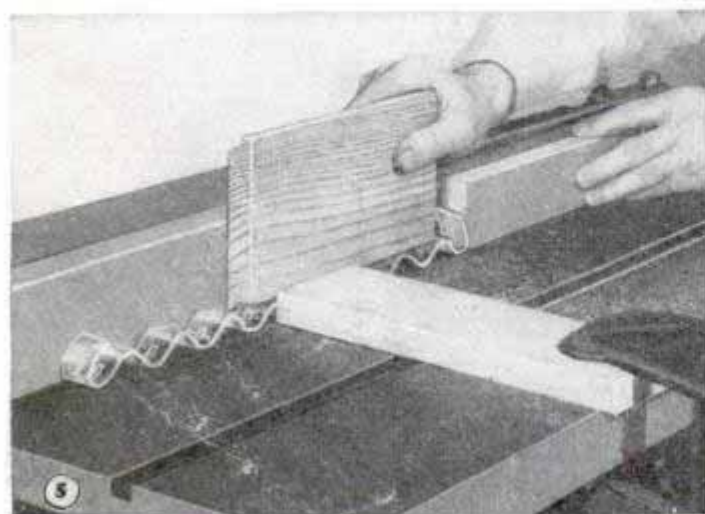

As a safety precaution, use a hold-down and pusher blocks when machine-sawing grooves in small pieces of plastic

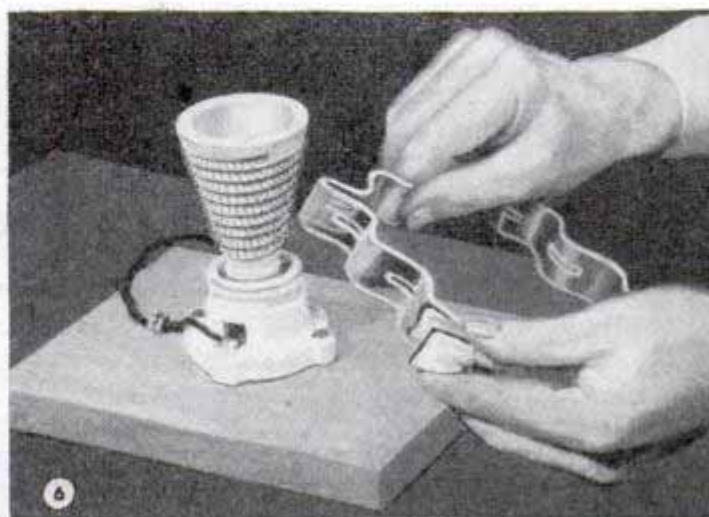

Localized heating for secondary bends can be provided by a heater element. Gloves need not be worn

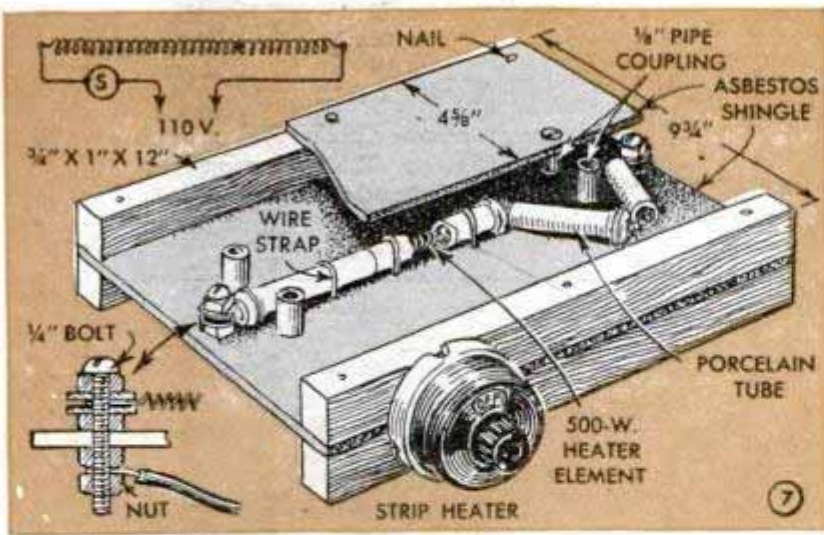

Many projects require only corner bends. The electric spot-heating device shown above concentrates heat only where the bend is to be made, permitting sharp corners to be formed as shown at the right

Twists: Ropelike twists are formed freehand after heating the plastic all over in an oven. A spring clothespin attached to each end facilitates bending, as shown in Fig. 10. The pins can be clipped to the plastic immediately after removal from the oven, or the clothespins can be attached before placing in the oven. In any case, the pins will mark the plastic slightly. The marks, being at the ends, can be cut off if objectionable.

Flat-strip forms: The flat-strip form is the most common jig for bending plastic strips. A typical example is the bud vase, Fig. 13, which is bent as in Fig. 12. Note that the end curve is pressed down with a cloth-padded wood block. Another example is the pin-up lamp shown in Fig. 15. The



form for this, Fig. 14, has a groove to hold the starting curve and the balance of the work follows the line of the form with the final curve being held by a wood block. No pressure is required at any time in the bending of thermoplastics; the only purpose of the form is to supply the correct shape. Sanded wood forms are used.

Sometimes more complicated forms are cast in plaster. Complicated jigs are not

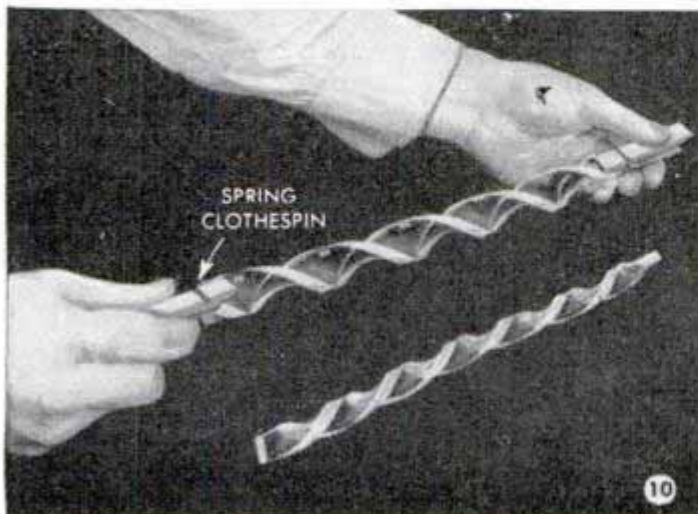

Attractive ropelike twists are formed easily by hand after the plastic has been heated in an oven

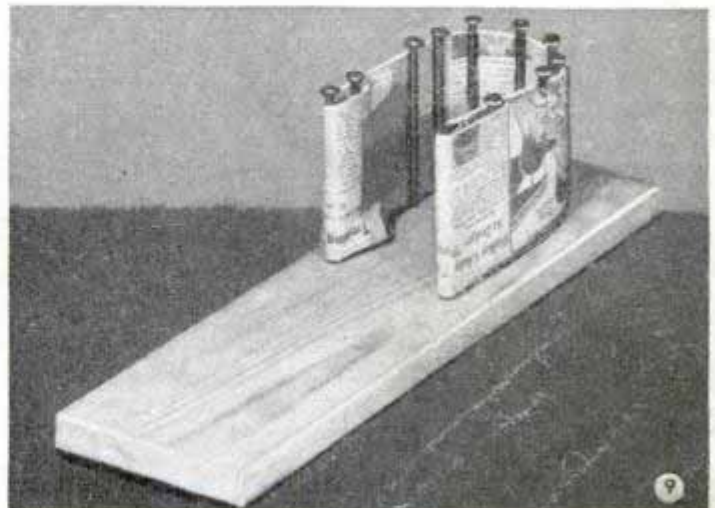

Simplified forming jigs can be made by driving nails into boards and padding them with bands of folded newspaper

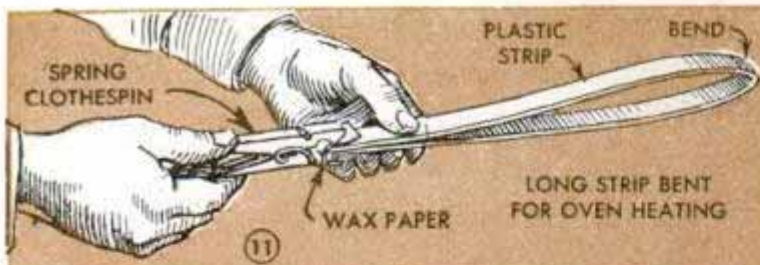

Flat-Strip Forms

This is the most common and useful method of forming flat strips. The form usually is of wood, well sanded and covered with cloth

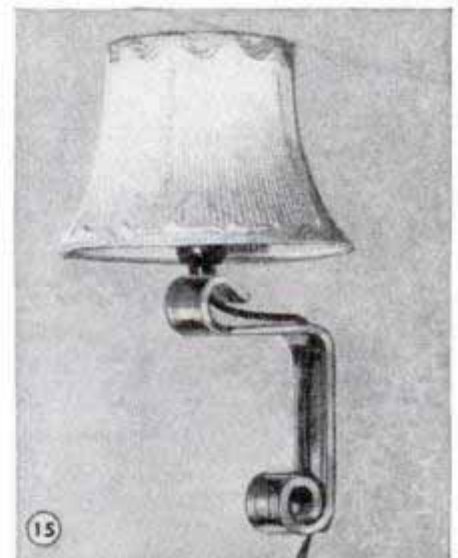
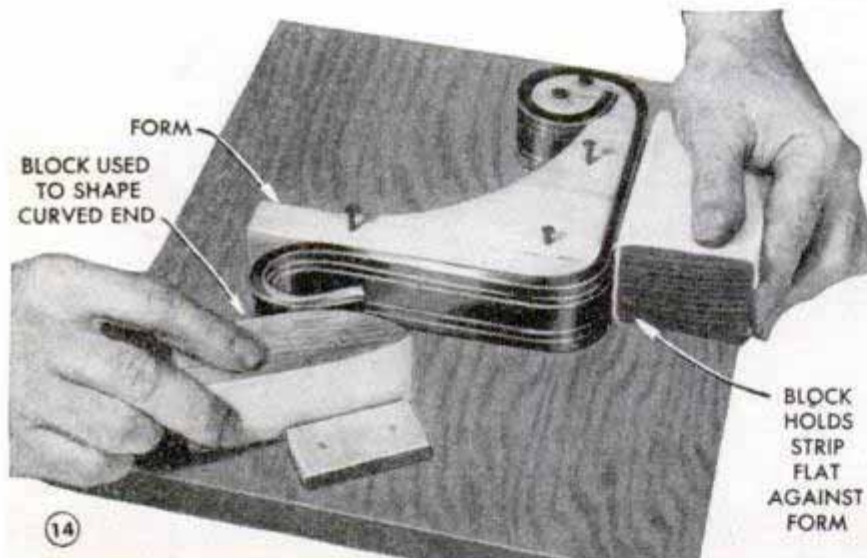
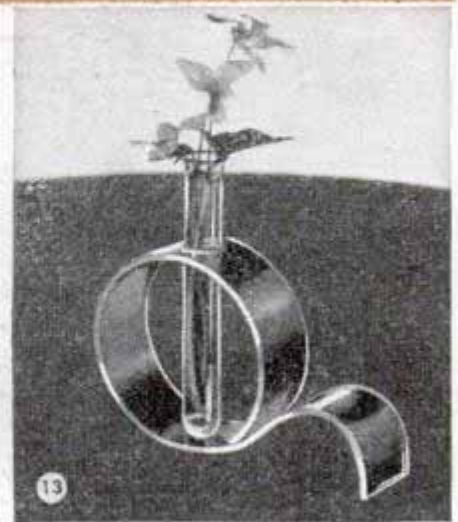
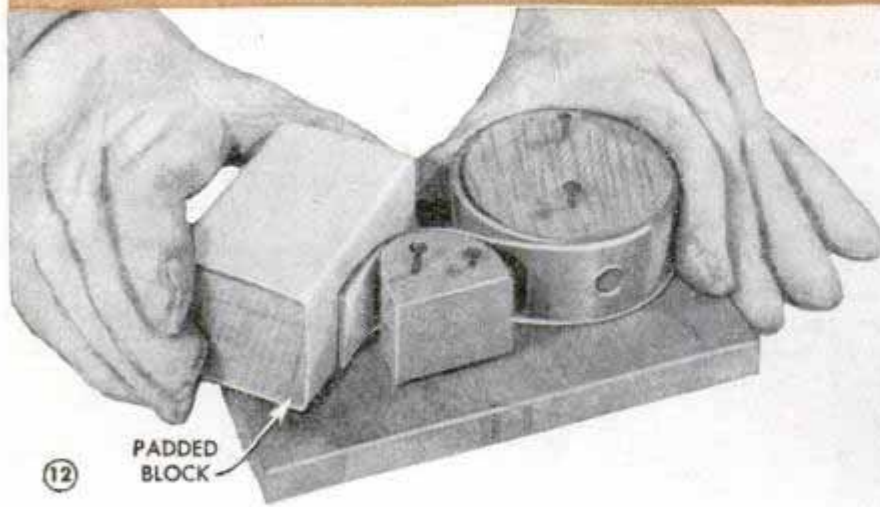

shown here but it will be apparent that certain projects requiring long strips and many bends will demand some ingenuity in making a form which will provide the proper shape and permit rapid working. In some instances, the strip required will be longer than can be accommodated in the oven. In this case, apply heat locally at the center of the strip and then clip the ends together with a spring clothespin, using waxed paper at the joint to prevent sticking, as shown in Fig. 11.

Half-cylinder form: The best method of working this much-used bend is illustrated in Figs. 16 and 18. The form should be a bit deeper than the work requires and should be covered with soft cloth, such as outing flannel. The forming ring is made to fit snugly over the combined form and plastic, as can be seen in Fig. 17. This method is particularly suited for production work.

When a single piece is being made, the form alone is sufficient, the plastic being formed by hand, as in Fig. 19, or by means of cloth-covered wood blocks which are pressed against the work. If the curve is not a complete half circle, the "sprung" method of forming, Fig. 20, is useful. All you do here is snap the hot plastic sheet in place between the retaining side pieces.

Machine operations: Bent plastics pose a problem as to whether machine operations should be done before or after bending. In some projects such as the bud vase, Fig. 13, and lamp, Fig. 15, the necessary holes can be drilled after the piece is formed. Craft workers favor this method because it permits exact placement of holes. The form itself can be used in most cases as a holding device and base block. Production workers favor doing machine work while the plastic is "in the flat." This

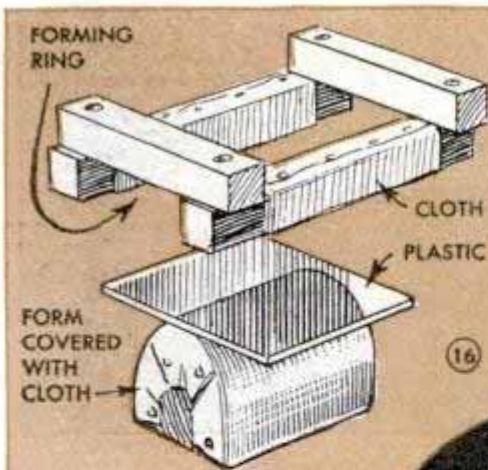

16

Half-Cylinder

This type bend is used for many projects. Cleanest method of working is with forming ring. Two other methods also are shown

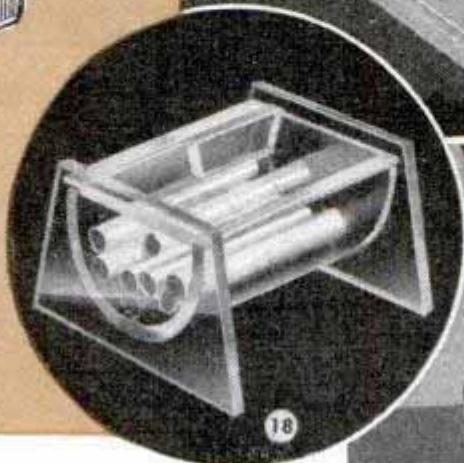

18

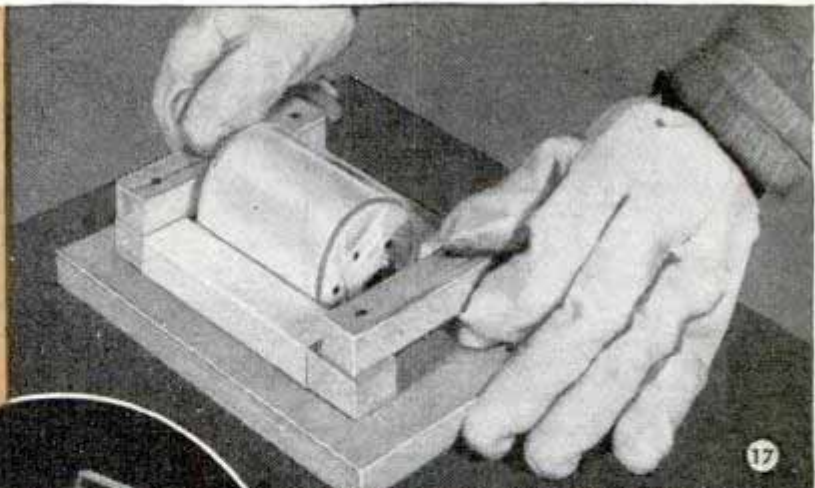

17

RING METHOD OF FORMING HALF CYLINDER

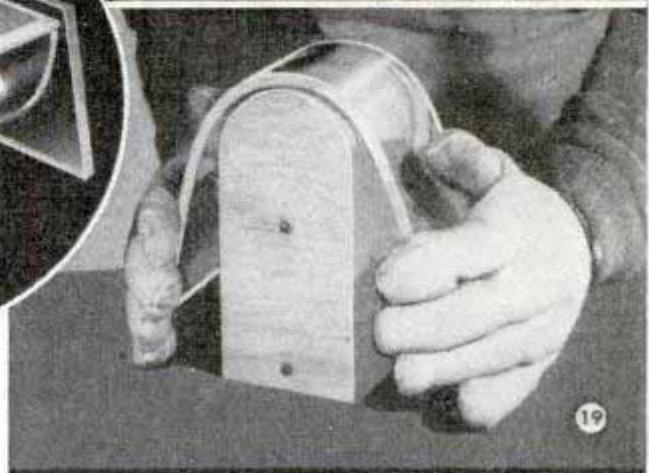

19

BENDING HALF CYLINDER SHAPE OVER FORM



20

"SPRUNG" METHOD GIVES GOOD RESULTS

method demands an initial bending of the piece to determine position of machine cuts. Once the right setup has been made, the work progresses quickly and accurately on repeat work. On pieces like the picture frame, Fig. 2, there is no choice but to machine the slot for the glass after the bends have been made. However, if the full frame shape is bent, it will be difficult to make the cut. Hence, the best practical solution is to bend the piece in a continuous strip, as in Fig. 4, after which it can be slotted, Fig. 5, and finally brought to the required shape by local heating and bending, as shown in Fig. 6.

Stretch forming shallow forms: Shallow three-dimensional forms such as curved crystals for clocks are best worked with



22

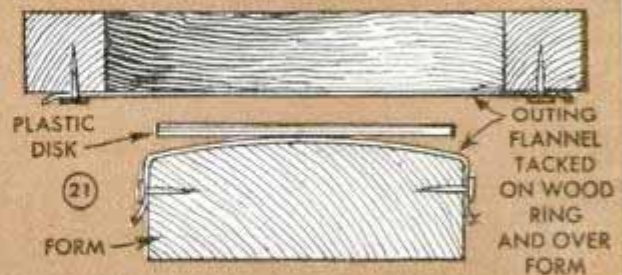

21

Stretch Forming

Cloth-ring method is most useful way of working and does perfect work on moderate curves. Form must be covered with cloth to prevent marring

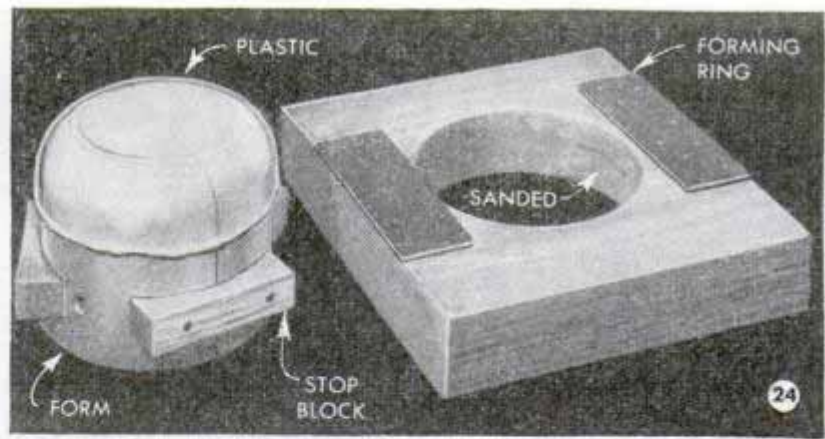

Stretch Forming Deep Forms

A close-fitting wooden ring permits drawing to about 1½ in. in a 5-in.-diameter dish. "Wrinkled" edge is later cut off by mounting form in lathe as shown below

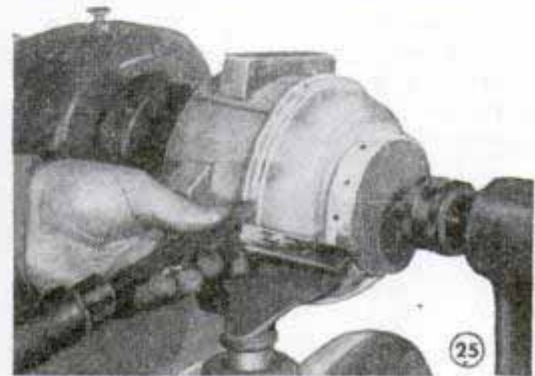

the cloth-ring method shown in Figs. 21 and 22. This method does perfect work and can be used for a wide variety of shallow forming. If the bend is fairly deep, the cloth should be proportionately loose.

Stretch forming deep forms: Deep stretch forming requires a more positive shaping device than can be obtained with a cloth ring. A typical setup for forming a dish is shown in Fig. 24. The form preferably should be covered with cloth or flocked, the latter consisting of shredded cloth applied to the wood over a sticky binder coating. The forming ring should be the exact shape of the widest part of the form, plus the double thickness of the plastic, and the starting edge of the forming ring should be sanded round to prevent tearing the

plastic which is heated to a temperature slightly higher than usual and then centered over the form. A single or double layer of soft cloth is placed over the disk, after which the forming ring is placed in position and pushed down to the limits of the stop blocks. Some deformity at the edges always results, but if an inch is allowed for trimming, very deep draws can be made easily by this method. Fig. 25 shows the dish being trimmed on the lathe after forming. One nice thing about bent plastics is that if you miss on the first attempt, all you have to do is replace the piece in the oven and start over again. Thermoplastics will stand repeated heating and bending without harm, and each time the work is heated it will return to its original shape.

Spring Water Piped to Covered Stock Tank Will Not Freeze Easily



Spring water is piped to this concrete stock tank, which is covered so that the water will not freeze so quickly. At the extreme left there is a small shed for hogs which keeps their waterer separate from the one used by cattle and horses. This arrangement also helps prevent the hogs from being trampled by the larger animals.

A. M. Wettach, Mt. Pleasant, Iowa.

☛ Tooth paste will substitute for tripoli or polishing rouge on many plastic materials.



Getting Started on the VHF Bands

INCREASING activity on the very-high-frequency bands is to be expected for several good reasons. There is plenty of room on the new 6-meter band and definite evidence of good distance (DX) when skip is on. In other words, with low power on the 6 and 10-meter bands many amateurs are working surprising distances, while others with high power on the congested 75-meter phone band are having difficulty in contacting comparatively close stations through the heavy interference.

Equipment of improved design now available for the experimenter in the VHF bands includes special receivers and various types of directional antenna arrays such as the 3-element beam for the 2-meter band shown in photo 1. This consists of a director and reflector; the driven element is a folded dipole. The average gain, front to back, is claimed to be about 30 decibels. It comes complete with mast, crossarms, insulating blocks and adjustable deck flange, and may be manually rotated. This VHF beam antenna is fed with 75-ohm Amphe-nol twin-lead transmission line. The VHF receiver illustrated in photos 2 and 4 is an improved superregenerative type that covers all wave lengths from 1 to 11 meters. Especially designed for operation in these bands, it is unusually compact and suitable for either fixed or portable operation. All bands are covered with the highly efficient plug-in coils shown in photo 3; these coils are located as indicated in photo 2 and are readily accessible for interchanging. Each band is accurately calibrated on the chart, which is mounted on the panel.

A National type 5886 power supply unit and 8-in. PM dynamic speaker complete this assembly which is designed to operate from a 115-volt a.c. supply line. Batteries can be used for portable operation.

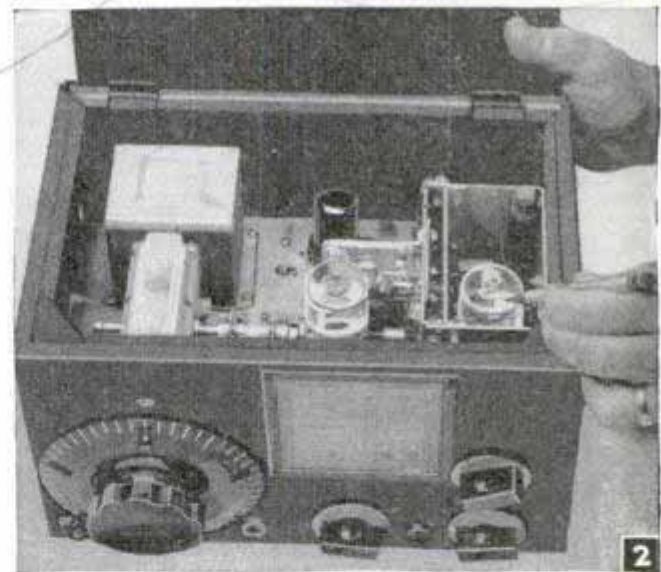

..... FIFTY-WATT TEN-METER

By S. A. Johnson—WØLBV

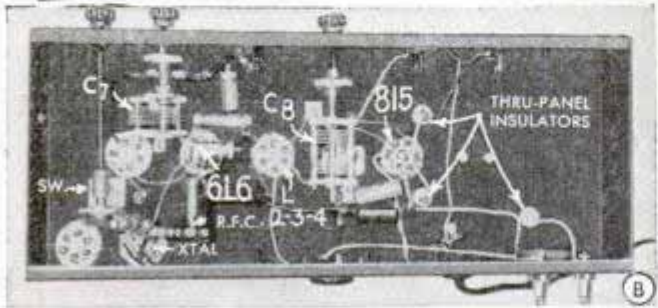

ALTHOUGH only four tubes are used in this compact 2-unit transmitter, it is capable of approximately 50 watts output on 10 meters—enough to give a transmitting range of 2000 to 4000 miles when connected to a suitable antenna. As illustrated and described, it is a complete CW transmitter that can later be converted into a 45-watt radio phone rig simply by adding a good 20 to 30-watt modulator unit.

Designed primarily for operation on 10 meters, it may also be used on the other ham bands merely by changing the coils and crystal. This not only provides a good flexible rig for the newcomer with his brand-new ham ticket, but it is also a keen performer that will please any amateur radio operator.

A schematic circuit diagram of the "twin" power unit appears in Fig. 1, and the 2-tube transmitter unit circuit diagram is given in Fig. 2. This transmitter uses a 6L6 tri-tet oscillator and the type 815 dual-beam tube as a class C amplifier; the 815 tube requires very little neutralizing even on 10 meters. The circuit is simple and employs a minimum of parts, as will be noted in photos A, B, C and E.

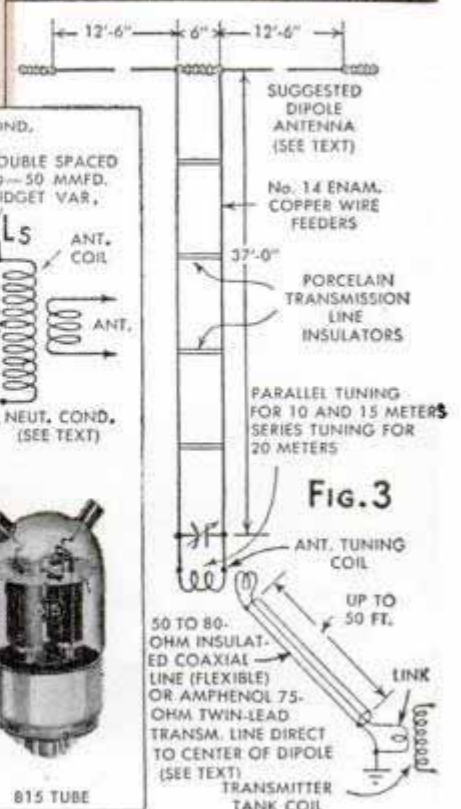
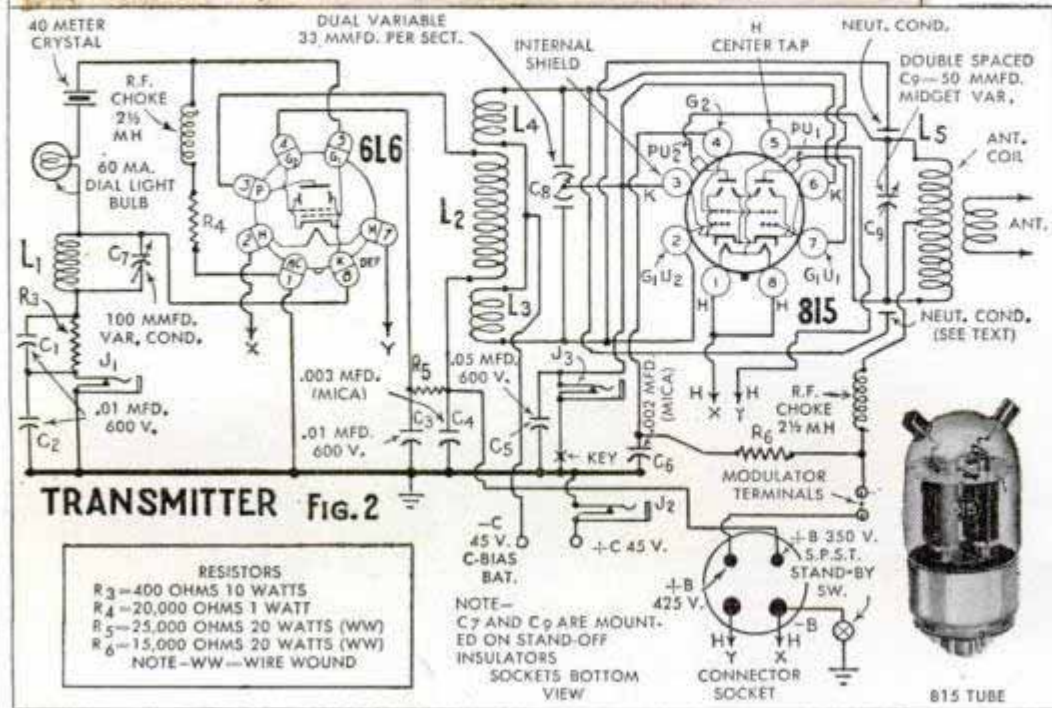
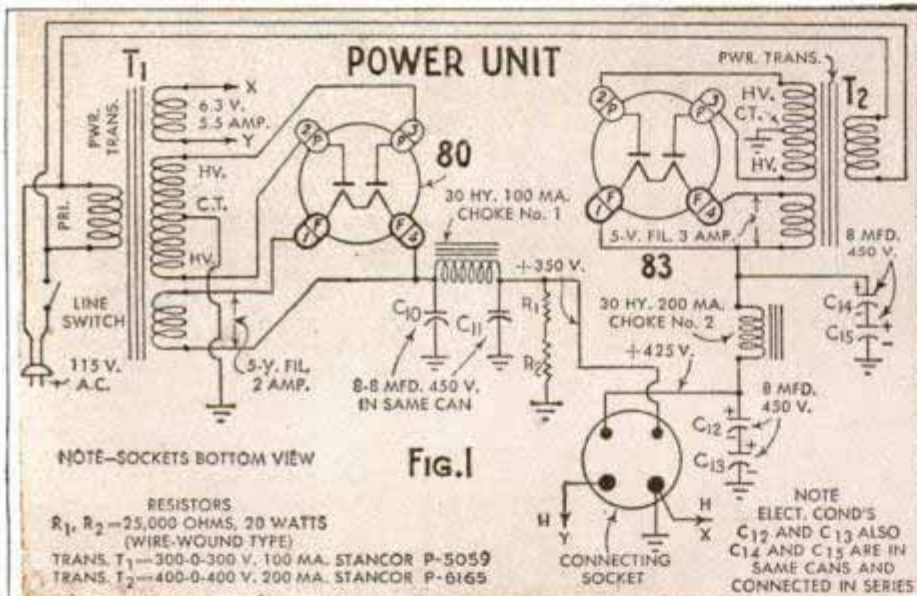

TRANSMITTER FOR BEGINNERS

The 2-tube power unit is shown in photo D.

A black crackle-finish chassis base is used for the transmitter. This is a standard size chassis 2 in. high, 7 in. wide and 17 in. long; it can be used in a relay rack later if desired. A chassis base of similar size is employed for the power unit. It will be noted that insulated shaft couplings are used on variable condensers C_7 and C_8 , also on the final tank tuning condenser C_9 that is mounted between the upright wood supporting blocks on top of the chassis base. The extension shafts are short lengths of $\frac{1}{4}$ -in. Bakelite rod; the stand-by switch is an s.p.s.t. rotary type in series with the negative B lead. It is mounted on a bracket near the crystal socket, with a bushing and extension shaft brought out to a control knob at front. Coil L_1 consists of 8 turns of No. 22 d.c.c. wire close-wound on a plug-in form $1\frac{1}{4}$ in. in diameter. Coils L_2 , L_3 and L_4 are wound on a polystyrene low-loss 6-prong plug-in form $1\frac{1}{2}$ in. in diameter; coil L_2 consists of 5 turns of No. 22 d.c.c. wire spaced to occupy $\frac{1}{2}$ in. in the center of the form. Coils L_3 and L_4 consist of 3 turns of the same size wire spaced to occupy $\frac{1}{4}$ in. on the form. They are wound on each side of L_2 and are spaced $\frac{3}{16}$ in. out from it. Amphenol coil dope is used to hold all coil turns in position. Coil L_5 is a Barker-Williamson 50-watt 10-meter plug-in center-tap type with center link fitted with a standard 5-prong steatite base. This coil fits into a standard ceramic 5-prong-tube socket.

When all wiring is completed, the oscillator should be tested first. A flashlight bulb connected to a small loop of wire should glow when coupled to the combination oscillator plate coil and amplifier grid coil when the latter is tuned to 10 meters. In order to obtain maximum output from the oscillator, it may be necessary to experiment with the number of turns on coil L_1 . Although the 815 tube requires practically no

(Continued to page 248)

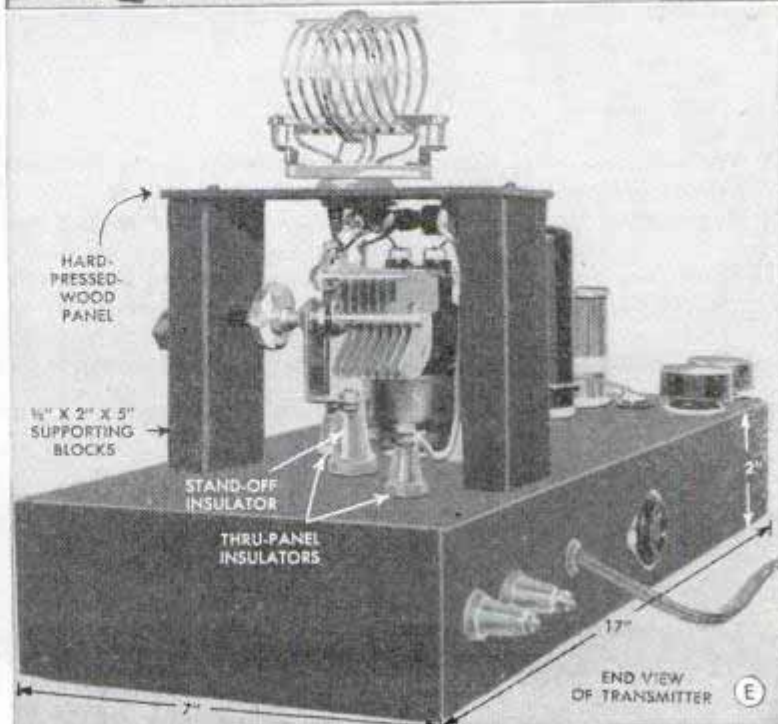
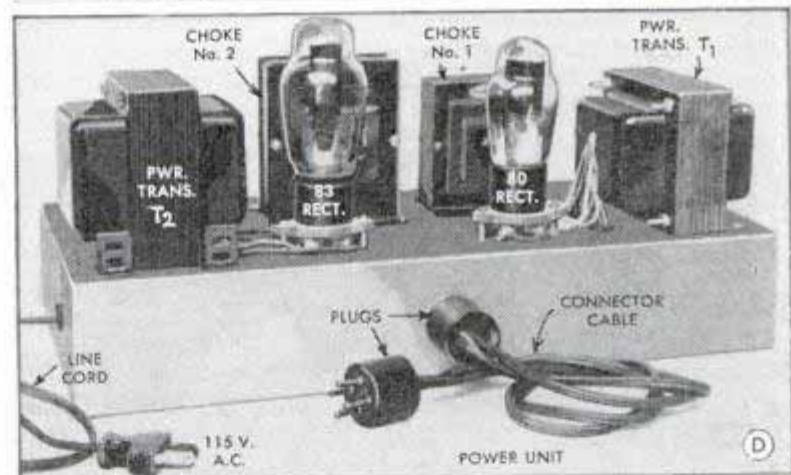

RADIO HINTS FOR TODAY

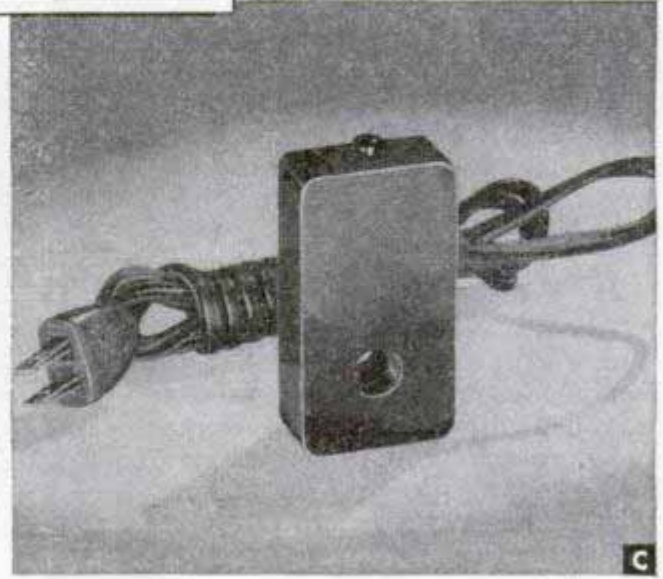
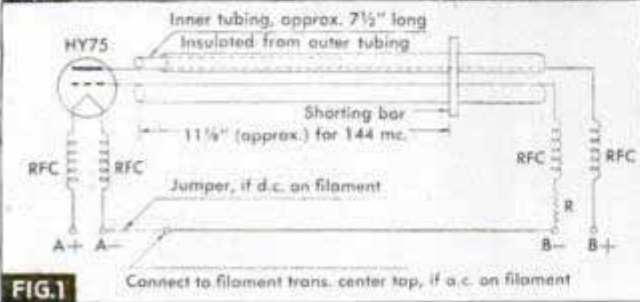
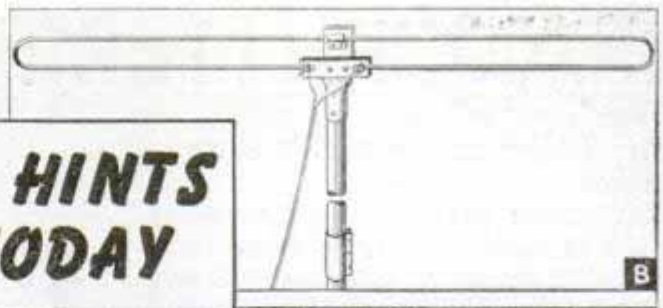

(A) Carefully engineered to make it easy to duplicate results, this efficient 1/4-meter linear oscillator is available in kit form for measurements and classroom demonstrations. It employs a type HY75 tube in the circuit shown in Fig. 1. (B) Directional folded dipole antenna for improving FM reception in areas of low signal strength. (C) Demagnetizer for small tools; they simply are passed through the hole in the field block

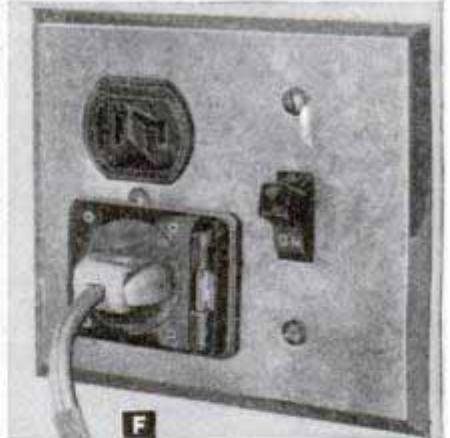
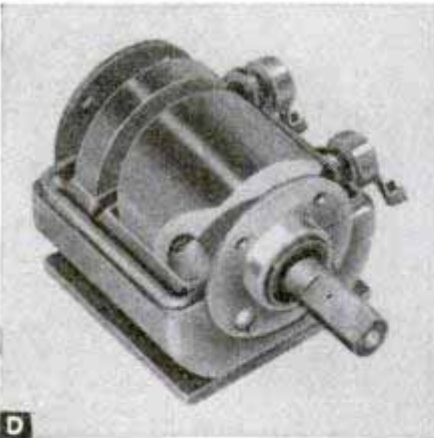

(D) Variable condenser claimed to eliminate acoustical feedback employs barrel-cam rotor instead of plates (E) Retractable slide mechanism permits 3-position inspection of National receiver in flush-wall installation (F) Plug-in pilot light for standard electric outlet or socket; neon light indicator shows appliance on or off

(G) Plastic stand-off insulator for 300-ohm twin-lead transmission line keeps line at fixed distance from any surface. (H) Shockproof plastic radio pliers. (J) Absorption wave meters available in many ranges. These handy frequency meters can be poked into small shield compartments, coil stages and corners to check harmonics and for similar applications, thus enabling the experimenter to find out exactly what is "going on" in the circuit

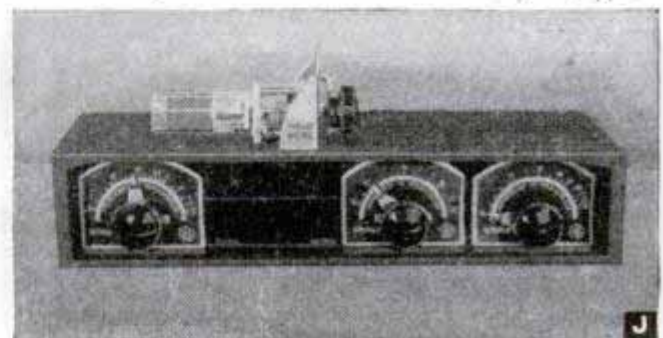

Kodak

KODAK MEDALIST II

...now on the way

A high-precision camera of all-purpose ability

THE KODAK MEDALIST II differs from other cameras . . . it is different in appearance, in scope, and in adaptability to an almost endless variety of photographic jobs. For you, this means that it is really several cameras in one—and all of them excellent.

Kodak Medalist II gives you the convenience of 620 (2¼ x 3¼) roll film—black-and-white or Kodacolor; refinement equal to that of a true precision miniature; and—with various accessories—back extension, ground-glass focusing, and the means for using film in packs or sheets. In sheet film you have a choice of black-and-white, Kodachrome, or Ektachrome Film. And you can readily adapt your Medalist for high-grade enlarging and copying.

The lens is the highly corrected Kodak Ektar 100mm. *f*/3.5, finest in the 2¼ x 3¼ field; superbly mounted, and *Lumenized* (hard-coated on all glass-air surfaces) for maximum light transmission and color purity, and minimum loss through reflection.

The shutter is a special model of the Kodak Flash Supermatic, the world's most accurate between-the-lens shutter; nine speeds from 1 to 1/400 second; eight apertures from *f*/32 to *f*/3.5; built-in synchronized-flash contacts with adjustment for Class F (such as SM) or Class M (such as No. 5) Photoflash lamps. The range finder is of the coupled split-field military type.

For further details see your Kodak dealer . . . Eastman Kodak Company, Rochester 4, N. Y.

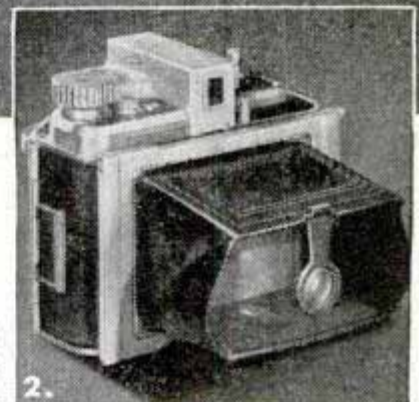

2.

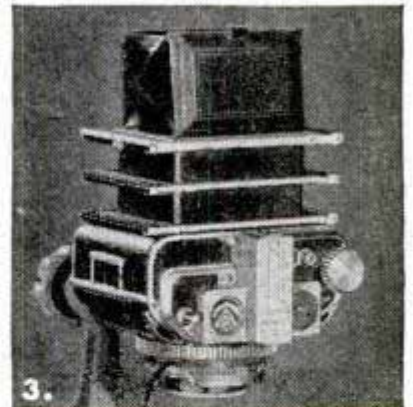

3.

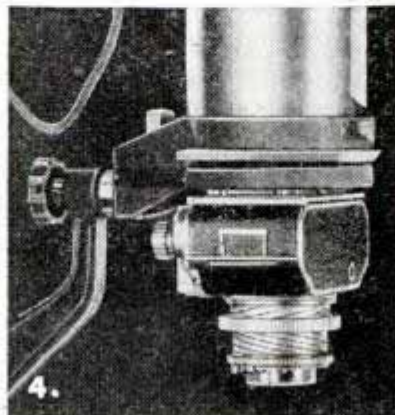

4.

- 1. A 2¼ x 3¼ precision-built, roll-film camera for flash, color, and regular black-and-white photography
- 2. A film-pack, sheet-film camera with both range finder and ground-glass focusing
- 3. An efficient copying camera
- 4. An enlarger (with special assembly) for its own negatives

For a Merry Christmas and a

Hobby New Year

X-ACTO KNIFE AND TOOL CHESTS

Hobbycrafters' dream gift, for amateurs or experts. Knives are *all-metal*. (No more substitute plastics!) Blades scalpel-sharp, with 13 different shapes. Tools especially designed for those small hobby jobs. Here are three of X-acto's many fine gift chests . . . and there's a barrel o' fun in every one!

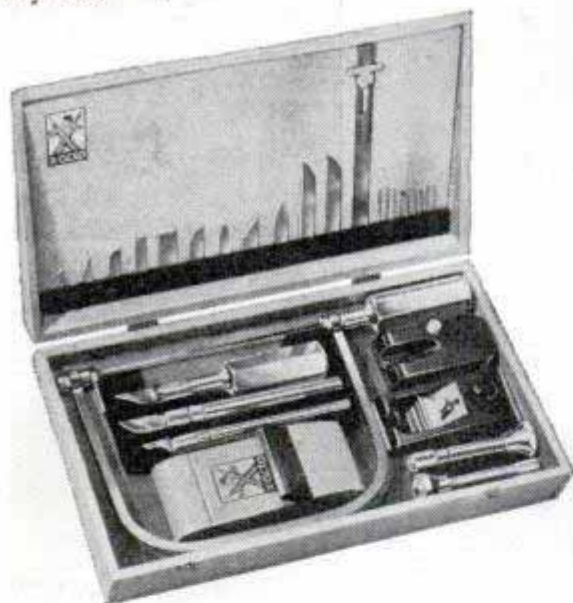

THE BIG SHOT — No. 85 X-acto Tool Chest. A Knife, a tool for every job: 3 knives; assorted blades; sander; stripper; saw; drills and holders; ruler. It's got everything! Complete in desk-drawer-size wooden chest, \$12.50.

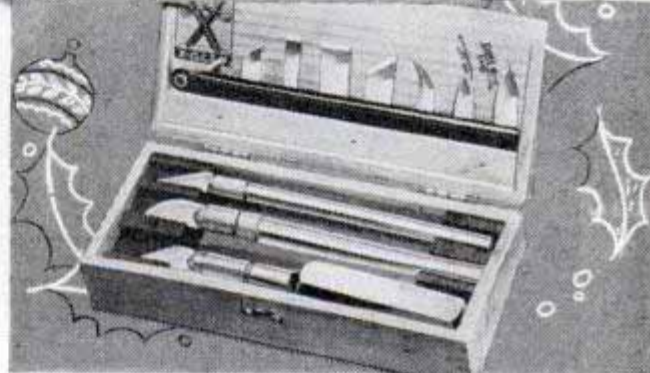

THE 3 MUSKETEERS — No. 83 De Luxe X-acto All-Metal Knife Chest: 3 duraluminum X-acto Knives, with 23 assorted blades. Perfect tools for arts, crafts, and model building; for tough or ticklish jobs; for wood, paper, leather, plastics. Chest—complete, \$5.00.

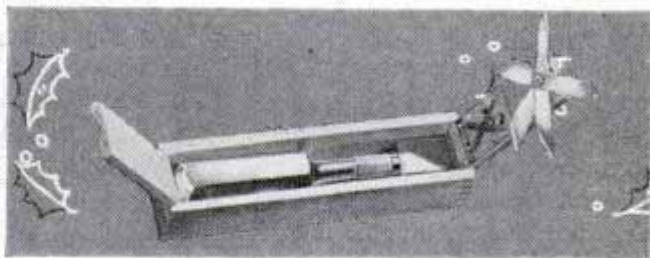

No. 80 WHITTLER'S SET — Hefty but easy-to-handle X-acto Knife, with assortment of five extra whittling blades. Vise-like collet locks in blades so they can't fold under. Firm control adds skill to the wrist, makes whittling *easy!* Complete in wooden box, \$2.

x-acto^{*}
KNIVES & TOOLS
At hobby, hardware, gift shops



*REG. U. S. PAT. OFF.

X-acto Hobby Knives and Tools — Singly or in sets —
50c to \$12.50

X-acto Crescent Products Co., Inc., 440 Fourth Avenue,
New York 16, N. Y. In Canada: Handicraft Tools,
Ltd., Hermant Bldg., Toronto.

REAMING TAPER CUTTING TURNING THREADING

Logan

A NAME TO REMEMBER WHEN YOU THINK OF **BETTER LATHES**
AND SHAPERS

TURNING FACING THREADING DRILLING BORING

REAMING THREADING TAPER CUTTING

TURNING REAMING DRILLING BORING

FACING CUTTING

TURNING THREADING DRILLING BORING

steel • cast iron • non-ferrous metals • plastics



**the right lathe
for small shops**

**compact Logan Lathe
performs variety of work with
speed, ease and accuracy**

**9 reasons why LOGAN
Lathes are BETTER lathes**

- 1 BALL BEARING HEADSTOCK**
for sustained accuracy.
- 2 RUGGED, ACCURATE BED**
within .0005" of parallelism.
- 3 SELF-LUBRICATING BEARINGS**
at vital points lengthen life.
- 4 BACK GEARS ENCLOSED
IN HEADSTOCK**
with shifter rack safely and conveniently
at your finger-tips.
- 5 RUBBER CUSHIONED COUNTERSHAFT**
for smoothness and accuracy in working
area.
- 6 THREE POINT SUPPORT**
Steadies the countershaft, prevents
rocking.
- 7 ENCLOSED BELTS, GEARS, PULLEYS**
Prevents accidents. Keeps lathe clean.
- 8 AUTOMATIC BELT TENSION RELEASE**
Makes belt changing easy and safe.
- 9 PRECISION BUILT THROUGHOUT**
For tool room accuracy in your shop.

The qualities which make the Logan Lathe a successful industrial tool are equally effective in the small shop. The wide variety of operations which can be handled on one Logan Lathe is an important advantage to the small shop owner. Designed for compactness as well as for efficiency, the Logan Lathe occupies a minimum of floor or bench space. The ball bearing mounted spindle requires no adjustment from 30 to 1450 rpm and permits use of high speed carbide cutting tools. Conveniently located levers and hand wheels enable the operator to work in safety and comfort and without fatigue. Rugged construction throughout, and self lubricating bronze bearings at vital points insure lasting accuracy and low maintenance.

WRITE FOR THE LOGAN CATALOG ...complete illustrated descriptions of Logan Lathes, Shapers and Accessories. LH-9

LOGAN ENGINEERING CO., 4921 LAWRENCE AVE., CHICAGO 30, ILL

**Thread pipe
faster, with less
bother, with these
smart, handy, little**

**RIGID
RATCHET
THREADERS
Nos. 00R and 111R**

Heads snap in
either side...
can't fall out



● With one of these efficient and tough little steel-and-malleable threaders at hand, pipe from $\frac{1}{8}$ " to $\frac{1}{4}$ " is quickly perfectly threaded. Die heads with heat-treated tool-steel chasers snap in from either side, can't fall out. No special dies are needed for close-to-wall threads. Smooth internal ratchet. No. 00R, $\frac{1}{8}$ " to 1"; No. 111R, $\frac{1}{8}$ " to $\frac{1}{4}$ ". Handy, fast, durable—try one and you understand their growing popularity. Ask your Hardware Store or your Supply House.

RIGID
WORK-SAVER PIPE TOOLS
THE RIDGE TOOL COMPANY · ELYRIA, OHIO, U. S. A.

Bootmaker for the Stars

(Continued from page 148)

Joe learned long ago not to be surprised at strange orders. Harpo Marx wanted oversize shoes, one of which could double as a dustpan. Edgar Bergen asked for several pairs of shoes for Charlie McCarthy. Victor Mature needed caveman's footwear for "One Million B.C." Tom Tyler wanted winged shoes for "The Bat Man."

Joe turned out high lace black shoes for a monkey. He built shoes for a gorilla costume, complete with toenails, and lion's feet with claws of leather.

A studio wanted Dutch shoes which wouldn't click against a hard floor. Joe came up with shoes which looked exactly like wooden shoes, but were made of thickly padded soft yellow leather.

For hurry-up odd jobs, Joe keeps strange materials handy. At any moment he may need feathers, fur, cloth, rubber, snakeskin, alligator hide, embroidery or jewels. He uses quantities of calfskin, horsehide, sheepskin and kid.

For color movies, he must supply color-corrected shoes. To do that, he matches colors with samples supplied by studio technicians. He keeps a stock of colored leathers—almost every shade under the sun. Sometimes he must mix his own dyes.

The biggest feet in Hollywood, by Joe's measurement, are the size 13 extra-wide feet of Victor McLaglen. Cornel Wilde wears $12\frac{1}{2}$, bigger than Wallace Beery's $11\frac{1}{2}$ quadruple E.

June Haver and Lily Pons tie for having the smallest feet Joe ever fitted—size 3.

Joe's idea of a perfect rest is to spend a day at the beach where every one is barefooted. That way, he says, he's not reminded of his work.

How Good a Driver Are You?

(Continued from page 175)

The test to determine whether a person is color blind is comparatively simple. The candidate is shown disks filled with a patchwork of variously colored spots and dots, some arranged to form numbers. Asked to name the numbers, almost all persons pass this test. Color weakness occurs in one woman out of 250 and one man out of 25, but complete color blindness is very rare.

Another eye test is for peripheral vision—ability to see objects at a considerable distance to the right or left while looking straight ahead. Two examinations with a half-circle device are given and averaged. The driver should see the object at 85 or 90

(Continued to page 240)

NEW "EVEREADY" FLASHLIGHT BATTERY LASTS 93% LONGER!

Tiny cell packs
enough ENERGY to
kick 186 field goals

Like football? Like to sit breathless while the Big Team goes into kick formation for a last-minute try? Then here's news: The great new "Eveready" flashlight cell NOW has energy equal to that used in making 186 big-time field goals from the 25-yard line! Extra power makes "EVEREADY" batteries the All-American choice for brilliant, lasting, low-cost light!

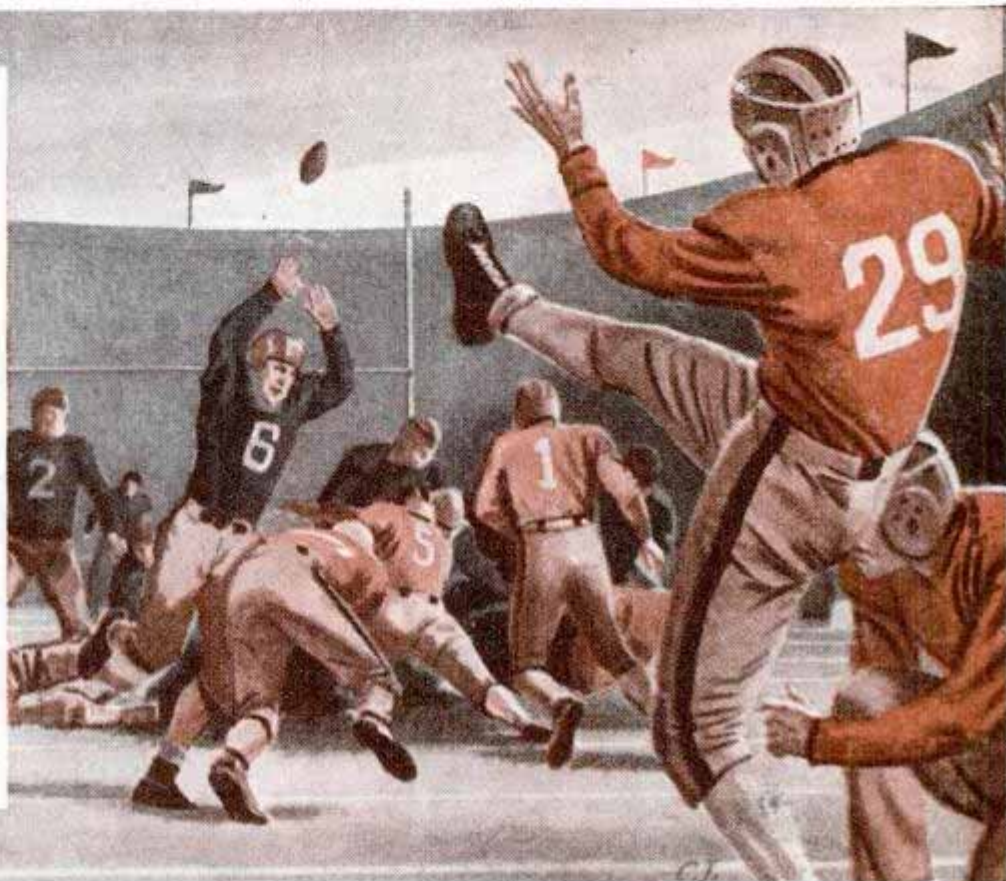

THE NEW "Eveready" flashlight cell literally *blasts* darkness with a dazzling beam of powerful white light. And does it for nearly *twice* as long as famous pre-war "Eveready" batteries. Because this new cell packs *93% more energy!* Service from "Eveready" flashlight batteries is nearly *doubled*... yet you *pay no more* for this far greater value! For longer life of brighter light... get these new "Eveready" flashlight batteries!

The registered trade-mark "Eveready" distinguishes products of
NATIONAL CARBON COMPANY, INC.
30 East 42nd Street, New York 17, N. Y.
Unit of Union Carbide  and Carbon Corporation

Nearly *twice* the electric energy... almost *two times longer* life of brilliant white light than even famous pre-war "Eveready" batteries... at no extra cost. *That's* today's *high-energy* "Eveready" battery, as proved by the "Light Industrial Flashlight" test devised by the American Standards Association.

93% MORE ENERGY



High Energy MEANS
BRIGHTER LIGHT, LONGER LIFE

EVEREADY
TRADE-MARK
FLASHLIGHT BATTERIES





REWARD

Faster action, better results with a Stanley Screw Driver

You'll get the reward an earnest craftsman deserves every time you use a good Stanley Screw Driver. It's a simple tool—but in every small detail, there's a superiority that you'll note and respect and prefer every time you use it.

Stanley No. 25 Screw Driver has polished blade of alloy steel tempered the entire length. Patented bolster construction securely anchors blade in hardwood handle. Tips are accurately crossground to size. Handle is correctly fluted for good grip. You'll find every needed size and type of screw driver in the extensive Stanley line.

THE TOOL BOX OF THE WORLD

STANLEY

Trade Mark

HARDWARE · HAND TOOLS · ELECTRIC TOOLS

Own these two Stanley Books

The first book is free . . . "The Joy of Accomplishment", a brief introduction to tools and their uses. The second is the famous textbook, "How to Work with Tools and Wood", recently revised, fully illustrated. The cost is only \$1.



STANLEY TOOLS,
1116 Elm St., New Britain, Conn.

Please send by return mail:

- The FREE booklet: "The Joy of Accomplishment".
- 188-page book: "How to Work with Tools and Wood". \$1.00 enclosed.

(In Canada: Send order to Stanley Tool Co. of Canada, Ltd., Roxton Pond, Quebec.)

Name

Address

City State

SAY YOU SAW IT IN POPULAR MECHANICS

Test-O-Lite the MODERN TROUBLE SHOOTER



THE NEON GLOW

LOCATES TROUBLE INSTANTLY in electric circuits, fuses, cut-outs, motors, radios, appliances. Tests everything electrical from 100 to 550 volts. Indicates hot or grounded wires. Tells AC from DC. Engineers prefer it because it has patented safety features.

PUTS "FINGER" ON THE TROUBLE SPOT -- QUICKLY

Far superior to ordinary clumsy test bulb. Saves precious time. Indispensable in shop or home. Vest pocket size. Lifetime guarantee. List \$1.50 (Pat. No. 1,778,883) Purchase through regular electrical dealers.

L. S. BRACH MFG. CORP.

200 Central Ave. Newark, N. J.



FUSES



MOTORS



OUTLETS

PAINTERS' STRIPING TOOL

A TOOL... NOT A BRUSH

NEW, IMPROVED

Modern—streamlined—fits the hand like a fountain pen! Easy to use as a pencil. Draws parallel lines—straight, curve or circular. Does expert job on autos, furniture, toys, bikes, model planes, signs, bulletins, linoleum. (Makes wall board look like tile.) Every painter and craftsman needs one! Type "M" MASTER Painters' Striping Tool complete with tip for 1/16" stripe, \$1.00. Extra tips 1/64", 1/32", 3/64", 1/16", 5/64", 3/32", 1/8"—75c each. Tool with complete set of 7 tips \$5.00. (C.O.D. orders 25c extra.) Paint dealers, write!

\$1.00
POST PAID

EASY AS USING A PENCIL!

WENDELL MFG. CO.

4234-B Lincoln Ave., Chicago 18, Illinois

BRUSH PLATING OUTFITS

for re-plating articles in the home and shop. No tanks necessary. Free particulars.
GUNMETAL CO., AVE. M, DECATUR, ILLINOIS

JET PROPULSION



GAS TURBINE Model Engine

★ ★ Be one of the first to build a real Turbo-Jet Model Engine. Single-stage centrifugal compressor and turbine. This is a real engine, easily made with ordinary home workshop equipment. Complete plans for construction . . . design formulas and curves for checking performance and testing.

\$2.00
Post paid

THE ROTOJET CO. Department 11
BOX 757 • LOS ANGELES 25 • CALIFORNIA

"How do you know it's a good saw, Dad?"



DAD: Well, here's the main reason, son—look at this name on the blade.

SON: Say, I've seen that name before—lots of times.

DAD: Sure you have. It's one of the best-known brands on the market, and men who buy saws have confidence in it.

SON: Does a name really mean that much?

DAD: It means plenty, son. When you buy branded merchandise—tools and hardware that carry the names of reliable manufacturers—then you know you're getting high quality.

SON: But some places sell tools with no

names at all. Or names you've never heard of.

DAD: I know they do. That's why I buy all *my* tools here at Bill Parker's hardware store. Bill carries all the well-known brands you can trust—and that's the only kind I want anything to do with.

*Your **HARDWARE DEALER**
sells **QUALITY** tools and
hardware. Buy from **HIM**.*



POPULAR MECHANICS

QUALITY

...where it
counts

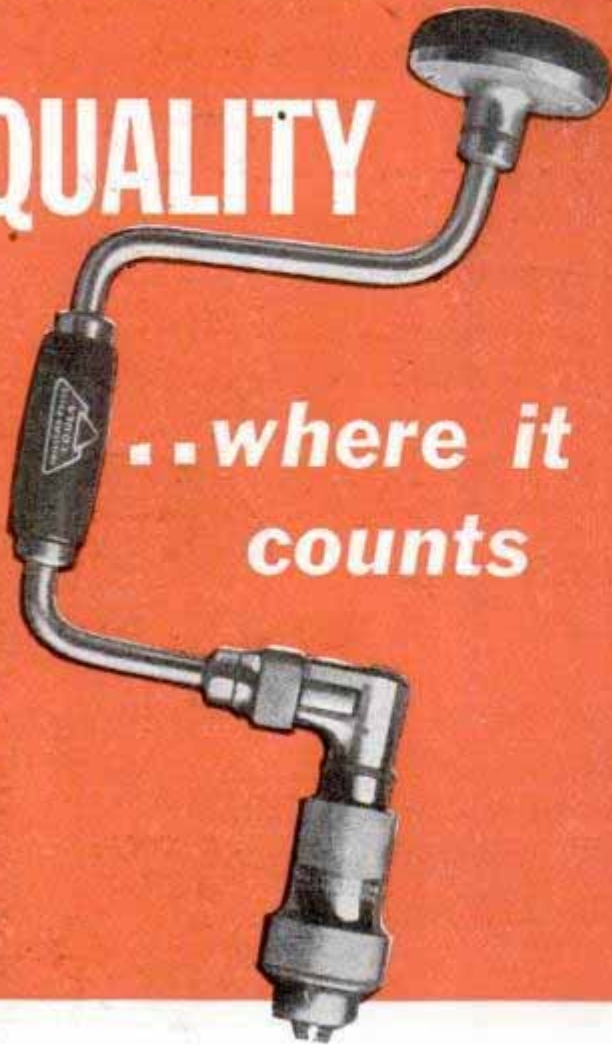

Millers Falls Braces are best for craftsmen because these quality features count for greater ease of operation, many *more* years of trouble-free service —

- Ball bearings at every point of wear
- Boxed ratchet operated by ring shift
- Finely-finished hardwood head and handle
- Highly-buffed nickel plate metal finish

The sturdy construction of **Millers Falls Braces** is recognized and preferred by professional carpenters everywhere. It can serve *you* as well. Be sure to ask for **Millers Falls Braces** when you see your hardware dealer next.

One Thing in Common — QUALITY!



MILLERS FALLS COMPANY
GREENFIELD, MASSACHUSETTS

degrees. Peripheral vision of 70 degrees or less for either eye would definitely handicap a driver.

To test whether a driver can judge distance accurately the AAF employs a string-operated device similar in principle to the depth perception tester used for aviation cadets. Good depth perception is necessary in overtaking and passing another car, turning in traffic, parking in small spaces and in judging the sizes and distances of objects ahead.

The final psycho-physical test measures the time it takes a driver to move his right foot from the accelerator to the brake pedal after a red light flashes. The average time required for a person to move his foot from the accelerator to the brake—after seeing the red light—is from $\frac{30}{100}$ to $\frac{41}{100}$ second.

Tests taken up to this point reveal a driver's deficiencies which can be compensated for, to a certain degree, by cautious driving. An important factor is that shortcomings are brought to the attention of the driver so he can exercise additional care.

In addition to these tests, the AAF puts its drivers through tough driving tests including one in which the candidate has to zigzag in and out around a line of wooden stanchions and then back the vehicle through the same course. If a fellow drives too slowly he is penalized, but if he tries to set a speed record and knocks over several posts he fails to pass the exam.

Drivers' test equipment similar to the AAF apparatus may be bought or borrowed from the American Automobile Association by truck fleet owners, schools, civic and other organizations interested in safe driving. Inquiries should be addressed to the association, Washington 6, D. C.

Like the AAF, the state of California has an effective series of drivers' tests and their effectiveness is increased by repetition. Drivers repeatedly involved in auto accidents are given the tests again.

The results are amazing. One group of 144 persons who figured in 225 traffic accidents in two years was called in and given the entire examination. During the next two years the same group was involved in only 12 accidents.











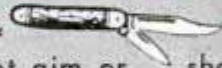

Edwin D. Fletcher, research director for the California State Division of Operators' Licenses, explained that the most significant thing about re-examination of drivers is that their limitations are called to their attention.

"The records show," he added, "that drivers immediately adapt themselves to their limitations, once these conditions become known to them. A man may learn, during

(Continued to page 244)

SHOOT SAFE BUDDY!

BOYS! SHOW THIS MESSAGE TO YOUR PARENTS!

You'll never see a real outdoorsman  aim or shoot his rifle at anything but a safe, proper target . . . he handles his firearms  with care and respect. Your Daisy  is made for fun shooting. It is not a lethal weapon but . . . like a knife,  or auto it may cause damage if handled carelessly. So do not aim or shoot at windows, street lights, song-birds,  pets, property or any other person . . . ever! Remember,  carelessness causes accidents to millions of Americans every year in cars, homes,  factories. So . . . if you are careless with your Daisy or abuse the privilege of owning one . . . your parents,  guardian  or police  have the right to take it from you . . . and  should!  Don't let this happen. Be careful. Aim and shoot safe, Buddy!

SAFETY TIPS

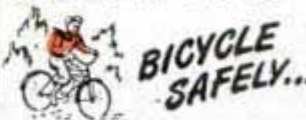

BICYCLE SAFELY...

Careless bicycling may cause accidental. Always ride single file. Never "hitch on" to car or truck. Follow all traffic signs, rules. Avoid ruts. Ride close to right edge of road. Use hand signals for turns, stops.

ROLLER SKATE SAFELY...

Avoid roller skating accidents by being careful. Always skate on sidewalk. Come to stop at curbs. Cross streets at corners only. Do not "hitch" on to bicyclists. Cross small cracks at right angles.



DRIVE SAFELY...

An average of more than ONE MILLION children, women, men are injured every year in traffic accidents! Think that over, Buddy! Decide now that when you are old enough to get your driver's license—and after you get it—you will remember and follow the safety driving rules you learned.

CROSS STREETS SAFELY...

Always stop at curb, look right and left to see if street is clear. Cross streets only at corners. Obey signal lights. Remember, an auto moves faster than you can run. And don't run . . . walk!

AND SHOOT SAFE BUDDY!

MEMORIZE THE SHOOTER'S SAFETY PLEDGE!
I pledge myself to PROTECT animals, property and people in my community by always aiming and shooting my Daisy safely!

Get Your DAISY HANDBOOK NOW!

Ready—the amazing 128-page DAISY HANDBOOK—your guide to safer shooting, more fun! Featuring Red Ryder, Buck Rogers comic strips—atomic bombs—how to saddle western style—adventure stories—jokes—mechanical marvels explained—trick shots—manual of marksmanship—woodcraft tips—many others. Also included . . . complete Daisy Air Rifle Catalog describing the beautiful Daisys being made and delivered to dealers fast as the supply of materials and labor permits. Get your Handbook. Hurry—limited supply. Mail dime (10c) and unused 3c stamp with name, address to Daisy—we'll send Handbook postpaid!



ILLUSTRATED BELOW IS THE FAMOUS DAISY 1000 SHOT

RED RYDER CARBINE

MODEL No. 311

\$4.25

Don't order air rifles direct from the factory.

DAISY

AIR RIFLES

... QUALITY PRODUCTS OF

DAISY MANUFACTURING COMPANY, 5412 UNION ST., DEPT. 6, PLYMOUTH, MICHIGAN, U. S. A.

Living Comfort NOW..



AND FOR YEARS TO COME!

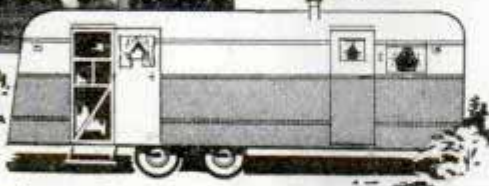

● In a Schult Luxury Liner you'll have every facility of a sturdy, 2-bedroom heated home, insulated for year-round comfort... and you can take it wherever you need it!

COMPLETELY FURNISHED
The modest cost includes built-in bed, convertible

sofa-bed; kitchen with oven range, refrigerator, double sink; ample food storage space, 3 wardrobes; plenty of drawers and closets. See your Schult dealer, or send for latest catalog featuring the 1946 Schult Luxury Liner.

SCHULT CORPORATION, Department 3212, Elkhart, Indiana
MEMBER: TRAILER COACH MANUFACTURERS ASSN.
In Canada John Inglis Co., Ltd., Toronto

SCHULT Trailer Coaches



How about your **CHRISTMAS PICTURES?**



Make sure they're better, get the new, improved

G-E exposure meter

Gives you more from your camera. Correct exposure in a jiffy. Lighter. Sturdier. New, easy-to-read dials. Accuracy you can trust. Get the new G-E meter at your photo dealer's. (Or whisper to Santa!) It's 3 meters in one. General Electric, Schenectady 5, N. Y.

Type DW-58 \$ **26.95** Federal tax included



GENERAL ELECTRIC

606-18717-6336

Electrically Welded Endless *Paramount*

BAND SAW BLADES



Made in widths from 1/8" to 1-3/4"

Make your band saw do more work for you. The proper width of blade will extend the scope of this important machine. Burrill's Paramount Blades are made from tough Nickel Alloy Steel properly tempered. Teeth accurately set and filed, and all saws carefully straightened. Send order and check today. Delivery will be made as promptly as conditions permit, from a few days to a week or two. You can obtain these saws at the following prices:

1/8"-3/16"-1/4"-3/8" wide, 5'6" long.....\$.90 each
1/4"-3/16"-1/2"-3/4" wide, 6'6" long..... .95 each
3/8"-3/16"-1/2"-3/4" wide, 7'6" long..... 1.10 each

Other sizes at proportional prices

ALSO METAL CUTTING BAND SAWS

Made in widths from 1/8" to 3/4"

Your satisfaction is guaranteed

BURRILL SAW & TOOL WORKS

407 E. Main St., Iilon, N.Y.



What paper gadgets, tied with string
Put addresses on anything?

Dennison SHIPPING TAGS

At Stationery Departments Everywhere

SAY YOU SAW IT IN POPULAR MECHANICS

CROSMAN *Silent* RIFLES



NOW AVAILABLE

America's favorite compressed air rifles for indoor or outdoor shooting are back again! Available in .22 Cal. Single Shot and Magazine Loading types. At your dealer—or order direct. Ask for Crosman SUPER-PELLS too—the better ammunition for all compressed air rifles: .177 Cal.—\$2.25 per M; .22 Cal.—\$2.50 per M.

CROSMAN ARMS CO., INC. ROCHESTER 7, N. Y.

DIE-LESS DUPLICATING

Many small parts can be formed without dies, to duplicated accuracy of .001" with DI-ACRO Precision Machines, — Benders, Brakes, Shears. Save die expense and time delay. Ideal for experimental and research work, making samples, models, etc., as well as regular production runs. Write for descriptive literature. O'Neil-Irwin Mfg. Company
341 8th Ave.
Lake City, Minnesota



Toys and Games

One Evening Projects

Tables

Furniture Lamps

Garden Furniture

Chairs

Novelties

Enough plans . . . projects . . . and ideas — for a whole year of woodworking fun

— in the popular hobbyist's magazine



THE Deltagram

A full year's subscription 6 Big Issues only 50¢

The Deltagram is your key to exciting avenues of woodworking fun. Delivered to your home six times a year, it brings you many pages of shop-tested ideas on what to make and how to make it.

It shows you how to operate power tools efficiently and safely . . . how to produce good-looking results that win admiration . . . even how to earn extra money.

Clear and Complete
Packed with plans, pictures, and projects, The Deltagram

leaves nothing to guesswork. It's detailed . . . specific. Step-by-step directions are complete and understandable to both beginners and experts. That's why The Deltagram is more popular every year.

Get Your Subscription In!
Paper shortages permit us to print only a limited number of Deltagrams. So to avoid disappointment, get your subscription in now!

Fill out the coupon and mail today with 50 cents in coin, postal note, or money order.

DELTA
MILWAUKEE
REG. U. S. PAT. OFF.

HOMECRAFT
POWER TOOLS



Subsidiary of Rockwell Manufacturing Co.

*Trade Mark Reg. U. S. Pat. Off.

Tear out coupon and mail today!

DELTA MANUFACTURING DIVISION
Rockwell Manufacturing Co.
681N E. Vienna Ave., Milwaukee 1, Wisconsin

HM-40

Enclosed is 50¢ in payment for a whole year's subscription to The Deltagram.

Name.....

Address.....

City..... (.....) State.....

THE ONLY BRUSH THAT

*Keeps the Air Clear
as it Cleans the Floor*

Also Eliminates
Sweeping Compound!



Arbitrin Sweeping fluid is put into a steel reservoir in the back of the Dustless brush.

As you sweep Arbitrin filters through the tufts — surrounds particles.

The dust itself is converted into sweeping compound—cannot rise into the air.

Dustless brushes used with Arbitrin sweeping fluid are 100 times more effective in controlling dust than ordinary floor brushes used with sawdust. When used daily, Dustless brushes actually reduce bacteria, normally in the air between sweepings, as much as 97%. These facts have been proved in tests made by independent health authorities. Dustless brushes are used in thousands of stores, factories, offices, schools, and institutions. They are unconditionally guaranteed to meet your requirements. Write today for sizes, styles, and prices.

MILWAUKEE DUSTLESS
BRUSH COMPANY

530 North 22nd Street • Milwaukee 2, Wisconsin

MANUFACTURERS OF DUSTLESS, SPEED SWEEP AND SPEED WASH BRUSHES

Milwaukee Dustless Brush Co., 530 N. 22nd St., Milwaukee 2, Wis.
Please send complete information about Dustless brushes and Arbitrin sweeping fluid.
Name.....
Address.....
City and State.....

his first test, that he reacts slowly or that he is a poor judge of distance, but often he forgets these facts in a couple of years."

California also places certain restrictions on drivers with physical handicaps. Some people suffer intensely with hay fever during the pollen season and might have spells that would cause them to lose control of their cars. They are not permitted to drive during this season. Limitations are placed on drivers with inadequate vision. The aged and the deaf must drive only in accordance with the restrictions listed on their driver's license.

As the safety experts made clear at the President's Highway Safety Conference, action along many lines is necessary to curb the mounting traffic death toll.

But one thing is certain, scientific drivers' tests—strictly enforced and repeated—will help a lot.

Harvest From the Sea

(Continued from page 143)

marine bottom deposits probably hold the secret of petroleum formation, geologists, chemists and biologists alike are interested in them.

Information on the conditions under which petroleum forms may help in locating existing oil deposits and possibly suggest ways in which organic matter may be used to produce oil under man-made conditions. For many years, oil geologists have made extensive use of oceanographic data in their quest for new fields.

Drillers as well as geologists are hopefully turning to the ocean for petroleum. Harold Ickes, until recently Secretary of the Interior, said that the continental shelf may be "our last totally unexplored great domestic source of petroleum." Already these tideland pools are being tapped by "slant drilling" from wells along the shore in California and from piers built out into the water off Texas and Louisiana.

Numerous devices have been proposed, patented or tried for harnessing the seemingly limitless power of the waves and tides. The Passamaquoddy project is an outstanding example. Such potential sources of power must not be overlooked, even though it has not been demonstrated that they can compete with power from other sources such as petroleum, coal or rivers.

Also, even though it is not economically feasible by any process yet known, sea water may some day be made fresh enough for irrigation and drinking purposes. Some promising small-scale experiments have been conducted in arid areas near the

(Continued to page 248)

New 1947 Models

GILBERT CHEMISTRY Laboratories



DEVELOPED at the GILBERT
HALL OF SCIENCE

The sets that bring boys fame and big awards
Spectacular new features for extra fun and thrills

More boys have won fame and big awards with Gilbert Chemistry Sets than any other kind. Because they are far more than "toy" sets. Range of chemicals and apparatus are based on real laboratory technique. Write messages in in-

visible or fire ink. Make chemical weather flag. Bleach flowers. Make paints, sparklers, soda water. Hundreds of other spectacular experiments in organic, inorganic and electro chemistry.



Big, three-compartment blue metal cabinet crammed with chemicals and apparatus. Puts 389 spectacular experiments at your finger tips.



WINS \$100.00 FOR CHEMICAL RESEARCH

Meet Frank Hoble of Chicago, America's No. 1 boy chemist of the year, who won a check for \$100.00 and national fame for outstanding research. The way is wide open for you to do the same. But be sure to start right—with a genuine Gilbert Chemistry Set.

ALL THESE ADVANCED FEATURES

NEW—All metal construction—rugged and easy to carry.

NEW—Each section designed as complete laboratory with trays and racks.

NEW—Tip racks for test tubes, for easier handling of test tubes.

NEW—Brown, lightproof bottles such as used for fine pharmaceuticals.

NEW—Rectangular shaped bottles and shelf spaces, holding bottles with label side out.

NEW—Postwar chemistry book, 144 pages profusely illustrated; large type, 8" x 10" page size and stay-open binding. Edited by Prof. Treat B. Johnson, distinguished Yale professor, author of hundreds of publications in the field of organic chemistry, member of the National Academy of Sciences, the National Research Council, the American Chemical Society, the American Institute of Chemists, and other scientific organizations.

\$200.00 IN CASH AWARDS

To the boy doing what, in my opinion, is the most important research in Chemistry. Microscopy or Electricity in 1947, I will award \$100.00 in cash. To the ten boys doing the next most important research, I will award \$10.00 each. Applicants must not be over 17 years old and must send me a full description of their experiments by May 1, 1947.

A. C. Gilbert

Founder of the Gilbert Hall of Science

ALSO DEVELOPED AT THE GILBERT HALL OF SCIENCE

AMERICAN FLYER TRAINS . . . SEE 'EM PUFF SMOKE . . . HEAR 'EM CHOO-CHOO—World's first scale model trains with realistic smoke and "choo-choo" sound effects—both synchronized with train speed. Authentic 3/16" two-rail track and other spectacular new features make railroading with American Flyer "just like real." Send 10¢ for giant catalog illustrated in 4 colors. The A. C. Gilbert Co., 55 Erector Square, New Haven, Conn.

ERECTOR—SUPER-MECHANIZED AND ALL-ELECTRIC

—Builds towering, realistic parachute jump—bridges that open and close—dozens of other colossal engineering marvels that buzz with action.

FREE—Illustrated catalog on new Chemistry Sets, Erector and other Gilbert scientific toys. Just send name and address on post card. The A. C. Gilbert Company, 101 Erector Square, New Haven, Conn. This offer good only in U. S. A.

Give Him a

WHIZZER for Christmas!

Ride one and
you'll buy one!

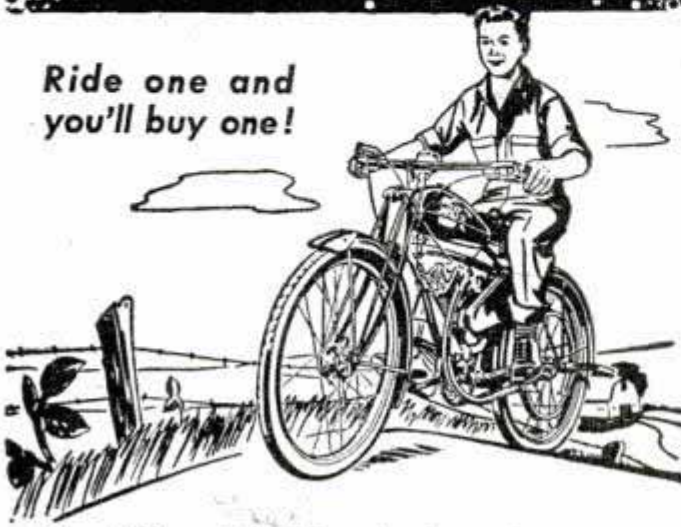

The Whizzer Bike Motor is the real answer to dependable, low cost transportation. Fits any balloon-tired bike. Built by automotive craftsmen in the heart of the auto industry, the Whizzer bike motor installs easily and will carry you fast (5 to 35 miles per hour) and far (125 miles or more on a gallon of gas). Enjoy new freedom and adventures with your Whizzer. Use it for errands, shopping, business, recreation and work. Whizzer's 2½ h.p. will take you there and bring you back! Does not interfere with normal pedaling of bike. Put a Whizzer on his bike for Christmas! WHIZZER MOTOR CO., Pontiac 15, Michigan.

Simple, positive controls. Easy to ride, too . . . Whizzer doesn't change balance or riding qualities of bike!

FACTORY PRICE

\$97⁵⁵
PLUS
TAX

See your **WHIZZER**
dealer today

IF NO LOCAL DEALER, USE COUPON

WHIZZER MOTOR COMPANY
Dept. 172, Pontiac 15, Mich.

I enclose \$99.97, which includes \$2.42 Federal Excise Tax, () check or () money order. Send me one Whizzer motor, complete, with full installation instructions. Written guarantee with every motor.

If descriptive literature only is desired, check here ().

NAME _____
ADDRESS _____
CITY _____ STATE _____

Dealers wanted

MORE PROFITS

with

MODERN LAWN MOWER SHARPENER



SHARPEN ANY LAWN MOWER from 5-inch Edger to 36-inch Power Mower in ten to twenty minutes with a MODERN LAWN MOWER SHARPENER because dismantling is unnecessary — neither handle, roller, wheels nor motor need be removed when sharpening any mower. . . . the MODERN SHARPENER eliminates all hand filing; it precision grinds to the extreme ends of both left or right reel blades. Bottom knife is held in same brackets for sharpening. NO EXTRA ATTACHMENTS! Order today! Price \$241.50 (less motor) f.o.b. Pasadena. (1/3 or 1/4 H.P. single phase motor recommended.)

Modern Mfg. Co., 156 N. Fair Oaks, Pasadena 1, Calif.

SHARPER CUTTING EDGES

Easy • Accurate • Quick

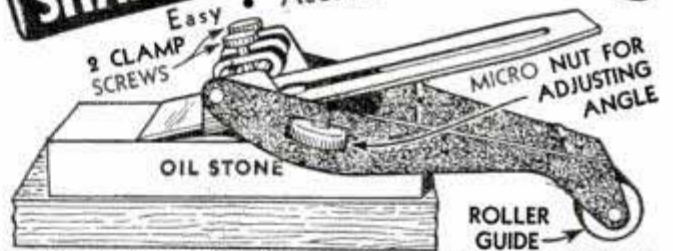

It's easy to hone keen cutting edges on your chisels and plane blades. Precision adjustment for ANY ANGLE of bevel. Roller glide makes every stroke uniform across oil stone. Light, strong — ideal for home craftsmen, hobbyists, carpenters, cabinet makers.

check or
money order
\$2.95

POST PAID

McLAREN INDUSTRIES, INC., Box 606, TROY, N. Y.

ELECTRONIC -

PROTECT YOUR TOOLS
PERMANENTLY - ELECTRICALLY

YOUR SIGNATURE OR DESIGN IN ANY METAL, BRASS, COPPER, GOLD, SILVER, TIN, LEAD, ZINC, ALUMINUM, STEEL, BRONZE, ETC. LASTS LONGER AND IS CLEARER AND BRIGHTER. 5 AMP. \$1.50 PREPARED. (NO COPIES)
FORWARDED BY VARIOUS TRADING COMPANIES
JAMES E. HARRISON CO., ANDOVER, SOUTH DAKOTA

YOUR
Personal Signature



SCRIBER

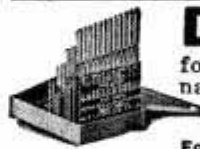

DRILL-INDEX

A compact container for indexing and filing twist drills. Eliminates search. Made entirely of steel in nine sizes. See your dealer or write to

HUOT MFG. CO.
Foot Schultz Bldg. St. Paul 1, Minn.

BUILD these ENGINES

GAS and STEAM NO CASTINGS! NO SPECIAL TOOLS!

All you need is a small lathe and some scrap shafting. Plans and detailed instructions for these and other high speed engines available. Illustrated literature on request. Write today.

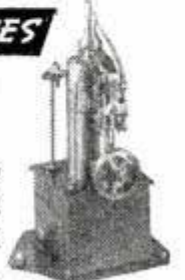

FREE
CATALOG

R. W. ROWE ENGINEERING
DEPT. B, 8889 APPOLINE DETROIT 27, MICH.

GET THE "BIG 3" OF

OUTBOARD MOTORING



It is Johnson that gives you the big three of outboard motoring: 1—Reverse, with 360° Steering. 2—Dual Carburetion, which makes low trolling speed possible in a powerful motor. 3—Perfected Alternate Firing, for silken smoothness. You get them *ALL* in a Sea-Horse! Plus 24 other quality features. Plus the advantage of our famous dealer-service organization trained and equipped to keep your Sea-Horse in tip-top condition.

Write for a copy of the new Sea-Horse Handy Chart, describing all Johnson motors. And see your Johnson dealer. Look for his name under "Outboard Motors" in your classified phone book.

JOHNSON MOTORS, 400 Pershing Rd., Waukegan, Ill.

JOHNSON SEA-HORSES for DEPENDability



WELD ANYTHING ANYWHERE ANYTIME

ALL PURPOSE ARC WELDER
9 Models . . . 32 Volt D.C., 110 to 440 A.C.

A complete workshop in itself! Weld, cut, braze or solder any type metal; iron, castings, aluminum, steel, bronze . . . in any gauge or weight, with equal ease. Compact, complete, sturdy as the Rockies. Formed steel and cast aluminum case, welded steel base, 4" cast wheels. Built with voltage control. Better on R.E.A. lines. No training needed. Sold throughout the world. **Unconditionally guaranteed for 2 years. Fully equipped—ready to use.**

FORNEY MFG. CO.
FORT COLLINS 2, COLORADO

BOILS WATER IN 3 MINUTES



UNCONDITIONALLY GUARANTEED

Wonderful for Homes, Cabins . . . Trailers . . .
Wherever hot water is wanted QUICKLY

ELECTRIC WATER HEATER

Immersion type . . . drop it into the water . . . it heats a basin or a sinkful pronto. 110 volts AC-DC. Comes with extra long heavy duty waterproof cord. Weighs 1lb. We'll mail it C.O.D. **\$245**

Write for Big free Trailer Parts Catalog

NATIONAL TRAILER STORES
Dept. 10, Box 2353 Terminal Annex
LOS ANGELES 54, CALIF.

Plus C. O. D. and postage

BRUNO SPECIAL Christmas Kit



What a gift for a man who likes good tools—two adjustable hole cutters in a colorful new box with a gay Christmas wrap! Plastic protective case keeps tools clean and blades sharp. One Bruno does the work of many fixed radius cutters—high speed steel blade makes clean, fast cuts in metal, wood, plastics. Easily sharpened. Available with square or straight shanks. **MONEY BACK GUARANTEE.** At all hardware stores or order direct Dept. PM-12.

 Beverly Hills, Calif.

ONLY \$785

Contains 2 Adjustable Hole Cutters that cut any diameter 3/8" to 2 1/2"

FOR HAPPY HOBBY DAYS!

THE FAITHFUL
HEART
OF YOUR FUEL
SYSTEM



AC

FUEL PUMPS

Pulsing steadily, hundreds of times a mile, your AC Fuel Pump is the strong, reliable heart of your fuel system. It has given you long, faithful service because of its inbuilt quality and scientific design.

You can prolong that faithful service indefinitely, if you insist upon an AC when you replace your present pump with a new or rebuilt one.

AC SPARK PLUG DIVISION • GENERAL MOTORS CORPORATION

ocean. Semipermeable pipes buried in the soil permit enough moisture to seep through and yet hold back the salt. At present, however, the cost is almost as prohibitive as that for evaporation and condensation of sea water.

The Colorado River constitutes the last important fresh water source which can be made available for southern California. Since it will be adequate for only another 100 years if the region continues to develop at the same phenomenal rate as in the last century, the day may come when California will look to the Pacific Ocean for drinking water.

Other arid areas of the world which adjoin the sea — such as the west coast of Mexico, northern Chile and Peru, the sea-coast of Arabia and Iran, and Australia's dry west coast—may some day be turned into productive farmland through the use of purified sea water.

While oceanographic research has done much to solve the mysteries of the sea, our knowledge of the ocean is woefully inadequate. Only about .1 percent of the world's scientists are engaged in oceanographic research. More is probably known about the face of the moon and the movements of distant stars than of the floor of the sea and the movement of ocean currents.

Approximately 71 percent of the earth, or 140,000,000 square miles, is covered with water. The average depth is approximately 12,500 feet while the average elevation of land above sea level is only 2300 feet. This means that if all the irregularities of the earth's surface were smoothed out, the resulting sphere would be covered with about 7500 feet of water.

The practical aspects of oceanographic research—together with the natural curiosity of man—should insure the continuation and expansion of the investigations of this last great unexplored frontier. Maybe science will even find a way to get that \$30,000,000,000,000 in gold some day!

Fifty-Watt Ten-Meter Transmitter for Beginners

(Continued from page 231)

neutralizing, some small neutralizing capacity is provided by means of short lengths of No. 14 wire mounted on feed-through insulators on each side of the tube socket and connected to tube grids 2 and 7; capacity is varied by moving the wires closer to or farther from the plates of the tube. One of these n.c. wires is clearly shown in photo C. Once the oscillator is working properly, plate voltage can be ap-

(Continued to page 252)

"Our garage could have been a mile from the house..."

Writes LLOYD A. TUPPER
Highland Park, Illinois

Minneapolis Honeywell Co.
433 E. Erie St.,
Chicago, Ill.

Attention Mr. W. Baak

Gentlemen:

Our garage could have been a mile from the house and just as much heat would have reached the rooms above it.

Auxiliary heat was always needed until your engineers got to work on the entire heating plant. Moduflow was installed together with some minor changes in the distribution system

The same plant now keeps those rooms over the garage comfortable in any kind of weather and in addition the heat is more evenly distributed throughout the entire house

Your engineers did a wonderful job.
We're all very happy.

Very sincerely,

Lloyd A. Tupper
177 Lakeside Manor Road
Highland Park, Ill.



MODUFLOW FOR APARTMENTS

NOW — "Personalized" heat control brings Moduflow to new and existing apartment buildings. It will be a "must" in modern apartments just as the mechanical refrigerator is today.



Have you a room that is "a mile from your house" so far as heat is concerned? Are your floors drafty? Have you "shiver spots" in some rooms? Are you wasting fuel?

Moduflow, the remarkable new heating system developed by Minneapolis-Honeywell, has cured such "heating headaches" in thousands of homes throughout the nation. For Moduflow is entirely different from ordinary on-and-off control systems. It furnishes heat *continuously* at whatever temperature is required to maintain comfort in any kind of weather. It does away with the drafty floors, or wasteful overheating, caused by ordinary intermittent heat supply.

Minneapolis-Honeywell Regulator Co., Minneapolis 8, Minnesota.
Canadian Plant: Toronto 12, Ontario.

Moduflow can be simply and inexpensively installed on practically any type of central automatic heating plant. You don't have to remodel or wait until you build a new home. Of course, if you are planning to build, your new home deserves the "Comfort Unlimited" that Moduflow has brought to the Tupper and to thousands of other homes. So, get the whole story of Moduflow. Just mail the coupon for the fascinating booklet, "Comfort Unlimited."

MODUFLOW

The New HONEYWELL Heating Control System



FREE!

SEND FOR THIS BOOK

Attractively illustrated, easy to read and understand; tells how MODUFLOW control can be applied to your automatic heating plant.

MINNEAPOLIS-HONEYWELL REGULATOR CO.
2756 Fourth Avenue South, Minneapolis 8, Minn.

Please send my free copy of
"Comfort Unlimited"

Name _____

Address _____

City _____ State _____

A really DIFFERENT Gift!

Give him a Smokemaster and make every day a holiday from rank, biting moisture

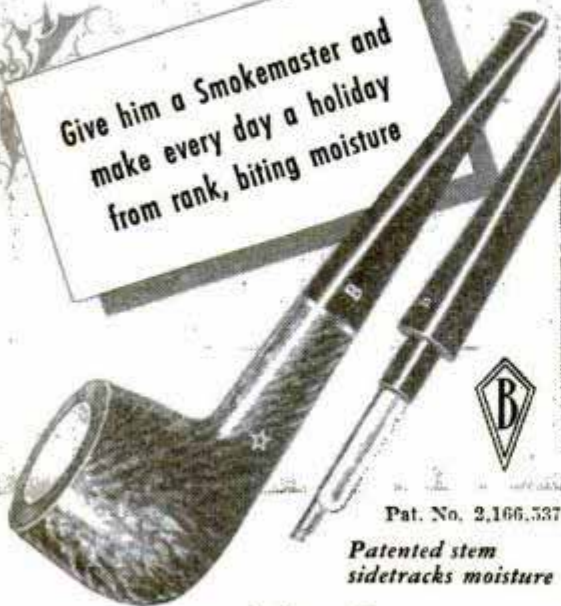

Pat. No. 2,166,537

Patented stem sidetracks moisture

Briarcraft Smokemaster

Here's the perfect answer to the perplexing question, "What can I give him that's different?" For Smokemaster is a completely different kind of pipe—a moisture-proof pipe that's always clean-tasting and sweet-smoking.

The exclusive Smokemaster stem sidetracks all moisture from the smoke passage as quickly as it forms . . . Prevents harsh, biting juices from contaminating the smoke.

Smoke passes through a special built-in metal tube which is slotted at the bottom. An ordinary pipe cleaner is folded and inserted into the stem just beneath the slot. As moisture condenses in the tube, it is instantly absorbed by the pipe cleaner.

At leading retailers everywhere in a full range of shapes.

Smokemaster Custom-made \$1.50

Smokemaster Standard \$1.00

Briarcraft, Inc., 347 Fifth Ave., New York 16, N.Y.

SAY YOU SAW IT IN POPULAR MECHANICS



STURDY STEEL CONSTRUCTION

Length Overall: 14"
Diameter: 1 3/4" OD
Lugs: 1/4" x 1 3/4" x 3 3/8"
Shaft: 1/2" or 3/8" Optional

POST PAID
\$8.00
IN U.S.

HEAVY DUTY, BALL BEARING, ALL PURPOSE MANDREL SHIELD PROTECTED

BALL BEARINGS . . . Ground precision type. Smooth running, vibrationless, long life. Completely shielded on exterior side.

SHAFT . . . True running, high quality Bessemer stock. Ends machined to accept bearings and eliminate longitudinal play. Work end has die-cut U. S. Standard threads. Pulley end machined and provided with milled flat to accept Standard size pulleys.

RIGID BODY . . . One piece heavy gauge SEAMLESS STEEL TUBING with welded-on mounting brackets. Ends internally machined to provide solid thrust supports for bearings.

WASHERS . . . Machined inside to provide firm grip on saw-blade, emery wheel, etc., and outside to provide hub, contracting inner bearing race transferring thrust to bearing only.

FINISH . . . Yes, it has "EYE APPEAL!" Body and brackets of lustrous, gray enamel. Hex nut and washers cadmium plated. Completely in harmony with any and all other fine equipment.

Now in use in thousands of workshops, machine shops, garages, hobby shops and on farms for saws, emery wheels, pulleys, buffing wheels, brushes, etc.

In ordering be sure to specify shaft size desired. Send money order or certified check.

CECO WHIZZ!!

10" All-Purpose Wheel



Double Radial Ball Bearings give this wheel speed plus! Puncture proof balloon—10" x 1 3/4". Heavy duty wheels — for racers, 4 wheel trucks, wagons, market carriers, golf bag carriers, scooters, garden and porch furniture, etc., etc.

Ceco "Whizz" wheels are completely assembled; ready for immediate use. They're smooth, quiet, stream-lined, STURDY. (We have axles and other parts: ask for prices.)

Cash with order or P.P., C.O.D. Supply limited; order today!

Dealers—Write for Quantity Prices.

\$2.75 COMPLETE
Including Tire and Bearings
EACH Set of 4—\$10.80

CECO SALES CO.

164 - 25th St., Brooklyn 32, N. Y.

Appliance \$10.95 Tester



LOCATES TROUBLE INSTANTLY IN ALL ELECTRICAL DEVICES

In this single unit are all the necessary tests for examining every appliance. Checks thermostats under working conditions. Tells instant it opens or closes. Controls heat on soldering irons. Prevents over-heating. Tests continuity, open circuits, automatic irons, vacuum cleaners, motors, coin machines, bulbs, 3-way switches, etc. Great time and money saver! ONLY \$10.95 COMPLETE, POST-PAID. NO C.O.D.'s, MONEY-BACK GUARANTEE.

Pat. Pend.

FREE with each Tester. New, Complete Practical Course in electrical appliance repairing. WRITE FOR CIRCULAR.

HANLAN CO., 1419-A, West Jefferson, Los Angeles 7, Calif.

SPECIAL!

Delco Permanent Magnet Motor 27V (D.C.). Runs off a 6V. battery. For miniature or model \$3.00 trains, boats etc.

Diamond Dressing Tool (used) for grinding wheels or cutting glass. 4/5 of diamond still use—\$1.50 able

Eye Levels (Govt. Surplus). Well constructed. Handy for \$1.00 many uses

All Prices Include Packing & Postage! Please remit in cash, U. S. Postal notes or international money orders.

Holland Hardware Co., Inc.
24 VESEY ST., New York 7, N. Y.

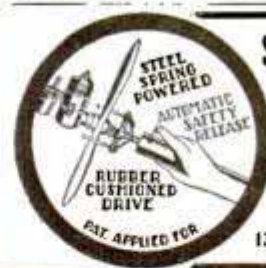

SPINIT—GAS MODEL STARTER

Ideal For Model Plane Builders

Gas model fans, this is IT! "If it will run—a SPINIT will start it!" Sturdily built. Finger tip release. Makes model flying more fun. Available at dealers; Standard model, \$4.00. Write for folder!

STREED ELECTRIC CO.

1315-A Harmon Pl., Minneapolis 3, Minn.



When you want to fix things fast . . . remember Weldwood Glue. It's quick to mix . . . easy to use . . . tremendously strong . . . stain-free . . . rot-proof . . . and permanent. At hardware stores, lumber yards, chain stores.



WELDWOOD
PLASTIC RESIN
WATERPROOF GLUE

UNITED STATES PLYWOOD CORPORATION, New York 18, N. Y.

PHOTOGRAPHERS:

PRINT PHOTOS
ON
BOOK COVERS!



CHINAWARE!



RECORD
ALBUMS!



GLASS
SILHOUETTES!



WOODEN
JEWELRY!

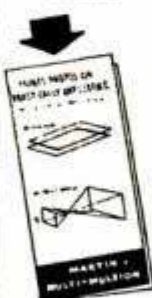

PHOTO MURALS
DEN WALLS!

Now You CAN PRINT PHOTOS
ON PRACTICALLY ANY SURFACE!

EASY TO USE — BY CONTACT, BY PROJECTION
— ON METAL, GLASS, PAPER, PLASTICS, WOOD, ETC.

Get This
Free Booklet
From Your
Dealer!



Let your imagination go! Find new uses for your photographic hobby! Put those pictures you prize most on display in hundreds of interesting ways. It's all possible with the new Martin Multi-Mulsion—a simple, practical emulsion which sensitizes almost any surface for photographic reproduction. Ready to use. Applied in one coating with a brush or cloth. Works with ordinary darkroom equipment. The Glenn L. Martin Co., Baltimore 3, Md.

ASK YOUR DEALER ABOUT

GLENN L.

Martin

MULTI-MULSION



ANCO RAIN-MASTER

"Dead-Locker"

WINDSHIELD WIPER
ARMS and BLADES

BLADE SNAPS ON...
STAYS PUT

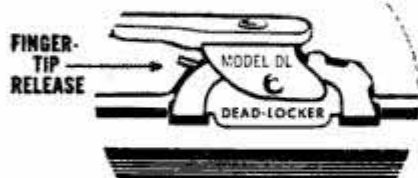

CAN'T FALL OFF
CAN'T BLOW OFF

(A war-born invention—by ANCO—first)
for military aircraft—now for your car.)

DON'T SHOOT YOUR GAS-PUMP MAN!

He's doing the best he can. Sure, he knows how dangerous it is for you to drive your car... in stormy weather... with your dull old windshield wipers that smear and smear. He'd gladly put on for you quickly a pair of keen new ANCO RAIN-MASTER Wiper Blades and Arms. He has them—Newest Models! But he forgets to remind you? Too busy? You can't shoot him for that!



After all, it's *your* car to protect. So *you* remind *him*. Get RAIN-MASTERS... patented features... original equipment on many makes of high grade cars and trucks... used in war—on our fighting tanks and trucks and ships and bombers too... because ANCO RAIN-MASTERS clean quicker, clean cleaner... last longer. May save you a costly smashup.

Ask for RAIN-MASTER Windshield Wiper Arms and Blades next time you buy gas.

THE ANDERSON COMPANY

Established 1918

GARY, INDIANA

plied to the amplifier section. A 0 to 200-mil meter should be plugged into jack J₃ to check cathode current. The key is cut in at X or it may be plugged in at either J₁ or J₃; the modulator terminals at the rear of the chassis are shorted, of course, when the rig is used for CW. C-bias is supplied by a 45-volt "B" battery. With the key down the transmitter should show a cathode current of about 40 ma. with the meter in jack J₃. Now when the antenna is coupled to the final tank this cathode current will rise to 175 mils. Grid current measured in jack J₂ should be 6 to 10 mils.

It will be noted that there are two sockets for crystals; one is for a spare. A simple dipole antenna using resonate feeders is detailed in Fig. 3; it is cut for 15-meter operation but will also work very well on 10 and 20 meters. Detailed student material list R-350 is available from Popular Mechanics Radio and Electronics department upon receipt of ordinary letter postage.

Home Town Circus

(Continued from page 157)

cialties of their own such as juggling or stilt walking and try out for places on the program. Although some of the acts remain basically the same they all are re-vamped each season.

In a sense the community circus "just happened." Gainesville has no traditional connection with circus life. It is a town of 12,000 population, 70 miles north of Dallas, and is the trading center for adjacent agricultural and petroleum areas.

The circus got its start back in 1930 when the Gainesville Little Theater decided a burlesque circus performance might bolster its bank account. Some of the members of the theater concocted odd costumes and dressed as clowns; some assembled spangled costumes and rehearsed simple stunts in the air, while others hastily taught their pet horses and dogs a few tricks.

Spectators liked the first performance so well that extra shows were held, and the performers enjoyed themselves so much they planned a bigger and better circus for the following year. That was the beginning, and soon neighboring towns were demanding to see the Gainesville circus.

The performers decided they would continue to act as unpaid amateurs but would charge money for the show. The cash would go into the treasury and would be spent for more elaborate costumes, a fireproof tent and other paraphernalia.

Today the community circus plays from eight to ten engagements per season and

(Continued to page 256)

NOW! Lionel Electronic Control

(FIRST TIME IN THE WORLD
AND EXCLUSIVE WITH LIONEL)

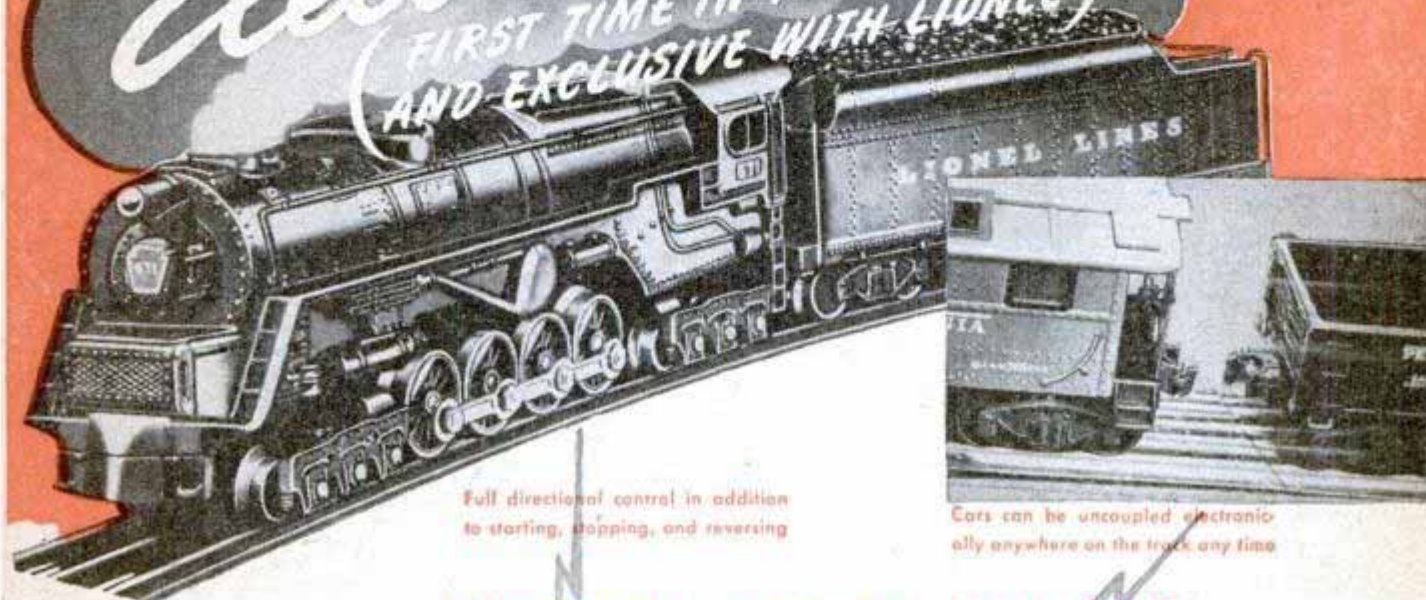

Full directional control in addition to starting, stopping, and reversing

Cars can be uncoupled electronically anywhere on the track any time

Cars can be unloaded electronically anywhere on the track layout

Simple to operate — just push the selective button

With LIONEL Electronic operation every unit of the train is under constant selective control ANYWHERE on the track. Electronic Control operates this way:—sensitive receivers on each car respond to Radio Frequency waves and make the cars or locomotive perform just as you direct. (No special wiring to track necessary).

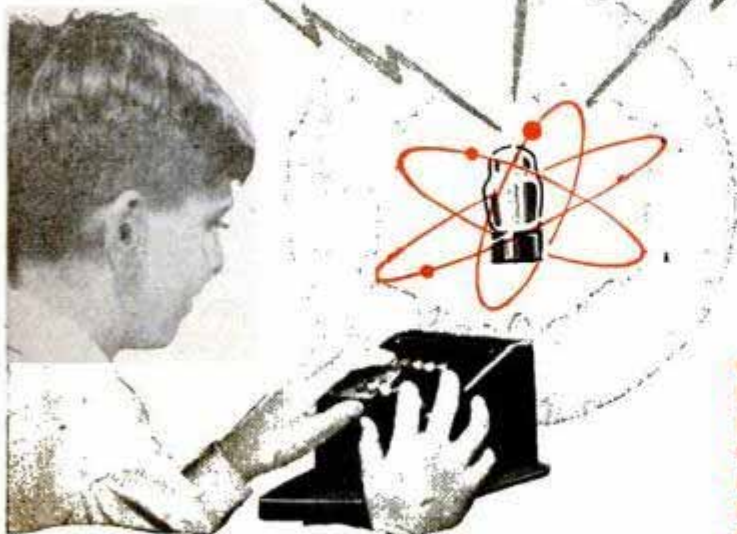

**LOCOS PUFF SMOKE
- WHISTLE LIKE REAL TRAINS**

*Send for
Color Catalog*

and SCENERY BOOK,
plus secret
"POP PERSUADER"



The Lionel Corporation, Dept. P.M.
15 East 26th St., New York 10, N. Y.

Please send me the new full color LIONEL TRAIN catalog, also the secret "Pop Persuader" and the book on Scenery Building. I enclose a DIME to cover postage and packing.



NAME _____
ADDRESS _____
CITY _____ ZONE _____

Please don't delay! Mail today!
Send 10c for mailing.

Useful Tools



This popular Set will come in mighty handy

if you work on an  or a  or a  Contains 7 thin wall sockets ranging from 3/8" to 3/4" with 3/8" square drive, a Hinge Handle and Cross Bar, all in a Steel Box.

Ask your jobber or dealer for the 40-T set.

WALDEN WORCESTER WRENCHES

STEVENS WALDEN, INC.

WORCESTER, MASSACHUSETTS

Give A Practical Gift for Xmas—

UNIVERSAL GRINDER and ARBOR SET



6" high x 7" long Base 5 1/4" x 6"

\$7.95

COMPLETE

An unassembled kit anyone can assemble it in fifteen minutes to half an hour



A powerful series wound motor with 6' cord and plug; 3/32 collet chuck will take all standard drills, reamers, mandrels, grinding wheels, etc., up to 3/32".

We ship to any part of the U.S.A. via Railway Express. Quantity is limited and requests are filled in the order received, so order your set at once. Send Check, Money Order, or Cash.

GENERAL AIRE CO. DEPT. PM-12 447 W. NORRIS STREET PHILADELPHIA 22, PA.

Here YOU ARE **WOODWORKERS**

THE NEW **CONSTANTINE MASTER MANUAL**

Bigger and better with more new pages of helpful articles and information on materials and supplies. Hundreds of familiar items back again; dozens of new additions including lumber, veneers, inlays, plywood, tools and finishing materials. The greatest 25c worth ever offered craftsmen and woodworkers. In addition, without charge, a year's subscription to Chips & Chats to keep you up to date on craftsmen's activities and many bargains. Send 25c now to **ALBERT CONSTANTINE & SON, INC.** 7915 East 135th St., New York 54, N. Y.



FREE 1 YR. SUBSCRIPTION TO **CHIPS & CHATS**

MAKE HUNDREDS OF FASCINATING **Radio-Electrical EXPERIMENTS**



Only \$4.99 POSTPAID U.S.A.

IDEAL XMAS GIFT FOR BOYS! Radio Electronic Experiment Kit

50 Piece Genuine Commercial war surplus Electronic apparatus. Includes headphones, capacitors, potentiometers, resistors, fuses, sockets, hook-up-wire, etc. Build hundreds of fascinating experiments. Learn electronics at home. Send \$4.99 for kit, complete instructions, also blueprint for home lab bench. Or send COD. **LECO ENGINEERING CO.** Box 931-PM3, Lincoln, Nebraska.

WANT TO BE INDEPENDENT? You can go into business for yourself. Learn the Stephenson Method of making and fitting corrective arch supports. Not medical—not chiropody. Men and women earn \$50-\$100 weekly in this respected profession. Learn at home on easy terms, no other capital needed. No goods to buy, no agency, you become your own boss at once. Write for our free booklet! 51 years in business. **THE STEPHENSON METHOD** 2812 BACK BAY, BOSTON, MASS.



Balance 4x9x4 1/2. With either Metric or Avoirdupois Weights \$600

All metal construction. Capacity 100 grams or 4 ounces. Send 10c for 36 Page Book Laboratory Supplies, Chemical & Apparatus of all descriptions.



HANDY BALANCE FOR ALL PURPOSES Photographic, Chemical Work, Etc. The ideal all-round scale for general laboratory work, neatly designed, accurate construction. Mounted on 4 x 11 base. The pans are of polished metal, 3 3/8" diameter with 7 1/2" beam. Balance measures 9 x 11". Furnished with 5 metric or avoirdupois weights \$5.00

STANDARD SCIENCE SUPPLY CO. 1236 N. Paulina Street, Chicago 22

LEATHER PANTS, JACKETS, VESTS Sheepskin Lined Zipper front, warm, light, wind-rain proof. Reprocessed like new. Satisfaction guaranteed. All sizes. **Pants \$10 Jackets \$18.75 Vests \$6.50** **NEW YORK CLOTHING CO.** DEPT. P.M., 2079 SECOND AVENUE NEW YORK 29

Big Money for Workers In Home or Shop

Licensed Concrete Specialists wanted. No experience needed. Make *Colorglazed* concrete pottery without molds. New, low cost, patented method. Cemetery products, novelties, tiles, etc. Basement leaksealing. Other big pay projects. Booklet, details free. Men only. **NATIONAL POTTERIES COMPANY** 542 Lincoln Avenue Fergus Falls, Minnesota



NEW! CLEAN POWDER LUBRICANT
WILL NOT SOIL CLOTHING!

Grafize
PACKAGE REG. U.S. PAT. OFF.



FOR CARS, HOME,
OFFICE, WORKSHOP

Positive lubrication in fine, clean, non-soiling powder form—in handy small bellows dispenser—blown by finger tip pressure—forms lasting lubricating film. No grit or abrasives.

Does away with squeaky hinges, bearings, casters. Frees sticking door locks, windows, etc. Lubricates working parts of over 1000 items. Get GRAFIZE now at hardware stores, auto accessory stores, filling stations. If your dealer cannot supply, write us for FREE SAMPLE giving dealer's name.

Schmidgall Manufacturing Co.
341 CASS STREET PEORIA 2, ILLINOIS

5 ROTARY CUTTING TOOLS IN 1



CENTER ROTARY CUTTER cuts holes, discs, grooves, beads, chamfers. Works in wood, plastics, soft metals. Only tool on market for decorative rotary work in all these. Maximum 5" diameter, 3" depth. 4 finest tool steel bits, one blank for special shaping. 3/8 inch shank fits hand or power tool chucks.

MODEL 101-A (illustrated) with high speed twist drill pilot, 4 bits, wrench, speed and lube chart \$3.50
MODEL 101-B with plain pilot, 4 bits, wrench, speed and lube chart \$2.50

Ask Your Dealer or Write

CENTER TOOLCRAFTERS, INC.

Jeff A. Hedden Co., National Sales Representatives
3184 ROSWELL ROAD, N. W., ATLANTA, GEORGIA
MADE BY WOODCRAFTSMEN FOR YOUR HOME WORKSHOP
Watch for Other Items in the Center Line



IDEAL GIFT FOR CAR OWNERS

The **HULL STREAMLINE AUTO-MOBILE COMPASS** is a quality instrument of time-proved reliability . . . used by hundreds of thousands of motorists and the armed forces. Universally acceptable, conveniently priced for Christmas giving. Price \$3.95. At your dealer's. Write for circular.



HULL MFG. CO.

P. O. Box 246-D13, Warren, Ohio

BUILD Boucher MODELS

CLIPPER

TANKER

FREIGHTER

Everything for the Model Ship Builder Since 1905

34 DIFFERENT
MODEL KITS
\$5 to \$35

Send 35c for 96
PAGE ILLUSTRATED
CATALOGUE

BOUCHER SHIP MODELS 36 EAST 12TH ST. NEW YORK, 3. N.Y.

3 in 1 OTTAWA SAW

THE WORLD'S FASTEST.

6-H. P.
EASY TO MOVE



**FELLS TREES,
SAWS BIG LOGS, SMALL LOGS, LIMBS**

One motor performs all three operations. Furnished with or without attachments shown below. Thousands in use.

Make **BIG** profits in the ever increasing wood business. Pulley for belt work. Fully guaranteed. Low direct-to-user prices. **FREE** details—write **TODAY**.

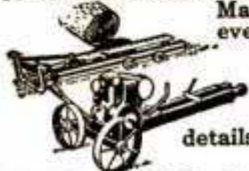

OTTAWA MFG. CO., 1227 Pine St., Ottawa, Kansas

Rolling your way!

The Great NEW 1947 HARLEY-DAVIDSONS

Thousands of riders — old and new — want the thrill of owning a 1947 Harley-Davidson. The new models, now on their way to dealers, are tops for streamlined beauty — champions in performance. What a wallop they pack in power and speed . . . ruggedly built for stamina! No wonder the demand is terrific! The sooner you see your Harley-Davidson dealer, the earlier you can enjoy exciting good times that come with owning a 1947 Harley-Davidson.



HARLEY-DAVIDSON
Motorcycles

HARLEY-DAVIDSON MOTOR CO.
Department P, Milwaukee 1, Wisconsin

Send free copy of 24-page "ENTHUSIAST" Magazine, filled with motorcycling pictures and thrilling stories.

Name _____
Address _____
City _____ State _____

SAY YOU SAW IT IN POPULAR MECHANICS



IF IT'S A MAKE-A-LITE —
IT'S A
Merry Christmas
FOR LUCKY CYCLISTS

BRILLIANT
ELECTRIC LIGHT

WITHOUT BATTERIES



PLAY SANTA CLAUS
RIGHT . . . WITH

MAKE-A-LITE

BICYCLE LIGHT Generator

GOOD LIGHT
EVEN AT A
WALK



An ideal Christmas gift for lasting year 'round enjoyment! No more bother and expense with batteries. Generates dependable electric light at all speeds—free of cost. Automatic voltage control generator prevents excess voltage and blowing of bulbs at high speed. Good light at a walk, brilliant light when riding. Be sure to see the new MAKE-A-LITE head lamps and tail lamps, too.

Easy TO INSTALL

Pays for
itself over
and over again!

Bike owners of all ages will thrill to MAKE-A-LITE'S efficiency and good looks. Play Santa Claus right with MAKE-A-LITE!

At Your Bicycle, Sporting Goods or Hardware Store

MAKE-A-LITE DIVISION
Chefford Master Mfg. Co., Inc., Fairfield, Ill.

turns down 30 or 40 other offers. It grossed \$25,000 in its biggest year before the war, shut down all its activities for the duration and opened again in 1946. Its present equipment weighs more than 75,000 pounds and is valued at \$15,000. This includes half a dozen ornamental parade wagons, public address system, "black light" electrical effects for some acts, seats for its three-ring big top, and a number of horses and ponies. Its latest purchase was a 53-whistle calliope for furnishing music during parades and performances.

In spite of a good income the circus officers and directors have to watch every dollar, for quite a bit of money is required to carry the organization over from season to season. Equipment must be stored each winter and the horses eat up big feed bills. Occasionally, too, a member gets hurt, though injuries are kept to a minimum by meticulous rehearsing of acts. Breaking an arm, being kicked by a horse, or spraining a back are the most common injuries, and medical bills are paid out of the treasury.

The riggings and properties used by the performers are designed and built by Alex Murrell and other members of the group, as are the seats and additional equipment. Most of the spangled costumes are put together during sewing circle sessions in the off season.

The full circus crew includes about 135 people, of whom no more than 45 are performers. The performers double up during the show so 100 different bits of entertainment can be presented. There's plenty of work for the nonperforming members. Tickets must be sold, programs and refreshments must be dispensed, and behind the scenes there are a dozen jobs before the show goes on and after it ends. The group employs a few paid hands.

Sometimes the circus travels by rail to a distant point but most of its performances are scheduled within a 100-mile circle of Gainesville. Men, women and children drive to the scene by automobile after working hours, with just enough time before the performance for a light lunch and a quick change into costume. Out-of-town engagements are usually held under the auspices of some local organization such as a county fair or a service club. No one loses more than 10 days from work during the season, not as much time as the average person takes for a summer vacation.

The circus performers range in age from 50 years down to 7-year-old Johnny Lucas who dresses up in clown costume and with an older brother exhibits the performing mule they have trained. For several sea-

(Continued to page 260)



STOP LEAKS!

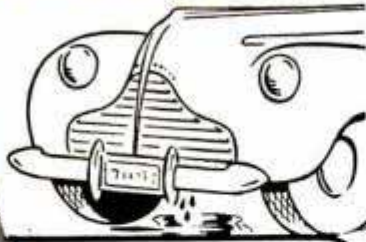

Cooling Systems Made Leak-Proof QUICKLY

WARNER LIQUID SOLDER—Non-Metallic—Deposits Tiny Fibers to Repair Leaks Anywhere in Cooling Systems. Simply pour in! Finds and REPAIRS every crack or hole. Do it yourself—or see your service man.

Warner-Patterson Co., 920 S. Michigan Ave., Chicago 5

Giffy
ELECTRIC HEATER

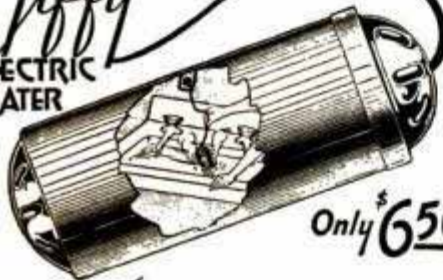

Only \$6.50

HOT WATER in 5 minutes

Send Money Order, Postage Paid or C.O.D.
Dealers Inquiries Invited—

The Ambory Corporation

21324 Stephenson Highway, Hazel Park, Michigan

CORROSION TROUBLE?

Use an oil that prevents rust while it lubricates
—shop appliances
—household devices
—mechanic's tools

Hardware and Sports Dealers

It's THE Triple Action Oil! Lubricates Prevents Rust Cleans

3-oz. SPOUT CAN 40¢

FIENDOIL

BUILD YOUR OWN ARC-WELDER

For Light or Heavy Work

No rewinding necessary—use coils taken from old auto generators.

Works on 110 or 220 A.C. Has 20 different heats. Complete plans and BIG Catalog 35¢. LEJAY MFG. CO. 3347 LeJay Bldg. Minneapolis, Minn.



"WONTWIST" ANIMAL TETHER



SAFE FOR ALL ANIMALS, BALL REVOLVES IN ALL DIRECTIONS.

Send Check or Money Order \$2.95 DEPT. P-6 Price Includes Delivery Charges

THE HAYDEN CO., Bryn Mawr, Pa.

AT LAST YOU CAN TIE-OUT YOUR ANIMAL SAFELY!

STRONG EFFICIENT



HERE THEY ARE

THE ORIGINAL

Paratroop Hunting Boots

The uppers are *waterproof elk*... for greater hunting, fishing and general outdoor utility. That's the only difference between these boots and the famous rugged and comfortable Paratrooper Jump Boots, made by Corcoran during the war.

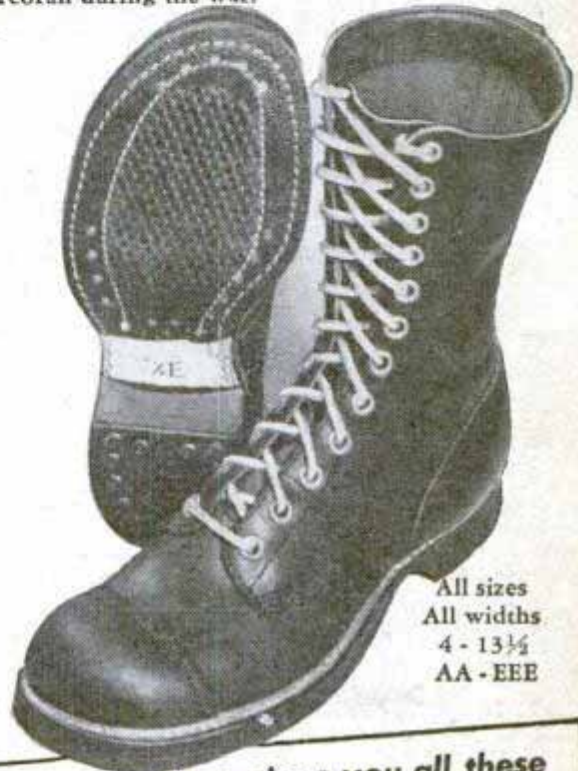

All sizes
All widths
4 - 13 1/2
AA - EEE

No other boot gives you all these EXCEPTIONAL FEATURES

- Made of soft, pliable elk with extra heavy oil waterproofing.
- Full 10 inch height gives proper support.
- Balanced construction gives ideal walking comfort.
- Special heel and toe construction prevents tiring.
- Counter, box toe and bottom filler all leather. Shank is made of steel.
- Heavy reinforcing tape on sides of instep prevents stretching and assures good snug fit.
- Middle sole is leather of outersole quality. Outside tap is rubber, sewed to middle sole in two places and nailed clear through to insole to prevent ripping off.
- Special Goodyear rubber heel gives maximum springiness and reduces hazard of tripping.

At this Amazing Low Price

These boots are not government surplus stock. We can offer them at this unusual low price only by selling direct to you. Money back if not satisfied on receiving them.

ONLY \$9.87 Plus Postage

Postage only is C.O.D.

CORCORAN INC., STOUGHTON, MASS.

Please rush a pair of Paratroop Hunting Boots. Check Money Order for \$9.87 is enclosed. I will pay postage C.O.D.

Name _____

Address _____

Size and width of Shoe _____

PM-12

S. CLAUS WORKSHOP

MERRY XMAS

SANTA USES AND RECOMMENDS THE BURGESS vibro-tool

60 cycles AC; 110 V.

Keeps on giving every day in the year! Writes names on tools, engraves jewelry, decorates glass, tools leather; cuts out cardboard signs and linoleum blocks. The ideal gift for man or woman boy or girl... for anyone interested in craft work or home workshop activities.

See your dealer or order direct.

Gives you the tool and 22 accessories, with sharpening stone... all conveniently accessible in handsome hinged, natural polish, wooden box.

60 cycles AC; 110 V.

\$16.50

HANDICRAFT DIVISION

BURGESS BATTERY COMPANY

166 N. Wabash Avenue • Chicago 1, Ill.

NEW SOLDERING GUN

WELLER SPEED IRON HEATS INSTANTLY



USE SPEED IRON FOR, Home Workshop, Radio Service, Telephone Installation, Electronic and Sound Maintenance, Appliance Repair, Laboratory Work.

New gun type soldering tool produces heat instantly by induction principle in soldering tip. Built-in transformer provides heating current when trigger switch is closed. Fast 5 second heating saves power, saves time, saves tip dressing and burning. Loop type tip is adjustable, gets into corners, lets you see where you are working. Short pistol grip gets you close to work, good balance makes tool very easy to handle. Can solder with aluminum solder or tin-lead solder. The soldering gun gives you for the first time really fast induction generated heat combined with real convenience of use. For the finest and most advanced soldering tool that money can buy, order a Speed Iron today! Price Complete \$14.95 Postpaid

ORDER DIRECT • MONEY BACK GUARANTEE

If not satisfied within 5 days

WELLER MFG. CO. 522 Northampton St. Easton, Pa.



HUNTER'S COMPASS

Hunting Case, Watch Type, All Metal, Jeweled Longines **\$2.50**

RUBBER SPORT GOGGLES

White Plastic Lens and Extra green Polarizing Lens, Plastic Lens are shatterproof, Polarizing Lens a protection against reflected glare, excessive light, dust and wind. Ideal for industrial use, Motoring, skiing and all kinds of outdoor use, Value \$3.50. **SPECIAL \$1.50** Per pair

Engineers All Metal Army Type Hand-Sighting

LEVELS

\$1.50



PUBLIC SPORT SHOPS

13 S. 16th St., Phila. 2, Pa.

No COD's



POLARIZED Rust Control



Again modern science has triumphed over an age-old problem. SHEATH eliminates the causes of rust! In its development, the world's best known rust preventives (lanolin, petroleum, synthetics, solvents new thin wonder oils) were blended... then, given...

The MAGIC OF POLAR ACTIVITY!

Thus was born an unprecedented discovery! No longer are corrosive elements grease-sealed to metal surfaces to continue their destructive work. SHEATH, through its amazing polarized action, goes through rain water, salt water, sweat, humidity, moisture, direct to the true metal surface and spreads and cleaves in a thin, soft, non-gumming film over the metal...

DISPLACES CAUSES OF RUST

Neutralizes the fingerprints, mildly lubricates as it protects. SHEATH can be applied in any simple manner. It loosens dirt and existing rust, prevents stains. 3-oz. kit bottle, ONLY 50c. 8-oz. bottle \$1.00. At your dealer's or postpaid.

BROWNELL INDUSTRIES, Dept. P-12 Montezuma, Iowa

MODEL MAKERS HOME HOBBYISTS SPORTSMEN

Attention: Protect your tools and equipment from the abuse of handling, use and storage. SHEATH withstands indefinite storage anywhere, counteracts elements — keeps new gear new — makes old look better, last longer.

New THOR "B" ENGINE - \$6.95

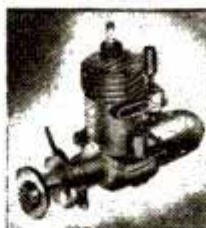

The new THOR "B"—Sensational miniature gasoline engine that really works. Super-power performance. Smooth, velvet power that roars into action with a "twist of the wrist." Over 15,000 already sold. 1/6 H.P. Complete with coil and condenser. Ready to run, only \$9.95. In KIT form, fully machined, 5 minutes to assemble, \$6.95, without coil and condenser. Powers all models. Fully illustrated instructions. Send \$1.00—shipped collect same day C.O.D. or send full price plus 25c extra and we ship parcel post insured.

FREE Just off the Press. Send for big 40-page illustrated hobby catalog with over 300 illustrations; over 1,000 listed items. The "Bible" of wide-awake modelers. Write for it now—no obligation, naturally!

AMERICA'S HOBBY CENTER

Dept. B126, 156 W. 22nd St., N. Y. 11, N. Y.

Sand Casting—Forging—Heat Treating—Case Hardening

BRONZE FOUNDRY



Is again available in limited quantity without priority. Orders filled in sequence as received. **INVENTORS—SCHOOLS—CRAFTSMEN** use FOUNDRYETTE for making castings quickly for new inventions, for instruction, and general purpose. Order now for early delivery. Three sizes are available capable of making bronze castings of 1½, 3, and 6 pounds weight, aluminum, copper, brass, etc., \$17.50, \$24.00, \$34.50, f.o.b. Kansas City. Domestic gas supply and 110 volt AC or DC energy required for operation. Write for circular.

KANSAS CITY SPECIALTIES CO. Box 6022, Dept. P-73

Kansas City, Mo.



Personalized
NAMECHAIN KEY CHAIN
Smells

YOUR NAME in full

DURABLY CONSTRUCTED

The Perfect Gift

Each NAMECHAIN made to your order — up to 14 letters allowed. Packed in gift box. Orders shipped in 48 hours. We pay' tax and postage.

- ★ GOLD PLATED \$3.50
- ★ STERLING \$7.00
- ★ SILVER

NAMECHAIN MFG. CO.
 19 East Pearson Street
 Dept. 41. CHICAGO 11

Portable Paint Sprayers

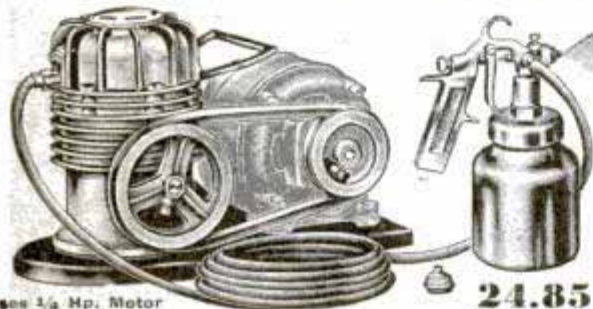

Uses 1/4 Hp. Motor

24.85

Complete as illustrated, less motor. Delivers 2 cu. ft. air per minute at 30 to 40# pressure. Sprays any kind of paint, lacquer, varnish. **SPRAY GUNS — 4.95** **25' AIR HOSE — 2.90**

INDIANA APPLIANCE CO.

20 East Sycamore Evansville 9, Ind.

BUILDING CONSTRUCTION



with composition cement and cheap wood builds 3 room house low as \$250, farm buildings low as \$50. Homemade forms make blocks, panels and tiles in color, and wallboard of sawdust and other compositions. Wall-high blocks, insulated, with finished sides. Stream-lined roof and walls. Cement gutters, trawled roofs and floors. Ten formulas. Cabins, stores and sectional. 100 money and labor saving ideas. Mixer and saw easily made from an old auto. Make doors and windows. 50 proved ways to earn \$10.00 to \$15.00 a day. Guaranteed, book, 100 illustrations, \$1.00.

MAKE FURNITURE OF COMPOSITION cement, sawdust, asbestos, paper. Some part scrap wood and metal. Illustrated instructions to make tables, cabinets, chests, racks, shelves, inclosed sinks, lawn novelties and toys, 500 per cent profit. 50c.

HOW TO MAKE ACCURATE SHOP MACHINES: Band, jig, and circular saws, electric drills, sanding wheels, force tools, electric wood cutters and many other things from old auto parts and washing machine motors. Illustrated. 50c.

HOME MFG. ENTERPRISES: 50 selected home shop projects, illus. 50c. **Special!** All four booklets described above, \$2.00 postpaid. No C.O.D. **HOME INDUSTRIES, 1318 So. 30th Ave., Dept. PM, Omaha 5, Nebr.**

LAWN ORNAMENT-NOVELTY PATTERNS

28 Lawn Ornament Patterns, 25c. Other patterns: 15-20" high; Dutch Girl, Dutch Boy, Pirate, Bull Terrier, Mexican Girl, Mexican Boy, Dwarf, Penguin, Flower Girl, 10c each. 25 Novelty Patterns, 30c. All 62 Full Size Patterns, \$1.00 Postpaid. **Strother Pattern Service Dept. P-8, Box 383, Belington, W. Va.**

ONE-MAN SAWMILL LESS THAN \$200.00

Easy To Turn Trees Into Money



Makes lumber, ties, shingles, crates, lath, studding, siding.

Belsaw Models in 10 to 24 foot sawing lengths. **MECHANICAL FEED,** accurate set works and positive dogs. Use tractor or old auto engine for low cost power. Thousands used for commercial sawing. Pays for itself quickly. Send post card today for FREE booklet, "How To Make Lumber" and Catalog of Woodworking Equipment. **BELSAW MACHINERY CO., 2811-F Field Bldg. Kansas City 2, Mo.**

315 Westport Road



STOP
Wasteful Leaks
in your
Heating System



Every crack, every leak, every loose connection, part or fixture in your furnace, boiler, tank, radiators and piping uses up heat.

Seal up those leaks promptly and effectively, like professional repair men do, with Smooth-On No. 1 Iron Repair Cement.

Smooth-On makes repairs that stay tight. Requires no heat to apply, no special experience. Keep a supply handy for emergencies. Get Smooth-On No. 1 in inexpensive 1 3/4-oz., 7-oz. or larger size at your regular hardware store. If they haven't it, contact us direct.



REPAIR HANDBOOK FREE

Practical, tested directions for ingenious, short-cut repairs around the house and garage. 40 pages. 170 diagrams. Pocket size, conveniently indexed.

-----SEND FOR YOUR COPY-----

Smooth-On Mfg. Co., Dept. 37
 570 Communipaw Ave., Jersey City 4, N. J.

Please send me a Smooth-On Repair Handbook.

Name

Address

12-46





YOU
ALWAYS
HAVE A

NEW CAR

IN THE
PALM OF YOUR HAND

*Start with the Finish and SIMONIZ it
For lasting beauty, greater protection*

Look again—new car or old? You can't tell by the finish because millions of motorists SIMONIZ from the start . . . and that keeps any car looking like new always. It saves the finish from damage by gritty mud, corrosive airborne chemicals and ultra violet rays. Saves washing, too. A dry cloth wipes off dust and dirt without scratching. If the finish on your car is already dull, restore the beauty with Simoniz Kleener . . . then apply SIMONIZ for protection.

THE SIMONIZ COMPANY, CHICAGO 16, ILLINOIS
Recognized for over thirty years as authorities
on preservation of fine finishes



sons the oldest clown was a county judge, age 65. Six people, including the Murrells and A. Morton Smith, newspaperman who is program director and announcer, have been with the circus since its inception.

All of the performers, old troupers and new ones, adhere to the old circus slogan: "The show must go on." Usually that means arriving at rehearsals and performances in plenty of time; occasionally it means a battle against rain, wind, hail and mud to get to the scene, set up the tents and equipment and start the show at the announced time. The circus has had its share of bad weather but has canceled shows only twice. Once the big tent was destroyed by a windstorm just before the show and no other tent large enough for the circus could be found. Another time the circus was rained out. It was impossible to drain the several inches of water that collected on the lot, and the same storm blocked the highways. Few if any spectators could be present and so the show was canceled. The following week, however, the "only show of its kind on earth" was playing to capacity crowds in a return engagement.

Inside the "Atom City"

(Continued from page 134)

University of Pennsylvania School of Medicine hopes to unravel some of the problems of diabetes by following the course of sugar containing radioactive atoms. The plan is to study a comparison of sugar and lactic acid metabolism in normal and diabetic animals. The University of Chicago will use Carbon 14 to study the processes by which plants take energy from sunlight and store it as chemical energy. The University of Minnesota plans to use tagged carbon atoms to trace the deposition of carbon compounds within the teeth and bones. The University of California will label fats with Carbon 14 and study their utilization by the liver, muscles and blood.

It is entirely possible, according to the Oak Ridge scientists, that atomic rays are capable of hastening or retarding old age. Dr. Howard J. Curtis, biologist at the Clinton Laboratories, reports that some types of radiation cause rats and mice to age rapidly and die prematurely. He predicts that this discovery will greatly aid the current scientific attack on the subject of aging.

Dr. Edgar J. Murphy, formerly chief of pilot-plant operations at Oak Ridge, recently pointed out: "It may be possible to find ways of using correct dosages and proper applications of radiations to extend the period of youth."

(Continued to page 264)

BETTER BY FAR

1 TURRET TOP, pioneered by Fisher Body, is formed of a single sheet of solid steel.

2 U-SHAPED STEEL ROOF BOWS are fused to the steel roof rails, affording extra ruggedness and shock resistance.

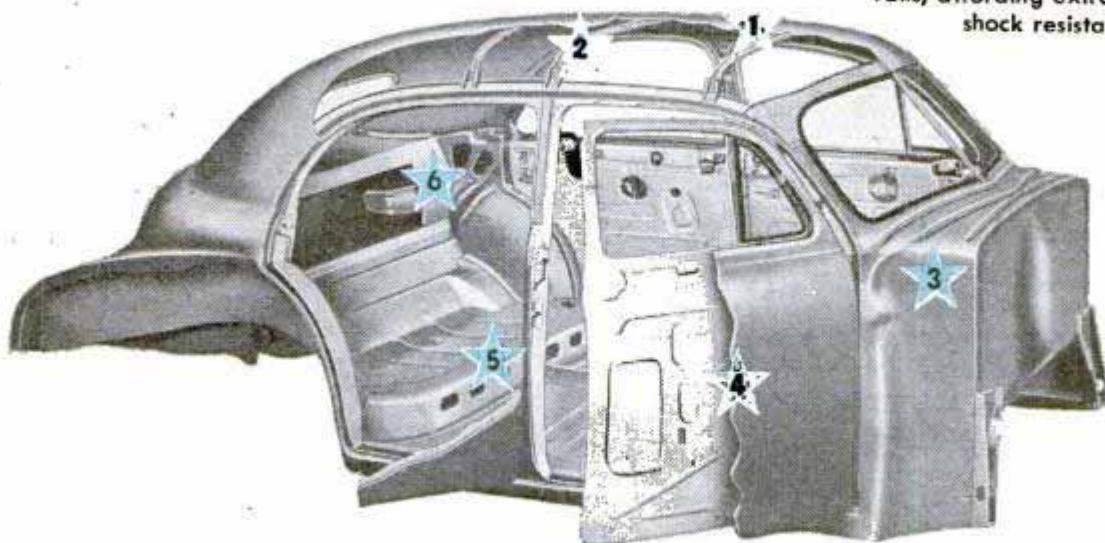

You'd know what we mean if you could watch one of these Fisher Bodies come down the assembly line.

Then you could see the extra steps we take to make them durable and rugged—how added strength and safety are built in by such features as you see listed at the right.

Your eyes tell you the new bodies by Fisher are beautiful when you see them on the road. And your knowledge of good craftsmanship will tell you they're "better by far" through and through, and that cars with Body by Fisher are well worth waiting for.

3 STEEL COWL AND DASH, ruggedly braced with a triangular truss construction, provide solid support for the front door hinge pillar.

4 Outer and inner DOOR PANELS are welded into one solid unit.

5 SOLID STEEL FLOOR, especially ribbed for extra strength, forms the foundation of the Unisteel Turret Top Body by Fisher.

6 BOX-TYPE REAR END BRACES give extra protection against weaving and twisting.

PLUS a long list of other features in design and construction, which would total more than a hundred.

Body by Fisher



BETTER BY FAR

Fisher Body Craftsman's Guild Model-Building Competition—8 university scholarships, 1212 other awards for boys 12 years of age and older. Enroll now! Headquarters: General Motors Bldg., Detroit 2, Michigan.

On the Air: HENRY J. TAYLOR, twice weekly.

You get Body by Fisher
only on
GENERAL MOTORS CARS

CHEVROLET • PONTIAC
OLDSMOBILE • BUICK
CADILLAC



The new 1946 Buick, Model 51
SUPER 4-door Sedan

BERNARDS work like a wrench. Parallel jaws fit snug on nut.

ORDINARY PLIERS

Cutters on outside of head. Easily cuts baling wire.

Breaks glass perfectly. Jaws close flat against glass.

Compound leverage greatly increases gripping power. Easily cuts 8-penny nail.

LESS WORK

Better Results

with **BERNARD** parallel action pliers

Just about the handiest, most efficient pliers a man ever had. Jaws close *parallel*, like a vise, hold fast, won't slip. Powerful cutters, on the *outside* of the head, easy to use, will bite through an 8-penny nail.

You'll do lots of jobs better and with less work with **BERNARD**... Your hardware merchant has them.

Send for complete catalogue of **BERNARD** tools.

WM. SCHOLHORN COMPANY
"Quality Tools Since 1870"

#402-6"

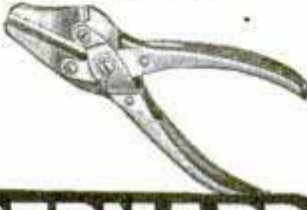

BERNARD

7512 Chapel Street
New Haven 9, Conn.

STOKER EMPTIES OWN ASH!

A remarkable stoker already used by thousands of home owners—fits into any furnace or boiler. Manufactured since 1934. So automatic it takes the coal from your present coal bin through a pipe to the furnace, going around corners if necessary. Keeps house at even temperature, empties its own ash in sealed containers, no coal to shovel, no clinkers to dig, only bituminous stoker of its kind on the market. Send for full information NOW!

POCAHONTAS FUEL COMPANY INCORPORATED
344 EAST 131st STREET • CLEVELAND 8, OHIO

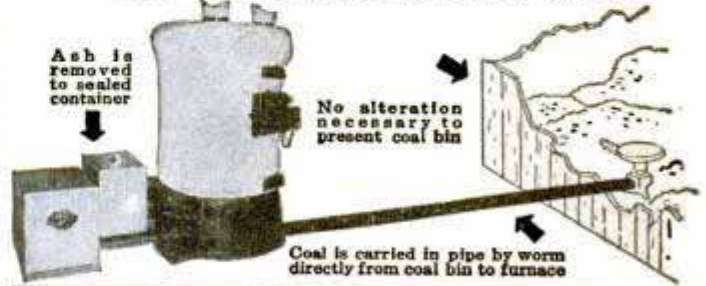

WOOD WORKERS

LUMBER—PLYWOOD AVAILABLE

Harold Hunt wants to send new No. 15 catalog. Over 148 pages of woodworking ideas. **UNEQUALLED BARGAINS** in imported and American woods, supplies, hard-to-find hardware. Send only 15c to cover postage and handling.

CRAFTSMAN WOOD SERVICE CO.
2729 S. Mary St., Dept. A-76, Chicago 8, Ill.

only 15¢

GIVE THIS FOR CHRISTMAS

Get This **NEW INVENTION**
CRACKS BLACK WALNUTS
BUTTERNUTS, ENGLISH WALNUTS

NO FLYING SHELLS

75% MEATS IN QUARTERS. Sold by all Hardware Stores or mailed direct for \$1.50 delivered. Send cash, check, stamps, or money order. Money-back guarantee. **C. E. POTTER, 263 Sapulpa, Okla.**



WALKIE SIREN

Formerly \$15.00 - Now Only \$3.95

GOV'T SURPLUS. A precision instrument. Easy turn of crank produces **CLEAR, FULL SIREN TONE.** Can be heard for great distance. Ideal for Boats, Autos, Schools, Sporting Events, etc. Dimensions 7" x 8" x 5". Wt. 4 1/2 lbs. Price includes shoulder strap and waterproof cover. **SEND NO MONEY.** Just name and address. We'll ship C.O.D. for \$3.95 plus postage, or send money in advance, we'll ship prepaid. Canadian price \$4.50. **ILLINOIS MERCHANTISE MART, Dept. 400, 1227 Loyola Ave., Chicago 26, Ill.**



CUSTOMER:
"That's a beautiful job, Pete."
PETE: "Yes, you can't beat the Foley for turning out a perfect cutting saw."

SAW FILING

is a Good Business

With the Foley Automatic Saw Filer you can have a fine cash business with steady customers and make a good living. The Foley automatically joints the saw, making all teeth even in size, shape, spacing. The Foley is the only machine that files all hand saws, also band and cross-cut circular saws.

SEND FOR FREE PLAN—Shows how to start a saw repair shop. No canvassing. Send coupon today.

FOLEY Automatic SAW FILER

FOLEY MANUFACTURING CO.
1216-6 Foley Bldg., Minneapolis 13, Minnesota
Send Free Plan on Saw Filing business, no obligation

Name _____
Address _____

SAFEGUARD AGAINST ATHLETE'S FOOT

and **BLISTERS** with **DALE VENT-O-SOLE, INC.**
45-7 Hallock St., Newark 4, N.J.



U. S. Army and British Govt. bought millions. Woven plastic shoe ventilator flows air under feet—helps prevent infection, keeps feet dry, rids shoes of perspiration. Retards fungi. Guaranteed. Free Folder.

MAKE BIG MONEY!

Be a floor surfacing contractor and send both new and old floors. Sanders are easy to operate and better still, you're your own boss. Write for latest "tell-all" booklet entitled "Opportunities in Floor Surfacing", enclosing 25 cents in coin or stamps to cover handling.

AMERICAN
FLOOR SURFACING MACHINE CO.
525 So. St. Clair Street • Toledo 3, Ohio

*It's a
Pleasure...*



... ON NORTHLANDS!

Expert and novice alike find it's easier to ski right on Northlands. Perfectly matched, carefully balanced Northlands are hand-built to give you better controlled skiing—greater skiing pleasure. Quantity limited, look for the Deerhead trademark.

★ Send 15c for Northland Ski Manual edited by Hannes Schneider or write for free booklet. Offer does not apply in Canada.

NORTHLAND SKI MFG. CO.
World's Largest Ski Manufacturers
95 MERRIAM PARK • SAINT PAUL 4, MINNESOTA

5 lbs. HANDY ASSORTMENT \$1.98
For Mechanics — Garages
— Workshops — Home Use

**SCREWS • NUTS • BOLTS • WASHERS
RIVETS • SPRINGS • BRACKETS • MISC.**



MORE THAN 1,000 PIECES—5 full pounds—a veritable treasure chest of fastening devices for every practical use. Satisfaction guaranteed. Order now... **\$1.98**
SPECIAL—2 assortments, over 2,000 pieces, for \$3.69.
Get on our **FREE Bargain Mailing List**—Many other valuable assortments to meet every need!
HUDSON TRADING CORPORATION
D1521 N. Wells St.
Chicago 10, Ill.

500,000!!!!

LENSES

Send 3 cent stamp for "BARGAIN" list.

A. JAEGER

BOX 84P SO. OZONE PARK 20, N. Y.

BOOKS FOUND FREE!

WHAT BOOKS DO YOU WANT?

We quote the lowest market prices. No charge for locating Hard-to-Find and Out-of-Print Books. All books, OLD or NEW, mailed **POST-FREE**.
SEARCHLIGHT BOOK CLUB, 22 East 17th St., New York City

PLASTAKIT

Make your own ornaments, decorations and jewelry designs out of plastic. Box of 60 pieces including pieces necessary to make your own pins, earrings, brooches and decorations. Unlimited uses. Send \$2... box sent postpaid. No C.O.D.'s.

WASHINGTON PLASTICS CO.

Dept. R Box 41 Pawtucket, R. I.
DECEMBER 1946

FREE

**ALLIED'S
1946 RADIO
CATALOG**



**LARGEST STOCKS
OF EVERYTHING
IN RADIO...**

SERVICEMEN! Dealers! Soundmen! Amateurs! Builders! Experimenters! Send for the handiest, most complete 1946 Buying Guide for Everything in Radio! Features latest radios, sound systems, amateur and builders' gear, thousands of radio and electronic parts—world's largest and most complete quality stocks—at lowest prices. Fastest service; expert help!



MORE THAN 10,000 ITEMS

Everything for every radio use: new model home radios, phono-radios, communications receivers, Ham kits, radio parts, tubes, tools, test instruments, public address equipment, easy-to-build kits, diagrams, instructive books—all at lowest prices!



HELPFUL RADIO BOOKS

- Radio Formulas & Data No. 37-752 10c
- Dictionary of Radio Terms No. 37-751 10c
- Radio Circuit Handbook No. 37-753 10c
- Radio Builders' Handbook No. 37-750 10c
- Simplified Radio Servicing No. 37-755 10c
- Radio Data Handbook No. 37-754 25c
- ALL SIX BOOKS No. 37-799... 75c**
- Parallel, Resistance and Series Capacitance Calculator. No. 37-960 25c
- R-F Resonance and Coil Winding Calculator. No. 37-955... 25c

ALLIED RADIO

ALLIED RADIO CORP.
833 W. Jackson Blvd., Dept. 5-M-6
Chicago 7, Illinois



- Send **FREE 1946 CATALOG**
 - Send Six Books No. 37-799
 - Send Books checked above
 - Send Calculators checked above
- } \$...enclosed

Name.....
Address.....
City.....Zone.....State.....

SAY YOU SAW IT IN POPULAR MECHANICS

Now! tests prove-

BRIGHT

STAR

BATTERIES



give more
bright light
longer

Here is your proof!

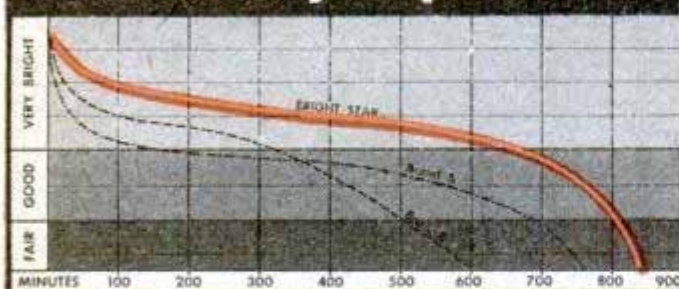

These results of vital service tests* prove that Bright Star batteries give you more *bright light* longer than the two other leading brands tested. Insist on the best—it's Bright Star by test!

*Chart based on laboratory tests conducted under government standards.

BRIGHT STAR BATTERY COMPANY, CLIFTON, NEW JERSEY

During research on the menace of radiations to workers in bomb plants, test animals were exposed to potent rays and death occurred in 10 to 30 days. If the radiation doses are large, of one type only and just below the killing level, or if they are small and repeated often over a long time, the animals die either of "old age," much sooner than normal animals, or of cancer.

Another promising research field expected to be investigated soon is radiation biochemistry. Besides their destructive chemical reactions, radiations may be able to synthesize certain organic compounds. This might be done in tomorrow's chemical laboratories on a commercial scale, according to Dr. Curtis.

Study of atomic energy no doubt will add to our heredity knowledge. By bombarding the eggs of insects with low-energy neutrons, it may be possible to produce mutations at a rate even higher than with X-rays.

Designed for Junior Engineers

(Continued from page 120)

A metal crayon kit appeals to parents. It permits selection of only one crayon at a time and it must be replaced before a second can be removed—calculated to teach neatness and color selection. Tiny electric washers will actually wash a handkerchief or dolls' clothing. Toy electric irons glow and become warm but will not burn.

Lightweight war metals are going into new model tricycles. One junior bicycle of magnesium weighs only 12½ pounds. Another manufacturer is building a tricycle with a frame of aluminum alloy so constructed that it can be converted to a high-front-wheel bicycle by removing the rear axle and one wheel. Several three-wheel models use chain drive. For the 2½ to 7-year group there is a four-wheel cycle, almost impossible to overturn. It steers with a wheel like a car and is propelled like a bicycle with a chain belt drive.

Metal construction sets are available again. With them or other build-your-own sets youngsters can make buildings, bridges, electric motors, steam engines, model airplanes, racing cars or locomotives. The educational value of these sets is enhanced by instruction books that carry practical information. With an electric motor kit, for example, there is a book of pictures, cartoons and diagrams which explain how it works and its relationship to electricity in television, X-ray and radio.

Another toy maker provides a merry-go-round or Ferris wheel along with a toy mo-

(Continued to page 268)

Boating's more fun

with
an

Evinrude "4"



From shove-off to "home again", every mile is more fun when there's an Evinrude "Four" on the stern of your boat. *More fun . . .* with four-cylinder starting ease, flexibility, responsiveness. *More fun . . .* with the thrilling surge of four-cylinder power that flows with matchless smoothness. Back of Evinrude four-cylinder models are millions of miles of fine performance, years of engineering advancement. A favorite four for small runabouts, fast family and fishing boats is the Lightfour. Weighing only 66 pounds, Lightfour develops 9.7 O.B.C. brake H.P. at 4000 R.P.M. See your Evinrude dealer — look for his name in your classified phone directory under "Outboard Motors". Catalog of complete line of 7 Evinrude models FREE. Address EVINRUDE MOTORS, 5396 N. 27th Street, Milwaukee 9, Wisconsin.

In Canada:
Evinrude Motors, Peterboro, Ontario



EVINRUDE

OUTBOARD MOTORS

WORKSHOP WISDOM

Laminated Salad Bowl ... Coasters

Use odd pieces of contrasting woods. Plane smooth. Spread on thin film of CASCAMITE and assemble as shown below. Clamp, and let set at 70° F. or warmer.

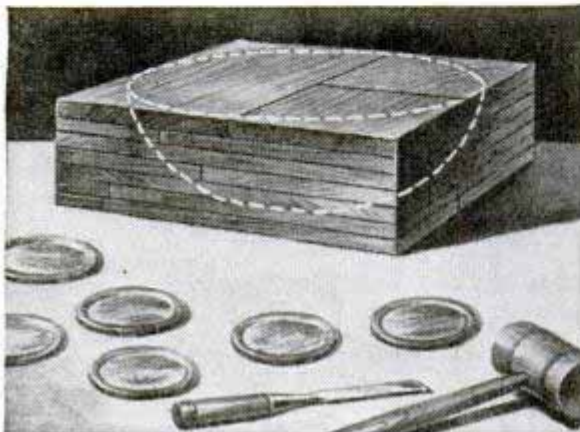

Stain-free CASCAMITE does not mar beauty of contrasting woods. Highly water resistant, too. Therefore, practical for salad bowls or coasters. Laminated pieces stronger than solid pieces.

Why folks prefer CASCAMITE:

Easy to mix. Just add CASCAMITE to cold water and stir.

Strong. CASCAMITE glue joints are stronger than the wood itself.

Economical. Mix CASCAMITE as you need it. No waste.

Get CASCAMITE—and CASCO, the standard casein household repair glue, at your hardware store—in 10¢, or 25¢, and larger sizes. For outdoor and boat work, use CASCOPHEN, the new, completely waterproof resorcinol-resin glue.

WRITE FOR FREE GLUING GUIDE: Contains complete gluing directions plus helpful hints for household repairs. Address a post card to: Casein Company of America, Dept. PM-26, 350 Madison Ave., New York 17, N. Y.



CASCAMITE

Dry Powder Urea Resin Glue

PRECISION-MADE STEEL WHEELS AND COLD ROLLED STEEL AXLES

To Build your Own Wagon Cart - Toy - Carrier, etc.

Sturdy, rubber tired, precision-made pressed steel wheels with red enamel finish. Ready to use axles—threaded at both ends. Acorn nuts supplied. Order today.

WHEELS WITH SOLID RUBBER TIRES	
4" Wheels, 1/4" bearing, Steel Disc.....	\$.75
6" Wheels, 3/8" bearing, Steel Disc.....	1.00
WHEELS WITH SEMI-PNEUMATIC TIRES	
6" x1.50 with 3/8" Selflube Oil Bearing.....	1.75
8" x1.75 with 3/8" Selflube Oil Bearing.....	2.25
AXLES, COLD ROLLED STEEL	
1/4" x14" long, threaded both ends, Nickel Cap Nuts	.40
3/8" x16" long, threaded both ends, Nickel Cap Nuts	.60
1/2" x18" long, threaded both ends, Nickel Cap Nuts	.80

Sent postpaid in U. S. on receipt of price.

CIRCLE METAL MANUFACTURING COMPANY
4266 E. PACIFIC WAY LOS ANGELES 23, CALIF.



GET THE BEST IN MUFFLERS V-8 DUALS & SINGLES

Finest Norman custom-built muffler sets—steel pack—torpedo type—heavy, perforated steel cores—chrome enamel finish—mellow, deep tone (improves with use)—designed to fit—all ways superior—double economy.

DUALS.....	\$17.50	SINGLES.....	\$7.50
V-8 Ford-Mercury		Buick, Olds., Chrys.	
SINGLES.....	\$5.50	ORDER TODAY! Will outlast	three ordinary mufflers.

Dealers—Write Today for Full Details

NORMAN'S MUSICAL MUFFLERS

Dept. PM-5, 1216 W. Slauson Ave., Los Angeles 44, Calif.



Write Dept. E for Free Catalog of 45 Kits Today

MEIER BRASS & COPPER CO.
1155 Bellevue, Detroit 7, Mich.

BRASS RODS For Home Work Shops

For use on model boats, airplanes, etc., keep a supply of these free-turning brass rods on hand. Kits available for all size requirements.

Say You Saw It in POPULAR MECHANICS

RACER POLISHED CAST ALUMINUM

8 1/2 inches long. Shining heavy single unbreakable casting. Free running rubber wheels. Can't rust. Trim, sleek lines. Looks like models selling up to \$12.00. Every youngster wants one.

DEALER INQUIRIES INVITED.
Barton Industrial Products Corp. Dept. 12
P.O. Box 1347, Beverly Hills, Calif.



SEND \$2.98

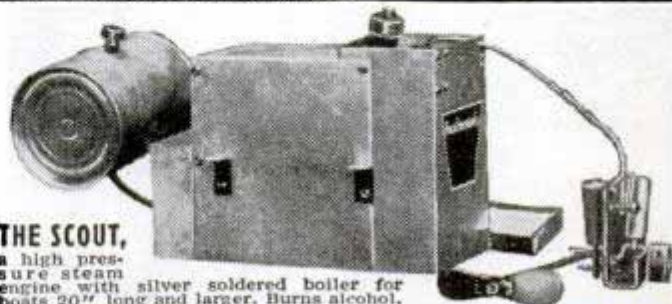

THE SCOUT,

a high pressure steam engine with silver soldered boiler for boats 20" long and larger. Burns alcohol. Runs 30 min. Drives a 2 1/4" propeller. Price complete ready to run with 70-lb. safety valve and accessories as shown... \$8.95
Postage extra, shipping wt. 4 lb. Distributors and dealers write for terms.
PHILIP STEVENSON CO., Box 162, Station D, Cincinnati 6, Ohio

Atlas - the compact, low-cost MILLER for tool rooms, production, commercial and home shops

Precision built . . . engineered for quick set-ups over a wide work range . . . the rugged, versatile Atlas miller greatly increases the scope of your shop. It handles all operations from slabbing and facing cuts to end milling, keyways, finishing, and layout work. Table travels 10" horizontally, 3½" cross, 6" vertically. Spindle speeds from 62 to 2870 RPM provide correct range for all types of work and cutters. Back geared power, complete V-belt drive, Timken bearings. Operates from 1/3 HP motor. Available now for fairly prompt delivery. See your Atlas distributor.

SEND FOR
FREE CATALOG



ATLAS PRESS CO.
1243 N. PITCHER ST. KALAMAZOO 13, MICH.

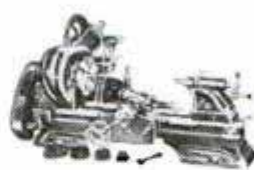

LATHES



DRILL PRESSES



MILLING MACHINES



SHAPERS

Atlas 4 TOOL TEAM

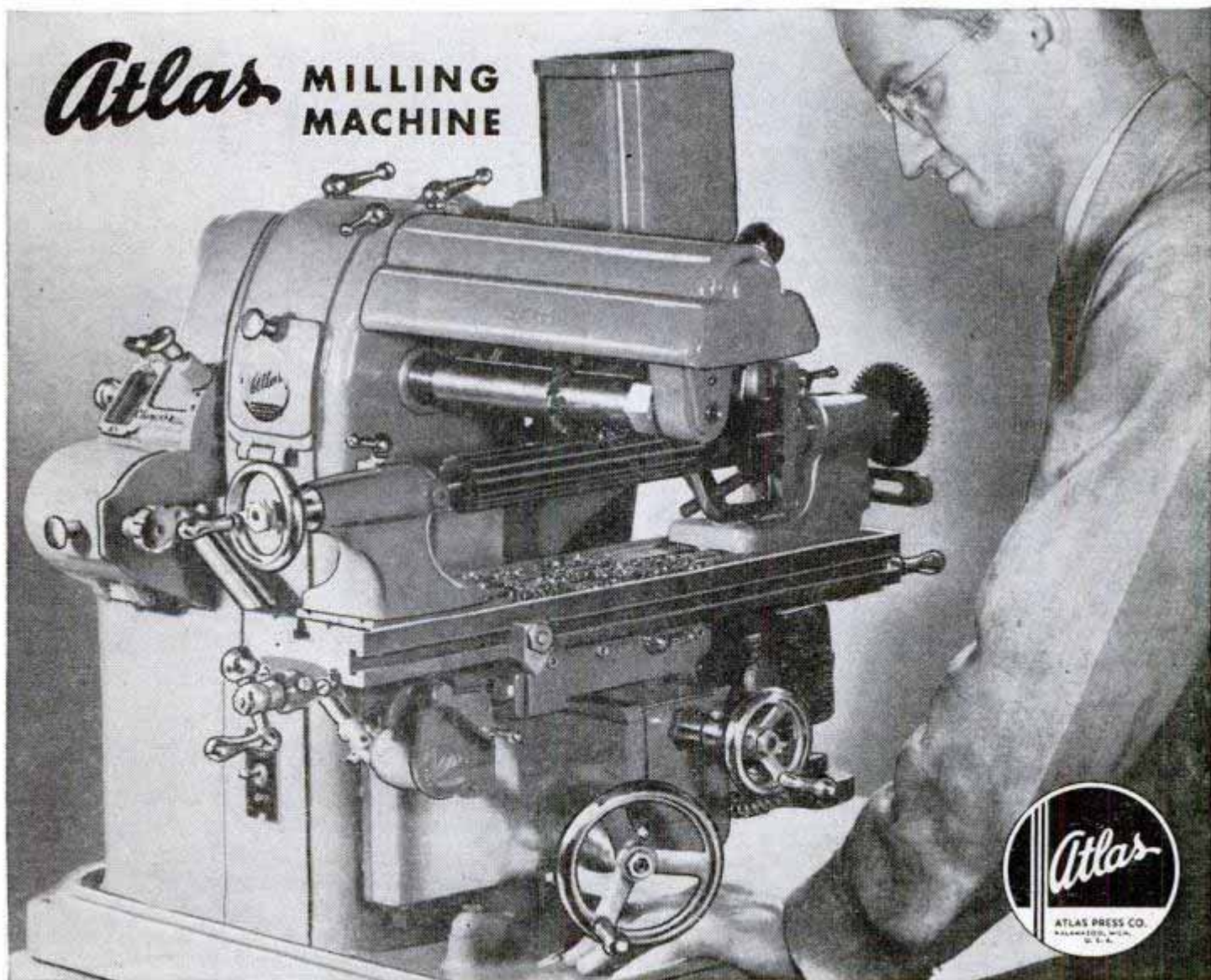

new!

PALMER WHEEL KIT eliminates "axle problems"

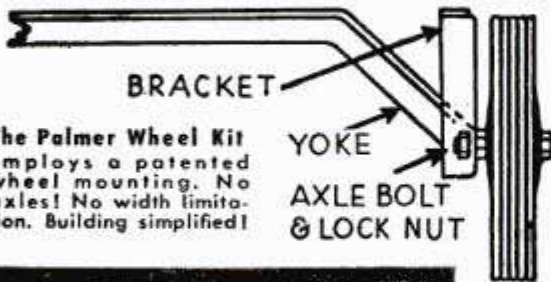

The Palmer Wheel Kit employs a patented wheel mounting. No axles! No width limitation. Building simplified!

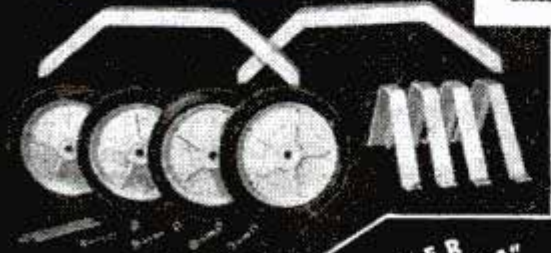

The ideal Xmas gift

for ages 8 to

80! Order now while
delivery may still be
made before Xmas.

Brackets and yokes are sturdy stamped steel; attractively finished in bright red baked enamel. Axle bolts are stainless steel... rust proof! Solid molded rubber tires with 1/4" treads wear longer than other types... do not mark linoleum or polished floors! Tires cannot loosen or slip due to special mounting process. Tests have shown 8" wheel able to withstand over 1000 lbs. vertical load. Compare **QUALITY, ECONOMY, DURABILITY**, with any other wheel kit!

PALMER WHEEL KIT "B" same as "A" except wheels are small diameter (5 1/2") with 3/4" molded rubber tire. **\$5.50**

Individual Wheels

8" DIA. with 3/8" bushings. \$1.40
8" DIA. with 1/2" bushings. 1.48
5 1/2" DIA. with 3/8" bushings .94

PALMER WHEEL KIT "A" contains four 8" steel wheels with solid rubber tires. (Grooved tread 1/4" wide). Four steel mounting brackets. Two steel yokes. Axle bolts, nuts and special wrench included. **\$8.25**

NOW you can design and build *"Anything on wheels"*

- Soapbox Racer
- Tool Cart
- Display Cases
- Scooter
- Mobile Caddy
- Wheelbarrow
- Market Carrier
- Rubbish Cart
- Bike Trailer
- Toy Wagons
- Boat Carriers
- Movable Furniture
- Luggage Mover
- Milk Can Cart

THE PALMER MFG. CO., Dept. 1
8115 Clinton Road, Cleveland 9, Ohio

Please send me: (indicate number of sets)

- PALMER WHEEL KIT "A"
- PALMER WHEEL KIT "B"
- 8" wheels, 3/8" bushings.
- 8" wheels, 1/2" bushings.
- 5 1/2" wheels, 3/8" bushings.

Enclose check or money order—all prices F.O.B. Cleveland, O.

NAME _____
ADDRESS _____
CITY _____ ZONE _____ STATE _____

tor. Steam engines have changed, too. One electric model has a plastic boiler that can withstand a 50-pound pressure. If the water boils out, the current automatically cuts off. It comes with a drive wheel and belt for powering models and it can be assembled with the boiler in horizontal, vertical or walking beam position.

Toy pulse-jet engines of the type that propelled the V-1 buzz bomb are available to drive racing cars and airplanes. For the first time there is a tiny Diesel-powered model plane, too.

Electronic controls have modernized familiar playthings. Cars of electric trains can be coupled or uncoupled electronically. There is an electronic doll which dances in perfect time to the rhythm from a radio, phonograph or piano. The doll is supported on a platform by a slender rod. Sound waves cause a contact to be alternately made and broken in the electronic base. This changes the voltage on the grid of a vacuum tube which in turn controls the amount of current flowing to the doll and giving motion to it.

A tiny radio, using a war-developed radar Germanium crystal, will pick up any station within 50 miles. Electric impulses govern the speed of the horses in a new horse racing game. Each player has a control button. When he presses it, an electric charge hits a steel ball which pushes the horse along a slotted track. In an electric football game it is possible to follow the play and the action of the ball carrier until he is stopped by a defensive player.

A lambskin-covered pup has magnetized jaws which grip a toy bone. Other stuffed animals glow in the dark. A pig bank squeals when a coin is inserted and there is a peg anvil which pushes one peg into hammering position when the second is hammered down.

The large juvenile population in our history will be learning from the new playthings. And if adults look closely enough, the toy makers say, they can learn a lot from toys, too.

I Rode the Turtle

(Continued from page 93)

that the "Truculent Turtle" could be leveled off at about 200 feet and a safe landing effected at the airport from which we departed. I might add that we were not called upon to test our fuel dumping system.

Our first bad weather came over Bougainville and New Guinea, but the worst was still ahead. When we hit the equatorial front, which our pilot, Commander Thomas

(Continued to page 272)

A PARROT TOO, CAN SAY...



**BUT HE DOESN'T
KNOW WHAT
HE'S TALKING
ABOUT EITHER**

 *Be Wise...
Buy "Crescent"**

CRESCENT TOOL COMPANY, JAMESTOWN, N. Y.

*"CRESCENT" A Trade Name registered in the United States and foreign countries. Crescent Wrenches are made only by the Crescent Tool Company of Jamestown, New York.

***CRESCENT TOOLS**
Give Wings to Work

Glorious **GIFTS**
at Money-Saving Prices



SAVE by ordering these fine watches directly from the importer. Every watch gift boxed, dependable, smartly styled, guaranteed.

- A-1** Men's watch, as shown above. Shockproof, waterproof, radium dial, sweep second hand. 7 Jewels. Compare! . . . **\$16.50**
- A-2** Same style, but with 17 Jewels. Steel back case. (\$39.50 value) . . . **\$28.50**
- A-3** Same style, but with 17 Jewels, and 14K Gold case. (\$125.00 value) . . . **\$74.50**

ALL PRICES INCLUDE FEDERAL TAX

SHOP BY MAIL. Send check, money order, or pay postman C. O. D.

MODERA CO. 562 Fifth Avenue, New York 19, N. Y.
Dept. M-12

**BELT SANDER
AND TOOL GRINDER**

WOODS MODEL 40—For home work shop woodworking and machine shop production

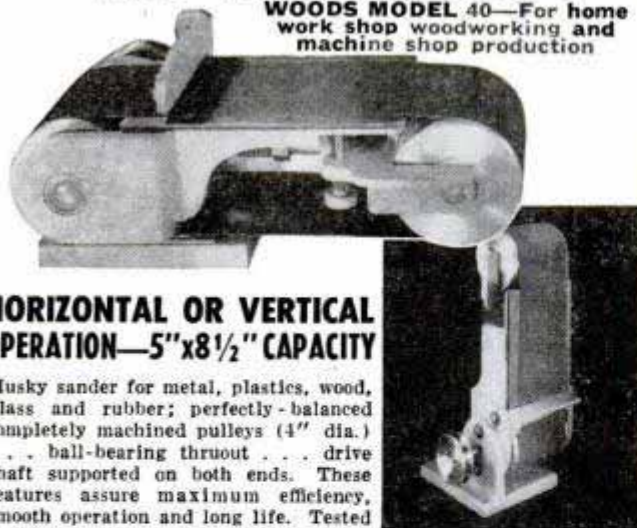

**HORIZONTAL OR VERTICAL
OPERATION—5" x 8 1/2" CAPACITY**

Husky sander for metal, plastics, wood, glass and rubber; perfectly-balanced completely machined pulleys (4" dia.) . . . ball-bearing thruout . . . drive shaft supported on both ends. These features assure maximum efficiency, smooth operation and long life. Tested to 5000 rpm. . . . easy adjustment for horizontal or vertical operation . . . reversible platen usable on either face.

Extra belts, 5" x 6" work table, and other accessories available from stock.

Order from your dealer or shipped FOB direct from our S. Norwalk Plant

SPECIFICATIONS

Abrasive Belt 4" X 36"
Bench Space 9" X 15"
Motor Recommended 1/3 hp.
Net Weight 17 1/2 lb.
Shipping Weight 22 lb.

**SANDER
COMPLETE WITH
BELT AND WORK DAM**
\$39.95

ATTENTION DEALERS!

A limited number of dealer territories are still open; write for information.

WOODS ENGINEERING CO.
NORWALK 11, CONN.

**Ball-Bearing
—SPEED WHEEL—
Construction Sets**



Including blueprints for making

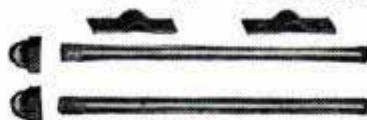

Build Your Own—

- Express Wagons** \$13.20
(Includes four 8" x 2" Tires, Wheels, Axles, etc.)
- Midget Racers** \$17.70
(Includes four 10" x 1.75" Tires, Wheels, Axles, etc.)
- Wheelbarrow Sets** \$4.85
(Includes one 10" x 1.75" Tire, Wheel, Axle, etc.)
- Bicycle Trailers** \$7.80
(Includes two 8" x 2" Tires, Wheels, Axles, etc.)

ORDER NOW FOR PROMPT DELIVERY

10% required with C.O.D.'s

JIM BROWN TOY COMPANY

869 E. Tallmadge Ave.

Akron 10, Ohio

**THE WORLDS' ONLY
"SKY-FLYER"**

**GIANT 4 FT. PLANE
TRAVELS WITHOUT
A MOTOR**

STAYS IN THE AIR FOR HOURS

THRILLS... FUN GALORE FOR YOUNG & OLD

OVER 1000 FT. ALTITUDE

STUNTS

U. S. PAT. 2,222,222 OTHER PATENTS PENDING

MAIL YOUR ORDER NOW

READY CUT & COLOR MARKED VERY SIMPLE TO ASSEMBLE

We Pay Postage in U.S.A. Only

Write Name Plainly and Enclose \$1.00

\$1.00 POSTPAID

AGENTS WANTED

SKY-FLYER SALES CO., NEW HYDE PARK, L. I., N. Y.

SAY YOU SAW IT IN POPULAR MECHANICS

**YOUR ELECTRIC DRILL
Has 100 Other Uses**

when used with K-Jax attachments
**METAL SAWING . . . SHEARING
RIVETING ATTACHMENTS**

Write for illustrated circular

K-JAX, 2600 Canton St., Dallas, Texas



Start a NEW BUSINESS

**Sharpen Dull
Pipe Wrenches**

Industries save hundreds of dollars. Some "wrench shops" make \$50 a day.

Write for information.

J. C. MOORE INDUSTRIES P. O. BOX 234 FREDONIA, PA.

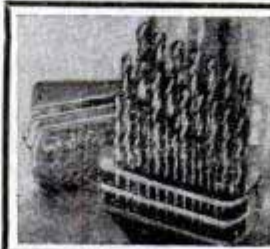

Why Hunt for Drills?

These Complete High Speed Drill Sets Now Available at Low Prices
#1 to 60 Drills, . . . \$12.95 Per Set
1/16-1/2 by 64ths, . . . \$16.95 Per Set
Drill Sets A-Z, . . . \$15.50 Per Set
(Drill Stands Free)
Send For Free Circular

SID TOOL CO.
MACHINE SHOP SUPPLIES
183 Grand St., New York 13, N. Y.

!!! WHOLESALE DISTRIBUTORS !!! EARN BIG MONEY!!

AMAZING PATENTED PRECISION SCREW HOLDING SCREWDRIVERS

Removes, Holds, Inserts Screws in HARD-TO-GET-AT Places

Genuine Opportunity, Capable Men

Hardware, automotive, electrical, radio, department stores buy quantities. Attractive displays, advertising literature make fast sales. Factories, shops, garages, service stations, mechanics, electricians also large buyers!

MEN with AMPLE CAPITAL to do a real BIG business. FAST SALES, LARGE ORDERS, BIG REPEATS. No commission salesmen or agents inquiries answered. Only WHOLESALE distributors wanted.

Refundable 30 day trial offer. Immediate delivery.

We are a large, established, soundly financed company.
Export inquiries solicited.

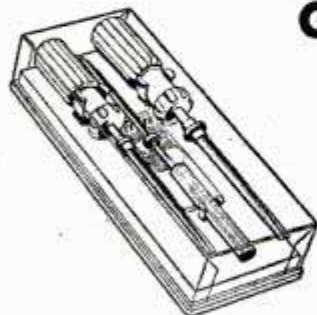

3 models mounted in an attractive transparent kit —makes a wonderful gift for homes and hobbyists.

WRITE or WIRE NOW

FOR FULL DETAILS and WHOLESALE DISTRIBUTORS TRIAL OFFER.



7 models — from small to large sizes

TREMENDOUS MARKET • BIG DEMAND • SPECTACULAR

DEMONSTRATOR Creates Tremendous Interest • Furnished with TRIAL OFFER

MILLEN MFG. CO., 4000 Miller Bldg., Boston 10, Mass.

SUPER DRILL GRINDER



Sharpens round shank drills from 3/32" to 1-1/16" diameter. Grinds Old Drills like new in 4 different drill point angles. Grinds Short, Medium and Long Twist Drills from 1 1/2" up to 11" long, for hand or power grinding wheels.

200,000 IN USE!

Grinds your drills like factory in 25 seconds. Gives perfect center and clearance. Saves drills, time and money. No shop should be without the Super Drill Grinder. Guaranteed to do the work or money back. The Grinder that gives a rounded point!

Only \$2⁹⁵

At Your Dealer's or Postpaid
CRANDALL MFG. CO.

1512 West Slauson, Dept. FA-12 Los Angeles 44, Calif.

METALLIZE BABY SHOES

Learn this easy, money making business from nationally recognized consultant. Small investment; perpetual market. For free details write Joseph B. Kushner, B.S. Ch.E., Metal Finishing Consultant, Stroudsburg, Pennsylvania, RD3T.

INVENTORS' ADVISORY SERVICE

Before spending time and large sums of money on final development and patent, get reliable impartial advice and constructive criticism from qualified technicians on the practicability, manufacturing problems and possible sales demand of your invention. SEND POSTCARD FOR FULL INFORMATION.
CARSON CONSULTANTS, Dept. PM, 30 W. Washington St., Chicago 2, Ill.

Funnier Than Ever "YOUNG" Barks!

Performs all sorts of Tricks and Barks too. More fun than a circus. For grown-ups and children. Well built. Nicely finished. Give "Young" to your friends for Christmas.

Price Postpaid — \$1.00 each

GIFT CENTER Dept. B, P. O. Box 1522, Milwaukee, Wis.



BUILD THIS RADIO Learn Step By Step

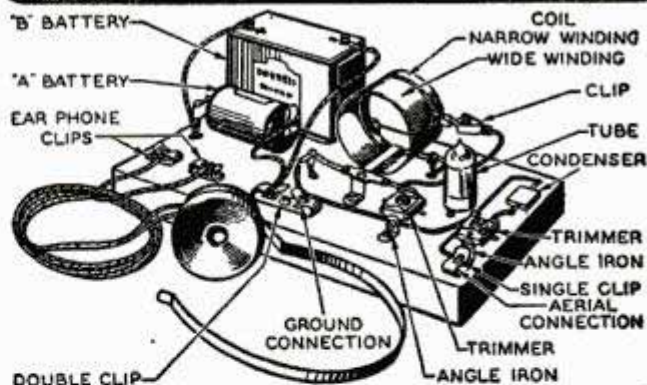

Have fun building your own Sky Prancer Midget Radio. Learn money-making radio principles. You can do it this easy, practical way.

Radio Kit comes complete with simplified, illustrated instructions for 10 educational experiments. Numbered and color-coded. No soldering, drilling or punching. Gets local, police, short wave and distant stations. Can be used as transmitter.

Complete with tube, phone and batteries, only \$7.95 postpaid. Or send \$1.00 and pay postman balance plus postage. **Order Today.**

Chapin Electronics Co., Inc.
Dept. A, 134 W. Onondaga St., Syracuse 2, N. Y.



2 Handy Sizes Packed
in a Handsome Gift Box

BMC

**PRESSURE LOCK
WRENCH**

..actually Six Tools in One!

It will save his temper . . . improve his skill . . . greatly increase his enjoyment of puttering around the house, hobby shop, motor boat, car or plane. If he's a worker on the farm, in the shop or factory, he can't afford to be without a set.

For here is a new marvellously improved kind of wrench that is actually six tools in one—adjustable end wrench, pipe wrench, gripping tool, pliers, hand vise, locking clamp. Fits as it grips . . . and it holds . . . with more than a ton pressure, even when the hand is taken away. Can be released with the flick of a finger.

JAWS ALWAYS PARALLEL

An exclusive, patented device keeps the jaws parallel when they close. Prevents rounding of nuts, slipping and accidents . . . assures even pressure and a firm grip to the very tip of the jaws.

Nos. 7 and 9 in a gift box . . . \$5.40

No. 7—Max. jaw opening 3/4" . . . \$2.45
 No. 9—Max. jaw opening 1" . . . 2.95
 No. 11—Max. jaw opening 1 1/2" . . . 4.60
 For sale at leading hardware, auto equipment, mill supply, plumbing and electrical departments.

BMC MANUFACTURING CORP.
 Binghamton, N. Y.

Davies, called "250 miles of bottled-up turbulence," we began to worry about the plane's ability to take such a pounding with so great a load. We were afraid the fuel tanks might leak, but nothing happened.

Over the Marshall Islands, at about 8000 feet, we ran into dense clouds and heavy rain. From there to Midway the weather was foul. Through radio check with Honolulu we learned that the Seattle area, where we planned to make a landfall, was "socked in tight" and there were icing conditions, so we shifted our course to take us in just north of San Francisco. Shortly after hitting the coast of the U. S. we were bucking a headwind and about then the tachometer recording the functioning of the left engine went out of order. At first we thought the engine was out and got set to feather the propeller, but just in time noticed the engine was running all right and that it was the tachometer that was faulty. A little later, ice caused our right engine to quit for about half a minute at 12,000 feet, but it cut back in when we opened an alternate heating system (air warmed by the manifold). After we got through the soup over the coast we estimated there were a thousand pounds of ice on our wings.

I'd say we used the Sperry automatic pilot about 99 percent of our trip.

We averaged in the neighborhood of 20 hours of sleep during the trip, on the basis of two men on and two men off every four hours. We got none, though, the first night, when the plane was virtually a flying gas tank and the air was turbulent. We had hot meals, steaks and soups, prepared on an electric stove. Our rubber mattresses were comfortable and the plane was as soundproof as an air liner. None of us had to use the oxygen or the benzedrine tablets that had been stowed on board. All in all, the trip was no tougher than a hard wartime patrol, and we'd all experienced our share of those. We shaved ourselves an hour before landing.

Even our lone passenger, a nine-month-old kangaroo named Joey, seemed to fare reasonably well, though he must have been a trifle uncomfortable in his small box. A 35-pounder, he was en route to the Washington Zoo as a gift from the Australian people.

The most unusual experience of our trip occurred while flying over the mainland through heavy weather. All of a sudden the sky was lighted by an eerie glow and little fingers of flame seemed to be dancing on the windshield. For a moment, thinking the engines had caught fire, our hearts were in our throats. A moment later we

(Continued to page 276)

Luther POWER GRINDERS

HAND AND POWER GRINDERS

Like all Luther Grinders, the power grinder shown here is famous for high quality and rugged construction. It is built to exact specifications for those who demand fine tools. For the Luther grinder that fits your needs, see your hardware dealer.

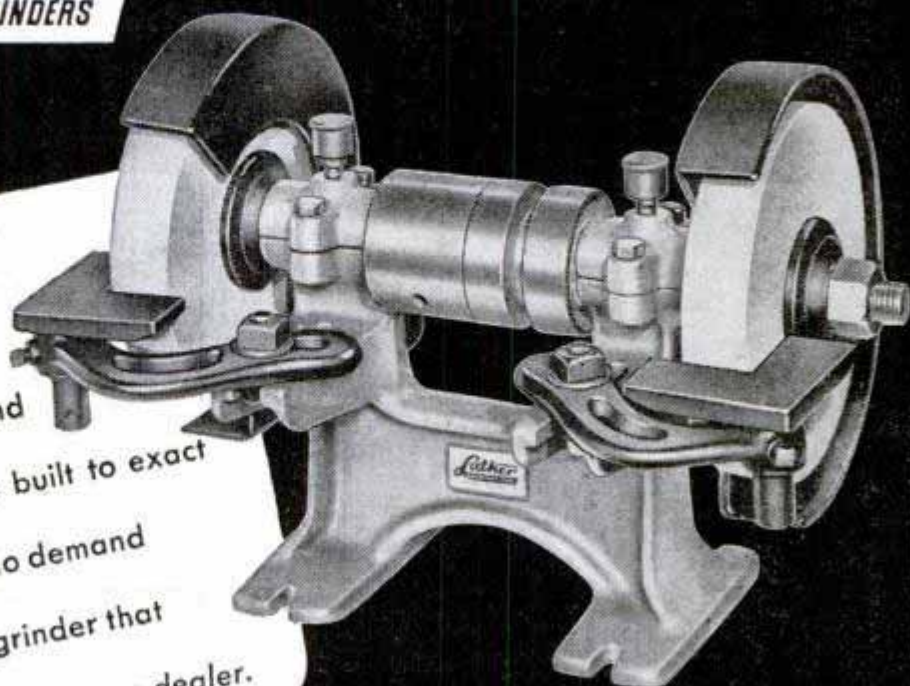

LUTHER GRINDER & TOOL CO.
(Established 1896) Sheboygan, Wisconsin

ELECTRONIC EXPERIMENTERS KIT

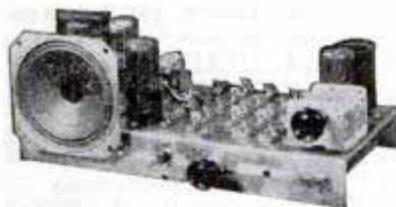

This complete electronics laboratory permits the experimenter to construct 18 different useful electronics devices, including sensitive broadcast and short-wave receiver, proximity detector and multivibrator circuits patterned after radar, phonograph amplifier, intercommunication system, code practice oscillator, time delay relay, home broadcaster, relay-amplifier for photo-electric circuit, and 10 others.

Kit includes rectifier, power amplifier, double triode, powerful 4" speaker-mike, plate relay, broadcast and SW coils, tuning condenser, and generous supply of resistors, condensers, chokes, and extra wire. Components held in place by special clips—screwdriver only tool required. Complete 48-page manual with diagrams and full instructions, clearly explained for hobbyists and novices. Sent postpaid anywhere in U. S. for \$22.50, sales tax included. Pat. applied for.

DEER & TAYLOR COMPANY

1340 MILVIA STREET

BERKELEY 9, CALIF.

FAMOUS

JIM DANDY

ALCOHOL BLOW TORCH

SAFE, DEPENDABLE, GUARANTEED PERFORMANCE, NON-EXPLOSIVE

- Ideal gift for the craftsman
- General soldering and brazing
- Heating chemicals, bending glass
- Portable cooking unit
- Automobile chassis work
- Moulding and casting

Add \$1 for 1/2 pt. fuel and all purpose solder

\$3

POSTPAID

Anywhere in U.S. or Alaska. C.O.D. orders enclose \$1; pay postman \$2 plus postage

NATIONAL GIFTWARE CO.

430 Board of Trade Building, Boston, Mass.

Power . . .
independent of outside interference

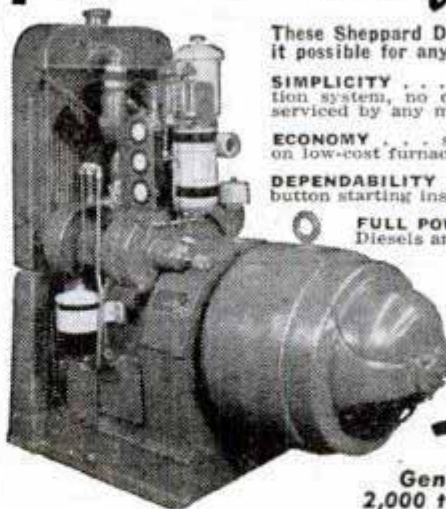

These Sheppard Diesel features make it possible for anyone . . . anywhere.

SIMPLICITY . . . no electrical ignition system, no carburetor. Can be serviced by any mechanic.

ECONOMY . . . starts and operates on low-cost furnace oil.

DEPENDABILITY . . . electric push button starting insures instant power.

FULL POWER . . . Sheppard Diesels are rated on their actual continuous power output while operating with full equipment.

SAFETY . . . no explosive fuel to handle and store.

Generating Sets
2,000 to 36,000 Watts

Power Units 3 3/4 to 56 H.P. • Marine Engines 3 3/4 to 62 H.P.
R. H. Sheppard Company, Inc., 48 Middle St., Hanover, Pa.

DIESEL'S THE POWER . . .

Sheppard's the Diesel



HANDKERCHIEF TEST

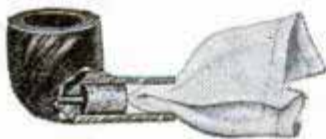

PROVES VITAL ZONE SPOTLESS
AND FREE FROM "GOO"—no matter
how often you smoke it!

Wm. DEMUTH & CO. Inc., N. Y. 22



HESSON GUARD MILANO

SAY YOU SAW IT IN POPULAR MECHANICS

Simplified Shaves ENDERS Speed SHAVER Easy does it



Get this sensational, modern razor today. Then see for yourself how simple, easy your shaving becomes. Enjoy Enders' extra keen blade and pressureless, graceful action. Save time. Shave closer with safety, comfort. Join the swing to simpler shaving—simpler, easier from start to finish. Get Enders today.

because
double thick deluxe blade
clicks in like magic
nothing to take apart
streamlined action
new safety

Address:
Dept. R

49¢
with
6 BLADES

DURHAM-ENDERS RAZOR CORP. · Mystic, Conn.

New Type



CORK POP GUN

IDEAL FOR BOYS 4 YEARS AND UP
100% safe and simple to operate

Neat Appearance — Good Workmanship — Satisfaction Guaranteed

Limited Supply — \$2.15 each — Send money order now to:

MARKEL TOYS DISTRIB. P.O. Box 373, East Chicago, Ind.

WINDOW SIGN LETTERS

For Store Fronts and Office Windows. Anyone can put them on. Samples furnished. Genuine Gold and Silver.
METALLIC LETTER CO., 430 N. Clark St., Chicago 10

Cute stuff TO BUILD



Make a big hit with these
NEW and ORIGINAL IDEAS

Easy to Make... Easy to Sell. (Christmas is coming). Full Size... Professional Plans

30c Each. Set of 8 for \$1.60

- Bird Door Knocker
- Turtle Flower Base
- Lobster Knife Rack
- Crocodile Game
- Ubangi Ash Tray
- Frog Pull Toy
- Duck Door Stop
- Chipmunk Nut Tray

Each item has some clever twist to the design to make it unusual and desirable.

PARKE PRODUCTS

78 Grand Street

Coldwater, Michigan

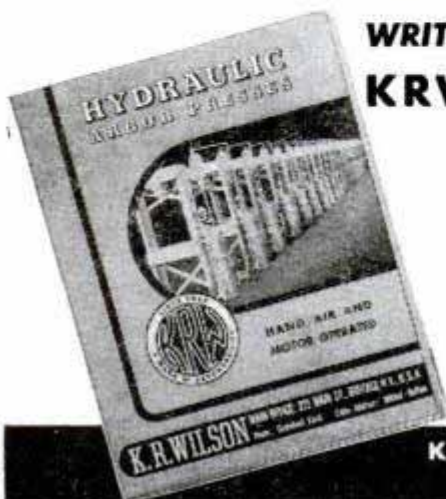

WRITE FOR YOUR FREE COPY OF THE NEW KRW HYDRAULIC PRESS BOOK

Describes all manner of Production and Shop Work on KRW Hydraulic and Bench Type Arbor Presses. 32 pages illustrating the new KRW Hand-operated, Electric-operated and Air-operated Hydraulic Presses.

Write for your copy today.

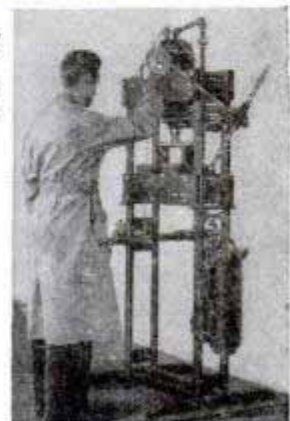

K. R. WILSON, DEPT. 17, 215 MAIN ST., BUFFALO 3, N. Y.
Builders of Shop Equipment for Ford Dealers Since 1916

FUN • SPEED GALORE • BUILD YOUR OWN RACER

with Large 10 inch Wheels

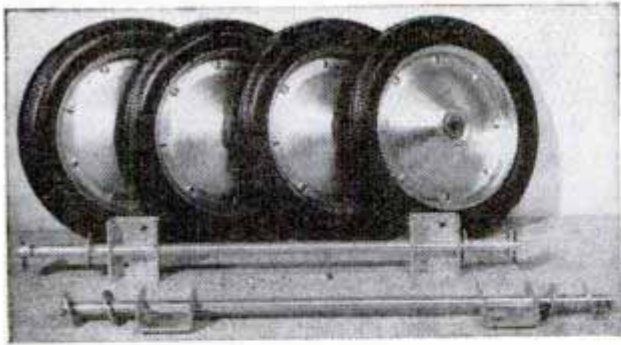

LOWEST PRICES: ORDER NOW

- 1 COMPLETE 10" WHEEL WITH 10x1.75 TIRE.....\$2.90
- 2 COMPLETE 10" WHEELS (without axle)\$5.50
- 4 COMPLETE 10" WHEELS (without axle)\$10.00

Kit "A"—2 complete 10" wheels . . . 1-20" long x ½" dia. axle—2 heavy hangers—4 washers & 2 cotter pins—all plated—ready for use.....Only—\$7.50

Kit "B"—4 complete 10" wheels . . . 2-20" long x ½" dia. axles—4 heavy hangers—8 washers & 4 cotter pins—all plated—ready for use.....Only—\$13.50

Kit "C"—4 complete 10" wheels . . . 2-24" long x ¾" dia. axles—4 heavy hangers—8 washers & 4 cotter pins—all plated—ready for use.....Only—\$16.00

F.O.B. Doylestown, or, add 10% for Prepaid Shipment anywhere in U.S.A.

Hundreds of repeat orders, is your guarantee of the Best Materials, Workmanship and Prices.

FREE Circular Showing Plans, Parts, Etc.

MADE TO OUTLAST
ANY OTHER TYPE WHEELS
with GOODYEAR
10.00 x 1.75 PUNCTURE
PROOF SEMI-
PNEUMATIC
DEEP TREAD
TIRES

(10x1¾" wheels)

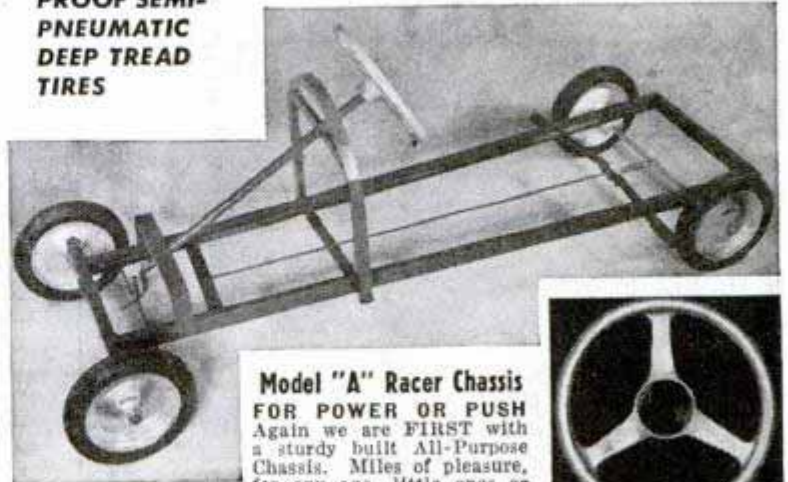

65 Inches Long
24 Inches Wide
Weight
Approx. 55 Pounds

**ORDER
TODAY**

Model "A" Racer Chassis

FOR POWER OR PUSH
Again we are FIRST with a sturdy built All-Purpose Chassis. Miles of pleasure, for any age, little ones or adults. This racer chassis engineered into the finest design for electric, gasoline or push power, giving you the choice of body design to build yourself. Equipped with Genuine Arguto OILLESS LIFETIME BEARINGS. Ready to roll and steer. COMPLETE AS \$4600 ABOVE, ONLY.. \$8.75



12 in. deluxe all weather steering wheel complete with steering rod. Hangers and jam nut assembly only.....\$8.75

OSBORN WHEEL COMPANY

115 So. Main St., Dept. P-12

DOYLESTOWN, PA.



U. S. Army RADIO (Water, Shock and Weather Proof) PHONES

Made to U. S. Army Specifications, passed by Signal Corps Inspectors. Dynamic Microphone and Dynamic Receiver of Finest Quality—Water, Shock, Weather and Altitude Proof, used on tank and aircraft (B19) intercom systems. For recording, for battery-less telephone, talk through your radio set or use earphones for pocket-size set loud speaker. Complete two receiver, cord set, head band, and dynamic hand microphone including special connecting cord set. A REAL BARGAIN AT THIS PRICE.

ONLY \$995 post paid
Order yours today

HERE IT IS: ELECTRIC SWITCH

VERSATILE SWITCH—MILLIONS IN POST WAR APPLICATIONS — Floodlight your porch when the door is opened — sounds alarm when window is opened — signals arrival of mail — controls heating of furnace — filling of water tank; these and many other services are performed by this versatile switch. Shipped with instruction sheet showing numerous illustrated uses. EXCEPTIONAL LOW \$100 post PRICE. ONLY paid
King Products Co., Dept. P-2, Batavia 2, Ill.



JIG SAW

XMAS GIFT FOR CRAFTSMEN

FOR YOUR WORKSHOP!
Shipping & Tax \$11.95
Included in U.S.A.

Below O.P.A.
Will Last A Lifetime!

RUGGED construction—seasoned Oak and Fir. Oil-less type bearings, no lubrication required. Working throat depth 15¾". Has Steel Work Table 9"x9". Will take to 1¾" soft or hardwoods, plastics, etc. Operates with any motor over 1/8 H.P. SAVE MONEY, EASILY ASSEMBLED. Instructions Included.

SEND \$11.95 or \$1.00 Deposit, Balance C.O.D.

CROSS & KENT

Dept. P.M., 4624 Sheridan Road, Chicago 40, Ill.

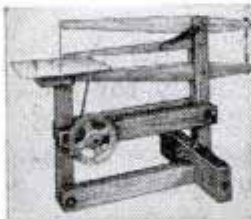

Larson

"MAKE YOUR OWN" CARPENTERS' SAW-HORSE SET

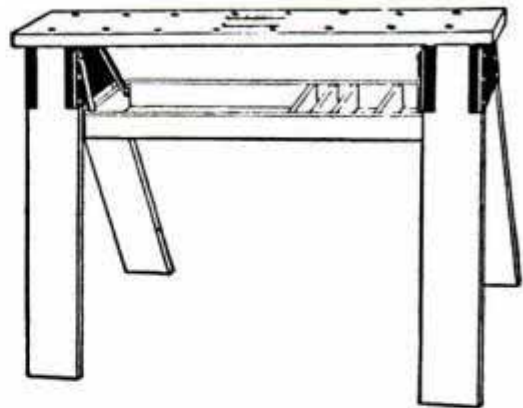

Makes a rigid saw horse that is actually a PORTABLE HOME WORK BENCH with many uses. Has a novel SWINGING TOOL TRAY. Complete hardware and copyrighted instruction sheet for easy assembly. Lumber is not included.



Prepaid \$1.35

CHAS. O. LARSON CO., BOX 358, STERLING, ILLINOIS

RESEARCH

IS THE BASIS

Pick any program on any station, however far away . . . and you'll marvel at the way the matchless National NC-2-40D brings it into your living room. You'll thrill to its performance . . . in almost any weather . . . thanks to the sensitivity and selectivity that earned National receivers a place on three-fourths of the Navy's warships. Years of unfiring research are back of its dependability. See and hear it for yourself. Write today for the name of your nearest dealer.

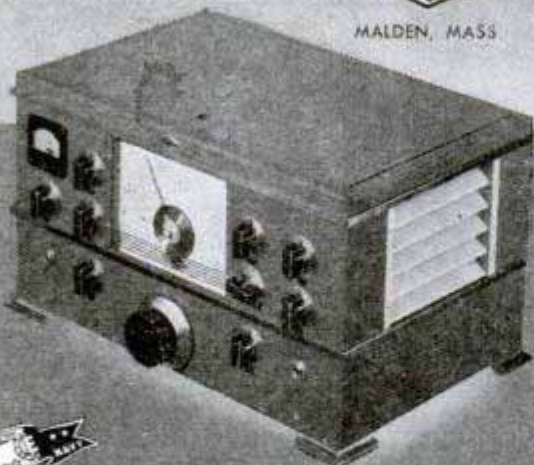

NATIONAL
COMPANY, INCORPORATED

THE MOST DISTINCTIVE NAME IN RADIO COMMUNICATIONS

realized what it was. The plane wasn't on fire—it was the phenomenon known as St. Elmo's fire, caused by electrical discharge from the plane into the atmosphere.

The "big jump," in my opinion, speaking collectively for the other pilots, was a successful venture. We had no definite geographical goal. We were to fly as far as the stamina of the plane, the health of the personnel and the weather would permit. From a pilot's point of view as well as from an engineering point of view, the Turtle and her sister P2Vs are good, capable airplanes which will write history in the realm of aviation achievement.

New Rivers for the West

(Continued from page 102)

Montana, Wyoming, Nebraska, North Dakota and South Dakota have projects under way for bringing water to nearly 100,000 acres. Irrigation and supplemental irrigation water for 105,000 acres in Utah are to be taken by canals from the Provo River.

In the Northwest, canal systems that are to be built soon include the hundreds of miles of channels that will distribute Columbia River water from behind Grand Coulee Dam to more than 1,000,000 dry acres in central Washington. Further development of irrigation canals from the Yakima River are under way in Washington and preparations are being made for construction of canals from behind the new Anderson Ranch Dam in Idaho.

During the past 44 years the Bureau of Reclamation has built more than 150 dams and 80 reservoirs in arid and semiarid regions in the West, providing water for the irrigation or supplemental irrigation of more than 4,000,000 acres of land. The many reclamation projects under way at the present time will provide water for another 4,000,000 acres. Much of this land will remain in private hands but in some cases public lands will be benefited and these will be opened for homesteading or for purchase at prices based on the cost of the irrigation improvements.

Work on some of the larger projects will not be completed for a number of years because of their magnitude, nor will all of the new farming land be needed immediately for food production. Nevertheless, the continuing westward shift of population shows the need in the West for the new irrigation projects.

☐ Train-to-train, locomotive-to-caboose and train-to-tower telephone communication is now in operation on the Pennsylvania Railroad between Harrisburg and Pittsburgh.



OWN A "POCKET SIZE" MACHINE SHOP

IMPROVED MOTO-TOOL

APPROXIMATELY
27,000 R.P.M.
CUTS CLEANER;
SAVES CUTTERS

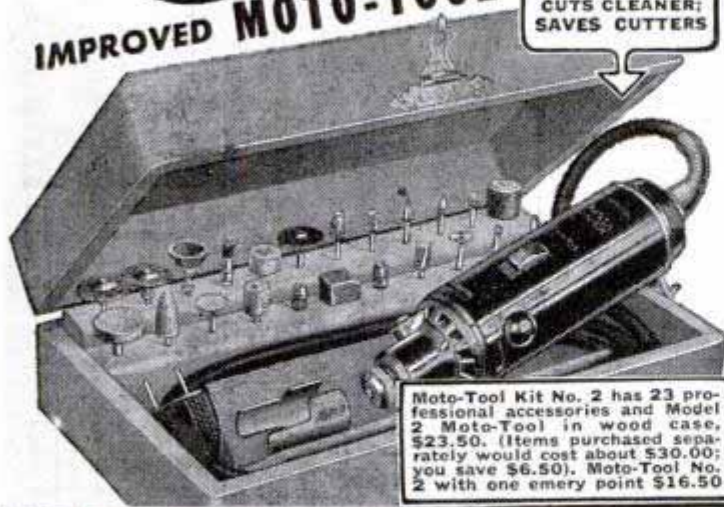

Moto-Tool Kit No. 2 has 23 professional accessories and Model 2 Moto-Tool in wood case, \$23.50. (Items purchased separately would cost about \$30.00; you save \$6.50). Moto-Tool No. 2 with one emery point \$16.50

HERE'S A CRAFTSMAN'S GIFT THAT PACKS YEARS OF PLEASURE

Here's a gift to please a man's heart. A gleaming "powerhouse" that holds promise of endless creative hours. This "pocket-size machine shop" is a war veteran . . . used by all branches of the armed forces in far flung repair bases . . . and it helped set production records at General Electric, Westinghouse, Remington Arms, Ford and other plants. Hobby enthusiast or expert craftsman . . . first choice is Model 2 "Moto-Tool" kit, with its handsome, felt-lined, highly finished wood case . . . with rows of tools begging to be put to work. The usefulness of "Moto-Tool" for precision work is increased by two versatile attachments now available at slight additional cost (see below).



Look For These

Moto-Tool Features

- Housing has "pencil-type" finger grip
- Instant-action, wrenchless chuck
- Oil-less, sealed, trouble-proof bearings
- Patented automatic chuck lock pin
- Oversize armature shaft, hardened, ground and polished
- 110 volt, universal type motor
- Easily replaced commutator brushes
- Sliding snap type switch
- Handy hanger hook
- Cord protector
- Sturdy, shockproof bakelite housing
- Dust-filtered, air-cooling system
- Weighs only 13 oz. . . . shaped to fit the hand
- Dynamically balanced for vibrationless operation.

Do These Better-Faster

- Cleaning
- Rasping
- Brushing
- Dressing
- Burring
- Grinding
- Routing
- Sanding
- Drilling
- Inlaying
- Sawing
- Scoring
- Cutting
- Carving
- Sharpening
- Burnishing
- Engraving
- Touching Up
- Mortising
- Polishing
- Finishing

Free Both Hands With Moto-Tool Attachments



Moto-Tool Stand (left), made of heavy cast iron, holds Moto-Tool at any position or angle. \$4.50

Moto-Tool Shaping Table \$2.50. (Shown with stand, right). Aids accuracy in routing and grinding.



volt, universal type motor

MONEY BACK GUARANTEE

Buy Dremel "Moto-Tool" and Accessories from your dealer. If he does not handle them, order direct from the factory on a 10 day trial, money back guarantee.

DREMEL MFG. CO., DEPT. 116-M, RACINE, WISCONSIN

EASY GLIDE Ball Point Pen

- Latest Sales Sensation
- Name Engraved FREE
- Guaranteed

Here it is! The famous Ball type Fountain Pen with New and improved features and at an amazingly low price that saves you more than half! Writes on almost any material . . . writes for months without refilling. Adjustable Ink-Flow . . . always ready. Available now for immediate delivery, but don't delay . . . mail your order Today. Postpaid with check or money order.

5⁰⁵ POSTPAID

WALTER J. RUBY
2624 W. 24th PL., CHICAGO 8, ILL.

BRONZE BUSHING STOCK

Cast in solid and cored bars 12 inches long
WRITE FOR LIST OF SIZES AND PRICES
SALEM BRASS FOUNDRY, 3220 State St., Salem, Oregon

DON'T USE CHISEL

Use KROIL, the new chemical lubricant that creeps into millionth inch spaces, dissolves rust and dried grease. **KROIL LOOSENS FROZEN PARTS**

The fastest penetrating oil known, 5000 industrial plants used Kroil to keep war production going. Try it on money back basis. AT YOUR DEALER or send \$1 for two 8 oz. spout cans, postpaid, send dealers name.

KANO LABS., 3021 Lincoln Tower, CHICAGO 1, ILL.

NOW YOU CAN OWN A FAMOUS ORIS WATERPROOF WATCH

An unusual limited offer — lowest price we ever sold an ORIS 7-jewel pin-lever time piece. Chrome top, stainless steel back — modern stainless steel expansion watch bracelet included.

SHOCK RESISTANT!
NON-MAGNETIC!
RADIUM DIAL!
SWEEP SECOND HAND!

\$1865 with steel expansion bracelet
Fed. Tax Included

Write for free illustrated booklet

Mail orders promptly filled
No C.O.D.'s
Postage Prepaid

LAMONT

Internationally Famous Watches
SUITE 1005 • 597 FIFTH AVE. • NEW YORK 17

A Fine, Precision EXPOSURE METER



\$14⁹⁵

WITH CASE
Including Tax
on Meter



The Sign of Precision

Make your camera take better, sharper photos. Eliminate guess-work, lost pictures and wasted film with a precision-built SKAN Exposure Meter. A *must* for color—still or movies. Be right in *any* light—day or night. Simple to use.

Sold at camera counters everywhere. For free literature write: G-M Laboratories Inc., 4290 N. Knox Ave., Chicago 41, Ill.



EXPOSURE METER

The Chief WORK BENCH

Built to Last a Lifetime!

With Bottom Shelf and 18" Sq. Drawer. 2"x6", Solid Plank, Grooved and Dovetailed Top and 1"x8" Back Rail, Shellacked to a Smooth, Satiny Finish.

MOHAWK LUMBER CO. Dept. 32
14525 W. Chicago Blvd. Detroit 27, Mich.
Enclosed Check Money Order for \$
Ship..... CHIEF WORK BENCHES at
Quantity
\$16.95 each, F.O.B. Detroit, Mich.
 Send C.O.D., \$5 Deposit Enclosed.

NAME.....
ADDRESS.....
CITY..... STATE.....
No Priority Necessary!

• 6 Ft. Long • 34" High • 26" Deep. Shipped Knock-down, with Bolts, Nuts and Screws and ABC Chart for Quick, Simple Assembly.

Prompt Delivery
MOHAWK LUMBER CO.
14525 W. Chicago Boulevard
DETROIT 32, MICHIGAN



\$16⁹⁵
F.O.B. DETROIT

Send Check or Money Order, or Will Ship C. O. D. (\$5 Deposit)

SMALL EFFICIENT SPEED REDUCER

Sturdy, compact (see dimensions). Proved in thousands of industrial installations. Case of heat treated aluminum. Gears, SAE 65 (British Gear) Bronze. Worm of case hardened steel. Timken Bearings throughout. Available in 4 different assemblies (shown below) and in these standard ratios:

4-1	25-1	64-1	200-1
8-1	30-1	75-1	300-1
10-1	40-1	80-1	400-1
16-1	50-1	100-1	600-1
20-1	60-1	150-1	800-1

Torque capacity 100 inch pounds. Especially suited for bench work, home work shops, light production, animated displays, etc. When ordering be sure to specify assembly and ratio required. Shipping weight in carton, 8 lbs. Full money back guarantee. Prompt deliveries.



\$15¹²

Ceiling Price
F. O. B. Cleveland

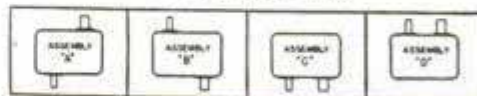

THE OHIO GEAR CO.

1412 EAST 179th ST. • CLEVELAND 10, OHIO

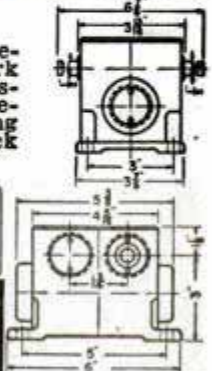

Build Your Power Tools With OUR BALL BEARING ARBORS



L. H. Th'ds
Also



C5 \$-8.25

PP.

C6 \$-9.25

PP.

Spindle

12 1/2 Long

Housing 2 1/4 x 8

Heavy Duty Ball Bearing Saw Arbors

Dealers Wanted

B33—\$4.95 PP.

5/8 x 4 1/2 Spindle Only

B15 Plain Spindle \$3.45 PP.

Also Flange Models

POLY PRODUCTS, 406 S. Chester Ave.

Ct. 1, Pasadena 5, California

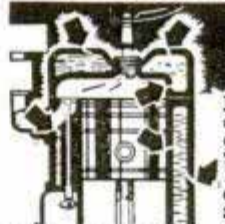

REPAIR CRACKED BLOCKS AND HEADS—

External and internal leaks in blocks, cylinders and valve ports quickly and easily with LUSCO PLASTIC SEAL. 90 day Service Guaranteed or your money back. Send money order or check for full pint—more than sufficient for average repair. **\$3.00** Postpaid

C. F. LUSK CO., 4601 Euclid Ave., Cleveland 3, Ohio

Low Price The OTTAWA "Buzz" Master



CLEAR LAND FAST! Powerful 6-HP motor with friction clutch for safe operation. Cuts down timber, brush, hedge; turn blade vertically and saw logs to length. Can be equipped to fell largest trees. Clutch pulley for belt work. Guaranteed.

OTTAWA MFG. CO., 1227 Brush Ave., Ottawa, Kansas

A CHRISTMAS PRESENT
HE'D APPRECIATE

**BUILD YOUR OWN
RADIO AND ELECTRONICS DEVICES
AT LOW COST**



with **NEWARK'S** KITS AND PARTS

You Can Easily Build Radio Receivers and Transmitters—Record Players and Other Exciting Radio and Electronics Devices.

Our **BIG BARGAIN COUNTERS** display new parts and unusual special equipment you'll enjoy seeing. Come in, look around, ask questions . . . it's fun.

Public address systems for every need and purpose.

Make a good radio receiver or fine record player at big savings. You can build these and many other things easily. In any of our stores our staff will gladly show you how—or will explain clearly by mail. **Write for our famous Big Bargain Bulletins**, listing all the newest things available. Send for it today. When writing, address Dept. C2.

NEW YORK 242-50 W. 55th St. New York 19, N. Y.

NEWARK

CHICAGO 323 W. Madison St. Chicago 6, Ill.

ELECTRIC COMPANY, INC.

New York City Stores: 115 W. 45th St. and 212 Fulton St. Offices and Warehouse: 242 W. 55th St., New York 19

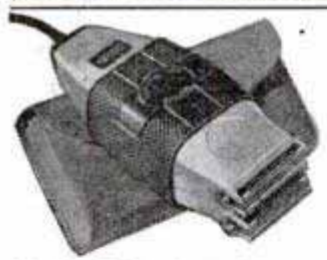

AMAZING OFFER!

"HARVARD" GUARANTEED DOUBLE HEAD Electric DRY SHAVERS \$5.95

- Complete in Smart Leatherette Case—(O.F.A. Approved)
- Two 1947 Deluxe Shaving Heads
 - New Post-War Non-Slip Rubber Grip
 - Ivory Plastic Streamlined Design
 - Self Sharpening, sharpens as you shave
 - Ground and Lapped Steel Cutting Blades
 - No Radio Interference
 - Self Starting
 - No Oiling Necessary
 - Precision Built Vibrator Type Motor
 - Written Guarantee with Each Shaver

SEND NO MONEY—
Pay postman \$5.95 plus postage . . . or send \$5.95 with order and we pay postage. Mail your order today!

SPAULDING INDUSTRIES 803 Milwaukee Ave. Dept. M12, Chicago 22, Ill.

TINY TIM — \$4.95
LIMITED QUANTITY AVAILABLE
MONEY BACK GUARANTEE

Single cyl. High Speed Oscillating Steam Engine. A precision built (like the big ones) miniature engine in every detail. Height 2 3/4". weight 4 oz. Ideal for model boats or stationary power plants.

ORDER NOW For Prompt Shipment. Remit \$4.95 with order and we prepay P.P. or C.O.D. Cash with orders get preferred shipping.

THE THOMPSON ENGINEERING CO.
405 Winchester Bldg., Grand Rapids 2, Mich.

MARCOT KEY MACHINE
Immediate Delivery

Marcot No. 8 Key Machine Mounted on Cabinet	\$ 75.00
Book on Modern Locksmithing	3.95
Auto Code Book and Auto Depth Keys	12.50
162 Doz. Popular Key Blanks	77.76
Set Key Files, Tools, Pins, Springs, Thimble	10.50
	<hr/> \$179.71

A. J. MARCOTTE CO., DEPT. PM, CHICAGO 51, ILL.
1200 N. KEDZIE AVE.

CHEVRON
THE WORKSHOP SAW

PRICE **\$44.95**
F.O.B. PROVIDENCE
AS SHOWN
LESS MOTOR
LESS SAW

A SUPERIOR Tilting Table Wood-Cutting SAW

14" x 18"
CAST IRON TABLE ALL STEEL BASE

Ready NOW for your Home Workshop!

- ★ It cuts Deeper! (app. 2-11/16" with 8" saw blade)
- ★ It's Sturdier, Heavier (60 lbs.) A Craftsman's Machine Tool!
- ★ No Die Cast Working Parts in **CHEVRON**

Adaptable for use with 1/2 H.P., 1750 R.P.M. motor, 4" pulley recommended, 2" spindle pulley furnished. • Table extensions and saws available . . . ask for specifications and prices. • Complete **CHEVRON** Specifications on Request!

ORDER NOW—WRITE DIRECT TO—

CHEVRON c/o Peerless Precision Products
387 CHARLES STREET
PROVIDENCE 4, RHODE ISLAND

Christmas cheer the YEAR 'ROUND



THE
GIFT THAT
KEEPS ON
GIVING

Dynamic WIRED AUTOMATIC RECORD PLAYER WITH MAGUIRE RECORD CHANGER

YOU NOW CAN HAVE the Latest Automatic Radio Phonograph Combination by just connecting this Dynamic AUTOMATIC record player to any radio. Shipped Prepaid Express anywhere in the U. S. ONLY **\$37.20**

- ♪ Feather weight TONE ARM: — Gives longer life to records, truer tone.
- ♪ TWO-POST CHANGER: — No friction or wear. Records will not chip or break.
- ♪ SINGLE LEVER CONTROL: — Automatic shut-off on last record.
- ♪ PERMANENT NEEDLE: — 10,000 playings.
- ♪ Current: — 110 volts, AC, 60 cycles.
- ♪ Mounted on attractive leatherette covered WOOD BASE.

♪ Dimensions: — 16½" long, 13½" wide, 9" high.

Dynamic
ELECTRONICS • NEW YORK, INC.

MAIL ORDERS TO
1926 BROADWAY, N. Y. 23, N. Y.

37 WEST 57th STREET
2 PARK AVENUE
BROADWAY at 65th ST.

SORRY: NO C.O.D.'S, SEND CHECK OR MONEY ORDER

BUILT-IN-SKILL For Your Shop

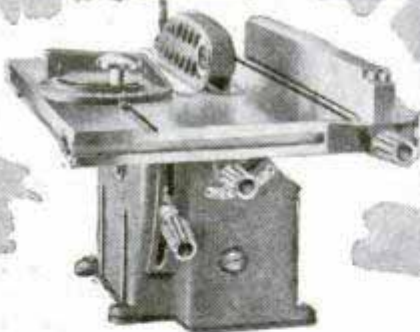

Darra-James again is FIRST with MORE in the newly designed 7" tilting table saw. The HOMEMASTER gives your shop more accuracy, more precision, more versatility.

Here's why you get more in the HOMEMASTER: You get equal capacity to many 8" saws; a 2¾" depth of cut; 45° tilting table; "sealed for life" ball bearings. You get the Mitre Gauge; Rip Fence; Guard and Splitter as Standard Equipment. You get Streamline Aluminum alloy construction for long rustproof life.

If your dealer is temporarily out of the D-J Power tool you want, please wait. You'll be glad you did.

Darra-James



CORPORATION

WATERBURY 14, CONN.

"Tornado" Dehydrator for Meat Whirls Particles in Air

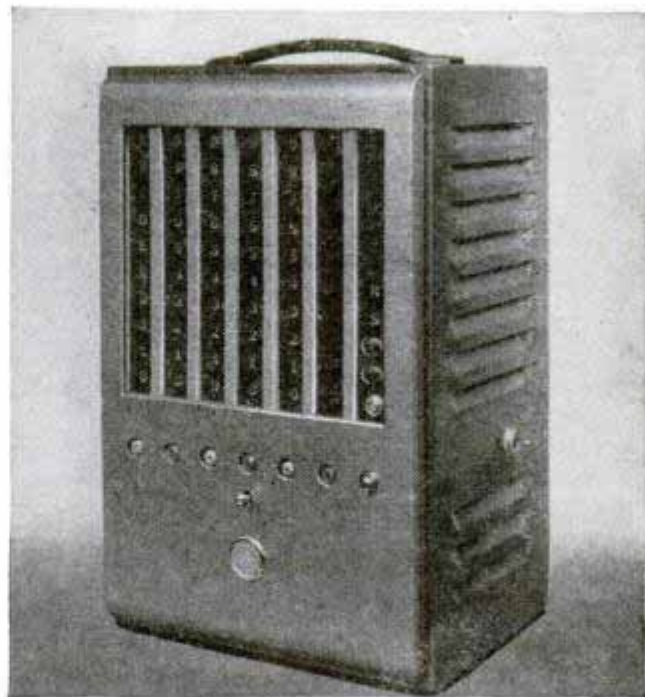

Ground meat "floats through the air" in a new dehydrating process to eliminate overdone particles that make other methods unsatisfactory. In former machines those portions that came in contact with the metal trays or wire drums were "overcooked." In the new machine the particles are blown upward in a blast of hot air and dance about until the drying process is complete. Fat becomes liquid and is drawn into a separate collecting duct at the bottom of the machine. When the lean meat is completely dehydrated it is whirled to the bottom and drawn off for packing. The machine was invented by William A. Noel, a U. S. Department of Agriculture engineer.

Electronic Watch Marks Time In 1/1,000,000 Second Intervals

Time intervals of as little duration as 1/1,000,000 second can be checked with an electronic stop watch. The instrument was originally designed to measure projectile velocities but has been converted to peacetime jobs such as counting drops of liquid falling from viscosity testing apparatus. It is also used as a timer in counting machines which automatically start, stop or change operations when a predetermined number of items has been counted. The instrument, developed by RCA, can count 1,000,000 objects per second.

☛ Night flyers will be able to detect dangerous clouds with a new instrument that receives and measures the heat emissions from them in the form of infrared waves.

• Test ALL Home Outlets
• Find Open Circuits

STAR TEST-PLIERS

• Locate Blown Fuses
• Remove Fuses SAFELY

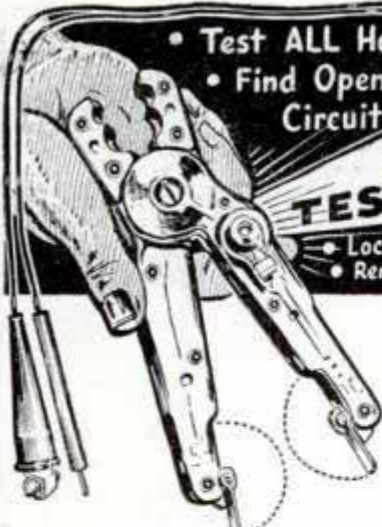

A must tool for electricians, maintenance men, home owners. Replaceable lamp inside Plier tests 110 to 250 Volts. Plier pulls fuses from 10 to 100 Amperes. Shockproof. Requires the use of only one hand. Can be obtained from General Electric or Westinghouse stores, or from local electric dealers.

A VERY WELCOME and USEFUL XMAS GIFT

Price \$2.75 without Leads, \$1.50 additional for Leads which provide greater reach and more flexibility.

STAR FUSE CO., 233 Canal St., New York 13, N. Y.

Special Surplus Savings on Plastics

GRADE A PLEXIGLAS

Reddish Black, Assorted sheet sizes, 1/4 inch thickness

\$1.90 per square foot

Also Plexiglas sheets new per sq. foot:

1/16	\$1.13	3/16	\$1.79
1/8	\$1.46	1/4	\$2.10

Add 10% for packaging on orders under \$10. Add \$1 for packaging on orders over \$10.

ALSO . . . complete line of RODS, TUBES, SHEETS, ODD SHAPES in all types of plastics. Dyes, cements, buffing compounds.

Franklin Plexiglas Anti-Static Wax, Burnisher & Cleaner

CADILLAC PLASTIC COMPANY

655 West Baltimore

Detroit 2, Michigan

How to SHAVE scientifically



Learn how you can harness forces of Nature (heat, cold and pressure) to improve the performance of any razor, any blade and any shaving soap. 16 page booklet 10 cents. Money back guarantee

RAZOR RESEARCH, 130 Water St., New York 5

New Designs in FRANZITE GRIPS

Modernize Your Gun! Improve Your Score! Most durable grips made. Positively unbreakable! For Colt, Smith & Wesson, Hi-Standard, Ortgies, Luger & Mausers in a wide choice of beautiful designs in ivory, pearl, walnut, onyx, etc. Low prices. FREE CATALOG. Dealers Wanted.

SPORTS, INC., (Mfrs.) 5501 Broadway, Dept. P-12, Chicago 40, Ill.

EXPERIMENT WITH LUMINOUS PAINT



See story "It glows in the dark" page 214 June issue of Popular Mechanics for many ideas on how to use our three color kit - contains one of each of 3 colors—LUMI BLUE, GARDENIA and CHARTRUSE. One ounce sealer. Guaranteed best quality.

COMPLETE KIT WITH 3 COLORS AND SEALER
\$4.25

New Address

F.O.B. Chicago

BLACK LIGHT PRODUCTS • 67 E. Lake St. • Chicago 1, Illinois

A TOOLSHOP IN YOUR HAND!

• GRIND • DRILL • ROUT
• POLISH • ENGRAVE
• CUT • SAND • SAW, etc.

Make Things From Wood—Plastics—Metals—Glass—Linoleum—Leather—Alloys—Horn—Stone—Bone, etc.



HANDEE TOOL OF 1001 USES

Smooth, steady power at your fingertips! Perform precision operations not possible with any other portable tool! With a Handee you can turn out professional looking projects for pleasure or profit—ship, plane and train models, costume jewelry, wood carvings, puppets, initialed tumblers, etc. AC or DC. 25,000 r.p.m. Wt. 12 oz.

USE THE RIGHT ACCESSORIES! Choose them from the most complete line . . . more than 300 made right in the Handee plant.

GET A GOOD START GET THE HANDEE KIT

HANDEE Tool and 45 most popular accessories packed in compact steel carrying case. You'll be amazed at what you can accomplish!



Postpaid, \$27.50

Handee, with 7 accessories, \$20.50

FOR YOURSELF OR A FRIEND... THE GIFT OF A LIFETIME!

NEW PRECISION ATTACHMENTS

Fit Handee only; enable novice or craftsman to do perfect work. Magically, easily, your offhand carving, routing, shaping will be exact as to depth of cut, accuracy of line. Set of 6 attachments with instructions, postpaid, \$7.95



ORDER NOW. SATISFACTION GUARANTEED!

FREE! NEW 52-PAGE MANUAL

CHICAGO WHEEL & MFG. CO.
1101 W. Monroe St., Dept. PM
Chicago 7, Ill.

Send Handee Kit Handee Tool Precision Attachments
 C.O.D. Remittance enclosed Send Manual

Name.....

Address.....



"In your opinion, which make of handsaw is highest in quality? Thousands of carpenters were asked that question. Three out of four replied, "Disston saws" . . . a high tribute indeed, for it comes from men who know saws best.

The reasons for this preference may be summed up in what one carpenter says, "You can't beat a Disston for good, clean cutting and long life."

Ask your Hardware Retailer for a fine looking, fine performing Disston Saw. Also ask him for a FREE copy of "The Disston Saw, Tool and File Manual," or write to us direct.



HENRY DISSTON & SONS, INC.

1211 Tacony, Philadelphia 35, Pa., U. S. A.

DISSTON The saw most Carpenters use

It's New! It's Terrific!

Supercharged THUNDERBIRD
Only Model Engine
with a
Genuine Supercharger



The SUPERCHARGED THUNDERBIRD packs a wallop of extra power because its exclusive supercharger impeller forces a denser gas mixture into the combustion chamber, thus increases in efficiency as the r.p.m.'s increase. The SUPERCHARGED THUNDERBIRD starts more easily, performs more smoothly, develops greater speed—faster! See this perfect racing engine for model airplanes, cars and boats at your dealer's today. If he hasn't stocked it yet, ask him to place a special order for you immediately.

\$24.95

Bore 31/32"
Stroke 7/8"
Displ. .645
Wt. 13 oz.

SCOTT MOTORS, INC.

Sky Harbor Airport

P. O. Box 831

Phoenix, Arizona

BEAUTIFUL SWISS WATCHES

AN AMAZING VALUE AT ONLY

\$8.50

COMPARE!

- Streamlined
- Steel Back
- Sweep Second Hand

Model B—7 jewels, stainless steel, radium dial . . . \$12.00

Model C—15 jewels, stainless steel, fancy radium dial . . . \$22.00

Model D—17 jewels, famous INCABLOCK movement, waterproof, shockproof, radium dial \$30.00

Each watch is carefully tested and checked by master craftsmen, delivered to you in perfect condition!

MONEY-BACK GUARANTEE

STAINLESS STEEL EXPANSION BAND (Fits Any Wrist) . . \$1.00
Add 10% Fed. Tax on all watch prices.

Send check, money order, or pay postman C.O.D. plus postage.

NO EXTRAS!—RUSH ORDER NOW!—Agents Wanted.

GOLDEN RULE CO. P. O. Kingsbridge Station
Dept. 23, New York 63, N. Y.



\$2.95

TORNADO GAS TORCH

The Modern Way of Soldering

Ideal for hard and soft soldering. Will heat quickly; solder will flow freely and smoothly. No compressed air required. Nothing to pump. Self-adjusting. Safe. Economical. Can be used for annealing small parts and bending metal parts. Generates a heat of 1700° Fahrenheit. Simply connect to any illuminating gas jet with a rubber hose and

operate. Tornado Torch No. 119 comes with three (3) tips, (1/8", 1/4", 3/8" blast).

The Tornado Gas Torch No. 119, complete with three tips, is \$2.95. See your dealer or order direct. Send check or money order—post paid.

ROBCO CORPORATION, 202 E. 44th St., New York 17, N. Y.

NEW! UNIVERSAL! SELF-CENTERING! MANDREL FOR HAND GRINDERS! ELECTRIC DRILLS



\$1.00
(less saw)

Fits all saws and grinding wheels with holes from less than 5/64" to more than 3/16" diameter. Centers any size saw or wheel precisely—automatically—immediately. All steel and brass construction—nickel plated. Precision machined; runs absolutely true. Fits any make grinder or drill. Patent applied for. Available with 1/4" or 3/32" diameter shank. Specify diameter desired. Sent postpaid with simple instructions. Dealer's inquiries invited. . . . **\$1.00**

PRECISION TECHNICAL SPECIALTIES CO.
59 Myrtle Ave., Brooklyn 1, N. Y.

USE Fine Walton Wheels to Make Your Own WAGONS—SHOPPING CARTS and RACERS



65¢

Each in Sets of 2 or 4—plus 10c ea. for postage. 4 1/2-inch with 3/8-in. bushing

Coaster wagons, scooters, shopping carts, bike trailers, golf bag carriers, etc., are easy to make. Use fine Walton DeLuxe Wheels! They're strong welded pressed steel construction. Ideal for making many things for use and play. Solid rubber tires. Red enameled. Send check or money order. No C.O.D.'s. Dealers and manufacturers write.

WALTON WHEEL COMPANY, Dept. J-4
Plankinton Bldg. Milwaukee 3, Wis.

START HOME MAIL ORDER BUSINESS

Start small—grow big. Amazing new course shows you the way. Rush your name and address today for full particulars. No obligation.

BELFORT (Dept. A) Engineering Bldg. Chicago 6, Ill.



FREE! Radionic Catalog

New, big, FREE 1947 Catalog full of radios, parts, accessories, tubes, record changers, phono players, etc.

RADIONIC EQUIPMENT CO.
170 Nassau St., Dept. 2012, New York 7, N. Y.



Cars must Start...no matter how cold

You know how difficult it is to start your engine on a bitter cold day. Time and again you've ground your battery away. Even a fully charged battery won't insure a start.

Casite is the *guaranteed* answer to winter starting. No matter how cold, it retards congealing of oil, lets the engine spin over rapidly and start—with less battery drain. Millions of car owners know this from experience.

Casite is sold by service stations, car dealers and garages in every community. For quick starting in winter, put a pint in your crankcase oil now and with every

oil change or each 1000 miles. For better and smoother performance year 'round, also put a pint through the air-intake every three months.

NEW MYSTERY THRILLER... "MICHAEL SHAYNE"

Tues.—8 P.M. ET • 7 P.M. CT • 6 P.M. MT

Wed.—7 P.M. PT—(West Coast) • MBS

THE CASITE CORPORATION • HASTINGS, MICHIGAN
IN CANADA: HASTINGS LTD., TORONTO

CASITE



Quick Starting in Winter Weather or double-your-money-back

GUARANTEE—We guarantee that any motor capable of being started in a warm room will start promptly in the coldest weather when Casite is added to the crankcase according to instructions. If your car fails to start quickly, you get double-your-money-back by filling out guarantee certificate and mailing it to The Casite Corporation, Hastings, Michigan. Maximum refund is \$1.30 per pint, twice the nationally advertised price of Casite.

65¢ A PINT
75c in Canada

YOU CAN GET 1/2-TON JAW PRESSURE WITH THIS WRENCH

SPECIAL CHRISTMAS OFFER

\$175

POSTPAID TO ANYWHERE IN U.S.A. NO C.O.D.



SAMSON LEVER - JAW WRENCH

OVER 1,000,000 IN USE

- Breaks loose and turns stubborn, rounded nuts no other type wrench can turn.
 - Excellent pipe wrench — sure grip, fast action.
 - Secure clamp for welding, soldering, drilling, etc.
 - Portable vise for holding small or irregular shapes for grinding or drilling and ideal for holding cold chisels or star drills.
- A kit of tools in one! Will pay for itself on one job! Made entirely of steel; cadmium plated; length 10 inches over all; hardened jaws open to 1 1/4 inches — can be locked in any position. Send your order today — you take no chance — satisfaction guaranteed or your money refunded.

SEND ORDERS TO

WM. TRUMAN TOOL CO.

153 S. YORK ST. ELMHURST, ILL.

RIDE-RITE

NEW TYPE — LIGHTWEIGHT — HEAVY-DUTY STRENGTH

UTILITY TRAILER AXLES

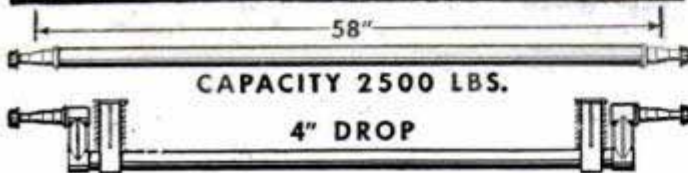

CAPACITY 2500 LBS.

4" DROP

EITHER TYPE AXLE AVAILABLE WITH OR WITHOUT SPRING SUSPENSION (Pat. Appl. For)



Build your own utility trailer and equip it with a Ride-Rite axle. Get the advantage of its new lightweight, heavy-duty tubular construction. Available with or without patented double-coil spring suspension. Straight axle has standard 58" tread; drop axle has 60" tread. Distance between spring hangers 48" on both axles. **BIG CAPACITY:** Axles made of 1 1/2-inch O.D. steel tubing have tested load capacity of 2500 pounds. Coil springs, four per axle, have minimum capacity of 650 pounds each. Ride-Rite axles will fit hubs and wheels made by Motor Wheel Corp., Kelsey Wheel Co., Ford Motor Co., and Industrial Machine Tool Co.

PRICED LOW AS

\$675

PRICES F.O.B. FENTON, MICH.

Remittance with order — No C.O.D.	Axle Only	Axle with Springs
Straight Axle, Std. Tread	\$ 6.75	\$19.70
Drop Axle, Std. Tread	12.50	25.45
(Springs fit Ride-Rite axles only)		
Axles can be furnished any tread desired for slight additional cost.		

MANUFACTURERS AND DEALERS!

Write for descriptive literature
QUANTITY LOT PRICES
FURNISHED ON REQUEST
WRITE ON YOUR LETTERHEAD

MANUFACTURED BY

INDUSTRIAL MACHINE TOOL CO., INC.
200 S. LEROY STREET FENTON, MICHIGAN

AUTOMATIC RETOOTHER

MAKES NEW PROFITS

FOR HAND SAWS

Cuts new teeth in 50 seconds! Any size tooth 4 to 16 points. Old teeth fall off as chips. Simple to operate. A perfect job.

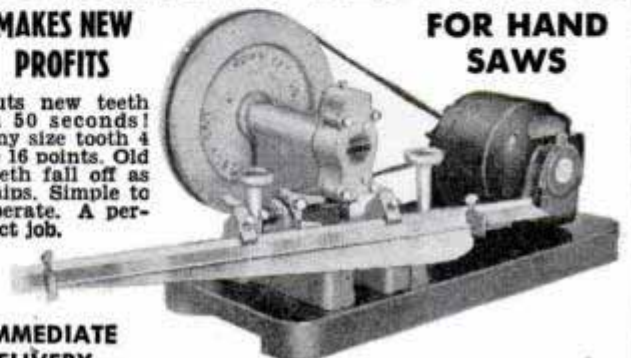

IMMEDIATE DELIVERY

BURR MFG. CO. 8933 Venice Blvd. Los Angeles 34, Calif.

As MODERN as the electric refrigerator, compared with the old ice box.

Install an aerial

VERTROD — vertical models eliminate poles — insulators — lightning arresters — filters — hanging aerial wires — climbing.

THE VERTROD WAY

VERTROD — 20 models cover all wave reception — FM — AM and Television.

The VERTROD way (with patented features) is the modern way. At most radio shops.

VERTROD — the most perfect scientific development approaching complete freedom from man made static.

Write for folder 403

VERTROD CORPORATION

60 EAST 42nd STREET · NEW YORK 17, N. Y.

New "THERMO-SAW" (cuts with heat)

MAKE THINGS FOR THE HOME or FOR SALE

• ANY CHILD CAN USE IT •

No Noise—No Vibration—No Sawdust

Boys and Mechanics thrill over the many interesting things that can be made with this NEW ALL-STEEL THERMO-SAW . . . You can cut out any pattern or design in 1/2 the time . . . Difficult patterns are made QUICK and EASY . . . No turning of work . . . Cuts in every direction! . . . Cuts plywood 1/8" or 1/4" . . . Cuts 1 1/2" x 3/8" board. Will cut 1 1/2" Plexiglas very well . . . A special transformer produces high frequency current in a tough steel wire "blade" from ordinary Alternating (AC) Current . . . IMMEDIATE DELIVERY!

Extra Blades ONLY 20c per dozen. ORDER TODAY
Machine Measures 11" x 4" x 3 1/2" High. Throat 7" Deep. PATTERN INCLUDED FREE.

AN IDEAL GIFT

NOTE: Operates on 110 volt Alternating Current. 50 to 60 cycle.

\$4.75 in Canada & Mexico. \$5.00 elsewhere. No C.O.D. Orders Please!

CUTS RAPIDLY AND CLEANLY THROUGH WOOD AND OTHER MATERIALS

A FEW OF THE MANY INTERESTING THINGS YOU CAN MAKE

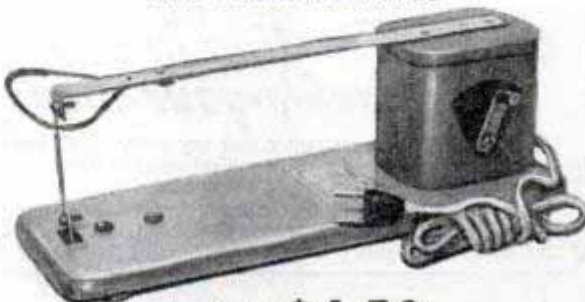

Boisselier Mfg. Co., Dept. P-12, Glen Ellyn, Ill.

Pat. No. 2,272,931 D-87-072

ONLY \$4.50 Postpaid

COMPLETE SAW outfit as illustrated with transformer and 12 spare blades. Ready to use.

**HANDIEST ITEM IN YOUR WORKSHOP
THE FLASHLIGHT THAT GOES
AROUND CORNERS**

**IT'S
FLEXIBLE**

**200 FROM
KALAMAZOO
FLEX-LITE**

**FOR THOSE HARD-
TO-GET-AT
PLACES:**

**PRICE
\$1.50**

**POSTPAID
Less Batteries**

**JUNIOR
FLEX-LITE
Model
A-35**

**IDEAL FOR MAINTENANCE MEN • PLUMBERS
CAR OWNERS • MECHANICS • REPAIRMEN
SPORTSMEN • RADIO MEN • HOME USE**

**See Your Favorite Dealer or
Send Order Direct to Factory**

**AERO-MOTIVE MANUFACTURING COMPANY
1803 Alcott Street • Kalamazoo 24, Michigan**

AMAZING MYSTERY BUTTON

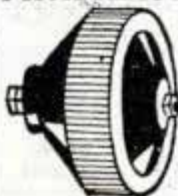

Startles Everybody. With this *Electronic Button* you can make your own Telephone-Amplifier-Detectophone. Attach this button to piece of cardboard - transmit conversation to another room. Music also transmitted to distant places. Most interesting electrical apparatus ever discovered. Enables you to perform hundreds of experiments. So tiny it can be concealed in dozens of places. A Pre-War Product. *Electronic Button* including 5000 word instruction booklet with 50 illustrated experiments, postpaid, only **\$1.00**

SUPER MYSTERY BUTTON

Many times as sensitive as our regular mystery button. Can be used for the same experiments and uses as the mystery button but with far better results. Needs no diaphragm of any kind. Ideal for musical instruments, intercommunication, recording, talking thru radio, and many other uses. When used with small head phone it makes an ideal inexpensive hearing aid. Shipped with 5000 word, 12 page booklet showing diagrams for dozens of uses. postpaid **\$2.00**.

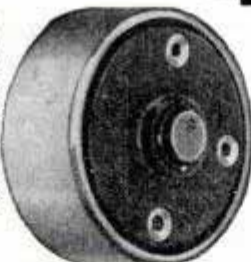

**Electronic Products Company
Saint Charles 1, Ill., U.S.A.**

SAY YOU SAW IT IN POPULAR MECHANICS

New Miracle Car Paint!

NO BRUSH! NO SPRAY! DRIES IN ONE HOUR!

Now! Paint your car easily, quickly, economically with DAB, the new wonder car paint! Apply with rag! Leaves no lap marks! No equipment needed! One qt. paints your car completely. 5 rich colors; Washington Blue, Brewster Green, Lt. Maroon, dk. Maroon, Black. 2 yr. guarantee. Send for DAB today. \$5.95, ck. or money order. Address DAB, 2160 Sunset Blvd., Los Angeles, Calif.

MUFFLERS

**STEELS and ALUMINUMS
with a motorboat tone**

SINGLES, Chev, V-8, Plymouth, Steels \$5.50, Aluminum \$6.50. Chry., Olds., Buicks, etc., Steels \$7.50, Aluminum \$8.50. V-8 and MERCURY DUALS, Steel \$17.50, Aluminum \$20.00. Aluminums are guaranteed for life of your car.
DEALERS WANTED

**V-8
DUALS
& SINGLES**



**SANDEE MUFFLER CO.
7523 S. WESTERN AVE., LOS ANGELES 44, CALIF.**

VIKING

ROTOPLANER AND ROTOSANDER

**Special Christmas offer — both tools for
\$11.95**

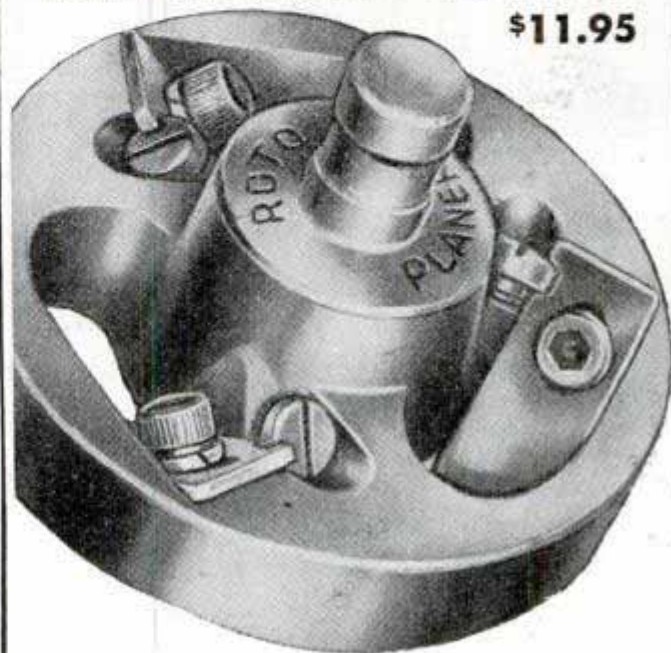

ROTOPLANER

List \$7.50

A masterly designed Rotary wood planer. Note the ingenious idea for extreme precision and easy adjustment of the wide hi-carbon steel knives.

Will fit any drill press and is made to rabbet, tenon, cut beads, panel and step cutting, routing, etc.

ROTOSANDER

A rotary surface sander of unique design. The body and rim screw together to rigidly bind and properly "cup" sandpaper.

List \$6.00

FREE

with purchase

Steel adapter. Get this "Aircraft precision-made" Arbor, FREE.

**See Your
Dealer Or
Order From Us**

**Ten-Day
Money-Back
Guarantee**



DELIVERY SAME DAY ORDER IS RECEIVED

Gentlemen: Send me Rotoplaner , Rotosander , Both . Enclosed find Check , Money Order , Cash for \$..... Ship prepaid on receipt of money or send C.O.D.

Name.....Address.....

City.....Zone....State.....

**VIKING INDUSTRIES COMPANY
2063 E. Gage Ave. Huntington Park, Calif.**

Light & Versatile

FOR BETTER SOLDERING



Built for speedy accurate soldering, this powerful little pencil iron will perform rugged heavy duty jobs as well as those requiring intricate exactness.

Check These Points!

- ✓ QUICK HEATING... 90 SECONDS
- ✓ LIGHTWEIGHT... 3.6 OUNCES
- ✓ HANDY SIZE... 7 INCHES
- ✓ SAVES ELECTRICITY... 20 WATTS

✓ *Perfect Balance*

These 4 INTERCHANGEABLE tips give you a point for each particular job.



No. 536 Pyramid Tip, made from Teflon

No. 537 Chisel Tip, made from Teflon

No. 537 Pencil Tip, made from Ekaloy A, Tip 1/8" dia.

No. 538 Chisel Tip, made from Ekaloy A, Tip 1/8" dia.

SEE YOUR NEAREST RADIO, HARDWARE OR HOBBY DEALER

WINGAR Electric Tools

BOX 2251, TERMINAL ANNEX - LOS ANGELES 54, CALIF.



WAKE UP YOUR Scalp

BE FAIR TO YOUR HAIR Want better-looking hair? Embarrassed by falling dandruff, itching scalp? Then try VITABRUSH, new electric driven scalp brush that gives your scalp a vigorous and invigorating "workout" in just three minutes of fun. Cleans scalp. Stimulates blood supply. Restful. Pleasant. Write today for complete information and satisfaction-guaranteed offer. Hershey Mfg. Co., 3717 Field Bldg., Chicago 3.

BIG OPPORTUNITY

BUILDING BLOCKS of CONCRETE CINDERS

Men of vision and Modest Capital see prosperity and independence in this big field today. Everywhere every kind of building to be done—residence construction biggest of all. Big demand for quality blocks at low cost. Our Blocker Vibrator produces high quality blocks from sand and gravel, limestone screenings, or any light weight aggregates. All steel construction—will make 800 to 1200 blocks every 8 hours.



WRITE for details and "How to Start and Operate a Concrete and Cinder Block Plant—a New Local Business Rich in Opportunity." Rush name, address today.

CONCRETE BLOCK EQUIPMENT CO.
920 CENTRAL, DEPT. 103 KANSAS CITY 6, MO.

New! 12" Sheet Metal Brake Only \$12

Fits in bench vise. Quickly, easily forms all kinds of angles in sheet metal, strap iron and aluminum, wire and plastic. Use it to make useful articles, experimental research work, patent models, etc. Simple gages made for quantity duplicating. Sheet Metal Pliers included. Form any length, angles, channels and crimps in thin sheet metal. 2 1/2" jaws. Now available. Send for details, or order direct. \$12 p.p. Wt. 10 lbs. C.O.D. \$2.00 deposit.

Companion Shear. Cuts sheet metal any length. Clamps to bench. Adjustable guide. Same price as brake. Both guaranteed.

VISE BRAXE MFG. CO., Dept. P. M., 1318 So. 30th Ave., Omaha 5, Nebr.

TRAILER AXLES, HITCHES, AND PARTS

● If you are interested in purchasing trailer axles, hitches, and other trailer parts, contact us promptly. **Write for free literature.**

HAMMER BLOW TOOL COMPANY, Dept. 112, WAUSAU, WIS.

OTTAWA TRACTOR SAW

350 SAW STROKES PER MINUTE



THOUSANDS IN USE

Falls trees quick—no lifting, pulled by tractor—easily swung into position. Saws large and small logs. Safety Friction Clutch. The most useful, low-priced tractor saw ever built. Thousands in use—NEW improvements making more useful than ever. Saw your wood lot into Cash while prices are high. Make your tractor pay bigger dividends. Lowest direct-to-user prices. Fully guaranteed. Send for Free details.

Costs Too Little To Do Without

OTTAWA MFG. CO., D1227 Forest Ave., Ottawa, Kansas

MILL IT ON YOUR LATHE

WITH A PALMGREN MILLING ATTACHMENT

Now — you can do milling, slotting, grinding, grooving, squaring shafts, sawing at angles, and many other important operations on your lathe. PALMGREN MILLING ATTACHMENT is a necessary fixture for small shops, schools and emergency work in large plants. Fits South Bend, Atlas, Craftsman, Logan, Sheldon and all other makes. It has graduation for rotary angle adjustments, also graduated feed and adjustment screw. Easily mounted by straddling lathe's regular tool post. Try one—it will quickly pay for itself.

IMMEDIATE DELIVERY

No.	Width Jaws	Depth Jaws	Jaws Open	Weight Pounds	Base Opening	Price F. O. B. Factory
150	3 1/4"	1"	1 1/2"	6 1/2	1"	\$18.75
250	2 1/4"	1 1/4"	2 1/4"	11	1 1/4"	24.75
400	4"	1 1/2"	4"	25	2"	39.75

Order from your dealer or jobber. Write for circular No. 349

CHICAGO TOOL AND ENGINEERING CO.
Mfrs. of PALMGREN PRODUCTS for Over 28 Years
8365 South Chicago Avenue ● Chicago 17, Illinois

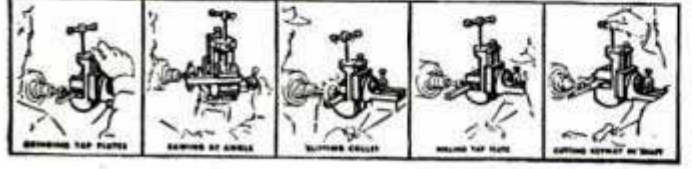

Look! Servicemen - Civilians too!

PRECISION BUILT

MILITARY WRIST WATCH



The watch you've been waiting for!
Swiss Movement!
 Precision made by
Expert Swiss Craftsmen

**WRITTEN GUARANTEE
 WITH EVERY WATCH**

A fortunate purchase makes this amazing offer possible. Latest military styling, red sweep second hand. Easy to read Extra Fancy Dial. Comes complete with Leather Strap. A watch you'll be proud to wear or give as a gift. Below O.P.A. Price.

Immediate delivery
\$8.49
 ONLY plus 10% Fed. Tax

SEND NO MONEY—Pay Postman \$8.49 plus 85c Fed. Tax and few cents postal charges, or, send \$9.34 with order and we pay postage. Return within 10 days if not delighted for refund providing watch has not been tampered with.

Hurry — Order Now — Supply Limited!

ORDER WITH CONFIDENCE FROM
AMERICAN MERCHANDISING CO., INC.
 Dept. PMW-6 12 Adams Ave. Montgomery 4, Ala.

—FREE PLASTICS CATALOG—

Tells about a new source of supply for everything you need to make beautiful projects of crystal-clear Plexiglas. Included is a fine assortment of ready-made kits based on what the craftsman needs. Available also are permanent dyes for coloring, polishing rouges, and a quick-setting special cement. You also get complete instructions on how to cut, drill, form, and polish. There's also a big "grab bag" kit out of which you can make hundreds of projects. Send for your free copy today.

Jackson Studio, Dept. M, 5440 N. Shoreland Ave., Milwaukee 11, Wis.



POCKET TOOL

Handy, useful, something you need many times during the day. Regardless of where you work—in the factory—

around the home—on the farm—this patented "Lucky 7" pocket tool will be worth its small cost many times over. Made of case-hardened steel— $\frac{1}{8}$ " thick—1" wide and $3\frac{1}{2}$ " long. Screw driver, rule, square, wrench, wire splicer, tack puller, bottle opener, friction top can opener, wire insulation stripper and other uses. Send only 25c in coins at once—and get yours, postpaid, while they last. Satisfaction guaranteed or your money back. **YATES MFG. CO., 611 MAIN ST., LAKE GENEVA, WIS.**

SAY YOU SAW IT IN POPULAR MECHANICS

**BUILD YOUR OWN!
 FAST FREEZER PLANS \$1.00**

It's easy to build this household appliance and profitable to use. Save up to 75%. Operates on 110 or 32 volts. Plans show 5 sizes and are easy to follow. **ENJOY MAKING ONE** of these freezers from new or used parts. No expert knowledge needed. Mail \$1.00 bill or check for complete plans and catalog.

LE JAY MFG., 447 LeJay Bldg., Minneapolis 8, Minn.



5 sizes
 8 to 40 cu. ft.

If They'll Bite You Can **CATCH 'EM** With The



FISHING GADGET
 Sets Hook Automatically

The greatest fishing invention since the fish-hook! Automatically sets the hook on fish that bite. First day's results insure lifetime use. Will last for years. Made of non-corrosive metal. Use on any line... for any kind of fishing. See your dealer or send coupon and \$1 bill for your Fishin' Gadget... Now!

MONEY-BACK GUARANTEE

BRUNSON MFG. CO.
 1405-7 Walnut St., Kansas City 6, Mo.

Here is a \$1 Bill. Send me a Fishin' Gadget quick!

NAME _____
 STREET _____
 TOWN _____ STATE _____

2-Way Talkie!

Hold conversation without the use of telephone... household electric current... Ideal for Home... Farm... Office... etc.



JUST FLIP THE SWITCH AND TALK!

It's lightweight and can easily be moved anywhere.

Talkie comes complete with both units, long life batteries and wire. There's nothing else to buy.

Operates on ordinary flashlight batteries.

Complete for Only

\$17.50
 Prepaid

Will operate at its Best Efficiency at 100 feet. Here are a few of the many uses for the 2-way talkie

- FROM ROOM-TO-ROOM IN THE HOUSE
- FROM OFFICE TO STOCKROOM
- FROM KITCHEN TO FRONT DOOR
- FROM EXECUTIVE TO SECRETARY
- FROM SICK ROOM TO KITCHEN
- FROM YOUR HOUSE TO A NEIGHBOR
- FROM DOCTOR TO NURSE
- FROM FARM TO BARN OR DAIRY
- FROM LAWYER TO SECRETARY
- FROM MAIN HOUSE TO GUEST HOUSE
- FROM HOUSE TO GARAGE

MAIL COUPON NOW!

UTILITY STORES, (Est. 1906), Dept. MM-10
 117 S. Wabash Ave., Chicago 3, Ill.

Please rush complete 2-WAY TALKIE. If I am not more than satisfied with my 2-WAY TALKIE after 5 days' trial I will return it to you and you will promptly refund my money in full.

Name..... PLEASE PRINT

St. or R.F.D.....

City..... Zone.... State.....

GET THAT **GLORIOUS FINISH** With One Coat of **RESINITE**
For Any Surface Anywhere

- RESINITE made of resins and chinawood oil that were proven on battlefield during World War II.
- RESINITE for indoor and outdoor painting.
- RESINITE dries quickly, leaves no brush marks, gives hard glossy finish. One coat covers. 1 qt. covers average car.
- RESINITE won't chip, crack or peel.
- RESINITE withstands salt air, salt water, rain, sleet, snow, sun, alcohol and road tar.

RESINITE the paint you have wanted, waited for and can buy at your dealers today or write us direct. RESINITE developed and proven during World War II. Scientifically compounded from synthetic resins and chinawood oil to give toughness, elasticity and durability.

Paint It Yourself With the New Post-War
RESINITE ONLY \$2.95 a QUART

Now available at your Dealers in choice of colors.

RESINITE the perfect coating for any surface anywhere. RESINITE so simple and easy to apply any beginner can do a beautiful job.

RESINITE for indoor and outdoor Woodwork, floors, furniture, tile, linoleum, concrete, cars, trucks, trailers, all types of farm machines and implements, boats and toys.

Dealers and Jobbers Inquiries Invited

RESINITE CHEMICAL CORPORATION

332 S. Michigan Ave. Chicago 4, Ill.

Build Your Own.. **RADIO INTERCOM AMPLIFIER TRANSMITTER**

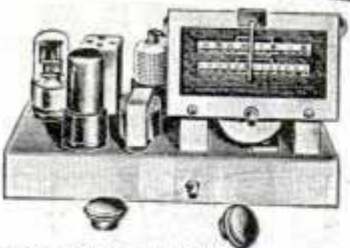

Famous POPULAR MECHANICS and other KITS

Enjoy thrill of building your own equipment from famous Popular Mechanics, Concord and other radio training Kits—ideal for home radio study and experimenting, and for classroom, radio club and Boy Scout radio training projects. 25 different Kits, various types, each including all parts, hardware, diagrams and instructions, now available from CONCORD.

MAIL COUPON FOR FREE CATALOG

Fill out and mail coupon below for new complete Concord Catalog listing famous Popular Mechanics and many other Radio Kits—plus complete line postwar-designed Radio Sets and Radio Parts, surplus and equipment for every need. Mail coupon for your free copy—NOW.

CONCORD RADIO CORP.

LAFAYETTE RADIO CORPORATION
CHICAGO 7, ILL. 901 W. Jackson Blvd. • 265 Peachtree St. ATLANTA 3, GA.

CONCORD RADIO CORPORATION, Dept. P-126
901 W. Jackson Blvd., Chicago 7, Ill.
Rush FREE copy of new, complete Concord Catalog.

Name.....
Address.....
City..... State.....

SpeedWay

No. 69 1/4 Drill \$11.80

No. 89 1/2 Drill \$29.95

Each month, more SpeedWay Drills come off the production line; are being shipped each day. But, frankly, though we are beginning to cut into our mountainous pile of back orders, there's a deal of waiting still for a lot of people who are ordering SpeedWay Tools today. However, because they are worth waiting for, we suggest that you place your order now with your local SpeedWay dealer for earliest possible delivery.

SPEEDWAY MFG. CO.
1863 S. 52nd Ave.
Chicago 50, Ill.
No. 89 equipped with Snap-Release Chuck
No. 89-J with Jacob chuck (as illustrated) \$5.00 extra

THE GEM MAKER

Amateurs or professionals... hobbyists or jewelers... Polish your own gems with a B&I Gem Maker. You will find this a profitable adventure. All necessary lapidary equipment is furnished. Including a super-charged diamond blade for sawing, and all wheels for grinding, shaping and polishing, also complete instructions. The complete equipment as shown, less motor and belt, for only \$29.50, f.o.b., Burlington, Wis. Write today for information and literature on the Gem Maker and accessories.

B & I MFG. CO., Dept. S, Burlington, Wis.

MACHINE SHOP EQUIPMENT

Just off the press!—Every man who owns a workshop should have a copy of the new, up-to-the-minute, 200 page catalog of Machine Shop Equipment—the latest tools made by the biggest manufacturers in the U. S. Replete with illustrations, descriptions, prices. Prompt delivery on most tools listed in this book. Available at cost of printing—50c a copy—get yours today! **Price of Catalog Refunded on First Order over \$5.00.** Send check or Money Order to

CENTER TOOL CO., 154 Centre St., New York 13, N. Y.

Make Your Own RUBBER MOLDS
Amazing New Method!....

Now, an amazing new method to make your own flexible rubber molds to recast sculptured models or subjects. Duplicate singly or in quantity, expensive original subjects at amazing low cost. Reproduce statuettes, plaques or any other models—any surface—with this new liquid rubber material. Hundreds of other uses.

PROFITABLE HOBBY!
Start this fascinating hobby that can lead to beginning of your own business. For only a few cents each, make hundreds of castings to resell at big profit prices. Easy to start. Big list of subjects you can reproduce.

SEND NO MONEY!
Just your name and address for BIG INTRODUCTORY KIT containing 14 different items; everything you need to work with including famous Indian model. Pay postman only \$1.49 plus C.O.D. postage. Money back if not satisfied. Or save C.O.D. by sending \$1.49 with order and we pay postage. Write for FREE CATALOGUE!

RUBBER-FOR-MOLDS, 321 W. Monroe, Dept. 49-S, Chicago 6, Ill.

JUST IN TIME FOR XMAS!

At Wholesale Prices

**Singer
RECORD PLAYER**

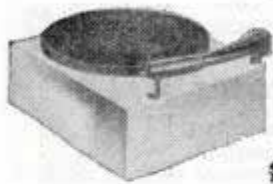

Your Price Complete with Tubes

\$13.95

less tubes **\$11.95**

Constant-speed rim-drive AC motor. Dynamic Speaker. 50L6 Output. Attractive Finish. Aluminum shielded case. Plays 10" and 12" records.

**Singer
TOASTER**



YOUR PRICE \$4.58

O.P.A. Ceiling \$6.10 Handsome, chrome-plated "Flip-Flop" type 500 watt element.

Money-back Guarantee IMMEDIATE DELIVERY!

N. J. INDUSTRIAL CO.
11 HILL ST. Dept. C NEWARK 2, N. J.
Money Order or Certified Check

First REAL Electric TOY IRON Since the War

A safe Christmas gift! Fully streamlined, Underwriters approved cord. 15 Watts—enough heat to iron—not enough to burn. Polished cast aluminum with black wrinkle finished handle. Order now for Christmas. Shipped postpaid immediately, anywhere in U.S.A. for

\$3.29



Size 3 1/4" high 5 3/4" long

M & J PRODUCTS, INC.
3730 N. Southport Ave. Chicago 13, Ill.

SMART RATS TRAPPED!

New Trap Can't Harm Children, Pets, Birds or Poultry!

It's amazing how the new HAVAHART catches rats, rabbits, squirrels, and other pests—yet it's harmless to you and yours! No springs, no jaws! Animal walks in to get bait, and the doors close! Send postal for free booklet. HAVAHART, 312 Water Street, Ossining, N. Y.



QUICK! "REPAIRING CAR BATTERIES!" MONEY! At Home! Easy Tool! Free Circulars!

Write, BATTERYMAN, Dept. 5, Grand Junction, Colo.



THE PLASTICOR

Something New, THE PLASTICOR, Plastic Injection Molding Machine, Molds Toys, Jewelry, Novelties. An excellent Xmas Gift. Send name for complete details. GRAY MODELS, Dept. PM, P.O. Box 1234, Syracuse 1, N. Y.

SAY YOU SAW IT IN POPULAR MECHANICS

now
WATER & OIL INJECTION
for **ALL** AUTOS · TRUCKS
BUSES · INTERNAL
COMBUSTION ENGINES



Gasolizer



PREHEATING WATER & OIL INJECTOR

\$12.95 and \$15.95

PATENT PENDING USA & FOREIGN



SALESMEN & DISTRIBUTORS
BIG PROFITS!
TAKING ORDERS FOR UNITS
Exclusive territories still available

✓ CHECK THESE FEATURES:

- ✓ ADDED POWER
- ✓ CARBON ELIMINATION
- ✓ UPPER CYLINDER LUBRICATION
- ✓ REDUCED GASOLINE CONSUMPTION
- ✓ LONGER ENGINE LIFE

Using principle successfully employed on military aircraft during the war



Gas Unit

6-8 Locke St., Buffalo 2, N. Y.

• WRITE US FOR COMPLETE DETAILS •

Roosting Age CHICKENS or PULLETS

Cheaper than raising them from baby chicks. No brooder needed. Light or Heavy breeds. Pictures. low prices FREE. Write IMPERIAL FARMS, Dept. 177, Ottumwa, Iowa.

TURN SCRAP INTO MONEY

AUTOPOWER tells you how in plain, easy, simple, and illustrated instructions that anyone can follow. Change auto generators into useful, practical AC and DC generators and motors with voltage from 2 to 1,000 volts, for power, light, welding, radio, sound, etc. No previous experience nor special tools needed. Generators can be driven by wind, water, fan belt, etc. Already used and endorsed by thousands. Send for your copy of "AUTOPOWER." Only \$1.00 postpaid.

AUTOPOWER INC., 2118 Pine St., St. Louis 3, Mo.

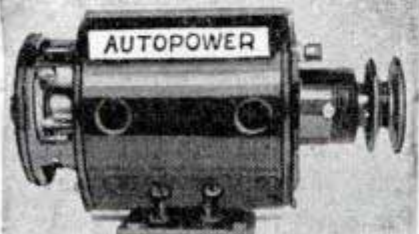

make your
TALLEST
wish come True



with
ELEVATORS
TRADE MARK

HEIGHT-INCREASING SHOES
"YOUR PERSONAL PEDESTAL"

De Luxe Grade
TRADE MARK OF STONE-TARLOW CO., INC.

Many more opportunities will come your way the moment you step into a pair of "ELEVATORS." For these amazing height-increasing shoes make you more than 1 1/2 inches TALLER instantly. And "secretly" too... for the heels are no higher.



\$15.95

Slightly higher Heel

STONE-TARLOW CO., Inc., Dept. PM12-46
Brockton 68, Mass.

Send Booklet and name of nearest dealer.

Name _____
(Please Print)
Address _____
City _____ State _____

The Original and Genuine "ELEVATORS" Manufactured Exclusively by STONE-TARLOW CO., Inc.

WRITE FOR Free Sample

GLOWS IN THE DARK

★ ★ Make Big Money ★ ★

Be the first to sell luminous house numbers and light switch plates. Also luminous pictures, statues, etc. Religious, nursery, glamour and other subjects. Sell on sight.

Represent a Large Manufacturer Est. 1912
MADISON MILLS • 303 Fourth Ave. • New York 10, N. Y.

Start a PLASTIC BUSINESS

this Marvelous Machine
NOW PAVES THE WAY
TO BIG PROFITS

Opportunity is all around this excellent machine. This S-K-W Press is ideal for manufacturers, custom molders, laboratories, home workshops, colleges, etc. Operates hydraulically, quickly, accurately, economically. Pays big dividends in a hurry. Electrically controlled heat under varying degrees of pressure and temperature. Platen area approx. 20 sq. in. Size of press 9 1/2 x 14 x 26". Ram pressure to 8 tons.

PRODUCES BOTH PLASTIC and RUBBER PARTS

NOW you can make your own plastic or rubber parts from your own mold, material can be secured in most localities. We can also save you money on any molds you desire. The plastic industry offers great opportunities for those who get into it TODAY.

USED FOR HUNDREDS of MOLDING NEEDS
This Machine offers an excellent start in this Big Money-Making Industry. Make YOUR OWN PRODUCTS. Establish YOUR OWN BUSINESS. ORDER TODAY. ONLY.....

IMMEDIATE DELIVERY

Wt. Approx. 100 lbs.
COMPLETE

\$160.00

F.O.B. Chicago

CLARENDON MFG. CO., Dept. P-12, 176 Adams St., Chicago 3, Ill.

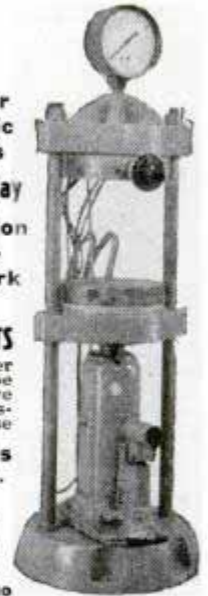

Made From
IMPORTED BRIAR

BULLDOG SADDLE



Enjoy unmatched sweet smoking quality, outstanding fine grains, in modern designs.

Write for FREE illustrated booklet. **\$3.50 to \$15**

C. B. WEBER & CO., 141 Cator Ave., Jersey City 5, N. J.



Profit by the Building Boom!

Start your own business manufacturing concrete building block and brick. Use Economy hand moulds. Make true, straight, easy-to-lay units which will pass any building code. Small investment, high production, big profits. One \$30.00 mould will make 1,000 5" x 8" x 12" blocks per day. Letters and repeat orders tell how pleased our customers are.

WRITE FOR FOLDER

Economy Manufacturing Company
Dept. P Stone Mountain, Georgia

Sensational New Liquid "Plastique" Linoleum Finish

OPENS BIG BUSINESS—DOES AWAY WITH SCRUBBING or WAXING

Here is a new experience awaiting you in a BIG PROFIT MONEY MAKER. Makes no difference what you have ever sold or if you never sold anything in your life before... THIS IS YOUR OPPORTUNITY... Every Home is your prospect and every housewife is an enthusiastic buyer... The first introduction in any community arouses unusual interest... You will be busy supplying the demand direct or through stores as you prefer... Sales keep piling up because housewives have been waiting for something like "Plastique." So HERE IT IS! It brushes on in a jiffy and adds LIFE and BEAUTY to the linoleum... This is not an ordinary product... It is sensational and opens a tremendous opportunity for sales and profits... All within your grasp... BUT YOU MUST ACT QUICK!

BIG MONEY MAKER
Write Today—

DISTRIBUTORS—AGENTS WANTED EVERYWHERE

Every community offers the same opportunity and as we want Distributors and Agents in every territory we would suggest prompt action on your part... The information is FREE and we are assigning territory NOW... Therefore do not delay... BE FIRST IN YOUR TERRITORY.

WONDERFUL OPPORTUNITY

PLASTIQUE NU-FLO PRODUCTS CO., Dept. P-12, 109 S. Clinton St., CHICAGO 6

DRIES IN 1/2 HOUR

Marvelous Smooth

Hard Protective

High Lustre Finish

NON-SKID—WATERPROOF

HOUSEWIVES ENTHUSIASTIC

Saves Time and Work and Money

The first pipe smoke!

Sir Walter Raleigh's servant dashes water on his master, to "out out the fire."
(from an old print—Bettman Archives)



Sir Walter Raleigh, father of pipe smoking, never knew the pleasures of a Sterncrest pipe. Poor chap, he was born too soon to puff an LHS of genuine Imported Briar, vita-fused for sweetness from the first puff.

IMPORTED BRIAR
Model #14 **\$5**

Dozens of others—antique or smooth finish.

LHS STERNCREST 14K, with gold band, imported briar **\$7.50**

Other LHS Pipes: \$25, \$10, \$3.50, \$1.50. at all good dealers

The best pipe smoke!



ZEUS Filter Cigarette Holder is back in Aluminum.

Write for "Pipes—for a World of Pleasure." It's FREE!
L & H STERN, INC., 56 Pearl St., Brooklyn 1, N.Y.

the FAMOUS B-29 GUN SIGHT

Convertible Into—

- SLIDE PROJECTOR
- SLIDE VIEWER
- BABY SPOT



Build all the above items plus many others with the TOP QUALITY, EXPENSIVE PARTS in this FAMOUS GUN SIGHT. The double achromat lens system can with the lighting assembly be adapted to a variety of optical or photographic uses. A Marvellous Value for the parts alone.

Free Conversion Sheet \$8.50 with Each Order—Rush P. Paid Order Today. ONLY

Send for FREE Catalog

B & B PRODUCTS CO., Dept. D
111 W. Jackson Blvd., CHICAGO

PRESS THE TRIGGER for

HEAT in 6 SECONDS



with the *Flash* SOLDERING GUN

YOU AIM IT AT YOUR WORK with a restful, natural wrist position

Engineered for every type of soldering, the Flash Soldering Gun gets around corners and into minute places. Heats only while pressure is on trigger—intensity of heat controlled at your finger tips. Equipped for immediate operation from our 110 V transformer, or from any standard (6-12V) storage battery in car, tractor, airplane, boat, etc. Ask about extra tips for special work, and for specifications for the heavy duty model, with its 5/8 inch tip. See your distributor, or send coupon.

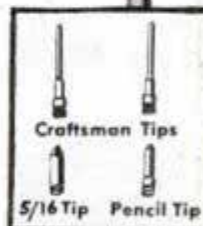

BLACK LIGHT XMAS DECORATIONS

Find Hidden Colors

FUN! THRILLS! PROFITS!

Find colors you'll never see with ordinary light. Designer's kit includes black light, generous supplies of glowing satins, crayons, lacquers, papers, full instructions.

Makes ideal Xmas decorations and gift. Guaranteed, F.O.B. Chicago **\$15.00**

FREE! Write for catalog: "The Invisible Ray"
BLACK LIGHT PRODUCTS, 67 East Lake St., Chicago 1, Ill.

BAKER-PHILLIPS COMPANY

2816-3 Aldrich Avenue South, Minneapolis 8, Minnesota
Please send circular on Flash Soldering guns.

Name
Address
.....
.....



'QUICK-CHANGE' GEAR BOX

CUT THREADS — 4 TO 224 PER INCH

Approximately .003 feed, for fine turning.
 New reverse furnished with box for Atlas.
 Bronze bearings throughout entire unit.
 Aluminum casting — All steel gears.
 Maintained accuracy.
 Speeds up production.
 Easy to install.
 Simple to set.
 Immediate delivery.

Only **\$75⁰⁰**

F.O.B. Chicago
 Guaranteed

FOR- Atlas, Logan, Craftsman
 and Power-Kraft Lathes

Write for information or order direct. Full instructions with shipment.
O'BRIEN MACHINE CO., Div. 600-A, 1620 Highland Ave., Chicago, Ill.

TWO-SPEED BREAST DRILL ONLY \$450

NO. 50. Chuck capacity to 1/2".
 3 steel chuck jaws, spring-controlled.
 Drill has two speed gears. Finished
 in cadmium nickel and red and black
 enamel, mahogany-finished handles.



HEAVY DUTY POLISHING HEAD ONLY \$600

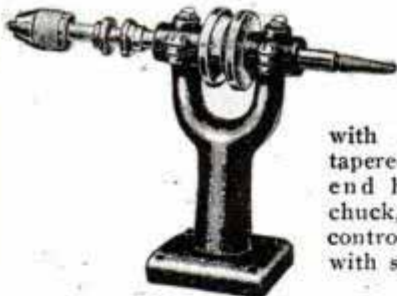

NO. 200A. Mas-
 sive, sturdy, made
 of cast aluminum.
 Tool steel shaft
 with adjustable bearings
 tapered at one end; other
 end has 3/8" capacity
 chuck, with three spring-
 controlled jaws. Furnished
 with steel flange nuts.

NO. 211. JUNIOR SIZE, 1/4" . . . \$3.00

MARS PRODUCTS COMPANY
 1170 BROADWAY, DEPT. CB NEW YORK, N. Y.

AUTHENTIC GUN MODELS

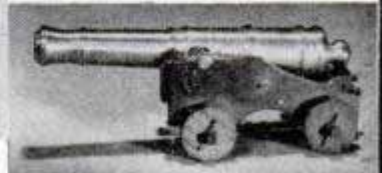

Beautiful, accurately
 detailed models of
 famous Naval Guns. Easy to build. Become real
 collector's items.
 No. 1103—SEA MORTAR—An authentic reproduction
 4" long, accurately detailed in every respect. Com-
 plete kit. \$3.75.
 No. 1104—ONE POUNDER—Modeled after one of
 our famous Revolutionary War Guns. 4 1/2" long.
 Complete kit. \$3.75

Address Dept. PB

MARINE MODEL CO., INC., Halesite, L. I., N. Y.



TALK-SING thru your own radio with RADIO MICROPHONE



Be the life of the party. Put on your
 own broadcasts at home. Talk-Sing
 make announcements from any room. Wonderful
 voice practice. Microphone easily attached to any
 radio. Follow enclosed instructions. SEND NO
 MONEY—pay postman \$1.98 plus postage. Send
 Money Order or check and save postage.

**EMPIRE RADIO & TELEVISION CO. (Dept. R2) 1521 Bedford Ave.
 Brooklyn 16, N. Y.**

SAY YOU SAW IT IN POPULAR MECHANICS

Automobile Mechanics

A new, simple tool for removing split locks from Hy-
 draulic shoes. Saves time. Order today \$1.00 post paid.
 C.O.D. postage extra.

Newfield Welding & Machine Company
 Newfield, New York

Now A DYNAMIC HEAVY DUTY INDUSTRIAL WELDER

IDEAL FOR AUTO - HOME APPLIANCE AND FARM REPAIRS

DESIGNED TO DO HIGH GRADE WELDING INEXPENSIVELY—Maintenance Men, Farmers' Mechanics; Machine Shops; Foundries; Auto, General Repair and Job Welding Shops; all using the DYNAMIC find it so indispensable and useful that they cannot afford to be without it. If inexperienced, you can easily learn to do a variety of high grade welding jobs by following the practical, simplified operating and welding instructions furnished. Once you see a DYNAMIC in operation, you won't want to be without it. Its simplicity will amaze you. In a year the DYNAMIC only costs you about 6c a day. Helmet, rods, cables, holder and operating instructions, etc., furnished.

SAVES YOU VALUABLE TIME AND MONEY!

This portable DYNAMIC WELDER—easily carried to the job—can be operated from any convenient, properly wired 110 volt, 60 cycle line. Can also be supplied for 220 volt, 60 cycle operation and for other voltages and cycles at slight additional cost. Works on IRON, STEEL, BRASS, BRONZE, AND OTHER METALS—has 8 metallic and carbon arc welding heat stages—does work you would think only possible with larger more expensive machine.

DYNAMIC WELDER CO. • 13 East 23rd St., FP., Chicago 16, Ill.

FOR ONLY

\$23⁵⁰

COMPLETE...

IDEAL AND PRACTICAL GIFT FOR ANY MAN

Get details on our 10 day trial offer.

Member Chicago Association of Commerce

ELECTRICITY FOR ANY JOB ANYWHERE

Reliable, economical electric service, anywhere, anytime, with an Onan Electric Plant. Driven by Onan 4-cycle, gasoline engines. Single-unit, compact design and sturdy construction. Water or air cooled.

Capacity range: 350 to 35,000 watts; 115 to 660 volts A.C., 50 to 800 cycles; 6 to 800 volts D.C. Combination A.C.-D.C. types. 65 different models

WRITE FOR FOLDER

ONAN

D. W. Onan & Sons, 2524 Royalston Ave., Minneapolis 5, Minn.

DO YOUR OWN PLATING

Beautiful *It's EASY* with the aid of this **PLATING RECTIFIER**



This unit is complete. Just plug into your 110V. A.C. - no moving parts to get out of order - only additional material required to do fine plating is glass or rubber tank and chemicals, which are readily available. . . . Any required voltage may be had by simply rotating large knob. Outputs are instantly read on large (3 1/2") voltmeter and ammeter on panel. . . . Economical to operate.

FREE WITH ORDER
256p **BOOK**
TELLS HOW

FREE WITH ORDER: Authoritative Book on Electroplating; 256 pages of information on methods, materials, solutions, currents and voltages required for plating with gold, silver, copper, etc.

SEND FOR DESCRIPTIVE FOLDER E. ELECTRO-TECH EQUIPMENT CO., 1178 Lafayette St., New York 13, N.Y.

FIND UNDERGROUND MINERALS and METALS with M-SCOPE



Employs same principle as Army Mine Detector. Unsurpassed in Efficiency. Write for Free 16 page booklet.

FISHER RESEARCH LABORATORY
PALO ALTO CALIFORNIA

SHORT WAVE XMTRS \$349

U. S. Signal Corps 5 MTR. (72.2 mc) **\$349**
Transmitter and Tube only.
One dry cell and 67 1/2 B operates it. Just attach di-pole, key or mike and its ON. Signal Corps spec components. High Stability. Easily converted to walkie-talkie and Ham Bands. Weighs less than 1 lb. Shipped express only. No COD or parcel post. Sacrifice at \$3.49 money order or certified check. Schematic diagram furnished.
NEWARK SURPLUS MATERIALS CO., 324 Plane St., Dept. M
Send stamp for Giant Catalog Newark 1, N. J.



MASTER CHAMPION LAWN MOWER SHARPENER
Also Mfg., Saw Sharpening & Key Machines
FRANK'S MFG. CO.
Dept. PM6
2501 E. Imperial Highway
Los Angeles 2, Calif.



A WHOLE SHOP FULL OF TOOLS IN ONE!

Use it for grinding, routing, drilling, sawing, polishing, carving, sanding and 9,994 other uses. Increases your skill and your scope. Precision-engineered, AC-DC. More exclusive features than any other tool.

Exclusive Safety Fingergrip for fine detail work

\$2250

COMPLETE WITH 36 ACCESSORIES IN FITTED STEEL CASE

Works **Wood, Metal, Glass, Plastics**

\$31.75 Value if Purchased Separately

CASCO ELECTRI-CRAFT TOOL KIT
CASCO PRODUCTS CORPORATION, BRIDGEPORT 2, CONN.

Look! CUTS IN ANY DIRECTION

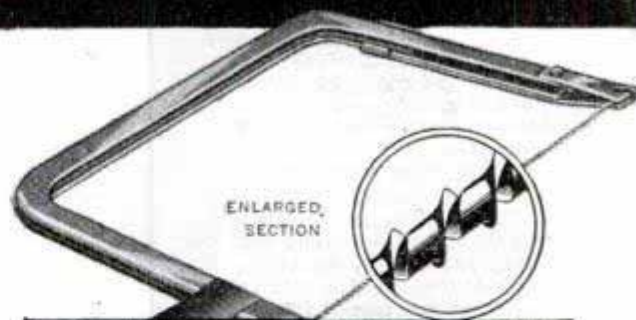

TRY THE NEW REVOLUTIONARY Tyler Spiral Saw

Now! Saw wood, plastics or light metals as never before. Backwards, sideways - any direction. It's the only saw that cuts difficult curves, square corners - any pattern - without shifting work. The sharp, long-lasting blades *won't break*. And the new Snap-On frame holds the right tension constantly. Get yours today! Frame, with four blades that also fit most jig saws - only 95c.

AT YOUR NEAREST HARDWARE STORE

or send \$1.00 direct for sample, to **TYLER MANUFACTURING CO. • 938 Pico Blvd. • Santa Monica, Calif.**

NEW TOOL READY!

War Industry's Handy, All'Round Machine

Now Available
To Home Shops!

The world-famous Mead Bandsander—invented for and used by hundreds of war plants—is at last available to you for home workshop use! This remarkable machine quickly shapes, sands, carves and polishes wood, metal, plastic! Works equally well on inside cut-out openings or irregular outside edges. Gets at places no other can! Tilting table for bevelling, chamfering. Rust-and-sweat proof top. Ball bearings. Saves time, labor, money on jobs in any home or industrial shop. Invaluable to home-craftsmen, makers of patterns, tools, dies, signs, costume jewelry, castings, forgings, ornaments, radio and electrical parts, stampings, etc. Nothing else like it. Sold on 5 Day Trial, money back guarantee. Circular Free!

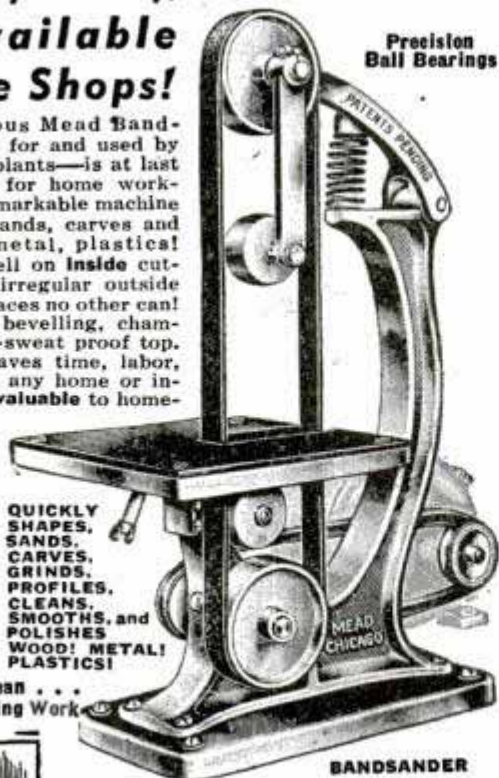

Precision
Ball Bearings

**QUICKLY
SHAPES,
SANDS,
CARVES,
GRINDS,
PROFILES,
CLEANS,
SMOOTHS, and
POLISHES
WOOD! METAL!
PLASTICS!**

Cuts Fast and Clean . . .
Saves Filing, Sanding Work



Write for FREE Circular

Send for free details on "the machine that amazed the experts!" Rush a postcard today for Circular, surprisingly low price. Hurry!

MEAD SPECIALTIES CO.

4114 N. Knox Ave., Dept. 1126, Chicago 41, Ill.

BANDSANDER

Quick Relief for Weak and FALLEN ARCHES

Build strong flexible arches with the DR. DAVIS FOOT MANIPULATOR. Not an arch support. Nothing to wear. A simple home treatment. One treatment will convince you. IF NOT SATISFIED return Manipulator within ten days and your money will be refunded. Write NOW for additional literature, or enclose \$4.95, check or money order.

DR. DAVIS FOOT MANIPULATOR
415 GOODHUE BLDG. BEAUMONT, TEXAS

TELESCOPING MEASURING TOOLS

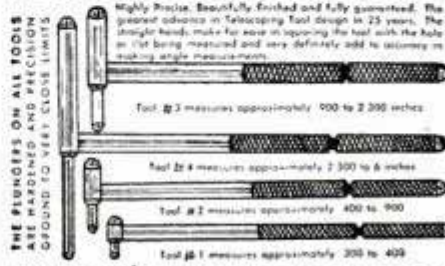

Micrometer Accuracy on
Inside Measurements
5 1/8 Inch to 6 Inches

**ONLY
\$4.95**

C.O.D.
PLUS POSTAGE
Completely finished
parts. Save \$10. Any-
one can assemble in less
than one hour. No tools
of any kind needed.

ALCO SHOP, 2214 Terminal Annex, Los Angeles 54, Calif.



Radiator Grille or Hood Initials

Solid cast aluminum, with polished face and red lacquered beveled edges. 2 3/4" high, 1/4 inch thick. Decorative, Distinctive. Helps identify your car, boat, or home. Attractive for signs, etc. Initials, complete with fastener, sent

postpaid anywhere in U.S.A. for **3 FOR \$1.50**
BROWN MANUFACTURING CO. Sheridan, Illinois

NOW AVAILABLE PLASTICS CATALOG and HANDBOOK

FUN AND PROFIT AHEAD
Plastics, colorful and glamorous materials of the future, offer you a fascinating hobby — or a profitable plastics fabricating business of your own.

CATALOG LISTS NEW MATERIALS
Ready now, the new 40-page Carmen-Bronson CATALOG gives you complete prices and data on all materials you need. Plexiglas, Lucite, Bakelite, Lumarith, Lignolite, Tenite etc. in sheets, rods, tubes and special forms—crystal-clear and in many rich, glowing colors. Catalog also lists numerous cements, dyes, compounds, accessories, supplies and semi-fabricated kits.

HANDBOOK GIVES INSTRUCTIONS
The new Carmen-Bronson PLASTICS HANDBOOK tells how to fabricate plastics easily and simply into beautiful objects for gift or sale. Contains construction plans for many simple and advanced projects. Profusely illustrated. Gives practical advice on how to start your business in this profitable field.

10¢ BRINGS BOTH BOOKS
Take the first step TODAY toward your brilliant future in plastics. Send only 10 cents NOW for your copies of the Carmen-Bronson CATALOG and Carmen-Bronson PLASTICS HANDBOOK.

CARMEN-BRONSON COMPANY
165 East 3rd Street, Dept. 12-B, Mount Vernon, N. Y.



**10¢
BRINGS
BOTH
BOOKS**



Send for Free List of LEADING BOOKS

on WATCH REPAIRING,
Clock Repairing, Engraving,
Industrial Diamonds,
Aircraft Instruments, etc.

Dept. 12
HENRY PAULSON & CO. CHICAGO 3, U.S.A.

Power Hacksaw \$35⁷⁰ Cap. 4" x 4" Swivel Vise



F.O.B. Kalamazoo, Mich. NO OTHER SAW LIKE IT for the price. Cast iron, ruggedly constructed. Quick action vise, jaws swivel to 45°. Bronze bearings. Draw cut action, saw lifts on return stroke. Automatic cut-off switch.

JOHN E. KANDLER—Machinery
214 N. Rose St., Kalamazoo 12, Mich.

Write for free literature

110 VOLT 60 CYCLE A-C MOTOR GENERATOR UNITS

TWO BRAND NEW COMPLETE UNITS COST NAVY \$97.50

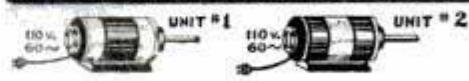

YOUR COST
**Only
\$6.99**
EXPRESS
PAID

Amazing value! You get two separate units. Will operate as two AC motors or as an AC generator. Precision built with ball bearings, polished aluminum housings. Operate small grinders, fans, polishing heads, etc. Students, schools can use to experiment with fascinating AC phenomena. Generate AC electricity, operate as rotary converter, synchronous motor-generator, use as phase shifter, variable transformer, etc. Free with each order—manual of interesting experiments and full instructions. Send money order, personal check, currency or will send C.O.D. Order today or send card for more details.

LECO ENGINEERING CO., Box 908-PM-12, Lincoln, Nebr.

QUICK · SAFE · SURE THE EASY WAY TO KILL RATS

You'll find K-R-O quick acting. It's constantly checked to maintain highest killing power. Made of *red squill*, it's *safer* to use around children, livestock, pets, and poultry. K-R-O kills rats or your money back! IN 2 FORMS . . . K-R-O Bis-Kits (nothing to mix) at 35c and \$1 . . . K-R-O Powder (enough to make 200 baits) only 75c. At most drug, feed, and seed stores.

FREE "Rat Proofing Buildings and Premises," by U. S. Dept. of Interior. Write for your copy, now. The K-R-O Company, Springfield, Ohio, Dept. 164.

K-R-O

RISCO HOLIDAY SPECIALS!!



SIGNAL CORPS KEYS . . . 49c

V.M. RECORD CHANGER. Plays 10" and 12" records at same time. 25% WITH ORDER, BALANCE C.O.D. **\$1750**



T-17-B Microphones 6' Cord and Plug **\$1.75**



Astatic L-70 & Shure Glider Crystal \$2.15 ea. 10 at \$1.95



RECORD PLAYER Attaches to any radio. With vol. ctrl., sw. and 6' cord. Walnut cabinet. Plays 10" and 12" records. **\$995**

RISCO SALES CO., 224 E. 65 St., N. Y. 21.

LAW

STUDY AT HOME for PERSONAL SUCCESS and LARGER EARNINGS. 38 years expert Instruction—over 108,000 students enrolled. LL.B. Degree awarded. All texts furnished. Easy payments. Send for FREE BOOK—"Law and Executive Guidance."

AMERICAN EXTENSION SCHOOL OF LAW
Dept. 72-M, 646 N. Michigan Ave., Chicago 11, Ill.

BUILD THESE PROJECTS

For garden or lawn. Easy to build. Easy to sell. Detailed Blueprints Model B-25 Dutch Windmill, 50c; Model Q24-60 Old Mill, 85c. Lawn Figure Patterns—Sunbonnet Girl, Dutch Boy, Tulip Girl, Holland Pair, 35c each, all 4—\$1. Catalog illustrating many models, send 10c, today.

CRAFTSMAN'S MODEL CO., Dept. P-98, 2030 N. 41st St., Milwaukee, Wis.

Say You Saw It in
POPULAR MECHANICS

AGENTS . . . Be First With Newest Products

It means quick easy sales and large profits. Our monthly **NEW PRODUCTS BULLETIN SERVICE** lists 100 **NEWEST** products, where to buy them, long before they appear on the market. Sample Bulletin \$1.00. **FREE** information. **HURRY—BE FIRST—BEAT COMPETITION.**

EDUCATIONAL BOOK CO., 2907 Berwick Ave., Baltimore 14, Md.

FIREWORKS

Rich Bros.' Famous Prewar Quality! Order now! Avoid disappointment! **BIG ASSORTMENT**—over 172 pieces including 100 2-Inch Salutes, 20 Cherry Flash Bombs, 25 Flitter Crackers, Comet, 2-Shot Repeaters, Whistle Bomb, Red Fire, Whistle Devil, Humdingers, Vesuvius Fountain, Flower Pot, Roman Candles, Rockets, Aerial Bombs, 2 Boxes Sparklers. **PLUS 2 Packages Chinese Fire Crackers.**

Retail value \$8.25.
Yours for ONLY \$4.95

Rich Bros.' Fireworks Company
Dept. E Box 5021 Raleigh, N. C.
Shipped Railway Express **ONLY.** Name nearest express office.
Many Other Assortments and Displays
SEND FOR FREE CATALOG

AMAZING VALUES!

**WAR
SURPLUS
ITEMS**

FINE GOV'T. MATERIAL

Many practical and experimental uses!



220 VOLT GENERATOR
No. MG1-24 to 32V—70 Amp. Input Westinghouse motor drives 220V, 4.55 Amp. generator and hydraulic pump with electric differential valve control. Complete unit 24" x 7 1/4" x 8 1/4". Wt. approx. 100 lbs. Fine for farm, small shop and school experimental 220V power. Generator can be engine driven. Motor usable separately. Cost Government about \$49.50 for



HYDRAULIC 1500# PRESSURE VALVE
No. HV7—Quick close, snap-action lever, precision seat valve for oil, water, gasoline, liquids or air. 1/2" S.A.E. Inlet and outlet connectors. Many hydraulic machine and factory uses. Lots of 10 at \$12.00. Single Valve **\$1.50**



AUTOSYN PRESSURE TRANSFORMER
No. AT2—Complete unit comprises 26 Volt, 400 cycle Autosyn Motor and Bourdon tube gauge. Ideal for ingenious experimenters. Convertible for remote control indications, etc. **\$3.50** Only

400 Cycle Transformer Capacitor

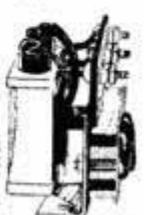

No. TCS—1 to 1 ratio transformer. 1.06 microfarad condenser. Great for 400 cycle experimentation, electronics students, colleges, mfrs. etc. Fine value at **3 for \$1.00** 50c ea. or . . .

MIRRORS (Plate Glass)



No. M3—5 3/8" x 2-3/16" x 3/16" thick. Fine for decorative trim, hunters, campers, rear view mirrors, Boy Scout Helio-graph signaling, etc. Made to Gov't. "Specs." Lots of 100, **\$12.50**; 50 for **\$1.00**; **\$7.50**; Package of 5 mirrors, Only

RUBBER CUSHION SHOCK MOUNT



No. 5M9—4 soft rubber mounts on black japanned aluminum plate 4" x 8". Protects delicate instruments, mobile radio transmitters and receivers in cars, trucks, boats, planes, etc. Mounts can be saved apart to adjust size or for separate use. **6 for \$2.00** 50c ea. or . . .

RENEWABLE FUSE HOLDER



No. FH10—Left turn removes knurled black plastic cap for replacement of standard SAG 10 to 150 Amp. fuse cartridge. "FUSE" lettered on face of cap in white. Ideal for many types of electrical panel boards. Bargain at **3 for 1 doz. \$3.00** \$1.



STIRRUP PUMP
(For Fire or Spraying)
No. SP4—4 gal. cap. sturdy galvanized tank with fine pump, 1 0' flexible hose, 1/4" solid stream plastic nozzle, replaceable with spray for insecticides, white wash, stains, stock dips, etc. Fine garden, greenhouse waterer. 4 per carton knocked down at **\$16.00**. Easily assembled. **\$5.00**

Gyro Gun Stabilizer

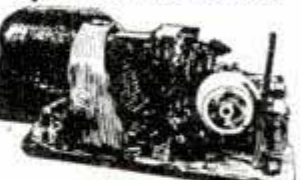

No. GS6—Consists of 1/50 H.P. 24V, gyro motor, variable resistor assembly, vibration dampener, small condensers, etc. Great for gyro control experiments, schools, inventors, etc. Motor removable for separate use. **\$12.50** A Bargain at

PRIMER PUMP



No. P5—Many uses as gasoline engine primers, oil or chemical injectors, etc. Inlet and outlet connectors for 1/8" tubing. Adaptable for football, basketball, sleeping bag and other air pump uses. Solid brass about **7" long. \$1.50** Only

CASH WITH ORDER! Shipped prepaid anywhere in Continental U. S. A.

WRITE for BULLETIN WL other War Surplus Values! See Adv. K3, K9, GUN-SIGHTS, Page 82.

WARSHAWSKY & LAZAR
2126 S. Michigan, Chicago 16

you'll do faster, better work with this
EFFICIENT SHOP TOOL

THE
Bantam
GRINDER



Polishing
Grinding
Carving
Drilling
Buffing
Plastic
Glass
Metal
Wood
Bone

You'll enjoy doing many shop jobs with the Bantam Grinder. Correctly balanced for easy handling. Precision-built of quality materials for dependable, long-life service. Operates on 110-115 Volt AC-DC. Speed approx. 20,000 R.P.M. Internal ventilating fan. Fingertip switch. Weight—15 oz. With 8-ft. cord and plug, 23 accessories, substantial gift box. . . **\$25**



If your dealer doesn't have it, write us.

Small Motors, Inc.

Dept. 80, 53 W. Jackson Blvd. • Chicago 4
Manufacturers of special small universal, fractional H. P. motors, shaded pole motors, heater motors for industrial and appliance uses.

**IMMEDIATE
DELIVERY!**



\$19.95

F. O. B.
ROYERSFORD, PA.

8 in. BENCH SAW

COMPLETE AS SHOWN

TABLE SEGMENT—Shows degree of table tilt—graduated. SPLITTER—Hard temper cold rolled steel. GUARD—Aluminum. MITER GAUGE—Aluminum. Accurately graduated 45° each side of center. BEARINGS—(2) Oil-lite bronze. CAPACITY—0 to 2 1/4". TABLE 12"x14". SHIPPING WEIGHT—44 lbs.

This Price is Below the Authorized O. P. A. Ceiling

AMERICAN MACHINE & TOOL CO., Inc.

DEPARTMENT 100 • ROYERSFORD, PA.

FIX IT TIGHT

WITH

X-PANDOTITE

The General Purpose Mortar-like repair and maintenance cement that expands as it sets!

You never before saw a household repair cement like X-Pandotite—as it hardens it expands and penetrates the pores of repaired surfaces, dries there like granite, may be colored. Generous 1/2 lb. can only 35c, 1 lb. can 60c.

At your local Hardware or Paint Store. Or send \$0.50 for 1/2 lb. or \$1.00 for 1 1/2 lbs. prepaid to:

X-PANDO CORP.
43-15 THIRTY SIXTH ST.
LONG ISLAND CITY, N. Y.

CLOSE-OUT BARGAINS

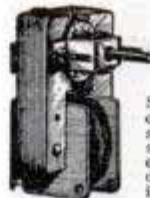

**POWERFUL
ALL PURPOSE
INDUCTION
MOTOR**

Sturdily constructed to precision standards, this self-starting shaded pole A.C. induction motor is ideal for experimenters—101 uses. Consumes about 15 watts of power and has a speed of 3,000 R.p.m. When geared down, will constantly operate an 18-inch turntable loaded with 200 lbs. dead weight.

3" high by 2" wide by 1 3/4" deep; 4 convenient mounting studs; shaft 1/8" long by 3/16" diameter; runs in self-aligning oil retaining bearings. Designed for 110-20 volts, 50-60 cycles. A.C. only. Shp. **\$295**
Wt. 2 lbs.

Send Money Order or Check. (No C.O.D.) Include Shipping Charges. 40 West Broadway, Dept. PM-126, New York 7, N. Y.

**WESTERN
ELECTRIC
BREAST
MIKE**



Fine light-weight aircraft carbon microphone. Weighs only 1 lb. Comes with breastplate mounting and has 2-way swiveling adjustment so that it can be adjusted to any desired position. 2 woven straps; one goes around neck, the other around chest. Can be snapped on and off quickly by an ingenious arrangement.

Mike can be adapted for home broadcasting or private communication systems. By dismounting breastplate, it can be used as desk mike. Comes complete with 8-foot cord and hard rubber plug. Finished in sherardized plate, non-rustable. Shp. **\$195**
Wt. 2 lbs.

BE A PERFUME DISTRIBUTOR

The most sensational profit possibilities in the whole field of selling; 100% year-round demand. Liberal distributor discounts. Sell consumers or dealers, or both. Employ sub-salesmen. No experience needed; we'll tell you how. Finest perfumes made, exquisite, long lasting fragrances women just can't resist at your low prices. Men big buyers for gifts. Beautifully packaged. Write TODAY for free sample and details of tested sales plan.

DUDAN PARFUMS, 21-P West Illinois St., Chicago 10, Ill.

FREE *Atom Bomb* IDENTIFICATION PATCH



COLLECT RARE MILITARY SHOULDER PATCHES

Now you can collect hard-to-get, famous U. S. and foreign military shoulder patches. To start your collection we have created an introductory package of 20 patches worn by some of the fightingest units in Uncle Sam's army. With this special bargain package you get absolutely FREE the rare, original Atomic Bomb patch and a beautiful illustrated catalog and price list containing hundreds of Army, Navy, Marine, Air Force, RAF, German, Jap and other foreign insignia. Start this fascinating hobby today. All patches are authentic . . . embroidered in the original colors. Send \$1.00 for the special introductory package of 20 and the FREE Atomic Bomb patch, catalog and price list, or 10c for the catalog and price list only.

THE PATCH KING, Dept. 112
P.O. Box 101, Madison Square Station, New York 10, N. Y.

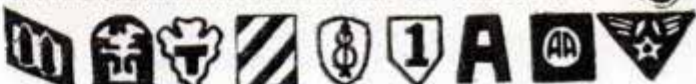

FINE *Cabinet* WOODS

For immediate delivery! Thousands of feet in sizes and grades to exactly meet your homecraft or woodshop needs. Bargains in Turning Blocks, Mouldings, Plywoods, Veneers.

CATALOG OFFER: (U.S.A.)

Complete Hobbywoods catalog with periodic helpful supplements sent along with a twenty-five cent can of Waterproof Veriply (urea resin) Glue—Both prepaid for .25c.

Address—

HOBBYWOODS

Eastern Ave. and Cedar
Baltimore 3, Md.

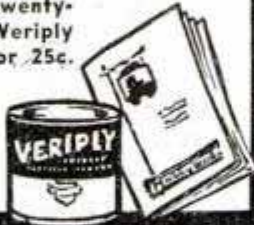

Hobbywoods

SHIPPED EVERYWHERE!

HotTip SOLDERING GUN

COPPER TIP
HEATS IN 5
SECONDS



Original Exclusive GRAPHCO Heating Element

Solders better, faster, easier on heavy or light work. Operates from 6 volt storage battery, car, truck, tractor, boat or 110 AC Transformer. Sold by your automotive, farm supply, radio parts, hardware or gas station dealer.

A few states still open for live wire Distributors to sell dealers and direct salesmen. Profits to \$20,000.00 yearly possible. Air Mail or wire today.

MET-ELEC CORPORATION, 2616 E. 29th St., Mpls., Minn.



"Frog Man" DIVING OUTFITS, no surface connections to worry about. Underwater construction and salvage, fishing, exploration. Other Navy Standard Diving Rigs.

OUTBOARD MOTORS—50-55 H.P. Evinrude and 22 H.P. Johnson surplus sets. 115 H.P. units for barges.

RUBBER BOATS—2-4 man, oars, pump etc.\$55.00
1 man size for beach or duck hunting.... 12.25

SLEEPING BAGS, Arctic type, new.... 18.95
Check or Money Order • Details on Request

M & E MARINE SUPPLY CO. P. O. Box 601
Camden, New Jersey

ARMY SURPLUS BARGAINS



Jacket (illus.)—B-3 type pilots sheepskin lined brown leather, water repellent finish, zipper front, large collar and strap. Newly mfg. from surplus material. 36-46....\$15.95
Jacket—O.D. Whipcord, pile lined.... 10.75
Write for free illustrated list "F" of jackets, pants, blankets, sweaters, etc. Orders sent postpaid except C.O.D.

Satisfaction or money back
CONSUMERS CLOTHING CO., INC.
Dept. 17, 2066 First Ave., New York 29, N. Y.

RADIO PARTS GRAB BAG!!

\$25 value assortment of Coils, Condensers, Transformers, Resistors, Controls, etc. An experimenter's dream. Order today! Only.....

\$3.98

MARKO SUPPLY, Dept. PM-12

2924 Logan Blvd.

Chicago 47, Ill.

COMPRESSED AIR INSTANTLY, Anywhere!!

Portable Air Compressor and storage tank. Ruggedly built of best materials using lifetime lubricated ball-bearing on connecting rod and oil impregnated main bearing on shaft. Unusual design forever eliminates valve trouble, the most common fault in air compressors. **PATENTED** unique air intake system increases efficiency tremendously over other compressors so that air output is much greater than that from larger compressors powered by heavier motors. Will deliver approximately 3500 cu. inches of air per minute at maintained pressure of 30 lbs., or will inflate a 90 lb. truck tire in less than one minute. Comes complete with 100 lb.

gauge, although finger-tip adjustment allows setting of output pressure at any value, which will automatically be maintained. Works from any 1/4 H.P. motor. Useful for spraying paints or lacquers, disinfectants, insecticides, annealing or brazing with natural gas, inflating tires, etc. Price \$14.50 postage prepaid anywhere in the U. S. Efficient, completely adjustable syphon type spray gun complete with 12 ft. of 100 lb. tested hose available for only \$7.75 with pint container, also prepaid. 25% required on all C.O.D. orders. Send for free catalogs of radio parts and surplus items.

BUFFALO RADIO SUPPLY; 219-221 GENESEE ST., DEPT. M-12, BUFFALO, N. Y.

Do Expert Welding At Home WITH THE HANDY Magic Wand WELDER



You just plug in on the nearest standard 110-V, 60-cycle AC outlet and do welding and brazing jobs like a professional. Heavy-duty transformer has 6 stages of welding heat. Electrode holders adaptable for electric flame or metallic arc welding. Special polarized outlet plug.

All built into strong, shockproof carrying case, weighing less than 30 lbs. packed. Kit includes welding, brazing and soldering supplies, helmet, instruction manual. Quickly pays for itself. Sold by hardware and auto supply dealers.

COMPLETE
\$34.50

F.O.B. Factory

FREE Welding Handbook

28 pages of valuable information on welding, brazing, soldering; how and when to use each process; how to handle various metals; new uses for welder, etc. Send postcard for your copy NOW.

JOHN H. GRAHAM & CO., INC.

General Sales Agent

Dept. D, 105 Duane St., New York 8, N. Y.

MADE BY PATENT SPECIALTIES, INC., NEW YORK, N. Y.

RED-ITCHY-SCALY ECZEMA

**Effective
Home
Treatment
Promptly
Relieves
Torture!**



First applications of Zemo—a Doctor's soothing yet highly medicated antiseptic formula—promptly relieve itching and burning and also help heal the red, scaly skin. Backed by a 40-year record of continuous success! *Invisible*—doesn't show on skin! First trial of clean, stainless liquid Zemo convinces! In 3 sizes. For severe cases ask for special *Extra Strength* Zemo. At all drugstores.

ZEMO



**Here at Last Is a Mechanic's Dream
COME TRUE!**

The all-purpose compressor-sprayer with 1001 uses

Here are just a few of the uses: Painting, spraying deodorants, drying hair and blowing away loose hair in barber shops, beauty parlors, etc., removing wall paper, applying paste to paper, applying stencil designs, etc., decorating, dyeing, lacquering shoes, spraying synthetic leather, operating laboratory burners in dental offices, cleaning clocks and watches, operating brazing and soldering torches in jewelry shops, pumping up tires, etc.

Compressor \$14.50 Gun \$4.90 Hose \$1.50

TRADE DISCOUNTS TO DEALERS

MIRACLE RADIO SHOP

675 Courtlandt Ave. Bronx, N. Y.
Checks payable to W. Van Noodall

WALKIE-TALKIES!

**Complete Army Sets
Ready to Operate**

Portable radio telephone sends and receives 10 to 15 miles! Used by the Army with great success. Ideal for amateurs, police, explorers, airports, utilities, boat owners, Government services, etc. Operates anywhere in the 28 to 52 MC band. Renewed by the Government and guaranteed. Shipped, ready to operate, complete with tubes, microphone, telescope antenna and new batteries. Price—only **\$45.00** each.

Extra batteries (80 hours continuous service) **\$4.75 each**



Radio-Telegraph Sending Keys

Real S-37 Signal Corps keys for your radio or telegraph set or for code practice. They have coin silver contacts and full adjustments. Valued at 3 times our low price. Send \$1.00 plus 20c for postage anywhere in U. S. Guaranteed.

New Radio-Electric Catalog

Send a dime for our catalog H 200 which contains hundreds of exciting values in Government parts and equipment.



WELLS SALES, INC.

4717-X West Madison St. Chicago 44, Illinois

WAR SURPLUS BARGAIN SPECIAL

**BRAND NEW!
VACUUM-AIR
HYDRAULIC**

**FUEL
PUMP**

**Original Cost
\$45.00
Now Only
\$9.95**

Postpaid in U.S.A.

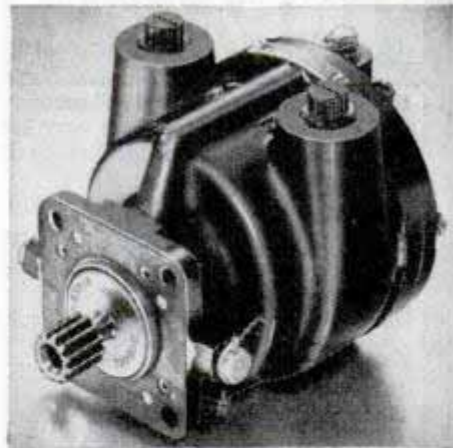

Adaptable for use on Home Oil Burners, Spray Machines, Milking Machines, Compressors, Vacuum Pumps, Hydraulic Systems, Presses, etc. Originally cost \$45.00. Used by the Air Corps to drive bomber de-icer boots, gyroscopes, automatic pilots, etc. May be used as air or fluid pump—for pressure or vacuum. Standard 3/8 inch pipe thread with interchangeable ports. Will pump 7 1/2 gal. SAE 30 oil per minute at 300 RPM. Builds air pressure of 30 lbs. per sq. in. at 1000 RPM. Vacuum will draw 26 inches of mercury at 1750 RPM. Runs forward or reverse. Self aligning shaft. Die cast aluminum housing 6x4x4 inches. Has stainless alloy steel vanes and impeller. Made by Bendix Avia Corp. Spline terminal for direct drive—readily replaced with a pulley. Rated capacity 1500 RPM with high overload factor. Special price for quantity users. Send check or money order today. Postpaid in U.S.A.

GROBAN SUPPLY CO. 1522 So. Michigan Avenue Dept. P.M.D., Chicago 5, Ill.

New! BALLOON-RING GAME

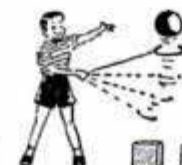

Patented split ring swings balloon up and releases it to fall into one of two scoring boxes. Kit of 3 different colored balloons, 1 split ring (adjustable size), 2 scoring boxes. Fun! Play indoors or out. An ideal gift. Sent postpaid, complete with instructions for **\$1**

THE PATENT BALLOON RING CO. 2032 S. Halsted St. Chicago 8, Illinois

MOLESKIN COATS \$15.95 ALPACA LINED

SURPLUS MARINE CORPS CLOTHING
Genuine Moleskin coat, fully alpaca lined, water-proofed, alpaca shawl collar, leather re-inforced pockets, knitted cuffs, set-in sleeves. Sizes 36-48. Send check or Money order. Money back guarantee.

**SEND FOR FREE CATALOGUE
MIDCITY SALES CO., Dept. PM
576 SECOND AVE., NEW YORK 16, N. Y.**



NEED NEW CLOTHES? Everyone does, a fact giving you a **REAL MONEY-MAKING OPPORTUNITY**. Everyone welcomes a chance to get real quality woolen materials for men's or women's suits and ladies' dresses, coats, etc. Make **BIG MONEY** just satisfying the needs of your friends, selling complete selection hard-to-get fabrics from national woolen mills, by the yard, direct to individual customers. Send for free sample book and full information. **WESTERN FABRICS, INC., 832 S. Spring, Los Angeles 14, Calif.**

COLOR CONCRETE WITH CHEMICALS

Get into business on small capital working at home, or shop. Start small grow big. There is real money in making Hollywood style pottery and bird-baths without molds. Our instructions cover a large variety of designs. Washing-wells, benches, garden light-houses, stucco-rock, imitation marble, cement water-paints and many more. 10c brings sample, details and pictures. **Hollywood Cementcraft, 8529 Wonderland Ave., Hollywood 46, Calif.**

AUTOMATIC HEAT CONTROL UNIT

Automatically controls heat by opening and closing damp-er. Simple to install. Saves Fuel and Labor. **\$21.50**
EXHAUST FANS, 12" to 24". Heaters, Iron Repair Kits, Fluorescent Fixtures, Electric Hair Clipper, and many other items at big savings while quantities last! Free literature.
DOMESTIC ELECTRIC CO., 118 E. 28th, New York 16, N. Y.

NEW! DECAL-CRAFT FULL COLOR TRANSFERS

Make circus wagons, animals, miniature streamliner train, many others. Easy to use—stick 'em on—saw 'em out. Mail \$2.00 TODAY for all of these plus patterns and instructions.
DECAL-CRAFT, 1112 BIRCH, EAU CLAIRE, WIS.

FREE BOOKLET OF WRENCH KITS

FOUR TYPES OF KITS
● Socket Screw Key Kit: 9 tools in 1.
● Socket Wrench Kit: 6 Tools in 1.
● Auto Key Kit: 8 tools in 1.
● Home Kit: 7 Tools in 1.
WRITE NOW FOR FREE BOOKLET
JENCO TOOL CO., 6911 New Utrecht Ave., Brooklyn, N. Y.



MAKE MORE MONEY

APPLYING OR SELLING CORKSTONE PLASTIC FLOORING

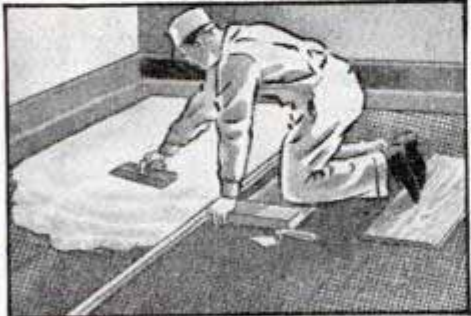

**EASY
TO
APPLY**

Here's your opportunity to get into business for yourself applying or selling Corkstone, the economical, top-grade plastic flooring. Plenty of profit. Act without delay!

Dealers & Agents Wanted
WRITE FOR DETAILS
LASTING PRODUCTS COMPANY
FRANKLINTOWN ROAD PLANT, BALTIMORE 23, MARYLAND

EXHAUST BLOWER

**NEW! IMPROVED
FOR MANY USES**

- Ventilators for office, kitchen, attic, cellar, etc.
- Darkroom exhaust fans
- X-ray and sterile rooms
- Photographic booths, commercial, etc.

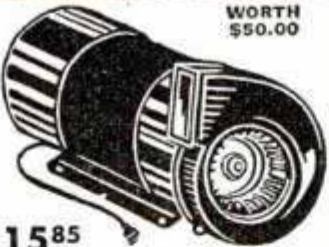

WORTH \$50.00

1585

Motor—Continuous, quiet, ball bearing, 110 volt A.C., 50-60 cycle. Capacity 100 cu. ft. per minute. Motor casing black crackle finish. Ends heavy cast aluminum.

Built for Long Life, Trouble Free Performance. Send Check or Money Order. No C.O.D.'s. West of Mississippi—Add 1.00 for mailing and handling.

IMMEDIATE DELIVERY
UNIVERSAL YONKERS CORP., 41-P Locust St., Yonkers 2, N. Y.

Mechanical & Electrical Bargain

7 lbs. net \$5.00 7 lbs. net

Includes ONE BACK GEARED A.C. MOTOR

can be used as display turntable, to operate toys, etc.

- | | | |
|----------|----------------|----------------|
| GEARS | COLLARS | CONDENSERS |
| SHAFTS | FLEX. SHAFTS | CONTACT POINTS |
| BUSHINGS | SWITCHES | CHOKES |
| ANGLES | RESISTORS | COILS |
| BRACKETS | CARBON BRUSHES | SPACERS |
| SPRINGS | INSULATORS | HARDWARE |

MORE THAN 200 PIECES

REMIT \$5.00 FOR EACH KIT WANTED

NO C.O.D. ORDERS — SUPPLY LIMITED

GEORGE BROOKS & ASSOCIATES
220 SOUTH HALSTED STREET CHICAGO 6, ILLINOIS



A GIFT HE'LL APPRECIATE

\$34⁹⁵

5-IN-1 HOME WORKSHOP

- LATHE
- SANDER
- CIRCULAR SAW
- DRILL PRESS
- EMERY WHEEL

For year 'round fun and profit. Thousands of satisfied owners. Five most useful power tools combined in HEAVY fabricated-steel unit. Runs free in bronze bearings. Lathe 30" between centers. Drill press pulls 1/2" drill in steel. Saw uses 6" or 8" blade. Write for literature or send \$17.50 for prompt shipment, balance COD, with ten-day trial. (Price does not include motor and saw blade. Shipping weight 65 pounds.)

EMRICK INC.
1602-A FULFORD ST.
KALAMAZOO 24, MICH.

40 POWER TELESCOPE

Finest Achromatic Lenses.
Brass Tubes.
Leather Covered
Main Section.

\$34.50



Variable Power Eyepiece Adjustable from 10X to 40X. Lower powers for target spotting and wide angle viewing. Higher powers for long range and astronomy. Achromatic objective lens over 2 inches diameter. Length closed 9 1/2", open 27". This is a precision American made instrument. Only \$34.50 Postpaid.

LABORATORY MICROSCOPE



\$19.50

A professional type microscope priced within the reach of the amateur. For school, laboratory, physician and the serious amateur. Color corrected achromatic lenses. Professional size eyepieces and objectives interchangeable with all standard professional makes. Height 14 inches. Weight 5 1/4 lbs. 2 wheel focusing. Body tilts any angle.

- Price complete with 75 power optics\$19.50
- Price complete with 240 power optics\$23.50
- Price complete with 600 power optics\$25.50

We pay the postage

Money Back Guarantee

BROWNSCOPE CO.

Dept. 12M 24 West 45th St., New York 19, N. Y.
TELESCOPES BINOCULARS MICROSCOPES

Famous Army Air Force B-3

All Leather Shearling Lined FLYING JACKET

$\frac{1}{3}$ ORIGINAL PRICE

only \$14.95

RECLAIMED FOR RE-ISSUE TOUGH Outside-WARM Inside

A rich looking, sturdy jacket made originally for the toughest assignment of all, the Army Air Forces. Complete protection against wind, rain, snow. Finest leather and best shearling available. For every type of outdoor activity, work or play. Resistant to scuff and hard wear, flexible. Neat appearance, combined with greatest warmth possible in a jacket. Far better than any civilian jacket because the Government demands and receives the best. Greatest value ever offered. Order today, while choice sizes are still available. Sizes: small—medium—large.

Order Direct and SAVE
Please send check or money order for \$14.95. Pay few cents express charges on delivery.

BENNETT MARSHALL 2601 UNION CENTRAL BLDG. Dept. 2/2
CINCINNATI 12, OHIO

COMPLETELY SHEEP LINED
COLLAR TURNS UP FOR SNUG FIT

FREE!

LAFAYETTE'S BIG NEW CATALOG

25th ANNIVERSARY

**SCARCE PARTS—STANDARD PARTS
FAMOUS BRANDS—EXPERIMENTERS' KITS**

This valuable, 144-page book is a must for all radio men. No matter if you're just starting out in radio, or if you're a top-flight engineer, you need the Lafayette Catalog. It's the world's biggest display of fine radio parts and equipment—at prices that will save you lots of money.

LAFAYETTE RADIO

RADIO WIRE TELEVISION Inc.

100 6th Ave. NEW YORK 13
110 Federal St. BOSTON 10
24 Central Ave. NEWARK 2

Lafayette Radio, Dept. LL-6
100 Sixth Ave., New York 13, N. Y.

Please RUSH my FREE copy of the big, new Lafayette Catalog.

Name _____
Street _____
City _____ Zone _____ State _____

Send for your FREE copy of catalog. Paste Coupon on Post-Card—Today.

Lamp Fits in Cigarette Lighter For Emergency Auto Use



When plugged into a cigarette lighter socket, a utility lamp with 12 feet of cord supplies light for many uses in an automobile. It is handy for reading road maps, changing tires, locating things in a handbag or the glove compartment and for working on the engine.

Army Bakes Bread in Tin Cans

Bread baked and distributed in vacuum-sealed cans is being tried by the Army. Inside surfaces of the cans are treated with an enamel that withstands baking heat without adding odors or flavors to the bread. It can be stored for long periods without losing nutritional values. Although the canned bread was designed to replace wartime biscuits and mobile field bakeries, it will also be handy for campers and explorers.

Bowling Ball Made of Aluminum

Aluminum bowling balls forged in two halves and given a black finish have been developed by the Aluminum Company of America. Engineers at Alcoa's Vernon Works, near Los Angeles, say the new ball resists chipping and develops no out-of-round condition with extensive use.

Five and one half million young fish were planted in 9529 farm ponds in the U. S. last year by the U. S. Fish and Wildlife Service.

**KEEP WARM!
SAVE FUEL!**

Mortite

BETWEEN YOU AND THE COLD

A pliable, plastic weather-stripping, easily, quickly applied to windows, doors, baseboards. Stops expensive heat leaks.

Just press into place. Use inside or outside. Can be painted. Mortite does not shrink or crack. Also plugs cracks around drainboards, bathtubs, etc.

Roll covers about 80 feet, enough for 5 windows.



\$1.25 AT HARDWARE, PAINT, DEPT. STORES AND LUMBERYARDS

Higher west of Rockies and Canada

Ask for Mortite Booklet!

J. W. MORTELL CO.

522 Burch St. Kankakee, Illinois

**BRAND NEW
JEEP
ENGINES**

**A GREAT
WAR
SURPLUS
BARGAIN**

**COMPLETE
READY TO RUN
60 HORSE POWER**

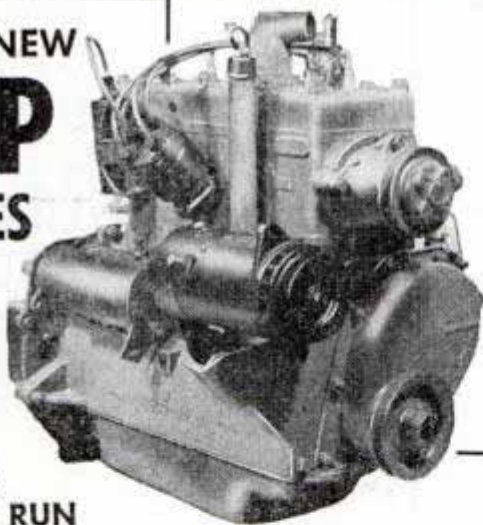

POWER GALORE in these great Jeep Engines. They are the ideal power plant for AUTOMOBILES, SPEED BOATS, COMPRESSORS, FARM EQUIPMENT, POWER SAWS, LIGHT SYSTEMS, PUMPS, SPRAYERS, and have hundreds of industrial uses.

SPECIFICATIONS: This powerful Jeep Engine is equipped with 4 cylinders. It has a compression ratio of 6.48-1, a crankcase capacity of 4 qts., horsepower, S.A.E., of 15.0, and actual horsepower of 60.

COMPLETE—READY TO RUN. Each Jeep Engine is complete—ready to run with fan, fan belt, water pump, generator, starter, distributor, coil, fuel pump, intake and exhaust manifolds, carburetor, oil filter, spark plugs, fly wheel, clutch pressure plate assembly, engine wiring.

All prices F.O.B. our yards in Chicago. Get in on this GREAT JEEP ENGINE BARGAIN NOW! Satisfaction guaranteed. We can supply standard JEEP and TRUCK PARTS. Tell us your needs. Catalog on request.

Write, wire or phone!
BERG TRUCK & PARTS CO.

America's 1st Jeep Distributor
1608 SO. WABASH AVE. CHICAGO 16, ILL.

BRAND
NEW, EA.

\$147⁵⁰

GOVERNMENT
REBUILTS

\$122⁵⁰

F.O.B. Chicago

ONE STANDS OUT

ALL WAYS—

You can recognize a Plumb tool when you look at it, hold it or work with it. You can see the black one-piece steel head and the red, tested hickory handle.

You can feel the perfect balance and grasp the carefully-shaped comfort-grip handle. And finally, when you use a Plumb you'll know it instantly by the ease with which it works, the quick, accurate strokes, the speed and power of every blow. By every test Plumb Tools stand out, all ways. Fayette R. Plumb, Inc., Phila. 37, Penna.

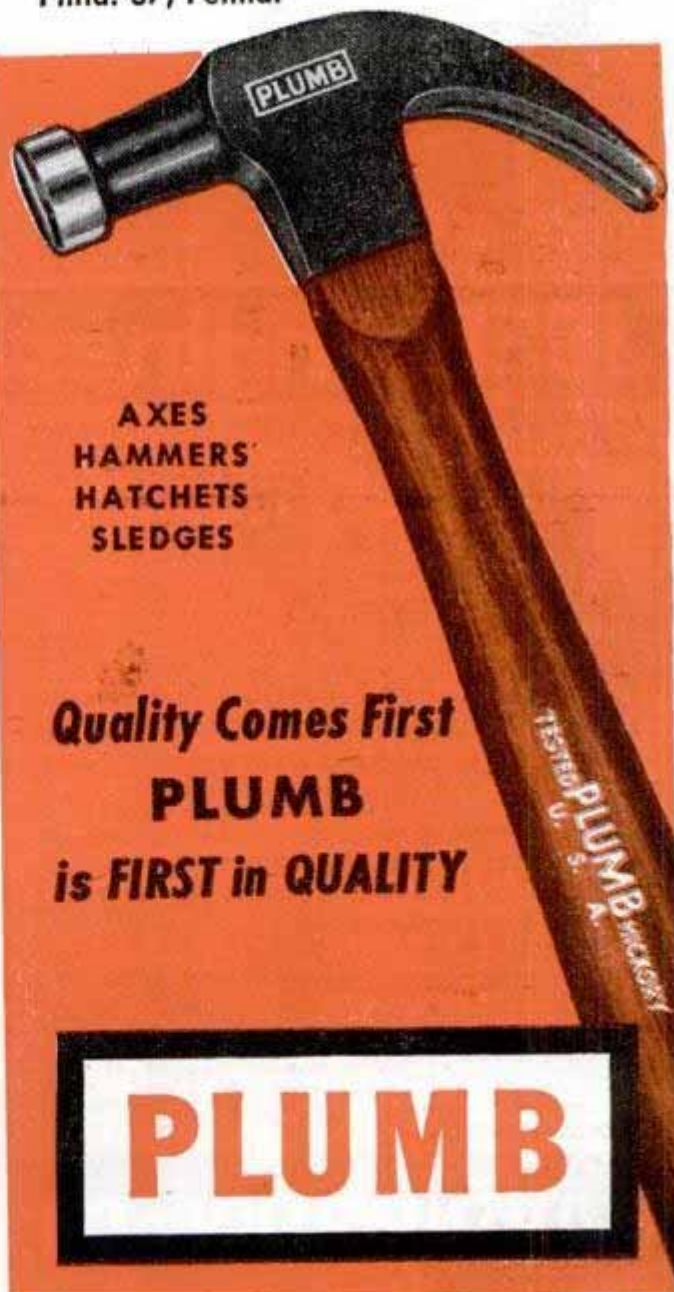

**AXES
HAMMERS
HATCHETS
SLEDGES**

Quality Comes First

PLUMB

is FIRST in QUALITY

PLUMB

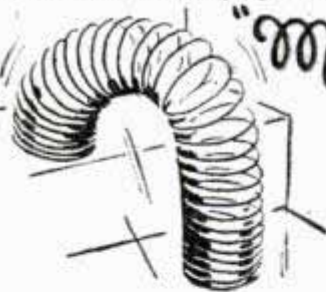

"Mr. Walker"

THE FASCINATING
ACTION TOY
FOR YOUNGSTERS
AND ADULTS

WALKS DOWNSTAIRS!

America's greatest post-war Action Toy. An ideal Xmas gift. It walks down a flight of stairs! Fascinating and exciting. Nothing to get out of order. No winding, no motor. Just set it on the top step, flip it and plop, plop, plop, it goes down stairs automatically like a giant night-crawler. Be the first to amaze your friends with this toy sensation. Fun galore! Sent anywhere in the U. S. Postpaid for

\$1

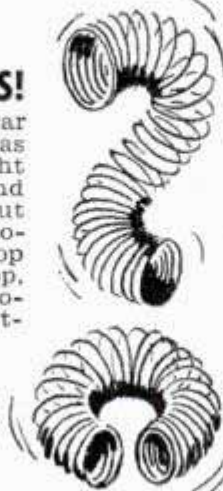

AGENTS WANTED—Easy to demonstrate, easy to sell. Write for special agents deal.

Travis Products Co.
224 W. Huron St.
Chicago 10, Ill.

JEEP Engines

60 H.P.

BRAND NEW!

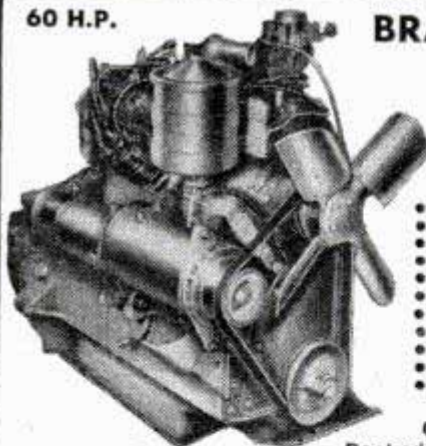

COMPLETE With All Engine Accessories

- GENERATOR
- STARTER
- DISTRIBUTOR
- CARBURETOR
- FAN & FAN BELT
- COIL
- WIRING
- WATER PUMP
- FUEL PUMP
- INTAKE MANIFOLD
- EXHAUST MANIFOLD
- OIL FILTER
- SPARK PLUGS
- FLYWHEEL
- CLUTCH and PRESSURE PLATE

GOV'T. SURPLUS
Packed in Original Crates

IMMEDIATE DELIVERY

COMPLETE and ALL READY TO RUN in

SPECIFICATIONS
No. of Cylinders.....4
Horsepower, actual.....60
Revolutions per min.....2000
Compression Ratio.....6.48-1
Crankcase capacity.....4 qts.
Horsepower S.A.E.....15.6
Torque, max. ft. lbs.....105

- POWER PLANTS
- LIGHT SYSTEMS
- BOATS
- BARGES
- AIR COMPRESSORS
- CONCRETE MIXERS
- POWER SAWS
- FARM & INDUSTRIAL USE, ETC.

PRICE ON REQUEST
Address DEPT. J

The Original
WARSHAWSKY & CO.
1900-24 So. State St., Chicago 16, Ill.,

SAY YOU SAW IT IN POPULAR MECHANICS



"YANKEE" VISES
hold work through every step
without a misstep

Any job locked in a "Yankee" Vise, is correctly positioned for every operation . . . hand or machine. Lifts on and off swivel base at bench. Machined accurately . . . top, bottom, sides and front end . . . V-grooved block for rounds. Four sizes, with and without swivel base . . . 1 1/2", 2", 2 3/4" and 4" jaw widths. At your dealer's.



Write for "Yankee" Tool Book

Division of
NORTH BROS. MFG. CO. The Stanley Works
Philadelphia 33, Pa.

METERS SPECIAL OFFER

SURPLUS—NEW—GUARANTEED

An ideal combination of **FIVE USEFUL METERS** for repair shops, laboratories, home and farm at a **SENSATIONAL NEW LOW PRICE.**

- A.C. VOLTMETER**—Westinghouse 2 1/4" aircraft style, 0-150 volts, A. C. black dial, luminous markings, suitable for use from 25 to 125 cycles.
- D.C. VOLTMETER**—Westinghouse 2 1/4" aircraft style, 0-30 volts D.C. black dial, luminous markings, 5 M.A. movement.
- D.C. AMPMETER**—General Electric 2 1/2" round, stamped metal case, 0-15 amp. D.C., moving vane type.
- D.C. MILLIAMMETER**—G.F. DW-41, 2 1/4" round, 0-1 M.A. movement, Scale marked 0-140 D.C. Volts M.A. & 0-500 D.C. M.A. Complete with paper Volt Ohm Milliammeter Scale.
- D.C. MILLIAMMETER**—Roller Smith 1 3/4" square miniature meter, special black scale 1.37 M.A. movement, full scale.

All **FIVE** of these meters can now be had **ONLY \$6.95** postage paid anywhere in the U. S. for

MARITIME SWITCHBOARD

Dept. PM5 336 Canal St. New York 13, N. Y.



PATTERNS—HOBBY OR MANUFACTURING

Novelty furniture and toys. Full size patterns. Mark out, cut out. Make Christmas presents. Choice of any 4 patterns \$2.00.

- #3 Stage coach, mantel piece 60c; #5 Covered Wagon-mantel piece, can be lighted 60c; #106 Fernery, easily decorated 60c; #82 Child's Set, Desk and chair 70c; #101 Radio, magazine and book table 75c; #135 Sewing Cabinet, floor model 85c; #38 Magazine rack, clothing, etc. 50c; #81 Child's Table, two chairs 75c; #12 Child's Chest, clothing, etc. 50c; #43 Sewing Basket 45c; #41 Waste Paper Basket, or Hamper 45c; #7 Corner Shelf, three shelves 50c; #19 Doll House 50c; #34 Hanging book or wall case, three shelves 50c; #106 Book Case, floor model, four shelves 75c. Prices prepaid.

Illustrated folder mailed to you on receipt of 15c in stamps.
GEORGE ANDRUS, Patterns, 3040 James Ave. So., Mpls. 8, Minn.

WOOD SHAPER

Ball Bearing—1/2 Inch Spindle—12x16 Table—Cast Iron and Aluminum Construction—Available Now—For details write—Murphree Mfg. Co., Sylacauga, Ala.

WAR SURPLUS

Without bidding, new products, stock articles, how to buy, prices, addresses. Advance information. Catalog sheets, free literature. If you want sample catalog sheets by return mail include \$1.00. **THE WAYNE ENGINEERING COMPANY, Dept. 1113, Greenville, Ohio**

BUILD YOUR OWN MACHINE TOOLS!
Blueprints \$1.00—Catalog FREE

Detail construction Blueprints on 6 Lewis metal and wood-working tools postpaid for \$1.00. Includes prints for Lewis 10" Shaper, Milling Machine, Drill Press, Vise, 8" Circular saw, 6" Jointer. Castings for these tools save up to 80% of comparable new tool cost. Illustrated 32-page Catalog—sent free with Blueprint Order—describes 21 Lewis tools. **WRITE TODAY!**

LEWIS MACHINE TOOL CO.
P. O. Box 7446, Sta. L, Dept. M, Los Angeles 23, Calif.



ARMY SURPLUS BARGAINS

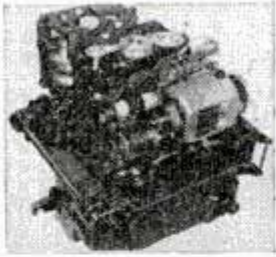

1. Sperry Calibrating Bomb Sight, K-3

Gadgeteer's delight! Contains hundreds fine gears, bearings, shafts, etc., driven by a VFG12 electric motor, 27 volt, 3000 RPM. Used. Weight 25 lbs.

\$7.50



2. Automatic Pilot Hydro. Servo Unit

Contains many fine machined gears, fittings, parts, etc. Can be used by experimenters, inventors; converted to air compressors, etc. Weight app. 30 lbs. Used.

\$7.50

3. Adel Pump and Motor, J-4

Brand new! AC-DC motor, with precision small volume liquid pump.

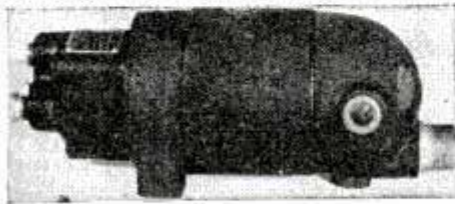

Pump has one inlet, two outlets. Used for pumping water in air conditioner, etc. Original cost far over a hundred dollars. Weight 2 3/4 lbs.

\$4.95

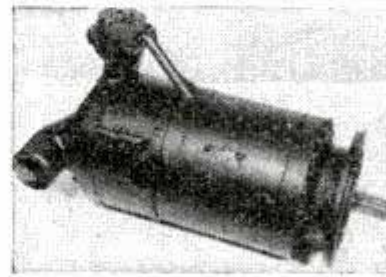

4. Generator for Electric Welding

P-1 Aircraft 200 amp. generator. Many uses; can be converted into 200 amp. electric welding machine. Used condition. Weight, 45 lbs.

\$24.50



5. Oxygen Flow Indicator, A-1

Can be used to indicate the flow of oxygen, air, water, any fluid, etc. 2 1/4" face. Used condition. Weight 12 oz.

69c



6. Oxygen Flow Indicator, A-3

Same No. 5 except uses Blinker system instead of the "floating" ball to indicate flow. Used condition. Weight 12 oz.

69c



7. Oxygen Cylinder Pressure Gage, K-1

Used to indicate air or liquid pressure in lbs. per sq. inch. 2 1/4" face. Used condition. Weight 6 oz.

69c

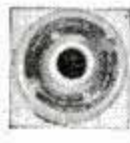

8. Pressure Relief Signal Valve, C-3

Used to signal over pressure of air or liquid. Used condition. Weight 8 oz.

59c



9. Suction Gage

Measures suction up to ten inches of Mercury. Good for experimenters, gadgeteers, industrialists, etc. Used condition. Weight, 6 oz. 2 3/4" face.

\$1.49



10. Amp. Meter, Air Corps Type F-1

Indicates amperage 0 to 40 minus; 0 to 380 plus. 2 1/2" face. Brand new! Uses external shunt. Weight 6 oz.

\$1.10



11. Carburetor Air Mixture Indicator

Indicates mixture of air and vapor in Centigrade. 24 volt. 2 1/4" face. By Weston. Used condition. Weight one lb.

\$1.65

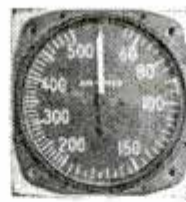

12. Airspeed, Army Air Force Type D-7

Indicates air flow or speed from 0 to 500 mph. Wonderful for water and ice boats, airplanes, autos, motorcycles, etc. Used condition. 10 oz. weight. 3" face. Also 0 to 700 mph. Both work at low speed of 50 mph.

\$4.95

13. Tachometer, Chronometric Type C-11

Indicates engine speed from 0 up to 4000 RPM. 3" face. Reconditioned. Good for boats, autos, etc. Weight 1 lb.

\$5.95

14. Radio Headphones, AAF Type ANB-H-1

Fine for Hams or experimenters. Two receivers, leather head bands, 10' cord with PL354 plug. Used condition, checked okay. Weight 10 oz.

\$1.00

15. Radio Throat Microphones, AAF Type T-30

Fine for radio use where use of hands is needed. Carbon type. Used but good condition. 8" cord with two prong plug.

\$1.00

16. Toggle Switches

New condition. Double pole-double throw, 1 1/2" x 2" 49c
Slightly used. Single pole-single throw, 1" x 2" 39c

17. Interphone Amplifier BC 347-A

24 volt interphone, 6" x 4". Brand new! Uses 1 6F8 tube. Interphone without tube, \$2.49. With 6F8 tube, (weight 1 1/2 lbs.) \$3.29

18. Mallory Radio Noise Filter, NF-1-1

Radionoise filter, size 2 1/2 x 3 3/4 inches, metal box. For cutting noise between radio and motor, etc. Brand new! Weight two lbs.

\$1.29

19. Radio Tubes (Brand new!)

6B8	50c	1626	95c
6SC7	65c	12SR7	50c
6J5	65c	1629	95c
6K7	65c	12J5 /GT	50c
2051	95c	6SN7	95c

20. Flying Goggles, AN6530

Clear lensed type, rubber face mask. Used by Aviators, motor cyclists, hunters, sportsmen, etc. Used but good condition. Weight, 6 oz.

\$2.95

IMPORTANT: We pay no shipping charges! Include adequate on cash orders to pay charges or we will ship collect charges. No orders accepted for less than \$2.00. No C.O.D.s shipped unless 20% deposit made in advance. App. weight of each item is listed.

AERO INSTRUMENT CO.
MUNICIPAL AIRPORT HOUSTON 12, TEXAS

AERO INSTRUMENT CO.

Municipal Airport, Houston 12, Texas

Send Express, Mail, Best Way — the following:

I have inclosed check, cash or money order for \$.....
or send COD.

Name.....

Address.....

Town and State.....

SP



Build the Sail-Master

Distinctively Designed Clipper Ship

- A Wonderful Christmas Gift

Your family or friends will be thrilled to receive this handsome ship model for mantel or radio. Its gleaming chrome sails, polished wood hull and graceful lines make the Sail-Master a gift everyone will prize. **EASY TO BUILD.** Construction Kit contains full instructions, all parts needed. Metal parts are completely finished and plated. No special tools required. Quantity limited. So send for your kit today! Mailed parcel-post prepaid anywhere in U. S. A. Send check or money order now!

\$4.00

WIL-SEL PRODUCTS COMPANY

3440 N. Knox Avenue

Chicago 41, Illinois



BELL
GUARANTEED
WATCHES

**WATERPROOF
SHOCKPROOF**

THE IDEAL CHRISTMAS GIFT

Anti-magnetic, radium dial and hands, unbreakable crystal, sweep second hand, precision tested.

- No. YP 197
17 jewels, stainless steel back..... **\$29.75**
- No. YP 188
17 jewels, all stainless steel case..... **\$47.50**
- No. YP 328 SELF-WINDING
17 jewels, all stainless steel case..... **\$59.75**

ORDER BY MAIL: Send check, money order, or pay postman C.O.D. Prices Incl. Fed. Tax & Postage. Gift Box. Wide choice of fine watches for men and women. Write for **FREE** Illustrated Booklet "YP"

Repair Service

All types and makes of watches repaired expertly and promptly. Free estimate on request.

BELL WATCH COMPANY, INC.

Time and Life Bldg., Rockefeller Center, New York 20, N. Y.

IMMEDIATE DELIVERY

FOR HIM — THE PERFECT GIFT

10" TABLE SAW

Home or
Shop Use

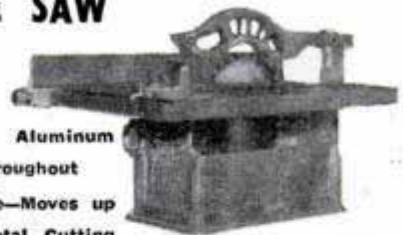

- All Stream Lined Aluminum Casting
- Close Tolerances Throughout
- 10" Blade Capacity
- Ball Bearing Spindle—Moves up and down 2"
- Dado Tools and Metal Cutting Discs easily attached
- Top tilts to 45°
- Sta-Rite One Piece Cast Aluminum Rip Fence and Miter Gauge
- Operates with 1/4 to 1/2 H.P. Motor

\$55.00

F.O.B. Factory N. Y. Less Blade and Motor

Distributorships Available — WRITE

ALLEN ARTCRAFT Inc., 261 Pearl St., New York 7, N. Y.

REYNOLDS BALL PEN

Guaranteed to write 15 years without refilling. Send \$3.85 and one Reynolds Rocket Ball Pen will be sent to you postpaid.

Dealers and agents write for our special proposition on this and other fast-selling items.

SYLVAN CO., Dept. P.M., 154 E. Erie, Chicago 11, Ill.



BRONZE BABY SHOES!

Big profits! Preserving baby shoes in gold, silver, bronze, pearl and ivory finishes! Details free. Write **R. O. MORGAN, Box 349, Long Beach 2, Calif.**

Say You Saw It in
POPULAR MECHANICS



PRACTICAL BOOKS ON HOME PLANNING BUILDING · REPAIRS

MAIL
ORDER
TODAY

Plan Now—Build When You Can
Books Sent C.O.D. Anywhere in U.S.A.

Select from this list of helpful books. In U. S. books sent postpaid if remittance accompanies order. Outside U. S. include 15% extra for shipping charges.

- How to Plan a House.....\$4.50
- House Construction Details.....\$3.00
- Painting, Decorating.....\$1.50
- Carpentry.....\$2.00
- Painting, Furniture Finishing and Repairing
Includes floor renewal.....\$1.50
- How to Remodel a House
Complete, practical.....\$4.75
- Building Insulation.....\$3.50
- Concrete Handbook
Do work for yourself, others.....\$1.50
- Blueprint Reading for Building Trades.....\$1.25
- Practical Bricklaying.....\$1.75
- Simplified Carpentry Estimating.....\$3.00

FAMOUS PLAN BOOKS
Books contain floor plans, photos, descriptions of homes.
AMERICA'S BEST LOW COST HOMES. 125 designs.....\$1.00
DE LUXE SMALL HOMES. 210 designs.....\$1.00

OUR FUTURE HOME. Wide selection of residences, summer homes, garage apartments.....\$1.00
MODERN HOME & GARDENING. 42 popular designs. Improvements, garden shortcuts, etc.....50c

Set of
Four
Books
\$3.50

Stair
Building
\$2.00



POPULAR MECHANICS PRESS

Dept. 000 • 200 E. Ontario St., Chicago 11

They're back again

... THOSE NATIONALLY FAMOUS RUBBER TIERED WALTON WHEELS FOR BUILDING YOUR OWN VEHICLES!

You can't buy better Wheels! WALTON DELUXE WHEELS are America's finest — don't be satisfied with anything less to build vehicles of your own design!

Hardened Steel Roller Bearings

Two sets of scientifically engineered roller bearings and massive jumbo balloon rubber tires give them rocket speed and provide you with almost unbelievable velvet-smooth rides.

IDEAL CHRISTMAS GIFT! HUNDREDS OF USES! Excellent for carts, trailers, golf bag carriers, mobile industrial equipment. Tremendous production direct from manufacturer makes possible our low price for such fine quality!

3 COMPLETE WHEEL KITS

Choose from these kits to make coaster wagons, racers, four-wheel trucks, etc.

WK1 Four 8x2" Wheels, two 20"x 1 1/2" diam. axles, 4 heavy hangers, 8 washers and cotter pins ready for use. **\$13.95**

WK2 Four 10x1 3/4" Wheels, two 24"x 1 1/2" diam. axles, 4 heavy hangers, 8 washers and cotter pins ready for use. **\$14.95**

WK3 Designed for heavy-duty needs. Includes four extra-heavy, big industrial type deluxe Wheels, two 24"x 1 1/2" diam. axles, 4 heavy hangers, 8 washers and cotter pins. Massive 10-inch rubber tires are 2 3/4 inches thick. Specially priced... **\$32.95**

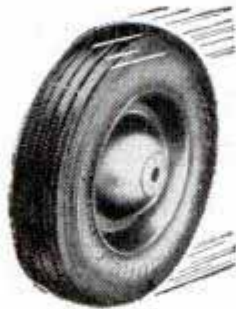

WHEELS ONLY

8x2" in sets of two. Each.....\$2.95
\$11.60 set of 4

10x1 3/4" in sets of two. Each.....\$3.25
\$12.80 set of 4

10x2 3/4" extra heavy industrial type in sets of two. Each...\$7.48
Single Wheel \$7.95
\$29.95 set of 4

Fast delivery. Send check or money order. No C.O.D.'s, please.

WALTON WHEEL COMPANY, Dept. J5

PLANKINGTON ARCADE MILWAUKEE 3, WISCONSIN
Dealers and Equipment Manufacturers — write for information.

YOU CAN NOW BECOME A PROSPECTOR!

HERE IS ONE OF THE WAR'S TOP SECRETS
BRAND (NEW) ARMY MINE DETECTORS!

Portable: Will Detect METALLIC and NON-METALLIC objects; Very Sensitive: using 955 Tube in detecting head; two tube amplifier using two 1N5gt; headset; or microphone; also 150 micro meter; Power supply: 3-45v.; one 6-v.; or 2 3-v. batteries. Complete with instr. Less Batteries; packed in original cases; shpg. wgt. 108 Lbs.

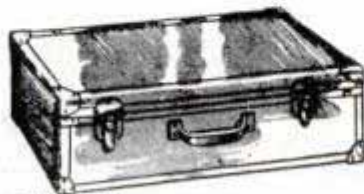

CARRYING CASE CT-51/PRS-1

FOB. From N. Y. Special

\$1750

No C.O.D.'s

Send order to

COLUMBO TRADING CO., INC.
304 CANAL ST. NEW YORK 13, N. Y.

The All-Purpose CUTTING TOOL

for HOME WORKSHOP CRAFTSMEN!



Set #95
\$9.95

It's Magic at Your Fingertips!

GENIE TOOL

Yes—GENIE TOOL is the hand-tool with a multiplicity of uses. Get yours today—find out how useful this versatile precision tool will be to you. It's without equal for the model builder... indispensable for general home use.

- IT CUTS!
- IT DRILLS!
- IT GOUGES!
- IT FILES!

For use on hard or soft woods — plastics — li-noleum and soft metals.
There's a GENIE TOOL Accessory for Every Use!

SEND FOR CATALOG TODAY!

DEPT. D
MODEL TOOLS
BOX 30 • BURBANK, CALIF.



War Surplus: Safety Belts

**AT A TREMENDOUS SAVING
Worth Many Times Our Low Price
Immediate Delivery—Order Today**

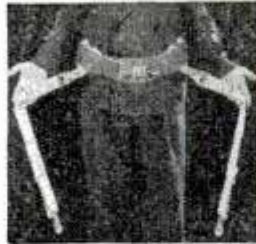

and scaffolds where safety to life is necessary. ADJUSTABLE to ANY SIZE. Expertly made: DURABLE and STRONG to withstand Government Requirements for SAFETY FROM HIGH ALTITUDES and PARACHUTES. Double reinforced, best quality, woven straps, leather guard, safety METAL CATCHES and SNAPS throughout. Made to last and made to hold. Cost the Gov't many times OUR LOW PRICE. Would suggest that you order as many as you need while this opportunity lasts. A REAL BARGAIN!

HERE is a fortunate opportunity to save a lot of money on these SAFETY BELTS. Ready instantly for many uses on the FARM, HOME and BUILDINGS on ladders

ONLY \$3.95

Postpaid in U.S.A.

DEALERS WRITE FOR QUANTITY PRICES

K and W SURPLUS SALES, 1347 No. Oakley Blvd., Dept. P, CHICAGO 22, ILLINOIS

for WINDOW WASHERS, TREE SURGEONS, FOREST RANGERS, TELEGRAPH LINE-MAN,, ETC., ETC. . . .

for HOMES, BUILDINGS, ON THE FARM AND ANY PLACE WHERE OUTDOOR WORK ON LADDERS AND SCAFFOLDS MEANS SAFETY TO LIFE

Now for EVERY WORK SHOP!

NEW Invention Electroplates by BRUSH



Easy to Plate CHROMIUM GOLD, SILVER, NICKEL, COPPER . . . For Pleasure and Profit!

If you have a workshop—at home or in business—you need this new Warner Electroplater. At the stroke of an electrified brush, you can electroplate models and projects—you can replate worn articles, faucets, tools, fixtures, silverware, etc. with a durable, sparkling coat of metal . . . Gold, Silver, Chromium, Nickel, Copper or Cadmium. Method is easy, simple, quick. Everything furnished—equipment complete, ready for use. *By doing a bit of work for others, your machine can pay for itself within a week.* So make your shop complete by getting a Warner Electroplater right away. Send today for FREE SAMPLE and illustrated literature. ACT AT ONCE! Mail Coupon. WARNER ELECTRIC CO., DEPT. K-4 1512 Jarvis Avenue, Chicago 26, Ill.

FREE Details & Sample!

WARNER ELECTRIC CO., 1512 Jarvis Avenue, Chicago 26, Dept. K-4
Gentlemen: Send Free Sample and Details to:
Name _____
Address _____
City _____ State _____

START A BATTERY FACTORY

—at home; the latest achievement; re-cast junk batteries into new Complete instructions. We supply everything. Big Profits!

THE BATTERY LABORATORIES
Dept. PM Minneapolis 13, Minn.



- Row Boat—12 Foot
- Dinghy—8 Foot
- Training Ship—6 Foot
- Sea Sled—9 Foot
- Outboard—12 Foot
- Cruiser—18 Foot
- Bicycle Boat—Kayak
- Row Boat—Sectional
- Dinghy—Sailing
- Canoe—16 Foot
- Sailing—12 Foot
- Outboard—12 Foot
- Pontoons Ice Yacht

FOR PLEASURE OR PROFIT DESCRIBES 17 LOW COST BOATS
Get this outstanding book and build a boat at home for your own use or to sell at a profit. You can do it. Just the boat you've always wanted—power, sail or row boat—17 different kinds and sizes.

Order BUILD A BOAT on postal card and pay only \$1.50 plus postage on delivery. Return in 5 days if not pleased and get money back. Or send \$1.50 with order and we'll pay postage. (Outside U. S. \$1.70 with order.) Order today.

POPULAR MECHANICS PRESS
Dept. 598, 200 E. Ontario, Chicago, 11

New 1947 Shop Notes Now Ready!

FOR EVERY MAN WHO USES TOOLS



One of these books is issued each year and is a reprint of articles published in our Shop Notes Department. It contains the cream of experience of years, of hundreds of our country's most successful mechanics. 50c per copy at your News Dealer, or send 60c to

POPULAR MECHANICS PRESS
Dept. 634 200 E. Ontario St. Chicago 11

6 handy tools in ONE!

- 1 MITERING GUIDE
- 2 DIAMETER GAGE
- 3 ACCURATE SQUARE
- 4 MARKING GAGE
- 5 CENTER FINDER
- 6 CONVENIENT RULER



\$2.00
POSTPAID

MITER-MASTER

MASTER SPECIALTY COMPANY
3018 EAST LAKE STREET • MINNEAPOLIS 6, MINN.

Miter Master takes the place of an expensive miter box accurately set to any angle. Scale marked for mitering 5, 6, and 8-sided frames. Steel construction. Built to last a lifetime. If your dealer can't supply you we will send it postpaid anywhere in the U. S. for \$2.00. (Foreign \$2.25.) Unconditional guarantee. If not satisfied within ten days for any reason whatsoever, your money will be refunded.

MULTI-PURPOSE, RUGGEDLY CONSTRUCTED FLEXIBLE SHAFTS

Sealed Against Dust & Dirt
53 1/2" Length, 3/8" Diameter (O.D.)

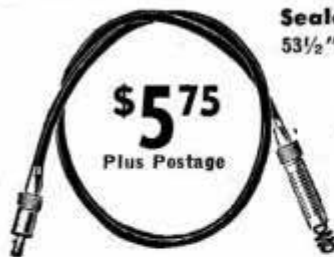

\$5.75
Plus Postage

These SHAFTS can be used on 1/2" motor shaft, or by removing the coupling, in a chuck up to 3/4" capacity. Shaft size on operating end is 3/8" diameter, 24 threads per inch. Speed range 1725 RPM to 3600 RPM. Can be bent or looped to small radius for working in hard-to-get-at places. Outer covering of oil-resistant Neoprene. Useful for many purposes, including Buffing, Grinding, and Transmission of Power.

Drilling, Polishing, Rotary Filing

U. S. Navy Battle Lantern

Throws 500 Ft. Beam, with on-off switch. Waterproof. Convenient handle. Requires 2 Standard Dry Cell Batteries. Has many uses. A suitable gift. Price—**\$5.75** Plus Postage Less Batteries



ELECTRIC TRADING CO.

313 CANAL ST.

NEW YORK 13, N. Y.

Electric Fans and Blowers in most sizes for every Industrial, Commercial and Domestic use. Table Saws—Air Compressors—Electrical Tools and Paint Spray Equipment in stock.

Money Making Pay Raising BOOKS Catalog FREE

SEND NAME AND ADDRESS TODAY—Selected books covering all trades, office helps, home workshop, spare time work, hobbies, etc. Learn how to earn more. 1946 edition. Popular Mechanics Press
200 E. Ontario St., Chicago 11



WHEELS AT BARGAIN PRICES

WE ARE OVERSTOCKED AND
MUST MOVE THIS SUPPLY OF
De Luxe BALL BEARING WHEELS

...8" x 2" Semi Pneumatic Tire. 7/16" Ball Bearing..\$2.75 ea.
...10" x 1.75 Semi Pneumatic Tire. 7/16" Ball Bearing 3.75 ea.
(CHEAPER IN SETS OF FOUR — WRITE FOR FREE LIST)

Write number wheels wanted in space provided, tear out and mail this ad. with check or money order and your name and address.
TRULSON MFG. CO., Dept. D, 811 East 31st, Kansas City, Mo.

U-MAK-IT New AQUAMOBILE V-18

Cut-to-Fit—for quick Home Assembly. Get used Ford motors A, B, V8. Chevrolets, etc. for trifle. Adjustable motorbeds fit all. Assembled frames ready for installation. Fast VEE bottom Marine Plywood hulls.



No Experience Necessary

SEND 10c (Coin) MONEY SAVING CATALOGS Show Kits for KAYAKS, ROWBOATS, OUTBOARDS, DINGHIES
KAYAK BOAT CO., 154P East 129th St., New York 35, N. Y.

Plane · Rabbet · Groove Rout · Panel · Tenon on Your Drill Press



This exclusive tool fits any drill press, simultaneously planes, rabbets, routs, tenons, beads, grooves. No extra blades to buy. Over fifty thousand now in use by hobbyists, pattern and cabinet workers, etc. Satisfaction guaranteed or your money back. Complete

\$7.50

ALL-METAL DRILL PRESS TABLE



\$9.85

Solid Alcoa aluminum heavily ribbed. Blanchard ground top and bottom. Equipped with Barron adjustable steel fence. Extra large working surface 13" x 18". Fits all standard drill presses. Instantly mounted or removed.

SPIRAL FLUTE ROUTER BITS

New 45° helix angle tool steel design for smoother, faster, accurate routing, grooving, carving, mortising. Extra long cutting flutes. Individual sizes 1/8" to 1/2". Prices on application. Complete set of six graduated sizes. **\$9.50**



ROTARY SURFACE SANDER



Fits chuck of any drill press. Provides satin smooth, even, accurate surfacing of woods, plastics and metals. No ridges, no striations. Original in design, a great labor saver. Complete with 20 sanding discs. Fully guaranteed. **\$5.95**

Liberal 10 Day Money Back Guarantee

Workshop Guide FREE

BARRON TOOL CO.

469 Architects Bldg., Detroit 1, Mich.

BARRON PRECISION WORK SHOP TOOLS

P-1 Generator Bracket

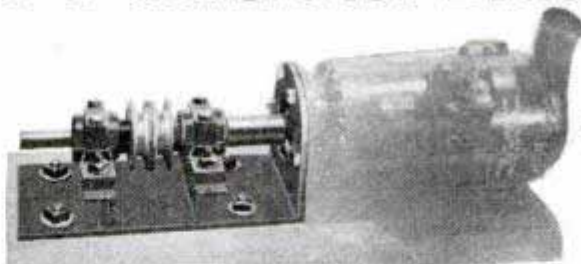

ONLY
\$8.95

Ideal for either Delco or Westinghouse Generator

Made of 1/4" Welded Steel. For use with 2 "B" "V" Belts. Can be used for combinations of 1 or 2 generators. Takes up the "Play" in the generator shaft. A Must for every generator user for longer life of the unit.

GOVERNMENT SURPLUS & HARDWARE SALES

1627 North Damen Ave., Chicago 47, Ill.

Telephone Arm. 2518

AMAZING LOW PRICE Look At This BIG ASSORTMENT



• Complete Assorted •

75 GRINDING WHEELS
SHARPENING STONES
and ROTARY CUTTERS
PLUS 200 assorted items
for Home or Shop

ONLY **\$5.95** RUSH YOUR ORDER TODAY

Postpaid in U.S.A.

- 12—Ass't Grinding Wheels up to 4" dia. Ass't Shapes and Sizes.
 - 1—Rotary File High Speed Steel 1/4" Shank.
 - 1—Rotary Cutter 1/8th inch Shank.
 - 12—Rotary Burs for Cutting Wood and Soft Metals, Ass't Sizes.
 - 10—Assorted Cut-Off Wheels, Ass't Sizes.
 - 3—Mounted Grinding Stones 1/8th inch Shank.
 - 3—Mounted Grinding Stones 3/32nd inch Shank.
 - 1—Drum Sander on 3/32 inch Mandrel.
 - 10—Bands for Drum Sander.
 - 6—Rubber Wheels 3/8 inch Diameter.
 - 10—Felt Wheels, Assorted Sizes Up To 2 inch Diameter.
 - 1—Wire Brush 1 inch Diameter on 3/32nd inch Shank.
 - 3—Bristle Brushes on 3/32nd inch Shank.
 - 2—Mandrels 1 each 3/32nd inch and 1 each 1/8th inch Shank.
- PLUS 200 ASS'TD ITEMS FOR HOME OR SHOP

D. SCHUPACK, 2256 E. 75th St., Dept. P-12, CHICAGO 49



REPAIRS BROKEN ARTICLES

DUCO CEMENT mends most everything—china, glassware, luggage, books, toys, furniture. It's waterproof, transparent and flexible. Keep a tube for instant use!



DUCO CEMENT

REG. U. S. PAT. OFF.

AMMCO 7" SHAPER

"A Precision Machine of a Thousand Uses"

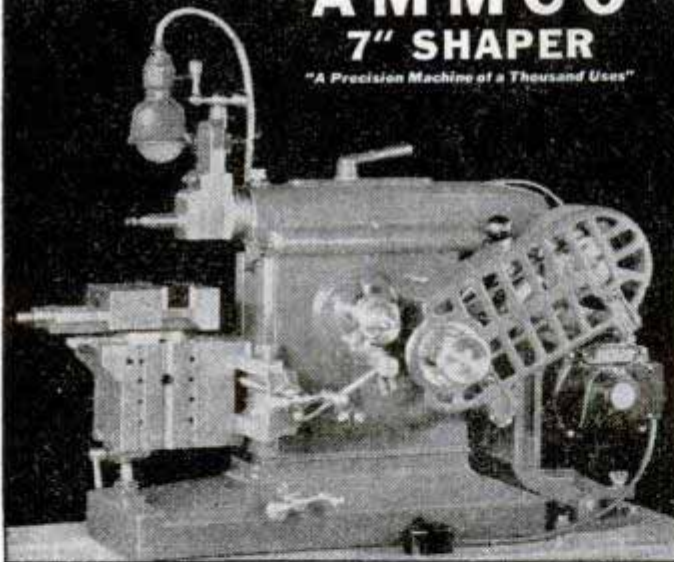

A wide variety of jobs can be done accurately, quickly, easily, and economically on the AMMCO Shaper (7" stroke). Construction incorporates many features you would expect to find only in larger, more expensive machines... For example: WAYS of ram, tool head, and front face of the main frame are of the "VEE" type, hand scraped to insure accuracy and long life. Available for stationary installation or as portable unit.

Write today for specifications and prices

AMMCO

2140 Commonwealth Ave. North Chicago, Ill.

Convert your 16mm
silent projector to



With the APEX Sound Converter use right through your own Radio.

1 Sound Adapter
1 Radio-Film Adapter
1 Mounting Bracket

OR 1 Sound Adapter
1 14-Watt Amplifier
1 12" Speaker and Case

ONLY \$59.95 ONLY \$97.90 Complete

Complete ready to use. Fits any 16mm silent projector. Immediate delivery. Mail money order for full amount or \$10.00 balance COD.

APEX VIDEO CO.

Dept. PM 4, 7356 Melrose Ave.

Hollywood 46, Cal.



IDENTIFICATION BRACELET only \$1.95. Heavy silver plated, name engraved without extra charge. Orders shipped same day. We also make these with a STERLING SILVER tag, heavy weight, with nickel silver chain, each boxed, \$2.95. We pay tax and postage.

MONT PETIT MFG. CO.
15 E. Pearson St., Dept. U Chicago, Ill.

DOWEL TROUBLES?



Now you can make dowels that match your wood! Amazing new SPEE-DOWL makes perfect, burnished dowels for arrows, cabinet work or other projects.

Simply rotate wood in lathe or drill press and push on SPEE-DOWL like pencil sharpener. Cast aluminum body, tool steel blade. A necessity for fine craftsmanship. Available in 2, 3, 4, 5, 6, 7, and 8/16" sizes. Only \$1. Special—any 4 sizes \$3; complete set of 7 for \$5. SENIOR MODEL.

9/16" to 1 1/4" only \$2.65 ea. Send postal note or check NOW for your SPEE-DOWL. Unconditionally guaranteed. Free literature.

JOHNS MFG. CORP., Dept. C-3 501 Sound Brook Rd. Dunellen, N. J.

SAY YOU SAW IT IN POPULAR MECHANICS

ATTENTION AUTO OWNERS!

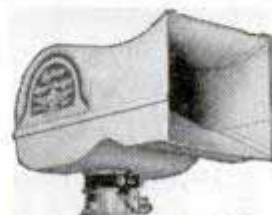

New Power, Pickup, Pep!

Amazing TYPHOON SUPERCHARGER is back again, ready to put new life into old motors, add to power, pickup, pep! 41,000 users find gas economy, you will, too. Motor knock vanishes, grease bath air cleaning keeps harmful dust out. Takes 5 minutes to install with screw driver on carburetor, replacing old air cleaner. Order today, mention make and model of car. Only \$5.95.

(Ohio orders add 3% sales tax, West of Rockies, add 10%.)
10 Day Money Back Guarantee!

TYPHOON PRODUCTS CO. 507-M Engineers Bldg. Cleveland 14, Ohio

G. I. POCKET STOVE



Famous Coleman make. Burns gaso-line. Use it for cooking, heating, etc. Metal container makes 2 cooking pots. Folds to 8 1/2 x 4 1/2 ins. Remarkably efficient—well made. Brand new. Shp. wgt. 3 1/2 lbs.

No. 5530
Each..... **\$10.95**

SIGNAL MIRROR



Used by downed air-men for rescue signalling. Brand new. Measures 4x5 in. with sighting guide. Shp. wgt. 1 lb.

Stock No. 527. Each... **98c**

ARMY SLIDE RULE



Designed for quick computation of range for artillery fire. Includes table for wind direction, cross wind, weight of projectile, etc. Measures 18 in. long by 3 in. wide. Has two extra sliding segments. Extra fine calibrations for accuracy. New. Wgt. 2 lbs.

Stock No. 544. **\$2.95**
Each.....

RAIN JACKET



All weather water-proof rain jacket with parka. Of durable oil slick material. Double sewn seams. Draw string in waist. Available in small, medium and large sizes. Specify size when ordering.

Shipping weight 5 lbs. Stock No. 133. **\$4.95**
Each.....

ARMY BANDOLEERS

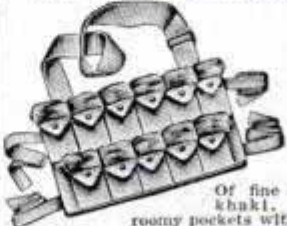

Of fine heavy khaki. Big roomy pockets with snap button fasteners. Fine also for shop work in carrying small parts, etc. Material alone is worth this price.

11 Pocket **49c** 5 Pocket **29c**
Type No. 129 EACH Type No. 110 EACH

POPULAR RECORD ASSORTMENT



Fifty records of modern dance, race, blues and hillbilly selections. No two alike. Famous name bands and artists included. Used in juke boxes, but guaranteed perfect. Shipped exp. collect only—no exchanges or refunds. Wgt. 28 lbs. No. A303—

\$9.64
50 records.....

PLASTIC 8 OZ. FLASK



For hunters, fishermen, scouts. Waterproof and transparent. Use it for liquids, matches, flies, bait, etc. Has screw cap top for liquids, plus full open top. 5 1/2 x 4 1/2 x 1 1/2 ins. Hundreds of uses. Wgt. 1 lb. No. A347.

Each..... **49c**

7 LB. EXPERIMENTER PARTS ASSORT. KIT



A "gold mine" for the radio serviceman. Hundreds of valuable radio parts, new radar and electronic parts and sub-assemblies, coils, resistors, trimming condensers—worth many times this low price.

A130R **\$1.79**
—7 lbs.

BOMB PARACHUTES

Of fine white nylon fabrics 5 x 8 feet in diameter with split seam for directional dropping. Designed for dropping fragmentation bombs, emergency rations, etc. Each packed in a metal container. Weight 6 lbs.

No. R-162
Each **\$1.95**
only

WOOL ARMY BLANKETS

100% wool, regulation OD. Army blankets. Class B, perfect. Used but renovated for re-issue. Wgt. 5 lbs. No. 233.

Each..... **\$4.89**

SATCHEL POUCH

Heavy canvas pouch. Ideal for toting lunches, shopping, books, etc. Has three 11 x 12 inch pockets. Brand new, guaranteed perfect.

11 x 12 in. Each... **\$1.69**



FISH KNIFE

For your fishing tackle box. Bone handle 5" long. 4 in. blade with safety catch. Has tapered hook remover at end. Shp. wgt. 1 lb.

No. 548. Each **\$1.95**

HAND MICROPHONE



Top quality hand microphone with control button in handle. Highly sensitive. Has rubber covered cord and tel. plug. Fine for use on home recorders, public address systems, etc. Brand new—perfect. Shp. wgt. 2 lbs. Stock No. 170. Each.....

\$1.95

BRONSON FISHING REEL



New! Level winding. 100 yd. capacity. Quadruple multiplying. Bright nickel finishing. New improved click. Shipping wgt. 8 ozs. No. F1133—Each... **\$2.35**

MESS KITS



Regulation two piece Army Mess Kits with folding handle. Used, but perfect. Weight 2 lbs. No. A116. Each **69c**

CANTEENS

Reg. U.S. issue canteens. Plastic screw top chained to body. Slightly used but perfect. Wgt. 1 lb. No. 117—Metal. No. 118—Plastic. Each.....



69c

CANTEN CUPS

All metal. Folding handle. Wgt. 1 lb. No. A120. Each..... **25c**

CANTEN COVERS

Heavy canvas. Button fastener. New. No. 530. Each..... **69c**
Used No. 119. Each..... **35c**

JUNGLE HAMMOCK



For back yard, country home and camp use. Has water-proof roof with mosquito-to-proof nylon netting side.

Lets you sleep outdoors safely. Finest construction. Originally designed for U. S. Army use. Shp. wgt. 7 lbs. No. 134. Each..... **\$9.95**

2 MAN MOUNTAIN TENT

Regulation Army type two man mountain tent. Complete with poles, guy ropes, etc. Of durable nylon with reinforced seams. Ideal for outdoorsmen, campers, etc. Shp. wgt. 10 lbs. A special did value. Stock No. 202. Each..... **\$9.95**



PUP TENTS

Regulation Army Pup Tents of durable, brown canvas. Used, but in good condition. Fine for campers, outdoorsmen, boy scouts, etc. Grand Xmas gift for children. Wgt. 5 lbs. A-100 Tent only..... **\$3.95**
A-110 Tent. New..... **\$7.95**
A-101 Ropes, wooden poles and stakes for above. Per set..... **\$1.00**

DECORATIVE CHROME STRIPS



For your car, boat, furniture, etc. Highly polished chrome finished strips with clinched edges for flush mounting to any surface. The 3 pound kit provides approx. 43 pieces in lengths from 4 inches to 3 feet and 1/4 to 3/4 inches wide.

Wgt. 4 lbs. No. R-224—3 lb. Assort. only **\$2.00**

G.I. PISTOL BELTS



Of heavy canvas webbing. Adjustable. Eyeleted all around. Used but perfect. Wgt. 2 lbs. No. 131. Each..... **98c**

G.I. POCKET BELTS

Regulation G.I. Belt with snap button fasteners on all pockets. New! Adjustable size. Wgt. 3 lbs. No. 109. Each..... **98c**

SHATTERPROOF GOGGLES

All purpose type. Sponge rubber frame. Red shatterproof flexible lens. Ad. head band. With case. New. Wgt. 1 lb. No. 139. Each..... **39c**



WIRE PLIER



Genuine Bernard 6 1/2 inch wire cutting plier. Parallel opening jaws. Reg. \$5.00 value. Wgt. 1 lb. No. 168. Each..... **\$1.29**

ORDER DIRECT FROM THIS AD

Values galore! Hundreds of hard-to-find items for home, shop and outdoors. Make remittances by money-order, bank draft or personal check. Send 25% deposit on C.O.D. orders. No C.O.D.'s on orders for less than \$5.00. Include sufficient postage on parcel-post orders—any overage will be promptly refunded. All quotations F.O.B. Chicago. Used items and materials are guaranteed serviceable and as described. Your money back if not more than satisfied.

BIG ILLUSTRATED CATALOG FREE

STARK'S Dept. PM1246
509 So. State St. CHICAGO 5, ILL.

LIFE PRESERVER BELTS

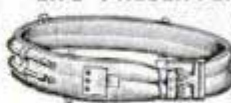

Right from the invasion beaches. Consists of two air chambers. May be inflated automatically with "sparklet" cartridges or manually by attached hose. Adjustable in waist size. One air chamber guaranteed air tight—other may need a tire patch. All belts are used and slightly soiled—but a bargain at this low price. No. 1261. Each..... **\$1.00**

WORLD'S

LOWEST PRICED ADDING MACHINE

VEST POCKET SIZE

MAKES IDEAL GIFT

Baby Calculator makes an ideal gift—for every Gift occasion, Birthday—Graduation—Christmas—Anniversaries. For men, women, children—teachers, business people, home or shop use. **COMES PACKED READY FOR GIFT WRAPPING.**

TEN DAY TRIAL

Money Back Guarantee

Because we know that our machine is the very best Calculator to be obtained at this low price, we make this 10 Day Trial offer, on a positive money back guarantee! Don't buy ANY Calculator without this guarantee! Send only name and address, pay postman \$2.50 plus postage (if cash is sent, we pay postage—you save up to 40c). (Send full cash if outside U.S.) Money back within 10 days if not delighted.



IDEAL XMAS GIFT

Fits vest pocket or purse. Guaranteed Accurate. Operated as easily, and as reliable, as machines costing many times as much. NOT A TOY or GADGET. Substantially made of 28-gauge steel—guaranteed for life against defects in construction. Beautiful looking, modernized design. Finished in Black, Silver and Red. You positively can't buy a Calculator of equal quality for as little money. **ACCEPTED AS THE FINEST OVER PRICED CALCULATOR FOR OVER 30 YEARS!** Operates with a flick of your finger. Adds, subtracts, multiplies, divides—counts up to ten million. Pays for itself over and over in mistakes avoided, and time saved.

CALCULATOR Machine Co. (Mfrs.)

DEPT. 185, P. O. BOX 248, GLENVIEW, ILLINOIS

AGENTS WANTED

FREE TRIAL

ONLY

\$2.50

TOTAL COST

SEND NO MONEY

FREE!!

Each Baby Calculator enclosed in beautiful rich-looking Leatherette Case—at no extra cost.



USE COUPON

CALCULATOR MACHINE CO. (Mfrs.)
P. O. Box 248, Dept. 185, Glenview, Ill.

Your Calculator is just what I've been looking for. Send one at once (C.O.D.) or (I am enclosing \$2.50).

Name.....

Address.....

City..... State.....

NEW TARPAULINS

GENUINE ProTecTo Tarp

FACTORY CANVAS COVERS
PRICES! Direct to You!

COMPLETE PROTECTION
SUN ★ WIND ★ RAIN

TOP QUALITY TARPAULINS! Waterproof, flameproof, mildewproof! Durable 11.6 oz. super-strength material. Double lock-stitched seams, 10-3 cord. Metal grommets set in double reinforced canvas. Immediate delivery while present stock lasts. Ideal for trailers, boats, machinery, farmers; etc. **WRITE FOR LIST OTHER SIZES!**

NO.	SIZE	PRICE
JRT501	6'x8'	\$4.49
JRT503	8'x10'	\$8.87
JRT505	10'x12'	\$13.10
JRT507	10'x16'	\$17.17
JRT510	14'x16'	\$23.76
JRT512	16'x20'	\$34.21

6' x 10' SIZE ONLY \$6.76 CASH
F.O.B. Zanesville, O. Agents Wanted

WRITE TO JOHN ROBERTS COMPANY
2226 S. MICHIGAN AVE. • CHICAGO 16, ILL.

GERSTNER Tool Chests

Better, finer, more desirable. That's why they are the choice of Machinists and Toolmakers everywhere. Free Catalog.

GERSTNER TOOL CHESTS
446 Columbia St., Dayton 7, Ohio

Can You Thread That Special Nipple?

You can, right on the job!

and you can thread more with your threader:

- Next a wall
- Long pipe
- Short pipe
- Up to 15° angle per pair of threads
- Fast
- Simple
- Accurate
- 1/4" thru 1"
- Hardened Electroplated

\$2.45 1/2" Wing Nipple-guide (above) or Pipe-chuck (in vise)

Drop card for information. Made by Wing S. Laboratory, 125 Water St., Grass Lake, Michigan. Sales organization being built. Applicants with character will be wanted in home office.

LAW

STUDY AT HOME for PERSONAL SUCCESS and LARGER EARNINGS. 38 years expert instruction—over 108,000 students enrolled. LL.B. Degree awarded. All texts furnished. Easy payments. Send for FREE BOOK—"Law and Executive Guidance."

AMERICAN EXTENSION SCHOOL OF LAW
Dept. 72-M, 646 N. Michigan Ave., Chicago 11, Ill.

SAY YOU SAW IT IN POPULAR MECHANICS

AUTO ENGINE SPEED CONTROL GOVERNORS

Give constant or changeable speed to any auto or truck engine, when used for power. Guaranteed. Instructions. Oil ring bearing, \$14.25. Full ball bearing, \$21.75. Postage, 50c; east of Miss., 85c. COD, or—Postage any country \$1.00 each.



These valves used where carburetors have outside attachments. State size of opening and distance between bolt holes.

1", \$3.75; 1 1/4", \$5.25; 1 1/2", \$6.50; 1 3/4", \$7.50; V8, \$8.00. Mailing weight, 3 lbs. If remitting, enclose for postage. Stocks carried: In Canada, Montreal 15: 7546 Wiseman St. In Skaneateles, N. Y.: Horle Welding Supply. Circulars.

CANDEE, Dept. P, 2641 S. Hill, Los Angeles 7, Calif.



AGENTS WANTED
Parts and Implement Dealers, Garages, Welders, Wreckers, Catalog and Mailing List Houses, etc.

AMERICAN TOOL CHEST!

COMPLETE 10-PIECE WOODWORKING OUTFIT

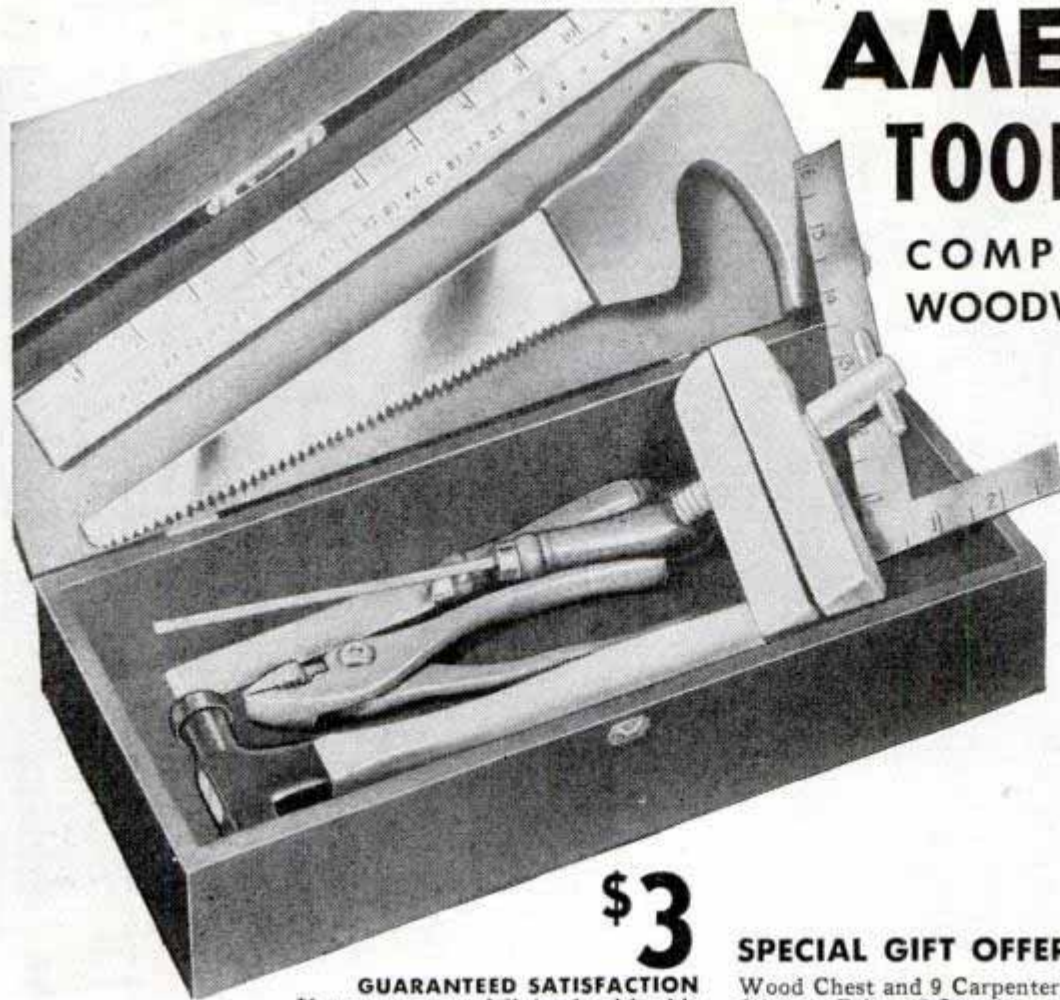

It's terrific! Make your own furniture, boats, toys. Get this handsomely finished sturdy wooden Tool Chest 12 $\frac{3}{4}$ x 5 $\frac{3}{8}$ x 3 $\frac{1}{4}$. Hinged lid and clasp lock, bright red lacquer finish. Full assortment of fine quality woodworking and other handy tools.

EVERYTHING YOU NEED!

12" spring steel cross-cut Saw cuts with or across grain. 12" Ruler with inch and fractional markings in 16ths. Handsomely finished carpenter's Level with standard brass mounted inset bubble gauge. Steel square with inches. Wooden combination vise and clamp holds work rigid. 9" Screw Driver. Chisel with $\frac{5}{8}$ " cutting edge. 6" Precision Pliers. 10 $\frac{1}{2}$ " Hammer with nail removing claws.

\$3

GUARANTEED SATISFACTION
If you are not delighted with this Chest after 24 hours inspection you may return for full refund. Act today.

SPECIAL GIFT OFFER! Limited quantity only. This handsome 10-piece set . . . Wood Chest and 9 Carpenter's Tools at manufacturers Introductory Price of \$3. At your dealers, or shipped direct as Gift in heavy cardboard carton. Get yours while they last. Just send three \$1 bills. Comes to you postpaid.

Electric WONDER PEN Outfit

Burns Beautiful Designs in Wood



Get this great handcraft tool PLUS all equipment on Special Gift Offer! Finest quality electrically heated WONDER PEN. Etches easily into wood with rich, varied tones of brown. Apply Colors for special effects, and sandpaper and varnish for fine durable finish. Decorate your home with handsome art pieces. Develop your skill. Make good money too, selling your own handwork.

Only Pen Guaranteed 800 Working Hours

Long life point and heating coils. Comfortable, cool cork grip. Standard 4 $\frac{1}{2}$ ft. cord and plug.

Decorate Cork, Leather, Etc. Too

Make coasters, trays, highball jackets. Decorate belts, fobs, monograms. Create your own art pieces.

Easy To Learn

Full instructions included with set. Use all-purpose point for lining, etching, shading.

ONLY \$3

COMPLETE — PEN AND ALL MATERIALS

- Guaranteed Electric Wonder Pen
- 2 Plaques 6 $\frac{5}{8}$ x4 $\frac{1}{2}$
- 4 Pc. Bookends 5x4
- 3 Plaques Approx. 4 $\frac{1}{2}$ x4
- 4 Plaques Approx. 3x4
- 2 Paint Brushes
- 6 Colors Paint
- Pkg. Nails
- 2 Sandpapers
- Bottle Varnish

IF YOUR DEALER CAN'T SUPPLY — MAIL COUPON

American Toy & Furniture Co., 727 S. La Salle, Chicago 5
Enclosed is \$..... Please send me the items checked.

American Tool Chest—\$3 Electric Wonder Pen Outfit—\$3

NAME.....

ADDRESS.....

CITY..... STATE.....

(Add 25c West of Rockies and Canada)

AMERICAN TOY & FURNITURE CO.

THE ALL-PURPOSE MACHINE TOOL FOR ALL TYPES OF SHOPS



**YOU CAN PERFORM ALL THESE
OPERATIONS WITH THIS LATHE**

On Metals, Alloys, Fibers, Plastics, Compositions, Wood, Other Materials

TURNING • FACING • BORING • DRILLING • REAMING
TAPPING • THREAD CUTTING • MILLING • GRINDING
FILING • POLISHING • HONING • LAPPING • BUFFING

Because they are accurate, versatile and dependable, South Bend Precision Lathes are widely used in every type of large and small metal working industry. The same qualities which make these lathes so valuable to industry, make them the favorites for auto, radio, and appliance repair work, tool and instrument shops, model making, and hundreds of other uses. South Bend Precision Lathes are made with 9", 10", 13", 14½", and 16" swings to meet the great majority of lathe needs. Mention size in which interested when writing for free catalog.

HOW TO RUN A LATHE

This valuable book shows you how easy it is to operate a South Bend Lathe, and the wide variety of work that can be done on it. Contains 128 pages, 365 illustrations. Price only 25c postpaid, U. S. coin or stamps.

10-INCH LATHE FEATURES

- Fine workmanship by highly skilled machine tool craftsmen
- Superfinished spindle with large, adjustable sleeve bearings
- Belt drive for smooth, silent operation at high speeds
- Back-gear drive for power and low speeds
- Spindle Speeds from 50 r.p.m. to 1357 r.p.m.
- Thread cutting range - 4 to 224 per inch, 48 pitches R.H. or L.H.
- Precision lead screw for thread cutting
- Worm drive and friction clutch for power longitudinal and cross feeds
- Three hand-scraped V-ways and a flat way on bed insure perfect alignment of headstock, saddle and tailstock

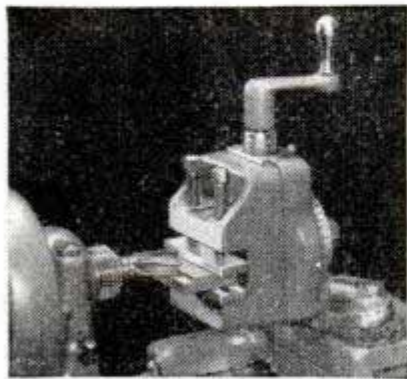

MILLING ATTACHMENT

Mounts on compound rest base. Permits using hand or power feeds for milling and boring. Made for all sizes of South Bend Lathes. Write for Catalog 77.



LATHE BUILDERS SINCE 1906

SOUTH BEND LATHE WORKS

455 E. MADISON STREET • SOUTH BEND 22, INDIANA



Printed by Popular Mechanics Company, Chicago, Ill., U. S. A.

UNANIMOUSLY ALL-AMERICAN by **FRANK WILLIAMS**

**DEWITT
"TEX"
GOULTER-**

...LAST YEAR'S GREAT
ARMY TACKLE...NOW
WITH THE NEW YORK
GIANTS



...PLACED ON EVERY LEADING
1945 ALL-AMERICAN LINE-UP
AFTER HIS FIRST FULL
SEASON AS A REGULAR
...HE WAS RATED AS ONE
OF THE BEST LINEMEN
EVER IN COLLEGIATE
FOOTBALL!



**HE FEELS
SHARP!**

...DESPITE HIS
225 LBS., "TEX" IS
AMAZINGLY ALERT
AND FAST...

...HIS
SPEED
AND BULK MAKE HIM
ONE OF THE BEST DOWN-
FIELD BLOCKERS IN THE GAME!

**HE LOOKS
SHARP!**

...AS HE ANTICIPATES ENEMY
PLAYS AND STOPS THEM WITH
UNCANNY PRECISION!

DON'T
ANNOY OUR
BALL
CARRIERS,
SONNY!



**look SHARP
feel SHARP
be SHARP**

use
**Gillette
Blue Blades**
with the **SHARPEST** edges
ever honed!

● You look sharp for you enjoy the swellest shaves ever. You feel sharp because they're refreshing and give you a lift. You are sharp for you get far more shaves per blade and save money. Ask for Gillette Blue Blades.



ENJOY BOXING
FRIDAYS AT
10 PM EST OVER ABC NETWORK. GILLETTE'S CAVALCADE OF
SPORTS ALSO AIRS WORLD SERIES AND OTHER CLASSICS YEAR ROUND.

HE IS SHARP!

...TEX GETS THE SMOOTHEST,
MOST REFRESHING SHAVES
A FELLOW CAN HAVE - AND
SAVES MONEY, TOO! YOU'VE
GUESSED IT! HE USES
GILLETTE BLUE BLADES
WITH THE SHARPEST EDGES EVER
HONED... GET HER MEN--
**DOUBLE EDGES MEAN
DOUBLE ECONOMY!**

Gillette Safety Razor Company, Boston 6, Mass.

Copyright, 1944, by Gillette Safety Razor Company