

POPULAR MECHANICS

MAGAZINE

WRITTEN SO YOU CAN UNDERSTAND IT

NOVEMBER 1946
25 CENTS

BARGE-CARRYING SHIP
PAGE 143



Tough, BUT OH SO GENTLE



When your automobile engine starts pumping oil or smoking, it will pay you to install Hastings piston rings. They stop oil-

pumping, *check* cylinder wear, restore engine performance. Ask your motor specialist.

HASTINGS MANUFACTURING CO. • HASTINGS, MICH.
Hastings Ltd., Toronto

Listen to
"RIGHT DOWN
YOUR ALLEY"

American Broadcasting
Company • Every
Sunday Afternoon
4:30 EST



HASTINGS STEEL-VENT
PISTON RINGS

TOUGH ON OIL-PUMPING GENTLE ON CYLINDER WALLS

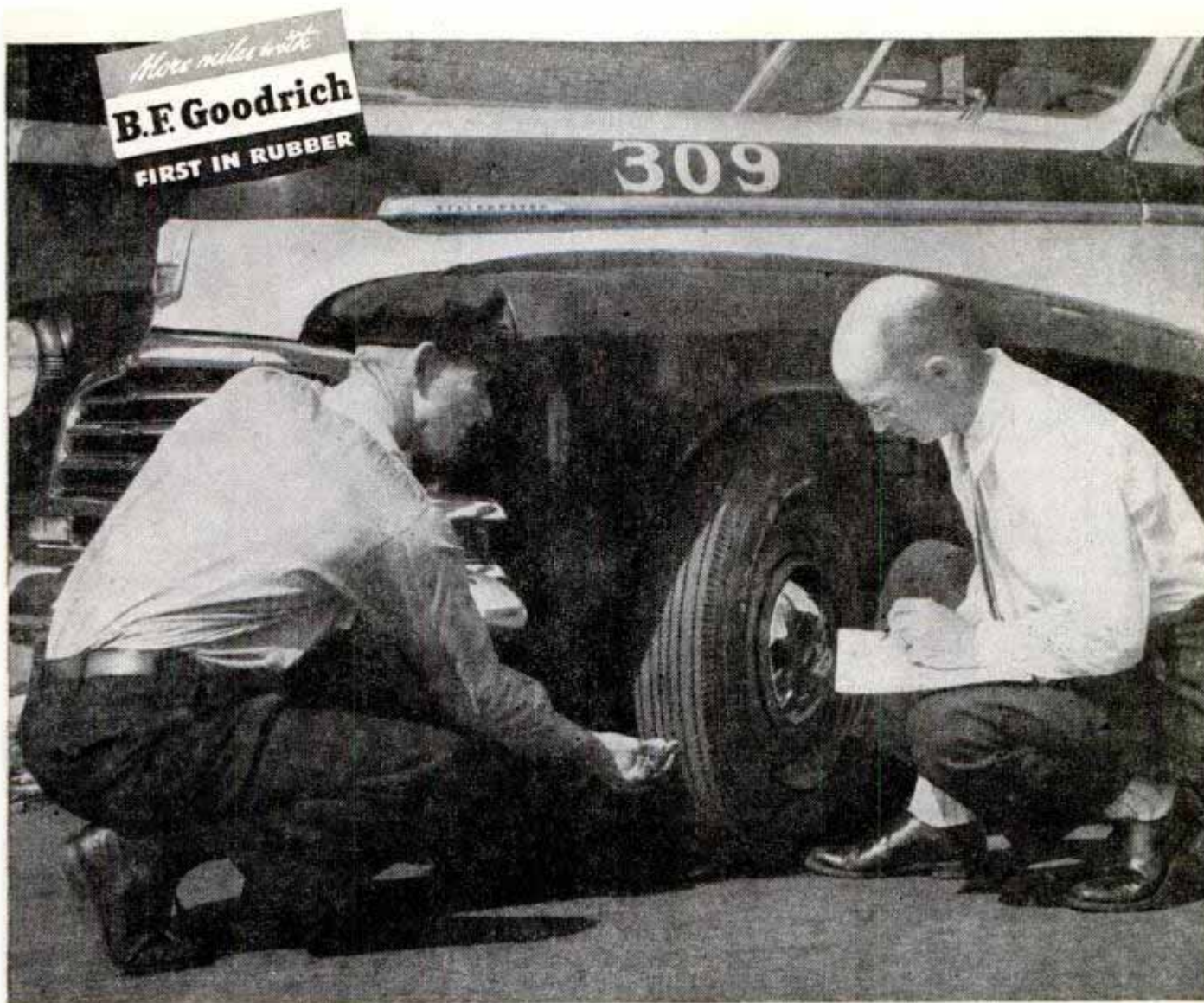

TAXICAB FLEET TESTS PROVE NEW TIRE OUTWEARS PREWAR TIRES

"RAIN OR SHINE, winter or summer, our cabs must serve the public twenty-four hours a day," says Mr. T. A. Ballantine, President, Yellow Cab Co., Louisville, Ky. "The new B. F. Goodrich tires meet *all* our tire requirements for such operation! In actual mileage, tests on our own fleet have proved conclusively that the new B. F. Goodrich tires *outwear prewar tires.*"

From taxi fleets and commercial car owners—from police departments and passenger car drivers—reports like this are coming in every week. They all tell how much better the new B. F. Goodrich Silvertown tires with the wider tread stand

up than the tires of prewar days.

These tires were *built* to take the punishment of thousands of miles of driving—designed with a wider, flatter tread that hugs the road and spreads wear over a greater area. This better-type tread is backed up by a 35% stronger cord body made with *more* cords and *stronger* cords. The result is extra miles of trouble-free driving.

Of course, supplies of tires are

still limited. In spite of greedy increased production, demand is even greater. This is especially true of the B. F. Goodrich tire that outwears prewar tires. Please check your needs well in advance. Talk to your B. F. Goodrich dealer about the size and number of tires you'll need. He'll do his best to keep you rolling until he can get the new tires for you. *The B. F. Goodrich Co., Akron, Ohio.*

B.F. Goodrich

FIRST IN RUBBER

The Eye That Never Closes

You are looking at a thermistor—a speck of metallic oxide imbedded in a glass bead hardly larger than a pinhead and mounted in a vacuum. The thermistor was developed by Bell Telephone Laboratories to keep an eye on the amplification in long-distance telephone circuits.

When a thermistor is heated, its resistance to electric current changes rapidly. That is its secret. Connected in the output of repeater amplifiers, it heats up as power increases, cools as power decreases. This change in temperature alters the resistance, in turn alters the amplification, and so maintains the desired power level.

Wartime need brought a new use for this device which can detect temperature changes of one-millionth of a degree. Bell Laboratories scientists produced a thermistor which could “see” the warmth of a man’s body a quarter of a mile away.

Thermistors are made by Western Electric Company, manufacturing branch of the Bell System. Fundamental work on this tiny device still continues as part of the Laboratories program to keep giving America the finest telephone service in the world.

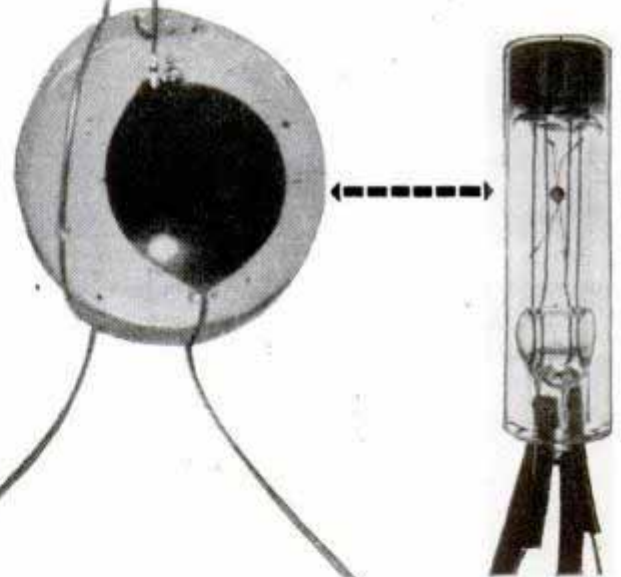

BELL TELEPHONE LABORATORIES

EXPLORING AND INVENTING, DEVISING AND PERFECTING FOR CONTINUED IMPROVEMENTS AND ECONOMIES IN TELEPHONE SERVICE

Popular Mechanics Magazine

Registered in U. S. Patent Office and Canada

H. H. WINDSOR, Founder

H. H. WINDSOR, Jr., Editor and Publisher

NEW CARS for next year was our standard leadoff article in the November issue in prewar years. Sorry we can't dazzle you with an array of 1947 models—but we believe we have the next best thing: an authoritative "Forecast From Detroit." This article gives the real low-down on what you can expect in the way of new cars during the next 12 months.

NEXT MONTH the lineup of features and story-telling pictures is so outstanding that every one is worth shouting about in this column. "Inside the 'Atom City'" takes you to Oak Ridge, Tenn., for the hitherto untold story of what goes on behind the walls of the most restricted area in the world. "Narrow Gauge Movies" opens new vistas for the 16-mm. camera fan and reveals the important role these films will play in future television programs. "Home Town Circus" is going to put a lot of ideas in the heads of community boosters. If they can do it in Gainesville, Texas, why not in Earlville, Ill., or Grand Island, Nebr.? Then there's "Special Delivery House," introducing a new type of prefab that can be erected by one man. "How Good a Driver Are You?" is packed with some alarming figures and a challenge to every auto owner.

HOME CRAFTSMEN planning to furnish a room for a younger member of the family get the first call next month in the Craftsman section. Complete details are given for the construction of two chests of subdued modern design and built of choice cabinet woods. There's also a practical feature on servicing your vacuum cleaner. Another story tells how to shape plastics by a simple heat-forming process. Photo fans will be clipping out the article telling how to shoot single-column pictures.

NEWCOMER "hams" will find a simple and efficient 50-watt 10-meter transmitter in the Radio and Electronics section next month.

Volume 86 NOVEMBER 1946 Number 5

Managing Editor..... Roderick M. Grant
Assistant Managing Editor..... Wayne Whittaker
Shop Notes and Crafts Editor..... James R. Ward
Radio and Electronics Editor..... Frank L. Brittin
Aviation Editor..... Aubrey O. Cookman, Jr.
Associate Editor..... John R. Kinsey
Eastern Editor..... Bill Reiche
Western Editor..... Thomas E. Stimson, Jr.
Art Director..... Frank Beatty

Assistant Editors

Donald R. Brooks Clifford B. Hicks Maston M. Jacks Virgil T. Swanson

Assistant Editors, Shop Notes and Crafts

W. Clyde Lammey Wayne C. Leckey John F. Shrock A. E. Youngquist

In This Issue

Forecast From Detroit	89
Speed Unlimited	96
On the Air—Through 20 Years	105
Scientific Fortune Tellers	112
By Willie Hoppe—How to Play	
Three-Cushion Billiards	122
Assembly Line Gobblers	134
Submersible Sheriff	138
The House Run by Pushbuttons	148
Making Money by the Ton	153
What's on the Shelf?	164
Build Yourself a Railroad	172

For the Craftsman

Aero-Driven Ice Boat	186
15 Christmas Gifts to Make	190
Model Gas Engine	201
Versatile Film Viewer	207
100 Concrete Blocks Per Hour	217
Vibration-Dampen Your Shop Tools	224
Radio and Electronics	229

[Table of Contents Continued on Page 8](#)

Published monthly by POPULAR MECHANICS COMPANY, 200 East Ontario Street, Chicago 11, Ill. H. H. Windsor, Jr., president; Paul H. Dunakin, vice president and general manager; D. F. Windsor, vice president and secretary-treasurer; William Harrison Petridge, vice president and assistant to the publisher; Clover L. Perkins, advertising manager; Alan M. Deyoe, circulation manager. Single copy in the United States and Canada, 25 cents; subscription rates in United States and possessions, Canada, and countries of the Pan-American Postal Union, 1 year, \$2.50; 2 years, \$4.50; 3 years, \$6.00. To all other countries add \$1.00 a year over United States prices for overseas postage. If you plan to move, notify us at least 60 days in advance so you will not miss an issue. Give both old and new addresses. Entered as Second Class Matter, September 15, 1903, at the Post Office at Chicago, Illinois, under Act of March 3, 1879. Entered as Second Class Matter at Post Office Dept., Canada. Copyright 1946, by Popular Mechanics Company. Copyright under International Copyright Union. Copyright in France. All rights reserved under Pan-American Copyright Union. Printed in the United States of America.

The Ernest Babcocks, Junior and Senior, model plane speed champs from Morris Plains, N. J. Here in their home workshop, tinkering with their stubby Class C model "Jughaid" (Yep, made with an X-acto!) which in unofficial practice flights has made as much as 130 mph.

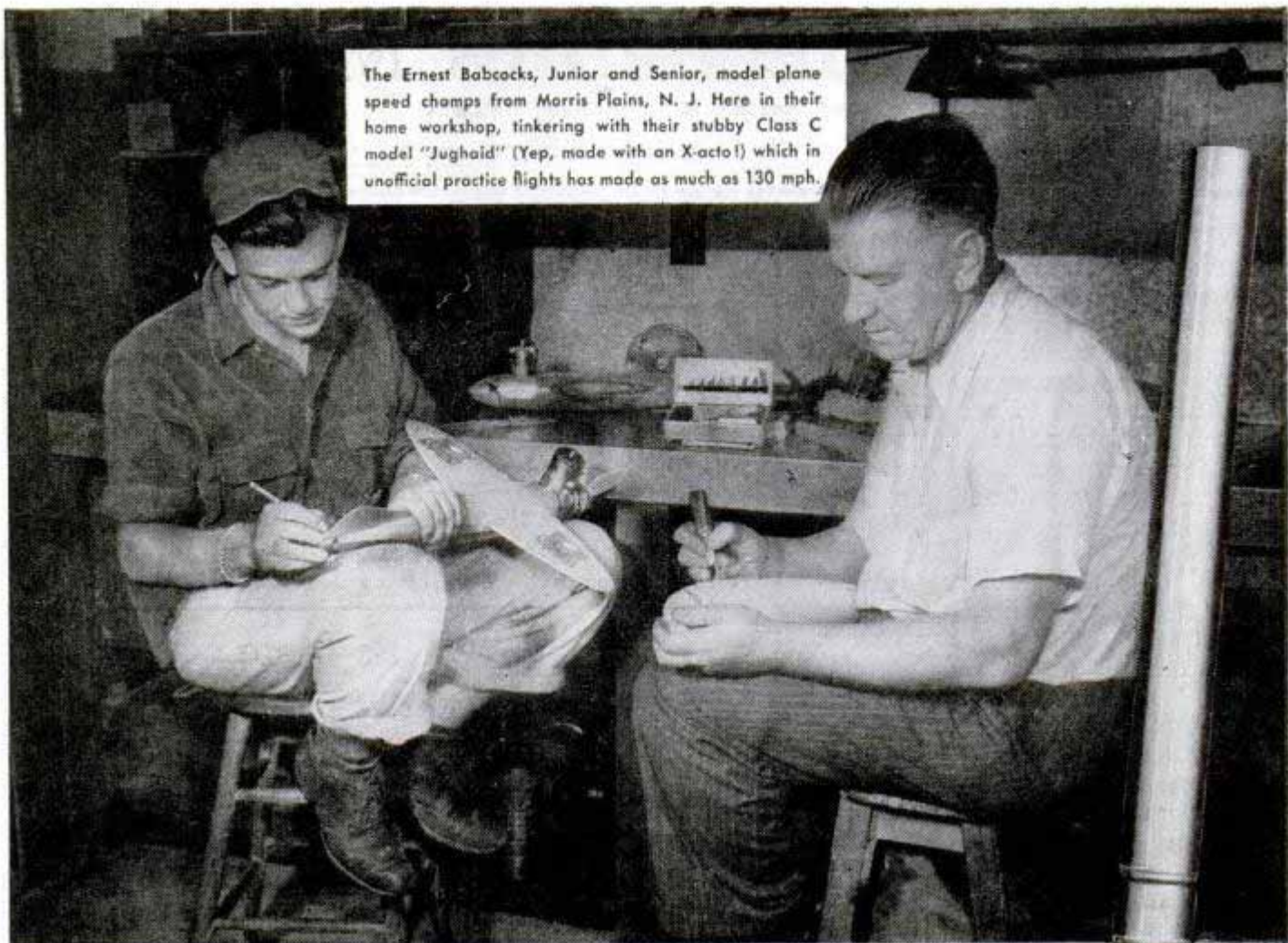

MEET THE CHAMPS...THE BABCOCK TEAM

...and read what *they* say about X-acto!

When thirteen-year-old Ernest Babcock asked his Dad for a model plane kit four Christmases ago, he got an X-acto Knife Chest, too. But, neither father nor son dreamed, then, that they'd become the nationally famous model plane team they are today.

Dad designs the planes, Junior flies them, but *both* work at building them with their trusty X-actos. Together, the amazing Babcocks have broken more records and run away with more top prizes than most ordinary mortals ever heard of.

Anyone who ever put a knife to wood knows a brilliant record like this takes more than expert skill in designing and handling the planes.

It takes the patience of a saint in building accurate models. And it takes good, dependable tools.

So when the Babcocks say, "We've used X-acto Knives since we first began building models, and find them *the handiest tools to have in a model shop*"... there's a tip for you, brother!

13 Blade Shapes Quickly Interchangeable!

X-acto is tops, as well, for whittlers, paper sculptors, or any other hobby crafter, be he amateur or expert. With 13 scalpel-sharp blades and 3 safety-grip handles (*all-metal, no more substitute plastics!*) you'll do a slicker job, and *quicker*, when you use super-sharp X-acto.

ALL METAL
X-acto No. 2 Solid Duraluminum Knife . . . **50c**
With 5 assorted blades, \$1. Other X-acto Knives, Tools, Chests, 50c to \$12.50.



Hobby crafter's Dream Gift. No. 85 X-acto Tool Chest—3 all-metal knives; full assortment of blades; saw; sander; stripper; planer; drills and holders; steel ruler; complete in wooden chests, \$12.50.

X-acto
KNIVES & TOOLS



At hardware, hobby and gift shops

X-acto Crescent Products Co., Inc.,
440 Fourth Ave.,
New York 16, N. Y.
In Canada: Handicraft Tools, Ltd.,
Hermant Bldg., Toronto

*Reg. U. S. Pat. Off.

WHAT GOES ON INSIDE A BATTERY?

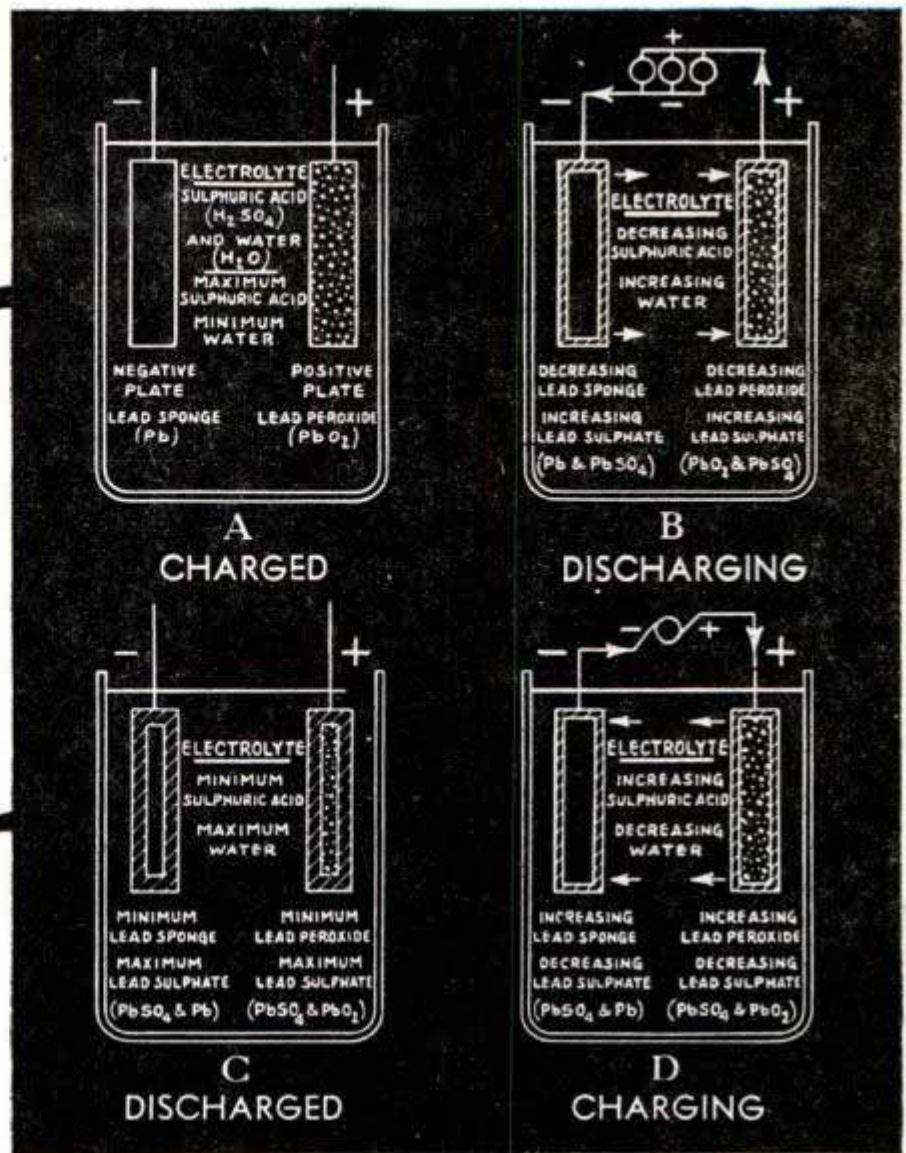

The pictures tell the story. When a cell (A) is fully charged, the negative plate is lead sponge (Pb), the positive plate is lead peroxide (PbO₂), and the specific gravity of the electrolyte (sulphuric acid, H₂SO₄, and water, H₂O) is at its maximum.

When discharging (B), the H₂SO₄ is divided into H₂ and SO₄.

The H₂ passes to the positive plate, liberates some of the Pb and combines with the plate's oxygen to form H₂O, thus increasing the water content of the electrolyte.

The SO₄ combines with the liberated Pb and forms lead sulphate, PbSO₄, on both plates, reducing acid content and specific gravity of the electrolyte. When sp. gr. reaches 1.150 the battery is discharged (C).

When recharging (D), the current flow and chemical changes are reversed and the plates and electrolyte returned to their original condition.

Because of lower capacities, some batteries discharge more rapidly than others. Exide Batteries are noted for their high capacity, long-life, low cost per mile of operation and strong starting power.

"WHEN IT'S AN EXIDE YOU START"

Would you like to know more about batteries? The complete story is told in a booklet, "THE STORAGE BATTERY, Its Fundamentals, Use and Maintenance." Mail a postal card today for a FREE copy.

Exide BATTERIES

THE ELECTRIC STORAGE BATTERY COMPANY, Philadelphia 32

Exide Batteries of Canada, Limited, Toronto

The Music of the Spheres



Are You In Tune With The Infinite?

HAS your whole being ever pulsated with a mysterious *exhilarating* rhythm? Have there been days when life suddenly and unexpectedly seemed especially enjoyable—when all of nature and yourself seemed to be swept up in a *silent symphony* of ecstasy? Have you longed to sustain such occasional experiences because of the self-confidence and peace of mind that they instilled within you?

High above the earth lies the cause of such strange phenomena. Within the canopy of space great worlds revolve at constant speed. With preciseness not conceivable by man, stupendous universes retain their relative distances—energies unwaveringly oscillate to and fro. Such is Cosmic motion—the orchestration of the *infinite*. If reducible to sound, it would be music Divine! Yet, silent as it is, this music of the spheres, this Cosmic *harmony*, prevails throughout all nature. The smallest living thing and the largest universe, alike, have their particular note in this scale of rhythm.

There are ways to attune yourself with these Cosmic and natural forces! There are ways in which your being may be continuously stimulated by this harmony of nature, resulting in an influx of greater *personal power*. The Rosicrucians (*not* a religion) are a world-wide philosophical fraternity. Let them show you in simple words how to attune yourself, mentally and physically, with the Infinite for the *fullness of living*.

Accept This Free Book

Write today for a *free* copy of the book, "The Mastery of Life." It has been instrumental in helping thousands to find themselves. It has revealed to many a heretofore *unsuspected* power. Use the coupon below for your copy.

Scribe E. E. H., Rosicrucian Order, AMORC
San Jose, California, U.S.A.

I am interested in knowing how I may attune myself with the harmony of the universe. Please send me the *free* book, "The Mastery of Life," which explains how I may receive such knowledge.

NAME _____

ADDRESS _____

The ROSICRUCIANS, (AMORC) • SAN JOSE • CALIFORNIA, U. S. A.



If YOU were Boss would YOU promote "YOU"?

valuable asset to any business organization. He never wants for a good job and above average earnings. He gets ahead.

Be honest now—

suppose that a better job had opened up in your company—carrying with it promotion and more money—could you qualify?

If you were boss, would you select "YOU" for that better job?

Consider before you answer.

First of all, could you *fill* the job? Has your experience fitted you for the step forward—have you been preparing for promotion apart from experience gained on the job?

Or have you just been filling a niche, doing daily tasks well but making no real and intelligent effort to learn and qualify for the job ahead so that if an opening should occur you would be ready to fill it?

The man who gets real promotion makes his own breaks—the man who slaves in the ordinary job at low pay just wishes and dreams of promotion and more money. Which are you?

Business is always willing to pay the man who knows—and pay him well. The man who is ready and willing to take responsibilities—and capable of directing the efforts of other men is a

We have helped thousands of men achieve promotion and more money—success sometimes beyond their dreams—a success that was started by a coupon similar to the one below.

Get out of that rut—don't be satisfied with a mediocre job at small pay—be a success in business—this coupon may be your first step.

So send it today—right now—tomorrow never comes for the man who consistently puts things off.

G. I. APPROVED

La Salle Extension University A Correspondence Institution

Dept. 1164-R

417 S. Dearborn, Chicago 5

If you can help me get the ability and knowledge for real promotion, I want to know it. Please send me your free 48 page booklet telling how I can succeed in the field I have checked below. I understand you will send this without obligation to me.

- | | |
|--|--|
| <input type="checkbox"/> Accounting | <input type="checkbox"/> Law: LL.B. Degree |
| <input type="checkbox"/> C. P. A. Coaching | <input type="checkbox"/> Foremanship |
| <input type="checkbox"/> Bookkeeping | <input type="checkbox"/> Industrial Management |
| <input type="checkbox"/> Business Management | <input type="checkbox"/> Traffic Management |
| <input type="checkbox"/> Effective Speaking | <input type="checkbox"/> Business English |

Stenotypy (Machine Shorthand)

Name.....Age.....

Position..... **This One**

Address.....

City and State.....



OBAU-L3U-C5SS

**SLUDGE
EXCESS
WEAR
CARBON**

PYROIL ADDS LIFE TO YOUR CAR!

When your gas station attendant adds Pyroil to your gasoline and crankcase, he is adding life and mileage to your car. Pyroil provides a constant protective film which reduces wear of pistons and cylinder walls . . . it removes sludge and carbon formations. One pint of Pyroil in the crankcase and one ounce of Pyroil added with each five gallons of gasoline is an easy way to more trouble-free miles. Next time you drive into your gas station . . . simply say . . . "add Pyroil" . . . and you add life to your car.

PYROIL FOR AIRCRAFT ENGINES

Use Aircraft Pyroil B for lubricating oil, Aircraft Pyroil A for gasoline.

Manufactured and Guaranteed by Pyroil Company, W. V. Kidder, Founder, 61 Pyroil Bldg., La Crosse, Wisconsin.



PYROIL COMPANY

61 Pyroil Bldg., La Crosse, Wisconsin

I want my car to last and run properly. Please tell me more about Pyroil and how it can accomplish this for me.

Name.....

Address.....

City or Town..... State.....



Jerry, the talking dog, is entertaining hospitalized veterans, by courtesy of the PYROIL Company. Picture of Jerry, sent on request.

TABLE OF CONTENTS (Continued)

AUTOMOTIVE

Push-button automobile heater has thermostat control.....	111
Runabout designed in London for disabled persons.....	118
Gas-tank whistle prevents spilling.....	119
"Mongrel" automobile assembled from parts of 17 different cars.....	121
Booster system for Ford V-8 heater gets water from each block.....	129
Tires of future made with "carbon white" to rival rainbow in color.....	133
De-icing vents in car hood keep windshield clear.....	147
Three-wheel French car travels 70 miles an hour on little gas.....	162
One steering wheel is removable in dual-control car.....	170

AVIATION

All-metal wings boost speed of Luscombe Silvalre.....	110
Flying wing bomber has 10,000-mile range.....	110
Midget cooler for airplanes.....	111
Movie reenactment of first tandem-wing glider flight.....	118
Mobile air conditioner for big planes.....	129
Clock-spring-driven model shows miles flown.....	163

HOUSE AND HOME

Three-room efficiency apartment on wheels.....	118
Chain arrangement permits lowering fluorescent light for cleaning.....	118
Sanitary aluminum capper for infant's bottles.....	129
Inside stuff for your home.....	130
Adjustable plastic gliders stop furniture wobble.....	146
Steel latch bolt guard protects spring lock.....	146
Thermostat with electric eye reveals position of damper.....	159
Weather-tight door saddle keeps out rain or draft.....	163
Luminous dial for telephone saves turning on light.....	176

INDUSTRY

"Rip cord" wrapping divides food products into equal helpings.....	143
Removable hold for ships floats like a barge.....	143
Two-direction conveyor belt carries load on return trip.....	151
Two trailers "bend" cargo around sharp corners.....	151
Temporary nonrusty coat saves metals in shipment.....	152
Photoelectric eye takes fish census 12 feet beneath surface.....	162
Radar plots underwater oil wells.....	169
"Triptane" rating for gasoline may replace octane system.....	170

PHOTOGRAPHY

Two-in-one metal easels make it possible to enlarge photos of all sizes.....	110
Adhesive on enlarging easel holds print paper in place.....	119
New equipment for the camera fan.....	180
Photos developed in daylight with light-tight tank.....	170

RADIO AND ELECTRICAL

Electrocutor rake kills weed roots.....	141
Pocket-size ammeter for batteries requires no wires.....	142
Midget power plants for radios.....	142
Tester spots electrical "leak" in wire insulation.....	142
Guns primed electrically.....	146
Radio "net" uses miles of wire.....	147
Portable fluorescent light spreads beam over half circle.....	152
Man tames 100,000-volt lightning bolt with guards on power line.....	159
Calls "beamed" to Catalina link island to mainland.....	159
Electric eye of metronome flashes in time with beat.....	171
Midget d.c. current converter fits phonograph or clock.....	176

STORE AND OFFICE

Braille typewriter for the blind has only six keys.....	110
Chinese typewriter prints 5400 characters.....	110
Letter files open sidewise to save space.....	121
Drafting board "mathematician" figures decimal equivalents.....	133

TOOLS

Hollow tool handle stores extra bits.....	111
Thumb-size scissors sharpener.....	119
Rotary hedge trimmer has teeth like saw.....	137
Scraper-loader for dump truck hoisted by backing up.....	141
Pipe reamer fits any size bowl.....	142
"Spark plug" power spray operates from car.....	146
Flashlight on semiflexible cable lights hard-to-reach spots.....	147
Blasting gun for cleaning picks up dust and reclaims abrasive.....	162
Slide rule figures chord notes by formula for music arrangements.....	163
Triple-duty paintbrush cleaner holds three brushes.....	170
Hand drill works at odd angles on hard-to-reach jobs.....	176
Lightweight steel miter box has 90-degree gauge.....	176

TOYS AND NOVELTIES

Midget masterpieces in silver.....	120
Glass menagerie.....	132
Pint-size British motor bus travels at 25 miles per hour.....	152
Paper horses are tough.....	158
Indelible golf-ball marker has its own ink pad.....	170
Racing model hydroplanes split waves at 30 m.p.h.....	171

MISCELLANEOUS

Vest-pocket check perforator.....	111
Utility heater can be submerged in open vat or stock tank.....	118
Coin changer returns change from dimes and quarters.....	119
Sound waves chase pigeons off courthouse perch.....	121
Pneumatic "coach" checks tackle power.....	133
Infrared rays made visible by adding lead to zinc sulfide phosphor.....	137
Bassinet taken from buggy serves as auto bed.....	137

(Continued to page 10)

BIOGRAPHY QUIZ

DO YOU KNOW THE ONE CORRECT ANSWER COVERING ALL OF THESE QUERIES ABOUT ASSORTED FAMOUS FOLK?

WHO

- ...is England's foremost political cartoonist?
- ...founded and built up the second largest auto manufacturing concern in all the world?
- ...is the Negro sea captain celebrated as the first of his race to obtain a Master's license and command an American ship?
- ...tripled the firing power of U. S. infantrymen when he invented the semi-automatic rifle used in World War II?
- ...is famous both as an automotive engineer and as a co-designer of the Liberty Aircraft Engine of World War I?
- ...rose from janitor for a sorority house to the presidency of one of the nation's largest railroads?
- ...designed the first outboard motor?
- ...won the Gordon Bennett cup as a racing-car driver and went on to head a great corporation manufacturing aircraft engines?

Answer: *James Watson* A former student of the International Correspondence Schools.

INTERNATIONAL CORRESPONDENCE SCHOOLS



BOX 5591-K, SCRANTON 9, PENNA.

Without cost or obligation, please send me full particulars about the course *before* which I have marked X:

- | | | | |
|---|---|---|--|
| <p>Air Conditioning and Plumbing Courses</p> <input type="checkbox"/> Air Conditioning
<input type="checkbox"/> Heating <input type="checkbox"/> Plumbing
<input type="checkbox"/> Refrigeration <input type="checkbox"/> Steam Fitting <p>Chemistry Courses</p> <input type="checkbox"/> Chemical Engineering
<input type="checkbox"/> Chemistry, Analytical
<input type="checkbox"/> Chemistry, Industrial
<input type="checkbox"/> Chemistry, Mfg. Iron & Steel
<input type="checkbox"/> Petroleum Refining <input type="checkbox"/> Plastics
<input type="checkbox"/> Pulp and Paper Making <p>Civil Engineering, Architectural and Mining Courses</p> <input type="checkbox"/> Architectural Drafting
<input type="checkbox"/> Architecture
<input type="checkbox"/> Bridge and Building Foreman
<input type="checkbox"/> Building Estimating
<input type="checkbox"/> Civil Engineering
<input type="checkbox"/> Coal Mining
<input type="checkbox"/> Contracting and Building
<input type="checkbox"/> Highway Engineering
<input type="checkbox"/> Lumber Dealer
<input type="checkbox"/> Reading Structural Blueprints
<input type="checkbox"/> Sanitary Engineering
<input type="checkbox"/> Structural Drafting | <p><input type="checkbox"/> Structural Engineering
 <input type="checkbox"/> Surveying and Mapping</p> <p>Communications Courses</p> <input type="checkbox"/> Electronics
<input type="checkbox"/> Practical Telephony
<input type="checkbox"/> Radio, General
<input type="checkbox"/> Radio Operating
<input type="checkbox"/> Radio Servicing
<input type="checkbox"/> Telegraph Engineering <p>Electrical Courses</p> <input type="checkbox"/> Electrical Drafting
<input type="checkbox"/> Electrical Engineering
<input type="checkbox"/> Electric Light and Power
<input type="checkbox"/> Lighting Technician
<input type="checkbox"/> Practical Electrician <p>Internal Combustion Engines Courses</p> <input type="checkbox"/> Auto Technician <input type="checkbox"/> Aviation
<input type="checkbox"/> Diesel-Electric
<input type="checkbox"/> Diesel Engines <input type="checkbox"/> Gas Engines <p>Mechanical Courses</p> <input type="checkbox"/> Aeronautical Engineering
<input type="checkbox"/> Aircraft Drafting
<input type="checkbox"/> Flight Engineer
<input type="checkbox"/> Foundry Work
<input type="checkbox"/> Heat Treatment of Metals | <p><input type="checkbox"/> Industrial Engineering
 <input type="checkbox"/> Industrial Metallurgy
 <input type="checkbox"/> Machine Shop
 <input type="checkbox"/> Mechanical Drafting
 <input type="checkbox"/> Mechanical Engineering
 <input type="checkbox"/> Mold-Loft Work
 <input type="checkbox"/> Patternmaking—Wood, Metal
 <input type="checkbox"/> Reading Shop Blueprints
 <input type="checkbox"/> Sheet-Metal Drafting
 <input type="checkbox"/> Sheet-Metal Worker
 <input type="checkbox"/> Ship Drafting <input type="checkbox"/> Ship Fitting
 <input type="checkbox"/> Tool Designing
 <input type="checkbox"/> Toolmaking
 <input type="checkbox"/> Welding—Gas and Electric</p> <p>Railroad Courses</p> <input type="checkbox"/> Air Brake <input type="checkbox"/> Car Inspector
<input type="checkbox"/> Diesel Locomotive
<input type="checkbox"/> Locomotive Engineer
<input type="checkbox"/> Locomotive Fireman
<input type="checkbox"/> Railroad Section Foreman <p>Steam Engineering Courses</p> <input type="checkbox"/> Boilermaking
<input type="checkbox"/> Combustion Engineering
<input type="checkbox"/> Engine Running
<input type="checkbox"/> Marine Engineering
<input type="checkbox"/> Steam Electric <input type="checkbox"/> Steam Engines | <p>Textile Courses</p> <input type="checkbox"/> Cotton Manufacturing
<input type="checkbox"/> Rayon Weaving
<input type="checkbox"/> Textile Designing
<input type="checkbox"/> Woolen Manufacturing <p>Business and Academic Courses</p> <input type="checkbox"/> Accounting <input type="checkbox"/> Advertising
<input type="checkbox"/> Arithmetic <input type="checkbox"/> Bookkeeping
<input type="checkbox"/> Business Correspondence
<input type="checkbox"/> Business Management
<input type="checkbox"/> Certified Public Accounting
<input type="checkbox"/> Commercial
<input type="checkbox"/> Cost Accounting
<input type="checkbox"/> Federal Tax
<input type="checkbox"/> First Year College
<input type="checkbox"/> Foremanship <input type="checkbox"/> French
<input type="checkbox"/> Good English <input type="checkbox"/> High School
<input type="checkbox"/> Higher Mathematics
<input type="checkbox"/> Illustrating <input type="checkbox"/> Motor Traffic
<input type="checkbox"/> Postal Service
<input type="checkbox"/> Salesmanship <input type="checkbox"/> Secretarial
<input type="checkbox"/> Sign Lettering
<input type="checkbox"/> Spanish <input type="checkbox"/> Stenography
<input type="checkbox"/> Traffic Management |
|---|---|---|--|

Name _____ Age _____ Home Address _____

City _____ State _____ Present Position _____

Working Hours _____ A.M. to _____ P.M. Length of Service in World War II _____

Special tuition rates to members of the Armed Forces. Enrollment under the G.I. Bill of Rights approved for War II Veterans. Canadian residents send coupon to International Correspondence Schools Canadian, Ltd., Montreal, Canada.

Infant seat ties to chair back and is handy for travel.....142
 Nature takers.....144
 Air pumped into polluted river hastens purification.....147
 Flashing dot on traffic signal tells time left until change.....147
 Nazi sub "cushions" fooled U. S. spotters.....151
 Vacuum leak detector uses helium as tracer.....152
 Folding crutches of aluminum double as sturdy canes.....176

Craftsman and Shop Notes Index

AUTOMOTIVE

Igniting patch-heating mixture.....180
 Rear compartment tool rack.....180
 Clean your own spark plugs with a hand "sandblaster".....215

FARM

Cork floats dairy thermometer.....215
 Barbwire spool handled safely in metal feed basket.....216
 Stretcher made from auto rim and length of pipe.....216
 Exterminator applied to crevices through oilcan spout.....216
 Milk cans kept in stock tank will not freeze.....228
 Preventing posts from rotting.....228
 Wire screen guards fruit trees against rabbits and mice.....228

HOUSE AND HOME

Way to anchor aquarium grass.....180
 To replaster a ceiling.....181
 Solving home problems.....182
 Bobby pin keeps photo upright.....184
 Cleanup tool for stoker fits around retort.....189
 Quick-drying putty to fill seams in linoleum floor.....189
 Appearance of open wall plaque improved with backing.....196
 Multi-jet steam unit sterilizes baby's bottles.....197
 Clock case made from skillet.....200
 Unused chimney can be covered.....210
 Files hold phonograph records.....210
 Sandpaper on poison container indicates danger in dark.....210

RADIO AND ELECTRONICS

Transceiver installed in car without drilling holes.....229
 Thirty-two watt amplifier operates four PM speakers.....230
 "Mirror" in television tube for brighter pictures.....232

TOOLS

Renewing hunting knife handles.....184
 Miter box hinged to sawhorse.....184
 Jig guides drill in end grain.....184
 Cutter guard protects fingers.....184
 Increasing capacity of hacksaw.....189
 Jigsaw mounted as portable unit.....196
 Friction tape wrapped on file serves as safety guard.....197
 Drill chuck used as drum sander.....200
 Hand grinder mixes casein glue.....200
 Spreader made of spring steel distributes glue evenly.....206
 C-clamp support for paintbrush.....206
 Adjusting length of plumb line.....210
 Craft quiz.....211
 Wrench for socket-head screws.....212
 Make your own speed reducers.....213
 Twin-tool holder speeds machining of shafts.....215
 Scale attachment for calipers aids in measuring work.....223
 Modified triangle saves time.....223
 Taping file protects work finish.....228
 Spectacle case holds micrometer.....228

TOYS AND NOVELTIES

Round erasers used as wheels for toys.....180
 Colorful novelties from crepe-paper raffia.....185
 Fragile figures glued to mirror will not break easily.....185
 Plastic cigarette-package holder.....212
 Salt shakers cut from walnuts are novel decoration.....212

WOODWORKING

Nine little lamps.....178
 Removing broken wood screws.....197
 Quarter-round strips cut from square stock.....206
 Removing rusty wood screws.....206
 Piano hinge is used on folding table-tennis table.....212

MISCELLANEOUS

Emergency powder gun made from envelope and tubing.....180
 Split rivets will hold screws in concrete or brick.....180
 Pad sweeps dust off records.....184
 Rolled-metal tube holds posters.....184
 Corner boundary-line markers.....185
 Reduction gears for model work obtained from clock.....196
 Hinge screws kept with hinge on cardboard.....198
 Say Merry Christmas with your own greeting cards.....198
 Small parts stored conveniently on "carryall" stand.....200
 Uses for burned-out flash bulbs.....200
 Extension arms on stepladder provide wall clearance.....206
 Mower converted to hand truck.....210
 One way to avoid spilling salt carried in lunch box.....212
 Making small steel springs.....215
 Temporary hanger for piping.....215
 Hook end supports display card.....215
 Trash cart has scoop that pivots with handle.....223
 Mechanics' hand soap paste.....223
 Pipe extension eliminates funnel when filling oilcan.....228

IMPORTANT NOTICE—It is the intention of this magazine to provide its readers with information regarding the latest developments in the mechanical arts. We take no responsibility as to whether the disclosures contained in our articles are covered by patents and advise readers to investigate this subject before making, using, or selling any of the products, machines, or processes described in order to avoid possible liability for patent infringements.

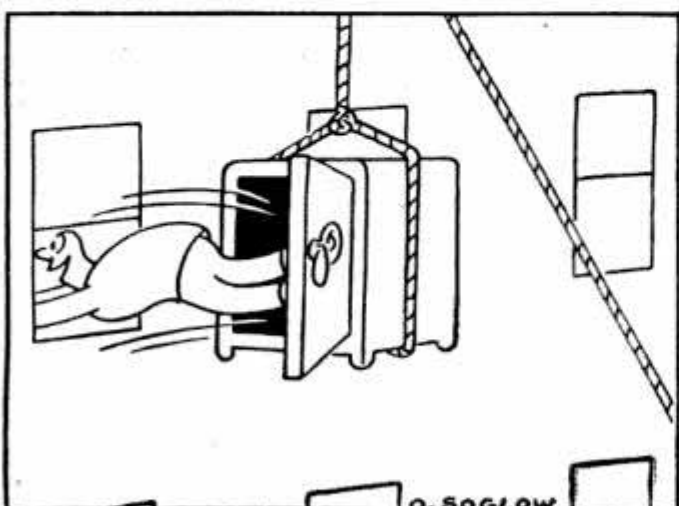
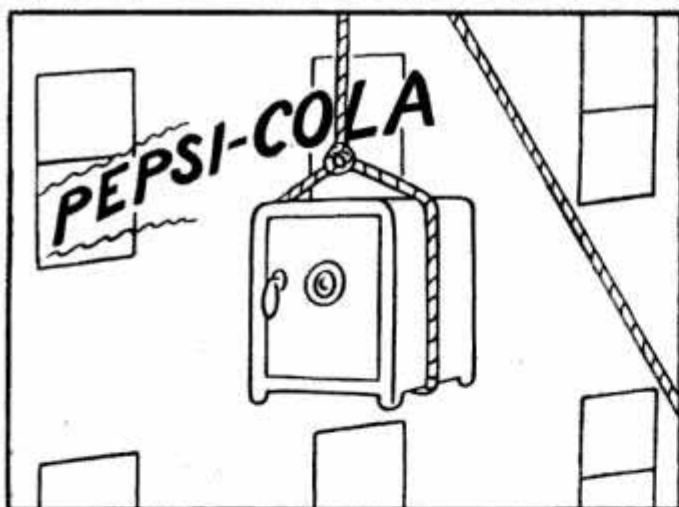
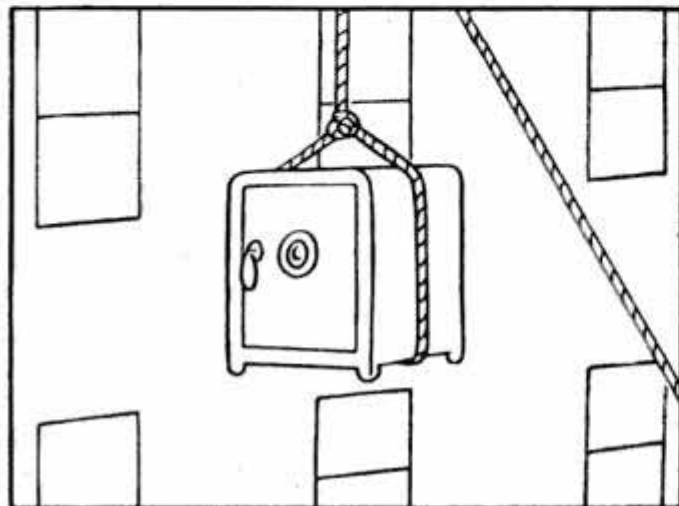
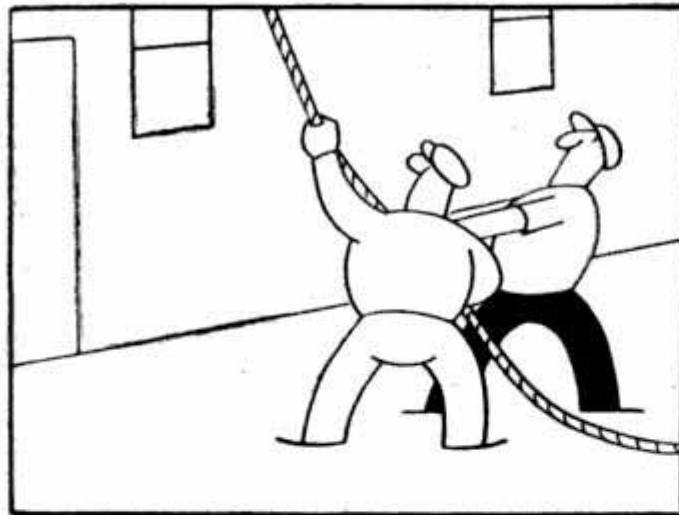

AUDELS REFRIGERATION & AIR CONDITIONING GUIDE.....\$4

New from Cover to Cover—1280 Pages, Fully Illus. Covering basic principles, servicing, operation & repair of household, commercial & industrial refrigeration & air conditioning. A gold mine of essential important facts for engineers, servicemen, users.

AUDELS CARPENTERS & BUILDERS GUIDES—4 Vols.\$6

A practical illustrated trade assistant on modern construction for carpenters, joiners, builders, mechanics and all woodworkers. 4 vols., 1600 pages, 3700 illustrations, flexible covers. Pocket size. Each volume sold separately \$1.50 a vol.

AUDELS AUTOMOBILE GUIDE.....\$4

A practical quick ready reference book for auto mechanics, service men, operators & owners. Explains theory, construction & servicing of modern motor cars, trucks, buses & auto type Diesel engines. 1540 pages, fully illustrated. 55 chapters. Indexed. A standard book for mechanics. New fluid drive covered.

AUDELS DIESEL ENGINE MANUAL.\$2

A practical, concise treatise with questions and answers on the theory, operation and maintenance of modern diesel engines including General Motors 2 cycle Diesel. 384 pages, fully illus., flexible binding, pocket size. All details plainly brought out, this book is of extreme value to engineers, operators & students.

AUDELS WIRING DIAGRAMS.....\$1

210 Pages. Illustrated. Gives practical facts on wiring of electrical apparatus. It shows clearly how to wire apparatus for practically all fields of electricity. Each diagram is complete & self-explanatory. Highly Endorsed Pocket Companion.

AUDELS PLUMBERS & STEAMFITTERS GUIDES—4 Vols.\$6

A Practical Trade Assistant & Ready Reference. Explains in plain language & by clear illustrations, diagrams, charts, graphs, pictures principles of modern plumbing practice including Marine Pipe Fitting and Air Conditioning. 4 Vols.—1670 Pages—3642 Diagrams. Pocket size. Each Vol. Sold Separately \$1.50 a Vol.

AUDELS SHEETMETAL WORKERS HANDY BOOK.....\$1

Practical inside information. Fundamentals of Sheet Metal Work. 388 pages. Illustrated. 11 sections. Clearly written. Essential & important facts, figures, pointers in everyday language. Ref. Index.

AUDELS SHEETMETAL PATTERN LAYOUTS.....\$4

Developed by Experts for Sheet Metal Workers, Layout Men & Mechanics. A Practical Encyclopedia in 10 Sections, size 7 x 10 x 2—1125 Pages—350 Layouts—1600 Illustrations. 1001 Key Facts. Fully indexed for ready reference in answering your layout problems. Covers all phases of sheet metal work including Pattern Cutting, Pattern Development & Shop Procedure.

AUDELS ANSWERS ON BLUE PRINT READING.....\$2

For Mechanics & Builders. Covers all types of blue print reading including ship & airplane. 376 pages, fully illustrated.

AUDELS NEW MACHINIST & TOOLMAKERS HANDY BOOK...\$4

Covers modern machine shop practice in all its branches. 5 practical books in 1. New from cover to cover. Tells how to set up & operate lathes, screw and milling machines, shapers, drill presses and all other machine tools. 1600 pages, fully illustrated, 5 x 6 1/2 x 2. Indexed. 5 sections. 1—Modern Machine Shop Practice. 2—Blue Print Reading & How to Draw. 3—Calculations & Mathematics for Machinists. 4—Shop Physics. 5—How to Use the Slide Rule. 60 chapters. Easy to read and understand. A shop companion that answers your questions.

AUDELS MATHEMATICS & CALCULATIONS FOR MECHANICS \$2

Mathematics for home study or reference. 700 pages, 550 illus. Practical mathematics from beginning. How to figure correctly. Easy, correct methods covering a complete review. Ill. & Indexed.

AUDELS HANDY BOOK OF PRACTICAL ELECTRICITY.....\$4

For maintenance engineers, electricians & all electrical workers. 1440 Pages, 2600 illus. Covers important electrical information in handy form—including Marine Wiring, Radio Principles, Welding. Indexed. A Key to a practical understanding of electricity.

AUDELS RADIOMANS GUIDE.....\$4

A key to the practical understanding of radio including Frequency Modulation, Television, etc., Aircraft & Marine Radio. For radio engineers, servicemen, amateurs. 772 pages. 400 Illustrations & Diagrams. Photos. Review Questions & Answers, Reference Index. Authentic, clear, concise.

AUDELS ELECTRONIC DEVICES...\$2

Tells What You Want to Know About Electric Eye. Easily Understood. Covers photo-electric cells & their applications. Amplifiers, illumination, frequencies, voltage, photocell, tubes, Ohm's Law, wiring diagrams, etc.

AUDELS WELDERS GUIDE.....\$1

A concise, practical text on operation & maintenance of all welding machines for all mechanics. Over 400 pages, illustrated. Covers all methods of electric and acetylene welding including airplane work.

AUDEL, Publishers, 49 W. 23 St., N. Y. 10



AN AUDEL GUIDE IS A GOOD FRIEND!

Use the brains and experience of others in these Guides of the Trades. Save time and money with right methods, short cuts, labor saving ideas. CHECK NOW! You can look over any Audel Guide in your home. Start the Easy Payments if satisfied.

CUT HERE MAIL ORDER

THEO. AUDEL & CO., 49 W. 23 St., New York 10, N.Y.

Please mail me for 7 days' free examination the books marked (X) below. I agree to mail \$1 in 7 days on each book or set ordered, and to further mail \$1 a month on each book or set ordered until I have paid purchase price.

If I am not satisfied with Guides I will return them.

- Audels OIL BURNER GUIDE \$1.
- Audels REFRIGERATION & Air Conditioning Guide. 4.
- Audels POWER PLANT ENGINEERS GUIDE 4.
- Audels PUMPS, HYDRAULICS & AIR COMPRESSORS 4.
- Audels WELDERS GUIDE 1.
- Audels BLUE PRINT READING 2.
- Audels SHEET METAL WORKERS Handy Book 1.
- Audels SHEET METAL PATTERN LAYOUTS 4.
- Audels AIRCRAFT WORKER 1.
- Audels MATHEMATICS and CALCULATIONS 2.
- Audels MACHINISTS & TOOLMAKERS Handy Book 4.
- Audels MECHANICAL Dictionary 4.
- Audels AUTOMOBILE GUIDE 4.
- Audels DIESEL ENGINE MANUAL 2.
- Audels MARINE ENGINEERS Handy Book 4.
- Audels SHIPFITTERS Handy Book 1.
- Gueths MECHANICAL DRAWING COURSE 1.
- Rogers DRAWING and DESIGN 2.
- Audels MILLWRIGHTS and Mechanics Guide 4.
- Audels CARPENTERS and Builders Guides (4 vols.) 6.
- Audels PLUMBERS and Steamfitters Guides (4 vols.) 6.
- Audels MASONS and Builders Guides (4 vols.) 6.
- Master PAINTER and DECORATOR 2.
- Audels GARDENERS & GROWERS GUIDES (4 vols.) 6.
- Audels ENGINEERS & FIREMANS EXAMINATIONS 1.
- Audels ENGINEERS and Mechanics Guides Nos. 1, 2, 3, 4, 5, 6, 7 and 8 complete 12.
- Audels Answers on Practical ENGINEERING 1.
- Audels ELECTRICIANS EXAMINATIONS 1.
- Audels WIRING DIAGRAMS 1.
- Audels Handy Book of PRACTICAL ELECTRICITY 4.
- Audels ELECTRICAL POWER CALCULATIONS 2.
- Audels ELECTRONIC DEVICES 2.
- Audels ELECTRIC Dictionary 2.
- Audels RADIOMANS GUIDE 4.
- Audels NEW ELECTRIC LIBRARY at \$1.50 a Volume Vols. I, II, III, IV, V, VI, VII, VIII, IX, X, XI, XII

Name _____

Address _____

Occupation _____

Employed by _____ PM

I Will
Show You
How to

Learn RADIO

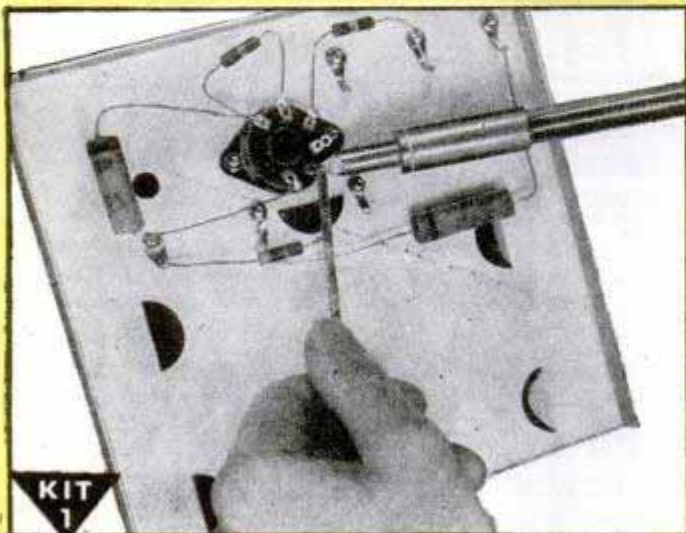

KIT 1

I send you Soldering Equipment and Radio parts; show you how to do Radio soldering; how to mount and connect Radio parts; give you practical experience.

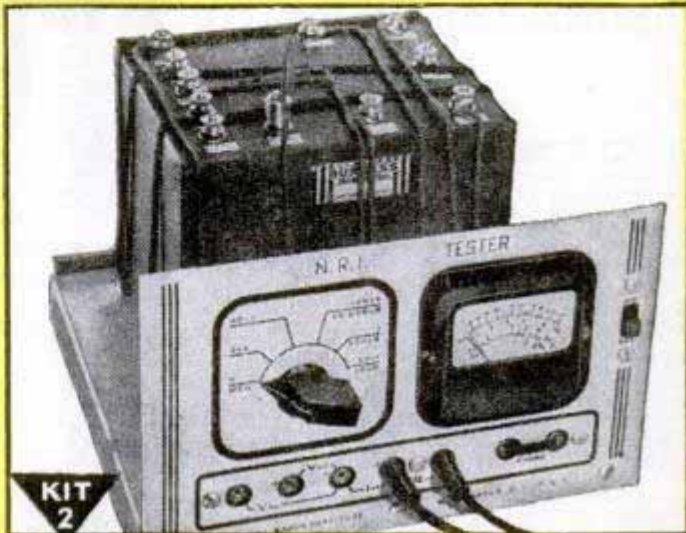

KIT 2

Early in my course I show you how to build this N.R.I. Tester with parts I send. It soon helps you fix neighborhood Radios and earn EXTRA money in spare time.

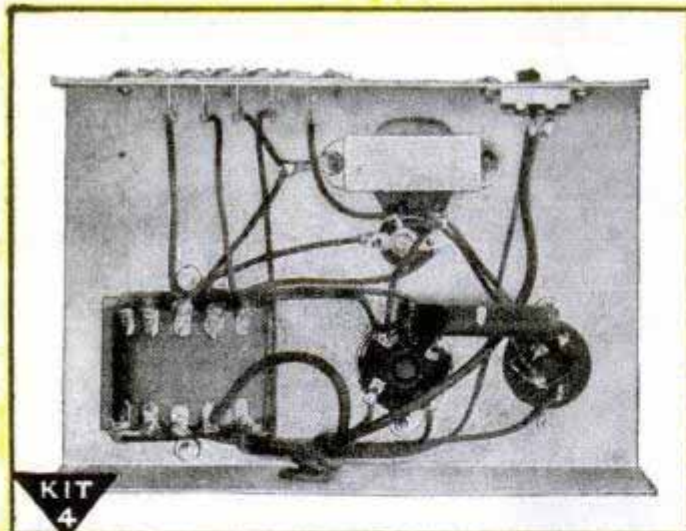

KIT 4

You get parts to build this Vacuum Tube Power Pack; make changes which give you experience with packs of many kinds; learn to correct power pack troubles.

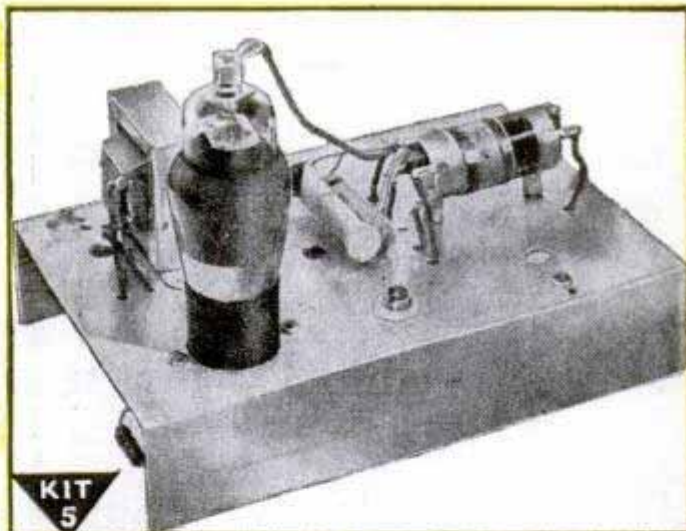

KIT 5

Building this A. M. Signal Generator gives you more valuable experience. It provides amplitude-modulated signals for many tests and experiments.

MEN I TRAIN AT HOME GET GOOD JOBS LIKE THESE

\$50 a Week From Own Shop

"Am making over \$50 a week profit from my own shop. Have another N.R.I. graduate working for me. I like to hire N.R.I. men because they know radio."—NORMAN MILLER, Hebron, Neb.



Fixing Radios Profitable Hobby

"I am doing radio work in my spare time, and find it a profitable hobby. My extra earnings run about \$10 a week. I certainly am glad I took your N.R.I. Course."—FERDINAND ZIRBEL, Chasleay, North Dakota.



Chief Engineer Station KWLM

"Am now Chief Engineer of Station KWLM and in charge of maintenance of Police Station KRIN, County Highway Dept. Also have my own business. Mighty glad to be in radio."—LLOYD V. STENBERG, 516 Litchfield Ave., W., Willmar, Minn.



Still Climbing in Air-craft Radio

"I am still climbing as a result of my N.R.I. training. I now do aircraft radio work at Greenwood Army Air Field, and operate a radio shop in my spare time."—JAMES L. BOYETT, P.O. Box 218, Greenwood, Miss.



by Practicing in Spare Time

I Send You
6 Big Kits
of Radio Parts

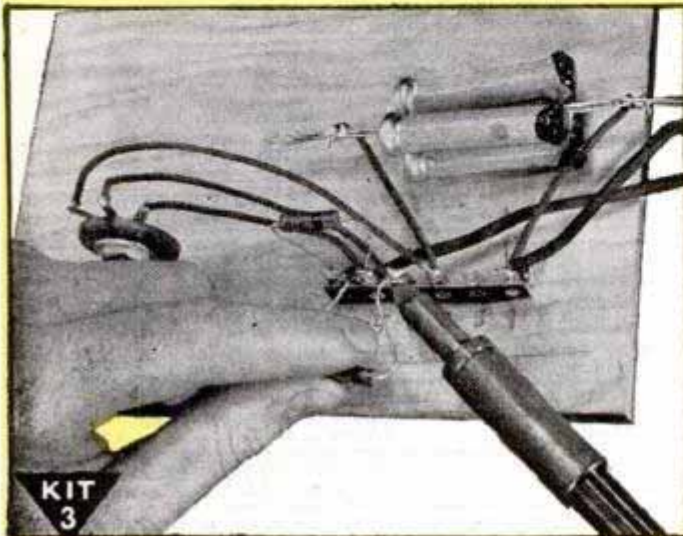

KIT
3

You get parts to build Radio Circuits; then test them; see how they work; learn how to design special circuits; how to locate and repair circuit defects.

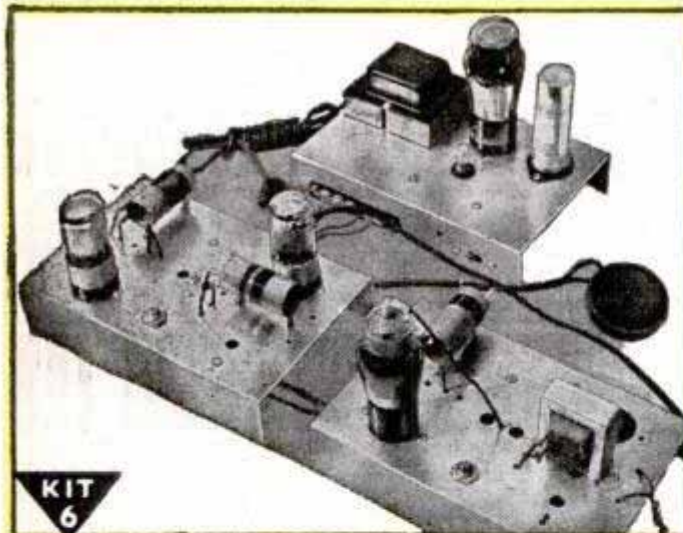

KIT
6

You build this Superheterodyne Receiver which brings in local and distant stations — and gives you more experience to help you win success in Radio.

**SAMPLE LESSON
FREE**

Gives hints on Receiver Servicing, Locating Defects, Repair of Loudspeaker, I.F. Transformer, Gang Tuner, Condenser, etc. Mail Coupon.

GETTING ACQUAINTED WITH
RECEIVER SERVICING

My Radio Course Includes
**TELEVISION • ELECTRONICS
FREQUENCY MODULATION**

KNOW RADIO *Win Success* I Will Train You at Home

Do you want a good-pay job in the fast-growing Radio Industry — or your own Radio Shop? Mail the Coupon for a Sample Lesson and my 64-page book, "Win Rich Rewards in Radio," both FREE. See how I will train you at home — how you get practical Radio experience building, testing Radio circuits with 6 BIG KITS OF PARTS I send!

Many Beginners Soon Make Extra Money
in Spare Time While Learning

The day you enroll I start sending EXTRA MONEY JOB SHEETS that show how to make EXTRA money fixing neighbors' Radios in spare time while still learning! It's probably easier to get started now than ever before, because the Radio Repair Business is booming. Trained Radio Technicians also find profitable opportunities in Police, Aviation, Marine Radio, Broadcasting, Radio Manufacturing, Public Address work. Think of even greater opportunities as Television, FM, and Electronic devices become available to the public! Send for FREE books now!

Find Out What NRI Can Do For You

Mail Coupon for Sample Lesson and my FREE 64-page book. Read the details about my Course; letters from men I trained; see how quickly, easily you can get started. No obligation! Just MAIL COUPON in envelope or paste on penny postal. J. E. SMITH, President, Dept. 6MP, National Radio Institute, Pioneer Home Study Radio School, Washington 9, D. C.

OUR 32nd YEAR of
TRAINING MEN for
SUCCESS in RADIO

MAIL NOW!

Mr. J. E. SMITH, President, Dept. 6MP,
National Radio Institute,
Washington 9, D. C.

Mail me FREE, your sample lesson
and 64-page book. (No salesman will
call. Please write plainly.)

Age.....

Name.....

Address.....

City..... State.....
(Please include Post Office zone number)



Approved for Training under GI Bill

8 BIG BUILDING BOOKS

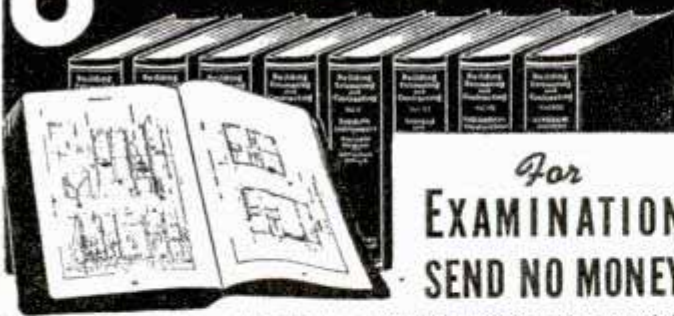

For
EXAMINATION
SEND NO MONEY

Learn to draw plans, estimate, be a live-wire builder, do remodeling, take contracting jobs. These 8 practical, profusely illustrated books cover subjects that will help you to get more work and make more money. Architectural design and drawing, estimating, steel square, roof framing, construction, painting and decorating, heating, air-conditioning, concrete forms and many other subjects are included.

BETTER JOBS — BETTER PAY UP-TO-DATE EDITION

The postwar building boom is in full swing and trained men are needed. Big opportunities are always for MEN WHO KNOW HOW. These books supply quick, easily understood training and handy, permanent reference information that helps solve building problems.

These books are the most up-to-date and complete we have ever published on these many subjects.

Coupon Brings Eight Big Books For Examination

AMERICAN TECHNICAL SOCIETY Vocational Publishers since 1898
Dept. G819 Drexel at 58th Street Chicago 37, Ill.

You may ship me the Up-to-Date edition of your eight big books, "Building, Estimating and Contracting," without any obligation to buy. I will pay the delivery charges only, and if fully satisfied in ten days, I will send you \$2.00, and after that only \$3.00 a month, until the total price of only \$34.80 is paid. I am not obligated in any way unless I keep the books.

Name

Address

City..... State.....

Please attach a letter stating your age, occupation, employer's name and address, and name and address of at least one business man as a reference. Men in service, also please give home address.

AVIATION Career

MAXIMUM TRAINING IN MINIMUM TIME

CAL-AERO TECH TRAINING will add dollars to your pay check all the rest of your life. Specializing in AERONAUTICAL ENGINEERING and MASTER AVIATION MECHANICS since 1929, Cal-Aero Tech training is carefully designed for just one thing—TO MAKE MORE MONEY FOR YOU. An alumni of over 6000 successful graduates proves our career training is unsurpassed.

VETERANS —Write us about Aviation Training, as provided under "G.I. Bill of Rights."



CAL-AERO TECHNICAL INSTITUTE
MAJOR C. C. MOSELEY PRES. SINCE 1929
FORMERLY CURTISS-WRIGHT TECHNICAL INSTITUTE
GRAND CENTRAL AIR TERMINAL
GLENDALE 1, CALIFORNIA
LOS ANGELES COUNTY

MAIL THIS COUPON TODAY!

Cal-Aero Technical Institute, Grand Central Airport, Glendale 1, California
Please send full information on Aviation Training FREE—without obligation, Dept. PM-11

Name..... Birth Date.....

Street.....

City..... State.....

How to Start YOUR OWN BUSINESS

Amazing Postwar Development Now Gives You the Opportunity to Make Money Fast!

Startling scientific discovery, just now becoming available for general use, will enable you to start your own business and reap great profits! Plastics, one of the most revolutionizing and rapidly expanding industries, offers a great opportunity to all enterprising men and women. This is one of the few industries in which home manufacturers thrive and prosper. You can start even on a spare time basis in your own home, and expand rapidly into a full time business, paying good profits.

LIQUID MARBLE
Make LIQUID MARBLE the amazing Plastic, with a thousand uses. LIQUID MARBLE can be poured into FLEXIBLE MOLDS for casting all kinds of artistic and serviceable articles such as: ornaments, novelties, desk sets, paper weights, book-ends, souvenirs, statuary, toys, etc.

FLEXIBLE MOLDS
Make your own FLEXIBLE MOLDS. The cost is low—in fact, a large sized mold costs but a few cents. Hundreds of casts can be taken from a single mold.

NO EXPERIENCE NEEDED!
No skill or previous knowledge is necessary. All you do is follow our easy-to-understand instructions.

UNLIMITED MARKET
The market is literally unlimited. You will find steady year-round demand in your own community. Your problem will not be in selling but in supplying the huge pent-up demand. Moreover, we supply you with names of big buyers for your finished products.

WRITE TODAY
Bing Products will show you how to start with a small investment and build a permanent, independent, profitable business! Don't fail to grasp this opportunity! Write today for FREE CATALOG.

BING PRODUCTS Dept. A-12, 88 Broad Street
BOSTON 10, MASS.

PHOTOGRAPHY for PLEASURE or PROFIT

QUALIFY AT HOME! Learn expert photography as a joy-full hobby, or to qualify for a well-paid position or your own studio. Previous experience unnecessary with N.Y.I.'s success-proved home study training. Details FREE. Also resident courses.

NEW YORK INSTITUTE OF PHOTOGRAPHY, Dept. 49
10 West 33 St. New York 1, N. Y. (37th Year)

ELECTRICAL TRAINING

Intensive 32 weeks residence course in fundamentals of industrial electrical engineering, including radio, electronics. Prepares for technician, engineering aides. Approved for veteran training. 53rd year. Catalog.

BLISS ELECTRICAL SCHOOL
7644 Takoma Ave., Wash. 12, D. C.

LEARN MONEY-MAKING CARTOONING

IN SPARE TIME — by Easy Picture Chart Method
Same Simplified Method that has helped train creators of "Terry & Pirates," "Freckles," "Out Our Way," "Winnie Winkle," "Regular Fellers," "Strange As It Seems," "The Neighbors," and many others. Earn while learning. Send 10c for Picture Chart (to test your ability), and full details. (State age.)

Landon School of Cartooning, Dept. 461 Philadelphia 1 Pa.

LEARN MEAT CUTTING At Home — In Spare Time

Get into the vital meat industry. Concise, practical Home Training based on 25 years proven instruction methods used at National's famous resident school. Prepares you for bigger pay as Meat Cutter, Supervisor, market manager or more money in your own store. Go as rapidly as your spare time permits. Diploma. Start NOW to turn your spare hours into money. Send for FREE bulletin today. No obligation.

National School of Meat Cutting, Inc., Dept. U-75, Toledo 4, Ohio

MAKE MONEY AT HOME

RUBBER MOLDS Low as 6¢ EA.

Amazing rubber mold-making outfit makes perfect flexible molds of plaques, ash trays, book-ends, etc. Molds cost 6c to 25c each. Each mold makes hundreds of novelties and gifts to sell for \$1.00 apiece and more! No experience necessary. Everything furnished. Quick and easy. Start profitable business in your home—sell to stores, gift shops, friends, resorts, road stands, by mail. Full or spare time. Write for complete FREE details and easy instructions.

SO-LO WORKS, Inc., Dept. M-800, Loveland, Ohio



INVENTORS



The patent laws provide that any new and useful art, machine, article of manufacture, composition of matter, or design, or any new and useful improvement thereof, may be patented if the act of invention is involved. Therefore, every inventor with a valuable invention should take advantage of the patent laws and proceed for patent protection in order to safeguard his rights.

A patent gives the inventor the exclusive right to prevent others from making, using, or selling the invention claimed in the patent for a period of 17 years.

The patent laws were enacted for the benefit of the inventor to give him protection for the features of his invention which are patentable. These features must be properly and concisely set forth and claimed in a formal application for patent in order to comply with the requirements of the U. S. Patent Office. For that reason, the Patent Office advises the inventor to engage a competent registered patent attorney to prepare his application for patent and represent him before the U. S. Patent Office Examiner.

A specially prepared booklet containing detailed information with respect to patent protection and procedure will be forwarded to you without obligation upon request.

Patents
Trademarks
Copyrights

Registered Patent Attorneys

CLARENCE A. O'BRIEN
& HARVEY B. JACOBSON

61-L Adams Building + Washington 4, D. C.

CLARENCE A. O'BRIEN & HARVEY B. JACOBSON
Registered Patent Attorneys
61-L Adams Building, Washington 4, D. C.

Please send me booklet containing information regarding patent protection and procedure. This request does not obligate me.

Name _____

Address _____

City _____ State _____

(Please write or print plainly.)

NOW SPRAYBERRY RADIO TRAINING

GIVES YOU 8 BIG KITS OF RADIO EQUIPMENT

WITH A COMPLETE 6 TUBE SUPER-HETERODYNE RECEIVER



YOU LEARN RADIO SERVICING THROUGH INTENSIVE "SHOP-BENCH" PRACTICE

YOU DO EXPERIMENTS, CONSTRUCTION, TROUBLE-SHOOTING

I'll show you how to perform over 175 instructive Experiments—how to build countless Radio Circuits. You'll learn a new, fast way to test Radio Sets without mfg. Equipment.



I give you a fine, moving-coil type Meter Instrument on Jewel Bearings—with parts for a complete Analyzer-Circuit Continuity Tester. You learn how to check and correct Receiver defects with professional accuracy and speed.

You'll get valuable experience and practice building this Signal Generator and multi-purpose Tester. Makes a breeze out of fixing Radios and you don't have to spend money on outside, ready-made equipment.



Soldering, wiring, connecting Radio parts . . . building circuits with your own hands—you can't beat this method of learning. When you construct this Rectifier and Filter, Resistor and Condenser Tester, etc., you get a really practical slant on Radio that leads to a money-making future.

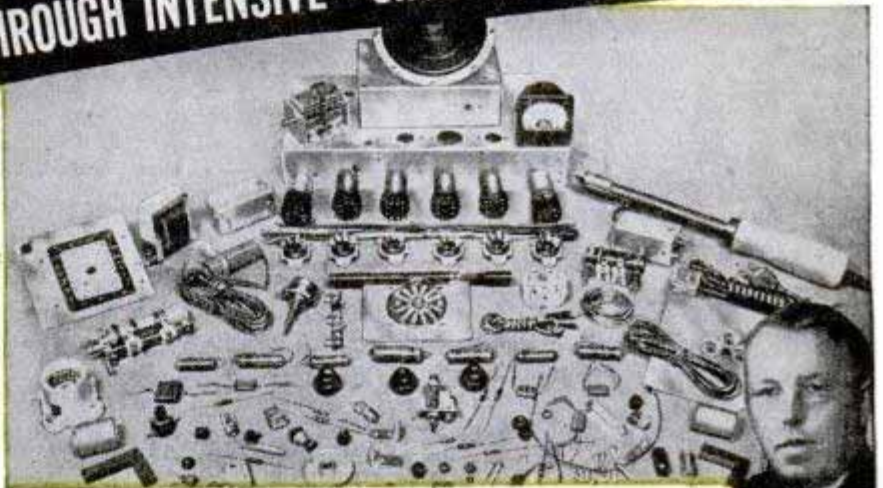

HERE'S THE LATEST, SIMPLEST WAY TO TRAIN at HOME for a GOOD LIVING in RADIO-ELECTRONICS & TELEVISION

I train your mind by putting you to work with your hands on a big 6-Tube Superheterodyne Receiver. And, believe me, when you get busy with real Radio Parts—8 big Kits of them—you really LEARN Radio and learn it RIGHT! You get the practical stuff you need to be useful in Radio, and that's what it takes to make money. You don't have to worry about what

to do with these 8 Kits of Parts. Step by step, I show you how to build circuits, test, experiment, trouble-shoot. And you don't need any previous experience. The Sprayberry Course starts right at the beginning of Radio! You can't get lost! Simplified lessons, coupled

with real "Shop" practice, makes every subject plain and easy to understand and remember.

A BUSINESS OF YOUR OWN . . . OR A GOOD RADIO JOB

Soon after you begin Sprayberry Training, I'll send you my sensational **BUSINESS BUILDERS**. You'll find out how to get and do neighborhood Radio repair jobs for nice profits and rich experience while learning. This sort of work can easily pave the way for a Radio Service business of your own. But with Sprayberry Training, you're not limited. You can swing into any one of the swiftly expanding branches of Radio-Electronics INCLUDING Radio, Television, FM, Radar, Industrial Electronics. Be wise! Decide now to become a fully qualified **RADIO-ELECTRONICIAN**. Get full details about my Training at once! Mail coupon below for my 2 big **FREE Books**.

SEND FOR THESE FREE BOOKS



"How to Read Radio Diagrams and Symbols"

Here's a valuable and wonderfully complete new book which explains in simple English how to read and understand any Radio Set Diagram. Includes translation of all Radio symbols. Send for this volume at once! It's free! Along with it, I will send you another Big Free book describing in detail my Radio-Electronic Training.

SPRAYBERRY ACADEMY OF RADIO

F. L. Sprayberry, President, Room 10116, Pueblo, Colorado

Please rush my **FREE** copies of "How to MAKE MONEY in RADIO, ELECTRONICS and TELEVISION," and "HOW to READ RADIO DIAGRAMS and SYMBOLS."

Name Age

Address

City State

(Mail in envelope or paste on penny postcard)

MAIL COUPON TODAY!

Yes! I Turn Weaklings into HE-MEN!

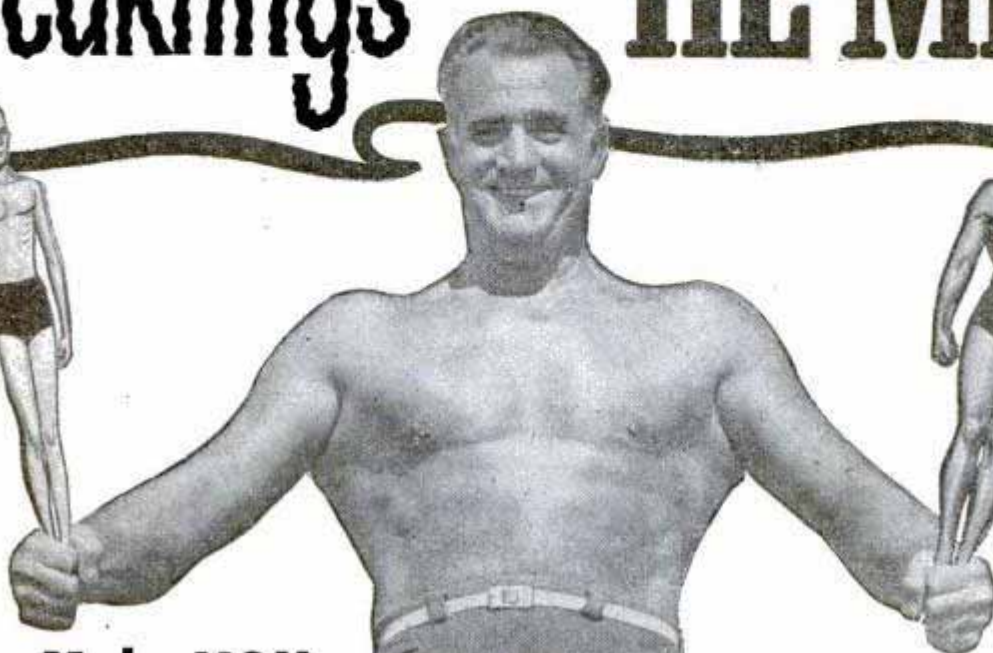

Let Me Make YOU a NEW MAN

—in Just 15 Minutes a Day!

YES, Sir, *that's my job!* I **RE-BUILD** skinny, run-down weaklings — fellows so embarrassed by their second-rate physical condition that they always hang back, let others walk off with the best jobs, the prettiest girls, the most fun and popularity. I turn weaklings like these into **HE-MEN** — **REAL SPECIMENS OF HANDSOME, MUSCULAR MANHOOD** — overflowing with pep, power, vitality! I'll **PROVE** that, in only 15 minutes a day, I can make **YOU** a **NEW MAN** too!

I'LL PROVE What I Say

I know what it's like to have a body others laugh at. I myself was once a 97-pound weakling—timid, ill-at-ease, ashamed to strip for sports or a swim.

Then I discovered "*Dynamic Tension*." It changed me from a scrawny "stringbean" into the winner of the title, "**THE WORLD'S MOST PERFECTLY DEVELOPED MAN.**" Since then my "*Dynamic Tension*" has transformed thousands of other weak, no-muscle men into real Atlas Champions!

Charles Atlas

Holder of title, "The World's Most Perfectly Developed Man."

What I'll Do For YOU!

Where do **YOU** want solid, tough **LIVE MUSCLE**? Are you fat and flabby? Or skinny and gawky? Are you short-winded, sluggish, always tired? I'll give you a sledge-hammer fist and mighty forearm. Add inches to your biceps. Put a coat of muscle straight across your stomach. Change those legs that are "always tired" into mighty, vigorous columns of speed and stamina. You'll begin to know what it feels like to really **LIVE!**

SEND FOR FREE BOOK

Mail coupon right now. I'll send you a **FREE COPY** of my famous illustrated book, "*Everlasting Health and Strength.*" In it I talk to you in straight-from-the-shoulder language—show you actual photographs of myself and other fellows who became **NEW MEN**, my way. You'll read the story of "*Dynamic Tension*"—what it has done for others, what I'm ready to **PROVE** in only 15 minutes a day, it can do for **YOU!** Send for this book **today!** **AT ONCE!** Address me personally. **CHARLES ATLAS, Dept. 8L, 115 East 23rd Street, New York 10, N. Y.**



**CHARLES ATLAS, Dept. 8L
115 East 23rd Street, New York 10, N. Y.**

I want the proof that your system of "*Dynamic Tension*" will help make a New Man of me—give me a healthy, husky body and big muscular development. Send me your free book, "*Everlasting Health and Strength.*"

Name
(Please print or write plainly)

Address

City State

Check here if under 16 for Booklet A.

INVENTORS

• **T**he Rules of Practice of U. S. Patent Office advises—unless the inventor is qualified to handle such matters—that he employ the services of a competent Patent Attorney in the preparation of his Patent Application. We are Registered Patent Attorneys fully qualified to represent you at the Patent Office. Our long and varied experience in patent practice, we believe, enables us readily to understand inventors' disclosures, to advise what is probably patentable, after conducting preliminary patentability investigation of prior U. S. patents, and to draw your specifications and claims in such manner as to present clearly the novel features.

Patent Laws Favor the Inventor Who Acts Promptly

Remember, the details of your invention do not have to be 100% perfect before you can obtain patent. Unwise inventors often

devote considerable unnecessary time working on unimportant details of their devices. This is expensive, hazardous and unnecessary. First step is to have us conduct search for the prior U.S. patents and render a report as to its patentability. Our Search Report is very valuable to you in that it clears up the course you should take in regard to your invention. If our Report is favorable, this report of the patentability of your device shows that your chances of patent protection are in your favor.

Have Patent Protection First

Unless you safeguard your invention by obtaining a patent, thereby securing a monopoly on same, it may become "public property," free to be made, used and sold by anyone, or it may be patented by some other person.

McMORROW, BERMAN & DAVIDSON

Registered Patent Attorneys

135-Y Victor Building, Washington 1, D. C.

McMORROW, BERMAN & DAVIDSON

Registered Patent Attorneys

135-Y Victor Building, Washington 1, D. C.

Send me further particulars on how to protect my invention and "Invention Record" form at once. I understand that this request does not obligate me.

Name.....

Address.....

City..... State.....

-(Write or print name clearly)-

•
COPYRIGHTS

PATENTS

TRADE MARKS
•

SCHOOL for VETERANS!

Learn while you earn!

You're in a class
by yourself with
I.C.S.—and Courses
are free to you
under the G.I. Bill
of Rights!

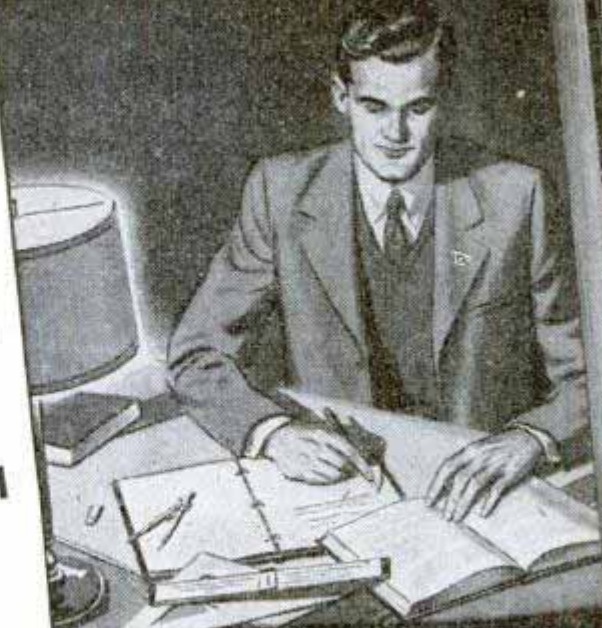

- I. C. S. Courses, paid for by the Government, are now available to honorably discharged World War II Veterans. And the Government's investment in your training will NOT be deducted from any future bonus.
- Get started now on your studies for success in business or industry! With I. C. S. you can do this in your spare time *while holding down a job!* You're in a class by yourself. There's no one to

hold you back . . . you progress just as fast as your abilities and ambition permit!

- Courses cover more than 400 commercial and technical subjects—many listed below. Check the subject that interests you—or write it in. We'll send you full information on the Course—and complete instructions on how to enroll with us under the G.I. Bill of Rights. Act now!

INTERNATIONAL CORRESPONDENCE SCHOOLS



BOX 5592-K, SCRANTON 9, PENNA.

Without cost or obligation, please send me full particulars about the course *before* which I have marked X:

- Air Conditioning and Plumbing Courses**
 - Air Conditioning
 - Heating Plumbing
 - Refrigeration Steam Fitting
- Chemistry Courses**
 - Chemical Engineering
 - Chemistry, Analytical
 - Chemistry, Industrial
 - Chemistry, Mfg. Iron & Steel
 - Petroleum Refining Plastics
 - Pulp and Paper Making
- Civil Engineering, Architectural and Mining Courses**
 - Architectural Drafting
 - Architecture
 - Bridge and Building Foreman
 - Building Estimating
 - Civil Engineering
 - Coal Mining
 - Contracting and Building
 - Highway Engineering
 - Lumber Dealer
 - Reading Structural Blueprints
 - Sanitary Engineering
 - Structural Drafting

- Structural Engineering
- Surveying and Mapping
- Communications Courses**
 - Electronics
 - Practical Telephony
 - Radio, General
 - Radio Operating
 - Radio Servicing
 - Telegraph Engineering
- Electrical Courses**
 - Electrical Drafting
 - Electrical Engineering
 - Electric Light and Power
 - Lighting Technician
 - Practical Electrician
- Internal Combustion Engines Courses**
 - Auto Technician Aviation
 - Diesel-Electric
 - Diesel Engines Gas Engines
- Mechanical Courses**
 - Aeronautical Engineering
 - Aircraft Drafting
 - Flight Engineer
 - Foundry Work
 - Heat Treatment of Metals

- Industrial Engineering
- Industrial Metallurgy
- Machine Shop
- Mechanical Drafting
- Mechanical Engineering
- Mold-Loft Work
- Patternmaking—Wood, Metal
- Reading Shop Blueprints
- Sheet-Metal Drafting
- Sheet-Metal Worker
- Ship Drafting Ship-Fitting
- Tool Designing
- Toolmaking
- Welding—Gas and Electric
- Railroad Courses**
 - Air Brake Car Inspector
 - Diesel Locomotive
 - Locomotive Engineer
 - Locomotive Fireman
 - Railroad Section Foreman
- Steam Engineering Courses**
 - Boilermaking
 - Combustion Engineering
 - Engine Running
 - Marine Engineering
 - Steam Electric Steam Engines

- Textile Courses**
 - Cotton Manufacturing
 - Rayon Weaving
 - Textile Designing
 - Woolen Manufacturing
- Business and Academic Courses**
 - Accounting Advertising
 - Arithmetic Bookkeeping
 - Business Correspondence
 - Business Management
 - Certified Public Accounting
 - Commercial
 - Cost Accounting
 - Federal Tax
 - First Year College
 - Foremanship French
 - Good English High School
 - Higher Mathematics
 - Illustrating Motor Traffic
 - Postal Service
 - Salesmanship Secretarial
 - Sign Lettering
 - Spanish Stenography
 - Traffic Management

Name _____ Age _____ Home Address _____

City _____ State _____ Present Position _____

Working Hours _____ A.M. to _____ P.M. Length of Service in World War II _____

Special tuition rates to members of the Armed Forces. Enrollment under the G.I. Bill of Rights approved for War II Veterans. Canadian residents send coupon to International Correspondence Schools Canadian, Ltd., Montreal, Canada.

Men! Why Trust to Luck for Your Future?

Choose the Field that Offers

**GOOD JOBS, STEADY
WORK, a REAL FUTURE!**

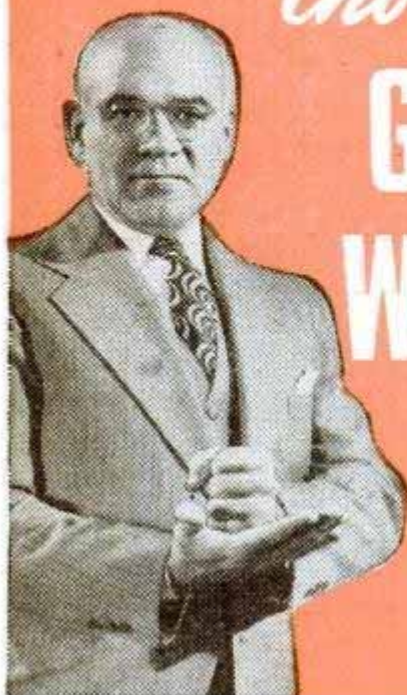

Then Get Practical Shop Training
at COYNE in Chicago..and Get Out
of the "One-Operation" Job Rut!

**Be Ready in a Few Short Weeks
FOR A LIFETIME OF BETTER JOBS, BIGGER PAY!**

This big fireproof building
was built and is occupied
entirely by COYNE—
America's headquarters for
practical Electrical and
Radio Training.

"Learn by Doing"
on Full-Size Equipment



You need training TODAY for the better jobs of TOMORROW. Not just any training, but practical, do-it-yourself instruction on full size equipment with the necessary theory given by interesting practical lectures, black-board work and demonstrations—in a field that offers a real future. That's what you get here at COYNE. When you come to Chicago for my course in Radio-Electronics, you can make rapid strides in my famous "Learn-by-doing" shops.

COYNE training is quick, streamlined. You work on real equipment, the same kind you'll use later on the job. Expert instructors guide every step. In a few short weeks you have knowledge that will aid you to a lifetime of steady work, advancement, better pay!

See What COYNE can do for YOU

RADIO - ELECTRONICS and TELEVISION

THIS TRAINING INCLUDES:

Radio and Electronics principles; circuits, tubes, condensers, coils, volume controls; assembling, wiring and trouble shooting on radio receivers; auto radio; F.M. (frequency modulation); public address, sound and television; how to set up a radio business of your own.

Leading to such jobs as:



RADIO MFG.



RADIO RECEIVERS



FM (Frequency Mod.)



ELECTRONICS



SOUND SYSTEMS



TELEVISION

SEND COUPON FOR BIG FREE BOOK

COYNE Gives "All-Around" Training

Many fellows have what they consider a good job, yet it may be actually only a "one-operation" type of work. They are not able to go into other branches of the same field because they lack training. At COYNE you learn many branches of Radio-Electronics. You get "all-around" knowledge to prepare you for the BEST that the future has to offer!

Student Finance Plan

I make it easy for you. If you don't have much cash, I'll arrange to finance most of your tuition and you can pay it in small monthly installments after you complete your training. We'll even help you get a part time job if you wish, so you can earn while learning. My Lifetime Employment Service is free to Coyne graduates whenever you need it. I have many plans to help you. Coupon brings all details. MAIL IT NOW!

INCLUDED!

Added training in INDUSTRIAL ELECTRONICS and Electric Refrigeration Now Included.



VETERANS!

Coyne is also equipped to train those who qualify for training under the G.I. Bill of Rights. Check the coupon for special G.I. Bulletin.

Also facilities for men with physical disabilities, whether due to war or other causes. Check coupon for special information.



Dozen of Pictures and Vital Job Facts ... Yours FREE

I have a big FREE BOOK on my training in Radio-Electronics. It shows dozens of scenes in my famous shops—tells how easily and quickly YOU can prepare for a wonderful future. Just fill in coupon below, then mail in envelope or paste on post card.

No salesman will call. YOU will be the sole judge. Your future is at stake—don't delay. Rush the coupon to me—NOW.

B. W. COOKE, Director, Radio-Electronics Div.

COYNE ELECTRICAL SCHOOL
500 S. PAULINA ST. Dept. 86-3H CHICAGO 12

FREE BOOK COUPON

B. W. Cooke, Director,
COYNE ELECTRICAL SCHOOL, Radio-Electronics Div.,
500 S. Paulina St., Dept. 86-3H, Chicago 12, Ill.

I want to build a REAL FUTURE for myself. Send your big FREE BOOK on Radio-Electronics, also details of your Student Finance Plan. Check if you are interested in information on the following:

Send special G.I. Bulletin Physical Disability details

NAME.....

ADDRESS.....

CITY.....STATE.....

...MAIL THIS TODAY!

PATENT PROTECTION *for* INVENTORS

A PATENT IS A VALUABLE RIGHT

On the basis of a constitutional provision Congress has established a system under which inventors may secure the exclusive right to prevent the unauthorized use, manufacture and sale of their inventions for periods of seventeen years. The inventor secures this protection by obtaining a patent from the United States Patent Office.

The United States Patent Office
RECOMMENDS

In its Rules of Practice that "an applicant is advised, unless familiar with such matters to employ a competent registered patent attorney or registered patent agent, as the value of patents depends largely upon the skillful preparation of the specifications and claims."

We
RECOMMEND

that you authorize us to conduct a search through the U. S. Patents pertinent to your invention and submit a report setting forth our opinion regarding its patentability.

VICTOR J. EVANS & CO., has a staff of experienced registered patent attorneys, available to represent inventors in the preparation and prosecution of their cases before the Patent Office. Detailed information and the steps to be taken in obtaining patent protection will be furnished upon request.

FORM BELOW FOR MAILING CONVENIENCE

**VICTOR J.
EVANS & Co.**

Merlin M. Evans

REGISTERED PATENT ATTORNEY

Main Office: 130-M Merlin Building, Washington 6, D. C.

Pittsburgh Office: 521-N Empire Building

Los Angeles Office: 738-N Security Building

Please forward to me detailed information regarding procedure to obtain Patent Protection, together with your convenient "Evidence of Invention" form.

Name.....

Address.....

City and State.....

PATENTS

TRADEMARKS

COPYRIGHTS

WHICH OF THESE *Opportunities* INTERESTS *You* MOST?

Accounting
Air Conditioning
Architecture & Building
Automotive Engineering
Aviation—Practical
Aviation Drafting & Design
Better Foremanship
Bookkeeping
Business Management

Contracting
Diesel Engineering
Drafting & Design
Electrical Engineering
Electricity—Practical
Electronics, Industrial
High School Courses
Machine Shop Operations
Mechanical Engineering

Plastics Engineering
Plumbing—Practical
Private Secretary
Radio Operating & Servicing
Railway Training
Refrigeration
Sheet Metal Pattern Drafting
Shop Management
Tool Making

THINK! LOOK FORWARD!

Business is making big, new plans

Men and Women are preparing for the future

WHAT ARE YOU DOING ABOUT YOUR TOMORROWS?

● *Today*, choose the job you want—and prepare for it. Or if you are already engaged in the work you like best, start training *now* for quicker promotion. Acquire the knowledge that will help you to get ahead faster, make more money and have greater security.

Invest part of your spare time in more rapid progress. Start training now, in spare time in your own home. Be ready to grasp your opportunity and step out ahead of those who lack the ability you have attained.

American School, founded in 1897 as an educational institution *not for profit*, can help you to reach your goal just as it has helped others during the past forty-nine years. Give serious thought to the list above. Pick one or more subjects that interest you. Then check the coupon at right, add your name and address and mail it at once. The school will send you details on its training plan and outline of study prepared by specialists. There is no charge, no obligation, so send the coupon immediately.

PRACTICAL, EFFECTIVE HOME - STUDY TRAINING SINCE 1897

Take This First Easy Step

CHECK, CLIP AND MAIL COUPON NOW

AMERICAN SCHOOL, Dept. G845, Drexel at 58th, Chicago 37, Ill.

Without obligation, Please send FREE and postpaid, bulletin and details of the Subject checked.

- | | | |
|--|--|--|
| <input type="checkbox"/> PLASTICS ENG'R | <input type="checkbox"/> Accounting | <input type="checkbox"/> Drafting and Design for Men and Women |
| <input type="checkbox"/> Refrigeration | <input type="checkbox"/> Electrical Engr. | <input type="checkbox"/> Radio |
| <input type="checkbox"/> Architecture and Building | <input type="checkbox"/> Electricity-Pract. | <input type="checkbox"/> High School |
| <input type="checkbox"/> Contracting | <input type="checkbox"/> Electronics, Industr. | <input type="checkbox"/> Air Conditioning |
| <input type="checkbox"/> Practical Plumbing | <input type="checkbox"/> Bookkeeping | <input type="checkbox"/> Mechanical Eng. |
| <input type="checkbox"/> Automotive Engineering | <input type="checkbox"/> Private Secretary | <input type="checkbox"/> Shop Management |
| <input type="checkbox"/> Aviation Drafting | <input type="checkbox"/> Diesel Engineering | <input type="checkbox"/> Tool Making |
| <input type="checkbox"/> Aviation | <input type="checkbox"/> Sheet Metal | <input type="checkbox"/> Better Foremanship |
| <input type="checkbox"/> Business Mgmt | <input type="checkbox"/> Pattern Drafting | <input type="checkbox"/> Machine Shop Operations |
| <input type="checkbox"/> Railway Training | | |

Name.....Occupation.....

Address.....Age.....

City.....State.....

AMERICAN SCHOOL

Dept. G845, Drexel at 58th Street, Chicago 37

"I'll show YOU how to make yourself COMMANDO-TOUGH

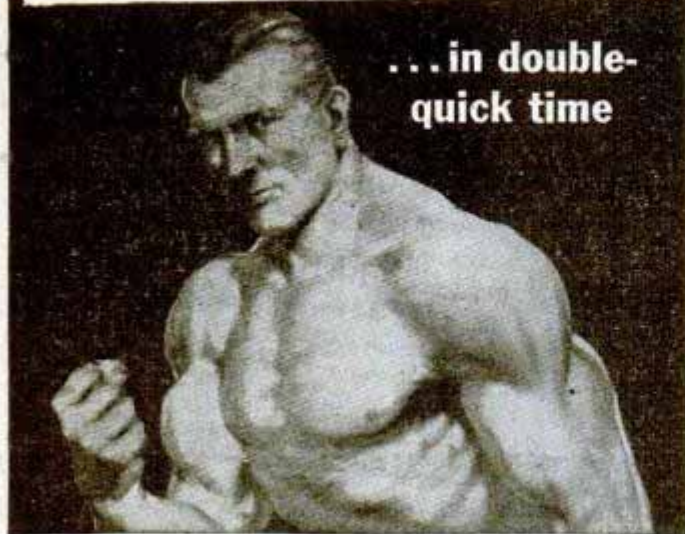

...in double-quick time

...OR IT WON'T COST YOU A CENT!"

says *George F. Jowett*

WORLD'S GREATEST BODY BUILDER

Let me prove to YOU that you can put inches of dynamic muscles on your arms! Add inches to your chest! Broaden your shoulders and power-pack the rest of your body. I can do for you what I've done for thousands the world over, including many officers and men now in the U. S. and British Armed Forces.

GIVE ME 10 MINUTES A DAY!

I'll Show You My Secrets Of Body Building

I'll help you learn the "Progressive Power Method" through which I rebuilt myself from a physical wreck to the holder of more strength records than any other living athlete or teacher! No matter how skinny or flabby you are, you can learn my methods right in your own home. Through my proved secrets I show you how to develop your power, inside and out, until YOU are fully satisfied that you are the man you want to be. "The Jowett System," says R. F. Kelly, Physical Director of the YMCA, Atlantic City. "is the greatest in the world!"

If you want a physique that will inspire respect from men, and admiration from women... ACT LIKE A HE-MAN! Decide at once! The famous book, "Nerves of Steel—Muscles Like Iron" will be included FREE! Priceless for the strength fan! Full of photos of marvelous power-bodied men who will show you what Jowett has done for them and how he can do the same for you. Reach out... Grasp this Special Offer today!

Jowett Institute of Physical Culture
230 Fifth Avenue
Dept. PM-611
New York 1, N.Y.

PROVE TO YOURSELF IN ONE NIGHT!

Send only 25c for test Course, "Molding a Mighty Arm." Read it the evening it arrives—learn from experience the thrill you can give your muscles!

SEND FOR THESE FIVE FAMOUS COURSES IN BOOK FORM

ONLY 25c EACH
or ALL 5 for \$1.00

This
Book
Free!



BOOK WITH PHOTOS OF FAMOUS STRONG MEN
MAIL COUPON NOW

FREE



Jowett Institute of Physical Culture
230 Fifth Avenue, Dept. PM-611, New York 1, N. Y.

George F. Jowett: Your proposition looks good to me. Send by return mail, prepaid, the courses checked below, for which I enclose (), include FREE book of PHOTOS.

George F. Jowett
Champion of
Champions

- All 5 courses for . . . \$1 Molding Mighty Legs 25c
 Molding a Mighty Arm 25c Molding a Mighty Grip 25c
 Molding a Mighty Back 25c Molding a Mighty Chest 25c
 Send all 5 C.O.D. (\$1 plus postage.) No orders less than \$1 sent C.O.D.

NAME Age
(Print name)

ADDRESS

LEARN

WATCH REPAIRING

AT HOME



Construction, repair, adjustment. New complete "PRACTICAL COURSE" for beginners and professional repairmen. All essential steps. Theory, operation. Many test cases. Full coverage of tools, materials. Fully illustrated. **\$2.95** Post Paid Only (if C.O.D. plus C.O.D. fee.) Money Back Guarantee

We Supply Tools, Materials at Lowest Cost

Illustrated catalogue of tools and materials, 50 cents, credited to your first order. We specialize in all books on Watchmaking, Jewelry, Metalcraft, Gem Cutting, Optics.

MODERN TECHNICAL BOOK CO., Dept. MMC
55 WEST 42ND ST. NEW YORK 18, N. Y.

JOIN our new TECHNICAL BOOK CLUB—free

Members receive current literature, guidance on all book problems, premiums. No obligation. ALL BOOKS: Technics, Chemistry, Physics, Plastics, Refrigeration, Air-conditioning, Building, Construction, Electricity, Radio, Television, Electronics, Automotives, Mathematics, Woodworking, Homecraft, Business, Languages, Farming, Sports, Photography, etc. — Write for free literature, please specify subject.

GET READY for the BUILDING BOOM

Learn about Earning Opportunities
in BUILDING CONTRACTING

FREE FACTS: Use Our Training Plan to Learn at Home in Spare Time

Do you want to be on the inside in the building boom—where big money is made? Learn about opportunities for Building Contractors whether or not you have previous experience in this field. Millions of dollars are going to be made in home and farm buildings, in construction of stores, garages, small industrial buildings. The building industry uses men with organizing ability by thousands in construction, supervision, management, sales. Properly trained men needed in production, distribution, finance, installation, marketing. Government estimates housing demand at 40 billion dollars. Others are preparing to get in now! Act immediately—get the facts! Mail postcard today—no obligation.

HOME BUILDERS TRAINING INSTITUTE, Dept. D-211
6312 N. Broadway Chicago 40, Illinois



MUFFLERS

STEELS and ALUMINUMS
with a motorboat tone

SINGLES \$5.50 to 8.00
V-8 DUALS 17.50 to 20.00

Reduce back pressure and increase engine performance. A Sandee is time proved and dependable. Aluminums are guaranteed for the life of your car.

DEALERS WANTED

SANDEE MUFFLER CO.

7523 S. WESTERN AVE., LOS ANGELES 44, CALIF.

"How to Make Money With Simple Cartoons"

A book everyone who likes to draw should have. It is free; no obligations. Simply address
CARTOONISTS' EXCHANGE

Dept. 911-D

Pleasant Hill, Ohio

Get U.S. Gov't. Job

Splendid salaries, vacations, pension when retired. My low-priced, home-study practice tests help one make higher grade in Gov't Exam. Write today, OZMENT SCHOOL, 80, St. Louis, Mo. (Veterans given preference)

Be Your Own Boss — in Your Own Business

Start at home . . . small capital needed . . . prepare for exciting plastics jobs or Your Own Plastics Business. We teach you Fabrication and Casting right in your own home. All materials furnished. Send ad with name and address for information. VETERANS: Eligible for resident training under G. I. bill, Check here

LEARN

PLASTICS

PLASTICS TECH

School of America, Inc.
5200 Euclid Avenue
Dept. M-11, Cleveland 3, Ohio

Now You can Use.

ALL OF THESE RADIO PARTS

to help You learn

RADIO

FASTER-EASIER AT HOME



YOU CAN BUILD **133**
FASCINATING EXPERIMENTS

At home—in your spare time—you get real Radio experience from these many interchangeable Radio parts and sub-assemblies. Our handy "Block System" eliminates unnecessary mechanical work; the convenient spring clip connections save a great deal of time. You quickly build Radio circuits that work. You experiment with Photo-Electric Cell "Magic" . . . a 5 tube Superheterodyne Receiver . . . a Radio Telephone, and scores of other fascinating projects. Little wonder learning Radio at home is so practical . . . effective and real fun—with this modern "Home Laboratory."

YOU USE "LEARN-BY-SEEING" MOVIES!

Think of the pleasure, as well as help you get from the use of a 16MM. Motion Picture Projector and exciting "movie" TRAINING FILMS. You will be surprised how much faster . . . easier . . . Home Movies help you understand Radio-Electronic fundamentals. Here's a preferred training method of tomorrow—yours today. SEE the principles of what you're learning—in motion . . . ANIMATED! See circuit sections otherwise hidden from the eye. You get this big Radio home training advantage—exclusively from DeFOREST'S TRAINING, INC. So act now! Mail coupon for complete details.



VETERANS!

Big things are happening at DeForest's Training, Inc., for veterans! See how we can prepare you WITHOUT COST for a GOOD JOB or a BUSINESS OF YOUR OWN in the vast Radio-Electronic opportunity field.

See how our fascinating SHOP METHOD Radio Training at home can help you toward a good start in the Billion Dollar Radio-Electronic Field. Write for our BIG FREE book, "VICTORY FOR YOU!" that has helped many to good pay jobs. You'll be surprised at the opportunities ahead in F.M. Radio, Aviation Radio, Broadcast Radio, a Profitable Business of Your Own, Motion Picture Sound Equipment, Electronics—plus the exciting future possibilities ahead of Television, Radar, etc.

You Get "ALL THREE"

Where else can you get such a combination of PROVED MAJOR training features as—(A) modern loose-leaf lessons that are well illustrated with helpful diagrams; (B) the use of "Learn by Seeing" home movie films and a 16mm. MOVIE PROJECTOR—and (C) eight big kits of

"Home Laboratory" Radio parts to give you valuable practical Radio experience—at home.

You Also Get EFFECTIVE EMPLOYMENT SERVICE . . . to help you get started toward a Radio-Electronic Job or a business of your own. Residential training in our Chicago laboratories also available!

DeForest's Training, Inc., includes instruction in Motion Picture Sound Equipment, FM Radio and Television . . .



DeFOREST'S TRAINING, INC., Dept. PM-C11
2535-41 N. Ashland Ave., Chicago 14, Illinois, U.S.A.
Send—FREE and WITHOUT OBLIGATION—illustrated book, "VICTORY FOR YOU" and KIT SUPPLEMENT, showing how Home Movies and Home Laboratory can speed my preparation for a place in the Radio-Electronics Industry.

Name.....Age.....

Address.....Apt.....

City.....Zone.....State.....

If under 16, check here for special information.
 If a discharged veteran of World War II, check here.

DeFOREST'S

TRAINING, INC.

CHICAGO 14, ILLINOIS

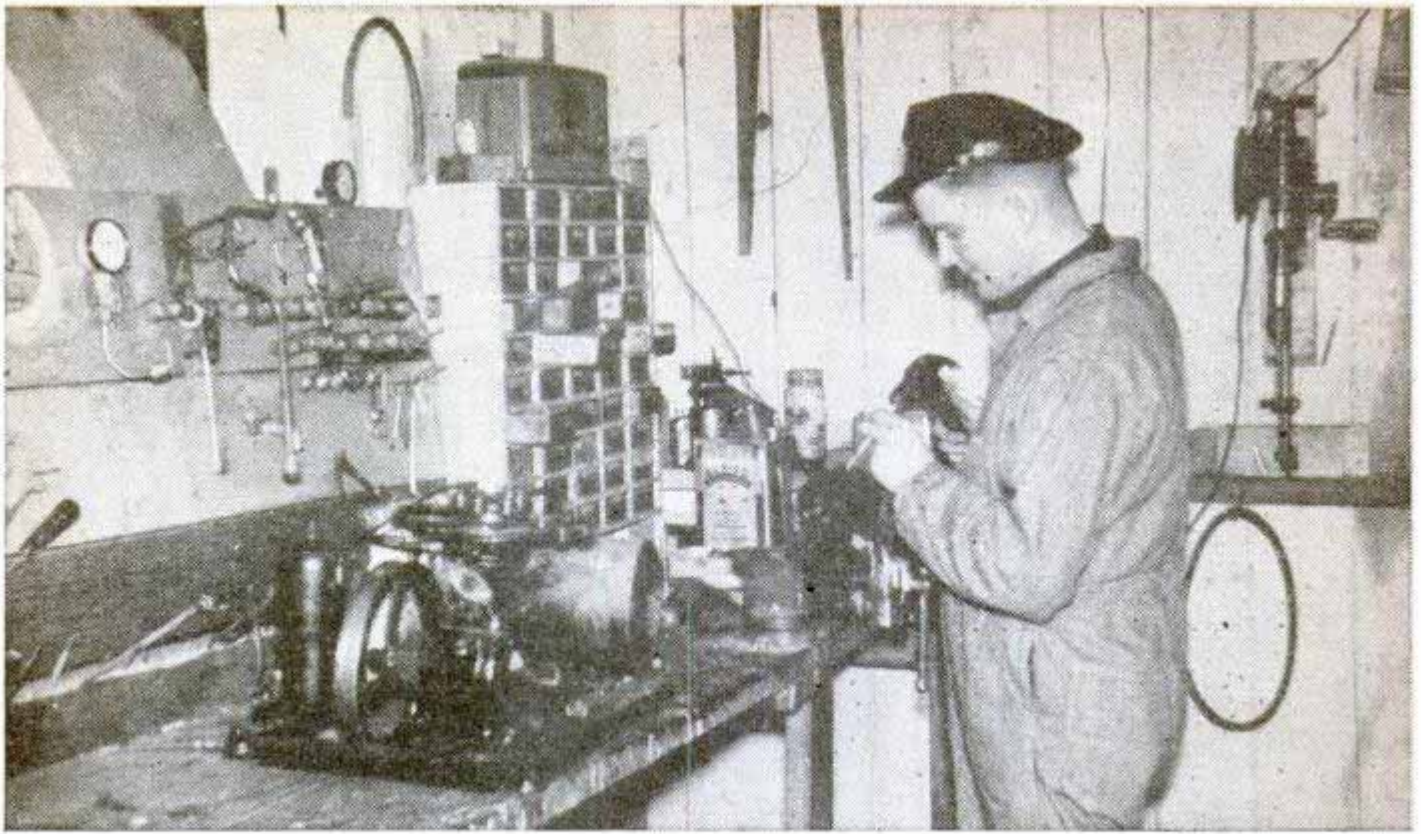

SO IT NEEDS FIXING

By S. T. CHRISTENSEN
the "Fix-it Man"

WELL, I guess I'm the fellow to see, for I've repaired thousands of refrigerators (home and commercial both), vacuum cleaners, radios, washing machines, irons, fans, lamps, mangles, motors, etc. In fact, many of my customers call me their "electrical appliance doctor." And, "doctoring," I might add, has paid me a good substantial income for quite a few years. Funny, in a way, how I got started. Always liked to tinker and by experimenting around I found that most electrical appliances had many things in common. That, regardless of what the appliance was used for, or who the manufacturer was, the basic principles were much the same. From fixing my own appliances to fixing friends' and then for strangers at a fee, seems now to have been but a small step.

What to Charge?

At first, I let the owner decide the charge and, frankly, I was amazed at what I earned per hour. But then, when one figures what initial costs are involved in buying most electrical appliances, one can readily see that spending extra dollars for repairs is well worth while. Before long I was making more in my spare time repairing than from my regular job. The result . . . I went into business for myself. When war came, business boomed, for new appliances were not available.

For a while, repair parts (needed on some

jobs) were a little difficult to get. But that situation quickly adjusted itself and many repair parts were given the high priority rating of AA2. After all, we had to provide for the health and well-being of our civilian population.

The Future Offers

Friends ask me about my future. And, I think I've got a grand one. Age is no handicap in repairing. I have in my files enthusiastic letters from repairmen ranging in age from 18 to 79 years. Now the war is over we are certain to see hundreds of new products on the market . . . products that the average person never dreamt of. These new products and our old appliances are all going to need at some time or other "fixing." Well, I'll still be the fellow to do it. The field open for appliance repairmen is unlimited. I don't worry at all about too much competition.

If You Are Ambitious

To the contrary, I've prepared a complete course, chuck full of simple, easy to understand photos and drawings and written in the same non-technical language as this article. I know the course is good, because I have hundreds of men all over the country writing to me telling me how the course has helped swell their pockets with cash. If you too want to prepare now for your future, I suggest you read the next page and send me the handy coupon."

Advertisement

**BIG MONEY
INDEPENDENCE**
*A PROFITABLE
LIFETIME
BUSINESS
OF
YOUR OWN!*

LEARN ELECTRICAL APPLIANCE REPAIRING

PREPARE NOW FOR THE FUTURE

If now employed, start your home appliance repair business NOW in your spare time and be set with a business of your own no matter what happens. You don't need elaborate fixtures or expensive equipment to be a successful repairman. Operate from your garage, basement, vacant store, etc. Work as many hours as you wish—the home appliance repairman is his own boss. It is a profitable occupation for on many types of repairs it is not unusual for a repairman to charge on the basis of \$5.00 to \$6.00 per hour. Don't gamble with your future—learn a trade that will always support you. Remember, as long as electrical appliances are used, there will be a need for electrical appliance repairmen.

If you are at all mechanically inclined—can hold and use tools—then you have all of the qualifications required for becoming a big money earning home appliance repairman. It does not matter if you have not had a great deal of schooling or had previous experience along these lines—**WE WILL TEACH YOU.** Age should be no barrier—nor should any minor physical handicap.

New Course Tells All

Profusely illustrated, our new course shows you in simple, easy to understand language and drawings how to make each repair on refrigerators, vacuum cleaners, washing machines, motors, etc. Explains and gives you a working knowledge of electricity, welding, nickel plating, etc. Shows you how to build the power tools you need and how to solicit and keep business coming to you. Not a theory course but an honest to goodness course written by and used by repairmen the country over. Price of course is so low that the savings on your own household appliance repairs will quickly pay for it. Act now! Mail the handy coupon below today.

Read What Our Students Say About Course

I really believe your course the best investment a mechanically minded man can make.—Claude E. Allen, Indianapolis, Ind.

I have received your Course in Appliance Repairing and I must say I am well pleased with same. I am only sorry I did not have said Course some years ago. I have learned so much more through this course I would not part with it.—Charles Schwarz, Hamilton, Ohio.

The Course in Appliance Servicing arrived a few days ago. Want to take out a few minutes of my valuable time to let you know that this is just what I have been looking for ever since I opened up my Fix-It shop. I must admit that you told the truth when you said that it contains quite a bit more information than I bargained for.—P. J. Bretl, Sebring, Ohio.

I am a mechanic for the Western Union Telegraph Co. Three days after receiving the lessons in refrigeration I earned the exact cost of the course.—Henry S. Lee, Washington, D. C.

I work day times at the shipyard and after 4:00 P.M. I operate from my cellar and garage. I average \$10.00 to \$15.00 clear every day.—Walter Hanby, Brockton, Mass.

GET STARTED TODAY — MAIL THIS COUPON

CHRISTY SUPPLY CO.
2835 N. Central Ave., Dept. D-3903
Chicago 34, Illinois

Please send me free illustrated literature about America's Fastest Growing Industry — **ELECTRICAL APPLIANCE REPAIRING.**

Name.....

Address.....

City..... State.....

WANT A GOVERNMENT JOB?



\$1,756 to \$3,021 Year to Start. Veterans Get Preference!

GET READY NOW FOR 1947 EXAMINATIONS

Railway Postal Clerks

Railway Postal Clerks get \$2,300 the first year regular, being paid on the first and fifteenth of each month. (\$95.84 each pay day.) Their pay is automatically increased yearly to \$3,600. Advance may be had to Chief Clerk at \$5,400 a year. (\$225.00 each pay day.) Age 18 to 35.



Travel for "Uncle Sam"

3 Days On -3 Days Off -Full Pay

Railway Postal Clerks on long runs usually work 3 days and have 3 days off duty or in the same proportion. During this off duty their pay continues just as though they were working. They travel on a pass when on business. When they grow old, they are retired with a pension.

City Mail Carriers, Post Office Clerks

Clerks and Carriers now get \$2,100 (\$175 a month) the first year on regular and automatically increase \$100 a year to \$3,100 (\$258.00 a month) and \$3,400. Age 18 to 50.



Ass't Statistical Clerk

Open to Men—Women 18 to 50. Entrance salary \$2,168 year. Appointments as Clerks in the Departments at Washington, D. C., are made from this examination.

Many Other Positions

Many other positions are obtainable. Those wishing these positions should qualify at once.

Get Free List of Positions

Fill out the following coupon. Tear it off and mail it today—now, at once.

This small investment may result in your getting a big-paid government job.

FRANKLIN INSTITUTE, Dept. B79, Rochester 4, N. Y.

Rush to me, entirely free of charge (1) a full description of U. S. Government Jobs; (2) Free copy of illustrated 32-page book, "How To Get A U. S. Government Job"; (3) List of U. S. Government Jobs; (4) Tell me what to do to prepare for one of these.

Name.....

Address..... Vet?.....

Use This Coupon Before you Mislaid it. Write or Print Plainly.

SAY YOU SAW IT IN POPULAR MECHANICS

Do You Make These Mistakes in English?

MANY persons say "between you and I" instead of "between you and me"—or use "who" for "whom"—or don't know whether to spell certain words with one or two "c's" or "m's" or "r's," or with "ie" or "ei," etc. Every time you speak or write you show what you are. Mistakes in English reveal lack of education, refinement. Lack of language power prevents you from presenting your thoughts in the strongest way. Real command of English will help you reach ANY goal. Stop making mistakes in spelling, punctuation, pronunciation, grammar. Increase your vocabulary.



Sherwin Cody

WONDERFUL INVENTION

Only 15 minutes a day with Sherwin Cody's new invention—and you can actually SEE your English improve. It teaches by HABIT—makes it easier to do the RIGHT way. Wonderful self-correcting lessons.

FREE BOOK ON ENGLISH Lack of language power may be cost- but your friendships, income, every year. See what Mr. Cody can do for you: it costs nothing to find out. Write this very minute for free book, "How You Can Master Good English in 15 Minutes a day." It will prove a revelation. WRITE NOW. SHERWIN CODY SCHOOL OF ENGLISH, 511 B & O Bldg., Rochester 4, N. Y.

AUTOMOTIVE MECHANICS BODY & FENDER REBUILDING

Pay is good in both these big branches of the Automobile Industry. Learn in few weeks in our big, modern training shops. Good pay for men who learn to service, repair, install all mechanical and electrical parts of autos. Learn to make used cars look like new—training in welding, aligning, mixing and matching colors, spray painting, power and hand tools. **CONSULTATION AND PLACEMENT SERVICE WHETHER YOU ARE INTERESTED IN WORTHWHILE JOB OR SETTING UP YOUR OWN BUSINESS** for men who learn to service, repair, install all mechanical and Mechanics for U. S. Army. If over 17 and under 60 learn how you can get started. Write for FREE FACTS today. If you are a veteran, we'll take care of all details if you qualify under G.I. Bill.

MOTIVE TRADES INSTITUTE, Dept. B-211

1400 Greenleaf

Chicago 26, Illinois

MAKE HUNDREDS OF FASCINATING

Radio-Electrical EXPERIMENTS

Only \$4.99 POSTPAID U.S.A.

IDEAL XMAS GIFT FOR BOYS!
Radio Electronic Experiment Kit

50 Piece Genuine Commercial war surplus Electronic apparatus. Includes headphones, capacitors, potentiometers, resistors, fuses, sockets, hook-up wire, etc. Build hundreds of fascinating experiments. Learn electronics at home. Send \$4.99 for kit, complete instructions, also blueprint for home lab, bench. Or send COD. LECO ENGINEERING CO., Box 931-PM2, Lincoln, Nebraska.



SHORTHAND in 6 Weeks at Home

Famous Speedwriting system. No signs or symbols; uses ABC's, Easy to learn; easy to write and transcribe; Fast preparation for a job. Surprisingly low cost. 100,000 taught by mail. Used in leading offices and Civil Service. Write for free booklet. **SPEEDWRITING, Dept. 1511-6, 55 West 42 St., N. Y. 18**

Learn Penmanship

You can learn plain, rapid writing or fancy ornamental writing for social and business advancement, right in your own home during spare time by my Simplified Method. Write for my free book, "How to Become an Expert Penman," which shows what others have accomplished by taking my Courses. Send 10c for one of my favorite Pen Points and your name with a beautiful flourished bird written on a card. Write today. T. M. Tevis, Box 25K, Chillicothe, Mo.

Fit-Rite makes False Teeth TIGHT

Makes loose dental plates fit snugly and comfortably. **LASTS for MONTHS!**

Simply squeeze on dental plate and put it in your mouth. Hardens and becomes part of plate. Money-back guarantee. **FREE** Generous package of Dental Plate Cleanser with each order. Send \$1.00 or mailed parcel post collect.

Fit-Rite Co., 1573 Milwaukee Ave. Dept. B-PM, Chicago, Ill.



POPULAR MECHANICS

Learn REFRIGERATION AND AIR CONDITIONING FROM THE INDUSTRIAL TRAINING INSTITUTE

America's Foremost School of **PRACTICAL TRAINING!**



ADMINISTRATION BUILDING



DEMONSTRATION LABORATORY



ELECTRONICS LABORATORY



REFRIGERATION LABORATORY



EXPERIMENTAL HOME

*Industrial
Training
Institute*

Here is an industry that offers every opportunity you could ask for. Good jobs—security—plenty of chance for advancement—a business of your own.

And here is a school equipped in every way to train you for Refrigeration and Air Conditioning work—one of the largest and most completely equipped schools of its kind in America—a school that already has trained thousands of men for just such opportunities.

GET READY NOW!

Learn Refrigeration and Air Conditioning—now, while the time is ripe. You don't need any advanced schooling or previous experience. If you are at all mechanically inclined and have gone to high school for at least one year or have an equivalent education, we can teach you Refrigeration and Air Conditioning.

**LEARN AT HOME
OR COME TO OUR SCHOOL**

You can take most of your training at home, in your spare time—or you can come to Chicago and take your entire training in our completely equipped shops and laboratories. Either way you quickly acquire the fine points, practical skill, and broad, tech-

nical "know how" that makes the expert Refrigeration and Air Conditioning Technician.

**FACTS ABOUT THE
INDUSTRIAL TRAINING INSTITUTE**

Founded in 1916. Has trained more than 400,000 men for practical work in industrial fields. From 1942 through 1945 trained specialized technicians, exclusively, for the Army, Navy and Marine Corps. Now training thousands of veterans under the G.I. Bill, both in its Residence Schools and by home-study. Occupies five buildings of its own. Has over \$500,000 invested in training facilities, with an instruction staff of more than 100 men. Known everywhere as America's foremost school of practical training for industry.

Get all of the facts about the opportunities in this interesting field of work, and about the I.T.I. system of training that has helped so many men into key jobs in this industry. Fill out the information coupon below and mail it TODAY. You will be under no obligation whatsoever.

**AUTHORIZED TO ACCEPT
VETERANS FOR G. I. TRAINING**



**REGISTRAR P-1L
INDUSTRIAL TRAINING INSTITUTE
2150 Lawrence Ave., • Chicago, 25, Ill.**

Please send me, FREE, your "Camera Visit" booklet and information about the opportunities for trained men in Refrigeration and Air Conditioning. It is understood that I will be under no obligation.

Name.....
Address.....
City..... State.....
Are you a veteran?.....

**GET THE FACTS MAIL THIS
COUPON
TODAY**

AUDELS POWER PLANT ENGINEERS GUIDE

WITH QUESTIONS AND ANSWERS

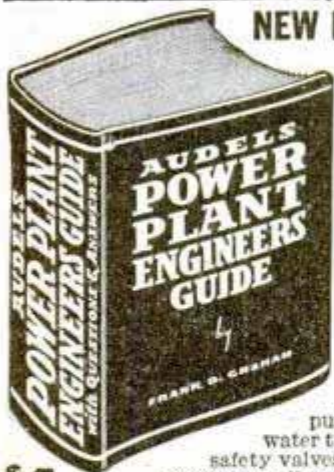

NEW FROM COVER TO COVER!

JUST PUBLISHED—For All Engineers, Firemen, Water Tenders, Oilers, Operators, Repair Men and Applicants for Engineers' License Examinations.

A Complete Steam Engineers' Library in One Book!
1500 PAGES—65 CHAPTERS
1700 ILLUSTRATIONS, FULL INDEX

1001 FACTS AT YOUR FINGER ENDS!

PRACTICAL INFORMATION IN HANDY FORM FEATURING:

Basic principles of Steam Engineering, including Boiler Construction, Operation and Repairs. Gives practical information on: Boiler Calculations, fuels, feed

pumps, water heaters, economizers,

water treatment, injectors, traps, draught,

safety valves, oil burners, stokers, condensers,

ejectors, cooling towers, evaporators, steam and hot

water heating, pipe fitting & tubing. Contains complete

data on all types of Steam Engines and Turbines, Indicators,

Valve gear, Valve setting, Air Compressors, Hoists,

Gas and Diesel Engine Operation, Lubrication.

\$4

COMPLETE

PAY \$1 A MONTH ONLY!

Get this information for yourself—ASK TO SEE IT—Mail coupon today!

AUDEL, Publishers; 49 W. 23 St., New York 10, N.Y.

Mail AUDELS Power Plant Engineers Guide (Price \$4) on 7 days free trial. If O.K. I will remit \$1 in 7 days and \$1 monthly until \$4 is paid. Otherwise, I will return it.

Name _____

Address _____

Occupation _____

Employed by _____ PM

Do you want

- ..to go to College?
- ..or to enter a Profession?
- ..or get an Office Position?

(Such as Accounting, Architecture, Nursing, Dentistry, Teaching, Social Work, Osteopathy, Beauty Culture, Optometry, Embalming, Chiropody, Law, Medicine, etc.)

High School Course at Home

Many Finish in 2 Years

American School, Dept. H-845, Drexel Ave. at 58th St., Chicago 37, Ill.

Gentlemen: Send me FREE information covering special training in subjects checked below. No obligation on my part.

- | | |
|--|--|
| <input type="checkbox"/> High School Course | <input type="checkbox"/> Diesel Engineering |
| <input type="checkbox"/> Architecture and Building | <input type="checkbox"/> Drafting and Design for Men & Women |
| <input type="checkbox"/> Automotive Engineering | <input type="checkbox"/> Plastics |
| <input type="checkbox"/> Business Management | <input type="checkbox"/> Private Secretary |
| <input type="checkbox"/> Electrical Engineering | <input type="checkbox"/> Mechanical Engineering |
| <input type="checkbox"/> Elec. and Gas Refrigeration | <input type="checkbox"/> Aviation |
| <input type="checkbox"/> Air Conditioning | <input type="checkbox"/> Salesmanship |
| <input type="checkbox"/> Railway Training | <input type="checkbox"/> Radio |
| <input type="checkbox"/> Electronics, Industrial | |

Name

Address

STUDY AT HOME

With An Educational Institution

Men with specialized training win higher positions, insure larger earnings, and are bigger successes in business and public life. Opportunities NOW greater than ever before. Send for our Catalog.

ARTS and SCIENCES

Courses in Philosophy; Education; Letters; Public Health; Medical Jurisprudence; Psychology; Sociology; Physics; Chemistry; Plastics; Geology; Political Science; Theology; Business and Commerce; Accounting; Mathematics; Statistics; Agriculture.

ENGINEERING

Courses in Electrical, Civil, Mechanical, Drafting, Architectural, Steam, Aeronautical, Radio, Structural, Mining, Industrial, Petroleum, Marine, Chemical, Diesel, Automobile, Refrigeration, and Air Conditioning Engineering.

LAW

Complete Professional Law Course includes 18 Hornbook Series college grade textbooks. Courses also in Commercial Law, Patent Law and Medical Jurisprudence.

McKinley-Roosevelt Incorporated, 4610-K, Sheridan Rd., Chicago 40, Ill.

ENGINEERING DEGREE IN 27 MONTHS

INDIANA TECHNICAL COLLEGE

Aeronautical, Chemical, Civil, Electrical, Mechanical, and Radio Courses, B.S. degree. 1-yr. diploma in Electrical, Mechanical, and Radio Service; Drafting, Prep. courses. Gov't. approved for GI's. Low rate. Earn board. Large industrial center. Demand for graduates. Enter Sept., Dec., March, June. Catalogue. 5116 E. Washington Blvd., Ft. Wayne 2, Ind.

LEARN MOVIE PROJECTION THEATRE MANAGEMENT



The Motion Picture Theatre Business offers big opportunities for trained men. Get into a fascinating field with a post-war future. Train at home in spare time. Free Catalog. Established 18 years.

THEATRE INSTITUTE, 370 Washington St., Elmira, New York

WHY JOB WORRY? LEARN ELECTROPLATING

Highly paid, uncrowded, interesting business. Part or full time. Chromium, Nickel, Gold, Silver, etc. Send postcard for FREE booklet and proof.

PLATER HYDE, Dept. M Post Office Box 176 National City, Calif.

FREE BARGAIN CATALOG of BOOKS

25,000 books of all publishers listed in our 52nd Annual Bargain Catalog of 320 pages. Old-time favorites—latest "best sellers." Reference, Fiction, Juvenile, History, Scientific, etc. Supplying schools, colleges, libraries and thousands of individual customers. Send postcard today for our new 1947 catalog, "Bargains in Books."

THE BOOK SUPPLY COMPANY, Dept. 134 564-566 West Monroe Street Chicago 6, Illinois



SAVE MONEY

PARAMOUNT ADJUSTABLE

BAR BELLS

DUMB BELLS \$9.95
at Factory Prices AND UP

WRITE FOR FREE BOOKLET WITH HINTS ON MUSCLE BUILDING

INDEPENDENT IRON WORKS

2414-40 E. 23rd St., L. A. 11, CALIF. DEPT. 10

ELECTRICIANS!

Free!

Get This Book of 150 Valuable Wiring Diagrams

ACCEPT THIS AMAZING BOUND VOLUME AS MY GIFT TO YOU! . . .

Here's one of the greatest "get acquainted" offers ever made. This book of 150 Electrical Shop Prints and Wiring Diagrams is YOURS—absolutely FREE. IT'S an outright gift—you pay nothing to get it and nothing to keep it.

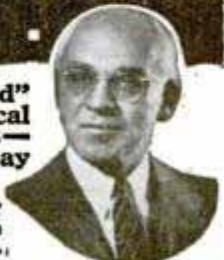

B. W. COOKE
Director

The book is "chuckful" of valuable charts, diagrams, wiring methods and instructions for reading and using wiring shop prints. You'll find its pages packed with up-to-the-minute electrical information. All the shop prints are full size with full explanatory information... they have all been developed and pretested in the big Coyne Training Shops. I WANT YOU TO HAVE THIS BOOK AS MY GIFT and HERE'S ALL YOU HAVE TO DO TO GET IT:

Examine My New 7 Volume Set Get This Book of 150 Shop Prints Free!

To get your FREE copy of this Shop Print book all you have to do is to let me send you my complete new 7 volume set of electrical books—COYNE PRACTICAL APPLIED ELECTRICITY for 7 days FREE examination. Here's a set of books written for the "beginner" or "oldtimer" in electrical work who is anxious to get ahead. This 7 volume set covers everything electrical from house wiring to advanced DC & AC motors and equipment. Thousands of "show how" diagrams and photos.

SEND NO MONEY!

The new 7 volume set of practical electrical books is so NEW, so DIFFERENT and so UNIQUE that you have to see the set to really appreciate how much it can mean to you and your future. So here's what I'll do—I'll send you the complete set of 7 volumes (pictured below) at my risk, postpaid for 7 days FREE Examination. I'll also send you the New Coyne Book of 150 Shop Prints & Motor Diagrams as my FREE gift to you TO KEEP REGARDLESS OF WHETHER OR NOT YOU DECIDE TO KEEP THE 7 VOLUME SET COYNE PRACTICAL APPLIED ELECTRICITY.

Keep ALL the books 7 days. If not 100% pleased with the 7 volume set just return it and you owe nothing. If you keep the 7 volumes you can pay for them at the special low rates shown here in the coupon at right.

Coupon Is Not An Order —UNLESS You Decide to Keep the Books

YOU'RE NOT BUYING THIS SET WHEN YOU SEND THIS COUPON, you're merely asking to see them FREE for 7 days. The coupon becomes an order only if you decide to keep the 7 vol. set after 7 days' examination. SEND COUPON NOW!



FREE BOOK COUPON

B. W. Cooke, Dir., Coyne Electrical School, Dept. 86-R6
500 South Paulina St., Chicago 12, Illinois

Send me the NEW 7 volume set COYNE APPLIED PRACTICAL ELECTRICITY. Also send me the bound volume of 150 Shop Prints which I am to keep FREE WHETHER I KEEP THE 7 VOL. SET OR NOT. I'll either return the 7 volume set in 7 days and keep the 150 Print book and owe nothing or I'll keep the 7 vol. set and pay \$3.00 in 7 days and \$3.00 per month until \$21.00 is paid or send \$19.75 cash. You include FREE one year consultation service and Technical Bulletins.

NAME _____ Age _____

ADDRESS _____

CITY _____ Zone _____ STATE _____

Check here if you want to pay postman cash price of \$19.75 (you save \$1.25) delivered. Same 7-day examination privilege and Money-Back Guarantee.

7 AMAZING VOLUMES

COVER everything from home wiring to DC-AC Motors and Equipment. Over 3000 subjects—2000 illustrations—5000 facts.

VOL. 1 Electrical Principles & circuits—signal systems—telephony; 450 pages.

VOL. 2 Wiring for Light, Power—Neon, Fluorescent, Aviation Lighting—Household Appliances—Farm Electricity; 460 pages.

VOL. 3 D. C. Motors and Controls, installation, operation and Maintenance, Welding—520 pages.

VOL. 4 A. C. Motors and Controls—Electronics—700 pages.

VOL. 5 Armature & Stator Winding and Repair—350 pages.

VOL. 6 Refrigeration & Air Conditioning; Radio—510 pages.

VOL. 7 Automotive, Diesel and Battery—420 pages.

COYNE ELECTRICAL SCHOOL

Dept. 86-R6 500 S. Paulina St., Chicago 12, Ill.

OIL BURNER

INFORMATION IN A HANDY FORM

JUST OUT!



A POCKET COMPANION THAT ANSWERS YOUR QUESTIONS!

AUDELS OIL BURNER GUIDE
— A new practical, concise treatise, 384 pages—31 Chapters — 321 Diagrams and Illustrations — covering Domestic and Industrial Oil Burners.

New from Cover to Cover, for mechanics interested in Oil Burners. Gives practical inside working knowledge of theory, construction, installation, operation, testing, servicing and repair of all types of oil burners. Includes electrical hook-ups and wiring diagrams of automatic control systems.

PRICE \$1 POSTPAID

Get this information for yourself. Mail coupon today. No obligation unless satisfied.

ASK TO SEE IT

AUDEL Publishers, 49 W. 23rd St., New York 10, N.Y.

Please mail AUDELS OIL BURNER GUIDE (Price \$1). If satisfactory, I will remit \$1 on its safe arrival, otherwise I will return the book.

Name

Address

Occupation

Employed by

Listen to this Record!



SPEAK SPANISH

FRENCH, GERMAN, OR ITALIAN

BIG OPPORTUNITIES and JOBS awaiting Americans who speak Spanish. Learn as easily as a child learns—“BY LISTENING” to these NEW CORTINA recordings.

Only 15 Minutes a Day

The CORTINAPHONE Method FAMOUS FOR 60 YEARS teaches you to speak SPANISH LIKE A NATIVE—right in your own home, relaxed and at ease. THOUSANDS have found it the most fascinating, most satisfactory method. Here is the quick, easy way to learn Spanish for PLEASURE and BUSINESS. Investigate!

Sent on 5 Days Approval



“THE CORTINA SHORT-CUT” tells just what you want to know. Interesting. Get it!

Write Today—NOW!

CORTINA ACADEMY (Language Specialists for 60 Years)
Dept. 6411, 105 West 40th Street, New York 18, N. Y.

Please send me—without obligation—your free booklet, “The Cortina Short-Cut.” I am interested in (mark):

SPANISH French Italian German

Name

Address

Learn PHOTOGRAPHY at Home Now

Portraiture, Press,

Commercial or Hobby



Whether it's for a full-time career or just plain fun, you'll enjoy learning photography this new, easy way. Every phase of photography is carefully covered, with the latest techniques and methods fully explained. There are thousands of opportunities in photography as a career, and hours of pleasure as a hobby, so make the most of them today.

12-Month Home Study Course

Written and directed by expert photographers with years of teaching experience at one of America's leading educational institutions. A really THOROUGH education in photography, taught in easy steps and simple terms. Write today for complete information.

MOODY EDUCATIONAL INSTITUTE, Inc.

208 E. Wisconsin Ave. Dept. 11-B6 Milwaukee 2, Wis.

LEARN WATCH REPAIRING



AT HOME. By our modern and original system of instruction you can learn every part of the WATCH REPAIRING TRADE AT HOME. Prepare yourself for a well-paying position or start in business after completing our course of instruction. Good watch repairers are in demand and generally earn very good salaries. For particulars apply to the Wisconsin School of Watch Repairing 759 North Milwaukee St., Milwaukee 2, Wis.

AVIATION TRAINING

Basic and Advanced Courses in
AERONAUTICAL ENGINEERING
also Pre-Engineering

Northrop Aeronautical Institute

1523 E. BROADWAY (Division of Northrop Aircraft, Inc.) LOS ANGELES COUNTY
HAWTHORNE CALIFORNIA

* SEND FOR ILLUSTRATED BOOK

CODE SPEED SHORT CUT

Be an expert. Learn to be a Telegraph or Radio Operator. Thousands of men needed. Intensely interesting work—good pay. Learn at home or wherever you are, quickly, easily with the famous Candler Speed System. Book of particulars Free. CANDLER SYSTEM CO., Dept. S-M, Box 928, Denver 1, Colo. U.S.A.

THERE'S MONEY IN CARTOONS!

RAYE BURNS will teach you HOW to CREATE ORIGINAL CARTOONS at home that you may SELL! Course contains 26 lessons and over 600 illustrations. All for Only..... \$2.85

Send name and address for free details.

RAYE BURNS SCHOOL, Dept. M, Box 3583, CLEVELAND, OHIO

Learn Public Speaking

Learn theory and fundamentals at home—in spare time. Then acquire actual experience and practice. Send for FREE booklet “Power of Effective Speech.”

— North American School, Dept. 1358
1315 S. Michigan Ave., Chicago 5, Illinois



MAKE MAGIC YOUR HOBBY

ENTERTAIN FOR FUN OR PROFIT!

Rush 25c for first issue of “MAGIC IS FUN,” new magazine that teaches how to do tricks with coins, cards, ropes, etc. FREE, with order, large catalog of magical apparatus. D. Robbins & Co., Dept. M-51, 152 W. 42 St., N.Y. 18, N.Y.

NOTICE: Over 125,000 ambitious men have been helped to higher paying jobs with the aid of books listed on this page.



Which of these books can help you GET A BETTER JOB AND MAKE MORE MONEY

CHECK THIS LIST OF MONEY-MAKING BOOKS

WOODWORKING

1. **CARPENTRY CRAFT PROBLEMS.** 320 pages explain and illustrate hundreds of practical solutions to all types of carpentry problems met by the amateur and professional woodworker. Complete in every detail...\$2.50
2. **BUILDING—FORMS, STAIRS, ROOFS.** Latest information on how to build forms, staircases, roofs, etc., correctly. For carpenters and their helpers. 250 pages, illus....\$2.50
3. **WOODEN BOAT AND SHIP BUILDING.** Solves every type of problem in building wooden boats and ships. 244 pp., illust...\$2.25
4. **HOW TO MAKE RUSTIC FURNITURE.** Hundreds of ideas and plans on making all types of rustic furniture for the home. Completely illust., thoroughly described...\$2.00
5. **WOOD TURNING.** An excellent book for every home craftsman. Tells and shows how to do the most artistic work. Numerous photos and many detailed drawings...\$2.50
6. **MODERN HOMECRAFT.** 240 pages of ideas for modern home furniture and how to make it. Scale drawings, fully illust...\$4.00
7. **BLUE PRINT READING.** A practical book that shows how to read and interpret blue prints. 111 pages, 69 illust...\$2.00
8. **CONCRETE DESIGN AND CONSTRUCTION.** 508 pages, 251 illust. A new and enlarged edition covering all phases of concrete work and how to do it...\$5.00
9. **HOME REMODELING.** An excellent book for those planning remodeling. Gives hundreds of ideas that save money and add beauty to the finished job. 528 pages, 319 illust. and 12 tables...\$5.00
10. **HOW TO PLAN A HOUSE.** Here's a book for every person who ever intends to build their own home. This book shows how to design every single part of a modern house to save you the most money. 525 pages, 8 full size blueprints...\$5.00

PAINTING

11. **HANDBOOK OF ORNAMENT.** For artists, designers, jewelers, architects, etc. Topics covered include: Elements of Decoration, Decorated Objects, and Ornaments as applied to Features. 3,000 illus., 548 pages...\$5.00
12. **INTERIOR WALL DECORATION.** Practical working methods for plain and decorative wall finishes. 185 illus., 491 pages...\$3.50
13. **THE MIXING OF COLORS AND PAINTS.** How to mix colors for interior decorating, arts, crafts, general mixing methods. 302 pages, fully illust...\$2.50

18. **CYCLOPEDIA OF PAINTING and DECORATING.** Covers methods, tools and materials for the home and workshop, including every branch of painting and decorating. Any particular job is fully explained with large illustrations to clarify text. 330 pages...\$3.50
19. **PAPERHANGING.** A practical book that shows you how to do your own papering and save many times the cost of this book. Plenty of illustrations. Over 200 pages...\$2.50
20. **FURNITURE, FURNITURE FINISHING, DECORATION and PATCHING.** Practical new book that covers Period Furniture, Furniture Decoration, Patching, Finishing and many special finishes. 580 pages, 300 illust...\$5.00

Guarantee

Gateway Books are guaranteed to be absolutely satisfactory in every respect, or your money will be cheerfully refunded. **The GATEWAY BOOK CO., Dept. PM-22 32 N. State — Chicago 2, Illinois**

AUTOMOTIVE SERVICE MANUALS JUST RELEASED!

Just released as Civilian Editions published for the most complete and authoritative information available. They cover all phases of repair and service and are specifically designed to be a source of information for all interested in automotive work. Books may be bought separately or in the money saving sets. Order books and sets by specific number.

SET NO. 1

21. **VOL. 1:** The Service Station, frames, wheels, suspension, steering and ride control, transmissions, clutches, universals, front and rear systems and brakes. App. 550 pages...\$4.00
22. **VOL. 2:** Power Plants, Oil and Cooling Systems, Engine Repair and Maintenance, Fuel and Ignition Systems, Automotive Electricity. Over 600 fact filled pages to help you...\$4.50
23. **Combination Price, the above two vols.** \$8.00

SET NO. 2

24. **The Engine**\$1.50
25. **Cooling, Lube and Fuel Systems**...\$1.50
26. **Automotive Electricity**\$1.50
27. **The Power Flow**\$1.50
28. **Chassis Units**\$1.50
29. **Combination Price, the above 5 volumes bound in paper, app. 300 pages**...\$6.75

REFRIGERATION - PLUMBING AIR CONDITIONING

30. **REFRIGERATION SERVICE MANUAL.** Domestic and Commercial refrigeration used in markets, milk depots, soda fountains, home refrigerators are all covered so you can service any of these and many other units easily.\$2.50
31. **PLUMBING INSTALLATION and REPAIR.** Practical 236 page book tells how to repair leaky faucets, clogged toilets, drains, pipes, traps, vents etc. 153 illust...\$2.50
32. **HEATING COOLING and AIR CONDITIONING.** 706 pages on heating of all types, cooling, Air Conditioning, equipment, furnaces, controls, etc. 64 charts, 351 illus...\$4.50

ELECTRICITY

33. **PRACTICAL ELECTRICITY and HOUSE WIRING.** An ideal book for around the home because it debunks all the mysteries of electricity and shows you how you can save plenty by doing all of your own wiring...\$2.00
34. **ARMATURE and MAGNET WINDING.** The construction of armatures and their repairs are fully covered with illust...\$2.00
35. **HOUSE WIRING MADE EASY.** Layout and plans for all phases of house wiring...\$1.50

METAL WORKING

36. **WELDING.** Arc, spot, butt and electric welding, etc. 280 pages, illust...\$2.00
37. **SHEET METAL WORKERS MANUAL.** Complete instructions and information on every phase of sheet metal working. Includes many tables. 552 pages, 375 illust...\$3.00
38. **METAL SPINNING** A new art of proven popularity. Step-by-step descriptions of the various phases of the craft show you how to make the most out of your metal work...\$1.75
39. **METAL SPINNING PROJECTS.** Tells how to make bowls, lamps, serving dishes, book ends, candle sticks, etc. Complete working patterns and instructions...\$2.75

HOBBIES

40. **TIN CAN PROJECTS.** Tells how to turn tin cans into objects of beauty that command high prices and praise. This handy book has all the working patterns and designs...\$1.50
41. **LEATHER WORKING.** Tells of tools, materials and equipment needed. Gives working drawings of key holders, billfolds, book marks, coin purses, belts, frames, etc...\$2.00
42. **HOW TO WHITTLE AND CARVE.** Complete directions for all types of whittling and carving of toys, jewelry, and novelties, etc. Illustrations simplify the work...\$2.75
43. **CREATIVE CRATE CRAFT.** Tells how to make clever and useful pieces of furniture from discarded crates and boxes...\$2.00
44. **IDEAS FOR THE YARD.** Novel book that gives hundreds of suggestions and plans for things you can make for your yard...\$1.50

SPECIAL If your purchase totals \$10.00 or more, and remittance is enclosed with order, we will send you any \$2.00 book you choose absolutely FREE.

14. **SPRAY PAINTING.** Spraying technique and operating instructions on paints, materials, finishes. 125 fully illust. pages...\$2.00
15. **HOUSE PAINTING METHODS.** 400 pages and 150 illust. cover the subject of house painting (of any surface) thoroughly...\$2.50
16. **WOOD FINISHING.** Wood finishes and problems, tools, materials...353 illust...\$2.50
17. **GRAINING.** A 240 page comprehensive book of instruction on the art of graining all surfaces. Many natural color plates...\$3.50

CHECK, CLIP AND MAIL THIS COUPON NOW

THE GATEWAY BOOK CO., 32 N. State St., Dept. PM-22, Chicago 2, Illinois

Please send the books I've circled. If C.O.D., I'll pay postman cost of books plus few cents postage and handling charge. If prepaid, Gateway pays all charges. If any book is not satisfactory, I will return it in 10 days and you will refund my money. No C.O.D.'s outside the U.S. Remit in U.S. funds.

1 2 3 4 5 6 7 8 9 10 11 12 13 14 15 16 17 18 19 20 21 22
23 24 25 26 27 28 29 30 31 32 33 34 35 36 37 38 39 40 41 42 43 44
(Please print name clearly)

Name.....

Address.....

City.....Zone.....State.....

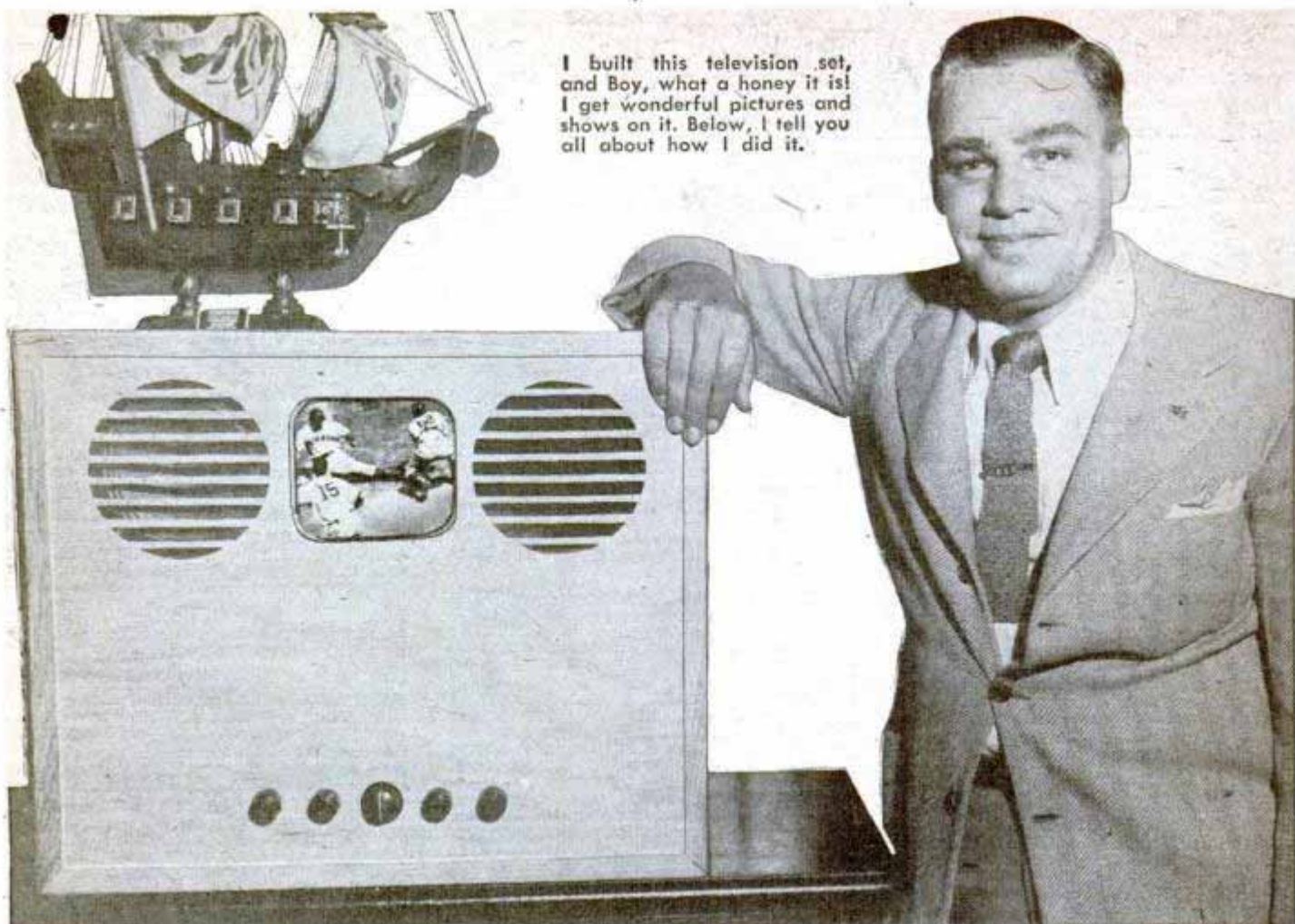

How I Built My Own Television Receiver

By Bill Nagel

NOT so very long ago, television was a complete mystery to me. But not only did I build a complete television receiver chassis, but I had a lot of fun doing it. And I've learned so much that I'm well on the road to becoming an expert.

The students you see with me also built receivers. The picture shows us aligning our sets.

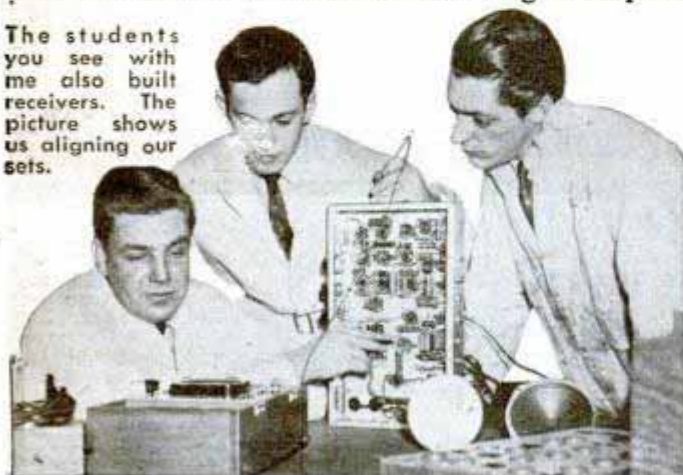

In a few years I'll be able to "write my own ticket."

I always had a yen to get into television, even while I was in the service. But I didn't know just how to go about it—until I heard about N.Y.T.I. of N.J. I went there with my discharge papers, and they did the rest. They showed me how the Veterans Administration would pay up to \$500 a year against my total educational expenses, under the G. I. Bill of Rights. This meant that I had to pay very little out of my own pocket. It's a big break for veterans like myself—especially when you get subsistence allowances in addition. And part-time jobs are easy to get so you can earn extra money. Of course, all of the students here aren't veterans.

What bothered me at first, was that my mathematics was kind of rusty. I soon found that the school had brush-up courses in math and even had facilities for teaching radio math from the beginning to students who had never had a high school education. I convinced them that I was sincere

Advertisement

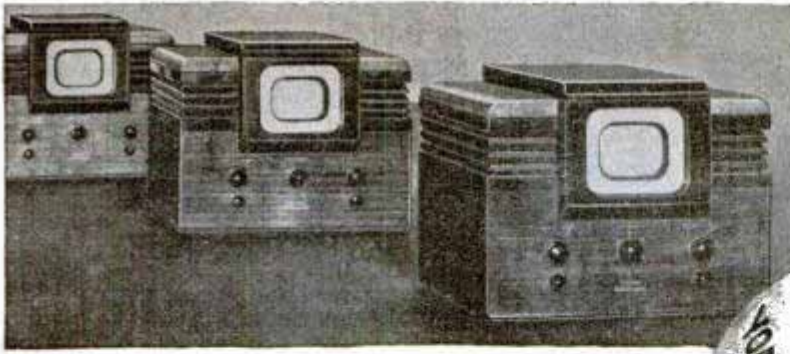

Here is a line of RCA television receivers that I and my fellow students use for comparative test purposes at N.Y.T.I. of N.J. The very latest equipment in television is ours to inspect and study at the school.

and enthusiastic and that I was technically inclined, and so I became a student. You know, you just can't build a television set right off. I built seven radio sets and had to go through a total of 75 electronic experiments, before they would even let me start on a television receiver.

Then I began work in earnest. The instructors around here have plenty on the ball, and it was amazing how fast I progressed. Boy, school was never like this. You should see the magnificent equipment. There's a swell gang here. They come from all over, because practical television schools are hard to find, and N.Y.T.I. of N.J. has a wonderful rep when it comes to television. I don't believe that you can find better training anywhere.

Another thing I like about N.Y.T.I. of N.J. (New York Technical Institute of New Jersey) is the convenient location. It's right in the heart of America's electronic industry, (Newark, N. J.), only 19 minutes from New York City. Big radio, television and electronics manufacturers are nearby—like RCA, General Electric and Edison. So are the big network stations like WJZ, WEAJ and WOR. This means that the school is always right in touch with the latest developments.

The conditions here are ideal. They have thousands and thousands of dollars worth of the latest



I want to learn about television transmitters also. Here you see one we have under construction. I hope to enroll for a special evening class on television transmitters.

types of equipment. There is a great deal of individual instruction and the instructors know their business.

I am sure there are a lot of fellows, particularly veterans, who want to get into this field. I understand there are about 120 openings now for new day students in the classes beginning this November and December. If you want the complete dope about the school, you can have a free bulletin, which illustrates and describes its facilities and equipment. It also tells the classes that may be attended, housing conditions, costs, hours, etc. There is no charge for this bulletin. Just ask for Bulletin 211. Send your postcard or letter to the New York Technical Institute of New Jersey, 158 Market Street, Newark, N. J.

These are my class-mates (note that I am second from the left, standing) with the television receiver chassis they built at the same time I built mine. I built the cabi-

net at home later on. Most classes are small, so you are sure of a lot of individual instruction, which is very important in learning the technical side of television.

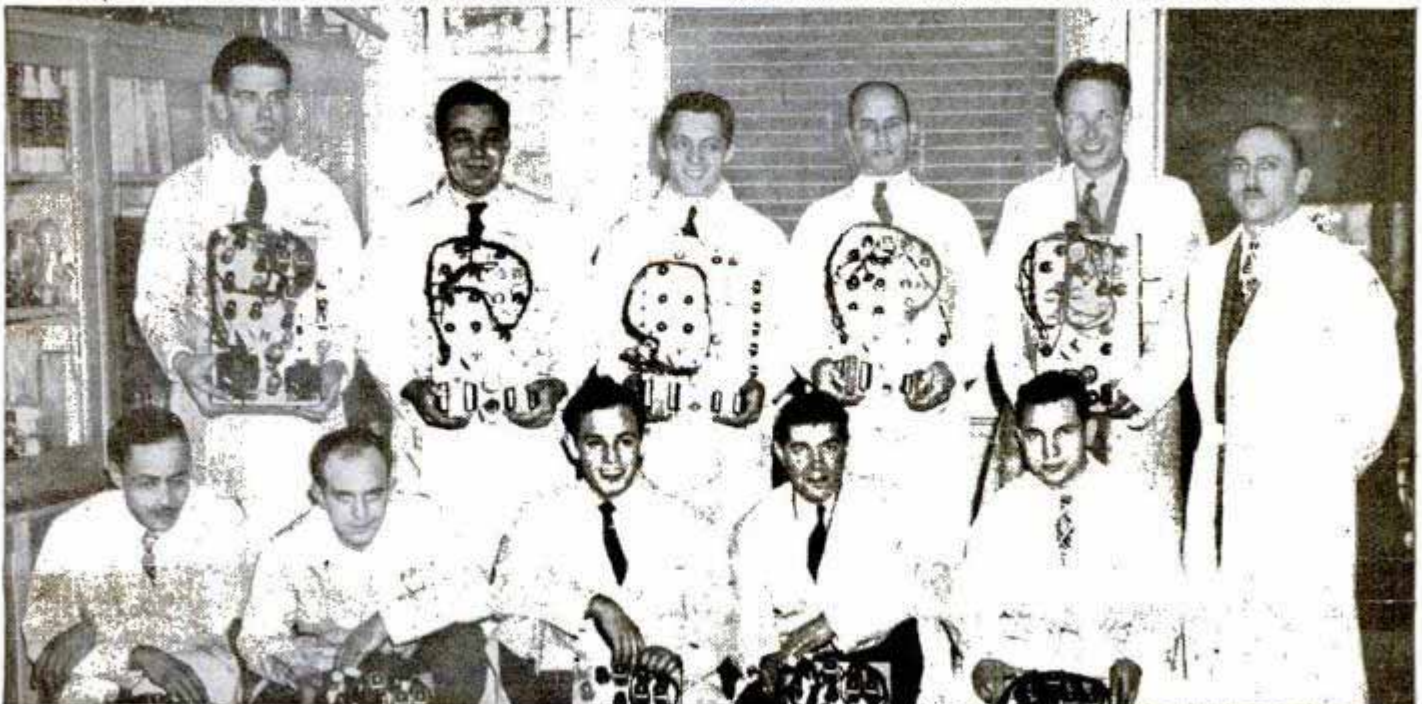

Advertisement

Give yourself the Backing of a
GREAT GROWING INDUSTRY



REFRIGERATION AIR CONDITIONING

Refrigeration and Air Conditioning have leading place in fast growing fields of our time. Trained men paid well to service, install, maintain, repair, rebuild household and commercial refrigerators. Important new developments such as Frozen Foods and many new industrial uses. Demand for commercial installations in restaurants, butcher shops, taverns, florists, bakeries, etc. — air conditioning in homes, offices, shops.



START NOW—Full and Part Time Earnings

There may never again be such opportunities for men who want better jobs or business of their own to get in on ground floor and go up fast! Many started with small investment who built good, growing business. If over 17 and under 60 learn how you can get started. **CONSULTATION AND PLACEMENT SERVICE WHETHER YOU ARE INTERESTED IN WORTHWHILE JOB OR SETTING UP YOUR OWN BUSINESS.**



Begin Training at Home or Come Directly to Shops

Begin your training at home in spare time, finish in our big, modern shops, or come directly to shops. At home you get C.T.I.'s SHOP PROVED HOME STUDY instruction—actual shop experience has gone into the practical lesson assignments. That is why it is easy for mechanically inclined men to learn by our Home Study training and start on actual refrigeration work.



A NATIONALLY KNOWN INSTITUTION

C.T.I. was only civilian school selected by Army to train service men for refrigeration. Same quality training available to you now. The method that has made rapid progress possible. Commercial Trades Institute has established its place in Air Conditioning and Refrigeration industries, and that is important to you in making your start.

VETERANS

Veterans qualifying under "G.I. Bill" have all expenses paid by Government plus monthly subsistence allowance. Just mail coupon, we will handle all details. (LOW TUITION, EASY TERMS if you are not a veteran.)

COMMERCIAL TRADES INSTITUTE
Dept. A-211

1400 W. Greenleaf Ave., Chicago 26, Ill.

FREE — Important Information Telling How to Get Started

CUT OUT COUPON BELOW

Fill Out, Cut Out, Mail Today

FACTS FREE for Men Who Want to Get Ahead
COMMERCIAL TRADES INSTITUTE, Dept. A-211
1400 W. Greenleaf, Chicago 26, Ill.

Send free illustrated Brochures and other information about Refrigeration and Air Conditioning.

Veteran

Non Veteran

Name.....

Address.....

City.....State.....

EASY to
PLAY

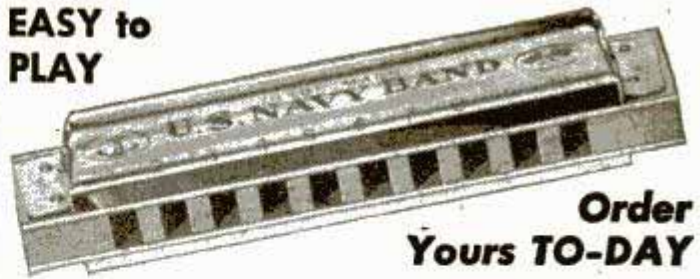

Order
Yours TO-DAY

The New Luellen HARMONICA

Most wonderful pocket instrument ever made is the harmonica. Easy to master, fun for Everyone. The Luellen has 10 holes, 20' notes. Key of C. Beautiful tone. Now ready. Postpaid Only..... **\$2.35**

INSTRUCTION BOOK. Simple for youngest child. No notes, scales nor exercises. Ten lesson charts show everything. Includes 75 popular songs. Price \$1.00. Here's our special introductory offer: The Instructor and the Harmonica, both postpaid, both for \$2.85. Send Check or Money Order Today.

JOHN LUELLEN & CO., 17034 Page Ave., Dept. 1103, Hazelcrest, Ill.

TRAIN for SUCCESS in the Poultry Business

Study at
Home in
spare time.
Earn extra
while learn-
ing.



YOU CAN MAKE MORE MONEY from POULTRY. Proper management means profits ANY season, for life. Get latest scientific methods that avoid losses and mistakes. Our famous system of Home Study Training has helped thousands to success. Extra profits from the start. **FREE Catalog;** describes courses, methods, service. Write today to Dept. 50.

NATIONAL POULTRY INSTITUTE, Adams Center, N. Y.

BUILDING



Millions of homes needed. Nation wide call for builders. Big opportunities. Learn now in spare time, — at home. Practical training with blue prints. No books. Send for **FREE Trial Lesson** and blue print plans.

CHICAGO TECHNICAL COLLEGE

P-150 Tech. Bldg., 2000 S. Mich. Ave.
Chicago 16, Ill.

What Every Mason Wants



We have important Masonic books for Blue Lodge, Chapter, Commandery, Scottish Rite, and Shrine.

Our Rituals Are Used the World Over. Send for free catalog of books and rituals for Masons, Odd Fellows, Knights of Pythias, Knights of Columbus, etc.

EZRA A. COOK, Publisher, P. O. Box 796, PN. Chicago 90, Ill.

FIGURE DRAWING WITHOUT A MODEL

This book brings famous art schools right to your home! Over 300 "real-life" drawings in this new Cliff Young book. Copy from them to guide your Art Career. Only \$1 postpaid. Order Now; Art Books list included **FREE.**

HOUSE OF LITTLE BOOKS, 80-A East 11th St., New York 3



SUPER YOUR GREATEST ASSET!

FACTS — FIGURES — FACES
at your command through the new improved **SUPERMEMORY** course
MEMORY
THOR BOOKS, Z-2, Box 1210, Chicago

Learn BAKING At Home

Baking is one of America's high industries in wages. Nearly depression-proof. Thorough basic home course lays sound foundation. If you have aptitude, write for **FREE BOOKLET, "Opportunities in Commercial Baking."**

National Baking School, 1315 Mich. Ave., Dept. 1358, Chicago 5





GET INTO RADIO TELEVISION ELECTRONICS... NOW

SAMPLE LESSON Free!



A BIG, POWERFUL RADIO AND EXPERIMENTAL EQUIPMENT ARE INCLUDED WITH YOUR TRAINING

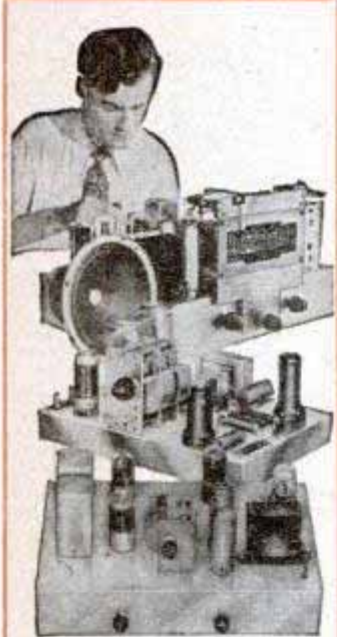

Here is some of the Radio equipment that is furnished you at no extra cost with National's Shop Method Home Training. BUILD A BIG, SEVEN TUBE, LONG DISTANCE SUPERHETERODYNE, an audio oscillator, a signal generator (low powered Radio transmitter) and many other units. Really Learn by Doing! Earn money early in the Course doing spare time Radio work.

Get Ready — at Home — in Spare Time For Opportunities of Peacetime Industrial Expansion PREPARE NOW—With Shop Method Home Training BY A REAL ESTABLISHED RESIDENT SCHOOL

No doubt about it! — Radio, Television and Electronics is a dynamic, growing industry that offers opportunity TODAY for the Trained Radio Technician. It is a field with a proved future. Good jobs, interesting and profitable jobs are available in Radio Service, Broadcasting, Marine and Police Radio, Manufacturing, Public Address, and other specialized phases. Untold Radio sets are in use—they need maintenance and repair. Many, many more must be built to satisfy even normal demand. Trained men are constantly needed to keep this pulsating industry moving ahead. If you are mechanically inclined, if you are sincere and will follow instructions, you too can find your opportunity in Radio, Television and Electronics—either in business for yourself or in a responsible position in industry. TAKE THE FIRST STEP TODAY! FOR FACTS-PACKED WITH OPPORTUNITY FOR YOU JUST MAIL THE COUPON BELOW.

Learn By Doing Right At Home

The secret of the success of this practical training method is the experience of working with actual full size, standard equipment during your training. Here's a fully tested and approved method—simple and direct, easy to understand and put into PRACTICE! You check what you know as you go along. You can see progress right from the start.

It will only take a moment to fill out and send the coupon for a sample trial lesson. PROVE TO YOURSELF HOW MUCH YOU CAN ACCOMPLISH IN A SHORT TIME.

National Training Is More Than Book Theory

National Schools can furnish you this modern, complete, up-to-date training in Radio, Television and Electronics for National has the Shops and Laboratories where instructors work with students and technicians to bring you—right in your own home—in your spare time—the kind of practical in-

struction, practice and experience that assures definite progress—step-by-step through the entire field.

Rush Coupon Today For Full Details

See what definite practical progress YOU YOURSELF CAN MAKE WITH JUST A SINGLE LESSON, sent to you with no obligation.

No salesman will call on you from National. You make up your own mind. IT COSTS YOU NOTHING TO READ THE INTERESTING FACTS.

VETERANS

—If you qualify for training under the G.I. Bill of Rights check the coupon for a Special Bulletin.

41 Years Experience Training Men for Success!

Get this complete, special manual "Modern Radio Servicing." It's full of valuable how to do it information.

See for yourself how YOU can become a thoroughly qualified Radio, Television and Electronics Specialist. No obligation. You may keep the manual. IT IS YOURS FREE.



ALSO THIS BIG OPPORTUNITY BOOK FREE!

Tells of the many fine, good-pay jobs in Radio, Television and Electronics—How to start your own life-time business. FILL OUT AND SEND THIS COUPON—NOW!

THESE MEN KNOW

For over 40 years National training has given ambitious men their start in life and helped them win success and security. National graduates everywhere gratefully admit that they owe their success to National Training. They all started the same—by investigating what National has to offer.



Joseph Michel, Jr., Granite City, Illinois, says: "I am enclosing a letter I received very shortly after enrolling . . . I shall receive a salary advance of \$225 per month with an increase of \$300 shortly. Had I not taken advantage of the work National Schools sent me I would not have been able to interest this employer."

Clifford Hannah, Portage LaPrairie, Manitoba, Canada, writes: "My training has brought results as I'm in line for another raise, thanks to National's encouragement and thorough training. You can count on me as a real National booster."



NATIONAL SCHOOLS

LOS ANGELES 37, CALIFORNIA EST. 1905



MAIL OPPORTUNITY COUPON FOR QUICK ACTION

National Schools, Dept. PM-11
4000 South Figueroa Street
Los Angeles 37, California

(Mail in envelope or paste on penny post card)

Mail me FREE the books mentioned in your ad including a sample lesson of your course. I understand no salesman will call on me.

NAME.....AGE.....

ADDRESS.....

CITY.....ZONE.....STATE.....

Check here if veteran of World War II

Ghirardi Makes it Easy for You to LEARN RADIO-ELECTRONICS

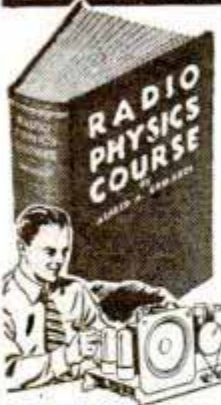

**AT HOME . . . IN SPARE TIME
FOR ONLY \$5 for the complete training**

We'll PROVE Ghirardi's famous RADIO PHYSICS COURSE book can teach you basic Radio-Electronics quicker and easier than any other book or course—for only \$5 COMPLETE. We'll prove you'll be pleasantly surprised how quickly it helps you understand every one of the hundreds of subjects covered. We'll prove that this 972-page book is so fine and so complete that, if broken into lesson form as a correspondence course, you'd regard it as a bargain at \$50 or more! If not more than satisfied after reading it for 5 full days, send it back. EVERY CENT will be cheerfully refunded.

36 BIG COURSES IN ONE

Ghirardi's RADIO PHYSICS COURSE book is more widely used for home study, by more Signal Corps and Navy Schools than any other book of its kind. Nothing is omitted, nothing condensed. Starting with Basic Electricity, it takes you step by step through the entire Radio field. Everything is made crystal clear. No lessons to wait for. Many students have completed it in a few weeks—and a high percentage of them are now successful Radio experts! 508 illus. 856 Self Test Review Questions.

9 OUT OF 10!

On actual survey among 817 radio experts, engineers, etc., 9 OUT OF 10 said Ghirardi's RADIO PHYSICS COURSE was their 1st choice—far better than any other radio instruction on the market!

5-DAY MONEY-BACK GUARANTEE

Dept. PM-116, Murray Hill Books, Inc., 232 Madison Ave., New York 16, N. Y.
 Enclosed find \$5 (\$5.50 foreign) for which send Ghirardi's RADIO PHYSICS COURSE book postpaid. Or, send C.O.D. (no foreign C.O.D.'s) for this amount plus postage. In either case, if not fully satisfied I reserve right to return book within 5 days for full refund.

Name.....
 Address.....
 City & Dist. No.....State.....

AUDELS Carpenters and Builders Guides 4 vols. \$6



Inside Trade Information for Carpenters, Builders, Joiners, Building Mechanics and all Woodworkers. These Guides give you the short-cut instructions that you want—including new methods, ideas, solutions, plans, systems and money saving suggestions. An easy progressive course for the apprentice and student. A practical daily helper and Quick Reference for the master worker. Carpenters everywhere are using these Guides as a Helping Hand to Easier Work, Better Work and Better Pay. To get this assistance for yourself, simply fill in and mail the FREE COUPON below.

Inside Trade Information On:

How to use the steel square—How to file and set saws—How to build furniture—How to use a mitre box—How to use the chalk line—How to use rules and scales—How to make joints—Carpenters arithmetic—Solving mensuration problems—Estimating strength of timbers—How to set girders and sills—How to frame houses and roofs—How to estimate costs—How to build houses, barns, garages, bungalows, etc.—How to read and draw plans—Drawing up specifications—How to excavate—How to use settings 12, 13 and 17 on the steel square—How to build hoists and scaffolds—skylights—How to build stairs—How to put on interior trim—How to hang doors—How to lay floors—How to paint.



THEO. AUDEL & CO., 49 W. 23rd St., New York City

Mail Audels Carpenters and Builders Guides, 4 vols., on 7 days' free trial. If O.K. I will remit \$1 in 7 days, and \$1 monthly until \$6 is paid. Otherwise I will return them. No obligation unless I am satisfied.

Name.....
 Address.....
 Occupation.....
 Reference.....PM

NOW! LEARN HARMONICA New, Quick, Easy Way

**10 Easy Lessons
in 10 Minutes!**

Master Harmonica music in matter of minutes! No notes. No scales. No exercises. Anybody, young or old, can learn quickly and easily by new Rhythm Method of Harmonica Magic. New method endorsed by world's largest distributor of Instruction Book on Harmonica. 75 SONGS INCLUDED WITHOUT A PENNY'S EXTRA COST! Don't wish you could play a Harmonica. START PLAYING right away and win new friends and still greater popularity over night. Rush order today while limited supply of Harmonica Magic Book of Easy Instructions is still available. We pay postage. Just enclose Remittance under Money-back Guarantee.



Only **50¢** WHILE THEY LAST

ORDER NOW!

THE NEW PLASTIC HARMONICA and INSTRUCTION BOOK.....\$1.00
 THE GAY ENTERPRISES Dept. PM-3, Box 3445 Merchandise Mart, CHICAGO 54, ILL.

LAW

STUDY AT HOME Legally trained men win higher positions and bigger success in business and public life. Greater opportunities now than ever before. **More Ability: More Prestige: More Money** We guide you step by step. You can train at home during spare time. Degree of LL.B. We furnish all text material, including 14-volume Law Library. Low cost, easy terms. Get our valuable 48-page "Law Training for Leadership" and "Evidence" books FREE. Send NOW. **G. I. APPROVED.** LASALLE EXTENSION UNIVERSITY, 417 South Dearborn Street A Correspondence Institution Dept. 1164-L, Chicago 5, Ill.

TRAIN Your VOICE!
Results GUARANTEED
 We build, strengthen the vocal organs—not with singing lessons—but by sound, scientifically correct silent and vocal exercises and absolutely guarantee complete satisfaction with results. Write for Voice Book. FREE. Sent to no one under 17 years old unless signed by parent. Perfect Voice Studios, Studio 1358, Kimball Hall Bldg., Chicago 4, Ill.

REFRIGERATION SERVICE MECHANICS COURSE AND AIR CONDITIONING

Learn at home—how to start your own repair shop on little capital. No previous experience needed. Common school education sufficient. Splendid opportunity for older men. Prepare now for your future. FREE illustrated booklet. **MECHANICS TRAINING SCHOOL** 7217 So. Broadway, Dept. P-11, Los Angeles 3, Calif.



OZMENT'S INVENTION, corrects poor penmanship in few hours. Guaranteed. Write, Ozment, 72, St. Louis, Mo.

BOOKS FOUND FREE!

WHAT BOOKS DO YOU WANT?
 We quote the lowest market prices. No charge for locating Hard-to-Find and Out-of-Print Books. All books, OLD or NEW, mailed POST-FREE. **SEARCHLIGHT BOOK CLUB**, 22 East 17th St., New York City

LEARN MASTER MACHINIST MECHANICAL DRAFTING

Expert training on Lathes, Milling Machines, Shapers, Grinders, etc.—Mechanical Drafting, Blueprint Reading and Designing. Allied shops are completely equipped and modern. Approved for G. I. Training Days, Evenings.

ALLIED SCHOOL OF MECHANICAL TRADES 1330 South Michigan Ave. Chicago 5, Illinois

THOUSANDS NOW PLAY

who never thought they could!



Learned Quickly at Home

I didn't dream I could actually learn to play without a teacher. Now when I play for people they hardly believe that I learned to play so well in so short a time.
*H. C. S., Calif.



Plays at Dances

I have completed your course and your lessons have been most satisfactory. I can play all of the popular songs. I have also earned money playing at dances.
*E. N. J., New York.



Wouldn't Take \$1000 for Course

The lessons are so simple that anyone can understand them. I have learned to play by note in a little more than a month. I wouldn't take a thousand dollars for my course.
*S. E. A., Kansas City, Mo.

You, too, can play any instrument by this easy A-B-C method



Finding New Joy

I am finding a new joy that I never experienced before, for I have always wanted to play, but had given up hope until I heard of your course.

C. S. Lucien, Okla.



Anyone Can Learn

I first thought I wouldn't ever learn to play by note, but I soon discovered that the lessons are so simple anyone can understand them. I am thankful that I study with your school.

R. F. Maxeys, Ga.

* Actual pupils' names on request. Pictures by professional models.

YOU think it's difficult to learn music? That's what thousands of others have thought! Just like you, they longed to play some instrument—the piano, violin, guitar, saxophone or other favorites. But they denied themselves the pleasure—because they thought it took months and years of tedious study to learn.

Learn in Spare Time at Home

And then they made an amazing discovery! They learned about a wonderful way to learn music at home—without a private teacher—without tedious study—and in a surprisingly short time. They wrote to the U. S. School of Music for the facts about this remarkable short-cut method. And the facts opened their eyes! They were amazed to find how easy it was to learn.

The result? Over 850,000 men and women have studied music at home this simple, A-B-C way. Now, all over the world, enthusiastic music-lovers are enjoying the thrilling satisfaction of creating their own music. They have found the key to good times, popularity and profit.

COSTS LESS THAN 7c A DAY

And that's what *you* can do, right now. Get the proof that you, too, can learn to play your favorite instrument—quickly, easily, in spare time at home

for less than seven cents a day. Never mind if you have no musical knowledge, training or talent. Just read the fascinating illustrated booklet and Print and Picture Sample that fully explain all about the famous U. S. School of Music method. If interested tear out the coupon now, before you turn the page. U. S. School of Music, 711 Brunswick Bldg., New York 10, N. Y. Largest school of its kind in the world.

Forty-eighth year
(Est. 1898)

NOTICE

Please don't confuse our method with any systems claiming to teach "without music" or "by ear." We teach you easily and quickly to play **real music**, any music, by standard notes . . . not by any trick or number system.

FREE PRINT AND PICTURE SAMPLE

U. S. School of Music, 711 Brunswick Bldg., N. Y. 10, N. Y. I am interested in music study, particularly in the instrument checked below. Please send me your free illustrated booklet, "How to Learn Music at Home," and your free Print, and Picture Sample.

Piano	Saxophone	Trombone	Practical
Guitar	Trumpet Cornet	Flute	Finger
Hawaiian	Reed Organ	Modern	Control
Guitar	Tenor Banjo	Elementary	Piccolo
Violin	Ukulele	Harmony	Mandolin
Piano Accordion	Clarinet		

Name..... Have you Instrument?.....
(Please print)

Address.....

City..... State.....

NOTE: If you are under 16 years of age, parent must sign coupon.

SAVE 2c — STICK COUPON ON PENNY POSTCARD



AUTO

BOOKS ON APPROVAL

SEND NO MONEY. Just mail the coupon for a complete set of Six Big Auto Books, 20th Edition. Whether you are a mechanic or helper, expert or apprentice, auto owner or driver, take immediate advantage of this FREE EXAMINATION OFFER.

**MAKE GOOD MONEY NOW
HOLD A PERMANENT JOB**

America wants its automobiles kept in good repair. Men with "know how" are in demand, at big pay. These books will help you get and hold an important job, or give you a chance to go into business for yourself now or later. Any man who half tries to improve himself can learn auto servicing and repairing by this quick reference method. Use the JIFFY INDEX to find easily understood answer to any auto problem. These wonder books prepared by eleven of America's great automobile engineers. Many hundreds of valuable illustrations. Send the coupon TODAY.

**[A year's consulting privileges with
our engineers now given with
these books without extra charge.]**
Vocational Publishers Since 1898

CAN YOU FIX IT?

These wonder books tell step by step HOW to make difficult repairs and adjustments, how to keep a car at maximum efficiency, including latest improvements in car design and operation. Engine troubles and how to correct them well covered.

6 BIG VOLUMES
2800 pages, 2000 illustrations, wiring diagrams, etc., including Diesel engines. Beautiful modernistic, washable cloth binding.

AMERICAN TECHNICAL SOCIETY, Dept. A819
Drexel Ave. at 58th St., Chicago 37, Ill.

I would like to examine your Six-Volume Set of Auto Books. I will pay the delivery charges only, but if I choose I may return them express collect. If after 10 days' use I prefer to keep them, I will send you \$2 and pay the balance at the rate of only \$3 a month until \$24.80 has been paid. Please include consulting service as offered above.

Name
Address

City State

Please attach letter stating age, occupation, employer's name and address and name and address of at least one business man as reference. Men in service, also please give home address.

Learn this Profitable Profession



**IN 90 DAYS
AT HOME**

Money-Making Career Open to Men and Women, 18 to 50

Hundreds of men and women between 18 and 50 make \$10 to \$20 in a single day giving scientific Swedish Massage and Hydro-Therapy treatments. There is big demand from doctors, hospitals, sanatoriums and clubs. Graduates earn large full time incomes from these or in private practice in their own offices. Others make good money from home treatments given in spare time. Learn this interesting, money-making profession in your own home, through our home study course. Same instructors as in our nationally known resident school. You can win independence and prepare for future security by qualifying for your Diploma. Course can be completed in 3 to 4 months. Many earn while they learn. Begin your training at once.



Anatomy Charts & Booklet FREE

Enroll now and we will include, at no extra cost, many needed supplies. Fit yourself to help meet growing demand for Scientific Swedish Massage. Send the coupon at once for complete details. Anatomy Charts and 32-Page Illustrated Booklet, FREE, postpaid.

THE COLLEGE OF SWEDISH MASSAGE
Dept. 664-P, 100 East Ohio St., Chicago 11, Illinois

Please send me FREE and postpaid, Anatomy Charts, 32-page Booklet and complete details on Home Training.

Name
Address

City State

BE A LANDSCAPE ARCHITECT WORK OUTDOORS



The field of Landscape Gardening offers unusual opportunities for trained men... greatly augmented by the huge home-building and modernizing program ahead. We provide thorough, interesting home-training during your spare time... adapted to your regional conditions.

Healthful, pleasant outdoor work in an uncrowded field.

APPROVED for VETERANS

BE YOUR OWN BOSS

A graduate says, "I finished the course about two months ago and now I average about \$2.00 per hour net for my time."

There are many employment opportunities in this profitable, uncrowded field or you can easily start your own business. Write today.

Service from Coast to Coast

NATIONAL LANDSCAPE INSTITUTE

DEPARTMENT P 756 SOUTH BROADWAY — LOS ANGELES 14

Learn SPANISH New Easy Way

How To Speak SPANISH



Learn Spanish New Easy Way

SELF-PRONOUNCING BOOK makes it easy to start right off speaking SPANISH sentences. Over 110 pages, gives hundreds of sentences, pronunciation tables, useful vocabulary. Ideal for high-school and college students, as well as business men and women. Beautifully printed, pocket size, stiff art-cloth binding. A book you'll prize a lifetime. Learn Spanish this new easy way. Send check or dollar bill.

POSTPAID ONLY
\$1.00

FIELDING-TURNER PRESS
323A Cypress Kansas City, Mo.

ACCOUNTING

STUDY AT HOME for C.P.A. and BIG PAY Accounting opportunities with 42 year old school. No previous training needed. Texts furnished. EASY PAYMENTS. Send for FREE BOOK.

Mac CORMAC EXTENSION SCHOOL
Dept. 11-B, 1170 East 63rd St., Chicago 37, Ill.



STATEMENT OF THE OWNERSHIP, MANAGEMENT, CIRCULATION, ETC., REQUIRED BY THE ACTS OF CONGRESS OF AUGUST 24, 1912, AND MARCH 3, 1933, of Popular Mechanics Magazine, published monthly at Chicago, Illinois, for October 1, 1946.

Before me, a Notary Public in and for the State and county aforesaid, personally appeared H. H. Windsor, Jr., who, having been duly sworn according to law, deposes and says that he is the Editor of the Popular Mechanics Magazine, and that the following is, to the best of his knowledge and belief, a true statement of the ownership, management (and if a daily paper, the circulation), etc., of the aforesaid publication for the date shown in the above caption, required by the Act of August 24, 1912, as amended by the Act of March 3, 1933, embodied in section 537 Postal Laws and Regulations, printed on the reverse of this form, to wit: First, That the names and addresses of the publisher, editor, managing editor, and business managers are: Publisher, Popular Mechanics Company, 200 E. Ontario St., Chicago, Ill.; Editor, H. H. Windsor, Jr., 200 E. Ontario St., Chicago, Ill.; Managing Editor, R. M. Grant, 200 E. Ontario St., Chicago, Ill.; Business Manager, P. H. Dunakin, 200 E. Ontario St., Chicago, Ill. Second, That the owner is: (if owned by a corporation, its name and address must be stated and also immediately thereunder the names and addresses of stockholders owning or holding one per cent or more of total amount of stock. If not owned by a corporation, the names and addresses of the individual owners must be given. If owned by a firm, company, or other unincorporated concern, its name and address, as well as those of each individual member, must be given.) Popular Mechanics Company, 200 E. Ontario St., Chicago, Ill.; H. H. Windsor, Jr., 200 E. Ontario St., Chicago, Ill.; H. H. Windsor, Jr., Trustee for H. H. Windsor III and Wm. T. Windsor, 200 E. Ontario St., Chicago, Ill. Third, That the known bondholders, mortgagees, and other security holders owning or holding 1 per cent or more of total amount of bonds, mortgages, or other securities are: (if there are none, so state.) The Equitable Life Assurance Society of the United States, 29 S. LaSalle St., Chicago, Ill. Fourth, That the two paragraphs next above, giving the names of the owners, stockholders, and security holders, if any, contain not only the list of stockholders and security holders as they appear upon the books of the company but also, in cases where the stockholder or security holder appears upon the books of the company as trustee or in any other fiduciary relation, the name of the person or corporation for whom such trustee is acting, is given; also that the said two paragraphs contain statements embracing affiant's full knowledge and belief as to the circumstances and conditions under which stockholders and security holders who do not appear upon the books of the company as trustees, hold stock and securities in a capacity other than that of a bona fide owner; and this affiant has no reason to believe that any other person, association, or corporation has any interest direct or indirect in the said stock, bonds, or other securities than as so stated by him. Fifth, That the average number of copies of each issue of this publication sold or distributed, through the mails or otherwise, to paid subscribers during the twelve months preceding the date shown above is (not daily publication). (This information is required from daily publications only.) H. H. Windsor, Jr., Editor. Sworn to and subscribed before me this 20th day of September, 1946. Vera L. Frechill, Notary Public. (My commission expires July 17, 1949.)

They're Back! BETTER THAN EVER BEFORE!

The New 1947-1948 **MIDWEST** POST-WAR ENGINEERED **RADIOS**

Featuring this Powerful
SERIES 16*
AM-FM
CHASSIS

AT SENSATIONAL
FACTORY-TO-YOU
PRICES

ONCE again Midwest demonstrates its 27 years of leadership with this amazingly powerful Super DeLuxe Series 16* 5-band world-ranging radio that brings you noise-free FM reception plus Standard Broadcast and 3 short wave bands. You'll be thrilled by its marvelous tone... its wealth of new post-war features... its world-ranging performance that brings you the world's finest radio programs with amazing clarity and strength. Send today for the new FREE 1947-1948 Midwest Catalog before you buy any radio and take advantage of our sensational Factory-to-you values and liberal 30 days Trial Offer.

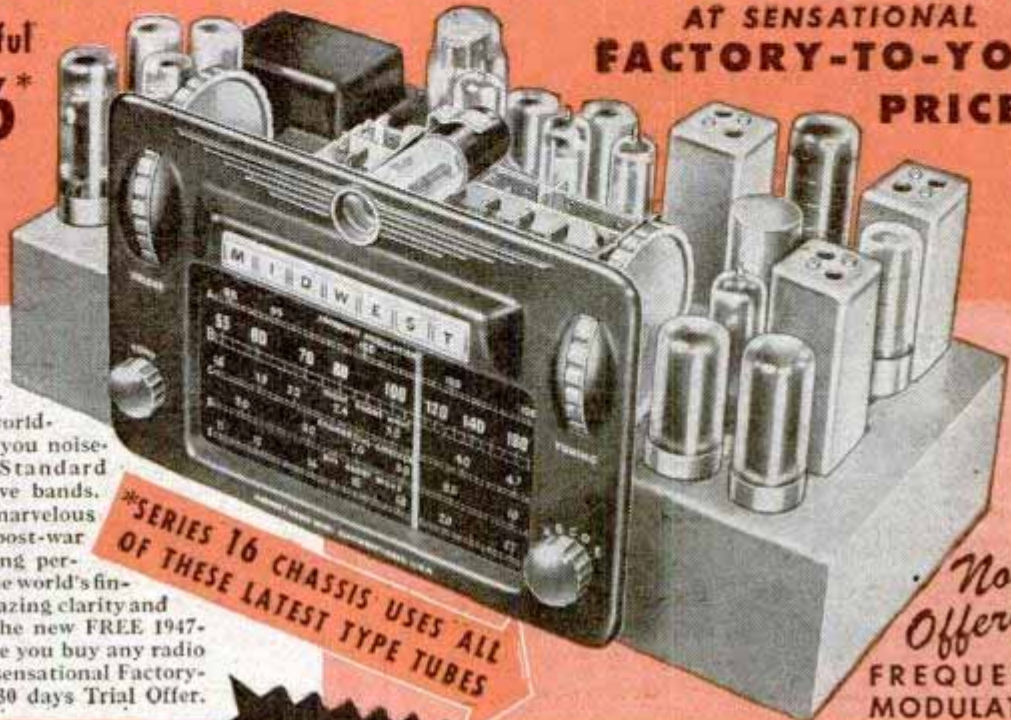

***SERIES 16 CHASSIS USES ALL OF THESE LATEST TYPE TUBES**

Now Offering
FREQUENCY MODULATION

PUT THIS WORLD RANGING CHASSIS IN YOUR PRESENT CABINET OR SELECT A NEW **MIDWEST** FROM

30 DAYS TRIAL

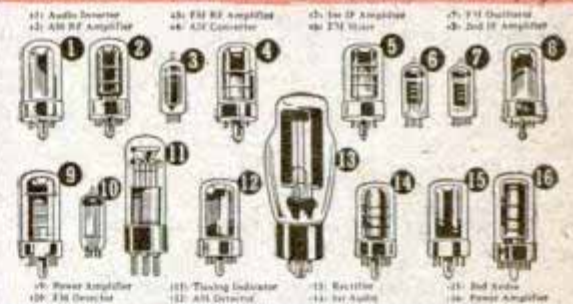

THE MAGNIFICENT LINE OF BRILLIANT NEW CONSOLE AND TABLE MODEL RADIOS AND RADIO-PHONOGRAPHS



The **SYMPHONY GRAND** SERIES 16* AM-FM RADIO-PHONOGRAPH CONSOLE with **NEW AUTOMATIC RECORD-CHANGER**

A REAL masterpiece of cabinet design and radio engineering... a luxurious musical instrument that brings you the newest marvels of radio science, including static-free FM, automatic record changing 5 wave bands and scores of marvelous new features and improvements—for your listening pleasure. For complete details of this and many other Midwest Radio models send for your copy of the 1947-1948 Midwest Catalog today.

EASY TERMS

Rush for Free Catalog!

FILL IN COUPON AND MAIL TODAY OR JUST SEND YOUR NAME AND ADDRESS ON 1c POSTCARD

MIDWEST RADIO CORP.
Dept. 25-A, 909 Broadway
Cincinnati 2, Ohio

Gentlemen: Please send me your new FREE catalog and details of your liberal 30 Days Trial.

Name _____
Address _____
City _____ Zone _____ State _____

MIDWEST RADIO CORP.
Dept. 25-A • 909 BROADWAY • CINCINNATI 2, OHIO

Learn HOW TO REPAIR ELECTRIC APPLIANCES

**START YOUR
OWN SHOP
Be Independent**



H. T. ARMSTRONG
General Manager

You Can Pay for Your Home Training With Just One Good Repair Job!

You can make more money when times are good, and you don't have to worry about losing your job when times are slow if you have your own electrical appliance repair business. There is always a demand for repairmen. And it's a type of work that can't be done by a machine. Nearly 5,000,000 additional American homes have been wired for electricity since 1940 . . . making the opportunity and demand for service mechanics in this field the greatest in history.

Interesting Work! Easy to Learn!

Our practical, easy to learn home training teaches you, during your spare time, how to repair washing machines, vacuum cleaners, stoves, lamps, motors, irons, etc., and how to do house wiring. You can start a business of your own in your garage or basement with \$20.00 worth of tools. One good repair job can pay for the cost of the entire course. Write today for further information, without obligation.

NEW BOOK "HOW TO START YOUR OWN BUSINESS" Sent at no extra cost if you act promptly. This valuable book covers locating your shop, contains drawings of how to build and wire work-benches, where and how to advertise, what to charge, how to hire solicitors, etc.

MAIL TODAY for FREE BOOK!

H. T. Armstrong, General Manager
PACIFIC TRAINING SCHOOL
7217 So. Broadway, Dept. 11-P, Los Angeles 3, Calif.
Dear Sirs: Please send me, without obligation, your free catalog and full details.

Name.....
Address.....
City.....State.....

Walt Disney Films

Your Own Little Theatre



**MICKEY MOUSE
VIEWER and
No. 1 Film Strip...**

\$1 This beautiful plastic Mickey Mouse Viewer and Walt Disney's world famous "Brave Little Tailor" in an exciting condensed version FULL color 16mm film strip. 16 actual scenes from the original film. The Special Gift Set includes the Mickey Mouse Viewer and 13 thrilling full color condensed version 16mm film strips, each strip showing 16 scenes from Walt Disney's world famous pictures, 3 Academy Award Winners!

PLEASE SEND ME A SPECIAL GIFT SET FOR ONLY \$3.95
 PLEASE SEND ME A MICKEY MOUSE VIEWER AND "BRAVE LITTLE TAILOR" FOR ONLY.....\$1.00

REMITTANCE ENCLOSED \$ —
AT YOUR DEALER'S, OR Dept., PM-11

CRAFTSMEN'S GUILD

6916 Romaine Street, Hollywood 38, California

EASY TO LEARN CODE

Learn or increase speed with an Instructograph—the Code Teacher that takes the place of an operator-instructor and enables anyone to master code without further assistance. Available tapes from beginners alphabet to typical messages on all subjects. Speed range 5 to 40 WPM. Always ready—no QRM. Thousands have "acquired the code" with the Instructograph System. Write today for convenient rental and purchase plans.



INSTRUCTOGRAPH COMPANY

Dept. M, 4701 Sheridan Road, Chicago 40, Ill.

INVENTING

—FOR PROFIT! If you have an inventive turn of mind, write for free 28-page booklet explaining how the Institute of American Inventors is helping inventors pre-test the profit possibilities of proposed devices to fill today's unprecedented demand for useful new inventions.

INSTITUTE of AMERICAN INVENTORS

Dept. 4, 1926 Eye St., NW, Washington 6, D. C.

So You Think You're Living?

Yes, you're going through the motion, all right—eating, sleeping, working and all that. But are you really LIVING? And how do you KNOW you are living? To find out read "Life Unlimited," a message for immortals. Your copy mailed free on request.

LIFE UNLIMITED, Dept. PM-11

3227 Indiana Ave.

St. Louis 18, Mo.

HOME STUDY OR SHOP TRAINING

Learn Plastics, Refrigeration or Diesel. Study at home, shop work later. Also shop courses in Body and Fender, Machine Shop, Tool and Die. 41,000 graduates. Established 1902. Free booklet. Specify trade.

GREER SHOP TRAINING, Dept. 1116, 460 S. State St., Chicago

WATCHES WANTED Broken or Usable

All kinds. Highest Prices paid for jewelry, rings, spectacles, gold teeth, diamonds, Sterling Silver, etc. Cash mailed promptly. Write for free shipping container.

LOWE'S, Dept. PM, Holland Bldg., St. Louis 1, Mo.

STAMMER?

This new 128-page book, "Stammering, Its Cause and Correction," describes the Bogue Unit Method for scientific correction of stammering and stuttering—successful for 45 years. **Benj. N. Bogue, Dept. 1842, Circle Tower, Indianapolis 4, Ind.**

GET THIS
FREE
BOOK!

MONEY for MEN ALL FREE

THE PLASTEX Industry needs manufacturers on small scale and for big production of Lamp and Clock Stands, Art Goods and Novelties in Plastex and Marble imitation. Experience unnecessary. 1 1/2¢ material makes regular 10¢ store sellers. Rubber moulds furnished for speed production. Small investment brings good returns. Big chain store orders now being placed. Ambitious men have chance for real prosperity. Our Free booklet will interest and benefit you.

PLASTEX INDUSTRIES, Dept. P, 1085 Washington Ave., New York, N. Y.



Find OPPORTUNITY Where DEMAND is Great!

AUTO BODY and FENDER REPAIRING



You men who are tired of being rutted in your job should look into a field where demand is huge—and gives every indication of growing even larger! Such a field is AUTO BODY and FENDER REPAIRING. As long as there are cars on the road, there'll be dents and bumps to be fixed, body repairs to be made, replacements of worn or damaged parts! The more cars—the more WORK!

Millions of old cars are on the road today, with fenders and bodies in great need of repair and refinishing. Thousands are rolling off production lines now. Within a short time they'll be coming into shops for maintenance.

Here is a Trade that Needs Manpower!

The man with ambition recognizes great opportunity here for life-time work, either at a dependable job or in his own business. For AUTO BODY and FENDER REPAIR is the kind of business which can be started with small capital. And, what's more, AUTO BODY and FENDER REPAIRING, as taught by UEI, is easy to learn! No previous experience nor high school education is necessary—what's needed is a liking for mechanical work.

Old Established School Offers Practical Training HOME STUDY AND SHOP PRACTICE

UEI's Course in *Auto Body and Fender Repairing* is arranged so you can begin your study in spare time, without interfering with your present job. You learn about auto body repairs and refinishing, body alignment, and many other subjects. Then, when you have completed your home study, you continue your course here in our well-equipped residential school where you receive practical experience in the repairing and refinishing of damaged bodies, tops, doors and fenders, the replacing of door panels and turret tops, use of tools, spray painting, acetylene welding, under personal supervision of capable instructors.

GET FULL FACTS FREE!

Since 1927, UEI has trained thousands of men for new opportunity fields, and students are making good. If you want to get ahead, get full facts about Auto Body & Fender Repairing, and its opportunities. Don't wait—investigate now. Mail coupon today.

OTHER U. E. I. TRAINING OPPORTUNITIES

Practical Shop Training after preliminary Home Study.

DIESEL

Engine Operation, fuel systems, auxiliary equipment, repairs and maintenance.

WELDING

Arc and Acetylene. With fundamentals of metallurgy and supervised welding practice.

REFRIGERATION

Servicing and installation for all commercial and domestic types.

AIR CONDITIONING

Installation, operation and maintenance of home and industrial equipment.

WRITE FOR FREE INFORMATION

FILL OUT AND MAIL COUPON

Founded 1927

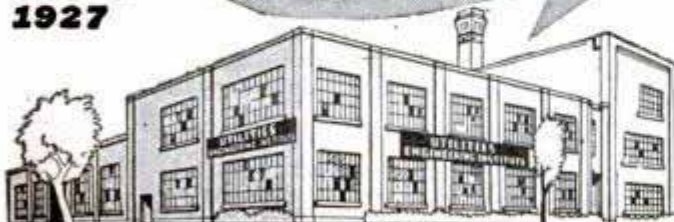

UTILITIES ENGINEERING INSTITUTE

1314 W. Belden Ave., Dept. 1116X Chicago 14, Ill.

Utilities Engineering Institute, Dept. 1116X
1314 W. Belden Ave., Chicago 14, Illinois

Yes! Send me the facts FREE about the field checked below.

- Auto Body and Fender
 Diesel Engine
 Welding
 Refrigeration
 Air Conditioning

NAME _____ Age _____

Address _____

City _____ ZONE or COUNTY _____ State _____

- If World War II Veteran give length of service _____
 Check here for special information if you are under 17.

HUNTERS! LEARN NOW AT HOME

to MOUNT BIRDS

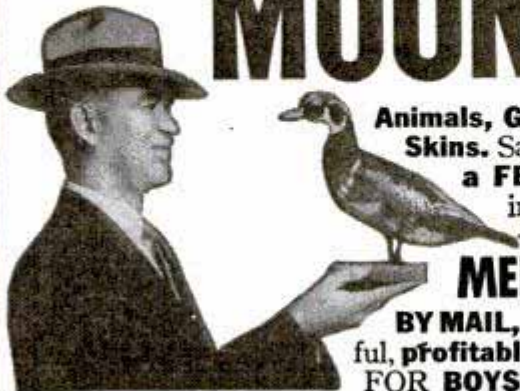

Animals, Game-heads, Fish, Pets and to Tan Skins. Save your valuable trophies. Kill only a FEW game birds but **DOUBLE** your interest and pleasure in hunting.

MEN, BOYS! Be an expert taxidermist! Learn quickly **BY MAIL**, from our simple lessons. A wonderful, profitable hobby for expert hunters and ALSO **FOR BOYS** and **YOUTHS** on farm or in city.

FUN • FASCINATION • PROFIT

Have a Home Museum

SPORTSMEN, YOUNG AND OLD. Here is the grandest hobby in the world for Hunters, Anglers. If you **EVER** hunt or fish, even seldom, **YOU** will be delighted with **taxidermy**. Save those wonderful trophies; mount them just like life, and create a **home museum** that will amaze family and friends and make you **well known and popular**.

Help Save the Game

Shoot fewer specimens, **yet double your fun**. Help save the disappearing wild-game. Join "**DUCKS UNLIMITED**" in wild-game preservation. Shoot only a **FEW** wild-ducks, mount them for your den or home and have **MORE PLEASURE** than you ever had by killing the bag limit. Help keep wild-game forever. "**Eat your trophy and have it too.**"

WHAT YOU LEARN

Our simple lessons teach you **QUICKLY**, right in your own home in your spare time, to **MOUNT**—beautifully and permanently, **BIRDS, ANIMALS, GAME-HEADS, FISH**, just like museum exhibits. You will also learn the wonderful **KROME-TANNING**. You can then **TAN** fine furs for garments, also skins into real leather. Write today.

LESSONS WORTH \$1,000.00

E. J. Riordan says: "I am more than delighted. My friends are amazed and urge me to mount their specimens. I think your course is worth a thousand dollars, yes it is priceless to sportsmen. I am known everywhere as a 'taxidermist,' and earn fine profits in my spare time mounting for other sportsmen. All thanks to your great school."

HE AND PARTNER SUCCEED

John H. Sizys writes: "I and Bob, my partner, who is only 14 years of age have mounted more than 50 specimens. I shall send you a picture of our 'museum,' which is becoming famous. We learned quickly from your simple lessons, in spare time. Your great school is doing a wonderful job. All sportsmen should join it."

MEN, BOYS, Send Today! Don't delay. Obtain **FREE BOOK** before the supply is exhausted. . . nothing like it in the entire world. Write Now. A Postal will do.

NORTHWESTERN SCHOOL OF TAXIDERM
3378 Elwood Bldg. Omaha 8, Nebraska

300,000 STUDENTS

This vast number of **MEN, BOYS AND WOMEN** are delighted members of the famous, reliable 35 year old sportsmen's school. Think of that! They are located all over the world. **YOU are invited to join this grand throng. Send for the FREE BOOK** this very minute.

Sportsmen, Boys

All hunters OF **COURSE** save their trophies now-a-days. The school **INVITES THE BOYS TOO**; boys as young as 12 or 13 years succeed in Taxidermy. **Get the FREE BOOK**, join the school.

BIG, EASY PROFITS

Mount and Tan for others. Work comes from far and near. Many students earn fine **PROFITS** from spare time. **SO CAN YOU. RUSH THE COUPON.**

Wild-Game Not Needed

Mount squirrels, rabbits, pigeons, frogs, chicks, crows, hawks. Make craft-work: book-ends, door-stops, gun-racks hundreds of valuable and delightful creations. **What a Hobby for you!**

FREE BOOK!

Yes, **FREE**, 44 pages, with 100 unique pictures of taxidermy work. No other book in the world like this. It will thrill and amaze you. **Ask today for your free copy. State your AGE.**

Send the Coupon!

Write name plainly in coupon or margin, or a post card will do. **Rush your request, as free books may be exhausted quickly. Decide now. Don't wait a moment. State your age.**

FREE BOOK

Northwestern School of Taxidermy,
3378 Elwood Bldg., Omaha, Neb.
Send me your free illustrated book, "How to Mount Game". Also tell me how I may learn this fascinating art easily and quickly by mail. No obligation. State your age.

Name _____ Age _____
Address _____



INVENTORS

The inventor who believes he has a new and useful invention, and finds himself in need of advice, should consult a competent registered patent attorney.

The question as to whether a subject matter is patentable can be substantially determined by a search of the United States Patent records.

Without obligation, write us for information as to what steps an inventor should take to secure a Patent.

RANDOLPH & BEAVERS

Registered Patent Attorneys

11-D Columbian Bldg., Washington 1, D. C.

RANDOLPH & BEAVERS

11-D Columbian Bldg., Washington 1, D. C.

Please send me full information on how to secure Patents & Trademarks.

Name.....

Street.....

City..... State.....



NEW EASY WAY TO LEARN TO PLAY

POPULAR PIANO with Wellerphone Educational Records and Instruction Books

Play popular Piano as the Professionals do! Learn this new, faster, easier way -- with records. Ben Weller, well known professional teacher, teaches you right at home in your spare time -- with his Wellerphone Educational Records and Instruction Books. You read a short, easy lesson; listen to the exercise on the record; follow the professional style in your practice. That's all. It's a quick, easy short-cut to Popular Piano as Professionals play it--Almost anyone with just a little Musical Knowledge can learn at a cost of less than 60¢ per lesson.

Plan now to begin. Write TODAY for full information on this new, faster, easier way to learn Popular Piano. Address

WELLERPHONE CO. DEPT. A
P. O. Box 2762 Kansas City, Mo.



HUNTING and FISHING

is a monthly magazine crammed full of hunting, fishing, camping, dog and boating stories and pictures, invaluable information about guns, fishing tackle, game law changes, best places to fish and hunt--countless ideas that will add more fun to your days afield.

Special Trial Offer
Send 25c in stamps or coin and we will send you Hunting & Fishing for six months.

HUNTING & FISHING MAGAZINE
251 Sportsmen's Bldg., Boston, Massachusetts



PATENTS AND TRADE MARKS
C. A. SNOW & CO.
Registered Patent Attorneys Since 1875
Write for Free Book and "Certification of Invention" form
427 SNOW BUILDING, WASHINGTON 1, D. C.

PATENTS Free preliminary advice
E. E. VROOMAN, Patent Lawyer
Registered Patent Attorney Since 1902
871 Woodward Building, Washington 5, D. C.

ARTISTS MAKE MONEY

Do you like to draw? Send name, address, age and occupation for FREE ART TEST, to find out your ability.

ART INSTRUCTION, Inc.

11136 ART INSTRUCTION BLDG., MINNEAPOLIS 15, MINN.

- ★ **PHOTO DEVELOPING & PRINTING** ★
- ★ Work and Service that can't be beat. Sixteen Famous ★
- ★ Century-Tone prints each 8-exp. roll 30c. FREE MAILERS. ★
- ★ Send roll and money. ★
- ★ **CENTURY PHOTO SERVICE Dept. X La Crosse, Wis.** ★

MECHANICS!

Engineers! Mathematicians! Others! Amazing new book gives instant solutions to 100,000 practical problems. Covers mechanics, hydraulics, electricity, construction, physics, chemistry, medicine, agriculture, shop-work, trigonometry, measures and weights. Details free.

Columbia Graphs, Columbia, Connecticut

HIGHWAY ENGINEERING
PRACTICAL TRAINING IN HIGHWAY DESIGN AND PRACTICE.
HOME STUDY -- BY MAIL ONLY -- WRITE US NOW!
SCHOOL OF HIGHWAY PRACTICE
DEPT. A, 2161 SHATTUCK AVE. BERKELEY 4, CALIF.

MAGIC FOR EVERYONE

Wonderful Magical Tricks for Pocket, Parlor, Club or Stage. Amusing Hobby. Profitable Profession. Profusely Illustrated Catalog of over 300 Magic Tricks sent for 10c coin or stamps.
A. MAGICIAN, 2463 Kensington Ave., Philadelphia 25, Pa.

LEARN INCREASE YOUR EARNINGS
Streamlined Home Study Course Now Available -- Prepared by Successful Accountant
ACCOUNTING Penny post card brings full information
WESTERN HOME STUDY INSTITUTE
P.O. Box 2506, San Francisco 26, Calif.

Say you saw it in POPULAR MECHANICS



Thrilling Work COLORING PHOTOS
Fascinating vocation learned at home by those with aptitude. Thrilling pastime. National method brings out life-like colors. Free booklet.
NATIONAL PHOTO COLORING SCHOOL
1315 S. Michigan, Dept. 1358, Chicago 5

100 DIFF. FOREIGN COINS \$5.00
2 small or 1 large Genuine Roman Coins 2000 years old. \$1.00
Lists -- Approvals

DEL MONTE • 40 W. 18 • New York 11



MAKE YOUR OWN COSTUME JEWELRY
BIG EARNINGS AT HOME

YOU can make costume earring and pin sets, brooches, necklaces, dress clips, cameos, etc.
WE supply the jewelry findings; bar pins, ear screws, jump rings, chains, screws, stone sets, sequins, shells, boxes, cement, cards, etc.

WRITE FOR FREE CATALOGUE

PHILADELPHIA BADGE, 1007 FILBERT ST., PHILA. 7, PA.

BIG MONEY and YOUR OWN BUSINESS in LIQUID MARBLE!

FREE INFORMATION ON THREE BIG NEW MONEY-MAKING OPPORTUNITIES

Regardless of your age, sex, previous experience, and whether you are an ex-serviceman or not, we will send you astonishing free facts about the unlimited possibilities — in your own business — with amazing LIQUID MARBLE and our other marvelous new products. To secure this information, absolutely free, fill in coupon below or send a letter or postcard. No salesman will call on you now or ever. Write TODAY! Offer limited.



- 1 **LIQUID MARBLE.** Make beautiful artificial Marble Slabs. Pour from liquid state. Glazed or unglazed. This marble may be mottled, veined, multi-colored or left in original snow-white state. The color is actually a part of the marble! Does not fade or wear away. LIQUID MARBLE is unsurpassed on kitchen or bathroom walls. Easy to make and install.
- 2 **PLASTIC FLOORING.** May be made in any color or combination of colors. Gives a lifetime of wear. Dustproof. Soundproof. Verminproof. Resilient to the tread. Lay out solid from wall to wall or in pattern design of various shaped blocks.
- 3 **FLEXIBLE MOLDS.** For plaster casting. Make your own molds for few cents each. \$1.00 in raw materials will make up to \$25.00 worth of finished goods. We furnish names of buyers.

FREE! EXTRA! If you write us promptly we will include free information about our other big money-making businesses. These include Compo-Tile Roofing and Caen Stone, Plastic Wood, Artificial Marble and Granite, Stone and Metal Solder, Plastic Tile Cement, Papier Mache, and many others.

FREE INFORMATION COUPON!

COMPO-TEX, Box 786-RP, St. Louis, Mo.

Please send me free details of your **BIG THREE** Money-Making Propositions including LIQUID MARBLE. Also include information about the additional new business possibilities given directly above.

Name.....
Street.....
City..... State.....

Greatest Opportunities NOW!

With reconversion going ahead full speed, NOW is the time to line up your own money-making business. We offer you our **BIG THREE** money-making opportunities together with other equally profitable businesses. (See paragraph at right.) Get the FREE facts TODAY!

COMPO-TEX, Box 786-RP, St. Louis, Mo.

FIX ANY RADIO

Amazing New Invention



PRICE ONLY \$1.50 COMPLETE

NEW PICTURE METHOD

Learn quickly to repair radio sets. New revolutionary different comparison picture method quickly simplifies all radio servicing. No previous radio knowledge required. Introductory training included. Find any radio fault with ease. Do expert radio work almost immediately. Repair radios in minutes instead of hours. Plan U. S. Copyrighted. Take advantage of this new invention. You can fix any radio after a few hours.

NO EQUIPMENT NEEDED

Most tests described require the use of only a screw driver, pliers, and a piece of wire — no testers needed. Simple point-to-point picture suggestions tell you where to look for defects, how to test radio circuits and parts, and how to make the repair. You may try the plan for 10 days without any risk.

RADIO MADE EASY

Let this unique plan with its easy-to-understand diagrams, hints, simplified illustrations, practical examples, and job-sheets teach you basic radio facts. Learn important short-cuts in radio trouble-shooting. Make needed tests without testers, trace the signal, find all faults within the hour after receiving the plan. Follow the comparison tests given on large trouble-shooting diagram blueprints. Over 1,000 repair hints. Data on all tubes. Circuits and hints for many types of radios — new and old models.

10 DAYS "NO RISK" TRIAL

Examine and use **Simplified Radio Servicing** plan for 10 days in your own home. Apply this technique and repair one or more radios. Then decide to keep this greatest radio training bargain, or return the material and get your money refunded in full. You take no risk.

Complete \$1.50 plan, only

In manual form, 8 1/2 x 11" Trouble-shooting charts. Data on 346 radio tubes. 63 large job-sheets. 1,000 time-saving hints. Covers all types of sets — new and old, FM, portables. Developed by Beitman, noted engineer, teacher, and author. Order today on 10-days no-risk-trial →

REPAIR RADIOS IN MINUTES

Read the introductory job-sheets, follow the step-by-step picture blueprints, and fix any radio in a matter of minutes. Do radio work for fun and profit. The complete simplified training is yours for only \$1.50.

MORE HELP — IF NEEDED

Supplement your study, clear-up all hard problems, get ahead in Radio. A companion 22 lesson **Radio Servicing Course** will give you added assistance, help you get ahead faster, presents important facts in greater detail. Include this large manual also in your trial order. See coupon →

NO RISK TRIAL COUPON

SUPREME PUBLICATIONS, 9 S. KEDZIE AVE., CHICAGO 12, ILL.

Ship the following manuals to me for 10 days' trial under your money-back guarantee. I am enclosing \$.....full price. Ship postpaid.

Simplified Radio Servicing @ \$1.50 **Radio Servicing Course @ \$2.50**
Complete manual as described. Companion Volume, 22 lessons.

Name:.....
Address:.....



BECOME an ACCOUNTANT

IF you are doing the "chore" work, of accounting as a bookkeeper, ledger clerk, cost clerk, or in one of the other many record keeping jobs—

You should consider climbing higher—becoming an accountant.

Why be satisfied all your life with a small salary and an ordinary job when there is such a large future for the man or woman who understands accountancy in all its forms and phases?

One big difference between you and the successful accountant is that he doesn't do the chores. He bosses those who do the drudgery and he gets the money and prestige. And he does that because he knows the principles behind the records you keep—can plan those records and interpret them to management. He knows what you know—and a lot more.

There are two ways in which you can get this knowledge which will qualify you for an accountant's position.

First—the old way of day-by-day experience on the job. This is the long route—taking many, many years, sometimes a lifetime. Most people taking this way never get anywhere. Why sacrifice years of success—lose time and money—when there is a better and easier way?

Second, the LaSalle way of learning in your spare time—studying and preparing for the step ahead. You learn by doing—you study accounting principles and solve accounting problems. You cover accountancy from the basic principles right up through Accounting Systems and Income Tax Procedure—C.P.A. training if you so desire.

Are YOU doing bookkeeping "chores"? CLIMB HIGHER!

As you go along you absorb the principles of auditing, business law, statistical control, cost accounting, organization, management and finance, etc.

This way is not magic. It is not easy. It requires giving up certain spare time to serious study. How long will it take you to acquire

this accountancy training is strictly up to you—you can go as fast or as slowly as you choose. But after you have gone part way (you need not wait until you are clear through the training) you will find yourself stepping up to better positions.

And once you have mastered this fascinating profession—once you have become an accountant—then you will have the money and the standing to make your dreams come true. You will be a respected member of the best paying profession and equipped to go out into public accounting or to climb to a top management position.

Our free 48-page booklet, "Accountancy, the Profession That Pays," tells you what you must know to be an accountant and how you can prepare in your leisure time at moderate cost. The coupon below will bring this booklet quickly without cost or obligation. You already have a start in this field; now find out how you can go all the way. Do it today.

G. I. APPROVED

LASALLE EXTENSION UNIVERSITY A Correspondence Institution

Dept. 1164-H 417 S. Dearborn Street, Chicago 5, Illinois

I'd like to know more about your home study program to help me prepare for an accounting career. Please send me your free 48-page booklet, "Accountancy, the Profession That Pays."

Name.....Age.....

Present position.....

Address.....

City & State.....

**WORLD'S
BEST
WANT AD
MEDIUM**

CLASSIFIED Advertisements



Advertisements in this section 50 cents per word, each insertion, minimum 10 words, payable in advance
To be inserted under proper classification in December issue, copy should be in our office November 1st

December issue on sale December 1st

F. W. Johnson, Manager, Classified Advertising

Popular Mechanics Magazine, 200 East Ontario Street, Chicago 11, Illinois

1603 CLASSIFIED ADVERTISEMENTS 1603 OPPORTUNITIES FOR YOU

AUTOMOBILES, MIDGET CARS

MOTORS—New battery operated, reversible, magnetic brake and reduction gears built integral, complete \$19.95. Varney, Tipp City, O.

"CUSTOM-STYLING" Manual—Easily make car look custom built, streamlined, luxuriously beautiful! Restyling instructions, illustrations, simplified refinishing, custom accessory plans, special mufflers, speed, foreign, roadster, model conversions, etc. \$2. Alquist Engineering (P), 447 - 64 Street, Brooklyn 20.

CLYMER Motor Books for Christmas. Power & Speed \$2.50—Motor Racing With Mercedes-Benz \$2.00—Motor History of America \$3.00—Speed, How to Obtain It \$1.50—Ab Jenkins' Racing Book \$1.50—Fastest on Earth racing book \$2.00—Clymer's Motor Scrapbooks, Editions 1, 2 & 3 each different \$1.50 each—Steam Automobile Book \$2.00—Motorcycling Manual \$2.00—Motorcycles, How to Manage Them \$1.50—Full Throttle \$3.50—Indianapolis Race History since 1909 \$3.50—1946 Indianapolis Book \$1.00; postpaid. Motor-book catalog free. Clymer, Dept. A-111, 2125 W. Pico, Los Angeles 6, Calif.

CONVERT Ford V-8 to V-4, outmileage the Jeep. Use present parts. Only cost, new gaskets. Instructions \$1.00. Pat Pardo, Box 183, Salem, Mass.

PIKES Peak auto race souvenir program booklet. History, facts, pictures, only 25c. Speed King, Box 68, West Station, Colorado Springs, Colorado.

BUILD Tractors from second hand automobiles. Convert horse drawn farm equipment into tractor hook-up. Tractor plans—\$1.50. Mowing machine and plow hook-up plans \$1.00. Nolan's Garage, East Wareham, Mass.

USE Scrap parts and easily build speedy two passenger, three wheeled, motorized scooter-car runabout or two passenger midget "jeep." Complete construction plans for both \$1.00. Universal, 2671 Algonquin, Toledo 6, Ohio.

FREE Catalog describes racing, historical, automobile, motorcycle books. 25 titles. Write Clymer, Dept. A-113, 2125 W. Pico, Los Angeles 6, Calif.

BETTER Performance with a Ford type carburetor on your car. We furnish adapters. Single throat \$1.50, dual \$2.00. Nicholson, 1627 Angelus Ave., Los Angeles 26.

RACING Car performance for all cars. Increase power, speed. Special "custom-built" equipment. Free literature. Write Lee Motorcraft, 1412-A Great Northern Bldg., Chicago 4, Illinois.

DUALTONE Twin muffler sets for Fords and Mercurys. Instructions included \$20. Replacement mufflers, all automobiles. Prices quoted on request. Designed to eliminate back pressure, giving increased gas mileage and horsepower. Has deep mellow tones. Three inch chrome tailpipe extension \$3.00. Dualtone Mufflers, 2636C India Street, San Diego (1), Calif.

INDIANAPOLIS 1946 Race History, including 80 illustrations, charts, drawings. World famous car, driver data. Highlights George Robson career. \$1.00. Complete Indianapolis Race Book, history every speedway race since 1909, 1000 illustrations, 320 pages, \$3.50 postpaid. Clymer, Dept. A-112, 2125 W. Pico, Los Angeles 6, Calif.

SEE Our ad under Motorcycles for midget car bargains. Midget Motors Directory, Athens, Ohio.

"FASTEST On Earth" history book all world's straightaway automobile speed records since 1898. 70 illustrations famous racing drivers, cars. \$2.00 postpaid. Clymer, Dept. A-114, 2125 W. Pico, Los Angeles 6, Calif.

CUSTOMIZE Your automobile. Illustrated, new restyling ideas, instructions, suggestions, specific model changes by simple methods. Postpaid \$1. Speedwheel, Box 723-E, Arcadia, California.

COLLECTORS: Albums, photographs, world's finest automobiles. List 10c. Box 1028, Minneapolis, Minnesota.

BUILD Speedy midget track racer from castoff parts! Plans, specifications, construction information, \$1.00. Motor Supply, Box 1682-CS, Toledo, Ohio.

MUFFLER Manual. Convert easily to Hollywood, Laguna, Westwood, duals, etc. Includes construction details, regulations, diagrams. Postpaid \$1. Mellotone, Box 723E, Arcadia, California.

PROFESSIONAL Midget racer, motor-scooter, midget roadster, and midget motorcycle. Plans, specifications for all four contained in illustrated handbook, 25c. Big list bargain priced used motors, motorscooters, servicycles, etc., included free! Midwest, 3839 Drummond, Toledo, Ohio.

R & R Mfg. Co., marine and auto division, Anderson, Indiana. Robert M. Roof, \$1.00 for our new 1946 speed and power equipment catalogue with price sheet—showing racing cars, midgets, speed boats with recommendations how to rebuild your motors for racing. Dual ignition racing cylinder heads for V-60-100 and Mercury Ford engines. Dual intake manifolds, racing pistons, camshafts, compound valve springs, Lynite flywheels, quick change gear boxes and numerous other supplies.

AUTOMOBILE Racing book, fifth edition, well illustrated. Instructions on building bodies, frames, engines. Ford A and B conversions. Plans. AAA rules, specifications. Roadster racing. Indianapolis cars. \$1.00 postpaid, \$1.30 C.O.D. Ray Kuns, Dept. 47, Madisonville, Cincinnati 27, Ohio.

AUTO SUPPLIES AND EQUIPMENT

WEATHERPROOF Your car's finish with Glitter Glaze. A brilliant, hard, durable coating that protects the finish, regardless of climatic conditions, by securely sealing the pores and covering the entire painted surface with a film as hard as glass. Contains no wax or grease. Will not mix with dust when heated and show a gray cast. Won't chip, crack or peel. Doesn't rain spot or mud streak. Outstanding on new cars, sensational on old. Highly endorsed by motor industry. Easily applied. Shipments U.S.A. only! No c.o.d.'s. Mail \$2.00 with order. Harry H. Cheatham Company, 1300 Summit Avenue, Baltimore 28, Md.

AUTO Parts, accessories. Describe needs. Page and Breton, Franklinville, N. Y.

1000 MOTORISTS Needed to make gas saving test. Up to 30% savings. For trial test offer write Vacu-matic Carburetor Co., 7617-1298 W. State Street, Wauwatosa, Wis.

DISTRIBUTORS wanted for high temperature, top cylinder lubricant. Large profit for fast moving item. 3759 Bellevue Avenue, Detroit 7, Michigan.

HANDY Spark plug—Cable and auto radio interference tester. Complete with leather case. 75c postpaid. Cord Electrical Supply Company, 309 Grand Street, Brooklyn 11, N. Y.

START Your car instantly this winter, and cut your costs with a Redispark Coil Booster. Produces powerful ignition for easy starting, gas and oil economy, long dependable service. Easy to install by any one in a jiffy. Fits all automobiles (Fords prior to 1942 excepted). Redispark applies a practical scientific principle to correct electrical leaks. Is of durable construction and different. That difference is important to you. Accept no substitute. Guaranteed satisfaction or money refunded. Send \$2.00 now with make and year of car for your Redispark by return mail. Limited supply. Electronic Products Co., 4026 Clifton Avenue, Baltimore 16, Md.

PATENTED Gasoline saving vacuum supercharger using gasoline motor's waste, same principle now being used standard equipment high priced motors only, price \$7.90. Self-addressed stamped envelope for pamphlet. McDowell Co., 2000 NE. Union, Portland, Ore.

OKINAWA "Flame thrower" slip-on soldering tip for fender men. Fits all torches. Postpaid anywhere in U. S. \$2.35. L. E. Kelly, 1947—19th Avenue, San Francisco 16, Calif.

USED Auto parts. I have it. Hayward Newlon, Simpson, W. Va.

GASOLINE Saving devices. Walert Company, 3429 North Tenth St., Milwaukee 6, Wisconsin.

ANTI-RUST For auto cooling systems. Amazing new chemical. 25c per ounce, one year supply. Mid-West Scientific Products, Box 177, Lorain, Ohio.

"HYDRO-CHARGER" Water injector—Increases power, mileage, octane! Eliminates knock, carbon! Simple, inexpensive to build. Plans \$1.98. Free "Speed Equipment Plans" folio! Alquist Engineering (P), 447 - 64 Street, Brooklyn 20.

UPHOLSTERY In your car dirty? Restore it's original lustre with this sensational cleaner. Used by professionals, \$1.00 brings 5 gallons. Krimco Products, 2235 Thomas St., Chicago 22, Illinois.

LOOK! Quickly start any automobile in zero weather. Formula 25c. Industrial Laboratory, Box 1726, Portland 7, Oregon.

"STOP Oil pumping without overhaul!" Safe, easy, effective method. Instructions, formula \$2. Alquist Engineering (P), 447 - 64 Street, Brooklyn 20.

FIBER Seat covers with leatherette trim. Sedan and coaches, \$15.75; coupes, \$11.50. 10% deposit required. Satisfaction guaranteed. Grilles for most cars. Meyers Auto Parts, 820 Dryades St., New Orleans, La.

RECLAIM And save on motor oil! Inexpensive, clean, easy method. Guaranteed instructions and plans \$1.00. Oil Reclaimers, 233A North Kenneth, Chicago 24.

TWIN-TONE Mufflers V-8 dual set 35 to 46 \$20.00. Single tone mufflers for all cars. Deep tone \$6.50 ea. A steel pack muffler giving less back pressure. Guaranteed to fit. Elmer's Muffler Shop, 139 East Manchester Ave., Los Angeles 3, Calif.

MONOGRAMMED Automobile seat covers personalized with your initials in gold. Fit your car perfectly. Finest pre-war quality leatherette in 18 beautiful combinations with fibre, sail cloth or mercerized cotton. Priced low. Mono Auto Seat Cover Co. of Hollywood, 608 South Hill Street, Los Angeles 14, California.

1946 SUPER Ignitioniter \$5.50. Atomic starting, pep, mileage. EG Mfg., 355A East 149th, New York 55.

GRILLES For all cars. Wagner Grille Co., Bernville, Route #2, Penna.

RACING Fuels; six tested guaranteed auto racing formulas. \$1.00 postpaid. Formula Research, 481 Pacific, San Luis Obispo, Calif.

AIR Compressor outfits, complete with quart size spray guns, less motors. Use your own 1/4 horse power motor. Limited quantity. Write for details. Box 172, North End Station, Detroit 2, Michigan.

HAVING Car trouble? New, used, guaranteed auto, truck parts save money. Transmission specialists. Describe needs; immediate reply. Victory, 2930 1/2 Northwestern, Chicago 18.

AUTO Parts for all autos and trucks. Trans., motors, differentials, fenders, carburetors. Also body parts. Security Auto and Truck Parts, 1941 BJ Eddy, Chicago 13.

OIL Pumping motors—Brought back to normal without ring job. Write for particulars. Joe Mullner, Box 3102, St. Paul 1, Minn.

GRILLES For all cars. Meyers Auto Parts, 820 Dryades, New Orleans, La.

PLATING Outfits for auto parts. Connect to a battery. No tanks used. Free particulars and proofs. Gunmetal Co., Ave. J, Decatur, Ill.

AUTO TRAILERS

TRAILERCOACHES—Learn about all types—sports, living or travel. Over 72 pages monthly—magazine tells all. Special \$1 year. Trail-R-News, Box 431, Glendale, Calif.

BUILD J. K. Tudor Tandem three room, bath, luxury liner trailer coach. Fluorescent lights, toilet, shower, electric refrigeration, gas range, etc. Large manual drawings, instruction, parts list, etc. \$2.00. Seven large blueprints \$5.00. Craftsmann Books, Box 1153-P33, Milwaukee 1, Wis.

AUTO-TRAILER Travel, monthly magazine, \$1 year. Magazine Mart, Plant City 8, Fla.

STREAMLINED Trailers. Has everything. Large manual full of drawings, instructions, etc. \$1.00. Illustrated circulars, dime. Craftsmann Books, Box 1153-P3, Milwaukee 1, Wis.

BUILD Your own trailer! Save money! Have every feature you want! Plans for house, sport, camp and utility trailers. Catalog describing 9 models 10c. 15c in Canada and overseas. Jim Dandy, Box 125-A, Wausau, Wisconsin.

MOTORCYCLES, BICYCLES, MOTOR-SCOOTERS AND SUPPLIES

HARLEY-DAVIDSON Parts. 24 hour service. Rebores \$2.50 per cylinder. Special rubber mask clear goggles with extra Polaroid green lens \$1.29 postpaid. Phila. Harley-Davidson Co., 857 N. Broad St., Philadelphia 23, Penna.

BUILD The first five passenger half-ton, three wheeled motorcycle in your locality, from Ford parts. Show your genius. Easy built, useful, handy. Nothing like it. Instructions \$1.00. Motorcycle Wizard, 73-A South Shirley, Pontiac 20, Mich.

BICYCLE Seats—War surplus. Genuine leather jumbo size. Also suitable for gasoline powered bikes, scooters, small motorcycles. \$7.00 value, only \$3.29 plus 25c for shipping. Midwest Surplus Sales, 1515 Locust, Kansas City, Mo.

BICYCLES, New boys', girls'. Frame sets to build your own bicycle. Send dime for list. Wholesale, retail. Century Cycle, 3447 Lawrence, Chicago 25, Illinois.

MOTORSCOOTER \$10. Motor \$3, tires \$2! Send 25c for big new catalog Number 934 listing scores of other sensational bargains in motors, wheels, motorscooters, motorbikes, Servicycles, tires, etc. Associated, Box CS-1764, Toledo, Ohio.

BICYCLE Motors \$88 f.o.b. Complete. All attachments. Send stamp for literature. Gerald Baughman, R.D. 2, Wadsworth, Ohio.

MOTORBIKE Manual containing motorbike, scooter plans and motor repair information \$1.00. Veco, Box 124, Evansville 5, Indiana.

CUSHMAN Motorscooter \$40, Briggs motor \$5, tires \$1.00! Send 25c for new bargain catalog packed with money saving buys in motorscooters, motorbikes, midget cars, motors, wheels, tires and parts. Gail and Company, 538 Erie, Toledo, Ohio.

ON Market for first time. Giant Motorcraft Manual with complete motorscooter, motorbike plans, instructions, and useful information. 50c. Reed, 215 North First Ave., Maywood, Illinois.

FACTORY Built midget racer chassis \$35 less motor; Clipper motorscooter \$30; Cushman less motor \$15; motors \$5 up; 49 army surplus Briggs & Stratton and Lauson motors; more than 5000 small balloon tires, 10 to 20 inches high, \$1.50 up. Mailorder only. Send 25c for new catalogue Number 16 just out listing these and hundreds of other bargains in motorscooters, small cars, parts, plans, etc. (35c by first class mail). Midget Motors Directory, Athens, Ohio.

NEW Racing books: Motorcycle speedway history, 256 pages, includes photos world-famous riders, machines, \$2.00—English speedway racing annual; complete history English racing, \$1.00 postpaid. Clymer, Dept. A-119, 2125 W. Pico, Los Angeles 6, Calif.

BUILD Snappy runabout, complete plans, specifications, 25c. Walter Laehr, 328 E. Third, Beaver Dam, Wisconsin.

MOTOR Scooter plans, drawings, specifications, \$2.00; Electric Bicycle Plans, \$1.50, postpaid. Clymer, Dept. A-115, 2125 W. Pico, Los Angeles 6, Calif.

FLOYD Clymer's popular motorcycle books: Motorcycle—How to Manage Them, \$1.50—Motorcycling Manual, \$2.00—English Motorcycle Service Manual, \$1.50—Speed, How to Obtain It, \$1.50—Sample English Motorcycle Magazine, 50c—Speedway Motorcycle Racing History, \$2.00—English Speedway Motorcycle Annual, \$1.00—Complete Plans attractive Motor Scooter, \$2.00—Plans Electric Bicycle, \$1.50. Prices postpaid. See our advertisement under "Automobiles." Motorbook catalog free. Clymer, Dept. A-110, 2125 W. Pico, Los Angeles 6, Calif.

MOTORCYCLE Enthusiasts! New Clymer publications—Book of Ariel, BSA, Norton, Triumph, Villiers Engine. Complete authentic service manuals, \$1.50 each, postpaid. Specify title wanted. Clymer, Dept. A-118, 2125 W. Pico, Los Angeles 6, Calif.

LARGE Stock Indian parts. Expert motor rebuilding. New and rebuilt Chief motorcycle, motors only. Indian Motorcycle Sales, Kansas City 1, Mo.

GENUINE Moto-Scot parts. Amsco centrifugal clutch, Windshields, sidescars. All other parts and accessories. Write for parts list. Also genuine engine parts for Briggs and Stratton, Lauson, American Moto-Scot Co., 1313-23 Carroll Ave., Chicago 7, Ill.

WHEELS! Build wagons, scooters, mowers, trailers, wheelbarrows, grocery carts, baby carts, play pens, baby carriages. 4" to 16". Free list. Trulsen Mfg. Co., 811 E. 31, Kansas City, Mo.

HARLEY-DAVIDSON New and used 45" motors, service, parts, accessories. Send \$2.25 for army motorcycle manual, 10c for bulletins. Knuth's (Harley-Davidson factory dealer), 2491 Fondulac, Milwaukee, Wis.

MOTORCYCLE Cams ground for speed and power, carburetion. For information write Harold Schaller, 247 West Main, Turlock, Calif.

BICYCLE Book, how to buy, rebuild, sell used bicycles 50c. John Collett, Handley, Texas.

TIRES, Inner tubes, wheels, for small trucks, wheelbarrows, midget cars, power scooters, farm equipment, carts, etc. Sizes 8" to 18" o.d. in 2, 4, and 6 ply first-line quality tires, with removable inner tubes and heavy duty demountable wheels. Also caster forks, straight or swivel types. Free circular and prices. Experienced tire engineers to advise on your special equipment problems. Jahant Co., 626 East Exchange Street, Akron 6, Ohio.

TIRES And industrial wheels, suitable for scooters, wheelbarrows, farm equipment, etc. All sizes. Bicycles and accessories. Largest assortment in America. Send dime for list. Cycle Transport Company, 1241 So. Michigan Ave., Chicago 5, Illinois.

BUILD America's lowest priced motor-scooter speedster! Complete plans, specifications, \$1.00. Big list bargain priced used motors, etc., included free! Motor Supply, Box 1682-CS, Toledo, Ohio.

BOYS, Illustrated "Bicycle Repair Manual" teaches brake repairing, re-spoking wheels, etc. Dealers wanted, 65c. Robt. Klausner, Shelbyville, Ill.

AVIATION

ENGINES—Kinner 5 cylinder aircooled radials, 160 hp. For snowplane, airdrive boats. Run on car gasoline 8 gallons hour. Complete, good condition, \$150, shipping deposit \$50. Cable, pulleys, tubing, dope, windshield material. Fresno Airmotive Company, Chandler Field, Fresno, Calif.

150 MPH Model airplane. See International Research advertisement page 266.

PROPELLERS, For any motor, including Airliner 3 blade, something new. Air-cool motor conversion diagrams 50c. Illustrated literature. Standard Aero-Craft, Ft. Worth, Texas.

JET Propulsion—Easy ways to make experimental jet engine shells—25c coin. Circulars free. Rush order. Maupin, Tipp City 6, Ohio.

ENGINES Surplus, propellers, accessories, instruments, trainers, hardware. Write for literature. Varney, Tipp City, Ohio.

SUPERCHARGERS—Aircraft surplus, ideal for furnace blowers, forced draft ventilating, experimenters. Can be converted to steam driven turbines, etc. Only \$12.50 each while they last. Industrial Sales Co., Atlantic Bldg., Washington, D. C.

VETERANS: Flight training under G.I. bill. Private, commercial, and flight instructor ratings. Write for information. Gottschalk School of Aeronautics, Adrian, Michigan.

VOLTAGE Regulator, 24 volts, aeroplane generator Automatic by Westinghouse. \$3.95 each, 3 for \$10.00. Postpaid. Lyell Hdw. Co., Box 5, Rochester, N. Y.

AIRLINE Opportunities. Get a job with a future in this rapidly expanding industry. Confidential report just released tells what you should know about the airline industry, employment opportunities, job classifications, qualifications, plus how and where to apply. \$1.00. Air Transport Research and Advisory Service, Dept. D, Box 1044, Kansas City 10, Missouri.

MODEL Buzz bomb engine plans, \$2.00 postpaid. Free circular. Williams Model Co., 873 E. McCreight, Springfield, Ohio.

AERO-SLED Plans, sedans \$5.00, open \$4.00. Adastic Engineering, Grand Rapids, Mich.

PROPELLERS For ice-snow sleds, airboats, lowest prices, fastest service. Illustrated literature 5c. Banks Propellers, R.F.D. 7, Ft. Worth, Texas.

CUBS, Wacos, Taylorcrafts, Aeroncas. Big catalog, 25c, lists these and thousands of other sensational airplane bargains. Some are "easy to repair" crackups. National, Box 1682-CS, Toledo, Ohio.

FLYING Flea, plans \$1.00. Lightplane manual \$1.00. Illustrated circulars 20c. Craftsmann Books, Box 1153-P1, Milwaukee 1, Wis.

ELECTRICAL SUPPLIES—EQUIPMENT

LAMP Parts—Every part necessary to build or repair lamps. Harps, finials, bases, vase caps, pipes, oil to electric converters, plugs, etc. 10c for catalog. Gyro Lamps, 5416 N. Clark, Chicago 40.

AVAILABLE—Electric neon display signs and clocks. Write for particulars. General Sales Service, P.O. Box 1092, Roswell, N. M.

BURGLAR Alarm equipment wholesale. Installation instruction free. Marchewicz Electric Engineering, 418 Pokagon, South Bend 17, Ind.

TOASTERS; Clocks; mixers; irons; other appliances. Immediate delivery. Price list. Mail Order Electric, 713 South Dearborn, Chicago.

5 POWERFUL Alnico magnets \$1.00. Ronald Eyrich, Box 849, Milwaukee 1.

MANUAL On multispeed three phase induction motors \$2.00 free literature. Electric Generator Mfg. Co., 1333 N. Dale St., St. Paul 3, Minnesota.

ELECTRONIC Timer Kit—1 to 80 seconds—all parts, cabinet, simple instructions—2 hour assembly. Mail \$9.95 now. Marcus, 1050 Willmohr St., Brooklyn, N. Y.

ELECTRIC Fan assemblies. Make your own. Ted Riseman, 425 East Jefferson, Springfield, Illinois.

ELECTRIC Pencil—6 volt. Engraves all metal. \$1.00 postpaid. Beyer Mfg., 4515-H Cottage Grove, Chicago 15.

RADIOS, Toasters, irons, clocks, heaters, stoves, supplies, etc. Jeannette Electric, 159 West 23rd Street, New York 11, N. Y.

PRACTICAL Winding of a.c. motors. A course of instruction on winding, connecting, and testing single, two, and three phase motors. Clearly written in everyday non-technical language. Illustrated throughout. This book is recommended for beginners interested in learning motor rewinding and repair. Satisfaction guaranteed or remittance refunded. \$2.00 prepaid. Educational Advancement Co., Dept. Y, Lakewood, New York.

NOW—Repair your own electrical appliances with Chanite Self-welding Electrical Heating Element Flux. Instructions delivered, price \$1.00. Stick form 25c ea., \$2.00 doz. Chanite Sales Company, 914 South Main, Fort Worth, Texas.

WELDING, SOLDERING, PLATING

BUILD D.C. arcwelder without rewinding armature. Plans \$1.00 each. 25 to 600 amperes from automotive d.c. motors, light plant generators, automobile starter-generators. Welders Club, AB-3432, Chicago 54.

USED Arc welders for home or shop. Lowest prices. Frazee Electric, Box 179, Santa Rosa, Calif.

ARC Welder, 110v. or 220v. Three kilowatt. Designed for garage or shop. Fully equipped. Send \$145.00. Acetylene outfit. Complete \$62.50. Freedom Co., 2203 Barclay, Baltimore 1, Md.

"THUNDERBOLT"—Transformer welder, dial-control, 3 heat stages, 60 amps., 110 volts—ac, up to 3/32 rod, carrying case, accessories, instructions. \$39.50. Also "Super-Welder," 110 volts, ac-dc \$19.95. Save 2%, send check. Or order c.o.d. Super-Welder Mfg. Co., Dept. PMC, 23 E. 20th St., New York 3, N. Y.

NEW Model electric welder 110 volt a.c.-d.c.; will weld all metals; easy to use; full directions. Complete with power unit, flame and metallic arc attachments, carbons, fluxes, rods, mask; all for \$19.95. Used by the navy. Magic Welder Mfg. Co., 239-MP11 Canal St., New York City.

WELDING, Cutting, aircraft welding and soldering equipment. Electric arc welders. Superior Oxy-Acetylene Co., Hamilton, Ohio.

MACHINERY, TOOLS AND SUPPLIES

IT'S Easy to build your own metal and woodworking tools from Lewis castings, materials and blueprints—and at savings up to 80%! Lewis mills, shapers, drill-presses and other shop tools have ample capacity and performance for home workshop jobs. New catalog—sent on receipt of 10c to cover mailing—describes 23 Lewis tools. Address Lewis Machine Tool Co., 3217 Union Pacific Avenue, Dept. M, Los Angeles 23, California.

GEARS For inventors, experimenters, model makers, schools, work shops, laboratories, etc. Government surplus made of brass, bronze, dural steel and stainless steel. 12 matched pairs; 24 gears, bevel, spur and ratchet. List price \$12.00, our price \$2.50. 25 matched pairs; 50 gears, includes larger gears, also sets of worm gears. List price \$30.00, our price \$5.00. 50 matched pairs; 100 gears better assortment, including worm sets. List price \$75.00, our price \$10.00. Limited quantity. Order now. Write for our bulletins on ball bearings, rectifiers, relays, selsyns, horns and government surplus materials. Met Exchange, 323 Canal Street, New York.

LABEL Your cigar boxes, drawers, cans, jars, bottles. Save hours of time. 100 large printed labels with titles for every purpose \$1.00 postpaid. Hinds Manufacturing Company, 223 Second Street, Niagara Falls, New York.

SPEED Reducing gear trains with Oilite bearings. Dual ratio 66.5:1 and 133:1. Each \$1.00. James Fred, Russiaville, Ind.

POWER Operated tile machines, mixers and block machines. Concrete Machinery Company, Hickory, North Carolina.

BUILD Electric sump pump with used auto part, your motor, instructions \$1.00. B. C. Biggs, Monrovia, Calif.

AMAZING Tool—Combination paint scraper, hammer, chisel, screw-driver, window jimmy, glazing point setter. Circular free. Babcock Tool Co., Oak Harbor, Ohio.

HARDWARE Tools, plumbing, electrical supplies. List on request. LeNard Industries, 179M West Washington, Chicago.

WAR Surplus in small tools for machine shop. Send 15c for bulletin. Travers Tool Company, Dept. F, 5 Court Square, Long Island City, N. Y.

AMAZING Tool! 4 screwdrivers in one! Use the same screwdriver for every job. Four steel blades lock into one tough plastic handle. Economical, efficient, space saving. Small set 2 1/2 to 5 1/2 inches \$6.95; large set 8 to 14 inches \$8.95. Geo. LeBec Co., Box D, Old San Diego Station, San Diego, California.

NEEDED Swiss. Circular 5c. Har-kay, 116 Nassau St., New York 7, N. Y.

MACHINE Shop tools released for private industry; 14" loose change lathes \$150; 16"—\$180; vertical miller \$430; 300 amp. a.c. welder \$130; 20" quick change lathes \$440; small miller \$130. Gould & Eberhart 16" shaper with gear box, 220v. motor \$580. 18" lathe \$340. Portable 300 amp. welding generator with controls \$140; 22" x8' American quick change lathe \$520. Conversion Parts Co., 278 Adams St., Boston 22, Mass.

TOOLS, Hardware, drills, taps, dies, mandrels, jeweler saws, pattern and model supplies, steel, brass, drill rod. Catalog 10c. Terek, 6304 Patterson, Chicago 34.

NEW Glass drill, Fastest ever invented. Drill 1/4 inch glass in one minute. Drill and instructions \$1.00. Box R188B, Seal Beach, Calif.

CEMENT Mixers, block, brick machines, garbage burners, easy stump remover. Blue Square, Excelsior, Minn.

TWELVE-IN-ONE Precision tool. Fine tempered steel. Fits pocket. All one unit includes: adjustable nut wrench, alligator wrench, screw driver, file, glass cutter, wire stripper, staple and tack puller, straight edge, magnet, rule, knife sharpener, bottle opener. \$1.00 postpaid; guaranteed. Bishop Tools, 111 W. Washington, Chicago 2.

DRILLS, Reamers, milling cutters, electric drills, grinders, flexible shaft equipment, torches, bearings, mandrels, machine screws, metals, Plexiglas, decorative plastic, etc. Catalogue E 10c. Metlplas Supply Co., 1420 South 16th, Maywood, Ill.

LATHE Milling attachment. Photograph for dime. Depoy Model Shop, Muncie, Ind.

TABLE Saws, post drills, sanders, bench drills, arborers, etc. Circular 3c. Sunshine, Berkshire Heights, Penna.

DRILL Grinder for twist drills \$2.95. See ad on page 266.

RIVET Guns—Aluminum air driven. Perfect condition. Famous makes. Limited quantity. Immediate delivery. \$9.95 postpaid. Free bargain catalog. Art's Surplus Mart, 329 W. Florence Ave., Dept. M, Los Angeles 44, California.

BALL-BEARINGS, One-fourth list price. Free list. Burgess, Box 168, Ferguson, Mo.

HARDEN, Temper all steels quickly, safely. Lasts indefinitely. Ingredients and instructions \$1. Pohasom, Box 185, Fort Wayne 1, Indiana.

ROTARY Cutters sharpened. Send stamp for prices. Russell Cook, Harrison, Mich.

CONCRETE Building block machines and molds. Catalog free. Concrete Machine Co., 5129 South Compton Ave., St. Louis 11, Mo.

8 INCH Bench saw mandrel, 3/4" arbor, 1/2" spindle, milled flanges, bronze bearings, raises and lowers, \$10.75 Denver. Woodcraft Mfg. Co., 1024 17th Street, Denver, Colo.

INDEX Heads for sale. Very inexpensive. Sixty-two different divisions. Used on small lathes, drill press, milling machines, etc. Make gears, hobs, cutters, etc. Very accurate, and durable. Not a toy. Used by defense schools and hobbyists. Write for free folder. Long's Index Heads, 2117 East B St., Torrington, Wyo.

BOATS, OUTBOARD MOTORS, ETC.

PLYWOOD Boat kits! Complete materials for building "Deltacraft," "Junior Dinghy," "Tadpole Skiff." Mahogany marine plywood and oak construction! Send 10c today for illustrated folder featuring these boat kits and other marine materials and supplies. Carmen-Bronson, Marine Department, Mount Vernon, N. Y.

8 FT. Pram dinghies, light weight, easy to row. Immediate delivery. Also inboard speedboats and day cruisers, marine engines, propellers. Descriptive folders on request, 1946 marine supply catalogue 40c. W. L. Masters & Son, 214 W. Chicago Ave., Chicago 10, Ill.

OUTBOARD Motor, Champion, 4.2 hp. New Bargain, R. Mishek, Waseca, Minn.

BOATS, Steam engines, model, real, catalog, 10c. Marinepress, Groton, Conn.

NOISELESS Oarlocks for fishing and hunting. Aluminum with plastic bearing, smooth bearing action, fits any boat. \$4.50 per pair complete, postpaid. Forward money with order. Aluminum Marine Hardware Co., Inc., Auburn, N. Y.

KEEP New or old fishing rowboat dry indefinitely. No paint, waterrot, deterioration, waiting. Inexpensive. Guaranteed instructions \$1.00. C.R.S.A., Box 8, Nanticoke, Penna.

NEW House trailers all aluminum. We represent 4 mfgs. 12' all aluminum V-bottom unsinkable boat, speed up to 30 mph, weight 80 lbs., only \$195; 12' plastic with car top rack, \$265; new propellers 14x10 and 14x8, while they last, \$9.95; new cruiser inboards, molded outboards and motors. Can make shipment before Xmas. Contact Selhorn's Sarasota, Fla. or East Lansing, Mich.

SKATE, Iceboat sails, canvas for boats, trailers, etc. Nylon rope, sailcloth, Italian linen rope, boat covers, yacht sails, catalogue, Alan-Clarke, 96 Chambers, N. Y. C.

REBUILT Tachometers 0-5000 and 0-8000 r.p.m. 4 1/2 diameter face. \$10.00 each, specify rotation. Zakarian Engineering, Box 416, East San Diego, Calif.

KAYAK Blueprints, deluxe models—catalogue 10c. Viking Canoes, Merrick, N. Y.

MARINE Power—Easily convert any Ford and Jeep motor (domestic and foreign) with Osco parts and kits. Complete catalogue 25c (coin). Osco Motors Corp., 2020 East Orleans Street, Dept. M, Philadelphia 34, Penna.

OUTBOARD Motor parts, new and used, for all makes. Our stock of used parts is too large to list. Write giving us the model and motor no. New parts for Waterwitch, Seaking, Mercury, Wizard, Lauson, Neptune, etc. New standard and over-size outboard pistons. Outboard motor cylinders honed and re-bored. Outboard Motor Mart, Inc., 309 Atlantic Ave., Boston 10, Mass.

ALL Copper water jacketed exhaust manifolds for marine conversions of automobile and aviation engines and marine engine replacements; any make, model or age. Joseph Van Blerck & Son, 397 Woodcleft Avenue, Freeport, N. Y.

BOATS And all about them. How to select, build, repair and operate. For 40 years the leading practical boating magazine. Half price trial subscription. 12 issues for \$1.00. Motor Boat, 62 Gold Street, New York 7.

USED Outboard motor parts. Outboard Exchange, 1194 Remsen Ave., Brooklyn, 12, N. Y.

FORD-Mercury-Zephyr marine conversions. Catalog 10c. Lehman Manufacturing Company, Dept. D, Newark 2, N. J.

BOAT Designers are highly paid professionals. Complete course by mail. Catalog. Westlawn, Montville, N. J.

NINE Plywood boat plans 50c. Catalog boat building plans 10c. The Rudder, 15 Murray Street, New York.

FULL Size, cut to shape boat patterns, blueprints, 7 1/2 - 38 feet. Illustrated "Build a Boat" catalog, 10c (coin). "How to Build Boats" book, \$1.00. Cleveland Boat Blueprints Co., Dept. A-66, Cleveland, Ohio.

USED Marine motors, propellers, marine fittings, conversion manifolds. Stokes Marine Supply, Coldwater, Michigan.

ENGINES, MOTORS, DYNAMOS

150 AMPERE Generator for welding \$47.50. Extra flexible cable, 8 ft. lengths \$2.75. Other bargains. Butler Electric Company, 1885 Milwaukee, Chicago 47.

AC-E Single phase coil winder, for winding concentric coils for electric motors, adjustable 1/2 to 2 h.p. Send for bulletin. Motor Industries, Quincy, Illinois.

6 V. D.C. motors as used in automobile heaters \$1.95. Greyhound, 2303 Surf Avenue, Brooklyn 24, N. Y.

1/2 H.P. Motors D.C., 27 volts—easily changed to A.C. 110 volts. Only \$4.95 each. Also 1 1/2 H.P., \$9.95 each. 1/5 H.P., \$2.50 each. All postpaid. Buy all three for \$15.00. Best buy in the world. Lyell Hdw. Co., Box 5, Rochester, N. Y.

WIZZ Electric motor: Assembles in a jiffy. Flashlight cell operates, parts complete, plus illustrated instructions 35c postpaid. Also the smaller "Mighty Midget" 1" model, third size, 30c. Eltro Company, 171B, Deer Park, N. Y.

"BUILD Your Own" gas drive arc welder easily with Hobart Generator. Save \$300 to \$500, and need only add used auto engine and chassis to build portable gas drive welder that goes everywhere after profitable construction and repair jobs. Write for free instruction book, further details. Hobart Brothers Co., Box M-1066, Troy, Ohio.

WINDING Data, listing 225 motors, single and three phase, \$1.00. Motor Data Co., Box 7631, Kansas City 3, Mo.

ATHLETIC EQUIPMENT, BODY BUILDING COURSES

BE Expert on punning bag by using new "Tru-Arc" swivel. Develops arm and shoulder muscles. Endorsed by professionals. Price: swivel only \$3.00 postpaid. Mulco Manufacturing Co., New Kensington, Penna.

DEADLY Judo—Fiercest fighting technique. Trick knockouts. (200 photographs—plus illustrations). Expert instructions. Three volumes. Complete \$2.25. Variety House, Box 46-BK, Wall Station, New York 5.

I BUILD Muscles fast! Todd grows muscles faster than any other living man, or money refunded! No apparatus! 3 complete courses, \$1.00. James Todd, Dept. MM106, 17 Ina, Springfield, Mass.

WORLD'S Most complete line barbell equipment. Quality plus lowest prices. Stamp for folders. Jackson Barbells, Springfield, N. J.

SPORTING GOODS, GUNS, FISHING TACKLE, TRAPPING, ARCHERY

IDEAL Christmas gift! "The Gun Digest": Biggest selling gun book ever published and its companion volume, "Fishing Tackle Digest": Encyclopedia of fresh water tackle demanded by thousands and now released for the first time. "The Gun Digest" is the one-and-only authentic guide to American and foreign rifles, shotguns, handguns and accessories. Every current American model is brilliantly illustrated, fully described. 164 pages! 25 sections! 750 illustrations! "Fishing Tackle Digest" is the "bible" to all popular rods, reels, lures and accessories. Complete specifications and hundreds of illustrations of all tackle now being manufactured for both fly fishing and bait casting. 16 experts reveal their secrets on selection, use and care of tackle. 140 pages, including special 8-page insert in gorgeous natural color featuring flies, baits, game fish. Both great books (giant 11" x 8 1/2" size) in Christmas package only \$2.50 postpaid (\$3.00 in Canada) or either book only \$1.25 (\$1.50 in Canada). Send us your list of friends and we will wrap and mail them individually for you at no extra cost. Send check or money order today. Money back guarantee. Klein's Sporting Goods, 227M West Washington, Chicago 6.

SHALLOW Water diving masks for next summer's fun can be made from surplus oxygen masks; latest type, cost government \$4.00. While they last, new \$1.75, used, good condition, \$1.00 postpaid. Ken Norberg, 21 Tamalpais, Mill Valley, Calif.

CASTING Rod handles—"Fit-all" \$4.80. Catalog and fishing calendar free. Goff, 5017 W. 22nd St., Cicero 50, Ill.

INDIAN War bonnet kit, archery catalog. Chas. T. Schneider, Whitehall, Mich.

HOWDY, Podnah! If you drink warm milk at the bar and wear lace on your shorts, you won't like Western Sportsman. It's a he-man's magazine about the new West—charging grizzlies, havalinas on the warpath, wily bucks of the high crags, fighting mountain trout, real western humor. Head a buck our way for 7 issues. Western Sportsman, 3303 Bridle Path, Austin, Texas.

BARBELLS—Dumbbells. Factory direct. \$9.95 up. Send for catalog. Independent Iron Works, Dept. 14, 2416 East 23rd St., Los Angeles.

HUNTING Knife, 5 inch high-carbon steel blade, aluminum knob handle, genuine leather sheath, \$2.00 each post-paid. R. H. Eckhouse, 2412 Avenue P, Brooklyn 29, New York.

DUCK Decoys—Fabric-covered and easily made. Complete pattern and instructions for \$1.00. Send to Duck Pattern, Okemah, Oklahoma.

SEND 10c For list 100 used guns. Frayseth's, Willmar, Minnesota.

CARTRIDGES, Shells, ammunition, guns, rifles, list 25c. Frank Farish, Vicksburg, Mississippi.

AUTOMATIC Bait—Positively weedless. Greatest invention in ages. Nothing like it. Write immediately for circular. Babcock Reel Co., Oak Harbor, Ohio.

12 GAUGE, 00 Buckshot shotgun shells. 75 rounds \$5.00. Money order. Rudolphs, Atchison, Kansas.

FINEST Glass eyes; taxidermy supplies. Catalog free. Elwood Supply Company, Dept. 234, Omaha 2, Nebr.

BOWS, Arrows for recreation, hunting, fishing. Beautiful Archery Instruction Book, 70 pages, 50 illustrations, only 50c. Illustrated catalogue 10c. Archery Sales Service, 617 So. State, Chicago.

3000 BARGAINS, Firearms, binoculars, war relics, catalog 30c. Smith Firearms, Runnemede, New Jersey.

"AMMUNITION"—New and used "shotguns," "rifles," "handarms." List 10c. Rudolph's, Atchison, Kansas.

FIELD GLASSES, MICROSCOPES, TELESCOPES, MAGNIFIERS

REFLECTING Telescopes, complete. 3 1/2" diameter, equatorially mounted. View planets, stars. \$19.75. Write Sky-scope Company, 475-P 5th Ave., New York.

BINOCULARS. Beautiful army type, all metal construction, compact, lightweight, with powerful 30mm. lenses. In handsome case. Only \$4.18 postpaid. Tax included. Guaranteed powerful. Utica Mail Order Co., 923 Eagle St., Utica, N. Y.

FIELD Glasses. High powered, case. \$35.00 cash. Frank Payne, Route 5, Kansas City 3, Kansas.

TELESCOPES—36 Inch, 3 section, 17 power, precision ground and polished lenses, including carrying case \$2.50 postpaid. Microscope, 50 power, complete with specimen slides \$2.98 postpaid. Dept. PM, Criterion Co., 438 Asylum St., Hartford, Conn.

WAR Surplus lens, 15" diameter, bargain, \$5.00. Leo's, Opportunity, Wash.

CLEAR Vision. Full power. Perfect lenses and instructions for making; 300X astronomical telescope; 400X compound microscope; 200 X telephoto camera. \$2.00 each project. 3 for \$5.00. Carl Jamer, Manorville 3, N. Y.

60 POWER Telescope, \$2.95. 250 power microscope, \$2.45. Also bargains in binoculars and surplus lenses. Send for free catalog. Brownscope Company, 24 West 45th Street, New York.

BUILD Your own reflecting telescope. Copy of instructions 10 cents. Catalogue free. Mayfloor, Katonah, N. Y.

BINOCULARS, Telescopes, watches. Buy, sell, trade. Paul Schweer, Donnellson, Iowa.

TELESCOPES, Microscopes, cameras, binoculars; bought, sold, repaired. Lists 10c. Specify instrument wanted. Rasmussen and Reece, 41 Market, Amsterdam, N. Y.

DOGS, PETS, BIRDS, RABBITS

RAISE Guinea pigs. Make money at home. Big demand. Booklet free. Taylors Guinea Pig Farm, Hapeville, Georgia.

RAISE Moneymaking Angora rabbits. Also New Zealand Whites. Wool \$15 pound. Plenty cash markets. Particulars free. White's Rabbitry, Lawrence, Kansas.

\$2000 PER Year raising Angora rabbits. We buy your output. Contract particulars free. Wilsons, 1065 Shryer, St. Paul 8, Minn.

BEAUTIFUL, Useful collies, collie-shepherds. Pups \$12. Paul Schultetus, New Liberty, Illinois.

SAMPLE Copy "Rabbit Profits" magazine, information regarding revolutionary new hutch plans and literature telling how to make most money from rabbits, 10c. Reliable Fur Industries, Dept. PM, Montebello, Calif.

RAISING Rabbits, Cavies, Hamsters, Chinchillas is a growing and profitable industry. Magazine 10c. Descriptive book and magazine 25c. Book and magazine (monthly) one year \$1.00. Address Small Stock Farmer, Pearl River 15, N. Y.

RAISE Giant Chinchilla rabbits. Year round income. Ideal occupation. Tremendous demand for gorgeous furs, delicious meat. Great scarcity means large profits. We buy your youngsters. Willow Farm, R15, Sellersville, Penna.

ANGORAS, Chinchillas, giant rabbits—finest pedigree! Catalogue free. Book "Profitable Rabbit Raising" tells everything \$1.00; scientific self-cleaning hutch plans \$1.00; automatic feeder plans \$1.00. All three \$2.50. Grinsteads, Dept. 15-E, Edwardsville, Illinois.

NOTHING But Angora rabbits. Literature and prices free. House of Angora, Springfield, Illinois.

SPORTSMEN: 200 Pointers, setters, straight cooners, combination hunters, rabbit and fox hounds. Reasonable. List free. Ramsey Creek Kennels, Ramsey 1, Illinois.

RAISE Guinea pigs. Profitable, low-cost feeding, small space required, small investment. Complete details 25c. Guinea Pig Farms, 3456 West 116th St., Chicago 43.

ZOOLOGICAL And pet animals for sale. Illustrated catalogue, literature, 25c. Trails End Zoo-5, St. Stephen, S. C.

ST. BERNARD Pups: Champion sired beauties. Franklin Young, R4, Riverhead, Long Island, New York.

STANDARD Rabbit Journal, Milton, Pa. 3 years \$1.00, sample dime.

FARMS, FARM LANDS, REAL ESTATE

WEST'S Fall catalogue: Hundred pages of farm and business bargains. Free copy write West's Farm Agency, HE-2, Pittsburgh 16, Penna.

OZARK Lands for all purposes. Actual river frontages. 5 acres \$90.00 and upwards. Free list and literature. Hubbard, 424-I, Minnesota Ave., Kansas City 4, Kansas.

STROUT'S Blue farm catalog—27 states—coast to coast—over 1300 bargains, money-makers—132 pages. Write today. Mailed free. Strout Realty, 255-P 4th Ave., New York 10, N. Y. 7 So. Dearborn St., Chicago 3, Ill. 453 So. Spring, Los Angeles 13, Calif.

\$5.00 MONTHLY Buys 40 acres near town; price \$200.00. Free list. Box 425-P, Carthage, Mo.

PREFABRICATED Homes. Save money. Get on manufacturers list early. Mail \$1.00 for complete report plus names of over 100 firms. Nash Business Reports, Dept. 11, Box 1310, Glendale, California.

OZARK Magazine, Eureka Springs, Arkansas. For homeseekers, sportsmen. Year. \$1.00.

GOVERNMENT Land \$1.50 acre up. Information all states 25c. National Tax Service Bureau, 834A Majestic Bldg., Detroit.

CALIFORNIA Motels. Pay well. For circulars write Frank Dykema, 813 Gretna Green Way, Los Angeles 24, Calif.

FARMS, Ranches. All kinds, sizes. Reasonable prices, terms. Wide variety locations, climates, recreational facilities. Free descriptive folders, price lists. Milwaukee Railroad territory; Washington, Idaho, Montana, the Dakotas, Minnesota, Iowa, Missouri, Indiana, Illinois, Wisconsin, Upper Michigan. R. W. Reynolds, 914, Union Station, Chicago 6, Illinois.

VIRGIN Missouri land \$4 acre. Terms, Write Armstrong, Wappapello, Missouri.

FREE Catalog, farm bargains, 13 mid-west states. Many fully equipped for convenient quick start. Many pictures. Special service to help you locate quickly, if you state requirements, payment plan and general location desired in first letter. United Farm Agency, 1796 Arcade Bldg., 1, St. Louis, Mo.

HOMESITES \$450—Low terms. California's finest garden spot. On Morro Bay's scenic shores. Wonderful fishing, hunting, boating, etc. Fertile soil, soft water, temperate climate, congenial community. Free literature. Richard M. Otto, 6560 Hollywood Blvd., Hollywood 28, Calif.

OZARK Farm bargains, 5 to 5000 acres. Frank, Mountain View, Mo.

GOOD Farms—ranches. Washington, Minnesota, Montana, Idaho, Oregon, North Dakota. Dependable crops, favorable climate. Write for literature, lists describing typical postwar farm opportunities. Specify which state. J. W. Haw, 119 Northern Pacific Ry., St. Paul 1, Minn.

POULTRY AND FARM SUPPLIES

YOUR Greatest poultry problem will look simple when you read American Poultry Journal regularly. 500,000 poultrymen do, why not you? 2 years 50c. 5 years \$1.00. American Poultry Journal, 533 So. Clark, Chicago.

RAISE Turkeys for profit! Part-time business, unlimited money-making possibilities. Leading all-turkey magazine brings latest tested helps. Twelve big issues \$2.00. Turkey World, Dept. 92, Mount Morris, Ill.

MAKE More money with poultry. Magazine with experimental farm explains how. Order today! One year 25c; five years \$1.00. Poultry Tribune, Dept. 41, Mount Morris, Ill.

RAISE Turkeys the new way. Write for free information explaining how to make up to \$3000 in your own backyard. Address National Turkey Institute, Dept. 3, Columbus, Kans.

PROFITABLE OCCUPATIONS

SCRAP Metal costing 5c pound brings \$4.00 in finished castings. Lifetime profits. Information. Fritz Foundry & Supply, 622 N. Fulton, Allentown, Penna.

MECHANICALLY Inclined men—Own and operate general appliance repair shop. Complete, illustrated course shows you how. Welding, refrigeration, motor repair, how to get business, etc., all phases covered. Free literature. Christy Supply, Dept. 470, 2835 N. Central Ave., Chicago.

ELECTROPLATING By battery. Illustrated instructions. \$1.00. Alvin, 553 William, Winnipeg, Manitoba.

NOW Anyone can learn piano tuning quickly. Unlimited possibilities. Western Music, Box 931, Post, Tex.

MUSHROOMS Grown. Boxes. Barrels. Illustrated instructions 50c. Spawn \$1.00. Gordons, 553 William, Winnipeg, Manitoba.

FOR An extremely profitable lifetime business, operate a collection agency-credit bureau. Easily learned. Write: Cole & Associates, Syracuse 2, New York.

LEARN Gagwriting. Profitable new field. Free particulars. Frankel, 1508 South Homan, Chicago 23.

MINDREADING And ventriloquism. Instructions \$1.00. Alvin, 553 William, Winnipeg, Manitoba.

STORY Writing simplified! Fascinating—complete home study. Ideal Christmas gift. Free circular. New Segment System, Postoffice Box 834, Spokane, Wash.

PHOTO Stamps. Illustrated instruction. \$1.00. Alvin, 553 William, Winnipeg, Manitoba.

"ALASKA—The last frontier offers thousands of job and business opportunities." Fur farming, mining, commercial fishing, aviation, construction, government homestead lands at 25c per acre. \$1 brings 1946 booklet explaining how-when-where to apply. Transcontinental Research, Box 2147-PM, Hollywood 28, Calif.

SOILLESS Farming. Illustrated instructions 50c. Chemicals \$1.00. Gordon, 553 William, Winnipeg, Manitoba.

FORTUNE. From yard or basement. Information 25c. Dillard, Box 2807, Kansas City 13, Mo.

BE Manufacturers' agent—Full-part time. Mimeo instructions 25c (silver). Swayne, Box 4694, Jacksonville, Florida.

ESTABLISH Permanent, profitable mail order business at home. Unusual opportunity. Write Strauss, Box 71, Kensington Station, Brooklyn 18, N. Y.

PANNING Gold—Learn how. Enjoy outdoor life. Be independent. Free illustrated booklet, "How to Get Started." Old Prospector, Box 21A3, Dutch Flat, Calif.

MAKE Seashell brooches, earrings and novelties. Catalog and illustrated instructions 10c. E. Frissell, 4627 Woodside Drive, Houston 3, Texas.

INTERESTED In South American and foreign employment? \$1 brings 1946 "Foreign Trade Research Report" listing 300 American firms with foreign interests and explaining how-when-where to apply for potential opportunities in oil, mining, construction, export-import, rubber, aviation. L. J. Enterprises, Box 2549-PM, Hollywood 28, Calif.

RAISE Earthworms, complete instructions \$1.00. W. L. Huffman, 391 Pleasant Lake, Rives Junction, Mich.

SHELL-O-CRAFT Kit, all materials furnished for ear bobs, brooches, etc. \$2.60 postpaid. With free instructions. Wonderful Christmas gift. Shell-O-Craft Co., Box 365, Station A, St. Petersburg, Fla.

MAKE Beautiful lifetime bracelets from stainless steel rod, sell \$10.00 up. Easy instructions, drawings \$1.00. G. W. Osborne, Opportunity, Wash.

BIG Profits, full- or sparetime, anywhere. Catalog free. Polesi, 232 East 165th, New York 56, N. Y.

TOYMAKERS: Bulletin illustrating latest expiring patents on toys and games available to public. Each a potential business. Also latest toy and game patents. \$1.15. Inventions Research, 4331 Kenwood Avenue, Los Angeles 37, California.

TYPEWRITER Repairing instructions, standard typewriters. Webers', Box 1008, Canton, Ohio.

PAINT Plaster plaques for Christmas! Sell locally. Beautiful, clear detail. Strong, hard castings. Fascinating fun! Paying profits! Popular prices! Molding rubber, artists' brushes, paints, instruction books available. List free. Pioneer, 394AY, Austin, Minnesota.

WANT An office-business serving others with heavy profits to yourself? Operate a personnel employment agency. Easily learned. Write "Hunt," Box 308, Burlington 15, Calif.

INSTRUCTIONS. For very profitable home business, included with \$1.00 package vitamin plant food. Temple, Pinellas Park, Fla.

GROW Chinese bean sprouts for home use or market. Anywhere. Anytime. Quick returns. Complete instructions \$3.00. Literature free. Oriental Food Products Service, St. Louis 7, Mo.

\$40.00 WEEKLY Made growing mushrooms, fresh, dried. Dominion patent 331583. Free spawn. North American, 169P Yonge, Toronto, Canada.

SHELL Jewelry, novelties. Easy to make at home as hobby or to sell. Beginners kit \$1.00. Catalog 5c. Burton, Box 27, Station A, St. Petersburg, Fla.

TADPOLES Make frogs, tremendous demand. Both make you money. 25c brings tell-how information. Chariton Corporation, Century Building, Chicago 4.

EXCELLENT Profits raising mink. Choice breeding stock available. Details furnished. Franklin Young, Riverhead, New York.

LEATHERCRAFT Supplies. Catalog 10c. Art Craft Supply Company, 1205 Throckmorton, Fort Worth, Texas.

MUNGOPUNGRO Sprouting beans. Free sample, instructions. Snyder, 406F West 47, New York 19.

TYPEISTS. Profitable business at home. Complete copyrighted information, 50c. Gaunt, 3521-Z Broadway, Chicago 13, Ill.

RAISE Profitable giant Chinchilla rabbits. Great scarcity means large profits for gorgeous furs and delicious meat. Little space. Pleasant occupation. Contact world's largest breeder. Willow Farm, R15-B, Sellersville, Penna.

WELDING—Electric arc. Learn profitable trade quickly through actual practice. Individual welder instructions at bare cost of materials. Full particulars free. Valuable welding lessons book 50c. Hobart Welding School, Box M-1064, Troy, Ohio.

BEAUTIFUL Mirrors from ordinary glass. Complete instructions, \$1.00. Tesco, PM-1, P.O. Box 189, Wilkes-Barre, Penna.

WOULD You pay 3%—first \$350 made? Color-illustrated book "505 Odd, Successful Enterprises" free! Some offer occasional "day off". Start at home, office. Expect something odd! Pacific, 2207½ Cloverfield, Santa Monica, Calif.

ELECTRIC Clocks are every where you go, buildings, homes, parking lots, factories. Repairs increasing. Our easy to learn course with pictures and drawings teach you how to repair these clocks. Electronic Supply Co., P.O. Box 2350A, Houston 1, Texas.

GOLD-STAMPING Is fascinating and profitable. Free booklet. Home City Specialties, Dept. PM1273, Springfield, Mass.

TYPEWRITER Repairsmen urgently needed. Earn \$40 to \$50 weekly spare time. Our easy to learn home study course teaches how to repair typewriters. Write for free information. Houston Typewriter Repair Service, P.O. Box 5357A, Houston 12, Texas.

ANNOUNCING Home study course in commercial baking. Practical basic training. Good field for those with aptitude. Nearly depression proof. Send for free booklet, "Opportunities in the Baking Industry." National Baking School, 1315 Michigan Ave., Dept. 3432, Chicago 5, Ill.

LOCKSMITHING—Profitable business or hobby! New course teaches you how to pick locks, fit keys, de-code, masterkey, etc. Easy self-instruction lessons. Bargain price. Fascinating 100-page illustrated catalog free! Write—Nelson Company, Dept. 2-02, Chicago 5.

BOOKS, PERIODICALS, PICTURES, POSTCARDS

INDIA—Strange unusual photos snake charmers, burning ghats, fakirs, set of 12 \$1.00. India Pic Photo Co., 1362 Ratliff St., Richmond, Indiana.

ARCHITECTURAL, Fine art and handicraft books. Most complete catalog of its kind ever published, listing hundreds of interesting and hard-to-get books. Now in printing, write for it at once to reserve your copy. Price 10 cents. Artcraft, Box 6827, Baltimore 4, Maryland.

MAGAZINES—Business, vocational, diversion. Profit by being informed on developments, opportunities, etc., in your line. Current single copies—choice of 816 publications—all fields. Free price-list. Directory of 3342 publications with addresses and subscription rates. \$1.00. Commercial Engraving Publishing Company, 34C North Ritter, Indianapolis 1, Indiana.

BOOKLOVERS! Our members save on every book in print. Plan new and different. Write for interesting particulars and free copy of "Books Current." Center Book Club, 243 Market, Newark 2, N. J.

ALEUTIAN Veterans. For your album. Five beautiful Kiska scenery pictures. Size 5x7, only \$1.00. Barrett, 356½ Grande Allee, Quebec, Que.

BOOKLOVERS! Best-sellers, new, at half-price! Free catalog! Popular Book Service, Box 8081-L, Newark 8, New Jersey.

BOOKS! (Out-of-print, scarce, unusual). Quickly supplied. Send wants. Spotlight, 141 Broadway, New York.

STEAMSHIP Normandie photo 10c. Frederick Forman, 868 Lorimer, Brooklyn 22, N. Y.

ATOM Bombed Nagasaki, 15 photos \$1.00, 12 Aleutian photos \$1.00. Makins Pictures, 538½ Washington, Bremerton, Wash.

24 PICTURES Of movie stars, bandleaders and vocalists for only 25c. Arden Specialties, 2147 86th St., Brooklyn 14, N. Y.

ONE Dollar a year brings any one book on our list. When read return by mail and receive another book. Send for our list today. King H. Densmore, 706 Haight Street, San Francisco, California.

NATIONAL Geographic Magazine, 1888-1945, any issue. Periodical Service, Dept. PM. Swarthmore, Penna.

WHAT Every Mason wants. We have Masonic books for Blue Lodge, Chapter, Commandery, Scottish Rite and Shrine. Our rituals are used the world over. Send for free catalog of books and rituals for Masons, Odd Fellows, Knights of Columbus, etc. Ezra A. Cook, Publisher, P.O. Box 796-PN, Chicago 90, Ill.

WILL Pay \$5,000 for certain old books; histories \$300; poems \$2,500. We also buy deeds, letters, autographs, etc. Catalog 10c. Ohio Historical Publishing Co.-PKM, 209 W. 11th Ave., Columbus, Ohio.

KODACHROME Slides for Christmas gifts. Free list. Views Beautiful, 2422 Fullerton Ave., Chicago 47, Illinois.

COMBAT Action pictures. Your own division, all campaigns. Twenty 4x5 glossy pictures with captions \$1.20 postpaid. Refund guaranteed. Official War Pictures Co., Dept. PR, 64-40 98th Street, Forest Hills, L. I., N. Y.

WHY Not investigate the Catholic Religion. Free literature. Catholic Bookrack, Box 142-H, Roxbury Station, Boston 19, Mass.

RARE. Unusual book. Extremely interesting. (Illustrated). 50c. Kogan, 1032-PA, New York 8.

PHOTOS, Postcards, books, lists. Big assortment. \$1.00 prepaid. Jack's Hobby Shop, 591—12th St., Oakland 7, Calif.

"A BUSINESS Of My Own." Arthur E. Morgan. Select your business carefully. Hundreds of successful small enterprises described. Second, enlarged edition. 185 pages. \$2.00 (paper, \$1.00). Community Service, Yellow Springs, Ohio.

YOU Too can read handwriting! Ten lessons, beautifully illustrated, \$1.00. Astonish your friends, make money. Satisfaction guaranteed. \$1.00 analysis of your handwriting free. St. John, Noel, Missouri.

MAGAZINE Export Sales Company, 2084 First Avenue, New York 29, N. Y. U. S. A. Over-issue popular American magazines and pocket-size novels. Comics, fashions, pictorials, romances, screens, pulps, many others. Export only.

BOOKFINDERS! (Scarce, out-of-print unusual books.) Quickly supplied. Send wants. Clifton, Box 1377PM, Beverly Hills, Calif.

BOOKS. (Out-of-print, new, used) quickly supplied. Many 35c bargains. Catalogue. Mid-West Book Service, 18870 Marx Ave., Detroit 3, Mich.

BIG Profits taking subscriptions for all magazines. Agents' confidential catalog listing over 2500 periodicals and complete starting supplies free. Pines Subscription Agency, Flushing, New York.

"30,000 JOB And Business Opportunities in Alaska"—Based on two years' Alaskan experience, this 15,000-word copyrighted report gives latest facts on fur farming, mining, agriculture, lumbering, transportation, commercial fishing, construction, business opportunities. Special section on climate, homesteading, mineral resources, rights, etc. Private firms and government projects listed—tells how, when, where to apply. \$1.00. Return for refund in 7 days if not satisfied. Pacific Industrial Research Bureau, Dept. 2D, 907 Terminal Sales Building, Portland 5, Oregon.

"TRUE Christian Religion." To obtain a free copy of an 80-page digest of this remarkable work by the famous scientist, philosopher and theologian, Emanuel Swedenborg, send your name and address to Swedenborg Foundation, Inc., Room 1649, 51 East 42 Street, New York 17.

BIBLE Says, "Swords into Plowshares." When? Free booklet explains. Ketchum, 1848 S. 18th, Springfield, Illinois.

SELF-EXPLAINING Bible: Illustrated circular free. Box 446-P, Minneapolis, Minn.

GOOD "Used" self-instruction educational books on all subjects bought, sold, rented, exchanged. Satisfaction guaranteed. Complete information and 100-page illustrated bargain catalog free! Write—Nelson Company, Chicago 5.

MAGAZINES (Back dated)—foreign, domestic, arts. Books, booklets, subscriptions, etc. Catalog 10c (refunded). Cicero's, 863 First Ave., New York 17, N. Y.

"100,000 POST-WAR Jobs Abroad"—South America, China, India, Burma, Japan, Russia, Malaya. How, when and where to apply. U. S. participation in world reconstruction and trade demands thousands of American-trained mechanics, salesmen, technicians, engineers, foremen, laborers and business representatives—every trade needed. Our 15,000-word copyrighted report—compiled from business, professional and government sources—lists over 200 big U. S. firms with foreign interests, gives job information, salary brackets, contract tips, application letters, passport information, climatic conditions, etc.—everything needed for your immediate application. \$1.00. Return for refund in 7 days if not satisfied. Pacific Industrial Research Bureau, 907-E Terminal Sales Building, Portland 5, Oregon.

MAGIC TRICKS, PUZZLES, JOKER NOVELTIES

SENIOR Magic set, contains twenty tricks, \$1.00. Amazing value. This special get-acquainted offer limited to new customers only. If you already have this set please do not send for another. Only one set to a customer. Bedford, 190 Rodney Street, Brooklyn 11, N. Y.

IT'S A Joke, son! Jumping candy—Watch 'em jump when they open the wrapped candy you give them! Send 25c to Wynn Novelty House, 3232 Lorain, Cleveland 13, Ohio.

BEWILDERING Color changing "magic eyes" card! 15c. Postways, Box 5325-L, Philadelphia 42, Penna.

FLOATING Cigarette trick—Cigarette floats in air. Instructions and apparatus, dime. Eastwood, Box 623, Parkersburg, W. Va.

200 ELECTRIC Stunts, 110 volts, \$1. Kutting Sons, Campbell, Calif.

"MULTIPLYING Rabbits"—Fun making pocket trick, 25c. Sensational "cut and restored rope" (including 18 feet special rope) 25c. Famous "cups and balls" (plastic cups) 50c. These tricks sell for one dollar each in exclusive magic shops. Bedford, 190 Rodney Street, Brooklyn 11, N. Y.

PERFORM Seemingly impossible feats: Playing cards containing over 12,000 secret marks, \$1.00. Attractive magic kit of 10 tricks, \$1.00. Kogel's Magic Novelty Co., 6751-A Colbert St., New Orleans 19, La.

TWISTED, Tangled wire puzzle, 10c. Scheetz, Branch Ave., Sellersville, Penna.

FREE—Catalog of novel and useful merchandise. Harold Edlund, 577 Kensington, Los Angeles 26, Calif.

CUT-RATE On magic tricks. Send stamped envelope. Sandell's, 66 W. 71, New York City.

AMAZE Everyone! Earn money in any crowd. Call names of strangers, tell unspoken questions. Professional course mind reading, faked spiritualism, etc., all exposed \$1.00. Free book of magic included. Smith, 708 Ellis, San Francisco 9, Calif.

LEARN Magic quickly. Book 250 easy tricks only 25c. Rush! Magic Mart, 1423 Palou, San Francisco 24, Calif.

WRIST Watch removal trick. Manuscript with drawings \$1.00. Dr. Flowers, Hickory, N. C.

FREE 5 Clever pocket tricks with magic catalog 25c. DeLuca's, 127E Pettis, Providence 4, R. I.

MAGIC Fish and boys' magic book 25c. F. Longfellow, Lambert Lake, Maine.

MAGIC! Big illustrated catalog and three baffling new pocket tricks! 25c. Modern Magic Shop, Woodbury, Conn.

FUNNY Licenses, permits, stationery. Samples 25c. Big assortment \$1.00. Colorpress, Box 179, Santa Rosa, Calif.

A NICKEL You can put in a pop bottle and take out instantly. \$1.00. Box R188B, Seal Beach, Calif.

NEW! Exciting! Sensational! Gigantic joker novelty and magic trick assortment, \$1.00! Samples, 10c. Harley Steele, Maumee, Ohio.

AMAZE Everyone. Thrillingly illustrated catalog. Over 300 magic tricks for pocket, parlor, club, stage, amusing hobby, profitable profession, 10c coin or stamps. The Magician, 2463-M Kensington Ave., Philadelphia 25, Penna.

THE Mystery arrow. No man can figure it out but a child can do it. Show it to your friends and make money too. \$1.00 with instructions. Box R188B, Seal Beach, Calif.

UNTIE Knot in human hair. Instructions, 50c. Details, listings, free. Newton Company, Bonham, Texas.

EARN Extra money giving magic shows. Magic book \$1.00. Free catalogs and lists. Thayer Mfg. Co., 814 S. La Brea, Los Angeles 36, Calif.

"BEYOND The Veil" and "Follow the Leader" two sensational new card tricks for one dollar. Ordinary cards—no sleights. W.R.P., Box 412, P.O. Van Nuys, Calif.

MAGIC Playing cards. Easy directions explain secret code on back of each card. Can do many kinds of "Magic" tricks. Only \$1.50. M & N Card Co., P.O. Box 1463, New Haven, Conn.

TRICK Poker hand diminishes in number of cards right under your eyes 25c. Carter, 47 Hempstead Ave., Rockville Centre, Long Island, N. Y.

500 TRICKS! New 1946-7 edition Douglas famous catalog now ready, only 10c. Brand new magic for pocket, parlor, club, stage, professional, amateur. America's fastest service to magicians everywhere for over 25 years. Send 10c today. Douglas Magicland, Dept. 1, Dallas, Texas.

SEND 25c And we will send you our 84 page catalog. Also 50c trick free to get you started. The Mystery Mart, Dept. PM-1, 737 N. Jackson St., Milwaukee 2, Wis.

VENTRILOQUISM Exposed. First time published. Free booklet. Quackenbus, Big Flats, N. Y.

"THE Fakir," monthly magazine for magicians. Copy 25c. Subscription \$2.00. Joseph Rachun, 114 Grand St., Brooklyn 11, N. Y.

VENTRILOQUISM—Handy, 54 page, pocket size volume 25c. Joe Jones, Box 1192, Columbus, Georgia.

VENTRILOQUISTS, 8 Lesson course \$1. Gotberg, 4207 Grandriver, Detroit 8, Mich.

MAGIC, Novelty catalog, trick, 10c. Wencel, 2615 Evaline, Hamtramck 12, Mich.

EARN Money in any crowd. Call names of strangers, tell unspoken questions. Professional course mind reading, faked spiritualism, etc., \$1. Henderson, Box 341, San Bernardino, Calif.

AMAZE And mystify your friends with highest quality magic. New catalogue 25c coin. Mazda Magic Co., 1135 Westgate Ave., Oak Park, Ill.

VENTRILOQUISM, Ten lesson course only \$1. LeSueur, 77 Wellesley, Toronto, Canada.

LEARN Ventriloquism. 3c stamp brings particulars. Smith, 801 Bigelow, Peoria, Ill.

ENTERTAINING Card routine Old Testament in deck cards, \$1.00. Ehbors, Box 6837, Philadelphia 32, Penna.

LARGE Illustrated professional catalog 10c. Williams, 900 Plymouth, Ellwood City, Penna.

NEW Vanishing key and catalog 25c. Sterling Magic, Box 191, Royal Oak, Mich.

FREE! Large catalog of magical apparatus if you remit 25c for "Magic Is Fun" magazine. Robbins Co., 152-F West 42nd Street, New York.

ENTERTAIN! Mystify! New, bigger magic catalog and 4 secret tricks 25c. Herbert, P-192 N. Clark, Chicago 1.

MAGIC: Big 160 page Illustrated Catalog Latest Magic Goods, 25c. For over 1/3 century we have supplied Professional as well as Beginner. Chicago Magic Co., 2300 N. Mason, Chicago 39.

MAGIC Tricks, puzzles, books, cards, punch boards. Catalog 10c. Specialty, Box 671, St. Louis 1, Mo.

GAMES AND ENTERTAINMENT

PLAY Football on checkered 15"x26" matboard field. Adjustable goals, 23 characterized wood counters, 50 pages of instructions, games, plays, diagrams, \$1.65 post paid. Nat'l Scrimmage Club, 2220 North 33rd Avenue, Omaha 10, Nebraska.

"INTERPLANETARY": Sensational new game. Astronomy. Educational, fascinating. Beautiful board, eight colors, 100 plastic, interlocking poker chips in five colors. Catalin dice, kasaloid space ships, \$2.50. Interplanetary, 211 Utica Street, Fulton, N. Y.

NEW Interlocking "Totem" puzzle. \$1.00 postpaid. Mason, 4337 Morton Rd., Lynwood, Calif.

MAKE Your own photos of movie stars and bandleaders. No chemicals, darkroom or experience required. Fun for all. Complete outfit \$1.00. You can use your own negatives also. Arden Specialties, 2187 86th St., Brooklyn, N. Y.

"MILITARY Ju-Jitsu, boxing," \$1.00! Agents wanted. Inquire. Enterprizes, Spring Valley, N. Y.

NEW Game. 3 ways having fun learning to spell. Children need it. 50 cents. Mudge, 201 Lewis Bldg., Riverside, Calif.

FASCINATING New card game. Free. P.O. Box 842, Denver 1, Colo.

COINS, TOKENS, CURRENCY

MEXICAN Bill and coin price lists—10c. Oliver Arnold, Macon, Mo.

NEW Coin buying list 10c. 209 South Church, Rockford 27, Ill.

WILL Pay \$10.00 each for certain Lincoln pennies! Indianheads \$50; dimes \$1,000. Catalogue 10c. Federal Coin Exchange, 11-PM, Columbus, Ohio.

START An Indianhead penny collection, 18 different dates mounted in Whitman board and price list \$1.00 postpaid. John Handy, 1403 Tenth Avenue, Greeley, Colo.

FIFTEEN Different coins and bills 25c. Oddehon, Box 482, St. Louis, Mo.

LINCOLN Pennies—1910S, 1912S, 1913S, 1914S, 1915S, 1921S, 1923S, 1924S, 1926S, 1931D, 1932D, 1933D, 10c each. Complete price lists 3c. Reynolds, 1118 Mathews, Flint 3, Michigan.

WE Purchase Indianhead pennies. Complete coin catalogue 10c. Spud Fairview, 277 Broadway, New York.

BARGAINS! Rare collection contains United States large cent over 90 years old, Flying Eagle cent, white Indian cent, 2c piece, 3c silver, 3c nickel, half dime, shield nickel, Liberty seated dime, Civil War cent, Confederate bill, foreign coin, foreign bill, our complete buying and selling catalogue. All for \$3.00. Catalogue alone 25c. Over 100 years old collection contains half cent, large cent, 5c piece, dime, quarter, half dollar and colonial coin all for \$5.00. Gold dollar \$5.00. 28 dates Indian cent \$1.00. 25 different foreign coins \$1.00. 5 different foreign silver dollars \$5.00. Worthy Coin Corporation, 152-A Washington, Boston, Mass.

OLD Money wanted. Do you know that coin collectors pay up to \$100.00 for certain U. S. cents? And high premiums for all rare coins? We buy all kinds. Send 4c for large coin folder. May mean much profit to you. Numismatic Co., Dept. 20, Fort Worth, Texas.

COLORFUL, Picturesque Japanese invasion currency, Malaya, Burma, Singapore, 1c, 5c, 10c, 50c, \$1, \$5, \$10, \$100, one rupee, rare \$1,000—note (uncirculated). Mint condition. All for (\$1—U.S.). Apply: Malayan Novelty, 4 Klynestreet, Kuala Lumpur, Malaya.

TWENTY Different Indian head cents \$1.00. Retail catalogue 10c. U. S. gold coins wanted. Top prices paid. Buying list 3c. Bebee Coin Company, 1180 East 63rd Street, Chicago 37, Illinois.

FOR Sale: 1893 Columbian half dollar, 60c; 50 assorted Indian head cents, \$1.00; 50 foreign coins, \$2.00; large coin price list, 10c. Ben's Coin Company, 72 West Washington, Chicago 2, Illinois.

GET Profit and pleasure in collecting old coins. Send 10c for 56-page illustrated coin catalog. You'll be delighted with it. Send for it now. B. Max Mehl, 370 Mehl Building, Fort Worth, Texas. Largest rare coin establishment in U. S. Established 46 years.

FOREIGN Coins, paper money. World-wide selection twelve different odd unusual only 25c. Richard Webb, Box 843, San Bruno, Calif.

WORLD Coins—List free. Harry Elsholz, Box 9014, Pittsburgh 24, Penna.

COMMEMORATIVE 3/4, Oregon, Texas, Kentucky, Cleveland, Long Island, \$2.00 ea. Illustrated catalogue 25c. Norman Shultz, Salt Lake 9, Utah.

FREE! Foreign coin, banknote and coin collectors illustrated catalog to approval service applicants. Send 3c postage. Tatham Coinco, Springfield-125, Mass.

OLD STAMPS WANTED

I WILL Pay \$100.00 each for 1924 1c green Franklin stamps, rotary perforated eleven (up to \$1,000.00 each unused). Send 6c today for large illustrated folder showing amazing prices paid. Vernon Baker, (PM611), Elyria, Ohio.

STAMP COLLECTING

FREE. Irish commemorative collection, including dramatic Easter Rebellion issue with approvals. Raymax, 123-Z William St., New York City.

ALBUM For 1200 stamps given with purchase of 25 different Iran stamps for 25 cents. Nagle, 1101 Marion, Reading, Penna.

FREE Sensational offer! \$1.00, \$2.00, \$4.00, \$5.00, \$10.00 stamps all for 3c postage with approvals! Thrifty Stamps, 727 Silver, Silver Spring, Md.

MOROCCO—Five different large mint pictorials including 163A, cataloging 55c, only 10c to approval applicants. Aldee, Box 38, Tremont Station, Bronx, N. Y.

XMAS In November! Free stamps to approval customers. Write for list and United States approvals. Jarr Stamps, Box 217-N, Madison Square, New York 10.

ROOSEVELT, Churchill, Stalin, Hitler and Vatican City stamps free to approval applicants. Eliot Stampco, 86-31 Eliot Avenue, Rego Park, N. Y.

CANAL Zone, Eritrea, Paraguay, San Marino, and French Morocco, are some of the countries represented in this select packet of 18 different airmails only, from 18 different countries! Send 10c and receive this superb air collection, plus some attractive air-approvals. Air-Line Stamp Company, 4472 North 39th Street, Milwaukee 9, Wisconsin.

EARN Extra stamps for your collection. Approvals and free exchange service. Andy's Exchange Service, Box 6992, Chicago, Ill.

STAMPS From 20 countries free. Quality penny approvals included. Harding Stamp Co., 5031 No. Harding, Chicago 25, Ill.

EARN Valuable stamps for your collection. Big bonus earnings! Fun for everyone. Request approvals and get amazing stamp earning plan immediately. Barton, Box 321, Elizabeth, N. J.

TREMENDOUS Bargain. Lot large U. S. commemoratives, assortment triangles, airmails, gorgeous pictorials. Everything 10c to approval applicants. Alpha, 1017 Longfellow Ave., New York 59.

UNEQUALED Bargain. Stamps from over 25 countries including Fiji, Swaziland, Pitcairn, Tonga, Trinidad, etc. Everything 10c to approval applicants. Bennett's, 39 Arlington, Toronto, Canada.

COMPLETE Roosevelt set (4), army, navy, coast guard, marines, merchant marine (25c value) only 10c to U. S. approval applicants. Metropolitan, 140 Nassau, New York 7.

WORLD'S Largest triangle stamp, included in rare Russian set of picturesque designs, mammoth stamps. This complete set including giant triangle retails for \$3.00 but only 10c to approval applicants. West Coast Stamp Service, Box 344, Hollywood Station, Hollywood 28, California.

FREE, Two New Zealand mint triangles plus New Zealand centennial with approvals. Veteran Stamp Co., 169 Kensington Ave., North Hamilton, Canada.

FREE Packet with approvals. Robert Smith, 801 Market, McKeesport, Penna.

24c PRESIDENT Harrison. Don't miss this scarce stamp. Only 5c with United States approvals. Willett Stamps, Box 507, Fort Chester, N. Y.

25 DIFFERENT Guatemala, or 25 different Egypt, 10c with approvals. Paul Rawden, Box 2920, Westville, Connecticut.

ROOSEVELT-ARGENTINA Commemorative mint. The famous "black beauty" only 5c to approval applicants. Thiem, 1100 1/2 St. Paul Street, Rochester, N. Y.

150 STAMPS—Giant triangle, diamond shapes included. 5c to serious approval applicants only. Regent Stamp Company, 316 Flatbush Avenue, Dept. P, Brooklyn 17, New York.

INFERIOR Stamps never pay. Try our superb general approvals. They've got something! Prices reasonable. Stamps, 821 Kingshighway, Edwardsville, Ill.

200 DIFFERENT 25c Includes triangles, approvals. Husak, 342 Liberty, Syracuse 4, N. Y.

FREE Wholesale lists. Filled approval sheet 10c. Dancer, Mansfield, Ohio.

MEMO Pad and lists free. Johnston's of Conshohocken 2, Penna.

PHILATELIC Printing — stockforms. Samples. Acmeprint, Box 245, East Flat Rock, No. Car.

CANADIAN Stamps, 500 well mixed \$1.00. Approvals if desired. T. Johnstone, 421 Mt. Pleasant R.D., Toronto 12, Can.

ATTRACTIVE Packet free to approval applicants. Rare Stamp Service, P.O. Box 4077, Miami, Fla.

55 DIFFERENT United States 10c to approval applicants. Standard, 3817 Sackett, Cleveland 9, Ohio.

TWENTY Different Ireland 10c. Approvals. Matthews, 815 Washington, Waterloo, Iowa.

WORLDWIDE, 100 Different stamps, 5c with approvals. Boerger Stamps, 206 Main, Toledo 5, Ohio.

"UNO" Set and 350 mixed Mexico \$1.00. Biehl's, Apartado 2887, Mexico City, D. F.

UNITED States flag stamps of occupied nations used set \$1.00. Steger, 1165 Downing, Denver 3, Colorado.

UNITED States commemoratives! 101 different used \$1.00. Acme Stamp Company, Box 222, Maywood, Illinois.

EIGHT President, including \$1.00 Wilson, 15 airmails, commemoratives. Approvals. All 10c. O. Burgett, Lima, Ohio.

DOLLAR Each—1200 better U. S.; 1500 foreign; 2000 Canada. Seiden, 1331 Intervale, New York 59.

50% DISCOUNT On our world-wide approvals. Central Stamp Company, New Providence 1, New Jersey.

100 DIFFERENT Stamps only 3c with approvals. Other bargains. Appleman, Ida, Mich.

SUPERVISED Exchange collection packets, new issues. Details, lists free. Shoto Stamp Shop, Two Rivers, Wisconsin.

MEDIUM Priced foreign approvals. Streiner, 898 East 75, Cleveland 3, Ohio.

FREE 22 U. S. and 23 foreign stamps with approvals. Rebeck, 5614 E. 3rd Place, Gary, Ind.

FREE—Airmails, commemoratives, pictorials with approvals. Enclose 3c postage. H. P. Wischart, Frankfort 1, Ohio.

THREE Hitler heads. Mint. Free on approval. M. Green Stamp Co., P.O. Box 287, Hollywood 28, Calif.

ARE You a philatelist? Ask Veritas Stamp Company, 35 Williston Way, Pawtucket, Rhode Island.

FLAG Stamp free with U. S. approvals. Wenigman, 929 Oakdale, Chicago.

FREE! Airmail packet with approvals. Deane Stamp Co., Box 1002, Miami Beach 39, Florida.

SCARCE Greek Roosevelt set complete 50c. Roosevelts and 25 different beautiful Haiti pictorials \$1.10. Roosevelts with 25 different valuable Curacao \$2.00. No approvals. E. Jesse, Kenner, Louisiana.

FREE! 25 Different Canada to approval applicants. Shank, 1240 Welton Way, Inglewood, California.

AMAZING! South Orkneys, Bechuanaaland, triangle, Lebanon, Luxemburg, Monaco, etc. Also 25 different Finland as extra prize. Everything 5c to approval applicants. Shaw, Box 819-W, Imperial Beach, Calif.

WE Buy desirable stamp collections, and accumulations. Top prices. National Stamp Sales, 276 West 43rd St., New York City.

A FINE Worthwhile collection of 125 different U. S. Catalog numbers penciled on back only \$1.00. No approvals. G. P. Kunz, 2054 Boulevard, Jersey City 5, N. J.

AIRMAILS, 100 Different \$1.00. John MacDonald, 30-M Seaman Ave., New York 34.

112 DIFFERENT World-wide, from 20 different countries, 10 cents to approval applicants. Daniel W. Menge, 827 North Lime Street, Lancaster, Penna.

BETTER Grade foreign stamps on approval for serious collectors. Palms Stamp Co., Palms Sta., Los Angeles, Calif.

ARGENTINE, Greece, Nicaragua Roosevelts, set six 25c to serious applicants. Turner, Box 1492, San Antonio, Texas.

ANNIEOPSQUOTCH Is a race horse. You'll "win" if you'll "place" a request to "show" you approvals! (Any country.) Purchase stamps from Purchase! Purchase's, 1209-J Woodruff, Hillside 5, New Jersey.

HUNGARY Inflation set—800 billion pengos, 5c to approval applicants. Irving Solomon, 3716 Kings Highway, Brooklyn 10, N. Y.

TWO Mint Costa Rica sets 10c with approvals. Vargo Stamps, 6044 South Fairfield, Chicago 29, Illinois.

FREE! 10 Different Peru to approval applicants enclosing postage. Ranson, 721 West Maple, Compton, Calif.

ABSOLUTELY Free—Roosevelt memorial set from Greece to sincere approval applicants. References. Charles Inskeep, Newburgh, Ind.

FRESHLY Mounted foreign on approval to dependable beginners and advanced collectors. Also new issue service. References. Wiaschim, 55 Nagle Ave., New York 34.

RUSSIAN—Berlin occupation "bears!" Set of 7. 5c. Approvals. Fields, Box 36, Brookhill, Va.

FREE—Liberia Triangle, Hitler stamps, half-stamp triangle, Devil's Island, others. Approvals. Postage 3c. Pilgrim Co., 6406 Old Hartford, Baltimore 14, Md.

MINT'S Famous Americans, etc. Get list. Marion Sikes, 1831 E. Allegheny, Philadelphia 34, Penna.

FIVE Vatican City stamps free to approval applicants. Florida Stamp Company, Box 807, Miami 5, Florida.

SOLOMON Islands, Grenada, Turks Caicos, Caymans, Dominica—everything 2c with approvals. Viking, 130-Z Clinton St., Brooklyn, N. Y.

BEAUTIFUL Australia victory set 25c with interesting approvals. Rheaume, 8949 Routhier, Montreal, Canada.

POSITIVELY Greatest free offer—Latest Scott's International \$5.00 stamp album, covering entire world, contains 36,000 illustrated descriptive spaces; Scott's 1947 Standard \$5.00 catalogues "Philately's Encyclopedia"—absolutely free to applicants for foreign approvals becoming customers. Bargain Stamp Service, Palm Springs, California.

WHAT Have you to offer? A collection? A "shoe box" accumulation? Anything in stamps. We urgently need them. Spot cash paid. Cosmopolitan Stamp Co., 157 Broadway, Dept. 11-E, New York.

ATTRACTIVE Approvals. Premiums on purchases. J. Dill, Box 1986, Chicago 90.

AIRMAIL Stamps on approval. Priced right. Write today. Evening Stamp Post, 225 W. 34 St., New York 1, N. Y.

PENNY Approvals by country. M. H. Hoerning, 115, Farmington, Ark.

JOIN The Stamp Club—\$1.00 year. Send dollar bill for membership today. Satisfaction guaranteed. Each month you receive free packet of 25 stamps for your collection. Exchange division. Send us 25 or more different stamps and we send you the same number without charge. Stamp World, 536 So. 30, Omaha 5, Nebraska.

STAMP Collections wanted. Complete collections, duplicate lots, surplus stock, mint and used. Prefer trade for printing or other items, buy outright if priced right. What have you, what's wanted? Vanroy Shirk, Lebanon, Penna.

FREE! Japanese airmail set. Complete, unused, obsolete. To approval applicants only. Riedell, Greensburg, Pennsylvania.

FREE Persia packet to approval applicants. Foreign only. Everglades Stamps, Box 3222, Sta. F, Atlanta, Georgia.

FLAGS! Flags! Flags! Beautiful collection flag stamps (value 25c). Manchukuo census set (value 8c). Packet 25 countries (value 57c) including scarce Macao, Morocco, etc. Perforation gauge (value 10c). Total value \$1.00. All—10c to approval applicants. Odd Stamps Co., Dept. A-3, 5391 Metropolitan Station, Los Angeles 55.

SPAIN'S "Nude Goya" set complete 30c. Approvals. Royal Stamp Company, Tamaqua, Penna.

25 DIFFERENT U. S. commemoratives 10c with approvals. Pomeroy, Minnetonka Beach, Minn.

EDWARD Eighth (Britain) mint set complete, 5c to approval applicants. Douglas, Hawkesbury, Ontario.

SUPER Value 21 different famous Americans 40c. 35 different \$2.39 or 200 different U. S. only \$1.00 to approval applicants. AAA Stamp Co., Arcade Bldg., St. Louis, Mo.

KENYA, Nigeria, etc., fifty different 10c. Approvals. Lists free. Ethier, Oshawa, Ontario, Canada.

SALE All 10c sets 8c, 5c sets 4c. Ecuador airmail commemorative set free to customers. Write now. Socker, 1508 Dickinson St., Philadelphia 46, Penna.

MAGNIFYING Glass, all plastic, non breakable, 50 different Italy, 50 different Sweden. All for 30c with approvals. Bradford, Box 636, G.P.O., Brooklyn 1, N. Y.

STAMP Assortments for stores. Wholesale. Inquire on business stationery. Edward Hammond Company, Auburndale, Massachusetts.

CHOICE United States approvals. Wallace Mageau, 1104-4 Ave., Virginia, Minn.

GOOD Stamps that satisfy at fair prices, sent to sincere approval buyers. John Bruno, 1442 South Kenneth Avenue, Chicago 23, Illinois.

VATICAN City set catalogs 46c, 10c with approvals. Jefferson Stamps, 1300 Jefferson St. N.W., Washington 11, D. C.

TOP Prices paid for collections, accumulations, old letters. Predota, 3126 W. 115, Cleveland 11, Ohio.

500 MIXED U. S., 100 varieties guaranteed, \$1.00. Want lists for U. S. welcome. Lowest prices. Hobbycraft, Bowler, Wis.

U. S. And foreign approvals sent. Metro Stamp Co., 55 Ave. C, New York 9, N. Y.

FREE Roosevelt Colombia issue to approval applicants. Blatt, 1015 Pine, Philadelphia 7, Penna.

25 DIFFERENT Hungarian war-peace issues; Horseman set, martyrs, surcharges, reconstruction, etc. The entire collection of all fine mint copies and handy perforation gauge only 5c with approvals that really satisfy. "Stanley the Stamp Man," 4232-A South Pine Ave., Milwaukee 7, Wisconsin.

STAMP Exchange. Send 200 different and 15c. Receive 200 different. Mumma, 212 Stevens, Lancaster, Penna.

FOREIGN Mixture (wide variety, many countries). 500 for 25c. 100 different Austria 40c. 100 different Japan 75c. 100 different Persia \$1.00. 100 different Spain \$1.25. Catalogs free. Mission Mart, Washington 17, D. C.

1000 MIXED U. S. old and new—25c; 2 lb. \$1.25. Weatherby, Medina, Ohio.

30 BEAUTIFUL Airmails, 10c. Selected approvals. Louis Morrison, Milmont Park 1, Penna.

SWITZERLAND: Air mails C 37-39 25c with stamps in sets on approval. Mutual, 6316 Wellsmar, St. Louis, Mo.

19th CENTURY U. S. stamps, 25 different 75c, 90 different commemoratives, \$1.00. Free U. S. price list. Write! A. Bartke, Palisade, N. J.

LARGEST. Oldest collectors society. Large sales department. Illustrated monthly journal. Write to: A.P.S. Central Office, Box 800, State College, Penna.

ROOSEVELT Memorial stamps from Nicaragua, Argentina and Greece plus beautiful photo of Roosevelt "collecting stamps" only 10c to approval applicants. National Stamp Sales, 276 West 43rd Street, New York City.

COMPLETE Set of eight Berlin bears and 100 different stamps only 10c to approval applicants. Reich Stamp Co., 4647 Kenmore, Chicago 40, Ill. Dept. M11.

\$3.35 VALUE For only 10c. Gorgeous bicolor issue depicting Greece glories. (12 values.) Send dime today for this outstanding offer. Imperial Stamp Co., Yonkers, N. Y.

UNITED States. #146, #182, #324, #548, #602 (mint), #613, #649 (mint), #J16. Send 50c. Approvals accompany. Whiton-Stamps, Westport 4, Connecticut.

BARGAIN! Caymans set, Nepal, Montserrat, Gilberts, St. Helena, 11 other countries. 10c with approvals. Marathon, 1246 W. Marshall, Ferndale 20, Michigan.

60 CORONATION Souvenir stamps 3c to approval applicants. Morrell, 203 Fenimore St., Brooklyn 25, N. Y.

PACKETS—List of 200 different countries free on request. Subway Stamp, 87 Nassau, New York.

FREE Mint Korea Flag with \$5 foreign packet or 125 different U. S. for dollar bill. Beattie, 2309 Huidekoper, Washington 7, D. C.

LIBERAL Offer! Includes Rhodes, Libia, Eritrea, Guiana, Djibouti, Rhodesia, numerous others. Everything 10c to approval applicants. Sovereign Stamp, 57 Casot, Quebec, Canada.

CHINA. Every stamp with a historical meaning. Twenty of these colorful stamps offered separately applicants for 10c. Colhns', 71 Coleridge, San Francisco 10, Calif.

TWO Scarce Quisling Occupation stamps, 15 other Norwegian, 1 Liberation, send one dollar reg. Airmail to Krabbe, Mesnali, Norway.

NEW Zealand. 60 varieties plus Airmail, Coronation, and Health sets. \$1.00. Lovell, Taupiri, New Zealand.

FREE Premium to new foreign approval applicants. Wesken Stamp Company, Box 66M, Queens Village, N. Y.

FREE—Handy pocket stamp wallet. Worldwide approvals 1c up. Free gift plan. Crown Stamp Co., 412 Maple St., Holyoke, Mass.

OWN Your own zoo! Rare collection of exotic animals and birds from jungle lands, with Camel, Elephant and Giraffe, Kagu, Kaviroindu Cranes, Kiwi, Koala, Kookaburra, Springbok, Territero, and twelve more exciting zoological stamps. Price only ten cents to serious approval applicants. Money back if not delighted! Charles Ernest, 69 Broadway, Staten Island 10, N. Y.

FREE: Bermuda victory commemoratives complete. Purkis, 6079 West Boulevard, Vancouver, Canada.

FREE—28 Different British Empire to approval applicants. Stamp Exchange, Brewer 1, Maine.

U. S. Mixture, lb. 60c. 1/4 lb. sample 20c. Nichols, 746 River, Mattapan, Mass.

YOUR Money's worth! Seychelles, Djibouti, Angola, Chinese hunger stamps and over 100 different other stamps. Everything 10c to approval applicants. Atlas Stamps, 4220 West 16th, Dep't L, Little Rock, Ark.

BRITISH Empire. Fifty different flashy stamps plus unique mystery stamp. 10c to penny approval applicants. Litsch, Box 535, Middletown, Ohio.

FREE Magazine for stamp collectors! Send today for sample copy of the new weekly stamp magazine—Philately. Complete and up-to-date U. S. and foreign stamp news and features. Modern format, excellently illustrated. Philately, 200-PM So. 7th St., St. Louis 2, Mo.

MYSTERIOUS Bechuanaland, scarce Tonga, dazzling Pitcairn, venerable Spanish Colonies, sparkling French Colonials—Everything 3c with approvals! Saxons, Walden, New York.

ALL-MINT British Colonial packet given to approval applicants enclosing ten cents. Stamp Fair, 253 South Hite, Louisville 6, Kentucky.

U. S. And foreign approvals. Vet Stamp Co., 1136-P Flatbush Ave., Brooklyn 26, N. Y.

GUARANTEED Job lots U. S., foreign, precancels. Each \$1.03. Pound old mixture \$1.15. Blackmon, Corcoran, Calif.

U. S. Commemoratives, 15 different 5c. Henderson, 962-M 72nd Street, Brooklyn 28, N. Y.

200 DIFFERENT Foreign. Many countries, 30c. Jem Stamps, Port Jefferson, N. Y.

FREE—New issues, Italian Republic, Greece, France, triangle, to approval applicants. Green and Company, Norwood 12, Ohio.

FREE! Stamp wallet, sincere approval buyers. Thiese, 9320 San Juan Ave., South Gate, California.

10 DIFFERENT U. S. over 40 years old, 5c. Foreign. U. S. approvals. Scott, 30 Baker Ave., Lexington 73, Mass.

FREE! Rhodesian bi-colored waterfall; old El Salvador issues; plus 25 different worldwide stamps. All free to approval applicants. Pladon Stamps, 1717-M Idaho, Toledo 5, Ohio.

MIXTURES. Worldwide accumulations 1,500 for \$1. Missions Outlet, Rev. Marshall, Paterson 1, N. J.

BRITISH, Spanish and French Colonies, Vatican, Hitler heads and airmail packet, free with approvals. Pan-American Stamp Co., Box 145, New York 33, N. Y.

BEGINNERS! My progressive U. S. approvals, postage or precancels, are intended for you! Send a postal today. Richard Cole, 43 Rinewalt, Williamsville, N. Y.

CHOICE Penny approvals—Some higher. Stamps, 1267 Tutwiler, Memphis 7, Tenn.

FREE—Abyssinia, Cayman Islands, Tuna triangle, Indochine, Syria, Ivoire, Philippines (Jap "shame" issue), Turkish harem, Damascus, Cambodia, African "beauty," Pirate Islands, Colonials, others—All free for 3c postage with approvals. Belmont Stamps, Washington 10, D. C.

160 U. S. Approvals. Return postage paid. Low priced foreign. Southern Stamp, Box 70, Miami, Florida.

EXCELLENT Pictorial approvals. Reasonably priced. Crown Stamp Company, Box 331, Toronto, Canada.

FREE! Bechuanaland! Trinidad! Iran! Assortment. Approvals. Stampco, Miami Springs, Florida.

AMAZING Offer! Assortment each of giant stamps, midget stamps, flag stamps, airmail stamps, Free French Colonies, U. S. commemoratives and numerous others. Everything only 10c to approval applicants. Simon, Box 508, Iraan, Texas.

FLASH! Amazing value! Djibouti, Bechuanaland, Sarkari, Cameroons, others. All 6c, approval applicants only. Southwest Stamps, Box 117, Long Beach 1, Calif.

FREE 25 Different Italy. Postage 3c. Robert Ewing, Wapakoneta, Ohio.

TRIANGLE Set 3c. Beginners approvals. Mallo, 767 Leith, Flint 5, Mich.

FREE—Scarce coronation! Bargain approvals. Gramatan, Box 1002 Church Street Station, New York 8.

25 JAPANESE Stamps 5c with approvals. Frank Stamps, 177 Elmcroft, Rochester 9, N. Y.

SPECIALIZE In U. S.! 174 different, \$1.00; 254 different, \$2.00; 324 different, \$3.00. Veteran's Stamps, 4714 N. Albany, Chicago.

5 HITLER Stamps only 3c, with approvals. Gaydos, Kenosha, Wis.

WORLD Album 10c. Fine approvals. Kress, Box 144, Hanover, Penna.

175 U. S. Commemoratives, etc., 10c. 500—25c. P.O. Box 457, Newark 1, N. J.

PORTUGUESE Colonies. 25 different 5c with approvals. Lorane Brown, Marion, Michigan.

GORGEOUS Colors, scarce airmail, surcharges, charities, sets, etc. All in our big premium packet only 3c to approval buyers. Dixie Stamp Company, Dept. M, Milwaukee 3, Wisconsin.

ADEN To Zanzibar! 40 different British Empire, including Cyprus, Malta, Dominica; 5c with approvals. Lyman Company, 95 Nassau Street, New York City 7.

U. S. Price list. Send postage. State Stamp Service, 1225 Park Building, Pittsburgh 22, Penna.

25 DIFFERENT Swiss 10c—with 1/4, 1/2, 1c approvals. Carroll's, 4357A S. Hoover, Los Angeles 37, Calif.

OLD Scarce U. S. seconds on approval. Slightly defective, nice appearance, bargain prices. Hernfield, 551 Clinton, Newark 8, N. J.

EXCHANGE Duplicates. Swappers everywhere. List 10c. Particulars free. Box 2166-M, Denver 1, Colorado.

ONE, Two, four, five dollar U. S. stamps free to approval applicants. United Stamp Service, Box 1789-M, Miami 10, Florida.

ZANZIBAR, Palestine, Manchukuo, Azerbaijan, Haiti, Iraq, Siam, Victoria, Hitler stamp 5c. Approvals. Postzegel, Windham, New York.

U. S. Price list. Send postage. Stanley Gibbons, 38-P Park Row, New York.

PENNY Approvals, that satisfy. Neil Gronberg, Box 5441-P, Philadelphia 43, Penna.

MINT Pictorials free to approval applicants. Surf Stamp Co., Box 2296, Miami Beach 40, Florida.

APPROVAL Sheets, Frederick B. Driver, 909 Finance Building, Philadelphia 2, Pa.

ZOWIE-E! A barrel of fun for only a dime. 500 United States stamps—absolutely unpicked and unsorted—just as received from church missions. Many varieties, including large commemoratives, airmails, high denominations up to \$5.00! Stampdom's biggest package of fun—and you might find something really valuable! Price only 10c to serious approval service applicants. Money back if not delighted. Illustrated bargain lists with each order. Mystic Stamp Company, Dept. 80, Camden, New York.

50 DIFFERENT United States, 10c. Price-list free. Seidenberg, Cassopolis, Mich.

CANADA—75c Diff. 25c. Approvals, Lists. Victoria Stamp Co., London 4, Canada.

FINE Approvals, freshly mounted. Fast, personal service. Tell me what countries you prefer and I'll send them stamps. Skinner, 438 Locust, Long Beach 2, Calif.

RICH Man's approvals, poor man's prices. Grand value packet containing five foreign sets, free with approvals. Stoll Stamp Service, 2630B West Burnett, Louisville 10, Kentucky.

FREE! Negro Triangle; Turks Islands "Cactus"; Dakar; Guinea; Palestine; "Fairy Tale," Pirate Chart, Map, Ship, Sea Lion and Snake stamps; French, British, Portuguese Colonies, etc. Free for 3c postage. Approvals. Potomac Stamps, Washington 10, D. C.

WOW! \$10.00 Worth of fun only 10c. What a treasure hunt! Big package 500 foreign stamps—just as received from foreign missions other sources. Includes stamps from Africa, South America, Philippines, Free French, Cape Juby, Palestine, etc., including airmails, commemoratives, and stamps worth up to 50c and 75c. This amazing offer is given for 10c to serious approval applicants only. One to a customer, money back if not more than delighted. Jamestown Stamp Co., Dept. 22, Jamestown, New York. Stamps—valued up to 50c and 75c each.

UNITED States approvals complete coverage, fine quality, attractive prices. Seminoles Stamps, Box 378, Coconut Grove, Florida.

FREE! Leeward Is., Cayman Is., Turks and Caicos plus 54 different mint World's Fair poster stamps, to approval service applicants sending 3c postage. Tatham Stamp Co., Springfield 30, Mass.

25 DIFFERENT India, 3c with approvals. Premiums with purchases. Brandwein Stamp Company, Box 92H, Bayonne, N. J.

50 DIFFERENT Including scarce diamond-shaped airmail 3c to approval service applicants. Avalon Stamp Co., Dept. M, Springfield 8, Mass.

DANDY United States approvals. Write immediately. Sullivan, Endicott Building, St. Paul 1, Minn.

1000 GRABAGS 15c Each. Super bags 25c. Zandy, 630 Bingham, Reading, Pa.

BOX Stamps containing hundreds all different, cataloging up to 25c each. Everything \$1.00. Longacre Shop, 108 West 42nd, New York City.

COMPLETE "United States" catalog with 1000 illustrations! Send 10c for mailing. Harris & Co., 137 Transit Building, Boston, Mass.

SCARCE "Pole to Pole" packet! Stamps from strange, mysterious countries only—Greenland (North Pole), Solomons, Spanish Morocco, Bhopal, Patiala, Siberia, Grahamsland (South Pole), Djibouti, Zanzibar, etc., and including stamps cataloging up to 25c each! Our price only 5c to approval applicants. Big dime packet list free! Methuen Stamp Service, Inc., Dept. 136, Lawrence, Mass.

FREE U. S. price list. Postage 3c. Mark Hanna, 335 - 5th Avenue, Pittsburgh 22, Penna.

FREE—Pick 25c worth of stamps from our first U. S. approval selection. Approximately 100 stamps to choose from. Excellent value. No obligation to buy. Lists illustrating the most popular U. S. stamps—at prices you can afford—will be included. Don't miss this opportunity! Write today. S. O. Engel Co., 38 Park Row, New York City.

FREE! Canadian sets, royal visit, George VI, George V, coronation, jubilee, others, to approval applicants. Ensign, Box 118-M, South Orange, N. J.

WORLD'S Largest diamond and triangle stamps, free stamp magazine, stamps from fighting Free French, 20 stamps from 20 different countries, pictorials, airmails, big bargain 5c with approvals. Capital Stamps, Dept. 2, Little Rock, Ark.

DEALERS—Wholesale list. Postage 3c. Frank, 5031 Queensberry, Baltimore 16, Md.

118 DIFFERENT Stamps including commemoratives, charities, airmail sets, etc., only 3c to approval buyers. We buy collections. Badger Stamp Co., Milwaukee 3, Wis.

VICTORY Packet free—Includes stamps from Tanganyika, British Cayman Islands, animal, scarce babyhead, coronation, early Victorian, airmail, map stamps, with big catalogue—all free. Send 5c for postage. Gray Stamp Company, Dept. PM, Toronto, Canada.

FREE! The Stamp Finder! Send today for the big new edition, fully illustrated, enabling you instantly to identify all difficult stamps! Also fine packet strange, fascinating stamps from Bosnia-Herzegovina, Monaco, Patiala, Cyprus, etc., including maps, ships, animals and strange scenes. All free to approval applicants inclosing 3c postage. Garcelon Stamp Company, Box 900, Calais, Maine.

MINT George VI eight crown colony pictorials including bi-colors 10c to serious approval applicants. Mutual Stamp Service, 5145P Village Green, Los Angeles 16, California.

HOBBIES AND COLLECTIONS

LET'S Swap! Whatcha got? Whatcher hobby? Three times two dimes. Swapper's Hobby Bulletin, Royal Oak, Mich.

"HOBBY Directory," descriptive registry, all types of hobbyists. Nation-wide for men and boys. Box 91, So. Orange, N. J.

KLONDIKE! For hobby jewelry makers! Novelty jewelry findings from tables of large manufacturers, parts for bracelets, pins, earrings, etc. Unfinished. Chains, rings, pins, stones, clips, beads, many other items—1 lb. bags \$2.00 per bag in 5 bag lots. Sample bag \$3.00, prepaid only. Mdse. Distributing Co., 19 E. 16th St., New York 13.

CAMPAIGN Ribbons—Beginner's package. Introductory price 50c. Contains assorted ribbons. Collectors desiring special ribbons specify your requirements. Mdse. Distributing Co., 19 E. 16th St., New York 13.

22 DIFFERENT Emblems—\$1.00 (value \$4.60). Introductory offer, never before equalled. Price and Insignia Guide 10c. Hobbyguild, R35 West 32nd St., New York.

WANTED: Old cigarette cards. Write Charles Bray, East Bangor, Penna.

COMBAT Action pictures. Your own division, all campaigns. Twenty 4x5 glossy pictures with captions \$1.20 postpaid. Refund guaranteed. Official War Pictures Co., Dept. PM 64-40 98th Street, Forest Hills, L. I., N. Y.

UNIQUE Gift items! Hobby Catalogue 10c. Reptile list 5c. Quivira Specialties, Topeka, Kansas.

BOOK Matches—your name, address, or initials. 50—\$1.25. Samples, Press, 749 S. Plymouth, Rochester 8, N. Y.

EXCHANGE Your duplicate stamps, match covers, post cards, or any hobby, with collectors everywhere! Exchange register listing swappers, 10c. (Mention hobby.) World Hobby House, Box 721-A, Olympia, Wash.

FOREIGN Medal ribbon packet. United Nations, Axis. \$1.00, sample 20c. Insignia-craft, 236 28th Avenue N.W., Calgary, Canada.

SWAPPER? Collector? Send 10c for sample copy Hobbyswap Contacts, 1326 South 27th, Omaha, Nebraska.

INVENTING Can be an interesting and profitable hobby. Write for complete particulars. Institute of American Inventors, Dept. 40-E, 1926-Eye St. N. W., Washington 6, D. C.

COLLECTING Hobbyists. Exchange duplicates. Swappers directory 10c. C. Bishop, Route 8, Kalamazoo 88, Michigan.

COLLECT Colorful Army patches. Pictures, prices and sample patch only 10c. Insignia Mart, 703 Broadway, N. Y.

UNUSED Match book covers. 100 all different \$1.00. 35 Royal Flash covers \$1.00. Free list. Charles Edelman, 1311C East 84, Cleveland 3, Ohio.

JEWELRY Stones removed from rings, etc., 100 assorted \$2.40; 50 large ones \$2.40. B. Lowe, Holland Bldg., St. Louis 1, Mo.

ANTIQUES, RELICS, INDIAN GOODS, CURIOS

20 ARROWHEADS Or 20" string old Indian beads \$1 each. Lynn Crandall, Box 697, Idaho Falls, Idaho.

MUSEUM Specimens. Indian relics, curios, den decorations. Illustrated catalogue, identification chart 25c. We also buy. Museum Supplies, 6601 Oshkosh, Chicago 31, Illinois.

50,000 INDIAN Arrows, tools, rainbow variations. Don McKillop, Regina, Sask.

SWORDS, Rapiers, daggers, pistols, armor. Illustrated catalog 50c. Robert Abels, 860-A Lexington Ave., New York.

4 FINE Ancient arrowheads, \$1.00. Stone Tomahawk, \$1.00. Flint knife, 50c. List free. Lear's, Box 569, Galveston, Texas.

MINERALS—PRECIOUS STONES

ASSORTMENT Of local minerals for cutting or specimens \$1.00. State which. Plummer, 5068 Brighton, San Diego 7, Calif.

WYOMING Jade: square inch each, light green, black, mottled. Also square inch each Montana Moss and Turritella Agate. Diamond Sawn. All for \$1.00. Money back guarantee. Jade & Agate Mfg. Co., Box 186, Casper, Wyoming.

BEAUTIFUL Polished Mexican Opals. Sample packet \$1.00 prepaid. Westland Sales Co., P.O. Box 1931, El Paso, Texas.

"GENUINE" Arizona rubies (garnets). Send quarter for packet. Mineral Specimens Company, Box 2651, Phoenix, Ariz.

CAMERAS AND PHOTO SUPPLIES

SENSATIONAL—Clix-O-Flex reflex type camera. Maestar lens—time and instantaneous shutter uses #127 films 16 exposures that most photo finishers through the country are equipped to print from this negative to 3 1/4x4" Price \$5.95. Conway Camera Company, 34 North Clark Street, Chicago 2, Illinois.

PHOTO Finishers. \$20 per thousand cash paid for empty #127 spools. Cash will be sent promptly or you may ship c.o.d. if you prefer. No other sizes desired at present. Howard West, 3 W. 42nd St., New York 18, N. Y.

300 WATT 2x2 Slide projector. Build with hand tools. Material cost approximately \$4.00 including lamp. Instructions, blueprints—\$1.00. Jackson Engineering, Box 776-HN, Chicago 90.

FILMS. 5 Rolls 127, \$1.20; 120 or 620, \$1.45; 116, 616, \$1.70. Best quality guarantee. New cameras. Roll finished, 16 pictures, 35c. Reprints 2c. Dodge Studios, Albany, Wisconsin.

PHOTO Printer kit \$1.00. L. Spada, 10 Lexington, Wethersfield 9, Conn.

CAMERAS, Enlargers, projectors. Lowest prices. Free catalog. Cavalier Camera, 1822 Center, Pittsburgh 19, Penna.

CASH! Spot cash for cameras, lenses, binoculars, movie and still equipment. Send full description for prompt cash offer. Over 36 years of dependability. Bass Camera Company, Dept. AG, 179 W. Madison St., Chicago 2.

BASS Says: Trade cameras? For 36 years Bass has satisfied thousands everywhere! Finest equipment available. Always satisfaction guaranteed or your money back! Bass buys 'em, sells 'em, trades 'em. Bass Camera Company, Dept. AG, 179 W. Madison St., Chicago 2.

USED Camera Directory, Box 1031-M, Canton, Ohio—lists hundreds of war-bargain used cameras—35mm., Speed Graphics, Kodaks, Rolleiflex—many others. Send 25c for latest issue.

HAVE You a camera? Improve your hobby of photography and learn how to make better pictures. Write today for our latest book catalog and sample copy of American Photography, containing articles and pictures by the world's foremost writers and photographers. Camera House, 601, 353 Newbury St., Boston 15, Mass.

PHOTOGRAPHY For pleasure or profit. Learn at home. Practical basic training. Long established school. Write for booklet. American School of Photography, 1315 Michigan, Dept. 3432, Chicago 5.

PHOTO FINISHING

HAND Colored in oil—8x10 double weight enlargement only \$1.00. Send negative and instructions. Tom Thumb Photo Service, Box 29, Van Nuys, Calif.

BEAUTIFUL 5"x7" Hand colored enlargement from negative 25c. From photograph 25c additional. Prompt service. Promenade Photos, Sta. D, Box 198, Dept. M2, New York 3, N. Y.

DOZEN Beautifully colored Christmas folders, enlargement, mailing envelopes \$2.50 postpaid. Send negative. Sterling's 679 Northampton, Easton, Pennsylvania.

FILM 127 Surplus \$3.59 dozen fast pan. Other sizes. We buy anything. "Camera-man," 542P 5th Ave., New York 19.

FIVE Beautiful 5x7 enlargements \$1. Photocraft, 110 Harris, LaGrange, Ill.

36 BIG 3x4 Enlargements from 35mm. film \$1.25. Photoshop, Linton, Indiana.

DE LUXE 8x10 Enlargement from your photo or negative 50c. Original returned unharmed. Photo Lab, 3123 N. Clark, Chicago 14.

CHRISTMAS Greeting cards from your own snapshots, send negative and \$1.00 for 18, (including envelopes). Rolls developed, 8 prints 25c, over 8 exposures 40c. Reprints 3c. Fred D. Eastman, Bode, Iowa.

CHRISTMAS Cards, with your picture. Send 5c and negative for sample card, list of styles and prices. Smith Studios, 8 Saint John Street, Plains, Pennsylvania.

25 BILLFOLD Size black and white copies from your favorite portrait. \$2.00. J. G. Jacob, 125 N. 4th Ave., Morton, Ill.

EITHER Size prints—Roll developed and 8 regular prints with coupon or 8 oversize prints, 25c. Reprints, regular 3c, oversize 5c. Service you'll appreciate. Jumbo Photos, Box 868PM, Minneapolis, Minn.

ENLARGEMENTS, 4x5, 10 for \$1; 5x7, 7 for \$1; 8x10, 3 for \$1. Overnight service. Free photos of San Francisco. DBW, 72 San Benito Way, San Francisco.

OVERNIGHT Service. Roll developed and 8 prints 30c. Finest quality guaranteed. Our 13th year. Tri-Plex Photo Service, Box 375-B, San Francisco 1, Calif.

DOUBLE Weight enlargements. 8x10's 30c. Four \$1.00. 5x7's 20c. Six \$1.00. Either size colored \$1.00 each extra. Send negatives. Empire Photos, Adams Center, N. Y.

6-8 EXPOSURE Rolls developed and enlarged mammoth size 30c. Reprints 3c. Thrifty Photos, Box E-46, South Gate, Calif.

DELUXE Photo finishing. Roll film developed with double size prints. 8 exposures 30c. 12—45c. Kensey, B-25, 211 W. 145th, New York 30.

15 REPRINTS 25c With this ad. Photographer, River Grove, Ill.

PRESERVE Forever your favorite snapshots or your Social Security Card! We'll lock them permanently within a sheet of unbreakable, crystal-clear plastic. Special offer to mail order buyers, only 50c each. Send snapshots or cards with remittance to Photo-Craft, Canton 1, Ohio.

SAVE Money. Instructions and kit makes 300 reprints. \$1.00. Russell Thomas, Jr., Plaistow, N. H.

ENLARGING, Printing, developing easily learned. Simplified instructions \$1.00. Fred Carpenter, Box 264, Hamlin, Texas.

ROLL Developed. 8 brilliant fadeproof Velox prints and two professional enlargements 25c. Overnight service. Young Photo Service, 405-C, Albany 2, N. Y.

FREE—Set of filters for names and addresses of four camera owners. Photo-Craft, Canton 1, Ohio.

8 PRINTS, All enlarged to nearly postcard size, from your roll or negative, 15c. Willard Studios, Box 3535A, Cleveland 18, Ohio.

XMAS Bargain—Your favorite snapshot enlarged 8"x10", beautifully oil colored, only \$1.75. Send negative and color instructions. Kolorkraft, 1626 Buena Vista, Alameda, California.

SPECIAL—50 Reprints \$1. Suburban Studio, 1410 Bond, Rockford, Illinois.

NEW Amazing Plastik-Prints. Secret process. Post war invention. Nothing like it. Sharper, clearer, fade-proof, water resistant prints. Lifetime guarantee. 6 or 8 exposure roll finished 30c. Reprints 3c. World Photo, Joplin 9, Missouri.

SAVE \$1.00. Order 100 reprints at 3c each and receive an 8x10 tinted enlargement in a beautiful mount (value \$4.75) for \$3.75. Fred D. Eastman, Bode, Iowa.

SNAP Service—8 exposure rolls developed, best quality velox prints, 35 cents. Reprints 4 cents. Snaps, Box 345, San Leandro, Calif.

CENTURY Delivers work and service that can't be beat. Sixteen famous Century-Tone prints each 8-exp. roll 30c. Free mailers. Century Photo Service, LaCrosse, Wis.

SMITH For quality! Any 8 exposure roll developed, 8 prints and two enlargements, 25c. 8 double-size prints, 25c. 35mm. fine grain developed, 36—3 1/4 x 4 1/2 enlargements, 90c; 18—55c. Cartridge refilled, 36 exposures, 35c; 18—20c. Write for sample print, mailers and price list. Smith Studios, 8 Saint John Street, Plains, Penna.

8 HOUR Service. Your 8 exposure roll developed and printed jumbo or regular size 25c, deckled edge if requested, 12 exposure rolls 35c, 16 exposures 50c, 36 exposures \$1.00. Reprints jumbo or regular size 3c each. All film developed fine grain. Workmanship, materials and 8 hour service guaranteed throughout. Quality Photo Service, Box 468, San Francisco 1, Calif.

2 BEAUTIFUL Hi-Gloss prints each good negative and enlarging coupon with each 6 or 8 exposure roll developed 28c. Owlphoto Co., Weatherford, Oklahoma.

AT Last we have films: 116 and 616, 38c ea.; 120 and 620, 33c ea.; 127, 27c ea. Roll developed, all your snapshots hand-colored as beautiful as most actual colored photography 35c. Hand colored reprints 4c each, 12 for 45c. Midwest Photo, Janesville 26, Wisconsin.

BIGGEST \$1.00 Value in 35mm. finishing today. 36 exposure fine grain 3 1/4 x 4 1/2 enlargements; deckled, embossed margin and date. Eighteen exposures 75c; 16 exposure splits 55c; 36 exposure reloads 50c. Special: return this ad with \$2.00 and we will send five 36 exposure reloads. Free mailers. 8 exposure rolls in beautiful, deckled contact finish with embossed wide margin, 25c. Mailbag Film Service, Box 5440A, Chicago 80, Ill.

GLOSS Finish enlargements. 4 5x7 from negative 50c. 3 5x7 from photo 50c. Robert Renshaw, Jr., P.O. Box 478, Chester, Penna.

PHOTOGRAPHY For pleasure or profit. Learn at home. Practical basic training. Long established school. Write for booklet. American School of Photography, 1315 Michigan, Dept. 3451, Chicago 5.

EVERY Picture an enlargement! 8 sparkling deckle-edge enlargements and roll developed 25c coin; 116 size or smaller; enlarge reprints 3c. Enlarge Photo, Box 791D, Boston, Mass.

SENSATIONAL Introductory offer! Send snapshot or negative, this ad, and 3c. We'll send you a beautiful 7"x5" enlargement! Or, Kodak roll developed with 16 guaranteed deckle-edge velox fade-proof prints or 8 double-size prints, 25c! Special! From your negatives, 16 regular-size or 8 double-size reprints, 25c! Candid rolls—36 exp. 35mm. developed, vaporated, enlarged to 3x4, \$1.00! 18 exp. 50c. Reprints, 3x4, 3c each. We have new, perfect 35mm. film. Low prices. Free mailers, details on request. American Studios, Dept. 279, LaCrosse, Wis.

MOTION PICTURES AND SOUND EQUIPMENT

VICTOR 16MM. sound projectors, Model 41A, 15 watt amplifier. Completely overhauled, good used condition, 90 day guarantee. \$237.50 f.o.b. Davenport, Eastin Pictures, Davenport, Iowa.

FILM—Movetone is back. It's Weston 12, nonhalation. Free processing—100 ft. 16mm. \$3.25; 25 ft. Double 88, \$1.50. Bulk film without processing—100 ft. 16mm. \$2.25; Double 88, \$2.45. Free circulars. Fromader Genera, Davenport 7, Iowa.

16MM. Sound films. Complete subjects, good condition, \$1.95 per 400' reel, up. Write for list of over 100 available titles. Blackhawk Films, Dept. PM29, Davenport, Iowa.

16MM. Sound, silent films exchanged, \$1.00. Write Victor Gordon, 567 10th Avenue, New York, N. Y.

TITLES Of quality give your movies that professional touch. Write for prices. Title Technicians, 3964 Ames St. N.E., Washington 19, D. C.

FOR Sale to highest bidder, 35mm. DeVry motion picture camera with F:3.5 50mm. lens and F:1.5 50mm. lens complete with DeVry 35mm. projector, all in A-1 condition. Village of Winnetka, Illinois, c/o B. W. Johnson.

35MM. Sound features, Westerns, projectors. C. Rogers, Box 26, East Atlanta, Georgia.

USED And new Castle films, 8-16mm. silent and sound. Send for lists. Alves Photo Service, Inc., Box 270, Quincy 69, Mass.

KODACHROME Movies, 8-16mm. Color sample, lists—dime. Projection length color sample—dollar. Also slides. Campus Films, 668-F, Ithaca, N. Y.

UNUSUAL Home movies, discounts. Catalog 5c. Jack Proctor, Melrose, Mass.

HOME Movies, 16mm., 100' subjects. Sound and silent. Write for list. Ultra Pictures, Box 319, No. Hollywood, Calif.

FREE List 8mm., 16mm., or sound. P. Simpson, Box 201, Charleston 21, W. Va.

OWNERS Of home movie projectors. Project the original, authentic outstanding home movie production free. Send postal card today. Preferred Films, Hamilton 24, Ohio.

NEW 1600' Reels \$1.75. Cans \$1.25. Combination \$2.50. 8-16mm. films bought, sold, exchanged. Literature, end title 10c. International (M), 2120 Strauss, Brooklyn, N. Y.

16-35MM. Silent, sound films, projectors. Bedner, 5300 So. Talman, Chicago.

BUY, Sell, trade 35mm., 16mm. projectors, equipment. Plaza Cinema, Bank Bldg., Secaucus, N. J.

8-16MM. Silent-sound films. Complete rental library. All latest subjects. Free catalogue (sample film 10c). Garden Film, 317 W. 50th, New York 19.

FREE Catalog; movies, cameras, projectors; photographic supplies; enlargers, printers, cameras. Goodwill Company, Jackson, Tennessee.

CLUB Plan 16 mm. sound rentals. Lowest rates. Details dime. R. A. Dechene, 90 State St., Albany 7, N. Y.

EXCITING Films — bullfights, movie stunts. Unusual subjects. Send only dime for sample film and special list. Exciting Films, 1071-F El Centro, Hollywood, Calif.

16MM. And 35mm. projectors, film. A. Savarese, Woodcliff Lake, New Jersey.

400 FT. 16MM. motor projectors \$20.95, \$35.95, 8mm. \$20.95, all postpaid. Send stamp for lists. Sterling's, 679 Northampton, Easton, Pennsylvania.

8MM.-16MM. Films, equipment bargains. Towers, 935 North Fortieth, Philadelphia 4.

NEW! Sensational! "Miss America of 1946." 8mm., 50 ft., \$2.00; Kodachrome, \$7.50, 16mm., 100 ft., \$4.00; Kodachrome, \$14.75. Kodachrome projection sample, "Waikiki Hula," \$1.00. Catalog, 25c. World in Color, Box 392-F, Elmira, N. Y.

RENT 16mm. sound films 50c reel. Large selection; free catalog. Film Service, 128 Chestnut St., Roselle Park, N. J.

"THE World's Greatest Passion Play," all sizes sound and silent. Write Hemenway Film, 33-F Melrose St., Boston 16, Mass.

FINEST Movie screens, inexpensive, make them yourself. Free literature. Snow White Screen Company, Danville, Illinois.

GUARANTEED Fresh movie film! Dilite loading! Processing free! Three spools double 8mm., \$3.45! Six single 8mm. for Univex, \$3.50! Postpaid. Eso-S, 828-B West 39th, Kansas City 2, Missouri.

LEARN Professional motion picture technique at home. Approved for veteran training under G.I. Bill. Free catalog. Motion Picture Institute, Birmingham 4, Mich.

FREE! 8mm.-16mm. catalog! Eso-S, 828-B West 39th, Kansas City 2, Missouri.

16MM. Motor driven projector \$18.00 postpaid. Selco Products, Danvers 1, Mass.

UNUSUAL 8-16 mm. Film subjects. Big catalog with sample film, 10c. National Film Exchange, Broadway, Sta. E, Toledo 9, Ohio.

FRESH Movie camera films 100'—16mm. \$2.25, three rolls \$6.00, 25' double 8mm. \$1.25 developing included. Ambassador, 479-A Quincy Street, Brooklyn, N. Y.

COMPLETE Stocks always of Castle, Official, Pictorial films, 8mm., 16mm., sound. Musicals, soundies, free catalogs. We exchange your films and equipment, or buy them for cash. Frank Lane, 5 Little Bldg., Boston, Mass.

TALKIES: Convert your silent 16mm. projector into sound with our guaranteed parts kit. Plays all 16mm. sound films. Quickly assembled at home. Special introductory offer: Send this ad now with \$19.95, check or money order, and we will include sound test film, instruction manual and full information on how to use with your radio, postpaid, or send \$1.50 for complete blue prints showing how to make adapter yourself. Soundtech, Box 3071, Hollywood 28, Calif.

HOME Movies. Rent, buy, swap 8mm.-16mm. silent and sound at money-saving rates. Details for a dime. Midland, Box 429, Oak Park 4, Ill.

BASS Says: 36 years of leadership in the motion picture equipment field. Sound projectors, 8 and 16mm. equipment, finest accessories. Bass buys 'em, sells 'em, trades 'em. Always satisfaction guaranteed or money refunded! Bass Camera Company, Dept. A, 179 W. Madison St., Chicago 2.

I BUY, Sell, swap, rent s.o.f., 8 and 16mm. films. List free. Harvey Iris, Box 539, Brockton, Mass.

MAKE \$8 To \$10 net profit daily with your 8mm. or 16mm. projector. Details free. Metcalf, 10806 Glenroy Ave., Chicago 43, Ill.

UNUSUAL Home movies—travel, adventure, sports, news, war films. Many film bargains. Big 1946 catalog and sample, dime. Audet, Box 6520-BG, Philadelphia 38, Penna.

LEARN Movie projection, management. Free catalog. Theatre Institute, Elmira, N. Y.

MOVIE Camera films, 100' 16mm. \$2.50. 25' double 8mm. \$1.25. Free developing. Better Films, 742 New Lots, Brooklyn 7, N. Y.

MUSIC AND MUSICAL INSTRUMENTS

LEARN To play the piano by ear in one week. The quick easy way. Write. E. Morrison, Box 9312-N, Station S, Los Angeles 5, Calif.

ACCORDIONS, New or used. Wholesale and retail. Cash or terms. Del Principe, 307 So. Wabash, Chicago.

POEMS Wanted! Send poem for immediate consideration. Eliot Wright, Master Composer, 107 Rivoli Theater Building, Portland, Oregon.

SONGWRITERS Outstanding proposition. Ed. Madden, G.P.O. Box 1226, Syracuse, N. Y.

WE Want song poems and lyrics on all subjects. We offer the services of a noted Hollywood motion picture composer and arranger. Send your poem today for consideration and our liberal offer. Hollywood Melodies, P.O. Box 2168 PM, Hollywood 28, California.

WRITE Songs? Songwriter's Magazine! 10c copy, \$1 year. Monthly contest. "Songwriter's Review," 1650-M Broadway, New York.

SWISS Musical movements \$4.50. Musical powder-cigarette-candy boxes (Lucite, metal, wood). Lucite photo album, wedding-baby album. Novelties of Distinction, 131 W. 42nd Street, New York City.

PIANO Play-at-site, the amazing ear method of our time. \$1.00. Teachers write. P. H. Kaufman, 6019 Hollywood 28, Calif.

GUITARISTS—Play professional—modernistic, runs, breaks, modulations, introductions, futuristic chords. Same material professionals use. (Diagrammed.) \$3.00. Nicosia, Box 596MK, Brooklyn 1, N. Y.

POEMS Wanted for musical setting. Many of our songs have been published by ASCAP and BMI publishers and broadcast. Send poem for immediate consideration. Five Star Music Masters, 630 Beacon Building, Boston.

SONGWRITING — Publishing, liberal plan. Barnhart, 1320 48th, Des Moines, Iowa.

SONGWRITERS — Free explanatory booklet, attractive offer. Song Service, 331-C West 46th, New York.

GUITARS, Mandolins, violins, accordions, banjos, amplifiers, pickups, accessories, phonographs, records. Catalogs free. Wack Sales, 3131-W, North, Milwaukee, Wisconsin.

PIANO—Play by ear in one week. Quickest, easiest, short cut system in the world. Write Duncan Institute, Ortega, Fla.

MUSIC Printed from manuscript. Music composed. Reginald Belcher, Florham Park, New Jersey.

MUSIC Printed, mimeographed, recorded, harmonized, composed, edited. Reasonable. Scovill, 5 Cornelia, N. Y. C.

SONGS And poems arranged, published, sold. Free melody—examination. National Songwriters, Hollywood, Calif.

BE A Hollywood star. Learn to sing new and fascinating way. Complete instructions including tuner sent postpaid for \$1.00. Regina Publishing Company, 741 Hague Ave., St. Paul 4, Minnesota.

MUSIC Composed, arranged. Vocal-piano-part specialist. Completed songs revised, edited, improved. Particulars sent free. Morse, 4612 Park Heights Ave., Baltimore 15, Md.

PIANO-PLAYERS: Sensational popular music chart shows 648 treble, 180 bass chords; includes names; symbols; readings; enharmonics; notation. You need this chart! \$1.00. Carol, Box 21PM Lefters, Brooklyn 25, N. Y.

ACCORDIONS, Wholesale prices. Request circular. New streamline accordions. All sizes and makes. Monarch Accordion Co., 44 N. Albany Ave., Chicago, Ill.

MUSIC Arranged. Songs printed. Frank Wildt, Music Publisher, Lancaster, Penna.

SONGWRITERS! Outstanding, ethical offer. Hibbeler, C5, 2157 N. Avers, Chicago.

SONGWRITERS: Have your songs completed by an honest, experienced arranger. Submit songs for free analysis. Tommy Kilbourne, Box 1253, Bakersfield, Calif.

"GUITARS"—"Band and orchestra instruments"—"harmonicas." List free. Rudolph's, Atchison, Kansas.

WANTED! Lyrics, melodies for songs. We arrange, publish, sell. Superior Song Studios, Passaic, N. J.

BEFORE Sending your poem to be set to music, know your composer. Free folder. Al Moquin, 5333 La Cresta Court, Hollywood 38, Calif.

SONG Writer's attention! The amazing demand for phonograph records, accelerated by more than 300,000 juke boxes and the hits popularized warrants your immediate consideration. We are offering song-poem writers the rare opportunity of having established composers collaborate on appealing material received this month. Recola Records, Box 987P, Hollywood 28, Calif.

POEMS Wanted for musical setting. Send poem for immediate consideration and free rhyming dictionary. Richard Brothers, 24 Woods Building, Chicago.

SONG Poems wanted. Free examination. McNeil, Master of Music, 510-PM South Alexandria, Los Angeles, Calif.

WRITE Songs. Big money and reputation. Write for information. J. Gordon Pub Co., 201 N. Hoyne Ave., Chicago.

RADIOS AND SUPPLIES

HEAD Phones; latest type, light weight, finest quality, adaptable for use in making crystal sets. Slightly used sets without head bands \$1.25. With leather covered adjustable head bands \$2.50. New sets without head bands \$1.75. New sets with leather covered adjustable head bands and rubber covers \$3.75. Add 25c for mailing, send check or money order—quantity limited. Department C, Nico Supply Co., 540 N. 17th St., Philadelphia 30, Penna.

ARE You interested in a clear-cut picture of the profits and general procedures of radio servicing? Send \$1.00 for this manual. G. E. Quill, 4637 W. Lexington St., Chicago 44, Ill.

"RADIO Announcing." A new book of instruction designed to teach beginners and aid professional radio announcers. Book contains pictures, quotations, and biographies of many top ranking announcers. \$2.00 post paid. Hollywood Radio Publishers, 5855 Hollywood Blvd., Hollywood, Calif.

BUILD Extra-loud crystal set. Instructions and crystal, 25c. "All About Crystal Sets," booklet, 45c. Amorose, Route Four, Richmond, Virginia.

"RADIOBUILDER"—Parts, data. Sample free. Laboratories, Box I-c, San Carlos, California.

NEW Used radio tubes for sale. Copy Ben's Trading Post 10c. Ben's Radio, North Tonawanda, New York.

BUILD Your own radio, phonograph combination, kits available. Radio, 120 Cedar St., New York, N. Y.

NEVADIUM Super crystal. Write for details. Box 764, Eiko, Nev.

RADIO Electronic Construction Library Vol. I, II, III. Now ready. Home constructors, servicemen. Diagrams galore. Fully explained. Compiled and approved by electronic engineers. Send \$1.25 per volume. Three for \$3.25 prepaid. E. H. Laboratories, Dept. C, 1565 South St. Paul, Denver 10, Colorado.

LEARN Radio at home. Earn money. Have fun building our "Educational Radio Kits." We teach you every step. Simple, easy to understand instructions. Free literature. Write immediately. Chapin Electronics, Inc., Dept. A., 134 W. Onondaga, Syracuse, New York.

NEW FM Radio. Build your own. New, simple, easily built. Parts cost less than \$5.00. Use separately or as converter on your broadcast receiver. Complete plans and instructions \$1.00. FM-2, 26 Rixey Drive, Alexandria, Va.

AC-1 Electro-Eye 2-stage amplifier, for home, office, factory. Metal cabinet, 115 v. a.c. \$11.43 net. Light Source—operates AC-1 over 30'. 115 v. a.c.-d.c. \$3.27 net. Full instructions 20% on c.o.d.'s. Radio Development Labs., 362-P Atlantic Ave., Brooklyn 2, N. Y.

ELECTRONIC Equipment built to your specifications. Estimates. Modern Electronic Laboratory, E-9, Box 353, Brunswick, Maine.

BUILD Combination radio display service unit and instrument test panel. Complete drawings and material list. Latest instructions \$2.00 postpaid. American, 12821 Phillips, Cleveland 12, Ohio.

ONE Tool does twelve jobs! See Bishop Tools ad under Machinery, Tools, Supplies.

TELEVISION Receiver circuits of RCA, GE, instructions, blueprints for building, parts source—\$1.00. Jackson Engineering, Box 776-GN, Chicago 90.

BROADCAST Through your radio with the "Tiny-Tone Little Mike." Perform many interesting experiments. Complete operating instructions included. Send 50c or mail postcard and we will send microphone C.O.D. G. F. Buckmann, 328 Union Street, Hackensack, New Jersey.

FREE New radio catalog is ready! Radionic's catalog lists hard-to-get radio parts, books, amateur, test and P.A. equipment. All available for immediate shipment. Send today to: Radionic Equipment Co., Dept. SS-11, 170 Nassau St., New York 7, N. Y.

ONE-TUBE—"All-Wave-DX," diagram—35c. Radiphone, 1697 Lanier, S.W., Atlanta.

WESTERN Electric fixed crystal. Extremely sensitive. Excellent for crystal sets. Gives strong loud signal. No adjusting. Cost government originally \$5.00, special 99c prepaid. New. Free list. Dept. M, Radio City Labs., 30 Church St., New York 7, N. Y.

FREE New fall lists, radio parts, books, specialties, diagrams. Dept. B, John Barron, Box 128, Ft. Hamilton Station, Brooklyn 9, N. Y.

"BUILD Your own radio." All kits complete including beautiful plastic cabinet, instructions for easy assembling. 4 tube T.R.F. \$10.95, tubes \$3.50. 5 tube superheterodyne \$13.75, tubes \$4.95. Satisfaction guaranteed. National Radio Distributors, 1029M East 163rd Street, New York 59, N. Y.

RADIOS! New or reconditioned. Hot plates, heaters, tubes, record changers, amplifiers. Re-Ampliphone, 2345 Hopkins, Milwaukee 6, Wisconsin.

SELSYN Motors 5G 110v-60 cycle or 50v-50 cycle, pair \$12.50. Quantity discounts. Others, R. Mautner, 201 W. 16 St., N. Y. C.

VEST Pocket radio! What fun! Listen while strolling or cycling. Local or distant reception. Plans sold around the world. Kits available. Cheap, easy. Free photograph with plans. Rush \$1.00. United Manufacturing Associates, 3316-8 Ave. G, Fort Worth 5, Texas.

FM Can now be heard on old radios! Postcard brings free data! Topical Emprise Corporation, 1527 Highland, Box 42, Louisville 4, Ky.

ELECTRONIC Organ easily constructed from radio parts. Plans \$1.00. Quaker Radio, Box 68, Salem, Ohio.

FAMOUS "Allen" midget semi-fixed crystal detector. Set building plans and 100 late crystal set distance reports all for 50c postpaid. Allen, 427-2, Clinton, Mo.

BUILD Your own radio. 5 tube super kit complete with tubes and cabinet using 50L6, 35Z5, 12SA7, 12SK7, 12SQ7. Easy to wire. Your cost \$16.95. McGee Radio Co., 1330 Broadway, Denver, Colorado.

RADIO Service men and experimenters send stamp for our giant radio catalogue. Save dollars. United Radio Co., (1000-V) Newark 1, N. J.

LOUD Speaking crystal radio, improved design. Illustrated plans 25c. Radio Clinic, 10631-C Euclid, Cleveland 6, Ohio.

PLAT Rate schedules improve profits. Compiled from 500,000 jobs. Write for information. Radio Equipment Co., 1415 W. Franklin Ave., Minneapolis 5, Minn.

RADIO. Electronic parts and equipment. New and used. Write for free list. Highbridge, 340 Canal Street, New York 13, New York.

MAKE Simple, tubeless, batteryless, distance-getting crystal radios. Crystal and illustrated instructions 25c postpaid. Allen, 427-P, Clinton, Missouri.

BUILD This world's smallest a.c.-d.c. radio with built in loudspeaker! Uses one tube! Easily fits in ladies' handbag or briefcase. Send 50c for plans, photos, instructions. Louis Toth, P.O. Box 110, Station H, New York 25, N. Y.

RADIO Technician and radio service courses. Training for federal licenses. American Radio Institute, 101 W. 63 St., New York City. Approved under G. I. Bill of Rights.

BUSINESS OPPORTUNITIES

START Home business making statuary, plaques, novelties, garden furniture, artificial marble flooring, liquid marble. Make your own flexible molds. Amazing profits. Folder free. Creative Publishers, Box 236-L, Winnetka, Illinois.

WHOLESALE Distributors! Amazing, patented screw-holding screw drivers! No competition. Removes, holds, inserts screws instantly in hard-to-get places! Factories, garages, mechanics, electricians, retail stores, buy quantities. Counter displays, advertising furnished free. Fast sales, large profits, big repeats. Refundable trial order! Millen Mfg., 363 Miller Building, Boston, Mass.

UPHOLSTERING — Profitable. Easy learned. Course \$2.50 prepaid. Write, Educational Service, Box 385-A, Lombard, Illinois.

315 GOLDEN Money-making opportunities now ready for you, selling by mail. Details free! Mailway Agency, 10-620P William, Winnipeg, Manitoba, Canada.

YOUR Own original, exclusive mail order business—the proved, tested way to success. Small capital. Free bulletin, details, proof. Erol Slater, 707 S. Hill, Los Angeles 14, Calif.

REALTY Salesman, how to buy, sell farms, properties, business. Covers every angle of salesmanship. Book 50c. Free list. Unusual books. Mell Specialties, Kerrick, Minn.

MECHANICALLY Inclined men — Own and operate general appliance repair shop. Complete, illustrated course shows you how. Welding, refrigeration, motor repair, how to get business, etc., all phases covered. Free literature. Christy Supply, Dept. 170, 2835 N. Central Ave., Chicago.

ENJOY Profitable, quick sales. Repeats. Amazingly easy bookkeeping system. Full year \$3.00. Details free. Gouffine's Service, 30 Church, New York.

EARN Extra spare time money taking subscriptions for leading magazines. Big Christmas season here. Send 25c complete supplies. American Readers' Service, Gwynedd, Penna.

BIG-PAYING Home mailorder business. Literature free. Jackson, Newfoundland 3, Kentucky.

START Selling costume jewelry, pearls, wholesale, retail, wonderful Xmas gifts. Costume Jewelers, 264 - 5th Ave., New York.

WORLD'S Best floor wax, 40c gallon. Use in your own home. Resell others. Big profits. Lifetime business. Write Westholz, Box 7324, New Orleans, La.

MAKE Liquid marble, flexible molds, statuary, art goods, novelties, artificial marble flooring. Literature free. Kemico, Park Ridge 11M, Ill.

OPERATE Profitable mail order business. Splendid opportunity. For details write Robert L. Brill, 647 E. Frederick St., Lancaster, Penna.

500 GIGANTIC Money-making ideas. First time offered to public. Widely endorsed plans, easy to follow guides to building permanent business with limited capital. Opportunity for manufacturing, selling, mail order, other type businesses. Details free. National Enterprises-X, 10 Waverly Place, New York 3.

MOULDS For lead toys. Sample mould and catalog \$1.00. Catalog 10c. Dandridge, 1557 Essex St., Rahway, N. J.

BEST Mail order seller in years. Be independent. Own your own business. Details free. Hadeland, Box 27A, Ridgewood, N. J.

OPERATE Profitable mail order business. Tremendous profits. Patrick Service, Box 1322, Cleveland 3, Ohio.

UNPAINTED Wall plaques, bookends, shelves, statuettes, novelties. Beautiful designs. Easily painted with water colors. Write Oman, 642-M Broadway, St. Paul 1, Minn.

MAKE Money at home. Small capital. No canvassing. Details free. Superior Distributors, 916 Hayes Street, San Francisco, Calif.

MAIL Order opportunities. Read oldest trade journal. 53rd year. Copy 25c. Mail Order News, Somerville, N. J.

CASH In now with tested profit maker, Advertising Tips on Selling by Mail. Circular free. Winkelpost, Box 517, Grand Central Annex, New York 17.

MAKE Soap at home. No machinery. Profitable. Literature free. Kemico, Park Ridge (SM-11), Ill.

UNLIMITED Possibilities! "Mail Order Pilot" free! Worth 25c. Charles Moody, 4 Spring, Salisbury, Mass.

START Profitable business, sell amazing cleaners under your name; used in every home. Samples 25c. Linnell Co., Box 1720A, Cleveland 5, Ohio.

LIQUID Plastic linoleum finish—State or county distributors wanted for exclusive protected territories. Write Wonder Plastic Products Company, 2609 S. Kedvale Ave., Chicago 23, Ill.

MAKE Strange, plastic Rub-R-Slate—1c pound. Makes durable, attractive floors, walls, roofs. Build for half. Bays Laboratory, Oklahoma City 9.

FORTUNES In formulas and trade secrets, practical, authentic, reliable. Details free. Stillman, 555 Kingston Ave., Brooklyn 3, N. Y.

SUPER X liquid molding rubber. Sample jar 25c, quart \$3.00, gallon \$10.00. Free instructions. W. Wooley, 115-A Donald, Peoria, Ill.

COLOR Concrete with chemicals. Make Hollywood style pottery; home or shop. Marbling, water-paints, 10c brings sample, pictures. Hollywood Cementcraft, 8527 Wonderland, Hollywood 46, Calif.

MAIL Order beginners! How to start, create and develop a profitable mail order business of your own with small capital! Instruction guide 25c. Send for it today. Kraft, Aurora 5, Mo.

MOLD—Model, mold making liquid, material supply catalogue free. Novelty manufacturing instructions, sales outlets. Aircure, 3873A California, San Diego, California.

EXTRA Cash! Operate home business. How Letter, Clarkston 1, Mich., offers ideas, counsel. Copy 25c.

START Profitable concrete block business. Details free. Wm. Horne, 206 West Wilder, Tampa 3, Florida.

ORIGINAL Plans for mail order business, free details. R. E. Reese, Emmaus, Penna.

MAIL Order beginners! "Business Development Plan," "Profitable Mail Selling Idea," "Pointers Along the Mail Order Trail." Noted mail sales specialist's, three-in-one, 10,000-word treatise, shows—step by step—"how," on small capital start. From Idea to Mailbag, 25c, postpaid. Satisfaction guaranteed. Maupin & Maupin, Lafayette 3, Indiana.

"GOLD Mine" opportunity. Mail brings \$10 to \$25 daily. Practically no capital to start. Experience unnecessary. Plan complete \$1.00. Instructions 10c, including wholesale source directory. Moneyback guarantee. Profit Builders, 305-A West 8th, Los Angeles 14, Calif.

FELLOW Hustlers—Salute two tested aristocrats. Mail orders fast dollar pullers. Tremendous profits. Investigate, compare. Details 10c. Word Products, 2742 Boulevard, Jersey City, N. J.

MAKE Plaster novelties. Special molding rubber. Free sample. Quart \$3.00, gallon \$10.50. Free instructions. Universal Sales, Box 1076-A, Peoria, Ill.

512 MANUFACTURING Formulas and business plans \$1.00. Circular free. Satisfaction guaranteed. Hayes Agency, 814 Newport, Chicago.

NEW Molds for Christmas trade—D4 compound. Vallance Art Products, 1873 E. 70 St., Cleveland, Ohio.

"FREE Details!" Locates thousands scarce bargain merchandise. Chemist, Box 1279-P, Joliet, Ill.

OPERATE Profitable mail order business. Splendid opportunity. For details write Loshen Supply House, 5927 Euclid Ave., Room 24, Cleveland 3, Ohio.

1000 CONTRACT Bookkeepers needed. Start your own business. Part or full time. Information free. Write A. J. Hawthorne, Public Accountant, Decatur, Ala.

PLASTIC Discs, shapes, metal findings, wholesale, free catalog. "Secors," Bradenton Beach, Florida.

DOLLARS Daily! Cleared \$1900.00 in two months. Details, Duffy, J56, Covington, Ky.

METALIZE Baby shoes! Easily learned. Universal Sales, Box 1076-A, Peoria, Ill.

DIRECTORY Of Business Opportunities. Do you want to buy a going business? Hundreds of unusual and profitable businesses—all types of opportunities in all sections of the country are listed in our directory. You deal direct with owners or their agents. Send \$2.00 for this directory. Directory of Business Opportunities, Office 524, 115 State St., Springfield, Mass.

PEANUT Machines work for you even while you sleep. Excellent earnings. Small investment. Start route in spare time. Build full time, dignified, dependable, cash business out of profits. Car or experience unnecessary. Free pamphlet. Becker Vending, 105B Dewey, Brillion, Wisconsin.

ADVERTISEMENT Writer. Long, successful experience creating powerful mail-order letters, literature, campaigns. Investigate! Les Finkle Advertising, 408 South Spring, Los Angeles 13, California.

"HOW To start a successful mail order business." The guide to sound, profitable mail merchandising. Only 25c. Manhattan House, 126-B Lexington, New York 16.

BIG Money selling cut flowers. Free details. Wells, Rt. 1, Box 367, Marysville, Wash.

FLEXIBLE Mold material especially prepared for casting plastic, plaster. Write: Long Plastic Products, P.O. Box 5821, Kansas City, Mo.

BRONZING And metallizing baby shoes! Gold, silver, copper, nickel, bronze, pearl, ivory, and "luminous glow" colors! Big profits! New field! Details free! Write R. O. Morgan, Box 349, Long Beach 2, Calif.

START Profitable mail business, booklet 25c. Colin Couch, Elkin, N. C.

OPERATE Profitable mail order business. Good opportunity. Write, Walter Service, A-4159 East 112th, Cleveland 5, O.

FIFTY Tested mail order ideas for profitable, fascinating sparetime home-operation. Send 3c stamp for complete details. Manhattan House, 126-D Lexington, New York 16.

20th CENTURY "business opportunities book." 144 pages of formulas, mailorder, homeworkers plans. \$1.00 postpaid or c.o.d. plus postage. Money back guarantee. Silver Crest Products, Dept. 1A, 3040 North Ave., Chicago 47.

EARN \$300 Or more, easily or quickly. Marvellous opportunities right now. Guaranteed system, only 25c coin. Southern Specialty Service, 210 North "E," Lake Worth, Florida.

OPERATE Your own mail order business. We will help you. Details free. George P. Beach, 79 Essex Street, Springfield, Mass.

START Home repair shop with inexpensive electric welder. Gether, AA-1615 Glendale, Milwaukee 11.

NEW Type latex developed for making flexible molds. Illustrated instructions for simple mold making 50c. Advanced mold making \$1.00. Apex Plastic Products, 1915 Lunt, Chicago.

ARE You "fed up" working for a boss? Own a permanent mail order business. Write: Gordon Crompton, P.O. Box 2567, Hollywood 28, Calif.

INVESTIGATE Mail selling! What's the one best thing to sell, happily, honestly, profitably? We know! Get free particulars. Free samples. What-to-Do Shop, Box 1082, Tacoma, Wash.

DETAILS And illustrated folders of mail specialties, mechanical devices, books, courses; others, 10c. Central Supply, Simpson 1, Kansas.

FREE Catalog ways of making money. Williams, Route Box 134, Gatesville, Tex.

"315 GOLDEN Opportunities"—How to make money, selling by mail. Write, General Mail Trade Service, 2272 M-Andrews Avenue, New York 53, New York.

OWN A mail-order paper products business. Sell envelopes, tags, bags, boxes by mail, wholesale. Tremendous demand. Steady profits. No capital necessary. Write Omaha Envelope Service, Dept. 171, 4721 California, Omaha 3, Nebr.

MAIL Order money maker. Big profits. Sell pocket size tools. Made of bright tempered steel. Not trinkets. Tools. Six in one multiple screw drivers. Automatic wrenches. Oriental letter openers. Conventional type screw drivers. Assorted \$8.00 per gross. Send \$2.00 for 12 assorted samples. United Sales Service, P.O. Box 55, Rockaway Beach, N. Y.

PLASTICS Casting, molding, forming easily learned. Simplified worksheets (70 illustrations) explain reliable methods. \$1. Circular free. Plastics Digest, 3937M Tracy, Kansas City 4, Mo.

OPERATE Profitable home business selling merchandise by mail. Splendid profits. Johnson Service, Box 23, Allston 34, Mass.

EARN Up to \$500 month part or full time keeping books for small firms. Simplified system. Write Tax-Saver System, Dept. G, Ft. Worth, Texas.

PLASTICS Directory—Wholesale and retail sources for thousands of items, materials, molds, equipment, machinery, supplies. \$1. Plastics Digest, 3937P Tracy, Kansas City 4, Mo.

OPERATE Vending machines. Small capital. Easy, profitable. Write for details. Thomas Novelty, 1572 Jefferson, Paducah, Ky.

BUILD Your own independent, fascinating and very profitable business at home, spare, or full time, \$75.00 and upwards weekly easily possible making beautiful brilliant, sparkling novelties and religious figures. Fast sellers through you, salesmen, stores. Quickly learned and few dollars starts you making real money. Successful manufacturer can tell you how and furnish everything. Start small, grow big. Write for full information and "amazing story of my success" at once. Inghram Company, 2845 Sixth Street, Detroit 1, Michigan.

HAVE Your own office! Learn new profitable business in uncrowded field. No selling. Many earn up to \$5,000-\$15,000 yearly. Write for free details. No obligation. No salesman will call. Franklin Credit School, Dept. 202-M, Roanoke 7, Virginia.

CREATE A business in spare time. Make extra money with limited capital. We have know-how. Free literature. Gulf Coast Enterprises, Box 1103-A2, Mobile 6, Alabama.

BECOME A finance man. Particulars free. George Lenhoff, Lincoln 8, Nebr.

AIRCURE: Liquid latex for flexible molds. Directions. 22 ounces \$2.50. Gallon \$9.00. Rubbercoat, 3873A California, San Diego, California.

EARN Up to \$400.00 monthly. Details free to mail order beginners only. F. C. Bradford, P.O. Box 246, Morenci, Arizona.

INTERESTED In immediate mail order cash? Read "Advance"—Voice of mail order. Offers money-making opportunities. Personal guidance and benefits to all. Sample copy 25c. American Mail Trade Association, 313 East 21st Street, Dept. 400, New York 10, N. Y.

WHY Job worry? Learn electroplating. Highly paid, uncrowded, interesting business. Gold, silver, nickel, chromium, etc. Send postcard for free booklet and proof. Plater Hyde, Dept. MC, P.O. Box 176, National City, Calif.

COPUBLISH Leading m.o. paper. Latest copy Mail Sale Advertiser and proposition, commemorative stamp. Vanroy Shirk, Lebanon, Penna.

EARN Money with textile painting course. Free details. George Gundrum, LeRoy, Michigan.

AT Home—Your own manufacturing business; making popular \$1.00 novelties. Cost you 3c to 15c. Everything supplied. Write So-Lo Works, Dept. L-500, Cincinnati, Ohio.

REAL Big money opportunity! Details, stamp. MacCormack, C-11, Madeira, Ohio.

CASTONE—Hardest coldcasting composition on earth. Snow white and colors, 10½ pounds assorted colors \$2.00. Hundred pounds \$6.00. New Era Products, 1321-NE Belmont, Chicago.

GO Into the mail order business. My 32 years' experience tells how. Send 25 cents for instructions. Mail Order Institute, Box 1902, Cleveland 6, Ohio.

PLASTIC Flooring offers profitable lifetime business! Write Palmer Company, Station A, Berkeley, California.

START Profitable mail order business, write Harry Punch, 1329 Grace, Cincinnati 8, Ohio.

BOOKKEEPERS: General ledger and tax report experience. Operate permanent, profitable accounting service for the smaller business. Part or full time. Simplified method. Write now! L. A. Bell, 1404 West 25th Street, Cleveland 13, Ohio.

MONEY Made in spare time teaching our streamlined "Bookkeeping in a Month." Classes formed by yourself. Details free. Educational Book Co., 2907 Berwick Ave., Baltimore 14, Maryland.

START Mailorder business selling valuable folios. Everything furnished. Immense profits. Steady business. 25c brings five exclusive plans, two folios, exciting information. Vallesp, New York 13.

HIGHLY Profitably repeat business selling. G.I. and other business men much needed simplified understandable Ramsay Systems which best protect their investment, reveal leaks, show added profits. Acknowledged leader. Bookkeeping knowledge unnecessary to sell or operate. Ramsay Systems Incorporated, 192 Lexington Avenue, New York 16, N. Y.

YES, You too can mail out a 32 page, two color catalog with your name and address printed and supplied free. Conduct your own business spare time right in your own home. Send for information, Manning, 3259 Decatur Ave., Bronx, N. Y.

PARATOL—Amazing new rubber latex moulding compound for perfect detail castings of all kinds tested and approved in long service. No worries—easy to apply, quick drying, maximum strength and long life. Why pay more—buy direct! Quarts—\$1.60, 1 gal.—\$4.90, 5 gals. \$4.45 gal. 4 oz. samples on request. Send 25c to cover mailing and handling charges. Full instructions sent with each order. Testworth Laboratories, Inc., Manufacturers of coating and adhesive products of all kinds, 407 S. Dearborn Street, Chicago 5, Illinois.

OPERATE America's lowest price penny peanut vender. Write Fielding Mfg. Company, Jackson, Michigan, Dept. PM11. Stock shipments.

CO-PUBLISH Magazine. Many profits. 16-page booklet 10c (refundable). Goldenberg, 5209-F Lindsay, Houston 3, Texas.

EARNSTLY Want independence? Write for our propositions. Nabers Distributor, 242BMK Gordon, Laurens, S. C.

FORGE Ahead in mail order the safest way. New arrangement enables you to establish permanent business of your own without usual risk. Distributors, past and present, beginners, veterans and others who are sincerely interested in profitable business are invited to investigate our offer, with guarantee of sales, new merchandise with free sales helps. Moderate starting capital required. Special setup furnished. Distributor Group, 5345-B Harper, Chicago 15.

RUBBERFLEX—Latex, "self-cure" molding liquid (wholesale price). Sample pint \$1.25; gallon \$5.50 with directions. Plastic Material Supply, 1416-26 W. Fletcher, Chicago.

START Mailorder and local business. Free literature. Stroups, Ashtabula, O.

OPPORTUNITY—Start your own business. Details free. Daniel, Box 413, Newburgh, New York.

NEW Item! Sell beautiful, fragrance-emitting, fast-selling novelty everybody likes. Wonderful year round seller. Excellent gift. Free particulars. Modern Products, 1216 Park Row Building, New York City 7.

PLASTIC—Liquid "fiber-glass" China glazes, protects any plaster object. Pint \$1.00, gallon \$3.50. New Era Products, 1321-NE Belmont, Chicago.

START Your own business! Free information. Reim, 3931 Bayo, Oakland 2, California.

BUILD Mail order business of your own—anywhere! Free illustrated prospectus on "Modern Mail Merchandising." Write at once. Mail Enterprises, Inc., 316-A Fox Building, Detroit 1, Michigan.

NOTICE If you are really interested in establishing a profitable mail order business of your own, write Metro Mail Service, P. O. Box 965, Lansing, Michigan.

RUBBER—Airlastex, genuine "Red Diamond" heavy mold making liquid. Pint \$1.50, gallon \$5.75 with instructions and sample mold. New Era Products, 1321-NE Belmont, Chicago.

"HOW To Succeed"—new, creative 50-page book shows sure way, increase income, contacts, personality, health and happiness no matter what you do. If lonely, sad, ill or need money, this book can mean turning point in your life. A powerful message by Robert Callahan, author of Santa Fe Trail, Daughter of Ramona, Human Whirlpool, and Wife Wanted just filmed, starring Kay Francis. His ideas and quarter million dollar Los Angeles enterprise proves "How to Succeed" can help you. Ideal gift, any occasion. One dollar bill prepaids book to you. Mission Village Press, 5675 W. Washington, Los Angeles 16, Calif.

INCREASE Your income by selling "Hot-spark" non-pulverizing flint, considerably decreasing cigarette lighter trouble. Sample package 25c postpaid, including lighter parts list. Cigarette Lighter Parts Manufacturing Company, 126 Lexington Avenue, New York 16.

START Profitable mail order business. PMT lists new propositions available; products, sources, accurate methods. Covers ad writing, letter logic, trade information. Send 10c for copy and get free instruction folio offer. Progressive Magazine, Sheboygan, Wisconsin.

REAL Opportunity! Start clean, legitimate mail order business with only \$80.00 capital. May not make you rich, but should bring \$30 weekly or more—in spare time. Details free. Opportunity Press, 5015 Lake Park, Chicago 15, Illinois.

DO IT with sea shells. Attractive jewelry. Profitable. Free instructions, Werts, 1429—56th Avenue, Oakland 3, Calif.

MERCHANDISE At half the standard advertised price. Ken Solomon Company, 813 Broadway, New York 3, N. Y.

LOOKING For opportunities? Ask for outstanding information. Stamp appreciated. New Age Enterprises, 578F Prospect, New York 55.

WHOLESALE Merchandise Sources Guide \$1.00. Reimer, 1119-A Chestnut, Saginaw, Michigan.

HOW I scored tremendous mailorder success from \$100 start that soon required eighteen office employees. Write Evans, Box 982 Beverly Hills, California.

SELECTED Opportunities, illustrated catalog, 36 pages, 25c. Novelty Supply-Printer, Box 320, Brenham, Texas.

GOOD Money in plumbing. Installation and repair complete instructions \$2.10. Lucas Supply, Dept. 23, 30 W. Washington, Chicago 2, Ill.

EARN \$10, \$25 Per week spare time. No canvassing. Experience unnecessary. Unique Service, Box 851P, Minneapolis, Minn.

40 MAILORDER Publications, magazines and circulars. A barrel of opportunity for 25c. Theodore Gordon, Box 1223, New Haven, Conn.

EMBOSS Christmas cards, letterheads yourself. "Embosso," gold, silver, \$1.00. Dexter, 45 Pleasant, Battle Creek, Mich.

FIFTY "Prize-Winning" mail order plans. Guides you to a profitable business; home or office. Free details. National Enterprises-F, 10 Waverly Place, New York City.

OPERATE Profitable mail order business. Splendid opportunity. Jay-Dee Sales, 49 Chalmers, Youngstown, Ohio.

ESTABLISH Profitable mail business at home. Opportunities literature free. Geele, 3754 N. Pt. Washington, Milwaukee 12, Wis.

BOOKKEEPERS, Cost clerks, accountants may earn fees of \$500 to \$5,000 as cost consultants installing modern cost control systems. Learn direct from successful firm of industrial analysts and cost consultants, through ten sets instructions at \$10.00 each. Unusual opportunity, territory limited. Room 1504, Fidelity-Philadelphia Building, Philadelphia 9, Pa.

FLASH, Classic novelty. Big business for you. Hurry, dime. Robert Martin, PM 57 Hart, New Britain, Connecticut.

OPERATE Mail order book shop. Sell books, magazines, post cards, stationery, office supplies by mail. Start small, at home, in spare time and expand rapidly. Kraft, Aurora 2, Mo.

LOOKING For new opportunities? Mail order and others? Get "The Practical Idea." Write: Veteran, Charleston 6, Ill.

MAKE Money selling by mail. Learn in one evening. Details free. Midwest Distributor, Box 4001 Station A, Kansas City 7, Mo.

MAKE Extra money now. Build to financial independence. Sell office supplies by mail from your home. I tell you how. Jo Troutwine, 8654 S.W. Ninth, Portland 1, Oregon.

ESTABLISH Own specialized, profitable advertising business. Make big money practically giving away advertising. E. J. Matteson, P.O. Box 580, Hanford, Calif.

WORK Evenings at home collecting names and addresses. Sell them by mail. Details free. MacAndrews, 8 Buick Street, Calais, Maine.

SELL By mail. Part or full time. Free details. Write Glenn Heck, Box 81, Russell, Kentucky.

SLOW In advancing? Struggling through life? Send now for free details of book that leads to success. Aesir Sales, 199N East Third, New York 9, N. Y.

OPERATE Profitable home business selling merchandise by mail. Past sellers. Large profits. Powell Service, 5713 Euclid, Cleveland 3, Ohio.

START A home business in spare time. Make extra money. Experience unnecessary. Literature free. Ellmar Services, Muncy, Penna.

GET Into mail order business, anywhere; start small, spare time, grow fast from profits. New, illustrated course, "Simplified Selling by Mail," fully outlines tested, winning methods for building fascinating, successful business, full or spare time. Complete course \$1.98; refunded if not satisfied. Descriptive prospectus free. Frank C. Arts, 1060 Harding Drive, Toledo 9, Ohio.

LIQUID Rubber, for making flexible molds, literature and sample free. H. Chaney, 1130 E. 16th St., Jacksonville 6, Fla.

HOW And where to obtain capital. Fully explained. Particulars free. Star Service, Wapakoneta, Ohio.

ASTOUNDING Modern mailorder plans bring quick profits. Darrah, Orono, Maine.

LOOK 25 All different mail order magazines and ad sheets 25c. W. E. Martin, Bassett, Va.

AMAZE Others. Add faster than adding machine. Free details. Math Institute, Box 633, Mobile 4, Ala.

1946 GIGANTIC Directory of opportunities, advertisers supplies, sources, trade information, mail order ideas, products, wholesalers, valuable tips—just published! Descriptive literature free. Wilkin & Co., 118-AP East Main St., Hillsboro, Ohio.

INVITATION To income. Contact Mib Associates, Fitzsimmons Building, Pittsburgh 22, Penna.

EVERY 25c Invested nets \$1. Details \$1 (refundable). Ray T. Johnson, Brookport, Ill.

ESTABLISH Salted nut route, everything furnished. Robinson Associates, 75 Menahan, Brooklyn 21, N. Y.

LIQUID Marble—Make in any color. Soundproof plastic flooring. Flexible molds. Cast novelties, plaques, statuary. Big money—your own business. Catalog free. Write—Bing Products, 88-A28 Broad Street, Boston 10, Mass.

BIG Paying jobs in welding. Complete welding lessons and reference books, 516 pages, 41 lessons, \$2.00 copy. Money-back guarantee. Hobartweld, Box M-1065, Troy, Ohio.

LIQUID Marble; snow-white, multi-colored. Glazed. Unglazed. Composition flooring. Lifetime wear. Any color. Flexible molds. Plaster casting. Get into the big money now. Full information given free. See our large ad page 35. Write—Compo-Tex, Box 786-R, St. Louis, Mo.

BELTS! Make 'em and make money. No tools! Sample 50c. Artinc Leather, 411 Joseph Ave., Rochester 5, N. Y.

METALLIZE Baby shoes! Learn this money making business from nationally recognized consultant. Get "know how" from outstanding authority! See Kushner ad, page 270.

DON'T Waste time! Get the newest and best offers without searching. New, unique service brings complete ready to start offers at low cost. Particulars free. American Enterprises, Box 595-B Grand Central Station, New York 17.

BIG Money—Start window washing business. Full instructions. \$1.00. P.O. Box 6, Springfield, Mass.

SPECIAL Training for entering successful businesses. You start small, grow big. We tell you what to start. What will pay. What to sell. Who will buy. Write, Hilton C. Cornwell, 1384 Dekalb Ave., Atlanta, Ga.

START A clock shop. Fascinating, easily learned profitable business requiring little capital. We teach you how to repair all kinds of clocks. Information free. Houston Clock Shop, P.O. Box 5086A, Houston 12, Texas.

START Home manufacturing business making Cleaning Compounds, Soaps, Insecticides (DDT), Cosmetics, Polishes. No machinery. Literature free. Kemix, Park Ridge, Ill.

MEN, Women, "Everybody Likes Candy." Learn to manufacture professionally at home. (Our 36th year.) Ragsdale Candies, East Orange 2, N. J.

SYNTHETIC Latex with Neoprene base for making flexible molds! Quick drying! Safe! For home, classroom, or industry. Quart \$2.00. Gallon \$5.95. Full instructions. Plastercraft Supply Company, 1406 East 43rd Street, Cleveland 3, Ohio.

"HOW To Make Simple Molds and Plaster Plaques." Profitable business or hobby! Instructive booklet 25c. Plastercraft Supply Company, 1406 East 43rd Street, Cleveland 3, Ohio.

10c BRINGS You hundreds of money-making propositions, plans, ideas, tips, wholesale supply sources, magazines. Gardenville Publishers, Gardenville 4, N. Y.

200 MONEY Making deals, Plans, Rare formulas. Schemes, Folio free. Formico Mart, Box 572, Dayton, Ohio.

BOOKKEEPERS. Operate professional bookkeeping service. Spare time. Information free. Bourque, 3712 Fifth, Marrero 1, Louisiana.

WOULD You pay 3%—first \$350 made? Color-illustrated book "505 Odd, Successful Enterprises" free! Some plans offer occasional "day off." Start at home, office. Expect something odd! Pacific, 2207½ Cloverfield, Santa Monica, Calif.

RAISING Canaries pays good profits. Valuable bird book—"Its Care, Breeding and Training." Price \$1.00. American Canary, 2839 N. Halsted, Chicago.

INCORPORATE Your business. Delaware laws. Many advantages, free details. Tax Research Bureau, Inc., Delaware Trust Building, Wilmington, Delaware.

SPECIALTY Manufacturing, the big money business that can be operated anywhere, start on a very small capital; we supply dependable formulas and complete instructions; get interesting free booklet, "Money-making Opportunities in Specialty Manufacturing." Howard Robinson, Ph.G., 1300-A South Ohio Street, Sedalia, Mo.

EARTHWORM Culture. A home industry. Send postcard for valuable free bulletin on "Earthworms: Their Intensive Propagation and Use." Thos. J. Barrett, Earthmaster Farms, Box B-488, Roscoe, Calif.

FELLOW Workers—Down with bosses—Start own business—Be independent—Booklet describing 137 tested plans, free. P. Padney, 307 York St., Jersey City, N. J.

LEARN Shell jewelry manufacturing. Complete, simplified home instruction course, beautifully illustrated, shows 45 styles pins, earrings, brooches, sprays, hair ornaments. Includes pearlizing, dyeing, gilding, glow-in-dark methods. No tools needed! Learn-earn within a week. Only \$1 postpaid, including wholesale prices of all raw materials, House of Gifts, Box 4550-RF, Coral Gables, Fla.

MINK Raising, information free. Complete. Lake Superior Mink Farm, Superior, EE, Wisconsin.

PROFITABLE Mailing merchandising business. Write Riegel, 1111 Harrison, Phila. (24), Penna.

TADPOLES Make frogs, tremendous demand. Both make you money. 25c brings tell-how information. Chariton Corporation, Century Building, Chicago 4.

25c **MAIL** Seller, 800% profit. Sample, details 10c. Harvey Teeple, Decatur, Ind.

COPPERIZE Baby-shoes, complete instructions, tested sales plan. Metaloids, Box 8087-b, Pittsburgh 18, Penna.

MAKE "DDT" Products. My ten master formulas show how. Literature free. Howard Robinson, Ph. G., 1302-A So. Ohio, Sedalia, Missouri.

SMALL Capital starts your own advertising agency, at home in spare time. Complete operation exposed. No stock or equipment. Opportunity for large earnings. Stamp brings folder and proof. P. Snyder, Box 4907-A, Philadelphia 19, Penna.

MAKE Flexible molds! Few cents each! Cast plaques, novelties, bookends! Free sample! H. Tooker, 630-A Chestnut, Hamilton, Ohio.

SPECIALIZED Mail business earned \$1400 monthly. Copyrighted instructions \$1.00. Wm. Boyd, 331 Fourth, Pittsburgh 22, Penna.

START A business of your own. Can put you next to new profitable business opportunities. Particulars free. Beiers, 837-A N. Hoffert St., Bethlehem, Penna.

WE Start you in business, at home, sparetime, earning \$10-\$30 weekly selling by mail. Stamp appreciated but not necessary. Driscoll Sales Service, Box 2771-A, Denver, Colo.

COLORGLAZED Concrete pottery made without molds. New, low cost, patented method. Cemetery products, novelties, tiles, floors, etc. Basement leaksealing. Other moneymaking projects. Booklet, details free. Men only. National Potteries Company, Fergus Falls, Minnesota.

ELITE Collection contains 137 practical money-making plans; local and mail order. New edition. Particulars free. Elite Co., 220-A Grand St., New York 13.

137 **WAYS** To make money, in home or office, business of your own. Full particulars free. Elite Co., 220-A Grand St., New York 13.

PLASTIC Homes—Build yourself! Resurface old buildings! Wonderful building material. Particulars free. Marbleizing Service, Edwardsville, Illinois.

LIQUID Marble—Colorful, glazed! Molded, brushed, sprayed! Composition floors. Rubberlastic molds. Particulars free. Marbleizing Service, Edwardsville, Ill.

HANDY Men—Earn money home operating Community "Fix-It" Shop. Write Stafford, 708 Rawlings, Carbondale, Ill.

LATEX For making flexible rubber moulds. Thoroughly tested. No shrinkage. Complete instructions with each order. Stoneham Rubber Co., Box 244, Stoneham 80, Mass.

YOUR Own business. Big profits, very small capital. National organization teaches, helps, supplies everything. Interesting service business. Big demand everywhere. Americlean, 211 North 7th Street, St. Louis 1, Mo.

MAIL Order business course shows you how to make money, spare or fulltime. Teaches professional mail order technique—not penny-snatching schemes. Fascinating 100-page illustrated success-catalog free! Write—Nelson Company, Dept. 4-02, Chicago 5.

BUILD Miracle homes. Yours. Others. Chamberlain, Fitzsimons Building, Pittsburgh 22, Penna.

BOOKKEEPERS—Operate your own "Dollar-A-Week" bookkeeping and tax service. Full or spare time. Details free. Ellis, Box 200, Cedar Grove, N. Carolina.

RUBBER Moulds for casting novelties. Latex for making moulds. Use thoroughly tested and approved products. Eastern Latex Laboratories, Box 153, Mattapan 25, Mass.

RECAST Old batteries into new. Latest achievements. Battery Laboratories, Minneapolis.

START Mailorder bookshop—Everything furnished; publisher cooperation. 25c brings booklet, exclusive setup, samples, exciting ideas. General Publications, Ossining, N. Y.

BECOME An "Attritionist Masseur." First improvement over Swedish massage in 100 years! Results unbelievable! Dr. Swearingen, 9128M, Station S, Los Angeles.

\$25 **WEEKLY** Working two hours daily. No canvassing. No manufacturing. Lycke, Box 2471, Cleveland 12, Ohio.

BRUSH Plating outfits connect to a battery. No tanks necessary. Good paying business at home plating autoparts, bathroom fixtures, bicycles, reflectors, silvering mirrors. No shop or experience required. Outfits furnished. Free booklet. Gunmetal Co., Ave. H, Decatur, Ill.

BUILD Neon signs and neon lighting. Easy to learn. Very small capital required. McMaster Sign Co., 730 State St., Bellingham, Wash.

BABY Shoes preserved. Complete instructions. Exclusive rights. M. E. Watson, Bellefontaine, Ohio.

MONEYMAKING OPPORTUNITIES

START Your own business, now! Local, mail order; full, spare time. No office, no store, required! Few dollars and "know-how" knowledge contained in "specially selected" courses, manuals, tells you how! Interesting, descriptive folder, free! Schoen Sales, 4860-B North 37th Street, Milwaukee 9, Wisconsin.

EARN While you learn the clock repair business! With our method of instruction, your income starts immediately. For details write Akron Clock Clinic, 964 Wye Drive, Akron 3, Ohio.

MECHANICALLY Inclined men—Own and operate general appliance repair shop. Complete, illustrated course shows you how. Welding, refrigeration, motor repair, how to get business, etc., all phases covered. Free literature. Christy Supply, Dept. 1170, 2835 N. Central Ave., Chicago.

FREE Mail of opportunities, profitable plans, samples. Dancer, Mansfield, Ohio.

IF You would like to start a part or full time mail order business that yields big profits, send for folder "B." Richard Ponto, Elkton, So. Dak.

START Easy-to-make slip cover business. Write. Educational Service, Box 385-D, Lombard, Illinois.

MAKE \$5000 Yearly selling specialties, just like I do. Write me. Guy Carylton, Bethany, Oklahoma.

"LUMINOUS Paint." Resilvering Mirror formulas 25c each. "50 Single Ingredient Formulas" \$1.00. Ideal Service, 300, Park Ridge, Ill.

RAISE Own capital, start own business! Copyrighted method. 25c brings proven money making offers. McCann, Ravine, Nutley 10, N. J.

UNPAINTED Wall plaques, novelties. Free list. Beginners write. J. Martino, 1228 Wilshire, Los Angeles 14, Calif.

ONE Pound big mail, 25c. Thomson, 857-M, East Jessamine, Fort Worth 3, Tex.

MAKE Extra money by recommending McGraw-Hill technical books to fellow workers in your spare time. Write for details to E. Kask, Dept. M, McGraw-Hill Book Co., 330 West 42nd St., New York City 18.

START Making money by mail immediately. Amazing plan, including 100 free all profit circulars 25c. Profit Builders, 305-C West 8th, Los Angeles 14, Calif.

SAFETY Contest. Moneymaking program. Free. Eblen, Box 5912, Kansas City 2, Mo.

MAKE, Sell over 100 fast repeating products under your name without machinery. Kohen, 506 W. 45th, Chicago 9.

MAKE Rubber stamps, stereotypes, yourself. Combination 6x9 outfit \$16.50. Information 3c stamp. Ehrenreich, 2035PM Belmont Avenue, Bronx 57, N. Y.

DOLLARS Daily! Cleared \$1900.00 in two months. Details. Duffy, J56A, Covington, Ky.

THOUSANDS Articles wholesale. "Supply Source Directory" 10c. Ideal Service, Park Ridge D-11, Illinois.

HUNDREDS Of opportunities. Three mail order magazines free. Thompson, Box 133-z 10, Tonawanda, N. Y.

MAKE \$5000 Yearly selling books by mail, from your own home, store, or office. Details free. Leroy Harris, 310 W. 14th Street, Cincinnati, Ohio.

START Profitable mailorder business. Keep 90c every dollar sale. Write. Smith, 1126 Vermont, Bristol, Virginia.

SEWING Machine repairs men make big money. Every neighborhood needs one. Be first. Hang out your shingle. Our manual repairs all makes. \$1.98. Guaranteed. Serviceman, Hamilton 5, Ohio.

MASTER Money-making system. Three complete volumes, opportunities. Guaranteed. Only \$1. Special cash plans free. Southern Specialty Service, 210 North E, Lake Worth, Florida.

\$20.00 **DAILY** Up selling advertising and personalized pencils. Six samples with your name, dealer proposition, order forms 40c coin. Warner Stationery Company, Havre de Grace, Maryland.

WANTED Agents, advertisers, co-publishers. Sample and details 25c. J. W. Arthur, Box 4, Montgomery, W. Va. Member N.M.D.A.

\$246.50 **MAKING** Baffling secret device without skill, machinery, from former top priority war material costing \$1.50! Guaranteed simple, revolutionary new discovery, unbelievably profitable. Universal appeal. Frank, illustrated proofs free! Rolls Industries, 115 West 16th, New York 11.

UNIQUE, Profitable business! Make famous Trucraft "practical" models. No skill or equipment needed. Quaker City Crafts, 1613 North Carlisle Street, Philadelphia 21, Penna.

PROFITABLE Home occupations. Valuable information free. Gether, AB-1615 Glendale, Milwaukee 11.

EARN Big money! Full-spare time. Mail merchandising. Book \$1.00. E. Villa, 1410 Linden Ave., Baltimore 17, Md.

TESTED Moneymakers, small capital business plans, self-help opportunities, spare time earning ideas, mail order business information rented. Bookmaster, Box 871E, Stillwater, Okla.

SMALL Monthly investment enables you to have moderate home income. Sample, particulars 10c. Hobbies, Box 35-A, Irvington 11, N. J.

SMALL Investment, immediate returns. Sell punchboards. Full or spare time. Write for circular and prices. Galentine Novelty Company, 520 East Sample Street, South Bend 18, Indiana.

MAKE Money at home. Paint and decorate wall plaques, brackets and book ends at home, no skill required, sell to stores, friends, bazaars, etc. Big demand, good profits. We furnish you with the plaques at very small cost. Write today. Marbleite Art Company, Ames Station, Box 53-P, Omaha, Nebraska.

WE Have three patents. You manufacture them, pay us only 5% royalty. Send \$1 cash for each plan. C. Chaddock, 1243 W. 22 St., Los Angeles, Calif.

MAKE Big money preserving baby shoes in metal, bronze, pearl, gold and silver! Kikavi Company, 8620 South Ruthelen, Los Angeles 44, California.

START Spare time business—Many ideas to choose from. Star, Box 41, Brooklyn 14, N. Y.

CARNIVAL Ride plans; easily built; kiddie auto ride plans \$5. Brill, 228-M N. University, Peoria, Illinois.

A BUSINESS Of your own. Make your spare time pay you a profit. A few hours a week can build a profitable enterprise for you. We tell you how. A. F. Giannelli, P.O. Box 993, Schenectady 1, New York.

"FOR Sale"—New, Different—"Catalogue" paper. Your imprint. Palmer, Berkeley, Norfolk 6, Virginia.

STOP Looking for work! Here is something you can put your hands on. Good paying jobs available in Florida. Send for free booklet, "Florida Opportunities." Florida Businessmen's Service, Box 767-B, Panama City, Florida.

ASSEMBLE Fast-selling jewelry with colorful plastic and metal parts. Profitable hobby; simple—inexpensive—fascinating! Free details. Hughes, 712 Kimball, Danville 3, Illinois.

NEW Lawn mower sharpeners. Details for stamp. Anton Wellert, 142 Gaylord Street, Binghamton, N. Y.

BUILD Big income mail order business at home. Free details. News Specialty Co., Mansfield, Ohio.

18,000 PATENTS Royalty-free. See Bishop Tools ad under "Patents For Sale."

HUNDREDS Of ideas. 140 page book with "know-how" \$1.00 postpaid. Free description. Charles Zak, Box 365, Cleveland 4, Ohio.

YOUR Opportunity to win contest cash. "Try" magazine tells how. Sample 25c. "Try," West Trenton, New Jersey.

WANT A beautiful home? A fine car? Respect and admiration of friends? Everything, in short, that money can buy? Then get "Building Your Fortune through Salesmanship" by Fred Elgin. Written by a top-notch salesman, this twenty-three thousand word brochure reveals facts you should know about this big moneymaking field. Warning! This is not a get-rich-quick scheme. Only honest, sincere hard workers will reap rich rewards in cash. Only \$2.00 postpaid. Cash, check or money order. Money back guarantee. Copeland House, Publishers, 46 Park St., Framingham, Mass.

QUICK Profits mailing postcards. Ideal for mail order beginners. Plan complete only 25c. Name listed, "National Opportunity Seekers Directory"—free with plan. Miller, 408 E. 83rd St., Los Angeles 3, Cal.

NYLONS! Supply sources, 50 manufacturers. \$1.00. Guaranteed information. New Age Enterprises, 578N Prospect, New York 55.

BOYS! Girls! Want dollar? Rush age, postal. Renschler's, Carrollton 2, Ky.

START Your own business! Big money manufacturing novelties, plaques, statuary. Free catalog. Write Bing Products, 88-A2E Broad Street, Boston 10, Mass.

UNPAINTED Figurines, plaques. List. Progress Company, 4033 Chowen, Minneapolis 10, Minn.

\$25 WEEKLY Working two hours daily. No canvassing or manufacturing. Lycke, Box 2471, Cleveland 12, Ohio.

EARN Money at home—steady income. Write Successful Income Builders, 508-A, Hollywood 28, California.

LEARN Metascience. Remarkable drugless healing. No manipulation. No apparatus. Unbelievable simplicity and results. Inexpensive correspondence course. Write Metascience, De Land, Florida.

RAISE Giant Chinchilla rabbits. Tremendous profits from gorgeous fur, delicious meat. Ideal business. Willow Farm, R15A, Sellersville, Penna.

BE Smart, make your own Christmas gifts or start a business. \$1.00 brings an illustrated instruction book on making shell jewelry, etc., with materials complete for two pins. Send for catalog. Woods Shellcraft, Box 306, Bradenton, Florida.

THIS Is it! Now offering the greatest agency plan ever! Handle over 400 technical books, Xmas, birthday, everyday greeting cards. Also operate your own magazine subscription agency handling every magazine printed! Complete supplies, catalogs, 25c. Greeting card sample boxes 75c. Caswell Distributors Service, Westfield, New Jersey.

EARN Up to \$2,000 year, inventing simple items for special cash markets. Ideas only. No patents. Hendrickson, Argyle 7, Wisconsin.

A BIG time mail order business can be started in your sparetime at home. No special equipment needed. We tell you how. H. S. Smith, 3139 So. Mabbett Ave., Milwaukee 7, Wisconsin.

TIPS, Ideas, opportunities galore in "Timely Tips," Paulding, Ohio. Independent monthly magazine. 18th year. \$1.00. Sample, dime. Trial 4 months 25c.

LEARN Battery repairing, rebuilding. Engineer offers money making methods. Battery Bureau, 2225 North 44th St., Milwaukee, Wis.

WIN Contest money. General contest bulletin shows how. 16 big pages of helps. Many current contests listed. Sample 25c. General Contest Bulletin, 1609½ East 5th, Duluth 5, Minn.

FREE "Prize Contest Bulletin" describes many contests. Money making opportunity. Cash Register-G, 210 Fifth Ave., New York 10.

I MADE \$1000 From 1000 tomatoes using my unique methods. Detailed instructions, \$1.00. (Refundable). Alfred Dinsmore, Marlborough, Mass.

WHOLESALE Catalog, directory 10c. Thousands of articles. Stafford, 961½ N. Jefferson, Indianapolis 1, Ind.

200 MONEY Making deals, plans, rare formulas. Schemes, Folio free. Formico-Eng., Box 572, Dayton, Ohio.

1001 MONEY-MAKING Ideas! Free details. Neuway Institute, Box 5463-M, Chicago 80.

WOULD You pay 3%—first \$350 made? Color-illustrated book "505 Odd, Successful Enterprises" free! Proven by "Little Fellows." Start at home, office. Expect something odd! Pacific, 2207½ Cloverfield, Santa Monica, Calif.

"THERE'S Big money in junk"! Easy! Fascinating! Free circular! Batteryman, Grand Junction 5, Colorado.

EARN Money evenings, copying and duplicating comic cartoons for advertisers. Adservice, Argyle (1), Wisconsin.

MONEY-MAKING Opportunities, exclusive supply sources, personal guidance guaranteed. For complete information, remit 25c. American Mail Trade Association, 313-F East 21st, New York 10, N. Y.

"HOW To Write Advertising," absolutely free! Dudley Bunn, 126-PM Lexington Avenue, New York 16.

FORTIFY The future! Start own business; home, office. Booklet describing "Collection of 137 Tested Plans" free. Elite Co., 220-A Grand St., New York 13.

PUBLISH Your own magazine. Hand-some 52 page format, well edited, illustrated. Cost low as \$1.00 month. Brings you prestige, profits. 25c brings sample, details. National, Ord, Nebr.

I MAKE Big money in the mail-order business. You can do the same at home with my copyrighted system. Write me. I'll tell you how. F. Little, Box 8, Glen-shaw P.O., Pittsburgh, Penna.

FORMULAS, PLANS, ETC.

10,000 FORMULAS And trade secrets. Free literature. Stillman, 555 Kingston Ave., Brooklyn 3, N. Y.

MAKE 25 Pounds soap for 25c in about 25 minutes. Three ingredients. No lye or grease. (Original). Also bubble liquid. Carpet cleaner. Soap substitute. Garment cleaning soap. All 25c coin. Smart circular free. Teycer, Chemist, Box 1287¼, Chicago 90.

MECHANIC'S Soap powder and 109 other money making formulas for 50 cents. K. Reeves, 3226 Tularosa Street, El Paso, Texas.

NEW Formulas, analysis, research. Write Dr. J. C. Hertstein, 330 Charles Ave., Grand Rapids 6, Michigan.

PUNCTURE Proof your tires. Prepare Sealtight mixture yourself, easily, economically. Formula, instructions, \$1.00. Cealtite Ltd., 656 Linden Ave., East Kildonan, Manitoba.

ANY Formula \$1 or money back. F. Armstrong, 212 Baldwin Ave., Charlotte, N. C.

GUARANTEED Formulas for any manufacturing chemical product or process. Free catalog. Starr Technics, 868 Eddy Rd., Cleveland, Ohio.

REAL Manufacturing formulas. Lists free. Cummings, Chemist, Gordon Ave., Syracuse 4, N. Y.

FORMULAS — Latest, best. Analysis. Giant formula catalog and chemical instruction sheet 10c. Refunded first order. Belfort, Engineering Building, Chicago 6.

NEED Chemists? Formulas. Analyses. Ideas. Consulting Scientific Company, Swarthmore, Pennsylvania.

MANUFACTURE Cleaners, flavors, cosmetics. Formula catalog free. Kemico, Park Ridge 16, Illinois.

PLASTICS

SPECIAL—Square foot Plexiglas, ¼" thick, \$2.00, postpaid. Price list for stamp. Yonkers Plastic Supply, 137 Riverdale Avenue, Yonkers 2, New York.

MAKE Plastic novelties with Hollywood kit containing 2 lbs. of Lucite and Plexiglas; 3 colors of dye, bottle of cement and complete instructions. Postpaid \$3.25. Hollywood Items Co., Box 1151, Hollywood 28, Calif.

NEW Liquid plastic. Clear, colors. Cast without heat. Embed flowers, insects, coins. Saw, drill, carve. Manual tells how. Send \$2.95 plus 20c postage for complete kit including one pound liquid Castolite. Castolite, 211, Kenilworth, Ill.

PRE-FABRICATED Plastic kits! Complete, ready for assembly. Ideal Xmas gifts! Assemble, sell. New designs. Illustrated catalog 10c. Plastic Products Co., 211 - 7th St. S.E., Canton, Ohio.

WRITE For free information, home fabrication, plastics. Learn, earn. Son-Wray Plastics Co., Topeka, Kansas.

PLASTICS; Sheets, rods, tubes. Free list. Plastic Supply Co., 2618 St. Louis Ave., St. Louis 6, Mo.

GUARANTEED! We are America's lowest priced plastic supply house. Write for free price lists. Allcraft Products, Box 212, Hempstead, N. Y.

MAKE Money assembling our pre-fabricated plastic kits. Sample kit 50c. Fabros, Box 156, Station F-1, Buffalo 12, N. Y.

WRITE Today for generous free samples "Lucy-Plex" and "Coty-Bak" fast action; dustless, greaseless, non-burning, optical polish plastic buffing compounds. 5000 plastic hobbyists now use them. Enclose 12c postage. Plastic Masterpieces, 529 West Manchester Ave., Los Angeles 44, Calif.

PLEXIGLAS And Lucite liquid cementing dye kit. Full color range. Excellent for cementing or dipping. \$2.00 postpaid in United States. Money orders only. Handicraft Supply, 409 N. Akard, Dallas, Texas.

\$100 CASH, Plus up to \$1000 "royalties." Enter "Allcraft Products Contest." Write immediately. Allcraft Products, Box 212, Hempstead, N. Y.

PLEXIGLAS, Lucite, Cellulose Acetate for hobbies, money-making opportunities. Sheets, rods, tubes, clear or colored. Full range of sizes. Cements, dyes, polishing compounds, buffs. Free price list. Plastic Parts & Sales, 1157 S. Kingshighway, Dept. H-2, St. Louis 10, Mo.

PLEXIGLAS—Prime sheets 12" x 12" 1/16"—1.20, 3/8"—1.37, 3/16"—1.94, ¼"—2.28. Include 10% for postage. Dyes, rods, cements, buffing compounds, jewelry findings, tools. Free listings. Craft Plastics, Box 129-M, Somerville, N. J.

SENSATIONAL plastic injection molding machine. Low price plexiglas; dyes, cements, shellcraft kits, molding sets, etc. Free literature. G. Baker Company, River Edge, New Jersey.

DECORATIVE Plastic, etc. Ad under Machinery. Metplias Supply Co., 1420 So. 16th, Maywood, Ill.

PLASTICOR Injection molding press produces 100 ¼ oz. Tenite moldings per hour! Mechanical pressure, electric heat, sixteen colors, 2½" x 2" x 1" molds. Commercial results! Magazine featured! Money-back guarantee! \$34.95 complete! Limited supply! Technicraft, 1156 Commonwealth, Boston 34, Mass.

PLEXIGLAS Pr. sq. ft. 3/16" \$1.80; ¼" \$2.00. First grade in following colors: pastel blue, rose, yellow, green and white opaque. Small scrap—35c per lb. Add 10% on orders under \$10.00. Rainbow Plastic Co., Box 163, Arlington, Texas.

FORMALIN Quicksetting liquid plastic sample kit \$2.50. Dealers wanted. Formalin Works, 5 W. Larned St., Detroit 26, Mich.

LUCITE—Price list. Special offer. Midwest Plastic Supply, 1717 No. 66, Omaha 4, Nebr.

PLASTICS And supplies—New Plexiglas, Lucite, Catalin sheet, rods, tubes, etc. Attractive prices. Exceptional kits \$2.00, \$5.00, \$8.00. Internal floral carving drill. We pay postage. Free list. Plas-met Sales & Engineering, 4648 Shirley Place, St. Louis 15, Mo.

MONEY In plastics! Lucite plastic hobby kit. Two pounds Lucite materials, coloring dye, cement. Instructions. Send \$2.50 to Plastic Specialty Co., (Dept. M), 192 Lexington Ave., New York 16. Also Swiss music movements, \$3.50 each.

PLEXIGLAS, Sheets and supplies, first quality, lowest prices. Plastics information folio free with first order. Details free. Art Plastics of California, 8127 East 14th St., Oakland 3, Calif.

LUCITE—Complete illustrated fabricating instructions, used in craft classes throughout the world, price list on lucite, dyes, complete supplies. Booklet 10c, with sample, 35c. "Gem-O-Lite" P.O. Box 686-B North Hollywood, California.

LEARN At home "Working With Plastics." Full information on sheets, blocks, rods, tubes. Trade names, sizes, colors for fabrication. Designing, tooling, bending, cementing, polishing. Also for homework-shop. Only \$1.25 postpaid. Money back guarantee. Modern Technical Book Co., Dept. MMC, 55 West 42nd St., New York 18.

PLEXIGLAS Prime sheets 12" x 12" 1/16" \$1.20, 3/8" \$1.37, 3/16" \$1.94, ¼" \$2.28. Include 10% for postage. Dyes, rods, cements, buffing compounds, jewelry findings, tools. Free listings. Craft Plastics, Box 129-P, Somerville, N. J.

PLASTICS. Make yours at home. Formula and moulding instructions \$1.00. Forester, Zone 84, Station K, Toronto, Canada.

"FORMALIN" Quicksetting liquid plastic "kit" with complete instructions \$2.50. National Plastic Products Co., 5 W. Larned St., Detroit 26, Mich.

BIGGEST \$1.00 Plastic value transparent plexiglas and lucite sheets and strips in irregular shapes and thicknesses. Useful for many projects and experimental work—big package by return mail, no waiting. Double size package with dye and cement included \$2.00. Send money order to HomeCraftsman Plastics, 1945 W. Harrison Street, Chicago 12, Illinois.

CHEMISTRY

HYDROGEN! 10 Charges \$1.00. Inflate balloons, etc. Miles Specialties, Kokomo, Indiana.

HANDBOOK For chemical experimenters, illustrated, hundreds of experiments, 50c. Experiment booklet 15c. Supply catalog 5c. Reading Scientific Company, Reading, Penna.

THE House of Winn, home of supplies for amateur chemists. See Winn's New Idea chemical kits and apparatus outfits for home experimenting. Send 10c for retail catalog. Established 1931. John H. Winn, Dept. 511, 124 West 23rd St., New York 11, N. Y.

STUDENTS' Laboratory supplies. Send 5c for catalog. Mel-Glo Chemical Co., 258 Fourth Ave., Brooklyn, N. Y.

APPARATUS, Chemicals, ounce quantities, catalog 5c. Fleischer's Laboratories, Everett 49, Mass.

LABORATORY Supplies, Chemicals and apparatus all descriptions. 36 page book 10c. Standard Science Supply Co., 1232 N. Paulina St., Chicago 22, Illinois.

CHEMICALS And apparatus for industrial, analytical, and private laboratories. Complete supply service for correspondence school students. Send 3c for catalog. Dept. M-43, Biological Supply Co., 1176 Mt. Hope Ave., Rochester 7, New York.

FREE Catalog. Chemistry, mineralogy, biology, optics. Tracey Laboratories, Evanston, Illinois.

HELP WANTED

OPPORTUNITY Of lifetime supplying DDT and other profitable products to farmers. No experience or capital required. Must have auto and good references. Permanent. Write or wire McNess Company, Dept. 712, Freeport, Ill.

LECTURER, Tutor. Full—part-time. Commission. Professor Martin, 406 Panama Bldg., Portland 4, Oregon.

KNITTING Machinist and operator, one well qualified through experience and interest, desirous of locating permanently in California. Position is with one of America's better knitting mills. State fully experience, salary, marital status, age, etc. Brisacher, Van Norden & Staff, 310 Crocker Building, San Francisco 4, Attention Dorothy Gibson.

PUBLICITY Firm is expanding and needs representatives in city and country. Part time work in public surveys, etc. Good pay. No selling. National Public Relations Service, Inc., Box 412, Thomasville, Ga.

50,000 EXCELLENT Job opportunities in Latin America. Send \$1.00 for details, how-when-where to apply for specified firms in mining-aviation-oil. Pan Americana, Box 424J, Hollywood 28, Calif.

AGENTS WANTED

SELL Full, part time individualized belts, buckles, cap badges, tie holders. 2,000 emblems to choose. Fast profits. Repeats. Write today special outfit offer. Hookfast Specialties, Box 1425, Providence, Rhode Island.

\$1 STARTS You in business. Sell de luxe ties, 100% wool interlining. Costs you only \$7 per dozen, you make \$5.00 dozen. Send \$1.00 for special introductory offer two de luxe ties. Catalog complete line free. Philip's Neckwear, 20 West 22nd St., Dept. K-5, New York 10.

AGENTS—Big money for men, women, boys, girls—selling gorgeous night-glowing orchids, gardenias; perfect imitation real flowers; last for years; all the rage for wear on hair or clothes. Write for wholesale prices. Marney's, Dept. M-4, P.O. Box 581, Ogden, Utah.

SELL Rad, the new "Antu" rat bait to dealers. Bellefeld, New Knoxville, Ohio.

AGENTS—Highly profitable local business, requiring no selling whatever on your part. Write today for amazing free particulars. Glass Products, Ellwood City 1, Penna.

SILVER Plating Liquid: (Nu-Silver). Apply with a cloth. Or by immersion of article in liquid. Whichever is easiest. In 1 minute deposits a light durable coating of genuine pure silverplating 1000 Fine. Unconditional money-back guarantee. Occasional applications and rub-ups will keep articles silvered brilliantly like new. No equipment, tanks, batteries, or brushes needed. This is a scientific method of chemically-applying silverplating to a list of certain affinitive metal surfaces, like silverware both Sterling and silverplated ware, and also brass, copper, bronze, zinc, and some other metals. Sells by every known method using personal demonstrations. If you want to sell it you must demonstrate it. Selling representatives are wanted to go out and introduce themselves, then show, explain, demonstrate and sell it. Good profits (4 for 1). Also a companion product for de-tarnishing silverware. Atomic Metal De-Tarnishing Plates. Likewise sells on a sensational thrilling demonstration. Allows a 5 for 1 profit margin. Two good sellers for salespersons who can and will demonstrate and sell. Full details by letter mail free. NuProcess Products Laboratories, Dept. 254, Aurora, Illinois.

ODOR "Mufflers," finest refrigerator deodorizer for ice boxes, closets, kitchens. Retail \$2.00. Sell consumer and retailer. Big profits, exclusive territory. Write L. A. Muffler, Continental Bldg., Los Angeles.

SELL Superb line personal printed stationery. High quality items, year 'round sales. Attractive sample book, supplies free. Writewell Stationery, Dept. 113, 108 Massachusetts Avenue, Boston.

SELL Christmas cards. Easy money showing exquisite Christmas, everyday, wrapping assortments, stationery. Over 100 quick sellers. Request \$1.00 Christmas box on approval. Free samples of 50 for \$1.00 Christmas cards. Special offers. Hedenkamp, 343 Broadway, Dept. N-22, New York 13.

LOOK: Agents. Golden rays kit. New, different. Past seller, big profits. Sample kit \$1.00. Clinton Sales Co., 237 So. 4th St., Hamburg, Penna.

STRANGE "Dry" window cleaner. Sells like wild. Replaces messy rags, liquids. Simply glide over glass. Samples sent on trial. Kristee 128, Akron, Ohio.

WAR Honor scroll. All branches of service, 12 by 16. Space provided for name and photograph. Agents make big money. Sample 25c. E. Condon, Upper Darby, Penna.

CHRISTMAS Card money-makers. Fifty magnificent dollar box assortments \$25.00. Postpaid. Catalog free. Greenport Art Company, 252P - 12th Street, Brooklyn 15, New York.

CHRISTMAS Gift orders pay big! Easy sales. Repeat orders. Build your own business with our help. Rush request for details, confidential commissions, all magazines. McGregor Magazine Agency, Dept. 23, Mount Morris, Ill.

POPULAR Fast-selling, stainless-steel bracelets. Easy 100% profit! Details and price list free. Special sample \$2.00 prepaid. Write today. Ar-Clo Guild, 2055 W. Summerdale, Chicago 25, Ill.

COSTUME Jewelry for Christmas, \$21.50 for sample dozen latest designs, retail to \$50.00. Wicks, 3528 99th Street, Corona, Queens, New York.

OPERATE Profitable mail order business. Splendid opportunity. For details write. Ladouceur Service Bureau, 10105 Beechdale, Detroit 4, Mich.

ADDITIONAL Line for greeting card salesmen. Sell household novelties, nursery pictures. Hillside Studios, West Bend, Wisconsin.

AGENTS—House to house men "night numbers" sweeping the country. "No competition." Earn \$200 to \$250 weekly. "Free particulars." Ross Industries, Box 5460, Philadelphia 43, Penna.

A GOLD Mine for house to house agents, write Easy, 712 Case Bldg., Rochester 4, N. Y.

BALLOONS, Balloons. Wholesale price list free. Collins Co., Forsyth, Ga.

COSTS 20c. Sells \$1.00. Millions prospects. \$20 daily. Samples free. Burns Company, Johnstown, Penna.

EASY To sell beautiful rock necktie slides. Sample 50c. V. Fish, 437 W. 56th St., Los Angeles 37, Calif.

MAKE Amazing profits! Easy, inexpensive process beautifully gold embossed names on greeting cards, stationery, etc. Write for seven big profit ideas, sample, and full details. Valvick Specialties, Warba, Minn.

OPERATE Profitable business selling, packaging products under your own name. Lyle Products, 5 E. Spaulding, Willoughby, Ohio.

NEW Specialty! 200% profit. Free advertising. Lorrac Products, Albany 1, N. Y.

NEW Cheap oil burner sweeping the country! South Dakota manufacturer discovers how to cook, bake and heat the easy economical modern way by inventing a new low cost oil burner for coal or wood ranges, cook stoves, circulating heaters, heating stoves and laundry stoves. Larger size for furnaces. With its sensational Fuelizer Starter vaporizing system it turns cheap 130 flash furnace oil, distillate, diesel, range, kerosene and like oils into oil gas heat without clogging up the vaporizing system. No more shoveling coal or ashes—better heating, cooking and baking. Every burner has a lifetime guarantee against defects. New sales plan is one of today's most exceptional money makers and you can get your new Quik Heat for introducing in your territory. The manufacturers are so much sold on their new oil burner that they will offer you \$1.00 bonus for testing and will let you try it in your own stove, range or furnace for one month. Be first to cash in on the tremendous demand for this new oil burner by sending in your name today to Northwest Mfg. Co., 416 A. Mitchell, S. Dakota.

FAST Sellers offer big profits. Potholders of colorful assorted slip cover fabrics, insulated, average size 7" square. Retail 20c. Your cost postpaid only \$1.25 for one dozen, \$6.60 for six dozen, \$10.20 for one gross. Send cash with order today. Domestic Specialties Company, 2157 Division, Chicago, Ill.

SELL Photo rings, enlargements. Big profits. Details free. J. H. Daniels Company, Route 3, Box 70-C, Meridian, Miss.

RUBERLYKE Plastic foneholder. New, novel, fast selling. Retail, 60c. Fair-traded. Everybody a prospect. You also sell retail outlets. Fits all phones. Telephone rests on shoulder. Leaves hands free. Sample 50c. Reyam Plastic Co., 1525-A-East 53rd St., Chicago 15.

ZIPPER Billfolds, English morocco. Sample postpaid \$1.95. Arrow Leather Goods, P.O. Box 807, Elmira, N. Y.

PLASTONE: Amazing new polishes for floor, furniture, autos. Beautifully packaged. Low priced. Whirlwind seller to stores, gas stations, homes. Fast repeater. Big profits. Unconditional moneyback guarantee. Write for "free sample offer" now. Plastone Company, 2207-PM11 West Chicago Ave., Chicago 22, Ill.

FREE Wholesale list multicolored Biblical wall mottoes, etc. C. C. Heflin, 380 So. Main, Memphis 3, Tenn.

CHRISTMAS Cards—Earn big money selling personals and boxed assortments. Samples. Lincoln Press, P220 Hartwell, Fall River, Mass.

MEXICAN Feather pictures. Christmas novelty. 50c (stamps) bring \$2.00 worth samples, details. Refunded if unsatisfied. Aztec Art, Apartado 762, Mexico City.

MEN! Make more money and build up a profitable business on fast selling popular priced items that are in big demand. This is a wonderful opportunity to go-getters. Hausman Sales Co., Dept. P, 1243 No. Harding, Chicago 51, Ill.

HERE Is a wonderful opportunity to make a lot of money selling new low priced fire extinguisher, needed in every home, office, store and auto. Big profit and steady all year 'round business. Fire-Out Equipment Co., 1243 No. Harding, Dept. P, Chicago 51, Ill.

LOW Prices, six cent cigars, and electric shavers. S. Kelley, 2302 Ontario St., Ft. Wayne 6, Ind.

SELL Mexican pottery, glassware, chairs etc., feathered bird pictures. Sample 25c. Large framed picture \$1.50. Wholesale catalog free. Foley's, 217 Grafton St., Brockton 6, Mass.

ONE Tool does twelve jobs! See Bishop Tools ad under Machinery, Tools, Supplies.

NO Money or experience required. Spare or full time writing orders for guaranteed men's hosiery. We deliver and collect. Advance profit and 33% cash bonus. Huge demand everywhere. Steady repeat business. Write for free sales outfit including everything needed to make money. Kentcraft, 44 Court St., Dept. KM, Brooklyn 2, N. Y.

UNBELIEVABLE! New discovery "fire doom" fireproofs (anything) absorbent! Demonstration sells anyone! \$5.00 (refundable) gallon prepaid! Agents. (PM) Laboratories, Box 742, Passaic, N. J.

MAKE Extra money selling "How to Succeed." 50-page book. Sells on sight. Increases income, health and happiness for anyone. Prepaid for \$1.00. Cook, Box 667, Hollywood, Calif.

INCREASE Your income by selling "Hot-spark" non-pulverizing flint, considerably decreasing cigarette lighter trouble. Sample package 25c postpaid, including lighter parts list. Cigarette Lighter Parts Manufacturing Company, 126 Lexington Avenue, New York 16.

SELLING To housewives? Double your sales with inexpensive premiums. Postal brings interesting details. A. Kinford, Wayne, Penna.

EXCELLENT Sideline for printing and advertising salesmen. Decalomania name plates in small quantities. Great demand. Also make money applying initials on automobiles. Free samples. "Ralco" XL-Roxbury, Boston 19, Mass.

HOUSE Numbers that glow in the dark. Luminous pictures, etc. Large mfr. wants factory representative. Wonderful new product. Fast seller. Free samples. Madison Mills, 303 4th Ave., New York City.

TAKE Orders for attractive plastic nameplates. Good commissions. Write for details. William Lacey, 8 Lewis, Medford 55, Mass.

\$1.00 STARTS: Sell 9" x 12" baby; religious, scenic, "mirror shadow box." Cost \$7.00 dozen, profit \$11.00, refunds. Test sales sample \$1.00. Hayner House, Ballston Spa, N. Y.

WHOLESALE — Toilettries, flavorings, concentrates, barber supplies. LaPura Laboratories, Toledo 4, Ohio.

REPRESENT Safeguard moth-proofing compound in your territory. Opportunity for state distributorship. Cannon's Compounding Co., Box 246-P, Doylestown, Penna.

WAR Action picture sets by divisions. Agents, distributors wanted. Official War Pictures Co., Dept. PL, 64-40 98th St., Forest Hills, L. I., N. Y.

AGENTS: Do you want \$50 per week? Selling a profitable line of fibre brooms, mops and floor dusters. Write, Burtz Fibre Broom Co., Columbia, Pa., Dept. A.

AGENTS—Big line including food products. Fast selling premium and bargain deals. Low prices. Send card for big profit offer with gift. Ho-Ro-Co, 2796 Dodier, St. Louis 7, Mo.

MEXICAN Bird pictures handmade with real feathers. Free particulars. Sample 15c. Importer C. O. Staff, 14960 Evanston, Detroit 24, Mich.

SELL Books by mail. Mammoth sales and huge profits. Everything furnished. Send 10c for complete details. Business Plans Foundation, Box 56-R, New York 10.

CALENDAR 1753 To 2152. Sample and quantity prices 35 cents. Tracy Newton, Decatur, Georgia.

WONDER Cleaner, new type bubble bath. Glasgow, sell fast. Tremendous profits. Supplies, circulars, furnished. Courier, 3829-I Delmore, Cleveland Heights 21, O.

CHRISTMAS Cards. Sell 50 for \$1.00, names imprinted. Samples free. Complete line boxed assortments. Dunbar Cards, New Brunswick 20, N. J.

300% PROFIT Possibilities! New post war item, "Artistic Honor Scroll" in six beautiful colors! Tremendous demand! Details free. Schoen Sales, 4860 No. 37th Street, Milwaukee 9, Wisconsin.

AMAZING Seller: "Soilless Garden Chemical." Grow plants, vegetables, fruits, flowers all year round without soil. In or outdoors. Tremendous demand. Excellent profits. Literature free. Nega & Co., 1824 W. Dickens, Chicago 14.

NEW Revolutionary PerfeCrease trouser and skirt hangers that millions of men and women will buy on sight. Designed by General Motors engineer. All metal. Beautifully plated. Lasts years. Simple demonstration averages three or more sales every home. Call back in week and they will buy more. Red hot Christmas seller. Exclusive territory. Sales kit including sample hangers, \$2.00 postpaid. Details free. Metal Products Company, Troy 1, Ohio.

SCHOOL Seniors—Sell classmates America's most beautiful, distinctive graduation name cards. 40% commission. Largest selection. Lowest prices. Free cards and sample kit. Printcraft, 1425 E. Elm Street, Scranton 5, Penna.

EASY Money now to Christmas. Up to 100% profit selling friends, others, marvelous new 1946 Christmas and year 'round box assortments—30 boxes 35c up. Odd cards 2½c up. Extra bonus. Request special feature \$1.00 Christmas assortment on approval. Send today for free samples of our fast selling 50 for \$1.00, 25 for \$1.00 personal Christmas cards and personal stationery lines. Special offers. New England Art Publishers, North Abington, Mass.

JUST Out! History of World War II. Huge volume. Popular price. Authentic text. Official photographs. Big profits. Riverside Book Company, Iowa Falls, Iowa.

SELL New-used clothing from home, auto, store. Men's suits \$1.09, Leather jackets 49c. Overcoats \$1.00. Dresses 22c. Ladies' coats 38c. Other bargains. Catalog free. S&N, 565A Roosevelt, Chicago.

BIG Profits selling used clothing, etc. Operate from home, auto, or store. Sensational low prices. Catalog free. Kadetsky & Son, 702 Barber Street, Dept. 14, Chicago 7, Illinois.

SCHOOL Seniors! Your postal will bring our wonder, Kwick-Sell Cardalog of popular graduation name cards. Biggest profits! Only firm giving free souvenir chest and card case. Don't miss out! Hurry that postal! Craftcards, Box 235(L), Pittsburgh 30, Pennsylvania.

AGENTS—300 % Profit selling genuine gold window letters; stores and offices. Free samples. Metallic Letter Co., 438-B North Clark, Chicago.

BIG Bargains for big profits. Over 100 sensational values. Men's used suits \$2.00, pants 35c, topcoats \$1.25, overcoats \$2.00, shoes 20c. Experience unnecessary. Free wholesale catalog. Superior, 1250-FB Jefferson, Chicago 7.

200 MONEY Making deals. Plans, rare formulas. Schemes. Folio free. Formico Service, Box 572, Dayton, Ohio.

137 COMPLETE Plans for starting own business: local—mail order. Particulars free. Elite Co., 220-A Grand St., New York 13.

AGENTS: Stamping names on pocket-key protectors. Sample check with your name, address, 25c. Stamping outfits. Emblem checks, check-fobs, name plates. Hart Mfg. Co., 303 Degraw St., Brooklyn, N. Y.

MAGIC Cleaner and laundry soap deal. Hotter than a firecracker. Big profits. Sample free. Bestco, 5007 Irving Park, Chicago.

\$3 FIRE Extinguisher; quick sales, wholesale or direct; liberal profits. "Fire-Killer," 109 N. Franklin, Syracuse 1, N. Y.

PLATING Outfits for autoparts, reflectors. Connect to a battery. No tanks necessary. Free booklet and particulars. Gunmetal Co., Ave. N. Decatur, Ill.

FREE Water and our concentrates, makes flavors, lotions, shampoos, 72 products, labels, bottles furnished. Qualco, E-20030 Russell, Detroit.

"OUR Flag"—famous picture. Four colors. 500,000 sold. Sample print—free. Our Flag Sales Corp., Dept. C1076, Excelsior Springs, Mo.

GOLD Lacquered window sign letters. Large sizes penny each. New foils. Absolutely beautiful. Free samples. Atlas, 544 W. 79th, Chicago 20.

HIGH-GRADE SALESMEN

SELL Record of Service certificates. All data from discharge paper may be copied on certificate for framing. Sales made easily. Sample \$1. Wilbur Sales Company, Box 451, Plymouth, Mass.

SALESMAN Wanted. To sell foot adjusters that fit in any shoe. Easily adjusted to raise arches proper height for individual foot comfort. Excellent opportunity for big earnings. Write for proposition now. C. H. Stemmons Mfg. Co., 300 E. 51st Street, Kansas City 2, Mo.

SALESMEN To sell simplified bookkeeping and tax record system small stores and public accountants. Sells \$13.50, your commission \$8.00. Exclusive franchise. Write, Hawthorne Sales Co., Decatur, Ala.

SALESMAN—Sell hard-to-get items on open account to drug, dept., variety, hardware and general stores for national organization. Liberal commission paid weekly. Full commission on repeats. Complete sales kit free. Write today! Lee Industries, 217B North Dearborn, Chicago 1.

VAST Shortage creates big market to sell new patented glass mail boxes and crystal wall vase. Amazing earnings. Skokie Industries, Skokie, Ill.

ORANGES, Most delicious, bursting full with health giving juice and vitamins, from our famous Indian River groves direct to consumers. Employers are placing now Christmas gift orders for employees and customers. Salesmen earn over \$100.00 commission weekly. Sunset Valley, Oak Hill 7, Florida.

LOOK Here! Wanted—Men and women to start in business on our capital. Sell some 200 farm-home products. Thousands our dealers now make quick sales, big profits. For particulars write Rawleigh Co., Dept. K-192-PPM, Freeport, Ill.

QUICK Profits with individualized belts, buckles, cap badges, tie holders, uniforms. Choice of thousand emblems. Sure repeat orders. Easy-selling outfit offer. Write Hook-Fast Company, Dept. 12, Roanoke, Virginia.

AMAZING New zipper shoe sells on sight. Big profits for salesmen. Leads line 200 splendid styles. Territories open. Get free sample outfit. Write Consolidated Shoe, Dept. S-203, Chippewa Falls, Wis.

EXCELLENT Sideline for printing salesmen. 300% profit. Samples 25c. "Acme," Oblong, Illinois.

TAX Law forces merchants keep records, sell Green's; every merchant your prospect; big commissions; yearly repeat business. Mill-Green Publishing Company, 370 Seventh Avenue, New York.

WAGON Salesman—Fast moving carded goods and 10c line. Long profit. Free facts. Peerless, 2717 Dodier, St. Louis 7, Mo.

SELL Christmas cards, everyday cards, pictures, books, novelties. Big profits. Bulletin free. Elfco, 432 North Wells, Chicago 10.

BIG Commissions—selling to stores celluloid pricing tickets, metal shelf moulding. To restaurants, menu covers, signs. P. Pricing Press, 124 White St., New York 13, N. Y.

FREE! Latest issue Opportunity Magazine. Salesman's Guide. Inspiring, constructive. Shows how to earn money selling for others or in your own business. Hundreds postwar opportunities. Send name and describe what you have sold or are selling. Illustrated copy sent free. Opportunity Magazine, 620 N. Michigan, Dept. 17, Chicago 11, Ill.

EDUCATIONAL AND INSTRUCTION

TUNE Pianos. Vibration principle. New course. New low price. \$1 lesson, chart, information. Oscar Fylling, 841 Robinson, Oroville, Calif.

NON-RESIDENT, High school, college, professional degrees. Bulletin free. Capital City College, Washington-5, D. C.

GOOD Jobs and a sound, substantial future await you in hotel and institutional field. Men and women—all ages—needed for well-paid positions that offer color, excitement, ever-new and fascinating duties. Record-breaking travel means even greater opportunities for trained men and women in hotels, clubs and institutions. Lewis School receiving calls for managers, assistant managers, stewards, hostesses, purchasing agents and 55 other types of important positions! From coast to coast there are important positions that offer splendid opportunities for advancement in a business where you are not dropped because you are over 40. Previous experience proved unnecessary! No need to leave your job to qualify. A good grade school education, plus Lewis Training qualifies you at home, in spare time. Our National Placement Bureau helps to place you—and our amazing Certified Job Plan—actually certifies you will "make good" when placed. Write today for free book! Veterans: This course approved for veterans' training. Lewis Hotel Training School, Room HW-368, Washington 7, D. C. (First and only school of its kind—now in its 30th year.)

GET A U. S. government job! Men-women. \$145-\$250 month. Paid vacations. Yearly raise. Veterans get preference. Try next examinations. Prepare now. Sample coaching with full particulars—list positions free. Write today. Franklin Institute, Dept. B24, Rochester, N. Y.

"INDUSTRIAL Engineering" the sure road to success. Learn this profitable profession now under personal supervision of internationally known professional engineer. H. G. Hecketsweller, 3355 N. Olcott Avenue, Chicago 34, Illinois.

STUDY Real estate at home. Free bulletin. DeVoto Realty Schools, 35 Vicente, San Francisco 16, Calif.

RESORT Hotel positions. Travel south and north. Beginners trained. Lee's Hotel Institute, 714 Winthrop Building, Boston 9.

WRITE Stories that sell. You can do it! Literature free. Gether, AC-1615 Glendale, Milwaukee 11.

BECOME A Doctor of Psychology or Metaphysics. Teach secret of contentment, happiness. Win degree of Ps.D. or Ms.D. Solve mental worries. Free book. College of Universal Truth, 5153-B North Clark, Chicago.

"HOW To Break and Train Horses"—a book every farmer and horseman should have. It is free; no obligation. Simply address Beery School of Horsemanship, Dept. 11011, Pleasant Hill, Ohio.

PIANISTS—Quickly improve playing technique, sightreading, accuracy, and memorizing through mental-muscular coordination. Free booklet. Broadwell Studios, Dept. 306-L, Covina, California.

A SUPER Memory is yours; new, improved, simple course available to you now! Write! Z-C2 Thor Books, Box 1210, Chicago.

USED Correspondence courses, books, bought and sold. Free catalog! Spotlight, 141 Broadway, New York.

PREPARE For civil service examination. Pay for course after securing position. Write Free School, Dept. PM-1, Kokomo, Ind.

LEARN Shoe repairing—Own your shop. G.I. apprv'd. Low tuition. Modern Shoe Rebuilding School, 2935 W. Belmont, Chicago 18.

FREE. Interview with world's champion job-hunter, now top-flight executive. Andrea, Barnegat, New Jersey.

LEARN Landscaping. Profitable, healthful career—absorbing hobby, for men, women. Thorough 45-lesson home-study course takes 8-12 months spare time. Hundreds of successful graduates. 31st year. Send for free catalog. American Landscape School, 6391 Grand Ave., Des Moines, Iowa.

SHORTHAND Learned at home. Recorded lessons giving unlimited dictation. Free literature. Tutorphone Institute, Jeffersonville, Indiana.

BRIEFSCRIPT—Simple, speedy, ABC shorthand, 50c. Eastern Book Co., 203 E. 18 St., New York.

INVESTIGATION Pays big. Study under former Federal Agent. American School of Investigation, Greenville 1, Ohio.

LEARN Magic shorthand. Unique system. Fascinating. Educational. 50c postpaid. Edward Morris, 356 South Spring Street, Concord, North Carolina.

1000 USED Correspondent courses; catalogue 10c. EG Co., Elmsford, N. Y.

USED Educational and technical books bought, sold, rented; catalog free. Educational Exchange, Henagar, Ala.

STUTTERING And stammering can be eliminated. 20 years successful experience. Send for free literature now. Frank Teurfs, 25-D East Jackson, Chicago, Ill.

PLANE Trigonometry. Master method. Instructions, \$1, guaranteed. J. Ziemba, 6123 Orchard, Dearborn, Mich.

DRAFTING—Prepare for a career. Learn latest technique for machine detail designs. Literature free. Tekage, 42 Vernon Street, Newton 58, Mass.

APTITUDE Testing \$1.00 complete. J. H. P., Box 112, Station P, Brooklyn 12, N. Y.

MODERN Welding school gives thorough training for one of industry's best paid jobs. Experienced instructors. Individual attention. Non-profit institution. Qualified under G.I. Bill. Write for literature and details. Hobart Brothers Co., Box M-1067, Troy, Ohio.

SELECT Your career easily. Use scientific testing method. "Folder" tells how. Write Vocational Service, 735 Bank of America Bldg., San Diego, Calif.

DETECTIVE-Fingerprint Course, \$1.00. Frank Mashak, 4114 Olive, St. Louis 1, Missouri.

HOME Bible course. Simple, helpful, instructive. Total cost \$3.00 includes textbooks, stationery, examinations, certificate. \$1.00 starts you, or simply request prospectus. The Bible Study School, Reverend Leslie Marshall, Secretary, 382 Van Houten Street, Paterson 1, N. J.

INVESTIGATOR Training. Phillips Secret Service, 1917B North Kenneth, Chicago 39, Illinois.

LEARN Foot correction. Permanent, dignified, profitable profession. Six weeks training. Tunis Corrective Foot System, 3041 S. Double Dr., El Monte, Calif.

HOME Study course, drugless therapy. Free literature. Institute of Drugless Therapy, Tama, Iowa.

GOOD "Used" self-instruction educational books on all subjects bought, sold, rented, exchanged. Satisfaction guaranteed. Complete information and 100-page illustrated bargain catalog free! Write—Nelson Company, Chicago 5.

29 LANGUAGES By Linguaphone. Russian, Spanish, Portuguese—Direct conversational method for mastering any language quickly, easily, correctly at home. Send for free book. Linguaphone Institute, 83 RCA Bldg., New York.

LEARN Photo-engraving at home or in oldest, largest school in America. Work for newspaper or establish own profitable business. New Tasope' Photo-Engraving equipment available soon. Write for information. Veterans ask about G.I. training. The Aurora School of Photo-Engraving, Tasope' Bldg., Aurora, Mo.

MASSO - Physio - Therapy. Chiropody. Evans natural therapeutics home study courses, P.O. Box 1195, San Antonio 6, Texas.

LOCKSMITH Course. Lock picking, key fitting, etc. \$1.00 prepaid. Locksmith, Canadian, Texas.

MEDICAL Laboratory technicians in great demand. We train you in your spare time, in your own home. You can practice while studying. Write for free catalogue. Imperial Technical Institute, Box 973-E, Austin, Texas.

SECRET Investigation. Experience unnecessary. Investigators particulars free. George Wagner, M 125 West 86th, New York.

USED Educational books on all subjects sold, rented, also bought and exchanged. Moneyback guarantee. Write today for free catalog and details. Lee Mountain, Pisgah, Alabama.

PLAYS, STORIES, MANUSCRIPTS

AUTHORS Write your story for Hollywood movie studios. Particulars free. Hollywood Select Press, 858 No. Mansfield Ave., Hollywood 38, Calif., Dept. P.M.

I WANT New writers to cash hundreds of checks for \$1 to \$100, offered each month. The easiest way to write for pay. No previous experience necessary. Send for free details. No obligation. Saunders M. Cummings, 467-M Independence Bldg., Colorado Springs, Colo.

NEW Writers needed to rewrite ideas in newspapers, magazines and books. Splendid opportunity to "break into" fascinating writing field. May bring you up to \$5.00 per hour spare time. Experience unnecessary. Write today for free details. No obligation. Postcard will do. Comfort Press, Inc., 210-P South Seventh St., St. Louis 2, Missouri.

WIN Fame, success, security writing short stories, newspaper features. New, easy plan shows you how. Write today for exclusive details. Writer's Institute, 4-M So. 15th St., Philadelphia 2, Penna.

BUSINESS SERVICE

CALIFORNIA? Questions about employment, vacations, business conditions, rentals, property prices, etc. answered complete for \$1.00. Business service reasonable rates. Clifford Wiehe, 3639 8th, Riverside, California.

WANT Anything in Hollywood? Information, remailing, special services, personal or business assignments. Hollywood Personal Services, Suite 218, 1154 No. Western Ave., Hollywood 28.

\$2.00 MONTHLY Maintains Washington, D. C., "capital address." Your business, personal mail reforwarded when wanted. Hawkins (Established 1917), 1300-A Taylor.

TYPING—Letters, forms, manuscripts. Reasonable rates. General Sales Service, P.O. Box 1092, Roswell, N. M.

COMMERCIAL And personal—Information, contacts, investigations. Write World Research Service, 4239 Third Avenue, New York, N. Y.

PHOTOSTAT Copies made of important papers. Maximum size 8 1/2 x 11 or smaller. General Sales Service, P.O. Box 1092, Roswell, N. M.

DISPLAY 45 Words 20,000 circulation \$3.00; classified 4c word. Mailorder World; sample 10c. Vickers, Chapmansville, West Virginia.

PUN! Pretend visiting San Francisco. 3 postcards 25c. You address, 1 remail. Letters remailed 15c. Permanent personal or business address maintained. Rose Letter Service, 451 Turk St., San Francisco 2, Calif.

TO Whom it may concern: We will represent you in all principal cities of the world. Personal or business assignments \$1 per hour. James W. Farley, Citizens Bldg., Cleveland 14, Ohio. Note: Would appreciate hearing from someone who wishes to enter this business in your city. Will send you assignments immediately. References exchanged. State qualifications.

SPECIAL SERVICES

MECHANICAL Drawing, tracings, prints, charts, etc. Send sketch for quotations. Dixie Drafting & Design Co., Drawer 748, Doucette, Texas.

DRAFTING Specialists—mechanical, patent, architectural drawings, blueprints. Selco, Danvers 1, Massachusetts.

EQUIPMENT Useless for lack of parts? Describe equipment and needs. Enclose 3c stamp insuring reply. Spare Parts Experts, Box 168, Sacramento, Calif.

PHOTOSTAT Your military discharge papers for leave pay and other needs—either actual size or wallet size, the price is only 35 cents each. They must come by mail only. This includes all legal papers and documents also. Pay postman upon receipt. The Photo-matic Company, 421 S. Wabash Avenue, Chicago.

HAVE Us analyze your refrigeration service problems. We are in active service and are state licensed refrigeration contractors. We have had experience on all makes of household refrigerators, and all types of commercial installations. Send \$1.00 with each problem. Frenchy's Refrigeration Service, 219 E. Standley, Ukiah, California.

WHAT Are your problems in plastics, radio, electricity, aviation, photography? Consult Techniconsel for practical help. Box 261-H, Mt. Kisco, N. Y.

MANUFACTURERS! Increase production. Reduce costs. Write for details Moore's Modern Production Control, and Wage Incentive Plans. Installations anywhere in United States. Fees reasonable. Moore and Company, Industrial Analysts and Consultants, Fidelity-Philadelphia Trust Building, Philadelphia 9, Penna.

GOOD "Used" self-instruction educational books on all subjects bought, sold, rented, exchanged. Satisfaction guaranteed. Complete information and 100-page illustrated bargain catalog free! Write—Nelson Company, Chicago 5.

CARTOONING, COMMERCIAL ART, SHOWCARD WRITING, SIGN PAINTING

HOW To originate "gags," humor. "Why didn't I think of that?" New dollar book reveals the mainspring! Free details. Cartoon-O-Mart, Box 6263, West Palm Beach, Fla.

ARTISTS! Make more money. We show you how regardless of your experience. Free details. No obligations. Art Book Shop, Arnold 9, Missouri.

NOW Paint signs in six months. Instructions \$1.00. Including "how to make" paints, bronzes, cardboards. Ideal Xmas gift. Jantzen, 252 West New York, New Jersey.

STUDENT'S Cartoons printed. Free literature. School of Cartoons, P.O. Box 3291, San Francisco 19, Calif.

EARN Money evenings, copying and duplicating comic cartoons for advertisers. Adservice, Argyle (1-B), Wisconsin.

PAINT Original brushless pictures without previous experience. Unusual discovery. Colorful details free. Weidner, 1321 Wellesley, Los Angeles 25, California.

LEARN Showcard writing at home spare time. Fascinating, lifetime business of your own. No special skill needed. Free information. Sherwood Publishing Co., Irvington 38, N. J.

"CARTOON Animals," illustrated, \$1.00. Two drawings criticized, 50c. Free lists! Blackwood, Box 103, Huntington, New York.

YOU Can draw anything you see with a low-cost Artiscope. Free details. Beeler Enterprises, North Hollywood 21, Calif.

MAKE Signs, 9 complete alphabet pattern sets, 3 complete numeral pattern sets and catalog \$1.00. Sign Letter Distributors, P.O. Box 101, Mineola, N. Y.

"HOW To Make Money With Simple Cartoons"—a book everyone who likes to draw should have. It is free; no obligation. Simply address Cartoonists' Exchange, Dept. 911-C, Pleasant Hill, Ohio.

COLORFUL Cartoon of your favorite snap-shot by well-known artist—\$1.50. Photo returned unharmed. Buddy Swoap, 1207 Decatur Street, Richmond, Virginia.

31 LESSON Art course. Cartooning and drawing with over 600 illustrations. Complete: \$1.00. Dorba Service, D-PM, Cashton, Wisconsin.

ARTISTS—Students: Auto-scale saves half time copying, enlarging, reducing drawings. Guaranteed. \$3. Particulars free. Disco, Box 761, Glendale 5, Calif.

CHALK Talks. Laugh producing program, \$1.00. Catalog 10c. Balda The Cartoonist, Oshkosh, Wisconsin.

CARTOON Course—22 easy lessons. 200 figure sketches. 25c coin postpaid. Snack-Pack Co., 32 E. Georgia, Indianapolis 4.

ADVERTISING AGENCIES, LETTER WRITERS, FOR ADVERTISERS

CURRENT Names, reliable, 1000 \$5.00, trial 100 50c. M-N Service, 24 Midland (3), Detroit, Mich.

SPECIAL Inch display advertisement, Mail Order World, year \$24. Wood's Popular Advertising Service, Atlantic City, (N. J.)

SPECIAL! 20 Words twice 25c Swapper's Hobby Bulletin, Royal Oak, Mich.

ADVERTISE Profitably: \$20.00 reaches 5,000,000 Sunday newspaper readers with 24-word ad. Newspaper, magazine, mailing-list ratebook free. Chicago Advertising Agency, 20-PA W. Jackson, Chicago 4.

MAKE More money through classified advertising. We show you how. Nineteen years mail-order experience. Booklet free. Machen & Co., Station "F," Toledo, Ohio.

1000 NAMES. Wealthy winter resort prospects, \$10.00, cash. BMA Co., 5027 Sunderland, Jacksonville 5, Florida.

MAILING Lists, accurate, productive, mdse. buyers trial 250—\$2.00. Zech, 7532 Buist, Philadelphia 42, Penna.

SEND To me for prices on all types of mailing lists. Grover Culler, 211 Willow, Kent, Ohio.

500 NAMES. Addresses of mail-order customers, 1945-6. \$1. Box 127 Station E, Columbus, O.

ADVERTISING Copy, effective layouts and artwork; placement service in magazines and newspapers. Write Mr. Thomas for folder. Diamond Advertising Service, 326 Pennsylvania Ave., Washington 3, D.C.

ORDER Pulling sales letters written, \$2 page. Twenty years' experience. Satisfaction guaranteed. Dudley Bunn, 126-PM Lexington Avenue, New York 16.

ADVERTISING. Art work, sales letters. C. F. Sanford, 5029 Maple Ave., St. Louis.

MAILING Lists, certified, productive, inexpensive, \$5.00 1000. Homeworkers, agents, buyers, etc. Write Dixie Service, King, N. C.

ADVERTISERS! 6,000,000 Circulation 25 Sunday national key newspapers. 18 words, \$40.79. "Terrific pullers" 20 popular newspapers \$8. "Free booklet." Newmarks Advertising Agency, 217-7th Ave., New York.

FREE! 1946 Advertisers Rate & Data Directory. 52 pages! E. H. Brown Advertising Agency, 20 N. Wacker, Chicago 6.

ADVERTISE: 24 Words, 40 newspapers \$3.50. List free. Advertising Bureau, 4515-C Cottage Grove, Chicago 15.

24 WORDS in 64 weeklies \$4.96. H. J. Darnell, 730 Hays, Jackson, Tenn.

ADS Placed in out of town newspapers and magazines. Low rates. Catalogue free. Ideas that pay. Baker Advertising Agency, Successors Ankrum Agency, 189 W. Madison, Chicago 2.

TYPEWRITERS, DUPLICATORS, OFFICE DEVICES

STENCIL Duplicators. Descriptive literature free. Monarch, 38-M Jefferson, Auburn, New York.

"PRINTOMATIC" Selffeeding post card stencil printing duplicators \$9.50 up. Office size duplicators, Speedprints, Hilcos, Excellographs \$33.41 up. Literature free. Pittsburgh Typewriter Supply, 339-WK Fourth Avenue, Pittsburgh 22, Penna.

REVOLUTIONARY Type cleaner. Cleans as its types. Liberal supply \$1.00. Sparkle-Type Capitol Station, Albany, New York.

RECONDITIONED Typewriters, mimeograph, multigraph printing devices, appliances, supplies. Catalog. Dixiegraph Service, King, N. Carolina.

RUBBER STAMPS, OFFICE SUPPLIES

3 LINES 40c; Signatures \$1.75; pads 25c. 35 personalized pencils \$1.50. Stamprite, Wauwatosa 13, Wis.

3 LINES. Cushioned, indexed, knob handle, \$1.00. Pad 25c. Warner Stationery Company, Havre de Grace, Maryland.

LEAD Pencil, the office friend. 3 dozen \$2.50; 1 gross \$4.80. The Roundtree Agency, 529 Elliott St., River Rouge 18, Mich.

PROMPT Service—cushioned, indexed. Real quality guaranteed. Knob handle. 1 line 35c, 2 lines 45c, 3 line 65c. Stampcraft, 1707 Virginia St., Gary, Indiana.

RUBBER Stamps. All types. Free catalogue. Print & Stamp Co., Box 172 Back Bay Annex, Boston, Mass.

BETTER Rubber stamps. Postal brings special offer. Lee-Vall Press, Box 1242, Indianapolis 6, Indiana.

RUBBER Stamps, all kinds. Send for catalog. Excello, Box 500, Shreveport, Louisiana.

PRINTING OUTFITS AND SUPPLIES

PRINTERS' Cuts and illustrations as low as 50c each. List free. Mann, 113 S. Third, St. Joseph 5, Mo.

PRINTERS. Make a quick-etch etcher for cuts, halftones. Details. Charles Medlock, Box 256C, Goodland, Indiana.

BRASS, Copper thinspaces. Ten sizes, \$1.50. Collins, 230 Bowman, South Bend, Indiana.

PRINTER'S Supplies. Numbering machines. Free folder. Atlas Printing Equipment, 90 Baxter, New York 13.

PRESESSES, Type, bookbinding machinery, supplies, bulletins 3c. Box 918, New York 8.

PRINT At home—Send 10c for catalogue—presses, type, supplies. Barnhard Co., 6 Columbia St., Newark 5, N. J.

PRINTING Press plans, \$1.00. Details, samples free. Homer DeSellier, 19 Stebbins, Springfield, Mass.

HOME-MADE Presses. Proofs free. Riegel, 1111 Harrison, Phila. (24), Penna.

CUTS—Make real halftones, line cuts yourself! Samples 25c. Particulars free. Rapid Chemical Service, Edwardsville, Ill.

INEXPENSIVE Home-made printing press. Details free. Novelty Shop, Downs-ville, Louisiana.

PRINTING, MULTIGRAPHING, MIMEOGRAPHING, GUMMED LABELS

MIMEOGRAPHING. Addressing, photo-stats, rapid service, lowest prices. Sargent Co., Fairburn, Lowell, Mass.

250 BOND Letterheads, 250 envelopes, both \$2.25 postpaid. Moye Press, Windsor, Vermont.

ENVELOPES, 6 $\frac{3}{4}$, 8 $\frac{1}{2}$ x11 Bond letter-heads, 5 $\frac{1}{2}$ x8 $\frac{1}{2}$ statements, order forms, 3 $\frac{1}{2}$ x5 $\frac{1}{2}$ cards, 250, \$1.25; 500, \$2.25; 1000, \$4.00. Delivered. Publishers Sales Service, Dept. M, Harbor Springs, Michigan.

500 6 $\frac{3}{4}$ ENVELOPES \$1.75. Mango, 555-A South 20th, Newark 3, N. J.

PHOTOSTATS \$1.00. Cuts 20c square inch. Artcraft Photoengravers, 5130 Cedar-springs, Dallas, Texas.

100 ENVELOPES, 100 Letterheads and 100 airmail stickers, \$1.50 postpaid. Keena, 1312 Jefferson, Grand Rapids, Mich.

ALL Types of printing. Send copy for estimates. Longstreets, Asbury Park, N. J.

1,000 BUSINESS Or professional cards \$2.50 postpaid. Free samples. 1040 Main Press, Clinton, Mass.

BUSINESS Or personal cards \$2.50 per 1000. Cosme Press, P.O. Box 6, New Bedford, Mass.

COLOR Prints, low price. Sherman Col-or Laboratory, 11541 Barman Street, Cul-ver City, California.

250 BUSINESS Cards—Relief process (all lettering in relief). Cards packaged in 10 practical card cases. Quality unsurpassed. Millions used monthly by national organizations throughout U. S. Only \$2.75 post-paid in U. S. A real bargain. Money back if not satisfied. "You can't talk big if your business card talks cheap." Relief Printing Corporation, 87 Summer Street, Boston 10, Mass.

MIMEOGRAPHING—24 Hour service. N. R. Everitt, 370 Whittemore St., Pon-tiac 20, Michigan.

2000 DODGERS \$6.50. List free. Kent, 3414 Spring, Dallas 10, Texas.

250 8 $\frac{1}{2}$ x11 LETTERHEADS And 6 $\frac{3}{4}$ en-velopes \$2.75 postpaid. Advance, Stras-burg, Ohio.

1000 BUSINESS Cards \$2.75. Samples and prices free. Dunrite Specialties, Box 98, Springport, Michigan.

MIMEOGRAPHING Specialists—Any copy. Reasonable. Mailers Service, Box 606-A, Chicago 90, Ill.

1,000 6 $\frac{3}{4}$ BOND Envelopes or letter-heads, \$4.50 postpaid. Modern Print, Box 34, Hyattsville, Md.

PERSONALIZED Pencils: Your name stamped on six first quality No. 2 pencils, 40c; 12-70c; 20-11.00; 100-44.50 postpaid. Warner Stationery Company, Havre de Grace, Maryland.

350 BUSINESS Cards \$1.00 postpaid. Artcraft, 40-06 97th, Corona 1, N. Y.

SOMETHING New—Bookform paneled calling and business cards. 4 books \$1.25. Agents wanted. Samples 15c. E. Anderson, 2344 W. 121st, Blue Island, Ill.

HAMMERMILL Letterheads, statements, billheads or whitewove envelopes, 150, \$1.00. Benneville Printing, Box 1931, Pittsburgh 30, Penna.

150-8 $\frac{1}{2}$ x11 HAMMERMILL Letterheads \$1.00 postpaid. Envelopes same. Race Printing, Hudson, New York.

PARTICULAR Customers—Our business is not founded on prices alone. Printing in any quantity. Introductory offer—500 20# bond letterheads and 24# white wove (or 20# bond) envelopes, \$7.00 to zone 5; \$8.00 beyond. "We pledge satisfaction." Richmond Printers, Box 179, Buffalo 1, N. Y.

200 MIMEOED Letters with printed let-terheads, \$2.50; 500, \$5.00. Horace Mohler, R-10, Dayton 9, Ohio.

"RESULT Producing printing." Samples free. Mail Printing, M93, Danvers, Mass.

DESIGNED For your convenience, "Zip-per-Rip" envelopes No. 6 $\frac{3}{4}$ \$6.00 for 1,000 unprinted \$7.00 printed. Additional thou-sands \$5.00. Trial three dozen postpaid U.S.A. 30c. Sample packet ten and details 15c. Satisfaction guaranteed "Adbarco," P.O. Box 832, El Dorado, Kansas.

25 CHRISTMAS Folders name imprinted \$1. Name, address, 150 sheets, 75 envelopes, \$1. Michel, Box 76F, New York 16.

MIMEOGRAPHING—Get the best. Free price list, samples. Bull Letter Co., 109 East Ninth, Ft. Worth, Texas.

200 HAMMERMILL 6x7 Letterheads, 100 envelopes, \$1.75 postpaid. Michigan Sta-tioners, 1484 Glynn, Detroit 6, Samples.

SPECIAL—150 8 $\frac{1}{2}$ x11 Hammerrill let-terheads, printed, postpaid, \$1.00. Enve-lopes same. Race Printers, Hudson, N. Y.

PRINTING. Mimeographing. Best and cheapest in the country. Imprint, Em-poria, Kansas.

150 LETTERHEADS And 150 envelopes \$2.00 postpaid. Going Print Shop, Box P1544, Muskogee, Oklahoma.

1000 FOUR Line stickers, \$1.00. Imprint, Box 361, Emporia, Kansas.

SAVE Money on printing—1000 photo-offset reproductions size 8 $\frac{1}{2}$ x11 printed for \$3.95; larger quantities less. Prompt ser-vice, samples free. Fidelity Company, Parkersburg 14, W. Va.

QUALITY Printing, embossing, plano-graphing. Lowest cost. Samples free. Adams, 30 West Washington, Chicago 2.

250 LETTERHEADS, Envelopes \$3.00. Mallo Press, 767 Leith, Flint 5, Mich.

QUALITY Printing: Business, personal stationery. Prepaid delivery. Samples free. Mero Products, 100 Morrison, Punxsutaw-ney, Penna.

BETTER Printing, attractively priced! Letterheads, envelopes, booklets, cards, labels. Samples, estimate free. Lonelm Publishers, Paulding, Ohio.

SEND 10c Now, for our 36-page 1946 pricelist—refunded first order. McCall Press, 1326 South 27th, Omaha, Nebraska.

BETTER Grade printing reasonable. Estimates on anything. Economic Press, Leonia, N. J.

500 3 $\frac{1}{2}$ x2 $\frac{1}{4}$ FOUR Line gummed stickers, 25c. Moritz Printery, Saginaw, Mich.

MIMEOGRAPHING—Letters, pricelists, formulas, instructions. Lowest prices. Lem's Letter Shop, 5710 Stanton, Detroit 8.

200 SHEETS 5 $\frac{1}{2}$ x8 $\frac{1}{2}$, 100 Envelopes, Hammerrill bond, \$2.00 postpaid. Samo-set Press, Plymouth, Mass.

PATENT ATTORNEYS

PATENT Protection—The U. S. Patent Office recommends—"an applicant is advised, unless familiar with such matters, to employ a competent registered Patent Attorney, as the value of patents depends largely upon the skillful preparation of the specifications and claims." Steps to be taken in obtaining patent protection will be sent upon request. Victor J. Evans & Co., 131-M Merlin Building, Washington 6, D. C.

INVENTORS: Learn how to protect your invention. The patent laws were enacted for the benefit of the inventor to give him protection for the features of his invention which are patentable. The United States Patent Office advises the inventor to engage a competent, registered patent attorney to represent him. We offer the inventor experienced, conscientious counsel and prompt, confidential service. A specially prepared booklet containing detailed information concerning patent protection and procedure with "Record of Invention" form will be forwarded to you upon request—without obligation. Clarence A. O'Brien & Harvey Jacobson, Registered Patent Attorneys, 61B-L Adams Building, Washington, D. C.

INVENTORS: Write for free brochure "Evidence of Invention." Labiner, World Building, New York 7.

C. A. SNOW & Co., M-427 Snow Bldg., Washington 1, D. C. Registered patent attorneys. Established 1875. Literature mailed on request.

PATENTS—U. S. and foreign patents secured. Trade-marks and copyrights reg-istered. Searches made to determine patent-ability and validity. Patent, trade-mark and unfair competition causes. Lan-caster, Allwine & Rommel, Registered Patent Attorneys, Suite 411, 815-15th St., N. W., Washington 5, D. C.

INVENTORS. Have patent protection first. Remember, the details of your invention do not have to be 100% perfect before you can obtain patent. First step is to have us conduct search of prior U. S. patents and render a report as to its patentability. Send at once for further particulars and "Invention Record" form. Request does not obligate you. McMor-row, Berman & Davidson, Registered Patent Attorneys, 1345 Atlantic Building, Washington 1, D. C.

INVENTORS: Without obligation, write us for information as to what steps an inventor should take to secure a patent. Randolph & Beavers, Registered Patent Attorneys, 21-C Columbian Bldg., Wash- ington 1, D. C.

PATENTS. Free preliminary advice. E. E. Vrooman, Patent Lawyer, Registered Patent Attorney, 871 Woodward Building, Washington 5, D. C.

"INVENTOR'S Guide." 100 mechanical movements, free; advises on patenting, selling inventions. Frank W. Ledermann, 154 Nassau Street, New York 7.

PATENTS—Trade marks. Irving L. McCathran, 315 McLachlen Bldg., Wash- ington 1, D. C. Registered Patent Attorney.

FOR INVENTORS

INVENTORS—If you consider your invention to be something of importance, you may take steps to protect it with a U. S. Patent which gives you the right to exclude others from making, using and selling the invention as claimed. Detailed information and steps to take to secure Patent Protection will be mailed to you promptly without obligation. Victor J. Evans & Co., Merlin M. Evans, Registered Patent Attorney, 132-M Merlin Building, Washington 6, D. C.

INVENTORS: Learn how to protect your invention. The patent laws were enacted for the benefit of the inventor to give him protection for the features of his invention which are patentable. The United States Patent Office advises the inventor to en- gage a competent, registered patent at- torney to represent him. We offer the in- ventor experienced, conscientious counsel and prompt, confidential service. A spe- cially prepared booklet containing detailed information concerning patent protection and procedure with "Record of Invention" form will be forwarded to you upon re- quest—without obligation. Clarence A. O'Brien & Harvey Jacobson, Registered Patent Attorneys, 61A-L Adams Building, Washington, D. C.

INVENTORS Get free bulletin and full information on proved 12 step plan for making money from inventions, either patented or unpatented. National Merchan- disers, 28 East Huron Street, Chicago 11, Illinois.

INVENTORS. Cash in on your "ideas." We help you contact waiting buyers. Get results. Write, Burvid, 100 Vine Street, Lynn, Massachusetts.

INVENTIONS Developed from idea stage. Circular free. Aye & Dee Technical Corp., 743 Carroll St., Brooklyn, N. Y.

INVENTORS. Have patent protection first. Remember, the details of your invention do not have to be 100% perfect before you can obtain patent. First step is to have us conduct search of prior U. S. patents and render a report as to its patentability. Send at once for further particulars and "Invention Record" form. Request does not obligate you. McMor- row, Berman & Davidson, Registered Patent Attorneys, 1344 Atlantic Building, Washington 1, D. C.

INVENTORS: The Patent Research Ser- vice offers you the best in Patent Office searching. Reports mailed in 5 days. Com- plete search with patent copies \$10.00. Disclosure forms free. Write Patent Re- search Service, 703-M Albee Building, Washington 5, D. C.

INVENTORS—Your commercially valu- able invention, any kind, patented, un- patented, may have cash, royalty possi- bilities in today's markets. Write today. Ex- planatory booklet, disclosure form, refer- ences, free. Invention Reporter, 5A-11106 So. Longwood Drive, Chicago 43.

PUBLICITY Sells patents. Low cost. Details free. Dudley Bunn, 126-P Lexing- ton Avenue, New York 16.

DRAWINGS Of your ideas—inventions, by college draftsmen. Drawings approved by patent attorneys. Chrisman, College Box 375, Manhattan, Kansas.

"INVENTOR'S Guide." 100 mechanical movements, free; advises on patenting, selling inventions. F. W. Ledermann, 154 Nassau Street, New York 7.

I SELL Patents. Established in 1900. Charles A. Scott, 773PM Garson Ave., Rochester, N. Y.

THE inventor who believes he has a new and useful invention, and needs ad- vice, should consult a competent registered patent attorney. Without obligation, write for full information on how to secure patents and trademarks. Randolph & Beavers, Registered Patent Attorneys, 11-E-Columbian Bldg., Washington 1, D. C.

INVENTORS: Avoid unnecessary expense. Write for free booklet explaining how our consulting and advisory service can assist you in deriving greatest profit from in- venting. Institute of American Inventors, Dept. 40-A, 1926-Eye St. N.W., Wash- ington 6, D. C.

CASH For practical ideas and inventions. Mr. Ball, AB-9441 Pleasant, Chicago.

RUBBER—Everything in rubber. Pat- ents developed. Dept. P.M. Broadway Rub- ber Mfg. Co., Louisville 2, Ky.

INVENTIONS WANTED

INVENTORS! Save time, money, by reading the book "Selling Inventions With and Without Patents"; contains methods for selling before patenting, court rulings, mechanical principles; how to market, finance inventions successfully. \$1 prepaid. Metzler, 11 West 42nd, New York.

INVENTORS: Sell direct to manufac- turers. Send \$1.00 for list of 212 man- ufacturers buying new inventions. Inven- tion Market Research, 342-PMK Madison Ave., New York 17.

INVENTIONS Wanted. Patented or pending. Inventors Exchange, Dept. B, Hartford 1, Connecticut.

ATTENTION: Have you a practical and saleable invention—patented or unpatented? Contact us immediately. John D. & Son, 140 Spruce St., PM-11, Box 3213, Bridgeport 5, Conn.

WANTED: Practical inventions for mar- keting through chain, drug, and cigar stores. Particularly desire lighters, smok- er's articles, etc., in plastic, wood or metal. Write Matt, 1412-DN Great Northern Bldg., Chicago 4.

CASH For inventions, patented, unpat- ented. Mr. Ball, A-9441 Pleasant, Chi- cago.

EARN Up to \$2,000 year, inventing sim- ple items for special cash markets. Ideas only. No patents. Hendrickson, Argyle (7-B), Wisconsin.

INVENTORS: Hundreds of manufac- turers have requested our assistance in locating marketable new products. Com- plete information, free. Institute of Amer- ican Inventors, Dept. 40-D, 1926-Eye St. N.W., Washington 6, D. C.

WANTED—Patented, unpatented inven- tions having profit possibilities, all kinds. If will sell, reply immediately. Descrip- tive booklet, references, free. Invention Reporter, 5B-11106 So. Longwood Drive, Chicago 43.

PATENTS FOR SALE

PENDING, New type electric hand saw, run power or battery, used anywhere, boards, "planks." John Cvetnic, Box 1, Pewamo, Mich.

NEW Design aluminum ladder. Pat. pending. Nationwide possibilities. Manu- facturers only. Box 207, Southampton, New York.

NEW Adjustable crutch. Patent pend- ing, features more freedom of movement. No under arm chafing. Light weight, stur- dy, inconspicuous construction. Suitably manufactured out of wood, metal or plas- tic. Sales possibilities unlimited. Royalty. George Eisenberg, 1437 Hooker, Denver 4, Colo.

MANUFACTURERS: Simple attachment for wood plane. Accurately produces be- veled edges. Gauges width, angles. Patent- able. John B. Kline, Lititz, Penna.

INVENTIONS For sale. Manufacturing only. All kinds. Tom Beaton, 928 South Hope, Los Angeles 15, California.

"VOL-K-NO" Automatic smoke ring ejecting incense burner. Makes perfect smoke rings. Useful. Has "eye appeal." Millions sale prospects. Patent pending. Write Dale Propst, Willamina, Ore.

DOUBLE Arm tractor loader with at- tachments. Number 2,341,776, cash or lease. W. L. Peters, 305 State Bank Build- ing, Fort Dodge, Iowa.

CAPTURED German and Jap patents, 18,000 enemy alien formulas, patents, ideas, plans, drawings. Use immediately; royalty free. Bishop Tools, 111 W. Wash- ington, Chicago 2.

JUST Patented, card game for chain store business. Royalty basis, information to manufacturers only. Oh-Kay Games, Box 127, Wilkes-Barre, Penna.

REALLY New: patented oil filter for cars, trucks, has simple metal filtering unit that cleans its self while engine is running. Great sales possibilities. E. Sei- fert, 124 E. Chestnut Ave., San Gabriel, Calif.

SIGNAL That indicates on dash when tires need air. Cheap to manufacture, in- stall on trucks, busses, automobiles. Pat- ent applied for. Robt. P. Eagles, R.F.D. #8, Richmond, Virginia.

18,000 ENEMY Inventions. Manufacture royalty-free. Instructions, subjects, \$1.00. Patent Service Company, Saint Cloud 4, Minnesota.

FOR Sale: Game. Patent number, 2,131,332. Covers both toy and larger models. Cash or royalty. Write Elmer N. Rose, P.O. Box 176, Escondido, Calif.

INVENTORS—Your patented, unpatented invention, if practical, may have spe- cific cash, royalty value in correct mar- kets. Find out now. Explanatory booklet free. Invention Reporter, 5D-11106 So. Longwood Drive, Chicago 43.

INVENTORS: Test the commercial value of your patented or unpatented inventions, quickly and inexpensively. Write for free information. Institute of American In- ventors, Dept. 40-B, 1926-Eye St. N.W., Washington 6, D. C.

MANUFACTURING

NAME Plates for manufactured prod- ucts. Any quantity. Ad-Craft, LaCrosse, Wis.

INVENTORS — Market study; develop- ing; manufacturing models. J-M, Burling- ton, Kentucky.

SEND Sketch for estimates. Manufac- turing Machinists, 114-111-PM 229th, St. Albans 11, N. Y.

CANVAS Items manufactured. What do you need? Cohanzick Canvas Goods Mfg. Co., Bridgeton, New Jersey.

MODELS—Small lot manufacturing. Metals, plastics, etc. Milburn, Burlington, Kentucky.

MODELS AND MODEL SUPPLIES

BUILD Modernistic plastic kit! Sixteen kits, stamp for price-list. Johnson, 366 Freeman, Long Beach 4, Calif.

PATTERNMAKERS, Modelmakers. Use metal. Workable with fingers. Hardens like steel. Sample included. \$1.00. Wm. Koppel, 167 Carter, Pawtucket, R. I.

MIDGET Steam engines \$2.98, boilers \$2.65. Stamp for literature. R. Looker, Box 105, Michigan City, Indiana.

REMEMBER. When selecting model equipment at GMCO, you will find a com- plete stock of model airplanes, gas engines, ship models, railroads, race cars, supplies and tools. Chances are we have just what you want in stock. Send 25c for your copy of our new catalogue to GMCO Modelcraft Hobbies, 91-17 (M11) 173rd St., Jamaica 3, New York.

ONE Tool does twelve jobs! See Bishop Tools ad under Machinery, Tools, Supplies.

TWO Cycle model engines traded. Bear- ings, rods, crankshafts, pistons made, fitted, alterations—Circular, New Pace- maker, Delong, Bantam, Arden, Rocket, Merlin engines—accessories. N. Hurst Smith, Cedar Glen, Athens, Tennessee.

$\frac{3}{4}$ " **SCALE** Steam locomotive, cheap. Simmonson, 3054 N. Greenview, Chicago, Illinois.

MAGNESIUM Dowmetal for light weight construction now available in miniature extrusion structural shapes and 1/16" flat stock. Write for size and prices. Sims & Associates, Grosse Pointe, Michigan.

150 MPH Model airplane. See Interna- tional Research advertisement page 266.

BRASS Gears and model supplies for the inventors. Send 10c for catalog. Pierce Model Works, Tinley Park, Ill.

WIZZ Electric motor 35c. Further de- tails under Engines, Motors heading.

STEAM Engines, boilers, castings. Cir- culars 10c. Anton Bohaboy, 2297 Price, Rahway, New Jersey.

FREE Catalog of model trains, airplanes, ships, accessories and tools. Ben's Hobby Company, 72 West Washington, Chicago 2, Illinois.

BUILD Complete miniature circus, $\frac{1}{8}$ " scale. Cage wagons, pole wagons, bag- gage, property, ticket, band wagons, cal- liope, 75c to \$1.25. Cast metal horses, drivers, lions, camels, giraffes, elephants, people, acts, 15c to 25c. Main tents, side- show tents, circus railroad cars. Send 35c for booklet-catalog "Building Miniature Circus." Bathgate, 30 Main, E. Orange, New Jersey.

BUILD Model ships, airplanes, railroads. Catalog 10c. Ideal, 21 West 18th Street, New York 11, N. Y.

SHIP Models and yacht supplies complete. Large 64 page catalogue 30c. Bill Wild's, 510 East 11 St., New York City 9.

LANDLOCKED Sailors! Here's a beautiful, richly illustrated, fully descriptive catalogue of famous model ships-whalers, slavers, corvettes, etc., authentic in every detail. Send for it today. Only 10c. Marine Model Company, Inc., Dept. C-17, Halesite, Huntington, N. Y.

ENGINE Castings, Supplies. Catalogue 10c. Howard A3, 2417 N. Ashland, Chicago, Ill.

RAILWAY Models, complete line, 123 page catalog, HO and O gauge 25c. Walthers, 247 Erie, Milwaukee 2, Wis.

SHIP And yacht model fittings and blueprints. Hundreds of items to choose from. Send 25c for new illustrated catalog. A. J. Fisher, 1002 Etowah Ave., Dept. M, Royal Oak, Mich.

MODEL Engine catalog, railroad supplies, 25c refunded. Simonsen, A-3054 Greenview, Chicago 13.

BIG Illustrated model engine catalog 10c. Active Products & Supply Co., 53 W. Jackson, Chicago 4.

SHIP Model kits and fittings. Complete line Fisher model yacht equipment. All Boucher, Fisher, Marine Model and Ideal kits, fittings and blueprints at standard prices. Most complete stock in New England. Send 10c for price list. James Bliss & Co., Inc., 220 State St., Boston, Mass.

MINIATURE Steam locomotives, 1/4", 1/2", 3/4" scales. Castings, parts, rail! Thorough drawings with instructions. Catalog 25c. Little Engines, Wilmington, Cal.

CATALOGS (Illustrated) for modellers! Airplanes, 60 page book on solids. Features construction data, specifications, camouflage, 15c; railroads: 128 page "HO" guide. Equipment, accessories, fittings. 25c (includes refund coupon). Send coin or stamps for each profusely illustrated catalog desired. Polk's, "Nation's Leading Hobby House," 314-PM Fifth Ave., New York City 1.

HOME CRAFTSMEN

SPECIAL—30 Silverplated earscrews—\$1.00. Refundable. Frances Jones, Box 2581, Sarasota, Fla.

DOLLAR Brings shell material for butterfly brooch, bracelet, floral spray. Shell catalog free. Dixie Shell Service, Lakeland, Fla.

WOODWORKING Outfit—Includes lumber, designs, tools, equipment, instructions. Make many fine toys, novelties, gifts for fun and profit! Only \$2.00 postpaid. Handicraft Creators, 1734 President Street, Brooklyn 13, N. Y.

PLYWOOD Cabinet kitchen plans 25c. Playne Cabinets, 4617 Johnson Avenue, Western Springs, Illinois.

ANYONE Can learn carving figures with penknife. Write Carv-It Projects, 343 Division, East Lansing, Michigan.

LEATHER Craftsmen—Hand engraved plastic transfers imprint design instantly for tooling. Sample 10c. Introductory set \$1.00. Lampkin Artcrafts, Box 641-M, Culver City, Calif.

\$46 FROM Square foot plywood; jigsaw necessary. Write. Woodarts, X-34, Bridgewater, Mass.

MAGNIFICENT New bronze genuine World War 2 army assault boat propellers. 3 blade. 12" dia., approx. 5 lbs. Makes marvelous souvenir base for numerous articles that can be made in your own shop. Only \$5.65 each postpaid. Remit with order. Baker Bros., Box 301F, Palatine, Ill.

TRUCRAFT Practical models make world's most unique, exquisite gifts. Use them yourself or sell them. Folder free. Quaker City Products, 1613 North Carlisle Street, Philadelphia 21, Penna.

HOBBYISTS! Join "Allcraft Club." Free, no obligations. Fun, profits galore! Write immediately: Allcraft Products, Box 212, Hempstead, N. Y.

CERAMIC Jewelry supplies, bar pins, ear screws, for ceramic and woodworkers; also glass and seashell assemblers. Free catalog. Philadelphia Badge Co., 1007 Filbert St., Philadelphia, Penna.

C-THRU-MIRRORS Allow you to see others without being seen yourself. Write Beeler Enterprises, North Hollywood 21, Calif.

MAKE Beautiful sea shell jewelry, easily. Biggest complete kit \$3.50 postpaid. Instruction booklet 35c. Wholesale price list. Shelart Studios, 2100 Tangerine Ave., St. Petersburg, Fla.

ONE Tool does twelve jobs! See Bishop Tools ad under Machinery, Tools, Supplies.

U. S. Leathercraft kits: coin purse, 50c; billfold, 90c; cigarette case, 50c; key case 60c; complete set of 4, \$2.25. No tools needed. Instructions included. U. S. Handicraft Service, 92 Lee Ave., Brooklyn, N. Y.

FINISHES For any type material. Electroplating chemicals and supplies; wood and metal finishes; shop chemicals; industrial and novelty finishes. Write for price list now being prepared. Craft-Finishes, Box 467 M, Arlington, Virginia.

KILNS, Electric, with Pyrometers three sizes. Factory guaranteed. Also pouring and press pottery molds. M. Fred Keglmyer, North Wales, Penna., Distributor.

JEWELRY Supplies, earbacks, pinbacks, metalcraft supplies. Write for pricelists. Milton Orkin-Crafts, 333 Washington St., Boston, Mass.

WHEELS! 5" Ball bearing steel wheels for 5/16" shaft. Molded rubber tire. 65c each, 4 for \$2.40 postpaid. Write for quantity prices. Westgate Electronics Company, 226 Green Briar Lane, Havertown, Penna.

SHELLCRAFT Supplies, wholesale; (buy direct) (complete line) plastic animal shapes; discs; pin backs; "instructions"; etc. Packages or gallon; dozen or gross quantities. (Free catalog.) Pace's, 2117-14 St., Bradenton, Florida.

TOY Plans, Free descriptive circular. Production Engineering, 403-C City Hall Building, Rockford, Illinois.

BLUE Prints and instructions to make new type lathe collet system, range 1/4" to 3/4" any steps desired. Not complicated. Ideal for home shops. Blue prints \$3.00. Prints and material \$15.00. Harry Smith, P.O. Box 623, South Gate, Calif.

NEW Super bandsaw blades cut wood, plastics, metals. Most sizes \$1.00 C.O.D. plus postage. Box 723, Cedar Rapids, Iowa.

JIGSAW Patterns, 26 assorted, \$1.00. Northwoods Specialties, 432 Detroit, Royal Oak, Michigan.

SHELL Workers, you now can buy all your supplies of seashells, plastic and jewelry findings at strictly wholesale prices. Catalog free. Beachcomber Novelty Co., Box 551, Fort Myers, Florida.

WOODWORKERS: Reconditioned rotary files 3 shapes \$2.00, 1/4 shank. Carving, shaping made easy. (New value \$8.00.) Muller Equipment Company, 1235 Main, Hartford, Conn.

LEATHER Scraps for hobbyist. Six pounds \$2.00. Hobby books "Applied Leathercraft" \$3.00. "Art of Whittling" \$2.00. "Wooden Toymaking" \$2.25. Hobby books catalog free. Northern Supply Co., Dept. A, Sheboygan, Wis.

CRAFTSMEN, Make children's playthings. Full size patterns rocking horse, swan rocker, stroller, cradle and wheelbarrow \$1.00 postpaid. Lincoln's Craft Shop, Farmington, Conn.

LEATHERCRAFTERS! Send for free catalog listing leather, kits, supplies. Kit Craft, 1607 S. Western, Los Angeles 6, Calif.

CRAFTSMEN—Lawn furniture plans, beautiful jigsaw designs—large selection—free folders. Summercraft Studio, 42 Vernon St., Newton 58, Mass.

30 FULL Size toy patterns 50c. 40 novelty and lawn ornament patterns 50c. Other patterns; craft supplies; lists 10c. Lynds, Medway, Mass.

PATTERNS 70 Lawn ornaments and novelties \$1.00. Five new hanging shelf \$1.00. Doll stroller, colonial cradle, circus group, table and chairs \$1.00. Milne's Hardware, 1501 Wadsworth, Saginaw, Mich.

FELTCRAFT Projects for Christmas sales. Beanie kit 59c, suspender kit 59c, de luxe suspender kit 98c, pennant kit 75c, needle holder or pen wiper kit 25c. Send 10c for felt color chart and book list. The Felt Crafters, Felcraft Dept., Plaistow 10, N. H.

BEAUTIFUL Mirrors from ordinary glass. Complete instructions, \$1.00. Tesco, PM-2, P.O. Box 189, Wilkes Barre, Penna.

MASONITE Mill ends 10 lbs. \$1.00 plus postage. Carl Sign Co., Wooster, Ohio.

INTERESTED In radio, electrical, mechanical devices from war surplus? List free. E. Siefke, Box 18, Station E, Buffalo 11, N. Y.

BALSA Wood. Ideal for modelers, craftsmen. Sample carving block 25c. List free. Sanlader, Manitowoc, Wis.

WHITTLER'S Supplies, readicut blanks, special woods, knives. Old Whittler, 1402 Charles, LaCrosse, Wis.

MAKE Shell jewelry—for gifts, as a hobby or start a business. Free catalogue and price list. Complete illustrated book of instructions 75c. Florida Shellcraft Company, Box 1840, Sarasota, Florida.

SOLDER Aluminum with ordinary soft solder and soldering iron! Send \$1.00 for generous supply of our new flux. Warhaven Industries, R.D. No. 3, East Aurora, N. Y.

SHELLCRAFT Kits for beginners—shells and complete supplies for making pins, earrings, combs and novelties. Instructions free. Kits \$2.00 and \$5.00. Herbert Diamond & Co., 1121 North East First Avenue, Miami 36, Florida.

35 PATTERNS Of action pull toys, trucks, carts, toy furniture, etc., \$1.00. Continental Homecrafter, 907 Birch, Eau Claire, Wisconsin.

SHELL Jewelry supplies. Wholesale only. McFarland Plastic Co., Sarasota, Fla.

CATALOG: Patterns plywood novelty furniture, letters, numerals, plaques, frames, weathervanes, silhouettes, lawn ornaments, 100 books and booklets on crafts and hobbies, picture frame mouldings, tools, large line decal transfers. Other lines. Hundreds articles finely illustrated. Write Wo-Met Shop, Ashburn, Ga.

KNOCKDOWN Cedar chest lumber veneers. Free price list. Giles-Kendall, Huntsville, Ala.

MAKE IT YOURSELF

BUILD A backyard railroad of wood and tin. Fun for all. Plans for engine, car and 3 inch track, \$3.00. Write for list of other plans. G. P. Padrick, 1535 S. W. 9th St., Miami 35, Fla.

BUILD Concrete block machine. Vibration and hand operated types. 100 blocks per hour. Easy, inexpensive. Sell blocks, build home, garage, barn at low cost. Details free. Horne, 206 West Wilder, Tampa 3, Florida.

BUILD Kitchen cabinet, 25 inches high. Sells for \$10.00. Made from fruit boxes. Plans \$1.00. Tapp, Box 2593, Little Rock, Ark.

BUILD Concrete mixer. Power driven, simple, inexpensive. Details free. Horne, 206 West Wilder, Tampa 3, Florida.

SPEEDY 1" Motor, runs on top of flashlight cell Parts, instructions, 35c. Arthur Fonskov, 655-L Amboy Ave., Perth Amboy, N. J.

ACTION Xmas toys. Steam shovel, loader, dump, tanker trucks. 4 big projects \$1.00. Alpha Co., 241 Orange, Suite 8, New Haven, Conn.

AIRPLANE Jettison gasoline tanks, streamlined, ten foot six inches by two foot four inches, 165 gallon, twenty gauge terne coated steel. Ideal for making boats, bob sleds, midget auto, etc. Price \$10.00 per tank, \$7.50 per tank quantities of five or more. General Truck Sales, Inc., 205 Market S.W., Grand Rapids, Michigan.

CONCRETE Block homes, 24 page booklet: drawings and instructions, how to build, \$1.00. H. C. Lightfoot, Civil Engineer, Richboro 1, Penna.

BUILD Concrete block machine, mixer, portable sawmill, woodworking, metalworking, farm machines. Free catalog. Nichols Equipment Co., Dept. PM, Purvis, Miss.

BUILD Your home as a hobby. No rent. No mortgage, save 50%. Use spare time. No special skill required. Amazing facts sent free. H. C. Lightfoot, Civil Engineer, Richboro 1, Penna.

GRANDFATHER Clock building system, simple, shop-tested, thousands built, with weight movements pictured in production \$1. Kuempl Chime Clocks, Minneapolis 16, Minn.

BUILD A famous Norwood direct positive camera. Plans \$1.50. (E.) Poch, 2858 So. Lawndale, Chicago 23, Ill.

BUILD Concrete mixer from oil drum. Inexpensive. Power or hand. No cogs. No gears. Complete, easy plans \$2.50 postpaid or write. Clyde Lee, Dept. A, Mountain View, Oklahoma.

BUILD Concrete block machine. New principle. Inexpensive. Motor vibrator or hand tamp. Make standard block per minute. Complete, easy plans \$3.50 postpaid or write. Clyde Lee, Mountain View, Dept. A, Okla.

HOW To build cabins, lodges and bungalows. Features costs, estimates, instructions: \$1.98. J. K. Lasser's famous book: "Your Income Tax." Helpful guide in filing 1946 returns: \$1. Add 10c postage per book. Canada 25c. Order C.O.D. or money order. Eastern Book Service, 520 Washington St., Hoboken, N. J.

HOT Water free—from sunlight. System efficient any locality year 'round. Standard materials—easily built—low cost. Facts free. Solar Water Co., Box 175, Dept. Q, Coral Gables, Florida.

HONEST Profits! \$3.00 up! Make Colored xylophones. Hand tuned steel notes, mallets, 12 songs, numbers, decorations, specifications. Guaranteed. At factory or postpaid. One octave \$1.00, two octaves \$2.00. Egerton, 195-29 Jamaica Ave., Hollis, N. Y.

PRINTS And instructions for building live centers, regular or pipe. State type and taper \$1.00. Planco, Box 7132, Houston 8, Texas.

BUILD Your own food freezer, save \$200.00. 33 drawings, material list and instructions, \$2.00. H. Gordon Anderson, Lakeshore Drive, Rome, Georgia.

BUILD 250 Amp. a.c. welder yourself. Simple, low cost. Complete instructions, \$3.50. Used successfully in industrial plants past seven years. Wesco Mfg. Co., Marshall, Texas.

BUILD Your own oil furnace. Inexpensive. Simple to operate. A clean method of heating. Plans \$1.00. Roland Kadletz, Box K-103, Salmon, Idaho.

WATCHES, OLD GOLD, JEWELRY, ETC.

LEARN The jewelry manufacturing trade at home. Excellent profits, pleasant work. Easy illustrated course teaches custom and production jewelry making, goldsmithing, gem setting, repairing, etc. Catalogue. The Gemcrafters, Dept. B, Kalispell, Montana.

GENUINE Diamonds, out-of-pawn low prices, wonderful values. Unredeemed loans and big buying power enable us to offer beautiful gems at prices far less than original cost. Shipped free for inspection, appraisal. Send for big free list showing fine diamonds at startling low prices. Lloyd J. Butler, President, Prudential Loan Association, 133-VM North Clark St., Chicago 2.

WOOLLY Lapel Santa Claus. Handmade. 50c. Cado Products, 4842C Hutchinson, Chicago 41, Illinois.

WANTED—Old, broken jewelry. Cash paid immediately. Mail gold teeth, watches, rings, silverware, diamonds, spectacles. Satisfaction guaranteed. Information free. Rose Smelting Co., 29-A East Madison, Chicago.

FREE Catalog: Watch repairing, chemistry, aeronautics, engineering, optics, etc. Engineers' Book Service, 19 West 44th St., New York City 18.

WATCH Repairing. Guaranteed. Complete overhauling and cleaning \$8.00. Price includes mailing, material and repairing. Postpaid—C.O.D. Apt Watch Repair, 1237 West Ohio Street, Chicago 22, Ill.

TROPICAL Charm for your wife or sweetheart, with jewelry from Miami. Beautiful Caribbean pearl (pat.) seashell necklace, \$2.39; bracelet, \$1.39 in her favorite color, tax paid, postpaid, satisfaction guaranteed or refund. Linda's Tropical Jewels, Riverside Box 1895, Miami, Fla.

MEN'S Beautiful new Swiss wrist watches \$7.95. Ideal Xmas gift. Money refunded in 5 days if not delighted. B-B Jewelry Sales, 311 Travis, Houston, Texas.

SEND Your discarded jewelry, watches, crowns, bridges, spectacles, silver, etc., for cash offer. Goods returned promptly if offer unsatisfactory. Old State Metal Co., 812 Erie, San Antonio, Texas.

"JEWELRY, Gem Cutting, Metalcraft." Fascinating designs for hobbies and money-making opportunities. New, complete illustrated book covers cutting, polishing, mounting gems, metal, jewelry work, etc. 287 pages, \$3.25 postpaid. Money back guarantee. We supply tools, materials at lowest cost. Modern Technical Book Co., Dept. MMC, 55 West 42nd St., New York 18.

GOLD \$35.00 Ounce—Mail old gold teeth, diamonds, jewelry, watches—receive cash by return mail. Satisfaction guaranteed. Free information. Dr. Weisberg's Gold Refining Company, 1500-Q Hennepin, Minneapolis, Minn.

GEMS, Precious and semi-precious, all genuine, from world wide sources. Deal direct, no overhead, save money. Catalog 10c. Hill Co., Route 7, Salem, Oregon.

WATCH Repairing easy learned by our home study course. Watch repairers are in demand and are among the highest paid craftsmen today. Write for free information. Houston Chronometer & Watch Co., P.O. Box 1140A, Houston 1, Texas.

WATCH And clock repairing—complete practical course in modern horology. 66 illustrated self-instruction lessons. Just out! Low price. Fascinating 100-page illustrated catalog free! Write—Nelson Company, Dept. 8-02, Chicago 5.

TOBACCO, SMOKERS' SUPPLIES

CIGARS, 100 choicest quality, hand-made. \$5.95 postpaid. Money order, check or cash. S. & E. Co., Dept. PM, Red Lion, Penna.

CIGARETTES—Popular brands, \$1.40 per carton postpaid. Minimum order 3 cartons. Cigars: Natural Bloom Dandies; bx. of 50, \$6.00. Ingersoll, Havana blend; bx. of 50, \$4.49. Pipes: Medico—\$1.00. Also Yello Bole, Kaywoodie, Weber, Milano, etc. Our policy—everything postpaid; satisfaction or full refund; amazingly fast delivery service. Ask for complete price literature or send your check or money order today to: Ace Mail Order Company, East Orange 86, N. J.

FREE To pipe smokers—For new pipe smoking thrills, write us your brand of tobacco and get free package mild, tasty "Green River." Pete Moberly, Box 997, Owensboro, Kentucky.

PIPE Smokers! Monthly pipe magazine! Pictures, articles, gadgets, ideas. Sample 10c. Cushman, 532P Pine, Long Beach 2, Calif.

TOBACCO And cigar bargains. Regular Coronas \$2.95 box 50. Others \$3.60 up. Pipe tobacco 8 oz. \$1.60. Briar pipes \$1.50. Free catalog. Zibar Co., Roselle 12, N. J.

\$3.00 CIGARETTE Lighter—case combination \$19.50 doz. Zipper leather tobacco pouches \$7.00 doz. Sample of both \$3.00. George Pierce, 18 Pryor St., Atlanta 3, Ga.

MAKE Your own pipes. Detailed, illustrated, pipe makers manual \$1.00. Harold Mangus, Rt. 3, Alliance, Ohio.

RAZORS, BLADES, SHARPENING

INGERSOLL \$1.00. Strapping outfit \$7.00 doz. George Pierce, 18 Pryor St. SW, Atlanta 3, Ga.

BLADES Last a lifetime same as old razors did if you use Razorlife as instructed. Send \$2.00. L. G. Eggers, Box 2406, Sarasota, Florida.

RAZOR Blades. 125 Champion double-edge \$1.25. 1000, \$8.90. Stephen Erdos, 129 East 61st, New York 21.

FOR SALE MISCELLANEOUS

MECHANICAL Drawing instruments—Veeco, 4 piece, compact, precision set, brand new in lined case, value \$12.50, special, \$7.25; \$10.00 Charvos 9 piece set, \$8.50. Army surplus slide rules, slightly used, 75c each. Hull automobile compass, for accurate road direction, brand new, \$2.50. Brand new folding valise knapsacks made of heavy olive green duck, heavily bound and reinforced, repellent to fire or water. Inside 3 large snap fastened pockets, heavy webbed straps, hand and shoulder handles, size opened 22"x54" closed 22" rolled. Useful to hunters, Boy Scouts, hikers and for all traveling use. A \$7.50 value, special \$2.25 postpaid. Prisms for 6X30 or 8X30 binoculars, brand new, \$1.50 each. Offset prisms to be attached to 7X50 B. & L. binoculars gives double the field of the ordinary 7X50 binocular. Cost \$98.00, special \$25.00. Green sunshades for binoculars, size 6X30 and 7X50, snap on type, value \$7.50, special \$1.25 per pair. Forward money order. No c.o.d. shipments. Public Sport Shops, 13 S. 16th, Philadelphia, Penna.

A FEW Beautiful ram heads whittled from choicest white pine. Horns measure eight inches, \$25. Picture sent on request. Eddy Radtke, Dover, N. J.

HOUSE Screw jacks, 500 used, like new, government surplus, 12 ton capacity, 14" overall height, 10" lift, 1 1/4" screw. With handle \$6.49. Special price, lots of 10. Midwest Surplus Sales, 1515 Locust, Kansas City, Mo.

CUTTERS, Dental burs, reclaimed, assorted 125 \$1.90; 400—\$4.90. Am. Standard, 1208 N. 13th, Philadelphia 22, Penna.

ARMY Clothes trunks (2,000 used). Made of durable plywood, size 32" long, 16" wide, 13" deep, with removable divided tray, for small articles. Reinforced corners, metal hardware fittings. Real value at \$4.98 with shipping charges paid. Midwest Surplus Sales, 1515 Locust, Kansas City, Mo.

STAINLESS Steel; strips, 3" squares, and odds, sixteen gauge. Send \$3.00 for 5 pounds postpaid. U. S. Good Measure. Buehrens Co., Dorchester, Wis.

TOASTERS; Clocks; mixers; irons; other appliances. Immediate delivery. Price list. Mail order. Electric, 713 South Dearborn, Chicago.

CLOTHESPINS, Clothespins. Guaranteed 100% hardwood. 10 gross only \$9.30; 50 gross \$43.49 (prepaid). Rush check, immediate delivery. Scheall, Box 263, Duluth, Minnesota.

WANTED MISCELLANEOUS

SUCCESSFUL Distributor planning enter manufacturing field. Interested in new products, preferably mass production items. Vermilye Corporation, 155 E. 44th St., New York 17, N. Y.

SUPPLY Source—Two-color process cards. Swayne, Box 4694, Jacksonville, Florida.

WANTED: Old watches for parts, discarded watches too old-fashioned to warrant costly repair; Key-wind watch movements; small clocks, any condition, traveling, repeater, alarm, automobile, ornamental, French carriage. Please pack carefully and insure when mailing. L. Rankin, Ocean City 11, Md.

WANT To swap-buy-sell anything? Send 25c for National Swapper's Guide. It's full eager swappers-buyers-sellers coast to coast and opportunities to swap-buy-sell almost anything under sun. National Swapper's Guide, P. O. Box 415, Evansville, Indiana.

MERCURY—Highest prices. Free containers. Write. Wholesale Terminal, Norwood, Mass.

MERCURY (Quicksilver). Write for quotation stating quantity. Metallurgical Products Co., 35th and Moore Sts., Philadelphia, Penna.

FOR THE HOME

REPLACEMENTS. Stoves, furnaces. Grates, firepots, linings. Craxmend. Majprudax, Royal Oak, Mich.

PRESERVE Lustre. Silver, brass, all bright metals. Easy to apply as nail polish. Protects indefinitely. \$1.00 postpaid. Madison Laboratories, Box 41, Madison, New Jersey.

PERSONAL

BEAUTIFULLY Designed and hand carved monogram of your initials. Use with stamp pad to make your own monogrammed stationery, greeting cards, invitations, books, etc. Has modern plastic handle, enamelled body. Two or three initials, \$1.50. Samples free. E. Horsley, 2132 (West Entrance) 9th Avenue East, Calgary, Alberta, Canada.

HAVE Fun! Mystify friends! Pretend visiting historical Philadelphia. 4 beautiful souvenir cards 25c. You address, return, I remail. Letters mailed 10c. Gehling, 1834 Fuller, Philadelphia 15, Penna.

DENVER Postcards—Three for 25c. Address and return. V. F. Markham, 765 Belaire, Denver 7, Colorado.

WORLD'S Shortest complete bookkeeping and income tax record for twelve months; copyrighted; boon to small businesses; \$2.00 postpaid, with vest pocket income tax digest without charge. Details free. Mixon, Postoffice Box 2048, Los Angeles 53, California.

MAIL Forwarded, confidential, 25c each letter. Box 38, Brooklyn 12, N. Y.

PRETEND Visiting Canada. One souvenir card 25c, 5 cards \$1.00. Address, return, I stamp, remail. Letters, 25c each. Murray Wilkins, 417 Hill, London, Canada.

NEW Inspirational book! "Yours Is the Power," presents unlimited possibilities to everyone. 50c a copy. Dulco, Box 5259M, Pittsburgh 6, Penna.

STARTLINGLY Beautiful sea gems, pure white seashell set \$2.00. Set consists of earrings and brooch. Federal tax included. Send payment with order. United States only. Ann Spence, Pine Gifts, Box 311, Seaside Heights, New Jersey.

POWERFUL Prescription for achieving personal and business success; works without expense or guesswork. You can use it. Write for free literature. Menders, 15857-A Coram Ave., Detroit 5, Michigan.

POOL Your friends. Make believe you're in Hollywood. Send 25c for two scenic cards. After receiving them, write message, address and return for mailing. E. McCarty, 923 So. Sherbourne Drive, Los Angeles 35, California.

SWAPPERS! Traders! Information. Write: "Swappers" Gazette," 2836-PM Slevin, Louisville 12, Kentucky.

NEW! Pencil sketch from your snapshot. Presto Method, Box 805, Rockford, Ill.

FALSE Teeth wearers. If your dental plate is loose and uncomfortable I have good news for you. Send name on postcard. No obligation. Dr. Reese, Dentist, Box 268-X, Winnetka, Illinois.

FALLING Hair, its cause and prevention. An informative and educational pamphlet entitled "How To Keep Your Hair Till Ninety" mailed free. James Hilton, 4819 A Fourth Ave., Brooklyn 20, N. Y.

"HOW To Create New Ideas"—Practical daily working plans for inventors, writers, business promoters, executives, advertisers, salesmen, students, others. Consultation service included. Satisfaction guaranteed. \$3.00 postpaid. Dudley B. Bunn, A-126 Lexington Avenue, New York 16, N. Y.

PHOTOSTAMPS. Details free. Pera, 165 Chattanooga, Dept. A1, San Francisco 14, Calif.

RUPTURED? Positive comfort, no understraps, no steel, no elastic. Write Smith Manufacturing Company, Preston, Ontario.

DETERMINE The occupation offering you the greatest opportunity for success. Use scientific testing method. Write Vocational Service, 735 Bank of America Bldg., San Diego, Calif.

VISIT Valley of the Sun. 3 beautiful post card views 25c. Address, return, re-mailed free. Letters airmailed, each ounce or fraction thereof 25c. Confidential, reliable service. Brooks, Box 2012, Phoenix, Arizona.

PERSONALIZED Pencils. Individual or firm name. Dozen 60c. 2 dozen \$1.00. 100 up 3c each. Same imprint. Cash. Delivered. Pencil Market, 611-15th St., Knoxville 16, Tenn.

HAVE Fun! Pretend visiting California. 3 postcard views 20c. Address, return. I remail. Letters mailed 15c. Free information. Ira Smith, 708 Ellis, San Francisco 9, California.

MAIL Forwarded. Reliable. 25c each letter. Box 536, Anaheim, Calif.

HOW You can find out! Information discreetly developed, any matter, person, problem, anywhere. Personal-business assignments, representations, undertaken. Nation-wide. Officially licensed and bonded service established 1922. Reasonable. All inquiries confidential. William Herman, 170 Broadway, New York.

POOR Penmanship corrected—few hours. New-way. Ozmert, 9, St. Louis, Mo.

HAIR Falling? Dandruff? Write Trichologist, 137 Lewis St., Phillipsburg, N. J.

MISCELLANEOUS

MAKE Delicious caramels, marshmallows, caramelcorn; three confectioners secret formulas, \$1.00. Frank Shilling, 1017-C Dueber, Canton 6, Ohio.

BLANKETS, Wool, rayon, cotton. Write for wholesale prices. Wigwam design, sa-teen bound, full size. Pacific Atlantic Textiles, Portland, Oregon.

WINDSHIELD Stickers—Attractive. Pike's Peak, Yellowstone, Denver, Grand Canyon, Miami, Los Angeles, Mexico City. Your choice dime each. Three for quarter. Address V. F. Markham, 765 Bellaire, Denver 7, Colorado.

"HOW To Repair Music Boxes." Complete instructions. Practical illustrations. Invaluable for hobbyists, watch-clock repair shops, collectors. \$1.00 postpaid. D'Ellentuc, 80 East First St., New York.

MAKE Your own Plastoplate printing cuts. Simple, easy process. Plastoservice, Argyle (1), Wisconsin.

A THOUSAND Laughs—Unique jackass cigarette dispenser. Holds 10 cigarettes. Simply press donkey's head down, tail rises—presto—out slips cigarette. Satisfaction guaranteed. Sent postpaid for \$1.00 with order or \$1.10 c.o.d. Ideal for Christmas gifts. Sanimo Industries, Dept. C-10, Spencer, Ind.

LUMINOUS Ash trays, novelties, pictures, statuettes "glow" in the dark. Descriptive list free. Gether, AD-1615 Glendale, Milwaukee 11.

CARPENTERS—50c Vestpocket calculator! Simplifies everything! Free particulars. Box 1414, Great Falls, Montana.

WRITE In gold, silver, copper raised metallics. Kit \$1.00. Roquevert, 1910 Du-maine St., New Orleans 19, La.

RESURRECTION Plants—Hundred \$6.00. Sample 35c. Mexican Products Co., 126 N. Main, Tulsa 3, Okla.

PREVENT Soiling and mutilation—Snapshots, miniature discharges, identification, membership cards, etc. Permanently sealed in transparent plastic. Up to 3 1/4" x 4 1/2" 35c. Solomson, 30 Walnut St., Malden, Mass.

SHOP Aprons, new, canvas, bib front, long wearing. Satisfaction guaranteed. 98c. New York Clothing Co., Dept. PM, 2079 - 2 Ave., New York 29, N. Y.

DRAFTSMEN. Architects, engineers. Piping template—2 to 12 inch standard pipe fittings, scales 1/4, 3/8, 1/2. \$2.00 pre-paid. Guaranteed or refund. Barlow, Box 3731, Los Angeles 54, Calif.

FOR Right methods of collecting postage meters subscribe for leading bulletin. Learn values, interests. \$1.00 yearly, chart 35c. Metered Mail, 6 So. Madison, La Grange, Ill.

ENTERTAINER'S Script catalog. 10c. Kleinman, 25-31-B 30th Road, Astoria 2, N. Y.

GIANT Mail, magazines, moneymaking opportunities, etc. 10c. Press, 828-A Stimson, Detroit 1.

MAKE Rats commit suicide wholesale lots. \$1 tells how. Wide Piper, 117 Boone, Little Rock, Ark.

SERVICE Discharge papers photocopied—\$1.00. Each copy notarized. Baltimore Photocopy Service, 2859 W. North Avenue, Baltimore 16, Maryland.

UNPAINTED Religious statues and novelties. Free list. Bill N. Varner, Picher, Oklahoma.

XMAS Tree preserver. Keeps needles on cut Xmas trees over 6 weeks. 25c. send coins. Cos-Day Products, 126 East Water St., Cincinnati, Ohio.

YOUR Favorite photo on attractive Christmas card. 25c postpaid. Send negative immediately. Joseph Bochniak, 98 West 19 Street, Bayonne, N. J.

STENCILS, Decalomania letters, for trucks, signs. Free folder. H. E. Sales, Dept. P, 3463 Itaska, St. Louis 11, Mo.

MERCHANDISE Of any kind. Paul, 425 E. Jefferson, Springfield, Illinois.

SQUARE Dance instructions, 25 sets, \$1.00. Rayburn, Eureka Springs, Arkansas.

FIREWORKS—Any time—any quantity—newest ideas—highest quality—best values. Giant salutes, aerial bombs, sky-screamers, battle-in-the clouds, new jet-propulsion plane rocket. 150-piece combination offer \$4.95. Satisfaction guaranteed. Write for big new catalog. Banner Fireworks, Dept. 35, Toledo, Ohio.

NYLONS—Ladies write for prices. Martin Co., Box 298, Wernersville, Penna.

BOOKFINDERS! (Scarce, out-of-print unusual books.) Quickly supplied. Send wants. Clifton, Box 1377PMM, Beverly Hills, Calif.

TATTOOING Outfits—engraving outfits. Circulars free. Write, Zeis Studio, 728 Lesley, Rockford, Illinois.

COMPASS, Directional, pocket watch size, famous make; metal case, unbreakable crystal, easy to read, fine bearing, sensitive. Ideal for hunters, fishermen, campers, motorists, etc. \$1.00 postpaid. Ross, 68 West Broadway, New York City 7.

HOLIDAY Gift packages. Tangerines half bushel package \$3.50. Prepaid express. O. L. Stroman, Mission, Texas.

HOMES, Pre-cut, prefabricated. Get on manufacturer's list. Mail \$1.00 for names of over 100 firms, and other vital information. Midwest, Box 298, Streator, Ill.

RECHARGE Fire extinguishers. Let us furnish recharges and fire extinguisher supplies; folder price. Armington Manufacturing Company, Sycamore, Illinois.

BUTTERFLY Cards—Open card butterfly flies out, 25c. Silky, amazing new scientific toy "walks downstairs" \$1.98. Sent postpaid. Free catalogue. Acme Merchandise, P.O. Box 157, Bronxville, N. Y.

SOUVENIR Luggage labels from everywhere. Five labels—25c, 25 labels—\$1.00. Dealer—agents wanted. Nabers Distributor, 242LMK Gordon, Laurens, S. C.

USEFUL Souvenir of World War II. Bomb timing device. All machined parts including 3 worm gears and 3 spur gears in reduction assembly. Inventors item. Applicable to many creative uses at a fraction of original cost. 50c plus 10c postage. No stamps. Money orders only. Surplus Outlet, 2048 Milwaukee Ave., Chicago 47, Illinois.

HOMES—125 Pictures with floor plans \$1.00. 414 for \$3.00. Money order, check, or C.O.D. Plans, 342 N. Volutsia, Wichita, Kan.

TECHNICAL, Religious and information books, mechanical novelties, manger sets, many other items. Make fine gifts. Information free. Edwards, 324 North 18th St., Quincy, Illinois.

LOTS Of mail from everywhere! Receive free samples, magazines, catalogues, literature, moneymaking opportunities! Mails galore! Your name listed in over 15,000 "surefire" directories, \$1.00. 5,000 listings. 50c; 2,000, 25c. Stanford, 6220-M 16th, Philadelphia 41.

EMBOSSING Ink outfits. \$1.00 postpaid. Peole, Box 708, Huntington Park, Calif.

LUMINOUS Paint kit, five jars, War Surplus, \$2.50. Far Hills Branch, Box 26, Dayton, Ohio.

RECEIVE Mails, literature, opportunities. Your name in numerous mailing lists 10c. Seth Greenwood, 277 Broadway, New York.

FUN For all. Win the treats. Earn money. Send dime. J. Dunphy, M.1136 E. Susquehanna Ave., Philadelphia 25, Pa.

MEXICAN Diamonds. Men's dazzling, brilliant, beautiful replica Mexican diamonds set in sterling silver. They're sensational copy of diamonds costing \$100.00. Special \$4.95. You'll be proud to wear this beautiful ring. Return in 5 days for refund if not delighted. B-B Jewelry Sales, 311 Travis, Houston, Texas.

DIAMOND Dust—20 beautiful Christmas cards and envelopes in gift box \$1.00 postpaid. Davis Specialty Shoppe, Box 213, Venice, Calif.

SOUVENIRS Of any state. 50c each, postpaid. Tapp, Box 2593, Little Rock, Ark.

SOILLESS Culture. Grow plants without soil. See the amazing results you can achieve with a few drops of "Ready Grow" the wonder plantfood, added to water or soil. 65c or two for \$1.00 postpaid or C.O.D. plus postage. Alfred Kittel, 1601 Nostrand Avenue, Brooklyn 26, N. Y.

MEMORANDUM Pads for all purposes, free samples. Photostatic copies of service records. A. Lightfoot, 4819 Penn St., Philadelphia 24, Penna.

INFORMATION. Any subject. The Roxbys, 747 S. New Hampshire, Los Angeles 5.

MERCHANTS Bookkeeping system \$3.50 postpaid. James Lamont, Distributor, Beacon, New York.

SWAPPERS. Buyers, sellers, advertise 2c word. Royal Swapper, 209 1/2 Elm St., Amesbury, Mass. Sample copy dime.

ADVANCE Dollar receive prepaid choice 15 wrenches or 5 pr. gears prepaid. Estreich, 150-06 Liberty, Jamaica 4, N. Y.

THE Lord's coming! Get free undeniable proofs today. Write International Evangelism, Box 263, Duluth, Minn.

WANTED—1000 Foot sufferers to test Custom Made Research Foot Balancers at our risk. Amazing foot relief awaits you. Rush name and address for free trial offer. Kindschi Foot Appliances, Dept. A4, 321 W. Jefferson, Dallas 8, Texas.

MEXICAN-AZTEC Featherwork tropical bird picture cards. Samples 25c. Bulletin free. Mexican Products Co., 126 N. Main, Tulsa 3, Okla.

RECEIVE Moneymaking opportunities, mails, samples, catalogs, magazines. Your name in thousand mailing lists. 25c. Glassmine, 1654-MX Amsterdam Avenue, New York 31.

CALENDAR 1753 to 2152. 35 cents postpaid. Tracy Newton, Decatur, Georgia.

EXPERIMENTER'S Special offer, 8 Alnico magnets, \$2.00. 100 diagrams and uses. 25c. Eljay, Box 891, Newark 1, N. J.

LUMINOUS Paint. Best quality. Glows bright blue in dark. 1 oz. each paint and sealer only \$1.59 f.o.b. Chicago. Black Light Products, 67 E. Lake St., Chicago 1, Ill.

GOOD "Used" self-instruction educational books on all subjects bought, sold, rented, exchanged. Satisfaction guaranteed. Complete information and 100-page illustrated bargain catalog free! Write—Nelson Company, Chicago 5.

"BIBLE Studies." 70 lessons 25c. Bulletin, Box 87, Station H, New York 25.

MEDICAL Laboratory technicians in great demand. We train you in your spare time, in your own home. You can practice while studying. Write for free catalogue. Imperial Technical Institute, Box 973-J, Austin, Texas.

METAL, Mineral locators latest 1946 electronic type ready for immediate shipment. Fisher Research Laboratory manufactured 2 million dollars worth of electronic equipment for the U. S. Army, including some of the finest metal-locators. Experience gained is yours in the best

INVEST In impressive New York City address for your business. Add prestige, increase your income. Excellent mail address for personal correspondence also. Low monthly rates. Write Multiservices, 3-B Park Row, New York 7, N. Y.

SELL Your pictures! Valuable folio, packed with information, lists over 100 picture markets. Tells where, how to sell. Only \$1 postpaid. Picmarts, 3 Park Row, New York 7, N. Y.

WHEELS Rubber tired. For coaster wagons, scooters, market carriers, mobile industrial equipment, trailers, carts of your own construction and for replacement. See our advertisements on pages 266 and 270. Walton Wheel Company, Plankinton Arcade, Milwaukee 3, Wis.

JEEP Hats 10c, meskits 35c, canteens 50c, covers, cups 15c, leggings 25c, holsters 50c, gunslings 75c, pistol cartridge belts 75c, field bags 95c, tool box, steel helmets, raincoats \$1.00, wading boots \$3. Catalogue. New York Salvage Co., 144 Chambers St., New York City.

CHINAWARE. Dozen cups, saucers \$2.00, etc. Send \$1.00 for samples, list. Garcia, 516 West 51 St., New York City 19.

Keep that "TICKING" Car

7 DAYS FREE TRIAL

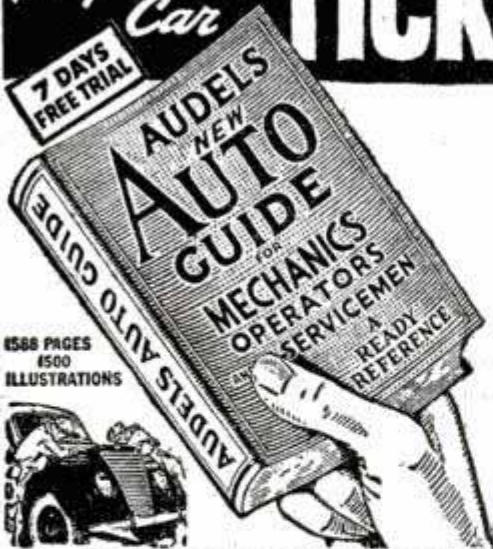

1588 PAGES
1500 ILLUSTRATIONS



Every operator and mechanic needs AUDELS AUTO GUIDE.

This book saves time, money and worry. Highly endorsed. It presents the whole subject of auto mechanics:

- 1—Basic principles
 - 2—Construction
 - 3—Operation
 - 4—Service
 - 5—Repair
- Handy Size, Easily understood.

NEW FLUID DRIVE, HYDRAULIC SHIFT AND DIESEL ENGINES FULLY COVERED

Over 1500 pages—1540 illustrations showing inside views of modern cars, trucks and buses with instructions for all service jobs.

ASK TO SEE IT!—To Get This Assistance for Yourself Simply Fill in and Mail Coupon Today.

4 COMPLETE • PAY ONLY \$1. A MONTH ←

AUDEL Publishers, 49 West 23rd St., New York
MAIL AUDELS NEW AUTO GUIDE for free examination. If O.K. I will send you \$1 in 7 days; then remit \$1 monthly until price of \$4 is paid. Otherwise I will return it.

Name.....

Address.....

Occupation.....

Employed by..... PM

VETERANS Learn WATCHMAKING

A Lifetime Profession

Regardless of Conditions, Age, Sex, or Physical Limitations

Veterans—Civilians!
Your Opportunity—
LEARN WATCHMAKING

Lift yourself from a futureless job into a position paying better than your present work. Fit yourself for the job that will permit you to establish your own shop, or be employed in a pleasant environment.

Watch Repairing—Jewelry—Engraving will always be in ever greater demand. Our graduates wanted everywhere. Dignified positions \$50-\$75-\$100 per week. Veterans write today for latest FREE enrollment requirements.

Kansas City School of Watchmaking
Largest Horological School in America
617-621 Wyandotte St. Kansas City 6, Mo.



SALESMEN FOR CITY AND COUNTY

Nationally Known Manufacturer

Build up a business of your own with Nationally Advertised Products bearing Underwriters' label. Sell to schools, factories, service stations, warehouses, hotels, restaurants, public institutions, truck and bus companies, grain elevators, house trailers, autos, farms, homes, etc. **Capable man can earn real money.** Established in 1916. Write letter with details, age, experience, etc.

Dept: 90-23 FYR-FYTER CO., Dayton 1, Ohio

Now You Can Join CLUB PLAN For BUSINESS SUCCESS FREE

Club Plan of Practical Business Administration now offered men in business and industry who want to follow a program in order to move up to executive positions. Plan available to employed men who wish advancement with present employer or elsewhere. Program will not interfere with present job. Serious minded, ambitious men invited to send for free facts at once.

AMERICAN TECHNICAL SOCIETY, Dept. 5211
Drexel & 58th CHICAGO, ILL.

PLASTAKIT

Make your own ornaments, decorations and jewelry designs out of plastic. Box of 60 pieces including pieces necessary to make your own pins, earrings, brooches and decorations. Unlimited uses. Send \$2... box sent postpaid. No C.O.D.'s.

WASHINGTON PLASTICS CO.
Dept. P Box 41 Pawtucket, R. I.

ANYONE CAN DO THIS IF THEY HAVE OUR CHART

SPECIAL OFFER FOR AGENTS

Blue Print 27"x36" now printed on both sides showing squares full size. Shows how to find the length of any rafter, find any angle in degrees, frame any polygon 3 to 16 sides, read the board foot and brace tables, octagon scale, rafter tables, many other uses can be scaled down for model work as well as full scale framing. Also chart changing pitches to degrees. For use with radial saws. About 13 square feet of printed copy. Sent post paid for \$1. Money order or check—no stamps. MASON ENGINEERING SERVICE, 2031 N. Burdick St., Dept. 11, Kalamazoo 81, Mich.

APTITUDE TESTS

for men, women, boys, girls, discover the kind of work or studies best for your success! You get a personal report—a guide for life—more happiness—more prosperity. Write for complete facts.

VOCATIONAL COUNSELING INSTITUTE
956 Maccabees Bldg., Detroit 2, Michigan

Train Your Own HORSES!

Colts — Stock Horses — Circus Horses
Gait Show Horses — Write for FREE BOOK
ANIMAL LOVERS' ASSOCIATION
Box KA-111, Tarzana, Calif.

FALSE TEETH

KLUTCH holds them tighter

KLUTCH forms a comfort cushion; holds dental plates so much firmer and snugger that one can eat and talk with greater comfort and security; in many cases almost as well as with natural teeth. Klutch lessens the constant fear of a dropping, rocking, chafing plate. 25c and 50c at druggists... If your druggist hasn't it, **don't waste money on substitutes**, but send us 10c and we will mail you a generous trial box. © I. P. INC.

KLUTCH CO. Box 4693-K ELMIRA, N. Y.

SAY YOU SAW IT IN POPULAR MECHANICS

POPULAR MECHANICS

DO ANY JOB.. EASIER.. QUICKER
MAKE MORE MONEY *in the*
BIG OPPORTUNITY
FIELDS

SEND NO MONEY
 Select the Books
 YOU Need Now!
 We Ship C.O.D.
 Anywhere in U. S.
 and Will Refund
 Amount Paid if
 Not Satisfactory.

Here's the Help You Need
For Best Paying Jobs
Right NOW!

FREE TRIAL
IN YOUR OWN HOME

Used by Army, Navy, Other Government
 Depts., 200 Schools and Industrial Firms.

Do it now! Get the better pay that goes to men with specialized knowledge. Get into one of these big opportunity fields. Big money and many other advantages await you if you prepare now. Here is the help you need—EASY—QUICK—AT LOW COST. Thousands of men have already used these famous books. Beginners and experienced men alike have doubled and tripled their earnings with this help. You too, can now get the special knowledge you need for top pay, better jobs, or a business of your own. This is your **GOLDEN OPPORTUNITY.**

AIR CONDITIONING

Big air conditioning boom interrupted by war will be bigger than ever. It's ready to GO now! Get this non-technical book by international authority and be ready for your share of millions to be spent. Covers whole field. 450 pages. Illustrated. \$4.00.

AIRPLANE WELDING

All metal airplane building offers big peacetime opportunities
 New 2nd edition of this famous book by J. B. Johnson, Materials Division, Wright Field. The authoritative and practical book on Airplane welding and materials brought right up to date. 420 pages, 193 pictures. \$3.50.

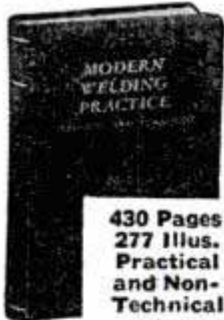

MODERN WELDING PRACTICE

Newest book on all types of welding and heat treatment of metals. Written by recognized specialists in training men for production jobs. Practical and Non-Technical.

430 Pages
 277 Illus.
 Practical and Non-Technical

Covers everything you need to know. Prepare for best pay jobs now. Price \$4.00.

BODY & FENDER REPAIR

Owners will spend big money to keep their good older cars looking like the new ones coming out. This is a practical money-making guide, ideal for shop owners and every man who wants a share of the millions to be spent in keeping old cars looking new. Tells how to get a good job or start business of your own with small capital. 325 pages, 232 illustrations. \$3.50.



DYKE'S FAMOUS CARBURETOR BOOK

This famous book has been the standard guide in the best paying auto work for a generation. It has helped thousands of men make money. New edition covers engine tune-up, compression, ignition, carburetion, fuel pump valves, etc. Use this book to specialize in this big field. 244 pages, 549 illustrations. \$3.50.

HOUSE WIRING NEW EDITION

Get this new sixth edition of this standard and practical electrical wiring book. It gives complete practical instruction on every phase of house wiring in one handy volume. Goes further than most books on subject. Hand-book style. Gives National Electric Code. 400 pages, 669 illustrations. Electrical work will reach a new high with millions of new homes to be built. Get started now. \$3.00.

15 Million Refrigerators
 Need Service and Repairs

REFRIGERATION—Book of the Hour!
Biggest Opportunity in Many Years!

NEW PRINTING—ALMOST 1000 PAGES

408 Pictures—17 Diagrams in Colors Makes All Refrigerator Service Maintenance, Repairs Simple as A. B. C.

Thousands of Refrigerators need repairs! Owners will pay big for competent service which will be needed more and more. Get **MODERN GAS AND ELECTRIC REFRIGERATION**, the non-technical guide to all types of refrigerators and get your share of this new profit. Get a job or start your own service business. This book will help you make money anywhere. Price \$5.00.



NEW 20th EDITION
Leading Auto Book for Over 32 Years

World's Greatest AUTO BOOK

New Material on Transmissions, Trucks, Tractors, Diesels, Aircraft and Auto Engines

Now with millions of cars needing repairs and thousands of men needed to do the work, you need the famous DYKE Auto Book more than ever before. Brand new 20th Edition covers all principles, construction, repair, adjustments, testing, troubles and remedies of all cars. Over a half million copies of 20 editions of Dyke's have been sold. Gives specifications of old and newer cars. World's biggest book value. \$7.00. This big book, a complete auto library in one volume, has 1483 pages—4600 illustrations and diagrams—weighs 6 lbs.—equal to 4 ordinary books.

ENGINEERS HANDBOOK

World famous Bailey's handbook of universal questions and answers for Stationary, Marine and DIESEL engineers and firemen. Prepares for any license examination. This is the one book that men should have if they want to reach the top in installation, maintenance and operation of Diesel and steam plants. Pocket size, \$2.00.

Goodheart-Willcox Co., Inc.
 2099 S. Michigan Ave., Dept. 111, Chicago 16, Ill.

SEND NO MONEY! Mail Coupon

GOODHEART-WILCOX CO.,
 2099 S. Michigan Ave., Dept. 111, Chicago 16, Ill.
 Send books checked, C.O.D. I will pay postman, plus few cents charges. If not satisfactory I will return books in 5 days and you will refund money paid. (Outside U.S. or possessions remit with order.)

- Gas & Electric Refrigeration \$5.00
- Dyke's Auto Book \$7.00
- Dyke's Carburetor Book . \$3.50
- Modern Welding \$4.00
- Airplane Welding \$3.50
- Sheet Metal Layout . . . \$3.50
- Air Conditioning \$4.00
- Engineers Handbook . . . \$2.00
- Body and Fender Repair . \$3.50
- House Wiring \$3.00
- Shop Math. (2 vols.) . . . \$3.00
- A.C. Power Wiring \$4.00
- D.C. Power Wiring \$4.00

If remittance accompanies order we will pay all postage charges under same return privilege.

Name
 Address
 City State

**NEW peacetime
production plans
mean**



BIGGER PAY FOR MACHINISTS
Master shop work quickly with these books

This big home-study and reference course gives you the practical facts on machines and methods you need to advance in machine shop work. Take advantage of the other man's experience as found in books, to solve your problems, increase your efficiency, with

**The AMERICAN
MACHINISTS' LIBRARY**

6 volumes—2368 pages—2516 illustrations
(A combined home-study course and reference library)

This library of machine shop practice was written for practical men. It gives you the best methods for every kind of machine shop work. It fully explains lathes, drills, and other machine tools and their operation, automatic screw machines, speeds and feeds, gear design and production, jigs and fixtures, punch and die work, metal surfacing, etc., etc. Plainly written—completely illustrated—the best kind of help to the machine shop man who wants to advance himself.

No money down—special price—easy payments.

EXAMINATION COUPON

McGraw-Hill Book Co., 330 W. 42nd St., N. Y. 18

Send me for ten days' examination the American Machinists' Library. If satisfactory I will send you \$4.00 in 10 days and \$4.00 monthly until the price of \$20.00 is paid. If not wanted, I will return the books postpaid. (To insure prompt shipment write plainly and fill in all lines.)

Name.....
Home Address.....
City and State.....
Company.....
Position..... PM 11-46

**BE PREPARED FOR
SICKNESS or ACCIDENT**

THIS HOSPITALIZATION PLAN
PROTECTS YOU AND
YOUR FAMILY



Costs only
3¢ A DAY • EACH ADULT
1 1/2¢ A DAY • EACH CHILD

Benefits begin the day you enter a hospital
FOR SICKNESS OR ACCIDENT
Hospital Expenses paid, up to \$540.00
FOR ACCIDENT
Doctor Expense paid, up to \$135.00
Loss of Wages reimbursed, up to \$300.00
Loss of Life by Accident \$1000.00
WAR COVERAGE AND EXTRA BENEFITS
Childbirth Expense paid, up to \$75.00

• It's easy to run into debt when sickness or accident hit. Under the Family Mutual Plan, you'll be able to pay your hospital bills. And in case of accident, you'll be reimbursed for your doctor expenses, for loss of time from work. You can enter any hospital in the United States. Your family doctor may attend you. Benefits applying to children are 50% of those paid adults.

MAIL COUPON TODAY—No Agent Will Bother You

FAMILY MUTUAL LIFE INSURANCE CO., WILMINGTON 99, DEL

Family Mutual Life Insurance Co. PM-16
601 Shipley St., Wilmington 99, Del.

Please send me, without obligation, complete information on your Economical Hospitalization Plan.

NAME.....
ADDRESS.....
CITY..... STATE.....

NEW MIDGET ELECTRIC

ARC WELDER

RETAILS ONLY
\$3.95

FULLY GUARANTEED



Plugs into Light
Socket—AC or DC

It's new! It's handy! It's efficient! Use the Midget Electric Arc Welder for hundreds of light-metal jobs. Does comparable welding work with a 1/16 inch welding rod on thin metal as that of larger and higher priced welders. Operates on 15 ampere fuse, 110 volt 60 cycle A.C. or D.C. current, by use of our special standard-coated 1/16-inch welding rods. Generous supply of rods supplied with machine. Recommended for all light welding like automobile fenders, etc. Take the Midget Arc anywhere to the job. Sturdily built and fully guaranteed. Comes complete—ready to use. Nothing else to buy. No previous welding experience needed to strike an arc. In a short time, anyone mechanically inclined can learn to weld with this machine.

You'll find hundreds of money-saving, time-saving uses for the Midget Arc around your home, garage, or workshop. Also in garages, factories, repair shops, tin shops, mechanics, farmers, inventors, etc. Order a Midget Electric Arc Welder now! SEND NO MONEY. We'll rush one to you, complete with rods and helmet (equipped with APPROVED welding glass). Pay postman only \$3.95 plus postage charges. If not satisfied, return Midget Arc in 5 days from receipt and we'll refund your money immediately. RUSH YOUR ORDER NOW.
MIDGET ARC WELDER CO., Strader Ave., Dept. P-202, Cincinnati 26, Ohio



GETS YOU YOUR FIRST BIG LESSON IN
CARTOONING!

Learn cartooning the easy, modern way! Just send your four-bits to Jack Dunning, Professional Artist and Instructor in cartooning at the Dayton Art Institute.

Address: JACK DUNNING
440 Schantz Ave., Dayton 9, Ohio

... AND HE'LL DO THE REST!

ANY BOOK IN PRINT

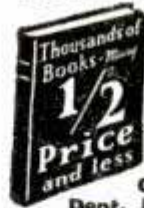

Delivered at your door. We pay postage. Standard authors, new books, popular editions, fiction, reference, medical, mechanical, children's books, etc. Guaranteed savings. Send for Clarkson's 1947 catalog.

FREE Write for our great illustrated book catalog. A short course in literature. The buying guide of 500,000 book lovers. The answer to your Christmas gift problem. Free if you write now—today!

CLARKSON PUBLISHING COMPANY
Dept. PM6, 1257 So. Wabash Ave., Chicago, Ill.

SAY YOU SAW IT IN POPULAR MECHANICS



BIG MONEY FOR YOU IN PLASTICS

SEND Offer includes 2 books: New Fabrication Manual & Giant Catalog, listing the most complete stock of Plastic Materials, Accessories, Tools.

10¢
BERTON PLASTICS, INC.
19 W. 21st St., N. Y. 10, N. Y.

PRINTING PAYS BIG

"Make your future secure. Prepare for a highly paid position or a print shop of your own. Students throughout the world are enthusiastic in their praise of our training program and the personal attention given each student. Rush name today for free literature and sample lesson. No salesman will call. Write Dept. M-106.

International School of Printing, Box 334, Dayton, Ohio

POPULAR MECHANICS

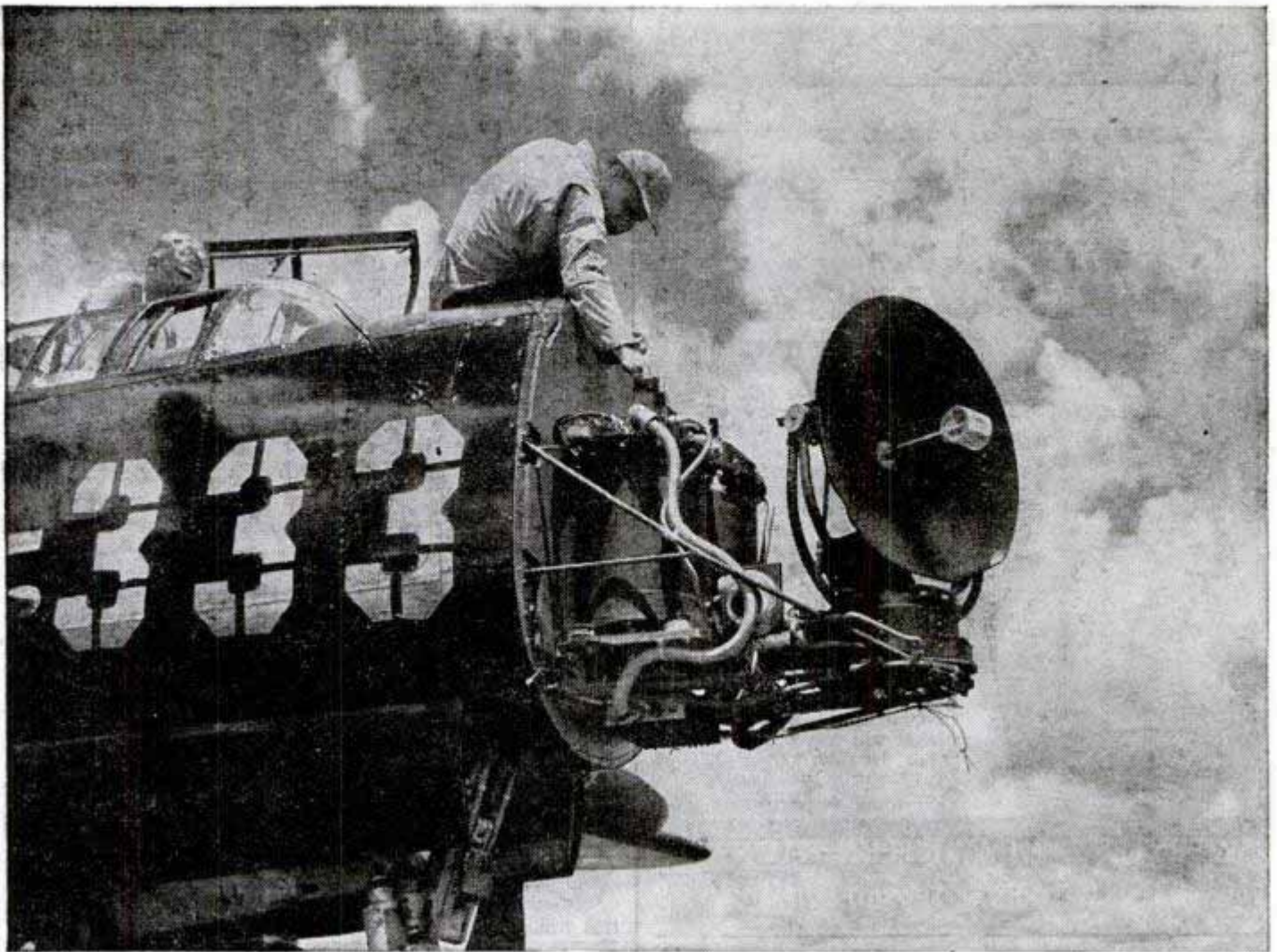

THE "ROVING EYE," child of Radar which peers through the densest fog, warns of obstacles, helps keep today's Army planes on their course.

Scientific training—how much does it cost?

Nothing — if you know where to look for it!
The new Regular Army offers you the best and pays you while you learn.

What could be more ideal? The Army — foster-father of thousands of thrilling new scientific and mechanical developments — has great teachers. And back of them all is the invaluable textbook of practical experience.

The civilian fields of tomorrow — such as Radar, Nuclear Energy, Supersonic Aviation, Advanced Electronics, Jet Propulsion — are the fields of *today* in the new Regular Army. Add the advantages of training in the world's

largest technical research organization to the merits of an Army career, and you've an educational opportunity that's hard to beat.

New higher pay, good food, lodging, medical and dental care, liberal furlough and retirement privileges, and the exhilarating experience of working with men of purpose make this a job you can't afford to miss!

You may choose your branch of service if you enlist now for 3 years. The most interesting fields are filling quickly. Don't delay a minute! See your nearest Recruiting Officer for further details.

Listen to "Warriors of Peace," "Voice of the Army," "Proudly We Hail" and Major Football Broadcasts on your radio.

U. S. ARMY RECRUITING SERVICE

A GOOD JOB FOR YOU
U. S. Army
 CHOOSE THIS
 FINE PROFESSION NOW!

YOUR REGULAR ARMY SERVES THE NATION AND MANKIND IN WAR AND PEACE

"The Supreme Authority"

in courts, schools, homes, newspapers
and Government offices

The Merriam- WEBSTER



YOU may have had to wait for a copy of WEBSTER'S NEW INTERNATIONAL DICTIONARY, Second Edition. However, more and more copies are reaching your dealer. He may have one for you now or very soon. The MERRIAM-Webster contains 3,350 pages, illustrations for 12,000 terms, and a total of 600,000 entries—122,000 more than any other dictionary. It is the only unabridged dictionary completely revised and rewritten in three decades. G. & C. Merriam Company, Springfield 2, Mass.

**WEBSTER'S NEW INTERNATIONAL
DICTIONARY • Second Edition**

Now for EVERY WORK SHOP! NEW Invention **Electroplates** by BRUSH



**Easy to Plate CHROMIUM
GOLD, SILVER, NICKEL, COPPER
... For Pleasure and Profit!**

If you have a workshop—at home or in business—you need this new Warner Electroplater. At the stroke of an electrified brush, you can electroplate models and projects—you can replat worn articles, faucets, tools, fixtures, silverware, etc. with a durable, sparkling coat of metal... Gold, Silver, Chromium, Nickel, Copper or Cadmium. Method is easy, simple, quick. Everything furnished—equipment complete, ready for use. *By doing a bit of work for others, your machine can pay for itself within a week.* So make your shop complete by getting a Warner Electroplater right away. Send today for **FREE SAMPLE** and illustrated literature. **ACT AT ONCE!** Mail Coupon.
**WARNER ELECTRIC CO., DEPT. K-3
1512 Jarvis Avenue, Chicago 26, Ill.**

FREE Details & Sample!

WARNER ELECTRIC CO., 1512 Jarvis Avenue, Chicago 26, Dept. K-3
Gentlemen: Send Free Sample and Details to:

Name _____
Address _____
City _____ State _____

Give DONALD DUCK Home Movies

Ideal
Christmas
Gift For
Projector
Owners



He's Always
The
"STAR"
Whenever
Shown

Cartoon Home Movies are ALWAYS received with delight. Give several of these popular films—Donald Duck, Mickey Mouse, and the favorite Walter Lantz Cartoons, 3 Monkeys and Oswald Rabbit.

FEATURE DONALD DUCK FILMS
100 Ft. 8MM\$3.00 200 Ft. 16MM.....\$6.00
Fast and Furious.....1452-B Donald's Day Off.....1454-B
The Fireman1453-B Donald The Skater.....1456-B

See At Your Photo Dealers Or Order Direct.
Catalog And Prices On Request. Write To:

HOLLYWOOD FILM ENTERPRISES, INC.
6060 Sunset Blvd., Dept. 115, Hollywood 28, Calif.



59c

COMB-A-TRIM THE NEW QUICK TRIMMER

Something New! Trim your hair without any experience. It's easy! The excess hair comes off smoothly and easily by just pulling trimmer through hair like an ordinary comb. Also removes hair from legs—armpits. Save on hair-cut bills... Trim your own hair or the whole family's. Send 59c and your Comb-A-Trim will be sent at once.

SPECIAL OFFER
Send \$1.00 for 2
Comb-A-Trims
and save 18c. **2 for \$1**

5 Extra Blades
(Year's Supply) 25c
Dept. R-12

COMB-A-TRIM CO.
Cincinnati, O.

1734 Carew Tower

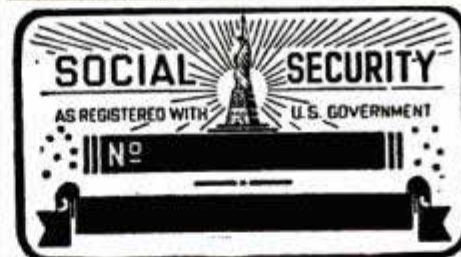

Beautiful brass Social Security plates (illustrated 1/2 actual size), priced at only 50c. Please print your name & number plainly.

ACME
Stamping Service
Box 836
Davenport, Iowa

CHAPMAN CHINCHILLAS

The originator of the first Chinchilla Farm in the United States. For information on purchasing the finest, selected breeding stock of these aristocratic animals that were virtually trapped to extinction write or visit—

Established
1919

Chapman Chinchilla Farm
4957 West 104th Street
Inglewood, California

RUPTURED?

Get Relief This Proven Way

Why try to worry along with trusses that gouge your flesh—press heavily on hips and spine—enlarge opening—fail to hold rupture? You need the Cluthe. No leg-straps or cutting belts. Automatic adjustable pad holds at real opening—follows every body movement with instant increased support in case of strain. Cannot slip whether at work or play. Light. Waterproof. Can be worn in bath. Send for amazing **FREE** book, "Advice To Ruptured," and details of liberal truthful 60-day trial offer. Also endorsements from grateful users in your neighborhood. Write:
CLUTHE SONS, Dept. 31, Bloomfield, New Jersey

Plan Your Way to **BIGGER PAY**

FREE Occupational Success Chart and How To Study Guide



Big jobs go to men who know how to make most of themselves. Valuable **OCCUPATIONAL SUCCESS CHART** and **HOW TO STUDY GUIDE** prepared by college authorities to help you get most from **CENTRAL EDUCATIONAL SERVICE** quality books. Get into one of the big, growing fields **NOW** when there is chance to go up fast. **ORDER**

FROM THIS LIST TODAY. Every book guaranteed to fully satisfy you or your money back. Even if you return books **YOU STILL KEEP OCCUPATIONAL SUCCESS CHART** and **HOW TO STUDY GUIDE** as our free gift to you.



EVERY BOOK GUARANTEED FULL SATISFACTION OR MONEY BACK

Order Now—Earn More, Win Promotion and Security

DIESEL. Here is a practical manual of Diesel engines covering Diesels on the road, on rails, on the water, in the air. **\$1.50**
WELDING. Beginning and complete course for man who wants to learn welding by himself. Gas, A.C. arc, brazing, metal cutting. **\$1.35**
ELECTRICITY. Practical how-to-do-it volume covers simple wiring diagrams, circuit layouts, knob and tube wiring plans. **\$1.35**
PLASTICS. How to work with plastics, tools needed, how to make dozens of useful objects for home use or own business. **\$1.35**
REFRIGERATION. Here is a practical, self-study service manual dealing with home and commercial installations of many types. **\$2.00**

Central Educational Service, Dept. K2
 6009 Belmont Avenue, Chicago, Ill.

AIR CONDITIONING. Practical, self-training text treats air conditioning of all types of buildings together with general applications of steam, hot-water, vacuum heating. **\$4.00**
RADIO. A practical text for the man who wants useful information in learning how to do trouble shooting and repairs. **\$2.00**

CARPENTRY. Excellent self-teaching volume written for carpenters and apprentices. Clearly written, easy to understand. **\$2.50**
BODY & FENDER REPAIR. Big earning opportunities keeping new cars beautiful, preparing used cars for resale. Practical book for man without previous knowledge who wants own business or good job. **\$3.50**
AVIATION ENGINES. Very complete, from elementary step-by-step to big engines. **\$3.25**
PLUMBING. Complete self-study course on how to install, design plumbing. **\$3.00**
PAINTING & DECORATING. Practical how-to-do-it information on principles and applications of paints, varnishes, etc. **\$1.85**
INVENTORS COURSE. Ingenious Mechanisms for Designers and Inventors. Basic volume every man with inventive mind should have. **\$5.00**

Send No Money or Remit With Order as You Prefer

CENTRAL EDUCATIONAL SERVICE, Dept. K2
6009 Belmont Avenue, Chicago, Ill.

Send books checked on **FREE TRIAL.** If I am not thoroughly satisfied, I will return books in 7 days and you will refund my money.

- I am enclosing payment with order.
- Send C.O.D. I will pay postman plus postage and C.O.D. fee. (No C.O.D. outside U.S.)
- Send free **OCCUPATIONAL SUCCESS CHART** and **HOW TO STUDY GUIDE.**

Name.....
 Address.....
 City..... State.....

- Diesel.....\$1.50
- Welding.....\$1.35
- Electricity.....\$1.35
- Plastics.....\$1.35
- Air Conditioning...\$4.00
- Refrigeration.....\$2.00
- Radio.....\$2.00
- Carpentry.....\$2.50
- Body & Fender....\$3.50
- Aviation Engines...\$3.25
- Plumbing.....\$3.00
- Painting & Dec't...\$1.85
- Ingenious Mech. for Inventors.....\$5.00

YOURS FREE—Even if you do not order any book, you still may send for *Occupational Success Chart and How to Study Guide.* Just fill out name and address, mail today!



CALLING ALL BOYS!

Yes, we're **CALLING ALL BOYS**, and we're calling **YOU**, too. Tune in on an interesting hobby that pays big returns in fun and interest. Even helps to prepare you for a career in radio. Learn how to make your own simple, tubeless, batteryless crystal radio. Just send 25c. We will send you postpaid by return mail a genuine Melomite crystal with complete illustrated instructions for making your very own set. Then you will enjoy competing with others for long-distant reception. With crystal and instructions we send *The Magic Crystal*, our own publication chock-full of news, diagrams, questions and answers of interest. Don't delay! Send 25c today!

ALLEN RADIO, Dept. PM-11 Clinton, Missouri

OTTAWA TRACTOR SAW



THOUSANDS IN USE

Falls trees quick—no lifting, pulled by tractor—easily swung into position. Saws large and small logs. Safety Friction Clutch. The most useful, low-priced tractor saw ever built. Thousands in use—**NEW** improvements making more useful than ever. Saw your wood lot into Cash while prices are high. Make your tractor pay bigger dividends. Lowest direct-to-user prices. Fully guaranteed. Send for Free details.

OTTAWA MFG. CO., D1127 Forest Ave., Ottawa, Kansas

Costs Too Little To Do Without



YOU CAN LEARN TO BE AN ARTIST

Start **DRAWING** At Home in Your **SPARE TIME!**

Draw for Money! Trained Artists are capable of earning \$40, \$60, \$75 and more a **WEEK!**

Your future is in your own hands. Prepare yourself now in **COMMERCIAL ART, DESIGNING** and **CARTOONING**—all in **ONE** complete home study course. No previous art experience necessary—we teach you step-by-step for a fascinating hobby and a profitable career. For 32 years WSA graduates have been "making good"—**WHY NOT YOU?** **FREE BOOK**, "Art for Pleasure & Profit" fully describes course and commercial opportunities. **TWO ART OUT-FITS** included with training. Mail coupon today.

(**VETERANS!** Course available under G. I. Bill.)

FREE BOOK gives details!

WASHINGTON SCHOOL OF ART,
 Studio 1211C, 1115 15th St., N. W., Washington, D. C.

NAME.....AGE.....
 Street.....
 City.....Zone () State.....



The Steady Pay Profession Good Times or Bad!

SCIENTIFIC CRIME DETECTION

FOLLOW
THIS MAN

Operator
No. 38



It Is Easy to Learn!

I will teach you this fascinating science during your spare time at home. It pays to be an expert in Finger Printing, Firearms Identification, Police Photography and Secret Service Methods. I have trained hundreds of men and women now successfully serving in identification bureaus throughout America. You, too, may quickly prepare yourself to become a well-paid valued officer of the law, often sharing in the generous rewards offered for wanted criminals.

FREE! 53 PER CENT

"BLUE BOOK OF CRIME"

This book is full of exciting information on scientific crime detection. It will show how you can get started in a grand career. Now, at amazingly low cost. Clip coupon now... Mail it today.

of all Identification Bureaus in the U. S. employ students and graduates of I. A. S. A majority of these men are heads of Bureaus. Many of them knew nothing about crime detection before training with me. Now they have steady jobs, good salaries and a fine future. Write today for full particulars and free book. Give age.

INSTITUTE OF APPLIED SCIENCE

1920 Sunnyside Ave., Dept. 1358 Chicago 40, Ill.

INSTITUTE OF APPLIED SCIENCE

1920 Sunnyside Ave., Dept. 1358, Chicago 40

Gentlemen: Without any obligation on my part, send me the "Blue Book of Crime," and complete list of Identification Bureaus employing your students or graduates, together with your low prices and Easy Terms Offer. (Literature will be sent ONLY to persons stating their age.)

Name.....

Address.....

Age.....

Learn WATCH REPAIRING

From An
Approved School
The Largest of Its Kind



EARN
WHILE
LEARNING

Spare Time Home Training
Prepares You For Big Pay

FREE WATCH working tools and watch included as part of our Watch Repairing Course

The demand for skilled watch repairers—men and women—is increasing with the step-up in the manufacture of watches. Now is the time to prepare yourself in this fascinating profession with the aid of our highly practical HOME TRAINING COURSE—in your spare time at home. Start your own business or accept a big pay position.

WRITE TODAY FOR FREE DETAILS

Earn while you learn with an "approved" school.
Get the facts—then judge.

ILLINOIS SCHOOL OF WATCH REPAIRING
6312 Huntington Street, Dept. PM-11, Chicago 30, Illinois

SEND FOR THIS TIME SAVING OHMITE Ohm's Law Calculator



Figures Ohms,
Watts, Amperes
Volts ... Quickly!
Any Ohm's Law
Problem solved
with one setting

of slide. All values direct reading. (4 1/8" x 9")

Send only 10c in coin to cover cost of handling.

OHMITE MFG. CO., 4931 Flournoy St., Chicago 44, Ill.

ANALYZE HANDWRITING

Qualify for Certified Grapho Analyst Degree at home, spare time. Credit, Employment, Personnel Managers, Business, Professional men, women use grapho-analysis in their work, earn substantial fees in spare time. Many study solely for personal benefit, no desire to earn money, find it so fascinating they start using it to add to their incomes. Entertainment field pays well, up to \$100 in a week reported. Others establishing profitable practices as Vocational and Family Problem Counselors, Personality Teachers, and lecturers.



GROWING—UNCROWDED PROFESSION

More and more police use grapho analysis handling suspects and criminals. They understand how criminals think. Their handwriting tells. Men like Hugh Dunlap, university student, Harry Allen, retired preacher, use it in court, win cases, earn fees even before graduation. Only school in world devoted to teaching grapho analysis offers thorough training to earnest, ambitious men and women regardless of where you live, small town, farm or city. Send for GRAPHO ANALYST, illustrated lesson, personal handwriting analysis offer, ALL FREE. Must be 21 or over. Address A. I. G. A. Inc., 120. Noel, Missouri.



FENCING World's Finest Sport Exciting Fun—Harmless



Just Out! Two 3 ft. Spring Steel Foils with Safety Rubber Buttons. Complete Outfit 2 foils (swords) with hand guards and Free Instruction Book Now Only \$1.98 Postpaid. Healthful, clean, makes you Strong & Alert. Instruction Book teaches Quickly—Easily. Mail check or Money Order today. Add 28c for Foreign Postage.

LEE PRODUCTS CO., Dept. 16-1613 First Ave., New York 28, N. Y.

YOU CAN MASTER MATHEMATICS

Key to the Electronic, Atomic age.

O - UNIVERSAL SCHOOL OF MATHEMATICS - O
623 Walter Story Bldg., Los Angeles, Calif.

RADIO

ENGINEERING, Broadcasting, Servicing, Electronics, Aviation, Marine & Police Radio taught thoroughly. 48 weeks' Engineering course equivalent to 3 years' college radio work. Approved Veteran Training. Co-educational. Catalog free.

VALPARAISO TECHNICAL INSTITUTE, Dept. D, Valparaiso, Ind.

Photography



for

PLEASURE or PROFIT

Learn at home. Spare time. Practical basic training. Long-established school. Many have earned while learning. Send coupon below for free booklet, "Opportunities in Modern Photography" and full particulars.

AMERICAN SCHOOL OF PHOTOGRAPHY

1315 Michigan Avenue Dept. 1358 Chicago 5, Illinois
Send booklet, "Opportunities in Modern Photography," full particulars and requirements.

Name..... Age.....

Address.....

City..... Zone..... State.....



No, that's not necessarily wishful thinking. You possibly can be taller. "BUILDING HUMAN STATURE" tells how in 368 pages of non-technical language, thoroughly illustrated for complete understanding.

Why the 8-foot Watussi and the 3-foot Bushman? There's a reason. What made the New Zealander average 5½ inches taller than the Indian? General Emmons reports many 6-foot tall Hawaiian Japanese whose forbears averaged only 5 feet 2 inches, and Professor Borsook tells you why. Some Russian-Jewish men in U. S. grew 5 inches taller than their parents. What did they do? Did you know that from 1½ to 6 inches increase in height may, in some cases, be obtainable from gland treatments?

HERE ARE THE SECRETS

In simple words this book, "BUILDING HUMAN STATURE," outlines the work of the world's greatest authorities—physicians, biologists, and physical culture experts—explaining the response of bones to stimuli, as well as other factors which these authorities affirm may increase height.

This is the only book published in which you will find simple and explicit instructions for making the Stretching and Suspension Apparatus from which some have claimed remarkable results.

Dr. H. LaChance, M.D., the distinguished orthopaedic surgeon, said: "Very comprehensive and very well written." Capt. Cano, Commander, Spanish Loyalist Army Health Services: "If a young man apply himself . . . it should make considerable difference in his ultimate height."



FATHER and SON
Son exceeds father's height by nearly a head. This young man grew almost 6 inches during a year that he followed instructions in "BUILDING HUMAN STATURE."

WISH YOU WERE TALLER?

SOME HEADINGS

Foreword by Capt. Juan Cano, of the "Health Service," Spanish Loyalist Army. — Discussion of Student Height Increase by head of Barnard College. — The Truth About Heredity in Height Increase. — Food for Stature Building. — U. S. Surgeon General's Dietary Advice. — Natural and Artificial Bone Growth. — How the Ductless Glands Affect Growth; "Gains in Height Varying from 1½ to 6 inches." — A Famous Dwarf: Doubled His Height at 39. — Advice of U. S. Director of Physical Fitness. — Improved Stature in Women Brings Easier and Better Child Bearing. — Stretching Exercises Which Cure Painful Menstruation. — Stature Gaining Factors According to Dr. Krogman. — Use of Weights for Stretching. — Body Suspension. — His Height Increased 6 inches in 12 Months. — Instructions for Making Suspension Apparatus. — Jobs as Instructors. 368 pages. Thoroughly illustrated by Photographs and Sketches. Most Practical Mailed in Plain Wrapper.

You owe it to yourself, and to those who one day may be dependent upon you, to know how maximum stature may be built. This book is a must if you are not to miss opportunities, for the taller person has many advantages. Turn wishing into action. Write at once, on this no risk 5 day free trial basis.

MONEY BACK GUARANTEE

CARILLON BOOKS

Dept. 73, Boerne, Texas

Please send at once "BUILDING HUMAN STATURE." I will pay postman \$3.50 plus C.O.D. charges on its arrival. It is understood that I may return the book in five days for refund if I am not completely satisfied.

Name

Address

NOTE: To get quickest action send check, money order, postal note, stamps or cash with order and pay only \$3.50.

Don't Envy The Plumber BE ONE!

Above all the TOP WAGE craftsmen stands the PLUMBER

Every skilled workman will tell you that Plumbers have the best of it. WINTER and SUMMER the Plumber is busy at top wages. No skilled Plumber is ever out of a job—compare his opportunities with any trade, plus the opportunities of having your own shop.

We teach you Plumbing with TOOLS (not books) under Licensed Master PLUMBERS in one of the finest equipped schools in America. We make you a Plumber, every branch is taught thoroughly—Lead Work—Blue Print for plan reading—all other tricks.

LEARN IN 30 WEEKS without previous experience

If you like to work with tools you owe it to yourself to investigate. No need to ever work as an apprentice. Get free bulletin. Write now! G.I. approved. Our 24th year.

UNIVERSAL PLUMBING SCHOOL
815 HOLMES STREET KANSAS CITY, MO.

TRI-STATE COLLEGE

B. S. Degree in 27 months in Engineering (all branches); Bus. Admin., Acc't and Sec. Science. 63rd year. School now filled to capacity. No applications can be accepted until further notice.
4116 College Ave., Angola, Ind.

SIMPLE EASY INVENTION TRIMS HAIR AT HOME!

SAVES BARBER BILLS

Trims hair as it combs! Easy! Quick! Keeps men's, women's children's hair trim, neat, freshly-cut looking all the time! Trims, tapers, thins out uneven hair. Use like ordinary comb. Safe, Simple.

No experience required. Fine for legs, underarms! Sells like wild!

SAMPLES FOR AGENTS Sample offer sent immediately to all who send name at once. A penny postal will do. SEND NO MONEY. Just your name.

KRISTEK CO., 687 Bar St., AKRON, OHIO

GET INTO AN OPPORTUNITY INDUSTRIAL FIELD



Prepare Now!

With Shop Method Home Training BY A REAL ESTABLISHED RESIDENT SCHOOL

If you like mechanics, get a thrill out of working with your hands as well as your head, you will find this training program the open road for promotion, a better job, or a business of your own.

Choose the one of these profitable fields that interests you:

1. Radio, Television Electronics
2. Diesel, Automotive and Allied Mechanics
3. Air Conditioning and Refrigeration
4. Electricity and Industrial Electronics
5. Machine Shop Training

If you sincerely want more money, prestige and a more responsible position, fill out the coupon below. Get the facts. Check the Course that interests you most. INFORMATION AND SAMPLE LESSON WILL BE SENT YOU FREE!



NATIONAL SCHOOLS
Established 1905

4000 S. Figueroa St., Los Angeles 37, Calif.

Rush COUPON for FACTS & SAMPLE LESSON Free

Check one Course

Radio, Tel. Elec.

Refrigeration & Air Conditioning

Machine Shop

Diesel, Auto & Mechanics

Electricity & Ind. Electronics

National Schools, 4000 S. Figueroa St., Dept. PMS-11, Los Angeles 37, Calif. Send me FREE information covering special training in Course checked.

NAME.....AGE.....

ADDRESS.....

CITY.....ZONE.....STATE.....

APPROVED FOR TRAINING UNDER G.I. BILL

YOU CAN AFFORD THE HOME YOU WANT!

▼ Stretch Your Dollars . . . Read This Practical New Book Now!

▼ You'll find dozens of money-saving ideas in this exciting new book . . . created by architects and builders to show you HOW TO GET THE MOST HOUSE FOR YOUR MONEY. Over 100 house designs . . . with clear pictures and floor plans. This big, interesting book includes:

- All styles of houses—small, medium and large
- Expandable homes
- Kitchens and interiors
- Heating and air conditioning
- How to choose a thrifty plan
- How to select a location

▼ Find out NOW how you can afford the house you want. Send for this practical, fascinating new book today. Use the coupon below . . . and mail it now!

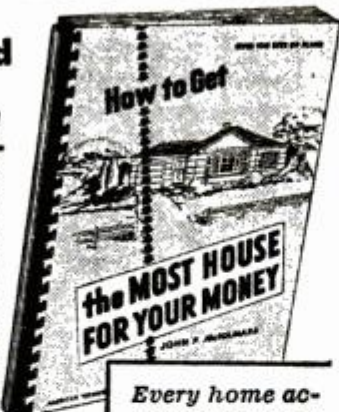

Every home actually built. Detailed plans available at low cost.

AMERICAN TECHNICAL SOCIETY

Vocational Publishers since 1899

Dept. K819, Drexel Avenue & 58th St., Chicago 37, Ill.

Please RUSH me the copy of HOW TO GET THE MOST HOUSE FOR YOUR MONEY. I enclose \$2.50—you pay postage. Send book C.O.D. for \$2.50, plus postage. (I may return book within 5 days of receipt for full refund if not satisfied.)

Name.....

Address.....

City..... Zone..... State.....

No Waiting to LEARN START NOW TO EARN!

This BIG BOOK SHOWS HOW



IF IT'S RESULTS YOU WANT—GET ACTION QUICKLY WITH THESE PRACTICAL IDEAS

Never before has a more helpful book been printed for those planning a business of their own. Gathered in this large illustrated volume are the formulas, recipes, facts and secrets that have contributed so largely to America's great industrial progress. Capitalize on this information for making most any conceivable product without experience, special equipment or previous knowledge of chemistry. Start at home, expand with profits—build for a profitable independence.

The experts who compiled this book are authorities, and present this information in simple, understandable language. They also give you wholesale supply sources for needed materials, short cuts and economy methods for the most profitable results. Hundreds of good paying businesses have been built on a product made from a simple

recipe. Opportunities in this field exist everywhere. Choose from any of the 162,000 facts and 10,000 formulas of which the following are only a very few: Adhesives, Alloys, Anti-Freeze Solutions, Cosmetics, Beverages and Liquors, Candy, Ceramics, Cheese, Cleaning Preparations, Concrete, Copper, Cotton, Dentifrices, Depilatories, Dyes, Embalming Fluids, Enameling, Glass, Glazes, Household Formulas, Inks, Insecticides, Iron, Jewelers' Formulas, Lacquers, Laundry Preparations, Leather, Linoleum, Lubricants, Manicure Preparations, Marble (artificial), Metals, Mirrors,

—Sell by Mail!

You will profit by the ideas contained in this big book for setting up a mail business you can easily run from your home in your spare time.

FORTUNES MADE FROM A SINGLE IDEA!

This comprehensive book is an accepted authority by chemists, schools, industry, etc. and is the largest and most comprehensive book of its kind ever issued. Nothing else like it in existence. A single formula has been worth a thousand times this book's small cost to countless owners. Crammed with money-making ideas. Invaluable for reference. Ideal for Factory, Home, Farm, Office or Workshop. As necessary as the dictionary and more useful for manufacturers, chemists and salesmen who put up products for profit.

\$3.50 postpaid. Canada or Foreign, \$3.85 U.S. Funds. (C.O.D. shipments U.S.A. only.) Immediate Shipment—Safe Delivery Guaranteed.

POSTPAID!
\$3.50
U.S.A.
\$3.85
FOREIGN

ADAMS BROWN COMPANY BOOKS OF APPLIED SCIENCE
Dept. 161, Chestnut Hill 67, Massachusetts, U. S. A.

MODERN SHOP TRAINING APPLIANCES

SERVICE REPAIR • INSTALL

Active and growing field for men who want good jobs or business of their own. Practical shop training on all kinds of appliances—washers, ironers, mixers, heaters, vacuum cleaners, stoves. Learn polishing, plating, motor rewinding, welding, how to use precision and necessary power tools. Good pay for repairing, maintaining, servicing, installing, selling electric appliances. Chance to get in on ground floor, go up fast! If over 17 and under 60 learn how you can get started. Write for FREE FACTS today. If a Veteran we'll take care of all details if you qualify under G.I. Bill.

APPLIANCE TRAINING SCHOOL, Dept. C-211
6312 N. Broadway, Chicago 40, Illinois

LEARN Accounting AT HOME - IN SPARE TIME

Bookkeepers, accountants, and secretaries are in great demand. Now is the time to prepare for the many opportunities open to business-trained men and women.

Write today for FREE copy of interesting new booklet, "Through Hill's To Success," which tells where the best positions are found and how you may train for them quickly at home in your spare time or in resident school.

Hill's is rated as one of America's leading business schools. Thousands of successful graduates. Nationwide Employment Service.

Hill's EXTENSION SCHOOL And Business University

619 West Main St., Oklahoma City 2, Okla.

HOW TO DESIGN, BUILD, AND FLY GAS-PROPELLED MODEL AIRPLANES

The only book that gives complete, easy-to-follow instructions on operating engines, designing a gas model, trouble shooting engines, the control-line model, flying and adjustments, structural design, experimental models, free-flight models, seaplanes and flying boats, propellers, airfoils, stunting models, materials.

GAS MODELS AND ENGINES

By WILLIAM WINTER, author of The Model Aircraft Handbook and WALTER L. SCHRODER
Get it today at your model store or \$3.00 from THOMAS Y. CROWELL CO., Dept. PM, 432 4th Ave., New York 16

EARN BIG MONEY BE AN ARTIST



Now you really can TEACH YOURSELF to be an artist with the help of one of the country's leading art directors—draw and paint for magazines, advertisements, calendars, etc. Big money, pleasant work. Cartooning, Pen & Ink Illustration, Figure Drawing, Water Color, Perspective, Oil Painting. Complete in 5 Books. ONLY \$1.

Genuine artists' models shown in actual professional poses. Over 100 illustrations. New Added Feature: progressive sketch sheets showing drawing from start to completion!

MONEY BACK GUARANTEE! Fill out coupon, enclose in envelope with one dollar bill or money order, and mail to

HOLLYWOOD ARTISTS
P.O. Box 2344 Los Angeles 54, Calif. (PM-3)

NAME.....

ADDRESS.....

CITY..... STATE.....

COMPLETE COURSE POSTPAID \$1.00

How to Make Easy, Big Profits

RADIO MAINTENANCE MAGAZINE offers the biggest bargain in the industry for alert, aggressive men who realize that radio servicing is just about the most lucrative of all fields... now and in the future. For only \$2.50 you can get 12 issues of RADIO MAINTENANCE MAGAZINE and, over a period of one year, you are assured of at least 365 of the newest ideas in radio servicing... ideas that will improve your technique, that make you a real radio authority, ideas that will enable you to set up your own profitable business, or get you a good, permanent, well-paying job.

RADIO MAINTENANCE MAGAZINE covers all problems of a radio shop... offers complete, comprehensive information on servicing AM, FM, Television, Test Equipment and P.A. Systems. Written by 18 best-known, best-qualified men in the field, RADIO MAINTENANCE MAGAZINE is a "must" for experts as well as beginners. Enter your subscription without delay. **TEAR OFF COUPON and mail today.**



NOT SOLD AT NEWSSTANDS - By Subscription Only

Only \$2.50

- How to eliminate noise in home receivers
- How to speed up your repair jobs
- How to install and service auto radios
- How to build your own test equipment
- How to put up a deluxe antenna for FM
- How to install new equipment efficiently
- How to install and service Television
- How to install and service public address
- Newest maintenance principles and technique

RADIO MAINTENANCE MAGAZINE
460 Bloomfield Avenue, Montclair, N. J.

Please enter my subscription as follows:

For 12 Issues at \$2.50 Name.....
 Occupation.....
 State whether Serviceman, Jobber or Dealer
 For 24 Issues at \$4.00 Address.....
 City.....
 Check Enclosed Zone..... State.....

ONE ISSUE FREE If Payment is Enclosed

Floyd Clymer's Popular MOTOR BOOKS

1946 INDIANAPOLIS "500" RACING BOOK \$1.00

80 ILLUSTRATIONS, drawings, charts. World famous driver, car data on 1946 race and highlights George Robson racing career. \$1.00. Large 320-page Indianapolis Race History every race since 1909, 1000 illustrations. Includes 1946 book. \$3.50.

FASTEST ON EARTH, by George Eyston, a racing history book of all world's straightaway land speed records since 1898. \$2.00. **MERCEDES-BENZ Grand Prix** race book, 176 pages, 93 photos, \$2.00.

Famous Motor Scrapbooks Nos. 1, 2 & 3 available, \$1.50 each; cloth-bound, \$2.50 each. **Power & Speed**, \$2.50. **Ab Jenkins' Race History Book**, \$1.50. **Speed—How to Obtain It**, \$1.50. All books postpaid. See our ad under Autos, Classified section.

CLYMER MOTORS, Dept. A-11
2125 W. Pico St. LOS ANGELES 8, CALIF.

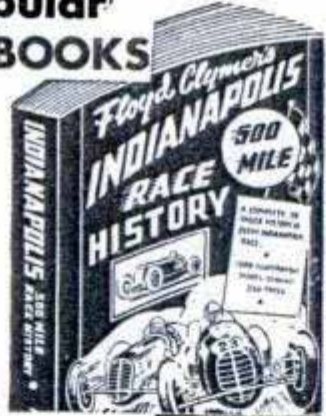

Send for FREE Motor Book Catalog

VETERANS! Here's Your Ring

Authentic insignia of your Honorable Discharge from Service in World War II. Heavy, Masculine Ring. Beautifully detailed in Raised Design. Sterling Silver or 10K Gold. Postage and Fed. tax included.

No. 1214 Sterling Silver. \$6.00
10K Solid Gold 18.00

Send for Circular of Service Jewelry.
EDWIN W. LANE CO., Dept. PM, 32 W. Randolph St., Chicago 1

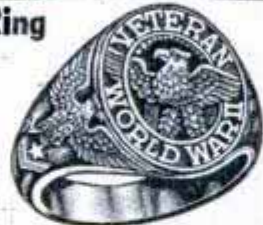

Locksmithing AND KEY MAKING Now Made Easy!

Practical up-to-date course teaches you how to pick locks, de-code, make masterkeys, repair, install, service, etc. New self-instruction lessons for every handyman, a homeowner, carpenter, mechanic, service station operator, fix-it shop, hardware dealer, gunsmith. 63 easy illustrated lessons. Low price! Satisfaction! Free details, write NELSON CO., 1139 S. Wabash, Dept. 1102, Chicago 5

Big Success—FREE Catalog yours

Become A Practical WELDING TECHNICIAN In 6 Months!

ARC WELDING presents one of today's most outstanding opportunities for steady income and future success.



WELDING has grown rapidly, replacing large and intricate castings, rivets, nuts, bolts, screws. It is commonly used in assembling cranes, hoists, bridges, structural steel work, ships, trains, airplanes, etc.

WELDING is used extensively in manufacturing farm machinery, new automobiles, refrigerators, air conditioning systems, etc. There is no limit to the application of welding in industry, increasing durability and reducing manufacturing costs.

GREAT DEMAND. There is a decided shortage of properly trained Arc and Gas Welders, Welding Technicians. For full information and catalog, send coupon TODAY.

MILWAUKEE SCHOOL of ENGINEERING

Institute of Electrotechnics

44th Year
PM-1146 North Broadway and East State, Milwaukee, Wis.

Without obligation send Free Booklet "The Dawn of a Gigantic Industry and Its Outstanding Opportunities."

Name..... Age.....
 City..... State.....
 PM-1146

SAY YOU SAW IT IN POPULAR MECHANICS

5 for \$1.00
12 for \$2.00
25¢ Each

Little Library of Useful INFORMATION

Here at amazingly low cost is the practical help and information you have always wanted. Articles in previous issues of Popular Mechanics have been classified according to subject and are now available in these handy reprint booklets. Check Titles wanted, clip ad and mail today.

BOOKLETS ON WORKSHOP EQUIPMENT

Power-Driven Saws—74: Complete details on scrollsaw, two circular saws, sliding cut-off saw, bandsaw.
Drill Presses, Plane, Grinders—79.
Sanders—80: Complete constructional details on 8 useful machines.
Wood & Metal-Turning Lathes—81: Two wood lathes, small metal-turning lathe.
Filing Machine, Hacksaw, Cutoff Wheel, Shaper—82.
Metal Lathe Tools You Can Make—101.
Workbenches & Tool Cabinets—47.
Spray Painting—94: Constructing spray guns, compressor, using spray gun.
From Pattern to Casting—91: How to make your own patterns and small castings.

BOOKLETS ON SHARPENING—USING TOOLS

Correct Measurements—106: How to use micrometers, gauges, calipers, etc.
Tool and Saw Sharpening—92.
Using & Sharpening Drills & Wood Bits—90.
Successful Wood Turning—32: All the information you need to master this art.
How to Read Blueprints—71: Tells you how to understand signs, symbols, and lines.
Metal Turning Lathe Kinks—99: Simple homemade tools, time and labor-saving shortcuts you can use.
Operating a Metal Turning Lathe—100.
Heat Treating & Case Hardening—102.
Working with Glass—103: Cutting, drilling, etching, blowing.

ELECTRICAL BOOKLETS

Rewinding & Servicing Electric Motors—78: Repairing and rewinding a.c. and d.c. motors. Locating trouble. Converting auto generators into 110 v. a. c. motors.
House Wiring—89: All the information you need to do a complete wiring job or install extra outlets.
Electromagnets & Solenoids—44: Designing and building.
Transformer Construction—41: Easy-to-understand instructions for all kinds of transformers.
The Boy Electrician—43: Easy-to-build motors, experiments.
Soldering & Brazing—17.
Arc & Spot Welders—5: Building and operating 110 v. a. c. arc and spot welders.
Treasure Finders—13: Build your own treasure finder and metal locator. Details for both large and small radio types.

ELECTROPLATING BOOKLETS

Electroplating with Copper, Nickel, Chromium, Lead, Zinc, Cadmium—86.
Plating Leather & Other Non-Metallic Objects—Plating with Gold, Silver, Alloys—87.

HOME IMPROVEMENT BOOKLETS

Simple Home Improvements—104: Modernizing: making storm sash, ironing boards, etc.
Building Extra Rooms in Attic—23.
Attractive Basement Playrooms—24.
Lower Your Fuel Cost—31: Practical kinks that will save you hundreds of dollars.
Hanging Wallpaper—38: Tricks of hanging wallpaper, removing old paper, etc.
Curing Leaky Basements—45.
Fitting Home Game Room—55: Construct own game & tennis tables, shuffleboard court, action game, portable playrooms.

Ridding the Home of Insect Pests—107: Exterminating and protecting against moths, flies, termites, mosquitoes, etc.
Built-in Fixtures—78: Step and space-saving kitchen units, built-in beds, corner cabinets, vanities, linen chest.
Constructing Indoor & Outdoor Fireplaces—88: Stone fireplaces, portable mantels, garden fireplaces.

GARDENING BOOKLETS

Backyard Gardening—39: Selecting, planning and getting the best results.
Lawn & Garden Novelties—72: Jig-sawed ornaments, parkway numbers, sundials, flower boxes.
Trellises, Pergolas, Fences—76.
Lawn & Garden Furniture—77: Modern bent-tube furniture, arbor and seat combinations, swings, lawn chairs.
Playground Equipment—73: Two playhouses, ferris wheel, roller coaster, treadmill, play store, slide, two merry-go-rounds.
Colored Concrete Garden Furniture—6: Garden benches, pottery, flower boxes, bird baths and sundial pedestals in colored concrete. How to build small concrete mixer.
Bird Houses—7: Easy to build homes for all kinds of birds.
Farm & Garden Tractors—8: Two tractors you can build from old automobile parts.

CRAFT WORK—HOBBY BOOKLETS

Complete how-to-make-it instructions for hundreds of practical projects.

Working with Plastics—61: Using brilliant-ly-colored plastics in craftwork.
Magazine Racks—49: Ten attractive racks.
Clock Cases—50: Large Hall, Colonial wall and mantel, ship's wheel, miniature grandfather, desk, Spanish style banjo.
Serving Trays for Every Occasion—53: Fourteen different designs.
Children's Room Furniture—51: Twelve attractive pieces.
Book Ends—52: Ten designs offer good selection.
Small Tables—54: Modern and colonial styling.
Smoking Stands—56: Seven designs given.
Jigsawed Novelties—57: Sewing kits, string holders, place-card holders, plywood kitchenware, plant and flower holders, coin banks, door stops, drawer pulls.
Desks—58: Colonial writing desk, two modern-type desks, student's study desk of plywood, combined chest and writing desk.
Book Cases—59: Eight designs.
Doll House & Doll Furniture—60.
25 Shelves You Can Make—64.
Novelties Turned on Lathe—62.
Inlay Pictures—Veneering—63.
Whittling and Wood & Soap Carving—65.
Action Toys—66: 21 easy-to-make toys.
High Flying Kites—67.
Windmills & Weathervanes—68.
Lamps in Wood, Metal, Plastic—69: Selection of 14 designs.
Metal Craft—28: Brass tapping and making of novelties both decorative and useful.
Small Looms—37: Building hand looms for weaving rugs, etc.; leather novelties.
Plain & Novelty Wood Finishing—40.
Gem Cutting—42: How to cut and polish semi-precious stones.
Rustic Furniture—18: How to build chairs, benches, tables, gates, summer house, etc.

BOAT BUILDING BOOKLETS

Build a boat at home—you can do it

14 Ft. Outboard Runabout—2: Here is a fast 14 foot V-bottom boat. Suitable for motors of 4 to 24 hp., estimated cost, \$30 to \$40.
14 Ft. Sailing Dinghy—26: This 14-foot boat combines strength and light weight. It carries 140 sq. ft. of canvas and weighs about 350 pounds. Actual photographs and diagrams illustrate every detail.
21 Ft. Sloop—46: Every fact needed by the amateur boat builder to construct this craft which carries eight to ten persons.
Rowboats, Bicycle Boat, Small Dinghy—83: All the information you need to construct four low-cost boats.
Small Sail Boats—84: 12-ft. sailing dinghy, 8-ft. "training ship" for young sailors, how to sail a boat.
Two Outboard Runabouts—85: 14-Ft. family outboard weighs about 400 lbs. and 12-ft. plywood outboard weighs about 110 lbs. Both are V-bottom type.
Build Your Own Canoe, Kayak, Surfboard—30: Complete details on 18-ft. Canadian-type canoe, 17-ft. kayak, and 12-ft. hollow surfboard.
Fast Class-E Ice Yacht—22: Build your own Class-E ice yacht. Every detail of construction carefully explained.

AUTOMOBILE BOOKLETS

Automobile Kinks and Shortcuts—10: Money-saving hints on upkeep, operation.
Building Trailers—27: Small Streamlined house trailer; several utility trailers.
Motor-Driven Midget Car & Scooter—34: Both use gas engine of washing machine type.
Curing Auto Electrical Troubles—95.

PHOTOGRAPHY BOOKLETS

Save Money by constructing your own photo equipment.

Photo Enlargers—1: Condenser lens type; simple vertical; horizontal.
Photo Printers & Dryer—25: Describes three practical printers, timer and negative dryer.
Photo Darkroom Equipment—96: Cabinets, light-tight box, timer, agitator, washer.
Picture Projector, Trick & Table Top Photography—97: Projectors that enlarge magazine illustrations and shop drawings. Tips for table toppers, photomontages, tricks.
Photo Kinks—98: 63 time and money-saving ideas you can use.

FORMULA BOOKLETS

Cleaning Preparations—11: Easy-to-make cleaners for walls, glass, etc. Removing fabric stains.
Cosmetic Formulas—12: Hand lotions, creams, rouge, bath salts, beauty clay, lip-sticks, etc.
Re-Silvering Mirrors—70: Formulas for silvering and coloring.

MISCELLANEOUS BOOKLETS

Knots and Ropework—105.
Chemical Experiments—93: Easy-to-perform experiments. Inexpensive lab.
Taxidermy—9: How to prepare skins and obtain life-like poses.
Log Cabins & Tourists Cottages—14: Year-round log cabins; inexpensive tourists' cabin.
Magic for Everybody—29: Simple tricks to puzzle your friends.
Trapping Small Animals—33: How to lure fur bearers, prepare bait and traps, dress skins.
Tricks of Training Your Dog—35.
Small Furnaces—36: Build own gas or electric.
Telescopes—20: Design and construction.
Poultry Houses—108: Structures, brooders and incubators.
Guns and Decoys—109: Cleaning, shooting; making decoys.

POPULAR MECHANICS PRESS,
200 E. Ontario St., Chicago 11, Ill.

I enclose (U. S. bills may be mailed if carefully wrapped)
for "Little Library" booklets numbers:

Name
Address Zone
City State

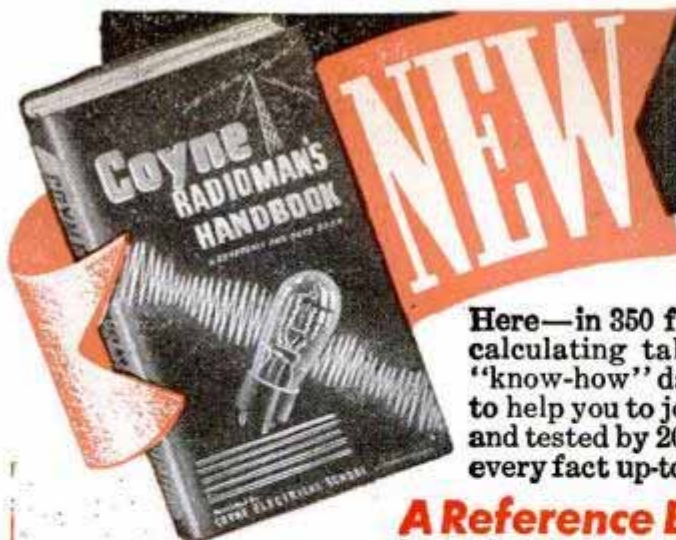

RADIOMAN'S HANDBOOK

A Pocket Library of Radio Facts

USE IT FREE for 7 Days

Here—in 350 fact-packed pages are authentic, up to date formulas, calculating tables, hook-ups, diagrams, wiring charts and other "know-how" data to bring you information you need on the job—and to help you to jobs of bigger pay and greater responsibilities. Written and tested by 20 years shop experience of the Coyne Electrical School; every fact up-to-date, practical, authentic. Yours to use for 7 days Free.

COYNE RADIOMAN'S HANDBOOK

Over 350 pages packed full of "know-how" facts about...

- Power Formulas
- Antenna Facts
- Coil Data
- Receivers
- Receiving Tubes
- Circuits
- Wiring Tables
- ...hundred of helps you need to get ahead in radio.
- Balance System
- Amplifiers

A Reference Book for Radiomen, NOT a Textbook

If you design, make, repair or maintain radio or television equipment this book contains the information to help you convince the boss that you are the man with the answers. THIS BOOK SAVES YOU HOURS OF TIME—GIVES YOU THE RIGHT ANSWERS INSTANTLY—enables you to do better work and to have complete confidence in yourself no matter what radio problems come your way.

Send No Money!

The coupon is not an order for the book—only a request to see it for 7 days FREE. If you don't think this book is worth several times \$3.25 send it back and you will owe nothing. If you decide to keep it just send \$3.25 after 7 days examination. Rush coupon!

MAIL THIS FREE TRIAL COUPON

EDUCATIONAL BOOK PUBLISHING DIVISION
COYNE ELECTRICAL SCHOOL, Dept. 86-R7
500 S. PAULINA ST., CHICAGO 12, ILL.

Send me the New Radioman's Handbook on 7-day free trial, I'll either return it in 7 days or pay \$3.25 cash and the book is mine.

Name _____

Address _____

City _____ Zone _____ State _____

If you want Radioman's Handbook sent C. O. D. (you pay postman) CHECK HERE. Same 7-day free trial money-back guarantee.

Educational Book Publishing Division

COYNE ELECTRICAL SCHOOL
500 S. Paulina St., Dept. 86-R7 Chicago 12, Ill.

Learn NOVELTY MANUFACTURING!!



Today's best bet for a business of your own starting with little money is the Casting of Wall Plaques, Book Ends and other Novelties. Large orders and profits waiting. Start in garage or basement, quickly learned. NO EXPENSIVE MOLDS TO BUY. Our system has started many on the road to a splendid financial future. Write today for free particulars.

PLASTEX PRODUCTS, 127 Clement St. San Francisco (18), Calif.

Get Started QUICK in DRAFTING

I Will Train You Until You Get a GOOD PAY JOB And I'll furnish all WORKING TOOLS

Get a better job with more pay and pleasant working conditions. Get into Drafting—where all products start. I will train you at home—give you experience—on the same kind of jobs you will do with the best paying firms. I furnish instruments, and all equipment when you start. Write today for vital facts and FREE Book. Give age.

ENGINEER DOBE, Div. 18, Libertyville, Ill.

Say You Saw It in POPULAR MECHANICS



LEARN PORTRAIT PAINTING AT HOME

• Previous art training or talent NOT necessary. This new Stuart System teaches you, in 11 simple, easy-to-follow lessons, to make exact charcoal and oil likenesses. Guidance for your every step. Send for free book today.

STUART STUDIOS,

121 Monument Circle, Room 611, Indianapolis 9, Ind.

Please send me free book and outline of lessons.

Name _____

Street _____

City _____ State _____

PARTS FOR MODEL MAKERS



ELECTRICAL "BUGS" INVENTORS AND MECHANICAL WIZARDS K3 AND K9 GUN-SIGHTS

TEST YOUR WITS! Create gadgets, electrical devices, etc. Great gifts for budding geniuses, mechanics, shut-ins, schools, etc. Perfect war souvenirs!

HUNDREDS OF PARTS
K3 GUN-SIGHT UNIT contains fascinating array of parts usable in 1001 ways! Amazing 1/50th H.P. 24 V. D.C. High-Speed Motor. Many wires, connectors, etc. Original cost approx. \$3000.00. You pay only..... **\$17.50**

EXCITING INVENTIVE CHALLENGERS

Countless gears, shafts, miniature bearings, lenses, dials, knobs, switches, clutches, electrical components, etc. Veritable Tinkers Paradise!

K9 GUN-SIGHT — comprises 3-1/50th H.P. 24 V. D.C. Motors, computer, sighting head, range pedal and connecting cables. A BIG "BUY" Hogular and level gears, switches, shafts, bearings, electrical parts, etc. Shipment includes (1) computer, (2) sighting head, (3) range pedal, (4) cables. War price about \$4000.00. Yours for only..... **\$27.50**



SHIPPED PREPAID ANYWHERE IN CONTINENTAL U.S.A. CASH WITH ORDER 24 V. quilted electric Bomb-Sight heating pad, 5 ft. cord, twist-lock connector, thermostat, 20" zipper, No. HP 10, only **\$1.49**

WARSHAWSKY & LAZAR
2126 S. Michigan, Chicago 16

SPECIALIZED TECHNICAL TRAINING

Prepare in 6 months to 3 years for specific technical occupations. Select the course that interests you most.

- * Institute of Electrotechnics
Applied Electricity, Electrotechnics,
Radio and Electronics
- * Welding Institute
Gas, Aircraft and Arc Welding
- * Refrigeration, Heating and
Air Conditioning Division
Service or Technician
- * College of Electrical Engineering
B.S. Degree With Major in Machinery
or Electronics

WRITE FOR MORE DETAILS AND FREE BOOKLET

MILWAUKEE
SCHOOL of ENGINEERING
Institute of Electrotechnics

"Has Served Industry 44 Years"

Milwaukee School of Engineering, Dept. PM-1146A
N. Broadway and E. State, Milwaukee, Wis.
Without obligation, send me free booklet "Career Building" and
more details on course in.....

Name.....Age.....

Address.....

City.....State.....

BOY IT'S KEEN! A REAL METAL "G-BOY" REPEATING CAP PISTOL RAPID FIRING



Looks and feels like an Automatic "45." It's made of strong lightweight aluminum... with a plastic "Pearl" handle. It's easy to reload. Send check or money order for immediate shipment—express charges collect. (Smallest order \$1.00. No C.O.D. orders).

ACTUALLY SMOKES ON FIRING
HAS LOUD EXPLOSIVE REPORT

\$1.95
Gun Only

Box of 5 Rolls
Caps only .15c
7 Boxes . \$1.00

GENUINE COWHIDE HOLSTER FOR FAMOUS "G-BOY" GUN . \$2
UTILITY STORES, 117 S. Wabash Avenue
DEPT. LL-6, CHICAGO 3, ILLINOIS

3000 Designs, Drawings & Sketches of MECHANICAL MOVEMENTS, DEVICES, APPLIANCES, CONTRIVANCES AND DETAILS

Every conceivable kind of mechanical motion and movement is briefly explained and illustrated in this unusually valuable and helpful book. As far as known, the only work in existence which aims to provide side by side suggestion sketches of the various methods in use for accomplishing any particular movement or work. Every engineer, inventor or mechanic finds the need of devising, simplifying or improving some mechanical process or method. No need to rely on memory or experience now!

SUCH AS: Accumulators, Anti-friction, Ball and socket, Bearings, Blowings, Brakes, Cams, Chain Gear, Chopping, Chucks, Circular motions, Clutches, Conveying, Cranes, Cranks, Cutting, Doors, Drilling, Eccentrics, Engines, Expanding, Filtering, Gears, Governors, Grips, Grinds, Heating, Hinges, Hydraulics, Indicators, Journals, Levers, Links, Lowerings, Lubricators, Measuring and Weighing, Mixing, Nozzles, Parallel Motions, Pipes, Pistons, Power, Propulsion, Raising, Ratchets, Rotary Engines, Safety Appliances, Shafting, Signals, Slides, Sounds, Speed, Spindles, Starting, Striking, Swivels, Traps, Turbines, etc.

If you work with machinery of any kind, you need this book. 355 pages, durably printed and bound in cloth. Mailed postpaid if you send order with \$2.98, or sent C.O.D. plus 27c postage. Money back if not exactly as described or if not satisfied.

Knickerbocker Pub. Co., 120 Greenwich St., Dept. M-7, New York 6, N. Y.

Handle Hundreds of Dollars Daily* IN YOUR OWN OFFICE

DEDUCT BIG COMMISSIONS FOR YOURSELF . . .

*That's the opportunity in this line of business which has thousands of successful offices in operation throughout the U. S. Many earn up to \$5,000-\$15,000 yearly. Others make good money in spare time. Have an office of your own. Earn while you learn. Experience unnecessary. No selling or goods to buy. Start at home, desk or office space. Complete training course sent at once to guide you in setting up and operating in 60 days or less. Easy terms. Money-Back agreement. Complete details FREE! No obligation. No salesman will call. Write Now!



FRANKLIN CREDIT SCHOOL, Dept. 1, Roanoke 7, Va.

AXONOMETRIC DRAWING

...the universal
picture language

PICTORIAL DRAFTING Modern Way of Drawing

This new 20-page booklet explains the principles of pictorial engineering drafting, as utilized in isometric and dimetric projection.

"Axonometric Drawing... The Universal Picture Language" by Paul F. Boehm is simple and easy to understand. Sent 10c postpaid.....only

JOHN R. CASSELL CO.
110 West 42nd Street, New York 18, N. Y.

Be an INDUSTRIAL ENGINEER

Industrial Engineering, today's newest great field in management enterprise wants thousands of trained men. Highest pay and many job opportunities now open. I. E. C. training quickly takes you out of the class of 30,000,000 non-professional workers. Get set for life—NOW! Qualify quickly under professional management engineers. The intensive I. E. C. course completely covers every branch of this newest, most vital science of industry. Fall and winter day and night classes starting now in Chicago. Dormitory facilities. Approved for G. I. training. Many work while taking course. Send for free information. INDUSTRIAL ENGINEERING COLLEGE, Dept. PM-11, 3309 West Washington Blvd., Chicago 34, Ill.



Today's Big
Opportunity
Make \$3,600
to \$10,000
a year!



RADIO TRAINER

Learn to design larger radios by building this simplified battery tube set model. Sensitive circuit brings in distant and local stations. Covers broadcast and short wave bands. Compact and portable. Uses no electricity. All parts furnished, including Tube, Batteries, Double Earphones, Aerial, Ground Wire and Easy-to-follow illustrated instructions. No soldering required. Complete, postpaid only \$9.95. Or send \$1.00—shipped C.O.D. for balance plus postage. Money-back guarantee. Order today! An Ideal Gift.

B. G. FLEMING MFG. CO.
Dept. 11-A, 906 Main St., Cincinnati 2, O.

LEARN TRIG QUICKLY—EASILY

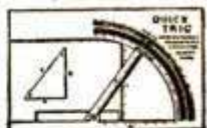

WITH QUICK TRIG. BY COMPETITIVE TESTS, it was found that QUICK TRIG gave answers faster to one with a slight knowledge of trig than to an expert on trig with a slide rule. Simply set the slides and read the answers for all three sides and angles of a triangle. Also gives degrees, sines, cosines and tangents of angles. Entirely automatic. Easy instructions included. We mail C.O.D. plus postage or enclose \$1.00, the full price, and we will mail postpaid. Send now for your QUICK TRIG, to REED MFG. CO., 124-L W. 4th St., Los Angeles 13, Calif.

LEARN CARTOONING

HAVE FUN! MAKE MONEY! Cash in on your sense of humor AT HOME — BY MAIL. No experience needed to start. Write today! Send 10c for TRIAL LESSON and full particulars.

Moon Gag Cartoon School, Dept. A Fall Creek, Wis.

REFRIGERATION

BIG SERVICE MANUAL—History, Physics, How heat is transferred, Compression principle, domestic refrigerators, absorption systems, refrigerants, different types, trouble shooting, general servicing tips, etc., etc. Only \$1 postpaid. 7-day money back guarantee. Write Padell Book Co., Dept. 37, 830 B'dway, N. Y. C.

Optical Illusion makes any view or object you wish to draw appear on the drawing paper in rich detail. Low-cost invention makes drawing simple tracing. Educates and amuses children and adults. Practical for artists. Free details. Dept. 21L, BEELER ENTERPRISES, No. Hollywood, Calif.

WAR SURPLUS Without bidding, new products, stock articles, how to buy, prices, addresses. Advance information. Catalog sheets, free literature. If you want sample catalog sheets by return mail include \$1.00. THE WAYNE ENGINEERING COMPANY, Dept. 1111, Greenville, Ohio

PLASTICS

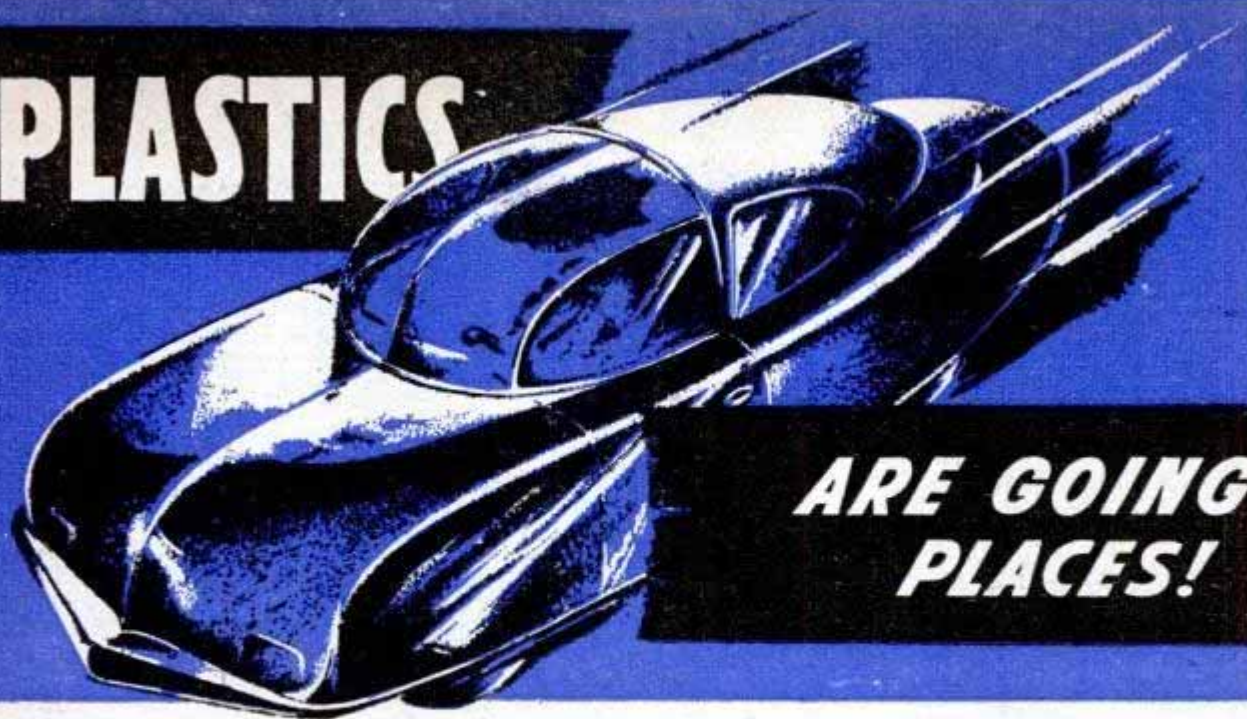

ARE GOING PLACES!

PREPARE **NOW** TO GO ALONG!

Every day you read of new and wonderful uses for plastics in this, our postwar world. The wide range of objects that can be made of plastics—from buildings to surgical appliances, from cars to textiles—challenges the imagination.

THE PLASTICS ERA IS HERE—Are you ready? Opportunities are opening in every branch of the plastics industry. Plastics know-how is necessary in practically every type of manufacturing. Are you capable of grasping these opportunities? If you want a choice position in this expanding plastics field, or a business of your own, act *now*—get in on the ground floor!

EXCLUSIVELY PLASTICS—Plastics Institute is America's oldest and largest educational organization which devotes all of its facilities exclusively to plastics.

A COMPLETE COURSE—You learn the various phases of plastics from this course . . . materials, designing, molding, fabricating, laminating and testing. You acquire a basic knowledge of plastics that can be in-

valuable to you in acquiring the type of position you want in this great new industry.

YOU LEARN AT HOME—Your present work need not be interrupted, and this thorough, easy-to-understand course requires no previous technical experience.

YOU MAKE THINGS—We supply materials. To give you practical experience in working with plastics, we supply handsome, colorful, rods, sheets and tubes of plastics from which you make useful, attractive creations. You cement, saw, buff, form, dye, decorate, cast and laminate various types of plastics. You also design your own plastics articles—develop your own ideas. You may earn money while learning.

START YOUR FUTURE TODAY—Mail the coupon below, now! You will get an interesting, illustrated, free booklet with valuable information about plastics. You will see how, at small cost you can prepare for a future in this important industry while carrying on your present work. Clip this coupon and mail it TODAY!

APPROVED FOR VETERANS

Plastics

INDUSTRIES TECHNICAL INSTITUTE

NEW YORK CHICAGO LOS ANGELES

Plastics Industries Technical Institute
Dept. PM6-11 1601 S. Western Ave., Los Angeles 6, Calif.

Mail in Envelope or
paste on penny postcard

Gentlemen: Please send me the booklet "Opportunities in Plastics" and information on your training. I understand there is absolutely no obligation.

Name (PRINT) Occupation

Street (PRINT) Age

City Zone State

Important: Please fill out coupon *completely*. If Veteran, please check.



FREE BOOKLET
Send For It Today!

WAR BARGAINS in LENSES and PRISMS

NOW! MAKE YOUR OWN BINOCULARS!



Complete Set of LENSES and PRISMS from Navy's 7X 50 Model

Save Up to \$150.00

Here's an unusual opportunity to secure a fine set of Binoculars at a tremendous saving of money. Build them yourself with all of the very same optics contained in the Navy's 7 Power Glasses. Or you can construct a Monocular (1/2 a Binocular) in which case exactly one half quantities of the Binocular Components will be furnished. All Lenses and Prisms are in excellent condition. Lenses are cemented and have the new low reflection coating. Complete assembly directions included for either project.

- Stock #5102-H Binocular Set of Lenses and Prisms**\$25.00 Postpaid
- Stock #5103-H Monocular Set of Lenses and Prisms**\$12.50 Postpaid
- CARRYING CASE WITH STRAPS FOR 7X 50 BINOCULARS**—Modern synthetic rubber construction—brand new—a regular \$12.00 value.
- Stock #44-H (Price includes tax)**.....\$4.80 Postpaid
- BATTERY COMMANDER'S TELESCOPE, MODEL BC-65**—Complete with Tripods . . . 10 power. New, in perfect operating condition. A Binocular type instrument. Govt. cost approx. \$1300.00 each.
- Stock #900-H**\$245.00 Postpaid
- PRISM TELESCOPE**—All the Lenses You Need to build your own 20 power Telescope! No mounts. Has wide field of view.
- Stock #5012-H**\$7.25 Postpaid
- MAGNIFIER SET**—5 Magnifying Lenses . . . powers from 1 to 10. Various diam. for many uses. **Free Booklet** on Home-made magnifiers included.
- Stock #1026-H**\$2.00 Postpaid
- 35 MM. KODACHROME PROJECTING LENS SET**—Consists of Achromatic Lens for projecting, plus a Condensing Lens and piece of Heat Absorbing Glass with directions.
- Stock #4025-H**\$1.95 Postpaid

AIR FORCES GUN SIGHT

With Polarizing Variable Density Attachment

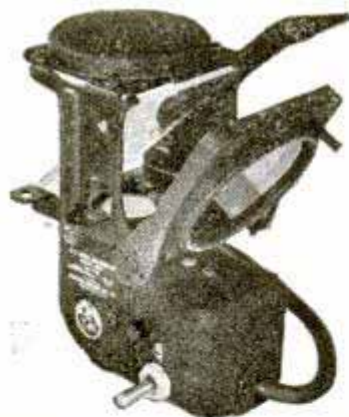

Can be used as Slide Viewer, or take it apart and you can get Polarizing Variable Density Attachment, Mangin Concave Mirror, Reflector Plate, Metal Reticule, Window, Lamp Housing, Ring and Bead Sight. The Polarizing attachment alone is worth many times the price of entire unit. Consists of 2 Polarizing Filters mounted with small handle which rotates one around the other. May be used in Photography, Research, Experiments, as Light Dimmer, etc.

Stock #908-H \$5.00 Postpaid
Same Unit Without Polarizing Attachment

Stock #916-H \$2.50 Postpaid

BOMBER SIGHTING STATION—A double end Periscope Type Instrument of highest precision. 6 ft. tall, shipping wt. 360 lbs. Orig. cost \$9.850. Consists of numerous Lenses, Prisms, Mirrors, Gears, Motors, Metal Parts and Electrical Gadgets.

- Stock #914-H** \$50 F.O.B. Oklahoma
- ACHROMATIC TELESCOPE OBJECTIVE LENSES**—Cemented—diam. 52 mm. F.L. 8 1/2 inches. Slight seconds.
- Stock #6188-H** \$3.50 Postpaid
- TANK PRISMS**—90-45-45 deg., 5 3/4" long, 2 1/8" wide, finely ground and polished.
- Stock #3004-H Silvered Prism (new & perfect)** \$2.00 Postpaid
- Stock #3005-H Plain Prism (new & perfect)** . \$2.00 Postpaid
- Stock #3100-H Silvered Prism (Second)** . . . \$1.00 Postpaid
- Stock #3101-H Plain Prism (Second)** \$1.00 Postpaid

We have literally millions of war surplus lenses and prisms for sale at bargain prices. Write for Catalog "H"—Sent Free! Satisfaction Guaranteed Order by Stock No.

EDMUND SALVAGE COMPANY
P. O. AUDUBON, NEW JERSEY

DOUBLE your INCOME IN YOUR SPARE TIME

LEARN SILK SCREEN PROCESS

Jealously Guarded Trade Secrets NOW Available to You

Develop a Profitable Business of Your Own . . . or a Hobby



Prepare yourself for an interesting top paying position. Thousands of jobs open. Silk Screen Process signs, displays, Xmas cards, toys, etc. IN GREAT DEMAND THE WORLD OVER. You may make enough the second week to pay for the entire course. EASY TO DO . . . EASY TO LEARN. No education or mechanical knowledge required. BOOKLET with 3-color Silk Screen Processed cover and Samples sent FREE. Write NOW!

COURSE INCLUDES A COMPLETE KIT OF SUPPLIES

CALIFORNIA SCHOOL OF SCREEN PROCESS

Dept. PM-116 2710 So. Spaulding Avenue, Los Angeles 16, California

MAKE MONEY CASTING AT HOME FREE FACTS SENT



Make hundreds of Plaster Casts, quick, easy. Sell output to stores, novelty shops, etc. Enormous profits. No experience. Very little capital needed. Start in basement, garage or workshop. Complete, simple instructions anyone can follow. Start now while merchants are begging for merchandise to sell. Rush.

PLASTIC ARTS STUDIOS, R. R. 5, Dept. 29, Muncie, Ind.

USE Fine Walton Wheels to Make Your Own WAGONS—SHOPPING CARTS and RACERS



65¢

Each in Sets of 2 or 4—plus 10¢ ea. for postage. 4 1/2-inch with 3/8-in. bushing.

Coaster wagons, scooters, shopping carts, bike trailers, golf bag carriers, etc., are easy to make. Use fine Walton Def-use Wheel! They're strong welded pressed steel construction. Ideal for making many things for use and play. Solid rubber tires. Red enameled. Send check or money order. No C.O.D.'s. Dealers and manufacturers write.

WALTON WHEEL COMPANY, Dept. J-2
Plankinton Bldg. Milwaukee 3, Wis.

LAW

STUDY AT HOME for PERSONAL SUCCESS and LARGER EARNINGS. 38 years expert instruction—over 108,000 students enrolled. LL. B. Degree awarded. All texts furnished. Easy payments. Send for FREE BOOK—"Law and Executive Guidance."

AMERICAN EXTENSION SCHOOL OF LAW
Dept. 71-M, 646 N. Michigan Ave., Chicago 11, Ill.

SAY YOU SAW IT IN POPULAR MECHANICS



AN OIL BURNER HANDBOOK

Learn how to repair and service oil burners. This book is different! It uses everyday language and takes guessing out of oil burner work. The chapters discuss in detail Domestic and Industrial Burners. Order from MASTER PLUMBER PUBLISHING CO. Eagle Building, Rocklyn 1, N. Y.

Self-Explanatory
Copyright-Permanence Instructions \$10.00 Complete
Shows Precisely What To Do & Exactly How To Do It.
Remit To R. Locker, 2804 Lucas/Hart Road,
Saint Louis 20, Missouri

CALLING ALL CHESS PLAYERS

FOR POSTAL CARD PLAY. INSTRUCTIVE SPECIMEN GAME AND INFORMATION SENT ON REQUEST. WRITE TODAY. ASK FOR DEAL C—FREE

PIONEER GAME CO., PASADENA 17, CALIFORNIA

SIGN MEN EARN WELL

Tremendous demand always for glass and electrical sign men. Post war expansion assures growing need for more sign men. Only small investment required to start own business. Write today for full FREE particulars. SIGN SERVICE, Dept. S-301, TAGUS, N. DAK.

PLASTIC HOMES



New Building Material! Resurface old homes; build new ones. Colorful, Beautiful! **LIQUID MARBLE—**Color-grazed! Moulded, brushed, sprayed, **SANITARY COMPOSITION FLOORING—**Dustless, noiseless; put on like plaster; resilient—yielding as cork; lasts like stone; plain or marked in tile design. **RUBBERLASTIC Mold Compound—**Mold novelties, statuary, toys, gifts, plaques, plaster animals. **COLORS POTTERY—**Birds, bath, garden furniture, vases. **TILEX** colored roofing. Illustrated literature FREE. **RAPID MARBLEIZING SERVICE, Dept. 10-B, Edwardsville, Illinois**

HOW TO MAKE MONEY BY MAIL

Down-to-earth facts, directions (illustrated) for running business profitably, using expertly for YOUR good fortune the employees, trains, planes which Gov't places at your disposal **CHEAP**. Get orders by mail, ship by express or freight or mail, get out of the kindergarten . . . 14th edition, enlarged to 576 pages, now selling. It's YOUR winner. Make this year and the following years worth more. THIS knowledge really **PAYS OFF**.

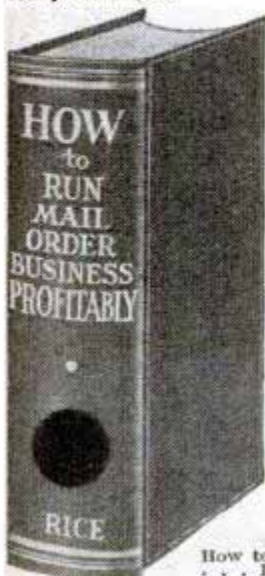

THE EASY WAY to start new or expand your present occupation. Do it NOW. Extraordinary plain, simple skill, know-how. No theory. Fact story of rich experience of author E. Rice day-by-day. How many times have we heard: "I wish I had some money, this patent would earn me a fortune," or "why can't my crop pay better?" or "I wish I knew how to sell this gadget myself," or "why should my boss alone do this when I too know how the money is made?" . . . Listen, **YOU DO NOT NEED MONEY TO START THIS RICE WAY**. His method automatically pays all bills same day rendered, no bank loans, pay as you go, no borrowing from relatives or friends, no salesmen. Also no worry, quickly a home of your own all paid for. Rice paid off \$5000 in mortgages a year after using this skillful idea.

46 Years of PROOF

Sounds fishy? Sure, but this has been done steadily for 46 years, depression or no depression, by the author; that is why he wrote this book, to pass the good word along. Make it go with anything you have which is salable, or with what you are now doing. Rice made his pay plan go from the start when living in one room in a city lodging house. Turn your city or country home, your work, your hobby, into money. How to get orders coming steadily at cost of only \$4 for each \$100 taken in. The popular error to avoid in trying for sales. Business won free while others have to pay for it.

How to conceive the money-getting advertisement. Profitable changes from ordinary ideas and methods. Not usual cut-and-dried pattern, 165 adventures, a dictated book in everyday talk by Rice doing day by day what he discloses in his book can be done by his method. No dictionary writing. . . . Read how others are profiting big.

Take a chance on this book being worth a fortune to you and yours and send \$2.95. Book mailed same day order is received. Or ask two friends to chip in 98 cents each with your 99c to get this book. Hundreds of buyers whose letters we show you declare emphatically its superlative goodness. Follow its easy pattern for success. Cloth-bound, 576 pages, 8 1/2 by 5 1/2. Best seller, 14th edition now selling. Cut out the \$2.95 HOW BOX here, pin or stick it to sheet of paper bearing your name and address, mail in envelope with money order or check for \$2.95 to

HOW
\$2.95

HOWARD ST. HOUSE, Melrose 76d, Massachusetts



MAKE MORE MONEY BE YOUR OWN BOSS!

\$1.00 VALUE
25c
40,000
WORDS

In "CASH IN" you now get THE real money-makers—dozens of profitable tested mail order plans, confidential business secrets, dozens of practical tested formulas, successful tested schemes—actual experiences of men who have started on a shoestring—with less than \$10 capital.

25c a copy postpaid. Send U. S. stamps, money order, or coin.

MONEY BACK GUARANTEE

NATIONAL PLANS COMPANY
P. O. Box 26L, Station N, New York 23, N. Y.

Say You Saw It in POPULAR MECHANICS

CARTOON TO SUCCESS!



Learn to cartoon! Big pay! Easy, enjoyable work! Cartoon course, gag course, anatomy course and business course full of plans, markets, ideas. Drawing set and criticisms. All one low price! Rush card for details!

HARTMAN SCHOOL, 2776 California Court, Lincoln 1, Nebraska

MAGIC LIQUID MAKES PHOTOS APPEAR

On Scarfs, Ties, Stationery, Etc.

Reproduce any snapshot on cloth, leather, wood, paper. Simply apply liquid. Like magic photo appears within 2 minutes in broad daylight. Harmless to negative. Won't wash off. Full colors included. Complete kit for 300 photos only \$1.50. Send no money, just name. Pay postman \$1.50 plus few cents postage on delivery. (Foreign, \$2.00 money order only. Order today.

STYLE-ARTS, Inc., Dept. 1-A, 4649 Broadway, Chicago 40, Ill.



FIND OUT WHY THE DEAF CALL IT A MIRACLE

THIS ONE TINY UNIT IS ALL YOU WEAR



About 1/8 size and weight of old-style hearing aids

You'd call this new Beltone Mono-Pac Hearing Aid a miracle, too, if you had been wearing a clumsy, annoying, battery pack strapped to your body with entangling wires, and then suddenly found the new Electronic Beltone. It's a single-unit hearing aid—so small you can hide it with the palm of your hand—so light you forget you are wearing it—so thin it is lost from sight—so efficient you bless the day you learned about it.

Those are a few of the reasons why more people are wearing Beltones than all other one-unit hearing aids combined.

GET FREE BOOK ABOUT HEARING PROBLEMS and about the

NEW Beltone MONO-PAC HEARING AID



FREE BOOK—MAIL COUPON

BELTONE HEARING AID CO., Dept. PM-11
1450 West 19th Street, Chicago 8, Illinois

Please send me, without obligation, FREE information concerning the new Beltone with the amazing X-Cell which out-performs units 5 times its size.

Name.....

Address.....

Town..... Zone..... State.....

Just look at
that reaction—

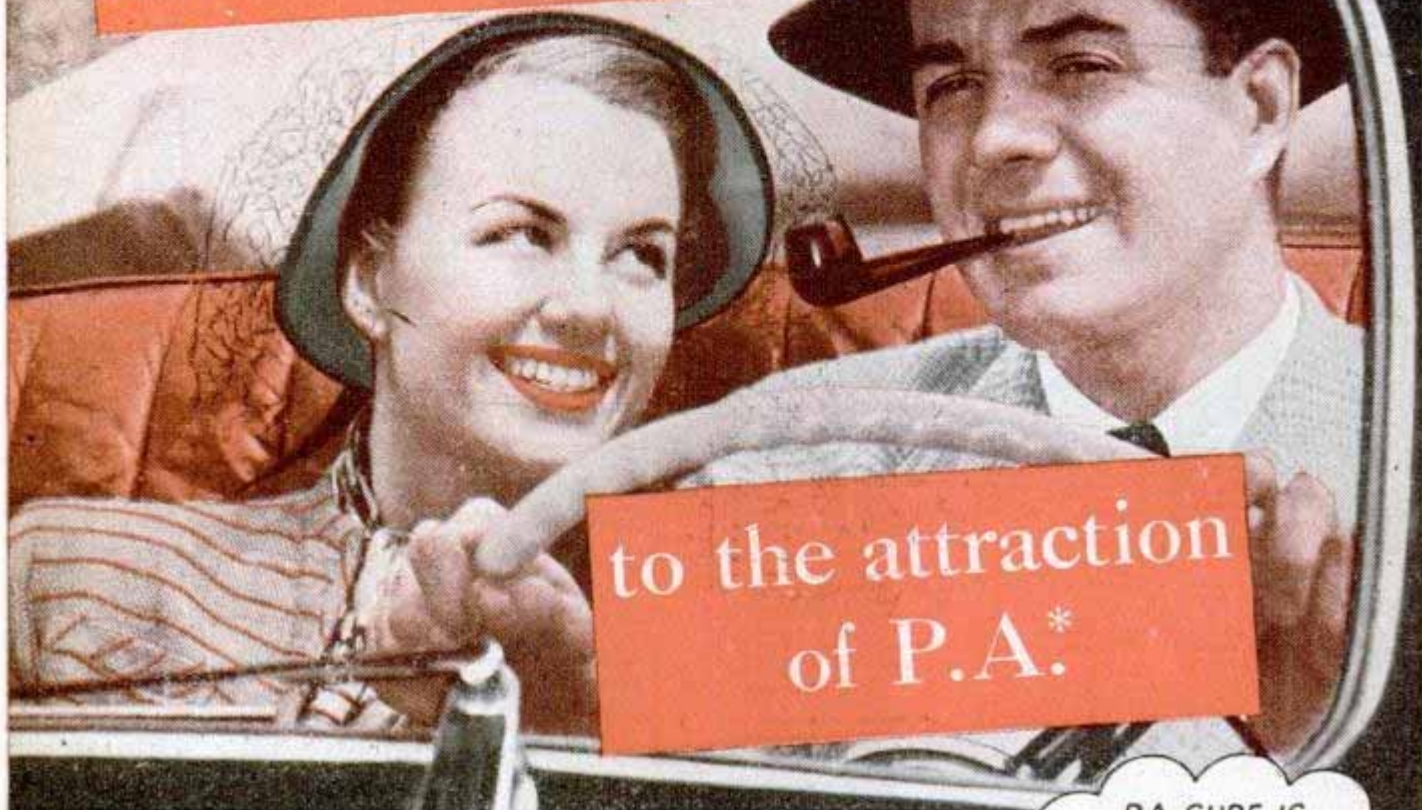

to the attraction
of P.A.*

P.A. SURE IS
GENTLE TO MY
TONGUE—NO
OTHER TOBACCO
LIKE IT!

P.A.* means **Pipe Appeal—**

Women love the looks of a pipe in a man's mouth. They call it "impressive"... "smooth." Like crisp linen, fine leather, good tweeds, a pipe is smart, manly, and...so comfortable!

P.A. means **Prince Albert**

● Insure your PIPE APPEAL by loading that pipe with PRINCE ALBERT. Its fine fragrance makes your pipe smell as good to her as it looks. And your tongue will say "thanks!" for P.A.'s wonderful mildness. The real flavor of fine tobacco—and so gentle to your tongue.

P. A. is swell for roll-your-owns too. Crimp cut clings to the paper...rolls quick, easy, and firm.

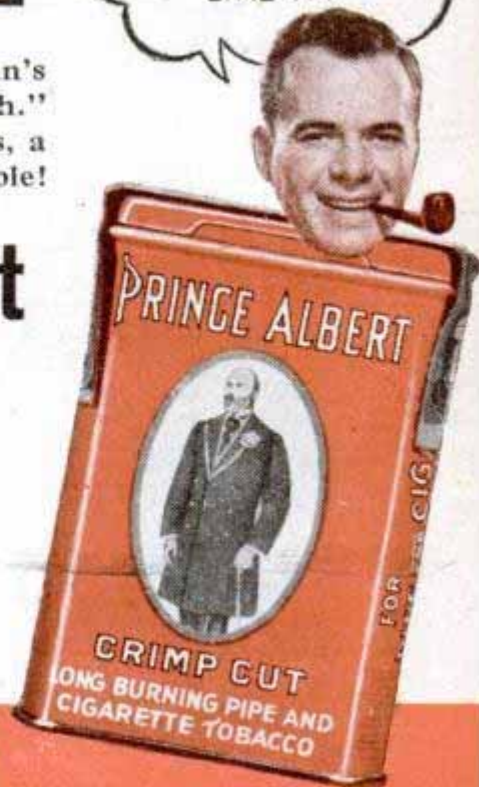

R. J. Reynolds Tobacco Co., Winston-Salem, N. C.

THE NATIONAL JOY SMOKE



Low and wide are the lines of quarter-size model being roughed in by Ford designer. It could be a '48 car

FORECAST from DETROIT

IF YOU HAVE been postponing your purchase of a new car until the first of the postwar "dream" cars is available, you'll have to wait at least another year.

Not that the automobile manufacturers haven't got some very attractive new cars designed, and some of them in test-model stages—but the circumstances thought propitious for introducing them haven't been brought into alignment.

The tip-off on another year's delay in bringing out the really new cars was the recent and almost simultaneous announcement by General Motors and Ford that their proposed lightweight cars had been indefinitely postponed.

Timed for release some time between Thanksgiving and New Year's, most of the 1947 models will be face-lifted cars with

By Leo Donovan

not-too-easily-discernible evolutionary changes. There will be new front-end designs featuring grillework attractions, decorative trim changes, new hub caps and additional mechanical improvements, but there won't be much that auto designers consider radical in 1947 cars.

The Big Three—General Motors, Ford and Chrysler—are competitors, even in a seller's market. In all probability each of them will introduce a model that will serve to indicate the trend in appearance changes you can expect in most cars in 1948. The balance of their models won't look much different from current vehicles.

Reasons for the gradual, rather than a sudden, change in the appearance of next year's models are many and practical. In the first place, production has been so light



Photo from Macy's

The first 1947 Crosley is launched in nautical style—and why not? Its 59-pound engine was developed in wartime for the Navy



Nine-foot span of glass across rear of Studebaker five-passenger Champion coupe affords excellent vision. Total window area in car (shown below) is 2430 square inches—a postwar pacesetter



in face of original anticipations and assembling capacity—and particularly in view of a terrific backlog of orders—that manufacturers insist upon full production first.

Public irritation over failure of the industry to produce cars by the millions despite strikes, material shortages and government pricing policies has the public relations experts worried. And reports of avaricious dealers making fortunes out of the shortage are further aggravating the situation.

Worries over the sheet steel supply for bodies are lessening in view of the steel mills' promise of a peak capacity of an additional 2,500,000 tons by next spring. Other basic shortages can be relieved only through changes in administration policy.

Retooling for new models takes a long time under the most favorable circumstances. And tool and die makers are reported to be far behind in their orders.

Chevrolet's postponement of its new lightweight car, for instance, could be due to many factors, including the possibility that its two huge plants in Cleveland, designed solely for that job, can't be finished for another 8 to 12 months because of lack of construction materials.

The automobile industry guards its secrets well, and it doesn't announce its plans until they're ready. It also has learned expensive lessons from sudden presentation of radical models. It makes thorough checks beforehand on what the public wants in the way of transportation before it approves its designers' sketches and invests millions in new tools.

But you can't keep too many secrets when they're shared by hundreds of designers, engineers and component parts suppliers. The Motor City, of course, is the center of such secrets, and rumors about what's on the drawing boards, the blueprints and the boss' mind cir-

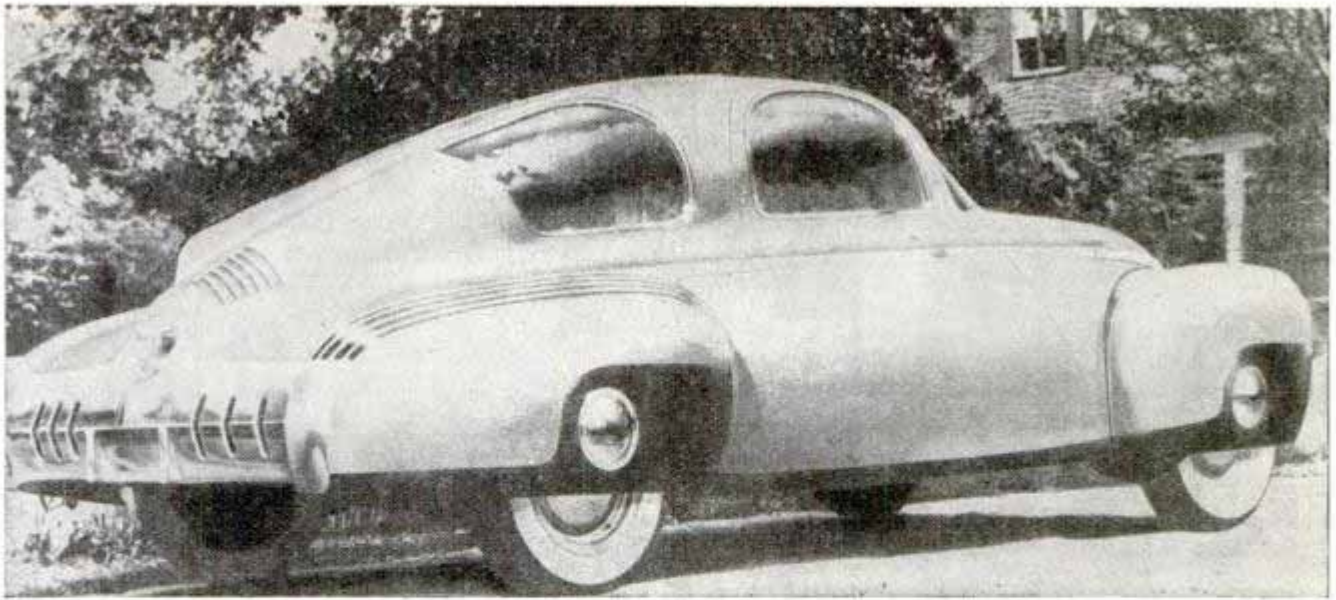

Tucker Torpedo has six-cylinder engine in rear; curved back window extends into the top for full vision. This revolutionary car carries six passengers and will be in the "medium price class"—\$1500 to \$1800

culate like hot air at a political convention.

Some of the new developments you can expect in 1947 models, however, include the probability that the new Cadillac Series 60 will lead the way in General Motors' parade showing the trend in design and engineering. A great many engineers not on the General Motors pay roll confide that Cadillac is, mechanically, the best car made. Its appearance in 1947 is likely to change more sharply than any other GM car. They say it will be roomier inside, with even wider front seat; that the windshield will be moved forward more than a foot; that automatic transmission will be standard; that its lines will be even more flowing than the Darrin-designed Kaiser Special and Frazer models.

Plans for the new Chevrolet are rumored to be moderate—the idea being that Chevrolet must regain its position as leader in the low-price field. Ford so far has outdistanced Chevrolet, principally because of General Motors' agonizing strike, but Chevrolet has the greater output capacity.

Buick, with an expansion program increasing its capacity 50 percent, is expected to startle the buying public with a chassisless, single-construction body having individual front-wheel suspension. However, under GM's production schedule, you might not see it until 1948.

Oldsmobile and Pontiac, according to the gossip, are due for face-lifting and mechanical improvements but little change in basic styling.

Chrysler Corporation is maintaining a discreet silence and in its advertising has referred only to its new cars without mentioning yearly models. Chrysler cars incorporated so many changes with their first postwar production, however, that it isn't likely they will produce anything startling, except in the New Yorker line. Body lines there may be lower and wider and automatic transmissions may become standard in more than one series. You can look forward to increased power in Chrysler engines. Plymouth, Dodge and De Soto are likely to present new models—after 1947

Peep preview—a new Ford glimpsed at Dearborn test track is wider and lower. You may see it late next year



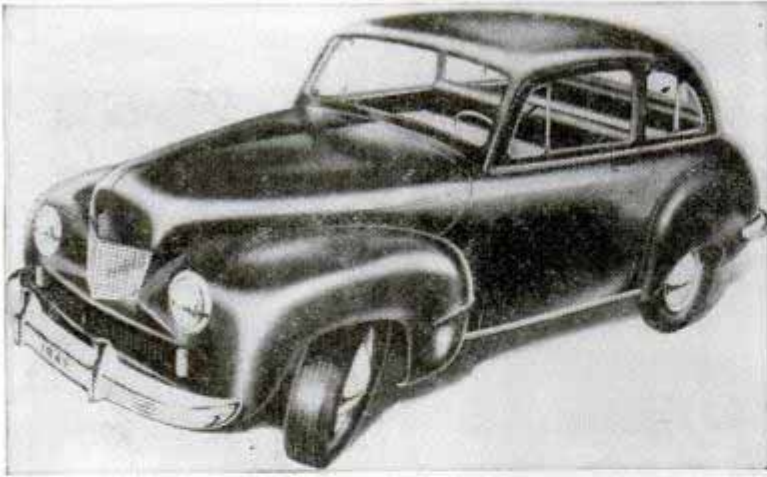

New six-cylinder Willys-Overland has independent suspension of all four wheels—a 1947 contender in low price market



Busy Buick assembly line is a treat for car-hungry eyes. Below, pride of Willow Run is the long-awaited '47 Frazer sedan

production begins to catch up with demand.

Henry Ford II has reorganized top personnel in a determined drive to match the range of prices of all General Motors cars with a long line of models for any purse.

Look for a radically designed new 1947 Mercury line, with fenders practically disappearing into the body. Look for the Lincoln Continental to surpass anything in appearance in the luxury line.

The new Ford won't be seen until 1948, but it meets its tests on the Dearborn track to the satisfaction of the engineers. However, they are convinced that the public wants transportation, not necessarily new models.

Output capacity at the River Rouge plant is estimated at 6500 cars a day, and Ford is running at about two thirds of capacity. Ford's production at other plants is being expanded. However, with a backlog of more than 1,000,000 orders it is estimated that it will take a year and a half of full production before Ford can catch up with the demand.

It would be considered highly impractical to shut down for 60 days for a new model change and lose production of 160,000 units in the process. And if Ford, Chevrolet and Plymouth all shut down for model changes the loss would be more than 500,000 cars, production engineers estimate.

Engineers in the know say Ford has a terrific six-cylinder engine in the testing laboratories. It is reported to have the best torque curve in the business. With less displacement it develops the same horsepower, but that doesn't mean that they'll forsake the V-8 engine.

(Continued to page 280)

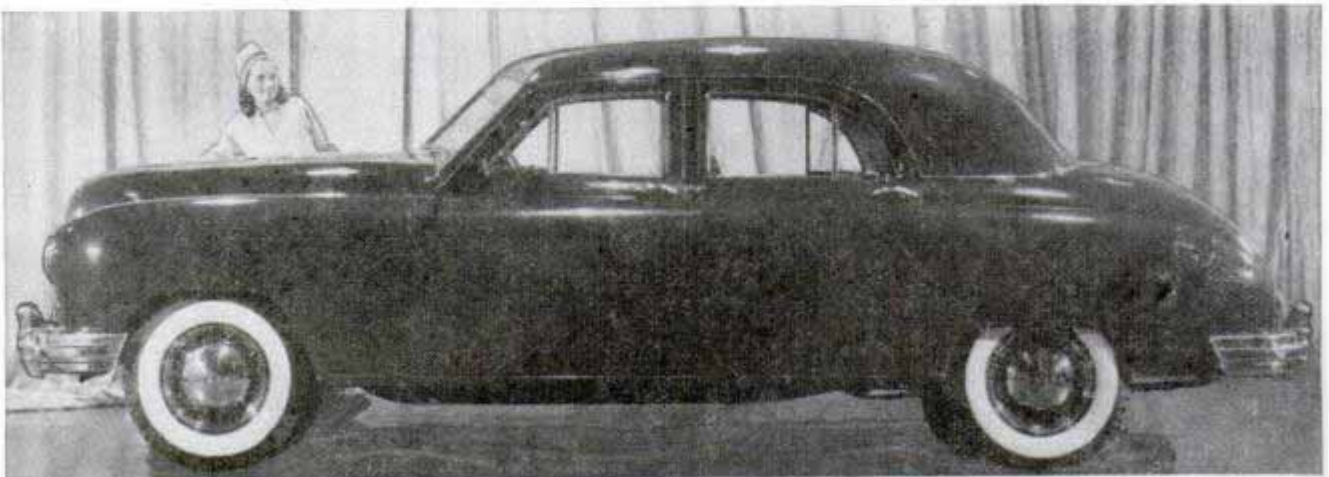

Midget "Cable Car" Launches Jets in 100 Yards



Jet fighter releasing steel cable "bridle" and taking to the air at 116 miles an hour after 340-foot run

Planes take off in a little more than 100 yards with an electric catapult built to launch aircraft from ship decks and small fields. The electropult, resembling a miniature cable-car line, is essentially a huge electric motor laid out in a straight line. It develops 15,000 horsepower, as much as three of the mightiest locomotives, and provides a quarter-mile track for a small shuttle car. A steel cable, with the two looped ends hooked over projections beneath the

plane's wings, is hitched to a lug at the front end of the car. The aircraft in tow rides along the tracks on its own wheels and when flying speed is reached the car stops abruptly, the bridle falls off and the plane takes to the air. Jet fighters normally requiring about 2000 feet can fly after a 340-foot run. It can be adapted to pull four-engine transports, which now need a 4000-foot run, into the air in 500 feet, according to Westinghouse engineers.

Hitching the "bridle" to shuttle car for takeoff and a view of the 1382-foot track on which plane is pulled

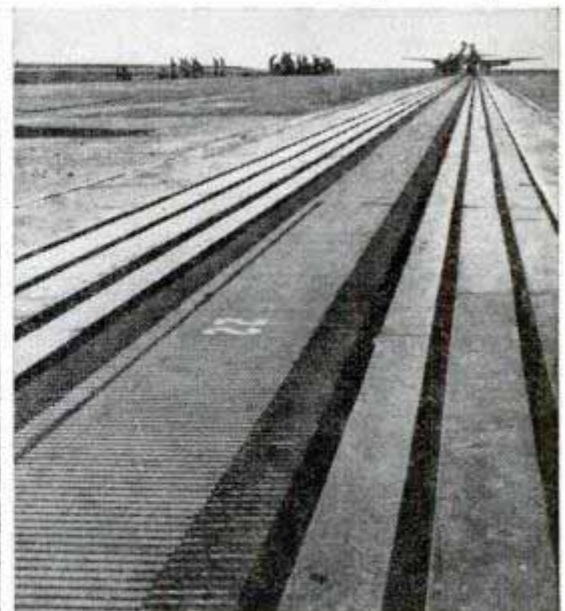

Plutonium in Atomic Bombs Weighs Between 22 and 66 Pounds

Two more facts about atomic energy have been made public: (1) the amount of plutonium used in an atom bomb is somewhere between 22 and 66 pounds. Until recently the War Department had revealed only that the amount was between 4.4 and

220 pounds. (2) Another chain-reacting substance, other than plutonium, can be manufactured. It can be made through use of uranium and thorium, but uranium, from which plutonium is made, is necessary to start with.



Oxygen Tank Cart Aids Football Team

Georgetown University's football team uses portable oxygen tanks to restore normal breathing in 30 seconds to players who have had their wind knocked out or have lost most of their wind through hard play. The two tanks mounted on a two-wheel cart are equipped with 11 outlets to refresh an entire team during a timeout. This method of administering to winded players is expected to become widely used.

Cranberry Sprayer 'Floats' Over Beds

Because cranberries are planted in beds instead of rows, heavy power spray machinery would damage the plants. One Wisconsin grower controls insects and fungus with a 40-foot spraying boom, light enough to be carried by two men. Pressure comes from a power spray drawn by a tractor along the dike surrounding the beds. A third worker carries the hose to prevent damaging the plants. Recoil from the 34 nozzles helps "float" the boom.



China Filter for Coffee Maker Saves Both of Paper Disks

Filters made of china for glass coffee makers require no cloth or paper disks and are virtually unbreakable. Metal clips on the filter can be spread to grip the sides of the glass tube, insuring a snug fit. The filter can neither fall out nor pop up when fastened in place. It will fit any standard glass coffee brewer and may be purchased as a separate accessory.

You may wish to obtain additional information about the new products described each month in Popular Mechanics. If you want to know the name and address of the manufacturer or distributor, just write to Bureau of Information, Popular Mechanics, 200 East Ontario Street, Chicago 11, Ill.

World's Largest Ship Sheds War Togs for Passenger Runs

The 83,673-ton liner Queen Elizabeth, world's largest vessel, has been reconverted to peacetime use and is again ready for passenger runs. Used as a troopship during the war, the ship was refitted in the King George V graving dock at Southampton. After the dock was drained of its 58 million gallons of water, the propellers, rudder and other underwater parts of the ship were cleaned and repaired in preparation for her maiden passenger run to New York.

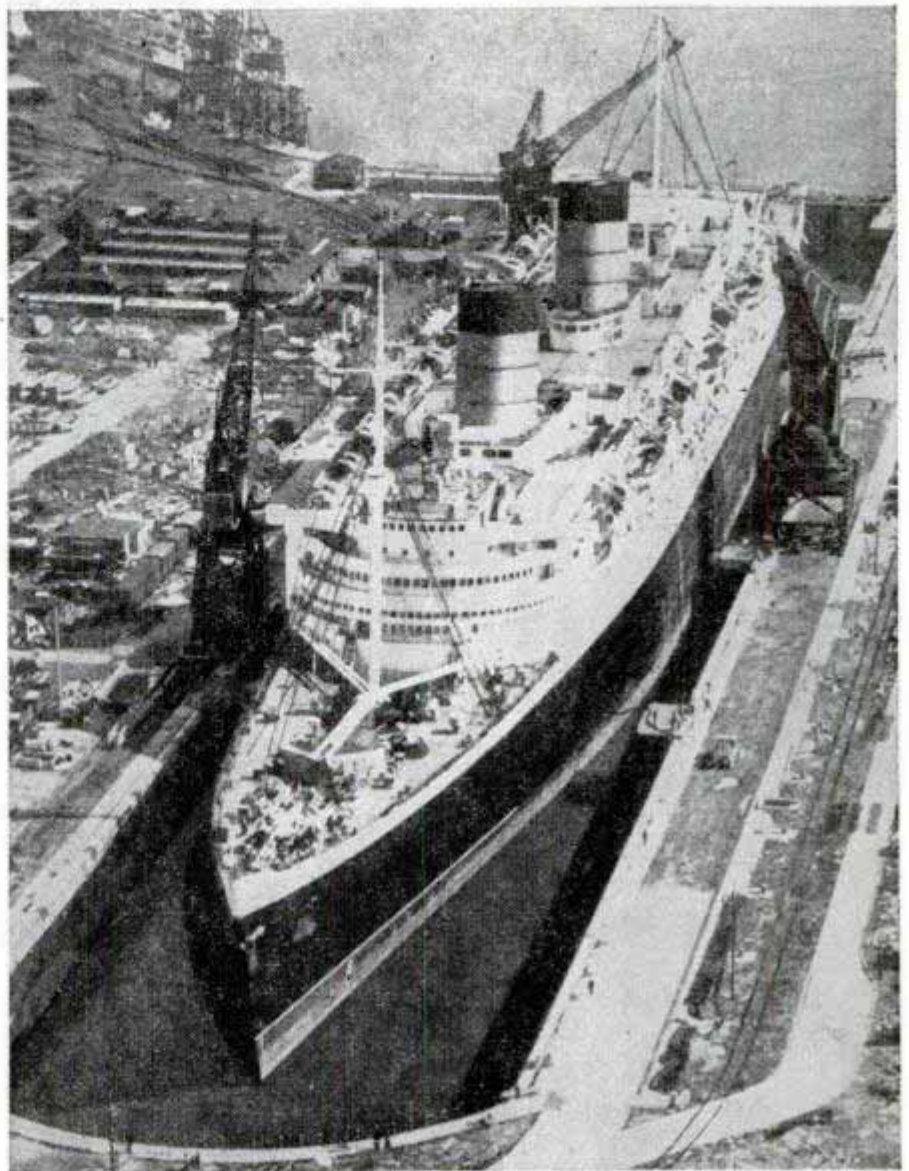

"Linguist" Radios Aid Conferences

Pocket-size radio receivers used at international conferences permit simultaneous translations of a speaker's words into seven different languages while he is talking. Developed by the International Business Machines Company, the receiver is equipped with earphones and an aerial embedded in a shoulder strap. The speaker's words are transmitted by radio to interpreters who make running translations of the speech into their own languages. These translations are re-broadcast to the listeners, who turn a knob on the receivers to select the language they understand. Listeners can move anywhere

within the loop of the antenna wire that encircles the auditorium. The power of the radio wave is so low that the broadcast cannot be received outside the building. Once the system is set up and functioning it requires no switching.

"Trigger" Keel Rights Duck Decoy If Overturned by Rough Water

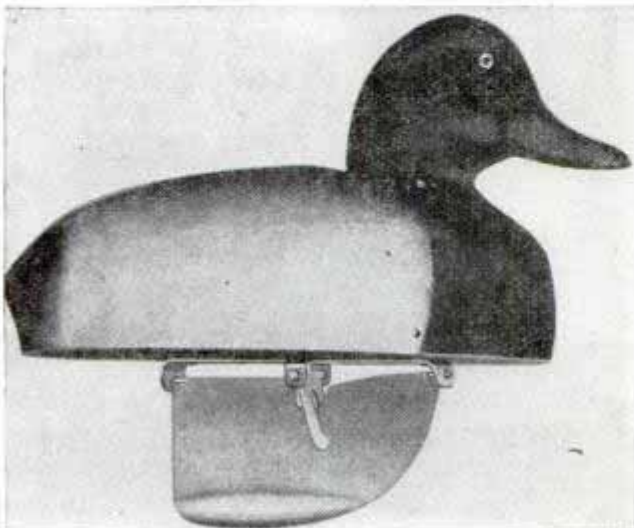

Duck decoys equipped with a "trigger" keel automatically right themselves if overturned by rough water. If the decoy is upset, a trigger drops, allowing the metal keel to fall on one side of the duck's base. This concentration of weight unbalances the overturned decoy and causes it to return to a right-side-up position. The trigger then automatically locks the keel in vertical position again.

Army Signal Corps meteorologists have developed reflectors which, when carried aloft by balloons and traced from the ground by radar, supply data on the speed and direction of winds as high as 100,000 feet above the earth.



Scientists believe the X-1 will reach the twilight limit where first magnitude stars are visible directly overhead as the sun sets or rises

MAN is about to open the door to a new world—the world of supersonic speed. Today projectiles are the only objects able to cross the strange barrier that occurs when the speed of sound is reached. However, soon an Army Air Forces test plane may cross the threshold and enter a new realm.

Sound travels approximately 725 miles per hour at sea level, varying widely with the temperature of the air and its pressure. When planes reach this speed, strange things happen to them. The air, instead of flowing smoothly around the wings and fuselage, seems to break up and pummel the plane with hammerlike blows. Control surfaces refuse to respond, the plane dives at increasing speed until it crashes. Pilots who have survived the experience of sonic speed say that fearful noises are heard and the plane shudders violently. Drag is increased manyfold—as much as 10 times normal—and stick motion which is normally a *pull* at subsonic speeds becomes a *push* at sonic speeds.

Speeds vary widely through what is called the transsonic region—from 600 to 900 miles per hour, depending on altitude, temperature and pressure. The shock waves generated at these speeds act like a barrier, and once the plane succeeds in

SPEED UNLIMITED

By E. M. ROGERS

In its race against the speed of sound, the Army Air Forces aims at "double or nothing" from its rocket-propelled X-1

Official AAF artist's conception of the rocket-propelled supersonic speed plane

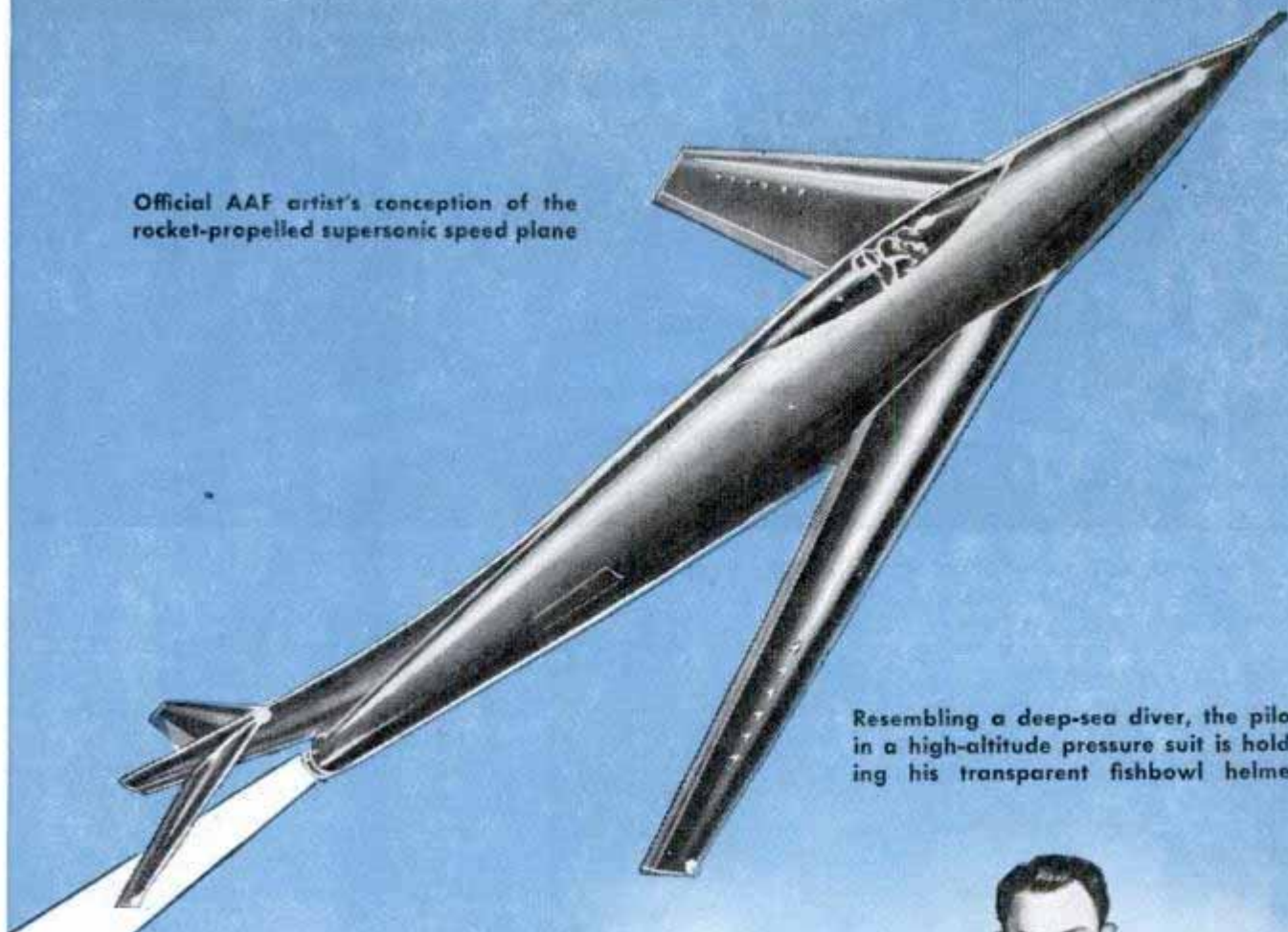

Resembling a deep-sea diver, the pilot in a high-altitude pressure suit is holding his transparent fishbowl helmet

passing through this hellish region it begins to act more normally.

Most of us do not think of sound as being a force. Yet it is. Notes from a pipe organ cause a building to vibrate. The shuddering effect of airplane engines that pass at low altitudes is another example of the force of sound.

When an object moves through air, the noise it generates, in the form of sound waves, precedes it. As the object's speed increases, it overtakes these waves, and at the speed of sound these waves or vibrations are compressed, since they cannot get out of the way, into a shock wave. This shock wave has a very definite force composed of all the smaller forces of sound.

At transsonic speed, or the region through which these shock waves are formed, air takes on peculiar characteristics. The shock waves bunch the air into almost solid blocks of matter. It resembles water flowing around the hull of a boat moving swiftly through it, only to become a seething mass in the turbulence of the wake as the water is broken up by the swiftly moving propeller.

At Aberdeen Proving Ground, the Army Ordnance Department has a supersonic wind tunnel with a miniature model sus-



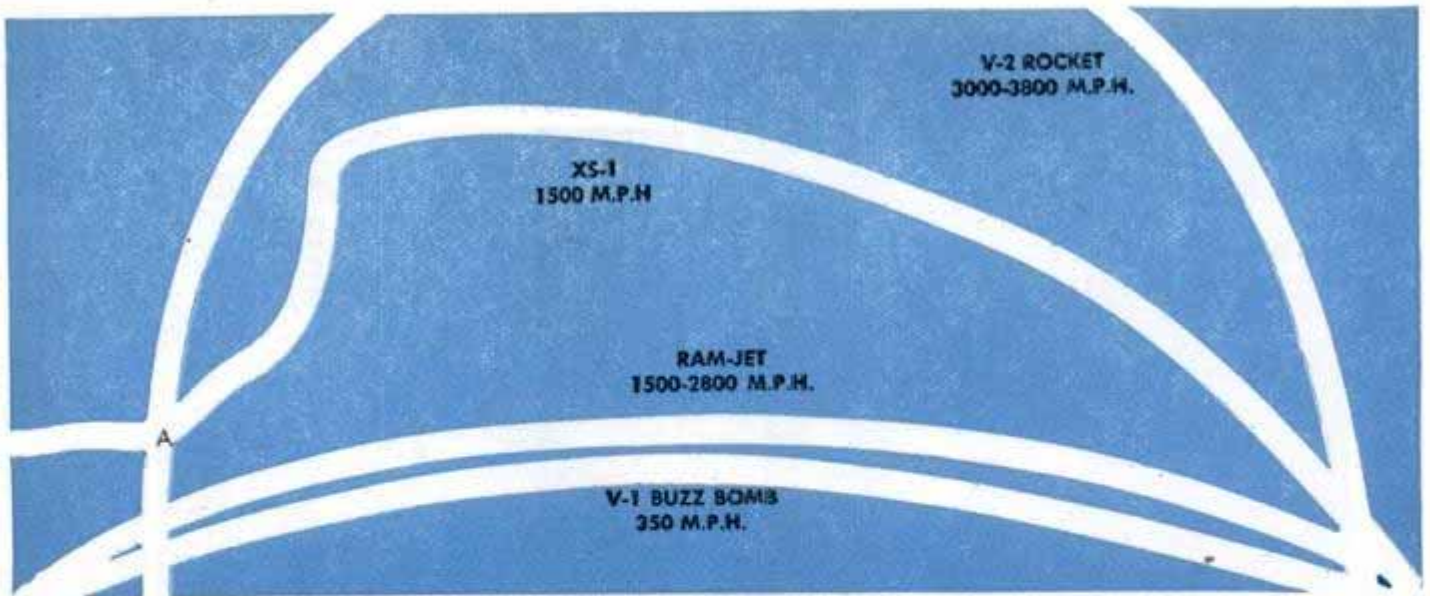

XS-1 will be released from a B-29 at point A, near 30,000 feet, then climb to about 80,000 and glide to earth

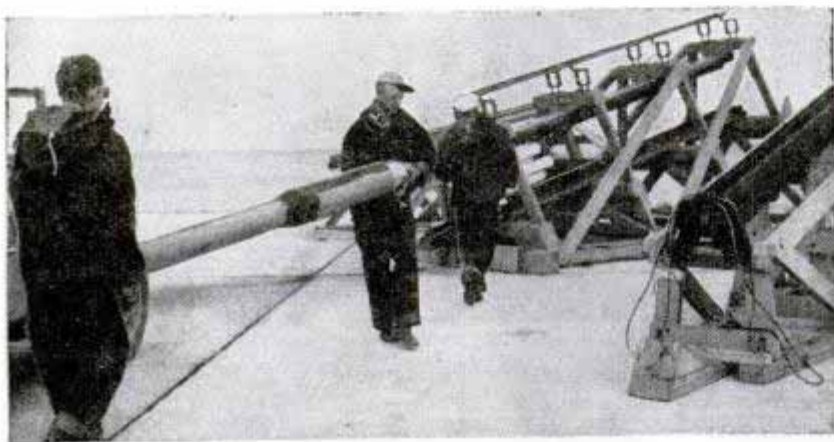

Above and below, launching 70-pound ramjet engine capable of speeds over 1500 miles an hour. Bottom, close-up view of the propulsion unit



pendent in the air stream. As air velocity increases to sonic speed, the turbulence can be seen with the eye. At sonic speed, suddenly a curved line is seen that flows back along the model. This is the shock wave. As speed is increased the shock waves bend more closely to the model and the turbulence ceases. Air speeds over four times that of sound have been reached in this tunnel. Even at supersonic speeds the shock wave clings to the nose of the object like a leech.

Calculations and tests have shown that a plane must have wing sections that are almost knifelike to fly at supersonic speeds. This poses the difficulty that an extremely thin wing section has very little lifting power at relatively low speeds. To overcome this, special flaps are built in the wings

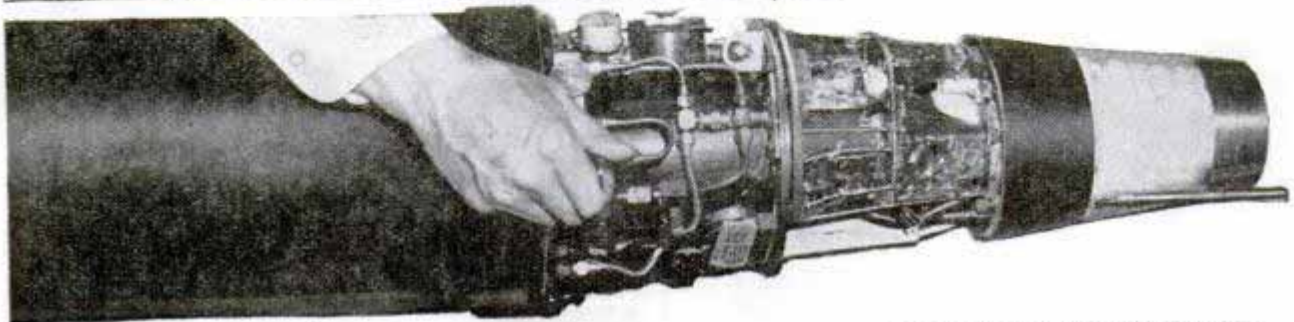
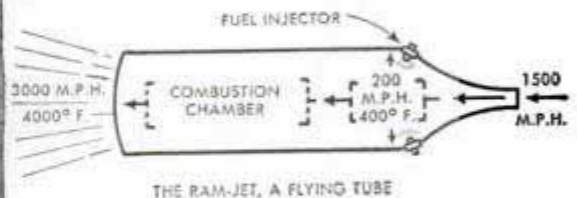

to allow the plane to take off and land at speeds that are not too hazardous.

In their attempts to use wind tunnels to test model planes, engineers found that no matter how much power they poured into the huge fans, the speed of the air would not increase above sonic speed. The tunnel was filled with turbulence, blocks of air choked the tunnel and destructive vibrations were encountered.

From this discovery, it is known that supersonic planes would have to use other means of propulsion than a propeller. Jet or rocket engines are the apparent solution.

The latest type of jet engine is the ramjet. It is somewhat like a stove pipe with a fire in it. Air enters the front, is mixed with a fuel, burned, and exhausted from the rear. It is difficult to imagine anything simpler.

The ramjet utilizes the basic processes common to any automobile engine. An automobile engine operates on a four-stroke cycle: (1) intake, (2) compression, (3) power, (4) exhaust. In the ramjet there is, first, intake and compression of air; second, combustion or heat release; third, expansion of air or power stroke. The complete cycle is applied to air moving continuously through the ramjet with no interruption.

As it hurtles through the air at sonic speeds, the compression, or increase in pressure which is furnished by a piston in an automobile engine, is obtained in the ramjet with an inlet diffuser which converts the kinetic or velocity energy of the fast moving air to pressure energy. In other words, the air moves into the engine with a high velocity. Once it is inside, the air is slowed down and compressed, creating a high pressure.

One unique feature of the ramjet engine is its utilization of the shock wave to compress air. As the air enters the diffuser it is moving at high speed. Since the diffuser is of much larger volume than the intake nozzle, the air slows down to fill it. As it slows down it passes through sonic speed and a shock wave is formed, which rams the air forward into the combustion chamber and builds up pressure. That pressure can be used to discharge the air through

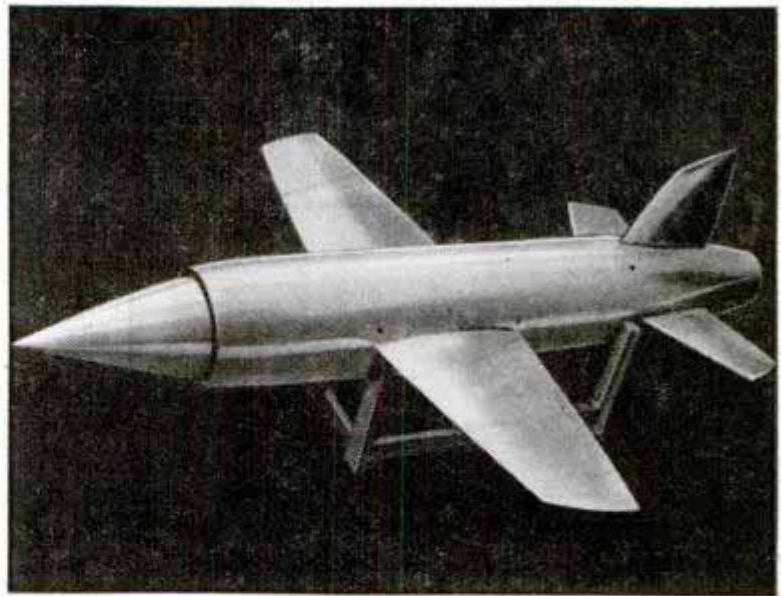

Mockup of 1000-m.p.h. jet plane proposed by British designers

Sketches show how conventional wing reacts to airflow at increasing speeds and how knife-edged design meets supersonic needs

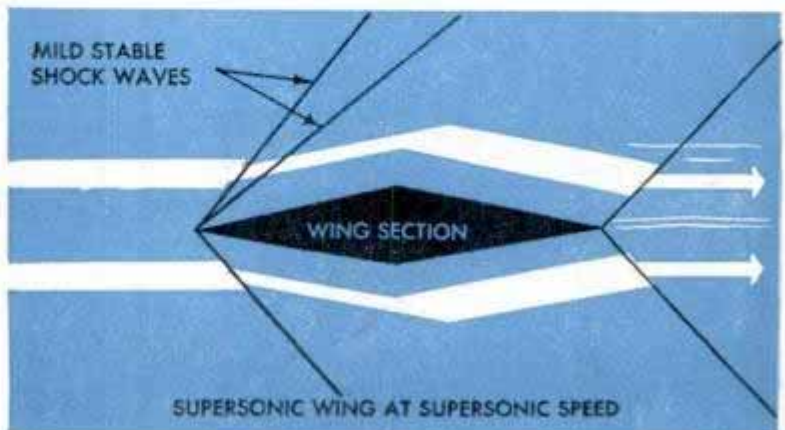
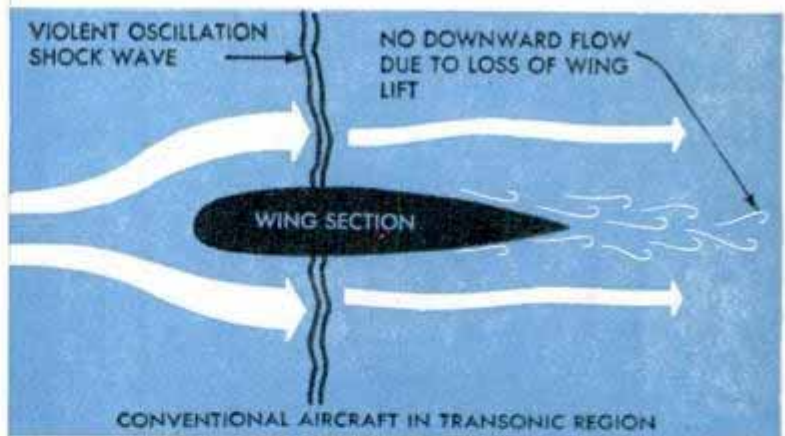
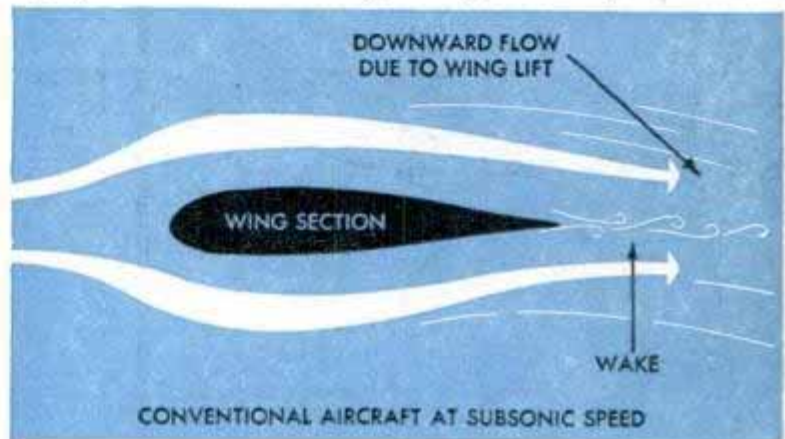

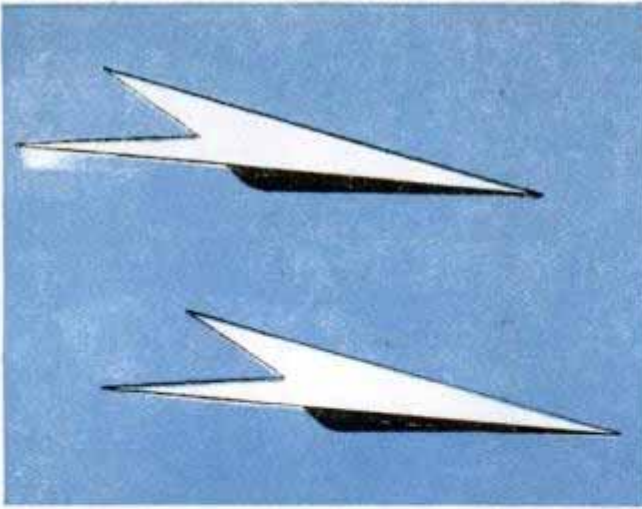

Some of the military designs now on the boards bear a startling resemblance to schoolboy's paper planes



Swept-forward wings are another possible answer to problems of supersonic speed. The British Swallow, below, races sound with wings angled back

the outlet at approximately the same speed it entered the engine.

If the air is heated while moving slowly and under high pressure and discharged through a small opening or nozzle, the outlet velocity can be made to exceed the inlet velocity by a wide margin. That increase in velocity at the outlet produces thrust or forward motion. The shock wave also prevents the combustion gases from exhausting through the forward inlet. It acts as a barrier. Its reaction force is similar to that caused by the water that rotates a lawn sprinkler. Rockets operate on the same principle.

Ramjet engines are not effective at low speeds and require another type of power plant or launching device to establish an operating speed.

At high speeds the chief competitor of the ramjet is the rocket. The ramjet requires about one sixth as much fuel as the rocket at 2300 miles per hour because it uses oxygen from the atmosphere while the rocket carries its own. At high altitudes the lack of oxygen makes the ramjet ineffective.

Thrust alone, however, is not the most striking feature of the ramjet; it is its low ratio of weight to horsepower developed. Standard internal combustion engines weigh roughly one pound per horsepower. The ramjet engine has a ratio of one half ounce per horsepower.

Since the ramjet works best at supersonic speeds, it cannot be tested in wind tunnels for the reasons mentioned before. Therefore, methods of testing them in free flight have been developed by the Applied Physics Laboratory of the Johns Hopkins

At the XS-1's pace, Chicago will be only about an hour from San Francisco and three hours from Paris



University, which developed the ramjet engine for the Navy. Pressures, accelerations, temperatures, fuel flows and other factors have been converted into radio signals which are broadcast from an antenna integral with the ramjet and then picked up and analyzed by field equipment at the test site. It was necessary to develop equipment so small and compact that a four-channel radio system, complete with power supplies, measuring instruments and broadcasting equipment, could be contained in a space only slightly larger than a man's two hands. Components of the proximity fuse were used for the set. This use of telemetering equipment greatly augmented the analysis of flight tests and speeded up the development program.

There are three possible fields for the

ramjet. Its greatest suitability is for supersonic planes or missiles. Because of its light weight and ease of manufacture, it can be used for subsonic expendable missiles. Again its light weight makes it suitable for rotary wing aircraft where rotor wing tips may approach the speed desired for ramjet operation and where the economy of weight and freedom from power transmission problems compensate for a higher fuel expenditure.

The Army Air Forces has a brand new type of plane for supersonic speeds, the XS-1, thus far only test flown in powerless glides. It was built by the Bell Aircraft Corporation. Powered by a rocket motor developing several thousand pounds of thrust, it is hoped that the plane will reach

(Continued to page 268)

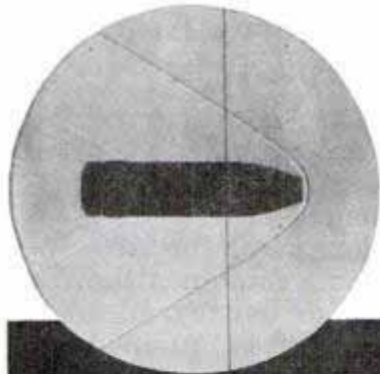
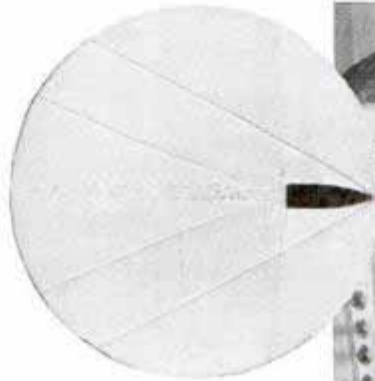
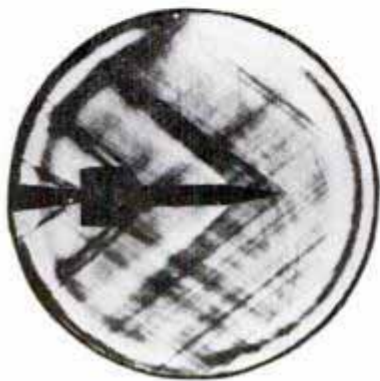

Photographs made at a millionth of a second show shock waves from supersonic missiles. In wind tunnel below and at right a series of hydraulic jacks constricts the tunnel throat, thus increasing air velocity

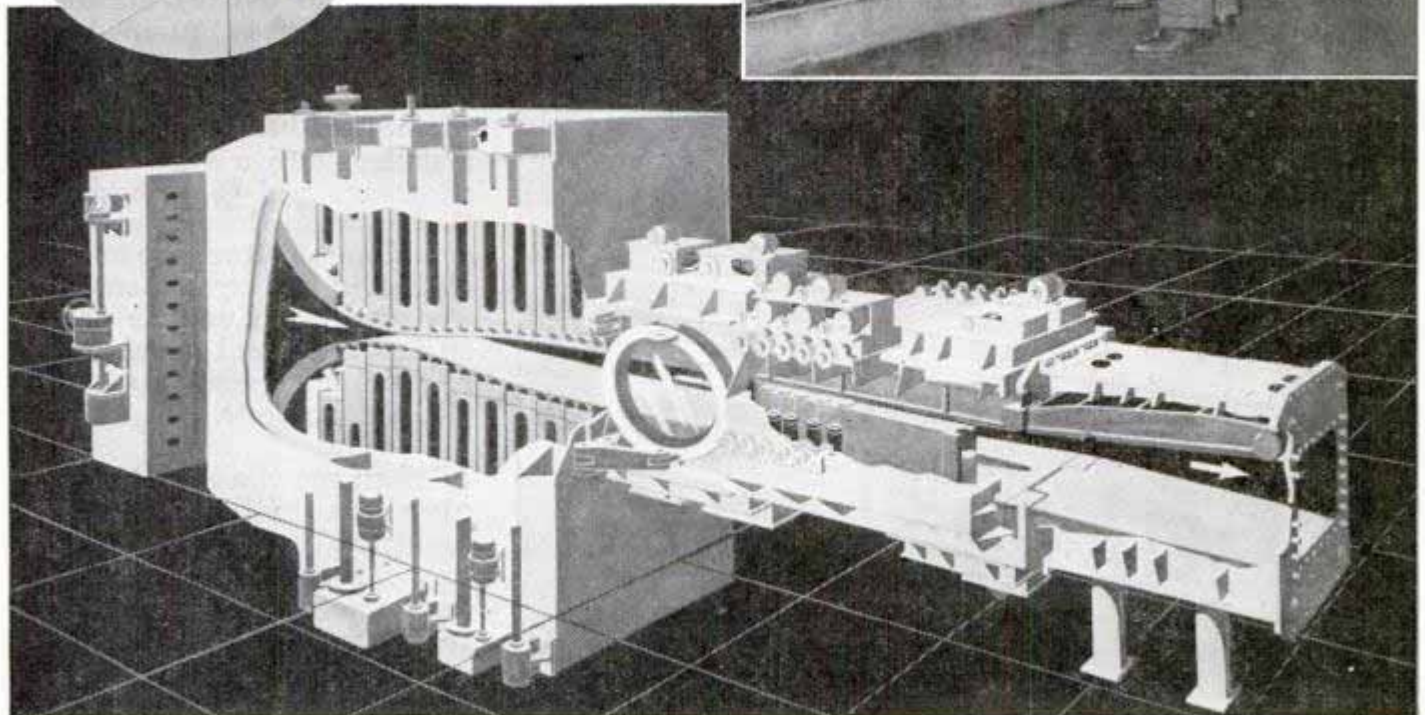
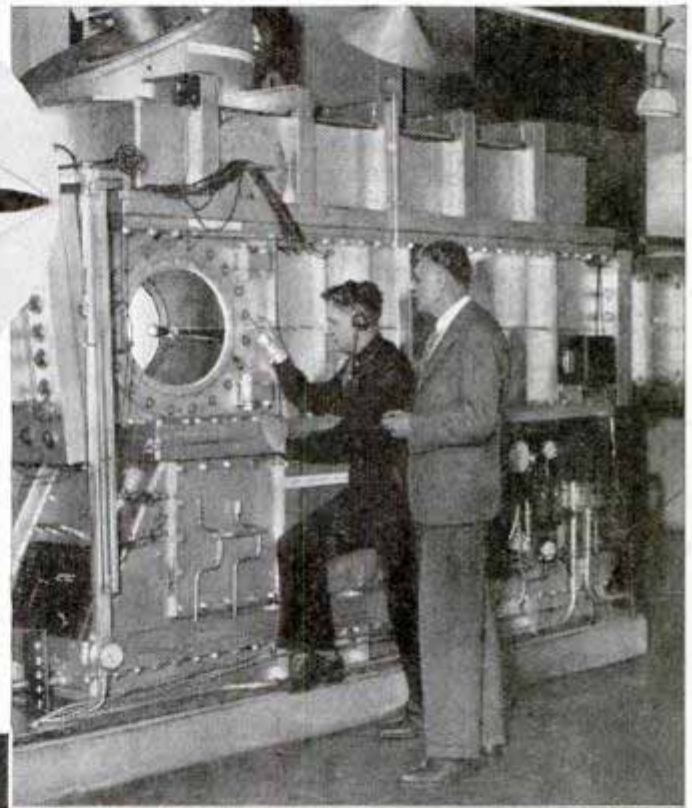

Navy Sharpens Air "Eyes" With Two New Scout Planes



Two new air "eyes" have been added to the U. S. Fleet. The lightweight Edo XOSE-1, catapult launched, is specifically designed for rough water operations. With a Ranger 550-horsepower engine, it travels well over 200 miles an hour and has a range of 1000 miles. The Curtiss SC-2 Seahawk, with a Wright Cyclone engine, exceeds 250 miles an hour and has a 650-mile range. Normally operated with Edo floats, it has a seat behind the cockpit for rescue work. Both planes have folding wings.

Flaps that retract automatically when hit by water are a new feature of the XOSE-1, while the Curtiss SC-2, below, has a cabin hood that can be thrown open by compressed air in emergencies



"Penthouse" Auto Sleeps Eight

Four air-conditioned rooms are provided in a luxurious "land cruiser" built for Dr. H. J. Sealey of Dumont, N. J. The \$20,000 vehicle combines the features of a house trailer and a truck. It is equipped to sleep eight persons and has a main salon, living room, tiled bathroom and a galley with a sink, refrigerator and gas range. Radios, telephones and complete furniture are included in the equipment. The seven-ton vehicle is 30 feet long and capable of attaining speeds up to 75 miles an hour.

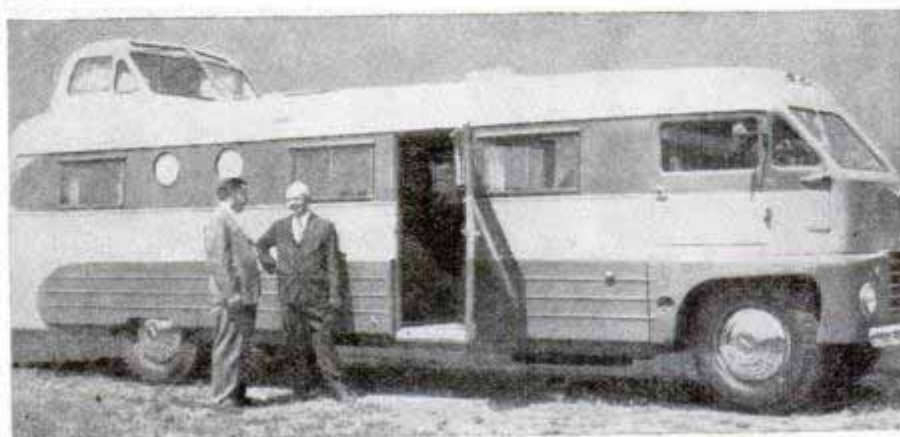

Ⓛ When snowflakes hit an airplane in flight they break up into 30 to 500 tiny fragments and produce enough static electricity to black out radio voice communications between plane and ground.

Gridders See Misplays At Post-Drill Movie

Movies of plays just rehearsed are shown to the University of Southern California football squad immediately after practice, permitting players to watch themselves in action and check their own mistakes while the plays are still fresh in mind. Similar motion pictures are made during important games, processed at once, and shown in the dressing room between halves so that the opponent's successful plays can be analyzed and defenses evolved. Speed-processing of the 16-mm. film is done in a portable machine similar to those used by race tracks when film of a race must be developed for immediate inspection by judges and stewards. The processing takes less than 10

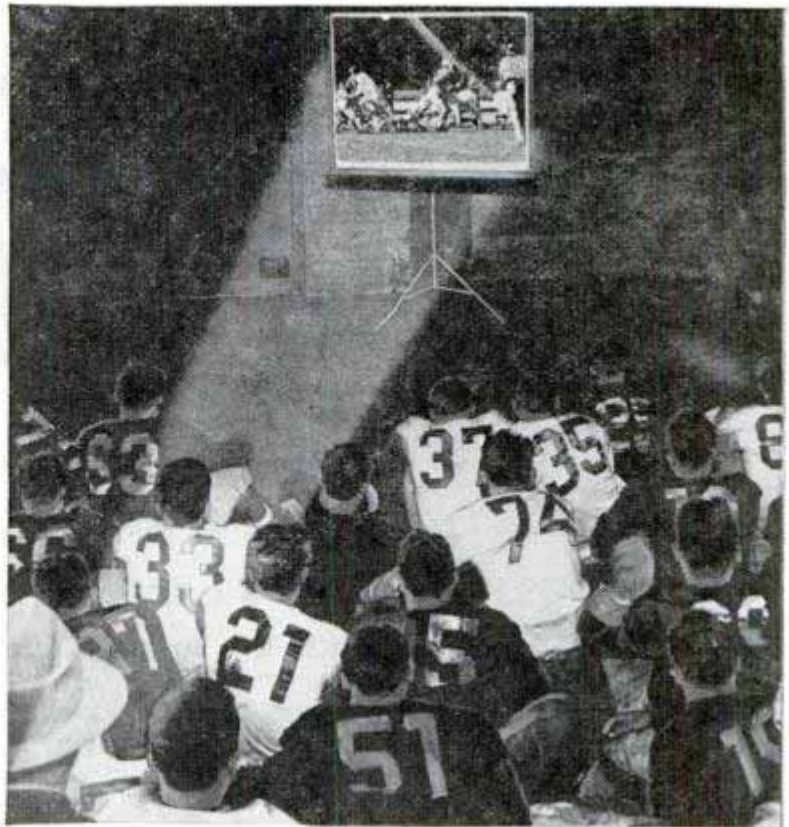

Above: Players studying movie of action filmed 20 minutes before by cameraman at left and a helper shooting close-ups from the sidelines. Every detail in the execution of plays can be quickly noted. Below: View of the drying compartment with doors open and a vertical drawing of the entire unit



minutes, including development, reversal, washing and drying. Heating and refrigeration units in a water jacket that surrounds the tanks keep the solutions at the proper temperature. The drying cabinet has infrared lamps, white lights and a constant stream of filtered air blowing on the film.

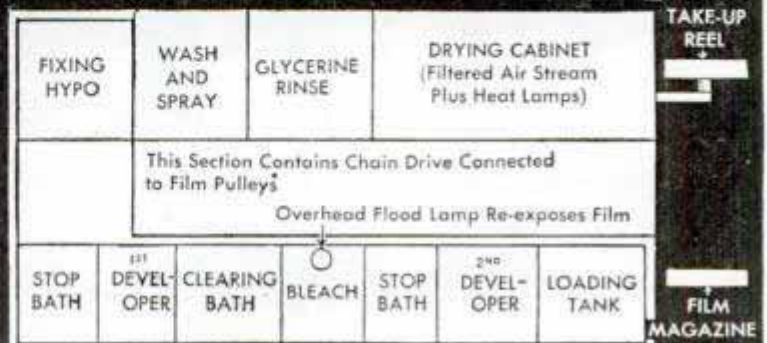
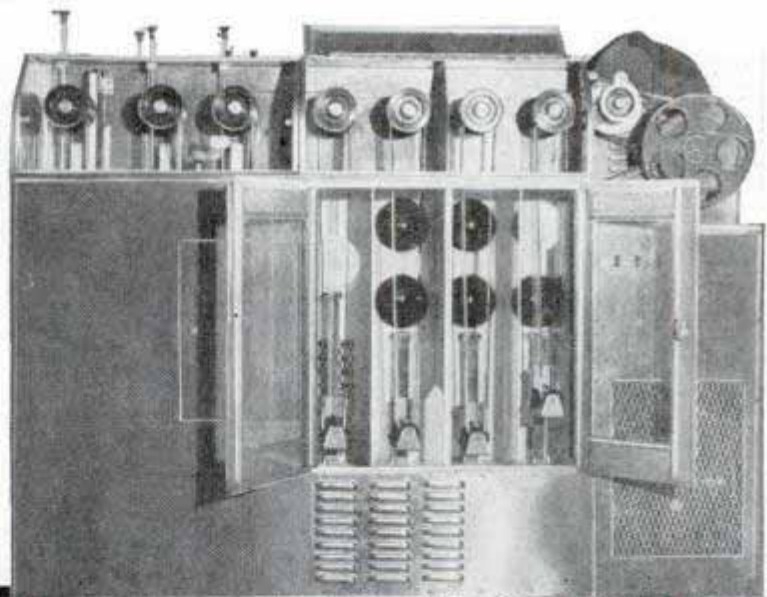

Double Walls Hold Water Jacket With Built-in Calrod Strip Heater and Freon Refrigeration Coils for Automatic Temperature Control

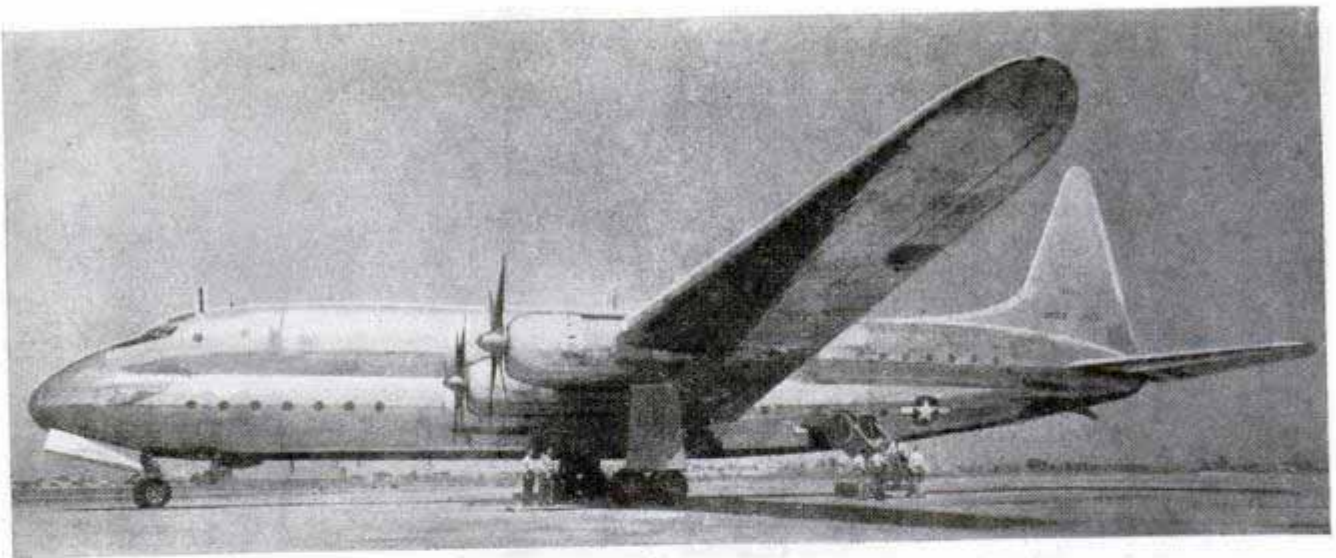

Largest airplane ever built for the U. S. Navy, the Lockheed Constitution is the first American transport with a wing specifically built for the installation of gas-turbine engines when they become available. The first model has four Pratt and Whitney Wasp Major engines totaling 12,000 horsepower. It has a wing span of 189 feet, length of 156 feet and carries over 34 tons of cargo and passengers. There are 92 seats on the upper deck and 76 on the lower, which is divided amidships by the

Navy's Largest Airplane

wing. Maximum ferrying range is 6000 miles and its top speed is 300 miles an hour. As an added safety factor for operating on rough island air strips or on steel mesh runways each of the main landing gears has four wheels. Man-size tunnels within the wings permit "in-flight" inspection and adjustment of all four engines and most mechanical, electrical and hydraulic fittings. Extra wide cargo doors, 106 by 74 inches, are large enough to permit loading of jeeps or other bulky items.

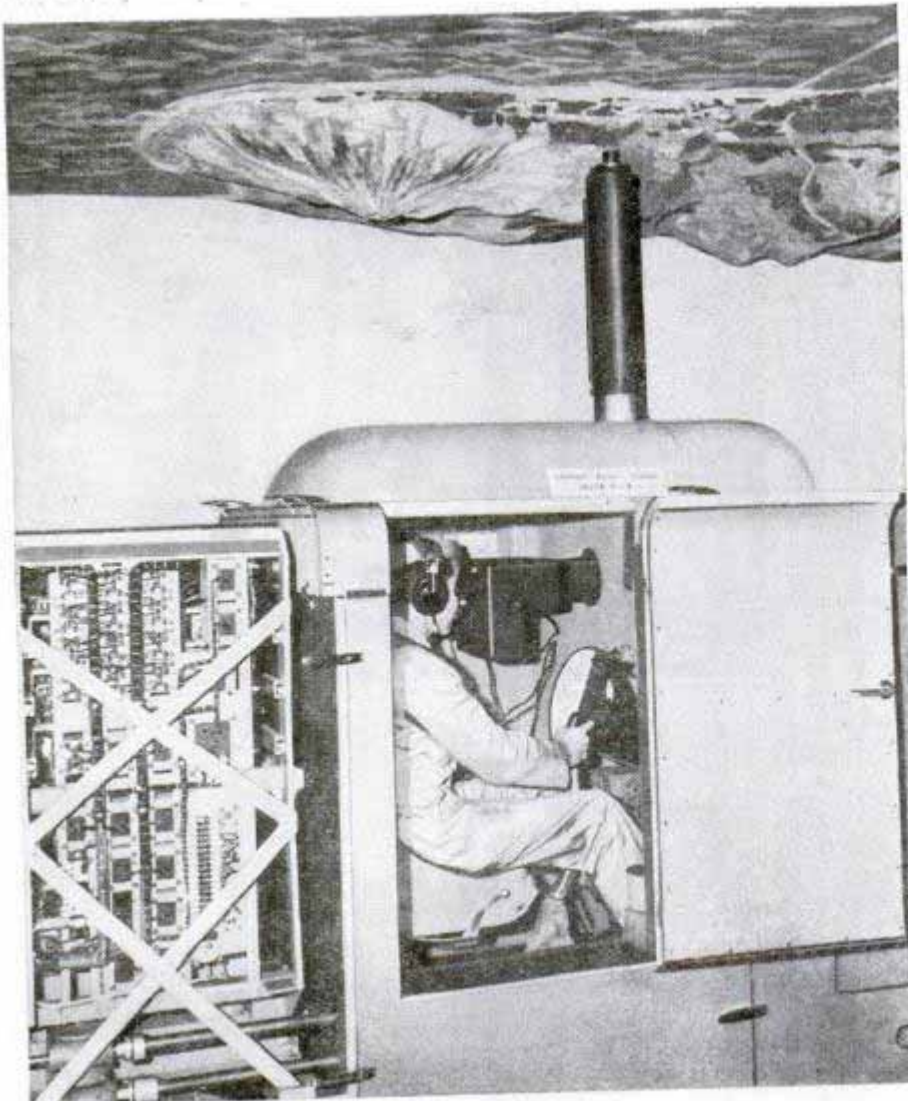

Pilots 'Fly' Contact In Indoor Trainer

Contact flight training can now be given in the classroom as well as the sky with equipment devised by the U. S. Navy. To the airman looking through a periscope mounted atop the trainer, the terrain reproduced upside down on the ceiling appears exactly as it would in flight. Purpose of the training is to speed recognition of landmarks and terrain. The device, exhibited at the Naval Research Center on Long Island, saves many weeks in the schooling of a flyer.

☞ Harnessing of the sun's rays to provide a source of industrial power by heating a boiler so that it develops a pressure of 150 pounds to the square inch has been disclosed by a Russian inventor who has put the helioboiler's energy to use in a cannery.



ON THE AIR...

there've been some changes made

First mass-produced radio (above) was built by Westinghouse in 1921. Below, RCA television camera "watches" football fans

By Bill Reiche

RADIO, airborne colossus of American amusement, has been described as an art and as a science. Primarily it is neither. It is a business—BIG business—which artists and scientists have served as faithful handmaidens.

Regularly scheduled broadcasting began in 1920 because a smart corporation executive realized that when people discovered that entertainment was to be had free in their own homes they would create a tremendous market for the machines which would enable them to receive it. Network broadcasts became a fact when sponsors were ready to pay for an expensive radio show and bear the additional cost of wire charges and



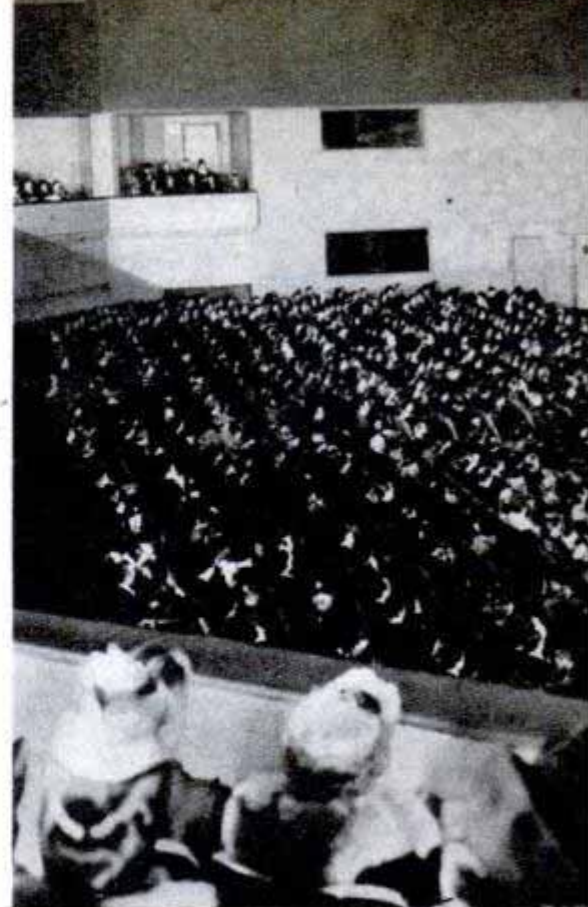

NBC photo

Back in 1924 Olga Petrova thrilled radio listeners; modern studio theater (right) was unknown in those days

of buying time on a number of stations.

Radio is a billion dollar business today because it sells a lot of soap, toothpaste and coffee—which is to say that you listen to it and buy these items by the ton.

There was only a handful of radio sets in the nation capable of receiving the first regularly scheduled broadcast by KDKA in Pittsburgh—the Harding-Cox election returns. In 1926 when the National Broadcasting Company formed the first permanent network there were an estimated seven million receivers and that number has swelled to 60 million today.

In 22 years, radio listeners increased from the handful who heard the Harding-Cox returns to a throng of more than a hundred million who heard FDR report to the warring nation in February 1942.

Granting that radio has grown into an industrial giant—what have the engineers and scientists done to make it more enjoyable to the public?

“There is no single development which can be cited as the great factor that has brought radio from its early technical imperfections to its present advanced state,” said O. B. Hanson, vice-president and chief engineer of the National Broadcasting Company. “Radio transmission and reception are essentially the same operations they were in the early 1920s; the vast betterment can be attributed to literally thousands of improvements and modifications in all types of components.”

But three types of equipment were cited

by Mr. Hanson and Robert G. Thompson, manager of technical operations for the Columbia Broadcasting System, as having raised the level of 1946 listening far above that enjoyed by the 1921 fans with the shockproof ears: microphones, tubes and speakers.

In a radio broadcast the microphone is the first piece of equipment to go to work and it is of prime importance since no transmitter can produce a signal of any better quality than it gets from the studio.

The first mikes were single diaphragm carbon types, similar in construction and performance to a telephone transmitter. How this cut down the range of sound may be appreciated when we consider that it had a range of only 100 to 2000 cycles per second, whereas music extends from 100 to 5000 c.p.s., speech from 250 to 2500 c.p.s.

This was succeeded by the infinitely superior condenser type, which operated on a change in voltage and had an amplifier incorporated in it. This type was finally displaced by the current dynamic microphone—as far removed from the carbon type as a Stradivarius from a squeaky door.

Of possibly even greater importance to the ultimate consumer was the evolution of the home loud-speaker—the final link in the long electronic chain which links coffee, McCarthy and citizen.

The first speaker possessed the same limited virtues as telephone receivers of the early 1920s, which was natural when we consider that it was an almost identical



Control rooms—old and new. The one above is NBC's original master control room as it looked in 1926

device with the addition of a horn. The horn vibrated excessively and reproduced practically no low notes at all.

But the radio fan automatically compared his crude set's output with that other audible living room entertainer—the phonograph. The “talking machine” used a horn which was no better—and frequently worse—and used acoustical recordings, which were made by mechanical means and betrayed their mechanical background when Caruso was heard in a recorded aria. Compared to this latter disturbance, the radio, bad as it was, sounded pretty good—and the user didn't have to buy and change records all the time!

Thus by the gradual improvement in the mechanical devices that changed sound into electric impulses and back into sound was the audible quality of radio enhanced.

Radio soon freed itself from the whimsicalities of the crystal detector as the vacuum tube, invented by Lee De Forest in 1906, took over as detector and amplifier. But it was still shackled to batteries—generally dry cells, but occasionally storage batteries—which nestled in the vicinity of every home receiver.

Electricity, which lighted the American home, toasted its bread and curled its hair, was as useless as uncontrolled lightning to power its radio sets. This impasse was eliminated in 1922 when Westinghouse engineers developed the thermionic vacuum tube with indirectly heated cathode, which permitted home radios to be operated on house current. The troublesome and ex-



Control room operators (foreground) keep eyes on newscaster and announcer in modern newsroom. Trio below takes NBC “pulse” in new master control room

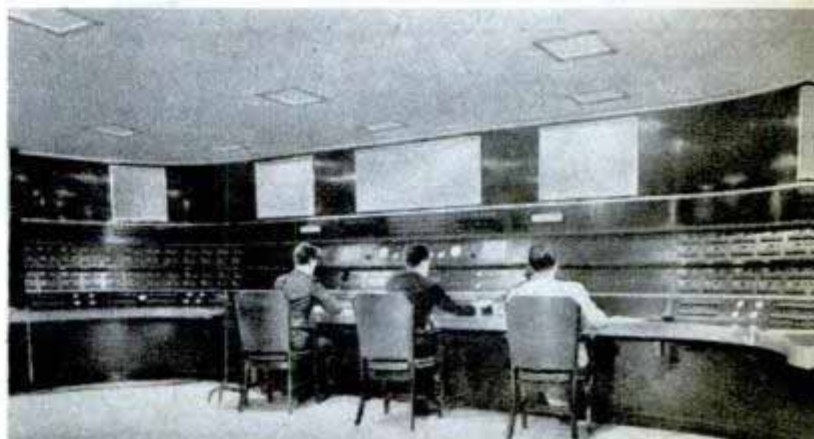

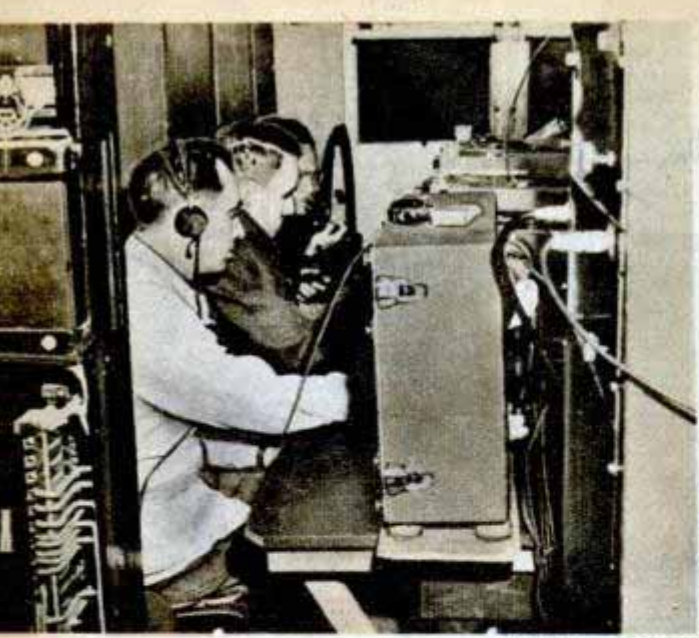

Telecasting football game with mobile unit parked outside stadium. Many big games have been broadcast with this outfit. Interior view (above) shows the operators working inside the unit

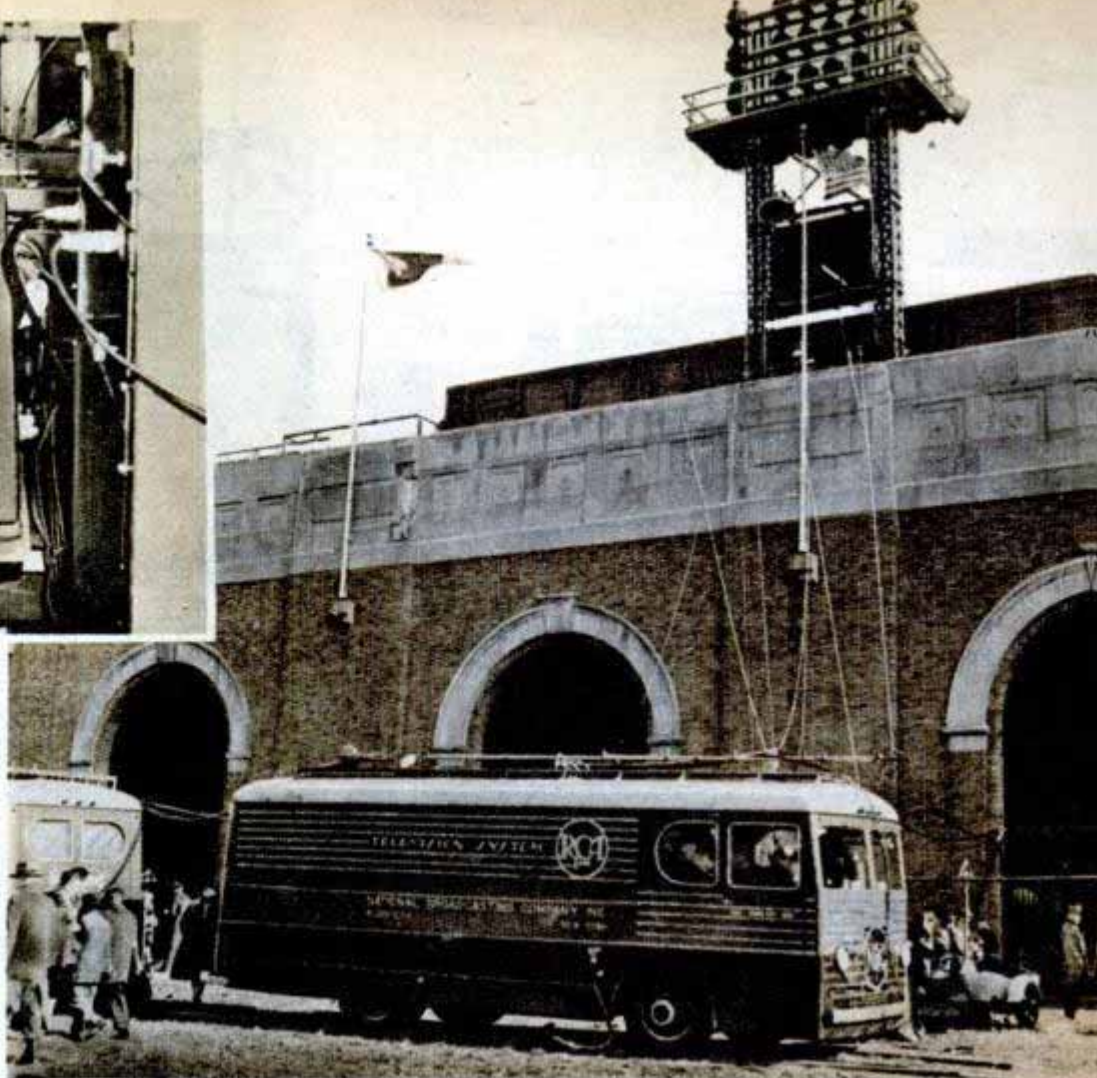

pensive batteries—which always seemed to go dead during the listener's favorite program—went the way of all second-best devices and receiver production swept on to new heights.

Radio broadcasting as we know it today can trace its origin directly to a \$5 bet on the accuracy of a \$12 watch in 1915, but the cornerstone of the art was laid by James Clerk Maxwell, a Scottish physicist, in 1865. He developed the theory that alternating current flowing in a wire causes some energy to be radiated off into space—holding that it was possible to transmit power through space without benefit of wires or other conducting agents.

A German and an Italian scientist, Hein-
1928—Amos and Andy at old-fashioned twin mike

rich Hertz and Guglielmo Marconi, took the theory and experimented it into the realm of fact. With this Hertz was satisfied and went on to other things, leaving Marconi to make wireless history which is too well known to stand repetition.

With the invention of the three-element vacuum tube in 1906 by De Forest the groundwork was sketchily laid for what was to become a great industry bringing information and amusement into the homes of the civilized world.

Nine years later Dr. Frank Conrad, assistant chief engineer of Westinghouse, had an argument with a friend as to whether his watch was the fine timepiece its \$12 cost seemed to justify. Dr. Conrad built a small

1946—John Vandercook, commentator, with new mike





receiver to pick up the time signals from the Naval Observatory at Arlington, Va., and soon became an ardent wireless fan.

The following year his new transmitter was licensed as station 8XK and Conrad began code and later voice transmission to every amateur radio operator he could contact. The latter medium he soon found taxing to his voice and he substituted phonograph records for ad libbing in 1919 to save his vocal cords. The response to this free entertainment was enthusiastic and by the summer of 1920 his twice-a-week "broadcasts" had sufficient following for the Joseph Horne department store in Pittsburgh to advertise "amateur wireless sets, \$10 up."

H. P. Davis, Westinghouse vice-president, read the ad and saw an industry in the making. Provide regular programs, he reasoned, and millions of people will want to buy sets. A more powerful transmitter was built, licensed as KDKA, and on November 2, 1920, it broadcast the first regularly scheduled program in radio history.

There followed one of the greatest scrambles since the Oklahoma land rush and the forty-niners. By the end of 1922, two years



NBC photos

In the early days of radio (top) everybody joined in to produce some weird sound effects. Today one man (above) handles recorded sounds as well as gear panel (his hand is on crank) simulating sound of machines, carton (just behind him) which is hit with a stick for pistol shot, and standard door for slamming at his right. The tank holds air for hissing sounds

after KDKA had broken the ice and the ether's silence, there were 600 broadcasting stations in the country; in 1924 there were 1400 and the air was bedlam. Harried listeners picked up a half dozen signals at once from the overcrowded and underpoliced air waves; stations changed wave

(Continued to page 264)



ALL-METAL WINGS replacing fabric-covered type boost speed of Luscombe Silvaire five to eight miles an hour. They're also more durable and easier to inspect

TWO-IN-ONE metal easels make it possible to enlarge photographs of all sizes. The masking assembly snaps out of place to permit enlargement up to salon size

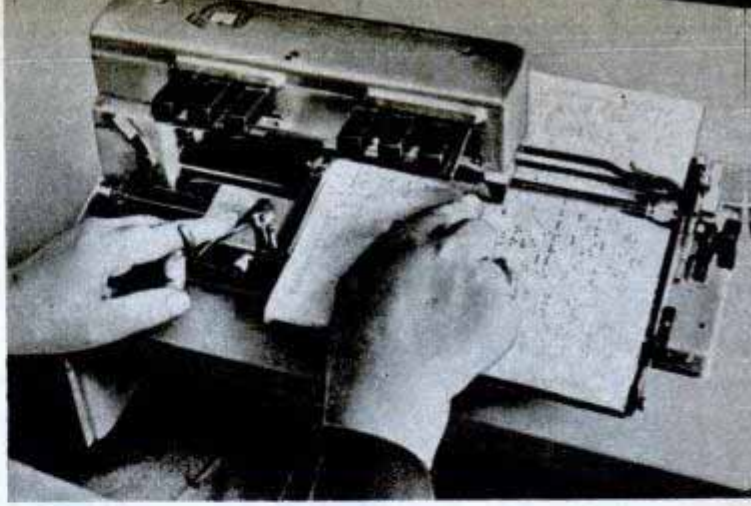
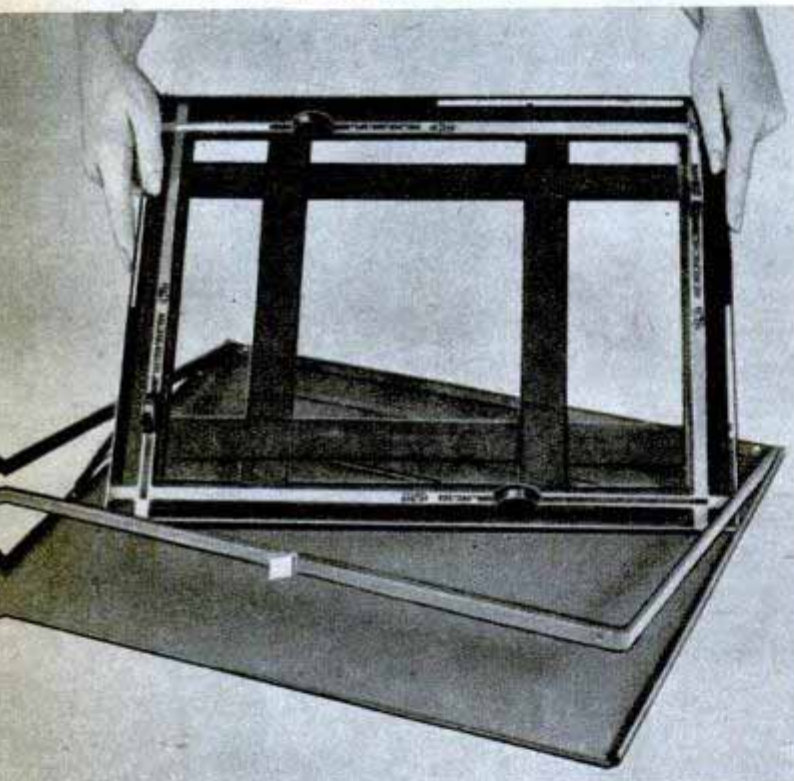

BRaille TYPEWRITER for the blind is an 11-pound portable machine with only six keys. Any of Braille's 63 raised characters can be typed at a single stroke

CHINESE TYPEWRITER, the first practical machine built for the language, prints 5400 characters. To make each one a typist must press four separate keys



FLYING WING BOMBER, the first of 15 that Northrop Aircraft is building for the Army Air Forces, rises into the air on its initial test flight. The high-speed camera momentarily "stops" the pusher-type eight-blade coaxial propellers. Performance figures are still secret but it has been revealed that the plane has a 10,000-mile range



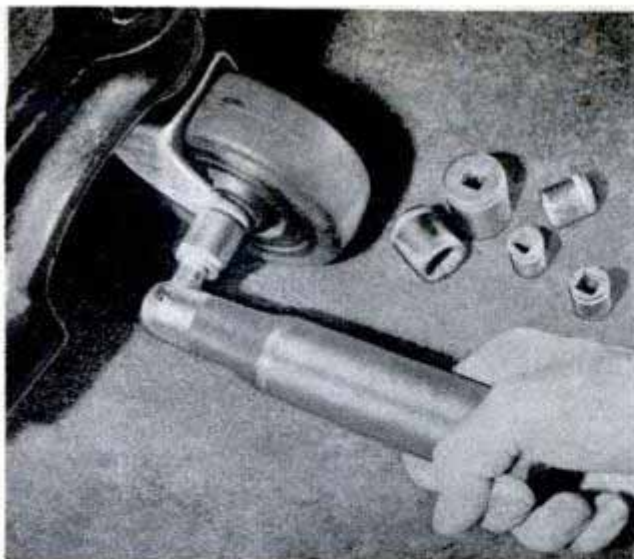

Hollow Tool Handle Stores Extra Bits

From five to nine interchangeable bits are stored in the hollow plastic handle of a handy tool that can perform many jobs in factory, garage or home. A swivel chuck is attached to the handle and bits can be changed in a jiffy. This tool—or “tool kit”—is available in several models including two socket screw kits, two socket wrench kits and one home kit. The chuck has a positive lock for straight line positions and also snaps into five different positions within a 180-degree radius to enable mechanics to reach hard-to-get-at places.

Vest-Pocket Check Perforator Punches Holes With Roller

Checks are protected from alteration by a new perforator that can be carried in the pocket like a pencil. The perforator is rolled across the writing on a check that has been placed on a blotter or other soft surface. A case-hardened steel roller punches small holes through the paper, making it impossible to erase the amount written on the check without tearing the paper. The perforations also prevent fill-ins and protect the check from other alterations. The pencil-shaped perforator is made of highly-polished aluminum.

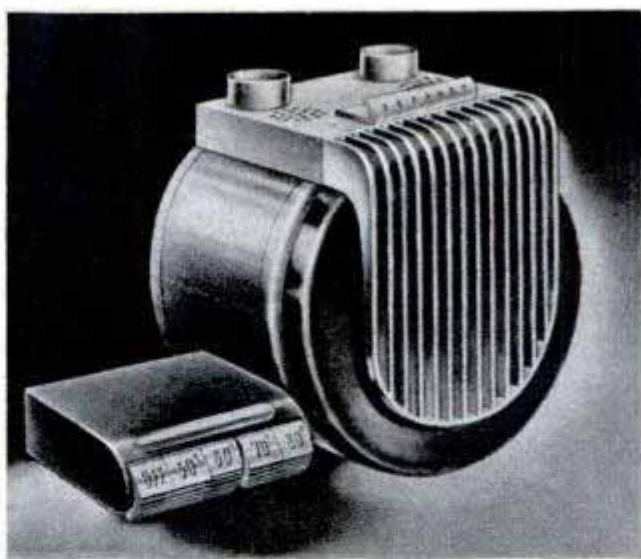
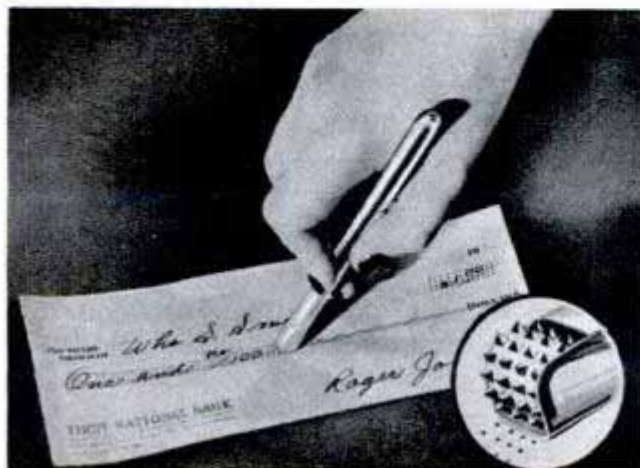

Push Button Automobile Heater Has Thermostat Control

Push-button control for temperature selection and a thermostat to maintain a desired temperature regardless of weather changes are features of a new gasoline car heater. Developed during the war to pre-heat airplane and tank engines and to heat Quonset huts and trailers, the heater produces in one minute 18,000 B.T.U. Push buttons enable the motorist to have a steady supply of heat at 50, 60, 70 or 80 degrees. The heater is expected to find use in heating trucks carrying fruit and other perishables,

Midget Cooler for Airplanes

One hundred thousand revolutions a minute are made by a three-pound air expansion turbine unit used to air condition planes. It weighs one fiftieth as much as a conventional refrigerating system of similar capacity. The compressed air enters the turbine at approximately 150 degrees Fahrenheit and leaves it at about 15 degrees Fahrenheit, cold enough to freeze the exit pipe and to blow snow on anything held in front of it. The turbine uses only air as a refrigerating medium and requires no additional source of power. It is self-lubricated and has only one moving part.

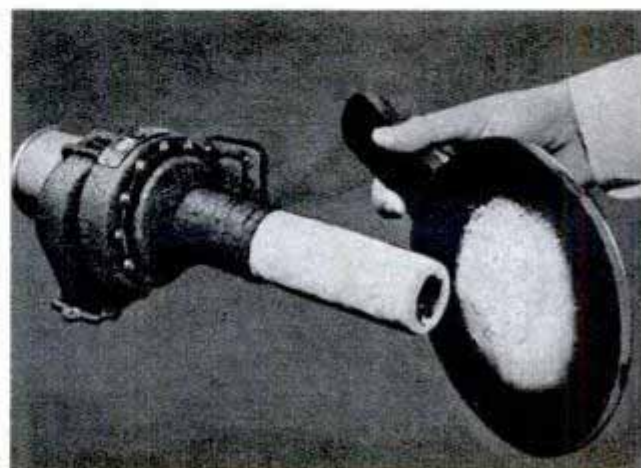

SCIENTIFI

If you're a welder and should be trombonist in a band, aptitude tests will set you right

BEFORE civilization got quite so complicated it was a simple thing to find your vocation. If grandpa was a plumber, father also was a plumber and so were you, in time. The village smithy was the father of a long line of village smithies, and if your ancestors were farmers or watchmakers or lawyers the odds against breaking the chain and becoming an artist or banker were high.

But now there are some 21,000 different ways to earn a living, ranging from accounting to zoology. To screen out the 20,999 less suitable jobs and pick the field most suited to the worker's talents and therefore most productive of success and happiness, industry and schools and individuals are turning increasingly to scientific aptitude tests.

Aptitude for a particular job doesn't guarantee success but it is one key to achievement.

Literally hundreds of thousands are getting the right steer toward a career by submitting to evaluation by trained engineers and psychologists. After filtering you through systems of questions, analyzing your personality and dexterity and creative capacity, watching you match colored blocks and fit together jigsaw puzzles, the experts who have formulated these talent measurement examinations through 40 years of research can pretty well tell where you belong.

Probably the biggest talent-sorting endeavor in history was accomplished by the military services, which did their best to keep from wasting a good radar man in public relations work or a good cook



Analysis of the temperament structure of a good and a poor mechanic: good worker, above, is stable and self-controlled. He works best by himself. Poor mechanic, below, goes to extremes. Overly aggressive, he is likely to arouse ill-will among fellow workers

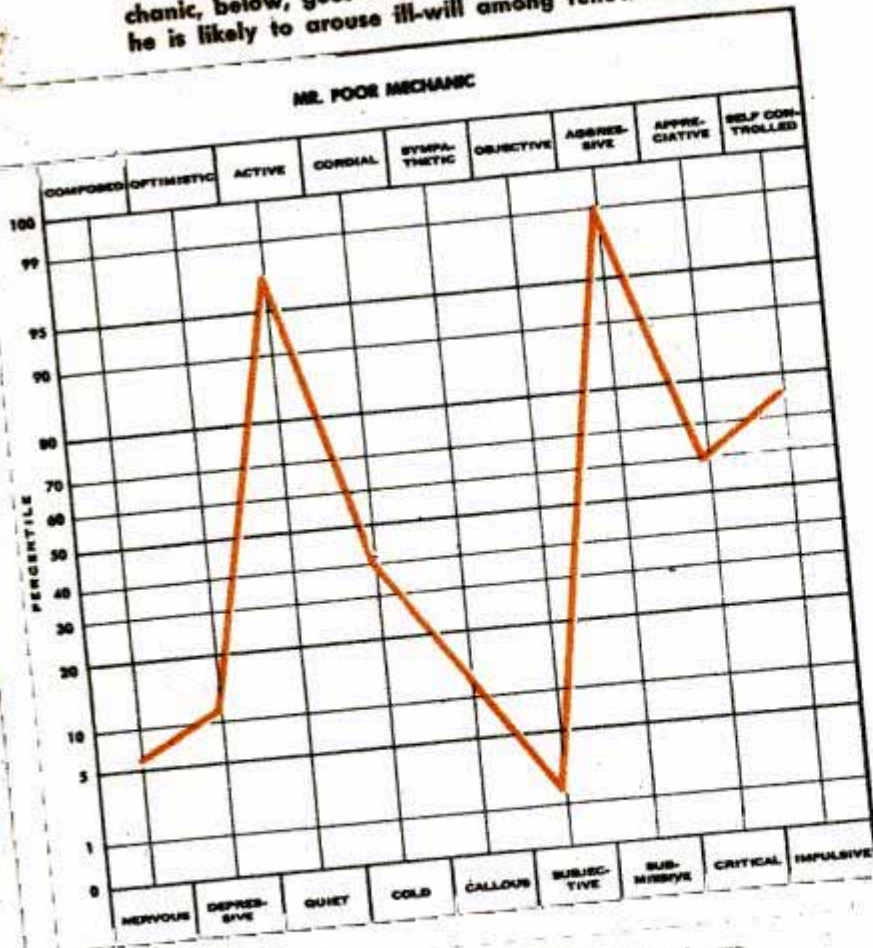

Copyright 1945 by Dalley, Brenner and Schreiber, Management Engineers

FORTUNE TELLERS

By Maston M. Jacks

in gunnery. Industry finds the aptitude tests invaluable in placing personnel. One railroad company reported a 90 percent decrease in operating mistakes by workers placed through tests. Many management engineering firms offer this service to industry, and many counselors help the individual chart his course from grade school age on. The usual fee for the individual runs from \$15 to \$30.

The Veterans Administration maintains its own staff of job-guidance counselors. Or VA may send the ex-service man to one of 200 approved testing centers established by universities or professional psychologists. After test scores are received, a job consultant will advise the most suitable



↑ Form board test is first cousin to jigsaw puzzle; time required to fit blocks into proper slots indicates subject's aptitude for three-dimensional problems





Human Engineering. It has laboratories in 10 cities where its researchers probe into the mental equipment and earning patterns of its clients. Human Engineering tests are used only in the organization's own laboratories. They are not published.

The Human Engineers label your mental characteristics as: personality, accounting aptitude, creative imagination, structural visualization, inductive reasoning, analytical reasoning, finger dexterity, tweezer dexterity, observation, memory for design, tonal memory, sense of rhythm and number memory.

An employer wants to know your "working" personality. To appraise personality makeup, the Robert N. McMurry Company in Chicago devised a "patterned" interview. Your answers to the administrator's questions indicate your stability, industry, perseverance, maturity, motivation and your ability to get along with other people. The interview is based on the premise that the administrator must carefully what he personality patterns

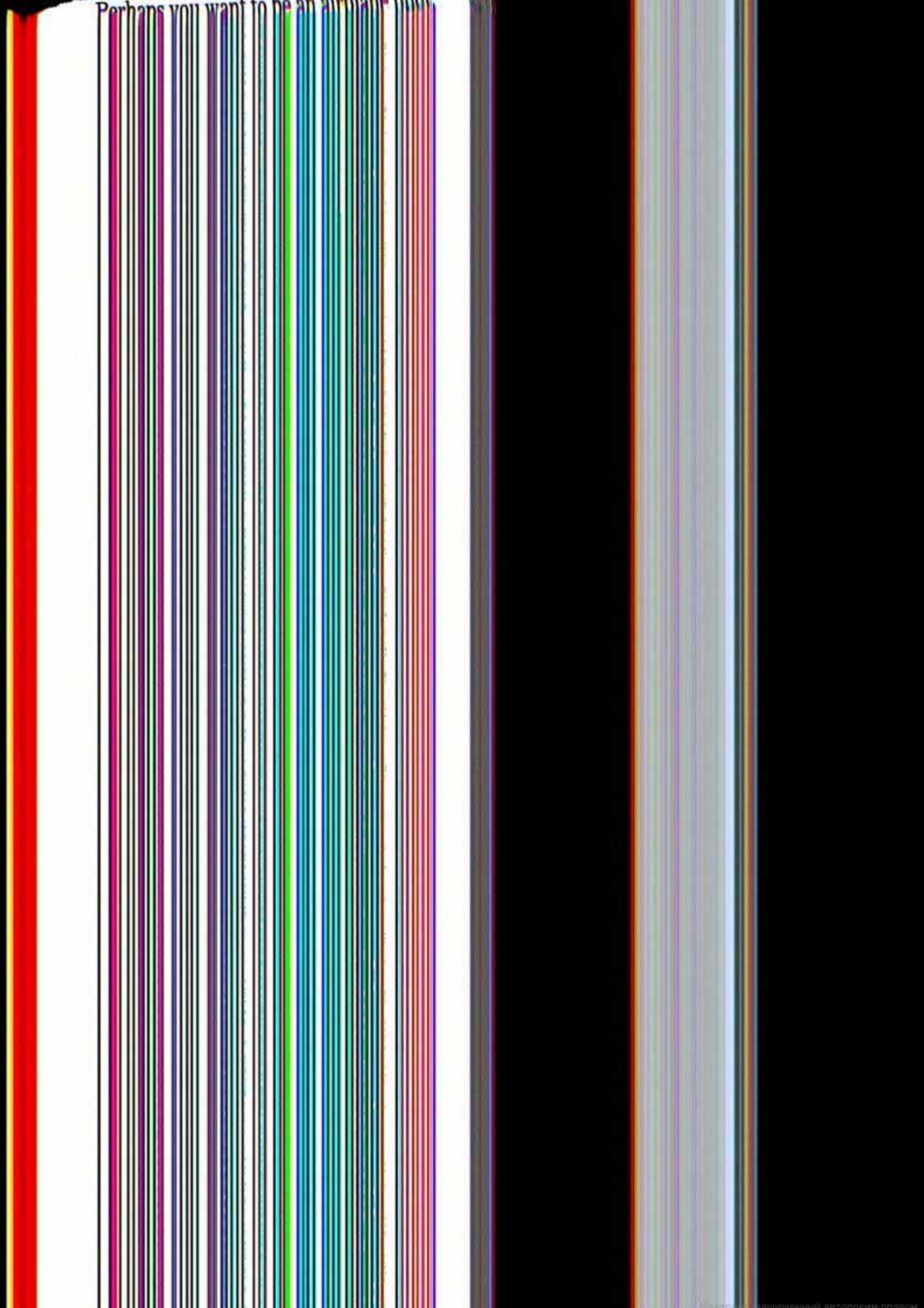

By Maston M. Jacks

in gunnery. Industry finds the aptitude tests invaluable in placing personnel. One railroad company reported a 90 percent decrease in operating mistakes by workers placed through tests. Many management engineering firms offer this service to industry, and many counselors help the individual chart his course from grade school age on. The usual fee for the individual runs from \$15 to \$30.

The Veterans Administration maintains its own staff of job-guidance counselors. Or VA may send the ex-service man to one of 200 approved testing centers established by universities or professional psychologists. After test scores are analyzed, the job consultant will be able to suggest the most suitable occupational fields.

Perhaps you want to be an airplane pilot, a musician, a mathematician. Each may require different aptitudes. Most tests used to measure those aptitudes are developed in university psychology laboratories or on the job. They are then published for mass application in schools or industry.

Psychologists define aptitude as an ability to learn in a specialized field. They search for the talent pattern by testing general intelligence, specific aptitudes, interest, emotional adjustment and skill. One of the most widely known interest tests is the Kuder Preference Record. Among industrial companies who use it are Ford, Western Electric and the Frigidaire, Delco and A. C. Spark Plug divisions of General Motors. In taking it, you decide which of three alternatives you like most and which you like least. For example, "Would you rather: (1) write articles on hobbies; (2) construct tables of figures on cost of living; (3) repair and refinish old furniture."

By checking your answers to such questions, the test administrator learns whether your interests are mechanical, computational, scientific, persuasive, artistic, literary, musical, social service or clerical.

For example, a mechanical engineer would need mechanical and scientific interests. After these were found, further skill tests would reveal his present ability to solve mechanical and scientific problems.

One testing laboratory believes it has isolated 13 mental elements which combine in more than 8000 different patterns covering 8000 jobs. This particular analysis was made by an organization called



↑ Form board test is first cousin to jigsaw puzzle; time required to fit blocks into proper slots indicates subject's aptitude for three-dimensional problems



↑ An ear for music? In tone test at Illinois Tech, subject must decide whether tones are same or different

↓ At Human Engineering laboratory, subject must arrange tiles in logical order in inductive reasoning test

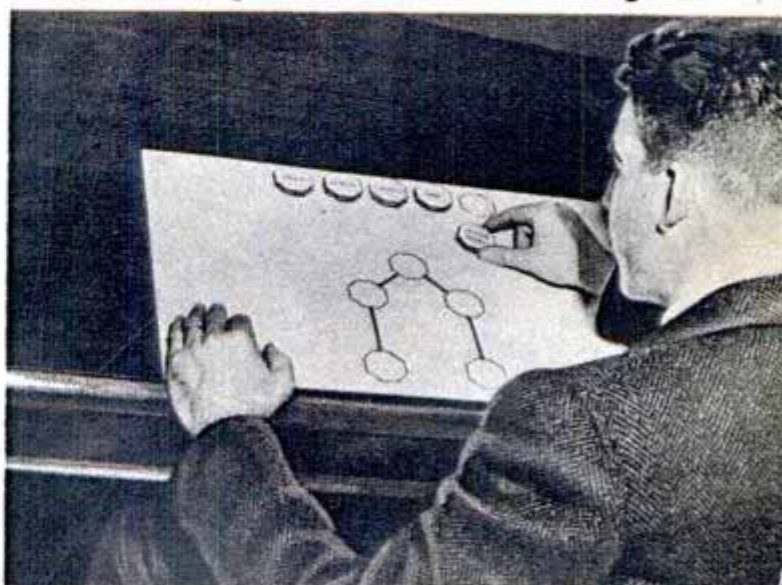

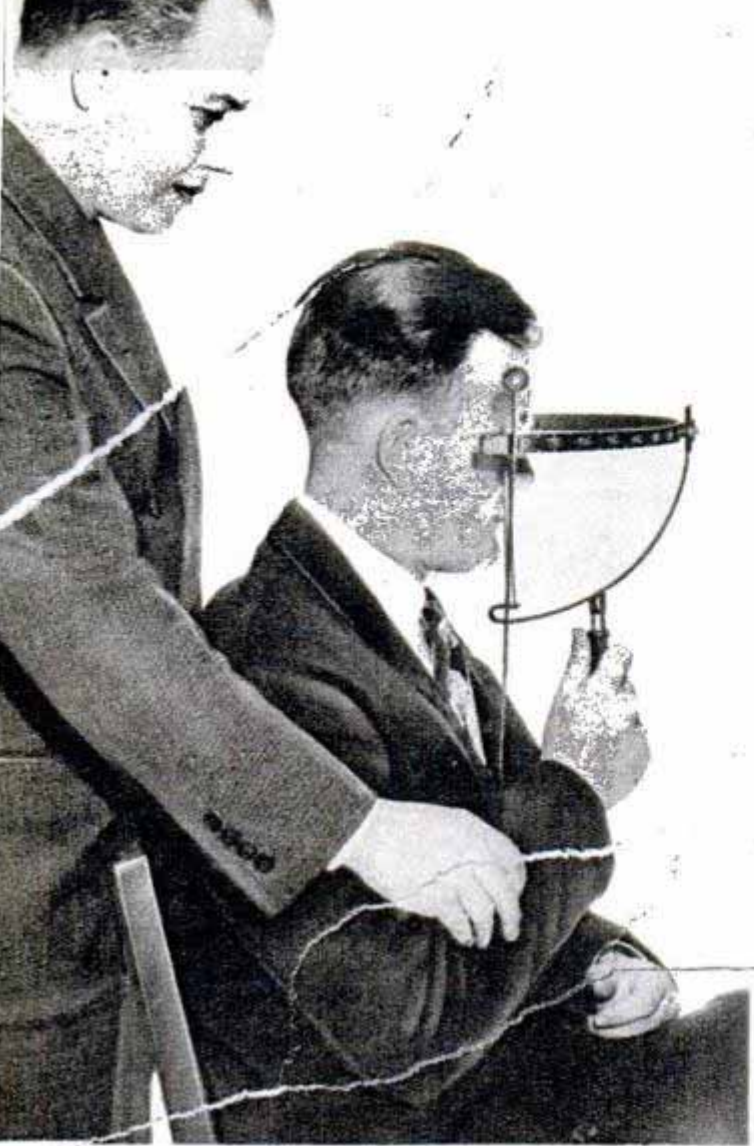

Many jobs require workers with wide vision. Applicant's sight is checked, above. Wiggly blocks, below, test ability to think in three dimensions. Time required to put them together is noted. Written tests are scored electrically in grading machine, right



the mental equipment and earning patterns of its clients. Human Engineering tests are used only in the organization's own laboratories. They are not published.

The Human Engineers label your mental characteristics as: personality, accounting aptitude, creative imagination, structural visualization, inductive reasoning, analytical reasoning, finger dexterity, tweezer dexterity, observation, memory for design, tonal memory, sense of rhythm and number memory.

An employer wants to know your "working" personality. To appraise personality makeup, the Robert N. McMurry Company in Chicago devised a "patterned" interview. Your answers to the administrator's questions indicate your stability, industry, perseverance, maturity, motivation and your ability to get along with other people. The interview is based on the premise that the best way to predict what a man will do in the future is to review carefully what he has done in the past. Personality patterns seldom change much.

Of all workers selected by this method at one war plant nearly 80 percent were successful in their jobs.

Other companies may use one of many written personality tests. Caterpillar Tractor, International Harvester and Bell and Howell, among others, check personality traits with the Adams Personal Audit. In answering, you indicate your degree of liking for certain activities such as acting as a master of ceremonies at a night club, interviewing applicants for a job or learning to fly an airplane.

Two of the most interesting Human Engineering tests are designed to measure

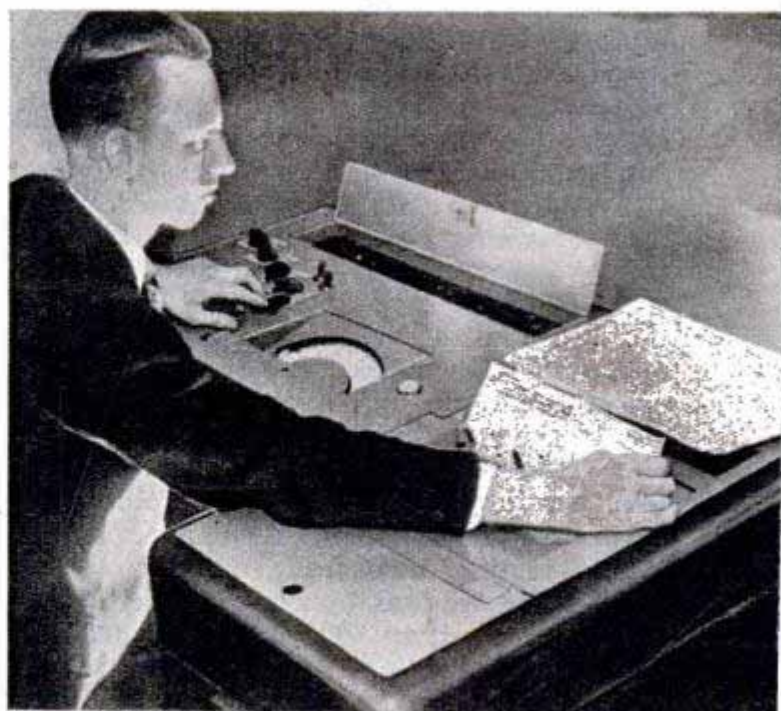

creative imagination and structural visualization. The test administrator might ask you, "How does it feel to be a fish?" and then give you 10 minutes to write as much as you can about what you think it would be like to be an angler's lure. Quality of the writing, misspelled words or faulty punctuation don't count. By counting the number of words you write, the administrator gauges your creative imagination. Writers, artists, advertising people, composers, schoolteachers and designers have a lot of it. So do many salesmen, architects, cabinetmakers and cooks.

Wiggly blocks, cut in jigsaw puzzle shapes, can forecast your ability to be a builder, engineer, surgeon, mechanic, carpenter, window decorator or geologist. They measure structural visualization—your ability to think in three dimensions. Either you'll be able to fit together the six to nine wavy pieces of wood into a solid block in thirty seconds or you'll fumble around so long, as many do, that you may become angry and refuse to have anything more to do with them. Highly successful scientists, contractors, city planners, airplane mechanics and production men have put the blocks together quickly.

The Human Engineers also check the three-dimensional thinking aptitude with a tray of wooden cubes. Some of the surfaces of the blocks are painted yellow and some black. The object is to build as quickly as possible, while the test administrator marks the time with a stop watch, one large block with all the black surfaces on the outside and all the yellow surfaces on the inside. Sounds simple, doesn't it? It is—if that is the way you think—but many intelligent adults score far below schoolboy levels on this test.

It is almost impossible to trick an aptitude test. Some persons try to indicate an absent aptitude by answering questions not as they would if they answered honestly but as they think a question should be answered. Innocuous questions, which seem to have little to do with the subject, invariably trip up such fakers.

Tests with peg boards, musical tones or simple mechanical problems may turn up other aptitudes and interests. It is dangerous to exaggerate the value of test results. Even to trained interpreters, each test indicates only a trend.

Supervisors, for example, must be able to exercise practical judgment in laying out jobs for workers. Psychologists get

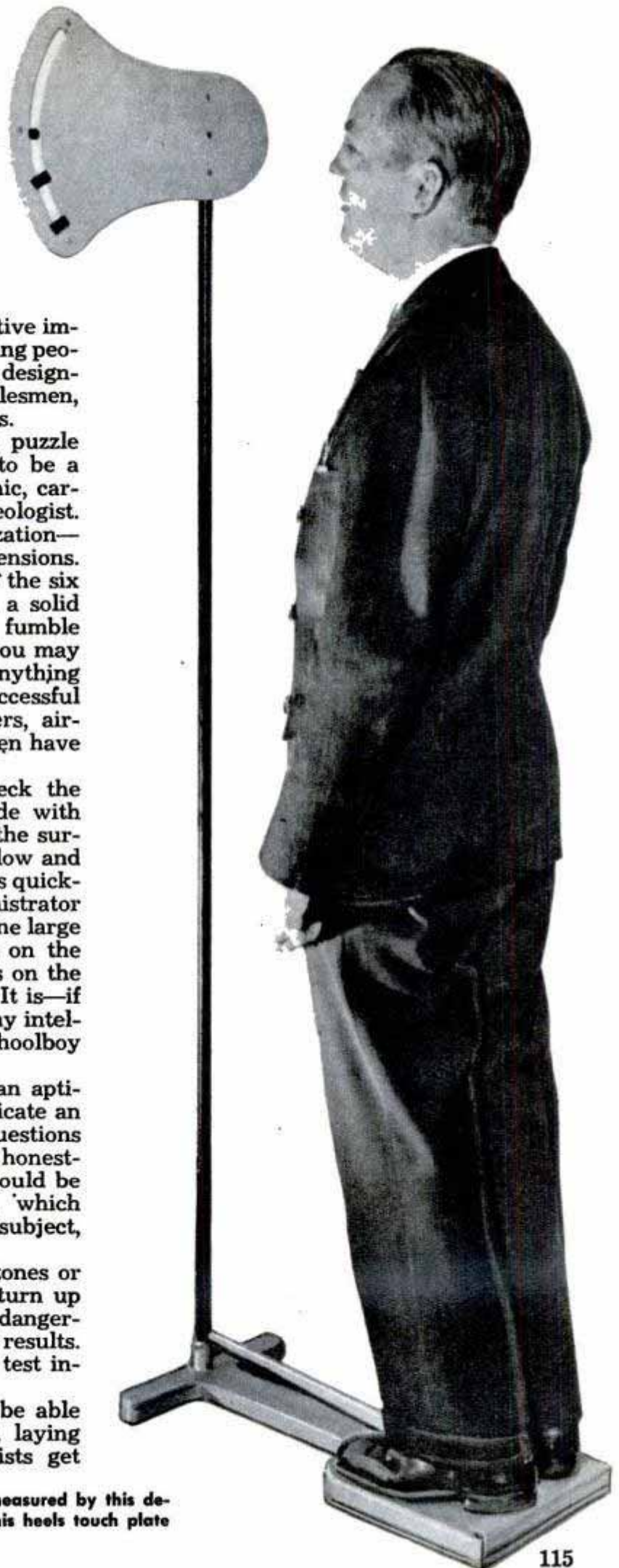

Worker's resistance to physical fatigue is measured by this device. Subject stands on toes, bell rings if his heels touch plate

INTERESTS

By studying the subject's answers to questions like these, a psychologist can determine the individual's special fields of interest. The person being evaluated circles "M" for the alternative liked most and "L" for the one liked least.

- M L Tinker with a broken sewing machine.
- M L Play a piano.
- M L Sketch an interesting scene.
- M L Weigh packages and look up amount of postage needed.
- M L Read manuscripts submitted for publication.
- M L Try out new automobiles to find out how they can be improved.
- M L Edit the financial news for a newspaper.
- M L Work on the development of a lighter and stronger metal.
- M L Manage a model village for factory workers.
- M L Be an expert on cutting jewels.
- M L Conduct research on developing a substitute for rubber.
- M L Be a radio commentator.
- M L Prepare the advertising copy for a new dishwasher.
- M L Determine the cost of producing the dishwasher.
- M L Sell dishwashers.

Copyright by G. Frederic Kuder. Published by Science Research Associates.

PRACTICAL JUDGMENT

From the answers given to a series of questions like these, the practical judgment of an individual can be diagnosed. The subject is asked to circle "1" for what he considers the best of four alternative answers, "2" for second best and "3" for third best.

What would you do if you wished to ask a favor of an acquaintance?

- 1 2 3 Impress upon him that he will benefit by it.
- 1 2 3 Discuss the benefits you will receive.
- 1 2 3 Offer to do something for him in return.
- 1 2 3 Ask him briefly, stating your reasons.

Why are traffic lights used at busy intersections?

- 1 2 3 To speed up traffic.
- 1 2 3 To give pedestrians a chance to cross.
- 1 2 3 To eliminate traffic officers.
- 1 2 3 To cut down accidents.

Why is electric refrigeration considered better than ice?

- 1 2 3 It provides more even refrigeration.
- 1 2 3 It improves the appearance of the kitchen.
- 1 2 3 It provides more space for food.
- 1 2 3 It eliminates the iceman.

What is the first thing you would do if the driver of the car in which you were riding fell asleep?

- 1 2 3 Wake him up.
- 1 2 3 Pull up the brake.
- 1 2 3 Turn off the ignition.
- 1 2 3 Take the wheel.

What should you do when you are criticized by your superiors?

- 1 2 3 Explain the situation.
- 1 2 3 Pay close attention to what he says.
- 1 2 3 Try to shift the responsibility.
- 1 2 3 Try to remedy the falling.

Copyright Science Research Associates.

some indication of potential supervisory ability from answers to the Cardall Test for Practical Judgment. Among the companies who use it are Ford, Trans World Airlines, Campbell's Soup and the Illinois Central Railroad. The person tested is asked to select the first, second and third best alternatives to problems. For example, "What would you do if the auto horn was stuck in your car? Would you: (1) pull out the wires under the dashboard; (2) call an auto repair shop; (3) call the nearest policeman; (4) look for the connection."

Your answers are linked closely with your general intelligence.

Careful analysis of thousands of jobs has isolated the aptitudes needed for successful performance. By comparing the results of your tests with standards established by others, the talent consultant can direct you to the proper occupational area. At one plant, workers were tested when they were hired. Some time later, supervisory workers rated their degree of success on the job. Checking test scores disclosed that most of those successful on the job had high marks on the tests.

Many school "intelligence" tests are really tests of acquired ability to do schoolwork. Tests of a group of chil-

PERSONALITY

Your likes and dislikes reveal your personality to trained aptitude appraisers. These are typical of the questions asked. The subject is told to circle "M" if he likes the following activities a great deal, "S" if he has some liking, "L" if little liking and "N" if he has practically no liking.

- M S L N Introducing strangers at a party.
- M S L N Being a delegate to a convention.
- M S L N Making application in person for a job.
- M S L N Looking at a musical comedy or vaudeville.
- M S L N Working for a commission rather than for regular salary.

Following are several common annoyances. The person being tested is asked to indicate his degree of annoyance by circling the "M" if a great deal, "S" if some, "L" if a little and "N" if none.

- M S L N To wait in a long line to see a show.
- M S L N To be detained when you are in a hurry.
- M S L N To run out of gasoline several miles from a filling station.
- M S L N To have someone break an engagement at the last minute.
- M S L N To have to talk when you don't feel like it.

Copyright by Clifford R. Adams. Published by Science Research Associates.

Six 6-digit numbers are flashed on screen in quick succession; subject then recalls as many as possible in Human Engineering's number-memory test

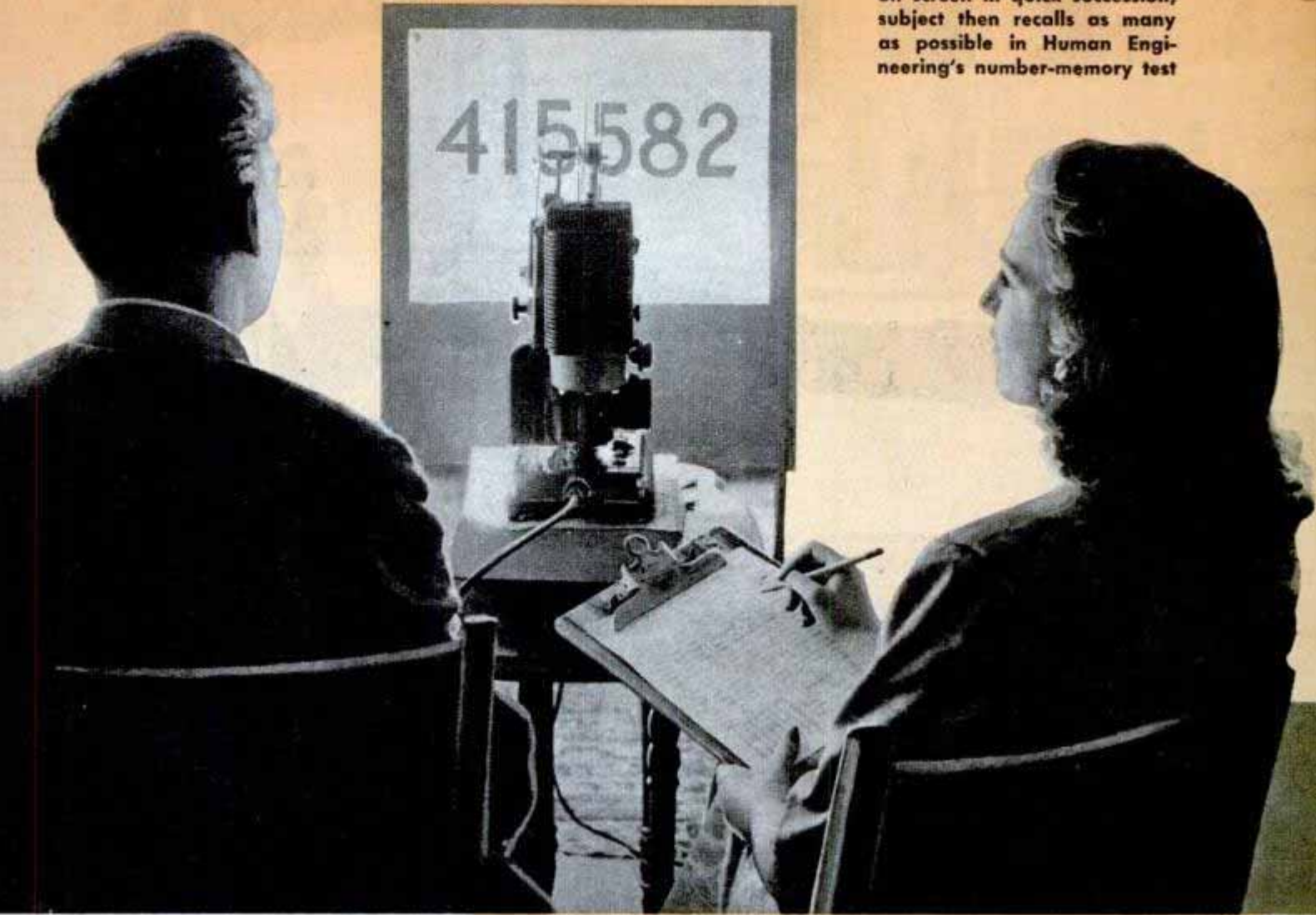

dren disclosed that of those failing in their lessons many had more strong aptitudes than those passing. Faulty instruction is to blame for such a condition. A follow-up survey by Human Engineering of one group tested divulged that most persons with high income are those using their strongest aptitudes and that those with low incomes are not.

On the Human Engineering scale of 13 aptitudes, four are enough if used properly. Only one person in 8000 has none, 13 in 8000 have one; 78 have two and 7500 are above average in four to nine.

Very probably you are six times as talented as you think you are, and you have five or six aptitudes which can be used profitably. Dig them out and use them. The talents are there waiting to be put to work.

Nonverbal picture test measures reasoning ability of persons unable to read or write. Subject eliminates the most different picture in each row
Copyright 1946, Robert N. McMurry & Co. Published by Science Research Associates

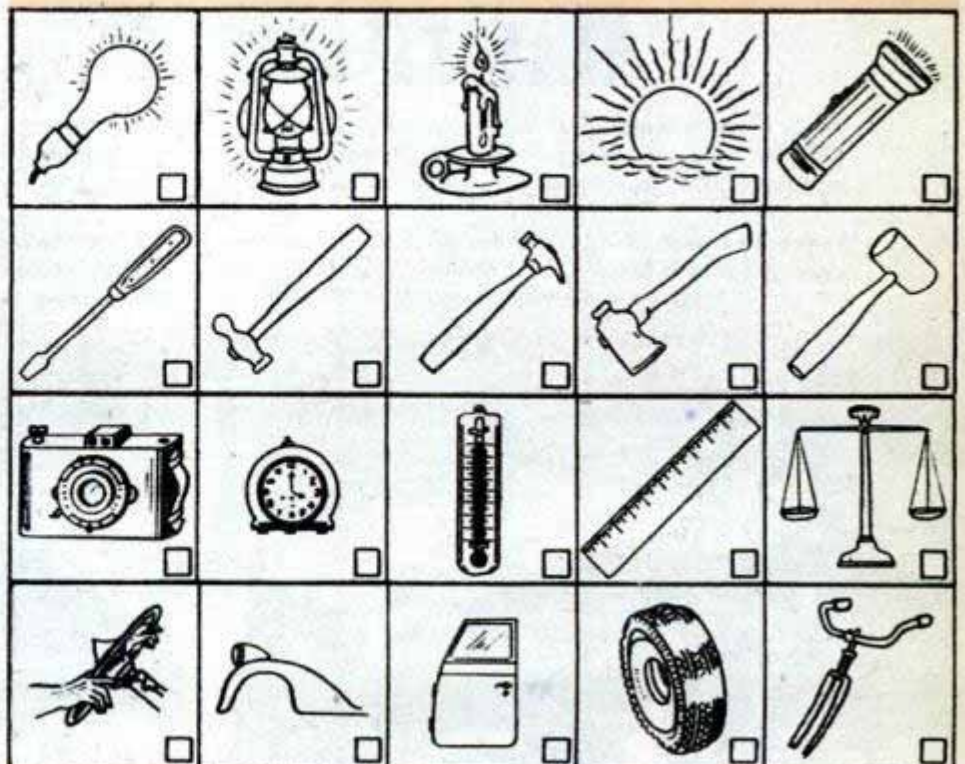

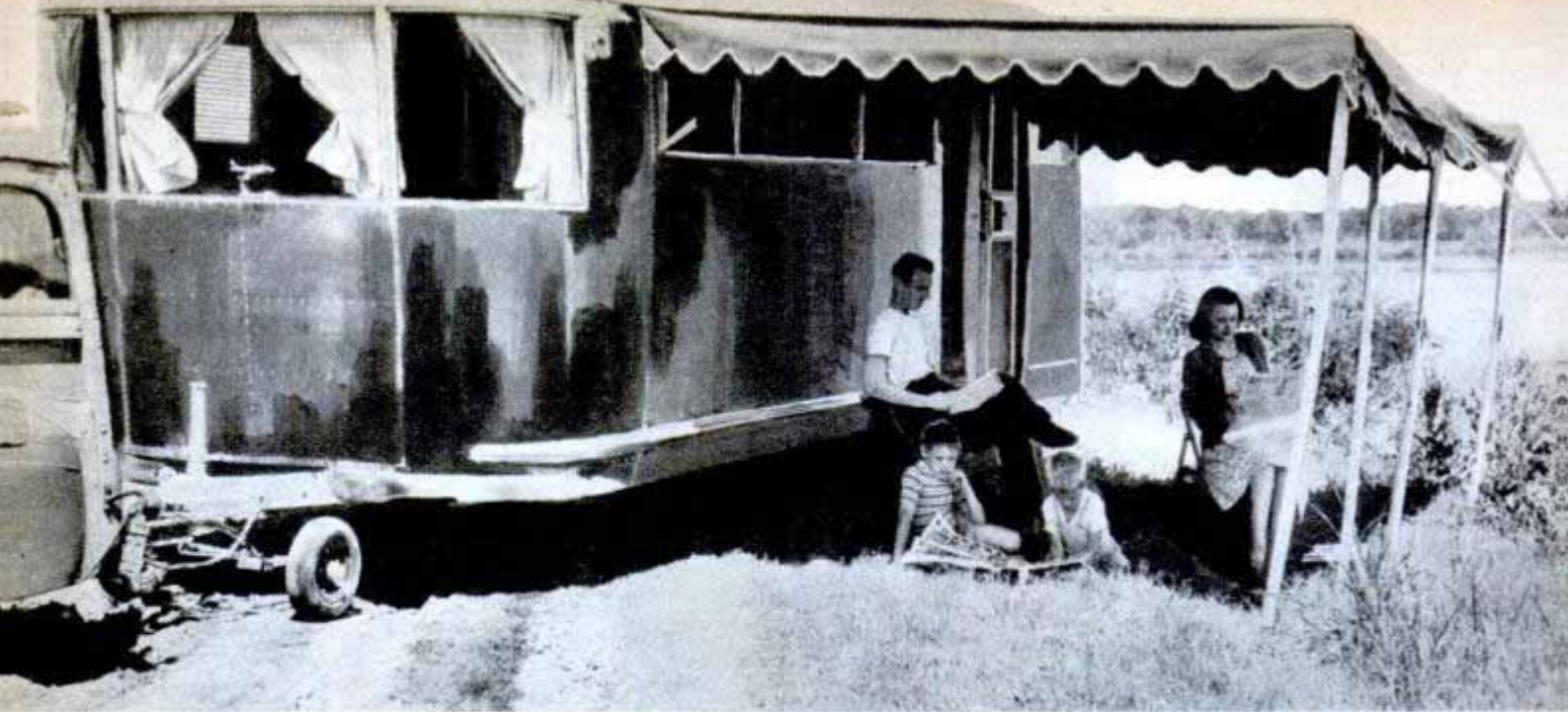

Three-room efficiency apartment on wheels, all-aluminum trailercoach has two-sink galley, bedroom with double bed and observation lounge outfitted with studio couch. It is 25½ feet long and weighs only 3500 pounds



Movie reenactment of first tandem-wing glider flight in 1905 by John Montgomery. Balloon lifted frail craft to 4000 feet to launch six-mile glide for cameramen

Runabout designed in London for disabled persons has interchangeable hand or foot controls. It gets 65 miles per gallon from 2½-hp. motor at speeds up to 40 m.p.h.



Chain arrangement on fluorescent light fixture permits lowering lamp enclosure and supports it while it is being cleaned. Chains unlock for complete removal

Hot water needed on farm can be heated on the spot with utility heater which can be submerged in an open vat or stock tank. It burns gasoline, kerosene or oil

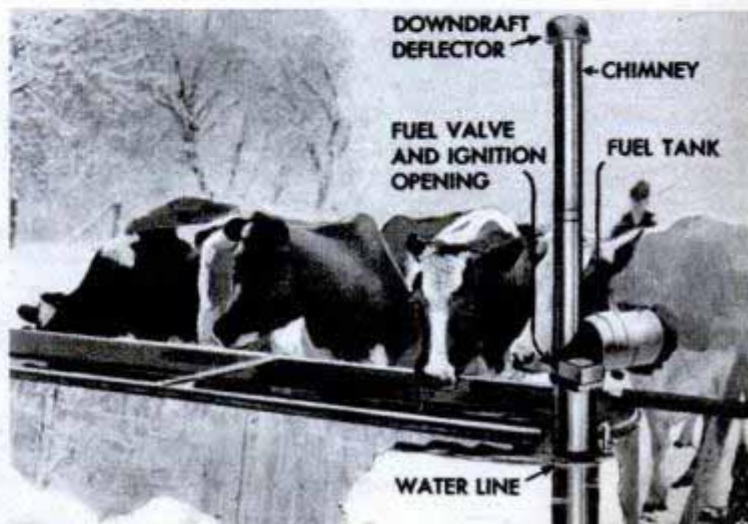

Thumb-Size Scissors Sharpener Holds Stone at Proper Angle

Dull scissors are given a sharp cutting edge by a thumb-size sharpener that is simple to operate. Made in a single stamped and nickel plated unit, the sharpener grips a carborundum stone at the exact angle to produce a keen edge.



One scissors blade is held in the left hand with the flat angle guide of the sharpener placed against the blade. This brings the cutting stone down on top of the blade and in precise position for sharpening. A few two-way strokes produce a sharp edge.

Adhesive on Enlarging Easel Holds Print Paper in Place

Borderless photographic enlargements that require no wasteful trimming can be made on a new easel that uses a thermo-plastic adhesive instead of moving parts to

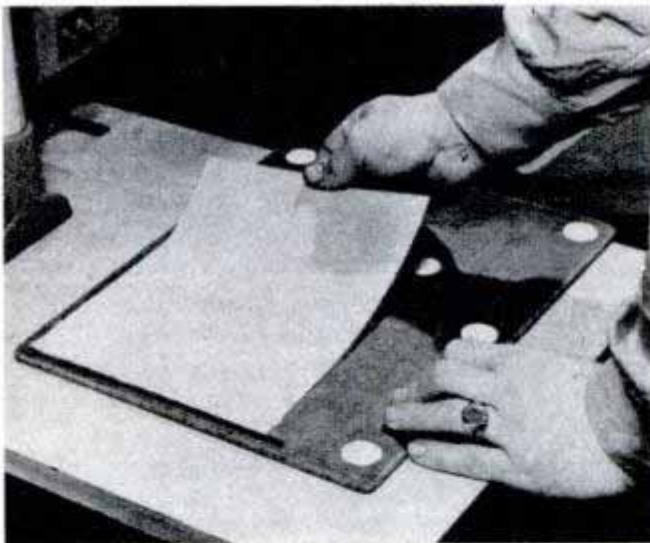

hold the sensitized paper in place. Retaining its tackiness permanently, the thermo-plastic holds the print flat during projection. Only slight pressure is necessary to fasten the paper to the easel, and no trace of the adhesive will adhere to the back of the prints. Conveniently placed holes provide an easy means of removing the exposed paper. The paper can be placed accurately on the easel even in complete darkness through use of a corner guide.

Like the drinking fountain that spurts as you bend over it, a liquid soap dispenser for surgeons squirts soap when a photo-electric beam is interrupted by the hand.



Coin Changer Returns Change From Dimes and Quarters

Customers who do not have a nickel handy can change their dimes or quarters into nickels with a fully automatic coin changer now installed on vending machines. The coin changer, produced by the Bell Aircraft Corporation, collects five cents for the merchandise and returns the correct amount from dimes or quarters to the customer. It is equipped with a slug-rejecting device. If merchandise in the machine is exhausted, the machine returns deposited coins.

Gas-Tank Whistle Prevents Spilling

Some automobile gas tanks are equipped with a fill tube that whistles when gasoline is pouring through it but stops whistling when the gas reaches one gallon from the top of the tank. When the whistle stops, the oil-station attendant shuts off the lever and no gasoline wastefully bubbles out of the tank. It is estimated that the whistle tube might save motorists an average of one half of one percent of the gasoline they purchase.

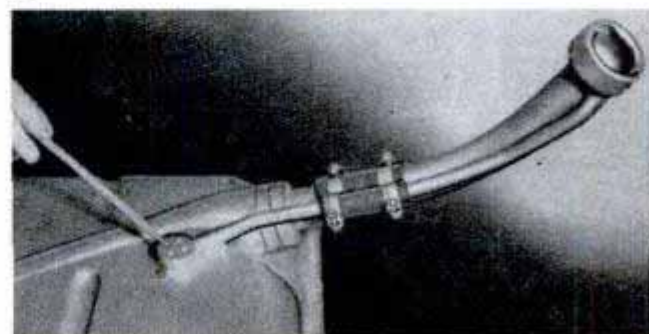



Midget Masterpieces in Silver

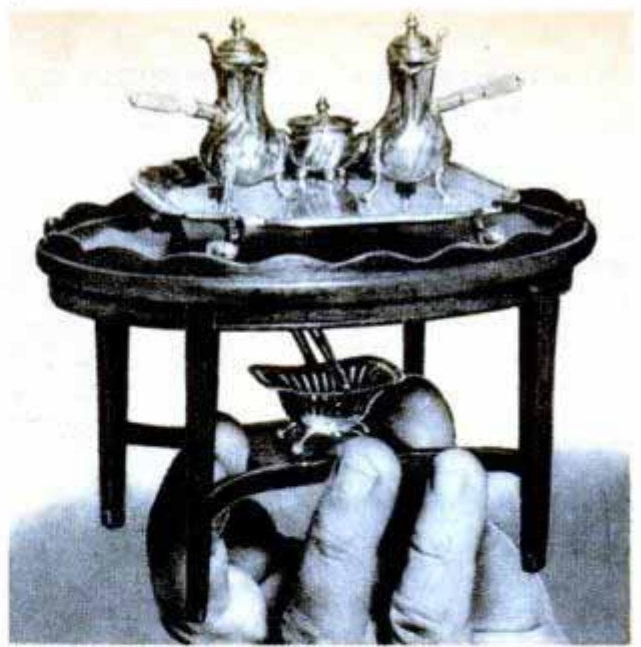

↑ Coffee service in French 1770 style weighs only three ounces, miniature pots stand 1¼ inches tall
↓ Finishing a fork with a special file is close work

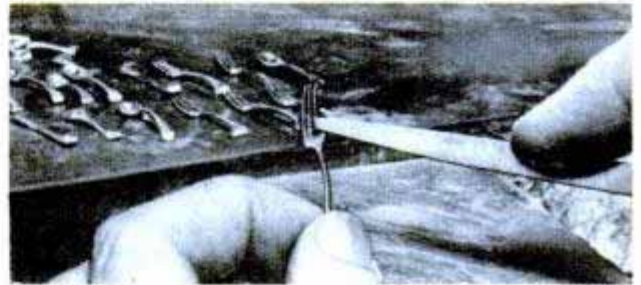

← Beating hardens silver, so half-finished pieces must be annealed on bed of pumice to make them soft again

WHEN silversmith William Meyers of Newark, New Jersey, chose a hobby he merely reduced the size of his regular work. Now collectors of miniatures are buying all the midget silver service that he can produce and Meyers has turned to his hobby as a livelihood. A jeweler's glass must be used to see the fine detail of his exquisite pieces. All covers are hinged, all spouts pour, and his lamps burn real fuel, fed by a needle!



Tiny reproduction of 18th century Sheraton table is set for six with authentic miniature silver service

"Mongrel" Automobile Assembled From Parts of 17 Different Cars

Harry Delaloye, 32-year-old Seattle, Wash., auto repairman, got tired of waiting for a 1946 automobile and built his own. He used parts from 17 dismantled cars, two trucks and one motorcycle. A 1934 Willys frame was lengthened by splicing into the middle a section from a 1939 Fiat frame. The Willys also supplied a double universal drive line and front and rear axles, while the Fiat's choke and throttle controls were utilized. Other parts included: 60-horsepower engine, transmission and radiator, Ford V-8; overdrive unit, 1942 Nash 600; shock absorbers, International truck; wheel bearings, hubs and brake drums, 1941 Studebaker Champion; hydraulic brake assembly and wheels, 1941 Nash 600; 5.00x16 tires from a motorcycle; hood narrowed down from 1937 De Soto; hood lock, 1941 Chevrolet; owner's name plate, 1941

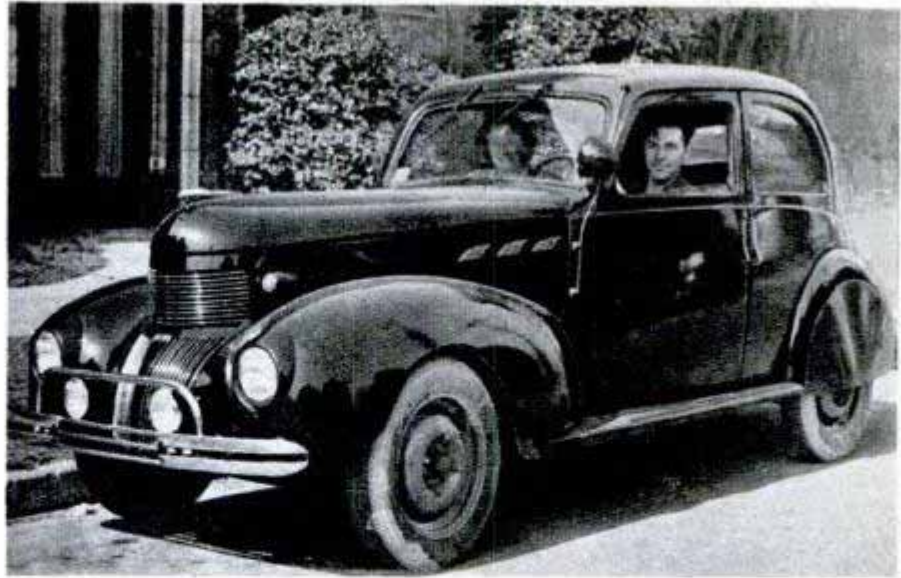

Hudson; front fenders, 1940 Mercury; motor generator, 1940 Lincoln; instrument panel, 1935 Oldsmobile; wiring harness and light switches, 1940 Dodge; taillights, 1941 Plymouth; rear license light, 1940 Pontiac; back-up lights and hood louvers, 1937 Graham-Paige; windshield wipers, Dodge truck; parking lights, 1940 Chevrolet. Delaloye says the car has ample power and speed.

Letter Files Open Sidewise to Save Space and Avoid Toppling

Letter files opening sidewise instead of vertically save space and are easy to manipulate. Called Rock-a-File because the entire inner compartment rocks a quarter

turn sidewise in opening, the new file saves an estimated 10 to 50 percent floor space. Other features are reduced accident hazard because it won't topple when fully loaded and opened, and the use of different compartments at the same time.



Sound Waves Chase Pigeons Off Courthouse Perch

Sound waves that can't be heard are driving unwanted pigeons from their perches on the courthouse at Minneapolis. To combat the pigeon nuisance, a pigeon annoyer was developed that drives off the birds with high-frequency sound waves. The device emits waves at 17,000 cycles per second, so high-pitched that they bother the birds. It was developed as a result of war research that proved there is a sound that annoys the ear of any living creature. The human ear is bothered by 2500-cycle waves, can still hear waves at 13,500 cycles per second, and can "feel" waves at 14,000 cycles. But the 17,000-cycle waves that are driving away the pigeons can't be heard or felt by the Minneapolis residents.

Leaks in fuel pipe lines under the English Channel are now spotted by using the same chemical with which downed airmen colored the water around their rafts.

How to play THREE-CUSHION BILLIARDS

By Willie Hoppe

THREE-CUSHION-BILLIARD addicts live longer than other people. Like chess players, they concentrate so hard on their game that they forget about business, OPA, shortages and other worries. They learn to relax and enjoy themselves.

An estimated 10,000,000 persons play billiards and a high percentage prefers the three-cushion variety, which is definitely a game of science. Mathematics, particularly geometry, enters into it.

But don't let that frighten you if you're thinking about learning the game. I've known many men who play an excellent game, yet they never studied mathematics.

They simply have played enough to "feel" the angles on the table through which a ball must travel to make a billiard.

Furthermore, if you decide to improve your game by applying a little science, all you have to do is learn the Diamond System and let the in-laid diamond markers on the table rails serve as direction guides for your shots.

Willie Hoppe, one of the world's greatest billiard players, prepares to make a masse shot

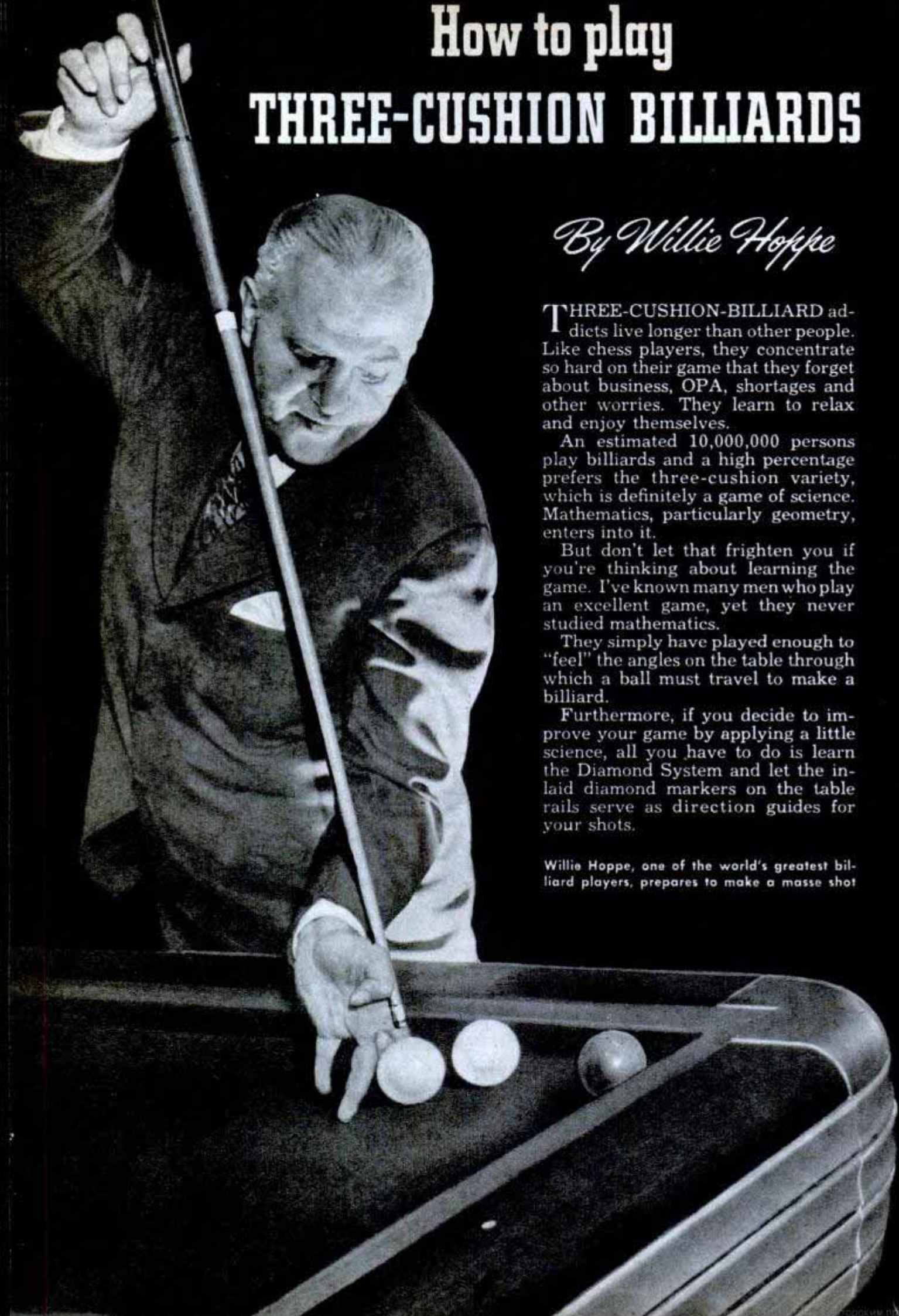

Follow the arrows drawn on this multiple-flash photograph and you can see how Hoppe makes a break (opening) shot. Millionth-of-a-second light flashes from a stroboscope "slowed" the speeding balls for photographing

I played billiards for at least 10 years before I learned and began using the Diamond System. Of course, I started playing at an earlier age than most fellows. In fact, I was only five years old when I played my first game of pocket billiards.

My father, himself an excellent player, operated a little hotel at Cornwall-on-the-Hudson, N. Y. We had a combination billiard and pocket billiard table and when things were slack Dad would teach me the fundamentals.

By the time I was nine I played a pretty good game. I never will forget one experience I had when I was still a boy in short

pants. A traveling salesman (we called them drummers then) stopped at the hotel and saw me practicing.

"I've got some spare time, sonny," he said, "so I'll be glad to play you a game and give you some pointers."

He suggested that we play 15 points of pocket billiards and I said that suited me. The salesman took the first shot, scattering the balls but failing to make the one he called. I got up and knocked in every one of the 15 balls without a miss. The stranger walked away, muttering:

"What kind of a town is this? I'm a fair player, but here even children beat me."

THE UNPARALLELED HOPPE RECORD

(WORLD TITLES AND MARKS)

THREE-CUSHION

World Champion:
1936, 1940, 1941, 1942, 1943, 1944
High Run.....25 (Exhibition)
High Run.....20 (League)
High Run.....15 (Challenge Match)
High Run, Choice of Balls.....20
High Grand Average.....1.161 (World Tournament)
Consecutive Tournament Victories.....35 (1940-41)
Tournament Victory Streak
38 out of 39 (1936, 1940, 1941)

18.1 BALKLINE

World Champion: 1906-07, 1908-11, 1914-46
High Grand Average.....36 4/11

18.2 BALKLINE

World Champion: 1907, 1910-20, 1923-24
High Run.....622 (Exhibition)

14.1 BALKLINE

World Champion: 1914-46
High Run.....303
High Single Average.....40
High Grand Average.....25.75

71.2 BALKLINE

World Champion: 1938-46
High Run.....248
High Single Average.....83
High Grand Average.....42

CUSHION CAROMS

World Champion: 1933-46
High Run.....53 (Challenge Match)
High Single Average.....11.36
High Grand Average.....6.43
Best Game.....22 Innings (250 Points)

Copyright 1941, Reilly & Lee Co.

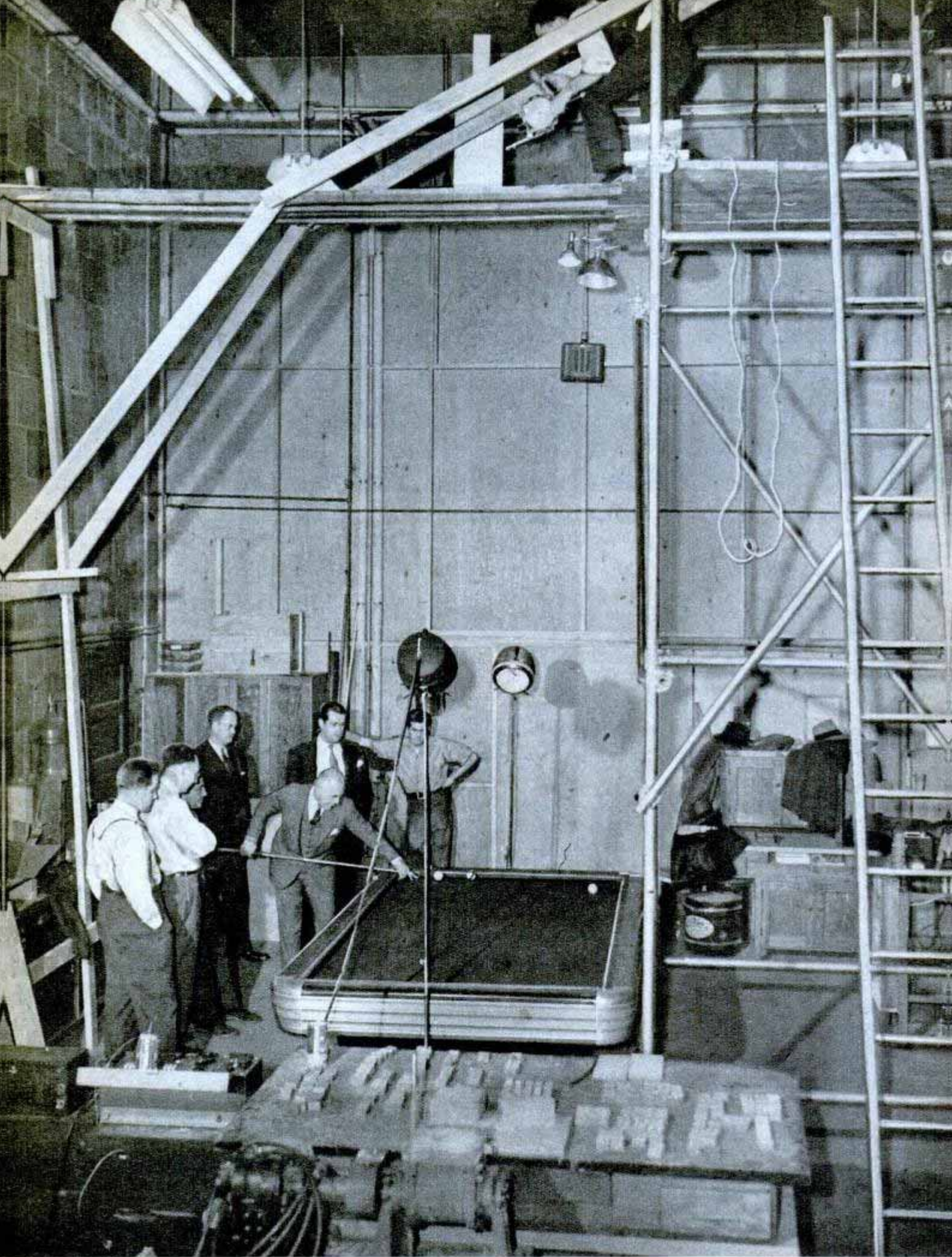

This is how the high-speed billiard photos were made for Popular Mechanics at Armour Research Foundation. As Hoppe shot, stroboscopic lamps at each end of the table blinked on and off every two-millionths of a second. The shot was photographed by a cameraman on a scaffold, who used a Speed Graphic with shutters open

Tape and arrows trace the path of the cue ball in making three-cushion break

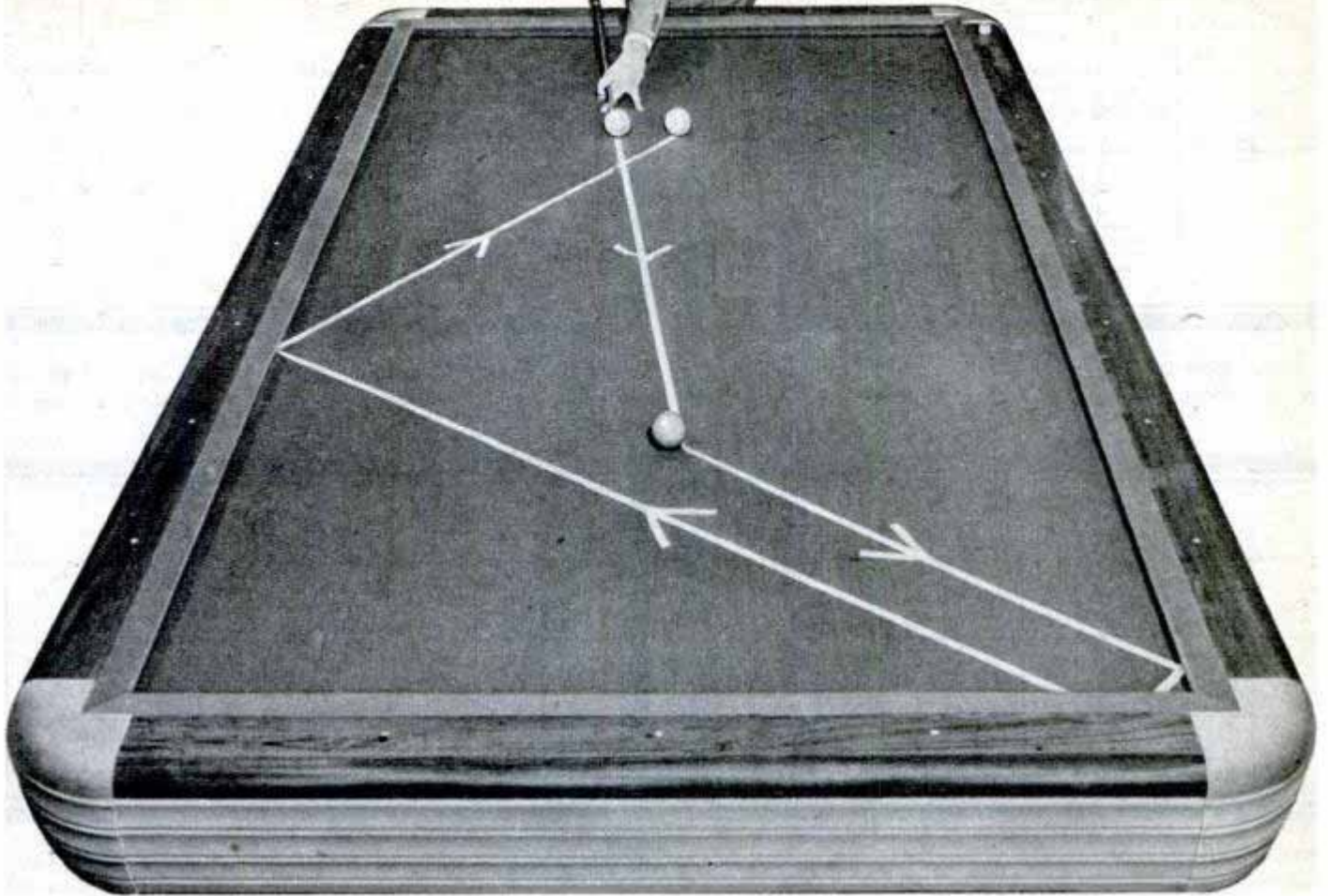

Some years later I decided to make billiards my profession and went to work for the Brunswick-Balke-Collender Company. By constant study and practice during my 57 years I've been able to win most of the world's billiard championships: three-cushion, 18.1 balkline, 18.2 balkline, 14.1 balkline, 71.2 balkline and cushion caroms.

Before describing the mechanics of three-cushion billiards and how to apply them to improve your game, perhaps I'd better explain the rules of the game.

Three balls are used, one red and two white ones. One white ball is marked with a small black spot on two sides to distinguish it from the other white ball. Each of two players selects a white ball as his cue ball. In order to score a point, the cue ball must strike three or more cushions before completing a billiard. By "completing a billiard," I mean that the cue ball strikes the other two balls.

If you've played straight billiards in which you score simply by hitting the cue ball against the other two balls, or pocket billiards (pool), it won't take long for you to

become a pretty good three-cushion player, IF—

You study and apply the seven essential fundamentals I shall describe in this article. Those seven points are:

- (1) Position at the table (stance)
- (2) Grip on the cue
- (3) The bridge (way you hold the cue near the tip)
- (4) Cuing the ball
- (5) The stroke (follow-through)

High-speed photo shows "up-and-down" three-cushion billiard shot

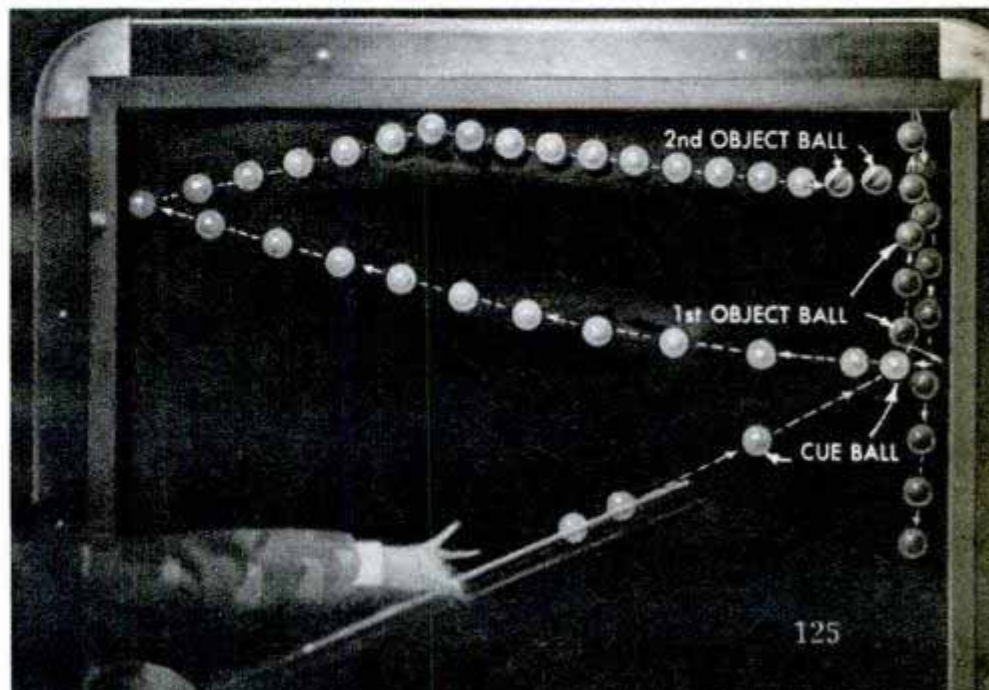

KEY SHOTS IN THREE-CUSHION BILLIARDS

Diagrams by Reilly & Lee Co., Publishers, Chicago, Ill.

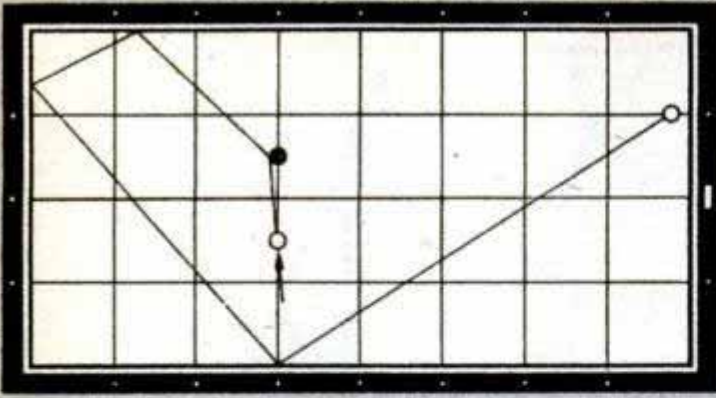

Hit object ball on the left, about a third of the way in from the edge. Strike cue ball a little to left of center

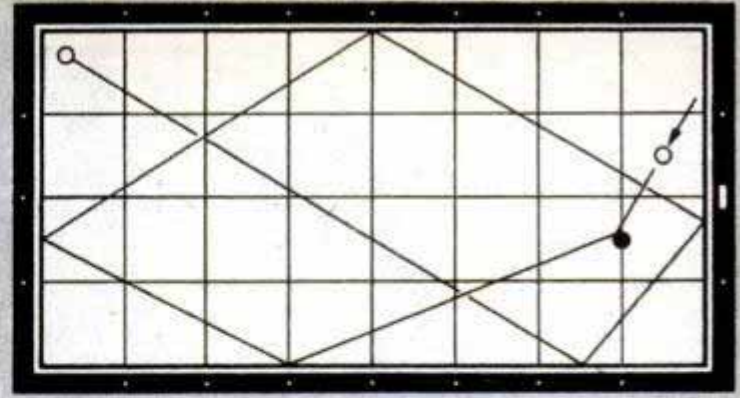

To make this five-cushion shot, hit the object ball fairly thin on the right while putting right english on cue ball

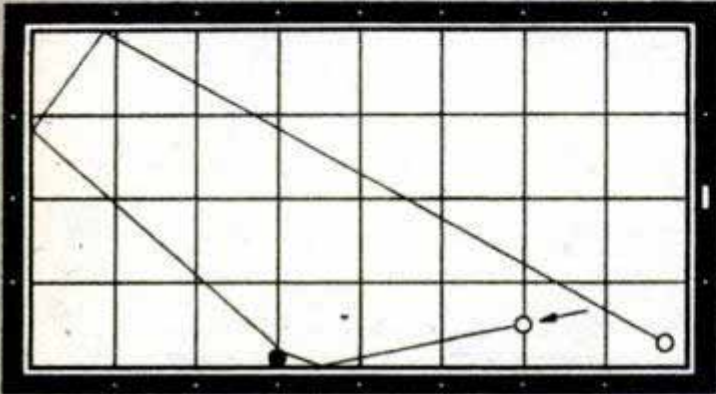

In this rail-first shot, hit the cushion as illustrated in the diagram. Strike cue ball in center and use no english

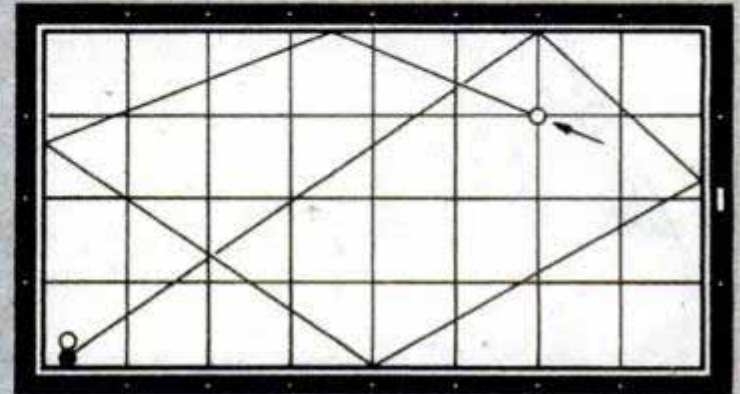

This makes a spectacular five-cushion bank shot. You use a moderately hard stroke with a little left-hand english

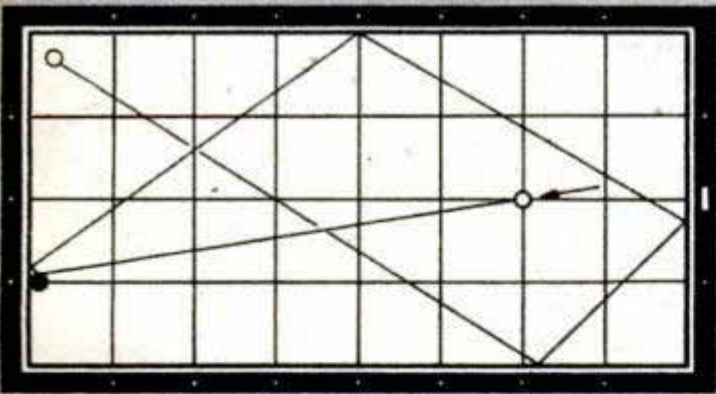

You have to have a "good eye" to make this shot because its success depends on your ability to hit the object ball thin

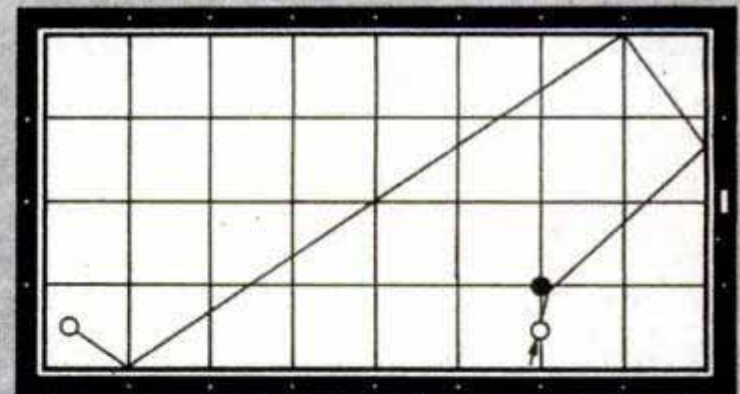

In executing this shot you hit the object ball on the right side while putting a little left-hand english on the cue ball

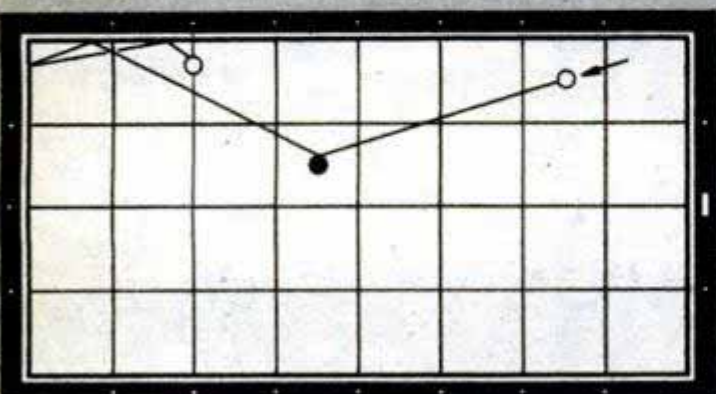

This is a tough shot but you can make it by putting plenty of right-hand english on the cue ball. For all shots, cue the ball within the dotted area (right) to avoid miscues

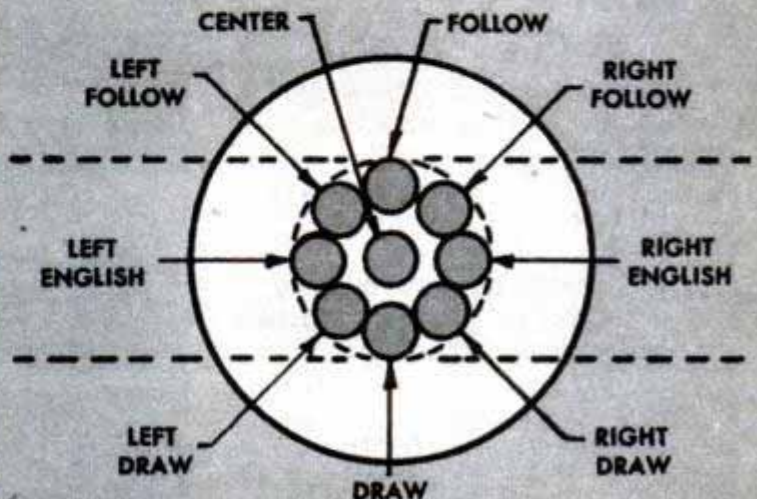

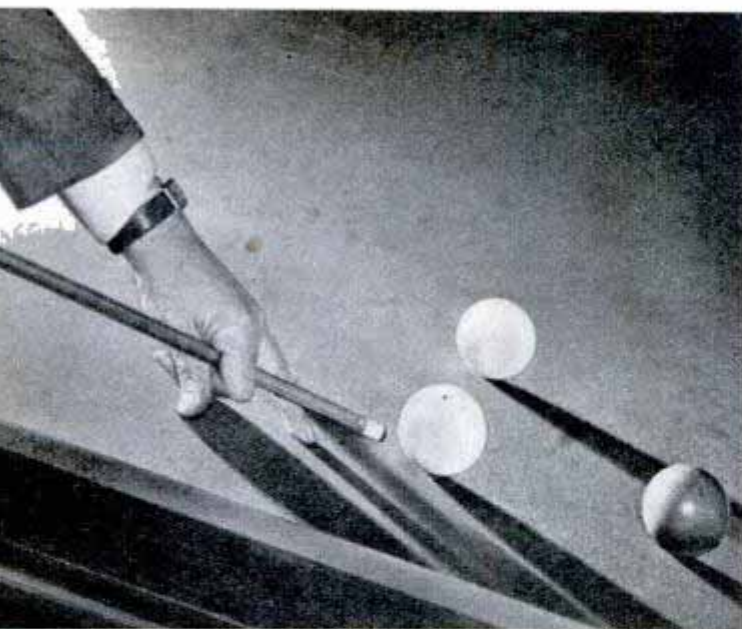

Steadiness and accurate aim are provided by holding the cue in what Willie Hoppe calls a "tripod" bridge

(6) Application of english (spin on the ball)

(7) Speed and force

Your position, or stance, at the table should be natural yet solid. You should be comfortable, relaxed in posture and in position to execute the shot facing you.

Face the shot squarely, your feet a slight distance apart, with the left foot forward to give you firmness. I stand with my feet about 19 inches apart. For clarity, all instructions in this article apply to right-handed players.

When you bend over to make a shot, keep your head directly over and on a line with the cue so that you can sight as a hunter sights a gun. The right arm swings freely with no interference from your body and the left arm is extended and kept straight with the hand resting on the table to form a bridge to hold the cue at the tip end.

In gripping the cue, only the thumb and the first finger are in contact with it. The contact is light but tight enough to be firm. The middle finger sometimes touches the cue in the grip of the average player, but very lightly. Hold the cue at or near the balance point. Don't grasp it in a rigid, viselike "death" grip.

There are variations in the bridge used by professional players, usually due to the difference in finger lengths, but the orthodox "tripod" bridge always is the basis.

Here is the four-step method I recommend for making your bridge:

- (1) Place your left hand flat on the table with the heel of the hand firmly on the cloth
- (2) Bend or double the forefinger until the tip rests against the thumb, forming a loop



Hoppe shows John R. Kinsey, associate editor, where to place the left hand for a shot off the cushion



The butt of a cue is grasped near the balance point and held with a light grip but tight enough to be firm. Below, guide cue in this manner for rail shots

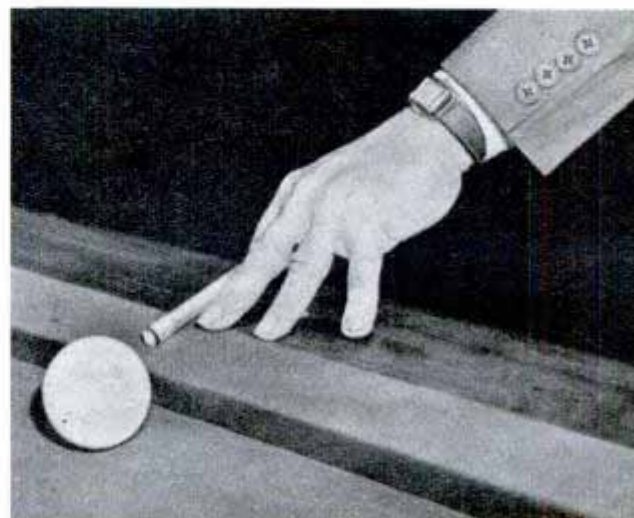

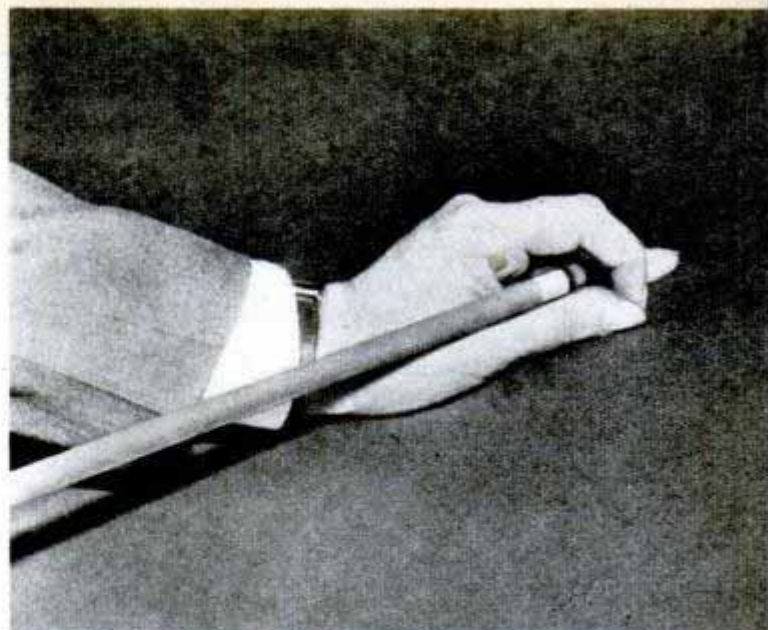
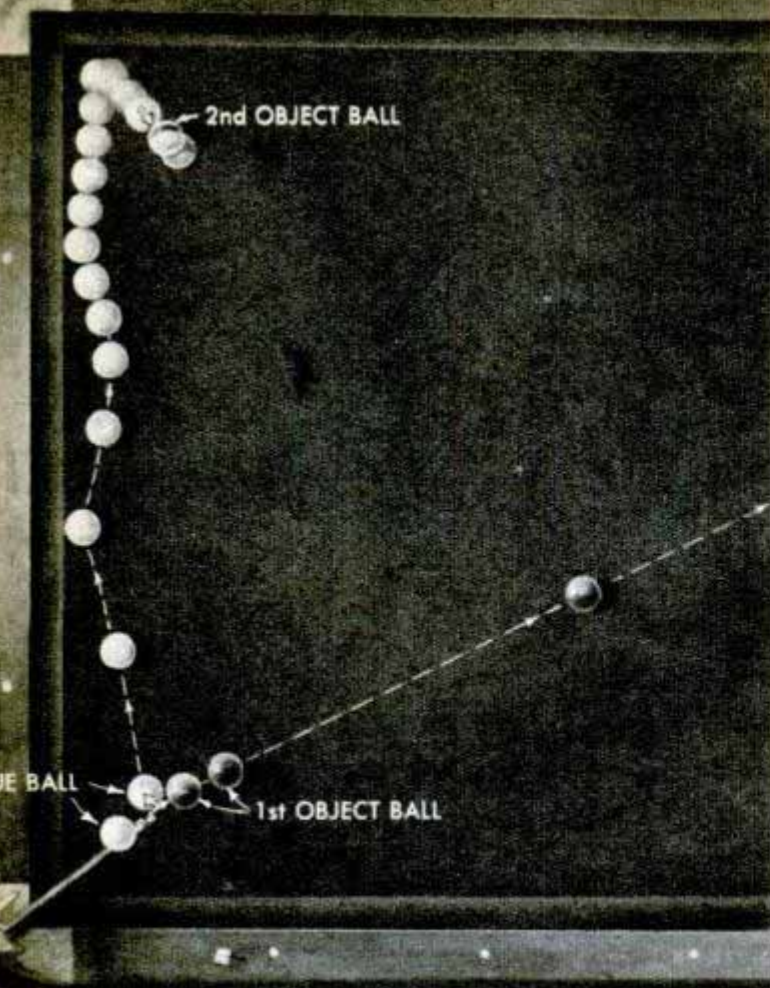

↑ How fingers form a "bridge" to hold billiard cue
 ← Cue ball hugs left cushion in this difficult shot

- (3) Place the cue in the groove between thumb and forefinger
- (4) Put the cue through the loop made by your forefinger and thumb, and pull your forefinger back firmly against the cue

Now, to form the orthodox tripod bridge, which I use and advocate for three-cushion

play, raise the heel of the hand off the table, putting all the pressure of the hand on your thumb, curled-back middle finger and third and little finger. You can automatically sense the firmness of this bridge.

The next lesson is on "cuing the ball." The manner in which you strike the cue ball with your cue determines whether or not you will make a billiard, assuming that you have figured out the correct angle.

The most important thing to remember is: Don't put too much english (spin) on the cue ball. Anyone who has watched

(Continued to page 248)

This bank shot, often called a "natural," is easy for the three-cushion player who knows the Diamond System

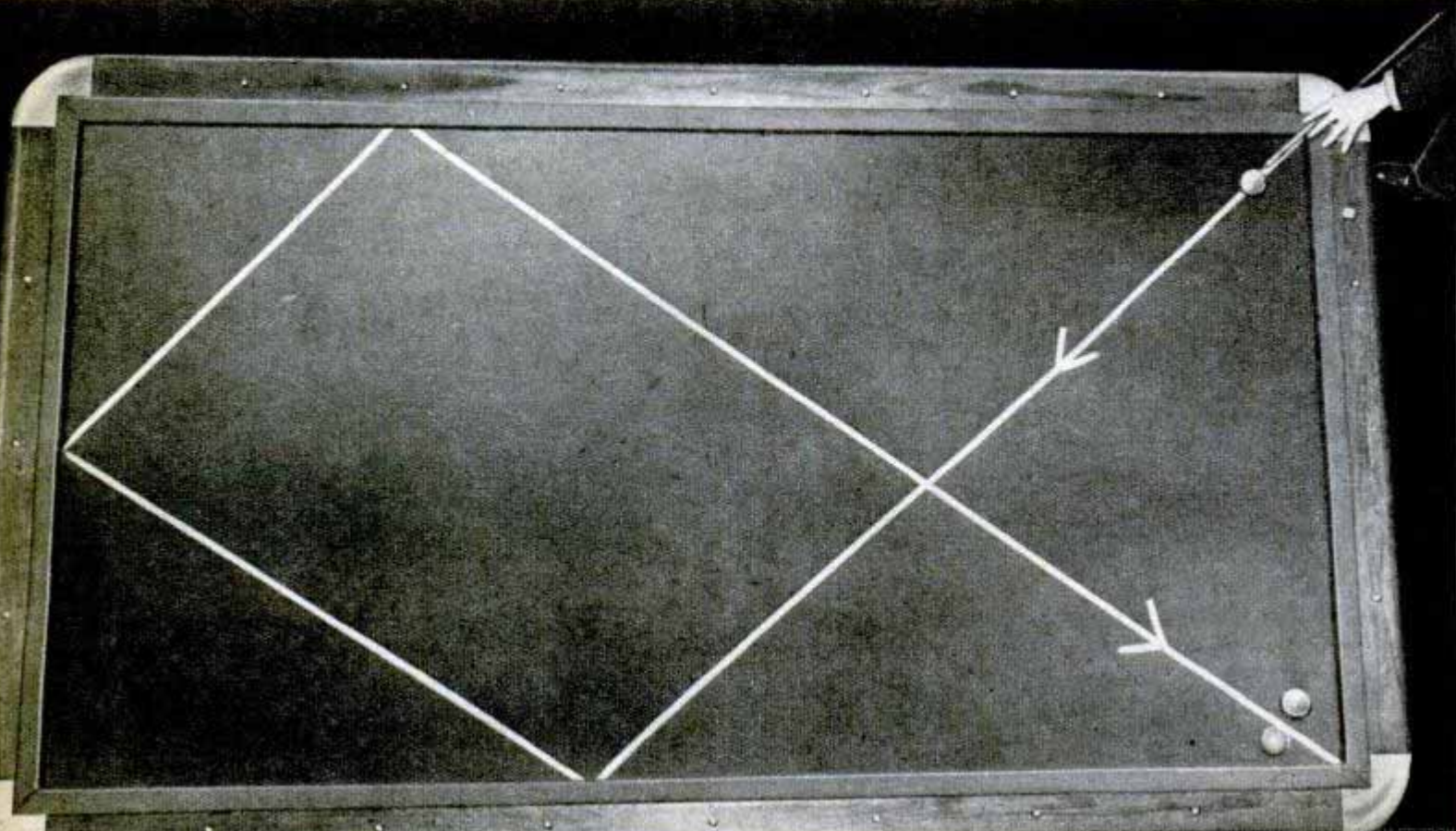

Mobile Air Conditioner for Big Planes Could Service Five Homes

Enough heat for five small homes or a cooling capacity equal to the melting of 10 tons of ice is provided by a mobile air conditioner for air liners. The truck-contained unit operates while the plane is grounded for loading or unloading. It is attached by a 20-foot flexible hose. In 120-degree heat the plane interior can be cooled to 80 in a few minutes, or at 30 degrees below zero the temperature can be boosted to 70 within an equally short period. Conditioned air is distributed through the plane's existing duct system and thermostatic temperature control is automatic. While designed for the largest planes, it is readily adaptable to the smallest types.

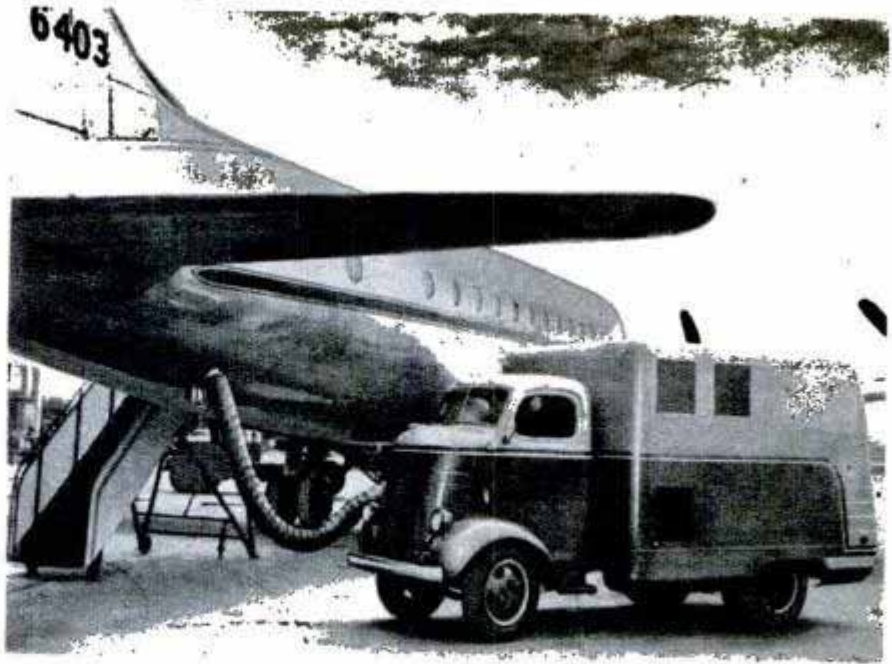

The unit can be used to preheat airplane engines or for other emergency heating or cooling problems.

Booster System for Ford V-8 Heater Gets Water From Each Block

Both blocks of Ford V-type engines can be made to supply warmth for the car heater through a system which employs both water pumps in series. A thermostat setting maintains a balanced temperature in both blocks and prevents overheating of one block or too quick cooling of the other. Water flows from the right bank of the engine through the heater to a T-fitting installed between the radiator and water pump on the left cylinder pump. This water is forced through the left engine block by the left engine pump to a check valve between the radiator and the right water pump of the right cylinder bank. If

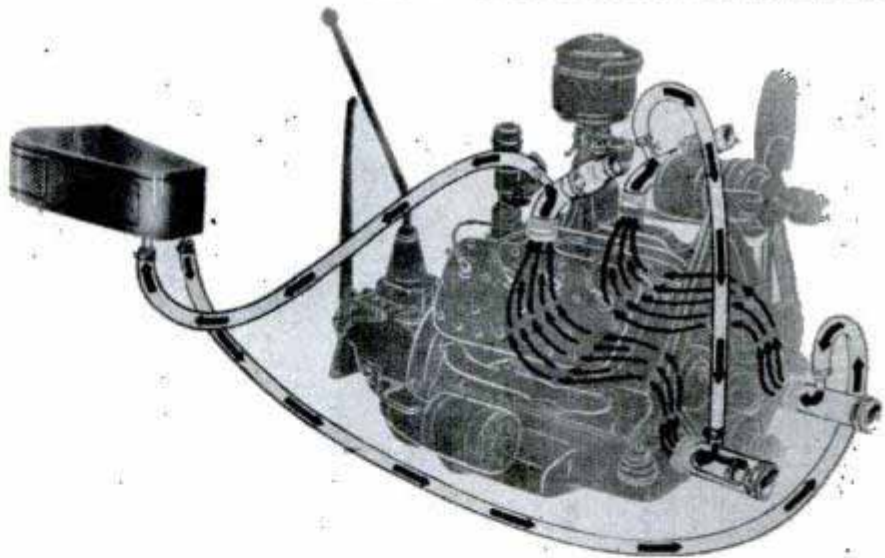

it should be too hot the thermostat control allows it to flow into the radiator for more cooling before it is pumped into the right engine block and to the heater again.

Sanitary Aluminum Capper for Infant's Bottles Keeps Hands Off Nipple



There's no danger of hands contaminating a baby's bottle with a capping device consisting of a pair of tongs and an aluminum frame which slips over the bottle. The nipple is placed on the frame with the tongs. The frame then is placed over the bottle and pushed down. The prongs of the frame spread and stretch the nipple over the mouth of the bottle.



Sturdy nursery chair also serves as a play table. The double seat is hinged and it and the back of the chair swing to the floor to become half the table.



False front over top two drawers of child's five-drawer chest drops to make a desk. The play table shown at left is chair again.

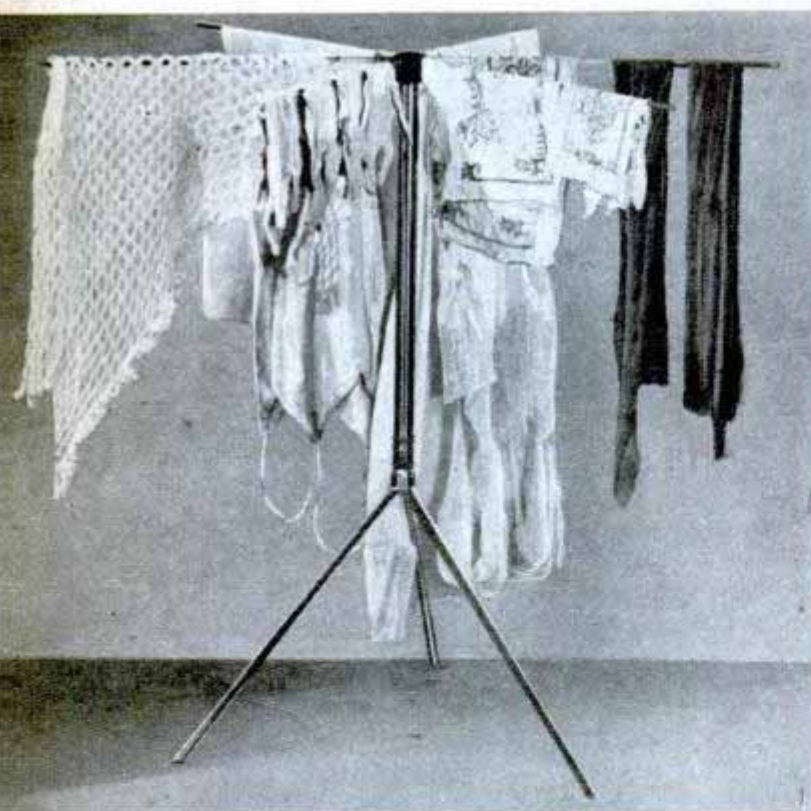

Clothes drier opens like an umbrella and requires little storage space when shut. Six drying arms and tripod legs are locked in position by sliding rings.

"Inside Stubb"

for Your Home

Clothesline tightener keeps line taut after downward pull tightens it. The tension can be released quickly by pulling on locking end of the tightener.

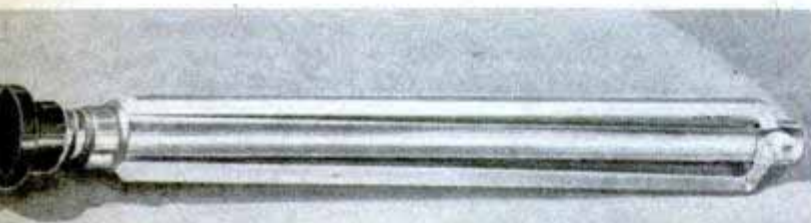



Slotted slats in Venetian blinds, above, can be removed for cleaning. Hauling a heavy basket of wet clothes to lines is easy job with laundry buggy below

Molded rubber plunger gives light dousing action for washing lingerie. Quarter turn locks "frog" in base of flower bowl, below

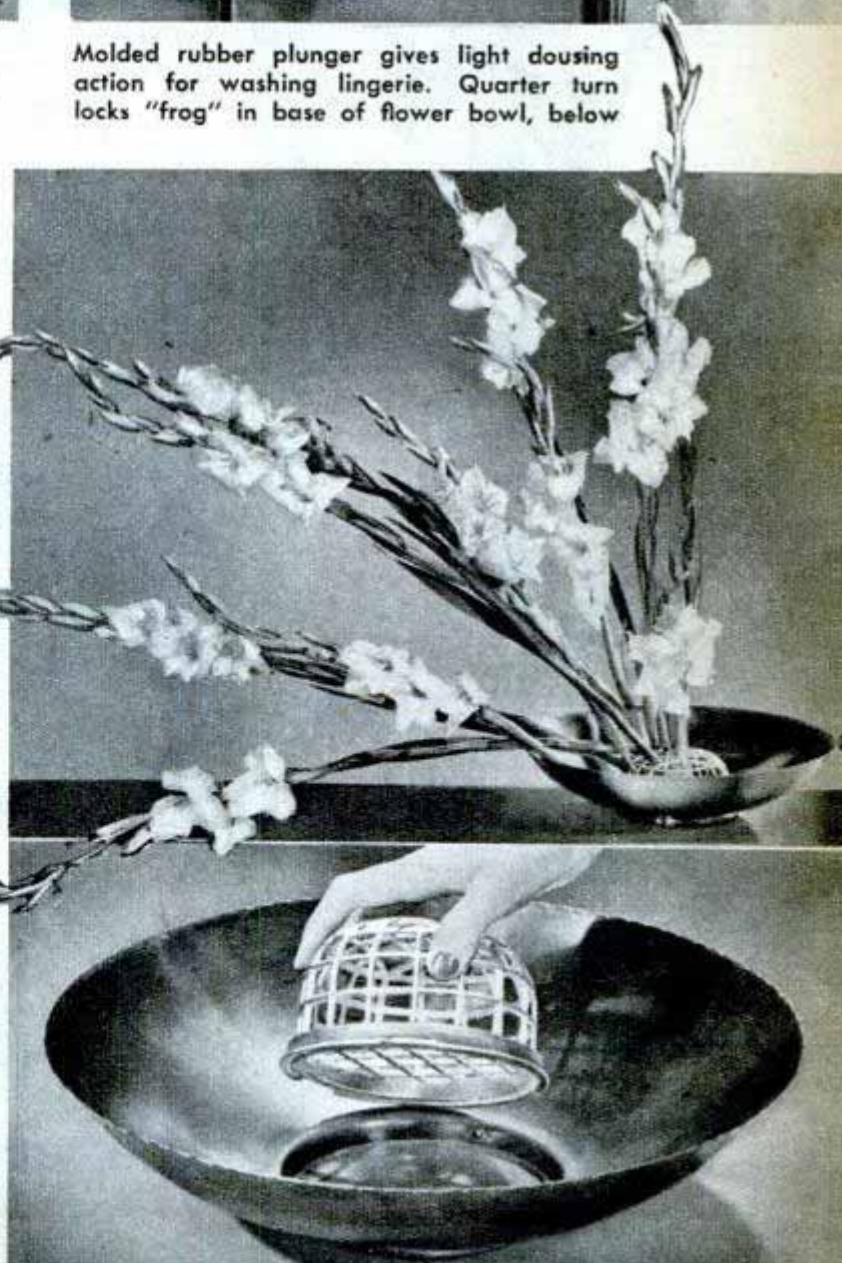

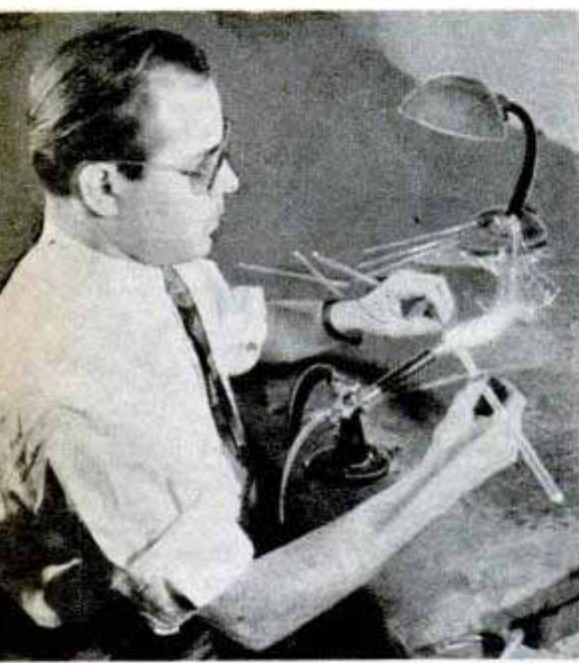
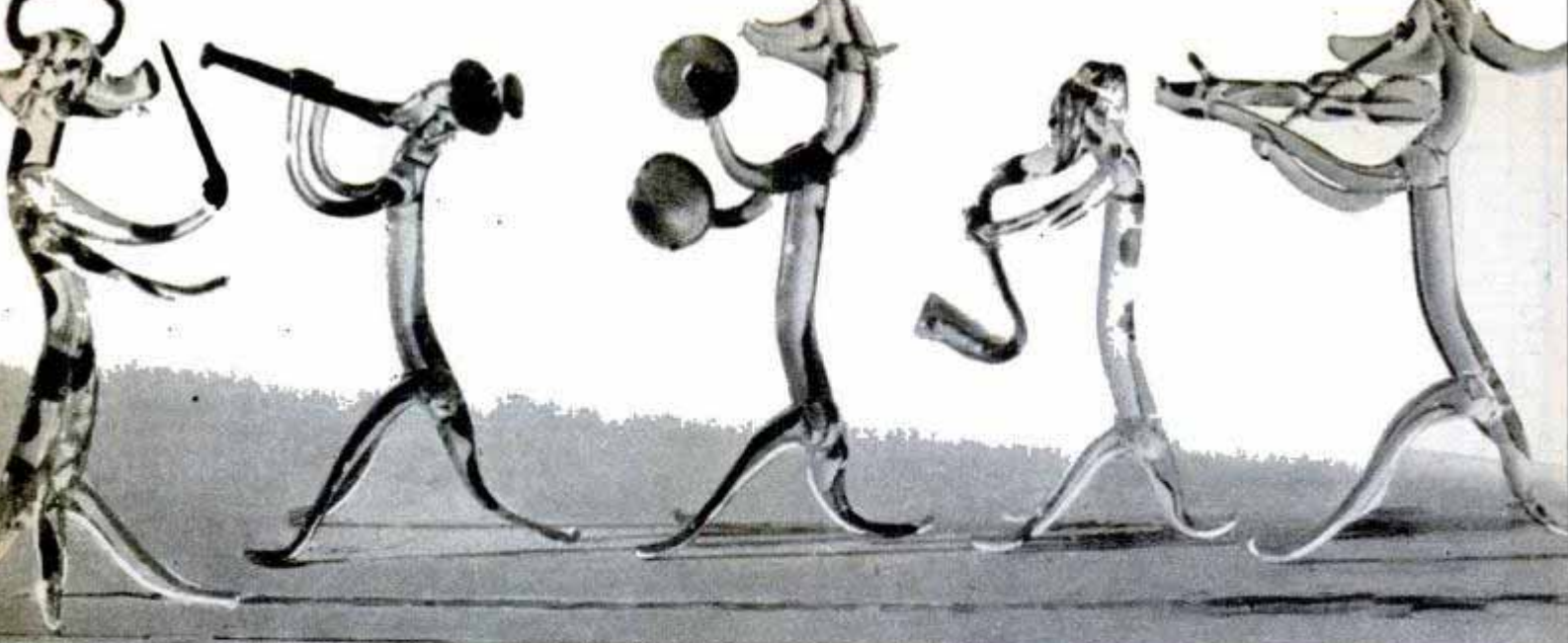

“GLASS MENAGERIE”

POSSIBLY because of the success of the hit play, “The Glass Menagerie,” collection of miniature glass animals has become a fad again after a lapse of many years.

Violin-playing cows, graceful deer and flamingos, and weird-looking creatures that defy identification now grace fireplace mantels and what-not shelves.

Most of these little figures are made in New York by Bohemian-born craftsmen who jealously guard the secrets of their art even though production line methods are becoming more and more commonplace.

Roughly speaking, the technique of sculpturing glass consists of holding a glass rod, usually about half an inch in diameter, in an oxygen and gas flame and then manipulating the molten mass into various fanciful shapes.

Besides the craftsmen's hands, the only tools used are a pair of flat-nosed pliers for bending purposes and a flat sheet of steel to press the soft glass edges into flat surfaces.

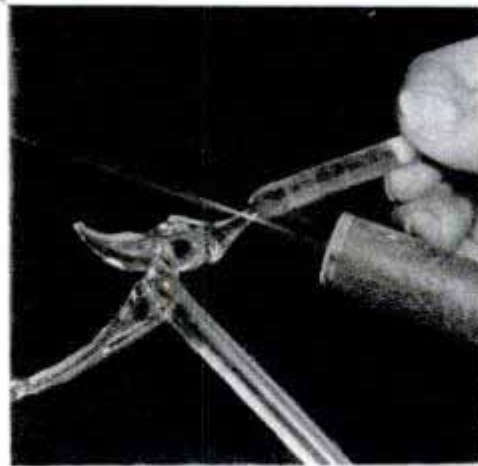

It takes a master craftsman to create the glass animal musicians shown at the top of this page. Note the implied action. Robert Miller (upper left) manipulates a glass rod in a flame to fashion a figure. Pliers and a piece of steel (below) are the only tools used

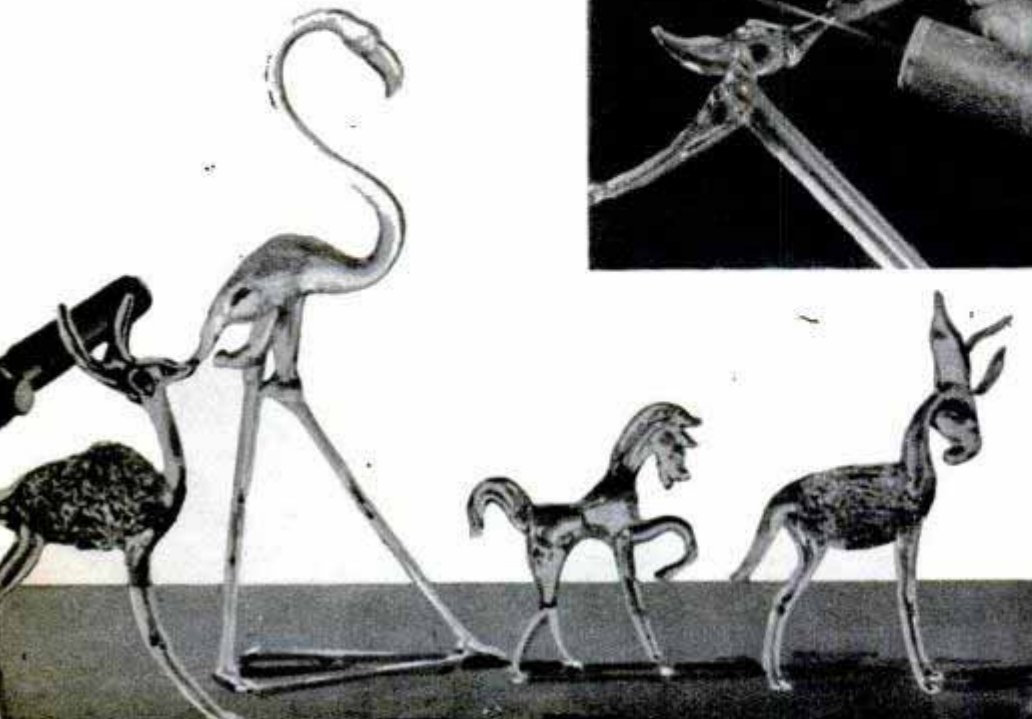



Football coaches now can check with scientific accuracy the force exerted by players in blocking and tackling. Mal Stevens, coach of the Brooklyn Dodgers profes-

Pneumatic 'Coach' Checks Tackle Power

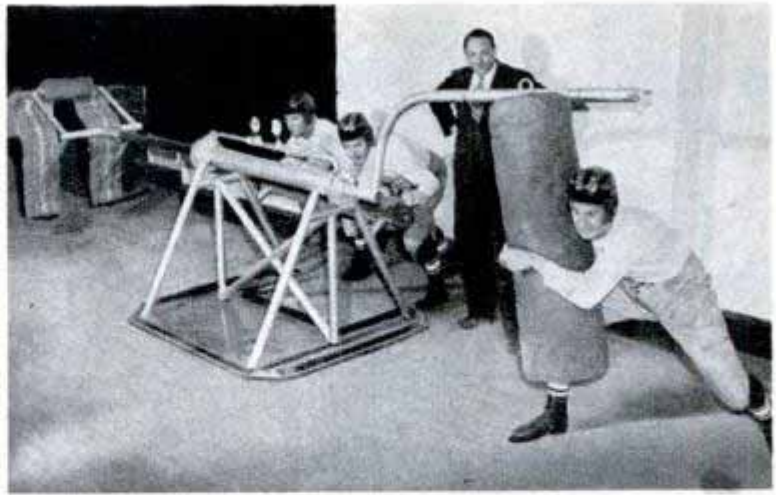

sional team, invented a pneumatic machine equipped with gauges to measure such force. The main purpose of the machine is to condition and train players indoors.

Tires of Future Made With "Carbon White" to Rival Rainbow in Color



Tires of baby blue, orchid, bright red or almost any other color of the rainbow will be practical and durable as a result of the discovery of "carbon white." The substance, actually not carbon at all, is a powder produced from sand through a complicated chemical process. In demonstrating the "white soot," chemists burn a liquid, formed in the final stage, in a cigarette lighter and collect the carbon white on a dark plate. It performs exactly as carbon black does in rubber compounds, giving extra tear resistance, abrasion resistance and tensile strength. Carbon black has prevented the use of colors in many rubber products because even tiny amounts of the substance discolors rubber. Carbon white

was discovered after 10 years of research by chemists of the B. F. Goodrich Company. In addition to its possible use in tires, it will be used in the production of rubber footwear, floor coverings and many other products. Overshoes, for example, no longer need be black but can be made in fancy colors. Commercial use of the compound will be delayed until mass production reduces the cost.

Drafting Board "Mathematician" Figures Decimal Equivalents

Decimal conversions are accomplished quickly and with no chance of error by referring to an aluminum decimal equivalent chart attached to drafting machines. The chart is three by five inches in size and has large legible lettering. When mounted on a drafting machine, next to the dividing head, it eliminates much unnecessary figuring for the draftsman.

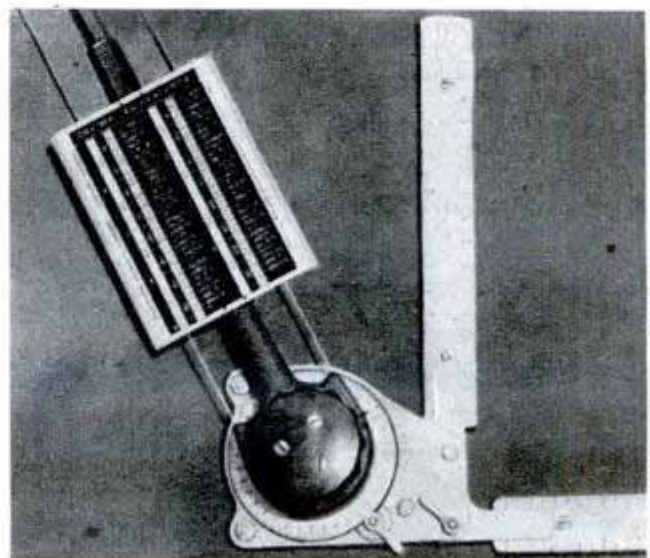



Assembly Line

By John R. Kinsey

THIRTY-EIGHT MILLION TURKEYS—one for almost every family in the U. S.—were raised this year. After a careful turkey census, the Department of Agriculture reports production is nearly double that of 10 years ago.

How was this possible with the manpower situation still a big headache for producers? The answer: electrical and mechanical "helpers."

From the egg to roast turkey, automatic devices assume much of the work formerly performed by man. And the tasks are done with scientific exactness.

From tiny poults to full grown strutters, 12,000 turkeys are raised almost entirely mechanically each year at the Oakhurst Terrace Farm, Genoa City, Wis.

Allen-Century photo



Gobblers

There are mechanical aids for cleaning and weighing eggs, mammoth incubators, thermostatically controlled brooders, pressure-fed watering troughs equipped with float valves, gravity-fill feeders of 2000-pound capacity, labor-saving elevators and conveyors, skid-mounted feeders and shelters which are moved easily by tractor to fresh ranges, and mechanical turkey pickers.

All this adds up to better quality poultry, decreased death loss from disease and increased production despite limited farm help.

To get an idea of how these mechanical contrivances are put to work, come along on a visit to the Oakhurst Terrace Turkey Farm, two miles northwest of Genoa City, Wis.

Bob Fox, owner and manager, is a great believer in using all the "practical" scientific equipment available to raise turkeys. He is busy right now marketing about 12,000 Broadbreasted Bronze turkeys which he and one other fellow raised during the past six months, with the assistance of a third man during the first eight weeks. A crew of 25 dressed the turkeys, 800 a day.

It is evident that Fox has to have a lot of automatic equipment to accomplish this. He has. Starting at the beginning, he has 51 brooder houses that shelter the turkeys from the time they're day-old poults until they are eight weeks old and ready for the range.

Each hexagon-shaped brooder house accommodates from 250 to 300 poults. Thermostatically controlled gas heats the houses, starting at 95 degrees when the turkeys are only a day old and dropping down five degrees per week until 70 degrees is reached. By this time the poults can get along fine in 70-degree temperature.

There are two lights in each brooder house. One seven-watt bulb burns every night to supply



During the first eight weeks young turkeys (poults) spend all their time in brooder houses where heat is carefully controlled



Fox has 51 brooders equipped with automatic water troughs, special lighting and wire platforms to insure sanitary conditions. Below, dismantling thermostatically controlled gas line

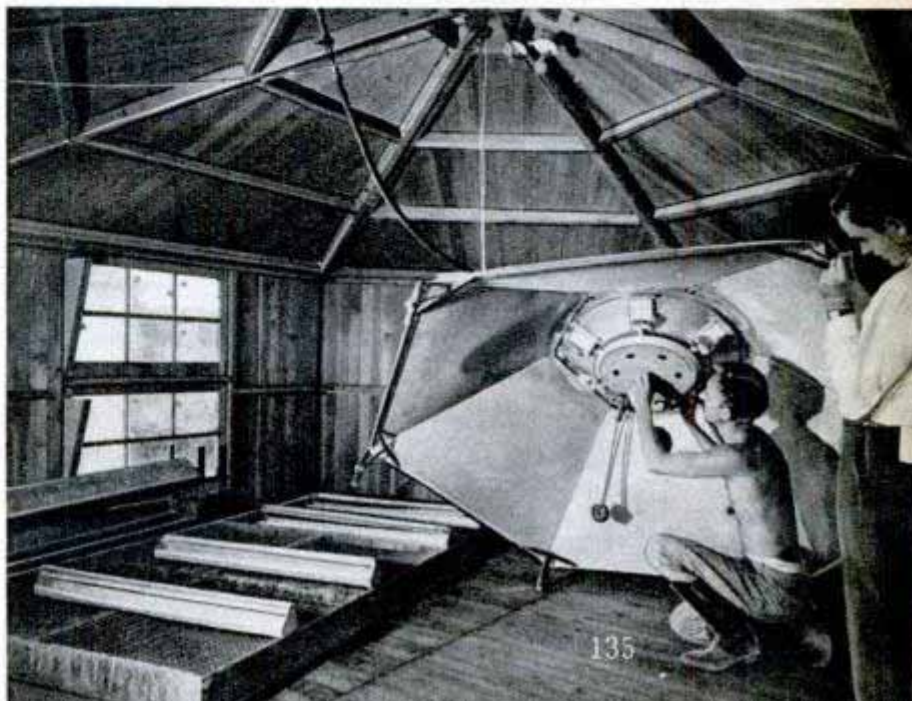

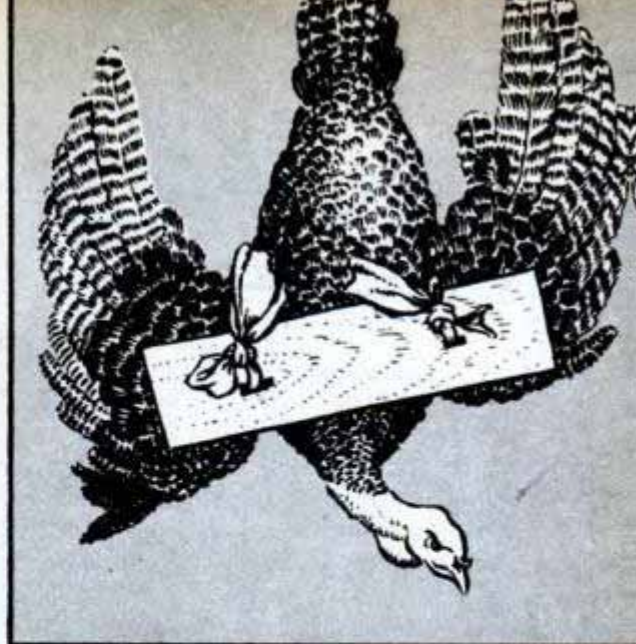

Once a week tractors pull skid-mounted shelters, feeders and watering troughs to fresh pastures in a matter of minutes. Right, a wooden guard is attached to the wings to prevent a turkey from flying over a fence

a little light and keep the turkeys calm and quiet. Sixty-watt bulbs can be turned on in the entire string of brooders by flipping a single switch. The stronger light is used to calm poults when a heavy storm comes up. Without light to reassure them, the young turkeys would run to a corner, pile on top of one another, and many would smother.

The poults stand on peat moss which is spread over the wooden flooring to absorb moisture and manure and make the houses warm and dry. Feeders and water troughs are set on 5 by 10-foot wire platforms to provide sanitary conditions.

Water under pressure is piped to the brooders, with float valves controlling the flow. When a day or two old, 12,000 poults drink about 72 gallons of water in 24 hours; six weeks later their daily capacity is over

1200 gallons. At maturity, the same turkeys drink 3000 gallons per day.

During the first eight weeks the poults are fed a starting mash which contains an abundance of vitamins and minerals. About 150 pounds of feed satisfies 12,000 poults the first day, but in 10 weeks it takes 5000 pounds daily to fill that number of birds. At fattening time, 12,000 pounds of feed disappear daily.

It's during the first six or eight weeks that Fox and his helpers really "mother" the little turkeys. Despite the safeguards of scientific equipment, the turkey raisers keep a constant watch over the brooder houses to see that nothing goes wrong.

The poults cost Fox 75 cents each and when they're a day old they weigh 1½

(Continued to page 256)

Float valves automatically regulate flow of water to troughs. Right, rubber-fingered mechanical feather picker

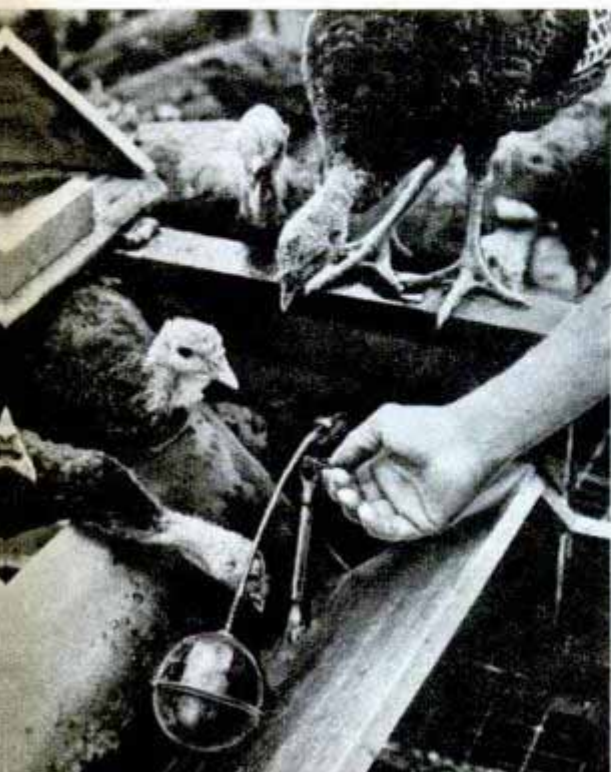



Bassinet Taken From Buggy Serves as Auto Bed

Baby can travel in comfort and safety in a double-duty bassinet which can be removed from the chassis of a baby carriage. It can be placed on a car seat to make a bed for the infant or it can be converted into a cradle or auto seat. It folds into a compact bundle small enough to store in the luggage compartment of a car.

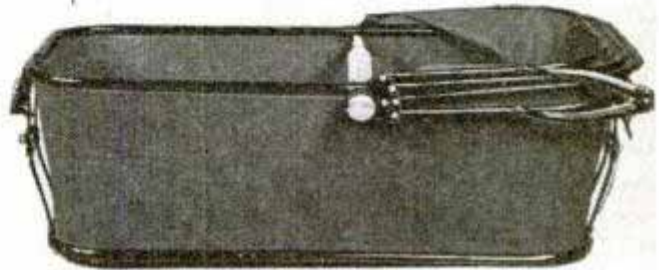

Infrared Rays Made Visible by Adding Lead to Zinc Sulfide Phosphor

Infrared rays, normally invisible to the naked eye, now can be seen for short periods as the result of a discovery by Dr. Gorton R. Fonda of the General Electric laboratory. The discovery may lead to a simplification of the Army sniper scope and snooperscope, infrared weapons used by soldiers during the war to see without being seen. It also may simplify the receivers that are used on Navy vessels to read infrared signals from other ships. Dr. Fonda

found that when a minute quantity of lead is added to zinc sulfide and exposed to infrared rays, the rays can be detected by an increase in brightness. Zinc sulfide is a phosphor with qualities that make it glow after a light source has been removed. Dr. Fonda discovered that the minute quantity of lead makes the zinc sulfide phosphorescent when exposed to infrared rays as well as rays of other wave lengths. The rays can be seen in the afterglow of the phosphor.

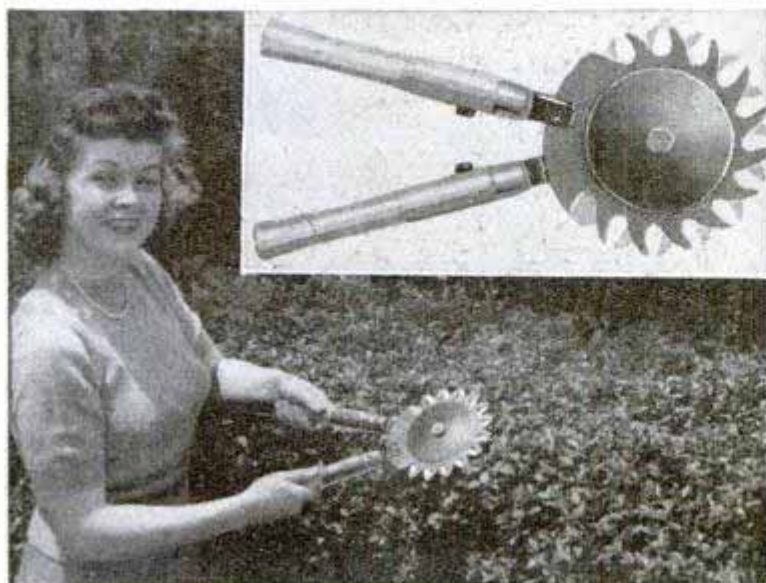

Rotary Hedge Trimmer Has Teeth Like Saw

Rotary trimmers make fast work of keeping hedges cut back to the desired height and width. The cutters are sharpened easily by taking apart two blades and filing the teeth the same as saw teeth.

¶ Fastest between-stops schedule of any American passenger train is claimed for the Burlington's streamline Morning Zephyr, which travels the 54.6 miles between East Dubuque, Ill., and Prairie du Chien, Wis., in 39 minutes—an average of 84 miles an hour.



Fast action is vital in emergency. Phone number of sheriff's diving crew is posted in public booths



Alert radio dispatcher at WQMF relays the message and directs underwater crew to the scene of the accident

Law officers in Michigan are saving lives and foiling criminals by adopting deep-sea diving techniques

STATION WQMF calling diving crew . . . go to Huron River near Flat Rock . . . investigate a drowning."

When such an order comes over the prowl car radio in Wayne County, Mich., deputy sheriffs race to the scene to begin rescue operations. They are organized in a diving and lifesaving team of "submersibles" unique among the nation's law enforcement agencies and ready for any underwater assignment.

The crew is particularly valuable during the summer when the number of drowning accidents increases. Sheriff Andrew C. Baird says that the ability of the divers to descend to the bottom of a lake or river to recover victims quickly is a great improvement over dragging and grappling methods used by most police departments. If a drowning person can be recovered soon enough there is always a chance that he can be revived. When a person's body becomes fastened or wedged beneath underwater obstacles it is impossible to locate it with grapples. Bad weather often interferes

with dragging operations but a diver ordinarily can work in inland streams during any kind of weather.

Because of the underwater division, Sheriff Baird points out, criminals are having a difficult time disposing of loot or weapons in Wayne County. Frequently, lawbreakers throw small weapons such as revolvers or knives into a stream, thinking that they cannot be found. The small size of such objects makes it particularly difficult to recover them by ordinary grappling methods. Divers using searchlights often locate them quickly in river bottoms.

Sheriff Baird believes the crew has an important duty to perform. Deputy Sheriff William Schwacha, a 25-year-old veteran who learned underwater work in the south Pacific, is in charge of the crew and is now training additional divers. Instruction covers all phases of diving from the proper method of underwater breathing to the correct way to handle air and communication lines when submerged. The officers also are taught how to avoid the bends and such

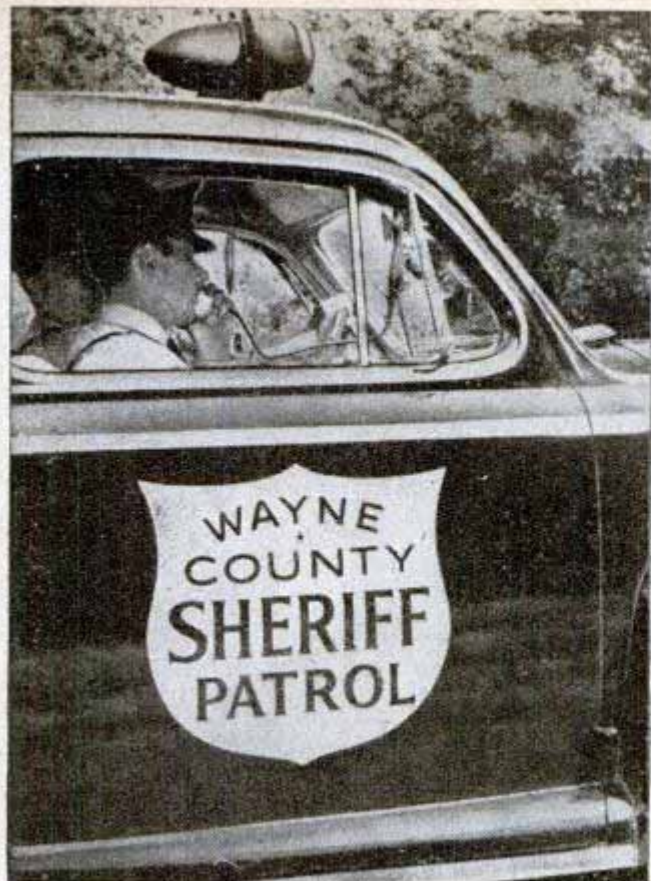

The call is received in prowler car by deputies trained in modern resuscitation methods



After last quick check on his equipment, officer is ready. Air compressor is portable so the diver can work anywhere

All water accident victims are given artificial respiration. If person is recovered in less than six minutes there is a fair chance to save a life





Trapped victims must be removed first. Then diver fastens salvage lines and wreckage is hauled to surface

hazards as nitrogen or oxygen poisoning.

The diving facilities have been made available to all law enforcement groups in Michigan. Display cards, telling how to call the diving service in an emergency, have been posted in prominent points in Detroit and other cities. Already word of the operation has spread. The crew recently flew to Cleveland to recover the bodies of persons killed in an airplane crash in Lake Erie.

The equipment consists of two Navy diving suits with telephone fittings. They are

suitable for use in almost any inland river and the Great Lakes. Each suit weighs 325 pounds. A compressor pumps seven cubic feet of oxygen per minute to the diver. A portable generator develops the power for the Pyrex sealed-beam reflector-type 300-watt lights used in underwater searches.

Plans are being made to emphasize the lifesaving function of the division. The deep diving equipment, with its rubberized suit, lead shoes and steel helmet, is too cumbersome for quick use in an emergency such as drowning. It takes several minutes

Sheriff's deputy William Schwacha starts mercy dive into Detroit River



to put it on and there is little chance of reviving a person who has been underwater as long as six minutes. Consequently the Wayne County officers have ordered a Lambersten amphibious respiratory unit designed for shallow water diving. It weighs only 25 pounds and can be adjusted quickly for use. While wearing it a diver can work for as long as 90 minutes at 60 feet or for 15 minutes at 100 feet below the surface.

When an emergency call comes in on a drowning, the diver in the sheriff's prowl car dons his suit. He can be ready for action in less than one minute. The other deputy in the car, also trained for just such a job, will be ready to apply artificial respiration.

Scraper-Loader for Dump Truck Hoisted by Backing Up

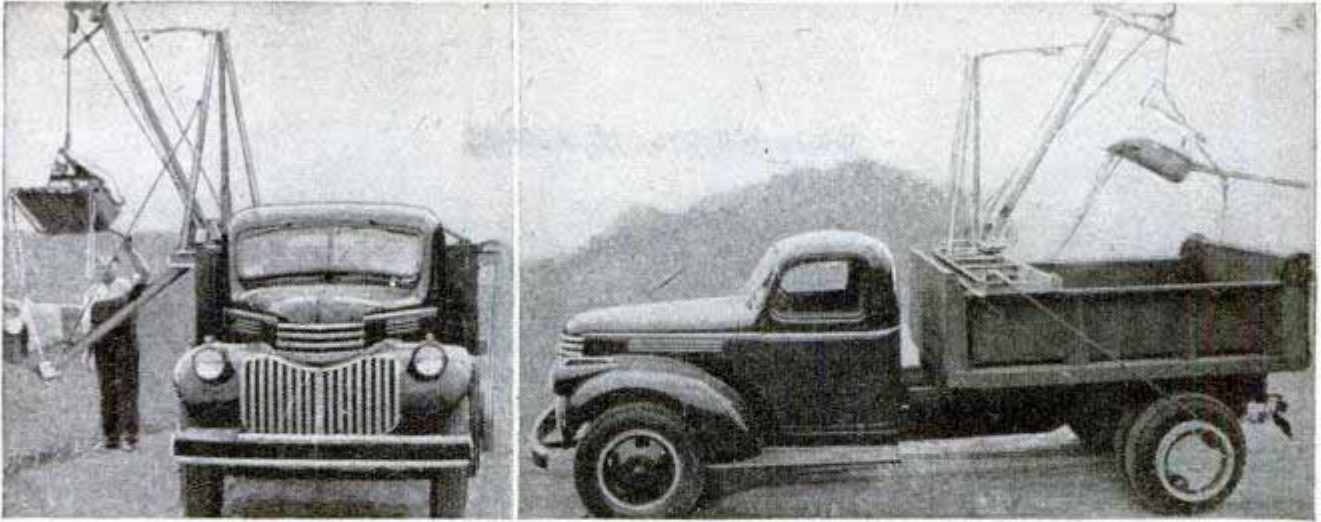

Two men operating a truck and scraper-loader which requires no power takeoff can pick up 25 loads of dirt per day — three times the average output of a driver and two men using hand shovels. The scraper-loader, adaptable to any standard dump truck, has a boom that swings out over

the ground from which soil is to be removed. When lowered into position, the scraper is pulled by means of a drawbar extending out from the truck. A cable attached to a winding drum on the left rear wheel hoists the load when the truck is backed and a trip line dumps it.

Electrocutor Rake Kills Weed Roots

Weed-choked farm lands are cleared for use by a machine that generates 12,000 volts to electrocute the weeds. The portable power unit is pulled by a tractor or a jeep, sweeping a 7½-foot path across weed-wasted lands. Attached to the power unit are rakes with copper electrode fingers. The fingers ride along the surface of the ground, striking the base of the foliage to sting the weeds to death. Even the root systems of deep-rooted perennials are affected by the electrical charge. Because electricity adds no ingredients to the soil, the treatment does not harm the dirt, neighboring crops or animals. From 10 to 15 acres of weed growth can be cleared in eight hours at a cost of \$10 per acre.

☛ The Soviet Steel Institute reports from Moscow the development of gold and rose-colored steel, applicable to decorative uses.

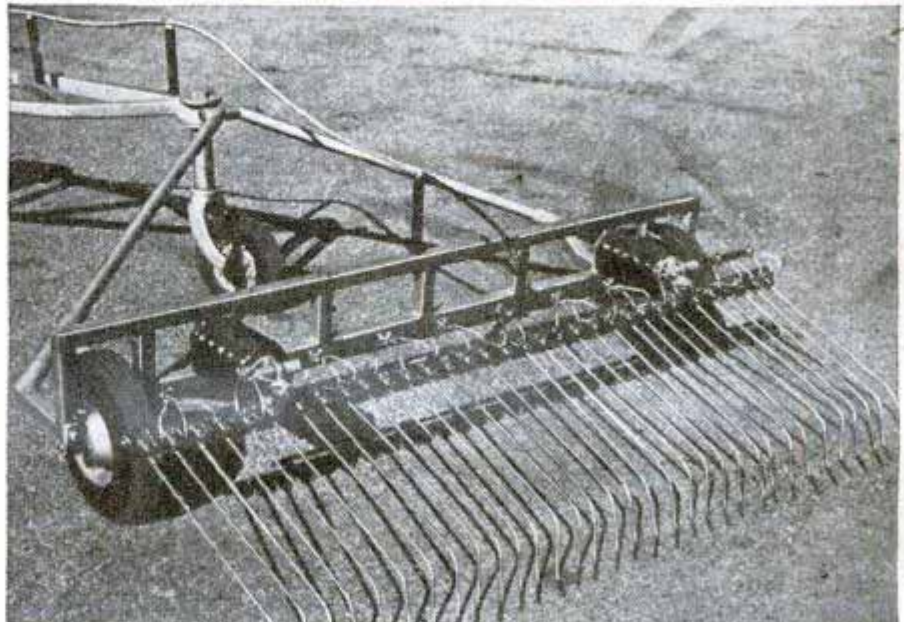
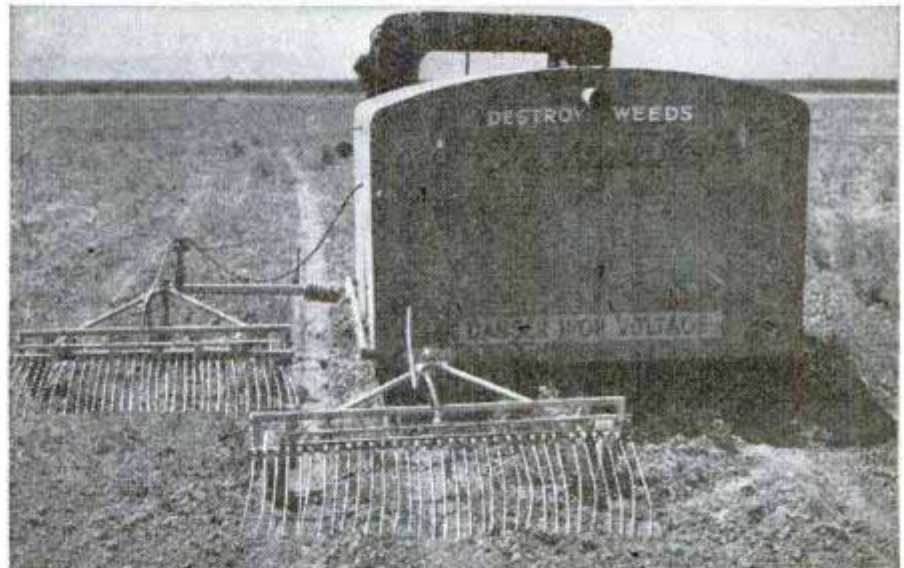

Infant Seat Ties to Chair Back And Is Handy for Travel



With an infant seat which ties to the back of a chair so that it rests at an angle, mother has no problem getting baby in position for feeding. It is also convenient in traveling, as it can be tied in place on an automobile or train seat. It is fixed at an angle restful for the baby because it allows him to lean back and relax. Easily carried, it weighs only three pounds.

Pocket-Size Ammeter for Batteries Requires No Wires



Batteries for photoflash synchronizers are tested by a small ammeter in less than a second. The battery is inserted in a slot which brings its positive and negative poles in contact with the ammeter's two contacts. The tester is sealed in glass and has an easy-to-read dial.

Midget Power Plants for Radios

Tiny batteries provide power for the radio transmitters in high-flying weather balloons. Developed by the Army Signal Corps, they are approximately four inches

long and 1½ inches wide. The "precharged" lead-acid batteries are vacuum packed in a dry state. They are activated by puncturing the container with a hollow steel rod which frees the acid. The container is opened by a key that winds up a strip below the top of the can. Excess acid is poured off and the battery is ready for use.

Tester Spots Electrical "Leak" In Wire Insulation

Impending breakdown of insulation that may force a costly shutdown of electrical equipment is spotted by an insulation resistance tester. The self-contained unit requires no batteries or outside source of power. It tests both alternating and direct current lines. The power is generated by turning a crank in either direction. If too much current is generated to obtain a

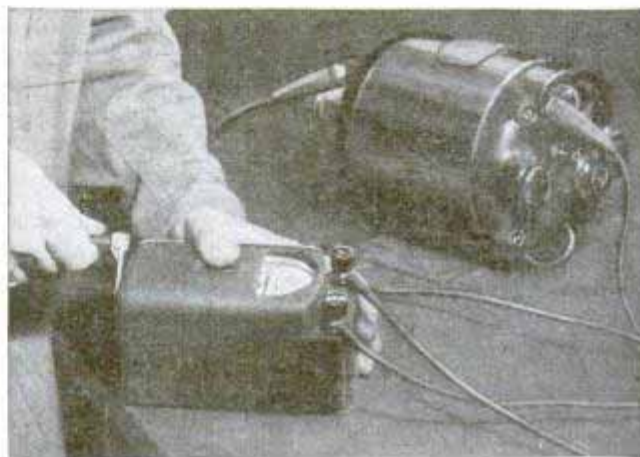

proper reading from the device, a regulator cuts down the voltage. Lights indicate the proper testing voltage.

Pipe Reamer Fits Any Size Bowl

Once an aluminum reamer is adjusted to fit the bowl of a pipe it can be locked to retain the proper size. The four reamer blades are expanded to fit any size pipe bowl by screwing down the adjusting bolt. A twist of the locking ring holds the adjusting bolt in place.

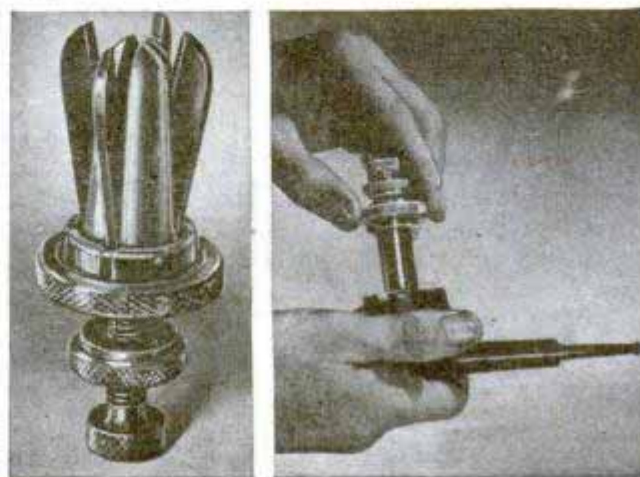

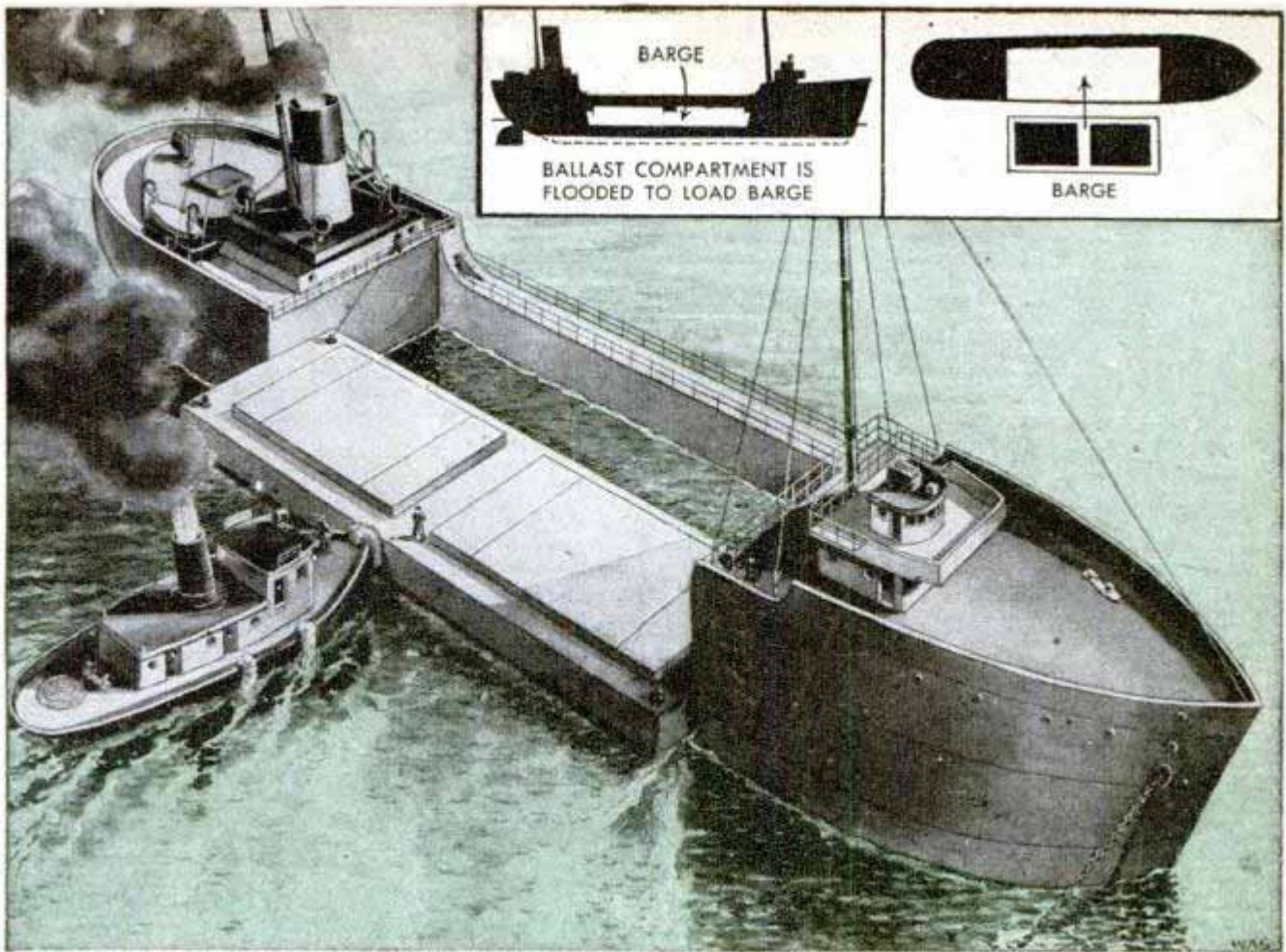

After a freighter makes port its immediate usefulness as an efficient ocean-

going carrier is done. Not until freight cranes and stevedores clear its holds and reload it with thousands of tons of cargo can it function again as a freight ship. Cargo is always carefully arranged for quick loading and unloading but if the number of idle days between voyages can be lessened, costs of water shipment probably can be slashed. One way in which this might be accomplished is through the use of sectional ships with removable cargo holds loaded or unloaded independently of the mother vessel. Patents have been granted for a

Removable Hold for Ships Floats Like a Barge

ship fitted with interchangeable barge midsections. In unloading, a ballast compartment in the double bottom of the ship is flooded. This lowers the ship in the water and the barge floats free. Then another barge, preloaded at the dock, is pushed into position by a tug. After the barge locking mechanisms are secured, the water ballast is pumped out and the ship floats normally with the barge as an independent but integral part. Such a ship, its designers say, is more seaworthy and capable of traveling at higher speeds than a tug and barge of equivalent tonnage. Engine rooms and crew quarters are located aft.

"Rip Cord" Wrapping Divides Food Products Into Equal Helpings

Strong thread embedded in transparent wrapping paper at regular, parallel intervals serves as an easy means of slicing the encased food product. To divide cheese, candy, cake or butter, a housewife pulls the "rip cord" near one end of the package. The thread knifes through the food and dislodges a serving.

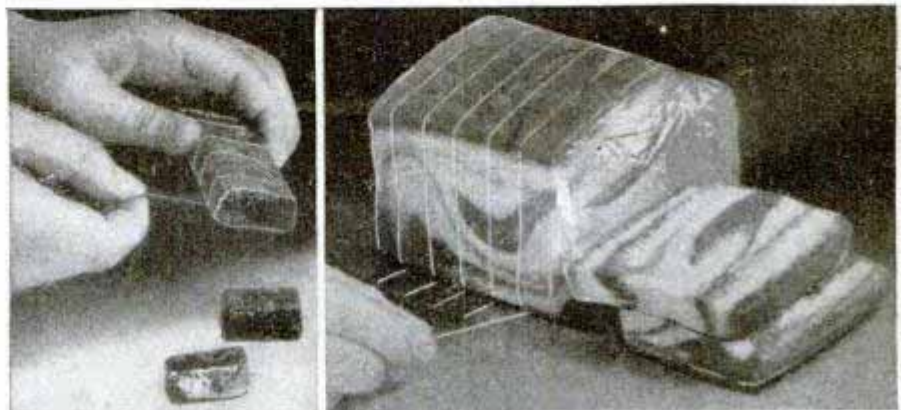

NATURE FAKERS



Plaster-of-paris fish supported by metal rods, and reefs built up from real coral, serve as props for realistic underwater exhibit at Chicago Natural History Museum. Watery effect is produced by indirect lighting

LIKE Hollywood, natural history museums have learned the fine art of faking natural scenery. By the trial and error method they have gradually been able to make realistic facsimiles of rock, grassland, desert, water and sky.

Museum taxidermists have been making snow out of sugar (instead of cornflakes as Hollywood does) for many years. When sugar became scarce they tried salt, but it didn't work. The salt gathered moisture and eventually turned brown.

The earth you see in habitat cases isn't really dirt but plaster of paris colored to resemble dirt. Leaves, twigs and the bark

By M. J. Bauer of trees are made from wax, though solid wood and tree trunks may be original specimens. Grass is made by painting strips of celluloid green.

Stones and rocks are made from mesh wire, covered with a coating of plaster of paris and painted. When they are properly made they are based on molds of original rock made in the field. Sometimes asbestos is used to cover the stones, giving them a rough texture.

The background scenery is painted in. When the sun or the moon is desired in the scene, a dimmed light is placed behind oiled paper. Fire is imitated by using red tissue paper over a light bulb.

Artist (left) uses a sharp tool to mark veins on a giant lily pad for an Amazon River display (right). The hyacinth plants likewise are formed from wax, but celluloid strips painted green represent the grass



The most difficult element to fake is water. For a smooth pond or lake a sheet of glass is used with its undersurface painted to look like water. If the water is to look disturbed, the taxidermist first models in clay the ripples and waves he desires. A plaster mold is made of this. Hot gelatine colored to resemble water is poured into this mold. After the gelatine has set it is removed and is ready to be put in the exhibit.

Most of the more striking underwater scenes, like those of tropical coral reefs, are of clear or deep water. This effect is achieved with nothing more than an intricate lighting arrangement. Black velvet is sometimes laid on the bottom of a case to give the appearance of depth.

The most difficult underwater scene to duplicate is that of water that is slightly muddy and where visibility is clear for only a couple of yards. Recently, the Chicago Natural History Museum wanted to represent a fresh-water lake bottom, typical of the midwest region. As lake bottoms are composed of soft mud and the water

(Continued to page 236)

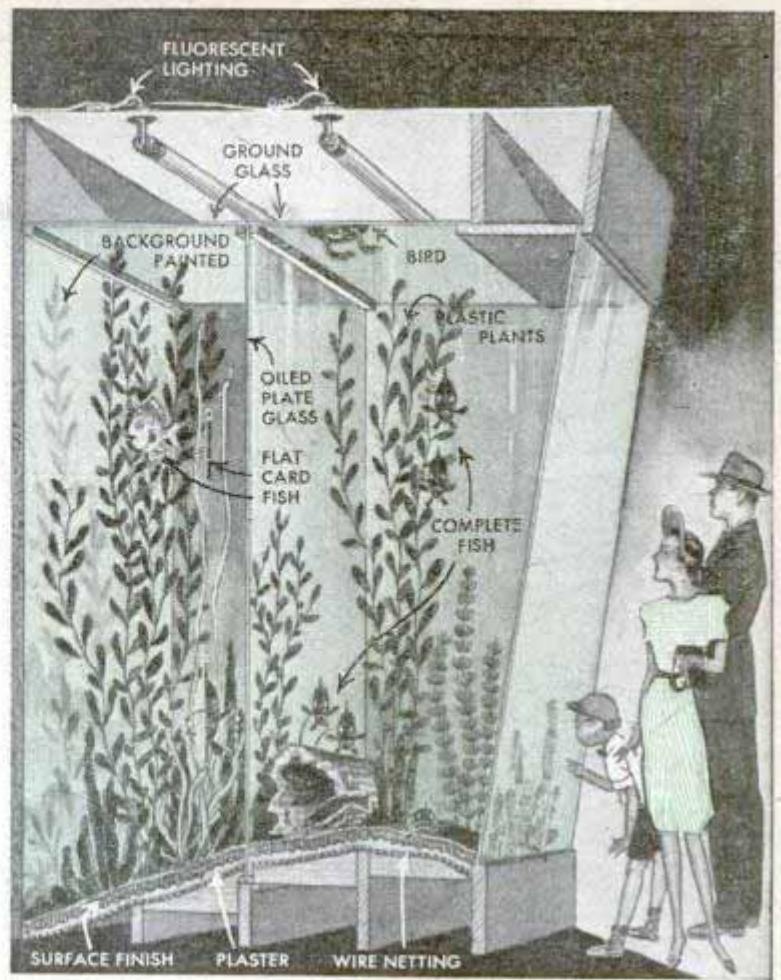

Drawing shows how partition of oiled plate glass gives illusion of depth to exhibit below. Fish are of painted balsa wood

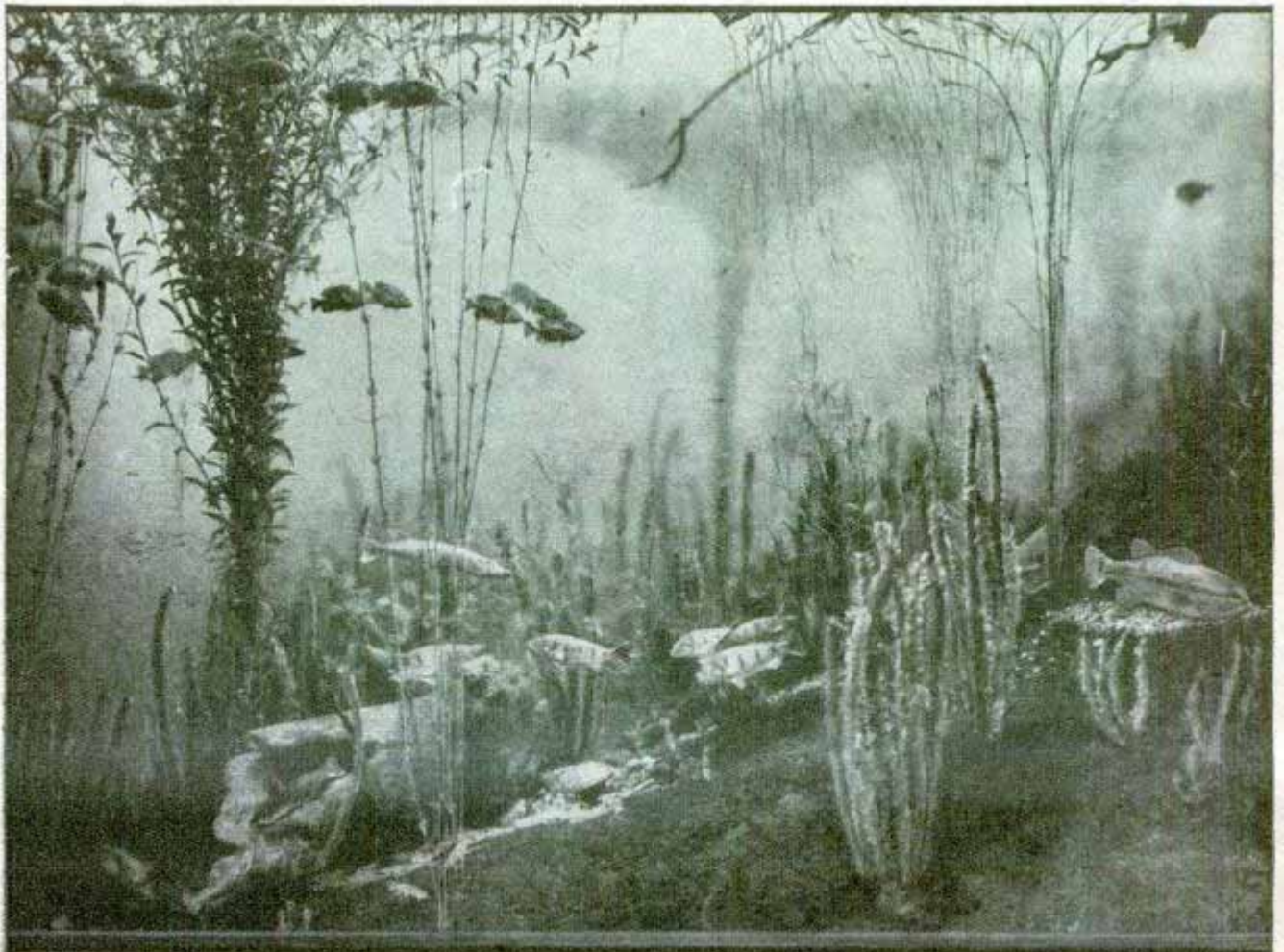



"Spark Plug" Power Spray Operates From Car

Pumping valves replace the first two spark plugs in an automobile engine and convert it into an air compressor to operate spraying equipment. The engine is reported unharmed by use of the valves which are designed so that gasoline or oil in the engine cylinders cannot enter the sprayer. The valves can be installed on any car of four or more cylinders. As a compressor they supply power for all kinds of spraying jobs.



Guns Primed Electrically

Aerial guns fire faster with an electric primer developed by the Army and the Remington Arms Company. Serving as spark plugs for the cartridges, the primers are struck by the firing pin to set off the powder in normal shells. War-time primers consisted of a special mixture of powder in a small cup in the cartridge head.

Adjustable Plastic Gliders Stop Furniture Wobble

Adjustable plastic gliders will cure furniture wobble caused by uneven floors. They can be easily attached with a screwdriver and stay on permanently. They are self-locking but a slight downward pull unlocks them for readjustment to new positions. To blend with most furniture they are available in clear or mahogany colors. The gliders permit wide adjustments for furniture pieces that stand partly on a rug and partly on the bare floor.

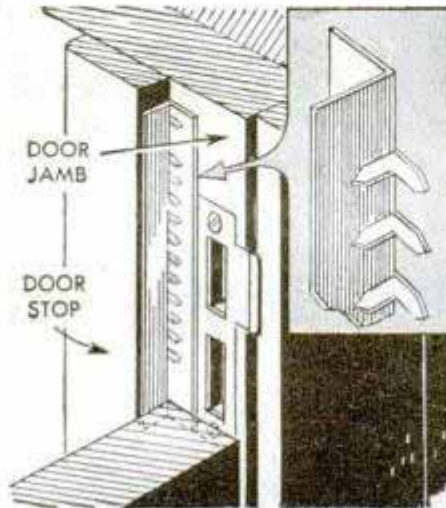
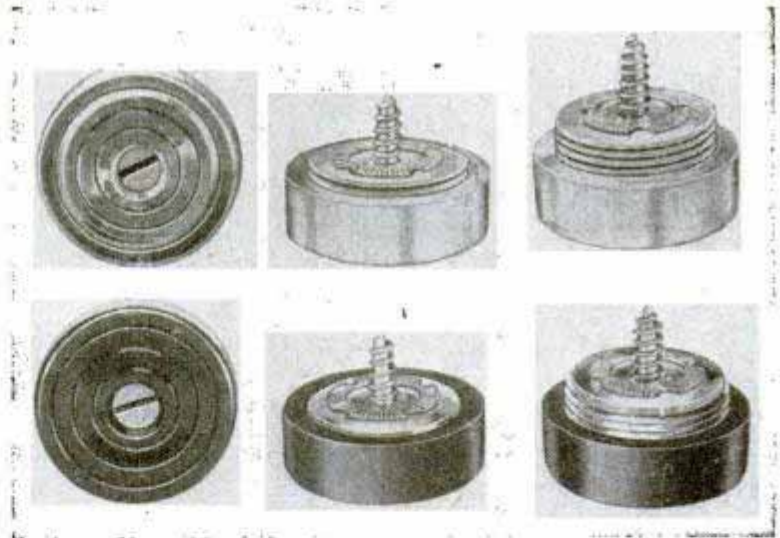

Steel Latch Bolt Guard Protects Spring Lock

Prying back the catch on a spring door lock is virtually impossible when a thin steel guard is installed in the door jamb. Made of hardened metal, the guard is thin enough to be mounted in any door stop.

☐ An instrument which measures generator power was designed by Westinghouse engineers to shave 59½ ounces off the total weight of a 65-ton B-29 Superfortress.

Flashing Dot on Traffic Signal Tells Time Left Until Change

Pedestrians who hesitate to cross a busy intersection because they don't know how much time remains before the green light will change are given a break by a new traffic signal. The signal is a large disk with the customary red "stop" and green "go" illuminated at intervals in the center. A dot of light travels around the edge of the circle in the same way a second hand passes around the face of a watch. When the dot reaches the top of the disk the signal changes. By watching the dot the pedestrian or driver is able to judge the time remaining before the change. The signal was invented by John Kluesing of Niles, Ill.

De-Icing Vents in Car Hood Keep Windshield Clear

De-icing vents attached to automobile hoods keep windshields clear by making use of heat from the engine and radiator. The heat is blown by the engine fan into two streamlined vents. The openings just

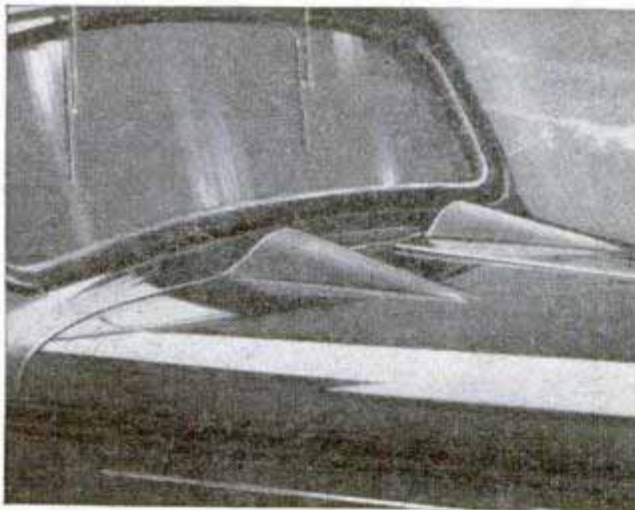

below the windshield distribute the heat evenly to prevent moisture from freezing. As an added advantage, the vents aid in dissipating the heat of the motor. They can be attached easily to any car.

Air Pumped Into Polluted River Hastens Purification

By pumping air into polluted rivers the flow distance a stream requires for the oxidation of waste materials is shortened considerably. Successful tests of the method have been made on the Flambeau River at Park Falls, Wis. A ton and a half of oxygen was pumped into the stream daily.

☐ Carbon dioxide, the soda-water gas, is now used as an anesthetic for insects while they are subjected to microscopic surgery in certain types of research.



Radio "Net" Uses Miles of Wire

Radio—the so-called wireless medium—actually requires 95,000 miles of telephone wires for coast-to-coast broadcasts. This network of wire is used to carry the programs to the stations in the various key cities. On reaching the city, more wires are needed to convey the program to an outlying transmitter. From the transmitter the radio program goes on the air for the first time and is picked up from there by your home set.

Flashlight on Semiflexible Cable Lights Hard-to-Reach Spots

Mounted on the end of a semiflexible cable which will retain the shape into which it is bent, a small flashlight provides sharp illumination in confined quarters. It was designed as an aid to auto mechanics and radio repairmen. The aluminum case is six inches long and holds two standard penlite batteries. The cable and socket extend nine inches beyond the end of the case.

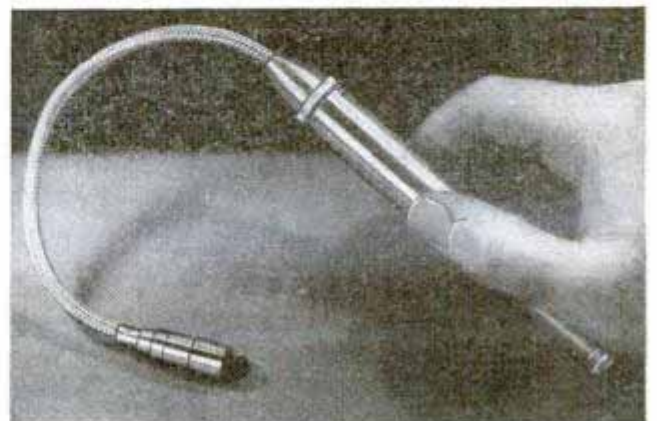

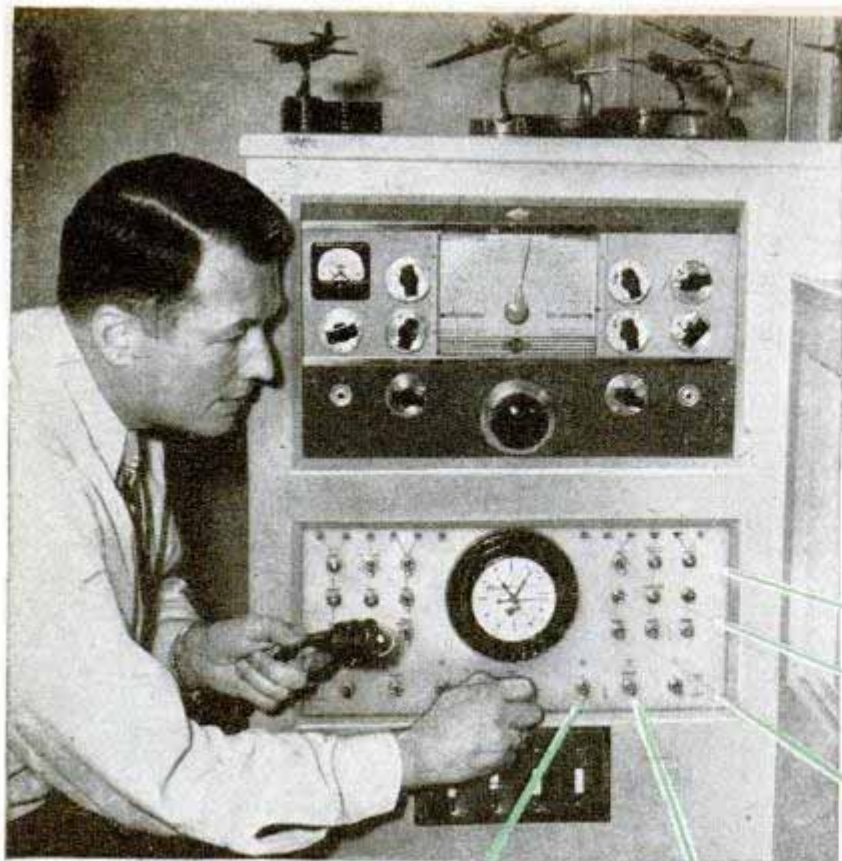

With his magic control board this Houdini of the hookups brews remote control coffee from his bed and warms his shoes with an electric current

Here's the switchboard that performs odd jobs around the Ellinwood home. At top of opposite page, the inventor works in front of vanishing alcove in his den. At bottom is pneumatic diving board

OPENS WINDOW

TURNS ON
ELECTRIC
GRILL

STARTS
FURNACE

The House That's Run by

GHQ at the residence of Ray Ellinwood, Los Angeles manufacturer, is a bedside pushbutton board. He can open or close the bedroom windows, draw the bedroom curtains and turn on the electric grill in the kitchen to make coffee without leaving his bed.

From the control board, too, he operates his garage doors and switches on the residence furnace or an electric heater in the bathroom. Still another switch turns on an electric shoe warmer before he arises.

The board controls standard-wave and short-wave broadcast receivers, an automatic phonograph and a microphone for cutting records. All switches may be operated manually or be preset through an electric clock to turn any circuit on or off at a predetermined time.

Recessed behind his bed are a telephone, house interphone, fluorescent lamp and "Steno-corder" dictating machine. Powered by house current or batteries, the "Steno-corder" preserves speech on small nonbreakable acetate records for future transcription by a secretary.

An inventor and manufacturer of aircraft control mechanisms during the war, Ellinwood has put a number of automatic control circuits to work around his house.

Water shoots automatically from his lawn sprinklers late in the afternoon and stops a half hour later. His garage doors open automatically when his car passes over a magnetic coil buried in the driveway. Any other automobile can operate the garage doors, however, if it is started while standing over the coil. Ellinwood is curing that

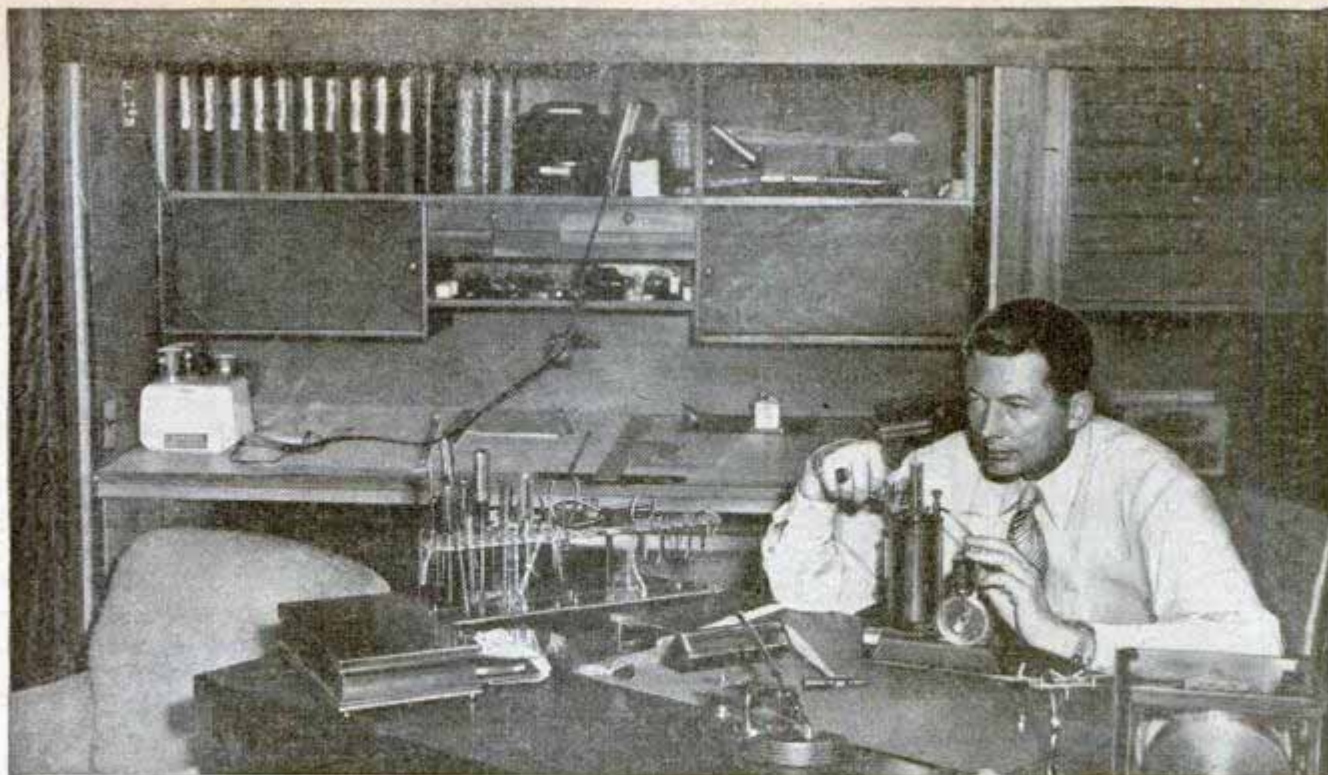

Pushbuttons

by making the garage doors operate only in response to a supersonic signal he is installing in his car.

There's no doorbell at his front door but chimes ring automatically when you approach the threshold. A "black light" infrared beam across the entrance takes the place of the doorbell button. The infrared circuit can also be connected to a concealed microphone and phonograph recorder to make records of conversations at the doorway.

His den, which he uses as a part-time office, has a paneled wall that rises out of sight when he pushes a pressure switch beneath the rug. In

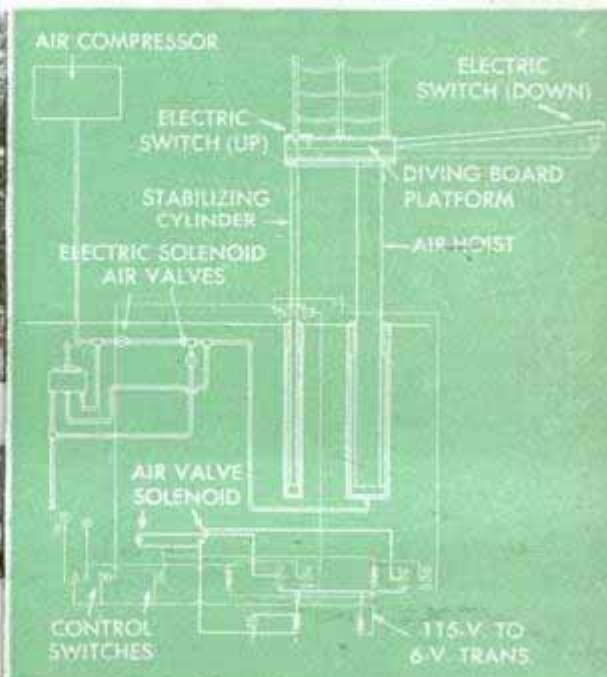
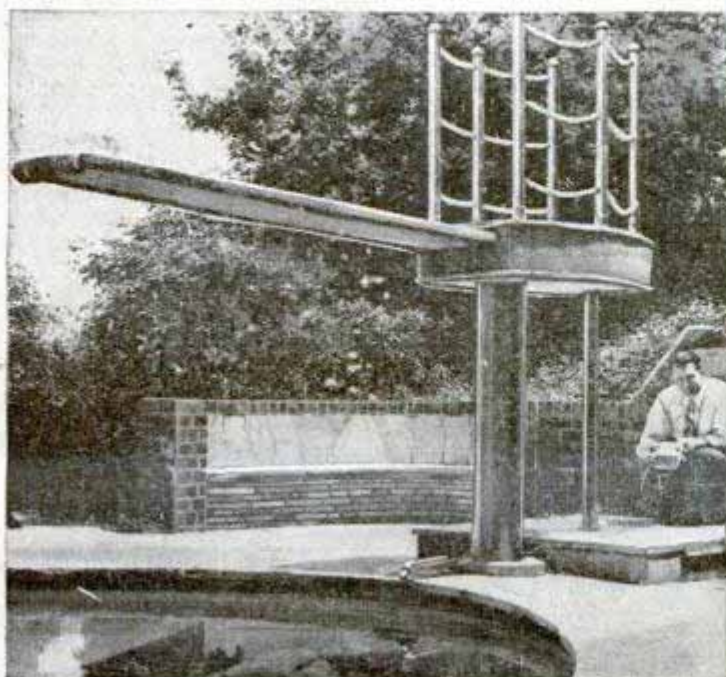

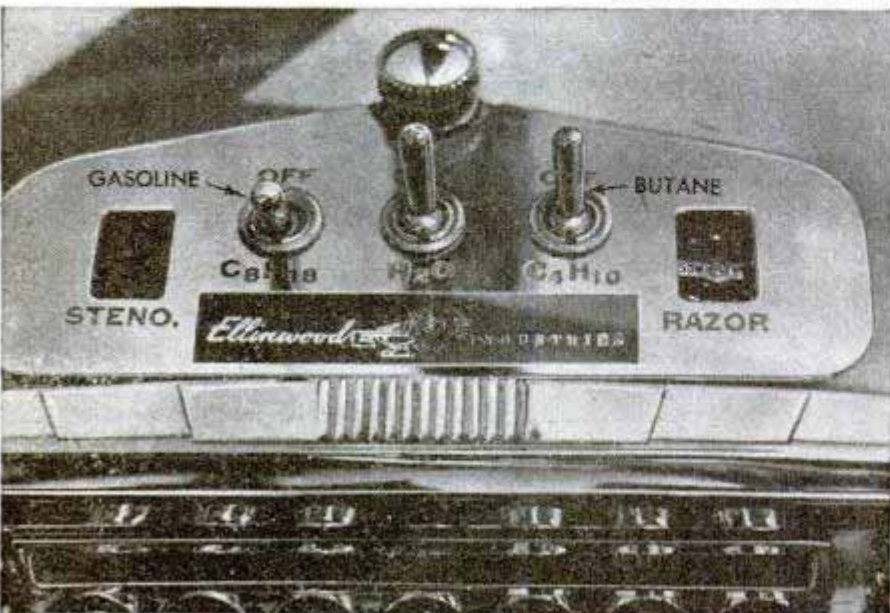
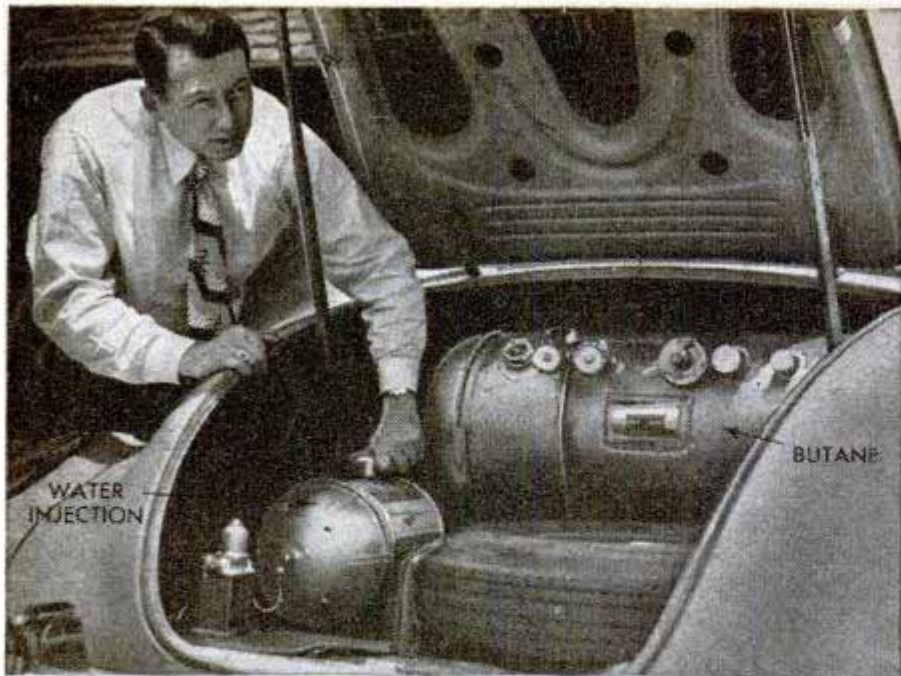

When his visitors cross an infra-red beam, the door chimes ring

the alcove behind the wall are a reference library, drafting board and other tools for developing ideas.

One of his recent innovations is a pneumatic diving board for his private swimming pool. Normally the board and platform rest at ground level beside the pool. When the diver stands on the platform and presses a switch with his foot the board and platform rise to "high board" position. They are lowered automatically to the ground again when he dives from the end of the board. His last step at the tip of the board operates another switch. Ellinwood's pneumatically operated diving board is built almost entirely from the parts of a standard hydraulic automobile hoist.

Tanks for butane and water injection give extra power to his car

In his car Ellinwood has a special overhead window for watching planes. A special panel on the instrument board has a plug-in for the "Steno-corder" as well as a plug-in for an electric shaver. Between these two outlets are switches for changing his fuel from gasoline to butane and for applying water injection to his motor when he wants a burst of extra power.

← Inventor can dictate letters while driving
↓ Panel on dashboard has injection switches and electric razor outlet

Garage doors open automatically when car crosses magnetic coil



Two-Direction Conveyor Belt Carries Load on Return Trip

Twice as much work is accomplished by a two-way conveyor belt that brings back a load of material on its "return run." A table-top model of the belt built by Goodyear Tire and Rubber Company demonstrates its operation. The top cover of the conveyor moves bulk material in two opposite directions at the same time. The new belt's principal application is in the steel industry where ore can be hauled in and slag taken out at the same time.

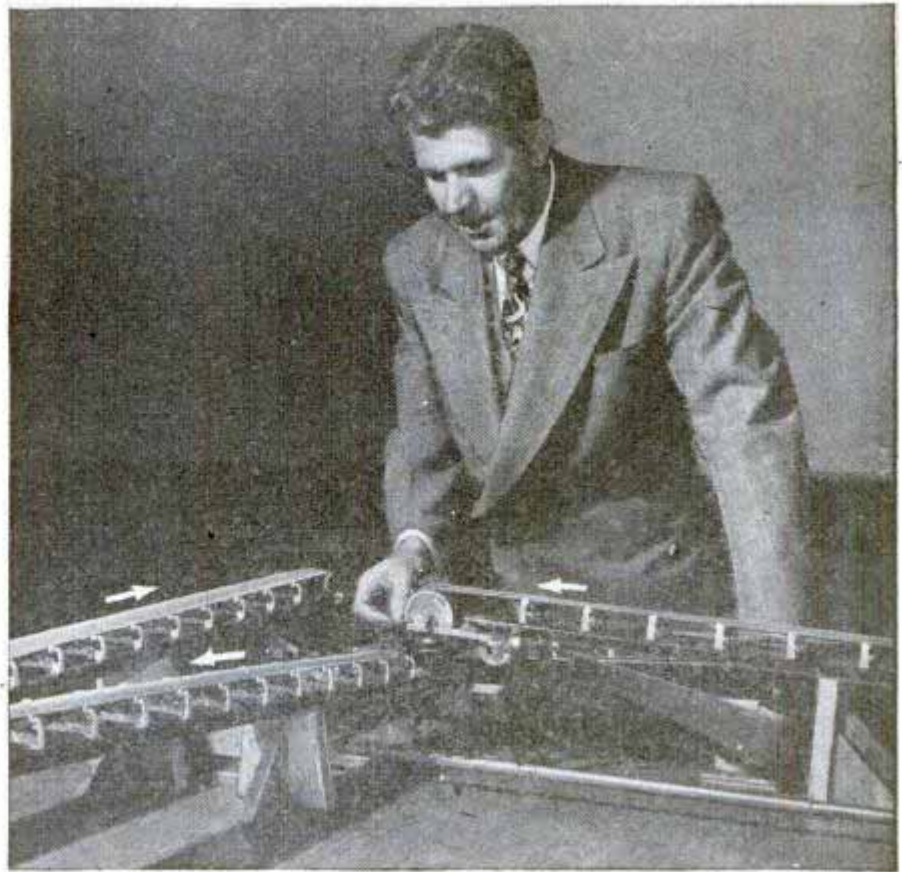

Nazi Sub 'Cushions' Fooled U.S. Spotters

Some Nazi submarines eluded American sonar-radio-buoys and other detection devices, it is now revealed, because of special rubber mountings cemented to steel machinery. These "cushions" prevented vibrations and eliminated telltale sounds. Two methods of bonding rubber to metal were used. In one, cement was applied directly to degreased and sandblasted steel and was employed for pieces to be used in compression. In the other, steel first was brass-plated and then the cement applied, a method suitable for mountings subjected to shear or torque. Cement formulas and details can be obtained from the Offices of Technical Services, U. S. Dept. of Commerce, Washington, D. C.

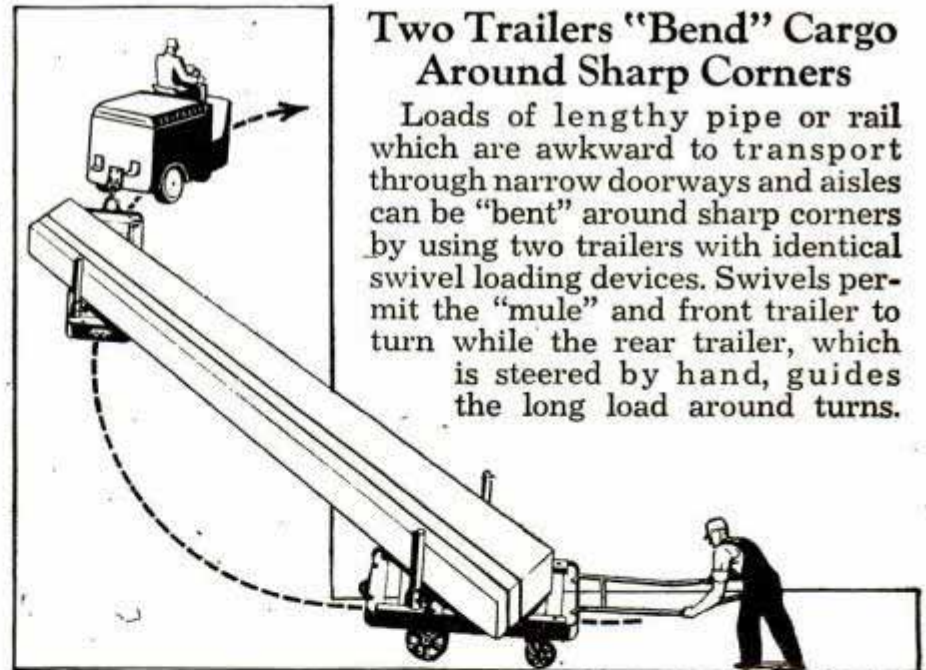

Two Trailers "Bend" Cargo Around Sharp Corners

Loads of lengthy pipe or rail which are awkward to transport through narrow doorways and aisles can be "bent" around sharp corners by using two trailers with identical swivel loading devices. Swivels permit the "mule" and front trailer to turn while the rear trailer, which is steered by hand, guides the long load around turns.

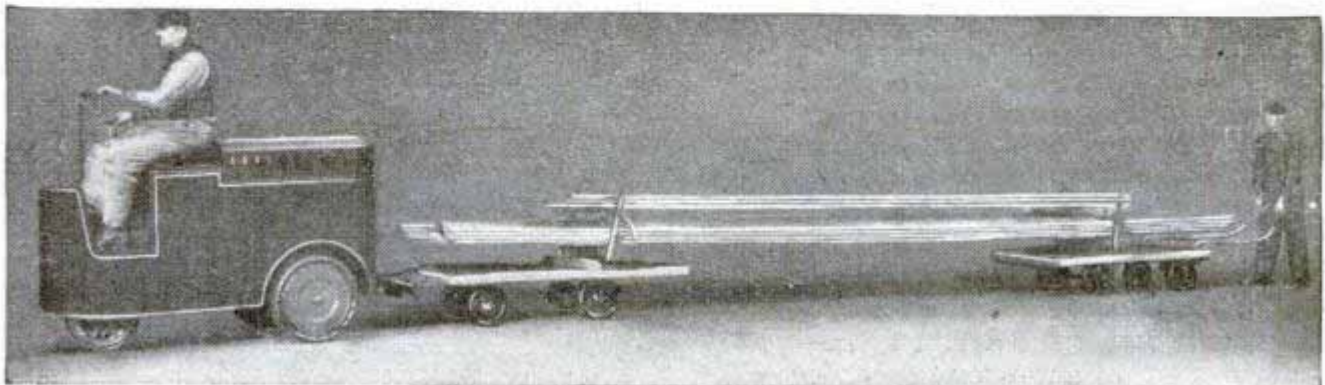

Portable Fluorescent Light Spreads Beam Over Half Circle



In contrast to a flashlight, illumination from a portable fluorescent light spreads over a 180-degree area. The unit weighs seven pounds complete with the B-battery which provides the current. It uses a standard six-watt fluorescent tube. The life of the battery is approximately 30 hours of continuous use and the fluorescent tube will last about 1000 hours. Fingertip control switches are located directly under the handle of the case.

Temporary Nonrust Coat Saves Metals in Shipment

Metal parts are protected against rust, corrosion or salt water during shipment by a temporary coating that can be removed by washing with gasoline. The mixture of wool fat, China wood oil, resin and white spirits was devised by the Germans. It has been made available by the U. S. Department of Commerce.

Pint-Size British Motor Bus Travels at 25 Miles Per Hour

Only eight feet long and two feet wide, a midget motor bus built by a former British soldier is powered by a one-horsepower gasoline engine. The toy-size vehicle attains speeds up to 25 miles per hour and travels 60 miles on a gallon of gas. Approximately 1000 children paid their fares to take rides in the little bus during one day in Brighton, England.

Vacuum Leak Detector Uses Helium as Tracer

Tiny leaks in vacuum tubes are indicated by the "leak detective," an instrument which spots leaks so small that 15,000 years would be required for the contents of a quart bottle of air at atmospheric pressure to pass through such an opening. The instrument, developed by General Electric engineers, makes possible improved methods of obtaining the "high vacuum" necessary for more efficient radio, electronic and X-ray equipment. Using helium as a tracer gas, the instrument will detect the gas in a vacuum system in about one second.



MAKING MONEY by the TON

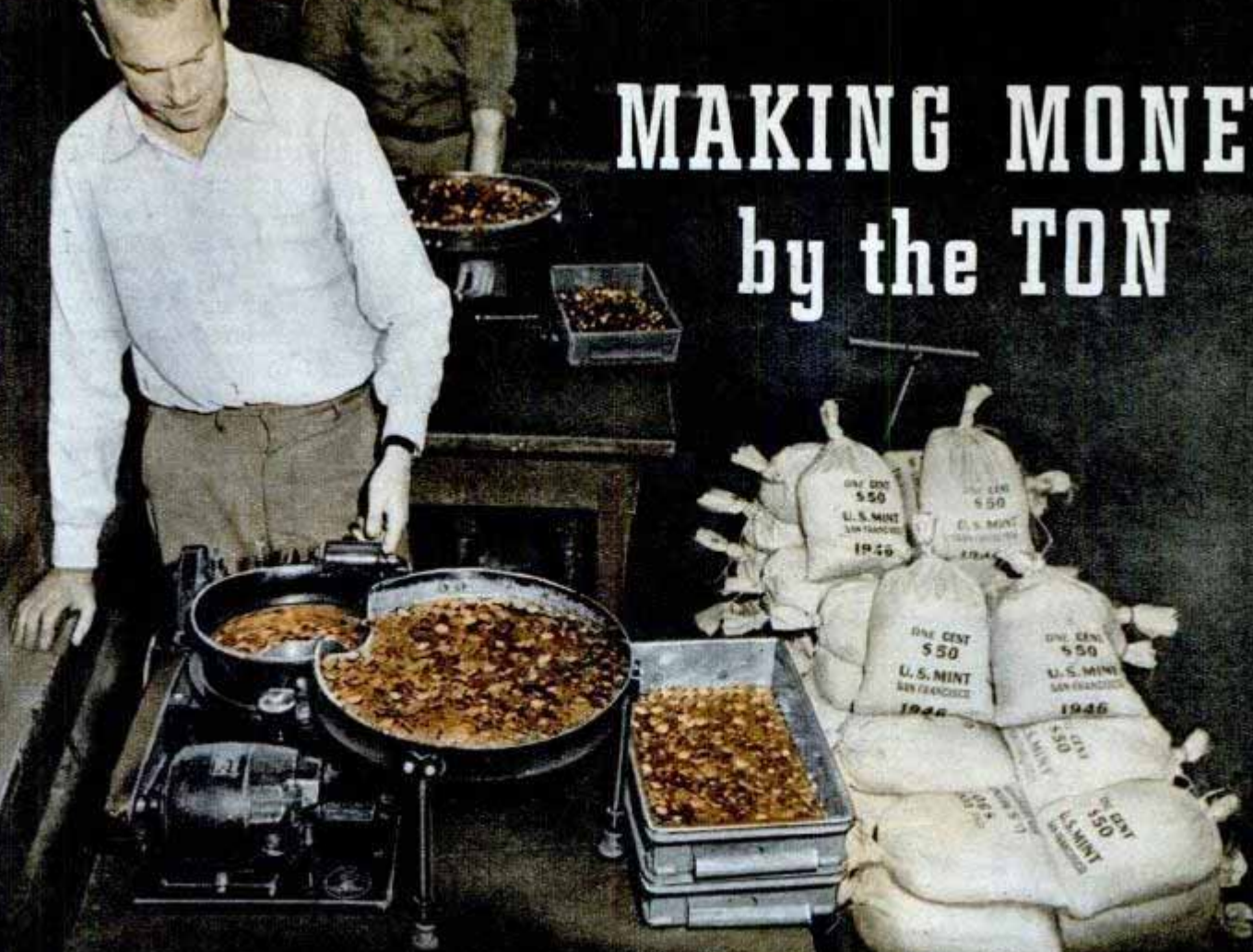

Machines unerringly count 5000 pennies for each bag. Below, sampling the white-hot alloy for silver coins

Forty-seven thousand tons of money! Whoever dreamed of a treasure trove like that?

It exists. In fact, you have part of it in your pocket. That enormous tonnage is the weight of the small change that America uses in its everyday transactions.

We require some \$1,300,000,000 worth of metal coins for running our dollars and cents economy. Your per capita share amounts to a double handful of coins worth a few cents more than nine dollars, of which \$2.23 is in pennies and nickels and almost six dollars is in dimes, quarters and half dollars. There aren't quite enough silver dollars to go around, so your share amounts to 99 cents.

Maintaining this supply of money is a tremendous task. The demand for coins is always increasing

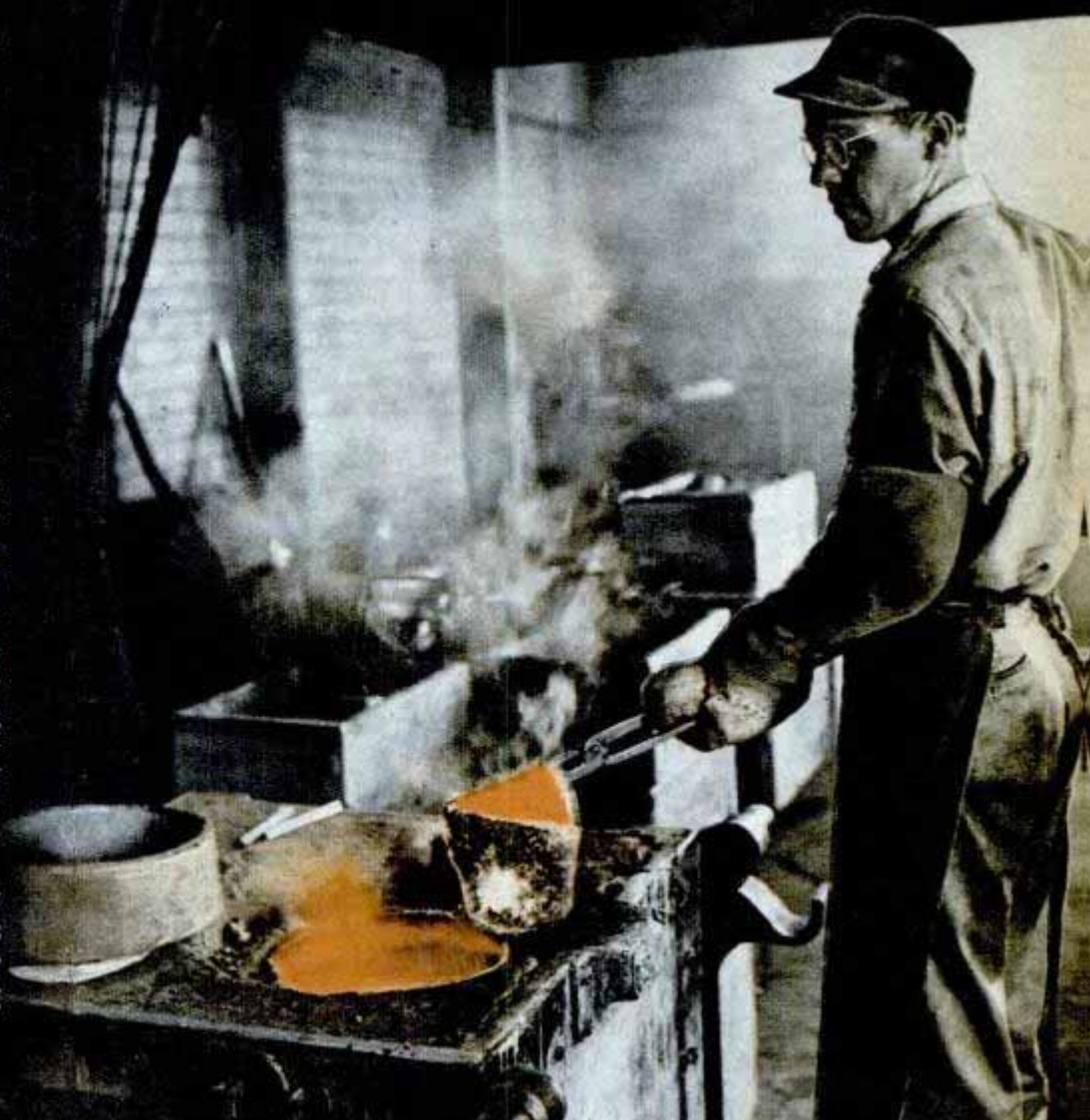



Dual-strike presses like these turn out 80,000 coins daily, with silver dollars requiring four times more pressure than pennies



Copper blanks soon to be pennies get "squeezed" in device above to give them thick edges, vital for long wear. Weighing machine, below, checks coins to be sure they are within legal tolerance



and, too, replacements must be provided for the coins that wear out or are otherwise lost from circulation. This is the task of the United States Mint Service, under the supervision of Nellie Tayloe Ross, director of the mint. The service operates the central mint at Philadelphia as well as two others at Denver and San Francisco.

During the war the mints worked three shifts a day, for we were manufacturing money for half the world. Pennies and shillings for Great Britain, annas and rupees for India and centavos and pesos for Colombia, among others, were provided by the United States during the time the foreign mints were busy on special war jobs.

Mints can run short of money just like the rest of us. Recently Neal H. Callaghan, superintendent of the San Francisco mint, found that he was almost out of pennies. There were only a million and a half one-cent pieces on hand. Sales taxes and an increase in the price of cigarettes had created a run on the copper coins. Callaghan at once put all his presses to making one-cent pieces, at the rate of 1,000,000 per day. Finally a backlog of nearly half a million dollars worth was built up.

Pennies are in greatest demand today, and least wanted are silver dollars. Twenty years ago in most parts of the West you were apt to receive 19 hefty silver dollars as change when you offered a \$20 bill in payment for a dollar meal. Gradually the convenient paper silver certificates became more popular and now the San Francisco mint issues only about 5,000,000 silver dollars per year. Many of these go to Nevada for use as gambling chips.

The next time you inspect a silver dollar it's quite likely that you will find it appears to be brand new and yet is dated 1878 or 1880 or some other year late in the last century. It's the old-style dollar, in mirror-bright mint condition. This oddity is due to the fact that for a long time the mints were required by law to manufacture more dollars than were actually needed. Now they draw on their old stocks.

United States silver coins contain nine parts of pure silver and one part of pure copper. Copper

improves the handling and wearing qualities of the coins. One-cent pieces contain a small amount of zinc for the same reason. Coinage of the wartime zinc and steel one-cent pieces ended in April 1945. The face value of any coin usually is far greater than the value of the metal that it contains, the difference being a seigniorage charge that is made by the government for producing the coin.

The wartime five-cent piece is unique in this respect because it contains just about a nickel's worth of bullion. Nickels that were coined before the war and those coined since April 1946 consist of 75 percent nickel and 25 percent copper. That's the standard alloy. But nickel was needed for other purposes during the war and so a different alloy was adopted, consisting of 35 percent silver, 56 percent copper and nine percent manganese. The manganese provides the electrical conducting property needed for operating coin machines. At the price of 90 cents an ounce for silver the silver in a wartime nickel is worth just about five cents. These coins are identified by a slightly brassy appearance and a large mint mark initial over the dome of Monticello on the reverse side.

Although gold coins have been withdrawn from circulation the mints still buy gold and also sell it to licensed dealers for such uses as dentistry, jewelry manufacture and the miscellaneous needs of industry. Gold that is to be placed in storage is melted, stirred and cast into 400-ounce bars that measure $1\frac{3}{4}$ by $3\frac{1}{2}$ by $6\frac{1}{2}$ inches. This is the so-called standard certificate bar that is used in international trade. Each bar is worth \$14,000.

For added protection, part of the concrete floor has to be lowered before the vault door can open

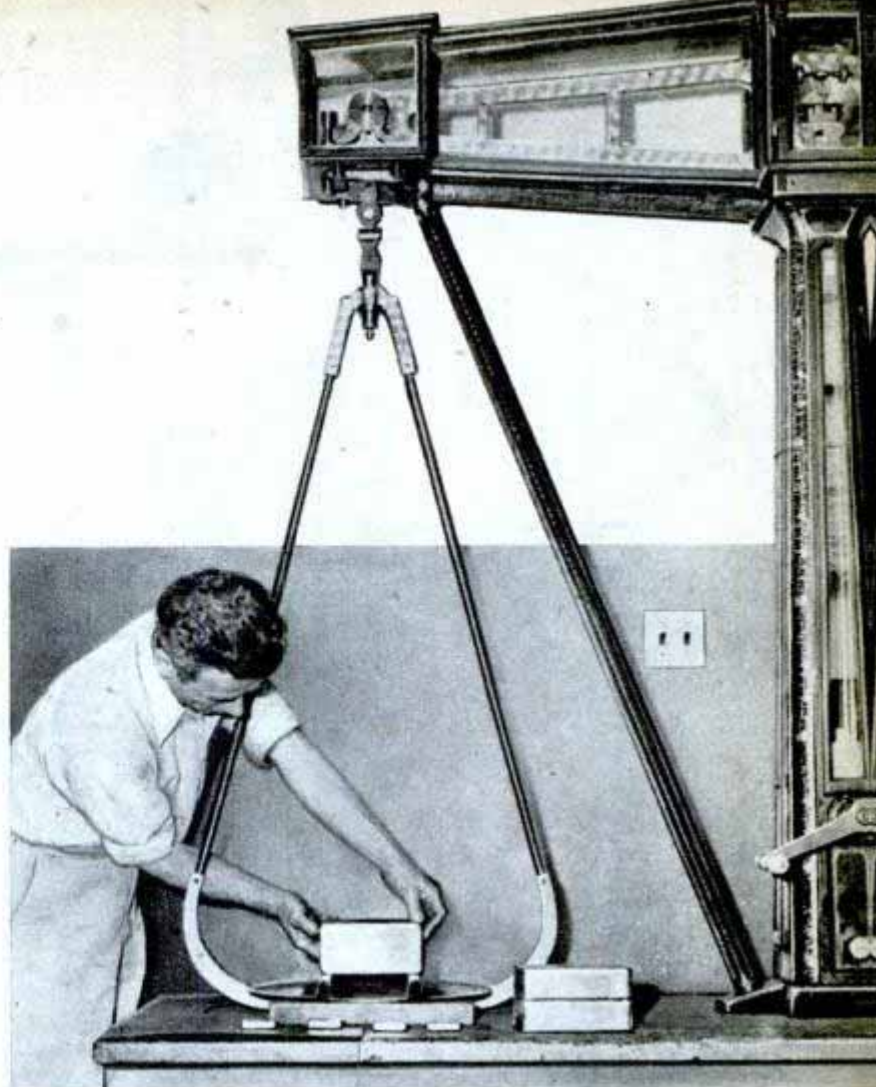
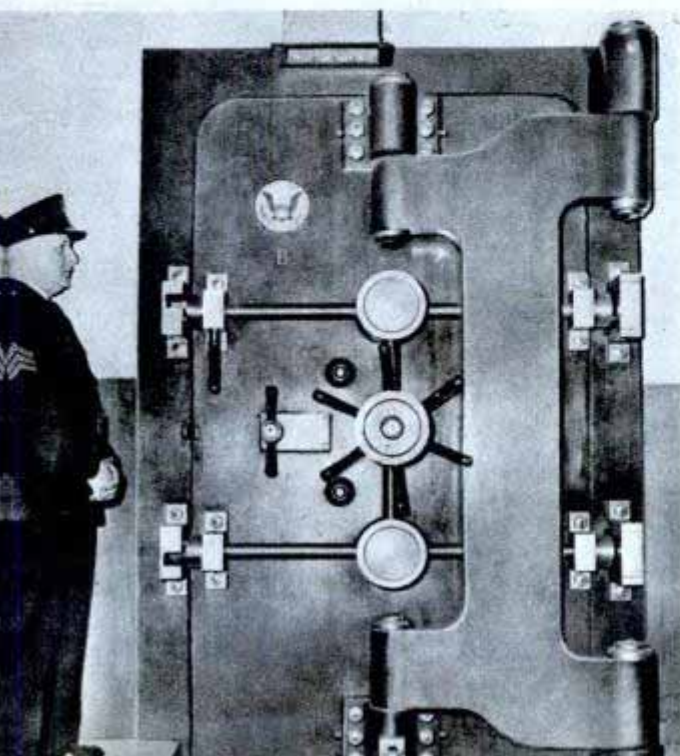

Checking the weight of a 400-ounce gold certificate bar worth \$14,000. Below, cleaning the electrodes of the power unit that operates the mint's electrostatic air cleaners





Making money for the public is simply a manufacturing process at the mints. When the San Francisco mint needs pennies, for example, the melting and refining department first weighs up batches of metal in the proportions of 950 parts of copper to 50 parts of zinc. The weighing is done on a huge balance or beam that has a capacity of 10,000 ounces and is accurate to within $\frac{1}{100}$ ounce.

Each batch of the two metals is melted in an electric furnace, thoroughly stirred and then cast into bars that are $\frac{1}{2}$ inch thick, $3\frac{1}{8}$ inches wide and 13 inches long. Each melt is sampled twice and assayed to make certain of purity and percentages.

The bars then go to the coinage department. Here each bar is run through a series of rolls that reduces its thickness to $\frac{48}{1000}$ inch and stretches it into an 8-foot-long strip of metal. These strips then are fed into punch machines that punch out four blanks at a time, 500 blanks for one-cent pieces from every strip. The clippings left over are remelted.

The punching process hardens the copper blanks and so the next step is to soften

Silver bullion is melted down, refined and poured into form until needed. The eight-foot strip of copper and zinc below, rolled from a short slab like the one in the other hand, will provide blanks for 500 pennies

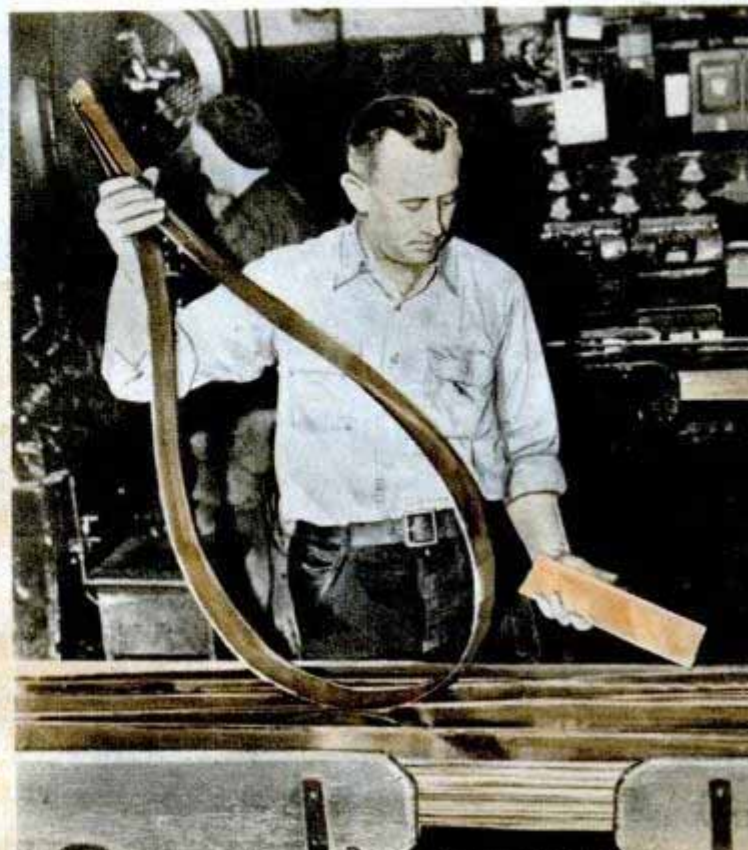

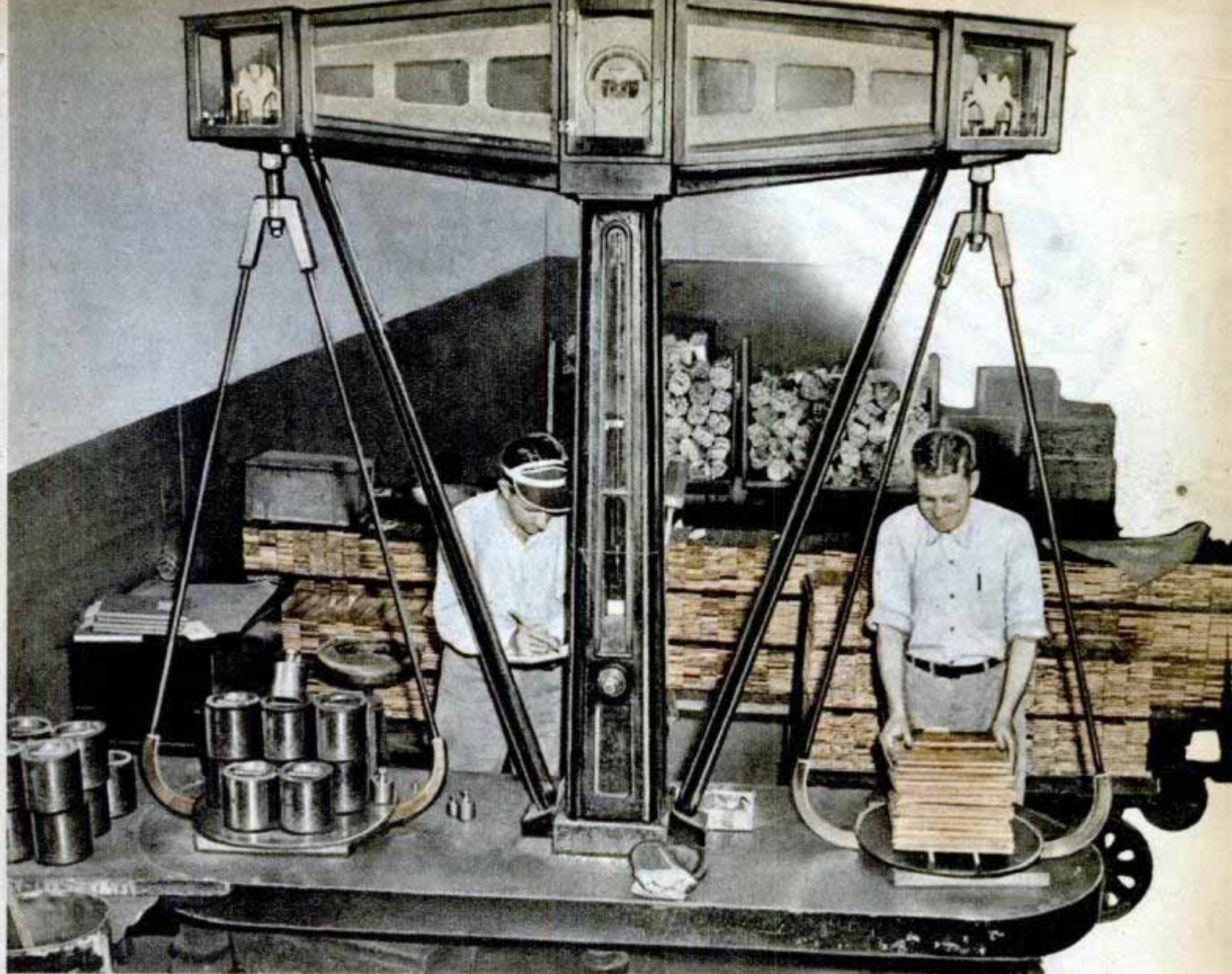

Weighing 5700 ounces of pure copper to be used in making one-cent pieces. Below, hopper in front of each press stacks coins and feeds them into place between dies, where designations are struck upon them



them in an annealing furnace. Then they are washed in abrasives and soap chips to remove the discolorations of annealing, rinsed, and dried in hot air centrifugal driers. From here the blanks go to a milling room where they receive a squeeze treatment that increases the thickness of their edges. Raised edges contribute to the wearing quality of a coin. At this stage all blanks that have been bent or damaged are culled out. Next the blanks are taken to the press room.

The San Francisco mint has 18 automatic high-speed presses. Each can be set to deliver 40 tons of pressure, needed for striking one-cent pieces, or they can be adjusted to produce as much as 160 tons of pressure for striking silver dollars.

Coin presses usually strike one coin at a time but some of the presses at San Francisco can strike two. Such a press is capable of producing 80,000 coins in eight hours. The dual-strike feature, invented by Joseph Steele, superintendent of coinage at San Francisco, and William Kruse, superintendent of machinery, also has been adopted

(Continued to page 240)



Paper Horses Are Tough

Wild-eyed rocking horses, bashful ducks and lazy turtles are the training aids and toys made in a Chicago factory — not of wood or metal but of paper. Chip board, a coarse light cardboard, is torn into strips and coated with glue. Three layers of the paper are smoothed inside a mold (above left). After the mold is slipped off, the horses are mounted in a roomy oven (above) where the glue is baked dry. Sprayed with shining black adhesive, they're placed in a tumbling machine (below) and bombarded with tiny particles of rayon or wool to give the animals a velveteen appearance. Curved steel tubes are bolted to the body as rockers and a leather saddle and rope tail installed. The ducks and turtles are touched up by hand (lower left). There are no frames in the horses—just wooden legs. Yet the manufacturer reports they'll support a 250-pound man if the younger generation gives him a chance to mount them.

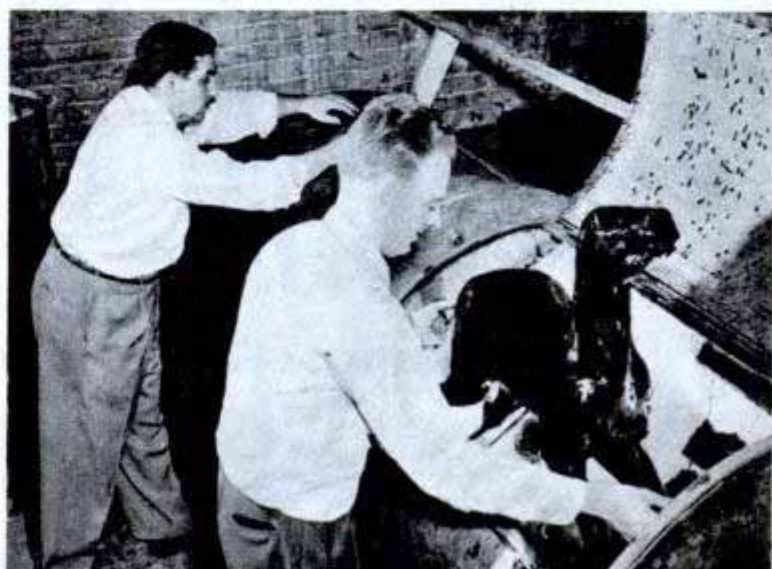

Man Tames 100,000-Volt Lightning Bolt With Guards on Power Line

Man-made lightning strikes a miniature power line and is quickly brought under control in a mobile electrical exhibit now touring the nation. Designed to demonstrate the latest type protective devices that stand guard over power distribution systems, the traveling lightning maker employs a surge generator to create 100,000-volt discharges that simulate thunderbolts. Spectators see exactly how power fuses, line reclosers, fused cutouts and lightning arresters go into action to prevent lightning from disrupting service and inflicting damage. The Westinghouse Electric Corporation built the mobile unit which includes all electrical apparatus required to operate and protect a real power line serving a 35-mile radius. The power fuses and other equipment are mounted on a panel depicting a panoramic scene of a typical community. Every phase of the demonstration is controlled from a small desk near the panel.



Calls "Beamed" to Catalina Link Island to Mainland

Catalina Island, 23 miles off the southern California coast, is now linked to Los Angeles and the mainland by a radio telephone system, the first established for regular commercial service. Tall transmitting and receiving antennas in conjunction with parabolic reflectors are set up on the island and on top of a Los Angeles building to handle the multichannel microwave system.

Thermostat With Electric Eye Reveals Position of Damper

Open and closed positions of furnace dampers are indicated by a visual signal flashed by an electric eye in a wall temperature thermostat. When the dampers are closed, the electric eye signal is off. A dim light discloses that automatic controls are in operation changing damper position. The eye shines brightly when the dampers are open. The signal is located at the top center of the wall thermostat in an aperture covered by a translucent red shell.



Photo darkroom becomes the decorative walnut cabinet shown at right when it's not in use. Doors and lid swing open to reveal shelves, enlarger, drain, timer, safelight and space for three trays



*For the
Camera
Fan*

Film viewer, lower left, becomes a projector for transparencies, left, by adding a lamp attachment
↓ Base may be used as table mount for small camera



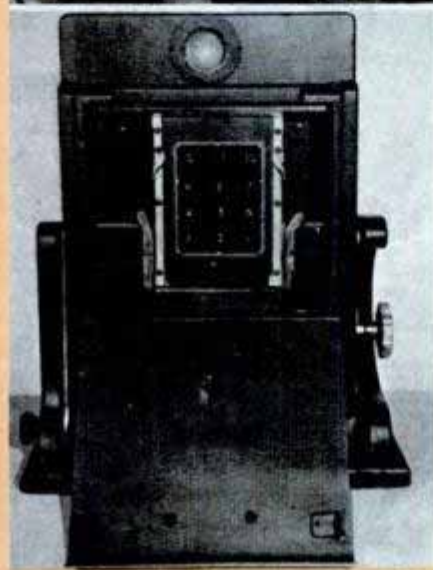
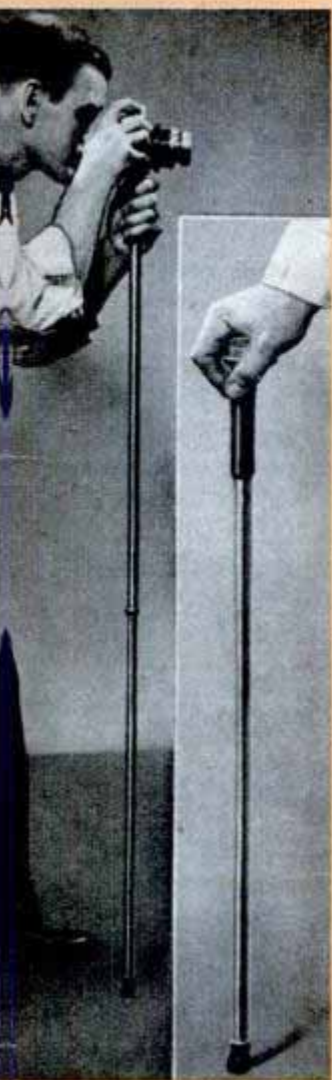

Monopode made of aluminum serves as camera support or lightweight cane, extends to 57½-inch length

Electric camera for identification photos or portraits takes 12 to 24 exposures on one negative. A single lever makes the exposure, moves the film to a new position and adjusts the camera to the proper range. A buzzer warns of the last exposure on the film. Photos can be taken in black and white or color

Squeegee wipes excess moisture from negatives or prints like a windshield wiper. A thin rubber blade dries each side of the paper

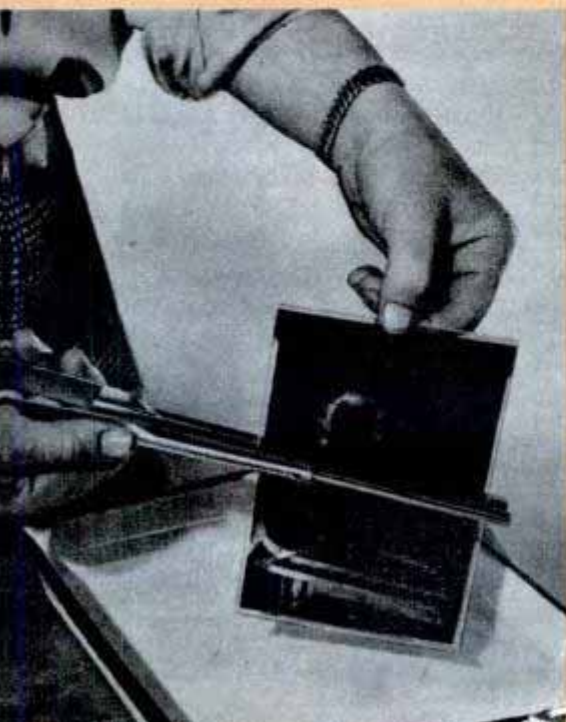

Movie screen rolls into its wood frame when not in use to reveal an attractive oil painting. Six different pictures are available in a choice of two types of frames

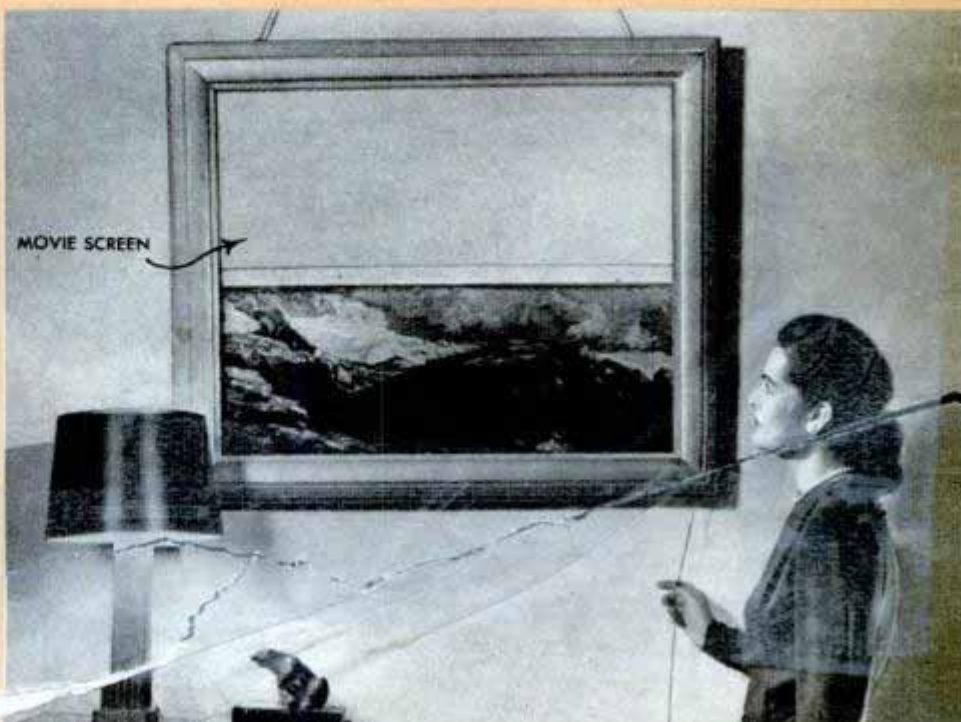

Three-Wheeled French Car Travels 70 Miles an Hour on Little Gas



Low gasoline consumption and fairly high speed are two advantages of a new three-wheeled French automobile. The little car seats four persons, three abreast in a front seat and one seated crosswise at the rear. A front-wheel drive model, the automobile is powered by a water-cooled flat twin engine which is said to give a top speed of nearly 70 miles per hour with gas consumption so low that the three-wheeler will travel more than 100 miles at moderate speeds on a gallon of gasoline.

Photoelectric Eye Takes Fish Census 12 Feet Beneath Surface

Science is probing far beneath the surface of muddy rivers and frozen ponds to learn what effect light has on the migratory habits of fish. At Lake Mendota, near Madison, Wis., a combination light meter and photoelectric fish detector counted the number of perch that hurried by when a beam of light was aimed down through the water 12 feet below the surface. Dr. Arthur D. Hasler of the University of Wisconsin and Dr. Lester V. Whitney of Southwest Missouri State Teachers College designed the equipment and conducted the tests.

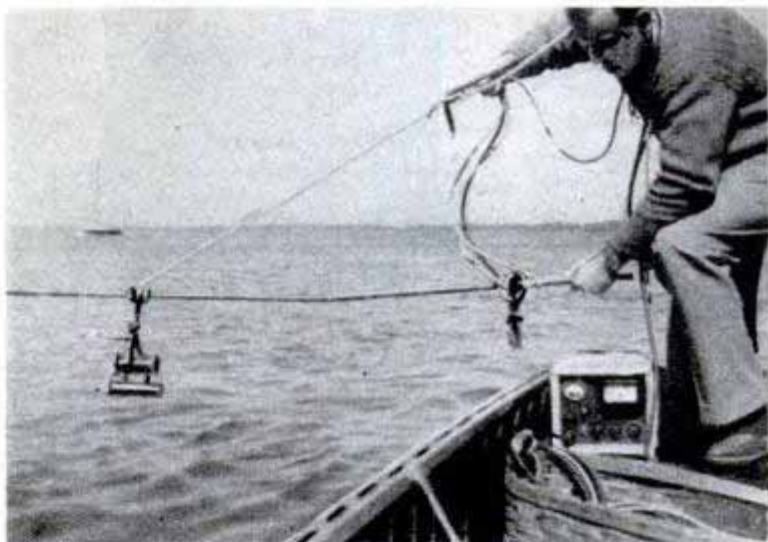

Blasting Gun for Cleaning Picks Up Dust and Reclaims Abrasive



Dust and dirt knocked loose from the exterior of buildings, ships and trains are absorbed by a giant vacuum cleaner which even reclaims steel grit it uses for abrasive. In one continuous operation, tiny steel pellets are bombarded from a blasting nozzle against a surface to dislodge grime which, with the abrasive, is sucked back to a tank where the abrasive is separated for further use.

Information, including manufacturers' names and addresses, concerning products described in this issue may be obtained by writing Bureau of Information, Popular Mechanics, 200 East Ontario St., Chicago 11, Illinois

Slide Rule Figures Chord Notes by Formula for Music Arrangements

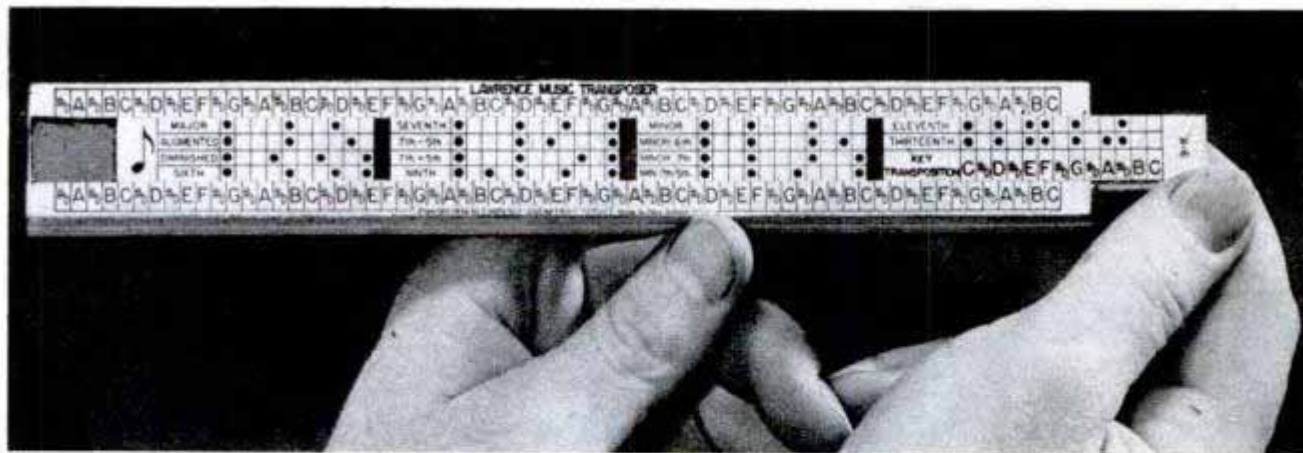

Many music arrangers now figure chords with a calculating instrument that looks and works like a slide rule. By setting the rule so that a red dot is directly below the key desired, the notes for a chord are clearly indicated by the red dot and other blue dots. To transpose from one key to another, the slide is moved so that the

known key in red is directly above the desired key in blue. All notes of the new key will then be found in blue, below the original notes in red. Other slide rules have been designed to help photographers determine the correct lens aperture, to assist in solving pricing and inventory problems, and to select cutting speeds for machines.

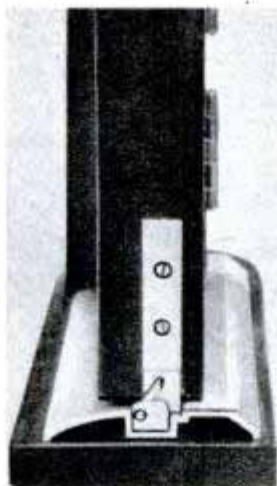
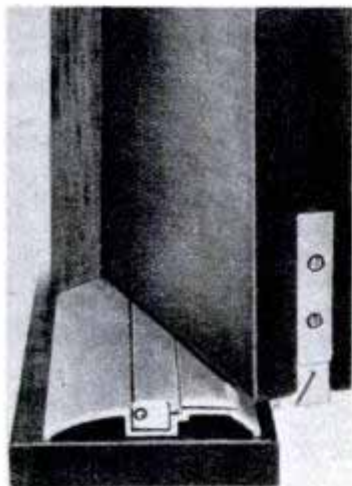

Weather-Tight Door Saddle Keeps Out Rain or Draft

Driving rains and cold drafts are prevented from seeping under doors equipped with a door saddle forming a weather-tight seal. The device is made of aluminum. As the door is closed, a slotted metal key engages the riser in the saddle, which is attached to the floor. The riser is pulled upright and forms an effective vertical barrier against rain or air. When the door is opened, the riser is disengaged by the key and lies flat in the saddle.

Clock-Spring Model Shows Miles Flown

Air lines passengers can check their flight position at all times on a cabin flight-position indicator developed in England. The instrument consists of a model airplane and a long strip map of the air route. The model airplane travels along the map as the air liner flies toward its destination. A clock-spring mechanism, preset to move across the map at speed corresponding to that of the air liner over its route, drives the model along the map flight-path.

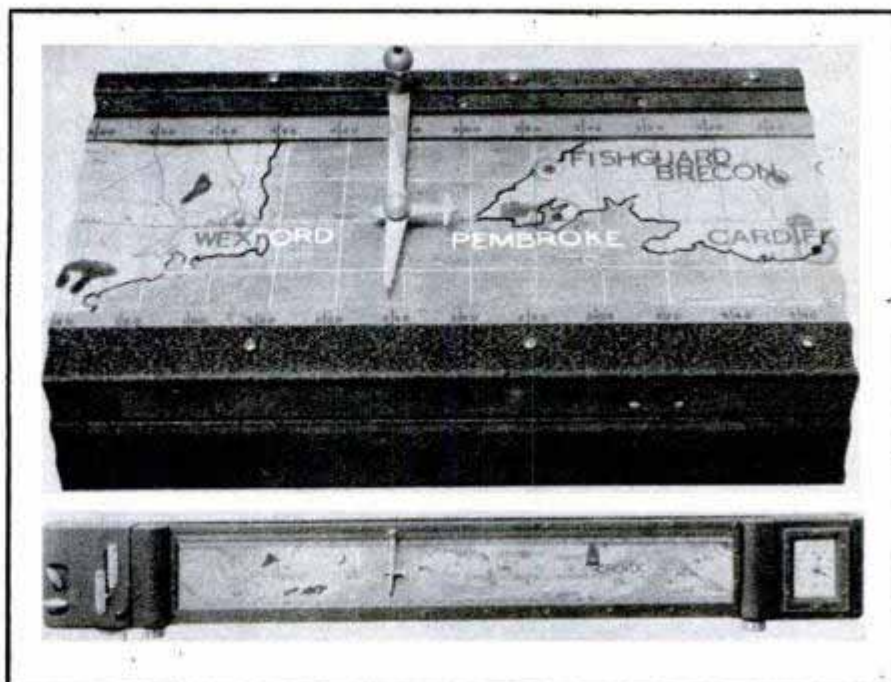

What's on the Shelf?

America's search for more oil now turns to the ocean floor surrounding our coastline



Tightening the drill pipe on a derrick boat working at Lake Salvador in Louisiana



Catwalk towers above an oil well chute, ready to connect derrick and boiler barges



Standard Oil Co. of N. J. photos
Drilling for oil in Galveston Bay, and below, an air view of well drilling operations close to Cape Hatteras, N. C.

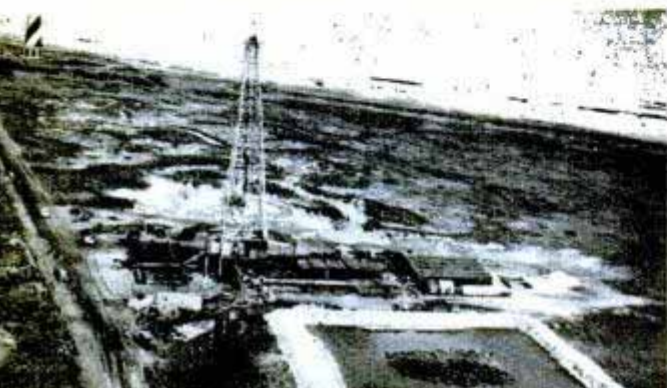

Derrickman perches on a board as he rides downward from his platform to adjust pipe

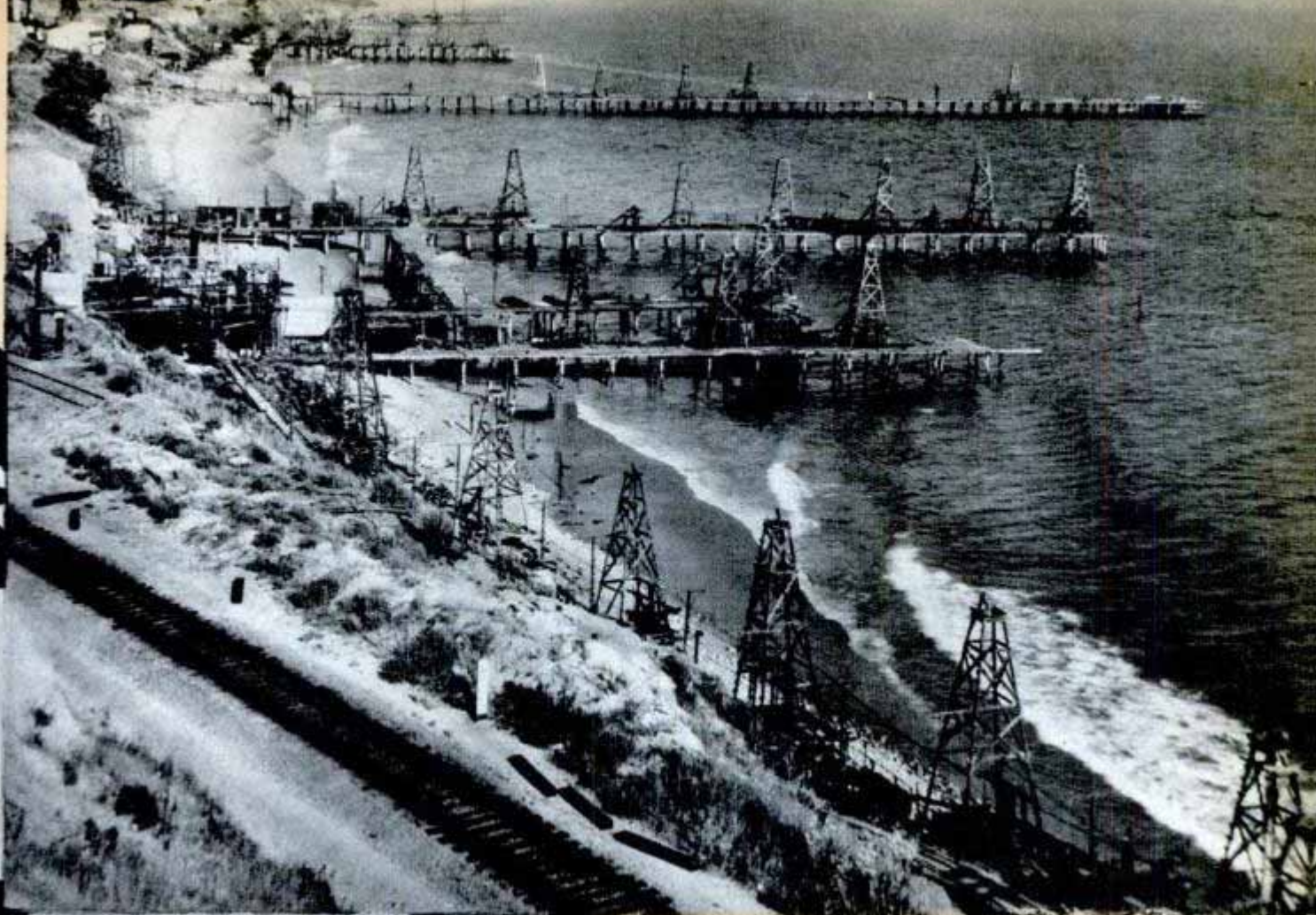

Oil companies are reaching out to tap tideland petroleum pools in search for more oil

By John L. Kent

HUNDREDS of scientists, engineers and geologists are getting ready for the greatest treasure hunt in modern times. The buried riches for which they will search include oil and other minerals spread over an area of 760,000 square miles, 50 percent larger than Alaska.

The area of this impending exploration is uninhabited—since it is uninhabitable, being on the ocean floor surrounding the coast of the United States. This section of the sea bed, a continuation of the mainland, is known as the continental shelf. It is looked upon as a new source of mineral wealth, especially oil.

These 760,000 square miles of underwater land were declared exclusive territory of the United States by proclamation of the President last September. Limits of the area are fixed by a depth of 600 feet.

Continents do not drop off sharply into the ocean, as a general rule, but slope gently for a distance which varies from a few miles to several hundred before the real depths of the oceans or seas are reached. Generally, submerged land contiguous to the continent and covered by no more than 100 fathoms (600 feet) of water is considered as the continental shelf.

The continental shelf on the east coast

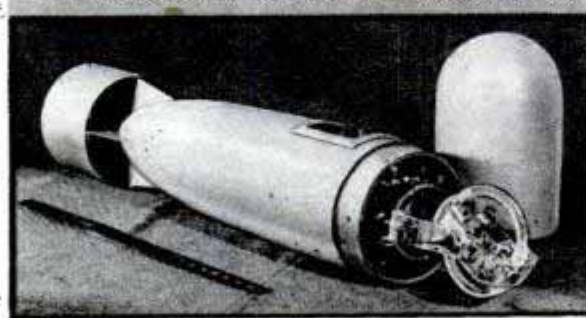
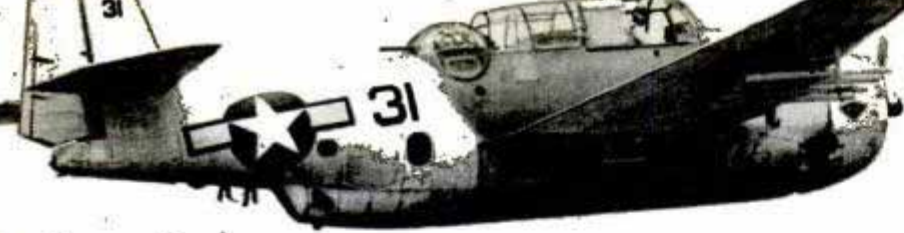

Bell Telephone Laboratories photo

Navy's magnetic "doodle bug," suspended from plane, was designed to detect enemy subs but now may be employed in aerial prospecting for oil and other minerals. The inset shows a closeup of the device

from Cape Hatteras north ranges from 60 to 250 miles in width. South to Florida it is 40 to 60 miles wide, although near Miami it is reduced to about 20 miles in width. Along the coast of the Gulf of Mexico the shelf is quite wide and that part of it belonging to the United States has an area of some 149,000 square miles.

Along our Pacific coast the shelf is narrower, averaging approximately 25 miles in width. Off Alaska the shelf widens considerably and under the waters of the Ber-

ing Sea extends for several hundred miles.

This newest treasure hunt will utilize the most modern scientific instruments and devices, some never before used for mineral prospecting purposes. The Department of the Interior has announced that new oil deposits along the Pacific continental shelf will be detected by means of radar adapted for underwater use. The radar equipment is to be built into special submarines.

Geological surveys of submerged areas have already been satisfactorily made by seismic methods. One company has made a systematic seismograph survey to a distance of 26 miles off the Louisiana coast.

Seismic surveys are based on records of the underground rock and soil strata. To obtain this record, a hole is drilled in the area where oil is anticipated, and a charge of dynamite is exploded in it. The record of the ground motion is registered on seismograph instruments. A geologist interprets the record and "reads" the depths and structure of the various strata of sand and rock. Knowing that oil is found only in specific strata and under certain conditions, the experienced oil prospecting engineer is in a position to recommend drilling operations or abandonment of search in that vicinity. This widely used method has already been adapted for un-

Reeling out geophone wires from a seismograph recording boat to locate underwater minerals. Right, recorder





Dynamite charge explodes at Cape Hatteras, N. C., during seismograph survey. Right, sighting the "shot" points.

derwater use. All drilling, blasting and recording is done from barges and boats on the surface.

Another method suggested for surveying the continental shelf is the magnetic survey, which can be made rapidly from airplanes. This survey furnishes information on the magnetic properties of subsea formations and aids in the recognition of structural features.

Since geological outcroppings known as "salt domes" usually herald the presence of oil, reflection and refraction seismic surveys are to be made from boats or instruments on the sea bottom to locate these deep salt domes. Another method of locat-

ing salt domes is by the gravimetric survey. This survey is done on the sea bottom, and the use of submarines and submarine diving bells has been suggested.

While the continental shelf in the Gulf of Mexico offers greatest promise of oil-bearing structures, additional areas of the continental shelf off the Pacific coast may produce oil, and there are indications that oil-bearing structures might be found off Alaska. Department of Interior experts believe there is a strong probability that oil-bearing strata may extend as far as 100 miles into the Gulf of Mexico.

Professor John L. Rich, University of Cincinnati geologist, believes the shoals of the Bahama Banks may hide a submarine oil field. Situated between the Bahama Islands and Cuba, the shoal area has a depth varying between six and 30 feet. Professor Rich flew over the region making aerial photographs from a height of 10,000 feet. He reported that the giant sand bars and ripples of the Bahama Banks bear a striking resemblance to the patterns of certain productive oil and gas sands in Ohio. Based on his photogrammetric maps, he urges further investigation of the Bahama Banks as a possible oil-bearing area.

In the Gulf Coast region, petroleum production began with the discovery of oil in the famous Spindletop dome near Beaumont, Texas, in 1901. Since that discovery, hundreds of salt domes and related structures have been located in the area. The existence of these productive salt domes immediately along the coast of the Gulf of Mexico and the extension of prospecting into the marshes, bayous and coastal bays of Louisiana made it evident that the oil

Seismograph record examined aboard geophone boat

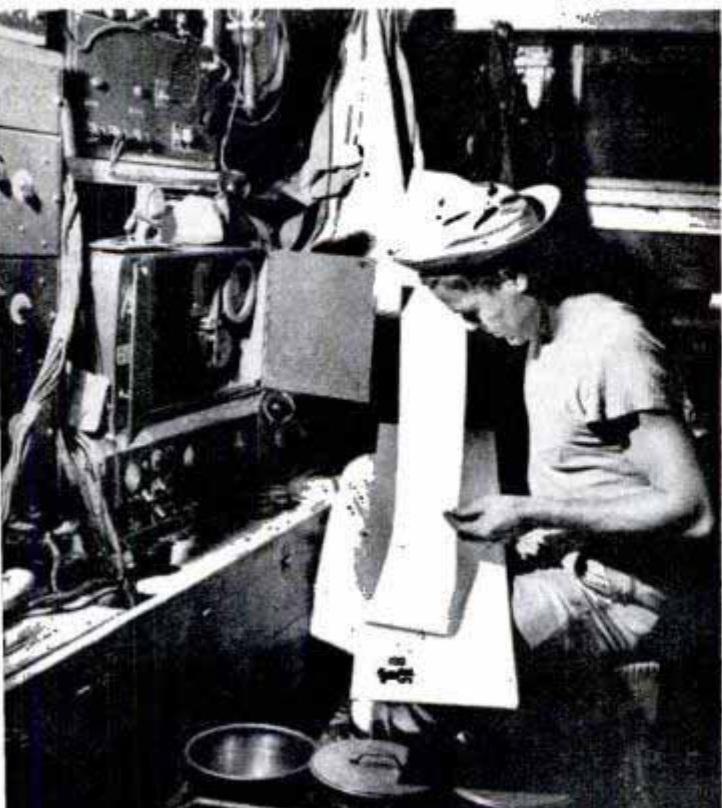

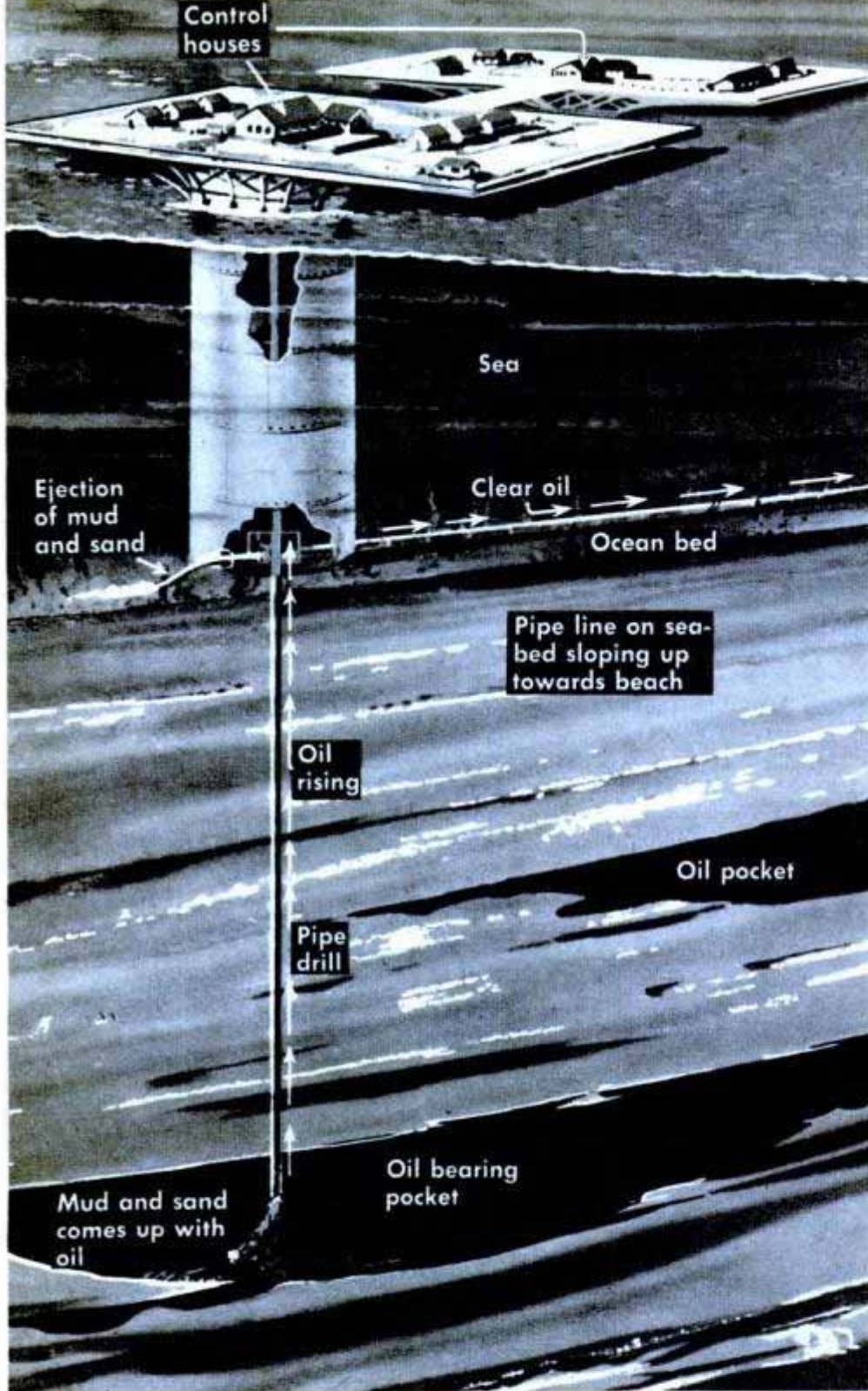

Drawing by E. G. Lambert of the London Sphere shows the novel method of oil extraction used off coast of Trinidad. Oil reaches shore by pipe line

productive province extended outward beneath the waters of the Gulf.

As early as 1927, Dr. David White of the U. S. Geological Survey announced his opinion that domes existed beneath the Gulf. At that time Dr. White suggested that the topography of the entire bottom of the continental shelf be surveyed by the then new method of sonic sounding.

Continued prospecting and drilling into partially submerged areas near the Louisiana coast eventually led to discovery in 1938 of the Creole field, about a mile

offshore from Cameron Parish and under 25 feet of water. A second field, Sabine Pass, was discovered in 1941, nearly two miles offshore from Jefferson County, Texas. Several other fields have been developed in bays along the Gulf Coast. Nothing, however, compares with the possibility of drilling for oil 50 or even a hundred miles from shore—in the open ocean. This is not at all impossible.

Indeed, this ocean area may be our last totally unexplored great domestic source of petroleum. And petroleum is one of the trinity of coal, iron and oil on which a nation's industrial greatness is based.

Just before his retirement as Secretary of the Interior, Harold L. Ickes declared:

"Of the three most important mineral contributors to our industrial greatness, and to the foundation of our position as a world power, we are probably most lacking in petroleum.

"Regardless of how much oil remains untapped elsewhere in the world, the national interest of the United States requires that we should have available at home, within easy reach, a supply of oil sufficient to care for this nation's needs in any future emergency."

The importance of oil to our national defense

cannot be underestimated. It was lack of oil and the gasoline derived from it that was in great measure responsible for the Germans' defeat. The U. S. Strategic Bombing Survey revealed that Germany went to war in 1939 with reserve stocks of only:

3.1 months' supply of aviation gasoline.

1.9 months' supply of motor gasoline.

2.4 months' supply of rubber.

Germany never recovered from this precarious position and throughout the war her oil stocks, particularly critical items

(Continued to page 260)

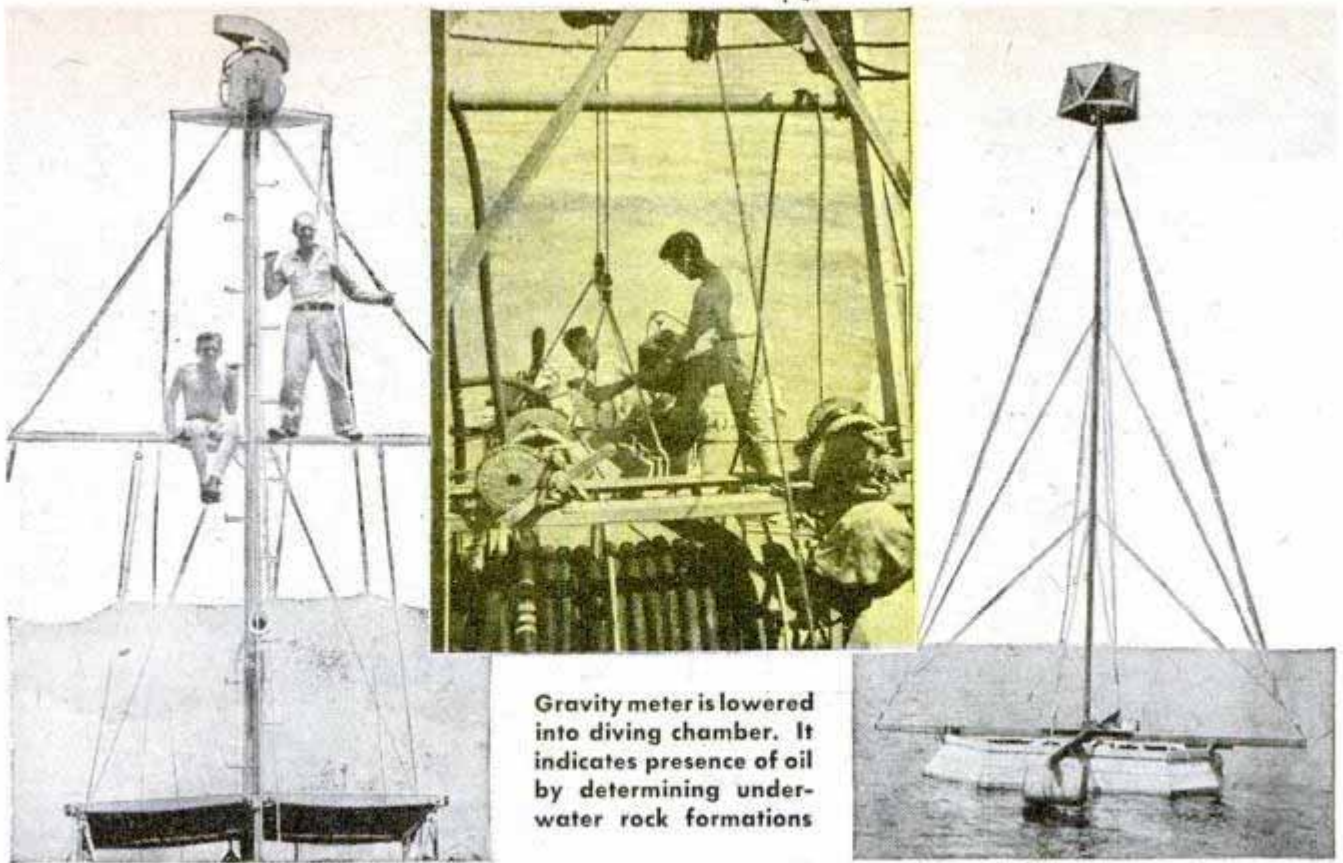

Gravity meter is lowered into diving chamber. It indicates presence of oil by determining underwater rock formations

Radar Plots Underwater Oil Wells

RADAR and a two-ton diving chamber are aiding petroleum scientists of the Standard Oil Company (New Jersey) in locating pools of oil beneath the ocean. Scientists are searching the waters of the Bahamas in an 11-foot ship, periodically low-

ering the diving chamber to the ocean floor. Inside the chamber a gravity meter furnishes indications of the presence of oil by determining rock formations. By bouncing radar signals off targets in the area, engineers plot the most promising test areas.

Radar antenna (top left) bounces signals off targets anchored in the area (top right) to plot ship's location when promising rock formations are found. Ship below is first oil research craft equipped with radar. Inset shows diving chamber returning from floor of ocean

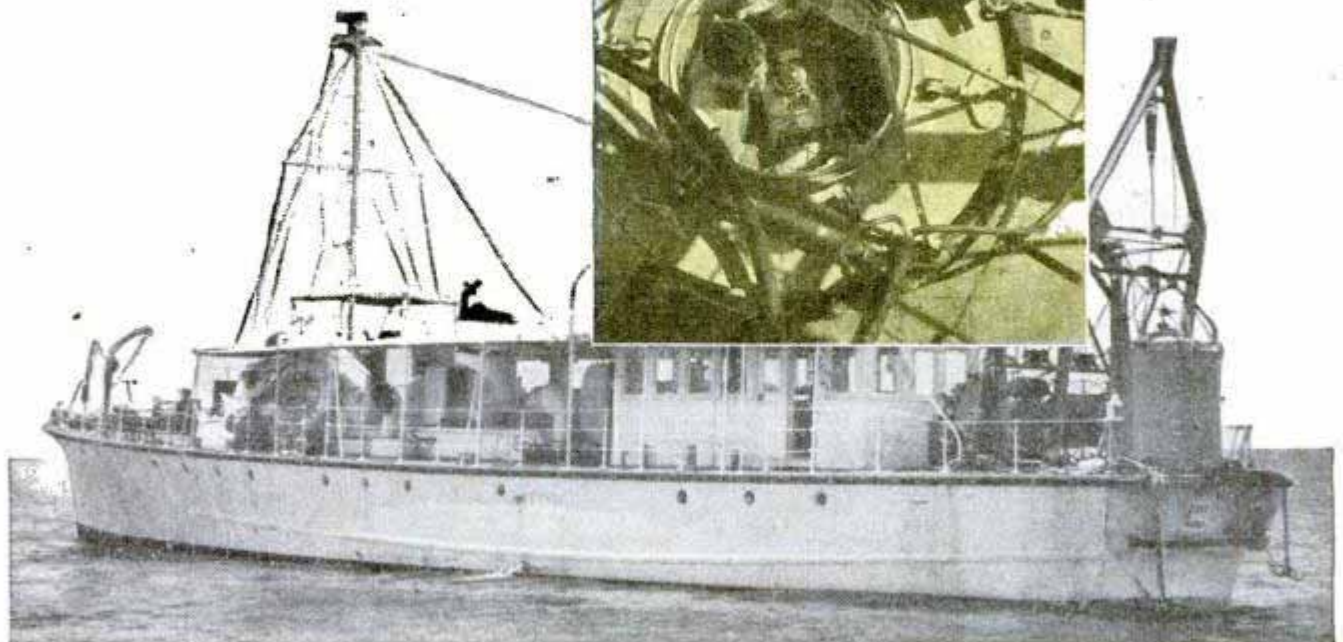
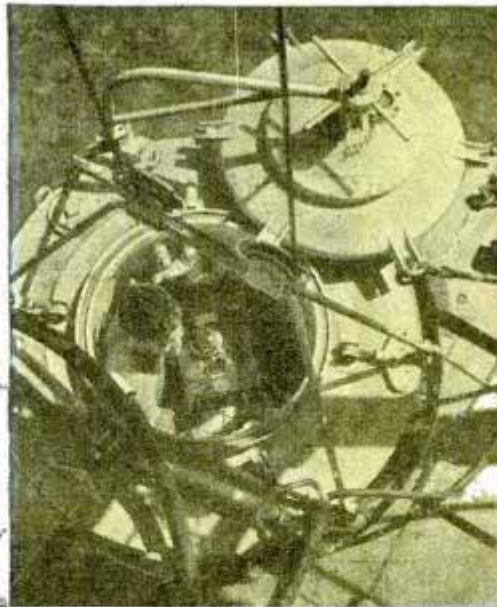

One Steering Wheel Is Removable In Dual-Control Car



To permit normal use of dual-control driver-training cars, Bill McKinley of Vancouver, B. C., designed removable controls. When the car is not being used for instruction, he removes the teacher's right side steering wheel.

Photos Developed in Daylight With Light-Tight Tank

After being loaded in darkness or under a dim light, a photographic tank equipped with light-tight pouring and drain vents develops pictures in daylight or under the



brightest light. Molded from Bakelite in one piece, the tank accommodates 12 films or plates in regular hangers in sizes up to 4 by 5 inches. With a solution capacity of a half gallon, the tank can be filled or emptied in 32 seconds. The hanger shelf has three dividing sections to segregate the hangers into groups of four and prevent sliding. Sloping ends of the tank serve as handles to facilitate agitation.

Triple-Duty Paintbrush Cleaner Holds Three Brushes

Three brushes covered with three different colors of paint can be cleaned simultaneously in a can of cleaning liquid that has a wire hanger to hold the brushes securely. After soaking a few hours in the cleaner, brushes emerge like new, ready to be wiped dry and used again.



Indelible Golf-Ball Marker Has Its Own Ink Pad

Owners can stamp their names indelibly into the surface of golf balls with a marker consisting of a pressure handle that bears the name in metal type, and a ball holder containing an ink pad in a grooved slot. Slight rotary pressure of the inked type impresses a person's name on the ball. The name is set by the manufacturer.

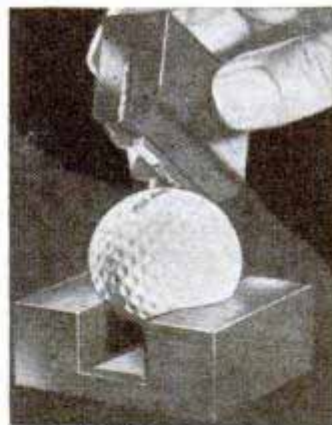

"Triptane" Rating for Gasoline May Replace Octane System

One of these days your gasoline may be rated with a "triptane number" instead of the present octane system. The National Bureau of Standards has proposed a rating in terms of blends of triptane and normal heptane, plus one tenth of one percent tetraethyl lead. Triptane is a relatively new compound of exceptionally high anti-knock rating, and its use in modern aviation fuels has outdated old octane ratings.

Racing Model Hydroplanes Split Waves at 30 M.P.H.

Pint-size hydroplanes achieve speeds up to 25 or 30 miles an hour on ponds and sheltered inland lakes. Their builders make them of balsa or other light wood and alter their design to fit engine size. They are built low so that slight winds and ripples cannot overturn them. All the variations of stepped and three-point suspension racing hulls can be incorporated in the 12-inch speedsters. Some craftsmen use half-inch to three-quarter-inch wood for the sides and up to quarter-inch wood for the bottom. The motor and two small batteries are mounted aft so that the sides protect them from spray. Propeller size depends upon the size of the craft but blades must be short enough to clear the water. If the metal rudder is preset at the proper angle before launching, the hydroplane will circle in a wide curve and return to its original starting place.

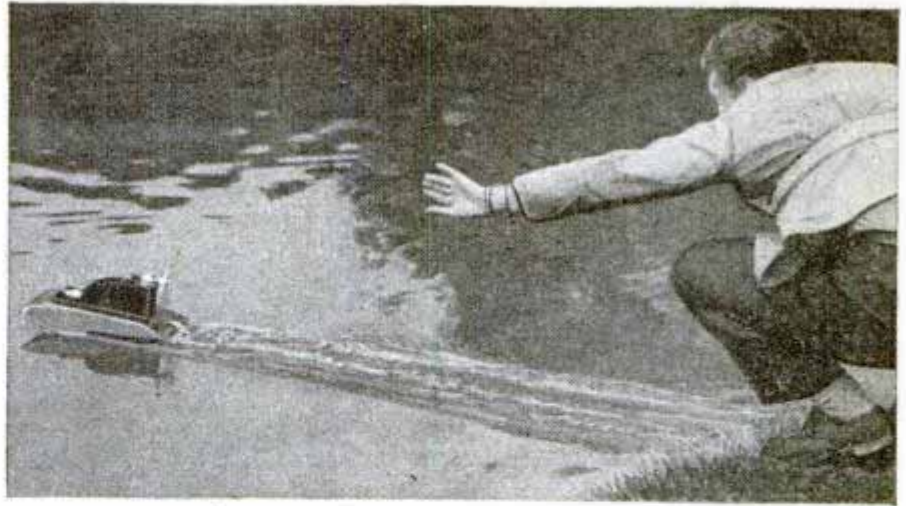

Tiny hydroplanes are made of balsa or other light wood. Many variations of stepped racing hulls are possible



Electric Eye of Metronome Flashes in Time With Beat



Simply plug an electric metronome into any alternating current outlet and it gives an even tone beat. An electric eye is synchronized to flash with the audible tempo of the instrument. The beat may be made loud or soft by adjusting the volume control and the tempo can be varied from 40 to 208 beats per minute.

Many of the products described in this issue are already available or are ready to be marketed. For additional information on these products, including the name and address of the manufacturer or distributor, simply write to Bureau of Information, Popular Mechanics, 200 E. Ontario St., Chicago 11, Ill.



Build Yourself a Railroad

SCORES of new trains will be rolling on schedule this winter—indoors. There is quickened interest in model railroading now that engines, cars, rails and model-making equipment are easier to get.

In every section of the country, in attics, basements, spare rooms and garages, men build and operate their own railroad systems. With some it may be only a few cars, a single engine and a few feet of track; with others it's an elaborate system complete with scenery and some such colorful name as the Lazy Lonesome Valley Road or the Hollow Tree Line.

It should be remembered that there is considerable difference between railroading with toy trains and true model railroading. Commercial toy trains usually are not actual reproductions of real trains. The dyed-in-the-wool model railroader insists on trains that are exact scale miniatures of life-size trains and he often seeks to reproduce sections of real railroad systems.

Model railroading breaks down naturally into five basic interests: track construction and arrangement, locomotives, rolling stock, signals and controls, and scenery.

Some enthusiasts are interested in all branches of this exciting hobby. Others concentrate on one or two. For example, a man with engineering ability who is handy with tools may devote himself entirely to building a model locomotive and never own a piece of track. At the other extreme is the man who spends his time creating a model village or landscape where the train becomes simply a bit of action to enliven the scene.

However, the average model railroader will follow all phases of the hobby to some degree. He will aim toward developing a system with an interesting track arrangement, as many locomotives and pieces of rolling stock as he cares to build or buy, signals and controls to manipulate his trains and a colorful background for realism.

There are three standard commercial sizes of miniature track and trains. These are: the HO for those who require the smallest or who wish to keep down expense; O gauge which is the largest and most popular; and OO gauge for those who want something in between. There are other gauges, but you will do well to ad-

For exact scale-model American Flyer locomotive, engineers reduce original blueprints of full-size engine

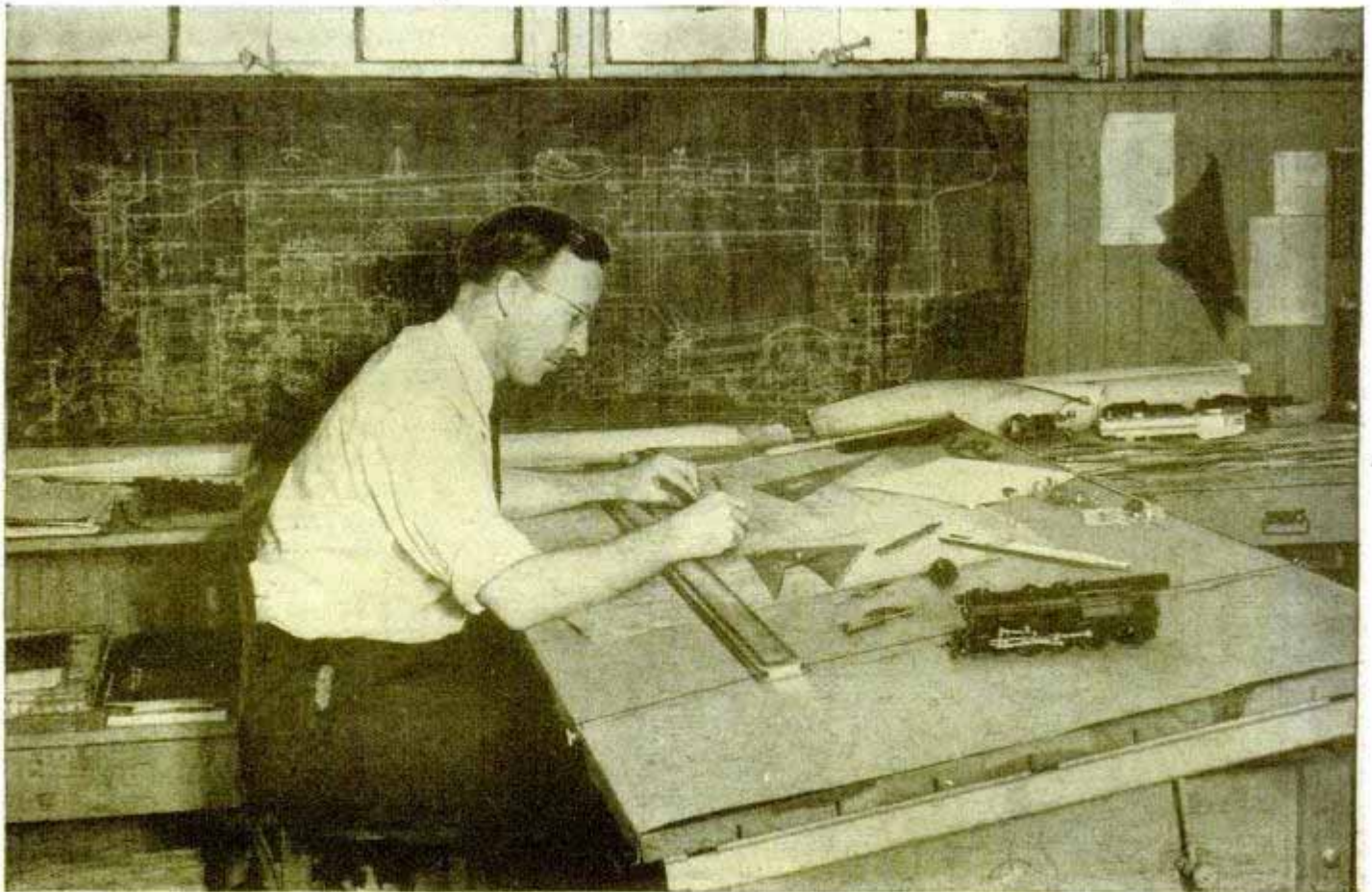



B&A (Basement and Attic) systems always haul a trainload of fun and an invitation: "Come aboard"

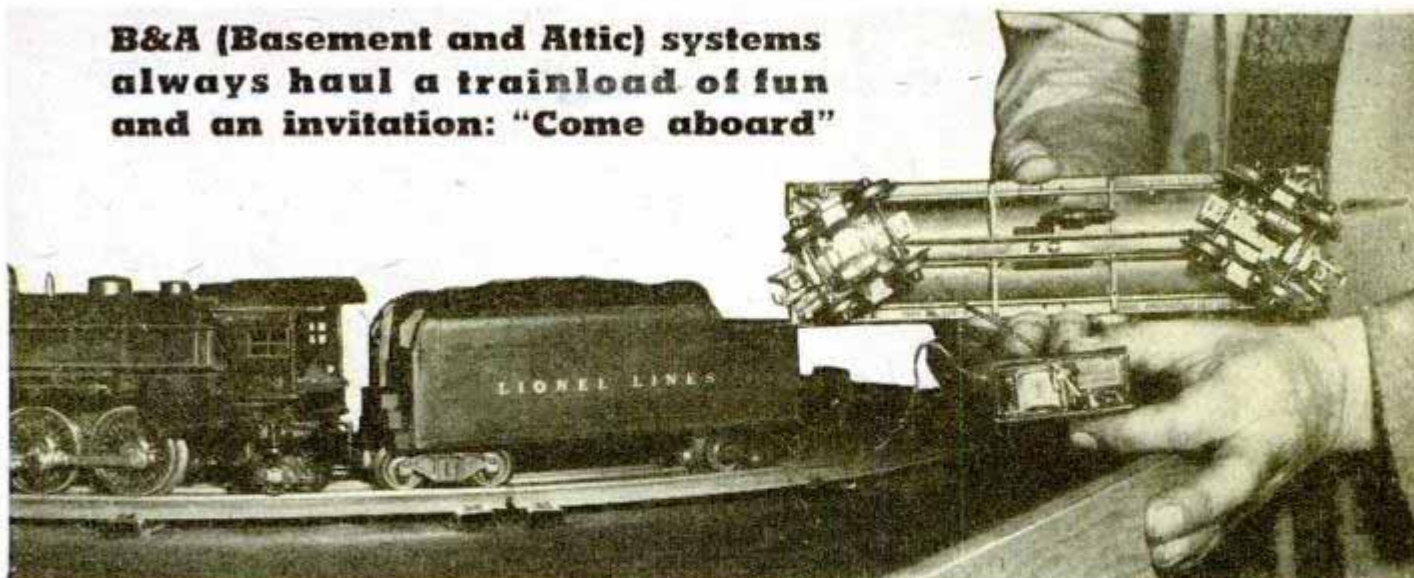

Electronic control system developed by Lionel Corporation reverses trains, blows whistles and uncouples cars. Signals are broadcast from one-tube transmitter to wrist-watch-size radio receiver installed under each car

here to one of the standards in case you wish to exchange or sell equipment or run your trains on a friend's track.

Next, you should make a careful layout of your proposed system on paper. Make a scale drawing of your available space and within it plan the layout of your track. It helps to think in terms of operation.

Make dummy trains of paper and push them over your diagram to see how they will meet switches, crossings, turntables, sidings or stations and how they will enter and leave yards.

There are two systems of track layout: the point-to-point and the loop. Point-to-point has a terminal at each end where

This train has a locomotive with a smoke-producing device synchronized to puff with action of driving rods. Transmitter under right hand of operator has 10 buttons which are depressed to control train operations

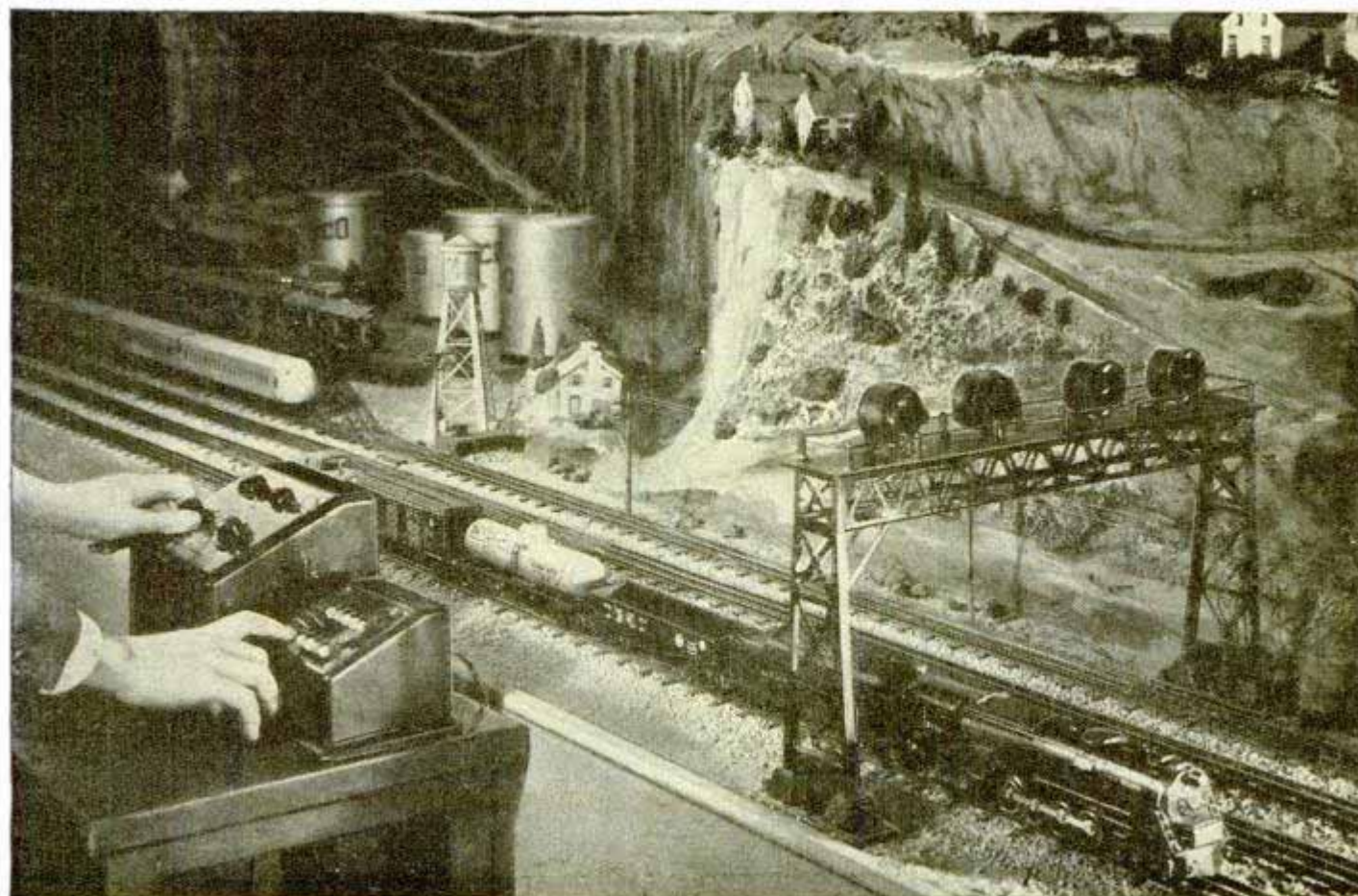

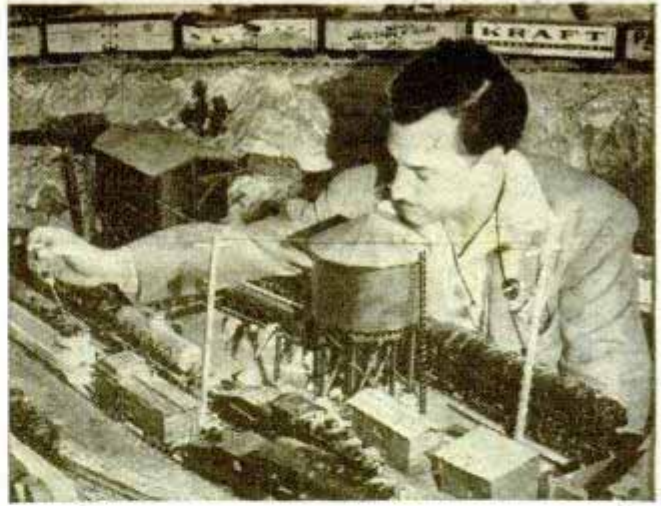

Centinela Valley Model Railroad Club of Hawthorne, Calif., serves miniature town of Caldwell, left. Before starting above, operator makes final check

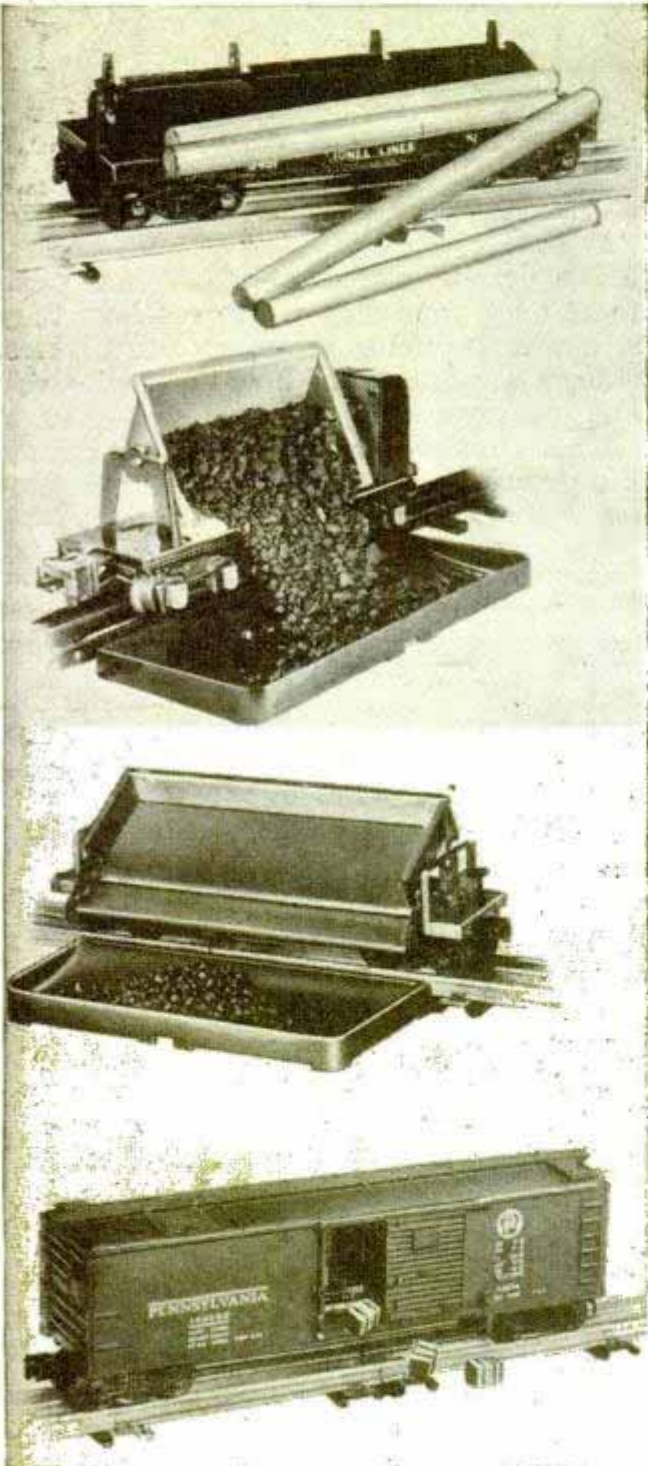

trains must be reversed or backed out. The loop provides for continuous one-way operation. To these basic patterns may be added any number of branch lines, sidings, blind sidings and crossovers. The locations of auxiliary lines, and switches to control them, should be included in your layout before construction begins.

With your layout complete, you are ready to build. Most model railroads are constructed on tables about four feet above the floor. The table is formed of 1 by 4-inch lumber with crosspieces to support the roadbed. Over this framework you spread ordinary window screen. Cover the screen with a mixture of plaster and wood sawdust. The screen can be cut or twisted to resemble mountains, valleys or rivers, and when dry it is painted to resemble a landscape. Backdrops and profile pieces give a

Models, left, do same hauling jobs as full-size cars. Careful craftsmanship results in locomotives like one below constructed by F. A. Nichols of Appleton, Wis.

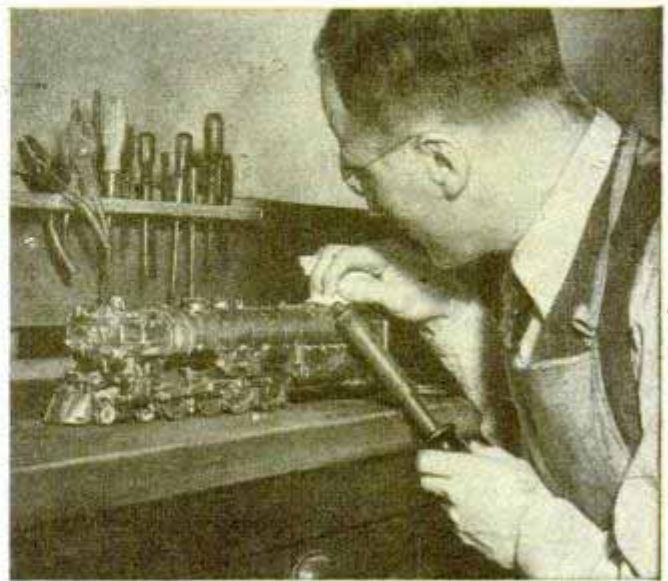

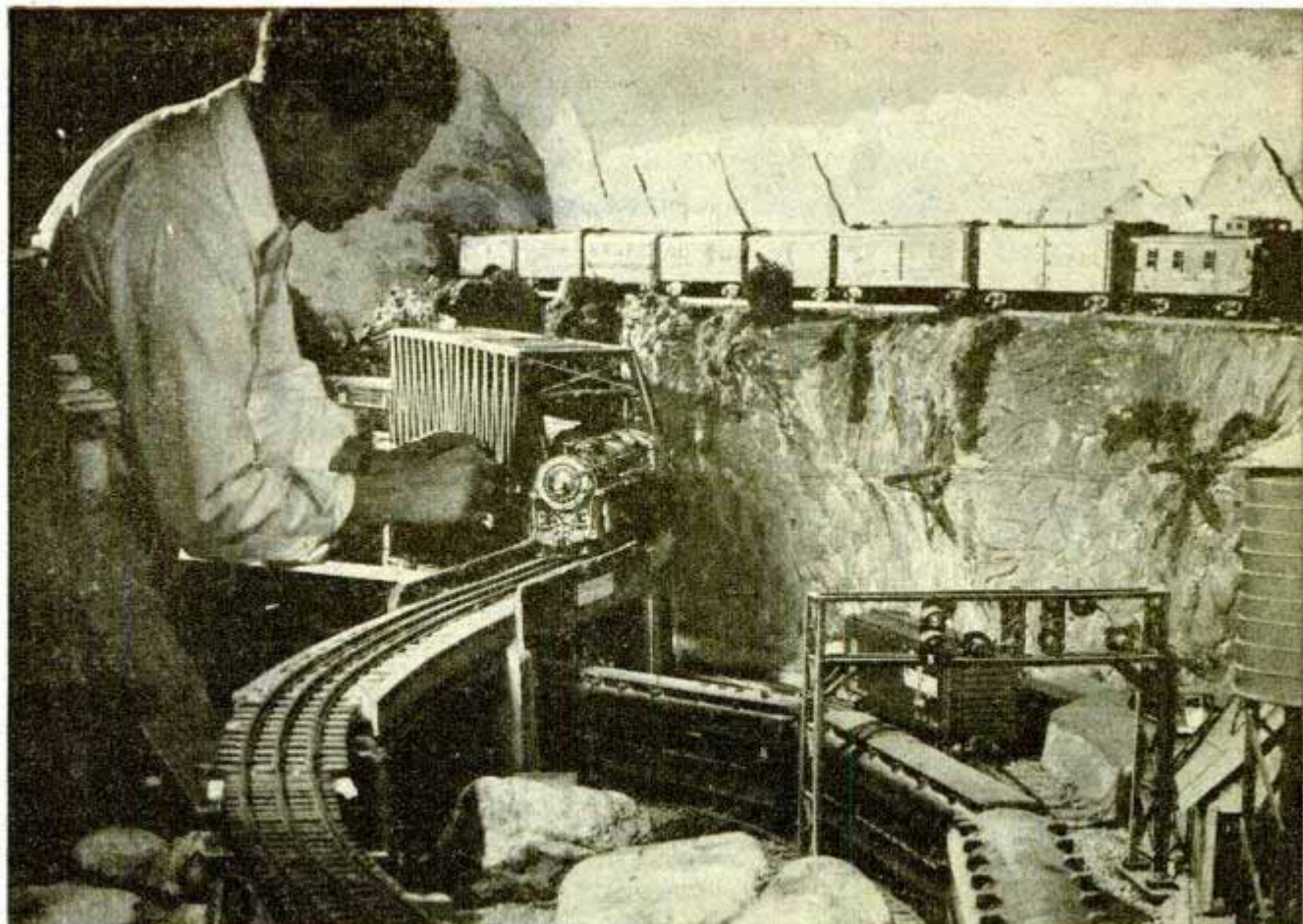

Model railroading includes the construction of background terrain, model communities, track and trestles

three-dimensional effect which can be accentuated by concealed lighting. The use of props such as people, animals, houses, trees, stations, automobiles or tunnels is limited only by the size of your layout and your own ambition. But remember this basic principle: everything should be planned in advance and carefully constructed to scale.

With locomotives and rolling stock, opportunities for individual expression are almost unlimited. You may want to start with a toy train. The Lionel Company makes both O and OO-gauge equipment, and the A. C. Gilbert Company makes O and HO-gauge equipment. The chances are that sooner or later you will want to build your own train exactly to scale.

Good craftsmen can start from designs supplied by many railroads and locomotive companies. But this is a long, exacting task. The beginner who has some skill with tools would do better to purchase one of the many kits available. In them the more intricate parts are already made and construction is more of an assembly job. You can also buy scale models ready to roll.

Signals and control boards are governed by your layout. Ordinarily a model railroad is divided into divisions and blocks

just as is a real railroad. Wires lead to a central control point where rheostats regulate speed and lever switches start and stop engines and couple and uncouple cars. Sectional keys are associated with each block for operating switches, lights and signals.

In nearly every large city there are model railroad clubs. If you do not want all the expense and work of building your own system, or if you haven't the room, you may wish to join or organize such a club. In Pelham Manor, N. Y., for instance, a group of fans got permission to build their system in an abandoned station of the New Haven line. Now, as they maneuver their model trains, they get the added thrill of hearing real trains thunder by outside. Many such clubs are affiliated with the National Model Railroad Association which now has over 5000 members. Equipment bearing the NMRA emblem conforms to standard.

You'll find railroading is a hobby that will fascinate your whole family—if not the whole neighborhood.

ⓘ Tiny ball bearings 1.5 millimeters in diameter and small enough to be used to replace jewels in a watch have been made by a Russian engineer.



Folding Crutches of Aluminum Double as Sturdy Canes



Made of sturdy but lightweight aluminum alloy, a folding crutch equipped with Neoprene rubber handgrip, armrest and tip can be adjusted for use by child or adult and is convertible into a cane. The crutch consists of a single shaft of satin-finish aluminum and a pair will support persons weighing as much as 400 pounds.

Hand Drill Works at Odd Angles On Hard-to-Reach Jobs

Areas ordinarily inaccessible to an upright hand drill can be reached with a drill which works in seven different positions

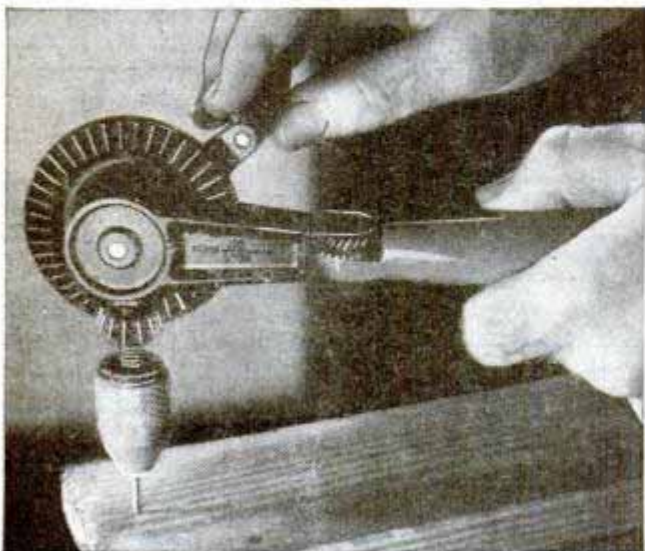

while its handle can be set at any angle along a 180-degree arc. Extended length of the drill is 10½ inches. Chuck size is ¼ inch. Extra bits can be stored in the hollow handle.

Luminous Dial for Telephone Saves Turning on Light

With a luminous dial there's no need to turn on bright lights at all hours of the night when dialing a number. A dial that glows in the dark can be slipped over the regular telephone dial to make night dialing easy.



Lightweight Steel Miter Box Has 90-Degree Gauge

Weighing only 2½ pounds, a miter box equipped with a 90-degree gauge fits any size board and accommodates any saw blade. Suitable for such work as framing doors and windows, the miter box eliminates the need for precutting wood before

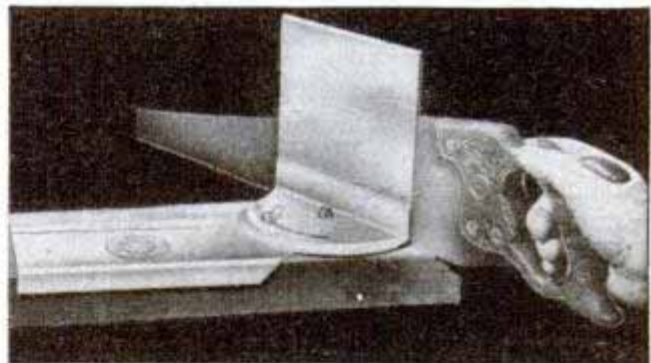

assembling the frame. The saw guide is made of cadmium plated 16-gauge cold rolled steel. It is secured at the proper angle with a quarter turn of a wing nut.

Midget D.C. Current Converter Fits Phonograph or Clock

Phonographs, clocks, electric razors and other electrical equipment designed to operate on alternating current can now be used with direct current by means of a vibrator inverter which converts the d.c. to a.c. Weighing only 14 ounces and measuring 2¼ by 4 by 4½ inches, the compact unit can be installed in the corner of a phonograph cabinet or some other convenient location. With an input of 115 volts d.c., the inverter's output is 110 volts, 60 cycle a.c., providing a maximum load of 25 watts.

The Craftsman

We have it direct from Santa that he doesn't at all mind a little competition. One look at the Christmas-gift story on pages 190 to 195 and it won't take you long to figure out how to say "Merry Christmas" from your own workshop. Then for the fellow who likes a bit of speed with his winter sports there are complete constructional details on a propeller-driven iceboat beginning on page 186. The original boat has been clocked at speeds up to 100 miles per hour and, brother, on the ground that's getting somewhere! On pages 207 to 209 we've described a dual-purpose film viewer designed for camera fans who like building their own equipment. But we've saved the big story for the last: On pages 217 to 222 are full directions for building a concrete-block machine capable of turning out 800 blocks per day. Not much to look at, maybe, but for making blocks it's the business



XMAS GIFTS

ICEBOAT

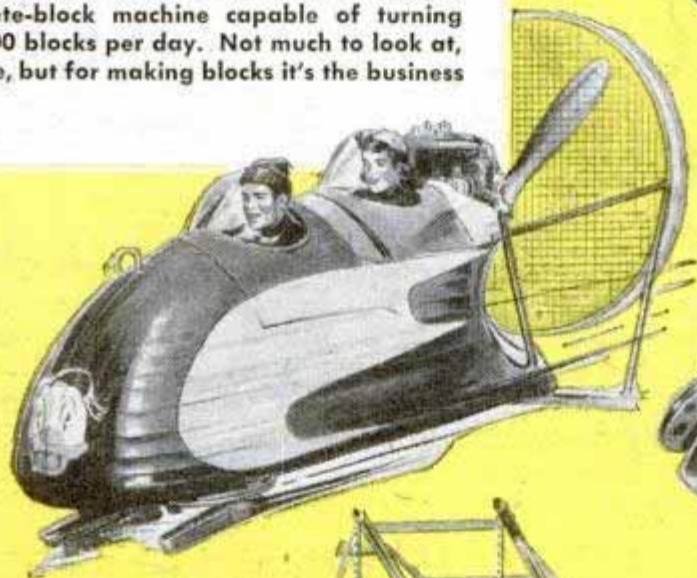

FILM VIEWER



CONCRETE-BLOCK MACHINE

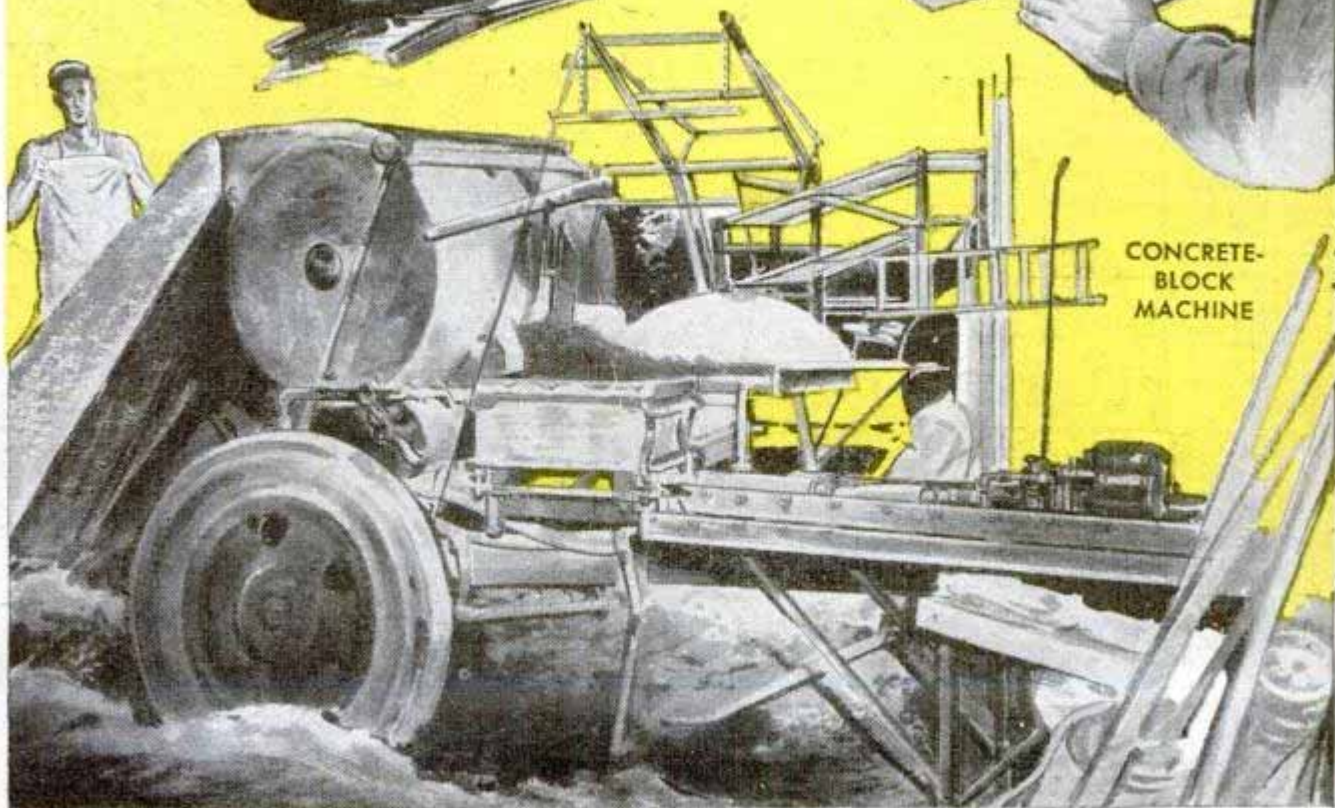

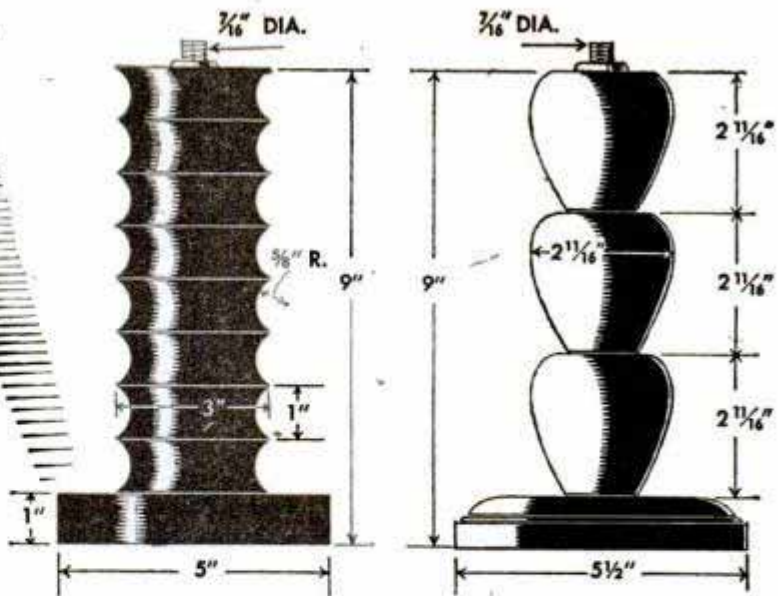
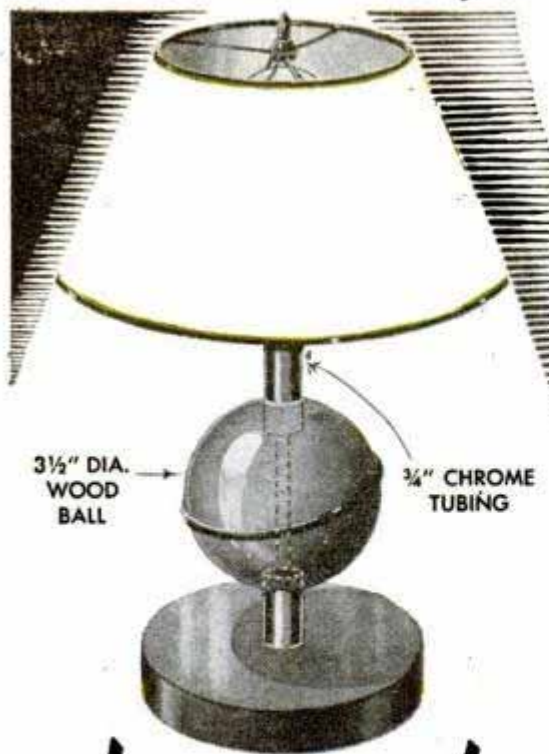

Light Up!

WITH THESE 9 LITTLE LAMPS



IF YOU'RE a woodturner at heart, here's a chance to make the chips fly. Take your choice of nine little table lamps that can be made of scraps of fancy wood, plastic, or both, some being made and finished completely in a lathe. With the exception of the fluted lamp below, the component parts of all lamps are "tied" together by a 3/8-in. fixture pipe. The fluted lamp consists of a solid block, counterbored at top and bot-

tom for locknuts, the top nut being concealed by a brass washer. The pipe extending above the base is encased in a 3/8-in. tube and the socket is screwed tightly against it. A hole is drilled through the side of the base for a lamp cord. If necessary, the fluting on the base can be done by hand, using a 3/4-in. gouge and then sanding smoothly with a round-nose block.

By Wayne C. Leckey

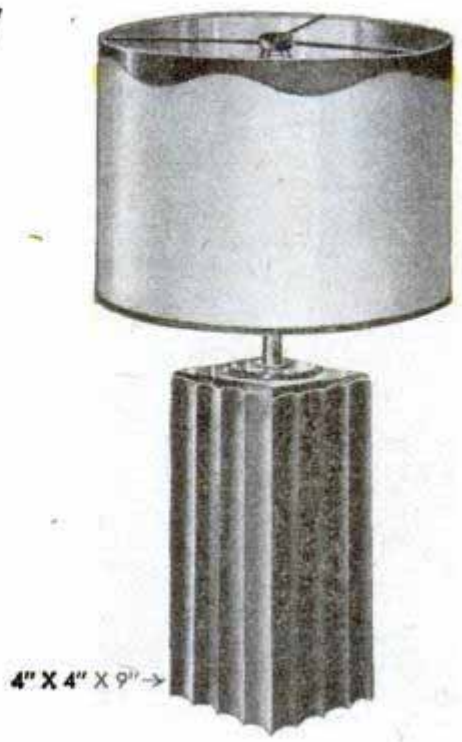
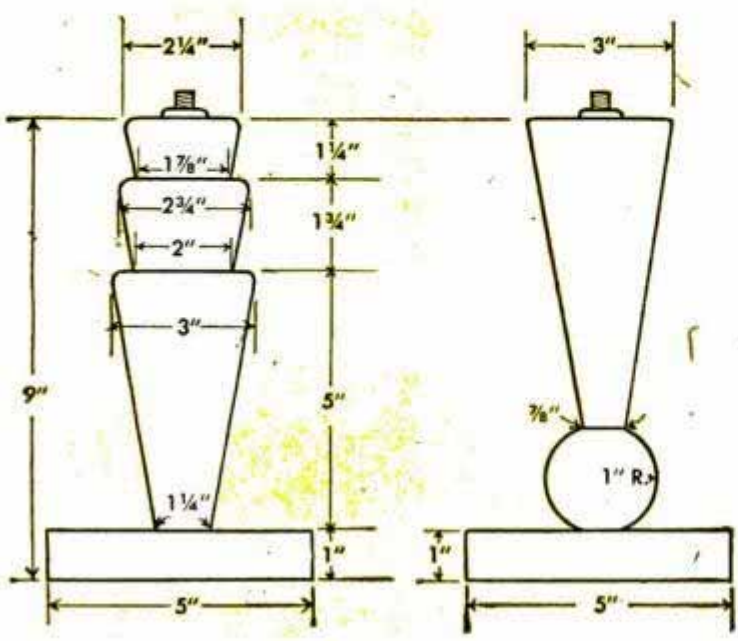

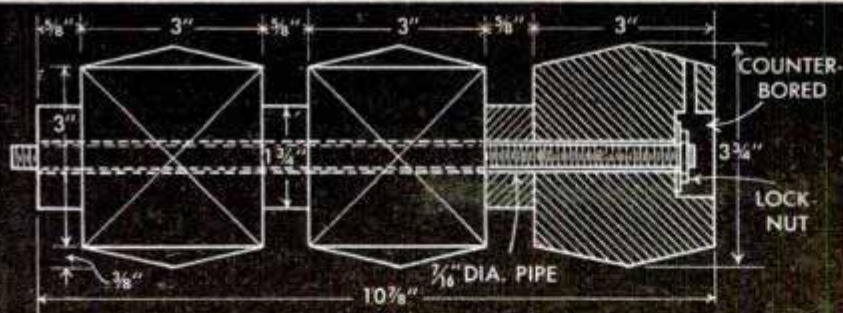

Finished in bone white with spacers of colored plastic, this stunning table lamp takes on a classic-modern appearance. The blocks are shaped identically and drilled through the center for a length of pipe. The bottom block is counterbored for a washer and locknut and then drilled through the side for a lamp cord. With a socket screwed to the top, the whole lamp is held together by the locknut. The diamond effect on the faces of the blocks can be shaped quickly on a disk sander, or the faces may be left plain. The lamp base should be covered with felt or rubber to prevent marring

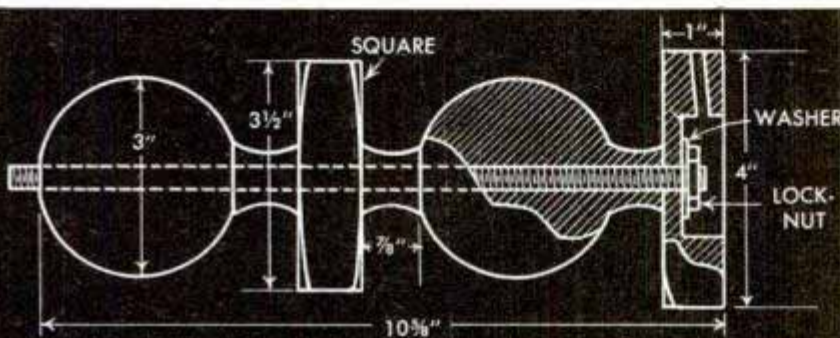
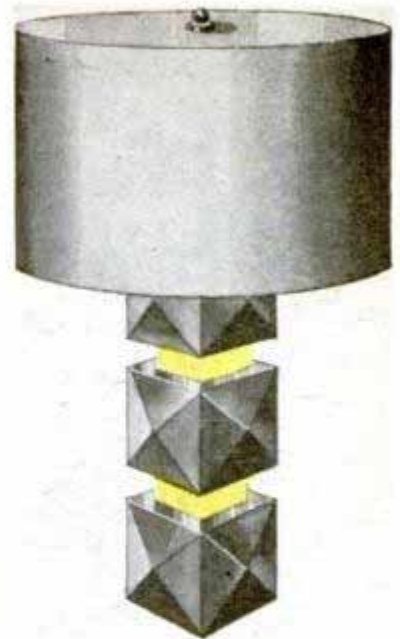

Strictly a lathe job, this boudoir lamp is turned in two sections and later connected by a pipe and locknut in the manner previously described. To facilitate centering the pipe hole lengthwise through the pieces, the work can be drilled beforehand, the holes plugged and the work then mounted in the lathe. A cardboard template will be helpful in checking the roundness of the ball turnings and in shaping both alike. Rounding the faces of the square spacer and base of the lamp is done by mounting the pieces on the lathe faceplate. You can counterbore the base at the same time

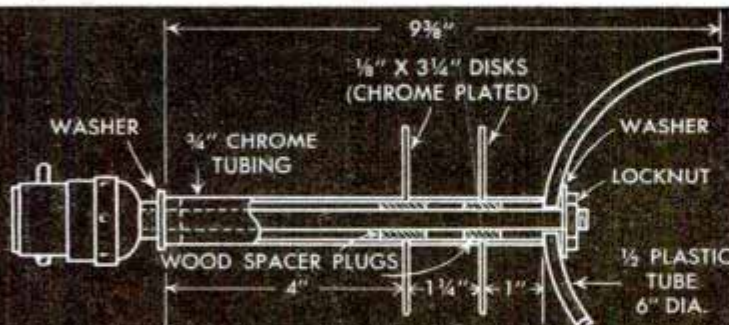

Here plastic and metal are combined. The base is formed of a 5-in. length of plastic tube cut in half and sanded and polished. The other half can be used in making a pair. The lamp post is in three sections with wood spacer plugs serving to align the pieces when assembling. Assembly is made by inserting the plugs half way in the ends of the sections and then placing the metal disks over the plugs. Tightening the locknut after the socket has been wired and fitted to the pipe "ties" the whole thing together like the others

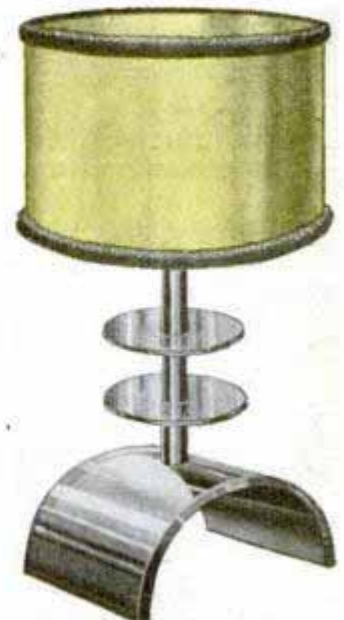

Emergency Powder Gun Is Made From Envelope and Tubing



Needing some sort of an emergency powder gun to blow flea powder on a pet, one housewife used an envelope and a piece of rubber tubing. The tubing, about $\frac{3}{4}$ in. long, was placed in the envelope with the powder. Then a pin hole was cut in one corner of the envelope. By alternately squeezing and releasing the tubing, a bellows action was obtained that forced the powder over the animal.

Split Rivets Will Hold Screws In Concrete or Brick

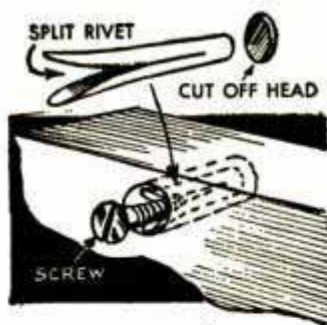

A split rivet can be used to anchor a small screw in concrete or brick. The rivet should be a loose fit in the hole into which the screw is to be driven. Cut the head off the rivet and insert it in the

hole with the split end outward. Then drive the screw between the halves.

Igniting Patch-Heating Mixture

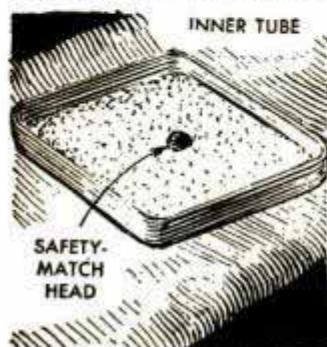

The heating mixture supplied in shallow metal pans for applying hot patches to inner tubes can be ignited, even in a high wind, very simply by the following method. To the surface of the

compound attach a safety-match head, using cellulose cement. To ignite the mixture, rub the match head against the abrasive strip found on the match boxes.

Kenneth Murray, Colon, Mich.

Round Erasers Used as Wheels For Children's Toys

Round type-writer erasers provide attractive wheels for toys. The wheels can be mounted with nails or small screws. The metal and rubber parts are painted to improve their appearance.

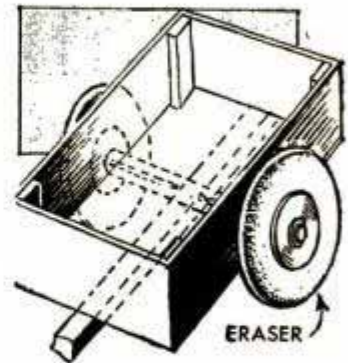

Way to Anchor Aquarium Grass

To keep the grass in a fish bowl from floating to the surface, one aquarium enthusiast uses wire solder. Short lengths are cut and the roots of the grass are wrapped around these pieces. Since water has little effect on this metal, it will not corrode.—J. Makowsky, New York City.

Rear Compartment Tool Rack Prevents Noisy Rattle

Tired of hearing the tools in the rear compartment rattling around, one motorist built a rack to hold them. A board was bolted to the back of the car and webbing was tacked to the board to provide pockets.

Robert S. Long, New York City.



To Replaster a Ceiling...



First step in renewing a badly cracked or sagging ceiling is to locate the joists and cover them with furring strips of lath, nailing the strips over the old surface in line with the joists



Next, plasterboard is nailed to the strips to form a smooth surface to which the new plaster will bond tightly. Place the sheets so that the joints are staggered and meet on centers at the strips



Strips of metal lath are used over joints, staggering them as shown. First coat is troweled about 1/4 in. thick and roughened with a whiskbroom while soft to provide a "key" for second coat



Second coat is applied 1/4 in. thick when the first is thoroughly dry. It should be pressed in to adhere to the rough surface of the first coat. For a three-coat job, second coat also is roughened



The final or "setting" coat should be 1/8 in. thick. It is applied when the second coat is nearly dry, but not too dry or the moisture will be drawn from the mixture, making it difficult to trowel



Final coat may be troweled to a hard finish, or it may be given the "sand-float" finish shown. This is done with a wooden trowel in a circular motion (Photographs courtesy U. S. Gypsum Company)

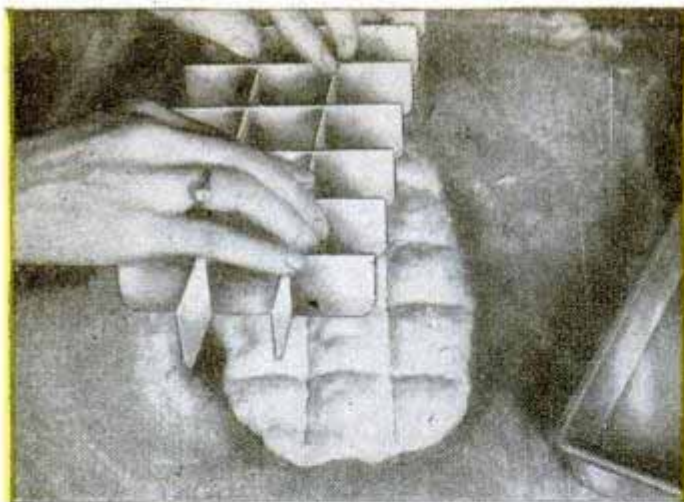

To cut biscuits in a hurry, use the divider from an ice-cube tray. After mixing the dough, roll it to the right shape and cut with the divider. When baked, separate the biscuits at the dividing lines

Tired of using rubber pads, metal plates and other unsightly objects to keep the feet of kitchen furniture off the linoleum, one housewife cut circular pieces of thick celluloid and placed them under the feet

Solving Home Problems



When storing or drying boots, use this converted clothes hanger to keep them off the floor. The hanger is cut and bent as shown, the space between the eyes being governed by the width of the sole

An old toothbrush will provide excellent service as a comb cleaner. Trim it to the correct size by cutting off all bristles except the three end rows

If a tape measure is wound on the spool of an adhesive tape container, it will not kink and become limp. Stored in this way, it's ready for use and will not become entangled in the workbasket

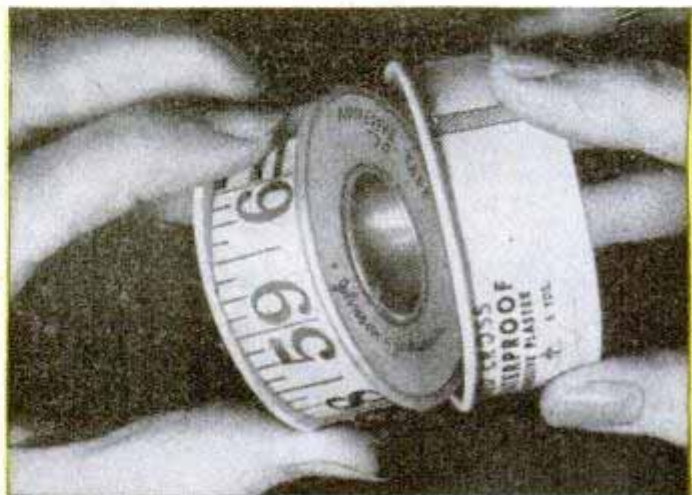
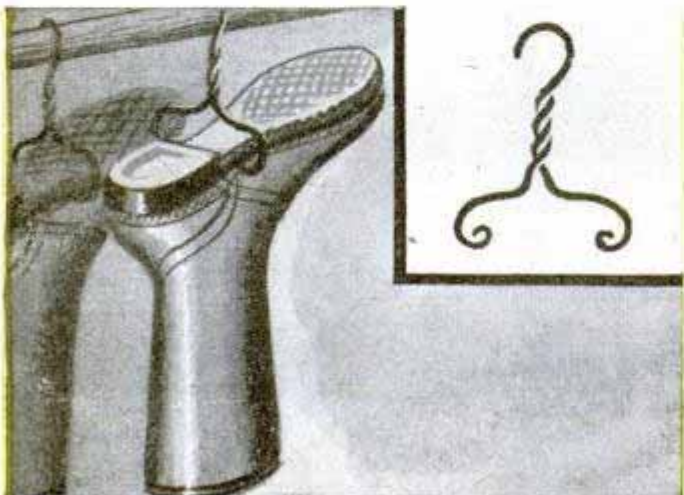

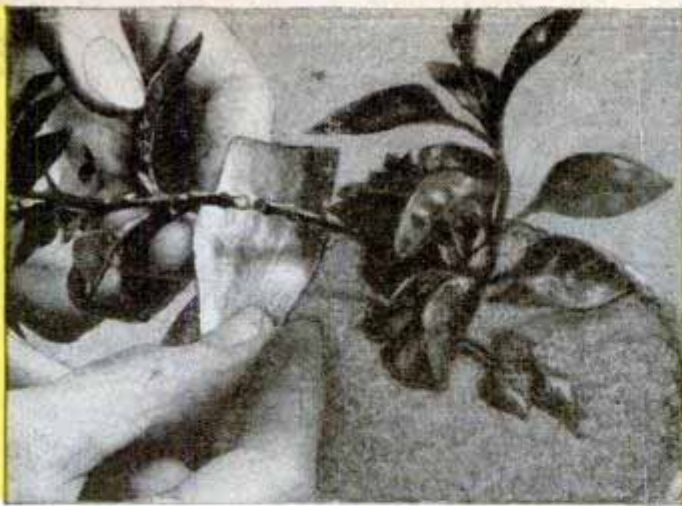

Wrap a piece of onion skin around the broken stalk or branch of a house plant to hold it securely until it has healed. This makes an inconspicuous patch and one that may save your favorite plant

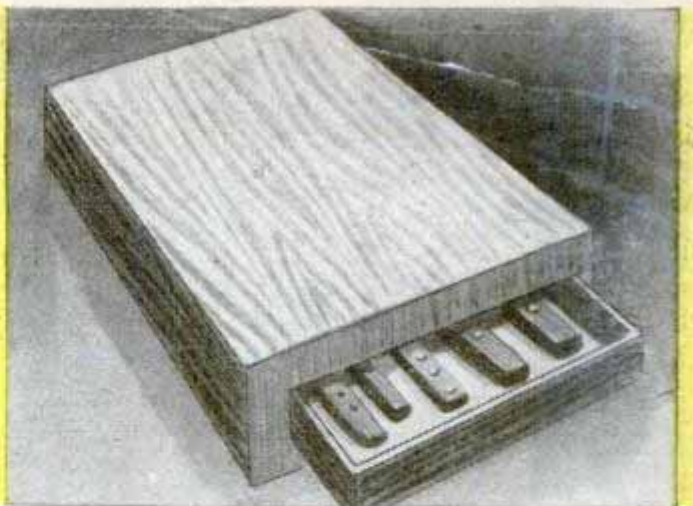

Made with a built-in drawer, this cutting block will hold most of your knives and other cutlery. The drawer is lined and spacers are provided to separate the knives so the edges are not dulled

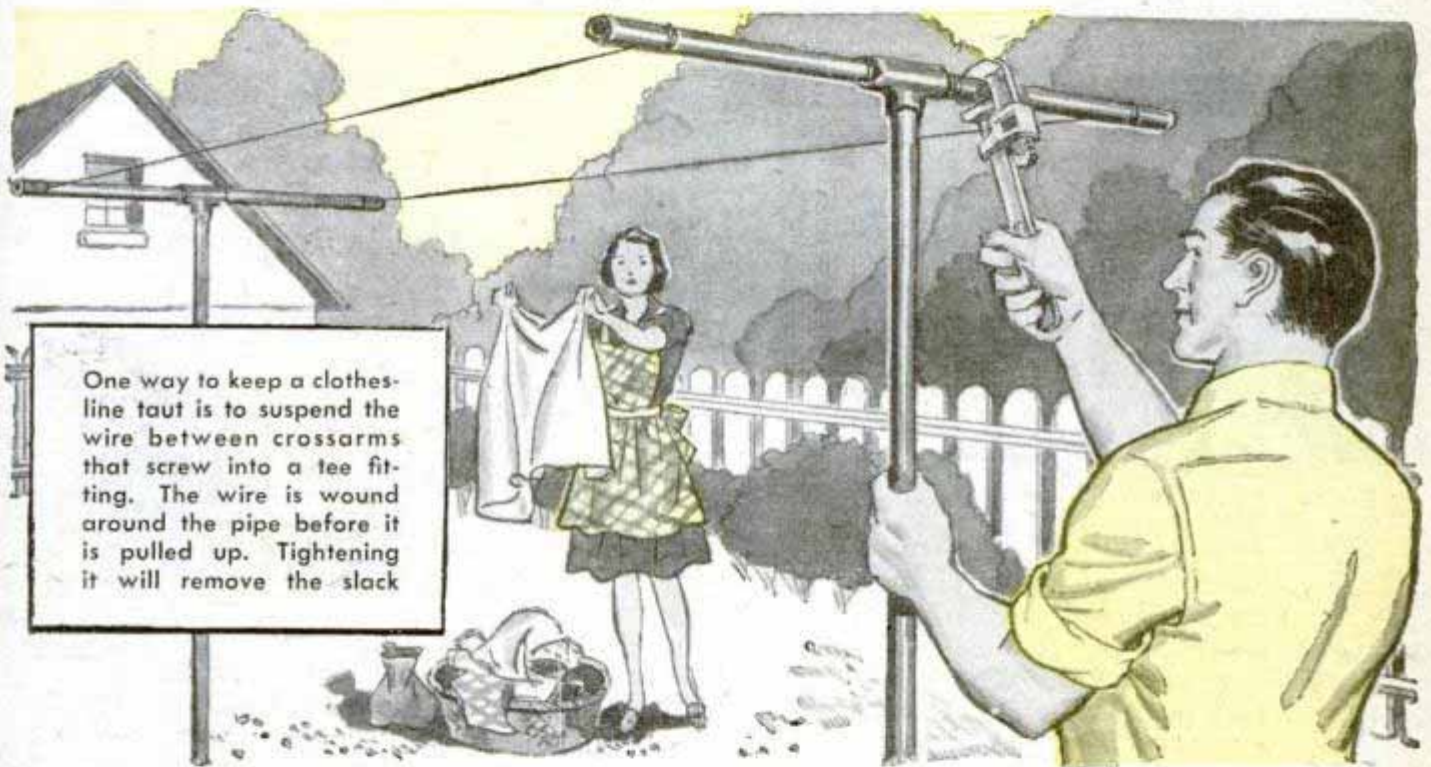

One way to keep a clothesline taut is to suspend the wire between crossarms that screw into a tee fitting. The wire is wound around the pipe before it is pulled up. Tightening it will remove the slack

In rainy weather, place a large desk blotter inside the front door so that wet rubbers and galoshes can be dried on it. When not in use, the blotter can be rolled up and kept in a hall closet

Brushing that steel soap dish with colorless nail polish will prevent unsightly rust spots from appearing where the protective coating has worn off. These spots cause the soap to stick to the dish

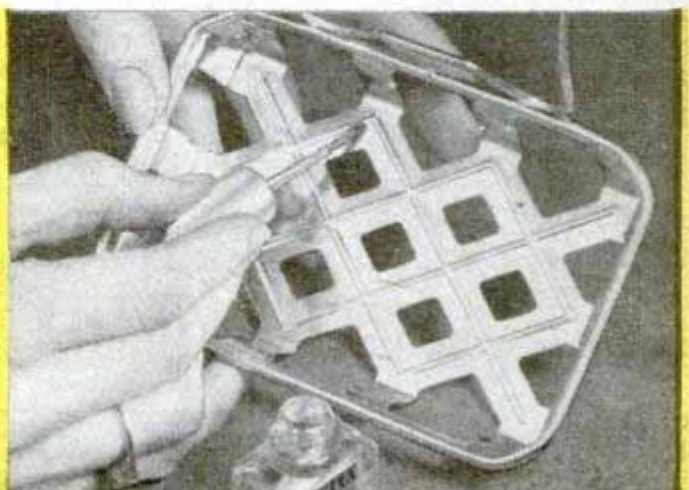

Bobby Pin Keeps Photo Upright

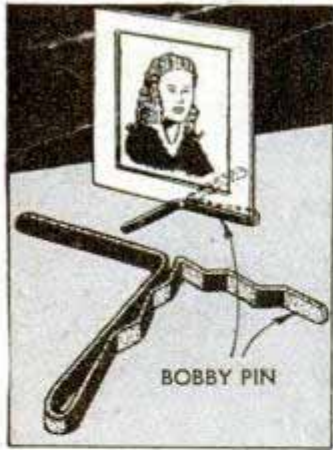

To hold a small photograph or picture upright, bend the legs of a bobby pin outward and then slip the picture between the parts of the legs which are still in contact. Cotter pins could be used in the same way.—G. E. Hendrickson, Argyle, Wis.

Miter Box Hinged to Sawhorse

Because the carpenter work around his home required frequent use of a miter box, one man hinged it to the end of a sawhorse.

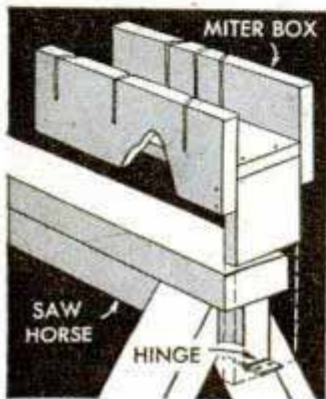

When in use the box rests on top of the sawhorse, but when the latter is in use the box folds down out of the way. The sides of the box extend down and fit over a vertical member of the sawhorse to provide additional steadiness.

Jig Guides Drill in End Grain

When building bookcase shelves and similar projects where it is necessary to drive the screws in end grain, a sheet-metal jig will aid in guiding the pilot drill for the screw starter holes. The jig is bent to fit over the board and has a hole of the proper size drilled in the center of the top. A rule is used to mark off the holes and, since it is 1 in. from the edge of the jig to center of the hole, this must be added to the dimension on the rule to get the correct distance. If the jig has a tendency to "creep," a clamp will hold it.—W. H. McClay, Pasadena, Calif.

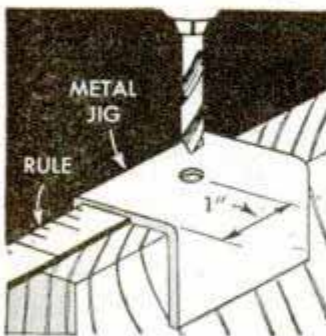

Renewing Hunting Knife Handles

Many hunting knives have handles made of leather or composition washers which tend to become soft or spongy after continued use. To restore the handle on such a

knife, lay it in the sun or a warm, dry place for several days until the material is thoroughly dry, then apply several coats of clear shellac. When it is dry, the handle will be firm and waterproof.

Cutter Guard Protects Fingers

Made of 1/2-in. angle iron, this guard will prevent you from getting your fingers too close to the knife when using a paper cutter. The bottom of the guard should be about 1/4 in. above the board so that it will be easy to slip paper under it. One end of the iron is bent at right angles to fit around the knife hinge and the other end is bent down so that it will fit over the board. Screws hold the guard in place.

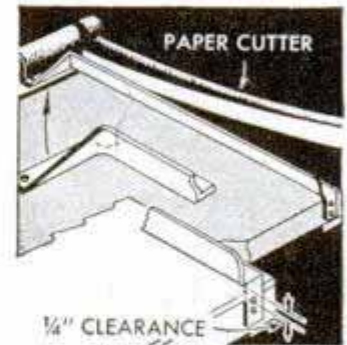

H. H. Fogg, West Somerville, Mass.

Pad Sweeps Dust Off Records

Scraps of velvet, velour and similar fabrics can be used to make a "sweep" that will brush dust off a record as it is being played. The squares of cloth have cross slits in the center

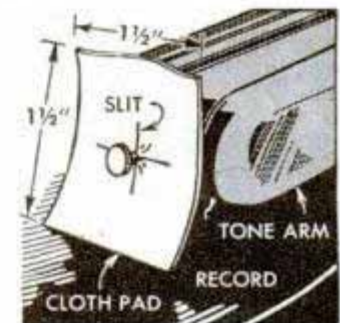

to slip over the needle tightening screw on the tone arm. The pad should be adjusted to clean the record in the path of the needle as the disk is rotating. It may be necessary to use cellulose tape to hold the cloth in the desired position.—Roger Hall Davis, Chicago.

Rolled-Metal Tube Holds Posters

As a method of keeping posters from being torn when tacking them on billboards in windy weather, one billboard maker made a tube with an open seam. The poster is rolled and inserted in the tube with one end projecting through the seam. This end is tacked first, the remainder of the poster being tacked in place as it is unrolled from the tube.



Colorful Novelties From Crepe-Paper Raffia

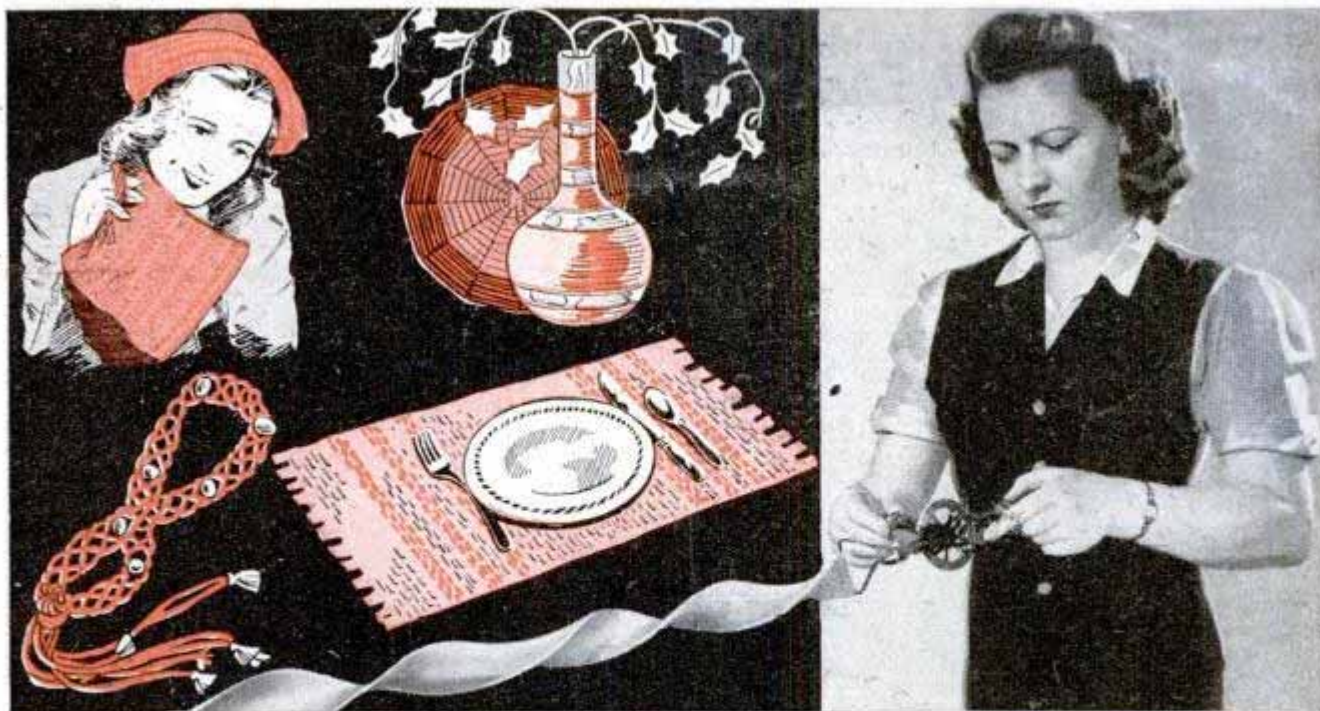

Raffia made from crepe paper can be crocheted, woven or braided into many useful and colorful items of wearing apparel and also fashioned by the same methods into decorative articles for the home. The sketches above suggest only a few. Here's a quick way to twist the crepe paper into cord of a uniform size: First cut a "bolt" of the paper into strips about 1½ in. wide, cutting through the entire thickness of the bolt each time. This gives you twelve or more streamers, each about 10 ft. long.

Next bend a short length of medium-heavy wire to form a hook shaped like that shown in the photo above. Loop one end of the streamer around the hook and fasten with Cellophane tape. Insert the hook in the chuck of a small hand drill and thumbtack the other end of the streamer to a door jamb or small block of wood placed on a table. Then simply turn the crank of the hand drill, at the same time keeping a light tension on the streamer.

Augusta Nixon, Buena Park, Calif.

Fragile Figures Glued to Mirror Will Not Break Easily

Many a lightweight ornamental figure has been broken because a stray breeze or the jar of a closing door has caused it to fall. If the figure is mounted on a small,

pocketbook-size mirror, using colorless nail polish as an adhesive, this will not happen. The mirror not only anchors the figure but, by reflecting it, makes the display more attractive. The small mirrors are obtainable in many sizes.

Benj. Nielsen, Aurora, Nebr.

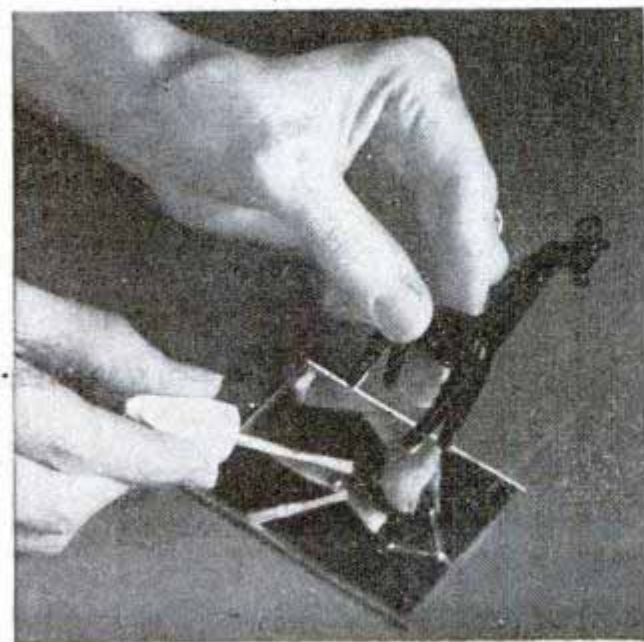

Corner Boundary-Line Markers

Hollow concrete blocks, when arranged in the manner shown, make ideal corner boundary-line markers, the hollow part of the block being filled with soil in which flowers or small shrubs have been planted. Such markers are easy to set up and they greatly improve the appearance of the lawn. — Beatrice E. Reese, St. Petersburg, Fla.



W.T.M. Concrete

"Meteor" AERO-DRIVEN

By Paul R. Bussler

SPEEDS approaching 100 miles per hour on ice and a mile a minute on snow are claimed by the builder of this streamlined aero-driven ice boat. The original was powered by a four-cylinder motorcycle engine, although a twin-cylinder one, converted for the purpose, can be used. The engine cradle or mount may vary somewhat in each particular case; otherwise, construction remains the same. The chassis consists of two 8-ft. lengths of 2" by 4-in. stock bolted to a runner plank as detailed in Fig. 5. At the front, the rails are cut to receive a round nose block, which is fastened permanently later. Next, cleats are nailed to the inside of the rails and 3/4-in. floor boards nailed to them in the manner shown. The king-pin assembly is improvised by brazing the spindle of an old Chevrolet front wheel to a length of 3-in. angle iron cut according to Fig. 2.

The fuselage formers are shown on squares in Fig. 1 for enlarging to full size, and Fig. 2 gives the position of each one. For economy, each former can be cut out in two parts and later joined at the center with a wood or sheet-metal gusset. If plywood is not available, the formers can be cut from solid stock and joined in the same manner. After the formers are fastened in place, the nose of the fuselage is framed as in Fig. 3. This is made up of seven plywood formers, a center one with three on each side. Fig. 4 gives the profile of the center one; the others are shaped and fitted, as the work progresses, to produce a nicely rounded nose. The upper ends of the formers are screwed to F1, while at the bottom a plywood plate, matching the contour of the nose block, permits fastening the formers with screws

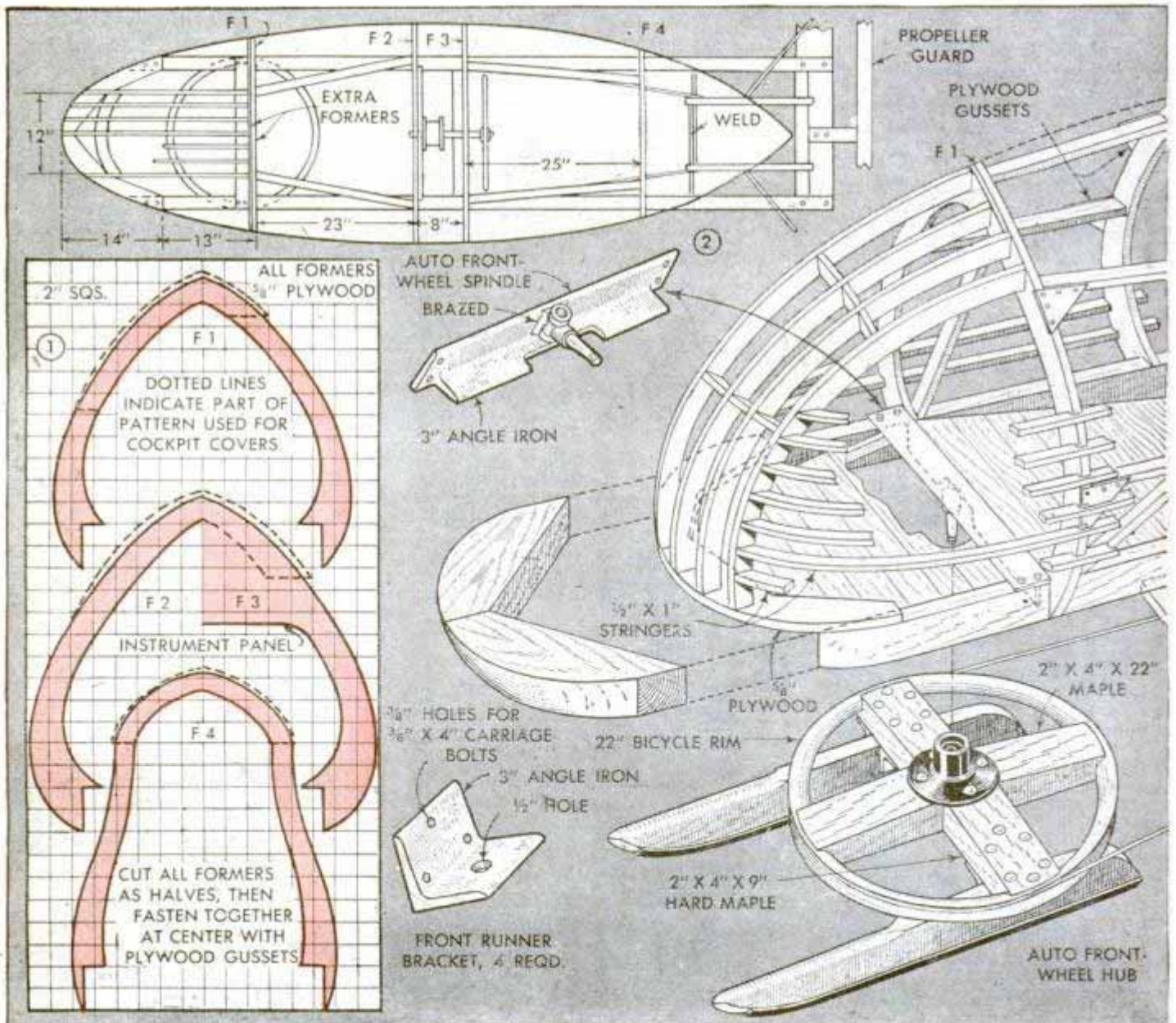

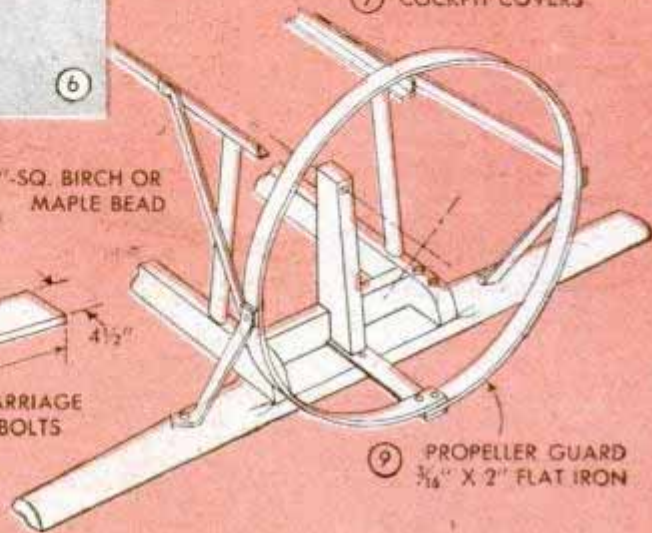
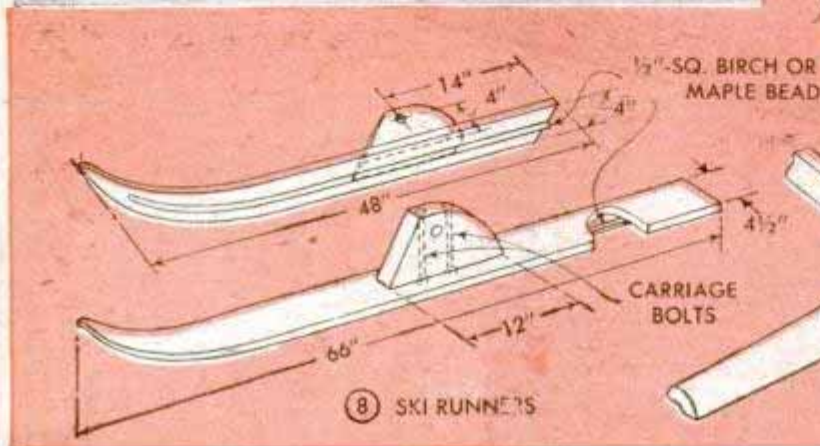
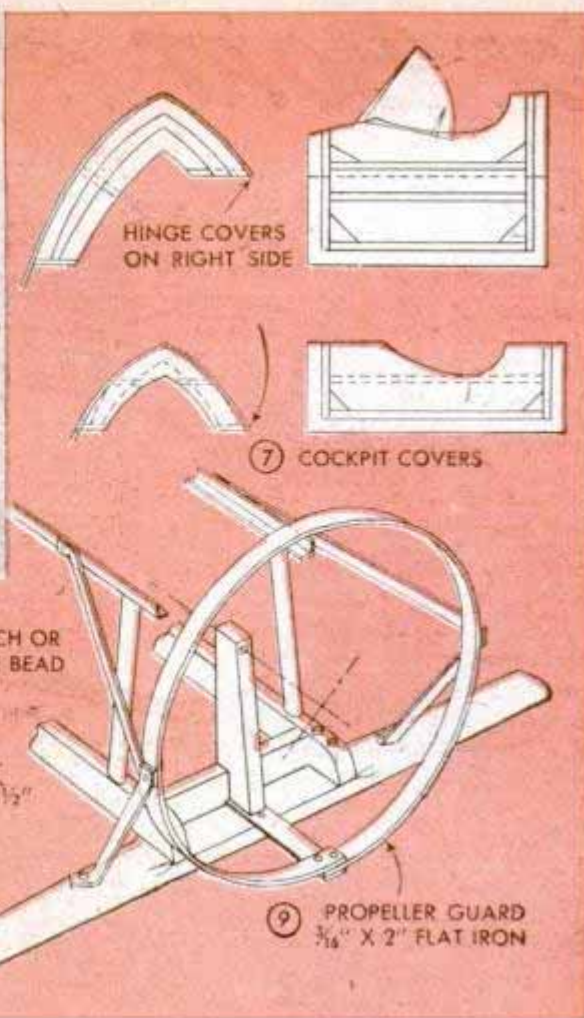
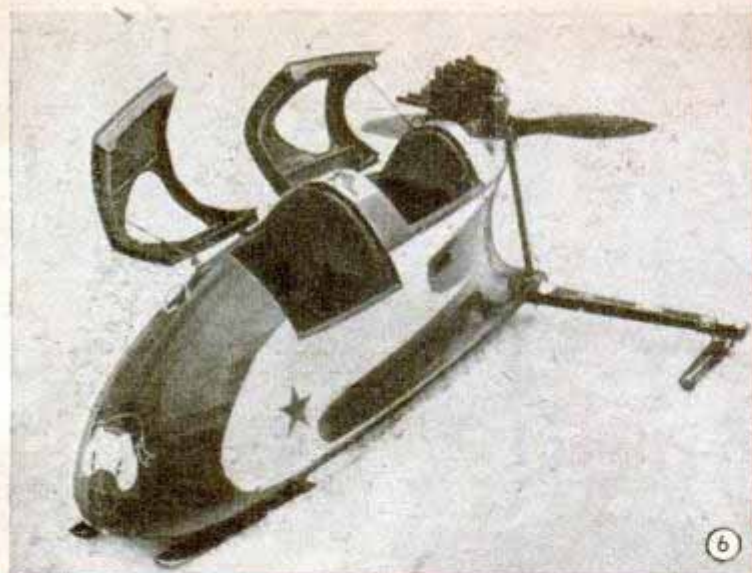

from the underside. With this done, the nose block can be fastened permanently.

From the nose you work on back, adding the rails and gussets between each former where indicated in Fig. 3. Note that F2 is fitted with a crosspiece to support the steering-wheel shaft, and that the space between F2 and F3 is covered with thin plywood down to the first crossrail on each side. Next, the stringers are added. These are narrow strips that run lengthwise from the nose to F4 to produce a framework for the cloth covering. The strips are glued in notches $\frac{1}{2}$ in. deep and spaced about 2 in. apart in the edges of the formers. The front ends may have to be steamed or kerfed to produce a sweeping curve. The board carrying the pulleys can be fastened next, also the pressed-board floor panel.

The front-runner assembly consists of an old bicycle rim, which is fastened to half-lapped crossmembers having a Chevrolet front-wheel hub bolted to them exactly in the center. The cable connecting the runners with the steering wheel is threaded through the pulleys and wrapped several times around a 2-in. spool pinned to the steering-wheel shaft. Both front and rear runners are pivoted in chocks cut from 3-in. angle iron. The runners detailed above Fig. 4 are for use on ice, while those shown in Fig. 8 are recommended for snow.

You'll do best to build the cockpit covers right in their openings, tacking the formers to the fuselage formers temporarily and then gluing and nailing $\frac{3}{32}$ -in. plywood to the edges. When dry, the unit is lifted out and braces and corner blocks are added according to Fig. 7. The shape of the formers for the cockpit covers is given in Fig. 1. Note that they must project $\frac{1}{2}$ in. above the others to be flush with the stringers. In Fig. 6 you can see how the covers are hinged along the right-hand side and how they are fitted with check cords. Heavy celluloid, supported by sheet-metal brackets, provides suitable windshields, and slit sections of rubber hose applied to the rough edge of the head openings pads the edges. As previously mentioned, the engine cradle may require changing somewhat to suit the engine being used, but it should be well braced in the manner shown. This is also true of the propeller guard detailed in Fig. 9. Rigidity of these parts is essential if the boat is to perform satisfactorily. Seats, gas tank and covering remain. Muslin is used for the covering and drawn firmly over the framework and tacked to the underside of the chassis and to a stern post bolted to the chassis. Then the cloth is coated three or four times with airplane dope to make it taut, after which it is painted.

Cleanout Tool for Stoker Fits Around Retort

Here's a handy cleanout tool for your stoker that fits the curvature of the firepot. It's made of heavy-gauge sheet metal with a $\frac{3}{8}$ -in.-pipe handle. Cut the sheet to the shape indicated on the diagram and drill holes for two $\frac{3}{16}$ -in. rivets where shown. Then round the sides to form the two "wings" of the scoop. The handle can be any convenient length. The 6-in. offset is about 8-in. long and the end is ground at an angle to avoid catching on the firepot or retort when the tool is being used. To facilitate handling the scoop, the end of the handle is bent at right angles for a grip so that the scoop cannot turn and spill ashes. — Thomas J. Mahan, East St. Louis, Ill.

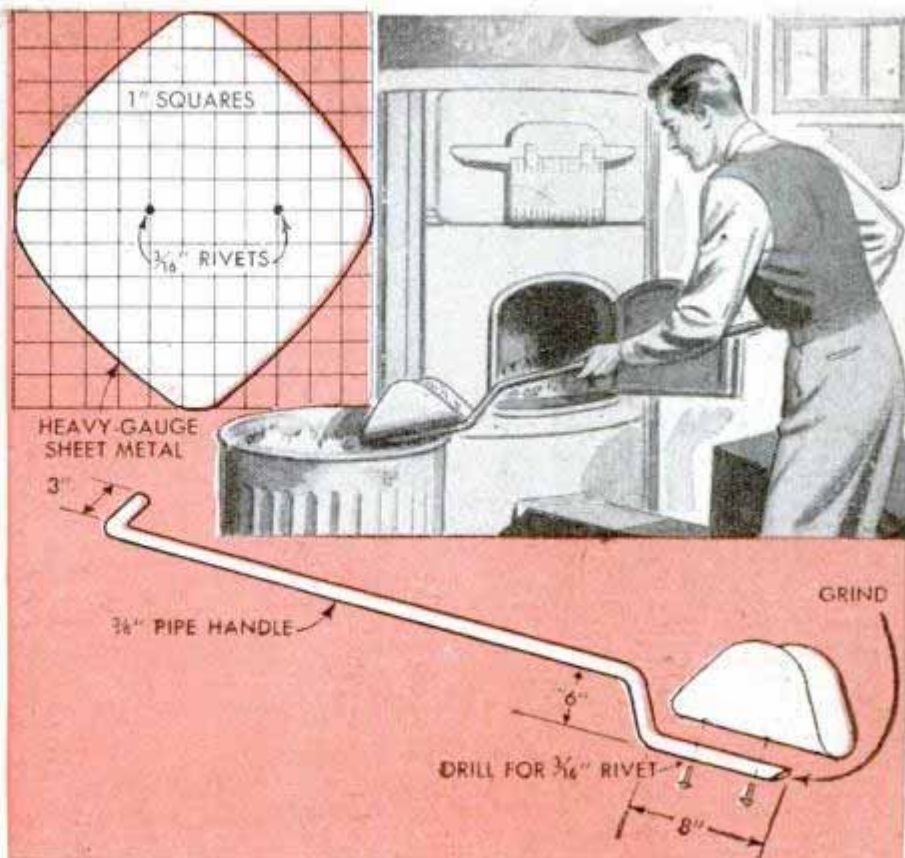

Quick-Drying Putty to Fill Wide Seams in Linoleum Floor

When laying inlaid linoleum, the space between the corner fittings may be larger than you wish. This can be filled by using a putty made of linoleum and shellac.

Scrape off shavings from the color you want with the back of a knife so the shavings will be very small. Mix these with enough shellac to make a thick paste. Apply this to the crack with a putty knife and you will have a permanent repair. If the linoleum is marbled, scrape off shavings that will have all the colors.

Delmer R. Brizendine, Forest Grove, Ore.



Increasing Capacity of Hacksaw

By adding an extension to the hacksaw frame, the depth to which the saw will cut is increased greatly. The angle at which the steel extension is cut must be such that the blade will fit on the pin. Two lugs overlap the saw frame to hold the extension in place and the third length that overlaps is to furnish rigidity. — C. L. Meehan, Lakeview, Ont., Can.

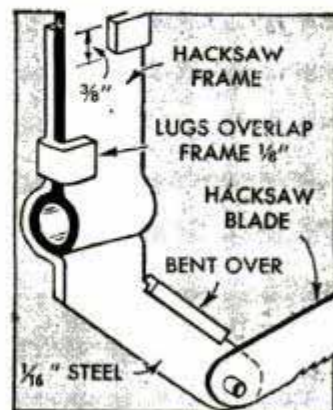

ⓘ Never wash eggs before storing as the unwashed shell carries a protective coating that is a natural seal for the shell pores.

15 Christmas Gifts

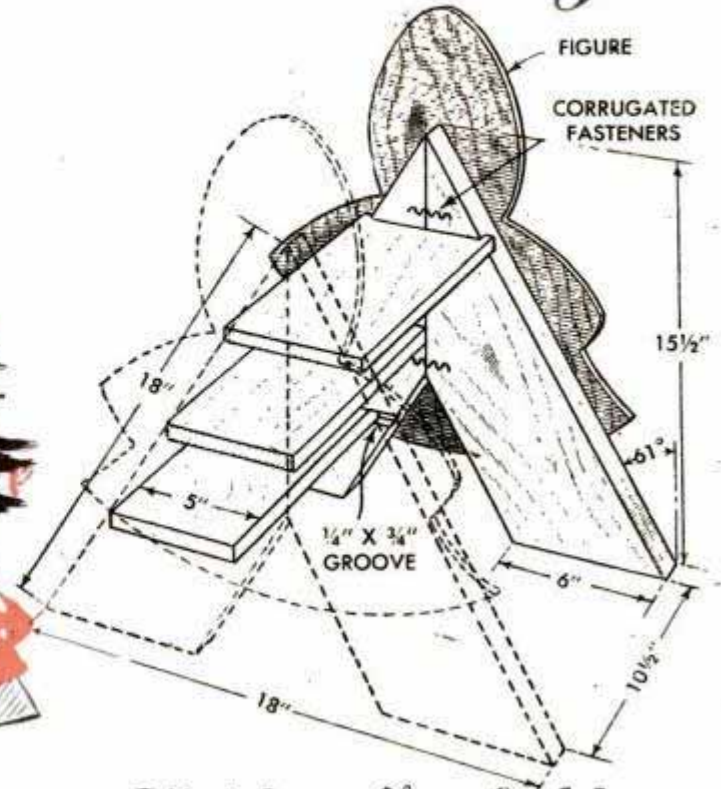

Kiddies Stepladder

Easily assembled, this stepladder will help little 'tots get at drawers and chests that are hard for them to reach. The clown which ornaments each side of the ladder is detailed on page 192 and construction of the steps and sides is indicated above. To lend the proper note of gaiety, paint the clowns in bright colors

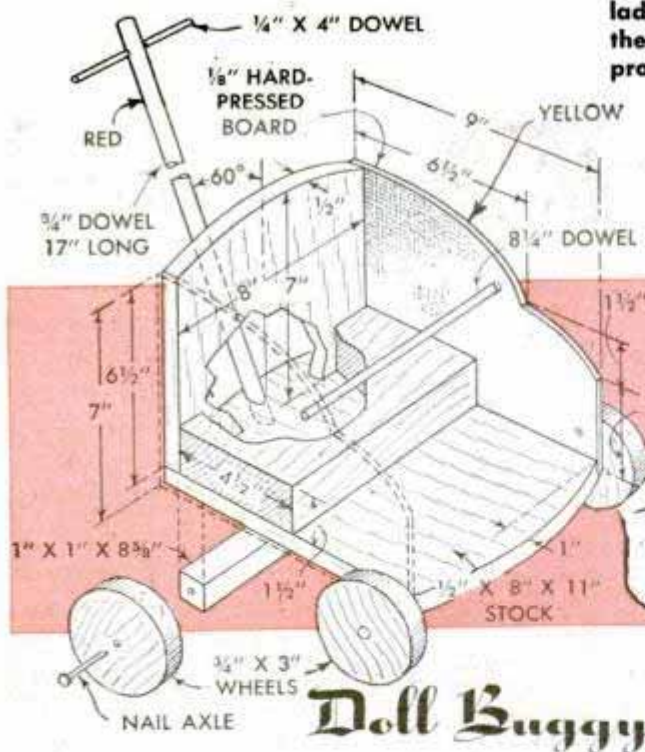

Doll Buggy

Here's a doll buggy that will make the young miss in your family very proud. While it's a little harder than the stepladder to cut out and assemble, the young man of the house might like to make it for "sis." A bright enamel finish in contrasting colors will decorate and protect the surface of the buggy



from Santa's Workshop

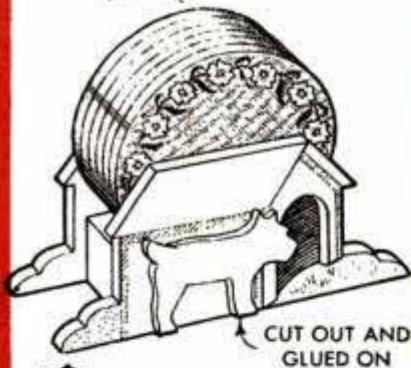
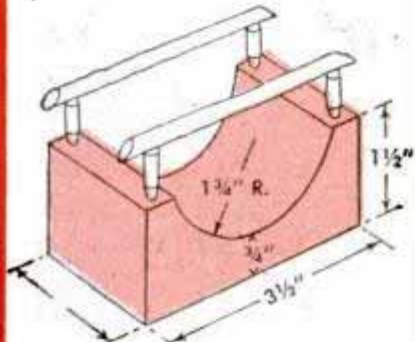
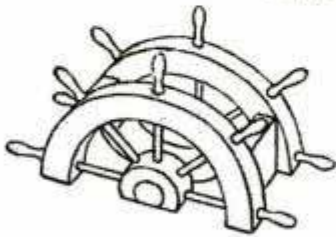
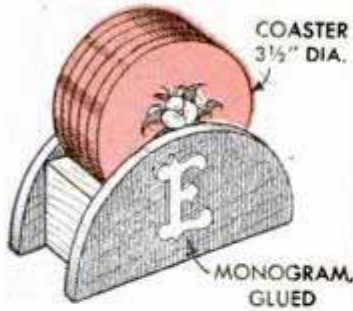

Coaster Holders

Made in short order with a disk cutter, these coasters may be of plywood, plastic or hard-pressed board. They are decorated with decalcomanias, or designs can be carved or painted on. Then they should be protected with several coats of spar varnish. A set of about six or eight will be sufficient. The base for the holder is of the dimensions given, the width depending upon the number of coasters in the set. Several ways of decorating the sides are suggested here

NOVEMBER 1946

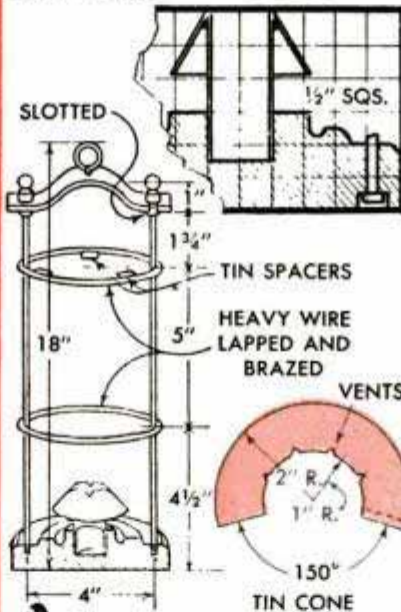
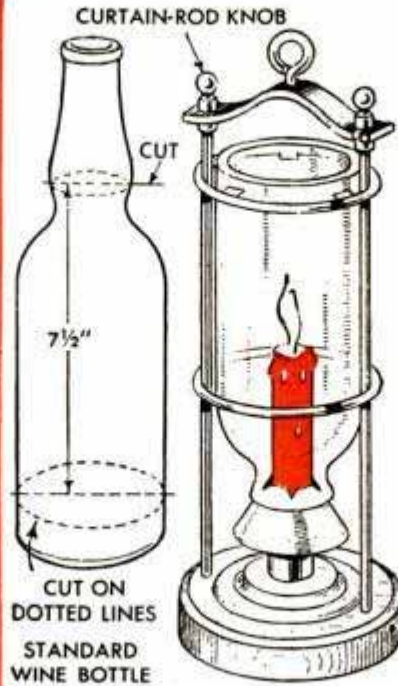

Antique Candlestick

Novel and attractive, this antique candlestick needs only some light curtain rod, heavy wire, a hardwood base and a wine bottle for its construction. The base is turned on a lathe and the tin cone, that acts as both a candle holder and a support for the bottle, is assembled next. The uprights with brazed rings and flat-iron handle are inserted in the base and the candlestick is complete except for the bottle. The neck and bottom are cut off with heated resistance wire

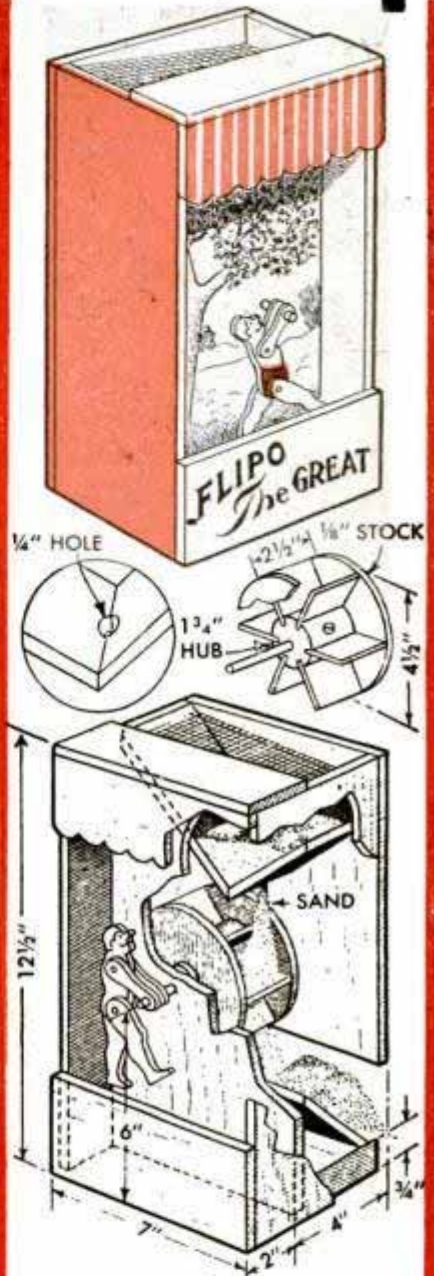

Sandmill Toy

For the very young, a sandmill toy such as this one will provide endless hours of amusement. Just pour a little sand into the hopper and the obliging Flipo will turn handsprings backward or forward, depending on which way he is pinned to the axle. Make the box of any suitable wood about 3/8 in. in thickness and assemble with brads and casein glue. The hopper is removable and the hardware cloth on the top screens the sand. Flipo himself is sketched on page 192

191

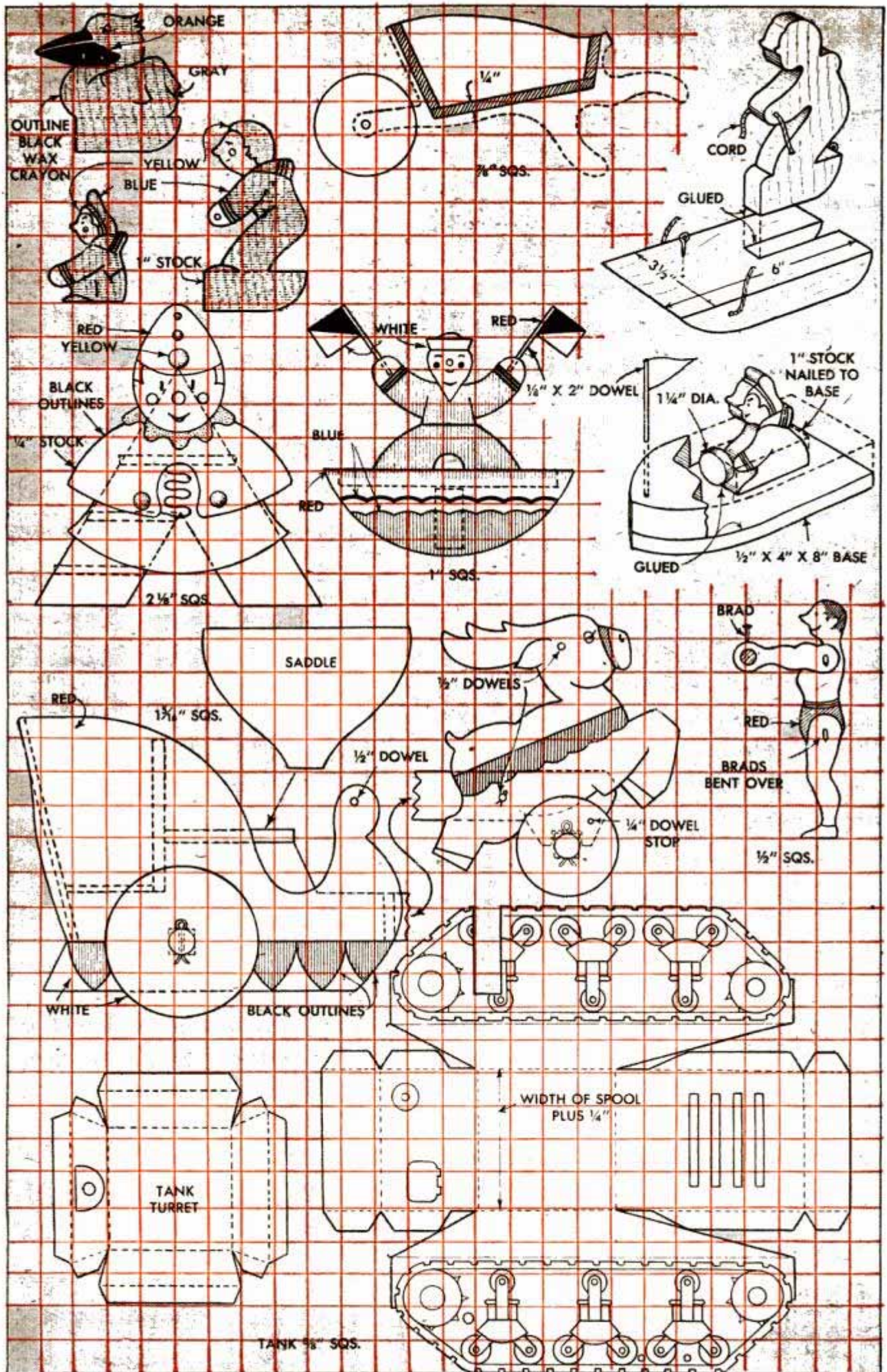



Signaling Sailor

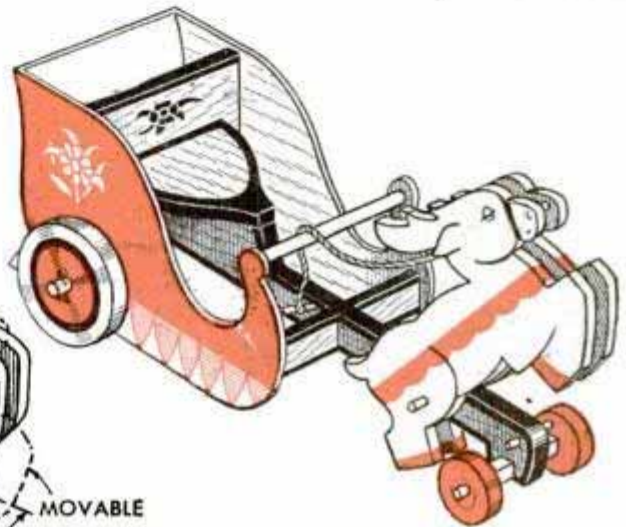
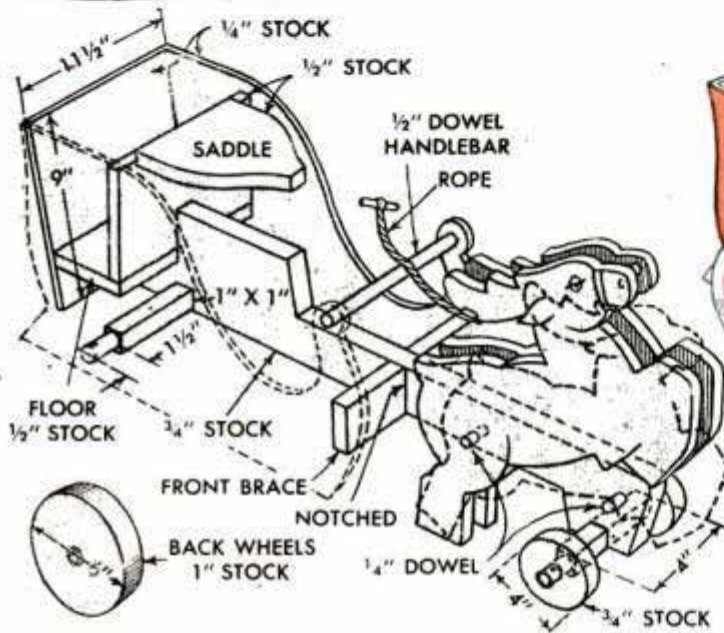

Reindeer-Sleigh Cart

Calling for attention, the signaling sailor is trying to attract the notice of the sailors and the pelican riding in the "aqua-train." Dimensions and suggested colors for these figures and craft are given at the top of the opposite page. Also shown at the center of the facing page is the cutout for the reindeer-sleigh cart which is illustrated above. Small boys will like to stage sham battles with replicas of the Sherman tank which is reproduced below and outlined on the page at the left. Rubber bands furnish the motive power to drive the tank

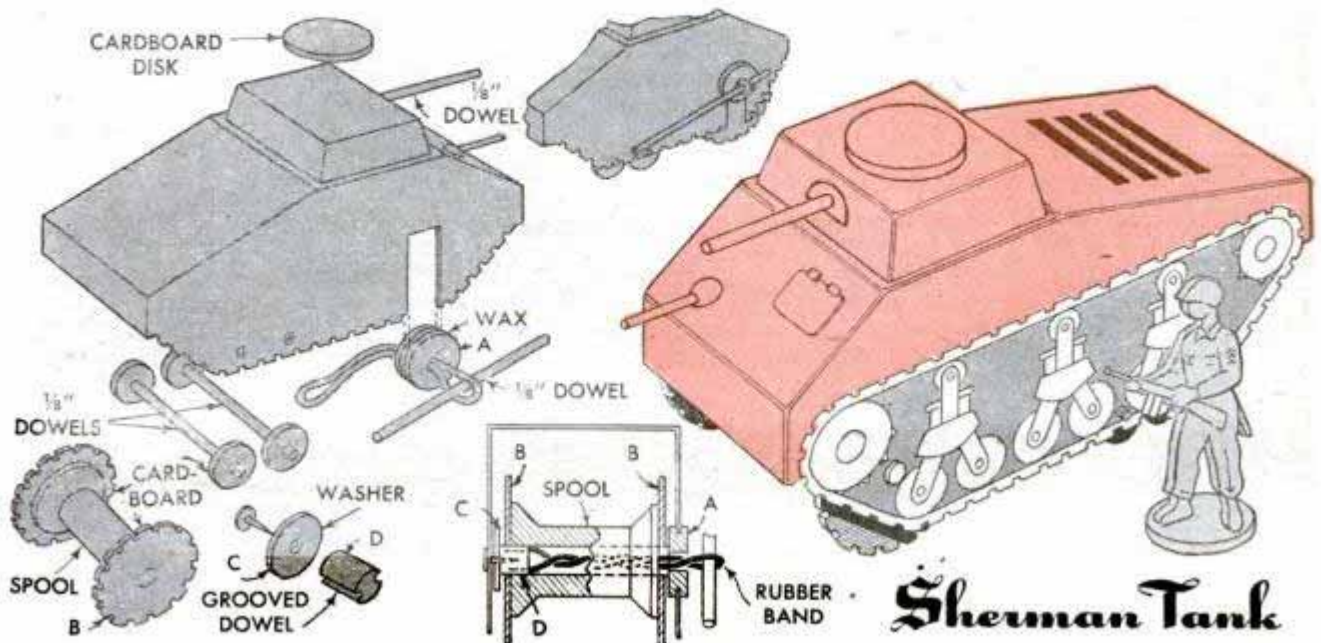

Sherman Tank

Foot Stool

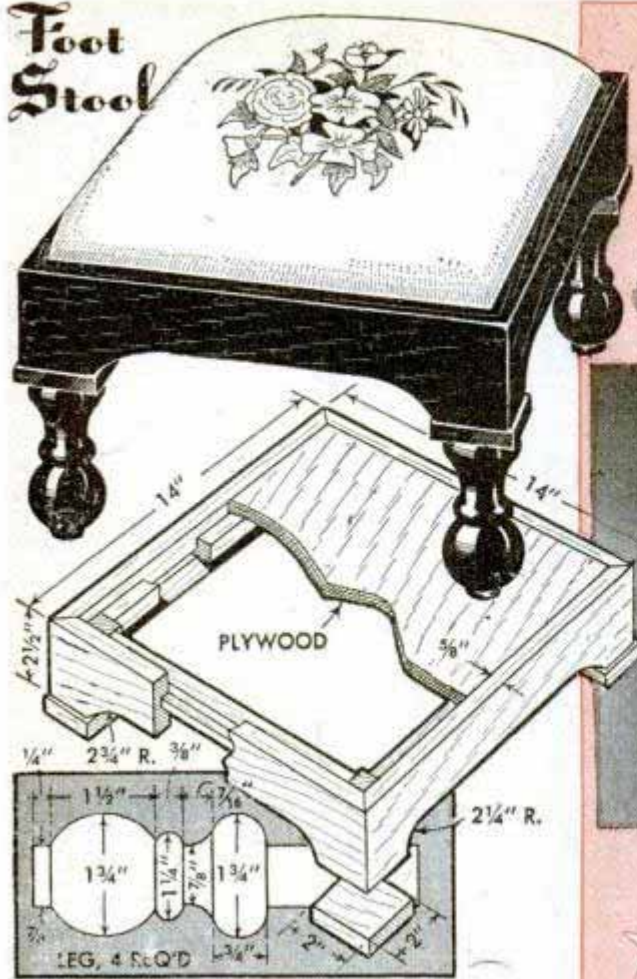

If some member of the family is handy at petit point, it will not be too difficult to make an attractive cover for this foot stool which has a plywood base and turned legs. Sturdy as well as being comfortable, the table and chair which are shown below will give your youngster furniture that is his "very own"

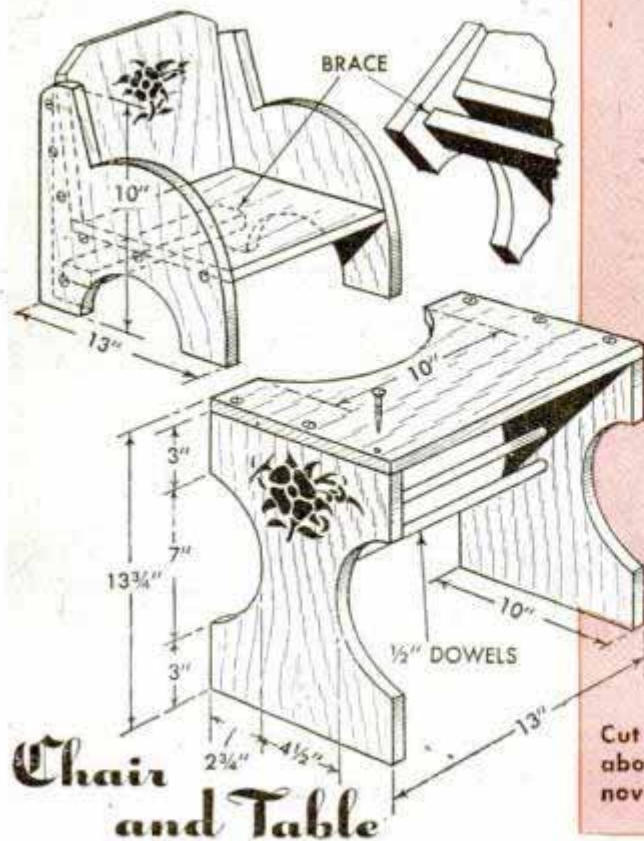

Chair and Table



Doll Playpen

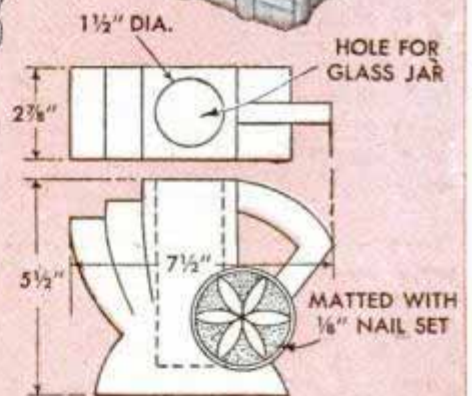

Vase

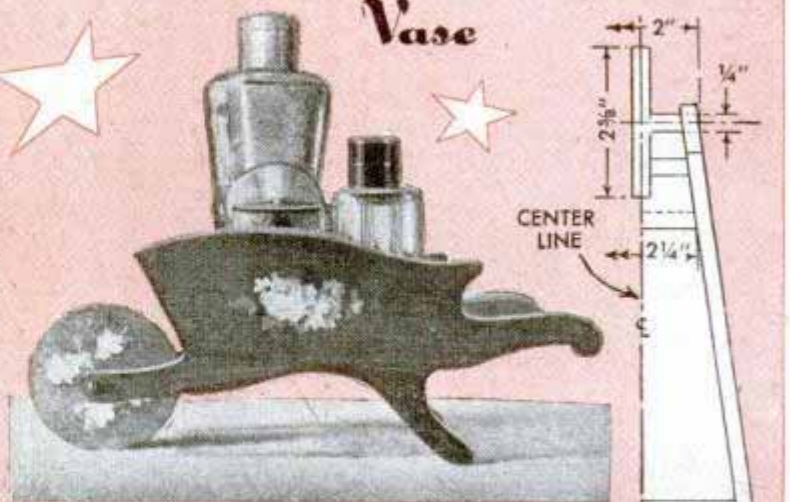

Perfume Barrow

Cut from one piece of wood with the handle added, the above vase is ornamented with copper. A perfume barrow is novel decoration for the vanity. Dimensions are on page 192

1/4" X 8 1/4" X 18 1/2" FLOOR
BOARDS

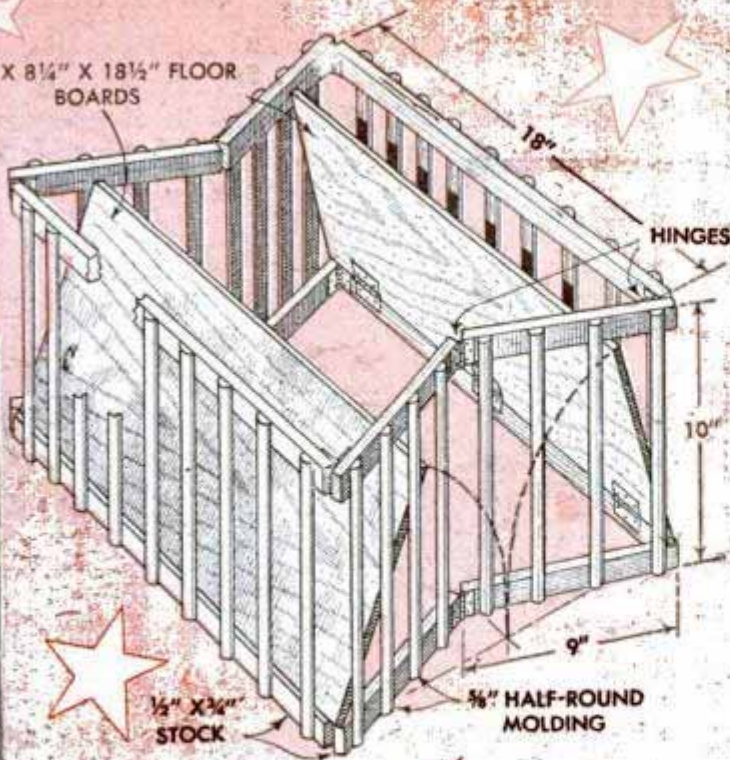

Because children like to play with toys which duplicate articles that are in the home, this doll playpen will receive a warm welcome. It has the advantage of being collapsible so it may be folded and put away when not in use. Half-round molding secured with brads nailed to longitudinal strips forms the sides and the floor is made of two boards. Hinges hold the pen together and, at the same time, permit it to be folded. The floor should fit tightly against the sides when the pen is opened to avoid pinched fingers. The size of the pen can be altered

In the winter you can be sure the baby will be snug and warm when bundled in the sleigh shown below. The seat is raised sufficiently from the floor to give protection from the cold and is tilted slightly to prevent the child from sliding out of position. A foot bar serves as a brace and a hand bar provides additional protection, as well as being used to hold additional blankets. Sides, back and seat are made of wood and the curved front piece is formed from light-gauge metal. Decals decorate sleigh



Nut Dish

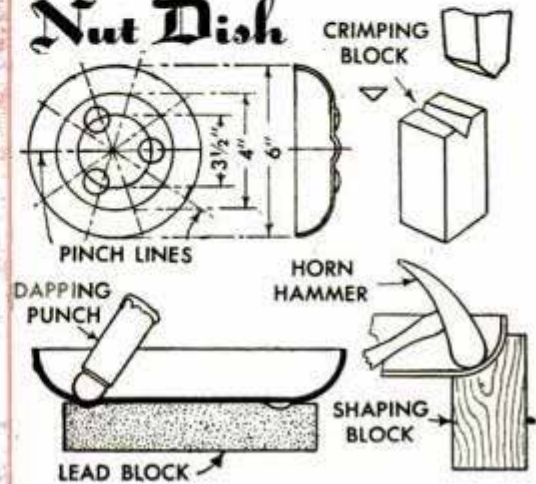

For the metal craftsman, this copper nut dish is an interesting project and makes an attractive gift. After the dish has been formed with the tools indicated, it is oxidized with a liver of sulphur solution to show the planishing effect to advantage. Buff with tripoli compound and jeweler's rouge to bring out the hidden highlights and then coat with clear metal lacquer



Baby Sleigh

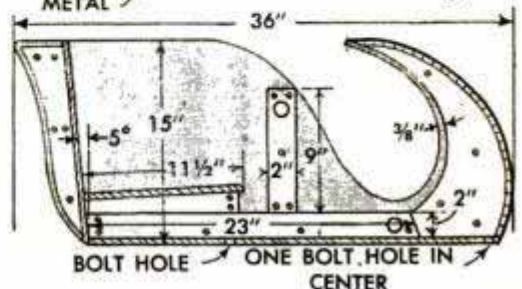

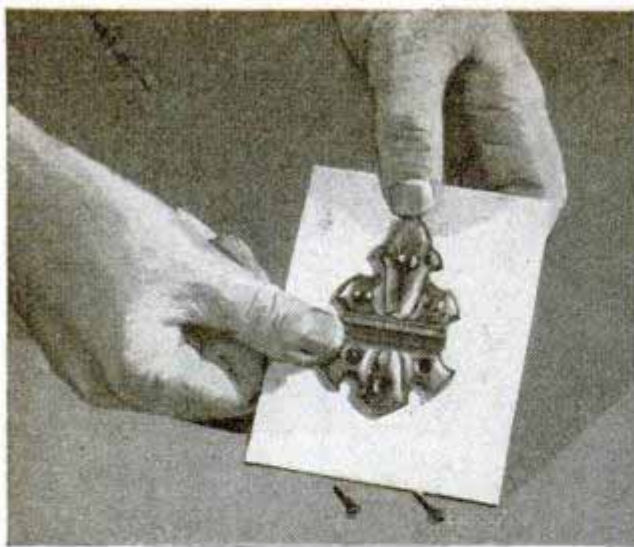

Hinge Screws Kept on Cardboard

When removing a hinge, make sure that the screws which fit it are not mislaid or mixed with others. Simply screw the hinge to a square of cardboard so all parts are kept together until the hinge is used again.

Jigsaw Mounted as Portable Unit

Mounted on a box to make a portable unit, this jigsaw has several advantages over some bench mountings. The height of the box elevates the saw to a handy working position when placed on a table. The door on the side of the box provides

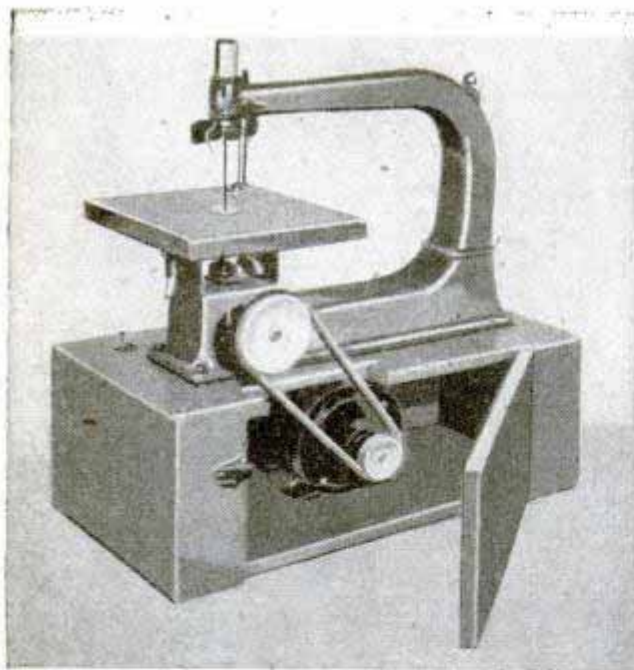

for the ventilation of the motor and the box itself has space for blades, extension cord, etc. If desired, the entire unit could be fitted with a cover for protection.

Charles A. Bailey, Gary, Ind.

☐ Waxing the inside and outside of porcelain washing bowls will help prevent them from cracking.

Appearance of Open Wall Plaque Improved With Backing

To improve the appearance of open wall plaques which permit the wall to be seen through the design, paste a piece of colored paper on the back of the plaque. This is effective especially when the plaque and



the wall are similar in color. The material of which the draperies are made, if available, will also produce a pleasing effect.

H. Schlossberg, Washington, D. C.

Reduction Gears for Model Work Obtained From Clock

If you need a set of reduction gears for a small machine or model, remove the wheels from an old clock and experiment until you find a pair that has a ratio which will give the speeds that are required. If the shafts are too small, drill them out carefully and substitute wire nails that have had the heads removed.

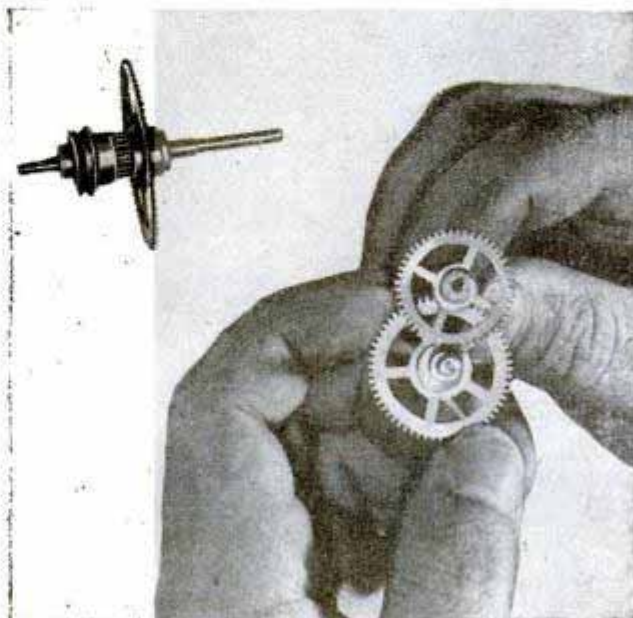

Multi-Jet Steam Unit Sterilizes Baby's Bottles

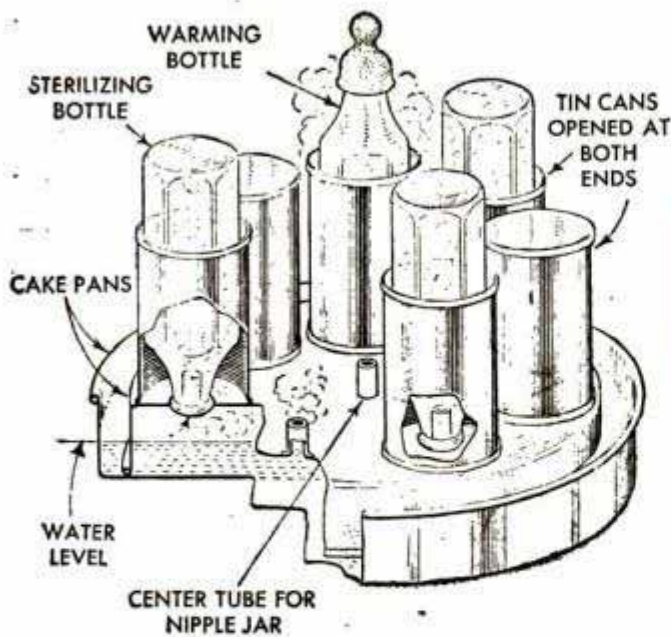

Mothers will find this efficient unit a real timesaver for warming and sterilizing a baby's bottles. It consists of two shallow cake pans, one inverted inside the other. Eight equally spaced holes are drilled in the bottom of the inverted pan and short lengths of $\frac{1}{4}$ -in. copper tubing are soldered in these holes so that the ends project about 1 in. to form steam jets. Seven soup cans, each with both ends cut out, are centered over the jets and soldered as shown. The cans serve as holders for the bottles. To use, fill the lower pan about half full of water and place the unit on the stove. Set the bottles to be sterilized in the holders, with

the neck of each bottle over a jet. The nipple jar is placed over the center jet. The average-size cake pan, half full, will contain enough water to boil about 10 minutes and this usually is sufficient for complete sterilization. The operation should be watched to see that the water does not boil away.

Maurice H. Baller, Washington, D. C.

Friction Tape Wrapped on File Serves as Safety Guard

If friction tape is wrapped around a file near the tang, it will serve as a temporary safety guard to protect the fingers against accidental injury should the file slip when sharpening an ax or other edged tool. Several layers of tape should be applied to make the wrapping thick enough so that the ax cannot cut through it or slide over it on the downstroke of the file.—David B. Clapp, Livingston, N. J.

Removing Broken Wood Screws

To remove a screw broken off in wood, use a spoon bit and bore with a counter-clockwise motion down to the end of the screw. Then remove the screw and plug, fill the hole and rebore for a new screw. A $\frac{3}{8}$ and $\frac{5}{8}$ -in. spoon bit are good sizes to have in your kit.

Worn-out brooms will do duty as floor polishers if the straws are trimmed evenly and covered with woolen socks or felt hats.

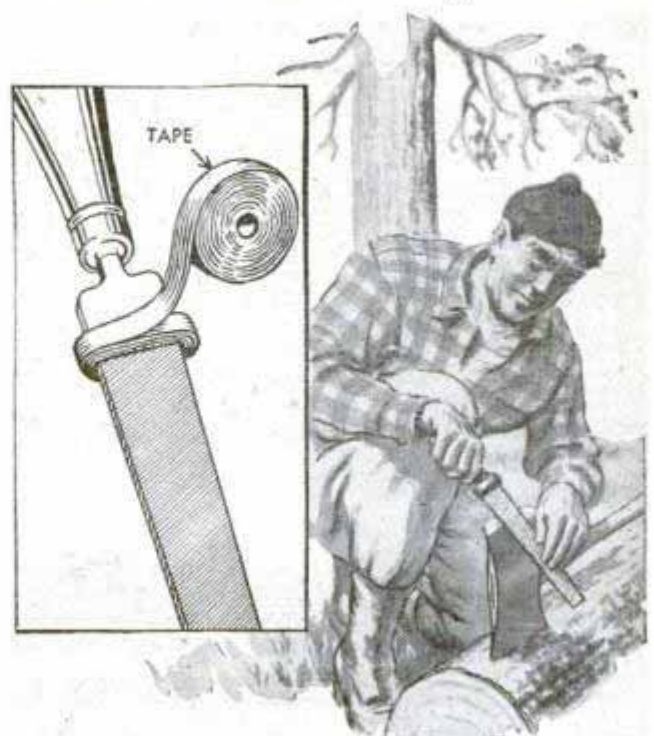

Say Merry Christmas with

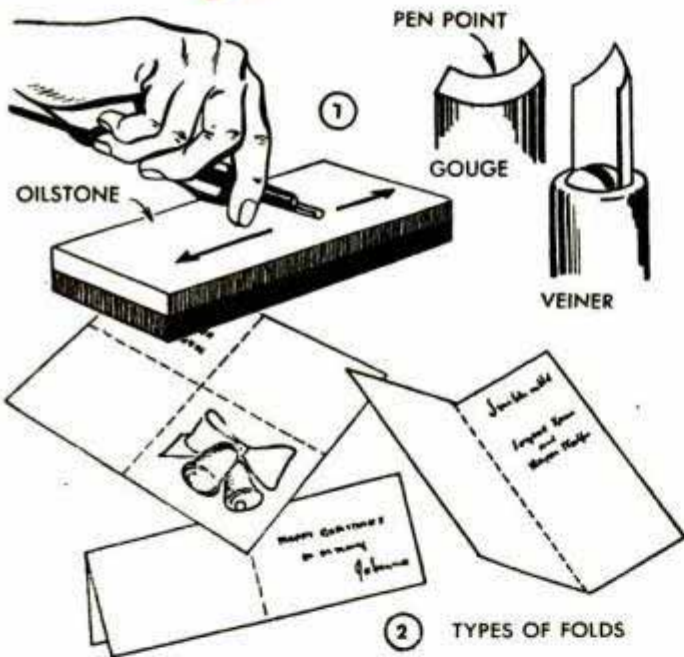

By JACK and JAN HOLMES

GREETING cards sent to your friends will be less commercialized and have a more intimate touch if you make them yourself. Almost endless designs are possible, and you can even characterize them to suit the recipient. Equipment to print them consists of a carved linoleum block, a tube of printer's ink and a roller for applying the ink. Figs. 3, 4, 6 and 7 give the idea briefly. You will need a penholder and a few pen points which are oilstoned as in Fig. 1 to make chisels for carving the linoleum. Fig. 2 suggests different ways of folding the completed cards.

The designs shown above are only to get you started. You can sketch your

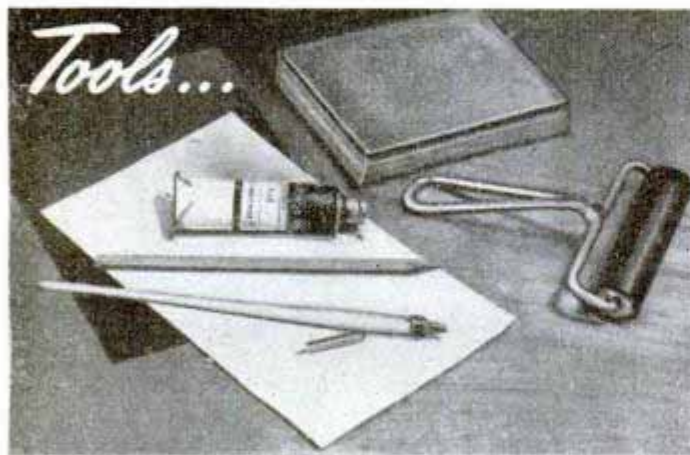

③ A linoleum block, carbon paper, tube of printer's ink, roller, pen holder and a few pen points are all you need

④ After transferring the pattern to the linoleum, you carve the design in relief, using the pen-point chisels

your own GREETING CARDS



Your "Best Wishes" will have extra meaning when they are sent on cards of your own exclusive design. You'll have fun, too, carving these linoleum-block "engravings"

own or trace them from the pages of magazines, catalogues and newspapers. Keep in mind that the lettering must be done in reverse. The linoleum block should be smoothed with fine sandpaper, and, if it is black, coat it with a very thin layer of showcard paint. The lighter finish will help show the tracing lines. With the carving tools, cut out the spaces to be left white, Fig. 5. The block should again be sanded after carving.

You are now ready to print. Thin the ink on a piece of glass, marble or other surface by adding a few drops of kerosene. Roll until thin and even, then transfer the solution to the linoleum block, rolling one way only until the surface is inked completely. Drawing paper or construction paper cut



to the correct size can be used for printing. At least 12 folded newspapers should be placed on the floor as a base for the paper to be printed, which then is placed in position and the block centered on it. Pressure is applied uniformly by rocking the ball of the foot back and forth for a few seconds on top of the block.

Block printing can be used for a number of things other than greeting cards. Students can design clever invitations to parties and adults may well use the same method to print unusual place cards and score cards.



⑥ The roller is charged with ink by passing it over an ink-coated glass, and then rolling across the linoleum cut



⑦ You "go to press" by centering the cut on the card, which is placed on a padded surface, and standing on it

Drill Chuck Used as Drum Sander Finishes Curved Work

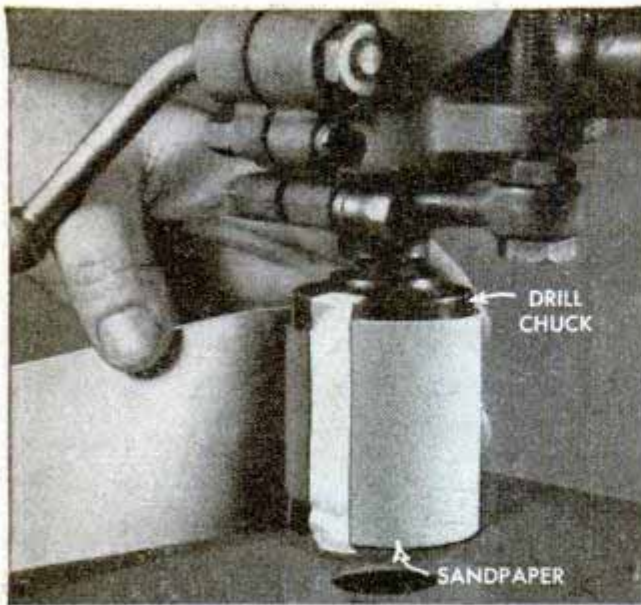

Needing a small drum sander and not having one available, one craftsman used the chuck on his drill press to serve the purpose. Although not recommended for continued use, this method is satisfactory in an emergency. Cut a strip of sandpaper the correct length and width and attach one end to the chuck with adhesive or cellulose tape. After wrapping the sandpaper around the chuck, fasten it at the top and bottom with rubber bands. Wrap the paper in the direction opposite the rotation of the chuck.

Clock Case Made From Skillet

Unique and practical, this kitchen clock has the movement taken from an ordinary alarm clock mounted on an aluminum skillet. A hole is drilled in the center of the pan for the pinion to which the clock hands are fastened. The dial numbers are painted on in a bright, attractive color and the rest of the skillet is left in its original finish.—Paul Hadley, Philadelphia, Pa.



Uses for Burned-Out Flash Bulbs

Used photoflash bulbs make good targets for either stationary or aerial practice with a .22-caliber rifle. When hit, they explode with a very satisfactory "pop." Anglers also have discovered their value for practice in the use of plugs. The caster who can break a bulb floating on the water from

a reasonable distance can be sure of his ability to place a lure at the right spot.

Claude M. Kreider, Long Beach, Calif.

Hand Grinder Mixes Casein Glue

Mixing small batches of casein glue can be facilitated by inserting a round-head bolt in the chuck of a hand power grinder and using it for mixing. The bolt head provides just enough action to mix the glue in a short time.



Small Parts Stored Conveniently On "Carryall" Stand

Small but frequently used items such as screw eyes, cotter pins, nuts and washers are held conveniently on this "carryall" stand. The standard is a short length of dowel into which curtain-rod hooks are screwed. A lid from a paint can, which serves as a base, is attached to the dowel with a screw.

Ronald Eyrich, Milwaukee, Wis.

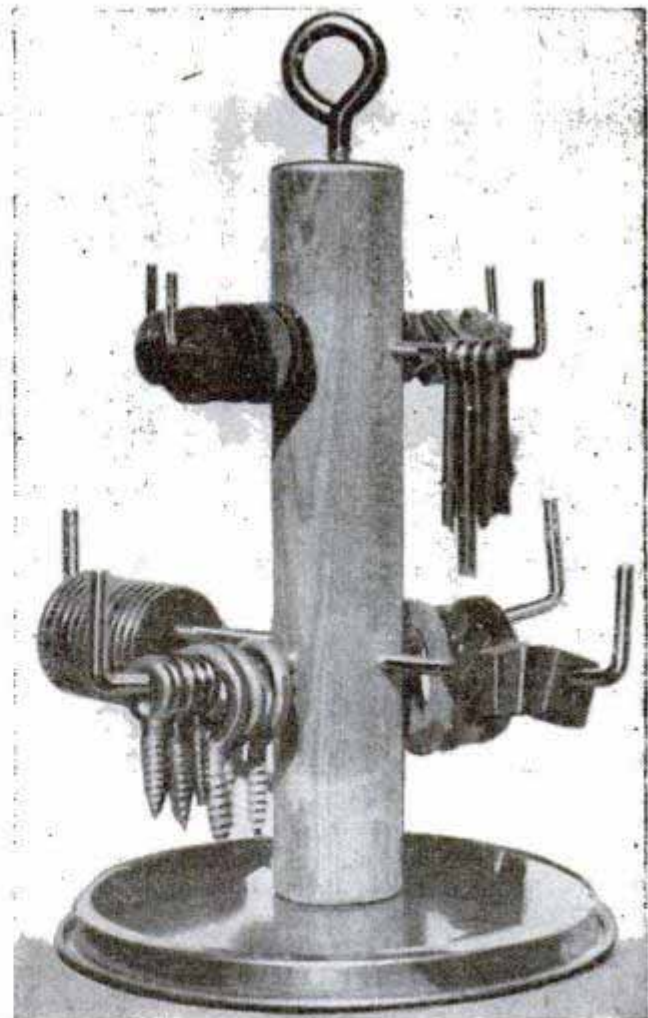

MODEL GAS ENGINE

PART II

By Gary Moore

WITH all the principal engine castings except the carburetor machined to size, as described last month, the job is made ready for the more detailed work on the moving parts. Here again the figure numbers given correspond to the key numbers of the parts shown in the assembly drawing, Part I. Nearly all of the work on the rocker arms, Fig. 13, is done with hand files. With care and selection of the right files anyone can do a creditable job on these two parts. The rocker-arm support, shaft, and the bushings and tappets, Figs. 14 to 17 inclusive, are ordinary lathe jobs. These parts are shown assembled in photo R, together with the adjustable push rods, Fig. 18. These are turned to diameter in a collet chuck, polished with crocus cloth and threaded on the upper end for the heads. The lower portion of each push rod is tapered and the end is ground spherical as indicated. Push-rod heads, Fig. 19, are turned from hexagon stock and tapped to screw onto the push rods. Lock nuts are made by redrilling and tapping standard hex nuts. The cam-follower guide, a small bronze casting, Fig. 20, is turned to diameter on one end and the flange is faced. It then is reversed in the chuck and the operation repeated. Holes for the cam followers, or lifters, are spotted and drilled. In this operation care must be taken to get the holes located accurately so that the lifters will center on the cams. The lifters, Fig. 21, are turned down from $\frac{1}{8}$ by $\frac{1}{4}$ -in. steel to an easy sliding fit in the guide holes. Large ends of the lifters are crowned to a $\frac{5}{8}$ -in. radius and opposite ends are drilled to house the ball ends of the push rods. Completed parts are shown in photo S. Here it's well to note that in the assembly care must be taken when fitting the cam-follower guide on the angular crankcase boss to assure that it bears on the whole of the trued surface, that is, the joining surfaces should meet "without light" between and the guide should be perpendicular to the cam shaft. Otherwise these parts soon will show undue wear.

When setting up for machining the piston, Fig. 22, chuck it first by the lug, bore the skirt to diameter and turn down the outer diameter to within the limits of the hold dimension. This should give a smooth push fit in the cylinder bore. Ring grooves

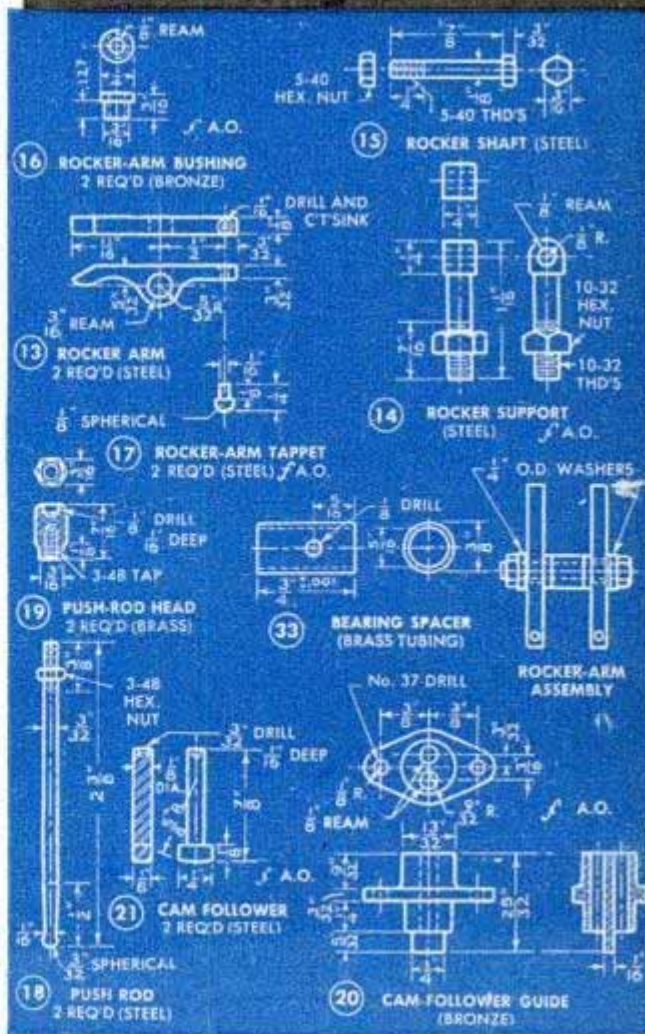

clockwise from the fly wheel end

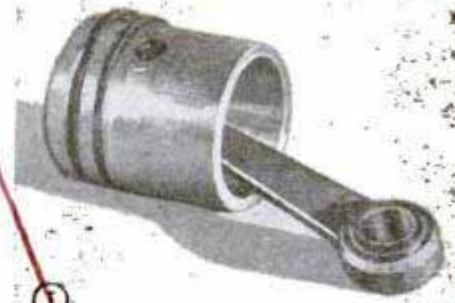
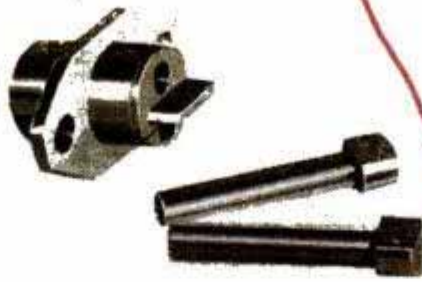
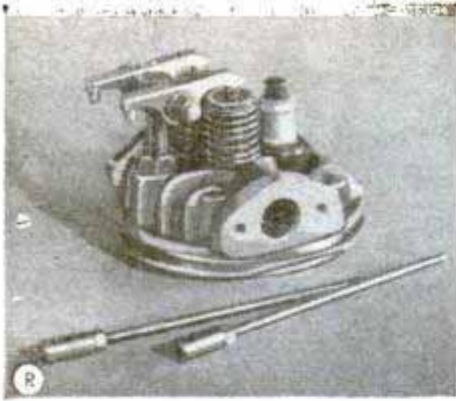

are cut with a parting tool just wide enough to allow the rings free movement. This done, reverse the work, cut off the chucking lug and face the piston head smooth and flat. Wrist-pin holes are drilled and reamed in the lathe, the drill bit and reamer driven by the live spindle and the piston supported in a crotch center. The wrist pin, Fig. 24, is turned and ground from drill rod and drilled hollow to cut weight to the minimum. Bronze plugs, Fig. 25, cover the ends of the wrist pin and protect the cylinder walls. The connecting rod, Fig. 26, is filed from steel bar stock to the rough shape. Then the holes are drilled and the large and small ends are trued up with the work mounted on a mandrel. Bushings, Figs. 27 and 28, are turned and drilled from

solid bronze rod to a light press fit. Piston rings, Fig. 23, can be purchased or turned from cast iron to the dimensions given. The completed job is shown in photo T, ready for assembly into the engine.

Next comes the crankshaft, which is really a two-part affair. It is detailed in Fig. 29 and the timing-gear crank, which drives the timing gear, is shown in Fig. 37. Also see photos V, W and X which show the completed parts. Crankshaft is turned from solid bar stock. The crank pin is turned first, then holes for the crank pin, Fig. 38, and the $\frac{1}{16}$ -in. hole for oil passage are drilled as in Fig. 29. Next the waste is sawed away and the part remounted between centers as in photo U, turned down to the dimensions indicated and threaded

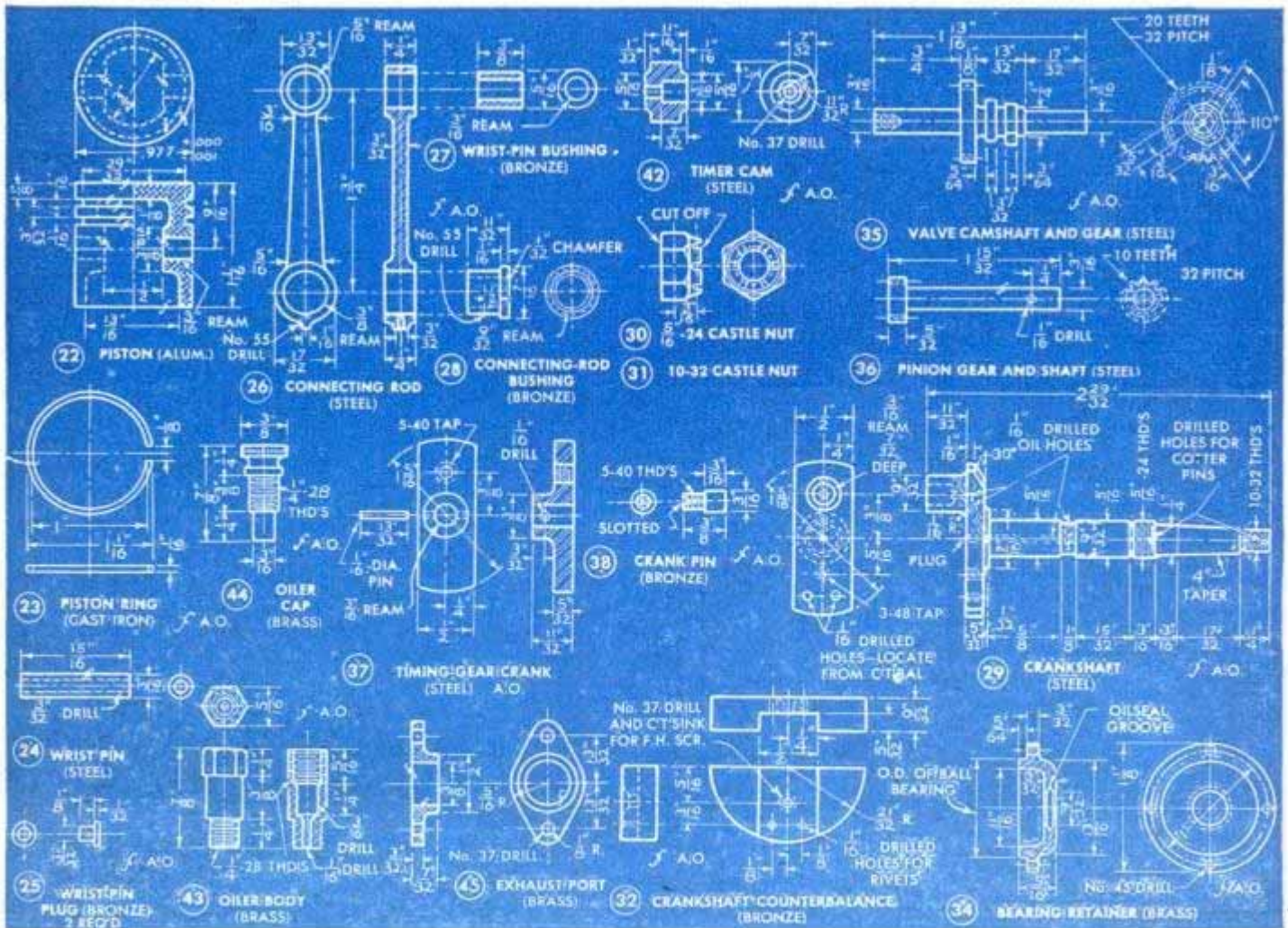

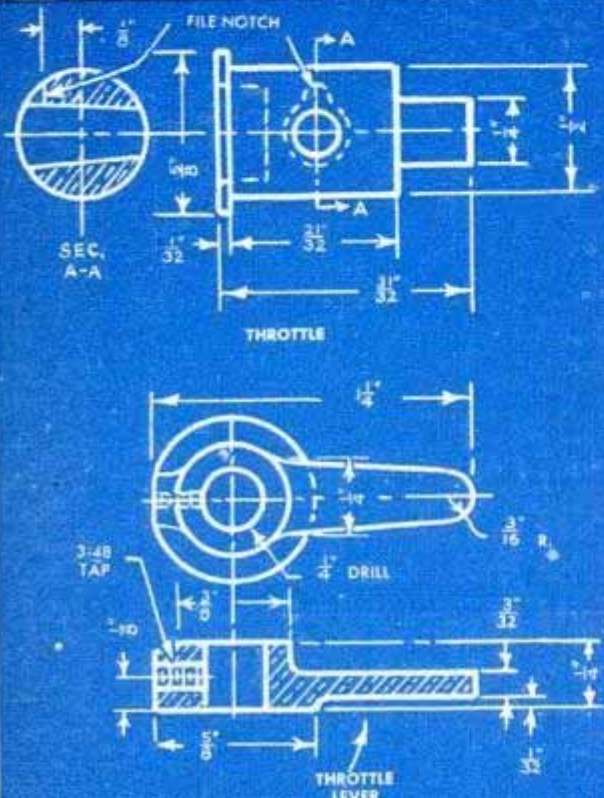
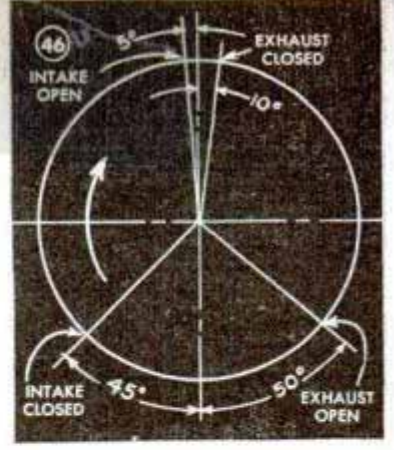
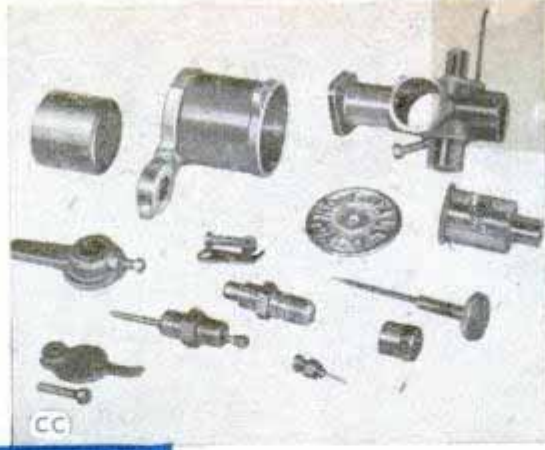
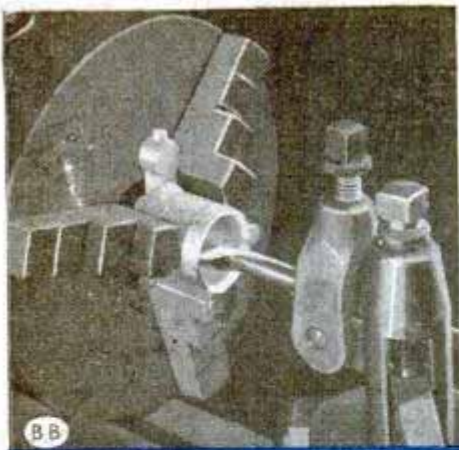

The timer body, Fig. 40, requires only one lathe operation, boring the mounting hole as in photo Y. The balance is merely locating and drilling the required holes and snagging and finishing the casting with a file. The breaker arm is a standard automobile part and is actuated by the timer or breaker cam, detailed in Fig. 42. The breaker arm is shown as part No. 41 in the assembly drawing, Part I, but is not detailed here. The cam is held in place and adjustment for position provided for by means of a screw turning into a tapped hole in the end of the camshaft. Photo Z shows the assembly complete ready to mount on the timing-gear housing. Fig. 47 details the carburetor parts full size and photo AA shows the rough castings. Photo BB shows the setup for boring out the shell or fuel chamber. You will note the absence of the finish symbol in Fig. 47, which means that

47 CARBURETOR

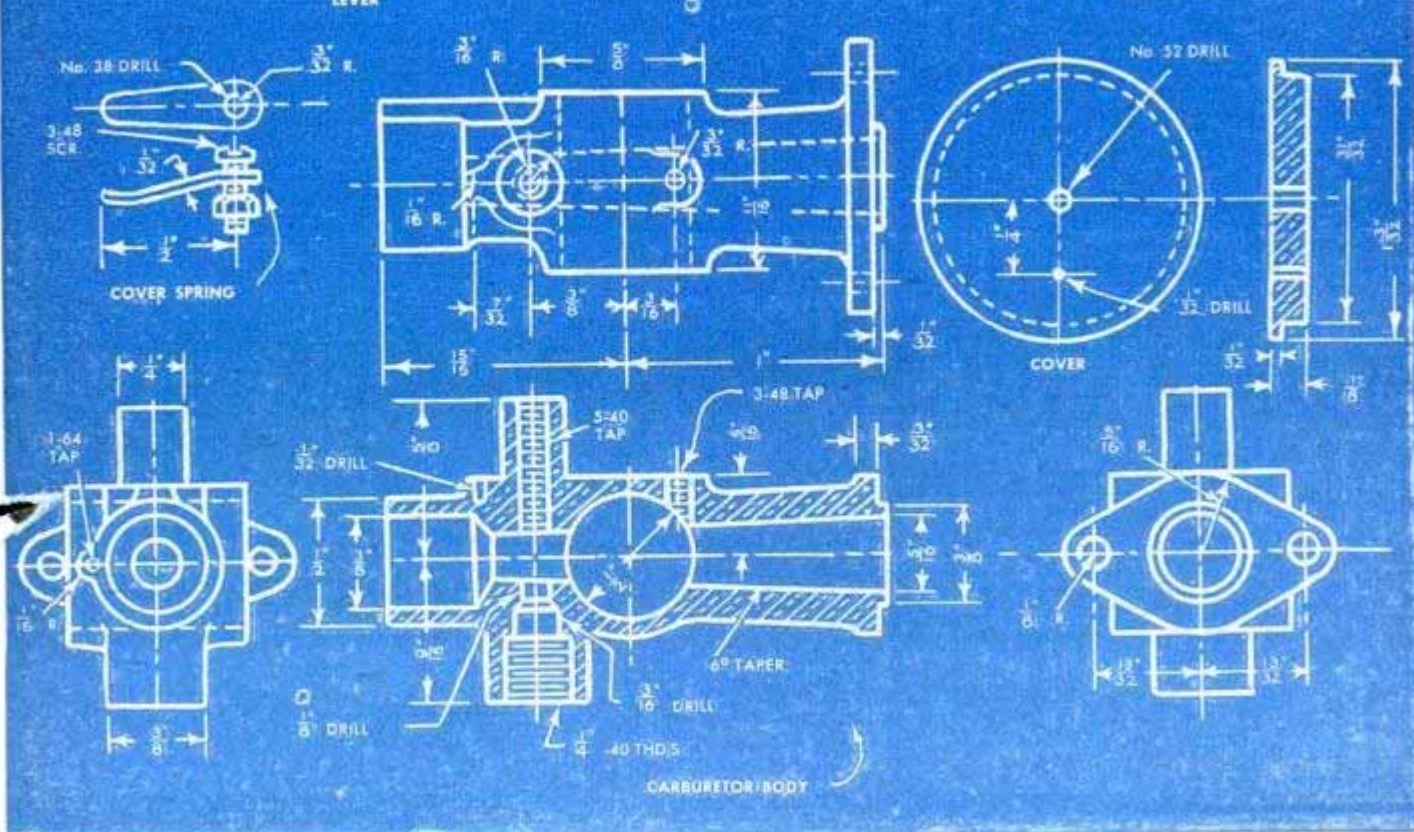

INLET OPENS 5° BEFORE TOP DEAD CENTER, CLOSES 45° AFTER BOTTOM DEAD CENTER. EXHAUST OPENS 50° BEFORE BOTTOM DEAD CENTER, CLOSES 10° AFTER TOP DEAD CENTER



the rough castings are finished only on meeting surfaces, such as flanges, tapers, etc. The valve needle and thumbscrew are turned from brass rod. A short length of nickel-steel wire is soldered to the lower end and tapered for $\frac{7}{16}$ in. of its length. The numbers 40 and 60 on the detail of the valve body denote the numbered drill sizes. A float needle is made from nickel-steel wire with the head turned separately and driven on, and the cork float is sanded to shape from an ordinary bottle cork. One thing to be especially careful about is the exact size of the $\frac{1}{32}$ by $\frac{1}{12}$ -in. slot filed on one end of the float valve. Take several trial measurements to be sure of the size. Finally photo CC shows completed carburetor parts, photo DD shows the unit assembled and in photo EE you see the completed engine, ready for the final assembly and test.

THE END

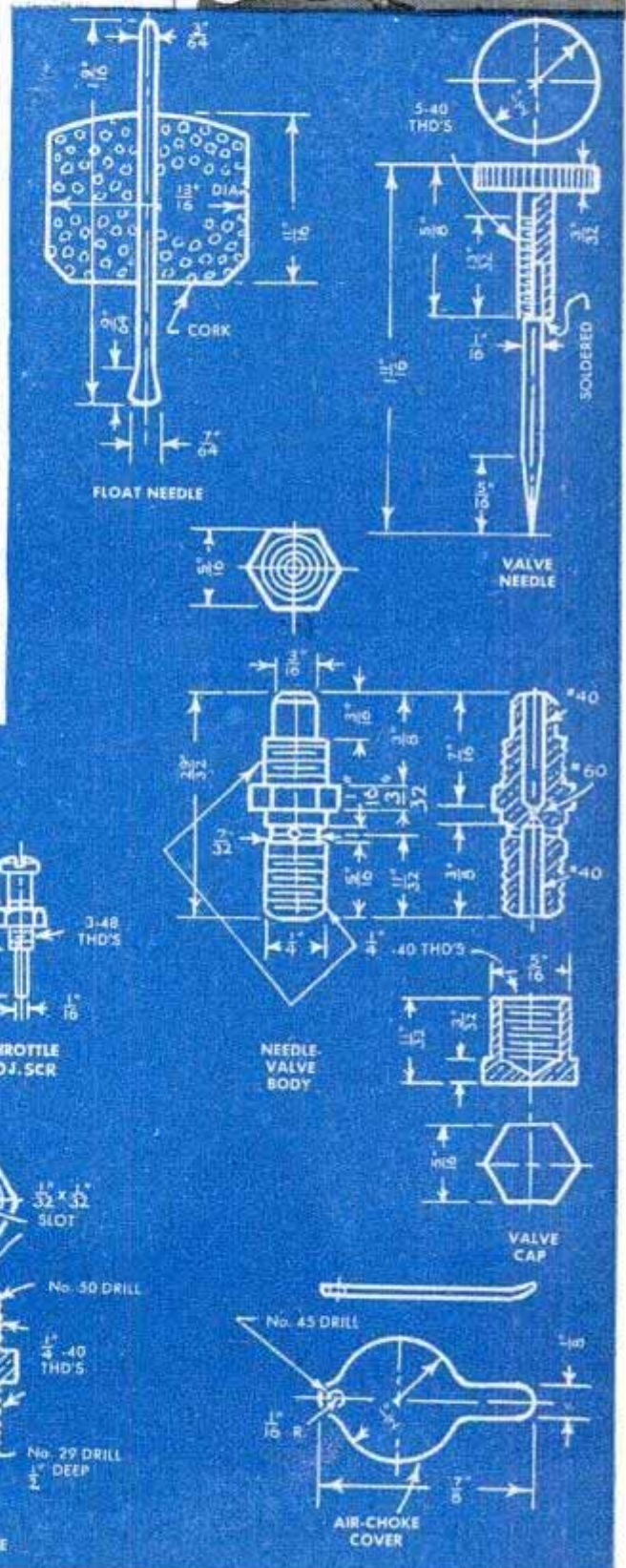

Quarter-Round Strips Can Be Cut From Length of Square Stock

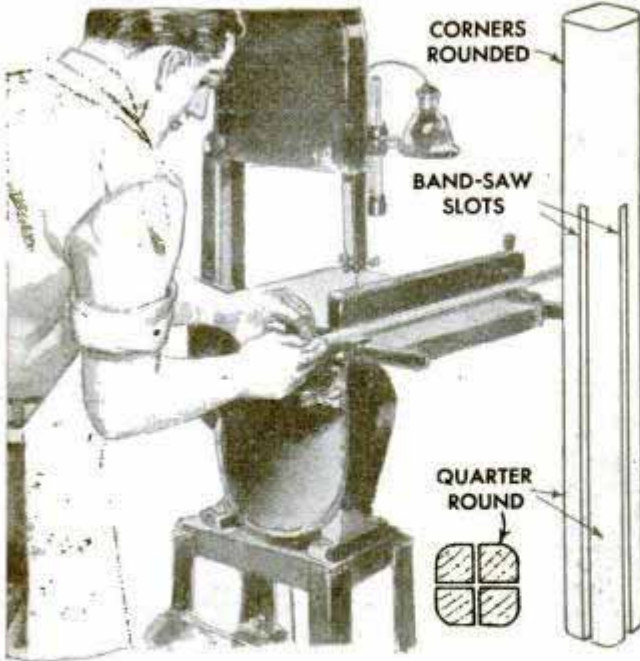

Quarter-round molding strips of almost any size can be made from a length of square stock. First the corners are rounded slightly, after which the stock is ripped along the center, leaving a small portion uncut at one end to hold the strips together. Then the stock is turned over and sawed again to produce four strips of equal size.

T. G. Sutherland, Chicago.

Extension Arms on Stepladder Provide Wall Clearance

If space is lacking, it is sometimes necessary to lean a stepladder against the wall in the closed position. However, when standing on the top step it is difficult to maintain your balance. These extension arms will hold the ladder away from the



wall and at the same time permit you to work in close quarters. The slotted arms are pivoted to the ladder with bolts and wing nuts and can be folded out of the way when not in use.

Spreader Made of Spring Steel Distributes Glue Evenly

Finding that a glue spreader made of wood tended to splinter and that a stiff brush would not get the glue into the cracks, one craftsman used a spreader cut from spring steel. The tool was cut from .006-in. spring steel

and tempered to a dark blue. Then it was soldered to a small paintbrush handle after the ferrule had been altered as shown. After the glue has dried on the blade, flexing the metal, as indicated in the circular detail, will remove the glue.

I. H. Guskin, Watertown, Mass.

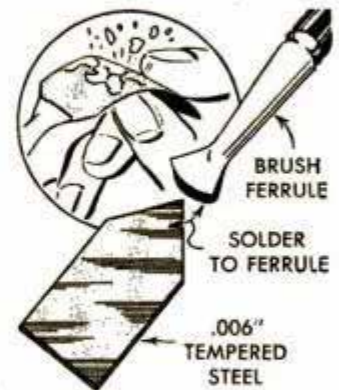

Removing Rusty Wood Screws

Drive the head of the screw with a nail set and hammer. Since screws rust in wood, this will serve to break the rust seal and the screw then can be removed easily with a screwdriver. When driving the head, care should be taken not to break it, as might happen if the screw is very rusty.

Francis W. Henry, Pottsville, Pa.

C-Clamp Support for Paintbrush

To support a paintbrush at just the right level in a jar containing cleaning solution or linseed oil, attach a C-clamp to the ferrule of the brush at the right height. The bristles will not rest on the bottom, and it will not be necessary to drill a hole through the brush for a supporting wire or nail, as sometimes is done.—D. J. Bachner, Jackson Heights, N. Y.

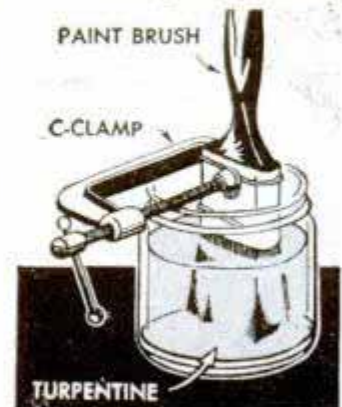

When erasing chalk from small blackboards, tufts of ordinary absorbent cotton can be used to substitute for felt erasers. The cotton is kept in the original container and tufts are withdrawn as needed.



VERSATILE FILM VIEWER

1 CAN BE USED WHEN EDITING MOVIE FILM



2 AS AN ILLUMINATED TRANSPARENCY VIEWER



3 OR FOR AN ILLUMINATED RETOUCHING EASEL



BY ROBERT SCOTT



This viewer serves the three-fold purpose of a transparency viewer for all film from 8-mm. to the 4 by 5-in. cut-film size, an illuminated retouching easel for negatives and an aid in editing 8-mm. or 16-mm. movie film, Figs. 1, 2 and 3. It also can be used in editing 35-mm. film by fitting an adapter.

Body of the viewer is made by cutting a 2-gallon can diagonally in half as you see in Figs. 5, 7 and 8. Lines where the cuts are to be made can be marked with a metal scriber. The diagonal cuts are made with a sharp, thin knife blade or similar tool. A pair of canvas gloves should be worn to protect the hands from injury. Smooth

the cut edges with emery cloth or a file.

Figs. 5 and 8 show how two strips are left attached when cutting away the unwanted portion of the can. These are later rolled to form feet which raise the back about $\frac{3}{4}$ in. above the surface on which it rests. The air vent thus made, in addition to the opening at the front and the three louvers above the lamp socket, provides ample ventilation for the 25-watt bulb. If the viewer is to be used on a polished surface, the feet and the two front corners can be covered with several layers of photo tape or felt to prevent damage to the surface. Openings for the opal glass and lamp socket are cut by placing the work on the end grain of a wooden block and cutting along carefully marked lines with a ham-

mer and a sharp cold chisel. Louver slots in the end of the can above the lamp socket are cut with a knife. The opening for the lamp socket should be just the right size to grip the threads of the socket firmly when it is turned into the hole, Figs. 5 and 7. In making an assembly of this type, of light sheet metal, be especially careful to avoid bending or denting the material. Dents and bends are difficult to hammer out flat.

A piece of opal glass $4\frac{1}{4}$ by $5\frac{1}{2}$ in. is used to diffuse the light. The opening is cut to fit this glass and, to hold it centered above the bulb, a $\frac{3}{8}$ -in. tab is cut at the upper and lower ends of the opening, running the entire width. These tabs then are bent to make a sliding fit for the ends of the glass,

made from a piece of light sheet metal. It is large enough to cover the opal glass and it has a 1 by $1\frac{1}{2}$ -in. opening cut at its center. The film is guided by four wooden rollers, Figs. 2 and 4, attached to eight semicircular tabs cut out of the metal and bent at right angles to the adapter. The exact size of the tabs and rollers is not important but there should be about $\frac{1}{16}$ in. clearance between the roller and the surface of the adapter. Also, the rollers should turn freely. A small hole is punched in each of the tabs and nails or brads are inserted in the ends of the rollers through these holes.

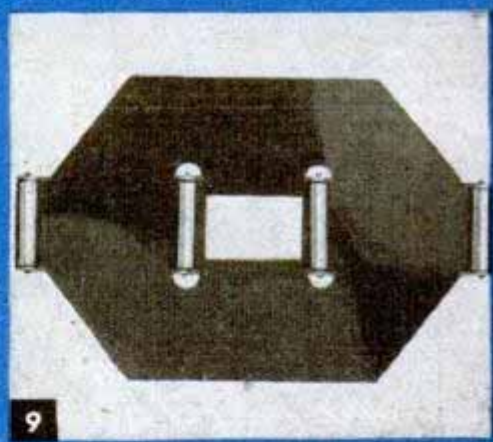
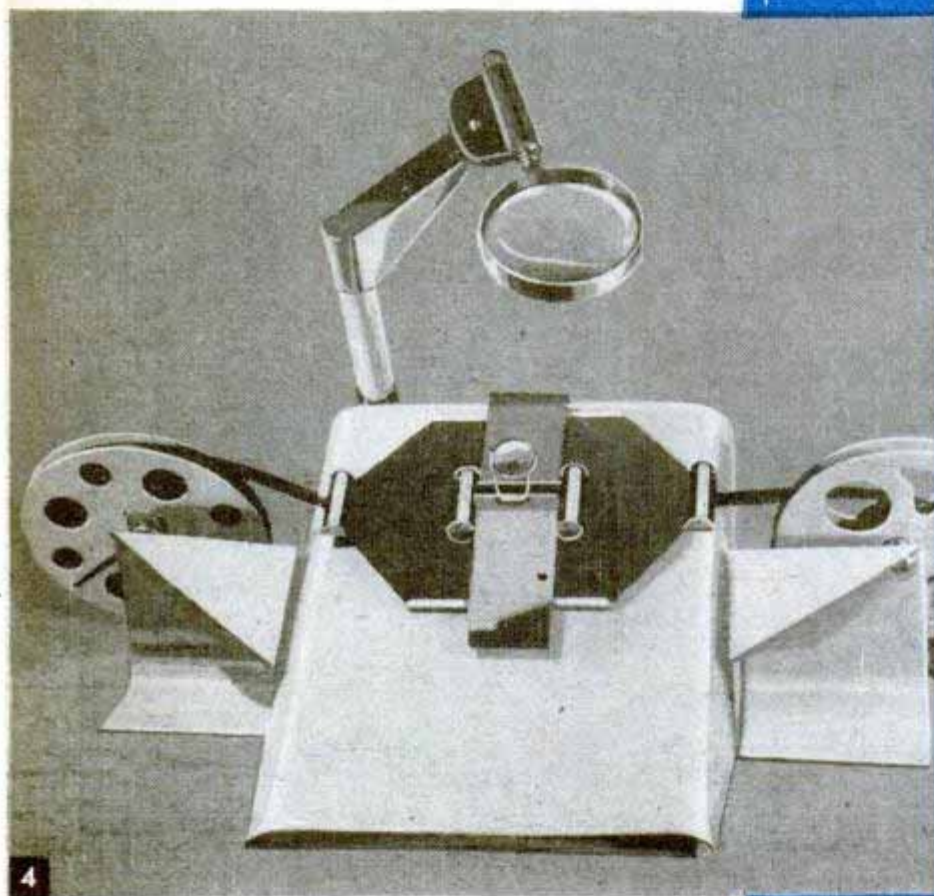

holding it in place as in Figs. 6 and 7.

The adjustable magnifier holder, Figs. 3, 8 and 13, is made to hold a standard reading glass. It consists of a short wooden dowel and three other parts made of light sheet metal. The clamp, Fig. 8, is fastened to the viewer with two bolts and it clamps around the dowel with the aid of a bolt and wing nut, permitting the dowel to be locked in any position. A $4\frac{1}{2}$ -in. metal arm, detailed in Fig. 13, fits tightly over the top end of the dowel, and a swiveling clamp which holds the magnifying glass is connected to the arm by a bolt and wing nut. This arrangement permits the magnifier to be adjusted quickly and easily.

The adapter for 35-mm. film, Fig. 9, is

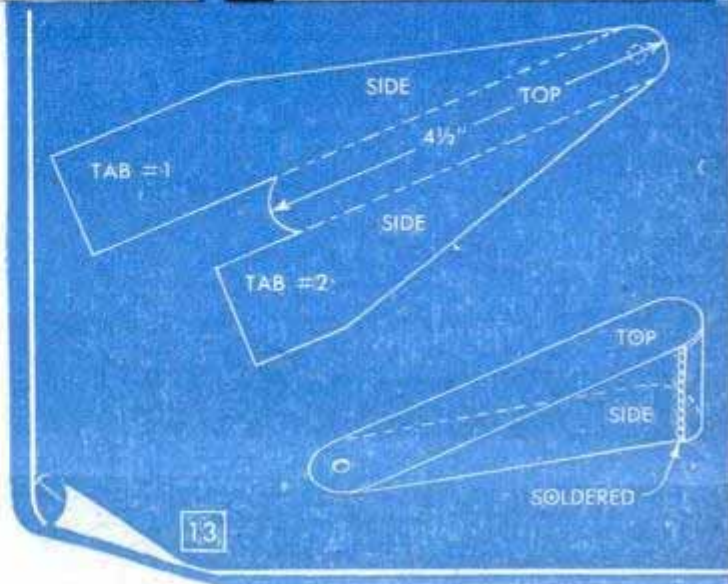

Using the viewer as an editor for 8-mm. or 16-mm. film requires only the addition of reel holders which clip to each side of the viewer and a film guide which fits over the center of the 35-mm. adapter, Figs. 4, 11 and 12. Fig. 4 shows the viewer being used for editing 8-mm. film. If you wish to use it for 16-mm. simply make the reel holders a little wider to accommodate the larger reels and make the film guide to fit 16-mm. film. The reel holders, Fig. 10, are each formed from a single piece of sheet metal. They are so made that they clip to the sides of the viewer and can be removed when not needed. Fig. 14 details the pat-

tern for the holders. Two $\frac{1}{4}$ by $1\frac{1}{2}$ -in. stove bolts serve as shafts on which the reels turn. They are fastened to the holders with a square nut and washer and the exposed threads are covered with a close-fitting sleeve made of sheet metal. Three washers are used on each shaft to permit the reels to turn freely.

The movie-film guide, Figs. 11 and 12, is made from a single strip of sheet metal $1\frac{5}{8}$ in. wide, rolled down at the top so it hangs over the upper end of the viewer as in Figs. 1 and 4. The 8-mm. guide is made by bending the strip at its center to form a channel 8 mm. wide with guides $\frac{3}{8}$ in. high at each side. A small rectangular opening equal in size to the 8-mm. frames is cut through at

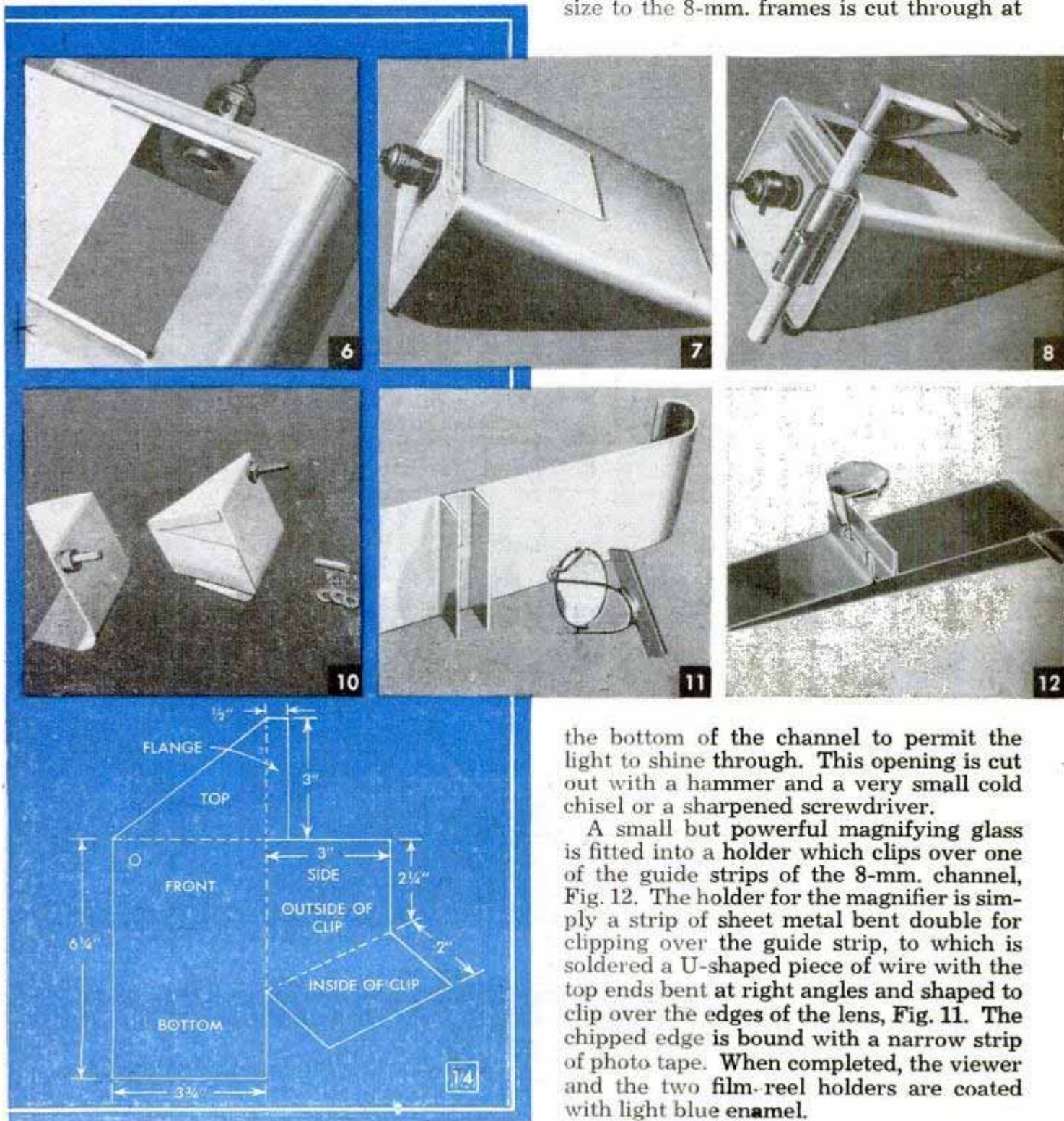

the bottom of the channel to permit the light to shine through. This opening is cut out with a hammer and a very small cold chisel or a sharpened screwdriver.

A small but powerful magnifying glass is fitted into a holder which clips over one of the guide strips of the 8-mm. channel, Fig. 12. The holder for the magnifier is simply a strip of sheet metal bent double for clipping over the guide strip, to which is soldered a U-shaped piece of wire with the top ends bent at right angles and shaped to clip over the edges of the lens, Fig. 11. The chipped edge is bound with a narrow strip of photo tape. When completed, the viewer and the two film-reel holders are coated with light blue enamel.

Mower Converted to Hand Truck Will Carry Light Loads

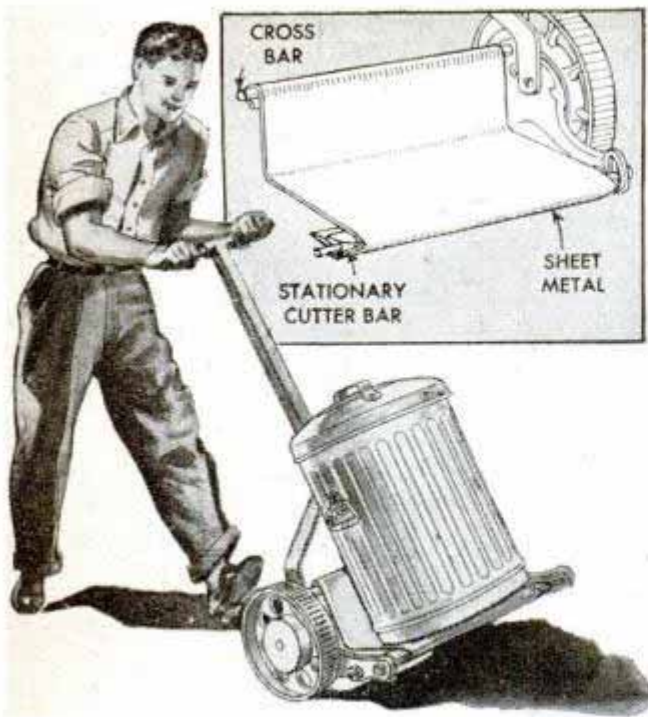

By removing the entire rotating cutter bar assembly from an old lawn mower, you can make a hand truck that will carry light loads. A piece of sheet metal that fits between the wheels is bent at right angles and the back and lip are secured by bending them around the cross bar and the stationary cutter bar.

C. C. Spreen, Detroit, Mich.

Sandpaper on Poison Container Indicates Danger in Dark

It's easy to mistake a bottle containing a perfectly safe liquid or pill for one that has



a poison when searching through the medicine cabinet in the dark. To prevent this, glue pieces of coarse sandpaper on the sides and caps of such containers. It's difficult to make a mistake when bottles are identified in this way. For a bottle that has sides which are more or less flat, a sheet of sandpaper is used; for a bottle that has rounded surfaces, the paper is cut into small pieces.

Mrs. Glad Lee, Los Angeles, Calif.

Adjusting Length of Plumb Line

Here's a reel that you can attach to a plumb bob quickly and easily. The reel should be cut from some nonrusting metal, such as aluminum or brass, and burrs are filed from the edges so the cord will not be cut when handling the line and reel. To adjust the

plumb bob, wrap the cord around the reel until the bob is at the right height, then engage the cord in the notched end.

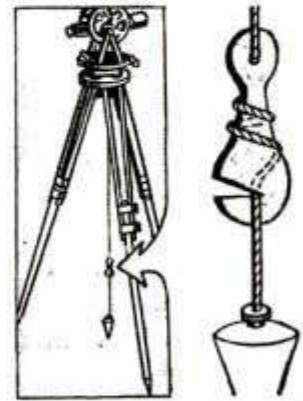

Unused Chimney Can Be Covered

When a chimney is not in use, the opening should be covered so that rain will not fall down the stack. One way of doing this is to lift the cap on the chimney and insert an asphalt shingle between it and the brick. After the cap has been replaced, the edges of the shingle are trimmed so they will not project beyond the chimney.

E. C. White, Medford, Okla.

Files Hold Phonograph Records

Old file cases can be converted to phonograph record holders with the addition of spacers. The type of records contained in the case—vocal, dance, symphonic, etc.—can be labeled on the back and an index to the individual records is lettered on the side that opens.

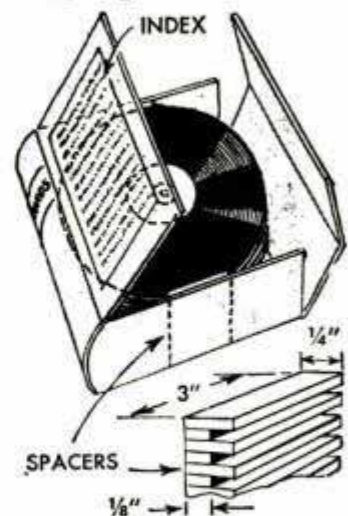

☐ If you have a cherished vase on display it is a good idea to weight it with sand. If this is done, there is much less chance of knocking it over.

CRAFT QUIZ



1. This wood eventually will be—
 (a) Plywood (c) Core stock
 (b) Paper (d) Veneer

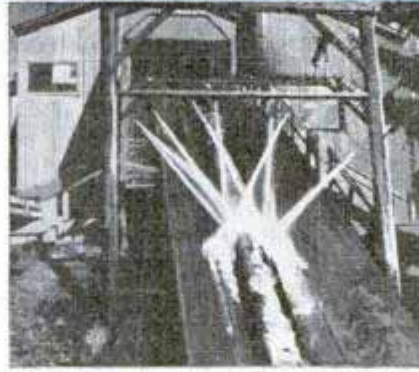

2. Log is entering a mill on the—
 (a) Runway (c) Bull chain
 (b) Skidder (d) Douser

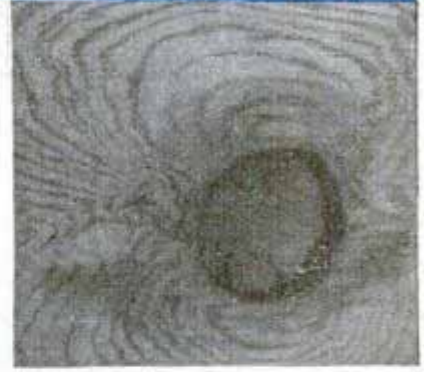

3. Board with loose knots graded—
 (a) Select (c) # 3 common
 (b) # 1 common (d) 1sts and 2nds



4. Lumber sorting table is called—
 (a) Long John (c) Wood path
 (b) Green chain (d) Grader



5. If you want him, yell—
 (a) Puler (c) Windjammer
 (b) Boom man (d) Water skate

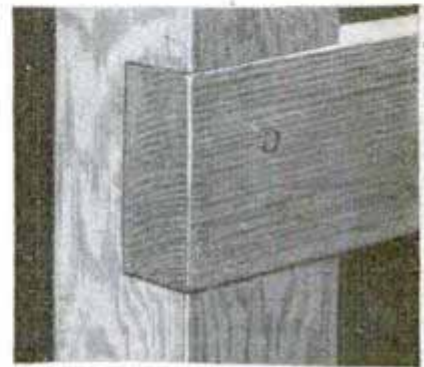

6. A "two by four" is—
 (a) 1 5/8" thick (c) 3 1/2" wide
 (b) 4" wide (d) 8' long



7. Forest harvest is called—
 (a) A hot seat (c) A cold deck
 (b) A skid road (d) A log jam



8. This chap is a—
 (a) Bucker (c) Grease monkey
 (b) Widow maker (d) Topper

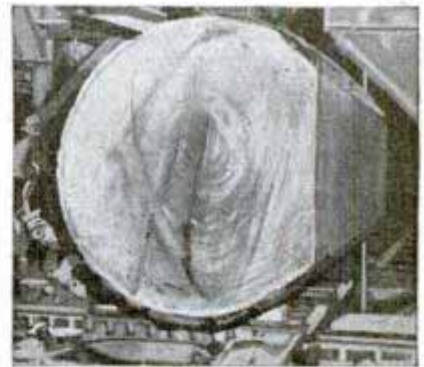

9. Here's a log at the—
 (a) Headrig (c) Carrier
 (b) Tailgate (d) Dump



10. Steam engine in the woods is a—
 (a) Bull (c) Monkey
 (b) Snort (d) Donkey

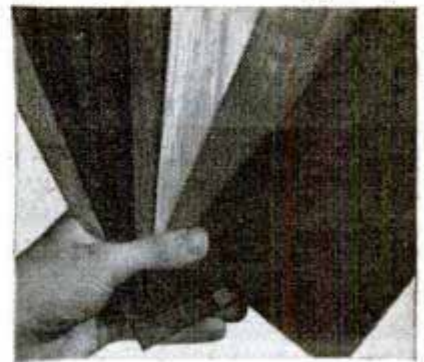

11. Odd wood here is—
 (a) Prima vera (c) Rosewood
 (b) Teak (d) Walnut

Photos courtesy American Forest Products Industries, Inc.

ANSWERS: 1—b; 2—c; 3—c; 4—b (lumber is green and unseasoned on this grading chain); 5—b; 6—a (dressing always reduces the named mill dimension); 7—c; 8—a; 9—c; 10—d; 11—c (tech. rosewood and walnut are very dark in color)

Plastic Cigarette-Package Holder Will Decorate Desk

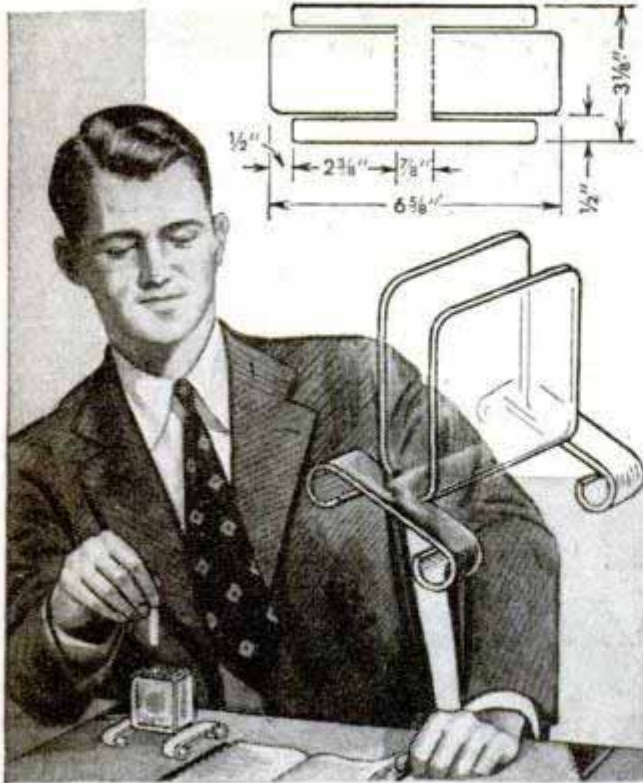

Made from $\frac{1}{8}$ -in. sheet plastic, this holder will keep cigarettes from spilling over the desk. Cut the material with a fine-tooth hacksaw and round off the corners with a file. Then smooth the edges with fine sandpaper until no cutting or filing marks are visible. Heat the plastic in an oven and bend to the shape illustrated. A $\frac{7}{8}$ -in. strip of wood is used as a form to bend the sides and the curved feet are bent around a dowel. Gloves should be used to handle this material after it is removed from the oven. After bending each strip, fasten with masking tape to hold it in place. It may be necessary to reheat the plastic and repeat the bending process.

Wrench for Socket-Head Screws

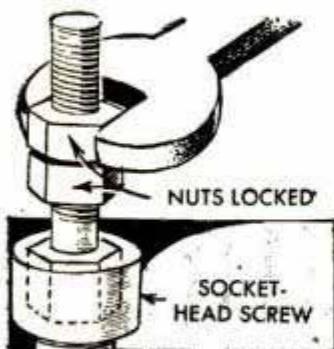

A wrench for socket-head screws can be improvised by using a hex-head bolt that fits the recess in the screw. Turn two nuts onto the bolt. Then fit the bolt head in the socket and tighten.

Piano Hinge Is Used on Folding Table-Tennis Table

In many cases it is desirable to have a table-tennis table that can be folded when not in use. I find that a piano hinge is ex-

cellent for this purpose, as it keeps the table from warping or twisting and does not interfere with the playing surface in any way.—Robin F. Tiesier, Easton, Pa.

One Way to Avoid Spilling Salt Carried in Lunch Box

To avoid spilling salt and pepper carried in his lunch box, one workman places a piece of waxed paper over the open mouth of the container and then screws on the cap. When lunch time comes the paper is removed and the shaker is used. After use, the paper is replaced in the top of the cap. On shakers that do not have screw tops, the paper can be held in position with rubber bands.



Salt Shakers Cut From Walnuts Are Novel Decoration

For those who like a touch of novelty in table appointments, these salt and pepper shakers made from black walnuts furnish an unusual touch. The base for each is a walnut half, with the end cut and recessed to provide a blind hole in which the cork is glued. To make the body of the shaker, a hole is drilled in a whole nut to fit the cork snugly and small holes are drilled in the top. The shakers are sanded lightly and finished with clear shellac.

R. M. Madden, Kansas City, Mo.

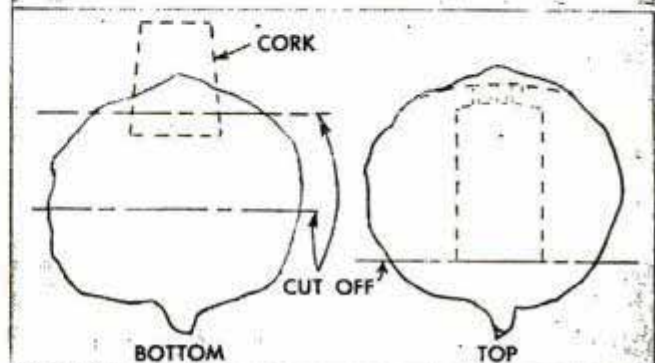
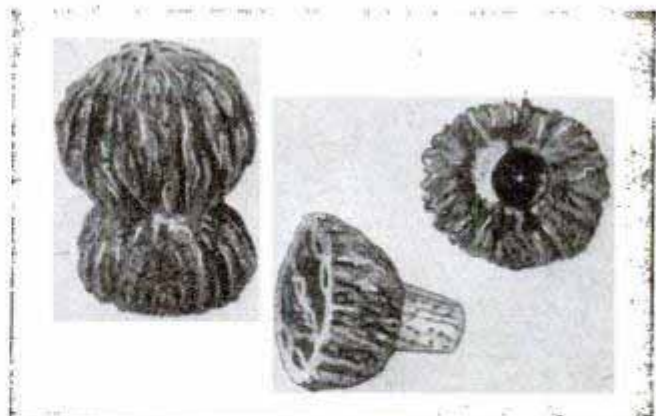



Shop Notes

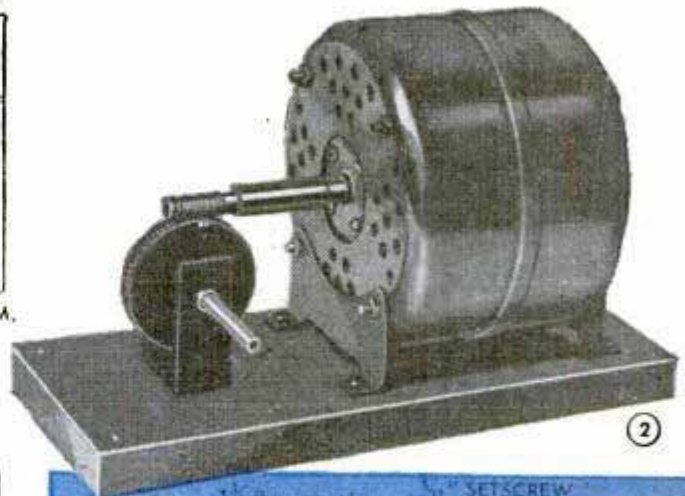
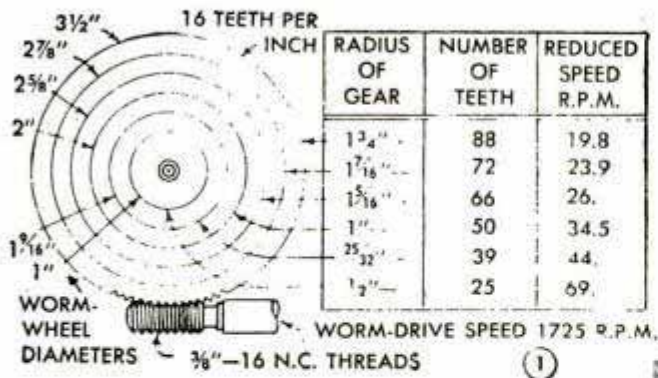

Make Your Own Speed Reducers

By Alexander Maxwell

IF YOU have liquid solutions that call for steady, monotonous stirring, photo developers that require measured agitation, mechanical toys or slow-motion window displays which must be power driven, then you have use for these simple speed reducers. By consulting the reduction table, Fig. 1, you will see how the speed of a 1750-r.p.m. motor can be reduced for various purposes. Any small motor, Fig. 2, will do for light drives. Fig. 3 gives the general dimensions for a 3/8-in. worm and Fig. 4 shows how the threads are lapped with a hard slipstone after cutting in the lathe. The worm should be of steel and for low-powered motors and light loads it need not be hardened. The wheel can be of bronze, Bakelite, mild steel or even a close-grained hardwood such as maple. When turning down the blank for the worm wheel, Fig.

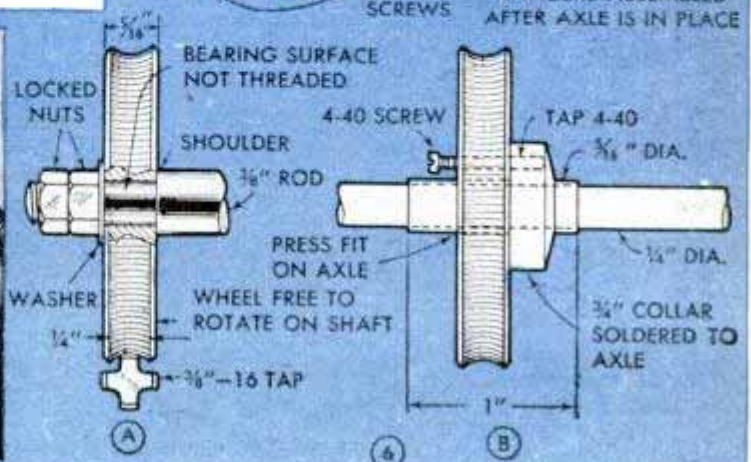
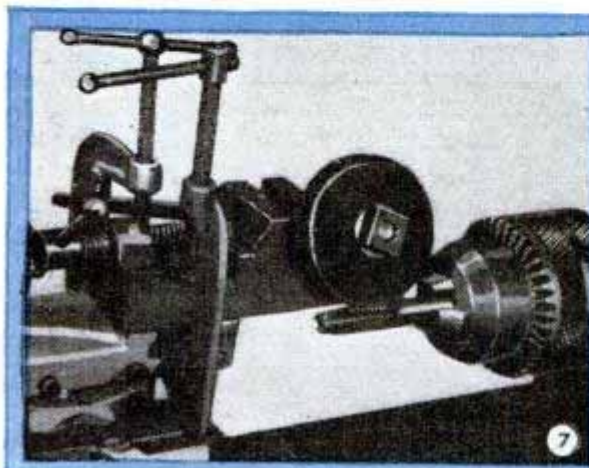
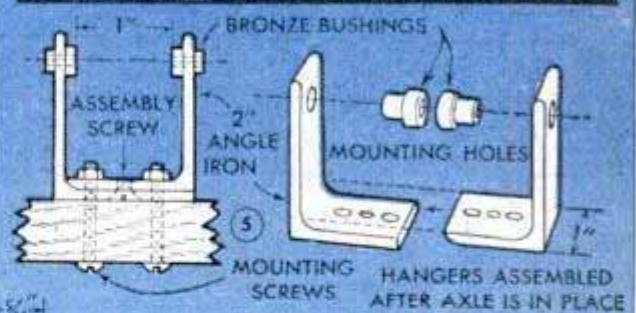
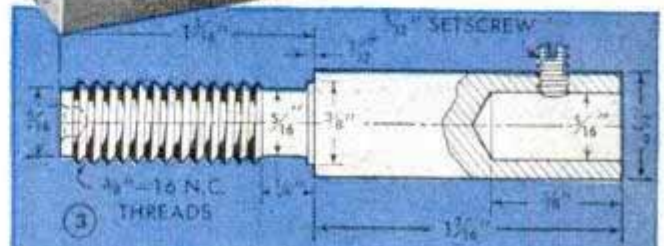

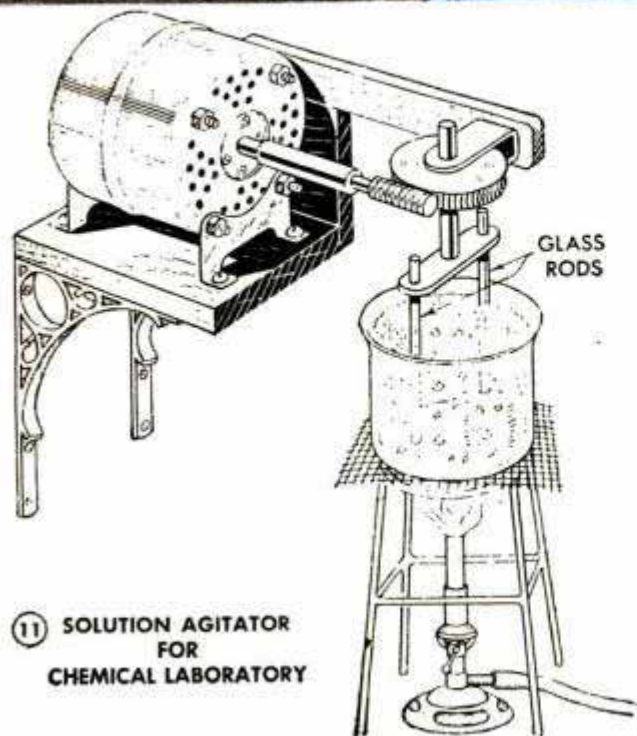
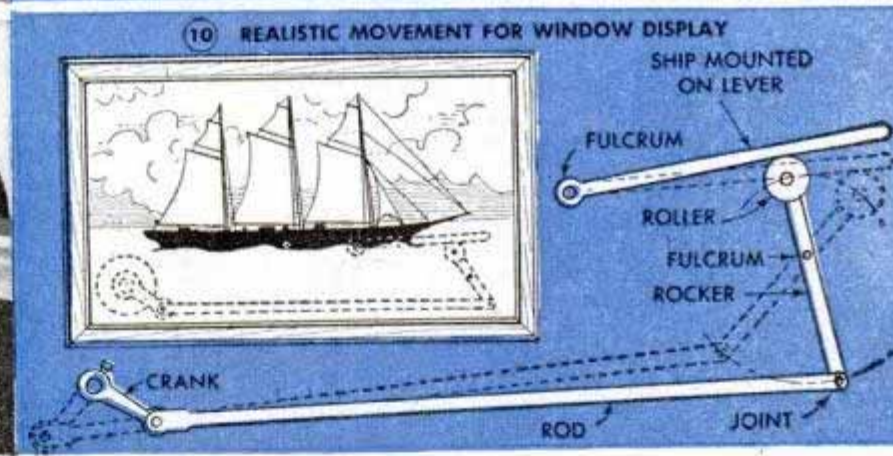
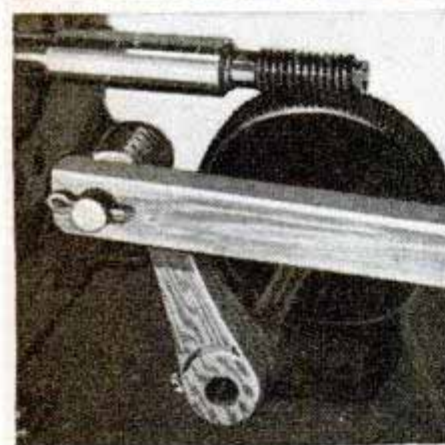
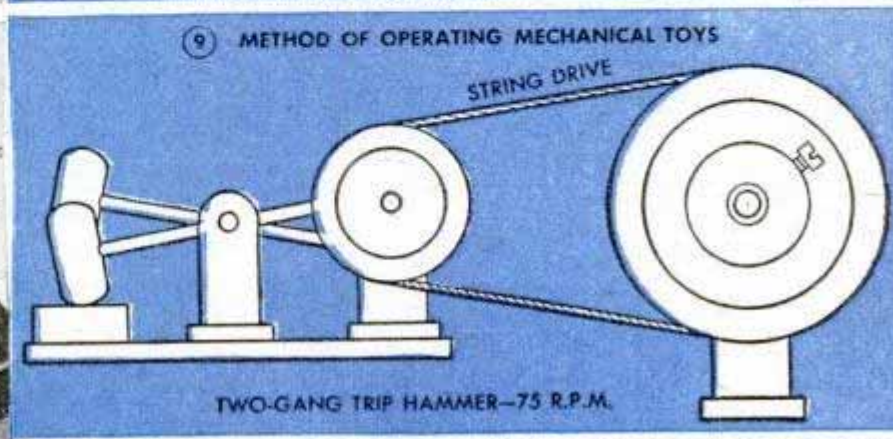
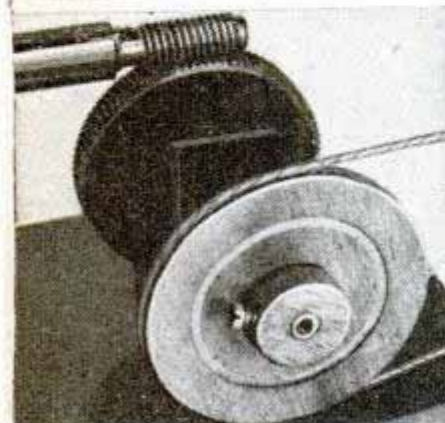
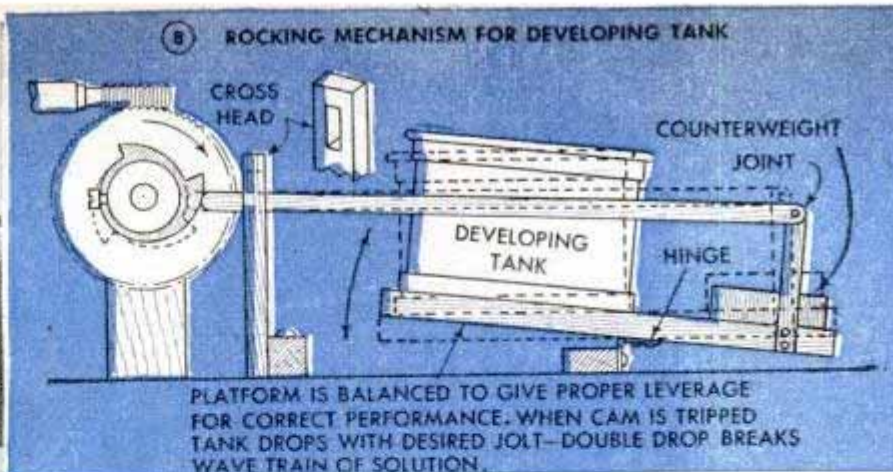
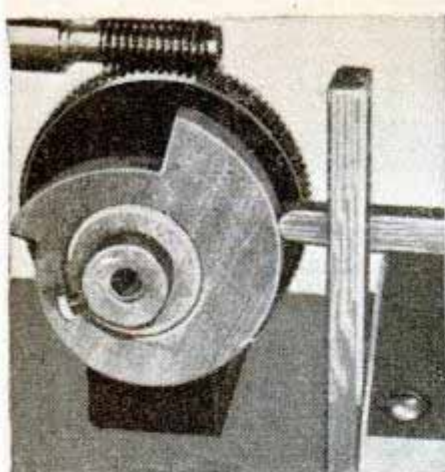

6A. allow a slight plus or minus on the diameter required, as you will note from Fig. 1 that the teeth do not come out in even fractions of an inch. Mount the blank on a short arbor as in Fig. 6A, lock it in a drill vise and then mount the whole thing on the lathe tool post as in Fig. 7. The cutter you see in Fig. 7 is a $\frac{3}{8}$ -in. tap held in a chuck driven by the live spindle. In feeding the wheel into the cutter, advance it slowly and take extremely light cuts. Continue until the teeth are cut full depth.

Mount the wheel on a shaft as in Fig. 6B. Hangers cut from angle iron and fitted with bronze bushings as in Fig. 5 support the wheel when mounted with the motor on a base as in Fig. 2. Adjust pressure of the worm by using wedges or shims under the motor mounting feet. Figs. 8 to 11 inclusive show a number of practical applications of this type of reduction drive.

Twin-Tool Holder Speeds Machining of Shafts

With this double holder you can eliminate several separate operations when turning shafts. It can be formed from ordinary steel to the shape indicated in the upper left-hand detail. The roughing tool runs ahead of the finishing tool. When in use, the roughing tool is turned upside down. When in use, the roughing tool is set to cut to the desired depth in the work.—Adolph Brauns, Bronx, N. Y.

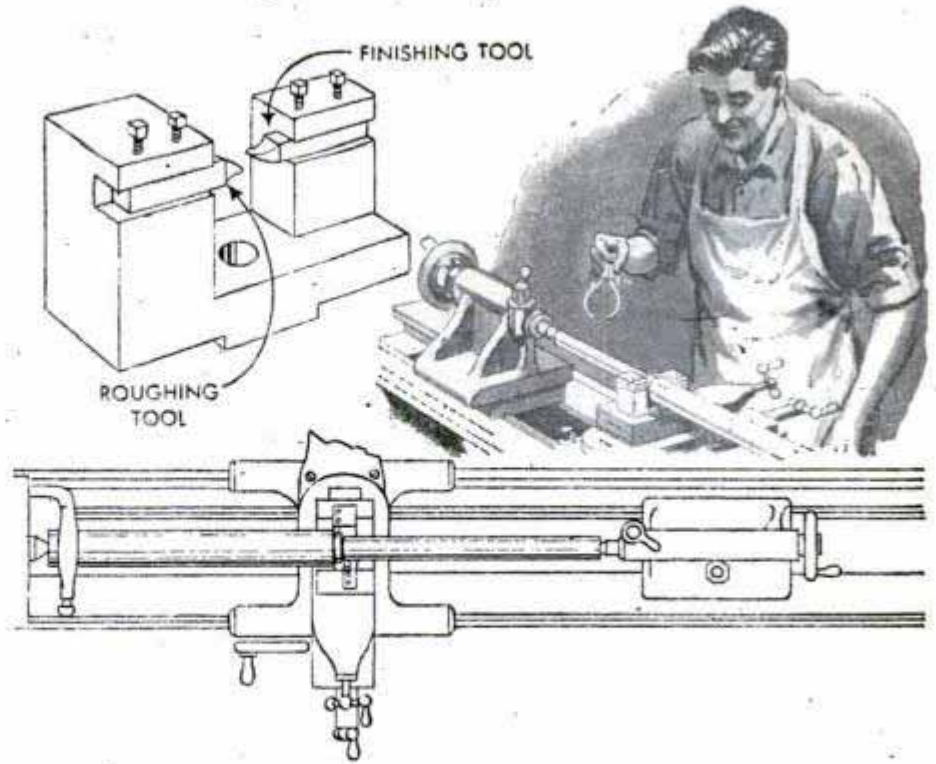

Clean Your Own Spark Plugs With a Hand "Sandblaster"

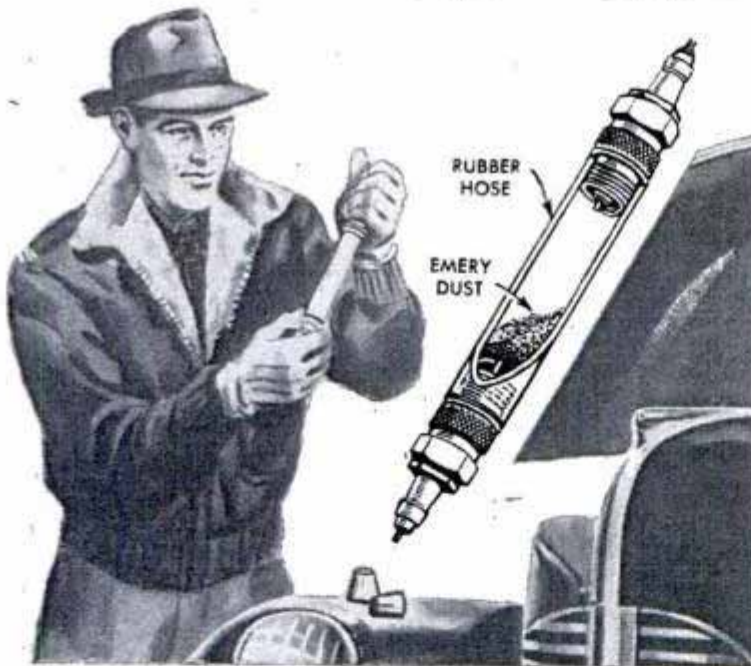

An 8-in. length of garden hose and a few ounces of medium-grade emery dust are all that are needed to "sandblast" dirty spark plugs. The emery is placed in the hose and a spark plug is "screwed" into each end. After several minutes of vigorous shaking, the plugs should be clean. Before the plugs are replaced, they should be washed thoroughly in gasoline to remove all traces of grit. When not in use, the ends of the hose are plugged with rubber stoppers to retain the emery.

Making Small Steel Springs

In making small springs of round steel, use a good grade of oil-tempered material and wind it cold. Because of the recoil, it may be necessary to experiment until the right size mandrel is obtained. Spacing is controlled by the feeds on your lathe. For round or flat steel springs, using an untempered spring steel, heat to a cherry red and then form, maintaining this heat as closely as possible while shaping the spring. Then bring the piece to a cherry red again and quench in fish oil. When the spring has cooled sufficiently, hold it over a flame until the oil starts to burn off.

Cork Floats Dairy Thermometer

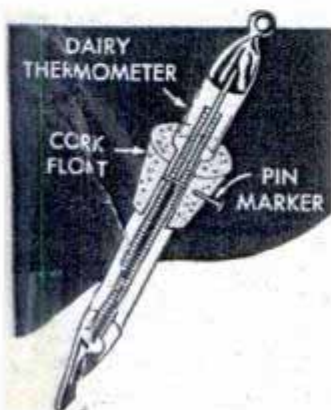

A large cork, drilled to receive a dairy thermometer and float it in the milk, may be made more serviceable by slotting one side to make the column of mercury visible. A straight pin inserted across the slot will serve as a marker.

Beeswax makes an excellent lubricant for use when tapping or turning copper, brass, aluminum and similar materials.

Barbwire Spool Handled Safely In Metal Feed Basket



To avoid the numerous—and more or less serious—injuries that accompany handling spools of barbwire on fencing jobs, one farmer uses a metal feed basket to carry or load the spool with safety and convenience. The basket is laid on its side to roll the spool in or out.

Stretcher Made From Auto Rim And Length of Pipe

Made from a section of auto-tire rim and a length of pipe, this wire stretcher will enable one man to take up the slack in short runs of barbwire fencing. The rim is

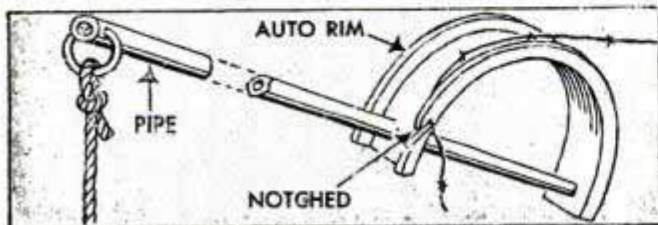

cut in half and drilled, receive a 7-ft. length of 1 1/4-in. pipe. A notch near one end to engage the rim acts as a fulcrum for the wire. In use the lever. A rope can be used as the lever when tightening the wire, which should be securely fastened in the notch to avoid any danger of slipping.

Temporary Hanger for Piping

As a temporary hanger to support overhead piping, a short length of chain and two bolts will serve. A bolt is slipped through each end of the chain and fastened to an overhead member.

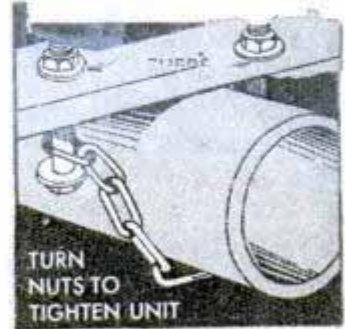

Washers are placed under the nut and head of the bolt. The bolts should be drawn up tight enough to hold the pipe rigid, but not so tight that "creeping" caused by expansion and contraction would be restricted.

Book End Supports Display Card

Showcards that are lettered on both sides for display on a counter or showcase may be supported with metal book ends. The signs are made of lightweight cards and are stapled, back to back, around three sides to form a pocket which fits over the book end.

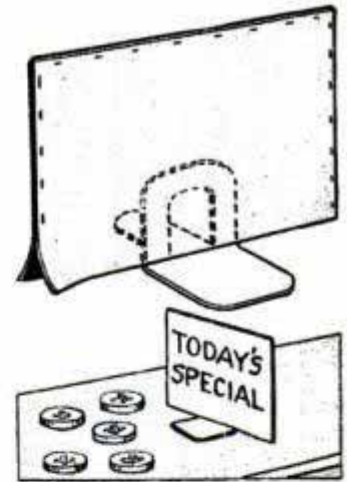

Exterminator Applied to Crevices Through Oilcan Spout

Inaccessible cracks and crevices in the chicken house can be reached with lice exterminator by using an oilcan having a long spout. If a dry powder is used it should be a fine grit that does not tend to stick together or to the container. It may be necessary to cut off a part of the spout so the hole will be big enough.



The hopper is raised for dumping by a hydraulic cylinder, Fig. 11. Arrangement of the hydraulic system is shown in Fig. 12 and the drive to both the hydraulic pump and the mixer is detailed in Fig. 15. Raising and lowering of the hopper is controlled by a 3-way valve, Figs. 11 and 12. By-passing the hydraulic fluid allows the pump to be operated continuously, thereby simplifying the drive. The vibrator shaft, Fig. 15, is pedal-operated and runs only when the pedal is depressed. One belt from the two-step cone pulley passes around an idler. The pulley driving the vibrator is located

between the driving pulley and the idler as shown in Fig. 15. When the pedal is depressed the center pulley engages the belt, and "throw" of the off-center weights, Fig. 11, vibrates the mold. The mold must be held rigidly in place for this operation and Fig. 11A details the quick-acting clamping device especially made for this purpose.

The mold and the ejector, Figs. 2 and 3, are made for three blocks. There are two cores in each compartment of the mold and note especially that each core is vented, Fig. 2, and tapered slightly so that it will draw easily without breaking the edges of

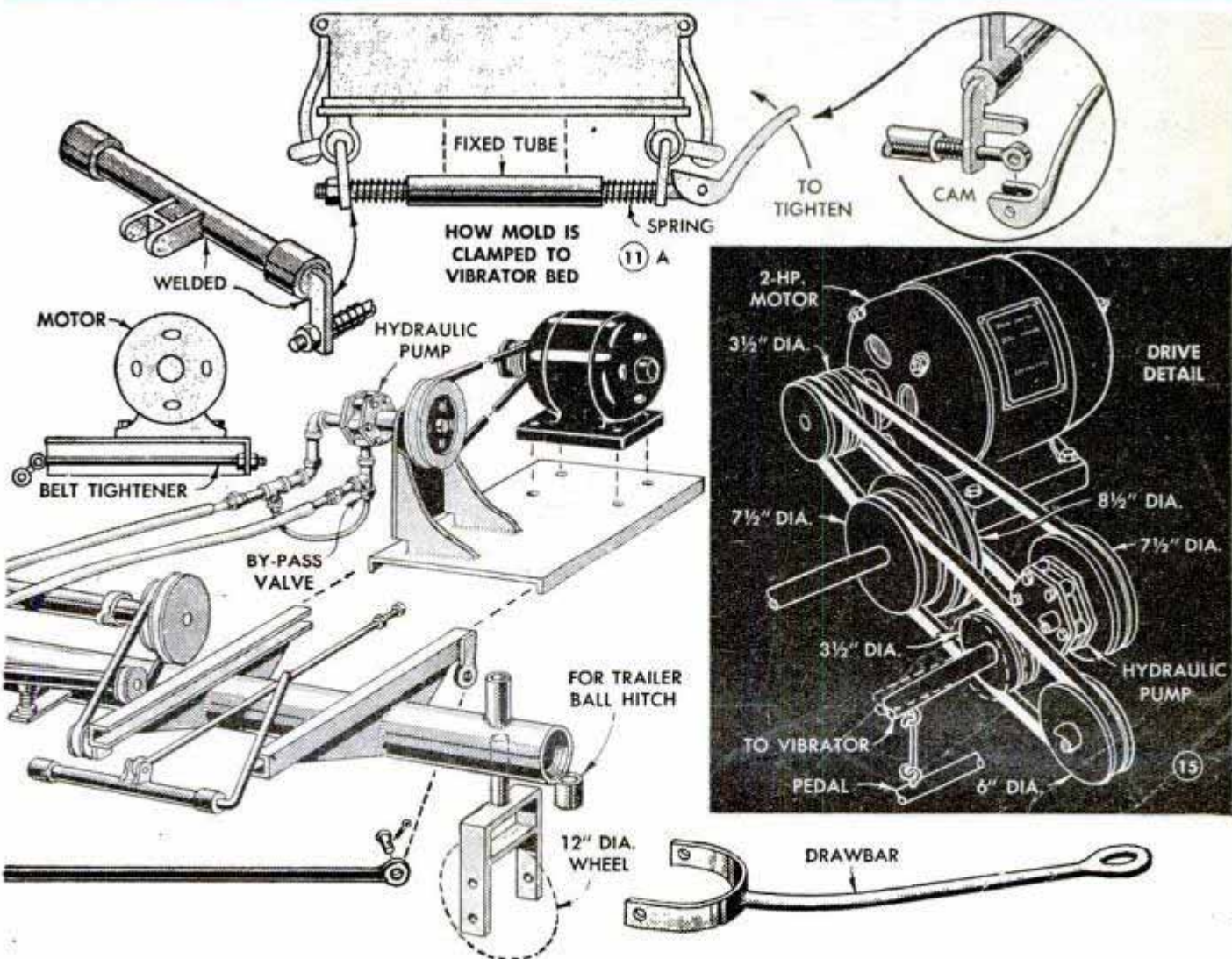
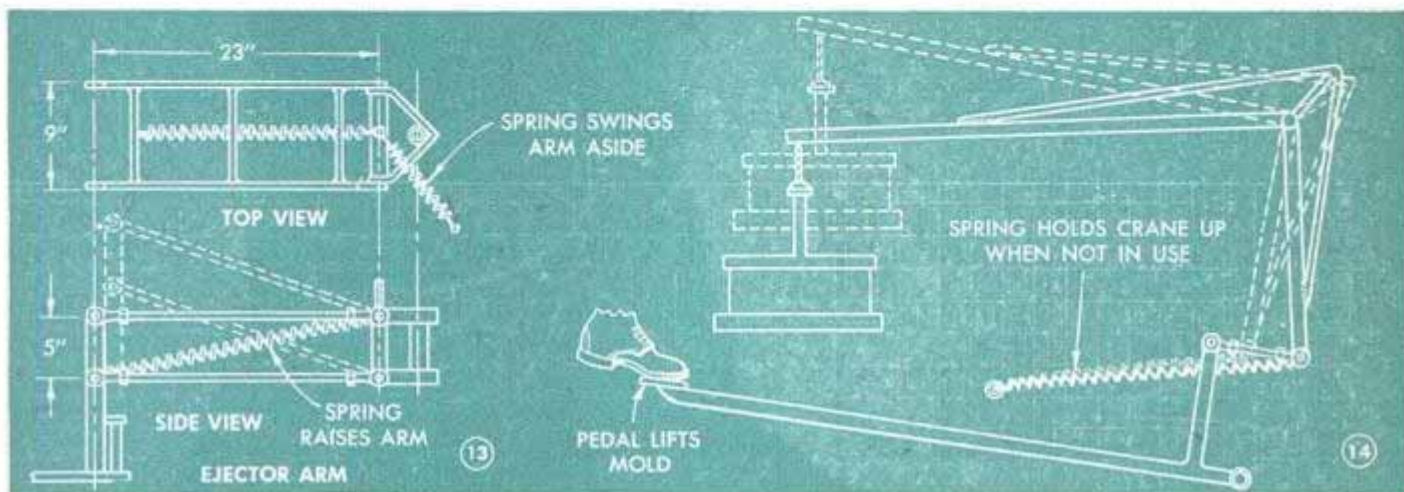

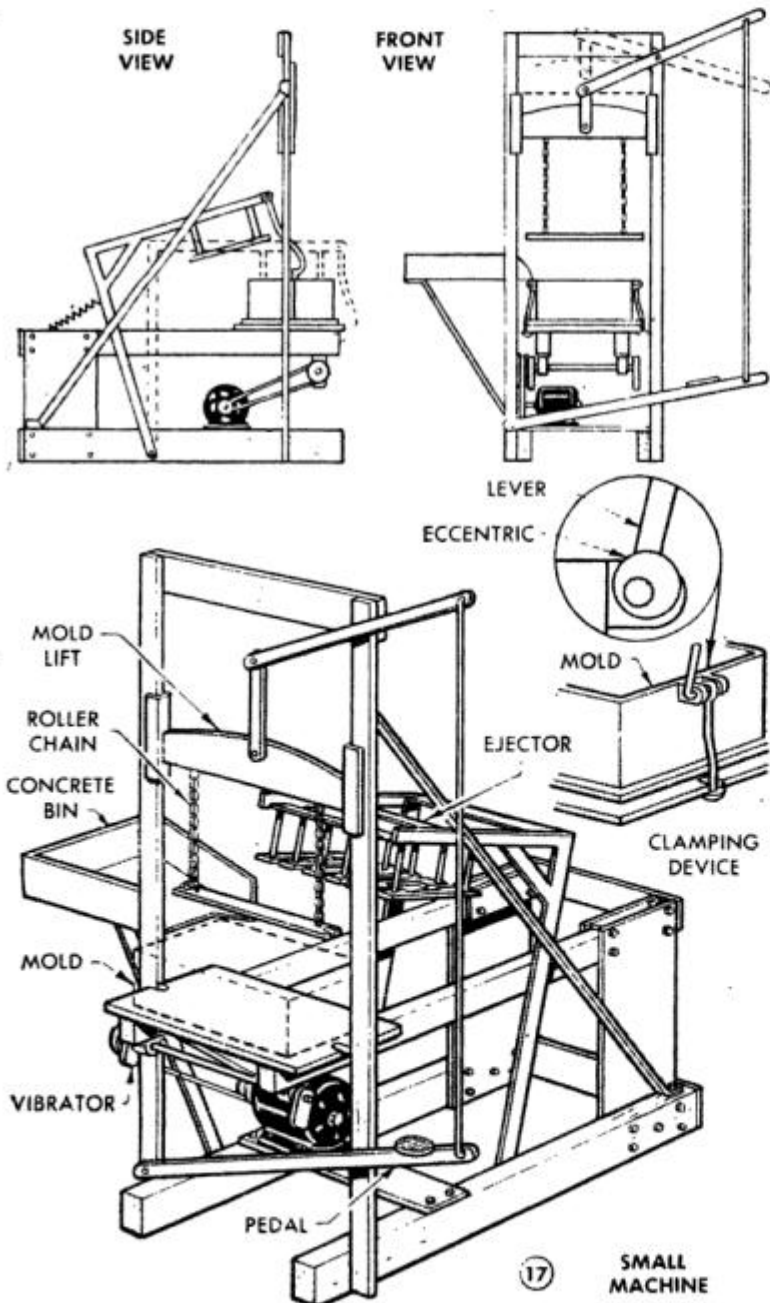
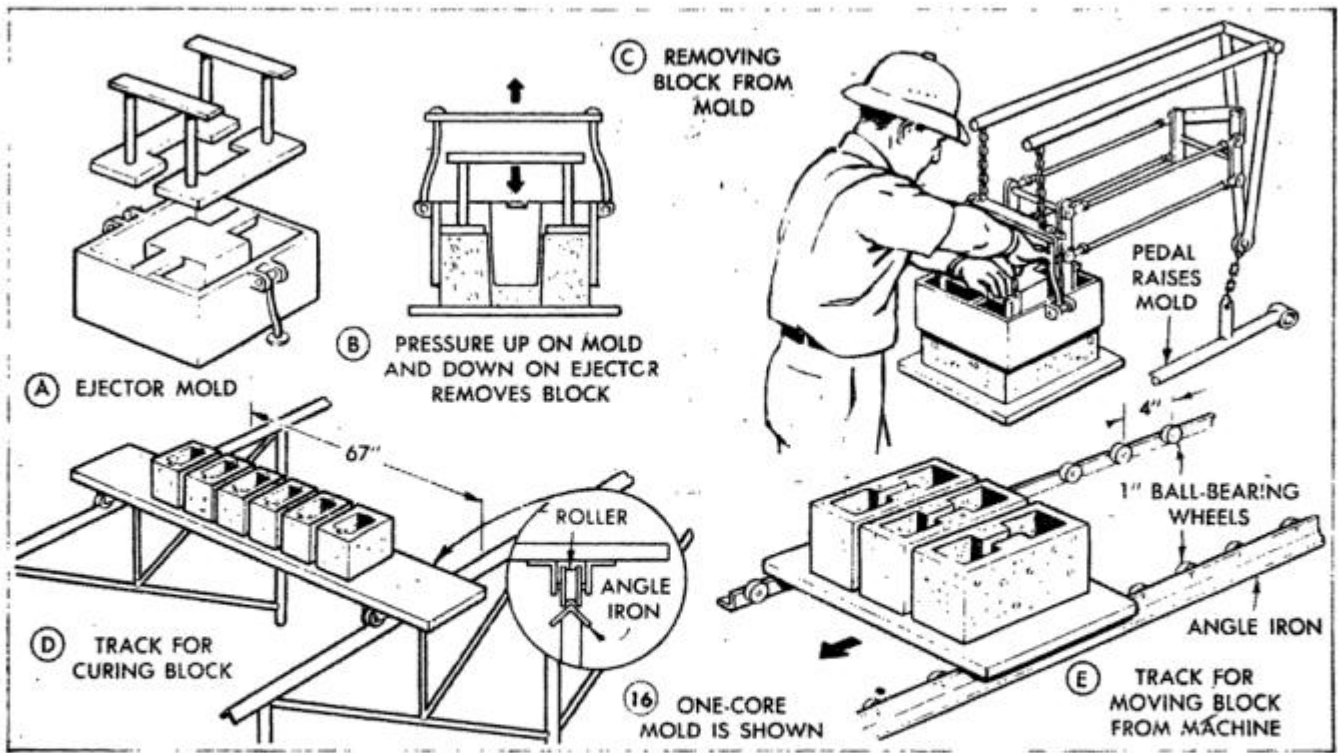

the block. Cores can be cast from a rich cement-sand mixture or they can be made of heavy sheet metal, welded. Where facilities and materials are available, they also could be cast from aluminum.

Fig. 16, details A to E inclusive, shows a one-core mold, A and B, which is suitable for certain special types of blocks. Detail C supplements Fig. 6 and shows more clearly the procedure and placement of the hands in ejecting the block from the mold, while details D and E suggest types of elevated tracks or rails for moving blocks away from the machine and to the curing yard, as in Fig. 7. Curing racks of any convenient size may be assembled from hardwood boards, steel angles and flanged rollers as in Fig. 16 D. Detail E suggests one way of providing for easy handling of the blocks from the machine to the curing racks.

General assembly views of a hand-operated machine for making a few blocks at a time are given in Fig. 17. Here most of the work is done by hand, only the vibrator being motor driven. It's easy to build for either a one, two or three-block mold. Proportions of the mix which have been found most satisfactory are 7 parts pea gravel, 12 parts sharp sand, 2 parts silt and $2\frac{1}{2}$ parts portland cement. The amount of water is determined by experiment as it depends on the dampness of the aggregate.

Trash Cart Has Scoop That Pivots With Handle

Here's a handy trash cart that will pick up leaves and other debris in the scoop and, when the handle is reversed, dump the trash into the bin. The cart is pulled by the user instead of being pushed. The wheels are taken from an axle assembly and fitted with a flat-iron cradle that holds the bin. The handle is made of pipe and the scoop is fastened to it and braced in such a manner that it will pivot with the handle.—Wm. P. Houser, Organ, N. Mex.



Scale Attachment for Calipers Aids in Measuring Work

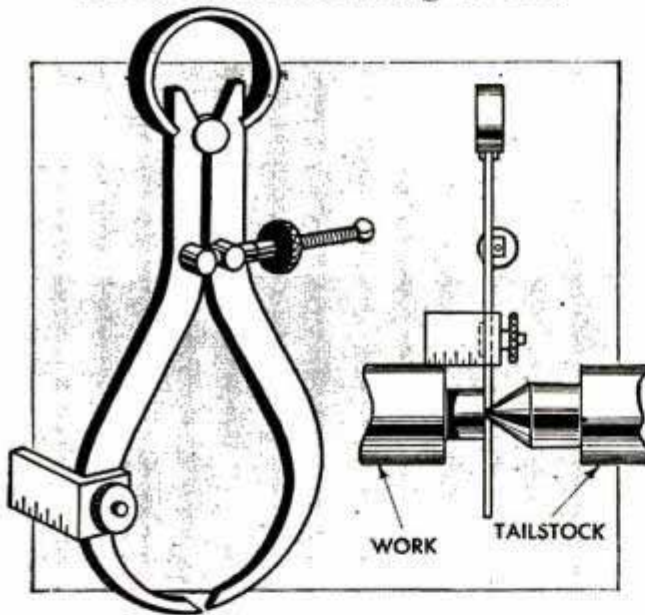

When turning a shoulder on shafting or other round work, it is frequently difficult to measure the length of the shoulder. If the dimension is not critical, a scale can be attached to a pair of calipers to obtain a quick reading. It is formed of flat iron and fastened to one leg of the caliper with a screw and knurled nut for easy removal. In use, one leg of the caliper is held flat against the end of the shaft and the desired dimension is read on the calibrated scale.

H. Moore, Kirkstall, Leeds, England.

Mechanics' Hand Soap Paste

For a hand soap that will get the dirt out, try the following mixture: white soap chips, 1½ lbs., borax, 6 oz., dry sodium carbonate, 3 oz., coarse pumice, 2 lbs., glycerine, 2 oz., and water, 3 pints. Dissolve the soap in

2 pints of water by heating and dissolve the borax and sodium carbonate in the remaining pint. Mix the solution thoroughly, add glycerine, stir in the pumice and then pour into suitable containers. You can vary the amount of water for a heavier or softer paste.

Modified Triangle Saves Time And Speeds Drawing

To eliminate the bother of changing triangles, a 45-degree triangle can be modified to serve as a 30, 60 and 90-degree triangle as well. The dotted lines show the original triangle and the solid lines show it after the new angles were cut. The 60-degree angle is made at the apex of the original 90-degree angle and the 30 and 90-degree angles are formed by altering the shape of the inside triangle.

D. A. Williams, Detroit, Mich.

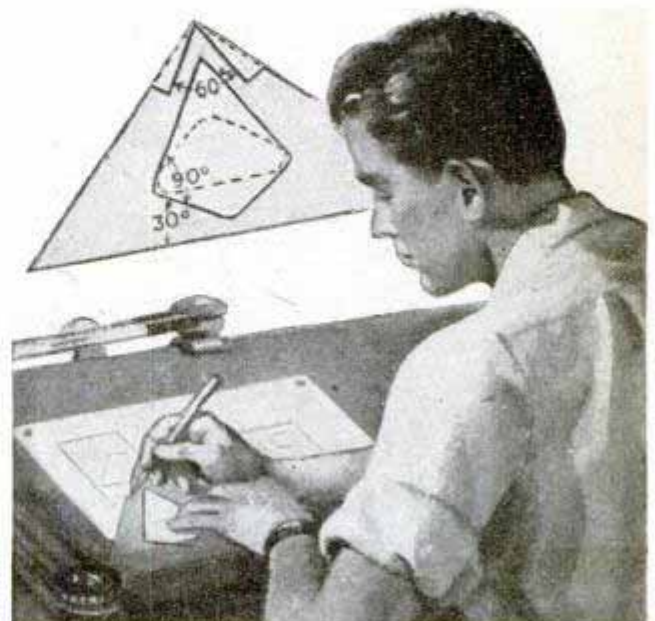

Quiet!

VIBRATION-

80 TO 90% OF THE NOISE DUE TO VIBRATION CAN BE ELIMINATED FROM HOME POWER TOOLS SUCH AS THE ONES SHOWN BELOW

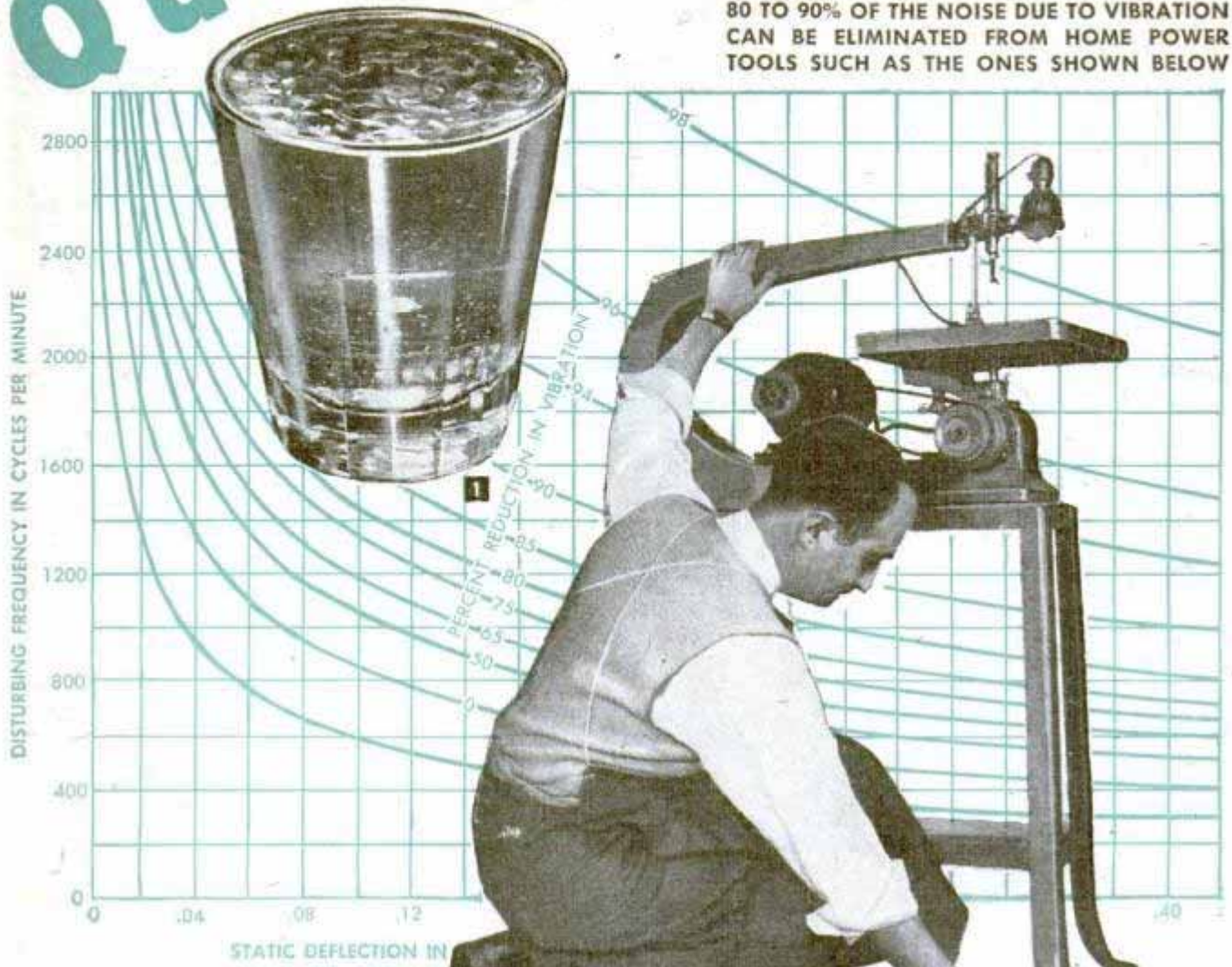

Vibration insulators are merely slipped underneath the legs of the machine stand, no attaching screws being necessary

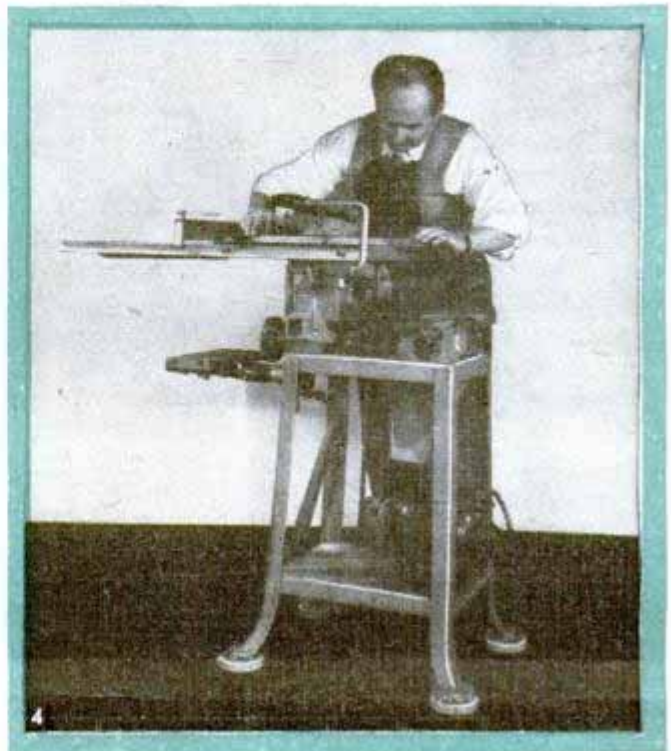
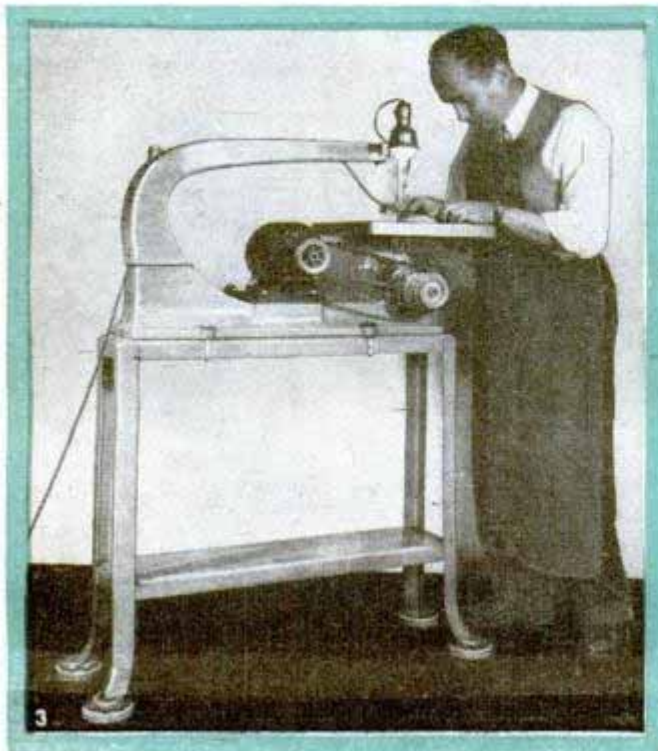

DAMPEN YOUR SHOP TOOLS

VIBRATIONS set up by power tools can be annoying, especially when the shop is in the home or an adjoining building. In some cases there may be an objectionable vibration set up by transmission of the mere hum of moving parts to connecting floors or walls which amplify the noise. Methods of applying vibration insulation to small power tools are use of rubber shims and cushion mountings for motors and parts, where applicable, and use of insulators under feet of supporting bases. In the first case both rubber shims and cushions can be used in the vertical or horizontal positions, while in the latter application direct compression and shearing-type insulators may be used. Rubber is most practical for workshop tools. Shearing and compression methods of loading rubber are illustrated in Fig. 20. For a visual check on vibration amplitude place a glass of water, Fig. 1, on the floor near a running machine or directly on it and notice, by reflected light, the strength and size of the "waves" set up on the water surface. Vibration rates can be plotted as indicated by the chart, but for practical purposes this is not necessary. Designing of insulators for use under the base of small power tools such as shown in Figs. 3, 4, 5 and 6 calls for the employment of engineering principles. An efficient design will reduce vibration by at least 80 percent. Ideal vibration insulators for the home-shop power tools can be made of ordinary materials and one design will be suitable for most small tools mounted on stands. It

By Kenneth Murray

combines both shearing and compression actions, Fig. 19,

and is self adjusting. Materials required are $\frac{3}{4}$ -in. plywood, a "live" automobile inner tube and a length of $\frac{3}{8}$ -in. dowel. Saw the plywood into the required number of 5-in. squares, one for each insulator, four insulators for each tool stand, and from each cut a round blank $4\frac{3}{8}$ in. in diameter on the bandsaw, as in Fig. 7. For rapid production use a jig clamped to the saw table, Fig. 8. Each square is centered over the projecting pin, pressed down and rotated against the blade. The same jig with a second pin is used for sanding.

With a compass set in the hole left by the pin, mark a 3-in. circle on each blank. A $\frac{3}{8}$ -in. pilot hole then is drilled through each blank just inside the circle. The drill-press table must be set at a 3-degree angle, Fig. 9. With the jigsaw table at a corresponding angle, cut out the center of each blank as in Fig. 10. The outside section forms the base of the insulator and the inside disk is the platform on which the leg of the tool stand rests. Plug the hole left in the edge of the platform with a short piece of dowel, using glue.

Each platform piece must be sanded down smoothly, and to keep the bevel, center the piece on the second jig pin and tilt the sander table to a 3-degree angle, Fig. 11. Disks are cut from the inner tube, using a $4\frac{1}{4}$ -in. cardboard template, Fig. 12. Lay two thicknesses on the base and press the platform into it as in Fig. 13. The platform should penetrate, under hand pres-

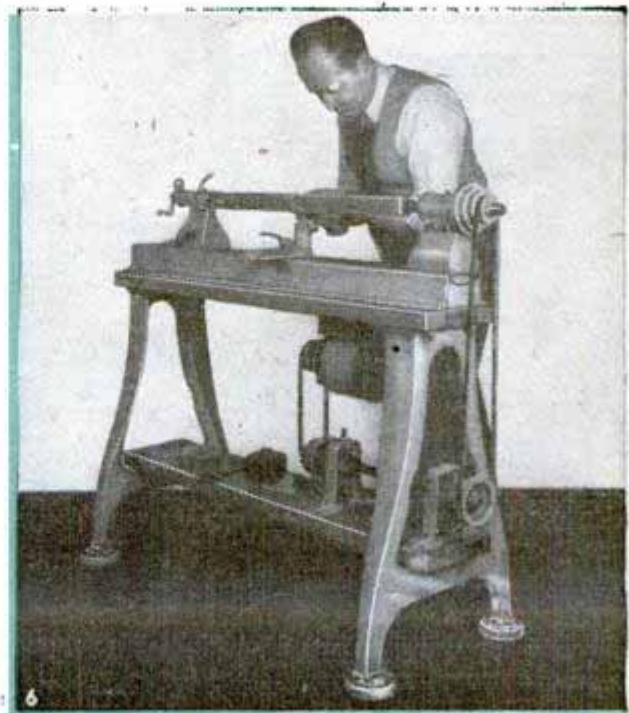



7
Disks sawed from squares of $\frac{3}{4}$ -in. plywood form the base of the vibration dampener for the common shop tools

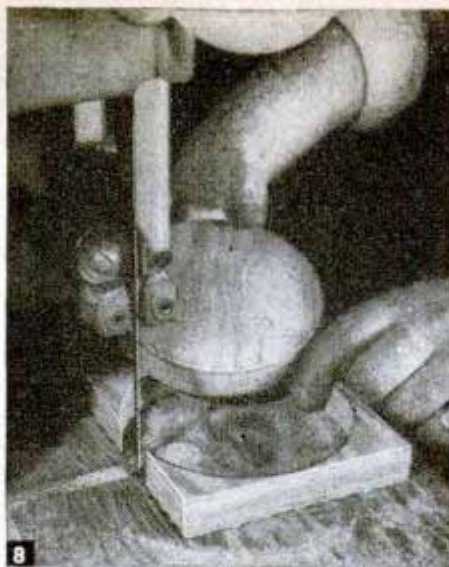

8
To assure accuracy and uniformity of size the disk is sawed out by turning the plywood block on a pivot pin

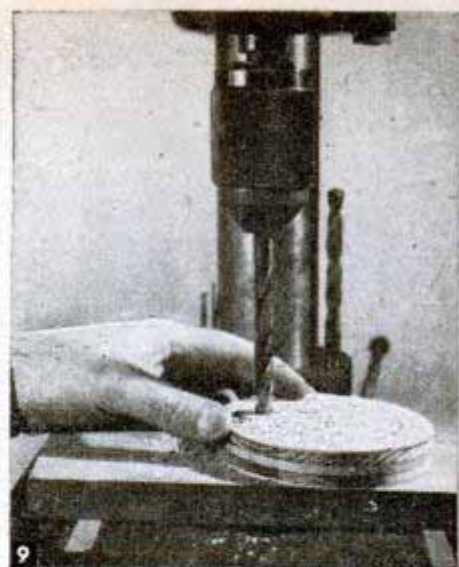

9
Then a $\frac{3}{8}$ -in. hole is drilled in the waste wood inside a scribed line so that a jigsaw blade can be inserted

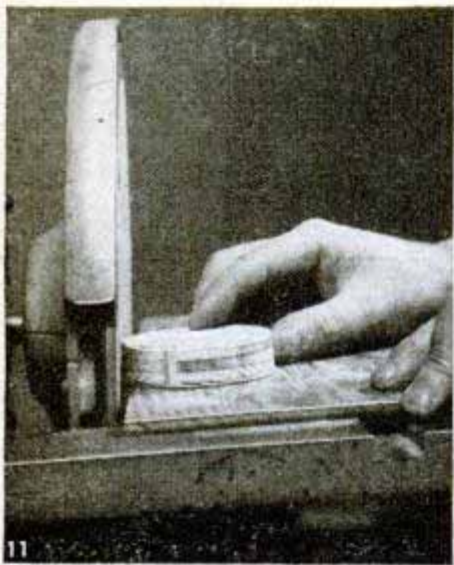

11
Disk is sanded smooth and the hole plugged with a $\frac{3}{8}$ -in. dowel. Sander table is tilted to a 3-degree angle



12
Using a cardboard template, disks are cut from "live" inner tube. Two rubber disks are required for each insulator



13
Over two thicknesses of rubber the disk should enter the ring not more than one fourth of its full thickness



15
If the insulators are used under a drill-press base an additional semicircular block is provided for a bearing

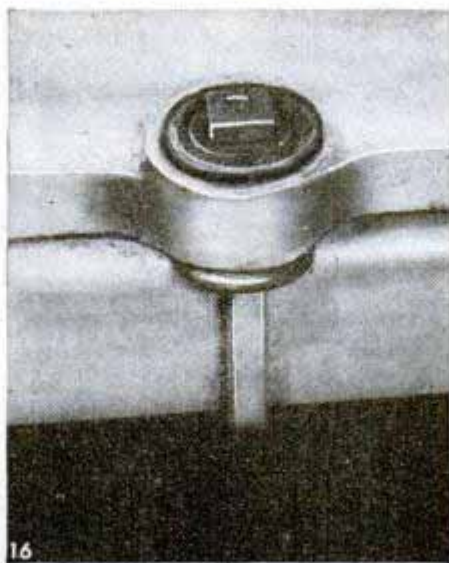

16
Rubber grommets that have lost their effectiveness should be replaced with either new parts or improvised ones

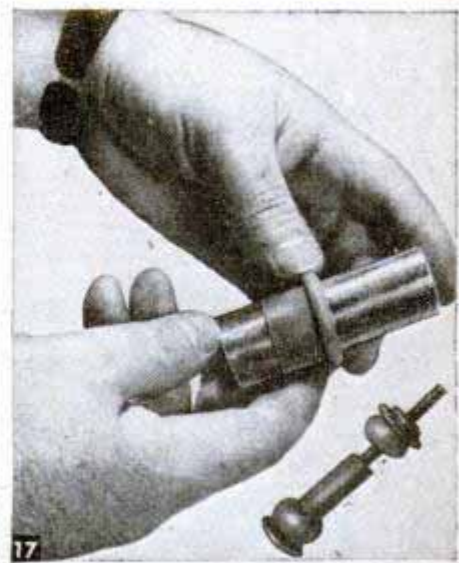

17
A substitute for ready-made grommets—just coat a length of rubber tubing with cement and roll the ends back

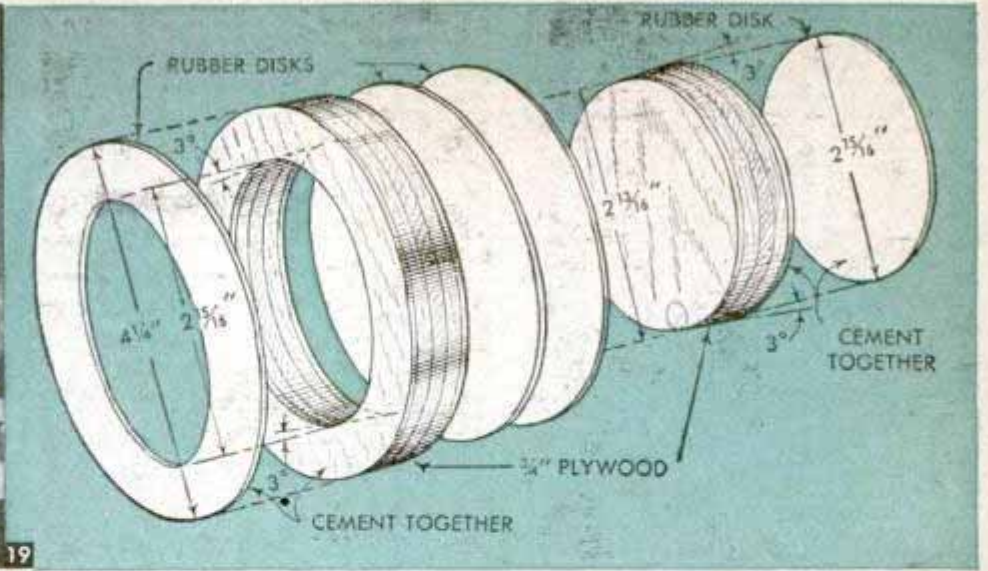

And finally, the center is sawed out of the disk leaving two separate parts, a ring and a matching inner disk

sure, one fourth of the way into the opening. Sand the outside of the base and give it one or two coats of shellac or varnish. Do not finish the inside surfaces. To avoid slippage in use, it is well to cement disks of rubber to the top of the platform and to the bottom of the base, as in Figs. 14 and 19. In use, the insulators are slipped underneath the legs of the power tool bases as in Fig. 2. Use of screws usually is unnecessary. When using insulation under a drill-press base of the type shown in Fig. 15, it may be necessary to add a wood block inside the outer flange.



Where insulators are not bolted to machine bases rubber facings are cemented to both the disk and the ring

Some power tools are manufactured with rubber cushions or grommets between parts to absorb vibration, but where they are not supplied, homemade substitutes can be provided. Sometimes the cushions, affected by oil and age, Fig. 16, deteriorate so that they are no longer effective. Often new cushions or grommets can be purchased ready-made, but an efficient insulating cushion can be made from rubber tubing and rubber cement. Slip the tubing over a suitable circular mandrel and roll down one or both ends, as in Fig. 17. Thick sections of rubber can be built up by punching holes in a strip and folding it accordionlike on a mounting bolt, Fig. 18. To absorb slight vibrations completely, use rubber heels cut into disks and provided, if necessary, with mounting bolts. However, these are suitable only for compression-type dampeners.

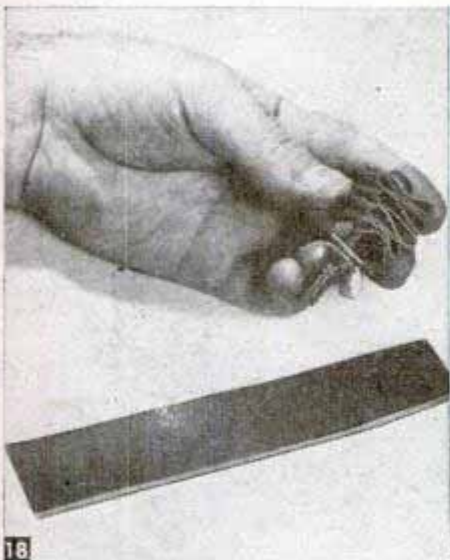

Rubber blocks are built up by punching holes in a strip, coating with cement and folding onto a mounting bolt

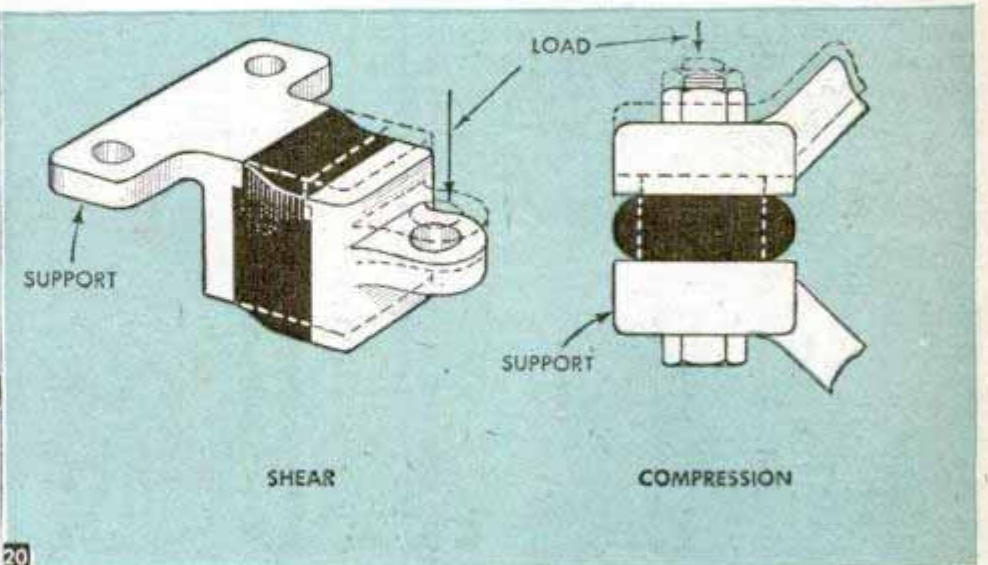

Shearing and compression methods of loading rubber are shown in the sketches above, which are only representative. The compression-type dampener is the most practical for home-workshop tools mounted on benches or stands

Pipe Extension Eliminates Funnel When Filling Oilcan

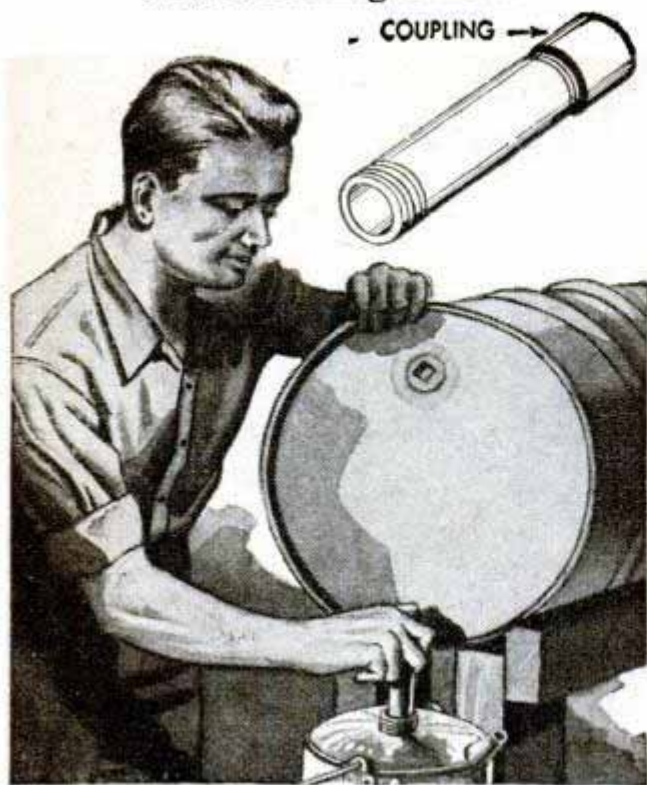

Where no funnel was available, I found that a short length of pipe could be used to fill a container from an oil drum. One end of the pipe was slipped over the spigot and the other inserted in the oilcan. Since the outside diameter of the pipe is slightly less than the opening in the container, a coupling screwed on one end prevents it from slipping into the container.

C. M. Pressey, Johnson, Vt.

Milk Cans Kept in Stock Tank Will Not Freeze

During cold weather it is necessary that milk awaiting delivery to dairies be kept from freezing. One dairyman sets the cans of milk in a stock tank that has a heater and the warm water keeps the milk from freezing.—Leo Beuerman, Lawrence, Kans.

Preventing Posts From Rotting

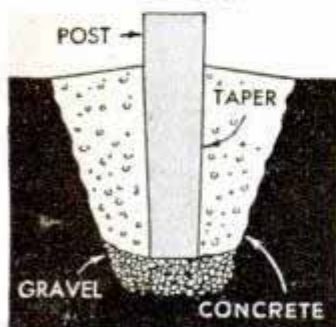

A frequent practice is to set fence posts in concrete with no provision for drainage of water that may work down around them and accumulate between the posts and concrete at the lower ends. To avoid this condition, set the posts on cinder or gravel bases and pour the concrete around them.

If the posts are tapered slightly, it will be easier to remove them should this become necessary.—A. Vena, Philadelphia, Pa.

Taping File Protects Work Finish

When working in close quarters, unused faces of the file that might mar finished surfaces should be covered. Strips of adhesive tape will serve the purpose.

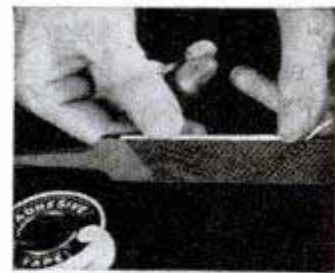

Spectacle Case Holds Micrometer

Slits cut in the back of a leather eyeglass case to form belt loops will convert it into a handy micrometer carrying case. Fastened to the belt, the instrument is always at hand. The usual size of case will accommodate a micrometer of from 0-1 to 0-3 in. and provide protection against damage when not in use.

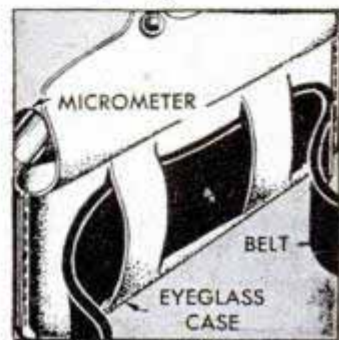

Wire Screen Guards Fruit Trees Against Rabbits and Mice

Wrapping pieces of wire screen around young fruit trees will keep them safe from girdling by rabbits and mice. The screen is fastened to the tree with heavy wrapping cord. Unlike paper, which will become pulpy when exposed to rain and snow, the screen will remain during all seasons.

A. M. Wettach, Mt. Pleasant, Iowa.



Radio and Electronics



Transceiver Car Installation Without Drilling Holes

PERHAPS you have hesitated to try out that new h.f. transceiver in your car because you could not figure any way to do it without drilling a few holes. The photos and diagram Fig. 1 show a simple arrangement made by a "ham" in Colorado which enables him to either install or remove his combination transmitter and receiver in two or three minutes without drilling any holes in the car.

The glove compartment door provides a handy shelf for the homemade transceiver as illustrated in photos A and B; a piece of hard-pressed wood is cut to fit over the hinges as shown in photo A. The unit is bolted to the pressed wood piece which in turn is strapped to the door.

A dipole antenna is employed as shown in photo C; this is fed with a short length of flexible coaxial cable as detailed in Fig. 1. The dipole is mounted on the end of a $\frac{3}{8}$ by 2-in. wooden strip about 4 ft. long. This strip is mounted on two blocks of wood which are bolted to a piece of pressed wood cut so that it has the same shape top and bottom as the window in the car door. Simply cranking up the window clamps the pressed wood in place and supports the antenna clear of the car.

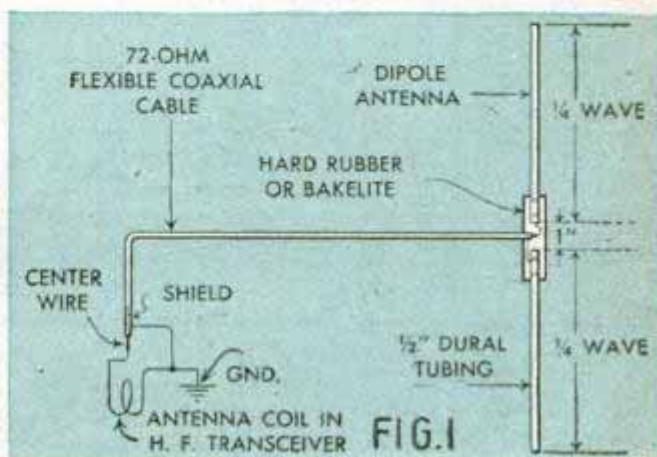
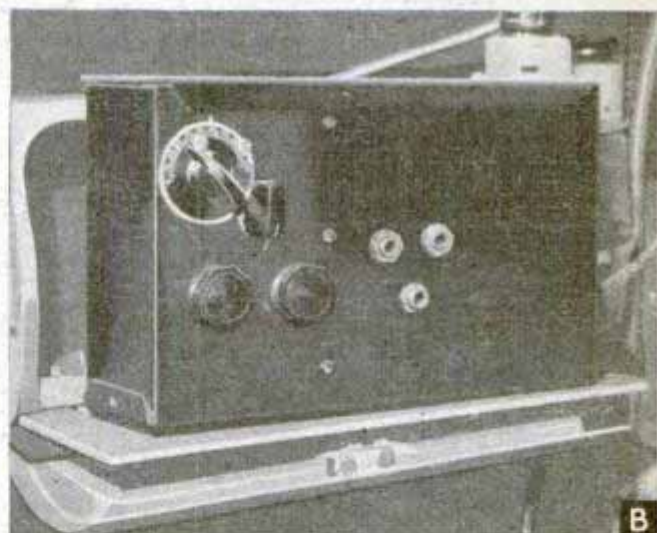

THIRTY-TWO WATT AMPLIFIER

By R. C. Hitchcock



THIS general-purpose audio amplifier has reserve power to serve 4 large speakers in emergencies and provide high quality music and public address facilities for school groups or outdoor activities. It may also be used with reduced gain for one permanent-magnet (PM) speaker or several extension speakers in the home.

Such were the purposes in mind when the writer designed and built the model shown in photo A. It employs push-pull class AB-1 6L6 tubes, has a maximum output of 32

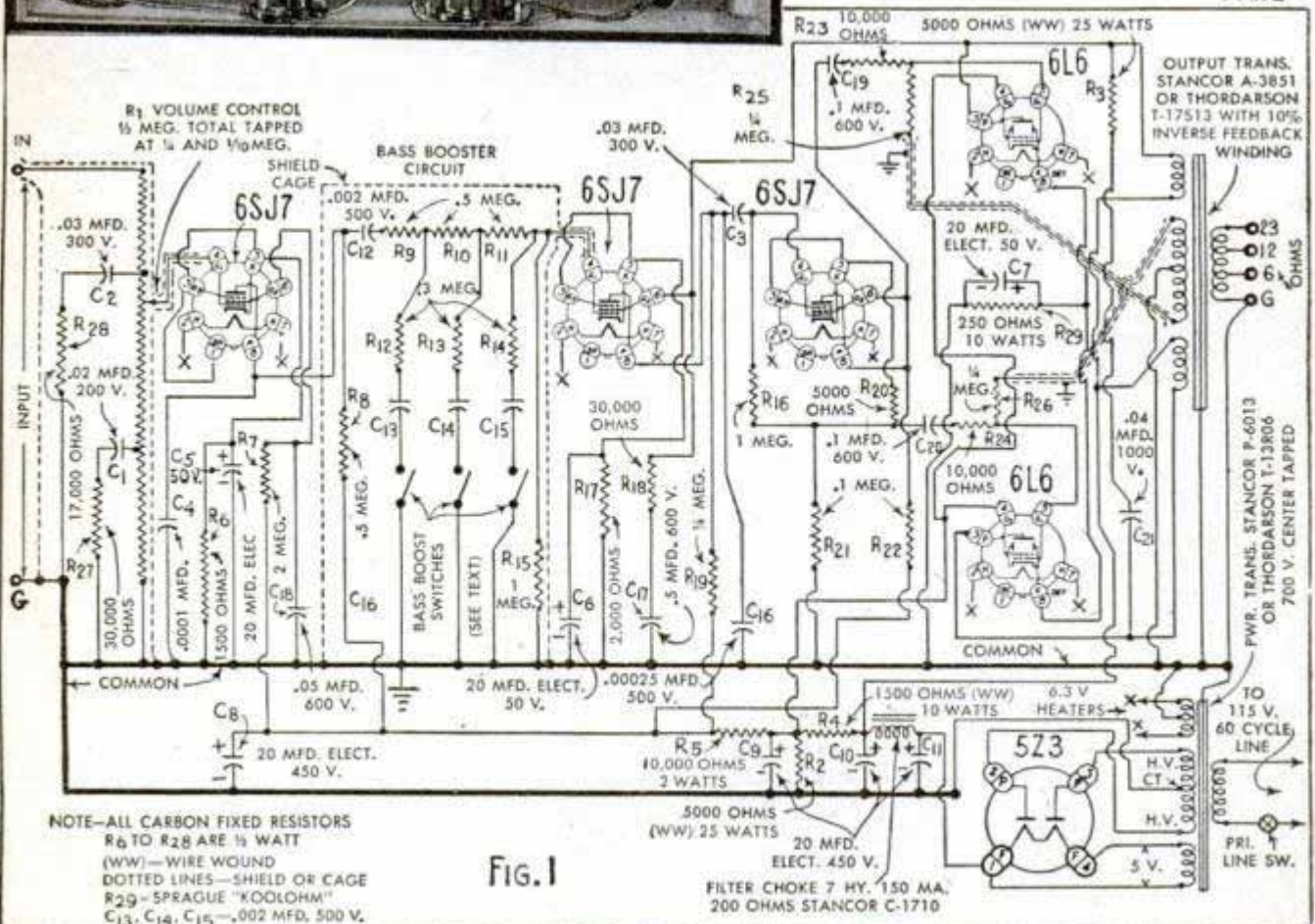
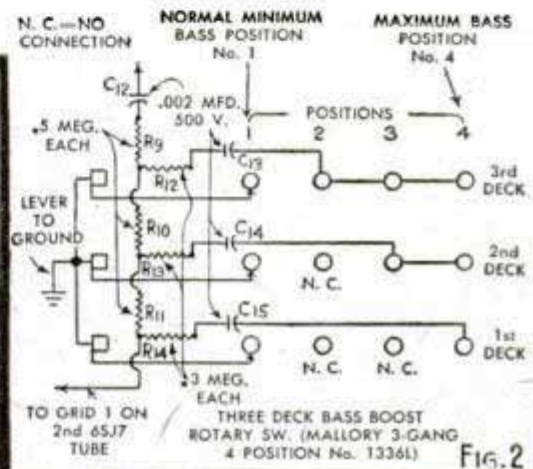
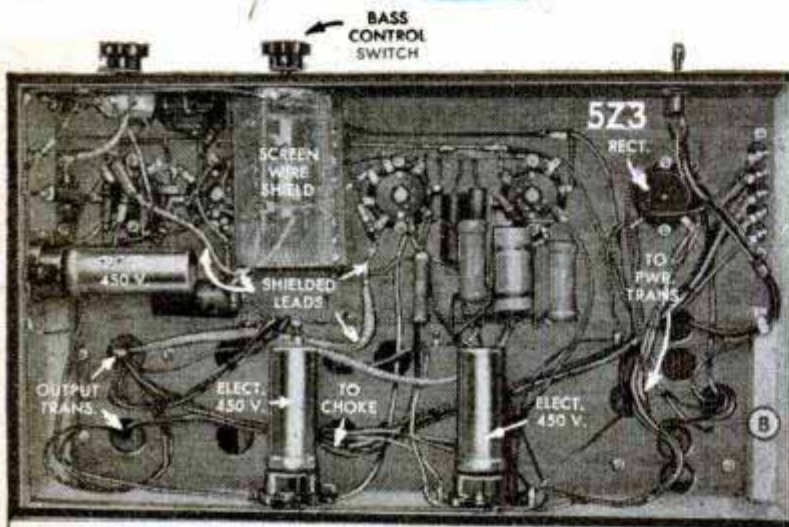

OPERATES FOUR PM SPEAKERS

watts and weighs only 22 pounds. The schematic circuit diagram, Fig. 1, shows the bass boost section connected by 3 single-pole single-throw switches for simplicity. This is actually done in the model with the 3-deck 4-position rotary switch, the hookup for which appears in Fig. 2. The switch may be seen in photo B, and it will be noted that it is enclosed in a circular screen-wire shield. This shield cage, and all shields indicated, are connected to a common bus-bar wire.

The rather unusual chassis is made of $\frac{1}{4}$ -in. plywood as detailed in Fig. 3; the top, sides and back are finished in Chinese red enamel and the front panels in natural wood with clear varnish. Photo C shows the screw-on top removed for easy access to the compartments that house the transformers and choke. There are three schemes for degenerative amplification necessary to protect equipment used in, and with, a high-powered amplifier. First, the 6SJ7 phase inverter tube, the cathode and plate of which are coupled to the push-pull grids of the 6L6 tubes. Second, the 10 percent degenerative feedback winding on the output transformer; to be sure that this winding on your output transformer is connected correctly refer to the manufacturer's instruction sheet. Third, the feedback from the plate of the upper 6L6 tube to the screen-grid of the second 6SJ7 tube. If oscillation occurs connect the wire to the other 6L6 tube plate. When making all oscillation tests use a 25-watt 110-volt lamp in series with a speaker and 6-ohm tap. Please note that no by-pass condenser is used from the cathode of the third 6SJ7 tube to ground. Keep plate leads away from all grid wires. Four 6-ohm permanent-magnet speakers can be connected, two in series and two in parallel, on the 6-ohm output terminals. Reference number for this article is R-349.

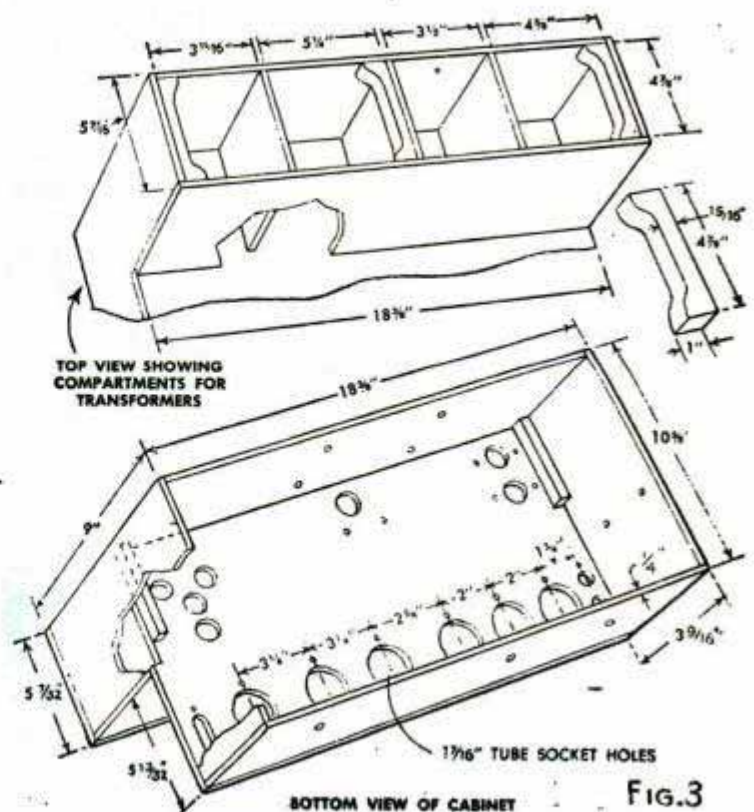
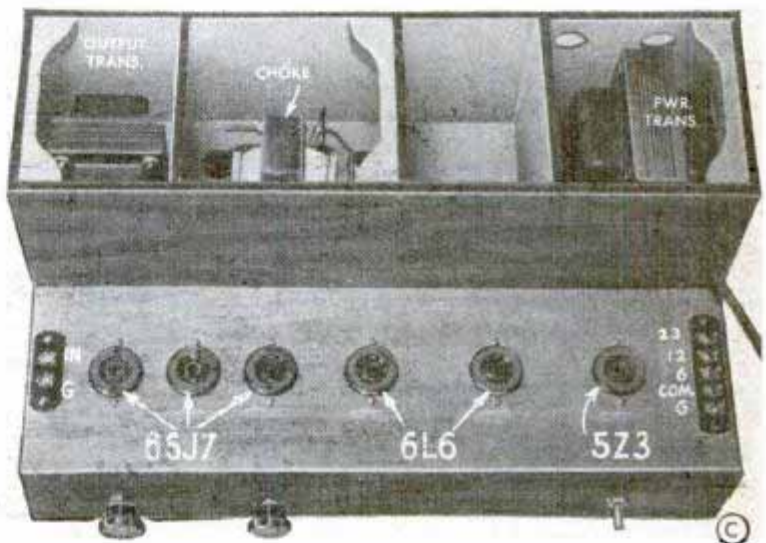

Radio blueprint list and detailed student material lists are always available from Popular Mechanics Radio and Electronics Department upon receipt of ordinary letter postage

"Mirror" in Television Tube for Brighter Pictures

By F. L. Brittin

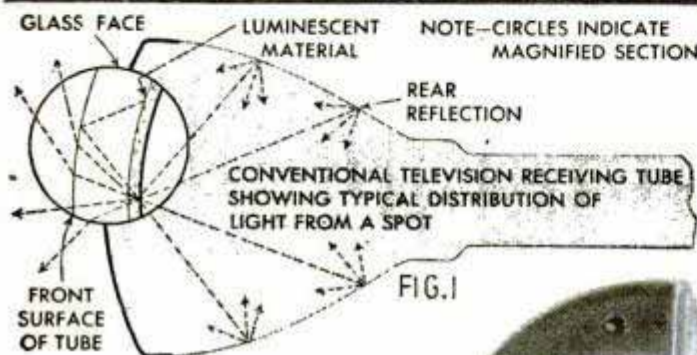
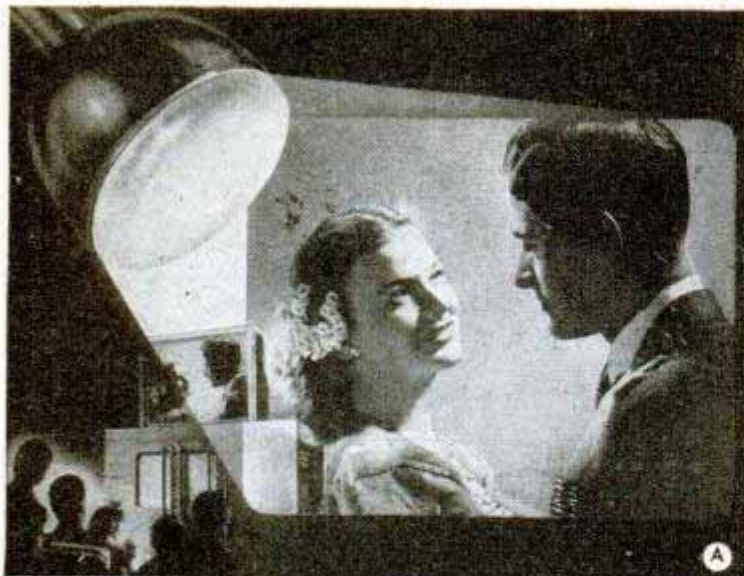

AN ALUMINUM coating about 1500 times thinner than this page is now used on the beam side of the fluorescent screen in the RCA 5TP4 projection-type cathode-ray television receiving tube. This light-reflecting metallic layer, applied by means of evaporation in a vacuum, is thin enough to permit the electron beam to penetrate, but is sufficiently thick to reflect back any light that might fall on it.

Fig. 1—a detailed enlarged section of the glass face of a conventional tube—shows how light losses occur, as at least 50 percent of the light generated in the screen is emitted toward the electron gun in the rear end of the tube. The improved tube, shown in photo B, includes the light-reflecting metallic layer, with the result illustrated in Fig. 2 and the manufacturer's pictorial contrast demonstration in photo A. It is said that the pictures are twice as bright when the new tube is employed.

Brighter pictures also are due to improvements in the television pickup "camera." The one shown in photo C affords easy access to the various tubes and parts. The video preamplifier compartment is in the lower section and the electronic view finder is above. An RCA image orthicon pickup tube, housed in a center compartment, is rated at light sensitivity approaching that of the human eye. A portable FM microwave transmitter, photo D, at

(Continued to page 244)

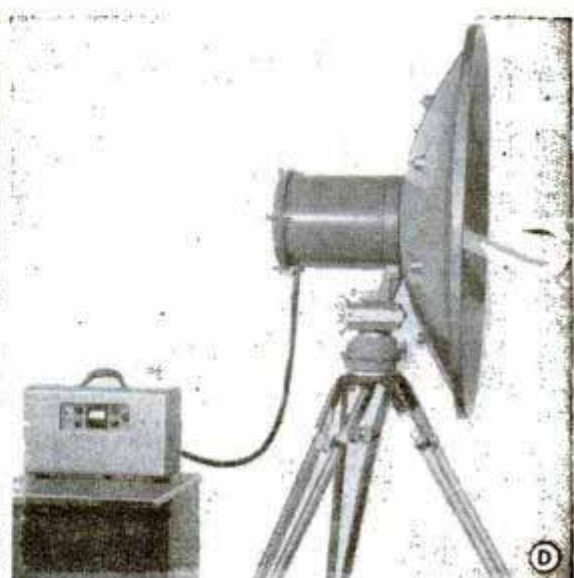
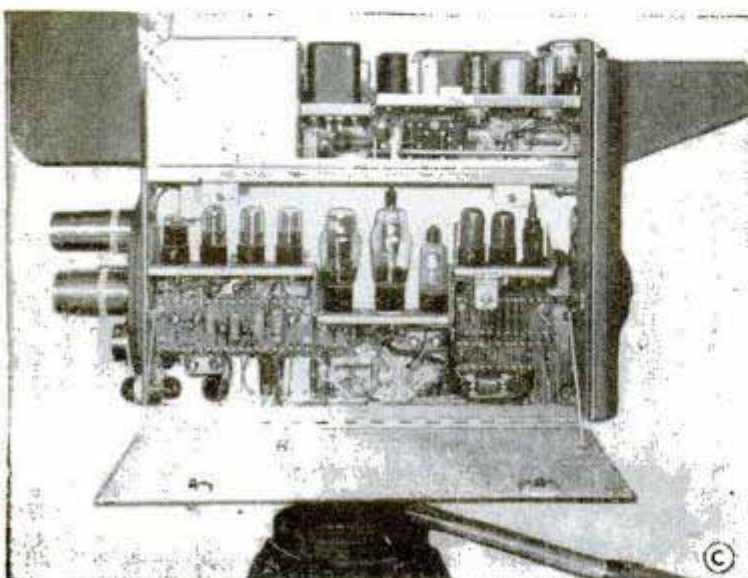

Designed right, to delight
the most critical hobbyist

Ciné-Kodak Magazine 8

In this compact home movie camera you'll find the things you appreciate—sound design, simplified operation, the balance and “feel” of quality, combined with true film economy. Three-second magazine loading with full-color Kodachrome or black-and-white films; *Lumenized* $f/1.9$ lens; six accessory lenses; four operating speeds, including slow motion; Universal Exposure Guide.

Ask your Kodak dealer, too, about the economical Ciné-Kodak Eight-25—roll loading; with fixed-focus *Lumenized* $f/2.7$ lens, full-vision eye-level finder, footage indicator, Universal Exposure Guide. Ask about the popular “Magazine 16,” too . . . Eastman Kodak Company, Rochester 4, N. Y.

Carrying Cases—Wide choice of cases for Ciné-Kodaks, film, accessories. Handsome, durable . . . complete protection for all your movie-making equipment.

Kodascope Eight-33—Fast $f/2$ lens teamed with 500-watt lamp gives brilliant image on screens up to 30 x 40 inches. Finger-tip tilting, threading, framing . . . major operating controls grouped on centralized panel.

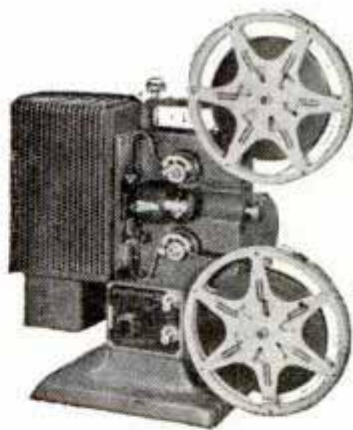

Ciné-Kodak Long-Focus Lenses “bring it up close.” Above, from left to right, (1) taken with standard 13mm. lens, (2) 25mm. lens, (3) 50mm. lens.

Kodak

**TO THE MILLIONS OF MEN WHO
THINK THEY CAN'T TAKE A PIPE...**

Why be a Pipe Exile?

Royalton
Smoke-Control

Assures Pipe Comfort through a great New Invention



The one big reason so many men give up pipes is that the smoke-volume in a standard pipe is too heavy—they can't "take it" . . . Royalton craftsmen set out to build a pipe that any man could smoke—that would allow the smoker to cut down or increase the draft to suit his personal preference . . . That pipe is here now . . . The Smoke-Control feature is a simple adjustable valve which widens or narrows the opening through which smoke flows. You can set this valve so that you draw in the exact amount of smoke for your taste and throat. Ask your dealer to demonstrate Royalton Smoke-Control.

Write for Interesting FREE Booklet . . . Henry, Leonard & Thomas, Inc., Dept. PM, Ozone Park 17, N. Y.

Put



in your



when the



fall—and

forget it till the first



● You don't *guess* with "Prestone" anti-freeze; you *know* you're safe from freeze-ups, no matter how suddenly the thermometer dives. There's no boiling away or foaming off ... no constant adding and testing. It prevents rust and corrosion too! Because there's not enough "Prestone" anti-freeze for everyone this year, you'd better get yours early ... see your dealer on that first chilly day. You'll have never a care till the warm days of spring—with "Prestone" anti-freeze.

The words "Eveready" and "Prestone" are registered trade-marks of

NATIONAL CARBON COMPANY, INC.

30 East 42nd St., New York 17, N. Y.

Unit of Union Carbide  and Carbon Corporation

SORRY— there still isn't quite enough "Prestone" anti-freeze for all who want it, because—

1 "Prestone" anti-freeze, like most other products, depends on the utilization of raw materials and equipment drawn from many fields. Recent industrial dislocations have affected our plant-expansion program, which was not authorized during the war. Planned for years, it is well advanced; but the real benefit will not be felt in 1946.

2 "Prestone" anti-freeze must be produced and *packaged* long before cold weather. Last spring and summer the food shortage diverted packaging materials to the need of starving millions, and adversely affected our ability to meet 1946 requirements. So your dealer may be selling "Prestone" anti-freeze from 5-gallon cans in addition to the familiar 1-gallon cans.



PRESTONE ANTI-FREEZE

TRADE-MARK

"YOU'RE SAFE AND YOU KNOW IT!"—ONE SHOT LASTS ALL WINTER



He's looking for bugs

HE'S HOPING, of course, that he doesn't find any. Because in the manufacture of files, the best way to keep out "bugs" (defects) is to keep looking for them. Nicholson inspectors do that endlessly—through scores of inspections and tests. They begin with the scrutinizing of every batch of steel and continue down to the "ringing" test for soundness and a final check on the appearance of the finished file.

Pictured above is a "spot" examination, through a hand magnifying glass, of a file that has just come from the cutting machine. Its purpose is to make sure that the file's teeth are properly raised and correct in shape for the kind of filing job they are to do.

It is "eternal vigilance" like this that helps to maintain the Nicholson high standard of quality and uniformity, and enables your hardware dealer to sell you Nicholson or Black Diamond files under the sweeping guarantee of *Twelve perfect files in every dozen.*

NICHOLSON
U.S.A.

NICHOLSON FILE CO.
22 Acorn St., Providence 1, R. I.
(In Canada, Port Hope, Ont.)



NICHOLSON
FILES FOR EVERY PURPOSE

Nature Fakers

(Continued from page 145)

above it is clouded with minute animal and plant life, the old problem of how to represent such water arose. After much consultation among the scientists, taxidermists, artists and carpenters, Arthur G. Rueckert, staff artist, suggested a plan.

A pane of ground glass was to be placed vertically in the exhibit, two feet from the front pane of glass and four feet from the back wall. This would allow clear visibility for two feet and then the objects would become hazy. As ground glass in itself is too opaque, something had to be done to make it more transparent. Mr. Rueckert knew that water poured on ground glass makes the glass almost transparent. What he wanted was something not that transparent, nor as opaque as the ground glass itself. He finally hit upon the idea of applying a coat of turpentine and a mixture of oils to the rough side of the glass. After experimenting with this formula, Mr. Rueckert found that if the surplus of this mixture was quickly rubbed from the glass a semi-transparent effect was produced.

Before the exhibit could be started, careful field notes had to be made. Scientists and taxidermists went on diving expeditions to one of our regional lakes. The flora and fauna were collected and color notes were taken.

As is true of most exhibits, very little of the actual plant or animal is used. The fish were carved out of balsa wood, as was the bird sitting on the water. The log along the bottom was a piece of mesh wire covered with painted wax. The water lilies were also made of wax. Old-fashioned Christmas tinsel served as seaweed. The larger waterweeds, like pickerel weed, were made from the new crinkled green celluloid tinsel. The fine, long strands of seaweed roots were green cloth-covered radio wiring.

(Continued to page 240)



Model Builders Attention!

	V	V-2	V-3
Hex	1/2"	3/8"	5/16"
Thread	3/8"-24	1/4"-32	1/4"-32
Thread Length	7/32	7/32	5/32
Weight, Grams	8	3 1/2	2 1/2

Actual Size V-Plug

Champion spark plugs for model gas engines give the same dependable performance as regular Champions. Sillment sealed. Sillimanite insulator. Alloy needlepoint electrodes for easy starting. One piece construction.

CHAMPION

SPARK PLUG COMPANY • TOLEDO 1, OHIO

The Favorite Spark Plug for Tough Jobs . . .

CHAMPION



On most construction jobs, dependable gas engine power is essential. Such tough and rugged service calls for day-in-and-day-out dependability from spark plugs—and here, as in all types of service on land, water and in the air, Champion Spark Plugs are preferred and used by the overwhelming majority. Here's powerful evidence that Champions make every engine a better performing engine. Champion Spark Plug Company, Toledo 1, Ohio.

**DEMAND CHAMPIONS
FOR YOUR CAR**

FOLLOW THE EXPERTS

ANCO RAIN-MASTER

"Dead-Locker"

WINDSHIELD WIPER
ARMS and BLADES

BLADE SNAPS ON...
STAYS PUT

FINGER-
TIP
RELEASE

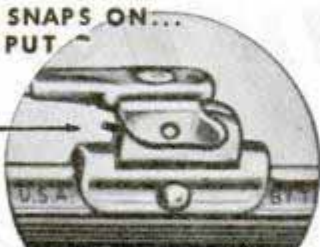

CAN'T FALL OFF
CAN'T BLOW OFF

(A war-born invention—by ANCO—first)
for military aircraft—now for your car.)

DON'T SHOOT YOUR GAS-PUMP MAN!

He's doing the best he can. Sure, he knows how dangerous it is for you to drive your car... in stormy weather... with your dull old windshield wipers that smear and smear. He'd gladly put on for you quickly a pair of keen new ANCO RAIN-MASTER Wiper Blades and Arms. He has them—Newest Models! But he forgets to remind you? Too busy? You can't shoot him for that!



After all, it's *your* car to protect. So *you* remind *him*. Get RAIN-MASTERS... patented features... original equipment on many makes of high grade cars and trucks... used in war—on our fighting tanks and trucks and ships and bombers too... because ANCO RAIN-MASTERS clean quicker, clean cleaner... last longer. May save you a costly smashup.

Ask for RAIN-MASTER Windshield Wiper Arms and Blades next time you buy gas.

THE ANDERSON COMPANY
Established 1918
GARY, INDIANA

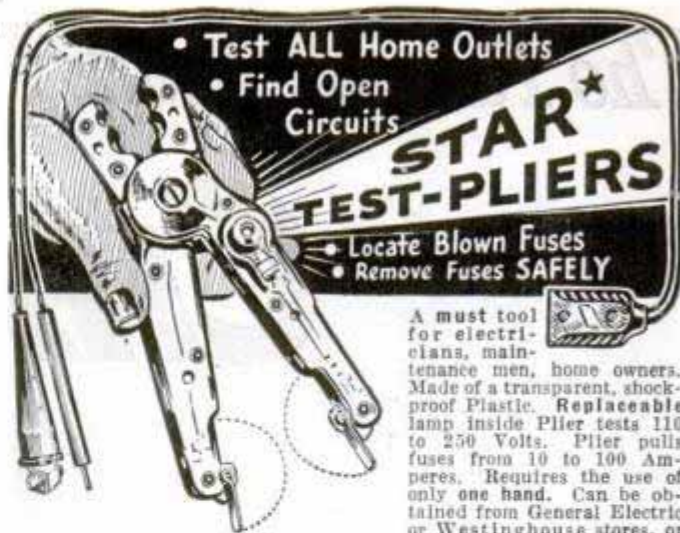

A must tool for electricians, maintenance men, home owners. Made of a transparent, shock-proof Plastic. Replaceable lamp inside Plier tests 110 to 250 Volts. Plier pulls fuses from 10 to 100 Amperes. Requires the use of only one hand. Can be obtained from General Electric or Westinghouse stores, or

from local electrical dealers. Order one TODAY.

Price \$2.75 without Leads, \$1.50 additional for Leads which provide greater reach and more flexibility.

STAR FUSE CO., 233 Canal St., New York 13, N. Y.

Imported SWISS POCKET WATCHES

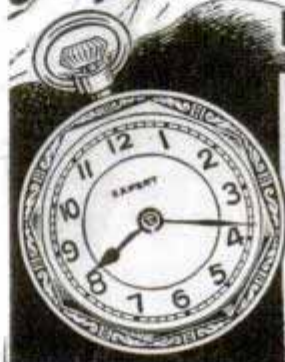

WRITTEN GUARANTEE
WITH EACH WATCH

Handsome, dependable, Swiss watches are renowned as excellent timekeepers because they are made by master watchcraftsmen. Sturdy. Finely-constructed. Genuine chrome case.

WEAR 10 DAYS
AT OUR RISK!

If not completely satisfied, return for refund. SEND NO MONEY. Simply pay postman \$8.50 plus 10% tax and postage on delivery. Cash orders sent postpaid. An exceptional bargain. United Products Co., 794 S. Halsted, Dept. PW-527, Chicago 20, Ill.

CROSMAN *Silent* RIFLES



NOW AVAILABLE

America's favorite compressed air rifles for indoor or outdoor shooting are back again! Available in .22 Cal. Single Shot and Magazine Loading types. At your dealer—or order direct. Ask for Crosman SUPERPELLS too—the better ammunition for all compressed air rifles: .177 Cal.—\$2.25 per M; .22 Cal.—\$2.50 per M.

CROSMAN ARMS CO., INC. ROCHESTER 7, N. Y.



MINIATURE ENGINES

Gasoline—Steam
Air—Locomotive



THE WORLD'S
MOST FASCINATING HOBBY

Build them yourself — In your own shop
With your own tools



Send 10 cents for my illustrated catalogue listing the world's largest selection of miniature engine castings and drawings.

WAYNE MILLER

Suite 200-A
Engineering Bldg., Chicago 6, U.S.A.

Logan

A NAME TO REMEMBER WHEN YOU THINK OF **BETTER LATHES**
AND SHAPERS

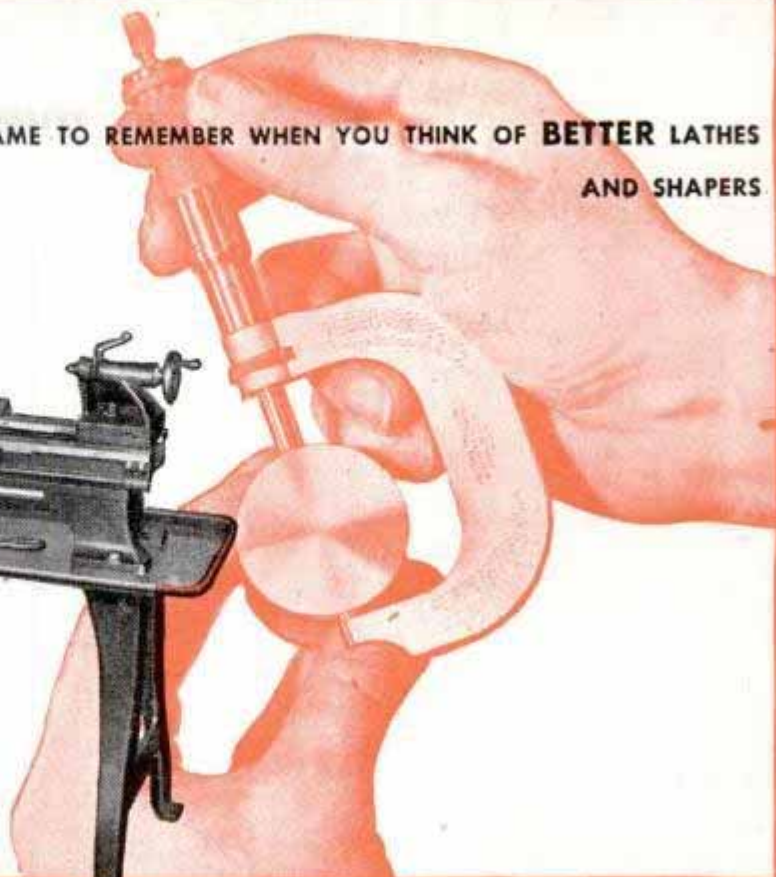
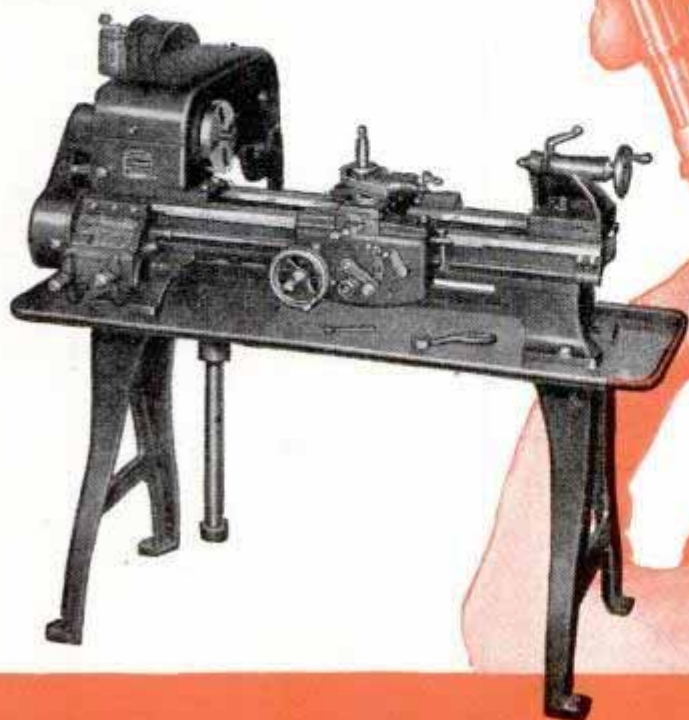

The Logan lathe

9 reasons why **LOGAN** Lathes are **BETTER** lathes

- 1 BALL BEARING HEADSTOCK**
for sustained accuracy.
- 2 RUGGED, ACCURATE BED**
within .0005" of parallelism.
- 3 SELF-LUBRICATING BEARINGS**
at vital points lengthen life.
- 4 BACK GEARS ENCLOSED
IN HEADSTOCK**
with shifter rack safely and conveniently
at your finger-tips
- 5 RUBBER CUSHIONED COUNTERSHAFT**
for smoothness and accuracy in working
area.
- 6 THREE POINT SUPPORT**
Steadies the countershaft, prevents
rocking.
- 7 ENCLOSED BELTS, GEARS, PULLEYS**
Prevents accidents. Keeps lathe clean.
- 8 AUTOMATIC BELT TENSION RELEASE**
Makes belt changing easy and safe.
- 9 PRECISION BUILT THROUGHOUT**
For tool room accuracy in your shop.

brings tool room accuracy to workshops

The craftsman who takes pride in the accuracy of his work will find real satisfaction in the jobs he turns on his Logan Lathe. The two V-ways and two flat ways of the Logan Lathe bed are precision ground to within .0005" of parallelism. Bearing faces on the Logan headstock are held to an accuracy of .0005". For lasting accuracy the Logan spindle is mounted on pre-loaded, grease-sealed New Departure ball bearings. Construction standards like these have identified the Logan name with accurate, dependable and economical performance in every field of industry. That is why the fact that he can now obtain the Logan Lathe for his own shop is important to every craftsman.

WRITE FOR THE LOGAN CATALOG . . . complete, illustrated descriptions of Logan Lathes, Shapers and Accessories.

LH-5

LOGAN ENGINEERING CO., 4921 LAWRENCE AVE., CHICAGO 30, ILL.

new!

PALMER WHEEL KIT eliminates "axle problems"

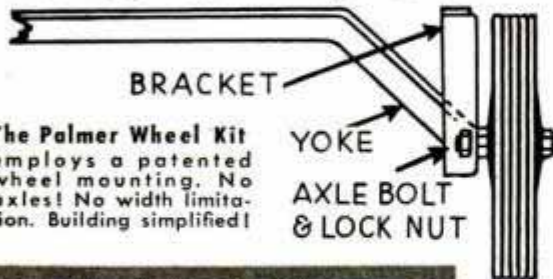

The Palmer Wheel Kit employs a patented wheel mounting. No axles! No width limitation. Building simplified!

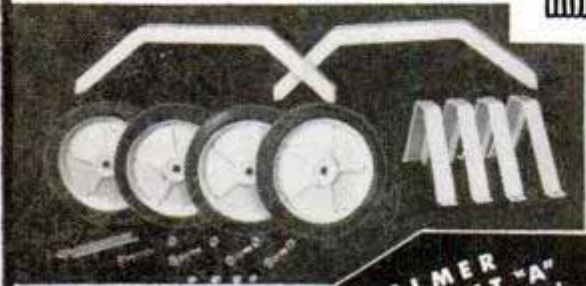

PALMER WHEEL KIT "A"
contains four 8" steel wheels with solid rubber tires. (Grooved tread 1 1/4" wide). Four steel mounting brackets. Two steel yokes. Axle bolts, nuts and special wrench included.
Only \$6.75

The PALMER patented wheel mounting simplifies every wheel application! Only short, individual wheel axles are used. No cross axle to limit design of your wagon, utility cart or racer. Brackets and yokes are sturdy stamped steel; attractively finished in bright red baked enamel. Axle bolts are stainless steel... rust proof! Solid molded rubber tires with 1 1/4" treads wear longer than other types... do not mark linoleum or polished floors! Tires cannot loosen or slip due to special mounting process. Tests have shown 8" wheel able to withstand over 1000 lbs. vertical load.

PALMER WHEEL KIT "B"
same as "A" except wheels are small diameter (5 1/2") with 3/4" molded rubber tire. **\$4.39**

Individual Wheels

8" DIA. with 3/8" bushings . \$1.40
8" DIA. with 1/2" bushings . 1.48
5 1/2" DIA. with 3/8" bushings .94

The Ideal Christmas Gift for Ages 8 to 80!

NOW you can design and build *"Anything on wheels"*
Soapbox Racer
Tool Cart
Display Cases
Scooter
Mobile Caddy
Wheelbarrow
Market Carrier
Rubbish Cart
Bike Trailer
Toy Wagons
Boat Carriers
Movable Furniture
Luggage Mover
Milk Can Cart

THE PALMER MFG. CO., Dept. 1
8115 Clinton Road, Cleveland 9, Ohio

Please send me: (indicate number of sets)

- PALMER WHEEL KIT "A"
 PALMER WHEEL KIT "B"
 8" wheels, 3/8" bushings.
 8" wheels, 1/2" bushings.
 5 1/2" wheels, 3/8" bushings.

Enclose check or money order—all prices F.O.B. Cleveland, O.

NAME _____
ADDRESS _____
CITY _____ ZONE _____ STATE _____

When the fish and accessories were completed, installation was begun. Because of the ground glass partition, the material had to be arranged to give the illusion of no glass at all. Many of the fish were cut in two, and one half attached behind the ground glass and the other in front of it. The plants were also pasted in front of and behind the glass to give the appearance of a continuous length of plant. The only original materials used in the exhibit were the skeleton of a turtle, the outer skeleton of a crayfish and some small stones.

The ambition of these "nature fakers" is not to fool the public but to enchant them with natural beauty—unnaturally produced.

Making Money by the Ton

(Continued from page 157)

by the Philadelphia and Denver mints.

Each press automatically stacks the blanks that are fed into its hopper, moves the coins two at a time into position between the upper and lower dies, and then simultaneously presses the dies into the metal blanks. When silver coins are being struck, die collars meanwhile create the indented reeding on their circumference.

The coins now are finished and ready for final inspection in a machine that checks the weight of each individual coin at the rate of 7000 units per hour. Then they are dumped into the hoppers of machines that count them out into sturdy storage bags. Filled with bright new coins, the bags are moved to the storage vaults for eventual distribution to Federal Reserve banks upon the order of the treasurer of the United States. The mints do not supply coins directly to the public or local banks.

The hundreds of tons of gold and silver in the mints are safeguarded by complex detection and alarm systems, time locks, strong walls and well trained armed guards.

Even so, thousands of dollars worth of bullion would disappear every year if it were not that elaborate precautions of another kind are taken.

Necessarily, bits of metal escape in the melting and processing operations. Flakes and slivers fall on the floors or are washed away. Some floats off in the air as dust or fumes. These losses could add up to important shortages, and so extraordinary salvage operations are employed to reclaim the last microscopic bit of precious metal.

In the first place, all debris, including old shoes, old clothes, sacks and other materials that collect in the mint, is burned in an incinerator instead of being thrown

(Continued to page 244)

"King-sized
brakes"

"The liveliest performer in
the low-priced
field"



"Rest-Ride
springs!"

"That best-dressed look!"



Ford's out Front WITH EVERYBODY!

"Extra large trunk...
that's no joke, son!"



"Wide-angle
vision!"

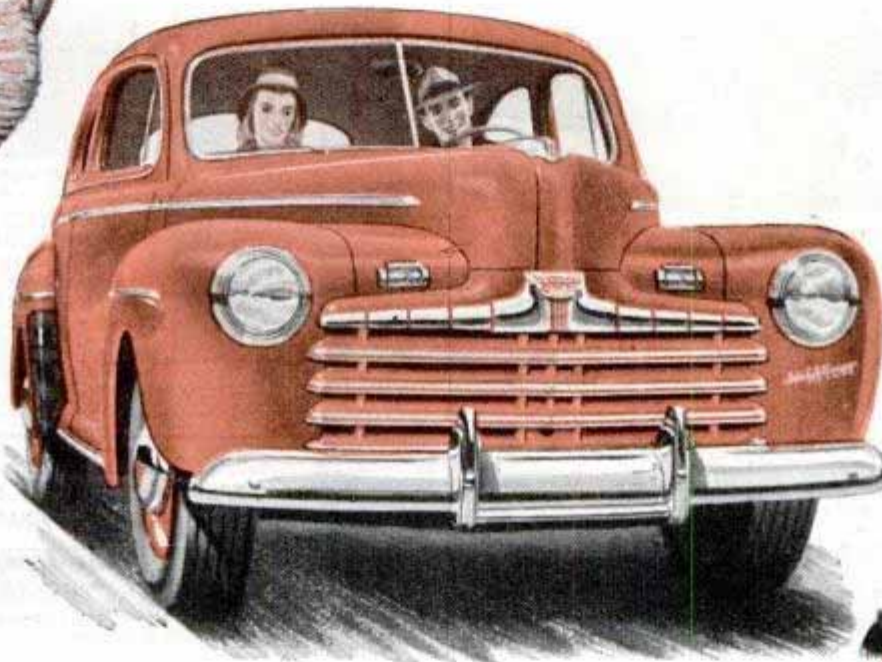

"Lifeguard body!"



"Aye,
and thrifty, too!"



"A roomy, two-tone
interior!"

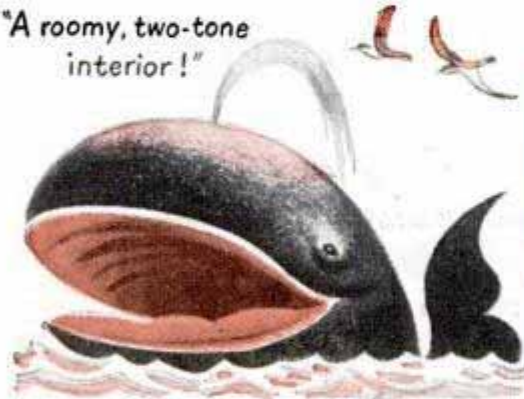

There's a *Ford*
in your future

"A wise
buy!"



FOR *Building* AND *Repairing* CHRISTMAS TOYS



use PLASTIC WOOD

You can get a professional finish on those jobs for the kids! For a slick, smooth finish that takes paint, lacquer or varnish perfectly, use Plastic Wood as your filler. Repairs such as cracks, gouges or loose joints are quickly mended and the toy is back in apple-pie order! *Handles like putty—hardens into wood!*

... dozens of other uses

FOR FILLING . . . FOR REPAIRING . . .

- Countersunk screws
 - Loose casters
 - Chipped furniture
 - Broken balusters
 - Nail and screw holes
 - Broken furniture
- You'll want Plastic Wood SOLVENT, too. Get both at one time. It is made especially to control the consistency of Plastic Wood . . . useful also in removing dried Plastic Wood from tools and fingers.

T. M. Reg. U. S. Pat. Off.

At all Hardware,
Paint and 10c Stores

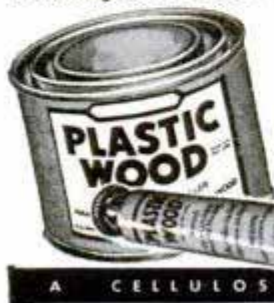

PLASTIC WOOD

Tube or Can

A CELLULOSE FIBRE FILLER

SAY YOU SAW IT IN POPULAR MECHANICS

Do a Better Job WITH ONE OF THESE EMPIRE LEVELS

Smallest, most handy and accurate Level made. "Cigar-shaped"—no sharp corners to tear pocket. Aluminum stock. Only 3 oz. wt. 9" long. Has Level, Plumb, 45° Vials.

EMPIRE TORPEDO LEVEL



No. 26\$1.75



ALUMINUM LEVEL — No. 151

Cast and Machined, a Beautiful Tool, with Patented, Removable Level and Vial. With 2 Plumb, 2 Levels, 2 — 45° Vials. 18"\$5.00
24"\$5.50 28"\$6.25

Order EMPIRE LEVELS from your local dealer.
Write direct for literature.

EMPIRE LEVEL MFG. CO.
717 S. 6th St. Dept. P-243 Milwaukee 4, Wis.

ONE MAN BOX CAR DOOR OPENER

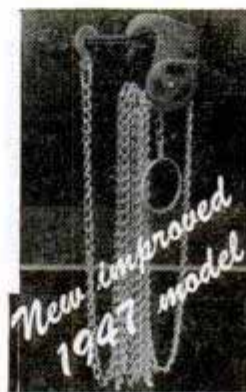

One man can quickly, safely open or close the most pig-headed, stubborn freight car door with the simple, powerful Monarch Car Door Opener. Thousands now in daily use. NO strained muscles • NO slips or falls • NO broken or mashed limbs • NO fatalities • NO time wasted • NO "gangs" needed • NO time lost

Only \$22⁵⁰ Ea. F.O.B. Bowerston, Ohio

THE MINING SAFETY DEVICE CO. • Dept. PM, Bowerston, Ohio

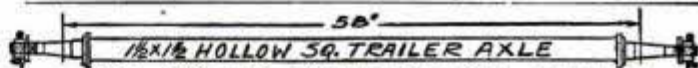

CAP.—2000 LBS.—\$6.75 EACH F.O.B. DETROIT

STRONG MACHINE & AXLE COMPANY

9710 Lumpkin

Hamtramck 12, Michigan

CORROSION TROUBLE?

Use an oil that prevents rust while it lubricates
—shop appliances
—household devices
—mechanic's tools

Hardware and Sports Dealers

It's THE Triple Action Oil
Lubricates
Prevents Rust
Cleans

3-oz. SPOUT CAN 40c

FIENDOIL

SPECIAL SURPLUS SAVINGS ON PLASTICS

CLEAR GRADE A PLEXIGLAS

Sheet Size 12" x 20" — 1/4 Inch Thickness

\$3.39 per sheet

Also Plexiglas sheets new per sq. foot:

1/16\$1.13 3/16\$1.79
1/8\$1.46 1/4\$2.10

Add 10% for packaging on orders under \$10.
Add \$1 for packaging on orders over \$10.

ALSO . . . complete line of RODS, TUBES, SHEETS, ODD SHAPES in all types of plastics. Dyes, cements, buffing compounds. FRANKLIN PLEXIGLAS ANTI-STATIC WAX, BURNISHER AND CLEANER.

CADILLAC PLASTIC COMPANY

651 WEST BALTIMORE

DETROIT 2, MICHIGAN

POPULAR MECHANICS

IT'S A GRAND FEELING,
TO RUN A
MINIATURE RAILROAD



IT'S A GRAND FEELING, TOO,
WHEN YOUR CAR IS
CUSHIONED WITH MARFAK
CHASSIS LUBRICATION

Miniature railroading is fun, with remote controls, realistic whistles, and real smoke. And a smooth riding car is lots of fun, too.

That "cushioned" ride you feel when your car is lubricated with *Marfak* is evidence that *Marfak* is doing its job . . . is furnishing a lubricating cushion for your vital chassis bearings. And *Marfak* lubricates for longer, too, a thousand miles and more.

It's because *Marfak* is scientifically designed to do its job . . . its special adhesive and cohesive qualities resist wash-out, jar-out, and squeeze-out. *Marfak* clings to the bearing surfaces . . . sealing out dirt and grime.

Yes, it's a grand feeling when your car is "cushioned" with *Marfak* chassis lubricant. See your Texaco Man today, and say: "*Marfak*, please."



With ordinary grease . . . you're taking the road shocks again after a few hundred miles.

Marfak stays on the job hundreds of miles longer — means more velvet smooth riding.

TEXACO DEALERS



SKY CHIEF
GASOLINE



FIRE-CHIEF
GASOLINE



HAVOLINE AND TEXACO
MOTOR OILS



MARFAK
LUBRICATION



THE
TEXAS
COMPANY

Tune in . . . TEXACO STAR THEATRE presents the new Eddie Bracken show every Sunday night. See newspapers for time and station

THE ONLY BRUSH THAT

*Keeps the Air Clear
as it Cleans the Floor*

Also Eliminates
Sweeping Compound!



Arbitrin Sweeping fluid is put into a steel reservoir in the back of the Dustless brush.

As you sweep Arbitrin filters through the tufts — surrounds particles.

The dust itself is converted into sweeping compound — cannot rise into the air.

Dustless brushes used with Arbitrin sweeping fluid are 100 times more effective in controlling dust than ordinary floor brushes used with sawdust. When used daily, Dustless brushes actually reduce bacteria, normally in the air between sweepings, as much as 97%. These facts have been proved in tests made by independent health authorities. Dustless brushes are used in thousands of stores, factories, offices, schools, and institutions. They are unconditionally guaranteed to meet your requirements. Write today for sizes, styles, and prices.

MILWAUKEE DUSTLESS
BRUSH COMPANY

530 North 22nd Street • Milwaukee 2, Wisconsin

MANUFACTURERS OF DUSTLESS, SPEED SWEEP AND SPEED WASH BRUSHES

Milwaukee Dustless Brush Co., 530 N. 22nd St., Milwaukee 2, Wis.
Please send complete information about Dustless brushes and Arbitrin sweeping fluid.
Name.....
Address.....
City and State.....

away. Then the ashes are panned, using the same process miners employ to separate small particles of gold from river sands. The material is swirled around and around in a pan of water. Heavy metals collect at the bottom while light materials escape over the side.

Similarly, old furnace linings, bricks, pots, stirring rods and other worn-out ceramic equipment from the melting rooms are crushed and panned. Even after all the apparent metal has been removed this material still has recoverable values. It is sold at a standard price to private metal refiners who put it through other extraction processes.

Dust and sweepings from the floors are sold as "sweeps" to metal refiners. Per ton, the daily sweeps may yield from one to 150 ounces of gold and from 50 to 2000 ounces of silver.

Too, none of the wash waters from the metal rooms are allowed to empty directly into the sewers. They flow first to tanks where all suspended particles of metal settle to the bottom for reclamation at regular intervals.

Not even the air escapes from the mint building without a laundering. All the ventilation air from the metal departments, all the stack gases and all the melting fumes are ducted to huge electrostatic air cleaners. Several tons of dirt and dust are collected yearly by the air cleaners, from which are reclaimed as much as 100 pounds of gold, silver and copper.

Still other precautions are taken to maintain the purity of our money and to prevent losses. The beams that weigh metal or coin are tested for accuracy every morning. In addition to the assays by which each batch of metal is checked, special tests of the coins themselves are made from time to time. Bullion or money is never moved from one department to another without the exchange of signed receipts. Last of all, audits are made each year of the stocks on hand at each mint by a board of officials from one of the other mints.

"Mirror" in Television Tube For Brighter Pictures

(Continued from page 232)

the remote pickup location, and a similar-looking receiver at the studio or station transmitter, provide a highly directional wide-band radio link over distances up to about 15 miles without the use of wires or coaxial lines. The cylindrical unit back of the parabolic reflector houses either the transmitter or receiver, which is monitored

(Continued to page 248)



ANNOUNCING
The New 1947
HARLEY-DAVIDSONS!

They're ready! — the new 1947 models you've been waiting for! What streamlined beauties, these new Harley-Davidson Motorcycles! Rugged — powerful — with plenty of zooming speed. And when it comes to *dependable performance*, these great new models are backed by

the truly remarkable wartime records for stamina established by thousands of Harley-Davidsons . . . world champion motorcycles that proved they could "take it" through years of punishing service — and under toughest weather and road conditions in all parts of the world. Better see your Harley-Davidson dealer **EARLY** — if you want the thrill of owning a new 1947 Harley-Davidson!



HARLEY-DAVIDSON
Motorcycles

HARLEY-DAVIDSON MOTOR CO.

Department P, Milwaukee 1, Wisconsin

Please send at once free copy of 24-page "ENTHUSIAST" Magazine, filled with motorcycle action pictures and thrilling stories.

Name.....

Address.....

City..... State.....

FOR PROJECTOR OR VIEWER

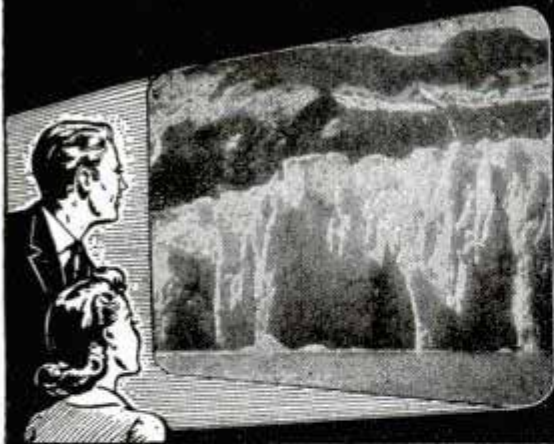

**Magnificent Natural Color
Wesco KODACHROME SLIDES**

"TURRETS OF SAPPHIRE...

and minarets of jade form colorful fairy castles of ice..." That's how Father Hubbard, "The Glacier Priest," describes the wondrous depth of color in the hundreds-of-feet-high ice towers formed when a glacier terminates in the sea. You will feel the same awe he did when you see the pictures he took during his expeditions reproduced in vivid true color and sharply detailed clarity on WESCO Kodachrome transparencies. They're exclusive with WESCO, part of our incomparable "add-a-slide" library.

OVER 200 SUBJECTS from which to choose additions to your own slide library; each a gem of photographic perfection, mounted and individually packaged with authentic detailed caption.

50¢ each



Also SETS OF 12

In addition to the Alaska series, the WESCO collection portrays exotic customs, costumes and places in Mexico, Guatemala and Hawaii... western scenes

of historic grandeur and breathtaking beauty. Buy slides individually at 50c, or in sets of 12 in captioned self-viewing panels.

\$5.85

A Complete START for \$4.95

for beginners in this fascinating hobby. WESCO's "starter set" features a third-dimensional-effect viewer and six slides of your own choice.

WESCO slide subjects are interesting, colors brilliant, detail keen even when highly enlarged in screen projection. See them at your dealer's.



Every Wesco Slide a Photographic Gem

Send for FREE list of WESCO slide subjects, with illustrations.

Western Movie Supply Co.
28 Geary Street
San Francisco 8,
Calif.



**KODACHROME SLIDES
AND VIEWER SETS**

SAY YOU SAW IT IN POPULAR MECHANICS

**KEEP WARM!
SAVE FUEL!**

**Mortite
BETWEEN YOU AND THE COLD**

A pliable, plastic weather-stripping, easily, quickly applied to windows, doors, baseboards. Stops expensive heat leaks.

Just press into place. Use inside or outside. Can be painted. Mortite does not shrink or crack. Also plugs cracks around drainboards, bathtubs, etc.

Roll covers about 80 feet, enough for 5 windows.



\$1.25 AT HARDWARE, PAINT, DEPT. STORES AND LUMBERYARDS

Higher west of Rockies and Canada

Ask for Mortite Booklet!

J. W. MORTELL CO.

522 Burch St. Kankakee, Illinois

**Build and Fly
CLEVELAND
MODELS**



B-17 Flying Fortress

77 1/2" Scale Flying Model. MFM Kit SF-100..... **\$14.50**

Other Scale Flying Models from \$3.00 to \$9.50

SEE your dealer first. In ordering direct, include 20c extra for packing-postage. Get our jumbo folder describing Kits from 25c to \$15.00. Send stamp..... **3c**

Cleveland Model & Supply Co.

4512L21 LORAIN AVE.



30" Stinson 150

Flying Contest Model. **\$100**

Kit I T-98.....

Other 30" Flying Contest Models -Shooting Star, Ryan Fireball, Globe Swift- **\$100** per Kit.....



Tether Sharpie \$100

Gas Model Kit GPL 5023 (less power and hdwe.)

Other gas models from \$1.00 to \$4.50

**MASTER CHAMPION
LAWN MOWER SHARPENER**

Also Mfg., Saw Sharpening & Key Machines

FRANK'S MFG. CO.

LUCAS 6929

Dept. PM5, 3312 Tweedy Bl. SOUTHGATE, CALIF., U.S.A.

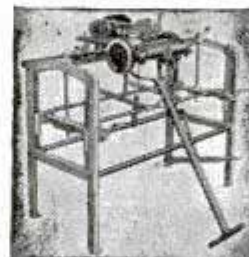

YOUR ELECTRIC DRILL

Has 100 Other Uses

when used with K-Jax attachments
**METAL SAWING . . . SHEARING
- RIVETING ATTACHMENTS**

Write for illustrated circular

K-JAX, 2600 Canton St., Dallas, Texas

NOW! Lionel Electronic Control

(FIRST TIME IN THE WORLD
AND EXCLUSIVE WITH LIONEL)

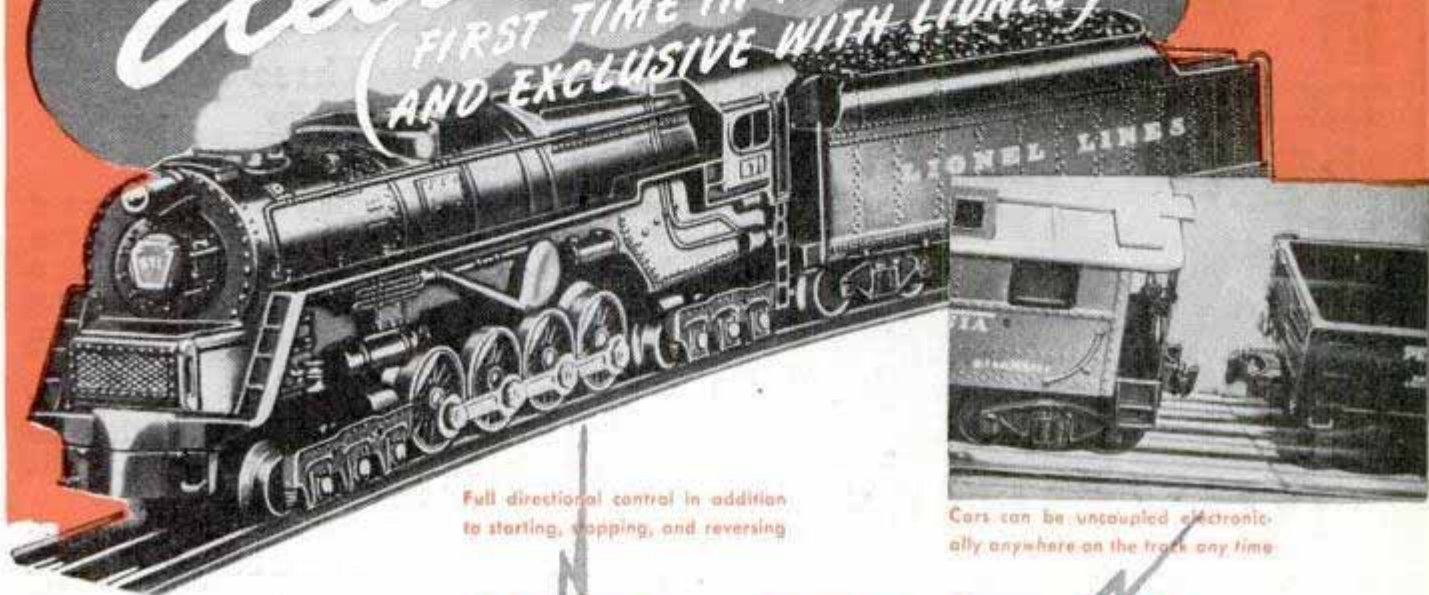

Full directional control in addition to starting, stopping, and reversing

Cars can be uncoupled electronically anywhere on the track any time

Cars can be unloaded electronically anywhere on the track layout



Simple to operate — just push the selective button

With LIONEL Electronic operation every unit of the train is under constant selective control ANYWHERE on the track. Electronic Control operates this way:—sensitive receivers on each car respond to Radio Frequency waves and make the cars or locomotive perform just as you direct. (No special wiring to track necessary).

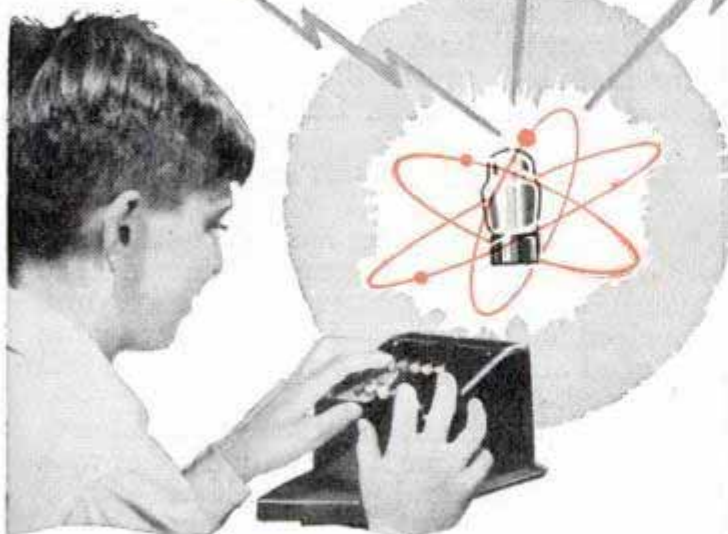

Send for
Color Catalog

and SCENERY BOOK,
plus secret
"POP PERSUADER"



The Lionel Corporation, Dept. P.M.
15 East 26th St., New York 10, N. Y.

Please send me the new full color LIONEL TRAIN catalog, also the secret "Pop Persuader" and the book on Scenery Building. I enclose a DIME to cover postage and packing.

NAME _____

ADDRESS _____

CITY _____

ZONE _____

Please don't delay! Mail today!
Send 10c for mailing.

**LOCOS PUFF SMOKE
-WHISTLE LIKE REAL TRAINS**



IF IT'S A MAKE-A-LITE—
IT'S A

Merry Christmas

FOR LUCKY CYCLISTS

BRILLIANT
ELECTRIC LIGHT

WITHOUT BATTERIES



PLAY SANTA CLAUS
RIGHT . . . WITH

MAKE-A-LITE

BICYCLE LIGHT
Generator

GOOD LIGHT
EVEN AT A
WALK



An ideal Christmas gift for lasting year 'round enjoyment! No more bother and expense with batteries. Generates dependable electric light at all speeds—free of cost. Automatic voltage control generator prevents excess voltage and blowing of bulbs at high speed. Good light at a walk, brilliant light when riding. Be sure to see the new MAKE-A-LITE head lamps and tail lamps, too

Easy TO INSTALL

Pays for
itself over
and over again!

Bike owners of all ages will thrill to MAKE-A-LITE'S efficiency and good looks. Play Santa Claus right with MAKE-A-LITE!

At Your Bicycle, Sporting Goods or Hardware Store

MAKE-A-LITE DIVISION
Chefford Master Mfg. Co., Inc., Fairfield, Ill.

by the portable control unit shown. A hook-shaped wave guide "pours" the video (picture) signal into the center of the reflector, amplifying the output about 9000 times. The receiver unit at the studio or station reverses this process, again multiplying the signal strength about 9000 times as the signal is fed from the receiver reflector to the wave guide; overall amplification, therefore, is approximately 81,000,000 times. Operation is at any selected frequency in the 6500 to 7050-megacycle band; the band width permits reproduction of the finest detail in the pickup "camera" picture.

How to Play Three-Cushion Billiards

(Continued from page 127)

average and expert players has observed that the ordinary player often hits the cue ball at the extreme left or right, putting a lot of spin on the ball but generally missing the shot. The expert uses a minimum amount of english.

The standard billiard ball is $2\frac{3}{8}$ inches in diameter. Now imagine a circle the size of a half dollar drawn in the center of that part of the ball that faces you.

Then mark this down "indelibly" in your mind: Never strike the cue ball outside this imaginary circle and you will eventually improve your game.

I can't emphasize this point too much. For one thing you will stand less chance of miscues. You've seen billiard players aim straight ahead but the ball skids off to the right or left? Well, often this is caused by hitting the cue ball outside that imaginary circle.

If you make a follow shot in which the cue ball follows the general direction of a struck object ball, hit the cue ball near the top of that circle. If you try a draw shot to pull your ball back toward you after hitting another ball, stroke the cue ball near the bottom of that circle. Left-hand and right-hand english, likewise, are obtained by hitting the ball on the left or right, but still within that circle.

In discussing stroke and follow-through, I'll start by explaining that whenever I see a player with an even, rhythmic stroke and a clean follow-through I know I'm watching a good billiard player or one who soon will be good.

To acquire an even stroke you must control your cue after it comes in contact with the cue ball. Hold your cue level—nearly parallel to the table top—for most shots. Follow through the cue ball regardless of whether the stroke is center ball, or is to

(Continued from page 128)

Brighten your life!

Your house stays "winter-bright" when Perfection keeps you warm! Because Perfection heat is sootless, smokeless and odorless—walls stay cleaner, floors and home-furnishings stay brighter.



Lighten your labors!

Just turn a Dial—that's all the work you do to get any degree of heat you want—instantly! No coal to carry, no fires to build and tend, no ashes to empty, no soot-streaked walls to clean.

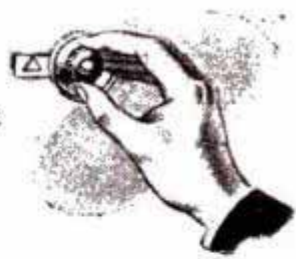

with **PERFECTION** Oil-Burning Heaters



**Constant Uniform Warmth
with PERFECTION!**

Wake up winter mornings in a house Perfection-warm . . . all over. You don't need a basement or any alterations to your present dwelling to enjoy this modern day and night warmth without work. Investigate Perfection . . . it means better living wherever you live.

IVANHOE MODEL 2205 SPACE HEATER equipped with Perfection's famous "Heat Directing" Shutter!

Model 750 "Firelight"
Perfection Portable Heater
Millions of portable Perfection Heaters are now in use for dozens of uses from bathroom to chicken brooder, or anywhere in between where "spot" heating is needed.



PERFECTION Oil Ranges and Heaters

PERFECTION STOVE COMPANY • 7855-B PLATT AVENUE • CLEVELAND 4, OHIO



"No, 32 Miles Back and Turn Left"

BE SURE WITH A

Sherrill COMPASS



Guessing directions is one way of traveling . . . but you will find that being sure of directions is a much more enjoyable way of getting to your destination . . . without delay. And a Sherrill Compass is your best insurance of more smiles per mile of travel. Accurate . . . Dependable . . . Makes a Fine Gift.

\$4.95 Auto and Boat Model
Illuminated Model \$5.95
Other Models from \$1.50 for Autos, Boats, Planes, Sports.
AT LEADING RETAILERS

Send for amazing booklet, "How to Find Your Way WITHOUT A Compass!"
Write to Dept. 40

Sherrill INSTRUMENT CORPORATION
CHICAGO 1, ILLINOIS

Simple Shaves



ENDERS
Speed SHAVER
Easy does it

See for yourself how amazingly simple, time-saving your morning shave can be. Your first Enders shave will astonish and delight you. Easier from start to finish—because you're shaving with a precision instrument, cleverly designed to do its job without fuss and feathers. Get an Enders Speed Shaver today.

because
double thick deluxe blade clicks in like magic nothing to take apart streamlined action new safety

Address: Dept. R **49¢** with 6 BLADES

DURHAM-ENDERS RAZOR CORP. - Mystic, Conn.

26-INCH

U. S.

SUBMARINE



OPERATING SCALE MODEL

Heavy duty spring motor drives twin propellers thru sealed gears, running in oil. Water ballast chamber and air control valve for diving. Runs on surface or under water. Kit includes complete parts for spring motor and gear drive unit, completely formed Aluminum hull and diving fins, Plastic conning tower, naval gun and drive shaft brackets. Brass propellers and trim.
COMPLETE KIT—110 parts, ready to assemble—POSTPAID \$14.95.
If your dealer cannot supply you, order direct.

WESTLAKE MODEL CO., DEPT. PM-116, ERIE, PA.

DOWEL TROUBLES?

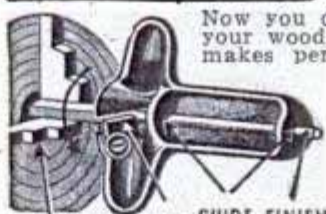

Now you can make dowels that match your wood! Amazing new **SPEE-DOWL** makes perfect, burnished dowels for arrows, cabinet work or other projects. Simply rotate wood in lathe or drill press and push on **SPEE-DOWL** like pencil sharpener. Cast aluminum body, tool steel blade. A necessity for fine craftsmanship. Available in 2, 3, 4, 5, 6, 7, and 8/16" sizes. Only \$1! Send check or M. O. now for your **SPEE DOWL**. Special—any 4 sizes \$3; complete set of 7 for \$5. Unconditionally guaranteed. Free literature.

CHUCK BLADE GUIDE FINISHED HOLES DOWEL

SPEE-DOWL, Dept. C-2, 34 Mali Dr., North Plainfield, N. J.

WRITE FOR YOUR FREE COPY OF THE NEW KRW HYDRAULIC PRESS BOOK

Describes all manner of Production and Shop Work on KRW Hydraulic and Bench Type Arbor Presses. 32 pages illustrating the new KRW Hand-operated, Electric-operated and Air-operated Hydraulic Presses.
Write for your copy today.

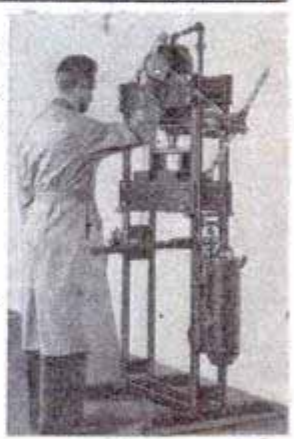

K. R. WILSON, DEPT. 17, 215 MAIN ST., BUFFALO 3, N. Y.
Builders of Shop Equipment for Ford Dealers Since 1916

The case of the Dull Drill

The man behind the counter told the novice it was a good drill, but the first few tough jobs took the heart right out of it. And so . . . another "bargain counter" tool ends up in the junk box—money thrown away.

As a reader of *Popular Mechanics* and long-time user of tools, you know nothing takes the place of quality . . . nothing can do the job like a good tool that proudly bears a good name.

You *get* quality and you *get* well-known merchandise when you buy from your hardware dealer. He has built his business by serving you best. *Depend* on him.



YOUR HARDWARE DEALER
Sells QUALITY Tools and
Hardware. Buy from HIM.

✓ **POPULAR MECHANICS**

BEFORE YOU PUT IN ANTI-FREEZE

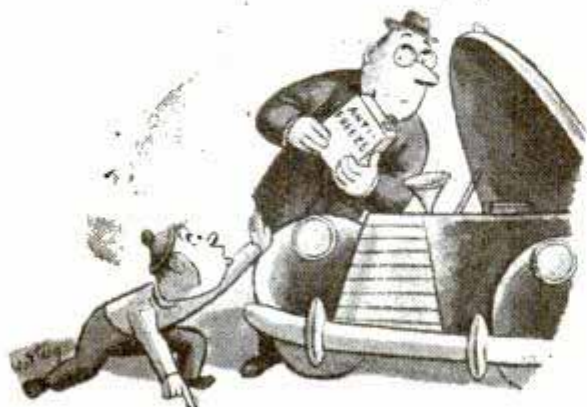

1. CLEAN OUT RUST

with **DU PONT**

Cooling System **CLEANSER**

Don't put anti-freeze into a rust-clogged radiator. Clean out the rust and scale *now* before winter sets in. Just pour a can of **DU PONT COOLING SYSTEM CLEANSER** into your radiator, run the engine 30 minutes or more, then drain. It cleans thoroughly without reverse flushing.



2. PREVENT LEAKS and LOSS OF ANTI-FREEZE

with **DU PONT**

Cooling System **SEALER**

After cleaning out the cooling system, make it leak-proof. Don't take chances on losing precious anti-freeze. Here's a product that stops leaks quickly and securely. Does not clog the radiator.



IF YOU RE-USE OLD ANTI-FREEZE

You can re-condition it by adding a can of **DU PONT ACID AND RUST INHIBITOR**. This neutralizes the acid and prevents rust from forming. Makes it safe to use anti-freeze a second year.

DU PONT Acid and Rust INHIBITOR



BETTER THINGS FOR BETTER LIVING
... THROUGH CHEMISTRY

impart follow, draw or english. Keep your cue on the line of aim and keep your bridge-hand on the table until after the stroke is completed. Never permit the cue tip to waver in the air after delivering your stroke. Never permit the cue tip to slide off to the right or left when putting english on the cue ball.

The speed of your stroke which, of course, determines the speed of your cue ball, often is the factor which decides victory in a billiard match. Speed has a lot to do with the action of the cue ball after it strikes an object ball.

For example, if you use extra speed, your cue ball (after hitting an object ball) will follow a path which forms a smaller (in billiards it's called "shorter") angle than if the ball had been shot with less speed. This is because a fast ball gives the english less chance to "turn" the ball to the right or left, depending on the type of spin imparted.

Experience will show you what speed to use but, in the meantime, if a short angle is required, use a hard stroke; if a long angle is needed, use an easy stroke.

To become a good three-cushion player you must study and practice the fundamentals until you automatically do the things I have recommended. Then you must become adept at visualizing the various angles through which the cue ball must travel to make various three-cushion shots.

Most players acquire that skill by watching good players and then practicing the things they learn. But if you want to eliminate a lot of guesswork, learn the Diamond System.

In order for me to fully explain the Diamond System, Popular Mechanics would have to turn over almost all the space in this magazine. I devoted an entire chapter to it in my book, "Billiards As It Should Be Played," copyrighted by the Reilly & Lee Company, Chicago, publishers.

I'll try here to tell you enough about the Diamond System to give you an idea of how it works. In the first place, it is based on a mathematical process using the in-laid diamond-shaped markers to guide the player in selecting the proper angle to make a shot.

Each diamond has two numbers—cue ball number and object ball number—which you must memorize from a chart. The numbers are not stamped on the rails because your position at the table determines the numbers you assign to each diamond. You always start counting the diamonds from the opposite end of the table from which you stand.

O.K. Now let's assume you have memo-

(Continued to page 256)

Snap-on

Octo-Grip TRADE MARK

SCREW DRIVERS



THE Right Driver FOR EVERY JOB . . .

● What a difference a good screw driver makes! But what makes a *good* screw driver . . . a Snap-on OCTO-GRIP screw driver? Nickel-molybdenum alloy steel blades, electrically heat treated to give the correct combination of toughness and hardness . . . tested hard-tempered tips, precision ground and shaped to prevent "chewing" and breakage . . . easily grasped, OCTO-GRIP plastic handles, non-rolling and shock-proof . . . balanced design that gives you deftness, sureness and speed under all working conditions. These are the "musts" in a really good screw driver . . . and they are in every Snap-on OCTO-GRIP driver you buy.

Snap-on also makes other fine screw drivers . . . more than 75 different models, including Phillips screw drivers in both one piece and detachable head models, Reed & Prince drivers, offset and hammer

head and spark testing drivers . . . a type and size for every service.

Snap-on screw drivers are part of a complete line of 4,000 tools available through Snap-on's nationwide tool service. Write for free catalog.



SNAP-ON TOOLS CORPORATION
8062-K 28th AVENUE • KENOSHA, WISCONSIN

A Fine, Precision
EXPOSURE METER



\$14.50

WITH CASE
Including Tax
on Meter



The Sign of Precision

Make your camera take better, sharper photos. Eliminate guess-work, lost pictures and wasted film with a precision-built SKAN Exposure Meter. A *must* for color—still or movies. Be right in *any* light—day or night. Simple to use.

Sold at camera counters everywhere. For free literature write: G-M Laboratories Inc., 4290 N. Knox Ave., Chicago 41, Ill.

SKAN

EXPOSURE METER



COMBINATION Letter Weigher & Ruler

8 Handy Instruments in One—Letter Weigher—Ruler—Magnifying Glass—French Curve—Compass—Protractor—Level—Mitre. The Xmas gift that's different. Order Now.

Send Check or Money Order.

\$2.00

We will not ship C.O.D.

CHESTER A. HANSON

831 Chapel Street

New Haven 10, Conn.



HUNTER'S
COMPASS

Hunting Case, Watch Type, All Metal, Jeweled Longines **\$2.50**

RUBBER SPORT GOGGLES

White Plastic Lens and Extra green Polarizing Lens, Plastic Lens are shatterproof, Polarizing Lens a protection against reflected glare, excessive light, dust and wind. Ideal for industrial use, Motorcycling, skiing and all kinds of outdoor use. Value \$3.50. **SPECIAL \$1.50**
Per pair

Engineers All Metal Army Type Hand-Sighting

LEVELS

\$1.50



PUBLIC SPORT SHOPS

13 S. 16th St., Phila. 2, Pa.

No COD's

GENUINE IMPORTED SWISS **WRIST WATCH**



\$8.90

Tax Included
Far Below
OPA Ceiling

Modern streamlined expansion watch band fits any wrist. Non-tarnishable silver finish, stainless steel. **\$100**
Regular \$2.50 value. Only
Also yellow or pink Gold plated expansion watch band. **\$2.50**

Sweep second hand! Highly polished chrome case, sturdy leather strap. Pocket watch, Swiss make. Clear dial, chrome case, only 3/8" thick. Our price \$8.90 tax included. Send check or money order. C.O.D.'s accepted.



CEDO SALES SERVICE, Dept. P.M. 57, P.O. Box 4, New York 51, N. Y.

New Designs in

FRANZITE GRIPS

Modernize Your Gun! Improve Your Score!

Most durable grips made. Positively unbreakable! For Colt, Smith & Wesson, Hi-Standard, Ortgies, Luger & Mausers in a wide choice of beautiful designs in ivory, pearl, walnut, onyx, etc. Low prices. FREE CATALOG. Dealers Wanted.

SPORTS, INC., (Mfrs.) 5501 Broadway, Dept. P-11, Chicago 40, Ill.

PLEXIGLAS

MANUFACTURERS' SURPLUS

A large assortment of workable sizes. Make your own Xmas gifts @ \$10 value.

7 1/2 LBS. \$3.95

SHARCO PLASTICS, Chicago 12, Ill.

Parva

Ingenious New Technical Methods

To Help You with Your
Reconversion Problems

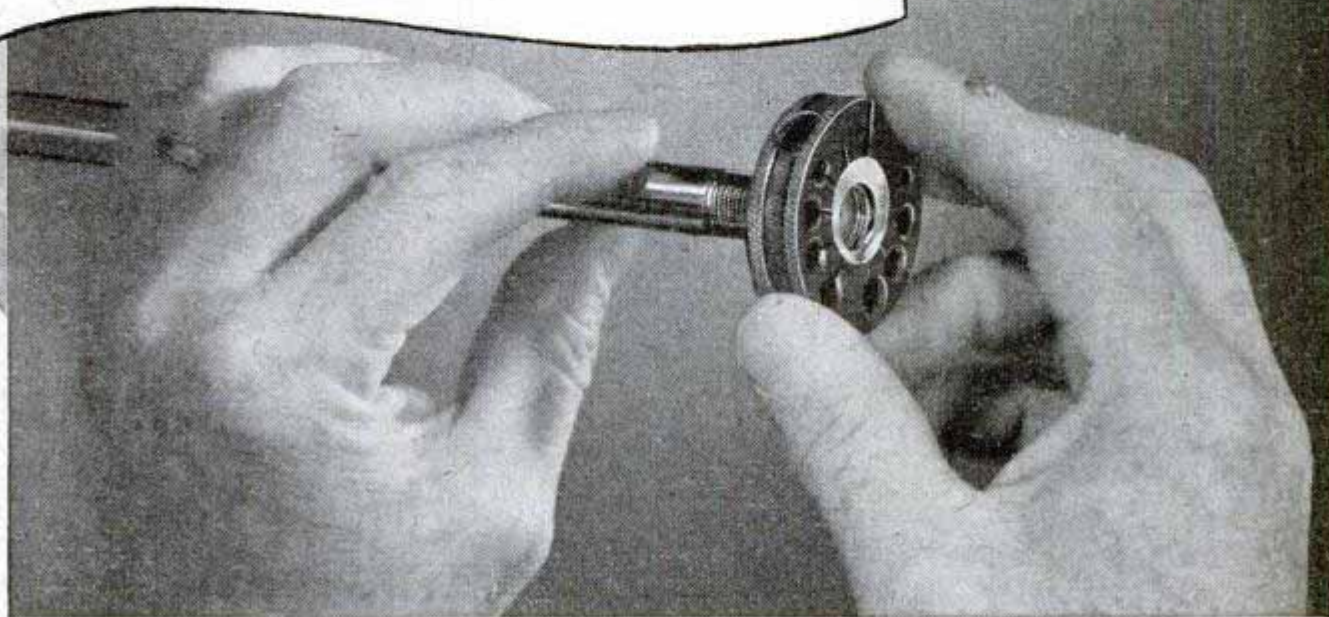

New Thread Ring Gage Starts Round Stays Round with every Adjustment!

Employing a new principle of design, the Woodworth Thread Ring Gage closes in round within .0002 maximum after .005 adjustment. It offers greater accuracy and stability since size adjustment is controlled along thread helix angle. Threads are held securely in alignment after adjustment, due to unique adjustment means. Wear is distributed over full circumference for all resettings, thus increasing life of gage.

Positive adjustment makes it almost impossible to change setting with ordinary knocks. Positive identification by a green "go" gage and red "not go" gage saves operator time. Aluminum alloy outer body cuts weight in half, to reduce operator fatigue and increase sensitivity.

To also reduce fatigue on precision jobs, many plant owners make chewing gum available for workers. Tests show that the act of chewing aids in relieving tension, which is often the cause of fatigue. These tests further reveal that chewing Wrigley's Spearmint Gum, for instance, helps workers stay alert, thus increases their efficiency to do more accurate work.

*You can get complete information from N. A. Woodworth Company
1300 East Nine Mile Road, Detroit 20, Michigan*

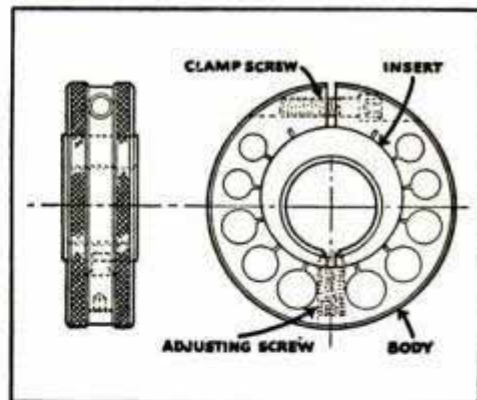

Woodworth Thread Ring Gage



AA-97



For truly superlative reception from stations both far and near — for unsurpassed dependability in almost any weather — pick a set with global reach! With the 12-tube superheterodyne National NC-2-40D, you can bring the world to your living room. You'll marvel at the remarkable sensitivity and selectivity that made National receivers the Navy's choice for three out of four of its fighting ships. Write today for the name of the dealer where you can see this incomparable set for yourself.

EST.  1914
MALDEN, MASS

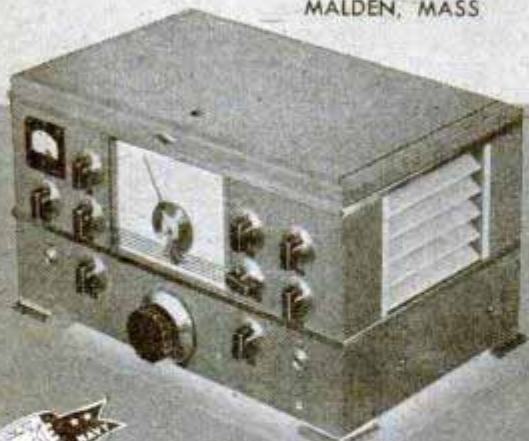

NATIONAL
COMPANY, INCORPORATED

THE MOST DISTINCTIVE NAME IN RADIO COMMUNICATIONS

rized the diamond numbers. Next you learn that the diamonds have a relationship with each other in that when your cue ball strikes a certain diamond (when traveling in a certain direction) it always will strike a second and then a third diamond (known to you). This means that you can scientifically determine the path of the cue ball to score a billiard.

I'll admit it sounds difficult. It is. You can't become an expert three-cushion billiard player by just banging the balls around a table. If you want to learn the Diamond System, be prepared for some serious study, possibly some instruction from an expert, and plenty of practice.

But keep this in mind. You can have a lot of fun playing the game even if you never learn the Diamond System.

Assembly Line Gobblers

(Continued from page 136)

ounces. Multiply 75 cents by 12,000 and you get a pretty good sized investment. The hens attain a maturity weight of 14 to 18 pounds, and toms from 22 to 30 pounds, with the average dressed weight 19 pounds.

Last fall the OPA wholesale ceiling price for dressed turkeys was in the neighborhood of 44 cents a pound. So, if Fox and his men can nurse 12,000 turkeys to maturity—and sell them at 44 cents a pound—the gross will be about \$100,000. Of course, feed costs, labor, equipment cost and maintenance, depreciation and other sums are deducted. Feed alone is a big item, since each turkey ate about \$4.50 worth of feed this year.

Under these circumstances the average man would look at each poult as a six-bit piece on legs which—if it stays alive long enough—will grow to be worth between \$6 and \$12. The poults, therefore, can be sure of careful handling.

Once over the hurdle of that first eight weeks, the turkeys are put out on the range. Fox has 40 acres in pasture (alfalfa and clover) where the turkeys live until they're ready for somebody's Thanksgiving table.

Fencing in an acre or two at a time, Fox divides his flock into three groups to minimize the danger of turkeys stampeding and trampling each other to death when a plane soars overhead or lightning crackles from the sky. If 12,000 turkeys were all massed together in one fenced-in area, a stampede might take a terrific death toll.

Once a week the fences and all equipment (shelters, feed and water troughs, etc.) are moved to a new pasture. This not only provides additional alfalfa and clover for the birds to eat, but the move to fresh

(Continued to page 260)

A New COMPLETE power driven workshop . . .



The greatest power tool value ever offered to American craftsmen

\$59⁹⁵-

6 Major Power Tools
Complete with Motor
and Full Assortment of Accessories



Made by a long-established power tool builder, many thousands of Duro tools have been used for years in home workshops, schools and industry. The motive power of this shop—the sturdy, rugged, Duro Hand Grinder—has long been recognized as one of the finest light grinders on the market—and is today in wide use in both industry and home shops.

Send for FREE Circular

giving complete description, specifications, and showing photographs of many unusual jobs that you can do with this shop. Also names of nearest dealers where you can see the shop on display. Mail coupon today!

Here is the greatest value in power tools ever offered to the American craftsman. Consider this: You get a Power-driven Drill Press, Lathe, Shaper, Router, Bench Grinder, Hand Grinder—complete with AC-DC motor, all ready to operate—with a compact accessories kit containing 50 sanding, grinding, drilling, polishing accessories—all for only \$59.95.

Handles Scores of Operations

Designed primarily for light work in wood, plastics and light metals—this remarkable shop can be used in many ways by home craftsmen and model builders for—routing, shaping, engraving, grinding, polishing, carving, cleaning, buffing, de-burring, sanding, drilling, turning, etc.

DURO METAL PRODUCTS CO.

2691 North Kildare Avenue, Chicago 39, Illinois

Gentlemen: Please rush me your free illustrated circular giving complete specifications and photos of the New Duro Workshop . . . plus a list of dealers where I can see the shop on display.

Name _____

Street Address _____

City _____ State _____

DURO METAL PRODUCTS CO.
2691 N. KILDARE AVE., CHICAGO 39, ILL.

For jobs like this...



—But for gluing **UNLIKE** surfaces,

CASCO FLEXIBLE CEMENT

Wood to metal . . .



Leather to fabric . . .



Plastic to felt . . .



Withstands shocks . . .

resists moisture . . .

clean and easy to use!

25¢ AT YOUR HARDWARE STORE

CASEIN COMPANY OF AMERICA • NEW YORK 17, N. Y.

Say you saw it in Popular Mechanics!

ELECTRICITY FOR ANY JOB

ANYWHERE

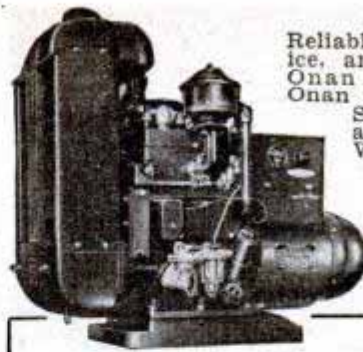

Reliable, economical electric service, anywhere, anytime, with an Onan Electric Plant. Driven by Onan 4-cycle, gasoline engines. Single-unit, compact design and sturdy construction. Water or air cooled.

Capacity range: 350 to 35,000 watts; 115 to 660 volts A.C., 50 to 800 cycles; 6 to 800 volts D.C. Combination A.C.-D.C. types. 65 different models

WRITE FOR FOLDER

ONAN

D. W. Onan & Sons, 2523 Royalston Ave., Minneapolis 5, Minn.



Does more things easier, quicker than any other tool. Remains locked to the work with hands removed. Holds anything, any shape, with a grip that never slips. Built with strength to back up its power. Made of fine alloy steel. Nickel plated. Two sizes, 7" and 10".

Sold thru Tool Jobbers and Dealers

Invented, Developed and Made World Famous by

PETERSEN MFG. CO., Dept. P-116

DeWitt, Nebr.

Ball-Bearing

SPEED WHEELS

Build Your Own—

- Coaster Wagons
- Racers
- Bike Trailers

Mach. Axles available

ORDER NOW FOR PROMPT DELIVERY



8 in. Wheel with Tire \$2.25 each

10 in. Wheel with Tire \$3.25 each

10% deposit required on C.O.D.'s

JIM BROWN TOY COMPANY

869 E. Tallmadge Ave.

Akron 10, Ohio



BE FAIR TO YOUR HAIR Want better looking hair? Embarrassed by falling dandruff, itching scalp? Then try VITABRUSH, new electric driven scalp brush that gives your scalp a vigorous and invigorating "workout" in just three minutes of fun. Cleans scalp. Stimulates blood supply. Restful. Pleasant. Write today for complete information and satisfaction-guaranteed offer.* Hershey Mfg. Co. 157 South La Salle St., Chicago

GIFT OF A LIFETIME!



The Handee Tool, famous "TOOLSHOP IN YOUR HAND" is packed with power and speed, designed for extreme accuracy, absolute dependability! It's the first and finest tool of this type for the skilled craftsman or the eager beginner. Handee grinds, drills, cuts, engraves, routs, polishes, carves, sands, saws, etc. And it works on any material—wood, metal; plastic, alloy, glass, leather, linoleum, horn, stone, bone, etc.

WHAT A THRILL! Smooth, steady power at the fingertips—a tool quick and sure, easy to guide as a pencil! Hundreds of useful articles can be made with Handee: ship, train and plane models, puppets, costume jewelry, initialed tumblers, wood carvings, etc.

EASY TO USE—Lightweight (only 12 oz.) and perfectly balanced, the easy to handle HANDEE runs at a cool 25,000 r.p.m., plugs into any AC or DC socket.

THE HANDEE KIT—Here is the very finest of all equipment—a practical combination that every craftsman will welcome. The Handee Tool, acclaimed the world over for its remarkable speed, power and long life . . . plus a complete assortment of 45 accessories including drills, steel cutters, saws, brushes, drum sander and bands, mounted wheels, etc . . . all packed in a handsome steel carrying case. Complete, postpaid **\$27.50**
Handee with 7 accessories (not in case) \$20.50.

**SHIPMENT in TIME
for CHRISTMAS
ORDER NOW
SATISFACTION GUARANTEED**

**GET THIS HANDEE KIT
FOR A FRIEND
AND YOURSELF**

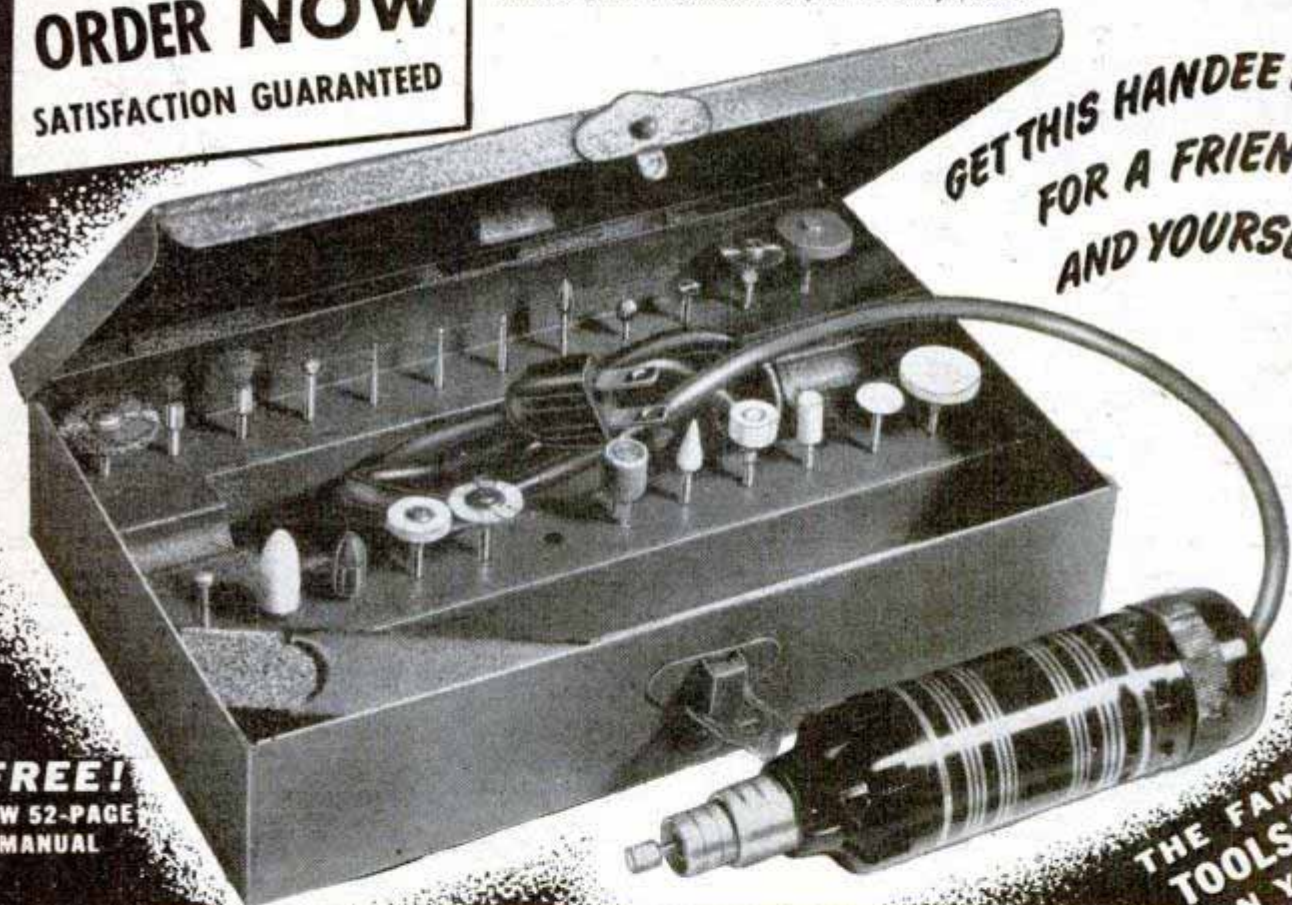

FREE!
NEW 52-PAGE
MANUAL

**THE FAMOUS
TOOLSHOP
IN YOUR
HAND**

* HANDEE

TOOL OF 1001 USES

PRECISION ATTACHMENTS

New! They fit Handee only! Both novice and craftsman do perfect work. Magically, easily, offhand carving, routing, shaping will be exact as to depth of cut, accuracy of line. Set of 6 attachments with instructions, postpaid, **\$7.95.**

*Reg. U. S. Pat. Off.

CHICAGO WHEEL & MFG. CO.
1101 W. Monroe St., Dept. PM Chicago 7, Ill.

Rush the Handee Kit Handee Tool
 Precision Attachments Remittance Enclosed
 Send C.O.D. Send Manual.

Name

Address

NEWEST RIDING

Sensation!



**Ride one
and you'll
buy one!**

**WHIZZER BIKE MOTOR
FITS ANY BALLOON-TIRED BIKE**

The real answer to dependable, low cost transportation. Fits any balloon-tired bike. Built by automotive craftsmen in the heart of the auto industry, the Whizzer bike motor installs easily and will carry you fast (5 to 35 miles per hour) and far (125 miles or more on a gallon of gas). Enjoy new freedom and adventures with your Whizzer. Use it for errands, shopping, business, recreation and work. Whizzer's 2½ h.p. will take you there and bring you back! Does not interfere with normal pedaling of bike. Put a Whizzer on your bike now. **WHIZZER MOTOR CO., Pontiac 15, Michigan.**

Simple, positive controls. Easy to ride, too . . . Whizzer doesn't change balance or riding qualities of bike!

FACTORY PRICE
\$97⁵⁵
PLUS TAX

**See your WHIZZER
dealer today**

IF NO LOCAL DEALER, USE COUPON

WHIZZER MOTOR COMPANY
Dept. 171, Pontiac 15, Mich.

I enclose \$99.97, which includes \$2.42 Federal Excise Tax, () check or () money order. Send me one Whizzer motor, complete, with full installation instructions. Written guarantee with every motor.

If descriptive literature only is desired, check here ().

NAME _____

ADDRESS _____

CITY _____ STATE _____

ground cuts down the menace of disease.

Because Fox used mechanical ingenuity in planning his turkey farm, this weekly move is made in three hours. The 71 pieces of equipment are all mounted on wooden skids for fast, effortless moving by tractor.

Evidence that moving from pasture to pasture pays off is seen by the fact that the turkey death rate at the Fox farm is less than 13 percent; the national turkey mortality rate (from disease and other factors, not including Thanksgiving) is 22.5 percent.

Among the pieces of portable equipment are six automatic water troughs 40 feet long and mounted on four by four-inch skids. Providing a total of 480 feet of drinking space, the troughs are lined with sheet metal and the water is fed through rubber hoses (2500 feet in all) at 40-pound pressure. The turkeys stand on wire platforms while drinking, thus decreasing dampness and disease. Each turkey is assured of fresh water by drains at the lower end of the troughs which prevent water from standing for long periods. Fox has two deep wells, drawing water from one but having the other ready in case the first one fails.

The 12,000 turkeys are fed by 20 one-ton gravity type hoppers (16 feet long) which are loaded from trucks in 20 minutes, and 200 feeders, four feet long and mounted 15 to a skid. Each four-foot feeder holds 33 pounds of feed. This all adds up to a "dinner table" 2240 feet long where the turkeys can eat all they want.

Thirty shelters, 12 by 16 feet, protect the turkeys from rain and strong wind and provide a roosting place for them to sleep and rest. Lanterns attached to each shelter are lighted at night to keep wild animals away.

"Raising turkeys isn't so tough after the first eight weeks," Fox explains. "Automatic equipment eliminates guesswork and many steps. And moving skid-mounted troughs and shelters by tractor to new pastures is the biggest time and manpower saver of all."

What's on the Shelf?

(Continued from page 168)

like aviation gasoline, were so tight that her whole military effort in the air and on the ground would have collapsed in three or four months had her oil supply dried up. That is why the U. S. Strategic Air Forces selected the German oil industry as a top priority target. Destruction of the enemy's oil stocks started right at the wells (remember the Ploesti air raids?) and carried on to the destruction of finished gasoline in tank cars and trucks.

(Continued to page 264)

FINE TOOLS NEED FINE OIL!



- Lubricates
- Prevents Rust
- Cleans • Polishes

SOLD EVERYWHERE

3-IN-ONE Oil

OTTAWA SELF-PROPELLED SUPER BUZZ MASTER EASIEST TO USE



Eliminates the hard work of clearing land of brush, saplings, and larger trees. Goes anywhere on its own power. Saws uphill as well as on level ground. Handiest saw ever built. Powerful motor. Belt pulley for many power jobs. Low operating cost. Costs too little to do without. Make big money clearing land. Write for low factory-to-user price. *Pats. Pending.*
OTTAWA MFG. CO., 1127 Walnut St., Ottawa, Kans.

SEARGENT JIG SAW

This finely constructed all metal jig saw is just the thing you need for your shop.

SPECIFICATIONS:

Net weight, approx. 10 lbs.
Height, overall 16"
Length, overall 17 1/2"
Depth of Throat 12"
Table, heavy gauge metal 8 1/2" x 8 1/2"
Pulley 3" Stroke 3/4"
Frame, Cast, 2 pieces. Uses standard 6" saw blade, any width up to 3/16". Enclosed Mechanism. Hardened Working Parts for long wear and durability.



Price - \$10.95

SEND YOUR MONEY ORDER NOW.
Shipping charges express collect.

BRAFTEX PRODUCTS CO.

1123 Broadway, Dept. 501

New York City

Here YOU ARE WOODWORKERS

THE NEW CONSTANTINE MASTER MANUAL

Bigger and better with more new pages of helpful articles and information on materials and supplies. Hundreds of familiar items back again; dozens of new additions including lumber, veneers, inlays, plywood, tools and finishing materials. The greatest 25¢ worth ever offered craftsmen and woodworkers. In addition, without charge, a year's subscription to Chips & Chats to keep you up to date on craftsmen's activities and many bargains. Send 25¢ now to ALBERT CONSTANTINE & SON, INC. 791R East 135th St., New York 54, N. Y.



FREE
1 YR. SUBSCRIPTION TO
CHIPS & CHATS

BOYS!



FOR FUN, THRILLS, EXCITEMENT GET

CHEMCRAFT

America's Leading Chemistry Outfits

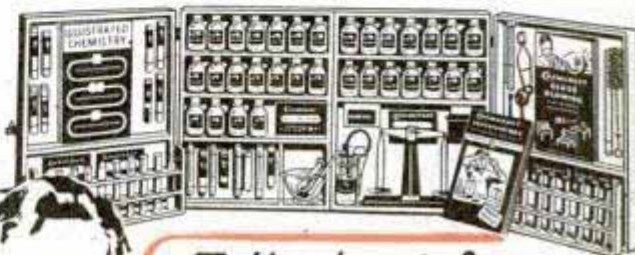

Talk about fun...
CHEMCRAFT IS TOPS!

Tell Mom and Dad that a Chemcraft set is what you want for Christmas. It brings the fun, thrills and adventures of a real chemical laboratory—right into your own home! The very first day you start amazing family and friends with almost unbelievable feats of chemical magic. But there's *more* to Chemcraft than magic. For example, you can make colored glass, or products like perfume, powdered milk, pearls, insecticides, photographic prints. With Chemcraft you do these and hundreds of other fascinating yet practical experiments. Get Chemcraft. Sold in the best stores all over the country.

BOYS-IT'S FREE!

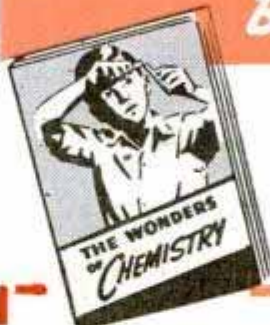

Send today for new, exciting Chemcraft Chemistry book—"The Wonders of Chemistry." Explains many fascinating home experiments, tells of the amazing things made possible by Chemistry. MAIL COUPON NOW!

THE PORTER CHEMICAL COMPANY
75 Prospect Avenue • Hagerstown, Md.

Mail me FREE, without obligation, your new booklet "The Wonders of Chemistry." (Please write plainly.)

Name..... Age.....

Address.....

City..... Zone..... State.....

SAY YOU SAW IT IN POPULAR MECHANICS

AT LAST...
a Different
XMAS GIFT
for HIM

COMBINATION MODEL 11
PRECISION PRESSURE LOCK WRENCHES
 BINGHAMTON, NEW YORK, U.S.A.

TWO HANDY SIZES
 IN GIFT BOX FOR
ONLY \$5.40

BMC **PRESSURE LOCK WRENCH**
 actually **6 TOOLS IN ONE**

Here's the gift of gifts for the man who loves to putter around the house, hobby shop, airplane or car . . . or for the serious worker on the farm or in the shop or factory. It's a new kind of wrench that's actually six tools in one. Works easier, faster, better than any wrench he has ever owned before. Fits as it grips . . . and it holds . . . with more than a ton pressure, even when the hand is taken away. Yet it can be released with the flick of a finger. Has hundreds of uses as an adjustable end wrench, a pipe wrench, gripping tool, multi-leverage pliers, hand vise or locking clamp.

JAWS ALWAYS PARALLEL

An exclusive, patented device that moves the toggle to accommodate for varying sizes of grip, keeps the jaws always parallel when they close. Prevents rounding of nuts, slipping and accidents . . . assures even pressure and a firm grip when used as a vise or clamp.

- No. 7 Max. jaw opening $\frac{3}{4}$ ".....\$2.45
- No. 9 Max. jaw opening 1".....-2.95
- Both Nos. 7 and 9 in gift box..... 5.40
- No. 11 Max. jaw opening $1\frac{1}{2}$ "..... 4.60

For sale at leading Hardware, Auto Equipment, Mill Supply, Plumbing and Electrical Departments.

BMC MANUFACTURING CORP.
 BINGHAMTON, N. Y.

Makers of Pressure Lock Wrenches; Change-A-Blade Scissors, Offset Screwdrivers for Regular and Phillips Head Screws

BEAUTIFUL SWISS WATCHES

AN AMAZING VALUE **\$7.50**
 AT ONLY



COMPARE!

- Streamlined • Steel Back
- Sweep Second Hand
- Model B—7 jewels, stainless steel, radium dial.....\$12.00
- Model C—15 jewels, stainless steel, fancy radium dial..\$22.00
- Model D—17 jewels, famous INCABLOCK movement, waterproof, shockproof, radium dial.....\$30.00

Each watch is carefully tested and checked by master craftsmen, delivered to you in perfect condition!

MONEY-BACK GUARANTEE

Add 10% Fed. Tax on all prices.

Send check, money order, or pay postman C.O.D. plus postage.

NO EXTRAS!—RUSH ORDER NOW!—Agents Wanted

GOLDEN RULE CO. P. O. Kingsbridge Station
 Dept. 21, New York 63, N. Y.

Sand Casting—Forging—Heat Treating—Case Hardening
BRONZE FOUNDRY



is again available in limited quantity without priority. Orders filled in sequence as received. INVENTORS—SCHOOLS—CRAFTSMEN use FOUNDRYETTE for making castings quickly for new inventions, for instruction, and general purpose. Order now for early delivery. Three sizes are available capable of making bronze castings of $1\frac{1}{2}$, 3, and 6 pounds weight, aluminum, copper, brass, etc., \$17.50, \$24.00, \$34.50, f.o.b. Kansas City. Domestic gas supply and 110 volt

AC or DC energy required for operation. Write for circular.

KANSAS CITY SPECIALTIES CO.

Box 6022, Dept. P-72

Kansas City, Mo.

LEPAGE'S GLUE



PROFIT-PRODUCING SPECIALTIES



• Build your business with proven money-makers—the outstanding line of specialties supplied for many years by Concession Supply Co.! Dept. C. These dependable products include Saratoga Kettle Poppers . . . Candy Floss Machines . . . Waffle Irons or Rosecake Molds . . . Ice Cream Cone Bakers . . . and other profit producers. Write for more details.

CONCESSION SUPPLY CO., Dept. C
 1858 Ottawa Drive Toledo 6, Ohio

SAY YOU SAW IT IN POPULAR MECHANICS



TOY RACER

Made of aluminum 9" long with 6 plastic wheels and tires. Lacquered in bright colors. Postpaid \$1.95 cash with order. Doz. lots \$1.15 collect.

CERTIFIED PRODUCTS CO., Dept. 80, Louisville, Ky.

500,000!!!!

LENSES

Send 3 cent stamp for "BARGAIN" list.

A. JAEGER

BOX 84P

SO. OZONE PARK 20, N. Y.



VanRoy

with the

Ajustomatic
STEM

FREE-TURNING

SELF-ALIGNING



VanRoy
Ajustomatic
Bard \$5

You will never have to fret with this new type screw-stem pipe. Its patented "float-mounted" stem lines up with hair-line precision every time—never locks off-angle. The Ajustomatic doubles your smoking pleasure through freedom from annoyance and the enjoyment of renowned VanRoy quality . . . At better stores throughout the United States and Canada. VanRoy Co., Inc., Empire State Building, New York 1.



SIGNET OF QUALITY IN PIPES

PHOTOGRAPHERS:

PRINT PHOTOS
ON
BOOK COVERS!



CHINAWARE!



RECORD
ALBUMS!



GLASS
SILHOUETTES!



WOODEN
JEWELRY!



PHOTO MURALS
DEN WALLS!

Now You CAN PRINT PHOTOS
ON PRACTICALLY ANY SURFACE!

EASY TO USE — BY CONTACT, BY PROJECTION
— ON METAL, GLASS, PAPER, PLASTICS, WOOD, ETC.

Get This
Free Booklet
From Your
Dealer!



Let your imagination go! Find new uses for your photographic hobby! Put those pictures you prize most on display in hundreds of interesting ways. It's all possible with the new Martin Multi-Mulsion—a simple, practical emulsion which sensitizes almost any surface for photographic reproduction. Ready to use. Applied in one coating with a brush or cloth. Works with ordinary darkroom equipment.

The Glenn L. Martin Co., Baltimore 3, Md.

ASK YOUR DEALER ABOUT

GLENN L.

Martin

MULTI-MULSION



NEW TOOL READY!

WAR INDUSTRY'S
MOST VERSATILE MACHINE
Is Now Available
TO HOME SHOPS



The Mead
Bandsander

Signs & Display



Model Building



Plastics, Novelties



Ornaments



Pattern
Shops

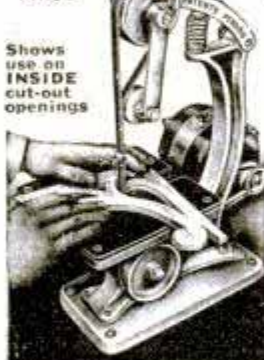

Shows
use on
INSIDE
cut-out
openings

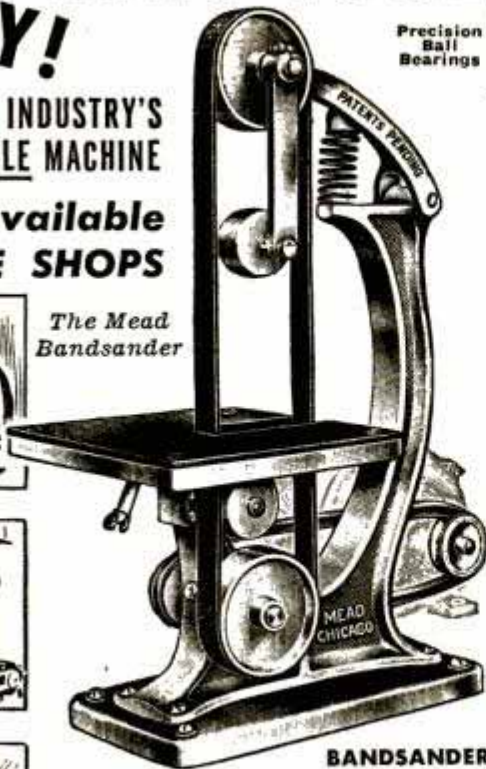

Precision
Ball
Bearings

BANDSANDER

**Cuts Fast, Clean — Saves
Filing and Sanding Work!**

**SHAPES • PROFILES • SMOOTHS
BEVELS • GRINDS • POLISHES
SANDS • CARVES • CLEANS**

Let the versatile war plant production-proved Mead Bandsander save you sweat and time on hand-filing and sanding jobs—on wood, metal, plastics! A god-send to home craftsmen, hobbyists, model-makers, pattern-makers, industrial shops. Handier than a grinding tool for sharpening drills, chisels, tool bits, garden tools. This all-around utility tool works equally well on irregular outside surfaces or inside cut-out openings. Gets into places no others can. For example, to work inside a cut-out opening, simply lead band through hole in work and in front of idler pulleys. You can work to the center of pieces up to 17" wide! Table tilts back or forward for bevelling or chamfering edges of any contour. Table top is rust-and-sweat proof. Bandsander operates on 1/4 h.p. motor at 1700-2200 r.p.m. Abrasive band surface passes work at 1600 feet per minute cutting fast, cool, clean. Narrow bands may be used for intricate patterns.

Rush Coupon for FREE Circular

Send no money—simply mail coupon for Free, lavishly illustrated Bandsander Circular. Read about "the machine that amazed the experts." Surprisingly low cost. Sold on 5 Days "No Risk Money Back" Trial. Ideal to give or get.

MEAD SPECIALTIES CO.
4114 North Knox Avenue
Dept. 1116 Chicago 41, Illinois

MEAD SPECIALTIES COMPANY,
4114 North Knox Avenue, Dept. 1116,
Chicago 41, Illinois.

Gentlemen: Without cost or obligation, send me your lavishly illustrated Circular on Mead Bandsander—the tool that takes the work out of home workshops!

NAME.....
ST. & NO.....
CITY.....STATE.....

The development of our undersea oil resources might prevent just such conditions in the United States in some future war. For, in spite of the atom bomb, gasoline still powers the machines of war. Oil is still the main lubricant for the millions of bearings and moving parts in engines, and an important source of synthetic rubber.

The Department of the Interior is now preparing a program for the exploration and survey of the continental shelf, which will be such a major undertaking that it is believed only the government has the resources to make it.

Although the eventual cost of a comprehensive search for oil in submerged lands some distance from shore may be large, there is every reason to believe that the cost will be recovered through the discovery of new sources of petroleum. Even if national safety were not at stake in finding new sources of oil, the economic prospects appear to justify the exploration program.

On the Air . . . There've Been Some Changes Made

(Continued from page 109)

lengths at will—and for a time nothing could be done about it. The Department of Commerce issued licenses, but had no regulatory power, and broadcasters governed themselves by "gentlemen's agreements."

The listeners and the ethical broadcasters howled for federal regulation and in early 1927 Congress passed a bill creating the Federal Radio Commission. All licenses were canceled and the commission undertook to separate the sheep from the goats—to protect the constructive and public-spirited broadcasters while putting the pirates out of business.

In the interim something had happened that was to give force and direction to the industry. National advertisers had learned the value of radio as a sales medium; the linking of widely separated stations by telephone lines had reached a practicable point, and good radio shows were difficult and expensive to assemble. Temporary networks of stations were created to bring the best broadcast programs to the largest number of people.

The man with something to sell was ready to spend real money, and radio, as always, obliged him. In November 1926 the National Broadcasting Company was formed with 25 stations situated from Boston south to Washington, D. C., and west to Kansas City. In its first year NBC grossed \$3,750,000 in sale of time; last year NBC, the American Broadcasting Com-

(Continued to page 268)

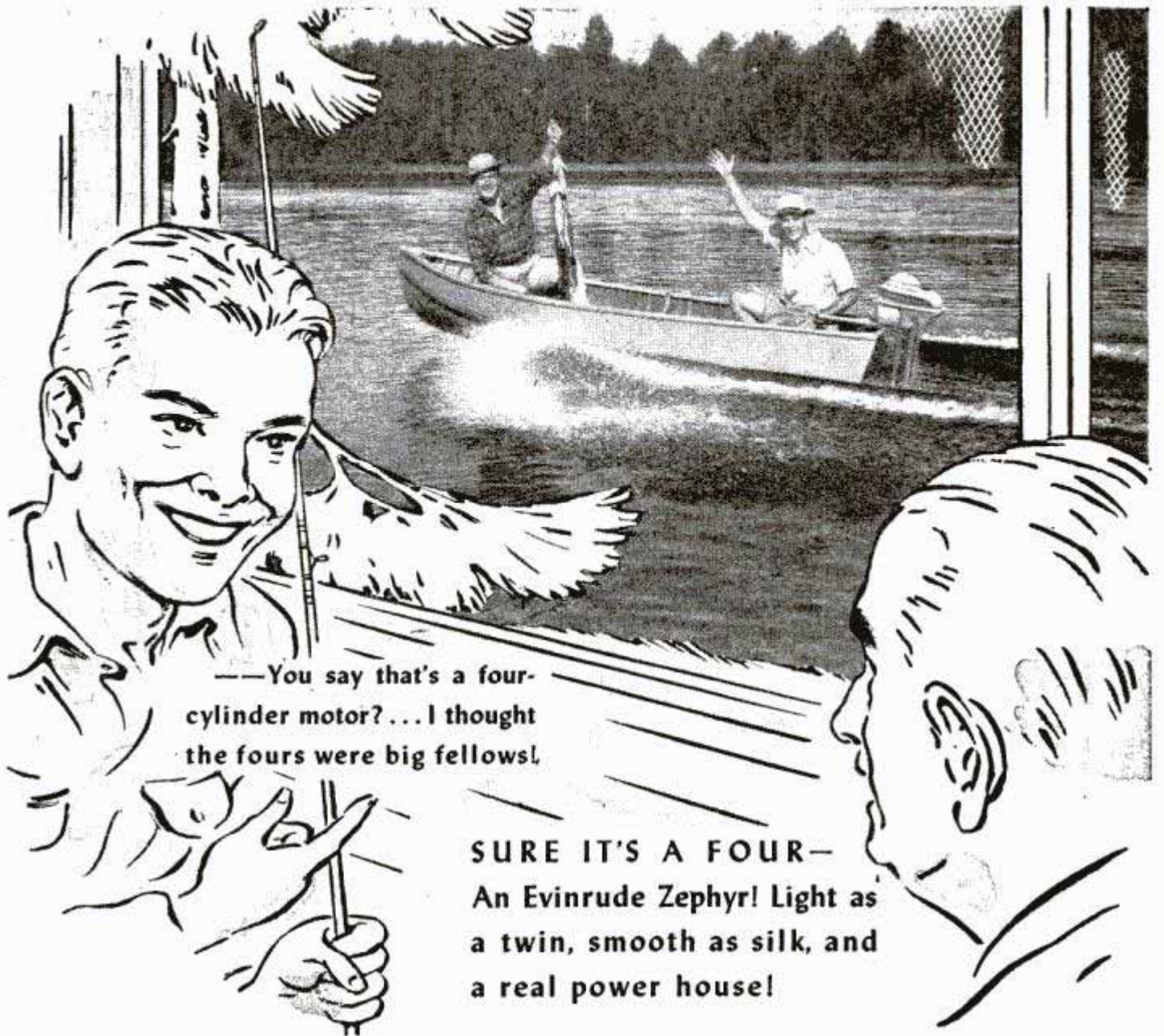

—You say that's a four-cylinder motor? ... I thought the fours were big fellows!

**SURE IT'S A FOUR—
An Evinrude Zephyr! Light as
a twin, smooth as silk, and
a real power house!**

Sounds almost too good to be true! But take the word of delighted "Zephyr" owners from coast to coast that *it is true!* Right in the range of two-cylinder power, weight and price you can enjoy matchless *four-cylinder* performance! The wonderful smoothness of 8,000 *balanced, overlapping* power strokes per minute! Exceptional starting ease! Thrilling responsiveness, and flick-of-the-throttle flexibility from slow trolling glide to surging top speed!

If you'd like a motor developing 5 horsepower or more, *you can have it in a "four"!* Four great "fours" to choose from — "Zephyr" and "Lightfour" for outstanding performance on family boats and fishing craft; "Speedifour" and "Big Four" for powering fastest outboard runabouts, cruisers, big utility boats. *Only Evinrude builds "fours" . . .* built into them is Evinrude's 37 years of outboard *Know How . . .* 18 years of leadership in four-cylinder engineering.

See your Evinrude dealer—look for his name in your classified phone directory under "Outboard Motors". Complete catalog of 8 Evinrude models sent free . . . address, EVINRUDE MOTORS, 5389 N. 27th Street, Milwaukee 9, Wis.

In Canada: Evinrude Motors, Peterboro, Ontario.

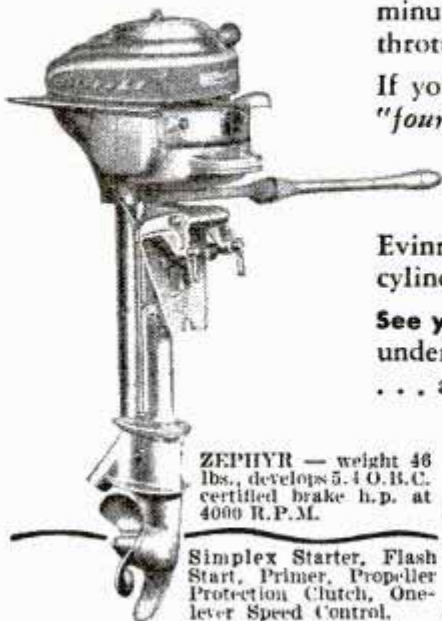

ZEPHYR — weight 46 lbs., develops 5.4 O.B.C. certified brake h.p. at 4000 R.P.M.

Simplex Starter, Flash Start, Primer, Propeller Protection Clutch, One-lever Speed Control.

EVINRUDE
OUTBOARD MOTORS

They're back again

... THOSE NATIONALLY FAMOUS RUBBER TIRED WALTON WHEELS FOR BUILDING YOUR OWN VEHICLES!

You can't buy better Wheels! WALTON DELUXE WHEELS are America's finest—don't be satisfied with anything less to build vehicles of your own design!

Hardened Steel Roller Bearings
Two sets of scientifically engineered roller bearings and massive jumbo balloon rubber tires give them rocket speed and provide you with almost unbelievable velvet-smooth rides.

IDEAL CHRISTMAS GIFT! HUNDREDS OF USES! Excellent for carts, trailers, golf bag carriers, mobile industrial equipment. Tremendous production direct from manufacturer makes possible our low price for such fine quality!

3 COMPLETE WHEEL KITS

Choose from these kits to make coaster wagons, racers, four-wheel trucks, etc.
WK1 Four 8x2 Wheels, two 20"x1 1/2" diam. axles, 4 heavy hangers, 8 washers and cotter pins ready for use.

Specially priced **\$13.95**

WK2 Four 10x1 3/4 Wheels, two 24"x1 1/2" diam. axles, 4 heavy hangers, 8 washers and cotter pins ready for use.

Specially priced **\$14.95**

WK3 Designed for heavy-duty needs. Includes four extra-heavy, big industrial type deluxe Wheels, two 24"x1 1/2" diam. axles, 4 heavy hangers, 8 washers and cotter pins. Massive 10-inch rubber tires are 2 3/4 inches thick. Specially priced... **\$32.95**



WHEELS ONLY

8x2" in sets of two.
Each **\$2.95**
\$11.60 set of 4

10x1 3/4" in sets of two.
Each **\$3.25**
\$12.80 set of 4

10x2 3/4" extra heavy industrial type in sets of two. Each... **\$7.48**
Single Wheel **\$7.95**
\$29.95 set of 4

Fast delivery. Send check or money order. No C.O.D.'s, please.

WALTON WHEEL COMPANY, Dept. J2
PLANKINTON ARCADE MILWAUKEE 3, WISCONSIN
Dealers and Equipment Manufacturers—write for information.



HERE'S *Fun*

AT YOUR FINGERTIPS

A TONIC . . . For World-Wearied Nerves

Slip away from everyday problems into the relaxing world of "railroading in miniature." The exquisite precision of Scale-Craft parts is a joy to active fingers, and the completed model, painstakingly detailed for realism, a source of never-ending joy.

Write today for complete "how to begin" information, and the name of your nearest dealer.



SCALE-CRAFT & CO., LIBERTYVILLE, ILLINOIS

SUPER DRILL GRINDER

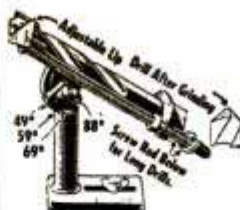

Sharpens round shank drills from 3/32" to 1-1/16" diameter. Grinds Old Drills like new in 4 different drill point angles. Grinds Short, Medium and Long Twist Drills from 1 1/2" up to 11" long, for hand or power grinding wheels.

200,000 IN USE!

Grinds your drills like factory in 25 seconds. Gives perfect center and clearance. Saves drills, time and money. No shop should be without the Super Drill Grinder. Guaranteed to do the work or money back. The Grinder that gives a rounded point!

Only **\$2.95**

At Your Dealer's or Postpaid
CRANDALL MFG. CO.

1512 West Slauson, Dept. FA-11 Los Angeles 44, Calif.

\$100 Cash for Inventors



We will pay \$100 cash to the person who develops the most practical civilian use for the Gunsight pictured here. These Gunsights were purchased from government surplus stocks. Precision built with the accuracy of a costly watch. We send you one of these valuable Gunsights on receipt of a deposit of only \$10. Their actual value is many times this small amount. When you finish with your experiments, return Gunsight collect and we will refund your deposit less \$2.50 to cover cost of express and handling. Or if you wish to keep this expensive instrument, send only \$12 additional as payment in full. For the most practical civilian use for the Gunsight, we will pay the sum of \$100 in cash. For example, many uses suggest themselves—Slide Projector for Colored Film, Light Source for Electric Eye, Film Enlarger, Gunsight for Shooting Gallery, Viewer for Movie Films, etc. The decision of the judges is final. Duplicate prizes in case of ties. Contest closes midnight, November 30, 1946, so rush your application for one of these valuable Precision-built government Gunsights.

ELECTRONIC PRODUCTS ST. CHARLES, ILLINOIS

150 MPH MODEL AIRPLANE

Improve your kit model or design and calculate your own prizewinning plane. Simplified scientifically correct aerodynamic charts. Complete easy to use instructions. \$2.00 POSTPAID.

INTERNATIONAL RESEARCH

P.O. Box 988 Los Angeles 53, Calif.

REAL BARGAINS 1/5 HP G.E. MOTORS, NEW, AC-DC, Ball Bearing... **\$5.95**
New Transformer for 110 V. AC, to give 5 to 40 volts in 5 volt steps, 10 Amps... **\$ 6.50**
New "Allied" Relays, Heavy Duty Contacts, with double pole double throw. Coil for 110 volts... **\$ 1.15**
New Delco-Westinghouse Generators (or use as a 5 HP Motor) 6 to 30 volts, 10 to 200 amps... **\$35.50**
For counters see Page 326 **GORRELL & GORRELL, Haworth, N. J.**

EXTRA SPECIAL—27,000 Kerney & Foote Co. 8-In. Hand Bastard Safe-Edge Files

Per doz. **\$2.45** Case Lots (50 doz.) **\$2.20**

Prepaid in U.S.A. First quality in every respect.
IRVING JOSEPH, Buyer & Distributor of Surplus Stocks
220 So. Halsted St. Chicago 6, Ill.

Correspondence Courses in RADIO and ELECTRICAL ENGINEERING LOW AS \$25

ELECTRICAL ENGINEERING. Get good grasp of wide electrical field. Modern. Very understandable. Theory made easy.
RADIO ENGINEERING. Extra fine course in radio, public address, photo-electric work. Trains you to be super-service man, real vacuum tube technician. Tuition ONLY \$25, either course. Deferred payment plan. Servicemen needed badly.
FREE Write for free copies of school catalogs, student magazines, etc.
LINCOLN ENGINEERING SCHOOL, Box 931-P95, Lincoln, Nebr.

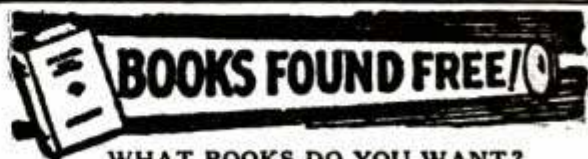

WHAT BOOKS DO YOU WANT?

We quote the lowest market prices. No charge for locating Hard-to-Find and Out-of-Print Books. All books, OLD or NEW, mailed POST-FREE.
SEARCHLIGHT BOOK CLUB, 22 East 17th St., New York City

Now that the days are short
play safe—replace with



LET SAFETY SHARE THE RIDE—
REPLACE WITH GUIDE



The more you drive at night, the more you appreciate the safety, efficiency and long life of Guide Sealed Beam headlamp units. The far-ranging upper beam and the glare-free lower beam give you headlighting at its best under every road and traffic condition.

Guide Sealed Beam units are original equipment on leading new cars in every price class. Insist on Guide units for replacement and get this *double* protection at no extra cost.

NO DIM-OUT—Because your Guide Sealed Beam unit is sealed against dirt, dust and traffic film, it stays bright throughout its long life—maintains high efficiency without service or maintenance.

NO BLACK-OUT—Because there is a separate bulb within the sealed unit, your Guide Sealed Beam unit will not fail in case of a cracked lens—will light the way safely until the damaged unit can be replaced.

GUIDE LAMP DIVISION OF GENERAL MOTORS CORPORATION

SAFE HEADLAMPS ARE "CORRECTLY AIMED" HEADLAMPS—HAVE YOURS CHECKED TODAY

FREE LAND

On March 1, 1946 I bought an 80-acre tract of thickly wooded land, and paid \$30 an acre for it.

The opinion of my surrounding neighbors was that I'd have a long grey beard before I dropped the last tree. The only way folks around here thought of clearing land was with the ax and cross cut, but I had seen the Lowther C-Saw at work in timber.

They've changed their minds now because they've watched me work with my Lowther C-Saw. They've seen me drop 335 18" to 30" oak trees (most of them up around 30") in 8 hours. I can clear 1 acre in 1 day. From that acre, I sell not less than \$61 worth of split posts—cut at least 3 cords of firewood, \$36. The trunks I sell for lumber at \$80 a thousand, or about \$240 worth an acre. This cleared land now worth five times what it sold for, isn't costing me one cent, besides it is paying me top wages for my work!

My Lowther C-Saw has established me in a business not only profitable but pleasant—after my return from war work.

Signed

Lonnie Peoples,

Wanatah, Indiana

pany, the Columbia Broadcasting System, Mutual Broadcasting System and the smaller networks grossed \$190,000,000.

This phase of radio business had come a long way since Frank Conrad gave the first sponsored program by naming the record shop which supplied him with the musical numbers he broadcast.

While not even its most enthusiastic admirer will claim that radio is perfect, from the technical and mechanical point of view it is better than it need be. Not one set in a hundred will handle the full range and reproduce with true fidelity the average signal broadcast by an AM transmitter today. Receiver manufacturers who offered sets which reproduce music with high fidelity—and at a higher than average purchase price—found to their sorrow that the public wouldn't buy them.

A number of independent consumer polls have proved that the average listener is disturbed by the high notes in a musical program and will adjust a radio to eliminate the treble, emphasizing the bass and giving an untrue "picture" of what is heard in the studio.

This is used as an argument by supporters of AM against FM, which, along with television, will serve to enrich the history of radio in the coming decades.

Speed Unlimited

(Continued from page 101)

speeds as high as 1500 miles per hour at an extremely high altitude.

Designed as a test plane, it will be filled with laboratory equipment to record all the factors it will encounter at supersonic speeds. The wings, with their sharp leading edge, sweep back toward the tail. In a cramped cockpit, the pilot sits and looks forward through the roof of his tiny cabin. There is no projecting bubble, just the slant of the fuselage toward the nose of the plane. Streamlining has been carried forward almost to its ultimate.

In preliminary trials the XS-1 was carried aloft and released from a mother ship to glide to earth. A hint of its tremendous speed is seen in its glides of over four hundred miles per hour, but test pilots say it is surprisingly easy to control and land.

We all are familiar with the pressurized and heated cabins of planes flying at high altitudes, due to the rarefied air and the intense cold. But in the XS-1, in addition to having a pressure cabin, the air is artificially cooled! Air friction, shock waves and solar radiation build up the heat to a point where the interior of the plane would

(Continued to page 276)



FELLING TREES

CUTTING LOGS

CLEARING LAND

HARRY A. LOWTHER COMPANY

141 W. Jackson Blvd.
Chicago 4, Illinois

Send me your fully illustrated circular #. 996 showing in detail the way the Lowther C-Saw works, and its many interesting and profitable uses.

\$85,000 IN AWARDS FOR BOYS



Roger H. Oetting, 14-year-old student at Foch Intermediate School, Detroit, was intrigued by the Napoleonic coach. His interest and perseverance brought him the \$5,000 first award in the Junior Division.



Leo C. Peiffer, 17, of Cedar Rapids, Ia., makes models as a hobby. It paid off with a \$5,000 scholarship, first award in the Napoleonic coach competition, Senior Division. He enters Iowa State College this Fall.



Virgil Max Exner, Jr., 13 years old, of South Bend, is a racing car enthusiast. With his \$4,000 first award in the Junior model car competition, he will enter Notre Dame, studying engineering and industrial design.

1,220 awards — university scholarships, \$2,000 to \$5,000 each, cash awards, trips — in the Fisher Body Craftsman's Guild 1947 model-building competitions

Here are 9 boys who are well started on the road of opportunity.

They are the major award winners in the 1946 Fisher Body Craftsman's Guild competitions — and each now has a scholarship, ranging in value from \$2,000 to \$5,000, to be used at the university of his choice.

Now 1,220 awards, totaling \$85,000 in value, are offered to boys between the ages of 12 and 19, inclusive, in the 1947 competitions.

You compete for these awards by building a model Napoleonic coach to plans supplied free — or by designing and building a model car to simple specifications. Both are real fun.

Any boy 12 years old or over and not yet 20 on September 1, 1946 may enter either competition. Junior and Senior Divisions with identical awards let you compete with boys in your own age division. There are no dues or entrance fees, and awards include cash, all-expense trips to the Guild Convention, and 8 university scholarships worth \$2,000 to \$5,000 each. (Duplicate awards are given if sons of GM employes win.)

A distinguished board of judges, including deans or presidents of 10 leading technical schools and universities, makes the awards.

To enter, you simply write for free membership in the Fisher Body Craftsman's Guild. In return, you receive a membership card and a full set of plans and instructions, all free. Competitions close June 15, 1947.

Why shouldn't *you* win one of these awards? Mail the coupon NOW and get started.



Robert J. Hartlieb, Jr., of Allentown, Pa., enrolled at 15 in the 1946 competitions. His model car scored so close to the Junior winner's that a tie was declared and an extra \$4,000 award was provided. Robert wants to be an engineer like his father.



Vincent J. Rauth, 19, son of a York, Nebraska farmer, walked off with the \$4,000 scholarship given as first award in the Senior Division of the model car competition. His hobby is aviation.



Eugene Schwietz is 15 and the son of a St. Paul, Minn., postal employe. He won second award in the Junior Division of the Napoleonic coach competition—a \$3,000 scholarship to be used when he is ready for college.



Walter Edwin Roth, Jr., 18, Detroit, Mich., "likes to build models." Entering the Napoleonic coach competition, Senior Division, he won second honors—a \$3,000 scholarship to complete his course at Wayne University.



Charles Clayton Bradley, 14, goes to Central High School in South Bend, Ind. When he finishes high school, his second place award, Junior model car section, will provide \$2,000 for a mechanical engineer's education.



David Wayne Whitman, 18, of Jackson, Mich., plans to be an automobile designer. With a \$2,000 scholarship, second award in the Senior model car competition, he starts at the General Motors Institute in Flint, Mich., this Fall.



MODEL CAR — You build a solid model, using only ordinary tools. Awards in each age division: Two \$4,000, two \$2,000 university scholarships; 588 cash state awards ranging down from \$100; 18 convention trips, all expenses paid.



NAPOLEONIC COACH — You receive complete plans and drawings, free of charge. Awards: Two \$5,000, two \$3,000 university scholarships; 588 cash state awards ranging down from \$125; 18 convention trips, all expenses paid. Junior and Senior awards are identical.

FISHER BODY CRAFTSMAN'S GUILD

An educational foundation sponsored by Fisher Body Division of General Motors

General Motors Bldg., Detroit 2, Michigan
Gentlemen: Please enroll me in the Fisher Body Craftsman's Guild for 1947, in the

- Napoleonic Coach Competition
 Model Car Design Competition

Send me full instructions without charge

Name _____

Address _____

City _____ Zone _____ State _____

I was born on the _____ day of _____ 19____

Name of parent or guardian _____

Dept. 2

New! Revolutionary!
... for All Gasoline Motors

The HINSCH Vacuum Control VALVE

HINSCH Vacuum Control VALVE. Domestic and Foreign patents pending.

Why pay for new piston rings or a rebores job when you can prevent this NOW by removing the cause with a HINSCH Vacuum Control VALVE?

WHAT IT DOES!

- ★ Reduces oil-pumping and carbon, exhaust smoke and obnoxious gases.
- ★ Reduces fouling of spark plugs.
- ★ Reduces dilution of oil by gasoline.
- ★ Prevents excessive motor wear — keeps lubricating oil where it belongs.
- ★ Prevents "loading up" — increases motor pep.

HOW IT OPERATES

The HINSCH Vacuum Control VALVE relieves EXCESS vacuum in all gasoline motors much as a safety valve relieves excess pressure in a steam engine. EXCESS vacuum (or suction) develops when you coast against your motor, when you shift gears, or when any gasoline motor decelerates. It fouls plugs, dilutes oil with gasoline, sucks oil right off cylinder walls; thus allowing abnormal friction and wear. The HINSCH Vacuum Control VALVE neutralizes EXCESS vacuum by automatically introducing a controlled amount of air (WHEN THROTTLE IS CLOSED). It allows your motor to operate normally at peak efficiency at all times. Does not interfere with vacuum-operated equipment.

Thousands in Use!

... on trucks and passenger cars in the Pacific Northwest. One truck fleet operator says: "We find that our oil consumption has been reduced 60% and gasoline consumption 15%." ... Endorsed and sold by leading car dealers and parts distributors of Washington and Oregon.

DEALERS!

Tune-up Men!
The HINSCH Vacuum Control VALVE is "hot" It's new! It's proving itself daily. Write at once for complete details of opportunities for qualified dealers and distributors.

INSTALL IT YOURSELF IN 30 MINUTES!

Full instructions accompany each valve.

PRICE \$12.50, plus postage. (Shipping weight, 1 lb.) If your dealer cannot supply you, write directly to

HINSCH ENGINEERING COMPANY

10649 31st Avenue S. W.

Seattle 66, Washington

MAIL THIS COUPON Today!

HINSCH ENGINEERING COMPANY,
10649 31st Ave. S. W., Seattle.

Gentlemen: Please send me.....HINSCH Vacuum

Control VALVES. I enclose money order

Please send C.O.D.....

★ Please send me descriptive literature.....

NAME

ADDRESS

Make and Year of Car, Truck, Motor.....

PM 11

SAY YOU SAW IT IN POPULAR MECHANICS

For Permanent Repairs to Leaking Faucets and Valves

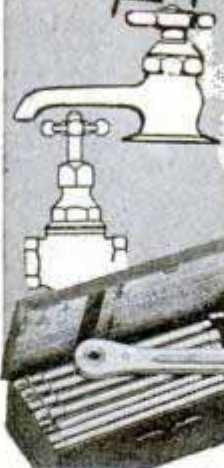

Use ECONOMY Renewable SEATS. Save fixtures, water and fuel. Make economical, permanent repairs, quickly and easily; permanent because these accurately machined hard brass self-sealing seats are as replaceable as a faucet washer.

THE JUNIOR KIT (Illustrated) repairs bathroom, kitchen and laundry fixtures.

THE MASTER KIT repairs also valves, bibbs and cocks, meeting the requirements of plumbers, steam fitters, institutions and industrial plants.

Distributed Thru Jobbers

ECONOMY VALVE SEAT CO.

2805 W. Fletcher St., Chicago 18, Ill.

USE Fine Walton Wheels to Make Your Own WAGONS—SHOPPING CARTS and RACERS



65¢

Each in Sets of 2 or 4 — plus 10¢ ea. for postage. 4 1/2-inch with 3/8-in. bushing

Coaster wagons, scooters, shopping carts, bike trailers, golf bag carriers, etc., are easy to make. Use fine Walton DeLux wheels! They're strong welded pressed steel construction. Ideal for making many things for use and play. Solid rubber tires. Red enameled. Send check or money order. No C.O.D.'s. Dealers and manufacturers write.

WALTON WHEEL COMPANY, Dept. J-2

Plankinton Bldg. Milwaukee 3, Wis.

SHALLOW WATER DIVING UNIT



For salvage, rescue, exploration dives and pool cleaning. Comfortable and efficient; seals absolutely. Low cost with long life. Also, complete line deep-diving gear. Write for details.

- Mask
- Weighted Belt
- Air Hose
- Portable Compressor

DIVING EQUIPMENT & SUPPLY CO.

1119 N. Water Street, Milwaukee 2, Wis.

METALLIZE BABY SHOES

Learn this easy, money making business from nationally recognized consultant. Small investment; perpetual market. For free details write Joseph B. Kushner, B.S. Ch.E., Metal Finishing Consultant, Stroudsburg, Pennsylvania, RD3S.



New! Complete! RADIO CATALOG

READY NOW! Send For Your FREE Copy!

Radio sets...radio kits (including 19 Popular Mechanics Kits)...radio parts...electronic equipment...amplifiers...complete, standard lines of post-war design'd equipment and supplies; pages and pages of what you've been waiting for...in the new Concord Catalog, ready now! Rush coupon for your copy...sent FREE!

CONCORD RADIO CORP.

LAFAYETTE RADIO CORPORATION

CHICAGO 7, ILL. 901 W. Jackson Blvd. • 265 Peachtree St. ATLANTA 3, GA.

CONCORD RADIO CORPORATION, Dept. P-116

901 W. Jackson Blvd., Chicago 7, Ill.

Rush FREE copy of new, complete Concord Catalog.

Name

Address

City..... State.....

BRAND NEW GOV'T SURPLUS

FOR USEFUL Christmas Gifts

**ALL
PRICES ARE
POSTPAID
WITHIN THE
U. S. A.**

1⁵⁰
Wrist Compass and Strap

587
Small, med., lge.
98c
O.C.D. Gas Masks

597
95c
Metal Tank Periscope

#655
Add 20% Fed Tax
60c
Canvas Utility School Bag

#557
1⁹⁵
2 1/2 Gallon Canteens

#615
2⁷⁵
Add 20% Fed. Tax
Canvas Musette Bag

#579
95c
14-pc. Spit and Gaff Set

623
2⁹⁵
U.S. Army Leather Holster

BAYONET TYPE KNIFE
#611 - Polished 6 1/4" blade. Metal and plastic guard handle, case. **3⁷⁵**

U. S. ARMY CANTEENS
#688 - All metal regulation. Plastic cap. One quart size. **1¹⁹**

RATION CONTAINER KIT
#589 - 2 Plastic containers in canvas case. Size 6" x 3 1/8" x 4 3/4". **1⁹⁵**

G. I. PISTOL BELTS
#687 - Khaki 2 1/4" web, non-rust hardware. Adjust to 42". (White belts \$1.95.) **1⁷⁵**

ALCOHOL STOVE
#652 - All metal. Burners have caps. 9" x 3 1/2" w. x 1 1/2" h. **75c**

U. S. NAVY SIRENS
#647 - Piercing tone. Hand operated. Metal. Has cover and strap. **6⁹⁵**

#660
1⁹⁵
2 1/2" Blade
Signal Corps Jack Knife

561
Will not shoot. Made of wood.
3⁹⁵
U.S. Army Training Rifles

507
2⁵⁰ O.P.A. 3.95
Waltham Jewelled Compass

#634
75c
Utility Apron Kit

COLEMAN G. I. STOVE
#632 - Sensational! Metal telescoping case. Burns gasoline. 8 1/2" h. x 4 1/2" dia. **10⁹⁵**

NAVY FOLDING COTS
#504 - White canvas cover. Non-rust hardware. wood frame. **6⁷⁵**

CANTEEN CASE
#689 - O.D. Cloth. Shoulder strap. Will hold qt. size canteen. **60c**

COLLAPSIBLE BUCKET
#671 - Heavy waterproof white canvas. Rope carrying handle. 12 1/2" diameter. **2⁹⁵**

COOK-EAT MESSKITS
#518 - All steel, U. S. Army style with non-slip folding handle. **95c**

TARGET BALLOONS
#681 - Red rubber target balloons that blow up to 7 feet. **75c**

#683
35c
4" x 5"
Metal Signalling Mirror

1⁵⁰
Garden Sprayer Pump
#543 - Sprays, pumps, bails! Metal, 27" high, 10 ft. hose.

8⁵⁰
Navy Ships Bell
#502 - Steel, painted bronze. 10" h. x 9 3/4" dia. 6" Clapper has 1" eye. Wt. 15 lbs. O.P.A. 12.50

3⁵⁰
25 Pc. Camp-Scout Kits
#514 - Plastic case. Has scout knife, safety razor, blades, plastic oil can, whistle, fire tabs.

1⁷⁵
Army Angle Flashlights
#700 - Plastic case. Metal clip. 2 bulbs (1 in cap), 2 batteries included.

4⁹⁵
U. S. Army Rucksacks
#520 - Steel frame. Heavy Army duck. Add 20% Fed. Tax

2⁵⁰
U.S.N. Sheath Knife
#703 - Parkerized no-glare 6" blade. Leather washer handle. Genuine leather sheath.

1⁰⁰
3" x 4"
Pocket Size Heatab Stove
#639 - Metal, folds flat. Complete with 10 Heatabs.

FEDERAL SURPLUS CORP. 3 EAST 4th ST. NEW YORK 3.

HOW TO ORDER
Order by number. Remit by money order or bank draft. Send 50% deposit on C.O.D. orders. No C.O.D. orders for less than \$5.00 total.



Fine Craftsmanship

Whether in a ship model or a pipe, fine craftsmanship wins instant admiration.

That's why we think you'll enjoy owning a Sterling Hall. Here is cool, sweet smoking combined with real pipe beauty. The selected IMPORTED briar is cut for utmost beauty of grain. Its hand-rubbed finish is of outstanding richness. And the *inlaid* sterling silver band imparts a touch of distinction which unmistakably sets it above the ordinary—adds strength to the shank too, and helps maintain a perfect fit for the stem.

Sterling Hall by Briarcraft



In all standard shapes... At leading dealers

Sterling Hall, Standard, \$3.50

Sterling Hall, Hand Made, \$5.00

Sterling Hall, Highest Grade, \$7.50

Briarcraft, Inc., 347 Fifth Avenue, New York 16, N. Y.

BUILD THIS MODELER'S LATHE!

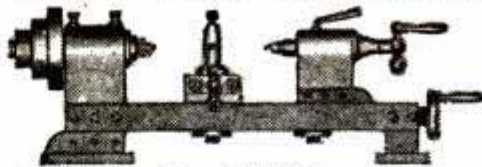

A LITTLE FELLOW THAT CAN TAKE IT!

23" Long Overall 8½" High 6" Swing 9" Between Centers
Here's that fine but rugged metal cutting lathe you've wanted to own. No castings required; all fabricated from cold rolled sheet metal and standard or scrap fittings. Many parts can be built right on the machine as it grows! Designed for fast, heavy duty. Build your own attachments, too!

Lathe Plans (Two Giant Sheets) and Instructions for Machining and Assembly. Easy to Read; Simple to Follow. Special Bargain Price..... **\$2⁹⁵**

Attachments for Lathe and Special Shop Tricks

- How to build a tool post grinder for a lathe from an old electric motor. Plans. Instruction.....\$1.00
- How to build two face plates—one slotted and one with tapped holes. Plans, instructions.....50c
- How to build a cross slide angle plate for milling or boring with lathe.....25c
- How to build drill plates for drilling or chucking thin parts in lathe.....25c
- How to build a sanding disk and table for lathe.....25c
- How to build a steady rest for machining long, slender work in lathe.....50c
- How to make driver plate and lathe dogs for machining between centers and for square, hex or other odd shapes.....50c
- How to make angle plates for machining odd shapes on lathe....50c

No C.O.D.'s please!

THE MODEL ENGINEERING CO.

737 N. Michigan Ave. Suite 502 Chicago 11, Ill.

WOOD WORKERS

LUMBER—PLYWOOD AVAILABLE

Harold Hunt wants to send new No. 15 catalog. Over 124 pages of woodworking ideas. UNEQUALLED BARGAINS in imported and American woods, supplies, hard-to-find hardware. Send only 15c to cover postage and handling.

CRAFTSMAN WOOD SERVICE CO.
2729 S. Mary St., Dept. A-75, Chicago 8, Ill.

only **15¢**



AMAZING MYSTERY BUTTON



Startles Everybody. With this *Electronic Button* you can make your own Telephone—Amplifier—Detectophone. Attach this button to piece of cardboard—transmit conversation to another room. Music also transmitted to distant places. Most interesting, electrical apparatus ever discovered. Enables you to perform hundreds of experiments. So tiny it can be concealed in dozens of places. A Pre-War Product. *Electronic Button* including 5000 word instruction booklet with 50 illustrated experiments—postpaid only \$1.00.

Electronic Products Company, Saint Charles, Ill.

SAVES MANY ELECTRIC APPLIANCES



NICHROCITE REPAIRS HEATING ELEMENTS IN A JIFFY . . .

Simply overlap ends, apply Nichrocite Paste and turn on current. Used by large utility companies. Trial order, \$1.00; 4 oz., \$2.50; 1 pound, \$8.00.

ARROWHEAD SALES & DIST. CO.
401 Phoenix Bldg., Minneapolis, Minn.



The Chief WORK BENCH

Built to Last a Lifetime!

With Bottom Shelf and 18" Sq. Drawer. 2"x6", Solid Plank, Grooved and Dovetailed Top and 1"x8" Back Rail, Shellacked to a Smooth, Satiny Finish.

MOHAWK LUMBER CO. Dept. 32
14525 W. Chicago Blvd. Detroit 27, Mich.
Enclosed Check Money Order for \$.....
Ship..... CHIEF WORK BENCHES at
Quantity.....
\$16.95 each, F.O.B. Detroit, Mich.
 Send C.O.D., \$5 Deposit Enclosed.

NAME.....
ADDRESS.....
CITY..... STATE.....
No Priority Necessary!

• 6 Ft. Long • 34" High • 26" Deep. Shipped Knock-down, with Bolts, Nuts and Screws and ABC Chart for Quick, Simple Assembly.

Prompt Delivery
MOHAWK LUMBER CO.
14525 W. Chicago Boulevard
DETROIT 27, MICHIGAN



A CHRISTMAS PRESENT HE'D APPRECIATE

\$16⁹⁵
F.O.B. DETROIT

Send Check or Money Order, or Will Ship C. O. D. (\$5 Deposit)

'ROUND THE TOWN ...

Switch to -
AUTO-LITE



MICHIGAN AVENUE—ONE OF CHICAGO'S BUSIEST TRAFFIC CENTERS

It's no fun fighting a stubborn engine in heavy traffic—and often so unnecessary. You may find all that is needed to cure that sluggish, unresponsive engine is to switch lazy, worn-out plugs for a new set of Auto-Lite Spark Plugs. When so

many leading car manufacturers specify these ignition engineered spark plugs you can be sure money cannot buy a better product. Why take chances! Before another day is done stop at your Auto-Lite Spark Plug Dealer and switch to Auto-Lite.

Toronto, Ont. THE ELECTRIC AUTO-LITE COMPANY Toledo 1, O

Tune in **DICK HAYMES**



Star of the

AUTO-LITE

Radio Show with Helen Forrest... Gordon Jenkins' Orchestra and Chorus

THURSDAYS
9 P.M., E.T.—CBS

AUTO-LITE SPARK PLUGS
"Ignition Engineered"

MONEY CANNOT BUY A BETTER SPARK PLUG

BUILD PRACTICAL THINGS for FUN and PROFIT!

**YOU HAVE TOOLS
and MATERIAL HANDY**

**PLANS
ARE**

ONLY 1.50 SIMPLE — EASY TO FOLLOW

The simple plans in the LeJay Manual are a source of enjoyment to non-experts in the electrical field. They are easy to follow, do not call for expensive equipment and produce practical results. A few of the many interesting projects are illustrated here.



POSTPAID

The tools you have around the house are all you need and much of the necessary material can be found in workshops, garages and scrap yards. If you need a welder, these plans will show you how easy it is to build one. They will enable you to make money in building or repairing things for others. Send for this Manual today—cash or C.O.D.



POWER TOOLS



ARMATURE WINDING



WELDING GENERATORS



ELECT. GO-BIKE

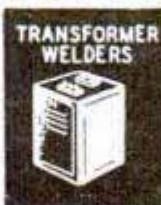

TRANSFORMER WELDERS



WIND PLANTS



MOTORS



INSECT KILLERS

BUILD A

LEJAY FAST FREEZER

No Knowledge of Refrigeration Required

A handy addition to every home which gives you frozen storage from 5° above to 10° below zero. Can be made in 5 sizes, from 8 to 40 cubic feet capacity. You don't have to be a refrigeration expert or a cabinet maker to build this LEJAY FAST FREEZER, and in these days of meat shortages and high prices, it will effect quite a saving in your household economy. Its sturdy simplicity and ease of construction appeal to every man who likes to make things. Free plans for a Milk Cooler are also included. Only \$1.00—cash or C.O.D. A Special offer—The LeJay Manual and Fast Freezer Plans Combination for \$2.25.



PLANS ONLY

\$1.00

ORDER NOW

BOTH FOR \$2.25

LEJAY MFG. CO

747 LeJay Building,

MINNEAPOLIS - 8 - MINN.

Be Your Own Boss



There's a great feeling to being in something for yourself, where all the profits go into your own pocket. American floor sanders make it possible for you to realize this ambition without special schooling or a big investment. Begin small and work up to as large an enterprise as you desire... It all depends on your ambition to get ahead.

Ask for "tell-all" booklet entitled "Opportunities in Floor Surfacing". Use coupon and enclose 25 cents in coin or stamps to cover handling.

AMERICAN FLOOR SURFACING MACHINE CO.

535 So. St. Clair St. • Toledo 3, Ohio

Gentlemen: Enclosed find 25c in stamps or coin for booklet "Opportunities in Floor Surfacing," telling me how I can start my own floor sanding business.

Name _____
Street _____
City _____ State _____



Amazing New KIND OF PLASTIC-LIKE POLISHES for AUTO, FURNITURE, FLOORS

Beautiful High Quality Lustre

HERE THEY ARE—3 Big Demand Items that fit perfectly into a waiting market... The public are enthusiastic and marvel at the ease with which they can now Clean and High Gloss the Auto, Furniture and Floors... A New Experience awaits the public... Of course you can sell products like these and they are unconditionally GUARANTEED... Don't pass up this unusual opportunity... It means big money for you if you ACT QUICK, IMMEDIATE DELIVERY.

Big Profits to Wide-Awake Distributors

Territory Going Fast!

- SAVES
 - TIME
 - EFFORT
 - MONEY
- USERS ARE ENTHUSIASTIC

Get The Facts Now WRITE TODAY

The PLASTONE Co., 2207 W. Chicago Ave., Dept. PN, Chicago 22

3 in 1 OTTAWA SAW

THE WORLD'S FASTEST.

6-H. P. EASY TO MOVE



FELLS TREES, SAWS BIG LOGS, SMALL LOGS, LIMBS

One motor performs all three operations. Furnished with or without attachments shown below. Thousands in use.

Make BIG profits in the ever increasing wood business. Pulley for belt work. Fully guaranteed. Low direct-to-user prices. FREE details—write TODAY.

OTTAWA MFG. CO., 1127 Pine St., Ottawa, Kansas

GRAPHITE GUS ASKS:

**KNOW YOUR
GRAPHITE AS A
FINE TOOL**



Does a craftsman-like lubricating job on bearings and metal surfaces operating under severest conditions of temperature, pressure, speed and solvents.

Nothing else even approaches dry lubricating graphite for use on absorptive materials like wood, leather, fibre textiles and rubber.

Write today for your free copy of Dixon's Data Sheet Directory, an entrance way to volumes of use knowledge about this amazing mineral.

The complete line of Dixon's products into which graphite is processed is stocked by Mill, Hardware, Automotive, Marine, Sporting Goods, Plumber and Janitor Supply stores everywhere.



30¢

DIXON'S GRAPH-AIR GUN

Filled with Microfyne powdered graphite, it's the slickest gadget you ever saw for lubricating locks and hard-to-reach mechanisms, in shop, office, car, boat, home. Will not leak or gum. Described on Data Sheet #8.



15¢

**DIXON'S
GRAPHITE SLIPSTIK**

For rub-on lubrication. Easy to use as a lip stick. Fine for fire arms, sticking doors and windows, bicycle chains—1001 mechanisms in shop, office, car, boat, home. Keep one near you. Described on Data Sheet #23.



20¢
1 Oz.
Tube

**DIXON'S GRAPHITE
LATHE-CENTER LUBRICANT**

Used in thousands of plants for one of the toughest lube jobs known—lathe dead centers—under severest conditions of heat, pressure and speed. Use wherever "hot spot" lubrication is needed. Described on Data Sheet #15.

Joseph **DIXON** Crucible Company • Div. 26C11 • Jersey City 3, N. J.



In Cylinders



On Pumps



On Bearings



On Chains



On Hoists



On Gears



On Pipe Threads



On Gaskets



On Packing



**BUILD YOUR OWN
RADIO AND ELECTRONICS DEVICES
AT LOW COST**



with **NEWARK'S** KITS AND PARTS

You Can Easily Build Radio Receivers and Transmitters—Record Players and Other Exciting Radio and Electronics Devices.

Our **BIG BARGAIN COUNTERS** display new parts and unusual special equipment you'll enjoy seeing. Come in, look around, ask questions . . . it's fun.

Public address systems for every need and purpose.

Make a good radio receiver or fine record player at big savings. You can build these and many other things easily. In any of our stores our staff will gladly show you how—or will explain clearly by mail. **Write for our famous Big Bargain Bulletins**, listing all the newest things available. Send for it today. When writing, address Dept. C1.

NEW YORK 242-50 W. 55th St. New York 19, N. Y.	NEWARK ELECTRIC COMPANY, INC.	CHICAGO 323 W. Madison St. Chicago 6, Ill.
---	--	---

New York City Branches: 115-17 W. 45th St. & 212 Fulton St.

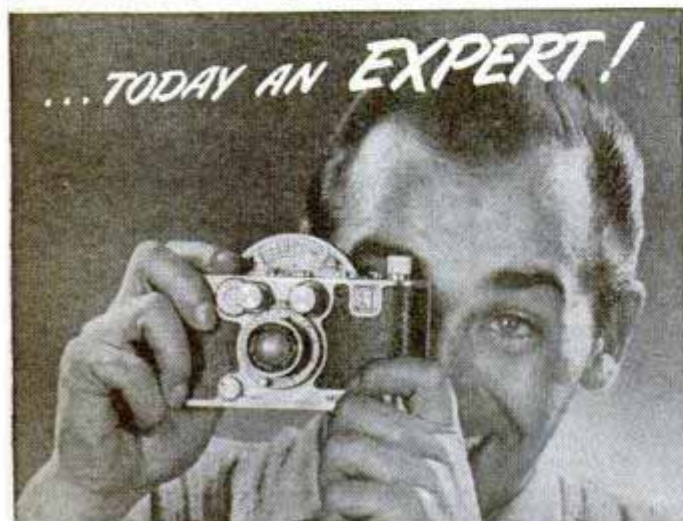

Anybody can be a candid camera expert almost overnight with the new

MERCURY II (It's a *UNIVERSAL*)

Expert candid camera shots are a snap with the Mercury II. Foolproof built-in features and unbelievable simplicity make "professional" shots easy for everyone.



DESIGNED ESPECIALLY FOR COLOR, Mercury II will give you sharper, clearer shots. Check Mercury II at your dealer's.

**UNIVERSAL CAMERA
CORPORATION**

NEW YORK • CHICAGO • HOLLYWOOD
Manufacturers of Mercury, Cinémaster, Corsair Cameras
and Photographic Equipment

reach 400 degrees. If he were not artificially cooled, the pilot literally would be cooked to death.

Air Force engineers had to develop refrigeration apparatus far lighter than any in use to meet the plane's requirements.

Since the rocket engines must carry oxygen to operate in rarefied atmosphere, fuel probably will be either liquid oxygen and alcohol, like that used in the V-2 rocket, or nitric acid and aniline, as used in the Ordnance Wac Corporal rocket. Both are very efficient with a slight edge in favor of the alcohol-liquid oxygen combination.

While able to take off from the ground, the XS-1 will be carried to a high altitude on its power tests to conserve fuel, then released and the rocket motor started. Climbing at a steep angle for several tens of thousands of feet, a point will be reached where, because of fuel consumed, the weight of the plane will be less than the thrust of the rocket motor. The pilot then will stand the plane on its tail and really start to climb. In the few minutes the fuel lasts, the plane will probably reach eighty or a hundred thousand feet—far higher than man has ever been before.

Scientists say that the plane will probably reach the twilight zone where stars of the first magnitude can be seen directly overhead as the sun sets or rises.

On this initial flight, the pilot will have two choices. He can see how high he can fly or he can climb for a few seconds, then level off under full power to see how fast he can go. It is highly probable that from his maximum altitude, on his glide toward the earth, he will travel faster than man ever went before.

The pilot will wear a pressure suit and a transparent fishbowl helmet that give him the bloated appearance of a deep-sea diver. Made of fabric and pink plastic, the suit gives him a fantastic appearance. If he runs into trouble, he presses a button and his detachable cockpit is hurled away from the plane with him in it. He remains in it until special devices have decreased the speed from supersonic to less than 500 miles per hour, and a safe altitude, below 30,000 feet, is reached. He then will be automatically ejected from the cockpit and his parachute will carry him safely to the ground.

Pilots flying the XS-1 will have problems of acceleration to overcome quite different from those encountered in pulling out of a fast dive. Measured in terms of gravitational force, at nine times the force of gravity pilots black out when they make a fast turn. Their blood is pulled from their brain to the lower portions of the body.

(Continued to page 280)

FAMOUS PIPE OF HISTORY



Footies offering the "PIPE OF PEACE" to General Rogers
(from an old print—Batman Archives)

FAMOUS PIPE OF TODAY

STERNCREST
STERLING

FAMOUS means "celebrated, distinguished". What better words to describe Sterncrest Sterling? The finest imported briar—the workmanship of skilled craftsmen—hard rubber bits—precious metal bands for strength and beauty: all of these are lavished upon Sterncrest Sterling and its sister pipes, Sterncrest 14K and Sterncrest Ultrafine.

"A good pipe is an investment in daily pleasure."

LHS STERNCREST 14K—specially selected briar, 14K gold band, \$7.50 LHS Sterncrest Ultra-Fine \$10. LHS Certified Purex \$3.50. AT ALL GOOD DEALERS.



\$5

IMPORTED BRIAR
Model #139. Plain finish. Sterling Silver Band. Dozens of other handsome models, plain and antique.



ZEUS Filter Cigarette Holders are back in ALUMINUM, with handy ejector.

Write for "Pipes—for a World of Pleasure". It's FREE.

L & H STERN, Inc., 56 Pearl Street, Brooklyn 1, N. Y.

PLASTICS

NEW LOW PRICES
NEW HANDBOOK
NEW CATALOG

FUN—AND PROFITS—FOR YOU!

Want a fascinating new hobby?...Fabricate plastics—colorful, glamorous materials of the future! Want a profitable business of your own? Make plastics into household articles, jewelry, novelties for quick sale to department and gift stores!...Veterans! Here is your opportunity!

C-B PLASTICS HANDBOOK TELLS HOW

You can learn easily at home to fabricate plastics. They're simple to cut, shape, cement, color. Practice with a few dollars worth of materials, and you'll quickly acquire skill. No need for expensive schooling!

The new Carmen-Bronson PLASTICS HANDBOOK gives you all the "tricks of the trade" in fabricating Plexiglas, Lucite, Bakelite, Polystyrene, Lignolite, and other plastics. It tells you how to establish your own business. It

features construction plans for many salable articles.

C-B CATALOG LISTS ALL MATERIALS

The Carmen-Bronson catalog gives you complete prices and data on all materials you need. Plexiglas, Lucite, Bakelite, Lumarith, Lignolite, Tenite, Polystyrene, etc., in sheets, rods, tubes and special forms—crystal-clear and in many rich, glowing colors. Also lists numerous cements, dyes, compounds, accessories, supplies and semi-fabricated kits. Extra low prices—plus whopping reductions for quantity users!

GET STARTED TODAY!

Take the first step TODAY toward your brilliant future in plastics! Send only 10 cents for latest C-B CATALOG and C-B PLASTICS HANDBOOK.



10¢
BRINGS
BOTH BIG
BOOKS

LOOK AT THESE C-B LOW PRICES!

CRYSTAL-CLEAR PLEXIGLAS

All standard sheet sizes. Basic prices per square foot are:

	Under 25 sq. ft.	25 to 49 sq. ft.	50 or more sq. ft.
1/16"	\$1.13	\$1.01	\$.90
1/8"	1.46	1.31	1.16
3/16"	1.79	1.61	1.43
1/4"	2.10	1.89	1.68

Sheet sizes, thicknesses, may be assorted in figuring total sq. ft. ordered. Prices F.O.B. Mt. Vernon, N. Y.

CARMEN-BRONSON COMPANY
165 East 3rd Street
Dept. 11-B
Mount Vernon, New York

NEW MATERIALS

Latest Carmen-Bronson Catalog lists these excitingly beautiful new plastics:

MOTTLED THERMATONE
POLYSTYRENE • VINYL FILM
PLASTIC LEATHER • FLEXGLASS

in addition to Plexiglas, Lucite, Bakelite, Lumarith, Lignolite, Tenite in all forms.

YOU CAN GET 1/2-TON JAW PRESSURE WITH THIS WRENCH

\$2.00

POSTPAID TO ANYWHERE IN U.S.A. NO C.O.D.



SAMSON LEVER - JAW WRENCH OVER 1,000,000 IN USE

- Breaks loose and turns stubborn, rounded nuts no other type wrench can turn.
 - Excellent pipe wrench — sure grip, fast action.
 - Secure c'amp for welding, soldering, drilling, etc.
 - Portable vise for holding small or irregular shapes for grinding or drilling and ideal for holding cold chisels or star drills.
- A kit of tools in one! Will pay for itself on one job! Made entirely of steel; cadmium plated; length 10 inches over all; hardened jaws open to 1 1/4 inches — can be locked in any position. Send your order today — you take no chance — satisfaction guaranteed or your money refunded.

SEND ORDERS TO

WM. TRUMAN TOOL CO.

153 S. YORK ST. ELMHURST, ILL.

BETTER WOODWORKING THESE 2 EASY WAYS!

1- ADJUSTABLE GRINDING ATTACHMENT

Chisels and plane iron blades can now be given a new tool grind. Convenient, time and money saving, your work will greatly improve using keener cutting edges. Easy to install and use. \$6.95



2- ROTARY SANDER

Operated with drill press or large electric drill, the newer Rotary Sander is excellent for surface or edge sanding. Produces smooth, true, accurate surfaces — without ripples or unevenness. \$4.95



At dealers or sent direct on receipt of purchase price. Send for descriptive folders. Write Dept. B

READ-LEWIS MACHINE CO.

393 Third Avenue Troy, N. Y.

JUST OUT — WAR SURPLUS — BRAND NEW DIAMOND SAW BLADES

With Actual Diamond Dust on Cutting Edge

Formerly Sold up to \$30 each!
Now at greatly reduced prices

6 inch \$3.60 — 8 inch \$4.70 — 10 inch \$5.80 ^{POST PAID}
(All have 5/8 inch arbor hole)

Useful for cutting of any hard material such as tile, glass, ruby, plastics, slate, stone, marble, quartz, etc. Ideal for Hobbyists, Mechanics, Jewelry, Glass and Porcelain Workers, Marble Cutters and all who need a fast, true cutting saw blade for hard substances.

Fit Skill saws and any ordinary motor shaft. Especially treated steel disks — original packing — Quantity Limited.

Mail order today. Enclose check or M.O. All prices postpaid. Sent C.O.D. plus cost, if you wish. Add 28c for foreign postage.

DIAMOND DISKS Dept. A2—140 West 42 St. New York 18, N. Y.

HOW TO CUT RAFTERS

New vest pocket book gives lengths, Side cuts, Plumb cuts, Deductions. For all rafters for any building from one inch to forty feet wide. Gives numbers to cut on square. Also degrees for knee cuts for Radial Saws. All standard pitches from 1/4 to 5/8. Just open book to pitch page and there are your lengths, side cuts, etc. Anyone who knows what a jack rafter is can frame a roof if he has this great book. Price one dollar prepaid. BUILDERS' TOPICS, Dept. M, Lock Box 828, Seattle, Washington. Original teachers of the square in five easy lessons by mail. SEND FOR FREE LIST OF TECHNICAL BOOKS. Learn to read blueprints etc.

SELL HARD-TO-GET ITEMS

Own and operate your own business—selling Electric Fans—Fluorescent Lighting. To stores, offices, factories, homes . . . immediate delivery. No investment necessary. Immediate commissions. Glorious opportunity because merchandise available now! Got your territory right away because other scarce items like cameras will be available soon. No bulky samples to carry around. You sell from beautiful illustrations. Send for complete sales story today! Write

ALL-AMERICAN MFG. CO.

1114 So. Michigan Ave. Dept. X Chicago 5, Ill.

ONE TOOL WITH 6 USES!

MITER-MASTER

- Mitering Guide
- Diameter Gage
- Accurate Square
- Marking Gage
- Center Finder
- Handy Ruler

It's a universal tool for the hobby shop and for carpenters because it has so many uses. Miter-Master takes the place of an expensive miter box, with scale marked to miter 5, 6, and 8-sided frames. Rugged steel construction. Full directions for use. Ask your dealer, or we will send it postpaid for \$2.00 (foreign \$2.25). Satisfaction guaranteed, or your money back.



\$2.00

POSTPAID

Enclosed is \$2.00 for Miter-Master, postpaid. (Foreign \$2.25)

PRINT NAME.....

ADDRESS.....

MASTER SPECIALTY COMPANY

3018 E. LAKE ST. MINNEAPOLIS 6, MINNESOTA

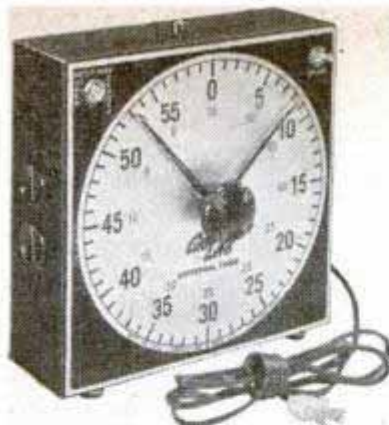

STANDARD MODEL \$22.95 Luminous Dial \$1 Extra.
Black Baked Enamel Case.

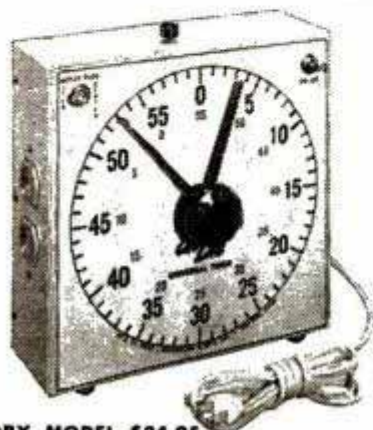

LABORATORY MODEL \$24.95
White Baked Enamel Case.

ACCURATE TIMING

Equipped with the finest synchronous motor—as dependable and accurate as your electric clock. No electronic tubes, no fluctuating intervals. When you set the Gra Lab Timer you can be sure you will get the exact interval you desire—every time!

FLEXIBILITY

Use it for automatically timing any operation. Times in any combination of minutes and seconds up to a FULL HOUR. Equipped with twin outlet plugs so two pieces of electrical equipment can be turned on or off at end of preselected interval. Capacity 750 watts.

YOU CAN DEPEND ON THE **GRA LAB** TIMER

VISIBILITY

Large 8" dial with legible numerals. Outer row of figures for presetting time interval. Inner row for indicating elapsed time.

Ideal for all photographic purposes, timing sporting events, recordings, etc., and for automatically timing infra-red and other therapeutic treatments.

STURDILY BUILT

The Gra Lab Timer is made from the finest materials by craftsmen skilled in the manufacture of precision instruments. Years of service are built into every timer.

AUDIBLE SIGNAL

Equipped with selective bell signal for announcing end of preset interval.

SEE YOUR LOCAL PHOTO SUPPLY DEALER OR WRITE

GRAY LABORATORY & MFG. CO.

43 W. APPLE ST., DAYTON 2, OHIO



Oh Boy ... It's Here ...
STANDARD

Genuine Telegraph Keys

MADE FOR THE U. S. ARMY SIGNAL CORPS
Make Your Own Communication Set

Keys are made of pure hardened finished brass. Will last a lifetime. You and a friend can set up a private telegraph line in less than an hour. Easy-to-follow instruction sheet and Morse Telegraph Code Sheet with each Telegraph Key FREE.

ORDER NOW!

Wisconsin Communication Co.
510-512 N. WATER ST. MILWAUKEE 2, WIS.

*Gee
This is
Fun!*



An Excellent
Christmas
Gift

\$1000 VALUE
2 COMPLETE TELEGRAPH KEYS \$2⁹⁹
1 KEY \$1.75

Check following and mail at once.

- I am sending \$2.99 full payment. Please rush my 2 telegraph keys, Postpaid.
- Send my 2 Telegraph Keys C.O.D. Am sending \$1.00 deposit.
- I want 2 Keys I want 1 Key

USE AC's FOR
**UTMOST
RELIABILITY**

Dairies and milk producers use factory-recommended AC Spark Plugs to assure utmost reliability in milk delivery. Your AC dealer can supply you with factory-recommended AC's for your car, truck or tractor, designed for today's fuels and driving conditions.

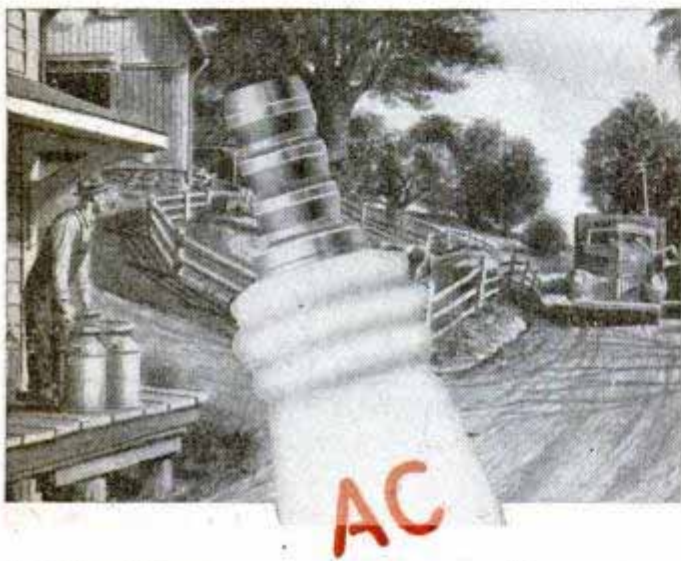

Look for this sign



Spark Plugs cleaned and adjusted "By the AC Method" may save as much gas as 1 gallon in 10

**AC
SPARK PLUGS**

AC SPARK PLUG DIVISION • GENERAL MOTORS CORPORATION

When the XS-1 accelerates, it will be in a straight line and acceleration forces will make all movements of the arms and legs difficult and perhaps impossible. New methods of controlling the plane, perhaps with buttons, will have to be worked out. At top speeds, turns will have to be made tremendously wide to prevent blacking out. A second's indecision, and the pilot has traveled three miles.

Today, projectiles are the only objects that are able to cross the barrier of sound safely. The V-2 rocket with its speed of 3600 miles an hour is the fastest man-made object, faster even than artillery shells. Its speed of over 5000 feet per second makes a rifle bullet's speed of 3000 feet per second slow in comparison. However, pilots soon will be challenging this record. Man is indeed at the threshold of a new era of speed.

Forecast From Detroit

(Continued from page 92)

Don't look for automatic transmissions in Fords until 1948. But expect them then. They'll be standard equipment on all but the lowest-priced Ford cars then, engineers predict.

Studebaker, having gotten the jump with the first really postwar car in appearance, will continue to produce the same model without any significant changes. It's the car to watch, and its greater visibility for the driver may be copied, in modified form at least, by many other manufacturers.

Some of the competition refer to the new "all-around" vision of the Studebaker as "mobile greenhousing," but most engineers and salesmen believe that drivers of other cars will suffer from claustrophobia when they get back in their own cars after driving the Studebaker.

Packard won't come forward with new models until well into 1947. Its changes will be evolutionary instead of revolutionary, engineers predict. But its new styling contemplates integrated fenders and body, a wider and lower appearance and wider windshield moved forward considerably.

The new Packard power plant can be relied upon to provide more efficient power, for Packard has devoted its best talents toward maintaining its mechanical distinction. President George T. Christopher has announced that the jet-propelled automobile is probably 10 to 15 years away.

Nash models for 1947 will show engineering improvements. Although the company won OPA price increase allowances because of mechanical advances, nothing startling is predicted until its 1948 models.

(Continued to page 290)

Atlas

7" SHAPER

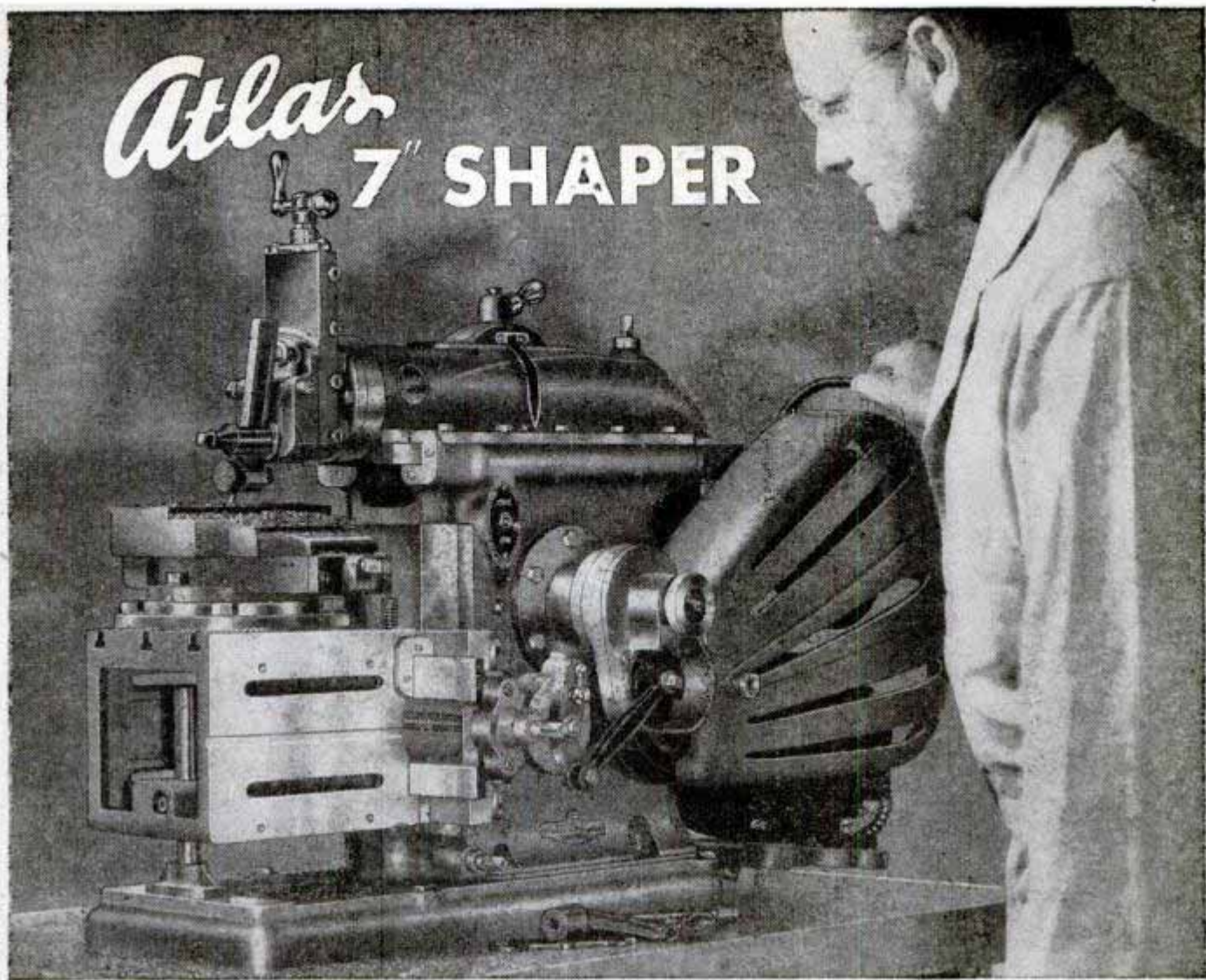

NOW YOU CAN ADD SHAPING TO YOUR SHOP'S WORK RANGE

The Atlas shaper has all the precision and power of larger shapers built down to scale for *compactness, quick set-ups, and low cost* for commercial and home shops.

It performs all shaping operations to close tolerances — dovetailing, keyseating, internal work, vertical, angular, V-cuts, and others. Its 7" stroke and 9 $\frac{3}{8}$ " horizontal table travel machine up to 65 $\frac{1}{2}$ sq. in. with one setting — ample for most shop requirements.

The cutting speeds range from 3 $\frac{1}{2}$ to 116 feet per minute — feeds .005 to .025 inches per stroke. Table dimensions are

8 $\frac{3}{4}$ " x 6" deep. Timken bearings assure smooth operation and lasting accuracy.

Built by advanced manufacturing methods, the Atlas shaper is most economically priced. Its operating cost is low, too — takes but a $\frac{1}{2}$ HP motor. Ask your Atlas distributor for details on the shaper and other members of the Atlas 4 Tool Team.

SEND FOR

"SUCCESS STORIES"

Reports of personal progress and success of men from coast to coast who have built profitable businesses starting with one or two Atlas tools. Sent free with latest Atlas catalog. Write Atlas Press Co., 1143 North Pitcher St., Kalamazoo 13D, Mich.



Atlas 4 TOOL TEAM

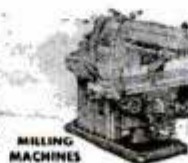

**KNOW THE FACTS!
STOP FORGETTING!
SAVE TIME!**



Be the man that has the answers, meets the deadline, gets the job done on time. **BE ORGANIZED**—help others do the same. Select the personal organizers (below) suited to your own (or company) needs. Order today—if not 100% satisfied, money returned without question. Thousands sold every year as business and personal gifts. Postage paid when cash accompanies order.

PLANNING GUIDE CALENDAR
A new idea in desk calendars. Organizer, reminder, classifier. Textile covers . . . \$2.75; genuine pigskin covers (loose leaf) . . . \$8.00



POCKET PAL SECRETARY
Contains: pad, mailing stickers, reservation cards, and other exclusive features for executives. Genuine morocco, 3 1/4" x 5 1/4", \$4.50 plus 60c Federal Tax.

DAYDEX MEMO CALENDAR
Pat'd. Week-at-a-Glance principle shows week's appointments instantly. Hammered-silver finish covers . . . \$2.00



LOOSE LEAF REMINDER
Carries 25 loose leaf cards with pockets for temporary and permanent data, etc. Genuine calfskin, \$2.50 plus 50c Fed. Tax.

MEMINDEX
Memory on cards. Temporary memos on dated, indexed cards in Pocket Case; permanent memos transferred to Desk Unit. *No transcribing!* Genuine cowhide Pocket Case, 425 ruled, round-cornered cards, and Desk Unit . . . \$5.75



★ **FREE CATALOG:** describes entire line, discounts for quantity. Write Dept. Q

WILSON MEMINDEX CO. EST. 1905
149 CARTER ST., ROCHESTER 5, N. Y.

SAY YOU SAW IT IN POPULAR MECHANICS

**STOP
LEAKS!**

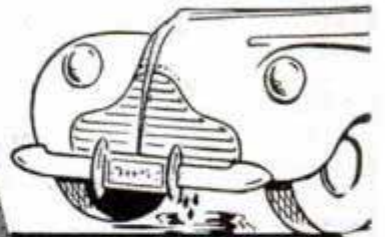

**Cooling Systems
Made Leak-Proof QUICKLY**

WARNER LIQUID SOLDER—Non-Metallic—Deposits Tiny Fibers to Repair Leaks Anywhere in Cooling Systems. Simply pour in! Finds and **REPAIRS** every crack or hole. Do it yourself—or see your service man.

Warner-Patterson Co., 920 S. Michigan Ave., Chicago 5



FAST DELIVERY!
APPROVED Model A-200
SIGNAL GENERATOR

*8 R.F. BANDS
100-250 Kc., 190-500 Kc., 420-1000 Kc., 1000-3000 Kc., 3 Mc.-9 Mc., 9 Mc.-25 Mc., 18 Mc.-50 Mc., 27 Mc.-75 Mc.
Internal modulation at 440 cycles. External modulation 40-36,000 cycles.
NET PRICE \$49.50 F.O.B. N. Y.
25% deposit with C.O.D. orders
SCENIC RADIO
53 Park Pl., Dept. P.M., New York 7, N. Y.

BUILD YOUR OWN MACHINE TOOLS!
Blueprints \$1.00—Catalog FREE

Detail construction Blueprints on 6 Lewis metal and wood-working tools postpaid for \$1.00. Includes prints for Lewis 10" Shaper, Milling Machine, Drill Press, Vice, 16" Circular Saw, 6" Jointer. Castings for these tools save up to 80% of comparable new tool cost.
Illustrated 32-page Catalog—sent free with Blueprint Order—describes 20 Lewis tools.
WRITE TODAY!

LEWIS MACHINE TOOL CO.
P.O. Box 7446, Sta. L, Dept. M, Los Angeles 23, Calif.



Get This **NEW INVENTION**
CRACKS BLACK WALNUTS
BUTTERNUTS, ENGLISH WALNUTS

**NO FLYING
SHELLS**

75% MEATS IN QUARTERS. Sold by all Hardware Stores or mailed direct for \$1.60 delivered. Send cash, check, stamps, or money order. Money-back guarantee. **C. E. POTTER,** 240 Sepulpa, Orla.



"I'LL TAKE THE WHITE ONE EVERY TIME!"

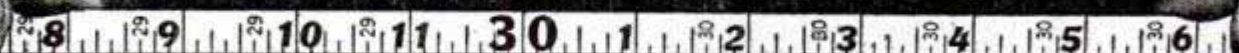

WYTEFACE
TRADE MARK
STEEL MEASURING TAPES

K≠Σ
KEUFFEL & ESSER CO.

PACKARD CableGRAM

FROM: Your friendly Packard Cable Serviceman TO: Car Owners who like good performance

YOUR PACKARD SERVICE DEALER OPERATES A SERVICE STATION, GARAGE OR CAR DEALERSHIP—KNOWS AUTOMOTIVE WIRING FROM A TO Z.



HERE ARE SOME OF THE CAR TROUBLES HE LICKS WITH PACKARD CABLE :

AND I THOUGHT SEALED BEAM HEADLIGHTS WERE POWERFUL!



WHAZAMATTER WITH THE %X& BATTERY IN THIS CAR?



FRAYED OR UNDERSIZED LIGHTING WIRES CAN CUT CANDLEPOWER IN HALF—REPLACE WITH PACKARD CABLE FOR BRIGHTER HEADLIGHTS

DON'T ALWAYS BLAME THE BATTERY—IT MAY BE CORRODED OR UNDERSIZED BATTERY CABLES. FOR SURE STARTING—REPLACE WITH PACKARD BATTERY CABLES.



EVERY WINNER OF THE INDIANAPOLIS RACE EXCEPT ONE SINCE 1928 HAS USED PACKARD SPARK PLUG WIRES. REPLACE OLD SPARK PLUG WIRES WITH PACKARD FOR PEP, POWER, PERFORMANCE



PACKARD CERTIFIED RE-WIRING SERVICE
This sign means cable service at its best—the right Packard cable and the right methods. Thousands of dealers provide better electrical service as a result of the Packard Certified Re-Wiring Program.



Packard
REG. U.S. PAT. OFF. TRADE MARK
PACKARD ELECTRIC DIVISION
GENERAL MOTORS CORPORATION
WARREN, OHIO

FOREMOST BUILDER OF AUTOMOTIVE AND AVIATION WIRING

Special Gifts for Christmas

Back Again

EMPIRE PANTS PRESSER



Now you can get it! This popular deluxe model electric Presser! Presses trousers even while worn—coats, ties, pleats, too. No wet cloth or pressure needed. Ready for duty at a minute's notice, anywhere, anytime. Complete with 6 ft. cord and plug. Easy to use—just plug in any AC or DC outlet; operates only 37 watts, and weighs only 10 ounces. Comes individually gift-boxed.

With a 1 Year Written Guarantee!

(Shp. Wgt. ¼ lb.)

Lots of 6 \$1.50

Price **\$1.65**

Plus postage



QWIK-LITE CIGARETTE LIGHTER

A real prewar-type lighter! Never fails! Smart looking, too, with slim, streamlined design finished in non-tarnishing aluminum. Individually gift-boxed.

Price **\$7.75**

1 doz. Plus postage

(Shp. Wgt. 2 lbs.) 6 doz. lots, \$7.45 doz.

Send Check or Money Order Today. No C. O. D.

FREE CATALOG—Send for new 1946 G & E Parts Catalog; Hundreds of hard-to-get items at money-saving prices. Write now!

G & E EQUIPMENT SUPPLY CO.

DEPT. PM 11, 400 N. SANGAMON ST.

CHICAGO 22, ILL.



AMONG EVERY 10
CARPENTERS THERE
ARE 9 OWNERS OF
DISSTON
HANDSAWS

In a nation-wide survey among carpenters, 92 out of every 100 reporting said they owned Disston saws. The reasons these experts give for such outstanding preference are that Disston saws are faster cutting, do finer work, require less frequent sharpening and last longer.

Ask your Hardware Retailer to show you Disston Hand Saws—you will see why they are the choice of the men who use them in their trade.

Also ask your Hardware merchant for a FREE copy of the Disston Saw, Tool and File Manual which tells how to use and care for tools, or write to us direct.



HENRY DISSTON & SONS, INC.

1111 Tacony, Philadelphia 35, Pa., U. S. A.

DISSTON The saw most
Carpenters use



NEW! CLEAN POWDER LUBRICANT
WILL NOT SOIL CLOTHING!

Grafize



FOR CARS, HOME,
OFFICE, WORKSHOP

Positive lubrication in fine, clean, non-soiling powder form—in handy small bellows dispenser—blown by finger tip pressure—forms lasting lubricating film. No grit or abrasives.

Does away with squeaky hinges, bearings, casters. Frees sticking door locks, windows, etc. Lubricates working parts of over 1000 items. Get GRAFIZE now at hardware stores, auto accessory stores, filling stations. If your dealer cannot supply, write us for FREE SAMPLE giving dealer's name.

Schmidgall Manufacturing Co.
341 CASS STREET PEORIA 2, ILLINOIS

ELECTRONIC EXPERIMENTERS KIT



This complete electronics laboratory permits the experimenter to construct 18 different useful electronics devices, including sensitive broadcast and short-wave receiver, proximity detector and multivibrator circuits, patterned after radar, phonograph amplifier, intercommunication system, code practice oscillator, time delay relay, home broadcaster, relay-amplifier for photo-electric circuit, and 10 others.

Kit includes rectifier, power amplifier, double triode, powerful 4" speaker-mike, plate relay, broadcast and SW coils, tuning condenser, and generous supply of resistors, condensers, chokes, and extra wire. Components held in place by special clips—screwdriver only tool required. Complete 40-page manual with diagrams and full instructions, clearly explained for hobbyists and novices. Sent postpaid anywhere in U. S. for \$22.50, sales tax included. Pat. applied for.

DEER & TAYLOR COMPANY

1340 MILVIA STREET

BERKELEY 9, CALIF.

RACER POLISHED CAST ALUMINUM

8½ inches long. Shining heavy single unbreakable casting. Free running rubber wheels. Can't rust. Trim, sleek lines. Looks like models selling up to \$12.00. Every youngster wants one.

DEALER INQUIRIES INVITED.
Barton Industrial Products Corp. Dept. 11
P. O. Box 43, Chicago 17, Ill.



SEND **\$2.98**

UP TO 16 PICTURES ON SAME ROLL 25c 30c for 2 SETS

7 FEATURES! Master-craftsman developing. Each print on special velox paper. Mirrotone finish. DECKLED EDGES. 1-day service. **SATISFACTION GUARANTEED.** FREE 5" x 7" Enlargement with each order of 30 prints (from your negatives) up to Size 116, at 2c each. Larger prints, 3c. Smaller lots—2½c and 3½c

BRIDGEPORT FILM STUDIOS
Dept. PM-1, Box 2061, Bridgeport 1, Conn.

FREE Return Postage

SAFEGUARD AGAINST ATHLETE'S FOOT

and **BLISTERS** with
DALE VENT-O-SOLE, INC.
45-7 Hallock St., Newark 4, N.J.



U. S. Army and British Govt. bought millions. Woven plastic shoe ventilator flows air under foot—helps prevent infection, keeps feet dry, rid shoes of perspiration. Retards fungl. Guaranteed. Free Folder.

ONE-MAN SAWMILL LESS THAN \$200.00

Easy To Turn Trees Into Money

Makes lumber, ties, shingles, crates, lath, studding, siding.

Belsaw Models in 10, 14, 20, 24 ft. sawing lengths. Patented Mechanical Feed, accurate set works and positive dogs. Use tractor or old auto engine for low cost power. Thousands used for commercial sawing. Pays for itself quickly. Send post card today for FREE booklet, "How To Make Lumber" and Catalog of Woodworking Equipment.

BELSAW MACHINERY COMPANY
Dept. 2811-E 3542 Main Street, Kansas City, Mo.

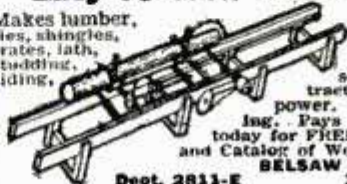



BEFORE

AFTER

CARL BRANDENFELS (Left) as he looked on October 8, 1945 and (Right) as he looks today after using his own treatment.

From all walks of life... Hundreds Report "I've Grown Hair!"

ENTHUSIASTIC USERS of BRANDENFELS' SCALP and HAIR TREATMENT have reported these results: HAS STOPPED EXCESSIVE falling hair... HAS IMPROVED hair appearance... HAS PROMOTED more lustrous hair... has given freedom from dandruff scale. Many who have faithfully followed this method have and ARE experiencing astonishing results—and a large number report growing hair.

Visit St. Helens, Oregon, home of the "Hair Farmer", see living proof and examine for yourself his files bulging with testimonials from hundreds of users all over the nation.

SEND TODAY FOR GENEROUS 5-WEEK HOME TREATMENT

PLEASANT TO USE... Its use involves no embarrassment or loss of time from work or social activities. The two liquid secret-formula solutions are non-sticky, odorless. Does not rub off on hat bands, clothing or bed linens. The simple directions are easy to follow in the privacy of your home.

COST IS REALLY MODERATE... Approximately 60 applications in each treatment, averaging only 30 cents per application.

AT FIRST SIGNS of receding hair, order Brandenfels' Scalp and Hair Treatment, for in many cases early use has saved hair.

POSITIVE PROOF

Based on Actual Statements by these men who are now Actually Growing Hair...

NEW HAIR...

"... My dandruff is gone, hair normal... baldness disappearing... Purchased BRANDENFELS' on advice of barber."

REV. L. C. ELLIOTT (Age 70).



NEW HAIR...

"... completely removed all traces of chronic scalp eczema after six weeks' application... 2 months later new hair is filling in... some of it more than one inch in length... good healthy hair."

L. C. COOLIDGE (Age 71)
Naval Architect, Seattle, Wash.



"HAIR IN SIX WEEKS!"

"... after 6 weeks... new hair all over bald area over an inch long."
HOWARD JONES

use BRANDENFELS' SCALP and HAIR TREATMENT

None genuine without this signature on every bottle:



ACT NOW! Mail Today!

(PLEASE PRINT PLAINLY)

CARL BRANDENFELS, "The Hair Farmer"
St. Helens, Ore. PM 11

Dear Sir: Please send me your 5-weeks Scalp and Hair Treatment with directions for use in my own home.

Cash I enclose \$15 plus 20% Federal Tax (\$3) total \$18 (Postpaid).

C.O.D. I agree to pay postman \$18 plus postal charges.

Name.....

Address.....

Town, Zone, State.....

SET UP YOUR OWN SHOP with **MULTIPRESS**

Amazing Bench Press
Easily Adapted to
Production Line

BLANKING STAMPING
BROACHING MARKING
FORMING PRESSING
PELLETING ASSEMBLING

and many other
operations!



4-, 6-,
and 8-ton
units

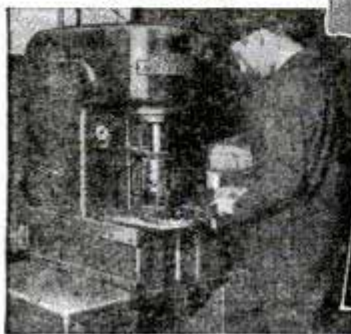

**PROFITABLE
Sub-Contracting
Opportunities
for Veterans and
Small Shop Owners**

You can turn out scores of different jobs with precision and profit on the power-packed MULTIPRESS. This compact, versatile bench machine is economical to install . . . easy to operate; girl operators are used exclusively in many shops—a single unit with many industrial uses by means of easily attached tooling accessories. Write for complete information on how this versatile machine tool can help you.

THE DENISON ENGINEERING CO.

1190 Dublin Road, Columbus 16, Ohio



DENISON
EQUIPMENT & APPLIED
Hydrolia

SMALL EFFICIENT SPEED REDUCER

Sturdy, compact (see dimensions). Proved in thousands of industrial installations. Case of heat treated aluminum. Gears, SAE 65 (British Gear) Bronze. Worm of case hardened steel. Timken Bearings throughout. Available in 4 different assemblies (shown below) and in these standard ratios:

4-1	25-1	64-1	200-1
8-1	30-1	75-1	300-1
10-1	40-1	80-1	400-1
16-1	50-1	100-1	600-1
20-1	60-1	150-1	800-1

Torque capacity 100 inch pounds. Especially suited for bench work, home work shops, light production, animated displays, etc. When ordering be sure to specify assembly and ratio required. Shipping weight in carton, 8 lbs. Full money back guarantee. Prompt deliveries.



\$15.12

Catalog Price
F. O. B. Cleveland

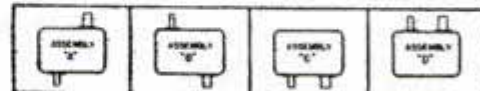
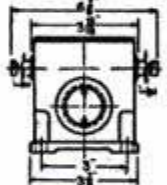

THE OHIO GEAR CO.

1411 EAST 179th ST. • CLEVELAND 10, OHIO

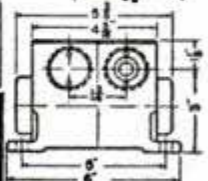

6-POWER ALUMINUM TELESCOPE \$1.69



This fine long range telescope brings planes, moving ships, stationary objects miles away several times closer. It's handsomely finished, all aluminum construction, waterproof, dustproof and moistureproof. Has scientifically ground 40mm. lens, easy to focus; clear, powerful vision. Length closed 8 inches, open, 15 inches. Send \$1.69 and we'll pay postage. Try for 10 days. Return for refund if not satisfied. Rush Order — Supply Limited.

UTICA MAIL ORDER CO., 923 Eagle St., Utica 3, N. Y.

FIND UNDERGROUND MINERALS and METALS with M-SCOPE

Employs same principle as Army Mine Detector. Unsurpassed in Efficiency. Write for Free 16 page booklet.

FISHER RESEARCH LABORATORY
PALO ALTO CALIFORNIA



Sensational New Liquid "Plastique" Linoleum Finish OPENS BIG BUSINESS—DOES AWAY WITH SCRUBBING or WAXING

Here is a new experience awaiting you in a BIG PROFIT MONEY MAKER. Makes no difference what you have ever sold or if you never sold anything in your life before . . . THIS IS YOUR OPPORTUNITY . . . Every Home is your prospect and every housewife is an enthusiastic buyer . . . The first introduction in any community arouses unusual interest . . . You will be busy supplying the demand direct or through stores as you prefer . . . Sales keep piling up because housewives have been waiting for something like "Plastique." So HERE IT IS! It brushes on in a jiffy and adds LIFE and BEAUTY to the linoleum . . . This is not an ordinary product . . . It is sensational and opens a tremendous opportunity for sales and profits . . . All within your grasp . . . BUT YOU MUST ACT QUICK!

**BIG
MONEY
MAKER**
Write
Today—

DISTRIBUTORS—AGENTS WANTED EVERYWHERE

Every community offers the same opportunity and as we want Distributors and Agents in every territory we would suggest prompt action on your part . . . The information is FREE and we are assigning territory NOW . . . Therefore do not delay . . . BE FIRST IN YOUR TERRITORY.

**WONDERFUL
OPPORTUNITY**

DRIES IN 1/2 HOUR

Marvelous Smooth
Hard Protective
High Lustre Finish

NON-SKID—WATERPROOF

HOUSEWIVES ENTHUSIASTIC
Saves Time and Work
and Money

PLASTIQUE NU-FLO PRODUCTS CO., Dept. PN, 109 S. Clinton St., CHICAGO 6

Convert your 16MM silent projector to

Sound

With the **APEX Sound Converter**

Use right through your own Radio

- 1 Sound Adapter
- 1 Radio-Film Adapter
- 1 Mounting Bracket

Only **\$59.95** Complete, ready to use

Immediate delivery. Mail money order for \$59.95, or \$10.00 balance C.O.D.

APEX VIDEO CO.

Dept. PM 3, 7356 Melrose Ave. Hollywood 46, Calif.



THE GEM MAKER

Amateurs or professionals . . . hobbyists or jewelers . . . Polish your own gems with a B&I Gem Maker. You will find this a profitable adventure. All necessary lapidary equipment is furnished, including a super-charged diamond blade for sawing, and all wheels for grinding, shaping and polishing, also complete instructions. The complete equipment as shown, less motor and belt, for only \$29.50, f.o.b., Burlington, Wis. Write today for information and literature on the Gem Maker and accessories. B&I MFG. CO., Dept. S, Burlington, Wis.

NEW! UNIVERSAL! SELF-CENTERING! MANDREL FOR HAND GRINDERS ELECTRIC DRILLS



\$1.00 (less saw) Fits all saws and grinding wheels with holes from less than 5/64" to more than 3/16" diameter. Centers any size saw or wheel precisely—automatically—immediately. All steel and brass construction—nickel plated. Precision machined; runs absolutely true. Fits any make grinder or drill. Patent applied for. Available with 1/4" or 3/32" diameter shank. Specify diameter desired. Sent postpaid with simple instructions. **\$1.00**

PRECISION TECHNICAL SPECIALTIES CO.
59 Myrtle Ave., Brooklyn 1, N. Y.

Low Price The OTTAWA "Buzz" Master



CLEAR LAND FAST! Powerful 6-HP motor with friction clutch for safe operation. Cuts down timber, brush, hedge; turn blade vertically and saw logs to length. Can be equipped to fell largest trees. Clutch pulley for belt work. Guaranteed.

OTTAWA MFG. CO., 1127 Brush Ave., Ottawa, Kansas

JET PROPULSION

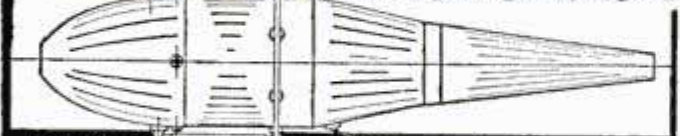

GAS TURBINE Model Engine

★ ★ Be one of the first to build a real Turbo-Jet Model Engine. Single-stage centrifugal compressor and turbine. This is a real engine, easily made with ordinary home workshop equipment. Complete plans for construction . . . design formulas and curves for checking performance and testing.

\$2.00 Post paid

THE ROTOJET CO. Department 11 BOX 757 • LOS ANGELES 25 • CALIFORNIA



HERE ARE A FEW "POINTERS" ABOUT BURD "GRAF-FLOX" PISTON RINGS . . .

When your engine lacks pick-up and starts using gas and oil excessively, just head for your favorite repairman and ask for a re-ringing job with Burd "Graf-Flox" Piston Rings. You'll be surprised at the instantly improved performance. Burd Rings are quicker seating . . . require no run-in . . . will not seize or score because of the exclusive "Graf-Flox" process. Electric furnace iron produces castings of uniform strength and tension. Precision grinding and finishing assures minimum wear of cylinder walls. Mail coupon today for two FREE booklets described below.

BURD PISTON RING CO., Dept. PM, ROCKFORD, ILL.

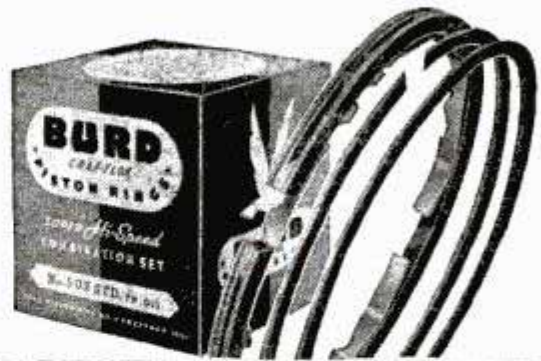

THIS COUPON BRINGS FREE BOOKS

BURD PISTON RING CO., DEPT. PM
Rockford, Illinois
Gentlemen:

I'd like a FREE copy of your "Handy Handbook" which tells how to keep my car in good working order. Also send a "Car Economy Record Book."

Name.....
Address.....
City..... State.....



IMMEDIATE DELIVERY 1,000 OR 1,000,000 CONGRESS DIAMOND BORED PULLEYS

The CONGRESS pulleys you see on your dealers counter are identical to the pulleys that have been used for years as standard equipment by America's leading industries. They are now available in sizes up to 16" diameter, at your local dealers for use in hobby shops, farm equipment and many other applications.

CONGRESS pulleys increase the performance in your workshop; provide efficient, long wearing service at low initial cost. You pay no more for CONGRESS pulleys than for ordinary pulleys. REMEMBER—You can't buy a better pulley than a CONGRESS pulley.

CONGRESS DIE CASTING DIVISION
Detroit 12, Michigan



LOOK FOR
THIS
DISPLAY
AT YOUR
DEALER'S



A TREASURE CHEST FOR MECHANICS GARAGEMEN—FARMERS—EXPERIMENTERS



100 POUND HANDY ASSORTMENT \$8.95
SCREWS—NUTS—BOLTS
WASHERS—RIVETS—SPRINGS

Think of it—this popular assortment specially priced at less than 9¢ a pound! Chest filled with 100 pounds of clean, new fasteners, mostly 1/4" and larger diameters—bound to come in handy in shops, garages, on farms, or wherever a large variety is needed. Chest, too, is valuable for many uses after original contents have been used. Shipping wt. 115 lbs. Price only \$8.95. Enclose remittance and shipping charges when ordering.

HUDSON TRADING CORP.
NA1521 N. Wells St. Chicago 10, Ill.

A TOOL... NOT A BRUSH

\$1.00 POST PAID

NOW! PAINT STRIPING MADE EASY!

PAINTERS' STRIPING TOOL

Easy to use as a pencil! Draws parallel lines, straights, curves, circles with paint, enamel, lacquer, etc. Do your own striping on autos, furniture, toys, bikes, model planes, signs, linoleum... make wall board look like tile. Painters—craftsmen, order today! Type "M" Master Painters' Striping Tool complete with tip for 1/16" stripe, \$1.00. Extra tips 1/64", 1/32", 3/64", 1/16", 5/64", 3/32", 1/8"—75c each. Tool with complete set of 7 tips \$5.00. (C.O.D. orders 25c extra.) Dealers write!

WENDELL MFG. CO.
4234-B Lincoln Ave., Chicago 18, Illinois

MARCOT KEY MACHINE

Immediate Delivery



Marcot No. 8 Key Machine
Mounted on Cabinet.....\$ 75.00
Book on Modern Locksmithing. 3.95
Auto Code Book and Auto Depth Keys 12.50
162 Doz. Popular Key Blanks.. 77.76
Set Key Files, Tools, Pins, Springs, Thimble 10.50
\$179.71

A. J. MARCOTTE CO., 1200 N. KEDZIE AVE., DEPT. PM, CHICAGO 51, ILL.

FREE Bikini Crossroads Patch



Send only \$1.00 for our beautiful selection of 20 different Flight Squadron and Shoulder Insignia and receive the RARE BIKINI BOMBFR leatherette breast patch absolutely FREE. Tremendous value. Colored insignia book with your order at no cost. Send to-day. Offer limited.

THE INSIGNIA MART, Dept. 88
703 Broadway, New York 3, N. Y.

TINY TIM — \$4.95

LIMITED QUANTITY AVAILABLE
MONEY BACK GUARANTEE

Single cyl. High Speed Oscillating Steam Engine. A precision built (like the big ones) miniature engine in every detail. Height 2 3/8", weight 4 oz. Ideal for model boats or stationary power plants.

ORDER NOW For Prompt Shipment. Remit \$4.95 with order and we prepay P.P. or C.O.D. Cash with orders get preferred shipping.

THE THOMPSON ENGINEERING CO.
405 Winchester Bldg., Grand Rapids 2, Mich.

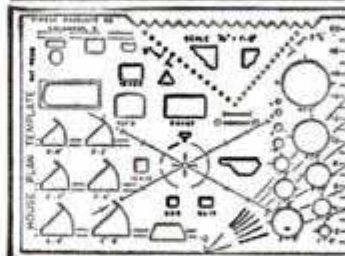
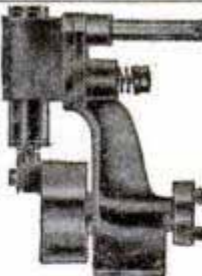

HOUSE PLAN TEMPLATE

Made of clear sheet plastic, with accurate cut-outs for drawing door-swings, plumbing and electric fixtures, fireplace, stairs, moldings, roof-pitch, etc. Standard 3/8" equals 1'-0" scale.

AT YOUR DEALER \$1.50
or mailed postpaid

Send card for list of templates

TIMELY PRODUCTS CO.
Box 206C, Columbus 9, Ohio

Decorative DECALCOMANIA Transfers

Imported designs of all Sizes and Types—Flowers, Fruits, Birds, Figures, Juvenile, Ships, Silhouettes, Oriental, Peasant, Inlay, Patriotic, Borders, Initials, etc.—for Furniture, Trays, Lamps, and many other articles. Pre-war. Limited Stocks.

CATALOG with 800 illustrations in Color — 25c
Also carry Decorative Prints—Leaflet 6c

L. C. WELLS, Dept. PM-611, 25 E. 26th St., New York 10

Look! Servicemen - Civilians too!

PRECISION BUILT

MILITARY WRIST WATCH



The watch you've been waiting for!

Swiss Movement!
Precision made by
Expert Swiss Craftsmen

WRITTEN GUARANTEE WITH EVERY WATCH

A fortunate purchase makes this amazing offer possible. Latest military styling, red sweep second hand. Easy to read Extra Fancy Dial. Comes complete with Leather Strap. A watch you'll be proud to wear or give as a gift. Below O.P.A. Price.

Immediate delivery
\$8.49
ONLY plus 10% Fed. Tax

SEND NO MONEY—Pay Postman \$8.49 plus 85c Fed. Tax and few cents postal charges, or, send \$9.34 with order and we pay postage. Return within 10 days if not delighted for refund providing watch has not been tampered with.

Hurry — Order Now — Supply Limited!

ORDER WITH CONFIDENCE FROM

AMERICAN MERCHANDISING CO., INC.
Dept. PMW-5 12 Adams Ave. Montgomery 4, Ala.



"LITTLE WONDER" Crystal Radio

NO ELECTRIC—NO BATTERIES—NO TUBES

One of the smallest genuine crystal radio sets in the world. Slider-contact tuning, binding posts for aerial and ground. Extra long range. **SEND NO MONEY.** Just send your name and address and when your "Little Wonder" arrives simply pay the postman \$1.99 plus a few cents postage. Sent prepaid if you inclose check or money order with your order.

MART DISTRIBUTORS, Dept. M, P.O. Box 6, Evanston, Ill.

EXPERIMENT WITH BLACK LIGHT!

FUN! THRILLS! PROFITS! Find hidden colors in things around your home. Make wonderful decorations with our paints, crayons, satins. We furnish all supplies—also fluorescent minerals. Get Designers Kit including genuine **BLACK LIGHT** only \$15, Guaranteed, F.O.B. Chicago. Write for free catalog "the invisible ray." New Address

BLACK LIGHT PRODUCTS, 67 East Lake Street Chicago 3, Illinois

START A BATTERY FACTORY

—at home; the latest achievement; re-cast junk batteries into new. Complete instructions, catalog.

BATTERY LABORATORIES
Dept. PM Minneapolis 13, Minn.

DON'T PULL HAIR FROM NOSE

May Cause Fatal Infection

Use the **Hollis KLIPETTE** Rotating Scissors

REG. U.S. PAT. OFF.

You can cause serious infection by pulling hair from nose. Ordinary scissors are also dangerous and impracticable. No better way to remove hair from nose and ears than with **KLIPETTE**. Smooth, gentle, safe, efficient. Rounded points can't cut or prick skin.



So Simple! Just turn the end. Surplus hair clipped off gently, safely.

\$1 Made from fine Surgical Steel, Chromium plated—also in 24 Kt. Gold Plate in smart leather case at \$3.50 (plus 70c Fed. Tax)

Guaranteed to Satisfy or Money Back

HOLLIS CO. • 11 Commerce St., Newark 2, N. J. • Dept. 232
Enclosed is \$..... for..... KLIPETTE(S) at \$1 (no tax); in gold plate at \$3.50 (plus 70c Federal Tax). If not satisfied, I may return the above for refund in 10 days.

Name..... Address.....



with **SMOOTH-ON**

Stop leaks, seal all cracks, tighten all loose parts and connections in your heating and plumbing systems — boilers, furnaces, flues, radiators, tanks, piping, etc.—with Smooth-On No. 1 Iron Repair Cement. You can do it yourself easily — and NOW.

Ask for Smooth-On No. 1 at your hardware store. It's a metallic powder that you mix with water and apply in paste form — no heat required. It sets to metallic hardness and expands a little as it hardens, making tight-fitting repairs. Has countless uses around the house and on the car. In 1 3/4-oz., 7-oz. and larger sizes at your hardware dealer's. If he hasn't it, write us.

FREE Home Repair Handbook

40 pages. 170 diagrams. Clear, concise directions for dozens of practical, time-saving, money-saving repair jobs. Pocket size. Just send coupon.



for the Motor Car and Boat, Home, Factory and Power Plant

—MAIL THIS TODAY—

Smooth-On Mfg. Co., Dept. 37
570 Communipaw Avenue, Jersey City 4, N. J.

Please send me a Smooth-On Handbook.

Name.....

Address.....

11-46.....

Do it with **SMOOTH-ON**

THE ANSWER TO EVERY BOY'S DREAM



TECHNICAL TRAINER for Juniors was created and designed by an outstanding staff of designers and engineers to meet the ever-growing interest of young and old technicians in the new forms of construction techniques.

It's Made of DURAL — the Wonder Metal

- WILL NOT RUST
- WILL NOT TARNISH
- A PLACE FOR EVERY PART
- DURABLE WOODEN CASE

\$8.95
Add 2% Tax in N.Y.C.

MAIL ORDERS TO
1926 BROADWAY, N.Y. 23, N.Y.

FREE DELIVERY IN METROPOLITAN AREA
ALL OTHERS F.O.B. N.Y.

Dynamic
ELECTRONICS • NEW YORK, INC.

37 W. 57th STREET, N.Y.
2 PARK AVE., N.Y.
BROADWAY AT 65th ST.

SORRY: NO C.O.D.'S, SEND CHECK OR MONEY ORDER

In Toledo, Willys-Overland is prepared for the competitive battle with a small light car which will go into production early next year. The new Willys has a six-cylinder engine.

At Willow Run, a new organization including some excellent production men and top-flight engineers is struggling to get into full production—a goal apparently several months off. The conventionally powered Kaiser Special and Frazer cars have won wide support from wishful new car owners. The front-wheel drive car, dear to Henry J. Kaiser's heart, probably won't be perfected by the engineers assigned to the job until next summer. But Kaiser-Frazer will turn out cars in volume to take part of the huge market and probably gain a toehold in public buying habits before the real selling job for dealers begins.

In Chicago, Preston J. Tucker has a 10-year lease on the former Dodge plant, and the revolutionary Torpedo with its Cyclops headlight, driver's seat between two passengers and rear-engine design may get into production before 1948. There are many car makers who feel his obstacles are too big to be overcome before then.

Whether the Crosley car will change its midget models in 1947 is uncertain, due largely to pricing conditions, but there is an admittedly large market for a small car selling for less than \$1000. And thousands of buyers will buy as many Crosleys and Bobbi cars as the manufacturers can assemble until the Big Three and the independents with cars in the lowest price field get into mass production.

A check of manufacturers, designers and engineers shows the trend is toward lower, wider passenger cars with more glass for better vision, fewer projecting handles, improved instrumentation, greater operating ease—meaning automatic transmissions—and more comfortable springing.

The Ford announcement of its 1947 models probably will emphasize the rumored individual front-wheel coil-spring suspension, with improved side springs in the rear.

Weight in standard passenger cars will incline downward, because weight costs money at so much per pound. The heavier the car, the more expensive, with heavier, more costly engines, larger brakes, bigger tires.

Magnesium, which costs about 75 cents a pound, could drop to seven cents a pound and still be unable to compete with steel at two or three cents a pound. Magnesium and aluminum are less ductile than steel and it costs more money to draw and machine them. The waste in production is

(Continued to page 294)

Paratroop
HUNTING
BOOTS
in Waterproof Elk



ONLY
\$9.87
plus postage

All sizes from 4 to 13½
All widths from AA to EEE

Newest thing in comfortable, serviceable boots. Ideal for hunting, fishing, hiking and all kinds of outdoor use. Made in soft, pliable, heavy-oiled waterproof elkskin. Same design, construction and high quality standards as famous boots worn by Paratroopers during war. Write to our Dept. PM-11 Specify size and width. Enclose check or money order for \$9.87. Boots sent immediately, postage C. O. D. Money back if you are not entirely satisfied on receiving boots.

CORCORAN INC., STOUGHTON, MASS.



The WINNER

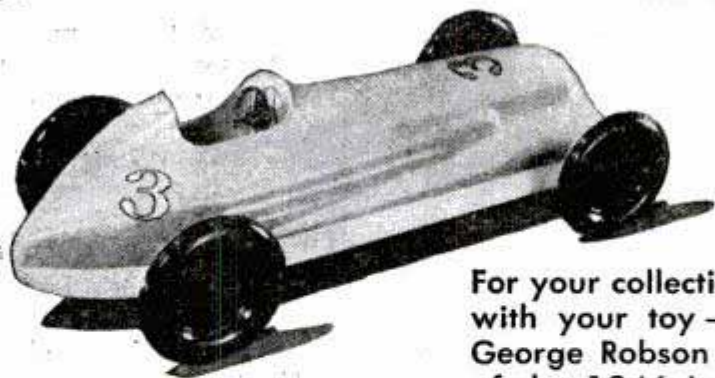

For your collection—in the package with your toy—a free picture of George Robson in the winning car of the 1946 Indianapolis Races.

Plastic Scale Model Racing Car. Built by the man who designed the winning car of the 1946 Indianapolis Races. A perfect scale model, 9½ inches long. It was the winner at Indianapolis and will be the winner for the lucky boy who owns one. Durable and exciting. Ideal for Christmas or any gift occasion. A toy the family can enjoy! The perfect Model for Hobbyists.

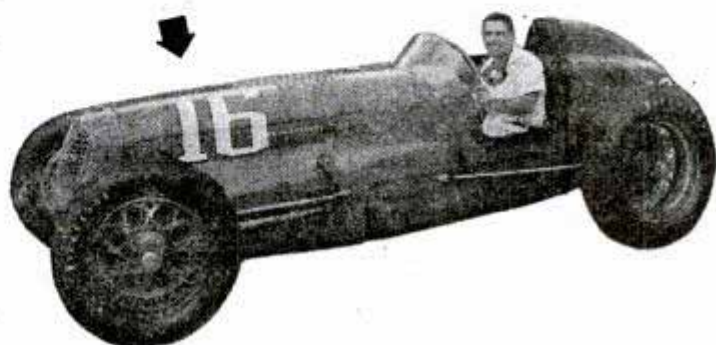

ORDER BY MAIL TO-DAY - \$2.00 POSTPAID
Satisfaction Guaranteed or Money Refunded

ART SPARKS • 11-2, 1396 E. WALNUT ST. • PASADENA 4, CALIF.



It's easy to hone keen cutting edges on your chisels and plane blades. Precision adjustment for ANY ANGLE of bevel. Roller glide makes every stroke uniform across oil stone. Light, strong—ideal for home craftsmen, hobbyists, carpenters, cabinet makers.
McLAREN INDUSTRIES, INC., Box 606, TROY, N. Y.

check or money order
\$2.95
POST PAID

SHAW and Peppy-Pal "DU-ALL" GARDEN TRACTORS

1 to 9 H.P. Circulars on request. Building more now. We supply repairs for all SHAW Tractors sold in our 42 years in business.

BUILD YOUR OWN RIDING TRACTOR—"WAR HORSE"

using old auto parts, powered by 2 H.P. or larger air-cooled engine; or walking type Garden Tractor ½ to 3 H.P. or convert truck or auto into Farm Tractor. Each with steel or rubber tires; will plow, cultivate. Plans for building, in few hours, any one of above, postpaid for \$1.00 (state which wanted) or all 3 for \$2.00. Money Back Guarantee.

SHAW MFG. CO., 4511 Front St.
Galesburg, Kansas
6888 North 4th St., Columbus, Ohio

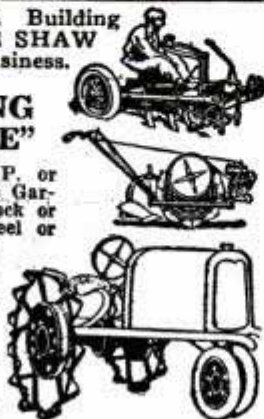

COMBINED

Keyway Milling Machine and DRILL for HOME WORKSHOP or FACTORY

A REAL TOOL—NOT A TOY

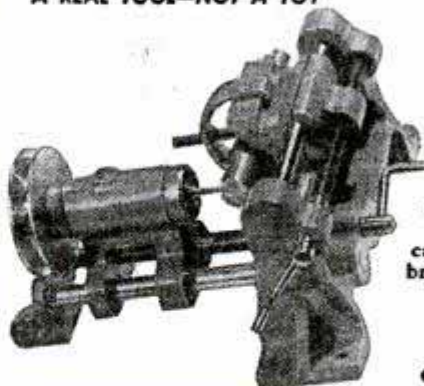

With this useful tool you can cut flat bottomed keyways and splines ¼", ⅜" and ½" wide on shafts from ⅜" to 1½" diameter. Simple and easy to use, it centers itself automatically. Sturdily built with cast iron frame and bronze bearings.

only **\$8.95**

Cutters 95c each extra

SAVEBACK PRODUCTS CORP.

SAVEBACK PRODUCTS CORPORATION, 6432 Cass Ave, Detroit 2, Mich.

Please send me 1 Keyway Milling Machine at \$8.95.

Also send cutters size _____ at 95c each.

Remittance of \$ _____ is enclosed. You pay the postage.

Send it C.O.D. I will pay the postage.

If not entirely satisfactory I am to return it within 10 days and you will refund my money.

Name _____ Address _____
City _____ State _____

DOES YOUR COOLING SYSTEM LEAK?

THEN USE



Best For Cracked Blocks, too!
DOES THE JOB OR YOUR MONEY BACK

When leaks develop in Cooling Systems, remember Moguloid! It's the amazing colloidal compounded of pure copper and chrome flour. Revolutionary 2-way action cures block cracks and cooling system leaks fast with a lifetime metallic bond... and dissolves rust and other foreign matter leaving block whistle clean. For guaranteed results be sure to get **\$2.50** Per Pint Moguloid.



ON SALE AT YOUR SERVICE STATION

SAY YOU SAW IT IN POPULAR MECHANICS



Have YOUR OWN Business

SAW FILING

You can have a good, steady, cash business of your own reconditioning saws with the Foley Automatic Saw Filer, which makes old saws cut like new again. The Foley is the **ONLY** machine that files all hand saws, also band and circular saws. Easy to operate—no eyestrain.

SEND FOR FREE PLAN—shows how to start in spare time—no canvassing. Send coupon today—no salesman will call.

FOLEY Automatic SAW FILER

FOLEY MANUFACTURING CO.
 1716-6 Foley Bldg., Minneapolis 13, Minnesota
 Send Free Plan on Saw Filing business, no obligation

Name _____

Address _____



STEEL IN KITS OF ASSORTED SIZE RODS!

KITS OF COLD DRAWN STEEL ROD

- No. RCD-1612** 1 ft. lengths, one each, 3/16" to 3/4" dia. **\$110**
 ROUNDS, by sixteenths. (Shp. Wt. 9 lbs.)
- No. RCD-1624** 2 ft. lengths, one each, 3/16" to 3/4" dia. **\$200**
 ROUNDS, by sixteenths. (Shp. Wt. 15 lbs.)
- No. SCD-1624** 2 ft. lengths, one each, 1/8" to 1/2" dia. **\$165**
 SQUARES, by sixteenths. (Shp. Wt. 5 lbs.)
- No. SCD-812** 1 ft. lengths, one each, 5/8" to 1" dia. **\$145**
 SQUARES, by eighths. (Shp. Wt. 11 lbs.)
- No. SCD-824** 2 ft. lengths, one each, 5/8" to 1" dia. **\$275**
 SQUARES, by eighths. (Shp. Wt. 20 lbs.)
- No. HCD-1624** 2 ft. lengths, one each, 3/16" to 1/2" dia. **\$145**
 HEXAGONS, by sixteenths. (Shp. Wt. 4 lbs.)
- No. HCD-812** 1 ft. lengths, one each, 5/8" to 1" dia. **\$155**
 HEXAGONS, by eighths. (Shp. Wt. 10 lbs.)
- No. HCD-824** 2 ft. lengths, one each, 5/8" to 1" dia. **\$265**
 HEXAGONS, by eighths. (Shp. Wt. 18 lbs.)

DRILL ROD IN KITS

Write for free Price List of Kits of Drill Rod—Rounds, Squares or Flats, and for quotations on any sizes and types of steel, brass or aluminum you require.



GENERAL METALS SUPPLY CO.
 744 PARK AVE. RIVER FOREST, ILL.



ROYAL CLIPPER METAL CUTTER

Cuts any light sheet material—metal, fibre, plywood, plastic. Just chuck it up in your drill and you have a handy, easy-to-use cutter. Saves time, leaves smooth workable edge. Buy from your dealer or **\$15.95** order direct.

C-B TOOL CO. LANCASTER, PA.

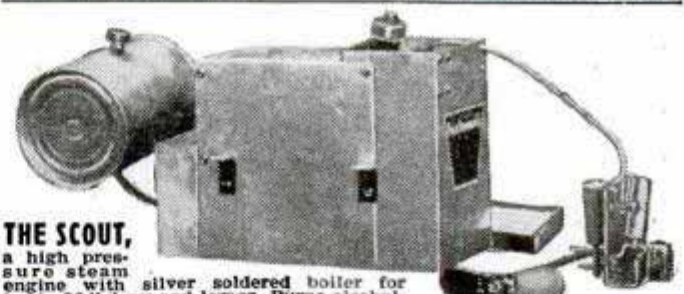

THE SCOUT, a high pressure steam engine with silver soldered boiler for boats 20" long and larger. Burns alcohol. Runs 30 min. Drives a 2 1/4" propeller. Price complete ready to run with 70-lb. safety valve and accessories as shown... **\$8.95** Postage extra, shipping wt. 4 lb. Distributors and dealers write for terms. **PHILIP STEVENSON CO., Box 162, Station D, Cincinnati 6, Ohio**

Build Your Power Tools With OUR BALL BEARING ARBORS

L. H. Th'ds Also

- C5** — \$8.25 PP.
- C6** — \$9.25 PP.
- Spindle 12 1/2 Long Housing 2 1/4 x 8
- Heavy Duty Ball Bearing Saw Arbors

B33 — \$4.95 PP. 5/8 x 4 1/2 Spindle Only
B15 Plain Spindle \$3.45 PP. Also Flange Models

POLY PRODUCTS, 406 S. Chester Ave. Ct. 1, Pasadena 5, California

NEW CHEAP OIL BURNER

FOR COOKING & HEATING STOVES-FURNACES HEAT YOUR HOME. COOK YOUR MEALS WITH CHEAP FURNACE OIL

NO MORE SHOVELING COAL OR ASHES. A New Fuelizer Starter Vaporizing System turns cheap 130 Flash Furnace Oil, Distillate, Kerosene etc. into Oil Gas heat without clogging up. **LIFETIME GUARANTEE** against defects. **\$1.00 Bonus Offer** for Testing. We will let you try it in your own stove or furnace for one month. Get yours for introducing. Big Profits QUICK. Be first. Send in your name TODAY.

NORTHWEST MFG. CO., 561-N 5th, Mitchell, So. Dakota

FUN • SPEED GALORE • BUILD YOUR OWN RACER

with Large 10 inch Wheels

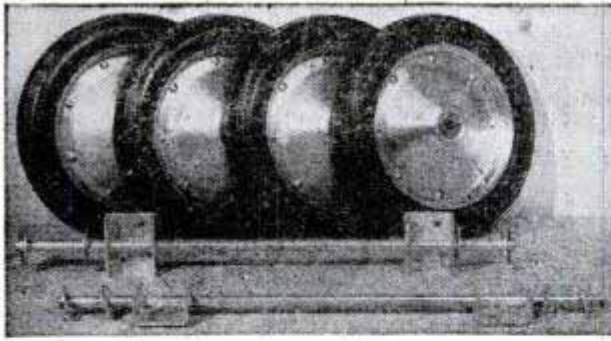

**MADE TO OUTLAST
ANY OTHER TYPE WHEELS
with GOODYEAR
10.00 x 1.75 PUNCTURE
PROOF SEMI-
PNEUMATIC
DEEP TREAD
TIRES**

(10x1 $\frac{3}{4}$ " wheels)

LOWEST PRICES: ORDER NOW

- 1 COMPLETE 10" WHEEL WITH 10x1.75 TIRE.....\$2.90
- 2 COMPLETE 10" WHEELS (without axle)\$5.50
- 4 COMPLETE 10" WHEELS (without axle)\$10.00

Kit "A"—2 complete 10" wheels ... 1-20" long x $\frac{1}{2}$ " dia. axle—2 heavy hangers—4 washers & 2 cotter pins—all plated—ready for use.....Only—\$7.50

Kit "B"—4 complete 10" wheels ... 2-20" long x $\frac{1}{2}$ " dia. axles—4 heavy hangers—8 washers & 4 cotter pins—all plated—ready for use.....Only—\$13.50

Kit "C"—4 complete 10" wheels ... 2-24" long x $\frac{3}{8}$ " dia. axles—4 heavy hangers—8 washers & 4 cotter pins—all plated—ready for use.....Only—\$16.00

F.O.B. Doylestown, or, add 10% for Prepaid Shipment anywhere in U.S.A.

Hundreds of repeat orders, is your guarantee of the Best Materials, Workmanship and Prices.

FREE Circular Showing Plans, Parts, Etc.

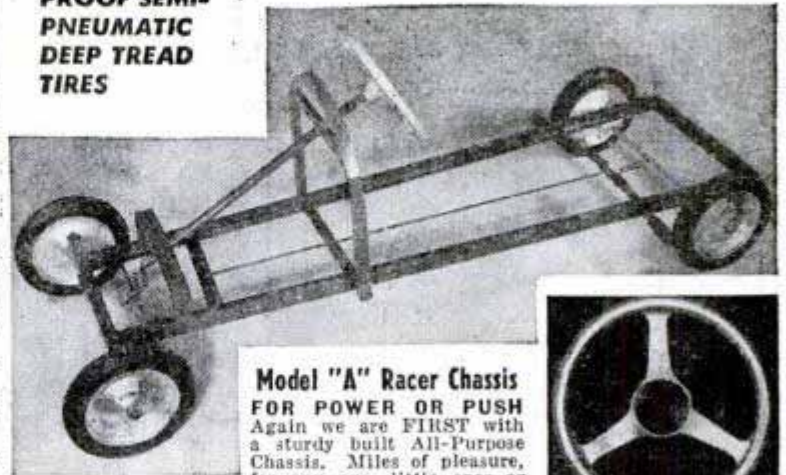

65 Inches Long
24 Inches Wide
Weight
Approx. 55 Pounds

**ORDER
TODAY**

Model "A" Racer Chassis

FOR POWER OR PUSH
Again we are FIRST with a sturdy built All-Purpose Chassis. Miles of pleasure, for any age, little ones or adults. This racer chassis engineered into the finest design for electric, gasoline or push power, giving you the choice of body design to build yourself. Equipped with Genuine Arguto OILLESS LIFETIME BEARINGS. Ready to roll and steer. COMPLETE AS ABOVE, ONLY...\$46.00



12 in. deluxe all weather steering wheel complete with steering rod. Hangers and jam nut assembly only.....\$8.75

OSBORN WHEEL COMPANY

115 So. Main St., Dept. P-11

DOYLESTOWN, PA.

5 lbs. HANDY ASSORTMENT \$1.98

For Mechanics—Garages
— Workshops—Home Use

SCREWS • NUTS • BOLTS • WASHERS
RIVETS • SPRINGS • BRACKETS • MISC.

MORE THAN 1,000 PIECES—5 full pounds—a veritable treasure chest of fastening devices for every practical use. Satisfaction guaranteed. Order now\$1.98
SPECIAL—2 assortments, over 2,000 pieces, for \$3.69.

Get on our FREE Bargain Mailing List—Many other valuable assortments to meet every need!

HUDSON TRADING CORPORATION
N1521 N. Wells St.
Chicago 10, Ill.



1 H. P. GASOLINE MOTOR

Ideal for Lawnmowers, Motorscooters, Motorbikes, etc.



2 $\frac{1}{2}$ " bore, 2" stroke—This motor includes Bendix Scintilla Magneto Ignition, Aluminum Cylinder Head, Air-cleaner, Muffler, Gas Tank, Blower Housing, Driving Pulley, etc.
AN EASY STARTING, long life, dependable engine made of aluminum—weight, 27 lbs. If you can perform a few simple machining operations on your lathe and drill press we are, FOR A LIMITED TIME ONLY, furnishing this engine in kit form with all complicated stampings, magneto, standard parts and precision castings furnished, together with complete working drawings and instructions for assembly.

COMPLETE MOTOR KIT, DRAWINGS AND INSTRUCTIONS PLUS EXPRESS CHARGES.....\$31.25

COMPLETE SET OF BLUEPRINTS AND ENGINEERING INFORMATION AS USED BY OUR FACTORY.....\$3.75

Immediate Shipment on Mail Orders

THE CAUFFIEL MOTOR AND ENGINEERING CO.

4144 River Road — Toledo, Ohio

CAMERA FANS

here's the GIFT to ask for

NEW, IMPROVED

G-E exposure meter

Get more out of your camera... glorious color, full detail... with correct exposure. Accuracy you can trust! New easy-to-read dials. Ask for a G-E meter... 3 meters in one. General Electric, Schenectady 5, N. Y.

\$26.95
Federal tax included
Type DW-50



FOR BETTER PICTURES



GENERAL ELECTRIC

606-1641-6336

Larson

"MAKE YOUR OWN" CARPENTERS' SAW-HORSE SET

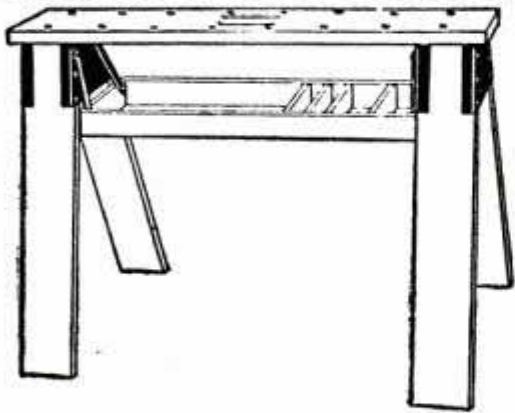

Makes a rigid saw horse that is actually a **PORTABLE HOME WORK BENCH** with many uses. Has a novel **SWINGING TOOL TRAY**. Complete hardware and copyrighted instruction sheet for easy assembly. Lumber is not included.

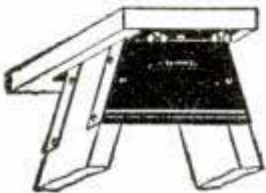

Prepaid \$1.35

CHAS. O. LARSON CO., BOX 358, STERLING, ILLINOIS

high and lighter cars would have to be smaller, both inside and outside, and have narrower treads.

The Society of Automotive Engineers, mirror of all things automotive except sales and promotion, believes that all action for more than two full production years will be concentrated in making substantial improvements in parts, material, performance and other hidden factors.

Some of the 1947 or 1948 models may introduce a rear axle which allows the rear wheels to be individually suspended by means of a universal joint on either side of the differential—a form of suspension used on some military vehicles.

Traditionally, American industry makes about a three percent technological gain each year. This saving in time or production cost in the automobile industry was curtailed by the war, and consequently the part it would have played in reducing the cost to the customer has been lost.

However, new production methods, as exemplified by Plymouth's plant with its waist-level operations, automatic paint sprayers and other advances, are just the beginning of giant forward steps by the auto industry in our generation.

The new car may not be radical. It may not even be on sale in '47. But if you've waited this long, you can wait a little longer for mechanical perfection and artistic appearance in your next automobile.

Bowl of Drain Trap Unscrews For Easy Cleaning

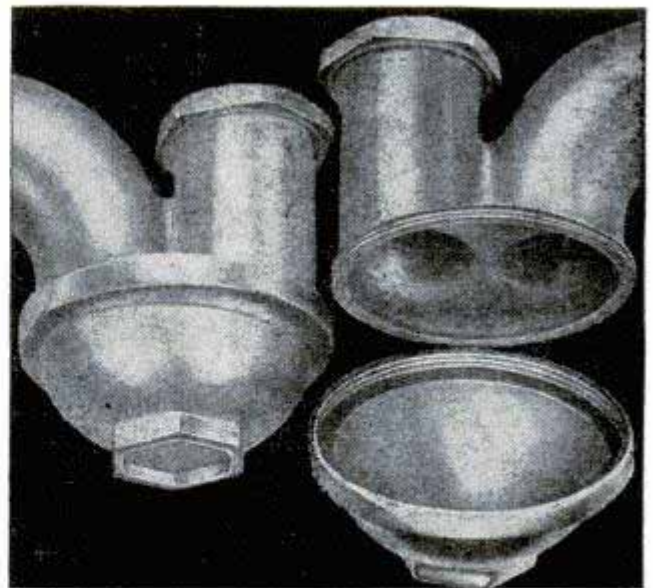

To make it easy to clean, a plumbing trap has been designed so that the entire bowl is removable. The bowl is threaded to the intake and vent pipes of the trap. It is made of brass castings, precision machined, with heavy chrome-plate finish.

SANTA USES AND RECOMMENDS THE BURGESS vibro-tool

\$1650

Keeps on giving every day in the year! Writes names on tools, engraves jewelry, decorates glass, tools leather; cuts out cardboard signs and linoleum blocks. The ideal gift for man or woman—boy or girl... for anyone interested in craft work or home workshop activities.

See your dealer or order direct.

Gives you the tool and 22 accessories, with sharpening stone... all conveniently accessible in handsome hinged, natural polish, wooden box. 60 cycles AC; 110 V.

HANDICRAFT DIVISION

BURGESS BATTERY COMPANY

166 N. Wabash Avenue • Chicago 1, Ill.

A welcome gift that is a year-'round reminder of your thoughtfulness at Christmas

THE *Delta*gram*
favorite magazine of woodworking hobbyists

Page after page of plans, pictures, projects — expert advice on doing good-looking work easily, quickly, safely. Enough to keep any homemaker happy for a long time! Give this gift of lasting pleasure — The Delta^gram. Send names and addresses today — with coin, postal note, or money order.

*Trade Mark Reg. U. S. Pat. Off.

6 Big Issues 50¢

DELTA MANUFACTURING DIVISION
Rockwell Manufacturing Company
681M E. Vienna Ave., Milwaukee 1, Wis.

HM-44

THE NEW *Boot King*
SUCCESSOR TO THE BOOT JACK

ONLY \$2.95

Here's the easy way to remove your ankle fitting boots, riding boots, shoes, rubbers, and galoshes quickly. No more pulling and tugging—it's easily done with *BOOT KING*, in seconds. Made of cast aluminum for a lifetime of use, rustproof, lightweight, easy to carry. Indispensable to hunters, fishermen, farmers, sportsmen and all men whose work requires the wearing of boots. Ideal gift. \$2.95 at your favorite store, or write to:

QUINN AND COMPANY
DEPT. 1-B, BELOIT, WISCONSIN

SAVE TRAVEL TIME SAFELY

HULL STREAMLINE AUTOMOBILE COMPASS, your sure-way guide over shortest routes, eliminates wrong-way travel and stops for bearings. You get there faster, at safe speeds, with a Hull. Price \$3.95. At your dealer's. Write for circular.

HULL MFG. CO., P. O. Box 246-D12, Warren, Ohio

Cute stuff TO BUILD EASY

Make a big hit with these NEW and ORIGINAL IDEAS

Easy to Make... Easy to Sell. (Christmas is coming). Full Size... Professional Plans

30c Each. Set of 8 for \$1.60

- Bird Door Knocker
- Turtle Flower Base
- Lobster Knife Rock
- Crocodile Game
- Ubangi Ash Tray
- Frog Pull Toy
- Duck Door Stop
- Chipmunk Nut Tray

Each item has some clever twist to the design to make it unusual and desirable.

PARKE PRODUCTS
78 Grand Street Coldwater, Michigan

Appliance \$10⁹⁵ Tester

LOCATES TROUBLE INSTANTLY IN ALL ELECTRICAL DEVICES

In this single unit are all the necessary tests for examining every appliance. Checks thermostats under working conditions. Tells instant it opens or closes. Controls heat on soldering irons. Prevents over-heating. Tests continuity, open circuits, automatic irons, vacuum cleaners, motors, coin machines, bulbs, 3-way switches, etc. Great time, and money saver! ONLY \$10.95 COMPLETE. No C.O.D.'s, shipping wt. 3 lbs.

Pat. Pend.

FREE electrical appliance repairing. WRITE FOR CIRCULAR.

HANLAN CO., 1419-A, West Jefferson, Los Angeles 7, Calif.

FREE ALLIED'S 1946 RADIO CATALOG

LARGEST STOCKS OF EVERYTHING IN RADIO . . .

SERVICEMEN! Dealers! Soundmen! Amateurs! Builders! Experimenters! Send for the handiest, most complete 1946 Buying Guide for Everything in Radio! Features latest radios, sound systems, amateur and builders' gear, thousands of radio and electronic parts—world's largest and most complete quality stocks—at lowest prices. Fastest service; expert help!

MORE THAN 10,000 ITEMS

Everything for every radio use: new model home radios, phono-radios, communications receivers, Ham kits, radio parts, tubes, tools, test instruments, public address equipment, easy-to-build kits, diagrams, instructive books—all at lowest prices!

HELPFUL RADIO BOOKS

- Radio Formulas & Data No. 37-752 10c
- Dictionary of Radio Terms No. 37-751 10c
- Radio Circuit Handbook No. 37-753 10c
- Radio Builders' Handbook No. 37-750 10c
- Simplified Radio Servicing No. 37-755 10c
- Radio Data Handbook No. 37-754 . . . 25c
- ALL SIX BOOKS No. 37-799 75c
- Parallel, Resistance and Series Capacitance Calculator. No. 37-960 . . 25c
- R-F Resonance and Coil Winding Calculator. No. 37-955 25c

ALLIED RADIO

ALLIED RADIO CORP.
833 W. Jackson Blvd., Dept. 5-L-6
Chicago 7, Illinois

FREE CATALOG

Send FREE 1946 CATALOG
 Send Six Books No. 37-799
 Send Books checked above
 Send Calculators checked above

\$...enclosed

Name.....
Address.....
City..... Zone..... State.....

The Saw with a Future

AVAILABLE NOW!

Here's a power tool that's really going places in home workshop and industry as every user finds that it more than meets every test to which it is put. The Model 95C floor type 12" tilting arbor saw comes complete with three extension tables, extra long rack, fence and mitre gauge, all made of solid aluminum. The motor mounting bracket mounts any standard motor.

A solid steel base steadies the saw for precision work. Accurate action is assured also by the "sealed for life" ball bearings and by the smooth movement of the tilting and elevating mechanism.

Write for more information about this and other Darra-James power tools for the workman who desires perfection.



MINIATURE STEAM ENGINE!

Not a toy . . . but a REAL working model

for only \$17.50

Strongly made of Bronze, Brass and Iron. COMPLETELY ASSEMBLED—READY FOR STEAM! A practical working model that performs and operates like a real steam engine. MADE TO EXACT SCALE. Educational, instructive, entertaining. For students, experiments, display. Suggested use: aerating pump in tropical fish tank. Many more uses. Specifications: Over-all length of base—6", Over-all height—3", weight—2 lbs. 4 oz., finish is red enamel with Brass trim.

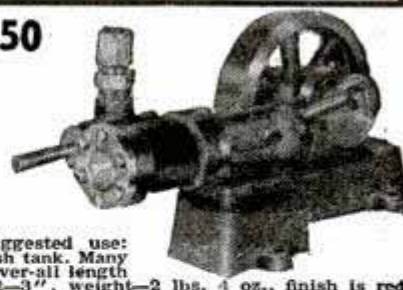

Order today. Remit with order. Sent postpaid.

HARRY ROSS, 70 West Broadway, New York 7, N. Y.

GET THE BEST IN MUFFLERS V-8 DUALS & SINGLES



Finest Norman custom-built muffler sets—steel pack—torpedo type—heavy, perforated steel cores—chrome enamel finish—mellow, deep tone (improves with use)—designed to fit—all ways superior—double economy.

DUALS	\$17.50	SINGLES	\$7.00
V-8 Ford-Mercury		Buick, Olds., Chrys.	
SINGLES	\$5.50	ORDER TODAY! Will outlast	three ordinary mufflers.
Chev., Ford, Plym.		Dealers—Write Today for Full Details	

NORMAN'S MUSICAL MUFFLERS

Dept. PM-5; 1216 W. Slauson Ave., Los Angeles 44, Calif.

TALK-SING thru your own radio with **RADIO MICROPHONE**

Be the life of the party. Put on your own broadcasts at home. Talk-Sing make announcements from any room. Wonderful voice practice. Microphone easily attached to any radio. Follow enclosed instructions. SEND NO MONEY—pay postman \$1.98 plus postage. Send Money Order or check and save postage.

EMPIRE RADIO & TELEVISION CO.
(Dept. R2) 1521 Bedford Ave., Brooklyn 16, N. Y.

Aluminum Oxide Cloth SANDING BELTS

These long-wearing, cloth sanding belts available in coarse, medium, fine, or assorted; be sure to specify grit desired; also, whether for wood or metal working.

Compare These Low Prices!

5	Belts	2 x 21"	\$ 1.00
4	Belts	3 x 24"	1.00
4	Belts	3 x 27"	1.10
4	Belts	4 x 36"	1.25
3	Belts	4 x 52"	1.35
3	Belts	6 x 42"	1.50
3	Belts	6 x 44 1/2"	2.25
3	Belts	6 x 48"	2.50

Other Sizes: Write for prices on sizes not listed; also, discounts on quantity lots. Be sure to specify size and quantity.

Prepaid if remittance accompanies order. No stamps accepted. Shipping charges added if C.O.D.

KAMMAN SUPPLY COMPANY

14631 Gratiot Ave., Detroit 5, Mich.

KAMMAN SUPPLY COMPANY Remittance enclosed

14631 Gratiot Ave., Detroit 5, Mich. Ship C.O.D.

Please ship sanding belts as follows: Wood or Metal

Quantity	Size	Grit	Amount
_____	_____	_____	\$ _____

Name _____

Address _____

City _____ Zone _____ State _____

THE PLASTICOR



Something New, THE PLASTICOR, Plastic Injection Molding Machine, Molds Toys, Jewelry, Novelties. An excellent Xmas Gift. Send name for complete details. GRAY MODELS, Dept. PM, P.O. Box 1234, Syracuse 1, N. Y.



The Modern PLASTIC for lasting Home Repairs

PERMANENTLY mends cracks or holes in wood, tile, stone or plaster. Sticks and stays put—Does not chip, shrink or fall out. Easy to use. Economical. Mold it, chisel it, polish or paint it. If unobtainable from your lumber, paint or hardware dealer, the big 4-lb. can will be sent you postpaid (in U.S.) for only \$1. Full money-back guarantee, order now.

DONALD DURHAM CO.
Box 604-O, Des Moines, Iowa

**Superior Quality
ROTARY
FILES
FOR HOME
CRAFTSMEN**



The nationally famous Ford Rotary Files, used for the past 25 years by leading precision manufacturers, are now available for the home craftsman in a handy dust proof case which contains six popular shaped tools.

The tools are made of the finest quality high-speed steel, hardened and tempered for maximum life. These ground cutters are efficient on steel, aluminum, brass, plastic or wood. The shapes will meet most home craftsman applications. These tools are made with standard 1/8-inch shank. Additional shapes and sizes are available.

Money with order prepaid

C.O.D.—postage extra

SIX TOOLS in Dust Proof Case \$6.25

M. A. FORD MFG. CO. 800 WEST FIRST STREET DAVENPORT, IOWA

AT LAST!

AVAILABLE AGAIN!!

Genuine STAINLESS STEEL 30 PIECE SET



'Make Your "Little Lady" Happy With This Ever-Gleaming Tableware



\$6.95

- Includes**
- 12 Teaspoons
 - 6 Tablespoons
 - 6 Forks
 - 6 Knives

NO PLATING TO WEAR OFF

Guaranteed

- Never to Rust!
- Never to Stain!
- Never to Tarnish!

Requires No Polishing

For a long time the use of stainless steel was highly restricted. Now WE CAN SUPPLY this gleaming, never-staining, never-tarnishing tableware again.

There's NOTHING ELSE to compare with STAINLESS STEEL. It can serve a lifetime. It is SOLID—the same metal and color all the way through—like sterling silver.

ORDER ONE OR MORE SETS—for yourself or for gifts—today!

SEND NO MONEY

Just mail coupon and pay postman on delivery. Or SAVE postage and C.O.D. fees by sending remittance with order.

AN IDEAL CHRISTMAS GIFT

FREE with every set—while they last—**Velour Lined Leatherette Case!** ORDER TODAY!

MAIL COUPON NOW

UNITED SILVERWARE, Dept. PM, 3620 Mdse. Mart, Chicago 54, Ill.

Please send me sets of your 30-piece set of Stainless Steel Tableware.

- I am enclosing \$.....herewith. Send postpaid.
- Send C.O.D. I will pay postman plus postal charges.

NAME.....

ADDRESS.....

CITY..... STATE.....

Please print clearly with pencil



SPINIT—GAS MODEL STARTER

Ideal For Model Plane Builders

Gas model fans, this is IT! "If it will run—a SPINIT will start it!" Sturdily built. Finger tip release. Makes model flying more fun. Available at dealers. Standard model, \$4.00. Write for folder!

STREED ELECTRIC CO.

1315-A Harmon Pl., Minneapolis 3, Minn.

TOLO A NEW AMERICAN GAME!

Assemble it yourself—no special tools needed. (Save \$5.10—Stores sell same item finished for \$10.95.)

COMPLETE \$5.85 KIT Postpaid

Ideal Christmas Gift—All Ages Love It!

Modern, streamlined, colorful—a versatile game for the entire family.

3 GAMES IN ONE: INDOOR TOLO, OUTDOOR TOLO, TOLO GOLF!

Kit contains top quality materials, accurately milled: 4 hardwood handles, 4 polished aluminum shafts, 4 balls, 8 discs, center "Tolo," 4 club heads, 8 welded circllets, parts for holder, lacquer, brush, glue, rule book, etc.

Order Today—Check or Money Order—Immediate Shipment (U.S. Only)
TOLO GAMES, INC., 1012 Pardee Street, Berkeley 2, California

New Miracle Car Paint!

NO BRUSH! NO SPRAY! DRIES IN ONE HOUR!

Now! Paint your car easily, quickly, economically with DAB, the new wonder car paint! Apply with rag! Leaves no lap marks! No equipment needed! One qt. paints your car completely. 5 rich colors; Washington Blue, Brewster Green, lt. Maroon, dk. Maroon, Black. 2 yr. guarantee. Send for DAB today. \$5.95, ck. or money order. Address DAB, 2160 Sunset Blvd., Los Angeles, Calif.



SING-TALK thru your own Radio with Radio MICROPHONE

Put on your own broadcast at home with this Radio Mike. Sing, Talk from any room in the house. Make announcements. Lots of fun! It's wonderful voice practice. Easily attached to any radio. SEND NO MONEY. Pay postman \$1.98 plus postage. Send check or money order and save postage.

ROLEY SALES CO. (Dept. 150-N), 154 Nassau St., New York 7, N. Y.

BRUSH PLATING OUTFITS

for re-plating articles in the home and shop. No tanks necessary. Free particulars.

GUNMETAL CO., AVE. M, DECATUR, ILLINOIS

WAR SURPLUS BARGAIN \$1.79 7 lbs.

Amazing assortment radio parts—Resistors, Trimmers, Springs, Sockets, Condensers, etc. Tremendous bargain at this price. Send check. M.O. MARKO SUPPLY, Dept. PM-11, 2924 Logan Blvd., Chicago 47, Ill.

Do Your Own Welding and SAVE MONEY



With the MAGIC WAND Welder, beginners soon become expert at welding, brazing and soldering. Heavy-duty transformer built into handy, shock-proof carrying case, ready for instant use. Just plug it in on nearest 110-V. 60-cycle AC outlet. Handles any metal—steel, iron, bronze, brass, aluminum, etc. 6 ranges of welding heat. Dual-purpose electrode holders (flame and arc). Welding, brazing and soldering supplies and helmet included. Weighs less than 30 lbs. packed. Sold by hardware and auto supply dealers.

Welding Manual FREE

28 pages packed with information—practically a course in welding, brazing, soldering. Tells when and how to use each process; handling of various metals; additional uses for welder; etc. Handy pocket size—should be in YOUR pocket. Write now for your free copy.

JOHN H. GRAHAM & CO., INC.
General Sales Agent
Dept. D, 105 Duane St., New York 8, N. Y.

Magic Wand WELDER

MADE BY PATENT SPECIALTIES, INC., NEW YORK, N. Y.

YOU CAN NOW BECOME A PROSPECTOR!

HERE IS ONE OF
THE WAR'S TOP SECRETS

BRAND (NEW) ARMY MINE DETECTORS!

Portable: Will Detect METALLIC and NON-METALLIC objects; Very Sensitive; using 955 Tube in detecting head; two tube amplifier using two 1N5gt; headset; or microphone; also 150 micro meter; Power supply; 3-45v.; one 6-v.; or 2 3-v. batteries. Complete with instr. Less Batteries; packed in original cases; shpg. wgt. 108 Lbs.

FOB. From N. Y.
Special

\$1750

Send order to

COLUMBO TRADING CO., INC.
304 CANAL ST. NEW YORK 13, N. Y.

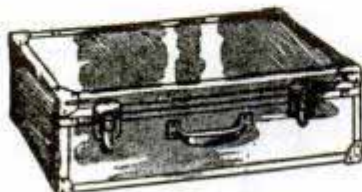

CARRYING CASE
CT-80/PRO-1

MORE PROFITS

with

MODERN LAWN MOWER SHARPENER

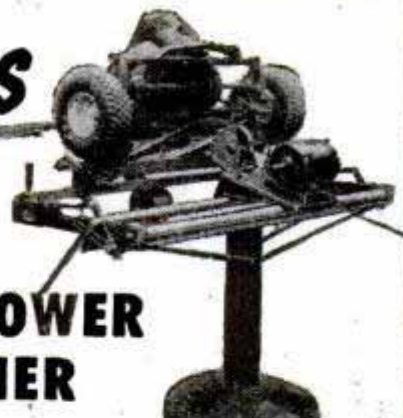

SHARPEN ANY LAWN MOWER from 5-inch Edger to 36-inch Power Mower in ten to twenty minutes with a MODERN LAWN MOWER SHARPENER because dismantling is unnecessary—neither handle, roller, wheels nor motor need be removed when sharpening any mower. . . . the MODERN SHARPENER eliminates all hand filing; it precision grinds to the extreme ends of both left or right reel blades. Bottom knife is held in same brackets for sharpening. NO EXTRA ATTACHMENTS! Order today! Price \$241.50 (less motor) f.o.b. Pasadena. (1/2 or 1/4 H.P. single phase motor recommended.)

Modern Mfg. Co., 156 N. Fair Oaks, Pasadena 1, Calif.

New THOR "B" ENGINE—\$6.95

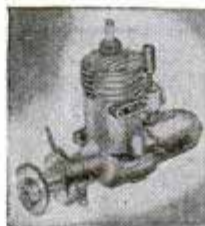

The new THOR "B"—Sensational miniature gasoline engine that really works. Super-power performance. Smooth, velveted power that roars into action with a "twist of the wrist." Over 15,000 already sold. 1/6 H.P. Complete with coil, condenser, and fully illustrated instructions, ready to run, only \$9.95. In KIT form, fully machined, 5 minutes to assemble \$6.95, without coil and condenser. Powers all models. Send \$1.00—shipped collect same day C.O.D. or send full price plus 25c extra and we ship parcel post insured.

FREE Just off the Press. Send for big 40-page illustrated hobby catalog with over 300 illustrations; over 1,000 listed items. The "Bible" of wide-awake modelers. Write for it now—no obligation, naturally!

AMERICA'S HOBBY CENTER
Dept. B116, 156 W. 22nd St., N.Y. 11, N.Y.



BLACK D MARKER

MADE IN U.S.A. Pat. Pend. No. 690643
Tipped With Carboloy Cemented Carbide
A SCRIBER FOR LAY OUT WORK, MARKING AND ETCHING STEEL AND OTHER HARD METALS, ETCHING AND CUTTING GLASS
Every Tool Kit Should Include One Price \$1.50 Postpaid
P.O. BOX 7, UNIVERSAL CITY, CALIFORNIA



Profit by the Building Boom!

Start your own business manufacturing concrete building block and brick. Use Economy hand moulds. Make true, straight, easy-to-lay units which will pass any building code. Small investment, high production, big profits. One \$30.00 mould will make 1,000 5 1/2" x 8" x 12" blocks per day. Letters and repeat orders tell how pleased our customers are.

WRITE FOR FOLDER

Economy Manufacturing Company
Dept. P Stone Mountain, Georgia

TRAILER AXLES, HITCHES, AND PARTS

• If you are interested in purchasing trailer axles, hitches, and other trailer parts, contact us promptly. Write for free literature.



HAMMER BLOW TOOL COMPANY, Dept. III, WAUSAU, WIS.



OWN A "POCKET SIZE" MACHINE SHOP

IMPROVED MOTO-TOOL

APPROXIMATELY
27,000 R.P.M.
CUTS CLEANER;
SAVES CUTTERS

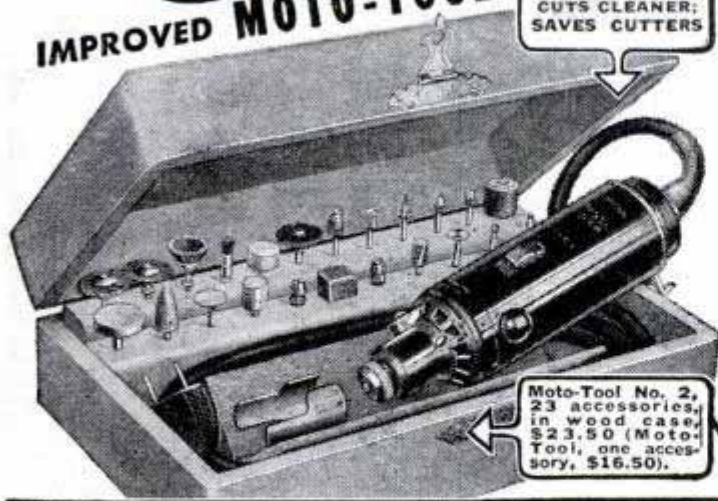

Moto-Tool No. 2,
23 accessories,
in wood case,
\$23.50 (Moto-
Tool, one acces-
sory, \$16.50).

HERE'S A CRAFTSMAN'S GIFT THAT PACKS YEARS OF PLEASURE

Here's a gift to please a man's heart. A gleaming "powerhouse" that holds promise of endless creative hours. This "pocket-size machine shop" is a war veteran . . . used by all branches of the armed forces in far flung repair bases . . . and it helped set production records at General Electric, Westinghouse, Remington Arms, Ford and other plants. Hobby enthusiast or expert craftsman . . . first choice is Model 2 "Moto-Tool" kit, with its handsome, felt-lined, highly finished wood case . . . with rows of tools begging to be put to work. The usefulness of "Moto-Tool" for precision work is increased by two versatile attachments now available at slight additional cost (see below).

Look For These

Moto-Tool Features

- Housing has "pencil-type" finger grip
- Instant-action, wrenchless chuck
- Oil-less, sealed, trouble-proof bearings
- Patented automatic chuck lock pin
- Oversize armature shaft, hardened, ground and polished
- 110 volt, universal type motor
- Easily replaced commutator brushes
- Sliding snap type switch
- Handy hanger hook
- Cord protector
- Sturdy, shockproof bakelite housing
- Dust-filtered, air-cooling system
- Weighs only 13 oz. . . . shaped to fit the hand
- Dynamically balanced for vibrationless operation.

MONEY BACK GUARANTEE

Buy Dremel "Moto-Tool" and Accessories from your dealer. If he does not handle them, order direct from the factory on a 10 day trial, money back guarantee.



Do These Better-Faster

- Cleaning
- Rasping
- Brushing
- Dressing
- Burring
- Grinding
- Routing
- Sanding
- Drilling
- Inlaying
- Sawing
- Scoring
- Cutting
- Carving

Free Both Hands With Moto-Tool Attachments



Moto-Tool Stand (left), made of heavy cast iron, holds Moto-Tool at any position or angle. \$4.50

Moto-Tool Shaping Table \$2.50. (Shown with stand, right). Aids accuracy in routing and grinding.



Free Both Hands With Moto-Tool Attachments

DREMEL MFG. CO., DEPT. 116-L, RACINE, WISCONSIN

AMAZING POST-WAR DISCOVERY!

PLASTICROME

CLEANS AND PROTECTS METAL

A PLASTIC PRODUCT THAT DISSOLVES RUST! RESTORES CHROME! PREVENTS CORROSION AND DISCOLORATION!

No. 1—Makes Metal Shine!
No. 2—Keeps It Looking Fine!

The modern miracle worker no home . . . no car should be without! Two liquids . . . one dissolves rust, grime, dirt and grease in a flash! The other is a plastic finish which protects against dirt, salt, corrosion and rust!



2-WAY PROTECTION KIT

98¢

PLASTICROME LABORATORIES
7012 Euclid Ave., Cleveland 3, Ohio
Please send me Plasticrome 2-Way Protection Kit, Postpaid.
Remittance of \$1 is enclosed. Money-back Guarantee!

Name _____
Address _____ State _____
City _____



PLASTICROME
for chrome bumpers, grilles, bicycles!



PLASTICROME
for refrigerators, bathroom fixtures!



PLASTICROME
for appliances, golf clubs, fishing rods!



IF YOUR DEALER CANNOT SUPPLY YOU

MAIL THIS COUPON!

Give a Gift that's

PRACTICAL! EXCITING! "Spar" All-Metal MICROSCOPE

50 Power—2 Lenses Adjustable eye tube and reflecting mirror



A gift that will delight both young and old. It will give hours of exciting pleasure to observe the intimate wonders and secrets of nature invisible to the naked eye.

Ideal for amateur chemists, scientists and bacteriologists. Order now as a Christmas gift or for your own use.

This sturdy, practical microscope can be yours for only \$2.98, post-paid, if you include check or money order, or just send us your name and address and pay postman \$2.98 plus a few cents postage when your "Spar" arrives.

Don't Delay
Order Today

ONLY
\$2.98

FREE SPECIMEN SLIDES AND DESCRIPTIVE BOOKLET

Special Price to Schools and Clubs in Quantity

MART DISTRIBUTORS

Dept. M-2, P. O. Box No. 6, Evanston, Ill.

RIDE-RITE

NEW TYPE—LIGHTWEIGHT—HEAVY-DUTY STRENGTH

UTILITY TRAILER AXLES

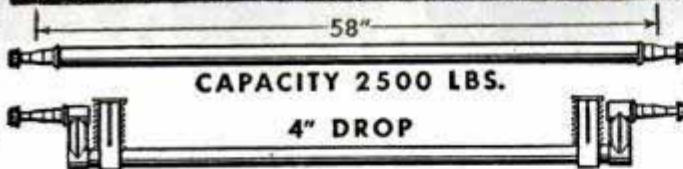

EITHER TYPE AXLE AVAILABLE WITH OR WITHOUT SPRING SUSPENSION
(Pat. Appl. For)

V SIDE VIEW
SPRING
SUSPENSION

Build your own utility trailer and equip it with a Ride-Rite axle. Get the advantage of its new lightweight, heavy-duty tubular construction. Available with or without patented double-coil spring suspension. Straight axle has standard 58" tread; drop axle has 60" tread. Distance between spring hangers 48" on both axles.

BIG CAPACITY: Axles made of 1 1/2-inch O.D. steel tubing have tested load capacity of 2500 pounds. Coil springs, four per axle, have minimum capacity of 650 pounds each.

Ride-Rite axles will fit hubs and wheels made by Motor Wheel Corp., Kelsey Wheel Co., Ford Motor Co., and Industrial Machine Tool Co.

PRICED LOW AS

\$6.75

PRICES F.O.B.
FENTON, MICH.

Remittance with order —No C.O.D.	Axle Only	Axle with Springs
Straight Axle, Std. Tread	\$ 6.75	\$19.70
Drop Axle, Std. Tread	12.50	25.45
	(Springs fit Ride-Rite axles only)	
Axles can be furnished any tread desired for slight additional cost.		

**MANUFACTURERS
AND DEALERS!**

Write for descriptive literature
QUANTITY LOT PRICES
FURNISHED ON REQUEST
WRITE ON YOUR LETTERHEAD

MANUFACTURED BY

INDUSTRIAL MACHINE TOOL CO., INC.
200 S. LEROY STREET FENTON, MICHIGAN

MEN'S WRIST WATCH

GENUINE SWISS
MOVEMENT

Below
O.P.A.
Ceiling

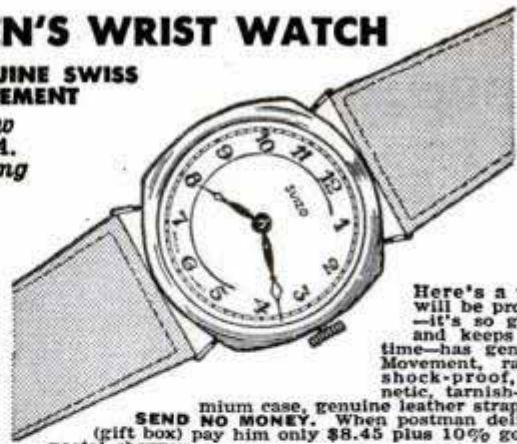

ONLY
\$845

plus 10%
Gov't Tax

Here's a watch you will be proud to wear—it's so good-looking and keeps excellent time—has genuine Swiss Movement, radium dial, shock-proof, non-magnetic, tarnish-proof chromium case, genuine leather strap.

SEND NO MONEY. When postman delivers watch (gift box) pay him only \$8.45 plus 10% gov't tax and postal charges.

GUARANTEE: If not delighted, return watch within 3 days and get your money back. Rush name and address today. Makes an ideal Xmas or birthday gift.

**LE CHARME COMPANY, 303 WEST 42ND STREET
DEPT. W-2, NEW YORK 18, N. Y.**

MUFFLERS

STEELS and ALUMINUMS

with a motorboat tone

SINGLES \$5.50 to 8.00

V-8 DUALS 17.50 to 20.00

Reduce back pressure and increase engine performance. A Sandee is time proved and dependable. Aluminums are guaranteed for the life of your car.

DEALERS WANTED

SANDEE MUFFLER CO.

7523 S. WESTERN AVE., LOS ANGELES 44, CALIF.

Here at Last—KITCHEN FLUORESCENTS

No extra wiring. Easily adaptable to your present fixture. Underwriters approved parts. Uses 2-20 watt lamps. Lamps 80c each extra. 25% required on C.O.D. orders. Send for Free Catalog.



RISCO SALES CO.

WHOLESALE RADIO DISTRIBUTORS

414 SECOND AVE., AT 23RD ST.

NEW YORK 10, N. Y.

TOYS—Five toys easily made from Stanley Project Plan Set No. 16—Wagon, Scooter, Rocking Horse, Wheelbarrow, Push Car. Postpaid, 10c. Stanley Tools, 1116 Elm Street, New Britain, Conn.

STANLEY



PINS 30¢ up RINGS \$1.50 up



For your class or club. Over 300 designs. Finest quality. Write Dept. N, Metal Arts Co. Rochester, N. Y.

FREE CATALOG

Quick Help for RUPTURE!

Learn About This
Perfected Invention

Light, cool, comfortable. Durable, cheap, **GUARANTEED** instant relief for reducible ruptures in men, women and children. Not sold in stores. No agents. You deal direct! Correspondence confidential.

FILLED WITH AIR



Sent on Trial!

Made-to-measure and sent on post-free actual wearing test. Act NOW.



Ordered
by
18,278
Doctors!

Send Postcard for **FREE Rupture Book**
BROOKS CO., 359-C State St., Marshall, Mich.

7 Unit Power WOODWORKING SHOP

The buy of a lifetime! Outfit your hobby shop with 7 precision type woodworking tools—complete with accessories and power take-off assembly (less motor). All yours for only

\$49.50
plus freight charges.

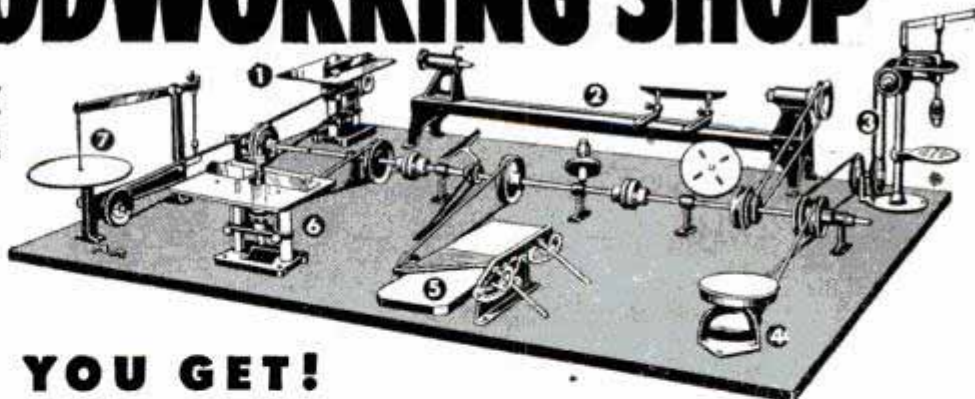

LOOK WHAT YOU GET!

- 1 **Circular Saw** with one combination rip and cross-cut blade. Table of pressed steel. Cast base, support adjusting slide. Die cast pulley.
- 2 **Power Lathe** for wood and plastic. 24" bed of rigid cold rolled steel. Headstock, tailstock and legs of strong castings. Pulleys—2 speed die castings, cadmium finished. $\frac{1}{2}$ " spindles. $4\frac{1}{2}$ " faceplate also provided, plus grinding wheel and adapter.
- 3 **Drill Press** 15" high, over all. 2" table adjustable with 5" space between chuck and table. $1\frac{1}{4}$ " spindle travel. Base, upper bracket and table are strong castings. Pulleys are pressed steel, rust proofed. Ball thrust bearing in top spindle. Chuck is rust proof plated, spring action with tool steel jaws. Takes drills up to $\frac{1}{4}$ ".
- 4 **Disc Sander** (horizontal). Turntable 4" in diameter of hard maple wood. Bearing runs free and true. Base is heavy casting. Pressed steel pulley. 6 No. 2/0 flint paper discs provided.
- 5 **4" Jointer** for planing, leveling, joining. $4\frac{1}{2}$ " high x $8\frac{3}{4}$ " wide x $13\frac{1}{4}$ " long. Table width $4\frac{3}{4}$ ". Two 4" tempered carbon steel knives set in machined solid cylinder are adjustable and removable. Frame and base are strong castings. Safety guard and adjustable fence provided.
- 6 **Spindle Shaper** (vertical) for making tongue-and-groove joints and bevels. Pressed steel table. Table support and adjusting slide are castings. Spindle of rustproof steel. Oil-less bearings and bushings for high spindle speed. Cutter of tool steel, hardened and oil tempered.
- 7 **Jig Saw** 15" long, 8" high, $6\frac{1}{4}$ " table. Blade will saw to middle of 17" circle. Frame is strong casting. Table, arms and pulley of cold rolled steel. Will saw plastic and thin metal as well as wood. Adapters supplied for any type blade with straight, loop or pin ends. Hardened steel roller saw blade guide also provided.

Plus all necessary line shafts, hangers, pulleys, couplings and rubber belting to connect and drive machines from 1/10 h.p. motor

Think of it! 7 fine power tools—a whole table-top shop to delight every father and son—now available for immediate delivery. Not a toy! These quality tools are accurate and dependable enough to speed the building of everything from bird houses to book-ends—hundreds of items that are easy to make for fun and for profit. Perfect for beginners... a worthwhile hobby for youngsters... the ideal practical gift for man and boy... Try all 7 of these wonder tools in your own hobby shop on GAMBLES famous guarantee. You must be completely satisfied or your money will be immediately refunded in full! Hurry—clip coupon below and order now!

ORDER RUSH—BEFORE PRICE INCREASES!

GAMBLES, Dept. 58-P
15 North Eighth Street, Minneapolis 3, Minnesota

Please send me immediately the above set of seven power woodworking tools with accessories, priced at \$49.50 F.O.B. Minneapolis. I enclose \$49.50, and will pay freight charges upon receipt of merchandise (Wt. 33 lbs. in shipping container). I understand that my money will be refunded in full if I am not satisfied.

Name _____
Address _____
City _____ Zone _____ State _____



WELD ANYTHING ANYWHERE ANYTIME

ALL PURPOSE ARC WELDER

9 Models . . . 32 Volt D.C., 110 to 440 A.C.
A complete workshop in itself! Weld, cut, braze or solder any type metal; iron, castings, aluminum, steel, bronze . . . in any gauge or weight, with equal ease. Compact, complete, sturdy as the Rockies. Formed steel and cast aluminum case, welded steel base, 4" cast wheels. Built with voltage control. Better on E.E.A. lines. No training needed. Sold throughout the world. Unconditionally guaranteed for 2 years. Fully equipped—ready to use.

FORNEY MFG. CO.
FORT COLLINS 2, COLORADO



METERS

AMMETERS Weston 528 portable, dual range 0-3 amp. & 0-15 amps., A.C. full scale, complete with genuine leather carrying case and test leads. Only . . . \$12.50
Gen. Elect. AO-22, 3 1/2" panel mounting 0-80 amperes A.C. . . . \$4.50
VOLTMETERS G.E., AO-22, 3 1/2" 150 volt A.C. panel \$5.50
W.H., 2 1/2" Aircraft type 0-150 volt A.C. bk sc lum mks, suitable for use from 25 to 125 cycles. . . . \$1.50

General Electric 2 1/2", Aircraft style, black scale 0-30 volt D.C. . . . \$1.25
MILLIAMMETERS G.E., miniature, 1 1/2" square, 1 M.A. 100 ohm mvt. 10 divis, bk scale, \$2.75
Roller Smith, miniature, 1 1/2" sq 1.37 M.A. mvt, spec bk sc . . . \$2.50
All orders F.O.B. New York City; 25% deposit on C.O.D. orders. We carry a complete line of electrical instruments. Send for free circular.

MARITIME SWITCHBOARD Dep't. PM3, 336 Canal Street NEW YORK 13, NEW YORK

\$1.00 BARGAIN OFFER!

1/4-pt. unit, **CASCOPHEN**: new, waterproof, resorcinol-resin glue for boatbuilding, sport equipment, etc., moderate pressure, cures at room temperature. *Retail value*

\$1.00

2-oz. tube, **CASCO FLEXIBLE CEMENT**: Ready-to-use adhesive for gluing unlike materials. Sticks most anything. Long-lasting, flexible bond heat- and moisture-resistant. *Retail value*

.25

TOTAL RETAIL VALUE > **1.25**
ALL FOR \$1.00

Fill in name, address, below. Mail this ad with \$1.00 (check or m. o.)

Casein Co. of America, Dept. PM-16
350 Madison Ave., New York 17, N. Y.

Send me this \$1.25 value for \$1.00!

Name _____
Street _____
City _____ State _____

Power . . . independent of outside interference

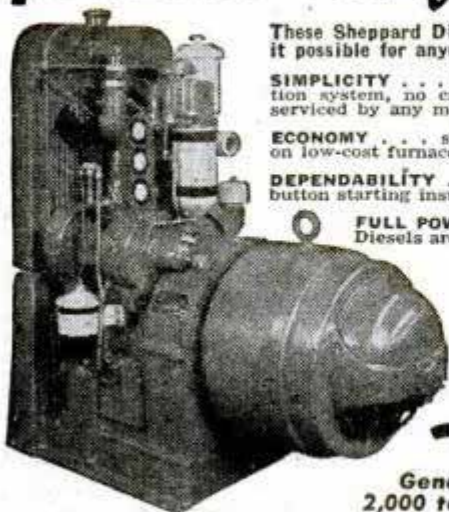

These Sheppard Diesel features make it possible for anyone . . . anywhere.

SIMPLICITY . . . no electrical ignition system, no carburetor. Can be serviced by any mechanic.

ECONOMY . . . starts and operates on low-cost furnace oil.

DEPENDABILITY . . . electric push button starting insures instant power.

FULL POWER . . . Sheppard Diesels are rated on their actual continuous power output while operating with full equipment.

SAFETY . . . no explosive fuel to handle and store.

Generating Sets
2,000 to 36,000 Watts

Power Units 3 3/4 to 56 H.P. • Marine Engines 3 3/4 to 62 H.P.

R. H. Sheppard Company, Inc., 48 Middle St., Hanover, Pa.

DIESEL'S THE POWER . . .

Sheppard's the Diesel



**YOUR WORKSHOP
IS NOT COMPLETE
WITHOUT THIS HANDY, EFFICIENT
MAGNAGRIP**

T.M. REG. PAT. PEND.

MAGNETIC TOOL HOLDER

Why clutter your bench with small tools when this amazingly efficient rack can hold any shape or size? Just touch the tool to the rack. The permanent magnetism grips it securely till you need it again!

Craftsmen use two or more, in a row, for every possible tool in frequent use. Ideal to hold screws and small production parts during assembly. With a Magnagrip, you have a place for everything, and everything is in its place.

Sturdily plated. Guaranteed to hold its magnetism. Can't get out of order. If your dealer doesn't yet carry them, send \$2.95 to —

R. E. PHELON COMPANY
DEPT. A11, 199 UNION ST., SPRINGFIELD, MASS.

Magic Mirrors



SEE THRU • They Can't See You!
FOR DOORS, OFFICES, FACTORIES, BARS, ETC.

PRICES

2" x 2"	... \$ 1.00
3" x 4"	... 3.00
5" x 7"	... 8.00
8" x 10"	... 18.00

Ideal for doctors offices, front door peep-holes, etc. Person on mirror side unaware you are looking at him. Order your mirror today . . . sent postage paid.

ACRA-LITE CO.

1235 W. 6th St. Dept. PM-11 Los Angeles 14

FOR VETS ONLY



**"PLASKASE" Protects
Your Discharge Paper**

Protect your original discharge paper from being torn, soiled or creased. Roll it up and keep it safe in the new "Plaskase." Plaskase is all plastic, crystal clear, strong and light in weight. It is 9" long and 1" in diameter. Your discharge paper is safe in "Plaskase." Send \$1.00 to

PLASTIC SALES EXCHANGE, BOX 709, HOLLYWOOD, CAL.

BUILD these ENGINES



**GAS and STEAM
NO CASTINGS!
NO SPECIAL TOOLS!**

All you need is a small lathe and some scrap shafting. Plans and detailed instructions for these and other high speed engines available. Illustrated literature on request. Write today.

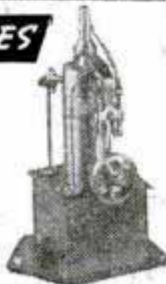

**FREE
CATALOG**

R. W. ROWE ENGINEERING
DEPT. B, 8889 APPOLINE DETROIT 27, MICH.



Make Your Own RUBBER MOLDS

with
RED LATEX MOLDING COMPOUND

Earn money, have fun; make your own molds for plaster objects. Produce novelties and gifts for home and to sell to friends. RED LATEX MOLDING COMPOUND (60% density) now available in quart and gallon quantities. Gives perfect results, easy to apply. Send for complete information and prices.

OHIO SUPPLY CO., Dept. M-2, 474 Lilley Ave., Columbus 5, Ohio

**Build Inlaid Smoking Accessories
and Useful Household Items**

with the New **WOODCRAFT CATALOG & MARQUETRY KIT**

Catalog just off the press! Only 25c. Contains photographs with accurate shop drawings and all instructions needed to construct de luxe inlaid Cigarette Boxes, Book Ends, Silent Butlers, Serving Trays, Tobacco Humidors, etc. Kits equipped with all necessary materials, including genuine black American walnut for base, and completely laminated marquetry (inlaid woods) walnut panel in authentic natural colors. Subjects—Pheasant, Horse, Duck, Dog, etc. Send 25c for your catalog today!

WOODCRAFT MARQUETRY KITS CO.

DEPT. A116, 302 OAKLAND ST. BROOKLYN 22, N. Y.

WINDOW SIGN LETTERS

For Store Fronts and Office Windows. Anyone can put them on. Samples furnished. Genuine Gold and Silver.
METALLIC LETTER CO., 430 N. Clark St., Chicago 10

COLOR CONCRETE WITH CHEMICALS

Get into business on small capital working at home, or shop. Start small grow big. There is real money in making Hollywood style pottery and birdbaths without moulds. Our instructions cover a large variety of designs. Washing-wells, benches, garden light-houses, stucco-rock, imitation marble, cement water-paints and many more. 10c brings sample, details and pictures.
Hollywood Cementcraft, 8529 Wonderland Ave., Hollywood 46, Calif.



The GLENWOOD MEMORIAL

Freight Paid Anywhere in U.S.A.

In all its beauty and durability is pictured in our free catalog of genuine Marble and Granite. Write for yours today.

U. S. MARBLE & GRANITE CO., A-18, Oneco, Fla.

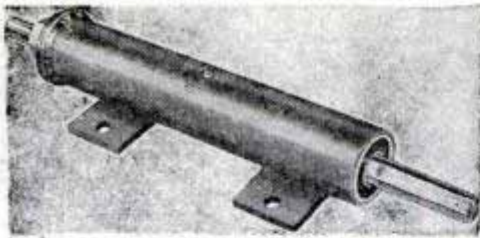

HEAVY DUTY, BALL BEARING, ALL PURPOSE MANDREL SHIELD PROTECTED

STURDY STEEL CONSTRUCTION

Length Overall: 14"
Diameter: 1 3/4" OD
Lugs: 1/4" x 1 3/4" x 3 3/8"
Shaft: 1/2" or 5/8" Optional

POST PAID
\$800
IN U.S.

BALL BEARINGS . . . Ground precision type. Smooth running, vibrationless, long life. Completely shielded on exterior side.

SHAFT . . . True running, high quality Bessemer stock. Ends machined to accept bearings and eliminate longitudinal play. Work end has die-cut U. S. Standard threads. Pulley end machined and provided with milled flat to accept Standard size pulleys.

RIGID BODY SEAMLESS STEEL TUBING . . . One piece heavy gauge with welded on mounting brackets. Ends internally machined to provide solid thrust supports for bearings.

WASHERS . . . Machined inside to provide firm grip on saw-blade, emery wheel, etc., and outside to provide hub, contracting inner bearing race transferring thrust to bearing only.

FINISH . . . Yes, it has "EYE APPEAL!" Body and brackets of lustrous, gray enamel. Hex nut and washers cadmium plated. Completely in harmony with any and all other fine equipment.

Now in use in thousands of workshops, machine shops, garages, hobby shops and on farms for saws, emery wheels, pulleys, buffing wheels, brushes, etc.

In ordering be sure to specify shaft size desired. Send money order or certified check.

If Your Dealer Cannot Supply You Write **TRIO MACHINE CO., Box 187, Willoughby, O.**

New Lauson Gasoline Engines

4 Cycle, Double end shaft; Speed Range 2100 to 3600 R.P.M.
Power Range—1/2 H.P. to 3/4 H.P. Net weight **\$4950**
31 lbs. Bench tested. Ready to run.
Complete with starting rope.

(Write for Special Quantity Prices)

FLEXIBLE SHAFTS 53 1/2" LENGTH \$5.75
15 FT. LENGTH 14.95

—VENTILATING FANS (A.C.)—

8" Blade—\$15.00; 10" Blade—\$17.50; 12" Blade—\$27.50
EXHAUST BLOWERS A.C.—3" Intake \$10.50
KITCHEN or ROOM VENTILATORS (A.C.) \$29.50
10" fan with shutter
U. S. NAVY BATTLE LANTERNS, waterproof. 500 ft. beam. \$5.75
Many Other Good Buys—Write for Catalog "M"

ELECTRIC TRADING CO.

313 CANAL ST. NEW YORK 13, N. Y.
Electric Fans and Blowers in most sizes for every Industrial, Commercial and Domestic use. Table Saws—Air Compressors—Electrical Tools and Paint Spray Equipment in stock.

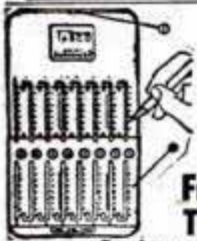

POCKET ADDING MACHINE

STURDY STEEL construction for lifetime use. adds, subtracts, aids multiplication. Capacity 999,999.99. A real machine—guaranteed 5 years. Thousands of satisfied users. Send name and address. We ship immediately. On delivery, pay postman \$2.50 (plus C.O.D. and postage charges). If you send \$2.50 with order, we pay postage. Leatherette case 25c additional. Your money back after 10 days trial if not satisfied.

Free \$2.50
Trial

Send no money

TAVELLA SALES CO., 19-PA West Broadway, New York 7, N. Y.

WANT TO BE INDEPENDENT?

You can go into business for yourself. Learn the Stephenson Method of making and fitting corrective arch supports. Not medical—not chiroprody. Men and women earn \$50-\$100 weekly in this respected profession. Learn at home on easy terms, no other capital needed. No goods to buy, no agency, you become your own boss at once. Write for our free booklet!

THE STEPHENSON METHOD
2811 BACK BAY, BOSTON, MASS.

NOW YOU CAN OWN
A FAMOUS

* ORIS *

WATERPROOF WATCH

An unusual limited offer—lowest price we ever sold an ORIS 7-jewel pin-lever time piece. Chrome top, stainless steel back—modern stainless steel expansion watch bracelet included.

SHOCK RESISTANT!

NON-MAGNETIC!

RADIUM DIAL!

SWEEP SECOND HAND!

\$1865 with steel
Only expansion bracelet

Fed. Tax Included

Write for free illustrated booklet



Mail orders promptly filled
No C.O.D.'s
Postage Prepaid

LAMONT

Internationally Famous Watches

SUITE 1005 • 597 FIFTH AVE. • NEW YORK 17

SAY YOU SAW IT IN POPULAR MECHANICS

FREE!



The COMPLETE NEW 25th ANNIVERSARY LAFAYETTE CATALOG of RADIO and ELECTRONIC EQUIPMENT

- hundreds of critical radio parts
- standard parts—leading brands
- build-it-yourself kits

This valuable, 144 page catalog offers you the latest, longest line of top-quality radio parts, amplifiers, test equipment, tools, radio sets, ham gear, phono-radios and other types of radio, electronic equipment and accessories. Plus a special price-slashed, bargain section that lists hundreds of surplus radio and electronic parts. Save time and money.

LAFAYETTE RADIO

Radio Wire Television Inc.

New York 13 Boston 10 Newark 2
100 Sixth Av. • 110 Federal St. • 24 Central Av.

LAFAYETTE RADIO, Dept. LK-6
100 Sixth Avenue, New York 13, N. Y.

Rush my FREE copy of the big, new LAFAYETTE CATALOG.

Name _____

Address _____

City _____ Zone _____ State _____

PASTE COUPON ON POSTCARD • RUSH TODAY

AMMCO 7" SHAPER

"A Precision Machine of a Thousand Uses"

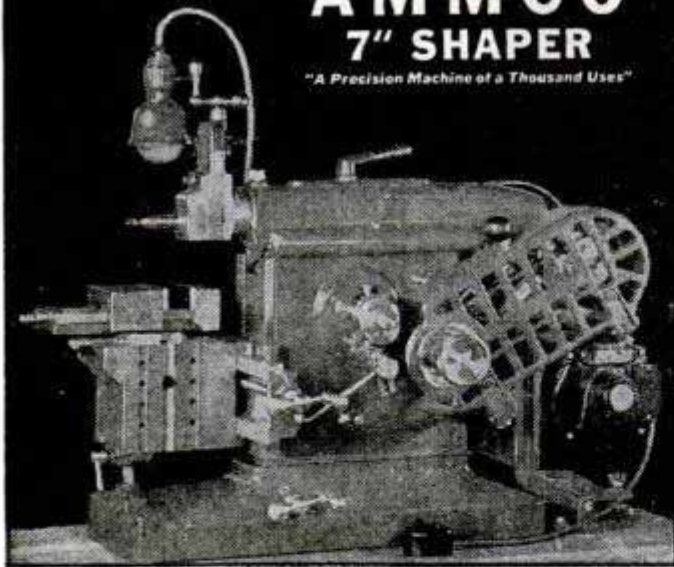

A wide variety of jobs can be done accurately, quickly, easily, and economically on the AMMCO Shaper (7" stroke).

Construction incorporates many features you would expect to find only in larger, more expensive machines . . . For example: WAYS of ram, tool head, and front face of the main frame are of the "VEE" type, hand scraped to insure accuracy and long life. Available for stationary installation or as portable unit.

Write today for specifications and prices

AMMCO

2140 Commonwealth Ave. North Chicago, Ill.

A warm and friendly welcome..

a quiet, comfortable, sleep-inviting room . . . right in the heart of downtown Cleveland. Hotel Cleveland adjoins Union Passenger Terminal, garage and Terminal office buildings... close to stores, theatres, and convenient to any place you'll want to go in Cleveland.

HOTEL CLEVELAND

Cleveland, Ohio



Repeating Automatic CAP PISTOL



**BARREL
ACTUALLY SMOKES
WHEN FIRED
FIRES 50 ROUNDS
WITHOUT RELOADING!**

Boy-oh-boy! This is the cap pistol you've been waiting for! It's a large full-size model of the Colt .45 Automatic carried by Army Officers during the war. Feels and handles like the real thing! Shoots with a "bang" every time you pull the trigger . . . with or without caps! Post-war constructed inside and out of aluminum and steel, with beautiful, lustrous plastic grip. Pistol "breaks" open for easy inside loading of caps. Fires 50 rounds — one after the other — with one loading! MONEY-BACK GUARANTEE! Rush your order today. Use pistol for 10 days. If not delighted, return it and your money will be refunded. Enclose check or money order for amount of your order. Pistol and ammunition shipped to you—express charges collect. Hurry! Quantity limited.

Only
\$1.95
FOR GUN

"BREAKS"
OPEN
FOR
LOADING



ORDER CAPS

Box of 250 Rounds 15c ea.
Box of 1750 Rounds . . . \$1.00 ea.
Box of 3500 Rounds . . . \$2.00 ea.

MINIMUM ORDER \$1.00—NO C.O.D.'s

SANTA SALES, Dept. D-18

5657 W. CHICAGO AVE.

CHICAGO 51, ILL.

BRUNO SPECIAL Christmas Kit



Two adjustable hole cutters in a colorful plastic protective case with a gay Christmas wrap! High speed steel blade makes clean, fast cuts in metal, wood, plastics. For drill press, portable drill or hand brace. MONEY BACK GUARANTEE.

At all hardware stores or write direct Dept. PM-11

BRUNO
TOOLS

Beverly Hills, Calif.

2 models
ONLY
\$7.85
cutting
range
3/8 - 2 1/2"

For Happy Hobby Days!

WANTED DISTRICT PURCHASING AGENTS

No experience or money required. Exceptional opportunity for those who want to establish themselves in a steady, year 'round, well paying business.

For details: Write

DEPT. C

PURCHASING MANAGER

2719 LAWRENCE AVE.

CHICAGO 25, ILL.

FREE PIPE SMOKER'S BIBLE for 1947



NOTHING LIKE IT-BETTER THAN EVER

- Helpful Hints
- Hundreds of Pictures.—
- Latest Pipe News!

RESERVE YOUR COPY NOW

SAVES YOU MONEY—

Big Book — packed full of pipe smoker's bargains from the world over. We import direct and save you money. Limited paper supply restricts printing to 185,000 copies. Bulk will go to regular customers. Only limited number in excess, so, if you want pipes and tobacco at Special Mail Order prices, reserve your copy now. Meantime, we'll send PIPE LORE magazine FREE. Mail penny postcard today for delivery in early November. ACT NOW!

READY IN NOVEMBER—SEND FOR IT NOW
WALLY FRANK, Ltd.

150 NASSAU ST., NEW YORK 7, N. Y., Dept. 227

SAVE MONEY ON GASOLINE

FITS ALL CARS



Now you can get up to **30%** extra gasoline mileage with a Vacu-matic on your car. Quicker pick-up, smoother running, added power saves money every day. Guaranteed. **Automatic Supercharge Principle** Vacu-matic is entirely different! Operates on the Supercharge principle. Saves gas. Automatically provides a better gas mixture. Guaranteed to give up to **30%** extra gas mileage, more power and better performance.

SALESMEN WANTED

Big profits. Every Car a Prospect. Send name and address for FREE PARTICULARS and how you get yours for introducing.

Vacu-matic Co., 7617-1300 W. State St., Wauwatosa 13, Wis.

FOR BIGGER PROFITS FROM SMALL LATHES!

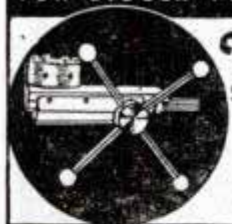

Unique NO. 50 BED TURRET
Available For
SOUTH BEND, ATLAS, LOGAN, CLAUSING

Send For Descriptive Circular
On Unique Production Equipment.

UNIQUE MANUFACTURING CO.
4807 N. 31st Ave., Omaha, Nebr.

BOWS & ARROWS

Write for 94 page Illustrated Instruction Hand Book 50c; 20 page catalog 5c; stamps or coin.
LE STEMMLER CO. QUEENS VILLAGE, N.Y.

RAISED WOOD SIGN LETTERS

MADE OF THE BEST IDAHO WHITE PINE.
ALL SIZES. FACTORY PRICES.
Send 10c for Catalog

SIGN LETTER DISTRIBUTORS, P.O. Box 101, Mineola, N. Y.

LAWN ORNAMENT-NOVELTY PATTERNS

28 Lawn Ornament Patterns, 25c. Other patterns; 15-20" high; Dutch Girl, Dutch Boy, Pirate, Bull Terrier, Mexican Girl, Mexican Boy, Dwarf, Penguin, Flower Girl, 10c each. 25 Novelty Patterns, 30c. All 62 Full Size Patterns, \$1.00 Postpaid. Strother Pattern Service, Dept. O-8, Box 383, Belington, W. Va.

CRESCENT TOOLS
Give Wings to Work

ASK YOUR
HARDWARE
DEALER

AMAZING VALUES!

WAR SURPLUS ITEMS

Your OPPORTUNITY to pick up motors, DC-AC inverters, metal utility radio-electronic boxes, tachometers, etc. ALL IN A-1 CONDITION at mere fractions of original cost!

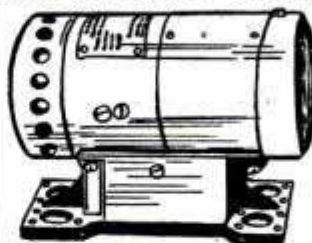

DC-AC INVERTER

No. NV1 — 24V. Input, 115V A.C. 400 cycle Output. Approx. 7" long, 5" high, 3 1/4" wide. For electrical experiments requiring A.C. D. C. motor drives A.C. Generator. Est. \$9.95 Orig. cost \$75.00. Your price



1/50th Hp. Gyro Motor
No. GM7—24V. High-speed D.C. Motor revs. up to 10,000 R.P.M. Use for precision grinders, buffers, dental, jewelry, model work, etc. 2 1/2" dia. \$4.95 buy at

TACHOMETER

No. T6—A precision instrument! Protective velvet carrying case. 6 second stop watch control. Complete with one adaptor for measuring motor, machinery speeds, etc. A remarkable "BUY" WITH CARRYING CASE. \$9.95



1" TO 3" PIPE VISE

No. PV5—Chain firmly grips 1" to 3" pipe, other round or odd shaped objects. Handy for home shop or farm. Drilled for bench fastening. Chain alone worth price of

\$1.95

400 Lb. Sq. In. Pressure Tank

No. PT4 — Original oxygen container for aviators. 5 1/2" dia., 14" long. 1/2 gal. capacity. Fine as air or gas tanks, floats, liquid containers, etc. Painted bright yellow. Only

\$1.49



PARACHUTE HARNESS



No. PH9—Maybe you came down safely in one! 8 to 9 feet of stout 1 3/4" wide reinforced canvas webbing, with buckles and clip hasps. Many uses for webbing and metal parts

50c ea.
3 FOR \$1

CASH WITH ORDER

PREPAID ANYWHERE IN CONTINENTAL U. S. A.



Metal Radio Utility Box

No. UB2 — Size, 16 3/4" long, 7 5/8" wide, 7 1/2" deep. Approx. 20 gauge steel. Pressed and bottom rib reinforced. Black wrinkle finish. Ideal as radio cases, tool or parts boxes. 6 FOR \$3.00

75c

RIGHT ANGLE POWER DRIVE

No. RD3—Transmits 3/8" shaft power via bevel gearing to 90° right angle 3/8" shaft. 3 bolt holes in metal housing for fastening, right or left. Many experimental, model and practical uses. ONLY

\$1.95



INERTIA CRANK

No. C10

MANY USES

Originally used to start airplane engines. Replaceable 1/8" dia. crank shaft, 2 1/2" long. 2 sections, ribbed revolving plastic handle 1 1/2" O.D., 4 1/2" long. Adaptable for starting engines, grindstones, well cranks, etc. 3 FOR \$2.00

75c

Drawer Pull or Trunk Grip

No. DP8—4 3/4" long. Cadmium plated. Ears drillable for screws or bolts. Fine for trailer, truck or farm wagon tie-downs, or lifting handles. TWO FOR 15c. Doz.

60c

WRITE for complete list other War Surplus Values! See Adv. K3, K9 Gun-Sights, page 83

WARSHAWSKY & LAZAR
2126 S. Michigan, Chicago 16

YOU NEED NOT WAIT FOR YOUR NEW HOUSE



HERE'S HOW TO AVOID THE LUMBER SHORTAGE. HERE'S HOW TO AVOID INFLATED PRICES.

You can get the home you want — right now — the home you've always dreamed of owning.

Here are details of construction methods and materials in simple, easy-to-understand language! Here are detailed, itemized lists of all the materials needed in your house, lists telling where to get each item, lists telling how much each item costs.

The author, an experienced engineer, shows how a large, modern, six-room, thoroughly insulated, fire-resistant, two-bath house with garage can be had, anywhere in the United States, for \$2800.00.

Included with the book are ten folded drawings, 12" wide x 18" long. These drawings by the author show all the details of such a house — the wiring, the plumbing, the automatic oil-burning heating system and the fluorescent lighting. The book is devoted to showing how similar savings can be made on any house of any style, size or floor plan.

Never has a more helpful book been printed for the person who is planning or building a house.

138 6" x 9" pages illustrated, Ten Large, Folded Drawings . . . Send \$2.00 to Technical Press, Box 12K Swampscott, Mass. and your copy of

"A SIX ROOM HOUSE, \$2800 COMPLETE, READY FOR YOU TO MOVE IN"

by George W. Pearce, will be rushed to you postpaid. Absolute money-back guarantee.

Woodworking Your Hobby?

JIG SAWS

IMMEDIATE DELIVERY!



Sturdy fir and oak woods. Movable parts mounted on oil-impregnated bearings . . . needs no lubrication.

16 INCH \$1295 (LESS MOTOR) 26 INCH \$1695

F.O.B. Philadelphia Send Check or M.O. With Order

WM. H. SHELLINGTON

Machinery Sales and Service
2055 Hunting Park Ave., Philadelphia 40, Pa., Dept. P.M.

EXPERIMENT WITH LUMINOUS PAINT



See story "It glows in the dark" page 214 June issue of Popular Mechanics for many ideas on how to use our three color kit — contains one of each of 3 colors—LUMI BLUE, GARDENIA and CHARTRUSE. One ounce sealer. Guaranteed best quality.

COMPLETE KIT WITH 3 COLORS AND SEALER \$4.25

New Address F.O.B. Chicago
BLACK LIGHT PRODUCTS • 67 E. Lake St. • Chicago 1, Illinois

Build Your Own Motor



- All metal parts cadmium plated.
- Motor size 2" x 1 3/4" x 4"
- New GE Formex magnet wire.
- Runs on any battery.
- Complete instructions and blue print.
- All parts ready to assemble. only **\$1.00** paid

MOTOR TOY CORP.
Dept. PM, 2349 Pitkin Avenue
Brooklyn 7, N. Y.

SAY YOU SAW IT IN POPULAR MECHANICS

PHOTO ENLARGEMENTS



Is Photography your hobby? Do you want a profitable easy business at home? Make **PHOTO ENLARGEMENTS** for yourself and others. Your cost 5c each and less. The **AU-TO-MATIC** requires no experience. Also **COPIES** any picture. Interesting circular **FREE**.

5¢ ANY SIZE

PHOTO-SPHERE, Dept. B, Long Island City 3, New York

BRASS AND STEEL ASSORTMENT—SCREWS, NUTS, WASHERS, RIVETS, MISC.

95% nickel or cadmium plated . . . positively best assortment value ever offered . . . deluxe selection . . . THOUSANDS of useful items for home or shop . . . all types, sizes. Many scarce items included. Sent C.O.D. anywhere in U.S.: postpaid if remittance with order. Satisfaction guaranteed.

9 lbs. \$3.85

A. C. Schatz & Co., 3036 N. Ashland Ave., Chicago 13, Ill.



DRILL-INDEX

A compact container for indexing and filing twist drills. Eliminates search. Made entirely of steel in nine sizes. See your dealer or write to **HUOT MFG. CO.**
Foot Schultz Bldg. St. Paul 1, Minn.

BUILD THIS FREEZER

FOR LESS THAN \$50!

SAVE FOOD Zero temperature freezes and stores 170 lbs. of meat, fruit, etc. Easy to build from steel barrels and other available material. Complete instructions and 14 view detail photo sent for **\$2.00**

SAVE MONEY

MASON FREEZERS, DEPT. PM, GENEVA, N. Y.

GERSTNER Tool Chests

They please Machinists and Toolmakers because they are made better. Free Catalog.

GERSTNER TOOL CHESTS
446 Columbia St., Dayton 7, Ohio



STOP THAT GLARE

only **\$2.95**

Save Your Eyes!

Drive Safely

with the entirely practical Wolverine Visor. Highgrade green-tinted Plexiglas relieves all road-glare—sun, snow and hood reflections. Once tried, always used. 6" x 14". Fits all cars. Instantly installed. Operates on universal swivel. Durable. No need to pay 3 and 4 times as much. Sent direct, \$2.95, postpaid, or C.O.D. Supply limited. Order now.

WOLVERINE COIL SPRING COMPANY
819 Front Ave., N.W., GRAND RAPIDS, MICH.

WOLVERINE PLEXIGLAS VISOR

Here It Is!

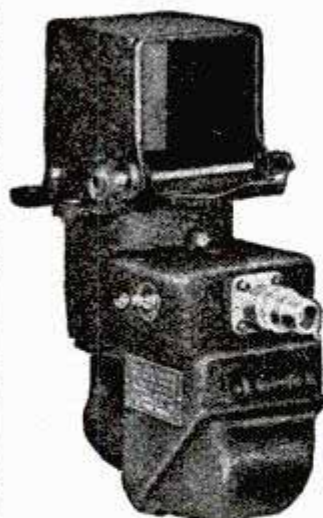

ONLY
\$850

Postpaid
Anywhere
in U.S.A.

Note: A Collimeter Instrument alone sells for about \$100 to camera repairmen.

Remit With Order

RUSH YOUR ORDER TODAY

The Famous B-29 A^{IR} FORCE GUN SIGHT

(Flexible)

PRECISION MADE FOR FINEST ACCURACY AND DEPENDABILITY

Convertible into:

- SLIDE PROJECTOR
- ENLARGER
- SLIDE VIEWER
- COLIMETER
- BABY SPOTLIGHT
- FIXED FOCUS MICROSCOPE, Etc.

Worth many times this LOW PRICE — Big value for the parts alone—Fortunate opportunity to Inventors and Experimenters . . . Many valuable parts that cost a young fortune to produce . . . All Top Quality Construction in this Expensive Air Corps Unit. The color corrected coated, double achromat lens system with the lighting assembly can easily be adapted to a variety of optical or photographic uses by craftsmen or home mechanics. The angular reflector if silvered, makes an ideal periscope reflector. The adaptations possible are endless and fascinating to the craftsmen . . . ALL NEW IN ORIGINAL CARTONS . . . Conversion sheet with each order.

• PARTIAL LIST OF PARTS •

- Double Achromat Lens System
- Reticle (circle and dot)
- Silvered Reflector Mirror
- Bayonet Socket
- Filter Glass
- Toggle Switch
- Diffuser Dust Glass—Over 20 Other Expensive Desirable Parts

Boys!

Here's the Famous TANK CRASH HELMET



ONLY **\$1.00** post paid

LEATHER LINED

BATTLE SCARRED BUT IN GOOD CONDITION

They Have Seen Actual Service

Boys here is just what you have been waiting for. The admiration for your war hero makes you want one of these CRASH HELMETS. Soon you will see other boys in your neighborhood wearing them and wish you had one. So BE FIRST, be the envy of the other boys. Just the thing for your football game, scooter, bike, racer or roller skates. Get a group of boys together and order one for each. Many boys are doing this. Its lots of fun and makes your games more exciting . . . More thrilling. They are made good and strong because they meant protection for the service men and saved many lives. This LOW PRICE represents a fractional part of the real cost as equipment. So take advantage of this opportunity and get as many as you want. Better Hurry. SEND FOR FREE CATALOG.

B & B PRODUCTS CO., Dept. C, 111 W. Jackson Blvd., CHICAGO

IMMEDIATE
DELIVERY!



\$19.95

F. O. B.
ROYERSFORD, PA.

8 in. BENCH SAW

COMPLETE AS SHOWN

TABLE SEGMENT—Shows degree of table tilt—graduated. SPLITTER—Hard temper cold rolled steel. GUARD—Aluminum. MITER GAUGE—Aluminum. Accurately graduated 45° each side of center. BEARINGS—(2) Oil-ite bronze. CAPACITY—0 to 2 1/4". TABLE 12"x14". SHIPPING WEIGHT—44 lbs.

This Price is Below the Authorized O. P. A. Ceiling

AMERICAN MACHINE & TOOL CO., Inc.

DEPARTMENT 100 • ROYERSFORD, PA.

BAUSCH & LOMB 7x50 BINOCULARS



Released by U. S. Navy

WATERPROOF — DUSTPROOF
FUNGUS PROOF

Brand new—complete with case **\$162***

ARGUS PRISMATIC TELESCOPE

Super grade—coated lenses

with Argus 20 power eyepiece.....\$74.50

with Brownscope 28 power eyepiece.....\$78.50

BROWNSCOPE LIGHTWEIGHT 8 x 30

Prism Binoculars. Finest achromatic optics. Central focusing. Leather case and straps.....\$49.50*

BROWNSCOPE 4 x 40 ACHROMATIC

Field Glass. Central focusing. Interpupillary adjustment. With leather case and straps.....\$16.50*

BROWNSCOPE 6 Power ACHROMATIC

Field Glass. Same as above but 6 power. With leather case and straps.....\$22.50*

*Binoculars and field glasses subject to 20% Federal Tax

WE PAY THE POSTAGE PROMPT SHIPMENT
MONEY BACK GUARANTEE

BROWNSCOPE CO.

Dept. 11M, 24 West 45th St., New York 19, N. Y.

TELESCOPES • BINOCULARS • MICROSCOPES

KILL RATS WITH TAT-ANTU

(FORMULA 83)

Rid your home of rats and their menace to your health and property. Use TAT-ANTU (Formula 83) . . . so powerful one lick kills rats. Contains ANTU, remarkably effective new rodenticide, tested and used by U. S. Public Health Service.

Ready to use. No mixing. Tasteless, pre-baiting unnecessary. Kills three ways—as feeding bait, drinking bait, and tracking dust. Satisfaction guaranteed or your money back. Get TAT-ANTU (Formula 83) from your dealer. Available in 3 popular sizes. If he cannot supply you, mail coupon below.

O. E. LINCK CO., INC. (PM 11-46)
Montclair, N. J.

Please send FREE Booklet, "Rats—Their Habits and Control." Also \$1.00 can of TAT-ANTU (Formula 83).

\$1.00 Enclosed Send C.O.D.

Name.....

Address.....

City or Town.....

TAT *Formula 83*
CONTAINING ANTU



A VICTOR PRODUCT

NATURAL FINISH **\$1.39**

GOLD PLATED **\$2.39**

TAX FREE — POST PAID

FEATURES: Non-Corrosive Stainless Steel. New Pat. Pend. Watch Attachment. Expands 2½ Times Its Length. Fits Any Wrist. Any Watch. Complete Instructions Enclosed.

MAIL COUPON NOW!

FRIENDLY JEWELRY CO., Box 93, North Station
Please Send: Providence 8, R. I.

.....Stainless SteelGold Plated

Name.....

Address.....

City.....State.....

.....Enclosed PaymentC.O.D. Plus Postage

A STURDY, HANDSOME WATCHBAND

AT A PRICE YOU
WANT TO PAY!

Adjustable, Stainless Steel

EXPANSION BAND

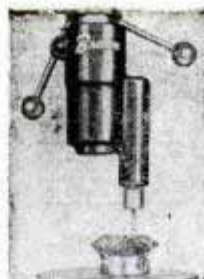

6 Tools in 1! BROWN DRILL PRESS CONVERTER

Transforms drill press rotary action to reciprocating action and performs filing, sawing, slotting, hammering and chiseling operations—all on one machine! Hardened steel cam . . . pre-loaded ball bearings . . . durometal housing . . . attached in 3 minutes.
1" stroke . . . \$23.50 • 1¾" stroke . . . \$31.50

THE BROWN TWO-WAY SLIDING TABLE

A sturdily-built work table that will insure precision work on every wood-working or metal-working operation. It's the only work table of its kind—a valuable tool in every home workshop! Weight 24 lbs.



Price \$42.50

Immediate delivery. Send check or money order direct to:
LEO G. BROWN ENGINEERING CO.
1127 RIVERSIDE DRIVE • LOS ANGELES 31, CALIFORNIA
DEALERS: Write for franchise.

REFRIGERATION and AIR CONDITIONING



Train where the Army trained. Learn at home or in our big shops. Expert instructors—real machines. Easy to learn. Write for big FREE catalog today. No obligation. **COMMERCIAL TRADES INSTITUTE**, 209 W. Jackson Blvd. (Dept. X211), Chicago, Ill.



VETERANS ASK FOR GI PLAN



ELECTRIC DRY SHAVER

New 1946 DeLuxe Shaving Head. Self Starting — Self Sharpening. 110-V. 60 cycle A.C. Operation. Precision Built Vibrator Type Motor. Available in Ivory Plastic. Distinctive Streamlined Design. Ground and Lapped Steel Cutting Blades. No Radio Interference. Fully Guaranteed.

SEND ONLY **\$5.00**
with case postpaid

ORDER NOW FOR XMAS
MEDELLIN SALES
919 S. Kedzie Ave. Chicago 12, Ill.



BRASS RODS

For Home Work Shops

For use on model boats, airplanes, etc., keep a supply of these free-turning brass rods on hand. Kits available for all size requirements.

Write Dept. C for Free Catalog of 45 Kits Today

MEIER BRASS & COPPER CO.
1155 Bellevue, Detroit 7, Mich.

CHANITE SELF-WELDING FLUX

REPAIRS ALL ELECTRIC HEATING ELEMENTS

So simple anyone can make repairs in your broken or burnt-out electrical appliances—irons, toasters, stoves, etc. Guaranteed nothing like it. From our mines to your appliances. \$1.00 per package. \$7.50 per doz. Stick form 25c. \$2.00 per doz.

CHANITE SALES COMPANY, 914 So. Main, Fort Worth 4, Texas

NEW TOOL—HAMMER PUNCH

Now you can get this new precision layout and center-Hammer Punch. Stop hunting for that punch and hammer. Save time and effort—Itach for the combination Hammer Punch and the job is done. Send no money. \$1.00 C.O.D. plus postage.

COLE TOOL WORKS 246 E. High Hicksville, Ohio



COLLECT U. S. ARMY Shoulder Patches

Send \$1 for sample selection of patches and PATCH CATALOGUE.

SPRINGER'S

EL PASO, TEX.

20
for
\$1

New "THERMO-SAW" (cuts with heat)

MAKE THINGS FOR THE HOME or FOR SALE

• ANY CHILD CAN USE IT •

No Noise—No Vibration—No Sawdust

Boys and Mechanics thrill over the many interesting things that can be made with this NEW ALL-STEEL THERMO-SAW . . . You can cut out any pattern or design in 1/2 the time . . . Difficult patterns are made QUICK and EASY . . . No turning of work . . . Cuts in every direction! . . . Cuts plywood 1/8" or 1/4" . . . Cuts 14" x 36" board. Will cut 1/8" Plexiglas very well . . . A special transformer produces high frequency current in a tough steel wire "blade" from ordinary Alternating (AC) Current . . . IMMEDIATE DELIVERY!

Extra Blades ONLY 20c per dozen. ORDER TODAY
Machine Measures 11" x 4" x 3 1/2" High. Throat 7" Deep. PATTERN INCLUDED FREE.

AN IDEAL GIFT

NOTE: Operates on 110 volt Alternating Current; 50 to 60 cycle.

\$4.75 in Canada & Mexico. \$5.00 elsewhere. No C.O.D. Orders Please!

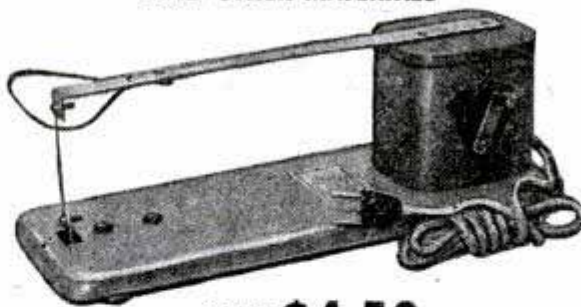

A FEW OF THE MANY INTERESTING THINGS YOU CAN MAKE

Boisselier Mfg. Co., Dept. P-11, Glen Ellyn, Ill.

Pat. No. 2,272,931 D-87-072

ONLY \$4.50 Postpaid

COMPLETE SAW outfit as illustrated with transformer and 12 spare blades. Ready to use.

BEAUTIFUL SAFETY CIGARETTE HOLDER



Exclusive feature protects dresser, bench, desk, table top, etc., from unsightly burns. Eliminates fire hazard. Legs support holder in upright position as illustrated. Disappears when not in use. A beautiful holder anyone will be proud to use. An ideal Xmas Gift.

\$1 POSTPAID IN U.S.A.

PATENT PRODUCTS

10112 S. MAPLEWOOD AVENUE, CHICAGO, ILLINOIS

AUTO ENGINE SPEED CONTROL GOVERNORS

(REGULADORES)



Give constant or changeable speed to any auto or truck engine, when used for power. Guaranteed. Instructions. Oil ring bearing, \$14.25. Full ball bearing, \$21.75. Postage west of Miss., 50c; east of Miss., 85c. Sent COD or—Postage to any country in the world \$1.00 each. Pulleys to 3", \$1.00, wt. 1 lb.; to 6", \$1.50, wt. 1 1/2 lb. Governor speed 1400 to 2400 rpm. Figure your pulley size.

Agents Wanted: Parts and Implement Dealers, Garages, Welders, Wreckers, Catalog and Mailing List Houses, etc.



These valves used where carburetors have outside attachments. State size of opening and distance between bolt holes. 1", \$3.75; 1 1/4", \$5.25; 1 1/2", \$6.50; 1 3/4", \$7.50; V8, \$8.00. Mailing weight, 3 lbs. If remitting, enclose for postage. You may order from this ad, or we will send circulars. Stocks carried: In Montreal 15, Canada: 7546 Wiseman St. In Skaneateles, N. Y.: Horie Welding Supply.

CANDEE, Dept. 5, 2641 S. Hill, Los Angeles 7, Calif.

SAY YOU SAW IT IN POPULAR MECHANICS

BOILS WATER IN 3 MINUTES



UNCONDITIONALLY GUARANTEED

Wonderful for Homes, Cabins... Trailers... Wherever hot water is wanted QUICKLY

ELECTRIC WATER HEATER

Immersion type . . . drop it into the water . . . it heats a basin or a sinkful pronto. 110 volts AC-DC. Comes with extra long heavy duty waterproof cord. Weighs 1lb. We'll mail it C. O. D.

\$2.45

Plus C. O. D. and postage

Write for Big free Trailer Parts Catalog

NATIONAL TRAILER STORES

Dept. 10, Box 2353 Terminal Annex LOS ANGELES 54, CALIF.

PRECISION BUILT

ADAPTERS FOR MACHINISTS MICROMETERS



These utility buttons may be adapted to any size micrometer for miking thread reliefs—gears—square threads—Acme threads—key-ways—serrations and other difficult miking problems. Fits any size micrometer. Precision-made of gauge steel—hardened—ground and lapped to .002. When ordering specify anvil diameter, whether .235, .250 or .270. Starts reading at .500. Complete set of three buttons packaged in attractive compact container.

ORDER BY MAIL TODAY • SEND CHECK OR MONEY ORDER • \$2.50 POSTPAID
1/8" EXTENSIONS AVAILABLE AT 25c PER BUTTON ADDITIONAL

W. NEWELL CO., 5356 FOUNTAIN AVE., LOS ANGELES 27, CALIF.

BOICE-CRANE POWER TOOLS

for shop men and
homecraftsmen.



BAND SAWS



JIG SAWS



DRILL PRESSES



THICKNESS PLANERS



SPINDLE SANDERS

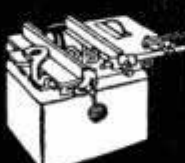

SAW-JOINTERS



LATHES



SPINDLE SHAPERS



BELT SANDERS

Write for literature on this
versatile, low-cost,
sturdy line.

BOICE-CRANE COMPANY
943 Central Ave., Toledo 6, Ohio

5 ROTARY CUTTING TOOLS IN 1



CENTER ROTARY CUTTER cuts holes, discs, grooves, beads, chamfers. Works in wood, plastics, soft metals. Only tool on market for decorative rotary work in all these. Maximum 5" diameter, 3" depth. 4 finest tool steel bits, one blank for special shaping. 3/8 inch shank fits hand or power tool chucks.

MODEL 101-A (illustrated) with high speed twist drill pilot, 4 bits, wrench; speed and lube chart \$3.50
MODEL 101-B with plain pilot, 4 bits, wrench, speed and lube chart \$2.50

Ask Your Dealer or Write

CENTER TOOLCRAFTERS, INC.

Jeff A. Hedden Co., National Sales Representatives
3184 ROSWELL ROAD, N. W., ATLANTA, GEORGIA
MADE BY WOODCRAFTSMEN FOR YOUR HOME WORKSHOP
Watch for Other Items in the Center Line

MAKE UP TO \$5⁰⁰ AN HOUR In Your Own YEAR ROUND Business!

ONLY A FEW
DOLLARS
PUTS YOU IN
BUSINESS!

Many Clearing as High as \$20 to \$30 a Day NET Renewing Rugs, Carpets, Upholstery. New Method Now Used for Auto Upholstery. Write for Facts About Quick, Easy Way to Get Started

Here is the chance you've been looking for to step into a pleasant, dignified, big-pay business of your own that offers you a steady, year 'round income. Start on "a shoe-string," full or spare time, right from your own home. Equal opportunities for men and women, young or old, in small towns or big cities. No experience needed. Many making big money with new American System just cleaning auto upholstery. Easy to learn. We send you complete instructions and quick-cleaning supplies so you can start making money the very first day! Quick method cleans upholstery, rugs and carpets like new without taking off floor! Tremendous demand in homes, apartments, hotels, stores, office and public buildings. Steady repeat business. Territories going fast. Write today for full FREE facts. No cost or obligation. Rush letter or postcard now to AMERICLEAN CO., Dept. G-2, St. Louis 1, Missouri.

WRITE
FOR FREE
DETAILS
NOW!



Steel WHEELS AND COLD ROLLED STEEL AXLES

Sturdy, rubber tired pressed steel wheels with red enamel finish. Ready to use axles—threaded at both ends. Acorn nuts supplied. Order today.

WHEELS WITH SOLID RUBBER TIRES
4" Wheels, 1/4" bearing, Steel Disc \$.75
6" Wheels, 3/8" bearing, Steel Disc 1.00
WHEELS WITH SEMI-PNEUMATIC TIRES
6" x 1.50 with 3/8" Seiflube Oil Bearing 1.75
8" x 1.75 with 3/8" Seiflube Oil Bearing 2.25

AXLES, COLD ROLLED STEEL
1 1/2" x 14" long, threaded both ends, Nickel Cap Nuts40
3/4" x 16" long, threaded both ends, Nickel Cap Nuts60
1/2" x 18" long, threaded both ends, Nickel Cap Nuts80
Sent postpaid in U. S. on receipt of price.

CIRCLE METAL MANUFACTURING COMPANY
4266 E. PACIFIC WAY LOS ANGELES 23, CALIF.

To Build
Your Own
WAGON
CART
TOY
or any
rolling
carrier

SAY YOU SAW IT IN POPULAR MECHANICS

New! 12" Sheet Metal Brake Only \$12



Fits in bench vise. Quickly, easily forms all kinds of angles in sheet metal, strap iron and aluminum, wire and plastic. Use it to make useful articles, experimental research work, patent models, etc. Simple gages made for quantity duplicating. Now available. Send for details, or order direct. \$12 p.p. Wt. 10 lbs.

SAMPLES
OF WORK



VISE BRAKE MFG. CO., Dept. P. M., 1318 So. 30th Ave., Omaha 5, Nebr.

BUILD THESE PROJECTS
For garden or lawn. Easy to build. Easy to sell. Detailed Blueprints Model B-25 Dutch Windmill 50c; Model OM-60 Old Mill, 85c. Lawn Figure Patterns—Sunbonnet Girl, Dutch Boy, Tulip Girl, Holland Pair, 35c each, all 4—\$1. Catalog illustrating many models, send 10c, today.

CRAFTSMAN'S MODEL CO., Dept. P-97, 2030 N. 4 1st St., Milwaukee, Wis.



NEW OTTAWA Wood Saw

FOR TRACTORS Makes wood sawing fast; easy. Cuts enough wood to pay for itself quickly. Easily moved while attached. Big blade; free details.

LOW
PRICE

OTTAWA MFG. CO., W-1127 Oak Ave., Ottawa, Kans.

Your Favorites are Returning—Watch for Them

BASS OUTDOOR FOOTWEAR

WEEJUNS
FOR
LEISURE-WEAR

QUAIL HUNTERS
FOR
FIELD & STREAM

SPORTCASINS
FIRST
ON THE FAIRWAY

SKI BOOTS
SMOOTH
ON THE SLOPES

G. H. BASS & CO., 65 MAIN STREET, WILTON, MAINE

ROL-E-Z-JACK NOW... YOU

For any size or weight of car—will lift up to 2 tons quickly and easily! Gets under places where other jacks can't—as low as 4 1/2"; lifts as high as 13". Heavy steel construction; no castings. A sealed thrust ball bearing gives the Rol-E-Z-Jack lifting drive and power. Ski type base prevents sinking into soft ground.

ONLY
\$7.00

CAN LIFT
IT WITH
EASE!

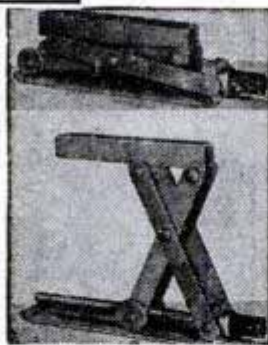

The Rol-E-Z-Jack lasts a lifetime. Easy on your pocketbook as well as your back. Tested and proved in use—satisfaction guaranteed!

SEND CHECK OR MONEY ORDER.

Dealers: Write for quantity prices.

CECO SALES CO.
164 - 25th St. Brooklyn 32, N. Y.

Utica Tools



**Pliers for
Every Need**

ASK YOUR DEALER

UTICA DROP FORGE & TOOL
CORPORATION
UTICA 4, NEW YORK

AUTOMATIC RETOOTHER

MAKES NEW
PROFITS

FOR HAND
SAWS

Cuts new teeth in 50 seconds! Any size tooth 4 to 16 points. Old teeth fall off as chips. Simple to operate. A perfect job.

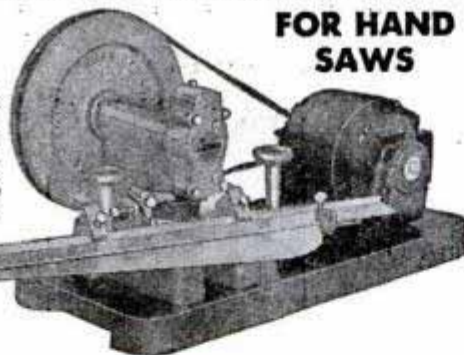

IMMEDIATE
DELIVERY

BURR MFG. CO. 8933 Venice Blvd.
Los Angeles 34, Calif.

DRILL CONCRETE *The Easy Way!*

CONCRETE
ASPHALT
BRICK
SLATE



WALLBOARD
LIMESTONE
and all other
construction
materials.



Tipped with
Carboloy
Coated Car-
bide—harder
than the hardest
steel

SLIP A CARBOLOY MASONRY DRILL INTO YOUR ROTARY DRILL, HAND BRACE, OR DRILL PRESS, AND WATCH IT GO—AND GO FAST!

- DRILLS 4 TIMES FASTER!
- STAYS SHARP 50 TIMES LONGER!
- CUTS CLEAN, TRUE-SIZE HOLES!

Goodbye to back-breaking masonry drilling! Cut clean, true-size holes in all masonry jiffy-quick! Use your rotary drill, hand brace, or drill press. Drill holes 1/2" apart without break-through. Ask about Handy 6-Drill Set (canvas case, free). See your dealer, or write.

CARBOLOY COMPANY, INC.
11185 E. 8 MILE BLVD., DETROIT 32, MICH.

Chronographs by



Seeland

THE FIVE-IN-ONE WATCH

Telemeter • Tachometer
Stopwatch • Timekeeper
Time-out Stopwatch

Quality
Dependability
Value

Since 1837

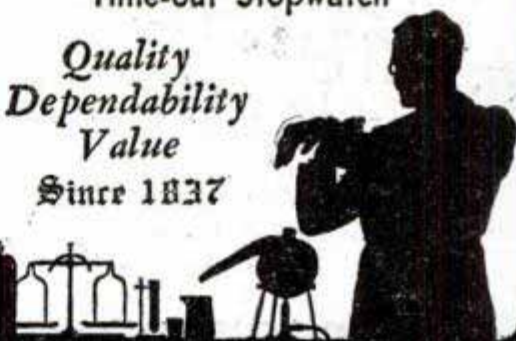

AT BETTER JEWELERS EVERYWHERE

FIXED FOR THE LAST TIME!

Repairs "Stay Put" when you
make them with remarkable

X-PANDOTITE

The General Purpose Mortar-like
repair and maintenance cement
filler that expands as it sets!

Repairs are fixed-to-stay-fixed when you make them with the remarkable new expanding household cement X-Pandotite. Simple and easy to use, may be colored. Generous 1/2 lb. can for only 35c, 1 lb. can 60c.

At your local hardware or paint store. Or send \$0.50 for 1/2 lb. or \$1.00 for 1 1/2 lbs. prepaid to:

X-PANDO CORP.
43-15 THIRTY SIXTH ST.
LONG ISLAND CITY, N. Y.

Proves Wonderful For Itching Skin!



Also Aids Healing

Here's a Doctor's anti-septic formula — Zemo — a stainless liquid which is invisible on skin — yet so soothing and highly medicated that first applications promptly relieve itching, burning of Eczema, Psoriasis and similar skin and scalp irritations due to external cause. Zemo ALSO aids healing.

Apply clean, stainless invisible Zemo at any time. It won't show on skin. In 3 sizes. For severe cases ask for super Extra Strength Zemo.

ZEMO

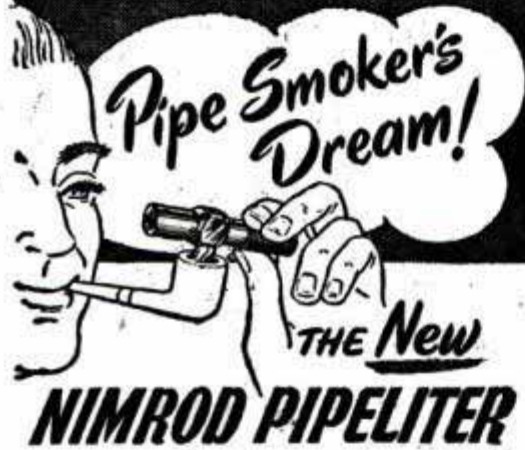

Amazing, new-type lighter! Flick . . . it lights instantly . . . always! Won't blow out . . . even in high wind (wick is inside)! When pipe smoker draws, flame is quickly, easily drawn down, thru bottom opening, directly into pipe bowl. Lights cigars, cigarettes, too . . . thru top opening. Weighs about one ounce — unconditionally guaranteed. Vest-pocket size. Order today!

only \$3.50 postpaid

A welcome, practical, sure-hit gift to sportsmen and pipe lovers . . . for birthdays . . . Christmas!

MONOGRAM STORES, INC.

Dept. PM-116, P. O. Box 1034, NASHVILLE 2, TENNESSEE

Please send Nimrod Pipelitters

Enclosed is check money order

NAME

ADDRESS

CITY STATE

AT LAST—A HANDY, POCKET-SIZE

ELECTRICAL AND RADIO TROUBLE-SHOOTER

quickly and conveniently checks radios, motors, fuses, wa-bags, jackets, switches, fuses, broilers, ovens, and all other electrical appliances from 30 - C. 50 D.C. to 550 volts A.C. or D.C.

Also distinguishes A.C. from D.C. Rigidly attached POCKET-CLIP permits tool to be carried like fountain pen.

Comes with genuine LEATHER CASE which permits tester to be carried in tool kit. Instruction sheet with every tester. No C.O.D. shipments outside U. S. A.

\$1.00

Send check or money order today!

CORD ELECTRICAL SUPPLY CO.
307 Grand St., Brooklyn, N. Y.
Dept. B-11

Machine Tools & Machine Shop Equipment

<p>DRILLS TAPS DIES REAMERS CUTTERS SLEEVES ARBORS</p>	<p>We can supply all your machine shop needs with fine tools made by leading U. S. manufacturers. Mail orders will be promptly dispatched. We invite you to send for our complete and illustrated catalogue—40c—which sum will be refunded on first order of \$10. Write to the</p> <p>Veteran Tool & Supply Co., Dept. A 88 Baxter Street, New York, N. Y.</p>	<p>ELECTRIC TOOLS GRINDERS COLLETS VISES CHUCKS MICROMETERS SURFACE PLATES</p>
---	--	---

WHEELS AT BARGAIN PRICES

WE ARE OVERSTOCKED AND MUST MOVE THIS SUPPLY OF De Luxe BALL BEARING WHEELS

... 8" x 2" Semi Pneumatic Tire, 7/16" Ball Bearing . . \$2.75 ea.
... 10" x 1.75 Semi Pneumatic Tire, 7/16" Ball Bearing 3.75 ea.
(CHEAPER IN SETS OF FOUR — WRITE FOR FREE LIST)

Write number wheels wanted in space provided, tear out and mail this ad. with check or money order and your name and address.

TRULSON MFG. CO., Dept. C, 811 East 31st, Kansas City, Mo.

SAY YOU SAW IT IN POPULAR MECHANICS

"For The SPARK That NEVER Fails"

Your Lighter Will WORK . . . better—with

RUMIN

Gold Coated FLINTS and LIGHTER FLUID

ROCK FLINT CO., 123 Doughty Boulevard, Far Rockaway, N. Y.

SUPER MYSTERY BUTTON

Many times as sensitive as our regular mystery button. Can be used for the same experiments and uses as the mystery button but with far better results. Needs no diaphragm of any kind. Ideal for musical instruments, intercommunication, recording, talking thru radio, and many other uses. When used with small head phone it makes an ideal inexpensive hearing aid. Shipped with 5000 word, 12 page booklet showing diagrams for dozens of uses, postpaid \$2.00.

Electronic Products Company
Saint Charles, Ill.

"WONTWIST" ANIMAL TETHER

AT LAST YOU CAN TIE-OUT YOUR ANIMAL SAFELY!

SAFE FOR ALL ANIMALS, BALL REVOLVES IN ALL DIRECTIONS.

Send Check or Money Order **\$2.95** DEPT. P-6
Price Includes Delivery Charges

THE HAYDEN CO., Bryn Mawr, Pa.

NEW TARPAULINS



NO.	SIZE	PRICE
JRT501	6'x8'	\$5.49
JRT503	8'x10'	\$8.87
JRT505	10'x12'	\$13.10
JRT507	10'x16'	\$17.17
JRT510	14'x16'	\$23.76
JRT512	16'x20'	\$34.21

FACTORY PRICES! Direct to You!
COMPLETE PROTECTION
SUN ★ WIND ★ RAIN

TOP QUALITY TARPAULINS! Waterproof, flameproof, mildewproof! Durable 11.6 oz. super-strength material. Double lock-stitched seams, 10-3 cord. Metal grommets set in double reinforced canvas. Immediate delivery while present stock lasts. Ideal for trailers, boats, machinery, farmers, etc. WRITE FOR LEAFLET!
8' x 10' SIZE ALL ORDERS ONLY \$8.87 CASH
 F.O.B. Zanesville, O.

WRITE TO **JOHN ROBERTS COMPANY**
 7326 S. MICHIGAN AVE. • CHICAGO 16, ILL.

WAR SURPLUS BARGAIN SPECIAL

**VACUUM-AIR
 HYDRAULIC
 FUEL
 PUMP**



Original Cost
\$45.00
 NOW ONLY
\$9.95

Postpaid in U.S.A.

Adaptable for use on Home Oil Burners, Spray Machines, Milking Machines, Compressors, Vacuum Pumps, Hydraulic Systems, Presses, etc. Originally cost \$45.00. Used by the Air Corps to drive bomber de-icer boots, gyroscopes, automatic pilots, etc. May be used as air or fluid pump—for pressure or vacuum. Standard 3/8 inch pipe thread with interchangeable ports. Will pump 7 1/2 gal. SAE 30 oil per minute at 300 RPM. Builds air pressure of 30 lbs. per sq. in. at 1000 RPM. Vacuum will draw 26 inches of mercury at 1750 RPM. Runs forward or reverse. Self aligning shaft. Spline terminal for direct drive—readily replaced with a pulley. Rated capacity 1500 RPM with high overload factor. Special price for quantity users. Send check or money order today. Postpaid in U.S.A.

GROBAN SUPPLY CO. 1522 SO. MICHIGAN AVE. Dept. PMN, Chicago 5, Ill.

Mechanical & Electrical Bargain

7 lbs. net **\$5.00** 7 lbs. net

Includes ONE BACK GEARED A.C. MOTOR
 can be used as display turntable, to operate toys, etc.

- | | | |
|----------|----------------|----------------|
| GEARS | COLLARS | CONDENSERS |
| SHAFTS | FLEX. SHAFTS | CONTACT POINTS |
| BUSHINGS | SWITCHES | CHOKES |
| ANGLES | RESISTORS | COILS |
| BRACKETS | CARBON BRUSHES | SPACERS |
| SPRINGS | INSULATORS | HARDWARE |

MORE THAN 200 PIECES

REMIT \$5.00 FOR EACH KIT WANTED
 NO C.O.D. ORDERS — SUPPLY LIMITED

GEORGE BROOKS & ASSOCIATES

220 SO. HALSTED STREET CHICAGO 6, ILLINOIS

START HOME NOVELTY MFG. BUSINESS

New course tells in simple language how to make plaster novelties of many kinds at home. Descriptive folder free.

W. BELFORT

Engineering Building Chicago 6, Illinois

MAKE YOUR OWN POLISH

Not wax, oil, paint, or varnish. Sensational new auto cleaner—polish. Comes in powder form; just add water; will make 1 1/2 quarts. Easily produces glossy finish which lasts six months to a year. No finger marks or smears. And it is also a fine furniture polish; cleans glass, chrome. **\$1.00** Postpaid
FOREST SALES CO., 6697 Forest Ave., Ridgewood 27, L. I., N. Y.

FIBRE ARMS AND LEGS!



Light, correctly fitted, strong and comfortable. Natural appearance. Braces for all deformities. Scientific design. Fair Terms.

BUCHSTEIN-MEDCALF 223 S. 6th St., Minneapolis, Minn.

QUICK! "REPAIRING CAR BATTERIES!" MONEY.

At Home! Easy Too! Free Circulars!
 Write, **BATTERYMAN, Dept. 5, Grand Junction, Colo.**

Service TELEVISION - FM - AM RADIOS with the NEW

Model SIGNAL GENERATOR B-45

Self modulated—provides a highly stable signal. RF frequencies from 150 Kc. to 12.5 Mc. on Fundamentals and from 11 Mc. to 50 Mc. on Harmonics. Modulation is accomplished by grid-blocking action—equally effective for alignment of amplitude and frequency modulation as well as for television receivers.

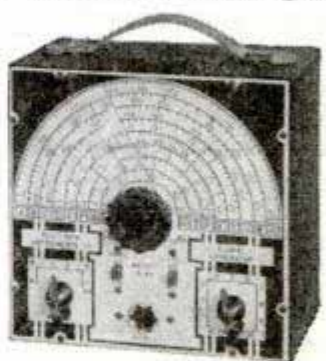

Self contained batteries. All calibrations are etched on the front panel.

Complete, ready to operate... **\$27.75**

IMMEDIATE DELIVERY FROM STOCK!

FREE Write for new 1947 catalog of all types of testing instruments.

Metropolitan

ELECTRONIC & INSTRUMENT CO.

6 MURRAY ST. Dept. PM11 N.Y. 7, N. Y.

BELT SANDER AND TOOL GRINDER

WOODS MODEL 40—For home work shop woodworking and machine shop production



HORIZONTAL OR VERTICAL OPERATION—5" x 8 1/2" CAPACITY

Husky sander for metal, plastics, wood, glass and rubber; perfectly-balanced completely machined pulleys (4" dia.) . . . ball-bearing thruout . . . drive shaft supported on both ends. These features assure maximum efficiency, smooth operation and long life. Tested to 5000 rpm. . . . easy adjustment for horizontal or vertical operation . . . reversible platen usable on either face. Extra belts, 5" x 6" work table, and other accessories available from stock.

SPECIFICATIONS

- | | |
|-------------------|------------|
| Abrasive Belt | 4" X 36" |
| Bench Space | 9" X 15" |
| Motor Recommended | 1/3 hp. |
| Net Weight | 17 1/2 lb. |
| Shipping Weight | 22 lb. |

Order from your dealer or shipped FOB direct from our S. Norwalk Plant

SANDER COMPLETE WITH BELT AND WORK DAM
\$39.95

ATTENTION DEALERS!

A limited number of dealer territories are still open; write for information.

WOODS ENGINEERING CO.
 NORWALK 11, CONN.

LOANS *by* MAIL

\$50 to \$300 IN A HURRY

CONFIDENTIAL

Salaried people, men or women, married or single, loans on your own signature, or your own security. NO personal interview. NO co-signers needed. NO wage assignments. You mail the application to us... we mail the money to you.

FOR A LOAN OF	YOU CAN REPAY MONTHLY			
	IN 15 PAYMENTS	IN 12 PAYMENTS	IN 9 PAYMENTS	IN 6 PAYMENTS
\$ 50	—	\$ 5.03	\$ 6.43	\$ 9.24
100	8.40	10.07	12.87	18.48
150	12.60	15.10	19.30	27.73
200	16.75	20.09	25.68	36.91
250	20.85	25.02	32.02	46.05
300	24.93	29.94	38.33	55.17

The above payments made at regular monthly intervals will repay the entire loan and all charges in the time indicated. Charges are based on the monthly rate of three per cent on unpaid principal balances to \$150.00 and two and one-half per cent on that portion of unpaid balances in excess of \$150.00 but not exceeding \$300.00. "Loans by Mail" may be repaid in larger amounts, more frequent payments or repaid in full at further savings to you.

CONVENIENT

Just write us how much money you need and how you wish to repay... there's no charge or obligation. Whatever your needs for cash now or in the future, write for your "Loans by Mail" plan, today.

MERCHANTS INVESTMENT CO.

819-G 1st Nat'l Bldg., Omaha, Nebr.

Without obligation, rush complete details and all papers necessary

for a loan of \$_____ to be repaid at \$_____ on the _____ day of each month.

Name _____

Address _____

City _____ State _____

Occupation _____

SAY YOU SAW IT IN POPULAR MECHANICS



FREE! Radionic Catalog

New, big, FREE 1947 Catalog full of radios, parts, accessories, tubes, record changers, phono players, etc.

RADIONIC EQUIPMENT CO.

170 Nassau St., Dept. 2011, New York 7, N. Y.



YOUR OWN HOME GYM

Americans are proud of their speed and endurance—their strong, solid muscular systems. You, too, can develop big muscles, broad shoulders and powerful arms. This new HOME GYM includes: Five Extra Heavy Steel Cables; Two Wooden Bars with Special Attachments; Special Wall Exerciser; Two Five-Pole Handles; One Pair of Foot Stirrups; Two Strong Steel-Spring Hand Grips; Two Illustrated Exercise Charts. **\$9.50** free on request. Sent postpaid; no C.O.D. only

BRIGHTON SPORTING GOODS

508 BRIGHTON BEACH AVE.

BROOKLYN 24, N. Y.

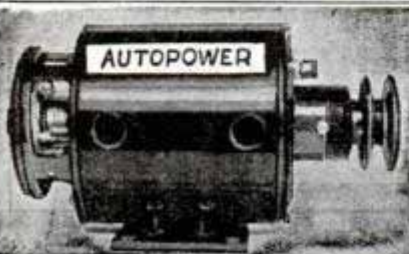

TURN SCRAP INTO MONEY

AUTOPOWER tells you how in plain, easy, simple, and illustrated instructions that anyone can follow. Change auto generators into useful, practical AC and DC generators and motors with voltage from 2 to 1,000 volts, for power, light, welding, radio, sound, etc. No previous experience nor special tools needed. Generators can be driven by wind, water, fan belt, etc. Already used and endorsed by thousands. Send for your copy of "AUTOPOWER." Only \$1.00 postpaid.

AUTOPOWER INC., 2118 Pine St., St. Louis 3, Mo.



WANTED

MAN WITH CAR



No Time Like Now to Get In McNess Business

It's no trick to make good money when you use your car as a McNess "Store on Wheels." Farmers buy everything they can from McNess Men because McNess Products are tops in quality, represent extra values. Attractive business-getting prizes and premiums; also money-saving deals to customers make selling McNess daily necessities a snap.

We Supply Capital—Start Now!

There's no better work anywhere. Pays well, permanent, need no experience to start, and we supply capital to help you get started quick. You begin making money first day. Write at once for McNess Dealer Book. It's FREE. Tells all—no obligation. (1)

THE McNESS CO., 320 Adams St., Freeport, Ill.

Use Your CAR to Raise Your PAY

CECO WHIZZ!!

10" All-Purpose Wheel



Double Radial Ball Bearings give this wheel speed plus! Puncture proof balloon—10" x 1 3/4". Heavy duty wheels—for racers, 4 wheel trucks, wagons, market carriers, golf bag carriers, scooters, garden and porch furniture, etc., etc.

Ceco "Whizz" wheels are completely assembled; ready for immediate use. They're smooth, quiet, stream-lined, STURDY. (We have axles and other parts; ask for prices.)

Cash with order or P.P., C.O.D. Supply limited; order today!

Dealers—Write for Quantity Prices.

\$2.75 COMPLETE Including Tire and Bearings EACH Set of 4—\$10.80

CECO SALES CO.

164 - 25th St., Brooklyn 32, N. Y.

FREE PLASTICS CATALOG

Tells about a new source of supply for everything you need to make beautiful projects of crystal-clear Plexiglas. Included is a fine assortment of ready-made kits based on what the craftsman needs. Available also are permanent dyes for coloring, polishing rouges, and a quick-setting special cement. You also get complete instructions on how to cut, drill, form, and polish. There's also a big "grab bag" kit out of which you can make hundreds of projects. Send for your free copy today.

Jackson Studio, Dept. M, 5440 N. Shoreland Ave., Milwaukee 11, Wis.

BUILD ARC WELDER PLANS 35c

We Show You How to build this new powerful welder without rewinding. For light or heavy work. Uses coils taken from old auto generators. Works on 110 or 220 volts A. C. Has 20 different heats. Send 35c for complete PLANS and valuable Catalog. Write today. **LEJAY MFG. CO., 1347 LeJay Bldg., Minneapolis 8, Minn.**



NEW-ALL QUICK CHANGE GEAR BOX
Increases Production up to 1000%

NEW IMPROVED MODEL!

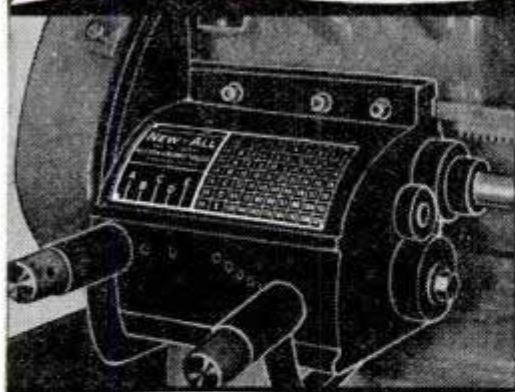

**PAYS
FOR
ITSELF
in
30
DAYS!**

30-DAY Money-Back Guarantee!

Drastically Cuts LABOR COSTS!

NO TIME LOST FINDING GEARS! Inexperienced workmen easily produce top output. Easy to install. You simply drill and tap four holes.

Guaranteed Accuracy!

IS GUARANTEED TO CUT ACCURATE THREADS from 4 to 224 per inch with approximately 3/1000 feed for fine turning. It safeguards entire production in process throughout the complete operation.

Precision Constructed

PRECISION CONSTRUCTED THROUGHOUT with gears of quality hobbled steel. Gear Box housing is made of high grade aluminum alloy casting—with replaceable bronze bearings.

NEW LOW PRICE . . . \$75.00 F.O.B. Los Angeles
For ATLAS, CRAFTSMAN, LOGAN, POWERKRAFT and SOUTH BEND 9-in., B & C.—Use Your Own Lead Screw.

Write Div. PM-11

WESTERN AIRCRAFT TOOL CO.
650 No. Hoover St. Los Angeles 4, Calif. NOrmandy 2-4711



Send for Free List of LEADING BOOKS

on WATCH REPAIRING, Clock Repairing, Engraving, Industrial Diamonds, Aircraft Instruments, etc.

HENRY PAULSON & CO. CHICAGO 3, U.S.A.

BECOME A MANUFACTURER'S AGENT

Engage in this highly profitable field. Be a substantial business man with little or no capital investment. Information supplied on methods of securing lines and companies to represent with details of operations. Digest and instructions on How to Become a Manufacturer's Agent sent postpaid for \$2.00. Satisfaction Guaranteed.

VIMAR COMPANY, Dept. 7, 536 Andrus Bldg., Minneapolis 2, Minn.



AUTO DRIVER

**Cold Weather Coming—Avoid SLOW STARTING
RUN DOWN BATTERY
ICE IN CARBURETOR
REPAIR BILLS**

Put the

SKINNER GASOLINE PURIFIER

on your car or truck **NOW**

The Skinner Purifier with everlasting Kwick Klean Kartridge is **GUARANTEED** to remove water, oil, dirt from fuel

TAKES 10 MIN. TO INSTALL—LASTS A LIFETIME

ALTBROOK PRODUCTS CO., 30 W. Washington St., Chicago, Ill.
Send me the Skinner Purifier. Enclosed find \$2.10. I will pay the postman \$2.10 plus postal charges.

Name

Address

Make and year of car

NOVEMBER 1946

You'll Save Money and Oil!

When your service station  makes this **Free AC Oil Test** and the **AC Test Pad** shows

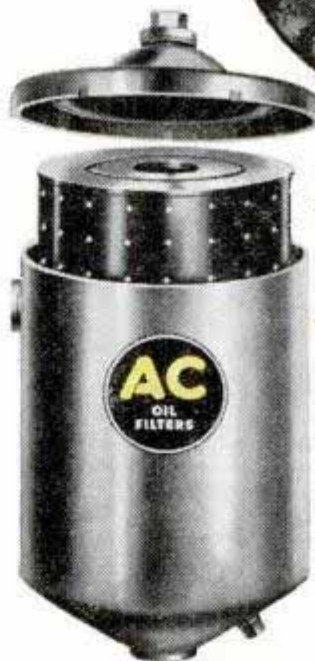

YOU TELL THE SERVICE MAN TO PUT IN THIS OR PUT IN THIS

Dirty oil wastes gasoline, as well as oil, and clogs vital oil slots in the piston rings. Then, carbon forms faster, valves gum, power is lost. Overhaul expense soon follows. So, get the **FREE AC Oil Test**, regularly, wherever you see the yellow - and - black

official AC Sign. Keep your oil clean with AC replacement Elements and AC Oil Filters.

AC SPARK PLUG DIVISION • GENERAL MOTORS CORPORATION



OIL FILTERS

SAY YOU SAW IT IN POPULAR MECHANICS

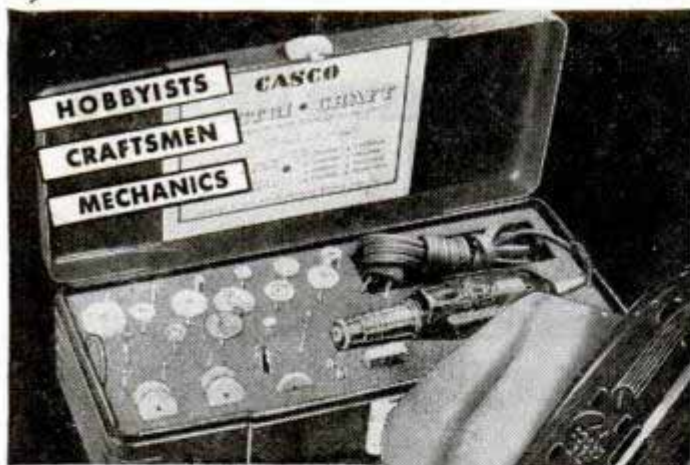

**A WHOLE SHOP
FULL OF TOOLS
IN ONE!**

Use it for grinding, routing, drilling, sawing, polishing, carving, sanding and 9,994 other uses. Increases your skill and your scope. Precision-engineered, AC-DC. More exclusive features than any other tool.

Works **Wood, Metal,
Glass, Plastics**

Exclusive
Safety
Fingergrip
for fine
detail work

\$2250

**COMPLETE WITH 36 ACCESSORIES
IN FITTED STEEL CASE**

\$31.75 Value if
Purchased Separately

CASCO ELECTRI-CRAFT TOOL KIT
CASCO PRODUCTS CORPORATION, BRIDGEPORT 2, CONN.

4 Project PLASTICS KIT!

**MAKE USEFUL OBJECTS
WORTH \$15.00 TO \$25.00**

Have fun, make money, with new 4-Project Plastics Kit with transparent Plexiglas and Lucite materials cut to size, plus cement, to make Paper Knife, Cigarette Box with Match Holder, Picture Frame, Candy Dish. Use simple home tools, coping saw, file, sand paper, kitchen oven and water glass. Produce objects which sell at \$15.00 to \$25.00 in gift stores. Or get same Kit, PLUS new Coloring Outfit for \$4.50. Includes Dyes, Cement, complete instructions, to produce gorgeous shades of aqua, gold, green, old rose and black. Many make big profits part-time and full-time. Use handy coupon.

**NEW 10,000
Word Manual
25c**

New fabricating manual sent postpaid for 25c. Gives answers to your plastics problems. Shows how to get best results in minimum time. Use coupon—NOW.

Now \$2.85
Only 2⁸⁵
POST PAID

MAKE
Objects shown, in transparent Plexiglas, or in gorgeous colors. Use at home or sell at big profit.



PAPER KNIFE



PICTURE FRAME



CIGARETTE BOX AND MATCH HOLDER



CANDY DISH

Mail KIT COUPON!

HOUSE BEAUTIFUL PLASTICS
Dept. M-3, 5534 W. Harrison St. Chicago 44, Ill.

Send materials with instructions as checked:

4-Project Kit postpaid. (I enclose \$2.85).

4-Project Kit, and Coloring Outfit of Dyes and Cement, C.O.D. for \$4.50 plus delivery charge.

I enclose 25c. Send Plastics Fabricating Manual, and Plastic Materials Price List.

Name.....

Address.....

City.....State.....

PAY-RAISING — EXTRA MONEY BOOKS

Use these books to prepare for a better job—bigger pay—to start a profitable spare time or full time business of your own, improve your home, start a hobby. Popular Mechanics specializes in popular mechanics books on many subjects. Send

supplying outstanding self-help books for our FREE catalog.

- How to Remodel a House**
Nothing is omitted...\$4.75
- Painting, Furniture Finishing & Repairing**
*New self-help book for craftsmen, home owners...\$1.50
- Shop Notes for 1947**
Now ready. For every man who uses tools...60c
- Shop Notes Library**
5 Vols.—1946, 45, 44, 42, 41. (No Dup. Mat.)...\$3.00
- Welding, Brazing & Soldering**
How to build own equipment and use it effectively...\$1.25
- Garden Book**
Build own trellises, lawn furniture, fireplaces, ornaments, etc....\$1.00
- Forty Power Tools**
Build own saw, drill, lathe, sander, etc., from scraps—save money...\$1.25
- Rewinding & Servicing Electric Motors (No. 75)**...25c
- Turn Scrap Into Money**
Convert old auto generators into motors, welders, etc. \$1.00
- House Wiring (No. 89)**
All information needed to do complete job...25c
- Modern Refrigeration**
Electric, Gas. Be service expert...\$5.00
- Dyke's Auto Ency. (includes Diesels, airplane engines)**
New 20th Ed. World's greatest book for mechanics...\$7.00
- Sheet Metal Work**
Self instruction in all phases...\$2.50
- Tool & Saw Sharpening (No. 92)**...25c
- Armature Winding**
Construction, winding, repairing AC & DC Motors, generators...\$2.00
- Build Your Own Boat**
Describes 17 popular boats—rowboats, sailboats, plywood outboard, etc. 192 pages \$1.50
- Forging Practice**...\$1.50
- Toys You Can Make of Wood**...\$2.50
- Carpentry**
Learn modern methods...\$2.00
- Foundry Work**...\$2.00
- Pattern Making**
Wood, metal...\$2.00
- Action Toys (No. 66)**
Plans for 21 easy-to-make toys...25c
- The Young Craftsman**
Over 450 things boys can make...\$1.50
- Five Acres and Independence**
How to make money on small farm...\$2.50
- Modern Welding Practice**
Useful data on welding of all kinds. Simplified, non-technical, easy-to-understand...\$3.50
- How to Plan a House**
Every detail carefully explained. 325 pages...\$4.50
- A Small Store and Independence**
Guide to successful retailing...\$2.00
- Modern Gas Turbine**
Complete up-to-date information on uses as supercharger and prime mover. Includes jet propulsion...\$4.00
- A.B.C. of Poultry Raising**...\$2.50
- How to Build Violin, Pipe Organ, Banjo-Uke**...\$1.00
- Knots, Ties, Splices**
For everyone who uses rope...\$1.25
- Plastics**
Latest information on manufacture and use...\$4.00
- Workbenches & Tool Cabinets You Can Build (No. 47)**...25c

- Concrete Handbook**
New book on using concrete around home, garden, farm...\$1.50
- Oil Burner Handbook**...\$2.50
- Photo Guide**
Construct own equipment, gadgets. Make better photos...\$1.50
- Welding, Electric**...\$1.25
- Welding, Oxy-Acetylene**
Welding, cutting...\$1.25
- Metallurgy**...\$2.50
- Ropp's Calculator**
Figuring made easy...50c
- Plumbing Installation & Repair**
For those without previous training...\$2.00
- Judo, 30 Lessons in Modern Jiu-Jitsu**...\$2.50
- Tool Making**...\$3.50
- Tool Design**...\$4.50
- Mechanism**...\$3.50
- Air Conditioning—Heating and Ventilating**
Principles and general applications of steam, hot water, vapor and vacuum heating...\$4.00
- Audels Sheet Metal Pattern Layout**...\$4.00
- Estimate for the Building Trades**
How To: Material and labor costs for masonry, plumbing, electricity, carpentry, heating, hardware, painting, etc. 629 pp. \$4.75
- Audels Masons and Builders Guides**
For Bricklayers, Cement workers, Plasterers, Tile Setters and Stone Masons.
4 Vols. \$1.50 each
- Lejay Manual of Home Made Electric Equipment**
How to construct 100 items that are scarce and valuable...\$1.50
- Drake's Refrigeration Service Manual**...\$2.00
- Slide Rule Simplified**...\$2.50
- Mathematics for Ready Reference**
Covers all phases of mathematics...\$2.00
- Mechanical Drawing Self-Taught**
With 21 simple step-by-step exercises, 56 pages of illustrations showing how to do it...\$1.00
- Audels New Automobile Guide**
1600 pages...\$4.00
- New Small Homes**
62 practical and popular designs...50c
- The Vegetable Growing Business**...\$3.50
- Rabbits for Food and Fur**...\$2.50
- Furniture Joinery**...\$2.50
- Principles of Woodworking**
Tools, processes, materials, projects...\$2.00
- Pottery Made Easy**...\$2.50
- The Art of Wood Turning**...\$2.00
- Essentials of Upholstery**...\$2.75
- Radio Physics Course**...\$5.00
A thorough training in radio fundamentals.
- Bookkeeping for Personal and Business Use**...\$2.25
- The Art of Inventing and What to Invent**...\$3.00



MAIL THIS COUPON TODAY

Check the books you want, write your name and address below, and mail this advertisement with money order or check. Outside U. S. A. include 15% additional for shipping charges.

Books selected will be mailed promptly on our "money back if you're not entirely satisfied" guarantee.

Name.....

Address.....

City.....State.....

Mail to POPULAR MECHANICS PRESS.
Dept. 604—200 East Ontario St., Chicago 11, Ill.

SAY YOU SAW IT IN POPULAR MECHANICS

**QUICK • SAFE • SURE
THE EASY WAY TO KILL**

RATS

You'll find K-R-O quick acting. It's constantly checked to maintain highest killing power. Made of *red squill*, it's *safer* to use around children, livestock, pets, and poultry. K-R-O kills rats or your money back! IN 2 FORMS . . . K-R-O Bis-Kits (nothing to mix) at 35c and \$1 . . . K-R-O Powder (enough to make 200 baits) only 75c. At most drug, feed, and seed stores.

FREE "Rat Proofing Buildings and Premises," by U. S. Dept. of Interior. Write for your copy, now. The K-R-O Company, Springfield, Ohio, Dept. 163.

K-R-O



**NOW! EASY-TO-MAKE
HOMECRAFT NOVELTIES
FOR PLEASURE AND PROFIT!**

FREE! NEW 40-PAGE CATALOG

Our new book is crammed with money-making facts about Leather Craft, Wood Carving, Clay Modeling, Lacing and Braiding, Wood Burning (Pyrography), Showcard Lettering, Ready-to-Finish Woodcraft, Plastics, Marblite Molding, etc., mailed FREE with order. Or send 10c for book only.

SPECIAL! EASY MONEY-MAKER!

Newest fashion idea. Leather Link Belts. Very smart for both men and women. Kit including everything for six easy-to-make belts (2 white, 2 black, 1 brown, 1 natural) to sell at \$2 each (\$12 total) sent to you complete for only \$3.50 postpaid. Or C.O.D., you pay postage. (No Canadian C.O.D.'s and no foreign shipments made.) Money back if not delighted. Sample Kit (1 belt) \$1.

DWINNELL CRAFT SHOP, Dept. P-611, Elm Grove, Wheeling, W. Va.

START HOME MAIL ORDER BUSINESS

Start small — grow big. Amazing new course shows you the way. Rush your name and address today for full particulars. No obligation. BELFORT (Dept. A) Engineering Bldg. Chicago 6, Ill.

Rubber Mold Latex

For making rubber molds. Qts. \$3. Doz. lots \$1.95. Gallons \$10.50. Best quality. Free instructions. Send remittance with order. CERTIFIED PRODUCTS CO., Dept. 90, Louisville, Ky.

HOLD-E-ZEE

**AUTOMATIC GRIP
SCREWDRIVERS**

**MORE WORK
IN LESS
TIME!**

PATENTED

UPSON
BROS., INC.,
86 Exchange St.,
Rochester 4, N. Y.

Hold-E-Zees do the job better, faster. They excel wherever screwdrivers are used. Gripper instantly released by spring action, sliding up out of way when not in use. All materials highest quality.

AT LEADING DEALERS EVERYWHERE

**Make Up To \$600
An Hour!**



Operate Your OWN Home- Weaving Business With AMAZING New DEEN Power Loom!

Make yourself financially independent! Start a steady business of your own . . . right in your home! Earn BIG PROFITS by weaving thousands of different designs of rugs on the new easily operated Deen Power Loom. Machine will automatically weave ten yards of beautiful intricate designs every hour.

DEEN LOOM TAKES UP LITTLE SPACE. You can put this marvelous weaving machine in a corner of your living room, basement, garage, or spare bedroom. Then later on, as your business expands, you can move into regular business establishment.

IDEAL BUSINESS FOR HANDICAPPED PEOPLE such as veterans and persons handicapped by loss of sight or limbs, and those unable to do strenuous labor. Loom is simple to operate . . . a child can run it. Any rug design you wish can be woven by merely changing paper guide pattern.

ORIGINAL INVESTMENT CAN BE RETURNED IN THIRTY DAYS. A small investment gets you started in your own business right away. Deen Loom has capacity of from eighty to one-hundred yards a day . . . in only one month it is possible to get back your original investment. Demand for home-woven rugs is GREATEST IN HISTORY. DON'T DELAY . . . start making plans for your own business NOW. Write today for free descriptive booklet and full information. Address THE GIBSON COMPANY, DEEN LOOM DIVISION, HARLAN, IOWA.

Distributorships Still Available in Some States

"Makers of DEEN Looms — FAMOUS Since 1895"

TWO-SPEED BREAST DRILL

ONLY \$450

NO. 50. Chuck capacity to 1/2". 3 steel chuck jaws, spring-controlled. Drill has two speed gears. Finished in cadmium nickel and red and black enamel, mahogany-finished handles.



HEAVY DUTY POLISHING HEAD ONLY \$600

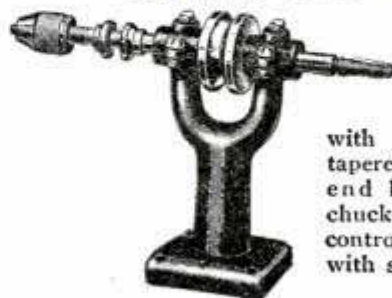

NO. 200A. Massive, sturdy, made of cast aluminum. Tool steel shaft with adjustable bearings tapered at one end; other end has 3/4" capacity chuck, with three spring-controlled jaws. Furnished with steel flange nuts.

NO. 211. JUNIOR SIZE, 1/4" . . . \$3.00

MARS PRODUCTS COMPANY

1170 BROADWAY, DEPT. CA NEW YORK, N. Y.

LOOK FELLAS!



The New Model
G-BOY
AUTOMATIC
REPEATER
PISTOL

Rapid Fires
50 Shots

Using any roll caps



The Most Realistic Toy Pistol Made **\$1.95**

What a thrill for any boy! This beauty of a repeater pistol. So keen-looking it will make him the envy of his pals. So absolutely safe, too, with caps enclosed by cover. Gun is made of die-cast white metal that won't break. Steel mechanism makes rapid-fire operation easy. Send for it now! Use coupon below.

ROLL CAPS
high quality, 50 shots each roll; 35 rolls (1750 shots) **\$1**

SEND NO MONEY!

"OFFICIAL" SALES COMPANY, Dept. O-2
2323 S. Michigan, Chicago 16, Ill.

- Send me G-Boy Automatic Pistol, \$1.95 With Roll Caps, \$2.95
 I will pay postman C.O.D., plus postage
 I enclose check or money order; you pay postage

Name _____
Address _____
City _____ Zone _____ State _____

WE CAN DELIVER NOW!



Radios 5 Tube A.C. & D.C.
15.95 and 24.50
Electric Food Mixers
9.95 and 22.50

Automatic Electric Irons
6.95 and 8.95
Plain Electric Irons
3.98 and 5.75



Electric 2 Slice Toasters
2.98 and 3.95
Electric 2 Burner Cookers
5.45 and 6.75

8 Light Christmas Tree Outfits
1.98 and 2.98
7 Light Christmas Tree Outfits
Best grade 3.95
Electric Room Heaters
3.98 and 5.98

Catalog shows 600 hard-to-get items—Electrical Appliances, Cooking Utensils, Hardware, etc.

JOSEPH WINKLER & CO.
671 N. Clark St., Dept. 796, Chicago 10, Ill.

WRITE FOR FREE ILLUSTRATED CATALOG



Boys! Girls! Here's the famous WOODY HERMAN "SWEETWIND"

An exact copy of Woody Herman's Celebrated Clarinet . . . a real musical instrument that you can quickly learn to play . . . with your "Sweetwind" comes an easy-to-follow song and instruction sheet—prepared by Woody Herman himself. High paying jobs with big name bands are always available to those who qualify. Learn to be a musician—let Woody Herman and the "Sweetwind" show you the way to a musical career! In no time at all you can learn to play almost anything you wish and wherever you go, you will be the life of the party! "Sweetwind" **\$1.95** and instruction sheet only **\$1.95** postpaid.

Send check or money order.

mayfair Gifts 72-08A AUSTIN ST.
FOREST HILLS, N. Y.

THE WORLDS' ONLY "SKY-FLYER"

GIANT 4 FT. PLANE TRAVELS WITHOUT A MOTOR

STAYS IN THE AIR FOR HOURS

OVER 1000 FT. ALTITUDE

STUNTS

MAIL YOUR ORDER NOW
Write Name Plainly and Enclose \$1.00

READY CUT & COLOR MARKED VERY SIMPLE TO ASSEMBLE
We Pay Postage in U.S.A. Only

AGENTS WANTED

THRILLS... FUN GALORE FOR YOUNG & OLD

Price Per Plane **\$1.00** POSTPAID

SKY-FLYER SALES CO., NEW HYDE PARK, L. I., N. Y.

12 lbs. SURPLUS RADIO PARTS...\$2.00

A gold mine of parts for repairmen, amateurs, and experimenters . . . relays, condensers, resistors, transformers, coils, hardware, wire, etc., etc. An outstanding bargain in **usable** parts! Send cash, check or M.O. today!

ELECTRONIC PARTS, Inc. Dept. M, 622 W. Randolph St. CHICAGO 6, ILL.

SAY YOU SAW IT IN POPULAR MECHANICS

INVENTORS' ADVISORY SERVICE

Before spending time and large sums of money on final development and patent, get reliable impartial advice and constructive criticism from qualified technicians on the practicability, manufacturing problems and possible sales demand of your invention. SEND POSTCARD FOR FULL INFORMATION.
CARSON CONSULTANTS, Dept. PM, 30 W. Washington St., Chicago 2, Ill.

SELL MERCHANDISE BY MAIL

Operate profitable home business selling merchandise by mail. 75c profit on fast selling \$1 items. Write TODAY.
POWELL CO., Dept. A, Sampliner Bldg., Cleveland 3, Ohio

Big Money for Workers In Home or Shop



Licensed Concrete Specialists wanted. No experience needed. Make *Colorglazed* concrete pottery without molds. New, low cost, patented method. Cemetery products, novelties, tiles, etc. Basement leaksealing. Other big pay projects. Booklet, details free. Men only.

NATIONAL POTTERIES COMPANY
542 Lincoln Avenue Fergus Falls, Minnesota

POPULAR MECHANICS

HAND MICROPHONE



Top quality hand microphone with control button in handle. Highly sensitive. Has rubber covered cord and tel. plug. Fine for use on home recorders, public address systems, etc. Brand new—perfect. Shp. wgt. 2 lbs. Stock No. 170. Each... **\$1.95**

HAIR CLIPPER

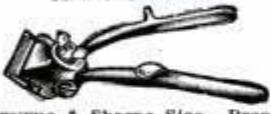

Browne & Sharpe Size. Brand new. Clean cutting—easy working. Stays sharp thru long service. Bright finish. Shp. wgt. 1 lb. No. 333—Each... **\$3.75**

Shatterproof Goggles



All purpose type. Sponge rubber frame. Red shatterproof flexible lens. Adj. head band. With case. New. Wgt. 1 lb. No. 139—Each... **39c**

POPULAR RECORD ASSORTMENT



Fifty records of modern dance, race, blues and hillbilly selections. No two alike. Famous name bands and artists included. Used in juke boxes, but guar. perfect. Shipped exp. collect only—no exchanges or refunds. Wgt. 28 lbs. No. A303—30 records... **\$9.64**

PROF. TELEGRAPH KEY

Purchased from the gov't. Finest design and construction. Base measures 3 x 4 3/4 inches. Original value \$2.50. All parts of instrument brass. Adjustable. A-147. Each... **98c**



2 Man Mountain Tent

Regulation Army type two man mountain tent. Complete with poles, guy ropes, etc. Of durable nylon with reinforced seams. Ideal for outdoorsmen, campers, etc. Shp. wgt. 10 lbs. A splendid value. Stock No. 202—Each... **\$9.95**

PUP TENTS



Regulation Army Pup Tents of durable, brown canvas. Used, but in good condition. Fine for campers, outdoorsmen, boy scouts, etc. Grand Xmas gift for children. Wgt. 8 lbs. A1—Tent only... **\$3.95**
A10—Tent, new... **\$7.95**
A101—Ropes, wooden poles and stakes for above. Per set **\$1.00**

MOSQUITO TENTS

Completely covers cot or hammock. Of fine mesh mosquito netting with taped seams. Metal rods and cross bars included. New! Shp. wgt. 4 lbs. No. 104—Each... **\$2.95**

SACHEL POUCH

Heavy canvas pouch. Ideal for toting lunches, shopping, books, etc. Has three 11 x 12 inch pockets. Brand new, guaranteed perfect. Has oversize flap with single strap fasteners. A113—Each... **\$1.69**



WAR SURPLUS AND HUNDREDS OF OTHER BARGAINS

SIGNAL MIRROR



Used by downed airmen for rescue signalling. Brand new. Measures 4x5 in. with sighting guide. Shp. wgt. 1 lb. Stock No. 527—Each... **98c**

KAPOK LIFE JACKET



A bargain surplus. Made of heavy OD material treated to be fire resistant. Filled with genuine kapok—more buoyant than cork. Worth twice this price. A real "buy" for boat owners, etc. Shp. wgt. 3 lbs. No. 546—Each... **\$2.95**

7 LB. EXPERIMENTER PARTS ASSORT. KIT



A "gold mine" for the radio serviceman. Hundreds of valuable radio parts, new radar and electronic parts and subassemblies, coils, resistors, trimming condensers—worth many times this low price. A130R—7 lbs... **\$1.79**

LIFE PRESERVER BELTS

Right from the invasion beaches. Consists of two air chambers. May be inflated automatically with "sparklet" cartridges or manually by attached hose. Adjustable in waist size. One air chamber guaranteed air tight—other may need a tire patch. All belts are used and slightly soiled but a bargain at this low price. No. 1261—**\$1.00** Each

SPARKLET CARTRIDGES
May be used with above belts. Also for making charged water. In boxes of 10. Stock No. 254. Per Box... **50c**

6x30 PRISM BINOCULARS

Bausch & Lomb make. Prism type individual eye focus. With leather case. Power 6x30. Used but perfect. \$100 value. Wgt. 5 lbs. No. 505 Price **\$37.50 plus \$7.50 tax. Total \$45.00**

JUNGLE HAMMOCK
For back yard, country home and camp use. Has waterproof roof with mosquito-proof nylon netting sides. Lets you sleep outdoors safely. Finest construction. Originally designed for U. S. Army use. Shp. wgt. 7 lbs. No. 134—Each... **\$9.95**

G.I. POCKET STOVES
Famous Coleman make. Burns gasoline. Use it for cooking, heating, etc. Metal container makes 2 cooking pots. Folds to 8 1/2 x 4 1/2 ins. Remarkably efficient—well made. Brand new. Shp. wgt. 3 1/2 lbs. No. 5530. **\$10.95** Each

U.S. Govt. BOLO KNIFE
Extra heavy. For farm, home or jungle use. Blade of Gov't. formula cutlery steel. Walnut riveted handle. 3 1/2 inch hilt, 10 1/2 inch blade. You'll find hundreds of uses for a Bolo knife. Blade will take and hold a keen cutting edge. Wt. 2 lbs. A112—with Army Sheath... **\$4.95**

MESS KITS
Regulation two-piece Army Mess Kits with folding handle. Used, but perfect. Weight 2 lbs. No. A116—Each... **69c**

CANTEENS
Reg. U.S. issue canteens. Plastic screw top chained to body. Slightly used but perfect. Wgt. 1 lb. 117—Metal **69c**
118—Plastic—Each... **69c**

CANTEEN CUPS
All metal. Folding handle. Wgt. 1 lb. No. A120—Each... **25c**

CANTEEN COVERS
Heavy canvas. Button fastener. New No. 530—Each... **69c**
Used No. 118—Each... **35c**

ARMY BANDOLERS
Of fine heavy khaki. Big roomy pockets with snap button fasteners. Fine for hunters, campers, boy scouts, etc., also for shop work in carrying small parts, etc. Material alone is worth this price. Shp. wt. 1 lb. 11 Pocket Type No. 120 Each **49c**
5 Pocket Type No. 110 Each **29c**

Wool Blanket
Full size and 100% wool. Used but renovated for re-issue. Use for camping, etc. Shp. wgt. 3 lbs. No. 233—Each... **\$4.89**

MOISTURE ABSORBENT
Protek-Sorb. A protective absorbent that eliminates moisture damage. In cloth bags of 4 oz. No. 138—Doz. 4 oz. bsgs... **\$1.00**

WIRE PLIER
Genuine Bernard 6 1/2 inch wire cutting plier. Parallel orienting jaws. Reg. \$3.00 value. Wgt. 1 lb. No. 168—Each... **\$1.29**

ORDER DIRECT FROM THIS AD

Values galore! Hundreds of hard-to-find items for home, shop and outdoors. Make remittances by money-order, bank draft or personal check. Send 25% deposit on C.O.D. orders. No C.O.D.'s on orders for less than \$5.00. Include sufficient postage on parcel-post orders—any coverage will be promptly refunded. All quotations F.O.B. Chicago. Used items and materials are guaranteed serviceable and as described. Your money back if not more than satisfied.

Big Illustrated Catalog Free

STARK'S Dept. PM1146
509 So. State St.
CHICAGO 5, ILL.

BUILD THIS RADIO

Learn Step By Step

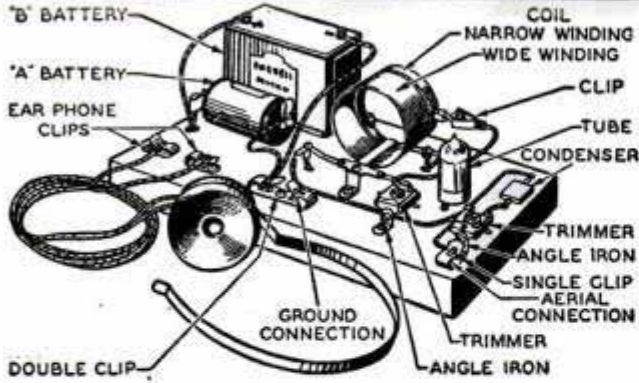

Have fun building your own Sky Prancer Midget Radio. Learn money-making radio principles. You can do it this easy, practical way.

Radio Kit comes complete with simplified, illustrated instructions for 10 educational experiments. Numbered and color-coded. No soldering, drilling or punching. Gets local, police, short wave and distant stations. Can be used as transmitter.

Complete with tube, phone and batteries, only \$7.95 postpaid. Or send \$1.00 and pay postman balance plus postage. **Order Today.**

Chapin Electronics Co., Inc.
Dept. A, 134 W. Onondaga St., Syracuse 2, N. Y.

SAY YOU SAW IT IN POPULAR MECHANICS



SIGNAL CORPS MICROPHONE

\$2.00

Add 25c for postage and handling

Here is a real communications microphone of the finest quality beautifully made by one of the nation's leading microphone manufacturers. They are widely used by the Army and are perfect for any communication or public address work. You can also entertain your friends by attaching it to your radio. Every microphone is brand new and complete with "press to talk" button, 3 wire rubber covered cord and plug. Send check (or M.O) for \$2.25 and we will ship your "mike" immediately parcel post prepaid in original tropicalized carton. (U.S. only.) Fully guaranteed.

Hundreds of Radio-Electronic Values

Our new catalog of exciting Army and Navy contract termination radio parts and equipment is now ready. Everything is new and has been carefully selected for radio amateurs and home experimenters. Send a dime today for your copy of catalog H 200.

WELLS SALES, INC.

4717-S West Madison St.

Chicago 44, Ill.

Handy Mail Order List

Little Library of Useful INFORMATION

5 for \$1.00
12 for \$2.00
25¢ Each

Here at amazingly low cost is the practical help and information you have always wanted. Articles in previous issues of Popular Mechanics have been classified according to subject and are now available in these handy reprint booklets.

How to Use Measuring Tools—Micrometers, Calipers, etc.—106.

Power Driven Saws—74. Drill Presses, Grinders, Etc.—79. Wood, Metal Turning—Lathes—81. Filing Machine, Hacksaw, Cut-off Wheel, Shaper—82.

Lathe Tools You Can Make—101. Workbenches—Tool Cabinets—47. Spray Painting—94. From Pattern to Casting—91. Tool and Saw Sharpening—92. Sharpening Drills, Wood Bits—90.

Successful Wood Turning—32. How to Read Blueprint—71. Metal Turning Lathe Kinks—99. Operating a Metal Lathe—100. Heat Treating, Hardening—102. Working With Glass—103.

Servicing Elec. Motors—75. Electromagnets & Solenoids—44. Transformer Construction—41. The Boy Electrician—43. Soldering and Brazing—17. Arc and Spot Welders—5.

Electroplating With Nickel, Chromium, Cadmium, Etc.—86. Plating Leather, Wood, etc.—87. Lower Your Fuel Costs—31. Curing Leaky Basements—45.

Fitting Home Game Room—55. Indoor & Outdoor Fireplaces—88. Backyard Gardening—39. Lawn and Garden Novelties—72. Trellises, Pergolas, Fences—76. Lawn and Garden Furniture—77. Playground Equipment—73.

Concrete Garden Furniture—6. Making Serving Trays—53. Sanders—80. House Wiring—89. Treasure Finders—13. Hanging Wallpaper—38. Built-in Fixtures—78. Bird Houses—7. Magazine Racks—49. Clock Cases—50.

Book Ends—52. Small Tables—54. Smoking Stands—56. Desks—58. Book Cases—59. Action Toys—66. High Flying Kites—67. Telescopes—20. Metal Craft—28.

Small Looms—37. Gem Cutting—42. Photo Enlargers—1. Photo Kinks—98. Cleaning Formulas—11. Taxidermy—9. Magic—29. Training Dogs—35. Small Furnaces—36.

Knots and Ropework—105. Working With Plastics—61. Simple Home Improvements—104. Ridding Home of Insect Pests—107. Children's Room Furniture—51. Jigsawed Novelties—57. Doll House & Doll Furniture—60. 25 Shelves You Can Make—64. Novelties Turned on Lathe—62. Inlay Pictures—Veneering—63. Wood, Soap Carving—65. Windmills & Weathervanes—68. Lamps from Wood, Metal—69. Rustic Furniture—18. Wood Finishing—40. Boats—14 ft. Outboard—2. Boats—14 ft. Sail Dinghy—26. Boats—21 ft. Sloop—46. Rowboats, Small Dinghy—83. Small Sail Boats—84. Two Outboard Runabouts—85. Build Own Canoe, Kayak—30. Build Class-E Ice Yacht—22. Auto Kinks, Shortcuts—10. Building Trailers—27. Motor-Driven Midget Cars—34. Stop Auto Elect. Troubles—95. Photo Printers and Dryers—25. Photo Darkroom Equipment—96. Trick and Table Top Photos—97. Cosmetic Formulas—12. Poultry Houses—108. Guns and Decoys—109. Re-Silvering Mirrors—70. Chemical Experiments—93. Log Cabins, Tourist Houses—14. Trapping Small Animals—33. Farm and Garden Tractors—8. Building Extra Attic Rooms—23. Attractive Basement Rooms—24.

Check Titles Wanted, Clip, Mail with Remittance to

POPULAR MECHANICS PRESS, Dept. 635, 200 E. Ontario, Chicago 11



MAKE YOUR OWN
POWER TOOLS
at Low Cost
from old Auto Parts, etc.



A New Edition

Featuring TOOLS of WOOD

Now you can have a good lathe, drill press, circular and band saw and other power tools in your home workshop, at a cost of only a few dollars each. Make them yourself from old auto parts, discarded sewing machines and other odds and ends that cost little or nothing. Get this new book—"Forty Power Tools You Can Make." Costs only \$1.25 postpaid. This book gives every detail in plain language you can understand and follow. Hundreds of pictures and plans show every step to follow in making the power tools you want. Actual photographs of finished machines included. Send \$1.25 today. Money back if not satisfied.

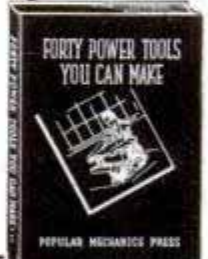

MAKE EVERY POWER TOOL NEEDED IN YOUR HOME WORKSHOP

- Some of the power tools you can make are:
- | | |
|--------------------|------------------------------|
| 2 Band Saws | 2 Drill Presses |
| 9 Sanding Machines | 1 Scroll Saw |
| 2 Circular Saws | 2 Wood Turning Lathes |
| 1 Metal Lathe | 3 Grinders |
| 1 Power Hack Saw | 1 Shaper or Moulding Machine |
| 1 Jig Shears | 1 Vibrating Pencil |
| 1 Cut-Off Wheel | and others |

Information too, about pulleys, belts, motors and drive methods. Just published. No other book like it. Order today.

POPULAR MECHANICS PRESS

Dept. 621

200 E. Ontario Street, Chicago 11



5
LATHE
DRILL
PRESS
CIRCULAR SAW
EMERY WHEEL
SANDER

Durable! Powerful! Heavily Built!
 Five power tools in one compact unit. Fabricated steel construction with high quality bronze bearings. Lathe 37" between centers. 6" or 8" circular saw. Drill press pulls 1/2" drill in steel. Uses 1/4 H.P. motor. Designed to handle all types of home woodworking jobs. Get the facts now before prices advance. Write Today!

EMRICK MACHINE CO.
 1602 FULFORD ST.
 KALAMAZOO, MICHIGAN

Write — FOR LITERATURE
MAKE MORE MONEY

APPLYING OR SELLING
CORKSTONE
PLASTIC FLOORING

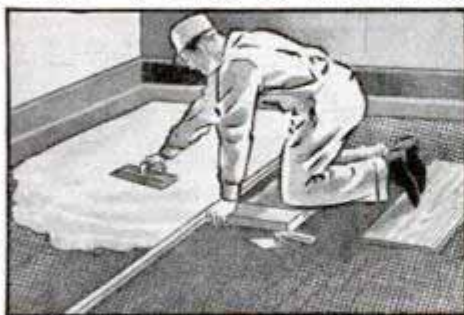

EASY TO APPLY

Here's your opportunity to get into business for yourself applying or selling Corkstone, the economical, top-grade plastic flooring. Plenty of profit. Act without delay!

Dealers & Agents Wanted
 WRITE FOR DETAILS
LASTING PRODUCTS COMPANY
 FRANKLINTOWN ROAD PLANT, BALTIMORE 23, MARYLAND

Hobart Bros. Co., Box 1116, Troy, O. "One of the World's Largest Builders of Arc Welders"



FREE
 Welder's Vest Pocket Guide

I'm interested in Hobart Arc Welding. Send my free book, and details on items I've checked below:

- Gasoline Drive Welder
- Build Your Own Welder
- A. C. Arc Welder
- Welding School

NAME _____

ADDRESS _____

Arc Welding
is Easier...

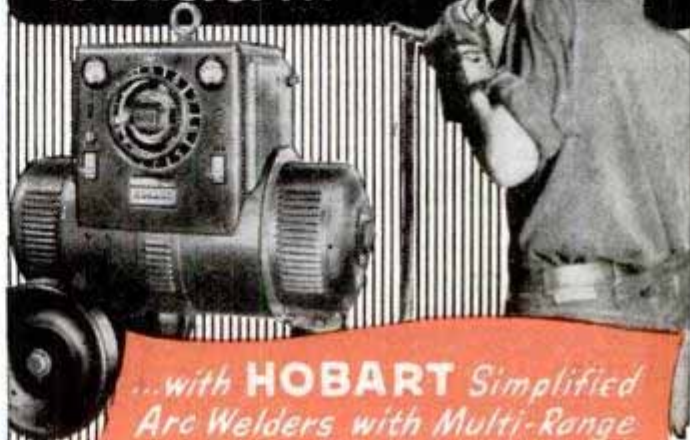

...with **HOBART** Simplified Arc Welders with Multi-Range and Remote Control



Gas Drive Portable



Generator Only



Start Your Own Business!

Here's your best opportunity to be your own boss and get into the big money! Start your own job welding shop — only a minimum investment is required. Hobart offers you 1000 welding combinations with Multi-Range Control for better welds — Hobart's Remote Control speeds up work — makes you more profit!

You Can "Build Your Own" HOBART

It's easy to save hundreds of dollars if you want to build your own gasoline drive Hobart arc welder. You need only a Hobart generator, a used auto engine and chassis. With this portable gasoline drive welder, you can go any place by towing the welder. Free booklet tells you how. Write for details.

The Finest A. C. Welder Ever Built

It's the Hobart A. C. Arc Welder for single phase lines. Handles auto repairs economically — ideal for all types of light metal work. Use coupon for details.

HOBART BROS. CO., Box 1116, Troy, O. • "One of the World's Largest Builders of Arc Welders"

HOBART Welding School



Thorough teaching in all branches of welding. Modern school, individual instruction, expert instructors, low cost. Qualified under G. I. Bill of Rights.



"One of the World's Largest Builders of Arc Welders."

NEW SOLDERING GUN

WELLER SPEED IRON HEATS INSTANTLY



USE SPEED IRON FOR:
Home Workshop, Radio
Service, Telephone Installa-
tion, Electronic and Sound
Maintenance, Appliance Re-
pair, Laboratory Work.

New gun type soldering tool produces heat instantly by induction principle in soldering tip. Built-in transformer provides heating current when trigger switch is closed. Fast 5 second heating saves power, saves time, saves tip dressing and burning. Loop type tip is adjustable, gets into corners, lets you see where you are working. Short pistol grip gets you close to work, good balance makes tool very easy to handle. Can solder with aluminum solder or tin-lead solder. The soldering gun gives you for the first time really fast induction generated heat combined with real convenience of use. For the finest and most advanced soldering tool that money can buy, order a Speed Iron today! Price Complete \$14.95 Postpaid

ORDER DIRECT • MONEY BACK GUARANTEE

If not satisfied within 5 days

WELLER MFG. CO. 522 Northampton St.
Easton, Pa.

the HARMONETTE

New, Unique
Musical
Instrument

POSTPAID
IN U.S.A.

Made of metallic silver plastic. Resembles organ pipes in miniature. The HARMONETTE has 10 notes, tuned in harmony with the piano. You can play any melody on it. Here is a great Christmas gift for anyone. Grown-ups will get a big bang out of the many songs that can be mastered. Includes instructions showing how to play several songs. A Swell Gift. ORDER NOW!



\$1.50



Harmon Distributing Co.

123 W. Madison

Chicago 2, Ill.

AHOY, GAME-ROOM SKIPPERS! BUILD THE JOE LANE!



This beautifully detailed, authentic replica of one of the first revenue brigs is a real collector's item. Easy to build from clear, carefully drawn plans. A model you'll be mighty proud to display! Complete kit of parts, plans and assembly in-structions . . . \$11.00

SHIP MODELS ILLUSTRATED

The complete guide to modeling. Pictures of all types from clippers to corvettes — actual plans and detailed drawings \$2.50

MARINE MODEL CO., Inc. Dept. PB
Halesite, L. I., New York

WAR SURPLUS BARGAIN WRECKING SETS

COMPLETE CHAIN HOIST with
SUPER STRUCTURE and TOW BAR

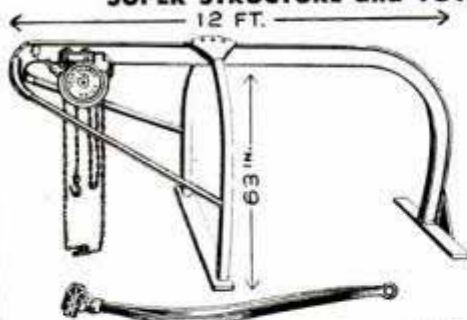

1½ TON CAP.
FOR TOW CARS
WRECKERS
GARAGES
HEAVY
HAULING
etc.

MAKES ANY TRUCK A TOW TRUCK—LIFTS and LOADS

Build your own wrecker. Equip yourself for heavy lifting, loading and hauling. Unit is completely assembled ready to mount on your truck. Has 1½ ton capacity Spur Geared Chain Hoist (Wright or Yale). Complete with superstructure and tow bar. Originally designed for army 2½ ton 6 x 6 cargo trucks. Makes any truck a tow truck. Used by garages, stone masons, nurserymen, machinery movers, etc. Original cost \$380.00. Your cost \$184.50 F.O.B. Chicago. Guaranteed perfect. Act quickly! Quantity limited. Write today.

VALUE \$380.00
YOUR COST \$184.50

Write for Quantity Price

B. M. K. SALES, Inc.



Illustration shows unit mounted on truck with Jeep in tow. Can be used for all types of heavy lifting, hauling and towing. It's a real value at this low price.

1720 SO. STATE ST.
CHICAGO, ILLINOIS

Build your home NOW



LESS COST.. LEARN HOW

Build an attractive home now for half the cost. No priorities! Build it yourself with CEM-ADOBE, the amazing new brick discovery you yourself can make from cement and soil. Now being used by hundreds of home builders. Learn how. Complete information in easy-to-understand instruction book. 50 illustrations. 40 chapters. complete home plans. Money back guarantee. Acceptable to loan agencies. Mail \$1 today to Cem-Adobe Co., Dept. APM, Box 81, West Los Angeles Station, Los Angeles 25.



U. S. Army RADIO (Water, Shock and Weather Proof) PHONES

Made to U. S. Army Specifications, passed by Signal Corps Inspectors. Dynamic Microphone and Dynamic Receiver of Finest Quality—Water, Shock, Weather and Altitude Proof, used on tank and aircraft (B19) intercom systems. For recording, for battery-less telephone, talk through your radio set or use earphones for pocket-size set loud speaker. Complete two receiver, cord set, head band, and dynamic hand microphone including special connecting cord set. A REAL BARGAIN AT THIS PRICE.

ONLY \$9.95 post
paid
Order yours today

HERE IT IS: ELECTRIC SWITCH

VERSATILE SWITCH—MILLIONS IN POST WAR APPLICATIONS — Floodlight your porch when the door is opened — sounds alarm when window is opened — signals arrival of mail — controls heating of furnace — filling of water tank. These and many other services are performed by this versatile switch. Shipped with instruction sheet showing numerous illustrated uses. EXCEPTIONAL LOW \$1.00 post PRICE. ONLY paid King Products Co., Dept. P. Batavia 2, Ill.



BETTER BY FAR

in Comfort

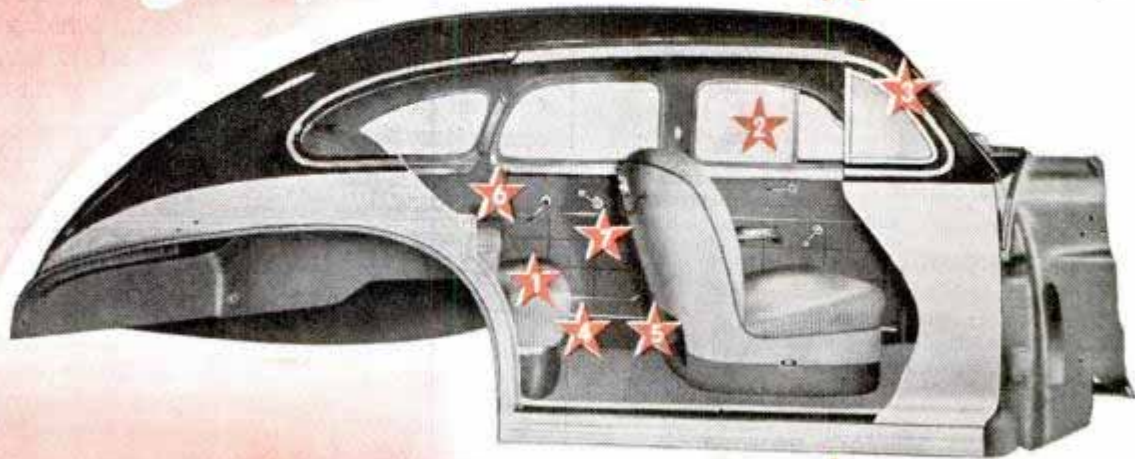

If comfort rates high on your list of automobile requirements, decide now to look at a car with Body by Fisher.

Here you will find all the roominess, convenience and built-in comfort developed by Fisher Body craftsmen during 38 years of fine coachcraft.

Such superior comfort gives added value to the unexcelled beauty, sturdy construction and the many extra safety features of the 1946 Body by Fisher.

1 Luxuriously upholstered seats with heavy layers of soft yet sturdy padding; strong, coiled springs, supported below by a rugged steel framework. Front seat easily adjustable.

2 Famous Fisher No-Draft Ventilation, individually controlled.

3 Scientifically Planned Vision affords all passengers an unobstructed view. Wide, V-type windshield gives the driver full command of the road.

4 Six different insulation materials combine to completely cover top, bottom and all sides — providing warmth in winter, coolness in summer and quietness all year round.

5 Footrest is recessed into back of adjustable front seat, thus providing maximum legroom.

6 Padded armrests are provided for the driver and both front and rear seat passengers.

7 Smartly designed appointments by Ternstedt* include: assist strap holder, interior door handles, window regulators and rear compartment ash tray.

*Fisher Body—Ternstedt Division

Body by Fisher



BETTER BY FAR

Thousands of dollars in university scholarships and cash awards for best miniature Napoleonic coaches or model cars submitted by boys of 12-19 years inclusive. For information, write: Fisher Body Craftsman's Guild, General Motors Bldg., Detroit 2, Michigan.

On the Air: HENRY J. TAYLOR, coast to coast, twice weekly. See your local newspaper for time and station.

You get Body by Fisher
only on

GENERAL MOTORS CARS

CHEVROLET • PONTIAC
OLDSMOBILE • BUICK
CADILLAC



The new 1946 Oldsmobile,
78 Series, 4-door Sedan

Plane · Rabbet · Groove
Rout · Panel · Tenon
on Your Drill Press



This exclusive tool fits any drill press, simultaneously planes, panels, rabbets, routs, tenons, beads, grooves. No extra blades to buy. Over fifty thousand now in use by hobbyists, pattern and cabinet workers, etc. Satisfaction guaranteed or your money back. Complete **\$7.50**

ALL-METAL DRILL PRESS TABLE

Solid Aleca aluminum heavily ribbed. Blanchard ground top and bottom. Equipped with Barron adjustable steel fence. Extra large working surface 13" x 18". Fits all standard drill presses. Instantly mounted or removed. **\$9.85**

SPIRAL FLUTE ROUTER BITS

New 45° helix angle tool steel design for smoother, faster, accurate routing, grooving, carving, mortising. Extra long cutting flutes. Individual sizes 1/8" to 1/2". Prices on application. Complete set of six graduated sizes. **\$9.50**



ROTARY SURFACE SANDER

Fits chuck of any drill press. Provides satin smooth, even, accurate surfacing of woods, plastics and metals. No ridges, no striations. Original in design, a great labor saver. Complete with 20 sanding discs. Fully guaranteed. **\$5.95**



Liberal 10 Day Money Back Guarantee

Workshop Guide FREE

BARRON TOOL CO.

269 Architects Bldg., Detroit 1, Mich.

BARRON PRECISION WORK SHOP TOOLS

SAY YOU SAW IT IN POPULAR MECHANICS

BIG SAVINGS ON HARD-TO-GET ITEMS



**.50 CAL. SHELL
Table or Desk
LIGHTER**

\$1 Souvenir of World War II
PREPAID

Reg. Price \$2. Chrome finish, holds 1 Month's Fuel Supply. Never Fails.

Adjustable
Stand
MAGNIFIER
\$1.25 PREPAID



Very powerful, swivels into any position, metal stand, 1 1/2" lens, easy to work under.

**ARMY
SIGHTING LEVEL**



\$1.50
PREPAID

Accurate surveying instrument. Pocket size complete with instructions.

**EYE
LOUPES**

\$1 Prepaid



Enlarges smallest parts, leaves hands free, all aluminum, unbreakable.

L.S. MODEL 9TH & ARCH DEPT. PHILA. 7, PA.

QUICK RELIEF

...for tired aching feet and legs

Build strong flexible arches with the DR. DAVIS FOOT MANIPULATOR. Not an arch support. Nothing to wear. A simple home treatment. One treatment will convince you. IF NOT SATISFIED return Manipulator within ten days and your money will be refunded. Write NOW for additional literature, or enclose \$4.95, check or money order.

DR. DAVIS FOOT MANIPULATOR
415 GOODHUE BLDG. BEAUMONT, TEXAS

MACHINE SHOP EQUIPMENT



Just off the press! — Every man who owns a workshop should have a copy of the new, up-to-the-minute, 200 page catalog of Machine Shop Equipment—the latest tools made by the biggest manufacturers in the U. S. Replete with illustrations, descriptions, prices. Prompt delivery on most tools listed in this book. Available at cost of printing—50c a copy—get yours today! **Price of Catalog Refunded on First Order over \$5.00.** Send check or Money Order to **CENTER TOOL CO.** 154 Centre Street New York 13, N.Y.



RAISE CHIN-CHINS

No experience needed. Just a few minutes daily and a few feet of backyard, garage or barn space. Several females and a male starts a large, profitable herd. **WE FURNISH FREE INSTRUCTIONS.** TREMENDOUS DEMAND for breeding and laboratory stock, meat, and world's most beautiful rabbit fur. Brokers, cut off from imported rabbit pelts by world famine, **NEED CHIN-CHIN FURS NOW,** and for years to come! Write for free illustrated catalog today. **WILLOW BROOK FARM • R-64, SELLERSVILLE, PENNA.**

**Money Making
Pay Raising
BOOKS
Catalog
FREE**

SEND NAME AND ADDRESS TODAY—Selected books covering all trades, office helps, home workshop, spare time work, hobbies, etc. Learn how to earn more. 1946 edition. **Popular Mechanics Press** 200 E. Ontario St., Chicago 11



THIS BOOK SHOWS
HOW TO DO IT
**STEEL SQUARE
POCKET BOOK**
Completely Revised

This concise and handy little book illustrates and describes the best methods of using the carpenter's steel square in laying out all kinds of carpentry work. It is easy to understand as a picture of the square laying directly on the work shows exactly how the various cuts are made. Its compact and handy size makes it convenient to carry in the pocket for quick reference.

Price \$1.00 Postpaid

POPULAR MECHANICS PRESS
DEPT. 627 200 E. ONTARIO, CHICAGO 11, ILL.

MILL IT—on Your Lathe with a **PALMGREN** MILLING ATTACHMENT

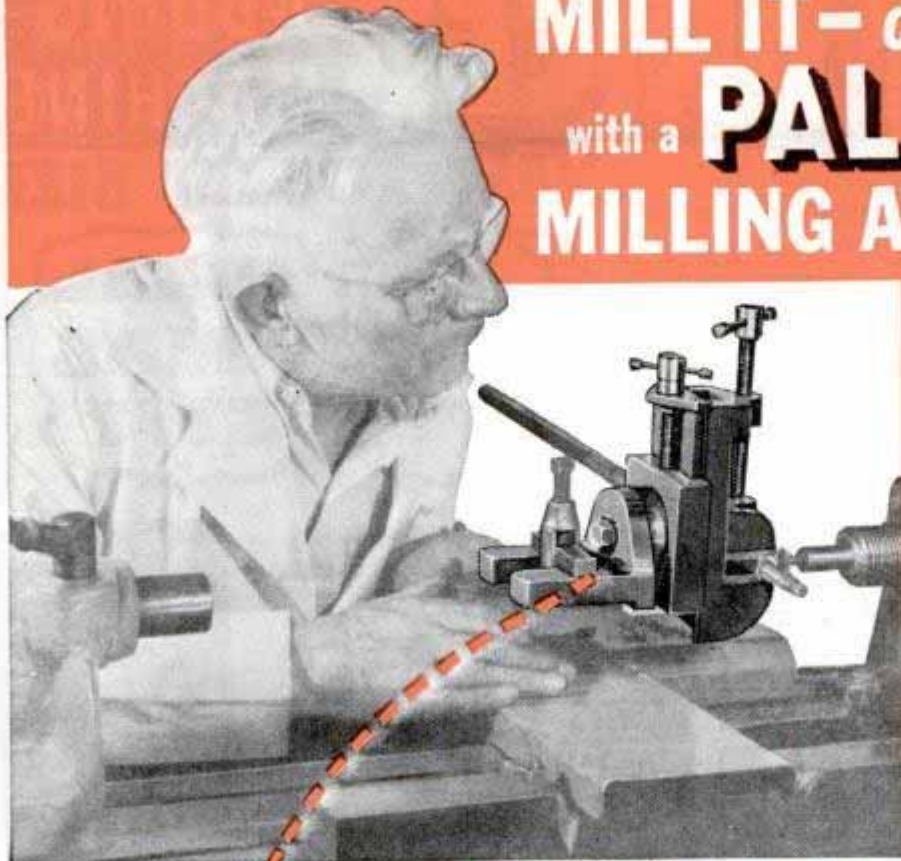

**JUST A FEW OPERATIONS YOU
CAN DO ON YOUR LATHE!**

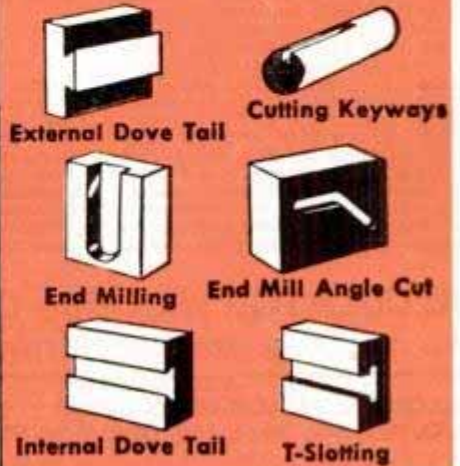

CONVERT LATHE in 10 SECONDS!

Now—in your own shop—on your lathe, you can Mill, Slot, Grind, Groove, Square Shafts, Saw at Angles, Recess, and do many other important jobs. Yes! In 10 seconds, you can convert your lathe—SAVE time and money by doing work you formerly had to send out. Lathe owners are amazed at the quality and variety of work that can be done with a PALMGREN MILLING ATTACHMENT. Don't overlook this important tool. Precision built, it has 360° graduation for rotary angle adjustments, also graduated vertical feed screw. Fits South Bend, Atlas, Craftsman, Logan, Sheldon and all other lathes. Easily mounted by straddling tool post. Thousands in use and highly valued in home work shops, small and large machine shops, repair shops, railroad shops, schools and experimental laboratories.

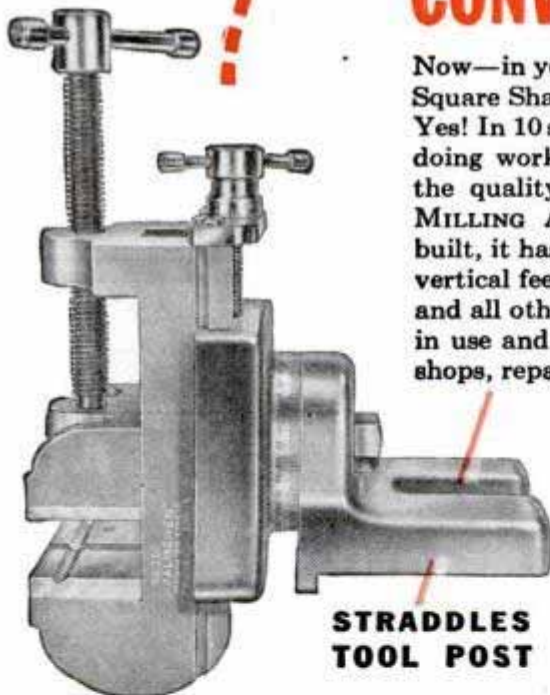

MAKES AN IDEAL XMAS GIFT.

3 SIZES

Made in 3 convenient sizes to handle small, medium or large pieces of work. One trial will convince and delight you. It will quickly pay for itself and add to your profits for years to come. Don't delay! Order today!

Nos.	Width Jaws	Depth Jaws	Jaws Open	Weight Pounds	Fits Tool Post	Price F. O. B. Factory
150	1½ in.	1 in.	1 ⅝ in.	6½	1 in. dia.	\$18.75
250	2½ in.	1 ⅞ in.	2½ in.	11	1½ in. dia.	24.75
400	4 in.	1½ in.	4 in.	24	2 in. dia.	39.75

AVAILABLE IMMEDIATELY

Your dealer or jobber will gladly show you one. However, if he cannot supply you, fill out the coupon, attach your remittance and we will send postpaid.

Write for Circular No. 1116

CHICAGO TOOL AND ENGINEERING CO.

Mfrs. of PALMGREN PRODUCTS for over 28 years
8374 South Chicago Avenue • Chicago 17, Illinois

MAIL THIS COUPON TODAY!

Gentlemen:—

Enclosed find draft or money order for \$_____. Please send prepaid a No. _____ PALMGREN MILLING ATTACHMENT.

NAME _____

STREET _____

TOWN _____ STATE _____

Print Name and Address—Use margin if needed.

WORLD'S

LOWEST PRICED ADDING MACHINE

VEST POCKET SIZE

MAKES IDEAL GIFT

Baby Calculator makes an ideal gift—for every Gift occasion. Birthday—Graduation—Christmas—Anniversaries. For men, women, children—teachers, business people, home or shop use. **COMES PACKED READY FOR GIFT WRAPPING.**

TEN DAY TRIAL

Money Back Guarantee

Because we know that our machine is the very best Calculator to be obtained at this low price, we make this 10 Day Trial offer, on a positive money back guarantee! Don't buy ANY Calculator without this guarantee! Send only name and address, pay postman \$2.50 plus postage (if cash is sent, we pay postage—you save up to 40c). (Send full cash if outside U.S.) Money back within 10 days if not delighted.



IDEAL XMAS GIFT

Fits vest pocket or purse. Guaranteed Accurate. Operated as easily, and as reliable, as machines costing many times as much. NOT A TOY or GADGET. Substantially made of 28-gauge steel—guaranteed for life against defects in construction. Beautiful looking, modernized design. Finished in Black, Silver and Red. You positively can't buy a Calculator of equal quality for as little money. **ACCEPTED AS THE FINEST LOW PRICED CALCULATOR FOR OVER 30 YEARS!** Operates with a flick of your finger. Adds, subtracts, multiplies, divides—counts up to ten million. Pays for itself over and over in mistakes avoided, and time saved.

FREE TRIAL

ONLY

\$2.50

AGENTS WANTED

TOTAL COST

SEND NO MONEY

FREE!!!

Each Baby Calculator enclosed in beautiful rich-looking Leatherette Case — at no extra cost.



CALCULATOR Machine Co. (Mfrs.)

DEPT. 184, P. O. BOX 248, GLENVIEW, ILLINOIS

USE COUPON

CALCULATOR MACHINE CO. (Mfrs.)
P. O. Box 248, Dept. 184, Glenview, Ill.

Your Calculator is just what I've been looking for. Send one at once (C.O.D.) or (I am enclosing \$2.50).

Name.....

Address.....

City.....State.....

Miracle Adhesive

(Not just a glue)

Sticks Fast • Stays Put
WET OR DRY • HOT OR COLD

Use on glass, metal, tile, brick, cement, plastics, mirrors, canvas. No nails, screws, heat, clamps.

War-tested—Now in handy tubes for households, shops, cars, boats. See your dealer or send 25c in coin to Dept. P., Miracle Adhesives Corp., 850 Clinton Ave., Newark 8, N. J. (In Canada send 35c to E. T. Sampson Co., LTD., Montreal.)



HI-SPEED COUNTERS—Veeder-Root, 5 figures, accurate to 40,000 per hour. Type A, lever operated, counts 99,999 and repeats, \$1.95. Type R, heavy duty, lever operated, with reset-to-zero knob, \$4.75. Type NR (illustrated), electrically operated. Use with machinery, computing devices, pistol machines, production control, operation of oil burners, refrigerators, etc. \$4.75. Other voltages and DC, add 50c. **GORRELL & GORRELL**, Haworth, N. J.

AGENTS... Be First With Newest Products

It means quick easy sales and large profits. Our monthly **NEW PRODUCTS BULLETIN SERVICE** lists 100 **NEWEST** products, where to buy them, long before they appear on the market. Sample Bulletin, \$1.00. **FREE** information. **HURRY—BE FIRST—BEAT COMPETITION.** **EDUCATIONAL BOOK CO.**, 2907 Berwick Ave., Baltimore 14, Md.

Radio Parts BARGAIN

Amazing war-surplus radio parts bargain, with new Coils, Condensers, Transformers, Resistors, Controls, others, \$15 to \$25 value. Ideal for experimenters, amateurs, home shop men. Now only \$3.98. **MARKO SUPPLY**, Dept. PM-11, 2924 Logan Blvd., Chicago 47, Ill.



\$3.98
AMAZING VALUE

LAW

STUDY AT HOME for **PERSONAL SUCCESS** and **LARGER EARNINGS**. 38 years expert instruction—over 108,000 students enrolled. **L.L.B. Degree** awarded. All texts furnished. Easy payments. Send for **FREE BOOK**—“Law and Executive Guidance.”

AMERICAN EXTENSION SCHOOL OF LAW
Dept. 71-M, 646 N. Michigan Ave., Chicago 11, Ill.

THERMOPLASTIC RING KIT

Contains complete material fabricating equipment and instructions for making 10 or more photo or signet rings in assorted colors valued at \$10.00. An ideal craft for the home, camps, clubs, scouts and servicemen. Now, Only \$1. Postpaid or COD. Money back guarantee. **Plast-O-craft Products**, 13401 Cerise Ave., Hawthorne, Calif.



WAR SURPLUS GRINDING WHEELS

NORTON — CARBURUNDUM — MACKLIN — MANHATTAN

30 PC. ASST. Known names—**NORTON—CARBURUNDUM—MACKLIN—MANHATTAN** in assortment of sizes from 1" to 10" diameter—1/4" to 1" thick and 1/8" to 1 1/2" holes. Invaluable for industry and home workshop. If wheels were bought singly, value would be over \$30.00. Amazingly low price for complete assortment of 30 new grinding wheels only \$4.95 postpaid. Send check or money order today.

GROBAN SUPPLY CO., Dept. PMN

1522 S. MICHIGAN AVE., CHICAGO 5, ILL.

INDUSTRIAL WHEELS

- 4 1/2 x 1 1/4 x 1 1/2 50 S-3 Carb Alex Rec. 60c ea.
- 6 x 1 1/4 x 1 1/4 Type S 3860-18 BE Rec White Norton 70c ea.
- 10 x 1 1/2 x 1 1/2 Rubber Cut off wheels 544 also Shellac Cut off wheels 80 MSL 60c ea.
- 12 x 1 1/2 x 5 Norton Carb Macklin Beveled edge 1850-1-402 and 5760-16 and 1960-16 and 800... 75c ea.
- 14 x 4 x 1 1/2 Steel Rim H60 RR C80J-15 V; 37 C6017 V; H060-18 VW, 38-46J for Ex-cell-o or Carboly or Hammond Grinders \$5.00 ea.
- 20 x 2 x 12 Rec slides Red 38461... \$8.00 ea.
- 20 x 4 x 12 BW 60-M 48V at slides Face A; N46 E K 35 H Sterling Vit straight \$10.00 ea.



MOUNTED GRINDING POINTS
ASSORTED MOUNTED GRINDING POINTS with 3/8" shank—all new! Special "hurry-up" offer gets you **SEVEN \$1.00** post mounted grinding points. **ONLY \$7.00** paid

An Ideal and Practical Gift For Any Man!

Now A DYNAMIC HEAVY DUTY INDUSTRIAL WELDER

Available Now—Immediate Deliveries

Designed to Do High-Grade Welding *Inexpensively*

Maintenance men, farmers, mechanics, machine shops, foundries, auto, general repair and job welding shops using the DYNAMIC WELDER find it so indispensable and useful that they cannot afford to be without it. If inexperienced you can easily learn to do a variety of high-grade welding jobs by following the practical, simplified operating and welding instructions furnished.

WORKS ON IRON, STEEL, BRASS, BRONZE and OTHER METALS

Has eight metallic and carbon arc welding heat stages. Does work you would think only possible with a larger, more expensive machine.

READ WHAT USERS SAY...

Repair Shop Owner says, "It will do more than you say"

"I want to say I operate a repair garage and am more than satisfied with the welder. It will do more than you say." C. P., Butler, Ohio

It's the Greatest Portable Outfit

"Now I am equipped for all kinds of welding and I must say it's the greatest portable outfit for welding any man could ever wish to own. I wouldn't sell mine for the cost of plenty welders I have seen which were very high in cost but not in convenience. You may put me on file as a booster of your wonderful welding product." W. J. B., St. John, N. B., Canada

Better Than I Expected

"I have done quite a little welding with my welder and will say it is better than I expected. The price, convenience, and variety of work that can be done with the Dynamic are the attractive points." W. R. P., Portland, Ore.

EASY TO OPERATE!

DYNAMIC SUPERCHARGED WELDER

GET DETAILS ON OUR 10-DAY TRIAL OFFER!

Once you see a DYNAMIC in operation you won't want to be without it. Its simplicity will amaze you. In a year the DYNAMIC only costs you about 6c a day. Comes complete, ready to operate, with helmet, rods, cables, electrode holder and operating instructions, etc. Nothing else to buy. Write today for Free particulars. Act now and get details on our amazingly low priced Dynamic Welder and 10 day trial offer.

DYNAMIC WELDER CO.

13 East 23rd Street—FM

CHICAGO 16, ILLINOIS

FOR ONLY
\$23⁵⁰
COMPLETE

AMAZINGLY SIMPLE TO OPERATE!

This portable Dynamic Welder, easily carried right to the job, can be operated from any convenient, properly wired 110 Volt 60 cycle line. Can also be supplied for 220 Volt 60 cycle operation and for other voltages and cycles at slight additional cost.

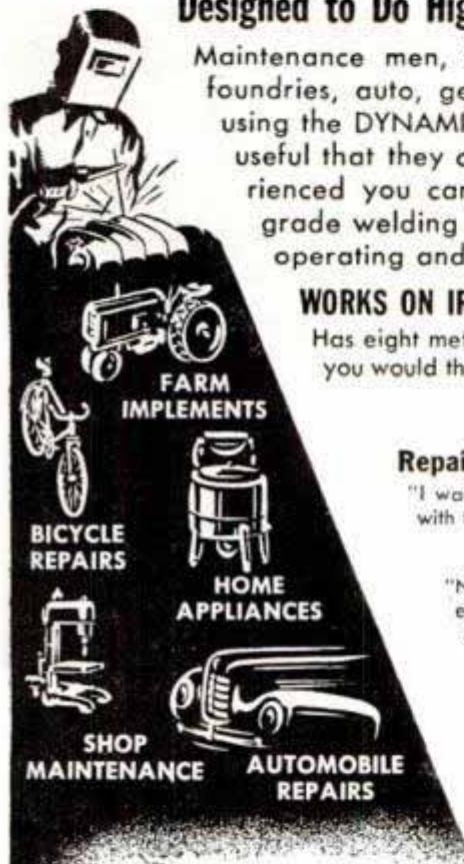

ACCURATE
VERSATILE
DEPENDABLE

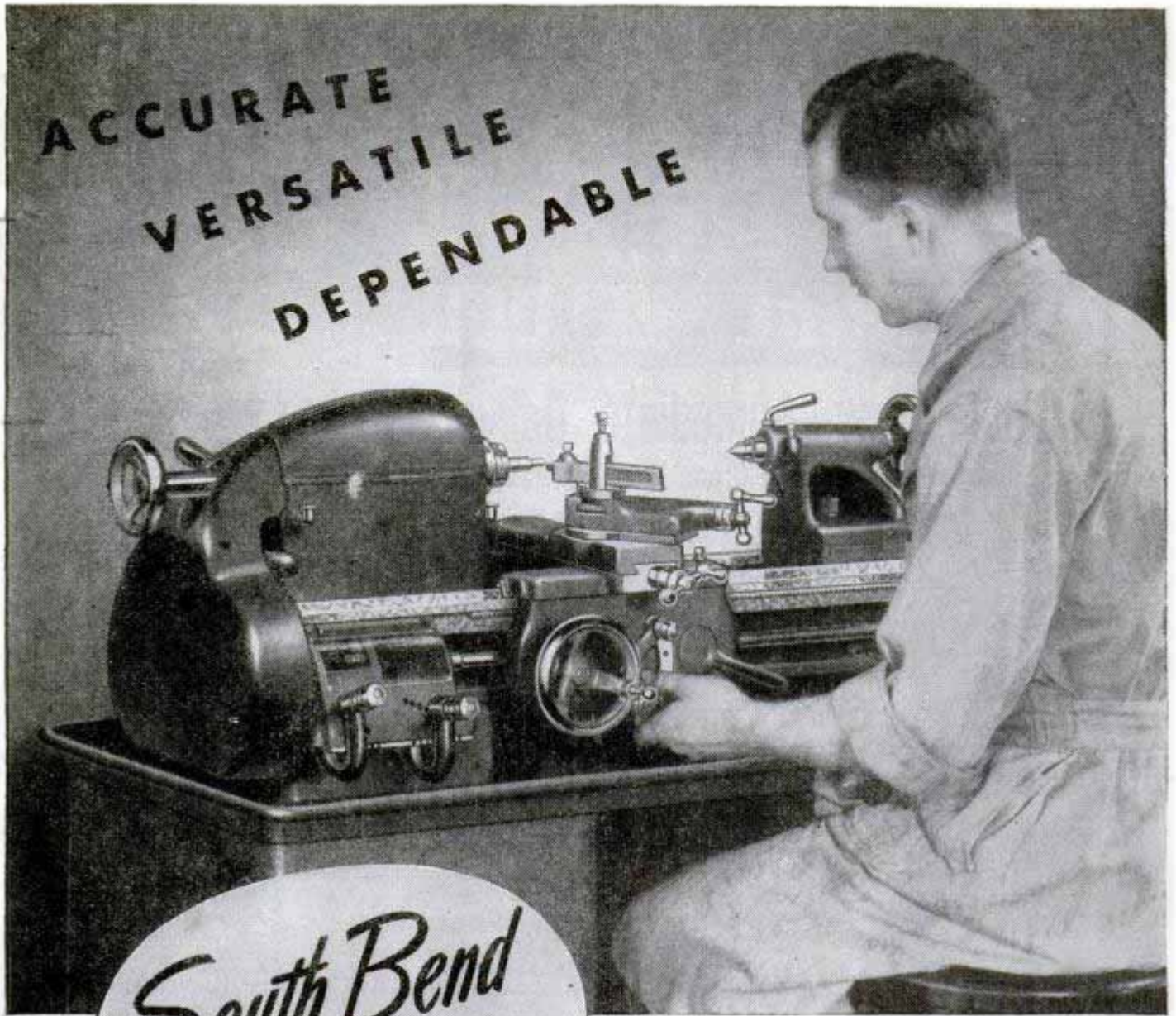

South Bend Lathes

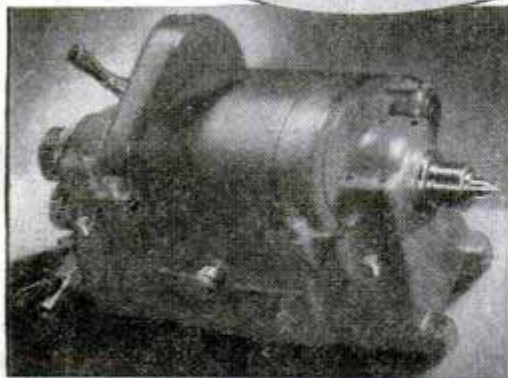

PRECISION-BUILT HEADSTOCK

The headstock construction of South Bend Precision Lathes is one of the reasons for their unvarying accuracy. Spindle bearing surfaces are super-finished to a smoothness of 5 micro-inches (.000005") which reduces wear and friction, permits higher spindle speeds, and assures precision.

Jobs worth doing are worth doing well. That's why the accuracy, versatility, and dependability of South Bend Precision Lathes are as important in the small shop as they are in the industrial toolroom and manufacturing plant. These qualities enable them to handle efficiently the many types of operations which regularly are encountered in tool and instrument shops, radio and appliance repair work, automotive and aviation maintenance and service, laboratories, model shops, and many other industries.

WRITE FOR FREE CATALOG. South Bend Precision Lathes are made with 9", 10", 13", 14-1/2", and 16" swings. Specify size lathe in which interested.



LATHE BUILDERS SINCE 1906

SOUTH BEND LATHE WORKS

455 EAST MADISON STREET • SOUTH BEND 22, INDIANA



RECORD-BREAKER EVERY WAY by FRANK WILLIAMS

STEVE VAN BUREN-
BRILLIANT
HALFBACK OF THE
PHILADELPHIA
EAGLES

...LAST YEAR HE
WON THE NATIONAL
FOOTBALL LEAGUE'S
GROUND-GAINING TITLE
WITH 832 YARDS
AND SCORED 18 TD'S
FOR A NEW ALL-
TIME 10-GAME
MARK!



ONLY WAY TO
STOP THAT
GUY IS WITH
A BAZOOKA!

HE LOOKS **SHARP!**
...STREAKING DOWN THE FIELD
WITH THE PIGSKIN...

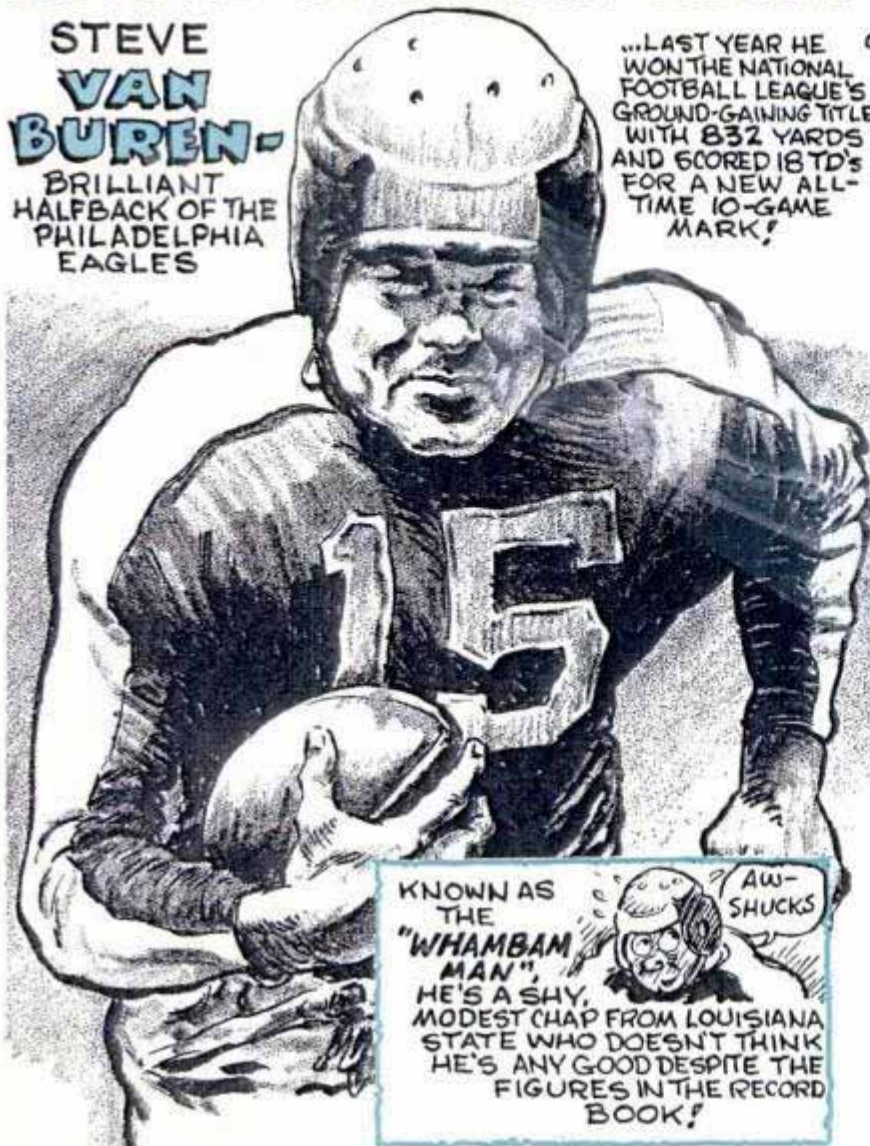

KNOWN AS
THE
"WHAMBAM
MAN",
HE'S A SHY,
MODEST CHAP FROM LOUISIANA
STATE WHO DOESN'T THINK
HE'S ANY GOOD DESPITE THE
FIGURES IN THE RECORD
BOOK!



AW-
SHUCKS



-PLUS
ONE IS SEVEN!

HE FEELS
SHARP!

...BOOTING THE BALL. STEVE'S
A GREAT PUNTER...WHAT'S MORE,
THE ONLY TWO PLACEMENT KICKS
HE TRIED DURING THE SEASON
HELPED HIM AMASS 110 POINTS FOR
THE 1945 POINT-GETTING TITLE!



HE IS **SHARP!**
...STEVE ALWAYS USES
GILLETTE BLUE BLADES
WITH THE SHARPEST EDGES
EVER HONED..THAT'S BECAUSE
THEY GIVE HIM THE SLICKEST,
MOST REFRESHING SHAVES A
FELLOW CAN HAVE AND SAVE
HIM MONEY, TOO!
YOU CAN'T FOOL STEVE--
DOUBLE EDGES MEAN
DOUBLE ECONOMY!

look **SHARP**
feel **SHARP**
be **SHARP**

use
Gillette
Blue Blades
with the **SHARPEST** edges
ever honed!



5 for
25¢

ENJOY BOXING
FRIDAYS AT
10 PM EST OVER ABC NETWORK. GILLETTE'S CAVALCADE OF
SPORTS ALSO AIRS WORLD SERIES AND OTHER CLASSICS YEAR ROUND.

Gillette Safety Razor Company, Boston 6, Mass.

Copyright, 1946, by Gillette Safety Razor Company.

"Now Daddy's got to go to another 'birthday party,' Son..."



SOMEWHERE high in the sky the stork is racing.

But the doctor will be at its destination first. Ready and waiting.

Whether bringing life or guarding it, the doctor's personal life fades into the background when duty calls.

But he isn't asking for any special credit. It's his job—and he does it.

According to a recent Nationwide survey:

MORE DOCTORS SMOKE CAMELS THAN ANY OTHER CIGARETTE

Your "T-Zone" will tell you...

T for Taste...T for Throat...

that's your proving ground for any cigarette.

See if Camels don't suit your "T-Zone" to a "T."



TEXAS and Rhode Island... lofty Colorado and the wheat-golden Dakotas... each and every state of the forty-eight was covered in this great nationwide survey of 113,597 doctors.

To these doctors, in every state and in every branch of medicine, three leading independent research organizations conveyed this question... What cigarette do you smoke, Doctor?

The brand named most was Camel!

CAMELS *Costlier* *Tobaccos*