

POPULAR MECHANICS

MAGAZINE

WRITTEN SO YOU CAN UNDERSTAND IT

REGD. TRADE MARK, GREAT BRITAIN, NO. 410425

REG. U.S. PAT. OFF.



*An Amazing
Improvement!*



RAY-O-VAC

LEAKPROOF FLASHLIGHT BATTERIES

Stay Fresh
FOR YEARS

NO DATING NECESSARY

RAY-O-VAC COMPANY, MADISON 4, WIS.

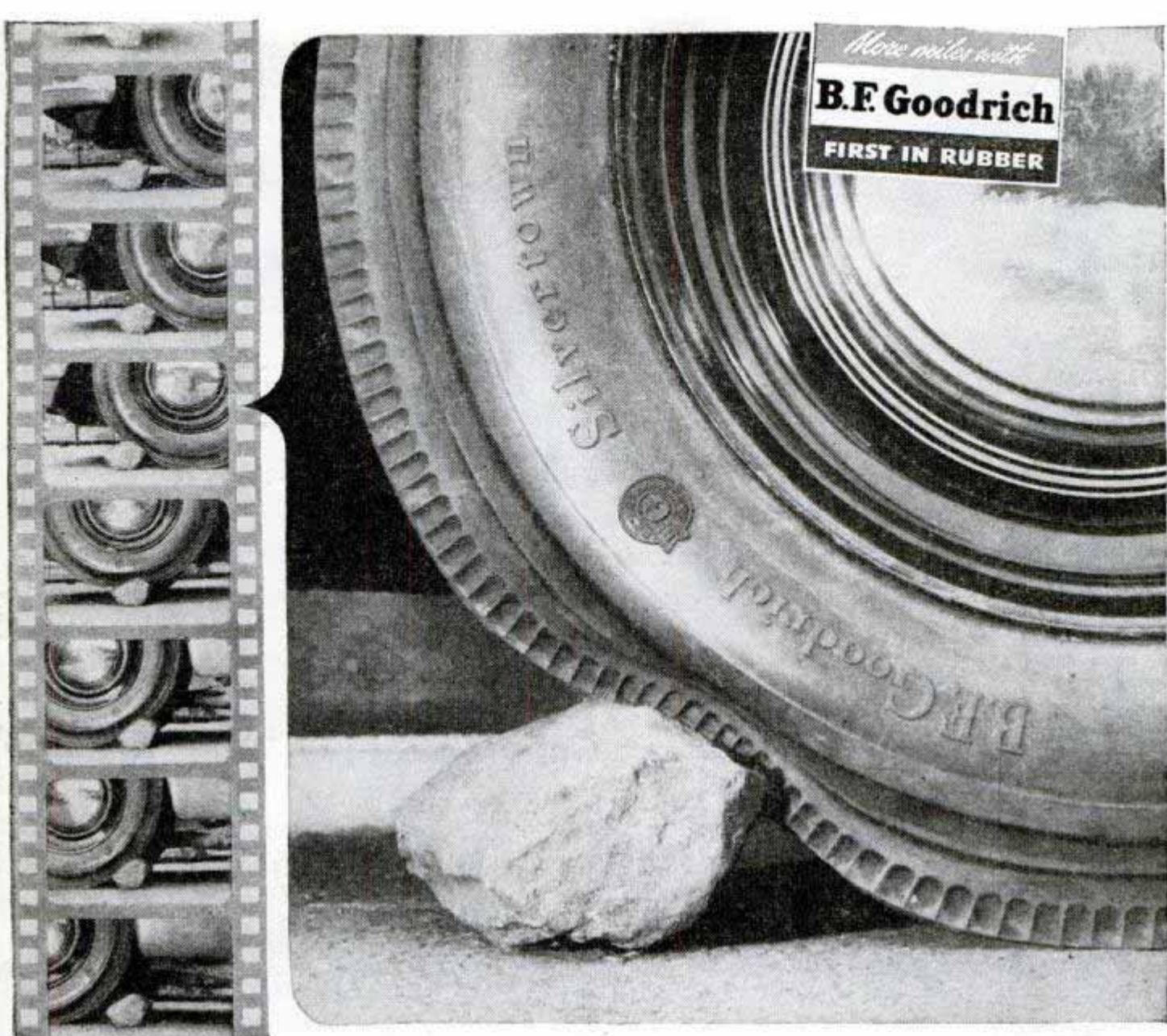

More miles with
B.F. Goodrich
 FIRST IN RUBBER

STRONGER BODY HELPS THIS NEW TIRE OUTWEAR PREWAR TIRES

You can order these better tires for your car now

NO SENSIBLE DRIVER would deliberately run his tires over a rock like the one in the picture. But sometimes it can't be helped . . . and that's when you will be glad if you have the new B. F. Goodrich tires on your car.

The tire body is 35% stronger than in wartime tires. It is built with more cords and stronger cords and better engineered. It was developed primarily to enable it to carry a wider, flatter tread. Although such a tread gives longer wear, it is not practical on an ordinary tire because of the strains that it would set up in the tire body. Thus, in developing

a stronger tire body to carry a more durable tread, B. F. Goodrich engineers at the same time built into it greater resistance to "road shock."

In comparative tests, the new B. F. Goodrich Silvertowns have again and again outworn prewar tires. And in millions of miles of test driving on taxi fleets, police cars, and special test cars they have proved their extra toughness and

durability. Now, on the cars of thousands of American motorists, they are giving extra mileage, extra safety, extra trouble-free service.

You can order these better tires for your car now. There's extra demand for B. F. Goodrich, but if you need tires, see your B. F. Goodrich dealer today. He may have your size in stock, but if he doesn't, he'll keep you rolling somehow until they come in. *The B. F. Goodrich Company, Akron, Ohio.*

B.F. Goodrich

FIRST IN RUBBER

Get the same safe lighting
that leading new cars have



LET SAFETY SHARE THE RIDE—
REPLACE WITH GUIDE



Here's one new-car advantage that *every* car owner can enjoy—the safety, efficiency and long life of Guide Sealed Beam headlamp units. Guide units are original equipment on Chevrolet, Pontiac, Oldsmobile, Buick, Cadillac . . . and on more trucks and buses than any other make of lamp. They are right for replacement on *all* cars and vehicles with Sealed Beam headlamps. When you need a new unit, replace with Guide—and get Guide's *double protection* at no extra cost.

NO DIM-OUT—Because your Guide Sealed Beam unit is sealed against dirt, dust and traffic film, it stays bright throughout its long life—maintains high efficiency without service or maintenance.

NO BLACK-OUT—Because there is a separate bulb within the sealed unit, your Guide Sealed Beam unit will not fail in case of a cracked lens—will light the way safely until the damaged unit can be replaced.

GUIDE LAMP DIVISION OF GENERAL MOTORS CORPORATION

SAFE HEADLAMPS ARE "CORRECTLY AIMED" HEADLAMPS—HAVE YOURS CHECKED TODAY

Popular Mechanics Magazine

Registered in U. S. Patent Office and Canada

H. H. WINDSOR, Founder

H. H. WINDSOR, Jr., Editor and Publisher

WILL ATOMS soon heat our homes, power our ships and drive our automobiles? Must we scrap our factories and appliances for this new form of energy? In this issue a man who took part in the engineering work on the atom bomb project brings you a down-to-earth article on future uses of atomic energy. He tells how science has already solved three of the five major problems that stood in the way of harnessing the atom.

NEXT MONTH'S cue on how to improve your skill in a popular game comes from Willie Hoppe, one of the world's greatest billiard players. He gives three-cushion beginners a basic lesson in the game and tells oldtimers how to improve their shots.

HOW does it feel to be a fish? That's one of the questions asked of hundreds of persons in discovering hidden abilities. A November feature explains how aptitude tests become "Scientific Fortune Tellers" to reveal surprising talents in the average man.

ALL ABOARD for an exciting hobby. Spare-time "big shots" operate more than 5000 railroads in basements and attics. A feature next month tells how to "Build Yourself a Railroad."

PERENNIAL puzzle—what to give the family for Christmas. A peek into "Santa's Workshop" in the November Craftsman section will give you not only ideas but complete plans for 15 gifts—something for every member of the family. Then there's an article on machines that cast cement blocks for the man who wants to build his own home or start a timely business venture. Camera fans will find plans for a film viewer to show up those prize transparencies.

FOUR large speakers can be operated with the 32-watt audio amplifier featured in the Radio section next month.

Volume 86 OCTOBER 1946 Number 4

Managing Editor.....Roderick M. Grant
Assistant Managing Editor.....Wayne Whittaker
Shop Notes and Crafts Editor.....James R. Ward
Radio and Electronics Editor.....Frank L. Brittin
Aviation Editor.....Aubrey O. Cookman, Jr.
Associate Editor.....John R. Kinsey
Eastern Editor.....Bill Reiche
Western Editor.....Thomas E. Stimson, Jr.
Art Director.....Frank Beatty

Assistant Editors

Donald R. Brooks Clifford B. Hicks Maston M. Jacks Virgil T. Swanson

Assistant Editors, Shop Notes and Crafts

W. Clyde Lammey Wayne C. Lockey John F. Shrock A. E. Youngquist

In This Issue

<u>Power From Atoms: How Soon?</u>	89
<u>New Queens of the Skyways</u>	98
<u>Where Redwoods Are Pygmies</u>	108
<u>Luxury Goes Back to Sea</u>	116
<u>Throwing Light on Mother Nature</u>	126
<u>Showman Turned Inventor</u>	133
<u>Platinum on Four Feet</u>	138
Will the Atom Drive Us	
<u>Underground?</u>	148
<u>The Dust Bowl Is Restless Again</u>	153
<u>Rigging an Eight-Ton Tuna Net</u>	164
<u>School for Jockeys</u>	170

For the Craftsman

<u>"Round-the-Corner" Table</u>	178
<u>Shotgun Footwork</u>	186
<u>"Overcoats" for Tender Shrubs</u>	194
<u>Model Gas Engine</u>	201
<u>Camera Becomes Enlarger</u>	211
<u>Milling-Machine Technique</u>	224
<u>Radio and Electronics</u>	229

Table of Contents Continued on Page 8

Published monthly by POPULAR MECHANICS COMPANY, 300 East Ontario Street, Chicago 11, Ill. H. H. Windsor, Jr., president; Paul H. Dunakin, vice president and general manager; D. F. Windsor, vice president and secretary-treasurer; William Harrison Fetridge, vice president and assistant to the publisher; Clover L. Perkins, advertising manager; Alan M. Deyoe, circulation manager. Single copy in the United States and Canada, 25 cents; subscription rates in United States and possessions, Canada, and countries of the Pan-American Postal Union, 1 year, \$2.50; 2 years, \$4.50; 3 years, \$6.00. To all other countries add \$1.00 a year over United States prices for overseas postage. If you plan to move, notify us at least 60 days in advance so you will not miss an issue. Give both old and new addresses. Entered as Second Class Matter, September 15, 1903, at the Post Office at Chicago, Illinois, under Act of March 3, 1879. Entered as Second Class Matter at Post Office Dept., Canada. Copyright 1946, by Popular Mechanics Company, Copyright under International Copyright Union. Copyright in France. All rights reserved under Pan-American Copyright Union. Printed in the United States of America.

Ingenious New Technical Methods

To Help You with Your
Reconversion Problems

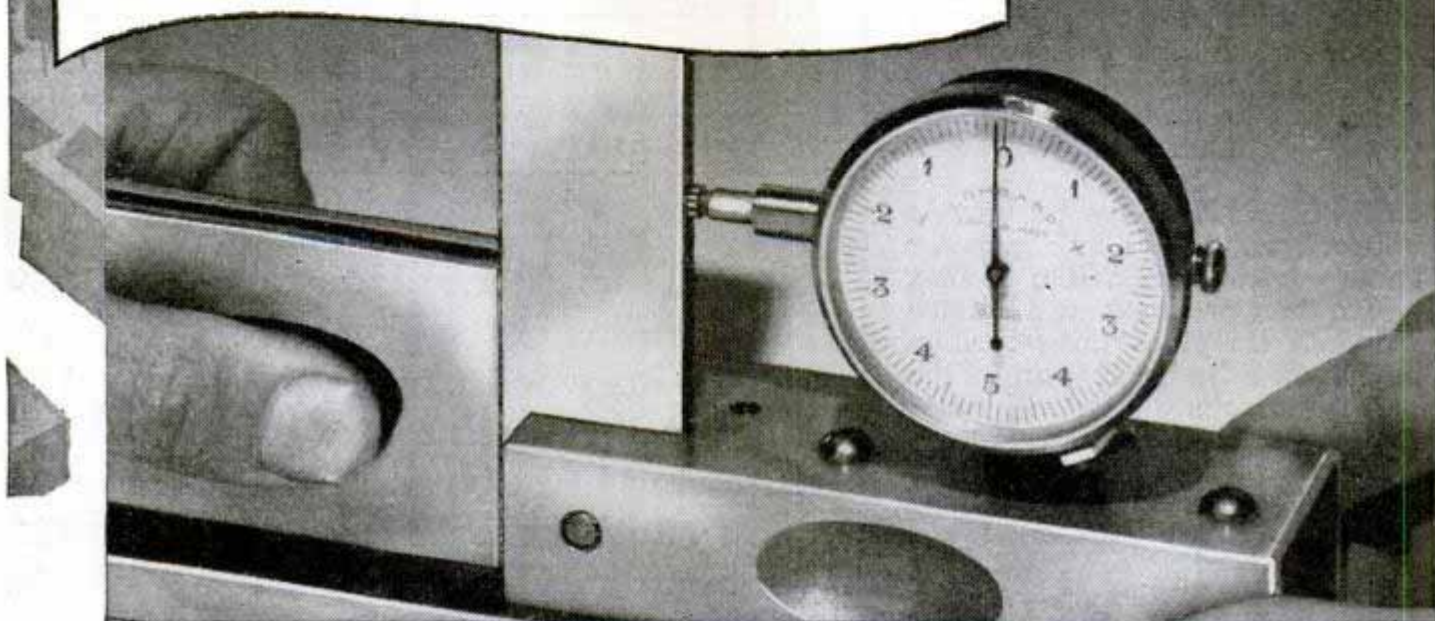

New Micro Square Instantly Checks Right Angles to One 10,000th Inch!

Ideal for precision testing, the Acro Micro-Sine Square quickly and accurately checks right angle work to 1/10,000th inch within a given distance. Its standard indicator dial instantly registers error, location of error, and amount of correction required. Designed for tool and die shops, machine shops and testing laboratories, it also provides a standard for checking master squares, tri-squares and tools.

The Acro Micro-Sine Square is very simple to operate, saves hours of time. Made of hardened tool steel, in ground and lapped precision construction. Available in two types: (1) Standard precision gauge in tenths, (2) Lever indicator in thousandths. Both complete with master checking blocks and carrying cases.

On precision jobs, requiring a static position and mental alertness, workers undergo nervous tension which often results in fatigue. Tests have shown that the act of chewing helps relieve tension—helps workers stay alert, thus increasing their efficiency to do more accurate work. For this reason, many plant owners urge workers to chew Wrigley's Spearmint Gum on this type of job.

*You can get complete information from Acro Tool and Die Works
4554 Broadway, Chicago 40, Illinois*

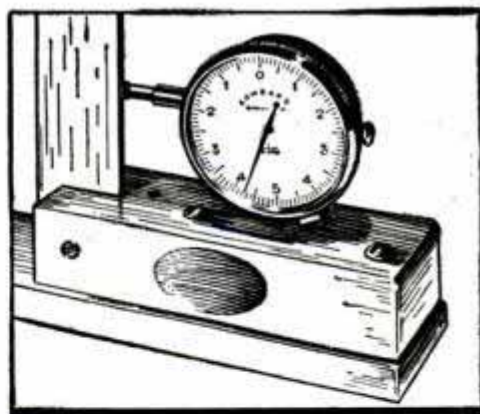

Standard Indicator Dial



AA-92

Every Outing is More Fun

with the

Coleman "G.I." POCKET STOVE

Ready for Instant Use Anywhere You Go!

Double the joy of all your outings with this new sensational Coleman "G.I." Pocket Stove. Ready in minutes for quick cooking action, making hot drinks, boiling water. The perfect pal for hunting, fishing, and camping trips. Fine for heat and hot coffee in a duck blind. Ideal for picnics, vacations, motor, canoe and hiking trips, backyard snack parties.



Easy to Carry—about quart jar size—weighs only 3 pounds. Slips easily into hunting coat pocket, glove compartment of car, or corner of picnic hamper.

Burns Any Kind of Gasoline—white or leaded.

Instant Lighting Power Burner—produces 5,000 BTU per hour. Boils quart of water in eight minutes.

2-Piece Aluminum Case—provides 1½-pint cup for coffee; 3-pint pot for food.

3 to 3½ Hours Operation on one filling of pint-size nickel plated brass fuel fount.

Folding Grates accommodate any ordinary size cooking utensil; made of stainless steel—will not rust.

Ask your dealer about the Coleman "G.I." Pocket Stove. You'll want one!

More Fun at Home, Too!

Dozens of uses around home for this midget stove—in the work shop for heating glue pot or soldering iron; for making soup or boiling water or for summertime use on the cool back porch.



Write for Free Illustrated Folder,

showing and describing the many unusual features and uses of this Coleman "G.I." Pocket Stove. Address nearest office.

America's Favorite Outdoor Sport Light

An instant-lighting Coleman Floodlight Lantern is essential equipment on all outings. Floodlights 100-ft. area. Strongest winds can't put it out. Safe—can't spill fuel even if tipped over. 1 and 2-mantle models. Get one from your dealer.



THE COLEMAN COMPANY, Inc.

Dept. 260-PM, Wichita 1, Kans.

Philadelphia 8, Pa.; Los Angeles 54, Calif.; Honolulu, T. H.; Toronto, Canada
(Terminal Commerce Bldg.)

Constance and Wesley Mueller, undersea explorer-photographers (and X-acto fans from 'way back!) snapped this picture of themselves with two of their special fish friends who follow them from reef to reef along the ocean floor! (Yes! That is a shark!)

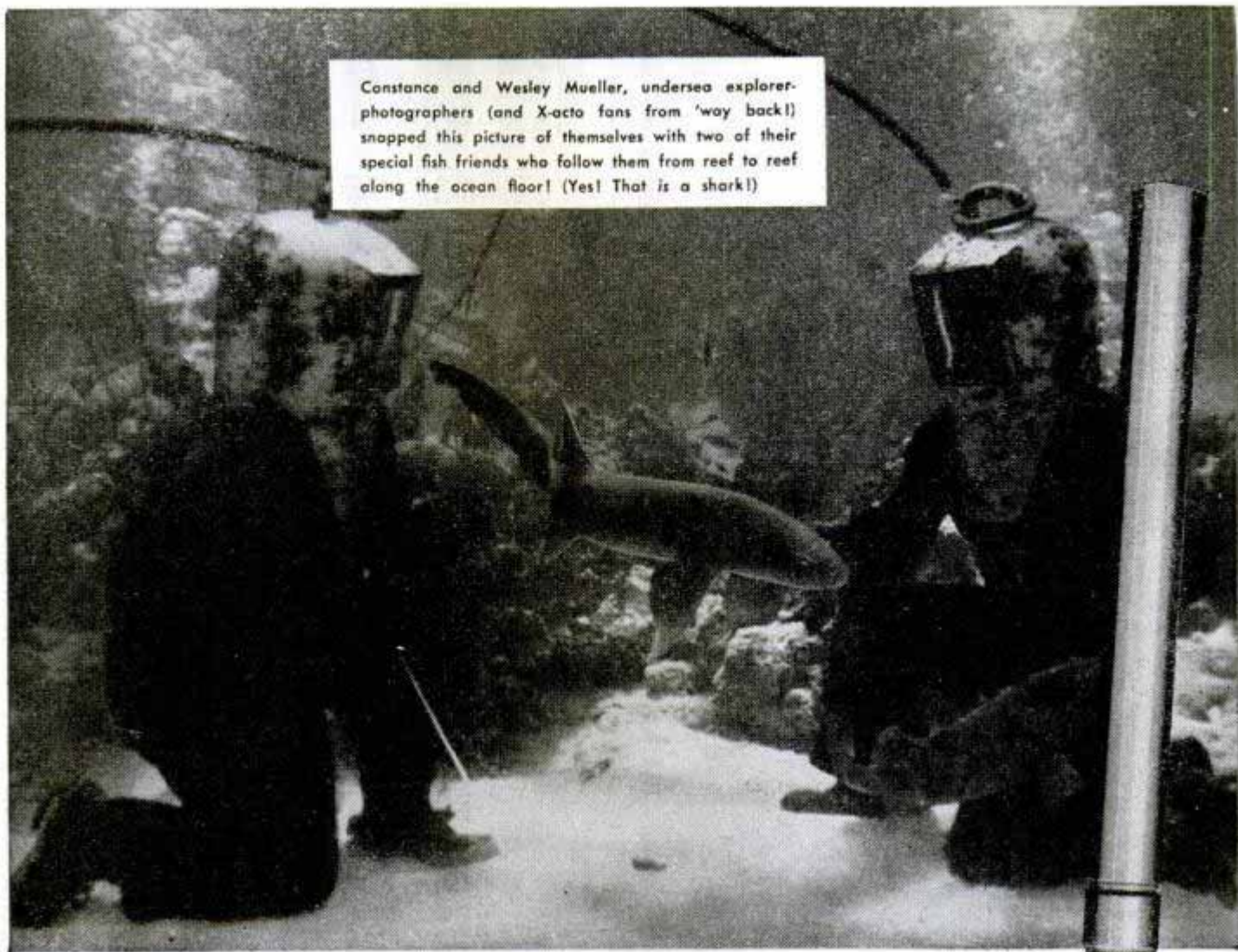

THEY EXPLORE THE OCEAN FLOOR ... and find a hundred uses for X-acto

THERE'S never a dull moment in the sea-going life of the Muellers. They run their own 40-foot cruiser, do their own diving, take their own photographs, and coax the "monsters" of the deep to pose for them.

In their laboratory, in designing and repairing their equipment, in preparing their photographs for publication, they "encounter a hundred jobs requiring implements for delicate as well as heavy cutting." And that's a hundred jobs for X-acto! In fact, say these exacting scientists, "X-acto Knives have now replaced a

nondescript group of tools we formerly used, because we found them *stronger, safer, keener.*"

13 Blade Shapes Quickly Interchangeable

Landlubbers, too, find X-acto Knives do their hobby and business cutting jobs, quicker, better and *easier*. With 3 *all-metal* handle styles (*No more substitute plastics!*) and 13 different blade shapes, X-acto is always scalpel-sharp, always ready. Amateurs or experts... whittlers, model builders, sculptors in paper, wood or plastics... choose X-acto for fun and best results.

ALL METAL
X-acto No. 2 Solid Duraluminum Knife . . . **50c**
With 5 assorted blades, \$1. Other X-acto Knives, Tools, Chests, 50c to \$12.50.



It's Got Everything! No. 85 X-acto Tool Chest - 3 all-metal knives; full assortment of blades; saw; sander; stripper; planer; drills and holders; steel ruler; complete in wooden chests, \$12.50.

X-acto
KNIVES & TOOLS



At hardware, hobby and gift shops.

X-acto Crescent Products Co., Inc.,
440 Fourth Ave.,
New York 16, N. Y.
In Canada: Handicraft Tools, Ltd., Har-
mant Bldg., Toronto

*Reg. U. S. Pat. Off.

Why be a BOOKKEEPER?

...When Accountancy
offers more Money
and Success...

If you are a bookkeeper, you are right on the threshold of a profession that pays far above average—where there's real opportunity to get ahead and move up fast.

Why not step *UP* from bookkeeping—be an accountant—make *real* money!

You can learn Accountancy by the interesting LaSalle Problem Method—in your convenient spare time, at home, without losing a day from your work. You learn by *doing*... you study Accounting principles and solve Accounting problems under the clear guidance of experienced C.P.A.'s. You cover Accountancy from the basic principles right up through Accounting Systems and Income Tax Procedure—to advanced training for the C.P.A. degree if you so desire. And as you go along step-by-step, you master the principles of auditing, business law, statistical control, cost accounting, organization, management, finance, etc.

You go as fast or as slowly as you choose. And you may start "cashing in" on your new ability long before you complete the training—as thousands of others have proved. Many advance quickly to better positions, even before they are half way through. And that is only the *beginning* of a growing and continuing success for the rest of your business life.

Why remain "just a bookkeeper" when Accountancy holds so much for you? Our free 48-page booklet, "ACCOUNTANCY, THE PROFESSION THAT PAYS," tells you what you must know to be an Accountant, and how you can prepare in your leisure time, at moderate cost and on easy terms.

Send the coupon today. Get all the facts and judge for yourself. There is no obligation. You are already started in this field...find out how you can rapidly go to the top! Mail coupon NOW!

FREE BOOKLET

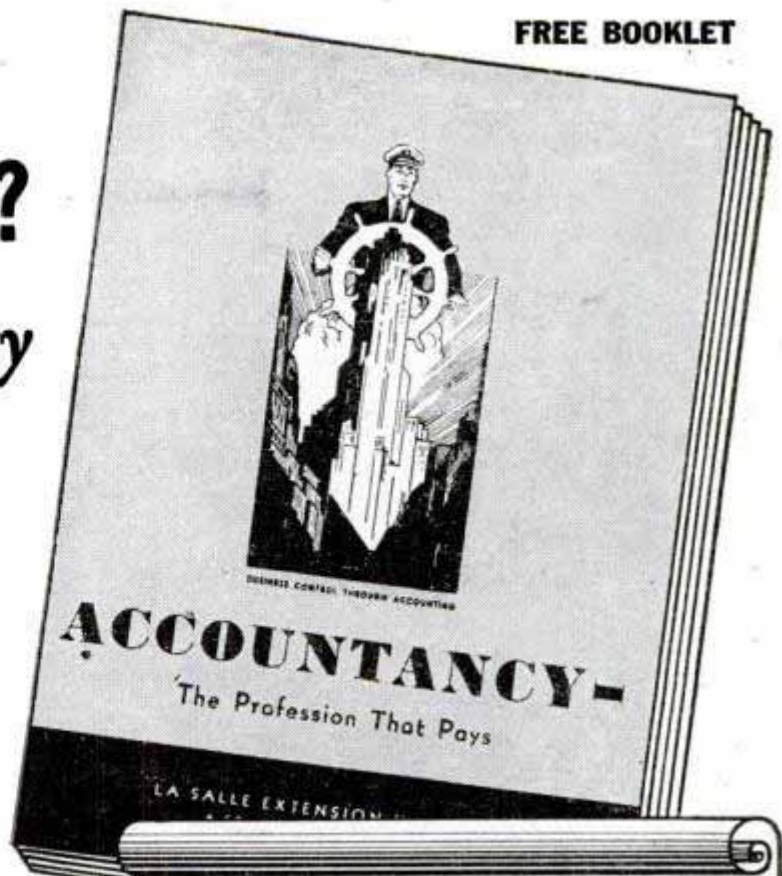

G. I.
APPROVED

LA SALLE Extension University
A Correspondence Institution

Dept. 1064-H • 417 S. Dearborn • Chicago 5, Ill.

I'd like to know more about your home study program to help me prepare for an accounting career. Please send me your free 48-page booklet, "Accountancy, the Profession That Pays."

Name

Position Age

Address

City, Zone and State

**"I'm GOING
to be an
ACCOUNTANT!"**



**LASALLE
EXTENSION UNIVERSITY**

This One



73EW-KF2-S8SK

PYROIL PROTECTION FOR YOUR CAR IS EASY and INEXPENSIVE

- Removes sludge and carbon formation
- Assures lubrication of cylinder walls
- Reduces frictional wear
- Makes starting easier, reduces battery drain

Manufactured and Guaranteed by Pyroil Company, W. V. Kidder, Founder, 60 Pyroil Bldg., La Crosse, Wis.

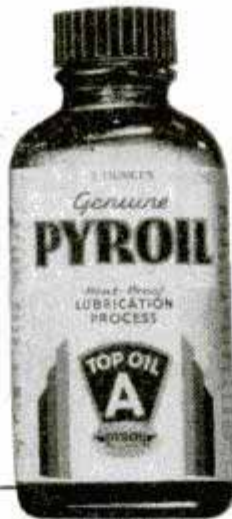

PYROIL COMPANY

60 Pyroil Bldg., La Crosse, Wisconsin.

I want my car to last and run properly. Please tell me more about Pyroil and how it can accomplish this for me.

Name.....

Address.....

City or Town..... State.....



Jerry, the talking dog, is entertaining hospitalized veterans, by courtesy of the PYROIL Company. Picture of Jerry, sent on request.

TABLE OF CONTENTS (Continued)

AUTOMOTIVE

V-shaped auto snowplow removes 24-inch drifts.....	97
Jeep converted to fire engine.....	114
Largest bus in Sweden.....	125
"Scrapmobile" travels 30 m.p.h. with 1½-hp. engine.....	129
Bus powered by two engines can use one or both.....	159
Dashboard baby-bottle warmer is operated by car battery.....	169

AVIATION

Lifesaving aids for airmen.....	95
Nazi "bubble bath" suits protect against chills.....	97
XB-36, world's largest bomber, dwarfs B-29.....	115
High-performance personal plane.....	115
Bellanca Cruisair travels 153 m.p.h. carrying four passengers.....	124
Giant 20-seat helicopters are planned for air-bus line.....	137
Auxiliary engine for soaring plane weighs 40 pounds.....	152
Synthetic plane grease "buttery" at 100 below.....	152
Plastic bubble covers antenna of radio compass on planes.....	162
Laboratory on wings.....	163
Decompression "test flight" amazes experts.....	174
Servicing "cafeteria" for planes.....	176

BOATS

Near-fireproof paint for ships contains aluminum powder.....	162
Pilot boats adopt facsimile telegraphy to report incoming ships.....	162
"AquaJet" pushes small boat.....	175
"Covered wagon" life raft supports 20 persons.....	176

FARM

Farmers use walkie-talkie to reach workers in field.....	97
Homemade tractor for small farms.....	106
Chemical nutrients and dissolved fertilizers injected into sick fruit trees.....	106
Zipp-r-equipped rubber boots for "bossy" aid hoof treatment.....	159

HOUSE AND HOME

Home sealer "bags" leftovers.....	107
Circus clown uses stilts at home.....	107
Ammunition cases provide part of lumber to build house.....	114
Hot box keeps food hot for three hours.....	114
Ink or oil spots wash off rugs made of plastic-coated paper.....	120
Abandoned lighthouse moved to solve housing problem for enterprising couple.....	125
Magic mantel.....	136
House moved on river barge.....	136
Door mat with revolving brushes removes shoe dirt.....	137
Inside stuff for your home.....	160
Peaches frozen in acid syrup hold true color for years.....	169

INDUSTRY

Roller conveyor for steel pipe.....	104
Big bridge across Rhine at Cologne floated into position.....	106
Diesel locomotive incorporates specifications furnished by 22 railroads.....	114
Accidental "bath" for silver wire reveals new way to polish.....	120
Turntable aids in polishing huge bearings used in giant generators.....	125
Cotton insulates freight cars.....	129
1330-degree heat for lenses increases strength 16 times.....	143
Scented oil taken from grass perfumes toilet soap.....	143
"Para-scooter" in civvie garb carries factory messages.....	175

LAWN AND GARDEN

"Pattern" sprinkler waters odd plots.....	104
Combination lawn mower, rake and snowplow.....	114
Dual purpose lawn-hose nozzle also serves as sprinkler.....	162
Spreader cap to sow grass seed fits over a fruit jar.....	175

OUTDOOR RECREATION

Card table secures deck and discards in outdoor play.....	96
Zipper-sealed chair tent for winter sportsman turns in any direction.....	129
Spring-powered fish catcher sets hook automatically when fish bite.....	143
Steel clamp straightens leaders attached to fishlines.....	152
Steel gripper for holding fish helps angler scale his catch.....	169

PHOTOGRAPHY

Quick-developing color film processed in any darkroom.....	96
"X-ray" patterns with your camera.....	136
Extension hood for cameras aids in picture composition.....	146
Trick photos of girl tennis player give illusion of action.....	147
Numbering machine marks film in bright daylight.....	175

STORE AND OFFICE

U. S. patent office seeks invention.....	97
Fluorescent lamp for stenographers.....	106
Processing rack keeps work at hand level.....	132

TOOLS

Automatic soldering iron ejects measured "doses".....	104
Special wrench for dual wheels.....	107
Right-angle "driver" fits corners.....	107
Loader fitting for grease gun.....	120
"Stethoscope" for machinery listens to ailments.....	124
Work holder dials angles of many sizes in joining operations.....	159

MISCELLANEOUS

Old process is revived for casting gas turbine blades.....	94
Radiophone speeds freight pickup for air shipment.....	96
Sculpturing with wire.....	105
Sandlottery try unsuccessfully to break "ballproof" glass.....	106
Artificial eye turns naturally.....	120
Milan pedals to work.....	121
Mother ship of the cable lines.....	122
Sound recorder uses paper tape to transcribe radio programs.....	124
Big baby buggy is labor-saver at English children's home.....	125
Chemical beads dry air in toolbox or storeroom.....	129
Radio steers Navy AA rocket.....	132
One finger plays four-note chords with keyboard attachment.....	136
"Elevator" on bread trailer loads 645 loaves a minute.....	137
Talking mountains.....	144

(Continued to page 10)



"When I had to leave school, I enrolled with I.C.S. The Course was excellent--and the beginning of an educational habit which has persisted through my life."

WALTER D. FULLER
President, The Curtis Publishing Company*

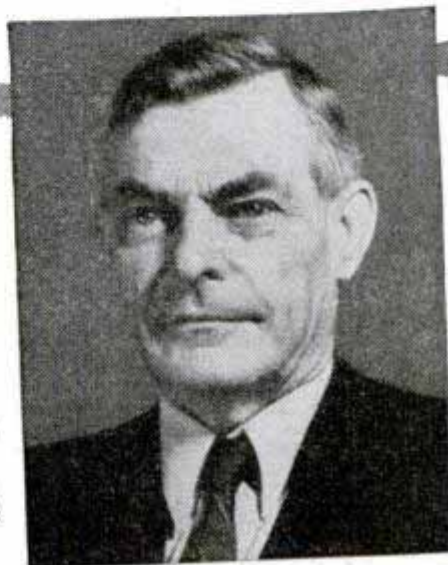

"To those who are denied the opportunity of a college education, I.C.S. offers a satisfying substitute. I know. I studied an I.C.S. Course myself."

JASPER McLEVY
Mayor of Bridgeport, Connecticut**

*Publishers of *The Saturday Evening Post*, *Ladies' Home Journal*, *Country Gentleman*, *Jack and Jill*.

**Now in his 12th consecutive year in this office.

INTERNATIONAL CORRESPONDENCE SCHOOLS



BOX 5589-K, SCRANTON 9, PENNA.

Without cost or obligation, please send me full particulars about the course before which I have marked X:

- | | | | |
|---|--|---|--|
| <p>Business and Academic Courses</p> <ul style="list-style-type: none"> <input type="checkbox"/> Accounting <input type="checkbox"/> Arithmetic <input type="checkbox"/> Business Correspondence <input type="checkbox"/> Business Management <input type="checkbox"/> Certified Public Accounting <input type="checkbox"/> Commercial <input type="checkbox"/> Cost Accounting <input type="checkbox"/> Federal Tax <input type="checkbox"/> First Year College <input type="checkbox"/> Foremanship <input type="checkbox"/> Good English <input type="checkbox"/> Higher Mathematics <input type="checkbox"/> Illustrating <input type="checkbox"/> Postal Service <input type="checkbox"/> Salesmanship <input type="checkbox"/> Sign Lettering <input type="checkbox"/> Spanish <input type="checkbox"/> Traffic Management <p>Air Conditioning and Plumbing Courses</p> <ul style="list-style-type: none"> <input type="checkbox"/> Air Conditioning <input type="checkbox"/> Heating <input type="checkbox"/> Refrigeration | <p>Chemistry Courses</p> <ul style="list-style-type: none"> <input type="checkbox"/> Chemical Engineering <input type="checkbox"/> Chemistry, Analytical <input type="checkbox"/> Chemistry, Industrial <input type="checkbox"/> Chemistry, Mfg. Iron & Steel <input type="checkbox"/> Petroleum Refining <input type="checkbox"/> Pulp and Paper Making <p>Civil Engineering, Architectural and Mining Courses</p> <ul style="list-style-type: none"> <input type="checkbox"/> Architectural Drafting <input type="checkbox"/> Architecture <input type="checkbox"/> Building Estimating <input type="checkbox"/> Civil Engineering <input type="checkbox"/> Contracting and Building <input type="checkbox"/> Highway Engineering <input type="checkbox"/> Lumber Dealer <input type="checkbox"/> Reading Structural Blueprints <input type="checkbox"/> Sanitary Engineering <input type="checkbox"/> Structural Drafting <input type="checkbox"/> Structural Engineering <input type="checkbox"/> Surveying and Mapping <p>Communications Courses</p> <ul style="list-style-type: none"> <input type="checkbox"/> Electronics <input type="checkbox"/> Practical Telephony <input type="checkbox"/> Radio, General <input type="checkbox"/> Radio Operating | <ul style="list-style-type: none"> <input type="checkbox"/> Radio Servicing <input type="checkbox"/> Telegraph Engineering <p>Electrical Courses</p> <ul style="list-style-type: none"> <input type="checkbox"/> Electric Drafting <input type="checkbox"/> Electrical Engineering <input type="checkbox"/> Electric Light and Power <input type="checkbox"/> Lighting Technician <input type="checkbox"/> Practical Electrician <input type="checkbox"/> Power House Electric <input type="checkbox"/> Ship Electrician <p>Internal Combustion Engines Courses</p> <ul style="list-style-type: none"> <input type="checkbox"/> Auto Technician <input type="checkbox"/> Diesel-Electric <input type="checkbox"/> Diesel Engines <p>Mechanical Courses</p> <ul style="list-style-type: none"> <input type="checkbox"/> Aeronautical Engineering <input type="checkbox"/> Aircraft Drafting <input type="checkbox"/> Flight Engineer <input type="checkbox"/> Foundry <input type="checkbox"/> Foundry Work <input type="checkbox"/> Heat Treatment of Metals <input type="checkbox"/> Industrial Engineering <input type="checkbox"/> Industrial Metallurgy <input type="checkbox"/> Machine Shop <input type="checkbox"/> Machine Shop Inspection | <ul style="list-style-type: none"> <input type="checkbox"/> Mechanical Drafting <input type="checkbox"/> Mechanical Engineering <input type="checkbox"/> Mold-Loft Work <input type="checkbox"/> Patternmaking—Wood, Metal <input type="checkbox"/> Reading Shop Blueprints <input type="checkbox"/> Sheet-Metal Drafting <input type="checkbox"/> Sheet-Metal Worker <input type="checkbox"/> Ship Drafting <input type="checkbox"/> Tool Designing <input type="checkbox"/> Welding—Gas and Electric <p>Railroad Courses</p> <ul style="list-style-type: none"> <input type="checkbox"/> Air Brake <input type="checkbox"/> Diesel Locomotive <input type="checkbox"/> Locomotive Engineer <input type="checkbox"/> Locomotive Fireman <input type="checkbox"/> Railroad Section Foreman <p>Steam Engineering Courses</p> <ul style="list-style-type: none"> <input type="checkbox"/> Boilermaking <input type="checkbox"/> Combustion Engineering <input type="checkbox"/> Engine Running <input type="checkbox"/> Marine Engineering <input type="checkbox"/> Steam Electric <p>Textile Courses</p> <ul style="list-style-type: none"> <input type="checkbox"/> Cotton Manufacturing <input type="checkbox"/> Rayon Weav'g <input type="checkbox"/> Woolen Manufacturing |
|---|--|---|--|

Name _____ Age _____ Home Address _____

City _____ State _____ Present Position _____

Working Hours _____ A.M. to _____ P.M. Length of Service in World War II _____

Special tuition rates to members of the Armed Forces. Enrollment under the G.I. Bill of Rights approved for War II Veterans. Canadian residents send coupon to International Correspondence Schools Canadian, Ltd., Montreal, Canada.



**FOR JOBS
NO OTHER TOOLS
CAN DO**

HOMECRAFTERS, tool and die makers, and precision-work mechanics generally, find using these special types of files both enjoyable and profitable. They enable doing things next to impossible with other tools. Nicholson quality makes their ownership an additional source of pride.

- Nicholson X.F. Swiss Pattern Files** are indispensable on fine-instrument and model work. Illustrated is an assortment of twelve in the Knurled-handle Needle style. Offered in handsome orange-and-blue plastic case that will delight the "hobbyist" in particular.
- Nicholson Rotary Files** are sweeping industrial and amateur ranks with their popularity. Operated with electric power tool, flexible shaft or drill press. The Nicholson Rotakit (glass-front hinged case) contains ten assorted shapes.

EXCELLENT GIFTS—for Christmas or any time. Sold through good hardware and mill-supply houses.



NICHOLSON FILE CO.
22 Acorn St., Providence 1, R. I.
(In Canada, Port Hope, Ont.)



**NICHOLSON
FILES** FOR EVERY PURPOSE

(Continued from page 8)

"Icebox" hats	146
Lubricant is floated on air in form of dry powder	146
Semiwaterproof paper bags will hold contents in rain	147
Motorcycle ambulances designed for rough terrain	147
Tiny town of plastics	158
"Take it or leave it" music	169
Surplus hangars become workshop	176

Craftsman and Shop Notes Index

AUTOMOTIVE	
Getting rid of hub cap rattle	185
Dog is kept safely in auto with hook fastened to leash	208
Motorist's vision is increased with sliding visor	216
Salt solution is used to check accuracy of battery hydrometer	221
Trouser clamp keeps floor mat away from working space	222
Fixing synthetic-rubber inner tubes	222
Repairing ignition system shorts	223
FARM	
Fence posts are pointed easily when held in standard	181
Feed box is hinged to manger for easier cleaning	220
Driving reins kept from falling if looped around horseshoe	220
Amount of grain in bin estimated with aid of chart	220
FURNITURE	
Oil colors applied to scratches touch up furniture	206
Panel hooked to high-chair legs prevents bad falls	206
Rack patterned after book end	206
Baby walker made with chair will please small child	206
HOUSE AND HOME	
Envelope sealed with fingernail polish will stay closed	180
Formation of mildew on leather prevented by copper sulphate	181
Recirculating connection conserves hot water	181
Solving home problems	182
Masking tape for window panes	185
Decal on framed piece of glass decorates child's room	192
Spring fastened to eaves trough screens trash from downspout	192
Leaves insulate house foundation	192
Vegetables are accessible if kept in unheated building	192
Aluminum-lined shower cabinet	193
Removable crosspiece on ladder simplifies window washing	208
OUTDOOR RECREATION	
Play ball made from basketball	180
Canvas strips tied on bottom of skis aid uphill climbing	197
This disk-throwing game tests skill of players	205
PHOTOGRAPHY	
Decorative ribbon ornaments framed photos	209
Glass strip in developing tray keeps film from sticking	209
Marked papers eliminate waste	209
Viewing glass aids photographer	209
Animated motion-picture titles photographed through glass	210
Cloth diffusers for photofloods are attached easily	210
Photographs recessed with iron	210
Clear nail polish adds luster to spotted glossy prints	210
Handy shelf arrangement when ferrotyping photoprints	213
Blue Cellophane attached to view finder eliminates need for filter	213
Obtaining longer interval with a photographic self-timer	214
Keeping ferrotype tins in place	214
Cut-film and film-pack drier	214
Tape is used to identify film	214
RADIO AND ELECTRONICS	
Low-cost 50-watt transmitter-exciter unit	229
All-wave a.c. 4-tube receiver for experimenters	230
Special purpose electronic devices	232
TOOLS	
Clamp to hold small articles formed by using hardwood clothespin	200
Straightener held by bench vise removes kinks from wire	208
File has pistol-grip holder	208
Craft quiz	215
Rack for hammer assortment	216
Lathe tool-post turret	217
Steady rest supports long pipe when threading in lathe	218
Trip hammer has many uses in small shop	219
Cutting keyways without a milling attachment	221
Blowing tool uses valve stem	222
Dolly facilitates quick shifting of shop tools	223
Adjustable holder for grinding produces accurate work	223
TOYS AND NOVELTIES	
Musical merry-go-round	184
Carved letter opener is cut from rosewood	197
Mailing tube novelties	198
Attractive photo bracelet from lens and letter opener	200
Novel photographic cutout is cellulose-tape dispenser	200
Capsules used on model airplane add realistic touch	205
MISCELLANEOUS	
Indicating light on map makes geography fun	185
Two-color triangular bandages identify different knots	185
Ink pad uses typewriter ribbon	192
Free lunch for birds	196
Inexpensive wood filler	197
Rubber cover protects padlock	205
Bolts and nuts are stored in jar	206
Etch it!	207
Nail polish used as protection for soap carvings	208
Plastic-glue filler mends holes in rotted frames and posts	216
How to rivet softwood joints	216
Bead aids when slipping tubing over insulated wire	216
Canvas pocket strapped to ankle carries finishing nails	219
Bands hold oil drum in position	220
Thumbtack pins eraser on board	220
Holes punched in fire bucket assure its proper use	222
Backing paper held in position with rubber bands	222

IMPORTANT NOTICE—It is the intention of this magazine to provide its readers with information regarding the latest developments in the mechanical arts. We take no responsibility as to whether the disclosures contained in our articles are covered by patents and advise readers to investigate this subject before making, using, or selling any of the products, machines, or processes described in order to avoid possible liability for patent infringements.

AUDELS REFRIGERATION & AIR CONDITIONING GUIDE.....\$4

New from Cover to Cover—1280 Pages, Fully illus. Covering basic principles, servicing, operation & repair of household, commercial & industrial refrigeration & air conditioning. A gold mine of essential important facts for engineers, servicemen, users.

AUDELS CARPENTERS & BUILDERS GUIDES—4 Vols.\$6

A practical illustrated trade assistant on modern construction for carpenters, joiners, builders, mechanics and all woodworkers. 4 vols., 1600 pages, 3700 illustrations, flexible covers. Pocket size. Each volume sold separately \$1.50 a vol.

AUDELS AUTOMOBILE GUIDE.....\$4

A practical quick ready reference book for auto mechanics, service men, operators & owners. Explains theory, construction & servicing of modern motor cars, trucks, buses & auto type Diesel engines. 1540 pages, fully illustrated, 55 chapters. Indexed. A standard book for mechanics. New fluid drive covered.

AUDELS DIESEL ENGINE MANUAL.\$2

A practical, concise treatise with questions and answers on the theory, operation and maintenance of modern diesel engines including General Motors 2 cycle Diesel. 384 pages, fully illus., flexible binding, pocket size. All details plainly brought out, this book is of extreme value to engineers, operators & students.

AUDELS WIRING DIAGRAMS.....\$1

210 Pages. Illustrated. Gives practical facts on wiring of electrical apparatus. It shows clearly how to wire apparatus for practically all fields of electricity. Each diagram is complete & self-explanatory. Highly Endorsed Pocket Companion.

AUDELS PLUMBERS & STEAMFITTERS GUIDES—4 Vols.\$6

A Practical Trade Assistant & Ready Reference. Explains in plain language & by clear illustrations, diagrams, charts, graphs, pictures principles of modern plumbing practice including Marine Pipe Fitting and Air Conditioning. 4 Vols.—1670 Pages—3642 Diagrams. Pocket size. Each Vol. Sold Separately \$1.50 a Vol.

AUDELS SHEETMETAL WORKERS HANDY BOOK.....\$1

Practical inside information. Fundamentals of Sheet Metal Work. 388 pages. Illustrated. 11 sections. Clearly written. Essential & important facts, figures, pointers in everyday language. Ref. Index.

AUDELS SHEETMETAL PATTERN LAYOUTS.....\$4

Developed by Experts for Sheet Metal Workers, Layout Men & Mechanics. A Practical Encyclopedia in 10 Sections, size 7 x 10 x 2—1125 Pages—350 Layouts—1600 Illustrations, 1001 Key Facts. Fully indexed for ready reference in answering your layout problems. Covers all phases of sheet metal work including Pattern Cutting, Pattern Development & Shop Procedure.

AUDELS ANSWERS ON BLUE PRINT READING.....\$2

For Mechanics & Builders. Covers all types of blue print reading including ship & airplane. 376 pages, fully illustrated.

AUDELS NEW MACHINIST & TOOLMAKERS HANDY BOOK...\$4

Covers modern machine shop practice in all its branches. 5 practical books in 1. New from cover to cover. Tells how to set up & operate lathes, screw and milling machines, shapers, drill presses and all other machine tools. 1600 pages, fully illustrated, 5 x 6 1/2 x 2. Indexed. 5 sections. 1—Modern Machine Shop Practice. 2—Blue Print Reading & How to Draw. 3—Calculations & Mathematics for Machinists. 4—Shop Physics. 5—How to Use the Slide Rule. 60 chapters. Easy to read and understand. A shop companion that answers your questions.

AUDELS MATHEMATICS & CALCULATIONS FOR MECHANICS \$2

Mathematics for home study or reference. 700 pages, 550 illus. Practical mathematics from beginning. How to figure correctly. Easy, correct methods covering a complete review. Ill. & Indexed.

AUDELS HANDY BOOK OF PRACTICAL ELECTRICITY.....\$4

For maintenance engineers, electricians & all electrical workers. 1440 Pages, 2600 illus. Covers important electrical information in handy form—including Marine Wiring, Radio Principles, Welding. Indexed. A Key to a practical understanding of electricity.

AUDELS RADIOMANS GUIDE.....\$4

A key to the practical understanding of radio including Frequency Modulation, Television, etc., Aircraft & Marine Radio. For radio engineers, servicemen, amateurs. 772 pages. 400 illustrations & Diagrams. Photos. Review Questions & Answers, Reference Index. Authentic, clear, concise.

AUDELS ELECTRONIC DEVICES...\$2

Tells What You Want to Know About Electric Eye. Easily Understood. Covers photo-electric cells & their applications. Amplifiers, illumination, frequencies, voltage, photocell, tubes, Ohm's Law, wiring diagrams, etc.

AUDELS WELDERS GUIDE.....\$1

A concise, practical text on operation & maintenance of all welding machines for all mechanics. Over 400 pages, illustrated. Covers all methods of electric and acetylene welding including airplane work.

AUDEL, Publishers, 49 W. 23 St., N. Y. 10



AN AUDEL GUIDE IS A GOOD FRIEND!

Use the brains and experience of others in these Guides of the Trades. Save time and money with right methods, short cuts, labor saving ideas. CHECK NOW! You can look over any Audel Guide in your home. Start the Easy Payments if satisfied.

CUT HERE MAIL ORDER

THEO. AUDEL & CO., 49 W. 23 St., New York 10, N. Y.

Please mail me for 7 days' free examination the books marked (X) below. I agree to mail \$1 in 7 days on each book or set ordered, and to further mail \$1 a month on each book or set ordered until I have paid purchase price.

If I am not satisfied with Guides I will return them.

- Audels OIL BURNER GUIDE\$1.
- Audels REFRIGERATION & Air Conditioning Guide. 4.
- Audels POWER PLANT ENGINEERS GUIDE 4.
- Audels PUMPS, HYDRAULICS & AIR COMPRESSORS 4.
- Audels WELDERS GUIDE 1.
- Audels BLUE PRINT READING 2.
- Audels SHEET METAL WORKERS Handy Book 1.
- Audels SHEET METAL PATTERN LAYOUTS 4.
- Audels AIRCRAFT WORKER 1.
- Audels MATHEMATICS and CALCULATIONS 2.
- Audels MACHINISTS & TOOLMAKERS Handy Book 4.
- Audels MECHANICAL Dictionary 4.
- Audels AUTOMOBILE GUIDE 4.
- Audels DIESEL ENGINE MANUAL 2.
- Audels MARINE ENGINEERS Handy Book 4.
- Audels SHIPFITTERS Handy Book 1.
- Gueths MECHANICAL DRAWING COURSE 1.
- Rogers DRAWING and DESIGN 2.
- Audels MILLWRIGHTS and Mechanics Guide 4.
- Audels CARPENTERS and Builders Guides (4 vols.) 6.
- Audels PLUMBERS and Steamfitters Guides (4 vols.) 6.
- Audels MASONS and Builders Guides (4 vols.) 6.
- Master PAINTER and DECORATOR 2.
- Audels GARDENERS & GROWERS GUIDES (4 vols.) 6.
- Audels ENGINEERS & FIREMANS EXAMINATIONS 1.
- Audels ENGINEERS and Mechanics Guides Nos. 1, 2, 3, 4, 5, 6, 7 and 8 complete 12.
- Audels Answers on Practical ENGINEERING 1.
- Audels ELECTRICIANS EXAMINATIONS 1.
- Audels WIRING DIAGRAMS 1.
- Audels Handy Book of PRACTICAL ELECTRICITY 4.
- Audels ELECTRICAL POWER CALCULATIONS 2.
- Audels ELECTRONIC DEVICES 2.
- Audels ELECTRIC Dictionary 2.
- Audels RADIOMANS GUIDE 4.
- Audels NEW ELECTRIC LIBRARY at \$1.50 a Volume Vols. I, II, III, IV, V, VI, VII, VIII, IX, X, XI, XII

Name.....

Address.....

Occupation.....

Employed by..... PM



BE YOUR

*I will show you how to start
a Radio Service Business
Full Time or Spare Time without capital*

**J. E. SMITH, President
National Radio Institute**
The man who has directed the Home Study Training of more men for the Radio Industry than any other man in America.

I Trained These Men



\$35 - \$45 A Week In Own Shop

"Previous to enrolling for your Radio training I made \$12 per week in a hardware store. Now I operate my own repair shop, and often clear \$35 to \$45 a week."—**FREDERICK BELL**, 76 Golf Ave., St. Johns, Newfoundland.

\$250 A Month In Own Shop

"I am now operating a radio shop for myself and own all my equipment. Right now repairing radios pays me an average of about \$250 a month."—**J. M. SCRIVENER, JR.**, Aberdeen, Miss.



Averages Over \$60 A Week

"Not long ago I was working 16 hours a day in a filling station at \$10 a week. Now I have my own Radio business and average over \$60 a week. The N. R. I. course is fine."—**ALBERT O. CHRISTENSEN**, 1116 Tenth Ave., Sidney, Neb.

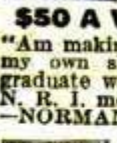

\$50 A Week From Own Shop

"Am making over \$50 a week profit from my own shop. Have another N. R. I. graduate working for me. I like to hire N. R. I. men because they know Radio."—**NORMAN MILLER**, Hebron, Neb.



\$50 A Month In Spare Time

"I have a spare time Radio and Electrical business of my own which has been very profitable, due to the efficient training I received from your Course. Last year I averaged over \$50 a month."—**FRED H. GRIFFIE**, Rt. 3, Newville, Pa.

Fixing Radios Profitable Hobby

"I am doing Radio work in my spare time and find it a profitable hobby. My extra earnings run about \$10 a week. I certainly am glad I took your N. R. I. Course."—**FERDINAND ZIRBEL**, Chaseley, N. Dak.



SAMPLE LESSON FREE SEE OPPOSITE PAGE

Do you want a good-pay job in Radio—or your own money-making Radio Shop? Mail Coupon for a **FREE** Sample Lesson and my **FREE** 64-page book, "Win Rich Rewards in Radio." See how N. R. I. gives you practical Radio experience at home—building, testing, repairing Radios with 6 **BIG KITS OF PARTS** I send!

Many Beginners Soon Make Good Extra Money In Spare Time While Learning

The day you enroll I start sending **EXTRA MONEY JOB SHEETS**. You **LEARN** Radio principles from my easy-to-grasp, illustrated lessons—**PRACTICE** what you learn with parts I send—**USE** your knowledge to make **EXTRA** money fixing neighbors' Radios in spare time while still learning! From here it's a short step to your own **full-time** Radio Shop or a good Radio job!

Future for Trained Men is Bright in Radio, Television, Electronics

It's probably easier to get started in Radio now than ever before because the Radio Repair business is booming. Trained Radio Technicians also find profitable opportunities in Police, Aviation, Marine Radio, Broadcasting, Radio Manufacturing, Public Address work. Think of even **greater** opportunities as Television and Electronics become available to the public! Send for free books now!

Find Out What N. R. I. Can Do For You

Mail Coupon for Sample Lesson and my 64-page book. Read the details about my Course. Read letters from men I trained, telling what they are doing, earning. See how quickly, easily you can get started. No obligation! Just **MAIL COUPON NOW** in an envelope or paste it on a penny postal. **J. E. SMITH, President, Dept. 6KP, National Radio Institute, Pioneer Home Study Radio School, Washington 9, D. C.**

Our 32nd Year of Training Men for Success in Radio

**MY COURSE INCLUDES
TELEVISION
ELECTRONICS
FREQUENCY MODULATION**

A TESTED WAY

OWN BOSS

LEARN RADIO BY PRACTICING IN SPARE TIME with 6 Big Kits of Radio Parts I Send You!

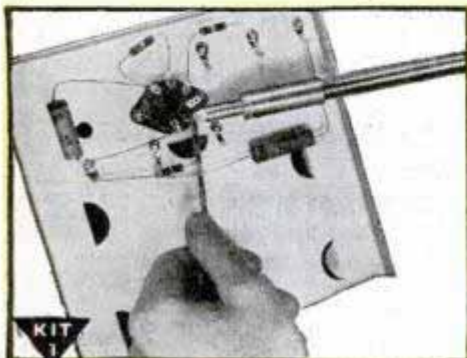

KIT 1
I send you Soldering Equipment and Radio Parts; show you how to do Radio soldering; how to mount and connect Radio parts; give you practical experience.



KIT 2
Early in my Course I show you how to build this N.R.I. Tester with parts I send. It soon helps you fix neighborhood Radios and earn EXTRA money in spare time.

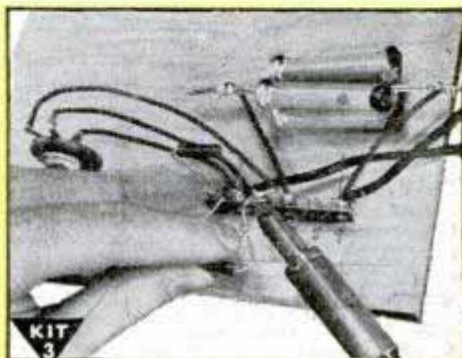

KIT 3
You get parts to build Radio Circuits; then test them; see how they work; learn how to design special circuits; how to locate and repair circuit defects.

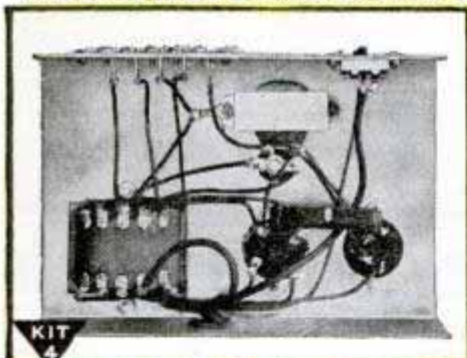

KIT 4
You get parts to build this Vacuum Tube Power Pack; make changes which give you experience with packs of many kinds; learn to correct power pack troubles.



KIT 5
Building this A. M. Signal Generator gives you more valuable experience. It provides amplitude-modulated signals for many tests and experiments.

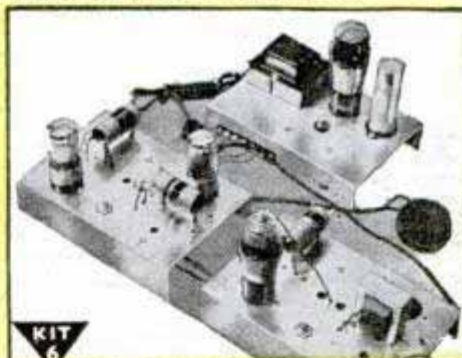

KIT 6
You build this Superheterodyne Receiver which brings in local and distant stations—and gives you more experience to help you win success in Radio.

SAMPLE LESSON

FREE

I will send you a FREE Lesson, "Getting Acquainted with Receiver Servicing," to show you how practical it is to train for Radio at home in spare time. It's a valuable lesson. Study it—keep it—use it—without obligation! Tells how Superheterodyne Circuits work, gives hints on Receiver Servicing, Locating Defects, Repair of Loud-speaker, I.F. Transformer, Gang Tuning, Condenser, etc. Thirty-one illustrations.



MAIL COUPON FOR FREE LESSON
AND 64-PAGE BOOK

Good for Both FREE

Mr. J. E. SMITH, President, Dept. 6KP
National Radio Institute, Washington 9, D. C.
Mail me FREE, without obligation, Sample Lesson and 64-page book about how to win success in Radio and Television—Electronics. (No salesman will call. Please write plainly.)

Age.....

Name.....

Address.....

City..... Zone..... State.....

Approved for Training under GI Bill



TO GOOD PAY

AUDELS Carpenters and Builders Guides

4 vols. \$6

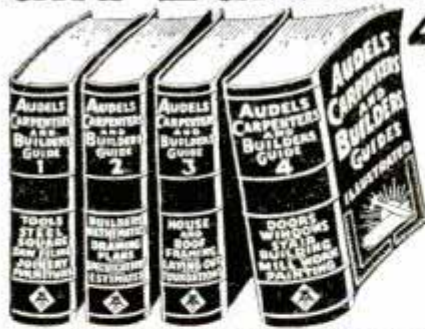

Inside Trade Information for Carpenters, Builders, Joiners, Building Mechanics and all Woodworkers. These Guides give you the short-cut instructions that you want—including new methods, ideas, solutions, plans, systems and money saving suggestions. An easy progressive course for the apprentice and student. A practical daily helper and Quick Reference for the master worker. Carpenters everywhere are using these Guides as a Helping Hand to Easier Work, Better Work and Better Pay. To get this assistance for yourself, simply fill in and mail the FREE COUPON below.

Inside Trade Information On:

How to use the steel square—How to file and set saws—How to build furniture—How to use a mitre box—How to use the chalk line—How to use rules and scales—How to make joints—Carpenters arithmetic—Solving mensuration problems—Estimating strength of timbers—How to set girders and sills—How to frame houses and roofs—How to estimate costs—How to build houses, barns, garages, bungalows, etc.—How to read and draw plans—Drawing up specifications—How to excavate—How to use settings 12, 13 and 17 on the steel square—How to build hoists and scaffolds—skylights—How to build stairs—How to put on interior trim—How to hang doors—How to lath—lay floors—How to paint



THEO. AUDEL & CO., 49 W. 23rd St., New York City

Mail Audel's Carpenters and Builders Guides, 4 vols., on 7 days' free trial. If O.K. I will remit \$1 in 7 days, and \$1 monthly until \$6 is paid. Otherwise I will return them. No obligation unless I am satisfied.

Name.....
 Address.....
 Occupation.....
 Reference.....PM



AUTO

BOOKS ON APPROVAL

SEND NO MONEY. Just mail the coupon for a complete set of Six Big Auto Books, 20th Edition. Whether you are a mechanic or helper, expert or apprentice, auto owner or driver, take immediate advantage of this FREE EXAMINATION OFFER.

MAKE GOOD MONEY NOW HOLD A PERMANENT JOB

America wants its automobiles kept in good repair. Men with "know how" are in demand, at big pay. These books will help you get and hold an important job, or give you a chance to go into business for yourself now or later. Any man who half tries to improve himself can learn auto servicing and repairing by this quick reference method. Use the JIFFY INDEX to find easily understood answer to any auto problem. These wonder books prepared by eleven of America's great automobile engineers. Many hundreds of valuable illustrations. Send the coupon TODAY.

A year's consulting privileges with our engineers now given with these books without extra charge.
 Vocational Publishers Since 1898

CAN YOU FIX IT?

These wonder books tell step by step HOW to make difficult repairs and adjustments, how to keep a car at maximum efficiency, including latest improvements in car design and operation. Engine troubles and how to correct them well covered.

6 BIG VOLUMES

2800 pages, 2000 illustrations, wiring diagrams, etc., including Diesel engines. Beautiful modernistic, washable cloth binding.

AMERICAN TECHNICAL SOCIETY, Dept. A719
 Drexel Ave. at 58th St., Chicago 37, Ill.

I would like to examine your Six-Volume Set of Auto Books. I will pay the delivery charges only, but if I choose I may return them express collect. If after 10 days' use I prefer to keep them, I will send you \$2 and pay the balance at the rate of only \$3 a month until \$24.80 has been paid. Please include consulting service as offered above.

Name.....
 Address.....
 City..... State.....
 Please attach letter stating age, occupation, employer's name and address and name and address of at least one business man as reference. Men in service, also please give home address.

BE A

LANDSCAPE ARCHITECT

WORK OUTDOORS



Healthful, pleasant outdoor work in an uncrowded field.

The field of Landscape Gardening offers unusual opportunities for trained men... greatly augmented by the huge home-building and modernizing program ahead. We provide thorough, interesting home-training during your spare time... adapted to your regional conditions.

APPROVED for VETERANS

BE YOUR OWN BOSS

A graduate says, "I finished the course about two months ago and now I average about \$2.00 per hour net for my time."

There are many employment opportunities in this profitable, uncrowded field or you can easily start your own business. Write today.

Service from Coast to Coast

NATIONAL LANDSCAPE INSTITUTE

DEPARTMENT P 756 SOUTH BROADWAY — LOS ANGELES 14

LEARN MONEY-MAKING CARTOONING

IN SPARE TIME — by Easy Picture Chart Method

Same Simplified Method that has helped train creators of "Terry & Pirates," "Freckles," "Out Our Way," "Winnie Winkle," "Regular Fellers," "Strange As It Seems," "The Neighbors," and many others. Earn while learning. Send 10c for Picture Chart (to test your ability), and full details. (State age.)



Landon School of Cartooning, Dpt. 4610 Philadelphia (1) Pa.

Learn Penmanship

You can learn plain, rapid writing or fancy ornamental writing for social and business advancement, right in your own home during spare time by my Simplified Method. Write for my free book, "How to Become an Expert Penman," which shows what others have accomplished by taking my Courses. Send 10c for one of my favorite Pen Points and your name with a beautiful flourished bird written on a card. Write today. T. M. Tevis, Box 25K, Chillicothe, Mo.

What Every Mason Wants

We have important Masonic books for Blue Lodge, Chapter, Commandery, Scottish Rite, and Shrine. Our Rituals Are Used the World Over. Send for free catalog of books and rituals for Masons, Odd Fellows, Knights of Pythias, Knights of Columbus, etc. EZRA A. COOK, Publisher, P. O. Box 796, P.O., Chicago 90, Ill.

SAY YOU SAW IT IN POPULAR MECHANICS

Get U.S. Gov't Job

Splendid salaries, vacations, pension when retired. My low-priced, home-study practice tests help one make higher grade in Gov't Exam. Write today, OZMENT SCHOOL, 80, St. Louis, Mo. (Veterans given preference)

TRI-STATE COLLEGE

B. S. Degree in 27 months in Engineering (all branches); Bus. Admin., Acct and Sec. Science. 63rd year. School now filled to capacity. No applications can be accepted until further notice.

4106 College Ave., Angola, Ind.

arc welding manual and text book...\$2.00
 Hobart Bros. Co., Troy, Ohio
 Teaches you how to become an arc welding operator — one of highest paid trades today! Write today!
 Box M-562

INVENTORS

The patent laws provide that any new and useful art, machine, article of manufacture, composition of matter, or design, or any new and useful improvement thereof, may be patented if the act of invention is involved. Therefore, every inventor with a valuable invention should take advantage of the patent laws and proceed for patent protection in order to safeguard his rights.

A patent gives the inventor the exclusive right to prevent others from making, using, or selling the invention claimed in the patent for a period of 17 years.

The patent laws were enacted for the benefit of the inventor to give him protection for the features of his invention which are patentable. These features must be properly and concisely set forth and claimed in a formal application for patent in order to comply with the requirements of the U. S. Patent Office. For that reason, the Patent Office advises the inventor to engage a competent registered patent attorney to prepare his application for patent and represent him before the U. S. Patent Office Examiner.

A specially prepared booklet containing detailed information with respect to patent protection and procedure will be forwarded to you without obligation upon request.

Patents
Trademarks
Copyrights

Registered Patent Attorneys

CLARENCE A. O'BRIEN
& HARVEY B. JACOBSON

61-K Adams Building + Washington 4, D. C.

CLARENCE A. O'BRIEN & HARVEY B. JACOBSON
Registered Patent Attorneys
61-K Adams Building, Washington 4, D. C.

Please send me booklet containing information regarding patent protection and procedure. This request does not obligate me.

Name _____

Address _____

City _____ State _____

(Please write or print plainly.)

LET ME TRAIN YOU

for RADIO ELECTRONICS & TELEVISION

I'll Supply a **FULL RADIO SET**

for SIMPLIFIED INSTRUCTION — PRACTICE & TESTING

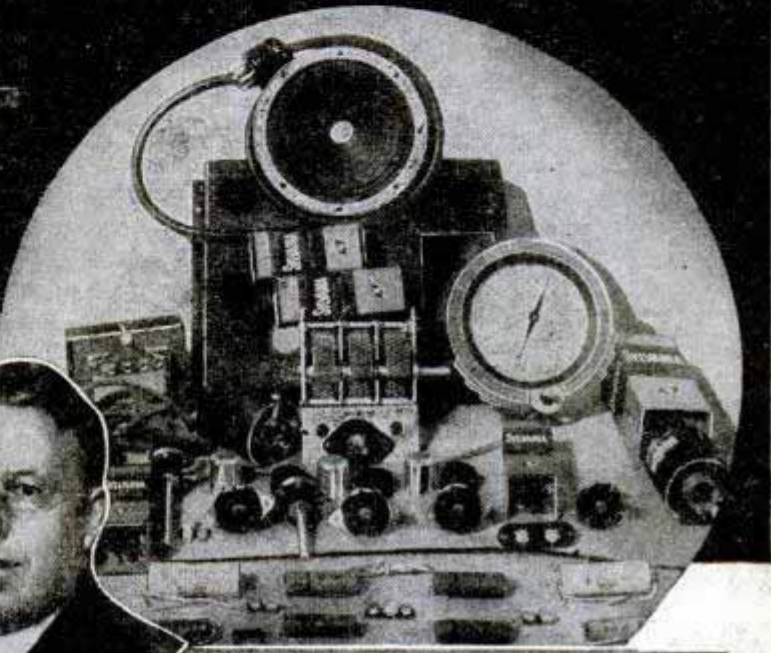
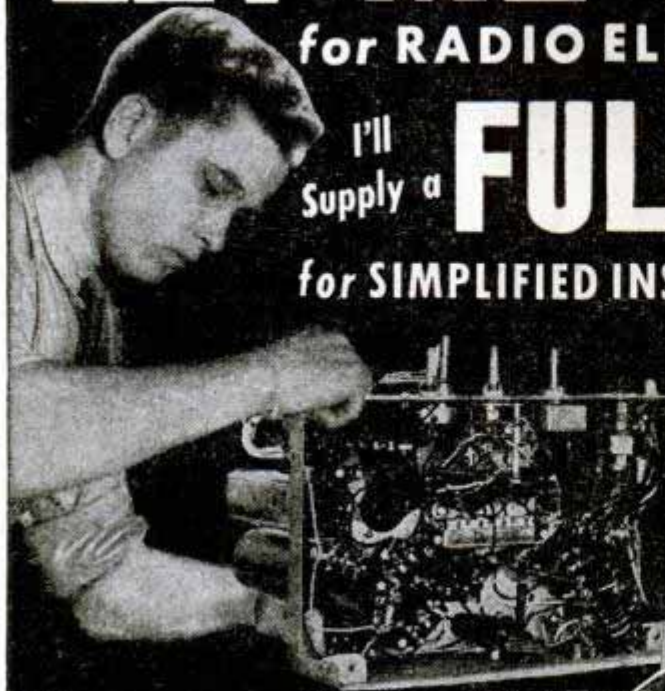

Beginners Learn **FAST**
START NOW! Big Developments
Ahead in F. M., Radar, Television



**MAKE GOOD MONEY IN
a Business of Your Own
...or a Good Radio Job.**

The offer I make you here is the opportunity of a lifetime. It's your big chance to get ready for a wonderful future in the swiftly expanding field of Radio-Electronics INCLUDING Radio, Television, Frequency Modulation and Industrial Electronics. Be wise! NOW'S the time to start. Opportunities ahead are tremendous! No previous experience is necessary. The Sprayberry Course starts right at the beginning of Radio. You can't get lost. It gets the various subjects across in such a clear, simple way that you understand and remember. And, you can master my entire course in your spare time.

You Do Practical Experiments

There's only one right way to learn Radio Electronics. You must get it through simplified lesson study combined with actual "shop" practice under the personal guidance of a qualified Radio Teacher. It's exactly this way that Sprayberry trains you... supplying real Radio parts for learn-by-doing experience right at home. Thus, you learn faster, your understanding is clear-cut.

I'll Show You a New, Fast Way to Test Radio Sets Without Mfg. Equipment

The very same Radio Parts I supply with your Course for gaining pre-experience in Radio Repair work may be adapted through an

exclusive Sprayberry wiring procedure to serve for complete, fast, accurate Radio Receiver trouble-shooting. Thus, under Sprayberry methods, you do not have one cent of outlay for manufactured Test Equipment.

Succeed As a Radio-Electronician

My training will give you the broad, fundamental principles so necessary as a background, no matter which branch of Radio you wish to specialize in. I make it easy for you to learn Radio Set Repair and Installation Work. I teach you how to install and repair Electronic Equipment. In fact, you'll be a fully qualified RADIO-ELECTRONICIAN, equipped with the skill and knowledge to perform efficiently and to make a wonderful success of yourself.

**Read What Graduate Says
"One Job Nets About \$26.00"**

"Since last week I fixed 7 radios, all good-paying jobs and right now I am working on an amplifier system. This job alone will net me about \$26.00. As long as my work keeps coming in this way, I have only one word to say and that is 'Thanks' to my Sprayberry training and I am not afraid to boast about it." — ADRIEN BENJAMIN, North Grosvenordale, Conn.

DON'T PUT IT OFF!

Get the facts about my training—now! Take the first important step toward the money-making future of your dreams. All features are fully along with another valuable FREE explained in my big, illustrated FREE Catalog which comes to you book you'll be glad to own.

FREE BOOKS

"How To Read Radio Diagrams and Symbols"

... a valuable new book which explains in simple English how to read and understand any Radio Set Diagram or circuit. Includes translations of all Radio symbols. Send for this FREE book now, and along with it I will send you another big FREE book describing my Radio-Electronic training.

**RUSH
COUPON
for BOTH**



SPRAYBERRY ACADEMY OF RADIO

F. L. Sprayberry, President
Room 10106, Pueblo, Colorado

Please rush my FREE copies of "How to MAKE MONEY in RADIO, ELECTRONICS and TELEVISION," and "HOW to READ RADIO DIAGRAMS and SYMBOLS."

Name.....Age.....

Address.....

City.....State.....

(Mail in envelope or paste on penny postcard)

MAIL COUPON AT ONCE!

You Can't Be a "CHAMP" With a "CHUMPS" Body!

Let Me Prove I Can Make You a New Man
In Only 15 Minutes a Day

HAVE YOU got a weakling body that others can "push around"? Are you ashamed to strip for sports or a swim? Then it's about time you GOT MAD—mad at letting other fellows walk off with the prettiest girls, the finest jobs, the best things of life. Mad enough to DO SOMETHING about it—to give me just 15 minutes a day.

Then I'll PROVE you can have a body you'll be proud of, packed with red-blooded vitality! "Dynamic Tension." That's the secret! That's how I changed myself from a scrawny, 97-pound weakling to the winner of the title, "World's Most Perfectly Developed Man."

Just 15 Minutes A Day

YOU can have big, broad shoulders—a fine, powerful chest—arms bulging with "smash"—legs rippling with muscular strength—a stomach ridged with sinewy muscle—and a build you can be proud of!

Just give me the chance to PROVE that "Dynamic Tension" can build this kind of "he man" body FOR YOU! Just 15 minutes each day is enough to show amazing results! What's more, it's actually fun—because "Dynamic Tension" does the work!

"Dynamic Tension" Does It

"Dynamic Tension" turned ME from a sparrow-chested nobody into the powerful HE-MAN I'm proud to be today! So if you're a weakling like I was, it's time YOU got mad—and changed that bag of bones into a handsome powerhouse of brawn and muscle.

I want to PROVE I can give you a sledgehammer fist; a mighty forearm; add inches to your chest, build a coat of muscle straight across your stomach, change your spindly, "always-tired" legs into vigorous columns of speed and stamina. My free book shows how YOU can get that kind of real "he-man" build!

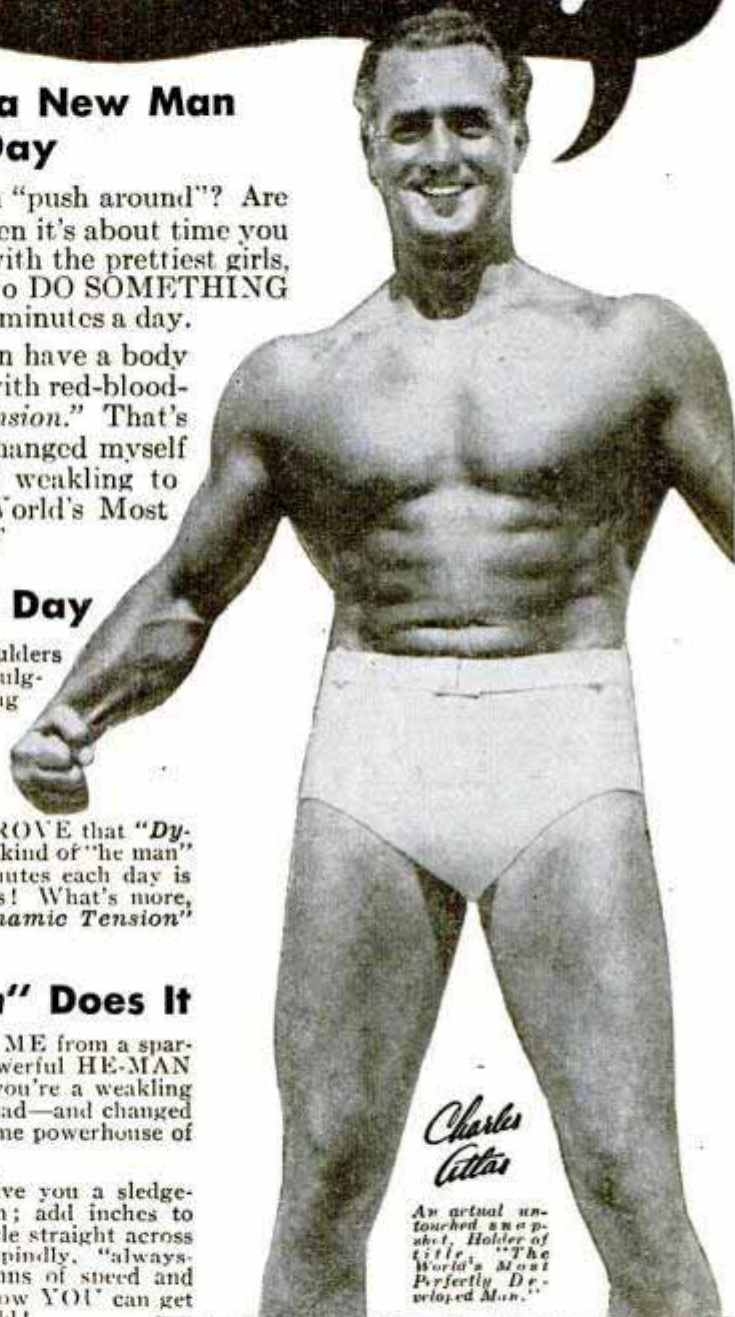

Charles Atlas

An actual untouched photograph. Holder of title, "The World's Most Perfectly Developed Man."

ALL YOU NEED FOR A
REAL HE-MAN BODY



GET MAD AT HOW
YOUR BODY LOOKS TODAY



MAIL THE COUPON
FOR MY FREE BOOK



LATER—HERE'S YOUR
NEW HE-MAN BODY!

MAIL COUPON FOR FREE BOOK

Get the facts fast! I want to show you how my method works! Mail the coupon right now and I'll send you a FREE copy of my famous illustrated book—"Everlasting Health and Strength"!

This Free Book tells you in plain, straight-from-the-shoulder language all about "Dynamic Tension"—and what it has done for others. It shows before-and-after photos of men I've changed from weaklings into Atlas Champions—tells what they have to say. And it tells how I can do the same for YOU—in only 15 minutes a day! So don't put it off! Address me personally: CHARLES ATLAS, Dept. 8K, 115 East 23rd St., New York 10, N. Y.



CHARLES ATLAS, Dept. 8K,
115 East 23rd St., New York 10, N. Y.

I want the proof that your system of "Dynamic Tension" will help make a New Man of me—give me a healthy, husky body and big muscular development. Send me your free book, "Everlasting Health and Strength."

Name.....
(Please print or write plainly)

Address.....

City..... Zone No. (if any)..... State.....

Check here if under 16 for Booklet A.

INVENTORS

The Rules of Practice of U. S. Patent Office advises—unless the inventor is qualified to handle such matters—that he employ the services of a competent Patent Attorney in the preparation of his Patent Application. We are Registered Patent Attorneys fully qualified to represent you at the Patent Office. Our long and varied experience in patent practice, we believe, enables us readily to understand inventors' disclosures, to advise what is probably patentable, after conducting preliminary patentability investigation of prior U. S. patents, and to draw your specifications and claims in such manner as to present clearly the novel features.

Patent Laws Favor the Inventor Who Acts Promptly

Remember, the details of your invention do not have to be 100% perfect before you can obtain patent. Unwise inventors often

devote considerable unnecessary time working on unimportant details of their devices. This is expensive, hazardous and unnecessary. First step is to have us conduct search for the prior U.S. patents and render a report as to its patentability. Our Search Report is very valuable to you in that it clears up the course you should take in regard to your invention. If our Report is favorable, this report of the patentability of your device shows that your chances of patent protection are in your favor.

Have Patent Protection First

Unless you safeguard your invention by obtaining a patent, thereby securing a monopoly on same, it may become "public property," free to be made, used and sold by anyone, or it may be patented by some other person.

McMORROW, BERMAN & DAVIDSON

Registered Patent Attorneys

135-X Victor Building, Washington 1, D. C.

McMORROW, BERMAN & DAVIDSON

Registered Patent Attorneys

135-X Victor Building, Washington 1, D. C.

Send me further particulars on how to protect my invention and "Invention Record" form at once. I understand that this request does not obligate me.

Name.....

Address.....

City..... State.....

-(Write or print name clearly)-

COPYRIGHTS

PATENTS

TRADE MARKS



Why be a Papuan?



OUR FRIEND, the anthropologist, told us that only a Papuan could have designed these ceremonial masks. We'd have believed him — except for one thing. We know the man who doodled them . . . just traced the outline of a paper clip and shaded to suit.

Try it. Or better yet — *don't* try it. There's no great demand for Papuans — or for constant doodlers — in the world of business and industry. The demand is for *trained* men and women. The large rewards — promotions, greater responsibilities, increased salaries — go to those who master commercial and technical subjects.

Training in all these fields is available through the International Correspondence Schools. In the time it takes a Papuan to make a mask . . . in the same time many a man spends in doodling . . . *you* can master Plastics or Accounting, Drafting or Radio — any of more than 400 subjects — through study with I. C. S.

If you're as smart as we think you are, you'll act today to obtain full information on the I. C. S. Course in your field of interest. Just mark and mail the coupon and you're in touch with us. Do it *right now!*

INTERNATIONAL CORRESPONDENCE SCHOOLS



BOX 5590-K, SCRANTON 9, PENNA.

Without cost or obligation, please send me full particulars about the course *before* which I have marked X:

- | | | | |
|---|--|--|--|
| <input type="checkbox"/> Air Conditioning and Plumbing Courses | <input type="checkbox"/> Structural Engineering | <input type="checkbox"/> Industrial Engineering | <input type="checkbox"/> Textile Courses |
| <input type="checkbox"/> Heating <input type="checkbox"/> Plumbing | <input type="checkbox"/> Surveying and Mapping | <input type="checkbox"/> Industrial Metallurgy | <input type="checkbox"/> Cotton Manufacturing |
| <input type="checkbox"/> Refrigeration <input type="checkbox"/> Steam Fitting | <input type="checkbox"/> Communications Courses | <input type="checkbox"/> Machine Shop | <input type="checkbox"/> Rayon Weaving |
| <input type="checkbox"/> Chemistry Courses | <input type="checkbox"/> Electronics | <input type="checkbox"/> Mechanical Drafting | <input type="checkbox"/> Textile Designing |
| <input type="checkbox"/> Chemical Engineering | <input type="checkbox"/> Practical Telephony | <input type="checkbox"/> Mechanical Engineering | <input type="checkbox"/> Woolen Manufacturing |
| <input type="checkbox"/> Chemistry, Analytical | <input type="checkbox"/> Radio, General | <input type="checkbox"/> Mold-Loft Work | <input type="checkbox"/> Business and Academic Courses |
| <input type="checkbox"/> Chemistry, Industrial | <input type="checkbox"/> Radio, Operating | <input type="checkbox"/> Patternmaking—Wood, Metal | <input type="checkbox"/> Accounting <input type="checkbox"/> Advertising |
| <input type="checkbox"/> Chemistry, Mfg. Iron & Steel | <input type="checkbox"/> Radio Servicing | <input type="checkbox"/> Reading Shop Blueprints | <input type="checkbox"/> Arithmetic <input type="checkbox"/> Bookkeeping |
| <input type="checkbox"/> Petroleum Refining <input type="checkbox"/> Plastics | <input type="checkbox"/> Telegraph Engineering | <input type="checkbox"/> Sheet-Metal Drafting | <input type="checkbox"/> Business Correspondence |
| <input type="checkbox"/> Pulp and Paper Making | <input type="checkbox"/> Electrical Courses | <input type="checkbox"/> Sheet-Metal Worker | <input type="checkbox"/> Business Management |
| <input type="checkbox"/> Civil Engineering, Architectural and Mining Courses | <input type="checkbox"/> Electrical Drafting | <input type="checkbox"/> Ship Drafting <input type="checkbox"/> Ship Fitting | <input type="checkbox"/> Certified Public Accounting |
| <input type="checkbox"/> Architectural Drafting | <input type="checkbox"/> Electrical Engineering | <input type="checkbox"/> Tool Designing | <input type="checkbox"/> Commercial |
| <input type="checkbox"/> Architecture | <input type="checkbox"/> Electric Light and Power | <input type="checkbox"/> Toolmaking | <input type="checkbox"/> Cost Accounting |
| <input type="checkbox"/> Bridges and Building Foreman | <input type="checkbox"/> Lighting Technician | <input type="checkbox"/> Welding—Gas and Electric | <input type="checkbox"/> Federal Tax |
| <input type="checkbox"/> Building Estimating | <input type="checkbox"/> Practical Electrician | <input type="checkbox"/> Railroad Courses | <input type="checkbox"/> First Year College |
| <input type="checkbox"/> Civil Engineering | <input type="checkbox"/> Internal Combustion Engines Courses | <input type="checkbox"/> Air Brake <input type="checkbox"/> Car Inspector | <input type="checkbox"/> Foremanship <input type="checkbox"/> French |
| <input type="checkbox"/> Coal Mining | <input type="checkbox"/> Auto Technician <input type="checkbox"/> Aviation | <input type="checkbox"/> Diesel Locomotive | <input type="checkbox"/> Good English <input type="checkbox"/> High School |
| <input type="checkbox"/> Contracting and Building | <input type="checkbox"/> Diesel-Electric | <input type="checkbox"/> Locomotive Engineer | <input type="checkbox"/> Higher Mathematics |
| <input type="checkbox"/> Highway Engineering | <input type="checkbox"/> Diesel Engines <input type="checkbox"/> Gas Engines | <input type="checkbox"/> Locomotive Fireman | <input type="checkbox"/> Illustrating <input type="checkbox"/> Motor Traffic |
| <input type="checkbox"/> Lumber Dealer | <input type="checkbox"/> Mechanical Courses | <input type="checkbox"/> Railroad Section Foreman | <input type="checkbox"/> Postal Service |
| <input type="checkbox"/> Reading Structural Blueprints | <input type="checkbox"/> Aeronautical Engineering | <input type="checkbox"/> Steam Engineering Courses | <input type="checkbox"/> Salesmanship <input type="checkbox"/> Secretarial |
| <input type="checkbox"/> Sanitary Engineering | <input type="checkbox"/> Aircraft Drafting | <input type="checkbox"/> Boilermaking | <input type="checkbox"/> Sign Lettering |
| <input type="checkbox"/> Structural Drafting | <input type="checkbox"/> Flight Engineer | <input type="checkbox"/> Combustion Engineering | <input type="checkbox"/> Spanish <input type="checkbox"/> Stenography |
| | <input type="checkbox"/> Foundry Work | <input type="checkbox"/> Engine Running | <input type="checkbox"/> Traffic Management |
| | <input type="checkbox"/> Heat Treatment of Metals | <input type="checkbox"/> Marine Engineering | |
| | | <input type="checkbox"/> Steam Electric <input type="checkbox"/> Steam Engines | |

Name _____ Age _____ Home Address _____

City _____ State _____ Present Position _____

Working Hours _____ A.M. to _____ P.M. Length of Service in World War II _____

Special tuition rates to members of the Armed Forces. Enrollment under the G.I. Bill of Rights approved for War II Veterans.

Canadian residents send coupon to International Correspondence Schools Canadian, Ltd., Montreal, Canada.

PATENT PROTECTION *for* INVENTORS

A PATENT IS A VALUABLE RIGHT

On the basis of a provision in the Constitution of the United States, Congress has established a system under which inventors may secure the exclusive right to prevent the unauthorized use, manufacture and sale of their inventions for periods of seventeen years. The inventor secures this protection by obtaining a patent from the United States Patent Office.

VICTOR J. EVANS & CO., established in 1898, has a staff of experienced registered patent attorneys, available to represent inventors in the preparation and prosecution of their cases before the Patent Office. Detailed information and the steps to be taken in obtaining patent protection will be furnished upon request.

FORM BELOW FOR MAILING CONVENIENCE

**VICTOR J.
EVANS & CO.**

Merlin M. Evans

REGISTERED PATENT ATTORNEY

Main Office: 130-L Merlin Building, Washington 6, D. C.

Pittsburgh Office: 521-N Empire Building

Los Angeles Office: 738-N Security Building

Please forward to me detailed information regarding procedure to obtain Patent Protection, together with your convenient "Evidence of Invention" form.

Name.....

Address.....

City and State.....

PATENTS • TRADEMARKS • COPYRIGHTS

MEN! Whether You're 16 or up to 40..

Learn ELECTRICITY

Student Finance Plan

Let me show you how to prepare for a **GOOD JOB NOW**—Get Ready **QUICKLY** for the field that offers **STEADY WORK** and a **REAL FUTURE**



A partial view of one of the Training Departments at Coyne

"LEARN-BY-DOING" IN A FEW WEEKS

Start now to prepare for a **Lifetime of Success**. Get into Electricity, the essential field that will continue to offer good pay and a real future all through the years. Coyne trains you, **NOT** by correspondence, but by actual shop work right on real electrical machinery. Then on my "**STUDENT FINANCE**" PLAN YOU CAN PAY MOST OF YOUR TUITION IN EASY MONTHLY PAYMENTS AFTER YOUR TRAINING PERIOD IS OVER.

In the Big Coyne Shops you get practical "all-around" training by actual work—not by correspondence. No advanced education or previous electrical experience needed. Many of my students had no previous experience. Others had experience in one or two branches but realized they needed all-around training for the better jobs and advancement.

Earn While Learning

If you are short of money and need part-time work to help pay for your room and board while training, my Employment Department will help you get a part-time job. When you have graduated, they will give you Lifetime Employment Service.

Learn by Doing

You get practical "Learn-by-Doing" training . . . wiring, installing, operating, testing, repairing and servicing various types of Electrical and Electronic equipment . . . you work on real armatures, motors, generators, refrigerators, electronic controls, etc.



PREPARE FOR PERMANENT JOBS LIKE THESE
 Light and Power Wiring
 Power Plant Work
 Armature Winding
 Substation Operator
 Maintenance Electrician
 Electrical Testing and Repair
 Signal Maintenance
 Industrial Electronics
 Electric Refrigeration
 and many others

Our Employment Bureau for graduates gives FREE lifetime employment service.

Industrial Electronics and Electric Refrigeration Training Now Included

Added training in these two great fields is now included with my Electrical Course. Industrial Electronics and Electric Refrigeration offer big opportunities. Get BOTH at Coyne!



B. W. Cooke

MEN WITH PHYSICAL DISABILITIES—

We also have facilities for men with physical disabilities whether due to war or other causes. Check coupon for particulars if you have a physical disability of any nature.

GET THE FACTS

Don't let lack of money keep you from sending in the Coupon now. My Big FREE Book is full of facts and photographs which tell you about Coyne training. It also gives you the details of my "Student Finance" Plan, Part Time Employment Plan, Graduate Employment Service, Lifetime Membership, etc.

MY GRADUATE EMPLOYMENT SERVICE HAS LETTERS FROM DOZENS OF FIRMS ASKING FOR COYNE TRAINED MEN FOR GOOD JOBS WITH A REAL FUTURE.



This modern fireproof building is occupied entirely by the Coyne Electrical School.

VETERANS

Coyne is also equipped to train those who qualify for training under the G. I. Bill of Rights. Check coupon for special G.I. Bulletin

ADDED TRAINING IN INDUSTRIAL ELECTRONICS AND ELECTRIC REFRIGERATION Now Included!

COYNE B. W. COOKE, Dir.
ELECTRICAL SCHOOL
 500 S. Paulina St., Dept. 76-72, Chicago, 12

Send Today for this FREE Book!



B. W. COOKE, Director
COYNE ELECTRICAL SCHOOL,
 500 S. Paulina St., Dept. 76-72, Chicago 12, Ill.

Without obligation send big free illustrated book with facts about Coyne and details of "Student Finance" Plan and added training in Industrial Electronics and Electric Refrigeration you are now including.

- Send special G. I. Bulletin.
- Send physical disability details.

Name.....

Address.....

City.....State.....

**I'll PROVE I can make
you, too,
TOUGH as a
MARINE**

..... and add
**Powerful POUNDS
and Vital INCHES of
DYNAMIC MUSCLE**
to your **ARMS, LEGS,
BACK, CHEST,
and SHOULDERS**

says
George F. Jowett
**WORLD'S GREATEST
BODY BUILDER**
..OR IT WON'T COST YOU A CENT!

Let me prove to YOU that you can put inches of dynamic muscles on your arms! Add inches to your chest! Broaden your shoulders and power-pack the rest of your body. I can do for you what I've done for thousands the world over, including many officers and men now in the U. S. and British Armed Forces!

GIVE ME 10 MINUTES A DAY!

I'll Show You My Secrets Of Body Building

I'll help you learn the "Progressive Power Method" through which I rebuilt myself from a physical wreck to the holder of more strength records than any other living athlete or teacher! No matter how skinny or flabby you are, you can learn my methods right in your own home. Through my proved secrets I show you how to develop your power, inside and out, until YOU are fully satisfied that you are the man you want to be. "The Jowett System," says R. F. Kelly, Physical Director of the YMCA, Atlantic City, "is the greatest in the world!"

If you want a physique that will inspire respect from men, and admiration from women... **ACT LIKE MUSCLES LIKE IRON!** Decide at once! The famous book, "Nerves of Steel—Muscles Like Iron" will be included FREE! Priceless for the strength fan! Full of photos of marvelous power-bodied men who will show you what Jowett has done for them and how he can do the same for you. Reach out... Grasp this Special Offer today!

**PROVE TO YOURSELF
IN ONE NIGHT!**

Send only 25c for test Course, "Molding a Mighty Arm." Read it the evening it arrives—learn from experience the thrill you can give your muscles!

SEND FOR THESE FIVE FAMOUS COURSES IN BOOK FORM

**ONLY 25c EACH
or ALL 5 for \$1.00**

**BOOK WITH PHOTOS OF FAMOUS STRONG MEN
MAIL COUPON NOW**

FREE

Jowett Institute of Physical Culture
230 Fifth Avenue
Dept. PM-610
New York 1, N. Y.

*This
Book
Free!*



Jowett Institute of Physical Culture
230 Fifth Avenue, Dept. PM-610, New York 1, N. Y.
George F. Jowett: Your proposition looks good to me. Send by return mail, prepaid, the courses checked below, for which I enclose (). Include FREE book of PHOTOS.

- George F. Jowett Champion of Champions
- All 5 courses for... \$1
 - Molding Mighty Legs 25c
 - Molding a Mighty Arm 25c
 - Molding a Mighty Grip 25c
 - Molding a Mighty Back 25c
 - Molding a Mighty Chest 25c
 - Send all 5 C.O.D. (\$1 plus postage.) No orders less than \$1 sent C.O.D.

NAME.....Age.....
(Please print plainly. Include Zone Number.)

ADDRESS.....

**TEXAS COLLEGE OF
PHOTOGRAPHIC ART**
1st
IN THE GREAT SOUTHWEST!

**Men and Women—Get set NOW in an
INTERESTING and PROFITABLE
LIFETIME CAREER**
**Veterans: MANY LIBERAL ALLOWANCES
UNDER "GI" BILL OF RIGHTS**
Address: Dept. A

**Texas COLLEGE
OF
PHOTOGRAPHIC Art**
SAN ANTONIO, TEXAS

EASY TO LEARN CODE

Learn or increase speed with an Instructograph—the Code Teacher that takes the place of an operator-instructor and enables anyone to master code without further assistance. Available tapes from beginners alphabet to typical messages on all subjects. Speed range 5 to 40 WPM. Always ready—no QRM. Thousands have "acquired the code" with the Instructograph System. Write today for convenient rental and purchase plans.



INSTRUCTOGRAPH COMPANY

Dept. M, 4701 Sheridan Road, Chicago 40, Ill.

AVIATION TRAINING

Basic and Advanced Courses in
AERONAUTICAL ENGINEERING
also Pre-Engineering

Northrop Aeronautical Institute

1523 E. BROADWAY (Division of Northrop Aircraft, Inc.) LOS ANGELES COUNTY
HAWTHORNE CALIFORNIA

* SEND FOR ILLUSTRATED BOOK

Good Handwriting
HELPS YOU WIN SUCCESS

It's so important to write a good hand for business and social advancement. Poor illegible penmanship often causes costly errors and marks you for failure. Why write a poor hand? It's so easy to learn at home in spare time. Write for our new free booklet today. If you wish, send 10c for a penpoint suitable for shaded writing and your name beautifully written.

THE TAMBLYN SCHOOL OF PENMANSHIP
In Business Since 1895 H-441 Ridge Bldg., Kansas City, Mo., U. S. A.

ARTISTS MAKE MONEY

Do you like to draw? Send name, address, age and occupation for **FREE ART TEST**, to find out your ability.

ART INSTRUCTION, Inc.

10136 ART INSTRUCTION BLDG., MINNEAPOLIS 15, MINN.

MONEY MEN ALL FREE

THE PLASTEX Industry needs manufacturers on small scale and for big production of Lamp and Clock Stands, Art Goods and Novelties in Plastex and Marble imitation. Experience unnecessary. Etc material makes regular 10c store sellers. Rubber moulds furnished for speed production. Small investment brings good returns. Big chain store orders now being placed. Ambitious men have chance for real prosperity. Our Free booklet will interest and benefit you.

PLASTEX INDUSTRIES, Dept. P, 1085 Washington Ave., New York, N. Y.

WHICH OF THESE *Opportunities* INTERESTS *You* MOST?

Accounting
Air Conditioning
Architecture & Building
Automotive Engineering
Aviation—Practical
Aviation Drafting & Design
better Foremanship
bookkeeping
Business Management

Contracting
Diesel Engineering
Drafting & Design
Electrical Engineering
Electricity—Practical
Electronics, Industrial
High School Courses
Machine Shop Operations
Mechanical Engineering

Plastics Engineering
Plumbing—Practical
Private Secretary
Radio Operating & Servicing
Railway Training
Refrigeration
Sheet Metal Pattern Drafting
Shop Management
Tool Making

THINK! LOOK FORWARD!

Business is making big, new plans

Men and Women are preparing for the future

WHAT ARE YOU DOING ABOUT YOUR TOMORROWS?

● *Today*, choose the job you want—and prepare for it. Or if you are already engaged in the work you like best, start training *now* for quicker promotion. Acquire the knowledge that will help you to get ahead faster, make more money and have greater security.

Invest part of your spare time in more rapid progress. Start training now, in spare time in your own home. Be ready to grasp your opportunity and step out ahead of those who lack the ability you have attained.

American School, founded in 1897 as an educational institution *not for profit*, can help you to reach your goal just as it has helped others during the past forty-nine years. Give serious thought to the list above. Pick one or more subjects that interest you. Then check the coupon at right, add your name and address and mail it at once. The school will send you details on its training plan and outline of study prepared by specialists. There is no charge, no obligation, so send the coupon immediately.

PRACTICAL, EFFECTIVE HOME - STUDY TRAINING SINCE 1897

Take This First Easy Step

CHECK, CLIP AND MAIL COUPON NOW

AMERICAN SCHOOL, Dept. G745, Drexel at 58th, Chicago 37, Ill.
Without obligation, Please send FREE and postpaid, bulletin and details of the Subject checked.

- | | | |
|--|--|--|
| <input type="checkbox"/> PLASTICS ENG'R | <input type="checkbox"/> Accounting | <input type="checkbox"/> Drafting and Design for Men and Women |
| <input type="checkbox"/> Refrigeration | <input type="checkbox"/> Electrical Engr. | <input type="checkbox"/> Radio |
| <input type="checkbox"/> Architecture and Building | <input type="checkbox"/> Electricity-Pracr. | <input type="checkbox"/> High School |
| <input type="checkbox"/> Contracting | <input type="checkbox"/> Electronics, Industr. | <input type="checkbox"/> Air Conditioning |
| <input type="checkbox"/> Practical Plumbing | <input type="checkbox"/> Bookkeeping | <input type="checkbox"/> Mechanical Eng. |
| <input type="checkbox"/> Automotive Engineering | <input type="checkbox"/> Private Secretary | <input type="checkbox"/> Shop Management |
| <input type="checkbox"/> Aviation Drafting | <input type="checkbox"/> Diesel Engineering | <input type="checkbox"/> Tool Making |
| <input type="checkbox"/> Aviation | <input type="checkbox"/> Sheet Metal | <input type="checkbox"/> Better Foremanship |
| <input type="checkbox"/> Business Mgmtment | <input type="checkbox"/> Pattern Drafting | <input type="checkbox"/> Machine Shop Operations |
| <input type="checkbox"/> Railway Training | | |

Name Occupation.....
Address..... Age.....
City..... State.....

AMERICAN SCHOOL

Dept. G745, Drexel at 58th Street, Chicago 37



For Men Who are Trained in **AUTO BODY & FENDER WORK**

Men 18 to 60. Want a future with good pay, perhaps a business of your own later? If you are mechanically inclined, start now to learn to become an auto body mechanic and fender repair man. This fast growing field has great possibilities for trained men with experience. U. E. I. spare time, home-study training combined with actual shop practice gives you sound, basic knowledge of latest, best methods so you may get the experience which may bring you big pay. Capable instructors supervise your studies and actual practice. Course includes acetylene welding, spray painting, use of hand and power tools, etc.

THOROUGH, RELIABLE TRAINING

U. E. I. has trained men for new opportunity fields since 1927 and many students are now making good. Auto body and fender repairing is one of the best profit-makers in any garage or service station. Little capital required for mechanically inclined men to get into this business. Free employment placement service, or we will show you how to start your own shop. Get the facts FREE, without obligation. Write today.

UTILITIES ENGINEERING INSTITUTE
AUTO-CRAFTS DIVISION
 1314 Belden Avenue, Dept. 1106X, Chicago 14, Ill.

Gentlemen:—YES! I want to get into profitable Auto Body and Fender Repair Work. Please send me FREE FACTS at once. This inquiry does not obligate me in any way.

Name _____ Age _____
 Address _____
 City _____ Zone _____ State _____

Learn this Profitable Profession



**IN 90 DAYS
AT HOME**
**Money-Making Career Open
to Men and Women, 18 to 50**

Hundreds of men and women between 18 and 50 make \$10 to \$20 in a single day giving scientific Swedish Massage and Hydro-Therapy treatments. There is big demand from doctors, hospitals, sanatoriums and clubs. Graduates earn large full time incomes from these or in private practice in their own offices. Others make good money from home treatments given in spare time. Learn this interesting, money-making profession in your own home, through our home study course. Same instructors as in our nationally known resident school. You can win independence and prepare for future security by qualifying for your Diploma. Course can be completed in 3 to 4 months. Many earn while they learn. Begin your training at once.



Anatomy Charts & Booklet FREE
 Enroll now and we will include, at no extra cost, many needed supplies. Fit yourself to help meet growing demand for Scientific Swedish Massage. Send the coupon at once for complete details. Anatomy Charts and 32-Page Illustrated Booklet, FREE, postpaid.

THE COLLEGE OF SWEDISH MASSAGE
 Dept. 664-M, 100 East Ohio St., Chicago 11, Illinois

Please send me FREE and postpaid, Anatomy Charts, 32-page Booklet and complete details on Home Training.

Name _____
 Address _____
 City _____ State _____

DOUBLE your INCOME IN YOUR SPARE TIME

LEARN SILK SCREEN PROCESS



Jealously Guarded Trade Secrets NOW Available to You
 Develop a Profitable Business of Your Own... or a Hobby

Prepare yourself for an interesting top paying position. Thousands of jobs open. Silk Screen Process signs, displays, Xmas cards, toys, etc., IN GREAT DEMAND THE WORLD OVER. You may make enough the second week to pay for the entire course. EASY TO DO... EASY TO LEARN. No education or mechanical knowledge required. BOOKLET with 3-color Silk Screen Processed cover and Samples sent FREE. Write NOW!

COURSE INCLUDES A COMPLETE KIT OF SUPPLIES

CALIFORNIA SCHOOL OF SCREEN PROCESS
 Dept. PM-106 2710 So. Spaulding Avenue, Los Angeles 16, California

LEARN Accounting AT HOME - IN SPARE TIME

Bookkeepers, accountants, and secretaries are in great demand. Now is the time to prepare for the many opportunities open to business-trained men and women.

Write today for FREE copy of interesting new booklet, "Through Hill's To Success," which tells where the best positions are found and how you may train for them quickly at home in your spare time or in resident school.

Hill's is rated as one of America's leading business schools. Thousands of successful graduates. Nationwide Employment Service.

Hill's EXTENSION SCHOOL
 And Business University
 619 West Main St., Oklahoma City 2, Okla.

WHY DON'T YOU WRITE?

Writing short stories, articles on business, homemaking, gardening, shop crafts, local and club activities, etc., will enable you to earn extra money. In your own home, on your own time, the New York Copy Desk Method teaches you how to write—the way newspaper men learn, by writing. Our unique "Writing Aptitude Test" tells whether you possess the fundamental qualities essential to successful writing. You'll enjoy this test. Write for it, without cost or obligation.

Veterans: This course approved for Veterans' Training.
NEWSPAPER INSTITUTE OF AMERICA
 SUITE 559-S, ONE PARK AVENUE, NEW YORK 16, N. Y.

BOOKS FOUND FREE/05

WHAT BOOKS DO YOU WANT?
 We quote the lowest market prices. No charge for locating Hard-to-Find and Out-of-Print Books. All books, OLD or NEW, mailed POST-FREE.
SEARCHLIGHT BOOK CLUB, 22 East 17th St., New York City

SAY YOU SAW IT IN POPULAR MECHANICS

LAW STUDY AT HOME for PERSONAL SUCCESS and LARGER EARNINGS. 35 years expert instruction—over 108,000 students enrolled. LL.B. Degree awarded. All texts furnished. Easy payments. Send for FREE BOOK—"Law and Executive Guidance."
AMERICAN EXTENSION SCHOOL OF LAW
 Dept. 70-M, 646 N. Michigan Ave., Chicago 11, Ill.

PLAY GUITAR LIKE THE COWBOYS DO... 8 LESSONS

Just out—very latest guaranteed, simple, easy method. Play cowboy songs the Western way in a few minutes by ear. Surprise and amaze your friends. So in big demand at parties, camps, public entertainments, on the radio, etc. 12 Complete Lessons.
SEND NO MONEY. Pay postman only \$1.00 charges, or send \$1.00 and get EXTRA SONGS all postpaid. (Canada, \$1.25 money order only.) Nothing else to buy. Positive money back guarantee. Rush order today.
WESTERN RANGER STUDIOS, Dept. 1510, Hutchinson, Kans.

SOON WE'LL PHONE HOME FROM AUTO

RADIO INDUSTRY POISED FOR BIG BOOM

Big Boom in FM Broadcasting

MARKET FOR 100 MILLION RADIOS REVEALED BY SYLVANIA SURVEY

COAST TO COAST NETWORK BEING PLANNED FOR FM

RADAR FUTURE

Let TODAY'S HEADLINES Guide You to TOMORROW'S OPPORTUNITIES

Learn RADIO ELECTRONICS this MODERN "A-B-C" WAY ... at Home

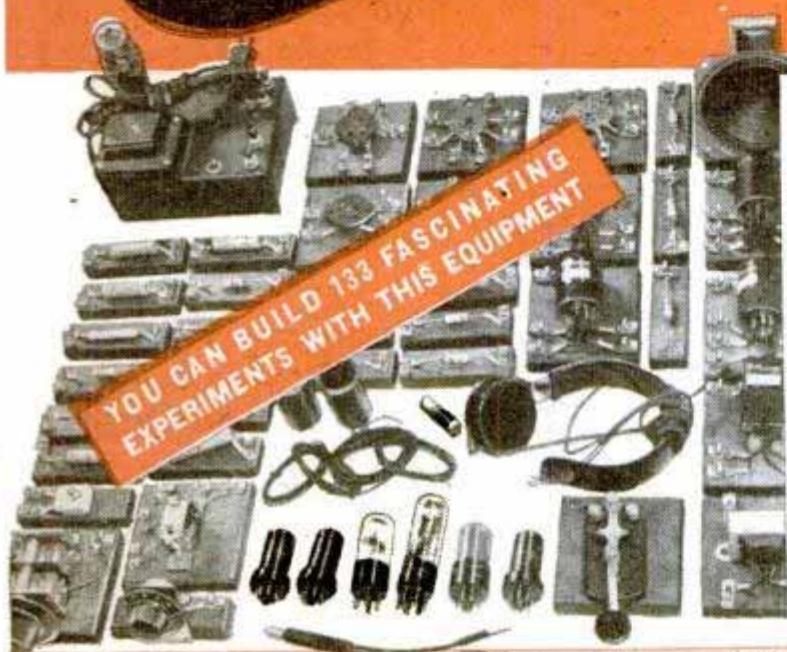

YOU CAN BUILD 133 FASCINATING EXPERIMENTS WITH THIS EQUIPMENT

Plan your future the way business men do: Watch the headlines! Pick a field that's "in the news"—one with many opportunities for interesting, PROFITABLE EMPLOYMENT or a good chance for establishing a BUSINESS OF YOUR OWN with little capital. Pick a field that offers a variety of interesting opportunities—a field with one of America's most promising futures... and see how you may MAKE YOUR START TOWARD A PLACE IN THIS FIELD BEFORE JOB COMPETITION BECOMES ACUTE. Write for Our Big, Free, Illustrated Book—"VICTORY FOR YOU." Learn how DeForest's Training, Inc. prepares you at home, in your leisure time—without interfering with the work you are now doing—then helps you make your start in the vast BILLION DOLLAR Radio-Electronics field.

You Get EMPLOYMENT SERVICE

Our Employment Service offers you the advantage of long and favorable contacts with some of America's foremost Radio-Electronics concerns. "VICTORY FOR YOU" tells you how this Service has helped many to their start in Radio-Electronics. You'll see how our students and graduates are prepared to win and to hold good paying jobs—how they start businesses of their own with little, if any, capital.

A You "LEARN-BY-DOING" at Home with Practical Equipment

Enjoy a "Home Laboratory." We provide you with 8 BIG KITS OF RADIO ASSEMBLIES AND PARTS to give you valuable practical experience at home. Build modern Radio Receivers and Circuits that operate. Build Electric Eye Devices, an Aviation Band Receiver, a Public Address System, a Wireless Microphone and numerous other fascinating experiments—in fact, 133 in all, in your spare time at home. NEW colorful Kit Supplement tells you about our "Home Laboratory," and how you use valuable Radio parts and sub-assemblies to get real practical experience as you learn.

VETERANS! Big things are happening at DeForest's Training, Inc. for veterans! See how you can prepare yourself WITHOUT COST for a GOOD JOB or a BUSINESS OF YOUR OWN in the vast Radio-Electronic opportunity field.

C WELL-ILLUSTRATED LOOSE-LEAF LESSONS

You also receive modern loose-leaf lessons that are easy to read and are well illustrated with many pictures and diagrams. ACT PROMPTLY! See how you can learn Radio this modern A-B-C Way by Reading... by Doing... by Seeing—at Home. Mail Coupon Now!

B Home MOVIES Help You Learn FASTER...EASIER



You also use a 16 mm. Motion Picture Projector and exciting training films to help you learn some of Radio's fundamentals FASTER EASIER. SEE what happens inside of many circuits you are working on. SEE how electrons function. SEE how RADIO waves are changed into sound. Get our big, free book! Use it as a key to show you the way to Radio-Electronics job opportunities of today and tomorrow—the opportunities the headlines tell about.

Send for FREE BOOK & SUPPLEMENT TODAY!

DeFOREST'S TRAINING INC., Chicago, Ill.

DeFOREST'S TRAINING, INC., 2733-41 N. Ashland Ave., Dept. PM-C10 Chicago 14, Illinois, U.S.A.

Send me both your big book "VICTORY FOR YOU" and Kit Supplement, showing how I may make my start in Radio-Electronics with your modern A-B-C home training plan. No obligation.



Name _____ Age _____ Address _____ Apt. _____ City _____ Zone _____ State _____ If under 16, check here for special information. If a discharged veteran of World War II, check here.



SO IT NEEDS FIXING

By S. T. CHRISTENSEN

the "Fix-it Man"

WELL, I guess I'm the fellow to see, for I've repaired thousands of refrigerators (home and commercial both), vacuum cleaners, radios, washing machines, irons, fans, lamps, mangles, motors, etc. In fact, many of my customers call me their "electrical appliance doctor." And, "doctoring," I might add, has paid me a good substantial income for quite a few years. Funny, in a way, how I got started. Always liked to tinker and by experimenting around I found that most electrical appliances had many things in common. That, regardless of what the appliance was used for, or who the manufacturer was, the basic principles were much the same. From fixing my own appliances to fixing friends' and then for strangers at a fee, seems now to have been but a small step.

What to Charge?

At first, I let the owner decide the charge and, frankly, I was amazed at what I earned per hour. But then, when one figures what initial costs are involved in buying most electrical appliances, one can readily see that spending extra dollars for repairs is well worth while. Before long I was making more in my spare time repairing than from my regular job. The result . . . I went into business for myself. When war came, business boomed, for new appliances were not available.

For a while, repair parts (needed on some

jobs) were a little difficult to get. But that situation quickly adjusted itself and many repair parts were given the high priority rating of AA2. After all, we had to provide for the health and well-being of our civilian population.

The Future Offers

Friends ask me about my future. And, I think I've got a grand one. Age is no handicap in repairing. I have in my files enthusiastic letters from repairmen ranging in age from 18 to 79 years. Now the war is over we are certain to see hundreds of new products on the market . . . products that the average person never dreamt of. These new products and our old appliances are all going to need at some time or other "fixing." Well, I'll still be the fellow to do it. The field open for appliance repairmen is unlimited. I don't worry at all about too much competition.

If You Are Ambitious

To the contrary, I've prepared a complete course, chuck full of simple, easy to understand photos and drawings and written in the same non-technical language as this article. I know the course is good, because I have hundreds of men all over the country writing to me telling me how the course has helped swell their pockets with cash. If you too want to prepare now for your future, I suggest you read the next page and send me the handy coupon."

Advertisement



**BIG MONEY
INDEPENDENCE**
*A PROFITABLE
LIFETIME
BUSINESS
OF
YOUR OWN!*

LEARN ELECTRICAL APPLIANCE REPAIRING

PREPARE NOW FOR THE FUTURE

If now employed, start your home appliance repair business NOW in your spare time and be set with a business of your own no matter what happens. You don't need elaborate fixtures or expensive equipment to be a successful repairman. Operate from your garage, basement, vacant store, etc. Work as many hours as you wish—the home appliance repairman is his own boss. It is a profitable occupation for on many types of repairs it is not unusual for a repairman to charge on the basis of \$5.00 to \$6.00 per hour. Don't gamble with your future—learn a trade that will always support you. Remember, as long as electrical appliances are used, there will be a need for electrical appliance repairmen.

If you are at all mechanically inclined—can hold and use tools—then you have all of the qualifications required for becoming a big money earning home appliance repairman. It does not matter if you have not had a great deal of schooling or had previous experience along these lines—**WE WILL TEACH YOU.** Age should be no barrier—nor should any minor physical handicap.

New Course Tells All

Profusely illustrated, our new course shows you in simple, easy to understand language and drawings how to make each repair on refrigerators, vacuum cleaners, washing machines, motors, etc. Explains and gives you a working knowledge of electricity, welding, nickel plating, etc. Shows you how to build the power tools you need and how to solicit and keep business coming to you. Not a theory course but an honest to goodness course written by and used by repairmen the country over. Price of course is so low that the savings on your own household appliance repairs will quickly pay for it. Act now! Mail the handy coupon below today.

----- Read What Our Students Say About Course -----

I really believe your course the best investment a mechanically minded man can make.—Claude E. Allen, Indianapolis, Ind.
I have received your Course in Appliance Repairing and I must say I am well pleased with same. I am only sorry I did not have said Course some years ago. I have learned so much more through this course I would not part with it.—Charles Schwarz, Hamilton, Ohio.

The Course in Appliance Servicing arrived a few days ago. Want to take out a few minutes of my valuable time to let you know that this is just what I have been looking for ever since I opened up my Fix-It shop. I must admit that you told the truth when you said that it contains quite a bit more information than I bargained for.—P. J. Bretl, Sebring, Ohio.

I am a mechanic for the Western Union Telegraph Co. Three days after receiving the lessons in refrigeration I earned the exact cost of the course.—Henry S. Lee, Washington, D. C.
I work day times at the shipyard and after 4:00 P.M. I operate from my cellar and garage. I average \$10.00 to \$15.00 clear every day.—Walter Hanhy, Brockton, Mass.

GET STARTED TODAY — MAIL THIS COUPON

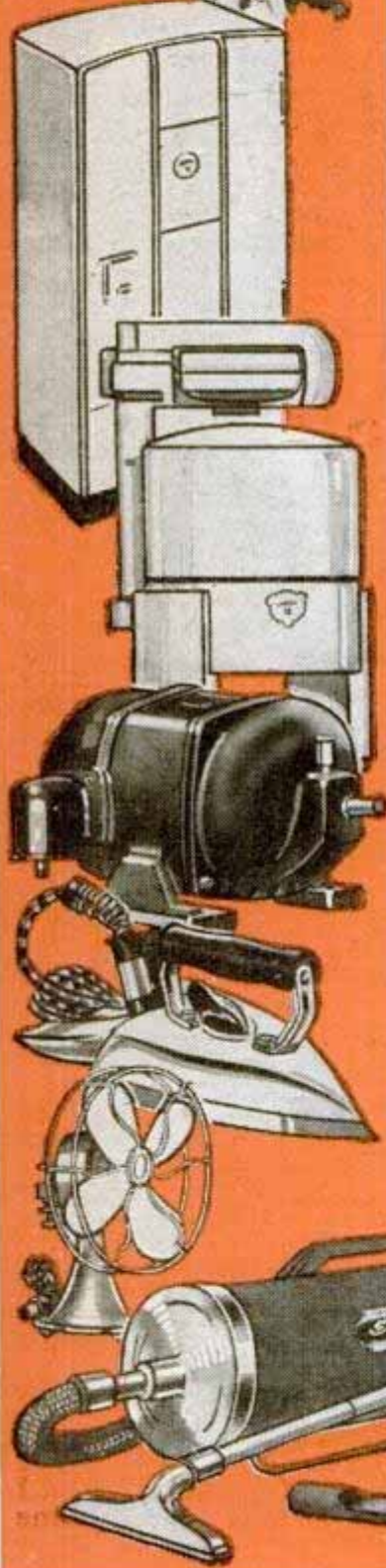

CHRISTY SUPPLY CO.
2835 N. Central Ave., Dept. D-3803
Chicago 34, Illinois

Please send me free illustrated literature about America's Fastest Growing Industry — ELECTRICAL APPLIANCE REPAIRING.

Name.....

Address.....

City..... State.....

ELECTRICIANS

Get THESE COMPLETE PRACTICAL BOOKS on 7 Days' FREE Trial!

Every one of these great books is packed full of money-making facts and ideas for practical electricians or radiomen. Ideas that can mark you as a leader in your field . . . facts that can put you in demand wherever there's a tough problem or trouble. They all add up to a steady job at more money!

Absolutely up-to-date in every detail, these fine books are written from, and backed by over 47 years of practical experience of Coyne, America's great Electrical School.

Look over the complete list of Coyne "Pay Raiser" Books below. Select any, or all of them—try them at home . . . refer to them on the job . . . put them to work for you for 7 days FREE. Prove to yourself, without sending a penny, what these books will mean to you!

SEND NO MONEY—JUST MAIL COUPON!

Just check all, or any of the books you want, and they'll be delivered to you postage paid. Try them for 7 days, and then, if you are not satisfied in every way, return them and you owe nothing. (We'll even pay the return postage.)

Understand, you can order one or more books. However, if you order all 14 books, then you'll have our complete library and you save \$6.00. And whether you keep the books or not, Coyne's Book of 150 Wiring Diagrams (as explained on the adjoining page) is yours to keep, FREE. That's my gift to you for just asking to see Coyne's 7 Volume Set "Applied Practical Electricity", or more. So rush the coupon today!

The COYNE 7 Volume Set APPLIED PRACTICAL ELECTRICITY



SEE ANY OR ALL THESE BOOKS FREE

The new sensational Coyne Electrical & Radio Books shown above includes the following 14 outstanding publications:

COYNE APPLIED PRACTICAL ELECTRICITY—7 volume Set.

Vol. 1 Elementary Principles—Circuits, Household Appliances	410 pages
Vol. 2 Home Wiring & Electrical Construction	470 pages
Vol. 3 DC Motors & Controls	420 pages
Vol. 4 AC Motors & Controls—Electronics	740 pages
Vol. 5 Armature & Stator Winding	289 pages
Vol. 6 Refrigeration & Air Conditioning—Radio	440 pages
Vol. 7 Automotive, Diesel & Battery.	510 pages

Price \$19.75 Cash or \$21.00 on time—(\$3.00 after 7 days and \$3.00 monthly)—1 year Free Consultation Service and Technical News Bulletins, which keep these books "up-to-the-minute."

COYNE ELECTRICAL & RADIO TROUBLE SHOOTING MANUAL—412 pages—500 Electrical and Radio Shop Prints and how to read them—step-by-step improved trouble shooting course—ideal for Electricians, Radio and Refrigeration Servicemen, Mechanics, etc. \$9.00 Cash or \$9.95 on time (\$3.00 after 7 days and \$3.00 monthly)—1 year Free Consultation

Service and Technical News Bulletins, which keep this book constantly "up-to-the-minute."

COYNE 150 SHOP PRINTS & HOW TO READ THEM—100 pages—Simple ABC of reading Wiring Diagrams—150 Full Size Shop Prints. \$1.95. Yours to keep FREE if you ask to see the Coyne 7 Volume Set, or more.

COYNE ELECTRONICS FOR RADIO MEN & ELECTRICIANS—412 pages—Installation and Trouble Shooting on Electronic Devices—latest information on this new field. \$1.95.

COYNE ELECTRICIANS HANDBOOK—354 pages—Latest data on Electrical laws, rules, formulas, methods—every Electrician needs it. Not a textbook. Price \$3.25.

COYNE RADIOMAN'S HANDBOOK—350 pages—Latest Data, Charts, Formulas, Methods, Circuits, valuable to every Radioman. Price, \$3.25.

COYNE STARTING YOUR OWN SHOP—180 pages—down-to-earth facts on what to do and what not to do to run a profitable full time or part time shop of your own. Ideas that mean money to you. Price, \$1.75.

COYNE ELECTRICAL, RADIO, ELECTRONICS DICTIONARY and DATA BOOK—3300 terms—\$1.50.

TECHNICAL BOOK DIVISION

COYNE ELECTRICAL SCHOOL

and Radiomen



B. W. Cooke
Director

BOOKS MUST EARN 5 TIMES THEIR COST OR YOUR MONEY BACK

If you decide to keep any Coyne books after 7 Day Free Examination, I guarantee that, at the end of one year after you receive these books and use them, they must earn 5 times their cost or you can return them and I'll refund every cent you paid. Many men report increased earnings during their week's free trial period—just by having the books on hand. That's why I give you this money-back guarantee—I know how much these books mean to men in the field!

Signed: B. W. Cooke, Director.

**EXAMINE THE BOOKS
at My Risk**

FREE

**"150 SHOP PRINTS
and How to Read Them"**

*Just for Looking
Over the 7 Volume
Set or More*

**KEEP IT EVEN
IF YOU RETURN
OUR BOOKS**



MAIL COUPON TODAY

B. W. Cooke, Director, COYNE ELECTRICAL SCHOOL, Dept. 76-R6
500 S. Paulina St., Chicago 12, Illinois

Send me the books checked below for 7 days' free trial. I'll either return them after 7 days, or pay for them as checked below.

Complete 14 Volume Coyne Electrical and Radio Library Consists of 7 volume Applied Practical Electricity Set, Trouble Shooting Manual, Electricians Handbook, Radioman's Handbook, Manual of Electronics, 150 Shop Prints, Electrical & Radio Dictionary, and Starting Your Own Shop. Also includes 2 years' free Consultation Service and Technical Bulletins. Cash price, \$35.50; on time, \$39.45 at \$3 per month. Include "150 Shop Prints" which I keep free even if I return any or all of the books.

BOOKS IN COYNE LIBRARY MAY ALSO BE ORDERED INDIVIDUALLY AS FOLLOWS:

7 Volume Set of Coyne Applied Practical Electricity, including one year Free Consultation Service and Technical Bulletins. Cash Price, \$19.75; on time, \$21.00 at \$3 per month. Also, send me "150 Shop Prints", mine FREE for looking over this set.

Coyne Electrical & Radio Trouble Shooting Manual—612 pages. Cash Price \$9.00; on time, \$9.95 at \$3 per month. 1 year Technical Bulletins Free.

150 Electrical Shop Prints—160 pages. \$1.95—(yours FREE if you ask to see 7 Volume set "Applied Practical Electricity," or more.)

Coyne Electricians Handbook—354 pages. \$3.25.

Coyne Electronics for Radiomen & Electricians—412 pages—including one year Free Technical Bulletins. Cash Price \$4.95.

Coyne Radioman's Handbook—350 pages. \$3.25.

Coyne Starting Your Own Shop—180 pages. \$1.75.

Coyne Electrical & Radio Dictionary—304 pages. \$1.50.

Name..... Age.....

Address.....

City..... Zone..... State.....

Where Employed.....

Check here if you want books sent C.O.D.—(you pay postman cash prices shown above.) Same 7 days' Free Examination and money-back satisfaction guarantee.

Coupon is Just a Request for FREE TRIAL

It becomes an order only if you keep the books after 7 days' free trial. So send the coupon now and get your FREE book besides.

**Save \$6 GET COMPLETE
14 BOOK
LIBRARY
AT DISCOUNT**

500 South Paulina Street
Dept. 76-R6, Chicago 12, Ill.

It's YOUR future — Make the most of it!



Start now to earn the bigger pay in electrical repair

Was there ever such an opportunity to get started in electrical maintenance and repair—and at top-notch wages? Are you ready—with experience and ability—to cash in on it? Others are getting just the sort of background needed—quick! practical!—to handle the great variety of electrical maintenance and repair work TODAY—from this well-known electrical library. You can too!

THE LIBRARY OF ELECTRICAL MAINTENANCE AND REPAIR

5 vols., 1826 pages, 1724 illustrations

Gives you the "know-how" to tackle any wiring or motor job. Five books show you HOW—to install all types of motor and generator units—to inspect and repair motor starters and generators—to diagnose motor and generator troubles—to figure new windings for old cores—DC and AC windings—to test armature windings—test induction motors, etc., etc. One book is full of trouble-shooting charts that show quickly symptoms, causes, specific remedies, etc.

Take the first step toward improving YOUR future—Mail this coupon TODAY

No money down—special price—easy payments—FREE trial

McGraw-Hill Book Co., 330 W. 42 St., New York 18, N. Y.

Send me for ten days' free examination the Electrical Maintenance and Repair Library. If satisfactory I will send you \$1.50 in 10 days and \$3.00 monthly until the price of \$16.50 is paid. If not wanted I will return books postpaid. (To insure prompt shipment write plainly and fill in all lines.)

Name.....
 Home Address.....
 City and State.....
 Company.....
 Position..... PM-10-48

AUDELS POWER PLANT ENGINEERS GUIDE

WITH QUESTIONS AND ANSWERS

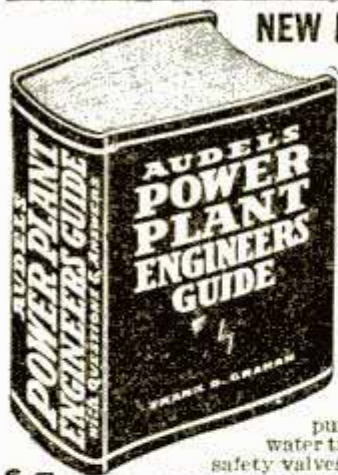

NEW FROM COVER TO COVER!

JUST PUBLISHED—For All Engineers, Firemen, Water Tenders, Oilers, Operators, Repair Men and Applicants for Engineers' License Examinations. A Complete Steam Engineers' Library in One Book! 1500 PAGES—65 CHAPTERS 1700 ILLUSTRATIONS. FULL INDEX

1001 FACTS AT YOUR FINGER ENDS!

PRACTICAL INFORMATION IN HANDY FORM FEATURING:

Basic principles of Steam Engineering, including Boiler Construction, Operation and Repairs. Gives practical information on: Boiler Calculations, fuels, feed

pumps, water heaters, economizers, water treatment, injectors, traps, draught, safety valves, oil burners, stokers, condensers, ejectors, cooling towers, evaporators, steam and hot water heating, pipe fitting & tubing. Contains complete data on all types of Steam Engines and Turbines, Indicators, Valve gear, Valve setting, Air Compressors, Hoists, Gas and Diesel Engine Operation, Lubrication.

\$4

COMPLETE PAY \$1 A MONTH. Get this information for yourself—ASK TO SEE IT—Mail coupon today!

AUDEL, Publishers; 49 W. 23 St., New York 10, N.Y.

Mail AUDELS Power Plant Engineers Guide (Price \$4) on 7 days free trial. If O.K. I will remit \$1 in 7 days and \$1 monthly until \$4 is paid. Otherwise, I will return it.

Name.....
 Address.....
 Occupation.....
 Employed by..... PM

ANALYZE HANDWRITING

Qualify for Certified Grapho Analyst Degree at home, spare time. Credit, Employment, Personnel Managers, Business, Professional men, women use grapho-analysis in their work, earn substantial fees in spare time. Many study solely for personal benefit, no desire to earn money, find it so fascinating they start using it to add to their incomes. Entertainment field pays well, up to \$100 in a week reported. Others establishing profitable practices as Vocational and Family Problem Counselors, Personality Teachers, and lecturers.



GROWING—UNCROWDED PROFESSION

More and more police use grapho analysis handling suspects and criminals. They understand how criminals think. Their handwriting tells. Men like Hugh Dunlap, university student, Harry Allen, retired preacher, use it in court, win cases, earn fees even before graduation. Only school in world devoted to teaching grapho analysis offers thorough training to earnest, ambitious men and women regardless of where you live, small town, farm or city. Send for GRAPHO ANALYST, illustrated lesson, personal handwriting analysis offer, ALL FREE. Must be 21 or over. Address A. I. G. A. Inc., 120 Noel, Missouri.



LEARN WATCH REPAIRING



AT HOME. By our modern and original system of instruction you can learn every part of the WATCH REPAIRING TRADE AT HOME. Prepare yourself for a well-paying position or start in business after completing our course of instruction. Good watch repairers are in demand and generally earn very good salaries. For particulars apply to the Wisconsin School of Watch Repairing 759 North Milwaukee St., Milwaukee 2, Wis.

LEARN MASTER MACHINIST MECHANICAL DRAFTING

Expert training on Lathes, Milling Machines, Shapers, Grinders, etc.—Mechanical Drafting, Blueprint Reading and Designing. Allied shops are completely equipped and modern. Approved for G. I. Training Days, Evenings.

ALLIED SCHOOL OF MECHANICAL TRADES

1330 South Michigan Avenue • Chicago 5, Illinois

LAW...

STUDY AT HOME Legally trained men win higher positions and bigger success in business and public life. Greater opportunities now than ever before.

More Ability: More Prestige: More Money We guide you step by step. You can train at home during spare time. Degree of LL.B. We furnish all text material, including 14-volume Law Library. Low cost, easy terms. Get our valuable 48-page "Law Training for Leadership" and "Evidence" books FREE. Send NOW, G. I. APPROVED. LASALLE EXTENSION UNIVERSITY, 417 South Dearborn Street A Correspondence Institution Dept. 1064-L Chicago 5, Ill.

"How to Make Money With Simple Cartoons"

A book everyone who likes to draw should have. It is free; no obligations. Simply address

CARTOONISTS' EXCHANGE
 Dept. 910-D Pleasant Hill, Ohio



Begin today. Write now for our Free Book, "How to Become a Good Penman." It contains specimens and tells how others learned to write in spare time. Enclose 10c for your name tastefully written and a pen point suitable for shaded writing. Write today.

THE TAMBLYN SCHOOL OF PENMANSHIP
 N-441 Ridge Building, Kansas City, Mo.

RADIO ENGINEERING, Broadcasting, Servicing, Electronics, Aviation, Marine & Police Radio taught thoroughly. 48 weeks' Engineering course equivalent to 3 years' college radio work. Approved Veteran Training. Co-educational. Catalog free.

VALPARAISO TECHNICAL INSTITUTE, Dept. D, Valparaiso, Ind.

\$\$\$ if trained in arc welding
 Big income jobs await you. Learn quickly and thoroughly. Enroll under G. I. Bill. Write today. Hobart Trade School, Box M-563, Troy, O.



INDUSTRIAL TRAINING INSTITUTE

AMERICA'S FOREMOST SCHOOL OF PRACTICAL TRAINING

WILL TRAIN YOU FOR A KEY JOB
OR A BUSINESS OF YOUR OWN IN

REFRIGERATION AND AIR CONDITIONING

A FIELD OF OPPORTUNITY

Here is an industry that offers every opportunity you could ask for. Good jobs—security—plenty of chance for advancement—a business of your own.

And here is a school equipped in every way to train you for Refrigeration and Air Conditioning work—the largest and most completely equipped school of its kind in America—a school that already has trained thousands of men for just such opportunities.

GET READY FOR YOUR BIG CHANCE

Learn Refrigeration and Air Conditioning—now, while the time is ripe. You don't need any advanced schooling or previous experience. If you are at all mechanically inclined and have gone to high school for at least one year or have equivalent education, we can teach you Refrigeration and Air Conditioning. Everything is made simple, fascinating and easy to grasp.

FACTS ABOUT THE INDUSTRIAL TRAINING INSTITUTE . . .

Founded in 1916. Has trained more than 400,000 men for practical work in industrial fields. From 1942 through 1945 trained specialized technicians, exclusively, for the Army, Navy, and Marine Corps. Now training thousands of veterans under the G. I. Bill, both in its Residence Schools and by home-study. Occupies five buildings of its own. Has over \$500,000 invested in training facilities, with an instruction staff of more than 100 men. Known everywhere as America's foremost school of practical training for industry.

AUTHORIZED TO ACCEPT
VETERANS FOR G. I. TRAINING



**REGISTRAR, P1K
INDUSTRIAL TRAINING INSTITUTE,
2150 LAWRENCE AVE., CHICAGO 25, ILL.**

Please send me, FREE, your "Camera Visit" booklet and information about the opportunities for trained men in Refrigeration and Air Conditioning. It is understood that I will be under no obligation.

NAME.....

ADDRESS.....

CITY..... STATE.....

ARE YOU A VETERAN:.....

GET THE FACTS WRITE FOR FULL DETAILS TODAY

AVIATION Career

MAXIMUM TRAINING IN MINIMUM TIME

CAL-AERO TECH TRAINING will add dollars to your pay check all the rest of your life. Specializing in AERONAUTICAL ENGINEERING and MASTER AVIATION MECHANICS since 1929, Cal-Aero Tech training is carefully designed for just one thing—TO MAKE MORE MONEY FOR YOU. An alumni of over 6000 successful graduates proves our career training is unsurpassed.



VETERANS —Write us about Aviation Training, as provided under "G.I. Bill of Rights."

CAL - AERO TECHNICAL INSTITUTE
 MAJOR C. C. MOSLEY PRES. SINCE 1929
 FORMERLY CURTIS WRIGHT TECHNICAL INSTITUTE

GRAND CENTRAL AIR TERMINAL
 GLENDALE 1, CALIFORNIA
 LOS ANGELES COUNTY

MAIL THIS COUPON TODAY!

Cal-Aero Technical Institute, Grand Central Airport, Glendale 1, California
 Please send full information on Aviation Training FREE—without obligation. Dept. PM-10

Name _____ Birth Date _____
 Street _____
 City _____ State _____

8 BIG BUILDING BOOKS

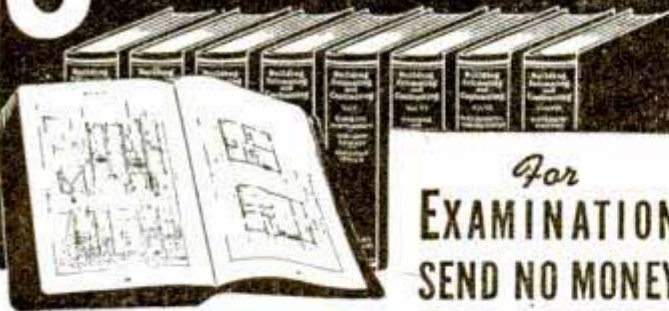

For EXAMINATION SEND NO MONEY

Learn to draw plans, estimate, be a live-wire builder, do remodeling, take contracting jobs. These 8 practical, profusely illustrated books cover subjects that will help you to get more work and make more money. Architectural design and drawing, estimating, steel square, roof framing, construction, painting and decorating, heating, air-conditioning, concrete forms and many other subjects are included.

BETTER JOBS — BETTER PAY

The postwar building boom is in full swing and trained men are needed. Big opportunities are always for MEN WHO KNOW HOW. These books supply quick, easily understood training and handy, permanent reference information that helps solve building problems.

UP-TO-DATE EDITION

These books are the most up-to-date and complete we have ever published on these many subjects.

Coupon Brings Eight Big Books For Examination

AMERICAN TECHNICAL SOCIETY Vocational Publishers since 1898
 Dept. G719 Drexel at 58th Street Chicago 37, Ill.

You may ship me the Up-to-Date edition of your eight big books, "Building, Estimating and Contracting," without any obligation to buy. I will pay the delivery charges only, and if fully satisfied in ten days, I will send you \$2.00, and after that only \$3.00 a month, until the total price of only \$34.50 is paid. I am not obligated in any way unless I keep the books.

Name
 Address
 City State

Please attach a letter stating your age, occupation, employer's name and address, and name and address of at least one business man as a reference. Men in service, also please give home address.

NOW! A Completely New Home-Study Course in PHOTOGRAPHY



Whether it's for fun or profit, you'll enjoy learning photography this new, easy way. Every phase of photography is carefully covered, with the latest techniques and methods fully

explained. It offers hours of pleasure as a hobby, and thousands of opportunities as a career.

12-Month Home-Study Course

Written and directed by expert photographers with years of teaching experience at one of America's leading educational institutions. A really THOROUGH education in photography, taught in easy steps and simple terms.

Write today.

MOODY EDUCATIONAL INSTITUTE, Inc.
 208 E. Wisconsin Ave. Dept. 10-B6 Milwaukee 2, Wis.



LEARN MEAT CUTTING At Home — In Spare Time

Get into the vital meat industry. Concise, practical Home Training based on 25 years proven instruction methods used at National's famous resident school. Prepares you for bigger pay as Meat Cutter, Supervisor, market manager or more money in your own store. Go as rapidly as your spare time permits. Diploma. Start NOW to turn your spare hours into money. Send for FREE bulletin today. No obligation.

National School of Meat Cutting, Inc., Dept. U-74, Toledo 4, Ohio

Now You Can Lick ANY AUTO REPAIR JOB!

Look up make, model, job in MoToR's AUTO REPAIR MANUAL—and go to work! Complete guide for every model built since 1935. 764 pages; 1000 illustrations; 500 charts; 200,000 repair facts. Index. After 7 days' Free Examination, send \$1; then \$1 monthly for 4 months, 35c postage. If not satisfied, return book, pay nothing. MoToR Book Dept., Desk 1M, 572 Madison Ave., New York 22, N.Y.

SAY YOU SAW IT IN POPULAR MECHANICS

STAMMER ?

This new 128-page book, "Stammering, Its Cause and Correction," describes the Bogue Unit Method for scientific correction of stammering and stuttering—successful for 45 years. Benj. N. Bogue, Dept. 1841, Circle Tower, Indianapolis 4, Ind.



Learn Public Speaking

Learn theory and fundamentals at home—in spare time. Then acquire actual experience and practice. Send for FREE booklet "Power of Effective Speech."

North American School, Dept. 1357
 1315 S. Michigan Ave., Chicago 5, Illinois

MAKE MONEY AT HOME

RUBBER MOLDS Low as 6¢ EA.

Amazing rubber mold-making outfit makes perfect flexible molds of plaques, ash trays, bookends, etc. Molds cost 6c to 25c each. Each mold makes hundreds of novelties and gifts to sell for \$1.00 apiece and more! No experience necessary. Everything furnished. Quick and easy. Start profitable business in your home—sell to stores, gift shops, friends, resorts, road stands, by mail. Full or spare time. Write for complete FREE details and easy instructions.



SO-LO WORKS, Inc., Dept. L-800, Loveland, Ohio



Which of these books can help you GET A BETTER JOB AND MAKE MORE MONEY

Here's how to beat job competition and insure yourself of a prosperous future. Gateway Books help you tackle those tough jobs you've always had your eye on . . . and they help you get back in the swing of things because they show you how to do the HARDEST jobs the EASIEST way in LESS time. Order today on our Money Back Guarantee. Use the POSTAGE FREE Coupon below. It saves you postage when ordering.

Order From This List

PAINTING

1. **HANDBOOK OF ORNAMENT.** For artists, designers, jewelers, architects, leather workers, etc. Gives thousands of designs and ornaments along with applications. Over 3,000 illustrations and 548 pages. Only . . . \$5.00
2. **INTERIOR WALL DECORATION.** Practical working methods for plain and decorative wall finishes you can master. 491 pgs. . . \$3.50
3. **THE MIXING OF COLORS and PAINTS.** How to mix colors for interior decorating, arts, crafts, general mixing methods. . . \$2.50
4. **CYCLOPEDIA of PAINTING and DECORATING.** Explains all types of painting jobs for home workshop of commercial work clearly and concisely. A book every man who paints should have. Large illust. and 250 pgs. . . \$3.50
5. **PAPER HANGING.** A practical book that shows you how to do your own papering and save many times the cost of this book. Plenty of large illust. 200 pages. . . \$2.00
6. **FURNITURE FINISHING, DECORATION and PATCHING.** Practical new book that covers Period Furniture, Furniture Decoration, Patching, Finishing and many special finishes. 580 pages and over 350 illust. . . \$4.00
7. **SPRAY PAINTING.** Spraying technique and operating instructions on paints, materials, finishes. 125 pages fully illust. . . \$2.00
8. **HOUSE PAINTING METHODS.** 400 pgs. and 150 illust. cover the subject of house painting (of any surface) thoroughly . . . a great time and money saver. Now, only \$2.50
9. **WOOD FINISHING.** Wood finishes and problems—tools—materials. 353 pgs. . . \$2.50

WOODWORKING

10. **CARPENTRY CRAFT PROBLEMS.** 320 pages explain and illustrate hundreds of practical solutions to all types of carpentry problems. Complete in every detail. . . \$2.50
11. **BUILDING—FORMS, STAIRS, ROOFS.** Latest information on how to build forms, staircases, roofs, etc., correctly. For carpenters and their helpers. 250 pages, illust. . . \$2.50
12. **HOW TO MAKE RUSTIC FURNITURE.** Hundreds of ideas and plans on making all types of rustic furniture for the home. Completely illust., thoroughly described. . . \$2.00
13. **WOOD TURNING.** An excellent book for every home craftsman. Tells and shows how to do the most artistic work. Numerous photos and many detailed drawings. . . \$2.50
14. **BLUE PRINT READING.** A practical book that shows how to read and interpret blue prints. 111 pages, 69 illustrations. . . \$2.00
15. **CONCRETE DESIGN AND CONSTRUCTION.** 508 pages, 251 illust. A new and enlarged edition covering all phases of concrete work and how to do it. . . \$5.00
16. **HOME REMODELING.** An excellent book that gives hundreds of ideas and SHOWS how to go about any remodeling job in the home . . . \$5.00
17. **HOW TO PLAN A HOUSE.** Here's a book that shows future home builders how to plan your house to save the most money. Practical in every detail. 525 pages. . . \$5.00

REFRIGERATION - PLUMBING AIR CONDITIONING

18. **REFRIGERATION SERVICE MANUAL.** Tells how to take care of and repair domestic and commercial refrigeration units such as used in markets, milk depots, soda fountains, quick freeze units and many others. \$2.00
19. **PLUMBING INSTALLATION and REPAIR.** Practical 236 page book tells how to repair leaky faucets, clogged toilets, drains, pipes, traps, vents, etc. 153 illust. . . \$2.00

Guarantee

Gateway Books are guaranteed to be absolutely satisfactory in every respect, or your money will be cheerfully refunded. The GATEWAY BOOK CO., Dept. PM-22 32 N. State — Chicago 2, Illinois

20. **HEATING, COOLING and AIR CONDITIONING.** 706 pages on heating of all types, cooling, Air Conditioning, equipment, furnaces, controls, etc. 84 charts, 351 illus. . . \$4.00

ELECTRICITY

21. **ELECTRICITY and HOUSE WIRING.** Practical book that tells how to repair and install any type of wiring around the home. Excellent for home putterers. . . \$2.00
22. **ARMATURE and MAGNET WINDING.** The construction of armatures and their repairs are fully covered with illust. . . \$1.50

USE THIS POSTAGE FREE COUPON NOW



INSTRUCTIONS FOR USING . . . read carefully. The top part of this coupon must be pasted securely on a post card or envelope. Card or envelope must be at least 4 1/2" wide and 3" deep. Drop card or envelope in nearest mail box. We pay postage.

MAILING PIECE MUST BE AT LEAST 4 1/2" x 3"



BUSINESS REPLY COUPON

FIRST CLASS PERMIT No. 29504, Sec. 510, P. L. & R. CHICAGO, ILL.

GATEWAY BOOK COMPANY

Dept. P.M. 22

32 N. STATE STREET

CHICAGO 2, ILL.

Paste above coupon on mailing side of envelope or card.

Use this side for your order.

Please send the books I've circled. If C.O.D., I'll pay postman cost of books plus postage and C.O.D. fees. If remittance is enclosed, we pay postage. Same money back guarantee applies. No C.O.D.'s accepted outside the United States.

- | | | | | | | | | | | | | | | |
|----|----|----|----|----|----|----|----|----|----|----|----|----|----|----|
| 1 | 2 | 3 | 4 | 5 | 6 | 7 | 8 | 9 | 10 | 11 | 12 | 13 | 14 | 15 |
| 16 | 17 | 18 | 19 | 20 | 21 | 22 | 23 | 24 | 25 | 26 | 27 | 28 | 29 | 30 |
- (Please print name clearly)

Name.....

Address.....

City.....Zone.....State.....

"The Strange Middle World"

...BEHIND YOUR CONSCIOUS MIND

YOU—your *conscious* self, is suspended between two worlds! There is the world of every day—of colors, sounds and substances. There is also the world of the universes—of moons, stars, and distant nebulae.

But has your mind ever been suddenly filled with the light of other realities—ideas which, although stimulating and informative, were strangely *new* and *different*? Have you had mental pictures of events that your mortal eyes have never seen? Do you feel at times as though an *intelligence* was striving to guide you? Have you found yourself listening to words of *inner* direction?

Behind your thinking mind lies a great *middle world*—the world of the subconscious. It is poised between the world of everyday existence and the great *intelligence* of the universe. It is this *middle world* which translates the subtle Cosmic forces which pervade your being, into the urges of self and into *intuitive impressions*. Do you want to know why you act as you do? Would you like to have access to the source of those talents and abilities which make for the mastery of life? Learn how to *explore* this middle world.

Accept This Free Book

The Rosicrucians (not a religion) are a world-wide fraternity of thinking, *inquiring* men and women. They have united their existence—they have brought together the physical world and the world of self into a *harmonious*, livable whole. They have learned to conquer fears and substitute knowledge for the so-called *mysteries* of life. Use the coupon below for a *free* copy of the book, "The Mastery of Life." It tells how you, too, may share this unique wisdom.

The ROSICRUCIANS

San Jose (AMORC) California

SCRIBE: K. W. Z. Rosicrucian Order, AMORC
San Jose, California

Gentlemen: I am interested in exploring the middle world of my mind. Please send me the *free* book, "The Mastery of Life."

NAME _____

ADDRESS _____

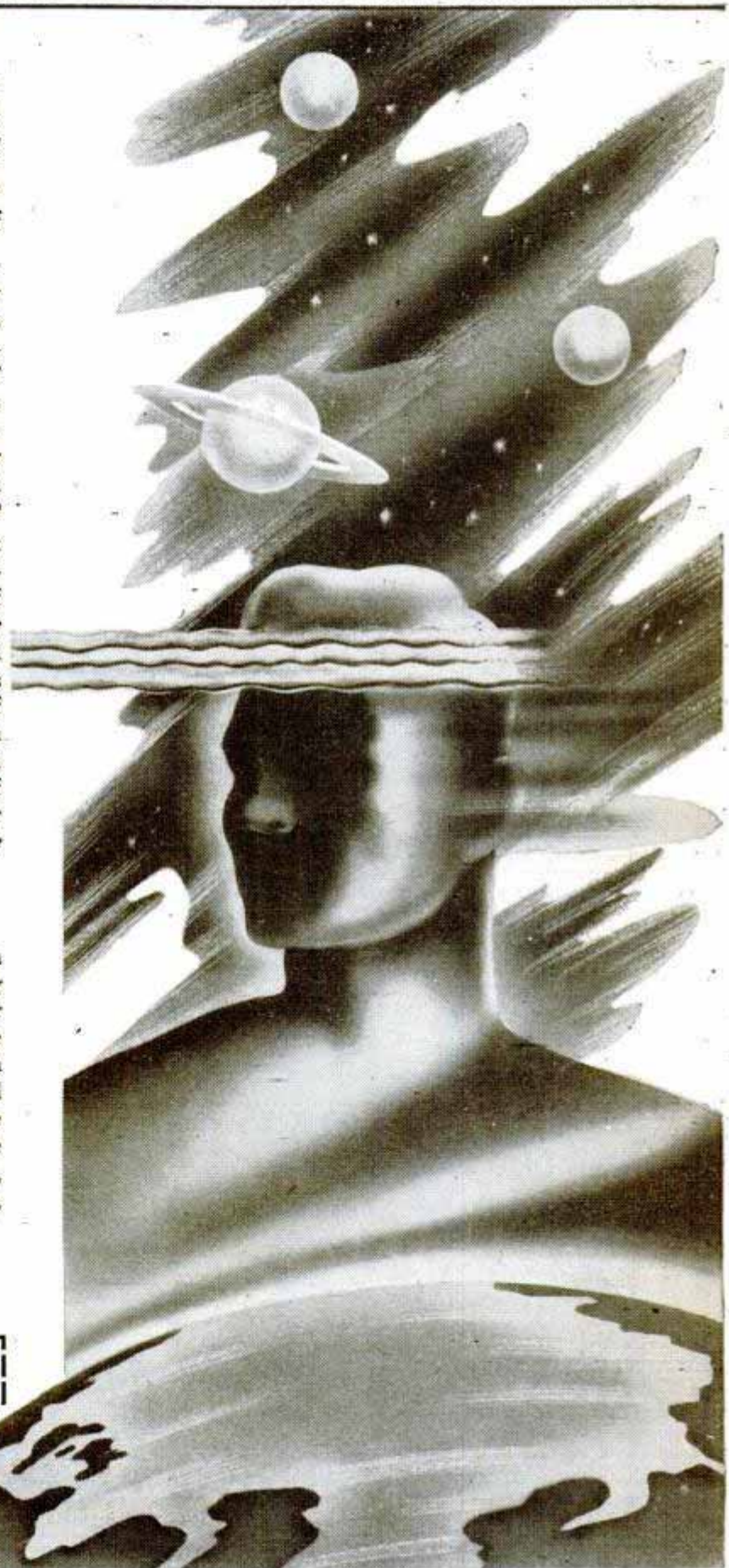

BIG MONEY and YOUR OWN BUSINESS in LIQUID MARBLE!

FREE INFORMATION ON THREE BIG NEW MONEY-MAKING OPPORTUNITIES

Regardless of your age, sex, previous experience, and whether you are an ex-serviceman or not, we will send you astonishing free facts about the unlimited possibilities — in your own business — with amazing LIQUID MARBLE and our other marvelous new products. To secure this information, absolutely free, fill in coupon below or send a letter or postcard. No salesman will call on you now or ever. Write TODAY! Offer limited.

Send for
FREE
Details

- 1 **LIQUID MARBLE.** Make beautiful artificial Marble Slabs. Pour from liquid state. Glazed or unglazed. This marble may be mottled, veined, multi-colored or left in original snow-white state. The color is actually a part of the marble! Does not fade or wear away. LIQUID MARBLE is unsurpassed on kitchen or bathroom walls. Easy to make and install.
- 2 **PLASTIC FLOORING.** May be made in any color or combination of colors. Gives a lifetime of wear. Dustproof. Soundproof. Verminproof. Resilient to the tread. Lay out solid from wall to wall or in pattern design of various shaped blocks.
- 3 **FLEXIBLE MOLDS.** For plaster casting. Make your own molds for few cents each. \$1.00 in raw materials will make up to \$25.00 worth of finished goods. We furnish names of buyers.

FREE! EXTRA! If you write us promptly we will include free information about our other big money-making businesses. These include Compo-Tile Roofing and Caen Stone, Plastic Wood, Artificial Marble and Granite, Stone and Metal Solder, Plastic Tile Cement, Papier Mache, and many others.

FREE INFORMATION COUPON!

COMPO-TEX, Box 786-RP, St. Louis, Mo.
Please send me free details of your **BIG THREE** Money-Making Propositions including LIQUID MARBLE. Also include information about the additional new business possibilities given directly above.

Name.....
Street.....
City..... State.....

Greatest Opportunities NOW!

With reconversion going ahead full speed, NOW is the time to line up your own money-making business. We offer you our **BIG THREE** money-making opportunities together with other equally profitable businesses. (See paragraph at right.) Get the **FREE** facts TODAY!

COMPO-TEX, Box 786-RP, St. Louis, Mo.

Keep that "Car" TICKING



Every operator and mechanic needs AUDELS AUTO GUIDE.

This book saves time, money and worry. Highly endorsed. It presents the whole subject of auto mechanics:

- 1—Basic principles
 - 2—Construction
 - 3—Operation
 - 4—Service
 - 5—Repair
- Handy Size. Easily understood.

NEW FLUID DRIVE, HYDRAULIC SHIFT AND DIESEL ENGINES FULLY COVERED

Over 1500 pages—1540 illustrations showing inside views of modern cars, trucks and buses with instructions for all service jobs.

4 COMPLETE • PAY ONLY \$1. A MONTH ←
ASK TO SEE IT!—To Get This Assistance for Yourself Simply Fill in and Mail Coupon Today.

AUDEL Publishers, 49 West 23rd St., New York
MAIL AUDELS NEW AUTO GUIDE for free examination. If O. K. I will send you \$1 in 7 days; then remit \$1 monthly until price of \$4 is paid. Otherwise I will return it.

Name.....
Address.....
Occupation.....
Employed by..... P M

YOU CAN LEARN TO BE AN ARTIST



Start **DRAWING** At Home in Your **SPARE TIME!**

Draw for Money! Trained Artists are capable of earning \$40, \$60, \$75 and more a WEEK!

Your future is in your own hands. Prepare yourself now in **COMMERCIAL ART, DESIGNING and CAR-TOONING**—all in ONE complete home study course. No previous art experience necessary—we teach you step-by-step for a fascinating hobby and a profitable career. For 32 years WSA graduates have been "making good"—**WHY NOT YOU? FREE BOOK.** "Art for Pleasure & Profit" fully describes course and commercial opportunities. **TWO ART OUT-FITS** included with training. Mail coupon today.

(**VETERANS!** Course available under G. I. Bill.)

FREE BOOK gives details!

WASHINGTON SCHOOL OF ART,
Studio 1210C, 1115 15th St., N. W., Washington 5, D. C.

NAME..... AGE.....
Street.....
City..... Zone () State.....



Individual instruction is necessary in teaching television. Here an instructor helps a student. Each student must build 7 radio sets before he is allowed to start on a television set.

Expert Television Technician, Bob Cohen, using \$625.00 RCA Sweep Generator to check television set for engineering inaccuracies. It is expected that television test equipment will be reduced in cost as the television industry gets into its stride.

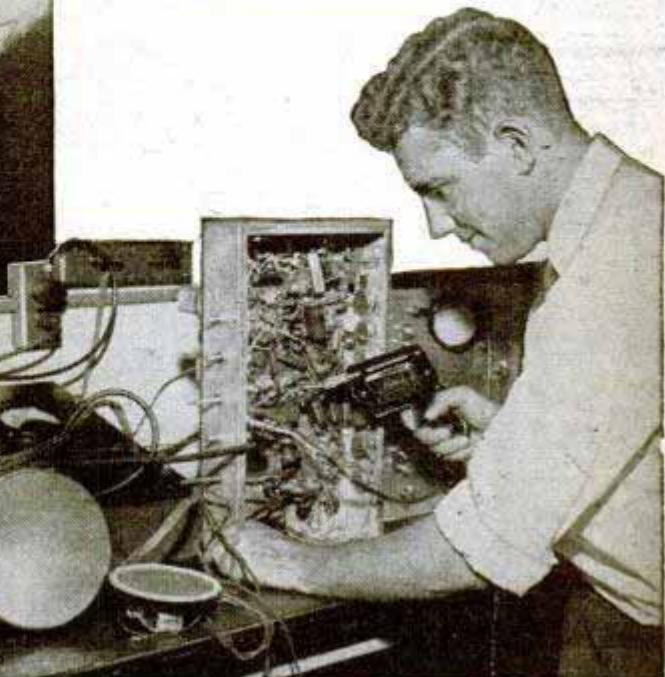

THEY BUILT THEIR OWN

MANY veteran students are now attending N.Y.T.I. of N.J. under the generous provisions of the G.I. Bill of Rights, which allows any approved school of the veteran's choice to charge the Veterans Administration up to \$500 a school year against the educational expenses of qualified veteran students. Full-time students, with dependents, are also paid a sub-

Student Walter E. Stevens, making engineering checks with \$395.00 United States Television Sweep Generator. The school is lavishly equipped with the most advanced test equipment.

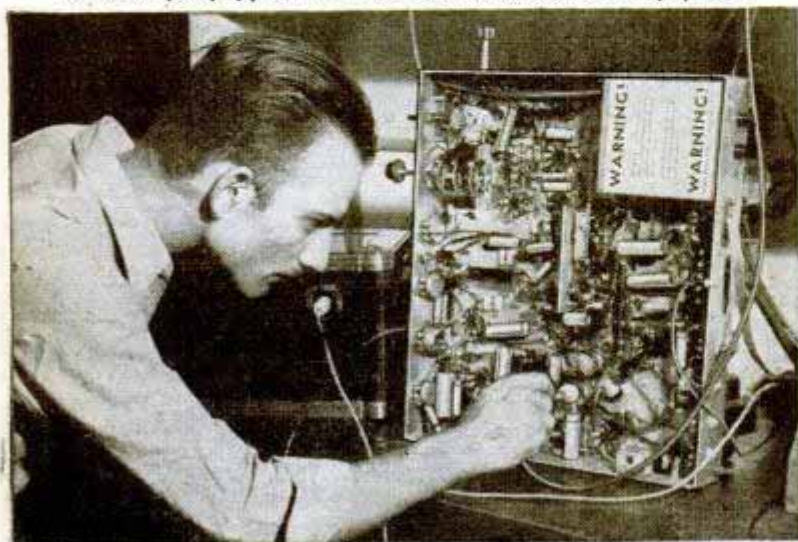

sistence allowance of \$90 monthly by the VA, and those without dependents, \$65. Many students hold part-time jobs, thus augmenting their monthly payments. However, you do not have to be a veteran to be accepted as a student.

A considerable number of out-of-state students attend the school because of its excellent, practical type of radio and television courses, so difficult to get anywhere else in the world today. Living quarters are obtainable by single students, but married students report considerable difficulty in finding quarters for their families.

No high-school diplomas are required. Every student must have at least a grammar-school education, however. And the school requires that a student be earnest, sincere and technically inclined. Students without proper mathematical backgrounds are taught the radio and television mathematics they need.

You probably have been wondering what N.Y.T.I. of N.J. means. It stands for the New York Technical Institute of

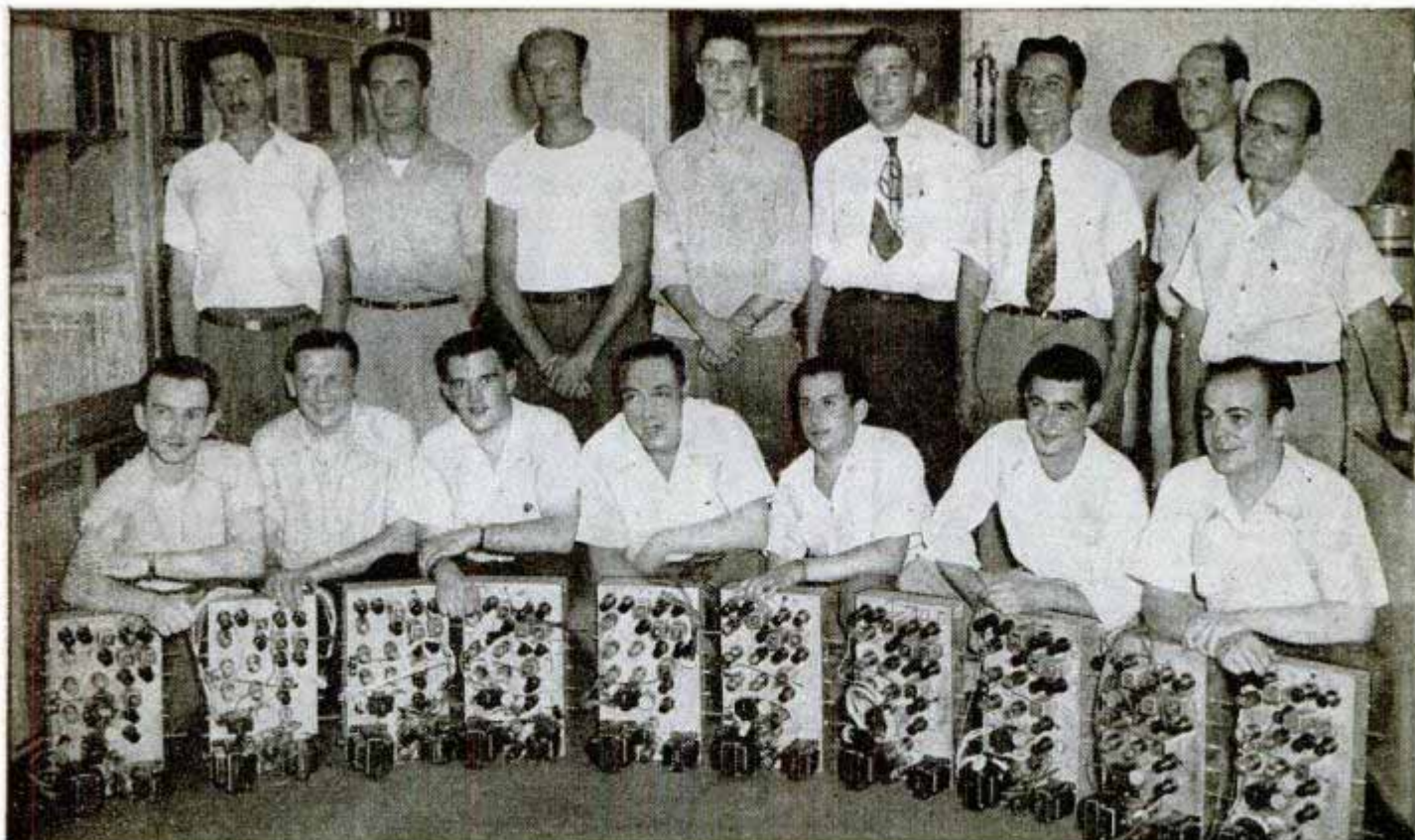

An Advanced Class in Television at N.Y.T.I. of N.J., famous television school, and the 17-tube television sets they built. Students at this school have been building television sets as part of their courses since 1939, when television programs were first broadcast regularly. School officials

found that this practical method of instruction is productive of very satisfactory results. Each student may build a set and keep it to use in his own home laboratory, if he chooses to. The school is located in the heart of the radio, television, electronics industry.

TELEVISION RECEIVERS!

New Jersey, a resident school located in Newark, N. J., just across the river from New York City (Only 20 minutes from Broadway by subway or train). The school is located in the heart of America's great radio and electronics industry. Such leading television, radio and electronics manufacturers as Western Electric, Du Mont, Federal and Edison are nearby. Newark also is near Radio Stations WJZ, WEA, WABC and WOR; each a leader in broadcasts going on networks all over the country. This means that the school offers numerous advantages, as it is in touch with most recent developments in radio and television. This also means that qualified radio and television engineers are available to the school for teaching purposes.

During the war N.Y.T.I. of N.J. was approved for the training of Signal Corps personnel by the Army. When the war ended the enrollment increased because of the influx of veterans desirous of getting practical television training. At the present time, there are

120 openings for new students for the several classes beginning in October & November 1946.

The school issues a special Bulletin, Numbered 210, which illustrates and describes its facilities and equipment and shows students using its varied laboratory equipment. Bulletin 210 also describes classes that may be attended, housing conditions, costs, hours, etc. To get complete information write for Bulletin 210 (for which no charge is made) to the New York Technical Institute of New Jersey, 158 Market Street, Newark, New Jersey.

A line of RCA television receivers used for comparative test purposes at N.Y.T.I. of N.J.

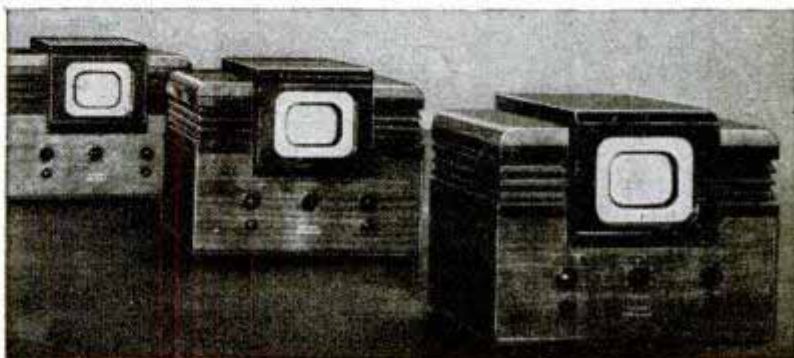

Beat the car shortage. Give your car new life. Here's

HOW TO KEEP YOUR CAR IN TIP-TOP RUNNING ORDER

and lick car troubles before they occur

Save cash and time with trouble-free performance

There are a lot more miles in your present car, no matter what age it is... if you know the tune-up tricks mechanics know. Now you get them all—so you can get the most in safe, comfortable, trouble-free driving, at least expense—in this new manual. It tells what every good mechanic knows about practical upkeep and repair in plain, non-technical terms for the car owner.



Just Out! EVERYDAY AUTOMOBILE REPAIRS

THIS MANUAL enables you to get every last ounce of service out of your car, with the least wear and tear on each part in it. It shows you how to track down trouble spots and make your own repairs—all about tools and how to use them to best advantage—what every part looks like and how it works—service and maintenance work that keeps parts performing smoothly—tricks on care and operation that make your car function better and last longer.

SEE IT 10 DAYS FREE
Mail coupon today

ILLUSTRATES body and engine construction
TELLS HOW to find and fix trouble spots in:

- fuel system
- engine lubrication system
- electrical system
- the clutch
- transmission
- springs and shock absorbers
- steering system
- brakes
- and all other systems and parts in your car

By **WILLIAM H. CROUSE**
Field Service Engineer,
Delco-Remy Division of
General Motors.
296 pages, 5½ x 8,
187 illustrations, \$3.00.

McGraw-Hill Book Co., 330 W. 42nd St., N. Y. C. 18

Send me Crouse—Everyday Automobile Repairs for 10 days' examination on approval. In 10 days I will send \$3.00 plus few cents postage or return book postpaid. (Postage paid on cash orders.)

Name _____

Address _____

City and State _____

Company _____

Position _____ PM. 10-46

For Canadian price write Embassy Book Co.
12 Richmond St. E., Toronto 1

STUDY AT HOME

With An Educational Institution

Men with specialized training win higher positions, insure larger earnings, and are bigger successes in business and public life. Opportunities NOW greater than ever before. Send for our Catalog.

ARTS and SCIENCES

Courses in Philosophy; Education; Letters; Public Health; Medical Jurisprudence; Psychology; Sociology; Physics; Chemistry; Plastics; Geology; Political Science; Theology; Business and Commerce; Accounting; Mathematics; Statistics; Agriculture.

ENGINEERING

Courses in Electrical, Civil, Mechanical, Drafting, Architectural, Steam, Aeronautical, Radio, Structural, Mining, Industrial, Petroleum, Marine, Chemical, Diesel, Automobile, Refrigeration, and Air Conditioning Engineering.

LAW

Complete Professional Law Course includes 18 Hornbook Series college grade textbooks. Courses also in Commercial Law, Patent Law and Medical Jurisprudence.
McKinley-Roosevelt Incorporated, 4610-K, Sheridan Rd., Chicago 40, Ill.

"YOU ARE UNDER ARREST!"



There's a Thrill in Bringing a Crook to Justice Through Scientific

CRIME DETECTION!

I have taught thousands this exciting, profitable, pleasant profession. Let me teach you, too, in your own home. Learn Finger Printing, Fire Arms Identification, Police Photography and Criminal Investigation thoroughly, quickly and at small cost.

Be A FINGER PRINT Expert

53% of All American Bureaus of Identification employ students or graduates of I. A. S. You, too, can fit yourself to fill a responsible crime detection job with good pay and steady employment. But don't delay—get the details now. Let me show you how easily and completely I can prepare you for this fascinating work, during spare time, in your own home. You may pay as you learn. Write today... Now... Be sure to state age.

FREE!!!
Send for Thrilling "BLUE BOOK OF CRIME"

INSTITUTE OF APPLIED SCIENCE
1920 Sunnyside Ave., Dept. 1357, Chicago 40, Ill.

Learn PLASTICS IN 12 SHORT WEEKS!

Be a Certified Plastics Technician. Learn factory methods at PTA. Have a business of your own or a high paying plastics job! No tools needed. Start any time! Prepare *Send for Free Folder* for the future... Mail a card today! **VETERAN APPROVED**

Plastic Training Ass'n of America, Inc., 1744 Champa, Denver 2, Colo. Dept. 1

Learn PLASTICS in DENVER!

FENCING World's Finest Sport Exciting Fun—Harmless



Just Out! Two 3 ft. Spring Steel Foils with Safety Rubber Buttons. Complete Outfit 2 foils (swords) with hand guards and Free Instruction Book Now Only \$1.98 Postpaid. A Healthful & Clean Sport, makes you Strong & Alert. Instruction Book teaches Quickly—Easily. Mail check or Money Order for \$1.98 today. Add 28c for Foreign Postage.

LEE PRODUCTS CO., Dept. 9-1613 First Ave., New York 28, N. Y.

MAKE YOUR OWN COSTUME JEWELRY BIG EARNINGS AT HOME

YOU can make costume earring and pin sets, brooches, necklaces, dress clips, cameos, etc.
WE supply the jewelry findings; bar pins, ear screws, jump rings, chains, screws, stone sets, sequins, shells, boxes, cement, cards, etc.

WRITE FOR FREE CATALOGUE

PHILADELPHIA BADGE, 1007 FILBERT ST., PHILA. 7, PA.



NOW! Build Your Future On

DIESEL

OPPORTUNITIES

IN INDUSTRY

ON LAND ON WATER



DIESEL POWER IS GOING PLACES!

COMPACT DIESEL TRUCK ENGINE

6 cylinders, 5 1/2" bore and 6" stroke, maximum horse power rating 200 H.P. at 2100 RPM.

You don't have to look far to see Diesel Power in action these days. Trucks, buses, tractors, streamliners and switching engines, ocean-liners and small watercraft, power and lighting plants, farm and road equipment — more and more depend on Diesel each day. And now aircraft are experimenting with the lighter units. On the farm, in factories, in communities large and small — Diesel is growing as it proves to be efficient, economical, dependable, streamlined power.

Diesel Knowledge is Earning Power

THE NEW AND INCREASING USES OF DIESEL open a broad field for trained men who can install, maintain, operate and repair DIESEL EQUIPMENT. Diesel engines need DIESEL-trained men! Now is the time to prepare for these opportunities.

LEARN NOW WHILE YOU KEEP YOUR JOB

If you are between 17 and 60 and mechanically inclined, you can get thorough, individual instruction right in your home. Through UEI balanced training, you learn first through home study the fundamentals of Diesel in all its phases, given to you in practical, easy to understand lessons from men with years of successful experience training this way. You will learn how Diesel Engines operate, how fuel systems work, how to make repairs, all about the latest accessories and auxiliary equipment, and a world of other Diesel basic "know how."

Actual Shop Practice

Then you get valuable practice in our big shop, working on costly equipment under Diesel men who really "know their stuff". This course is new and up to the minute, including latest techniques for handling new and old equipment under today's conditions. UEI offers placement service for graduates and has numerous other features which have contributed to the reputation of this outstanding school—now in its 20th success-making year. Coupon below brings complete information.

DO IT NOW! It costs you nothing to get all the facts about Diesel opportunities and training. Simply mail the coupon below. Time is important—and the time to begin is NOW! Make up your mind after you get the facts, but write for them at once. Send coupon today!

OTHER U.E.I. Training Opportunities

Practical Shop Training Follows Preliminary Home Study

AUTO BODY AND FENDER REPAIR
Includes Welding, Metal Work, Spray Painting and Refinishing.

MECHANICAL REFRIGERATION
Servicing and Installation for all commercial and domestic types.

WELDING
Arc and Acetylene. With fundamentals of metallurgy and supervised welding practice.

AIR CONDITIONING
Installation, operation and maintenance of home and industrial equipment.

Founded 1927



UTILITIES ENGINEERING INSTITUTE

1314 W. Belden Ave., Dept. 110-D Chicago 14, Ill.

UTILITIES ENGINEERING INSTITUTE, Dept. 110-D
1314 W. Belden Avenue, Chicago 14, Illinois

Please send me FREE facts about UEI training and opportunities in the field checked below.

- DIESEL
- WELDING
- REFRIGERATION
- AIR CONDITIONING
- AUTO BODY AND FENDER REPAIR

Name _____ Age _____

Address _____

City _____ Zone or County _____ State _____

If World War II veteran give length of service _____
 Check here for special information if you are under 17.



Start \$1,756 to \$3,021 a Year

**Get Ready Now for Examinations
In Your Section**

Veterans Get Preference

Railway Postal Clerks

Railway Postal Clerks get \$2,300 the first year regular, being paid on the first and fifteenth of each month. (\$95.70 each pay day.) Their pay is automatically increased yearly to \$3,400. Advance may be had to Chief Clerk at \$5,400 a year. (\$225.00 each pay day.)

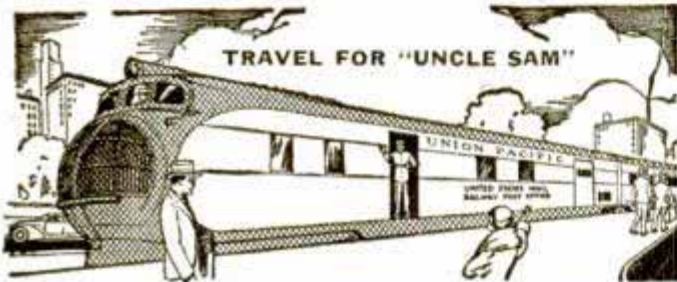

3 Days On — 3 Days Off — Full Pay

Railway Postal Clerks on long runs usually work 3 days and have 3 days off duty or in the same portion. During this off duty their pay continues just as though they were working. They travel on a pass when on business. When they grow old, they are retired with a pension.

City Mail Carriers, Post Office Clerks

Clerks and Carriers now get \$2,100 the first year on regular and automatically increase \$100 a year to \$3,100. Open to men-women 18 to 50.

**GOVERNMENT
CLERK**



Many Other Positions

Many other positions are obtainable. Rural Carriers—Stenographers—Typists—Assistant Statistical Clerks—Customs Inspectors—Office Machine Operators—etc. Those wishing these positions should qualify at once.

Get Free List of Positions

Fill out the following coupon. Tear it off and mail it today—NOW, at once.

This investment can result in your getting a big-paid government job.

FRANKLIN INSTITUTE, Dept. A86, Rochester 4, N. Y.

Rush to me, entirely free of charge (1) a full description of U. S. Government Jobs; (2) Free copy of Illustrated 32-page book, "How To Get A U. S. Government Job"; (3) List of U. S. Government Jobs; (4) Tell me what to do to prepare for one of these jobs.

Name.....

Address..... Vet?.....

Use This Coupon Before You Mislays It. Write or Print Plainly.

SAY YOU SAW IT IN POPULAR MECHANICS



**A Lifetime
Profession**

Regardless of Conditions, Age, Sex, or Physical Limitations

Veterans—Civilians!
Your Opportunity—
LEARN WATCHMAKING



Lift yourself from a futureless job into a position paying better than your present work. Fit yourself for the job that will permit you to establish your own shop, or be employed in a pleasant environment.

Watch Repairing—Jewelry—Engraving will always be in ever greater demand. Our graduates wanted everywhere. Dignified positions \$50-\$75-\$100 per week. Veterans write today for latest FREE enrollment requirements.

Kansas City School of Watchmaking
Largest Horological School in America
617-621 Wyandotte St. Kansas City 6, Mo.

**PRACTICAL SHOP TRAINING
in AIR CONDITIONING**

Domestic - Commercial - Industrial

**REFRIGERATION
SERVICE-MAINTENANCE
INSTALLATION**

Approved for G. I. Training

Write for Details

COMMERCIAL TRADES INSTITUTE
202 So. 20th St. BIRMINGHAM, ALABAMA
Train in the Magic City of the South



WITH GOOD INVENTIONS

Should write us without delay for FREE BOOKLET, Protective Disclosure Form and facts about The Inventor's Most Logical Markets. Patented. Unpatented Inventions, all kinds, Cash, Royalty, needed by specific manufacturers. If your invention is for sale, write today for full particulars. A Post-Card will do! Address:

THE INVENTION REPORTER
5C-11106 South Longwood Drive Chicago 43, Illinois

HOME STUDY OR SHOP TRAINING

Learn Plastics, Refrigeration or Diesel. Study at home, shop work later. Also shop courses in Body and Fender, Machine Shop, Tool and Die. 41,000 graduates. Established 1902. Free booklet. Specify trade.
GREER SHOP TRAINING, Dept. 1106, 460 S. State St., Chicago

**WHY JOB WORRY?
LEARN ELECTROPLATING**

Highly paid, uncrowded, interesting business. Part or full time. Chromium, Nickel, Gold, Silver, etc. Send postcard for FREE booklet and proof.

PLATER HYDE, Dept. S Post Office Box 176 National City, Calif.

Learn RADIO- ELECTRONICS- TELEVISION

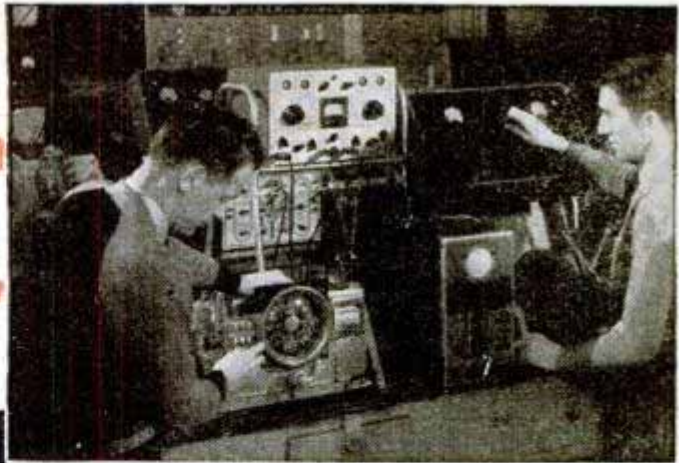

RADIO TESTING AND SERVICING—Students learning to locate troubles with modern radio analyzers.



ELECTRONIC CIRCUIT TESTING — Instructor showing students use of large Cathode Ray Oscilloscope.

**TRAIN FOR A GOOD
JOB NOW** one that
offers **STEADY WORK**
with a **REAL FUTURE**

Don't be caught napping. Prepare for a good job now that will still be a good job with a real future when conditions change. If you are not a trained man you may have to compete with millions of other untrained men. Get into a field that offers real opportunities in good-times and bad-times. Tremendous expansion in Frequency Modulation and Television is predicted because of war time discoveries now being re-converted to civilian use. Radio-Electronics trained men are needed today—they will be needed in the years ahead!

"Learn by Doing"

RIGHT HERE in the SHOPS of COYNE — in a Few Weeks

Student Finance Plan

We train you on real Radio, Television and Sound equipment—RIGHT HERE IN THE COYNE SHOPS IN CHICAGO. Whether or not you have had Radio experience you need Coyne all-around Radio Electronics training. Many of my students had no previous experience. Others had experience in one or two branches but realized they needed all-around training for better jobs and advancement.

EARN WHILE LEARNING

If you need part-time work to help pay living expenses while at school, we will help you get it. Coyne graduates also receive a Life Membership with Lifetime Employment Service, free technical service and privilege of review without additional tuition charge.

MEN WITH PHYSICAL DISABILITIES—whether due to war or other causes—we also have facilities for you. Check coupon for particulars if you have a physical disability of any nature.

PREPARE FOR JOBS LIKE THESE

Frequency Modulation (FM)
Radio Manufacturing
Radio Set Serviceman
Television Servicing
Electronics Maintenance
Public Address Systems, etc.
Your Own Radio Shop
Industrial Electronics and Electric
Refrigeration Now Included

**ADDED
TRAINING**

This training included to help you get ready for the better jobs in these great fields

THE HOME OF
COYNE



VETERANS!
Coyne is also equipped to train those who qualify for training under the G. I. Bill of Rights. Check coupon for special G. I. Bulletin.

Real Opportunities for the Radio Trained Man

Prepare for jobs as assembler, inspector and tester—Radio sales or service and installation work, electronics, television, sound work, aircraft-radio, auto-radio, etc. Many opportunities in the vast Radio-Electronics field.

GET MY BIG NEW BOOK

It tells all about my big Chicago shops and my plans to help you get ahead. Packed with facts and pictures of students at work in my shops. Mail coupon for this Big New Book now! Coupon will also bring details on how I'll finance most of your tuition... facts on how I help you "Earn-While-Learning"... information on FREE EMPLOYMENT SERVICE FOR LIFE... and other plans to help you. ACT NOW TO MAKE SURE YOU GET MY GENEROUS OFFER. Sending for this interesting free book can be your first big step to success. No obligation. No salesman will call. Mail coupon today.



B. W. Cooke

B. W. COOKE, Dir.

Founded 1899

COYNE ELECTRICAL SCHOOL
RADIO-ELECTRONICS DIV.

500 So. Paulina Street Dept. 76-3H CHICAGO 12, ILLINOIS

B. W. COOKE, Dir., Radio-Electronics Div.,
COYNE ELECTRICAL SCHOOL
500 S. Paulina St., Dept. 76-3H,
Chicago 12, Ill.

Dear Mr. Cooke: Send me your Big Free Radio-Electronics Book and all the facts... also full details of your "Student Finance" plan. Send special G. I. Bulletin. Send physical disability details.

NAME.....

ADDRESS.....

CITY.....STATE.....

NEW! FOR BEGINNERS Learn ELECTRIC MOTOR REPAIR!



Easily, Quickly, at home for only \$5

Every day, more and more electric motors are being used BOTH in industry and in home appliances. The motor repair expert is a valuable man in this Electrical Age! **ELECTRIC MOTOR REPAIR**, the new big book for only \$5, teaches all about this fascinating work—quickly and easily. Explains every detail of motor trouble diagnosing, repair and rewinding.

TRAIN FOR GOOD PAY IN AN UNCROWDED FIELD!

Covers alternating—and direct-current motors, synchronous motors and generators and BOTH mechanical and electronic motor control systems. Quick-reference guides at end of every chapter show exactly how to handle specific jobs. Invaluable for either beginners who want to learn HOW—or for actual bench use in busy repair shops. There's big money in the work. The field is not overcrowded.

680 pages
900 illustrations
and diagrams

SHOWS YOU HOW EVERY STEP OF THE WAY!

Based on what you can learn at home from this big book, you can train yourself to prompt and PROFITABLY service practically any motor. Every step of the work is demonstrated VISUALLY by more than 900 easily-understood diagrams. These are indexed for quick on-the-job reference. The unique Duo-Spiral Binding divides book into 2 sections permitting BOTH text and related illustration to be seen AT THE SAME TIME. Lies open flat on bench while you work!

Unique Duo-Spiral binding

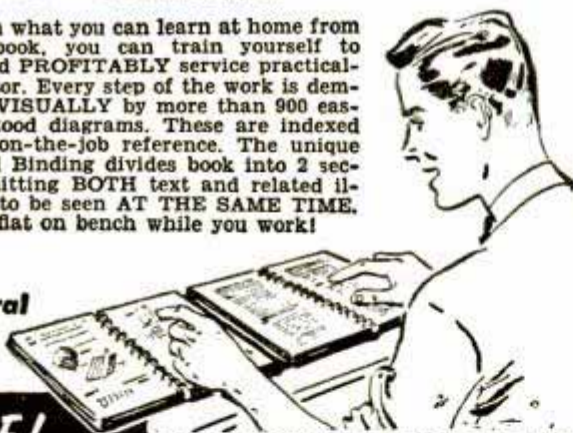

FREE! Check coupon for free literature on famous **GHIRARDI RADIO-ELECTRONIC Training Books**

"BORROW" IT FOR 5 DAYS

Send coupon now. Practice from **ELECTRIC MOTOR REPAIR** for 5 full days. If not more than satisfied with the book, return it to us. Every cent of your money will be cheerfully refunded—and no questions asked. What could be fairer?

5-DAY MONEY-BACK GUARANTEE

Dept. PM-106, Murray Hill Books, Inc.
232 Madison Ave., New York 16, N. Y.

Enclosed find \$5 (\$5.50 foreign) for my copy of the big **ELECTRIC MOTOR REPAIR** book; or send C.O.D. (in U.S.A. only) for this amount plus postage. In either event, if unsatisfactory for any reason, I may return book in 5 days and have my money refunded.

CHECK HERE for free literature on Ghirardi **RADIO-ELECTRONIC** books.

Name.....

Address.....

City & Dist. No.....State.....

Say you saw it in Popular Mechanics

LEARN HOW TO WRITE GAGS!



**Be the Life of the Party!
MAKE MONEY! WIN
SUCCESS and FAME!**

BE A POPULAR GAG WRITER—now it's easy! No experience or special talent is needed. Al Garry, the famed writer for radio stars—Frank Sinatra, Abbott and Costello, Phil Baker and others—will show you how!

Ten Easy Lessons Teach You

Garry's 10-lesson course on **RADIO GAG WRITING** tells all: how to originate and develop gags; characterizing gags; gag switching; timely gags; developing gags from everyday incidents; script writing from gags, and many secrets you need to know for gag-writing success! **EXTRA:** you get 1000 side-splitting, original gags—start your own gag file and rework these immediately for money! Don't delay fame, fortune, fun—**START NOW!** Complete, easy-to-learn **RADIO GAG WRITING COURSE** only \$5.95. **Send for it today!** **SATISFACTION, OR YOUR MONEY BACK** Look this Course over for 7 days. If you're not 100% satisfied—if you don't put your friends in stitches with your new sparkling wit, return the Course and I'll refund your money. Send \$5.95 money order or check NOW—I'LL RUSH THE COURSE TO YOU POSTPAID AND GUARANTEED.

AL GARRY, Gagmaster, Dept. 1
IN THE HEART OF RADIOLAND
48 WEST 48TH STREET, NEW YORK 19, N. Y.

AUTOMOTIVE MECHANICS BODY & FENDER REBUILDING

Pay is good in both these big branches of the Automobile Industry. Learn in few weeks in our big, modern training shops. Good pay for men who learn to service, repair, install all mechanical and electrical parts of autos. Learn to make used cars look like new—training in welding, aligning, mixing and matching colors, spray painting, power and hand tools. **CONSULTATION AND PLACEMENT SERVICE WHETHER YOU ARE INTERESTED IN WORTH-WHILE JOB OR SETTING UP YOUR OWN BUSINESS.** Our Institute gained nationwide fame training Auto Mechanics for U. S. Army. If over 17 and under 60 learn how you can get started. Write for **FREE FACTS** today. (If a Veteran you are entitled to free training and living expenses. Just write us—we'll take care of all details if you qualify under G.I. Bill.)

MOTIVE TRADES INSTITUTE, Dept. B-210
1400 Greenleaf Chicago 26, Illinois

TRAIN for SUCCESS in the Poultry Business



Study at home in spare time. Earn extra while learning.

YOU CAN MAKE MORE MONEY from POULTRY. Proper management means profits ANY season, for life. Get latest scientific methods that avoid losses and mistakes. Our famous system of Home Study Training has helped thousands to success. Extra profits from the start. **FREE** Catalog; describes courses, methods, service. Write today to Dept. 50.

NATIONAL POULTRY INSTITUTE, Adams Center, N. Y.

CODE-RECEIVING-SPEED

Learn to send and receive Radio Code with greater speed. Stop nervous tension. Have confidence. Be proficient. Same system used by radiotelegraph specialists. Thousands of operators needed. Rush name for **FREE** book.

CANDLER SYSTEM CO.
Dept. 5-L, Box 928, Denver 1, Colo., U. S. A.

INVENTING

-FOR PROFIT! If you have an inventive turn of mind, write for free 28-page booklet explaining how the Institute of American Inventors is helping inventors pre-test the profit possibilities of proposed devices to fill today's unprecedented demand for useful new inventions.

INSTITUTE of AMERICAN INVENTORS
Dept. 4, 1926 Eye St., NW, Washington 6, D. C.

No Waiting to LEARN
START NOW TO EARN!
 This BIG BOOK SHOWS HOW



IF IT'S RESULTS YOU WANT—GET ACTION QUICKLY WITH THESE PRACTICAL IDEAS

Never before has a more helpful book been printed for those planning a business of their own. Gathered in this large illustrated volume are the formulas, recipes, facts and secrets that have contributed so largely to America's great industrial progress. Capitalize on this information for making most any conceivable product without experience, special equipment or previous knowledge of chemistry. Start at home, expand with profits—build for a profitable independence.

The experts who compiled this book are authorities, and present this information in simple, understandable language. They also give you wholesale supply sources for needed materials, short cuts and economy methods for the most profitable results. Hundreds of good paying businesses have been built on a product made from a simple

recipe. Opportunities in this field exist everywhere. Choose from any of the 102,000 facts and 10,000 formulas of which the following are only a very few: Adhesives, Alloys, Anti-Freeze Solutions, Cosmetics, Beverages and Liquors, Candy, Gum, Casein, Celluloid, Ceramics, Cheese, Cleaning Preparations, Concrete, Copper, Cotton, Dentifrices, Depilatories, Dyes, Embalming Fluids, Enameling, Glass, Glazes, Household Formulas, Inks, Insecticides, Iron, Jewelers' Formulas, Lacquers, Laundry Preparations, Leather, Linoleum, Lubricants, Manicure Preparations, Marble (artificial), Metals, Mirrors,

—Sell by Mail!

You will profit by the ideas contained in this big book for setting up a mail business you can easily run from your home in your spare time.

Man, Beast or Fowl, Rubber Products, Refrigerants, Soaps, Solider and Soldering, Tooth Cements, Transfers, Transparencies, Varnishes and Thousands of others for making all sorts of profitable and practical things.

FORTUNES MADE FROM A SINGLE IDEA!

This comprehensive book is an accepted authority by chemists, schools, industry, etc. and is the largest and most comprehensive book of its kind ever issued. Nothing else like it in existence. A single formula has been worth a thousand times this book's small cost to countless owners. Crammed with money-making ideas. Invaluable for reference. Ideal for Factory, Home, Farm, Office or Workshop. As necessary as the dictionary and more useful for manufacturers, chemists and salesmen who put up products for profit.

\$3.50 postpaid. Canada or Foreign, \$3.85 U. S. Funds. (C.O.D. shipments U.S.A. only.) Immediate Shipment—Safe Delivery Guaranteed.

ADAMS BROWN COMPANY BOOKS OF APPLIED SCIENCE
 Dept. 160, Chestnut Hill 67, Massachusetts, U. S. A.

POSTPAID!
\$3.50 U.S.A.
\$3.85 FOREIGN

Pilot's Radio Operations Manual

All the answers in one complete book. Latest information about Range Flying—License Questions—Terminology—Traffic Control and Radio Phraseology. Fully illustrated. Ideal for G.I. Aircraft Training Program Manual. Order your copy direct. **ONLY \$1.50 POST PAID.**

LINDSEY AIR RADIO, INC.
 MUNICIPAL AIRPORT WICHITA, KANSAS



Durn Your Hide!

Since 1938 we have published a magazine for you—and you've never seen a copy of it! Rustle of wings at dawn over the marshes, splash of a striking bass, roar of a charging grizzly—Western Sportsman is crammed full of articles, pictures and information about the New West, greatest outdoors country on earth! 7 issues, \$1. Write, Joe Austell Small, Editor, WESTERN SPORTSMAN, Dept. E, 3303 Bridle Path, Austin, Texas.

SELL BIBLE SOUVENIR

METAL COINS, LORD'S PRAYER, ONE SIDE; JOHN 3:16 ON THE OTHER—Quick Easy Sales—Very attractive pocket piece. Quantity Price \$6.00 per 100; \$27.50 per 500; \$50.00 per thousand. Don't wait. Order Today. Sample Order 15 Coins with Display Card, \$1 Postpaid. **LOUIS LE VITE, 21 E. Van Buren St., Dept. P5, Chicago 5.**

SILVER DOLLAR SIZE



LEARN PORTRAIT PAINTING AT HOME

• Previous art training or talent NOT necessary. This new Stuart System teaches you, in 11 simple, easy-to-follow lessons, to make exact charcoal and oil likenesses. Guidance for your every step. Send for free book today.

STUART STUDIOS,
 121 Monument Circle, Room 610, Indianapolis 9, Ind.
 Please send me free book and outline of lessons.

Name _____
 Street _____
 City _____ State _____

BOYS! MEN!
 now you can
MOLD PLASTICS AT HOME!



Get in on the newest hobby craze! Make beautiful buttons, pins, ornaments, etc. of colorful plastics. Fascinating! Modern! And so EASY with



PLASTIC MOLDING SETS

Designed by expert Plastic Chemists and Engineers. Contain everything the home craftsman needs to start this absorbing pastime—assorted plastics in various colors, a practical, easy-to-use press, assortment of die-cast aluminum molds, fuel tabs, finishing materials, complete instructions—all packed in a sturdy metal box.

The Number 1 Outfit costs only **\$2.60**
 Number 2 Outfit (illustrated) — more different kinds and colors of plastics in larger quantity, more and larger molds **\$4.85**

If your dealer cannot supply you, use coupon and send money order or check direct.

(DEALERS: Write for particulars)

CANNON & COMPANY
 216 Elliott Street, N. W., Atlanta, Ga.

CANNON & COMPANY,
 216 Elliott Street, N. W., Atlanta, Ga.
 Please send me, postpaid, Cannon Craft Plastic Molding Outfit Number Remittance of \$..... is enclosed.

Name
 Address

If you are between 15 and 55

\$200
a month

is all you have to pay for Old Line, Legal Reserve LIFE INSURANCE

This is half the Permanent-Rate, payable until the 6th year. You get \$1,754 of Protection all your life if you are now 20, \$1,460 if you are 30, \$1,142 if 40, etc. Proportionate amounts at other ages. Budget your Insurance like Rent.

YOUR POLICY WILL BE FULLY PAID-UP IN 30 YEARS

with no more premiums to pay and all benefits continued. Send Coupon at once! for full details and amount of life long Protection offered at your age!

MAIL COUPON NOW FOR FREE BOOKLET

Postal Life Insurance Company
511 Fifth Ave., Dept. D, 619
New York, 17, N. Y.

Mail me complete information about your new "\$2.00-per-month", 30-Payment Modified 5 Whole Life Policy at my age.

Name _____
Occupation _____ Date of Birth _____
Address _____

Include P. O. District Number, if any

MAGIC FOR EVERYONE

Wonderful Magical Tricks for Pocket, Parlor, Club or Stage. Amusing Hobby, Profitable Profession. Profusely Illustrated Catalog of over 300 Magic Tricks sent for 10c coin or stamps. A. MAGICIAN, 2463 Kensington Ave., Philadelphia 25, Pa.

AIR
RIFLES

BENJAMIN

AIR
PISTOLS

ARE IN PRODUCTION

ORDER BENJAMIN AIR RIFLES & BENJAMIN AIR PISTOLS from your DEALER. Send for our FREE FOLDER and Complete Specifications TODAY. Both Calibre Benjamin H-C Pellets are available now.

BENJAMIN AIR RIFLE CO., 812 MARION ST., ST. LOUIS 4, MO.



HUNTING and FISHING

is a monthly magazine crammed full of hunting, fishing, camping, dog and boating stories and pictures, invaluable information about guns, fishing tackle, game law changes, best places to fish and hunt—countless ideas that will add more fun to your days afield.

Special Trial Offer

Send 25c in stamps or coin and we will send you Hunting & Fishing for six months.

HUNTING & FISHING
MAGAZINE

251 Sportsmen's Bldg., Boston, Massachusetts

How to Start YOUR OWN BUSINESS

Amazing Postwar Development Now Gives
You the Opportunity to Make Money Fast!

Startling scientific discovery, just now becoming available for general use, will enable you to start your own business and reap great profits! Plastic, one of the most revolutionizing and rapidly expanding industries, offers a great opportunity to all enterprising men and women. This is one of the few industries in which home manufacturers thrive and prosper. You can start even on a spare time basis in your own home, and expand rapidly into a full time business, paying good profits.

LIQUID MARBLE

Make LIQUID MARBLE the amazing Plastic, with a thousand uses. LIQUID MARBLE can be poured into FLEXIBLE MOLDS for casting all kinds of artistic and serviceable articles such as: ornaments, novelties, desk sets, paper weights, hook-ends, souvenirs, statuary, toys, etc.

FLEXIBLE MOLDS

Make your own FLEXIBLE MOLDS. The cost is low—in fact, a large sized mold costs but a few cents. Hundreds of casts can be taken from a single mold.

NO EXPERIENCE NEEDED!

No skill or previous knowledge is necessary. All you do is follow our easy-to-understand instructions.

UNLIMITED MARKET

The market is literally unlimited. You will find steady year-round demand in your own community. Your problem will not be in selling but in supplying the huge pent-up demand. Moreover, we supply you with names of big buyers for your finished products.

WRITE TODAY

Bing Products will show you how to start with a small investment and build a permanent, independent, profitable business! Don't fail to grasp this opportunity! Write today for FREE CATALOG.

BING PRODUCTS Dept. A10, 88 Broad Street
BOSTON 10, MASS.

MAKE HUNDREDS OF FASCINATING
Radio-Electrical EXPERIMENTS
Only \$4.99 POSTPAID U.S.A.
IDEAL XMAS GIFT FOR BOYS!
Radio Electronic Experiment Kit

50 Piece Genuine Commercial war surplus Electronic apparatus. Includes: headphones, capacitors, potentiometers, resistors, fuses, sockets, hook-up-wire, etc. Build hundreds of fascinating experiments. Learn electronics at home. Send \$4.99 for kit, complete instructions, also blueprint for home lab bench. Or send C.O.D. LECO ENGINEERING CO., Box 931, PM1, Lincoln, Nebraska.

MAKE MONEY CASTING AT HOME FREE FACTS SENT

Make hundreds of Plaster Casts, quick, easy. Sell output to stores, novelty shops, etc. Enormous profits. No experience. Very little capital needed. Start in basement, garage or workshop. Complete, simple instructions anyone can follow. Start now while merchants are begging for merchandise to sell. Rush.
PLASTIC ARTS STUDIOS, R.R. 5, Dept. 28, Muncie, Ind.



AMAZING DEVICE! Guides your hand—corrects poor penmanship in few days—big improvement in three hours, no failures. Complete Outline Free. Write, Mr. Ozment, 34, St. Louis, Mo.

ELECTRICAL TRAINING

Intensive 32 weeks residence course in fundamentals of industrial electrical engineering, including radio, electronics. Prepares for technician, engineering aides. Approved for veteran training. 53rd year. Catalog.

BLISS ELECTRICAL SCHOOL
7642 Takoma Ave., Wash. 12, D. C.



BUILDING HUMAN STATURE

"I grew 6 inches during a year I followed instructions given in 'BUILDING HUMAN STATURE,'" says the younger man at left. "Now I am a head taller than my father."

If you wonder why you are short send for FREE outline of this remarkable book loaded with practical information.

CARILLON BOOKS, Dept. 59, Boerne, Tex.

**EASY to
PLAY**

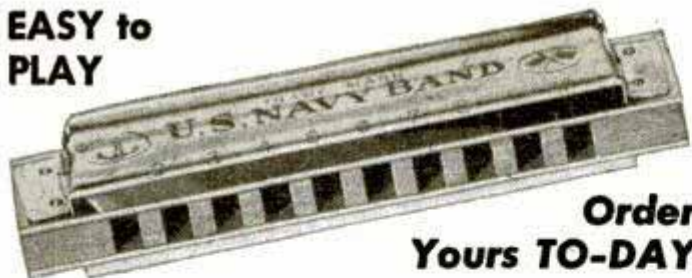

**Order
Yours TO-DAY**

**The New Luellen
HARMONICA**

Most wonderful pocket instrument ever made is the harmonica. Easy to master, fun for Everyone. The Luellen has 10 holes, 20 notes. Key of C. Beautiful tone. Now ready. Postpaid Only..... **\$2.35**

INSTRUCTION BOOK. Simple for youngest child. No notes, scales nor exercises. Ten lesson charts show everything. Includes 75 popular songs. Price \$1.00. Here's our special introductory offer: The Instructor and the Harmonica, both postpaid, both for \$2.85. Send Check or Money Order Today.

JOHN LUELLEN & CO., 17034 Page Ave., Dept. 1003, Hazelcrest, Ill.

*Give yourself the Backing of a
GREAT GROWING INDUSTRY*



**REFRIGERATION
AIR CONDITIONING**

Refrigeration and Air Conditioning have leading place in fast growing fields of our time. Trained men paid well to service, install, maintain, repair, rebuild household and commercial refrigerators. Important new developments such as Frozen Foods and many new industrial uses. Demand for commercial installations in restaurants, butcher shops, taverns, florists, bakeries, etc. — air conditioning in homes, offices, shops.



START NOW—Full and Part Time Earnings

There may never again be such opportunities for men who want better jobs or business of their own to get in on ground floor and go up fast! Many started with small investment who built good, growing business. If over 17 and under 60 learn how you can get started. **CONSULTATION AND PLACEMENT SERVICE WHETHER YOU ARE INTERESTED IN WORTHWHILE JOB OR SETTING UP YOUR OWN BUSINESS.**



**Begin Training at Home or
Come Directly to Shops**

Begin your training at home in spare time, finish in our big, modern shops, or come directly to shops. At home you get C.T.I.'s **SHOP PROVED HOME STUDY** instruction—actual shop experience has gone into the practical lesson assignments. That is why it is easy for mechanically inclined men to learn by our Home Study training and start on actual refrigeration work.



A NATIONALLY KNOWN INSTITUTION

C.T.I. was only civilian school selected by Army to train service men for refrigeration. Same quality training available to you now. The method that has made rapid progress possible. Commercial Trades Institute has established its place in Air Conditioning and Refrigeration industries, and that is important to you in making your start.

VETERANS

Veterans qualifying under "G.I. Bill" have all expenses paid by Government plus monthly subsistence allowance. Just mail coupon, we will handle all details. (LOW TUITION, EASY TERMS if you are not a veteran.)



COMMERCIAL TRADES INSTITUTE
Dept. A210

1400 W. Greenleaf Ave., Chicago 26, Ill.

FREE — Important Information Telling How to Get Started

CUT OUT COUPON BELOW

Fill Out, Cut Out, Mail Today

FACTS FREE for Men Who Want to Get Ahead
COMMERCIAL TRADES INSTITUTE, Dept. A210
1400 W. Greenleaf, Chicago 26, Ill.

Send free Illustrated Brochures and other information about Refrigeration and Air Conditioning.

Veteran Non Veteran

Name

Address

City State

SEND FOR THIS

**HOW to
BREAK
and
TRAIN
HORSES**



FREE!

Make money with horses. Every farmer, every lover of horseflesh should have a copy of this booklet. If you want to know how to break, train and make money with horses, write today for full information **FREE!** together with my special offer of a course in Animal Breeding. If you are interested in Galting and Riding the saddle horse check here. Do it today—now. You'll never regret it.

BEERY SCHOOL OF HORSEMANSHIP
Dept. 11010-D Pleasant Hill, Ohio

HOW TO CUT RAFTERS

New vest pocket book gives lengths, Side cuts, Plumb cuts, Deductions. For all rafters for any building from one inch to forty feet wide. Gives numbers to cut on square. Also degrees for same cuts for Radial Saws. All standard pitches from 1g to 5g. Just open book to pitch page and there are your lengths, side cuts, etc. Anyone who knows what a jack rafter is can frame a roof if he has this great book. Price one dollar prepaid.

BUILDERS' TOPICS, Dept. M, Med. Arts Bldg., Seattle 1, Wash.
Original teachers of the square in five easy lessons by mail. Send for **FREE** list of plan books—Kamp Kabins to Mansions.

LEARN HOW TO KEEP MONEY



Get these two great books and profit from their amazing secrets. Learn "Seven Cures for a Lean Purse," and "How to Keep Your Money and Attract Good Luck," both by Clason. Order one at \$1—both, \$1.75. Don't let money slip away any longer. Order today! Satisfaction guaranteed.

E. J. RASKE ENTERPRISES
Suite 239—354 S. Spring Street, Los Angeles, California

MAKE MAGIC your HOBBY

ENTERTAIN FOR FUN OR PROFIT!
Rush 25c for first issue of "MAGIC IS FUN," new magazine that teaches how to do tricks with coins, cards, ropes, etc. **FREE!** with order, large catalog of magical apparatus.
D. Robbins & Co., Dept. M-49, 152 W. 42 St., N. Y. 18, N.Y.

THERE'S MONEY IN CARTOONS!

RAYE BURNS will teach you **HOW** to **CREATE ORIGINAL CARTOONS** at home that you may **SELL!** Course contains **26 lessons** and **over 600 illustrations.** All for **Only..... \$2.85**

Send name and address for free details.
RAYE BURNS SCHOOL, Dept. M, Box 3583, CLEVELAND, OHIO

INVENTORS

The inventor who believes he has a new and useful invention, and finds himself in need of advice, should consult a competent registered patent attorney.

The question as to whether a subject matter is patentable can be substantially determined by a search of the United States Patent records.

Without obligation, write us for information as to what steps an inventor should take to secure a Patent.

RANDOLPH & BEAVERS

Registered Patent Attorneys

11-D Columbian Bldg., Washington 1, D. C.

RANDOLPH & BEAVERS

11-D Columbian Bldg., Washington 1, D. C.

Please send me full information on how to secure Patents & Trademarks.

Name.....

Street.....

City.....State.....

MODERN SHOP TRAINING APPLIANCES SERVICE REPAIR • INSTALL

Active and growing field for men who want good jobs or business of their own. Practical shop training on all kinds of appliances—washers, ironers, mixers, heaters, vacuum cleaners, stoves. Learn polishing, plating, motor repair, how to use precision and necessary power tools. Good pay for repairing, maintaining, servicing, installing, selling electric appliances. Chance to get in on ground floor, go up fast! If over 17 and under 60 learn how you can get started. Write for FREE FACTS today. (If a Veteran you are entitled to free training and living expenses. Just write us—we'll take care of all details if you qualify under G.I. Bill.)

APPLIANCE TRAINING SCHOOL, Dept. C-210
6312 N. Broadway, Chicago 40, Illinois

WANT A GOVERNMENT JOB?

\$1,756 to \$3,021 FIRST YEAR

RAILWAY POSTAL CLERKS

Veterans Get
Special
Preference



Many other Government Jobs. City and Rural Carriers — Postoffice Clerks — Patrol Inspectors — Accountant — Stenographers — Typists — etc. Prepare Now for next Examinations.



PATENTS

AND TRADE MARKS

C. A. SNOW & CO.

Registered Patent Attorneys Since 1875
Write for Free Book and "Certification of Invention" form
427 SNOW BUILDING, WASHINGTON 1, D. C.





PATENTS

Free preliminary advice

E. E. VROOMAN, Patent Lawyer

Registered Patent Attorney Since 1902
871 Woodward Building, Washington 5, D. C.





TRAIN Your VOICE!

Results GUARANTEED

We build, strengthen the vocal organs—not with singing lessons—but by sound, scientifically correct silent and vocal exercises and absolutely guarantee complete satisfaction with results. Write for Voice Book, FREE. Sent to no one under 17 years old unless signed by parent.
Perfect Voice Studios, Studio 1357, Kimball Hall Bldg., Chicago 4, Ill.



BUILDING

Millions of homes needed. Nation wide call for builders. Big opportunities. Learn now in spare time.—at home. Practical training with blue prints. No books. Send for FREE Trial Lesson and blue print plans.

CHICAGO TECHNICAL COLLEGE

N-150 Tech. Bldg., 2000 S. Mich. Ave.
Chicago 16, Ill.



Your Future in PHOTOGRAPHY

Nationwide opportunities, sound future waiting. Photographers needed by studios, newspapers, advertisers, in business, industry, science. Qualify through success-proved home study courses. Also resident instruction. Write for full details.
N. Y. INSTITUTE OF PHOTOGRAPHY,
Dept. 49, 10 W. 33 St., New York 1, N. Y.

Comic Stripper

Transfer newspaper pictures, comics on cloth, paper or wood with this amazing new transfer liquid. Buyers enthusiastic.

Agents—tremendous profits. Repeat sales. Easy to demonstrate. Write for free sample pictures and Money Making Offer today, or send \$1.00 and this ad. for three fifty cent kits.
H. B. KETCHUM, INC., 1122 So. Boulevard, Charlotte 1, No. Car.

FRANKLIN INSTITUTE,
Dept. A79, Rochester 4, N. Y.

Sirs: Rush to me, without charge, copy of 32-page book, "How to Get a U.S. Government Job," list of positions, and full particulars telling how to prepare for them.

Name.....

Address.....Vet?.....

GET THIS NEW BOOK FREE

**JUST OFF
THE PRESS**

Starting and
Operating a
Profitable
**ELECTRICAL
or RADIO
BUSINESS**

Just for
Examining this
New 1946 Electrical
**TROUBLE
SHOOTING
MANUAL**

COYNE
ELECTRICAL and RADIO
**TROUBLE
SHOOTING
MANUAL**

500 SHOP PRINTS and MOTOR DIAGRAMS
HOW TO READ AND USE THEM
EXPLAINING D. C. and A. C. MOTORS, ARMATURES, SWITCHBOARDS, ELECTRONIC CONTROLS, RADIO RECEIVERS, AUTO IGNITION, REFRIGERATION and AIR CONDITIONING, etc. Most amazing book of its kind ever published.
NEW "TOP-BOTTOM" TROUBLE SHOOTING MESSAGES
ELECTRICAL and RADIO MESSAGES
SPACE-TIME FOR PLANE

Sensational new 612-page "Coyne Electrical and Radio Trouble Shooting Manual". 500 shop prints and "how to use them"—plus many other practical features—all in one giant 8½" x 11" handsomely bound volume. New time saving, easy-to-follow methods of shooting trouble. Includes D. C. and A. C. Motors, Armatures, Switchboards, Electronic Controls, Radio Receivers; Auto Ignition, Refrigeration and Air Conditioning, etc. Most amazing book of its kind ever published. You get it FREE for 10 day trial plus the new book "Starting and Operating a Profitable Electrical or Radio Shop" as our outright gift to you. Rush coupon today for this amazing offer.

... FREE with TROUBLE SHOOTING MANUAL

Act now and I'll include 1 full year of personal counsel from the Coyne Staff—technical advice by mail on any Electrical or Radio problem. A real help in your daily work.

ALSO FREE: 1 year subscription to Coyne Technical News—latest facts on Electrical and Radio Progress, illustrated and explained.

B. W. COOKE, Director
COYNE ELECTRICAL SCHOOL
500 S. Paulina Street, Dept. 76-R7, Chicago 12, Ill.

SEND NO MONEY

Yes, that's right! You get Coyne's sensational new book "Starting and Operating an Electrical or Radio Shop" FREE—HERE'S MY OFFER—Mail the coupon below—and I'll rush you a copy of 1946 edition of Coyne "Electrical and Radio Trouble Shooting Manual" for 10 days free trial—plus FREE copy of my "Starting a Shop" book. Examine the "Trouble Shooting Manual" 10 days, then DECIDE. IF NOT 100% pleased return the manual and owe nothing—if you keep it, pay according to terms in coupon below. But REMEMBER, whether you keep the "Coyne Electrical and Radio Trouble Shooting Manual"—or return it—the "Starting and Operating an Electrical or Radio Shop" book is yours to keep FREE.

10 DAYS' FREE TRIAL

"Starting and Operating a Profitable Electrical or Radio Shop" tells you how to start full or part time Electrical or Radio Shop on small capital. Explains how to finance, choose a location, how and what to buy, advertising, salesmanship, business and legal angles, record keeping. For a Limited Time this amazing new book is given absolutely FREE . . . just for examining the sensational new 1946 edition of Coyne's "Electrical and Radio Trouble Shooting Manual" 10 days at our expense. ACT NOW—mail the 10 days' FREE TRIAL coupon today!

MAIL COUPON FOR FREE BOOK

B. W. COOKE, Director, COYNE ELECTRICAL SCHOOL, Dept. 76-R7, 500 South Paulina Street, Chicago 12, Illinois

OK,—send me your new Coyne Electrical and Radio Trouble Shooting Manual, post-paid along with my FREE COPY of "Starting and Operating a Profitable Electrical or Radio Shop." Within 10 days after the books come I'll either return the "Trouble Shooting Manual" to you AND OWE NOTHING or send \$3.00 and \$5.00 a month until a total of \$9.95 is paid. EITHER way I keep the "Starting and Operating an Electrical or Radio Shop" book as my free gift.

Name _____

Address _____

Town _____ Zone _____ State _____

Occupation _____

SAVE 10% Send cash price, \$9.00—you save over 10 per cent. Same 10-day free trial and MONEY BACK SATISFACTION GUARANTEE.

What keeps YOU from making more MONEY?



Just what is the matter—why aren't you making more money? Look around you. Probably many of the people you know are doing a lot better than you are.

What's the reason?

Your own native ability is probably just as good as theirs—probably nothing wrong with your personality and appearance.

But—they *have something you lack*. The fact that they have a better job and more money proves that. Success in business today is measured by the dollar sign.

The secret is this—the man who prepares himself for the job ahead—is the one who gets advancement and more money. He doesn't need "pull." The man who really has something on the ball—"push" enables him to get what he wants.

Ambitious men and women have found in LaSalle the way to get ahead in business. This has been going on for 38 years. Hundreds of thousands of students have enrolled—our files are full of grateful letters from people who have bettered their earnings and position through LaSalle.

Perhaps we can help you. You should at least find out. The coupon below will bring full information. Just check the field of your choice and we'll send you full information, without obligation—the money making possibilities in that field, and how you can prepare in your spare time at moderate cost.

For a brighter future in the business world—more money and a better job—send the coupon today. Tomorrow you might forget.
G. I. APPROVED.

LA SALLE Extension University a Correspondence Institution Dept. 1064-R Chicago, Ill.

I want to better my position—make more money. Send me your free booklet on the field I have checked below.

- | | |
|--|--|
| <input type="checkbox"/> Higher Accountancy | <input type="checkbox"/> Expert Bookkeeping |
| <input type="checkbox"/> Foremanship | <input type="checkbox"/> Industrial Management |
| <input type="checkbox"/> Executive Management | <input type="checkbox"/> Traffic Management |
| <input type="checkbox"/> Law: I.L.B. Degree | <input type="checkbox"/> Salesmanship |
| <input type="checkbox"/> Stenotypy (Machine Shorthand) | |

Name..... Age.....
 Present Position.....
 City, Zone and State.....



**WORLD'S
BEST
WANT AD
MEDIUM**

CLASSIFIED Advertisements



Advertisements in this section 50 cents per word, each insertion, minimum 10 words, payable in advance
To be inserted under proper classification in November issue, copy should be in our office October 1st

November issue on sale November 1st

F. W. Johnson, Manager, Classified Advertising

Popular Mechanics Magazine, 200 East Ontario Street, Chicago 11, Illinois

YOU'LL PROFIT

By reading and answering the classified ads in this section. Hundreds of opportunities to make and save money.

Mr. F. W. Johnson, Mgr.,
Popular Mechanics,
Chicago, Ill.

Dear Mr. Johnson:

The longer our advertising runs, the greater the returns. Every new issue practically doubles in number of inquiries, which at present averages 580 a month. (Not counting the late stragglers.) The cost comes to a little less than 1/2c per inquiry. (One-half cent.)

(Original letter on file in our office)

Yours very truly,
THE MAIL ORDER NEWS.

1543 CLASSIFIED ADVERTISEMENTS 1543 OPPORTUNITIES FOR YOU

AUTOMOBILES, MIDGET CARS

BUILD Tractors from second hand automobiles. Convert horse drawn farm equipment into tractor hook-up. Tractor plans—\$1.50. Mowing machine and plow hook-up plans \$1.00. Nolan's Garage, East Wareham, Mass.

USE Scrap parts and easily build speedy two passenger, three wheeled, motorized scooter-car runabout or two passenger midget "jeep." Complete construction plans for both \$1.00. Universal, 2671 Algonquin, Toledo 6, Ohio.

FLOYD Clymer's 1946 Indianapolis Race History Supplement now ready. 60 charts, drawings, illustrations, cartoons, complete details 1946 "500" race results, postpaid \$1.00. Complete 320-page History Book describing every Indianapolis race since 1909, including 1946 supplement, 1000 illustrations, \$3.50 postpaid; in de luxe binding, \$5.00. Clymer, Dept. A-100, 2125 W. Pico, Los Angeles 6, Calif.

BETTER Performance with a Ford type carburetor on your car. We furnish adapters. Single throat \$1.50, dual \$2.00. Nicholson, 1627 Angelus Ave., Los Angeles 28.

RACING Car performance for all cars. Increase power, speed. Special "custom-built" equipment. Free literature. Write Lee Motorcraft, 1412-A Great Northern Bldg., Chicago 4, Illinois.

DUALTONE Twin muffler sets for Fords and Mercurys. Instructions included \$20. Replacement mufflers, all automobiles. Prices quoted on request. Designed to eliminate back pressure, giving increased gas mileage and horsepower. Has deep mellow tones. Three inch chrome tailpipe extension \$3.00. Dualtone Mufflers, 2636C India Street, San Diego (1), Calif.

SPEED And mileage manual—Shows how to boost speed, power, mileage, get racing car performance with reduced expenses! Includes simplified tuneup, maintenance, gasoline saving tips, formulas, plans for making speed equipment, power mufflers, economizers, fast conversions, superchargers, etc. Postpaid \$1.98. Almqvist Engineering, 447 - 64 Street, Brooklyn 19.

"CUSTOM-STYLING" Manual—Easily make car look custom built, streamlined, luxuriously beautiful! New edition includes restyling instructions, illustrations, simplified refinishing, custom accessory plans, special mufflers, speed, roadster, model, conversions, etc. \$2. Almqvist Engineering, 447 - 64 Street, Brooklyn 19.

SEE Our ad under Motorcycles for midget car bargains. Midget Motors Directory, Athens, Ohio.

CUSTOMIZE Your automobile. Illustrated, new restyling ideas, instructions, suggestions, specific model changes by simple methods. Postpaid \$1. Speedwheel, Box 723-E, Arcadia, California.

COLLECTORS: Albums, photographs, world's finest automobiles. List 10c. Box 1028, Minneapolis, Minnesota.

BUILD Speedy midget track racer from castoff parts! Plans, specifications, construction information. \$1.00. Motor Supply, Box 1682-CS, Toledo, Ohio.

MUFFLER Manual. Convert easily to Hollywood, Laguna, Westwood, duals, etc. Includes construction details, regulations, diagrams. Postpaid \$1. Mellotone, Box 723E, Arcadia, California.

FREE 1946 List photos, racing cars, drivers. Photographer, Midland Park, N. J.

PROFESSIONAL Midget racer, motor-scooter, midget roadster, and midget motorcycle. Plans, specifications for all four contained in illustrated handbook, 25c. Big list bargain priced used motors, motorscooters, servicycles, etc., included free! Midwest, 3839 Drummond, Toledo, Ohio.

R & R Mfg. Co., marine and auto division, Anderson, Indiana, Robert M. Roof, \$1.00 for our new 1946 speed and power equipment catalogue with price sheet—showing racing cars, midgets, speed boats with recommendations how to rebuild your motors for racing. Dual ignition racing cylinder heads for V-80-100 and Mercury Ford engines. Dual intake manifolds, racing pistons, camshafts, compound valve springs, Lynite flywheels, quick change gear boxes and numerous other supplies.

AUTOMOBILE Racing book, fifth edition, well illustrated. Instructions on building bodies, frames, engines. Ford A and B conversions. Plans. AAA rules, specifications. Roadster racing. Indianapolis cars. \$1.00 postpaid, \$1.30 C.O.D. Ray Kuns, Dept. 47, Madisonville, Cincinnati 27, Ohio.

AUTO SUPPLIES AND EQUIPMENT

NEW Auto thief alarm protects car, tires and accessories. Amazing invention blasts loud alarm instant thief tampers with any part of car or truck. Write for descriptive circular and prices. Joyce Distributing Co., 30 W. Washington St., Room 940, Chicago 2, Illinois.

1000 MOTORISTS Needed to make gas saving test. Up to 30% savings. For trial test offer write Vacu-matic Carburetor Co., 7617-1293 W. State Street, Wauwatosa, Wis.

WELDERS! Increase your daily earnings. Using Vernon's All-Purpose Flux. Can \$2. Details free. A. N. Behr, 3439 Michigan, Chicago 16.

GREATER Mileage, more power, speed. Vacuum supercharger, only \$7.90. Stamped, self-addressed envelope for pamphlet. McDowell Co., 2000 N. E. Union, Portland 12, Ore.

GASOLINE Saving devices for 156 models 1933-1946. Walert Company, 3429 North Tenth St., Milwaukee 6, Wisconsin.

EMERGENCY Ignition system for on the road break downs. Just connect and go. Save time and money. Illustrated instructions 25c. Shaltis, 127 Coolidge St., Linden, N. J.

MONOGRAMMED Automobile seat covers personalized with your initials in gold. Fit your car perfectly. Finest pre-war quality leatherette in 18 beautiful combinations with fibre, sail cloth or mercerized cotton. Priced low. Mono Auto Seat Cover Co. of Hollywood, 808 South Hill Street, Los Angeles 14, California.

SUPER Charge your automobile, by air-ramming. Free literature. Kokomo Enterprises, Box 270-M, Kokomo, Indiana.

GRILLES For all cars. Wagner Grille Co., Bernville, Route #2, Penna.

UPHOLSTERY In your car dirty? Restore it's original lustre with this sensational cleaner used by many. \$1.00 brings 5 gallons. Krimco Products, 2235 Thomas St., Chicago 22, Illinois.

1946 **SUPER** Ignitioniter \$5.50. Atomic starting, pep, mileage. EG Mfg., 355A East 149th, New York 55.

AUTOMATIC Automobile nurse: Heats baby's nursing bottle or small food can while driving. Ask your auto accessory, baby, drug or department store for free literature. If not available in your locality, write, or send \$3.25 check or money order. "Auto Nurse," Box F, Ocean Park, Calif.

AUTO Parts, accessories. Describe needs. Page, Box 115, Franklinville, N. Y.

TRAILERCOACHES—Learn about all types—sports, living or travel. Over 72 pages monthly—magazine tells all. Special \$1 year. Trail-R-News, Box 431, Glendale, Calif.

RACING Fuels: six tested guaranteed auto racing formulas. \$1.00 postpaid. Formula Research, 481 Pacific, San Luis Obispo, Calif.

AIR Compressor outfits, complete with quart size spray guns, less motors. Use your own 1/4 horse power motor. Limited quantity. Write for details. Box 172, North End Station, Detroit 2, Michigan.

HAVING Car trouble? New, used, guaranteed auto, truck parts save money. Transmission specialists. Describe needs; immediate reply. Victory, 2930 1/2 Northwestern, Chicago 18.

AUTO Parts for all autos and trucks. Trans., motors, differentials, fenders, carburetors. Also body parts. Security Auto and Truck Parts, 1941 BJ Eddy, Chicago 13.

OIL Pumping motors—Brought back to normal without ring job. Write for particulars. Joe Muller, Box 3102, St. Paul 1, Minn.

GRILLES For all cars. Meyers Auto Parts, 820 Dryades, New Orleans, La.

PLATING Outfits for auto parts. Connect to a battery. No tanks used. Free particulars and proofs. Gunmetal Co., Ave. J, Decatur, Ill.

NOW! Standard micrometer measures threads, bearing sleeves, tubing, etc., with "clin on" Myk-A-Dapt. Only \$1.50. See advertisement page 267. G. L. Lang.

AUTO TRAILERS

BUILD J. K. Tudor Tandem three room, bath, luxury liner trailer coach. Fluorescent lights, toilet, shower, electric refrigeration, gas range, etc. Large manual drawings, instruction, parts list, etc. \$2.00. Seven large blueprints \$5.00. Craftsman Books, Box 1153-P33, Milwaukee 1, Wis.

STREAMLINED Family Trailer—Build it yourself. Includes all conveniences—Cookstove, sink, ice box, electric lights, closets, cupboards, sleeping accommodations for four. Fifteen feet long. Weighs 1400 lbs. Complete set of 6 blueprints only \$1.50. Ask for Plans No. 937-942. Popular Mechanics Press, 200 East Ontario St., Chicago 11, Illinois.

AUTO-TRAILER Travel. monthly magazine, \$1 year. Magazine Mart, Plant City 8, Fla.

STREAMLINED Trailers. Has everything. Large manual full of drawings, instructions, etc. \$1.00. Illustrated circulars, dime. Craftsman Books, Box 1153-P3, Milwaukee 1, Wis.

BUILD Your own trailer! Save money! Have every feature you want! Plans for house, sport, camp and utility trailers. Catalog describing 9 models 10c. 15c in Canada and overseas. Jim Dandy, Box 125-A, Wausau, Wisconsin.

MOTORCYCLES, BICYCLES, MOTOR-SCOOTERS AND SUPPLIES

WRITE For free literature about new five passenger (half ton), three wheel motorcycle made of Ford parts. Easy built, thrilling, handy. Build first in your locality. Show your genius. Nothing like it on earth. Instructions \$1.00. Motorcycle Wizard, 73 Shirley So., Pontiac 20, Mich.

HARLEY-DAVIDSON Parts. 24 hour service. Rebores \$2.50 per cylinder. Special rubber mask clear goggles with extra Polaroid green lens \$1.29 prepaid. Phila. Harley-Davidson Co., 857 N. Broad St., Philadelphia 23, Penna.

MOTORBIKE Manual containing motorbike and scooter plans and motor tune up information \$1.00. Veco 1, Post Office Box 124, Evansville, Ind.

NEW Bicycle motors \$88 f.o.b. Complete all attachments. Stamp brings illustrated folder. Gerald Baughman, Wadsworth, O.

BICYCLES And velocipedes. Complete men's and ladies' frames, brand new. Also accessories. Wholesale. Retail. Send dime for price list. Century Cycle Company, 3447 Lawrence, Chicago 25, Illinois.

MOTORSCOOTER \$10. Motor \$3, tires \$2! Send 25c for big new catalog Number 934, just printed, listing scores of other sensational bargains in motors, wheels, motorscooters, motorbikes, servicycles, tires, etc. Associated, Box CS-1764, Toledo, Ohio.

MOTORCYCLE Parts, new and used. List 10c. Ballak, 811 N. 9th, St. Louis 1, Mo.

LARGE Stock Indian parts. Expert motor rebuilding. New and rebuilt Chief motorcycle, motors only. Indian Motorcycle Sales, Kansas City 1, Mo.

CUSHMAN Motorscooter \$35; Rock-ola \$30; 1930 Harley Single motorcycle \$45; power lawn mower \$30; motors \$6 up; over 4700 small tires for motorscooters and midget cars. \$1.50 up. Send 25c for new Directory Number 15, listing these and hundreds of other bargains in midget racers, motors, motorscooters, parts, plans, supplies, etc. (35c by first class mail). Midget Motors Directory, Athens, Ohio.

ASSEMBLE King Midget racer runabout from our factory-built units. Low cost. Just bolt together. Send 25c for four actual photographs, three view drawing and price list of all parts. Midget Motors, Athens, Ohio.

GENUINE Moto-Scot parts. Amsco centrifugal clutch, Windshields, sidecars. All other parts and accessories. Write for parts list. Also genuine engine parts for Briggs and Stratton, Lauson. American Moto-Scot Co., 1313-23 Carroll Ave., Chicago 7, Ill.

WHEELS! Build wagons, scooters, mowers, trailers, wheelbarrows, grocery carts, baby carts, play pens, baby carriages. 4" to 16". Free list. Trulsen Mfg. Co., 811 E. 31, Kansas City, Mo.

MIDGET Car \$18. Briggs motor \$5, tires \$1.00! Send 25c for new bargain catalog packed with money saving buys in motor-scooters, motorbikes, midget cars, motors, wheels, tires and parts. Gail and Company, 538 Erie, Toledo, Ohio.

MODERN Motorcycle Mechanics manual, 560 pages, 300 illustrations, covers Harley, Indian and English makes. The most complete motorcycle book published. \$3.00 postpaid. Nicholson Bros., Motorcycle Engineers, Saskatoon, Sask., Canada.

HARLEY-DAVIDSON New and used 45" motors, service, parts, accessories. Send \$2.25 for army motorcycle manual, 10c for bulletins. Knuth's (Harley-Davidson factory dealer), 2491 Fondulac, Milwaukee, Wis.

MOTORCYCLE Cams ground for speed and power, carburetion. For information write Harold Schaller, 247 West Main, Turlock, Calif.

GET Your copy of the new Ranger bicycle lubrication chart. A genuine check-chart which shows you how to service your bicycle. Only 10c. Mead Cycle Co., 4530 W. Madison Street, Chicago 24, Illinois.

BICYCLE Book, how to buy, rebuild, sell used bicycles 50c. John Collett, Handley, Texas.

TIRES, Inner tubes, wheels, for small trucks, wheelbarrows, midget cars, power scooters, farm equipment, carts, etc. Sizes 8" to 18" o.d. in 2, 4, and 6 ply first-line quality tires, with removable inner tubes and heavy duty demountable wheels. Also caster forks, straight or swivel types. Free circular and prices. Experienced tire engineers to advise on your special equipment problems. Jahant Co., 626 East Exchange Street, Akron 6, Ohio.

TIRES And, industrial wheels, suitable for scooters, wheelbarrows, farm equipment, etc. All sizes. Bicycles and accessories. Largest assortment in America. Send dime for list. Cycle Transport Company, 1241 So. Michigan Ave., Chicago 5, Illinois.

BUILD America's lowest priced motor-scooter speedster! Complete plans, specifications, \$1.00. Big list bargain priced used motors, etc., included free! Motor Supply, Box 1682-CS, Toledo, Ohio.

BOYS, Illustrated "Bicycle Repair Manual" teaches brake repairing, re-spoking wheels, etc. Dealers wanted, 65c. Robt. Klausner, Shelbyville, Ill.

AVIATION

ALUMINUM Airplane floats, dandy for air-driven or water-propelled amphibious craft and catamarans. Two cylinder 8 h.p. air-cooled engines. Small pneumatic tired wheels. Write for literature. Karl Ort, York, Penna.

PROPELLERS—Correct size for any motor. Airliner 3 blade, shorter diameter, lower position, better thrust. For sleds, boats. Illustrated literature. Aircool conversion diagrams 50c. Standard Aircraft, Ft. Worth, Texas.

LARGE Supply new surplus airplane engines, propellers, accessories, equipment. Send for price list. Varney, Tipp City, O.

AIRLINE Opportunities. Get a job with a future in this rapidly expanding industry. Confidential report just released tells what you should know about the airline industry, employment opportunities, job classifications, qualifications, plus how and where to apply. \$1.00. Air Transport Research and Advisory Service, Dept. D, Box 1044, Kansas City 10, Missouri.

MODEL Buzz bomb engine plans, \$2.00 postpaid. Free circular. Williams Model Co., 873 E. McCright, Springfield, Ohio.

AERO-SLED Plans, sedans \$5.00, open \$4.00. Adastic Engineering, Grand Rapids, Mich.

SKYWAYS. Superlative monthly magazine. \$4 year. Satisfaction guaranteed. Magazine Mart, Plant City, Fla.

PROPELLERS For ice-snow sleds, air-boats, lowest prices, fastest service. Illustrated literature 5c. Banks Propellers, R.F.D. 7, Ft. Worth, Texas.

CUBS, Wacos, Taylorcrafts, Aerocas. Big catalog, 25c, lists these and thousands of other sensational airplane bargains. Some are "easy to repair" crackups. National, Box 1682-CS, Toledo, Ohio.

FLYING Flea, plans \$1.00. Lightplane manual \$1.00. Illustrated circulars 20c. Craftsman Books, Box 1153-P1, Milwaukee 1, Wis.

150 MPH Model airplane. See International Research advertisement page 267.

ELECTRICAL SUPPLIES, EQUIPMENT

ELECTRIC Fan assemblies. Make your own. Ted Riseman, 425 East Jefferson, Springfield, Illinois.

LAMPS—All parts for building or repair. Catalog 10c. Refund first order. Gyro Lamps, 5416 N. Clark, Chicago 40.

AVAILABLE—Electric neon display signs and clocks. Write for particulars. General Sales Service, Box 1092, Roswell, N. M.

CONNECTOR, 4 Circuit, stream lined, bakelite, male and female. For extensions, radios, motors, etc. 25c. Value \$2.00. Kensington, P.O. Box 91, Brooklyn 18, N. Y.

ELECTRIC Pencil—6 volt. Engraves all metal. \$1.00 postpaid. Beyer Mfg., 4515-H Cottage Grove, Chicago 15.

BROKEN—Burned out electrical heating elements quickly repaired. Use new amazing Nichrome paste, simply overlap ends and turn on current. Family size \$1.00 bill. Satisfaction guaranteed. Arrowhead Sales & Distributing Co., 406 Phoenix Bldg., Minneapolis, Minn.

RADIOS, Toasters, irons, clocks, heaters, stoves, supplies, etc. Jeannette Electric, 159 West 23rd Street, New York 11, N. Y.

PRACTICAL Winding of a.c. motors. A course of instruction on winding, connecting, and testing single, two, and three phase motors. Clearly written in everyday non-technical language. Illustrated throughout. This book is recommended for beginners interested in learning motor re-winding and repair. Satisfaction guaranteed or remittance refunded. \$2.00 prepaid. Educational Advancement Co., Dept. Y, Lakewood, New York.

10,000 ALNICO Magnets available. Literature free. Eylich, Box 849, Milwaukee 1.

NOW—Repair your own electrical appliances with Chanite Self-welding Electrical Heating Element Flux. Instructions delivered, price \$1.00. Stick form 25c ea., \$2.00 doz. Chanite Sales Company, 914 South Main, Fort Worth, Texas.

WELDING, SOLDERING, PLATING

USE Feltons electric cast flux with your electric welder. Keeps cast cool. Cleans, no preheating. Agents wanted. \$1.50 prepaid. Wm. Felton, Ortonville, Minn.

NEW Model electric welder 110 volt a.c.-d.c.; will weld all metals; easy to use; full directions. Complete with power unit, flame and metallic arc attachments, carbons, fluxes, rods, mask; all for \$19.95. Used by the navy. Magic Welder Mfg. Co., 239-MP10 Canal St., New York City.

BUILD Latest type 110/220 volt a.c. welder. 10-180 amp. Hairline current control (no "plugs"). Parts available. Copy-righted plans \$2.00. Write Wilson Welders, Hollins 2, Alabama.

ACETYLENE Welding outfits like new; Lincoln welders; welders book \$1.75. Eagle Welding, Dept. PM, 5085 Broadway, Chicago 40, Ill.

30" SILICON Steel strips. Random widths 2"-5", 8 lbs. \$1. 3/8" fiber 4 1/2" by 10". \$1.25 doz. Noyes, 32328 Brush Blvd., Royal Oak Twp., Mich.

ACETYLENE Welding outfits. Gauges, hose, torch—5 tips, goggles, etc. Send \$62.50. Freedom Co., 2203 Barclay, Baltimore 18, Maryland.

BUILD Small, medium or large d.c. or a.c. arcwelder. Plans \$1.00 each. Welders Club, AB-3432, Chicago 54.

"THUNDERBOLT"—Transformer welder, dial-control, 3 heat stages, 60 amps., 110 volts—ac, up to 3/32 rod, carrying case, accessories, instructions, \$39.50. Also "Super-Welder" 110 volts, ac-dc \$19.95. Save 2%, send check. Or order c.o.d. West of Mississippi \$5.00 deposit on Super-Welder, \$10.00 on Thunderbolt. Super-Welder Mfg. Co., Dept. PMC, 23 E. 20th St., New York 3, N. Y.

WELDING, Cutting, aircraft welding and soldering equipment. Electric arc welders. Superior Oxy-Acetylene Co., Hamilton, Ohio.

MACHINERY, TOOLS AND SUPPLIES

RIVET Guns—Aluminum air driven. Perfect condition. Famous makes. Limited quantity. Immediate delivery. \$9.95 postpaid. Free bargain catalog. Art's Surplus Mart, 329 W. Florence Ave., Dept. M, Los Angeles 44, California.

BUILD, Make money with cement brick machine. Concrete block machines. Mixers. Blue Square, Excelsior, Minn.

USED 3" Air vises with filters. Guaranteed. \$22.50 postpaid. Best Co., Box 5802, Cleveland 1, Ohio.

OVER 100 Brand new, finely machined and fabricated parts of stainless steel, brass, bronze, steel, dural, aluminum, etc. including matched gears, shafts, knobs, pulleys, clamps, springs, bearings, bushings, etc. \$3.00. Value over \$20.00. A bargain for inventors, experimenters, model makers, schools, mechanics, laboratories, work shops. Weight about 6 lbs. New aluminum kitchen or dark room vents \$4.50 complete with shutter. Weight 4 lbs. All orders f.o.b. The famous Baker Bros. versatile table saw ready for delivery now. Reasonable. Balzer, 19 Micteli Place, Brooklyn 18, New York.

TORQUE Wrench $\frac{1}{2}$ " square drive, capacity .0 to 105 foot lbs. (2 dials) permanently accurate, list \$18.70, our price \$4.95, no c.o.d. We pay express charges in U.S.A. Haveson Sales Co., Cranford, N. J.

BALL-BEARINGS, One-fourth list price. Free list. Burgess, Box 168, Ferguson, Mo.

CEMENT Mixers; concrete brick machines; garbage burners; stump remover. Reasonable. Blue Square, Excelsior, Minn.

GEARS For inventors, experimenters, model makers, schools, work shops, laboratories, etc. Government surplus made of brass, bronze, dural steel and stainless steel. 12 matched pairs; 24 gears, bevel, spur and ratchet. List price \$12.00, our price \$2.50. 25 matched pairs, 50 gears, includes larger gears, also set of worm gears. List price \$30.00, our price \$5.00. 50 matched pairs; 100 gears better assortment, including worm sets. List price \$75.00, our price \$10.00. Limited quantity. Order now. Write for our bulletins on ball bearings, rectifiers, relays, selsyns, horns and government surplus materials. MET Exchange, 323 Canal Street, New York.

HARDEN, Temper all steels quickly, safely. Lasts indefinitely. Ingredients and instructions \$1. Pohasom, Box 185, Fort Wayne 1, Indiana.

TANKS, Stainless steel—9 gallon capacity. Internal pressure: 400 pounds. Diameter: 12". Length 24". Tapped both ends for $\frac{1}{4}$ " pipe connections. Prime coated ready for painting. Can easily be made into buoys, floats, pure water containers for boat, car, truck or camp. Ideal as a receiver for small air compressor unit. Complete "How to Make It" instructions with every order. Remember, this tank is pure stainless steel! Supply is limited. Order today! \$7.99 f.o.b. Ireland & Vice, 48 Chedell Place, Auburn, N. Y.

IT'S Easy to build your own metal and woodworking tools from Lewis castings, materials and blueprints—and at savings up to 80%! Lewis mills, shapers, drill-presses and other shop tools have ample capacity and performance for home workshop jobs. New catalog—sent on receipt of 10c to cover mailing—describes 23 Lewis tools. Address Lewis Machine Tool Co., 3217 Union Pacific Avenue, Dept. M-63, Los Angeles 23, California.

TOOLS, Hardware, drills, taps, dies, saw mandrels, jeweler saws, screws, drill rod, steel, brass. Catalog 10c. Terek, 6304 Patterson, Chicago 34.

ROTARY Cutters sharpened. Send stamp for prices. Russell Cook, Harrison, Mich.

TAILSTOCK Turrets direct from manufacturer. 1 or 2 taper, \$15.00 postpaid. Money back guarantee. Ballard Mfg., 601 E. Colorado, Glendale, Calif.

DRILL Grinder for twist drills \$2.95, and other craftsman's tools. See ad on page 275.

CONCRETE Building block machines and molds. Catalog free. Concrete Machine Co., 5129 South Compton Ave., St. Louis 11, Mo.

H. S. Drills, mills, reamers, rotary files, N. P. & M. Wks., 122 Brunswick, Buffalo, N. Y.

AIR Compressors—27 volt a.c. d.c. new—3 stage. Weight 28 lbs. Cost government over \$200.00—convert with transformer or 4-1000 watt heating elements. Precision built—hook up furnished. 1500 pound pressure to square inch—motor 4500 r.p.m. Real buy—\$15.00. General Surplus Stores, 1439 Grand Avenue, Kansas City, Mo.

LAWN MOWER Sharpening machines renew edges factory like. Write M. C. Hardies, 4148 Cornwall, Berkeley, Mich.

BENCH Saws, hack saws, post and bench drills, sanders, band saw blades, etc. Circular 3c. Sunshine, Berkshire Heights, Penna.

PAINT Scraper, new, patented, combination, scraper, hammer, chisel, screwdriver, glazing point setter, window jimmy. Circular free. Babcock Reel & Tool Mfg. & Sales Co., Oak Harbor, Ohio.

8 INCH Bench saw mandrel, $\frac{3}{4}$ " arbor, $\frac{1}{2}$ " spindle, milled flanges, bronze bearings, raises and lowers, \$10.75 Denver. Woodcraft Mfg. Co., 1024 17th Street, Denver, Colo.

WAR Surplus in small tools for machine shop—Send 10c for bulletin. Travers Tool Company, Dept. P, 5 Court Square, Long Island City, N. Y.

SHARPEN Dull pipe wrenches with new patent grinder. No competition. One operator made \$321 in one week. J. C. Moore Industries, Box 234 Fredonia, Penna.

PIPE Gauge. Accurately measures pipe, heavy and thin wall conduit from $\frac{1}{8}$ " to 12". Simply place gauge against outer contour of pipe and the dial instantly registers the size. Also indicates drilling size for tapping. Handy pocket size \$1.50 ea., with leatherette case \$2.00 ea. Postage paid. Money order or check. Farm Products Co., 406 Green Bay Rd., Kenilworth, Ill.

INDEX Heads for sale. Very inexpensive. Sixty-two different divisions. Used on small lathes, drill press, milling machines, etc. Make gears, hobbos, cutters, etc. Very accurate, and durable. Not a toy. Used by defense schools and hobbyists. Write for free folder. Long's Index Heads, 2117 East B St., Torrington, Wyo.

NOW! Standard micrometer measures threads, bearing sleeves, tubing, etc., with "clip on" Myk-A-Dapt. Only \$1.50. See advertisement page 267. G. L. Lang.

BOATS, OUTBOARD MOTORS, ETC.

REBUILT Tachometers 0-5000 and 0-8000 r.p.m. $\frac{4}{8}$ diameter face. \$10.00 each, specify rotation. Zakarian Engineering, Box 416, East San Diego, Calif.

KAYAK Blueprints, deluxe models—catalogue 10c. Viking Canoes, Merrick, N. Y.

MARINE Power—Easily convert any Ford and Jeep motor (domestic and foreign) with Osco parts and kits. Complete catalogue 25c (coin). Osco Motors Corp., 2020 East Orleans Street, Dept. M, Philadelphia 34, Penna.

PLYWOOD—Waterproof type for boat-building! Many grades, panel sizes, thicknesses now becoming available. Send 10c today for complete lists! Carmen-Bronson, Marine Department, Mount Vernon, N. Y.

OUTBOARD Motor parts, new and used, for all makes. Our stock of used parts is too large to list. Write giving us the model and motor no. New parts for Waterwitch, Seaking, Mercury, Wizzard, Lauson, Neptune, etc. New standard and over-size outboard pistons. Outboard motor cylinders honed and re-bored. Outboard Motor Mart, Inc., 309 Atlantic Ave., Boston 10, Mass.

ALL Copper water jacketed exhaust manifolds for marine conversions of automobile and aviation engines and marine engine replacements; any make, model or age. Joseph Van Blerck & Son, 397 Woodcleft Avenue, Freeport, N. Y.

BOATS And all about them. How to select, build, repair and operate. For 40 years the leading practical boating magazine. Half price trial subscription. 12 issues for \$1.00. Motor Boat, 62 Gold Street, New York 7.

USED Outboard motor parts. Outboard Exchange, 1194 Remsen Ave., Brooklyn, 12, N. Y.

FORD-Mercury-Zephyr marine conversions. Catalog 10c. Lehman Manufacturing Company, Dept. D, Newark 2, N. J.

BOAT Designers are highly paid professionals. Complete course by mail. Catalog. Westlawn, Montville, N. J.

NINE Plywood boat plans 50c. Catalog boat building plans 10c. The Rudder, 15 Murray Street, New York.

FULL Size, cut to shape boat patterns, blueprints. $7\frac{1}{2}$ - 38 feet. Illustrated "Build a Boat" catalog, 10c (coin). "How to Build Boats" book, \$1.00. Cleveland Boat Blueprints Co., Dept. A-66, Cleveland, Ohio.

USED Marine motors, propellers, marine fittings, conversion manifolds. Stokes Marine Supply, Coldwater, Michigan.

ENGINES, MOTORS, DYNAMOS

1000 ELECTRIC Motor diagrams and tables. A brand-new electrical book of practical information on fractional horsepower, two phase, three phase and direct current motors and controllers. Includes connecting diagrams, rewinding instructions. New special circuits. Several hundred electrical tables. Price \$7.25 prepaid. Money-back guarantee. Educational Advancement Company, Dept. MP, Lakewood, New York.

400 CYCLE Dynamotors, 485VA 28VDC input 115VAC output. Shaft extension, black crackle \$12.50. Amplidyne motor-generators 530W 28VDC to 60VDC \$10.50. New. Postpaid. Free list aircraft, electrical, radio parts. Erecos, 1006 Hewitt, Everett, Wash.

WIZZ Electric motor: Assembles in a jiffy. Flashlight cell operates, parts complete, plus illustrated instructions 35c postpaid. Also the smaller "Mighty Midget" 1" model, third size, 30c. Eltro Company, 171B, Deer Park, N. Y.

MOTOR Winding tester, indicates burned out or partly shorted coils in single or three-phase motors, indispensable for repairmen. Send for bulletin. Motor Industries, Quincy, Illinois.

BARGAIN—20 H.P. to 200 h.p. electric motors. Also, 10 h.p. to 150 h.p. steam boilers. A-1 condition. Bailey, 401 Hampton Ave., Greenville, S. C.

"BUILD Your Own" gas drive arc welder easily with Hobart Generator. Save \$300 to \$500, and need only add used auto engine and chassis to build portable gas drive welder that goes everywhere after profitable construction and repair jobs. Write for free instruction book, further details. Hobart Brothers Co., Box M-1066, Troy, Ohio.

150 AMPERE Generator for welding \$47.50. Extra flexible cable, 8 ft. lengths \$2.75. Other bargains. Butler Electric Company, 1885 Milwaukee, Chicago 47.

WINDING Data, listing 225 motors, single and three phase, \$1.00. Motor Data Co., Box 7631, Kansas City 3, Mo.

ATHLETIC EQUIPMENT, BODY BUILDING COURSES

WORLD'S Most complete line barbell equipment. Quality plus lowest prices. Stamp for folders. Jackson Barbells, Springfield, N. J.

DEADLY Judo—Fiercest fighting technique. Trick knockouts. (200 photographs—plus illustrations). Expert instructions. Three volumes. Complete \$2.25. Variety House, Box 46-BJ, Wall Station, New York 5.

GUERRILLA Self-defense beats jiu-jitsu. Circular free. Crown Books, Charlotte, Mich.

BE A power-house of muscle! No apparatus! 3 courses. Guaranteed. \$1.00. James Todd, Dept. MM96, 17 Ina, Springfield, Mass.

BARBELLS, Texas Master Bodybuilding combinations. Folders. Texas Barbell Company, Jack Word, 201 Pine, Palestine, Texas.

LEARN Hand-balancing quickly. W. Power, 923 W. Vine, Kalamazoo, Mich.

BARBELLS, Exercise equipment. Courses. Special offers! Free booklet. Good Barbell Co., Reading, Penna.

SPORTING GOODS, GUNS, FISHING TACKLE, TRAPPING, ARCHERY

FISHING Poles: Native canes, bamboos, Calcuttas, Tonkins, made-up poles. Sample jointed native cane (without reel seats, clamps, guides) \$2.50. Bamboo 6' rod one-piece with clamps, wrapped handle, rubber butt, tip top, guides, varnished, \$5.50 prepaid. Dealers write. Bob Pace, Combs, Ark.

DUCK Decoys—Fabric-covered and easily made. Complete pattern and instructions for \$1.00. Send to Duck Pattern, Okemah, Oklahoma.

BINOCULARS, Holsters, cartridge belts, knives, telescopes, compasses, officers badges; sporting goods. Special folder for stamp. Nassau Sales Co., Floral Park 2, N. Y.

SILENCER For 22 rifle or pistol. Sounds like air-gun! Simple plans \$1.00. Singer, Dept. B, 1014 College Avenue, New York 56, N. Y.

SPORTSMEN'S Trophies preserved. Museum methods. Smith's Taxidermy Studio, Eaton, Indiana.

"SHOTGUNS", 12 Gauge single barrels, grade 1 government surplus, with 3 boxes shells \$20.00. Rudolph's, Atchison, Kas.

SEND 10c For list 100 used guns. Frayseth's, Willmar, Minnesota.

MAKE Your own decoys. It's fun—and easy too with our plans. Our booklet also gives information on gun care. All included for only 25c. Ask for Booklet No. 109. Popular Mechanics Press, 200 East Ontario St., Chicago 11, Illinois.

CARTRIDGES, Shells, ammunition, guns, rifles, list 25c. Frank Parish, Vicksburg, Mississippi.

BARBELLS—Dumbbells. Factory direct. \$9.95 up. Send for catalog. Independent Iron Works, Dept. 12, 2416 East 23rd St., Los Angeles.

NEW Sauer & Sohn double gun with 8 x 57mm. rifle barrel underneath \$500. N. Smith, P.O. 308, Oklahoma City.

AUTOMATIC Bait—Possibly weedless. Greatest invention in ages. Nothing like it. Write immediately for circular. Babcock Reel Co., Oak Harbor, Ohio.

12 GAUGE, 00 Buckshot shotgun shells. 75 rounds \$5.00. Money order. Rudolphs, Atchison, Kansas.

THROWING KNIVES, perfectly balanced, handcrafted, with instructions, \$1.50. Frank Stark, 1718 Walnut, Allentown, Penna.

ATHLETIC Journal, monthly magazine, \$1.50 year. Satisfaction guaranteed. Magazine Mart, Plant City, Fla.

CROSMAN Compressed air rifle, excellent for small game, \$19.80. Albert Schants, Baden, St. Louis 15, Mo.

FINEST Glass eyes; taxidermy supplies. Catalog free. Elwood Supply Company, Dept. 234, Omaha 2, Nebr.

FISH At night with Johnstone electric lighted bobber. \$1.00 prepaid. Circular on request. Dealers wanted. Johnstone Bobber Co., 425 Second St., Aurora, Indiana.

BOWS, Arrows for recreation, hunting, fishing. Beautiful Archery Instruction Book. 70 pages, 50 illustrations, only 50c. Illustrated catalogue 10c. Archery Sales Service, 617 So. State, Chicago.

3000 BARGAINS, Firearms, binoculars, war relics, catalog 30c. Smith Firearms, Runnemed, New Jersey.

"AMMUNITION"—New and used "shotguns," "rifles," "handarms." List 10c. Rudolph's, Atchison, Kansas.

FIELD GLASSES, MICROSCOPES, TELESCOPES, MAGNIFIERS

WAR Surplus lens, 15" diameter, bargain, \$5.00. Leo's, Opportunity, Wash.

TELESCOPES—Make them yourself. Real fun. It's easy with our plans. Booklet giving various plans only 25c. Ask for Booklet No. 20. Popular Mechanics Press, 200 East Ontario St., Chicago 11, Illinois.

BINOCULARS. Beautiful army type, all metal construction, extremely lightweight, with powerful 3x30mm. lenses. In handsome case. Only \$3.55 postpaid. Tax included. Guaranteed powerful. Utica Mail Order Co., 923 Eagle St., Utica, N. Y.

CLEAR Vision. Full power. Perfect lenses and instructions for making: 300X astronomical telescope; 400X compound microscope; 200 X telephoto camera. \$2.00 each project. 3 for \$5.00. Carl Jamer, Manorville 3, N. Y.

TELESCOPES—36 Inch, 3 section, 17 power, precision ground and polished lenses, including carrying case \$2.50 postpaid. Microscope, 50 power, complete with specimen slides \$2.98 postpaid. Dept. PM, Criticism Co., 327 Trumbull St., Hartford, Conn.

TANK Periscope, two 5 1/4" prisms, original package, \$4.00. Aircraft gunsight, type N-6A, two lenses, mirror, switch and lamp, can be made into projector, original package, \$2.50. Three power artillery telescope, used, length 27", weight 11 pounds, good, \$7.50. Postpaid, Lloyd Demrick, 1424 Grant Ave., San Francisco 11, California.

TELESCOPES, Powerful 17 power, 3 lenses, \$2.50; 7 power plastic \$1.49; 6 power \$1.00. Karl Gruenewald, 3837-P Coolidge, Oakland 2, Calif.

60 POWER Telescope, \$2.95. 250 power microscope, \$2.45. Also bargains in binoculars and surplus lenses. Send for free catalog. Brownscope Company, 24 West 45th Street, New York.

REFLECTING Telescopes, complete. 3 1/2" diameter, equatorially mounted. View planets, stars, \$19.75. Write Sky-scope Company, 475-P 5th Ave., New York.

BUILD Your own reflecting telescope. Copy of instructions 10 cents. Catalogue free. Mayfloor, Katonah, N. Y.

BINOCULARS, Telescopes, watches. Buy, sell, trade. Paul Schweer, Donnellson, Iowa.

TELESCOPES, Microscopes, cameras, binoculars: bought, sold, repaired. Lists 10c. Specify instrument wanted. Rasmussen and Reece, 41 Market, Amsterdam, N. Y.

DOGS, PETS, BIRDS, RABBITS

BEAUTIFUL Useful collie-shepherd pups \$12. Paul Schultetus, New Liberty, Ill.

RAISING Rabbits, Cavies, Hamsters, Chinchillas is a growing and profitable industry. Magazine 10c. Descriptive book and magazine 25c. Book and magazine (monthly) one year \$1.00. Address Small Stock Farmer, Pearl River 15, N. Y.

RAISE Guinea pigs. Make money at home. Big demand. Easily raised, little space. Booklet free. Taylors Guinea Pig Farm, Hapeville, Georgia.

BE Independent, raise Angora rabbits, booklet "how" 50c. We buy back stock raised. Sigmond Angora Ranch, Kensett, Iowa.

PEAFOWL, Pheasants, Mallards, pigeons, rabbits. Prices free. Jewel Game Farm, Danville, Ill.

CAT Owners Magazine, Room 764, 751 State, Utica, N. Y. Five months, \$1.00; sample, 25c.

RAISE Moneymaking Angora rabbits. Wool \$14.50 pound. Plenty markets. Particulars free. White's Rabbitry, Lawrence, Kan.

\$2000 A YEAR raising Angoras our plan. Particulars free. Wilson Farms, 1065 Shryer, St. Paul 8, Minn.

RAISE Giant Chinchilla rabbits. Year round income. Ideal occupation. Tremendous demand for gorgeous furs, delicious meat. Great scarcity means large profits. We buy your youngsters. Willow Farm, R15, Sellersville, Penna.

CHOICE Rabbits for sale. Particulars free. Senior Rabbitry, Box 155P, Lawrence, Kansas.

ANGORA Rabbit raisers necessary equipment. Illustrations free. New patents. Write. Modern Small Stock Equipment Co., Kurtz, Ind.

MEAT Shortage troubles? Raise rabbits for meat and profit. Send \$2.00 for fine 250 page instruction book and sample kit of supplies. Nadri, Cleveland 16, Ohio.

ANGORAS, Chinchillas, giant rabbits—finest, pedigree! Catalogue free. Book "Profitable Rabbit Raising" tells everything \$1.00; scientific self-cleaning hutch plans \$1.00; automatic feeder plans \$1.00. All three \$2.50. Grinsteads, Dept. 15-E, Edwardsville, Illinois.

DOG World, huge monthly magazine, tops. \$2 year. Magazine Mart, Plant City, Fla.

NOTHING But Angora rabbits. Literature and prices free. House of Angora, Springfield, Illinois.

60 VARIETIES Pigeons, etc. Catalogue 10c. Jim Houck, Tiffin, Ohio.

SPORTSMEN: 200 Pointers, setters, straight cooners, combination hunters, rabbit and fox hounds. Reasonable. List free. Ramsey Creek Kennels, Ramsey 1, Illinois.

RAISE Guinea pigs. Profitable, low-cost feeding, small space required, small investment. Complete details 25c. Guinea Pig Farms, 3456 West 116th St., Chicago 43.

ZOOLOGICAL And pet animals for sale. Illustrated catalogue, literature, 25c. Trails End Zoo-5, St. Stephen, S. C.

ST. BERNARD Pups: Champion sired beauties. Franklin Young, R4, Riverhead, Long Island, New York.

STANDARD Rabbit Journal, Milton, Pa. 3 years \$1.00, sample dime.

FARMS, FARM LANDS, REAL ESTATE

FARMS, Ranches. All kinds, sizes. Reasonable prices, terms. Wide variety locations, climates, recreational facilities. Free descriptive folders, price lists. Milwaukee Railroad territory; Washington, Idaho, Montana, the Dakotas, Minnesota, Iowa, Missouri, Indiana, Illinois, Wisconsin, Upper Michigan. R. W. Reynolds, 914, Union Station, Chicago 6, Illinois.

186 ACRE Farm home, 2 houses, large barns, private gas well, 25 acres orchard. Price \$25,000 including tools. Johnson Realty Co., Canandaigua, N. Y. Established 1918.

STROUT'S Blue Farm Catalog—27 states, coast to coast, over 1300 bargains, money-makers, 132 pages. Write today. Mailed free. Tell us what you want—Where? Price? Terms? We will try to save you time and money. Strout Realty, 255-P 4th Ave., New York 10, N. Y. 7 So. Dearborn St., Chicago 3, Ill. 453 So. Spring, Los Angeles 13, Calif.

WEST'S Fall catalogue: Hundred pages of farm and business bargains. Free copy. Write West's Farm Agency, HE-1, Pittsburgh 16, Penna.

\$5.00 MONTHLY Buys 40 acres near town; price \$175.00. Free list. Box 425-P, Carthage, Mo.

VIRGIN Missouri land \$4 acre. Terms. Write Armstrong, Wappapello, Missouri.

FREE Catalog, farm bargains, 13 mid-west states. Many fully equipped for convenient quick start. Many pictures. Special service to help you locate quickly, if you state requirements, payment plan and general location desired in first letter. United Farm Agency, 1796 Arcade Bldg., 1, St. Louis, Mo.

ILLINOIS, Florida, Missouri lands cheap. Easy terms. Williams Realty, Mt. Vernon, Illinois.

LIFE Time opportunity for mechanic. A home and business for sale. Write: Owner, 512 S. McKinney St., Mexia, Tex.

FARM Journal, monthly magazine, 60 big issues, \$1. Magazine Mart, Plant City, Fla.

MINNESOTA Lake, river lots, acres. Terms. Box 404-A, Minneapolis 1, Minn.

\$5.00 MONTHLY Buys 40 acres near town; price \$175.00; free list. Box 425-P, Carthage, Mo.

HOMESITES \$450—Low terms. California's finest garden spot. On Morro Bay's scenic shores. Wonderful fishing, hunting, boating, etc. Fertile soil, soft water, temperate climate, congenial community. Free literature. Richard M. Otto, 6560 Hollywood Blvd., Hollywood 28, Calif.

OZARK Lands for all purposes. Actual river frontages. 5 acres \$90.00 and upwards. Free list and literature. Hubbard, 424-I, Minnesota Ave., Kansas City 4, Kansas.

OZARK Magazine, Eureka Springs, Arkansas. For homeseekers, sportsmen. Year, \$1.00.

OZARK Farm bargains. 5 to 5000 acres. Frank, Mountain View, Mo.

GOOD Farms—ranches. Washington, Minnesota, Montana, Idaho, Oregon, North Dakota. Dependable crops, favorable climate. Write for literature, lists describing typical postwar farm opportunities. Specify which state. J. W. Haw, 119 Northern Pacific Ry., St. Paul 1, Minn.

POULTRY, FARM SUPPLIES

RAISE Turkeys the new way. Write for free information explaining how to make up to \$3000 in your own backyard. Address National Turkey Institute, Dept. 3, Columbus, Kans.

BUILD Your own Poultry Houses. Save money. Carpenter experience not needed. Our plans are simple. Also make electric and kerosene heated brooders, incubators. All this in our Plan Book for only 25c. Ask for Booklet No. 108. Popular Mechanics Press, 200 East Ontario St., Chicago 11, Illinois.

AMERICAN Poultry Journal, big monthly magazine, 25c year. Magazine Mart, Plant City, Fla.

PROFITABLE OCCUPATIONS

LEATHERCRAFT Supplies. Catalog 10c. Art Craft Supply Company, 1205 Throckmorton, Fort Worth, Texas.

SCRAP Metal costing 5c pound brings \$4.00 in finished castings. Lifetime profits. Information, Paul Frits, Dept. 11, 622 N. Fulton, Allentown, Penna.

ESTABLISH Permanent, profitable mail order business at home. Free literature describes giant collection of tested, practical business plans. Write Strauss, Box 71, Kensington Station, Brooklyn 18, N. Y.

MUNGOFUNGRO Sprouting beans. Free sample, instructions. Snyder, 406F West 47, New York 19.

INSTRUCTIONS For very profitable home business, included with \$1.00 package vitamin plant food. Temple, Pinellas Park, Florida.

GEM Making—Fascinating! Profitable! Free catalog shows how. Lapidary Company, 2020 Westlake, Seattle 1, Wash.

HARMONICAS: Musical instruments. Wholesaler's, 2 E. Centre Street, Baltimore 2, Md.

TYPISTS. Profitable business at home. Complete copyrighted information, 50c. Gaunt, 3521-Z Broadway, Chicago 13, Ill.

INVESTIGATE Novelty manufacturing. Five years ago we started the manufacture of wall plaques, book ends, etc., and developed a highly profitable business. You could do the same on little money. Write today. Plastex Products, 127 Clement, San Francisco 18.

OPPORTUNITIES—Start small, grow big. Box 46A, Wall Station, New York 5.

FOR An extremely profitable lifetime business, operate a collection agency—credit bureau. Easily learned. Write Cole & Associates, Syracuse 2, New York.

ELECTROPLATING By battery. Illustrated instructions \$1.00. Alvin, 553 William, Winnipeg, Manitoba.

EXCELLENT Opportunity raising prize-winning platinum foxes, mink. Expert counsel. Birch Lake Ranch, Hackensack, Minnesota.

MUSHROOMS Grown. Boxes, barrels. Illustrated instructions 50c. Spawn \$1.00. Gordons, 553 William, Winnipeg, Manitoba.

MAKE Photo stamps. Illustrated instructions. \$1.00. Alvin, 553 William, Winnepeg, Manitoba.

"FREE Details!" Locates thousands scarce bargain merchandise! Chemist, Box 1275-P, Joliet, Ill.

50,000 JOB Opportunities in South America. Send \$1.00 now for list of over 200 American firms doing business in Central and South America. How and where to apply with sample application form included. Write Dept. 151, Box 3112, Winston-Salem, N. C.

EARN More for Christmas! Paint plaster plaques. Sell locally. Beautiful, clear detail. Strong, hard quality. Fascinating! Popular! Profitable! List free. Artists' brushes, paints, instruction books available. Pioneer, 394AX, Austin, Minnesota.

MAKE Big money. Train horses, cattle, etc., with secret methods circuses use. Make up to \$100 daily with trick horse, mule, or bull at fairs, rodeos, etc. Buy horses \$50 to \$150, train them, sell \$300 to \$1500. Information free. American Horse Training Institute, Dept. 10, Columbus, Kansas.

IF You want a business of your own write for free details. Hubbard, 293 Magnolia, Cranston 10, R. I.

RAISE Profitable giant Chinchilla rabbits. Great scarcity means large profits for gorgeous furs and delicious meat. Little space. Pleasant occupation. Contact world's largest breeder. Willow Farm, R15-B, Sellersville, Penna.

RAISING Frogs for profit. Be independent, raise giant frogs for food, full time job. Send \$3.00 for complete illustrated book on frog raising. This book is factual, written by president of Texas Frog Industries, operator of large frog farm. Can supply breeder frogs. Address Robert B. Van Meter, Box 912, San Benito, Texas.

SHELL Jewelry—Profitable hobby! Samples and instruction \$1.00. Shell packages, 10c and 50c. For folder write Sarasota Shell Shop, Box 2046, Sarasota, Fla.

MECHANICALLY Inclined men—Own and operate general appliance repair shop. Complete, illustrated course shows you how. Welding, refrigeration, motor repair, how to get business, etc., all phases covered. Free literature. Christy Supply, Dept. 469, 2835 N. Central Ave., Chicago.

WELDING—Electric arc. Learn profitable trade quickly through actual practice. Individual welder instructions at bare cost of materials. Full particulars free. Valuable welding lessons book 50c. Hobart Welding School, Box M-1064, Troy, Ohio.

BEAUTIFUL Mirrors from ordinary glass. Complete instructions, \$1.00. Tesco, PM-1, P.O. Box 189, Wilkes-Barre, Penna.

PROFITABLE, Fascinating, selling books by mail. Write Parcell, 2701 Main, Elkhart, Ind.

BALLOONS! We ship pronto! 10c retail sells to you \$5.95 gross. Hot profit item. Ellsworth Balloon Headquarters, Lajunta, Colorado.

EARN While you learn the clock repair business! With our method of instruction, your income starts immediately. For details write Akron Clock Clinic, 964 Wye Drive, Akron 3, Ohio.

SHELL Jewelry, novelties. Easy to make at home as hobby or to sell. Beginners kit \$1.00. Catalog 5c. Burton, Box 27, Station A, St. Petersburg, Fla.

"FROG Raising!" New book tells how. Marlboro House, 1035 Marlborough, Detroit 15, Michigan.

WOULD You pay 3%—first \$350 made? Color-illustrated book "505 Odd, Successful Enterprises", free! Some offer occasional "day off". Start at home, office. Expect something odd! Pacific, 2207 1/2 Cloverfield, Santa Monica, Calif.

ELECTRIC Clocks are every where you go, buildings, homes, parking lots, factories. Repairs increasing. Our easy to learn course with pictures and drawings teach you how to repair these clocks. Electronic Supply Co., P.O. Box 2350A, Houston 1, Texas.

GOLD-STAMPING Is fascinating and profitable. Free booklet. Home City Specialties, Dept. PM1273, Springfield, Mass.

TYPEWRITER Repairmen urgently needed. Earn \$40 to \$50 weekly spare time. Our easy to learn home study course teaches how to repair typewriters. Write for free information. Houston Typewriter Repair Service, P.O. Box 5357A, Houston 12, Texas.

ANNOUNCING Home study course in commercial baking. Practical basic training. Good field for those with aptitude. Nearly depression proof. Send for free booklet, "Opportunities in the Baking Industry." National Baking School, 1315 Michigan Ave., Dept. 3432, Chicago 5, Ill.

EXCELLENT Profits raising mink. Choice breeding stock available. Details furnished. Franklin Young, Riverhead, New York.

\$40.00 WEEKLY Made growing mushrooms, fresh, dried. Dominion patent 331583. Free spawn. North American, 169P Yonge, Toronto, Canada.

LOCKSMITHING—Profitable business or hobby! New course teaches you how to pick locks, fit keys, de-code, masterkey, etc. Easy self-instruction lessons. Bargain price. Fascinating 100-page illustrated catalog free! Write—Nelson Company, Dept. 2-02, Chicago 5.

TADPOLES Make frogs, tremendous demand. Both make you money. 25c brings tell-how information. Chariton Corporation, Century Building, Chicago 4.

BOOKS, PERIODICALS, PICTURES, POSTCARDS

INSTRUCTIVE Books, trade journals. Catalog 10c (refunded). Egan Bookhouse, Box 84, Vanderveer Station, Brooklyn 10, New York.

MAGAZINES—Business, trade, professional. Keep informed on developments, opportunities, etc. in your line. Current copies. Choice 760 publications. All fields. Free price-list. Commercial Engraving Publishing Co., 34C North Ritter, Indianapolis 1, Indiana.

POSTCARDS—Cincinnati views. 10 different, 25c; 20 different, 50c. 15 different "double meaning" postcards, 50c. All postpaid. Order today from Flinn's Hobby Shop, 4224 Montgomery Road, Norwood 12, Ohio.

BACK Number magazines reasonable. Cavaliere, 618 Carroll St., Brooklyn, N. Y.

HALL Marked off colored photos. Write Scenic Oilcraft, 11319 Iowa Ave., Los Angeles 25, Calif.

TECHNICAL Books—Bought, sold. Best Co., Box 5802, Cleveland 1, Ohio.

YOU Too can read handwriting! Ten lessons, beautifully illustrated, \$1.00. Astonish your friends, make money. Satisfaction guaranteed. \$1.00 analysis of your handwriting free. St. John, Noel, Missouri.

ATOM Bombed Nagasaki, 15 photos \$1.00. 12 Aleutian photos \$1.00. Makins Pictures, 538 1/2 Washington, Bremerton, Washington.

DON'T Buy \$3.00 book—Rent it for 19c. Write Mighty Midget Publications, Box S352, South Omaha, Nebraska.

FREE. Price list of interesting books. Luhn, St. Joseph 4, Mo.

WHAT Every Mason wants. We have Masonic books for Blue Lodge, Chapter, Commandery, Scottish Rite and Shrine. Our rituals are used the world over. Send for free catalog of books and rituals for Masons, Odd Fellows, Knights of Columbus, etc. Ezra A. Cook, Publisher, P.O. Box 796-PO, Chicago 90, Ill.

BATTLESHIP Missouri photo 10c. Frederick Forman, 868 Lorimer, Brooklyn 22, N. Y.

BOOKS! All kinds! List free. Monica Lake, 527-A 9th Street N.W., Room 205, Washington 4, D. C.

BOOKS! (Out-of-print, scarce); quickly supplied. Send wants. Spotlight, 141 Broadway, New York.

READ Priceless personality and face value—Win success, popularity and happiness. Literature free. Economy, 323-PM2 East Lanvale, Baltimore 2, Md.

25 PICTURES Of movie stars, band-leaders and vocalists for only 25c. Arden Specialties, 2147 - 86th St., Brooklyn, N. Y.

MOST Helpful technical books on electricity, refrigeration, heating, air conditioning, plumbing, welding, mathematics, radio, automobile. Lucas Supply, Dept. 24, 30 W. Washington, Chicago 2, Ill.

TECHNICAL Books, largest list. Edwards, 324 North 18th, Quincy, Illinois.

VISIT Pittsburgh, Pennsylvania or Detroit, Michigan by proxy. Three postcards 25c. Address; return; we remail. Francine, P.O. Box 6460-N, Pittsburgh 12, Penna.

MAGAZINE Export Sales Company, 2084 First Avenue, New York 29, N. Y. U. S. A. Over-issue popular American magazines and pocket-size novels. Comics, fashions, pictorials, romances, screens, pulps, many others. Export only.

FIGUROLOGY—Vest pocket mathematical short-cuts, calculator, trigonometrical and percentage mark-up charts—50c. Figuurology, Box 222, Chicago 90.

STRANGE, Interesting and unusual books, also books to help you in your work, trade or business. Write for free interesting catalogue. Fuller Company, 201 Dewey St., Newark 8, N. J.

PHOTOS, Postcards, 8000 subjects. 50 assorted 50c prepaid. Jack's Hobby Shop, 591-12th St., Oakland 7, California.

BOOKFINDERS! (Scarce, out-of-print unusual books.) Quickly supplied. Send wants. Clifton, Box 1377PM, Beverly Hills, Calif.

BOOKS. (Out-of-print, new, used) quickly supplied. Many 35c bargains. Catalogue. Mid-West Book Service, 18870 Marx Ave., Detroit 3, Mich.

BIG Profits taking subscriptions for all magazines. Agents' confidential catalog listing over 2500 periodicals and complete starting supplies free. Pines Subscription Agency, Flushing, New York.

"30,000 JOB And Business Opportunities in Alaska"—Based on two years' Alaskan experience, this 15,000-word copyrighted report gives latest facts on fur farming, mining, agriculture, lumbering, transportation, commercial fishing, construction, business opportunities. Special section on climate, homesteading, mineral resources, rights, etc. Private firms and government projects listed—tells how, when, where to apply. \$1.00. Return for refund in 7 days if not satisfied. Pacific Industrial Research Bureau, Dept. 2D, 907 Terminal Sales Building, Portland 5, Oregon.

"TRUE Christian Religion." To obtain a free copy of an 80-page digest of this remarkable work by the famous scientist, philosopher and theologian, Emanuel Swedenborg, send your name and address to Swedenborg Foundation, Inc., Room 1649, 51 East 42 Street, New York 17.

OPERATE Magazine subscription agency: wholesale catalog, complete supplies, 25c. Cassell Publishers Service, Westfield, New Jersey.

"100,000 POST-WAR Jobs Abroad"—South America, China, India, Burma, Japan, Russia, Malaya. How, when and where to apply. U. S. participation in world reconstruction and trade demands thousands of American-trained mechanics, salesmen, technicians, engineers, foremen, laborers and business representatives—every trade needed. Our 15,000-word copyrighted report—compiled from business, professional and government sources—lists over 200 big U. S. firms with foreign interests, gives job information, salary brackets, contract tips, application letters, passport information, climatic conditions, etc.—everything needed for your immediate application. \$1.00. Return for refund in 7 days if not satisfied. Pacific Industrial Research Bureau, 907-E Terminal Sales Building, Portland 5, Oregon.

BIBLE Says, "Swords into Plowshares." When? Free booklet explains. Ketchum, 1848 S. 18th, Springfield, Illinois.

MAGAZINES (Back dated)—foreign, domestic, arts. Books, booklets, subscriptions, etc. Catalog 10c (refunded). Cicerone's, 863 First Ave., New York 17, N. Y.

GOOD "Used" self-instruction educational books on all subjects bought, sold, rented, exchanged. Satisfaction guaranteed. Complete information and 100-page illustrated bargain catalog free! Write—Nelson Company, Chicago 5.

SELF-EXPLAINING Bible: Illustrated circular free. Box 446-P, Minneapolis, Minn.

MAGIC TRICKS, PUZZLES, JOKER NOVELTIES

500 TRICKS! New 1946-7 edition Douglas famous catalog now ready, only 10c. Brand new magic for pocket, parlor, club, stage, professional, amateur. America's fastest service to magicians everywhere for over 25 years. Send 10c today. Douglas Magicland, Dept. 1, Dallas, Texas.

NEW Magic Monthly, 25c a year. Sample copy and magic catalogue free. Magic Factory, Minneapolis 2, Minn.

NEW! "Tricky elephant and donkey" or tricky dogs. 4 pairs \$1.00, sample 35c. Leeart, 7438 Chappel, Chicago 49, Illinois.

RISING Cigarette trick: Cigarette magically rises from pack. Apparatus and instructions dime. Eastwood, Box 623, Parkersburg, W. Va.

SEND 25c And we will send you our 84 page catalog. Also 50c trick free to get you started. The Mystery Mart, Dept. PM-1, 737 N. Jackson St., Milwaukee 2, Wis.

VENTRILOQUISM Exposed. First time published. Free booklet. Quackenbus, Big Flats, N. Y.

SENSATIONAL New card trick "Mystery of the Talking Cards" ordinary pack—no sleights; fifty cents. Box 412 P.O., Van Nuys, California.

LEARN Magic quickly. Book 250 easy tricks only 25c. Rush! Magic Mart, 1423 Palou, San Francisco 24, Calif.

MAMMOTH Joker assortment—\$1.00. Samples, 20c. Harley Steele, Maumee, O.

SENIOR Magic set, contains twenty tricks, \$1.00. Extraordinary value. Bedford, 190 Rodney Street, Brooklyn, N. Y.

SELL Funny business cards, tricks, jokes. Samples 10c. National, Box 301-M, Cincinnati 1, Ohio.

LATEST Amateur, professional magic catalog 25c. Refunded. DeLuca's, 127-D Pettis, Providence 4, R. I.

"THE Fakir," monthly magazine for magicians. Copy 25c. Subscription \$2.00. Joseph Rachun, 114 Grand St., Brooklyn 11, N. Y.

VENTRILOQUISM — Handy, 54 page, pocket size volume 25c. Joe Jones, Box 1192, Columbus, Georgia.

VENTRILOQUISTS, 8 Lesson course \$1. Gotberg, 4207 Grandriver, Detroit 8, Mich.

MAGIC, Novelty catalog, trick, 10c. Wencil, 2615 Evaline, Hamtramck 12, Mich.

SCOTCHMAN'S Purse—Amusing, fascinating, life of party. Leather postpaid \$1.00. Lee Bishop, Box 304, Rockton, Ill.

THE Magic tubes—A real baffler. (Similar to the shell game.) Requires no skill—Defies detection. Complete with my. Unusual Booklet (not catalog) of Simplified Tricks—\$1.00. Western Industrial, Box 1726, Portland 7, Oregon.

EARN Money in any crowd. Call names of strangers, tell unspoken questions. Professional course mind reading, faked spiritualism, etc., \$1. Henderson, Box 341, San Bernardino, Calif.

SENSATIONAL "Wonder blocks." Baffling pocket trick. Easy to perform anywhere without skill. Precision made. Not a cheap "gadget." One dollar only. Magic Spot, 726B East Oak Street, Stockton 37, Calif.

AMAZE And mystify your friends with highest quality magic. New catalogue 25c coin. Mazda Magic Co., 1135 Westgate Ave., Oak Park, Ill.

VENTRILOQUISM, Ten lesson course only \$1. LeSueur, 77 Wellesley, Toronto, Canada.

SECRET Writing made easy! Learn to code and decode your own messages by secret methods used by international agents, spies and military forces. Complete kit gives you coding device and code book with instructions. Works like magic—writes your personal messages in secret form, then decodes automatically! No skill necessary. Thousands of combinations. A real professional-type secret message writer—not a toy. Strongly built, lithographed in four colors. Send \$1.00 for complete kit postpaid. Delighted or your money back. Crypto, P.O. Box 462, Oak Park, Ill.

MAGIC: Big illustrated catalog free! Modern Magic Shop, 126 Lexington Ave., New York 16.

ELECTRIC Fun! 200 stunts, 110 volts, \$1. Kutting, Campbell, Calif.

LEARN Ventriloquism. 3c stamp brings particulars. Smith, 801 Bigelow, Peoria, Ill.

ENTERTAINING Card routine Old Testament in deck cards, \$1.00. Ehbör, Box 6837, Philadelphia 32, Penna.

PRECISION Wooden puzzles that defy efforts to disassemble. Three different puzzles \$1.00. Blake Industries, 2355 Guardian Bldg., Detroit 26.

LARGE Illustrated professional catalog 10c. Williams, 900 Plymouth, Ellwood City, Penna.

FREE Big illustrated lists, magic tricks, illusions, mind reading, pocket, parlor, club or stage. Jokes, novelties of all kinds. Magician, 2463-M Kensington Ave., Philadelphia 25, Penna.

NEW Vanishing key and catalog 25c. Sterling Magic, Box 191, Royal Oak, Mich.

FREE! Large catalog of magical apparatus if you remit 25c for "Magic Is Fun" magazine. Robbins Co., 152-F West 42nd Street, New York.

ENTERTAIN! Mystify! New, bigger magic catalog and 4 secret tricks 25c. Herbert, P-192 N. Clark, Chicago 1.

MAGIC: Big 160 page Illustrated Catalog Latest Magic Goods, 25c. For over 1/3 century we have supplied Professional as well as Beginner. Chicago Magic Co., 2300 N. Mason, Chicago 39.

BE A magician. Large professional magic catalogue of latest tricks 25c. Ireland, C-109 North Dearborn, Chicago 2.

MAGIC Tricks, puzzles, books, cards, punch boards. Catalog 10c. Specialty, Box 671, St. Louis 1, Mo.

PERFORM Seemingly impossible feats: Playing cards containing over 12,000 secret marks. \$1.00. Attractive magic kit of 10 tricks \$1.00. Kogel's Magic Novelty Co., 6751-A Colbert St., New Orleans 19, La.

GAMES AND ENTERTAINMENT

"84 CARD Tricks." 25c! Free: "Money-making Opportunities!" Hirsch, Spring Valley 2, N. Y.

PLAY 4 Handed chess. Illustrated directions 20c. 1100 Belmont St., Waverly, Mass.

UNITED Nations puzzle and game. Baffling! Amazing! Few people can solve it. 25c postpaid, Junior-Pro, 3206 Morganford, St. Louis, Mo.

CHECKERS, New book by Hopper, \$1.25. Book Mart, Plant City, Fla.

MAKE Your own photos of movie stars and bandleaders. No chemicals, darkroom or experience required. Fun for all. Complete outfit \$1.00. You may use your own negatives also. Arden Specialties, 2147 - 86th St., Brooklyn, N. Y.

CHESS Players! Play postal card games. Instructive specimen game and information sent on request. Write today. Ask for deal B—free. Pioneer Game Co., Pasadena 17, Calif.

HOBBY Books. Latest titles. Catalog free. Popular Mechanics Press, (C-43), 200 E. Ontario, Chicago.

COINS, TOKENS, CURRENCY

WILL Pay \$10 each for certain Lincoln pennies! Indianheads \$50; dimes \$1,000. Catalogue 10c. Federal Coin Exchange, 10-PM, Columbus, Ohio.

THIRTY Different coins and bills, \$1.00. Oddehon, Box 482, St. Louis, Mo.

TWENTY Different Indian head cents \$1.00. Retail catalogue 10c. U. S. gold coins wanted. Top prices paid. Buying list 3c. Bebee Coin Company, 1180 East 63rd Street, Chicago 37, Illinois.

UNITED States coins bought. Excellent prices paid. Buying price list 20 cents. Rockhill, Jamaica, N. Y.

WE Purchase Indianhead pennies. Complete all coin catalogue 10c. Fairview, 277 Broadway, New York.

BARGAINS! Rare collection contains United States large cent over 90 years old, Flying Eagle cent, White Indian cent, 2c piece, 3c silver, 3c nickel, half dime, shield nickel, Liberty seated dime, Civil War cent, Confederate bill, foreign coin, foreign bill and our complete buying and selling catalogue all for only \$3.00. Catalogue 25c. 28 dates Indian cents \$1.00. 25 different foreign coins \$1.00. Worthy Coin Corporation, 152 Washington, Boston, Mass.

COLLECTOR'S Oddity! Pennies, double heads or tails! \$1 each. Four Confederate bills, \$1. Aiken, 16 Burt, Auburn, N. Y.

OLD And modern coins wanted. Free list. Jones, 1942 Wallace, Philadelphia 30, Pennsylvania.

FOR Sale: 1893 Columbian half dollar, 60c; 50 assorted Indian head cents, \$1.00; 50 foreign coins, \$2.00; large coin price list, 10c. Ben's Coin Company, 72 West Washington, Chicago 2, Illinois.

GET Profit and pleasure in collecting old coins. Send 10c for 56-page illustrated coin catalog. You'll be delighted with it. Send for it now. B. Max Mehl, 370 Mehl Building, Fort Worth, Texas. Largest rare coin establishment in U. S. Established 46 years.

FOREIGN Coins, paper money. World-wide selection twelve different odd unusual only 25c. Richard Webb, Box 843, San Bruno, Calif.

LINCOLN Pennies—1910S, 1913S, 1914S, 1915S, 1921S, 1923S, 1924S, 1926S, 1931D, 1932D, 1933D—10c each, or any 11 for \$1.00. Price lists 3c. Reynolds, 1118 Mathews, Flint 3, Michigan.

WORLD Coins—List free. Harry Elsholz, Box 9014, Pittsburgh 24, Penna.

COMMEMORATIVE \$½, Oregon, Texas, Kentucky, Cleveland, Long Island, \$2.00 ea. Illustrated catalogue 25c. Norman Shultz, Salt Lake 9, Utah.

FREE! Foreign coin, banknote and coin collectors illustrated catalog to approval service applicants. Send 3c postage. Tatham Coinco, Springfield-125, Mass.

OLD STAMPS WANTED

I WILL Pay \$100.00 each for 1924 1c green Franklin stamps, rotary perforated eleven (up to \$1,000.00 each unused). Send 6c today for large illustrated folder showing amazing prices paid. Vernon Baker, (PM-610), Elyria, Ohio.

STAMP COLLECTING

POSITIVELY Greatest free offer—Latest Scott's International \$5.00 stamp album, covering entire world, contains 36,000 illustrated descriptive spaces; Scott's 1947 Standard \$5.00 catalogues "Philately's Encyclopedia"—absolutely free to applicants for foreign approvals becoming customers. Plymouth Specialty Company, Dept. A-9, Bell, California.

YOUR Money's worth! Seychelles, Djibouti, Angola, Chinese hunger stamps and over 100 different other stamps. Everything 10c to approval applicants. Atlas Stamps, 4220 West 16th, Dep't L, Little Rock, Ark.

BRITISH Empire. Fifty different flashy stamps plus unique mystery stamp. 10c to penny approval applicants. Litsch, Box 535, Middletown, Ohio.

ROOSEVELT Mourning stamps from Nicaragua, Greece, Argentina plus beautiful glossy photograph of "Roosevelt collecting stamps" only 10c to approval applicants. National Stamp Sales, 276A West 43rd Street, New York 18.

SPLendid Offer! Gilberts, Seychelles, Solomons, U. S. commemoratives, Anzac commemoratives, Bolivia commemoratives, liberated countries and multitude other stamps. Everything only 10c to approval applicants. Stav, 147 Victoria, Kamloops, B.C., Canada.

FREE Magazine for stamp collectors! Send today for sample copy of the new weekly stamp magazine—Philately. Complete and up-to-date U. S. and foreign stamp news and features. Modern format, excellently illustrated. Philately, 200-PM So. 7th St., St. Louis 2, Mo.

USED United States and foreign stamps sent on approval by paralyzed shut-in Rose Krenz, 823 South Covell, Sioux Falls, South Dakota.

MYSTERIOUS Bechuanaland, scarce Tonga, dazzling Pitcairn, venerable Spanish Colonies, sparkling French Colonies—Everything 3c with approvals! Saxons, Walden, New York.

THE Bargain of your life includes St. Helena, Bechuanaland, Cyprus, Nyassaland, Tangier and 25 different other countries—10c to approval applicants only. Excelsior Stamps, P.O. Box #95, Hackensack, N. J.

SCRIBBLE A line—United States approvals, right price, real nice. Jarr, Box 217c, Madison Square Station, New York 10.

U. S. Mint: Singles, blocks, plate# blocks, complete sheets. Finest quality. Reasonable prices. Send for price lists. Mission Mart, Washington 17, D. C.

ALL-MINT British Colonial packet given to approval applicants enclosing ten cents. Stamp Fair, 253 South Hite, Louisville 6, Kentucky.

HURRY! British Colonials with S. Helena, Caymans, Nepal, Falklands, French Colonials, Portuguese Colonials, Spanish Colonials and others. Everything 10c with approvals. Foster & Son, 3525 Hull Avenue, Bronx, N. Y.

REWARD—1870-90 U. S. "Liberty" postal card—rewarded to those requesting packet "51," which includes: Greclan "Roosevelt" stamp, plus 50 different U. S. stamps, 10c approvals. Gerhardt, 2804 Rio-grande, Austin, Texas.

START Your own stamp business—100 approval reports, 100 letterheads, 100 standard approval forms, 100 for commemoratives, 100 for sets—All 500 printed with your name and address. Only \$2.00 postpaid. Stamp World, 536 So. 30, Omaha 5, Nebraska.

ROOSEVELT Memorial set mint 4 var. 12c to serious applicants for our better grade approvals. Loma Stamp Shop, Blanket, Texas.

CAPE Juby set 5c with approval. Sweep-er, 141-C West St., Newark 3, N. J.

50% DISCOUNT On first approval selection. Central Stamp Company, New Providence 1, New Jersey.

U. S. And foreign approvals. Vet Stamp Co., 1136-P, Flatbush Ave., Brooklyn 26, N. Y.

FRANKLIN Roosevelt complete set 5c. U. S. approvals. Canfield Stamps, 921 Beechwood, Hagerstown, Maryland.

FREE Cuban set, 3c. approvals. Kapp, 3058 - 123rd, Toledo, Ohio.

WILL Buy U. S. mint stamps, also plate blocks. Rickert, 1985 Grand, St. Paul, Minn.

300 DIFFERENT Given free with approvals. Postage 3c. Windsor Stamps, 1435 East 67th Place, Chicago 37.

BLACK Harding cover 55 United States 10c. Approval applicants. Standard, 3817 Sackett, Cleveland 9, Ohio.

STAMP Magazine—Full year 25c. P.O. Box 1052, Newark 1, N. J.

FREE—Commemorative-pictorial packet with approvals. Enclose 3c postage. Wisehart Stamp Service, Frankfort, Ohio.

AUSTRIA 12 Beautiful 1946 pictorials 15c to approval applicants. Home Stamp Service, 4048 Cicero Ave., Chicago 41, Ill.

ADULTS Only: Pictorial set free. Approvals. Davis, 1320 South 12th, Waco 3, Texas.

GUARANTEED Job lots U. S., foreign, precancels. Each \$1.03. Pound old mixture \$1.15. Blackmon, Corcoran, Calif.

OLTRE Giuba B1 to B6 (cat. 90c) 15c. Approvals. Millhiser, 7724 Abbott, Pittsburgh 21, Penna.

CANADA War set, 10 var., 10c with interesting approvals. Rheume, 8949 Routhier, Montreal, Canada.

MINT Curacao #164-68 only 10c if requesting approvals. Glen Colter, New Haven, Mo.

ALL Different—25 Egypt 20c, 25 Russia 20c, 100 Germany 45c, 20 Portugal 15c. Elsea, Bowling Green, Ohio.

U. S. Commemoratives, 15 different 5c. Henderson, 962-M 72nd Street, Brooklyn 28, N. Y.

200 DIFFERENT Foreign. Many countries, 30c. Jem Stamps, Port Jefferson, N. Y.

THREE Hitler heads free with approvals. Everglades Stamp Company, Box 3222, Station F, Atlanta, Georgia.

VATICAN City, Council Trent complete, only \$1.00 with approvals. Robert Smith, 801 Market, McKeesport, Penna.

FREE! Scarce unused set Manchurian Provisionals to approval applicants. Riedell, Greensburg, Pennsylvania.

BOHEMIA—Moravia, 50 different, \$1. Bradford, Box 638, GPO, Brooklyn 1, N. Y.

FREE! 25 Different Canada to approval applicants. Shanks, 1240 Welton Way, Inglewood, California.

50 DIFFERENT Denmark, 10c with approval selection. Paul Rawden, Box 2920, Westville, New Haven, Conn.

THREE Beautiful old Nova Scotia stamps \$1.00. Mayfield, Route Three, Chattanooga, Tenn.

FREE—New issues, Italian Republic, Greece, France, triangle, to approval applicants. Green and Company, Norwood 12, Ohio.

FREE! Stamp wallet, sincere approval buyers. These, 9320 San Juan Ave., South Gate, California.

DOLLAR Each—1200 better U. S.; 1500 foreign; 750 Australia. Seiden, 1331 Intervale, New York 59.

10 DIFFERENT U. S. over 40 years old, 5c. Foreign, U. S. approvals. Scott, 30 Baker Ave., Lexington 73, Mass.

FREE! Rhodesian bi-colored waterfall; old El Salvador issues; plus 25 different worldwide stamps. All free to approval applicants. Pladon Stamps, 1717-M Idaho, Toledo 5, Ohio.

100 DIFFERENT U. S. and foreign 10c. Approvals. Budwitz, P.O. Box 108, Meriden, Conn.

STAMPS 100 Years old. It is now 106 years since the world's first stamp was issued. Every collector should have at least a few stamps 100 years old or nearly so, but have you? Probably not because most early stamps are hard to get and are therefore not often offered. Nevertheless, we have prepared a selection of 12 all 19th century stamps. Very old, everyone of them, even if not fully 100 years old. We will send these for only 10c to sincere approval applicants. Write for them today, and kindly state whether approvals shall consist of United States or foreign stamps, or both. Approval Headquarters, Globus Stamp Company, 268 Fourth Ave., New York City 10, Dept. 201.

SETS On approval. Sample 10c. J. Durak, 3229 W. Thomas St., Chicago 51, Ill.

FREE! Big packet stamps, U.S., foreign approvals. Verne Stamp Company, 916 Fallowfield, Charleroi, Penna.

MIXTURES. Worldwide accumulations 1,500 for \$1. Missions Outlet, Rev. Marshall, Paterson 1, N. J.

EVERY Stamp a star, red, white, blue, green China stamp picturing Chiang Kai-Shek and Chinese flag, large colored stamp commemorating independence of the Philippines, stamp issued for Netherlands liberation; Austria Rener issue highest value of set, all only 15c with approvals. Cornetta Bros., 228 West 25th, New York.

WHAT Have you to offer? A collection? A "shoe box" accumulation? Anything in stamps. We urgently need them. Spot cash paid. Cosmopolitan Stamp Co., 1457 Broadway, Dept. 10-E, New York.

UNITED States approvals. Send today for fine selection. Willett Stamps, Box 507, Port Chester, New York.

115 FOREIGN, Each different, only 10c to approval applicants. Sandy Bay Stamp Co., Rockport, Mass.

FLAGS! Flags! Flags! Beautiful collection flag stamps (value 25c). Manchukuo census set (value 8c). Packet 25 countries (value 57c) including scarce Borneo, Pahang, etc. Perforation gauge (value 10c). Total value \$1.00. All—10c to approval applicants. Odd Stamps Co., Dept. A-2, 5391 Metropolitan Station, Los Angeles 55.

FREE! Complete Balkan aviation set with approvals. Beaman, Glenburnie 1, Maryland.

EXCHANGE Stamps, postcards universe. "Exchangers" Bry 226, pres Paris, France. Particulars free.

100 DIFFERENT Foreign stamps and Mexican banknote only 10 cents. Nagle, 1101 Marion, Reading, Penna.

COLORFUL Collection; Solomons, Gilberts, Falkland, other island stamps, entire lot 5c. Approvals. Amberg, 537M 35th, Union City, N. J.

SELLING Out. Entire stock made into lots of 200 varieties each, regardless of original cost of stamps. Contains many high priced stamps. Guaranteed to catalogue over \$5.00. Every lot different. \$1.00 each. Fedor Stamp Service, 246 Wallington Ave., Wallington, N. J.

LIBERAL Offer thick packet with Seychelles, Gilberts, Reunion, Inhambane, Mozambique, Inini, Porto Rico, Philippines and multitude others, everything only 10c to approval applicants. Burmaster, Box 1910 M, Los Angeles 53, Calif.

BRITISH, Spanish and French Colonies, Vatican, Hitler heads and airmail packet, free with approvals. Pan-American Stamp Co., Box 145, New York 33, N. Y.

105 DIFFERENT Including Vatican Cardinal set 10c to approval applicants. Quality Stamp Company, Department M, Box 202, Sta. F, Buffalo 12, N. Y.

BEGINNERS! My progressive U. S. approvals, postage or precancels, are intended for you! Send a postal today. Richard Cole, 43 Rinewalt, Williamsville, N. Y.

FREE Packet with approvals. Premiums. Thompson, Box 151, East Orange, N. J.

15 DIFFERENT Persia 5c with approvals. Libby, Box 43-P, Brooklyn 12, N. Y.

PHILATELIC Listing Bureau, Ellington, Missouri. Inquiries invited. Stamp please.

NICARAGUA Roosevelt set of three ten cents with approvals. Murray, 2152 Vogel Road, Evansville 14, Indiana.

188 U. S. Commemoratives, etc. 10c. Dorenbusch, 501 Ridgeway, Cincinnati 29, Ohio.

FREE! Mint pictorials with approvals. Deane Stamp Co., Box 1002, Miami Beach 39, Florida.

U. S.—10 Old, 25 commemoratives, 10 famous Americans 50c. Reico, Morrison 8, Oklahoma.

STAMPS From waste paper. Mueller Salvage Co., Ellington, Missouri.

CHOCK-FULL Stamp news, information, bargain ads! "Stamp Post," 12 issues 20c! Station A. Pasadena 3, Calif.

UNITED Nations, scarce 5c U. S. commemorative and packet 30 different U. S., including airmail, commemoratives, revenues, etc. Catalogs 85c—to approval applicants for 5c. Curhan Stamp Company, Dept. H, Gloucester, Mass.

ONE Tenth catalogue value! Uncanceled Greece 1937 historical issue complete, thirteen values! Lovely Venus, court lady, Olympics, bull fight, etc.! Catalogues \$2.70! Only 27c plus 3c postage with attractive approvals! "Stanley the Stamp Man," 4232-A South Pine Avenue, Milwaukee 7, Wisconsin.

PENNY Approvals—10 free from first 500 book. Bob Harris, 511 No. Wasatch, Colorado Springs, Colorado.

CHOICE Penny approvals—Some higher. Stamps, 1267 Tutwiler, Memphis 7, Tenn.

FREE — Abyssinia, Cayman Islands, Tuna triangle, Indochina, Syria, Ivoire, Philippines (Jap "shame" issue), Turkish harem, Damascus, Cambodia, African "beauty," Pirate Islands, Colonials, others—All free for 3c postage with approvals. Belmont Stamps, Washington 10, D. C.

50 DIFFERENT 3c To approval applicants. C. Ripperdan, 1832 Thomas, Fresno 3, Calif.

EXTRAORDINARY Pictorial collection including Tahiti spearfishing, Melanesian idol, Djibouti, Reunion, Newfoundland, Madagascar, Wurtemberg, Ivory Coast, Colombo harbor, Ingavi battle, many others only 5c. Imperial Stamps, Yonkers, N. Y.

160 U. S. Approvals. Return postage paid. Low priced foreign. Southern Stamp, Box 70, Miami, Florida.

THREE "Hitlers" free. Request approvals. Suburban Stamp Sales, St. Louis 14, Mo.

73 U. S. Airmails, commemoratives 35c. Corryville Exchange, 119 St. Clair, Cincinnati, Ohio.

FIRST Day covers on approval. Knobel, 1918 S.W. 12 St., Miami, Florida.

31 DIFFERENT With George Washington stamps from Brazil and Ecuador; Pirate Island; victory issue; medical set; others—all 4c with approvals. Grayson Company, Sherman, Texas.

EXCELLENT Pictorial approvals. Reasonably priced. Crown Stamp Company, Box 331, Toronto, Canada.

PENNY And two penny approvals by country. Hoerning, Farmington, Ark.

FREE! Bechuanaland! Trinidad! Iran! assortment. Approvals. Stampco, Miami Springs, Florida.

AMAZING Offer! Assortment each of giant stamps, midget stamps, flag stamps, airmail stamps, Free French Colonies, U. S. commemoratives and numerous others. Everything only 10c to approval applicants. Simon, Box 608, Iraan, Texas.

NEWFOUNDLAND Set, Mozambique triangular air, jubilee, Coronation, Constitution. 6 Czechoslovakia independence, mythological, Confederation, 57 others 10c approval applicants. 100 Newfoundland mixed 40c. 17 Netherlands Admirals \$1.00. Kendall, 30 Crescent, Amherst, N. S., Canada.

WOT! No peace? Nations may fight, but you'll have no quarrel when you purchase stamps from Purchase! Fifty different, free. With approvals, any country. Purchase's, 1209-F Woodruff, Hillside 5, New Jersey.

FREE Mint complete Italian pneumatic set sent with approvals. 20th Century, P.O.B. 3413, Philadelphia, Penna.

RAMPANT Lion, submarine telephone, Battle of Ingavi, Mayan Monolith, Tylon-Perisphere, silver jubilee, many more superb items, all 10c with approvals. Scoban, 516 Colorado, Austin, Texas.

FREE! 18 Different Switzerland with approvals. Excel, Box 1315, Chicago 90.

U. S. Commemoratives, 90 different \$1.00. National parks set 50c. Write for free U. S. price list. A. Partke, Palisade, N. J.

UNITED States commemorative packet. Tremendous value only 10c to approval applicants. 200 different U. S. airmails, postage, Civil and Spanish American war revenues, etc. \$1.00. AAA Stamp Co., Arcade Bldg., St. Louis, Mo.

FREE Packet, approval applicants. Wynter, 224 Jefferson Avenue, Brooklyn 16, N. Y.

FREE Over 100 different stamps—triangle and diamond stamps included, with approvals. Send 5c for postage and handling. Regent, Dept. M-316, Flatbush Ave., Brooklyn 17, New York.

FREE—World-wide stamps, also hinges with first approvals. Send 3c stamp. Peter Nerger, Palisade, N. J.

FAMOUS Cocos Island set and fifty others from 15-20 countries 10c with approvals. Champion, Box 4725 A Florence Branch, Los Angeles 1, Calif.

"JURO Bureau"—Newsy gossip column for foreign mint collectors. Issued monthly. 10c per year with approvals. Juro Stamps, 1041 Waller, Chicago 51, Ill.

FLASH! Amazing value! Djibouti, Bechuanaland, Sarkari, Cameroons, others. All 6c, approval applicants only. Southwest Stamps, Box 117, Long Beach 1, Calif.

EX-JAP Naval base, scarce Nauru ship stamp. Bolshevik music stamp, victory stamp for 5c to approval applicants. Bob's Stamp Service, 430 Ralston, San Francisco 12, California.

50 CANADIAN, Newfoundland including earlies, commemoratives, 10c. Approvals. Reede, 696 Gerrard, Toronto.

FREE 25 Different Italy, Postage 3c. Robert Ewing, Wapakoneta, Ohio.

THIRTY Airmails, commemoratives, others. Approvals. 10c. O. Burgett, Lima, Ohio.

FINE Stamps at fair prices, on approval. Inter-Continental Stamps, Englewood 2, Florida.

FOLD-O-HINGES Free. Regular 10c package to approval applicants who enclose 3c postage. Baker Stamps, Evansdale Street, Lake Mary, Fla.

TRIANGLE Set 3c. Beginners approvals. Mallo, 767 Leith, Flint 5, Mich.

ILLUSTRATED Listings, Vatican, Italy, Colonies, free, Cray Stamps, 2 Cray Avenue, Mt. Vernon, N. Y.

SPAIN'S "Nude Goya" set complete 25c. Approvals. Royal Stamp Company, Tamaqua, Penna.

FREE—Scarce coronation! Bargain approvals. Gramatan, Box 1002 Church Street Station, New York 8.

SPECIAL—Stamp tons, perforation card, 9 mint French Colonies, to approval customers only, 5c. Co-operative Stamp, Box 69B, Brooklyn 29, N. Y.

LOW Priced United States approvals. Panther, Box 76, Dorchester 24, Mass.

20,000 VARIETIES 1c-5c each! Gordon Davison, Box 1019B, Manchester, N. H.

25 JAPANESE Stamps 5c with approvals. Frank Stamps, 177 Elmcroft, Rochester 9, N. Y.

FIFTY Different British Empire, 10c. Approvals. Arcadiac, Box 21, Station "J," Toronto.

SPECIALIZE In U. S.! 174 different, \$1.00; 254 different, \$2.00; 324 different, \$3.00. Veteran's Stamps, 4714 N. Albany, Chicago.

500 DIFFERENT Stamps \$1.00. Approvals. Mantle Stamp Company, London, Canada.

5 HITLER Stamps only 3c, with approvals. Gaydos, Kenosha, Wis.

WORLD Album 10c. Fine approvals. Kress, Box 144, Hanover, Penna.

ROOSEVELT Nicaragua stamp showing him with his stamp albums and four other scarce foreign Roosevelt stamps, 25c with approvals. Western Stamps, Box 4042, Los Angeles 24, California.

200 DIFFERENT Foreign stamps 53 cents. McQuitty, Box 254, Columbia, Mo.

175 U. S. Commemoratives, etc., 10c. 500—25c. P.O. Box 457, Newark 1, N. J.

10 DIFFERENT Peru to approval applicants enclosing postage. "Ranson," 721 W. Maple, Compton, Calif.

FREE! Tiny Chinese "midget" war set. Approvals. Seminole, Glenburnie 1, Md.

VATICAN City—Ten different eye-filling pictorials, entire set 6c with approvals. Viking, 130-Z Clinton St., Brooklyn, N. Y.

AERO-PHILATELISTS. Send for current price list. Baker, East Setauket, N. Y.

PORTUGUESE Colonies, 25 different 5c with approvals. Lorane Brown, Marion, Michigan.

BAVARIA, 17 Different 5c to approval buyers. Boerger Stamp Company, 206 Main, Toledo 5, Ohio.

GORGEOUS Colors, scarce airmail, surcharges, charities, sets, etc. All in our big premium packet only 3c to approval buyers. Dixie Stamp Company, Dept. M, Milwaukee 3, Wisconsin.

ADEN To Zanzibar! 40 different British Empire, including Cyprus, Malta, Dominica; 3c with approvals. Lyman Company, 95 Nassau Street, New York City 7.

BRAZIL Diamond shaped set 10c, with approvals. Vargo Stamps, 6044 South Fairfield, Chicago 29, Illinois.

U. S. Price list. Send postage. State Stamp Service, 1225 Park Building, Pittsburgh 22, Penna.

FIVE Vatican City stamps free to approval applicants. Florida Stamp Company, Box 807, Miami 5, Florida.

25 DIFFERENT Swiss 10c—with 1/4, 1/2, 1c approvals. Carroll's, 4357A S. Hoover, Los Angeles 37, Calif.

CHINA. Every stamp with a historical meaning. Twenty of these colorful stamps offer approval applicants for 10c. Col-lins', 71 Coleridge, San Francisco 10, Calif.

OLD Scarce U. S. seconds on approval. Slightly defective, nice appearance, bargain prices. Hernfeld, 551 Clinton, Newark 8, N. J.

EXCHANGE Duplicates. Swappers everywhere. List 10c. Particulars free. Box 2166-M, Denver 1, Colorado.

ONE, Two, four, five dollar U. S. stamps free to approval applicants. United Stamp Service, Box 1789-M, Miami 10, Florida.

ZANZIBAR. Palestine, Manchukuo, Azerbaijan, Haiti, Iraq, Slam, Victoria, Hitler stamp 5c. Approvals. Postzegel, Windham, New York.

U. S. Price list. Send postage. Stanley Gibbons, 38-P Park Row, New York.

PENNY Approvals, that satisfy. Neil Gronberg, Box 5441-P, Philadelphia 43, Penna.

MINT Pictorials free to approval applicants. Surf Stamp Co., Box 2296, Miami Beach 40, Florida.

APPROVAL Sheets, Frederick B. Driver, 909 Finance Building, Philadelphia 2, Pa.

ZOWIE-E! A barrel of fun for only a dime. 500 United States stamps—absolutely unpicked and unsorted—just as received from church missions. Many varieties, including large commemoratives, airmails, high denominations up to \$5.00! Stampdom's biggest package of fun—and you might find something really valuable! Price only 10c to serious approval service applicants. Money back if not delighted. Illustrated bargain lists with each order. Mystic Stamp Company, Dept. 80, Camden, New York.

50 DIFFERENT United States, 10c. Price-list free. Seidenberg, Cassopolis, Mich.

CANADA—75c Diff. 25c. Approvals, Lists. Victoria Stamp Co., London 4, Canada.

FINE Approvals, freshly mounted. Fast, personal service. Tell me what countries you prefer and I'll send their stamps. Skinner, 438 Locust, Long Beach 2, Calif.

RICH Man's approvals, poor man's prices. Grand value packet containing five foreign sets, free with approvals. Stoll Stamp Service, 2630B West Burnett, Louisville 10, Kentucky.

FREE! Negro Triangle; Turks Islands "Cactus"; Dakar; Guinea; Palestine; "Fairy Tale," Pirate Chart, Map, Ship, Sea Lion and Snake stamps; French, British, Portuguese Colonies, etc. Free for 3c postage. Approvals. Potomac Stamps, Washington 10, D. C.

WOW! \$10.00 Worth of fun only 10c. What a treasure hunt! Big package 500 foreign stamps—just as received from foreign missions other sources. Includes stamps from Africa, South America, Philippines, Free French, Cape Juby, Palestine, etc., including airmails, commemoratives, and stamps worth up to 50c and 75c. This amazing offer is given for 10c to serious approval applicants only. One to a customer, money back if not more than delighted. Jamestown Stamp Co., Dept. 22, Jamestown, New York. Stamps—valued up to 50c and 75c each.

UNITED States approvals complete coverage, fine quality, attractive prices. Seminole Stamps, Box 378, Coconut Grove, Florida.

FREE! Leeward Is., Cayman Is., Turks and Caicos plus 54 different mint World's Fair poster stamps, to approval service applicants sending 3c postage. Tatham Stamp Co., Springfield 30, Mass.

25 DIFFERENT India, 3c with approvals. Premiums with purchases. Brandwein Stamp Company, Box 92H, Bayonne, N. J.

50 DIFFERENT Including scarce diamond-shaped airmail 3c to approval service applicants. Avalon Stamp Co., Dept. M, Springfield 8, Mass.

DANDY United States approvals. Write immediately. Sullivan, Endicott Building, St. Paul 1, Minn.

1000 GRABAGS 15c Each. Super bags 25c. Zandy, 630 Bingham, Reading, Pa.

BOX Stamps containing hundreds all different, cataloging up to 25c each. Everything \$1.00. Longacre Shop, 108 West 42nd, New York City.

SCARCE "Pole to Pole" packet! Stamps from strange, mysterious countries only—Greenland (North Pole), Solomons, Spanish Morocco, Bhopal Patiala, Siberia, Grahmland (South Pole), Djibouti, Zanzibar, etc., and including stamps cataloging up to 25c each! Our price only 5c to approval applicants. Big dime packet list free! Methuen Stamp Service, Inc., Dept. 136, Lawrence, Mass.

FREE U. S. price list. Postage 3c. Mark Hanna, 335 - 5th Avenue, Pittsburgh 22, Penna.

COMPLETE "United States" catalog with 1000 illustrations! Send 10c for mailing. Harris & Co., 137 Transit Building, Boston, Mass.

FREE—Pick 25c worth of stamps from our first U. S. approval selection. Approximately 100 stamps to choose from. Excellent value. No obligation to buy. Lists illustrating the most popular U. S. stamps—at prices you can afford—will be included. Don't miss this opportunity! Write today. S. C. Engel Co., 38 Park Row, New York City.

FREE! Canadian sets, royal visit, George VI, George V, coronation, jubilee, others, to approval applicants. Ensign, Box 118-M, South Orange, N. J.

WORLD'S Largest diamond and triangle stamps, free stamp magazine, stamps from fighting Free French, 20 stamps from 20 different countries, pictorials, airmails, big bargain 5c with approvals. Capital Stamps, Dept. 2, Little Rock, Ark.

DEALERS—Wholesale list. Postage 3c. Frank, 5031 Queensberry, Baltimore 15, Md.

118 DIFFERENT Stamps including commemoratives, charities, airmail sets, etc., only 3c to approval buyers. We buy collections. Badger Stamp Co., Milwaukee 3, Wis.

VICTORY Packet free—Includes stamps from Tanganyika, British Cayman Islands, animal, scarce babyhead, coronation, early Victorian, airmail, map stamps, with big catalogue—all free. Send 5c for postage. Gray Stamp Company, Dept. PM, Toronto, Canada.

FREE! The Stamp Finder! Send today for the big new edition, fully illustrated, enabling you instantly to identify all difficult stamps! Also fine packet strange, fascinating stamps from Bosnia-Herzegovina, Monaco, Patiala, Cyprus, etc., including maps, ships, animals and strange scenes. All free to approval applicants enclosing 3c postage. Garcelon Stamp Company, Box 900, Calais, Maine.

MINT George VI eight crown colony pictorials including bi-colors 10c to serious approval applicants. Mutual Stamp Service, 5145P Village Green, Los Angeles 16, California.

HOBBIES AND COLLECTIONS

"GEM Cutting." Profitable, interesting hobby. Instructive illustrated booklet, one dollar. Mineral Specimens Company, Box 1191, Santa Monica, California.

BOOK Matches—your name, address, or initials. 50—\$1.25. Samples, Press, 749 S. Plymouth, Rochester 8, N. Y.

THE Hobby Directory for men and boys. Box 91, Sc. Orange, N. J.

JOIN World's most popular hobby club, receive money-saving privileges. Free magazine "Fun With Hobbies." Send 10c for 32 page catalog. All details, Hobbyguild, B34 West 33rd St., New York.

EXCHANGE Your duplicate stamps, match covers, post cards, or any hobby, with collectors everywhere! Exchange register listing swappers, 10c. (Mention hobby.) World Hobby House, Box 721-A, Olympia, Wash.

YOUR Wartime ship painted in oils, lifetime souvenir for den, office, 8"x10". Send ship's name, class, and five dollars. Eric Lee, Box 245, San Anselmo Post Office, California. Refund if unsatisfied.

LET'S Swap! Whatcha got? Whatcha hobby? Dime trial "National Exchange Bulletin," Royal Oak, Mich.

INDIAN War bonnet kits, archery supplies. Write Chas. T. Schneider, Whitehall, Michigan.

GROWING Easter lilies is an interesting and profitable hobby. 3 mature bulbs \$2.00 or \$6.00 a dozen, formerly sold to nurserymen and florists only. Shaprack Outdoor Nurseries, Crescent City, Calif.

FOREIGN Medal ribbon packet, United Nations, Axis. \$1.00, sample 20c. Insignia-craft, 236 28th Avenue N.W., Calgary, Canada.

SWAPPER? Collector? Send 10c for sample copy Hobbyswap Contacts, 1326 South 27th, Omaha, Nebraska.

MILITARY Insignias: 22 different for \$1.00 (value \$4.60.) Introductory offer, never before equalled. Prices and insignia guide 10c; sample 5c. Hobbyguild, P35 West 32nd Street, New York.

INVENTING Can be an interesting and profitable hobby. Write for complete particulars. Institute of American Inventors, Dept. 40-E, 1926-Eye St. N. W., Washington 6, D. C.

COLLECTING Hobbyists. Exchange duplicates. Swappers directory 10c. C. Bishop, Route 8, Kalamazoo 88, Michigan.

COLLECT Colorful Army patches. Pictures, prices and sample patch only 10c. Insignia Mart, 703 Broadway, N. Y.

UNUSED Match book covers, 100 all different \$1.00. 35 Royal Flash covers \$1.00. Free list. Charles Edelman, 1311C East 84, Cleveland 3, Ohio.

JEWELRY Stones removed from rings, etc., 100 assorted \$2.40; 50 large ones \$2.40. B. Lowe, Holland Bldg., St. Louis 1, Mo.

ANTIQUES, RELICS, INDIAN GOODS, CURIOS

MUSEUM Specimens. Indian relics, curios, den decorations. Illustrated catalogue, identification chart 25c. We also buy. Museum Supplies, 6601 Oshkosh, Chicago 31, Illinois.

ANTIQUA Firearms, swords, daggers. Lists free. Mart, 1536 Wellington, Philadelphia 21, Penna.

COINS, Minerals, glass, Indian relics. Catalogue 5c. Cowboy Lemley, Las Cruces, New Mexico.

50,000 INDIAN Arrows, tools, rainbow variations. Don McKillop, Regina, Sask.

SWORDS, Rapiers, daggers, pistols, armor. Illustrated catalog 50c. Robert Abels, 860-A Lexington Ave., New York.

4 FINE Ancient arrowheads, \$1.00. Stone Tomahawk, \$1.00. Flint knife, 50c. List free. Lear's, Box 569, Galveston, Texas.

MINERALS, PRECIOUS STONES

TWENTY Square inches cabochon blanks, jaspers, agates, etc. \$2.50 postpaid. Fred's Gem Shop, Hansen, Idaho.

"GENUINE" Arizona rubies (garnets). Send quarter for packet. Mineral Specimens Company, Box 2651, Phoenix, Ariz.

METAL Detectors. We have the latest in circuit and mechanical design plus the know how. Free literature. Hedden Metal Detectors, 221 Hemlock St., Pittsburgh 12, Penna.

IDENTIFIED Mineral and rock specimens, 31 different (1x1) sent in mailing envelope \$2.00. List of additional specimens included. Tharp's Gem Shop, 506 Bellevue Place, Austin 21, Texas.

ROCKS And Minerals, big monthly magazine, \$2 year. Magazine Mart, Plant City, Fla.

WYOMING Jade: square inch each, light and dark green. Slab each dinosaur carnelian, turritella agate. All for \$1.00. Money back guarantee. Jade & Agate Supply Company, Box 166, Casper, Wyoming.

CAMERAS AND PHOTO SUPPLIES

NOW Available: Your 8mm. home movies unit: For outdoor and indoor use: Black and white and Kodachrome. Revere 88, coated F2.5 lens and case, \$75.00. Three lens turret model Revere 99 coated F2.8, \$97.50. Wide angle and telephoto lenses available. Revere 85, 500 watt, de luxe projector, \$95.50. Projector carrying case, \$11.95. Beaded screens, all sizes. Also splicers, films, filter kits, projector stands, rewinds, accessories. Immediate delivery. Conway Camera Company, 34 North Clark Street, Chicago 2, Illinois.

PRINT Box: Build your own. Professionally designed to include special spot lighting device. Complete blue prints and instructions \$1.00. Complete kit for home finishing and assembly. 5"x7" window \$10.50. 4"x5" window \$7.50. Pettit Pac Products, Box 112, South Pasadena, Calif.

SURPLUS Bargains, scarce cameras, nationwide directory 25c. Seymour, 101-H Sherman Avenue, New York 34.

1,000,000 **CANDLEPOWER** Electronic photoflash gun. Free literature. Kokomo Enterprises, Box 270 P, Kokomo, Ind.

FILM, No limit, 6 rolls 127, \$1.65; 120-820, \$1.98; 116-616, \$2.30; Falcon candid cameras with case, \$3.98, cash or c.o.d. Imperial Foto, 122 Sharon, Glendale, Ohio.

35MM. Spartus camera F7:7 36 exposures, automatic counter, \$11.75 postpaid. Cavalier Camera, 1822 Center, Pittsburgh 19, Penna.

MINICAM Photography, big monthly magazine, wonderful, \$2.50 year. Magazine Mart, Plant City, Fla.

CAMERAS, \$4.20 Postpaid. Adams Service, 1009 South Seventh, Waco, Texas.

PHOTO Printer kit \$1.00. L. Spada, 10 Lexington, Wethersfield 9, Conn.

FILMS, 5 Rolls, postpaid 127—\$1.40; 120 or 620—\$1.70; 116 or 616—\$1.95. We buy cameras, lenses, etc. "Cameramen," 542x Fifth Ave., New York 19.

CAMERAS, Enlargers, projectors. Lowest prices. Free catalog. Cavalier Camera, 1822 Center, Pittsburgh 19, Penna.

ADVANCED Amateurs anticipating opening business, amazing details. Photographer, Midland Park, N. J.

BASS Says: Trade cameras? For 36 years Bass has satisfied thousands everywhere! Finest equipment available. Always satisfaction guaranteed or your money back! Bass buys 'em, sells 'em, trades 'em. Bass Camera Company, Dept. AG, 179 W. Madison St., Chicago 2.

HAVE You a camera? Improve your hobby of photography and learn how to make better pictures. Write today for our latest book catalog and sample copy of American Photography, containing articles and pictures by the world's foremost writers and photographers. Camera House, 601, 353 Newbury St., Boston 15, Mass.

CASH! Spot cash for cameras, lenses, binoculars, movie and still equipment. Send full description for prompt cash offer. Over 36 years of dependability. Bass Camera Company, Dept. AG, 179 W. Madison St., Chicago 2.

PHOTOGRAPHY For pleasure or profit. Learn at home. Practical basic training. Long established school. Write for booklet. American School of Photography, 1315 Michigan, Dept. 3432, Chicago 5.

USED Camera Directory, Box 1031-M, Canton, Ohio—lists hundreds of war-bargain used cameras—35mm., Speed Graphics, Kodaks, Rolleiflex—many others. Send 25c for latest issue.

PHOTO FINISHING

BEAUTIFUL Enlargements from negatives. 5x7—30c. 8x10—50c. 11x14—\$1.00. If you send photo include 50c extra. Jeannine Photo Service, 3855 N. Tripp Ave., Chicago 41, Ill.

GREETING Cards—Christmas, Thanksgiving, wedding, birthday, etc. with your picture on them. Send for free sample and list of styles and prices now. Photo Craft, 61 Wales St., Boston 24, Mass.

ROLL Developed, 8 brilliant fadeproof Velox prints and two professional enlargements 25c. Overnight service. Young Photo Service, 405-C, Albany 2, N. Y.

DOUBLE Weight enlargements. 8x10's 30c. Four—\$1.00. 5x7's 20c. Six—\$1.00. Either size colored \$1.00 each extra. Send negatives. Empire Photos, Adams Center, N. Y.

QUALITY And service; rolls developed and printed 25c, with jumbo enlarged prints 30c. Skrudland, 6444-Z Diversey, Chicago.

PROFESSIONAL Coloring! Photos oil colored, 5x7, \$1.00; 8x10, \$2.00. Send negative or photo with complete instructions. Esaki, 608 Pearl, Monterey, California.

FREE—Set of filters for names and addresses of four camera owners. Photo-Craft, Canton 1, Ohio.

1c PHOTO Sale! Order one 8x10-in. enlargement of your favorite snapshot at new low price of 39c, and get another for 1c. Send only 40c and negative (not print) for two 8x10 enlargements, and free literature—"How to Color Your Own Photos." Write today. Bostonian Photo Lab., Dept. 104-B Uphams Corner, Boston 25, Mass.

PHOTO Finishing by mail. Our door is as close as your mail box. Mailing envelopes and price list upon request. Quick, expert, and inexpensive service. Dobris Photo, P.O. Box 346, Glendale, Calif.

PHOTO-STATUES Made from your snapshots. Circular free. Brooklyn Model Shop, 818-B Coney Island Ave., Brooklyn 18, N. Y.

8 PRINTS, All enlarged to nearly postcard size, from your roll or negative, 25c. Willard Studios, Box 3535A, Cleveland 18, Ohio.

SPECIAL—50 Reprints \$1. Suburban Studio, 1410 Bond, Rockford, Illinois.

EMBOSS Christmas cards from your own negative. For samples send negatives and 25c. Film Capital Service, 818 Dewey Avenue, Rochester 13, N. Y.

XMAS Bargain—Your favorite snapshot enlarged 8"x10", beautifully oil colored, only \$1.75. Send negative and color instructions. Kolorkraft, 1626 Buena Vista, Alameda, California.

ROLL Developed, 2 enlargements, 16 prints, 25c. Dick's Photo, F-7, Louisville, Ky.

NEW Amazing Plastik-Prints. Secret process. Post war invention. Nothing like it. Sharper, clearer, fade-proof, water resistant prints. Lifetime guarantee. 6 or 8 exposure roll finished 30c. Reprints 3c. World Photo, Joplin 9, Missouri.

ROLLS Finished, 8 ex. 20c., 12 ex. 25c. Free folder and mailers. Acme Photo Service, 11810 Geraldine Ave., Cleveland 11, Ohio.

SAVE \$1.00. Order 100 reprints at 3c each and receive an 8x10 tinted enlargement in a beautiful mount (value \$4.75) for \$3.75. Fred D. Eastman, Bode, Iowa.

ROLL Developed and 8 beautiful enlargements 2 to 6 times larger. Deckled edge—high gloss. Any 8 exposure roll 25c coin. 12 ex. 35c—16 ex. 50c—36 ex. \$1.00. Reprint enlargements 3c each. Alden Photos, 94-3 Astor Sta., Boston, Mass.

8x10 **ENLARGEMENTS** 40c; 5x7, 20c. DBW, 72 San Benito Way, San Francisco, Calif.

SNAP Service—8 exposure rolls developed, best quality velox prints, 35 cents. Reprints 4 cents. Snaps, Box 345, San Leandro, Calif.

ROLLS Developed and printed 25c, or eight reprints for 25c plus double weight professional enlargement coupon free with each roll. Cut rate quality would cost you more elsewhere. Films for all cameras now available. Cut Rate Photo Service, Dept. S, Box 236, Regina, Sask.

FREE Snapshots! Free album! Mail this ad and two negatives for free snapshots complete in album! When you see these free samples you'll want more. Artisto, Dept. 131, Drawer 220, Regina, Sask.

ROLL Developed, 8 prints, 25c. Free enlargement coupon. Free mailer on request. Smith's Foto, 9621-A Dobson, Chicago 28, Ill.

CENTURY Delivers work and service that can't be beat. Sixteen famous Century-Tone prints each 8-exp. roll 30c. Free mailers. Century Photo Service, LaCrosse, Wis.

SMITH For quality! Any 8 exposure roll developed, 8 prints and two enlargements, 25c, 8 double-size prints, 25c. 35mm. fine grain developed, 36—3 1/4x4 1/2 enlargements, 90c; 18—55c. Cartridge refilled, 36 exposures, 35c; 18—20c. Write for sample print, mailers and price list. Smith Studios, 8 Saint John Street, Plains, Penna.

8 HOUR Service. Your 8 exposure roll developed and printed jumbo or regular size 25c, deckled edge if requested. 12 exposure rolls 35c, 16 exposures 50c, 36 exposures \$1.00. Reprints jumbo or regular size 3c each. All film developed fine grain. Workmanship, materials and 8 hour service guaranteed throughout. Quality Photo Service, Box 468, San Francisco 1, Calif.

2 BEAUTIFUL Hi-Gloss prints each good negative and enlarging coupon with each 6 or 8 exposure roll developed 28c. Owlphoto Co., Weatherford, Oklahoma.

FAST Delivery. Satisfaction guaranteed. Eight exposure rolls with two prints of each exposure, 30c; or eight jumbo size prints, 35c, completely finished. Write for special reprint prices. Pioneer Photo Print Service, Box 123, Wichita, Kansas.

AT Last we have films: 116 and 616, 36c ea.; 120 and 620, 33c ea.; 127, 27c ea. Roll developed, all your snapshots hand-colored as beautiful as most actual colored photography 35c. Hand colored reprints 4c each, 12 for 45c. Midwest Photo, Janesville 26, Wisconsin.

BIGGEST \$1.00 Value in 35mm. finishing today. 36 exposure fine grain 3 1/4x4 1/2 enlargements; deckled, embossed margin and date. Eighteen exposures 75c; 16 exposure splits 55c; 36 exposure reloads 50c. Special: return this ad with \$2.00 and we will send five 36 exposure reloads. Free mailers. 8 exposure rolls in beautiful, deckled contact finish with embossed wide margin, 25c. Mailbag Film Service, Box 5440A, Chicago 80, Ill.

GLOSS Finish enlargements. 4 5x7 from negative 50c. 3 5x7 from photo 50c. Robert Renshaw, Jr., P.O. Box 478, Chester, Penna.

PHOTOGRAPHY For pleasure or profit. Learn at home. Practical basic training. Long established school. Write for booklet. American School of Photography, 1315 Michigan, Dept. 3451, Chicago 5.

BEAUTIFUL Double-size pictures 3 1/2x5 each, from 116 and 120 negatives, 3 1/4x4 1/2 from all other sizes. All work guaranteed. Overnight service. Roll developed and 8 pictures 30c. Roll 12 pictures 45c. Roll 16 pictures 60c. Enlargements on double weight portrait paper 5x7—30c, 8x10—50c. Copies made from any picture 75c. Pacific Photo Service, Box 666, San Francisco, Calif.

EVERY Picture an enlargement! 8 sparkling deckle-edge enlargements and roll developed 25c coin; 116 size or smaller; enlarge reprints 3c. Enlarge Photo, Box 791D, Boston, Mass.

SENSATIONAL Introductory offer! Send snapshot or negative, this ad, and 3c. We'll send you a beautiful 7"x5" enlargement! Or, Kodak roll developed with 16 guaranteed deckled-edge velox fade-proof prints or 8 double-size prints, 25c! Special! From your negatives, 16 regular-size or 8 double-size reprints, 25c! Candid rolls—36 exp. 35mm. developed, vaporated, enlarged to 3x4, \$1.00! 18 exp. 50c. Reprints, 3x4, 3c each. We have new, perfect 35mm. film. Low prices. Free mailers, details on request. American Studios, Dept. 279, LaCrosse, Wis.

6-8 EXPOSURE Rolls developed and enlarged mammoth size 30c. Reprints 3c. Thrifty Photos, Box 46, South Gate, Calif.

MOTION PICTURES AND SOUND EQUIPMENT

400 FT. 16MM. motor projectors \$20.95, \$35.95, 8mm. \$20.95, all postpaid. Send stamp for lists. Sterling's, 679 Northampton, Easton, Pennsylvania.

35MM. -16MM. Sound-silent; comedies, features, shorts. Victor Cromwell, Darien, Connecticut.

ZENITH 35MM. sound projector, amplifier and speaker, special \$85.00. Cinematograph 35mm. sound projector, amplifier and speaker \$135.00. Lot of sound films. Mohawk Film Service, Box 201, South Lancaster, Mass.

FILM—Processing not included—100 ft. lengths Double 8, Weston 6 \$1.95; Weston 64, \$3.95; Single 8, Weston 6, \$1.15; Weston 64, \$2.40; 16mm. Weston 6, \$1.85; Weston 24, \$3.80; Weston 64, \$3.90. Free circulars. Fromader Genera, Davenport 7, Ia.

FIVE Slide views—Oldest convict ship afloat 25c. Slide Supply Service, 3111 West Tuscarawas, Canton, Ohio.

8MM.-16MM. Films, equipment bargains. Towers, 935 North Fortieth, Philadelphia 4.

WE Buy, sell, trade, rent, movie film, machines. Send stamps for listings. Mutual Theatre Supply, Springfield, Illinois.

NEW! Sensational! "Miss America of 1946." 8mm., 50 ft., \$2.00; Kodachrome, \$7.50. 16mm., 100 ft., \$4.00; Kodachrome, \$14.75. Kodachrome projection sample, "Waikiki Hula," \$1.00. Catalog, 25c. World in Color, Box 392-F, Elmira, N. Y.

8-16MM. Film bargains. Sound, silent rentals. Big catalog Kodachrome sample 20 cents. Warrington Films, 1418 Knecht Ave., Halethorpe 27, Md.

KODACHROME Movies—8-16mm. Color sample, lists—dime. Projection length color sample—dollar. Campus Films, 668-F, Ithaca, N. Y.

RENT 16mm. sound films 50c reel. Large selection; free catalog. Film Service, 128 Chestnut St., Roselle Park, N. J.

35MM. Sound films. Outright sale. Rogers, Box 26, East Atlanta, Ga.

"THE World's Greatest Passion Play," all sizes sound and silent. Write Hemenway Film, 33-F Melrose St., Boston 16, Mass.

BARGAINS: 16mm., 35mm. movie cameras, projectors. Avond, 24 West 46, New York.

PINEST Movie screens, inexpensive, make them yourself. Free literature. Snow White Screen Company, Danville, Illinois.

HOME Movies, big monthly magazine, knockout. \$2.50 year. Magazine Mart, Plant City, Fla.

FREE List 8mm., 16mm., or sound. P. Simpson, Box 201, Charleston 21, Va.

GUARANTEED Fresh movie film! Dalite loading! Processing free! Three spools double 8mm., \$3.45! Six single 8mm. for Univex, \$3.50! Postpaid. Eso-S, 828-B West 39th, Kansas City 2, Missouri.

TRIMENSIONAL — Latest multiplane home movies, 8-16mm. Descriptive catalog free. Producers Service, Suite 118, 6770 Hollywood Blvd., Hollywood 28, Calif.

LEARN Professional motion picture technique at home. Approved for veteran training under G.I. Bill. Free catalog. Motion Picture Institute, Birmingham 4, Mich.

ADD Sound to your 16mm. silent projector. Details on request. Home movies. All kinds. Catalog 10c. Box 337-A, Valley Stream, N. Y.

FREE! 8mm.-16mm. catalog! Eso-S, 828-B West 39th, Kansas City 2, Missouri.

8MM. Films. Big bargain list! Exchange plan! Free! Values, Woodbury, Conn.

RENT 8MM.—16mm. and sound films by week. New catalogs. Lowest rates. Dayton Film, 2227 Hepburn, Dayton 8, Ohio.

16MM. Motor driven projector \$18.00 postpaid. Selco Products, Danvers 1, Mass.

UNUSUAL 8-16 mm. Film subjects. Big catalog with sample film, 10c. National Film Exchange, Broadway, Sta. E, Toledo 9, Ohio.

TALKIES: Convert your silent 16mm. projector into sound with our guaranteed parts kit. Plays all 16mm. sound films. Quickly assembled at home. Special introductory offer: Send this ad now with \$19.95, check or money order, and we will include sound test film, instruction manual and full information on how to use with your radio, postpaid, or send \$1.50 for complete blue prints showing how to make adapter yourself. Soundtech, Box 3071, Hollywood 28, Calif.

COMPLETE Stocks always of Castle, Official, Pictorial films, 8mm., 16mm., sound, Musicals, soundies, free catalogs. We exchange your films and equipment, or buy them for cash. Frank Lane, 5 Little Bldg., Boston, Mass.

FRESH Movie camera films 100'—16mm. \$2.25, three rolls \$6.00, 25' double 8mm. \$1.25 developing included. Ambassador, 479-A Quincy Street, Brooklyn, N. Y.

HOME Movies. Rent, buy, swap 8mm.-16mm. silent and sound at money-saving rates. Details for a dime. Midland, Box 429, Oak Park 4, Ill.

BASS Says: 36 years of leadership in the motion picture equipment field. Sound projectors, 8 and 16mm. equipment, finest accessories. Bass buys 'em, sells 'em, trades 'em. Always satisfaction guaranteed or money refunded! Bass Camera Company, Dept. A, 179 W. Madison St., Chicago 2.

I BUY, Sell, swap, rent s.o.f., 8 and 16mm. films. List free. Harvey Iris, Box 539, Brockton, Mass.

MAKE \$8 To \$10 net profit daily with your 8mm. or 16mm. projector. Details free. Metcalf, 10806 Glenroy Ave., Chicago 43, Ill.

UNUSUAL Home movies—travel, adventure, sports, news, war films. Many film bargains. Big 1946 catalog and sample, dime. Audet, Box 6520-BG, Philadelphia 38, Penna.

LEARN Movie projection, management. Free catalog. Theatre Institute, Elmira, N. Y.

MOVIE Camera films, 100' 16mm. \$2.50, 25' double 8mm. \$1.25. Free developing. Better Films, 742 NewLots, Brooklyn 7, N. Y.

16MM. Projectors, films, sound, silent. Lists. Myror Osborn, Lebanon, Ohio.

MUSIC AND MUSICAL INSTRUMENTS

GUITARS, Mandolins, violins, accordions, banjos, amplifiers, pickups, accessories, phonographs, records. Catalogs free. Wack Corner, 32nd and North, Milwaukee, Wisconsin.

10 POPULAR Records \$3.00. James Weinman, Box 54, Jericho, N. Y.

NEW Italian accordions, all sizes. Wholesale prices. Free catalog. American Accordion Center, 39 So. Kedzie Ave., Chicago 12, Illinois.

FINE Harmonicas: \$2.90, \$5, \$7.75, \$9.75 instrument bargains. Musician's Shop, 2 E. Centre Street, Baltimore 2, Md.

PIANO-PLAYERS: Sensational popular music chart shows 648 treble, 18c bass chords; includes names; symbols; readings; enharmonics; notation. You need this chart! \$1.00. Carol, Box 21PM Lefters, Brooklyn 25, N. Y.

PIANO. Play by ear in one week. Quickest, easiest short cut system in the world. Write Duncan Institute, Ortega, Jacksonville, Florida.

POEMS Wanted! I'll compose special music. Send poem for free examination. Elliot Wright, Master Composer, 107 Rivoli Theater Building, Portland, Oregon.

NEW Booklet, "Hints on Writing Song Hits." Instructive, enlightening, interesting. Send \$1.00 today. Howard Simmon, 2012½ Fairfield Avenue, Fort Wayne 6, Indiana.

POEMS Wanted for musical setting. Send poem for immediate consideration. Many of our songs have been published by ASCAP and BMI publishers and broadcast. Five Star Music Masters, 63c Beacon Building, Boston.

ACCORDIONS, Wholesale prices. Request circular. New streamline accordions. All sizes and makes. Monarch Accordion Co., 44 N. Albany Ave., Chicago, Ill.

GUITARISTS—Play professional—modernistic, runs, breaks, modulations, introductions, futuristic chords. Same material professionals use. (Diagrammed.) \$5.00. Nicosia, Box 596MJ, Brooklyn 1, N. Y.

PIANISTS—Quickly improve technique, sightreading, accuracy, memorizing, playing through mental-muscular coordination. Free booklet. Broadwell Studios, Dept. 46-K, Covina, Calif.

HAWAIIAN Guitar charts (A, E tunings): all stringed, fretted instruments. Play popular numbers from piano music, no transposing. Copyrighted charts show notes on staff, fingerboard position. Easy, \$1 each. Ted Richards, P.O. Box 507, Santa Rosa, Calif., Dept. A.

HARMONICAS: \$1.50, \$2.00, \$2.90. Double row: \$5.00, \$7.75, \$9.75. Accordions, guitars, drums. Free pricelists. Musician's Shop, 2 E. Centre Street, Baltimore 2, Md.

GET The best! We have prepared many song hits. Write for details. Holly-Star Music, 6411 Hollywood Blvd., Hollywood 28, Calif.

WORLD'S Simplest method! Beautiful Hawaiian guitar given! Play songs first lesson. National Institute, Exchange Building, Spokane 8, Wash.

USED Juke box records. Dollar brings surprise package of four popular recordings. Victory Sales, 425 Burnet Avenue, Syracuse, New York.

MIGHTY Organ recording of your song. Details free. Hanert, 11030 Hermosa, Chicago 43.

SONGWRITERS—Send poems for immediate examination and free book, "Your Future in Songwriting." Radio City Music Academy, 1674 Broadway, New York City 19.

TRANSPOSE Music yourself. Save hours of labor. Send \$1.00 for the "Wizard Transposer." Walters, 4170 Blenheim St., Vancouver, B.C., Canada.

CAN You write verse? Kleinman, 25-31-B 30th Road, Astoria 2, N. Y.

WE Want song poems and lyrics on all subjects. We offer the services of a noted Hollywood motion picture composer and arranger. Send your poem today for consideration and our liberal offer. Hollywood Melodies, P.O. Box 2168PM, Hollywood 28, Calif.

MUSIC Composed to your words; music printing done. Reginald Belcher, Florham Park, New Jersey.

YOUR Poem musicalized, \$2. Recording, \$3. Guaranteed. Professionals, Mill Valley, California.

SONGWRITERS—Write today for free booklet "Getting Ahead in Songwriting" and our attractive offer. Song Service, 331-C West 46th, New York.

SONGWRITERS! Melodies composed, reasonable. Billy Hannon, 6703 N. Oshkosh, Chicago 31.

MUSIC Arranged. Songs printed. Frank Wildt, Music Publisher, Lancaster, Penna.

SONGWRITERS! Outstanding, ethical offer. Hibbeler, C5, 2157 N. Avers, Chicago.

SONGWRITERS, Have your songs completed by an honest, experienced arranger. Submit songs for free analysis. Tommy Kilbourne, Box 1253, Bakersfield, Calif.

THE 96 Page "The Complete Songwriter" tells how to write music, words, arrangements and publishing. Send \$2.00 M.O. Puritan Publishing Co., Inc., 343 So. Dearborn St., Chicago 4, Ill.

"GUITARS"—"Band and orchestra instruments"—"harmonicas." List free. Rudolph's, Atchison, Kansas.

WANTED! Lyrics, melodies for songs. We arrange, publish, sell. Superior Song Studios, Passaic, N. J.

BEFORE Sending your poem to be set to music, know your composer. Free folder. Al. Moquin, 5333 La Cresta Court, Hollywood 38, Calif.

SONG Writer's attention! The amazing demand for phonograph records, accelerated by more than 300,000 juke boxes and the hits popularized warrants your immediate consideration. We are offering song-poem writers the rare opportunity of having established composers collaborate on appealing material received this month. Recola Records, Box 987P, Hollywood 28, Calif.

POEMS Wanted for musical setting. Send poem for immediate consideration and free rhyming dictionary. Richard Brothers, 24 Woods Building, Chicago.

SONGWRITERS—Send poems for immediate examination and free book, "Your Future in Songwriting." Radio City Music Academy, 1674 Broadway, New York City 19.

SONG Poems wanted. Free examination. McNeil, Master of Music, 510-PM South Alexandria, Los Angeles, Calif.

WRITE Songs. Big money and reputation. Write for information. J. Gordon Pub Co., 201 N. Hoyne Ave., Chicago.

LEARN To play the piano by ear in one week. The quick easy way. Write. E. Morrison, Box 9312-N, Station S, Los Angeles 6, Calif.

RADIOS AND SUPPLIES

VEST Pocket radio! What fun! Listen while strolling or cycling. Local or distant reception. Plans sold around the world. Kits available. Cheap, easy. Free photograph with plans. Rush \$1.00. United Manufacturing Associates, 3316-8 Ave. G, Fort Worth 5, Texas.

50 PAPER And mica condensers \$1.00. Brand new. Fine assortment. Popular sizes. Weight 1 lb. FOB. Dalizer, 19 Micieli Place, Brooklyn 18, New York.

FM Can now be heard on old radios! Postcard brings free data! Topical Emprise Corporation, 1527 Highland, Box 42, Louisville 4, Ky.

"RADIOBUILDER"—Parts, data. Sample 10c. Laboratories, Box I-c, San Carlos, California.

THROAT Microphone button, with instructions. Army surplus. \$1.00 postpaid. Radio Roy, P.O. Box 2225, Portland 14, Oregon.

ELECTRONIC Organ easily constructed from radio parts. Plans \$1.00. Quaker Radio, Box 68, Salem, Ohio.

AMAZING Radio. Operates free. Positively needs no house current, no batteries. Has no tubes. Remarkably, requires no ground connection and no lengthy old-fashioned aerial. Has specially designed, radio impulse receptor, 6½ ft. sq. Receives local standard broadcasting stations. (Exciting long distance reception at night.) Radio gives headphone operation for personal use. Has excellent tone; adequate volume, sensitivity and power of selectivity. Exceedingly simple to operate. Can be built even by teen-age youngsters using wire and only a few ordinary, readily obtainable, reasonably priced, new or used parts. This practical radio sensation may well develop into an "atomic bomb hit" amongst hobbyists, young and old. Be the first in your neighborhood to build and enjoy this thrilling radio. For all necessary plans and illustrations send \$1 to: Paul Seman, Dept. 4, 1522 Fred St., Whiting, Ind.

NEW! Quality test meter for 1½-90 volt battery packs. Sample \$3.50. Agents wanted. Ehmann Company, Geneva, Ill.

FAMOUS "Allen" midjet semi-fixed crystal detector. Set building plans and 100 late crystal set distance reports all for 50c postpaid. Allen, 427-2, Clinton, Mo.

1946 RCA, Philco, radios. Refrigerators. Washers. Appliances. Fast delivery. Write Gravelle's, Kennedy, Alabama.

MONEY in radio. Now. Complete radio service and repair course (all types). Also instructs on establishing own business. Easy, quick. Only simple education needed. Formerly \$6.45, sent complete including charts for \$1.15 postpaid. Thousands sold. Hazleton Enterprises, Dept. 3, 302 Temple Court Bldg., Chattanooga, Tenn.

FREE New radio catalog is ready! Radionic's catalog lists hard-to-get radio parts, books, amateur, test and P.A. equipment. All available for immediate shipment. Send today to: Radionic Equipment Co., Dept. SS-10, 170 Nassau St., New York 7, N. Y.

TEST Condensers, resistors, leaky, shorted, open, found instantly! "Most used tester." Plans, instructions \$1.25. Ceeten Products, 300 Bolling, Radford, Va.

YOU Can't beat these prices on "hard-to-get" transmitters, parts, electronic equipment. Portable and mobile FM transmitter and receiver—complete with 80 crystals, tubes, telephone handset, aerials, accessories, less batteries—\$79.50! RAK-7 long wave receiver, complete with extra set of parts and tubes—\$64.50! Telephone handset, TS-13 with 6 foot cord and PL-55 and PL-68 plugs—\$2.95! T-17 B 200 ohm carbon mike—\$1.75! 80 meter transmitter BC-233-A (less tubes)—\$22.50! Headphone 8000 ohm HS23—\$1.50! Hurry! Quantities limited! Rush order today! Send 25c deposit with order. Hundreds of other money-saving values in Mid-America's big catalog! It's free! Mid-America Company, Dept. P-106, 2412 S. Michigan, Chicago 16, Ill.

BUILD Your own radio. 5 tube super kit complete with tubes and cabinet using 50L6, 35Z5, 12SA7, 12SK7, 12SQ7. Easy to wire. Your cost \$16.95. McGee Radio Co., 1330 Broadway, Denver, Colorado.

RADAR Crystals for your crystal set. Free details. Hayes, 4004-H Arcade Bldg., Seattle 1, Wash.

RADIO Craft, big monthly magazine, unusual. \$2.50 year. Magazine Mart, Plant City, Fla.

FREE New fall lists, radio parts, books, specialties, diagrams. Dept. M, John Barron, Box 128, Ft. Hamilton Station, Brooklyn 9, N. Y.

WESTERN Electric fixed crystal. Extremely sensitive. Excellent for crystal sets. Gives strong loud signal. No adjusting. Cost government originally \$5.00, special 99c prepaid. New. Free list, Dept. 79, Radio City Labs., 30 Church St., New York 7, N. Y.

CATHODE Ray tubes 5CP1's brand new \$7.95 (plus 6-lbs. shipping), socket with tube 45c, otherwise 90c. 5CP1 steel shields 85c (3-lbs.) Brand new 954.956 Acorn tubes, original cartons, 89c each postpaid. Free electronic bargain list. Ohmeyer Engineering, Dept. D, Fairview Blvd., Hempstead, N. Y.

CRYSTAL. "Extra-loud" set instructions, catalog, 25c. "All About Crystal Sets," booklet, 45c. Amorose Radio, Route Four, Richmond, Virginia.

RADIO Service men and experimenters send stamp for our giant radio catalogue. Save dollars. United Radio Co., (1000-V) Newark 1, N. J.

LOUD Speaking crystal radio, improved design. Illustrated plans 25c. Radio Clinic, 10631-C Euclid, Cleveland 6, Ohio.

FLAT Rate schedules improve profits. Compiled from 500,000 jobs. Write for information. Radio Equipment Co., 1415 W. Franklin Ave., Minneapolis 5, Minn.

RADIO. Electronic parts and equipment. New and used. Write for free list. Highbridge, 340 Canal Street, New York 13, New York.

BUILD This world's smallest a.c.-d.c. radio with built in loudspeaker! Uses one tube! Easily fits in ladies' handbag or briefcase. Send 50c for plans, photos, instructions. Louis Toth, P.O. Box 110, Station H, New York 25, N. Y.

MAKE Simple, tubeless, batteryless, distance-getting crystal radios. Crystal and illustrated instructions 25c postpaid. Allen, 427-P, Clinton, Missouri.

RADIO Technician and radio service courses. Training for federal licenses. American Radio Institute, 101 W. 63 St., New York City. Approved under G. I. Bill of Rights.

BUSINESS OPPORTUNITIES

MODERNISTIC Plastic name plates for home, office. Excellent sideline sells for \$1.50. Send \$1.00 for your own name plate. Use as sample. Sales kit included. Justice Plastic Co., 2196 Parkman, Warren, Ohio.

SHELL Jewelry—Easy to make, easy to sell, highly profitable. Beginners kit, containing all materials and illustrated instructions for making six colorful brooch and earring sets, sent postpaid for only \$3.00. Free price list of shellcraft supplies. Department B, Don-Dee Shellcraft Industries, 120 N. Orange Avenue, Orlando, Florida.

OWN And operate your own business—selling "hard-to-get" electric fans, fluorescent lighting. No investment necessary. Immediate commissions. Glorious opportunity because merchandise available now! Get your territory right away because other scarce items like cameras will be available soon. No bulky samples to carry around. You sell from beautiful illustrations. Send for complete sales story today! Write or wire All-American Mfg. Co., Dept. C, 1114 So. Michigan Ave., Chicago 5, Ill.

ESTABLISH Profitable mail business at home. Opportunities literature free. Geele, 3754 N. Pt. Washington, Milwaukee 12, Wis.

BOOKKEEPERS. Cost clerks, accountants may earn fees of \$500 to \$5,000 as cost consultants installing modern cost control systems. Learn direct from successful firm of industrial analysts and cost consultants, through ten sets instructions at \$10.00 each. Unusual opportunity, territory limited. Room 1504, Fidelity-Philadelphia Building, Philadelphia 9, Pa.

BEST Mail order seller in years! Be independent. Have your own business at home. Full-part time. 25c brings how booklet, plans, exciting ideas. Hadeland Publications, Box 27-A, Ridgewood, N. J.

FIFTY "Prize-Winning" mail order plans. Guides you to a profitable business; home or office. Free details. National Enterprises-P, 10 Waverly Place, New York City.

FLASH. Classic novelty. Big business for you. Hurry, dime. Robert Martin, PM 57 Hart, New Britain, Connecticut.

OPERATE Mail order book shop. Sell books, magazines, post cards, stationery, office supplies by mail. Start small, at home, in spare time and expand rapidly. Kraft, Aurora 2, Mo.

BIG Profits. Sell books by mail. Clark, Box 515, Schenectady, N. Y.

BRONZING Baby-shoes! Big profits! New field! Details free! Write, R. O. Morgan, Box 349, Long Beach 2, Calif.

OPERATE Profitable mail order business. Splendid opportunity. For details write Gus G. Niforos, 380 So. Winooski Ave., Burlington, Vermont.

MAKE Liquid marble, flexible molds, statuary, art goods, novelties, artificial marble flooring. Literature free. Kemico, Park Ridge 10M, Ill.

START Big-paying home mailorder business. Write. Jackson, Newfoundland 2, Kentucky.

SHORTHAND And typewriting. Complete course, 50c coin. George Gundrum, LeRoy, Michigan.

"AIRCURE" Liquid rubber makes genuine flexible molds. Quart \$2.95, gallon \$9.00. Special, three different production molds \$2.95. Molds made to order. High-luster finish, china glazes plaster, gallon \$4.00. "Chipproof" casting material \$5.00 per 100 pounds. Illustrated mold, material catalogue, manufacturing information, "free with order." Terms cash. Prices f.o.b. Aircure, 3873A California, San Diego.

ILLUSTRATED. How to make simple flexible molds. 50c. Illustrated advanced mold making \$1.00. Apex Plastic Products, 1740 Estes, Chicago.

SIX Mail order magazines, all different. 16 to 72 pages each. Full of money-making information, 25c. Kraft, Aurora 11, Mo.

PLASTICS. Start your own business immediately with \$500-\$600 capital. Complete equipment for permanently plastic laminating all types valuable papers, photos, identification cards, badges, etc. Write for free folder. Preco Incorporated, 956 E. 61st St., Los Angeles 1, Calif.

CANDY Kitchen in your own home. Profitable business. Small investment. Complete six lesson course. \$1.00 postpaid. Sokola, 8751 Portland, Detroit 17, Mich.

LOOKING For new opportunities? Mail order and others? Get "The Practical Idea." Write: Veteran, Charleston 6, Ill.

NEW Era of prosperity is here! Start your own business with limited capital. 185 proven business ideas plus hundreds of manufacturing formulas. Win security. Free particulars. National Enterprises-P, 10 Waverly Place, New York.

ADDITIONAL Earnings. Home business. Part or full time. M & M Service, 134 Landon, Buffalo 8, N. Y.

MAIL Order beginners! Hundreds sing praises of "How to Build Your Own Mail Order Business," as uncolored, unbiased, fact-packed "know how" for small-capital-start. Six-step procedure, from idea to mail-bag, 10,000 words. Satisfaction guaranteed. 25c postpaid. Maupins', 327 So. 28th, Lafayette, Indiana.

THE Best air-curing liquid latex for flexible molds. Apex Plastic Products, 1740 Estes, Chicago.

HERE Is five brand new profit making mail selling plans. Free literature. Frank Davis, 68 N.E. Stanton, Portland 12A, Oregon.

MAKE Money selling by mail. Learn in one evening. Details free. Midwest Distributor, Box 4001 Station A, Kansas City 7, Mo.

MAKE Soap at home. No machinery. Profitable. Literature free. Kemico, Park Ridge (SM-10), Ill.

COMPLETE New line of molds for Christmas trade. Vallance Art Products, 1873 E. 70 St., Cleveland, Ohio.

LEARN Practical mail order selling. 15 lessons \$1.00. Details free. Reliance Publications, P.O. Box 755, St. Louis, Mo.

HAVE Your own office! Learn new profitable business in uncrowded field. No selling. Many earn up to \$5,000-\$15,000 yearly. Write for free details. No obligation. No salesman will call. Franklin School, Dept. 202, Roanoke 7, Virginia.

OPERATE Profitable mail order business. Tremendous profits. Patrick Service, Box 3122, Cleveland 3, Ohio.

OPERATE Profitable mail order business. Splendid opportunity. For details write Alfred J. Boucher, 198 Lincoln St., Lewiston, Maine.

TESTED Moneymakers, small capital business plans, self-help opportunities, spare time earning ideas, mail order business information. Low rental; generous travel-time allowance. List free. Bookmaster, Box 871-E, Stillwater, Okla.

MAKE Extra money now. Build to financial independence. Sell office supplies by mail from your home. I tell you how. Jo Troutwine, 8654 S.W. Ninth, Portland 1, Oregon.

BE Independent operating 137 tested money-making plans. Write for full particulars. Star, Box 41, Brooklyn 14, N. Y.

TOM Thumb peanut venders now available again, stock shipment. Write Fielding Mfg. Company, Pearl Street, Jackson, Michigan.

PLEASANT And profitable future. Own stationery and greeting card business. One earned \$1,600 first ten weeks. Details free. Ken Carleton, 25 W. 17 St., Bayonne, N. J.

OPERATE Profitable mail order business. Splendid opportunity. For details write: Wm. F. Liska, Box 337, Cranford, N. J.

YOUR Own cleaning, pressing and dyeing business. Small capital. Good returns. Complete course. \$1.00 postpaid. Sokola, 8751 Portland, Detroit 17, Mich.

DON'T Throw it away! There could be a fortune in your attic or cellar. Write Research Enterprises, P.O. Box 5296, Highlandtown, Baltimore, Md.

OPERATE Profitable mail order business. Good opportunity. Write Walter Service, A-4159 East 112th, Cleveland 5, O.

ESTABLISH Own specialized, profitable advertising business. Make big money practically giving away advertising. E. J. Matteson, P.O. Box 580, Hanford, Calif.

WORK Evenings at home collecting names and addresses. Sell them by mail. Details free. MacAndrews, 8 Buick Street, Calais, Maine.

SELL By mail. Part or full time. Free details. Write Glenn Heck, Box 81, Russell, Kentucky.

ASTOUNDING Modern mailorder plans bring quick profits. Darrah, Orono, Maine.

SELL Merchandise by mail. Proven method shows how. Free details. Johnson Service, Box 23, Allston 34, Mass.

FREE Literature describing many money making plans. Evangeline Mail Order, 910 Prairie Ave., Abbeville, La.

MORE Money than ever will be made this year by our spare time representatives for leading magazines. Send for supplies now for big Christmas season ahead. American Readers' Service, Gwynedd, Pa.

YOUR Future? Mail order your opportunity. Many began small, now make thousands yearly. Send name. Bailey's, 1244 Silva, Long Beach 5, California.

SOAPMAKING: Learn at home. No machinery needed. Posera, AO-4545 Bartlett, Milwaukee 11, Wisconsin.

NEW In mail order! Solve your problems with "The Mail Order Council Book." Hot off the press! Details free. Richard Ponto, Elkton, S. D.

YOUR Own profitable business selling Ramsay Systems. Be first to help G.I. business men and others set up much needed simplified, understandable book-keeping system that will best protect their investment, stop leaks, show added profits. Acknowledged leader. No bookkeeping knowledge necessary to sell or operate. Accountants can service more clients quicker. Large daily commissions. Ramsay Business Systems, Inc., 192 Lexington Ave., New York 16, New York.

SLOW In advancing? Struggling through life? Send now for free details of book that leads to success. Aesir Sales, 199N East Third, New York 9, N. Y.

OPERATE Profitable home business selling merchandise by mail. Fast sellers. Large profits. Powell Service, 5713 Euclid, Cleveland 3, Ohio.

MILLIONS Names. All kinds. State your needs. Q Service, 422 South Dearborn, Chicago 5, Illinois.

OPERATE Your own employment agency. Opportunity for large earnings. Easily learned. Stamp brings particulars. Hunt, Box 308, Burlingame 11, Calif.

DISTRIBUTE Great 64 page mail order monthly under your own name! Sample copy and 12 page confidential manual 25c. L. McCloy, 2261 Marquette, Detroit 8, Michigan.

MANUFACTURE Shell jewelry for Christmas gifts. A great hobby at a great profit. Junior set includes all shells and accessories necessary to make ear bobs, brooches, etc. Complete instructions. Send for free catalogue. Shell-O-Craft Co., Box #365, Station A, St. Petersburg, Fla.

START A home business in spare time. Make extra money. Experience unnecessary. Literature free. Ellmar Services, Muncy, Penna.

FIFTY Tested mail order ideas for profitable, fascinating sparetime home-operation. Send 3c stamp for complete details. Manhattan House, 126-D Lexington, New York 16.

START Profitable business, sell amazing cleaners under your name. Mail or local. Samples 25c. Linnell Co., Box 1720A, Cleveland, Ohio.

A PROFITABLE Mail order business can be yours. Pleasant, easy work, at home, spare time. Start small, grow big. We tell you how. Baker, 303 Sanchez, Ocala, Fla.

LOOKING For opportunities? Ask for outstanding information. Stamp appreciated. New Age Enterprises, 578F Prospect, New York City 55.

BEAUTIFUL Hand-painted novelties. Variety of samples \$1.00. Free list. Plastex Products, 1141 Manhattan Ave., Brooklyn 22, N. Y.

PROFITABLE Home sparetime business, making wallets, belts, other fast-selling leather novelties. Simple to make. Tools not necessary. Amazing opportunity. Send for free catalog. Gold Leathercraft, 632 Desplaines, Forest Park, Ill.

"HOW To start a successful mail order business." The guide to sound, profitable mail merchandising. Only 25c. Manhattan House, 126-B Lexington, New York 16.

REAL Big money opportunity! Details, stamp. MacCormack, C-10, Madeira, Ohio.

AT Home—Your own manufacturing business; making popular \$1.00 novelties. Cost you 3c to 15c. Everything supplied. Write So-Lo Works, Dept. K-600, Cincinnati, Ohio.

"ALASKA—The last frontier offers thousands of job and business opportunities." Fur farming, mining, commercial fishing, aviation, construction, government homestead lands at 25c per acre. \$1 brings 1946 booklet explaining how-when-where to apply. Transcontinental Research, Box 2147-PM, Hollywood 28, Calif.

INTERESTED In South American and foreign employment? \$1 brings 1946 "Foreign Trade Research Report" listing 300 American firms with foreign interests and explaining how-when-where to apply for potential opportunities in oil, mining, construction, export-import, rubber, aviation. L. J. Enterprises, Box 2549-PM, Hollywood 28, Calif.

OWN A mail-order paper products business. Sell envelopes, tags, bags, boxes by mail, wholesale. Tremendous demand. Steady profits. No capital necessary. Write Omaha Envelope Service, Dept. 163, 4721 California, Omaha 3, Nebr.

SELL Books by mail! Big profits! Samples, details, 25c. Variety, 6112 E. 11th, Indianapolis 44, Ind.

MAIL Order business. Sell books by mail. Large profits. Experience unnecessary. Literature free. E. Panico, 306 Fort Hale Road, New Haven 13, Conn.

BUILD Big income mail order business at home. Free details. News Specialty Co., Mansfield, Ohio.

GET Into mail order business, anywhere; start small, spare time, grow fast from profits. New, illustrated course, "Simplified Selling by Mail," fully outlines tested, winning methods for building fascinating, successful business, full or spare time. Complete course \$1.98; refunded if not satisfied. Descriptive prospectus free. Frank C. Artz, 1060 Harding Drive, Toledo 9, Ohio.

DOLLARS Daily! Cleared \$1900.00 in two months. Details. Duffy, H56, Covington, Ky.

FORTUNES In perfume—Plan 27c. Income telephoning 19c. Profitable no capital business 21c. All three, catalogue, magazine 50c. "Arrival," 319 S-Marengo, Pasadena, Calif.

HOW And where to obtain capital. Fully explained. Particulars free. Star Service, Wapakoneta, Ohio.

\$246.50 MAKING Baffling secret device without skill, machinery, from former top priority war material costing \$1.50! Guaranteed simple, revolutionary new discovery, unbelievably profitable. Universal appeal. Frank, illustrated proofs free! Rolls Industries, 115 West 16th, New York 11.

LOOK 25 All different mail order magazines and ad sheets 25c. W. E. Martin, Bassett, Va.

MAIL Order business established 1960 for sale. Fox Mercantile Company, Fero, N. Dakota.

MAKE Money by mail at home. Our folio shows you how. Details free. George Beach, 79 Essex Street, Springfield, Mass.

WIRE Products—Large profits, spare time. Designs, instructions 90c. Send now. Enterprise Co., Builders Exchange, Minneapolis.

AMAZE Others. Add faster than adding machine. Free details. Math Institute, Box 633, Mobile 4, Ala.

1946 GIGANTIC Directory of opportunities, advertisers supplies, sources, trade information, mail order ideas, products, wholesalers, valuable tips—just published! Descriptive literature free. Wilkin & Co., 118-AP East Main St., Hillsboro, Ohio.

SMALL Inexpensive greenhouse pays big—Details free. Bowers, Loyalton, Penna.

SELL Religious goods by mail. Big profits. Work spare, full time. Small capital. Everything furnished. Cleveland, 243-B7 White, Clyde, Ohio.

EARN \$10-\$25 Per week spare time. No canvassing. Experience unnecessary. Unique Service, Box 851P, Minneapolis, Minn.

MOTION Picture industry needs trained men. We want representatives. Full or part time, to distribute motion picture correspondence courses. Approved under G.I. bill. Protected territories. Commission basis. References. Write Motion Picture Institute of the U.S.A., Inc., Birmingham, Michigan.

TREMENDOUS Profits mailing literature, dealers' information 3c. General-print, East Orange, N. J.

BUILD Mail order business of your own—Anywhere! Free illustrated prospectus on "Modern Mail Merchandising." Write at once. Mail Enterprises, Inc., 316-A Fox Building, Detroit 1, Michigan.

INVITATION To income. Contact Mib Associates, Fitzsimmons Building, Pittsburgh 22, Penna.

SUPER X liquid molding rubber. Sample jar 25c, quart \$3.00, gallon \$10.00. Free sample. W. Wooley, 115-A Donald, Peoria, Ill.

SPECIALIZED Business information. Lists free. Arkay, Box 37-PM, Westfield, N. J.

40 MAIL Order publications, magazines and circulars. A barrel of opportunity for 25c. Theodore Gordon, 872 Grande Ave., New Haven 11, Conn.

EVERY 25c Invested nets \$1. Details \$1 (refundable). Ray T. Johnson, Brookport, Ill.

MAIL Order magazines, sample free. Schultheis, Box 449, Irwin, Penna.

ESTABLISH Salted nut route, everything furnished. Robinson Associates, 75 Menahan, Brooklyn 21, N. Y.

HARMONICAS, Musical instruments, free pricelists. Wholesalers, 11 E. Centre Street, Baltimore 2, Md.

MAKE Plaster novelties! Special molding rubber. Free sample. Quart \$3.00, gallon \$10.50. Free instructions. Universal Sales, Box 1076-A, Peoria, Ill.

\$46 FROM Square foot plywood. Jigsaw necessary. Write, Woodarts, X-33, Bridgewater, Mass.

PANNING Gold. Learn how and enjoy outdoor life. Booklet, How to Get Started and list of mining books free. Old Prospector, R90, Dutch Flat, Calif.

YOUR Chance for financial independence in your own business. Start spare-time, re-invest profits—grow big! Investigate mail order selling. 40 page book—25c. Literature free. Monham Mail Service, (PMA)-2145 Elm, Norwood, Ohio.

POUR Scrap metal into cash. Instructions \$1.00. Universal Sales, Box 1076-A, Peoria, Ill.

LIQUID Marble—Make in any color. Soundproof plastic flooring. Flexible molds. Cast novelties, plaques, statuary. Big money—your own business. Catalog free. Write—Bing Products, 88-A28 Broad Street, Boston 10, Mass.

VENDING Machines. Be independent. Own a big money business operating coin machines. Earn as high as \$7.00 weekly on machines costing as low as \$11.75 each. Car and experience unnecessary. Routes can be operated either in your spare or full time. Act quickly. Write for details and catalogue showing our amusement games, postage machines, candy-gum nut vendor, scales, and stationery machines. Parkway Machine Co., 623C-W, North Avenue, Baltimore 17, Maryland.

PLASTICS Directory—Wholesale and retail sources for thousands of items, materials, molds, equipment, machinery, supplies. \$1. Plastics Digest, 3937P Tracy, Kansas City 4, Mo.

MECHANICALLY Inclined men—Own and operate general appliance repair shop. Complete, illustrated course shows you how. Welding, refrigeration, motor repair, how to get business, etc., all phases covered. Free literature. Christy Supply, Dept. 169, 2835 N. Central Ave., Chicago.

WHY Job worry? Learn electro-plating, interesting, highly paid business. Postcard brings full details, free. Plater Hyde, Dept. MC, P.O. Box 176, National City, Calif.

SELL Religious goods by mail. Make your own items. Universal Sales, Box 1076-A, Peoria, Ill.

FORTUNES In formulas and trade secrets, details free. Stillman, 555 Kingston Ave., Brooklyn 3, N. Y.

APPLIANCE And building repairs. Simplified. Free literature. Porter, Box 6346-A, Pittsburgh 12, Penna.

CO-PUBLISH Magazine. Many profits. 16-page booklet 10c (refundable). Goldenberg, 5209-E Lindsay, Houston 3, Texas.

OPERATE Profitable business selling, packaging products under your own name. Lyle Products, 5 E. Spaulding, Willoughby, Ohio.

BIG Paying jobs in welding. Complete welding lessons and reference books, 516 pages, 41 lessons, \$2.00 copy. Money-back guarantee. Hobartweld, Box M-1065, Troy, Ohio.

LIQUID Marble, plastics, marbleite, plasters, make your own. Universal Sales, Box 1076-A, Peoria, Ill.

EXCLUSIVE Franchise (patent applied). Exterminating device; big profit. Vogel Mfg. Co., 4510 N. Paulina St., Chicago 40, Ill.

PLASTICS—Casting, molding, forming easily learned. Simplified work-sheets, 70 illustrations, explain reliable methods. \$1. Circular free. *Plastics Digest*, 3937M Tracy, Kansas City 4, Mo.

1000 REPRESENTATIVES Needed. Ford accessory, tremendous profits. Acme, Box 809, Milwaukee 1, Wis.

OPERATE Profitable mail order business. Splendid opportunity. For details, write: Cardinal Sales, Box 146-A, Morganfield, Ky.

MAKE Money making movies, 23,000 word "how" book, \$2.00. Information stamp. World in Color Productions, Box 392X, Elmira, N. Y.

ACCOUNTANTS—Bookkeepers: Operate our system. Forms furnished. Professional assistance. Barnhart & Kennedy, Public Accountants, Chambersburg, Penna.

RUBBER—Airlastex, red or black, prewar quality mold making liquid. Quart \$2.25, gallon \$5.50. Instructions free. New Era Products, 1321-N Belmont, Chicago.

OPERATE Profitable mail order business. Good opportunity to make \$5000 yearly. Details free. Leroy Harris, 310 W. 14th Street, Cincinnati 14, O.

GET The facts concerning "My View Points" about mail order schemes, plans, ideas, sales letters, circulars, booklets, formulas, advertising, circular-mailing and mailing-lists. Know the relationship of these "ten vital subjects" to the "direct-by-mail" order business. Only 25c a copy. Henry E. Piltz Publications, Box 148, East Orange 3, New Jersey.

SIGNS Made easily. Instructions and ten sets modern alphabets, numerals, patterns. Sizes up to eight inches. All for \$1.00. Co-operative Business, Box 638, Chicago.

AMAZING Profits in peanut vendors. Free booklet. Becker Vending, Brillion 1, Wis.

JOIN The National Imprint Dealer Union. 100,000 circulars, your name and address. Look 50,000 circulars \$1.00. Information 10c. Tipton, 229 Overton Place, Knoxville, Tenn.

HOMEWORKERS—Make \$50.00, \$75.00, \$100.00 weekly; plastic gifts, plaques, novelties; material, molds, instructions furnished. Sample pint with rubber mold \$2.00. Plastic Products, 1416-24 Fletcher, Chicago.

LIQUID Marble; snow-white, multi-colored. Glazed. Unglazed. Composition flooring. Lifetime wear. Any color. Flexible molds. Plaster casting. Get into the big money now. Full information given free. See our large ad page 35. Write—Compo-Tex, Box 786-R, St. Louis, Mo.

PROFITS From scrap. Above average return for spare time work. An excellent and interesting hobby. Material cost of less than 50c returns \$2.50. Only tools needed are hammer, chisel, tin snips, file and paint brush. Send for particulars now. Wud-N-Metal Products, Ferris, Texas.

START Profitable mail order business. Write Harry Punch, 1329 Grace, Cincinnati 8, Ohio.

BELTS! Make 'em and make money. No tools! Sample 50c. Artinc Leather, 411 Joseph Ave., Rochester 5, N. Y.

RUBBERFORM—Airlflex "self-cure" latex makes molds overnight; quart \$2.00, gallon \$5.75 with sample mold, directions. Plastic Products, 1416-24 Fletcher, Chicago.

METALLIZE Baby shoes! Learn this money making business from nationally recognized consultant. Get "know how" from outstanding authority! See Kushner ad. page 267.

A BUSINESS Of your own. Make your spare time pay you a profit. A few hours a week can build a profitable enterprise for you. We tell you how. A. F. Giannelli, P.O. Box 993, Schenectady 1, New York.

MAKE Money operating home business spare time. Details free. Fred Timme, 110 Milner Hotel, Omaha 2, Nebr.

DON'T Waste time! Get the newest and best offers without searching. New, unique service brings complete ready to start offers at low cost. Particulars free. American Enterprises, Box 595-B Grand Central Station, New York 17.

MONEY By mail! Profitable proven plan. Valley Service, Box 745-B, Appleton, Wis.

CASTONE—Hardest coldcasting composition on earth, snow white and colors. 15 pounds assorted colors \$2.00, hundred pounds \$7.00. New Era Products, 1321-N Belmont, Chicago.

EARN Up to \$500 month part or full time keeping books for small firms. Simplified system. Write Tax-Saver System, Dept. F, Ft. Worth, Tex.

MAKE Unlimited Christmas profits beginning today, and start a permanent business producing "practical" Trucraft models. They have eye appeal and buy appeal. No skill or equipment needed. Quaker City Crafts, 1613 North Carlisle Street, Philadelphia 2, Penna.

START Profitable business, selling by mail. Write—Ramsey, Monticello, Ky.

MAKE Plenty of money the year around selling greeting cards and exclusive art specialties. Sell at home, direct, or by mail. New book of plans and ideas shows how to make easy, quick profits and establish your own business. Gift coupons, amazing "door opener" plan, wholesale list and free samples. Write for "proven" money making details. Valvick, Warba, Minn.

BIG Money—Start window washing business. Full instructions. \$1.00. P.O. Box 6, Springfield, Mass.

FIBERGLASS—Liquid plastic, china glazes any plaster object. Sample quart \$1.00. Gallon \$3.00. New Era Products, 1321-N Belmont, Chicago.

SPECIAL Training for entering successful businesses. You start small, grow big. We tell you what to start. What will pay. What to sell. Who will buy. Write. Hilton C. Cornwell, 1384 Dekalb Ave., Atlanta, Ga.

LIQUID Rubber, for making flexible molds, literature and sample free. H. Chaney, 1130 E. 16th St., Jacksonville 6, Fla.

START Profitable home business. Write Donald Eakin, Route No. 1, Harrisville, Penna.

START A clock shop. Fascinating, easily learned profitable business requiring little capital. We teach you how to repair all kinds of clocks. Information free. Houston Clock Shop, P.O. Box 5086A, Houston 12, Texas.

START Home manufacturing business making Cleaning Compounds, Soaps, Insecticides (DDT), Cosmetics, Polishes. No machinery. Literature free. Kemix, Park Ridge, Ill.

ONE "Best" item for mail operation. Repeats. 100%. Literature, ideas, samples, 10c. Central, Simpson 1, Kansas.

MEN, Women, "Everybody Likes Candy." Learn to manufacture professionally at home. (Our 36th year.) Ragsdale Candies, East Orange 2, N. J.

SYNTHETIC Latex with Neoprene base for making flexible molds! Quick drying! Safe! For home, classroom, or industry. Quart \$2.00. Gallon \$5.95. Full instructions. Plastercraft Supply Company, 1406 East 43rd Street, Cleveland 3, Ohio.

MANUFACTURERS Getting rich with new war-born products. You can easily make them at big profit from guaranteed formulas and analyses. Literature free. Miller, Analytical Chemist, Tampa 6, Fla.

"HOW To Make Simple Molds and Plaster Plaques." Profitable business or hobby! Instructive booklet 25c. Plastercraft Supply Company, 1406 East 43rd Street, Cleveland 3, Ohio.

EXTRA Cash! Learn "how" to build profitable business in spare time at home. Our "how" letter offers ideas, marketing helps. Trial, quarter. William Stamp, Clarkston 1, Mich.

ALASKA! Personal letter concerning any locality Alaska. Names prospective employers, etc. \$2.00 plus postage. Sourdough, Box 97, St. Louis Park, Minnesota.

10c BRINGS You hundreds of money-making propositions, plans, ideas, tips, wholesale supply sources, magazines. Gardenville Publishers, Gardenville 4, N. Y.

WHY Money worry? Own-operate typewriter repair business. Low capital required. Large earnings! Qualify quickly. Easy directions from: Athey's Typewriter Supply, P-9, Tarentum, Penna.

200 MONEY Making deals, Plans. Rare formulas. Schemes. Folio free. Formico Mart, Box 572, Dayton, Ohio.

BOOKKEEPERS: General ledger and tax report experience. Operate permanent, profitable accounting service for the smaller business. Part or full time. Simplified method. Write now! L. A. Bell, 1404 West 25th Street, Cleveland 13, Ohio.

BOOKKEEPERS. Operate professional bookkeeping service. Spare time. Information free. Bourque, 3712 Fifth, Marrero 1, Louisiana.

GET The facts. Sell names by mail. Spare time. Big money making opportunity. Send name for free details. Forest Book Co., Box 297, North Hollywood, Calif.

PLASTIC-INTERMIX Makes ordinary casting plaster "shatterproof." Gallon develops 100 pounds. Pint \$1.50, gallon \$4.00. 20th Century Products, 3151-NW Southport, Chicago.

PROFITABLE Small investment reclaiming crankcase oil. Particulars. Chechot, 5421PM Pine, Philadelphia 43.

WOULD You pay 3%—first \$350 made? Color-illustrated book "505 Odd, Successful Enterprises" free! Some plans offer occasional "day off." Start at home, office. Expect something odd! Pacific, 2207 1/2 Cloverfield, Santa Monica, Calif.

START Profitable mail order business. Less than \$5 capital. 4 way profit. Prospectus showing how 10c. George Diafas, 109 Mt. Hope, Dover 2, N. J.

RAISING Canaries pays good profits. Valuable bird book—"Its Care, Breeding and Training." Price \$1.00. American Canary, 2839 N. Halsted, Chicago.

NEW Opportunities await you—Write today for free descriptive circular. Vocational Guidance Co. "Success Builders," Dept. A-1, 4701-10th Ave. So., Minneapolis 7, Minnesota.

INCORPORATE Your business. Delaware laws. Many advantages, free details. Tax Research Bureau, Inc., Delaware Trust Building, Wilmington, Delaware.

SPECIALTY Manufacturing, the big money business that can be operated anywhere, start on a very small capital; we supply dependable formulas and complete instructions; get interesting free booklet, "Moneymaking Opportunities in Specialty Manufacturing." Howard Robinson, Ph.G., 1300-A South Ohio Street, Sedalia, Mo.

HARDWARE Business is one of the most interesting and profitable of them all. Be independent. You can start your own retail store with small investment and no previous experience. 15,000-word, copyrighted booklet tells you how. \$1.00 postpaid. C. R. Divan, P.O. Box 325, Santa Monica, Calif.

DO It with sea shells. Attractive jewelry. Big profits. Free instructions. Werts, 1429-56th Ave., Oakland, Calif.

START Costume jewelry business. Write Costume Jewelers, 264-5th Ave., New York.

EARTHWORM Culture. A home industry. Send postcard for valuable free bulletin on "Earthworms: Their Intensive Propagation and Use." Thos. J. Barrett, Earthmaster Farms, Box B-488, Roscoe, Calif.

QUICK Money! "Repairing car batteries." At home! Easy too! Write. Batteryman, Grand Junction 5, Colorado.

TWENTY Thousand customers. Listed on the Blue List. Write Addressee, Box 1251, Chicago 90, Illinois.

FELLOW Workers—Down with bosses—Start own business—Be independent—Booklet describing 137 tested plans, free. P. Padney, 307 York St., Jersey City, N. J.

LEARN Shell jewelry manufacturing. Complete, simplified, home instruction course, beautifully illustrated, shows 45 styles pins, earrings, brooches, sprays, hair ornaments. Includes pearlizing, dyeing, gilding, glow-in-dark methods. No tools needed! Learn-earn within a week. Only \$1 postpaid, including wholesale prices of all raw materials. House of Gifts, Box 4550-RF, Coral Gables, Fla.

START Home business making statuary, plaques, novelties, garden furniture, artificial marble flooring, liquid marble. Make your own flexible molds. Amazing profits. Folder free. Creative Publishers, Box 236-L, Winnetka, Illinois.

MINK Raising, information free. Complete. Lake Superior Mink Farm, Superior, EE, Wisconsin.

PROFITABLE Mailing merchandising business. Write Riegel, 1111 Harrison, Phila. (24), Penna.

TADPOLES Make frogs, tremendous demand. Both make you money. 25c brings tell-how information. Chariton Corporation, Century Building, Chicago 4.

25c MAIL Seller, 800% profit. Sample, details 10c. Harvey Teuple, Decatur, Ind.

COPPERIZE Baby-shoes, complete instructions, tested sales plan. Metalloids, Box 8087-b, Pittsburgh 16, Penna.

MAKE Strange new plastic—1c pound. Makes durable, attractive floors, walls, roofs. Build for half. Bays Laboratory, Oklahoma City 9.

MAKE "DDT" Products. My ten master formulas show how. Literature free. Howard Robinson, Ph. G., 1302-A So. Ohio, Sedalia, Missouri.

SMALL Capital starts your own advertising agency, at home in spare time. Complete operation exposed. No stock or equipment. Opportunity for large earnings. Stamp brings folder and proof. P. Snyder, Box 4907-A, Philadelphia 19, Penna.

MAKE Flexible molds! Few cents each! Cast plaques, novelties, bookends! Free sample! H. Tooker, 630-A Chestnut, Hamilton, Ohio.

SPECIALIZED Mail business earned \$1400 monthly. Copyrighted instructions \$1.00. Wm. Boyd, 331 Fourth, Pittsburgh 22, Penna.

START Moneymaking home mailorder business, sparetime. Interesting literature free. Goodrich, Edgewood Terrace, Longmeadow 6, Mass.

GUARANTEED Profits, your yard: basement; kitchen. Information 25c. Dillard, Box 2807, Kansas City 13, Missouri.

GO Into rug and upholstery cleaning and mothproofing business. Extra double profits selling these two professionally used products to stores and homes. Russell-Johnson Company, Clarkfield, Minn.

START A business of your own. Can put you next to new profitable business opportunities. Particulars free. Beiers, 837-A N. Hoffert St., Bethlehem, Penna.

WE Start you in business, at home, sparetime, earning \$10-\$30 weekly selling by mail. Stamp appreciated but not necessary. Driscoll Sales Service, Box 2771-A, Denver, Colo.

COLORGLAZED Concrete pottery made without molds. New, low cost, patented method. Cemetery products, novelties, tiles, floors, etc. Basement leaksealing. Other moneymaking projects. Booklet, details free. Men only. National Pottery Company, Fergus Falls, Minnesota.

ELITE Collection contains 137 practical money-making plans; local and mail order. New edition. Particulars free. Elite Co., 220-A Grand St., New York 13.

137 WAYS To make money, in home or office, business of your own. Full particulars free. Elite Co., 220-A Grand St., New York 13.

PUBLISHER Of seventy page trade magazine offers cooperative distributorships to men desiring advancement in mail order field. Splendid opportunity. Good earnings. Send 10c for handbook; application form Progressive Publications, Sheboygan, Wisconsin.

PLASTIC Homes—Build yourself! Re-surface old buildings! Wonderful building material. Particulars free. Marbleizing Service, Edwardsville, Illinois.

MAILING List! 5000 women mailorder buyers, \$25.00; 3000, \$15.00; 1000, \$6.00. Guaranteed accurate! Try them! Woods Remants, Bedford, Penna.

LIQUID Marble—Colorful, glazed! Molded, brushed, sprayed! Composition floors. Rubberlastic molds. Particulars free. Marbleizing Service, Edwardsville, Ill.

HANDY Men—Earn money home operating Community "Fix-It" Shop. Write Stafford, 708 Rawlings, Carbondale, Ill.

YOUR Own business. Big profits, very small capital. National organization teaches, helps, supplies everything. Interesting service business. Big demand everywhere. American, 211 North 7th Street, St. Louis 1, Mo.

MAIL Order business course shows you how to make money, spare or fulltime. Teaches professional mail order technique—not penny-snatching schemes. Fascinating 100-page illustrated success-catalog free! Write—Nelson Company, Dept. 4-02, Chicago 5.

BUILD Miracle homes. Yours. Others. Chamberlain, Fitzsimons Building, Pittsburgh 22, Penna.

BOOKKEEPERS—Operate your own "Dollar-A-Week" bookkeeping and tax service. Full or spare time. Details free. Ellis, Box 200, Cedar Grove, No. Carolina.

LATEX For making flexible rubber molds. Thoroughly tested. No shrinkage. Complete instructions with each order. Stoneham Rubber Co., Box 244, Stoneham 80, Mass.

RUBBER Moulds for casting novelties. Latex for making moulds. Use thoroughly tested and approved products. Eastern Latex Laboratories, Box 153, Mattapan 26, Mass.

RECAST Old batteries into new. Latest achievements. Battery Laboratories, Minneapolis.

START Mailorder bookshop—Everything furnished; publisher cooperation. 25c brings booklet, exclusive setup, samples, exciting ideas. General Publications, Ossining, N. Y.

BECOME An "Attritionist Masseur." First improvement over Swedish massage in 100 years! Results unbelievable! Dr. Swearingen, 9128M, Station S, Los Angeles.

\$25 WEEKLY Working two hours daily. No canvassing. No manufacturing. Lycke, Box 2471, Cleveland 12, Ohio.

BIG Money making Hollywood style pottery, bird baths, wishing-wells, benches, stucco-rock. New method. Clever designs. Color with chemicals, water-paints. Marbling, colored glaze effects. Dime brings samples, pictures, literature. Hollywood Cementcraft, 8527 Wonderland Ave., Hollywood 46, California.

BRUSH Plating outfits connect to a battery. No tanks necessary. Good paying business at home plating autoparts, bathroom fixtures, bicycles, reflectors, silvering mirrors. No shop or experience required. Outfits furnished. Free booklet. Gunmetal Co., Ave. H, Decatur, Ill.

BUILD Neon signs and neon lighting. Easy to learn. Very small capital required. McMaster Sign Co., 730 State St., Bellingham, Wash.

BABY Shoes preserved. Complete instructions. Exclusive rights. M. E. Watson, Bellefontaine, Ohio.

MONEYMAKING OPPORTUNITIES

HOBBY Swappers—Many items listed. Interesting, informative hobby stories. Sample magazine 10c. Co-publishers wanted. Write today. Hobby Supplement, Box 35-AN, Irvington 11, N. J.

FOR Sale—New, different—"catalogue" paper. Your imprint. Palmer, Berkeley-Norfolk 6, Virginia.

FIVE Popular mail order magazines 10c. Thomason, 857 East Jessamine, Fort Worth 3, Texas.

GOLD, Silver, copper embossing ink. Complete formula, directions \$5.00. M & M Service, 134 Landon, Buffalo 8, N. Y.

UNPAINTED Figurines, plaques. List. Progress Company, 4033 Chowen, Minneapolis 10, Minn.

SMALL Investment, immediate returns. Sell punchboards. Full or spare time. Write for circular and prices. Galentine Novelty Company, 520 East Sample Street, South Bend 18, Indiana.

UNPAINTED Wall plaques. Dime brings sample pair and list. William Grunditz, 12783 Filbert, Detroit 5, Mich.

CARNIVAL Ride plans. Build em yourself; kiddie auto \$5. Brill, 228-M N. University, Peoria, Illinois.

PLASTIC Flooring offers profitable lifetime business! Write Palmer Company, Station A, Berkeley, California.

\$25 WEEKLY Working two hours daily. No canvassing or manufacturing. Lycke, Box 2471, Cleveland 12, Ohio.

OILFIELDS Offer good paying jobs from boomtown to city offices. Names, addresses 100 companies list of jobs and pay rates. Oilco, Box 559, Victoria, Texas.

THOUSANDS Articles wholesale. "Supply Source Directory" 10c. Ideal Service, Park Ridge D-10, Illinois.

EARN Money at home—steady income. Write Successful Income Builders, 508-A, Hollywood 28, California.

KWIK Kast. A new discovery for plaster and plastic casters. No cooking, or curing, or waiting. Apply one coat and cast plaques, book ends, figures, etc. Not a rubber or gelatine. Can be used over and over. Patented. Eliminates drudgery. Makes casts in minutes. Trial two lb. jar prepaid \$2.75. Kwik Kast, 742 N. Pascal, St. Paul, Minn.

CLEAN Up \$5000 a year selling specialties. just like I do. Easy, too. Write me. Guy B. Caryton, Bethany, Okla.

MAKE Big money, operating a business of your own, in spare, or full time on \$5.00 capital. Free details. Harvey H. Bane & Son, 380 Columbus St., Wabash, Indiana.

MONEYMAKING Opportunities! Free literature. Joy Ser., 12 Centre, Brockton, Massachusetts.

18,000 PATENTS Royalty-free. See Blishop Tools ad under "Patents."

THOUSAND Per cent profit. Descriptive literature. Sample 25 cents coin. Garlen, Box 178, Richmond 1, Va.

START A home business in spare time. Make extra money. Experience unnecessary. Details free. (Dealers wanted.) Richard Ponto, Elkton, So. Dak.

REAL Mailorder profits. Make 90c each dollar sale. Write Smith, 1126 Vermont, Bristol, Virginia.

HOMEMAKERS. Make money on side. Read "100 Selling Ideas," worth reading. Price 50c. Goulding, 1037 Elm, Manchester, N. H.

LEARN Metascience. Remarkable drugless healing. No manipulation. No apparatus. Unbelievable simplicity and results. Inexpensive correspondence course. Write Metascience, De Land, Florida.

RAISE Giant Chinchilla rabbits. Tremendous profits from gorgeous fur, delicious meat. Ideal business. Willow Farm, R15A, Sellersville, Penna.

YOUR Name on our mailing list for one year. Receive mail daily. Fee 25c. Ace Service, 4304E Maryland, St. Louis 8, Mo.

START Your own business! Big money manufacturing novelties, plaques, statuary. Free catalog. Write Bing Products, 88-A2B Broad Street, Boston 10, Mass.

MECHANICALLY Inclined men—Own and operate general appliance repair shop. Complete, illustrated course shows you how. Welding, refrigeration, motor repair, how to get business, etc., all phases covered. Free literature. Christy Supply, Dept. 1169, 2835 N. Central Ave., Chicago.

FREE Literature—Wholesale supply sources, money making opportunities, mail shoppers guide, information, etc. Economy, 323-PM1 East Lanvale, Baltimore 2, Md.

BE Smart, make your own Christmas gifts or start a business. \$1.00 brings an illustrated instruction book on making shell jewelry, etc., with materials complete for two pins. Send for catalog. Woods Shellcraft, Box 308, Bradenton, Florida.

PANNING Gold. Free literature, pictures. Old Prospector, Box 21R89, Dutch Flat, Calif.

AGENTS. Get a jar wrench without cost. Post Southside, Box 87, Elmira, N. Y.

THE Best luminous ink recipe 10c. Donald Mantoath, Salem, Indiana.

MEN'S Heavy massive Mexican rings. Skull crossbone, Indian head. \$36.00 dozen. Sample \$3.95. Box 1952, Houston, Tex.

THIS Is it! Now offering the greatest agency plan ever! Handle over 400 technical books, Xmas, birthday, everyday greeting cards. Also operate your own magazine subscription agency handling every magazine printed! Complete supplies, catalogs, 25c. Greeting card sample boxes 75c. Cas-sell Distributors Service, Westfield, New Jersey.

EARN Up to \$2,000 year, inventing simple items for special cash markets. Ideas only. No patents. Hendrickson, Argyle 7, Wisconsin.

A BIG time mail order business can be started in your sparetime at home. No special equipment needed. We tell you how. H. S. Smith, 3139 So. Mabbett Ave., Milwaukee 7, Wisconsin.

TIPS, Ideas, opportunities galore in "Timely Tips," Paulding, Ohio. Independent monthly magazine. 18th year. \$1.00. Sample, dime. Trial 4 months 25c.

LEARN Battery repairing, rebuilding. Engineer offers money making methods. Battery Bureau, 2225 North 44th St., Milwaukee, Wis.

INVESTIGATE Mail selling! What's the one best thing to sell, happily, honestly, profitably? We know! Get free particulars. Free samples. What-to-Do Shop, Box 1082, Tacoma, Wash.

WIN Contest money. General contest bulletin shows how. 16 big pages of help. Many current contests listed. Sample 25c. General Contest Bulletin, 1609½ East 5th, Duluth 5, Minn.

FREE "Prize Contest Bulletin" describes many contests. Money making opportunity. Cash Register-G, 210 Fifth Ave., New York 10.

WHOLESALE Catalog, directory 10c. Thousands of articles. Stafford, 961½ N. Jefferson, Indianapolis 1, Ind.

PAINT Wall plaques at home. Big profits. No experience needed. My course tells how. Valuable information free. Alfred Novak, 2601 Division, Cleveland 13, Ohio.

ILLUSTRATED Two-color agents, opportunity-seekers directory, 10c. National, R5, Saginaw, Michigan.

200 MONEY Making deals, plans, rare formulas. Schemes. Folio free. Formico-Eng., Box 572, Dayton, Ohio.

GROW Easter lilies at home. Profitable business. Experience unnecessary. Big demand. Write for particulars. Shaprack Outdoor Nurseries, Crescent City, Calif.

COMIC, Xmas cards, free samples. Cal's, 347 W. Baker, St. Paul 7, Minn.

FREE Literature describing many moneymaking plans. Exton Publications, 25-07A Thirtieth Avenue, Long Island City 2, N. Y.

1001 MONEY-MAKING Ideas! Free details. Newway Institute, Box 5463-M, Chicago 80.

WOULD You pay 3%—first \$350 made? Color-illustrated book "505 Odd, Successful Enterprises" free! Proven by "Little Fellows." Start at home, office. Expect something odd! Pacific, 2207½ Cloverfield, Santa Monica, Calif.

HOMEWORKERS — Assemble colorful handmade jewelry! Profitable sideline. Free details. Beginner's outfit, \$1 (refundable). Hughes, 712 Kimball, Danville 3, Ill.

SCHOOL Seniors—Sell classmates America's most beautiful, distinctive graduation name cards. 40% commission. Largest selection. Lowest prices. Free cards and sample kit. Printcraft, 1425 E. Elm St., Scranton 5, Penna.

"LUMINOUS Paint." Resilvering Mirror formulas 25c each. Soapmaking, (20 formulas) \$1.00. Ideal Service, 300, Park Ridge, Ill.

"THERE'S Big money in junk"! Easy! Fascinating! Free circular! Batteryman, Grand Junction 5, Colorado.

I MADE \$1000 From 1000 tomatoes using my unique methods. Detailed instructions, \$1.00. (Refundable). Alfred Dinsmore, Marlborough, Mass.

EARN Money evenings, copying and duplicating comic cartoons for advertisers. Adservice, Argyle (1), Wisconsin.

MONEY-MAKING Opportunities, exclusive supply sources, personal guidance guaranteed. For complete information, remit 25c. American Mail Trade Association, 313-F East 21st, New York 10, N. Y.

THOUSANDS Of alarm clocks need repairing. Jewelry stores swamped. Our simplified course teaches you how to repair these clocks. Necessary tools and supplies furnished with course. Alarm Clock Repair Service, P.O. Box 2350A, Houston 1, Texas.

"HOW To Write Advertising," absolutely free! Dudley Bunn, 126-PM Lexington Avenue, New York 16.

PORTIFY The future! Start own business: home, office. Booklet describing "Collection of 137 Tested Plans" free. Elite Co., 220-A Grand St., New York 13.

PUBLISH Your own magazine. Handsome 52 page format, well edited, illustrated. Cost low as \$1.00 month. Brings you prestige, profits. 25c brings sample, details. National, Ord. Nebr.

I MAKE Big money in the mail-order business. You can do the same at home with my copyrighted system. Write me. I'll tell you how. F. Little, Box 8, Glenshaw P.O., Pittsburgh, Penna.

START Your own mail order business! 50 profitable small capital plans show how! Details free! Mailway, 620-A William, Winnipeg, Manitoba, Canada.

FORMULAS, PLANS, ETC.

PRINT Photos on cloth, letterheads, etc. Complete sensitizing formulas \$1.00. Strauss, 1610-43 Street, Brooklyn 4, N. Y.

DISCOVERED: Time dollar saving method of self hair cutting. New Winner POMO order \$1.00. Engineering, Box 342, Cambridge, Mass.

FORTUNES In formulas, 10,000 trade secrets, recipes and processes. 900 pages. \$2.50 postpaid. Houston, 35 Linmar, Aliquippa, Penna.

SKIN Lotion—make your own. Price one dollar. Elizabeth Moxon Cosmetics, 1264 Marentette Avenue, Windsor, Ontario, Canada.

MAKE Laundry, bath and liquid soap. Five formulas \$1.00. Saginaw Soap Products, Saginaw, Michigan.

FROZEN Custard. Send 5 dollars for the very best recipe—money maker. All flavors. B. C. Stroud, Tallmadge, Ohio.

GUARANTEED Formulas, analyses all new war-born products. Literature free. Miller, Manufacturer's Chemist, Tampa 6, Florida.

REAL Manufacturing formulas. Lists free. Cummings, Chemist, Gordon Ave., Syracuse 4, N. Y.

10,000 FORMULAS And trade secrets, authentic, reliable, practical; send for free literature. Stillman, 555 Kingston Ave., Brooklyn 3, N. Y.

PUNCTUREPROOF Your tires. Prepare sealtight mixture yourself, easily, economically. Formula, instructions, \$1.00. Cealtite Ltd., 656 Linden Ave., E. K. Winnipeg, Canada.

FORMULAS — Latest, best. Analysis. Giant formula catalog and chemical instruction sheet 10c. Refunded first order. Belfort, Engineering Building, Chicago 6.

NEED Chemists? Formulas, Analyses. Ideas, Consulting Scientific Company, Swarthmore, Pennsylvania.

MANUFACTURE Cleaners, flavors, cosmetics. Formula catalog free. Kemico, Park Ridge 16, Illinois.

PLASTICS

PLASTICS And supplies—New Plexiglas, Lucite, Catalin sheet, rods, tubes, etc. Attractive prices. Exceptional kits \$2.00, \$5.00, \$8.00. Internal floral carving drill. We pay postage. Free list. Plas-met Sales & Engineering, 4648 Shirley Place, St. Louis 15, Mo.

LUCITE Two lb. \$1.25. Five lb. \$2.50, postage extra. Charles Gass, 307 - 14th, Arnold, Penna.

PLASTICS: Sheets, rods, tubes, other supplies. Plastic Supply Co., 2618 St. Louis Ave., St. Louis 6, Mo.

MAKE Rubber fish lures, novelties. New, easy. Circulars. Shuman Tackle, Green Terrace, 3 Kent, Ohio.

MONEY In plastics! Lucite plastic hobby kit. Two pounds Lucite materials, coloring dye, cement. Instructions. Send \$2.50 to Plastic Specialty Co., (Dept. M), 192 Lexington Ave., New York 16. Also Swiss music movements, \$3.50 each.

COLORED Plastics—mottled colors; sheets and rods. Free price list. Hanson Plastics, Dept. M, 7625 South Park Ave., Chicago 19.

LEARN Plastic moulding. Great demand. Full course \$2.00. Easily learned. Free model. Plastics, 424 N.W. Flanders, Portland, Oregon.

PLEXIGLAS, Sheets and supplies, first quality, lowest prices. Plastics information folio free with first order. Details free. Art Plastics of California, 8127 East 14th St., Oakland 3, Calif.

PROFITS In plastics. Factory-like methods. Send stamp. Craftco, 3928 Dumaine, New Orleans.

SENSATIONAL New plastic injection molding machine, electrically heated; use as hobby or business. Free literature. Toy plastic molding sets; shellcraft kits, dyes, dye concentrate, colored cements; low price plexiglas. G. Baker Company, River Edge, New Jersey.

NOVELTY, Mold makers. Government surplus latex rubber plus 3 models—\$1.00. Bishop's, 5708 W. North Ave., Milwaukee 8, Wis.

"FORMALIN" Quicksetting liquid plastic "kit" with complete instructions \$2.50. National Plastic Products Co., 5 W. Larned St., Detroit 26, Mich.

LUCITE Price list. Mid-west Plastic Supply, 1717 No. 66, Omaha, Nebr.

FREE! Lucite bracelet with 10c craftsman's catalog. Technicraft, 1156 Commonwealth, Boston 34, Mass.

PLASTER Workers. Just created, new Christmas plaque. (Old Santa.) Don't miss this one. Every home a prospect. Model only \$1.00. You will make money on this one. Order early. Walter G. Williams, 3525 Ave. O, Galveston, Texas.

MAKE Liquid Marble, Plaster Plaques, Statuary. Instructions, formulas, \$1.00. Ideal Service, 179-M, Park Ridge, Ill.

EARN At home "Working With Plastics." Full information on sheets, blocks, rods, tubes. Trade names, sizes, colors for fabrication. Designing, tooling, bending, cementing, polishing. Also for homeworkshop. Only \$1.25 postpaid. Money back guarantee. Modern Technical Book Co., Dept. MMC, 55 West 42nd St., New York 18.

PLEXIGLAS Prime sheets 12" x 12"; 1/16" \$1.20, 1/8" \$1.37, 3/16" \$1.94, 1/4" \$2.28. Include 10% for postage. Dyes, rods, cements, buffing compounds, jewelry findings, tools. Free listings. Craft Plastics, Box 129-P, Somerville, N. J.

PLEXIGLAS Clear 12" x 12", 1/16" — \$1.50; 1/8" — \$2.00; 1/4" — \$2.75; dyes, dye concentrates, cements—clear, colored; plastic molding sets; shellcraft kits. Free list. G. Baker Company, 685 Center Ave., River Edge, New Jersey.

PLASTICS. Make yours at home. Formula and moulding instructions \$1.00. Forester, Zone 84, Station K, Toronto, Canada.

PLASTICS, Plexiglas, Lucite, Catalin. Jewelry craftsman supplies, including 48 page illustrated catalogue 10c. Douglas Homcraftsmen, Box 34 B, Stamford, Connecticut.

LUCITE—Complete illustrated fabricating instructions, used in craft classes throughout the world, price list on lucite, dyes, complete supplies. Booklet 10c, with sample, 35c. "Gem-O'-Lite," P.O. Box 686-B North Hollywood, California.

BIGGEST \$1.00 Plastic value transparent plexiglas and lucite sheets and strips in irregular shapes and thicknesses. Useful for many projects and experimental work—big package by return mail, no waiting. Double size package with dye and cement included \$2.00. Send money order to HomeCraftsmen Plastics, 1945 W. Harrison Street, Chicago 12, Illinois.

CHEMISTRY

LABORATORY Supplies for chemistry, biology, physics. America's headquarters for home students. Catalogue 10c. National Scientific Co., Dept. 2, 2204 W. North Ave., Chicago 47, Illinois.

THE House of Winn, home of supplies for amateur chemists. See Winn's New Idea chemical kits and apparatus outfits for home experimenting. Send 10c for retail catalog. Established 1931. John H. Winn, Dept. 510, 124 West 23rd St., New York 11, N. Y.

HYDROGEN! 10 Charges \$1.00. Inflate balloons, experiment, etc. Miles Specialties, Kokomo, Indiana.

STUDENTS' Laboratory supplies. Send 5c for catalog. Mel-Glo Chemical Co., 258 Fourth Ave., Brooklyn, N. Y.

APPARATUS, Chemicals, ounce quantities, catalog 5c. Fleischer's Laboratories, Everett 49, Mass.

INTRODUCTORY Chemistry brochure 10c. Lankton Chem-Research Bureau, (Established 1944), Lansing 15, Michigan.

LABORATORY Supplies. Chemicals and apparatus all descriptions. 36 page book 10c. Standard Science Supply Co., 1232 N. Paulina St., Chicago 22, Illinois.

CHEMICALS And apparatus for industrial, analytical, and private laboratories. Complete supply service for correspondence school students. Send 3c for catalog. Dept. M-43, Biological Supply Co., 1176 Mt. Hope Ave., Rochester 7, New York.

HANDBOOK For chemical experimenters. Illustrated, hundreds of experiments, 50c. Experiment booklet 15c. Chemistry catalog 5c. Reading Scientific Company, Reading, Penna.

FREE Catalog. Chemistry, mineralogy, biology, optics. Tracey Laboratories, Evanston, Illinois.

HELP WANTED

BRANCH Manager-Salesmanager. Educational self-advancement lecture program. \$15,000 class. Commission. All English-speaking countries open. Professor Noble Ben Martin, 406 Panama Bldg., Portland 4, Oregon, U.S.A.

DON'T Read this unless you want a business of your own. Here are the down to earth facts you must know before starting a business of your own. How to choose the right business, the possible profits, capital needed, competition, risks involved, the pitfalls to be avoided in starting any business. 338 handsomely bound pages chock full of information. Fully guaranteed. May save you thousands for only \$2.98 prepaid or sent c.o.d. Address Business, Box 559, Victoria, Texas.

PARAMOUNT Atmospheric conversion gas burners. Quickly installs into any heating plant. Absolutely guaranteed. Sell and install. Peerless Sales, 4322 Sheridan, Lincoln 6, Nebraska.

AGENTS WANTED

EASY Money. Sell friends sensational 50 for \$1 personal Christmas cards. Also extraordinary Christmas card, everyday, gift wrapping boxes. Quick sales. Up to 100% profit. Experience unnecessary. Write today for free self-selling sample portfolios 50 for \$1.00. 25 for \$1.00 name imprinted Christmas cards, personal stationery. Special offer. Rainbow Greeting Card Co., 36 East 12 St., Dept. 27-B, New York.

MEN! Women! Make more money and build a profitable business of your own, full or part time, without investment. Real glossy photos, amazing stamp size miniature, 100 for only \$2.00. Repeat orders insure steady income. Write today for free samples and information. American Photo Stamp Co., Dept. A, 38 West 33rd Street, New York 1.

AGENTS—Big line including food products. Fast selling premium and bargain deals. Low prices. Send card for big profit offer with gift. Ho-Ro-Co, 2796 Dodier, St. Louis 7, Mo.

EARN Tremendous profits selling costume jewelry. Experience unnecessary. Write for sample outfit proposition. Fairview, 475A Fifth Avenue, New York 17, N. Y.

\$1 STARTS You in business. Sell deluxe ties, 100% wool interlining. Costs you only \$7 per dozen, you make \$5.00 dozen. Send \$1.00 for special introductory offer two deluxe ties. Catalog complete line free. Philip's Neckwear, 20 West 22nd St., Dept. K-4, New York 10.

SILVER Plating Liquid — (NuSilver Trademark No. 245,336 and Replate Trademark No. 367,355). This is a colloidal affinitive solution containing a large percentage of pure genuine Government Treasury Department Domestic (U.S.A.) Silver. New improved 1946-1947 Formula now in production and being shipped on all orders. NuSilver Plating Liquid is a method of chemically-applying silverplating to affinitive metals without tanks, machinery, batteries or any special equipment. Simply rub-on, rinse and polish-up, —or— simply immerse in the Liquid 1 or 2 minutes, rinse and polish-up. As simple as that. Puts on a durable coating of genuine Silver 1000 Fine. Won't brush off, or wash off, or boil off. Guaranteed. Unexcelled for keeping Sterling and all plated Silverware of all kinds like new. Renews everything in the Silver line. Also silverplates onto brass, copper, bronze, zinc, nickel-silver, german-silver, chrome-silver, and some others of the new composition metals. Several hundred different uses reported to date. Several thousand more uses remain to be found by working sales—distributors in various territories and supplied. Try it on your plating problem and see. Sells wholesale to merchants with counter displays for resale. Sells retail to hotels, restaurants, cafes, clubs and all eating places for their own use. Sells successfully house-to-house canvassing upon an amazing home demonstration. Every selling method we know of (except one) is selling this Silver Plating Liquid successfully and profitably. It is a good seller. It is a profitable item (4 for 1). May be your territory is not being worked right now? Why not find out? We want experienced working sales-distributors with cars to work where no work is going on now. To sell this Silver Plating Liquid in every way they know how, wholesale, retail, appoint agents, put out sales persons, and blanket the territory. There's good business to be had, good money to be made, if you can do it. We also have one other good item (5 for 1). Atomic Metal Cleaner Plates. Are you open for a deal along this line for your territory? We may have here just what you really need? NuProcess Products Laboratories, Dept. 249, Aurora, Illinois.

MEXICAN Bird pictures handmade with real feathers. Free particulars. Sample 15c. Importer C. O. Staff, 14960 Evanston, Detroit 24, Mich.

CHRISTMAS Cards. Earn \$5.00 with every ten \$1.00 21 card assortments you sell. Also wrappings, note paper and imprinted cards. Write for samples today. Howard P. Ellis, Dept. PM-10, Pitman, N. J.

SELL Personalized soap. Name on every cake. Ideal Christmas gifts. Get sample offer. Dunbar Soap, New Brunswick, N. J.

DISTRIBUTORS, Salesman, agents. New patent. Automobile accessory. Sale possibilities unlimited. Literature free. Mass production = distribution + fortune. Little Giant Holder Company, 919 South Vermont, Los Angeles 6, Calif.

SELL Christmas cards. Easy money showing exquisite Christmas, everyday, wrapping assortments, stationery. Over 100 quick sellers. Request \$1.00 Christmas box on approval. Free samples of 50 for \$1.00 Christmas cards. Special offers. Hedenkamp, 343 Broadway, Dept. O-22, New York 13.

AGENTS, Jobbers distributors, make big money selling manufacturers products to stores. Write for details. Evans, 6362 Hollywood Boulevard, Hollywood, California.

SELL Books by mail. Mammoth sales and huge profits. Everything furnished. Send 10c for complete details. Business Plans Foundation, Box 56-R, New York 10.

CALENDAR 1753 To 2152. Sample and quantity prices 35 cents. Tracy Newton, Decatur, Georgia.

GREETING Card money-makers. Write for folder. Greenport Art Company, (Dept. 108), 252 - 12th Street, Brooklyn 15, N. Y.

AGENTS Wanted to sell religious scroll. Mexart, 119 West Locust, San Antonio, Texas.

SELL Sensational Reynolds ball point pen. New low price. Nationally advertised. Big discount to qualified men. Large earnings. Write now for details. Style-Rite-4, 4554 Broadway, Chicago 40.

SHINE Shoes without "polish." New invention. Lightning seller. Shoes gleam like mirror. Samples sent on trial. Kristee, 127, Akron, Ohio.

EARN 100% Selling 50 for \$1.00 Christmas cards with name imprinted free. 15 selections. Nothing to invest. Free samples. Ed-Brite Co., Dept. C, Mt. Vernon, N. Y.

LOW Prices. Six cent cigars. S. Kelley, 2302 Ontario St., Ft Wayne 6, Ind.

UNLIMITED Money-making opportunities taking orders for Christmas gift subscriptions for all magazines. We furnish everything. Write for free book of confidential commissions. McGregor Magazine Agency, Dept. 22, Mount Morris, Ill.

WONDER Cleaner, new type bubble bath, Glasglo, sell fast. Tremendous profits. Supplies, circulars, furnished. Courier, 3829-I Delmore, Cleveland Heights 21, O.

AGENTS, Distributors. \$28.00, \$140.00 per day. Flo-Glo plastic linoleum finish. Write. Acme, Box 404, Mount Vernon, N. Y.

BALLOONS. Available now in all colors and sizes. Write for prices. Unger Novelty, 406 South Canal St., Chicago, Illinois.

BIG Profit selling amazingly easy book-keeping. Repeats. Details free. Goulines Service, 30 Church, New York.

AUTOMOTIVE Distributors! Repeat auto product! Millions need this! Profits tremendous! Information — free offer. Thermoxwks, Peoria 4, Ill.

CHRISTMAS Card salespeople double your profits. Write Walter Service, D-1459 E. 112 St., Cleveland 5, Ohio.

EARN \$20.00 To \$60.00 weekly mailing our literature. Nothern Co., Lake City, Arkansas.

SELL Christmas store signs, religious mottoes, business slogans. Beautifully illustrated with sparkling tinsel. Everyone a prospect. Huge profits. Send for catalog or enclose dime for sample. Silverglo, 4824 Barry, Chicago 41, Illinois.

PLASTONE—Amazing new polishes for automobiles, furniture, floors. Beautifully packaged. Priced low, 100% profit! Volume sales—fast repeater to stores, gas stations, industrial users and friends. Unconditional money back guarantee. Write for details and sample kit offer—now! Plastone Company, 2207-P10 West Chicago Ave., Chicago 22, Illinois.

CHRISTMAS Cards. Sell 50 for \$1.00, names imprinted. Samples free. Complete line boxed assortments. Dunbar Cards, New Brunswick 20, N. J.

300% PROFIT Possibilities! New post war item, "Artistic Honor Scroll" in six beautiful colors! Tremendous demand! Details free. Schoen Sales, 4860 No. 37th Street, Milwaukee 9, Wisconsin.

200% PROFIT. Millions of prospects. Quick sales. Lorrac Products, Albany 1, N. Y.

AMAZING Seller: "Soiless Garden Chemical." Grow plants, vegetables, fruits, flowers all year round without soil. In or outdoors. Tremendous demand. Excellent profits. Literature free. Nega & Co., 1824 W. Dickens, Chicago 14.

SELL Full, part time, individualized belts, buckles, cap badges, tie holders. Thousand emblems. Every veteran prospect. Fast profits. Repeats. Write today special outfit offer. Hook-Fast, PM, Box 1425, Providence, R. I.

MYSTERIOUS Atomic cigarette lighter operates on ignition glow method. No fuel, no flame, guaranteed wind-proof. Precision built for long use. Simple, safe, dependable. 2 samples postpaid, \$1.00. Special prices dozen, gross lots. Jewel Products, 108 Magnolia St., Hartford, Conn.

AGENTS—New deal. Every home prospect. Take orders for the sensational 2-tone statuette. Low price. Big cash daily. Outfit free. Kent Jewelers, 105 North Clark, Chicago.

MEXICAN Curiosities. Biggest line. Lowest prices. Prompt delivery. List free. I.I.E.A. Lucerna 63-8, Mexico City.

MEXICAN Bird pictures, genuine feathers in brilliant color tones. Ideal Xmas gifts. Sample 25c. Rio Imports, P.O. Box 104, Steinway Sta., L. I. City 3, N. Y.

NEW Revolutionary PerfeCrease trouser and skirt hangers that millions of men and women will buy on sight. Designed by General Motors engineer. All metal. Beautifully plated. Lasts years. Simple demonstration averages three or more sales every home. Call back in week and they will buy more. Red hot Christmas seller. Exclusive territory. Sales kit including sample hangers. \$2.00 postpaid. Details free. Metal Products Company, Troy 1, Ohio.

OPPORTUNITY Of lifetime supplying DDT and other profitable products to farmers. No experience or capital required. Must have auto and good references. Permanent. Write or wire McNess Company, Dept. 712, Freeport, Illinois.

SCHOOL Seniors—Sell classmates America's most beautiful, distinctive graduation name cards. 40% commission. Largest selection. Lowest prices. Free cards and sample kit. Printcraft, 1425 E. Elm Street, Scranton 5, Penna.

EASY Money now to Christmas. Up to 100% profit selling friends, others, marvelous new 1946 Christmas and year 'round box assortments—30 boxes 35c up. Odd cards 2½c up. Extra bonus. Request special feature \$1.00 Christmas assortment on approval. Send today for free samples of our fast selling 50 for \$1.00, 25 for \$1.00 personal Christmas cards and personal stationery lines. Special offers. New England Art Publishers, North Abington, Mass.

SELL New-used clothing from home, auto, store. Men's suits \$1.09. Leather jackets 49c. Overcoats \$1.00. Dresses 22c. Ladies' coats 38c. Other bargains. Catalog free. S&N, 565A Roosevelt, Chicago.

BIG Profits selling used clothing, etc. Operate from home, auto, or store. Sensational low prices. Catalog free. Kadetsky & Son, 702 Barber Street, Dept. 14, Chicago 7, Illinois.

COMIC Xmas cards, free samples. Jerry's, 182 W. Bernard, St. Paul 7, Minn.

SCHOOL Seniors! Your postal will bring our wonder, Kwick-Sell Cardalog of popular graduation name cards. Biggest profits! Only firm giving free souvenir chest and card case. Don't miss out! Hurry that postal! Craftcards, Box 235(L), Pittsburgh 30, Pennsylvania.

SELL Fast moving punch board premium deals to taverns, roadhouses, drug stores, cigar stores, etc. Send for big profit deal. Howard Machine Products Company, 2754 Diversey Blvd., Chicago 47, Ill.

CHRISTMAS Cards. Earn big money. Take orders galore from friends. 25 exquisite folders with name \$1.25. Free samples 10 designs. America's fastest selling 21 Christmas folder box. Costs 50c. Sells \$1. Request samples today. Sunshine Art, Dept. E, 115 Fulton St., New York City.

JUST Out! History of World War II. Huge volume. Popular price. Authentic text. Official photographs. Big profits. Riverside Book Company, Iowa Falls, Iowa.

AGENTS—300 % Profit selling genuine gold window letters; stores and offices. Free samples. Metallic Letter Co., 438-B North Clark, Chicago.

BIG Bargains for big profits. Over 100 sensational values. Men's used suits \$2.00, pants 35c, topcoats \$1.25, overcoats \$2.00, shoes 20c. Experience unnecessary. Free wholesale catalog. Superior, 1250-FB Jefferson, Chicago 7.

200 MONEY Making deals. Plans, rare formulas. Schemes. Folio free. Formico Service, Box 572, Dayton, Ohio.

MEXICAN Feather pictures. Unusual novelty. 50c (stamps) bring \$2.00 worth samples, details. Refunded if unsatisfied. Aztec Art, Apartado 762, Mexico City.

100% PROFIT On famous, popular Pines birthday, Christmas and all-occasion greeting cards. Wonderful 12 to 24 card, boxed assortments sell on sight for \$1.00. Write today for information and extra bonus distributors' plan. R. Pines, Box 32, Flushing, N. Y.

137 COMPLETE Plans for starting own business: local—mail order. Particulars free. Elite Co., 220-A Grand St., New York 13.

AGENTS: Stamping names on pocket-key protectors. Sample check with your name, address, 25c. Stamping outfits. Emblem checks, check-fobs, name plates. Hart Mfg. Co., 303 Degraw St., Brooklyn, N. Y.

MAGIC Cleaner and laundry soap deal. Hotter than a firecracker. Big profits. Sample free. Bestco, 5007 Irving Park, Chicago.

\$3 FIRE Extinguisher; quick sales, wholesale or direct; liberal profits. "Fire-Killer," 109 N. Franklin, Syracuse 1, N. Y.

PLATING Outfits for autopaarts, reflectors. Connect to a battery. No tanks necessary. Free booklet and particulars. Gunmetal Co., Ave. N, Decatur, Ill.

EXCELLENT Sideline for printing salesmen. Decalomania name plates in small quantities. Also, make money applying initials on automobiles. Free samples. "Ralco," X-164, Boston (18), Mass.

FREE Water and our concentrates, makes flavors, lotions, shampoos, 72 products, labels, bottles furnished. Qualco, E-20030 Russell, Detroit.

"OUR Flag"—famous picture. Four colors. 500,000 sold. Sample print—free. Our Flag Sales Corp., Dept. C1076, Excelsior Springs, Mo.

GOLD Lacquered window sign letters. Large sizes penny each. New foils. Absolutely beautiful. Free samples. Atlas, 544 W. 79th, Chicago 20.

SELL Needed eyeglass cleaner, prevents steaming. 8 25c tubes \$1.00. Shurberg, Box 1514, Hartford 1, Conn.

HIGH-GRADE SALESMEN

STACLEAR. Keeps snow, ice, sleet off windshield. Money maker. Salesman wanted. Territory allotted. Write Kenyons Mfg. Co., Ortonville, Minn.

WAGON Salesman—Fast moving carded goods and 10c line. Long profit. Free facts. Peerless, 2717 Dodier, St. Louis 7, Mo.

AMAZING New zipper shoe sells on sight. Big profits for salesmen. Leads line 200 splendid styles. Territories open. Get free sample outfit. Write Consolidated Shoe, Dept. S-202, Chippewa Falls, Wis.

START Your own business on our capital. Always your own boss. Hundreds average \$6,000 to \$25,000 annual sales year after year. We supply stocks, equipment on credit. 200 home necessities. Selling experience unnecessary to start. Wonderful opportunity to own pleasant, profitable business backed by world wide industry. Write Rawleigh Co., Dept. J-U-PPM, Freeport, Illinois.

SELL Mexican pottery, glassware, chairs, trays, baskets, sandals, feathered bird pictures. Sample 25c. Particulars free. Foley's, 217 Grafton St., Brockton 6, Mass.

SELL Full or part time, individualized belts, buckles, caps, cap badges, tie holders, thousands emblems to choose from. Past profits. Repeats. Write today special outfit offer. Hook-Fast Company, Roanoke, Virginia.

SALESMEN—Looking for good selling lines where it's possible to make up to \$75.00 cash commissions weekly address Schutt Co., 244 East Ohio St., Indianapolis 4, Indiana.

REPRESENT Us in your territory. Future of state distributorship. Safeguard for mothproofing. Cannon's Compounding Co., Box 246-P, Doylestown, Penna.

SELL Christmas cards, everyday cards, pictures, books, novelties. Big profits. Bulletin free. Elfco, 432 North Wells, Chicago 10.

BIG Commissions—selling to stores celluloid pricing tickets, metal shelf moulding. To restaurants, menu covers, signs. P. Pricing Press, 124 White St., New York 13, N. Y.

FREE! Latest issue Opportunity Magazine. Salesman's Guide. Inspiring, constructive. Shows how to earn money selling for others or in your own business. Hundreds postwar opportunities. Send name and describe what you have sold or are selling. Illustrated copy sent free. Opportunity Magazine, 620 N. Michigan, Dept. 17, Chicago 11, Ill.

AGENCIES WANTED

ADVERTISERS. Desiring to be represented in Portugal and colonies; send conditions and information about your products to A. Feio, Apartado 202, Lisbon, Portugal.

EDUCATIONAL AND INSTRUCTION

NO Advance payment! Study Automatic Screw Machine Engineering at home. Complete from machine elements to cam layout. Pay as you learn. Warren's School of Engineering, 9 S. Kedzie Ave., Dept. 310, Chicago 12, Illinois.

PLANE Trigonometry. Master method. Instructions, \$1, guaranteed. J. Ziemia, 6123 Orchard, Dearborn, Mich.

SLIDE Rule: List for sharp readings \$1.00. Also engineering calculations. Prices. Calculator, Box 342, Cambridge, Mass.

PIANISTS—Quickly improve playing, technique, sightreading, accuracy, and memorizing through mental-muscular coordination. Free booklet. Broadwell Studios, Dept. 306-K, Covina, California.

DRAFTING—Prepare for a career. Learn latest technique for machine detail designs. Literature free. Tekage, 12 Vernon Street, Newton 58, Mass.

WANT A gov't job? Commence \$145-\$250 month. Men-women. Vets get preference. Try next examinations. Prepare at home. 32 page civil service book with sample coaching—list positions free. Write today sure. Franklin Institute, Dept. A24, Rochester, N. Y.

STORY Writing simplified. Fascinating; complete home study. Free circular. New Segment System. Postoffice Box 834, Spokane, Wash.

REGULAR Railway mail clerks start \$2300 yearly. Prepare now for exam. Write Ozment School, 75, St. Louis, Mo.

LEARN Scientific detection. Kits for testing blood stains, mud clues and many others. No chemistry required. Sample mud clue test and list—quarter. Detlab, Box 20, Station "U," New York 29.

APTITUDE Testing \$1.00 complete. J. H. P., Box 112, Station P, Brooklyn 12, N. Y.

"HOW To Break and Train Horses"—a book every farmer and horseman should have. It is free; no obligation. Simply address Beery School of Horsemanship, Dept. 11010-C, Pleasant Hill, Ohio.

UPHOLSTERING Pays. Easy learned, profusely illustrated course, \$2.50 prepaid. Money back guarantee. Lyle Educational Service, Box 385-A, Lombard, Illinois.

STUDY Real estate at home under experienced brokers. Unlimited opportunities. Free bulletin. DeVoto Realty Schools, 35 Vicente, San Francisco 16, Calif.

ELECTRICAL Examination books. Quick preparation. A. Quizbook, 603 Brighton Ave., Brooklyn 24, N. Y.

WINTER And summer hotel positions. Travel south and north. Beginners courses. Lee's Hotel Institute, 714 Winthrop Building, Boston 9.

MODERN Welding school gives thorough training for one of industry's best paid jobs. Experienced instructors. Individual attention. Non-profit institution. Qualified under G.I. Bill. Write for literature and details. Hobart Brothers Co., Box M-1067, Troy, Ohio.

SELECT Your career easily. Use scientific testing method. "Folder" tells how. Write Vocational Service, 735 Bank of America Bldg., San Diego, Calif.

REMEMBER Anything you want to—through quick, sure Super-Memory. Write for information. ZC-1, Thor Books, Box 1210, Chicago.

GOOD Jobs and a sound, substantial future await you in hotel and institutional field. Men and women—all ages—needed for well-paid positions that offer color, excitement, ever-new and fascinating duties. Record-breaking travel means even greater opportunities for trained men and women in hotels, clubs and institutions. Lewis School receiving calls for managers, assistant managers, stewards, hostesses, purchasing agents and 55 other types of important positions! From coast to coast there are important positions that offer splendid opportunities for advancement in a business where you are not dropped because you are over 40. Previous experience proved unnecessary! No need to leave your job to qualify. A good grade school education, plus Lewis Training qualifies you at home, in spare time. Our National Placement Bureau helps to place you—and our amazing Certified Job Plan—actually certifies you will "make good" when placed. Write today for free book! Veterans: This course approved for veterans' training. Lewis Hotel Training School, Room HT-368, Washington 7, D. C. (First and only school of its kind—now in its 30th year.)

USED Correspondence courses, books, bought and sold. Free catalogue! Spotlight, 141 Broadway, New York.

"SUCCESSFUL Mail Merchandising" course teaches how to make money "on the side." Details free! E. Villa, 1410 Linden Ave., Baltimore 17, Md.

LEARN Cartooning, complete course \$1.00. Colby Studios, 2131 N. Southport, Chicago.

SPANISH—Learn to speak this important language new easy way. 112 pages, self pronouncing book gives hundreds of sentences you can speak immediately. Stiff art-cloth binding. Pocket size. Only \$1.00 postpaid. Fielding-Turner Press, 323 Cypress, Kansas City, Missouri.

CIVIL Service jobs. Men-Women. Examinations coming. Valuable information free. Columbian Correspondence College, Washington 2, D. C.

DETECTIVE-FINGERPRINT Course, \$1.00. Frank Mashak, 4114 Olive, St. Louis 1, Missouri.

PRACTICAL. Thorough education can cost less, be quicker. Learn aviation, electricity, plastics, radio. Technibook, Box 261-F, Mt. Kisco, N. Y.

LEARN Appliance, building repairs. Comprehensive, simplified course \$3 complete, postpaid. Descriptive literature free! Cline-Porter Course, Box 6346-F, Pittsburgh 12, Pennsylvania.

SWIFT Writing. Simple. Unscript, 25c. Jesse L. Cook, Bartow, Florida.

HOME Bible course. Simple, helpful, instructive. Total cost \$3.00 includes textbooks, stationery, examinations, certificate. \$1.00 starts you, or simply request prospectus. The Bible Study School. Reverend Leslie Marshall, Secretary, 382 Van Houten Street, Paterson 1, N. J.

USED Educational and technical books on all subjects bought, sold, rented; catalog free. Educational Exchange, Henagar, Ala.

MASSO - Physio - Therapy. Chiroprody. Evans natural therapeutics home study courses. P.O. Box 1195, San Antonio 6, Texas.

LEARN Foot correction. Permanent, dignified, profitable profession. Six weeks training. Tunis Corrective Foot System, 3041 S. Double Dr., El Monte, Calif.

TYPEWRITING Learned in 10 lessons guaranteed (your home); Also: shorthand, bookkeeping including accounting—ninety hours each; low rates (Osborne-Chilcoat "Psycho-Methods"). Osborne College of Short System, 213 West Third Street, Los Angeles 13, California.

USED Mechanical self instruction courses. Send card for free list. Mechanics' Press, P.O. Box 1043A, Houston, Tex.

HOME Study course, drugless therapy. Free literature. Institute of Drugless Therapy, Tama, Iowa.

GOOD "Used" self-instruction educational books on all subjects bought, sold, rented, exchanged. Satisfaction guaranteed. Complete information and 100-page illustrated bargain catalog free! Write—Nelson Company, Chicago 5.

29 LANGUAGES By Linguaphone. Russian, Spanish, Portuguese—Direct conversational method for mastering any language quickly, easily, correctly at home. Send for free book. Linguaphone Institute, 83 RCA Bldg., New York.

LEARN Photo-engraving at home or in oldest, largest school in America. Work for newspaper or establish own profitable business. New Tasope' Photo-Engraving equipment available soon. Write for information. Veterans ask about G.I. training. The Aurora School of Photo-Engraving, Tasope' Bldg., Aurora, Mo.

INVESTIGATOR Training. Phillips Secret Service, 1917B North Kenneth, Chicago 39, Illinois.

LOCKSMITH Course. Lock picking, key fitting, etc. \$1.00 prepaid. Locksmith, Canadian, Texas.

MEDICAL Laboratory technicians in great demand. We train you in your spare time, in your own home. You can practice while studying. Write for free catalogue. Imperial Technical Institute, Box 973-E, Austin, Texas.

SECRET Investigation. Experience unnecessary. Investigators particulars free. George Wagner, M 125 West 86th, New York.

USED Educational books on all subjects sold, rented, also bought and exchanged. Moneyback guarantee. Write today for free catalog and details. Lee Mountain, Pisgah, Alabama.

PLAYS, STORIES, MANUSCRIPTS

WRITERS. Create original plots from published stories without plagiarizing. Folio shows how. Guaranteed. Price 50c. Information free. Writecraft, Box 202-M, Chicago Heights, Ill.

I WANT New writers to cash hundreds of checks for \$1 to \$100, offered each month. The easiest way to write for pay. No previous experience necessary. Send for free details. No obligation. Saunders M. Cummings, 467-M Independence Bldg., Colorado Springs, Colo.

NEW Writers needed to rewrite ideas in newspapers, magazines and books. Splendid opportunity to "break into" fascinating writing field. May bring you up to \$5.00 per hour spare time. Experience unnecessary. Write today for free details. No obligation. Postcard will do. Comfort Press, Inc., 210-P South Seventh St., St. Louis 2, Missouri.

WIN Fame, success, security writing short stories, newspaper features. New, easy plan shows you how. Write today for exclusive details. Writer's Institute, 4-M So. 15th St., Philadelphia 2, Penna.

BUSINESS SERVICE

YOUR Letters compiled and re-typed into business form. \$5.00 per page. Donald Stelzner, N.A.S., Minneapolis, Minn.

EXPERT Service on sales letters, specialty letters, business counseling. Free details. Fred Trest, Dothan, Alabama.

WE Will represent you in Connecticut. Business and personal assignments \$1 per hour. J. L. Vibbert, P.O. Box 828, Waterbury, Conn.

BALTIMORE, Maryland, mail address. Branch office, etc. Single letter forwarded 10c. Box 765, Baltimore 3, Maryland.

LETTERHEADS. Envelopes, statements, cards, blotters, etc. Ace Printing, Brentwood, Maryland.

CLASSIFIED Mailing lists. Details, stamp. 2451 Chelsea, Kansas City 1, Mo.
YOUR Office conducted Los Angeles, Hollywood, \$1.50 month. Hollywood Personal Services, Suite 218, 1154 No. West-ern, Hollywood 28.

TO Whom it may concern: We will represent you in all principal cities of the world. Personal or business assignments \$1 per hour. James W. Farley, Citizens Bldg., Cleveland 14, Ohio. Note: Would appreciate hearing from someone who wishes to enter this business in your city. Will send you assignments immediately. References exchanged. State qualifications.

USE Our office as your office! \$3.00 monthly maintains Washington, D. C. "Capital" address. Your business, personal mail reforwarded when wanted. Hawkins, (established 1917), 1300 Taylor.

SPECIAL SERVICES

MANUFACTURERS! Increase production. Reduce costs. Write for details Moore's Modern Production Control, and Wage Incentive Plans. Installations anywhere in United States. Fees reasonable. Moore and Company, Industrial Analysts and Consultants, Fidelity-Philadelphia Trust Building, Philadelphia 9, Penna.

MAIL Forwarded from Ozarks playgrounds—25c. Leming Service, Russellville, Arkansas.

COLLECT Notes, bills, accounts anywhere 50%. Bonded. Kessinger, Box 503, Riverside, Calif.

MAIL Forwarded 25c each letter. Personal assignments. Reliable. Box 8431, Portland, Oregon.

STENCILS Cut, 1 1/4" letters, 15 letters—two spaces per line. 50c line, minimum \$1.00 postpaid. Bond, Box 986, Borger, Texas.

NYLON Stockings! Information where to get. Service, 418 Gregory, Rockford, Ill.

VISIT Greater New York by mail. Send 25c for 4 post card views. You address, return, we remail. Letters with New York postmark mailed 15c. Personal or business assignments transacted honestly and confidentially. Small fee. Jon Kelly, 126 Lexington Ave., New York 16.

GOOD "Used" self-instruction educational books on all subjects bought, sold, rented, exchanged. Satisfaction guaranteed. Complete information and 100-page illustrated bargain catalog free! Write—Nelson Company, Chicago 5.

CARTOONING, COMMERCIAL ART, SHOWCARD WRITING, SIGN PAINTING

SIGN Painters—Save time removing signs and decals from glass. I know how. Will cost you little but guaranteed to save time. Write D. M. Chapin, 307 South 7th, Artesia, New Mexico.

CARTOON Gags! Twelve for two dollars! James Jacobs, Box 421, General Post Office, New York 1.

"WHY Didn't I Think of That?" New dollar book explains the mainspring of humor. Free description! Cartoon-O-Mart, Box 6263, West Palm Beach, Florida.

UNUSUAL Art course eliminates technique. Paint original brushless pictures without previous experience. Inexpensive. Colorful particulars free. Weidler, 1321 Wellesley, Los Angeles 25, California.

ARTISTS! Make more money. We show you how regardless of your experience. Free details. No obligations. Art Book Shop, Arnold 1, Missouri.

"HOW To Make Money With Simple Cartoons."—A book everyone who likes to draw should have. It is free; no obligation. Simply address Cartoonists' Exchange, Dept. 910-C, Pleasant Hill, Ohio.

SIGN Painting taught at home by an old master. Ben Kerns, Dept. A, Box 812, Greenville, S. C.

SHOWCARD Writing—Learn "modern way." Inexpensive. One big complete lesson. Information write Palette Art, Box 604, Los Angeles 34, California.

LEARN Showcard writing at home in spare time. Fascinating, lifetime business of your own. No special skill needed. Free information. Sherwood Publishing Co., Irvington 31, N. J.

CARTOONING Instruction course. Covers everything from beginning to advanced stages. Over 600 illustrations. 50c complete. Lawrence & Belyea, 230 West 99th St., New York 25, N. Y.

EARN Money evenings, copying and duplicating comic cartoons for advertisers. Adservice, Argyle (1-B), Wisconsin.

HILARIOUS Chalk talk fascinates any audience. Twenty minute program \$1.00. Sample drawing dime. Bobby Earl, 2806 Virginia, Connersville, Indiana.

NEW Show card lettering course. Illustrated. Postpaid \$2. Art Instructions Studios, 47-23rd Ave., Paterson 3, N. J.

ARTISTS—Students: Auto-scale saves half time copying, enlarging, reducing drawings. Guaranteed. \$3. Particulars free. Disco, Box 761, Glendale 5, Calif.

CHALK Talks. Laugh producing program. \$1.00. Catalog 10c. Balda The Cartoonist, Oshkosh, Wisconsin.

CARTOON Course—22 easy lessons. 200 figure sketches. 25c coin postpaid. Snack-Pack Co., 32 E. Georgia, Indianapolis 4.

MAKE Signs, letters, stencils. 9 complete alphabet pattern sets. 3 complete numeral pattern sets and catalog \$1.00. Sign Letter Distributors, P.O. Box 101, Mineola, N. Y.

ADVERTISING AGENCIES, LETTER WRITERS, FOR ADVERTISERS

MAILING List, 1000 names, wealthy winter resort prospects. \$10.00 cash. BMA Co., 5027 Sunderland, Jacksonville, Fla.

100,000 NAMES 1946 Maryland automobile owners. Gummed labels. \$7.00 1000. Lynch Agency, 402-6 Hazlett, Baltimore 29, Md.

INCH 22,000 Readers \$4.00. 20 words 30c. Renick, Holland, N. Y.

ADVERTISING Placed everywhere lowest rates. Reliable guidance on publications, expert assistance on ads without charge. Newspaper, magazine, mailing-list ratebook free. Chicago Advertising Agency, 20-P West Jackson, Chicago 4.

MAILING Lists—Accurate. State type wanted. Charles, Dept. M1 Station "A," Manchester, Conn.

200 OPPORTUNITY Seekers on gum stickers. \$1.00. Acme, Box 809, Milwaukee 1, Wis.

BUYER'S Guide aid to shopping. Patronize the advertisers. Advertisers appearing in The New Day are patronized by millions that buy at no other place, but those appearing in The New Day issues. New York City and coast to coast circulation. Inch display. 4 issues \$4.80. Weekly paper. Rate folder, copy and mailing—dime. New Day Advertising, 1216 Park Row Building, New York 7, N. Y.

AMAZING Results now. Newspaper classified. 20 papers, 24 words \$10.60. Catalog 70 selected lists FREE. We specialize. Machen & Co., Station "F," Toledo, Ohio.

ADVERTISERS! "Advertise South." 5,000,000 circulation, 28 popular Sunday newspapers, 24 words \$52.52. "Proven pullers." Free rate bulletin. Alabama Advertising Agency, 216 Exchange Building, Birmingham 3, Alabama.

SPECIAL! 20 Words twice 25c. Swap-Hobby Bulletin, Royal Oak, Mich.

OUT Of town mailing lists, 1000 names per \$1.00. Name city desired. Punch, 172 East 63 Street, New York City, N. Y.

ADVERTISING Copy, effective layouts and artwork; placement service in magazines and newspapers. Write Mr. Thomas for folder. Diamond Advertising Service, 326 Pennsylvania Ave., Washington 3, D. C.

ORDER—Pulling sales letters written, \$2 page. Twenty years' experience. Satisfaction guaranteed. Dudley Bunn, 126-PM Lexington Avenue, New York 16.

ADVERTISING. Art work, sales letters. C. F. Sanford, 5029 Maple Ave., St. Louis.

MAILING Lists, certified, productive, inexpensive, \$5.00 1000. Homeworkers, agents, buyers, etc. Write Dixie Service, King, N. C.

ADVERTISERS! 6,000,000 Circulation 25 Sunday national key newspapers, 18 words, \$40.79. "Terrific pullers." 20 popular newspapers \$8. "Free booklet." Newmarks Advertising Agency, 217-7th Ave., New York.

FREE! 1946 Advertisers Rate & Data Directory. 52 pages! E. H. Brown Advertising Agency, 20 N. Wacker, Chicago 6.

ADVERTISE: 24 Words, 40 newspapers \$3.50. List free. Advertising Bureau, 4515-C Cottage Grove, Chicago 15.

24 WORDS In 64 weeklies \$4.96. H. J. Darnell, 730 Hays, Jackson, Tenn.

ADS Placed in out of town newspapers and magazines. Low rates. Catalogue free. Ideas that pay. Baker Advertising Agency, Successors Ankrum Agency, 189 W. Madison, Chicago 2.

SELL Your patent through a small classified ad in Popular Mechanics. Many inventors have found buyers in this way. Ask me for proof—I'll gladly send it to you. F. W. Johnson, Manager Classified Advertising, 200 E. Ontario St., Chicago.

TYPEWRITERS, DUPLICATORS, OFFICE DEVICES

PRINT-O-MATIC \$9.50 With kit supplies. Handy postal scale 69c; Used mimeograph \$25. All makes office machines bought, sold, repaired. Schubert, 2800 Sunset, Los Angeles 26.

RECONDITIONED Typewriters, mimeograph, multigraph printing devices, appliances, supplies. Catalog. Dixiegraph Service, King, N. Carolina.

PRINT Your own postal cards, paper, or anything on "Printomatic Self-feeding Rotary Postal Card Stencil Duplicator." Only \$9.50 with \$2.35 worth of supplies, stencils, ink, etc. Literature free. Pittsburgh Typewriter Supply, 336-RB Fourth Ave., Pittsburgh 22, Penna.

RUBBER STAMPS, OFFICE SUPPLIES

RUBBER Stamps. All types. Free catalogue. Print & Stamp Co., Box 172 Back Bay Annex, Boston, Mass.

THREE Line rubber stamp 65c. Centry, 1304 Mack, Detroit, Mich.

PICTORIAL Rubber stamps for children. Sample 15c; 6 different 75c; ink pad 25c; catalog free. Stamporium, 2660P Rochester, Detroit 6, Mich.

3 LINES, Cushioned, indexed, knob handle, \$1.00. Pad 25c. Warner Stationery Company, Havre de Grace, Maryland.

BETTER Rubber stamps. Postal brings special offer. Lee-Vall Press, Box 1242, Indianapolis 6, Indiana.

TOP Quality rubber stamps, rubber cushioned, full size handle, gold indexed, 35c per line. 3 lines \$1. Bernell Products, Inc., Dept. B, 170 Broadway, New York 7.

RUBBER Stamps, all kinds. Send for catalog. Excello, Box 500, Shreveport, Louisiana.

3 LINES 40c. Signatures \$1.75. Pads. 25c. Stamprite, Wauwatosa, Wis.

PRINTING, MULTIGRAPHING, MIMEOGRAPHING, GUMMED LABELS

PRINTING—100 Half letterheads, 100 envelopes, good, \$1; better, \$1.25; best, \$1.50. Stillman Taylor, Cologne, N. J.

100 MIMEOGRAPHED Blotters \$1.35 prepaid. Your copy. Free estimates any mimeographing work. Guaranteed. Western Letter Service, 814 Grant Building, San Francisco 3.

250 8 1/2x11 LETTERHEADS And 6 3/4 envelopes \$2.75 postpaid. Advance, Strasburg, Ohio.

500 BOND Letterheads \$2.00. 8 1/2x11, postpaid. Moyer Press, Windsor, Vermont.

SPECIAL—150 8 1/2x11 Hammermill letterheads, printed, postpaid, \$1.00. Envelopes same. Race Printers, Hudson, N. Y.

QUALITY Mimeographing. Any copy. Reasonable. Mimeo Shop, 812 Talma, Aurora, Ill.

NEW Business printing. Samples free. Special: 1000 business cards \$2.50 postpaid. 1040 Main Press, Clinton, Mass.

PRINTING, Mimeographing. Best and cheapest in the country. Imprint, Emporia, Kansas.

250 EACH Hammermill letterheads, envelopes \$3.00. Samples. Parker Press, 479 Main, Groveland, Mass.

150 LETTERHEADS And 150 envelopes \$2.00 postpaid. Going Print Shop, Box P1544, Muskogee, Oklahoma.

NAME, Address printed 100 sheets, 100 envelopes \$1. Michel, Box 76P, New York 16.

1000 FOUR Line stickers, \$1.00. Imprint, Box 361, Emporia, Kansas.

100 ENVELOPES—100 Letterheads (or statements) \$1.50 postpaid 4th-5th zones \$1.75. Keena, 1312 Jefferson, Grand Rapids, Mich.

3000 SHEETS 3 1/2x5 1/2 Yellow paper printed in typewriter type, fancy border for \$5.00. Send for sample, prices. Frank Michalucine, 3206 Eastwood, Chicago, Ill.

SAVE Money on printing—1000 photo-offset reproductions size 8 1/2x11 printed for \$3.95; larger quantities less. Prompt service, samples free. Fidelity Company, Parkersburg 14, W. Va.

500 LETTERHEADS (8 1/2x11) And 500 #8 3/4 envelopes—\$5.00 postpaid. Immediate delivery. Samples. Treaster Printing, Milroy, Penna.

ST. LOUIS Poultry Printing Co. Specialists. 250 letterheads with envelopes, plain \$2.00; printed \$3.70; any business; postpaid. 2324 Walnut St., St. Louis 3, Mo.

BUSINESS Cards—500—\$2.50—1000—\$3.50 postpaid. Grentius, 109 West 68th, New York 23.

PATENT ATTORNEYS

100 POSTCARDS—white or yellow—Your name and address, any color ink, \$1.50 postpaid. Tracy Printing Service, 7, 6623 Sixth, Spokane 15, Wash.

AT Last! Satisfactory printing. Samples. Mail Printing, M93, Danvers, Mass.

GOVERNMENT Postals imprinted low rates. Samples. Barry Press, Bay Shore, New York.

PRINTING, Mimeographing combinations. Top quality. Samples. Salem Print Shop, 4720 Salem, Dayton 5, Ohio.

75 HAMMERMILL Letterheads and 75 Whitewave envelopes \$1.00 postpaid. Benneville Printing, Box 1931, Pittsburgh 30, Penna.

MIMEOGRAPHING. Multigraphing. Highest quality. Reasonable. Letter Service, Box 1849, Chicago 90, Illinois.

QUALITY Printing, embossing, planographing. Lowest cost. Samples free. Adams, 30 West Washington, Chicago 2.

SUPERIOR Printing, postpaid. Samples free. Palmer Company, Berkley-Norfolk, Virginia.

SPECIAL! 500 Envelopes printed \$2.00 f.o.b. Mango, 555A South 20th, Newark 3, N. J.

UNIVERSITY And college stationery personalized with your name. Samples 10c. Details free. 1040 Main Press, Clinton, Mass.

100 LETTERHEADS, 100 Envelopes, \$1.25 postpaid. Tucker, P.O. Box 45, Indianapolis 4.

FREE Mimeographing with order. We mimeograph letters, circulars, etc. Write Gabb, 1298 Lauderdale, Memphis 6, Tenn.

250 LETTERHEADS, Envelopes \$3.00. Mallo Press, 767 Leith, Flint 5, Mich.

QUALITY Printing: Business, personal stationery. Prepaid delivery. Samples free. Mero Products, 100 Morrison, Punxsutawney, Penna.

BETTER Printing, attractively priced! Letterheads, envelopes, booklets, cards, labels. Samples, estimate free. Lonelm Publishers, Paulding, Ohio.

SEND 10c Now, for our 36-page 1946 pricelist—refunded first order. McCall Press, 1326 South 27th, Omaha, Nebraska.

BETTER Grade printing reasonable. Estimates on anything. Economic Press, Leonia, N. J.

MIMEOGRAPHING—Any copy. Reasonable. Mailers Service, Box 606-A, Chicago 90, Ill.

500 3/4x2 1/4 FOUR Line gummed stickers, 25c. Moritz Printery, Saginaw, Mich.

MIMEOGRAPHING—Letters, pricelists, formulas, instructions. Lowest prices. Lem's Letter Shop, 5710 Stanton, Detroit 8.

200 SHEETS 5 1/2x8 1/2, 100 Envelopes, Hammerrill bond, \$2.00 postpaid. Samoset Press, Plymouth, Mass.

PRINTING OUTFITS AND SUPPLIES

4"x6" HAND Press, \$50. Neostyle mimeograph, \$20. Best Co., Box 5802, Cleveland 1, Ohio.

CUTS Made to order. Free estimates. Schumacher, 5130 Cedarsprings, Dallas, Texas.

MAKE Cuts from photos and drawings. Simple. Inexpensive. Both processes \$1.00. Lucius Dawsona, Box 20-A Sta. "J," New York.

PRINT At home—Send 10c for catalogue—presses, type, supplies. Barnhard Co., 6 Columbia St., Newark 5, N. J.

MAKE Cuts, zinc line etchings, reverse plates, half-tones. Free details. Mechano, 2344 W. 121st, Blue Island, Ill.

PRINTING. Bookbinding machinery, type, cabinets, perforators, photocopy machines, jewelers pantograph, bulletins 3c. Box 918, New York 8.

PRINTING Press plans, \$1.00. Details, samples free. Homer DeSellier, 19 Stebbins, Springfield, Mass.

PRINTERS. Make cuts the Quick Etch method. Details free. Charles P. Medlock, Box 256C, Goodland, Indiana.

HOME-MADE Presses. Proofs free. Riegel, 1111 Harrison, Phila. (24), Penna.

CUTS—Make real halftones. Line cuts yourself! Samples 25c. Particulars free. Rapid Chemical Service, Edwardsville, Ill.

PRINTING—Equipment, type and supplies. Send stamp for details or dime for complete illustrated supply book. Kelsey Inc., X-11, Meriden, Conn.

INEXPENSIVE Home-made printing press. Details free. Novelty Shop, Downs-ville, Louisiana.

BUSINESS Or personal cards \$2.50 per 1000. Cosme Press, P.O. Box 6, New Bedford, Mass.

INVENTORS. Have patent protection first. Remember, the details of your invention do not have to be 100% perfect before you can obtain patent. First step is to have us conduct search of prior U. S. patents and render a report as to its patentability. Send at once for further particulars and "Invention Record" form. Request does not obligate you. Mc Morrow, Berman & Davidson, Registered Patent Attorneys, 1342 Atlantic Building, Washington 1, D. C.

INVENTORS: Write for free brochure "Evidence of Invention." Labiner, World Building, New York 7.

PATENT Protection—The U. S. Patent Office recommends "an applicant is advised, unless familiar with such matters, to employ a competent registered Patent Attorney as the value of patents depends largely upon the skillful preparation of the specifications and claims." Steps to be taken in obtaining patent protection available upon request. Victor J. Evans & Co., established 1898, 131-L Merlin Building, Washington 6, D. C.

INVENTORS: Learn now—without obligation—how to protect your invention. The patent laws were enacted for the benefit of the inventor to give him protection for the features of his invention which are patentable. The United States Patent Office advises the inventor to engage a competent, registered patent attorney to represent him. We offer the inventor experienced, conscientious counsel, and prompt, confidential service. A specially prepared booklet containing detailed information with respect to patent protection and procedure will be forwarded to you without obligation upon request. Clarence A. O'Brien & Harvey Jacobson, Registered Patent Attorneys, 61B-J Adams Building, Washington, D. C.

PATENTS And trade marks. Wilfred E. Lawson, 1524 K Street N.W., Washington 5, D. C.

PATENTS—U. S. and foreign patents secured. Trade-marks and copyrights registered. Searches made to determine patentability and validity. Patent, trademark and unfair competition causes. Lancaster, Allwine & Rommel, Registered Patent Attorneys, Suite 411, 815-15th St., N. W., Washington 5, D. C.

INVENTORS: Without obligation, write us for information as to what steps an inventor should take to secure a patent. Randolph & Beavers, Registered Patent Attorneys, 21-C Columbian Bldg., Washington 1, D. C.

PATENTS. Free preliminary advice. E. E. Vrooman, Patent Lawyer, Registered Patent Attorney, 871 Woodward Building, Washington 5, D. C.

"INVENTOR'S Guide." 100 mechanical movements, free; advises on patenting, selling inventions. Frank W. Ledermann, 154 Nassau Street, New York 7.

PATENTS—Trade marks. Irving L. McCathran, 315 McLachlen Bldg., Washington 1, D. C. Registered Patent Attorney.

C. A. SNOW & Co., M-427 Snow Bldg., Washington 1, D. C. Registered patent attorneys. Established 1875. Literature mailed on request.

FOR INVENTORS

INVENTIONS. New products, ideas, models, special machines, tools are our business. Write Model Crafters, Inc., Box 612, Hamilton, Ohio.

MACHINES. Mechanical inventions designed and built. Louis, 86 Walther Ave., Ridgewood, N. J.

WE Develop your ideas: You bring the idea, we will turn your idea into a profitable product. Confidential invention work and developing for individuals are our specialties. Elio Developing Company, 29-28 41st Avenue, Long Island City, N. Y.

PROTECT Your invention with registered trade mark. Complete instructions \$2. Satisfaction guaranteed. Charles Hall, Supelveda, Calif.

INVENTORS—Detroit and Michigan manufacturers may be interested in your idea, your classification list \$5.00. Theo. F. Madej, 19428 West Warren, Detroit 10, Mich.

INVENTORS! Have you good patentable ideas? Write Mr. Metzler, 11 West 42nd, New York.

INVENTORS—Your commercially valuable invention, any kind, patented, unpatented, may have cash, royalty possibilities in today's markets. Write today. Explanatory booklet, disclosure form, references, free. Invention Reporter, 5A-11106 So. Longwood Drive, Chicago 43.

INVENTORS: You save up to 300% when dealing with your patent searcher direct. Complete search with patent copies \$6.00. Invention protection forms free. Write Raymond L. Smith, Patent Searcher, 703-M Albee Building, Washington 5, D. C. (Former U. S. Patent Office employee.)

INVENTORS. Have patent protection first. Remember, the details of your invention do not have to be 100% perfect before you can obtain patent. First step is to have us conduct search of prior U. S. patents and render a report as to its patentability. Send at once for further particulars and "Invention Record" form. Request does not obligate you. Mc Morrow, Berman & Davidson, Registered Patent Attorneys, 1342 Atlantic Building, Washington 1, D. C.

INVENTORS—Free information "Temporary Protection For Few Cents." Searches from patent files. Patent drawings made to give you utmost protection. Capitol Design and Drafting Center, Box 4741XP, Washington 20, D. C.

INVENTORS—Victor J. Evans and Co., established 1898, has a staff of registered patent attorneys, available to represent inventors in the preparation and prosecution of their cases before the Patent Office. Detailed information and the steps to be taken to obtain patent protection will be furnished upon request. Victor J. Evans & Co., 132-L Merlin Building, Washington 6, D. C.

INVENTORS—Sale of your invention for greater profit and satisfaction made possible with our market survey and sales recommendations. We analyze markets, sales possibilities, contact manufacturers, negotiate sales. Send for free instruction bulletin. National Merchandisers, Inventors Service Division, 28 E. Huron, Chicago 11, Ill.

INVENTORS-MANUFACTURERS! Sell your product to variety chains. New, complete list; \$2.00. La Bell Advertising, Lyman Building, Muskegon, Michigan.

YOUR Idea can bring big cash returns. Write for free advice now! William H. Jacques Associates, Licensed Professional Engineers, Zobel Bldg., Red Bank, N. J.

PUBLICITY Sells patents. Low cost. Details free. Dudley Bunn, 126-P Lexington Avenue, New York 16.

INVENTORS: Learn now—without obligation—how to protect your invention. The patent laws were enacted for the benefit of the inventor to give him protection for the features of his invention which are patentable. The United States Patent Office advises the inventor to engage a competent, registered patent attorney to represent him. We offer the inventor experienced, conscientious counsel, and prompt, confidential service. A specially prepared booklet containing detailed information with respect to patent protection and procedure will be forwarded to you without obligation upon request. Clarence A. O'Brien & Harvey Jacobson, Registered Patent Attorneys, 61A-J Adams Building, Washington, D. C.

DRAWINGS Of your ideas—inventions, by college draftsmen. Drawings approved by patent attorneys. Chrisman, College Box 375, Manhattan, Kansas.

"INVENTOR'S Guide." 100 mechanical movements, free; advises on patenting, selling inventions. F. W. Ledermann, 154 Nassau Street, New York 7.

WANTED: Practical inventions. Inventors Exchange, Research Division, B6, Hartford 1, Connecticut.

I SELL Patents. Established in 1900. Charles A. Scott, 773PM Garson Ave., Rochester, N. Y.

THE Inventor who believes he has a new and useful invention, and needs advice, should consult a competent registered patent attorney. Without obligation, write for full information on how to secure patents and trademarks. Randolph & Beavers, Registered Patent Attorneys, 11-E-Columbian Bldg., Washington 1, D. C.

INVENTORS: Avoid unnecessary expense. Write for free booklet explaining how our consulting and advisory service can assist you in deriving greatest profit from inventing. Institute of American Inventors, Dept. 40-A, 1926-Eye St. N.W., Washington 6, D. C.

CASH For practical ideas and inventions. Mr. Ball, AB-9441 Pleasant, Chicago.

RUBBER—Everything in rubber. Patents developed. Dept. P.M. Broadway Rubber Mfg. Co., Louisville 2, Ky.

INVENTIONS WANTED

INVENTORS: Sell direct to manufacturers. Send \$1.00 for list of 212 manufacturers buying new inventions. Invention Market Research, 342-PMI Madison Ave., New York 17.

ATTENTION: Have you a practical and saleable invention—patented or unpatented? Contact us immediately. John D. & Son, 140 Spruce St., PM-10, Box 3213, Bridgeport 5, Conn.

WANTED: Practical inventions for marketing through chain, drug, and cigar stores. Particularly desired lighters, smoker's articles, etc., in plastic, wood or metal. Write Matt, 1412-DN Great Northern Bldg., Chicago 4.

INVENTIONS WANTED: suitable light manufacturing; possessing practical, popular appeal; royalty preferred; send sketch, sample or patent copy; describe fully. Frank Lewis, 4522 North 20th Street, Omaha 11, Nebraska.

NEW Photographic products (Patented or unpatented) wanted by client doing national business. Cash sale or royalty arranged after free market investigation. Give general description of your invention in first letter. Lessing Advertising Co., Inc., 910 Walnut Bldg., Des Moines, Iowa.

CASH For inventions, patented, unpatented. Mr. Ball, A-9441 Pleasant, Chicago.

EARN Up to \$2,000 year, inventing simple items for special cash markets. Ideas only. No patents. Hendrickson, Argyle (7-B), Wisconsin.

INVENTORS: Hundreds of manufacturers have requested our assistance in locating marketable new products. Complete information, free. Institute of American Inventors, Dept. 40-D, 1926-Eye St. N.W., Washington 6, D. C.

WANTED—Patented, unpatented inventions having profit possibilities, all kinds. If will sell, reply immediately. Descriptive booklet, references, free. Invention Reporter, 5B-11106 So. Longwood Drive, Chicago 43.

PATENTS FOR SALE

AUTOMATIC Garage door, application filed. Locking, simple, safe. Royalty desired. Ballelectric Garage Door, Milton, Washington.

HIGH Class dental surveyor, designed for low manufacturing cost. Patent applied for. Manufacturers only. E. C. Harris, 284 Castro St., Hayward, Calif.

HANGER "Cap," slips over wire hanger to protect and hold garments in good shape. For cleaning shops and general use. Mrs. M. Rader, 5715 King Hill Ave., St. Joseph 46, Mo.

TWO Good items—Automatic jar top wrench, combination can opener and jar opener. "Patent applied for." Sell outright or royalty. Nathan D. Hoskins, Box 542, Parsons, Tennessee.

INVENTORS—Your patented, unpatented invention, if practical, may have specific cash, royalty value in correct markets. Find out now. Explanatory booklet free. Invention Reporter, 5D-11106 So. Longwood Drive, Chicago 43.

PATENT Pending, plastic reflectors, Christmas tree or other lights. Simple. Cash or royalty. John Schwab, 44 Ellen St., Winnipeg, Man.

RULED Reinforcing bars. Patent 2,245,133. Simple money saver for the lively construction program. Thomas Hopkins, 52 S. Hallett, Mobile, Ala.

CAPTURED German and Jap patents, 18,000 enemy alien formulas, patents, ideas, plans, drawings. Use immediately; royalty free. Bishop Tools, 111 W. Washington, Chicago 2.

INVENTORS: Test the commercial value of your patented or unpatented inventions, quickly and inexpensively. Write for free information. Institute of American Inventors, Dept. 40-B, 1926-Eye St. N.W., Washington 6, D. C.

MANUFACTURING

ROBBINS Aluminum Foundry. Aluminum, brass castings made. Job work and manufacturing. P.O. Box 2446, Denver 1, Colo.

INDUSTRIAL Diamonds mounted \$1.50. Models, small lot manufacturing. Tools, dies. Specialty Machine, 2821 Mitchell, Racine, Wis.

MODELS. Mechanical work. Wide variety. Baum's Metal Specialties, Kansas City, Mo.

SEND Item or drawings for estimates. Machinists, 14-111-PM 229th, St. Albans 11, N. Y.

WANTED Manufacturer (wood turner) to produce small, accurate, wood, machine-made brush handles, 2 1/2" and up, in quantities with prompt deliveries. Andrew Mack & Son, Jonesville, Michigan.

CANVAS Items manufactured. What do you need? Cohanzick Canvas Goods Mfg. Co., Bridgeton, New Jersey.

INVENTORS—Market study; developing; manufacturing models, J. M., Burlington, Kentucky.

MODELS—Small lot manufacturing. Metals, plastics, etc. Milburn, Burlington, Kentucky.

MODELS AND MODEL SUPPLIES

CABIN Cruiser speedboat. Complete kit including die cut sheet parts, partially shaped hull, full size detailed plan. Length of finished model 8", 75c each. Write for free list of other boats, famous racing planes, planes of World War I and II, and historic planes. Georges', P.O. Box 86, Universal City, California.

"MODEL Rail News," 5c. Lionel, Gilbert, scale railroading. HO circus catalog, 5c. Both free with HO-OO steel rule, showing scale feet—40c! Hoxie, 150-P Stewart, Providence 3, Rhode Island.

SHIP Modeling kits. Making model blocks and deadeyes faster 40c; color and age ship models 40c; antique ship models 25c; all three \$1.00. Ship models illustrated \$2.00. All four \$2.85 postpaid. R. E. Hancock, 323 Douglas Ave., Portsmouth, Virginia.

MODEL Makers: miniature electric motors, made for government, ball bearings, reversible, permanent field, 27.5 volts d.c., shaft .125", \$2.85 each postpaid, cash or money order. Palo-Myers, Inc., 81 Reade Street, New York 7, N. Y.

MODEL Engines, plane and boat kits, model supplies. Circular 10c. Wilco, 4608 1/2 North Kedzie, Chicago 25, Ill.

DOWMETAL Magnesium now available in miniature extrusion structural shapes and 1/16" flat stock. Write for sizes and prices. Sims & Associates, Grosse Pointe, Mich.

BRASS Gears and model supplies for the inventors. Send 10c for catalog. Pierce Model Works, Tinley Park, Ill.

WIZZ Electric motor 35c. Further details under Engines, Motors heading.

ELECTROLYTIC Battery chargers—flash light size rechargeable batteries. Write Kimley, 103 Highland, Williamsville 21, N. Y.

BOATS, Engines, model, real, catalog, plans, 25c. Marinepress, Groton, Conn.

STEAM Engines, boilers, castings. Circulars 10c. Anton Bohaboy, 2297 Price, Rahway, New Jersey.

PATTERNMAKERS, Modelmakers. Use metal. Workable with fingers. Hardens like steel. Sample included, \$1.00. Wm. Koppel, 167 Center, Pawtucket, R. I.

150 MPH Model airplane. See International Research advertisement page 267.

FREE Catalog of model trains, airplanes, ships, accessories and tools. Ben's Hobby Company, 72 West Washington, Chicago 2, Illinois.

BUILD Complete miniature circus, 1/8" scale. Cage wagons, pole wagons, baggage, property, ticket, band wagons, calliope, 75c to \$1.25. Cast metal horses, drivers, lions, camels, giraffes, elephants, people, acts, 15c to 25c. Main tents, side-show tents, circus railroad cars. Send 35c for booklet-catalog "Building Miniature Circus." Bathgate, 30 Main, E. Orange, New Jersey.

BUILD Model ships, airplanes, railroads. Catalog 10c. Ideal, 21 West 18th Street, New York 11, N. Y.

SHIP Models and yacht supplies complete. Large 64 page catalogue 30c. Bill Wild's, 510 East 11 St., New York City 9.

LANDLOCKED Sailors! Here's a beautiful, richly illustrated, fully descriptive catalogue of famous model ships—whalers, slavers, corvettes, etc., authentic in every detail. Send for it today. Only 10c. Marine Model Company, Inc., Dept. C-17, Halesite, Huntington, N. Y.

ENGINE Castings, Supplies, Catalogue 10c. Howard A3, 2417 N. Ashland, Chicago, Ill.

RAILWAY Models, complete line, 128 page catalog, HO and O gauge 25c. Walthers, 247 Erie, Milwaukee 2, Wis.

SHIP And yacht model fittings and blueprints. Hundreds of items to choose from. Send 25c for new illustrated catalog. A. J. Fisher, 1002 Etowah Ave., Dept. M, Royal Oak, Mich.

MODEL Engine catalog, railroad supplies, 25c refunded. Simonsen, A-3054 Greenview, Chicago 13.

BIG Illustrated model engine catalog 10c. Active Products & Supply Co., 53 W. Jackson, Chicago 4.

SHIP Model kits and fittings. Complete line Fisher model yacht equipment. All Boucher, Fisher, Marine Model and Ideal kits, fittings and blueprints at standard prices. Most complete stock in New England. Send 10c for price list. James Bliss & Co., Inc., 230 State St., Boston, Mass.

MINIATURE Steam locomotives, 1/4", 1/2", 3/4" scales. Castings, parts, rail! Thorough drawings with instructions. Catalog 25c. Little Engines, Wilmington, Cal.

CATALOGS (Illustrated) for modelers! Airplanes, 60 page book on solids. Features construction data, specifications, camouflage, 15c; railroads: 128 page "HO" guide. Equipment, accessories, fittings, 25c (includes refund coupon). Send coin or stamps for each profusely illustrated catalog desired. Polk's, "Nation's Leading Hobby House," 314-PM Fifth Ave., New York City 1.

HOME CRAFTSMEN

HAND Painted, professionally designed ties. Make your own in 30 minutes. Complete kit of instructions, patterns, samples, and advice on new styles \$2.00. Pettit Pac Products, Box 112, South Pasadena, Calif.

EXPERIMENTERS — Bargain assortments, surplus 48-pitch gears, assemblies. Fifty pieces, \$4.75; hundred, \$8.50; postpaid. Scientific Construction Company, Box 438, Hackensack, New Jersey.

CRAFTSMAN, Hobbyist, homeworkers, individual bulletins issued semi-monthly. Plans, ideas, short cuts. All crafts. Free details. Crafts, 2705 West Olympic, Los Angeles 6, California.

LEATHER Scraps for hobbyist. Six pounds \$2.00. Hobby books "Applied Leathercraft" \$3.00, "Art of Whittling" \$2.00, "Wooden Toymaking" \$2.25. Hobby books catalog free. Northern Supply Co., Dept. A, Sheboygan, Wis.

CRAFTSMEN, Make children's playthings. Full size patterns rocking horse, swan rocker, stroller, cradle and wheelbarrow \$1.00 postpaid. Lincoln's Craft Shop, Farmington, Conn.

LEATHERCRAFTERS! Send for free catalog listing leather, kits, supplies. Kit Craft, 1607 S. Western, Los Angeles 6, Calif.

CRAFTSMEN— Lawn furniture plans, beautiful jigsaw designs—large selection—free folders. Summercraft Studio, 42 Vernon St., Newton 58, Mass.

FREE! \$1.00 Shellcraft instructor, 48 illustrated pages. Free! Catalogue of supplies, shells! Colored and natural, package or gallon quantity. (Complete line) To serve the beginner, experienced, or dealer. Pace's, 2117 14 St. W., Bradenton, Fla.

MAKE Beautiful bracelets with simple tools. Kits complete—Non-tarnishable aluminum, materials, patterns, instructions. Leaf link or band design \$1.00 each. Both \$1.85. Guaranteed. Lewis Metalcrafts, Box 755, Los Angeles 25, California.

30 FULL Size toy patterns 50c. 40 novelty and lawn ornament patterns 50c. Other patterns; craft supplies; lists 10c. Lynds, Medway, Mass.

PATTERNS 70 Lawn ornaments and novelties \$1.00. Five new hanging shelf \$1.00. Doll stroller, colonial cradle, circus group, table and chairs \$1.00. Milne's Hardware, 1501 Wadsworth, Saginaw, Mich.

24 BEAUTIFUL Pieces of plastic and shell jewelry. Kit \$3.00. Craft Co-op, 3928 Dumaine, New Orleans.

FELTCRAFT Projects for Christmas sales. Beanie kit 59c, suspender kit 59c, de luxe suspender kit 98c, pennant kit 75c, needle holder or pen wiper kit 25c. Send 10c for felt color chart and book list. The Felt Crafters, Felcraft Dept., Plaistow 10, N. H.

FREE Turning brass rods, rounds, squares, hexagons. Bronze bearings and bushings. Sheets, tubes, screws, nuts and washers. Steel drill rod. Richards Industries, Box 362E, Jamaica, New York.

TOY Plan, easily made, \$3.00 and 10% comm. James E. Van Dyke, 6012-B Middleton St., Huntington Park, Calif.

MAKE Cute baby rockers, different, sell easily. Full size plans 25c. Frieders, 609 North Root, Aurora, Illinois.

BEAUTIFUL Mirrors from ordinary glass. Complete instructions, \$1.00. Tesco, PM-2, P.O. Box 189, Wilkes Barre, Penna.

FREE Toy plans descriptive circular. Write Production Engineering, 403-C City Hall Bldg., Rockford, Illinois.

INTERESTED in radio, electrical, mechanical devices from war surplus? List free. E. Siefke, Box 18, Station E, Buffalo 11, N. Y.

BALSA Wood. Ideal for modelers, craftsmen. Sample carving block 25c. List free. Sanlader, Manitowoc, Wis.

DELUXE Plastic kit, contents: assorted plastic dye, cement, instruction, jewelry findings, \$2.25 prepaid. Free catalogue. Novalte Plastic, P.O. Box 106, Brooklyn 19, N. Y.

MAKE Your own tubular chrome breakfast set. We furnish chrome parts and trimmings, plans. Tri-Angle Mfg. Co., Evansville, Ind.

MAGNIFICENT New bronze genuine World War 2 army assault boat propellers. 3 blade, 12" dia.; approx. 5 lbs. Makes marvelous souvenir base for numerous articles that can be made in your own shop. Only \$5.65 each postpaid. Remit with order. Baker Bros., Box 301F, Palatine, Ill.

BRAND New government surplus surgical knives, used by leading doctors, hospitals, dentists, veterinarians, taxidermists, model makers, photo retouchers, woodcarvers. Send \$1.00. Supply limited. Ruff Surplus, 1311 East California Ave., Glendale 6, Calif.

LEATHERCRAFT—Make wallets, key-cases! Learn tooling, carving! Write Craftsman, 25 Wetmore Ave., Morristown, New Jersey.

LEATHER Craftsmen! Something new under the sun! Lampkin Artcraft Transfers imprint design on leather instantly. May be used repeatedly. Tiresome tracing eliminated. Hundreds of exciting, imaginative, original designs. Decorate belt, billfold, bookends, cigarette case, blotter strip, handbag, etc. with special introductory transfer designs. Send \$1.00 for this offer and literature describing Lampkin Artcraft Transfers. Lampkin Artcrafts, P.O. Box 641-M, Culver City, California.

MASONITE Mill ends 10 lbs. \$1.00 plus postage. Carl Sign Co., Wooster, Ohio.

MAKE Shell jewelry! Profit! Pleasure! Shellcraft instruction book free! Express your artistic inspiration! 450 Caribbean shells, including findings for making \$6 worth, \$1. Satisfaction guaranteed. Shell Company, Miami 36, Florida.

WHITTLES'S Supplies, readicut blanks, special woods, knives. Old Whittler, 1402 Charles, LaCrosse, Wis.

SOLDER Aluminum with ordinary soft solder and soldering iron! Send \$1.00 for generous supply of our new flux. Warhaven Industries, R.D. No. 3, East Aurora, N. Y.

JEWELRY Accessories, Findings. Plastic and metal pinbacks, screw eyes, ear wires, clasps, chains, rings, pearls, cameos, stones, etc. Prompt shipping service. Lists 10c. Doremby Co., Chisholm 1, Me.

MAKE Shell jewelry—for gifts, as a hobby or start a business. Free catalogue and price list. Complete illustrated book of instructions 75c. Florida Shellcraft Company, Box 1840, Sarasota, Florida.

SHELLCRAFT Kits for beginners—shells and complete supplies for making pins, earrings, combs and novelties. Instructions free. Kits \$2.00 and \$5.00. Herbert Diamond & Co., 1121 North East First Avenue, Miami 36, Florida.

35 PATTERNS Of action pull toys, trucks, carts, toy furniture, etc., \$1.00. Continental Homecrafter, 907 Birch, Eau Claire, Wisconsin.

SHELL Jewelry supplies. Wholesale only. McFarland Plastic Co., Sarasota, Fla.

BUILD And sell lawn chairs. Plans \$1.00. We tell you how and where we sell. The Woodcraft Shop, Danby, Vermont.

CATALOG: Patterns plywood novelty furniture, letters, numerals, plaques, frames, weathervanes, silhouettes, lawn ornaments, 100 books and booklets on crafts and hobbies, picture frame mouldings, tools, large line decal transfers. Other lines. Hundreds articles finely illustrated. Write Wo-Met Shop, Ashburn, Ga.

KNOCKDOWN Cedar chest lumber veneers. Free price list. Giles-Kendall, Huntsville, Ala.

MAKE IT YOURSELF

BUILD 250 Amp. a.c. welder yourself. Simple, low cost. Complete instructions, \$3.50. Used successfully in industrial plants past seven years. Wesco Mfg. Co., Marshall, Texas.

BUILD Your own oil furnace. Inexpensive. Simple to operate. A clean method of heating. Plans \$1.00. Roland Kadletz, Box K-103, Salmon, Idaho.

BUILD Concrete block machine, new principle, motor vibrator or hand tamp, in 2 days for \$10, exclusive of motor. Makes standard block per minute. Complete plans, photos and instructions for building machine \$3.50 postpaid. Order from advertisement or write for details. Clyde Lee, Dept. A, Mountain View, Okla.

MAKE Your own store fixtures by my complete plans and instructions. Drug fixtures, meat coolers and fish cases to fit your requirements. Mail card for complete information. G. P. Padrick, 1535 S.W. 9th St., Miami 35, Fla.

MAKE Your own "Rustic Furniture." Our "Easy to Understand" plans tell how. You can make chairs, benches, tables, lamps, bird houses, summer house, and scores of other things. Our complete plan booklet only 25c. (Worth dollars.) Ask for Booklet No. 18. Popular Mechanics Press, 200 East Ontario St., Chicago 11, Illinois.

MAKE Her a popular black and white cameo pin with delicate Florida shells. Complete kit, instructions \$1.00. Poppe-well, 20 Plaza, Ridgewood, N. J.

BUILD Concrete block machine. Vibration and hand operated types. 100 blocks per hour. Easy, inexpensive. Sell blocks, build home, garage, barn at low cost. Free details. Horne, 206 West Wilder, Tampa 3, Florida.

BUILD Concrete mixer. Power driven, simple, inexpensive. Details free. Horne, 206 West Wilder, Tampa 3, Florida.

GUARANTEED Savings to 60%. "The Solution to the Housing Problem." Details on proven construction methods, unique lifetime material. \$1.00 postpaid. Associated Printing Company, 400 Main, Wood-Ridge, New Jersey.

8 DOLLAR Casting produces \$100 tool post grinder, plans included. 4" wheel capacity, use 1/4 H.P. motor. 2427 90th Ave., Oakland, Calif.

MAKE Photoelectric cell. Turn on lights, ring bell with light beam. Many magical experiments. Material for several cells and instructions 50c. Selenium, 1027 Center Ave., Norfolk 2, Va.

BUILD Powerful, compact garden tractor. Different principle. Plans \$2.00. Chas. Garber, Box 508, Far Hills Branch, Dayton, Ohio.

RECORD Player. Easily assembled yourself. 3 styles. Details 25c. We have amplifiers, tubes, etc. Re-Ampliphone, 2250 North 27, Milwaukee 8, Wisconsin.

BUILD Your home as a hobby. No rent. No mortgage. Save 50%. Use spare time. No special skill required. Amazing facts sent free. H. C. Lightfoot, Civil Engineer, Richboro 1, Penna.

GRANDFATHER Clock building system, simple, shop-tested, thousands built, with weight movements pictured in production \$1. Kuempe Chime Clocks, Minneapolis 16, Minn.

CONCRETE Mixer, efficient hand power, inexpensive from oil drum. Plans \$2.00. A. Mitkos, 8802 Corwin, St. Louis 21, Mo.

BUILD Concrete block machine, mixer, flame weeder, blueprints 50c each. Portable sawmill prints \$3.00. 12" planer, treesaw, edger, \$1.00 each. Catalog other prints 10c. Nichols Equipment Company, Purvis, Miss.

40 POWER Tools You Can Make. Book giving full details \$1.25. Popular Mechanics Press, (C-43), 200 E. Ontario, Chicago.

HOW To build cabins, lodges and bungalows. Features costs, estimates and instructions: \$1.98. Householders Complete Handbook, hundreds of "know-how" and "make it yourself" helps: \$1. Be Your Own Boss, book of opportunities: \$1.98. One book add 10c postage. Two or more prepaid. Order c.o.d. or money order from Eastern Book Service, 520 Washington St., Hoboken, N. J.

PLANS AND BLUEPRINTS

HOME Planning kit. If you plan to build you need this unique portfolio. 17" x 22" layout sheets for floor plans. Scale furniture cutouts. Landscape layout sheet. Building equipment selector. Budget planner. Dream House check list. Hours of fun planning your home with this loose-leaf portfolio. New. Practical. \$1.98. Money back guarantee. Red Lion Press, Golf 10, Illinois.

WATCHES, OLD GOLD, JEWELRY, ETC.

WOOLLY Lapel bunnies. Handmade 50c pair. Cado Products, 4842C Hutchinson, Chicago 41, Ill.

LEARN The manufacturing jewelry business at home. Easy illustrated course. There's money in jewelry! Catalogue. Gemcrafters, Dept. B, Kalispell, Mont.

SWISS Watches—Automatic calendars; immediate delivery, by registered post c.o.d.; thanks to International regime. First class 17 jewels wrist stop watch calendar, steel \$60; 18 crt. gold \$150; traveling folding eight day alarm calendar radium \$55 and \$65; Nahon, Estatuto 58, Tangier.

SEND Your discarded jewelry, watches, crowns, bridges, spectacles, silver, etc., for cash offer. Goods returned promptly if offer unsatisfactory. Old State Metal Co., 812 Erie, San Antonio, Texas.

UNUSUAL Novel rings, acrylic made, set with, genuine tooth \$1.50. Edwards, 2699 Pizer, Memphis, Tenn.

AMERICAN Horologist, watchmakers monthly magazine, \$2 year. Kimbel, Plant City, Fla.

BEGINNERS Jeweled pocket watch movements "as is" \$2.00 each. Bezkor, 1491 Metropolitan Ave., New York 62.

EARN, While learning watch repairing. C. Brandt, 3717 E. Hillsboro, Tampa, Fla.

"JEWELRY, Gem Cutting, Metalcraft." Fascinating designs for hobbies and money-making opportunities. New, complete illustrated book covers cutting, polishing, mounting gems, metal, jewelry work, etc. 287 pages, \$3.25 postpaid. Money back guarantee. We supply tools, materials at lowest cost. Modern Technical Book Co., Dept. MMC, 55 West 42nd St., New York 18.

GOLD \$35.00 Ounce—Mail old gold teeth, diamonds, jewelry, watches—receive cash by return mail. Satisfaction guaranteed. Free information. Dr. Weisberg's Gold Refining Company, 1500-Q Hennepin, Minneapolis, Minn.

GUARANTEED Watch repairing. Mail only. 8-10 day service. Vaughan's, 304 Arbor Drive, Columbia, S. C.

GEMS, Precious and semi-precious, all genuine, from world wide sources. Deal direct, no overhead, save money. Catalog 10c. Hill Co., Route 7, Salem, Oregon.

WATCH Repairing easy learned by our home study course. Watch repairers are in demand and are among the highest paid craftsmen today. Write for free information. Houston Chronometer & Watch Co., P.O. Box 1140A, Houston 1, Texas.

WANTED—Old or broken jewelry. Cash paid immediately. Mail gold teeth, watches, rings, silverware, diamonds, spectacles. Satisfaction guaranteed or merchandise returned. Information free. Rose Smelting Co., 29 East Madison, Chicago, Dept. A.

WATCH And clock repairing—complete practical course in modern horology. 66 illustrated self-instruction lessons. Just out! Low price. Fascinating 100-page illustrated catalog free! Write—Nelson Company, Dept. 8-02, Chicago 5.

TOBACCO, SMOKERS' SUPPLIES

MAKE Your own pipes. Detailed, illustrated, pipe makers manual \$1.00. Harold Mangus, Rt. 3, Alliance, Ohio.

CIGARETTES—Popular brands; minimum 3 cartons. Price \$1.40 per carton; postpaid. Send check or money order. Ace Mail Order Co., East Orange 84, N. J.

CIGARS And tobacco bargains. Regular size Coronas \$2.95 box 50. Others \$3.50 to \$10.00. Finest pipe tobacco, 8 oz. \$1.50. Free catalog. Zibar Co., Roselle 12, New Jersey.

CIGARS, 100 Choiceest quality, hand-made. \$5.75 postpaid. Money-order, check or cash. S. & E. Co., Department PM, Red Lion, Penna.

FREE To pipe smokers—For a new pipe smoking thrill, write us your brand of tobacco and get free package mild, tasty "Green River." Pete Moberly, Box 997, Owensboro, Kentucky.

SMOKING Pipes: Broken stems replaced. All makes. Straight \$1.00. Curved \$1.50. Jumbo \$2.00. Pipes polished like new. Send pipe and money to P.O. Box 277, Station D, New York 3, N. Y.

SURVEYING INSTRUMENTS

GUARANTEED Factory rebuilt transits and levels for sale (cash or terms) or rent (with purchase option). We will repair, trade, or buy old instruments. Ship prepaid for estimate and valuation. For complete information, write for list M-210. Warren-Knight Co., (Manufacturers of Transits and Levels), 136 N. 12th St., Philadelphia 7, Penna.

FOR SALE OR EXCHANGE

GENUINE Confederate money, 3 different bills, only \$1.00. Coin Shop, 814 Royal St., New Orleans 16, La.

FOR SALE MISCELLANEOUS

MECHANICAL Drawing instruments—Veeco, 4 piece, compact, precision set, brand new in lined case, value \$12.50, special, \$7.25; \$10.00 Charvos 9 piece set, \$8.50. Army surplus slide rules, slightly used, 75c each. Hull automobile compass, for accurate road direction, brand new, \$2.50. Brand new folding valise knapsacks made of heavy olive green duck, heavily bound and reinforced, repellent to fire and water. Inside 3 large snap fastened pockets, heavy webbed straps, hand and shoulder handles, size opened 22" x 54" closed 22" rolled. Useful to hunters, Boy Scouts, hikers and for all traveling use. A \$7.50 value, special \$2.25 postpaid. Prisms for 6X30 or 8X30 binoculars, brand new, \$1.50 each. Offset prisms to be attached to 7X50 B. & L. binoculars gives double the field of the ordinary 7X50 binocular. Cost \$98.00, special \$25.00. Green sunshades for binoculars, size 6X30 and 7X50, snap on type, value \$7.50, special \$1.25 per pair. Forward money order. No c.o.d. shipments. Public Sport Shops, 13 S. 16th, Philadelphia, Penna.

WAR Surplus, new navy issue, dungarees \$1.50, blue chambray shirts \$1.05, fatigue pants \$1.75, utility shirts \$1.05. (1 of each item to customer, 10c additional for packing). Raincoats, black, dressy, \$5.95. All wool o.d. sweaters \$4.95. Sun helmets 85c. Money back guarantee. Send for free catalog. Stone's Army and Navy Supplies, 242 Canal St., New York City 13. Money order or check, no c.o.d.

COVERALLS, New tan twill, full cut, all sizes \$4.98; shirts, o.d. new all wool worsted, all sizes, \$5.98. Satisfaction guaranteed. New York Clothing Co., Dept. PM, 2079 Second Ave., New York 29, N. Y.

SHOPWORN Costume jewelry—bracelets, necklaces, breastpins, clasps, buckles, etc. 5000 pieces. Sacrifice. Make offer. A. J. Sherer, 1310 1/2 6th Ave., Los Angeles 6, Calif.

PLASTIC Wristwatch strap; grease-proof, stainproof, long wearing. Colors: silver, clear, brown. Easily attached. 69c postpaid. Marex Co., 242 Canal St., New York 13.

40MM, Shell solid brass table lamp, 15" high, 1 1/2" round, \$5.00. P.O. Box 64, Newton Centre 59, Mass.

ARMY Goods (used). Jeep hats 10c, meskits 35c, canteens 50c, covers, cups 15c, leggings 25c, holsters 50c, gunslings 75c, pistol cartridge belts 75c, field bags 95c, tool box, steel helmets, raincoats \$1; wading boots \$3. Catalogue. New York Salvage Co., 144 Chambers St., New York City.

STAINLESS Steel; strips, 3" squares, and odds, sixteen gauge. Send \$3.00 for 5 pounds postpaid. U. S. Good Measure. Buehrens Co., Dorchester, Wis.

TOASTERS; Clocks; mixers; irons; other appliances. Immediate delivery. Price list. Mail order. Electric, 713 South Dearborn, Chicago.

CLOTHESPINs, Clothespins. Guaranteed 100% hardwood. 10 gross only \$9.30; 50 gross \$43.49 (prepaid). Rush check, immediate delivery. Scheall, Box 263, Duluth, Minnesota.

WANTED MISCELLANEOUS

WILL Pay \$5,000 each for certain old books; histories \$300; poems \$200; and songs. Catalog 10c. Ohio Historical Publishing Co., 209 West 11th Ave., P9M, Columbus, Ohio.

DO You want to swap-buy-sell anything? Regardless what it is, send for The National Swapper's Guide. It's full swappers-buyers-sellers coast to coast and opportunities to swap-buy-sell almost anything under sun. Postpaid 10c. National Swapper's Guide, P.O. Box 415, Evansville, Indiana.

WANTED: Travelling clocks, any condition; automobile clocks, small repeaters and alarms; key-wind watch mvts.; discarded watches. Send insured or mail desc.; price fairly. L. Rankin, Ocean City, 11, Md.

MACHINES Wanted for making (all phases) artist and striping brushes. Andrew Mack & Son, Jonesville, Michigan.

WANTED—Souvenir snapshots. Guadalcanal, New Caledonia. Quote price. C. Boyden, 604 21st St., N.W., Washington, D. C.

WANTED Manufacturer who can produce 2 1/2" brush handles in quantities from any wood-substitute with similar resistances. Andrew Mack & Son, Jonesville, Michigan.

MERCURY—Highest prices. Free containers. Write, Wholesale Terminal, Norwood, Mass.

MERCURY (Quicksilver). Write for quotation stating quantity. Metallurgical Products Co., 35th and Moore Sts., Philadelphia, Penna.

FOR THE HOME

PRESERVE Lustre. Silver, brass, all bright metals. Easy to apply as nail polish. Protects indefinitely. \$1.00 postpaid. Madison Laboratories, Box 41, Madison, New Jersey.

TACKYBACK—Agents gold mine for profits. "Prevents rugs from slipping." One minute demonstration sells housewife. No competition. Act quick for territory. Amherst Blanket Co., Northampton, Mass.

CONVERSION Gas burners. AGA approved. Limited supply. Furnaces 90 days. Moore Equipment Co., Lincoln 6, Nebr.

SAVE Money. Prefabricated homes: List of 109 manufacturers \$1.00. Fabrication Service, Box 804-A, Battle Creek, Mich.

REPLACEMENTS, Stoves, furnace grates, firepots, linings, fire plastic. Majprudax, Royal Oak, Mich.

PERSONAL

CASH'S Woven names. For marking men's, women's, children's clothing. Circular free. Oumette's, 4744 Coggeshall, New Bedford, Mass.

PHOTOSTAMPS. Details free. Pera, 165 Chattanooga, Dept. A1, San Francisco 14, Calif.

FORGET Birthdays, anniversaries? We won't let you. Personal Service, Woodville, Ohio.

NEWSPAPER Clippings of you or your family. Personal, business or social items. Fool your friends. One dollar and up. Stamp appreciated for information. Publisher, 1024 Cavalry, Detroit 9, Michigan.

FALLING Hair, its cause and prevention. An informative and educational pamphlet entitled "How To Keep Your Hair Till Ninety" mailed free. James Hilton, 4819 A Fourth Ave., Brooklyn 20, N. Y.

RUPTURED? Positive comfort, no understraps, no steel, no elastic. Write Smith Manufacturing Company, Preston, Ontario.

MEXICAN Law. General practice atty. J. Cenicerros, 1203 Arizona St., El Paso, Texas.

AMAZING—Teeth cleaning tablet. New discovery. Cleans teeth beautifully. Sweetens breath. 80 tablets and 50c nylon tooth brush—only 51c. Cressler Products, Newton, Kansas.

DETERMINE The occupation offering you the greatest opportunity for success. Use scientific testing method. Write Vocational Service, 735 Bank of America Bldg., San Diego, Calif.

FALSE Teeth wearers. If your plate is loose I have good news for you. Send name on postcard. No obligation. Dr. C. N. Reese, Dentist, Box 268-X, Winnetka, Ill.

VISIT Valley of the Sun. 3 beautiful post card views 25c. Address, return, re-mailed free. Letters airmailed, each ounce or fraction thereof 25c. Confidential, reliable service. Brooks, Box 2012, Phoenix, Arizona.

VISIT Beautiful romantic San Francisco by proxy. Send 25 cents for 3 postcards. Return for remailing. Letters forwarded 25 cents each. Charles W. Garrison, 81 Blake St., San Francisco 18, Calif.

LETTERS Forwarded, 25c each letter. Dependable. Miller, 889 Stanford Ave., Palo Alto, California.

PERSONALIZED Postcards. Ideal for acknowledgments, inquiries, etc. Samples. Hatch Press, Meriden 1, Conn.

PERSONALIZED Pencils. Individual or firm name. Dozen 60c. 2 dozen \$1.00. 100 up 3c each. Same imprint. Cash. Delivered. Pencil Market, 611-15th St., Knoxville 16, Tenn.

HAVE Fun! Pretend visiting California. 3 postcard views 20c. Address, return. I remail. Letters mailed 15c. Free information. Ira Smith, 708 Ellis, San Francisco 9, California.

SWAPPERS! Traders! Free list. "Swappers' Gazette," 2836-PM Slevin, Louisville 12, Ky.

MAIL Forwarded. Reliable. 25c each letter. Box 536, Anaheim, Calif.

HOW You can find out! Information discreetly developed, any matter, person, problem, anywhere. Personal-business assignments, representations, undertaken. Nation-wide. Officially licensed and bonded service established 1922. Reasonable. All inquiries confidential. William Herman, 170 Broadway, New York.

NERVOUS, Self-conscious, fears? Be courageous, self-confident, magnetic. Sensational psychology course. Only \$1.00. Dr. Malcolm Smith, 1104 Union Ave., Montreal 3, Canada.

POOR Penmanship corrected—few hours. New-way. Ozment, 9, St. Louis, Mo.

HAIR Falling? Dandruff? Write Trichologist, 137 Lewis St., Phillipsburg, N. J.

MISCELLANEOUS

LUMINOUS Paint kit (non toxic). Complete 3 bottle kit, instructions and brush \$1.00 postpaid. Nite-Glo Paint Co., 4513-PM Cottage Grove Ave., Chicago 15.

WRITE In raised gold, silver or copper metallic letters. Individualize stationery, etc. Kit complete \$1.00. Particulars free. Rogers Bros. Distributors, Orwell, Ohio.

SWAPPERS, Buyers, sellers, advertise 2c word. Royal Swapper, 209 1/2 Elm St., Amesbury, Mass. Sample copy dime.

VETERANS' Terminal leave. Former finance officer offers exclusive, extremely important information absolutely free. Send stamped addressed envelope. Andrea, Barnegat, N. J.

GREAT Fun. Travel by mail. Letters mailed New York or any U. S. city 20c. Montreal 25c. London, Paris, Prag 30c. Details plus photo card 10c. Nu-art, 436 New York Ave., Brooklyn 25, N. Y.

ATLANTIC City's famous salt water taffy. 75c lb. postpaid. Kadef, Box 875, Atlantic City, N. J.

AVAILABLE Now. Tempered spring bronze weatherstrip. 30 pieces introductory offer \$3.00 postpaid. Double Seal Co., 2725 Ross Ave., Waco, Texas.

ADVANCE Dollar receive prepaid choice 15 wrenches or 5 pr. gears prepaid. Estreich, 150-06 Liberty, Jamaica 4, N. Y.

WHAT? When? Where? Who? How? The answers may be in your tea-cup! Learn to read them. "Tea Leaves are Fun" teaches you how. 50c postpaid. Box 14, Orinda, California.

HALAZONE Water purifier, war surplus, 200 tablets 25c. Andler, 10 Dorrance St., Charlestown, Mass.

LUMINOUS Nursery wall decorations, fascinating cutouts glow in darkness. Complete set 35c. Two glowing nursery pictures suitable framing 25c. Circulars, Luminov-elities, 469 Irving, Brooklyn, N. Y.

PAINT Spray the modern way. Complete unit except motor, \$24.85. O.P.A. list. Free circular. Airflo Co., 2505 East 75th St., Chicago 49, Ill.

ATTENTION Veterans World War II! New sensational "Glow in the Dark" Division Insignia plaque. In what division did you serve? Discharge and service insignia emblem in full color. Attaches to Auto License. Only \$2.25. Rush order today! Emblematic Supply, Dept. 7, 1118 E. Monroe, Phoenix, Ariz.

CHINAWARE, Dozen cups, saucers \$2.00, etc. Send \$1.00 for samples, list. Garcia, 516 West 51 St., New York City 19.

FIREWORKS—Any time—any quantity—newest ideas—highest quality—best values. Giant salutes, aerial bombs, sky-screamers, battle-in-the clouds, new jet-propulsion plane rocket. 150-piece combination offer \$4.95. Satisfaction guaranteed. Write for big new catalog. Banner Fireworks, Dept. 34, Toledo, Ohio.

CHINESE Firecrackers, sparklers, cap guns, caps, balloons, etc. Lowest prices. Price list on request. Wholesale only. Wentworth Sales, Inc., 165 W. Madison, Chicago, Ill.

IT Works! Positive short-cut method, properly applied, helps win business, social success. Step ahead of the crowd by sending today for FREE booklet, preliminary course chart. No obligation. School of Personal Psychology, Incorporated, Louisville 2, Kentucky.

"GOLDEN Rays Process Kit" engraves in gold, silver and copper \$1.00. Roquevert, 1910 Dumaine St., New Orleans 19, La.

HOUSES—Prefabricated types. Learn true facts. Write—Ramsey, Monticello, Kentucky.

MEMORANDUM Pads for telephone messages, correspondence, records, scores, etc., free samples. A. Lightfoot, 4819 Penn St., Philadelphia 24, Penna.

THE Lord's coming! Get free undeniable proofs today. Write International Evangelism, Box 263, Duluth, Minn.

SWAP. Buy, sell or exchange articles you want. Many scarce. Advertising 5c per word. Subscription \$1.50 per year. Weekly publication. Sample copy 10c. The Universalist, Box No. 2494, Kansas City 6, Mo.

SAFETY And success personnel contest—20c. Eblen, Box 5912, Kansas City 2, Mo.

INVEST In impressive New York City address for your business. Add prestige, increase your income. Excellent mail address for personal correspondence also. Low monthly rates. Write Multiservices, 3-B Park Row, New York 7, N. Y.

YOUR Name in beautiful polished cast aluminum for home, desk, trailer, etc., only \$2.50. Arizona Mfg. Co., 20th and Jackson, Phoenix, Arizona.

SELL Your pictures! Valuable folio, packed with information, lists over 100 picture markets. Tells where, how to sell. Only \$1 postpaid. Picmarts, 3 Park Row, New York 7, N. Y.

REFRIGERATION Without flame, motor, ice. Full instructions, 25c. M1. Box 2759, Cleveland 11, Ohio.

MODERN Flame thrower kills weeds quickly. Burns kerosene, mostly air. Sterilizes, irrigates, disinfects, sprays, thaws. Endorsed by agricultural experts. Immediate delivery. Write for full description and prices. Sine Equipment, P376, Quakertown, Penna.

50 BEAUTIFUL 1946 Christmas cards, assorted, with envelopes, \$1.00 postpaid. Descriptive folder on request. Shipp Greeting Card Co., 625 N.W. 19 St., Oklahoma City 3, Oklahoma.

RECEIVE Mails, literature, opportunities. Your name in numerous mailing lists 10c. Greenwood, 277 Broadway, New York.

CUTTERS. Dental burs, reclaimed assorted 125—\$1.90; 700—\$6.75. Am Standard, 1208 W. 13th, Philadelphia 22, Penna.

TATTOOING Outfits—Electric machines, supplies, Steele, 540-L Leavenworth, San Francisco 9, California.

WANTED—1000 Foot sufferers to test Custom Made Research Foot Balancers at our risk. Amazing foot relief awaits you. Rush name and address for free trial offer. Kindschi Foot Appliances, Dept. A4, 321 W. Jefferson, Dallas 8, Texas.

SQUARE Dance calls, instructions, illustrated. \$1.00. Guide, Eureka Springs, Arkansas.

MEXICAN-AZTEC Featherwork tropical bird picture cards. Samples 25c. Bulletin free. Mexican Products Co., 126 N. Main, Tulsa 3, Okla.

MAKE Your own plastoplate printing cuts. Simple, easy process. Plastoplate, Argyle 1, Wisconsin.

AMAZING Bubble blowing novelty. Nothing like it before. Scented liquid makes many beautifully colored, long lasting bubbles. Fancy box 2 bottles and wands 50c postpaid. Seafoam, Box 973, Charlotte, N. C.

HUNDREDS Of articles auctioned by mail. List free. Auction Exchange, 801 Fifth, Gretna, Louisiana.

"RECEIVE Mail." Moneymaking offers, opportunities, catalogs. Name listed 10c. Ideal Service, 100, Park Ridge, Ill.

RECEIVE Moneymaking opportunities, mails, samples, catalogs, magazines. Your name in thousand mailing lists, 25c. Glassmine, 1654-MX Amsterdam Avenue, New York 31.

CALENDAR 1753 to 2152. 35 cents postpaid. Tracy Newton, Decatur, Georgia.

EXPERIMENTER'S Special offer, 8 Alnico magnets, \$2.00. 100 diagrams and uses, 25c. Eljay, Box 891, Newark 1, N. J.

LUMINOUS Paint. Best quality. Glows bright blue in dark. 1 oz. each paint and sealer only \$1.59 f.o.b. Chicago. Black Light Products, 67 E. Lake St., Chicago 1, Ill.

GOOD "Used" self-instruction educational books on all subjects bought, sold, rented, exchanged. Satisfaction guaranteed. Complete information and 100-page illustrated bargain catalog free! Write—Nelson Company, Chicago 5.

"BIBLE Studies." 70 lessons 25c. Bulletin, Box 87, Station H, New York 25.

MEDICAL Laboratory technicians in great demand. We train you in your spare time, in your own home. You can practice while studying. Write for free catalogue. Imperial Technical Institute, Box 973-J, Austin, Texas.

METAL, Mineral locators latest 1946 electronic type ready for immediate shipment. Fisher Research Laboratory manufactured 2 million dollars worth of electronic equipment for the U. S. Army, including some of the finest metal-locators. Experience gained is yours in the best metal, mineral locator. Free 16 page booklet upon request. Fisher Research Laboratory, Palo Alto, California.

SECRETS OF LOCKSMITHING

ONLY \$1.00



Now available to all, big book crammed full of valuable information. Written by experienced lock experts. Contains practical, simple instructions on Key Duplicating, Fitting, Lock Repairing, Changing Combinations, Master Keying, Lock Opening, and many others. Hundreds of illustrations. Teaches locksmithing easily, quickly at home. Costs only \$1.00. Send your \$1.00 today, on positive satisfaction or money back guarantee. (\$1.25 outside U. S.)

REPAIR SHOP SERVICE Box 264-1 Skokie, Illinois

SAVE MONEY

PARAMOUNT ADJUSTABLE

BAR BELLS

DUMB BELLS \$9.95

at Factory Prices



WRITE FOR FREE BOOKLET WITH HINTS ON MUSCLE BUILDING

INDEPENDENT IRON WORKS

2416-40 E. 23rd ST., L. A. 11, CALIF. DEPT. 9

Floyd Clymer's Popular MOTOR BOOKS

INDIANAPOLIS "500" RACING BOOK

Just out! 1000 illustrations; 320 large pages; complete data on every race 1909-1946 incl., \$3.50; with De Luxe red Fabrikoïd binding, \$5.00. Book on 1946 race only, \$1.00.

Racing With Mercedes-Benz

176 pages, 93 action photos. Famous Grand Prix drivers, speedways, cars described. Graphic, thrilling incidents on European tracks. \$2.00; cloth-bound, \$3.00.

Famous Motor Scrapbooks

Nos. 1, 2 & 3 available, \$1.50 each; cloth-bound, \$2.50 each. Power & Speed, \$2.50. Ab Jenkins' Race History Book, \$1.50. Speed—How to Obtain It, \$1.50. All books postpaid. See our ad under Autos, Classified section.

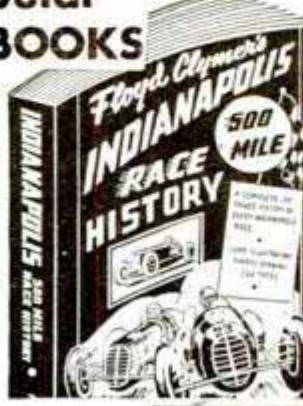

CLYMER MOTORS, Dept. A-10

2125 W. Pico LOS ANGELES 6, CALIF.

Send for FREE Motor Book Catalog

PLEASURE AND PROFIT IN

Photography

IMPROVE YOUR SKILL — STUDY AT HOME



B & J PRESS CAMERA

Whether you wish to make a career of photography or want to gain additional skill as an amateur, the American School of Photography offers practical basic training, which requires only spare time study.

With proper aptitude and application, this Course should provide you with a fundamental background which may open the door to valuable professional experience . . . or add fascination and zest to your hobby.

OLD ESTABLISHED SCHOOL. Backed by years of experience, our training covers every phase of Modern Photography through spare time study at home. Basic photographic principles are taught by inspiring "learn-by-doing" method, step-by-step, under the supervision of a qualified instructor.

GET FREE BOOKLET! Send coupon today for free booklet, "Opportunities in Modern Photography," and full particulars.

AMERICAN SCHOOL OF PHOTOGRAPHY

1315 S. Michigan Ave. Dept. 1357
Chicago 5, Illinois

AMERICAN SCHOOL OF PHOTOGRAPHY

1315 S. Michigan Ave., Dept. 1357, Chicago 5, Ill.

Please send me without obligation your free booklet, "Opportunities in Modern Photography," and full particulars.

NAME.....AGE.....

ADDRESS.....

CITY.....ZONE.....STATE.....

Become A Practical WELDING TECHNICIAN In 6 Months!

ARC WELDING presents one of today's most outstanding opportunities for steady income and future success.



WELDING has grown rapidly, replacing large and intricate castings, rivets, nuts, bolts, screws. It is commonly used in assembling cranes, hoists, bridges, structural steel work, ships, trains, airplanes, etc.

WELDING is used extensively in manufacturing farm machinery, new automobiles, refrigerators, air conditioning systems, etc. There is no limit to the application of welding in industry, increasing durability and reducing manufacturing costs.

GREAT DEMAND. There is a decided shortage of properly trained Arc and Gas Welders, Welding Technicians. For full information and catalog, send coupon TODAY.

MILWAUKEE SCHOOL of ENGINEERING
Institute of Electrotechnics

44th Year

PM-1046, North Broadway and East State, Milwaukee, Wis.

Without obligation send Free Booklet "The Dawn of a Gigantic Industry and Its Outstanding Opportunities."

Name..... Age.....

City..... State.....

PM-1046

Learn WATCH REPAIRING

From An Approved School The Largest of Its Kind



EARN WHILE LEARNING

Spare Time Home Training Prepares You For Big Pay

FREE WATCH working tools and watch included as part of our Watch Repairing Course

The demand for skilled watch repairers—men and women—is increasing with the step-up in the manufacture of watches. Now is the time to prepare yourself in this fascinating profession with the aid of our highly practical HOME TRAINING COURSE—in your spare time at home. Start your own business or accept a big pay position.

WRITE TODAY FOR FREE DETAILS

Earn while you learn with an "approved" school. Get the facts—then judge.

ILLINOIS SCHOOL OF WATCH REPAIRING
6312 Huntington Street, Dept. PM-10, Chicago 30, Illinois



SALESMEN FOR CITY AND COUNTY

Nationally Known Manufacturer

Build up a business of your own with Nationally Advertised Products bearing Underwriters' label. Sell to schools, factories, service stations, warehouses, hotels, restaurants, public institutions, truck and bus companies, grain elevators, house trailers, autos, farms, homes, etc. Capable man can earn real money. Established in 1916. Write letter with details, age, experience, etc.

Dept. 90-22 FYR-FYTER CO., Dayton 1, Ohio



RADIO TRAINER

Learn the theory and practical side of radio by building this simplified battery tube set. Experimental model teaches you to design larger radios, not just assemble them. Sensitive circuit brings in distant and local stations. Covers broadcast and short wave bands. Compact and portable. Can be used on camping trips and farms without electricity. All parts furnished including Tube, Batteries, Double Ear-phones, Aerial, Ground Wire and Easy-to-follow illustrated instructions. No Soldering required. Complete, postpaid, only \$9.95. Or send \$1.00—shipped C.O.D. for balance plus postage. Money-back guarantee. Order today!

B. G. FLEMING MFG. CO., Dept. 10-A, 906 Main St., Cincinnati 2, O.

LEARN MOVIE PROJECTION THEATRE MANAGEMENT

The Motion Picture Theatre Business offers big opportunities for trained men. Get into a fascinating field with a post-war future. Train at home in spare time. Free Catalog. Established 18 years.

THEATRE INSTITUTE, 370 Washington St., Elmira, New York

GET INTO REFRIGERATION AND AIR-CONDITIONING

Build your future in fast-growing industry. Prepare for high pay jobs or get into your own business. Resident classes only.

Send ad with name and address for information. VETERANS Eligible for training under G. I. Bill. Check here

BOSTON TECHNICAL INSTITUTE
School of Refrigeration, 4707 Euclid Ave., Cleveland 3, Ohio

ACCOUNTING

STUDY AT HOME for C.P.A. and BIG PAY Accounting opportunities with 42 year old school. No previous training needed. Texts furnished. EASY PAYMENTS. Send for FREE BOOK.

Mac CORMAC EXTENSION SCHOOL
Dept. 10-B, 1170 East 63rd St., Chicago 37, Ill.

Learn BAKING At Home

Baking is one of America's high industries in wages. Nearly depression-proof. Thorough basic home course lays sound foundation. If you have aptitude, write for FREE BOOKLET. "Opportunities in Commercial Baking."

National Baking School, 1315 Mich. Ave., Dept. 1357, Chicago 5

HIGHWAY ENGINEERING

PRACTICAL TRAINING IN HIGHWAY DESIGN AND PRACTICE. HOME STUDY — BY MAIL ONLY — WRITE US NOW!

SCHOOL OF HIGHWAY PRACTICE
DEPT. A, 2161 SHATTUCK AVE. BERKELEY 4, CALIF.

Fit-Rite makes False Teeth TIGHT

Makes loose dental plates fit snugly and comfortably. LASTS for MONTHS!

Simply squeeze on dental plate and put it in your mouth. Hardens and becomes part of plate. Money-back guarantee.

FREE Generous package of Dental Plate Cleanser with each order. Send \$1.00 or mailed parcel post collect.

Fit-Rite Co., 1573 Milwaukee Ave. Dept. A-PM, Chicago, Ill.

LEARN TO MOUNT BIRDS and ANIMALS



SPORTSMEN • MEN, BOYS -

Here is something **NEW** — something **MARVELOUS**. Act **NOW**.
Learn **TAXIDERMISTRY** at home. Save your wild-game trophies.

HAVE A HOME MUSEUM

Here is the **GRANDEST HOBBY** in the world for **hunters, anglers, sportsmen**. **DOUBLE** your interest in hunting and fishing. Save your marvelous trophies. Mount **Birds, Animals, Heads, Fish**, all kinds of beautiful specimens, wild or tame. Tan leathers and fine furs. It is grand to be a **TAXIDERMIST**. You become well known and famous.



WILD-GAME NOT NEEDED

Mount common specimens, squirrels, crows, fish, frogs, pigeons. Make useful and humorous groups. A highly interesting hobby. You will be amazed and delighted.

TAN SKINS

Learn easily, fine **KROME-TAN METHODS**. Make sole, rawhide, harness leather, and **TAN** skins and furs. Create beautiful rugs. Decorate your home, and **MAKE FINE PROFITS** doing work for others.

CRAFT-TAXIDERMISTRY!

Make wild-game and domestic specimens into alluring **CRAFT-ART**, like the lamp shown above. You can devise a vast variety of alluring creations. Easily learned. Decorate with mounted specimens, **book-ends, door-stops, hat-racks, match and pen-holders**, and scores of delightful and **USEFUL** home articles and gifts. We teach you so easily, both **wild-game** and also **Craft Taxidermy**. Investigate **NOW**.

Rush Coupon TODAY!

The beautiful book will go to you by **RETURN MAIL**. Nothing like its strange and amazing art ever seen before. It is **FOR SPORTSMEN** and **NATURE-LOVERS**, and it is **FREE** if you send the **COUPON NOW**. Hunters, Men, Boys. Mail the coupon **this MINUTE**. You will **WIN**, new interests.

NORTHWESTERN SCHOOL OF TAXIDERMISTRY
3377 Elwood Bldg., Omaha 2, Nebr.

FUN • PROFITS

THINK of the fun and joy of mounting and saving your own hunting trophies. Right in your home, will be the prizes of your fine hunting and outing trips. It's simply great!

SPARE-TIME PROFITS

All of your sportsmen friends will be proud of you and your work. **THEY WILL URGE YOU TO MOUNT THEIR SPECIMENS**. They will be delighted to pay you liberally. Many students earn splendid profits while learning. **YOU can now be a Taxidermist, for pleasure and profits.**

300,000 Students

Many of our vast number of students are employed in the **BIGGEST and FINEST MUSEUMS**, which endorse our school. No higher recommendation can be had in America. **WE CAN TEACH TAXIDERMISTRY TO YOU**, men, boys, and women. Yes, more than 300,000 are members of this fine school, and endorse it enthusiastically. Here is your opportunity, long awaited. Send the **COUPON** without fail.

GET THE FREE BOOK

This new, strange, unique **FREE BOOK** will open a new world of fine pleasure to you. Write for it **NOW**. **IT TELLS THE WHOLE STORY**. 44 pages, over 100 photos of wild-game, and stories of success that will thrill you. Shoot fewer specimens, double your fun, and help conserve the wild-game.

Send the **COUPON THIS MINUTE**. State your **AGE**.

Send
for
Free
Book

Mail Coupon Now

Northwestern School of Taxidermy,
3377 Elwood Building, Omaha 2, Nebr.

Please **Rush the FREEBOOK to Me**. I am interested. Please send the **FREE BOOK ON TAXIDERMISTRY** and tell me about how I can **BECOME A FINE TAXIDERMIST**.

Without obligation on my part, explain how I can **double my interest** and fun in hunting, outdoor life.

Name.....

Address..... Age.....



**BE A
DIESEL
EXPERT**
Training Books
on Approval
Send No Money

Prepare NOW for the BIG opportunities in Diesel Power—revolutionary power for railway trains, trucks, buses, tractors, boats, power plants, construction equipment, etc. Fit yourself for a better, more permanent job.

Latest 6 Volume Edition

is packed full of up-to-date and easy-to-learn facts about Diesel design, manufacture, operation and repairing. Written in simple language by prominent Diesel authorities. Over 3400 pages. Hundreds of illustrations and diagrams. Durably bound. Start at once to master this New, Big-Pay Profession. Send the coupon. Examine the books. If you are not thoroughly satisfied, return them and you'll not owe us a cent. Don't delay. Send today.

AMERICAN TECHNICAL SOCIETY, Vocational Publishers Since 1898
Dept. 0719, Drexel at 58th Street, Chicago 37, Ill.
Send for 10 days' free trial, 6 volumes on Diesel Engineering. I will pay delivery charges only. If I decide to keep them I will send \$2.00 in 10 days, then only \$3.00 a month until \$29.80, total price, is paid. If not satisfied, I will return books in 10 days and owe you nothing. Include Consulting Service Privilege.

Name.....
Address.....
Please attach letter stating age, occupation, employer's name and address, and name and address of at least one business man as reference. Men in service, also please give home address.

You Too Can Become a MAGICIAN!

"Introduction to Magic" fully explains 141 New professional magic tricks. An expert magician teaches you how to do them. This is a complete library size edition. 101 illustrations. Take this high-road to fun and popularity. Order Now. — \$1.00.

LEISURE LIBRARY, Publishers, Dept. DA, 112 E. 19th St., New York City



**LANGUAGE
IS POWER**

... Forge ahead, win special assignments, promotion, better job in global peace time opportunities through ability to speak a foreign language.

**MASTER A NEW LANGUAGE
quickly, easily, correctly by**

LINGUAPHONE

The world-famous Linguaphone Conversational Method brings voices of native teachers INTO YOUR OWN HOME. You learn the new language by LISTENING. It's amazingly simple; thousands have succeeded.

HCME-STUDY COURSES IN 29 LANGUAGES

Send for FREE book—

LINGUAPHONE INSTITUTE

98 RCA Building, New York 20, N.Y. • Circle 7-0830

LINGUAPHONE INSTITUTE,
98 RCA Bldg., New York 20, N.Y.
Send me the FREE Linguaphone Book.

Name.....
Address..... City.....
Language Interested.....

Walter Lantz Productions

OSWALD RABBIT—THREE MONKEYS

Both feature Cartoons and every film packed with laughs. Get these OSWALD RABBIT "Hits".

50 Ft. 8mm. \$1.75 100 Ft. 16mm. \$3.00

- Buzzing Around20-A
- Magic Wand21-A
- Goofy Gopher22-A
- Remote Control23-A



Show also a Mickey Mouse and Donald Duck Cartoon for enjoyable Home Movie entertainment.

At your Photo Dealer or order direct. For prices and lists of available films, write—

HOLLYWOOD FILM ENTERPRISES, Inc.

6060 Sunset Blvd. Dept. 115 Hollywood 28, Calif.

**NEW PLASTICS
Fabricating MANUAL**



Make beautiful objects of Plexiglas, Lucite, Catalin, Polystyrene at home. Jewelry, novelties, accessories. Send for new 10,000 word manual on how to fabricate, weld and form latest plastic materials in home workshop. Hundreds of practical suggestions. Written by leading plastics engineer. Price prepaid 25c (stamps or coin). Or get FREE information and price list covering transparent plastic sheets, rod, tubing cut to your size. Write today: HOUSE BEAUTIFUL PLASTICS, Dept. L-3, 5534 W. Harrison St., Chicago 44, Ill.

**ENGINEERING DEGREE IN
27 MONTHS**

**INDIANA
TECHNICAL
COLLEGE**

Aeronautical, Chemical, Civil, Electrical, Mechanical, and Radio Courses. B.S. degree. 1-yr. diploma in Electrical, Mechanical, and Radio Service; Drafting. Prep. courses. Gov't. approved for GI's. Low rate. Earn board. Large industrial center. Demand for graduates. Enter Sept., Dec., March, June. Catalogue. 5108 E. Washington Blvd., Ft. Wayne 2, Ind.



48 PLANS

\$100

48 complete plans of toys, ash trays, garden ornaments, Dutch boys and girls, what-not shelves, and many other interesting projects. Finest selection available. Novel method allows you to make finished project any size desired. PLUS FREE De-Luxe Plan of corner shelves. Send only \$1 to Jackson, 5439 N. Shoreland Ave., Milwaukee 11, Wis.



New 1947 Shop Notes Now Ready!

FOR EVERY MAN WHO USES TOOLS

One of these books is issued each year and is a reprint of articles published in our Shop Notes Department. It contains the cream of experience of years, of hundreds of our country's most successful mechanics. 50c per copy at your News Dealer, or send 60c to

POPULAR MECHANICS PRESS

Dept. 634 200 E. Ontario St. Chicago 11

100 DIFF. FOREIGN COINS \$5.00

2 small or 1 large Genuine Roman Coins 2000 years old. \$1.00

Lists — Approvals

DEL MONTE • 40 W. 18 • New York 11



**WHY WEAR
DIAMONDS**

When diamond-dazzling Zircons from the mines of far-away mystic Siam are so effective and inexpensive? Thrilling beauty stand acid, true backs full of FIRE! Exquisite mountings. See before you buy. Write for FREE catalog.

National Zircon Co., Dept. 20
Wheeling, W. Va.

**Catalog
FREE!**

DO ANY JOB.. EASIER.. QUICKER
MAKE MORE MONEY in the
BIG OPPORTUNITY
FIELDS

SEND NO MONEY
 Select the Books
YOU Need Now!
 We Ship **C.O.D.**
 Anywhere in U. S.
 and Will Refund
 Amount Paid if
 Not Satisfactory.

Do it now! Get the better pay that goes to men with specialized knowledge. Get into one of these big opportunity fields. Big money and many other advantages await you if you prepare now. Here is the help you need—**EASY—QUICK—AT LOW COST.** Thousands of men have already used these famous books. Beginners and experienced men alike have doubled and tripled their earnings with this help. You too, can now get the special knowledge you need for top pay, better jobs, or a business of your own. This is your **GOLDEN OPPORTUNITY.**

Here's the Help You Need
For Best Paying Jobs
Right NOW!

FREE TRIAL
IN YOUR OWN HOME

Used by Army, Navy, Other Government
 Depts., 200 Schools and Industrial Firms.

AIR CONDITIONING

Big air conditioning boom interrupted by war will be bigger than ever. It's ready to GO now! Get this non-technical book by international authority and be ready for your share of millions to be spent. Covers whole field. 450 pages. Illustrated. \$4.00.

AIRPLANE WELDING

All metal airplane building offers big peacetime opportunities
 New 2nd edition of this famous book by J. B. Johnson, Materials Division, Wright Field. The authoritative and practical book on Airplane welding and materials brought right up to date. 420 pages, 193 pictures. \$3.50.

BODY & FENDER REPAIR

Owners will spend big money to keep their good older cars looking like the new ones coming out. This is a practical money-making guide, ideal for shop owners and every man who wants a share of the millions to be spent in keeping old cars looking new. Tells how to get a good job or start business of your own with small capital. 325 pages, 232 illustrations. \$3.50.

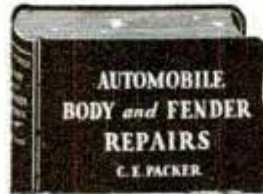

DYKE'S FAMOUS
CARBURETOR BOOK

This famous book has been the standard guide in the best paying auto work for a generation. It has helped thousands of men make money. New edition covers engine tune-up, compression, ignition, carburetion, fuel pump valves, etc. Use this book to specialize in this big field. 244 pages, 549 illustrations. \$3.50.

HOUSE WIRING
NEW EDITION

Get this new sixth edition of this standard and practical electrical wiring book. It gives complete practical instruction on every phase of house wiring in one handy volume. Goes further than most books on subject. Hand-book style. Gives National Electric Code. 400 pages, 669 illustrations. Electrical work will reach a new high with millions of new homes to be built. Get started now. \$2.50.

15 Million Refrigerators
Need Service and
Repairs

REFRIGERATION—Book of the Hour!
Biggest Opportunity in Many Years!

NEW PRINTING—ALMOST 1000 PAGES
408 Pictures—17 Diagrams in Colors Makes All Refrigerator Service Maintenance, Repairs Simple as A. B. C.

Thousands of Refrigerators need repairs! Owners will pay big for competent service which will be needed more and more. Get **MODERN GAS AND ELECTRIC REFRIGERATION**, the non-technical guide to all types of refrigerators and get your share of this new profit. Get a job or start your own service business. This book will help you make money anywhere. Price \$5.00.

NEW
20th
EDITION

Leading
Auto
Book
for Over
32 Years

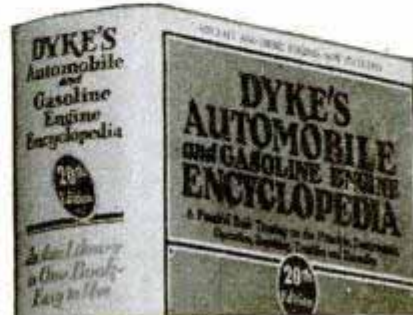

World's Greatest AUTO BOOK

New Material on Transmissions, Trucks, Tractors, Diesels, Aircraft and Auto Engines

Now with millions of cars needing repairs and thousands of men needed to do the work, you need the famous **DYKE Auto Book** more than ever before. Brand new 20th Edition covers all principles, construction, repair, adjustments, testing, troubles and remedies of all cars. Over a half million copies of 20 editions of Dyke's have been sold. Gives specifications of old and newer cars. World's biggest book value. \$7.00. This big book, a complete auto library in one volume, has 1483 pages—4600 illustrations and diagrams—weighs 6 lbs.—equal to 4 ordinary books.

ENGINEERS HANDBOOK

World famous Bailey's handbook of universal questions and answers for Stationary, Marine and DIESEL engineers and firemen. Prepares for any license examination. This is the one book that men should have if they want to reach the top in installation, maintenance and operation of Diesel and steam plants. Pocket size, \$2.00.

Goodheart-Willcox Co., Inc.
 2099 S. Michigan Ave., Dept. 110, Chicago 16, Ill.

SEND NO MONEY! Mail Coupon

GOODHEART-WILCOX CO.,
 2099 S. Michigan Ave., Dept. 110, Chicago 16, Ill.
 Send books checked, C.O.D. I will pay postman, plus few cents charges. If not satisfactory I will return books in 5 days and you will refund money paid. (Outside U.S. or possessions remit with order.)

- Gas & Electric Refrigeration \$5.00
- Dyke's Auto Book \$7.00
- Dyke's Carburetor Book \$3.50
- Modern Welding \$4.00
- Airplane Welding \$3.50
- Sheet Metal Layout \$3.00
- Air Conditioning \$4.00
- Engineers Handbook \$2.00
- Body and Fender Repair \$3.50
- House Wiring \$2.50
- Shop Math. (2 vols.) \$3.00
- A.C. Power Wiring \$4.00
- D.C. Power Wiring \$4.00

If remittance accompanies order we will pay all postage charges under same return privilege.

Name.....
 Address.....
 City..... State.....

Brand New! Just Published!

COYNE RADIOMAN'S HANDBOOK

800 pages of the latest Radio facts, tables, diagrams, etc., for on-the-job use. "Quick-as-a-wink" reference index for over 1,200 subjects. The world of radio principles and calculations at your "finger tips". Written by the Coyne Technical Staff and backed by 47 years of experience.

EVERYDAY REFERENCE FOR RADIO WORKERS

Whether you make, repair or maintain radio equipment, you can use this handbook to good advantage. A single day's use could raise you high in the boss' estimation. Quick facts—bring quick promotions. Especially valuable for radiomen running their own shop. Every chart and formula is authentic. Every HOOK-UP pre-tested by COYNE.

SEE IT 7 DAYS FREE

You may have this NEW Radioman's Handbook for examination 7 days free. Look it over leisurely. If you don't think it's the best \$3.25 investment you can make—send it back and you owe nothing. If you keep the book send \$3.25. But see it free anyway.

SEND NO MONEY! Just a request to see this book 7 days FREE. Mail it today. You take no risk. This book is just off the press and quantities are limited. Technical Book Div. Coyne Electrical School 500 S. Paulina St., Dept. 76-W Chicago 12



- Over 300 pages-1200 Subjects
- Power Formulas
- Amplifiers
- Coils
- Antenna Data
- Receiving Tubes
- Receivers
- Wiring Tables
- Circuits
- Balance System
- ... facts you need to get ahead in radio...

COYNE ELECTRICAL SCHOOL, Dept. 76-W
Technical Book Div. 500 S. Paulina St., Chicago 12, Ill.

I want to see the New Coyne "Radioman's Handbook". Send me a copy for 7 days' FREE examination. If after 7 days I do not want the book I will return it and owe you nothing. If I keep it I will pay \$3.25 within 7 days and the book is mine.

NAME _____ AGE _____

ADDRESS _____

TOWN _____ ZONE _____ STATE _____

If you prefer to pay postman \$3.25 on delivery, check here. Same FREE Examination and Money-Back Guarantee.

BE A HIGHLY PAID AUTOMOBILE STYLIST

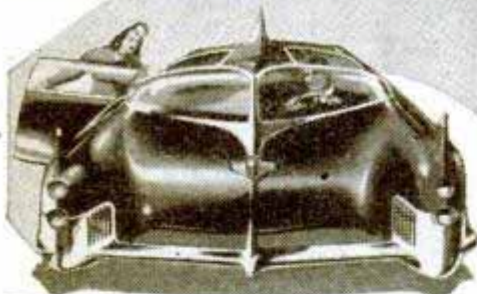

Learn
at
Home

HERE is an unlimited opportunity for automobile enthusiasts of any age. Now, for the first time, you can learn automobile styling at home from a course originating in dynamic Detroit—directed by Harley J. Earl, responsible for the styling of twenty million cars here and abroad. Instructions are scientifically planned and packed with inside information on techniques and tricks of the trade. Each lesson gets detailed and sincere evaluation and criticism by top-notch designers.

No qualifications are needed—just your interest in the era of new postwar cars. Enrollments are accepted at any time.

DETROIT INSTITUTE OF AUTOMOBILE STYLING

Operated by the Harley Earl Corporation

Dept. 10-P, 5533 Woodward Avenue • Detroit 2, Michigan

Without cost or obligation, please send me full particulars on your Automobile Styling Course.

NAME _____ AGE _____

ADDRESS _____

CITY _____ ZONE _____ STATE _____

SEND FOR FREE FULL PARTICULARS

Do You Make These Mistakes in English?

MANY persons say "between you and I" instead of "between you and me"—or use "who" for "whom"—or don't know whether to spell certain words with one or two "c's" or "m's" or "r's," or with "ie" or "ei," etc. Every time you speak or write you show what you are. Mistakes in English reveal lack of education, refinement. Lack of language power prevents you from presenting your thoughts in the strongest way. Real command of English will help you reach ANY goal. Stop making mistakes in spelling, punctuation, pronunciation, grammar. Increase your vocabulary.



Sherwin Cody

WONDERFUL INVENTION

Only 15 minutes a day with Sherwin Cody's new invention—and you can actually SEE your English improve. It teaches by HABIT—makes it easier to do the RIGHT way. Wonderful self-correcting lessons.

FREE BOOK ON ENGLISH Lack of language power may be costing you friendships, income, every year. See what Mr. Cody can do for you; it costs nothing to find out. Write this very minute for free book, "How You Can Master Good English in 15 Minutes a Day." It will prove a revelation. WRITE NOW. SHERWIN CODY SCHOOL OF ENGLISH, 510 B & O Bldg., Rochester 4, N. Y.

NEW PRODUCTS WANTED!

One of our clients is anxious to contact inventors, designers of new products in the sporting goods field. If you have a product for that market, our client will be glad to meet with you and discuss either the outright purchase of your product, or its manufacture and marketing on a royalty basis. ALSO, our client is interested in talking with present manufacturers of sporting goods items who might be interested in a sales arrangement with our client whose salesmen cover the sporting goods market nationally. Inquiries read in confidence. Please address:

ERWIN, WASEY & COMPANY, Advertising
Rand Tower, Minneapolis, Minnesota

25 DIFFERENT **INDIA** **3c**
to approval applicants.
Premiums with purchases.
BRANDWEIN STAMP CO., Box 92X, Bayonne, N. J.

SAY YOU SAW IT IN POPULAR MECHANICS

- ★ **PHOTO DEVELOPING & PRINTING** ★
- ★ Work and Service that can't be beat. Sixteen Famous ★
- ★ Century-Tone prints each 8-exp. roll 30c. FREE MAILERS. ★
- ★ Send roll and money. ★
- ★ **CENTURY PHOTO SERVICE Dept. X La Crosse, Wis.** ★

FIGURE DRAWING WITHOUT A MODEL

This book brings famous art schools right to your home! Over 300 "real-life" drawings in this new Cliff Young book. Copy from them to guide your Art Career. Only \$1 postpaid. Order Now; Art Books list included FREE.



HOUSE OF LITTLE BOOKS, 80-A East 11th St., N. Y. 3

Train Your Own HORSES!

Colts — Stock Horses — Circus Horses
Gait Show Horses — Write for FREE BOOK
ANIMAL LOVERS' ASSOCIATION
Box KA-111, Tarzana, Calif.



SHINE WITHOUT 'POLISH'

New Invention! • Sells Like Wild



Replaces messy pastes, liquids. Simply glide over shoes—and PRESTO! — you have a lustrous, long-lasting shine. No mess. No muss. No soiled hands. Clean. Handy. **WORKS LIKE MAGIC!** For Men's, Women's and Children's Shoes. Low priced. Lightning seller!

SAMPLES FOR AGENTS Sample offer sent immediately to all who send name at once. A penny postal will do. **SEND NO MONEY—just your name.** KRISTEE CO., 686 Bar Street, AKRON, OHIO

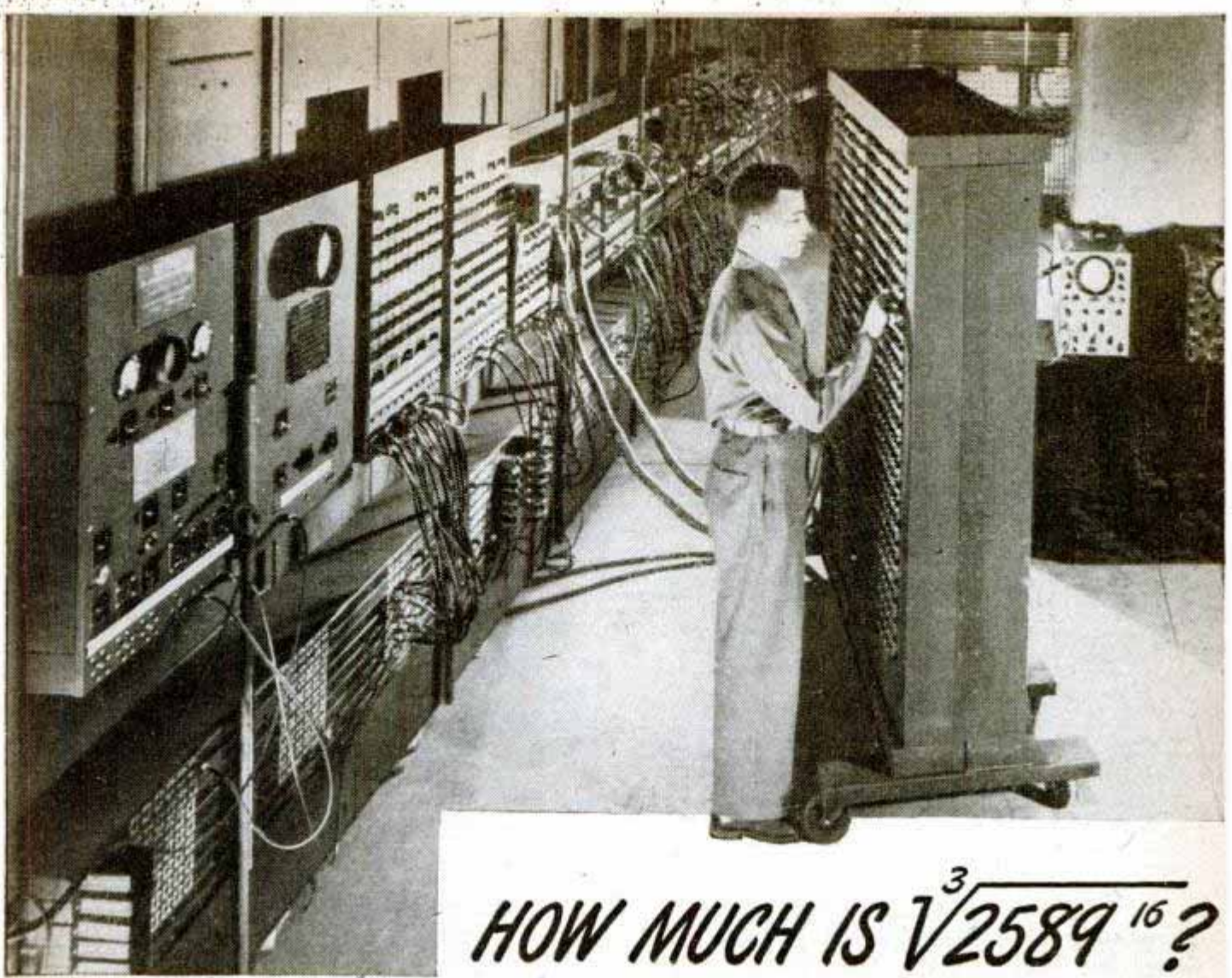

HOW MUCH IS $\sqrt[3]{2589^{16}}$?

The Army's ENIAC can give you the answer in a fraction of a second!

Think that's a stumper? You should see *some* of the ENIAC's problems! Brain twisters that if put to paper would run off this page and feet beyond . . . addition, subtraction, multiplication, division—square root, cube root, any root. Solved by an incredibly complex system of circuits operating 18,000 electronic tubes and tipping the scales at 30 tons!

The ENIAC is symbolic of many amazing Army devices with a brilliant future for you! The new Regular Army needs men with aptitude for scientific work, and as one of the first trained in the post-war era, you stand to get in on the ground floor of important jobs

YOUR REGULAR ARMY SERVES THE NATION AND MANKIND IN WAR AND PEACE

which have never before existed. You'll find that an Army career pays off.

The most attractive fields are filling quickly. Get into the swim while the getting's good! 1½, 2 and 3 year enlistments are open in the Regular Army to ambitious young men 18 to 34 (17 with parents' consent) who are otherwise qualified. If you enlist for 3 years, you may choose your own branch of the service, of those still open. Get full details at your nearest Army Recruiting Station.

A GOOD JOB FOR YOU
U. S. Army
CHOOSE THIS
FINE PROFESSION NOW!

Listen to this Record!



SPEAK SPANISH

FRENCH, GERMAN, OR ITALIAN

Big opportunities and jobs awaiting Americans who speak Spanish. Learn as a child learns—"by listening" to these new CORTINA recordings.

Only 15 Minutes a Day

The Cortinaphone Method famous for 60 years teaches you to speak Spanish like a native—right in your own home, relaxed and at ease. Thousands have found it the most fascinating, most satisfactory method. Here is the quick, easy way to learn Spanish for Pleasure and Business. Investigate!

Sent on 5 Days Approval



"The Cortinaphone Short-Cut"—tells just what you want to know. Interesting. Get it!

Write Today—NOW!

CORTINA Academy (Language Specialists for 60 Yrs.)
Suite 6410, 105 W. 40th St., New York 18, N. Y.

Please send me—without obligation—your free booklet. I am interested in (mark):

SPANISH French Italian German

Name.....

Address.....

Do you want

- ..to go to College?
- ..or to enter a Profession?
- (Such as Accounting, Architecture, Nursing, Dentistry; Teaching, Social Work, Osteopathy, Beauty Culture, Optometry, Embalming, Chiropody, Law, Medicine, etc.)
- ..or get an Office Position?

To get anywhere, you practically MUST finish High School FIRST. You can complete our simplified High School Course in SPARE time at home, as FAST as your time and abilities permit. Equivalent to resident school work—prepares you for college, pre-professional examinations, business, industry. Standard texts furnished. Diploma. Credit for H. S. subjects already completed. Single subjects if desired. Low tuition, easy terms. American School, Chicago, est. 1897—endorsed by educators. Finish your high school education NOW, Write TODAY!

High School Course at Home

Many Finish in 2 Years

American School, Dept. H-745, Drexel Ave. at 58th St., Chicago 37, Ill.

Gentlemen: Send me FREE information covering special training in subjects checked below. No obligation on my part.

- | | |
|--|--|
| <input type="checkbox"/> High School Course | <input type="checkbox"/> Diesel Engineering |
| <input type="checkbox"/> Architecture and Building | <input type="checkbox"/> Drafting and Design for Men & Women |
| <input type="checkbox"/> Automotive Engineering | <input type="checkbox"/> Plastics |
| <input type="checkbox"/> Business Management | <input type="checkbox"/> Private Secretary |
| <input type="checkbox"/> Electrical Engineering | <input type="checkbox"/> Mechanical Engineering |
| <input type="checkbox"/> Elec. and Gas Refrigeration | <input type="checkbox"/> Aviation |
| <input type="checkbox"/> Air Conditioning | <input type="checkbox"/> Salesmanship |
| <input type="checkbox"/> Railway Training | <input type="checkbox"/> Radio |
| <input type="checkbox"/> Electronics, Industrial | |

Name.....

Address.....

LEARN WATCH REPAIRING AT HOME



Construction, repair, adjustment. New complete "PRACTICAL COURSE" for beginners and professional repairmen. All essential steps. Theory, operation. Many test cases. Full coverage of tools, materials. Fully illustrated. **\$2.95** Only (if C.O.D. plus postage fee.)
Post Paid
Money Back Guarantee

We Supply Tools, Materials at Lowest Cost

Write for illustrated catalogue of tools, materials. We specialize in all books on Watchmaking, Jewelry, Metalcraft, Gem Cutting, Optics.

MODERN TECHNICAL BOOK CO., Dept. MMC
55 WEST 42ND ST. NEW YORK 18, N. Y.

JOIN our new TECHNICAL BOOK CLUB—free

Members receive current literature, guidance on all book problems, premiums. No obligation. ALL BOOKS: Technics, Chemistry, Physics, Plastics, Refrigeration, Air-conditioning, Building, Construction, Electricity, Radio, Television, Electronics, Automotives, Mathematics, Wood-working, Homecraft, Business, Languages, Farming, Sports, Photography, etc. — Write for free literature, please specify subject.

IMPROVE YOUR PLAYING



PIANISTS—Send for FREE Booklet showing how you may greatly improve your technique, accuracy, memorizing, sightreading and playing thru Mental-Muscular Coordination. Quick results. Practice effort minimized. Used by famous pianists, organists, teachers and students. No obligation.

BROADWELL STUDIOS, Dept. I56-K Covina, Calif.

Thrilling Work COLORING PHOTOS



Fascinating vocation learned at home by those with aptitude. Thrilling pastime. National method brings out life-like colors. Free booklet.

NATIONAL PHOTO COLORING SCHOOL
1315 S. Michigan, Dept. 1357, Chicago 5

APTITUDE TESTS

for men, women, boys, girls, discover the kind of work or studies best for your success! You get a personal report—a guide for life—more happiness—more prosperity. Write for complete facts.

VOCATIONAL COUNSELING INSTITUTE
956 Maccabees Bldg., Detroit 2, Michigan

WATCHES WANTED Broken or Usable

All kinds. Highest Prices paid for jewelry, rings, spectacles, gold teeth, diamonds, Sterling Silver, etc. Cash mailed promptly. Write for free shipping container.

LOWE'S, Dept. PM, Holland Bldg., St. Louis 1, Mo.

SUPER YOUR GREATEST ASSET!

FACTS — FIGURES — FACES

at your command through the new improved SUPERMEMORY course

THOR BOOKS, Z-1, Box 1210, Chicago

YOU CAN MASTER MATHEMATICS

Key to the Electronic, Atomic age.

O · UNIVERSAL SCHOOL OF MATHEMATICS · O
623 Walter Story Bldg., Los Angeles, Calif.

LEARN INCREASE YOUR EARNINGS

Streamlined Home Study Course Now Available — Prepared by Successful Accountant

Penny post card brings full information

WESTERN HOME STUDY INSTITUTE
P.O. Box 2506, San Francisco 26, Calif.

RAISED WOOD SIGN LETTERS

MADE OF THE BEST IDAHO WHITE PINE.
ALL SIZES. FACTORY PRICES.
Send 10c for Catalog

SIGN LETTER DISTRIBUTORS, P.O. Box 101, Mineola, N. Y.

BIG MONEY FOR YOU IN PLASTICS

SEND 10c Offer includes 2 books: New Fabrication Manual & Giant Catalog, listing the most complete stock of Plastic Materials, Accessories, Tools.

BERTON PLASTICS, INC.
19 W. 21st St., N. Y. 10, N. Y.

ACT TODAY!

Don't think MUSIC IS HARD



Just strike these notes and you're playing the beginning of the "Merry Widow" Waltz. Look at the diagram. The first note of the music is "D." Following the dotted line to the keyboard you'll find "D" is the white key between the two black keys near the middle of the keyboard. Now read below



...ted Free Booklet and
... this remarkable

Learn

HOW TO REPAIR
ELECTRIC
APPLIANCES

NEW
ARC

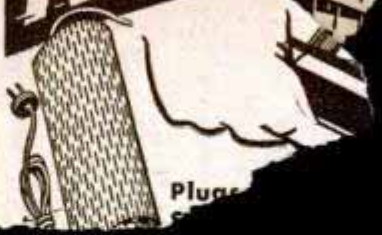

Plug

STAP

To those who think LEARNING MUSIC IS HARD



Just strike these notes and you're playing the beginning of the "Merry Widow" Waltz. Look at the diagram. The first note of the music is "D." Following the dotted line to the keyboard you'll find "D" is the white key between the two black keys near the middle of the keyboard. Now read below how you can learn to play any instrument quickly and easily.



Easy as A-B-C--COST LESS than 7c a day!

Perhaps you think learning music is a tedious grind. It isn't any longer! Long hours of practicing scales and monotonous exercise are over.

You have no excuse for not getting started toward musical good times now! For through an easy method you can now learn to play right at home—without a teacher—for less than 7c a day.

Learn to Play by Playing

The lessons come to you by mail from the famous U. S. School of Music . . . complete instructions, clear diagrams, and all the

music you need. You learn to play by playing real tunes by note. First you are told how to do a thing. Then a picture shows you how. Then you do it yourself and hear it. Remember, don't confuse our method with any system claiming to teach music "by ear" or by trick methods. We teach you to play only from real notes!

SUCCESS!

Here's what one of our thousands of pupils writes: "I learned more from your course than many of my friends who studied under private teachers have for years. The fact that I've already taken 2 courses and am now enrolling for a third should speak for itself." F. A. S., Indiana.

Don't delay. Send now for our illustrated Free Booklet and "Print and Picture" Sample which fully explain this remarkable method. So decide which instrument you want to play and mail the coupon today. U. S. School of Music, 710 Brunswick Bldg., New York 10, N. Y. (Successful 48th Year)

FREE! Print and Picture Sample

U. S. School of Music
710 Brunswick Bldg., New York 10, N. Y.

Please send me Free Booklet and Print and Picture Sample. I would like to play instrument checked below.

- | | | |
|--|--|--|
| <input type="checkbox"/> Piano | <input type="checkbox"/> Saxophone | <input type="checkbox"/> Modern Elementary |
| <input type="checkbox"/> Guitar | <input type="checkbox"/> Trumpet, Cornet | <input type="checkbox"/> Harmony |
| <input type="checkbox"/> Hawaiian Guitar | <input type="checkbox"/> Reed Organ | <input type="checkbox"/> Mandolin |
| <input type="checkbox"/> Violin | <input type="checkbox"/> Tenor Banjo | <input type="checkbox"/> Practical Finger |
| <input type="checkbox"/> Piano Accordion | <input type="checkbox"/> Clarinet | <input type="checkbox"/> Control |

Name..... Have You Instrument?.....

Address.....

City..... State.....

Save 2c—Stick Coupon on Penny Postcard

FIX ANY RADIO

Amazing New Invention



PRICE ONLY
\$1.50
COMPLETE

NEW PICTURE METHOD

Learn quickly to repair radio sets. New revolutionary different comparison picture method quickly simplifies all radio servicing. No previous radio knowledge required. Introductory training included. Find any radio fault with ease. Do expert radio work almost immediately. Repair radios in minutes instead of hours. Plan U. S. Copyrighted. Take advantage of this new invention. You can fix any radio after a few hours.

NO EQUIPMENT NEEDED

Most tests described require the use of only a screw driver, pliers, and a piece of wire—no testers needed. Simple point-to-point picture suggestions tell you where to look for defects, how to test radio circuits and parts, and how to make the repair. You may try the plan for 10 days without any risk.

RADIO MADE EASY

Let this unique plan with its easy-to-understand diagrams, hints, simplified illustrations, practical examples, and job-sheets teach you basic radio facts. Learn important short-cuts in radio trouble-shooting. Make needed tests without testers, trace the signal, find all faults within the hour after receiving the plan. Follow the comparison tests given on large trouble-shooting diagram blueprints. Over 1,000 repair hints. Data on all tubes. Circuits and hints for many types of radios—new and old models.

10 DAYS "NO RISK" TRIAL

Examine and use Simplified Radio Servicing plan for 10 days in your own home. Apply this technique and repair one or more radios. Then decide to keep this greatest radio training bargain, or return the material and get your money refunded in full. You take no risk.

Complete \$1.50 plan, only

In manual form, 8 1/2 x 11" Trouble-shooting charts. Data on 346 radio tubes. 63 large job-sheets. 1,000 time-saving hints. Covers all types of sets—new and old, FM, portables. Developed by Beitman, noted engineer, teacher, and author. Order today on 10-days no-risk trial—

REPAIR RADIOS IN MINUTES

Read the introductory job-sheets, follow the step-by-step picture blueprints, and fix any radio in a matter of minutes. Do radio work for fun and profit. The complete simplified training is yours for only \$1.50.

MORE HELP—IF NEEDED

Supplement your study, clear-up all hard problems, get ahead in Radio. A companion 19 lesson Practical Radio manual will give you added assistance, help you get ahead faster, presents important facts in greater detail. Include this large manual also in your trial order. See coupon—

NO RISK TRIAL COUPON

SUPREME PUBLICATIONS, 9 S. KEDZIE AVE., CHICAGO 12, ILL.

Ship the following manuals to me for 10 days' trial under your money-back guarantee. I am enclosing \$.....full price. Ship postpaid.

Simplified Radio Servicing @ \$1.50 Practical Radio Manual @ \$2.95
Complete manual as described. Companion Volume, 19 lessons.

Name:.....

Address:.....

Learn HOW TO REPAIR ELECTRIC APPLIANCES

**START YOUR
OWN SHOP
Be Independent**



H. T. ARMSTRONG
General Manager



You Can Pay for Your Home Training With Just One Good Repair Job!

You can make more money when times are good, and you don't have to worry about losing your job when times are slow if you have your own electrical appliance repair business. There is always a demand for repairmen. And it's a type of work that can't be done by a machine. Nearly 5,000,000 additional American homes have been wired for electricity since 1940 . . . making the opportunity and demand for service mechanics in this field the greatest in history.

Interesting Work! Easy to Learn!

Our practical, easy to learn home training teaches you, during your spare time, how to repair washing machines, vacuum cleaners, stoves, lamps, motors, irons, etc., and how to do house wiring. You can start a business of your own in your garage or basement with \$20.00 worth of tools. One good repair job can pay for the cost of the entire course. Write today for further information, without obligation.

**NEW
BOOK**

"HOW TO START YOUR OWN BUSINESS"
Sent at no extra cost if you act promptly. This valuable book covers locating your shop, contains drawings of how to build and wire work-benches, where and how to advertise, what to charge, how to hire solicitors, etc.

MAIL TODAY for FREE BOOK!

**H. T. Armstrong, General Manager
PACIFIC TRAINING SCHOOL**

7217 So. Broadway, Dept. 10-P, Los Angeles 3, Calif.

Dear Sirs: Please send me, without obligation, your free catalog and full details.

Name.....

Address.....

City.....State.....

SAY YOU SAW IT IN POPULAR MECHANICS

NEW MIDGET ELECTRIC ARC WELDER



**Plugs into Light
Socket—AC or DC**

It's new! It's handy! It's efficient! Use the Midget Electric Arc Welder for hundreds of light-metal jobs. Does comparable welding work with a 1/16 inch welding rod on thin metal as that of larger and higher priced welders. Operates on 15 ampere fuse, 110 volt 60 cycle A.C. or D.C. current, by use of our special standard-rated 1/16-inch welding rods. Generous supply of rods supplied with machine. Recommended for all light welding like auto-mobile fenders, etc. Take the Midget Arc anywhere to the job. Sturdily built and fully guaranteed. Comes complete—ready to use. Nothing else to buy. No previous welding experience needed to strike an arc. In a short time, anyone mechanically inclined can learn to weld with this machine.

You'll find hundreds of money-saving, time-saving uses for the Midget Arc around your home, garage, or workshop. Also in garages, factories, repair shops, tin shops, mechanics, farmers, inventors, etc. Order a Midget Electric Arc Welder now! **SEND NO MONEY.** We'll rush one to you, complete with rods and helmet (equipped with APPROVED welding glass). Pay postman only \$3.95 plus postage charges. If not satisfied, return Midget Arc in 5 days from receipt and we'll refund your money immediately. **RUSH YOUR ORDER NOW.**
MIDGET ARC WELDER CO., Strader Ave., Dept. N-202, Cincinnati 26, Ohio

Be Your Own Boss — In Your Own Business

Start at home . . . small capital needed . . . prepare for exciting plastics jobs or Your Own Plastics Business. We teach you Fabrication and casting right in your own home. All materials furnished. Send ad with name and address for information. **VETERANS:** Eligible for resident training under G. I. bill. Check here

**LEARN
PLASTICS
PLASTICS TECH**
School of America, Inc.
5200 Euclid Avenue
Dept. M-10, Cleveland 3, Ohio

Popular Mechanics' 1946 Useful Ideas And 1947 Home Kinks

have just been issued and are on sale at all newsstands. As usual, both are full of the best time and money-saving short cuts and ideas that have appeared in Popular Mechanics. Look for them! Keep your collection complete! Only 25c each. (30c in Canada.)

Correspondence Courses in RADIO and ELECTRICAL ENGINEERING

LOW AS \$25

ELECTRICAL ENGINEERING. Get good grasp of wide electrical field. Modern. Very understandable. Theory made easy.

RADIO ENGINEERING. Extra fine course in radio, public address, photo-electric work. Trains you to be super-service man, real vacuum tube technician. Tuition ONLY \$25, other course. Deferred payment plan. Services needed badly.

FREE LINCOLN ENGINEERING SCHOOL, Box 931-P94, Lincoln, Nebr.

MECHANICS!

Engineers! Mathematicians! Others! Amazing new book gives instant solutions to 100,000 practical problems. Covers mechanics, hydraulics, electricity, construction, physics, chemistry, medicine, agriculture, shop-work, trigonometry, measures and weights. Details free.

Columbia Graphs, Columbia, Connecticut

Arc Welded Design "Know-How"

Only \$3.50 each Each volume contains over
3 different volumes 100 welding designs. Write
\$10.00 postpaid Hobart Bros. Co. Box M-561, Troy, O.

ENSHRINE THEIR MEMORIES WITH

U. S. MONUMENTS \$14. UP
Freight Paid

There is none better. Our free catalog is ready for you. Write today. A-18 U. S. Marble & Granite Co., Oneco, Fla.

POPULAR MECHANICS



You Need Not Wait For

Your NEW HOUSE

Here's how to avoid the lumber shortage.

Here's how to avoid inflated prices.

You can get the home you want — right now — the home you've always dreamed of owning.

Here are details of construction methods and materials in simple, easy-to-understand language! Here are detailed, itemized lists of all the materials needed in your house, lists telling where to get each item, lists telling how much each item costs.

The author, an experienced engineer, shows how a large, modern, six-room, thoroughly insulated, fire-resistant, two-bath house with garage can be had, anywhere in the United States, for \$2800.00.

Included with the book are ten folded drawings, 12" wide x 18" long. These drawings by the author show all the details of such a house—the wiring, the plumbing, the automatic oil-burning heating system and the fluorescent lighting. The book is devoted to showing how similar savings can be made on any house of any style, size or floor plan.

Never has a more helpful book been printed for the person who is planning or building a house.

138 6" x 9" pages Illustrated, Ten Large, Folded Drawings . . . Send \$2.00 to Technical Press, Box 11B, Swampscott, Mass. and your copy of

"A SIX ROOM HOUSE, \$2800 COMPLETE, READY FOR YOU TO MOVE IN"

by George W. Pearce, will be rushed to you postpaid . . . Distributed solely by Technical Press, not sold in book stores . . . Absolute money-back guarantee.

KNOW HOW TO DEFEND YOURSELF

A complete scientific course in Jiu Jitsu, Wrestling, Foot fighting and Police tactics. 200 Action Photographs illustrate the deadliest hand fighting technique known to modern man. (Acquire the self-confidence and courage that comes from knowing how to defend yourself.) Special — \$1.00. LEISURE LIBRARY, Dept. D.A., 112 E. 19th St., New York City.

AMERICAN
COMBAT
JUDO

USE Fine Walton Wheels to Make Your Own WAGONS—SHOPPING CARTS and RACERS



65¢

Each in Sets of 2 or 4 — plus 10c ea. for postage. 4 1/2-inch with 3/8-in. bushing

Coaster wagons, scooters, shopping carts, bike trailers, golf bag carriers, etc., are easy to make. Use fine Walton Deluxe Wheels! They're strong welded pressed steel construction. Ideal for making many things for use and play. Solid rubber tires. Red enameled. Send check or money order. No C.O.D.'s. Dealers write.

WALTON WHEEL COMPANY, Dept. J-1
Plankinton Bldg. Milwaukee 3, Wis.



CARTOON TO SUCCESS!

Learn to cartoon! Big pay! Easy, enjoyable work! Cartoon course, gag course, anatomy course and business course full of plans, markets, ideas. Drawing set and criticisms. All one low price! Rush card for details! HARTMAN SCHOOL, 2776 California Court, Lincoln 1, Nebraska

Become a Doctor of PSYCHOLOGY

Win the degree of Ps.D. Teach the secret of contentment, happiness. Solve mental worries. Experience the revelation of truth. Chartered college. Individual help. Write for FREE book. COLLEGE OF UNIVERSAL TRUTH, 5153-B North Clark St., Chicago.

HEAT & TEMP. INDICATORS \$1.50

CAR — TRUCK — MARINE — TRACTOR

Repaired like new—Any Condition

Guaranteed
AUTOMOTIVE INSTRUMENT SERVICE
2836 W. Montrose Chicago, Ill.

Plus Post.

TIME & MOTION STUDY

DON'T COMPETE WITH 30,000,000 NON-PROFESSIONAL WORKERS. Train with professional engineers for your big pay job now. Approved for "G.I." training. Fall classes starting now. Send for free details and your copy of INDUSTRIAL ENGINEERING BENEFITS.

INDUSTRIAL ENGINEERING COLLEGE
3309 W. Washington Blvd. Chicago, Illinois

WAR SURPLUS BARGAIN \$1.79 7 lbs.

Amazing assortment radio parts—Resistors, Trimmers, Springs, Sockets, Condensers, etc. Tremendous bargain at this price. Send check, M.O. MARKO SUPPLY, Dept. PM-10, 2924 Logan Blvd., Chicago 47, Ill.

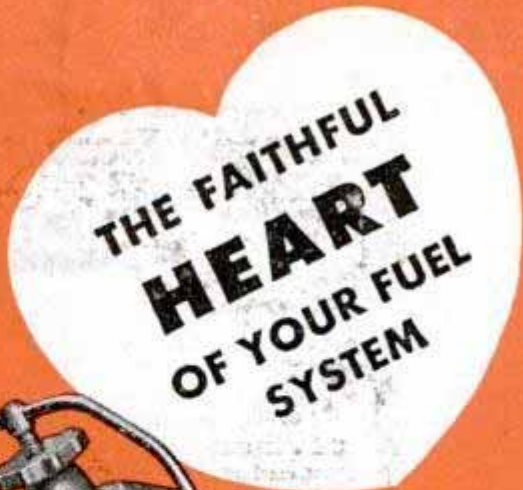

AC

FUEL PUMPS

Pulsing steadily, hundreds of times a mile, your AC Fuel Pump is the strong, reliable heart of your fuel system. It has given you long, faithful service because of its inbuilt quality and scientific design.

You can prolong that faithful service indefinitely, if you insist upon an AC when you replace your present pump with a new or rebuilt one.

AC SPARK PLUG DIVISION - GENERAL MOTORS CORPORATION

HORSES

**How To Select, Care For,
and Handle Them!**

HERE in one fine, big book is "everything you want to know about Horses"—from purchasing to prize-winning!

Out of thirty years' experience in selecting, riding, breaking, training, hunting with, and showing horses, Margaret Cabell Self gives you in easy-to-understand language the facts, instructions, and professional advice that can make owning and caring for your own horse the finest hobby of all!

Clear, complete explanations of how to judge a horse; how and where to buy; equipment for grooming, riding, driving, harnessing, etc.; how to feed, water, bed, groom, shoe, clip, tie; first aid for common horse injuries, diseases; causes, control of 19 "vices"; how to ride, drive; teaching children, the Show Ring, etc. Complete with helpful glossary, 40 photos and drawings.

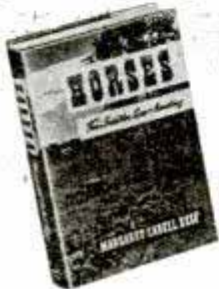

SEND NO MONEY. Simply write and ask for your copy of "Horses: Their Selection, Care, and Handling." Upon delivery, deposit with postman only \$3 plus actual postage. Unless delighted, return book in 5 days for full refund. Address:

A. S. Barnes & Company, Publishers, Dept. 210, 67 W. 44th St., New York 18, N. Y.

NOW! LEARN HARMONICA New, Quick, Easy Way

**10 Easy Lessons
in 10 Minutes!**

Master Harmonica music in matter of minutes! No notes. No scales. No exercises. Anybody, young or old, can learn quickly and easily by new Rhythm Method of Harmonica Magic. New method endorsed by world's largest distributor of Instruction Book on Harmonica. 75 SONGS INCLUDED WITHOUT A PENNY'S EXTRA COST! Don't wish you could play a Harmonica. **START PLAYING** right away and win new friends and still greater popularity over night. Rush order today while limited supply of Harmonica Magic Book of Easy Instructions is still available. We pay postage. Just enclose stamps or coin under Money-back Guarantee.

THE NEW PLASTIC HARMONICA and INSTRUCTION BOOK \$1.00
THE GAY ENTERPRISES Dept. PM-2, Box 3445 Merchandise Mart, CHICAGO 54, ILL.



Only **50¢**
WHILE THEY LAST

ORDER NOW!

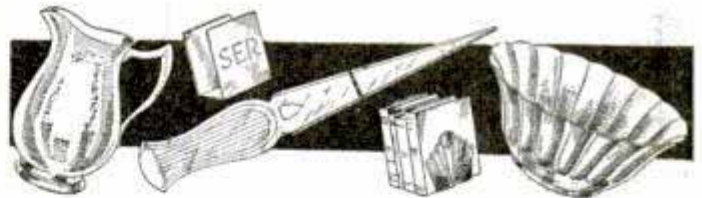

FUN with METALCRAFT

"Methods of Working in Metal," by Robert E. Smith, gives you full, simplified instructions in this enjoyable, profitable hobby. The processes of hammering, chasing, engraving, and piercing metal are interestingly explained and lavishly illustrated by photos, drawings, and dimensional work diagrams. There is a complete section of Metal Projects which you can make, such as: Trays, Coasters, Book-Ends, Ash Trays, Letter Openers, Bowls, Pitchers, Table Lamps, etc.—with patterns, ornamental designs, and step-by-step instructions. The tools used in metalcraft are few and simple. The work is hardy and pleasant and the results are very gratifying. Send only \$1.00 for the book—or we will ship C.O.D. plus postage. Money back guarantee if not more than pleased. Write to:

HOBBY BOOK MART, 150 Nassau St., Dept. P-55, New York 7, N. Y.

GET READY for the BUILDING BOOM Learn about Earning Opportunities in BUILDING CONTRACTING

**FREE FACTS: Use Our Training Plan
to Learn at Home in Spare Time**

Do you want to be on the inside in the building boom—where big money is made? Learn about opportunities for Building Contractors whether or not you have previous experience in this field. Millions of dollars are going to be made in home and farm buildings, in construction of stores, garages, small industrial buildings. The building industry uses men with organizing ability by thousands in construction, supervision, management, sales. Properly trained men needed in production, distribution, finance, installation, marketing. Government estimates housing demand at 40 billion dollars. Others are preparing to get in now! Act immediately—get the facts! Mail postcard today—no obligation.

**HOME BUILDERS TRAINING INSTITUTE, Dept. D-210
6312 N. Broadway Chicago 40, Illinois**

Say You Saw It in POPULAR MECHANICS

PLASTIC HOBBYCRAFT KIT

Kit contains 2 lbs. PLEXIGLASS and LUCITE factory cutoff sheets and strips, dye, cement sand paper, buffing compound and fabricating instructions for experimental purposes and making novelties. Send \$3.00 money order to Dept. S.

HOME CRAFTSMAN PLASTICS, 1945 W. Harrison St., Chicago 12, Ill.

LAW

STUDY AT HOME for PERSONAL SUCCESS and LARGER EARNINGS. 35 years expert instruction—over 108,000 students enrolled. LL.B. Degree awarded. All texts furnished. Easy payments. Send for FREE BOOK—"Law and Executive Guidance."

**AMERICAN EXTENSION SCHOOL OF LAW
Dept. 70-M, 646 N. Michigan Ave., Chicago 11, Ill.**

PRINTING PAYS BIG

"Make your future secure. Prepare for a highly paid position or a print shop of your own. Students throughout the world are enthusiastic in their praise of our training program and the personal attention given each student. Rush name today for free literature and sample lesson. No salesman will call. Write Dept. M-106.

International School of Printing, Box 334, Dayton, Ohio

Learn to Draw the . . .

FIGURE BEAUTIFUL

Get this **PICTURE-PACKED** New Art Book

Featuring the Female Form. An assortment of Lovely Artists, Models photographed in various positions, together with charts and notes.

A MUST for the professional or Student Artist. ONLY \$1.00

Two Separate Editions, Vol. 1 and Vol. 2 **EACH**



Outside U. S. A. Send \$1.25 each

Major Book Co., Dept. 320-B, 241 East Broadway, New York, N. Y.



GET INTO RADIO TELEVISION ELECTRONICS... NOW

A BIG, POWERFUL RADIO AND EXPERIMENTAL EQUIPMENT ARE INCLUDED WITH YOUR TRAINING

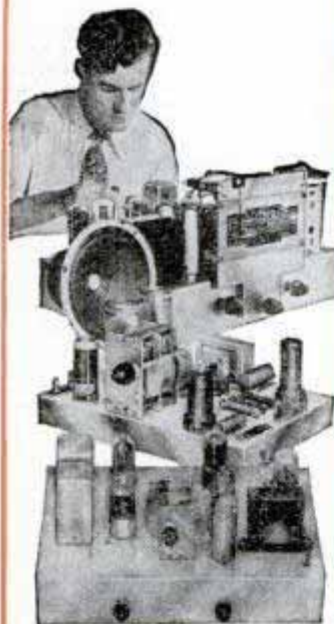

Here is some of the Radio equipment that is furnished you at no extra cost with National's Shop Method Home Training. BUILD A BIG, SEVEN TUBE LONG DISTANCE SUPERHETERODYNE, an audio oscillator, a signal generator (low powered Radio transmitter) and many other units. Really Learn by Doing! Earn money early in the Course doing spare time Radio work.

Get Ready — at Home — in Spare Time For Opportunities of Peacetime Industrial Expansion

PREPARE NOW—With Shop Method Home Training BY A REAL ESTABLISHED RESIDENT SCHOOL

No doubt about it! — Radio, Television and Electronics is a dynamic, growing industry that offers opportunity TODAY for the Trained Radio Technician. It is a field with a proved future. Good jobs, interesting and profitable jobs are available in Radio Service, Broadcasting, Marine and Police Radio, Manufacturing, Public Address, and other specialized phases. Untold Radio sets are in use—they need maintenance and repair. Many, many more must be built to satisfy even normal demand. Trained men are constantly needed to keep this pulsating industry moving ahead. If you are mechanically inclined, if you are sincere and will follow instructions, you too can find your opportunity in Radio, Television and Electronics—either in business for yourself or in a responsible position in industry. TAKE THE FIRST STEP TODAY! FOR FACTS PACKED WITH OPPORTUNITY FOR YOU JUST MAIL THE COUPON BELOW.

Learn By Doing Right At Home

The secret of the success of this practical training method is the experience of working with actual full size, standard equipment during your training. Here's a fully tested and approved method—simple and direct, easy to understand and put into PRACTICE! You check what you know as you go along. You can see progress right from the start.

It will only take a moment to fill out and send the coupon for a sample trial lesson. PROVE TO YOURSELF HOW MUCH YOU CAN ACCOMPLISH IN A SHORT TIME.

National Training Is More Than Book Theory

National Schools can furnish you this modern, complete, up-to-date training in Radio, Television and Electronics for National has the Shops and Laboratories where instructors work with students and technicians to bring you—right in your own home—in your spare time—the kind of practical in-

struction, practice and experience that assures definite progress—step-by-step through the entire field.

Rush Coupon Today For Full Details

See what definite practical progress YOU YOURSELF CAN MAKE WITH JUST A SINGLE LESSON, sent to you with no obligation.

No salesman will call on you from National. You make up your own mind. IT COSTS YOU NOTHING TO READ THE INTERESTING FACTS.

VETERANS

—if you qualify for training under the G.I. Bill of Rights check the coupon for a Special Bulletin.

41 Years Experience Training Men for Success!

NATIONAL SCHOOLS

LOS ANGELES 37, CALIFORNIA EST. 1905



MAIL OPPORTUNITY COUPON FOR QUICK ACTION

National Schools, Dept. PM-10
4000 South Figueroa Street
Los Angeles 37, California

(Mail in envelope or paste on penny post card)

Mail me FREE the books mentioned in your ad including a sample lesson of your course. I understand no salesman will call on me.

NAME.....AGE.....

ADDRESS.....

CITY.....ZONE.....STATE.....

Check here if veteran of World War II

THESE MEN KNOW

For over 40 years National training has given ambitious men their start in life and helped them win success and security. National graduates everywhere gratefully admit that they owe their success to National Training. They all started the same—by investigating what National has to offer.



Joseph Michel, Jr., Granite City, Illinois, says: "I am enclosing a letter I received very shortly after enrolling. I shall receive a salary advance of \$225 per month with an increase of \$300 shortly. Had I not taken advantage of the work National Schools sent me I would not have been able to interest this employer."

Clifford Hannah, Portage LaPrairie, Manitoba, Canada, writes: "My training has brought results as I'm in line for another raise, thanks to National's encouragement and thorough training. You can count on me as a real National booster."



SAMPLE LESSON Free!



Get this complete, special manual "Modern Radio Servicing." It's full of valuable how to do it information.

See for yourself how YOU can become a thoroughly qualified Radio, Television and Electronics Specialist. No obligation. You may keep the manual. IT IS YOURS FREE.

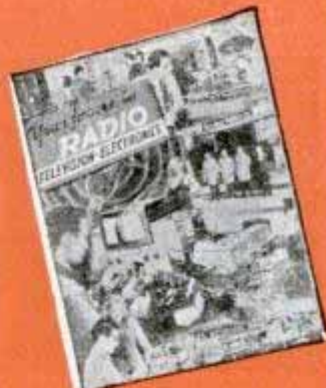

ALSO THIS BIG OPPORTUNITY BOOK FREE!

Tells of the many fine, good-pay jobs in Radio, Television and Electronics — How to start your own life-time business. FILL OUT AND SEND THIS COUPON — NOW!



E-Z MARK
THE MECHANICAL BOOK MARK
a byword for Book Lovers

Here's a book mark all readers will want. Keeps your exact place at all times. No fumbling, no lost places, no lost time. Just put it in your book when you start reading. It holds your place to the last page.

INTRIGUING . . . Mechanically perfect, it may be personalized with engraved initials on page separator. Packed in a smart box with instructions for use on inner platform.

AN IDEAL YEAR ROUND GIFT AT \$1.00

Sold in book and stationary departments everywhere. If you cannot be served by your local store, mail us a \$1.00 postal money order and we shall send you an "E-Z Mark" directly postpaid.

SAPPHIRE PRODUCTS, Dept. B
 28 West 22nd Street, New York 10, N. Y.
 Made in U. S. A. Pat. No. 2387607

SAY YOU SAW IT IN POPULAR MECHANICS

SPECIALIZED TECHNICAL TRAINING

Prepare in 6 months to 3 years for specific technical occupations. Select the course that interests you most.

- * **Institute of Electrotechnics**
Applied Electricity, Electrotechnics, Radio and Electronics
- * **Welding Institute**
Gas, Aircraft and Arc Welding
- * **Refrigeration, Heating and Air Conditioning Division**
Service or Technician
- * **College of Electrical Engineering**
B.S. Degree With Major in Machinery or Electronics

WRITE FOR MORE DETAILS AND FREE BOOKLET

MILWAUKEE
SCHOOL of ENGINEERING
Institute of Electrotechnics

*"Has Served Industry 44 Years"

PM-1046 A North Broadway and East State, Milwaukee, Wisconsin

Without obligation send more details on.....course and free booklet "Career Building."

Name.....Age.....

City.....State.....

PM-1046A

WAR BARGAINS in LENSES and PRISMS

NOW! MAKE YOUR OWN BINOCULARS!

Complete Set of LENSES and PRISMS from Navy's 7X 50 Model

Save Up to \$150.00



Here's an unusual opportunity to secure a fine set of Binoculars at a tremendous saving of money. Build them yourself with all of the very same optics contained in the Navy's 7 Power Glasses. Or you can construct a Monocular (1/2 a Binocular) in which case exactly one half quantities of the Binocular Components will be furnished. All Lenses and Prisms are in excellent condition. Lenses are cemented and have the new low reflection coating. Complete assembly directions included for either project.

- Stock #5102-H Binocular Set of Lenses and Prisms.....\$25.00 Postpaid
- Stock #5103-H Monocular Set of Lenses and Prisms.....\$12.50 Postpaid
- UNMACHINED LEFT AND RIGHT BODY AND COVER PLATE CASTINGS. Stock #820-H.....\$2.50 Postpaid
- 35 MM. KODACHROME PROJECTING LENS SET—Consists of 2 Achromatic Lenses for projecting, plus 2 Condensing Lenses and piece of Heat Absorbing Glass with directions. Stock #4029-H.....\$3.10 Postpaid
- POLARIZING FILTER—Diam. 73 mm. Perfect condition. Stock #637-H.....\$3.00 Postpaid
- TANK PRISMS—90-45-45 deg., 5 3/4" long, 2 1/8" wide, finely ground and polished. Stock #3004-H Silvered Prism (new & perfect).....\$2.00 Postpaid
- Stock #3005-H Plain Prism (new & perfect).....\$2.00 Postpaid
- Stock #3100-H Silvered Prism (Second).....\$1.00 Postpaid
- Stock #3101-H Plain Prism (Second).....\$1.00 Postpaid

We have literally millions of war surplus lenses and prisms for sale at bargain prices. Write for Catalog "H"—Sent Free! Satisfaction Guaranteed Order by Stock No. **EDMUND SALVAGE COMPANY** P. O. AUDUBON, NEW JERSEY

Walt Disney Films

Your Own Little Theatre



MICKEY MOUSE VIEWER and No. 1 Film Strip... \$1 This beautiful plastic Mickey Mouse Viewer and Walt Disney's world famous "Brave Little Tailor" in an exciting condensed version FULL color 16mm film strip. 16 actual scenes from the original film. The Special Gift Set includes the Mickey Mouse Viewer and 13 thrilling full color condensed version 16mm film strips, each strip showing 16 scenes from Walt Disney's world famous pictures. 3 Academy Award Winners!

- PLEASE SEND ME A SPECIAL GIFT SET FOR ONLY \$1.95
 - PLEASE SEND ME A MICKEY MOUSE VIEWER AND "BRAVE LITTLE TAILOR" FOR ONLY.....\$1.00
- REMITTANCE ENCLOSED \$ — AT YOUR DEALER'S, OR Dept. PM-10

CRAFTSMEN'S GUILD

6916 Romaine Street, Hollywood 38, California

AUTOMOBILE—ELECTRICAL

OVER 100 QUESTIONS AND ANSWERS

to everyday Automobile and Electrical problems by expert with over 40 years practical experience. Also many important Business Opportunities. All for.....**\$1.00**

W. J. C. PUBLISHERS 127 FRANKLIN STREET JERSEY CITY 7, N. J.



Learn modern watch and clock repairing

At home, spare time. Good field now... security and contentment in future. Start part-time business and earn while you learn. Horology is precision instrument work... a great and growing field, sensational opportunities. Easy self-instruction course. Low price. Money-back guarantee. Write now for Free Success-Catalog. Nelson Co., 1139 S. Wabash Ave. Dept. 1K02 Chicago 5, Illinois



"I'M PROUD OF JIM

He's doing so well in **PLASTICS**

"He had the foresight to know that the man who is *trained* in plastics gets the best opportunities. He took the Plastics Institute course and enjoyed every minute of it. Of course he learned a lot, there are so many interesting things to know about plastics. But it paid off...and now we can afford the luxuries we've always wanted..."

People all over the world are saying similar things. For Plastics Institute, America's oldest and largest plastics educational organization that devotes all of its facilities exclusively to plastics, has trained men in every section of the world. Hundreds of testimonials telling of fine positions and booming new businesses prove the value of the Plastics Institute course.

LEARN AT HOME—Continue your present job and learn plastics in your spare time! The thorough, easy-to-understand course presented by Plastics Institute requires no previous technical experience.

A COMPLETE COURSE—Everything you should

know about plastics is included . . . materials, designing, molding, fabricating, laminating and testing. You will acquire a basic knowledge of plastics that can be invaluable in getting you the type of fine position you want in this great, new industry.

YOU MAKE THINGS—To give you practical experience in working with plastics, we supply handsome, colorful, rods, sheets and tubes of plastics from which you can if you wish, make useful, attractive creations. You cement, saw, buff, form, dye, decorate, cast and laminate various types of plastics. You design plastics articles—develop your own ideas. You may earn money while learning.

START YOUR FUTURE TODAY—Mail the coupon below, now! You will get an interesting, illustrated, free booklet with worthwhile information about plastics. You will see how, at small cost you can prepare for a bright future in the booming plastics industry. Clip the coupon and mail it TODAY!

Write Dept. PM6-10, 1601 S. Western Ave., Los Angeles 6, California
Home Training Courses and Resident School APPROVED FOR VETERANS

Plastics

INDUSTRIES TECHNICAL INSTITUTE
NEW YORK CHICAGO LOS ANGELES



FREE BOOKLET
Send For It Today!

Plastics Industries Technical Institute
Dept. PM6-10 1601 S. Western Ave., Los Angeles 6, Calif. Mail in Envelope or paste on penny postcard
Gentlemen: Please send me the booklet "World of Plastics" and information on your training. I understand there is absolutely no obligation.
Name (PRINT) Occupation
Street (PRINT) Age
City Zone State
Important: Please fill out coupon *completely*. If Veteran, please check.



REFRIGERATION AIR CONDITIONING

Air Conditioning and Refrigeration are among the great industries of today and tomorrow. Installations everywhere—in restaurants, shops, homes, etc., need service. Thousands of businesses are waiting for new installations. Today, more and more homes are being air conditioned. The Refrigeration and Air Conditioning industries are headed for greater prosperity and men who have the "know how" and experience should ride along.

Train Now Before the Expected EXPANSION Begins

Experts predict large demand for men to install and service Air Conditioning and Refrigeration equipment... Rise to the kind of job which requires a competent, trained man who can carry the responsibilities of installing costly equipment and maintaining it. If he knows the answer when he is called in for consultation, his reputation grows and his pay should grow also.

Follow This Way to Knowledge

If over 17, and under 60, here's all it takes to get you ready for experience in this modern industry. Just invest a limited amount of your spare time—while you are still on your present job. Through our balanced training, you learn first through home study, how to handle Installation, Maintenance & Service Work on Refrigeration and Air Conditioning equipment. Then you can get practical training in our big shops under capable instructors—experienced men who'll take a personal interest in helping you learn. When you're through you should have knowledge that enables you to get started in this vast industry.

WANT YOUR OWN REPAIR SHOP?

UEI training is easily understood by mechanically inclined men. You gain experience when you complete your course. Equipment, tools and personal following can accumulate as you progress. Soon you may find it wise to set up your own shop.

GET FREE FACTS RIGHT NOW!

It costs you nothing to get all the facts about this great field. Simply mail the coupon below and we'll tell you, without obligation the whole, sensational story of what's ahead in Refrigeration and Air Conditioning. Mail the FREE coupon now.



REFRIGERATION TRAINING Since 1927

UTILITIES ENGINEERING INSTITUTE

1314 W. Belden Avenue, Dept. 1106, Chicago 14, Ill.

Please send me the FREE FACTS about opportunities in Air Conditioning and Mechanical Refrigeration. I have marked the one that interests me most.

Air Conditioning Mechanical Refrigeration

NAME _____ AGE _____

ADDRESS _____

CITY _____ ZONE _____ STATE _____

APPLIANCE REPAIRMEN

MONEY SAVING PRICES — IMMEDIATE DELIVERY

RENUALL Iron element. Guar. 1 year. Package of 6.....	\$3.12
Toaster element forms. Clear Mica. Fits most toasters. 10 for..	1.80
Heating element wire 10 ft. coiled 1/4" O.D. #20.....	2.55
Heating element wire 10 ft. coiled 3/16" O.D. #22.....	1.77
Christy Electric Heating Element Welding Flux for repairing flat irons, toasters, electric stoves, etc. Enough for 50 elements..	1.00
Appliance cord. Rubber covered. 20 ft. \$1.00; 100 ft.....	4.50
Ribbon element heating wire. Std. size. 100 ft.....	.75
Percolator elements. Universal. Flat type. 1 yr. guar. 2 for..	1.20
Element cement. Withstand 3000° F. 1 lb. pkg. \$1.00, 5 lb. pkg.	3.50
Lead wire. Asbestos covered heater hook-up wire. 10 ft.....	1.00
Iron Cord Sets with complete plug attachments. 10 for.....	5.00
Carbon brush set. Assorted. 104 brushes, 15 springs. Complete set	3.00

Here is your opportunity to save on repairing your own appliances and to earn extra money repairing appliances for friends and neighbors.

CHRISTY SUPPLY COMPANY

2835 N. Central Ave., Dept. T-350, Chicago 34, Ill.

Don't Envy The Plumber BE ONE!

Above all the TOP WAGE craftsmen stands the PLUMBER

Every skilled workman will tell you that Plumbers have the best of it. WINTER and SUMMER the Plumber is busy at top wages. No skilled Plumber is ever out of a job—compare his opportunities with any trade, plus the opportunities of having your own shop.

We teach you Plumbing with TOOLS (not books) under Licensed Master PLUMBERS in one of the finest equipped schools in America. We make you a Plumber, every branch is taught thoroughly—Lead Work—Blue Print for plan reading—all other tricks.

LEARN IN 30 WEEKS without previous experience

If you like to work with tools you owe it to yourself to investigate. No need to ever work as an apprentice. Get free bulletin. Write now! G.I. approved. Our 24th year.

UNIVERSAL PLUMBING SCHOOL

815 HOLMES STREET KANSAS CITY, MO.

Learn to Write

Short Stories, Mysteries, Novels, Articles—at home in spare time

THE demand for writers is creating great new opportunities for people with an urge to write. It's not as hard to succeed as you may imagine. Most famous authors come from ordinary walks of life. At home, you too may learn fiction writing, the best basis for all fields—short stories, novels, features, articles, radio scripts. Palmer Institute's Home Study Training (Established 1917) is endorsed by Rupert Hughes, Ruth Comfort Mitchell, Gertrude Atherton, Katharine Newlin Burt and other famous authors and by scores of successful graduates. Complete instruction material and professional coaching to develop your own style. FREE book explains how you may enjoy an ideal part time or full time career. Write today (no salesman will call).

PALMER INSTITUTE OF AUTHORSHIP, Desk T120

Palmer Building, Hollywood 28, Calif.

FREE 32-PAGE BOOKLET ABOUT MODEL RAILROADING

THE WORLD'S MOST FASCINATING HOBBY



FREE 32-PAGE BOOKLET tells all about this absorbing hobby for skilled tradesmen, business and professional men. Give yourself hours of satisfaction and relaxation building your own scale model railroad which performs and looks like the real thing. It's easy and relatively inexpensive. Get started now. Send at once for our free booklet "Your Model Railroad."

MODEL RAILROADER MAGAZINE DEPT. 624M MILWAUKEE 3, WISCONSIN

HOW TO MAKE MONEY BY MAIL

Down-to-earth facts, directions (illustrated) for running business profitably, using expertly for YOUR good fortune the employees, trains, planes which Gov't places at your disposal CHEAP. Get orders by mail, ship by express or freight or mail, get out of the kindergarten . . . 14th edition, enlarged to 576 pages, now selling. It's YOUR winner. Make this year and the following years worth more. . . . THIS knowledge really PAYS OFF.

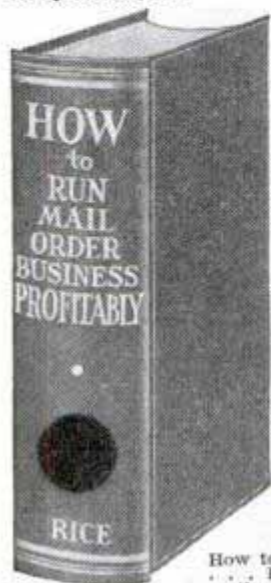

THE EASY WAY to start new or expand your present occupation. Do it NOW. Extraordinary plain, simple skill, know-how. No theory. Fact story of rich experience of author E. Rice day-by-day. How many times have we heard: "I wish I had some money, this patent would earn me a fortune," or "why can't my crop pay better?" or "I wish I knew how to sell this gadget myself," or "why should my boss alone do this when I too know how the money is made?" . . . Listen, YOU DO NOT NEED MONEY TO START THIS RICE WAY. His method automatically pays all bills same day rendered, no bank loans, pay as you go, no borrowing from relatives or friends, no salesmen. Also no worry, quickly a home of your own all paid for. Rice paid off \$5000 in mortgages a year after using this skillful idea.

46 Years of PROOF

Sounds fishy? Sure, but this has been done steadily for 45 years, depression or no depression, by the author; that is why he wrote this book, to pass the good word along. Make it go with anything you have which is salable, or with what you are now doing. Rice made his pay plan go from the start when living in one room in a city lodging house. Turn your city or country home, your work, your hobby, into money. How to get orders coming steadily at cost of only \$4 for each \$100 taken in. The popular error to avoid in trying for sales. Business won free while others have to pay for it.

How to conceive the money-getting advertisement. . . . Profitable changes from ordinary ideas and methods. Not usual cut-and-dried pattern, 165 adventures, a dictated book in everyday talk by Rice

doing day by day what he discloses in his book can be done by his method. No dictionary writing. . . . Read how others are profiting big.

Take a chance on this book being worth a fortune to you and yours and send \$2.95. Book mailed same day order is received. Or ask two friends to chip in 98 cents each with your 99c to get this book. Hundreds of buyers whose letters we show you declare emphatically its superlative goodness. Follow its easy pattern for success. Cloth-bound, 576 pages, 8 1/2 by 5 1/2. Best seller, 14th edition now selling. Cut out the \$2.95 HOW BOX here, pin or stick it to sheet of paper bearing your name and address, mail in envelope with money order or check for \$2.95 to

HOW
\$2.95

HOWARD ST. HOUSE, Melrose 76d, Massachusetts

REFRIGERATION AND AIR CONDITIONING

SERVICE MECHANICS COURSE

Learn at home—how to start your own repair shop on little capital. No previous experience needed. Common school education sufficient. Splendid opportunity for older men. Prepare now for your future. FREE illustrated booklet.

MECHANICS TRAINING SCHOOL

7217 So. Broadway, Dept. P-10, Los Angeles 3, Calif.

SAY YOU SAW IT IN POPULAR MECHANICS

So You Think You're Living?

Yes, you're going through the motion, all right—eating, sleeping, working and all that. But are you really LIVING? And how do you KNOW you are living? To find out read "Life Unlimited," a message for immortals. Your copy mailed free on request.

LIFE UNLIMITED, Dept. PM-10

3227 Indiana Ave.

St. Louis 18, Mo.

MUFFLERS

STEELS and ALUMINUMS with a motorboat tone

SINGLES \$5.50 to 8.00

V-8 DUALS 17.50 to 20.00

Reduce back pressure and increase engine performance. A Sandee is time proved and dependable. Aluminums are guaranteed for the life of your car.

DEALERS WANTED

SANDEE MUFFLER CO.

7523 S. WESTERN AVE., LOS ANGELES 44, CALIF.

TRAIN AT HOME FOR RADIO-ELECTRONICS

for only \$5

for the complete 972-page book

36 COURSES IN ONE

Learn Radio-Electronics! Learn fast and right! Learn at a price you can afford. Learn from the same big book that has given more beginners their start than any other book or course of its kind—in home study, in Army-Navy training and in schools all over the world.

Nothing like Ghirardi's RADIO PHYSICS COURSE at any price. For only \$5 it gives complete basic training for Radio, Electronics, Television, F-M, Facsimile, Broadcasting, Servicing, Aviation Radio, Communications, Radar, etc.

Starts right at the beginning. You'll understand every word. Nothing omitted. Nothing condensed. If broken into monthly lessons, you'd regard it as a bargain at \$75! Many who never saw a circuit diagram before have completed it in a few weeks. This is the basic training that is endorsed by leading radio experts themselves—and we back it up with our UNRESERVED 5-Day Money-Back Guarantee, 972 pages, 508 illus., 856 self-test review questions. You cannot lose! Send coupon now!

LEARN IN A FEW WEEKS

...no previous training needed!

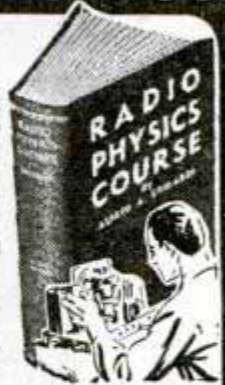

FIX RADIOS FOR FUN AND PROFIT!

This "Automatic Helper" Tells What to do — Exactly How to do it . . . ON OVER 4800 RADIO MODELS

You don't have to be an expert! You don't require a lot of costly test equipment in order to repair radios—NOT when you have A. A. Ghirardi's 744-page RADIO TROUBLE-SHOOTER'S HANDBOOK. Just look up the receiver you want to repair in the big, 404-page Trouble Case History section. Nine times out of ten Ghirardi's HANDBOOK will automatically tell you EXACTLY what is wrong—EXACTLY how to fix it. No lost time! No needless, tedious testing! The HANDBOOK teaches you—automatically! Over 300 additional pages contain hundreds of charts, graphs, color codes, diagrams, hints, and compilations that will help you repair any radio ever made EASIER, BETTER and

TWICE AS FAST! Only \$5 complete.



BE A PROFESSIONAL RADIO SERVICE EXPERT

It's easy with this book! Never before has there been such a demand for professionally trained technicians with exactly the training Ghirardi gives you in this big 1300-page MODERN RADIO SERVICING. Ideal for home study. Explains all test instruments; how to make preliminary trouble checks; how to analyze circuits scientifically; how to troubleshoot; how to make all kinds of repairs and installations—and hundreds of other subjects including How to Start and Operate a Successful Service Business of Your Own. Over 700 illus. Only \$5—on a 5-DAY MONEY-BACK GUARANTEE.



5-DAY MONEY-BACK GUARANTEE

MURRAY HILL BOOKS, Inc., Dept. PM-106
232 Madison Ave., New York 16, N. Y.

- Enclosed find \$ for books checked; or send C.O.D. (U.S.A. only) for this amount plus postage. If not fully satisfied, I'll return the books within 5 days for complete refund.
- RADIO PHYSICS COURSE \$5 (\$5.50 foreign) MODERN RADIO SERVICING \$5 (\$5.50 foreign)
- RADIO TROUBLE-SHOOTER'S HANDBOOK \$5 (\$5.50 foreign) MONEY-SAVING COMBINATION Offer—BOTH Modern Radio Servicing AND Troubleshooter's Handbook ONLY \$9.50 (\$10.50 foreign)

Name

Address

City & Dist. No. State

Does she love him?

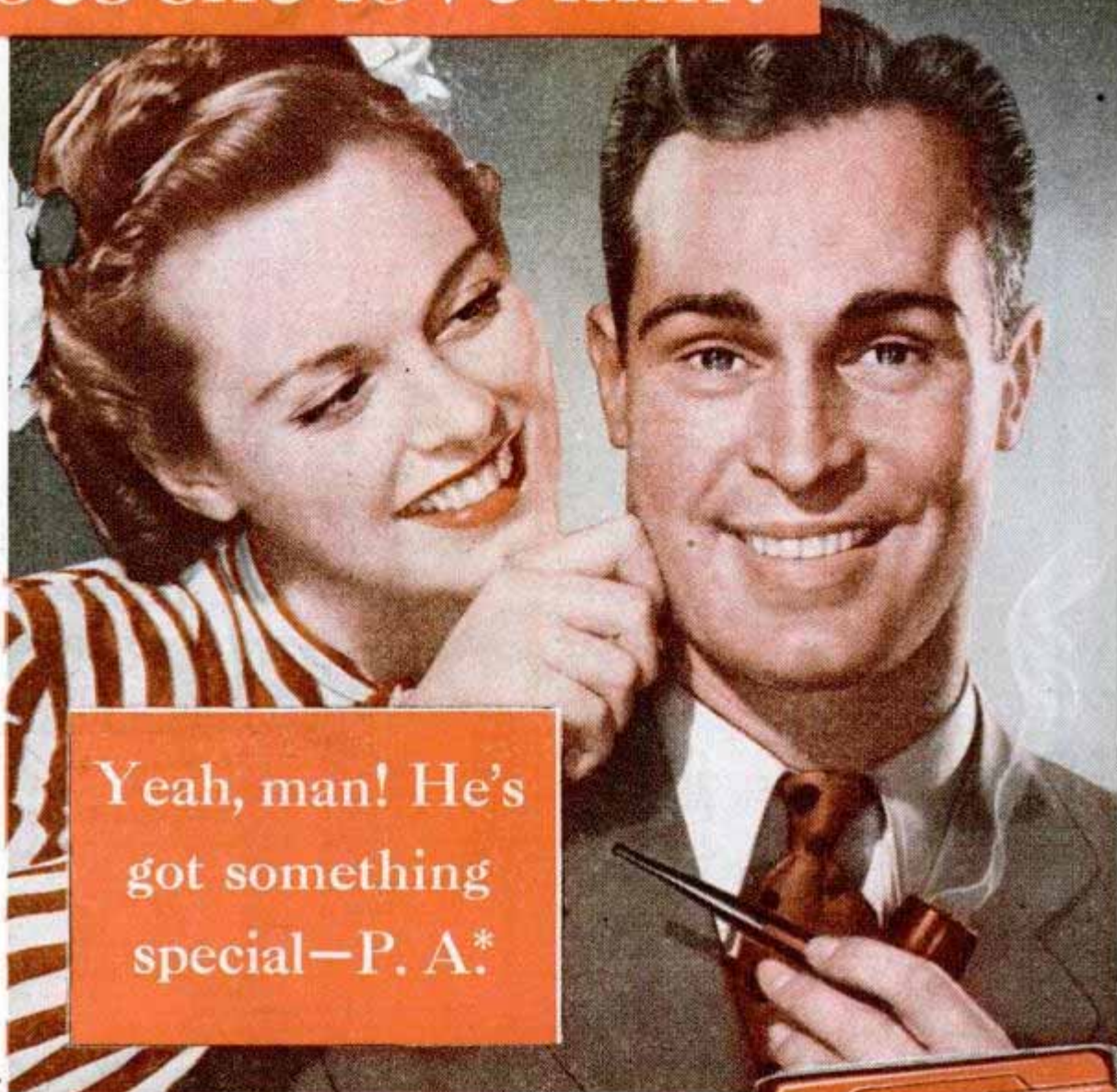

Yeah, man! He's got something special—P. A.*

R. J. Reynolds Tobacco Co.,
Winston-Salem,
N. C.

P.A.*

means Pipe Appeal—

Boy meets girl. Boy lights pipe. And *up* goes boy's chances of girl going for boy. Women prefer to see men smoke pipes. Like fine leather and tweeds, there's just something smart and masculine about a pipe. Women love it.

means Prince Albert



Great for roll-your-owns. Clings to the paper. No mess, no spilling. Twirls up into a firm, smooth cigarette.



MY TONGUE'S MIGHTY GRATEFUL FOR P.A.'S GENTLE MILDNESS. TONGUE-EASY FOR CERTAIN!

• Many a man has wanted to smoke a pipe to please his pretty one, but his tongue said "No!" Tongue bite is no fun. Page P. A. if that's ever happened to you. It's gentle to your tongue. Rich flavor. Crimp cut too, for cool burning. Get P. A. (Pipe Appeal) with P. A. (Prince Albert).

THE NATIONAL JOY SMOKE

WRITTEN SO YOU CAN UNDERSTAND IT
VOL. 86 NO. 4

POWER From Atoms: How Soon?

By **E. V. Murphree**

Mr. Murphree, executive vice-president of the central research and technical organization of Standard Oil Company (New Jersey), was one of the scientists who participated in the engineering work on the atom bomb project. This significant article on the peacetime use of fissionable material was originally prepared for The Lamp, a company publication.

CREATION of atomic energy, aside from its influence on war or peace, has posed these basic questions for the world: How soon can energy from atoms be harnessed to do man's daily work? How much of this power will there be, to what degree will it supplant present fuels, and what does it imply for the future? The answers are encouraging.

An atom—once thought to be “the smallest building block of matter”—may be pictured as made up

Scientists who helped usher in Atomic Age include, left to right, Dr. H. C. Urey, Dr. Leo Szilard, Dr. L. B. Borst and J. C. Stearn

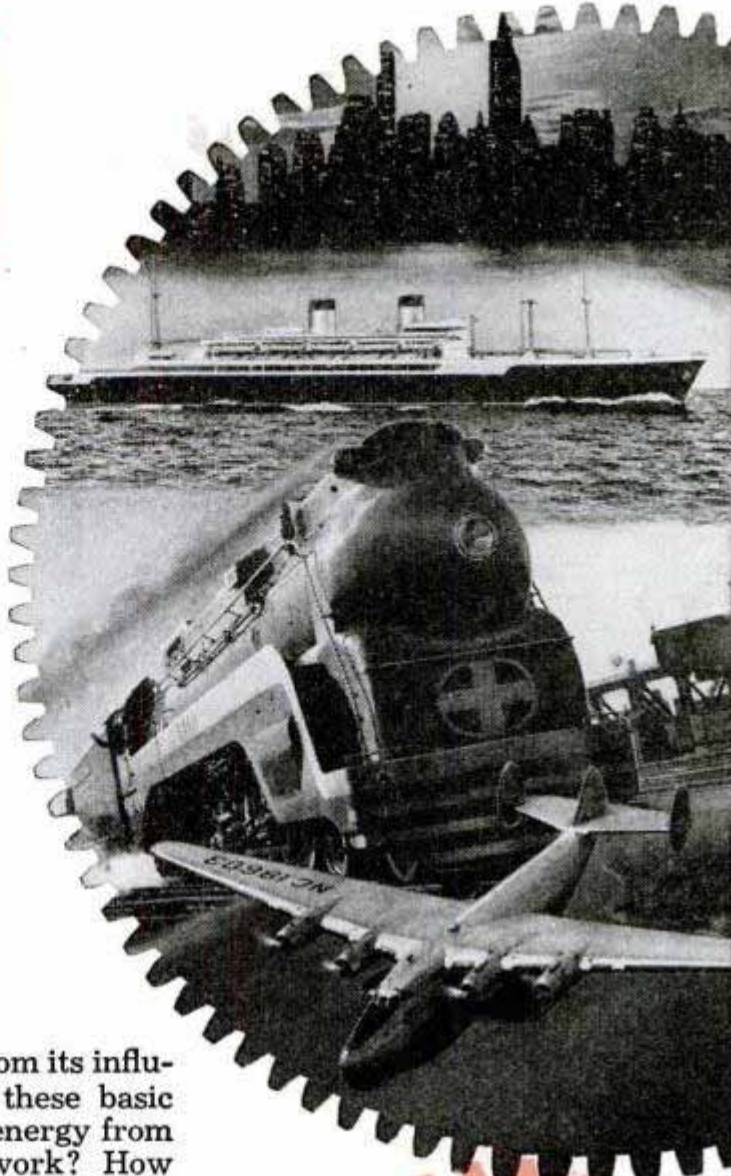

of particles which, with one exception, are electrically charged; the charges are either positive or negative. The electrical attraction of these particles for each other holds the atom together.

The one uncharged particle is called a neutron because it is neutral in its relationship to the electrically charged particles. It is the neutron which makes possible release of atomic energy.

An atom of the type useful for the production of atomic energy is split when its nucleus, or core, captures a neutron. On being split, such an atom releases both particles and rays. The energy of the particles in motion and the energy of the radiation together make up what we call atomic energy.

In beginning the process, neutrons may be set free by one of several well-known means or be picked up from the atmosphere. As each atom is split thereafter, other neutrons are released to continue the process.

To produce effective atomic energy, the initial reaction must grow in intensity. This is what is called a chain reaction. To achieve a chain reaction, more material which can cause fission, or breaking apart of the atom's particles, must be produced than is consumed in the process. Therefore, to bring about a chain reaction, more than one neutron must be produced from each atom as it is split.

Actually the process is more complicated than that. There may be impurities present which capture some of the neutrons so that they do not cause further fissioning. Some neutrons may get out of the reaction without causing fissioning and be lost. Further, for most applications it is desirable to create new material that will fission to replace the material which is used up. If this is done, one additional neutron per fission is required. These various factors mean that more than two neutrons per fission must be liberated to produce a practical chain reaction of the type now known.

One of the first questions that is encountered in considering the application of atomic reactions is whether such reactions can be controlled.

Fortunately, this has been adequately demonstrated by the operation of the government plutonium plants at Hanford, Washington. Here nuclear reactions are carried out on a very large scale involving liberation of about a billion British thermal units per hour. This hourly heat liberation is equivalent to that obtained from about 7100 gallons of fuel oil. It has been possible to operate these plants day in and day out with the

ATOMIC POWER PLANT

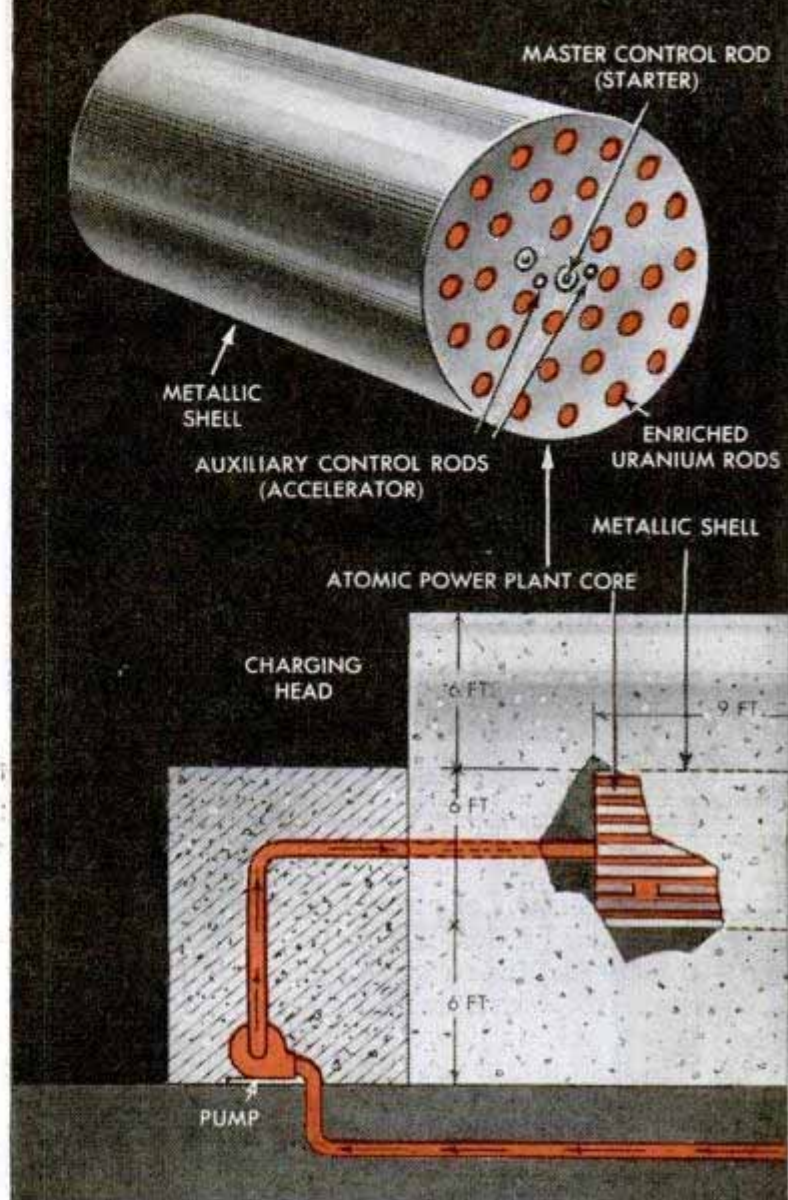

reaction controlled at the intensity desired. There should therefore be no question that, under proper conditions, reactions involving nuclear fission can be controlled.

How can people in the vicinity of an atomic energy machine be protected against radiation in a practical way?

Of the lighter higher-speed particles given

Chart shows that atomic engines might power ships and locomotives but wouldn't fit into planes and cars because of heavy shield required to protect passengers from rays

ARE ATOMIC ENGINES PRACTICAL?

	Total weight (tons)	Horsepower	Weight of atomic power plant for equivalent hp.
Battleship (Iowa class)	52,600	200,000	500 tons
Locomotive (turbine)	496	6,900	100 tons
Airplane (DC-6)	42	8,400	15 tons*
Automobile	1½	100	50 tons

(Atomic powered car would cost \$500,000)

* Would weigh same as auto engine if equipped with full shielding

FOR BATTLESHIP OF THE FUTURE?

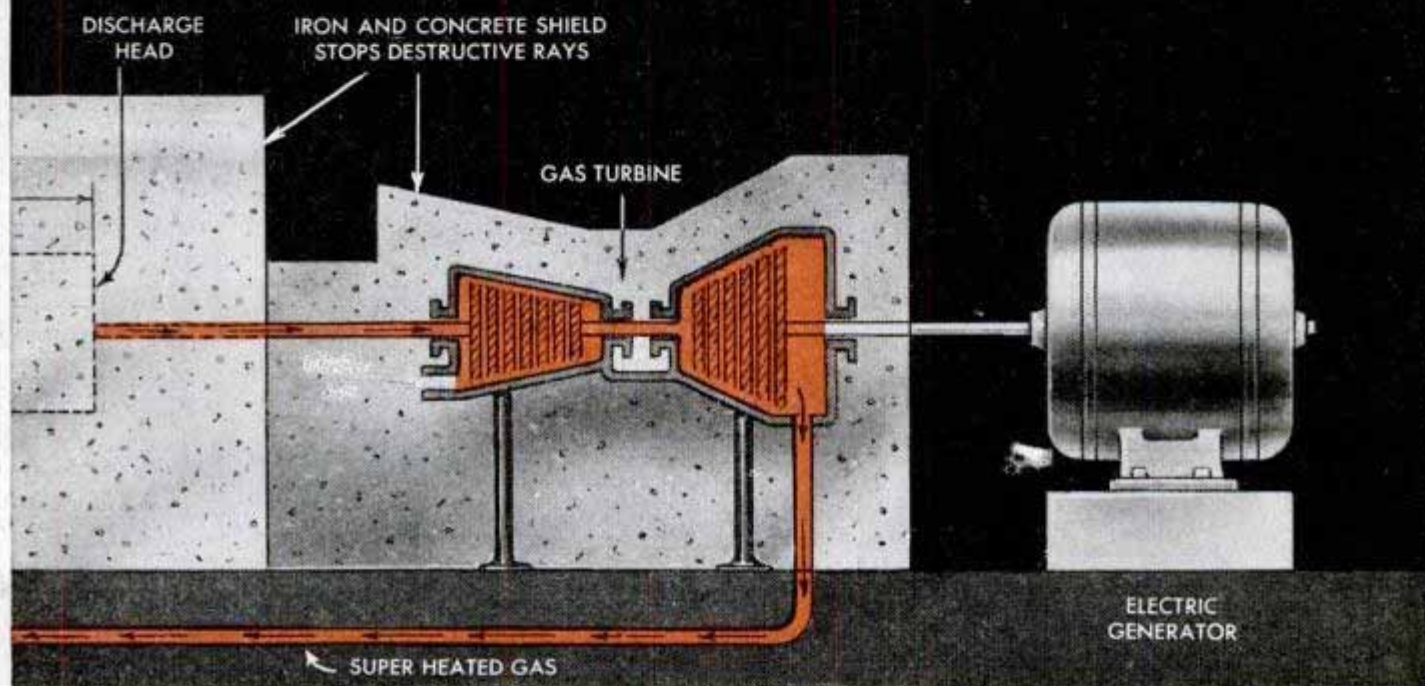
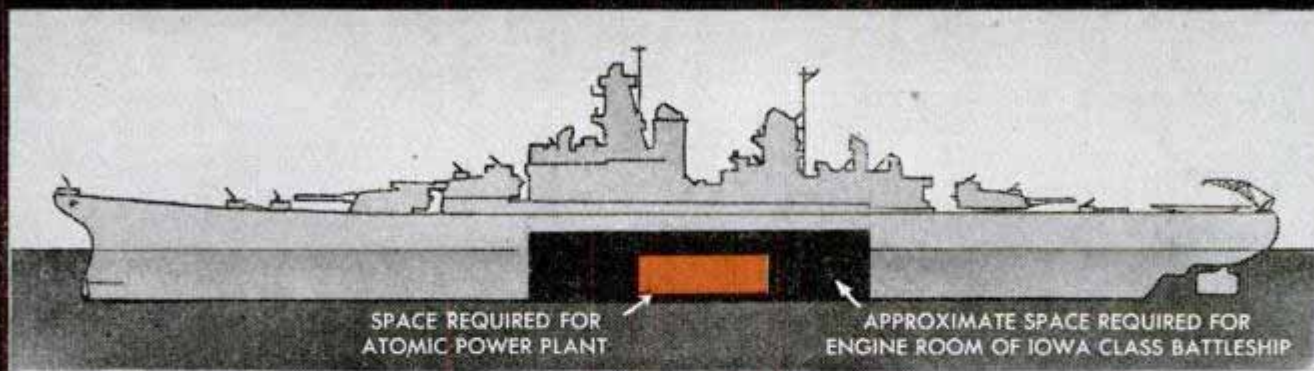

Artist's conception of a 200,000-horsepower atomic power plant for a battleship. It would weigh 500 tons but would require less space than today's engines. Ship could stay at sea for long periods without refueling

off by a bursting atom, four are electrically charged. These four—alpha particles, deuterons, protons and electrons—provide almost no problem in shielding. Because of their electrical charge, they interact with other particles as they fly through matter. Thus, when going through even a thin shield they are slowed by the electrical charge of nearby atoms, deflected from their course and finally stopped. In general, a mere sheet of paper can shield against alpha particles; six sheets, against deuterons; 10 sheets, against protons; 500 sheets, against electrons. But great complications arise when we seek a shield against the uncharged neutrons and gamma rays.

We know, of course, that any substance in the world—even a sheet of hardest steel—consists of an enormous number of atoms with a great deal of space between their

nuclei. The intervening space is occupied by clouds of electrons which are held in place by the electrical charges of the nuclei. Since neither the neutrons nor the gamma rays have electrical charges to attract them to the atoms of matter through which they pass, they may easily continue their penetration for some distance. Neutrons can be halted or slowed down only if they crash headlong into the nucleus of an atom or pass very close to it. Gamma rays interact with both atoms and electrons under circumstances that have a low degree of probability, and thus are not very likely to be deflected.

Thus extensive shielding against both neutrons and gamma radiation is required. Roughly, it takes the equivalent of two inches of lead to shield against gamma rays; it takes six feet of water to shield against



neutrons. In both these cases the shielding is still incomplete in that the particles or rays are not stopped but merely decreased in concentration and speed or intensity. The bulk of such shielding is a major problem in applying nuclear energy to many commercial uses.

We know it is possible to shield against neutrons and gamma rays because this was done successfully in the wartime atomic piles at Hanford. These piles—latticelike structures in which plutonium was produced from uranium—were run by remote control and built within massive shields that hemmed in radiation. The tremendous bulk of the shielding required for the wartime piles is not practical in many commercial uses, and scientists are searching for a more compact method of shielding. Whether this quest will be successful is very questionable.

Will we have an adequate supply of fissionable materials?

Uranium is basic in our atomic work today. While accurate figures on the world's known deposits of normal uranium are not available, it is believed that readily available deposits are about 30,000 tons. Normal

uranium consists of about 99.3 parts of uranium 238, which as such is not fissionable, and only 0.7 parts of another uranium isotope—uranium 235—which is fissionable. (An isotope is a form chemically similar but with certain physical differences making possible methods by which it can be separated.) Thus 30,000 tons of normal uranium yield only 210 tons of uranium 235.

The situation is more hopeful, however, than these figures indicate. Plutonium, which is equivalent to uranium 235 from the standpoint of atomic energy, can be created from uranium 238 by absorption of a portion of the neutrons liberated in fissioning uranium 235. By proper design, the amount of plutonium so created can be made equivalent to the uranium 235 destroyed. The plutonium so produced will, on fissioning, in turn produce an equivalent amount of new plutonium.

By continuing this process all of the normal uranium (uranium 238) can eventually be utilized to give atomic energy. Since one pound of uranium when fissioned gives heat equivalent to that of 6000 barrels of oil, 30,000 tons of uranium would be equivalent, from the standpoint of energy produc-

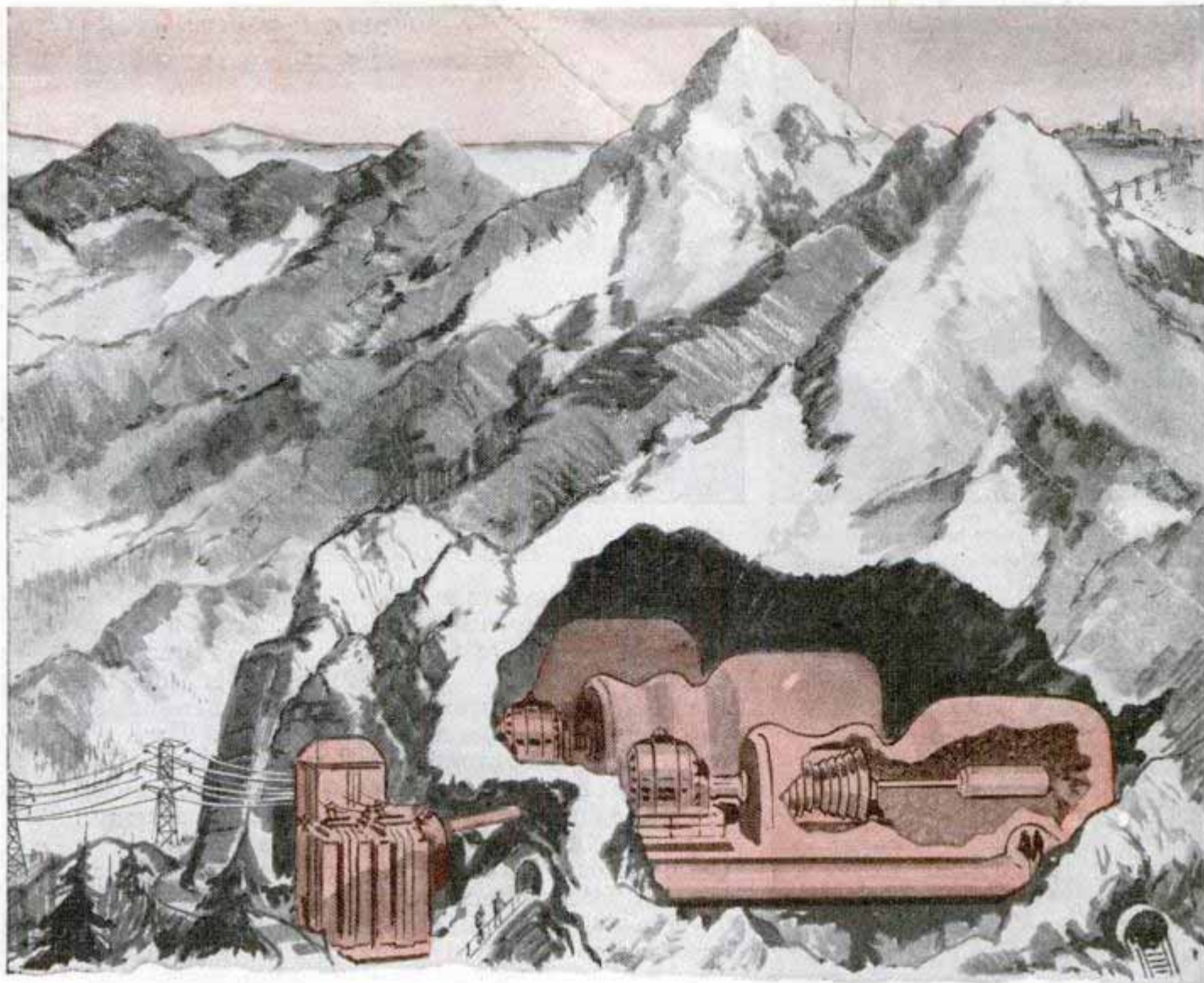

Atomic power plants, buried deep in the earth for protection, soon may provide electricity for entire cities

tion, to 360 billion barrels of oil, or about 18 times the proved U. S. oil reserves.

Thorium, another heavy metal, can be converted by neutron absorption into uranium 233, another isotope which also is fissionable through a process similar to that used for making plutonium.

If it becomes possible to get more than one part of plutonium produced for one part of uranium 235 destroyed, then the excess plutonium could be added to thorium which then could be made to yield atomic energy by a process similar to that discussed for uranium. In this way the supply of atomic energy could be still further extended. Also, the demand for uranium and thorium will certainly inspire new searching for deposits to bolster the known supply. It may reasonably be concluded that ample raw materials for atomic power will be available for the world's predictable needs.

The fourth problem is: How will nuclear power be geared into our industrial and social system?

The popular fancy of pellets of uranium burned like oil or coal in something like

an internal combustion engine does not fit present facts. A chain reaction cannot be created unless there is a certain minimum amount of fissionable material present. This is what physicists call "critical size." This minimum amount depends on the concentration of fissionable material. For high concentrations the critical size may be measured in pounds; for substances containing low concentrations of fissionable materials the critical amount of such substances may be measured in tons. In any case, bulky shielding is required for protection of human beings nearby.

The two considerations of critical size and shielding, particularly the latter, make it undesirable at the present time to adapt atomic power from piles to small units. Energy from the atom will not, so far as we can tell now, power automobiles and airplanes, and an atomic furnace will not be feasible in the basement of a home. But atoms may very well furnish energy to cities and large industrial installations where space and weight are not a consideration. We already have means at hand

(Continued to page 276)



Model blades are cast in wax and mounted in holder. Below, assembly is surface-treated and covered with flask. Above right, flask filled with hardened cement is baked in oven to melt wax, leaving mold

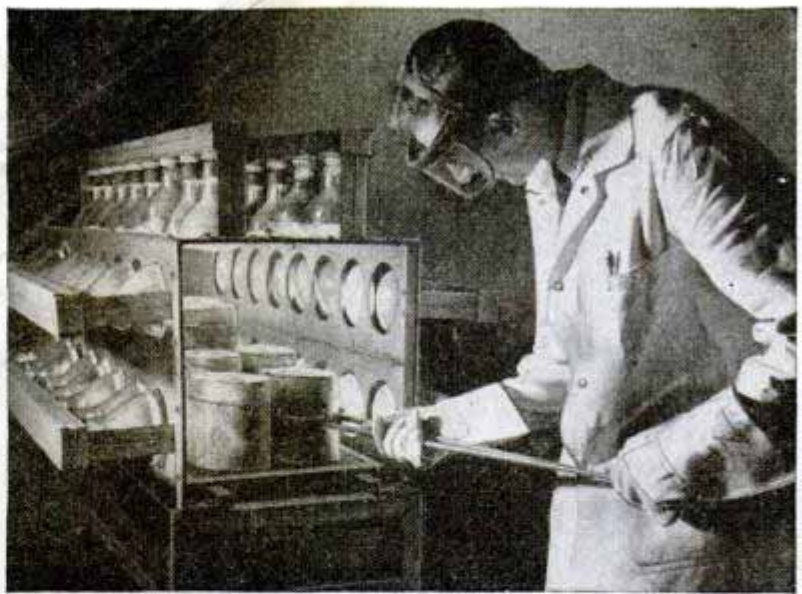

Gas Turbine Blades Cast in Wax

Four hundred years ago the Italian sculptor Benvenuto Cellini invented a casting process that modern engineers have revived to mass produce gas turbine blades. These four-inch blades turn the shafts of jet and turbine type engines when blasted with compressed gas at 1500 degrees F. They are made of cobalt-chromium alloy. In the original method of making the blades, the superhard metal broke the dies of the drop forge. Then metallurgists at Westinghouse turned to a process developed by Cellini to cast statues. A die from a master pattern is filled with molten wax to make a model blade. Twelve of these blades are mounted on a hollow wax base and covered with a metal flask. The flask is filled with a cementlike solution. When the mixture has hardened, the flask is baked in an infrared oven, melting away most of the wax to leave an exact mold in the cement. The mold then is filled with the cobalt-chromium alloy. When the metal has cooled the cement is smashed loose to reveal the 12 blades, each as precise in measurement and smooth in surface as though it had been machined on a lathe.



New "Million-Mile" Diesel Locomotive Develops 6000 Horsepower

Six-thousand-horsepower Diesel-electric turbines provide the pulling power of a new locomotive built by the American Locomotive Company. The locomotive, which was built in three units, was designed for passenger trains traveling at speeds up to 120 miles per hour. The "6000" was developed to give increased power in a relatively lightweight engine. It is designed to operate over a million miles during three years of service without a major overhaul.

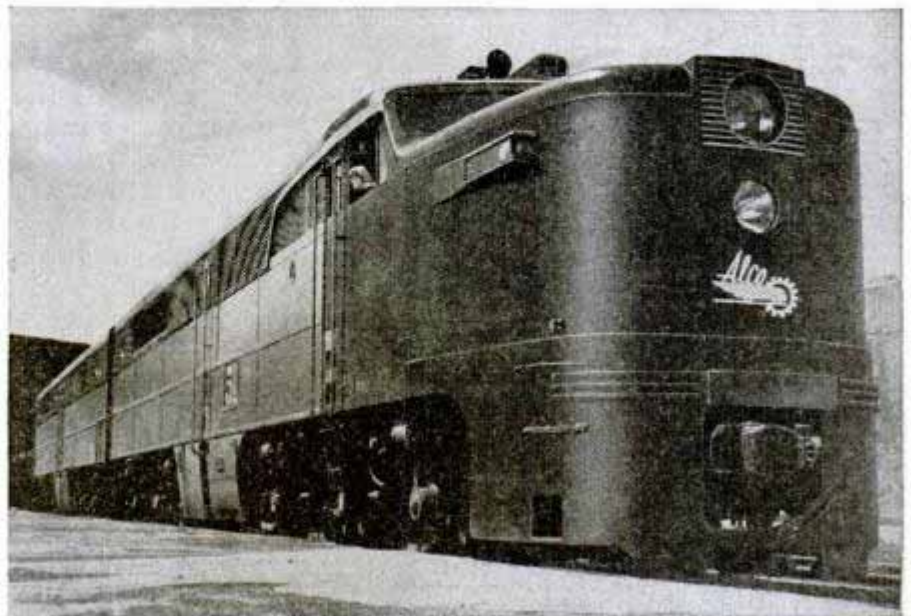

Mr. Sci. Co. 11/10



Lifesaving Aids For Airmen

Lifesaving is always the top objective of the Air Materiel Command's personal equipment laboratory. A trigger pulled by the airman above fires a gun which shoots both him and his seat into space at 60 feet a second. The container below his arm automatically explodes three seconds later, freeing him from the seat. The aneroid parachute release, upper right, opens the chute automatically after the user falls free to an altitude safe from anoxia. Air pressure compresses the aneroid and discharges a cartridge pulling the release. Most of the jar from jumps at high altitudes and speeds is eliminated with the slower opening ribbon chute at right. The 104-man rescue raft below, carbon dioxide inflated, is for large transports and surface vessels.

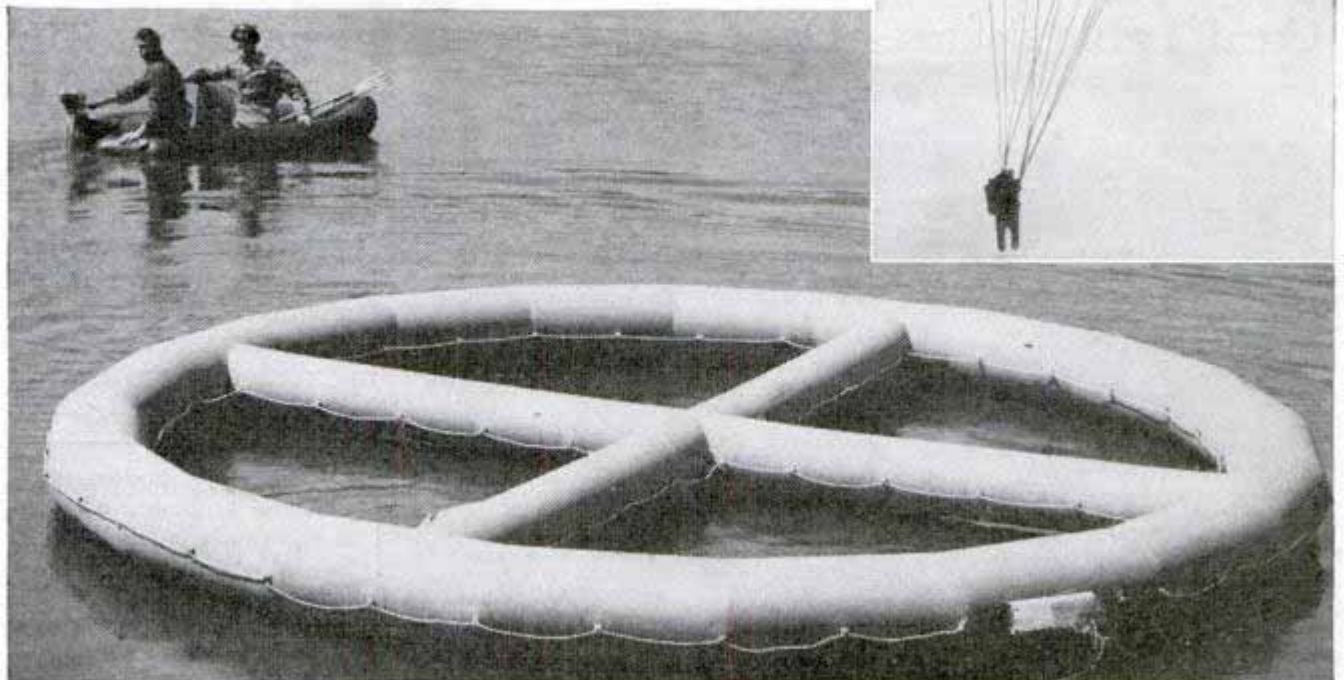
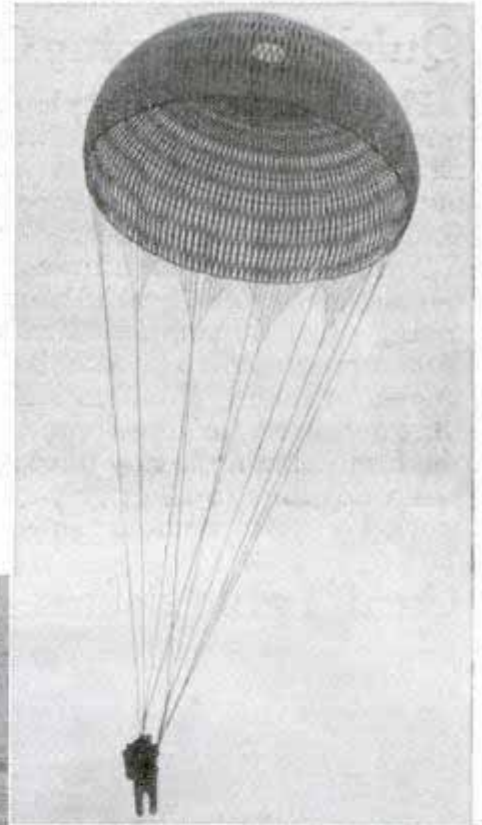

Radiophone Speeds Freight Pickup for Air Shipment



Two-way radiophone communication between truck dispatchers and truck drivers—successful at distances up to 15 miles—is speeding pickup and shipment of air freight. When an air line receives notice of freight to go by air, the dispatcher calls the air freight truck driver over the radio-

phone. The driver's itinerary is rerouted to pick up the shipment so that within a few minutes it is enroute to the airport. Previously the dispatcher had to check the driver's schedule, telephone to his next stop and leave word for the driver to call, sometimes resulting in several hours' delay.

Quick-Developing Color Film Processed in Any Darkroom

Photographers can develop color transparencies in their own workrooms with a new color film and processing kit developed by the Eastman Kodak Company. Called Kodak Ektachrome film, the new film requires only 90 minutes for complete development. The first 19 minutes of processing must be completed in a darkroom, but subsequent steps can be carried out under ordinary illumination. The short time required for development may make the film valuable to any photographer who has a deadline to meet or wants to see his work before a studio setup is torn down.

Fidelity to the subject's basic hues and no significant change in shadow areas beyond a deepening of color are features claimed for the film. Tests have indicated that the developers now available for processing the film are less likely to cause skin irritation than black-and-white developers. Chemicals for the five required solutions are available in kits that process 8, 16 and 56 eight-by-ten prints. The film costs approximately one half as much as equivalent sizes in Kodachrome sheet film. It is available in types for both artificial and daylight illumination.

Card Table Secures Deck and Discards in Outdoor Play



Strong wind fails to disturb outdoor gin rummy games played on a game board equipped with small metal springs and slotted borders to hold the deck, discards and spreads. The board folds compactly for easy carrying and can be used for all types of card games.

Information, including manufacturer's names, concerning products described in this issue may be obtained by writing Bureau of Information, Popular Mechanics, 200 E. Ontario, Chicago 11

V-Shaped Automobile Snowplow Removes 24-Inch Drifts

Attached to the front bumper of an automobile, a V-shaped snowplow makes short work of removing snow 14 to 24 inches deep from a driveway. Weighing 175 pounds and made of steel, the plow is equipped with a shoe that helps it over rough places. The blades rest on the ground instead of hanging suspended to avoid strain on bumper.

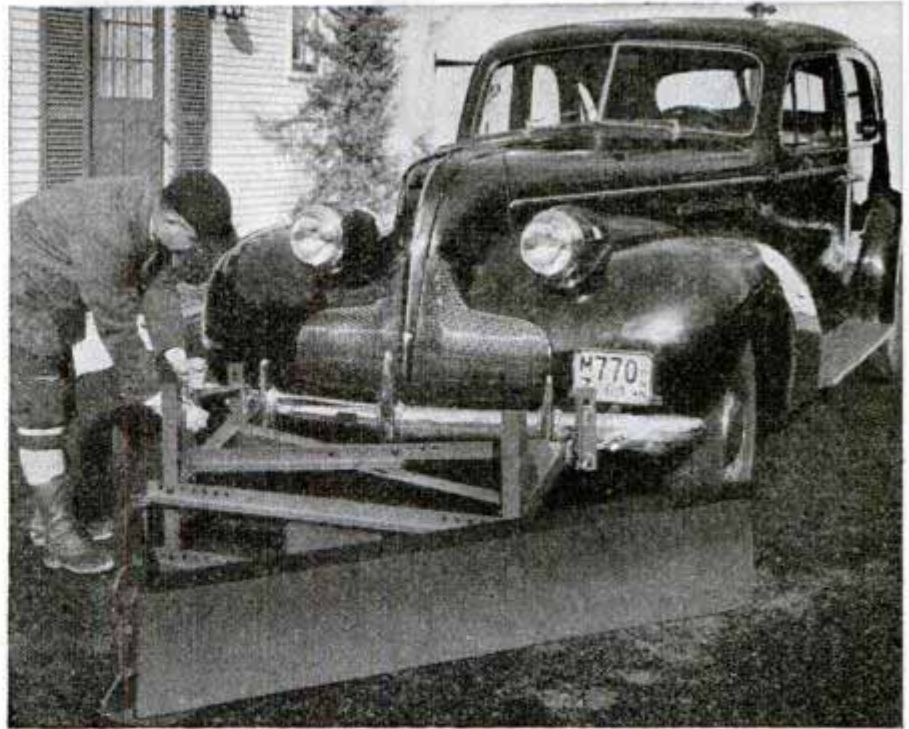

U. S. Patent Office Seeks Invention

Although the U. S. Patent Office has granted over 2,400,000 patents in its 110 years of operation, officials are now seeking an inventor who can invent something for them. The office needs a new system of classification for scientific and technical developments. Over 8000 applications for patents are received monthly, and officials must search through extensive files to determine whether the applications are for

inventions that are actually new. Scientists and inventors also have difficulty in finding the information they seek. Because of the enormous number of patents and many recent developments, the inventions defy efficient classification by any filing system known at present.

Farmers Use Walkie-Talkie to Reach Workers in Field



War surplus walkie-talkies, the midget radios that provided communication between small Army units during the war, have been given a new job on the nation's farms. Progressive farmers have purchased the hand radios for communication between farm buildings and fields. With two of the radios the farmer at the barn can direct work in the fields or his wife can talk kitchen-to-tractor with the farmer himself.

Nazi "Bubble Bath" Suits Protect Against Chills

Chemicals rubbed into protective suits produced a bubbly foam when German airmen toppled into the sea, diminishing loss of body heat for three hours and prolonging chances for rescue. The foam powder contained sodium bicarbonate, citric and benzoic acid crystals, a gelatine emulsion and two other chemicals. Experiments with captured equipment are being conducted by U. S. armed forces.



United Air Lines photo
Paris shopping tours will be overnight from New York in the Stratocruiser

NEW QUEENS of the

By Aubrey O. Cookman, Jr.

TAKE your pick—they're all "queens" in their own right. The nation's newest air liners and those on the eve of service will provide wonders of mass transportation that will reach out to every home in the United States.

No less than seven major aircraft manufacturers are potential suppliers of one or more models. In 1941 the air lines had 6200

seats on 359 planes, only five of them four-engined. By the middle of next year they expect to offer more than 45,000 seats on 1300 planes, more than a third four-engined. They'll be used on overseas lanes and some 150,000 regular air route miles in the U. S.

Many prophets envisioned 200 to 400-passenger airborne leviathans, with every-

thing but a grand ballroom, in operation by 1947-1948. Actually, though, you'll probably be riding the more practical 30 to 80-passenger models in the 300-mile-an-hour class for a long time. The frequent service and high percentage of occupied seats demanded for economical air line operation dictates the size, though there is no doubt about the flying abilities of the big birds.

The Air Transport Association predicts the trend will be to greater speed, economy of operation and increased passenger comfort. There'll be no letup in safety advances, though the industry points proudly to 1945 when 18 lines went with-

There's more leg room and aisle space for passengers on daytime flights
Boeing Aircraft photo



Airport delays are cut to a minimum through the use of two doors and quickly adjustable loading ramps
Eastern Air Lines photos

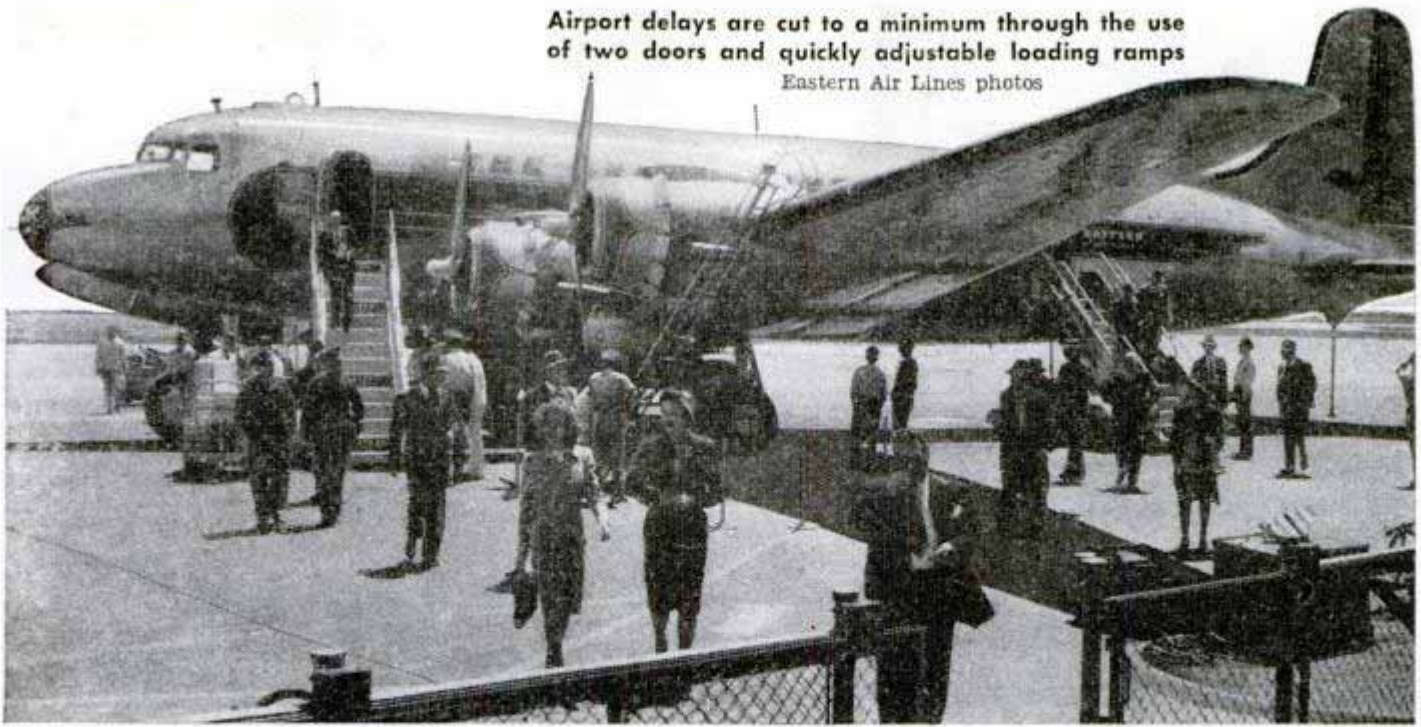

SKYWAYS

out a fatal accident. Comparing latest statistics, air travel is safer than autos or taxis.

Wartime research pushed the development of flying aids 5 to 10 years ahead of its normal pace. There are now radar and electronic devices which will permit landing under practically zero ceiling and visibility and avoid risk of collision by enabling pilots to see other planes in even the murkiest weather. Some of the new inventions are the gyro-synchronized compass, the radio altimeter and Loran, long-range radar navigation.

Most of the nontechnical innovations are common to all the new models, differing only in the distinctive touch of the manu-

Roomy galleys have replaced cramped serving shelves

Boeing Aircraft photo

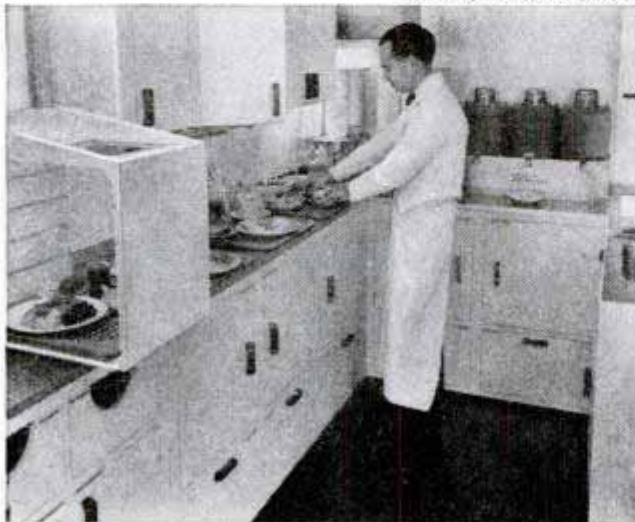

facturer or in special modifications made for a particular air line. Some will arrange the same number of seats differently, or eliminate a few to add elbow room, especially for long overwater schedules.

Berths are seven inches wider than those on trains

Boeing Aircraft photo



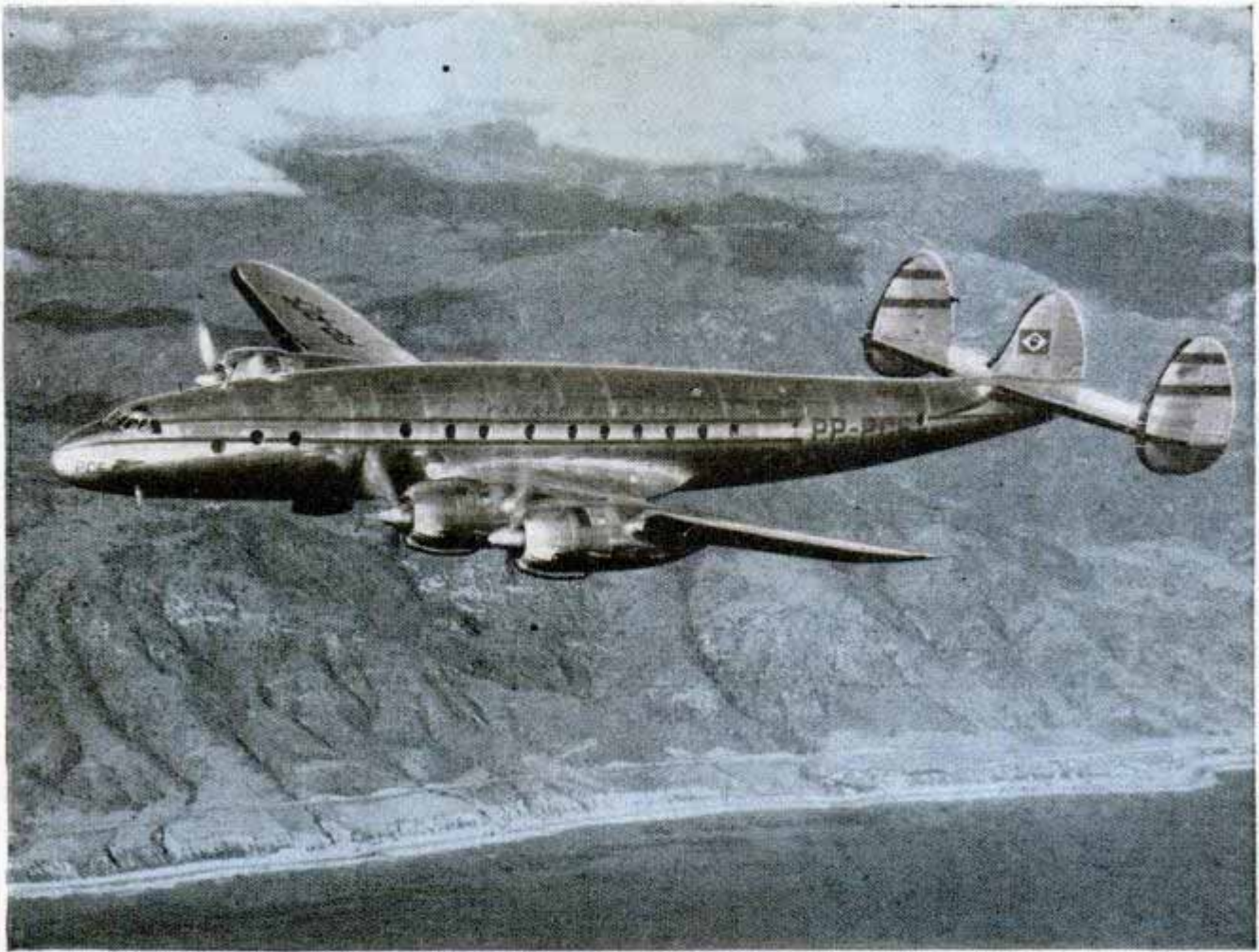

Lockheed Aircraft photo

First new plane to go into commercial operation, Constellations set overseas and transcontinental speed records

The commercial fleet now in the making was planned with a particular eye to the demands of women. Where only every fifth prewar passenger was a woman indications are they'll soon match the males in number. Their lounges will have dressing tables with indirect lighting and other frills.

Interiors will run to the greens and blues decorators have found most restful, though some of the shorter-run planes will continue with the more exciting color combinations. There'll be closet space opposite the entrance where coats and hats may be stowed without wrinkling and also handy luggage compartments where traveling

bags can easily be reached during flight.

For "over-the-weather" flying pressurized cabins maintain sea-level conditions at 15,000 feet and an 8000-foot "altitude" up to 30,000. The new planes are as quiet as your living room and shock mountings throughout virtually eliminate vibration. The frostproof windows are larger and better arranged for observation and there's always fresh air circulating.

Seats are wider, with adjustable shaped backs and head rests and, instead of a meal tray on your lap, a table attaches to your seat. Sound movies are on hand to help kill time during long night flights.

Republic's 400-mile-an-hour Rainbow relies on jet thrust from exhaust gases for added cruising power and range

Republic Aircraft photo



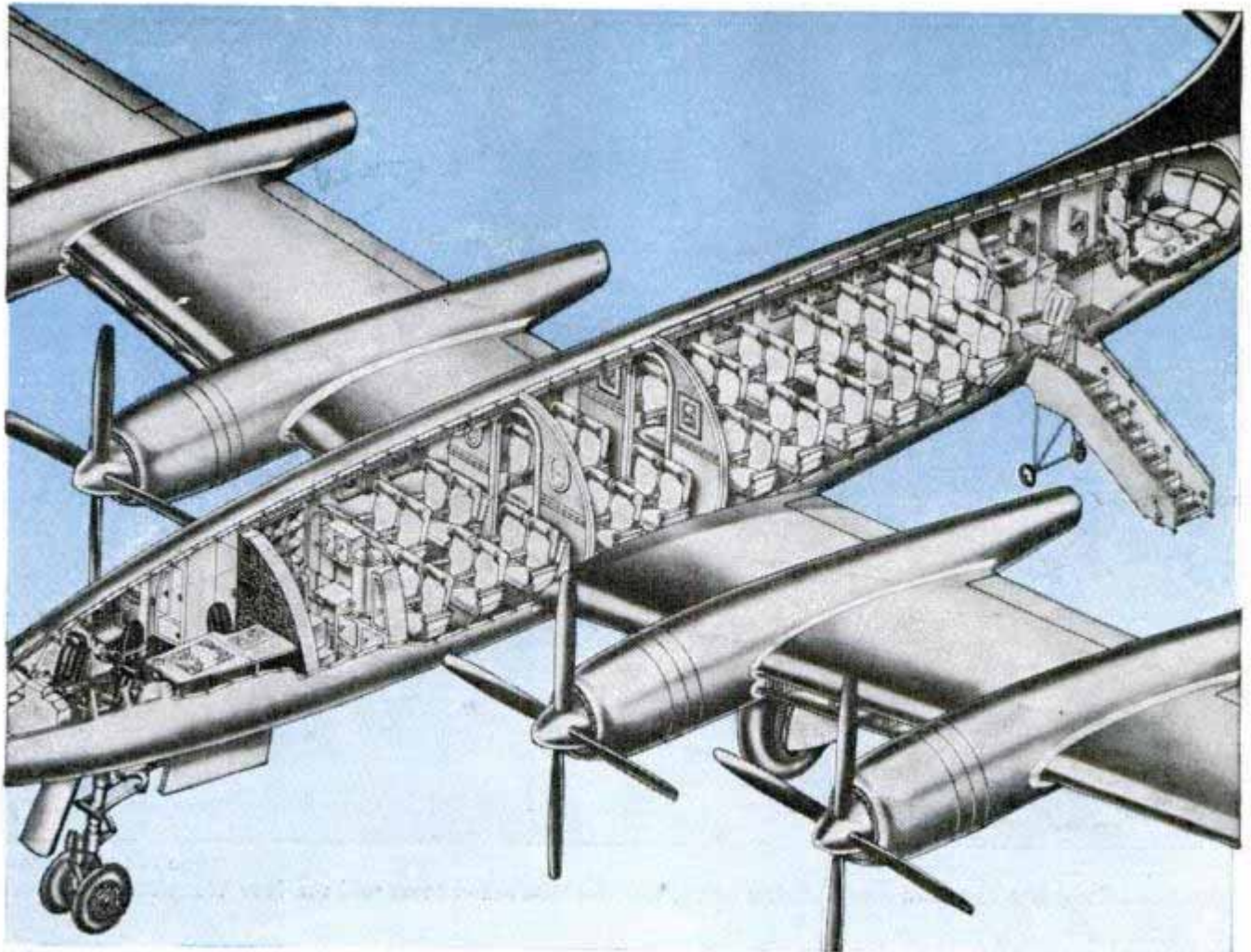

Sectioned view of the Rainbow (above) shows three passenger compartments, galley and a lounge in the tail Republic Aircraft photo

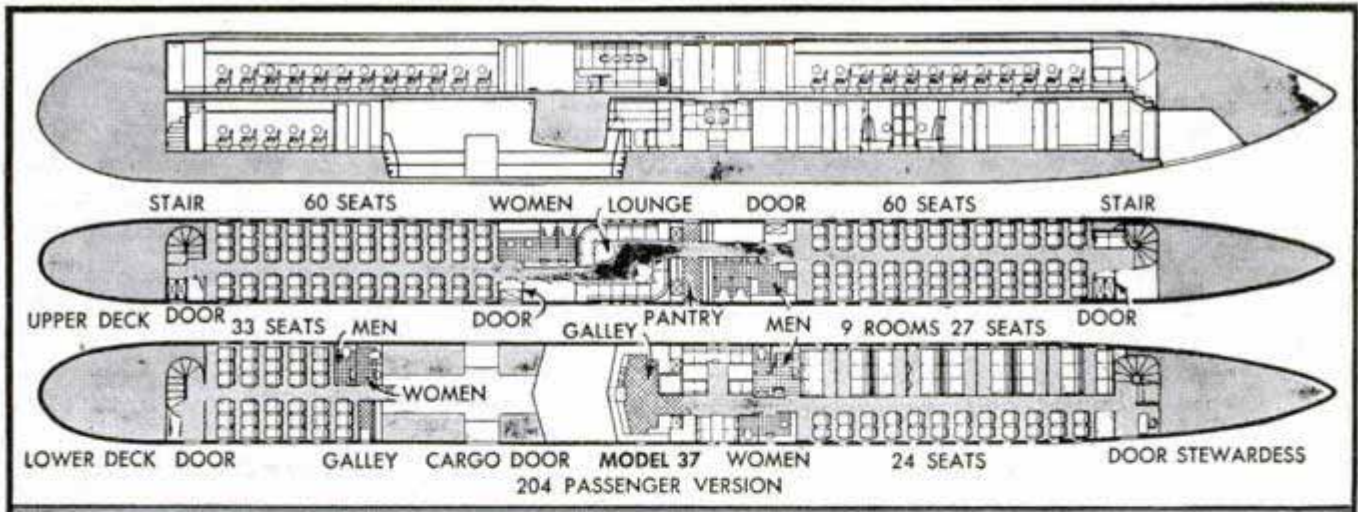

Biggest of those slated for production, Consolidated's Model 37 weighs 67 tons. Sketch above shows how its space will be utilized Consolidated-Vultee photo



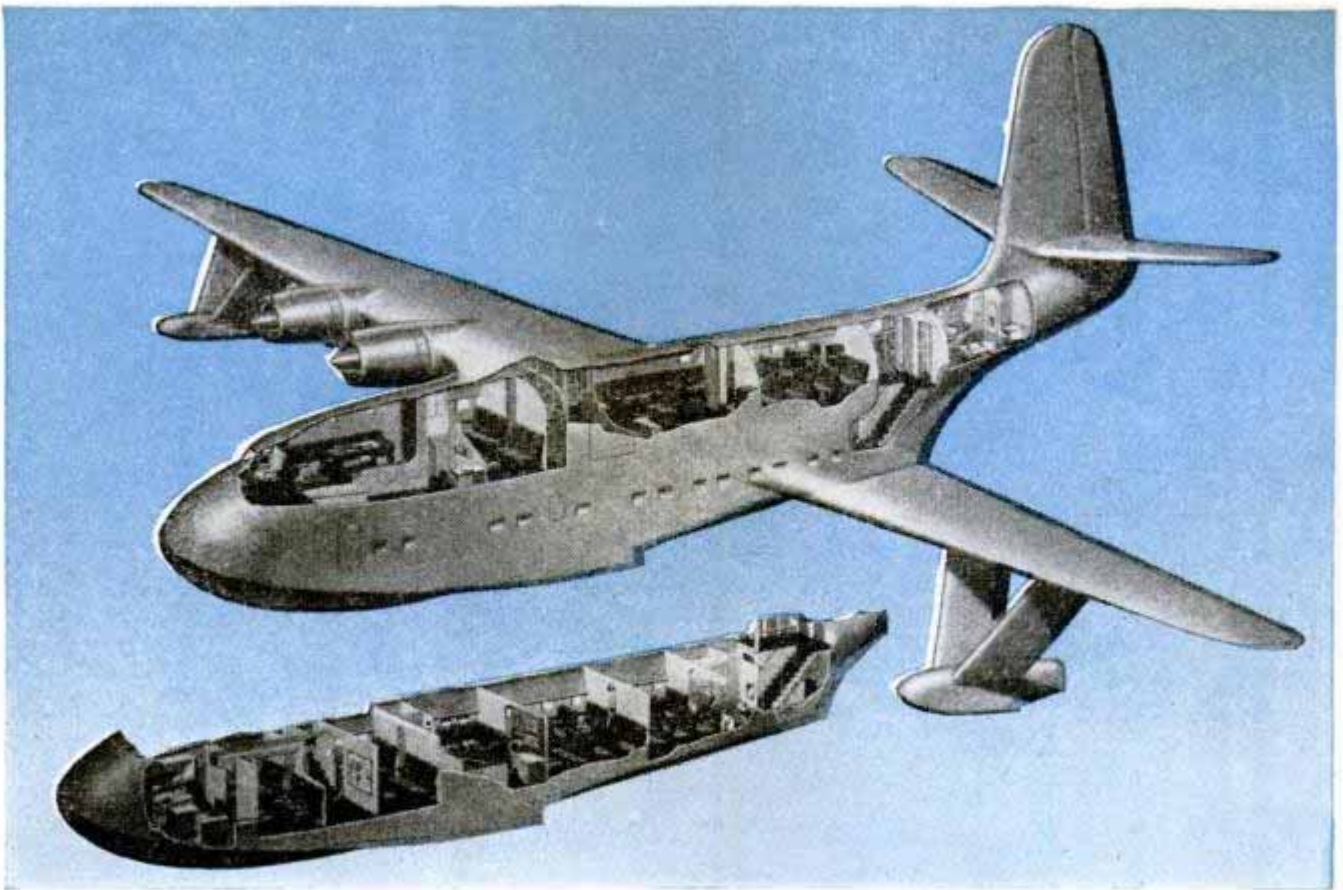

Glenn L. Martin photo

Latest of a long line of Glenn Martin flying boats, this double-decked Mars will use four Wasp Major engines

An old bugaboo, airsickness, took a bad licking from the bigger planes during recent years and may disappear entirely with altitude-conditioned cabins. It was recently brought out that now only three out of every 1000 passengers become airsick and only one in 2000 has ear trouble.

Most recent of the air liners to be introduced for both global and domestic operations is the Douglas DC-6, a bigger, faster version of the war-working C-54 (DC-4) Skymaster. It carries 72 daytime passengers and cruises above 325 miles an hour. Four Pratt & Whitney Double Wasp engines drive its electrical reversible-pitch

propellers. Just over 100 feet in length, it has a wing span of 117 feet and a gross weight over 80,000 pounds. Along with the DC-4s and 6s, the twin-engine 21-passenger DC-3, backbone of prewar air line operation will remain a familiar sight on the airways for shorter runs.

Fastest newcomer is the slender 400-mile-an-hour Republic Rainbow, capable of New York to Los Angeles flights in six hours and New York to London in nine. Equipped for high-altitude transoceanic schedules, the Rainbow carries 46 passengers and crew. Slightly shorter than the DC-6, its wing span of 129 feet is nearly

Stratocruiser's lighting and interphone control unit

Boeing Aircraft photo



As comfortable as your home—five miles above the earth

Boeing Aircraft photo





Bigger and faster than the war-famed C-54 Skymaster, the Douglas DC-6 cruises more than five miles a minute

12 feet greater. Four Pratt & Whitney Wasp Major engines are augmented by extra jet thrust from compressed exhaust gases. Its gross weight is 116,500 pounds.

Boeing's candidate is the double-decked Stratocruiser, 67-ton descendant of the B-29 Superfortress. It rates one of the "biggest" tags with accommodations for a maximum of 114, wing span of 141 feet and over 110-foot length. Further emphasizing its roominess, the top main cabin is 80 feet long, 10½ feet wide and almost eight feet high. A lower deck snack bar and lounge has space for 14 or more passengers. It has Wasp Major engines and cruises at 340 miles an hour. The company is also producing the 417, a twin-engined high-wing transport for local or feeder service.

First of the high-speed heavyweights in commercial service was Lockheed's Constellation, readily spotted by a sharklike appearance and novel triple tail. She cruises around 320, carries up to 64 passengers and has a fully loaded range of 3000 miles. Guinea pig for many postwar air line innovations, the Connies were grounded briefly following a training accident caused by an electric short circuit which ignited cabin insulation material. This hazard has been eliminated. Lockheed is also bidding for short-haul recognition with the 14-seater Saturn, a high-wing twin-engined transport cruising 250 miles an hour.

Veteran builder Glenn L. Martin is putting three planes forward, topped by the

giant Mars, a double-decked flying boat with a span of 200 feet and more than 120 feet long. It seats 125 and four Wasp Major engines pull its nearly 90 tons through the air. In the short-range group Martin has the 202 and 303, both twin-engined and carrying 40 passengers. The latter is pressurized and will cruise above 300, aided by jet thrust. Both have optional front and rear doors to speed loading.

Biggest plane slated for commercial use is Consolidated-Vultee's Model 37, a 160-tonner accommodating 204 passengers in a double-decked fuselage. It is a mid-wing type with a span of 230 feet and a length of 182 feet. Six pusher-type engines are expected to provide a cruising speed above 340 miles an hour. In the medium class Consolidated has the 30-passenger Model 110 and the 40-passenger Model 240. The latter will be pressurized and cruise over 300 miles an hour, using exhaust thrust. Some of the planes are being built with rear loading ramps installed.

A potential in the field is Northrop, with the XB-35 Flying Wing presenting a radically new design for air transport. Its 10,000-mile range is exceptional and engineers estimate it will carry one fourth more passenger load than the same size conventionally designed plane. Gross weight of 65 tons and a wing area of 4000 square feet represent sufficient size for converting the plane, now flying as an Army bomber, to commercial transport use.

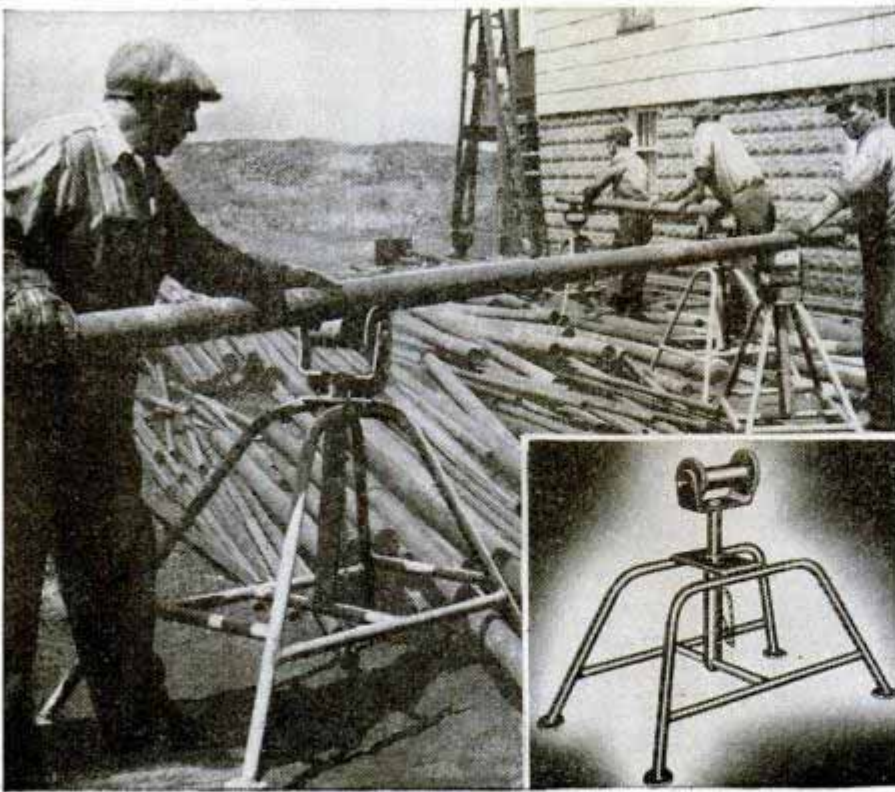

Roller Conveyor For Steel Pipe

Used as a single unit or in line, a portable roller conveyor for quick loading or unloading of steel pipe, rods and bars saves muscle power and handling time. The material to be loaded is placed on the roller of the conveyor and pushed along to its destination. An adjustable swivel center post permits the roller to be raised to a height of 51 inches. Minimum height is 38½ inches. Built of tubular stock and weighing 81 pounds, the conveyor will take pipe up to 12 inches in diameter. Its capacity is 1000 pounds.

Automatic Soldering Iron Ejects Measured "Doses"

Measured amounts of solder are ejected from a reel in the handle of an automatic-feed, electric soldering iron. The amount of solder released is regulated by a micrometer adjusting wheel. The tip, drop-forged and covered with a corrosion-resistant alloy, needs no filing or sanding and can be "painted" clean while hot with a stick of solder. The iron is balanced at a point over the trigger to lessen operator fatigue, and is equipped

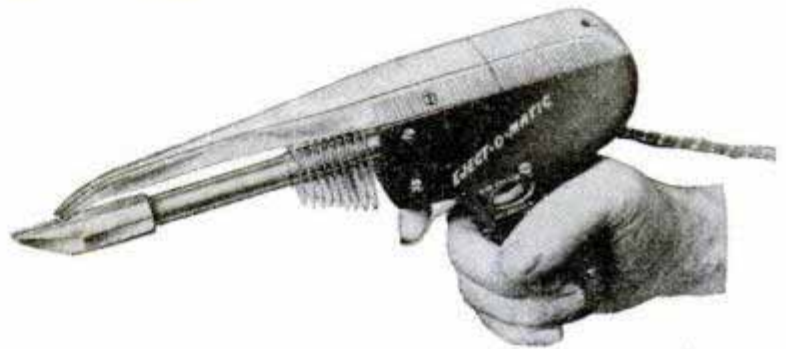

with a stand that minimizes the danger of a workman or bench being burned. The stand also enables the operator to use the iron while both his hands hold the work.

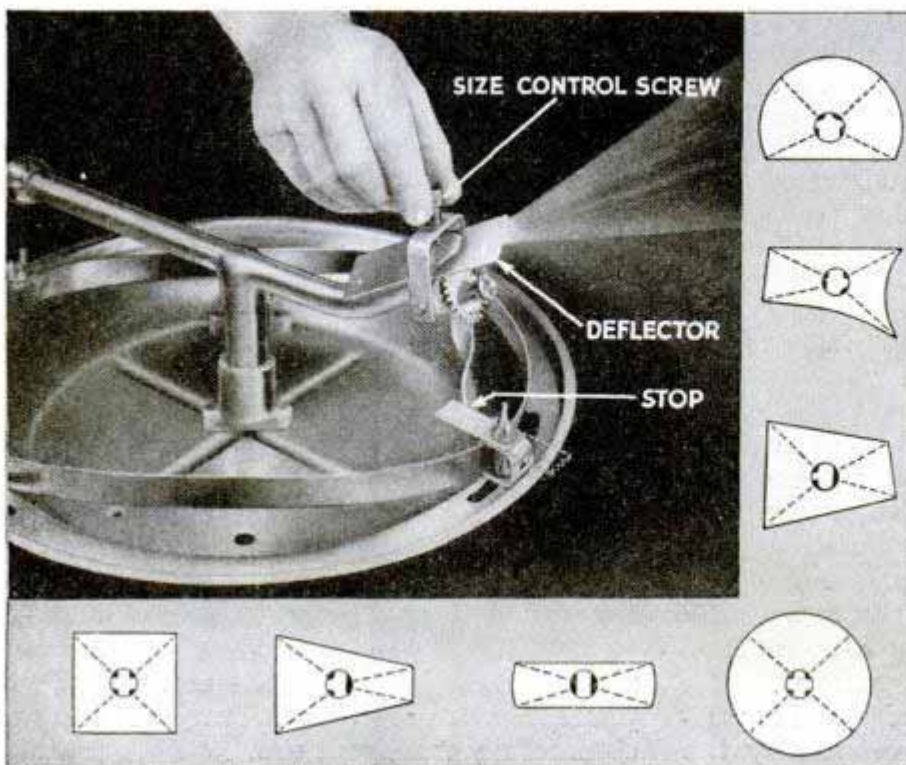

"Pattern" Sprinkler Waters Odd Plots

Whether a lawn is shaped like a triangle, semicircle or rectangle, every square inch can be watered thoroughly (with no waste spray covering sidewalks, drives and buildings) by a sprinkler that has an adjustable stainless steel track. The track is adjusted to the pattern of the plot to be watered.

Due to lack of rail facilities, Bolivia plans to transport meat by airplane between slaughterhouses set up in grazing areas and principal cities.

Sculpturing

WITH WIRE



Wire, shaped in fanciful forms, and glass reflectors give a bizarre effect to headdress of Bali dancer

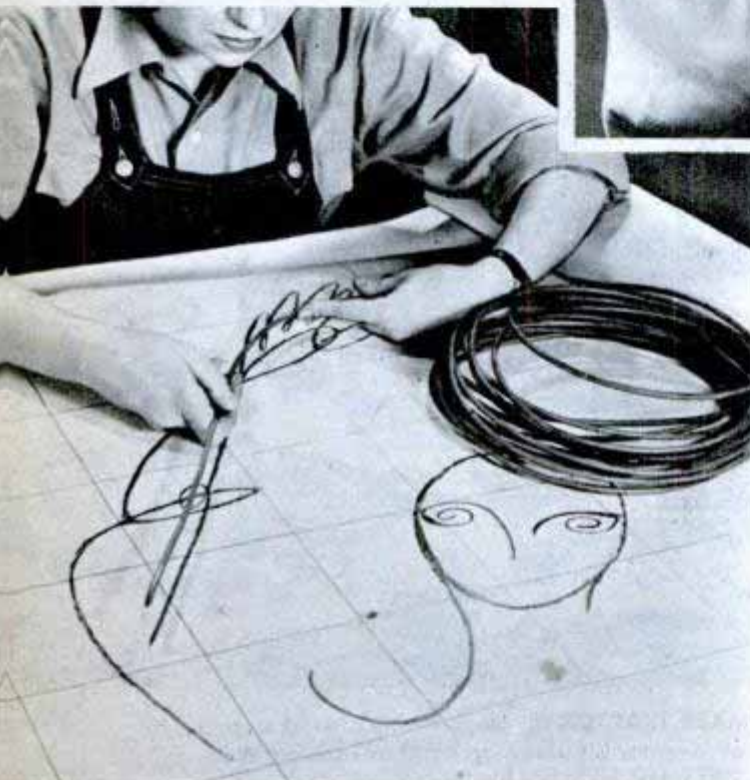

For figures, wire is bent to conform to sketched shape, then soldered in place. Face, below, was created of chicken wire, copper screening and artist's imagination

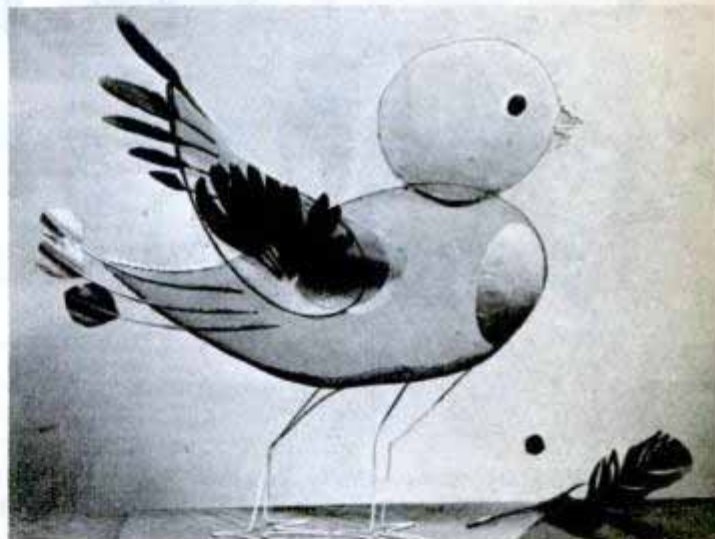

Chicken feather plumage adds to novelty of bird, above, made of wire screening. As capable of flight as design it copies is metal model of early airplane, below

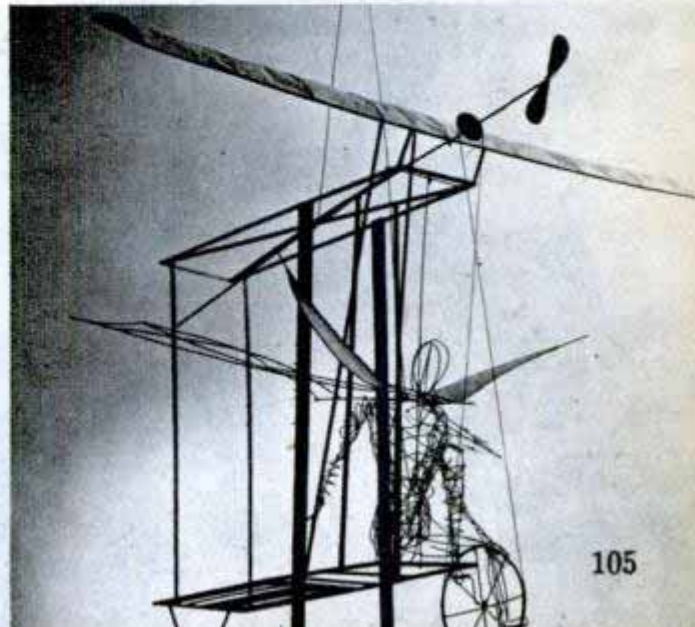

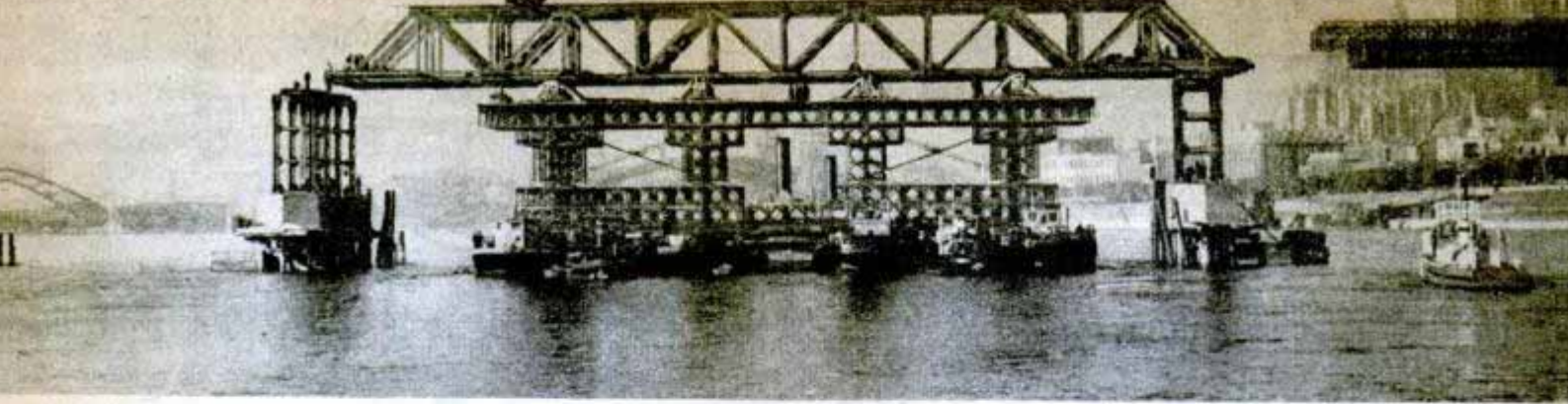

BIG BRIDGE across the Rhine at Cologne was floated into position on a raft. Four 1000-ton barges were joined together to form the huge float. The spans, weighing 450 tons each and standing 50 feet above water, were mounted on the raft. When the bridge was in position the barges were partially sunk and floated away



SANDLOTTERS try unsuccessfully to break the glass in one of the new GE floodlights at New York's Yankee Stadium. The "ballproof" glass is only $\frac{1}{4}$ inch thick

NEEDLES on this machine, developed by a Michigan State College horticulture expert, inject chemical nutrients and dissolved fertilizers into sick fruit trees



HOMEMADE TRACTOR for small farms proved so popular that inventor Charles Marchand of Tacoma, Washington, has set up an assembly line to manufacture them

FLUORESCENT LAMP designed for stenographers can be attached to all standard copyholders, flooding light over the desk and eliminating clamps and bars



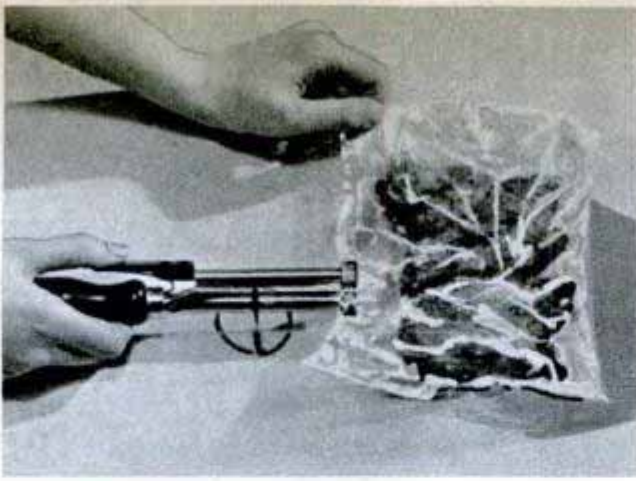

Home Sealer "Bags" Leftovers

Flat sheets of moistureproof Cellophane can be fused with an electric sealing iron into airtight bags for storing perishable foods, leftovers, pastries or lunches. Any size bag can be formed by pulling two Cellophane sheets in either a curved or straight direction through the serrated rollers of the sealing iron. Such protective envelopes also seal tools or garments against moisture, rust or moths.

Special Wrench for Dual Wheels

Dual wheels are removed easily from trucks with a leverage wrench operated by one mechanic. The tool removes the outer and inner wheel cap nuts separately by means of an inner socket wrench that holds the inner cap nut tight while the outer nut is being removed. The wrench stand has a height adjustment mechanism and a self-locking device.



Circus Clown Uses Stilts at Home

Not for laughs does Bill Alcott, a professional circus clown, buckle on his circus stilts when he is at his home in Minneapolis. He uses them as a substitute for a ladder while washing windows or cleaning hard-to-reach spots around the house.

Right-Angle "Driver" Fits Corners

With a revolving blade center-mounted in a split shank, a reversible, double-end screwdriver fits different size screw heads. A spring-locked sliding cuff holds the blade in place so that either point may be used. The blade can be turned at right angles for work where space is limited.

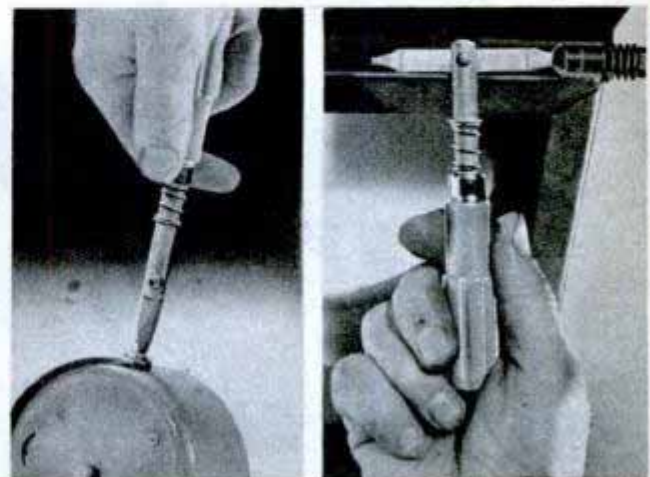

WHERE REDWOODS ARE

By Thomas E. Stimson, Jr.

CALIFORNIA'S redwoods are the largest trees that ever grew and when you pause before an exhibit of them in the California State Museum and Exposition Building in Los Angeles you wonder if the 300-foot giants of the forest have produced a grove of pygmies, for the redwoods on display are only five feet tall.

The miniatures have shaggy red bark, drooping limbs and fine green needles, typical of the huge redwoods, 1000 years old or older, that flourish on the West Coast. Scattered between their bases are the houses, automobiles and outdoor theater of a public park, all scaled down in proportion to the trees that tower over them.

Natural as they appear to be, the trees are artificial models created by A. Nick, model artist attached to the museum who is famed for his skill at modelmaking and for his method of preserving foliage and other natural materials in their true colors.

The trunks of the miniature redwoods, Nick explains, consist of strips of redwood bark glued to wooden poles cut to the right sizes and shapes. The limbs and branches are twigs of the right proportions. The nee-

dles that make up the foliage, while not as small as they should be, are the smallest evergreen needles he can find. This greenery and the other miniature trees and shrubs have been treated to retain their natural colors for decades to come.

With a sharp knife Nick can carve a castle out of soft sugar pine in a matter of minutes. Complete to towers and battlements, the model is no larger than a silver dollar. After sawing out the main parts he needs only half an hour to finish and assemble numerous bits of wood into a five-inch model of a part of Jerusalem. He takes less time to build a tiny church with windows, bell tower and ornate outer walls.

Cycloramas that depict mountain sports areas or other scenes in miniature are one of Nick's specialties, and many of the cycloramas at the State Museum and Exposition Building were built by him. These realistic miniatures, assembled in front of backdrops that are painted to carry out the perspective, give spectators an airplane view of many of the state's famed scenic spots.

Occasionally some of these cycloramas need to be brought up to date. Miniature



Giant redwood trees are reproduced in miniature form (right) by A. Nick. Wire is used (below) to attach branches

PYGMIES

Nature's rival is this king of craftsmen who creates realistic forests five feet high and midget cities complete with sound effects





Flowers that look real are made of plastic that retains color for decades. Below, cyclorama of a California resort

automobiles, for instance, must be replaced by more modern designs to keep up with the times. Under the direction of Louis C. Venator, director of exhibits, Nick is preparing to change many of the details of one huge cyclorama that shows the port of San Pedro. Tiny radar antennas and clusters of anti-aircraft guns must be added to some of the battleships that are shown clustered behind the breakwater. Drydocks and airfields built during the war must be added to adjacent Terminal Island.

Department stores often call on Nick at Christmas time for Nativity scenes and other miniature exhibits for display in their show windows. During the war he built realistic scale models of the scenes of many of our invasion undertakings. One 11-foot-long model of the Normandy invasion showed all of western Europe from the south of France to Finland, with cities, mountain ranges and rivers indicated and colored as they would appear from a tremendous height.

Nick's pride is not his modelmaking or the realistic flowers that he cuts and shapes from plastics or even his reproductions of animal life from dinosaurs to present day types. The accomplishment for which he is best known is his method of preserving insects and vegetable life in special solutions



prepared from seaweed. The process preserves the shape, natural coloring and texture of the material, whether it be flowers, leaves or even a collection of bugs. Some 500 different shades of color are found in different varieties of seaweed and kelps, and his method consists basically of steeping the material for days in an essence prepared from a seaweed of the desired color.

He won't go into details of the process but the results are amazingly lifelike. The Geneva International Museum Association has awarded him a gold medal for re-creating groups in their natural colors.

Nick is an all-around expert at the arts and crafts required in museum work. One of his early specialties was re-creating groups of animals from their fossilized bone structures, then placing them in surroundings indicated by the other fossilized materials found with the bones. In the last 35 years he has been attached to museums in London, Capetown and Leningrad, and has done work for several museums in the United States.

In creating a permanent model for a museum Nick builds up the ground contours with layers of thick plaster board, cut to shape and size, and fills in with a mixture of sawdust and glue. Easier to make but not as durable are models built up of one part of plaster of paris mixed with three parts of sawdust in water. This material can be shaped

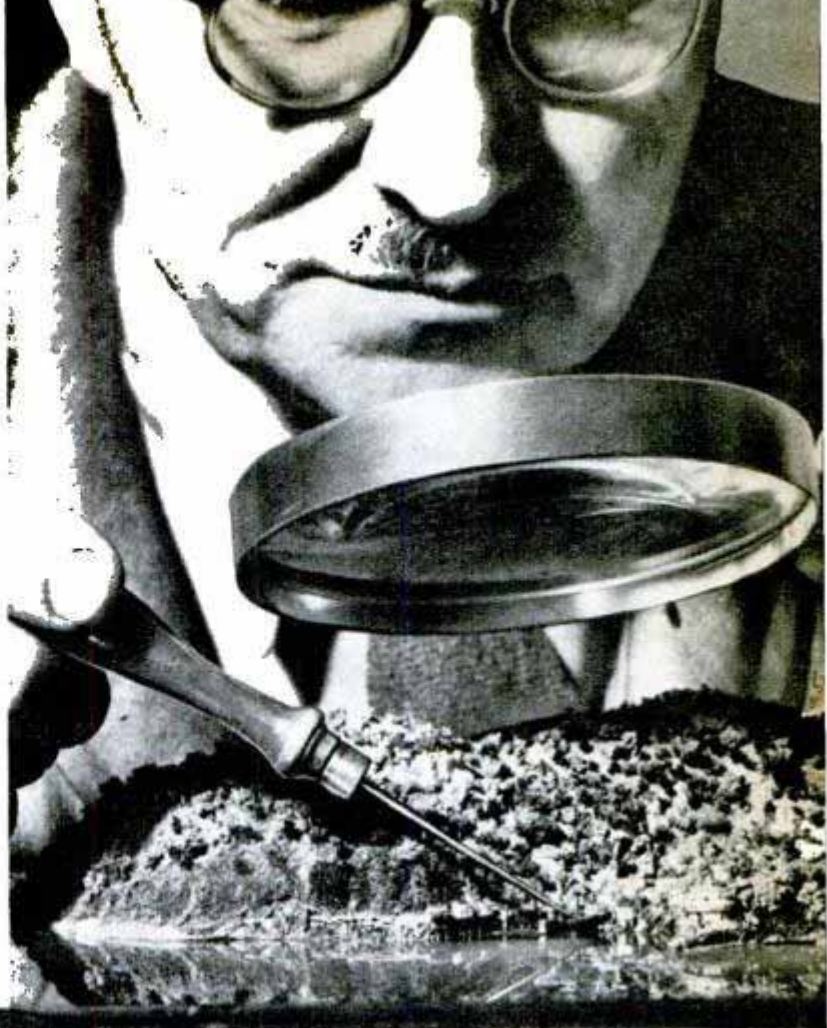

Using a strong magnifying glass, Nick changes the position of a midget house $\frac{1}{4}$ inch high on his model of Catalina Island. So complete is the model (below) that you can even see seaweed and imitation fish underwater



PORTS FOR VIEWING SUBMARINE GARDENS



into hills and valleys and remains soft for several weeks, allowing time for "planting" the tiny twigs that represent trees.

Dry colors are mixed in turpentine for painting this imitation earth. Oil paints are not used because they produce shiny, unreal-looking surfaces. Water colors are preferred for coloring the tiny wooden buildings. When oil paints must be used their dried surfaces may be rubbed with a cheesecloth pad saturated with fresh buttermilk to remove the shine.

Nick uses no nails and puts his scale model buildings together with plastic glue. He uses a small round file for indenting lines in his buildings, and he produces round towers or the slants of the roofs by rubbing the models against a sanding block. He uses three blocks, each surfaced with a sandpaper of a different degree of coarseness.

Small trees may be shaped from bits of sponge cut with scissors but more natural effects usually are produced by hunting through a patch of brush for small growths that can give the effect of trees in miniature. Nick keeps a collection of some 400 kinds of weeds, seed stalks and twigs on hand for such uses.

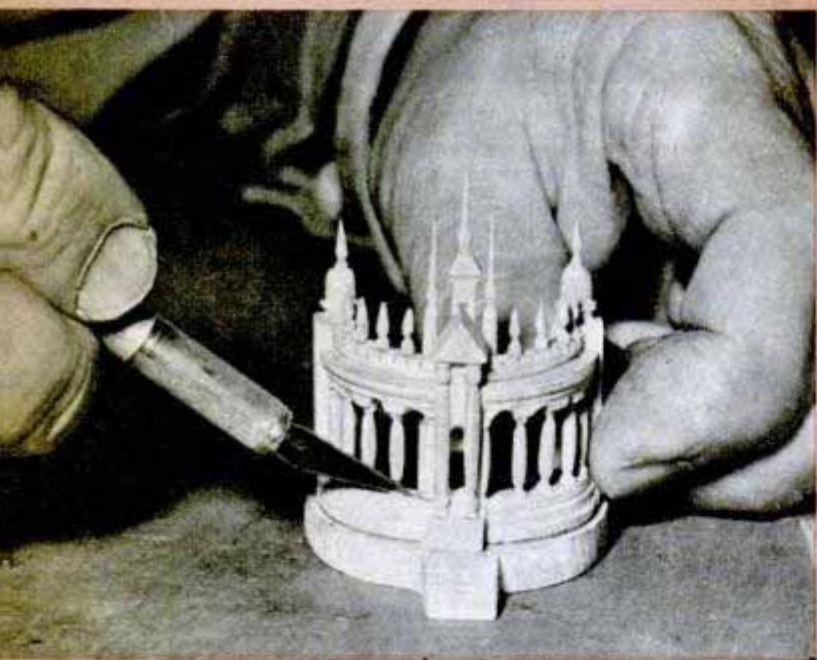

A fairly good method of preserving these natural materials is to dip them in liquid celluloid, prepared by dissolving celluloid chips in acetone in the proportions of one pound of celluloid to one gallon of acetone. After dipping, shake to remove the excess solution, and let it dry. The material then may be spray-painted with permanent color. Celluloid and acetone are both highly inflammable and must be kept away from any kind of fire.

Realistic lakes and rivers are created by pouring acetate, dissolved in acetone, over flat glass used as the base. Dust is added to the mixture if the water is to appear muddy. During the time the material is hardening it can be wrinkled to produce the effect of waves. When making large bodies of water a cardboard or wooden base usually takes the place of the glass base. The wood or cardboard can be paint-



Intricate powerhouses, dams and reservoirs (top) are fashioned by the master of miniature. Center, with a sharp knife he carves a castle out of white pine. Left, model of Jerusalem is five inches high

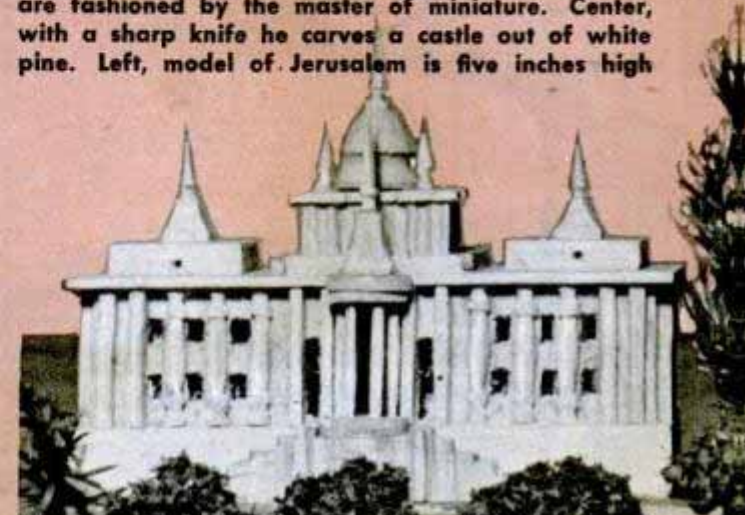



Nick adds the last plaster cow to an exhibit which ed light blue to imitate the reflection of the sky, mottled to indicate varying depths of water, and darkened along the shore line to indicate the shadows of trees. This coloring shows through the thin layer of acetate that is poured over the base.

Modeling clay is the best material for waterfalls or other turbulent water since it can be shaped to the wave patterns desired, then painted. Tiny human figures are best simulated from a bit of cotton covered with soft wax. This makes a pliable material that can be worked into shape. Finishing touches are added with a toothpick or knife and the figure then is painted.

Most of Nick's museum pieces, realistic as they are, seem crude in comparison with the diminutive scale models on which he works during his evenings. One of these is

represents California's beef industry a 10-inch model of a Balkan mountain wilderness that contains a church and other buildings, including a castle. There also is a tiny lake with a boat "afloat."

The model contains 300 trees and shrubs from $1\frac{1}{4}$ inches to $\frac{1}{8}$ inch high. Each tree consists of a young cedar shoot or other natural material, selected for size and trimmed to shape, then preserved by one of Nick's formulas. The castle and other buildings are carved of ivory and illuminated from within. Windows are $\frac{1}{32}$ inch square.

(Continued to page 252)

Smaller than matchboxes, models of Swedish mansion (left) and Palermo cathedral even have shrubbery. Note how their size compares with knife at the right

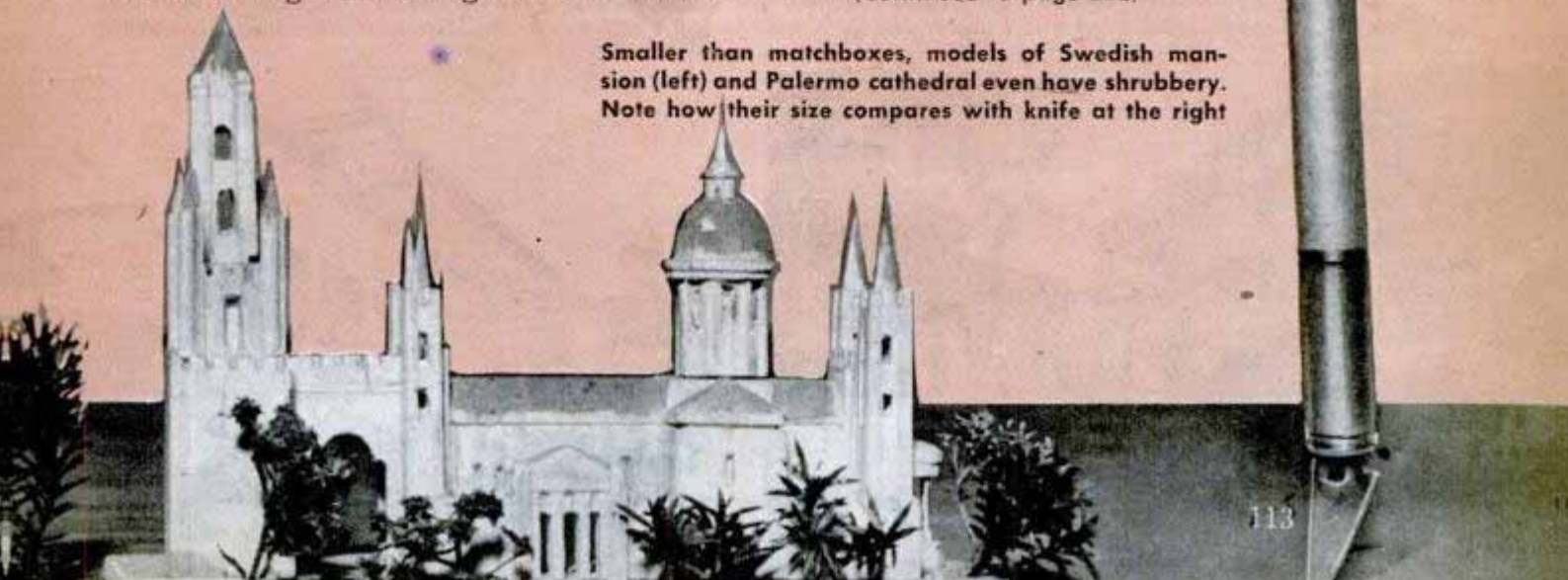



SURPLUS AMMUNITION CASES provided part of the lumber for Carl Hendrickson of St. Paul, Minn., to build a house. When this picture was made, the boxes still bore Army and Navy ammunition labels on the side



HOT BOX heated by charcoal in a pan at the bottom keeps food hot for three hours and is useful for delivering meals from restaurants or for picnics. Holes in the shelves permit heat to reach all the dishes

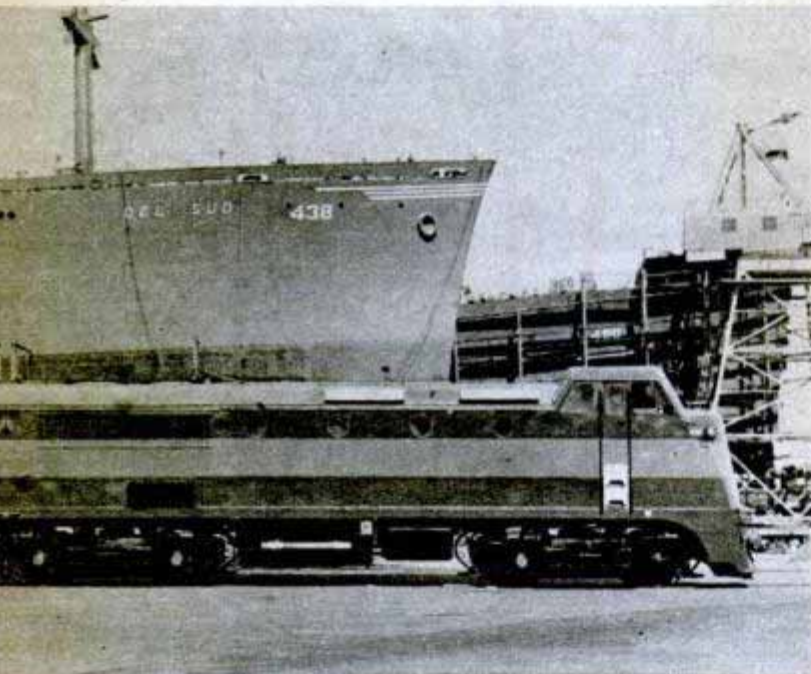

DIESEL LOCOMOTIVE that incorporates specifications furnished by 22 railroads was built in the shipyards of the Ingalls Shipbuilding Corp. at Pascagoula, Miss.

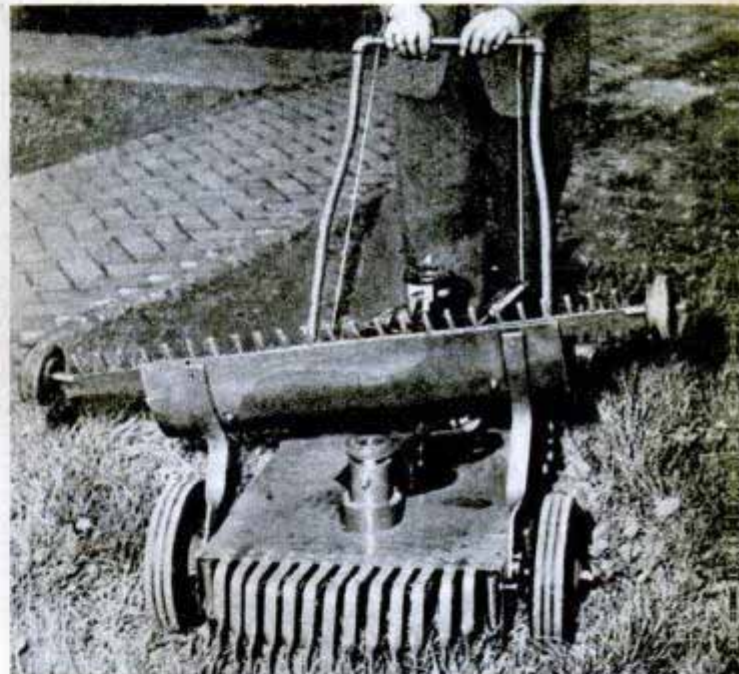

COMBINATION LAWN MOWER, rake, snowplow invented by James Badlat, Des Moines, Iowa, is powered by $\frac{3}{4}$ -horsepower motor. Brush sweeps sidewalk

JEEP FIRE ENGINE, a dwarf compared to a regular size machine, is ideal for hurdling ditches and speeding across bumpy fields to combat fires in rural communities. Some industrial plants also use the modified war jeep to scoot through production aisles and hurriedly reach the scene of a fire or explosion. The fire jeep costs \$2800



World's Largest Bomber Dwarfs Superfortress

Nearly double the B-29 in size and performance is the Army Air Forces' cigar-shaped XB-36, the largest bomber ever built. It has a maximum range of 10,000 miles and carries more than 30 tons of bombs, triple the Superfort's capacity. Fully loaded it could make a nonstop round trip between San Francisco and Tokyo. Built by Consolidated-Vultee Aircraft Corporation, the 130-ton giant houses a crew of 15 in two pressurized compartments.

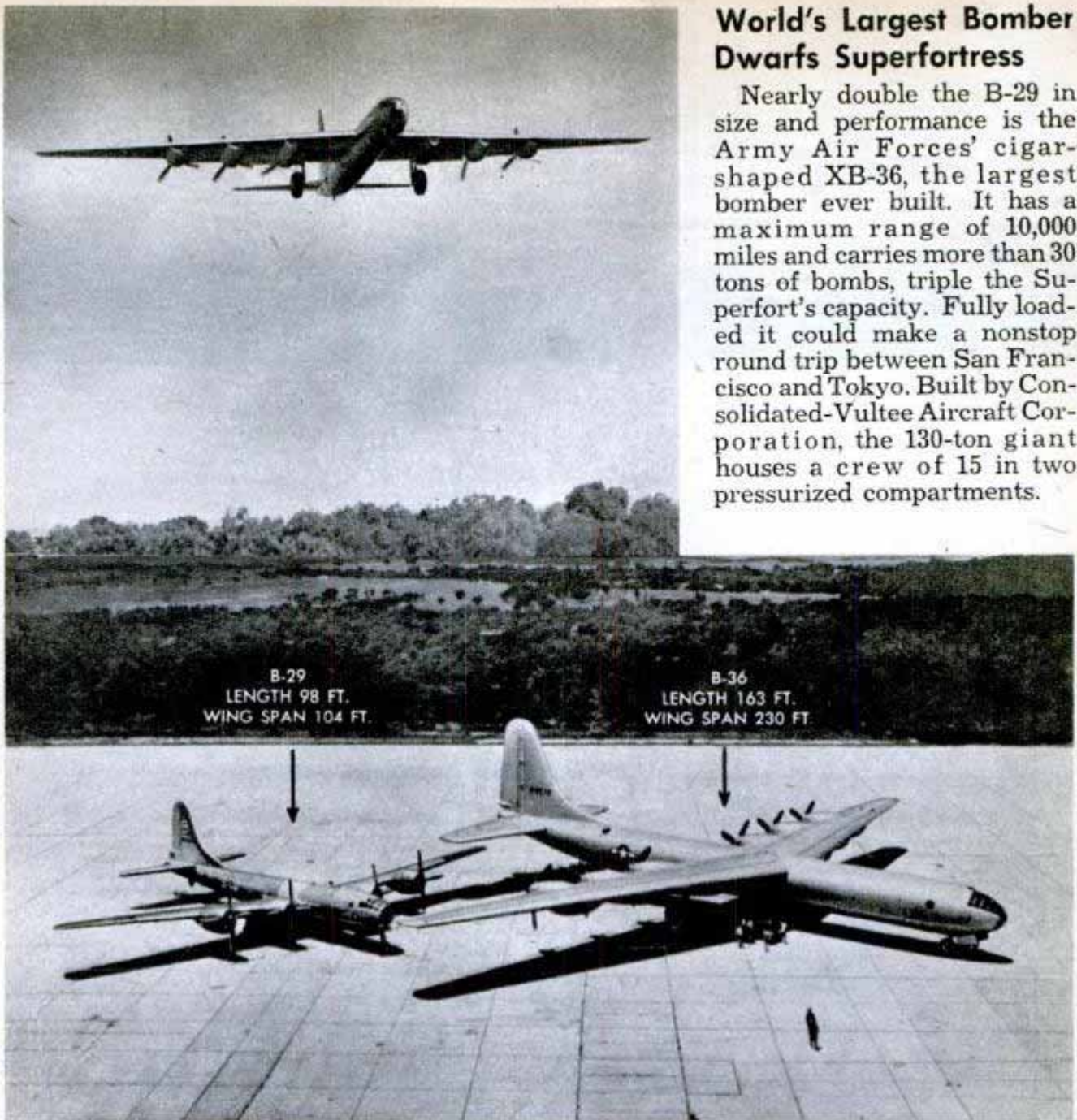

140-Mile Top Speed For Hockaday Comet

With either a Continental or a Franklin 125-horsepower engine, the two-place Hockaday Comet has a top speed of 140 miles an hour and a range of 500 miles. It features a quickly removable metal cowling for speeding engine servicing and a curved safety windshield affording unobstructed vision over a wide area. The fuselage is metal covered to the rear of the cabin and fabric back to the tail. It lands at 50 miles an hour.

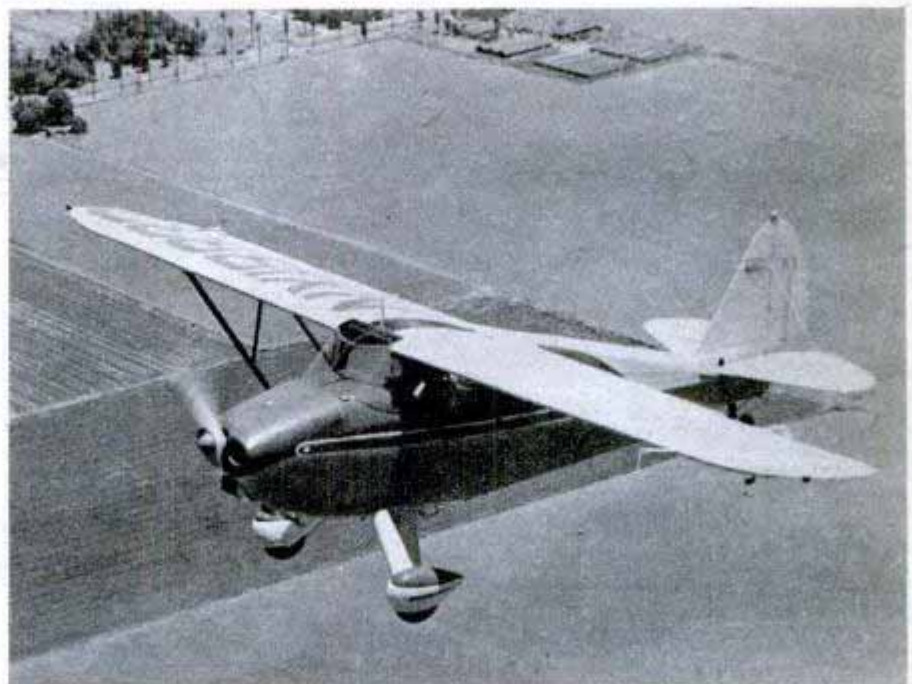



*Luxury
goes back
to sea*

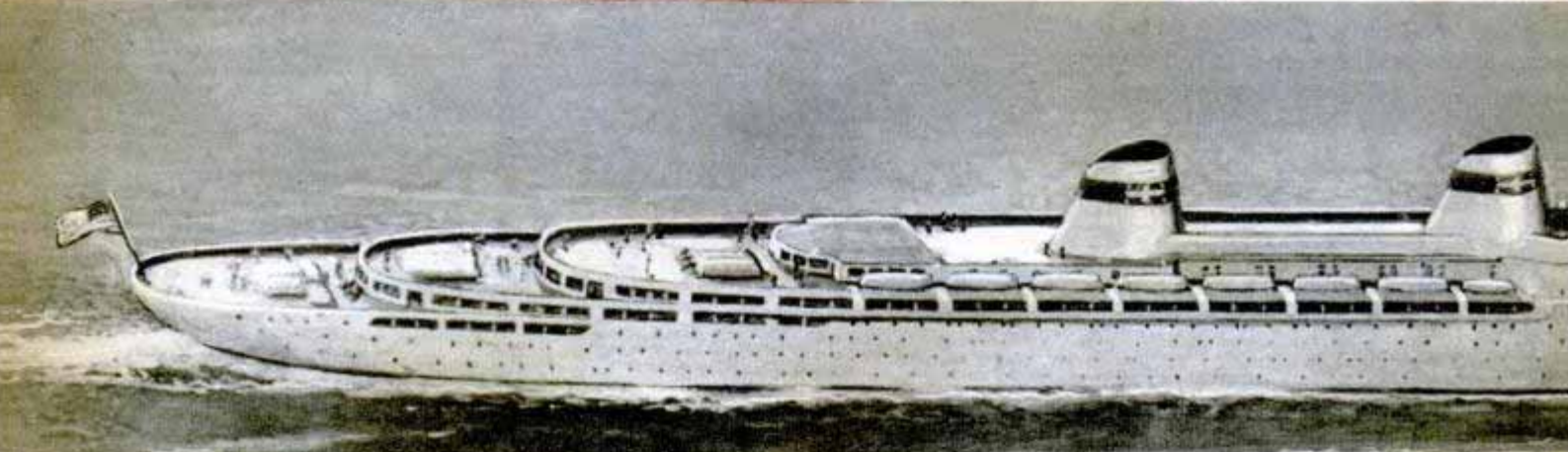

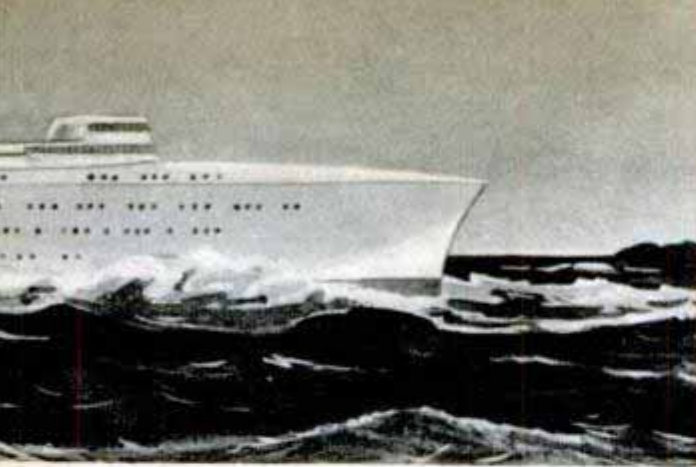

Largest and fastest American ships ever built are coming soon. Liner above is Maritime Commission design. War-born radar protected troopships and will add to safety of peacetime service

UNLESS you're a diplomat, a government official or a foreigner being repatriated, your chances of enjoying an ocean voyage during the next few months are remote.

The freedom of the seas is not for you—not yet, that is. But within the next two years you'll be able to take that long-delayed trip to Europe, the Orient or Hawaii. If you were disappointed this summer by lack of passenger accommodations, you may, by next summer, find it possible again to travel on the seven seas.

According to the National Federation of American Shipping, which represents 95 percent of American shipowners, 11 major steamship lines plan to place 89 new vessels in world-wide passenger and cargo service within three years.

Several ultramodern speedy ships are already under construction and others are scheduled to be delivered this year. Two of these ships are to be 920-foot express passenger liners, larger and faster than any ever built in this country. The 33,000-ton vessels, known as Great Circle liners, will be of the U. S. Maritime Commission de-

One of three Good Neighbor vessels, reconverted SS Uruguay, left, goes on South American run. Great Circle liner, below, is 920 feet long, will carry 1200 passengers to Orient in eight days

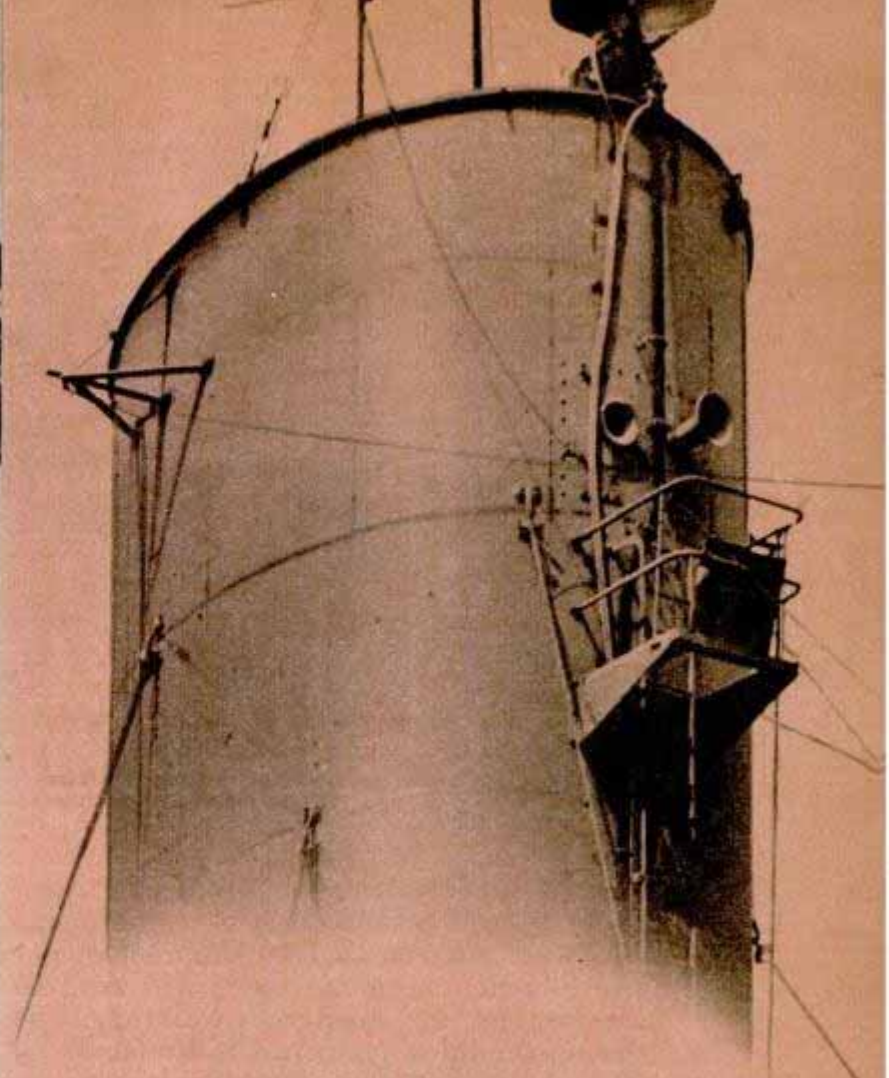
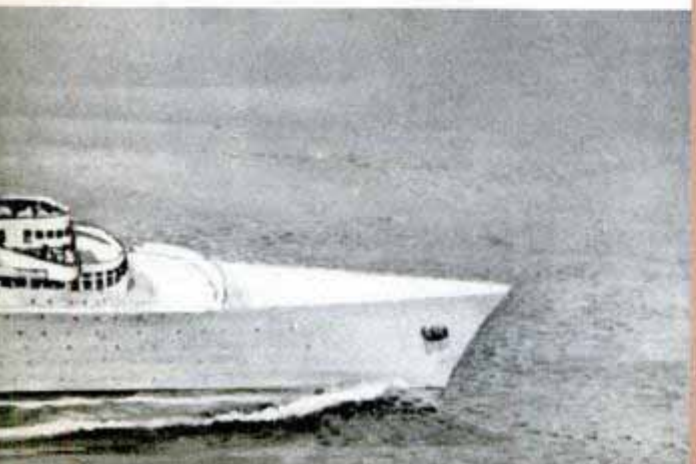

sign P5-S2-E1 which the Commission has had under preparation for several years. They are planned for transpacific service.

Capable of transporting 1200 passengers on each sailing, they will be able to reach Japan over the northern route in eight days. They will have twice the horsepower of the largest liner thus far built in the United States—the SS America—and under average sea conditions will have a speed of 30 knots. All accommodations are on a luxury scale including three swimming pools, complete air conditioning and a theater. A crew of 590 is required.

One outstanding feature will be the superstructure which is to be built mainly of aluminum. About 770 tons of the metal will be required. Research by naval architects of the Maritime Commission has established that use of aluminum will enhance the vessel's stability by permitting her to have a beam of only 86 feet. The ship thus can attain greater speed with considerably less horsepower than heretofore has been possible.

Another innovation of the Great Circle liners will be a circular marine veranda on the teardrop-shaped sun deck. This play spot, 72 feet in diameter and 55 feet above the ocean surface, complete with bandstand, dance floor, cocktail lounge and bar, will command an unobstructed view of the blue water ahead across enclosed bow sec-

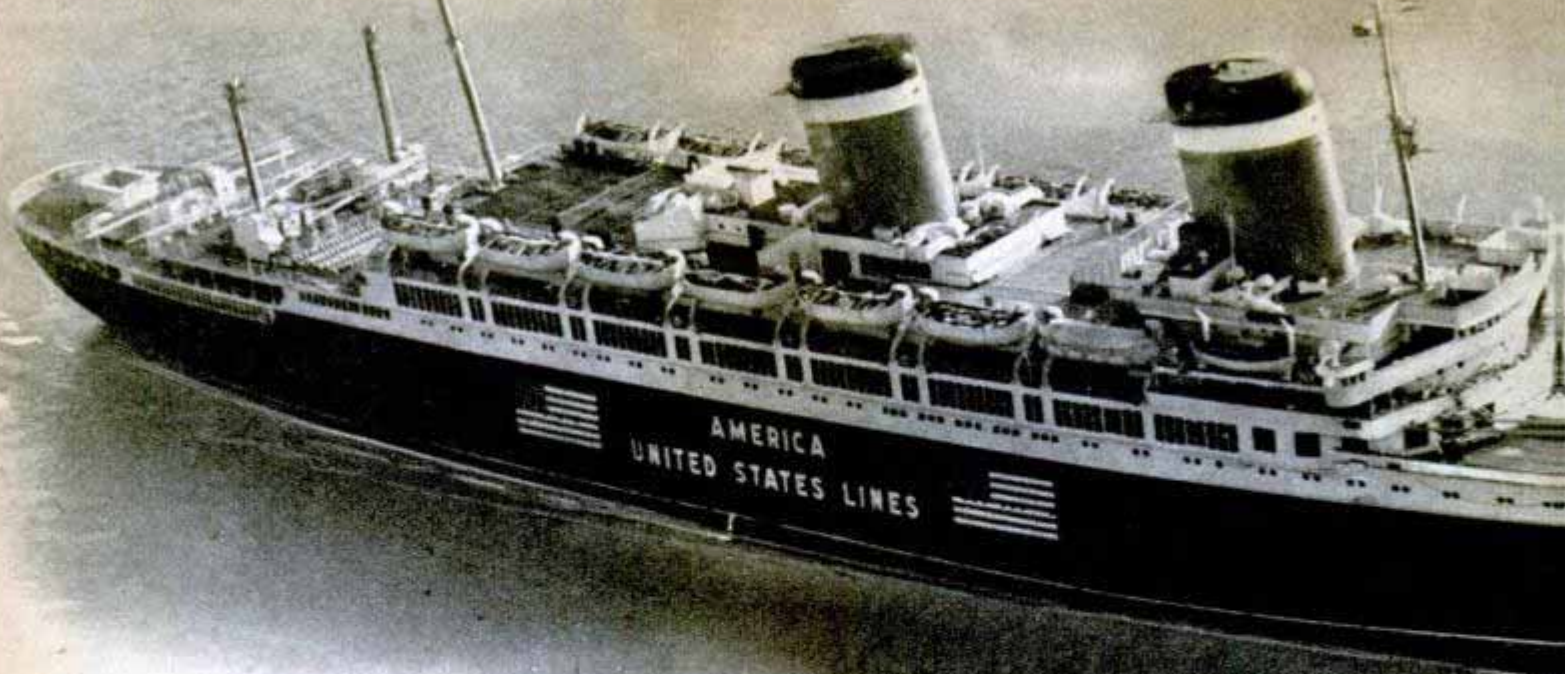

During the war the 26,000-ton SS America, largest ship yet built in U. S., was troopship USS West Point. It will be luxuriously refitted for passenger trade
Official U. S. Navy photo

tion machinery. Unusually extensive open deck space is provided on the promenade deck. In addition to 1700 square feet entirely open to salt air there will be 1700 square feet for sheltered walking. The three swimming pools are 16 by 60, 22 by 32 and 16 by 29 feet. The theater accom-

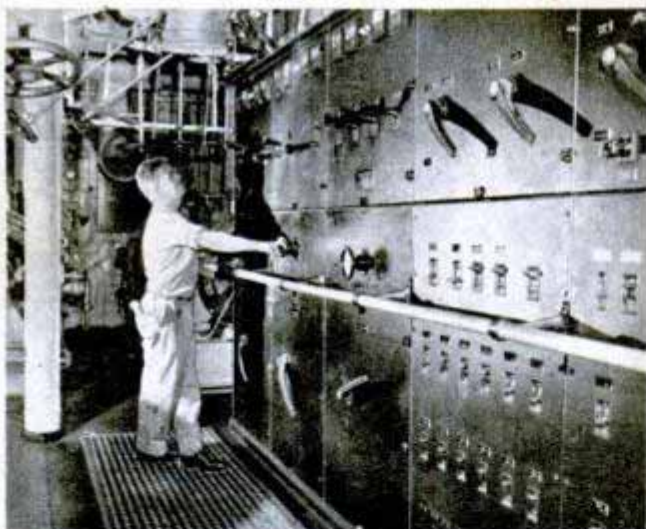

Grace Lines SS Santa Barbara is one of nine combination passenger-cargo ships in South American service. Above, portion of the vessel's electric control panel

modates 300 people. There will be four dining salons in which a total of 826 can be seated at one time.

How soon the commission's new construction program will get started is problematical. President Truman recently ordered a 50 percent cut in expenditures for new ships. But there is no intention of abandoning the entire program of new construction, according to Robert W. Straus of the commission.

Two other types of streamliners are planned. For the South American trade, the Maritime Commission contemplates construction of two Southern Cross ships, but has deferred award of contracts until 1947. Passengers may breakfast in their rooms. Luncheon will be served on deck. Dinner will be a formal meal, followed by open-air dancing and fiestas. The ships are open to the sun and air conditioned

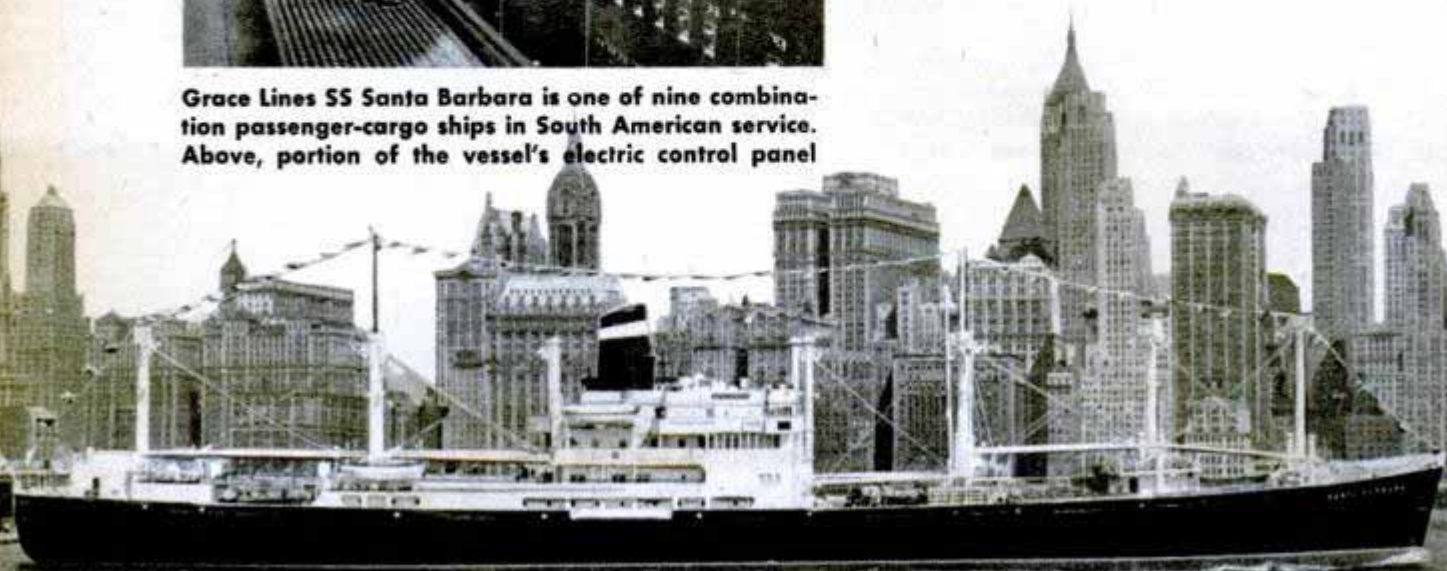



Vladimir Yourkevitch, Normandie designer, proposes 34-knot super-liner for Atlantic service carrying 4000 persons

below decks. Refrigerated fast freight will fill the hold.

Powerful turbines will drive the 731-foot liners at an average speed of 28 knots and enable them to make the New York to Rio trip in one week, cutting existing schedules in half. Because of the cargo they will carry but 543 passengers. A crew of 447 is required.

For the Mediterranean service, 681-foot turbine-driven Sunliners are planned. Although running at only 22 knots, they will make two trips each month to ports in the Mediterranean. They will go by the southern route and will have great sunny play decks for recreation and sun bathing. The Sunliners are designed to carry 654 passengers, a crew of 452 and a refrigerated cargo of 45,900 cubic feet.

When completed, the Great Circle liners, the Southern Cross ships and the Sunliners will join the war-service ships now being reconverted for peacetime service.

During the war every passenger and merchant ship was pressed into service as a troop transport or cargo vessel. The 26,000-ton SS America became the troop transport USS West Point. Two other large passenger ships, the SS George Washington and the SS Manhattan, carried troops as the USS Mount Vernon and USS Wakefield. Scores of other ships also became troop carriers. Now the job is to reconvert them. The work is estimated to cost \$500,000 during the next three years.

Restoration and modernization of a ship
(Continued to page 264)

Upper berths in cabins of SS Amerita fold into ceiling, right. In another design, below, they fold into wall. During daytime, lower berths serve as sofas



Accidental "Bath" for Silver Wire Reveals New Way to Polish

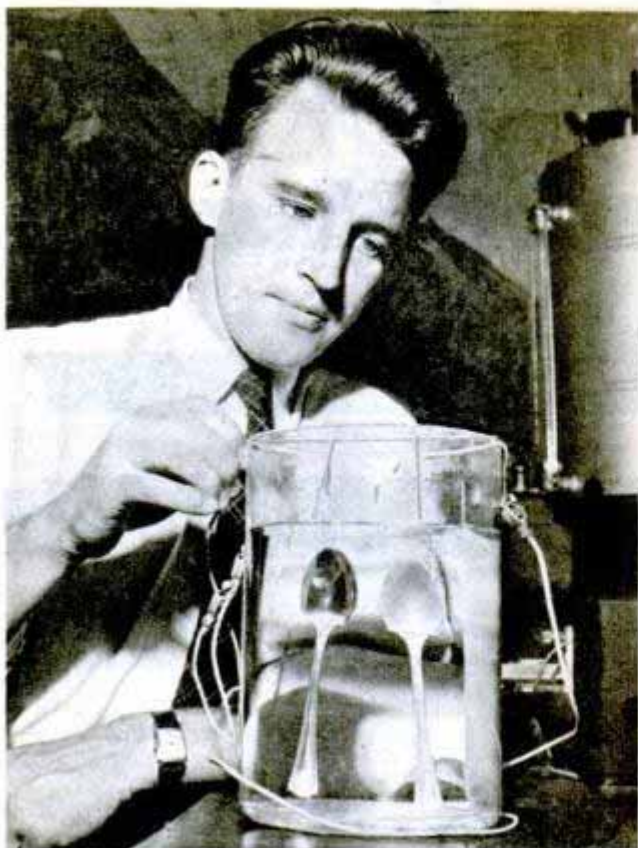

Accidental use of a silver-plated wire in cleaning tiny parts for electronic tubes has given birth to a new polishing process that may be a boon to the silver industry. Dennis R. Turner, Westinghouse physicist, stumbled onto the process when he attached a diaphragm from a tube to a dull white silver-plated wire and suspended it in a cyanide solution through which positive electricity was passing. When he removed the wire he noticed it had taken on a high luster. Further tests revealed that this system, in less than a minute, adds the glittering finish to dull silver-plated objects that formerly required buffing. The silver industry has been searching for years to find a way to electropolish silver plating.

Loader Fitting for Grease Gun

Speedier and less wasteful loading of hand grease guns is accomplished with a new system that saves taking them apart. A loader fitting mounted on the hand gun permits grease to flow into the reservoir in



Ink or Oil Spots Wash Off Rugs Made of Plastic-Coated Paper

Paper-fiber rugs coated with flexible plastic are nearly immune to stains from ink, gravy or food and may be cleaned by scrubbing with a brush or wiping with a damp cloth. They are made by coating paper-fiber twine with plastic before weaving. Color is added to the rugs, which are resistant to water, wear, mildew and fading, by dyeing both the paper twine and the plastic cover. In addition to its use as porch and playroom floor coverings, the plastic-coated paper can be made into handbags, shopping bags, shoe tops, auto seat covers and furniture slip covers.

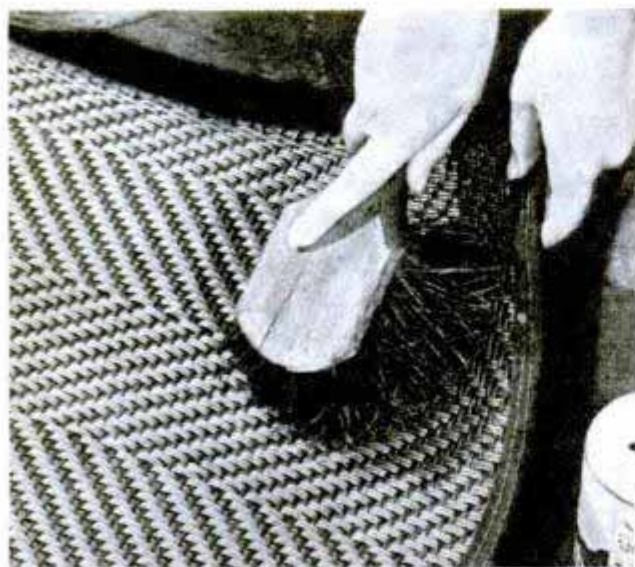

the same manner it flows into a bearing in normal lubrication. The gun fitted with the loader is placed on a companion loader valve while the pump is operated, automatically disconnecting when fully loaded.

Artificial Eye Turns Naturally

Improved fitting techniques are giving artificial eyes a more natural appearance. Dr. A. D. Ruedemann of Cleveland, Ohio, stitches the artificial eye into the socket so that it moves with the natural eye. A fine mesh of tantalum is fastened to the back of the plastic artificial eye. The eye surgeon then stitches the mesh to the eye muscles.



For personal transportation in Milan, rent a bicycle or roll along in trailing seat of bicycle taxi, right



Versatile vehicles carry woman shopper to market, above, or haul furniture, right. Flat tires are headache to driver of cab-over-front-wheels taxi, below



MILAN Pedals to Work

BICYCLES always have been a favorite mode of transportation in European cities. They are more important than ever now. Few civilian trucks or automobiles are running. Pedal power drives almost every kind of conveyance in the large industrial city of Milan in northern Italy. The "bicicletta," remodeled and redesigned to fit particular hauling needs, serves as personal vehicle or light truck. Even the taxicab drivers depend on pedal pushing for a livelihood. In one model, passengers ride in a cab built over the front wheel. Instead of one front wheel, many models have two and must be classified as tricycles.

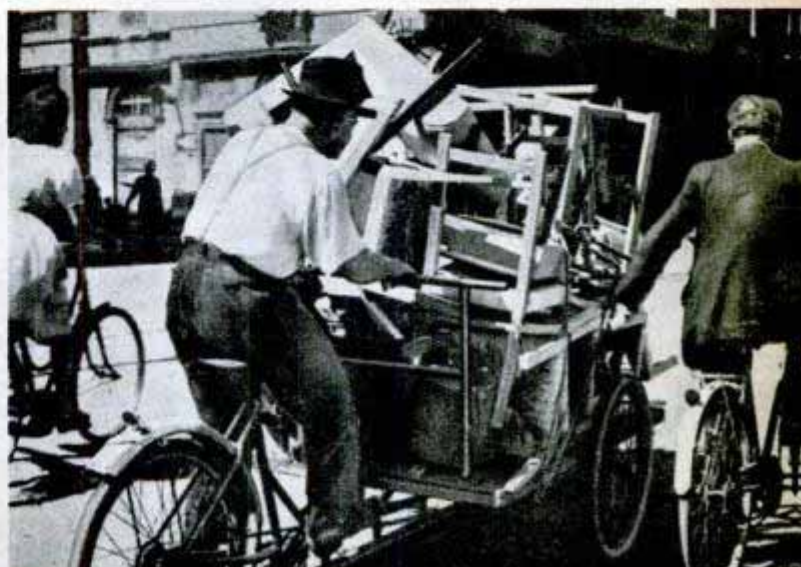

Mother Ship of the Cable Lines

THE world's largest cable-laying and repair ship carries enough cable—2500 miles—to span the Atlantic in one operation. The cable is coiled around four huge spools sunk in “cable tanks” on the new British vessel, Monarch. Because the ship may be lightened by some 8000 tons (weight

of cable laid and fuel and fresh water consumed) on a single trip, it has special water-ballast equipment. It is the first cable ship to have electrically driven cable gear. Radar is used for navigation. As the message-carrying cable comes off the spools (below) 10 men check it to prevent kinking.

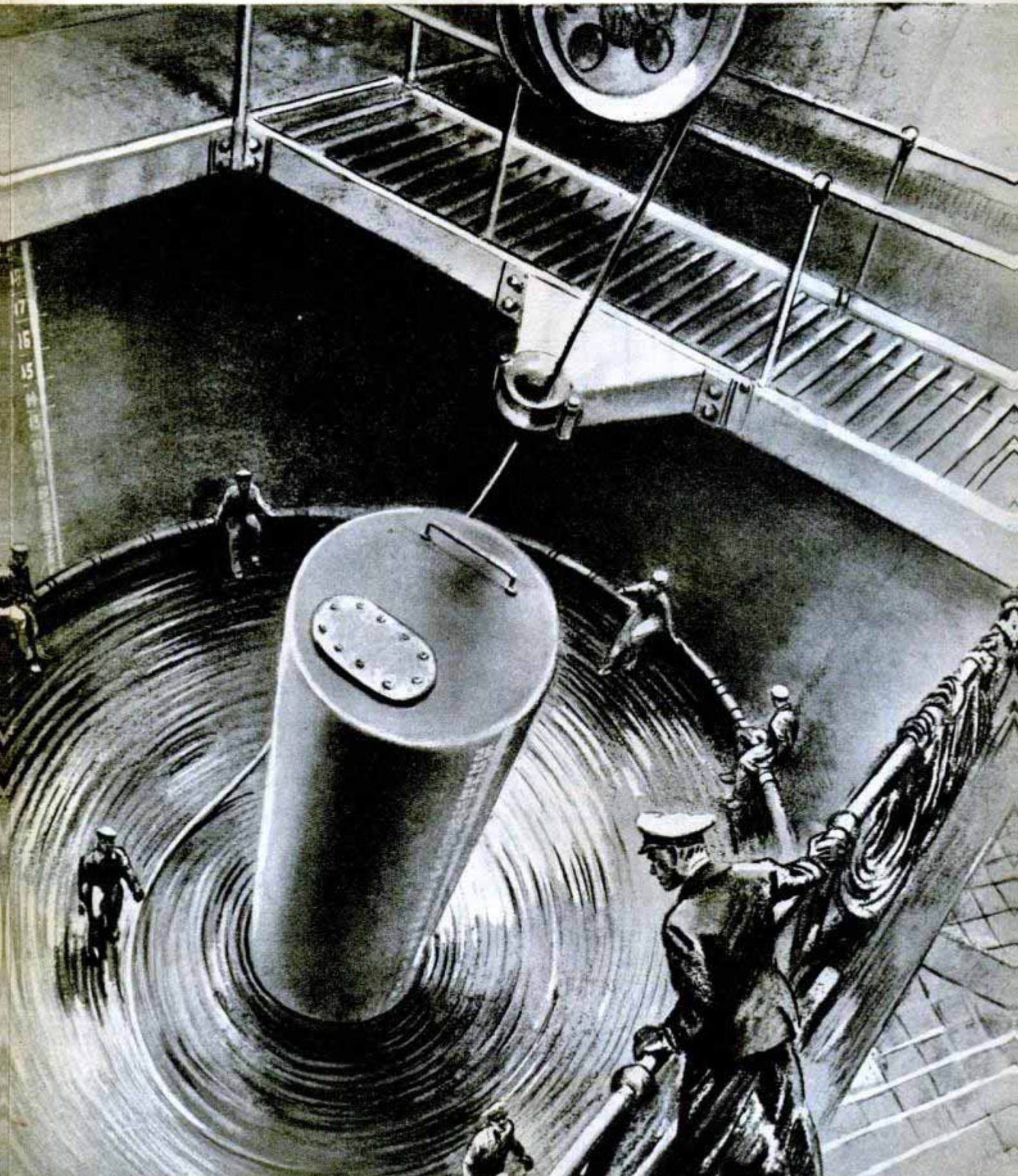

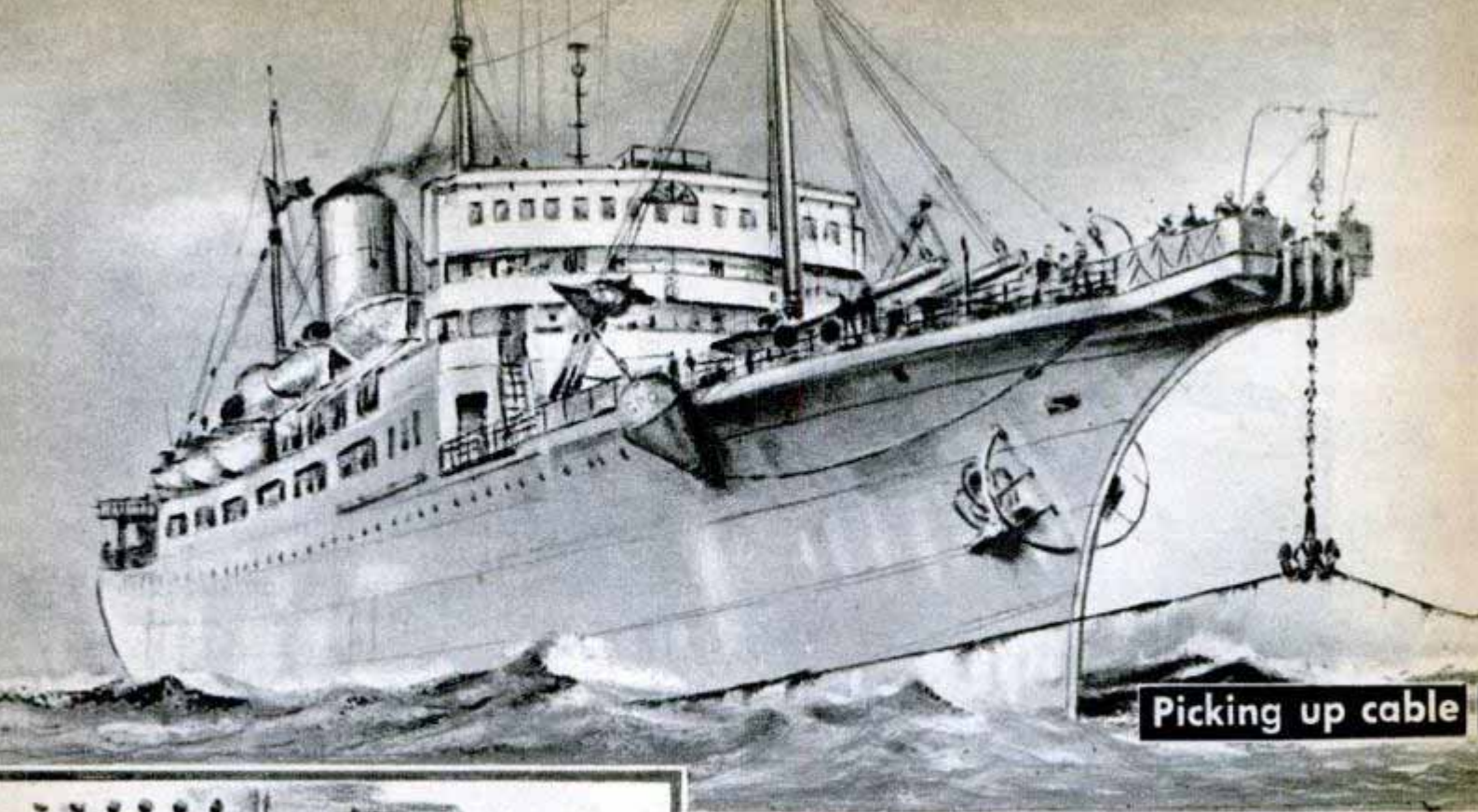

Picking up cable

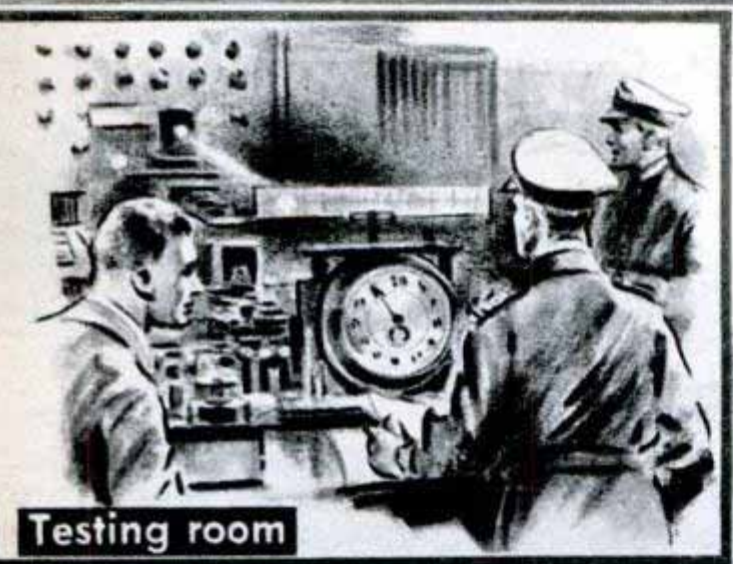

Testing room

Cable is picked from sea bed for checking or repair by pronged grapple raised or lowered from bow sheaves

In the testing room, technicians look for cable flaws. When the light moves on the scale something's wrong

Fine wire crossing the cable aids in calculating slack needed so cable will lie flat on uneven ocean floor

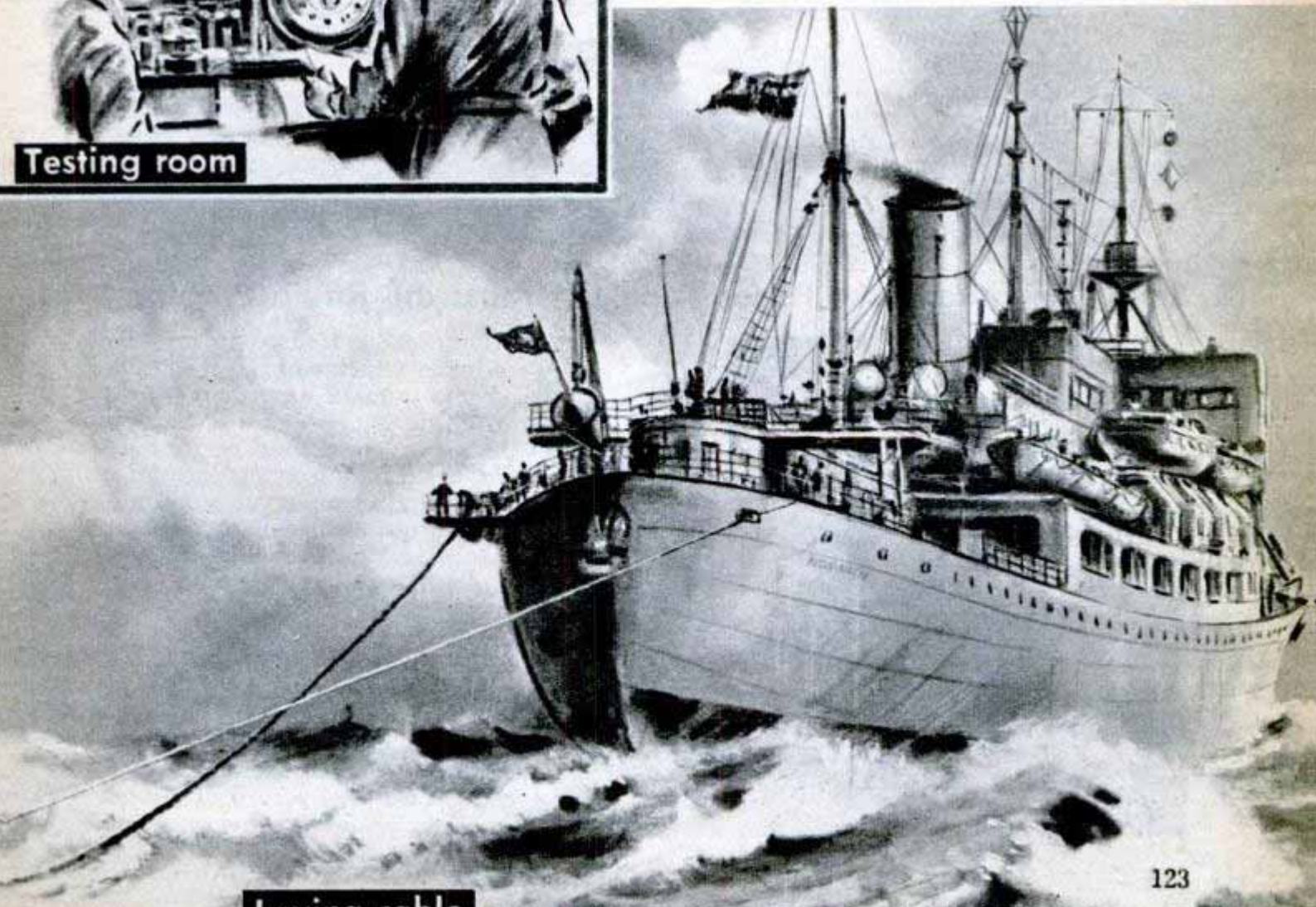



"Stethoscope" for Machinery Listens to Ailments

Engineers listen carefully for hums and wheezes through a resonance tube "stethoscope" to diagnose the ailments of steam turbines just as a doctor examines the human body. In normal operation steam turbines have little characteristic noise but when something is wrong unusual hums or wheezes may be heard. The resonance tube, which consists of a hollow plunger fitted into a "sleeve," tunes in the discordant sound frequency when the plunger is extended or retracted. At any one position only one frequency can be heard and the wave length of the sound can be determined by a mathematical formula. Westinghouse engineers, who use the resonance tubes, have precomputed the wave lengths of various "trouble sounds." After the diagnosis, minor repairs can be undertaken without tearing down the entire machine.

Bellanca Cruisair Travels 153 M.P.H. Carrying Four Passengers

Among the fastest personal planes, cruising 153.6 miles per hour, the four-place Bellanca Cruisair Senior has many other features demanded by prospective plane purchasers, such as a retractable landing gear, one-piece full-view Plexiglas windshield, electric starter and dual controls. Stalling speed is just under 45 miles an hour and the plane requires 485 feet of runway with no wind.



Sound Recorder Uses Paper Tape to Transcribe Radio Programs



Paper tape is used in a sound recorder which can be attached to a radio to make a permanent record of various programs. Parts in the recorder include two movie-film spools for reeling the paper tape, an electromagnet, small motor and two radio tubes. To eliminate part of a recording, the tape can be cut and spliced with cellulose tape.

By inserting a fine wire in an elbow vein and pushing it forward until its tip rests inside the heart and connecting the other end to a recording galvanometer doctors can get a direct record of electric currents of human heart action.



BIG BABY BUGGY is a labor-saver for nurses at an English children's home. One nurse can push about a dozen kids to mass outings in the novel "buggy-truck"

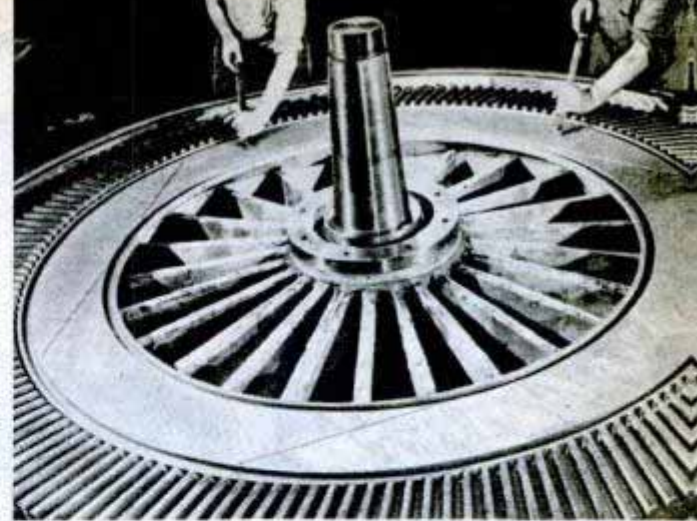

TURNTABLE aids in polishing huge bearings used in giant generators. Westinghouse workers grind the "doughnuts" with abrasives, then rub with hands

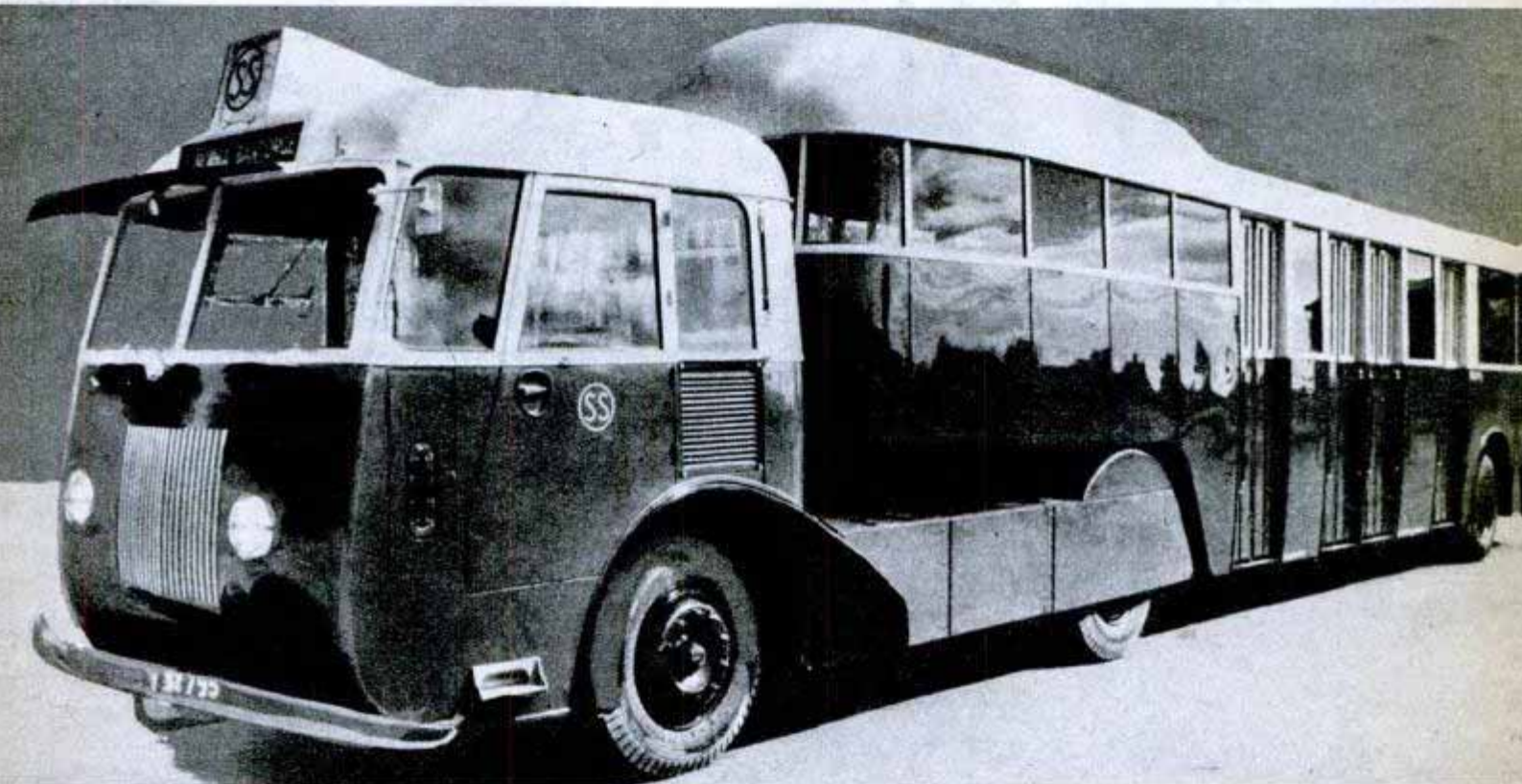

LARGEST BUS in Sweden is this 180-hp. semitrailer-type vehicle, 45 feet long with an air-conditioned body. Both the driver and the conductor can give information to passengers through a public address system

ABANDONED LIGHTHOUSE was moved from the juncture of the Columbia and Willamette Rivers to Burlington, Oregon, to solve the housing problem of an enterprising couple. A huge crane mounted on a barge lifted the lonesome 50-year-old structure from its heavy pilings and carried it to its new site on the shore





Sunshine and soil are strangers to these soybeans grown in chemicals and under light bulbs

Throwing Light on

By John R. Kinsey

SCIENCE has the plant world all confused. Chrysanthemums, which normally bloom in October, now may hold off until Christmas. On the other hand, asters, Shasta daisies, pansies and other spring flowers often burst into bloom weeks ahead of schedule.

It's all done by light—artificial light. Rows of light bulbs in reflectors above the plants are turned on when the sun sets. The plants think it still is daytime. Mums figure, with days so long, this can't be October, so it isn't time to bloom. Spring flowers interpret artificially lengthened days to mean that winter is over, so let's bloom.

Some florists fool chrysanthemums in another way. They cover the plants with black cloths in the late afternoon to simu-

Which orchid would you want? The one on the right, of course. It has had a five-week dose of extra light



WITHOUT
ARTIFICIAL
LIGHT

126

WITH
SUPPLEMENTAL
ARTIFICIAL
LIGHT



Fluorescent lamps radiate less infrared than Mazda lamps and are used when little daylight is available

late shorter days and trick the mums into blooming ahead of schedule.

Maybe plants don't think but they do bloom—when science lets them alone—in

Mother Nature

accordance with the amount of light energy they absorb every 24 hours. Plants which normally bloom in the spring and fall do so as a result of the relatively short hours of



Growers profit by out-of-season tomato seedlings hurried to maturity under 300-watt spot and floodlights

daylight. Plants that bloom in the middle of summer are influenced by the long daylight period.

What difference does it make if a gorgeous chrysanthemum doesn't bloom until Christmas, or delicate snapdragons peep their colorful heads through green raiment a couple of months early?

Well, for one thing, you can make your wife happy by buying her a beautiful bouquet of spring flowers while soot-covered snow still blankets your garden. This

Hotbed stimulated by soil heating cable and overhead lights produces larger seedlings than usual manure bed

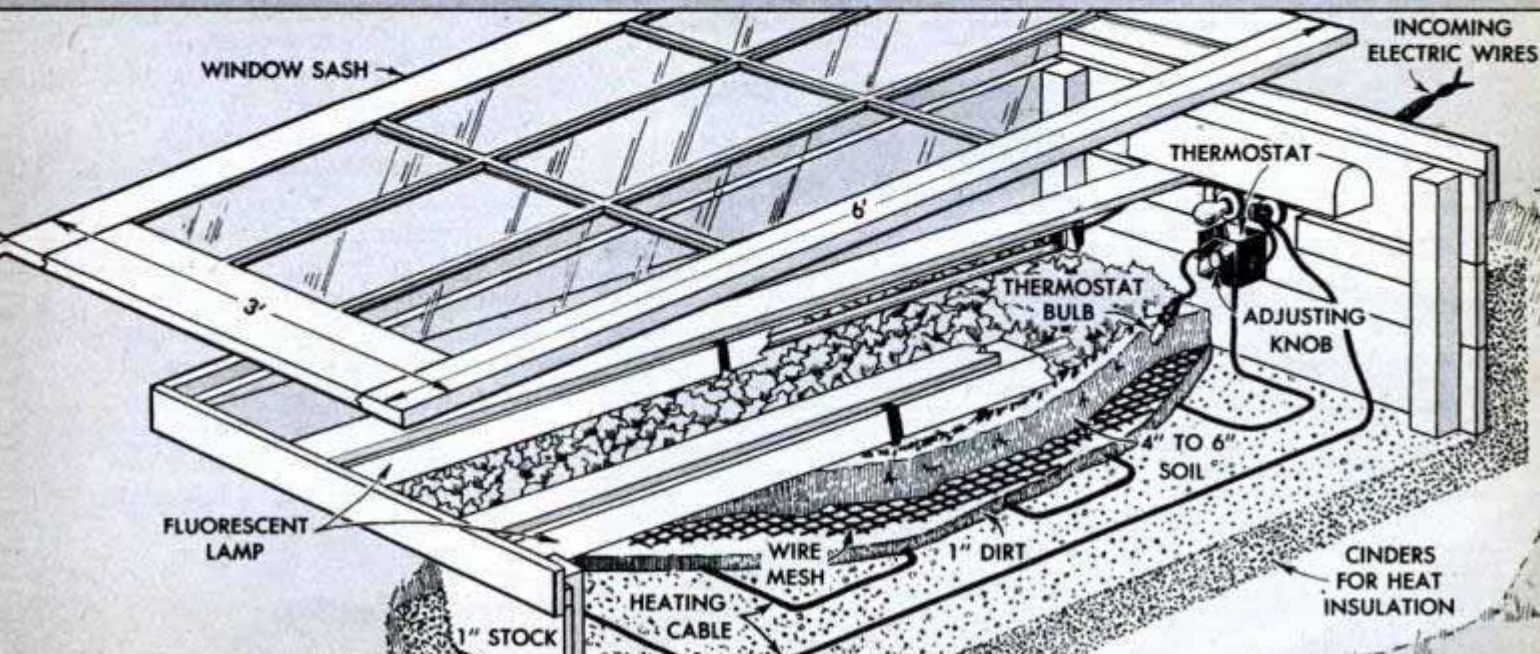



↑ Studies made by Mrs. Alice P. Withrow, research assistant at Purdue Agricultural Experiment Station, have revealed growing secrets. With meter she measures intensity of fluorescent light over test bed



↑ Chrysanthemums on left get four hours artificial light stimulation each night in delayed blooming demonstration. Those on right get none.
↓ Plants in gravel-covered concrete bed are nourished with chemicals

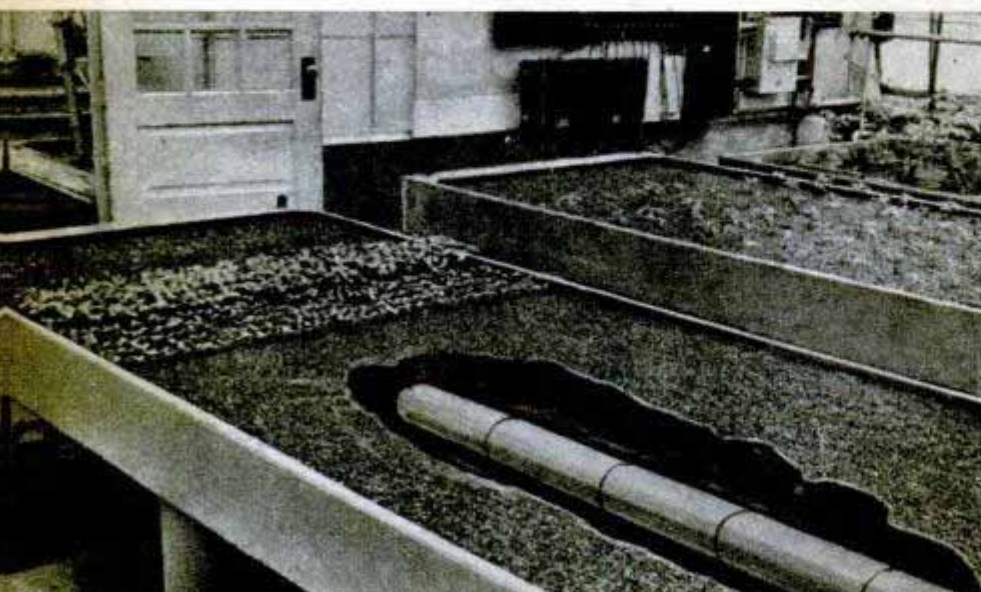

means more business for florists and greenhouses.

Most progressive florists are turning more and more to the use of artificial light to supply the public with out-of-season flowers and for many other reasons. For example, man-made daylight, when used to hasten blooming, shortens the time that plants occupy valuable greenhouse space. Artificial light also increases the number of flowers per plant and increases stem length and size.

Vegetables, for the most part, have not proved commercially profitable when grown under supplemental lighting with its increased costs. But there are some exceptions—notably tomatoes. When tomato seedlings receive extra light, bud drop is greatly reduced and the final weight of the harvested tomatoes is increased considerably. A 150-watt or 300-watt reflector bulb spot and floodlight works well for lighting tomato seedlings.

For speeding or retarding the blooming of flowers, tungsten filament incandescent bulbs (commonly known as Mazda lamps) are the most satisfactory. They come closest to duplicating the radiation composition of the daylight that comes into greenhouses. Radiation from a Mazda lamp has somewhat smaller components of near ultraviolet and violet radiation and larger components of red and infrared than daylight. However, all daylight wave lengths are present.

Size of the bulbs depends upon a number of things. From 5 to 15 footcandles of light are sufficient to hasten blooming. But to make up for the deficiency of daylight on dark, gloomy days, 50 to 100 footcandles may be required, according to General Electric engineers' tables based on hundreds of tests.

Biologists at the University of Houston estimate that the electricity needed to advance a plant's blooming from one

(Continued to page 272)

"Scrapmobile" Travels 30 M.P.H. With 1½-Hp. Lawn Mower Engine

Scrap wood, sheet metal, a 1½-horsepower motor, tires and wheels from a lawn mower and bicycle were used by Robert Mustard of Wellesley, Mass., to build a car. His tub-shaped auto has a top speed of 30 miles an hour and averages 40 to 50 miles per gallon of gas. He uses an iron bar for a steering lever and a window seat for the driver's seat.

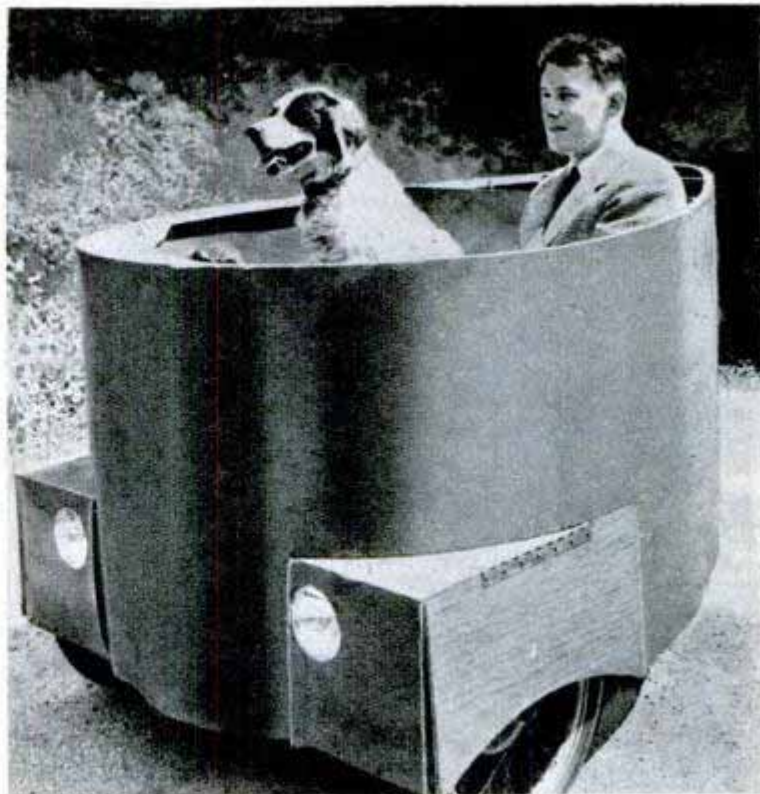

Chemical Beads Dry the Air In Toolbox or Storeroom

Moisture from the air is picked up by a new beadlike chemical that can be used in homes or applied to industries. A few beads of the material keep tools in a kit from rusting or prevent salt in a shaker from caking. The humidity of rooms can be reduced sharply by using the chemical in air-conditioning units to dry the air as it passes through. Air dried with the chemical keeps machinery and equipment of idle war vessels from corroding. Each bead is honeycombed with microscopic pores that absorb as much as 40 percent of the moisture from air. When the beads are saturat-

ed they can be dried out at 300 degrees Fahrenheit and used again. The new substance, developed by the Socony-Vacuum Oil Company, does not become powdery after use, the chief objection to other absorptive materials.

Zipper-Sealed Chair Tent for Winter Sportsman Turns in Any Direction

Discomforts of winter hunting or ice fishing can be avoided with a one-man tent which provides easy-chair comfort for the

sportsman. Lightweight steel tubing forms the center chair and frame which supports the tent. The tent revolves on a central pivot so that the hunter can rotate it to face any desired direction. It is sealed by zipper fastenings which can be adjusted to govern the size of the gun-port openings. It can be folded into a package small enough to stow in an automobile luggage compartment.



Cotton Insulates Freight Cars Saving 3000 Lbs. on Each

Cotton insulation for refrigerator cars has been used experimentally by the Illinois Central System railroad in transporting strawberries from Louisiana to various points throughout the nation. Combined with aluminum-foil jackets, the cotton batts insulating 1550 square feet in a single car provide a 1½-ton weight reduction and 25 to 50 percent more heat resistance, according to W. A. Johnston, president of the railroad.



Light from enlarging camera goes through plant leaf (above) to print photo resembling X-ray. Below, framing a pansy with ferns in a holder



“X-RAY” PATTERNS

with your camera

By Lynwood M. Chace

THERE is always new adventure for the candid camera hobbyist. Let me tell you how I unexpectedly hit on a method of producing an X-ray effect in pictures.

One sunny day I was taking pictures in my flower garden with a Korelle-Reflex camera, equipped with a Radionar f:2.9 lens. I spent an hour working around an elephant ear plant, or yam. While concentrating on one huge leaf I had the camera on the ground shooting up and with strong backlighting.

I noticed that the veins and structure of the leaf seemed to stand right out, creating a beautiful photographic effect. If strong sunlight rays coming through the leaf made such an unusual effect, I thought, what would happen if I put this leaf in the negative holder of my enlarging camera and projected strong light through it?

Trying the experiment, I placed a leaf in the negative holder and slid the holder into position in the enlarger. I put a piece of white paper into an 8x10 printing frame and switched off the light, snapped on the enlarger and started to focus on the white paper in the printing frame.

There was the same effect I had seen in the garden, except that the veins and structure of the leaf seemed to show up more prominently. I was using a 5x7 studio enlarger equipped with a Carl Zeiss Jana-Tessar f:4.5 lens—12 cm. Then I put a sheet of 8x10 No. 1 enlarging paper into the printing frame and made an exposure of eight seconds. I next put the paper into the developer (D-72—two-to-one mixture) and soon the leaf began to “come up.” However, my first print was a little overtimed so I tried another and gave this one five seconds, then developed it. This one was just right, and by using contrast paper it brought out the veins and texture of the leaf in a strikingly clean-cut manner.

Later I produced a similar effect with insect wings, sliced vegetables and skin shed by a water snake.



Silhouette of a dragonfly

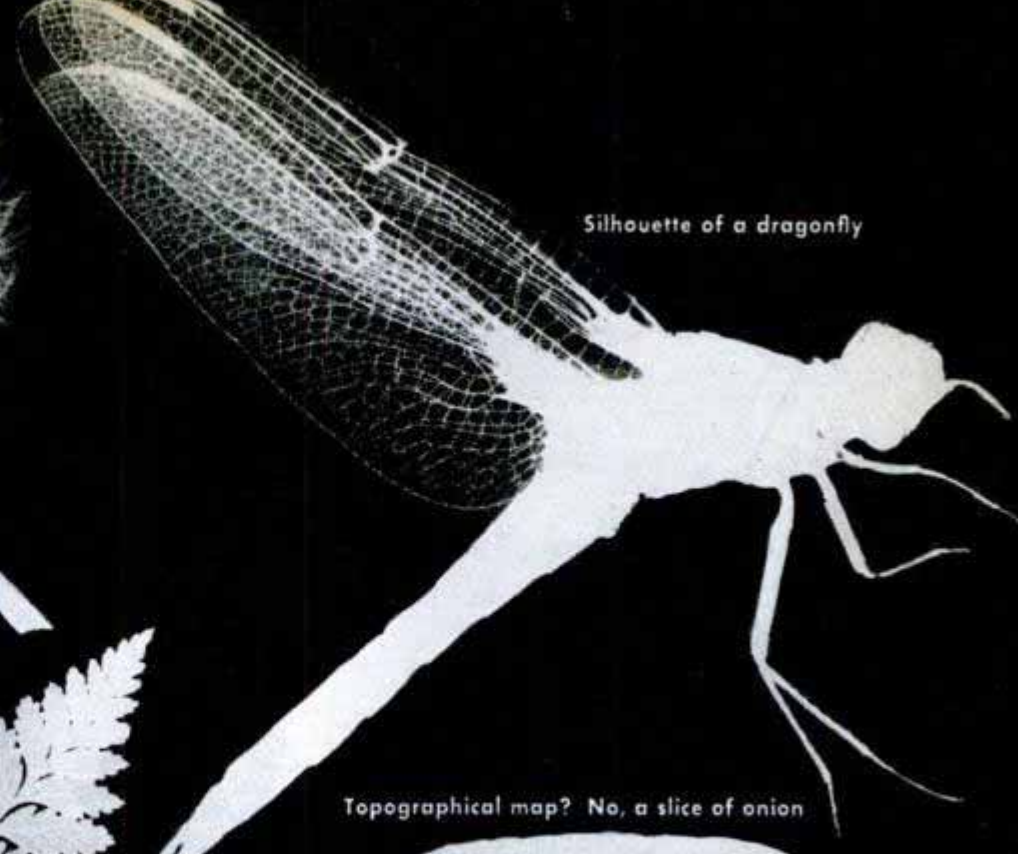

Photos of dandelion (above) and fern reveal delicate structures

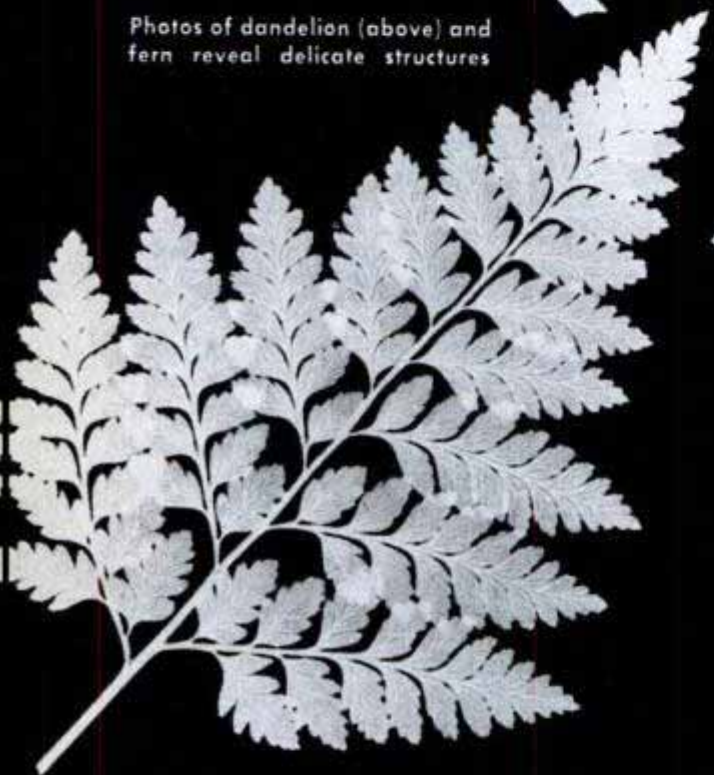

Topographical map? No, a slice of onion



An "X-ray" of a water snake's skin



Portrait of a maple leaf

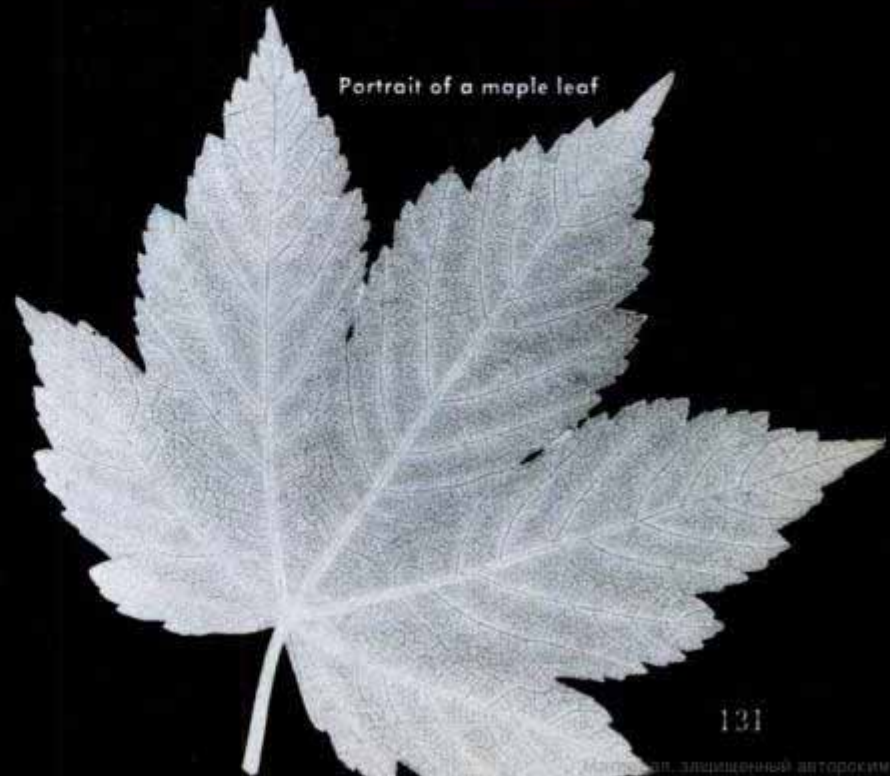

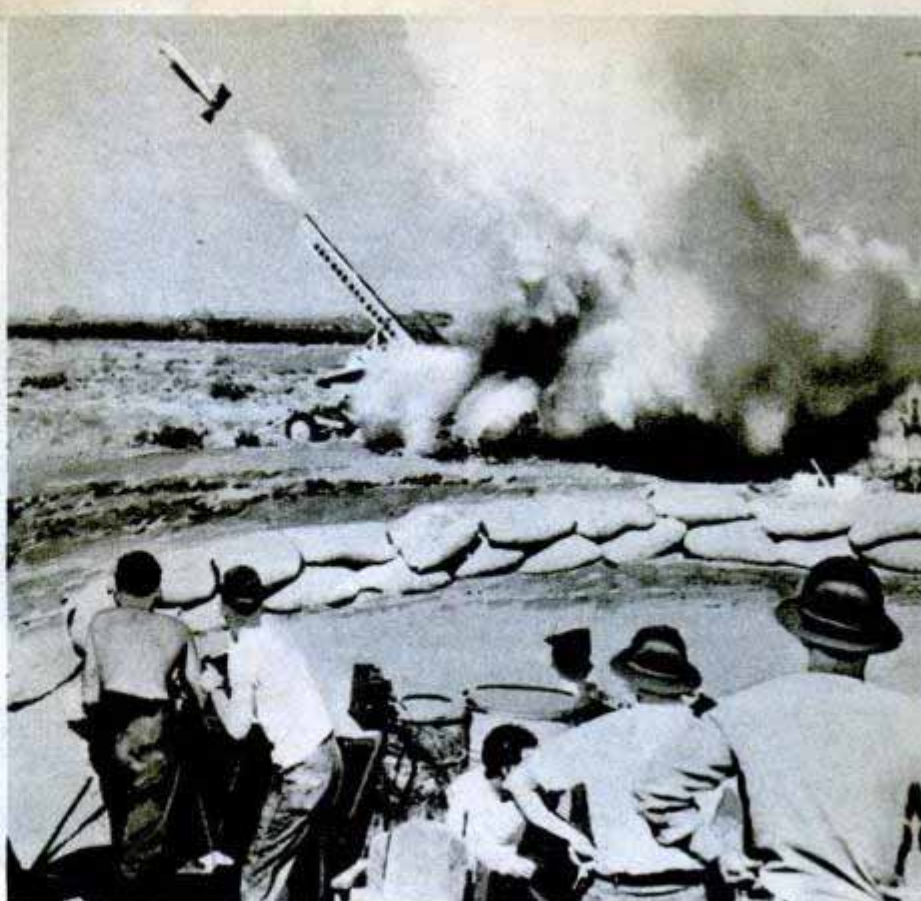
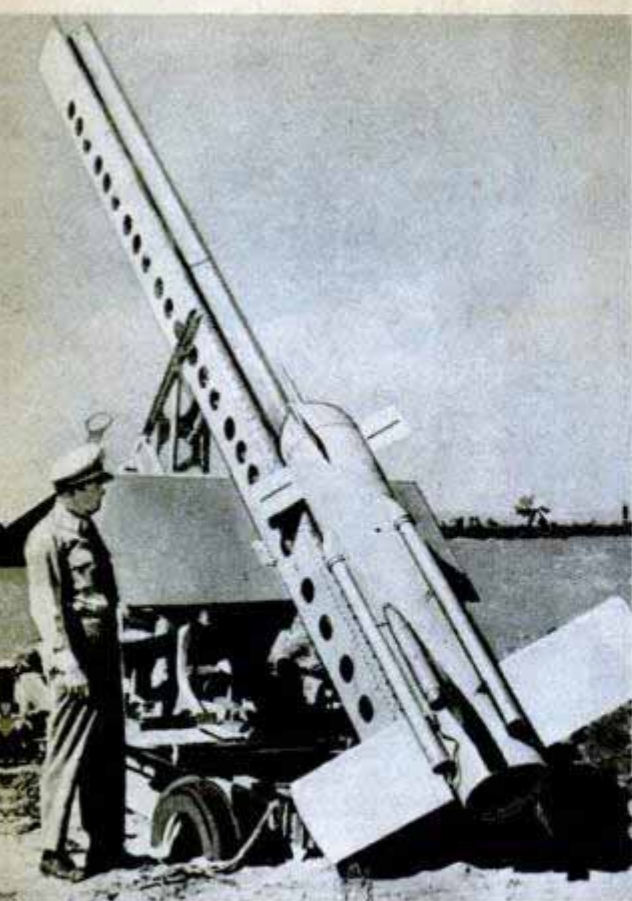

One of the many new developments in military weapons is the U. S. Navy's "Little Joe," a radio-guided missile for launching from shipboard. It was recently tested in

Radio Steers Navy AA Rocket

the desert at Mojave, Calif. The rocket weapon was designed for use against attacking aircraft. No details of the missile's construction have been revealed.

Processing Rack Keeps Work at Hand Level Despite Weight Changes

Self-leveling racks are designed to increase production by maintaining work to be processed at a convenient working level despite changes in weight as the material

is handled. Items to be processed are placed on a rack to the left of the operator. Finished work is dropped into a similar rack on the right. Trays in the left rack automatically rise to working level as the rack is emptied.

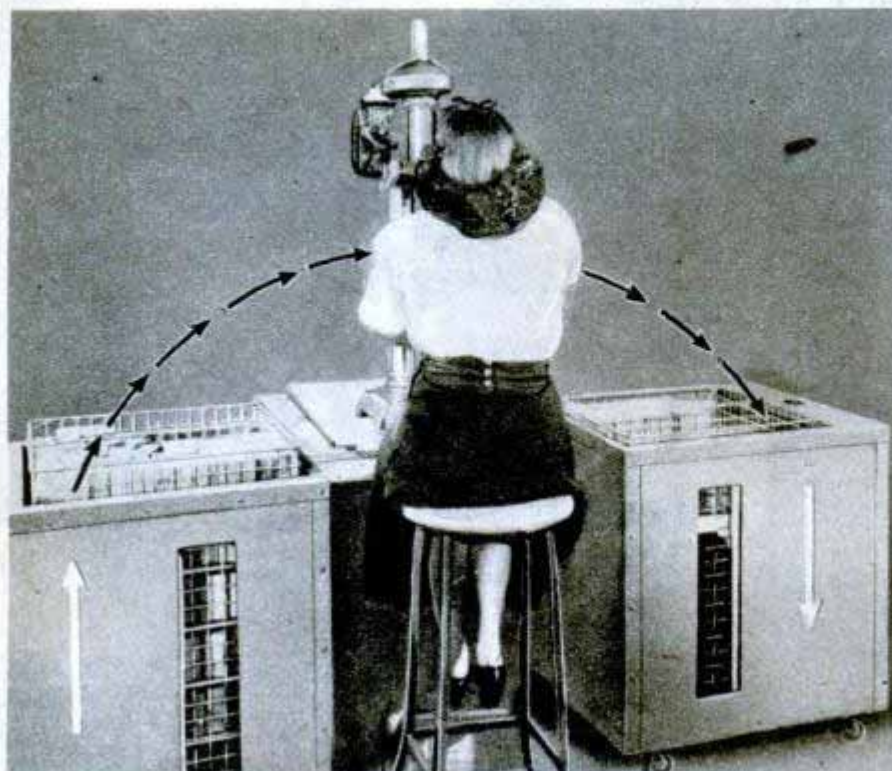

As finished parts are placed on the rack at the right the trays are depressed by their weight. Springs built into the racks actuate the trays. When a rack is filled it can be wheeled away on its casters and used for storage. Reloading is accomplished by placing material on the platform, where it automatically finds the proper level.

Ⓢ Electric current to light an automobile fog lamp for an hour or more is developed by a tiny storage battery weighing only a few ounces and small enough to be held in the palm of the hand.



Showman Turned Inventor

REMEMBER Arthur Hammerstein, the theatrical producer who staged 31 consecutive musical comedy hits including "Rose Marie"?

Today, white haired and 73, he has graduated from the show business to an inventor's workshop that would be a midwinter night's dream to any hobbyist of mechanical bent.

This "cathedral" of shops is one of the busiest spots on Hammerstein's 300-acre dairy farm near Chicago—the place he calls "Headacres Farm." Within its tool-lined walls he spends hours, night and day, repairing electrical and mechanical equipment and inventing things, such as a salt shaker that never clogs.

Interest in mechanical contrivances was first displayed by Hammerstein when, as a boy of 13, he took a job setting type at his father's

With a superworkshop as his "stage," retired theatrical producer Arthur Hammerstein now invents things. At top he inspects a wind indicator, shown next to an electric glass cutter. Right, expansion drill he designed

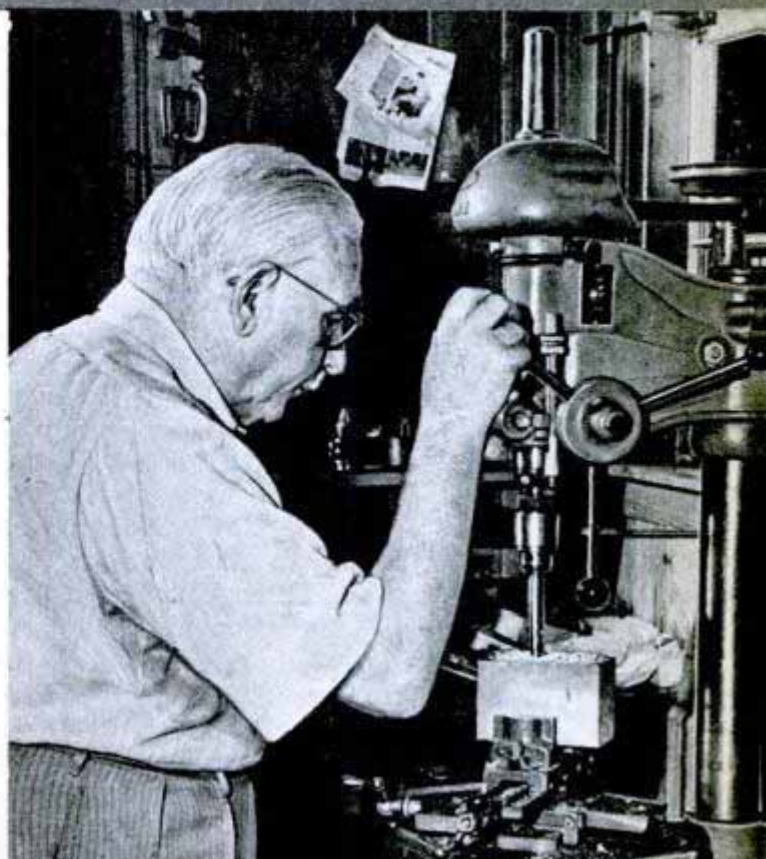

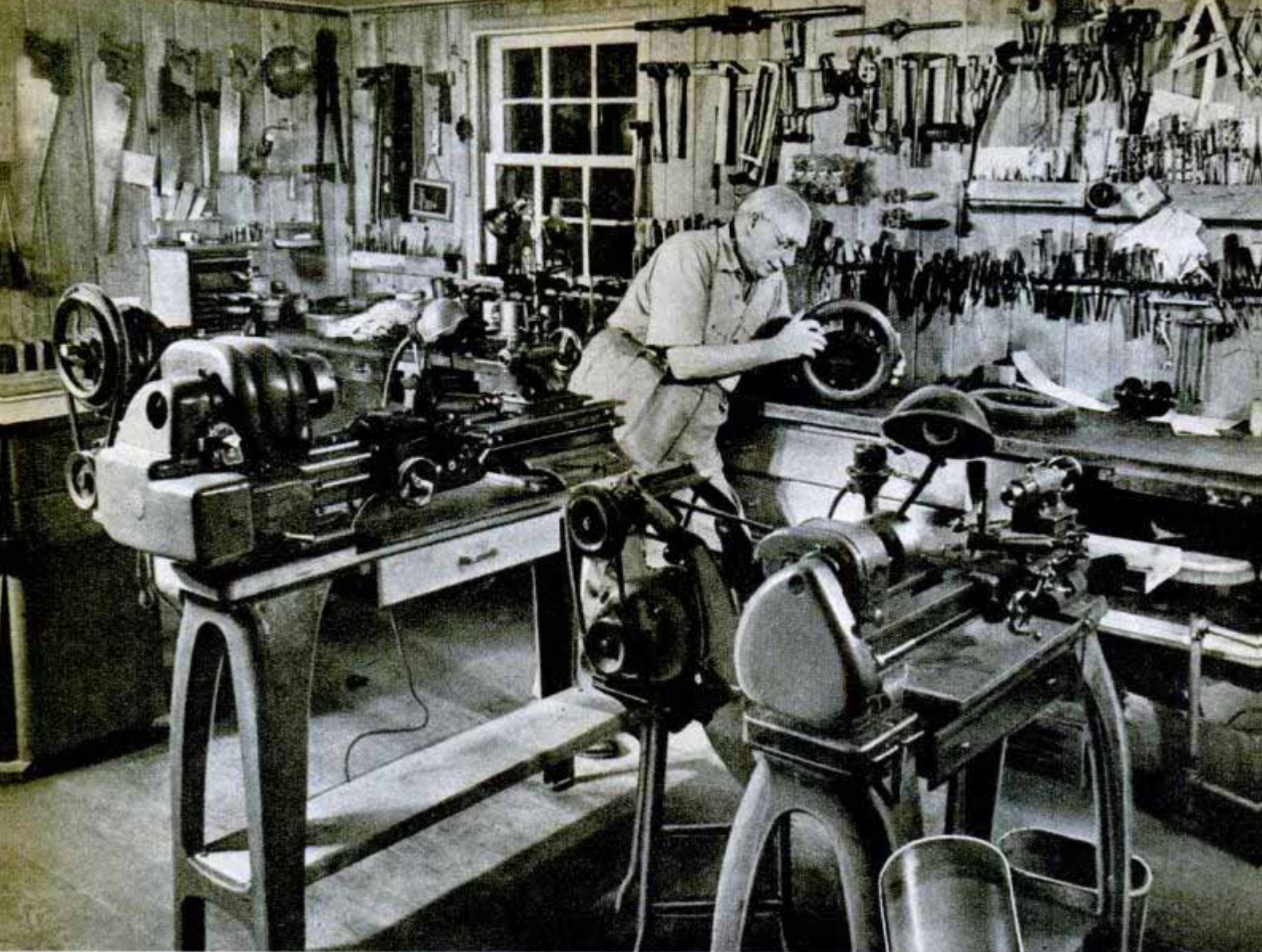

Hammerstein keeps all mechanical devices on his dairy farm in top shape. Here he adds a rubber tire to the wheel for a new milk truck

U. S. Tobacco Journal in New York. The father, Oscar Hammerstein, who later was in show business, had a machine shop that provided Arthur's first education with tools.

While still in his teens Arthur also learned plastering and brick laying and became construction superintendent when his father built a number of theaters. About this time, Arthur's theatrical "blood" took charge and he jumped into show business and put aside his mechanical inclinations for almost half a century.

Now that he's retired, Hammerstein has returned to his first love. He spends many hours in his workshop which contains \$4000 worth of tools. Every conceivable kind of hand tool hangs ready for use, such as 18 pliers of various types and sizes. In the power tool line he has two drill presses, two lathes, circular saw, band-saw, planer, polisher, sander and grinder. There are delicate gauges to check the accuracy of his work and stop watches to clock the revolutions of shafts.

Hammerstein sometimes gets up in the



A push on the knobs of Hammerstein's never-clog salt shaker (above and below) and salt pours out freely

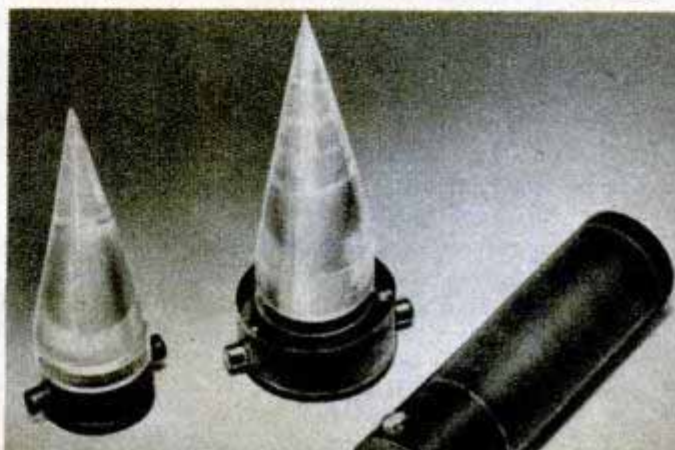



Hammerstein's wife, Dorothy Dalton of the silent movies, takes charge of the animals

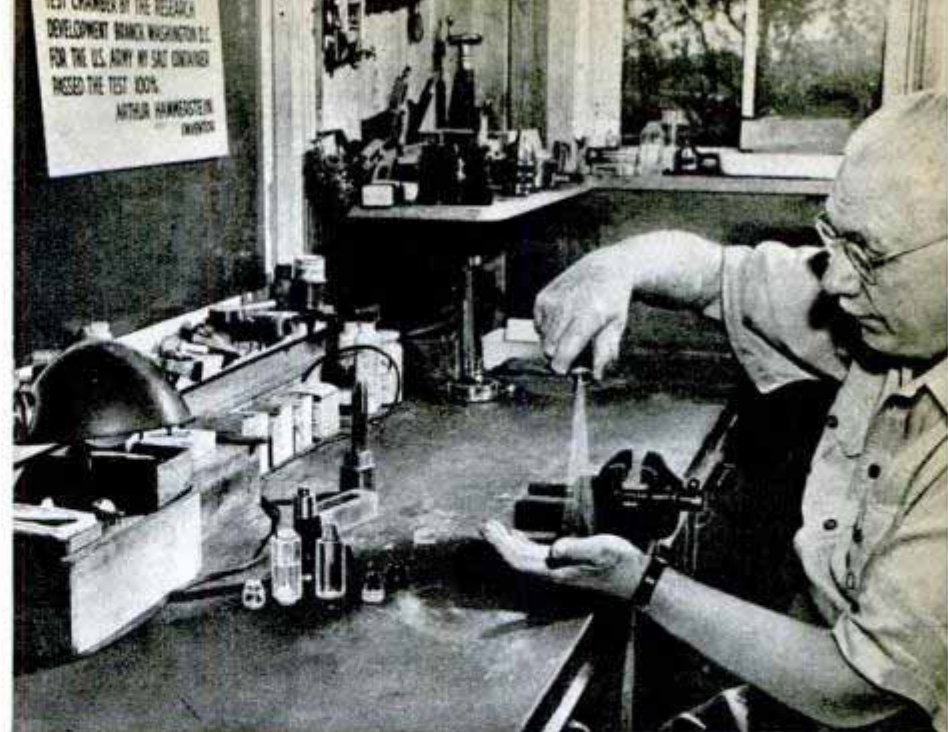

The clogless salt shaker, demonstrated here by the former producer, has a rubber valve which prevents moisture from entering

middle of the night and rushes down to his workshop to start experimenting with an idea for an invention.

One night recently he hit on an ingenious scheme to build a wind indicator that would reveal—in the living room—from what direction the wind was blowing.

He hopped out of bed and worked until dawn. Then he took a nap and went back to work. In a few days he had built a complicated instrument equipped with electrical contacts, which he proposed to erect on the roof of his 20-room house. Next he made a circular dial with holes punched in the top in which he planned to install electric lights that would glow to indicate the direction of the wind.

When his wife (Dorothy Dalton of silent movie fame) learned of his plan, she said, "No, I'm not going to have holes chopped in my living room ceiling just so you can hook up a thing to show where the wind is coming from."

Thus died a Hammerstein invention.

But the former showman has come up with one invention that promises to be a real success.

It's a salt shaker that permits no moisture to reach the salt and consequently never gets clogged. Key to the shaker is a tight-fitting rubber valve which opens only when two knobs are pushed. With the valve closed, no moisture can reach the salt as it does in the ordinary shaker. The container is of transparent Lucite, a material Hammerstein likes to use. A Chicago firm is manufacturing the "pinch-o-salt" shaker which is considered a natural for lunch boxes and picnic baskets.

Hammerstein, proud of his clogless salt

(Continued to page 256)

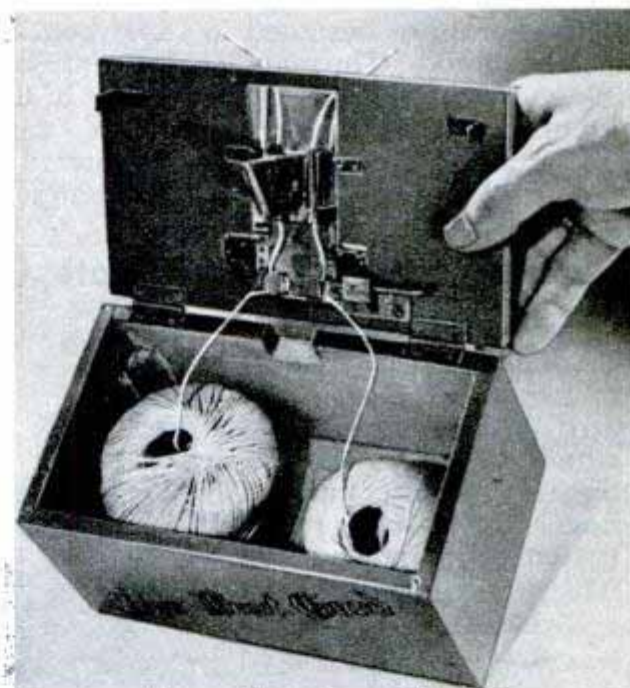

Another invention by the gentleman farmer is a twine cutter which uses a razor blade to snip the cord. Named "The Lost Cord" by Hammerstein, the device actually prevents lost cords by a snap-up spring

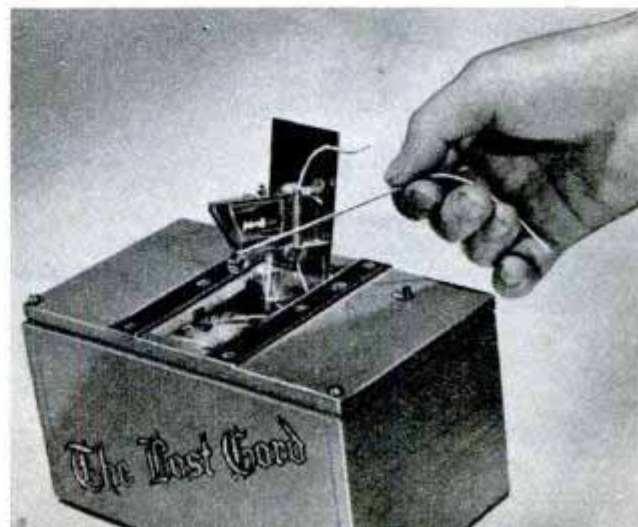

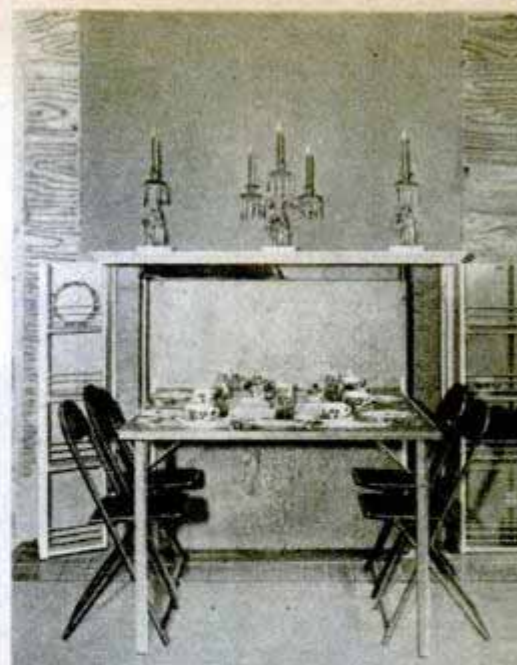
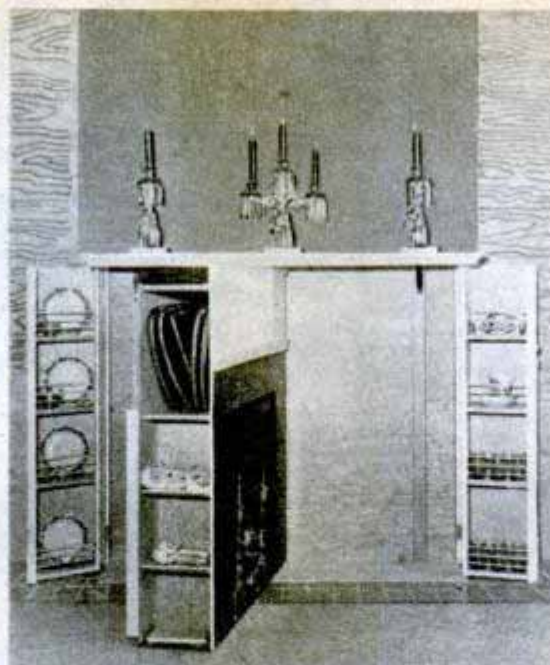
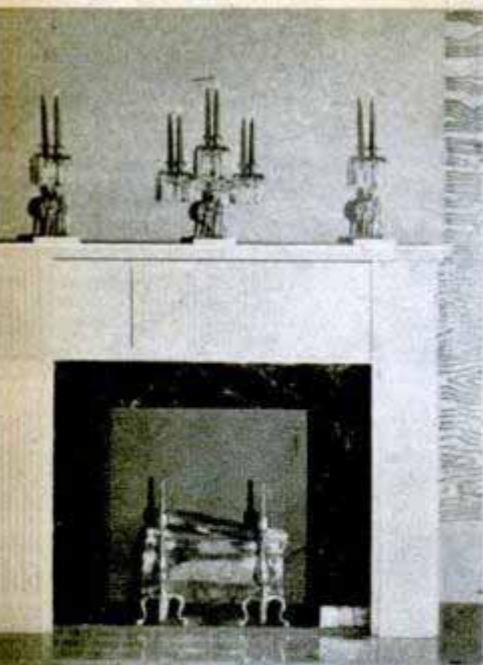

Decorative mantel, left, opens out to reveal storage space, center. Complete dining set is shown at right

Distinctive mantels that can be converted into dining tables with chairs are designed to save room in modern homes. The mantel is conventional in appearance with an electric outlet in the fireplace for installation of a bulb to simulate a fire. When the fireplace is rotated it reveals a compact storage area complete

MAGIC MANTEL

with four to eight folding chairs.

A 42 by 46-inch table lifts away from the mantel and is supported on four folding legs. Two outlets are provided above the table for electric appliances. The open mantel also reveals eight end shelves that provide extra space for dishes, linen, silverware and other table service.

One Finger Plays Four-Note Chords With Keyboard Attachment

Playing the piano is simplified by mechanical fingers which play three and four-note chords when touched by a single finger. The mechanical fingers are attached to the bottom of a plastic box which fits over the keyboard. On the top of the box are eight numbered white keys which are operated in accordance with numbers on sheet music.



House Moved on River Barge

Cut into sections, a house near Rumson, N. J., was floated 2½ miles by river barge to its new site. Two small boats towed the house and barge to the main channel of the Shrewsbury River where it was picked up by a river tug.

Names and addresses of manufacturers of new products featured in this issue will be supplied promptly by the Bureau of Information, Popular Mechanics, 200 E. Ontario, Chicago 11.

Giant 20-Seat Helicopters Are Planned for Air-Bus Line

Use of helicopters carrying from 12 to 20 persons is planned by Greyhound Lines in setting up nationwide air-bus service. Tests have been conducted at Detroit with four-place helicopters landing within 100 feet of highway intersections where buses stood ready to take on passengers, mail and light freight. Further trial flights will be made with the four-place helicopters until larger models are available. Residents of small towns and cities not served by air service are expected to be the principal users of the air-bus service



which also will provide feeder service for air lines. Approximately 80 bus lines have filed applications to operate helicopters.

Door Mat With Revolving Brushes Removes Shoe Dirt

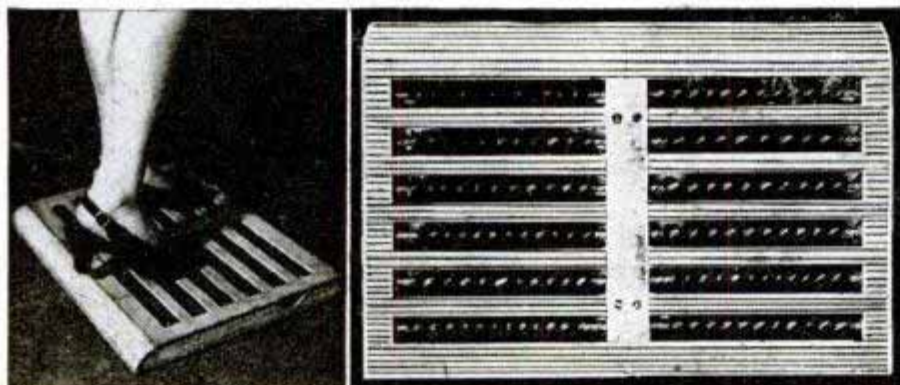

Twelve revolving brushes on a door mat wipe the dirt off shoes and deposit it in a tray beneath the unit. When the tray is full the top section of the mat can be removed and the tray emptied. The brushes permit a wiping motion without tripping. All the parts except the brushes are of aluminum.

"Elevator" on Bread Trailer Loads 645 Loaves a Minute

One man can load a 33-foot truck trailer with bread in 20 minutes with an electrically operated winch and ramp. This loading apparatus unfolds from compartments beneath the trailer. After the loading, the remote control switch is disconnected and the winch and ramp are returned to their compartments.

Freight planes equipped with a dry-ice compartment, a blower and sealed cabin are making cross-continental test flights with perishable shipments of gardenias and orchids to test the practicability of refrigerated planes.



Platinum on Four Feet

Don't expect to get rich overnight raising chinchillas. One fur coat may sell as high as \$35,000—but the entire jackpot doesn't go to the farmer



Chinchilla litters are small—one to three animals—with weight at birth only two ounces

RAISING the world's most valuable and luxurious fur is a back-yard hobby with scores of people who started with a couple of chinchillas each and now have herds worth more than \$20,000.

It takes only half an hour a day to care for several dozen chinchillas. Pens tucked away in the garage or along the garden wall shelter the fabulous animals. Feed bills are insignificant—only two dollars a year per head, as the balls of fur consume only a couple of ounces of food daily. Yet their pelts are worth from \$10 to \$75 with prime skins bringing \$100 or more. But

don't think you can make a fortune overnight raising fur coats—a chinchilla farm has many a drawback.

Chinchillas are strange little animals that look like squirrels who wanted to be rabbits. They originally breathed the thin air of the high Andes in South America. Native hunters almost killed off the species before M. F. Chapman captured 11 specimens in 1923 and shipped them in his private stateroom to the United States. All 20,000 or more chinchillas in this country are grandchildren, several times removed, of this handful, plus a few later importa-

Favorite food of this expensive ball of fur is a raisin

Popular pastime is scurrying along an exercise wheel

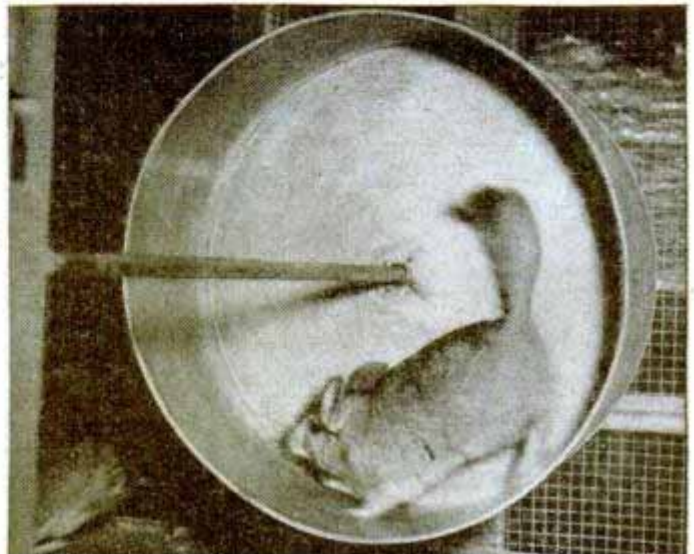

tions. Ten years ago a dozen people raised chinchillas. Today about 300 own valuable herds.

You can make money raising chinchillas with a minimum of time and trouble, but it takes more than a few dollars to get started, and you won't get rich overnight. Cheap breeding stock is worthless. A pair of prime breeding animals costs \$800 to \$1200. Five or six years from now your herd may become profitable. Then you can look forward to a steady income of several hundred to several thousand dollars a year.

Chinchillas breed twice a year and produce one to three offspring per litter. This multiplication rate has led to extravagant claims that one pair of chinchillas will multiply into a large herd within a few years. Actually, conservative owners figure on no more than a 100 percent increase in desirable animals per year. They cull out the poor specimens instead of keeping them in the herd.

Raising chinchillas in captivity is still a young industry. Owners have made most of their money by selling top quality animals as breeding stock to new chinchilla farmers. Few animals have been killed for the value of their pelts and most of the skins that have been marketed have come from nonproducers, undesirables or casualties. That's the reason why good chinchilla fur is practically unobtainable and explains the fantastic prices that have been charged for the 30-odd chinchilla garments that have been manufactured to date. A full-length chinchilla fur coat made up of 180 to 200 skins has sold as high as \$35,000.

Now, with the herds built up to comparatively large numbers, more animals are being killed for their pelts. Several thousand pelts will be auctioned in 1947. Owners expect prices to drop shortly and perhaps stabilize eventually at \$25 to \$50 for the better grades of skins.

Lower prices will mean more

Chinchilla fur, prized for its luxuriant softness, durability and rarity, makes the world's most expensive coat. A single chinchilla garment once sold for \$35,000





Milk formula is fed to baby chinchilla with eyedropper

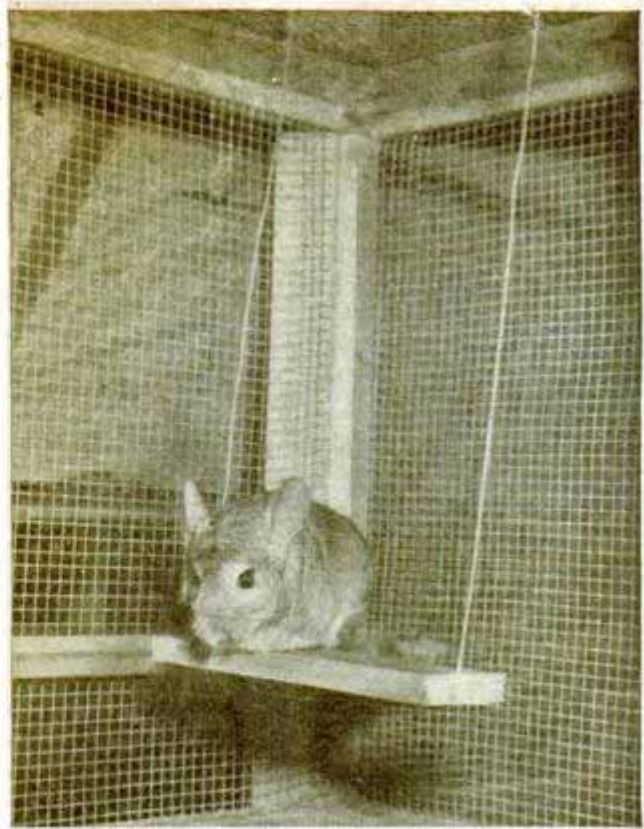

Frisky animals like to play on swings in their cages

money, the chinchilla ranchers agree, for chinchilla will be able to compete with fox and mink on a much wider market. Possibly within a decade the price of chinchilla garments will sink to a low of \$3500! But by the time the market price for skins is down the chinchilla ranchers expect to have bigger herds to boost their income.

Small back-yard chinchilla ranches are scattered throughout the United States and Canada. The hardy little animals will thrive practically anywhere. They should be protected from the sun in hot weather and insulated with wood-floored nest boxes in subzero weather.

A typical small rancher, Dr. George E. Davis of Pasadena, Calif., started in 1940 with a single pair and now has a herd of some 40 animals, exclusive of the animals he has sold to cover his initial investment. He also serves as secretary to a group of nine other chinchilla breeders.

Some of the earliest entrants into the chinchilla business have long since passed the hobby stage and are now large commercial enterprises. Chapman Chinchilla Farms, Inglewood, Calif.; Fur Farms, Inc., Gardena, Calif., and R. E. Hughes, Idaho Falls, Ida., all have more than 1000 chinchillas each in their farm pens.

Baby chinchillas are born with their eyes open, fully furred and active. They weigh no more than two ounces at birth, nurse for about 50 days, and attain an average weight of 22 ounces within four months. They are ready to reproduce within a year to 18 months. If a chinchilla is not to be used for breeding it is usually killed at 10 months when its fur is in prime condition. Chinchillas have amiable dispositions, thrive under intelligent care, are odorless and free from parasites.

Chinchilla fur is highly prized both for its rarity and certain basic qualities that include beauty, softness, thickness and durability. The body

The comparison between a human hair and that of the chinchilla, showing from 80 to 100 hairs growing from a single root. This very unusual hair structure makes the chinchilla fur more dense and yet lighter and more luxurious in texture than any other fur

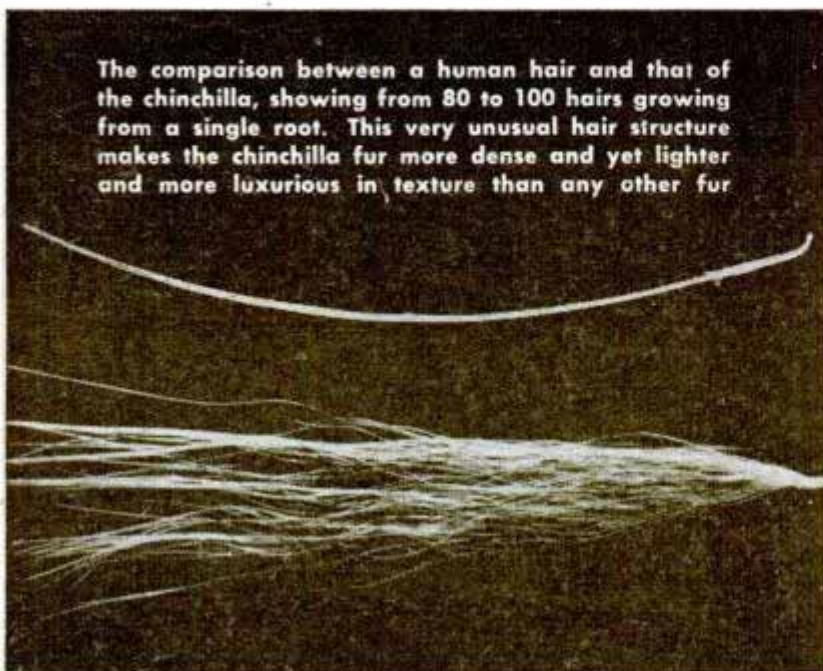



A fortune in fur is tacked to the board and held by the owner. Prime pelts bring as much as \$100 apiece

of the fur is blue-gray, with a pearl-white bar just below a black tip. It has never been imitated successfully.

Other fine furs such as fox and mink are made up of one hair per follicle but a single chinchilla follicle sprouts as many as 100 hairs, all of extreme fineness, giving the fur density and luxuriant softness. The fur is so soft that most people actually can't tell when they're touching it with the palm of their hand. Visitors at a chinchilla farm who doubt this statement are asked to close their eyes, lower a hand, palm down, on a chinchilla pelt, and open their eyes the instant they feel the fur. Surprisingly, they find that their hand sank a quarter of an inch into the fur before they noted contact.

Chinchillas ordinarily are housed in wire cages or pens about 2½ by 5 feet in cross section, 18 to 24 inches high, with wood or wire floors. Being seminocturnal, the animals spend most of their time in the dark nest boxes, one of which is placed inside each pen or is attached to the side of the pen. A wooden nest box with a wire floor may measure 12 by 18 by 12 inches. Chinchillas enjoy exercise and some owners place small swings and exercise wheels inside the cages for their use.

Feed consists of grains and large seeds, plus hay, bean or carrot tops, or even a few

green weeds. Prepared pellets similar to rabbit pellets are also available as food.

Good money can be made in the chinchilla business but beginners need sound advice in getting started. When fox and mink farming enjoyed its first boom about 20 years ago many enthusiasts who plunged into the new occupation were disappointed when the breeding animals for which they had paid high prices proved to be poor, unproductive specimens. Many owners failed, too, because they didn't learn the rudiments of animal care and management.

Purchasers of chinchillas can have the same unfortunate experiences unless they

Large nest boxes attached to the wire cages provide sleeping quarters

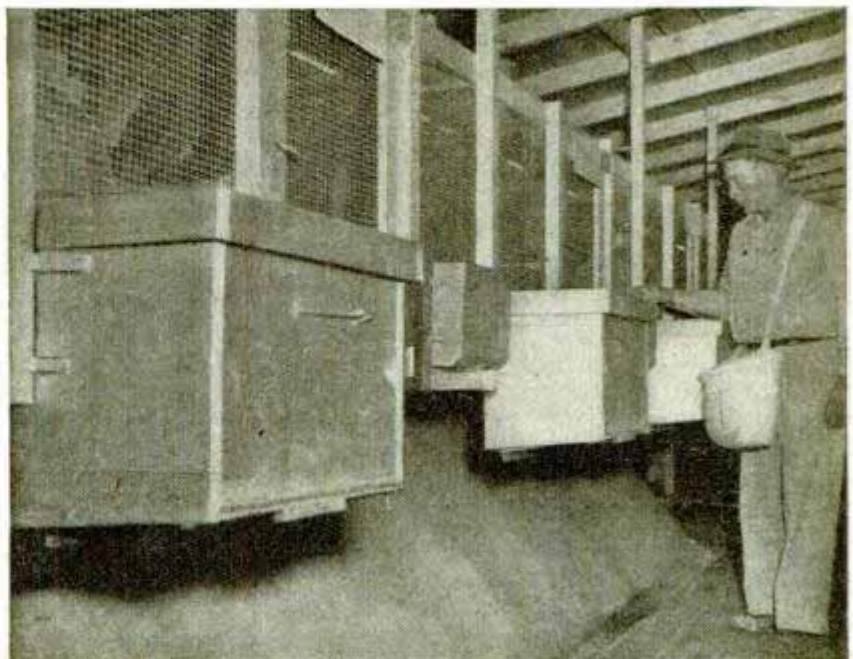

NATIONAL CHINCHILLA SHOW
3003 118 First ave
SALT LAKE CITY, UTAH



Owner examines some of his prize animals that were shipped by airplane

take sensible precautions. Only 25 percent of the chinchilla population ranks as first-class breeding stock and an untutored purchaser needs help in making sure he is getting sound stock for his money.

Probably the best advice is that he should deal with a well known, reputable ranch where others have made satisfactory purchases. He should expect to receive a pedigree with his animals, which is no guarantee of quality in itself but should show that blood lines have not been crossed. Reputable ranches also issue a warranty with the provision that if a pair of animals proves to be nonproductive they will be replaced free with another pair of like quality plus the average increase in young. Some ranchers are adopting a scoring system by which their animals are individually judged according to general appearance, clearness of color, luster and texture of fur, and other points based on the preference of the fur trade.

Most large ranchers advise that prospective purchasers spend from several days to two weeks at the ranch before they take home their new animals. This is the best way to learn the methods of housing, feeding and general care. Mating must be carried on according to hereditary laws and accurate records must be kept of the blood lines of all the animals so they can be mated to produce the largest litters of the most desirable specimens.

Chinchilla owners have their own national magazine with articles on successful breeding and raising of the little animals. Some owners who live in the same community have also organized clubs.

The future of all kinds of fur looks optimistic. The United States imports millions

of dollars worth of fine furs every year. Hundreds of thousands of pelts are taken from domestic trapping and ranching annually. Most fur ranches are a steady source of profit to their owners. There are 2800 mink ranches alone in the United States. Ranchers receive an average of \$20 to \$25 per mink pelt. These facts may indicate a similar future for chinchilla ranching.

Like fox and mink, chinchillas that are raised in captivity have pelts that are vastly superior to those taken in the wild state. Plenty of food, controlled conditions in captivity and intelligent management have produced larger, heavier animals with longer fur of better coloring and quality. Chinchilla pelts today are running 12 to 13 inches in length with an occasional 15-inch skin, as compared with the 10-inch pelts of the original chinchilla importations.

That platinum sheen in a chinchilla's fur can mean money in the rancher's pocket. But the novice faces a big initial investment and he'll have a good many headaches unless he knows the tricks of fur farming.

Each pelt is carefully tacked to dry before tanning. Ranchers test the quality of the fur by blowing on it

Each pelt is carefully tacked to dry before tanning. Ranchers test the quality of the fur by blowing on it



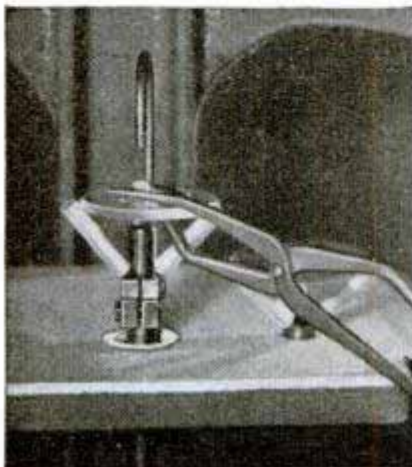

Spectacle lenses are accurately hardened in an automatic electric furnace and cooling chamber in about the same time it takes to soft-boil an egg. Hardened lenses are approximately 16 times stronger than untreated lenses. The auto-

1330-Degree Heat for Lenses Increases Strength 16 Times

matic unit, developed by Bausch and Lomb, weighs 264 pounds and

operates at a temperature of 1330 degrees Fahrenheit. The unit raises the lens into the electric furnace, heats it, cools it and lowers it from the cooling chamber.

Spring-Powered Fish Catcher Sets Hook Automatically When Fish Bite

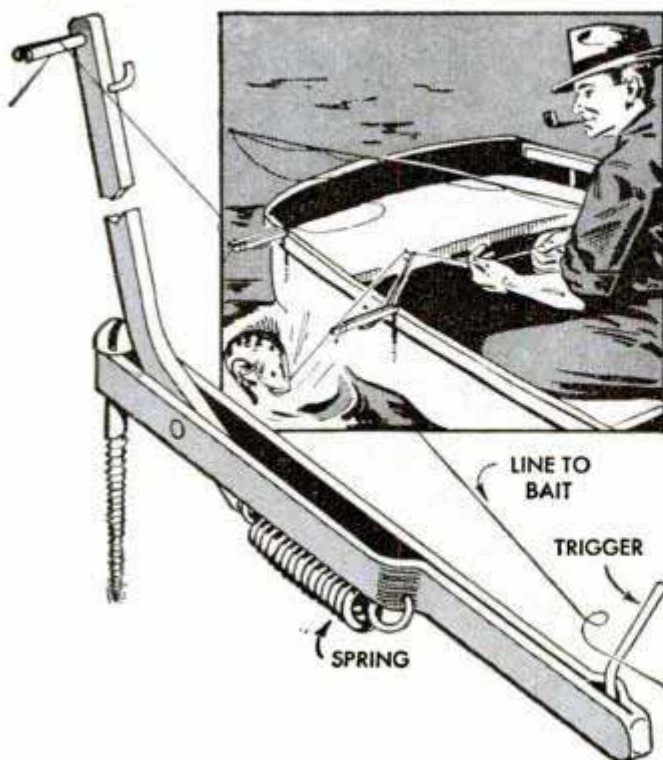

Fishermen can take life easy with a new fish catcher that sets the hook automatically. The catcher is a four-inch lever with a spring on one end that is screwed to the boat or dock. The lever is cocked by forcing it down against the pull of the spring and fastening it with a free-swinging trigger pin. The line is passed through a split pin and looped around the trigger. When a fish bites, the slightest tug releases the trigger. The lever then flies back, jerking the hook to set it.

Scented Oil Taken From Grass Perfumes Toilet Soap

Grass provides the delicate scent of many perfumed toilet soaps. In Guatemala, lemon grass and citronella, also used as an insect repellent, are being raised in quantity for their scent. This is a comparatively new industry in America. Most of the world supply formerly came from the Far East.



Talking Mountains



Motorola Radio photos

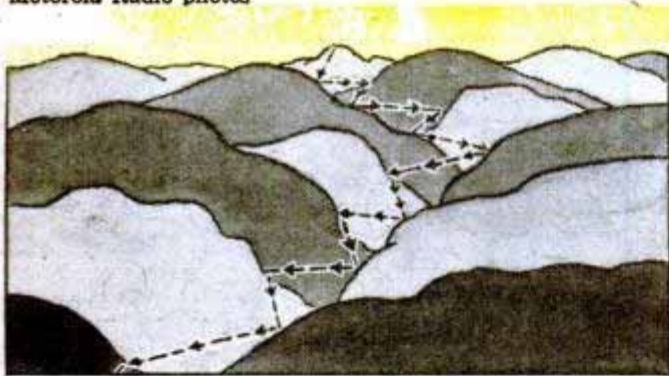

Officer speaking into the "mike" can beam his voice across the roughest terrain, even bouncing it through historic Deadwood pictured above. The sketch shows how the beam ricochets between the sides of valleys

TWO mountains that once looked down on the roaring gun battles of Wild Bill Hickok and other characters of the Old West have joined the police force to become "officers" in a police radio system that blankets the South Dakota Black Hills.

This radio blanket isn't woven in the same pattern as conventional police radio systems. Messages for high-frequency police radios are usually piped by phone lines to transmitters that can reach line-of-sight to patrol cars. But the messages sent to and from the mountain tops skid along on "Yagi" beams, zigzagging through gullies and bouncing off sheer cliffs. The path of the beams is definitely not line-of-sight. The message actually ricochets across the

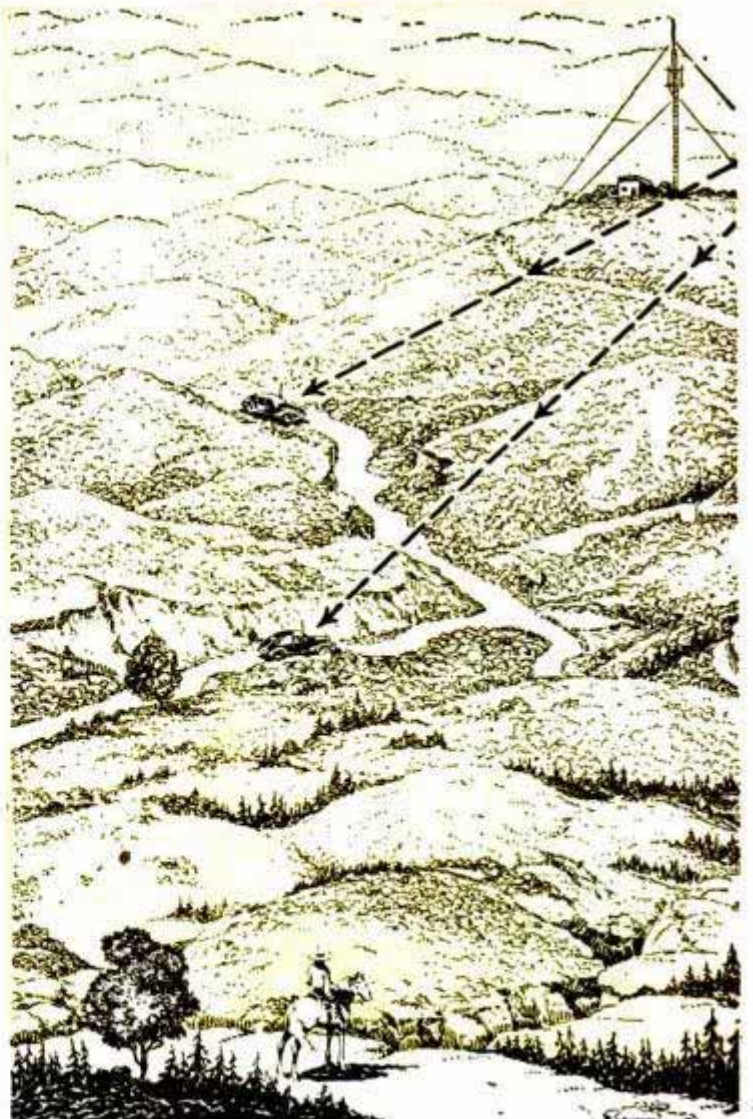

rough terrain from one station to another.

Here's the way the system works. Atop Mt. Terry's 7070-foot mass and Mt. Coolidge's peak 50 miles away are lonely shacks that house unattended radio transmitters. The system's headquarters is in Pierre, the state capital, 173 miles east of Mt. Terry. Chief Agent Les Price of the attorney general's law enforcement division can sit comfortably in his office and transmit a message that tightens a road net around any part of the state.

When a police officer at Pierre sends out instructions, the message is automatically picked up by one of the two top-of-the-mountain stations. The message itself "triggers" a receiver that kicks on a relay transmitter and the orders angle off on the second leg of their journey.

Rapid City subheadquarters, about midway between the two mountains, is next to pick up the message. There the instructions are interpreted and orders are sent, via the mountain tops again, to individual patrol cars.



Switches on these panels control 500 pinpoint lights on a wall map to maintain a visual check on each patrol car's position

It's the transmission across the rugged area between the mountain tops and Rapid City that's unique. Mountain masses, jagged cliffs and deep gullies are obstacles that stand directly in the path of the radio beam. Line-of-sight transmission is im-

(Continued to page 248)

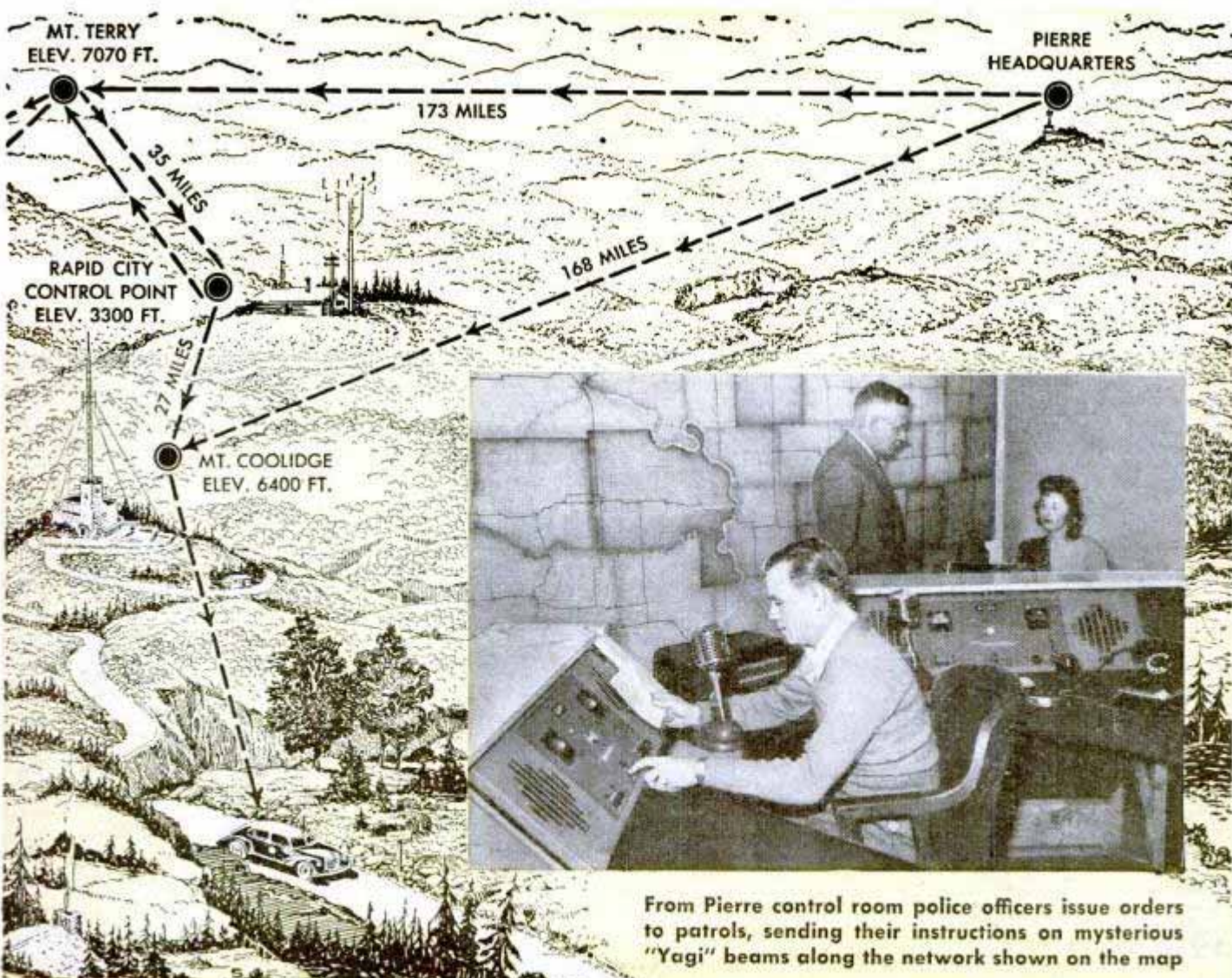

From Pierre control room police officers issue orders to patrols, sending their instructions on mysterious "Yagi" beams along the network shown on the map



Some Boston women keep their hats in refrigerators, which really isn't strange because the hats are decorated with real orchids and other costly flowers. Florist Elynor O'Neil designs the blooming bonnets and sells them for \$10 to \$75, depending on the number and rarity of the flowers. The

"ICEBOX" HATS

flowers are chosen to be in their best bloom on a birthday, wedding anniversary or some other special occasion. When not being worn, the hats are kept in refrigerators to preserve the freshness of the blossoms for perhaps six wearings. Foundations are of felt covered with maline and veiling.

Extension Hood for Cameras Aids in Picture Composition

Stray light is kept out by an extension hood which aids in focusing or picture composition with reflex-type cameras. The hood folds flat when not in use and can be

carried in the pocket or camera case. It fits many types of reflex cameras. Use of the hood makes it possible to see the ground glass more clearly while shooting the picture from waist height.



Lubricant Is Floated on Air In Form of Dry Powder

Finer than face powder, a new lubricating powder is applied by squeezing the sides of its bellows-type container. The lubricant is light gray in color and therefore does not soil hands or clothing like black graphite. It does not freeze at 40 degrees below zero and withstands heat up to 6300 degrees. Because the powder is so fine it will float in the air, it works into many places that conventional lubricants cannot reach. Squeezing the sides of the container ejects a small amount of powder in a stream of air.



It does not freeze at 40 degrees below zero and withstands heat up to 6300 degrees. Because the powder is so fine it will float in the air, it works into many places that conventional lubricants cannot reach. Squeezing the sides of the container ejects a small amount of powder in a stream of air.

More than 700 different languages are spoken in Africa exclusive of dialects.

Trick Photos of Girl Tennis Player Give Illusion of Action

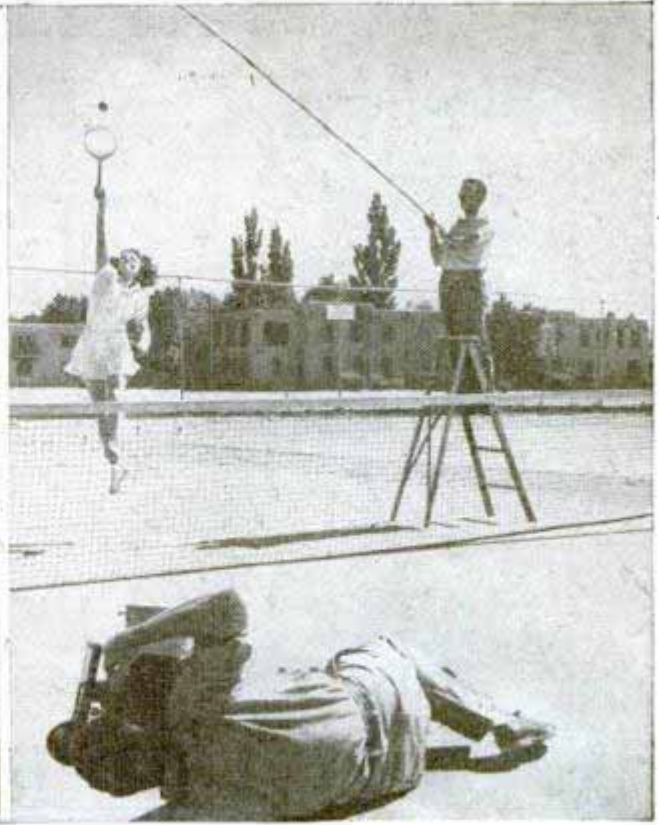
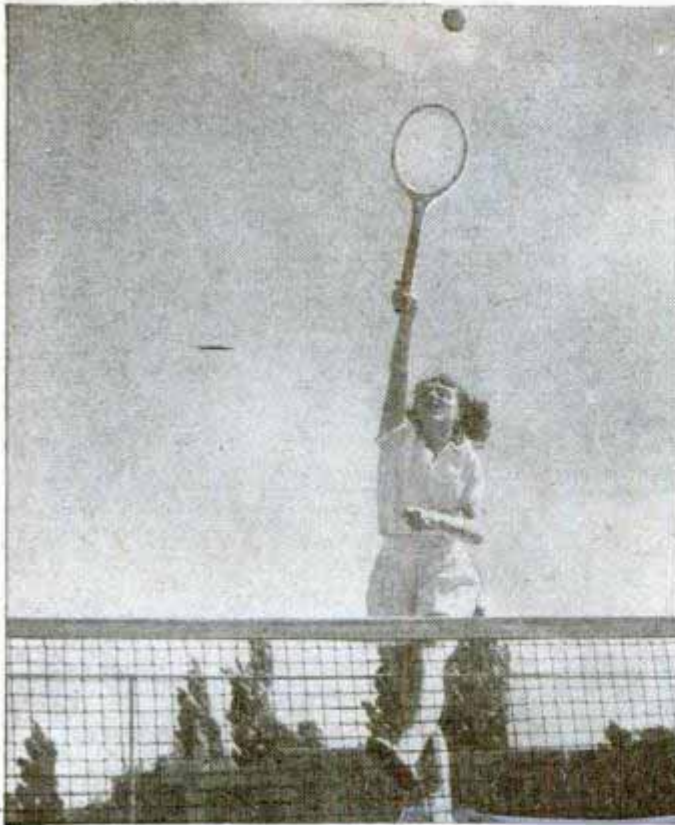

By planning the "action" in advance a photographer can give the illusion of movement in still pictures. For a photo of a girl tennis player smashing at a drive, Dale Britton, of Albuquerque, N. Mex., needed

an assistant, a fishing pole and a length of string. He tied the ball to the fishing pole and his assistant dangled it into the picture area while the girl leaped into the air and swung her racket as if she had hit it.

Semiwaterproof Paper Bags Will Hold Contents in Rain

Bags made of "wet strength" paper will absorb the moisture on wet vegetables or cold beverage bottles without splitting. They will hold their contents safely even when drenched with rain. The paper is made by treating the paper fibers with chemicals which impart extra strength

when wet. Seams of the bags are sealed with a waterproof adhesive which can remain in water from four to 48 hours without losing its grip. Some "wet strength" paper bags, fitted with Cellophane windows, are being used for prepackaging moist fresh vegetables at produce markets.

Motorcycle Ambulances Designed for Rough Terrain

In England motorcycles have been redesigned to serve as ambulances in places where poor roads would make it difficult for the usual first-aid vehicles to operate. They can be driven by one man, at speeds up to 60 miles an hour on highways.

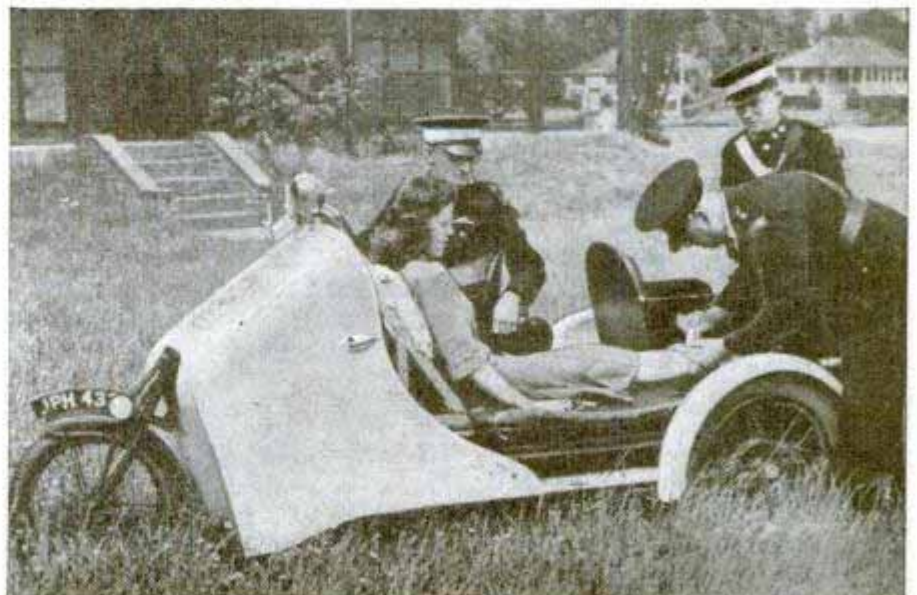

Names and addresses of manufacturers of new products featured in this issue will be supplied promptly by the Bureau of Information, Popular Mechanics, 200 East Ontario Street, Chicago 11, Illinois.

Will the Atom Drive Us Underground?

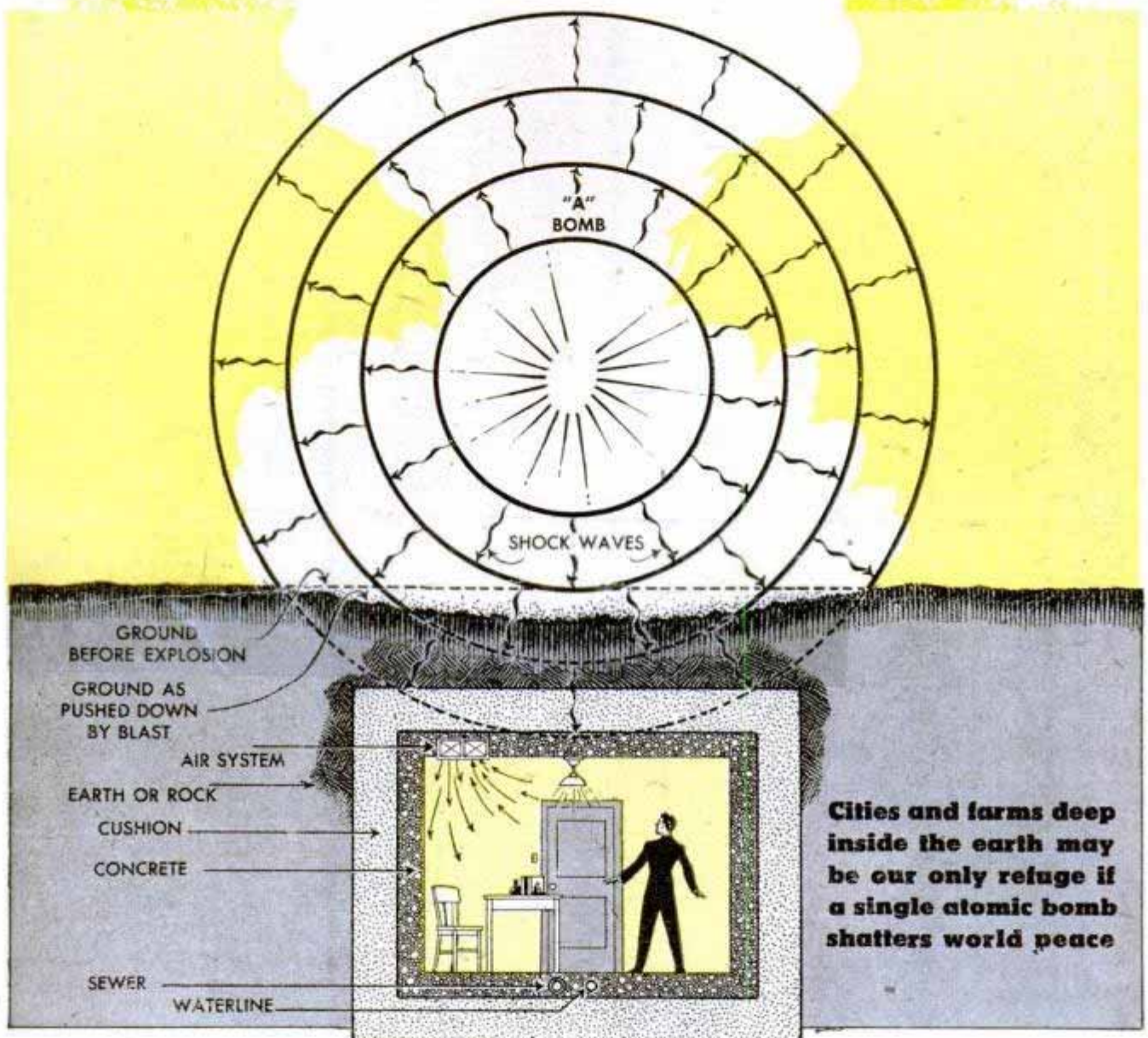

WOULD you like to live and work in a cave? **By John L. Kent**

The unhappy possibility that we might again become cave dwellers, fulfilling the gloomy predictions of sociologists and historians, was given a basis in fact recently.

The Army and Navy plan to move industrial and military installations underground in the event of another war because it might otherwise be impossible to defend them against enemy atom bombs. To obtain the same protection, Americans might live in caves close to the underground workshops.

The Army and Navy Munitions Board, charged with industrial mobilization in an emergency, has started a survey of under-

ground sites which might be used for long-term storage of

machine tools and war production equipment, and which, if necessary, may be adaptable in wartime for industrial production. Army engineers, working under the direction of a special "underground sites committee" of the board, are now cataloging underground areas and will grade them according to their various characteristics. Both natural caves and man-made caverns such as mines are being studied.

Production can conceivably be carried on in the caverns of many national parks. Carlsbad National Park in New Mexico, for example, has 45,000 acres of underground trails and rooms, some still unexplored.

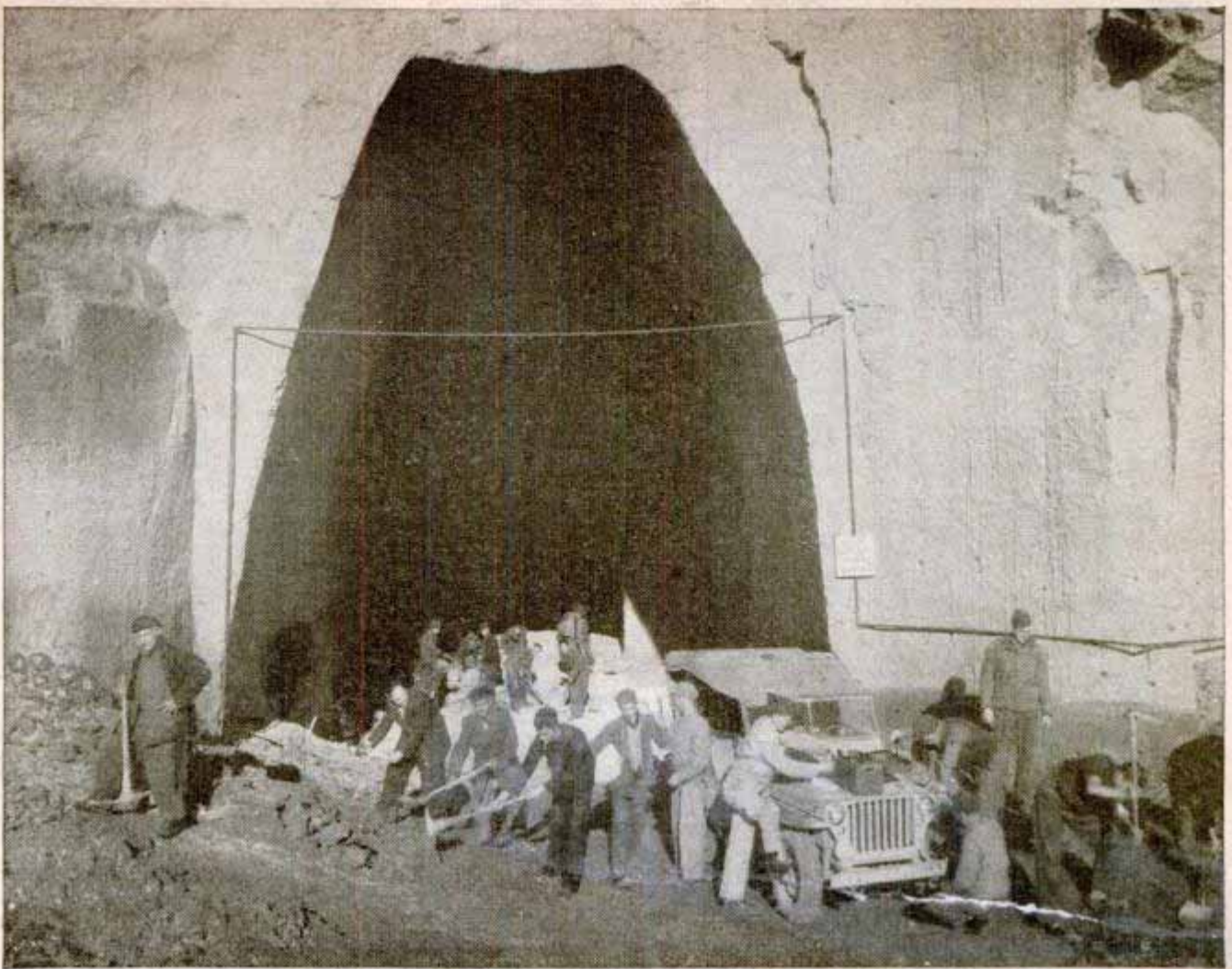

Dark entrance leads to huge cave that was home to 1000 Italian families during the war. U. S. Army equipment was stored there later. At right is a section of the underground assembly line of a German airplane engine factory. Below, concrete shields cover each machine in a synthetic rubber plant

There are also the nationally owned Mammoth Cave Park in Kentucky and Wind Cave Park in South Dakota. Then there are privately owned caverns kept as scenic attractions, such as the Howe Caverns in New York and the chain of caverns in the Shenandoah Valley of Virginia.

Using caves for storage is not new. The Europeans have used both natural and man-made caves for the storage of wine, beer and cheese for centuries. In the United States, a 15,000-acre cave near Atchison, Kansas, is a vast icebox for the storage of surplus food. Built for \$2,000,000 by the War Food Administration, the natural limestone vault can hold 52,000 tons of food. Three compressors maintain a temperature of about 40 degrees Fahrenheit.

Underground factories are not new either. Key factories of the

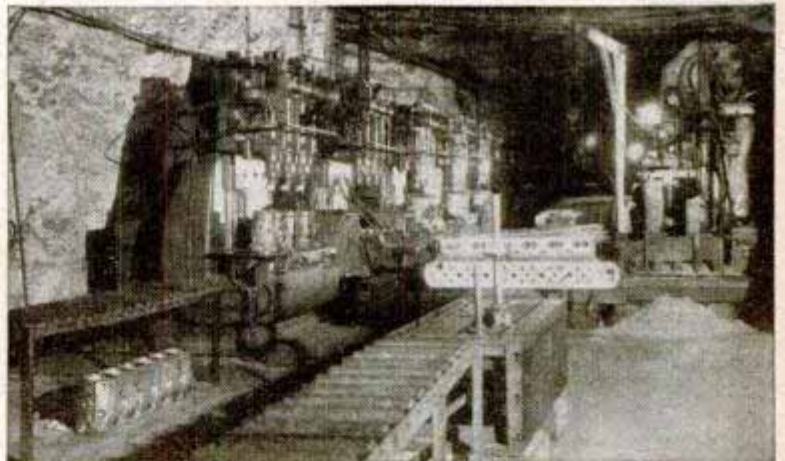



Caves along the Italian beach provided ideal shelter for invading GIs. The "bedroom" can be seen at the rear

German armament industry were dispersed in subterranean locations in France, Germany, Italy and especially in the former protectorate of Bohemia.

The British used underground factories,

Will these steps in Kentucky's Mammoth Cave some day lead to an assembly line? The cave has five distinct levels which afford living as well as working space



too. When war interrupted the London Underground extension, completed sections of the railway tunnel were used to house an aircraft factory.

In Riva, Italy, the Fiat factory produced airplane motors for the Luftwaffe in a seven-mile-long tunnel. Another factory, making JU-88 engines, was in an old stone quarry in the Mossbach area. It had a working area of 16,000 square feet. At Thil, France, an underground unit was making parts for flying bombs.

At Neuhof, Germany, a vast storehouse of ammunition, medical supplies and clothing in an underground salt mine covered some 64 square miles. In June 1946 an entire German wartime underground city was discovered in Polish territory. Consisting of nearly 80 miles of tunnels, it had its own power plant, electric railway with four stations, and water mains.

Underground dispersal by the Nazis had progressed to such a point that within six months after V-E day they might have been able to ward off the worst effects of our air attacks. The Germans admitted that they began to build these underground factories and depots too late.

U. S. investigators questioned former Nazi officials about the underground storage and manufacturing facilities, especially for making synthetic oil. Field Marshal Milch, former inspector general of the German Air Force, and Albert Speer, former Reich minister for armaments, stated they

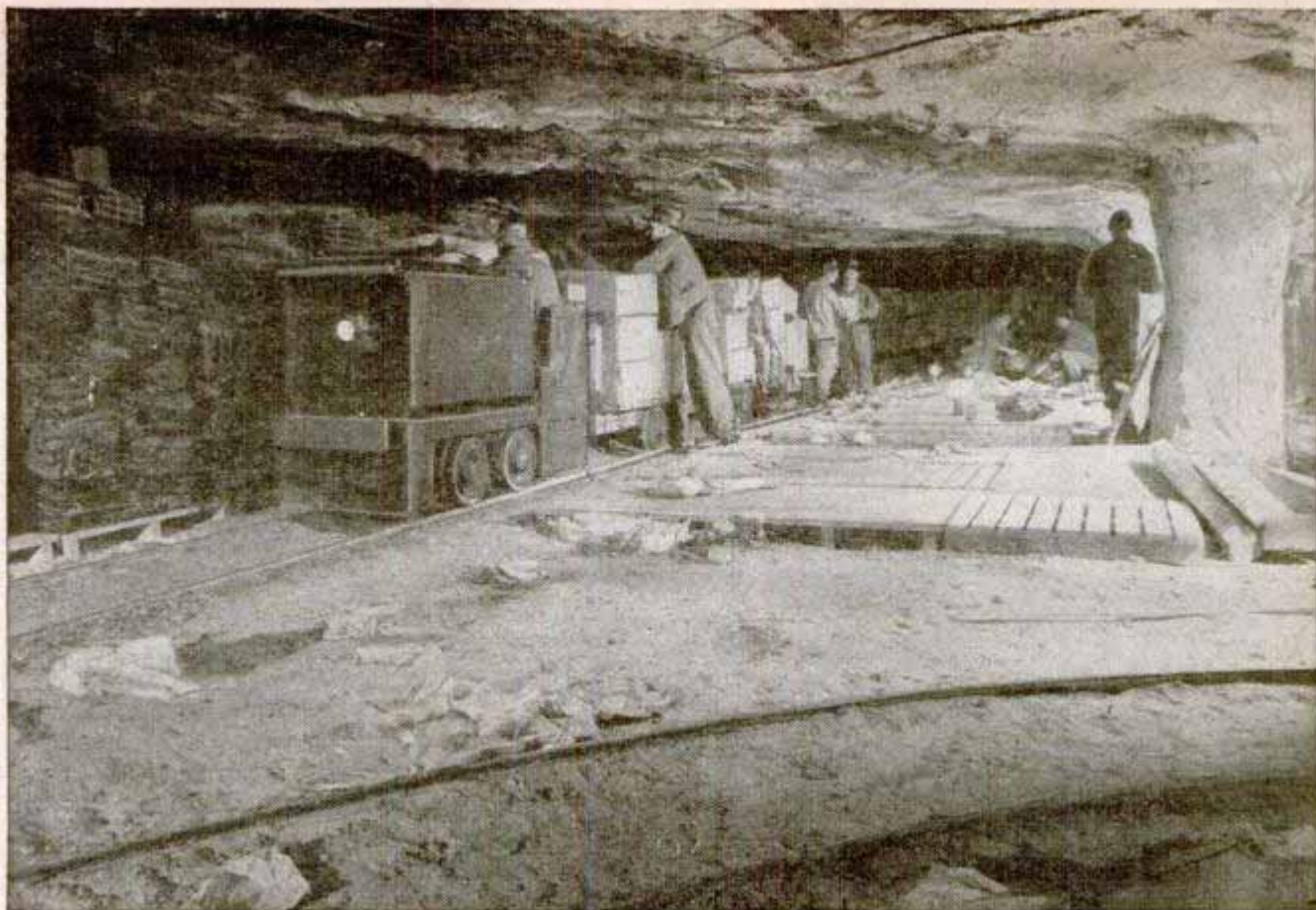

Vast stores of ammunition and supplies were cached by Germans in this 64-square-mile underground salt mine

had consulted competent authorities on the possibility of locating synthetic oil plants in underground sites, such as mines, but that difficulties involved were said to be too great. The synthetic oil plants were a prime target of Allied bombers. Finally, the Nazis decided to put the plants underground, and from October 1944 onward, SS troops were assigned to projects in the Nordhausen and Porta Westphalica areas.

The Germans believe they have solved the ventilation problem—a big step—because a synthetic oil plant gives off quantities of steam and smoke.

How underground storage of oil saved one third of the Germans' strategic reserve of this vital fluid was recently revealed by the Army and Navy.

Before the Normandy invasion, the Ger-

(Continued to page 240)

Natural limestone vault near Atchison, Kansas, covers 15,000 acres; holds about 52,000 tons of perishable foods



Auxiliary Engine for Soaring Plane Weighs 40 Pounds



Soaring planes, which depend on rising air currents to keep them aloft, can draw auxiliary power from a 25-horsepower magnesium engine weighing only 40 pounds. The engine is a four-cylinder, two-cycle, air-cooled, horizontal opposed type. Steel engines of comparable size and power weigh up to 125 pounds. Installed in a soaring plane, the engine is fed by a three-gallon gas tank, permitting its intermittent use for a total of an hour and a half at 65-mile-per-hour cruising speed.

Synthetic Plane Grease "Buttery" at 100 Below

Lithium-base grease mixed with a synthetic compound remains "buttery" at all temperatures between 100 degrees below zero and 300 above, providing efficient operation for such aircraft equipment as bearings, propeller governors, instruments, cameras and tiny radar motors. Light tan in color, the grease also is prepared in a form containing rust inhibitors for use where excessive moisture or salt sprays are encountered.

Steel Clamp Straightens Leaders Attached to Fishlines

Wire leaders for fishlines can be straightened easily with a rustproof device small enough to fit into a tackle box or pocket. The straightener is a stainless-steel plate bent until the two sides almost touch each other. Indentations on the ends guide the leader between the sides which are pressed tightly together. Bumps on one side with corresponding depressions on the other straighten the wire when it is drawn through the device.

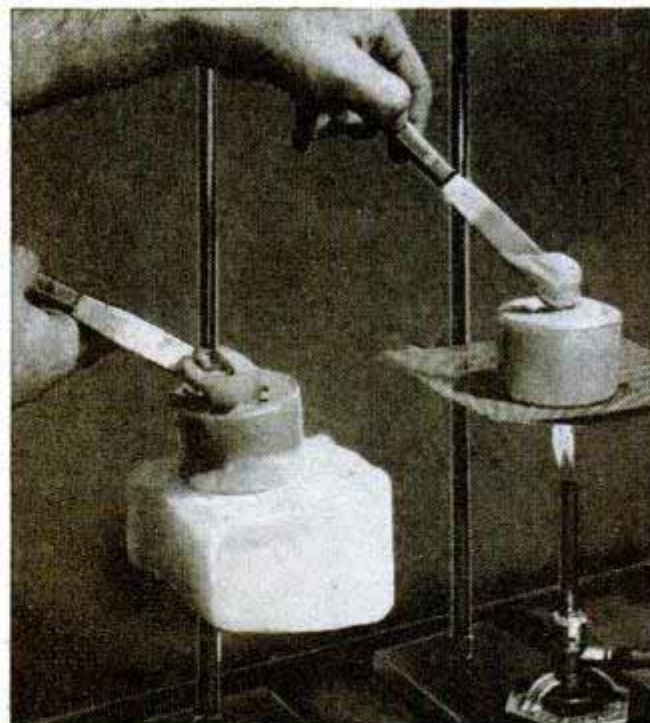
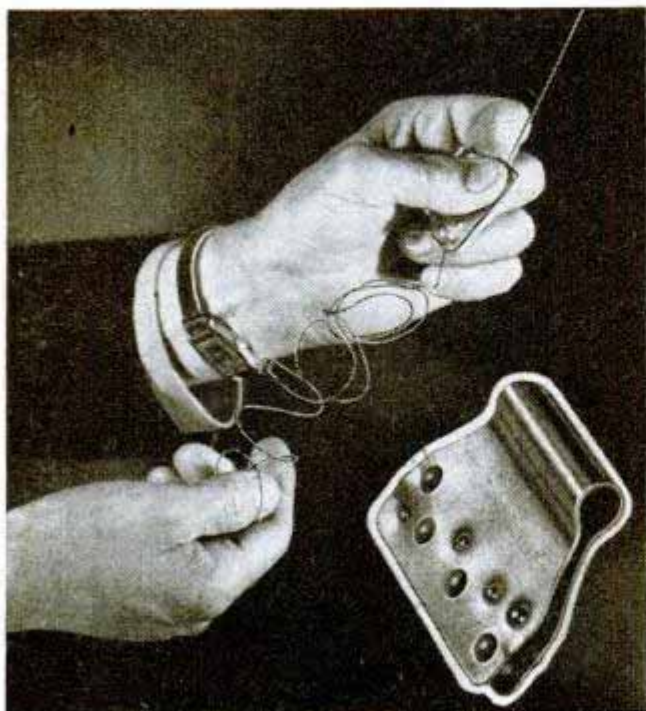

☐ Sheets of aluminum, preformed to interlock and fit over the 32,000 square feet of curved roof area of the half dome and barrel arch ceiling of the Cincinnati Union Terminal, insure a strong weather-resisting surface weighing only one twentieth as much as the former terra cotta tile roof.

The Dust Bowl is Restless Again

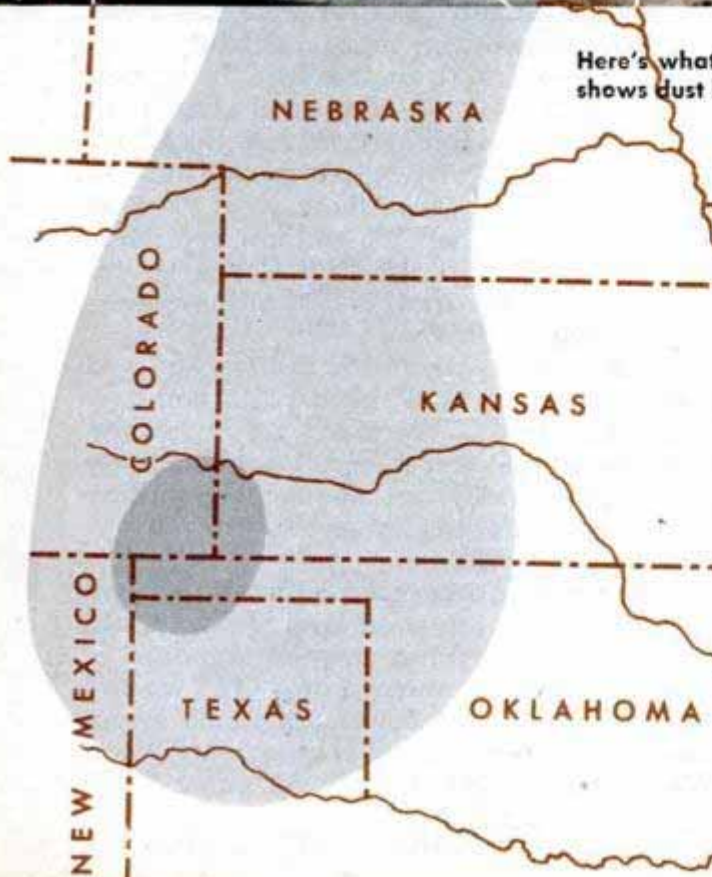

Here's what happens when 30-m.p.h. wind lifts lid from field. Map shows dust bowl and other areas seriously menaced by wind erosion

By Clifford B. Hicks

SOIL in the Great Plains "dust bowl" is growing restless again, like a runaway kid who's strayed from home once and wants to repeat his adventure. Strong winds swept topsoil by the inch off farm lands this year, leaving a wake of wasted fields. Black blizzards similar to the disastrous dust storms of 1934 and 1935 rolled across the Great Plains to dump their heavy loads miles from home.

Wind erosion this year was on a small scale compared to the scouring of great land areas in those bleak days of the dust bowl. But keeping the nation's topsoil at home is a recurrent problem. Conservation experts squint anxiously at capricious funnels of dust above the Great Plains farms and wag their heads ominously at



Contour furrows anchor this field in place and snag soil blown from the poorly protected field in the background

occasional storms that roll across southwestern states. These are warnings of a return to the dark days of the dust bowl.

Always short of moisture, the southern plains have suffered a serious drop in rainfall during the past year. Moisture conditions have improved in a very few localities, but in others the soil is dry and caked, in ideal shape to tag along with the wind. And the storms that swept across the Great Plains last spring climbed to mile-high altitudes in places. Aviation was hampered at Kansas City when visibility was reduced to a half mile. The winter wheat crop in Kansas and Oklahoma was threatened when tons of dust settled over the fields.

Three ingredients mixed in the dust bowl mean danger to farm lands—drought, high winds and loose soil. The farmers can't do a thing about the rainfall or the wind, but the soil itself is under their control. Use or abuse of the earth can keep the soil in its place or drive it far from home.

Experts blame the new dust threat on a minority of thoughtless farmers who are completing the same cycle that brought disaster after the first war. The world's

hunger again calls for all the crops that can be harvested. The farmer is sure of a market for all he can raise, and he can raise more by plowing up marginal land.

After the first war the farmer turned over 11 million acres of natural grass land and about 20 million acres of marginal land to plant crops. Further extravagant use to date has ruined 100 million acres of good crop land. Another 100 million are damaged, according to the Soil Conservation Service, and still another 100 million acres are eroding too fast.

We now have about 460 million acres of good crop land available in the country. That's all there is. We can't get any more. If we spend that soil we'll not only be broke but starving. All but about 72½ million acres of this total is subject to erosion unless it's protected.

Conservation experts point out that we can survive on the good land we have left, but we can't keep our present standard of living if we lose much more. Yet we are allowing about 500,000 acres to be swept away by some form of erosion each year. We give away this land at an annual cost

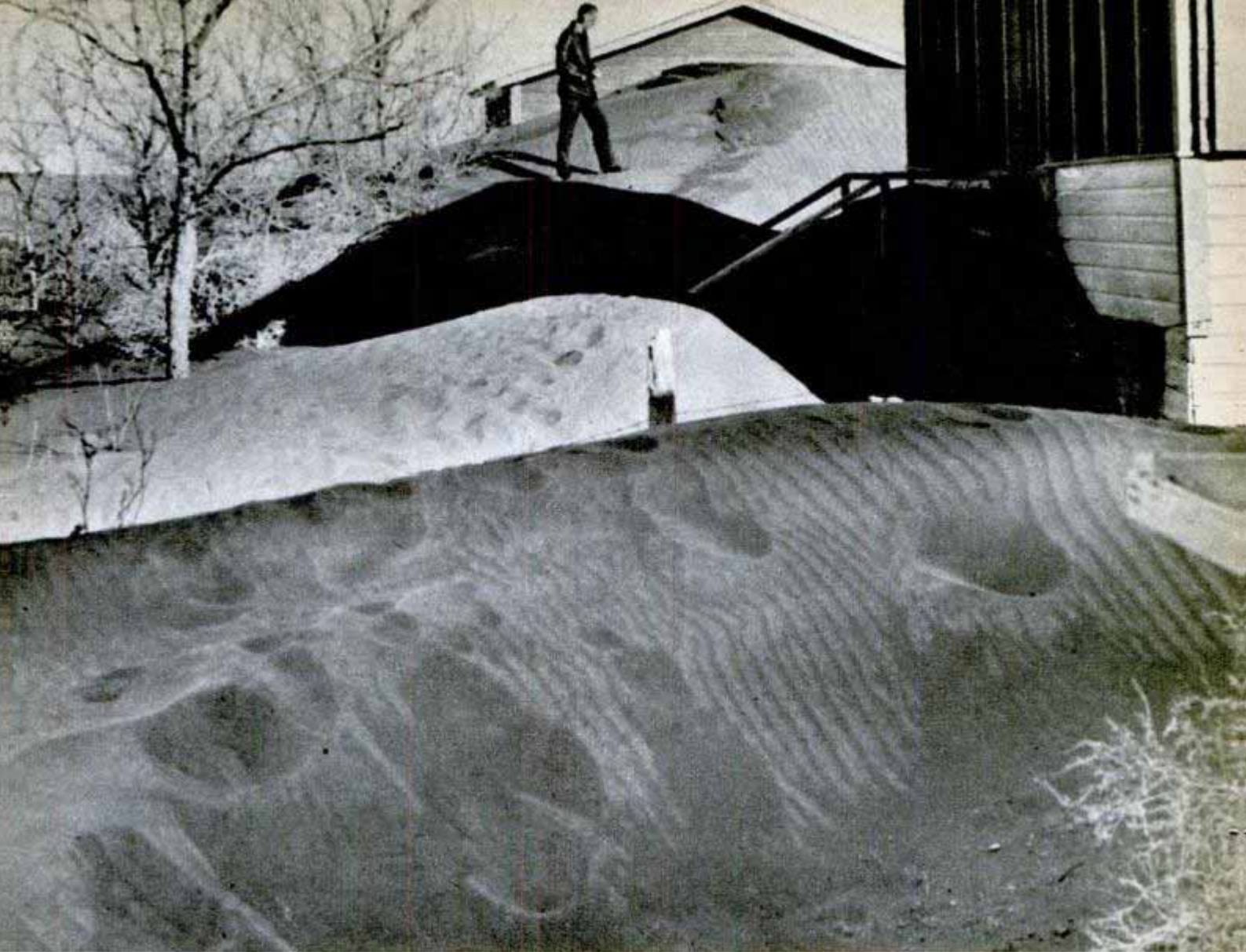

Drifts of dust 10 feet deep smother an abandoned farmyard. Right, a lonely tree held soil around its roots when the surrounding field was blown away

of almost four billion dollars—dollars that come from every taxpayer.

Wind-blown soil does not disappear. It does still more damage. Often it is dumped on neighboring farms or areas many miles away to smother acres of crops.

By plowing up thousands of acres of natural grass land to meet the war-born need for greater harvests, farmers are gambling with their personal prosperity as well as the prosperity of the country. Listen to Dr. Hugh H. Bennett, chief of the Soil Conservation Service:

“A dangerous trend, accelerated in recent years, is the plowing of additional range and pasture land for crop production. Wind recently has been whipping the surface soil off culti-

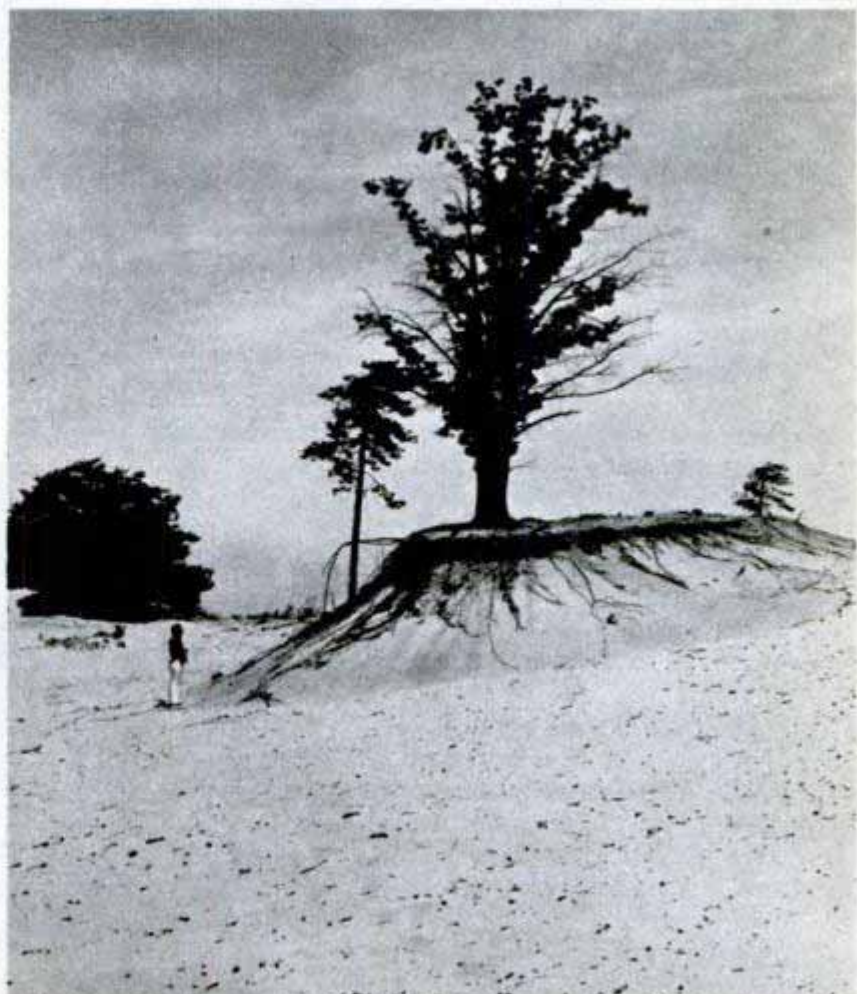

vated fields in areas of sandy and shallow lands not suitable to cultivation. In some cases the land has been sheared off down to the subsoil."

Soil can be eroded by wind or water a thousand times as fast as new soil is produced by the disintegration of rock. Wind erosion blows the mantle off the earth, leaving the ground naked and sterile. Soil-blowing is really a landslide with the force of the wind substituted for the force of gravity. The slide starts in a small way at various points, gathering momentum and size until whole field-tops move into the air in a murky cloud. That's why conservation experts are worried about the miniature whirlpools of dust that are rising from the fields today—they can grow to landslide proportions if the topsoil isn't protected.

Farmers learned quickly the methods of preserving soil when they saw their fields rise into the air and float away during the dust bowl days. They're gambling their land against increased production by lifting the lid from their fields again.

Landslides can't occur unless the land lies loose and unbalanced. The art of preventing the blowing of soil consists in keeping heavy nonblowing materials on the surface. Big chunks of earth cover a field that has been plowed properly in a wind-menaced area. Crops and crop residues are left above the surface to bind the soil together.

But when the soil does blow, it can be stopped only in the same way a landslide is stopped—by cross ledges that snatch part of the moving mass. That's why fields are cultivated in ridges, terraces and strips, and why wind-breaks are recommended.



Plow was abandoned at the end of a furrow just after this field was blanketed by dust from adjacent pasture land, plowed up for crop production



↑ Farm teamwork clears the "blow" dirt away from half-buried buildings

↓ Drifting sand has reached almost to the roof of this little farm home; fences have been torn down to permit the suffocating sand to blow away





When the government purchased the land, a cover crop of sudan cane and broom corn was planted. Next step will be revegetation with native grasses

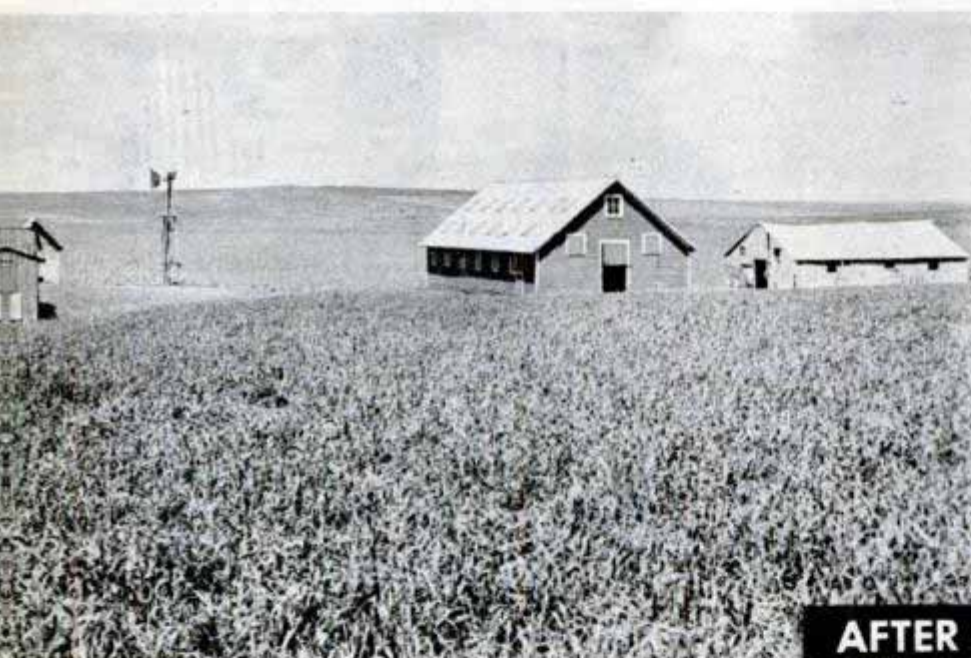

↑ Same farm made a comeback when plowed in strips and planted to barley

↓ An adequate cover crop was planted by the government. When the soil has been completely reclaimed it will probably be used as pasture land



Here are some of the ways the farmer can anchor his land where it belongs:

By plowing his fields in contours, he fits his furrows to the lay of the land. Rainfall is trapped in each furrow and soaks into the ground. The topsoil stays moist and strong to resist wind.

Terraced slopes hold the water on a hill like the rim of a saucer. The rain can't run off because low barriers have been built up to keep it from flowing away.

Strip-cropping—planting strips of close-growing grass or clover between strips of cultivated crops—keeps the soil moist and offers a barrier to the wind. The grassy plants hold water to feed the cultivated strips.

“Trashy cultivation” sounds like the way a lazy man would manage his land, yet it's practiced by the most progressive farmers. Also called “stubble-mulching,” it consists of leaving crop residues on the ground instead of plowing them under. These materials, such as grain stubble, straw and cornstalks, tie down the soil and protect it from baking and blowing.

Cover crops such as clover blanket the ground like a mat of hair. Fields can't be lifted by the wind when they're tied in place with millions of threads.

Irrigating drought-baked soil is another way man can conserve rainfall. Enough rain falls across the nation to provide sufficient water for most fields. Distributing it is the problem. Water-logged soil won't blow away, but it's difficult to move the water to some areas.

If land unsuitable for cultivation is planted to hay the farmer protects neighboring fields. Shelterbelts and windbreaks

(Continued to page 256)

TINY TOWN OF PLASTICS

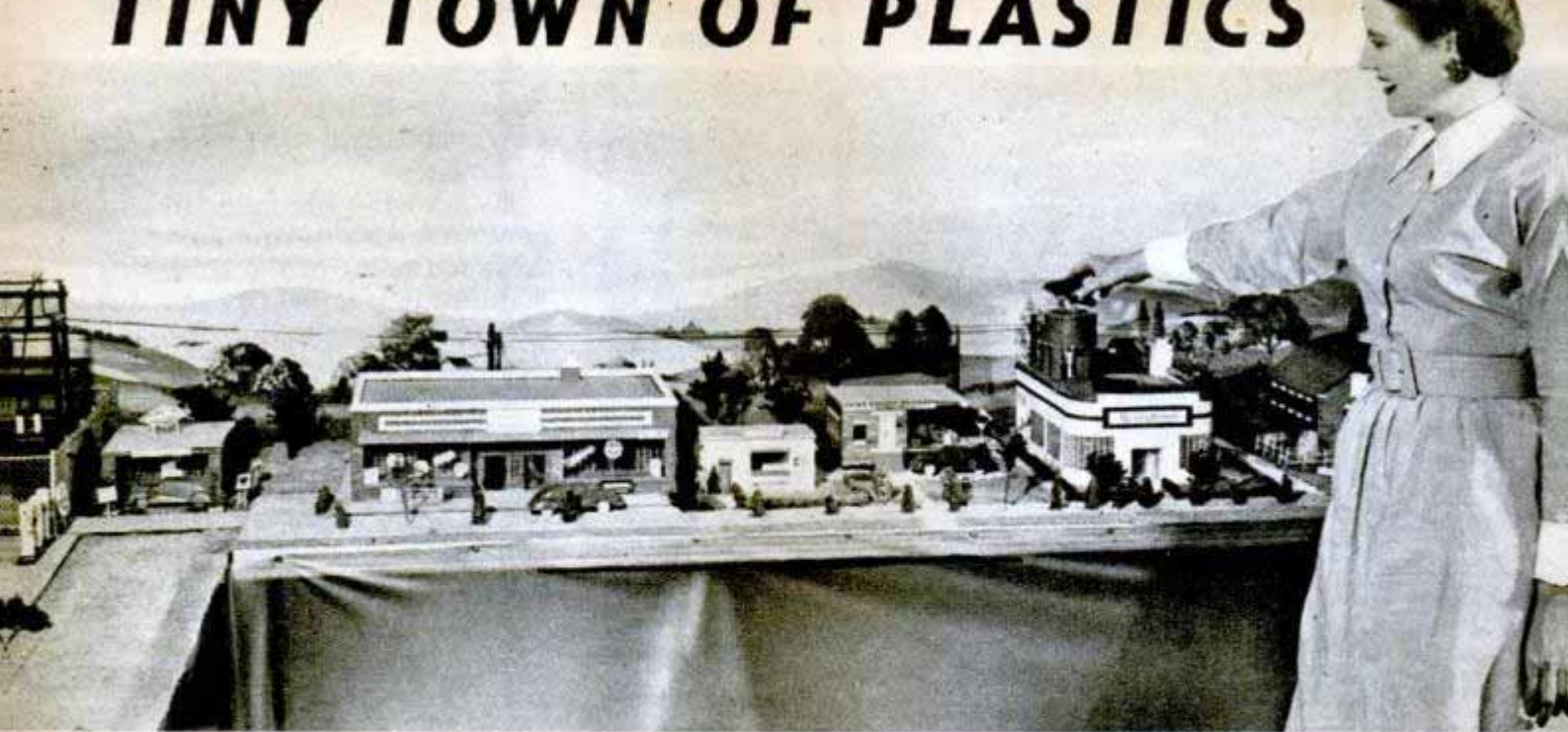

Built of slender sticks and plastic bricks, this miniature village is complete with a factory, stores and homes. The tiny parts are included in a new toy building set that may also be valuable to average home planners

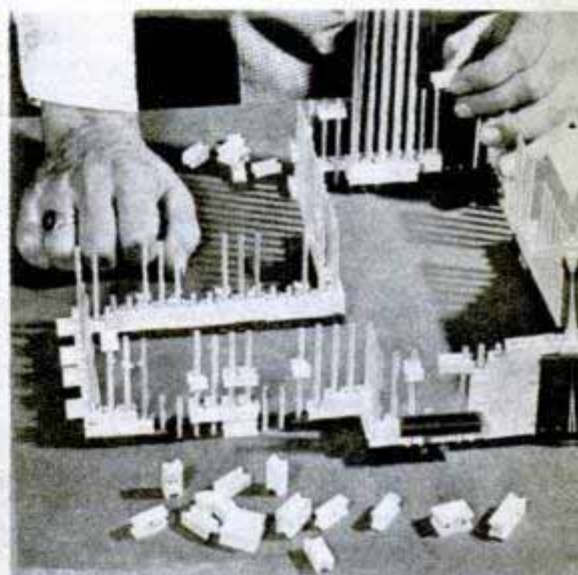

Ingenious landscaping makes grass of dyed towels, sidewalks of sandpaper and trees of painted weeds. Buildings have been wired with tiny bulbs. Church, firehouse and theater are brightly lighted at night

Four different building sets are available, complete with blueprints. The town was built with several of the sets. At right is first step in building house at far left, showing how bricks slide over the sticks

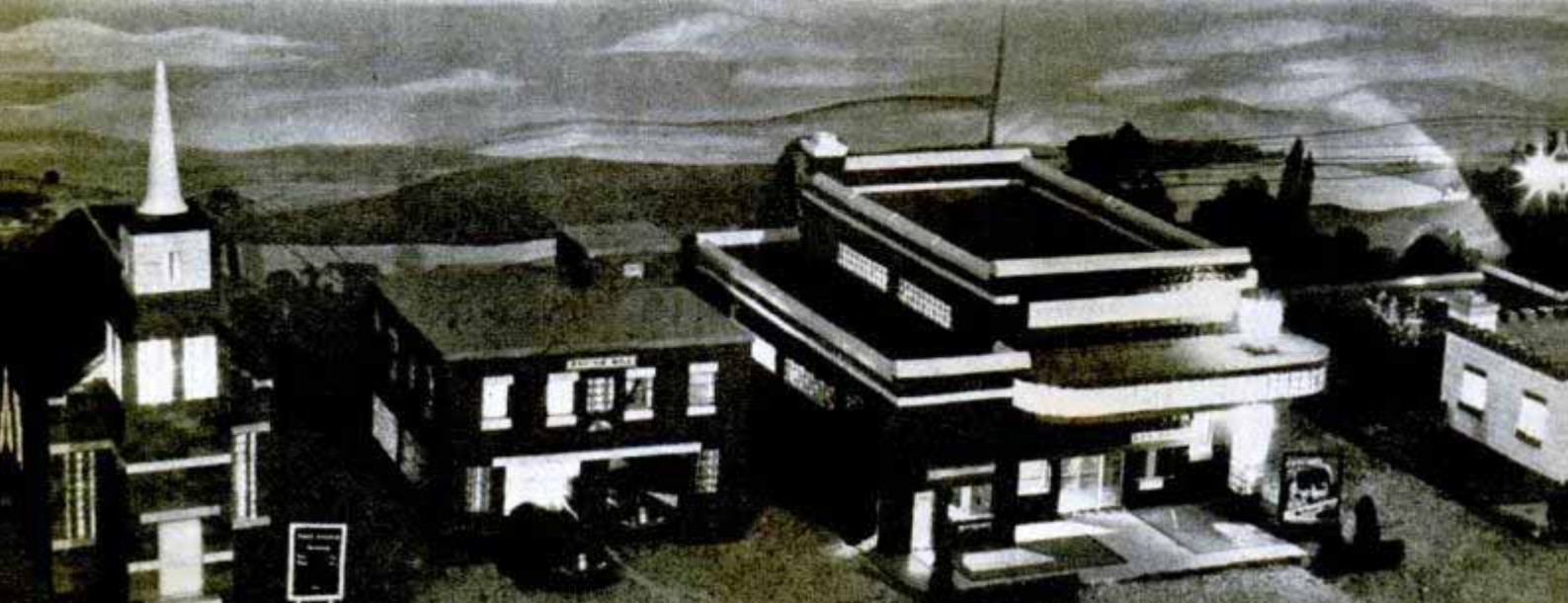

Work Holder Dials Angles of Many Sizes in Joining Operations

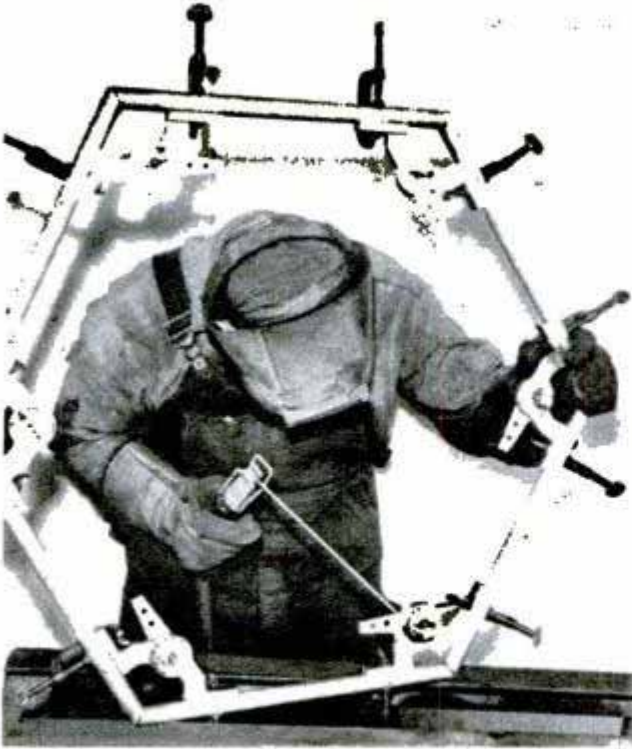

Joining operations, such as welding pipes together at odd angles, are simplified by a work holder equipped with two clamps and an adjustable dial that registers any angle from zero to 180 degrees. Double-head

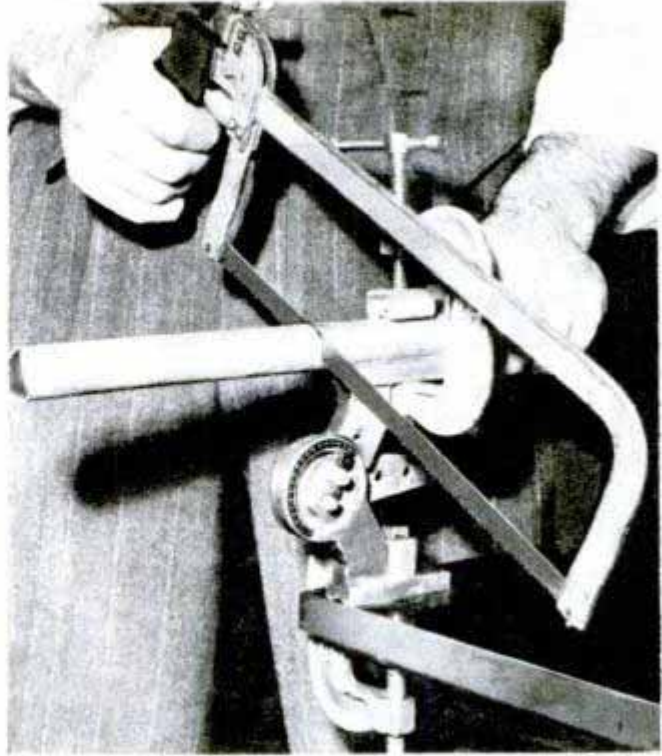

screws on the face of the dial assure positive locking. Cast aluminum alloy is used for the bracket of the holder which is built in three sizes with 2½-inch, 4½-inch and 6½-inch faces.

Bus Powered by Two 93-Horsepower Engines Can Use One or Both

Two 93-horsepower engines, mounted side by side in the rear, power a new style passenger bus that seats 37 persons and has air cooling in summer and air heating in winter. Heat controls are provided at each pair of reclining seats. Power of the two Chevrolet engines is combined through

a chain of gears into a single transmission. There are separate starter motors for each engine, and the bus can operate on only one engine in case of failure of the other. Designed and built by the Flexible Company, Loudonville, Ohio, the bus has 168 cubic feet of luggage space.

Zipper-Equipped Rubber Boots for "Bossy" Aid Hoof Treatment

Special zipper-equipped rubber galoshes protect cows' feet against disease and aid in the treatment of hoof diseases. U. S. Rubber Company's technical laboratory at Passaic, N. J., designed the new type footwear.

Protein foods, which the digestive juices of the human body break down into body-building acids, can be predigested and dissolved in water so that persons unable to take nourishment normally can "drink" such foods as beefsteak.

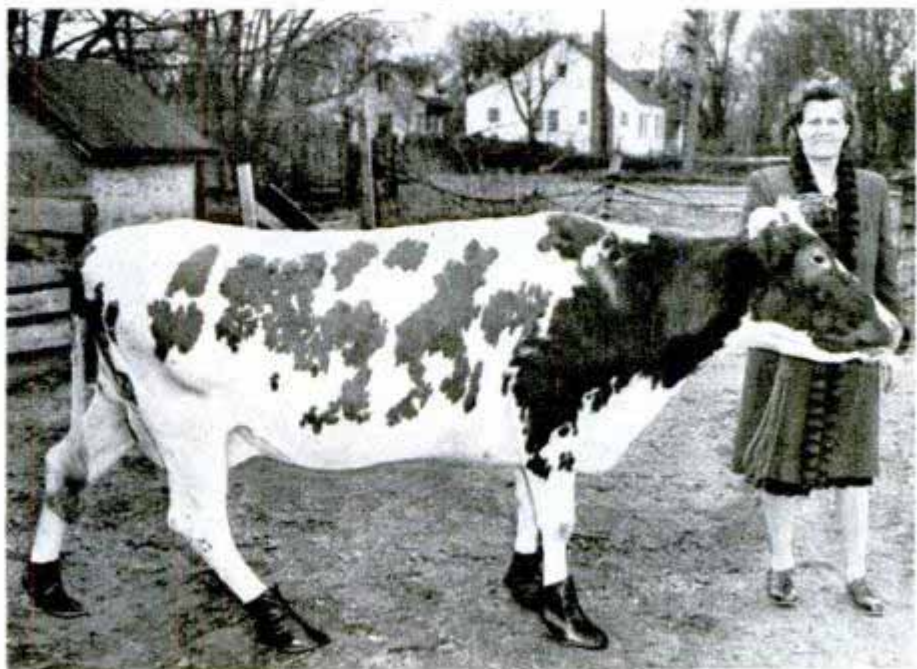

"Inside Stubb" for Your Home



»
CLOTHESPINS with double ends are ready for instant use no matter how they're picked up. Made of wood, they save time and tempers

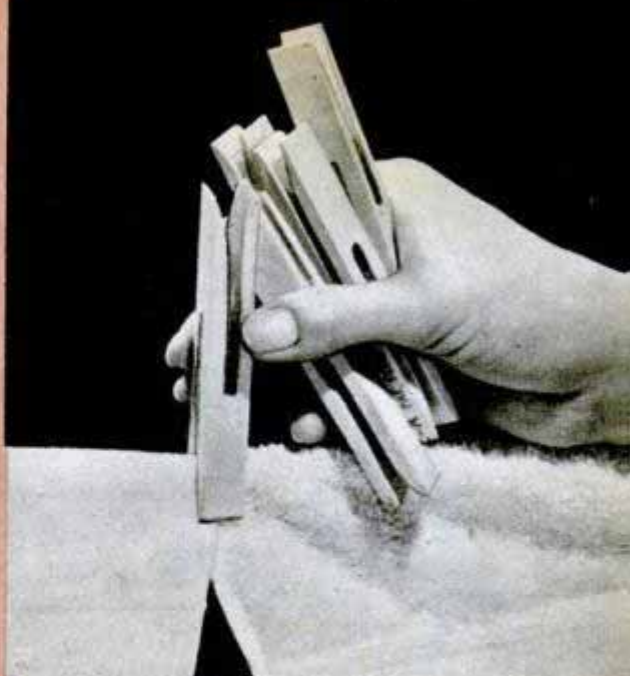

«
IRONING BOARD for apartment dwellers and travelers can be hooked to any door knob for support and folds flat for easy storage

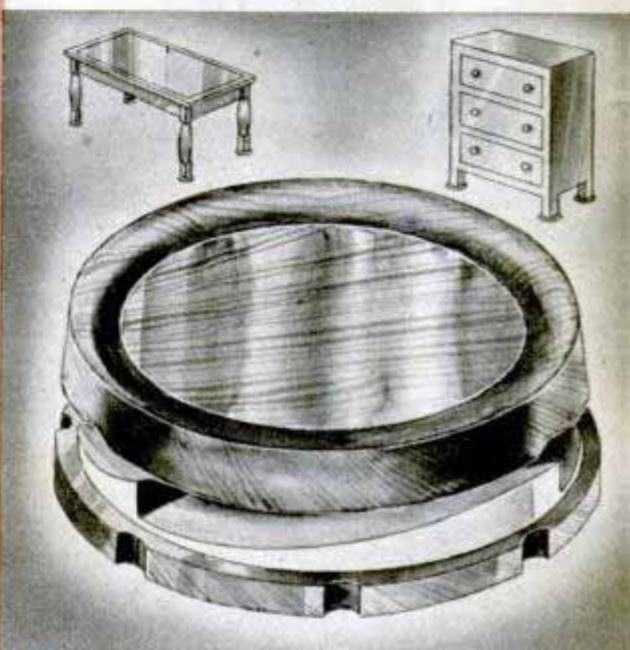

»
FURNITURE CUPS for rug and floor protection can be adjusted to any height to take the limp out of uneven desk and table legs



«
LAMP SHADES bring the garden indoors with real flowers, specially treated, pressed between two sheets of frosted Lumarith plastic



»
PLASTIC MIXER churns butter, whips cream, mixes desserts and malted milk, and colors margarine in plain view of the operator

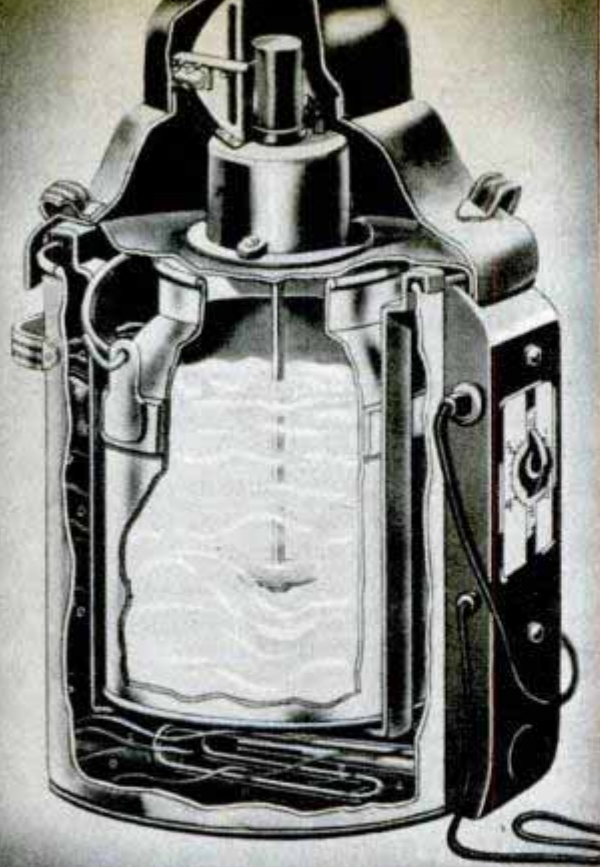

« **MILK PASTEURIZER** protects farms and homes where pasteurized milk is not available, heats two gallons of milk electrically

» **STEAM OVEN** preserves natural flavor and color of vegetables by eliminating water in pans. It can be used to sterilize dishes



« **JAR LIFTER** protects home canners from burns. Clamp grips the top of the jar securely and a trigger handle permits quick release

» **TROUSERS HANGER** with a spring handle for insertion snaps quickly inside the cuffs and holds a neat crease down each pant leg

« **TINY NEON LIGHT** plugs into ordinary sockets to prevent sleepy stumbling. Current consumption costs less than a cent a month

» **TIME-SWITCH CLOCK** turns electric appliances on or off at preset intervals. Owner can set up favorite radio programs for the day

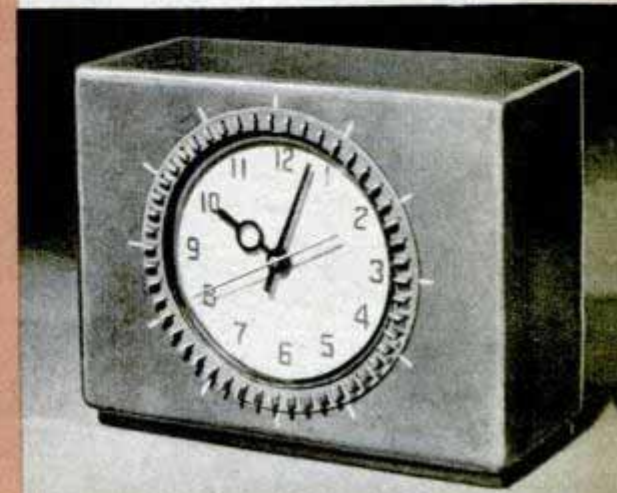
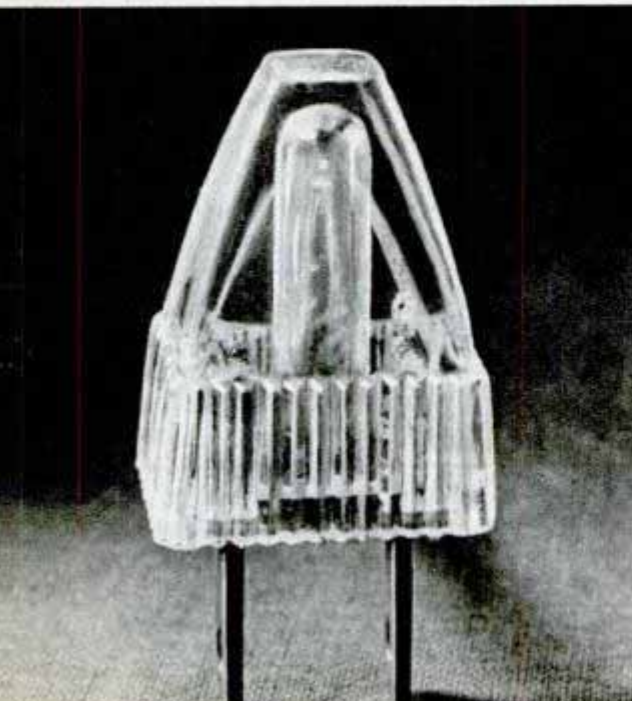
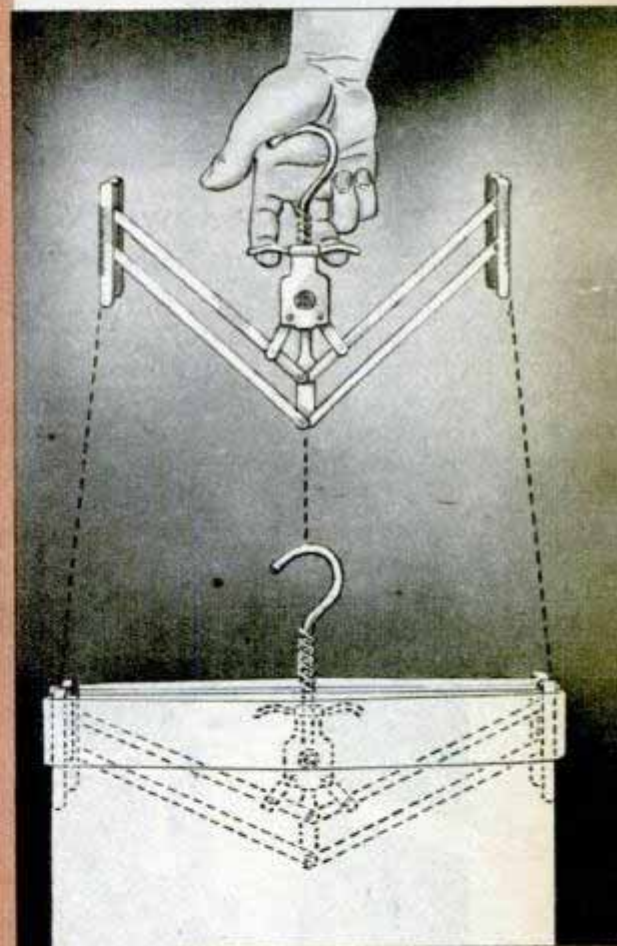
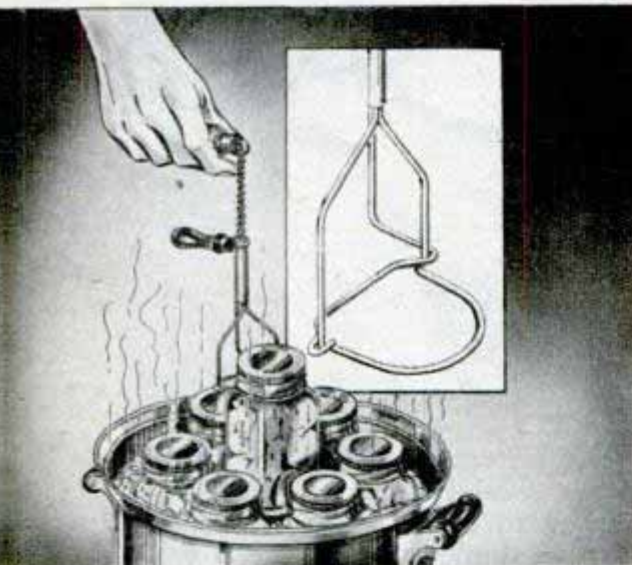

Pilot Boats Adopt Facsimile Telegraphy to Report Incoming Ships



News of ocean-going vessels approaching New York Harbor is now flashed by facsimile telegraphy from pilot boats to the Marine News room at New York. The captain of a pilot boat which meets incoming ships writes the message on a telegraph blank and wraps it around the cylinder of a transmitter in the wheelhouse of the pilot boat. The telegram then is transmitted over a radio beam to New York where it arrives as a facsimile reproduction of the message. Replacing the old method of telescopic observation, this procedure, developed by Western Union engineers, eliminates error in identification or failure to report ships due to fog or darkness.

Plastic Bubble Covers Antenna Of Radio Compass on Planes

Only four inches in diameter, the loop antenna of a new lightweight automatic radio compass for planes is housed in a streamlined plastic bubble. Although



Dual Purpose Lawn-Hose Nozzle Also Serves as Sprinkler

Equipped with a folding grip which can be held in the hand or hung on a fence or clothesline, a hose nozzle also can be used as a lawn sprinkler. The grip is so constructed that water will not drip on hands or clothing when the nozzle is hand held. When hung as a sprinkler, the nozzle can be adjusted to release a fine spray.

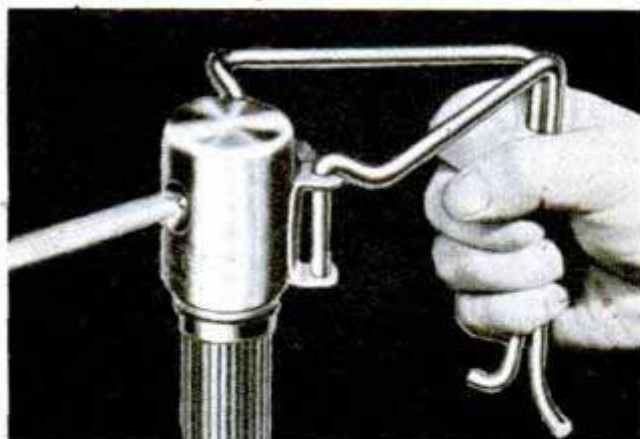

smaller than antennas in general use the tiny loop has greater sensitivity, according to the manufacturer. Its plastic housing is designed to minimize drag and weight for increased aircraft payload.

Near-Fireproof Paint for Ships Contains Aluminum Powder

Sailors may do less chipping of paint in the future because the Navy has found that aluminum powder added to priming coats helps stop the spread of fire. Formerly when repainting, all old paint was chipped off. This was done to lessen the fire threat of thick paint. The mixture is obtained by adding 80 percent aluminum powder paste to the primer coat in the proportion of one pound of paste to two of primer.

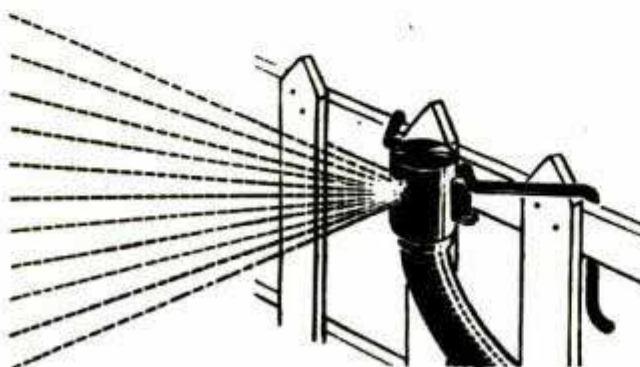

Names and addresses of manufacturers of new products featured in this issue will be supplied promptly by the Bureau of Information, Popular Mechanics, 200 E. Ontario St., Chicago 11, Illinois.

Laboratory On Wings

FIVE tons of laboratory fittings were installed in a C-54 sent to the southwest Pacific by the Air Materiel Command for a study of the factors that cause deterioration of equipment in the tropics. High-power microscopes, sterilizers, two refrigerators, an electric stove, DDT bombs, two motor-generator sets and screen doors were among the items carried to make the flying laboratory complete. The scientific mission's 19 members also were equipped with both motion and still-picture cameras.



Laboratory tables, overhead storage litters and wardrobe section extend toward the rear of the fuselage. The refrigerators and electric stove are shown below.

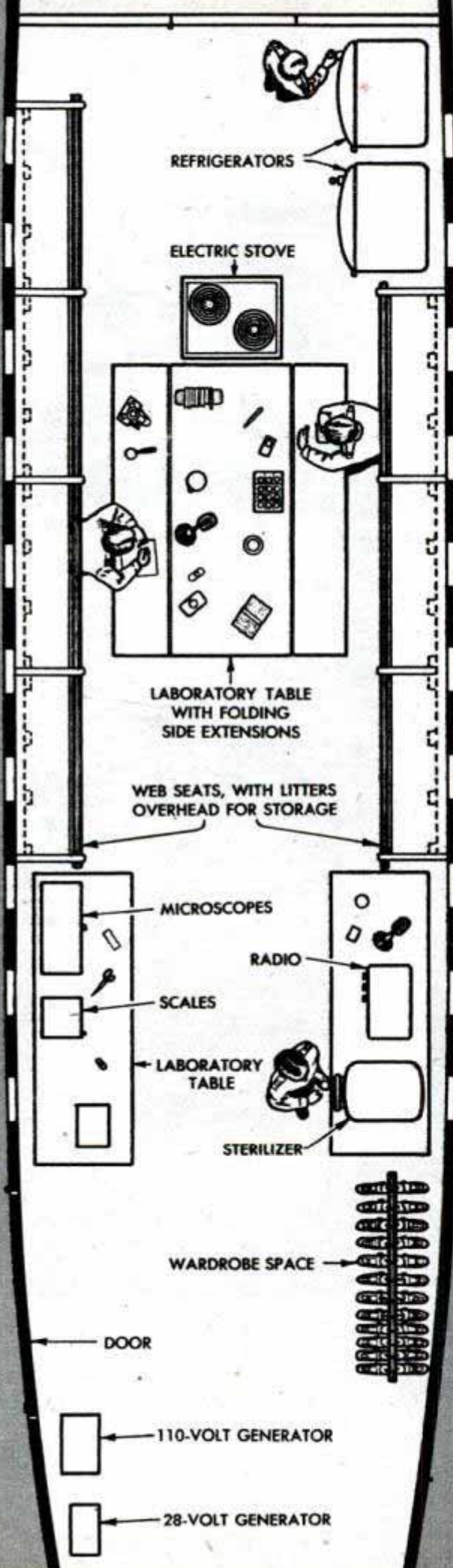

RIGGING AN EIGHT-TON



Purse seines of the fishing fleet cover a wharf at a Pacific port. A record catch of tuna and a season's profits depend on the knots of these fish nets

By RICHARD W. EMERY

Photos by R. O. Ritchie

If PAUL BUNYAN, fabulous lumberjack, had been a salt-water fisherman, he might have used such a net! The modern purse seine, which wraps up 150 tons of live fish at a single haul, would give the prodigious Bunyan a burden worthy of his strength. To rig that enormous net, fishermen must

TUNA NET



Cork beads for a tuna man. In groups of three, 10,000 of them are tied to the cork line to keep afloat the \$15,000 circle of tarred net that pulls in tasty tuna for your table. A crew of 11 men handles the net

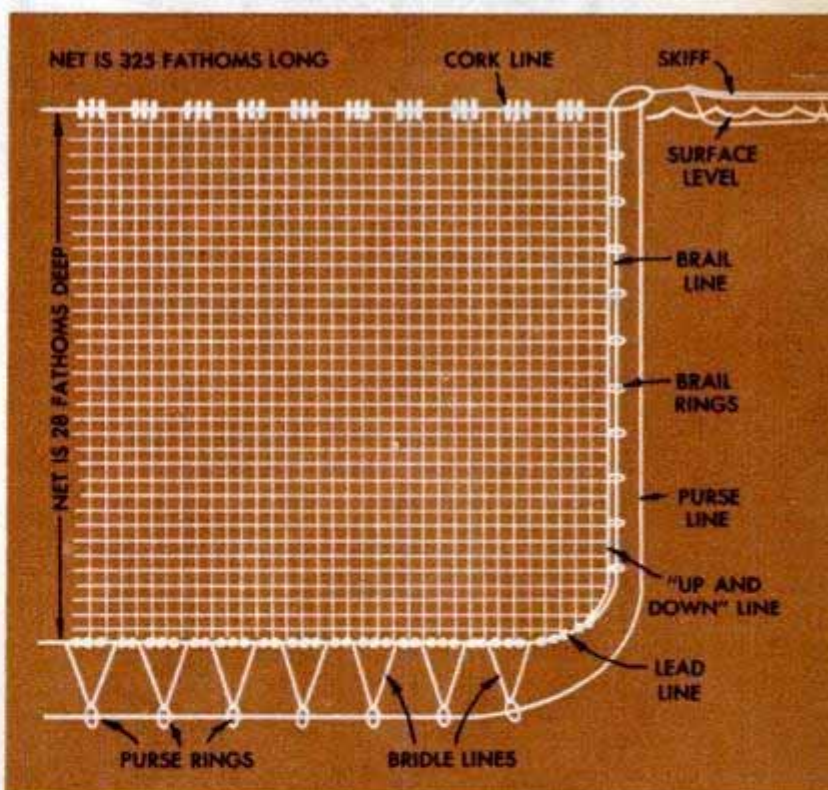
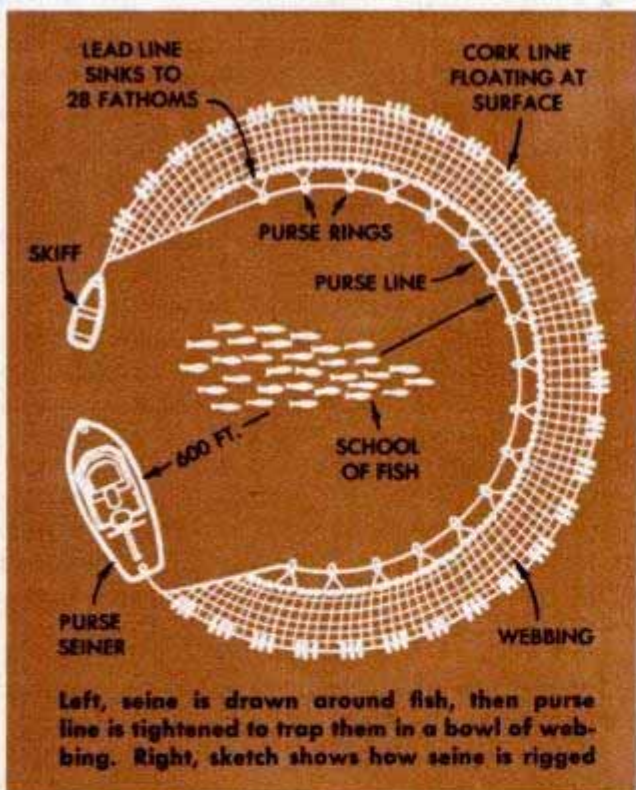

have enough webbing to carpet 12 football gridirons. They must have two miles of strong rope. They must have 10,000 sinkers and 10,000 big cork floats.

Day after day, on sun-scorched wooden wharves reeking of tar, they must labor to sew together the edges of six or seven narrow strips of webbing. They must thread

rope lines through the thousands of ring-shaped sinkers and through the thousands of doughnut-shaped corks. Steel rings for the purse line must be tied to bridles and the bridles in turn must be tied to the lead line. It's a labor of knots, knots and more knots—and the season's profits depend on those knots holding under great strain.



No place to lose a needle. Five to seven strips of mesh like that above are hand-sewn edge-to-edge to form complete net. Along half-mile-long lead line are strung 10,000 sinkers such as on salvaged net, right, which pull it down to form underwater tuna trap



↑ Fishermen prepare a purse seine for use with wood tools which have changed little in over 3000 years

↓ In a good season when the fish are running, the crew will haul from the sea a cargo worth \$75,000



The whole net must be tarred or tanned, or both, to protect its fibers from fish slime. And when the fishermen are done with their big job of rigging the net, the net weighs eight tons. Its materials alone have cost from twelve to fifteen thousand dollars. The net itself contains hundreds of thousands of hand-tied knots and around 10,000,000 machine-tied knots.

No simple rig is this immense fishing net! It's designed for big-scale fishing operations in deep water on the open sea, and does its job both well and spectacularly—if the net makers have built it right. At full speed, the seiner turns in a wide circle around a school of tuna, paying out the net. Corks float one edge of the net; sinkers quickly pull the other edge down. Within minutes, a vertical wall of mesh, 28 fathoms deep and 325 fathoms long, surrounds the fish in a circular area about 600 feet in diameter. Then members of the seiner's crew pull in the "purse line" which draws the bottom of the net together, closing off escape for the fish.

By pulling in the net until all the fish are crowded into a small area, the fishermen can dip a brailing net into the threshing mass and hoist the catch aboard.

Big purse seines can "wrap up" 150 tons of tuna or 200 tons of yellowtail. Seines of smaller mesh can scoop up a bigger batch of sardines than even the great Bunyan might have tried to lift.

If they're lucky and the net holds togeth-



Purse seiners, right, moored alongside wharf at San Pedro, Calif., for overhaul of fishing gear. Since success of voyage depends on nets, inspection of them is thoroughgoing



↓ Like old-fashioned moneybag, enormous purse seine has a "drawstring." It's a one-inch rope threaded through steel rings tied to bottom lead line. After several seasons of use, this one must be replaced

↓ Husky crews man the fishing boats. They go to sea in good weather or bad and stay until hold is filled with fish. Powerful booms and the crow's nests of the lookout identify Pacific purse seining fleet





A power-driven turntable at the stern hauls in the eight-ton tuna net when everything is ready. The big skiff, which marks the free end of the seine, and the utility boat, top, are loaded aboard; then the purse seiner (below) heads for the open sea and—with luck—good fishing

er through the fishing season, the 11-man crew of a typical purse seiner should pocket \$5000 per man for the year's work. An average take is \$3000. But troubles with the net can spoil everything. One big shark, snarled in the net and slashing back and forth in an effort to escape, can lay the seiner up for many days while members of the crew repair the mesh.

The modern purse seine has developed step by step in fairly recent years, and has been enlarged and improved in the wartime and postwar effort to feed a hungry world. Seiners do not account for the entire Pacific Coast catch, but they take a large share. And the ocean catch of California alone runs around \$30,000,000 per year.



Peaches Frozen in Acid Syrup Hold True Color for Years

Fresh peaches stored in a syrup of sugar and citric and ascorbic acid will retain their natural color even if kept frozen for years. Dr. J. G. Woodroof, who used the process at the Georgia experiment station, recommends the following formula for home freezing: sliced peaches, six pounds; sugar, one pound; citric acid, one teaspoonful; ascorbic acid, one half teaspoonful. Make a syrup of the sugar and acids and cover the peaches after placing them in containers.

Steel Gripper for Holding Fish Helps Angler Scale His Catch

Clamped firmly on the slippery tail of a fish, a gripper aids the angler in scaling his catch. The device is a piece of spring steel bent double so the ends form jaws with

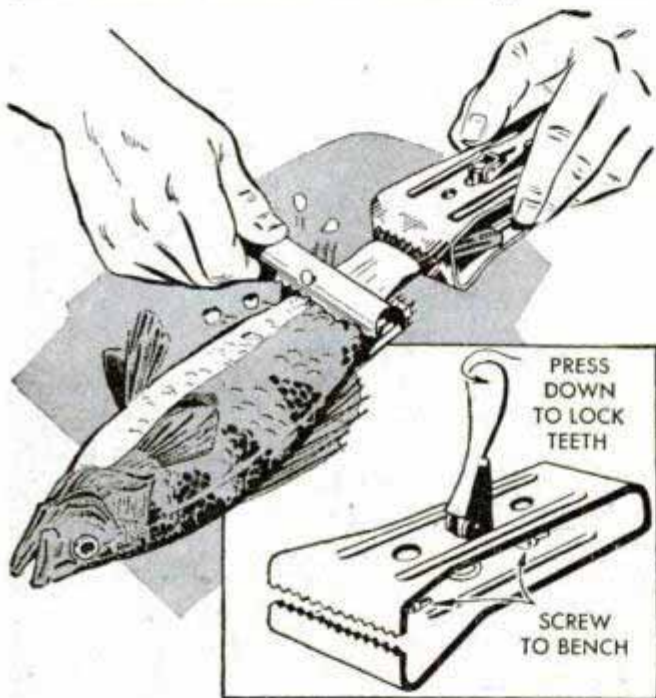

interlocking teeth. It is screwed to a board or a bench. After the fish tail is inserted, a lever is pressed to clamp the jaws tightly to the fish. The fisherman's hands are then free to scale his catch.

"Take It or Leave It" Music

Studios "piping" recorded music by telephone wires to wall boxes in restaurant booths now announce the next selection to be played. If the customer wishes to hear the number, he inserts a nickel. Otherwise, no music comes out.

Popular Mechanics is always ready to supply further information to readers about various products described in any issue. Just write to Bureau of Information, Popular Mechanics, 200 East Ontario Street, Chicago 11, Illinois, for a prompt reply.

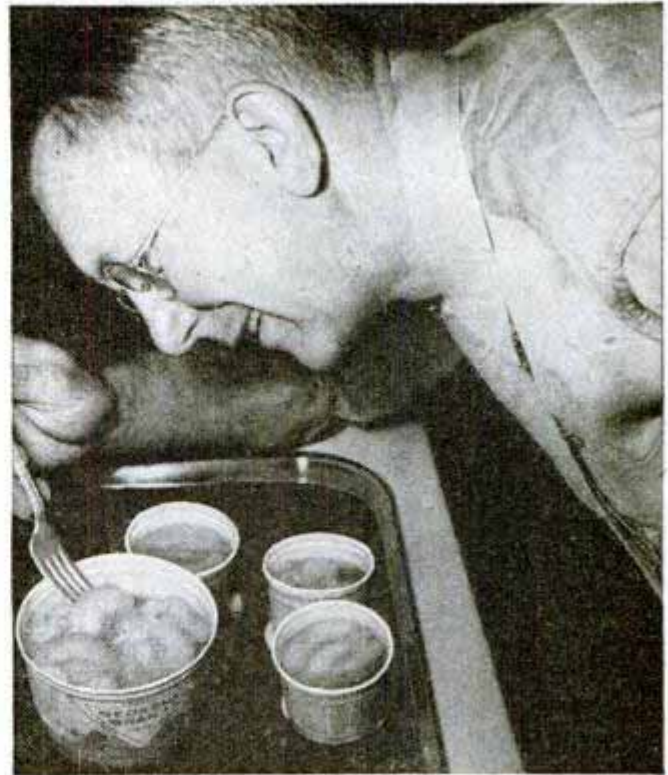

Dashboard Baby-Bottle Warmer Is Operated by Car Battery

With a heating element operated by a car battery, a baby's bottle can be warmed during an auto trip. The heating element is sealed in a Pyrex glass tube inserted in the bottle. A surgical-rubber cap fits over the tube and mouth of the bottle to assure sterility. The heating element plugs into a dashboard socket. The bottle is warmed to proper temperature in about eight minutes.

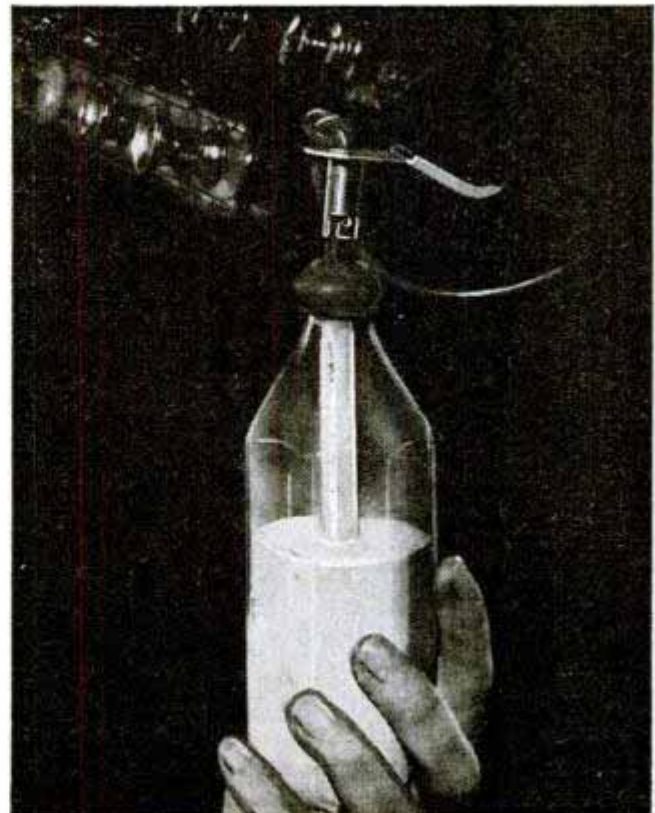

WANTED JOCKEYS

WANTED—Several good jockeys. Can earn \$15,000 per year and up."

So rapidly has the sport of horse racing grown in the last few years that, although advertisements like the above have not really appeared, owners and track managements are on the lookout for good lightweight riders who can be depended upon to win races.

A few of the country's very best jockeys earn upwards of \$75,000 per year, as much as is paid the President of the United States. Incomes of \$10,000, \$15,000 and \$20,000 are not at all uncommon among the many riders who compete on the country's 20 major racing strips.

Such large sums are paid because it is the best riders plus the best horses, combined, that win the most races. Often a good jockey can help a mediocre horse along so well that the team beats a better animal that is not as expertly ridden.

So much are good jockeys in demand that at a number of tracks classes are conducted to teach apprentice riders and stable boys the secrets of fast racing. Experienced jockeys put the boys up on horses, show them how to grip with their knees and how to stay in rhythm with the moving animal. The instructors explain how a rider can move his body to help the horse along. The jockey travels in an even line, so to speak, and the horse moves up and down under him. That way the horse doesn't have to lift the rider at each stride.

These informal classes culminated last fall in the opening of a complete jockey school at the Santa Anita track in California. The school had its own dormitory, classrooms and racing stable. Restricted to a few students at the start, only 16 boys were accepted from 175 who applied. Nine of these were graduated at the end of the eight weeks of instruction. All the gradu-



SIT WELL FORWARD, GRIPPING WITH KNEES

ates received jobs with well-known racing stables at once, starting out as exercise boys. They can look forward to receiving their papers as apprentice riders this season or next.

The Santa Anita school is planned as an annual affair, starting on October 15 of each year. Tuition and room and board were furnished free last year.

To be eligible, applicants must be between 16 and 21 years of age, weigh 100 pounds or less (certain exceptions made) and furnish reports on their scholastic, athletic and business backgrounds. They also must tell of their past experience with horses and racing and provide other information. They must submit written statements as to why they wish to become jockeys, what their conception of the work is and their ideals in reference to the sport. Final selection of the students is made after personal interviews with Carleton F. Burke, director of racing at the track.

Students at the Santa Anita school received practical training as well as classroom instruction. William Mills, Santa Anita starter and former jockey, acted as

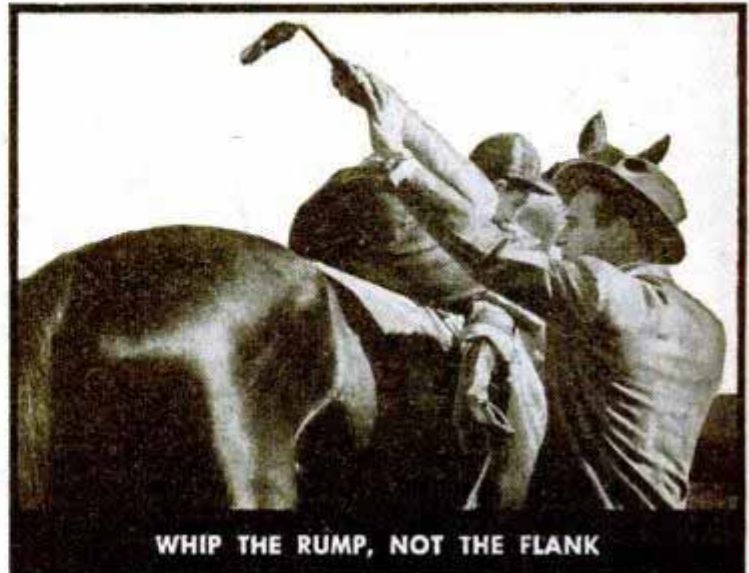

WHIP THE RUMP, NOT THE FLANK



CROSS THE REINS FOR A FIRM GRIP

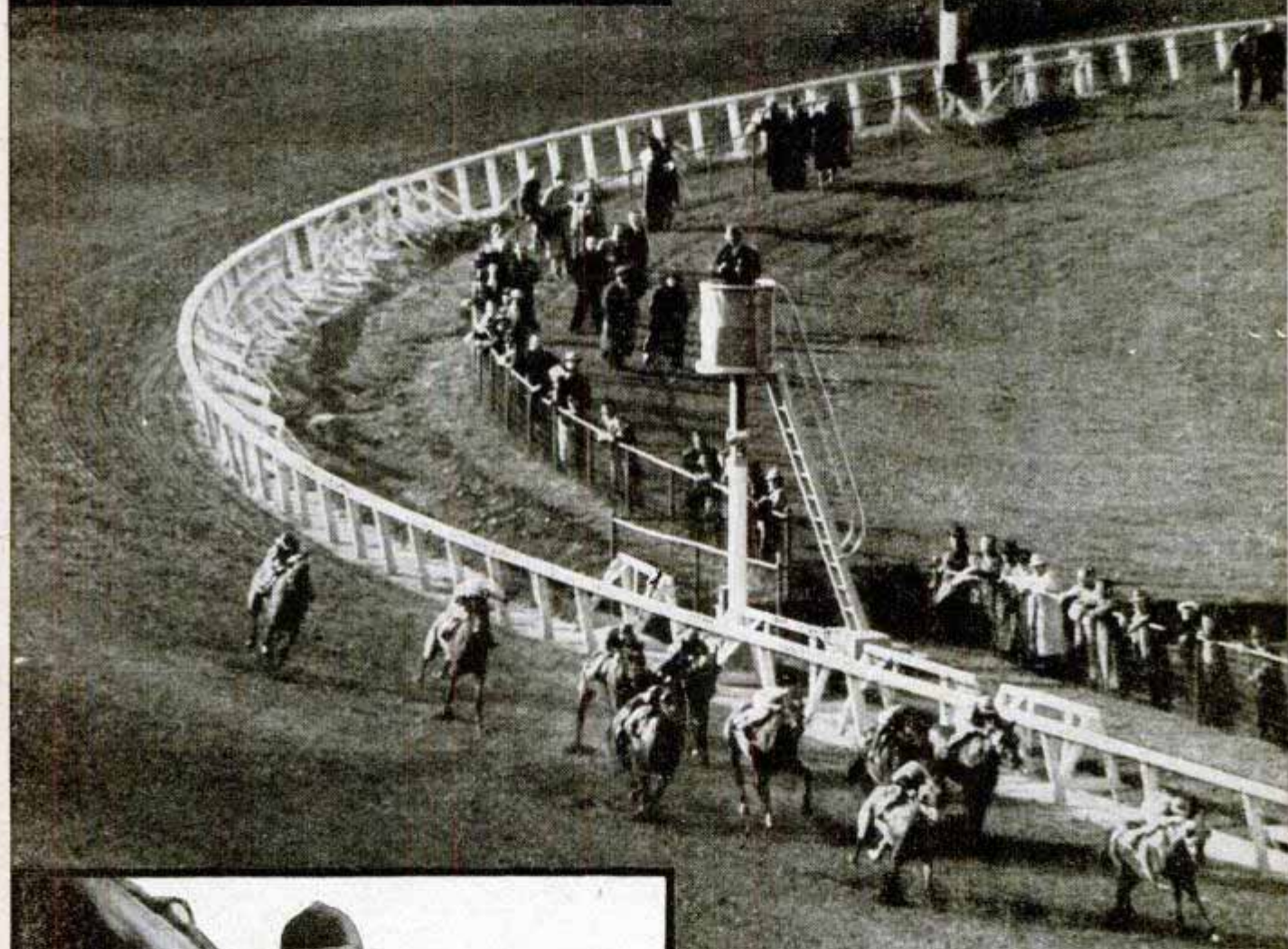

Still bunched after coming out of the turn, fast-flying horses head into the stretch at a California racetrack



PUSH AGAINST NECK TO LENGTHEN STRIDE



Normal running stride of a race horse is from 18 to 24 feet. The problem of the jockey is to keep his mount running at full normal capacity because every inch the horse extends itself will count at the finish line

out-of-doors superintendent. James Tunney, football referee and high school instructor, was in charge of indoor classes. The school day began at 6 a.m. with the manual work of a racing stable. The boys cleaned out stalls, carried water, walked hot horses and rubbed them down. Riding instruction was conducted in a practice ring and on the main track itself.

Among other things, Mills explained to his students that a good jockey makes friends with the animals he will ride. He studies the temperament of each and handles each horse accordingly. Meanwhile the horse is sizing up its riders. It may like the way one jockey handles it as compared to its other riders. It actually seems to run faster for its favorite jockey.

Little things count. The students dis-

cover that some horses have a tender mouth and won't take hold of the bit. These must be ridden with a loose rein. Others clamp onto the bit and will respond to every slight movement of the reins.

Some horses, the students learn, pay no attention to their companions and move down the track with their minds on their own business. Others are flighty and are curious about everything that goes on around them. Riders must chirp to these to keep their minds on the job of moving ahead at full stride.

One of the first things that the student jockeys are taught is to watch the animal's ears. A horse that pins its ears back against its head when the whip is applied, for instance, is going to be nervous and unreliable under the whip. For such animals the

Student jockeys line the rail at the Santa Anita training track while others of the class get practical instruction in the secrets of fast riding. In order to win, jockeys must know racing quirks and peculiarities of their mounts



whip is not to be used. Mills teaches his students that the normal stride of a race horse is from 18 to 24 feet, depending on the size of the animal and the way it handles its legs. But, he adds, the horse doesn't always run at its full stride. A jockey's task is to get the animal to extend itself to its full normal capacity, reaching out and taking full strides. Every extra inch that the horse can be made to extend itself will count at the finish wire.

Encouraging the horse with the voice is often a big help. Tapping the animal on the rump with the whip just as it starts its stride helps it to reach out. Correct use of the whip is a course of study all by itself because if the whip is improperly used a horse is apt to be knocked off stride and thus will run slower.

The fundamentals of hand riding, at which few riders excel, are also taught. Essentially this consists of using the hands to lift and push at the animal's neck just as the horse is in its stride. Seemingly unimportant, this can be a big help in causing the horse to stretch out and cover more ground at each stride.

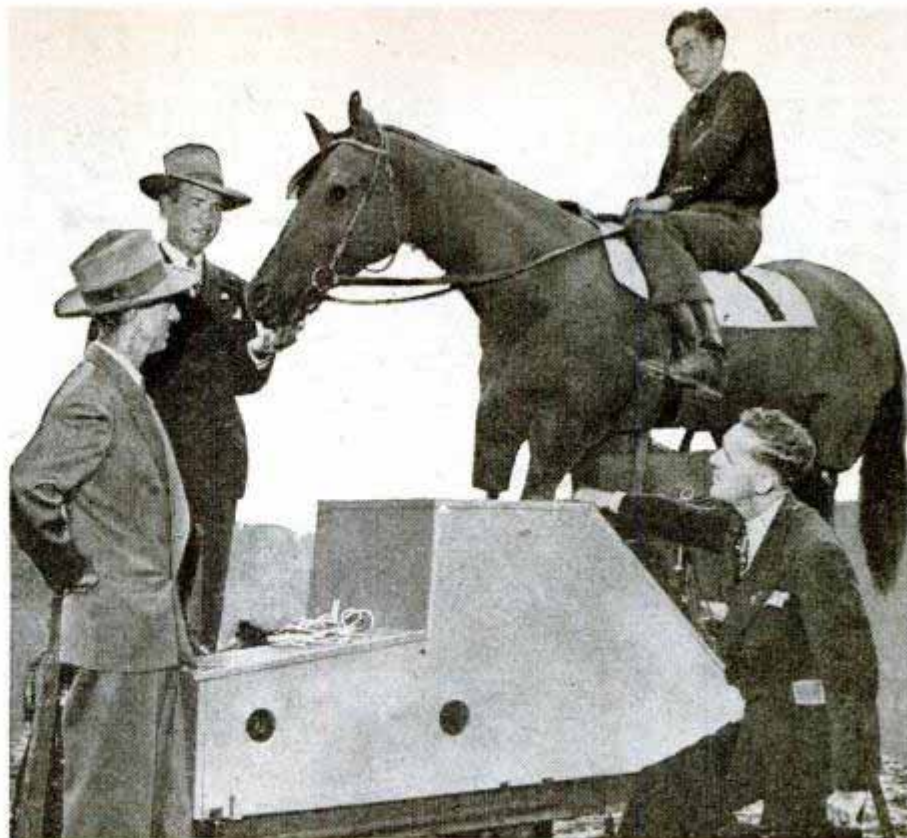

Movements of mechanical horse controlled by motors in box match those of race horse. It is used at Hollywood Park to teach proper riding positions

"All this sounds pretty simple," Mills warns his students, "but you must learn to do everything in moderation. Some of you are going to try too hard at first and one result may be that you will make your mount overstride. He'll take one big leap, get out of balance, and will need a few short strides to get back in form. Meanwhile the whole field will breeze by you."

(Continued to page 236)

Riders learn through practice how to hold their tense horses steady in the padded stalls of the electric starting gate. They must get out in a hurry the instant the bell rings and the barrier snaps open, or be left at the post

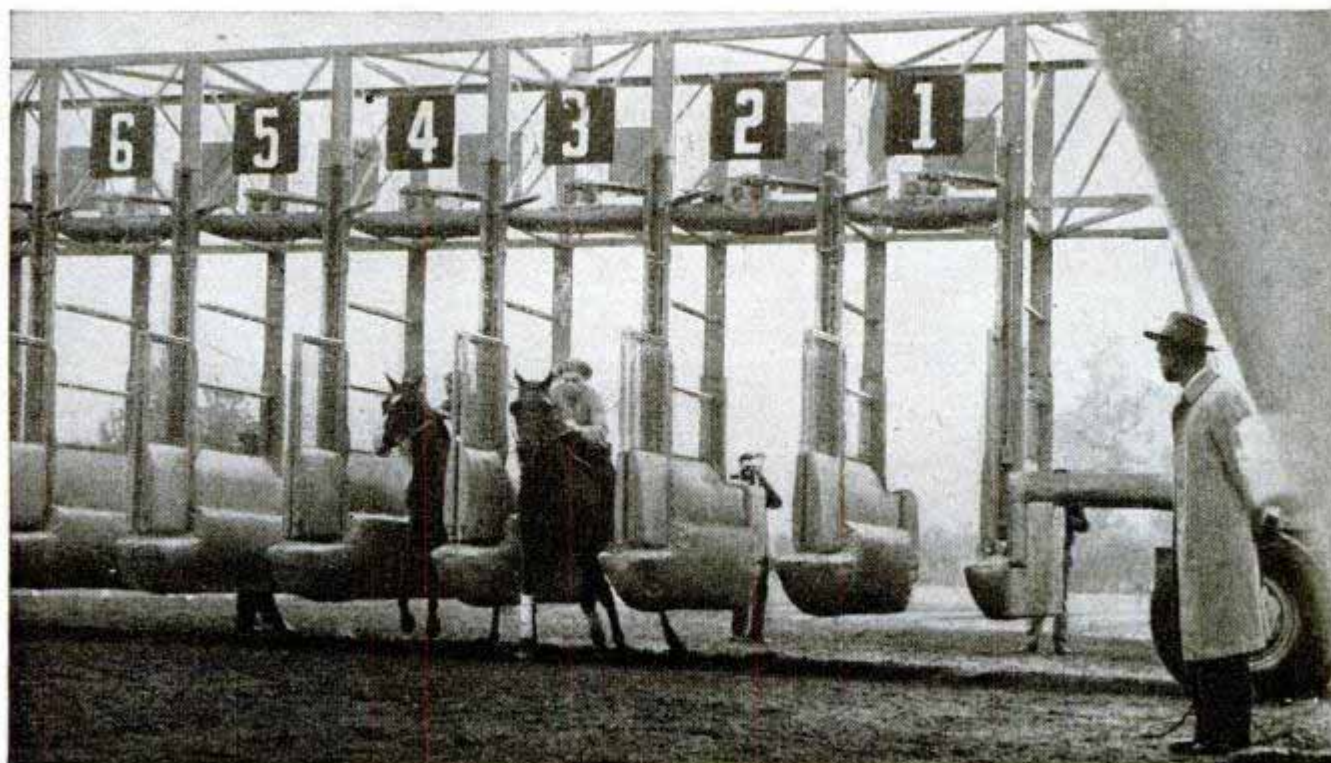

Decompression "Test Flight" Amazes Experts

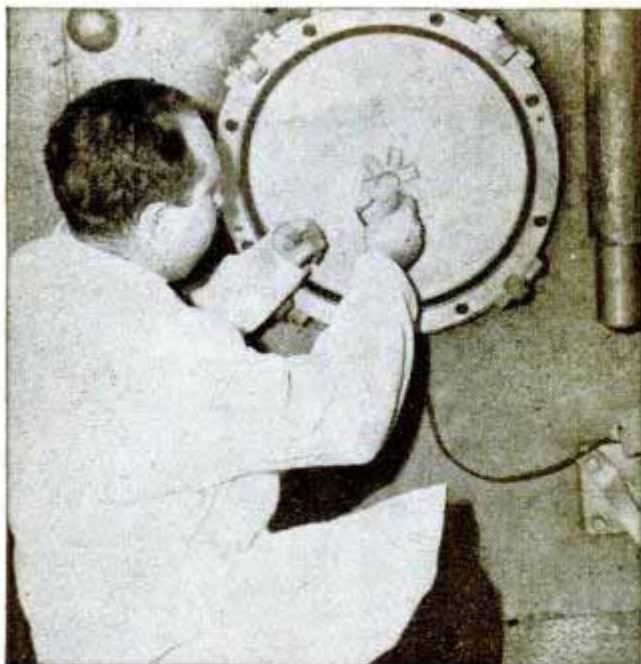

In this test an electric wire punctures a hole in paper panel to let air enter decompression chamber. Contact with the subject in the chamber is maintained by means of an intercommunication system.



Dr. Fred Hitchcock of Ohio State University locks the heavy steel door of the decompression tank for a test. With a loud report, the panel is blown out and pressure in the two chambers rapidly becomes equalized.



Can a pilot flying seven miles up survive if the pressure in his cabin is suddenly released, either by accident or by penetration of an enemy missile? Yes, says Dr. Fred A. Hitchcock of Ohio State University, and he can back his statement with personal experience, plus that of more than 250 others who have subjected themselves to explosive decompression in tests performed there for the Office of Scientific Research and Development. To the amazement of scientists, Dr. Hitchcock insists there will be no serious effects. The research at Ohio is done, not in high altitude aircraft, but on the ground in a thick steel two-room pressure chamber. Pressure



equal to that at 8000 feet is maintained in the compartment in which the subject, wearing an oxygen mask, is placed. In the second room, air is pumped out until the pressure is equivalent to that at 70,000 feet, nearly a vacuum. Between the two compartments is an airtight porthole with a piece of paper as "window pane." At the proper moment, experimenters rupture the paper electrically by sending a current through a high-resistance wire attached to the paper. The result is literally an explosion. The "pane" is blown into the low-pressure compartment and, in less than a second, the pressure in both rooms becomes equal to that at 35,000 feet. "There is a rush

of air from the nose and mouth," says Dr. Hitchcock, who has personally undergone the test dozens of times. "There is also a feeling of distension in the chest and abdomen, and there may be severe gas pains, but in more than a thousand experiments no ill effects have been noted." The research has also indicated that chances of getting "aviator's bends" are only slightly greater when decompression is explosive than when it is slow. Although humans have been explosively decompressed to the pressure found at 45,000 feet, dogs have been "sent up" to 50,000 feet in 1/50 second, and, at slower rates, to 70,000 feet.

Numbering Machine Marks Film In Bright Daylight

Film negatives can be marked with identifying numbers in bright daylight with a numbering machine that acts as a second camera. Formerly it was necessary to take the cut film in holders into the darkroom to write the number along the edge. To operate the daylight printer the number is

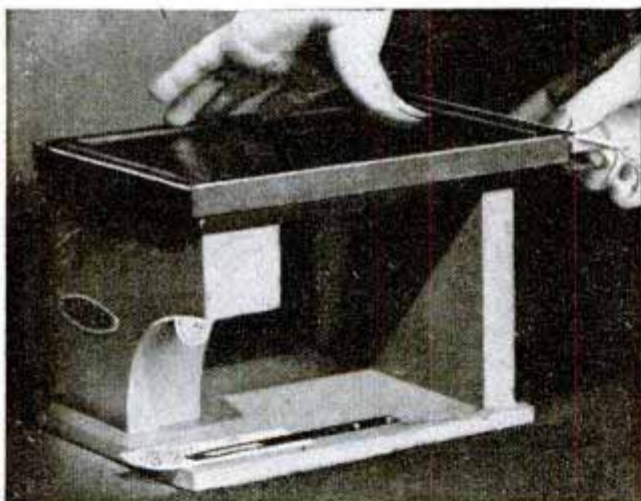

placed in position on the base of the machine and the film holder is placed on top. The slide is withdrawn about one inch from the holder. The numbering light is turned on and the number is photographed by a small segment of the negative. The numbering machine is made for four by five, five by seven or eight by ten film.

"Aquajet" Pushes Small Boat

Even outboard motors have felt the impact of jet propulsion. The "aquajet," a motor built by an English manufacturer, propels the boat by squirting a powerful jet of water from a nozzle in the underwater housing. The submerged pump which discharges the water is driven by a three-horsepower motor that will run 3½ hours on a gallon of gasoline and propels the boat at a speed of eight miles an hour.

"Para-Scooter" in Civvie Garb Carries Factory Messages



Declared surplus as military equipment, a paratroop scooter designed for quick movement of men behind enemy lines is now doing duty as a light delivery vehicle at a radio manufacturing plant. The scooter is used within the plant for messenger and delivery jobs. The only addition to the vehicle is a carryall box in the rear.

Spreader Cap to Sow Grass Seed Fits Over a Fruit Jar

To spread grass seed evenly over a lawn, a spreader cap which fits a fruit-jar top is useful. Shaking the jar sets up a rotating motion which causes a disk inside the cap to tumble the seeds over a wide circular area. The rate of flow can be regulated.

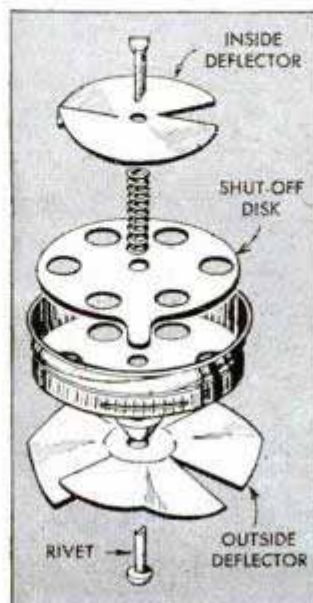



Servicing 'Cafeteria' For Planes

Starting power, fire protection and fresh water are supplied to big air liners with a single mobile ground servicing unit. It is operated by one man. Two 24-volt generators provide 400 amperes of power for engine starters. A carbon-dioxide bottle with a 75-pound charge hooks into a plane's internal fire-fighting system to snuff out fires. Wash water from the service truck's 50-gallon tank is pumped at the rate of 10 gallons a minute into an air liner's tanks.

'Covered Wagon' Life Raft Supports 20 Persons

Latest development in air-sea rescue equipment is a "covered wagon" life raft, so named because of a large canopy to protect as many as 20 occupants. Designed by the Air Materiel Command, the raft is made of rubber and inflated with carbon dioxide, which also fills the tubular arches supporting the canopy. If one side is punctured, the other half is so constructed that it still will support 20 persons. An inflated seat is provided for the protection and comfort of each occupant.

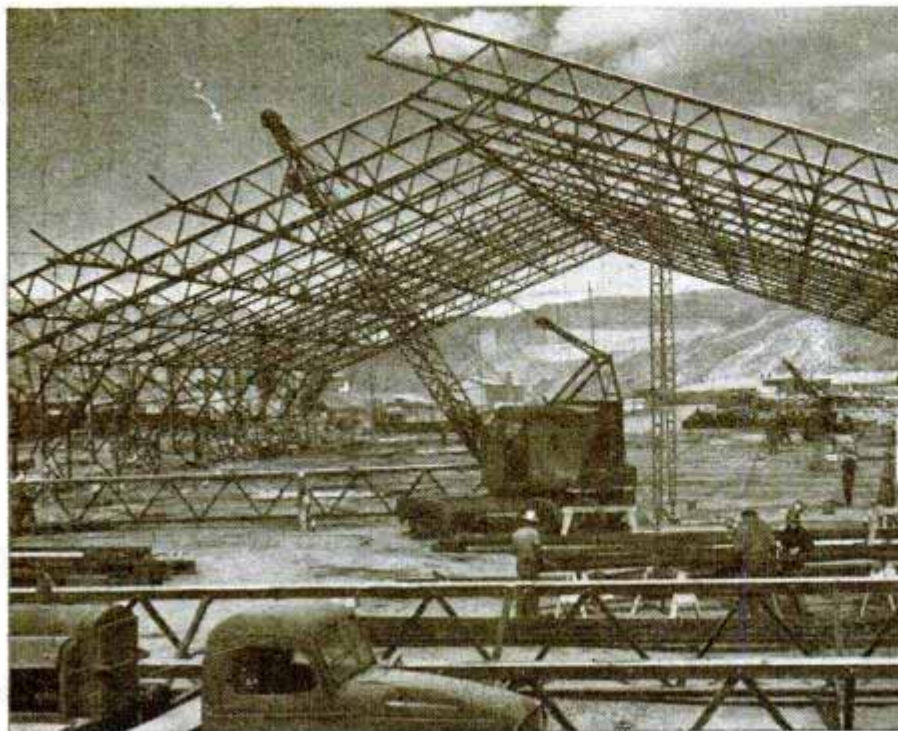

Surplus Hangars Become Workshop

Using two surplus combat-type Army aircraft hangars, the Bureau of Reclamation is building a combination shop for repairing trucks, tractors and power shovels used at Grand Coulee Dam in Washington. It is 140 feet wide, 274 feet high and will be covered with corrugated aluminum.

Female oysters lay eggs only when minute quantities of manganese are present in sea water over oyster beds, according to the U. S. Fish and Wildlife Service.

The Craftsman

Ever have quail or pheasant boil out from under your feet, giving you such a start that you spent the next second or so blasting away at the sky? Of course, nothing fell—except silence. But good shotgunners say it happens to everyone and that often it's a case of faulty footwork and not just "nerves." A story on page 186 discusses this angle of shotgun shooting. An article (page 201) starts the modelmaking season with constructional details on a small gas engine, and tying in with it, page 224, there's a piece on milling-machine technique by a well-known authority. Woodworking craftsmen get a good break on the corner table, page 178

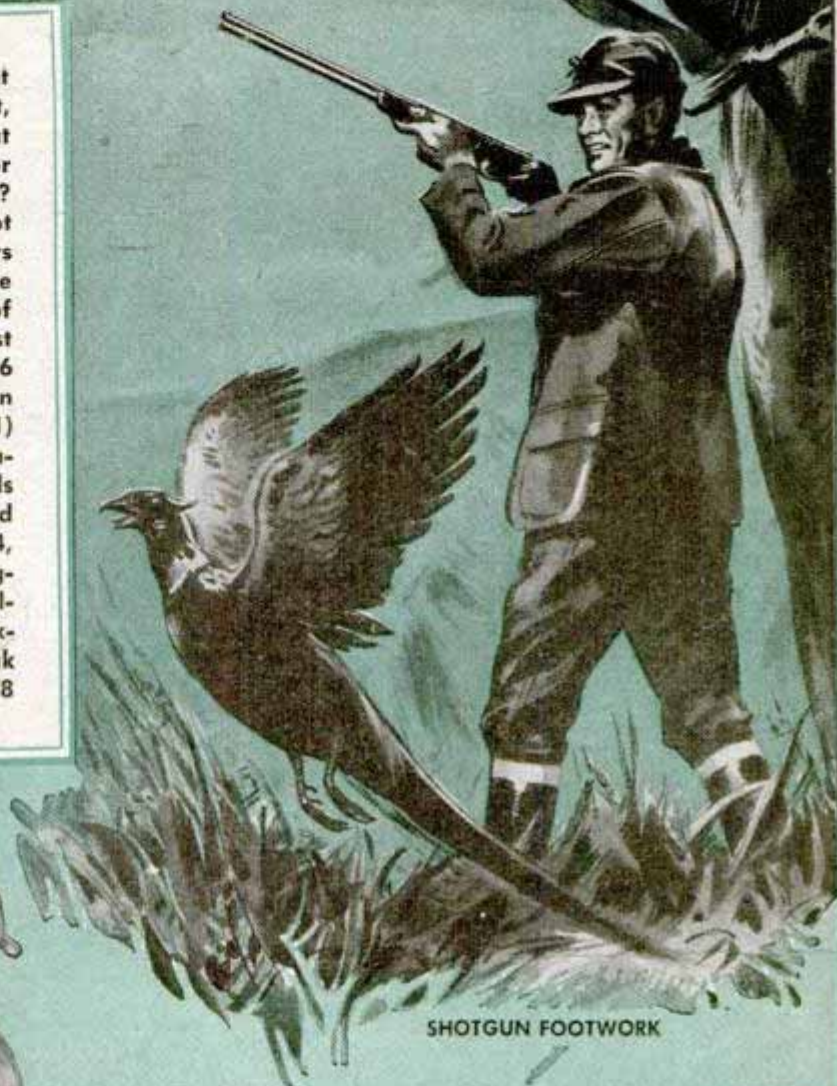

SHOTGUN FOOTWORK

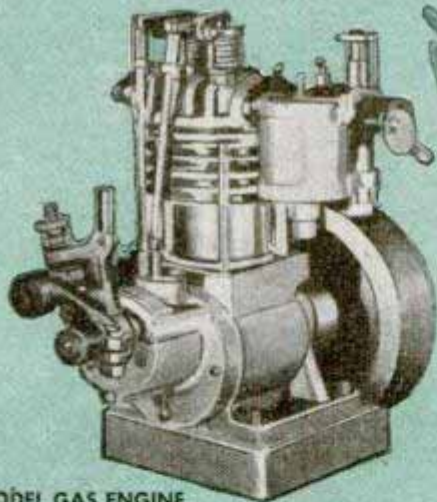

MODEL GAS ENGINE

MILLING MACHINE TECHNIQUE

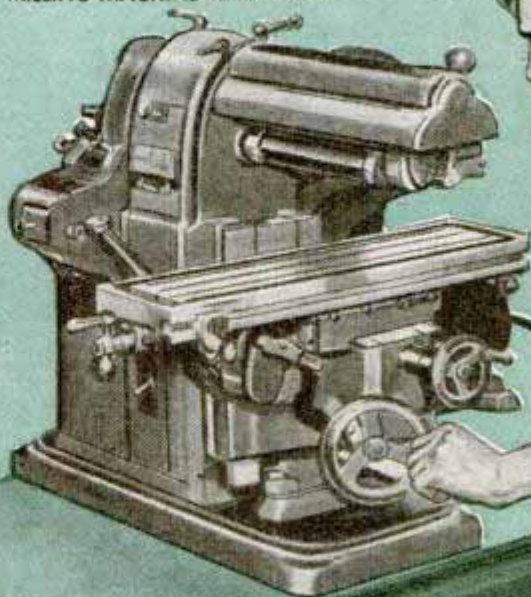

CORNER TABLE

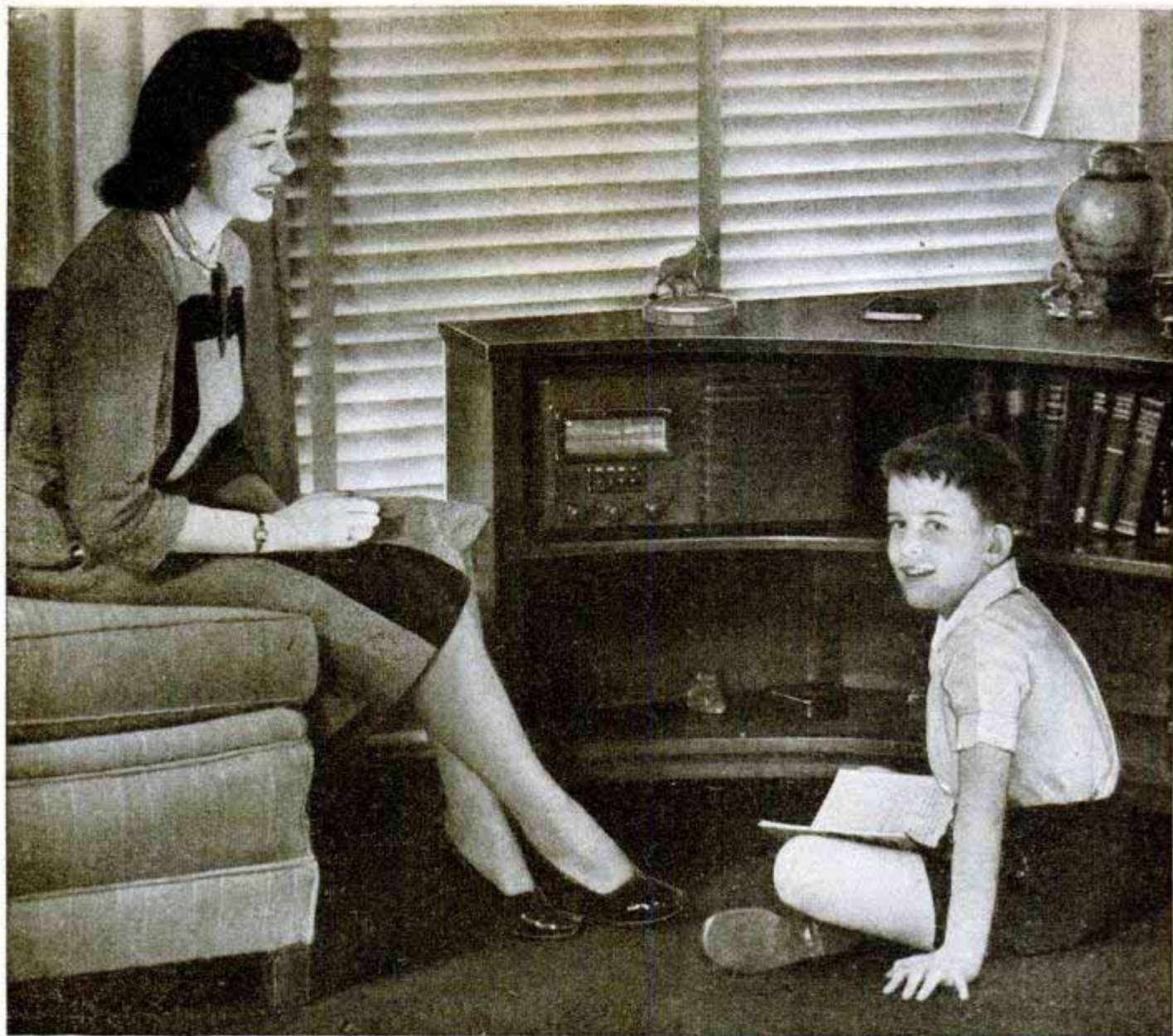

“Round-the-Corner” Table

WITH a sectional sofa this smart-looking table is the latest treatment for a corner window, although you'll find it adaptable to almost any room. Whether in the living room, bedroom or game room, you'll think of a dozen ways to make use of its utility and space-saving features.

If available, plywood will save a lot of gluing, but if you prefer to work with solid cabinet woods, the drawings show how the top and shelves can be built up economically of random pieces and then trimmed to size later. Select pieces with the nicest grain for the top of the table and joint them carefully edgewise. Plain butt joints will do, although a doweled joint or a groove-and-tenon joint is considerably stronger. As shown in the cutaway view in Fig. 1, the table requires seven full-length legs

“Triangular” table utilizes waste corner space and has place for books and radio

and one stub leg which is doweled between the halves of the curved stretcher as in Fig. 2. Begin work by

assembling the two end units as in Fig. 3. Note that each leg is grooved to a point $2\frac{3}{4}$ in. from the tapered end for the rabbeted members which fit flush with the outer face of the leg. Keep in mind that you must have a right and a left-hand unit. The three remaining legs are likewise grooved to take rabbeted members, after which the whole thing is glued and drawn together with several bar clamps. After this, a false back is fitted between the back legs (see Fig. 7) and glued and nailed in place. While the curved stretcher can be bent of steamed wood kerfed on the back, you may prefer to bandsaw it from wide stock. The stretcher is doweled and glued to the stub leg first and then to the rest of

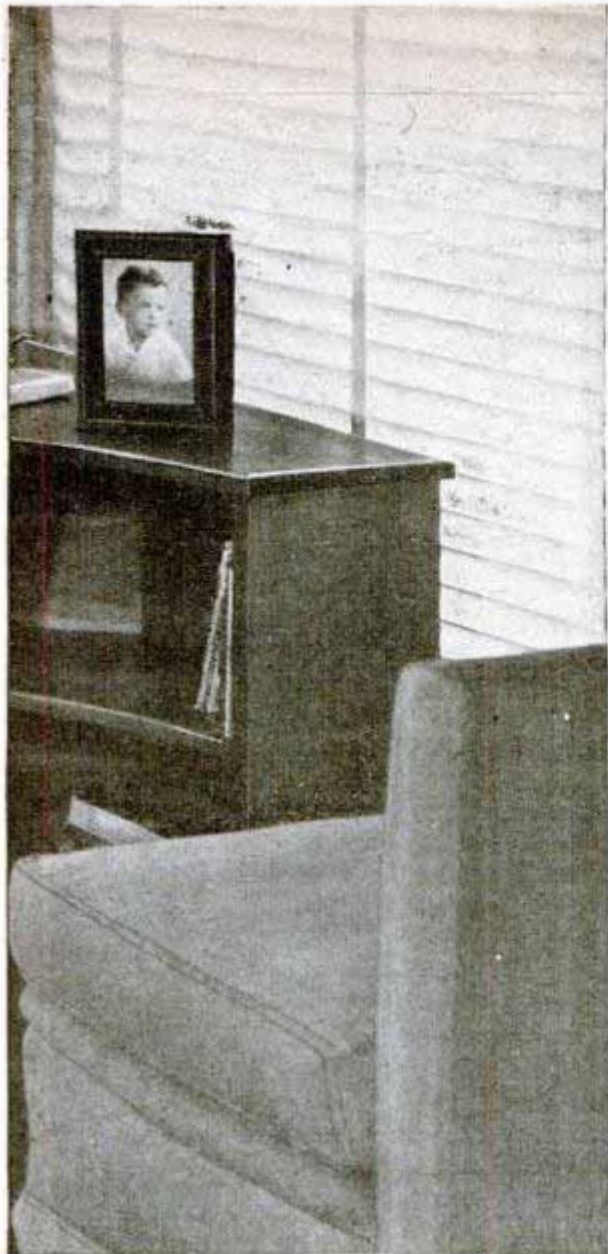

By
WALLACE W. BUFFMIRE

the assembly. In the latter case, you'll be able to spring the ends of the table outward sufficiently to engage the dowels in the holes in the legs.

This leaves only the fitting of the two shelves and the top, Figs. 4, 5 and 8. Each one is made up of two parts, mitered and grooved edgewise at the center to take a plywood spline. The bottom shelf is fastened with screws driven up through the stretcher and also in from the back of the table. The center shelf is fastened similarly, while the top is held with standard, metal table-top fasteners of the type shown in the circular detail in Fig. 1. This method of assembly conceals all fastenings and makes a neat job.

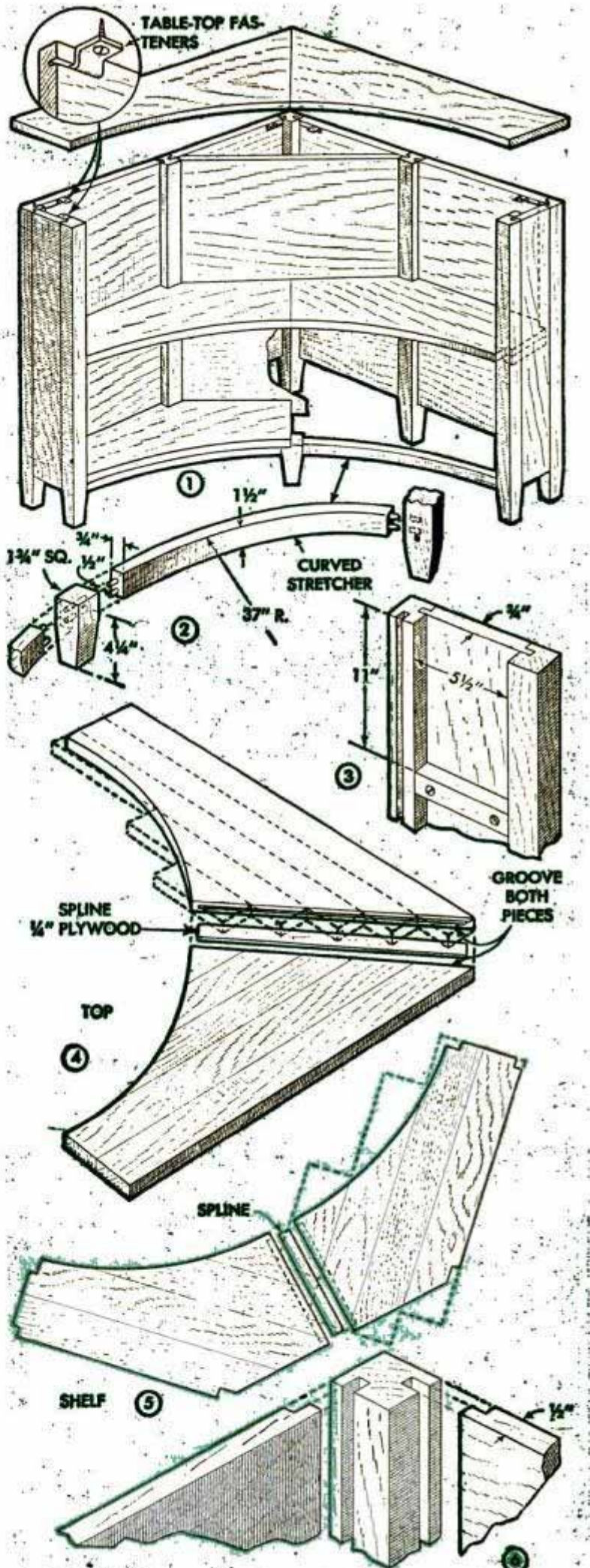

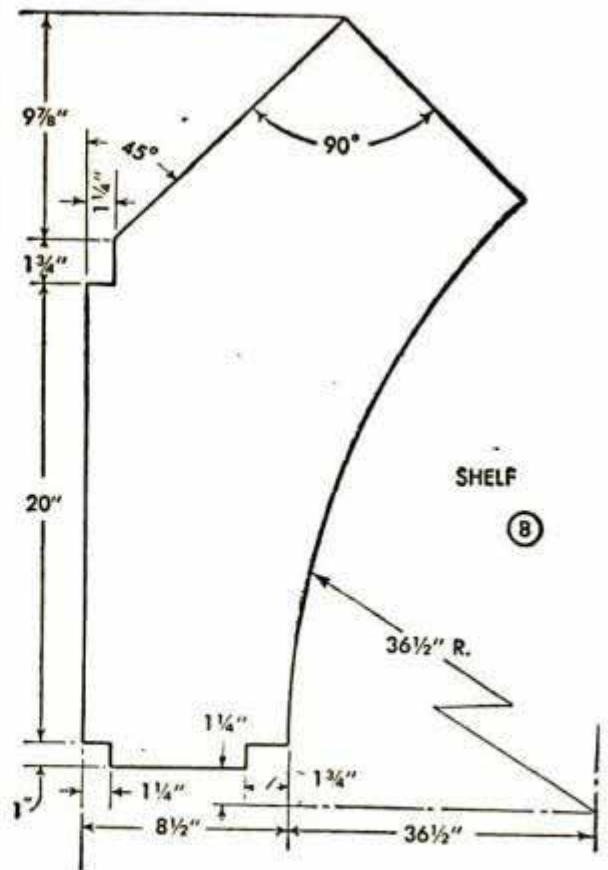
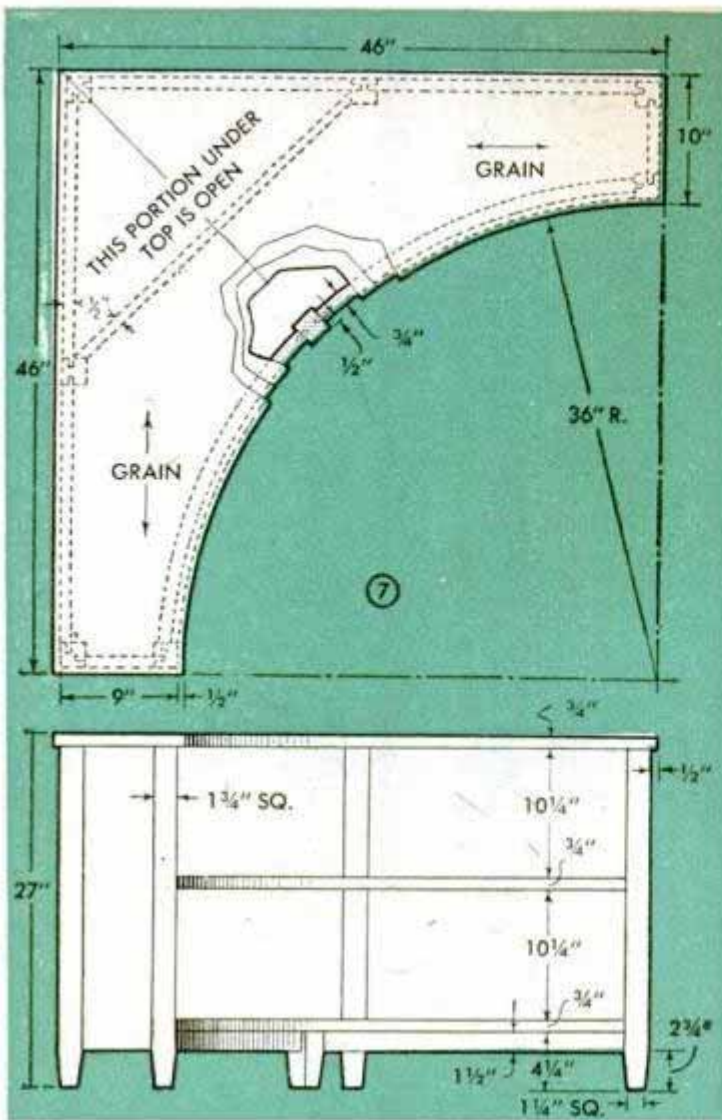

BILL OF MATERIAL

2 pcs.	3/4 x 21 x 46 in.	Top
7 pcs.	1 3/4 x 1 3/4 x 26 1/4 in.	Legs
1 pc.	1 3/4 x 1 3/4 x 4 1/2 in.	Stub leg
2 pcs.	3/4 x 6 1/4 x 23 1/4 in.	Ends
4 pcs.	3/4 x 18 x 33 in.	Shelves
4 pcs.	1 1/2 x 23 1/4 x 20 in.	Back
1 pc.	1 1/2 x 23 1/4 x 29 1/2 in.	False back
2 pcs.	3/4 x 1 1/2 in.	Curved stretchers

Now to finish the table. The type of wood used will vary the finishing procedure somewhat but for the most part it is the same whether you have used walnut, mahogany, birch or maple. First you should go over the whole table and give it a thorough sanding, beginning with a coarse paper and using progressively finer grades until all flaws have been sanded away and the surface is glass smooth. Here you must

decide whether you want a natural finish. If so, then you omit staining the wood and strive to bring out its natural beauty by the use of varnish or wax alone. In the case of birch or maple, unless a blond finish is desired, the wood is usually stained to imitate walnut or mahogany. In this event you forego filling the wood because birch and maple are close-grained woods and do not require filling.

HSC-51

Envelope Sealed With Fingernail Polish Will Stay Closed

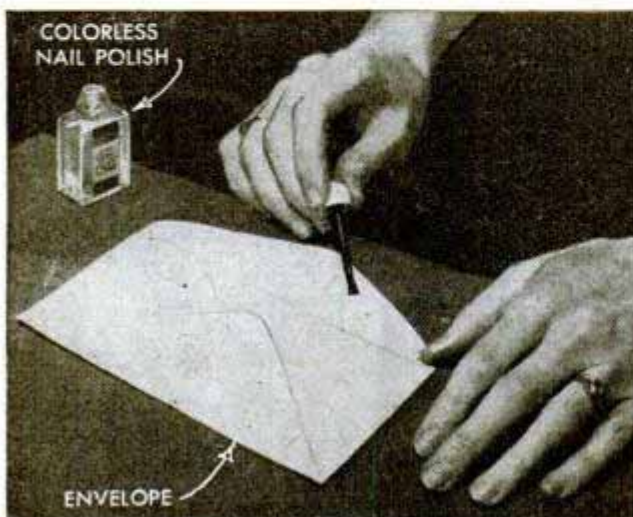

When the adhesive on an envelope flap does not seal tightly, use colorless nail polish as a glue. It dries almost instantly and leaves no smudge. A letter sealed in this manner cannot be steamed open.

Play Ball Made From Basketball

If you have an old basketball that is no longer usable because the bladder is worn, try making it into a play ball for small children. The bladder is removed and the cover is stuffed with kapok. This makes a ball that is light and soft enough so that it will not injure children should they be hit accidentally.—C. E. Edson, Lakewood, Ohio.

Recirculating Connection Conserves Hot Water

Here's one way to conserve hot water and avoid a long draw-off until the temperature at the faucet is hot enough. By recirculating the water through the heater continually, that which normally would cool off in the piping remains hot. In this case, the recirculating connection was made at a tee in the drain and at another tee in the riser. This latter connection should be as close to the faucet as practical to allow as much recirculation as possible. Hot water coming off the top of the tank will flow through the horizontal run and back into the tank through the lower connection in much the same manner that water circulates through the radiators and piping in a hot-water gravity-feed system. To avoid loss of heat through the piping, it should be covered with insulation. Although this may seem to require extra piping, the economy is considerable and

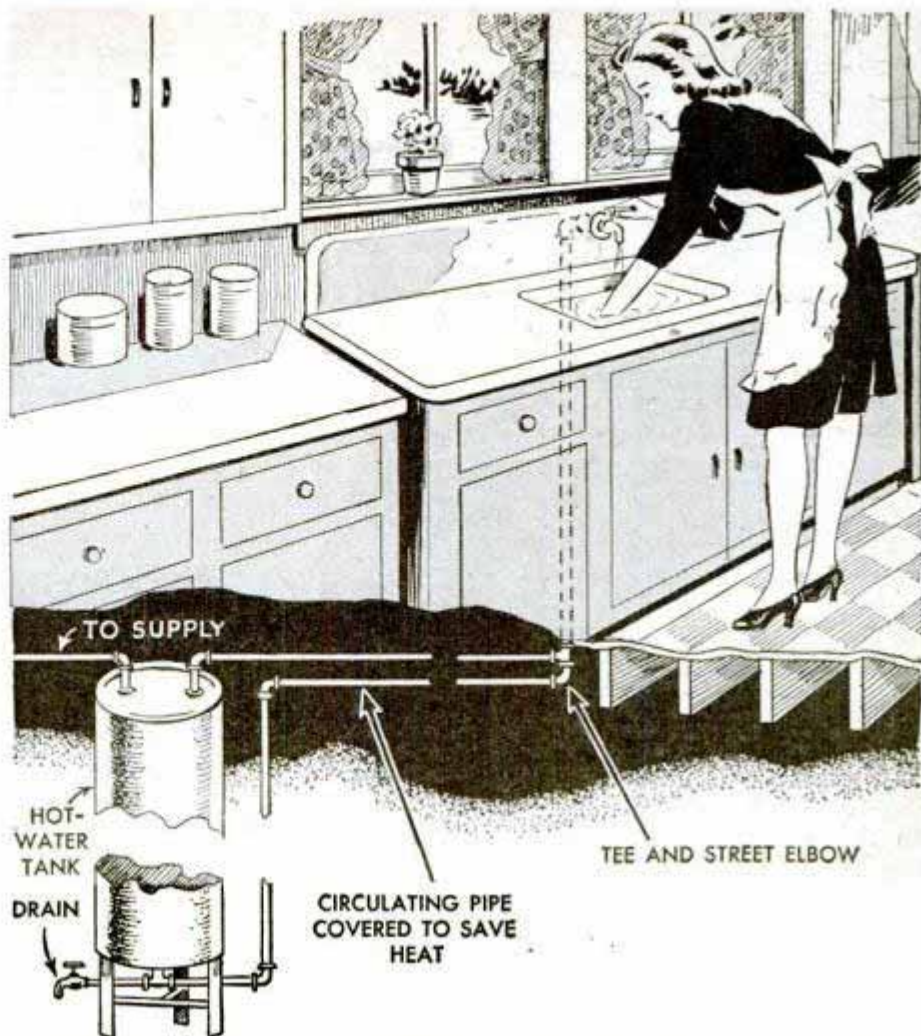

the annoyance of waiting while the cold water runs out of the pipe is overcome.

Lee W. Panney, Ionia, Mich.

Fence Posts Are Pointed Easily When Held in Standard

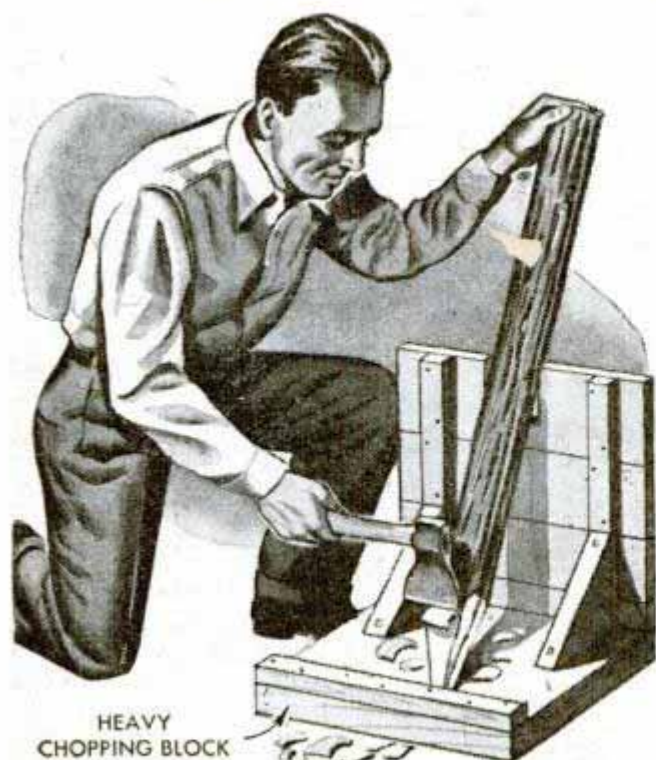

One man can point fence posts easily when using this simple standard. The upright has a slot that holds the post at the desired angle and the base has a stop to keep the post from slipping. The base should be made of fairly heavy wood.

Formation of Mildew on Leather Prevented by Copper Sulphate

To prevent leather-bound books from mildewing, copper sulphate can be applied. A piece of absorbent cloth is soaked in a solution made by dissolving a small amount of the sulphate in water and then the cloth is allowed to dry. When dry, the cloth is rubbed over the book to protect the binding.—Walter E. Klein, Mansfield, Ohio.

Small children who cannot read will quickly learn to identify phonograph records if appropriate pictures are pasted over the labels. Then they will no longer have to ask older persons to select records.

Solving Home Problems



1



2

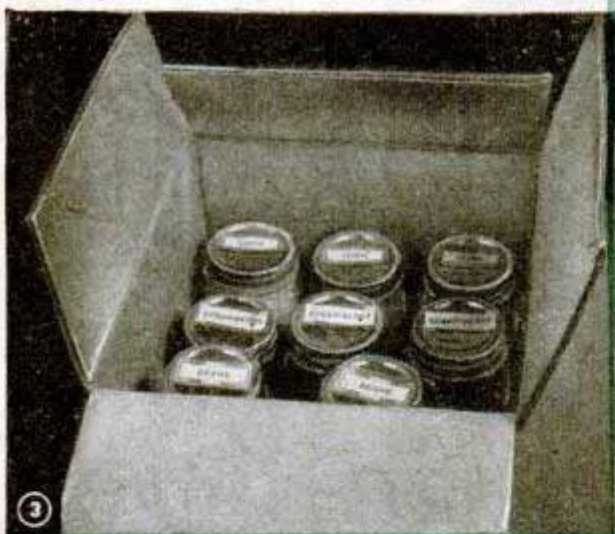

3

1 Serving meals to someone in bed is something of a problem because the dishes will slip on the tray. A corrugated mat that is trimmed to fit the tray, with cutouts for the dishes, will solve this problem

2 Removing the kinks from yarn that has been used can be done easily with a quart milk bottle. When unraveling the yarn, wind it around the bottle and then dip it in water. When dry, it will be free of kinks

3 When shelf room is taxed to capacity and canned goods must be stored in boxes, it's a good idea to place the label on the top of the jar where it can be seen rather than the side as is done usually

4 To keep brown sugar from drying out and hardening into lumps, cut an apple and place half of it in the sack with the sugar. This should provide enough moisture to keep the contents in the proper condition

5 For those who prefer to use bulk tea rather than in small bags, this "tea ball" will come in handy. A small can is perforated with a darning needle and is suspended in the teapot from a strong cord

6 If you have trouble pouring heavy syrup from a bottle with a small mouth, insert a soda straw in the opening so air is admitted above the liquid. This will cause it to flow more evenly than before

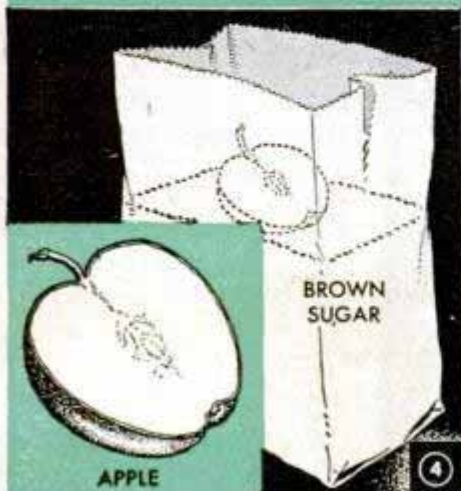

4

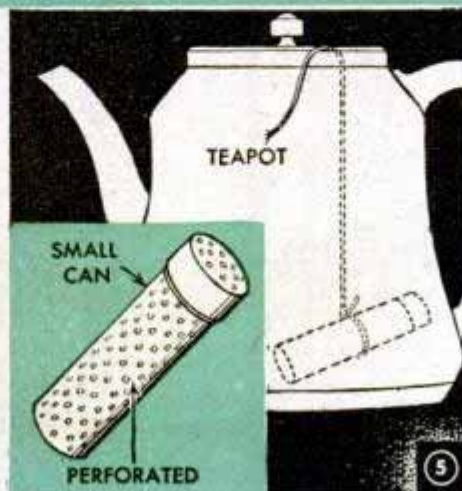

5

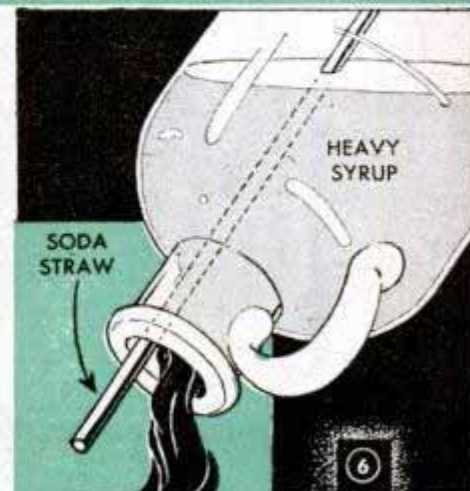

6

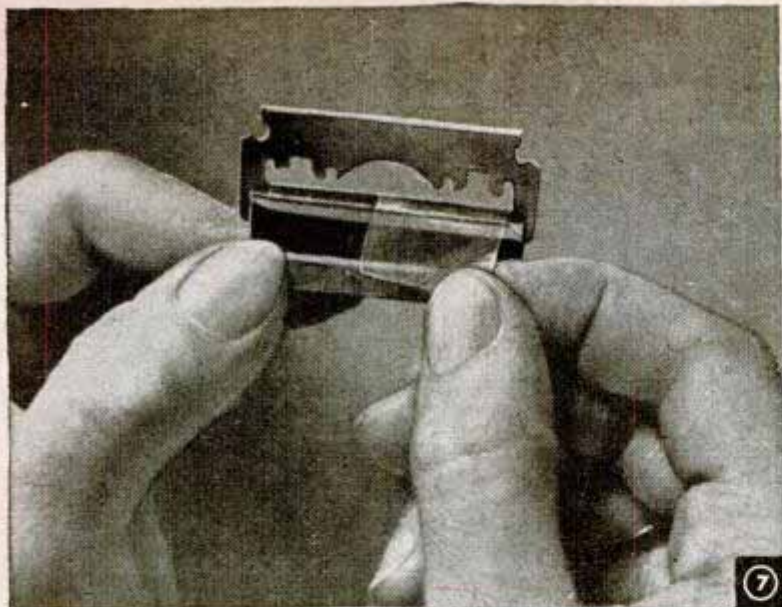

7

7 Although ideal for ripping sewing, a double-edge razor is difficult to handle without cutting yourself. For a holder, use the striking end of a paper-match book and fasten in place with cellulose tape

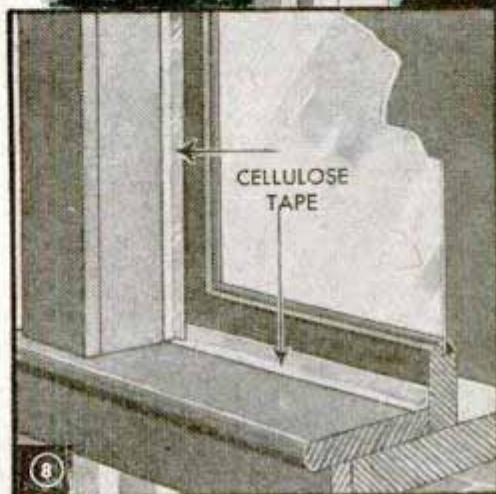

8

8 Here's an easy way to weatherproof your windows for winter if you don't have storm sash. Apply cellulose tape to the inside of all cracks around the sash and sills, being sure it doesn't wrinkle

9 Try removing those stubborn jar lids by using a length of rubber hose of a suitable size as a hand grip. The hose is looped around the lid and then the ends are grasped to provide a firm hold

10 With a screw hook and a rubber stopper of the type used in ammonia bottles, you can make a wardrobe hook that will be satisfactory. A hole is drilled in the stopper which slips over the hook

11 Converting a large cupboard drawer into a vegetable bin is not a difficult job. Just cut out a section of the front and cover this opening with a coarse screening to secure adequate ventilation

12 Small children cannot tamper with gas-stove jets if this wood and metal guard is placed over them. The boards are held in place with flat-iron strips that are bent and clamped to the top of the stove



9

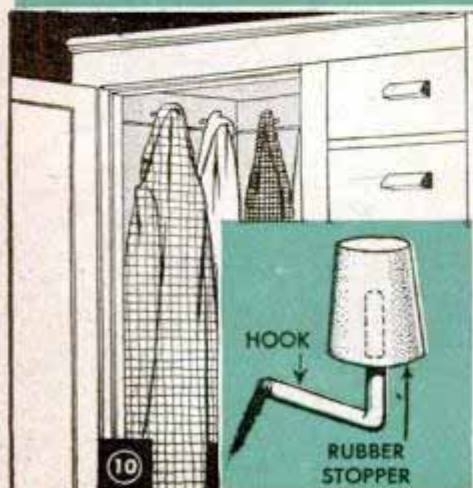

10

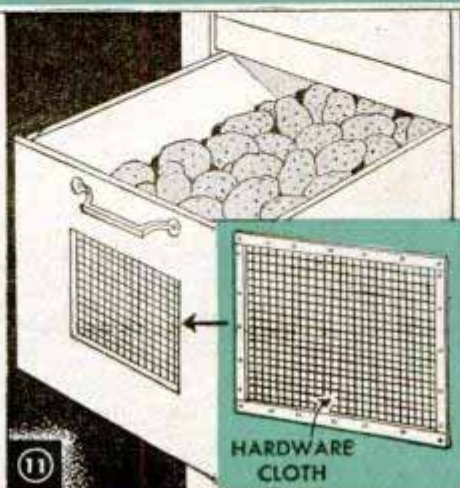

11

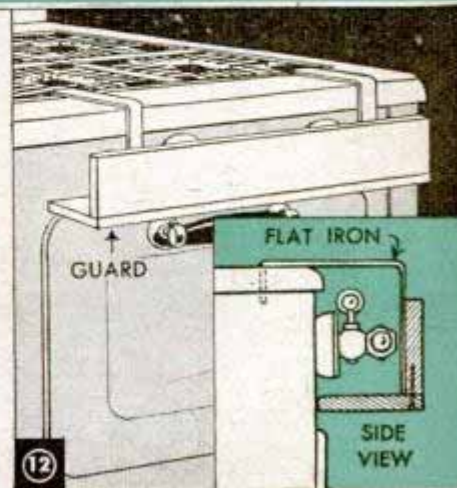

12

Musical MERRY-GO-ROUND



IN THIS toy, which is crank operated, a small music box of the type often used in ladies' powder boxes provides the sound effect every youngster likes. Fig. 1 gives the plan view showing the location of the music box and rollers on which the circular platform rotates. The sectional view in Fig. 2 and the cutaway in Fig. 3 indicate the general assembly. Note that one of the rollers is fitted with a crank and is wrapped with a rubber band to provide a friction drive for the platform. A roller on the platform standard drives a small roller on the music box, the latter roller being wrapped with a rubber band to produce a friction drive. Fig. 4 suggests a sleigh and animal cutouts, and Fig. 5 shows their relative positions on the platform. Mount the animals in pairs with each sleigh.

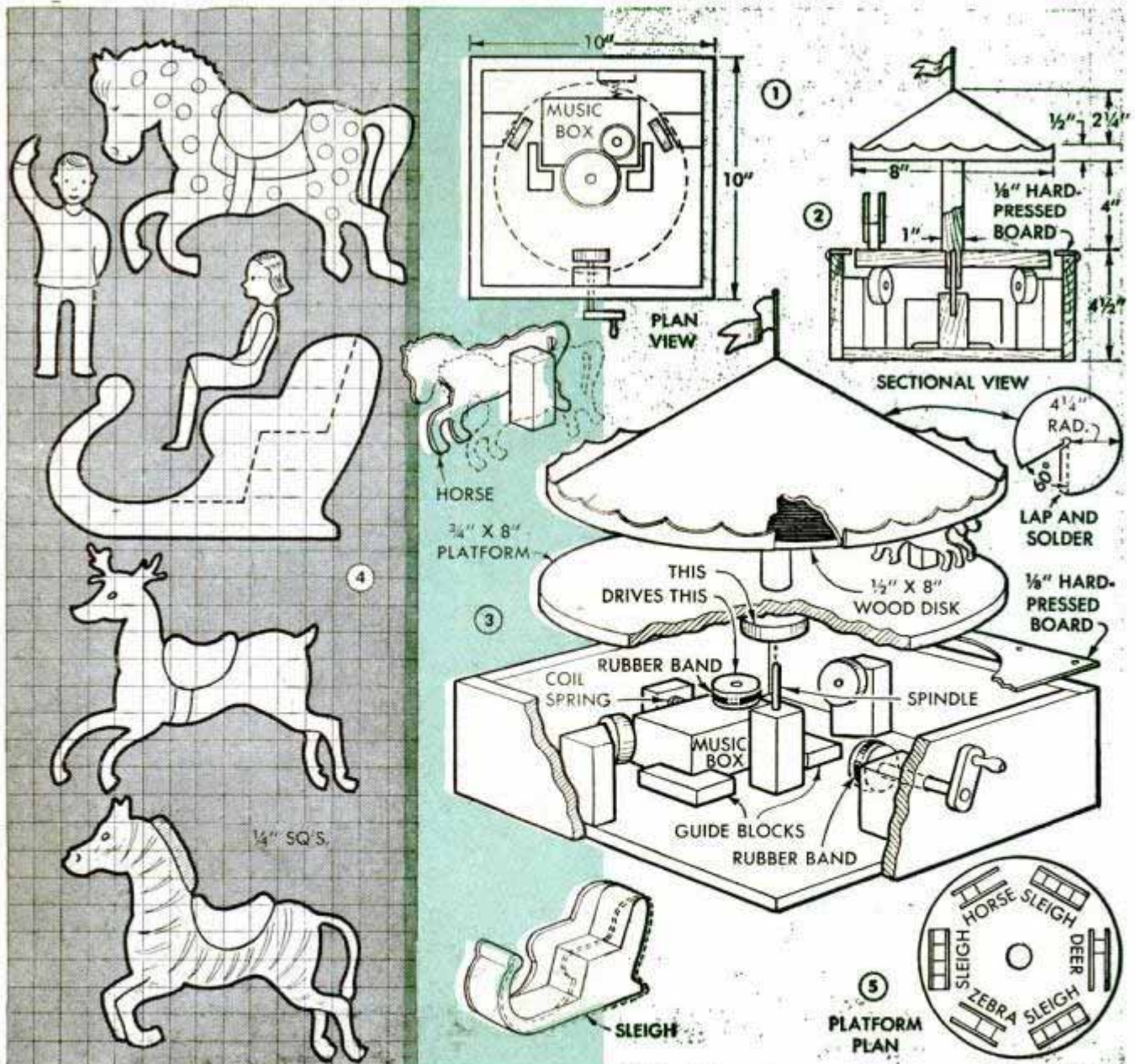

Indicating Light on Map Makes Geography Fun

Studying geography is a lot more fun with this map that has a flashing light to indicate when the pupil has touched the right city with the pointer. In this case, the map was mounted on a piece of $\frac{1}{8}$ -in. hard-pressed board. The contact points are brass tacks to which the wires on the back of the map are soldered. Names of the cities are listed along the side of the map and wires run from the tacks here to the tacks corresponding to the cities in their proper locations. The teacher has a sliding contact which is connected to a 6-volt power source. A bulb is in series with this connection. When the teacher touches the contact at a certain city, the pupil completes the circuit by touching the pointer to the tack representing the city on the map.

—G. R. Ursenbach, Toronto, Ont., Can.

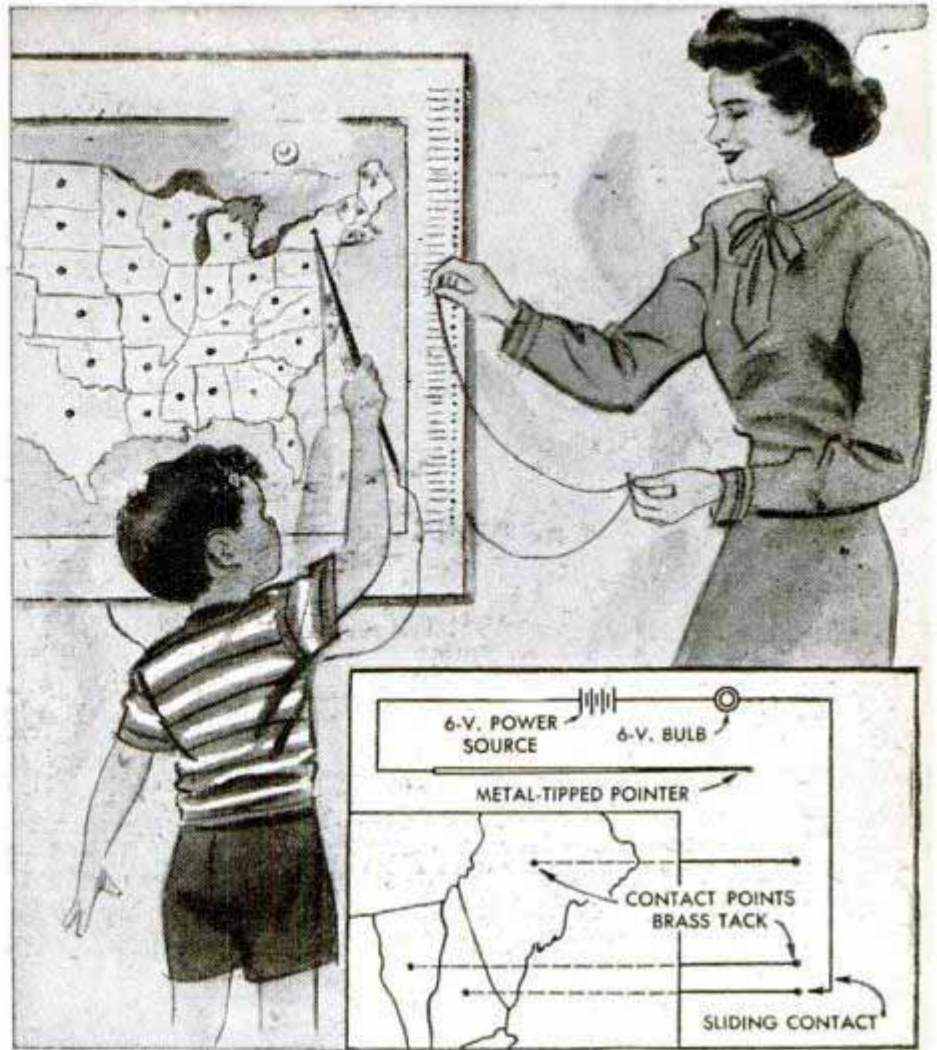

Two-Color Triangular Bandages Identify Different Knots

To teach students in first aid quickly, one instructor found that if one half of a triangular bandage is dyed red and the other

half remains white, the pupils will learn to tie knots and apply bandages rapidly. The folds and turns stand out much more clearly than they would if the cloth were one color.

John C. Sommer, Saginaw, Mich.

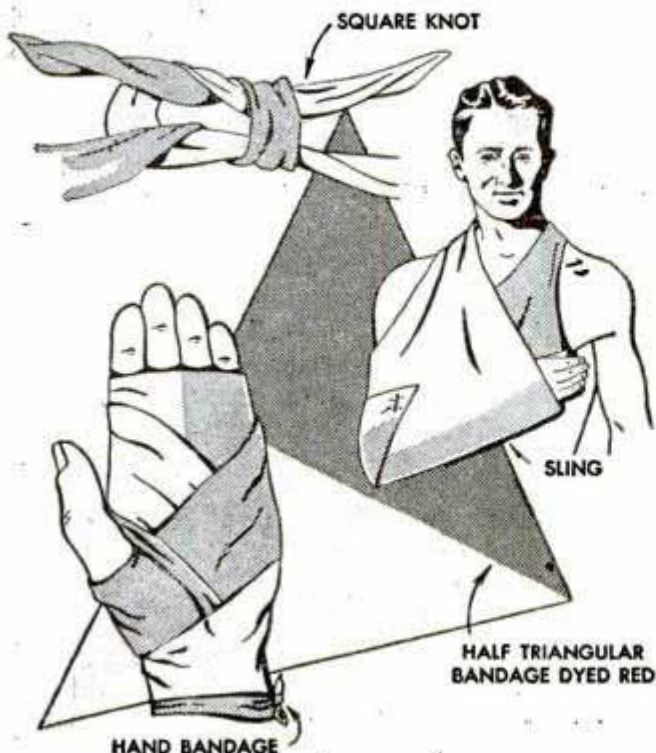

Masking Tape for Window Panes

If you are painting window frames and do not have a brush small enough to avoid getting paint on the glass, a substitute for masking tape can be had by utilizing newspaper. Cut the paper into strips about 2 in. wide and dip them in water. When wet they will adhere to the glass and after the painting is finished they are removed easily.

W. L. Dysart, Louisville, Ky.

Getting Rid of Hub Cap Rattle

If you have an annoying rattle in one of your car hub caps, put adhesive tape around the opening where the cap contacts the hub. The same treatment is good for hood squeaks. Find the spot that's rubbing and stick adhesive tape to it.

James W. Campbell, Willimantic, Conn.

Shotguns

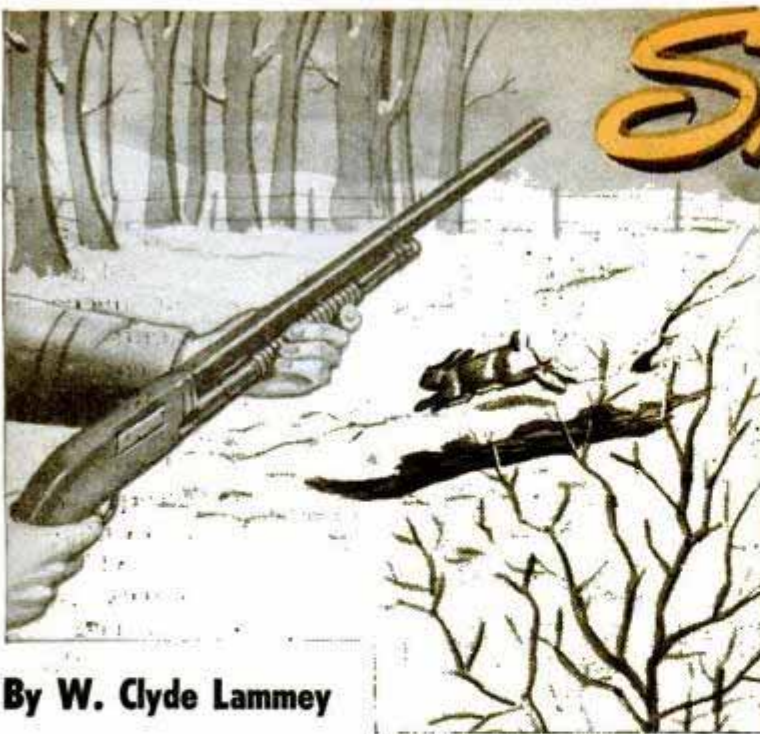

By W. Clyde Lamme

WHEN quail rise from nearby thickets and streak away through the low cover, or a cock pheasant blasts unexpectedly into the air from a spot almost under your feet, you'll find it easy to agree with those experienced shooters who have called shotgun pointing a sport of "controlled relaxation." That's just what it takes—a delicately controlled coordination of feet, legs,

shoulders, arms, hands, head, eyes and senses. Each mental and physical process must be assigned a definite place in a smooth continuity of motion, all to the end of accomplishing several specific things in a split second of time. Like other outdoor games requiring a high development of skill and dexterity, it calls for a lot of practice. When flushed birds are winging away at mile-a-minute speeds there's no time to take into deliberate account all the variables offered by each shot. Essentially the problem is simple—mainly that of intercepting one moving body, the target, with another, the shot charge. But suppose you are standing in the open and, without warning, a flying target suddenly appears, moving across in front of you from left to right at a speed of say 88 feet per second, or about 60 miles per hour. Some game birds fly even faster. How to place a shot charge at just the proper distance and posi-



① Beginning of the gun swing in firing at a target crossing in front at right angles from left to right. Note that the shooter first swings left to pick up the target, using the gun as a "pointer"



② Here the shooter starts the reverse swing, the pivot to the right continuing until after the shot is fired so that speed of gun swing will not diminish. Note that feet remain in the same position

Footwork



tion in the sky ahead of this speeding target to catch it when it comes along—that's the trick.

It begins with footwork. If a shooter is caught off balance at the instant his target is trapped, or has the wrong foot forward when a bird flushes in the field, he's almost sure to miss, unless he's practiced approved methods of getting quickly into shooting position. Many grouse hunters move through likely cover with a short, halting step and gun held in both hands. Experienced quail shooters, moving in for the flush behind dogs holding rock-steady on point, do much the same. Each must have his feet "under him," ready for quick,

controlled action when the birds take off.

If all the variables of any given shot are calculated mathematically and the necessary impulses and body movements are considered separately, the thing can be made to appear impossible. But the answer to that one is that a single mental process can be trained to control several physical reactions which may be required to produce a definite result, just as in driving a car or playing golf or tennis. At the outset the shotgun pointer acquires the habit of "facing the shot." If he's a right-handed shooter he comes to think of the right leg as the balance or "steering" leg. His left leg becomes the "pivot" leg. In

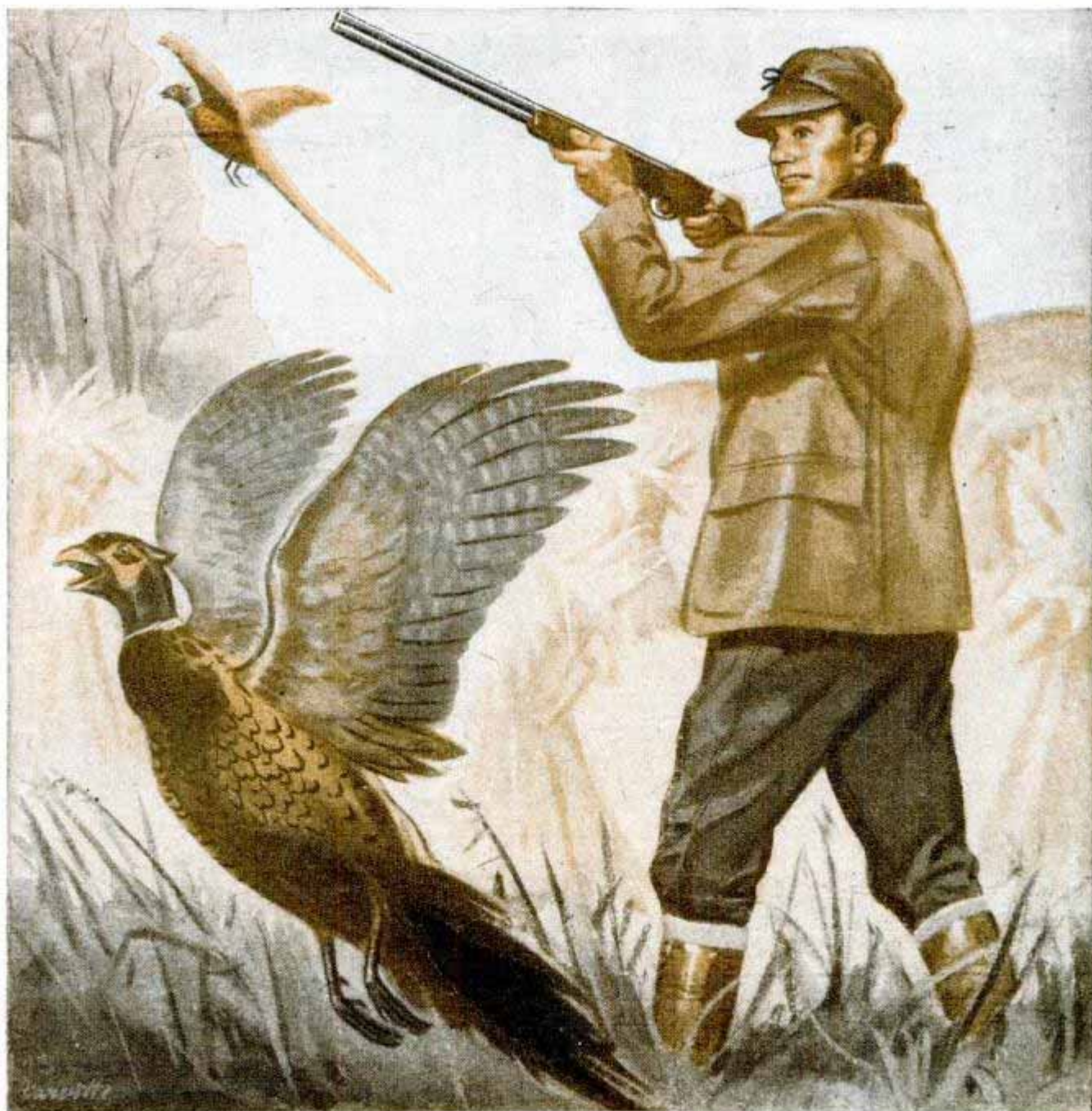

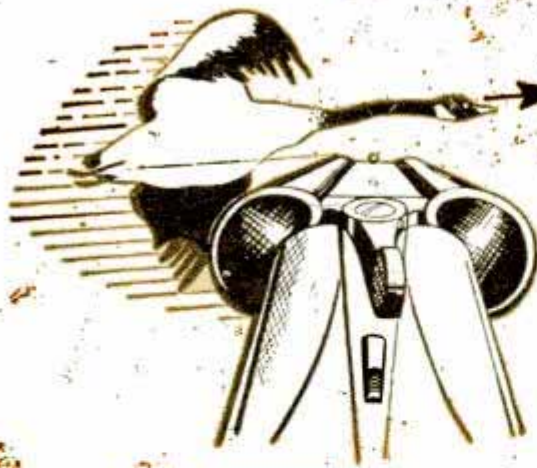

SWINGING PAST



POINTING OUT

trap, skeet and upland game shooting the feet normally are kept quite close together. Irregularities in posture, such as feet spread wide apart, bent knees, or body bent far forward, destroy the muscular torsion and body balance so necessary to a quick, rhythmic swing to right or left. In facing the shot the left toe usually points slightly to the right of the spot where it is expected the shot charge will be delivered. The feet are separated at an angle, the right foot normally a few inches back of the left. Nearly everyone can take this position, raise, or mount, the gun and swing it right or left through a combined angle of 60 degrees or so without experiencing undue muscular tension or discomfort and without lifting either heel from the ground. In this position most of the weight will be on the left foot. When a swing is made in either direction, muscles of the feet and legs will be placed under a torsional strain which increases progressively until the extremes are reached. The gun muzzle is lowered to follow running game by bending the body forward at the hips, raised by a slight backward bend and swung right or left by pivoting, not swaying. Arms, head,

torso and gun move as a unit, except that in a swing from left to right, right-handed shooters may find it necessary to slide the cheek along the comb of the gunstock. In depressing the muzzle the left leg takes more of the weight, while in elevating the gun the right takes the greater share. However, in a good shooting position the transfer of weight is hardly noticeable.

Body and foot positions in Figs. 1 and 2, A to F inclusive, show in a way how the whole procedure works out in practice. The broken line shows the approximate position of the gun in relation to the foot position. Some good shotguns stand with the feet even closer together than indicated, while others, especially skeet shooters, find it more to their advantage to stand with the feet somewhat farther apart. There are no hard-and-fast rules but in any case when facing the shot the feet are the foundation from which the gun swing is made and both should be firmly on the ground during the whole maneuver.

Watch a top-rate wingshot take the four pairs of doubles in a round of skeet, where the traps are sprung simultaneously, and the shots usually are taken from stations



④ This shotgunner is taking a surprise target flying away sharply to the right. He must withdraw the right foot, pivot on the toe and step in the direction of the flying target with the left foot

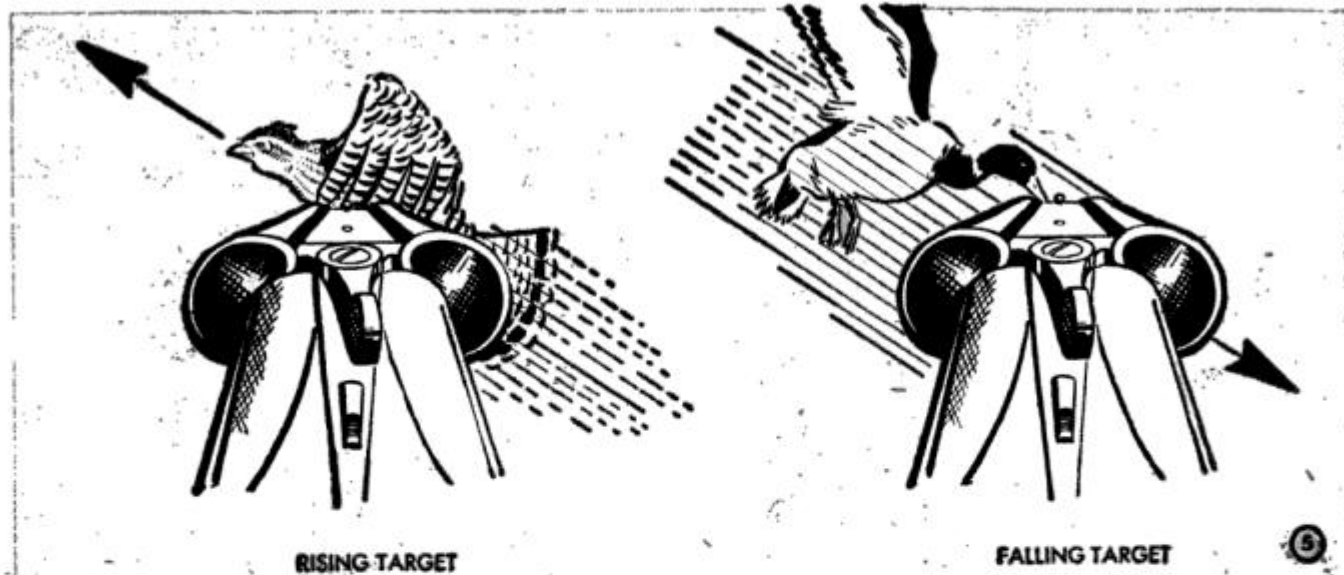

RISING TARGET

FALLING TARGET

1, 2, 6 and 7. In the ready position the shooter faces the shot on the near side of the spot where the targets will cross in flight. In this way he has his feet already placed in the best position to swing on the second bird. He takes the outgoing target first, then swings for the incomer from the same foot position. Also, if you observe closely you will see that the gun swing doesn't start at the precise instant the targets are trapped, but that the shooter holds for the briefest moment until the targets are in clear view. Then, like the golfer, he must have perfectly controlled coordination, but he must move a lot faster.

In this demonstration two things take place that you don't see. In order to estimate instantly the apparent speed and direction of the swiftly moving targets, the shooter very likely is using the imaginary vertical clock system, Figs. 7 and 8, and, to bring the gun to bear on the flying clay birds before they get out of bounds, he must cut his timing pretty thin. There's no time to swing the gun in front of each individual bird and maintain a measured lead. So the shooter uses a trick effective at the shorter ranges and known to shotgun

pointers as the fast swing or "swinging-past" method, Fig. 3. In this the gun muzzle follows the line of the target's flight in a fast swing, overtakes it from behind and swings past. As the gun muzzle passes the target the shooter pulls the trigger, and the gun, swinging faster than the bird, builds up the required lead. The essential thing is that the gun be moving uniformly. Any irregularity in the swing, such as flinching or stopping the swing at the instant the trigger is pulled, likely will cause a miss. Speed of the swing is important, too. For example, the speed of the swing in a crossing shot must vary from that employed in a quartering shot. Practice of the fast-swing method usually is to be recommended only for the shorter ranges where flight of the targets is uniform and predetermined, such as in skeet or certain shotgun games and also in upland game shooting where the nature of the cover and the character of the bird's flight call for quick work at close range. Some wild-fowl hunters using high-speed ammunition use the fast swing at medium-long ranges. On the other hand, at the traps, pass shooting, or along game-bird flightways where the



6 Caught out of position with the right foot forward and the target flying to the right rear, the shooter throws his weight on the right leg, pivots and swings the left foot to face the target

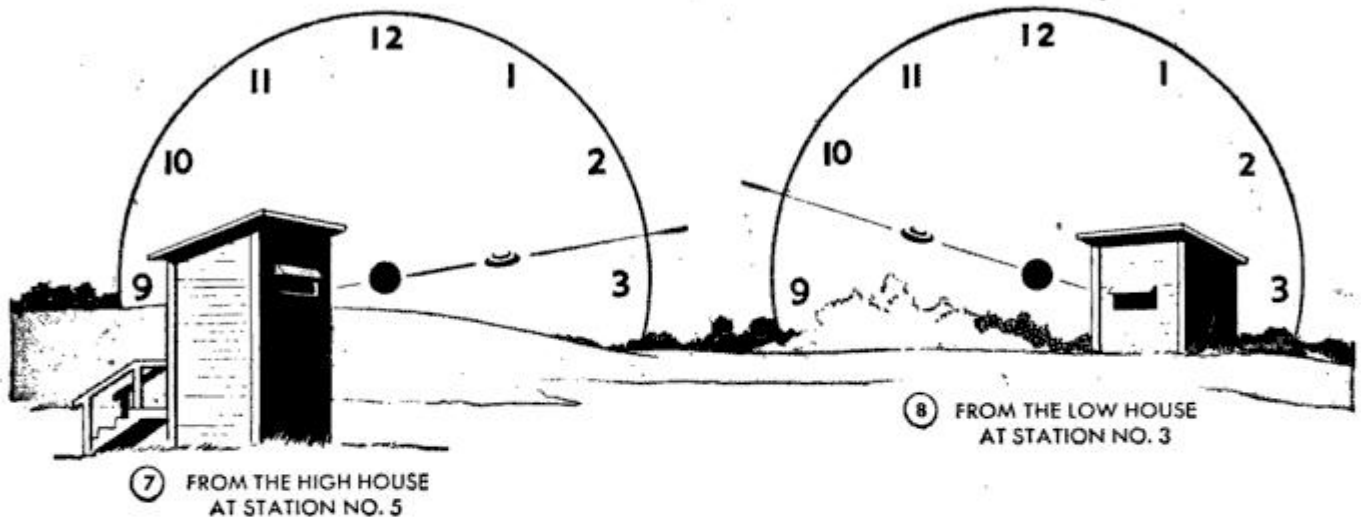

shots are taken at comparatively long ranges, good shooters generally use what is known as the slow swing or "pointing-out" method, Fig. 3. This involves a more precise calculation of distance, apparent speed of flight and gun swing. Actually the eye controls the whole procedure. Here the gun is swung ahead of the bird and a measured lead maintained until after the shot is fired. In this the apparent speed of the target is important. A target crossing in front of you at right angles and another quartering away either right or left may be moving at the same rate of speed but the quartering target will appear to be moving much slower. This is due to perspective, or obliquity of the line of flight to the eye. Because of this apparent reduction in speed the forward allowance or lead will need to be reduced accordingly. All this assumes that the target is maintaining a more or less level flight. Sharply rising or falling targets, Fig. 5, introduce another factor. You have to lead a rising bird above as well as ahead. To connect with a falling target you have to get well under it. Figs. 3 and 5 are merely approximations. The sketches do not represent actual leads.

Most right-handed shooters find it easier to swing on a target crossing from right to left than on one from left to right. Often it will take considerable practice with the gun before one can accomplish the maneuver with equal facility in either direction. If you're a right-handed shooter, it's a good idea to practice the left-to-right swing shown in Figs. 1 and 2, details A to F inclusive. This can be done anywhere there is room to swing the unloaded gun. Keep the feet in the same position during the whole maneuver. Such practice, "dry shooting" as it often is called, is a valuable aid in mastering the finer points of gun swing and coordinated footwork. Left-handed shooters will find it extremely helpful to practice

a right-to-left swing in the same manner.

Fig. 4 illustrates a surprise situation where the shooter is moving through cover in the field. As the bird flushes and makes away well to the right and toward the right rear, the shooter's left foot is forward as at A. He must shift the right foot, pivot on the right toe and step in the direction of the flying target with the left foot as at B. Then by a third movement he comes to the position shown at C with the gun raised to point out the bird. Note that in this maneuver swinging and mounting of the gun and the footwork are done simultaneously. Fig. 6, A, B and C, shows much the same thing as Fig. 4, with one important variation. In this case, the shooter is taking a surprise shot to the right while advancing at a normal pace but caught out of position with the right foot forward when the bird gets up. The shooter finishes the step as at B, then pivots on the right foot and brings the left foot into position as at C. The foot positions in Fig. 6, C, have purposely been shown slightly incorrect to illustrate what often takes place. In making a quick pivot of this nature the tendency is to place the feet directly opposite whereas the left foot should be farther forward for good balance. Some practice may be necessary to correct this tendency. The maneuvers shown in Figs. 4 and 6 are among the most difficult foot movements for the upland gunner on uneven ground, or at the various "walk-up" gun games where the shooter must fire at surprise targets thrown at unknown angles. Practicing these foot movements for surprise shots from both the right and left will be a help in field shooting.

Use of the imaginary vertical clock face in applying method to the business of pointing a shotgun is quite simple in both theory and practice. In skeet or trap shooting the clock-face zero, represented by the

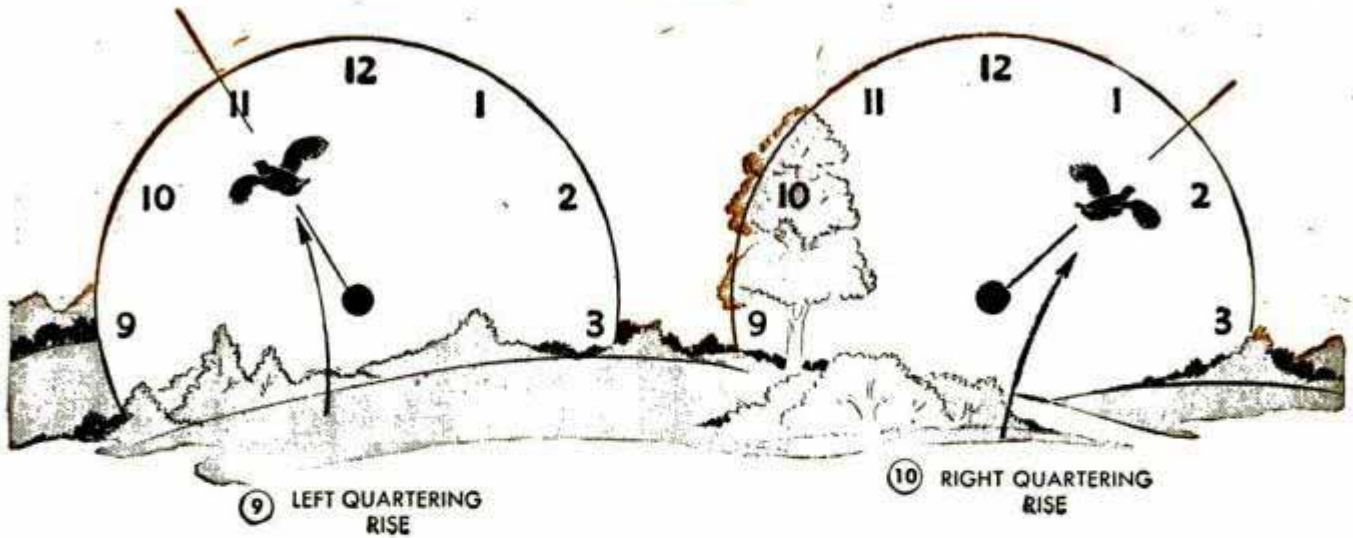

solid black circles in Figs. 7 and 8, will be the point in space near the trap house where you expect the target to appear in clear view. Once the target is sighted clearly, it's easy to think of it as a "2-o'clock" shot, a "2:30-o'clock" shot or a "9:30-o'clock" shot, depending on where the apparent line of flight will cut the circle of the imaginary clock face. When you face the shot at that point where you expect the target to appear, it takes only a comparatively short swing to put the gun on either a 10-o'clock or a 2-o'clock bird. This will be more clearly seen from Fig. 11, the zero point A representing the point at which the bird was first sighted. In upland shooting at birds which rise from cover, the zero point of the clock face can be thought of as being only in the vicinity of the spot where the bird was first sighted, as in Figs. 9 and 10. If you accustom yourself to its use, the clock face will form in your imagination the instant you recognize the flushing bird as a legitimate target.

In the 11:30-o'clock or 12:30-o'clock shot, Fig. 11, the lead and swing are reduced almost to zero, gun movement merely compensating for the rise of the target. In addition to footwork the shooter should consider stock length, drop, pitch and barrel boring to suit his purpose.

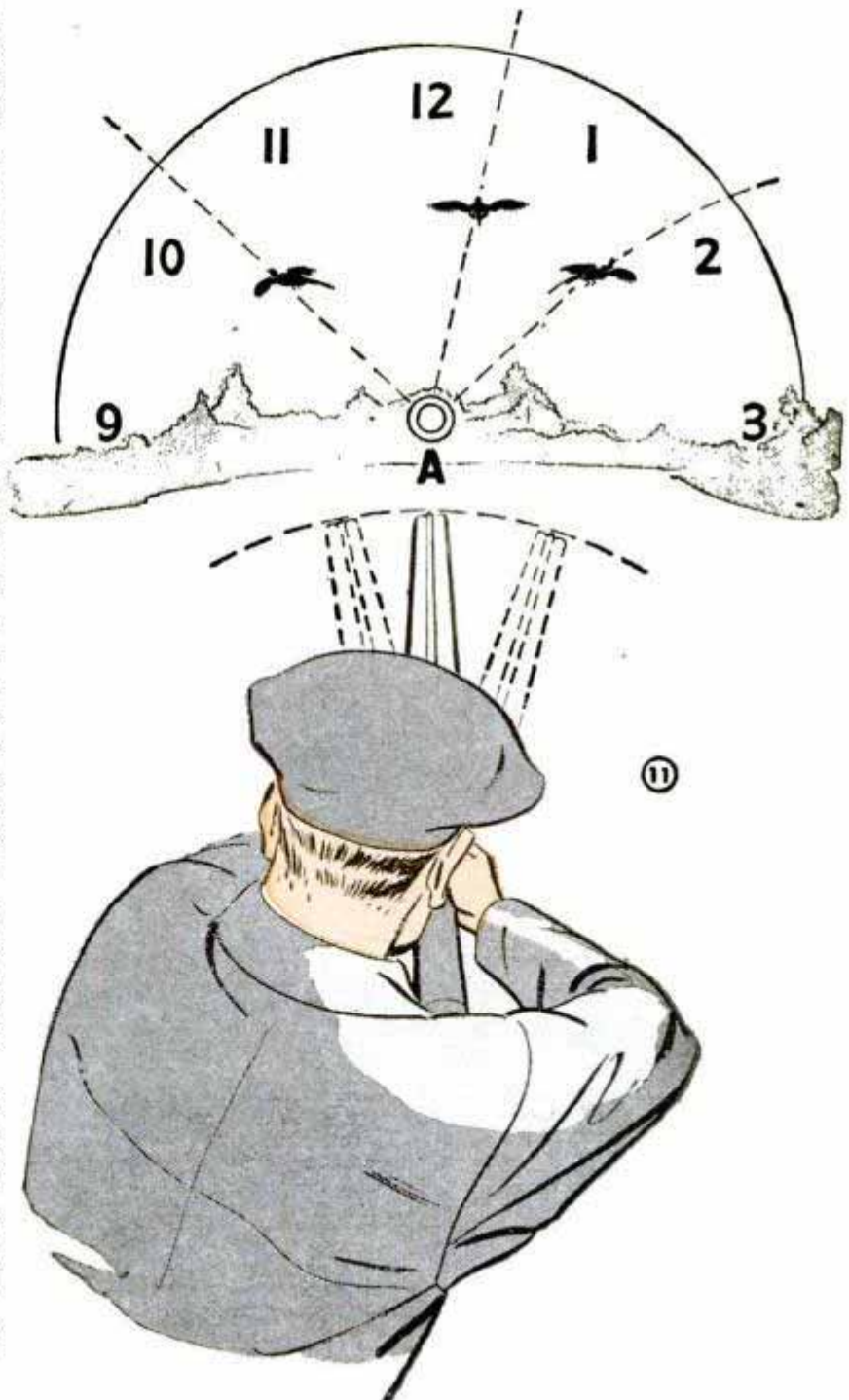

Decal on Framed Piece of Glass Decorates Child's Room

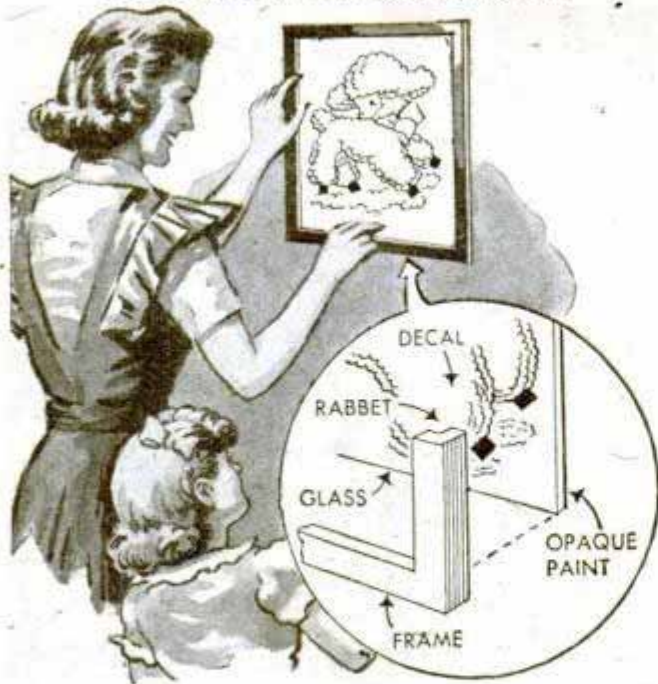

Pleasing wall plaques for a child's room can be made with a small frame, a piece of glass, an amusing decal and some paint. The decal is transferred to the glass and the reverse side is painted. For this purpose aluminum or bronze paint is particularly suitable as it will reflect the figure in the manner of a mirror. When dry the glass is framed. Several such plaques will do much to add to the gaiety of the room.

H. Klein, Pittsburgh, Pa.

Leaves Insulate House Foundation

One farmer who had an unheated basement found that in cold weather the inside cellar walls would frost over and food would freeze. He remedied this condition by insulating the foundation with leaves held against the outside walls by a picket fence of the lath-and-wire type. The fence is staked about 8 in. from the wall. In the spring the fence is rolled up and put away and the leaves are used for mulch in the garden.—D. R. Baldwin, Bellefontaine, O.

Spring Fastened to Eaves Trough Screens Trash From Downspout



Leaves and other trash that may be blown into an eaves trough will not clog a downspout if a mattress or chair spring is inserted in the mouth of the spout. If no spring of this type is available, a length

of stiff wire such as is used for fencing will be suitable if it is coiled to a tapered spiral.

D. L. Pfister, Aurora, Ind.

Ink Pad Uses Typewriter Ribbon

An emergency ink pad that may be carried in your pocket is made of old typewriter ribbon. Attach a cloth hinge to two 2 by 3-in. pieces of cardboard and staple on several strips of ribbon. Stretch the strips tightly and place them close together but do not overlap or the surface will be uneven.

Frank Shore, New York, N. Y.

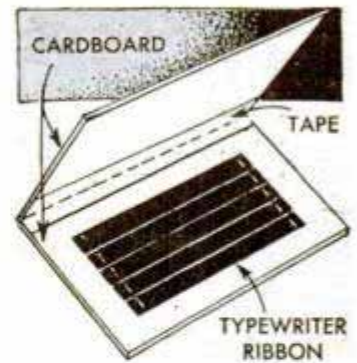

Vegetables Are Accessible If Kept In Unheated Building

Vegetables stored in barrels sunk in the garden or yard are difficult to get at during the winter, but if you have a garage or other unheated building with a dirt floor, try the solution adopted by one householder. In one side a pit is dug about 8 ft. long by 30 in. wide and 30 in. deep. Then a bottomless box of the same outside dimensions is sunk into the hole. The box should be divided into four equal compartments with a hinged lid for each section. To prevent sweating, air holes are drilled in the lids and the vegetables are packed in layers, preferably spread out so they don't touch. To fill between layers, sawdust or sand and leaves can be used. The division of the box into four compartments makes it easier to find the vegetables.

Margaret E. Singleton, Rochester, N. Y.



Aluminum-Lined SHOWER CABINET

LINED with war-surplus aluminum sheets, this shower cabinet is attractive in appearance and easy to keep clean. Any light-gauge aluminum will do as the metal is backed with wallboard. If the sheets are obtained in 3-ft. widths, they will fit the walls without requiring any vertical laps. The shower pan is cement cast in the form indicated by Fig. 3. The rim of the pan should equal the thickness of the wallboard that serves as backing for the metal lining, and the latter is lapped over to make a waterproof seal, detail D, Fig. 2. The frame is made of 2 by 2-in. lumber with 2 by 4-in. pieces at the corners and at the sill. Either wallboard or plywood can be used for the inner and outer sheathing. The aluminum is applied as indicated in Fig. 1 and details C and D of Fig. 2. It is bonded to the wallboard with any adhesive that is suitable for the purpose. Plastic edging strips are applied to the corners and edges by the methods shown in details A and B of Fig. 2. The sill plate in the doorway is of stainless steel.

John L. Hathaway, Los Angeles, Calif.

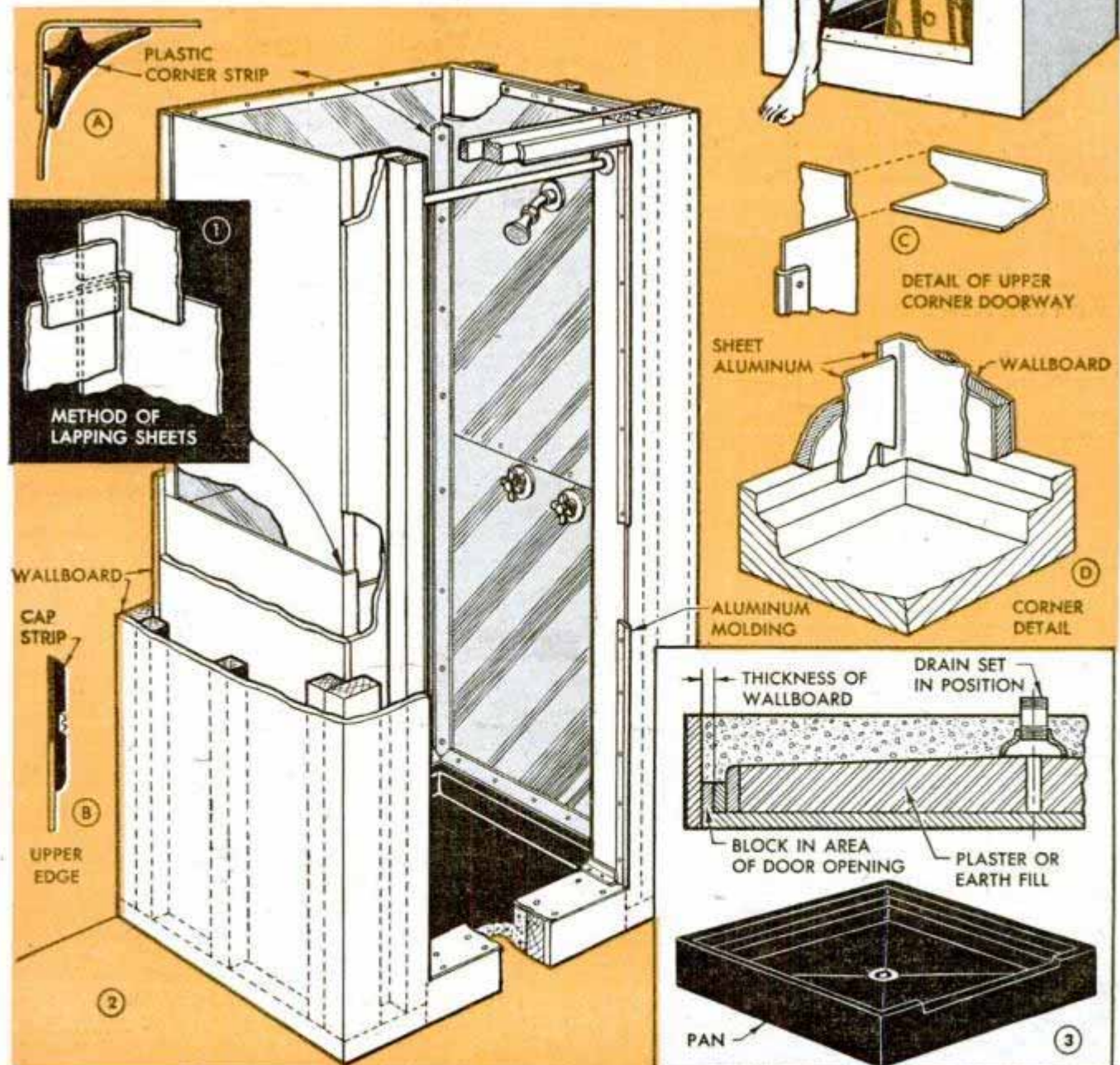

"Overcoats"

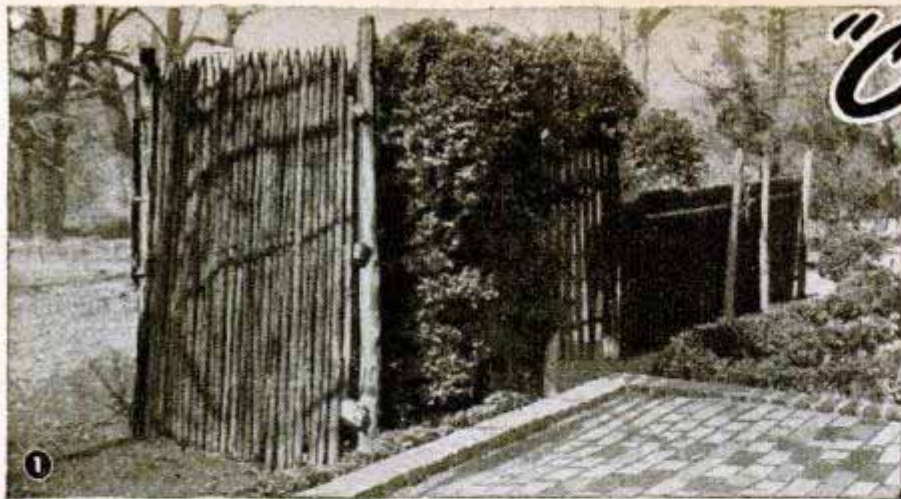

Pole fence on the windward side protects the taller-growing shrubs from severely cold winds

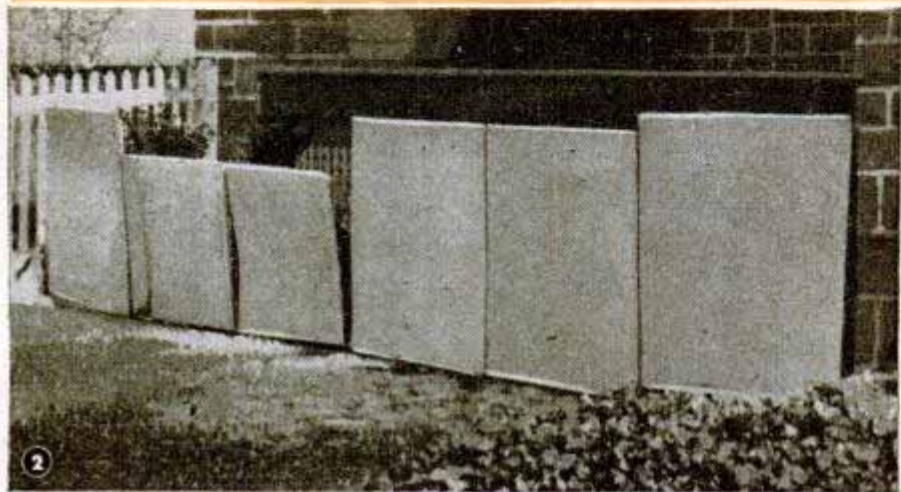

Pieces of corrugated cardboard cut from packing boxes and nailed to stakes make a good windbreak

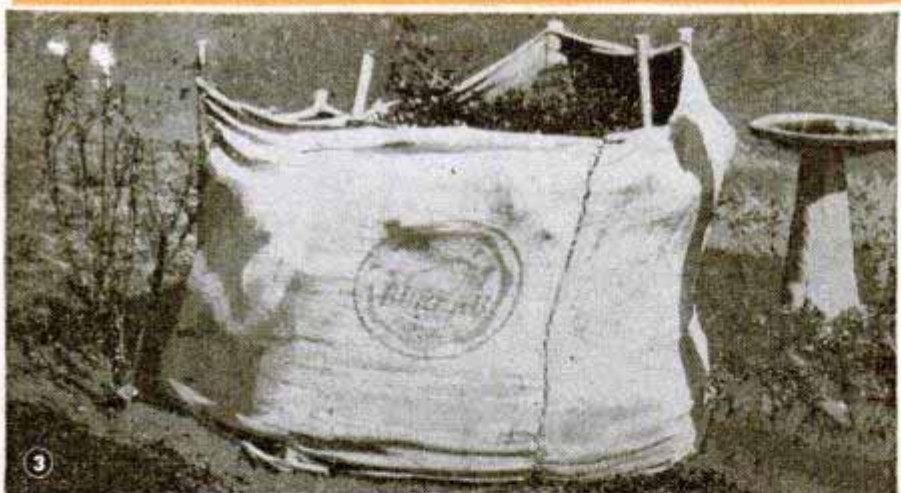

For low-growing shrubs a combination windbreak and sunshade can be made from burlap and stakes



Sunshades made by tying long grass or cornstalks in bundles and supporting them with a frame

for Tender Shrubs

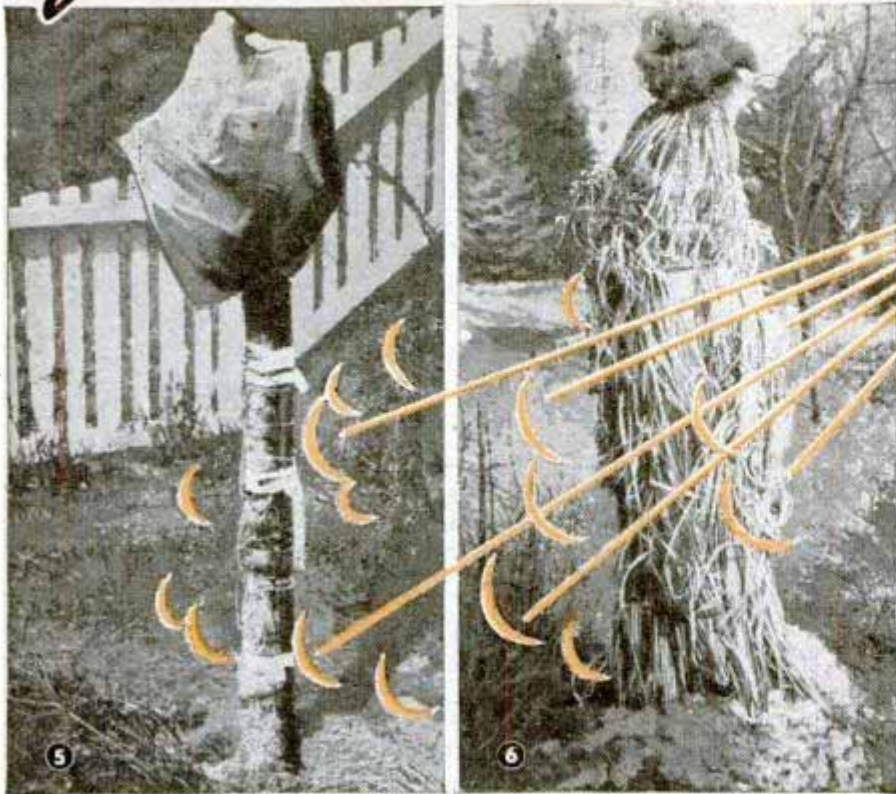

Most high and low-growing shrubs exposed to winter winds and reflected sunlight need additional protection

By Paul Hadley

MANY valuable shrubs, plants and small ornamental trees require some protection from cold winds and drifting snows if they are to survive the winter without damage. Species which are hardy in protected locations during average winters will often winterkill when fully exposed to cold winds for long periods. Others suffer from freezing and thawing of the bark when exposed alternately to bright sunlight in daytime and the cold of long winter nights. Some plants, particularly evergreens, which are located close to white walls that reflect the sunlight on the foliage while the roots are still frozen in the ground, often suffer from "winter-burn," which dries and withers foliage and twigs.

Single shrubs may be protected by driving stakes around the plant and covering these with burlap as in Fig. 3. The purpose of the burlap "fence" is not to keep out the cold, but to keep the temperature more nearly uniform. Tender shrubs, such as English boxwood, need this protection in the colder climates. Sheets of cardboard cut from large packing cartons and arranged about the plants as in Fig. 2 make a good windbreak or a sunshade when necessary. Other materials suitable for making windbreaks are coarse straw, tall grass and dry cornstalks. Small trees may be wrapped with a thick covering of tough grass, Fig. 6, or a long windbreak may be made by using posts and supporting strips to hold the material in place as in Fig. 4.

Low ornamental trees can be wrapped with burlap and the top pruned back to such an extent that it also can be covered with a protecting layer of the same material, Fig. 5. Heavy paper may be used for this purpose, but it must be tied securely in place. When wrapping shrubs, be careful not to break the tender twigs or stems.

Rustic pole fences, Fig. 1, snow fences or latticed frameworks make good two or three-sided windbreaks. Where a low shrub planting covers considerable area, an open board fence along the windward side will offer some protection and also will help to drift protective snow over the planting. Often a pole fence, such as that in Fig. 1, along one side of a hedge or other planting will be sufficient protection. A thin coating of dry straw spread uniformly and held down with light woven wire or poultry netting makes a good covering for hedges or other low growth which require protection from wind and cold. In some locations a sunshade is more important than a covering or even a windbreak. This is especially true on the south side of a white wall or on any southern slope or exposure where heat from the midday sun raises the temperature above freezing for several hours during the day. Evergreens of most varieties never become entirely dormant; some growth takes place the year 'round. After a dry fall water evergreens before the ground freezes. If soil around the roots freezes "dry" the plant is very apt to suffer.

FREE LUNCH

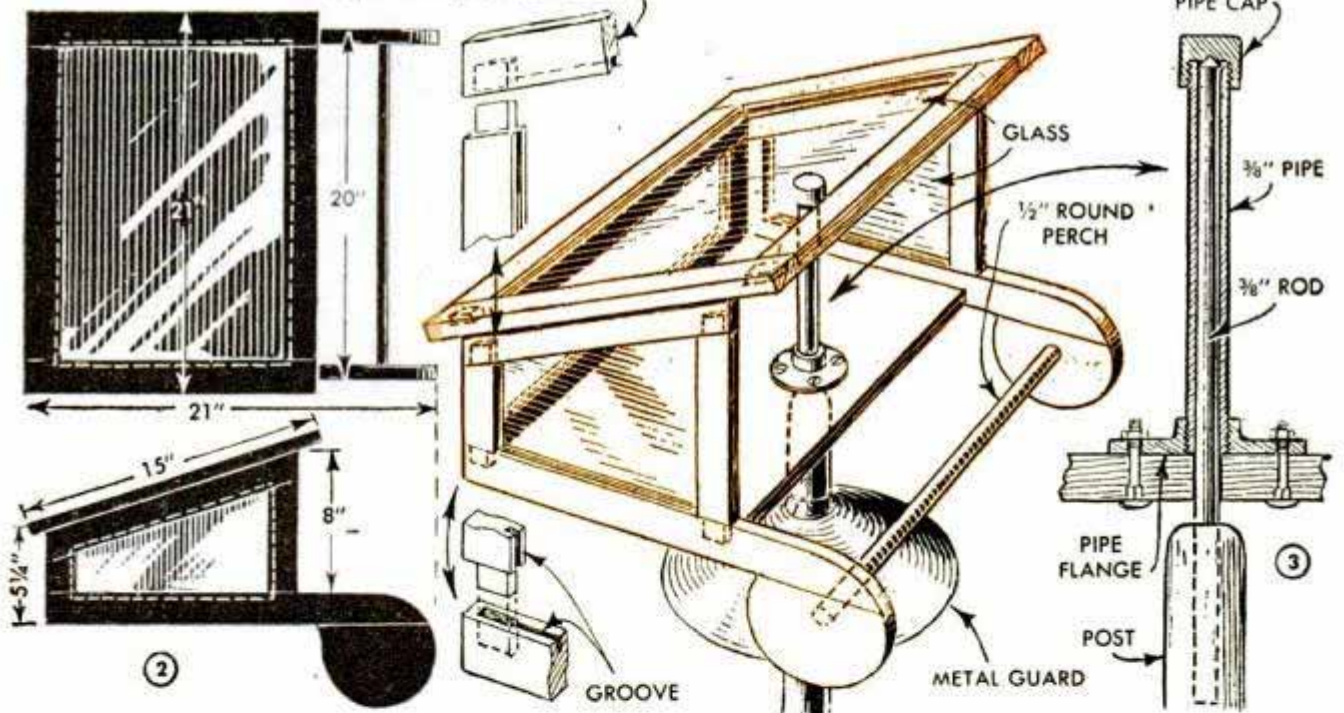
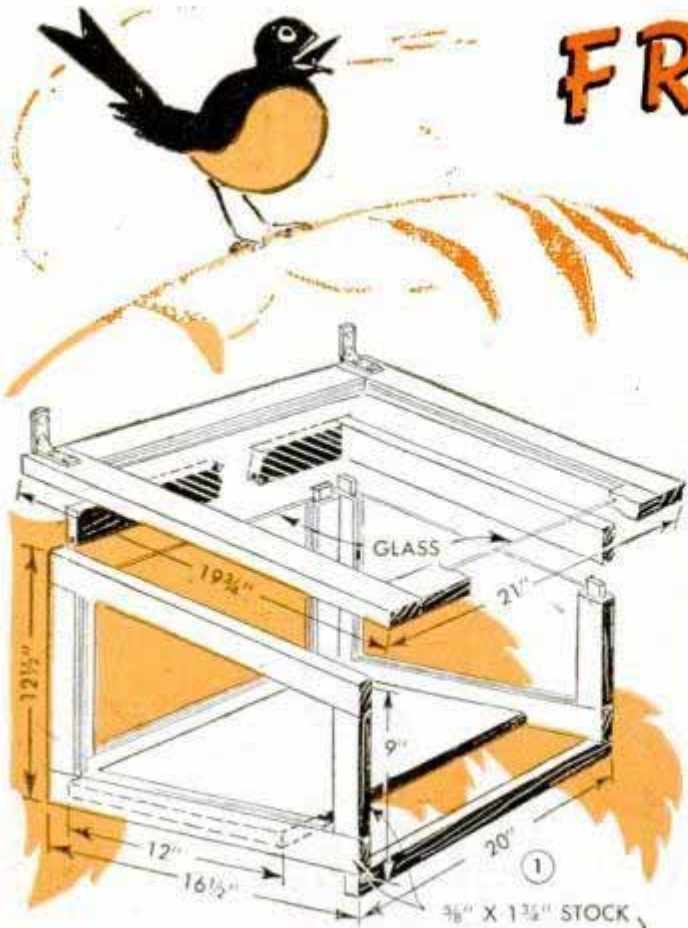

Providing abundant free lunches by means of a feeder will induce many types of birds to remain with you all winter. Feed scattered on the ground not only brings the birds down where they are easy prey for cats, but is wasteful and invites rats and mice. The two types of feeders shown will serve most birds which remain during the winter. The weathervane type is an all-purpose feeder that rotates so that the open end is always away from the wind. The window-sill type was made primarily for cardinals.

The sill-type feeder, Fig. 1, is nothing more than a glass-paneled box open on one side and having a sloped top and a wood bottom. On the weathervane feeder, which is of similar size and shape, the vanes are glued to the underside of the bottom members as indicated in Fig. 2. It is best not to extend the bottom of either feeder beyond the glass top as any projection beyond the top will catch the snow.

The weathervane feeder is set on a post which has a pointed rod in the upper end. This fits into a pipe assembly attached to the bottom of the feeder as in Fig. 3 and located so that the feeder balances on the rod. The pointed end of the rod resting in a shallow countersunk hole in the pipe cap provides a needle-point bearing. Cats and other climbing animals are kept from the feeder by a metal guard.

Carved Letter Opener Is Cut From Rosewood

Although this particular letter opener was carved from South American rosewood, any similar species possessing fine grain and deep color will be satisfactory. Or stain may be used where the grain is desirable but color is lacking. A block of wood $\frac{1}{2}$ by 2 by 12 in. is about the right size for the opener. Draw two patterns on paper, one for the front and one for the side view. Trace the front on the surface of the wood and cut out the silhouette on a jigsaw. Then do the same for the side view, roughing out the high and low areas. After the blocking-in is complete, touch up the work with a sculptor's rasp. To finish, start with coarse sandpaper and work through progressively finer grades. Then rub in wood filler and, when this has hardened, apply a wax finish to give the letter opener the proper highlights.



If a high gloss is desired; apply several thin coats of shellac without waxing.

Simon S. Palestrant, New York.

Canvas Strips Tied on Bottom of Skis Aid Uphill Climbing

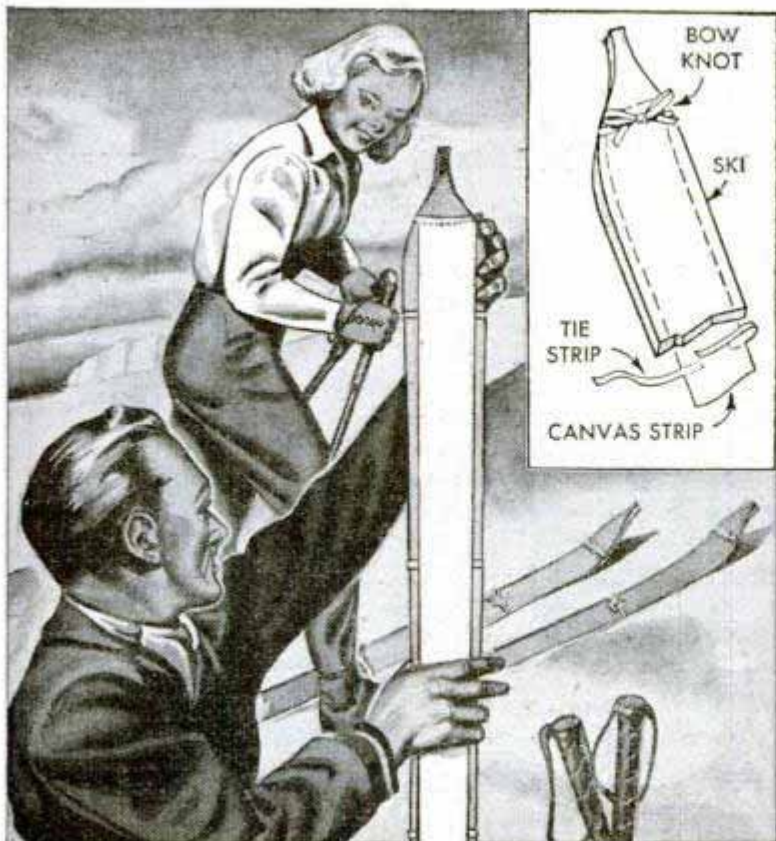

You can climb steep slopes without herringboning by fastening a homemade canvas strip to the bottom of each ski. The canvas should be an inch less than the width of the ski and should run almost the entire length. Cloth tapes are sewed to the canvas at regular intervals and the strip is tied to the ski with bow knots. When the top of the hill is reached, remove the strips and you're set for the downhill run. — Ormal I. Sprungman, San Diego, Calif.

Inexpensive Wood Filler

When it is desired to stain or color a common wood to imitate a more expensive one, coat the entire surface with thin hot glue and when dry rub it with fine sandpaper. The glue will prevent the stain from penetrating the soft parts of the wood and rendering an uneven color.



STRAW SERVER

Dapper Dan purposely "blew his top" to let you put soda straws in his stovepipe hat. Make him from a tube 8 in. long and see that the brim of his hat fits snugly around the tube, 3 in. from the top. He's attached to a circular base by a disk nailed to the top, and then dolled up with a sporty polka-dot tie. His features can be applied with a wax crayon and the rest done in water colors as suggested below. Finish with clear shellac and let dry



CIGARETTE BOX

Treat your friends to a smoke from this novel cigarette box. The lower end of the tube is capped with a two-part base the same as Dapper Dan. The lid is built up of 4 disks, the topmost one being drilled for a cord and set on edge. A screw driven up from the bottom fastens all 4 disks together. The design and cross-hatching are drawn with wax crayons and then the background is done in water colors. Seal the colors with a coat of shellac

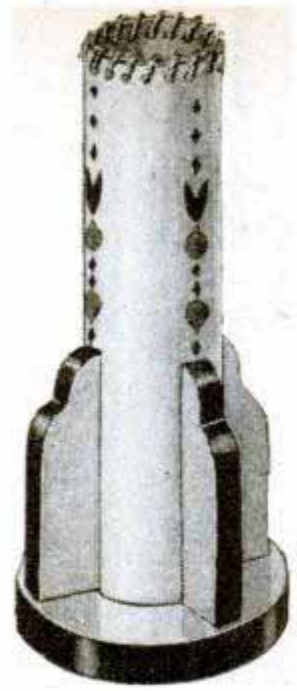

ARTIFICIAL FLOWER VASE

Just the thing to hold paper flowers. You start by making a two-piece base like you did for the others. The tube sets over the top disk of the base and is glued or nailed to it. Four side supports are spaced equidistantly around the tube and fastened to the base with brads. Then holes are punched around the upper edge of the tube and laced with a cord to give a finish. Wax crayons color the side pieces; the tube is painted with water colors

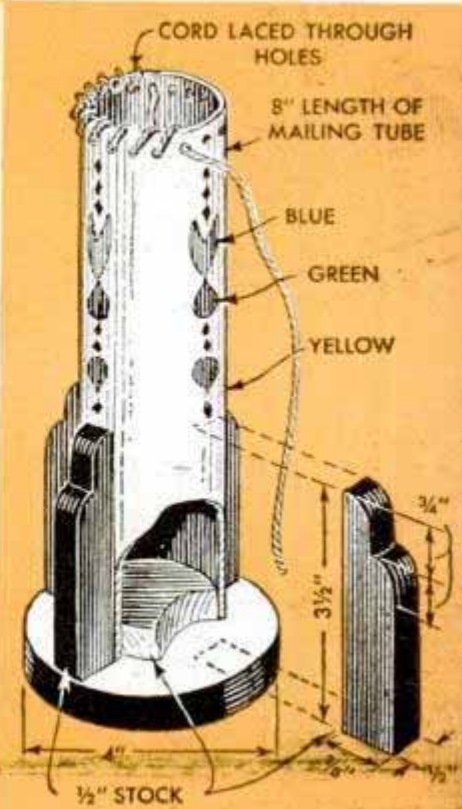
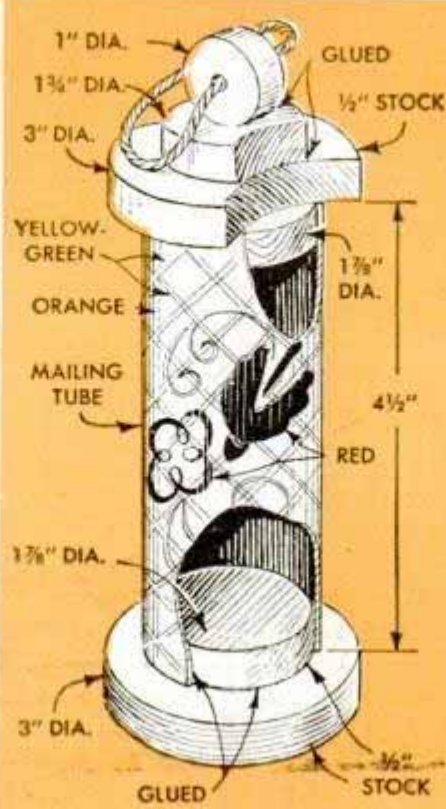
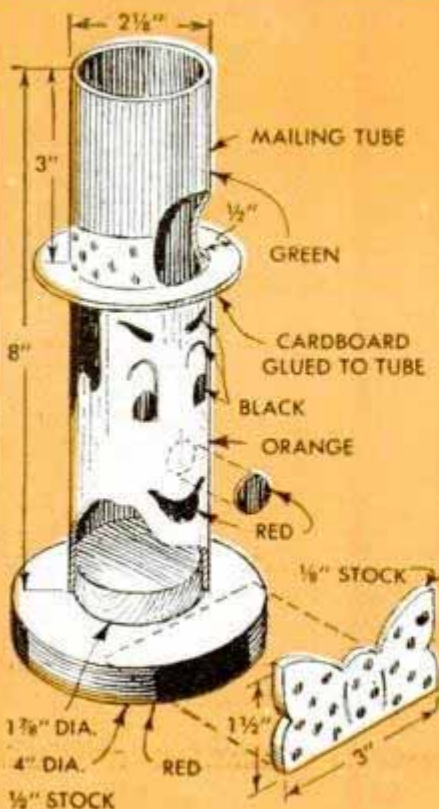

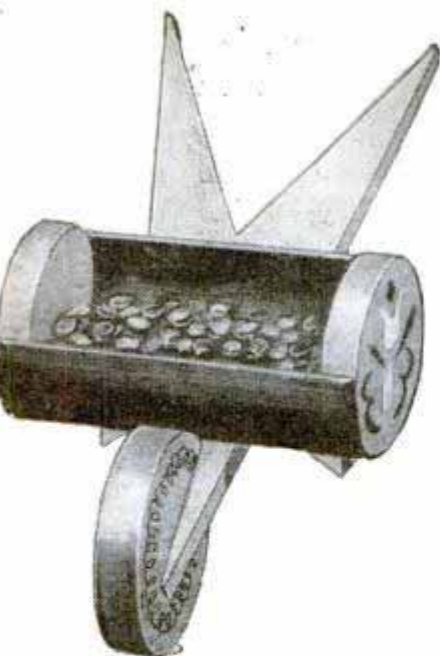

CANDY AND NUT TRAY

Candy by the wheelbarrow—or you may put this little novelty to work as a cigarette holder. A length of mailing tube, cut as shown and fitted with wooden ends, forms the hopper. The rest of the cart is made of scraps of $\frac{1}{4}$ and $\frac{1}{2}$ -in. pine. The wheel can be made to turn or it can be simply glued in the slotted end. Draw in the flower designs with yellow and red crayons and give the rest of the work a coat of yellow water-color paint

MAILING TUBE NOVELTIES

By Roberta L. Fairall

WITH a few paper mailing tubes, some scrap wood and a little ingenuity you'll be surprised at the number of unusual and attractive novelties that can be made at practically no cost. And with a ready market for such novelties here's your chance to cash in. Wax crayons and water colors are used to decorate the novelties, after which they are finished with clear shellac to seal the colors. The four examples presented here show what can be done and will give you a start. Notice in each case that the novelty is built around a piece of mailing tube. Bases are of scrap wood and, if desired, you could perhaps incorporate plastic. If you have a lathe, you'll be able to turn out perfect disks for the bases in a jiffy, or you may find that you can do better by cutting them on a scrollsaw, sawing several at a time, and then smoothing the edges with sandpaper or a file. Choice pieces of scrap wood, such as walnut, maple or cherry, could be used and finished in their natural color with a coat of shellac or varnish. Quick-drying lacquers can be used to speed the painting. If you size the paper tubes first with a thin wash coat of clear lacquer or shellac, the paint will not be absorbed as readily. Another finishing method is flocking. Flock can be had in a variety of colors and is simply sifted onto the work after it is coated with glue. The excess flock is shaken off and re-used. The finish obtained is a velvety texture resembling cloth and gives a professional looking job. Natural or dyed sawdust sprinkled on a tacky surface and pressed with your fingers will also give the work a novel finish.

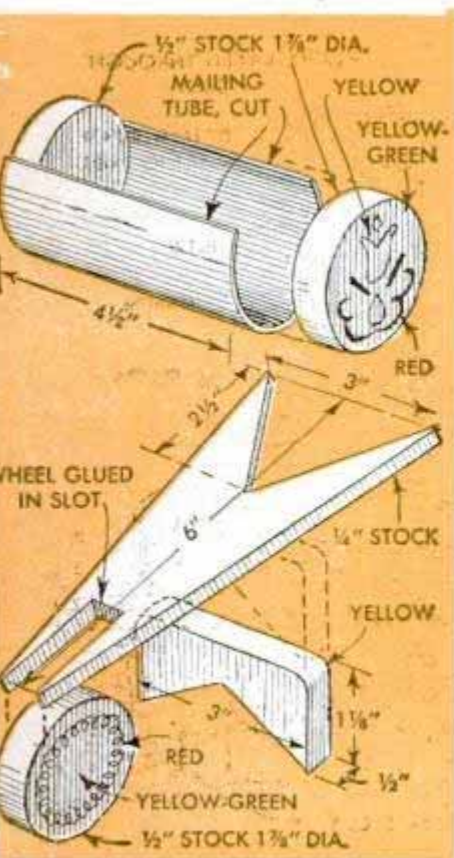

Novel Photographic Cutout Is Cellulose-Tape Dispenser

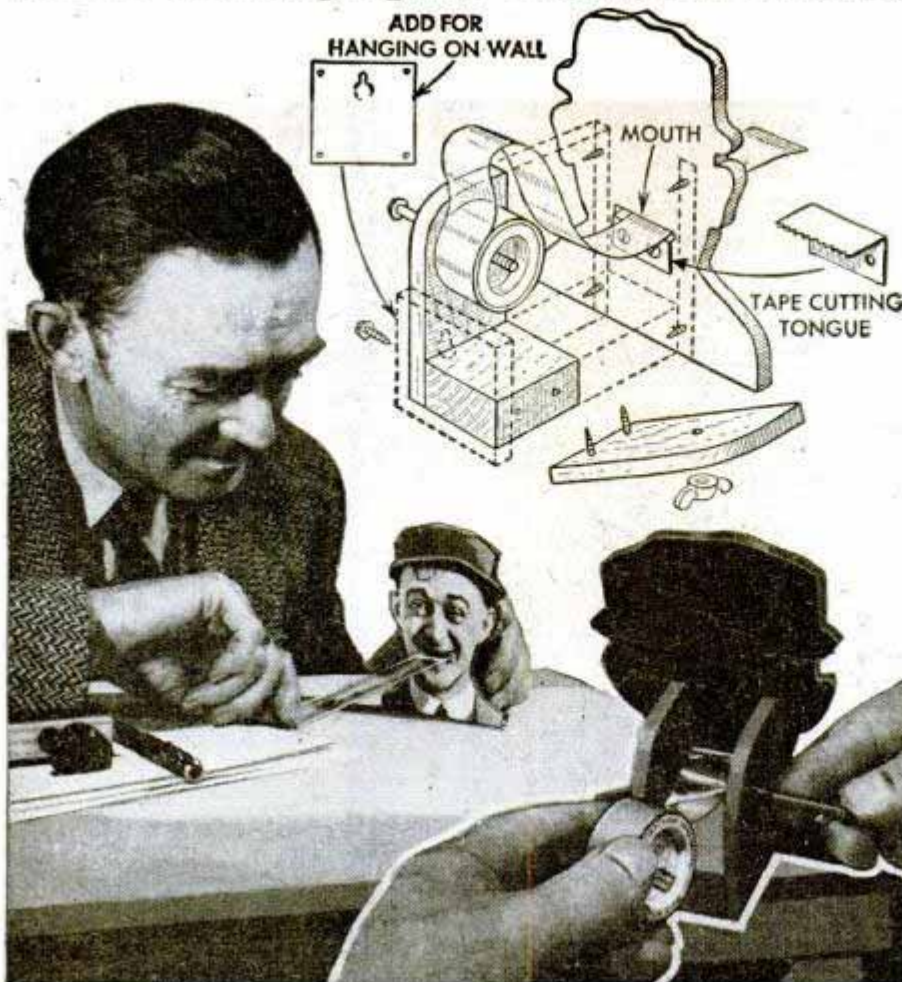

Any portrait can be used to make one of these novelty holders for cellulose tape, but a comic picture is more amusing. The tape is pulled from the mouth and torn off on the saw-tooth edge of the metal "tongue." Glue the picture to a piece of thin plywood and cut out the head with a scrollsaw. The two side pieces and spacer block are screwed to the panel as shown in the upper right-hand detail. The lower right-hand illustration shows how the tape is held in the holder. Cut the tongue from a piece of thin steel or brass and notch one end. Then fasten it so the notched end projects through the mouth. When desired, the holder can be made to hang from the wall if the hanger indicated by the dotted lines is added.

Attractive Plastic Photo Bracelet Made From Lens and Letter Opener

Made from either a combination lens and letter opener or a plastic scale and lens, this photo bracelet is a novel bit of costume jewelry. Numbers or scale markings are removed with sandpaper and the scale is then formed to the desired shape by immersing it in hot water until it is soft enough to bend. The photo should be cut to fit inside the circular mounting and then glued to the lens with transparent glue. The plastic has sufficient spring so the bracelet can be put on and removed easily.

Wm. Riederich, Flint, Mich.

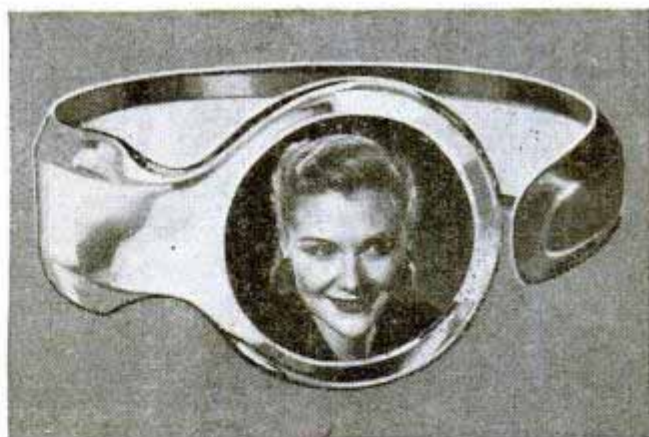

Clamp to Hold Small Articles Formed by Using Hardwood Clothespin

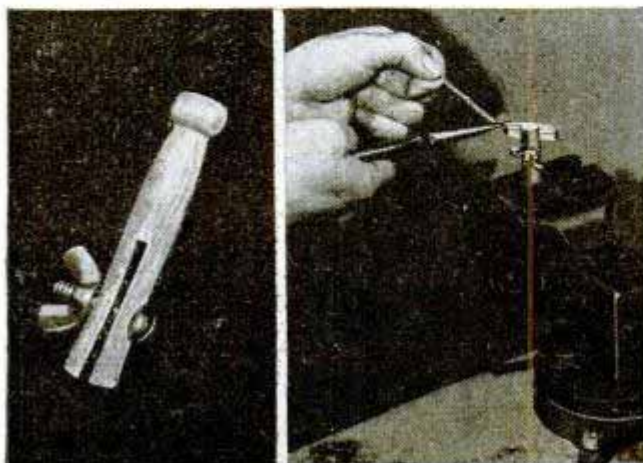

Handy for holding small articles such as jewelry, trinkets and model parts, this clamp is made from a hardwood clothespin. The ends of the pin are cut off and bolt holes are drilled through the pin as indicated. A bolt is slipped through the holes and fastened with a wing nut and washer.

☞ When making a cedar chest, use cedar that is kiln dried as it is more apt to hold its shape without warping. When cedar is not available for the whole chest, a plain wood chest lined with cedar $\frac{3}{16}$ in. thick generally is satisfactory.

MODEL GAS ENGINE

PART I

By Gary Moore

c/o C. W. WOODSON
376 OAKWOOD AVE
EAST AURORA, N.Y.

HERE'S something really good in a model gas engine — watchmaking precision, usable power and spectacular high-speed performance packed into just about the smallest model it's practical to build in the four-cycle type. With the exception of the valve mechanism, carburetor, studs, cylinder liner and

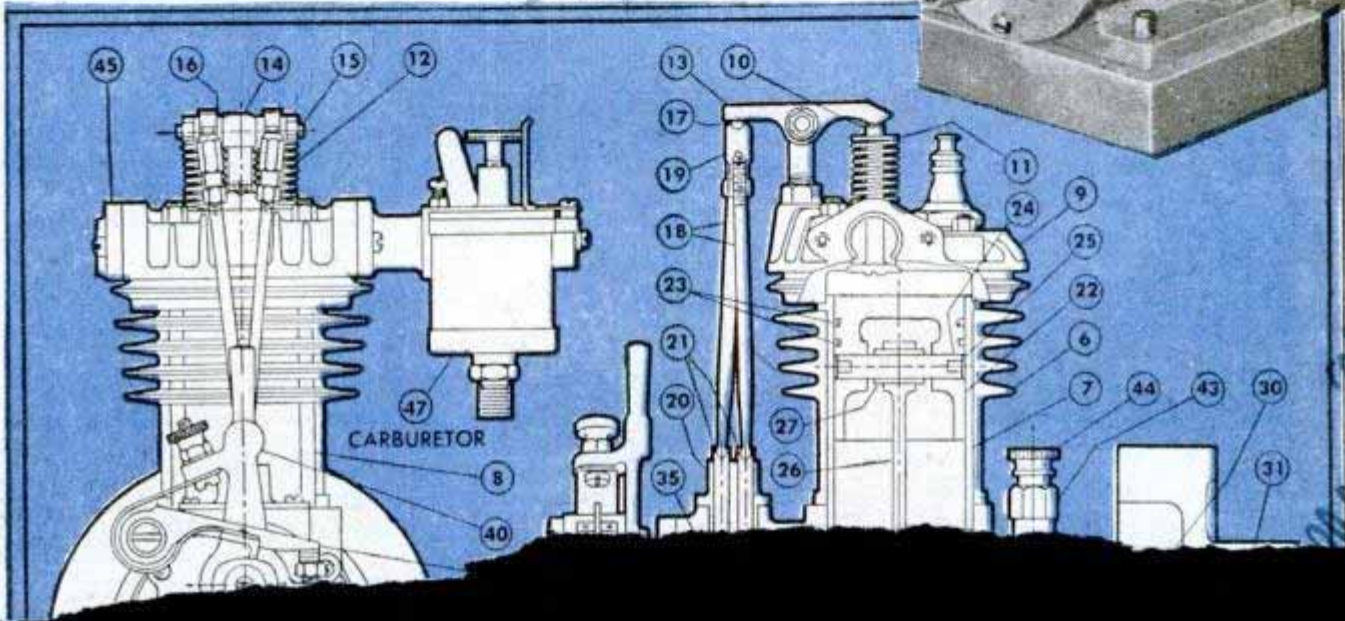
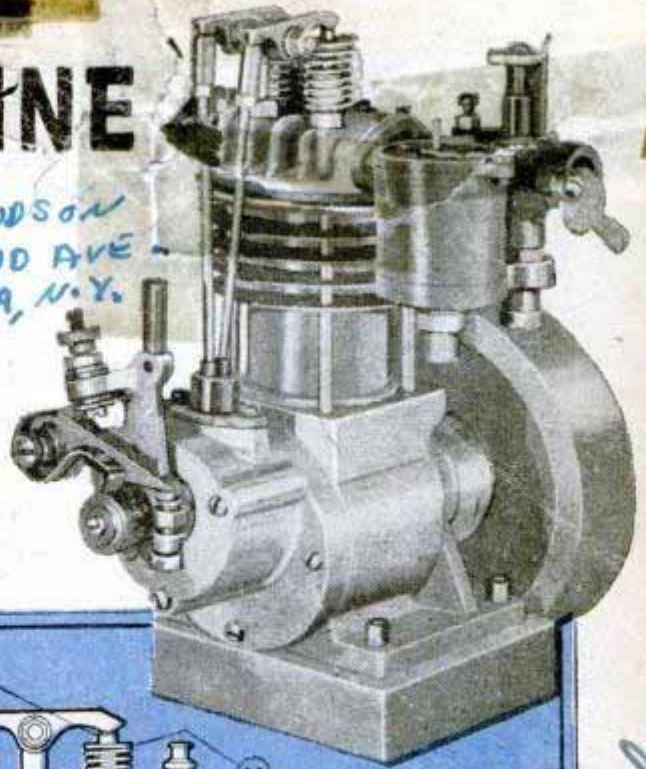

W. H. Field
St. Louis, Mo.

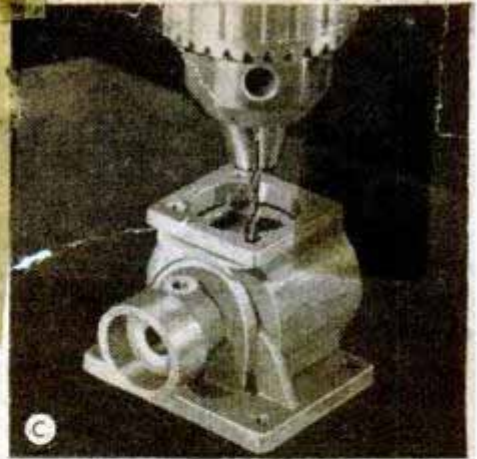
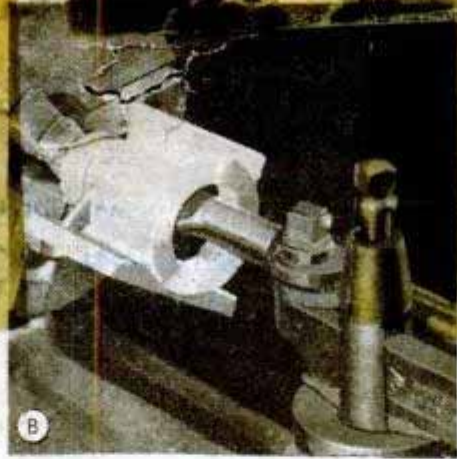

in photo C. This first stage of the job then ends up as in photo D, which shows the inner crankshaft bearing in place.

The valve-gear housing, Fig. 2, and the cover, Fig. 5, are chucked as in photos E, F and G. The gear housing is faced off and step-machined to a snug snap fit in the crankcase opening. Hold the step dimension closely, as bearing alignment depends largely on its accuracy. Then the work is chucked off center, photo F, and the inside bored out to size. Bore holes for the inner camshaft bushing and the long bushing carrying the floating crank which drives the valve gear. See Figs. 3 and 4 and also the assembly drawing. Note that the outer camshaft bushing is in the gear-housing cover, and that the cover is step-machined. It is well to hold this step dimension to the same limits as that given for the housing.

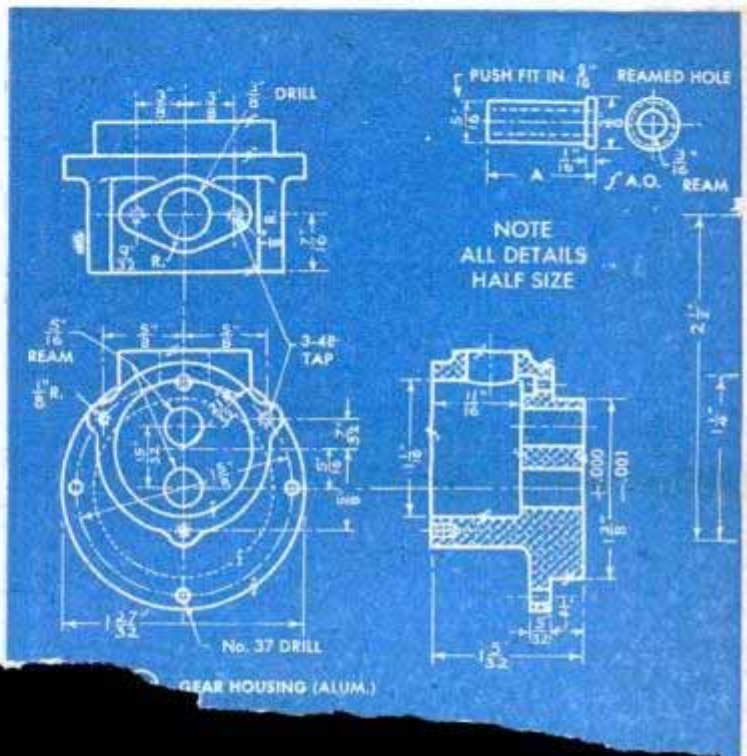

MODEL GAS ENGINE

PART I

By Gary Moore

c/o C.W. WOODSON
376 OAKWOOD AVE
EAST AURORA, N.Y.

HERE'S something really good in a model gas engine — watchmaking precision, usable power and spectacular high-speed performance packed into just about the smallest model it's practical to build in the four-cycle type. With the exception of the valve mechanism, carburetor, studs, cylinder liner and

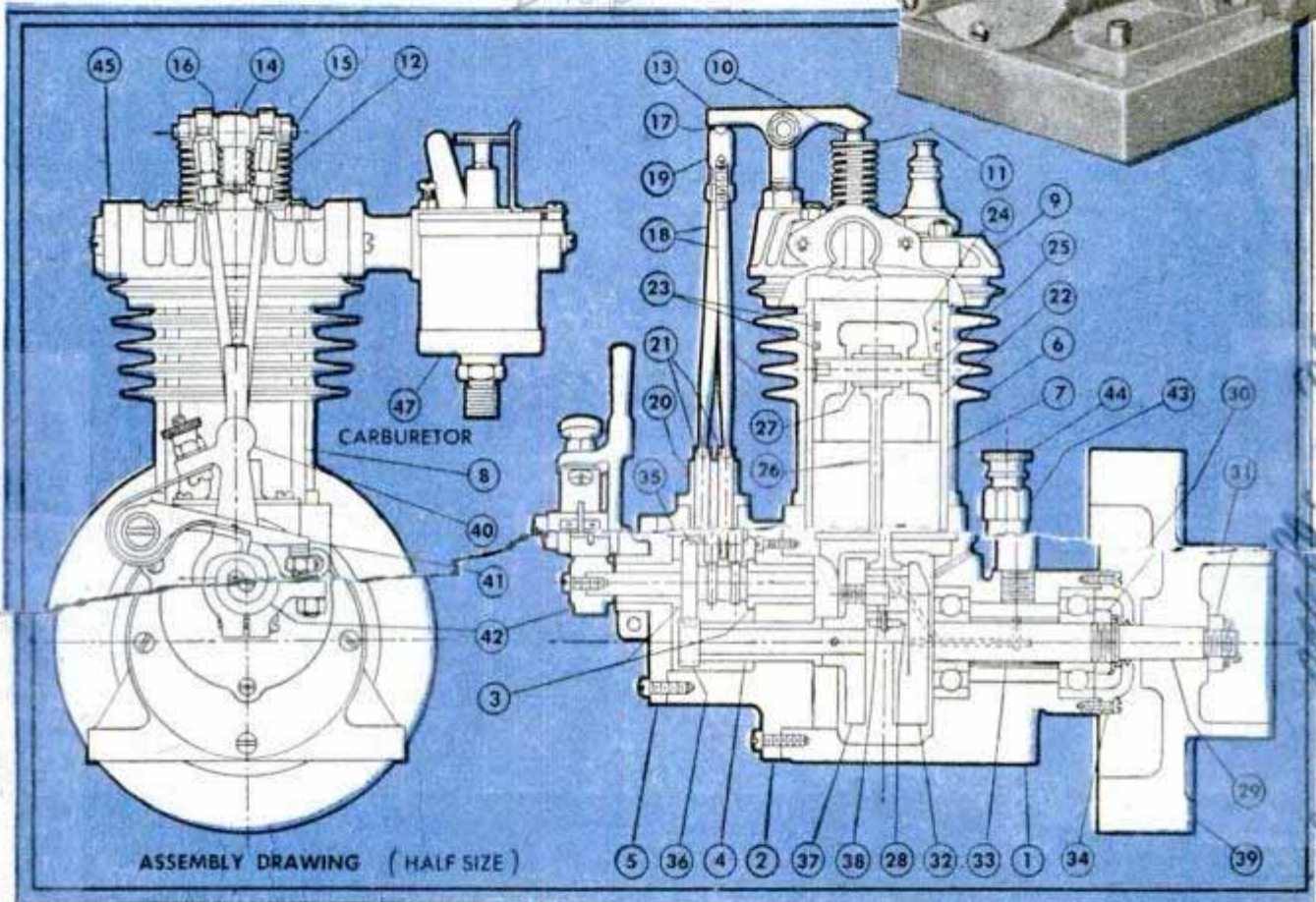
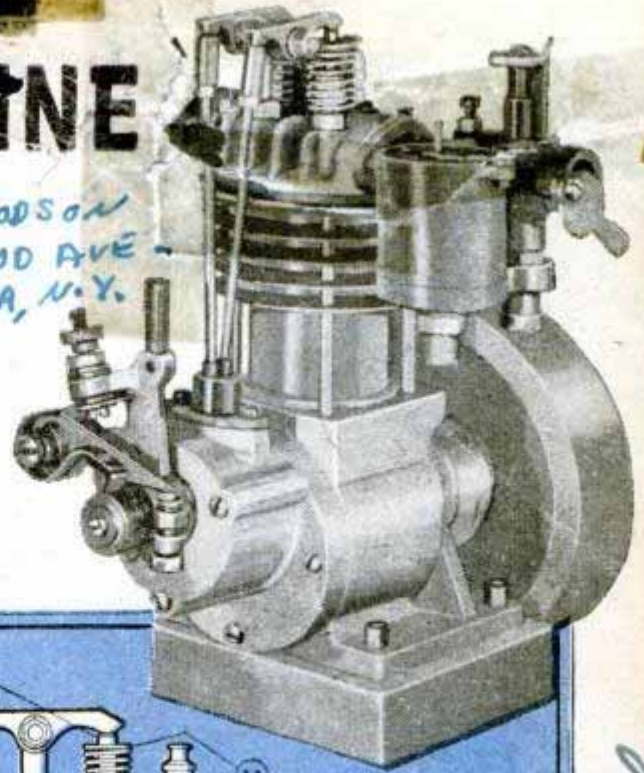

ASSEMBLY DRAWING (HALF SIZE)

*Elmer H. Woodfield
5700 N. Ogden, Ill.*

certain rotating parts the engine is made wholly of aluminum. A complete set of castings is available. As you can see from the assembly drawing above, the counter-balanced crankshaft is mounted on high-speed angular ball bearings and the outer end of the shaft housing is fitted with an oil seal to prevent loss of the crankcase oil. Note that the key numbers given above correspond to the figure numbers on the detailed parts; that is, part No. 5 above is detailed in Fig. 5. Fig. 46 has been purposely omitted from the assembly drawing. It will be referred to in Part II.

Work begins on the crankcase casting, detailed in Fig. 1 and shown in the four-jaw chuck in photo A. A light facing cut trues

the bottom of the casting and assures that the base will set squarely on any flat surface. Then the casting is reversed in the chuck, the top faced off to the height dimension, and counterbored to take the cylinder liner. Next you set up the job in the three-jaw scroll chuck, using the chucking lug as in photo B. Note that certain dimensions on the crankcase must be held within plus or minus .001 in. The opening for the valve-gear housing is faced and bored to size and the hole for the crankshaft drilled through and reamed. The inner recess for the ball bearing is bored at this stage, but the recess for the outer bearing should be machined with the work mounted on a mandrel. Finally, tap and screw holes are drilled as

Castings

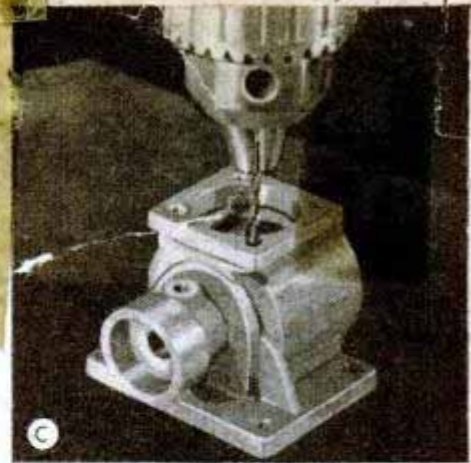
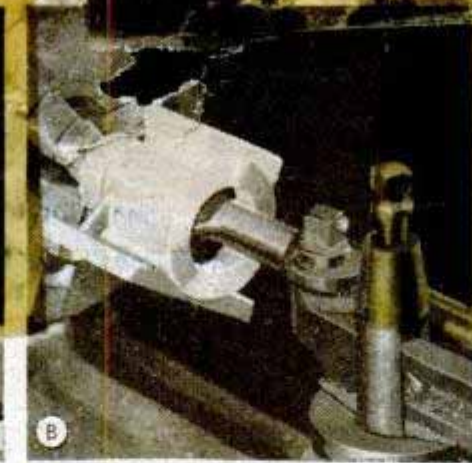

in photo C. This first stage of the job then ends up as in photo D, which shows the inner crankshaft bearing in place.

The valve-gear housing, Fig. 2, and the cover, Fig. 5, are chucked as in photos E, F and G. The gear housing is faced off and step-machined to a snug snap fit in the crankcase opening. Hold the step dimension closely, as bearing alignment depends largely on its accuracy. Then the work is chucked off center, photo F, and the inside bored out to size. Bore holes for the inner camshaft bushing and the long bushing carrying the floating crank which drives the valve gear. See Figs. 3 and 4 and also the assembly drawing. Note that the outer camshaft bushing is in the gear-housing cover, and that the cover is step-machined. It is well to hold this step dimension to the same limits as that given for the housing-to-crankcase fit. In rechucking to finish the bearing boss cast on the cover, be sure that the work is backed snugly against the chuck body. Bore and ream for the bushing in the same setup. Drill all screw holes in both parts with a tap drill through the cover into the housing. Then run through the tap-size holes in the cover with a body-size drill. Holes for screws holding the housing to the crankcase are drilled in the same manner. The angular boss for the valve guide is finished by milling or with a hand file. Photo H shows the finished parts with bushings in place.

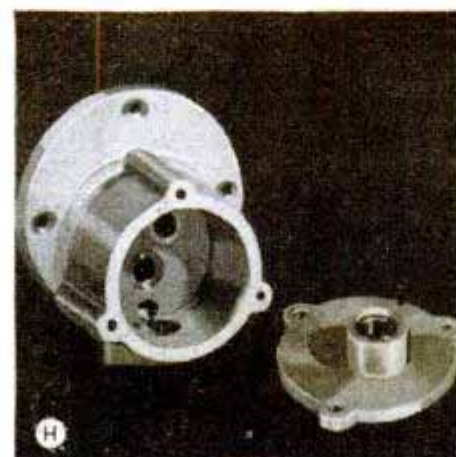
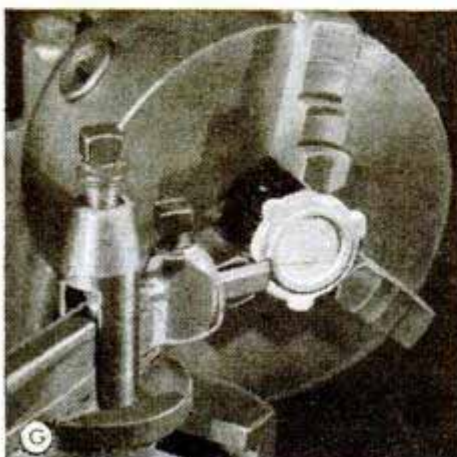
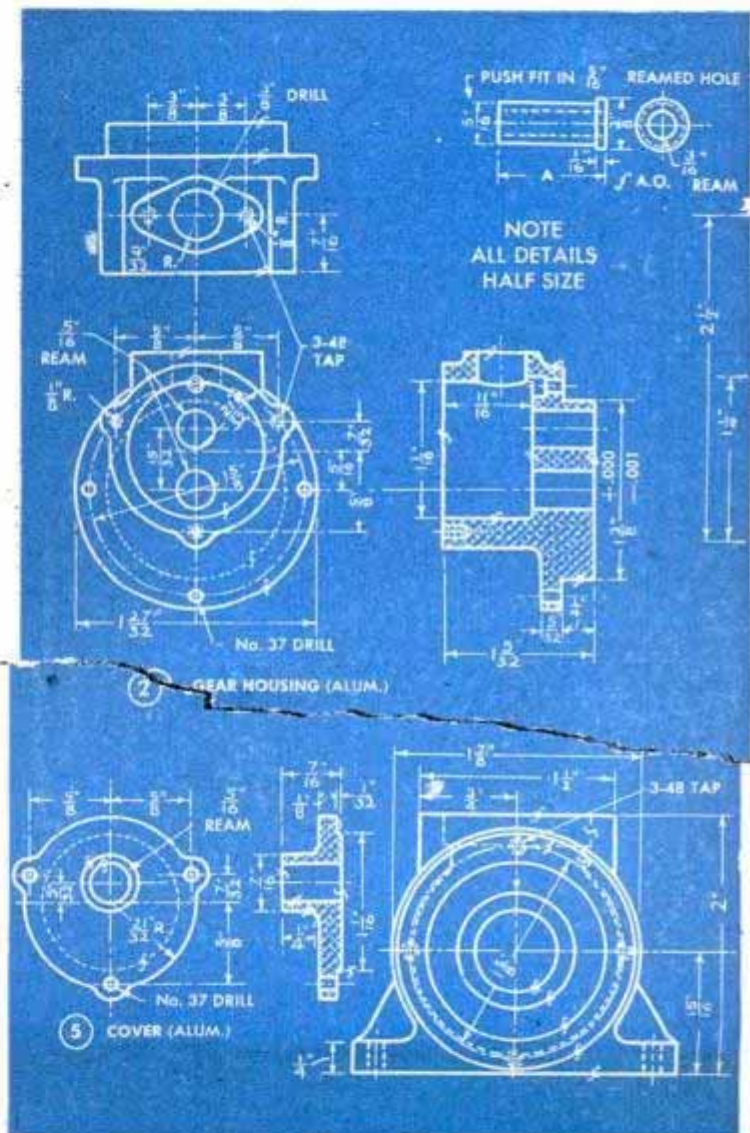

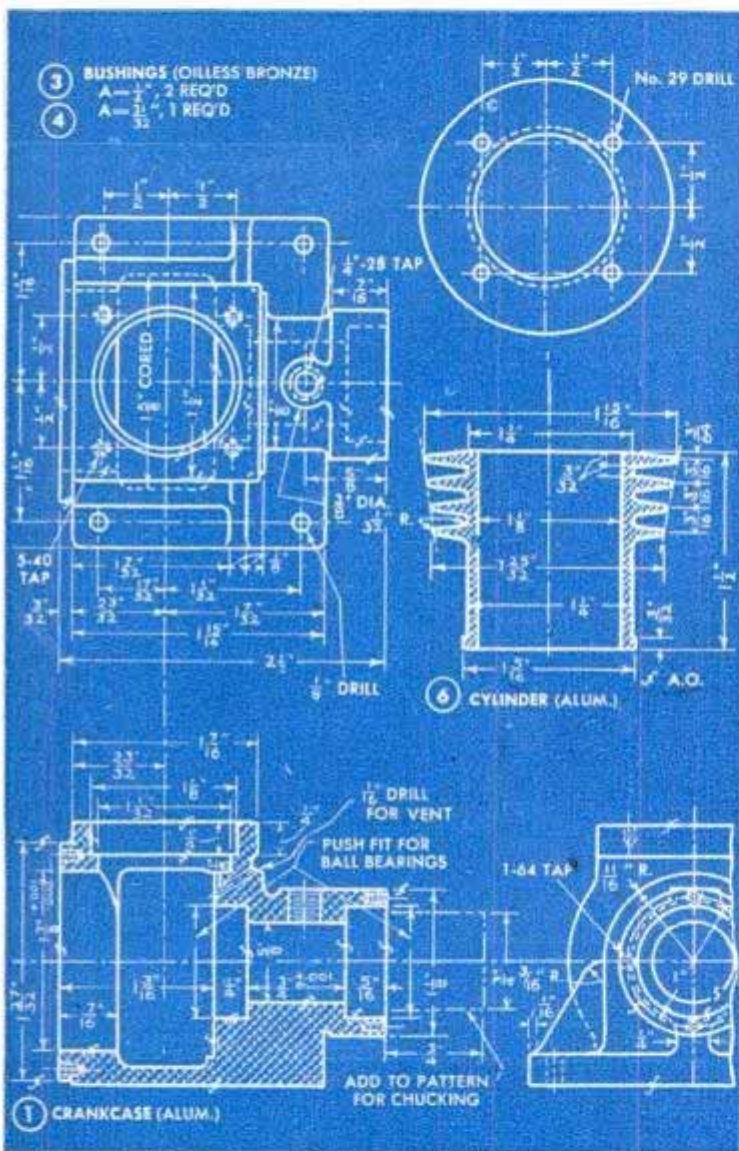
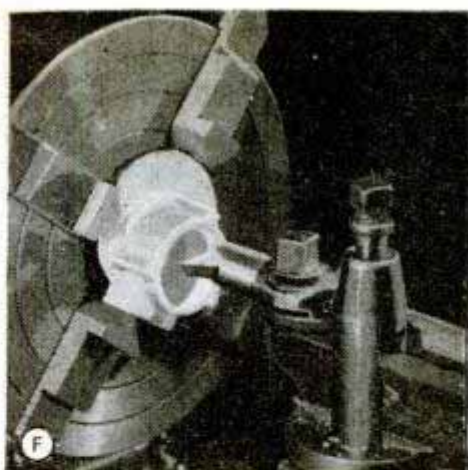
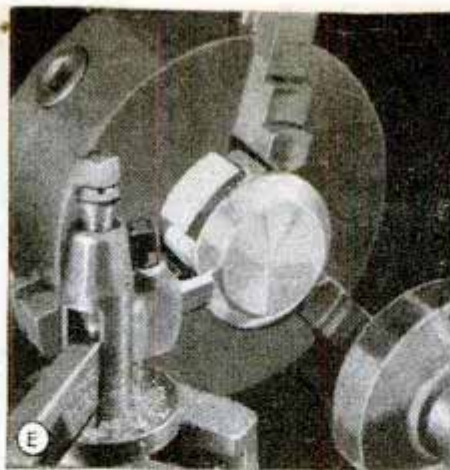
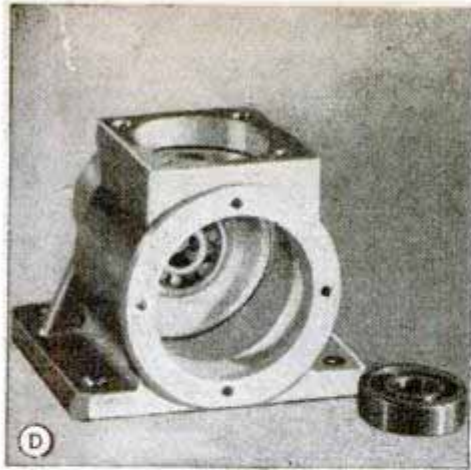

Next comes the cylinder casting, Fig. 6, and the first operation is boring out the barrel to diameter. Then the job is mounted on a mandrel, photo J, the fins are trued up and the lower half of the barrel turned down to the two diameters given, leaving a flange at the lower end. Note the symbol "f.A.O." which, of course, means that the casting is finished all over. Both sides of the fins are machined down to the barrel diameter to assure that they are the same thickness. Sides of the fins are tapered and the cuts end in a 1/32-in. radius at the barrel diameter. Spacing between the fins must be exact.

Machining the iron cylinder liner, Fig. 7, is a simple lathe job, but it requires care. For the bore, chuck the work in the three-jaw chuck as in photo K. In this, care must be taken not to clamp the chuck jaws too tightly, for there is some danger of distortion. Easy on the chuck wrench does it. Come down to within about .002 in. or so of the finish dimension with several light roughing cuts, then regrind the tool bit to a sharp V-point in the same manner as you grind a threading tool. Hone the tip so it is just slightly rounded. Set the lathe to the finest power feed and the slowest speed and bore through to the finish dimension. Then, without moving the tool or the feed setting, reverse the power feed and back the tool out. Carefully done, this will give the bore the next thing to a mirror finish.

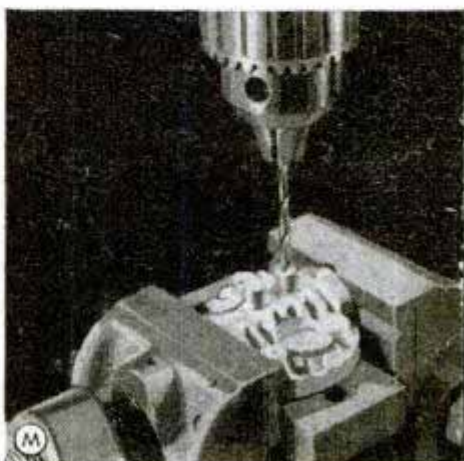
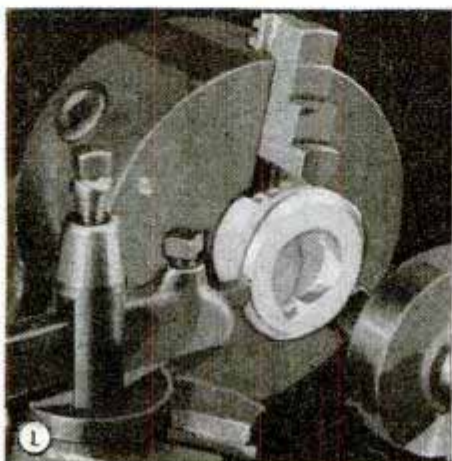
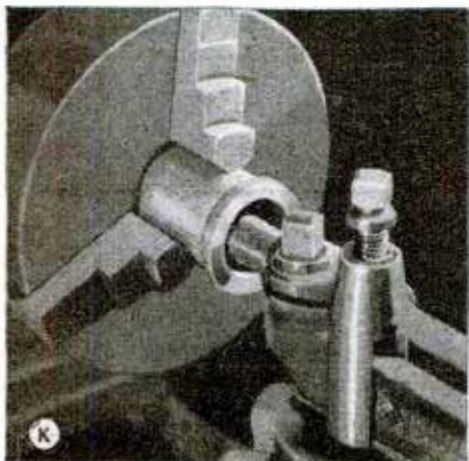

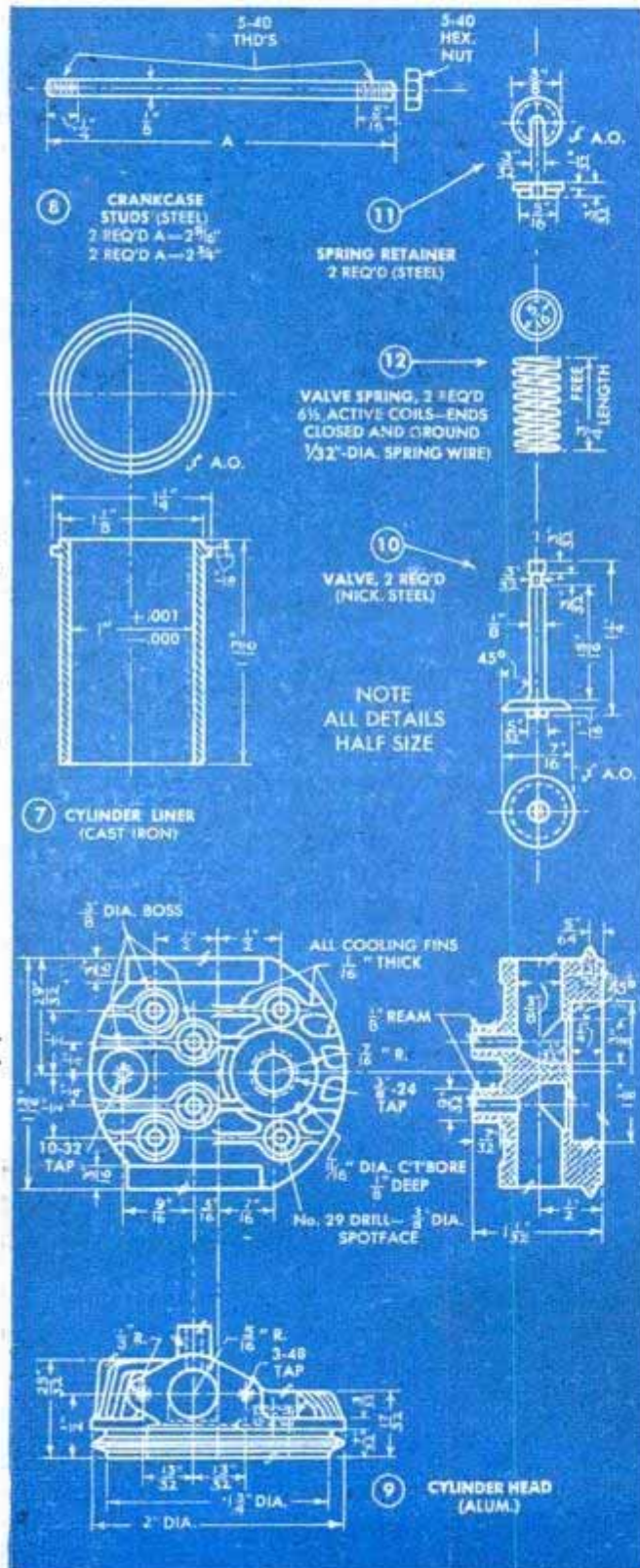
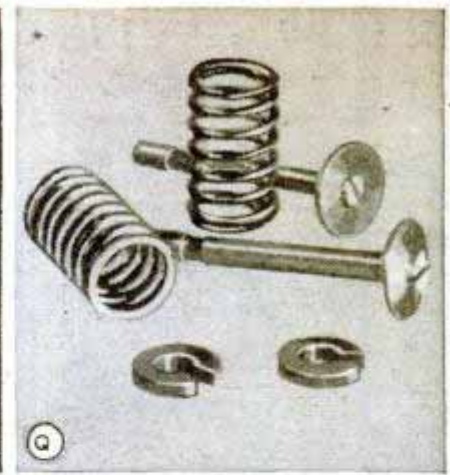
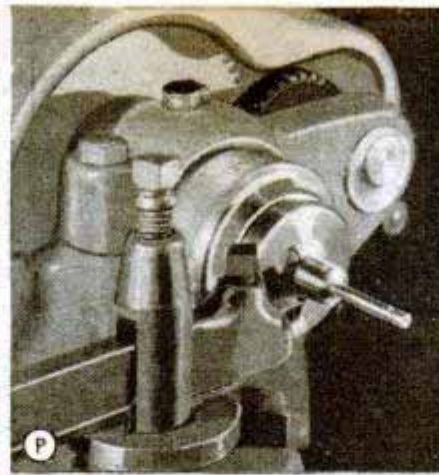

Outer diameters on the liner are machined to dimensions on a mandrel. Be sure that the latter is clean; also, precautions must be taken to prevent the liner from "freezing" on the mandrel. With the parts cold the liner should be a tight drive fit in the cylinder. Heat the cylinder and force the liner into place with a vise. This operation must be done quickly before heat from the cylinder can transfer to the liner.

The cylinder-head casting, Fig. 9, first is chucked bottom out by holding the flat surface of the casting hard against a drill pad mounted in the tailstock spindle. Leave a projection beyond the chuck jaws to allow for machining to fit the cylinder as in photo L. Then face off, bore to depth and turn to the size given. The angular bosses for mounting the carburetor and exhaust pipe can be faced with a shaper or, with care, a hand file. Of course you can use a lathe milling attachment if available. Balance of the work indicated on the head is completed on the drill press as in photo M. Valve seats are carbored with a tool turned from 1/2-in. drill rod, photo N. Cutting teeth are formed into a beveled section of the tool by heating. These teeth cut the valve seats. The tool must be hardened by heating to a bright straw color and quenching in hardening oil. The tool then is reheated slightly to draw the glass hardness so the cutting edges will stand up without chipping. Holes for the stud bolts, valve stems and the single hole for the spark plug are spot-faced with tools made in a similar manner. The valves are turned from 1/2-in. drill rod as in Fig. 10 and photo P. Check to see that both valves seat properly. Finally there are the four long cylinder studs, made from mild steel rod, Fig. 8, and valve springs and retainers, Figs. 11 and 12. The valve springs are wound on a mandrel from ordinary spring wire, both springs being wound as one and later cut apart. Ends are ground flat. With these finished as in photo Q, you're ready for crankshaft, valve gear and remaining parts.

(To be continued)

This Disk-Throwing Game Tests Skill of Players

It looks easy, but when you try to toss the disks into the bag you'll find they can be tricky in flight. The bag, which serves as the target, is a net onion sack or other bag of similar material, the mouth being held open by a barrel hoop cut down to a diameter of 15 to 18 in. This target is suspended between two uprights by a cord or light rope. The two ends of the sack are tied to a piece of broomstick which, in turn, is fastened to a third upright. The disks with which the game is played are 6 in. in diameter; there are six sets of disks numbered from 1 to 6, and each set is painted a different color for identification. Either plywood or pressed board is a suitable material from which to make them. To play the game, each person throws his set from a base line that is 50 ft. from the target. Throwing one set of disks is counted as a round and each

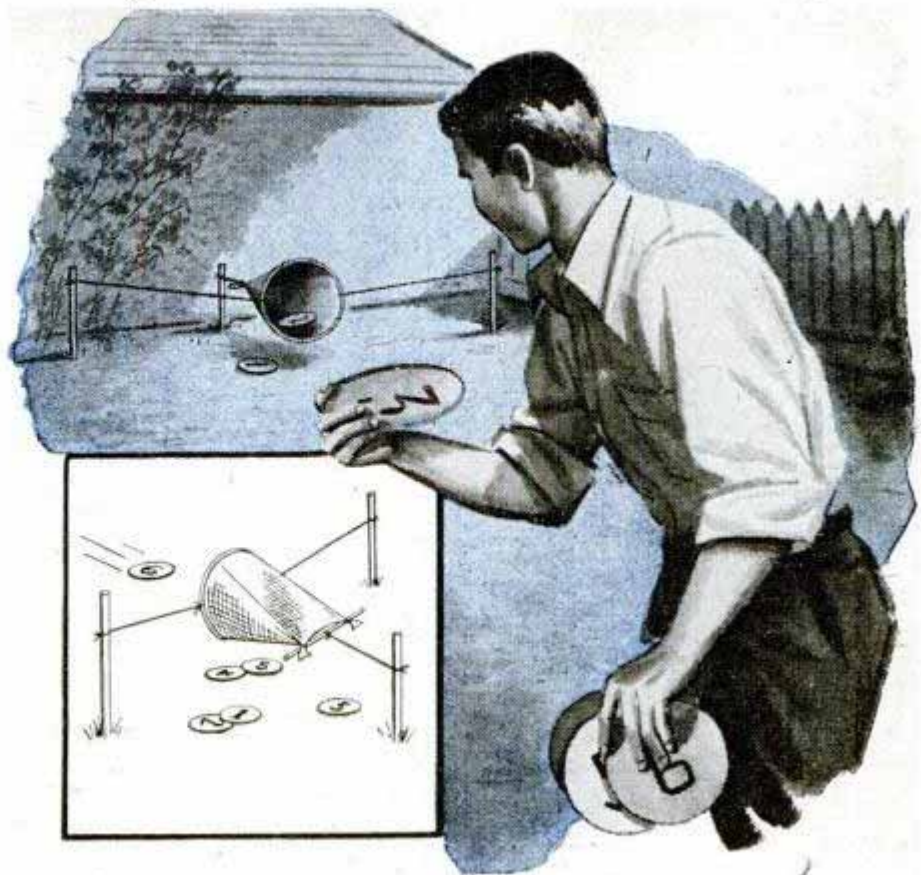

player has two rounds to a game. The numbers on the disks that remain in the bag are added and the high scorer wins the game.—C. L. Meehan, Lakeview, Ont., Can.

Capsules Used on Model Airplane Add Realistic Touch

Capsules of the kind that can be obtained at any drug store will add realism to parts of your model airplane. They are cut and

formed to represent blisters, wing lights and, as the lower circular detail indicates, they will also make good bombs.

Fons Conway, Jr., Shamokin, Pa.

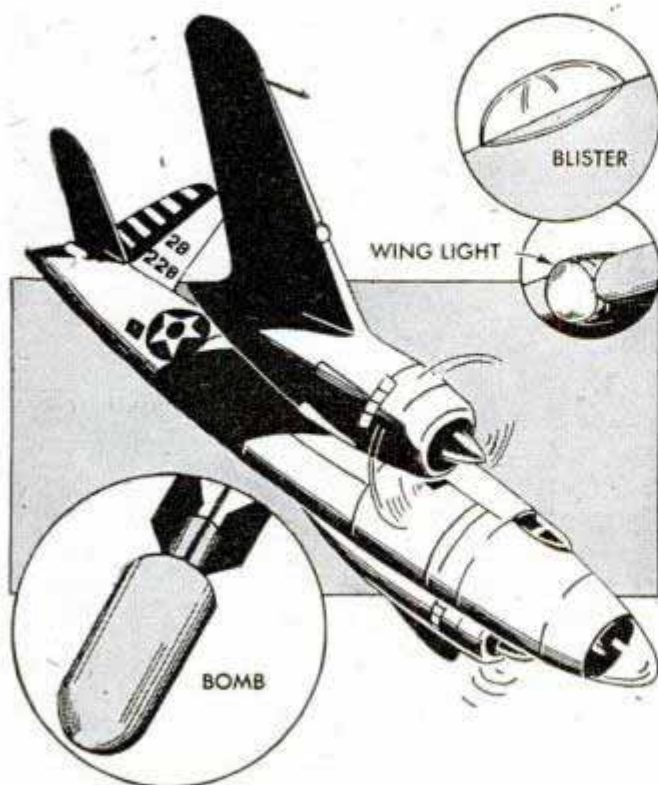

Rubber Cover Protects Padlock

Padlocks that are exposed to the weather may rust or freeze so they are no longer usable, or at best, hard to open and close. If an oval piece of inner tube is cut with two holes that fit tightly over the shackles, this will keep out moisture. For padlocks that have a keyhole in the side, the rubber should be cut to lap over the hole.

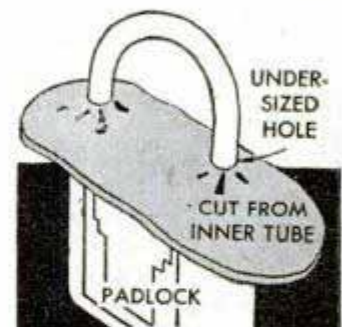

☐ Clothes can be kept from freezing to the line in cold weather by dipping a cloth in strong salt-water solution and wiping the line with it. Adding a small amount of salt to the last rinse water also will help.

Baby Walker Made With Chair Will Please Small Child



Made from an old cane-bottom chair, this baby walker will please any small child. After the cane is removed the seat frame is covered with oilcloth which is tacked to the underside. A paddle-shaped seat is cut from $\frac{3}{4}$ -in. wood and bolted to the front and rear rungs of the chair. The casters in the legs are the ball-bearing furniture type.—E. T. Gish, Mt. Joy, Pa.

Bolts and Nuts Are Stored in Jar

The double jars in which photographic chemicals are packed are useful for storing small bolts and nuts in your workshop. Labels which are pasted on the jars will serve to identify the contents. The bolts are placed in the bottom jar and the nuts in the top. Kept in this manner, any size is located with a minimum of effort.—D. E. Horn, River Forest, Ill.



Oil Colors Applied to Scratches Touch Up Furniture

To touch up scratched spots on furniture, obtain a tube of oil color to match the finish, and mix this putty-like pigment with a small amount of turpentine. Apply with a

brush and wipe off with a soft, dry cloth. This will cover all scratches or spots except those that are very deep. These spots should be filled with stick shellac, after which color as it comes from the tube is applied with the tip of your finger. After the color and shellac have hardened, the entire piece is either varnished or shellacked to complete the job.

Francis W. Henry, Pottsville, Pa.

Rack Patterned After Book End

Patterned after a conventional type of book end, this magazine rack will hold a dozen of your favorite magazines. The back and base are of plywood and the back has beveled edges. The metal strip which holds the magazines is formed over an iron pipe. After the assembly is completed and sanded, it can be finished to suit your particular taste.

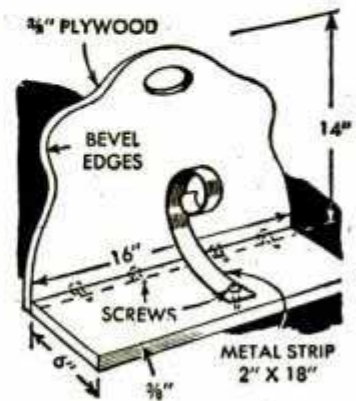

R. M. Woodbury, Haverhill, Mass.

Panel Hooked to High-Chair Legs Prevents Bad Falls

Many an accident will be prevented if the legs of baby's high chair are fastened to this panel. In size the panel should extend several inches each way beyond the legs of the chair. Screen-door hooks are screwed to the legs and eyes are fastened to the board, which can be of $\frac{3}{8}$ -in. plywood. Nuts holding the eyes should be countersunk and covered with tape to avoid scratching the floor.

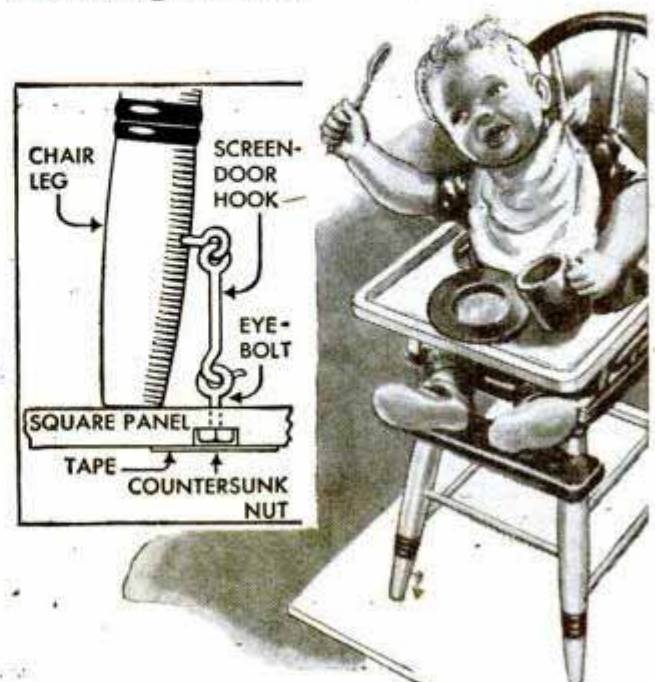

ETCH IT!

By Nathan Bogoch

UNUSUAL wall plaques can be made by etching designs in sheet brass or copper or thin brass or copper plates of the desired size. When completed, the plaques may be framed or frames can be simulated on the plates by etching suitable designs. The steps in Figs. 1 to 12 inclusive give the general procedure.

After cleaning the work, warm it and apply a smooth coat of asphalt and immediately press lead foil over it. Smooth the foil carefully and then sketch or trace the design onto the foil with a sharp, hard pencil. Cut out the design, cutting through the foil and asphalt to the copper. Scrape off as much of the exposed asphalt as possible and remove what remains with a cloth and turpentine.

Next mold a ring or dam around the design to retain the acid, using a mixture of yellow beeswax, 2 oz., pine resin, 2½ oz., tallow, 1 oz., and turpentine, ½ oz. Simmer this over a low flame. After the dam has been formed, level the work and apply equal parts of hydrochloric acid and nitric acid. When the design has been etched to the desired depth, wash off the acid with copious amounts of warm water, pull off the foil and remove the asphalt by scraping and then washing with turpentine.

If desired, you can color the design. To do this, again warm the work and press colored sealing wax into the etched lines. Excess wax should be scraped off while still soft. The plaque can now be given a mat finish by a second etching, which consists of coating it with acid, immediately applying common salt and then scrubbing with a soft brush, after which the acid and salt are washed off, using plenty of water to remove all traces of acid.

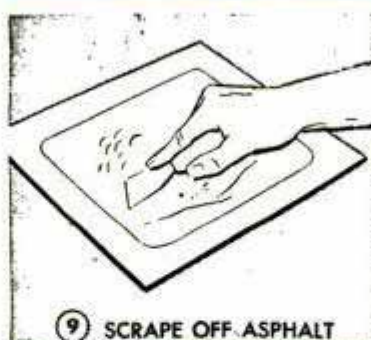
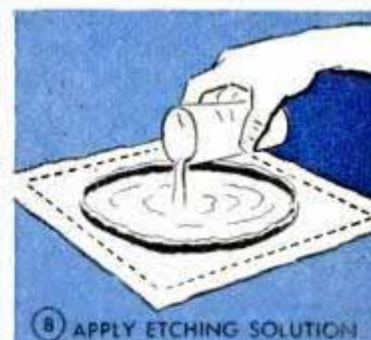
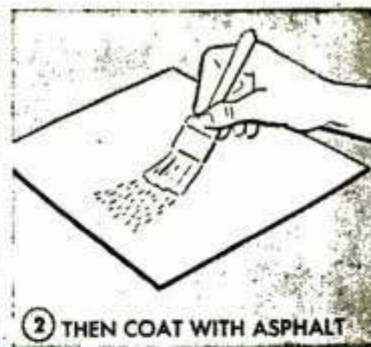

Dog Is Kept Safely in Automobile With Hook Fastened to Leash



To prevent his pet from unexpectedly jumping out of a car, one dog owner fashioned a spring-steel hook to which he attached the dog's leash. The hook slips over the back of the front seat and can be removed when the animal is not in the car.

Straightener Held by Bench Vise Removes Kinks From Wire

Easily made, this wire straightener will perform its job in a jiffy. The round pieces are made from a discarded shovel handle or other 1 1/4-in. dowel. The edges are filed

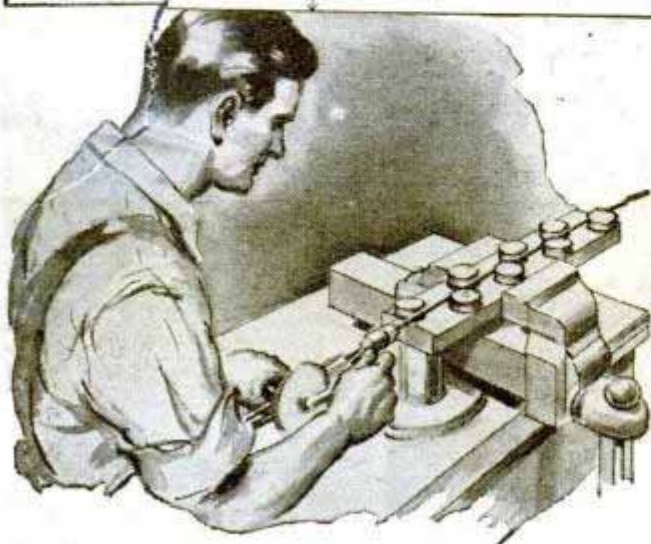
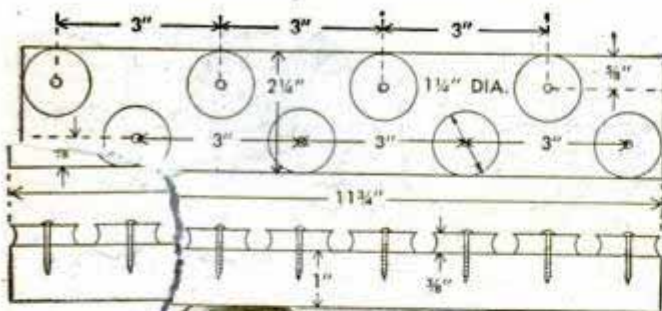

slightly concave to guide the wire. In operation, the straightener is clamped in a bench vise and the piece to be straightened is oiled. It is then threaded between the round pieces and one end is chucked in a hand drill which is rotated slowly as the wire is drawn through. As the rounds are worn, they can be turned to a new position.

Wallace H. McClay, Pasadena, Calif.

File Has Pistol-Grip Holder

Working with a large file or wood rasp is easier if you fashion the holder shown here. The pistol-grip handle and the knob grip provide a comfortable hold. The file is held with metal clips screwed to the holder.

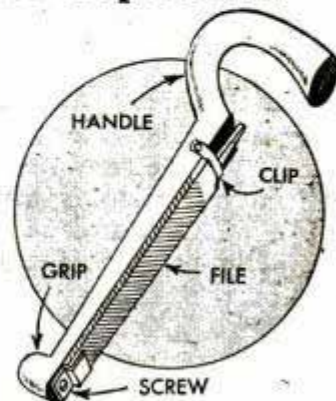

Nail Polish Used as Protection For Soap Carvings

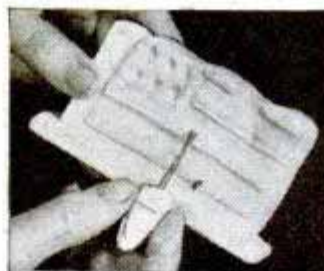

A coating of colorless nail polish will keep that collection of soap carvings clean and new looking. It is applied easily and dust and grime will not adhere to

its surface. To get into small crevices, it may be necessary to use a finer brush than the one that comes with the bottle.

Benj. Nielson, Aurora, Nebr.

Removable Crosspiece on Ladder Simplifies Window Washing

When second-story windows are washed on the outside from an ordinary ladder, the job is both difficult and dangerous because the ladder has to be placed at one side of the window or rest on the sill. From either position it is not easy to reach all parts of the window pane. However, if two pieces of flat iron are bolted over the ends of the ladder and a wood crosspiece inserted, the ladder can be placed directly over the window.

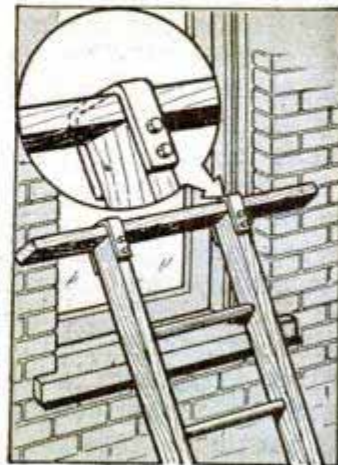

Decorative Ribbon Ornaments Framed Photos



If the appearance of some of your framed photographs becomes monotonous, give them borders of colorful Cellophane ribbon of the type used for tying Christmas packages. Use the narrow ribbon in color combinations of red or blue with gold or silver. Lengths of the ribbon are placed near the edges of the photograph and secured on

the back with cellulose tape. The glass should be laid over the picture before inserting it in the frame so that the ribbons will stay in position. If you can obtain narrow strips of colored cellulose tape, which comes in a variety of bright colors, it can be used in place of the ribbon and will not require any additional adhesive.

Glass Strip in Developing Tray Keeps Film From Sticking

To prevent cut or pack film from sticking to the bottom during tray development, lay a strip of glass diagonally across the tray so the film will not lie flat on the smooth enamel bottom. This will also provide a finger hold for turning or agitating the film. The edges of the glass should be rounded with fine emery cloth.

David W. Roberts, Bartow, Fla.

Marked Papers Eliminate Waste

Confusion and waste of photographic printing paper occur when the outside envelopes and the black wrapping papers become separated in the box. There is a possibility that the different grades of paper

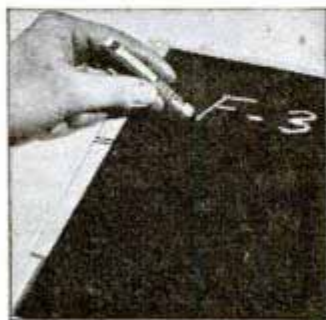

will become mixed, and printing with the wrong grade means that the sheet is wasted. To avoid this, mark the black wrapper with a white or yellow crayon or marking pencil.

Cracks and chipped places on plastic developing tanks can be repaired and filled by using a mixture of clear plastic cement and lampblack.



Viewing Glass Aids Photographer

A blue viewing glass helps a photographer "see" the picture better since the glass eliminates most of the color from the scene and shows how the picture will look in black and white. Such a glass, large enough to cover both eyes, can be carried in the case with the other camera equipment.

Animated Motion-Picture Titles Photographed Through Glass

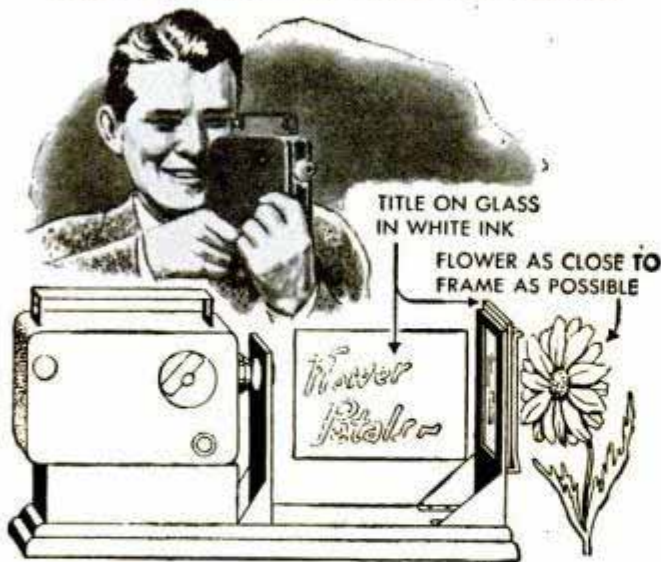

For those who want movie titles that are different, here's an unusual effect that can be obtained with a standard titler. A sheet of glass is cut to fit the frame and the lettering is done with white ink. Then, if the subject matter is flowers, for example, several blossoms are placed behind the glass and made to wave as in a breeze. The flowers will be slightly out of focus, but this will serve to increase the artistic effect. Many variations of subject matter are possible.—W. V. Athanas, Ashland, Ore.

Cloth Diffusers for Photofloods Are Attached Easily

Diffusers for any size of photofloods are made from a piece of cheesecloth and a few spring paper clips. The cloth should be folded to form a triple thickness, although more may be used if desired. The air spaces at the top, bottom and sides serve to pre-



vent overheating. One advantage of this diffuser is that it may be detached and washed when soiled.

George A. B. Hulbert, Springfield, Mass.

Photographs Recessed With Iron

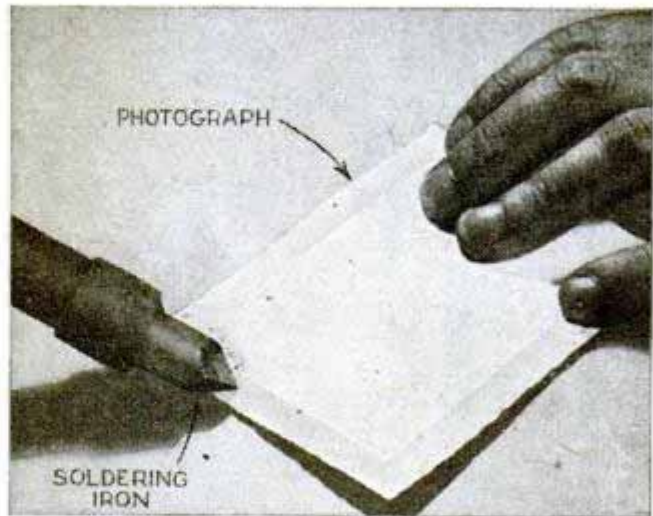

It is not easy to give a plate-sunk or recessed finish to a glossy photograph without cracking the gloss, but this difficulty can be overcome by using a warm soldering iron. Moisten the back of the print slightly with a damp sponge, lay it face down over a cardboard template of the right size and press around the border with the tip of a soldering iron. The iron should not be so warm that it will discolor the surface of the paper.

Clear Nail Polish Adds Luster To Spotted Glossy Prints

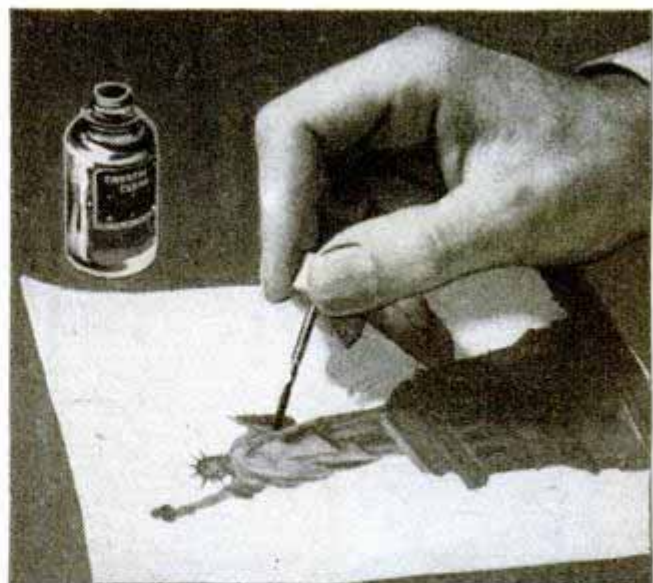

If a glossy print is spotted with small dull areas when it comes off the tin, instead of ferrotyping it again just touch up the dull spots with clear fingernail polish. This dries rapidly to a high luster which matches the finish of the print.

William Swallow, Brooklyn, N. Y.

Camera Becomes Enlarger

Your camera supplies the lens and bellows for this enlarger — all you have to make is the lamp house and column. Quick-change adapter permits camera to be clamped in place in a jiffy. View camera is preferred, though most any folding-type camera will do

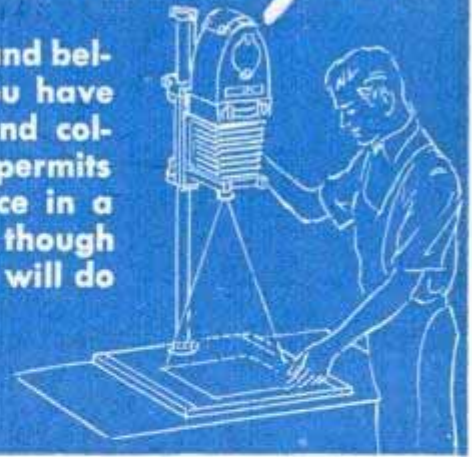

By **Walter B. Ford**

IF YOU have a bellows-type camera, it's likely that it can be used as an enlarger simply by removing the ground glass and constructing a lamp house and column to fit. The enlarger described here, Fig. 1, was made with a 5 by 7-in. view camera, but others can be adapted by altering the size of the lamp housing, column and platform to suit your camera. It may be necessary, in this case, to experiment and determine the height of the standard and the position of the camera in relation to the enlarging board and the focal length of the lens so the negative is properly projected.

Two pieces of plywood form the ends of the lamp house and are cut in the form of a parabola. Only the part that shapes the contour of the sheet-metal reflector need be a true parabolic curve, however; the rest is straight. Cut a 5-in. circle in one piece and fit it with a sheet-metal access door as indicated in Fig. 2. This is provided for the removal of the lamp. In the same piece cut an opening for the negative holder, which may be a contact printing frame of a size to fit the camera. The lamp base is mounted on the other endpiece and a hole is drilled above the socket for the lamp cord. The lamp should be centered so light is distributed uniformly over the opal glass. This can be checked with a light meter as in Fig. 6. The hardwood sidepieces that serve as guides for the negative holder, Fig. 5, are cut and fitted with spring

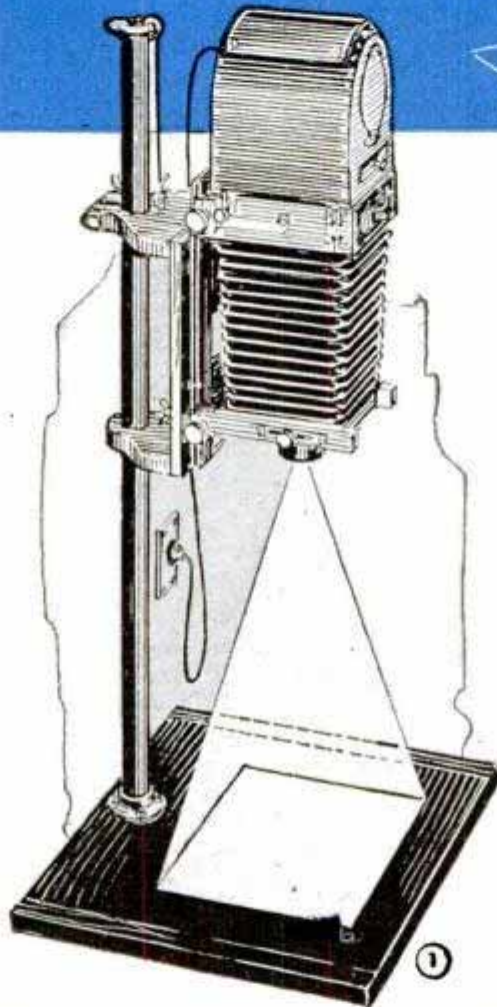

clips, right-hand detail of Fig. 2. Place the opal glass and secure it with two small strips on the endpieces. After the ends and sidepieces are assembled, the sheet-metal cover is added. To provide adequate ventilation, holes are drilled in the top. A baffle is provided for the ventilation holes and is held in place with spacers and machine screws. The interior of the house is finished with aluminum paint. After rabbeting the ends and sidepieces to fit the back of the camera, drive in phonograph needles to engage the ground-glass retaining clips. If you use a contact printing frame as a negative holder, Fig. 5, remove the back and

any clips on the sides that may have been used to hold the back in position. A knob is added to remove and insert the holder. Two sheets of plate glass are cut to fit the holder and the negative is carried between them. If desired, a set of masks can be made for different sizes of film down to 35-mm. film. Paint all exterior parts of the lamp house a dull black.

To make the camera platform and column, cut a piece of 1¼-in. pipe—48 in. long in this case—and thread one end. Notch the other end and fit it with a collar and pulley as in the upper detail of Fig. 3. The platform consists of a base and the two endpieces, Fig. 4. The lower piece serves as a guide only, and the upper piece, which is slotted, clamps the platform in position when the wing-nut-and-bolt adjustment is tightened. The camera is held in posi-

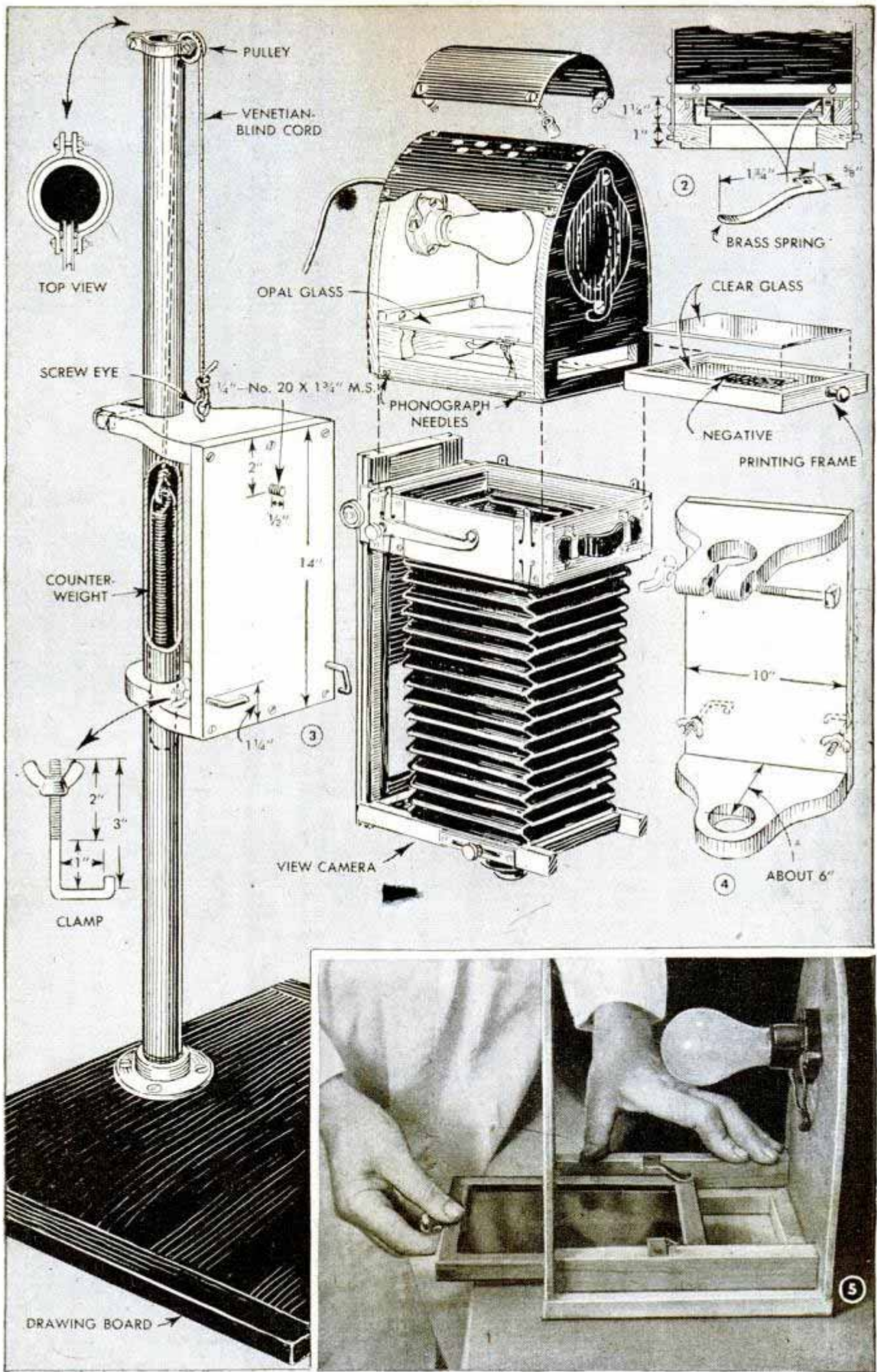

tion on the platform by means of a 1/4-in. No. 20 tripod screw, which fits the tripod base, and two adjustable clamps that fit over the bed. Here again it will be necessary to take measurements from your own camera to determine the size of the platform and location of the screw and clamps.

When the platform is attached to the camera, it should be weighed and a lead counterweight made which rides inside the pipe, Fig. 3, using venetian-blind cord to attach it. The weight should be equal to that of the camera and platform. This will make raising and lowering the camera easier. A suitable base for the enlarger is made from a drawing board of the type used by students. A 1 1/4-in. floor flange is screwed to the center of one side. The column is screwed into this. All exposed wood parts should be finished in a dull black color to prevent unwanted light reflections.

Although no particular type of switch is indicated, a snap switch can be installed in the cord, or, to leave both hands free, a foot switch can be used. The latter usually is

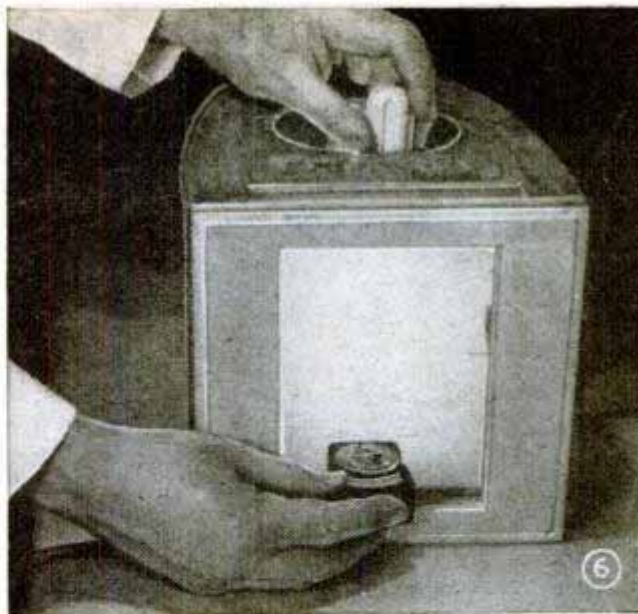

preferred. A standard enlarging bulb of the proper size for your lamp house should be used. Any enlarging easel will do as long as it fulfills the requirements of your work and is not too large for the platform.

Handy Shelf Arrangement When Ferrotyping Photoprints



Here's a handy shelf for your ferrotype tin that will eliminate much of the muss and fuss when ferrotyping photoprints. It is made of any suitable hardwood and should be several inches larger than the tin. The shelf is hinged to a board that, in turn, is screwed to the wall. This will permit folding against the wall. The shelf is covered with rubber matting as a protection from the water and it also makes a good backing for the tin. A leg is attached to the lower end of the shelf and this also folds when not in use. A table is placed beneath the shelf and a tray is set on the table to catch the water that drains off the tin. After the prints are squeegeed, the tray is removed and the prints, when dry, will drop onto the table.

George T. Hewitt, Salem, Ore.

Blue Cellophane Attached to View Finder Eliminates Need for Filter

Many photographers use a blue filter to aid them in judging light values properly. If you have been using such a filter you can eliminate one piece of equipment from your case by making the view finder do double duty, both as a finder and filter. Select a sheet of blue Cellophane that is the correct shade for such a filter and cut a piece that will fit the larger opening in the view finder with no white-light leaks around the edges. The fit should be close as too much white light might affect the evaluation to some extent. The Cellophane is held in place with cellulose tape.

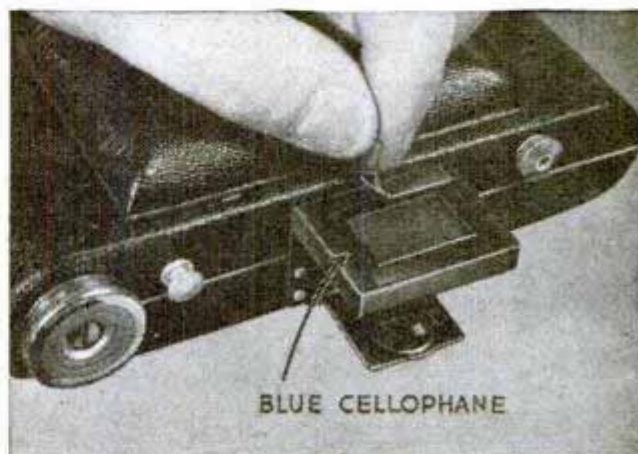

Obtaining Longer Interval With a Photographic Self-Timer

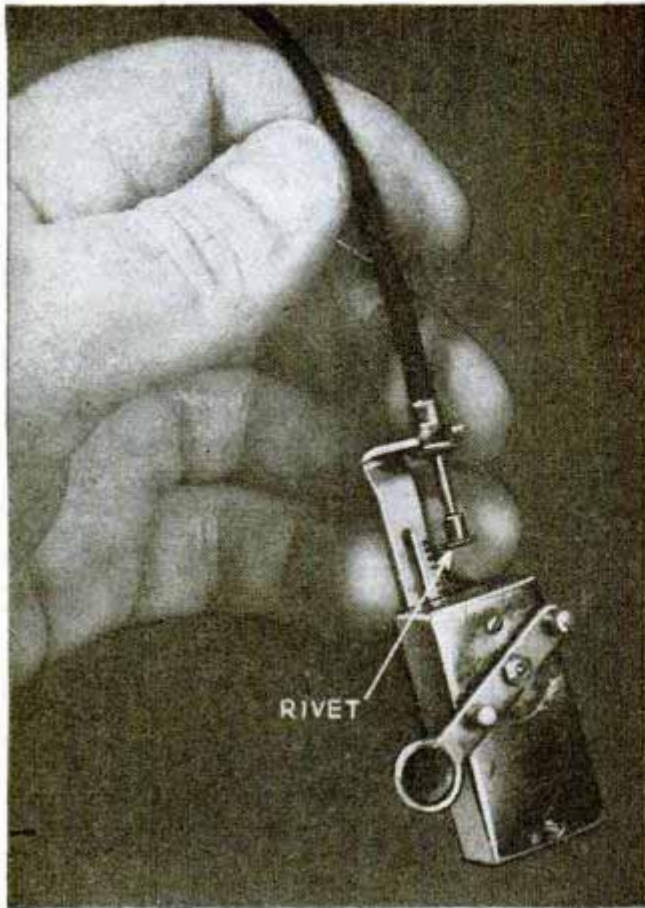

It's possible to obtain a longer delay interval with your photographic self-timer by making a few alterations on the cable release. Cut off the release button so the stem will be as short as possible while still allowing the shutter to be tripped. Then solder a small rivet on the stem to replace the original button. This means that the body will have to travel a greater distance on the timer arm before touching the button and releasing the shutter and, in turn, this will allow you more leeway to get in the picture. Learn to count the seconds exactly so you will know when the shutter will be tripped. Knowing this will be an aid in posing the picture to best advantage.

Cut-Film and Film-Pack Drier

This drier will dry film in about 15 min. if the surface moisture is removed first with a chamois or sponge. It consists of a wooden disk 12 in. in diameter with wood clips fastened to the edge. A 100-watt bulb and socket are mounted in the center of the disk. The unit is suspended by means of a screw eye and a cord or wire.



Max Navis, Brooklyn, N. Y.

Keeping Ferrotypes Tins in Place

Ferrotypes tins will not slip when leaned against a wall while prints are drying if they are held in place with rubber bands slipped over the tins. In addition, the rubber bands will catch and hold the prints as they drop off the tins, preventing them from falling to the floor.

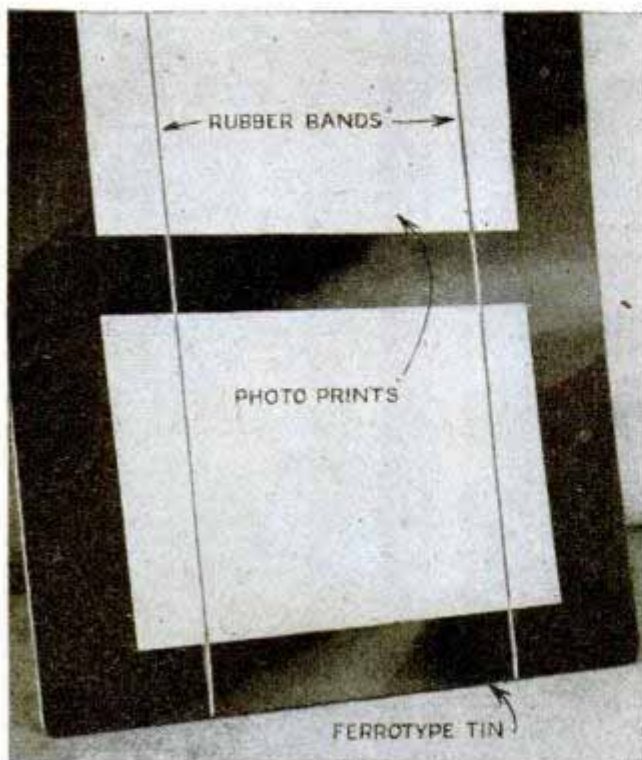

Tape Is Used to Identify Film

When using different types of film in several holders, some method of identification is necessary. I use short pieces of light masking tape and fasten them on the holders. The type of film and the emulsion speed are noted on the tape with indelible ink so that it will not smear. The tape is easily removed when unloading the film.

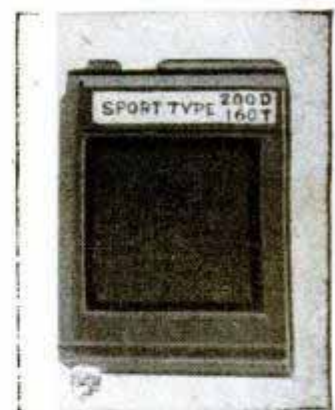

George T. Lundeen, Madison, Wis.

When a number of glossy prints are to be made with a limited number of ferrotypes tins, the sun will speed the drying time. The tin with the prints on it is placed in a sunny spot and finished pictures are ready in a short time.

CRAFT QUIZ



1. This operation requires a—
 (a) Knurling tool (c) Faceplate
 (b) Spur center (d) Center rest



2. 1000 4-penny nails weigh—
 (a) 4 lbs. (c) 10 lbs.
 (b) 6 lbs. (d) 3 lbs.



3. This finishing material is—
 (a) Paint (c) Varnish
 (b) Lacquer (d) Filler



4. Wrong in this picture is—
 (a) Hand position (c) Plane direction
 (b) Kind of plane (d) Kind of wood



5. On boat frame he is planing—
 (a) Chine (c) Batten
 (b) Garboard (d) Keel

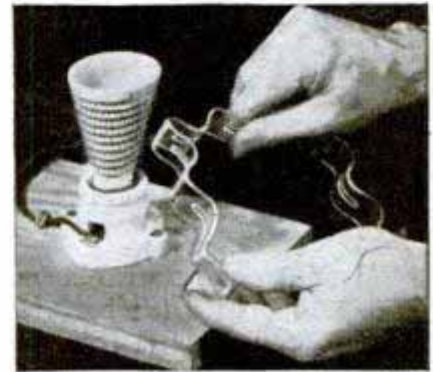

6. You can see this plastic is—
 (a) Thermoplastic (c) Laminated
 (b) Thermosetting (d) Phenolic

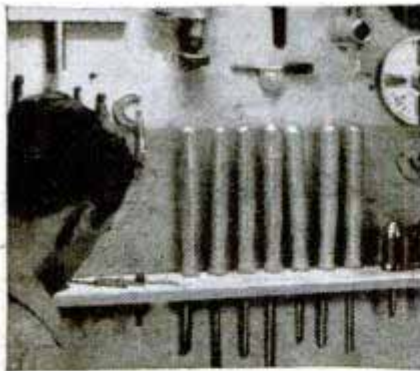

7. This tool panel goes with a—
 (a) Bandsaw (c) Wood shaper
 (b) Wood lathe (d) Tenoner



8. What is wrong here?
 (a) His hands (c) The guide
 (b) The work (d) The blade

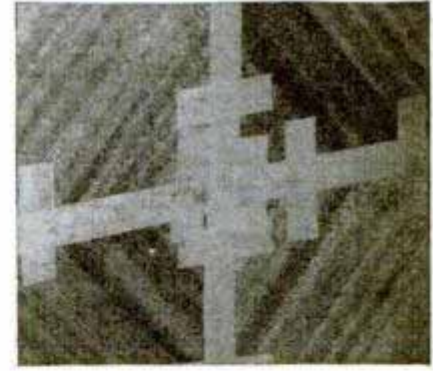

9. This veneer pattern is called—
 (a) Diamond (c) Herringbone
 (b) Book (d) X-match

ANSWERS: 1—b; 2—a (4-penny is same as saying 4 lbs. per 1000 nails); 3—c (typical varnish cup with strike wire); 4—c (against grain); 5—a; 6—a; 7—b; 8—c (guide 190 high); 9—a; 10—d (connected in series); 11—c

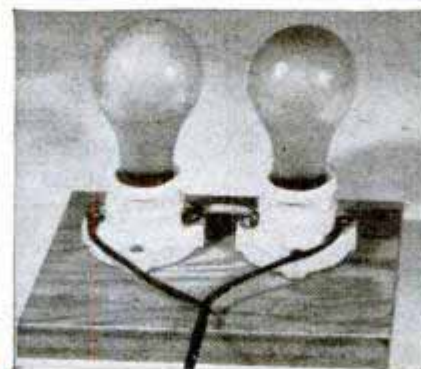

10. Lamps in this circuit will—
 (a) Burn bright (c) Blink
 (b) Burn out (d) Burn dim

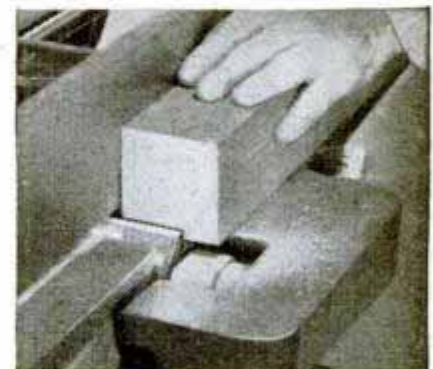

11. He is cutting a—
 (a) Groove (c) Rabbet
 (b) Dado (d) Mortise

Motorist's Vision Is Increased With Sliding Visor

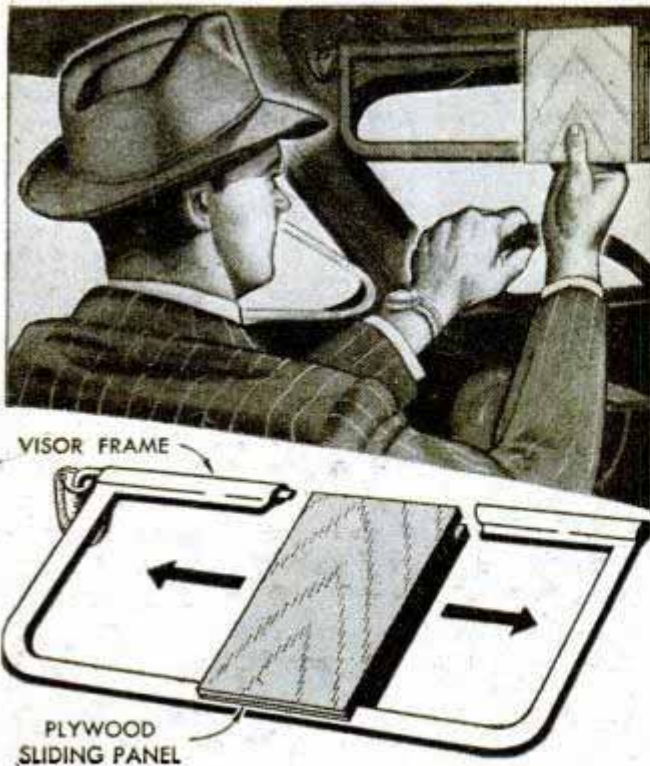

Because the area blotted out by the sun visor on a car often interferes with driving, one motorist used this panel which slides in the framework of the visor. The panel is large enough to cut out the central glare and it can be adjusted to any position normally covered by the visor. The panel is made of plywood and grooved to fit the visor frame after the cloth has been removed.—Opie Read, Jr., Chicago.

Plastic-Glue Filler Mends Holes In Rotted Frames and Posts

When parts of window frames or other sash work subjected to the weather have rotted or checked badly, repair them with a filler made of plastic glue. Mix the latter



with enough water to form a creamy consistency, then add sufficient sawdust to make a thick paste. The material is unaffected by water.

How to Rivet Softwood Joints

Fastening a softwood joint that must withstand severe twisting is done usually with a bolt having a flat washer, a lock washer and a nut on the end. A much smoother and less conspicuous joint can be made with a round-head rivet. Bore a hole with a diameter slightly less than the rivet so that it will be a drive fit in the hole. Then place a flat washer over the end and cut off the projecting portion, leaving only enough to form a head. To be sure the rivet will head up right, slot the projecting end. Large rivets should be cross slotted.

Charles Kimball, Los Angeles, Calif.

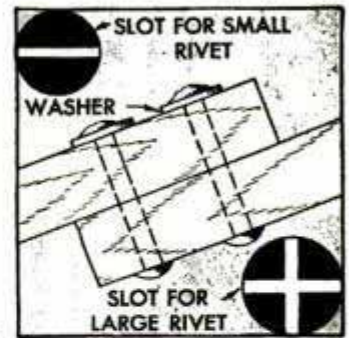

Bead Aids When Slipping Tubing Over Insulated Wire

Slipping rubber tubing over insulated wire sometimes is desirable in automotive and radio wiring because it furnishes additional protection. This can be done easily if the insulation is stripped off for a short distance and a glass bead slipped over the bare wire. The circumference of the bead should be slightly larger than the outside diameter of the insulation.

A. H. Waychoff, Phoenix, Ariz.

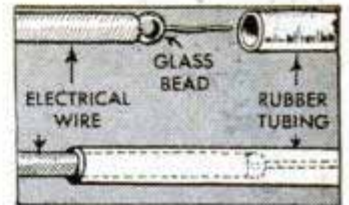

Rack for Hammer Assortment

A rack that holds your assortment of hammers in an easy-to-reach position is made with a few odds and ends of scrap lumber. The dimensions given are general and can be altered to suit the number and types of hammers you have. One advantage of this holder is that there are no clips to scratch the hammer heads.

Carlton A. Burmeister, Toledo, Ohio.

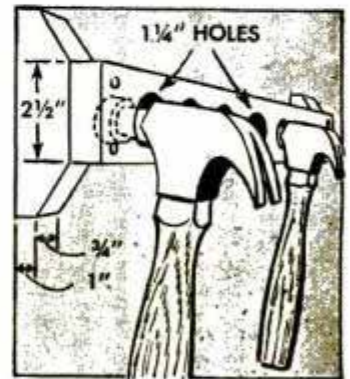

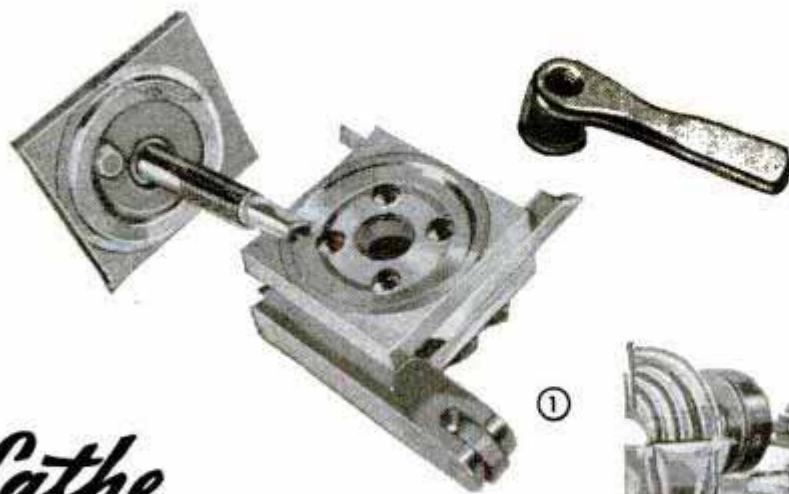

Lathe TOOL-POST TURRET

By Kenneth Murray

THIS four-way turret can be made to fit any lathe in the small and medium sizes and is especially handy where machining operations are required on duplicate small parts. A double-threaded locking screw equipped with a convenient handle provides for a quick change of the tools. Positive alignment in all four positions is assured with a lock or index pin.

Looking over the detail drawings and the photos, Figs. 1 and 3, you'll see that all the machining operations can be done in the lathe with the aid of a milling attachment. Mild steel in stock sizes or scraps from bar stock can be used for the machined parts. Although on the original turret the handle was a brass casting, an ordinary cast-iron handle of the same general shape will serve the purpose. Two dimensions on the clamp screw, Fig. 2, and also the dimension "X" in Figs. 4 and 5 have been omitted. These must be determined from the lathe on which the turret is to be used. The dimensions will vary according to the swing of the

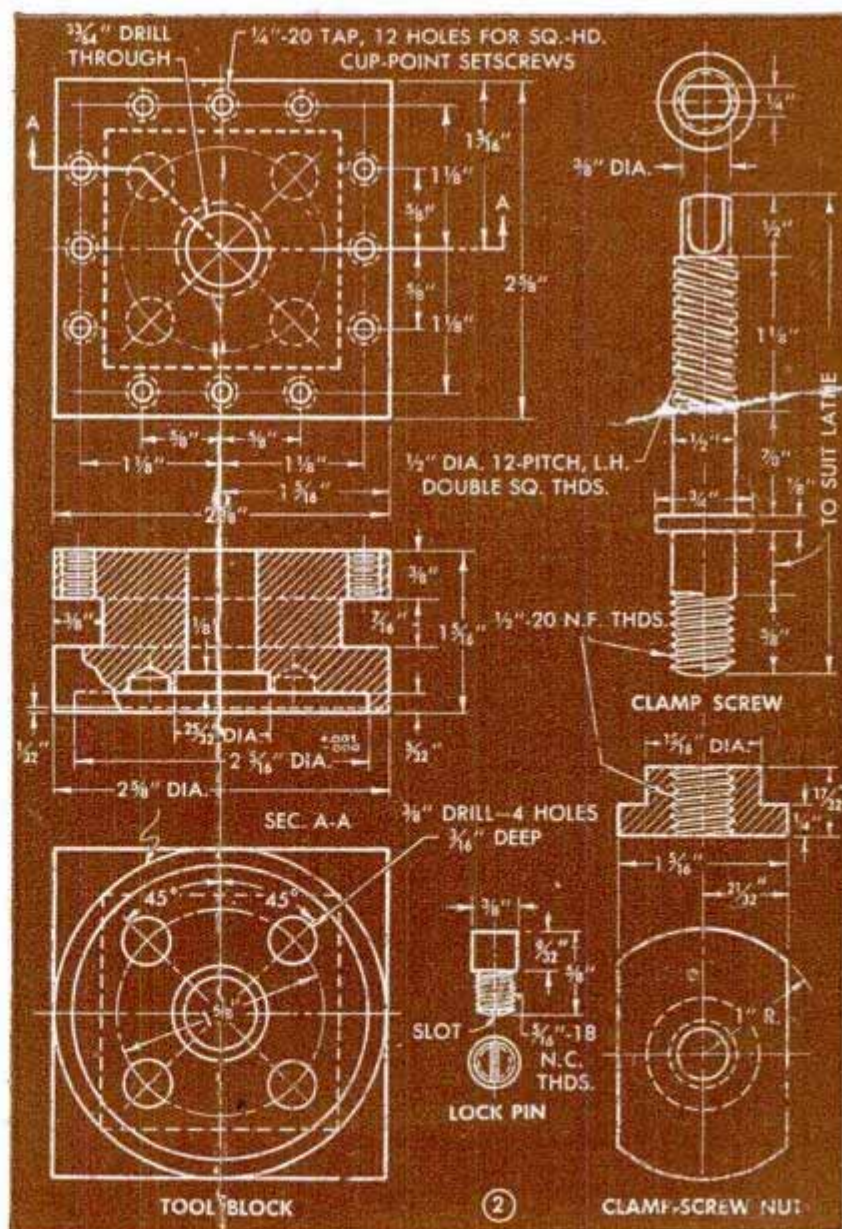

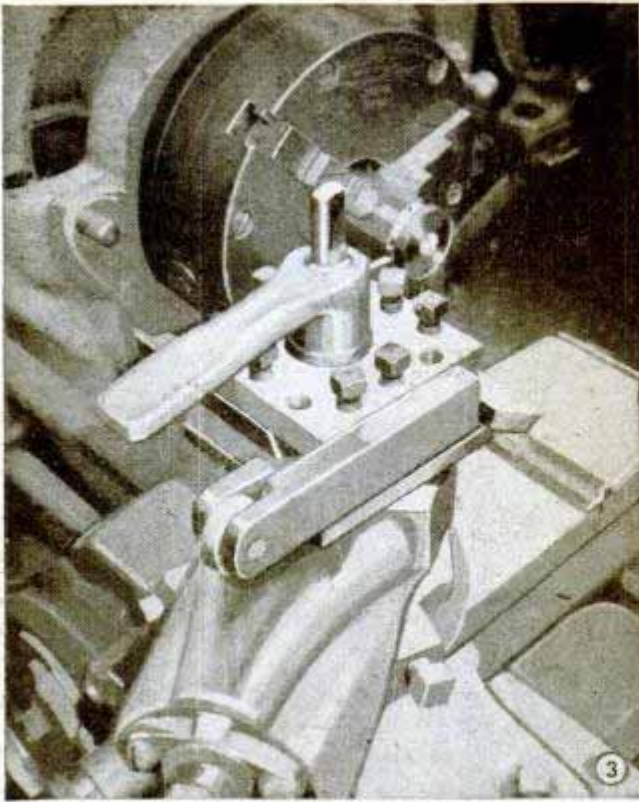

lathe. Before machining the clamp-screw nut, Fig. 2, be sure to check the dimensions of the tool-post slot on the lathe carriage. This also may vary. The thickness of the base must be such as to locate the cutting tools on the lathe center line, Fig. 5, when the turret is assembled.

Accuracy of the turret depends to a considerable extent on maintaining the tolerance dimension on both the tool block, Fig. 2, and the base, Fig. 4. Special care also must be taken in laying out the four indexing holes on the bottom of the tool block. It's a good idea to drill $\frac{1}{16}$ -in. pilot holes. The drill press should be carefully checked for the proper depth setting, and drills should be ground to the correct angle. Although not indicated, a $\frac{1}{32}$ -in. chamfer on the end of the indexing pin will facilitate quick action in shifting the cutting tools.

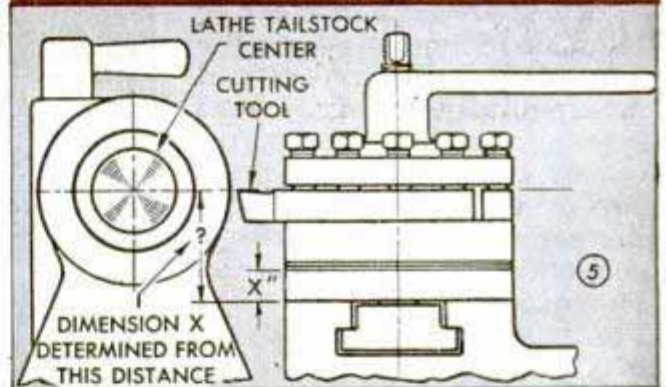
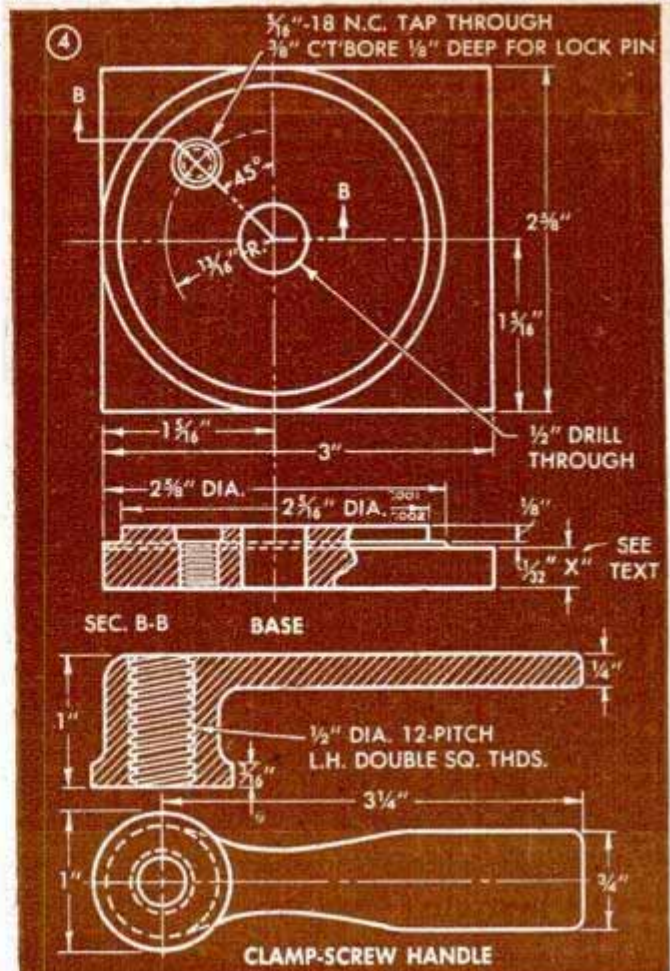

Permanent accuracy depends to a considerable extent on maintaining the tolerance dimension on the tool block and base, as indicated in Fig. 2 and detail above. Also, dimension "X" should be carefully determined

Steady Rest Supports Long Pipe When Threading in Lathe

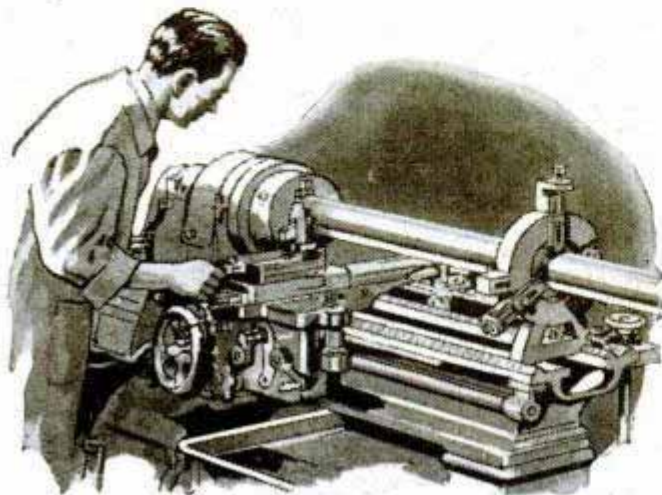

When threading large-diameter pipe in lengths too long for the lathe, the tailstock can be removed and a steady rest used in its place. The work is chucked from the inside so threads can be started at this end of the pipe. When one thread has been cut the pipe is turned end for end to repeat the process. This operation is necessary for pipe too large to be threaded with a pipe die.—Wm. D. Evans, Glendale, Calif.

☞ To bring a new art brush to a fine point, first clean it with soap and water, dry it and then soak it in turpentine. Allow it to hang overnight and the brush will be ready.

Trip Hammer Has Many Uses in Small Shop

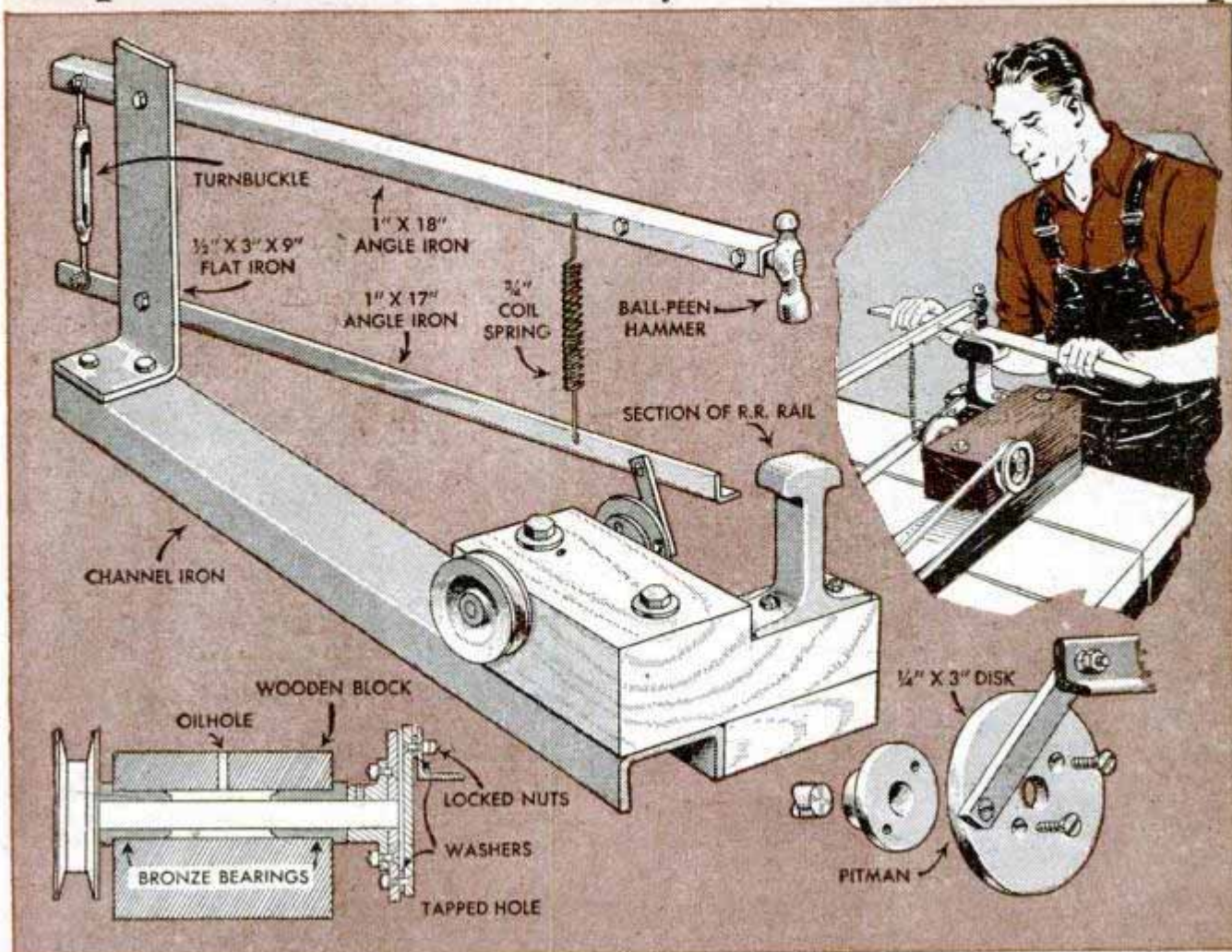

Operating somewhat like a jigsaw, this power-driven hammer is ideal for light peening and riveting operations, and various kinds of decorative metal hammering can be done with it in a fraction of the time required by hand. As an example of its versatility, the builder of the original machine used it to hammer dents out of the lids of carbide cans. The base consists of a length of channel iron and a block of hardwood shaped as indicated. The latter also serves as a housing for bronze bushings

which carry the drive shaft. Parts are not fully dimensioned as you have considerable choice of bearings and other fittings. However, for best results the arms should be of the length given. Efficient operation depends largely on careful fitting of the moving parts and particularly on adjustment of the turnbuckle. Size of the motor and machine pulleys should be such as to give about 500 to 800 hammer strokes per minute.—Everett Goddard, Sidney, Vancouver Island, B.C., Can.

Canvas Pocket Strapped to Ankle Carries Finishing Nails

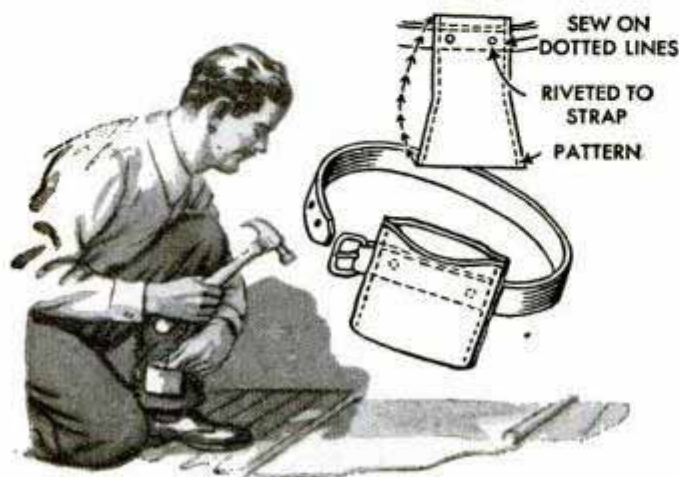

Here's a convenient pocket in which to carry nails when laying a floor. It is made of heavy canvas and cut according to the pattern so there will be a slight bulge for greater nail-carrying capacity. The pocket is riveted to a strap that is buckled around the ankle.

☐ If no other source of heat is available when forming certain types of plastics, a 100-watt lamp bulb mounted in a No. 2 tin can and suspended about 1/2 in. above the material will warm the plastic so that it can be molded into the desired shape.

Feed Box Is Hinged to Manger For Easier Cleaning

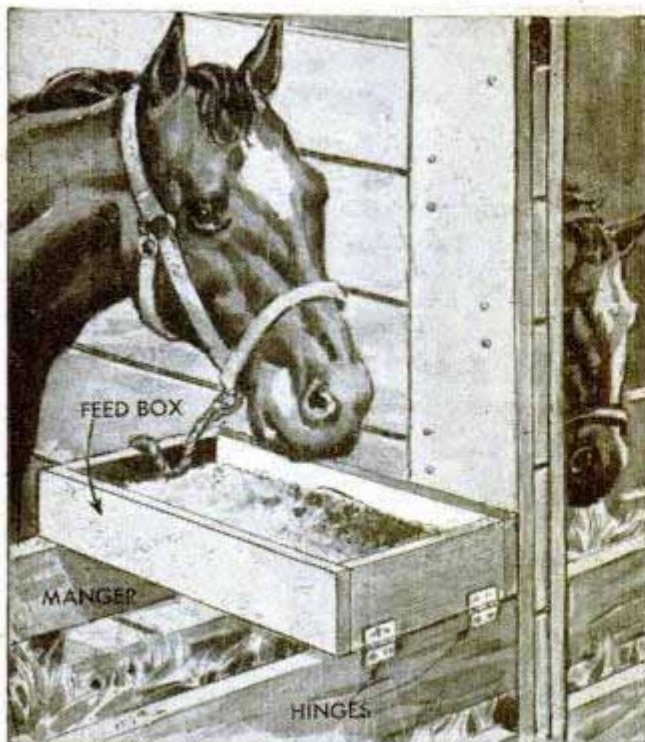

In order to have a feed box that is cleaned easily, attach the front end of the box to the manger with hinges. To clean, just turn the box over. Another way to make the box movable is to place round pegs in the manger and drill registering oversize holes in the bottom. The box can be lifted out for cleaning.

Driving Reins Kept From Falling If Looped Around Horseshoe

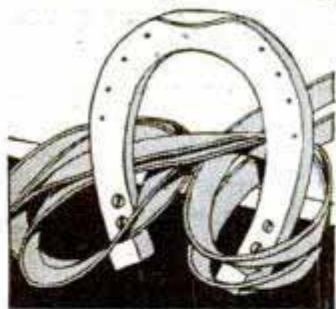

To hold the driving lines of his team and keep them from falling to the ground and tangling in the wheels, one farmer attached a horseshoe to the dashboard of his wagon. The reins are pulled through the shoe and looped in the manner shown.

Thumbtack Pins Eraser on Board

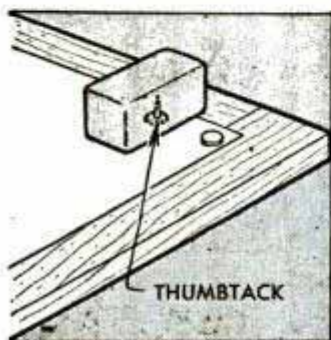

One draftsman uses a thumbtack which sticks up through the drawing paper with the head resting on the board to keep his eraser from rolling off. When not in use, the eraser is

pressed down on the point of the tack. The tack is placed at the upper right-hand corner of the board.

Bands Hold Oil Drum in Position

Metal bands, bent to form a semicircle with the ends extending downward for legs, make a good support for an oil drum. Held in this manner, the drum will not roll off the platform or stand upon which it has been placed.

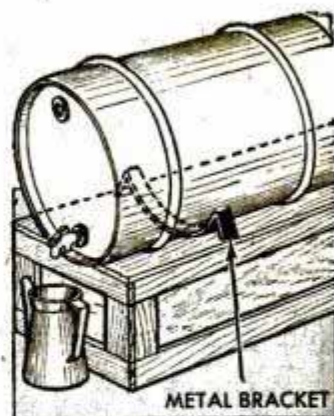

Amount of Grain in Bin Estimated With Aid of Chart

With this alignment chart, it is easy to determine the number of bushels of grain stored in a cylindrical bin if the diameter and the height of the grain in the bin are known. The inside diameter is noted on column C and the height on column A. Then a line is drawn to connect these two points. The number of bushels in the bin is read at the point where the line crosses B. In the example given, the diameter is 40 ft. and the height is 100 ft. A line connecting the two points indicates there are 100,000 bushels.

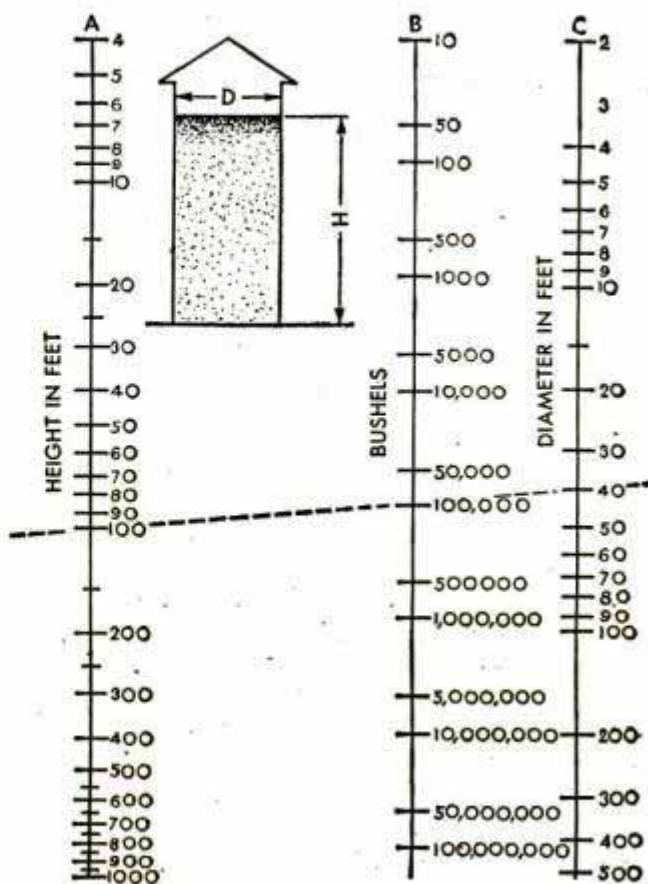

Cutting Keyways Without a Milling Attachment

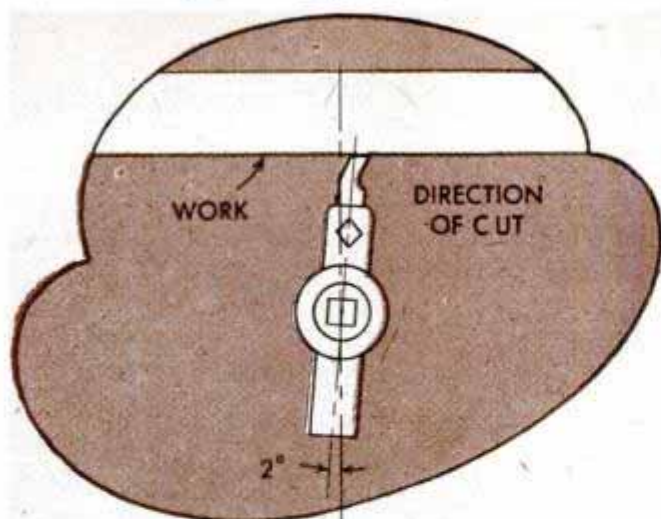

Machining either a blind or open keyway without a special milling attachment is a simple trick that can be done accurately on any metal lathe having a screw feed. Here's the way it is done: First a shallow hole is drilled in the work at each end of the proposed slot as in Fig. 1. Size of the holes is governed by the desired width of the keyway. Next, the tool bit is ground to look like the one shown in the detail above, after which it is inserted sideways in the tool holder as in Fig. 2. To make the initial cut, the lathe compound is advanced to engage the tool bit in the left-hand hole in the work. Then, taking a light cut, the bit is advanced to the opposite hole by turning the carriage handwheel. With each passing of the bit, the tool is returned to the starting hole and the operation is repeated until the desired depth is reached. Reversing the tool bit in the holder and reversing the direction of travel permits cleaning up the keyway at the starting hole.

To cut a groove or open keyway in a shaft a setup is used such as shown in Fig. 3. Here the lathe chuck is removed and replaced with the live center, and then the work is center-drilled for the live center and gripped by a drill chuck placed in the tailstock. This permits using the automatic feed of the carriage to make the cut while the work is held stationary. A very coarse feed and high gear speed are recommended



to obtain rapid travel of the carriage and to assure a smooth cut. As before, only light cuts should be taken with each passing of the bit. Sometimes chattering of the tool will cause trouble in a cut of this nature. Where this happens you often can correct the tendency to chatter by moving the tool in or out very slightly without changing the angle.

Axel E. Jensen, New York City.

Salt Solution Is Used to Check Accuracy of Battery Hydrometer

To test the accuracy of a battery hydrometer, one garage mechanic uses a brine solution. Pure salt (sodium chloride), 2½ lbs., is dissolved in water, 1 gal., being sure that all the salt is in solution. The resultant mixture should give a specific gravity reading of about 1.191, accurate enough for all practical purposes. As a further check, the solution may be weighed. It should weigh about 10 lbs.—Jack Bronte, Colfax, Calif.

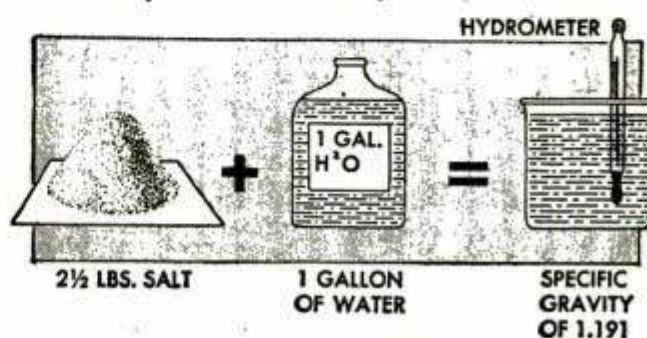

Trouser Clamp Keeps Floor Mat Away From Working Space



To keep the floor mat in a car out of the way while removing floor boards for inspection or repair, one mechanic slips a bicycle trouser clip over the rolled mat. Secured in this manner, there is less likelihood that grease from the floor boards will smear the mat.

Backing Paper Held in Position With Rubber Bands

Due to conditions of high or low humidity, backing paper tacked or stapled to a drawing board will wrinkle and make it difficult to ink work on either drawing or tracing paper that is taped to it. To prevent

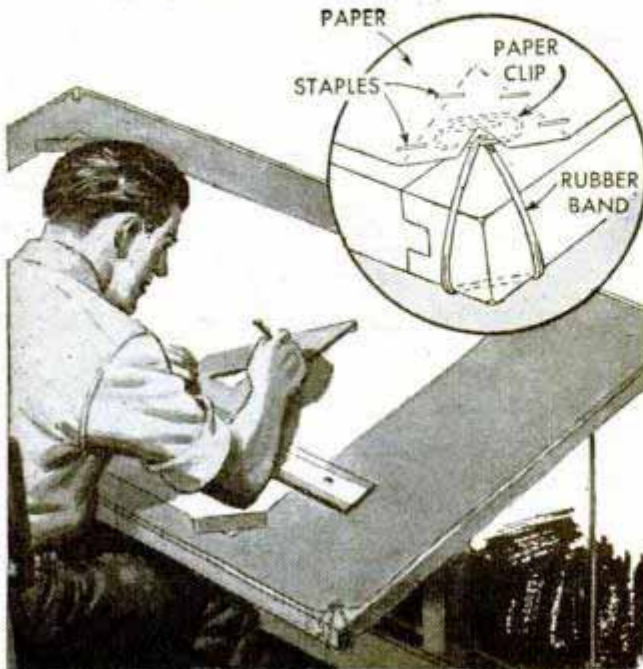

wrinkling, trim the backing paper to fit the board, turn each corner under to form a pocket and cut a V-shaped opening in the doubled thickness on the edge. Slip rubber bands into four paper clips and place a clip inside each corner pocket with the rubber band extending through the V-shaped opening. Close the two sides of the pockets with staples and fasten the paper to the drawing board by slipping the rubber bands over the corners.

B. Tolk, Brooklyn, N. Y.

Holes Punched in Fire Bucket Assure Its Proper Use

Because workers in a freight depot kept using fire pails hung above sand and water barrels for other purposes, members of a fire-fighting crew punched three holes in the bottom

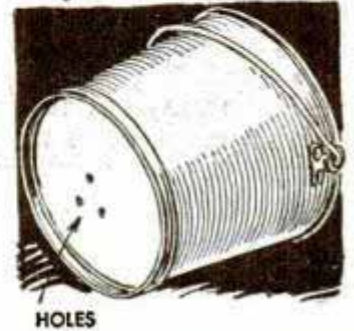

of these buckets. The holes were not large enough so there would be a rapid loss of water or sand, but it did make them useless for any purpose other than fire fighting.

Thomas Carey, Staten Island, N. Y.

Fixing Synthetic-Rubber Tubes

Before a tear in a synthetic-rubber inner tube is patched, the ends of the tear should be rounded to prevent an extension of the opening after the patch is applied and the tube has been inflated. This can be done with a $\frac{1}{8}$ -in. hollow punch of the same type that is used when cutting holes in harness and leather belts.

Blowing Tool Uses Valve Stem

In order to blow water or dirt from the top of a motor block, to dry out the distributor of a car or to perform any other blowing-out operation, one auto mechanic uses a valve stem with a copper tube soldered to one end to direct the air stream. In use, the valve is pressed into an air-hose chuck and the air is blown out through the discharge tubing. The flange which is on the stem provides a good hand grip.

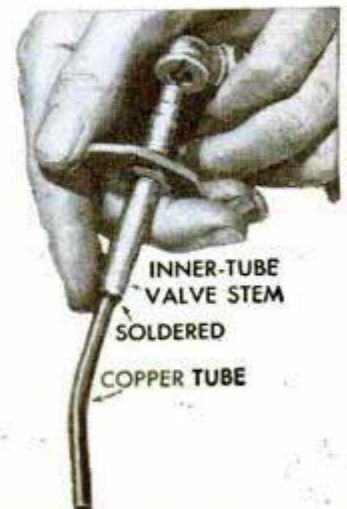

Dolly Facilitates Quick Shifting of Shop Tools

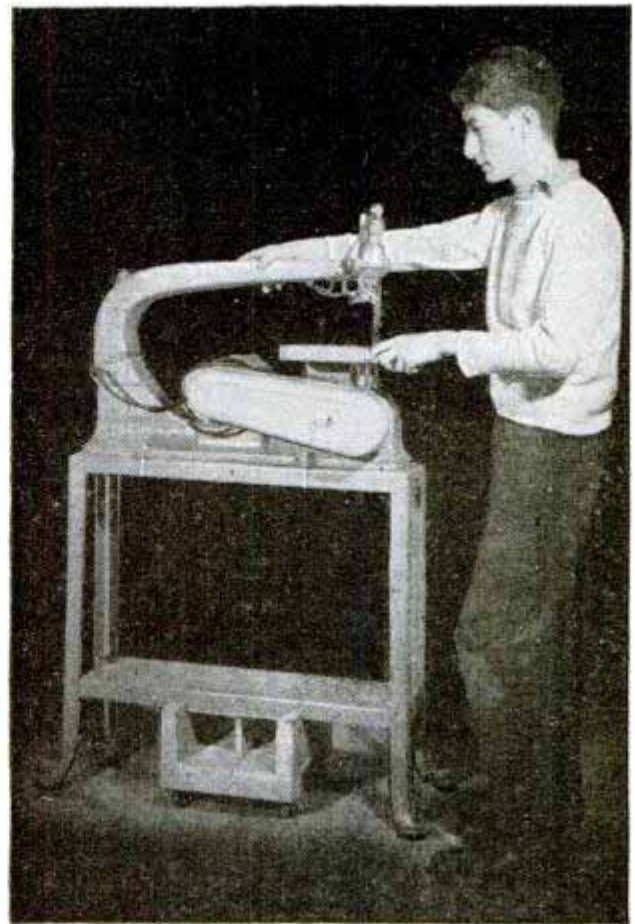
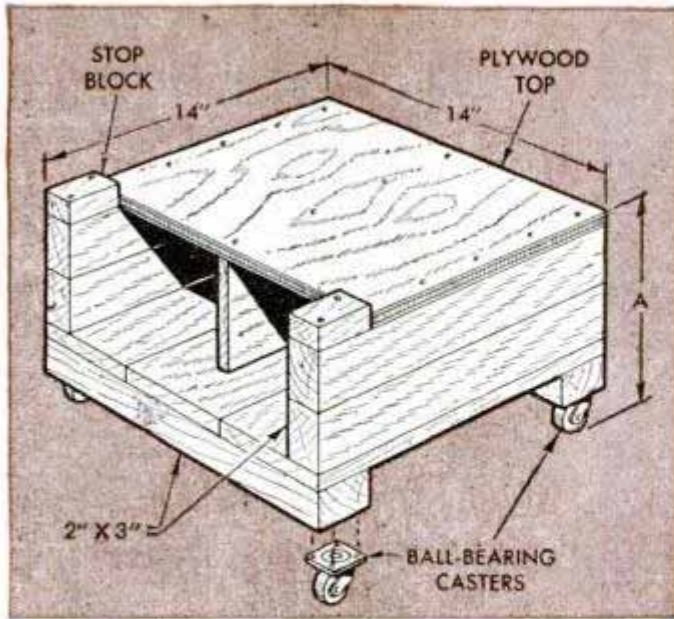

If your garage doubles as a workshop where your power tools must line the walls to provide room for the car, don't strain yourself moving heavy machines about when you wish to use them. All you need is this sturdy dolly to slip under the machine stand. It can be made of any scrap lumber that you may have. The important thing is its height. Distance A, which includes the casters, should be about $\frac{3}{8}$ in. greater than the distance from the floor to the underside of the machine-stand shelf. To mount a machine, you merely slide the dolly alongside the stand, lift up one end of the machine and kick the dolly under.

The machine then can be pushed out to the center of the room with little effort. The dimensions given will accommodate a narrow-type machine stand, such as a scroll-saw, belt sander or lathe.

D. J. Bachner, Jackson Heights, N. Y.

Adjustable Holder for Grinding Produces Accurate Work



To do more accurate grinding, one mechanic made this adjustable holder for round work. The flat-iron bracket is bolted to the bench, and the holder, which also is of flat iron, is fastened to the bracket with a bolt, wing nut and washer. The V-cut in the holder supports the work.

Will D. Candee, Los Angeles, Calif.

Repairing Ignition System Shorts

As a temporary repair for some short circuits that develop in automobile ignition systems, try two or three coats of fingernail polish. Allow a few minutes between applications for the polish to dry. Best results are obtained with the polish when applied to shorts on distributor heads and coils.—Wm. L. Matthews, Pensacola, Fla.

One of the most important reasons for keeping your car in a garage at night is the fact that dew and moisture condensing on the surface harms the exterior finish.

FUNDAMENTALS of MILLING -

RANKING second only to the lathe in importance in many machine shops, the modern milling machine is so efficient from the standpoint of operation that it compensates for at least 85 percent of operator experience. Because of this and the fact that the small bench-type machines of today incorporate to the smallest detail all features found in modern floor-type tools, owners of small machine shops, garages and even home workshop enthusiasts are becoming interested in them. Although intended for the reader who has had very little of this phase of machining, this article also should prove of value to the lathe hand who has had some experience with a milling attachment.

Milling Machine Technique

The first step in mastering the miller is to study the various components of the ma-

chine, such as movements, and the levers, cranks and other means which control them, Fig. 1.

Acquaint yourself thoroughly with the micrometer dial facilities which permit raising the table on its traverse and transverse advance in increments of .001 in. As with most machining operations, the essentials for milling accurately are based on the selection and care of the cutting tools and the speeds and feeds favoring their life, as well as the cutting rate and quality of work.

Know Your Cutters

Only milling operations on work held in a swivel vise or on an angle plate are covered here. Cutters described are therefore those commonly used on such work. High-speed steel cutters are preferred as they give long service when proper attention is given to preserving the cutting edges.

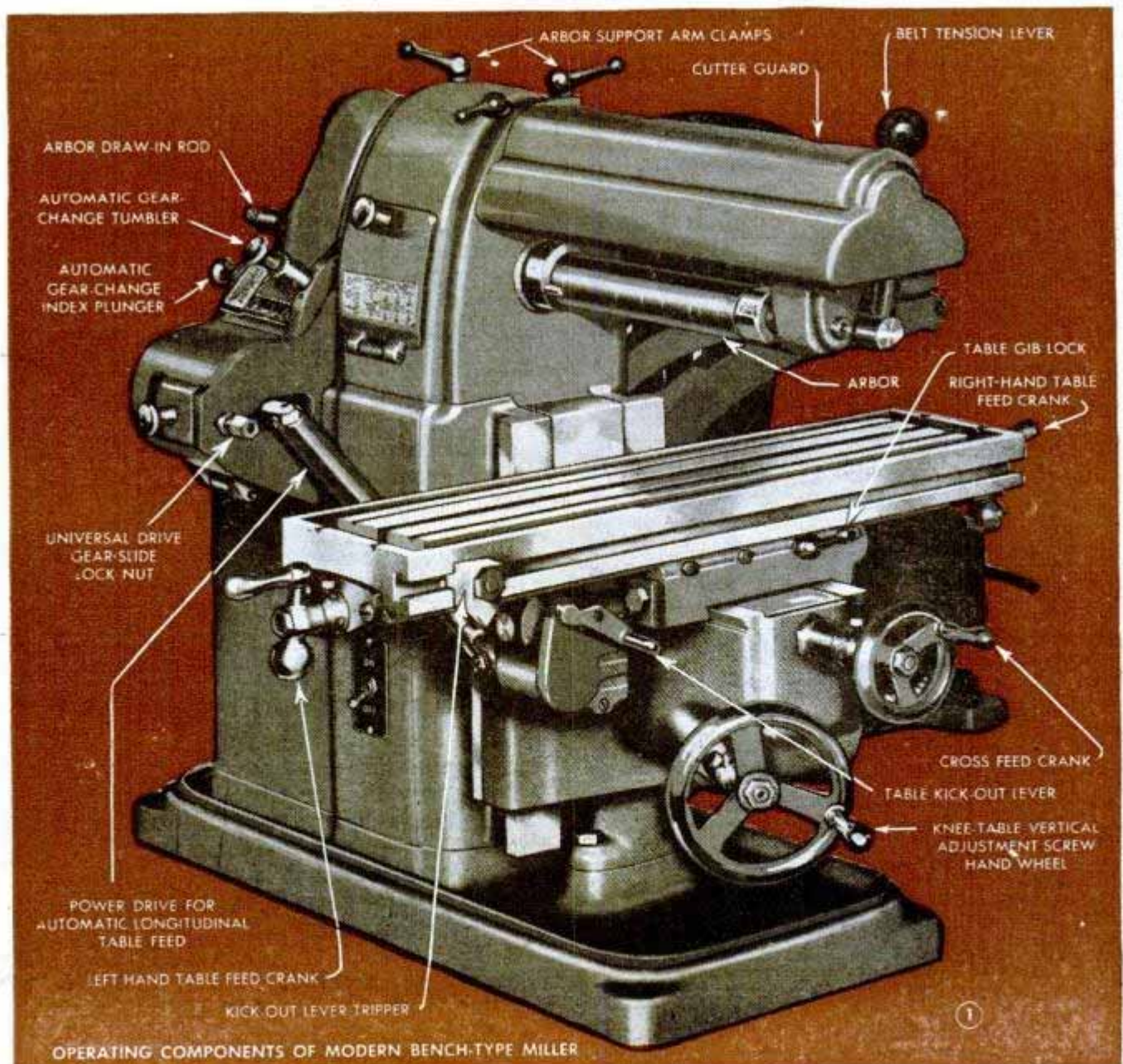

OPERATING COMPONENTS OF MODERN BENCH-TYPE MILLER

MACHINE OPERATION

The cutter being used in Fig. 2 is called a plain or slabbing mill and is intended to make a cut equal to, or less than, its own width. Since this cutter has peripheral teeth only, it is used for surfacing, or slabbing, as this operation often is termed. The cutter in Fig. 3 is a side mill, the teeth having cutting edges on both sides. It is used when milling a certain depth of cut the width of the mill, or any desired width through repeated cuts. Fig. 4 shows a slitting saw, its chief purpose in the small machine shop being to cut off bar stock.

One of the most popular cutters is the shell end mill shown in Figs. 7 and 8. This is the most efficient tool to use when the nature of the cut permits because it is mounted on the end of the spindle nose and gives maximum cutting power. A similar but lighter cutter is the end mill shown in Fig. 9. With this tool, the end teeth and not the peripheral teeth do most of the cutting. A typical application of an end mill is shown in Fig. 10 where the tool is sinking a cut into a small steel plate bolted to an angle plate. Another very useful cutter is the angular or dovetail mill shown cutting a male dovetail in Fig. 11. It also has side teeth and requires careful use to preserve the delicate points resulting from angular peripheral teeth. Fig. 12 shows the same mill cutting the female or mating dovetail.

Right and Left-Hand Cutters

Milling can be done with the spindle rotating in either direction, but on most machines the cutting must be done with the work or table traveling in the direction opposite to cutter rotation. However, climb milling or feeding the work in the same direction as cutter rotation is now being done in machines designed for this method. To attempt this in a light milling machine not intended for this purpose will prove disastrous to both machine and cutting tool. The cutters shown in Figs. 2, 3, 4 and 5 are of the type that only have to be reversed on the arbor to operate right or left hand. Other cutters cannot be used in this way as the teeth are made to cut either left or right hand.

To determine the difference, hold a mill with the top of the teeth coming toward you as in Fig. 6-A. Note that the side teeth are cut on the left side of the mill which makes it a left-hand angular or dovetail cutter. Cutter 6-D is therefore the opposite, or right hand, and so are end mill B and shell end mill C.

There is no need for having cutters of both hands, particularly for experimental

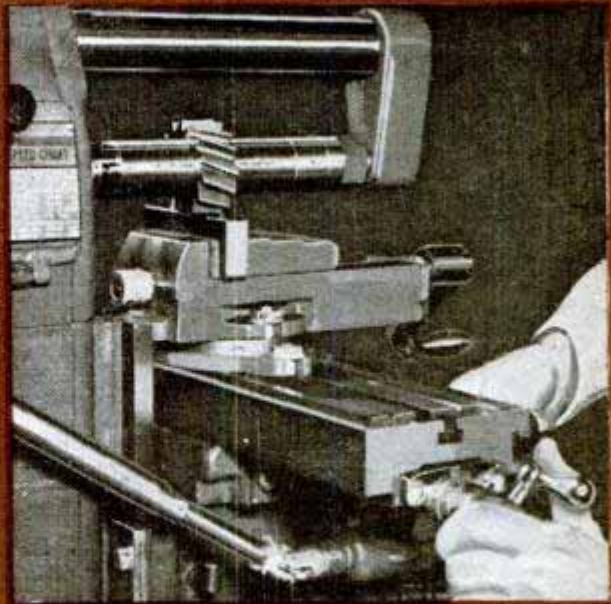

② SLAB MILLING STRAIGHT WORK HELD IN SWIVEL VISE

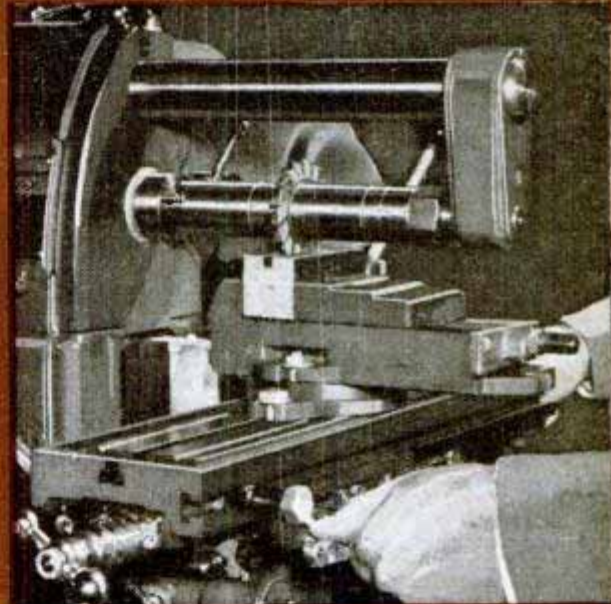

③ SIDE MILL MAKES CUT THE FULL WIDTH OF TEETH

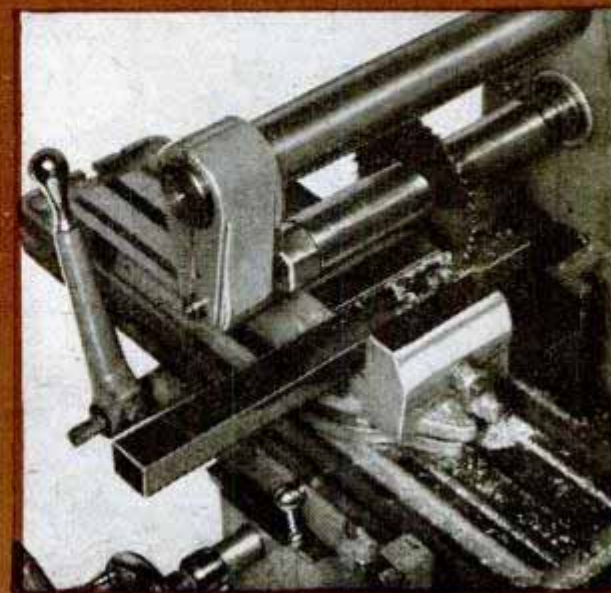

④ SLITTING SAW CUTTING OFF STOCK IN SWIVEL VISE

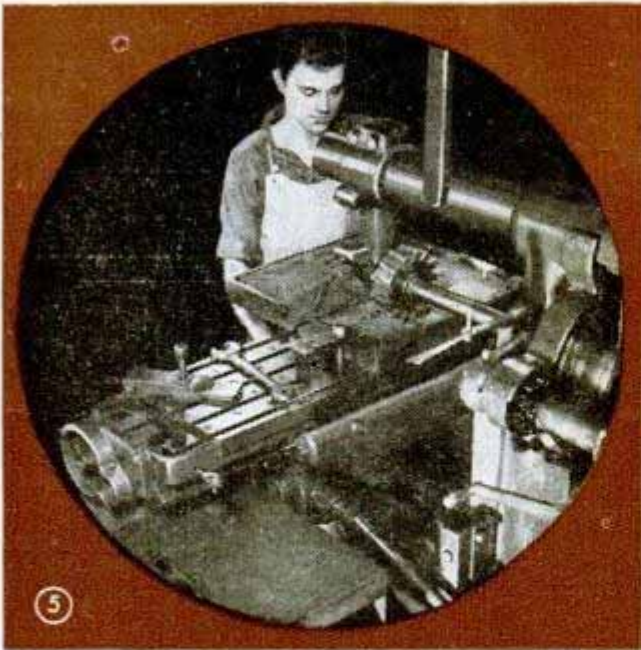

or limited milling operations; instead, specialize in either right or left-hand cutting mills. All cutters used herewith are milling right-hand.

Keep Cutters Sharp

There's no secret about keeping cutters sharp. Simply go over them frequently with a medium-grade oilstone. If you viewed one of the cutting edges through a high-power microscope, it would appear rough; that is, full of peaks and valleys. The cavities thus formed pick up small particles of metal which cause the edge to roll over. On the other hand, oilstoned edges have a straight, uninterrupted line. The idea is to use the oilstone so that minute chips don't have a chance to become embedded in the cutting edges. The oftener the stone is used, the better.

Peripheral teeth of all cutters should be

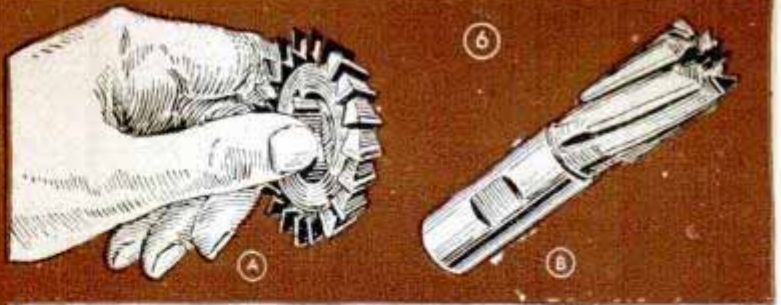

oilstoned while mounted on the arbor, taking care to preserve the original clearance of the teeth; the stone should be held at the correct angle to avoid destroying the edges of adjacent teeth. The side teeth of shell end mills should be oilstoned by resting the cutter on a small surface plate or similar smooth surface as in detail A of Fig. 13. The side teeth of side mills always should be favored. It is advisable to oilstone them only every fourth time the peripheral teeth are conditioned. A good way to check the side teeth is shown in detail B. All that's needed is a pencil and a shaving action which shows whether or not the cutting edges are still in good shape.

The end mill gets its toughest treatment on the end teeth and it is imperative that all end teeth present a flat surface or be square in relation to the peripheral teeth. After oilstoning as shown in detail C, squareness is determined by holding the mill on any flat surface, detail D. Any rocking action indicates a variation in the height of the end teeth, which must be corrected by stoning until the mill will remain upright on the plate without holding it and with no light showing under the teeth.

Although some cutters are still being made with teeth cut on center, as shown in

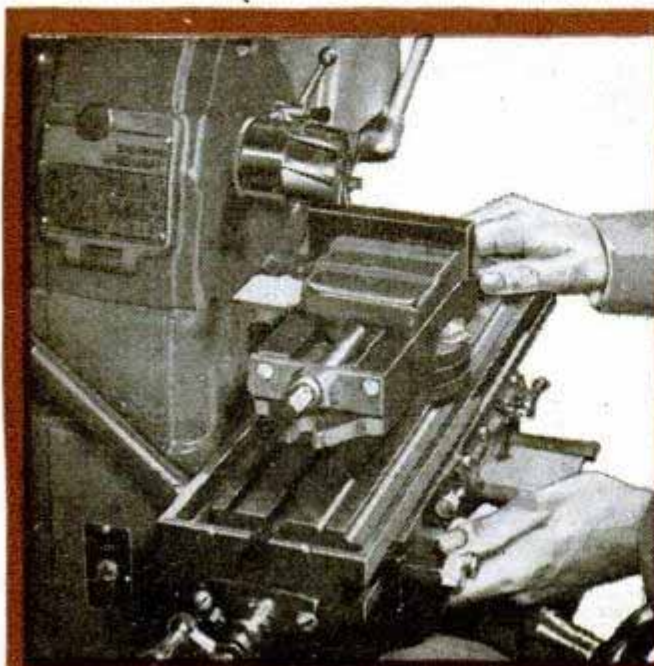

7 SHELL MILL HAS CUTTING EDGES ON SIDE AND END

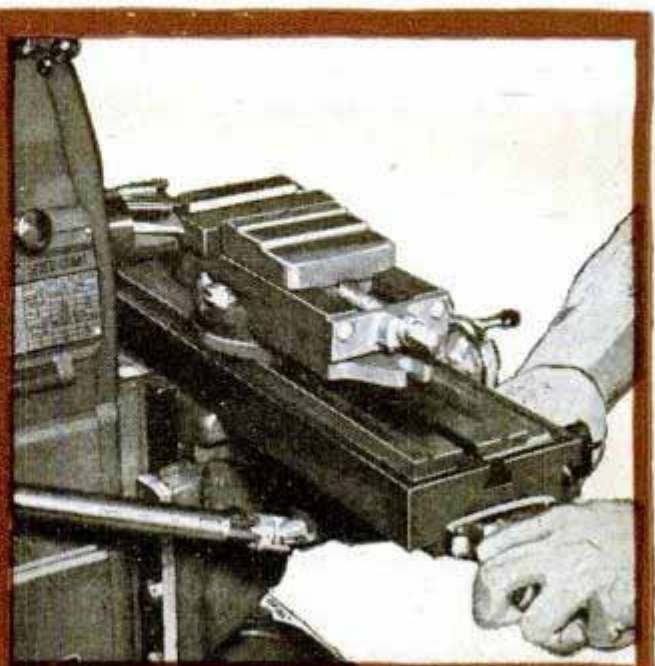

8 SHELL-END MILL FACING WORK HELD IN SWIVEL VISE

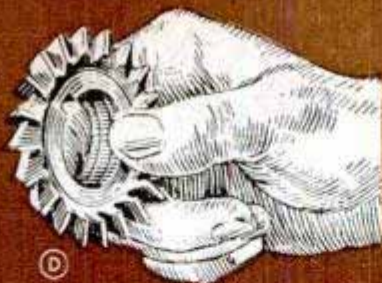

detail A of Fig. 14, most of them have undercut teeth as in detail B. In the process of manufacture, the cutter blank is located on center in relation to the tool doing the cutting, then the blank is relocated or thrown off the actual center at a predetermined margin, X, detail A, to provide a 10-degree undercut as shown when the cutting edge of the tooth coincides with the center or axis of the blank as in B. The usual tooth clearance is from 4 to 6 degrees with 5 degrees a standard, provided the face of the tooth is on center as in detail A. However, if the undercut cutter at B had only a 5-degree clearance, its cutting edges would actually be in reverse in relation to its axis by 5 degrees. To compensate for the 10-degree undercut, the clearance of cutter B must therefore be 15 degrees as the gauge indicates; in other words, this represents a compound angle of 5 plus 10 degrees, although the cutting edge actually has but a 5-degree clearance.

The clearance of side or end teeth on a cutter is approximately one half that of the peripheral, usually $2\frac{1}{2}$ or 3 degrees. Care must be exercised when oilstoning side or end teeth to avoid reducing the original clearance. It's equally important not to alter the shape of the cutting edges.

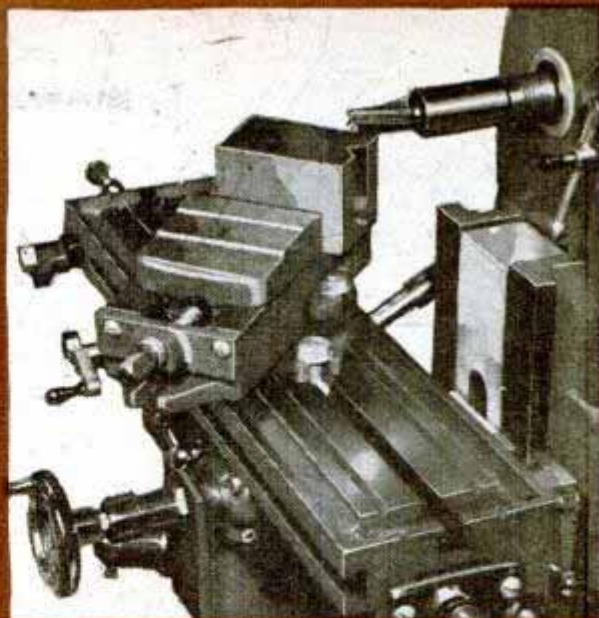

9 END MILL CUTTING VEE IN WORK SET AT 45 DEGREES

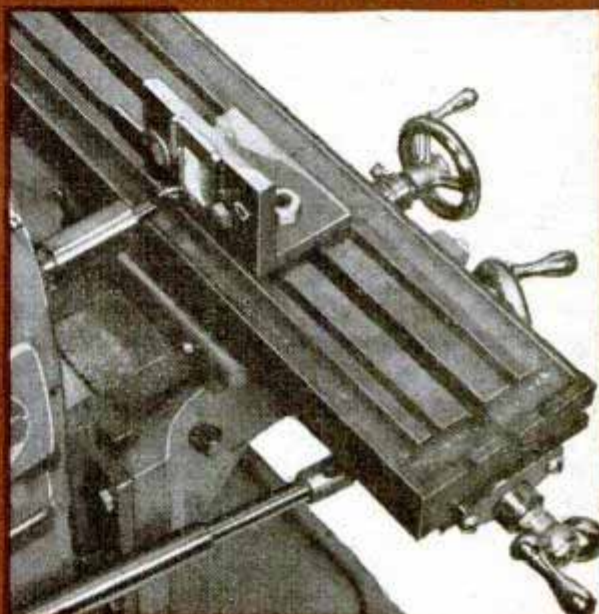

10 END MILL CUTTING WORK MOUNTED ON ANGLE PLATE

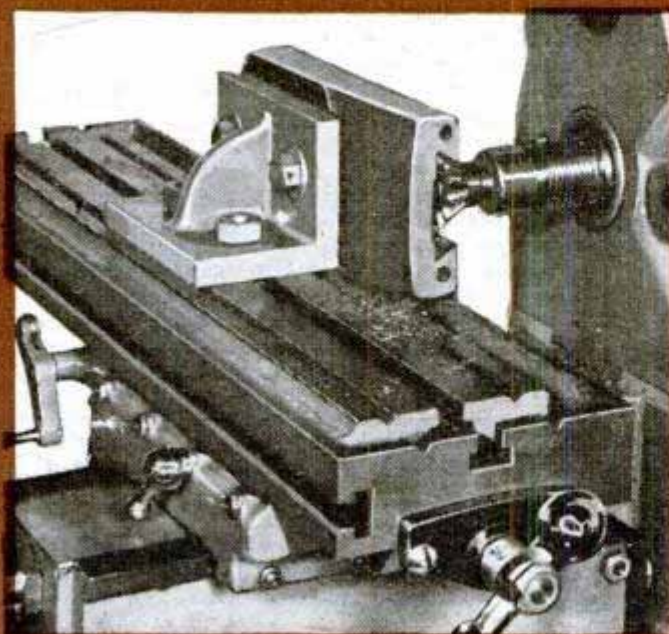

12 ANGULAR MILL CUTTING FEMALE HALF OF DOVETAIL

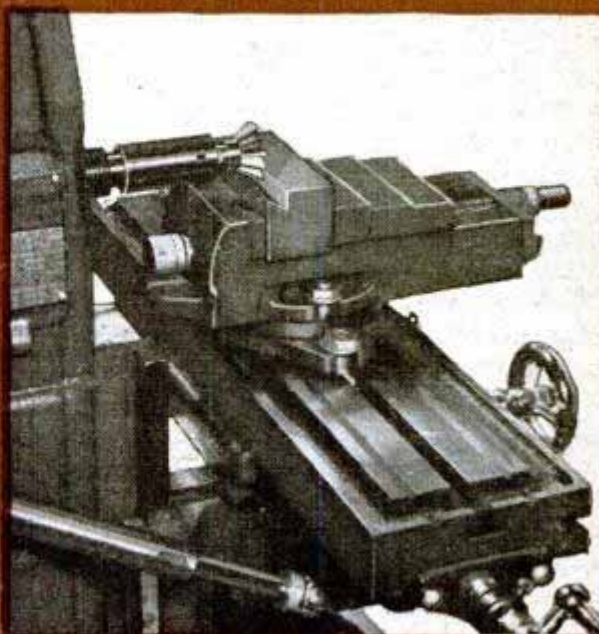

11 ANGULAR MILL MAKING FIRST CUT IN MALE DOVETAIL

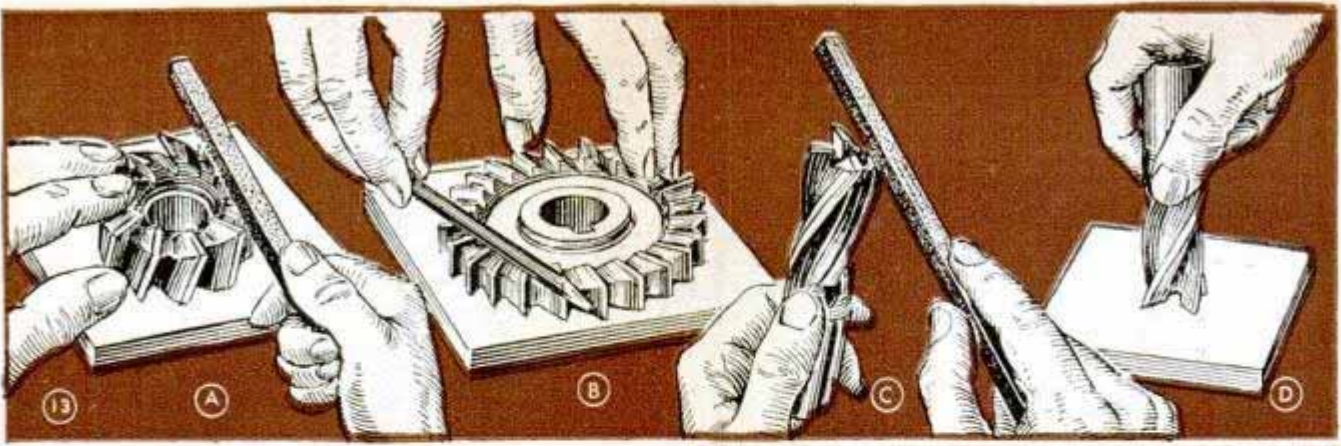

Spindle Speeds and Work Feeds

The term "speed" refers to the rotation of the spindle or cutter, and "feed" means the rate at which the work is moved into the cutter. The kind of material to be milled, the kind of material of which the cutter is made and the depth and width of cut all are factors affecting the selection of cutter speeds. These factors, as well as the rigidity and power of the machine, finish desired and accuracy of work, must be taken into consideration in determining rate of feed. General speed recommendations to aid the beginner are given in Fig. 15.

The rate of spindle speed is computed in surface feet per minute, or the distance the cutter would travel if it were rolling on the ground. Table or work feed is, of course, in linear inches. It is well to remember that the speed of a cutter in revolutions per minute does not by itself determine the rate at which the cutting edge is advancing through the work. The diameter of the cutter and its revolutions per minute really determine what is referred to as the surface feet per minute of the cutter. For example: If a cutter is 2 in. in diameter, its circumference is approximately 6 in. (2×3.1416), so at 500 revolutions per minute it covers 3000 inches or 250 surface feet per minute. The table of speed recommendations is at least a good starting point. Depth of cut is a problem you must solve yourself. The various cutter speeds given apply to a normal depth of cut, meaning the most efficient work the cutter can produce without being overloaded.

To determine the speed and feed for the respective machine dial or chart settings, knowing the diameter of and number of teeth in the cutter, let us again refer to Fig. 15. The rule to establish cutter speed is to divide cutter speed in feet, as given in the table for the kind of material being milled, by the circumference of the cutter expressed in feet. To establish the amount of table travel or work feed per minute, multiply feed per tooth per revolution by number of teeth in cutter and then by speed (number of revolutions per minute). The

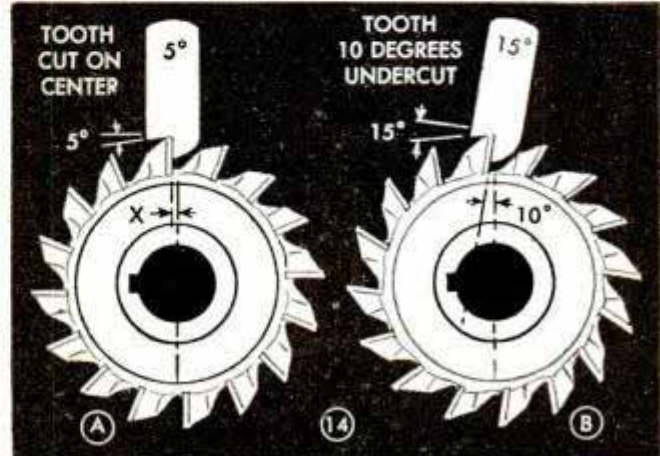

15 GENERAL SPEED RECOMMENDATIONS		
Kind of Material to Be Milled	Cutter Speed in Feet Per Minute Using High-Speed Steel Cutter	
	Min. F.P.M.	Max. F.P.M.
Steel—Soft	60	90
Steel—Medium	50	80
Steel—Hard	30	50
Cast Iron—Soft	50	80
Cast Iron—Hard	30	50
Cast Iron—Chilled	20	40
Malleable Iron	70	100
Brass—Soft	70	175
Bronze—Hard	65	130
Bronze—Very Hard	30	50
Aluminum	500	1000

Note — With cutters made of carbon steel, reduce speeds given from 40% to 50%.

Five Simple Rules in Speed-Feed Arithmetic

- 1—Diameter of cutter in inches multiplied by 3.1416 (circumference), multiplied by revolutions per minute, divided by 12 gives speed of cutter in feet per minute (F.P.M.).
- 2—Feet per minute divided by circumference of cutter in feet (diameter multiplied by 3.1416, divided by 12) gives revolutions per minute (R.P.M.).
- 3—Feed per minute divided by revolutions per minute gives feed per revolution (F.R.).
- 4—Feet per minute in inches divided by number of teeth per minute (number of teeth in cutter multiplied by revolutions per minute) gives feed per minute.
- 5—Feed per tooth per revolution multiplied by number of teeth in cutter, multiplied by revolutions per minute, gives feed per minute. Also, feed per revolution multiplied by revolutions per minute gives feed per minute.

five rules given serve to make all computations easily. Figures obtained will not, of course, correspond exactly to those listed on machine charts or dials, but will come close enough to be dependable. On most work of a more precise nature it's always well to calculate the speed-feed ratios as a precaution against overloading.

Flexible Low-Cost Transmitter

This compact amateur transmitter unit is capable of a power output of 50 watts in any amateur frequency band up to and including the 14,000-14,400 kc band. It may also be used in the 28,000-30,000 kc (10 meter) band with an output of 20 to 30 watts. Based on an original design that appeared in the American Radio Relay League's Radio Amateur's Handbook, it is a commercial version of a "ham's" favorite two-tube plug-in coil transmitter-exciter unit. It consists of a 6L6 tri-tet crystal oscillator-doubler or beam tetrode crystal oscillator, driving an 807 amplifier or frequency doubler. The 6L6 may also be used as a frequency doubler driven by a "signal shifter."

Photos 1, 2 and 3 show various views of this flexible unit, which is ideal for either low-power transmitting or as an exciter unit for high power amplifier stages. In other words, it provides the main unit, or heart, of a highly efficient amateur transmitter. In photo 1, the switch at right controls the meter for reading plate current on either the 6L6 or the 807 tubes.

A suitable power supply diagram is shown in Fig 1. This separate power supply unit and a 45-volt C-bias battery are all that are required for CW operation as illustrated in the station transmitter rack assembly sketch at top right. The transmitter unit terminal strip showing the power supply connections is detailed in Fig. 1-A.

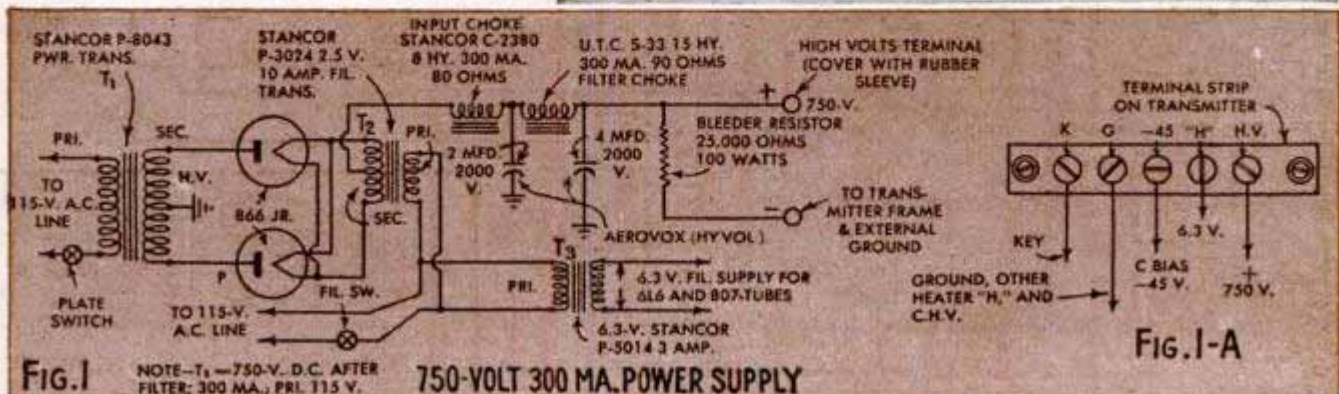
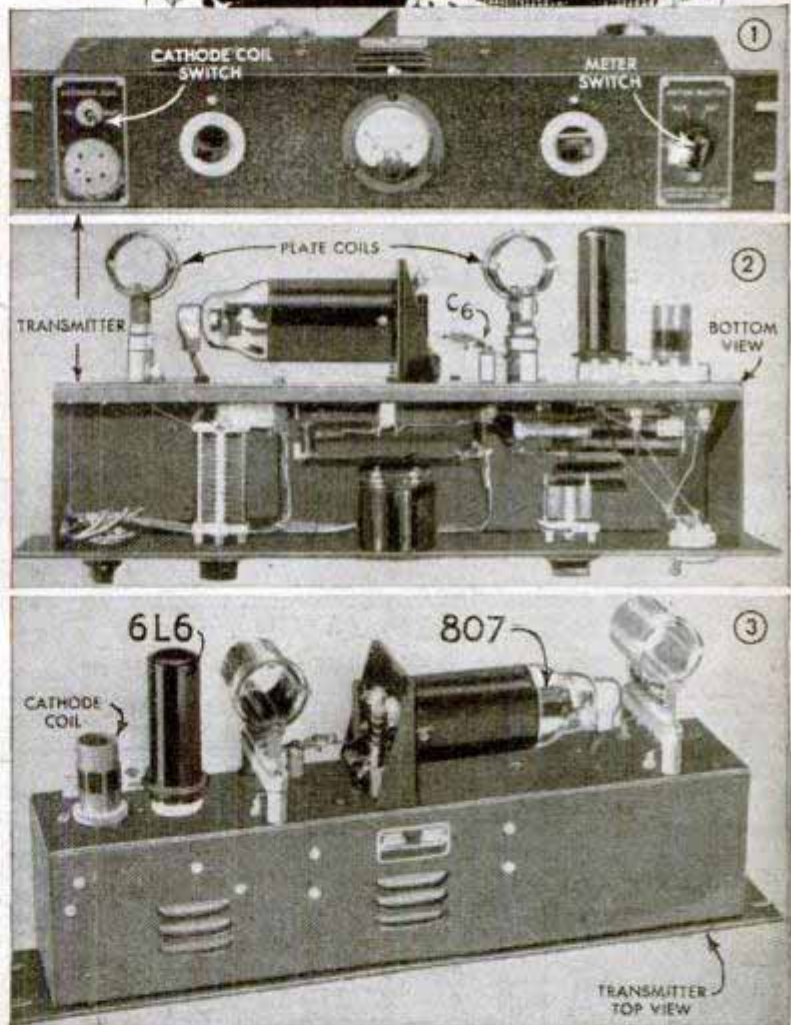

T.R.F. ALL-WAVE A.C.



By Arthur I. Rattray

COVERING five ranges with six pairs of standard 4-prong plug-in coils, this 4-tube tuned-radio-frequency receiver operates on your 115-volt 60-cycle a.c. line and is designed for either headphones or a small built-in PM speaker. Now that the foreign DX stations are again broadcasting programs, short-wave listeners and experimenters are asking for all-wave receiver circuits. Some parts for superheterodyne circuits are still scarce, therefore this t.r.f. set offers the experimenter an opportunity to assemble an all-wave receiver that is an excellent performer from available non-critical materials now listed in the radio parts catalogs.

The circuit consists of a 6SK7 r.f. amplifier tube, a 6C8 regenerative detector and first audio amplifier, a 6F6 tube used as a

power amplifier and a type 5Y3 serving as rectifier. It will be noted that the r.f. stage is capacitively coupled to the detector instead of being inductively coupled as in the average t.r.f. set. This makes possible the use of standard "Bud" type 2-winding plug-in coils that are available. Twelve coils are used in pairs and cover from 11 to 565 meters; two pairs are required to cover the standard broadcast range. One pair tunes from 185 to 360 meters and the other pair from 350 to 565 meters. The coil rack, photo A, is 9 in. long, 3 3/4 in. wide and 1 1/4 in. high. It is made by bending a piece of sheet metal over a block of wood; holes 1 1/8 in. in diameter are drilled to take ten 4-prong wafer-type sockets. The chassis base also is made from 1/16-in. sheet metal and is 7 in. wide, 8 in. long and 2 5/8 in. high. This base is fastened directly to the 8 by 8-in. metal front panel. The original model is housed in an I.C.A. hinged metal cabinet 8 in. high, 8 in. wide and 10 in. long, and the front panel is supplied with the cabinet. A complete schematic circuit diagram is given in Fig. 1; the detailed pic-

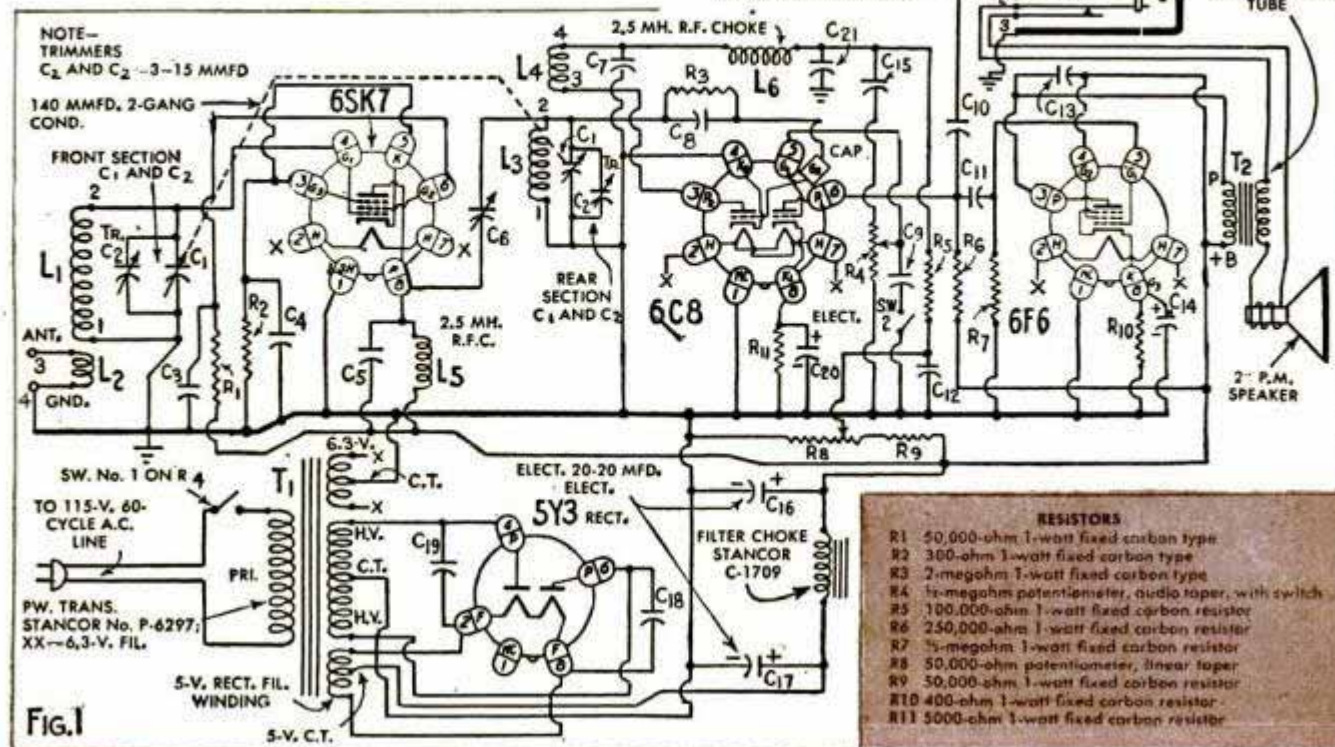
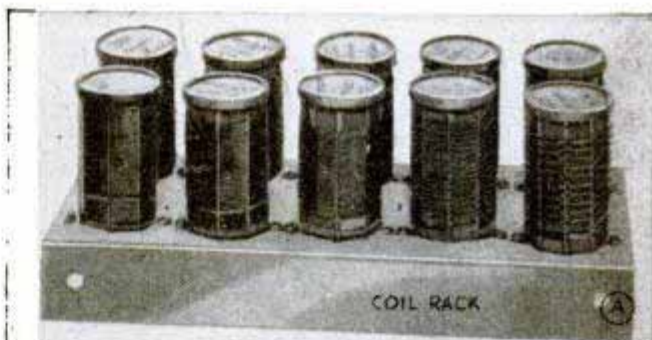

FOUR-TUBER for EXPERIMENTERS

torial wiring diagram that appears below shows all parts in their relative positions under the base, and all connections running to the 2-gang variable condenser and other units that are mounted on top of the base. The tiny 2-in. PM speaker is mounted on the inside of the cabinet directly back of the louver as indicated in photo D.

The toggle switch on the front panel connects a .01-mfd. by-pass condenser across the plate of the output tube to give better tone on broadcast reception. For broadcast stations it will be found that best results are obtained with the r.f. coupling condenser (C6) set at minimum capacity. This setting gives a fairly good relationship between selectivity and sensitivity. On short waves it may be necessary on some bands to couple the r.f. stages more "tightly," depending upon the antenna that you are using; therefore the best setting of C6 is a matter of experiment. Tuning follows common t.r.f. regenerative set practice. Any ordinary 50 to 75-ft. outdoor

(Continued to page 240)

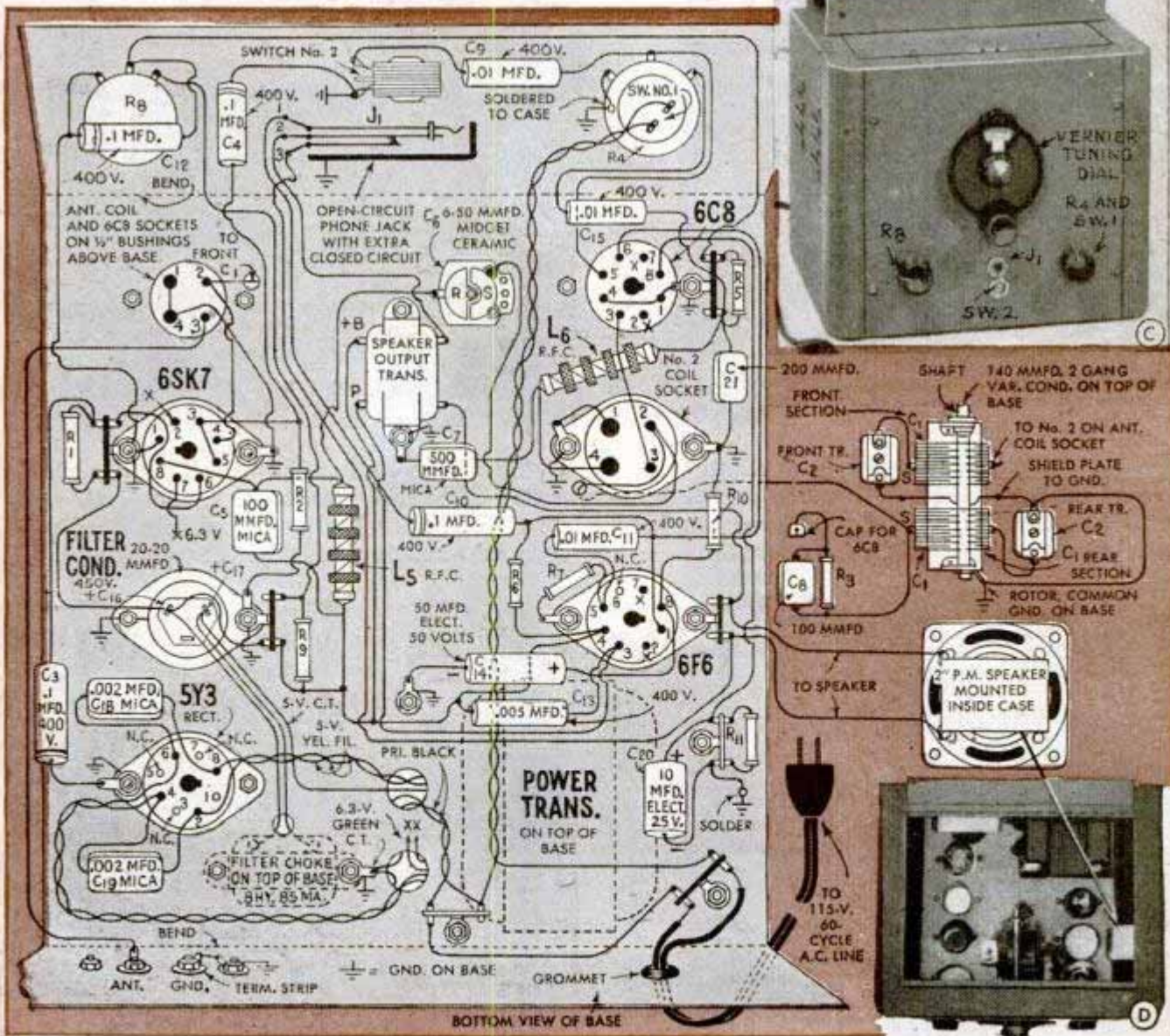
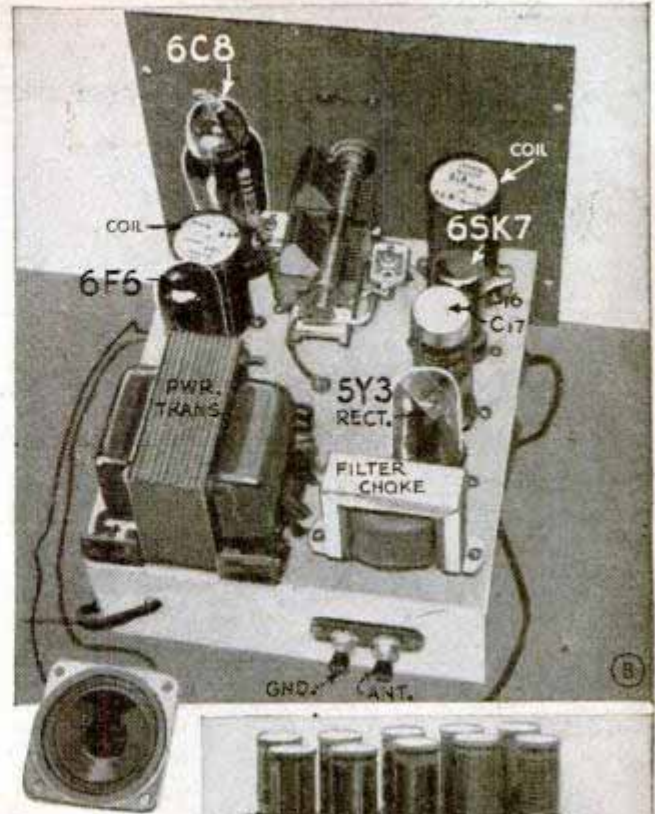

Practical Thinking Behind Electronics Devices



A—Convenience was foremost in the minds of General Electric engineers who designed this portable self-charging broadcast receiver. The compact 5-tube set employs a small leakproof airplane-type storage battery that will operate the set for 20 hours at full power before recharging. Power is quickly restored when the set is played on ordinary a.c. house current.

B—The Operadio Soundcaster shown is a rugged 40-watt amplifier planned especially for plant broadcasting service. A 3-way switch on the control panel permits preset volume selection for continuous "work" music, voice paging and announcements.

C—Photo shows a Radio-Matic coin-operated receiver for hotel rooms. It is similar in appearance to recent table models but is equipped with a coin mechanism on the top of the cabinet where quarters are inserted. An electric timing device, which runs only when the set is in operation, determines the listening period. The number of coins deposited registers automatically.



D—Low cost and simplicity are features of the Belmont television receiver demonstrated here. It employs a 7-in. picture tube and tunes as easily as a broadcast set.

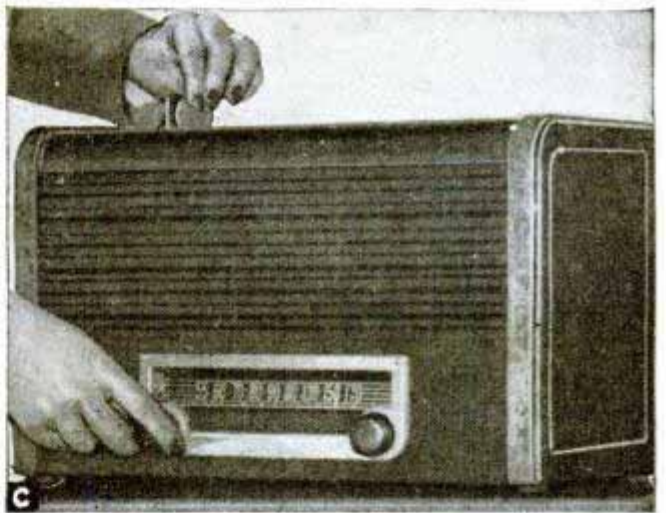

E—Accuracy and speed highlight the Finch home facsimile receiver, claimed to produce 46 square inches of broadcast picture copy or 550 words of 8-point type a minute.



With flash-equipped Kodak, you're set to shoot anywhere, any time

Illustrated: New Kodak Reflex. Big image in the ground glass makes composition easy . . . helps you get in focus fast. Finder lens and taking lens are Kodak Anastigmat $f/3.5$'s . . . taking lens *Lumenized* to reduce flare and ghost images. Shutter is 1/200-second Flash Kodamatic.

Twelve $2\frac{1}{4} \times 2\frac{1}{4}$ shots on a roll of 620 Kodak Film . . . And nine full-color pictures, $2\frac{1}{2} \times 2\frac{1}{2}$, with Kodacolor Film. At your Kodak dealer's . . . Eastman Kodak Company, Rochester 4, N. Y.

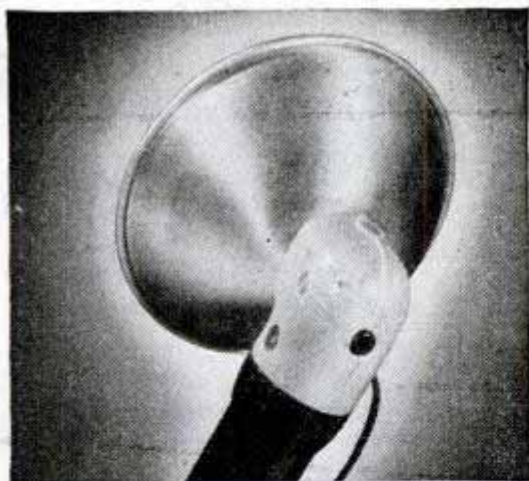

Ejector button on Kodak Flashholder saves burned fingers

New Kodak Flash Shutter—designed to operate in accurate synchronization with peak flash of lamp used . . . either “fast” Class F or “slow” Class M. **Kodak Flashholder**—Light, strong, equipped with brilliant, anodized aluminum reflector. Socket accepts either Class F or Class M midget bulbs.

Better pictures begin with this new, concise, comprehensive book on the “how’s and why’s” of photography. Sound and thorough treatment of night photography, exposure, color, filters, developing and printing, etc. Price, \$2.00.

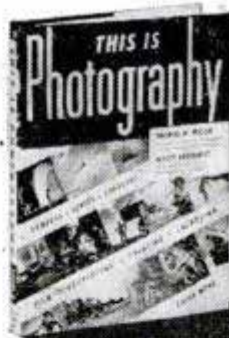

The latest on Kodachrome Prints

made from your Kodachrome transparencies . . . New size 3X, $3 \times 4\frac{3}{8}$ inches, 85¢. New low price on 2X size, 60¢. Minimum charge per order, \$1.

Kodak



Go where there's
FUN-
 on a
HARLEY-DAVIDSON

MOTORCYCLING — “the world’s greatest sport” — is now at a new peak of popularity. In every section of the country—more motorcycle fans want Harley-Davidsons than ever before. Even with our production at an all-time high—dealers are selling Harley-Davidsons faster than we can produce them. That’s why it’s *important* to see your dealer **EARLY**

— if you want the excitement, fun and thrills that go with owning a Harley-Davidson Motorcycle. Because the newest models have *everything you’ve always wanted* in streamlined beauty together with power, speed, and stamina — they’re well worth waiting for until your dealer can make delivery of *your* Harley-Davidson!



HARLEY-DAVIDSON

Motorcycles

HARLEY-DAVIDSON MOTOR COMPANY, Dept. P, Milwaukee 1, Wis.

Please send at once free copy of 24-page “Enthusiast” Magazine, filled with motorcycle action pictures and thrilling stories.

Name.....

Address.....

City..... State.....





REPUBLIC SEABEE



FAIRCHILD F24R



JOHNSON ROCKET 185



GRUMMAN WIDGEON



CULYER MODEL "V"



AERONCA CHAMPION



BEECHCRAFT D185



CESSNA 140



ERCOUPE 415C



GLOBE SWIFT



WACO MODEL E



STINSON VOYAGER 150



BELLANCA CRUISAIR SENIOR



NORTH AMERICAN NAVION

*Here's why
most **Personal Planes**
are equipped with*

CHAMPION Spark Plugs



HOCKADAY COMET



LUSCOMBE SILHAIRE



TAYLORCRAFT BC12D



PIPER CUB SPECIAL

In personal planes the ultimate in dependable engine performance is a "must." Champion Spark Plugs are specified as standard equipment on the overwhelming majority of these engines and used by most private pilots.

Here once again is dramatic proof that Champions make every engine a better performing, more dependable engine. That's why dependable Champions are preferred in every field—why experts insist on them!

Insure championship performance and dependability in every engine you operate—automotive, aircraft or marine—by insisting on dependable Champion Spark Plugs. Champion Spark Plug Company, Toledo 1, Ohio.



THEY'RE DEPENDABLE!



FOLLOW THE EXPERTS . . . DEMAND DEPENDABLE CHAMPIONS FOR YOUR CAR

For Cabinet Finishing

use **PLASTIC WOOD**



in your
HOME WORKSHOP!

If you'd like a satiny smooth, professional finish on your next cabinet job—use Plastic Wood! It's an ideal filler for cracks or rough grains, dries tight and hard, sands to a swell finish and takes paint, lacquer or varnish perfectly. Here's an extra hint—knot holes or gouges just disappear when this handiest filler is used! *Handles like putty—hardens into wood!*

... dozens of other uses

FOR FILLING ...

- Countersunk screws
- Chipped furniture
- Nail and screw holes

FOR REPAIRING ...

- Loose casters
- Broken balusters
- Broken furniture

- You'll want Plastic Wood SOLVENT, too. Get both at one time. It is made especially to control the consistency of Plastic Wood ... useful also in removing dried Plastic Wood from tools and fingers.

T. M. Reg. U. S. Pat. Off.

At all Hardware,
Paint and 10c Stores



PLASTIC WOOD

Tube or Can

A CELLULOSE FIBRE FILLER

School for Jockeys

(Continued from page 173)

The student jockeys are shown how the electric starting gate operates and they learn to hold their mounts steady in the stalls of the starting gate. They learn, too, how to get their animals out with a rush at the instant that the bell rings and the barriers snap out of the way.

No small part of a good jockey's bag of tricks is the generalship that comes partly from training but principally from experience. In time he learns how long he should hold a horse in to save the animal's energy and when, depending on the competition, he should make his attempt to get up in front and stay there.

A jockey must be a responsible individual. Mills explains that a rider may be in full charge of an animal valued as high as a fifth of a million dollars and that in one race alone he may be competing for stakes that comprise more money than the total lifetime earnings of some people. Obviously a jockey must conduct himself as a good sportsman.

The rules and ethics of racing are also stressed. Jockeys have succumbed to temptation in the past and have tried using illegal devices and stunts to make their horses go faster or to slow down their competition. Mills explains just how each of these tricks is attempted, then shows how unerringly all such tricks can be detected.

The boys are taught to conduct themselves always as gentlemen, for they will be under almost constant scrutiny by the public and racing officials. During a race itself, for instance, the actions of each jockey are recorded by four telefilm motion picture cameras placed at different angles around the track as well as the "photo finish" cameras at the finish wire. In addition, six patrol judges are stationed on towers around the track and these officials, as well as the three placing judges and the three stewards at the finish line, watch the horses and riders constantly during the race.

Students at the Santa Anita school were taken on trips to outlying breeding farms and were taught the points by which prospective good horses can be recognized. They watched motion pictures of famous races and listened to talks by outstanding turf officials.

A jockey's career seems to be a colorful one yet it is not at all easy. Even a short race is hard, gruelling work, for the rider hangs on and maintains his balance principally by the grip of his knees. A good

(Continued to page 240)



AMAZING NEW BATTERY —

Needs water only 3 times a year...

IN NORMAL CAR USE

Lasts longer, too!

The Auto-Lite "Sta-ful" Battery has more than 3 times the liquid reserve of ordinary batteries. In normal car use the plates are kept submerged to help deliver full life and power long after the plates in ordinary batteries are exposed and inactive.

In addition, oversize electrical capacity, plus Fibre-glass insulation, gives longer life than batteries without the Auto-Lite "Sta-ful" features.

Be sure your next battery is an Auto-Lite "Sta-ful."

AUTO-LITE BATTERY CORPORATION TOLEDO 1 OHIO

Manufacturing Plants at:
 Niagara Falls • Indianapolis • Atlanta
 Oakland • Oklahoma City • Toronto



Tune in the Auto-Lite Radio Show Starring
Dick Haymes HELEN FORREST • GORDON JENKINS'
 ORCHESTRA & CHORUS
 Thursdays 9:00 p. m., E. T., CBS

HERE'S WHAT MAKES THE DIFFERENCE



Unique new design and construction gives Auto-Lite "Sta-ful" more than 3 times the liquid reserve of ordinary batteries.

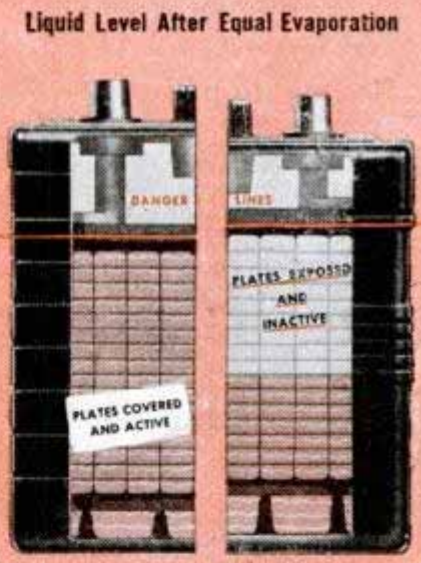
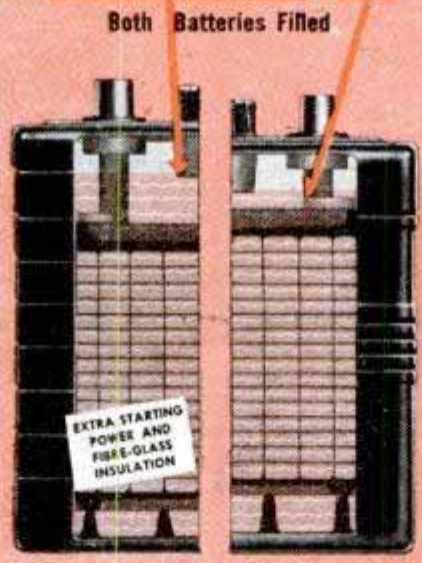

Auto-Lite "Sta-ful" Ordinary Type Auto-Lite "Sta-ful" Ordinary Type

Illustrations above show the result of equal evaporation in the Auto-Lite "Sta-ful" Battery and other batteries. As shown by illustration on the far right, plates of ordinary batteries are exposed sooner by water loss and then become inactive faster.

For sale by Auto-Lite battery dealers everywhere

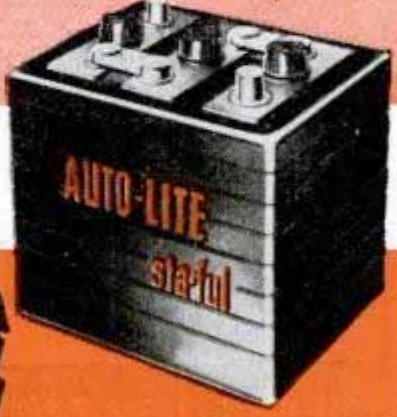

AUTO-LITE

GET YOUR RADIATOR READY FOR WINTER



CLEAN OUT RUST

with **DU PONT**

Cooling System **CLEANSER**

Here's a safe, sure way to clean out rust and scale—to get ready for anti-freeze. Just pour a can of **DU PONT COOLING SYSTEM CLEANSER** into your radiator, run the engine for 30 minutes or more, and drain. No reverse flushing needed. No fussing with the hose or flush gun.



Then KEEP OUT RUST

with **DU PONT**

Acid and Rust **INHIBITOR**

After cleaning out the radiator, you can keep it free from rust all season by pouring in a can of **DU PONT ACID and RUST INHIBITOR**. It prevents rust forming, and keeps out acid, too.



AVOID RADIATOR LEAKS

with **DU PONT**

Cooling System **SEALER**

You can stop leaks quickly and securely—and make the cooling system **LEAK-PROOF**—by pouring in **DU PONT COOLING SYSTEM SEALER**. It will not clog the radiator.



BETTER THINGS FOR BETTER LIVING
... THROUGH CHEMISTRY

Paratroop HUNTING BOOTS in Waterproof Elk



ONLY
\$9⁸⁷
plus postage

All sizes from 4 to 13½
All widths from AA to EEE

Newest thing in comfortable, serviceable boots. Ideal for hunting, fishing, hiking and all kinds of outdoor use. Made in soft, pliable, heavy-oiled waterproof elkskin. Same design, construction and high quality standards as famous boots worn by Paratroopers during war. Write to our Dept. PM-10 Specify size and width. Enclose check or money order for \$9.87. Boots sent immediately, postage C. O. D. Money back if you are not entirely satisfied on receiving boots.

CORCORAN INC., STOUGHTON, MASS.

YOUR ELECTRIC DRILL

Has 100 Other Uses

when used with K-Jax attachments
**METAL SAWING . . . SHEARING
RIVETING ATTACHMENTS**

Write for illustrated circular

K-JAX, 2600 Canton St., Dallas, Texas

What's easy as a stamp to buy?
What makes your note take off and fly?



Dannison

AIR MAIL LABELS

At Stationery Departments Everywhere

LEPAGE'S GRIPSREADER MUCILAGE

LEPAGE'S WHITE PASTE

**LEPAGE'S
GLUE**

Keeps Horsepower Rollin



CASITE

**GUARANTEES QUICK STARTING
IN WINTER WEATHER
OR DOUBLE-YOUR-MONEY-BACK**



Get your car ready for the cold weather ahead. Knock that "winter starting problem" for a row of ten pins—with Casite! Even at sub-zero, Casite retards congealing of oil—lets motors spin over rapidly for fast battery-saving starts—greatly reduces start-up wear.

Casite protects new motors during the critical break-in period . . . gives old motors extra zip and power.

For quick starting in winter, put a pint in your crankcase oil now—and with every oil change—or each 1000 miles. For better and smoother performance year 'round, also put a pint through the air intake every three months. Sold by service stations, garages and car dealers everywhere.

THE CASITE CORPORATION • HASTINGS, MICHIGAN

IN CANADA: HASTINGS LTD., TORONTO

CLEANS MOTORS • KEEPS MOTORS CLEAN

**LISTEN TO
"Right Down
Your Alley"**

American Broadcasting Co.
Every Sunday Afternoon • 4:30 EST

GUARANTEE—Add Casite to crankcase and run through air intake according to instructions, then drive your car 100 miles or for 60 days, whichever is first. If not convinced that Casite gives you better and smoother performance, you

get double-your-money-back by filling out guarantee certificate and mailing it to The Casite Corporation, Hastings, Michigan. Maximum refund is \$1.30 per pint, twice the nationally advertised price of Casite.

**65¢
A PINT
75¢
IN CANADA**



You always have a
NEW CAR
 in the Palm
 of Your Hand

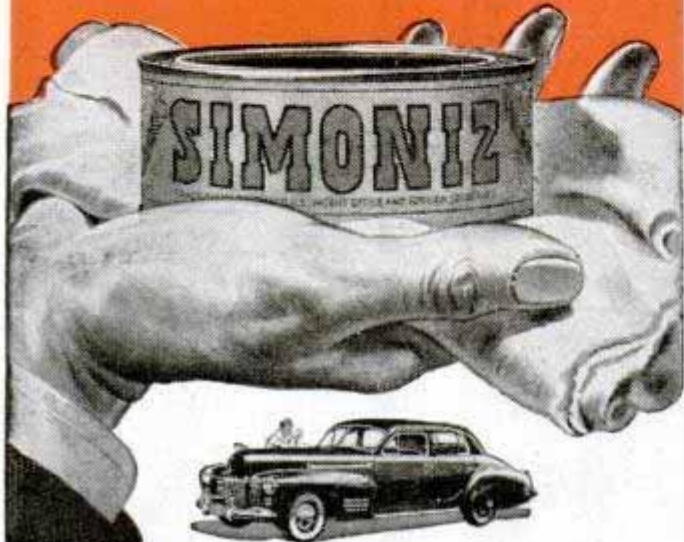

**Simoniz Gives any Car
 New Beauty that Lasts!**

New or old, keep your car good-looking always by SIMONIZING it now! If the finish is already dull, an easy "once over" with Simoniz Kleener restores beauty immediately. Then SIMONIZ keeps your car ever beautiful and easier to clean with a dry cloth. Get SIMONIZ and Simoniz Kleener, liquid or paste, today!

The Simoniz Company, Chicago 16, Illinois

Sold by grocery, hardware, variety, drug, paint, 5 cents to \$1, auto accessory and department stores—and by linoleum dealers everywhere.



rider actually doesn't need to use stirrups.

Too, as he grows older a jockey tends to become heavier, and every extra pound he puts on is a handicap to fast riding. He tries to eat a balanced, sensible diet that will keep his weight down and still give him strength. Going without meals and using chemicals will reduce his weight, but these drastic measures also reduce his strength. Nearly all jockeys bundle themselves up in wool and rubber sweat suits for daily exercises or lean themselves down by taking daily sweat baths.

T.R.F. All-Wave A.C. Four-Tuber For Experimenters

(Continued from page 231)

antenna may be used. Regeneration is controlled with R8 and the line switch is combined with the volume control R4.

Optimum efficiency is realized only when the r.f. and detector stages are balanced properly. This is done by first plugging in the two 185 to 360-meter coils; tune in a station near the minimum capacity of the tuning condenser; then with a small screwdriver adjust trimmer condensers C2 on the front and rear sections of the 2-gang condenser until the station is received at maximum volume. This setting is sufficient for all coils. On short waves when tuning the foreign bands you should tune slowly, since three or four stations may be passed in one turn of the tuning knob on the vernier dial. Detailed student material list R-348 is available from our radio and electronics department upon receipt of ordinary letter postage.

Will the Atom Drive Us Underground?

(Continued from page 151)

man supply was concentrated in three large surface dumps at Paris-Argenteuil, Bordeaux and Lyons. In July 1944 they discovered to their dismay that nothing had been done about changing the location of the dumps. The Nazi commander ordered the Argenteuil dump moved into the Metro subway tunnels of Paris, and the transfer of this oil saved it. The dumps at Bordeaux and Lyons, however, went up in smoke following an air raid on August 2, 1944.

German officials believe that bombing was not as effective against their aircraft plants as it was against oil refineries. They believe that this was due partly to the use of underground aircraft workshops.

Although the head of the Messerschmitt

(Continued to page 244)

Warmth without work...

Clean, quick warmth that carries to far corners, warms floors, spreads comfort all over the house—this can be yours day and night with Perfection!

Advanced Perfection engineering gives you trouble-free, smokeless, odorless, instant heat! Wherever you live you can enjoy this modern blessing. No basement is necessary, no costly alteration required. Look to Perfection for Better Living!

- yours with

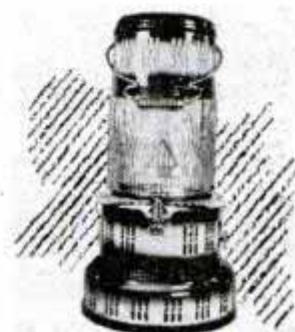
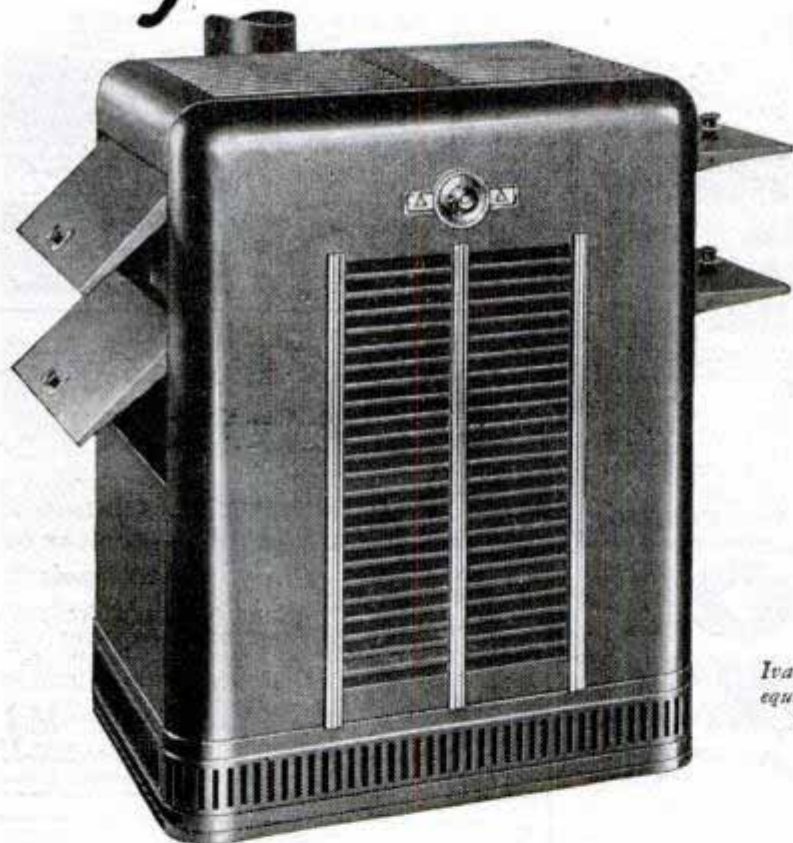

For chilly spring and fall days you'll find the Fire-light portable Model 750 ideal for "spot" heating.

Ivanhoe Model 2205 Space Heater equipped with Perfection's famous "Heat-Directing" Shutters.

PERFECTION-made Oil Heaters

PERFECTION STOVE COMPANY • 7855-A PLATT AVENUE, CLEVELAND, OHIO

**START
A FIRE
BUT ONCE A YEAR!**



MODEL 520

MODEL 420A

With
Built-in
Automatic
Draft
Regulator

Trade Reg. In U.S. and Can. Pat. Off.
**WARM MORNING
COAL HEATER**

**Heats All Day and Night
WITHOUT REFUELING!**

It's the heater with amazing, patented, interior construction features . . . different from all others . . . more than a million now in use!

Holds 100 pounds of coal. Requires no special diet . . . burns any kind of coal, coke or briquets. Clean, healthful heat . . . with substantial fuel saving.

See the WARM MORNING at your dealer's. (K)

LOCKE STOVE COMPANY

114 West 11th St., KANSAS CITY 6, MO.

**STOP
LEAKS!**

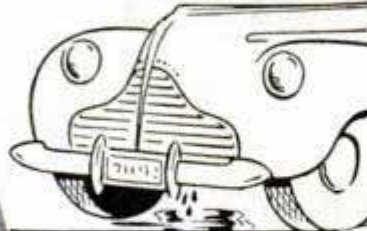

**Cooling Systems
Made Leak-Proof QUICKLY**

WARNER LIQUID SOLDER—Non-Metallic—Deposits Tiny Fibers to Repair Leaks Anywhere in Cooling Systems. Simply pour in! Finds and REPAIRS every crack or hole. Do it yourself—or see your service man.

Warner-Patterson Co., 920 S. Michigan Ave., Chicago 5

*Your Best
CHRISTMAS
BUY!*

**The
BURGESS
vibro-tool**
Trade Mark Reg. U.S. Pat. Off.

The Deluxe Kit illustrated above contains the Vibro-Tool, 22 accessories and sharpening stone in handsome hinged wooden box, natural polish finish. Ready to do every type of craft job easier, faster, better.

Complete \$16.50
60 cycles AC; 110 V.

See your dealer or order direct.

Tools
Leather

Engraves
Jewelry

Decorates
Glass

Carves
on Wood

The Vibro-Tool alone with engraving needles for only **\$7.50**

HANDICRAFT DIVISION
BURGESS BATTERY COMPANY
166 N. Wabash Ave.
Chicago 1, Illinois

**MINIATURE
ENGINES**

Gasoline—Steam
Air—Locomotive

**THE WORLD'S
MOST FASCINATING HOBBY**

**Build them yourself — In your own shop
With your own tools**

Send 10 cents for my illustrated catalogue listing the world's largest selection of miniature engine castings and drawings.

WAYNE MILLER
Suite 200-A
Engineering Bldg., Chicago 6, U.S.A.

58"
1/2 x 1/2 HOLLOW SQ. TRAILER AXLE
CAP.—2000 LBS.—\$6.75 EACH F.O.B. DETROIT
STRONG MACHINE & AXLE COMPANY
9710 Lumpkin Hamtramck 12, Michigan

CROSMAN Silent RIFLES

NOW AVAILABLE

America's favorite compressed air rifles for indoor or outdoor shooting are back again! Available in .22 Cal. Single Shot and Magazine Loading types. At your dealer—or order direct. Ask for Crosman SUPER-PELLS too—the better ammunition for all compressed air rifles: .177 Cal.—\$2.25 per M; .22 Cal.—\$2.50 per M.

CROSMAN ARMS CO., INC. ROCHESTER 7, N. Y.

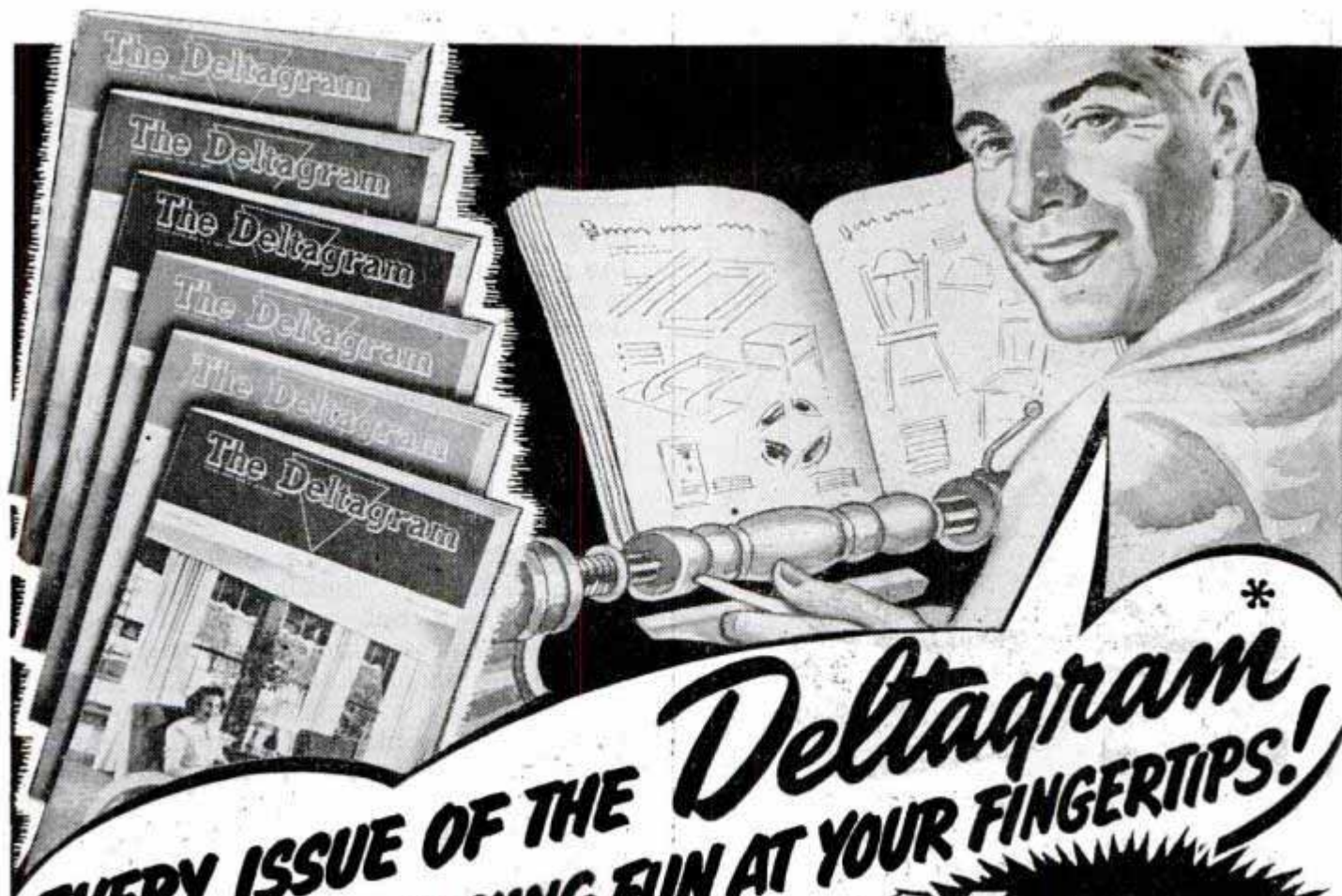

EVERY ISSUE OF THE *Delta* PUTS WOODWORKING FUN AT YOUR FINGERTIPS!

6 big issues only 50¢

These Helpful Features Appear In Every Issue:

- ★ One Evening Projects. Quickly-built projects that are enjoyable to work on, such as ash trays, lamps, bird houses, wall racks, etc.
- ★ Designs and Plans. Material that ranges from simple wall brackets to old masters in period furniture.
- ★ Expert "Know-How." Authoritative advice to help you produce finer, better-looking work.
- ★ Special Shop Kinks. Ideas that help you achieve greater mastery of tools and operations.
- ★ Shop Ideas. Suggestions on arranging your shop for greatest convenience and efficiency.
- ★ Activities. Interesting news about other woodworking hobbyists and their projects.

Page after page of how-to-do-it information for making furniture, lamps, toys and games, other projects

Right to your mailbox—6 times a year — comes a gold-mine of information for more fun from your woodworking hobby. It's The Delta!

Plan-packed! Pleasure-packed!

Between the covers of this popular homecrafters' magazine is a *whole year's supply* of photographs, working drawings, and step-by-step instructions. You get new ideas on beautifying your home. Inspiration for projects that win the admiration of family and

friends. Tips on using tools efficiently and safely.

The Delta leaves nothing to guesswork. Everything is detailed and specific. Complete directions are given in common, every-day language.

A Real Bargain!

You get *all this* for only 50¢!

No wonder so many homecrafters call The Delta *"the biggest half-dollar's worth in the hobby field!"*

Subscribe Now!

Get your subscription in *now*, for a year of enjoyment from The Delta.

Paper restrictions limit the number of subscriptions we can accept. So to avoid disappointment, fill out the coupon below and mail it today with 50¢ in coin, postal note, or money order.

*Trade Mark Reg. U. S. Pat. Off.

HM-41 Watch for the arrival of Delta Homecrafts* Power Tools at a department or hardware store near you! Let the people there help you plan.

Tear out coupon and mail today!

DELTA MANUFACTURING DIVISION
681L E. Vienna Ave., Milwaukee 1, Wisconsin
Enclosed is 50¢ in full payment for a whole year's subscription to *The Delta*

Name.....
Address.....
City..... (.....) State.....

DELTA MILWAUKEE Delta Mfg. Division
Rockwell Manufacturing Co.
Milwaukee 1, Wisconsin



How do you choose BENCH PLANES?

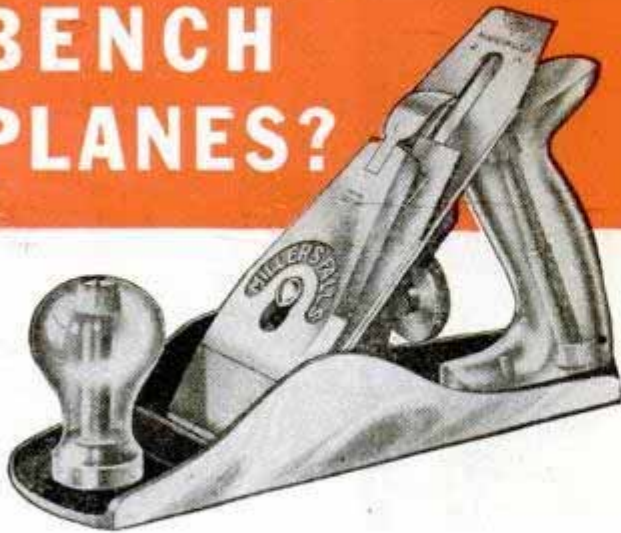

?

APPEARANCE—That's important. And Millers Falls Planes are brilliant in their high polish, gleaming enamel and fine rosewood or transparent red Permaloid handles.

?

PERFORMANCE—Naturally! You want a Jack Plane to give you swift, heavy cuts . . . a Smooth Plane to finish flat, broad surfaces perfectly . . . a Jointer Plane to dress edges precisely. All Millers Falls Planes give you such performance because their cutters are fashioned of carefully selected high-carbon steel.

?

REPUTATION—That's a good guide, too! Just remember that professional carpenters and experienced craftsmen have preferred Millers Falls Tools since 1868.

Choose tools on appearance, performance and reputation and your choice will be Millers Falls. See your dealer.

**MILLERS FALLS
TOOLS**

SINCE
1868

**MILLERS FALLS
C O M P A N Y**

**GREENFIELD
MASSACHUSETTS**

airplane company estimated that Germany's potential aircraft production was reduced by as much as 50 percent due to plant dispersal, he was a strong advocate of underground factories. He said that in 1935, believing it the best safeguard against air attack, he sought to place his plants underground. He received no support from the government, however, because of the expense involved and because of overconfidence as to the strength of the Luftwaffe.

Lessons learned from the German attempts to put their industrial plants underground, and the results of the Bikini atom bomb tests, are helping to guide our policy.

Authorities differ on possible results of an atom bomb explosion over an underground storage or manufacturing site. Dr. Verne R. Mason of the University of Southern California believes that three feet of concrete is protection against the type of atom bomb dropped on Japan. Dr. Mason, who studied the effects of the Jap atom bombing, based his opinion on the fact that 22 telephone operators who fled to a concrete underground shelter at the approach of the bombing plane were uninjured although their dugout was directly under the main blast area.

On the other hand, experts at the Army Ordnance Ballistics Research Laboratory at Aberdeen Proving Ground, Maryland, believe that shock waves might make even deep underground caverns untenable during atomic attack.

Using complicated electrical hookups, laboratory scientists are examining shock waves in connection with atomic fission experiments and will apply what is already known to lessons learned during the atom bomb tests.

Colonel Leslie E. Simon, director of the Aberdeen Laboratory, asserted that after the results of the Bikini blasts are compiled they could "determine at what height an atom bomb should be exploded to crush solid rock to a depth of 150 to 200 feet." According to Colonel Simon, these studies, based on the performance of shock waves in both earth and water, are a continuation of experiments made during the war on shock waves in air. A 24-channel recording cathode-ray oscillograph is used in determining their extent.

These shock waves, upon which much of the effect of the atom bomb depends, do not always perform uniformly. This is revealed in a recent report by Major General Leslie R. Groves, commanding general of the Manhattan Project, which makes public some of the details of the Hiroshima and Nagasaki bombings.

(Continued to page 248)

AMMCO 7" SHAPER

"A Precision Machine of a Thousand Uses"

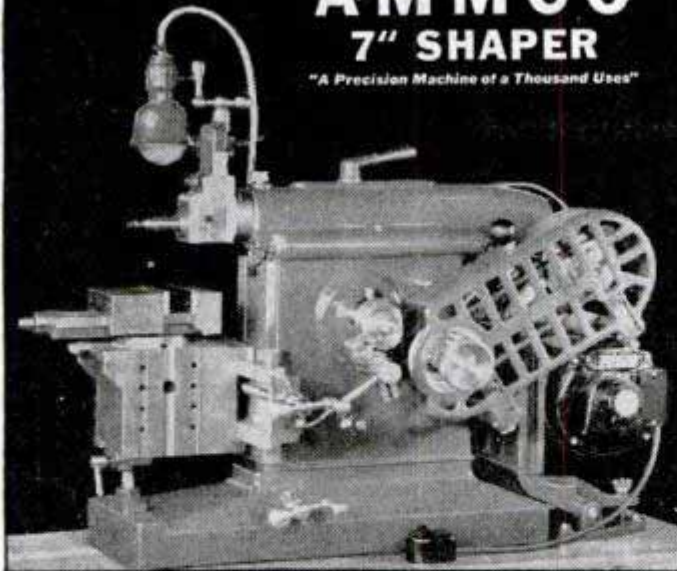

A wide variety of jobs can be done accurately, quickly, easily, and economically on the AMMCO Shaper (7" stroke).

Construction incorporates many features you would expect to find only in larger, more expensive machines... For example: WAYS of ram, tool head, and front face of the main frame are of the "VEE" type, hand scraped to insure accuracy and long life. Available for stationary installation or as portable unit.

Write today for specifications and prices

AMMCO

2140 Commonwealth Ave. North Chicago, Ill.

REPAIR FURNITURE

WITH THE GLUE THAT
MANUFACTURERS USE

FRANKLIN GLUE

GENUINE LIQUID HIDE GLUE
READY-TO-USE

Makes joints stronger than the wood itself. No mixing — No heating — No unpleasant odor — No chilled joints.

THE FRANKLIN GLUE CO., COLUMBUS 15, OHIO

AT YOUR HARDWARE DEALER



SPONGE-AWAY

KILLS TICKS



Sponge your dog with (or dip him in) Sponge-Away solution; you kill the ticks which are making your dog miserable. Sponge-Away also kills fleas, lice; allays itching, checks scratching; promotes healing, hair regrowth; helps dog get over Summer Eczema from fleas. Get 25c bottle (makes one quart) from pet, drug or department store and free your dog of ticks without delay.

A PULVEX QUALITY DOG PRODUCT

A TOOLSHOP IN YOUR HAND!

- GRIND • DRILL • ROUT
- POLISH • ENGRAVE
- CUT • SAND • SAW, etc.

Make Things From
Wood—Plastics—Metals—
Glass—Linoleum—
Leather—Alloys—
Horn—Stone—Bone,
etc.

HANDEE TOOL OF 1001 USES

Smooth, steady power at your fingertips! Perform precision operations not possible with any other portable tool! With a Handee you can turn out professional looking projects for pleasure or profit—ship, plane and train models, costume jewelry, wood carvings, puppets, initialed tumblers, etc. AC or DC. 25,000 r.p.m. Wt. 12 oz.

USE THE RIGHT ACCESSORIES! Choose them from the most complete line... more than 300 made right in the Handee plant.

GET A GOOD START GET THE HANDEE KIT

HANDEE Tool and 45 most popular accessories, packed in compact steel carrying case. You'll be amazed at what you can accomplish!

Postpaid, \$27.50

Handee, with 7 accessories,
\$20.50

FOR YOURSELF OR A FRIEND...
THE GIFT OF A LIFETIME!

NEW PRECISION ATTACHMENTS

Fit Handee only; enable novice or craftsman to do perfect work. Magically, easily, your offhand carving, routing, shaping will be exact as to depth of cut, accuracy of line. Set of 6 attachments with instructions, postpaid, \$7.95



ORDER NOW. SATISFACTION GUARANTEED!

FREE! NEW 52-PAGE MANUAL

CHICAGO WHEEL & MFG. CO.

1101 W. Monroe St., Dept. PM
Chicago 7, Ill.

Send Handee Kit Handee Tool Precision Attachments
 C.O.D. Remittance enclosed Send Manual

Name.....

Address.....

SAY YOU SAW IT IN POPULAR MECHANICS



**"Twinplex
Your Blades
For Perfect Shaves!"**

Here's the truth, men ... you can get more, better, smoother shaves from all double-edge safety razor blades by *stropping* with the famous Twinplex! Truthfully, you've never had a *real* shave unless you've first *sharpened* your blade with Twinplex—because—it's the *blade edge* that *cuts* whiskers. Use your favorite beard softener and safety razor blade—but be sure to *strop* it *sharp* with Twinplex. Just insert blade, turn the crank—Twinplex *strop-leather* rollers do the rest! No skill required. Only \$2. Ideal for gifts. Ask your dealer for a Twinplex demonstration today. If he cannot supply you, order direct.

TWINPLEX MFG. CO.
1800 Roscoe St., Dept. 2-106
CHICAGO 13, ILLINOIS



OWNERS BRAG ABOUT—

Twinplex
BLADE STROPPER

USED BY MILLIONS SINCE 1915



**...a profitable future with this
NEW LINCOLN WELDER**

Ben Braucher, McDonaldsville, Ohio, is enthusiastic about this new "Fleet-Arc Jr." Welder because it welds metals and alloys of all thicknesses easier—enables him to attract more jobs and do them faster for greater income. Profit from plowshares alone is about \$5 per hour.



Farmers, garages, machine shops, and repair shops are finding this new low-priced Lincoln Welder one of the best investments they ever made. Its exclusive "Arc Booster" makes arc striking as simple as striking a match on a hot stove. Range 20 to 180 amps, with "dial tuning" control—no plugs or taps. Meets power company and REA requirements. Write for free Bul. 365 today.

THE LINCOLN ELECTRIC COMPANY
Dept. 513 • Cleveland 1, Ohio

Largest Manufacturer of Arc Welding Equipment in the World

Genuine BRIAR PIPES

Albatross, wave carved, beveled bowl, tapered balanced bit. Unusual high standard value. In attractive gift box. Sent postpaid anywhere in U. S. on receipt of check, money order or cash. (No Stamps, No C.O.D.'s.)



ALBATROSS
GENUINE BRIAR

Briar Pipes, P.O. Box 244, Bremerton, Washington

\$2.00

**1 New - Improved
OIL FOR ALL ---
HOUSEHOLD - SPORTSMAN - MECHANIC
Lubricates - Prevents Rust - Cleans Metal**

**3 oz.
40c**

FIENDOIL

AMAZING MODEL AUTOGIRO

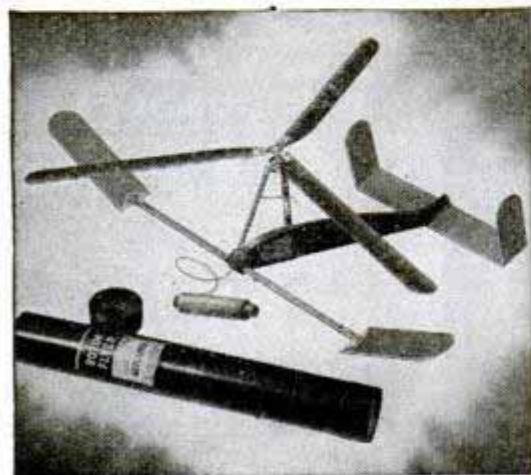

Really flies!
Chupp

ROTOR-FLYER
CAPTIVE AUTOGIRO

Be first in your neighborhood to own and fly the sensational new ROTOR-FLYER. This captive autogiro needs only an 8-mile breeze. Enthusiastic owners report flights over 2000 feet! More than a toy—an amazing scientific model—designed by an experienced aeronautical engineer. The ROTOR-FLYER is based on the same patents... embodies the same principles... as full-size autogiros. Sturdily constructed of the best materials.

Send name and address for **INTERESTING FREE BOOKLET** and name of nearest dealer.
Address: ROTOR-FLYER,
Dept. P-10, Room 202,
230 Fifth Ave., New York 1, N. Y.



RIDE-RITE

NEW TYPE—LIGHTWEIGHT—HEAVY-DUTY STRENGTH

UTILITY TRAILER AXLES

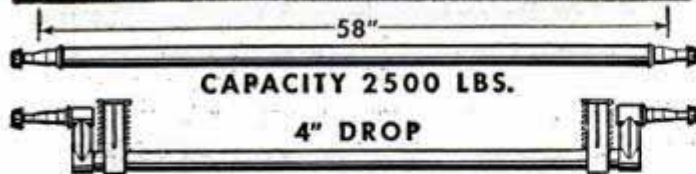

EITHER TYPE AXLE AVAILABLE WITH OR WITHOUT SPRING SUSPENSION (Pat. Appl. For)



Build your own utility trailer and equip it with a Ride-Rite axle. Get the advantage of its new lightweight, heavy-duty tubular construction. Available with or without patented double-coil spring suspension. Manufactured in straight and drop-type, for low gravity center. Strongly welded. Standard tread 58".

BIG CAPACITY: Axles made of 1 1/2-inch O.D. steel tubing have tested load capacity of 2500 pounds. Coil springs, four per axle, have minimum capacity of 650 pounds each.

Ride-Rite axles will fit hubs and wheels made by Motor Wheel Corp., Kelsey Wheel Co., Ford Motor Co., and Industrial Machine Tool Co.

PRICED LOW AS

\$6.75

PRICES F.O.B. FENTON, MICH.

Remittance with order —No C.O.D.	Axle Only	Axle with Springs
Straight Axle, Std. Tread	\$ 6.75	\$19.70
Drop Axle, Std. Tread	12.50	25.45
(Springs fit Ride-Rite axles only)		
Axles can be furnished any tread desired for slight additional cost.		

MANUFACTURERS AND DEALERS!

Write for descriptive literature
QUANTITY LOT PRICES
FURNISHED ON REQUEST
WRITE ON YOUR LETTERHEAD

MANUFACTURED BY

INDUSTRIAL MACHINE TOOL CO., INC.
200 S. LEROY STREET FENTON, MICHIGAN

Ball-Bearing SPEED WHEELS



Build Your Own—

- Coaster Wagons
- Racers
- Scooters
- Bike Trailers

ORDER NOW FOR PROMPT DELIVERY

8 in. Wheel with Tire \$2.25 each
10 in. Wheel with Tire \$3.25 each
10% deposit required on C.O.D.'s

JIM BROWN TOY COMPANY
869 E. Tallmadge Ave. Akron 10, Ohio

New! ALL-ALUMINUM MICROSCOPE

— 50 Power —

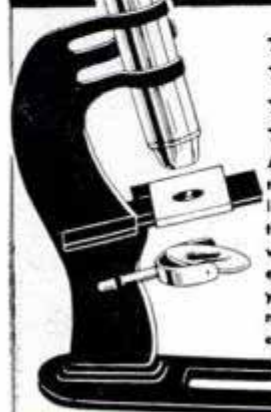

- ★ 2 FOCUSED LENSES
- ★ 2 SPECIMEN SLIDES
- ★ EASY ADJUSTING EYE TUBE
- ★ UNIVERSAL ADJUSTABLE MIRROR

\$3.00 each
prepaid in U.S.A.

A new world opened before your very eyes — with the BRAFTEX microscope . . . that looks and acts like a scientific instrument. It is truly the toy for the scientific-minded! If you would probe into the wonders of chemistry, biology, and the other sciences, let this microscope open the door wide for you. It is durably constructed of heavy gauge aluminum in baked crackle finish. Free instruction manual explains its operation and offers helpful suggestions.

BRAFTEX CO., DEPT. 505
1123 BROADWAY • N.Y. 10, N.Y.

STANLEY ZIG-ZAG RULES

Made to Measure for Your Hobby!



Never was a neater, handier rule designed for the home workshop and odd jobs around the house. Pick up your Stanley 6 foot Zig-Zag Rule and it's ready to measure any distance from a sixteenth — up!

There's a wide choice — and many craftsmen like the "Green End" Zig-Zag with vertical figures and double edge graduations — readable at any angle. The sticks are of selected hardwood, fitted with concealed joints, tips and strike plates of rust-proof metal. The fine, durable finish is marked with large, black figures and graduations.

Due to the great demand for Stanley Tools, your dealer may not always have "Green End" Rules in stock.

To put skill in your hands and quality in your work — buy Stanley.

STANLEY

Trade Mark

HARDWARE · HAND TOOLS · ELECTRIC TOOLS

Here are two books well worth owning. The first book is free . . . "The Joy of Accomplishment", a brief introduction to tools and their uses. The second is the famous textbook . . . "How to Work with Tools and Wood", recently revised, fully illustrated. The cost is only \$1.



STANLEY TOOLS,
1 106 Elm St., New Britain, Conn.

Please send by return mail

- FREE booklet: "The Joy of Accomplishment."
- 188-page book: "How to Work with Tools and Wood." \$1.00 enclosed.

(In Canada: Send order to Stanley Tool Co. of Canada, Ltd., Roxton Pond, Quebec.)

Name.....

Address.....

City.....State.....

Now! tests prove-

BRIGHT STAR BATTERIES



give more
bright light
longer

Here is your proof!

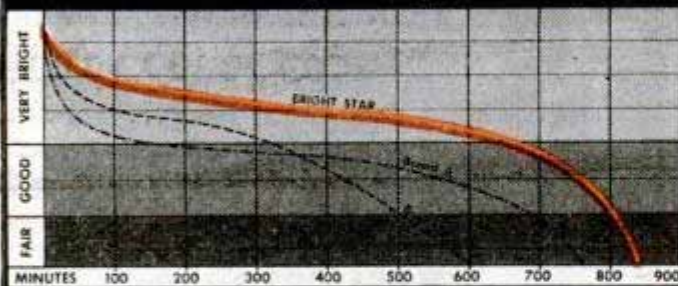

These results of vital service tests* prove that Bright Star batteries give you more *bright light* longer than the two other leading brands tested. Insist on the best—it's Bright Star by test!

*Chart based on laboratory tests conducted under government standards.

BRIGHT STAR BATTERY COMPANY, CLIFTON, NEW JERSEY

In Nagasaki, 2000 feet from "X"—the ground point directly below the burst—reinforced concrete buildings with 10-inch walls were collapsed and some 9-inch concrete walls were completely destroyed. Yet, at the same distance, reinforced concrete walls only 4 inches thick, although damaged, remained standing.

Engineers probably will find a way of insulating the caves or concrete walls of underground buildings from these shock waves so that humans can live in them. This and protection against radioactivity are major problems awaiting solution.

Although it will take some time to get accustomed to living underground, man will not suffer physically from it. We can live without natural sunlight or free air. Some of our newer office buildings do not have windows either for light or ventilation, relying on air conditioning and electric lights.

In the underground city water under pressure will be brought to any level. Smoke and gases will be exhausted by giant fans. The housewife will buy fruits and vegetables produced by farmers who will cultivate "fields" under artificial sunlight lamps. Workmen in factories will work under ultraviolet-ray lamps which will furnish the beneficial rays given off by the sun.

Regardless of whether or not we are forced to live in underground caves or cities within our lifetime, members of the Army and Navy Munitions Board are taking no chances. It is their responsibility, working with other agencies, to plan full application of the nation's strength for military purposes in the shortest possible time in an emergency. The underground sites survey is one phase of that responsibility.

Talking Mountains

(Continued from page 145)

possible. So little-known "Yagi" beams give enough zip to the messages to carry them in a wandering path across the cluttered terrain.

"Yagi" beams were named for the Japanese radio engineer who discovered them. Most radio transmission is in a complete circle with the transmitter in the center. But all the strength of "Yagi" beams is focused in one direction, toward the receiver. Grotesque antennas do the job, pulling radio beams from one direction to boost them along in another. The antennas act as a funnel to pour all the strength of the transmission toward the receiver.

The resultant gain in strength sends the

(Continued to page 252)

The case of the Shedding Brush



A brand new paint brush on its very first job, but it's losing hair like a mangy terrier. Whose fault? The buyer's fault—for letting himself be tempted by a "bargain counter" price.

Things like that don't happen to you. One reason you read *Popular Mechanics* is that you like to do things *right*—and that goes for buying as well as building.

Your hardware dealer is just as quality-minded as you are. He *has* to be—his business success depends on it. When you need tools and hardware, you'll always get more for your money from him.

**YOUR HARDWARE DEALER
Sells QUALITY Tools and
Hardware. Buy from HIM.**

✓ **POPULAR MECHANICS**

Dependable Bike Light MEANS SAFETY



**GOOD LIGHT
EVEN AT A WALK
WITHOUT BATTERIES**

**CAN'T
BLOW BULBS**

MAKE-A-LITE BICYCLE LIGHT Generator

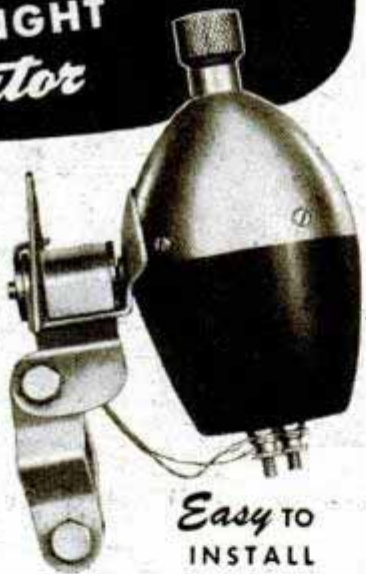

MAKES night cycling safe! Run-down batteries and dim lights account for numerous accidents. Make-A-Lite provides bright, unfailing light, even at a walk, without batteries! Generates electricity, cost-free.

Automatic voltage control generator prevents blowing of bulbs at high speed. Separate circuits for head and tail lamps prevent damage of one from affecting the other. Both lamp bulbs interchangeable.

**At Your Bicycle, Hardware
or Sporting Goods Store**

*Easy TO
INSTALL*

MAKE-A-LITE DIVISION
Chefford Master Mfg. Co., Inc., Fairfield, Ill.

SAY YOU SAW IT IN POPULAR MECHANICS

and a "YANKEE"

Quick-Return Spiral Screw Driver

Got to drive screws where it's hard to use both hands? Take it easy . . . with one hand and a "Yankee" 130A Spiral Driver. "Quick-return" spring in handle keeps the bit in the slot, returns the handle after each push.

Write for the "Yankee" Tool Book.



NORTH BROS. MFG. CO.

Division of The Stanley Works
Philadelphia 33, Pa.



WELD ANYTHING ANYWHERE ANYTIME



ALL PURPOSE ARC WELDER

9 Models . . . 32 Volt D.C., 110 to 440 A.C. A complete workshop in itself! Weld, cut, braze or solder any type metal; iron, castings, aluminum, steel, bronze . . . in any gauge or weight, with equal ease. Compact, complete, sturdy as the Rockies. Formed steel and cast aluminum case, welded steel base, 3" cast wheels. Built with voltage control. Better on R.E.A. lines. No training needed. Sold throughout the world. Unconditionally guaranteed for 2 years. Fully equipped—ready to use.

FORNEY MFG. CO.
FORT COLLINS 2, COLORADO



BRASS RODS For Home Work Shops

Write Dept. A for Free Catalog
of 45 Kits Today
MEIER BRASS & COPPER CO.
1155 Bellevue, Detroit 7, Mich.

For use on model boats, airplanes, etc., keeps a supply of these free-turning brass rods on hand. Each kit contains a complete assortment of sizes.



HUNTER'S COMPASS

Hunting Case, Watch Type, All Metal, **\$2.50**
Jeweled Longines

**Engineers All Metal Army
Type Hand-Sighting**

LEVELS
\$1.50



PUBLIC SPORT SHOPS

13 S. 16th St., Phila. 2, Pa.

No COD's

"How many cylinders should an outboard have?"

Of course there is much more to an outboard motor than cylinders and pistons. But the *number* of cylinders does have a lot to do with smoothness, flexibility, power, *performance!* When you come to choose your new outboard motor here are "cylinder facts" worth remembering!

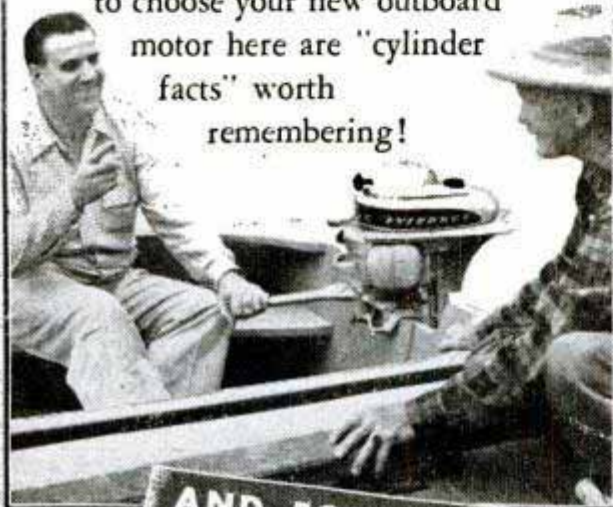

AND FOR TOPS IN THRILLING PERFORMANCE — CHOOSE A "FOUR"

Tens of thousands of enthusiastic owners will tell you, "For tops in performance and pleasure — own a four". Only Evinrude offers four-cylinder outboards, and Evinrude builds with a background of 18 successful years in perfecting these superbly smooth and spirited motors Four great "fours"* to choose from — two of them smack in the range of two-cylinder power, weight, price!

See your Evinrude dealer — look for his name in your classified phone directory under "Outboard Motors". Complete catalog of 8 Evinrude models sent free . . . address EVINRUDE MOTORS, 5374 N. 27th St., Milwaukee 9, Wis.

In Canada:
Evinrude Motors, Peterborough, Ontario.

*Motor shown is the "Lightfour", 66 lbs., 9.7 O.B.C., certified brake horsepower at 4000 R.P.M.

ONE CYLINDER IS FINE . . .



For small outboard motors, where light weight and handy portability are prime considerations; single cylinder construction is highly satisfactory. Single cylinder design has come a long way since Ole Evinrude "started it all" back in 1909, and Evinrude's highly developed "Ranger" and "Sportsman" are favorites with outdoor folks everywhere.

TWO CYLINDERS . . . EXCELLENT

The next step up in power for heavier loads and higher speeds logically calls for two cylinders, which is as far as outboard engineering is ordinarily carried. Evinrude has consistently advanced twin cylinder design, and Evinrude's "Sportwin" and "Speeditwin" are today two of the most popular models in the two-cylinder field.

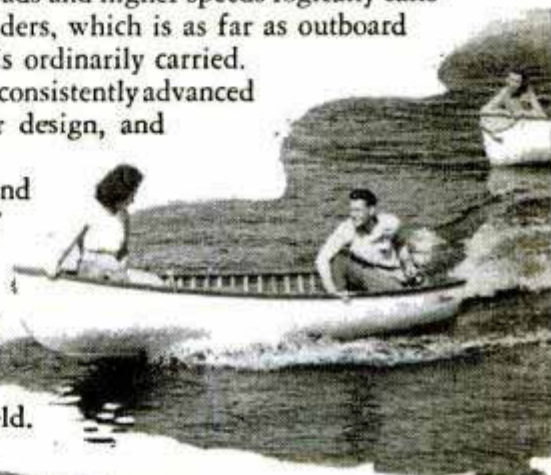

EVINRUDE

OUTBOARD MOTORS

**ARMY SURPLUS
SENSATIONS!**

OFFICIAL

**U. S. AIR FORCE
PARACHUTE
SEAT CUSHIONS**

A "Natural" for seating concessionaires! Heavy Khaki canvas, hair-filled for resiliency, double-stitched, water-repellant—they'll wear for years! Use 'em in home, offices, ball games, theatres!

SINGLE CUSHION \$1.29

M. O. or Cash
(10 OR MORE, \$1.00 EA.)
(100 OR MORE, 85c EA.)

POSTAGE PREPAID!
BIG! 13 x 16 x 2"

**THE REAL "McCOY"
U. S. NAVY
DEBARKATION LITE**

Lamp of 1,000 uses! Sturdy steel construction, Forward and side deflectors. Ideal for road distress signal, boating, night light. Uses single cell batteries. Kids!—get these and set up signal system in the gang!

only **\$2.95**

MONEY ORDER OR
CASH POSTPAID

**5 DIFFERENT COLOR
LENSES!**



Here it is!
**THE WAR FAMOUS
WILLYS
JEEP ENGINE
COMPLETE!**

With all accessories including Carburetor, Generator, Starter, Fuel Pump, Fan and Clutch. For car replacement, boats, power units.

\$169.00

SEND \$25. M. O.
OR CASH—BALANCE
C. O. D. ON DELIVERY

F. O. B.
CINCINNATI

Order Direct!
**ASSOCIATED
SUPPLY COMPANY**

118 E. 8TH ST. CINCINNATI 1, OHIO
TELEPHONE MAIn 1942

message with enough force to cross the uneven ground even though it's not line-of-sight. The beam travels in one direction until it strikes an obstacle, then bounces in another like a ball on a billiard table. It actually ricochets between the mountains and cliffs in the general direction of the receiver without the benefit of relay transmitters. The receiver atop the mountain or at Rapid City, depending upon which direction the message was sent, then snatches the message out of the air.

Despite the need for relay stations on top of the two mountains, the system is extremely flexible. Either headquarters can talk to any patrol car and the cars can talk among themselves. Pierre headquarters can plug up a road net 200 miles away minutes after orders are transmitted.

Where Redwoods Are Pygmies

(Continued from page 113)

Nick's tiniest and most perfect creation is a scale model of Catalina Island, 21 inches long, an inch to the mile. The island is covered with Lilliputian trees from 1/4 to 1/8 inch high. Tiny roads wind through the hills. About 100 of the principal buildings of Avalon are in their proper places, complete to windows and chimneys. You can even hear the soft notes of chimes being played from the chime tower on the hillside.

After dark, Nick turns a switch and immediately the windows of the microscopic buildings glow with light. Lighthouses along the coast send out their beams. A general moonlight effect is created by soft illumination from a Lucite moon.

The model rests on an ebony base containing five inspection ports fitted with magnifying lenses. When you peer through these ports you see typical underwater scenes, with tiny bits of seaweed in the foreground and giant kelp stalks towering overhead. Each illuminated scene is like a bit of fairyland, in natural colors.

Suddenly, to your amazement, you see a tiny fish swimming through the underwater forest. It tugs at a bit of seaweed and then moves away. Other fish swim past and seaweed sways just as it does in a current.

The animated fish, typical of the species in Catalina waters, are actuated by three small electric motors in the base. Each thumb-sized motor had to be built for its job. They also operate gears that make the seaweed sway back and forth.

This Catalina Island model is the greatest of Nick's achievements. He has been working on it for four years and some of the details still are unfinished. It would be hard to estimate its value.

America's costliest cars have V-type engines. Only Ford has it in the low-priced field!



Ford's out Front

WITH THE ONLY V-8 ENGINE IN THE LOW-PRICED FIELD!

The only 100 h.p. engine in its class...the champion performer!



New 4-ring aluminum pistons save ye a pur-r-ty penny on gas and oil!

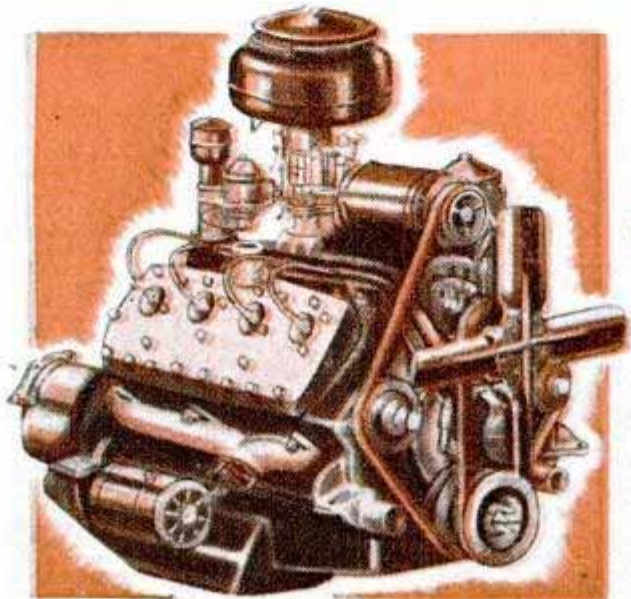

V-8's extra smoothness comes from overlapping power strokes!

V-8 makes fewer turns per mile the car "hustles" while the engine "loafs." That means longer life!



Look! Only Ford production magic brings you this finest type engine at lowest cost!



THERE'S A



IN YOUR FUTURE!

This handy Red-Top

RIGID

yoke vise makes your
pipe work easier

Handy, integral pipe
rest and pipe bender

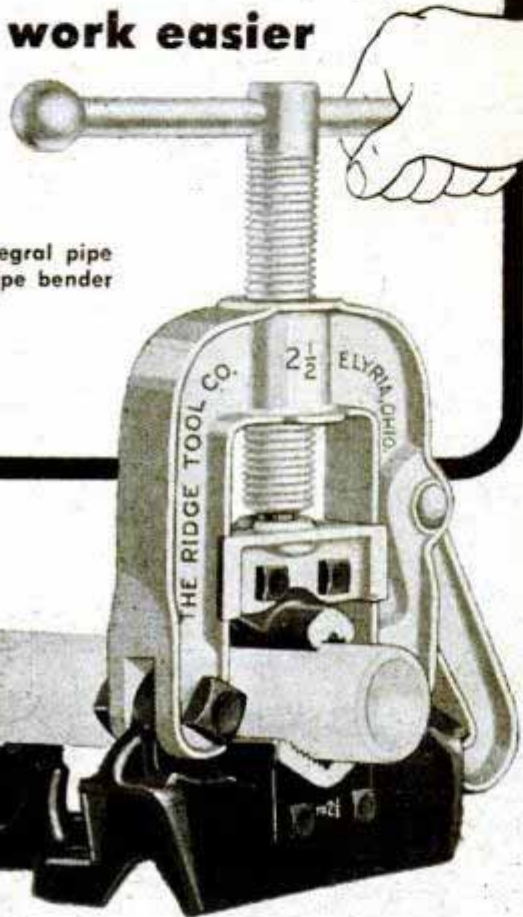

● Look for the red yoke on a black base when you buy a bench vise—for this sturdy RIGID of strong special malleable offers you unusual convenience. It has an integral pipe rest for easier cutting and threading; it has a handy pipe bender. Its tool-steel LonGrip jaws are easy on polished pipe. It's more for your money—buy in any of 8 sizes for pipe to 6 inches, at your Hardware Store or Supply House.



RIGID Vises,
Yoke & Chain
in 9 styles, 23
sizes.

RIGID

WORK-SAVER PIPE TOOLS

THE RIDGE TOOL COMPANY · ELYRIA, OHIO, U. S. A.

**YOUR ENGINE
CAN FILL FLATS!**



Why sweat and strain pumping up flat tires by hand? Replace one sparkplug with this Engine Driven Tire Pump and substitute 10 Horsepower for One Manpower! Adapters furnished to fit any

gas engine. Clean air from outside engine pumped through 12 ft. of hose to tire.

ENGINE DRIVEN TIRE PUMP Only \$4.95

**DUAL POWER
SPRAYER
Only \$14.95**



Spray 600 to 1000 sq. ft. per hr. with paint, varnish, lacquer, insecticide or any other free-flowing liquid, using this Dual Power Sprayer, which

converts your car, truck or tractor into a high-powered air compressor. Equipment includes 2 Auto Power Air Pumps, 2 sets adapters, 2 Pulsation Chambers, Y hose connection, 25 ft. hose, and Pistol Grip Sprayer as shown.

Also **SINGLE POWER SPRAYER** with Pistol Grip, only \$10.00 will handle 300 to 500 sq. ft. per hr. as above. Includes single set of units to operate off one sparkplug hole with 10 ft. hose.

Send Money Order and Save Shipping Charges

MARS PRODUCTS COMPANY

Dept. C, 1170 Broadway

NEW YORK, N. Y.

DRILL CONCRETE *The Easy Way!*

CONCRETE

ASPHALT

BRICK

SLATE

WALLBOARD

LIMESTONE

and all other
construction
materials.



Tipped with
Carbide Cemented
Carbide—harder
than the hardest
steel.

SLIP A CARBIDE MASONRY DRILL INTO YOUR ROTARY DRILL, HAND BRACE, OR DRILL PRESS, AND WATCH IT GO—AND GO FAST!

- DRILLS 4 TIMES FASTER!
- STAYS SHARP 50 TIMES LONGER!
- CUTS CLEAN, TRUE-SIZE HOLES!

Goodbye to back-breaking masonry drilling! Cut clean, true-size holes in all masonry jiffy-quick! Use your rotary drill, hand brace, or drill press. Drill holes 1/8" apart without break-through. Ask about Handy 6-Drill Set (canvas case, free). See your dealer, or write.

CARBIDE COMPANY, INC.

11185 E. 8 MILE BLVD., DETROIT 32, MICH.

\$2.95



**TORNADO
GAS TORCH**

The Modern Way of Soldering

Ideal for hard and soft soldering. Will heat quickly; solder will flow freely and smoothly. No compressed air required. Nothing to pump. Self-adjusting. Safe. Economical. Can be used for annealing small parts and bending metal parts. Generates a heat of 1700° Fahrenheit. Simply connect to any illuminating gas jet with a rubber hose and

operate. Tornado Torch No. 119 comes with three (3) tips, (3/8", 1/4", 3/16" blast).

The Tornado Gas Torch No. 119, complete with three tips, is \$2.95. See your dealer or order direct. Send check or money order—post paid.

Robert Manufacturing Co. Inc., 202 E. 44th St., New York 17, N. Y.



John Surrey's

Golden Burl Prima

...\$5



THE COLLECTOR'S PIPE...

AN EXTRA MEASURE of pride comes with the ownership of a John Surrey GOLDEN BURL PRIMA. For its beauty says what its performance proves... here is a pipe of unmistakable quality.

Fashioned from the choicest imported briar, John Surrey's GOLDEN BURL PRIMA is hand-made with infi-

nite care by expert pipe craftsmen. Observe its rich golden finish, unmarred by varnish or lacquer sprays. Instead, the briar is polished with a costly wax to bring out the full beauty and color of its handsome grain.

Ask for John Surrey's GOLDEN BURL PRIMA at your favorite tobacconist's.

OTHER LINES: Sir John \$2.50, Royal House \$3.50, Drury Prima \$5.00, Sun Flame \$7.50

JOHN SURREY, LTD., 509 FIFTH AVENUE, NEW YORK 17



OWN A "POCKET SIZE" MACHINE SHOP

IMPROVED MOTO-TOOL

27,000 R.P.M.
CUTS CLEANER.
SAVES CUTTERS

Moto-Tool No. 2,
23 accessories,
in wood case,
\$23.50. Moto-
Tool, with one ac-
cessory, \$16.50.

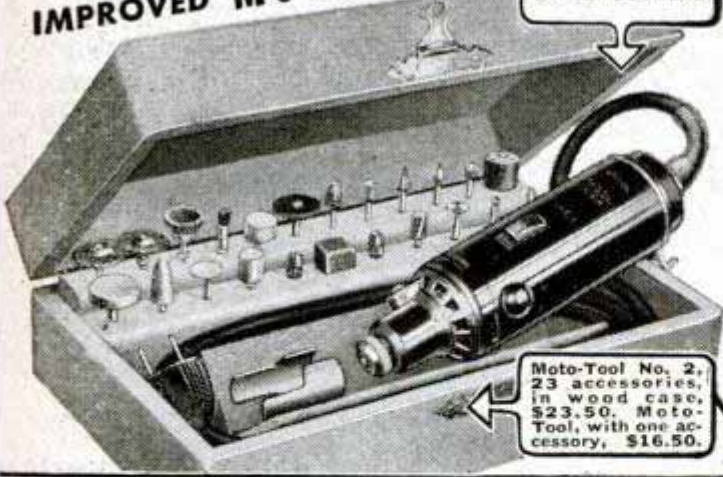

LOOK
FOR THESE
MOTO-TOOL
FEATURES

Patented, automatic
chuck lock pin.
Instant-acting,
wrenchless chuck.

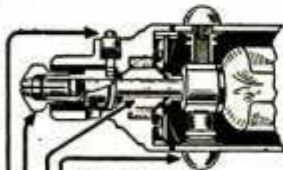

Easily replaceable
commutator brushes.
Oil-less type,
sealed bearings.

Weights only 13 oz.
• Operates on 110-
120 AC or DC current
• Shockproof bak-
elite housing fits the
hand • Dynamically
balanced armature
eliminates vibration
• Cooled by dust-
filtered air • Sliding,
snap-type switch •
Hang-up hook •
Cord protector.

• Dremel "Moto-Tools" have been used by toolmakers, machinists, pattern makers, electrical and radio repairmen, home craftsmen, model makers, jewelers, hobbyists, sportsmen and handymen for over 10 years. "Moto-Tool" is a "war veteran" . . . Thousands of them were used at far flung maintenance bases by every branch of the armed forces. "Moto-Tools" are in use in tool rooms and on production lines at General Electric, Westinghouse, Remington Arms, Ford, Nash-Kelvinator, Consolidated Aircraft, Douglas and others.

DO THESE JOBS BETTER AND FASTER WITH A "MOTO-TOOL" Sharpening taps, gouges, chisels, wood drills, lawnmowers, knives, scissors, cutting tools, etc.; for grinding, routing, drilling, cutting, carving, engraving, sanding, polishing, cleaning, etc., in metal, wood, plastics, etc.

MONEY BACK GUARANTEE—Ask your dealer about Dremel "Moto-Tools" and accessories. If he does not handle them, order direct from the factory on a 10 day trial, money back guarantee.

DREMEL MFG. CO. Dept. 116-K RACINE, WIS.

MAIL THIS COUPON TODAY
DREMEL MANUFACTURING COMPANY, Dept. 116-K
Racine, Wisconsin

- Enclosed find \$..... (Money order or draft). Ship the following at once:
 - "Moto-Tool" Kit No. 2—\$23.50
 - "Moto-Tool" Model 2 with one accessory—\$16.50
- Enclosed find \$2.00. Ship above C.O.D. I'll pay postman balance plus postage.
- Send catalog of Dremel Tools and Equipment, FREE.

Name.....
Address.....
City..... Zone..... State.....

THE ONLY BRUSH THAT

Keeps the Air Clear as it Cleans the Floor

Also Eliminates
Sweeping Compound!



Dustless brushes used with Arbitrin sweeping fluid are 100 times more effective in controlling dust than ordinary floor brushes used with sawdust. When used daily, Dustless brushes actually reduce bacteria, normally in the air between sweepings, as much as 97%. These facts have been proved in tests made by independent health authorities. Dustless brushes are used in thousands of stores, factories, offices, schools, and institutions. They are unconditionally guaranteed to meet your requirements. Write today for sizes, styles, and prices.

MILWAUKEE DUSTLESS
BRUSH COMPANY

530 North 22nd Street • Milwaukee 2, Wisconsin

MANUFACTURERS OF DUSTLESS, SPEED SWEEP AND SPEED WASH BRUSHES

Milwaukee Dustless Brush Co., 530 N. 22nd St., Milwaukee 2, Wis.

Please send complete information about Dustless brushes and Arbitrin sweeping fluid.

Name.....

Address.....

City and State.....

Showman Turned Inventor

(Continued from page 135)

shaker, shows visitors a sign in his workshop which reads:

"After six weeks in the tropical test chamber by the Research Development Branch, Washington, D. C., for the U. S. Army, my salt container passed the test 100%. Arthur Hammerstein, Inventor."

Other Hammerstein inventions include:

(1) Clock-operated egg timer in which water is released from a cylinder to conclude the cooking at the right time.

(2) Clamp attached to a cord to hold a hot soldering iron and prevent it from marring a work surface.

(3) Machine that cuts twine and holds onto the spool end of the cord to keep it within easy reach and to avoid snarls. It was designed for wrapping counters.

(4) Glass cutting machine that employs an emery wheel cooled by dropping water.

(5) Electrical magnetizer which magnetizes screwdrivers to pick up small screws.

(6) Bottle cutter that uses heat from an electric wire. (Asked why he wants to cut bottles, Hammerstein said, "I just wanted to see if this idea would work.")

That typifies Hammerstein—"workshop showman" full of ideas and action.

The Dust Bowl Is Restless Again

(Continued from page 157)

reach into the air to snare soil that starts to blow, protecting nearby fields by dissipating the force of the wind.

These are a few of the many methods recommended by the Soil Conservation Service of the U. S. Department of Agriculture. Congress passed the Soil Conservation Act authorizing the service in the days of the dust bowl when the nation watched helplessly as great sections were blown from the heart of America.

In 1937 the first state enabling acts were passed authorizing soil conservation districts. Today nearly 1500 such districts blanket three million farms and 800 million acres of the country's land. All the states now have soil conservation district laws or other legislation enabling farmers to carry on organized erosion control and obtain federal and state assistance in doing so.

Here's the way the system works. Each district is a cooperative unit independent of federal dictation. Any of the three million farmers or ranchers living in these districts can seek assistance from the Soil Conservation Service. Any farmer has complete access to the information and

(Continued to page 260)

Luther POWER GRINDERS

HAND AND POWER GRINDERS

Like all Luther Grinders, the power grinder shown here is famous for high quality and rugged construction. It is built to exact specifications for those who demand fine tools. For the Luther grinder that fits your needs, see your hardware dealer.

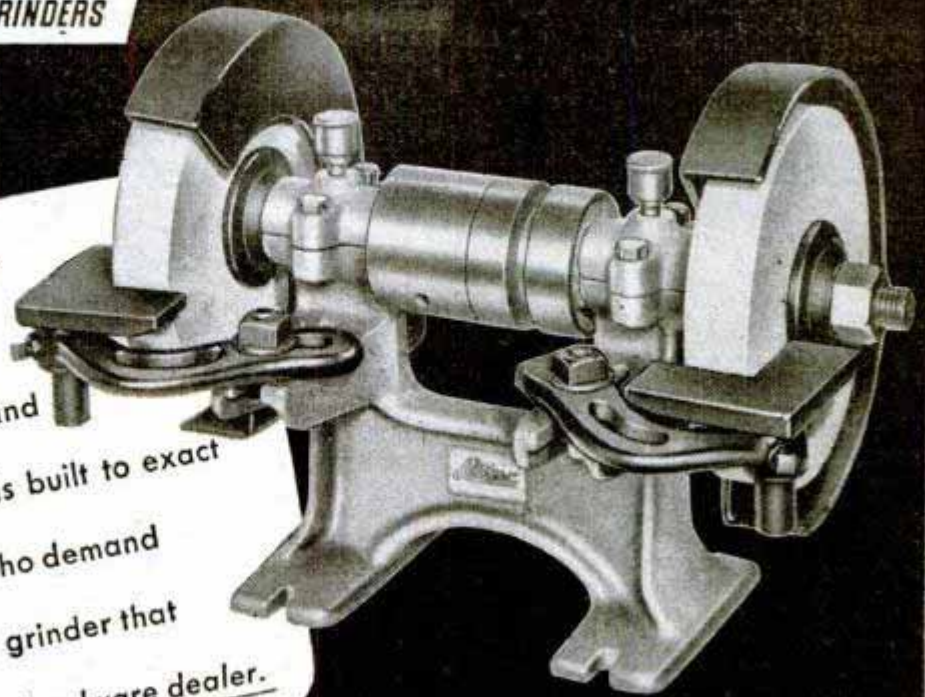

LUTHER GRINDER & TOOL CO.
(Established 1896) Sheboygan, Wisconsin



AMAZING NEW DOUBLE LENS CAMERA

Only \$6.95 Complete with shoulder cord

Now you can take perfect pictures ... because you see exactly what you'll get on your film before you snap the shutter! Yes, you see the ENTIRE IMAGE in sharp, clear focus (as in the costliest cameras) with the GROUND GLASS VIEW FINDER of the amazing new double-lens Metro-Flex Camera ... available for the first time since the war at a remarkable low price! With the Metro-Flex Camera you're sure of results on all kinds of shots. Close-ups, scenes, people, events ... they all come out just as you see them in the Ground Glass View Finder ... before you snap the shutter!

TWO MATCHED LENSES ...

One lens focuses the picture for you. The other snaps the picture. Both lenses, working in harmony, give you sharp focus never before available except in most expensive cameras. The Metro-Flex is a beautiful camera ... handsomely, sturdily made ... modern-design plastic case ... bright aluminum, rust-proof trimmings ... high speed, optician-ground lens ... time exposure adjustment ... and complete with plastic shoulder cord. Easy to load and use. Will give years and years of picture-taking fun. Takes 8 exposures on standard No. 127 film.

GROUND GLASS VIEW FINDER

Same Type as in Highest Priced Cameras

- 1 Easy focusing ... you see entire picture before you take it, just as it will look when developed!
- 2 No tilting ... your eyes tell you if picture is centered on film.
- 3 Everything you want to take ... no disappointments, because you see the whole picture, framed as it will appear on the film.

SPECIAL! 20-Page Photo-Album included with Camera at no extra cost!

SEND NO MONEY!

Order your Metro-Flex Camera now, complete with Ground Glass View Finder, double lenses, and shoulder cord. Send No Money. Just mail coupon at right and pay postman only \$6.95 plus postage on delivery — we pay postage if you enclose \$6.95. Use Metro-Flex Camera for 10 days, and if you're not delighted, return it, and your money will be instantly refunded. Rush coupon. Supply limited.

Williams Camera Co., Dept. C-603
412 S. Market St., Chicago 7, Ill.

WILLIAMS CAMERA CO., Dept. C-603,
412 South Market Street, Chicago 7, Ill.

Please rush Metro-Flex Camera, complete with Ground Glass View Finder, double lenses, and shoulder cord. Include 20-Page Photo-Album at no extra cost. I will pay my postman \$6.95 plus postage on delivery. **ALSO**

SEND ME 3 Rolls—127 film for 96c 6 Rolls—127 film for \$1.92
No film sold without camera, on first order, but as a METRO-FLEX owner you may order future supplies of film from us at above prices.

NAME _____
ADDRESS _____
CITY _____ STATE _____
CHECK HERE: If you are enclosing full payment. Then we pay postage. Satisfaction guaranteed.



SEE the picture BEFORE You Take It!

FILM AVAILABLE!

The METRO-FLEX uses any standard make of No. 127 film. Order a supply of film on coupon below when you order camera.

3 Rolls (8 exposures per roll) 96c
6 Rolls (6 exposures per roll) 1.92

No film sold without camera, on first order but as Metro-Flex owner you may order future supplies of film from us at above prices.

FREE ALLIED'S 1946 RADIO CATALOG



**LARGEST STOCKS
OF EVERYTHING
IN RADIO . . .**

SERVICEMEN! Dealers! Soundmen! Amateurs! Builders! Experimenters! Send for the handiest, most complete 1946 Buying Guide for Everything in Radio! Features latest radios, sound systems, amateur and builders' gear, thousands of radio and electronic parts—world's largest and most complete quality stocks—at lowest prices. Fastest service; expert help!



MORE THAN 10,000 ITEMS

Everything for every radio use: new model home radios, phono-radios, communications receivers, Ham kits, radio parts, tubes, tools, test instruments, public address equipment, easy-to-build kits, diagrams, instructive books—all at lowest prices!

HELPFUL RADIO BOOKS

- Radio Formulas & Data No. 37-752 10c
- Dictionary of Radio Terms No. 37-751 10c
- Radio Circuit Handbook No. 37-753 10c
- Radio Builders' Handbook No. 37-750 10c
- Simplified Radio Servicing No. 37-755 10c
- Radio Data Handbook No. 37-754 . . . 25c
- ALL SIX BOOKS No. 37-799 75c
- Parallel, Resistance and Series Capacitance Calculator. No. 37-980 . . 25c
- R-F Resonance and Coil Winding Calculator. No. 37-955 25c

ALLIED RADIO

ALLIED RADIO CORP.
833 W. Jackson Blvd., Dept. 5-K-6
Chicago 7, Illinois

- Send FREE 1946 CATALOG
 - Send Six Books No. 37-799
 - Send Books checked above
 - Send Calculators checked above
- } \$...enclosed

Name.....
Address.....
City..... Zone..... State.....



BETTER FLYING MODELS!

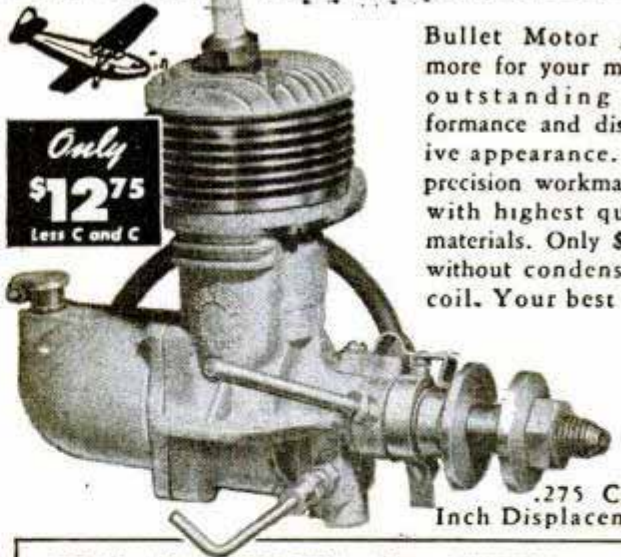

Only
\$12.75
Less C and C

Bullet Motor gives more for your money, outstanding performance and distinctive appearance. Fine precision workmanship with highest quality materials. Only \$12.75 without condenser or coil. Your best buy!

.275 Cubic
Inch Displacement.

BORE — ¼" • STROKE — ⅜" • WEIGHT — 4 ¼ oz. (Bare Wt.) • RPM — 6 to 10,000 • FINISH — Baked crinkled black plastic. External parts nickel plated. • GAS TANK — Center screw attached. Can mount motor any position. • CYLINDER — Broached for concentricity, super-honed for smoothness. • PISTON — Mechanite, centerless ground for fine finish.

If hobby dealer is unable to supply Bullet Motor, send order to us with name and address AND name and address of dealer.

BULLET MOTORS

Manufactured By MINIATURE MOTORS, INC.
8557 HIGUERA STREET • CULVER CITY, CALIF.

Appliance \$10.95 Tester



Pat. Pend.

LOCATES TROUBLE INSTANTLY IN ALL ELECTRICAL DEVICES

In this single unit are all the necessary tests for examining every appliance. Checks thermostats under working conditions. Tells instant it opens or closes. Controls heat on soldering irons. Prevents over-heating. Tests continuity, open circuits, automatic irons, vacuum cleaners, motors, coin machines, bulbs, 3-way switches, etc. Great time, and money saver! ONLY \$10.95 COMPLETE. No C.O.D.'s, shipping wt. 3 lbs.

FREE with each Tester. New, Complete Practical Course in electrical appliance repairing. WRITE FOR CIRCULAR.
HANLAN CO., 1419-A, West Jefferson, Los Angeles 7, Calif.



- Test ALL Home Outlets
- Find Open Circuits

STAR TEST-PLIERS

- Locate Blown Fuses
- Remove Fuses SAFELY

A must tool for electricians, maintenance men, home owners. Made of a transparent, shock-proof Plastic. Replaceable lamp inside Plier tests 110 to 250 Volts. Plier pulls fuses from 10 to 100 Amperes. Requires the use of only one hand. Can be obtained from General Electric or Westinghouse stores, or

from local electrical dealers. Order one TODAY.

Price \$2.75 without Leads. \$1.50 additional for Leads which provide greater reach and more flexibility.

STAR FUSE CO., 233 Canal St., New York 13, N. Y.

There is no substitute for *experience*. So ask any fisherman you know, "What make of outboard motor should I buy?" The chances are two to one he will tell you, "buy a Johnson Sea-Horse." He knows from experience that the biggest thing in outboard motors is **DEPENDability**.

Write for new Sea-Horse Handy Chart. Free!



JOHNSON MOTORS
400 PERSHING RD., WAUKEGAN, ILL.

★ ★ ★ **PHOTOGRAPHERS:**

PRINT PHOTOS ON BOOK COVERS!



CHINAWARE!



RECORD ALBUMS!

GLASS SILHOUETTES!



WOODEN JEWELRY!



PHOTO MURALS DEN WALLS!

Now You CAN PRINT PHOTOS ON PRACTICALLY ANY SURFACE!

EASY TO USE — BY CONTACT, BY PROJECTION — ON METAL, GLASS, PAPER, PLASTICS, WOOD, ETC.

Get This Free Booklet From Your Dealer!



Let your imagination go! Find new uses for your photographic hobby! Put those pictures you prize most on display in hundreds of interesting ways. It's all possible with the new Martin Multi-Mulsion—a simple, practical emulsion which sensitizes almost any surface for photographic reproduction. Ready to use. Applied in one coating with a brush or cloth. Works with ordinary darkroom equipment.

The Glenn L. Martin Co., Baltimore 3, Md.
ASK YOUR DEALER ABOUT

GLENN L. *Martin*



MULTI-MULSION

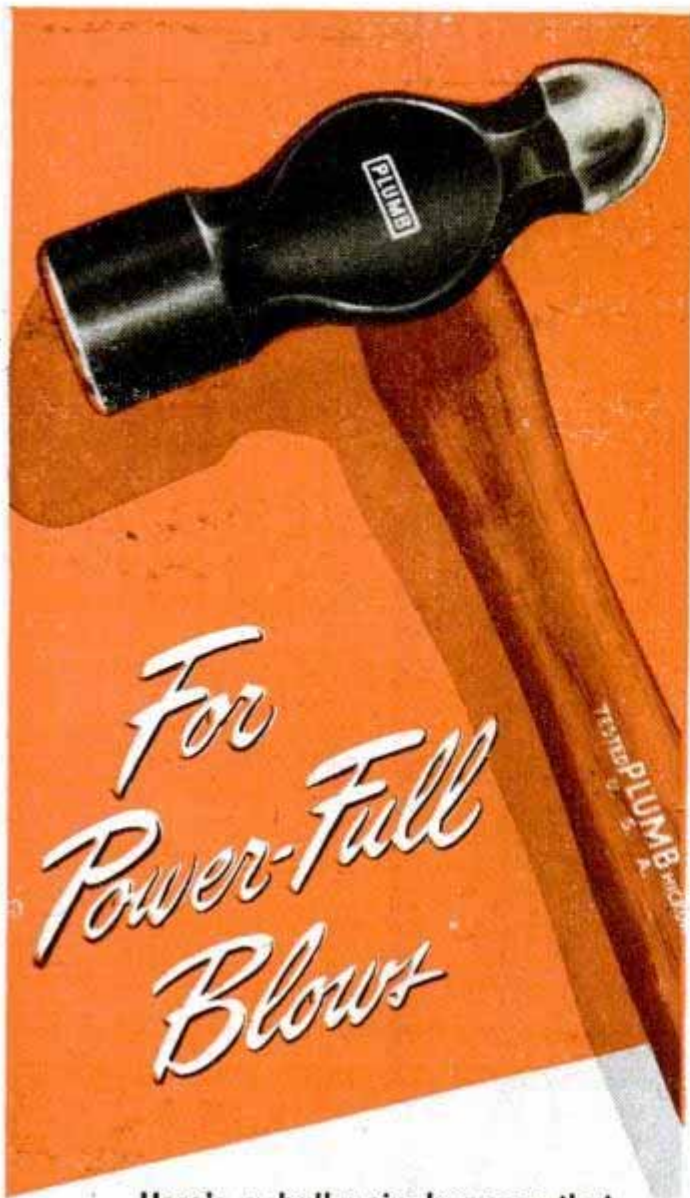

*For
Power-Full
Blows*

Here's a ball peen hammer that delivers quick, accurate strokes — packed with power. It does the work better, faster — because it's a Plumb.

Like all Plumb Tools, it is designed for superior performance. And it's perfectly balanced to lessen fatigue. From the very testing of the steel, through the forging, the tempering, the final polishing...even to the extreme care in selecting the close-grained, easy grip hickory handles...these tools are made to give you more power per blow. Fayette R. Plumb, Inc., Phila. 37, Penna.

PLUMB

HAMMERS • HATCHETS • AXES • SLEDGES

records provided by the service. Under certain conditions a farmer in any one of the districts can obtain special equipment or stock, seed and other materials.

The farmer himself has absolute authority over his own land. Soil conservationists assist him—when he asks for help. Together, a farmer and a technician walk from field to field, studying each patch of land and checking it with the "land capability map," a chart drawn by the service that shows the best possible use of the land. Then they work together on a blueprint for the future. Land that can be used for "cash crops" is selected, then second-rate fields for growing feed for livestock. Farmers like to make their own decisions. They do it with the help of the Soil Conservation Service.

If the farmer is determined to carry out these plans, he may be forced to move fences and farm roads to follow the contours of land and fit the terraces he will plow. Field boundaries may be changed so that each field will have land of only one class. Tired cropland may be converted to pasture, meadow or woods.

Perhaps the farmer can do only a small part of this work each year. But when he's finished he knows that he's using each particle of loam the way it should be used—that he's not mistreating his soil.

Planned use of the land pays off, too. A survey taken during the war, when soil helped to fight the nation's battles, shows that soil conservation practices boosted yields by at least 20 percent on the average. Such a boost means a 20 percent raise in the farmer's income and probably more than that in the sale value of the farm.

Complete conservation methods have been applied with the aid of the Soil Conservation Service to some 80 million acres of land. Additional millions of acres have received indirect benefits from the service. In the opinion of Dr. Bennett there has never been any program started anywhere on earth that can compare with this one in the accomplishment of permanent protective work on the land.

But Dr. Bennett emphasizes that this is just a start. Farmers in some of the areas where soil is the most restless have not yet organized conservation districts. In other areas conservation is forgotten in the desire to boost the crop yield and thereby cash in on today's market. Marginal land is again plowed and planted to corn or wheat.

Signs of possible disaster appeared in southeastern Colorado during a dry spring season that made dust of unprotected fields. Winds as high as 60 miles an hour recently

(Continued to page 264)

FOR ALL TIME...

For all Men

Time, Speed, Distance—decisive factors to men of affairs in industry, science, medicine and sports.

The **LEMANIA CHRONOGRAPH** gives you the split-second accuracy of a magnificent wrist watch and stop watch, and determines speed . . . measures distance. A precision instrument, its name means exacting craftsmanship . . . handsome design.

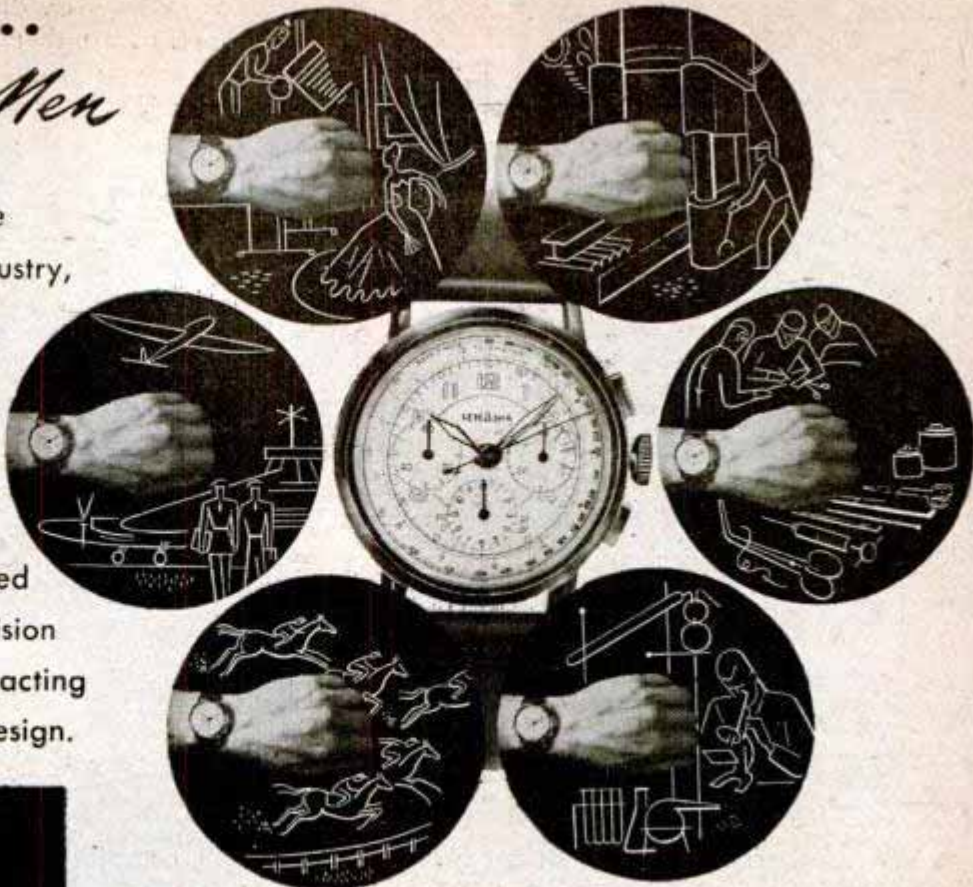

At Your Jeweler's

Sole U.S. Agent: **BERNARD S. LIPPMAN CO., 630 FIFTH AVE., N. Y. 20**

VanRoy with the

Ajustomatic **STEM**

FREE-TURNING

SELF-ALIGNING



Step away from temperamental, old-fashioned screw stem pipes—step up to VanRoy Ajustomatic. This new pipe has a patented "float-mounted" stem that can't lock at an off-angle, that lines up straight as a die, always. You'll enjoy extra smoking satisfaction with the Ajustomatic, made in the VanRoy quality tradition. At better stores in United States and Canada . . . **VANROY CO., INC., Empire State Bldg., N. Y. 1.**

VanRoy
Ajustomatic
Bard \$5



SIGNET OF QUALITY IN PIPES

ANCO RAIN-MASTER

"Dead-Locker"

WINDSHIELD WIPER
ARMS and BLADES

BLADE SNAPS ON...
STAYS PUT

FINGER-
TIP
RELEASE

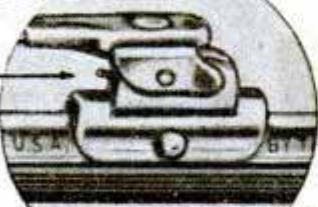

CAN'T FALL OFF
CAN'T BLOW OFF

(A war-born invention—by ANCO—first)
for military aircraft—now for your car.)

DON'T SHOOT YOUR GAS-PUMP MAN!

He's doing the best he can. Sure, he knows how dangerous it is for you to drive your car... in stormy weather... with your dull old windshield wipers that smear and smear. He'd gladly put on for you quickly a pair of keen new ANCO RAIN-MASTER Wiper Blades and Arms. He has them—Newest Models! But he forgets to remind you? Too busy? You can't shoot him for that!



PATENTS
MAKE JOBS

After all, it's *your* car to protect. So you remind *him*. Get RAIN-MASTERS... patented features... original equipment on many makes of high grade cars and trucks... used in war—on our fighting tanks and trucks and ships and bombers too... because ANCO RAIN-MASTERS clean quicker, clean cleaner... last longer. May save you a costly smashup.

Ask for RAIN-MASTER Windshield Wiper Arms and Blades next time you buy gas.

THE ANDERSON COMPANY

Established 1918

GARY, INDIANA

Say you saw it in Popular Mechanics

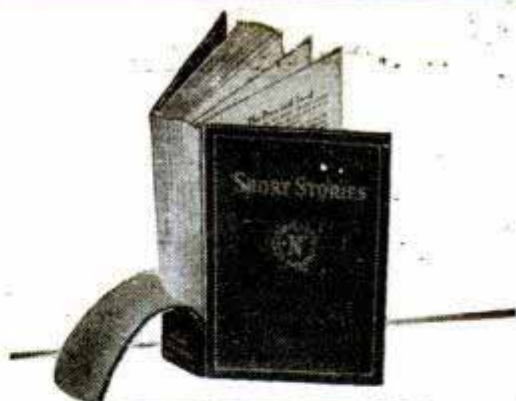

FIXES

BOOK BINDINGS

...also broken china, glassware, toys, furniture and luggage. It's waterproof, transparent and flexible. Get a tube today!



DUCO CEMENT

\$11.85 ELECTRONIC VOLT-OHMMETER

Twenty Ranges. Billion Ohms. 0-5000v. DC. 0-5000v. AC.

Write for FREE circular about this amazing instrument kit.

Postpaid 166 N. Sierra Bonita Pasadena, Calif.

OTTAWA TRACTOR SAW



350 CUTS PER MINUTE

Make money sawing wood. Use Ottawa—fastest cutting. Cuts large, small logs easiest way. Fells trees. One man operates. Thousands in use. Built to last with heavy, stiff saw blade. Positive safety clutch control; uses power take-off any tractor. OTTAWA MFG. CO., D1027 Forest Ave., Ottawa, Kan.

Costs Too
Little
To Do
Without

BOILS WATER IN 3 MINUTES



UNCONDITIONALLY
GUARANTEED

Wonderful for Homes,
Cabins... Trailers...
Wherever hot water
is wanted QUICKLY

ELECTRIC WATER HEATER

Immersion type... drop it into the water... it heats a basin or a sinkful pronto. 110 volts AC-DC. Comes with extra long heavy duty waterproof cord. Weighs 1lb. We'll mail it C.O.D.

\$245

Plus C. O. D.
and postage

Write for Big free Trailer Parts Catalog
NATIONAL TRAILER STORES

Dept. 10, Box 2353 Terminal Annex
LOS ANGELES 54, CALIF.

Here it is! **The tape that tackles everything**



Strong! Waterproof! 6 Colors!

Once you use MYSTIK "Self-Stik" you won't be without it. Hundreds of uses in home, office, shop—seals, repairs, decorates, weather-strips, masks, holds. Six useful colors. Sticks tight without moistening. Peels off clean. Be extra handy with this handiest of all fixers. 25c, 50c and \$1 at hardware, drug, department and stationery stores—Mystik Adhesive Products, 2653 N. Kildare, Chicago 39.



Weather-stripping is clean, quick and positive with MYSTIK. Peels off easily. This is just one of hundreds of MYSTIK uses.

Build Your Own RADIO RECEIVER

And listen to your own radio programs—this Kitcraft Radio Set brings them in clear as a bell. Easy to build; works anywhere. Complete with mica condenser, tested galena crystal and 20-page illustrated manual containing diagrams, theory and step-by-step building and operating instructions. Base of "Lucite" plastic; no soldering or batteries required. Uses any type earphone. Thousands in use. **MONEY BACK GUARANTEE:** See your dealer today. Or have Kit sent prepaid by sending \$2.95 direct to Dept. — PM-10

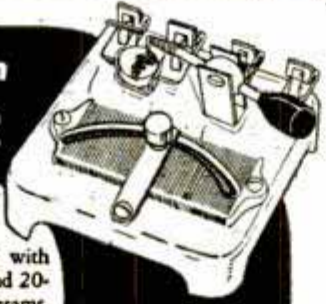

only **\$2.95** complete
less phones

KITCRAFT INC. 614 North San Vicente, Los Angeles 46, California

YOU NEED THIS TOOL

Vise-Wrench—a most useful tool around home or shop. Portable and convenient as pliers, with grip as powerful as a locked vise. Adjusting screw at end sets jaws for any desired thickness. Self locking. Easily and quickly released. 10-inch, \$2.35. 7-inch, \$2.00.

KNU-VISE, INCORPORATED
Dept. P.M., 2200 Eighth St., Detroit 16, Mich.



Get the SMOOTH-ON REPAIR HABIT

Keep your heating and plumbing systems, your household equipment, utensils, tools, etc. in repair with handy Smooth-On No. 1 Iron Repair Cement. You can do it yourself—make good-looking repairs that stay tight—yet are very inexpensive.

Smooth-On comes in powder form. You mix it with water to apply. It hardens like metal. Stops leaks. Seals cracks. Tightens loose bolts, screws, rivets, parts, fixtures. Holds in metal, wood or masonry. Requires no heat, and usually no need to take things apart.

Keep a can of Smooth-On No. 1 always on hand. Does not deteriorate. Get it at your regular hardware store in inexpensive 1 1/4-oz., 7-oz. or larger size. If you don't find it there, write us direct.

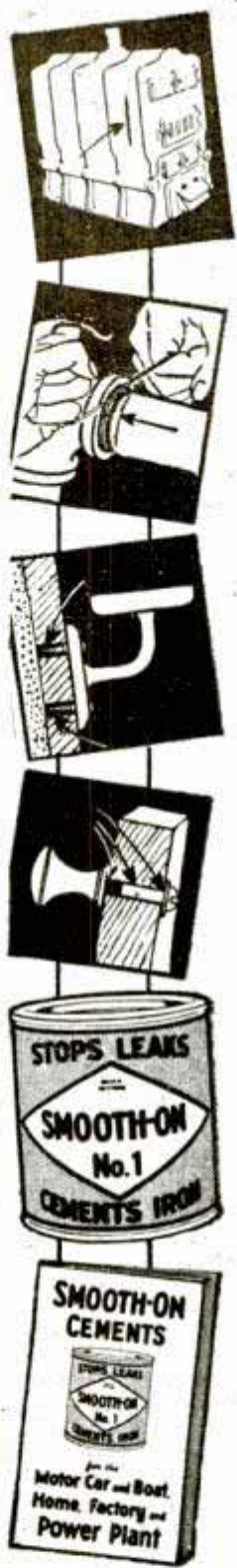

THIS REPAIR HANDBOOK FREE

Shows easy, short-cut home repairs. 40 pages. 170 diagrams. Simple directions. Pocket size. Convenient index. Absolutely free—just send the coupon.

----- **SIGN AND MAIL NOW** -----

Smooth-On Mfg. Co., Dept. 37
570 Communipaw Avenue, Jersey City 4, N. J.
Please send me a Smooth-On Handbook.

Name.....
Address.....
10-46.....

Do it with **SMOOTH-ON**
IRON CEMENT

Hobart
helps you
SUCCEED

in ARC WELDING



The HOBART "Build Your Own" (Generator Only)

A Big Pay Business—and it's all yours! It's so easy to start your own job welding shop and reap the big dividends that Hobart Arc Welders bring you. There's plenty of arc welding repair and construction work everywhere, customers even bring it to you.

Hobarts Weld Better—that's because of exclusive operation features that save you time and money. The exact welding heat is easy to get, for Hobart lets you select from 1000 volt-amp combinations. Hobart's Remote Control saves valuable time by allowing you to adjust welding heat at the work. Hobarts last longer because they're built better!

"Build Your Own"—and save hundreds of dollars! Make your own gas drive portable arc welder using the Hobart "Build Your Own," a reconditioned motor and chassis. Free booklet gives complete instructions.

Send the Coupon—for complete details on the Hobart Arc Welder you desire — there's no obligation.

HOBART
Jr. Electric
150 Ampere
Welder



The HOBART
A. C. Welder
for single
phase lines

**The HOBART SCHOOL
of ARC WELDING** —

It's a modern trade school in which students learn by doing. Expert instructors give individual attention. Each student has own welding booth and welder. Fully accredited under G. I. Bill of Rights. Send coupon.

HOBART BROTHERS COMPANY

BOX M106, TROY, OHIO. "One of the
World's Largest Builders of Arc Welders"



HOBART

HOBART BROS. CO., BOX M106, Troy, Ohio

Send me the Free Book, and also information on items I've checked below:

- Electric Drive A. C. Welder
 "Build Your Own" Welding School

NAME _____

ADDRESS _____

Free!

Arc Welder's Vest
Pocket Guide with
charts, tables, equa-
tions, charts, etc.



whipped across western Nebraska to do a good deal of damage. Last spring, dust storms swept across western Kansas and the Texas and Oklahoma panhandles. Heavy rains that blanketed the fields at the last minute saved wheat crops.

The soil may run away again unless the farmer anchors it at home through intelligent application of conservation methods.

Luxury Goes Back to Sea

(Continued from page 119)

is not cheap. F. A. Bailey, president of the Matson Navigation Company, has stated that a total of \$18,000,000 will be spent upon reconversion of three of his company's liners, the Lurline, Mariposa and Monterey. This is \$6,000,000 per ship. It will take up to six months' work on each ship before it can receive passengers.

The Matson Line, which operates to Hawaii, plans to go back to the prewar schedule of weekly sailings in each direction with the modernized ships. Other lines are also rushing reconversions.

The American Export Lines expects to have ready in 1948 three new luxury liners to serve their routes to the Mediterranean, Near East and north Africa. They will be streamlined and air conditioned.

Moore-McCormack Lines will use five new ships on their South American and Scandinavian runs; the Grace Line nine to South America; Atlantic Gulf and West Indies Steamship Lines five to West Indies; United Fruit Company 20 to the West Indies and Central and South America.

Other companies putting new ships in service are American South African Line, American President Lines, United States Lines Company, American Mail Lines and Mississippi Shipping Company.

The Mississippi Shipping Company is placing three new combination passenger-cargo luxury ships on its South American routes. The first of these ships, the SS Del Norte, slid down the ways at the Ingalls Shipbuilding Corporation yards at Pascagoula, Miss., early this year. The Del Norte is the first passenger liner to be constructed as such since the war and will make her maiden voyage early this fall. The ship will be joined later by her sister ships, the Del Sud and the Del Mar.

The three ships are modifications of the Maritime Commission's C-3P design, built during the war as cargo vessels. This type now has been redesigned to provide passenger accommodations exceeding even those of prewar luxury liners. In outward appearance the Del Norte, with raked stem

(Continued to page 268)

In the Air or in the Home MODUFLOW MAINTAINS "Comfort Unlimited"

HONEYWELL "Moduflow" Cabin Temperature controls are now in use on four-engined planes operated by the major airlines in the United States. They automatically and continuously "measure out" heat in direct proportion to cabin heat losses as outside temperature varies with altitude.

Moduflow control systems for home heating plants operate on the same principle as these cabin temperature controls. They are entirely different from the ordinary on-and-off control system. Moduflow furnishes heat *continuously* but modulated to whatever temperature is required for comfort. It eliminates the drafts and "shiver spots" caused by intermittent heat supply.

Moduflow can be easily and inexpensively installed on your present automatic heating plant. Whether you are planning to build or modernize, you should get the facts about Moduflow . . . Honeywell's attractively illustrated booklet, "Comfort Unlimited," explains just how Moduflow operates. It will be particularly interesting to Popular Mechanics readers. Mail the coupon today for your free copy.

MODUFLOW

the new HONEYWELL heating control system

MINNEAPOLIS-HONEYWELL REGULATOR CO.
2755 Fourth Avenue S., Minneapolis 8, Minn.

Please send my free copy of
"Comfort Unlimited"

Name _____

Address _____

City _____

State _____



FREE!

MAKERS OF THE FAMOUS M-H ELECTRONIC AUTOPILOT WHICH IS STANDARD ON AAF 4-ENGINE BOMBERS

A Fine, Precision EXPOSURE METER



\$13.95
COMPLETE WITH
LEATHER CASE
Including Tax
on Meter



The Sign of Precision

Make your camera take better, sharper photos. Eliminate guess-work, lost pictures and wasted film with a precision-built SKAN Exposure Meter. A *must* for color—still or movies. Be right in *any* light—day or night. Simple to use.

Sold at camera counters everywhere. For free literature write: G-M Laboratories Inc., 4290 N. Knox Ave., Chicago 41, Ill.

SKAN

EXPOSURE METER
SAY YOU SAW IT IN POPULAR MECHANICS

BROADCAST Your Own PROGRAMS Thru Your Own RADIO!



Tell jokes, imitate stars, sing, give news reports, make funny remarks about your friends present. Loads of fun! Surprise friends by cutting in and out of regular radio programs to your own home broadcast. Test your radio voice, discover hidden talent, improve diction, amateur hour practice, etc. A real metal microphone NOT A TOY. Size 8" x 3 1/2". Can be attached to any AC-DC radio. Comes complete with flexible cord for hiding it in another room, and Push-Button Switch for cutting in and out of programs.

SEND NO MONEY—10 Day Trial
Satisfaction Guaranteed or Money Back.
Immediate delivery. Pay postman C. O. D. only \$1.49 plus postage, or send payment and we pay postage. You'll be thrilled!

GREAT AMERICAN SALES CO., 2226 Silverton Road, Dept. 587, Chicago 16, Ill.



Only
\$1.49



SPINIT—GAS MODEL STARTER

Ideal For Model Plane Builders

Gas model fans, this is IT! "If it will run—a SPINIT will start it!" Sturdily built. Finger tip release. Makes model flying more fun. Available at dealers. Standard model, \$4.00. Write for folder:

STREED ELECTRIC CO.

1315-A Harmon Pl., Minneapolis 3, Minn.

MARCOT KEY MACHINE

Immediate
Delivery



Marcot No. 8 Key Machine
Mounted on Cabinet.....\$ 75.00
Book on Modern Locksmithing. 3.95
Auto Code Book and Auto Depth
Keys 12.50
162 Doz. Popular Key Blanks, 77.76
Set Key Files, Tools, Pins,
Springs, Thimble 10.50
\$179.71

A. J. MARCOTTE CO., 1200 N. KEDZIE AVE., DEPT. PM, CHICAGO 51, ILL.

ELECTRONIC GUN-SIGHTING STATIONS

Surplus—Made for B-29—Cost Govt. \$1500

Each Ring Station Assembly Contains: 1—Part # 8672162G6 Gyro (D.C.); 1—Part # 8672162G7 Gyro (D.C.); 1—Part # 8601501 Pt. 4 Reflector Sight; 4—Model 2J1P1 Selsyn Generator; 1—Ball Bearing Mtd. 26 Inch Bronze Ring Gear—over a dozen other Precision Gears—Ball Bearings—Castings—Switches—Electrical Connectors—Rheostats—Lighting System, etc. The Selsyns Alone Are Worth \$35.00 each.

LIMITED
SUPPLY
\$35
EACH

WM. NYE — 1541 E. 113th — SEATTLE 55, WASH.

LAWN ORNAMENT-NOVELTY PATTERNS

28 Lawn Ornament Patterns, 25c. Other patterns; 15-20" high; Dutch Girl, Dutch Boy, Pirate, Bull Terrier, Mexican Girl, Mexican Boy, Dwarf, Penguin, Flower Girl, 10c each. 25 Novelty Patterns, 30c. All 62 Full Size Patterns, \$1.00 Postpaid. Strother Pattern Service, Dept. N-8, Box 383, Belington, W. Va.

Attention!
**OIL
BURNER
MEN**

New, Accurate Sliding Scale Heat and Radiation

Rapid CALCULATOR

The only simplified sliding scale of its kind for quickly and reliably determining the heat requirements of any room or rooms. It shows the amount of steam, hot water and warm air radiation needed for various types of buildings. Saves laborious calculations and insures greater accuracy. Refiguring of heating plants, due to errors in ordinary time-consuming methods of calculating heat losses, is eliminated. Sufficient radiation and proper size boilers for thoroughly efficient heating are assured.

This sliding scale calculator is of inestimable value to oil burner service men and salesmen, engineers, plumbers and steamfitters.

Pocket size 7" x 3". Simple to understand; made of Vinylite (an exceptionally durable plastic). Based on engineering standards of B.T.U. heating losses. Instruction folder included. Order NOW.....

ONLY
\$3.00
POST PAID

SMITHSON CO., Box 67A, Rutherford, N. J.

POPULAR MECHANICS

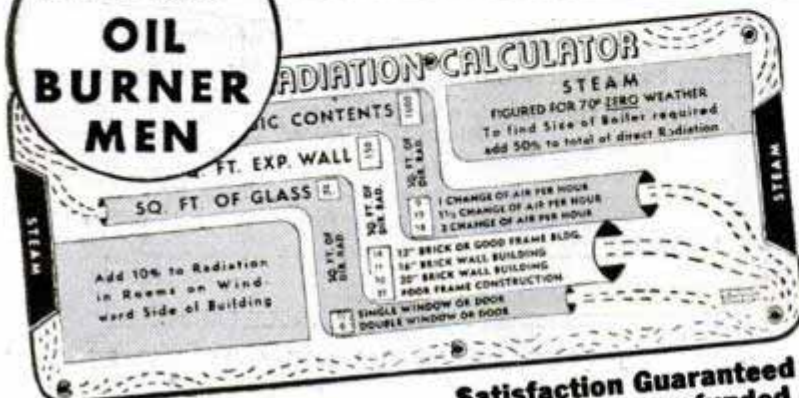

**Satisfaction Guaranteed
or money refunded**



**NOW - STANDARD
MICROMETER MEASURES
TUBING OR THREADS
WITH "CLIP-ON"
MYK-A-DAPT***

\$1.50

CLIPS ON IN 5 SECONDS!

MYK-A-DAPT* spring clip adaptors instantly convert standard 1" micrometer for measuring threads, tubing walls, bearing sleeves, etc. . . . Clip to anvil of micrometer . . . simple to compute . . . merely subtract .100 from reading . . . Clip on back of yoke when not in use.

Precision machined of high carbon tool steel — .0002 in. tolerance — rust resistant . . . Increase the utility of your standard 1" micrometer. Eliminate need for costly special purpose micrometer. Send for your set of two (2) MYK-A-DAPTS* complete with instruction sheet, only **\$1.50** postpaid or C. O. D. plus postage. *Pat. Pending

SEND CASH, CHECK OR MONEY ORDER TO

G. L. LANG Lang's Little Industry
P. O. BOX 739 **SPRINGFIELD, MASS.**

**SHEATH - POLARIZED -
"THE NEW MAGIC" -
Rust Control**



Again modern science has triumphed over an age-old problem. SHEATH eliminates the causes of rust! In its development, the world's best known rust preventives (lanolin, petroleum, synthetics, solvents, new thin wonder oils) were blended...then, given...

The MAGIC OF POLAR ACTIVITY!

This was born an unprecedented discovery!—No longer are corrosive elements grease-sealed to metal surfaces to continue their destructive work. SHEATH, through its amazing polarized action, goes through rain water, salt water, sweat, humidity, moisture, direct to the true metal surface and spreads and cleaves in a thin, soft, non-gumming film over the metal...

DISPLACES CAUSES OF RUST

Neutralizes the fingerprints, mildly lubricates as it protects, SHEATH can be applied in any simple manner. It loosens dirt and existing rust, prevents stains. 3-oz. kit bottle, **ONLY 50c.** Large economy 8-oz. bottle **\$1.00.** At your dealer's or postpaid.

BROWNELL INDUSTRIES, Dept. P10 Montezuma, Iowa

**MODEL MAKERS,
HOME HOBBISTS,
SPORTSMEN**

Attention! Protect your tools and equipment from the abuse of handling, use and storage. SHEATH withstands indefinite storage anywhere, counteracts elements — keeps new gear new—makes old look better, last longer.

150 MPH MODEL AIRPLANE

Improve your kit model or design and calculate your own prizewinning plane. Simplified scientifically correct aerodynamic charts. Complete easy to use instructions. **\$2.00 POSTPAID.**

INTERNATIONAL RESEARCH

P.O. Box 988 **Los Angeles 53, Calif.**

METALLIZE BABY SHOES

Learn this easy, money making business from nationally recognized consultant. Small investment; perpetual market. For free details write Joseph B. Kushner, B.S. Ch.E., Metal Finishing Consultant, Stroudsburg, Pennsylvania, RD3R.

**NO HUFFING... NO PUFFING
with this Jim Dandy... GUARANTEED
SELF-BLOWING Alcohol BLOW TORCH**



This is the handiest little dandy you ever used. No workshop is complete without one. Gives a pointed flame of concentrated heat of over 1400° F. Made entirely of brass and nickel plated throughout. Leakproof construction insures long life flame and maximum pressure. Priming is automatic. Operates about 1/4 of an hour on each alcohol filling. Operation starts within 15 seconds and it remains working for about 1/4 of an hour. Immediate deliveries.

\$1.75
ea.
plus 10¢ for postage.
Check or M.O.

BRAFTEX CO 1123 BROADWAY NEW YORK 10, N. Y. **DEPT. 202**



The New Remarkable Martin Outboard Motor gives you everything you'd expect in a fine outboard . . . **PLUS** many exclusive features!

The new MARTIN "60" Outboard Motor is a sensational alternate firing twin, with full reverse **PLUS** an amazing combination of extra features, to be found **ONLY** in the new MARTIN "60":

Mechanically Controlled Poppet Valves give MARTIN operators mile-an-hour trolling . . . or top speed cruising!

Unusual Horsepower. More than one horsepower for each 61bs. of motor wt. (Wt. only 42 lbs.—MARTIN develops 7.2 H.P.!)

Easy Grip Clamp Screw Handles. Easily reached and operated . . . easy to grasp.

Durable Baked Enamel Finish and special aluminum lacquer insure added life and beauty . . . prevent corrosion.

3 Resting Positions. "Ears" at 4 corners give motor 3 resting positions . . . **PLUS** added protection, easy packing!

Hollow Drive Shaft gives lightness plus strength where it's most needed.

New Manifold insures virtually flood-proof starting.

Exclusive Patented Full Swivel facilitates checking lower unit without reaching into the water. **ENTIRE MOTOR MAY BE TURNED END-FOR-END!** For roomier boating, motor may be left in crosswise position and tilted backward out of boat.

Exclusive Combined Filler Cap, Air Vent and Spare Shear Pin Clip. Can't come loose, can't rattle. Opened effortlessly. Under side holds two spare shear pins. Built in, leak-proof air vent.

MARTIN Vertical Stern Adjustment—a few turns of the knob to achieve correct vertical motor position. Adjustment can be made while boat is under way!



It's the motor that has everything . . . **PLUS**

Martin

OUTBOARD MOTORS

MARTIN MOTORS, Eau Claire, Wis.
Division of National Pressure Cooker Co.

SAY YOU SAW IT IN POPULAR MECHANICS

WORKSHOP WISDOM

Gluing rickety porch chairs

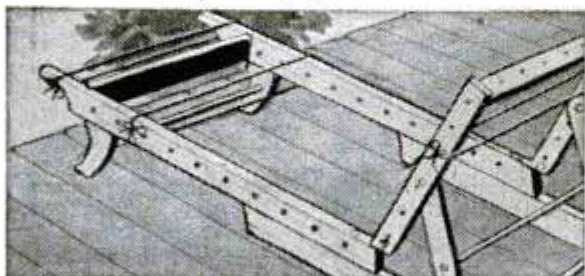

Porch and garden sets need an outdoor glue for lasting repair, a glue which will withstand repeated soaking and drying.

CASCOPHEN is the outdoor glue that makes rickety porch and garden sets snap back "solid as new." *Binds and weather-proofs simultaneously.*

To repair all wooden furniture:

Take loose chair or table apart.

Clean out old glue, then re-glue, coating both parts of a joint.

Bind with heavy cord. Let set according to directions on package.

Important—for outdoor furniture use CASCOPHEN—protects joints from weather, moisture, etc.

—for indoor furniture use CASCO—the standard household repair glue.

For veneering and stain-free gluing of fine cabinet work use CASCAMITE.

Highly water- and moisture-resistant. Forms bond strong as wood itself. Has many repair and model-building uses.

Get CASCOPHEN, CASCAMITE, and CASCO—at your hardware, paint, and lumber dealers.

WRITE FOR FREE GLUING GUIDE—contains many household repair and gluing hints. Address a post card to: Casein Company of America, Dept. PM-06, 350 Madison Ave., New York 17, N. Y.

CASCOPHEN



and cruiser stern, gives a glimpse into the future of streamlined ships. Among the many engineering advancements built into the ship is a new method of dispersing smoke and gases above the deck. The ship is air conditioned, even to crew's quarters. Casement windows replace the usual portholes in the staterooms.

Passenger-cargo combination ships are popular on the South American runs. The Grace Line's nine new ships are to be of this type. These follow the basic design of the C-2, another wartime cargo ship slightly smaller than the C-3, but with a greater cruising radius. The Grace Line ships will have a speed of 15½ knots on 80 percent of their 6000 horsepower. They will carry 52 passengers and a crew of 76. They are air conditioned and offer many facilities normally found only on premium transatlantic ships. The staterooms are provided with studio beds and furnishings which give them the daytime appearance of living rooms.

Safety has not been forgotten. The ships are equipped with the most modern fire detection, safety and navigation devices. Radar equipment will be added as soon as it is ascertained which type will best meet requirements. Radar already has been installed on many passenger liners. One of the most decisive weapons of the war, it also played an important part in the return of troops to the United States. Almost all of our troop-transport ships were radar equipped. Several disasters were averted by the efficient use of radar which spotted floating mines that had broken loose from their moorings following a storm. Official Army reports showed that the Rensselaer Victory, the India Victory and the Kokomo Victory, ships that normally carried 1500 or more troops, had spotted the mines on their radar indicators and thus were able to change course in time to prevent a collision and possible disaster.

In passenger ships, radar will eliminate the delays caused by bad weather, and to a great extent will avoid reducing speed during periods of poor visibility and waiting outside harbors for fog to lift.

The new ships for tomorrow's passengers are not going to be pipe dreams, but in many respects they will offer startling innovations in shipbuilding. Ship speeds are being increased, cutting prewar schedules in half in some cases. Nearly all ships feature outside cabins with private baths, air conditioning and more space and light. New light metal, plastics and glass will be in evidence.

Some time next year you should be able to see for yourself.

HE LEARNED THE HARD WAY by FRANK WILLIAMS

DAVE "BOO" FERRISS-

PITCHING STAR
OF THE
BOSTON
RED SOX!

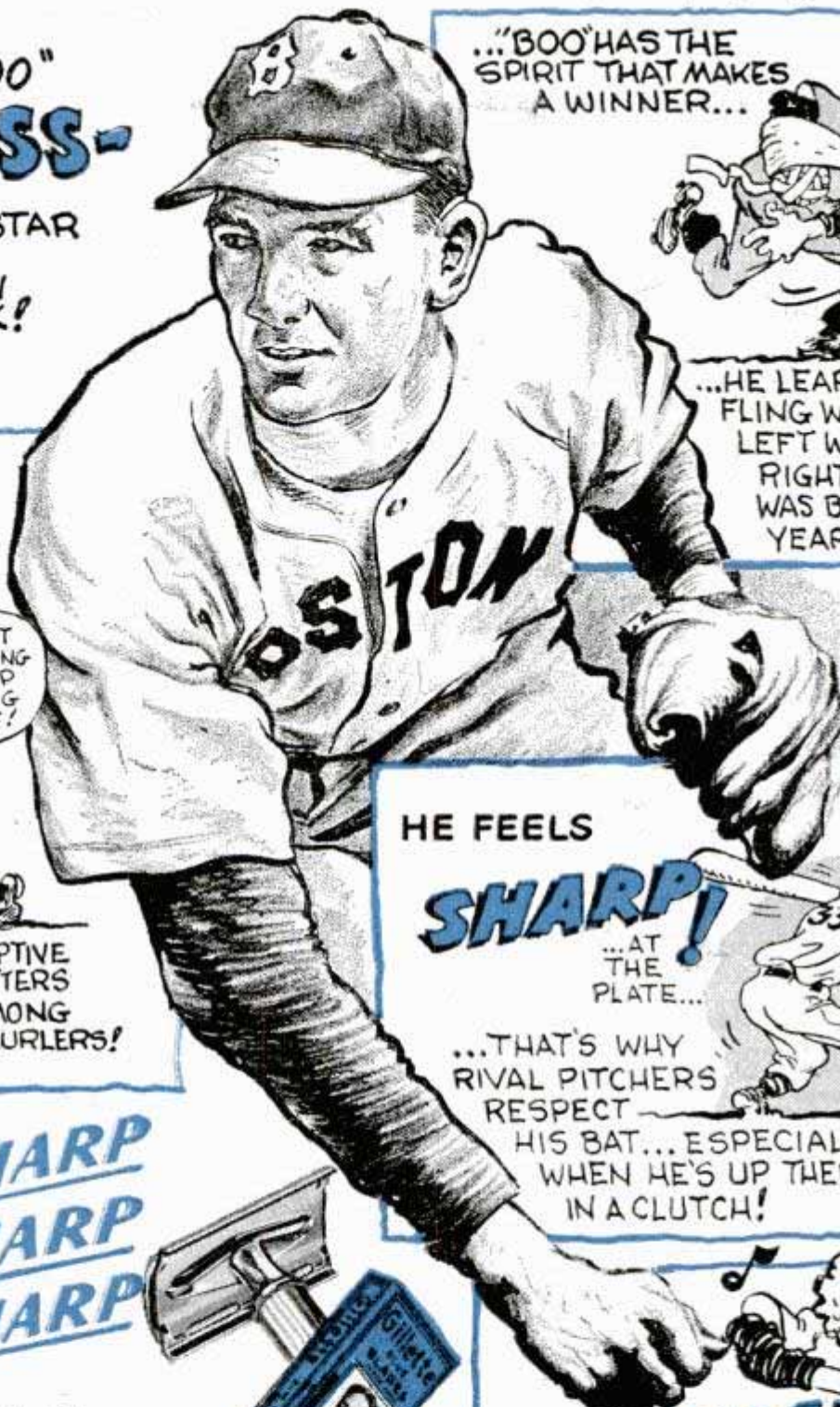

... "BOO" HAS THE
SPIRIT THAT MAKES
A WINNER...



... HE LEARNED TO
FLING WITH HIS
LEFT WHEN HIS
RIGHT ARM
WAS BROKEN
YEARS AGO!

HE LOOKS
SHARP!

... HASN'T
GOT A THING
- I KEEP
TELLING
M' SELF!



... SHOOTING HIS DECEPTIVE
SINKER BY THE BATTERS
TO WIN A SPOT AMONG
THE SEASON'S BEST HURLERS!

HE FEELS

SHARP!

... AT
THE
PLATE...



... THAT'S WHY
RIVAL PITCHERS
RESPECT
HIS BAT... ESPECIALLY
WHEN HE'S UP THERE
IN A CLUTCH!

look **SHARP**
feel **SHARP**
be **SHARP**

use
Gillette
Blue Blades
with the **SHARPEST** edges
ever honed!



**5 for
25¢**

ENJOY BOXING
FRIDAYS AT
10 PM EST OVER ABC NETWORK. GILLETTE'S CAVALCADE OF
SPORTS ALSO AIRS WORLD SERIES AND OTHER CLASSICS YEAR'ROUND.

HE IS **SHARP!**
DAVE GETS THE SLICKEST-LOOKING
SHAVES IN THE BOOK... THE QUICKEST
AND EASIEST... AND SAVES MONEY,
TOO! ... YOU BET -
HE USES LONG-LASTING
GILLETTE BLUE BLADES
WITH THE **SHARPEST** EDGES
EVER HONED!

Gillette Safety Razor Company, Boston 6, Mass.

Copyright, 1946, by Gillette Safety Razor Company.



HANDKERCHIEF TEST

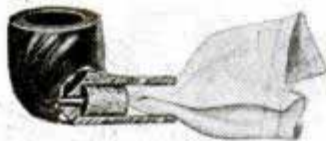

PROVES VITAL ZONE SPOTLESS
AND FREE FROM "GOO"—no matter
how often you smoke it!

Wm. DEMUTH & CO. Inc., N. Y. 22



HESSON GUARD MILANO

**STRIPE
WITH
PAINT
EASY
AS
USING
A
PENCIL**

PAINTERS' STRIPING TOOL

NOW you can do your own expert striping on furniture, bikes, model planes, bulletins, autos, toys, signs, linoleum, wall board... make plain walls look like tile! It's easy to paint straight, curved, circular, even parallel lines with any color. Handiest paint tool in your workshop! Type "M" Master Painters' Striping Tool complete with tip for 1/16" stripe, \$1.00. Extra tips 1/64", 1/32", 3/64", 1/16", 5/64", 3/32", 1/8"—75c each. Tool with complete set of 7 tips \$5.00. (C.O.D. orders 25c extra.) WENDELL MFG. CO., 4234 - 13 Lincoln Ave., Chicago 18, Ill.

**A TOOL...
NOT A BRUSH**

Dealers
Write
Today!

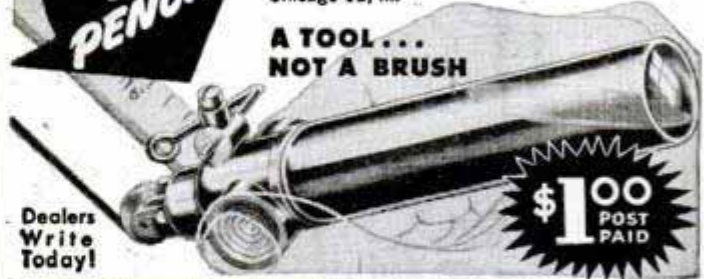

**\$1.00
POST
PAID**

Sand Casting—Forging—Heat Treating—Case Hardening

BRONZE FOUNDRY



is again available in limited quantity without priority. Orders filled in sequence as received. INVENTORS—SCHOOLS—CRAFTSMEN use FOUNDRYETTE for making castings quickly for new inventions, for instruction, and general purpose. Order now for early delivery. Three sizes are available capable of making bronze castings of 1½, 3, and 6 pounds weight, aluminum, copper, brass, etc., \$17.50, \$24.00, \$34.50, l.o.b. Kansas City. Domestic gas supply and 110 volt AC or DC energy required for operation. Write for circular.

KANSAS CITY SPECIALTIES CO.

Box 6022, Dept. P-71

Kansas City, Mo.

"WONTWIST" ANIMAL TETHER



SAFE FOR ALL ANIMALS, BALL REVOLVES IN ALL DIRECTIONS. Send Check or Money Order \$2.95. Price Includes Delivery Charges

AT LAST YOU CAN TIE-OUT YOUR ANIMAL SAFELY!

STRONG EFFICIENT



THE HAYDEN CO., Bryn Mawr, Pa.



NEW OTTAWA Wood Saw

FOR TRACTORS Makes wood sawing fast; easy. Cuts enough wood to pay for itself quickly. Easily moved while attached. Big blade; free details.

LOW PRICE

OTTAWA MFG. CO., W-1027 Oak Ave., Ottawa, Kans.

WRITE FOR YOUR FREE COPY OF THE NEW KRW HYDRAULIC PRESS BOOK

Describes all manner of Production and Shop Work on KRW Hydraulic and Bench Type Arbor Presses. 32 pages illustrating the new KRW Hand-operated, Electric-operated and Air-operated Hydraulic Presses.

Write for your copy today.



K. R. WILSON, DEPT. 17, 215 MAIN ST., BUFFALO 3, N. Y.

Builders of Shop Equipment for Ford Dealers Since 1916

Have Fun and Win Popularity THROUGH MUSIC!



Don't envy the fellow who plays an instrument... You, too, can be popular and have fun *making music!* You can entertain others... be the "life of the party." Playing a wind instrument is *easy...* and *it's a lot more fun than just listening!* Anyone who can whistle a tune can play a new Conn. The fingering is simple and the scale comes easily because of exclusive, patented Conn features and advanced design. *Get all the thrilling details.* See for yourself how *you* can have fun and win popularity through music. See your friendly Conn dealer, or write direct to Conn for FREE copies of the profusely illustrated, interesting books shown at right. Do it today.
CONN BAND INSTRUMENT DIVISION ¹⁹¹⁴

Write... FOR FREE BOOKS

TEEN-AGERS—Ask for "Fun and Popularity Through Music." Ideas and examples of how *you* can enjoy advantages and opportunities which playing a wind instrument provides.

PARENTS—Ask for "Music, The Emotional Outlet for Youth." An important guide in rearing children that is widely acclaimed by authorities on youth problems.



CONN BAND INSTRUMENT DIVISION,
C. G. Conn Ltd.,
1031 Conn Building, Elkhart, Indiana.

Without obligation, please send FREE Book checked below.

- "Fun and Popularity Through Music"
 "Music, The Emotional Outlet for Youth"

NAME _____

ADDRESS _____

CITY _____ ZONE _____ STATE _____

WORLD'S LARGEST MANUFACTURERS OF BAND INSTRUMENTS

it's **FREE!**



**BIG
RADIO
and
ELECTRONIC
CATALOG**

SEND FOR IT TODAY!

It's on the press! ... 144 pages packed with the latest in radio parts, radio sets, ham gear and test equipment. This big new Lafayette Catalog will offer you the most complete line of everything that's new in radio and electronics. *Plus* an added extra . . . a special bargain section that lists hundreds of surplus, standard-make radio and electronic parts at money-saving prices. Mail the coupon below **NOW** - reserve your **FREE** copy - and cash in on these smashing radio values!

- Hundreds of hard-to-get parts
- Build-it-yourself-kits
- Radio sets and combinations
- The newest in ham gear
- Standard parts and leading brands

**25
Years
of
VALUES**

LAFAYETTE Radio

RADIO WIRE TELEVISION INC.
100 Sixth Ave., New York 13
Boston 10 • Newark 2

LAFAYETTE RADIO, Dep't LJ-6
100 Sixth Ave., New York 13, N.Y.
Reserve my FREE copy of the big, Lafayette Catalog and send as soon as ready.

NAME.....
ADDRESS.....
CITY.....ZONE.....STATE.....

PASTE ON PENNY POSTCARD. MAIL TODAY!

Throwing Light on Mother Nature

(Continued from page 128)

to four months costs from .9 to .006 cent per flower. This is a small fraction of the increased price for out-of-season flowers.

Tests made at Purdue University by Robert B. Withrow, associate professor of biophysics, and his wife, Mrs. Alice P. Withrow, research assistant at the Agricultural Experiment Station, have supplied a vast amount of data on the use of artificial light in horticulture. They found that sufficient light to advance the blooming of most greenhouse plants was supplied by low light intensities produced by 15 to 40-watt Mazda lamps. Also, they discovered that one lamp will light as much as 30 square feet of bench space. Good results were reported when lights were automatically turned on for four to six hours nightly.

Electric lights are used even in hotbeds to speed up the growth of seedlings. Experiments conducted by General Electric revealed that eight 15-watt bulbs, plus a 60-foot electric soil heating cable, produced in 60 days various seedlings whose stems often were twice as long as seedlings grown in a manure hotbed.

At Bradley Beach, N. J., newly seeded golf greens were floodlighted at night to hasten the growth of grass and make the greens playable as quickly as possible. Not only was the growth hurried, but toughness and quality of the grass were improved.

Artificial light is used by some aquariums to stimulate the growth of plants on which fish feed. The U. S. Department of Agriculture and Cornell and Ohio Universities have grown plants entirely under artificial illumination in rooms with closely controlled temperature and humidity.

In apartments with few windows, combination floor lamps and plant holders supply light for reading and at the same time disperse light energy to the plants.

As a result of advances in electrical horticulture and nutriculture (chemically growing plants in water or fine gravel), the advantages of Mother Nature are being duplicated and the disadvantages eliminated.

Maybe the day is not far away when perfect plants will be produced in windowless greenhouses in which everything is controlled—light, temperature, humidity—and germ-killing rays will eliminate airborne bacteria.

☞The Eye-Bank for Sight Restoration, Inc., is establishing "banks" throughout the U. S. to supply healthy corneal tissue for graft operations on the blind.

ATTENTION!

**MODEL MAKERS,
EXPERIMENTERS,
INVENTORS**

NOTE THIS
MINIATURE BALL-BEARING
ELECTRIC MOTOR

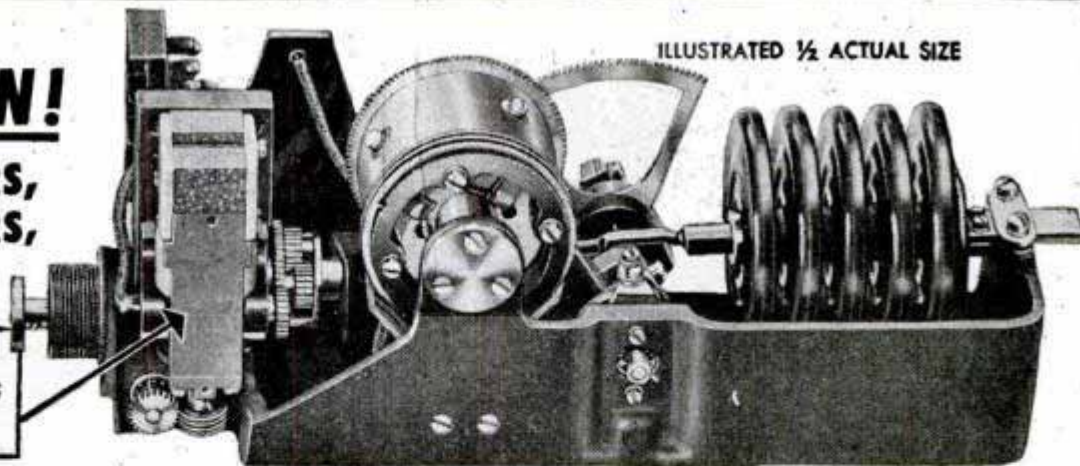

ILLUSTRATED 1/2 ACTUAL SIZE

THE ARMY PAID \$300.00 ... you pay only 4.95

AN INGENUOUS PRECISION INSTRUMENT

This Barometric Motor-Actuated Altitude Control (a component part of the famed, hitherto-secret SPERRY GYRO AIRPLANE PILOT) kept our huge bombers at a constant altitude. A miracle of electricity and physics, with a wealth of fascinating precision parts that can be reworked into many a gadget by the model-maker and experimenter. Over-all size, 9" x 4 1/2" x 3 3/4" ... weight, 2 3/4 lbs. *Each instrument brand new, in original Government packing!* Note particularly the MARVELOUS miniature electric motor, *half the size of a safety match-box!* ... alone worth much more than our price for the entire unit! Operates on 6 to 24 volts DC, equipped with ball-bearing armature and worm gear; ideal for powering miniature boats, locomotives, working models. Among the other parts is an aneroid barometer mechanism that might be remounted and calibrated ... a miniature geared differential ... a geared magnetic signal pickoff (with collector rings and solid silver brushes) adaptable as a small cable-drum or continuous rotary contact ... 14 miniature ball-bearing races ... gears, shafts, other precision parts ... all mounted on metallic magnesium chassis.

No wonder this instrument cost the Army \$300! *What a buy at only \$4.95, postpaid.* Send check or money order. No C.O.D.'s.

4.95
POSTPAID
ANYWHERE
IN U.S. OR
CANADA

Please send me.....Instruments @ \$4.95

NAME.....

ADDRESS.....

CITY.....STATE.....

THE NEWMAN-STERN CO. • CLEVELAND 14, OHIO

BUILD YOUR OWN Food Freezer SAVE UP TO \$300

Easy -to- follow drawings, instructions, and material lists of 4 cabinet sizes. Net storage 525-1200 lbs. No technical knowledge required. Can be made with ordinary tools and materials. Highly efficient economical operation. Sectional construction — easily moved.



Four Sizes: 15, 21, 27, 34 cu. ft.
PLANS \$1

FOOD FREEZER ENGINEERS Box 3322 Dept. B106 St. Paul, Minn.

VETERANS! YOUR DOG TAGS ARE VALUABLE!



To get a Pension, Loan, Compensation or Schooling, etc., you must produce your Individual Service Serial Number which appears on your Dog Tags. Your tag also serves as immediate Proof of Service or Identification. Its value to you, merely as a souvenir is actually priceless!

● PRESERVE THIS PRECIOUS MEDAL!

We will mount and seal your Dog Tag inside air-tite, unbreakable, clear Lucite and attach it to a sturdy key chain.

Sealed inside the unbreakable Lucite block, your Dog Tag remains in brand new condition forever, and with your keys, always ready to serve you quietly.

RARE COIN COLLECTORS! Take advantage of this new sealing process and your preserving problem is solved!

MEDAL WINNERS! Now you can carry that hard won award wherever you go! No more scratches! No more tarnishing! Sealed inside unbreakable Lucite your medal retains its sparkling brand new appearance forever. Attached to your key chain you have it with you to show whenever the occasion arises.

SEND NO MONEY! Pay postman only \$1.00 plus postage C. O. D. for each processed item; but ACT NOW! Address:

MAR-LYN SPECIALTIES
P.O. Box 1917 Wilshire La Brea Sta.
LOS ANGELES 36, CALIFORNIA



Start a SAW REPAIR BUSINESS!

MAKE A GOOD LIVING IN YOUR OWN BUSINESS —sharpening saws with the Foley Automatic Saw Filer. It makes old saws cut like new again. All hand saws, also band saws and cross-cut circular saws can be filed on this ONE machine.

THERE ARE HUNDREDS OF SAWS TO BE FILED in your own neighborhood, used by farmers, carpenters, homes, schools, factories, etc. W. L. Tarrant writes: "I left my old job last September and in 10 months have filed 2,159 saws. We have a lovely business worked up and cannot keep up with the work."

SEND FOR FREE PLAN—Shows how to start this steady cash business. No experience needed, no eyestrain, no canvassing. Send coupon today.

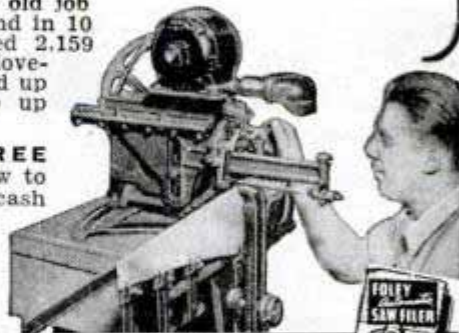

FOLEY Automatic SAW FILER

FOLEY MANUFACTURING CO.
1016-6 Foley Bldg., Minneapolis 13, Minnesota
Send Free Plan on Saw Filing business, no obligation

Name _____
Address _____

**Build
Your
Own..**

**• RADIO •
INTERCOM
AMPLIFIER
TRANSMITTER**

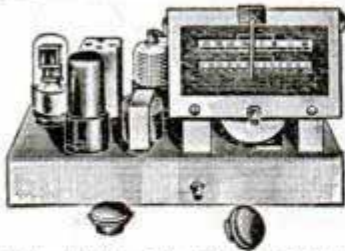

**Famous
POPULAR
MECHANICS
and other KITS**

Enjoy thrill of building your own equipment from famous Popular Mechanics, Concord and other radio training Kits—ideal for home radio study and experimenting, and for classroom, radio club and Boy Scout radio training projects. 25 different Kits, various types, each including all parts, hardware, diagrams and instructions, now available from CONCORD.

MAIL COUPON FOR FREE CATALOG

Fill out and mail coupon below for new complete Concord Catalog listing famous Popular Mechanics and many other Radio Kits—plus complete line postwar-designed Radio Sets and Radio Parts, supplies and equipment for every need. Mail coupon for your free copy—NOW.

CONCORD RADIO CORP.

LAFAYETTE RADIO CORPORATION

CHICAGO 7, ILL. 901 W. Jackson Blvd. • 265 Peachtree St. ATLANTA 3, GA.

CONCORD RADIO CORPORATION, Dept. P-106
901 W. Jackson Blvd., Chicago 7, Ill.
Rush FREE copy of new, complete Concord Catalog.

Name.....
Address.....
City..... State.....



"In your opinion, which make of hand saw is highest in quality?" Thousands of carpenters were asked that question. Three out of four replied, "Disston saws" ... a high tribute indeed, for it comes from men who know saws best.

The reasons for this preference may be summed up in what one carpenter says, "You can't beat a Disston for good, clean cutting and long life."

Ask your Hardware Retailer for a fine looking, fine performing Disston Saw. Also ask him for a FREE copy of "The Disston Saw, Tool and File Manual," or write to us direct.



HENRY DISSTON & SONS, INC.

1011 Tacony, Philadelphia 35, Pa., U. S. A.

DISSTON The saw most
Carpenters use

Superior Quality

**ROTARY
FILES
FOR HOME
CRAFTSMEN**



The nationally famous Ford Rotary Files, used for the past 25 years by leading precision manufacturers, are now available for the home craftsman in a handy dust proof case which contains six popular shaped tools.

The tools are made of the finest quality high-speed steel, hardened and tempered for maximum life. These ground cutters are efficient on steel, aluminum, brass, plastic or wood. The shapes will meet most home craftsman applications. These tools are made with standard 1/8-inch shank. Additional shapes and sizes are available.

Money with order prepaid

C.O.D.—postage extra

SIX TOOLS in Dust Proof Case \$6.25

M. A. FORD MFG. CO.

800 WEST FIRST STREET
DAVENPORT, IOWA

**FIND UNDERGROUND
MINERALS
and METALS
with M-SCOPE**



Employs same principle as Army Mine Detector. Unsurpassed in Efficiency. Write for Free 16 page booklet.

**FISHER RESEARCH LABORATORY
PALO ALTO CALIFORNIA**

SHARPER CUTTING EDGES!
Easy • Accurate • Quick

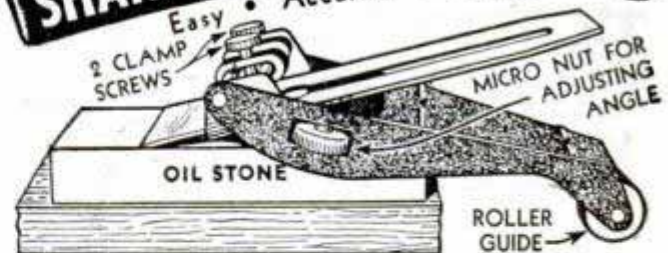

It's easy to hone keen cutting edges on your chisels and plane blades. Precision adjustment for ANY ANGLE of bevel. Roller glide makes every stroke uniform across oil stone. Light, strong—ideal for home craftsmen, hobbyists, carpenters, cabinet makers.

check or money order
\$2.95

POST PAID

McLAREN INDUSTRIES, INC., Box 606, TROY, N. Y.



**Why be an
ABECEDARIAN***

25c

*Webster says it's a tyro, a beginner, a novice, i.e., one who hasn't read Hodgman's 1946 Handy Book of Sportsmen's Secrets—the latest, biggest issue, sparkling with 168 pages of authentic, little known outdoor tricks—bulging with facts, crowded with dope on how to cram your creel and garnish your game bag. Order your copy now—it will be off the press soon. Only 25c—or a special DeLux edition for \$1.00.

HODGMAN RUBBER CO.
Paul St. Framingham, Mass.



LUMINOUS
MEASURE IN THE DARK
 WITH *Lumi-Rule*

SAVE YOUR EYES! USE IT IN POOR LIGHT

USE IT IN THE DARK ROOM • FOR NIGHT FISHING
 FOR PLUMBERS, MECHANICS • IN THE HOME ETC.,
 Indestructible, Waterproof, Made of highest quality
 plastics, Money back guarantee,
 Sent anywhere in U.S. or Canada 12 inch size \$1.00
 on receipt of remittance. 18 inch size \$1.50

CARBOGRAPHIC STUDIOS
 800 N. CLARK ST., CHICAGO 10, ILL.

ALCRAFT RADIO
BUILT IN ONE HOUR!

You can assemble this all-electric 2-tube radio in about an hour. Receives local and long distance stations with excellent volume. So sensitive it receives many stations without an antenna. No ground connection ever required. The Aircraft Radio is furnished with 2 high quality tubes, and finest 1946 reproducer unit. There is nothing else to buy!

The Aircraft kit includes, steel chassis and panel with large gold finish dial, tube sockets, volume control, tuning condenser, coils, knobs, electrolytic condensers, cord and plug, hook-up wire and solder, plus all hardware, resistors, etc.

Supply of Aircraft Radio kits is limited. Order today at only \$5.95. We will ship prepaid.

Algonquin Parts, Inc., Darien, Conn.



2-TUBE MIDGET
 ALL-ELECTRIC
ONLY \$5.95
 Nothing else to buy!

BUILD Boucher MODELS

CLIPPER TANKER FREIGHTER
Everything for the Model Ship Builder Since 1905

34 DIFFERENT
 MODEL KITS
 \$5 to \$35

Send 35c for 96
 PAGE ILLUSTRATED
 CATALOGUE

BOUCHER SHIP MODELS 36 EAST 12th ST. NEW YORK, 3, N.Y.

BURNED OUT or BROKEN ELECTRIC

HEATING ELEMENTS REPAIRED
 WITH NEW AMAZING NICHROCITE

Simply overlap ends, apply Nichrocite Paste and turn on current. Used by large utility companies. Trial order, \$1.00; 4 oz., \$2.50; 1 pound, \$8.00.

ARROWHEAD SALES
 406 Phoenix Bldg. Minneapolis, Minn.



YOU NEED THESE CRAFTSMAN'S TOOLS
SUPER DRILL GRINDER SUPER ARBOR SUPER HACKSAW

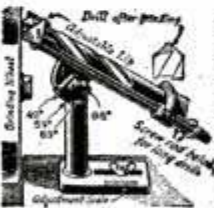

Sharpens round shank drills from 3/32" to 1 1/16" diameter. Grinds Old Drills like new in 4 different drill point angles. Grinds Short, Medium and Long Twist Drills from 1 1/2" up to 11" long, for hand or power grinding wheels.

100,000 IN USE!

Grinds your drills like factory in 25 seconds. Gives perfect center and clearance. Saves drills, time and money. No shop should be without the Super Drill Grinder. Guaranteed to do the work or money back. The Grinder that gives a round point!

Only
\$2.95

(PATENT PENDING)
 A combination drilling or grinding wheel attachment. For 3/8" motor shafts. Will take grinding wheel with 1" hole on shaft and 3/8" hole on small end. Extension can be used for rag or wire wheel, or 3/4", 24-thread drill chuck which holds drills from No. 60 to 3/4" in diameter. Right hand thread only.

Price Only
\$1.50

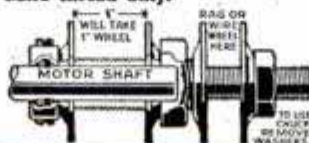

AND FLAT DIE FILE HOLDER

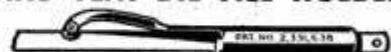

The tool with 100 uses! Holds broken hacksaw blades—used by mechanics, electricians, plumbers, auto mechanics, hobbyists and repairmen. Perfect for all-round household needs; ideal for difficult close-quarter work. Nothing like it for tool and die men. Price, without saw blade.

Only
95c

At Your Dealer's or Postpaid
CRANDALL MFG. CO.
 1512 West Slauson, Dept. FA-10
 Los Angeles 44, Calif.

Sweetener

because you never
 draw through
**RANK, BITING
 MOISTURE**



PAT. NO.
 2,166,537



An exclusive

Smokemaster
feature . . .

Here's the pipe that's winning new friends daily — because it's the pipe that *sidetracks pleasure-robbing moisture!*

Note its patented stem. The aluminum tube through which smoke passes is slit at the bottom, and under it a folded pipe cleaner absorbs all moisture as it condenses in the tube. Result — a clean, mellow, friendly smoke that leaves you thoroughly satisfied.

Smokemaster offers so much more in smoking pleasure, that you'll want to enjoy it without delay. Ask your dealer to show you his selection of models.

Smokemaster Custom-made \$1.50

Smokemaster Standard \$1.00

Briarcraft, Inc., 347 Fifth Ave., New York 16, N.Y.

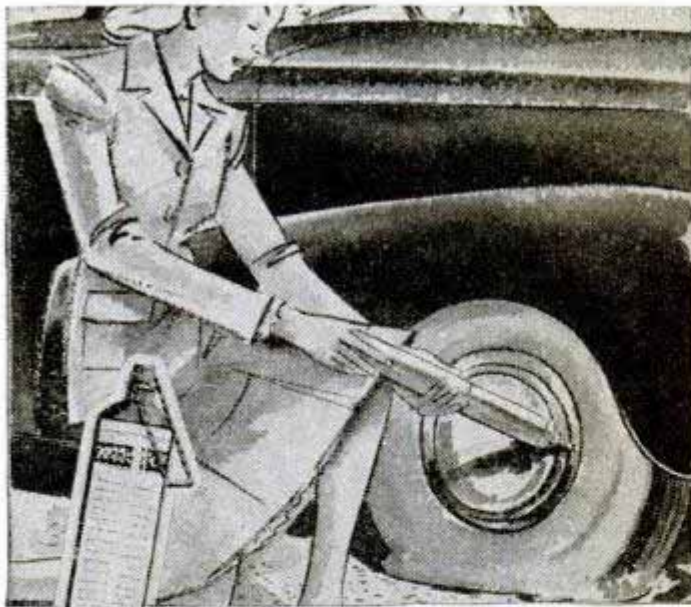

Instant Pressure for Flat Tires!

Always ready for an emergency, this small, convenient cartridge of CO₂ gas contains enough pressure to inflate 3 flat tires. You can avoid most roadside tire changing. Saves time and tire damage—the most convenient auto accessory ever developed. Can be refilled for only \$1.00.

Ready to Put Out Fires, Too

CO₂ gas is a perfect fire extinguisher. It smothers even gasoline and electrical fires with a harmless vapor. Pressure for tires—Safety from fires. Send check (or M.O.) for \$5.00.

POSTPAID ANYWHERE

\$5.00

BREAKSTONE & CO.

2155 W. Harrison St.

Chicago 12, Illinois

BOYS! Have fun with CHEMCRAFT!



FREE-

This exciting new book



Send today for new, FREE Chemcraft Chemistry book—"The Wonders of Chemistry". Shows how to amaze friends and family with chemical magic. Describes many fascinating home experiments like making perfume, windshield cleaner, soap, etc. Loads of fun, thrills, excitement and adventure await boys who start now to obtain knowledge of Chemistry. Act now! Send for FREE Chemcraft Chemistry book—TODAY!

CHEMCRAFT
America's Leading Chemistry Outfits

REG. U. S. PAT. OFF.

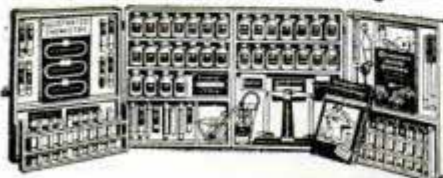

Sold in the best stores all over the country. Address below for your FREE copy of "THE WONDERS OF CHEMISTRY."

THE PORTER CHEMICAL COMPANY
55 Prospect Avenue • Hagerstown, Md.

Power From Atoms: How Soon?

(Continued from page 93)

for creation of stationary atomic energy plants on land and there are definite possibilities for the use of such plants on ships.

The piles such as those at Hanford that make plutonium for atomic bombs also produce heat in quantity. Heat is, of course, one form of energy. At present the heat of these piles is dissipated through use of cooling water. The reason for this is that the piles were built to make plutonium for atomic bombs and not to make power.

However, the water used for cooling piles could be converted into steam which in turn could be used for generation of electricity. Such steam would be radioactive and in general not suited to use for steam heating or purposes other than to generate electricity. The radioactive steam could be used to convert additional water into steam of lower pressure; the steam so generated would not be radioactive, at least to an appreciable degree. As an alternative to generation of steam, an inert gas may be used as a cooling means for the pile and the hot inert gas under pressure passed through a gas turbine to generate electricity. In either case the electricity could be fed by wire to cities or industries.

Obviously, therefore, it would not be necessary for industries to discard their present machinery with the coming of a new era, for the power they would receive would be in the same form as the power they now use.

The fifth major problem is: Will atomic energy be commercially economic?

To supplant oil and coal as a means of producing power, energy must be produced from atomic reactions at less cost than energy produced from conventional fuels. Atomic powerhouses will probably require somewhat greater investment than power based on oil or coal. To attract capital, atomic energy must be produced at sufficiently lower cost than energy from oil or coal to bring a return on the greater investment that may be required.

The cost of production of pure uranium 235, even if produced in improved plants, will be high, amounting to perhaps \$40,000 to \$50,000 per pound. From the standpoint of heat, this would be equivalent to fuel oil at about \$8.00 per barrel, compared to the present selling price in New York Harbor of \$1.72 per barrel as of July 1, 1946. Normal uranium—which can be used for production of power at central power stations or in ships—contains about 0.7 percent of uranium 235. The uranium 235 in a pound

(Continued to page 280)

The first pipe smoke!



Sir Walter Raleigh's servant dashes water on his master, to "put out the fire."
(from an old print—Bettman Archives)

Sir Walter Raleigh, father of pipe smoking, never knew the pleasures of a Sterncrest pipe. Poor chap, he was born too soon to puff an LHS of genuine Imported Briar, vita-fused for sweetness from the first puff.

IMPORTED BRIAR

Model #14 \$5

Dozens of others—antique or smooth finish.

LHS STERNCREST 14K, with gold band, imported briar \$7.50

Other LHS Pipes: \$25, \$10, \$3.50, \$1.50. at all good dealers

The best pipe smoke!



Write for "Pipes—for a World of Pleasure." It's FREE L & H STERN, INC., 56 Pearl St., Brooklyn 1, N.Y.



STERNCREST
STERLING

ZEUS Filter Cigarette Holder is back in Aluminum.

NEW SOLDERING GUN

WELLER SPEED IRON HEATS INSTANTLY



USE SPEED IRON FOR, Home Workshop, Radio Service, Telephone Installation, Electronic and Sound Maintenance, Appliance Repair, Laboratory Work.

New gun type soldering tool produces heat instantly by induction principle in soldering tip. Built-in transformer provides heating current when trigger switch is closed. Fast 5 second heating saves power, saves time, saves tip dressing and burning. Loop type tip is adjustable, gets into corners, lets you see where you are working. Short pistol grip gets you close to work, good balance makes tool very easy to handle. Can solder with aluminum solder or tin-lead solder.

The soldering gun gives you for the first time really fast induction generated heat combined with real convenience of use. For the finest and most advanced soldering tool that money can buy, order a Speed Iron today! Price Complete \$14.95 Postpaid 110 Volt A.C.-60 cycle

ORDER DIRECT

WELLER MFG. CO.

522 Northampton St. Easton, Pa.

MEN WANTED
In Building Industry



Here's a chance to get into one of the future's most profitable and promising businesses... Be a floor surfacing contractor and sand both new and old floors during the coming building boom! Sanders are easy to operate—no big overhead—no large investment—no special schooling... Just the ambition to get ahead and be your own boss. Ask for latest "tell-all" booklet entitled "Opportunities in Floor Surfacing"—use coupon and enclose 25c in coin or stamps to cover handling.

AMERICAN FLOOR SURFACING MACHINE CO.

535 So. St. Clair St. • Toledo 3, Ohio
Gentlemen: Enclosed find 25c in stamps or coin for booklet "Opportunities in Floor Surfacing," telling me how I can start my own floor sanding business.

Name _____
Street _____
City _____ State _____



KILL RATS WITH TAT-ANTU

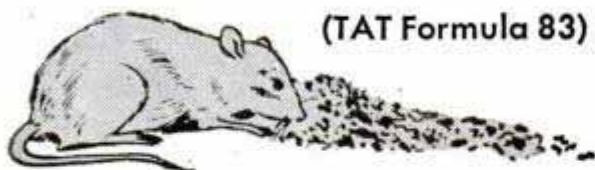

(TAT Formula 83)

• Rid your home of rats and their menace to your health and property. Use TAT Formula 83 . . . SO POWERFUL ONE LICK KILLS RATS. Contains ANTU, remarkably effective new rodenticide, tested and used by U. S. Public Health Service.

• Ready to use. No mixing. Tasteless, prebaiting unnecessary. Kills three ways — as feeding bait, drinking bait, and tracking dust. Satisfaction guaranteed or your money back. Get TAT Formula 83 from your dealer. Available in 3 popular sizes. If he cannot supply you, mail coupon below.

O. E. LINCK CO., INC. (PM 10-11-46)
Montclair 1, N. J.

Please send FREE booklet, "Rats — Their Habits and Control." Also \$1.00 can of TAT Formula 83.

\$1.00 Enclosed Send C.O.D.

Name.....

Address.....

City or Town.....

TAT Formula 83

CONTAINING ANTU

RACER POLISHED CAST ALUMINUM

8½ inches long. Shining heavy single unbreakable casting. Free running rubber wheels. Can't rust. Trim, sleek lines. Looks like models selling up to \$12.00. Every youngster wants one.



DEALER INQUIRIES INVITED.
Barton Industrial Products Corp. Dept. 10
P. O. Box 43, Chicago 17, Ill.

SEND \$2.98

FINE TOOLS
NEED
FINE OIL!



• Lubricates



• Prevents Rust

• Cleans • Polishes

SOLD EVERYWHERE

3-IN-ONE Oil

Hundreds of Thousands Drive by HULL Automobile Compass

THE HULL STREAMLINE AUTOMOBILE COMPASS is depended upon by hundreds of thousands of motorists. Why not adopt this sure-way guide? Circular free. At your dealer's. Price \$3.95.

HULL MFG. CO., P.O. Box 246-D11, Warren, Ohio



ONE-MAN SAWMILL LESS THAN \$200⁰⁰

Easy To Turn Trees Into Money

Makes lumber, ties, shingles, crates, lath, studding, siding,

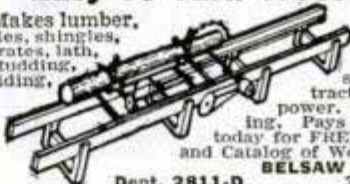

Belsaw Models

in 10, 14, 20, 24 ft.

sawing lengths. Pat-

ented Mechanical Feed, accurate

set works and positive dogs. Use

tractor or old auto engine for low cost

power. Thousands used for commercial saw-

ing. Pays for itself quickly. Send post card

today for FREE booklet, "How To Make Lumber"

and Catalog of Woodworking Equipment.

BELSAW MACHINERY COMPANY

3542 Main Street, Kansas City, Mo.

Dept. 2811-D

PULVEX FLEA POWDER

DDT

now also contains



Kills the fleas QUICKLY!

Keeps others off for days!

Still 25¢ and 50¢



'QUICK-CHANGE' GEAR BOX

CUT THREADS — 4 TO 224 PER INCH

Approximately .003 feed, for fine turning. New reverse furnished with box for Atlas. Bronze bearings throughout entire unit. Aluminum casting — All steel gears. Maintained accuracy. Speeds up production. Easy to install. Simple to set. Immediate delivery.

Only \$75⁰⁰

F.O.B. Chicago
Guaranteed

FOR-Atlas, Logan, Craftsman
and Power-Kraft Lathes

Write for information or order direct. Full instructions with shipment.
O'BRIEN MACHINE CO., Div. 602-B, 1620 Highland Ave., Chicago, Ill.

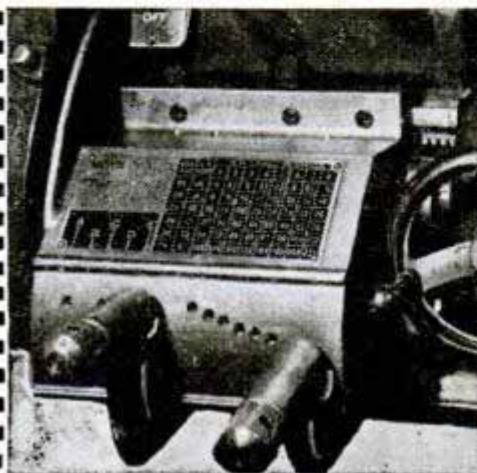

200 PIECE GRINDING KIT ASSORTMENT

For Industry & Home Shop — War Surplus — All New

- 10 ass'td. Grinding wheels with such famous names as NORTON-CARBURUNDUM, etc.
- 5 Cut off wheels ass'td. sizes
- 5 Felt polishing wheels ass'td. sizes 1 to 2 inch
- 5 Round steel brushes with handles—ass'td. widths
- 10 Abrasive cloth cones ass'td. sizes and grits
- 2 Rotary files finest high speed steel
- 5 Mounted grinding points ass'td. on 1/2" shank
- 2 Steel mandrels 3/32 and 1/4
- 6 Felt Bobs square & pointed
- And 150 other items for your shop.

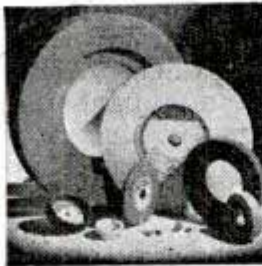

\$6.95
Postpaid in U.S.A.

200 piece complete assortment at sensationally low price of \$6.95 postpaid in U. S. Rush check or money order today.

GROBAN SUPPLY CO. 1522 S. Michigan Ave. Dept. PMO, Chicago 5, Ill.

ALSO LARGE STOCK Surplus Government Grinding Wheels. All New Stock Carburundum, Norton, Macklin at fraction of original list.

- | | |
|--|--|
| 4 1/2 x 1 1/4 x 1 1/2 50 S-3 Carb Alox Rec. 60c ea. | 14 x 4 x 1 1/4 Steel Rim H60 RR C60-15 V; 37 C60-17 V; H60-18 VW. 32-46J for Ex-cell-o or Carboly or Hammond Grinders \$5.00 ea. |
| 6 x 1 1/4 x 1 1/4 Type S 3860-18 BE Rec White Norton 70c ea. | 20 x 2 x 12 Rec sides Red 38461 \$8.00 ea. |
| 10 x 1/2 x 1 1/2 Rubber Cut off wheels. 544 also Shellac Cut off wheels 80 MSL. 60c ea. | 20 x 4 x 12 BW 60-M 48V at sides Face A; N46 E K 35 H Sterling Vit straight \$10.00 ea. |
| 12 x 1/2 x 5 Norton Carb Macklin Beveled edge 1850-1-402 and 5760-16 and 1960-16 and 800 75c ea. | |

All prices subject to prior sale—F.O.B. Chicago

GROBAN SUPPLY CO. 1522 S. Michigan Ave. Dept. PMO, Chicago 5, Ill.

DOWEL TROUBLES?

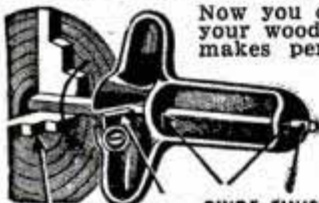

Now you can make dowels that match your wood! Amazing new **SPEE-DOWL** makes perfect, burnished dowels for arrows, cabinet work or other projects. Simply rotate wood in lathe or drill press and push on **SPEE-DOWL** like pencil sharpener. Cast aluminum body, tool steel blade. A necessity for fine craftsmanship. Available in 2, 3, 4, 5, 6, 7, and 8/16" sizes. Only \$1! Send check or M. O. now for your **SPEE DOWL**. Special—any 4 sizes \$3; complete set of 7 for \$5. Unconditionally guaranteed. Free literature.

SPEE-DOWL, Dept. C, 34 Mall Dr., North Plainfield, N. J.

NEW THOR "B" ENGINE—\$9.95

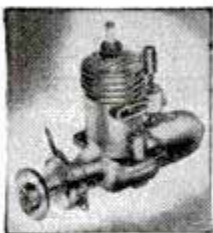

The new **THOR "B"**—Sensational miniature gasoline engine that really works. Super-power performance featuring new presto starting device. Smooth, velvety power that roars into action with a "twist of the wrist." Over 15,000 already sold. 1/6 H.P. Complete with coil, condenser, and fully illustrated instructions, only \$9.95. Ready to run, guaranteed. Powers all models. Send \$1.00—shipped collect same day C.O.D. or send \$10.20 and we ship parcel post insured.

FREE Just off the Press. Send for big 40-page illustrated hobby catalog with over 300 illustrations; over 1,000 listed items. The "Bible" of wide-awake modelers. Write for it now—no obligation, naturally!

AMERICA'S HOBBY CENTER

Dept. B106, 156 W. 22nd St., N.Y. 11, N.Y.



BUILD YOUR OWN FAST FREEZER



It's easy to build this household appliance and profitable to use. Save up to 75%. Operates on 110 or 32 volts. Plans show 5 sizes and are easy to follow. **ENJOY MAKING ONE** of these freezers from new or used parts. No expert knowledge needed. Mail \$1.00 bill or check for complete plans and catalog.

LE JAY MFG., 447 LeJay Bldg., Minneapolis 8, Minn.

5 sizes 8 to 40 cu. ft.

Special

ADVERTISING OFFER
SLIGHT "SECONDS" OF OUR
\$7.50 GOURMET PIPES

Made of the finest IMPORTED VIRGIN BRIAR

These are our regular \$7.50 GOURMET pipes that have slight surface imperfections, which are guaranteed not to impair their wonderful smoking quality. The graining of these Virgin Briars is beautiful.

RUSH YOUR ORDER IN TODAY AND SAVE MONEY.

ONLY \$2.00
POST-PAID



smokes sweet and cool with a delightful flavor

Supply Limited, Order Today.

SEND FOR FREE CATALOG

Fill in and Mail Coupon Today

WALLY FRANK, Ltd.

150 NASSAU ST., NEW YORK 7, N. Y. DEPT. 130

Enclosed find \$2.00 for which send me postpaid one "Second" of the \$7.50 GOURMET pipe as described above. If, upon inspection, I am dissatisfied in any way, I will return the pipe and you will refund my \$2.00.

PRINT NAME AND ADDRESS BELOW

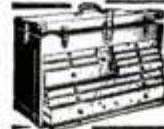

GERSTNER Tool Chests

The proven values of Gerstner chests have made them first choice of Machinists and Toolmakers for 40 years. Free catalog.

GERSTNER TOOL CHESTS
446 Columbia St., Dayton 7, Ohio

Electrically Welded Endless

Paramount

BAND SAW BLADES



Made in widths from 1/8" to 1-3/4"

Make your band saw do more work for you. The proper width of blade will extend the scope of this important machine. Burrill's Paramount Blades are made from tough Nickel Alloy Steel properly tempered. Teeth accurately set and filed, and all saws carefully straightened. Send order and check today. Delivery will be made as promptly as conditions permit, from a few days to a week or two. You can obtain these saws at the following prices:

- 1/2"-3/16"-1/4"-3/8" wide, 5'6" long \$.90 each
- 3/4"-3/16"-1/2"-3/8" wide, 6'6" long95 each
- 1"-3/16"-1/2"-3/8" wide, 7'6" long 1.10 each

Other sizes at proportional prices

ALSO METAL CUTTING BAND SAWS

Made in widths from 1/8" to 3/4"

Your satisfaction is guaranteed

BURRILL SAW & TOOL WORKS

407 E. Main St., Iilon, N.Y.

**Useful
Tools**



This popular
Set will come
in mighty handy

if you work on an  or a



or a



Contains 7

thin wall sockets ranging from
 $\frac{3}{8}$ " to $\frac{1}{4}$ " with $\frac{3}{8}$ " square drive, a Hinge
Handle and Cross Bar, all in a
Steel Box.

Ask your jobber or dealer
for the 40-T set.



STEVENS WALDEN, INC.

WORCESTER, MASSACHUSETTS

IMMEDIATE DELIVERY
1,000 OR 1,000,000

CONGRESS DIAMOND BORED PULLEYS

The CONGRESS pulleys you see on your dealers counter are identical to the pulleys that have been used for years as standard equipment by America's leading industries. They are now available in sizes up to 16" diameter, at your local dealers for use in hobby shops, farm equipment and many other applications.

CONGRESS pulleys increase the performance in your workshop; provide efficient, long wearing service at low initial cost. You pay no more for CONGRESS pulleys than for ordinary pulleys. REMEMBER — You can't buy a better pulley than a CONGRESS pulley.



**LOOK FOR
THIS
DISPLAY
AT YOUR
DEALER'S**

CONGRESS DIE CASTING DIVISION
Detroit 12, Michigan



of normal uranium is the equivalent of 0.7 percent of 6000 barrels of fuel oil, or about 42 barrels. The cost of production of normal uranium metal eventually may be about \$4.00 per pound. On this basis the cost of the uranium 235 in normal uranium from a heat-producing standpoint measured in terms of fuel oil would be around 10 cents per barrel. It can be seen, therefore, that basically atomic energy can be cheap providing it may be economically liberated and converted into a usable form of energy such as electricity.

This is the problem for the future; from here on getting power from atoms is primarily a development and engineering problem for it may be said to be largely out of the research phase.

The problems presented here are not regarded as insurmountable. Indeed, if economic application were certain enough to warrant the manpower and facilities necessary, it is conceivable that we might have atomic power within three years.

At the outset, it might be immediately practicable in those isolated sections of the world where transportation makes the costs of other sources of energy such as coal, oil or water power comparatively high.

For ships, particularly naval vessels, atomic energy is of real interest since here the need for carrying a heavy load of fuel oil as well as the need for frequent refueling could be eliminated.

Of the five problems discussed, those dealing with control, protection from radiation and adequate supply of raw materials may be considered as essentially solved, so far as they concern large installations such as would be used in central powerhouses and on ships. The two remaining problems, that is, how to convert atomic energy into useful energy and the economics of so doing, are definitely related and their solution from the standpoint of commercial energy is a challenge to the development and engineering skill of the world.

In addition to the opportunities offered for more economic large-scale generation of power, atomic power can give us new substances we never have known before.

Already atomic by-products — the particles made available by the splitting of the atom — are doing service in laboratories and medical research. New radioactive materials and isotopes produced through atomic reactions will give a new insight into medical problems and the natural sciences, thus promising great benefits to humanity.

Few scientists would care to predict to what extent our world will change in the decade ahead, but it seems unlikely that the change will be very sudden.

Amazing New Wartime Chemical Discovery

MAKES LEATHER and LEATHERETTE LIKE NEW · IN 5 SECONDS

NOT A DYE OR
VARNISH BUT
PLASTIC

LEAVES
NO
BRUSH
MARKS

SAVES COST OF BUYING NEW LEATHER GOODS

**Renew Leather Covered Furniture · Luggage ·
Shoes · Handbags · Auto Seat Covers · Golf Bags ·
Any Leather or Leatherette Covered Material**

MAKE CANVAS DUCK AND MANY OTHER MATERIALS LOOK AND WEAR LIKE LEATHER

This new wartime chemical discovery called Leathercote makes leather and leatherette look like new in just five seconds. Simply spread it on like paint, with brush or spray gun—it dries quickly leaving a leather-like covering. Does not show brush marks. Costs only a fraction of the cost of new leather goods. A Leathercote job is washable. Will not peel or crack in coldest weather. Will not become sticky in hottest weather.

Not only does this amazing plastic make leather look like new, but you can use it on most cloth to make your own leather-like material. Porch swings, deck chairs, gliders, tarpaulins and many other items can now be made into waterproof, weatherproof, leather-like material.

COATS LEATHER AND LEATHERETTE WITH NEW FINISH AND COLOR—DOES NOT CRACK-PEEL-SCUFF

Non-Toxic—Acid, Alcohol and Caustic Proof

Leathercote when applied will not crack, peel or scuff. A Leathercote job will remain clean and fresh as long as an expensive re-upholstering job. Comes in all standard colors. Easily cleaned and withstands repeated washings with strongest soaps. Leathercote will save many dollars on leather goods that would otherwise have to be thrown away. Act quick—send for your FREE SAMPLE today—a 1c postcard will do.

COMES IN
ALL BASIC
COLORS

EVEN A CHILD
CAN BRUSH IT ON

*Free!
Sample*

**JUST MAIL
COUPON**

No Obligation

Let Me Show You How To GET INTO BUSINESS FOR YOURSELF

*I'll Show You How To Train Men · How To Handle
Big Jobs Such As Restaurants · Bars · Grills · Movie Houses*

**You Train Men—They Do The Work
You Collect Big Profits**

As a representative for Leathercote, I'll show you how to cash in on an exclusive territory. I'll show you the secrets of this business—put you in business for yourself. You do not risk one penny of your money. Just send me your name and address on a penny postcard, I'll do the rest.

E. E. Black Sales Mgr.

LEATHERCOTE CO.

713a LINWOOD BLVD., Dept. P-10, KANSAS CITY, MO.



Mr. E. E. Black, Sales Mgr.

Mr. Black has put many representatives into the Leathercote business—Shown them how to make tremendous profits—Let him show you how to make big money.

LEATHERCOTE CO.

713a Linwood Blvd., Dept. P-10, Kansas City, Mo.

Mr. Black—Send me a sample of Leathercoting, and your money making plan. I understand I am not obligating myself in any way by requesting this sample.

NAME

ADDRESS

CITY

STATE

Fill out—Tear out—Paste on 1c Postcard and Mail



Light as a feather
Protection!

STASAFE
ALL PLASTIC
EYE MASK
SAFETY - LIGHTWEIGHT
PERFECT FIT-LOW COST
OPTICAL PERFECTION

Here's plus eye protection for you . . . for work shop, garage, farm, industry . . . anywhere except for welding. It's the new all-plastic StaSafe Eye Mask that has all the toughness of pliable plastic in its optically perfect protective lenses. Built to stand the gaff of hard service, it weighs only 1 3/4 ounces . . . has wide-vision, impact-resistant lenses . . . is precision curved for continued wearing comfort . . . ventilated, too. Check all the Eye Mask Features! See for yourself how this sensational new safety goggle has been designed and priced to give you the finest in extra protection, extra comfort and extra confidence.

IN CLEAR OR GREEN LENSES
per pair postpaid **\$2.25**

Use this handy coupon-Order Today!-No COD orders

Enclosed is _____ for _____ pairs of the new StaSafe Eye Mask with clear green lenses.

Name _____

Address _____

City _____ State _____

STANDARD SAFETY EQUIPMENT COMPANY

232 W. Ontario St. Chicago 10

NEWARK LOS ANGELES CLEVELAND

SAY YOU SAW IT IN POPULAR MECHANICS

**KEEP WARM!
SAVE FUEL!**

Mortite

BETWEEN YOU AND THE COLD

A pliable, plastic weather-stripping, easily, quickly applied to windows, doors, baseboards. Stops expensive heat leaks,

Just press into place. Use inside or outside. Can be painted. Mortite does not shrink or crack. Also plugs cracks around drainboards, bathtubs, etc.

Roll covers about 80 feet, enough for 5 windows.



\$1.25

AT HARDWARE, PAINT, DEPT. STORES AND LUMBERYARDS

Ask for Mortite Booklet!

J. W. MORTELL CO.

522 Burch St. Kankakee, Illinois

Higher west of Rockies and Canada

SOLDERING SET

FOR ONLY \$5.50



Torch and 5 attachments—flame reducer, solder ladle and 3 copper points—for only \$5.50. Other attachments available. Use it as a blow torch or as a Soldering Iron. Burns white gasoline or naphtha. Self-generating—no pump. Send for it—Set 12-39-R—today!

JUSTRITE MANUFACTURING CO.

2063 N. Southport Ave., Dept. M-8, Chicago 14, Ill.

CRAFTSMEN'S BARGAINS

BIG BOY RATCHET SET

Here is the ratchet set you've been waiting for. Vanadium steel, Cadmium pltd. 1/4" drive tools. Contains 11 single hex, double hex, double square sockets, heavy duty ratchet wrench, Spintite nut driver with plastic handle, Universal driver with cross bar and connector. Pocket-size metal case. A high grade tool priced amazingly low! Ship. Wt. 2 lbs. No. 9273. 17 pc. set only..... **\$5.50** plus postg.



FIBRE WASHER ASSORTMENT



This is the biggest bargain of the year, an assortment of over 3500 bakelite and fibre washers in the most commonly used types and sizes for radio and all electrical work. Shipping weight 2 3/4 lbs. No. 8905. **\$2.50** plus postg.

Over 3500 washers. Only..... **\$2.50** plus postg. Send check or money order, including postage.

FREE CATALOG

Send for the new 1946 G & E Refrigerator Parts Catalog. Hundreds of hard-to-get parts at money saving prices. Write now! **G & E EQUIPMENT SUPPLY CO.** Dept. PM10, 400 N. Sangamon St. CHICAGO 22, ILL.

SPORTSMEN—BOATMEN

FOR SALE

ALLISON ENGINES

12 Cylinder • Liquid Cooled • V-Type Model 1710 • Rated 1110 HP at 2600 RPM

All engines excellent condition. Average time in service 300 hours. Each engine equipped with oil pump, cooling pump, magneto, carburetor and supercharger.

Price \$200.00 Each f.o.b. New Orleans, La.

Crated and Ready for Immediate Delivery

INDUSTRIAL SUPPLY CO.

P. O. BOX 381 — NEW ORLEANS, LA. — GA. 1181



Steel WHEELS

AND COLD ROLLED STEEL AXLES

Sturdy, rubber tired pressed steel wheels with red enamel finish. Ready to use axles—threaded at both ends. Acorn nuts supplied. Order today.

WHEELS WITH SOLID RUBBER TIRES
4" Wheels, 1/4" bearing, Steel Disc..... \$.75
6" Wheels, 3/8" bearing, Steel Disc..... \$ 1.00

WHEELS WITH SEMI-PNEUMATIC TIRES
6" x 1.50 with 3/4" Selflube Oil Bearing..... \$ 1.75
8" x 1.75 with 3/4" Selflube Oil Bearing..... \$ 2.25

AXLES, COLD ROLLED STEEL
1 1/2" x 14" long, threaded both ends, Nickel Cap Nuts .40
3/4" x 16" long, threaded both ends, Nickel Cap Nuts .60
1/2" x 18" long, threaded both ends, Nickel Cap Nuts .80
Sent postpaid in U. S. on receipt of price.

CIRCLE METAL MANUFACTURING COMPANY
4266 E. PACIFIC WAY LOS ANGELES 23, CALIF.

To Build Your Own WAGON CART TOY or any rolling carrier

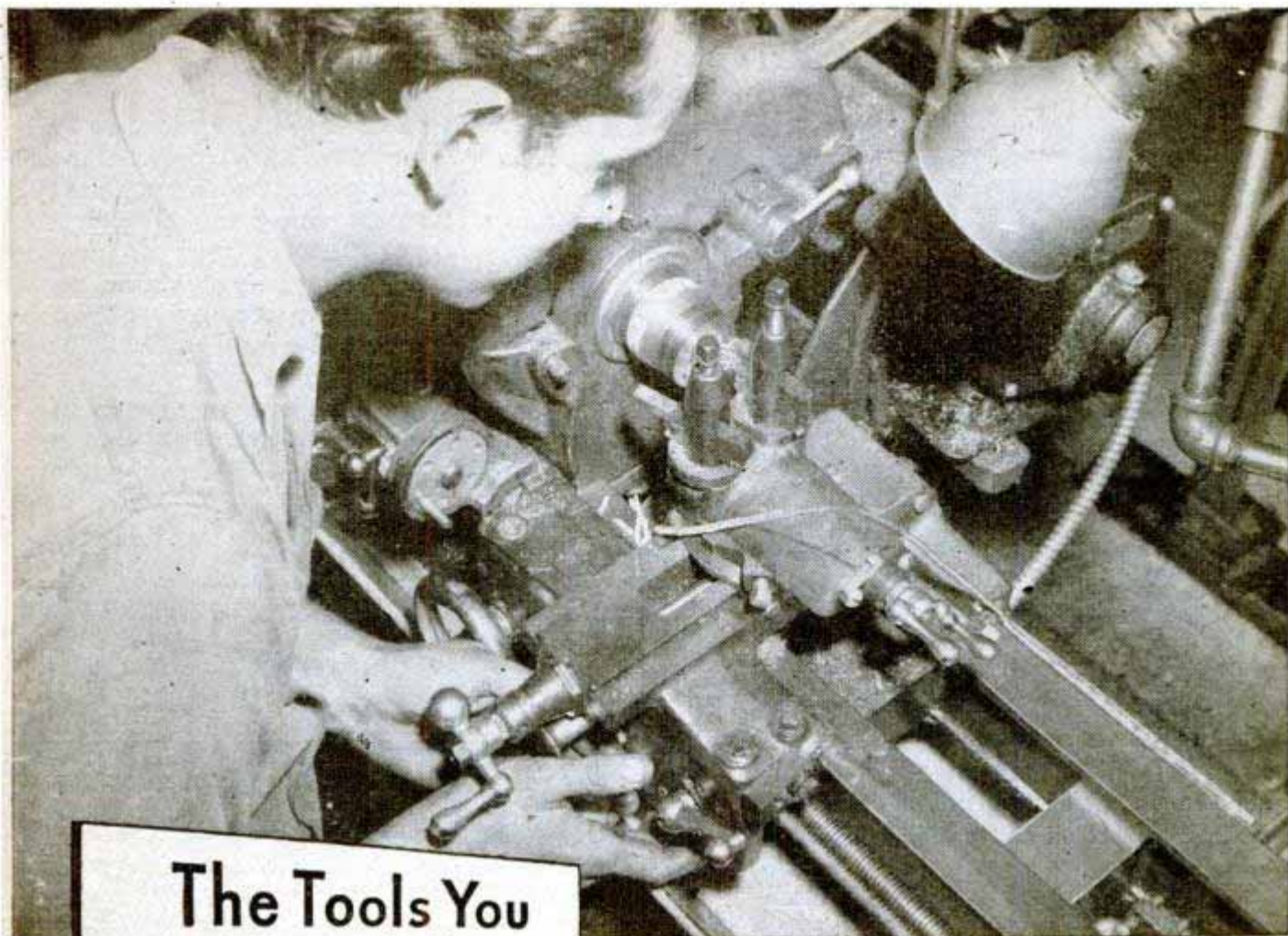

**The Tools You
Need for
YOU, INCORPORATED**

Setting up your own shop is usually a one-time investment — for a lifetime of dividends.

Whether you have in mind the highly practical part of such a fascinating hobby — building and repairing home equipment — or will use the shop in your business, you need *precision* tools of *wide versatility*.

Atlas engineers had that in mind when they designed the 4 Tool Team.

Accuracy in construction and operation, of course, was basic. Then they made sure Atlas tools could handle all the types of

machining you might require. Next extra-heavy castings were designed to assure solid machines for smooth operation even under unusual loads. Finally, they devised ingenious production methods, new to the industry, to bring you the tools at lower cost.

These are just a few of the many advantages developed for you in Atlas tools. Ask your Atlas distributor for specific operating features of the tools you need right now.

"Success Stories" — FREE

Just off the press! Read how other men have realized their ambitions with Atlas tools. Shows photographs of small shops from coast to coast with reports of personal progress and success. Sent free with latest Atlas catalog. Write Atlas Press Co., 1043 N. Pitcher St., Kalamazoo 13D, Michigan.



Atlas 4 TOOL TEAM



WE WANT YOUR IDEAS

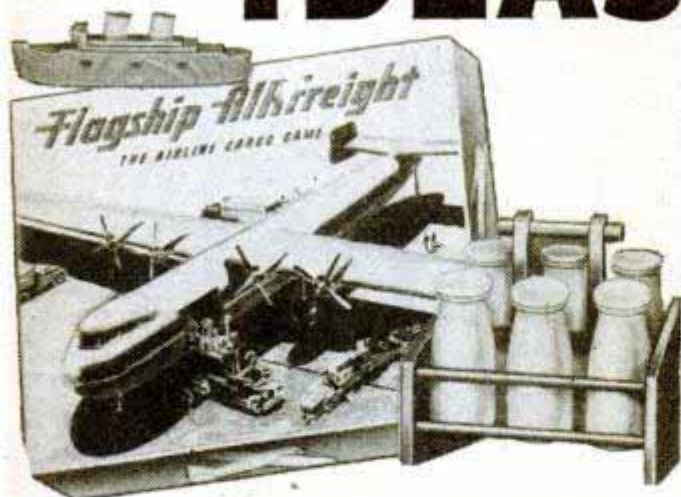

THEY MAY BE WORTH REAL MONEY

Someone who is now reading this advertisement has a first rate idea for a new toy, game or novelty . . . an idea which is worth extensive promotion, volume production and nation-wide distribution by my company.

You may be that someone. If so, we will pay you well for your ideas. All suggestions will be carefully studied and fully protected against any use not specifically authorized by you. If your idea is acceptable we will pay you cash for it or offer you a royalty. Further, we will pay for any necessary development work ourselves.

This is not a contest . . . it is a business proposition. Ours is a fast-moving business. As a leading manufacturer of toys, games, novelties, educational materials and kindred items, we are constantly searching for new ideas and paying well for them. We make and sell games of chance, skill and action for all ages. We mass-produce toys and other products in paper, wood, metal, and plastics.

Write me today about your ideas — a brief letter or rough pencil sketch will do for the present. I will let you know our decision promptly and sincerely hope that it will be the most profitable letter you ever wrote.

Sincerely,

James J. Shea
President

MILTON BRADLEY CO.
Springfield 2, Massachusetts

Makers of the World's
Best Games — Since 1860

STOKER EMPTIES OWN ASH!

A remarkable stoker already used by thousands of home owners—fits into any furnace or boiler. Manufactured since 1934. So automatic it takes the coal from your present coal bin through a pipe to the furnace, going around corners if necessary. Keeps house at even temperature, empties its own ash in sealed containers, no coal to shovel, no clinkers to dig, only bituminous stoker of its kind on the market. Send for full information NOW!

POCAHONTAS FUEL COMPANY INCORPORATED
344 EAST 131st STREET • CLEVELAND 8, OHIO

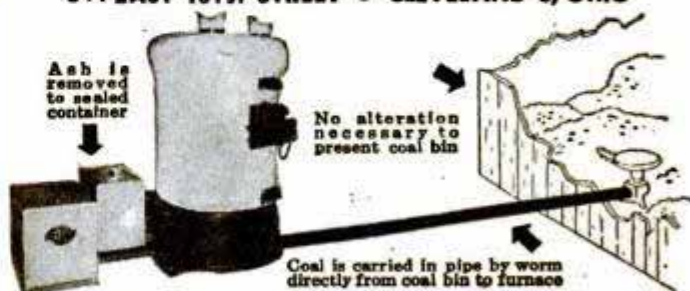

GET THE BEST IN MUFFLERS V-8 DUALS & SINGLES

Finest Norman custom-built muffler sets — steel pack — torpedo type — heavy, perforated steel cores — chrome enamel finish — mellow, deep tone (improves with use) — designed to fit — all ways superior — double economy.

DUALS \$17.50	SINGLES \$7.00
V-8 Ford-Mercury	Buick, Olds., Chrys.
SINGLES \$5.50	ORDER TODAY! Will outlast three ordinary mufflers.
Chev., Ford, Plym.	Distributors — Write for Full Details

NORMAN'S MUSICAL MUFFLERS

Dept. PM-5, 1216 W. Slouson Ave., Los Angeles 44, Calif.

SAY YOU SAW IT IN POPULAR MECHANICS

TRAILER AXLES, HITCHES, AND PARTS

• If you are interested in purchasing trailer axles, hitches, and other trailer parts, contact us promptly. **Write for free literature.**

HAMMER BLOW TOOL COMPANY, Dept. 110, WAUSAU, WIS.

Here YOU ARE WOODWORKERS

THE NEW CONSTANTINE MASTER MANUAL

Bigger and better with more new pages of helpful articles and information on materials and supplies. Hundreds of familiar items back again; dozens of new additions including lumber, veneers, inlays, plywood, tools and finishing materials. The greatest 25c worth ever offered craftsmen and woodworkers. In addition, without charge, a year's subscription to Chips & Chats to keep you up to date on craftsmen's activities and many bargains. Send 25c now to **ALBERT CONSTANTINE & SON, INC.** 791P East 135th St., New York 54, N.Y.



If you want to tour the American football gridirons this fall, you'll need a long-range radio like the National NC-46. It's a great open-field runner when it comes to avoiding interference and bringing in the game you want. Write us today for the name of your nearest National dealer.



NATIONAL COMPANY

INCORPORATED



EST.  1914

MALDEN, MASS.

THE MOST DISTINCTIVE NAME IN RADIO COMMUNICATIONS

JET PROPULSION



GAS TURBINE Model Engine

★ ★ Be one of the first to build a real Turbo-Jet Model Engine. Single-stage centrifugal compressor and turbine. This is a real engine, easily made with ordinary home workshop equipment. Complete plans for construction . . . design formulas and curves for checking performance and testing.

\$2.00
Post paid

THE ROTOJET CO. Department 11
BOX 757 • LOS ANGELES 25 • CALIFORNIA

DIAMOND POINTED ENGRAVING OUTFIT

Ideal for hand lettering Jewelry, Glass and Chinaware. Etches Iron and Steel. Designs Leather. Numerous other uses for hobbyist and manufacturer. Outfit Complete (with transformer) \$19.50. Order today.

The ZEIS STUDIO
728 LESLEY AVE. D. E.
KOCKFORD, ILLINOIS

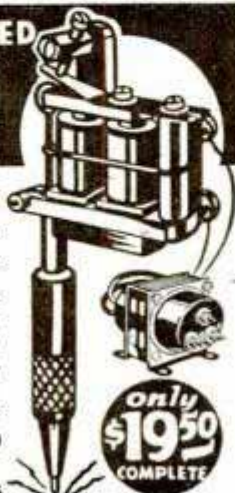

only \$19.50
COMPLETE

PRESS THE TRIGGER for
HEAT in 6 SECONDS

with the *Flash*
SOLDERING GUN

YOU AIM IT AT YOUR WORK
with a restful, natural wrist position

Engineered for every type of soldering, the Flash Soldering Gun gets around corners and into minute places. Heats only while pressure is on trigger — intensity of heat controlled at your finger tips. Equipped for immediate operation from our 110 V transformer, or from any standard (6-12V) storage battery in car, tractor, airplane, boat, etc. Ask about extra tips for special work, and for specifications for the heavy duty model, with its 5/16 inch tip. See your distributor, or send coupon.

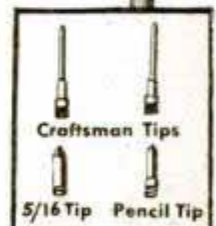

BAKER-PHILLIPS COMPANY

3069 Lyndale Avenue South, Minneapolis 8, Minnesota
Please send circular on Flash Soldering guns.

Name.....
Address.....

SCHERR TOOLS—enduring precision—reasonable price—quick delivery

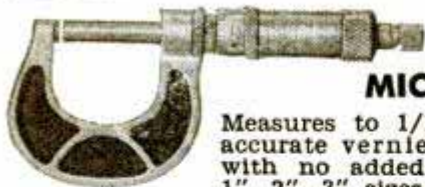

SCHERR MICROMETER

Measures to 1/10,000" with accurate vernier, standard with no added charge, on 1", 2", 3" sizes. Burnished, superhard thread gives long-wearing accuracy and velvet-smooth action. In the "feel" of this mike every good mechanic will recognize true quality. Locknut and ratchet.

Price (vernier included) 1" size, \$8.25 plus 10c postage Without Locknut and Ratchet, \$6.75



SCHERR DIAL INDICATOR SET

Reads to 1/1000" at a glance. Thoroughly dependable—extremely sensitive. Set has clamp,

toolpost holder, inside measuring attachment, 3 contact points. Indicator has ball-joint, any-angle adjustment. **IN FITTED HARDWOOD BOX, \$19.75.**

WANTED—SHOP AGENTS

Earn extra money by selling Scherr Precision Tools to your shopmates. Mechanics want their own personal micrometers, dial indicators, surface gages, etc. From the famous Scherr line of reasonably priced, modern tools, you can supply them and make good profits too. Here is an opportunity to turn your initiative and "push" into extra income. No money investment. Get full details. **WRITE NOW.**



SCHERR 5-IN. SINE BAR

Every time you set off a precision angle you wish you had your own Sine bar. Here it is—a handy, valuable, high precision tool. **PRICE \$22.20.**

VERNIER CALIPERS

Both stainless and tool steel. Read to 1/1000". Immediate delivery. Various types. Write for bulletin and prices.

The Scherr 10-day money-back offer, with no strings attached, protects you absolutely. You take no chances in ordering. We know Scherr tools are good or we could not make this offer. In ordering send money order, check, or we'll ship C.O.D.

NEW CATALOG FREE

"Small Tools for Mechanics" gives latest developments in precision measuring and the Scherr Tools that do it. Every ambitious mechanic will want this book. Your copy is waiting. **WRITE.**

ATTENTION FOREIGN BUYERS. Scherr tools are available with Metric Calibrations. Write for details.

GEO. SCHERR COMPANY, Inc. 200-A LAFAYETTE STREET NEW YORK 12, N. Y.



WRITE FOR **Free Sample**

★ ★ **Make Big Money** ★ ★

Be the first to sell luminous house numbers and light switch plates. Also luminous pictures, statues, etc. Religious, nursery, glamour and other subjects. Sell on sight.

Represent a Large Manufacturer Est. 1912
MADISON MILLS • 303 Fourth Ave. • New York 10, N. Y.



RADIO CONVERTER-100 Kc to 1550 Kc

Brings in the standard and long wave band. Designed specifically for army surplus receivers BC-312-342-348 and National NC 100. With minor alterations will work on the 10-meter band. Easy to connect with special adapter. Remit 25% **\$15.00** on C.O.D. orders.

RELIANCE ELECTRONICS
633 Plymouth Ct. Chicago 5, Ill.

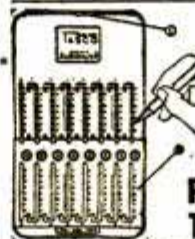

POCKET ADDING MACHINE

STURDY STEEL construction for lifetime use. adds, subtracts, aids multiplication. Capacity 999,999.99. A real machine—guaranteed 5 years. Thousands of satisfied users. Send name and address. We ship immediately. On delivery, pay postman \$2.50 (plus C.O.D. and postage charges). If you send \$2.50 with order, we pay postage. Leatherette case 25c additional. Your money back after 10 days trial if not satisfied.

Free Trial **\$2.50**

Send no money
TAVELLA SALES CO., 19-NA West Broadway, New York 7, N. Y.

SAY YOU SAW IT IN POPULAR MECHANICS

CHANITE SELF-WELDING FLUX

REPAIRS ALL ELECTRIC HEATING ELEMENTS

So simple anyone can make repairs in your broken or burnt-out electrical appliances—irons, toasters, stoves, etc. Guaranteed nothing like it. From our mines to your appliances. \$1.00 per package. \$7.50 per doz. Stick form 25c. \$2.00 per doz.
CHANITE SALES COMPANY, 914 So. Main, Fort Worth 4, Texas

MAKE UP TO \$5.00 AN HOUR

In Your Own **YEAR ROUND** Business!

ONLY A FEW DOLLARS PUTS YOU IN BUSINESS!

Many Making High as \$20 to \$30 a Day—in New Kind of Business—Re-newing Rugs, Upholstery—New, Quick, Easy Way

Most unusual opportunity to have your own steady, dignified business—earn **BIG PROFITS**, working full or spare time—yet start on a "shoestring"! Regardless of your former occupation—where you live—whether you're a War Veteran or not—young or old—man or woman. You can operate from your home at first—open regular business establishment later out of profits. Many have started making **BIG PROFITS** first day! We Send You Instructions and Quick-Cleaning Material for easily and quickly cleaning rugs and carpets without taking them off floor—by amazing, new method which takes old-fashioned drudgery out of such work. **Tremendous Demand Everywhere**—in homes, apartment buildings, hotels, stores, offices—for speedy, high-grade rug, carpet and upholstery cleaning at **HIGH PRICES**, with repeat business. Territories going fast. **Hurry!** Send for **FREE** information. No obligation. No salesman will call on you. Write today!

AMERICLEAN CO., INC.; Better Homes Dept. G-1
211 N. 7th St. St. Louis 1, Mo.

WRITE FOR FREE DETAILS NOW!

"Jet" Propelled! SPEED BOAT



Actually sounds like a real speedboat!

No Springs!

No Gears!

\$1

Complete, Postpaid

... Fuel Supply Included at no Extra Cost

All Metal! No Moving Parts

Runs half an hour on a small piece of fuel. (Fuel included). Sounds like a real 2-cylinder speed boat. Easy to operate. Will delight both young and old. Order several. They make a wonderful gift.

MAIL ORDERS DIRECT TO
UTILITY STORES, 117 S. Wabash,

Dept. KK-14

CHICAGO 3, ILLINOIS

7 LB. EXPERIMENTER PARTS ASSORT. KIT



A "gold mine" for the radio serviceman. Hundreds of valuable radio parts, new radar and electronic parts and sub-assemblies, coils, resistors, trimming condensers—worth many times this low \$1.79 price. A130R—7 lbs.

SACHEL POUCH

Heavy canvas pouch. Ideal for toting lunches, shopping, books, etc. Has three 11 x 12 inch pockets. Brand new, guaranteed perfect. Has oversized flap with single strap fasteners.



A113—EACH \$1.69

PUP TENTS



Regulation Army Pup Tents of durable, brown canvas. Used, but in good condition. Fine for campers, outdoorsmen, boy scouts, etc. Grand Xmas gift for children. Wgt. 8 lbs. A1—Tent only . . . \$3.95 A110—Tent, new . . . \$7.95 A101—Ropes, wooden poles and stakes for above. Per set \$1.00

U.S. Govt. BOLO KNIFE



Extra heavy. For farm, home or jungle use. Blade of Gov't. formula cutlery steel. Walnut riveted handle. 3 1/2 inch hilt. 10 1/2 inch blade. You'll find hundreds of uses for a Bolon knife. Blade will take and hold a keen cutting edge. Wt. 2 lbs. A112—with Army Sheath . . . \$4.95

CAVALRY SPURS



Genuine wish-bone type cavalry spurs. Nickel plated brass. A102, Pair . . . 98c A103—S p u r straps per set of four . . . 50c

METAL BUSHINGS

Of light weight Duro metal from 1/4 to 2 1/2 in. long. Inside diam. 1/8 to 5/16 in. Approx. 125 pieces. No. 169—Per 1 lb. asst. . . . 98c

LIFE PRESERVER BELTS



Right from the invasion beaches. Consists of two air chambers. May be inflated automatically with "sparklet" cartridges or manually by attached hose. Adjustable in waist size. One air chamber guaranteed air tight—other may need a tire patch. All belts are used and slightly soiled but a bargain at this low price.

No. 1261 Each . . . \$1.00

WAR SURPLUS AND HUNDREDS OF OTHER BARGAINS

SPECIALS FOR BOY SCOUTS, CAMPERS, HUNTERS



MESS KITS
Regulation two-piece Army Mess Kits with folding handle. Used, but perfect. Weight 2 lbs. No. A116—Ea. 69c

PROF. TELEGRAPH KEY

Purchased from the gov't. Finest design and construction. Base measures 3 x 4 3/4 inches. Original value \$2.50. All parts of instrument brass. Adjustable.



A-147—each 98c

MICROPHONE BUTTON

Brand new. For radio, electronics and other experiments. Full 2 1/2 inch diameter. Wgt. 1 lb. No. 512—Each . . . 98c

TANK PRISMS

Sighting Prism for tank gunner. Reflects images at right angles. Used but perfect. Wgt. 2 lbs. No. 234—Each . . . 98c

BOMB PARACHUTES

Of fine white nylon fabric 5 x 8 feet in diameter with split seam for directional dropping. Designed for dropping fragmentation bombs, emergency rations, etc. Each packed in a metal container. Weight 6 lbs. No. R-162—Each only . . . \$1.95

WOOL ARMY BLANKETS

100% wool, regulation O.D. Army blankets. Class B-perfect. Used but renovated for re-issue. Wgt. 5 lbs. No. 233—Ea. \$4.89



CANTEENS

Reg. U. S. issue canteens. Plastic screw top chained to body. Slightly used but perfect. Wgt. 1 lb. 117—Metal 118—Plastic—Ea. 69c



CANTEN CUPS

All metal. Folding handle. Wgt. 1 lb. No. A120—Each . . . 25c

CANTEN COVERS

Heavy canvas. Button fastener. New No. 530—Each . . . 69c Used No. 110—Each . . . 35c



ARMY BANDOLEERS
Of fine heavy khaki. Big roomy pockets with snap button fasteners. Fine for hunters, campers, boy scouts, etc., also for shop work in carrying small parts, etc. Material alone is worth this price. Shp. wt. 1 lb. 11 Pocket Type No. 49c 5 Pocket Type No. 29c 129 EACH 110 EACH

ASSORTED NEW LENSES

Assort. of 27 precision ground lens elements, and prisms—positives, negatives, etc. Assorted diameters and focal lengths. Fine for building experimental optical systems, etc. Actual value over \$100.00. No. A519—27 pieces . . . \$7.95

SEMI-FINISHED LENSES

Same lenses as above, but in various stages of finish. Included are fine and coarse ground surfaces—some polished one side only. No. 520—50 Asst. Lenses, only . . . \$1.95

POPULAR RECORD ASSORTMENT

Fifty records of modern dance, race, blues and hillbilly selections. No two alike. Famous name bands and artists included. Used in juke boxes, but guar. perfect. Shipped exp. collect only—no exchanges or refunds. Wgt. 28 lbs. No. A303—50 records . . . \$9.64

ORDER DIRECT FROM THIS AD

Values galore! Hundreds of hard-to-find items for home, shop and outdoors. Make remittances by money-order, bank draft or personal check. Send 25% deposit on C.O.D. orders. No C.O.D.'s on orders for less than \$5.00. Include sufficient postage on parcel-post orders—any overage will be promptly refunded. All quotations F.O.B. Chicago. Used items and materials are guaranteed serviceable and as described. Your money back if not more than satisfied.

BIG ILLUSTRATED CATALOG FREE

STARK'S Dept. PM1046 509 So. State St. CHICAGO 5, ILL.



GAS MASKS
Brand new! Original cost \$2.50. Big plastic goggles, rubber face, adj. head bands. Loads of fun as a toy and relic—useful too. Shp. wgt. 2 lbs. No. 701—Each . . . 98c

ONE MAN BOATS

Designed for one man use. Each boat complete—packed in a special parachute bag. Wgt. 15 lbs. No. 526—Each . . . \$17.95

G.I. PISTOL BELTS



Of heavy canvas webbing. Adjustable. Eyeleted all around. Used but perfect. Wgt. 2 lbs. No. 131—Each . . . 98c

G. I. POCKET BELTS

Regulation G.I. Belt with snap button fasteners on all pockets. New! Adjustable size. Wgt. 3 lbs. No. 109—Each . . . 98c

ANTENNA UNITS



Purchased from U.S. Gov't. Eliminates radio interference. Improves reception. New. Wgt. 4 lbs. No. 637—Each . . . \$2.95

DECORATIVE CHROME STRIPS



For your car, boat, furniture, etc. Highly polished chrome finished strips with clinched edges for flush mounting to any surface. The 3 pound kit provides approx. 43 pieces in lengths from 4 inches to 3 feet and 1/4 to 3/4 inches wide. Wgt. 4 lbs. No. R-224—3 lb. Assort. only . . . \$2.00

MOISTURE ABSORBENT



Protek-Sorb. A protective absorbent that eliminates moisture damage. In cloth bags of 4 oz. No. 138—Doz. 4 oz. bags . . . \$1.00

STILLS



Distill your own water with one of these fine portable stills. Purchased from the Gov't. Completely self contained. Has 1 gallon capacity; output 1 1/2 gal. per hour. Fitted with genuine Coleman double burner stove. Operates 5 to 7 hrs. on one filling. Heat output 20,000 BTU's. Stove alone is worth this price. All new and guaranteed. Instr. included. Weight 100 lbs. No. 206—\$59.50 Each . . .

you'll do faster, better work with this
EFFICIENT SHOP TOOL

THE Bantam GRINDER



★
Polishing
Grinding
Carving
Drilling
Buffing
Plastic
Glass
Metal
Wood
Bone



You'll enjoy doing many shop jobs with the Bantam Grinder. Correctly balanced for easy handling. Precision-built of quality materials for dependable, long-life service. Operates on 110-115 Volt AC-DC. Speed approx. 20,000 R.P.M. Internal ventilating fan. Fingertip switch. Weight—15 oz. With 8-ft. cord and plug, 23 accessories, substantial gift box... **\$25**

If your dealer doesn't have it, write us.

Small Motors, Inc.

Dept. 80, 53 W. Jackson Blvd. • Chicago 4
Manufacturers of special small universal, fractional H. P. motors, shaded pole motors, heater motors for industrial and appliance uses.

SAY YOU SAW IT IN POPULAR MECHANICS

REMOVES ALL FINISHES



New type semi-paste remover quickly lifts off paint, enamel, varnish, shellac, lacquer, bakelite and other synthetic resin finishes. (Removes emulsified resin water paints, too.) Stays wet longer — stays put on upright or overhead surfaces — strips clean, quick. One coat usually enough (apply with brush or spray). Contains no benzol, acid, caustic, alkali, or wax — harmless to hands, bristles, surface stripped. All sizes (pint 65c) at paint and hardware stores.

FREE CIRCULAR

"How to Remove Paints, Varnishes, Lacquers, etc." Also describes other Savogran Products: Heavy Duty Cleaner, Crack Filler, Wood Putty, Remover & Bleacher (renews floors), Paint Brush Cleaner, Coldfoam Soapless Soap Powder.

THE SAVOGRAN CO.
DEPT. 34, BOSTON 10, MASS.

It's Orange!



NO BENZOL-ACID-CAUSTIC-ALKALI- SAFER TO USE

SAVOGRAN STRYPEEZE

IN EVERY WELL-EQUIPPED HOME WORKSHOP

SMALL EFFICIENT SPEED REDUCER



Sturdy, compact (see dimensions). Proved in thousands of industrial installations. Case of heat treated aluminum. Gears, SAE 65 (British Gear) Bronze. Worm of case hardened steel. Timken Bearings throughout. Available in 4 different assemblies (shown below) and in these standard ratios:

4-1	25-1	64-1	200-1
8-1	30-1	75-1	300-1
10-1	40-1	80-1	400-1
16-1	50-1	100-1	600-1
20-1	60-1	150-1	800-1

Torque capacity 100 inch pounds. Especially suited for bench work, home work shops, light production, animated displays, etc. When ordering be sure to specify assembly and ratio required. Shipping weight in carton, 8 lbs. Full money back guarantee. Prompt deliveries.

\$15.12

Ceiling Price
F. O. B. Cleveland

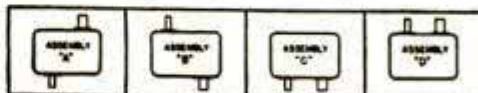
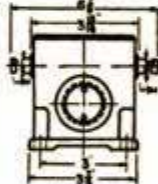

THE OHIO GEAR CO.

1410 EAST 179TH ST. • CLEVELAND 10, OHIO

TINY TIM — \$4.95

LIMITED QUANTITY AVAILABLE
MONEY BACK GUARANTEE

Single cyl. High Speed Oscillating Steam Engine. A precision built (like the big ones) miniature engine in every detail. Height 2 3/8", weight 4 oz. Ideal for model boats or stationary power plants.

ORDER NOW For Prompt Shipment. Remit \$4.95 with order and we prepay P.P. or C.O.D. Cash with orders get preferred shipping.

THE THOMPSON ENGINEERING CO.
405 Winchester Bldg., Grand Rapids 2, Mich.

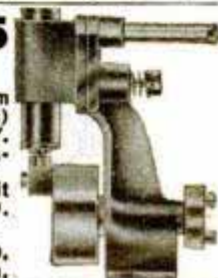

ATTENTION AUTO OWNERS!

New Power, Pickup, Pep!

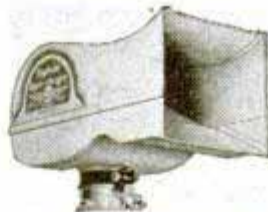

Amazing TYPHOON SUPERCHARGER is back again, ready to put new life into old motors, add to power, pickup, pep! 41,000 users find gas economy, you will, too. Motor knock vanishes, grease bath air cleaning keeps harmful dust out. Takes 5 minutes to install with screw driver on carburetor, replacing old air cleaner. Order today, mention make and model of car. Only \$5.95.

(Ohio orders add 3% sales tax, West of Rockies, add 10%.)
10 Day Money Back Guarantee!

TYPHOON PRODUCTS CO. 507-H Engineers Bldg.
Cleveland 14, Ohio

EXPERIMENT WITH LUMINOUS PAINT



See story "It glows in the dark" page 214 June issue of Popular Mechanics for many ideas on how to use our three color kit — contains one of each of 3 colors—JUMI BLUE, GARDENIA and CHARTRUSE. One ounce sealer. Guaranteed best quality.

COMPLETE KIT
WITH 3 COLORS
AND SEALER

\$4.25

F.O.B. Chicago

BLACK LIGHT PRODUCTS • 67 E. Lake St. • Chicago 1, Illinois

CAR - TRUCK - TRACTOR OWNERS

DO YOU STILL CHANGE MOTOR OIL?

IF SO — you can END this needless waste and expense FOREVER with...

"RECLAIMO"

Utilizes motor heat (while driving) to continuously re-refine crankcase oil!

REMOVES SOLIDS BY FILTRATION—
WATER & FUEL DILUTION BY HEAT
AND DISTILLATION!
ELIMINATES ALL OIL CHANGES!

"Oil does not wear out mechanically"; U.S. Bureau of Standards Bul. 86. "Reclamo's" re-refining action not only supports this fact but has given positive proof to thousands of enthusiastic owners. Again available, also to dealers. Complete details in FREE Booklet "Oil Facts"—Write today!

Reclamo Mfg. Co. 5085 Elston Av. Dept. 18, Chicago 30, Ill.



POPULAR MECHANICS

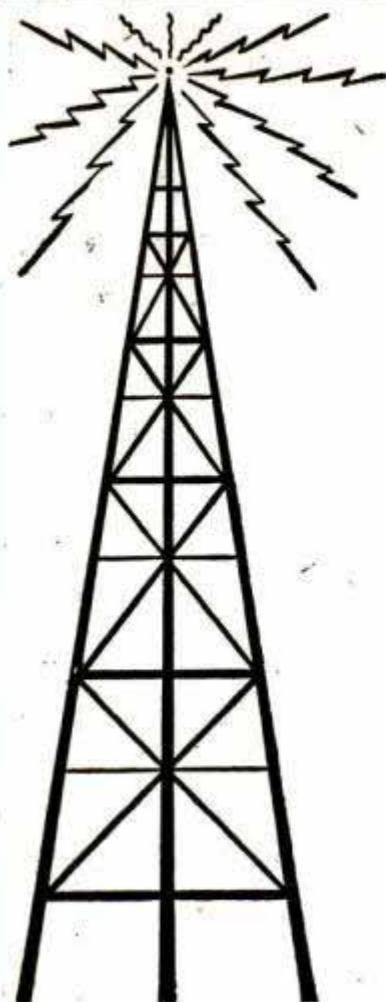

AMAZING RADIO OPERATES FREE

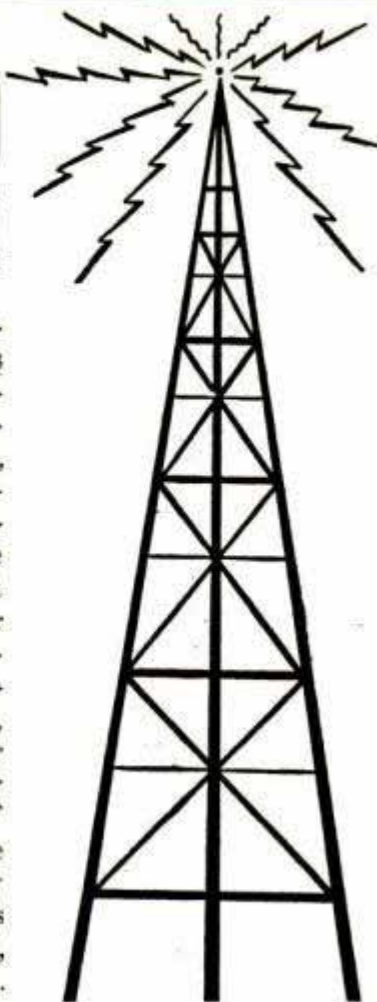

Positively needs no house current, no batteries. Has no tubes. Remarkably, requires no ground connection and no lengthy old-fashioned aerial. HAS SPECIALLY DESIGNED, RADIO IMPULSE RECEPTOR, 6½ ft. sq. Receives local standard broadcasting stations. (Exciting long distance reception at night.) Radio gives headphone operation for personal use. Has excellent tone; adequate volume, sensitivity and power of selectivity. Exceedingly simple to operate. Can be built even by teen-age youngsters using wire and only a few ordinary, readily obtainable, reasonably priced, new or used parts. This practical radio sensation may well develop into an "ATOMIC BOMB HIT" amongst hobbyists, young and old. Be the first in your neighborhood to build and enjoy this thrilling rad'io. For all necessary plans and illustrations send \$1 to PAUL SEMAN, Dept. 1, 1522 Fred St., Whiting, Indiana.

TALK-SING thru your own radio
with
RADIO MICROPHONE



Be the life of the party. Put on your own broadcasts at home. Sing, talk, make announcements from any room. Wonderful voice practice. Microphone easily attached to any radio. Follow enclosed instructions.

\$1.98
Postpaid
No C.O.D.s

EMPIRE RADIO & TELEVISION CO.
(Dept. R2) 1521 Bedford Ave., Brooklyn 16, N. Y.

HANG THAT DOOR THE PROFESSIONAL WAY!

USE THE TIME SAVING
—LABOR SAVING... **E-Z MARK BUTT GAGE**
YOU DO THIS AND GET THIS!



In one split second operation you get a clean cut deeply etched profile. All that's left for you is the chips which practically fall off.

Repeat this operation on the jamb and hang the door.
THAT'S ALL—NO MORE!

Place in desired location and strike

- Hang more doors better.
- No adjustments.
- No errors.
- Used and approved by Master mechanics.
- Comes in 3½" and 4" (standard) sizes.
- Precision made.
- Your satisfaction guaranteed!

Every E-Z Mark Butt Gage comes in individual leatherette case for E-Z carrying and E-Z storing.

Cost ONLY \$1.75 each or \$3.00 a set at your hardware store. If your Hardware Dealer can't supply you send only \$1.00 with your order and pay Postman balance, plus postage C.O.D.

E-Z MARK TOOLS • P. O. BOX 8377 • LOS ANGELES 16, CALIF.

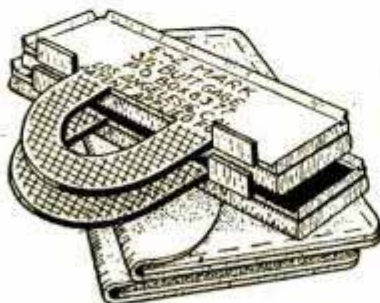

This strikingly beautiful, inlaid
Silent Butler retails for \$12.00
Build it yourself for only \$4.25
with the New
WOODCRAFT MARQUETRY KIT

A Silent Butler is a handy household item. Can be used to empty ashtrays, collect crumbs from the dinner table or to serve nuts and candies. Makes a perfect Christmas gift for lady friend, mother or wife. Thrill to the pride of constructing it and to the gratitude of the lucky lady who receives it as a welcome adjunct to her home!

Choose from these attractive subjects—Pheasant (shown above), Mallard, Duck, Horse or Rooster. In natural colored woods painstakingly collected from various parts of the world.

Kit contains genuine black American walnut for all wood parts; removable, easily cleaned copper tray; hinge and screws; felt for bottom; a completely laminated marquetry (inlaid wood) top cover ¾" thick in authentic colors, plus shop drawing and complete instructions.

FULL KIT Only \$4.25 — Order Now!
(Add 25c for postage and insurance)

WOODCRAFT MARQUETRY KITS CO.
Dept. A10, 302 Oakland St., Brooklyn 22, N. Y.

CATALOGUE NOW READY

Contains ten (10) photographs with shop drawings and instructions for finishing. Includes Silent Butlers, Book Ends, Tobacco Humidors and other useful items. Catalogue price 25c.

PLASTICS PLEXIGLAS

The Crystal-Clear Versatile Plastic
Colored and Transparent

Our complete warehouse facilities afford you
great savings on guaranteed Grade "A" Plexiglas

ORDERS PROMPTLY FILLED

Clear Plexiglas Sheets

New Per sq. foot:			
1/16	\$1.24	1/4	\$2.34
1/8	1.61	3/8	3.07
3/16	1.97	1/2	4.07

Colored Plexiglas Sheets 10% additional. Add 10% for packaging
on orders under \$10, Orders over \$10 — \$1.00 Packaging Charge.

Write for literature on Plastics and how to work them. Price
lists on request for complete line of rods, sheets, tubes, odd
shapes in all types of plastics. Enclose 10 cents to cover handling
and mailing.

Also dyes, cements, buffing compounds and accessories.

Prices subject to change without notice.



7604 Fenkell, Dept. LW Detroit 21, Mich.

YOU CAN NOW BECOME A PROSPECTOR!

HERE IS ONE OF
THE WAR'S TOP SECRETS
BRAND (NEW)
ARMY MINE
DETECTORS!

Portable: Will Detect
METALLIC and NON-
METALLIC objects;
Very Sensitive; using
955 Tube in detecting
head; two tube ampli-
fier using two 1N5gt;
headset; or micro-
phone; also 150 micro
meter; Power supply;
3-45v.; one 6-v.; or
2 3-v. batteries. Com-
plete with instr. Less
Batteries; packed in
original cases; shpg.
wt. 108 Lbs.

FOB. From N. Y.
Special

\$1750

Send order to

COLUMBO TRADING CO., INC.
304 CANAL ST. NEW YORK 13, N. Y.

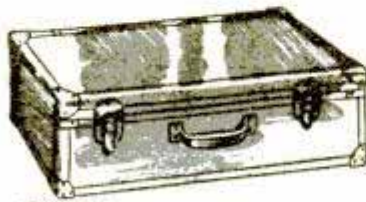

CARRYING CASE
CY-91/PMS-1

CECO WHIZZ!!

10" All-Purpose Wheel



Double Radial Ball Bearings give this
wheel speed plus! Puncture proof bal-
loon—10" x 1 3/4". Heavy duty wheels
— for racers, 4 wheel trucks, wagons,
market carriers, golf bag carriers,
scooters, garden and porch furniture,
etc., etc.

Ceco "Whizz" wheels are completely
assembled; ready for immediate use.
They're smooth, quiet, stream-lined,
STURDY. (We have axles and other
parts; ask for prices.)

Cash with order or P.P., C.O.D.
Supply limited; order today!

Dealers—Write for Quantity Prices.

\$2.75 COMPLETE
EACH Including Tire
and Bearings
Set of 4—\$10.80

CECO SALES CO.

164 - 25th St., Brooklyn 32, N. Y.

Decorative DECALCOMANIA Transfers

Imported designs of all Sizes and Types—Flowers, Fruits, Birds,
Figures, Juvenile, Ships, Silhouettes, Oriental, Peasant, Inlay,
Patriotic, Borders, Initials, etc.—for Furniture, Trays, Lamps, and
many other articles. Pre-war. Limited Stocks.

CATALOG with 800 illustrations in Color — 25c
Also carry Decorative Prints—Leaflet 6c

L. C. WELLS, Dept. PM-610, 25 E. 26th St., New York 10

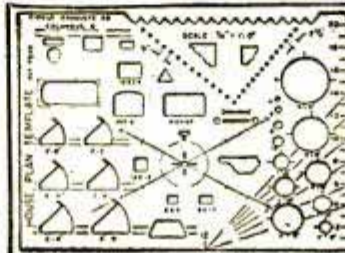

HOUSE PLAN TEMPLATE

Made of clear sheet plastic, with
accurate cut-outs for drawing
door-swings, plumbing and elec-
tric fixtures, fireplace, stairs,
moldings, roof-pitch, etc. Stand-
ard 1/4" equals 1'-0" scale.
AT YOUR DEALER \$1.50
or mailed postpaid

Send card for list of templates
TIMELY PRODUCTS CO.
Box 206C, Columbus 9, Ohio

500,000!!!!

LENSES

Send 3 cent stamp for "BARGAIN" list.

A. JAEGER'S

BOX 84P

50. OZONE PARK 20, N. Y.

Low Price The OTTAWA "Buzz" Master



CLEAR LAND FAST! Powerful 6-HP motor
with friction clutch for safe operation.
Cuts down timber, brush, hedge; turn blade
vertically and saw logs to length. Can be
equipped to fell largest trees. Clutch
pulley for belt work. Guaranteed.

OTTAWA MFG. CO., 1027 Brush Ave., Ottawa, Kansas

START HOME MAIL ORDER BUSINESS

Start small — grow big. Amazing new course shows you the way.
Rush your name and address today for full particulars. No obligation.

BELFORT (Dept. A) Engineering Bldg. Chicago 6, Ill.

NEW CHEAP OIL BURNER

FOR COOKING & HEATING STOVES-FURNACES
HEAT YOUR HOME, COOK YOUR MEALS
WITH CHEAP FURNACE OIL



NO MORE SHOVELING COAL OR
ASHES. A New Fuelizer Starter
Vaporizing System turns Cheap 130
Flash Furnace Oil, Distillate, Kero-
sene etc. into Oil Gas heat without
clogging up. LIFETIME GUARANTEE
against defects. \$1.00 Bonus Offer
for Testing. We will let you try it in your own stove or
furnace for one month. Get yours for introducing. Big
Profits QUICK. Be first. Send in your name TODAY.

NORTHWEST MFG. CO., 561-M 5th, Mitchell, So. Dakota

Prompt Delivery!

Model
000-U1

WYCOFLEX
"Universal"
**HIGH SPEED
GRINDER**

COMPLETE WITH G. E. MOTOR,
AC-DC 10,000 R.P.M. — SIX
ASSORTED ACCESSORIES
COMPLETE IN HANDSOME METAL CASE
ONLY \$31.25

GRINDER ONLY — \$24.75

Stands on aluminum base or hangs anywhere, even on belt! Best helper in home workshop. Unequaled for grinding, burring, filing, sanding, polishing. All accessories available. Exclusive, Patented Inner-liner, Shaft—vibrationless. True-running, long life. Ball-bearing handpiece and 1/4" collet. Order from dealer or write direct today. Supply limited.



only
\$31.25



WYZENBEEK & STAFF, INC. 838 W. HUBBARD ST. CHICAGO 22, ILLINOIS

Makers of famous WYCO Flexible Shaft Machines

**DIE-LESS
DUPLICATING**

Many small parts can be formed without dies, to duplicated accuracy of .001" with DI-ACRO Precision Machines. — Benders, Brakes, Shears. Save die expense and time delay. Ideal for experimental and research work, making samples, models, etc., as well as regular production runs. Write for descriptive literature.

O'Neil-Irwin Mfg. Company
341 8th Ave. South
Minneapolis 15, Minn.



"MEET THE CHOPPER" NO C.O.D.'s

U. S. ARMY—M1—MACHINE GUN. A full size model of the famous "Tommy"—"whose hot breath was largely responsible for routing the Japs from Guadalcanal". 34 1/2" long—5 1/2" wide at butt end. Same specifications — and made by the same company that manufactured the original. All parts cut to shape. Ready for a little work and assembly into a model that cannot be told from its prototype at 10 ft. \$395 P.P. 25c

879 Eighth Ave. Dept. P-10 INTERNATIONAL MODELS, INC. New York 19, N. Y.

THE GEM MAKER

Amateurs or professionals . . . hobbyists or jewelers . . . Polish your own gems with a B&I Gem Maker. You will find this a profitable adventure. All necessary lapidary equipment is furnished, including a super-charged diamond blade for sawing, and all wheels for grinding, shaping and polishing, also complete instructions. The complete equipment as shown, less motor and belt, for only \$29.50, f.o.b., Burlington, Wis. Write today for information and literature on the Gem Maker and accessories. B&I MFG. CO., Dept. S, Burlington, Wis.

TOY RACER

Made of aluminum 9" long with 6 plastic wheels and tires. Lacquered in bright colors. Postpaid \$1.95 cash with order. Doz. lots \$1.15 collect.

CERTIFIED PRODUCTS CO., Dept. 80, Louisville, Ky.

**Big Money for Workers
In Home or Shop**

Licensed Concrete Specialists wanted. No experience needed. Make *Colorglazed* concrete pottery without molds. New, low cost, patented method. Cemetery products, novelties, tiles, etc. Basement leaksealing. Other big pay projects. Booklet, details free. Men only. NATIONAL POTTERIES COMPANY 542 Lincoln Avenue Fergus Falls, Minnesota

**RIDE ONE
and you'll
buy one!**



**Make Your Bike a Motor Bike
With a WHIZZER Motor!**

The modern idea in dependable, low-cost transportation. Thoroughly proved through eight years of service. Fits any balloon-tired bike. Opens up thrilling new adventure and travel opportunities. Use it on your trips, for errands, shopping, recreation, business, work. 2 1/2 h.p. — drives through V-belt, unaffected by road or weather conditions. Speeds up to 35 m.p.h. 125 miles per gallon of gas. Plenty of power for hills. Does not interfere with normal pedaling of bike. Put a Whizzer on your bike now! Easily installed. Complete, except bike. See your dealer or mail coupon. Available now. WHIZZER MOTOR COMPANY, Pontiac 15, Michigan.

FACTORY PRICE
\$97.55
PLUS TAX

Precision - designed, precision-built by automotive craftsmen in the heart of the auto industry. And auto-type assembly line production has brought its price within reach of all!

IF NO LOCAL DEALER, USE COUPON

WHIZZER MOTOR COMPANY
Dept. 170, Pontiac 15, Mich.

I enclose \$99.97, which includes \$2.42 Federal Excise Tax, () check or () money order. Send me one Whizzer motor, complete, tax paid, with full installation instructions. Written guarantee with every motor. If descriptive literature only is desired, check here ().

NAME _____
ADDRESS _____
CITY _____ STATE _____

Yours to Enjoy..

- THREE-ROOM PRIVACY
- COMFORT WHEREVER YOU GO
- AT MODEST COST

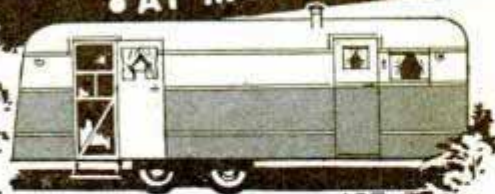

● In a Schult Luxury Liner you have every facility of a 2-bedroom house, plus insulation and an efficient heating plant for year-round comfort.

COMFORTABLY FURNISHED

Double bed built into bedroom; sofa-bed in living room converts into extra double bed. Kitchen includes oven range, double sink, refrigerator, and ample food storage space. 3 large wardrobes, plenty of drawers, closets for clothes and belongings.



See these mobile homes by which others are judged at your Schult dealer, or send today for latest catalog featuring 1946 Schult Luxury Liner.

SCHULT CORPORATION, Department 3210, Elkhart, Indiana
MEMBER: TRAILER COACH MANUFACTURERS ASSN.
In Canada: John Inglis Co., Toronto

SCHULT Trailer Coaches

MAKE MORE MONEY

APPLYING OR SELLING

CORKSTONE PLASTIC FLOORING

EASY TO APPLY



Here's your opportunity to get into business for yourself applying or selling Corkstone, the economical, top-grade plastic flooring. Plenty of profit. Act without delay!

Dealers & Agents Wanted

WRITE FOR DETAILS

LASTING PRODUCTS COMPANY

FRANKLINTOWN ROAD PLANT, BALTIMORE 23, MARYLAND

"Two Way TALKIE" by Dictograph



For household, shop, office or farm. Two way communication — set up anywhere. Can be moved from room to room. Nothing to plug in. Just flip the switch to talk. Flip it back to listen. Nothing to get out of order! Sent anywhere in U. S. for

\$17.95

Prepaid or C.O.D. Complete with 2 instruments, batteries, wires.

MART DISTRIBUTORS, Dept. M P. O. Box No. 6 Evanston, Ill.

15 JEWEL SWISS



MEN'S SUPERB WATCH

15 jeweled movement insures accuracy, dependability. Waterproofed! Radium dial and hands. Sweep second hand. Unbreakable crystal. Stainless steel back. The Swiss master watch craftsmen put these superb movements in handsome, lustrous, chrome cases. Truly a distinctive watch priced to sell quickly.

WRITTEN GUARANTEE WITH EACH WATCH!

Wear for 10 days at our risk and expense. SEND NO MONEY. Simply pay postman \$17.50 plus 10% tax and postage on delivery. Cash orders sent postpaid. Limited supply.

United Products Co., 7941 S. Halsted St., Dept. RR-154, Chicago 20, Ill.

SAVE MONEY ON GASOLINE

FITS ALL CARS

Now you can get up to 30% extra gasoline mileage with a Vacu-matic on your car. Quicker pick-up, smoother running, added power saves money every day. Guaranteed. **Automatic Supercharge Principle** Vacu-matic is entirely different! Operates on the Supercharge principle. Saves gas. Automatically provides a better gas mixture. Guaranteed to give up to 30% extra gas mileage, more power and better performance.



SALESMEN WANTED

Big profits. Every Car a Prospect. Send name and address for FREE PARTICULARS and how you get yours for introducing.

Vacu-matic Co., 7617-1296 W. State St., Wauwatosa 13, Wis.

BUILD THESE PROJECTS



For garden or lawn. Easy to build. Easy to sell. Detailed Blueprints Model B-25 Dutch Windmill 50c; Model OM-60 Old Mill, 85c. Lawn Figure Patterns—Sunbonnet Girl, Dutch Boy, Tulip Girl, Holland Pair, 35c each, all 4—81. Catalog illustrating many models, send 10c, today.



CRAFTSMAN'S MODEL CO., Dept. P-96, 2030 N. 41st St., Milwaukee, Wis.

COMB-A-TRIM THE NEW QUICK TRIMMER

Something New! Trim your hair without any experience. It's easy! The excess hair comes off smoothly and easily by just pulling trimmer through hair like an ordinary comb. Also removes hair from legs—armpits. Save on hair-cut bills... Trim your own hair or the whole family's. Send 59c and your Comb-A-Trim will be sent at once.



59c

SPECIAL OFFER
Send \$1.00 for 2 Comb-A-Trims and save 18c. **2 for \$1**

5 Extra Blades (Year's Supply) 25c

COMB-A-TRIM CO.

1734 Carew Tower

Dept. R-11

Cincinnati, O.

POPULAR MECHANICS

PLASTICS

NEW LOW PRICES
NEW HANDBOOK
NEW CATALOG

FUN—AND PROFITS—FOR YOU!

Want a fascinating new hobby?...Fabricate plastics—colorful, glamorous materials of the future! Want a profitable business of your own? Make plastics into household articles, jewelry, novelties for quick sale to department and gift stores!...Veterans! Here is your opportunity!

C-B PLASTICS HANDBOOK TELLS HOW

You can learn easily at home to fabricate plastics. They're simple to cut, shape, cement, color. Practice with a few dollars worth of materials, and you'll quickly acquire skill. No need for expensive schooling!

The new Carmen-Bronson PLASTICS HANDBOOK gives you all the "tricks of the trade" in fabricating Plexiglas, Lucite, Bakelite, Polystyrene, Lignolite, and other plastics. It tells you how to establish your own business. It

features construction plans for many salable articles.

C-B CATALOG LISTS ALL MATERIALS

The Carmen-Bronson catalog gives you complete prices and data on all materials you need. Plexiglas, Lucite, Bakelite, Lumarith, Lignolite, Tenite, Polystyrene, etc., in sheets, rods, tubes and special forms—crystal-clear and in many rich, glowing colors. Also lists numerous cements, dyes, compounds, accessories, supplies and semi-fabricated kits. Extra low prices—plus whopping reductions for quantity users!

GET STARTED TODAY!

Take the first step TODAY toward your brilliant future in plastics! Send only 10 cents for latest C-B CATALOG and C-B PLASTICS HANDBOOK.



10¢
BRINGS
BOTH BIG
BOOKS

LOOK AT THESE C-B LOW PRICES!

CRYSTAL-CLEAR PLEXIGLAS

All standard sheet sizes. Basic prices per square foot are:

	Under 25 sq. ft.	25 to 49 sq. ft.	50 or more sq. ft.
1/16".....	\$1.13	\$1.01	\$.90
1/8".....	1.46	1.31	1.16
3/16".....	1.79	1.61	1.43
1/4".....	2.10	1.89	1.68

Sheet sizes, thicknesses, may be assorted in figuring total sq. ft. ordered. Prices F.O.B. Mt. Vernon, N. Y.

CARMEN-BRONSON COMPANY

165 East 3rd Street
Dept. 10-B
Mount Vernon, New York

NEW MATERIALS

Latest Carmen-Bronson Catalog lists these excitingly beautiful new plastics:

MOTTLED THERMATONE

POLYSTYRENE • VINYL FILM

PLASTIC LEATHER • FLEXGLASS

in addition to Plexiglas, Lucite, Bakelite, Lumarith, Lignolite, Tenite in all forms.

CASTINGS

SMALL MACHINE TOOLS AND ATTACHMENTS

Many of these castings previously described in Popular Mechanics may be ordered either rough or semi-finished with plans:

Tool Post Grinder; Adjustable-Jaw Vice for Milling, Shaping, and Lathe Face Plate work; Step Collet; Boring Bar Holder; 3" and 4" Tool Post Turrets; V-Blocks; Angle Plates; Face Plates 6" and 9"; Chuck Back Plates 4", 5", and 6".

We make castings and patterns for special projects—send blue prints or write us. Also equipped to machine small metal parts in limited quantities for experimenting, small production items, etc.

T-P Manufacturing Company, P. O. Box 7024, Dallas, Texas

Test-O-Lite the MODERN TROUBLE SHOOTER



THE NEON GLOW

... LOCATES TROUBLE INSTANTLY in electric circuits, fuses, cut-outs, motors, radios, appliances. Tests everything electrical from 100 to 550 volts. Indicates hot or grounded wires. Tells AC from DC. Engineers prefer it because it has patented safety features.

↑ PUTS "FINGER" ON THE TROUBLE SPOT -- QUICKLY

Far superior to ordinary clumsy test bulb. Saves precious time. Indispensable in shop or home. Vest pocket size. Lifetime guarantee. List \$1.50 (Pat. No. 1,778,883) Purchase through regular electrical dealers.



FUSES



MOTORS



OUTLETS

L. S. BRACH MFG. CORP.

200 Central Ave. Newark, N. J.

Aluminum Oxide Cloth SANDING BELTS

These long-wearing, cloth sanding belts available in coarse, medium, fine, or assorted; be sure to specify grit desired; also, whether for wood or metal working.

Compare These Low Prices!

5	Belts	2 x 21"	\$ 1.00
4	Belts	3 x 24"	1.00
4	Belts	3 x 27"	1.10
4	Belts	4 x 36"	1.25
3	Belts	4 x 52"	1.35
3	Belts	6 x 42"	1.50
3	Belts	6 x 44½"	2.25
3	Belts	6 x 48"	2.50

Other Sizes: Write for prices on sizes not listed; also, discounts on quantity lots. Be sure to specify size and quantity.

Prepaid if remittance accompanies order. No stamps accepted. Shipping charges added if C.O.D.

KAMMAN SUPPLY COMPANY

14631 Gratiot Ave., Detroit 5, Mich.

KAMMAN SUPPLY COMPANY Remittance enclosed
14631 Gratiot Ave., Detroit 5, Mich. Ship C.O.D.
Please ship sanding belts as follows:

Quantity	Size	Grit	Wood or Metal	Amount
_____	_____	_____	_____	\$ _____
Name _____				
Address _____				
City _____ Zone _____ State _____				

SAVE TIME



Almost any job is *less work* if you have the proper tool. These cleverly designed BERNARD parallel action pliers belong on every work bench because they more than earn their keep, by doing jobs easier and better. At your local hardware store. Descriptive literature on request.

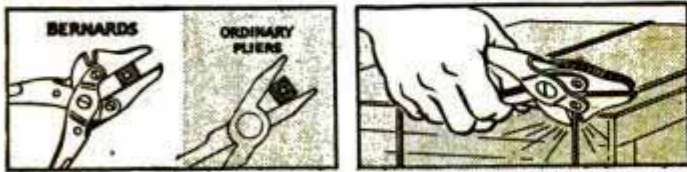

BERNARD

TRADE MARK REGISTERED

WM. SCHOLLHORN CO.

"Quality Tools Since 1870"

7510 Chapel St., New Haven 9, Conn.

AUTO ENGINE SPEED CONTROL GOVERNORS

(REGULADORES)

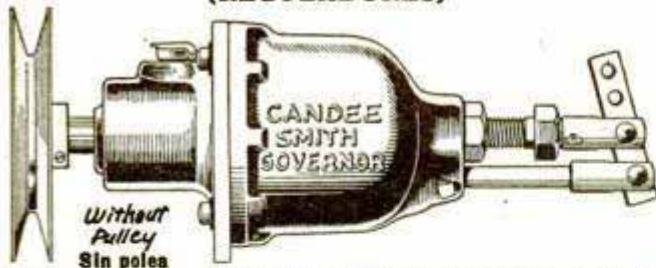

Give constant or changeable speed to any auto or truck engine, when used for power. Guaranteed. Instructions. Oil ring bearing, \$14.25. Full ball bearing, \$21.75. Postage west of Miss., 50c; east of Miss., 85c. Sent COD or Postage to any country in the world \$1.00 each. Pulleys to 3", \$1.00, wt. 1 lb.; to 6", \$1.50, wt. 1½ lb. Governor speed 1400 to 2400 rpm. Figure your pulley size.

Agents Wanted: Parts and Implement Dealers, Garages, Welders, Wreckers, Catalog and Mailing List Houses, etc.



These valves where carburetors have outside attachments. State size of opening and distance between bolt holes. 1", \$3.75; 1¼", \$5.25; 1½", \$6.50; 1¾", \$7.50; V8, \$8.00. Mailing weight, 3 lbs. If remitting, enclose for postage. You may order from this ad, or we will send circulars. Stocks carried: In Montreal 15, Canada: 7546 Wiseman St. In Skaneateles, N. Y.: Horie Welding Supply.

CANDEE, Dept. R, 2641 S. Hill, Los Angeles 7, Calif.

RATS

K-R-O Kills 'em or Your Money Back!

Safe! K-R-O Red Squill Powder *kills rats only*—is relatively harmless to farm animals, dogs, cats, chickens. Economical! Two-ounce package at 75c will make 200 quick-killing baits. At most drug, feed, and seed stores. Get K-R-O, today!

FREE "Rat Proofing Buildings and Premises," by U. S. Dept. of Interior. Write for your copy, now. The K-R-O Company, Springfield, Ohio, Dept. 162.



SUPER MYSTERY BUTTON

Many times as sensitive as our regular mystery button. Can be used for the same experiments and uses as the mystery button but with far better results. Needs no diaphragm of any kind. Ideal for musical instruments, intercommunication, recording, talking thru radio, and many other uses. When used with small head phone it makes an ideal inexpensive hearing aid. Shipped with 5000 word, 12 page booklet showing diagrams for dozens of uses, postpaid \$2.00.

Electronic Products Company
Saint Charles, Ill.



THE PLASTICOR

Something New, THE PLASTICOR, Plastic Injection Molding Machine, Molds Toys, Jewelry, Novelties. An excellent Xmas Gift. Send name for complete details. GRAY MODELS, Dept. PM, P.O. Box 1234, Syracuse 1, N. Y.

NEW! UNIVERSAL! SELF-CENTERING! MANDREL FOR HAND GRINDERS ELECTRIC DRILLS



\$1.00 (less saw)

Fits all saws and grinding wheels with holes from less than 5/64" to more than 3/16" diameter. Centers any size saw or wheel precisely—automatically—immediately. All steel and brass construction—nickel plated. Precision machined; runs absolutely true. Fits any make grinder or drill. Patent applied for. Available with 1/8" or 3/32" diameter shank. Specify diameter desired. Sent postpaid with simple instructions. \$1.00

PRECISION TECHNICAL SPECIALTIES CO.
59 Myrtle Ave., Brooklyn 1, N. Y.

PEPSI-COLA HITS THE SPOT

KROIL LOOSENS RUSTY FROZEN PARTS



Frozen bolts, pipe threads, bearings, etc., yield to KROIL, the new chemical lubricant that creeps into millionth inch spaces and dissolves rust and dried grease. Fastest penetrating oil known. Now used by 5000 industrial plants for emergencies. Use it on money back basis—AT YOUR DEALER or send \$1 for two 8-oz. spout cans, postpaid. Send dealer's name.

KAND LABS., 3020 Lincoln Tower, CHICAGO 1, ILL.



The WINNER

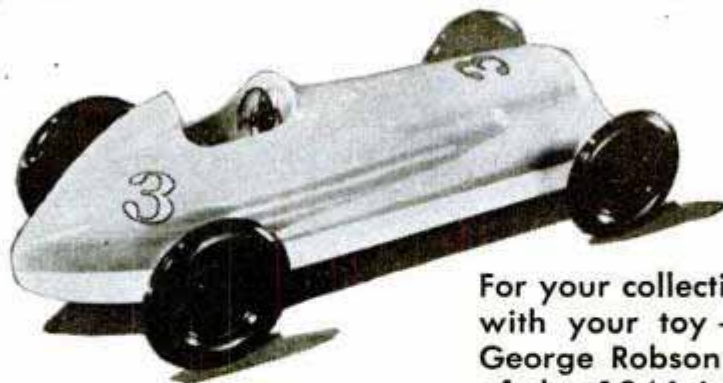

For your collection—in the package with your toy—a free picture of George Robson in the winning car of the 1946 Indianapolis Races.

Plastic Scale Model Racing Car. The winner at Indianapolis and the winner for the Lucky Boy who owns one. Durable! Exciting! As much fun for Dad as for the Gang. Ideal for Christmas or any gift occasion. A toy the family can enjoy! The perfect Model for Hobbyists.



ORDER BY MAIL TODAY—\$2.00, plus postage

ART SPARKS • 10-1, 1396 E. WALNUT ST. • PASADENA 4, CALIF.

ROL-E-Z-JACK NOW...YOU

For any size or weight of car—will lift up to 2 tons quickly and easily! Gets under places where other jacks can't—as low as 4 1/2"; lifts as high as 13". Heavy steel construction; no castings. A sealed thrust ball bearing gives the Rol-E-Z-Jack lifting drive and power. Ski type base prevents sinking into soft ground.

ONLY \$7.00

CAN LIFT IT WITH EASE!

The Rol-E-Z-Jack lasts a lifetime. Easy on your knuckles as well as your back. Tested and proved in use—satisfaction guaranteed!

SEND CHECK OR MONEY ORDER.

Dealers: Write for quantity prices.

CECO SALES CO.

164 - 25th St. Brooklyn 32, N. Y.

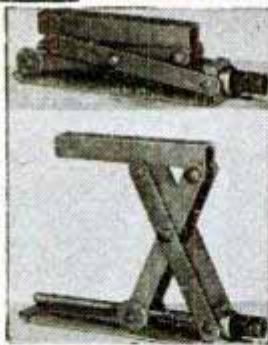

ATTENTION

Prospectors & Plumbers



AN/PRS-1 Mine Detector. Brand new. Used to locate buried treasure, pipes, etc. Complete less batteries,

\$19.85

ESSE RADIO COMPANY

140 W. NEW YORK STREET • INDIANAPOLIS 4, INDIANA



This Complete Home Workshop \$34.95

5 LATHE
DRILL
PRESS
CIRCULAR SAW
EMERY WHEEL
SANDER

Durable! Powerful! Heavily Built! Five power tools in one compact unit. Fabricated steel construction with high quality bronze bearings. Lathe 37" between centers. 6" or 8" circular saw. Drill press pulls 1/2" drill in steel. Uses 1/4 H.P. motor. Designed to handle all types of home woodworking jobs. Get the facts now before prices advance. Write Today!

EMRICK MACHINE CO.
1602 FULFORD ST.
KALAMAZOO, MICHIGAN

Write—FOR LITERATURE

The Saw with a Future

AVAILABLE NOW!



Here's a power tool that's really going places in home workshop and industry as every user finds that it more than meets every test to which it is put.

The Model 95C floor type 12" tilting arbor saw comes complete with three extension tables, extra long rack, fence and mitre gauge, all made of solid aluminum. The motor mounting bracket mounts any standard motor.

A solid steel base steadies the saw for precision work. Accurate action is assured also by the "sealed for life" ball bearings and by the smooth movement of the tilting and elevating mechanism.

Write for more information about this and other Darra-James power tools for the workman who desires perfection.

Darra-James CORP.

WATERBURY 14, CONNECTICUT

Now for EVERY WORK SHOP!

NEW Invention Electroplates by BRUSH



Easy to Plate CHROMIUM GOLD, SILVER, NICKEL, COPPER . . . For Pleasure and Profit!

If you have a workshop—at home or in business—you need this new Warner Electroplater. At the stroke of an electrified brush, you can electroplate models and projects—you can replate worn articles, faucets, tools, fixtures, silverware, etc. with a durable, sparkling coat of metal . . . Gold, Silver, Chromium, Nickel, Copper or Cadmium. Method is easy, simple, quick. Everything furnished—equipment complete, ready for use. *By doing a bit of work for others, your machine can pay for itself within a week.* So make your shop complete by getting a Warner Electroplater right away. Send today for FREE SAMPLE and illustrated literature. **ACT AT ONCE! Mail Coupon.** WARNER ELECTRIC CO., DEPT. K-2, 1512 Jarvis Avenue, Chicago 26, Ill.

FREE Details & Sample!

WARNER ELECTRIC CO., 1512 Jarvis Avenue, Chicago 26, Dept. K-2

Gentlemen: Send Free Sample and Details to:

Name _____

Address _____

City _____ State _____

SAFE-T-PLANE

**CUTS WOOD, METAL, PLASTICS
FITS ANY DRILL PRESS!**



Positive cutting action eliminates scraping or tearing in hard, medium or soft woods, including balsa, irrespective of grain position. A special cutter is available for making square-shouldered cuts, another for work in non-ferrous metals and many plastic products.

Features: single cutting blade; "one-spot" blade adjustment; polished bell guard protects eyes and hands, directs flying chips downward; vibrationless precision operation, rugged strength, versatility and long working life.

Only \$5.95 fully guaranteed.

At Your Dealer—or Postpaid. Literature available

A. D. MCBURNEY, 939 W. SIXTH STREET, DEPT. PM-10, LOS ANGELES 14, CALIF.

WOOD WORKERS

LUMBER—PLYWOOD AVAILABLE

Harold Hunt wants to send new No. 15 catalog. Over 124 pages of woodworking ideas. **UNEQUALLED BARGAINS** in imported and American woods, supplies, hard-to-find hardware. Send only 15c to cover postage and handling.

CRAFTSMAN WOOD SERVICE CO., 2729 S. Mary St., Dept. A-74, Chicago 8, Ill.

only 15¢



SOLVE TRIG QUICKLY—EASILY

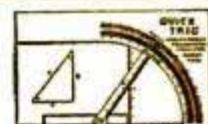

NEW QUICK TRIG SLIDE RULE, patent pending, solves trig. ratio, electricity and carpentry problems **FAST**. Simply set the slides and read the answers for all three sides and angles of a triangle. Also gives degrees, sines, cosines and tangents of angles. Entirely automatic. No figuring on paper necessary. Easy instructions included. We will mail C.O.D. plus postage or enclose \$1.00, the full price, and we will mail postpaid. Send now for your **QUICK TRIG**, to:

REED MFG. CO., 124-J W. 4th St., Los Angeles 13, Calif.



DRILL-INDEX A compact container for indexing and filing twist drills. Eliminates search. Made entirely of steel in nine sizes. See your dealer or write to:

HUOT MFG. CO., Foot Schultz Bldg., St. Paul 1, Minn.

Do You Need More Money?

SELL FAMOUS SUNSHINE CHRISTMAS CARDS

EXTRA SPARE TIME DOLLARS FOR YOU! Take orders galore from friends for 25 **SUPER VALUE CHRISTMAS FOLDERS** \$1.25. With name. Others to \$2.50. 50 Designs. **AMERICA'S LEADING \$1. BOX ASSORTMENT OF 21 FOLDERS. COSTS 50c.** A complete box line. **CURRIER & IVES, GLITTERS, OILLETTES, GRANDMA ROSES, Gift Wraps, Everyday's, Personal Line, 21 Asst. and Sunshine Notes** on approval. **FREE SAMPLES** of Personal Cards. Write today. **ORGANIZATIONS—** Ask for "Sunshine Money-Making Plan" and Samples. **SUNSHINE ART STUDIOS, 115 FULTON ST. Dept. EP, NEW YORK 8, N. Y.**

FREE SAMPLES PERSONAL CARDS



BULLET LIGHTER

**Dependable
Durable**

Made in a .50 caliber aircraft machine gun bullet shell. Highly polished.

This little dependable lighter will fit the pocket, purse or can be used as a table lighter. It is attractively highly polished, fine workmanship. Simple in operation and will make a fine gift.

\$1.00
POST PAID
IN
U.S.A.

Made by Veterans
FOX INDUSTRIES

BOX 45 POCATELLO, IDAHO

**NOW AMAZINGLY
SMALLER!**



NEW
Beltone
MONO-PAC
HEARING AID

THIS IS ALL
YOU WEAR

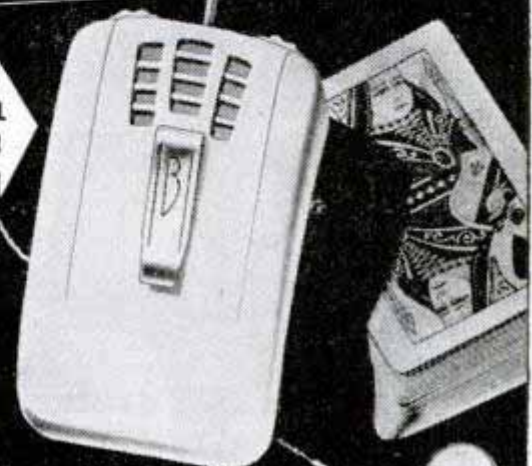

About 1/3 Size and Weight of
Old-Style Hearing Aids

**ONE TINY UNIT
does it all!**

More people wear the Beltone Mono-Pac than all other one unit hearing aids combined. Learn WHY . . . and get startling new facts on deafness in fascinating FREE booklet. How deafness "creeps up on you"—how it can be overcome—and how this remarkable new Beltone Hearing Aid has helped thousands to hear again.

*Learn Why There Are More
Beltone Mono-Pacs in Use Than
All Other One-Unit Hearing
Aids Combined*

Mail Coupon—FREE Book on Deafness

Beltone Hearing Aid Co.
Beltone Building, Dept. PM-10
1450 W. 19th Street, Chicago 8, Ill.
Please rush FREE booklet containing the facts about deafness and what can be done to overcome it.

Name.....
Address.....
Town..... Zone..... State.....

**WHEELS
AT BARGAIN PRICES**

We have on hand extra stock of wheels, sizes from 4" to 16", which we must move due to shortage of storage space—so are offering this stock at bargain prices.

BUILD YOUR OWN—wagons, mowers, scooters, wheelbarrows, grocery carts, kiddie toys, etc.

FREE LIST—Write For It—
T & H MFG. CO., Dept. B, 811 East 31 St., Kansas City 3, Mo.

LIQUID MARBLE COLORED POTTERY

Different! Marvelous! Color-glazed, Brush, spray, mold tiles, table-tops, ornaments!
SANITARY COMPOSITION FLOORING—Dustless, noiseless; put on like plaster, plain or tile designs; yielding as cork, lasting as stone. **RUBBERLASTIC Mold Compound**—For plaster casting, novelties, statuary, toys, plaques, dolls. **TILEX Colored Roofing.** Build Modern **PLASTIC HOMES.** Illustrated literature free.
RAPID MARBLEIZING SERVICE, Dept. 10-A, Edwardsville, Illinois

FREE! Radionic Catalog

New, big, FREE 1947 Catalog full of radios, parts, accessories, tubes, record changers, phono players, etc.

RADIONIC EQUIPMENT CO.
170 Nassau St., Dept. 2010, New York 7, N. Y.



BE FAIR TO YOUR HAIR Want better looking hair? Embarrassed by falling dandruff, itching scalp? Then try VITABRUSH, new electric driven scalp brush that gives your scalp a vigorous and invigorating "workout" in just three minutes of fun. Cleans scalp. Stimulates blood supply. Restful. Pleasant. Write today for complete information and satisfaction-guaranteed offer. Hershey Mfg. Co. 149 South La Salle St., Chicago

SOUND ON ANY SILENT 16mm. PROJECTOR

Play through your own Radio. Complete Ready to use, only \$59.95, mail your money order now for immediate delivery.



7356 MELROSE AVE., HOLLYWOOD 46, CAL.

MULTI-PURPOSE, RUGGEDLY CONSTRUCTED FLEXIBLE SHAFTS

Sealed Against Dust & Dirt
53 1/2" Length, 3/8" Diameter (O.D.)

ONLY..... **\$5.75**
Plus Postage

15 FT. LENGTH, with
right-angle offset at-
tachment 5/8" **\$14.95**
Diameter (O.D.)

These SHAFTS can be used on 1/2" motor shaft, or by removing the coupling, in a chuck up to 3/8" capacity. Shaft size on operating end is 3/8" diameter, 24 threads per inch. Speed range 1725 RPM to 3600 RPM. Can be bent or looped to small radius for working in hard-to-get-at places. Outer covering of oil-resistant Neoprene. Useful for many purposes, including Buffing, Grinding, Drilling, Polishing, Rotary Filing and Transmission of Power.

VENTILATING FANS

Complete with motor for AC, 110 Volts, 60 Cycles, single phase. Equipped with Aluminum blade. In frame, ready for mounting.

- 8" Blade Size.....\$15.00 (Plus Postage)
 - 10" Blade Size.....\$17.50 (Plus Postage)
 - 12" Blade Size.....\$27.50 (Plus Postage)
- Other Sizes up to 42" on quotation.

KITCHEN or ROOM VENTILATOR

10" Wall Box Fan with auto-matic shutter on outdoor side and grille on in" **\$29.50**
door side

U. S. NAVY BATTLE LANTERN

Mfd. by Delta. Throws a 500 ft. beam. Water-proof. With switch. **\$5.75** Plus Postage
Less Batteries.

EXHAUST BLOWER **\$10.50**

for Furnace use or dark room ventilation. 3" intake, with motor for use on alternating current, 110 V, 60 Cycles. 1 ph. Plus Postage

ORDER NOW... DEALERS INVITED
ELECTRIC TRADING CO.

313 CANAL ST. NEW YORK 13, N. Y.
Electric Fans and Blowers in most sizes for every Industrial, Commercial and Domestic use. Table Saws—Air Compressors—Electrical Tools and Paint Spray Equipment in stock.

PAY-RAISING — EXTRA MONEY BOOKS

Use these books to prepare for a better job—bigger pay—to start a profitable spare time or full time business of your own, improve your home, start a hobby. Popular Mechanics specializes in supplying outstanding self-help books on many subjects. Send for our FREE catalog.

- How to Remodel a House
Nothing is omitted...\$4.75
- Painting, Furniture Finishing & Repairing
New self-help book for craftsmen, home owners...\$1.50
- Shop Notes for 1946
Now ready. For every man who uses tools... .60c
- Shop Notes Library
5 Vols.—1946, 45, 44, 42, 41. (No Dup. Mat.)...\$3.00
- Welding, Brazing & Soldering
How to build own equipment and use it effectively...\$1.25
- Garden Book
Build own trellises, lawn furniture, fireplaces, ornaments, etc...\$1.00
- Forty Power Tools
Build own saw, drill, lathe, sander, etc., from scraps—save money...\$1.25
- Rewinding & Servicing Electric Motors (No. 75)... .25c
- Turn Scrap Into Money
Convert old auto generators into motors, welders, etc...\$1.00
- House Wiring (No. 89)
All information needed to do complete job... .25c
- Modern Refrigeration
Electric, Gas. Be service expert... \$5.00
- Dyke's Auto Ency. (includes Diesels, airplane engines)
New 20th Ed. World's greatest book for mechanics...\$7.00
- Sheet Metal Work
Self instruction in all phases...\$2.50
- Tool & Saw Sharpening (No. 92)... .25c
- Armature Winding
Construction, winding, repairing AC & DC Motors, generators...\$2.00
- Build Your Own Boat
Describes 17 popular boats—rowboats, sailboats, plywood outboard, etc...\$1.50
- Forging Practice...\$1.50
- Toys You Can Make of Wood...\$2.50
- Carpentry
Learn modern methods...\$2.00
- Foundry Work...\$2.00
- Pattern Making
Wood, metal...\$2.00
- Action Toys (No. 66)
Plans for 21 easy-to-make toys... .25c
- The Young Craftsman
Over 450 things boys can make...\$1.50
- Five Acres and Independence
How to make money on small farm...\$2.50
- Modern Welding Practice...\$2.50
Useful data on welding of all kinds. Simplified, non-technical, easy-to-understand.
- How to Plan a House
Every detail carefully explained. 525 pages...\$4.50
- A Small Store and Independence
Guide to successful retailing...\$2.00
- Modern Gas Turbine
Complete up-to-date information on uses as supercharger and prime mover. Includes jet propulsion...\$4.00
- A.B.C. of Poultry Raising...\$2.50
- How to Build Violin, Pipe Organ, Banjo-Uke...\$1.00
- Knots, Ties, Splices
For everyone who uses rope...\$1.25
- Plastics
Latest information on manufacture and use...\$4.00
- Workbenches & Tool Cabinets
You Can Build (No. 47)... .25c
- Concrete Handbook
New book on using concrete around home, garden, farm...\$1.50
- Oil Burner Handbook...\$2.50
- Photo Guide
Construct own equipment, gadgets. Make better photos...\$1.50
- Welding, Electric...\$1.25
- Welding, Oxy-Acetylene
Welding, cutting...\$1.25
- Metallurgy...\$2.50
- Ropp's Calculator
Figuring made easy... .50c
- Plumbing Installation & Repair
For those without previous training...\$1.50
- Judo, 30 Lessons in Modern Jiu-Jitsu...\$1.89
- Tool Making...\$3.50
- Tool Design...\$4.50
- Mechanism...\$3.50
- Air Conditioning—Heating and Ventilating. Principles and general applications of steam, hot water, vapor and vacuum heating...\$4.00
- Audels Sheet Metal Pattern Layout...\$4.00
- Estimate for the Building Trades
How To: Material and labor costs for masonry, plumbing, electricity, carpentry, heating, hardware, painting, etc. 629 pp...\$4.75
- Audels Masons and Builders Guide
For Bricklayers, Cement workers, Plasterers, Tile Setters and Stone Masons.
4 Vols...\$1.50 each
- Lejay Manual of Homemade Electric Equipment
How to construct 100 items that are scarce and valuable...\$1.50
- Drake's Refrigeration Service Manual...\$2.00
- Slide Rule Simplified...\$2.50
- Mathematics for Ready Reference
Covers all phases of mathematics...\$2.00
- Mechanical Drawing Self-Taught
With 21 simple step-by-step exercises. 56 pages of illustrations showing how to do it...\$1.00
- Audel's New Automobile Guide
1600 pages...\$4.00
- New Small Homes
62 practical and popular designs...\$5.00
- The Vegetable Growing Business...\$3.50
- Rabbits for Food and Fur...\$2.50
- Furniture Joinery...\$2.50
- Principles of Woodworking
Tools, processes, materials, projects...\$2.00
- Pottery Made Easy...\$2.50
- The Art of Wood Turning...\$2.00
- Essentials of Upholstery...\$2.75
- Radio Physics Course...\$5.00
A thorough training in radio fundamentals.
- Bookkeeping for Personal and Business Use...\$2.25
- The Art of Inventing and What to Invent...\$3.00



MAIL THIS COUPON TODAY

Check the books you want, write your name and address below, and mail this advertisement with money order or check. Outside U. S. A. include 15% additional for shipping charges.

Books selected will be mailed promptly on our "money back if you're not entirely satisfied" guarantee.

Name

Address

City..... State.....

Mail to **POPULAR MECHANICS PRESS.**
Dept. 604—200 East Ontario St., Chicago 11, Ill.

SHAW and "Peppy-Pal" "DU-ALL" GARDEN TRACTORS

1 to 9 H.P. Circulars on request. Building more now. We supply repairs for all SHAW Tractors sold in our 42 years in business.

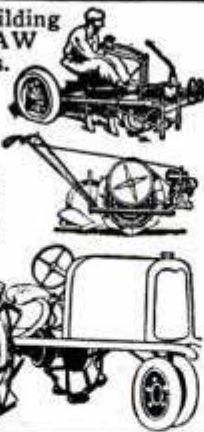

BUILD YOUR OWN RIDING TRACTOR—"WAR HORSE"

using old auto parts, powered by 2 H.P. or larger air-cooled engine; or walking type Garden Tractor 1/2 to 3 H.P. or convert truck or auto into Farm Tractor. Each with steel or rubber tires; will plow, cultivate. Plans for building, in few hours, any one of above, postpaid for \$1.00 (state which wanted) or all 3 for \$2.00. Money Back Guarantee.

SHAW MFG. CO., 4510 Front St.
Galesburg, Kansas

668G North 4th St., Columbus, Ohio

a real professional microphone TURNER CHALLENGER



MODEL BX
\$10.85
LIST

for hams and home recording. Reproduces voice or music crisp and clear. Precision built with moisture proofed crystal. Works indoors or out. Beautifully finished in rich bronze enamel.

Ask your dealer

Write for Free Literature describing Turner Microphones.

THE TURNER COMPANY

921 17th Street, N. E., Cedar Rapids, Iowa

Crystals licensed under patents of the Brush Development Co.

High Speed DRILLS

What the home work shop owner has been waiting for. A COMPLETE SET OF HIGH SPEED DRILLS For Shop .. Inventors .. Hobby Work, Etc.

60 Drill Set sizes No. 1 to 60.....\$14.95
29 Drills 1/16" to 1/2" by 64ths.\$17.75
21 Drills 1/16" to 3/8" by 64ths.\$ 8.95

\$14.95



HANDY TOOL SUPPLY

With Stand

1409 N. Keeler Ave. Chicago 51, Ill.

SAY YOU SAW IT IN POPULAR MECHANICS

BE A PERFUME DISTRIBUTOR

The most sensational profit possibilities in the whole field of selling; 100% year-round demand, liberal distributor discounts. Sell consumers or dealers, or both. Employ sub-salesmen. No experience needed; we'll tell you how. Finest perfumes made, exquisite, long lasting fragrances women just can't resist at your low prices. Men big buyers for gifts. Beautifully packaged. Write TODAY for free sample and details of tested sales plan.

DUDAN PARFUMS, 21-P West Illinois St., Chicago 10, Ill.

FRACTIONAL H.P. MOTORS

1/5 HP new G.E. for fans, appliances, grinders, etc. Operates AC-DC\$5.95
1/2 HP new G.E. ball bearing with built-in fan. Operates AC-DC 28 volts. On 110 volts AC produces about 1/2 to 3/4 HP.....\$9.95

ALSO (a) new G.E. 2 cylinder gear driven air compressor with 1/3 HP motor (AC-DC); 1000 lbs. pressure sq. in. \$35.50 (b) New Westinghouse D.C. generator 6 to 28 volts and 200 amps. for rapid battery charging, plating, or welding. \$35.50.

Send check or money order. Pay express man for shipping charges.

GORRELL & GORRELL

Haworth, N. J.

HAMS! STUDENTS! REPAIRMEN!

Spare Parts Find — Navy Surplus

A B K Series — I F F Units (declassified). Some parts have been removed—Remaining parts are new and in excellent condition. Cabinet — Vibration Mount—25 Condensers—11. Bathtub Condensers—40 Resistors—2 Electric Relays—1 Automatic Voltage Regulator — 1 Voltage Divider — 11 Coils — 1 Radio Frequency Transformer — 10 Tube Sockets.

COMPLETE F.O.B. YONKERS 3.75 SORRY NO C.O.D.'S SEND CHECK

Circular Listing Parts on Request UNIVERSAL MARINE SUPPLY CORP. Dept. F, 41 Locust St. Yonkers 2, N. Y.



make your

TALLEST

wish come true



with

ELEVATORS

TRADE MARK

HEIGHT-INCREASING SHOES
"YOUR PERSONAL PEDESTAL"

De Luxe Grade

TRADE MARK OF STONE-TARLOW CO., INC.

Many more opportunities will come your way the moment you step into a pair of "ELEVATORS." For these amazing height-increasing shoes make you more than 1 1/2 inches TALLER instantly. And "secretly" too... for the heels are no higher.



SEND FOR FREE BOOKLET

STONE-TARLOW CO., Inc., Dept. PM10-46
Brockton 68, Mass.

Send Booklet and name of nearest dealer.

Name _____
(Please Print)

Address _____

City _____ State _____

The Original and Genuine "ELEVATORS" Manufactured Exclusively by STONE-TARLOW CO., Inc.

STEEL IN KITS OF ASSORTED SIZE RODS!

KITS OF ROUND DRILL ROD

Water Hardening Quality—in 1 foot (approximate) Lengths

No. RDR-16—One each, 1/16" to 1/2" dia. by sixteenths. (Shp. Wt., 3 lbs.)..... \$160
No. RDR-32—One each, 1/16" to 1/2" dia. by thirty-seconds. (Shp. Wt., 6 lbs.)..... \$280
No. RDR-64—One each, 1/16" to 1/4" dia. by sixty-fourths. (Shp. Wt., 2 lbs.)..... \$125

KITS OF SQUARE DRILL ROD

No. SDR-16—One each, 1/16" to 1/2" squares by sixteenths. (Shp. Wt., 4 lbs.)..... \$200
No. SDR-32—One each, 3/32" to 1/2" squares by thirty-seconds. (Shp. Wt., 5 lbs.).... \$375

KITS OF FLAT DRILL ROD

No. FDR-125—One each, 1/4" to 1" wide flats all 3/8" thickness. (Shp. Wt., 4 lbs.)... \$255
No. FDR-187—One each, 1/4" to 1" wide flats all 3/16" thickness. (Shp. Wt., 6 lbs.)... \$235

NOTE: When ordering, add cost of postage to prices quoted here.

COLD-ROLLED STEEL

Write for free price list of Kits of Cold Drawn Steel Rods—Round, Square, and Hexagon, or for quotations covering sizes and types of steel, brass, or aluminum you require.



GENERAL METALS SUPPLY CO.

744 PARK AVE.

RIVER FOREST, ILL.

DIESEL GENERATED
Power
AT YOUR FINGERTIP

WHERE YOU NEED IT! WHEN YOU NEED IT!

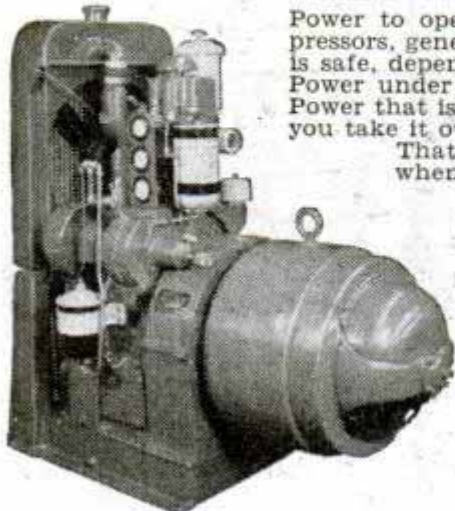

Power to operate pumps, compressors, generators. Power that is safe, dependable, economical. Power under your own control. Power that is ready to use when you take it out of the crate.

That's what we mean when we say... Diesel's the Power... Sheppard's the Diesel.

Generating Sets
2,000 to
36,000 watts

Power Units,
3 3/4 to 56 H.P.

Marine Engines,
3 3/4 to 62 H.P.

R. H. SHEPPARD COMPANY, INC., 48 Middle St., Hanover, Pa.

DIESEL'S THE POWER...

Sheppard's the Diesel

B-17 BOMB SIGHT
SHIPPING WEIGHT 165 LBS.

COST
U.S. GOV'T
\$6000.00

YOURS
FOR
\$35.00
F.O.B.
CHICAGO

B-17 Bomb Sight with automatic computers. High precision mechanical instruments for engineers, technical schools, inventors, and model makers. Use for study—demonstration—parts. Hundreds of gears, gyros, metal bellows, pressure switches, lenses, motors, spirals, levers, etc.

SEND MONEY ORDER TODAY

WEIS, 2929 Pulaski Road, Chicago 41, Illinois



AT LAST—A HANDY,
POCKET-SIZE

**ELECTRICAL AND
RADIO TROUBLE-SHOOTER**

quickly and conveniently checks radios, motors, fuses, neon signs, sockets, switches, irons, broilers, roasters and all other electrical appliances from 60 A.C. 90 D.C. to 550 volts A.C. or D.C.

Also distinguishes A.C. from D.C. Rigidly attached POCKET-CLIP permits tool to be carried like fountain pen.

Comes with genuine LEATHER CASE which permits tester to be carried in tool kit. Instruction sheet with every tester. No C.O.D. shipments outside U. S. A.

\$1.00

Send check or money order today

CORD
ELECTRICAL SUPPLY CO.
307 Grand St., Brooklyn, N. Y.
Dept. B-10

3 in 1 OTTAWA SAW

THE WORLD'S FASTEST.

BIG FREE BOOK

6-H. P.
EASY TO MOVE



**FELLS TREES,
SAWS BIG LOGS, SMALL LOGS, LIMBS**

One motor performs all three operations. Furnished with or without attachments shown below. Thousands in use.



Make **BIG** profits in the ever increasing wood business. Pulley for belt work. Fully guaranteed. Low direct-to-user prices. **FREE** details—write **TODAY**.

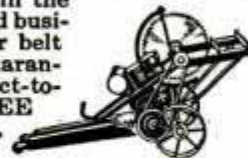

OTTAWA MFG. CO., 1027 Pine St., Ottawa, Kansas

ACE
LATHE TOOL SET
\$14.50



Be permanently tooled-up for every operation on your Metal Cutting Lathe

The ACE Set is complete—there's nothing more to buy. Drop forged by the manufacturers of cutting tools used by 96 per cent of the plants and shops in industry they are correctly designed, are of special steel, are finely finished, are stronger—will last a lifetime. You can cut easier, faster and more accurately with ACE TOOLS.

At your Hardware

ARMSTRONG BROS. TOOL CO.

"The Tool Holder People"

368 N. Francisco Ave., Chicago 12, U.S.A.

Turning Tool, 7 Collets, all Tools, Knurling Tool, Boring Tool, Threading Tool, High Speed Steel Cutters and Blades, and 2 Wrenches in Fitted Steel Case.

BUILDING CONSTRUCTION



with composition cement and cheap wood builds 3 room house low as \$250, farm buildings low as \$50. Homemade forms make blocks, panels and tiles in color, and wallboard of sawdust and other compositions. Wall-high blocks, insulated, with finished sides. Stream-lined roof and walls. Cement gutters, troweled roofs and floors. Ten formulas. Cabins, stores and sectional. 100 money and labor saving ideas. Mixer and saw easily made from an old auto. Make doors and windows. 50 proved ways to earn \$10.00 to \$15.00 a day. Guaranteed, book, 100 illustrations, \$1.00.

MAKE FURNITURE OF COMPOSITION cement, sawdust, asbestos, paper. Some part scrap wood and metal. Illustrated instructions to make tables, cabinets, chests, racks, shelves, inclosed sinks, lawn novelties and toys, 500 per cent profit. 50c.
HOW TO MAKE ACCURATE SHOP MACHINES: Band, jig, and circular saws, electric drills, sanding wheels, forge, tools, electric weed cutters and many other things from old auto parts and washing machine motors. Illustrated. 50c.
HOME MFG. ENTERPRISES: 50 selected home shop projects, illus., 50c.
Special: All four booklets described above, \$2.00 postpaid. No C.O.D.
HOME INDUSTRIES, 1318 So. 30th Ave., Dept. PM, Omaha 5, Nebr.

SAY YOU SAW IT IN POPULAR MECHANICS

Made From
IMPORTED BRIAR



- Sweet Smoking
- Superior Grains
- Modern Designs
- From \$3.50 to \$15

The Author SEND FOR FREE ILLUSTRATED BOOKLET

C. B. WEBER & CO. 146 Cator Ave., Jersey City 5, N. J.

MAGIC LIQUID MAKES
PHOTOS APPEAR

On Scarfs, Ties, Stationery, Etc.

Reproduce any snapshot on cloth, leather, wood, paper. Simply apply liquid. Like magic photo appears within 2 minutes in broad daylight. Harmless to negative. Won't wash off. Full colors included. Complete kit for 300 photos only \$1.50. Send no money, just name. Pay postman \$1.50 plus few cents postage on delivery. (Foreign, \$2.00 money order only.) Order today.



STYLE-ARTS, Inc., Dept. 1, 4649 Broadway, Chicago 40, Ill.



RADIO PHONES

Made to U. S. Army Specifications, passed by Signal Corps Inspectors. Dynamic Microphone and dynamic receiver of finest quality—Water, shock, weather and altitude proof, used on tank and aircraft (B19) intercom systems. For recording, for battery-less telephone, talk through your radio set or use earphones for pocket-size set.

Complete two receiver, cord set, head band, and dynamic hand microphone including special connecting cord set. Less than regular cost of dynamic mic. **\$9.95** Postpaid

King of ELECTRIC SWITCHES

Versatile Switch of a Thousand Uses Millions in Post War Applications

Floodlights your porch when the door is opened—sounds alarm when window is opened—signals arrival of mail—controls heating of furnace—filling of water tank, these and many other services are performed by this versatile switch. Shipped with instruction sheet showing numerous illustrated uses for this device at the low price of **\$1.00** Postpaid



BATAVIA 2, ILLINOIS



Titan Slide Rule

6" diameter. Easily read, clearly marked single index scales. Gives logarithms, reciprocals, squares, square roots, sines, and tangents. Continuous circular calibrations cannot go "off-scale." Invaluable in multiplication, division, proportion, conversion, all mathematical problems. Made of durable heavy pure white Vinylite. Complete with instructions, \$2.95. Leatherette case 75c additional. Money-back guarantee.

PRECISION INSTRUMENT CO.
Box 654, Dept. BG Church St. Annex New York 7, N. Y.

New Designs in FRANZITE GRIPS

Modernize Your Gun! Improve Your Score!

Most durable grips made. Positively unbreakable! For Colt, Smith & Wesson, Hi-Standard, Ortgies, Luger & Mausers in a wide choice of beautiful designs in ivory, pearl, walnut, onyx, etc. Low prices. FREE CATALOG. Dealers Wanted.

SPORTS, INC., (Mrs.) 5501 Broadway, Dept. P-10, Chicago 40, Ill.

NEW! 12" SHEET METAL BRAKE ONLY \$12

Fits in bench vise. Quickly, easily forms all kinds of angles in sheet metal, strap iron and aluminum, wire and plastic. Use it to make useful articles, experimental research work, patent models, etc. Simple gages made for quantity duplicating. Now available. Send for details, or order direct. C.O.D. \$2.00 deposit. Wt. 10 lbs.



VICE BRAKE MFG. CO.

1318 SO. 30th AVE.

OMAHA 5, NEBRASKA

SAY YOU SAW IT IN POPULAR MECHANICS



INDEX HEADS for Sale

Very inexpensive. Sixty-two different divisions. All degrees and half degrees of circle. Used on lathes up to 20" swing, drill-press, milling machine etc. Make things shown in illustration. Very accurate and durable. Write for free folder. Satisfaction guaranteed.

LONG'S INDEX HEADS
BOX 537 TORRINGTON, WYO.

BUILD ARC WELDER PLANS

We Show You How to build this new powerful welder without rewinding. For light or heavy work. Uses coils taken from old auto generators. Works on 110 or 220 volts A. C. Has 20 different heats. Send 35c for complete PLANS and valuable Catalog. Write today. LEJAY MFG. CO., 1347 LeJay Bldg., Minneapolis 8, Minn.



COLLECT U. S. ARMY Shoulder Patches

Fascinating hobby. Patches 10c to 50c each. Complete set of 250 for \$50. Official patches available for every major Army and Air Corps unit. Send \$1 for sample assortment of patches and illustrated patch catalogue.

SPRINGER'S
275 San Francisco St. EL PASO, TEXAS

BELT SANDER

AND TOOL GRINDER

WOODS MODEL 40

For home work shop woodworking and machine shop production

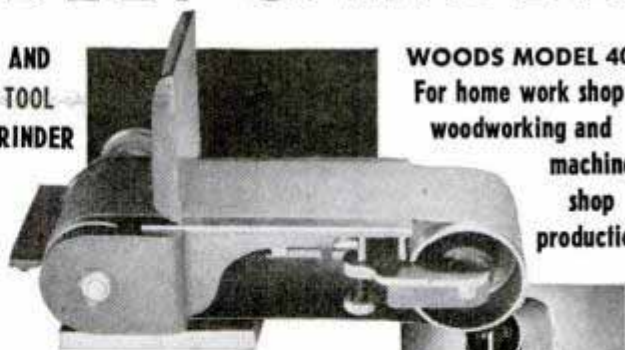

HORIZONTAL OR VERTICAL OPERATION—5" x 8 1/2" CAPACITY

Husky sander for metal, plastics, wood, glass and rubber; perfectly balanced completely machined pulleys (4" dia.) . . . ball-bearing thruout . . . drive shaft supported on both ends. These features assure maximum efficiency, smooth operation and long life. Tested to 5000 rpm. . . easy adjustment for horizontal or vertical operation . . . reversible platen usable on either face. Extra belts, 5" x 6" work table, and other accessories available from stock. Order from your dealer or shipped FOB direct from our S. Norwalk Plant



SPECIFICATIONS

Abrasive Belt 4" X 36"
Bench Space 9" X 15"
Motor Recommended 1/3 hp.
Net Weight 17 1/2 lb.
Shipping Weight 22 lb.

SANDER COMPLETE WITH BELT AND WORK DAM
\$39.95

ATTENTION DEALERS!

A limited number of dealer territories are still open; write for information.

WOODS ENGINEERING CO.
NORWALK 11, CONN.

BELL

GUARANTEED WATCHES



Self-Winding
WINDS AS YOU WALK
Automatic . . . arm movement keeps it wound. Specially guaranteed not to overwind.

17 jewels, waterproof, shockproof, anti-magnetic; radium dial and hands, unbreakable crystal, sweep second hand, precision tested.

No. VN 189
Stainless steel back..... **\$49.50**

No. VN 328
All stainless steel case..... **\$59.75**

Other fine ladies' and men's watches from \$24.75.

ORDER BY MAIL: Send check, money order or pay postman C.O.D. Prices Incl. Fed. Tax & Postage.

Write for FREE Illustrated Booklet "VN"

Repair Service

All types and makes of watches repaired expertly and promptly. Free estimate on request.

BELL WATCH COMPANY, INC.

Time and Life Bldg., Rockefeller Center, New York 20, N. Y.

NEW TOOL READY!

War Industry's Handy, All'Round Machine

Now Available
To Home Shops!

The world-famous Mead Bandsander—invented for and used by hundreds of war plants—is at last available to you for home workshop use! This remarkable machine quickly shapes, sands, carves and polishes wood, metal, plastics! Works equally well on inside cut-out openings or irregular outside edges. Gets at places no other can! Tilting table for bevelling, chamfering. Rust-and-sweat proof top. Ball bearings. Saves time, labor, money on jobs in any home or industrial shop. Invaluable to home-craftsmen, makers of patterns, tools, dies, signs, costume jewelry, castings, forgings, ornaments, radio and electrical parts, stampings, etc. Nothing else like it. Sold on 5 Day Trial, money back guarantee. Circular Free!

Cuts Fast and Clean . . .
Saves Filing, Sanding Work

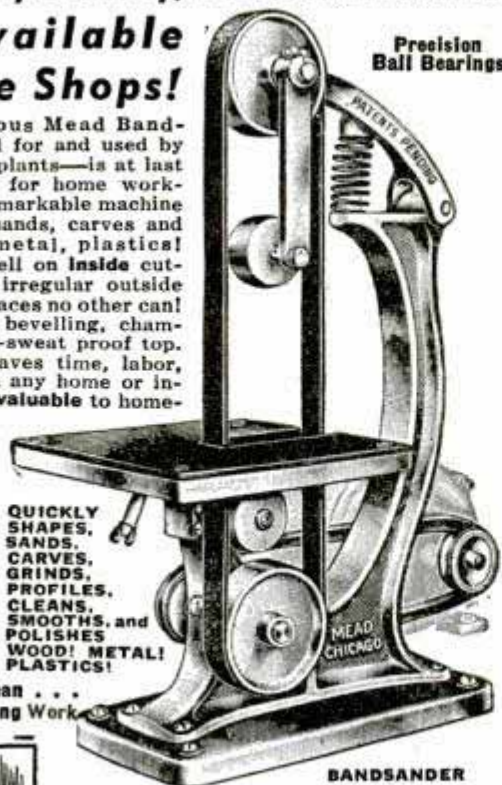

QUICKLY
SHAPES,
SANDS,
CARVES,
GRINDS,
PROFILES,
CLEANS,
SMOOTHS, and
POLISHES
WOOD! METAL!
PLASTICS!

BANDSANDER

Write for FREE Circular

Send for free details on "the machine that amazed the experts!" Rush a postcard today for Circular, surprisingly low price. Hurry!
MEAD SPECIALTIES CO.
4114 N. Knox Ave., Dept. 1106, Chicago 41, Ill.



ELECTRICITY FOR ANY JOB ANYWHERE

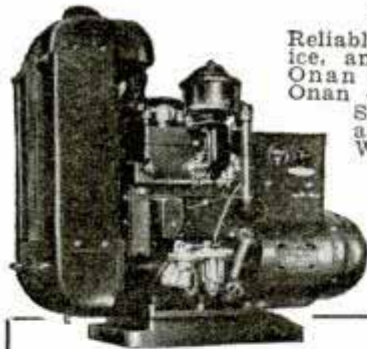

Reliable, economical electric service, anywhere, anytime, with an Onan Electric Plant. Driven by Onan 4-cycle, gasoline engines. Single-unit, compact design and sturdy construction. Water or air cooled.

Capacity range: 350 to 35,000 watts; 115 to 660 volts A.C.. 50 to 800 cycles; 6 to 800 volts D.C. Combination A.C.-D.C. types. 65 different models

WRITE FOR FOLDER

ONAN

D. W. Onan & Sons, 2522 Royalston Ave., Minneapolis 5, Minn.

Van's BOOT SAVER



Here's the smart way to dry your boots and other outdoor footwear quickly—also to store them to save folding and prolong life. Indispensable to hunters, fishermen, farmers and all outdoor workers and sportsmen. On trips carry in coat pocket.

\$1.25 prepaid in U. S. A. if your dealer can't supply you.

NOEL VAN TILBURG CO.

1029 Washington Ave. S. E., Minneapolis 14, Minn.

MUFFLERS

STEELS and ALUMINUMS
with a motorboat tone

SINGLES \$5.50 to 8.00
V-8 DUALS 17.50 to 20.00
Reduce back pressure and increase engine performance. A Sandee is time proved and dependable. Aluminums are guaranteed for the life of your car.

DEALERS WANTED

SANDEE MUFFLER CO.

7523 S. WESTERN AVE., LOS ANGELES 44, CALIF.

V-8
DUALS
& SINGLES



AMAZING MYSTERY BUTTON



Startles Everybody. With this Electronic Button you can make your own Telephone-Amplifier-Detectophone. Attach this button to piece of cardboard—transmit conversation to another room. Music also transmitted to distant places. Most interesting, electrical apparatus ever discovered. Enables you to perform hundreds of experiments. So tiny it can be concealed in dozens of places. A Pre-War Product. Electronic Button including 5000 word instruction booklet with 50 illustrated experiments postpaid only \$1.00.

Electronic Products Company, Saint Charles, Ill.

SAVE PRESSING BILLS with New WILBAR \$1.50

PANTS and SKIRT HANGER



This new invention saves its small cost many times over by cutting pressing bills. Holds 5 trousers or 5 skirts—always ready to wear. Easy to slip garments on and off hanger. Clips leave no marks, takes little closet space. Attach quickly and easily to wall or molding. Nickel plated Spring steel clips fastened to strong steel brackets, finished in lustrous black baked enamel. Needed in every home. Makes ideal gift. Order quick before limited supply is exhausted. Include remittance with order for postpaid delivery. If preferred will send C.O.D. plus C.O.D. fee and postage. Rush order today. **WILBAR SALES CO.,** 549 W. Washington Blvd., Dept. 15, Chicago, Ill.

MASTER CHAMPION LAWN MOWER SHARPENER

Also Mfg., Saw Sharpening
& Key Machines

FRANK'S MFG. CO.

LUcas 6929

Dept. PM4, 3312 Tweedy Bl.
SOUTHGATE, CALIF., U.S.A.



WANT TO BE INDEPENDENT?

You can go into business for yourself. Learn the Stephenson Method of making and fitting corrective arch supports. Not medical—not chiroprody. Men and women earn \$50-\$100 weekly in this respected profession. Learn at home on easy terms, no other capital needed. No goods to buy, no agency, you become your own boss at once. Write for our free booklet!

THE STEPHENSON METHOD

2810 Back Bay, Boston, Mass.

RUPTURED?

Get Relief This Proven Way

Why try to worry along with trusses that gouge your flesh—press heavily on hips and spine—enlarge opening—fail to hold rupture? You need the Cluthe. No leg-straps or cutting belts. Automatic adjustable pad holds at real opening—follows every body movement with instant increased support in case of strain. Cannot slip whether at work or play. Light. Waterproof. Can be worn in bath. Send for amazing FREE book, "Advice To Ruptured," and details of liberal truthful 60-day trial offer. Also endorsements from grateful users in your neighborhood. Write:

CLUTHE SONS, Dept. 31, Bloomfield, New Jersey

NO TEDIOUS HAND TURNING!

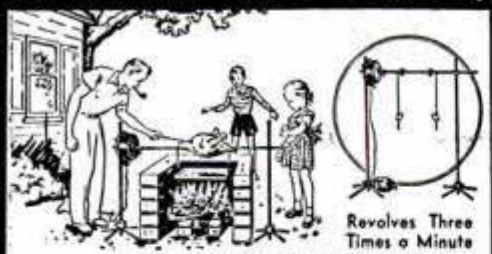

KASSON

Electric Bar-B-Q

GENERAL DIE AND STAMPING CORPORATION
270 Mott St. Dept. MP New York 12, N. Y.

Revolves Three Times a Minute
Sturdy, adjustable, it's equipped with 50 feet of cord; 110 V. AC. Useful indoors too. At better stores or write for literature. \$39.50 each.

Beautiful Modern

SIGN LETTERS

Signs anywhere, quickly, easily... Write for money making-saving plan... Samples
PINNACLE SIGN LETTERS, Mound City, Ill.

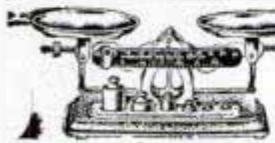

Balance 4" x 9" Base. With either \$6.00 Metric or Avoirdupois Weights...
Catalog with 3000 Illustrations of laboratory apparatus, and over 10,000 prices sent for \$1.00. Catalog of 80 Scientific books. Price \$1.10.
LABORATORY MATERIALS CO.
7321 Vincennes Ave. Chicago 21, Ill.

CRESCENT TOOLS

Give Wings to Work

ASK YOUR
HARDWARE
DEALER

SELL MERCHANDISE BY MAIL

Operate profitable home business selling merchandise by mail. 75c profit on fast selling \$1 items. Write TODAY.
POWELL CO., Dept. A, Sampliner Bldg., Cleveland 3, Ohio

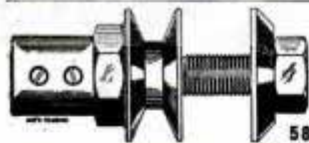

MOTOR ARBOR AND COMBINATION V-PULLEY
1/2" right .65c 1/2" left .75c
5/8 & 3/4 R & left. \$1.00
Add 10c postage each. U.S.A. Trade disc.
B. DOWICK, Dept. P
584 Communipaw Ave., Jersey City 4, N. J.

FIBRE ARMS AND LEGS!



Light, correctly fitted, strong and comfortable. Natural appearance. Braces for all deformities. Scientific design. Fair Terms.
BUCHSTEIN-MEDCALF
223 S. 6th St., Minneapolis, Minn.

BOWS & ARROWS

Write for 94 page Illustrated Instruction Hand Book 50c; 20 page catalog 5c; stamps or coin.
LE STEMLER CO. QUEENS VILLAGE, N.Y.

SET UP YOUR OWN SHOP with MULTIPRESS

Amazing Bench Press Easily Adapted to Production Line

- BLANKING
- BROACHING
- FORMING
- PELLETING
- STAMPING
- MARKING
- PRESSING
- ASSEMBLING

and many other operations!



4-, 6-, and 8-ton units



PROFITABLE Sub-Contracting Opportunities for Veterans and Small Shop Owners

You can turn out scores of different jobs with precision and profit on the power-packed MULTIPRESS. This compact, versatile bench machine is economical to install . . . easy to operate; girl operators are used exclusively in many shops—a single unit with many industrial uses by means of easily attached tooling accessories. Write for complete information on how this versatile machine tool can help you.

THE DENISON ENGINEERING CO.

1190 Dublin Road, Columbus 16, Ohio



DENISON
EQUIPMENT & APPLIED
Hydrolics

AMAZING NEW "THERMO-SAW"

CHILDREN ARE ENTHUSIASTIC USERS AND OPERATE IT WITH SAFETY **(Cuts With Heat)**

WOW! How the Boys and Mechanics go for this NEW "THERMO-SAW" . . . Operates simple, easy and quick . . . Cuts plywood 1/8" to 1/4" . . . Excellent for cutting difficult patterns . . . Cuts 14" x 36" board . . . NOISELESS — NO VIBRATION — NO SAWDUST and SPEEDY . . . Also, NO TURNING OF THE WORK . . . Cuts in EVERY DIRECTION! A special transformer produces high frequency current in a tough steel wire "blade" from ordinary Alternating (AC) Current . . . Will cut 1/8" Plexiglas very well . . . Extra Machine Measures 11" x 4" . . . Blades, ONLY x 3 1/2" High, Throat 7" Deep. 20c per dozen. PATTERN INCLUDED FREE. Order Today.
Boisselier Mfg. Co., Dept. P-10, Glen Ellyn, Ill.

CUTS RAPIDLY AND CLEANLY THROUGH WOOD AND OTHER MATERIALS
NOTE: Operates on 110 volt Alternating Current only; 50 to 60 cycle.

\$4.75 in Canada & Mexico. \$5.00 elsewhere. No C.O.D. Orders Please!

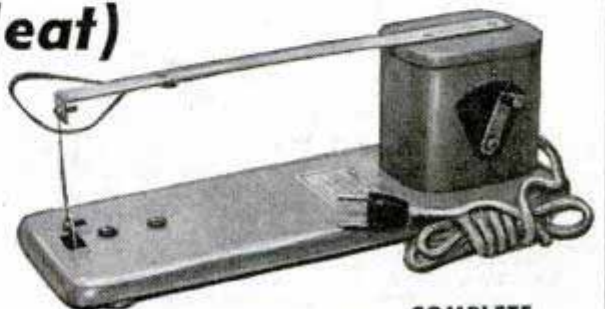

ONLY \$4.50 Postpaid

COMPLETE outfit as illustrated with transformer and 12 spare blades.

WORLD'S

LOWEST PRICED ADDING MACHINE

VEST POCKET SIZE

MAKES IDEAL GIFT

Baby Calculator makes an ideal gift—for every Gift occasion. Birthday—Graduation—Christmas—Anniversaries. For men, women, children—teachers, business people, home or shop use. **COMES PACKED READY FOR GIFT WRAPPING.**

TEN DAY TRIAL

Money Back Guarantee

Because we know that our machine is the very best Calculator to be obtained at this low price, we make this 10 Day Trial offer, on a positive money back guarantee! Don't buy ANY Calculator without this guarantee! Send only name and address, pay postman \$2.50 plus postage (if cash is sent, we pay postage—you save up to 40c). (Send full cash if outside U.S.) Money back within 10 days if not delighted.



IDEAL XMAS GIFT

Fits vest pocket or purse. Guaranteed Accurate. Operated as easily, and as reliable, as machines costing many times as much. NOT A TOY or GADGET. Substantially made of 28-gauge steel—guaranteed for life against defects in construction. Beautiful looking, modernized design. Finished in Black, Silver and Red. You positively can't buy a Calculator of equal quality for as little money. **ACCEPTED AS THE FINEST LOW PRICED CALCULATOR FOR OVER 30 YEARS!** Operates with a flick of your finger. Adds, subtracts, multiplies, divides—counts up to ten million. Pays for itself over and over in mistakes avoided, and time saved.

CALCULATOR Machine Co. (Mfrs.)

DEPT. 183, P. O. BOX 1118, CHICAGO, ILLINOIS

USE COUPON

CALCULATOR MACHINE CO. (Mfrs.)
P. O. Box 1118, Dept. 183, Chicago, Ill.

Your Calculator is just what I've been looking for. Send one at once (C.O.D.) or (I am enclosing \$2.50).

Name.....

Address.....

City.....State.....

AGENTS WANTED

FREE TRIAL

ONLY

\$2.50

TOTAL COST

SEND NO MONEY

FREE!!

Each Baby Calculator enclosed in beautiful rich-looking Leatherette Case—at no extra cost.



MOULD LATEX—No Shrinkage

Use a thoroughly tested material for making your moulds. It will pay you to investigate our product. Instructions sent with each order.

1 quart \$1.75 1 gallon \$6.00

All shipments F.O.B., Stoneham, Mass.

Stoneham Rubber Co., Box 244, Stoneham 80, Mass.

GENUINE MILITARY WRIST WATCH Complete with New Style EXPANSION BAND

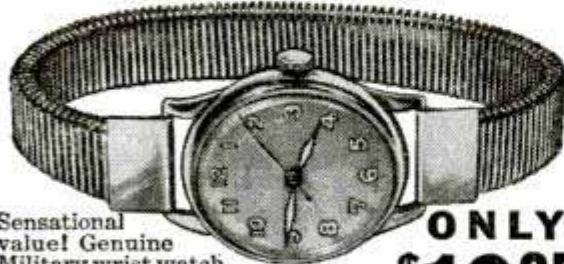

Sensational value! Genuine Military wrist watch, precision built, split-second time-keeper, for **ONLY \$12.95** plus tax! Water-protected, shock absorber. Radium dial and hands, easily read in the dark, unbreakable crystal, **red sweep second hand.** Handsome, non-corrosive stainless steel case. Genuine non-corrosive stainless steel expansion bracelet fits all wrists. Order yours today! **SEND NO MONEY!** Rush order now. Pay postman only \$12.95 plus postage and 10% Fed. tax. If not delighted, return within 10 days for refund. **CORONA WATCH SALES COMPANY**
809 W. Madison St., Dept. X-84 Chicago 7, Ill.

PHOTO ENLARGEMENTS



Is Photography your hobby? Do you want a profitable easy business at home? Make **PHOTO ENLARGEMENTS** for yourself and others. Your cost 5c each and less. The **AU-TO-MATIC** requires no experience. Also **COPIES** any picture. Interesting circular **FREE.**

5¢ ANY SIZE

PHOTO-SPHERE, Dept. B, Long Island City 3, New York

Make Your Own ELECTRIC FAN

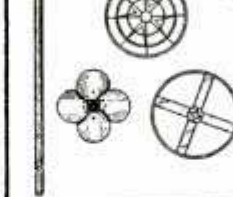

Using Your Own Washing Machine 1/4 H. P. Motor. We Furnish the Parts—18 In. Balanced Blade \$7.00, Guard \$3.00, 23-Inch Base \$6.00., 3 or 6 Foot Stem and Motor Mount \$3.00, or 4 Items for \$18.00. We can furnish the blade with a 1/2, 3/4 or 3/4 inch bore.

Mail Orders Add Sales Tax

BRUNIA Electric

312 Grand Avenue, Des Moines 9, Iowa

SAY YOU SAW IT IN POPULAR MECHANICS

BRUSH PLATING OUTFITS

for re-plating articles in the home and shop. No tanks necessary. Free particulars.

GUNMETAL CO., AVE. M, DECATUR, ILLINOIS

LAW

STUDY AT HOME for PERSONAL SUCCESS and LARGER EARNINGS. 35 years expert instruction—over 108,000 students enrolled. LL.B. Degree awarded. All texts furnished. Easy payments. Send for **FREE BOOK**—"Law and Executive Guidance."

AMERICAN EXTENSION SCHOOL OF LAW
Dept. 70-M, 646 N. Michigan Ave., Chicago 11, Ill.

START HOME NOVELTY MFG. BUSINESS

New course tells in simple language how to make plaster novelties of many kinds at home. Descriptive folder free.

Engineering Building **W. BELFORT** Chicago 6, Illinois

W-E-L-L-P

Guardian of your loved ones and valuables is the **AUTOMATIC WATCHMAN BURGLAR ALARM** with full easy-to-install instructions. For homes, windows, doors, closets, offices, etc. 100% effective against burglary.

\$26.50 per unit
\$1.50 for each additional opening protected
Dealer Inquiries Invited

S & S CONTROL CORP.

575 Riverdale Ave.

Brooklyn 7, N. Y.



Automatic Watchman



Send for Free List of LEADING BOOKS

on WATCH REPAIRING, Clock Repairing, Engraving, Industrial Diamonds, Aircraft Instruments, etc.

HENRY PAULSON & CO. CHICAGO 3, U.S.A.

FOR BIGGER PROFITS FROM SMALL LATHES!

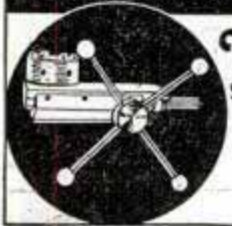

Unique NO. 50 BED TURRET
Available For
SOUTH BEND, ATLAS, LOGAN, CLAUSING

Send For Descriptive Circular
On Unique Production Equipment.

UNIQUE MANUFACTURING CO.
4807 N. 31st Ave., Omaha, Nebr.



Saw Arbor

B33—\$4.95 PP.

BALL BEARING SAW ARBORS

Saw arbors, grinding arbors; quality guaranteed. Extremely well designed and engineered. Build your own power tools economically with **POLY PRODUCTS**. Other models also available: B15 sanding arbor, plain spindle, \$3.45 PP. B20 flange plain spindle, \$3.45 PP. B41 flange saw arbor, threaded spindle, \$4.95 PP. All spindles 5/8" diameter only. Plain spindle working ends 1 1/2" and 1 3/4". Threaded spindles, pulley end, 1 3/4"; space between collar and washer, approx. 3/4". All models in stock. L.H. threads available.

BALL BEARING HEAVY DUTY SAW ARBORS

5/8 Spindle \$8.25 P.P.
3/4 Spindle \$9.25 P.P.

Spindle 1 1/2 Long
Housing 2 1/4 x 8



POLY PRODUCTS

406 S. Chester Ave.
Ct. 1, Pasadena 5, California

GREASED LIGHTNING!



Use **WALTON DELUXE WHEELS**—they are better—America's finest—build your wheel vehicles to your own special design. Don't be satisfied with anything less!

Hardened Steel Roller Bearings! Accurately fitted roller bearings and massive jumbo balloon rubber tires give them rocket speed and provide you with almost unbelievable velvet smooth rides.

Quick Delivery—Low Price for So Much Fine Quality! Ideal gift! Hundreds of uses! Excellent for boat carriers, golf bag carriers, carts of all kinds, trailers, etc. Tremendous production direct from manufacturer makes possible our low price to you.

3 Complete Wheel Kits
You get wheels, plus two 1/2" axles, 4 hangers, 4 cotter pins, 8 washers, ready for use.

WK1 — Includes above equipment and four 8x2" rubber Deluxe Wheels. Specially priced . . . \$13.95

WK2 — Includes above equipment and four 10x 1 3/4" rubber Deluxe Wheels. Specially priced . . . \$14.95

WK3—Designed for heavy-duty needs. Includes above equipment, four extra-heavy big industrial type Deluxe Wheels. Massive 10" rubber tires are 2 3/4" thick. Specially priced \$32.95

FAST DELIVERY. SEND CHECK OR MONEY ORDER. NO C.O.D.'S. PLEASE.

WALTON WHEEL COMPANY

635 N. Plankinton St.

Milwaukee 3, Wis.

Dealers and Equipment Manufacturers — Write for Information

Build these yourself

Only—
\$2.95
8 X 2
Inch



Racers Wagons



Boat Carriers Scooters



Trailers Carts



SPEED UP HARD-TO-DO JOBS

WITH

AIR-SPEED SAW and FILE!

Simplifies Difficult Sawing or Filing Jobs



**LIGHT
COMPACT
POWERFUL**

DEPENDABLE air-powered saw and file—Weight: 3 1/2 pounds — Operating speed and cutting stroke adjustable — Ideal for key hole, dead-end and scroll cutting in iron, steel, aluminum, copper, plastics, brass, wood, hard fibre and other materials — File can be inserted in chuck for all filing operations — Only two moving parts guarantee long life — Fully warranted — Retail for \$39.50 — Immediate deliveries — See your Dealer.



AIR-SPEED TOOL COMPANY

1500 W. Slauson Ave., Dept. PM-10, Los Angeles 44, Calif.

Simplified Shaves ENDERS



Speed SHAVER
Easy does it

See for yourself how amazingly simple, time-saving your morning shave can be. Your first Enders shave will astonish and delight you. Easier from start to finish—because you're shaving with a precision instrument, cleverly designed to do its job without fuss and feathers. Get an Enders Speed Shaver today.

because
double thick deluxe blade
clicks in like magic
nothing to take apart
streamlined action
new safety

Address: Dept. R

49¢
with 6 BLADES

DURHAM-ENDERS RAZOR CORP. - Mystic, Conn.

NOW HOT WATER QUICKLY! — EASILY!



AMAZING
LOW PRICE **298**
P. P.

Now you can have hot water anywhere quickly by just plugging HEAT-KWIK into any socket, AC or DC. Comes with a 5-year-guarantee. Sent C.O.D., plus postage — or send \$2.98 and we ship postpaid.

ROLEY SALES CO., Inc., Dept. 808-M

154 NASSAU STREET

NEW YORK 7, N. Y.

Look! Servicemen - Civilians too! PRECISION BUILT MILITARY WRIST WATCH



The watch you've been waiting for!
Swiss Movement!
Precision made by
Expert Swiss Craftsmen

WRITTEN GUARANTEE
WITH EVERY WATCH

A fortunate purchase makes this amazing offer possible. Latest military styling, red sweep second hand. Easy to read Extra Fancy Dial. Comes complete with Leather Strap. A watch you'll be proud to wear or give as a gift. Below O.P.A. Price.

Immediate delivery
\$8.49
ONLY plus 10% Fed. Tax

SEND NO MONEY—Pay Postman \$8.49 plus 85c Fed. Tax and few cents postal charges, or, send \$9.34 with order and we pay postage. Return within 10 days if not delighted for refund providing watch has not been tampered with.

Hurry — Order Now — Supply Limited!

ORDER WITH CONFIDENCE FROM
AMERICAN MERCHANDISING CO., INC.
Dept. PMW-4 12 Adams Ave. Montgomery 4, Ala.

Handy Mail Order List

Little Library of Useful INFORMATION

5 for \$1.00
12 for \$2.00
25¢ Each

Here at amazingly low cost is the practical help and information you have always wanted. Articles in previous issues of Popular Mechanics have been classified according to subject and are now available in these handy reprint booklets.

How to Use Measuring Tools—Micrometers, Calipers, etc.—106.
Power Driven Saws—74.
Drill Presses, Grinders, Etc.—79.
Wood, Metal Turning Lathes—81.
Filing Machine, Hack Saw, Cutoff Wheel, Shaper—82.
Lathe Tools You Can Make—101.
Workbenches—Tool Cabinets—47.
Spray Painting—94.
From Pattern to Casting—91.
Tool and Saw Sharpening—92.
Sharpening Drills, Wood Bits—90.
Successful Wood Turning—32.
How to Read Blueprint—71.
Metal Turning Lathe Kinks—99.
Operating a Metal Lathe—100.
Heat Treating, Hardening—102.
Working With Glass—103.
Servicing Elec. Motors—75.
Electromagnets & Solenoids—44.
Transformer Construction—41.
The Boy Electrician—43.
Soldering and Brazing—17.
Arc and Spot Welders—5.
Electroplating With Nickel, Chromium, Cadmium, Etc.—86.
Plating Leather, Wood, etc.—87.
Lower Your Fuel Costs—31.
Curing Leaky Basements—45.
Fitting Home Game Room—55.
Indoor & Outdoor Fireplaces—88.
Backyard Gardening—39.
Lawn and Garden Novelties—72.
Trellises, Pergolas, Fences—76.
Lawn and Garden Furniture—77.
Playground Equipment—73.
Concrete Garden Furniture—6.
Making Serving Trays—53.

Knots and Ropework—105.
Working With Plastics—61.
Simple Home Improvements—104.
Ridding Home of Insect Pests—107.
Children's Room Furniture—51.
Jigsawed Novelties—57.
Doll House & Doll Furniture—60.
25 Shelves You Can Make—64.
Novelties Turned on Lathe—62.
Inlay Pictures—Veneering—63.
Wood, Soap Carving—65.
Windmills & Weather Vanes—68.
Lamps from Wood, Metal—69.
Rustic Furniture—18.
Wood Finishing—40.
Boats—14 ft. Outboard—2.
Boats—14 ft. Sail Dinghy—26.
Boats—21 ft. Sloop—46.
Rowboats, Small Dinghy—83.
Small Sail Boats—84.
Two Outboard Runabouts—85.
Build Own Canoe, Kayak—30.
Build Class-E Ice Yacht—22.
Auto Kinks, Shortcuts—10.
Building Trailers—27.
Motor-Driven Midget Cars—34.
Stop Auto Elect. Troubles—95.
Photo Printers and Dryers—25.
Photo Darkroom Equipment—96.
Trick and Table Top Photos—97.
Cosmetic Formulas—12.
Poultry Houses—108.
Guns and Decoys—109.
Re-Silvering Mirrors—70.
Chemical Experiments—93.
Log Cabins, Tourist Houses—14.
Trapping Small Animals—33.
Farm and Garden Tractors—8.
Building Extra Attic Rooms—23.
Attractive Basement Rooms—24.

Sanders—80.
House Wiring—89.
Treasure Finders—13.
Hanging Wallpaper—38.
Built-in Fixtures—78.
Bird Houses—7.
Magazine Racks—49.
Clock Cases—50.

Book Ends—52.
Small Tables—54.
Smoking Stands—56.
Desks—58.
Book Cases—59.
Action Toys—66.
High Flying Kites—67.
Telescopes—20.
Metal Craft—28.

Small Looms—37.
Gem Cutting—42.
Photo Enlargers—1.
Photo Kinks—98.
Cleaning Formulas—21.
Taxidermy—9.
Magic—29.
Training Dogs—35.
Small Furnaces—36.

Check Titles Wanted, Clip, Mail with Remittance to

POPULAR MECHANICS PRESS, Dept. 635, 200 E. Ontario, Chicago 11

★ ★ ★

MAKE YOUR OWN POWER TOOLS at Low Cost from old Auto Parts, etc.



A New Edition Featuring TOOLS of WOOD

Now you can have a good lathe, drill press, circular and band saw and other power tools in your home workshop, at a cost of only a few dollars each. Make them yourself from old auto parts, discarded sewing machines and other odds and ends that cost little or nothing. Get this new book—"Forty Power Tools You Can Make." Costs only \$1.25 postpaid. This book gives every detail in plain language you can understand and follow. Hundreds of pictures and plans show every step to follow in making the power tools you want. Actual photographs of finished machines included. Send \$1.25 today. Money back if not satisfied.

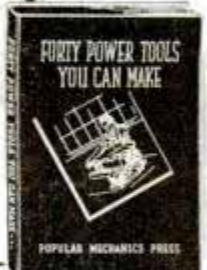

MAKE EVERY POWER TOOL NEEDED IN YOUR HOME WORKSHOP

Some of the power tools you can make are:

- | | |
|--------------------|------------------------------|
| 2 Band Saws | 2 Drill Presses |
| 9 Sanding Machines | 1 Scroll Saw |
| 2 Circular Saws | 2 Wood Turning Lathes |
| 1 Metal Lathe | 3 Grinders |
| 1 Power Hack Saw | 1 Shaper or Moulding Machine |
| 1 Jig Shears | 1 Vibrating Pencil |
| 1 Cut-Off Wheel | and others |

Information too, about pulleys, belts, motors and drive methods. Just published. No other book like it. Order today.

POPULAR MECHANICS PRESS

Dept. 621

200 E. Ontario Street, Chicago 11

POPULAR MECHANICS

DON'T WORK IN THE DARK!

TOOL LIFE
Newest Invention
For Home, Shop



Handiest, most practical tool developed in years! A powerful flashlight complete with two (2) long-lasting batteries PLUS non-chip steel screwdriver—all in one complete, handy device.

Flashlight throws bright, steady beam to light up darkest corners and the most out-of-the-way places. Saves time and work. Prevents skinned knuckles and ruffled

tempers. Handiest tool ever invented to have around the house and in shop, office or factory.

GUARANTEED NON-BREAKABLE!

Flashlight case made of hard, non-breakable plastic with streamlined design for comfortable, easy grip. Slotted screwdriver fits tightly over rectangular nipple to prevent slipping and twisting. Screwdriver slips on and off in a jiffy. Complete with two (2) batteries and one 3" x 3/16" screwdriver for only \$2.45 prepaid anywhere in U.S. or Canada. Immediate delivery guaranteed while limited supply lasts. Additional screwdriver heads may be ordered in following sizes, 6" x 1/4, 48c, 3" x 1/4, 45c, 6" x 3/16, 43c. Rush order today to

ARRECAL'S, Dept. P-1, 4941 Grace St., Chicago, Ill.

"CASE HARDEN" YOUR PLASTER CASTINGS THIS NEW, EASY WAY!

Just dip your plaster castings in a solution of DONALITE TEMPERING COMPOUND

This amazing solution gives the plaster a smooth, uniformly hard, chip-, scratch-, moisture- and heat-resistant surface. Easy to apply; non-volatile and non-toxic. No critical proportions or drying temperatures.

A \$3.00 unit will treat approx. 300 sq. ft. of plaster surface. Send your order for a trial unit today.

We prepay shipping charges when remittance accompanies order or will ship C.O.D. on dollar deposit.

E. A. WITKE LABORATORIES

1709 Loma Street, P. O. Box 506, Santa Barbara, Calif.

EXPERIMENT WITH BLACK LIGHT!

FUN! THRILLS! PROFITS! Find hidden colors in things around your home. Make wonderful decorations with our paints, crayons, satins. We furnish all supplies—also fluorescent minerals. Get Designers Kit including genuine **BLACK LIGHT** only \$15. Guaranteed, F.O.B. Chicago. Write for free catalog "the invisible ray." New Address:

BLACK LIGHT PRODUCTS, 67 East Lake Street, Chicago 1, Illinois

MIKE Jr.
NOW ONLY \$1.39

SING—TALK—AMUSE YOUR FRIENDS through your own radio set. Practice to become an announcer. Simple to install—Not a Toy. Just send your name and address and when your **MIKE Jr.** arrives, pay postman \$1.39 plus few cents postage.

ORDER TODAY. Send \$1.39 postpaid. No Stamps. **MART DISTRIBUTORS**, 1572 Sherman Ave., Evanston, Ill.



Onan Portable Lighting Plant

115 VOLTS A. C. FOR COTTAGE, CAMP, BOAT, ETC.

This rugged little power plant was built for the Army by Onan. It is conservatively rated at 350 watts—enough for a radio and several lights. It may be safely over-loaded to 500 watts if necessary. When used with a 12 volt storage battery, the gas engine will self-start. Battery recharges while generator supplies 115 Volts A. C. Engine runs 4 hours on one gallon of gasoline. The low price includes carrying cart with aircraft wheels and tires, battery table, spare parts and tools. New in original crates. Guaranteed. Shipping weight 275 lbs. Price \$149.50 F.O.B. Chicago.

Quantity limited.

WELLS SALES, INC.

4717 W. Madison St.

Chicago 44, Illinois

IMMEDIATE DELIVERY!



\$19.95

F. O. B.
ROYERSFORD, PA.

8 in. BENCH SAW

COMPLETE AS SHOWN

TABLE SEGMENT—Shows degree of table tilt—graduated. **SPLITTER**—Hard temper cold rolled steel. **GUARD**—Aluminum. **MITER GAUGE**—Aluminum. Accurately graduated 45° each side of center. **BEARINGS**—(2) Oil-ite bronze. **CAPACITY**—0 to 2 1/4". **TABLE**—12"x14". **SHIPPING WEIGHT**—44 lbs.

This Price is Below the Authorized O. P. A. Colling

AMERICAN MACHINE & TOOL CO., Inc.

DEPARTMENT 100 • ROYERSFORD, PA.

BRUNO NEW EXPANSIVE BIT

HEAVY DUTY
with Straight Shank for Use in Electric Drill and Drill Press

Cuts 1 1/4" to 3 1/2" holes in wood... fast, clean, with long curled shaving!

Works like a lathe... requires less pressure... actually pulls itself through. Positive lock with patented triangle blade. Diamond grind on lead screw prevents spinning. Wide throat for chip clearance. Easy-to-read adjustment scale. All cutters of finest grade high carbon tool steel for long cutting life. Easy to sharpen. **MONEY BACK GUARANTEE.**

See your dealer or write direct. Dept. PM-10

Model No.	Trail Length	Expansion Capacity	Shipping List Weight	Price
271	1" overall straight shank	Short blade 1-1/2" - 1-1/2" Long blade 2-1/2" - 3-1/2"	9 oz.	\$5.00

\$5.00
Complete with 1 short cutter blade and 1 long cutter blade



BRUNO TOOLS 9330 Santa Monica Blvd.
Beverly Hills, California

When convenience counts...

and comfort is important you'll appreciate the central location, the friendly hospitality of Hotel Cleveland. In the very heart of Cleveland, adjoining Union Passenger Terminal, garage, and Terminal office buildings. Convenient to stores, theatres, boat docks, Public Hall, Stadium.

HOTEL CLEVELAND

Cleveland, Ohio



Make Your Own

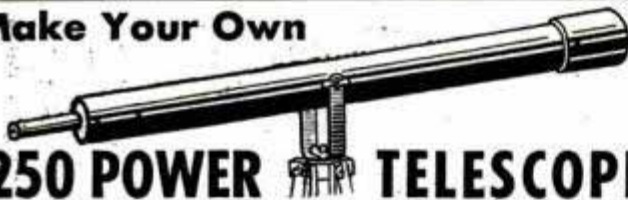

250 POWER TELESCOPE

COMPLETE LENS SET only \$2.50

See the mountains and craters on the moon, the ringed planet Saturn, the moons of Jupiter, distant ships, people, and hundreds of other interesting sights. Make your own high powered telescope in one evening of easy work. All optical parts for 6 ft. long refracting telescope completely finished. Set consists of 3 inch diameter 75 inch focal length ground and polished objective lens and all eyepiece lenses needed to give magnifications of 50X, 100X, 150X, 200X, and 250X as an astronomical telescope, and 50X, 100X, and 150X as a terrestrial telescope. Complete lens set with full directions for mounting, only \$2.50 postpaid.

BROWNSCOPE CO., Dept. 10M, 24 W. 45th St., New York 19, N. Y.

NEW PORTABLE KEYWAY CUTTER

CUTS WITHOUT REMOVING SHAFT—ANY WIDTH—DEPTH—LENGTH... No milling machines—no chisels needed. Cuts new splines, recuts old. Ideal for home or industry.

Guaranteed—send check or money order for immediate delivery.

SPECIAL PRICE \$3.75

ORDER TODAY PREPAID HOMER MARTIN, ASSOC.

416 BOOK BLDG. • DETROIT 26, MICHIGAN



AUTOMATIC RETOOTHER

MAKES NEW PROFITS

FOR HAND SAWS

Cuts new teeth in 50 seconds! Any size tooth 4 to 16 points. Old teeth fall off as chips. Simple to operate. A perfect job.

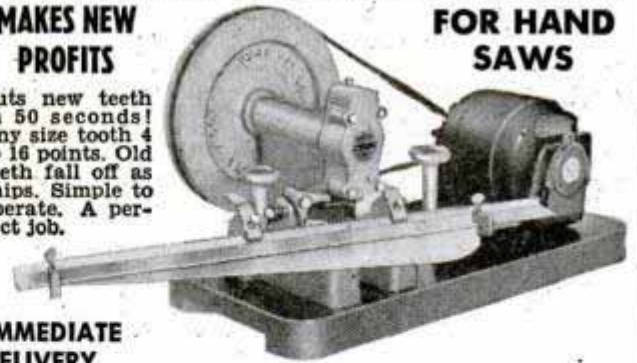

IMMEDIATE DELIVERY

BURR MFG. CO. 8933 Venice Blvd. Los Angeles 3, Calif.



BUILD a BOAT

Row Boat—12 Foot
Dinghy—8 Foot
Training Ship—6 Foot
Sea Sled—9 Foot
Outboard—12 Foot
Cruiser—18 Foot
Bicycle Boat—Kayak
Row Boat—Sailing
Dinghy—Sailing
Canoe—16 Foot
Sailing—12 Foot
Outboard—12 Foot
Pontoons—Runabout
Ice Yacht

FOR PLEASURE OR PROFIT DESCRIBES 17 LOW COST BOATS

Get this outstanding book and build a boat at home for your own use or to sell at a profit. You can do it. Just the boat you've always wanted—power, sail or row boat—17 different kinds and sizes.

Order BUILD A BOAT on postal card and pay only \$1.50 plus postage on delivery. Return in 5 days if not pleased and get money back. Or send \$1.50 with order and we'll pay postage. (Outside U. S. \$1.70 with order.) Order today.

POPULAR MECHANICS PRESS
Dept. 598, 200 E. Ontario, Chicago, 11

WHY BREAK YOUR BACK?

Not wax, oil, paint, or varnish. Sensational new auto cleaner—polish. Comes in powder form; just add water; will make 1 1/2 quarts. Easily produces glossy finish which lasts six months to a year. No finger marks or spears. And it is also a fine furniture polish; cleans glass, chrome. **\$1.00** Postpaid

FOREST SALES CO., 6697 Forest Ave., Ridgewood 27, L. I., N. Y.

SAFEGUARD AGAINST ATHLETE'S FOOT and BLISTERS

with DALE VENT-O-SOLE, INC. 45-7 Halleck St., Newark 4, N.J.



U. S. Army and British Govt. bought millions. Woven plastic shoe ventilator flows air under feet—helps prevent infection, keeps feet dry, rids shoes of perspiration. Retards fungi. Guaranteed. Free Folder.

OPTICAL ILLUSION

makes any view or object you wish to draw appear right on the drawing paper in rich detail and full color. New, low-cost invention makes drawing simple tracing. Develops talent. Postcard brings details. Dept. 21-K, Beeler Enterprises, No. Hollywood, California.

Radio Parts BARGAIN

Amazing war-surplus radio parts bargain, with new Coils, Condensers, Transformers, Resistors, Controls, others, \$15 to \$25 value. Ideal for experimenters, amateurs, home shop men. Now only \$3.98. **\$3.98 AMAZING VALUE**

MARKO SUPPLY, Dept. PM-10, 2924 Logan Blvd., Chicago 47, Ill.

Get This NEW INVENTION CRACKS BLACK WALNUTS BUTTERNUTS, ENGLISH WALNUTS

NO FLYING SHELLS

75% MEATS IN QUARTERS. Sold by all Hardware Stores or mailed direct for \$1.50 delivered. Send cash, check, stamps, or money order. Money-back guarantee. C. E. POTTER, 239 Sapulpa, Okla.



SAY YOU SAW IT IN POPULAR MECHANICS

POPULAR MECHANICS

FUN • SPEED GALORE • BUILD YOUR OWN RACER

with Large 10 inch Wheels

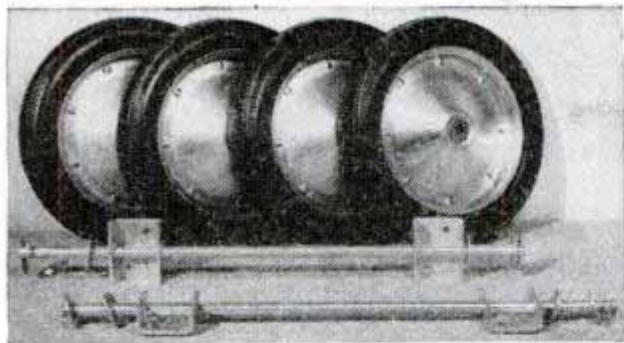

MADE TO OUTLAST
ANY OTHER TYPE WHEELS
with GOODYEAR
10.00 x 1.75 PUNCTURE
PROOF SEMI-
PNEUMATIC
DEEP TREAD
TIRES

(10x1 3/4" wheels)

LOWEST PRICES: ORDER NOW

- 1 COMPLETE 10" WHEEL WITH 10x1.75 TIRE.\$2.90
- 2 COMPLETE 10" WHEELS (without axle)\$5.50
- 4 COMPLETE 10" WHEELS (without axle)\$10.00

Kit "A"—2 complete 10" wheels . . . 1-20" long x 1/2" dia. axle—2 heavy hangers—4 washers & 2 cotter pins—all plated—ready for use.....Only—\$7.50

Kit "B"—4 complete 10" wheels . . . 2-20" long x 1/2" dia. axles—4 heavy hangers—8 washers & 4 cotter pins—all plated—ready for use.....Only—\$13.50

Kit "C"—4 complete 10" wheels . . . 2-24" long x 5/8" dia. axles—4 heavy hangers—8 washers & 4 cotter pins—all plated—ready for use.....Only—\$16.00

F.O.B. Doylestown, or, add 10% for Prepaid Shipment anywhere in U.S.A.

Hundreds of repeat orders, is your guarantee of the Best Materials, Workmanship and Prices.

FREE Circular Showing Plans, Parts, Etc.



65 Inches Long
24 Inches Wide
Weight
Approx. 55 Pounds

ORDER TODAY

Model "A" Racer Chassis

FOR POWER OR PUSH
Again we are FIRST with a sturdy built All-Purpose Chassis. Miles of pleasure, for any age, little ones or adults. This racer chassis engineered into the finest design for electric, gasoline or push power, giving you the choice of body design to build yourself. Equipped with Genuine Arguto OILLESS LIFETIME BEARINGS. Ready to roll and steer. COMPLETE AS \$46.00 ABOVE, ONLY..



12 in. deluxe all weather steering wheel complete with steering rod. Hangers and jam nut assembly only.....\$8.75

OSBORN WHEEL COMPANY

115 So. Main St., Dept. P-10

DOYLESTOWN, PA.

LOWEST PRICES ON PLEXIGLAS

Crystal-clear Plexiglas available for immediate shipment in all standard sheet sizes. Look at these basic prices per square foot:

- 1/16"\$1.13 1/8"\$1.46
- 3/16"\$1.79 1/4"\$2.10

Much lower prices when ordered in quantities of 25 or 50 square feet. Send 10 cents for catalog, listing many other plastics and materials, and Plastics Handbook.

CARMEN BRONSON COMPANY

165 East 3rd Street, Dept. 10LP, Mount Vernon, New York

SMART RATS TRAPPED!

New Trap Can't Harm Children, Pets, Birds or Poultry!

It's amazing how the new HAVAHART catches rats, rabbits, squirrels, and other pests yet it's harmless to you and yours! No springs, no jaws! Animal walks in to get bait, and the doors close! Send postal for free booklet. HAVAHART, 286 Water St., Ossining, N. Y.



SING-TALK thru your own Radio
with
Radio MICROPHONE

Put on your own broadcast at home with this Radio Mike. Sing, Talk from any room in the house. Make announcements. Lots of fun! It's wonderful voice practice. Easily attached to any radio. SEND NO MONEY. Pay postman \$1.98 plus postage. Send check or money order and save postage.

ROYLEY SALES CO. (Dept. 105-M), 154 Nassau St., New York 7, N. Y.

BUILD THIS FREEZER

FOR LESS THAN \$50!

SAVE FOOD

SAVE MONEY

Zero temperature freezes and stores 170 lbs. of meat, fruit, etc. Easy to build from steel barrels and other available material. Complete instructions and 14 view detail photo sent for \$2.00

MASON FREEZERS, DEPT. PM, GENEVA, N. Y.



NEW

185 H.P. LYCOMING

New AIRCRAFT ENGINES Reserved

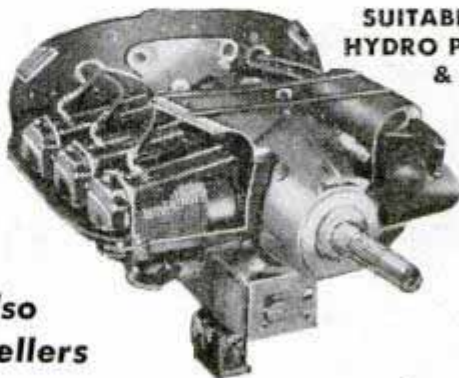

SUITABLE FOR
HYDRO PLANES
& SNOW
SLEDS

Also
Propellers

AIR MOVING & TUNNEL VENTILATION

\$499.00 Crated
F.O.B. Honolulu

Woolley Aircraft Co.
Pier 12, Honolulu, T. H.

GIFTS FOR THE "OLD SALT"



New SHIPS' BELLS—Made for the Captain's Gig—dandy for any boat. Also useful as dinner bell, momento, to call children, etc. 10" high, 9 3/4" bell, bronze finish, clear tone. — \$9.65 Postpaid.

New RUBBER BOATS—Air Corps design, durable, compact, ideal as dingy, also excellent for fishing or duck hunting. Packed in handy bag easily carried anywhere. Large pump inflates 10 min. Shipped complete with oars, pump, bag, sail outfit, CO₂ Automatic Emergency Inflation Cylinder — \$55.00 via Express.

New DIVING OUTFITS—Easy to free that fouled wheel with these outfits. Treasure hunt, explore "Davy Jones' Locker," fish with a spear! Several types available: Army style, air supply from storage tank, tire tube, etc.. Navy style with double acting pump. Scoop! Self-contained LUNG—no surface connections to worry about, swim 1 1/2 miles under water. Detailed information cheerfully given on request.

New OUTBOARD MOTORS—Speed, power, thrills with this 50-55 Surplus Evinrude. New improved bracing mount, 5500 RPM, complete all extras. Limited quantity available.

Attention: Famous "Mae West" inflatable Life Jacket still available.....\$2.00 Postpaid

M & E MARINE SUPPLY CO.

P.O. BOX 601 CAMDEN, NEW JERSEY

MONEY MAKERS



There's more profit for you in concessions—when you depend on products offered by Concession Supply Company! Whether it's Saratoga Kettle Poppers . . . Candy Floss Machines . . . Waffle Irons or Rosecake Molds . . . Ice Cream Cone Bakers . . . and other specialties, our products are proven money-makers for concession operators from coast to coast! Write for more details.

Concession Supply Co., Dept. A 1857 Ottawa Drive TOLEDO 6, OHIO

Magic Mirrors



SEE THRU • They Can't See You!
FOR DOORS, OFFICES, FACTORIES, BARS, ETC.

PRICES

2" x 2" . . .	\$ 1.00
3" x 4" . . .	3.00
5" x 7" . . .	8.00
8" x 10" . . .	18.00

Ideal for doctors offices, front door peep-holes, etc. Person on mirror side unaware you are looking at him. Order your mirror today . . . sent postage paid.

ACRA-LITE CO.

1235 W. 6th St. Dept. PM-10 Los Angeles 14

STAMPED, HEAVY GAUGE STEEL

Spot Welded 8" WHEELS

8" X 1"

SOLID RUBBER TIRES



COMPLETELY ASSEMBLED. Unpainted. For carts, trucks, scooters, etc. Carry up to 500 lbs. per wheel. 1/2" dia. hub doubly reinforced with seamless tubing spun in place. Hubcaps, 10c each extra. Satisfaction guaranteed. Send moneyorder or check today.

\$1 EA.

Plus 15c ea. Parcel Post

C. W. YOUNG MFG. CORP.
208 Burnet Syracuse, N. Y.

Also, 5" dia. rubber tire wheel, painted red, same construction as above; with 1/2" dia. hub. 75c ea. plus 10c ea. postage.

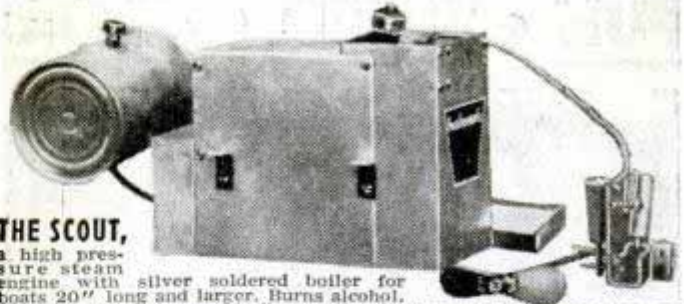

THE SCOUT,

a high pressure steam engine with silver soldered boiler for boats 20" long and larger. Burns alcohol. Runs 30 min. Drives a 2 1/4" propeller. Price complete ready to run with 70-lb. safety valve and accessories as shown... **\$8.95** Postage extra, shipping wt. 4 lb. Distributors and dealers write for terms. **PHILIP STEVENSON CO., Box 162, Station D, Cincinnati 6, Ohio**



MODEL: Gasoline Engine Ready to Run

A precision built and engineered single cylinder FOUR-CYCLE model gasoline engine; adjustable valves; steel pinion and cam gears; a real ignition system; speed 300 to 3,000 rpm; develops approximately 1/2 hp. Bench tested and ready to run. Available with stationary or marine engine base. Full instructions. Lots of fun. Price \$40.00 complete, with coil, condenser and starting rope. Immediate delivery.

The THOMPSON ENGINEERING CO.

7 3/4" high—3" wide Cyl. 1" dia.; stroke 1" 206 Winchester Place, Grand Rapids 2, Mich.

now! SOUND

For your HomeMovie. Works on any 16mm silent projector. Complete parts kit guaranteed, instruction manual, test film and full information on how to use with your radio. Only \$19.95. Mail Money Order now for immediate delivery. **SOUNDTECH, Box 3071, Hollywood 28, Calif.**

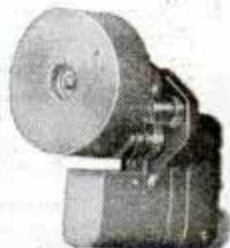

Why Hunt for Drills?

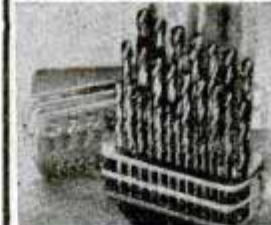

These Complete High Speed Drill Sets Now Available at Low Prices
#1 to 60 Drills.....\$12.95 Per Set
1/16-1/2 by 64ths.....\$16.95 Per Set
Drill Sets A-Z.....\$15.50 Per Set

(Drill Stands Free)
Send For Free Circular

SID TOOL CO.
MACHINE SHOP SUPPLIES
183 Grand St., New York 13, N. Y.

COLOR CONCRETE WITH CHEMICALS

A business of your own. Big money making Hollywood style pottery and birdbaths without moulds. Wishing-wells, stucco-rock, benches. Marbling and cement water-paints. 10c brings sample, literature, pictures. **Hollywood CementCraft, 8529 Wonderland Ave., Hollywood 46, California**



BLOWERS HEATING COOLING

Blowers and Cooling Supplies. Gas and Oil Burning Furnaces. Conversion Burners. Good Profits. Wanted — men to sell and install.

PEERLESS SALES, 4318 Sheridan, Lincoln 6, Nebr.

BECOME A MANUFACTURER'S AGENT

Engage in this highly profitable field. Be a substantial business man with little or no capital investment. Information supplied on methods of securing lines and companies to represent with details of operations. Digest and instructions on How to Become a Manufacturer's Agent sent postpaid for \$2.00. Satisfaction Guaranteed.

VIMAR COMPANY, Dept. 1, 536 Andrus Bldg., Minneapolis 2, Minn.



Make Your Own RUBBER MOLDS

with **RED LATEX MOLDING COMPOUND**

Earn money, have fun; make your own molds for plaster objects. Produce novelties and gifts for home and to sell to friends. **RED LATEX MOLDING COMPOUND** (60% density) now available in quart and gallon quantities. Gives perfect results, easy to apply. Send for complete information and prices.

OHIO SUPPLY CO., Dept. L-2, 474 Lilley Ave., Columbus 5, Ohio

102 Booklets filled with Money and Time-Saving Helps

Little Library of Useful INFORMATION

5 for \$1.00
12 for \$2.00
25¢ Each

Here at amazingly low cost is the practical help and information you have always wanted. Articles in previous issues of Popular Mechanics have been classified according to subject and are now available in these handy reprint booklets. Check Titles wanted, clip ad and mail today.

BOOKLETS ON WORKSHOP EQUIPMENT

Power-Driven Saws—74: Complete details on scrollsaw, two circular saws, sliding cut-off saw, bandsaw.
Drill Presses, Plane, Grinders—79.
Sanders—80: Complete constructional details on 8 useful machines.
Wood & Metal-Turning Lathes—81: Two wood lathes, small metal-turning lathe.
Filing Machine, Hacksaw, Cutoff Wheel, Shaper—82.
Metal Lathe Tools You Can Make—101.
Workbenches & Tool Cabinets—47.
Spray Painting—94: Constructing spray gun, compressor, using spray gun.
From Pattern to Casting—91: How to make your own patterns and small castings.

BOOKLETS ON SHARPENING—USING TOOLS

Correct Measurement—106: How to use micrometers, gauges, calipers, etc.
Tool and Saw Sharpening—92.
Using & Sharpening Drills & Wood Bits—90.
Successful Wood Turning—32: All the information you need to master this art.
How to Read Blueprints—71: Tells you how to understand signs, symbols, and lines.
Metal Turning Lathe Kinks—99: Simple homemade tools, time and labor-saving shortcuts you can use.
Operating a Metal Turning Lathe—100.
Heat Treating & Case Hardening—102.
Working with Glass—103: Cutting, drilling, etching, blowing.

ELECTRICAL BOOKLETS

Rewinding & Servicing Electric Motors—75: Repairing and rewinding a.c. and d.c. motors. Locating trouble. Converting auto generators into 110 v. a. c. motors.
House Wiring—89: All the information you need to do a complete wiring job or install extra outlets.
Electromagnets & Solenoids—44: Designing and building.
Transformer Construction—41: Easy-to-understand instructions for all kinds of transformers.
The Boy Electrician—43: Easy-to-build motors, experiments.
Soldering & Brazing—17.
Arc & Spot Welders—5: Building and operating 110 v. a. c. arc and spot welders.
Treasure Finders—13: Build your own treasure finder and metal locator. Details for both large and small radio types.

ELECTROPLATING BOOKLETS

Electroplating with Copper, Nickel, Chromium, Lead, Zinc, Cadmium—86.
Plating Leather & Other Non-Metallic Objects—Plating with Gold, Silver, Alloys—87.

HOME IMPROVEMENT BOOKLETS

Simple Home Improvements—104: Modernizing; making storm sash, ironing boards, etc.
Building Extra Rooms in Attic—23.
Attractive Basement Playrooms—24.
Lower Your Fuel Cost—31: Practical kinks that will save you hundreds of dollars.
Hanging Wallpaper—38: Tricks of hanging wallpaper, removing old paper, etc.
Curing Leaky Basements—45:
Fitting Home Game Room—55: Construct own game & tennis tables, shuffleboard court, action game, portable playrooms.

Ridding the Home of Insect Pests—107: Exterminating and protecting against moths, flies, termites, mosquitoes, etc.
Built-in Fixtures—78: Step and space-saving kitchen units, built-in beds, corner cabinets, vanities, linen chest.
Constructing Indoor & Outdoor Fireplaces—88: Stone fireplaces, portable mantels, garden fireplaces.

GARDENING BOOKLETS

Backyard Gardening—39: Selecting, planning and getting the best results.
Lawn & Garden Novelties—72: Jig-sawed ornaments, parkway numbers, sundials, flower boxes.
Trellises, Pergolas, Fences—76.
Lawn & Garden Furniture—77: Modern bent-tube furniture, arbor and seat combinations, swings, lawn chairs.
Playground Equipment—73: Two playhouses, ferris wheel, roller coaster, treadmill, play store, slide, two merry-go-rounds.
Colored Concrete Garden Furniture—6: Garden benches, pottery, flower boxes, bird baths and sundial pedestals in colored concrete. How to build small concrete mixer.
Bird Houses—7: Easy to build homes for all kinds of birds.
Farm & Garden Tractors—8: Two tractors you can build from old automobile parts.

CRAFT WORK—HOBBY BOOKLETS

Complete how-to-make-it instructions for hundreds of practical projects.

Working with Plastics—61: Using brilliantly-colored plastics in craftwork.
Magazine Racks—49: Ten attractive racks.
Clock Cases—50: Large Hall, Colonial wall and mantel, ship's wheel, miniature grandfather, desk, Spanish style banjo.
Serving Trays for Every Occasion—53: Fourteen different designs.
Children's Room Furniture—51: Twelve attractive pieces.
Book Ends—52: Ten designs offer good selection.
Small Tables—54: Modern and colonial styling.
Smoking Stands—56: Seven designs given.
Jigsawed Novelties—57: Sewing kits, string holders, place-card holders, plywood kitchenware, plant and flower holders, coin banks, door stops, drawer pulls.
Desks—58: Colonial writing desk, two modern-type desks, student's study desk of plywood, combined chest and writing desk.
Book Cases—59: Eight designs.
Doll House & Doll Furniture—60.
25 Shelves You Can Make—64.
Novelties Turned on Lathe—62.
Inlay Pictures—Veneering—63.
Whittling and Wood & Soap Carving—65.
Action Toys—66: 21 easy-to-make toys.
High Flying Kites—67.
Windmills & Weathervanes—68.
Lamps in Wood, Metal, Plastic—69: Selection of 14 designs.
Metal Craft—28: Brass tapping and making of novelties both decorative and useful.
Small Looms—37: Building hand looms for weaving rugs, etc.; leather novelties.
Plain & Novelty Wood Finishing—40.
Gem Cutting—42: How to cut and polish semi-precious stones.
Rustic Furniture—18: How to build chairs, benches, tables, gates, summer house, etc.

BOAT BUILDING BOOKLETS

Build a boat at home—you can do it

14 Ft. Outboard Runabout—2: Here is a fast 14 foot V-bottom boat. Suitable for motors of 4 to 24 hp., estimated cost, \$30 to \$40.
14 Ft. Sailing Dinghy—26: This 14-foot boat combines strength and light weight. It carries 140 sq. ft. of canvas and weighs about 350 pounds. Actual photographs and diagrams illustrate every detail.
21 Ft. Sloop—46: Every fact needed by the amateur boat builder to construct this craft which carries eight to ten persons.
Rowboats, Bicycle Boat, Small Dinghy—83: All the information you need to construct four low-cost boats.
Small Sail Boats—84: 12-ft. sailing dinghy, 6-ft. "training ship" for young sailors, now to sail a boat.
Two Outboard Runabouts—85: 14-Ft. family outboard weighs about 400 lbs. and 12-ft. plywood outboard weighs about 110 lbs. Both are V-bottom type.
Build Your Own Canoe, Kayak, Surfboard—30: Complete details on 16-ft. Canadian-type canoe, 17-ft. kayak, and 12-ft. hollow surfboard.
Fast Class-E Ice Yacht—22: Build your own Class-E ice yacht. Every detail of construction carefully explained.

AUTOMOBILE BOOKLETS

Automobile Kinks and Shortcuts—10: Money-saving hints on upkeep, operation.
Building Trailers—27: Small streamlined house trailer; several utility trailers.
Motor-Driven Midget Car & Scooter—34: Both use gas engine of washing machine type.
Curing Auto Electrical Troubles—95.

PHOTOGRAPHY BOOKLETS

Save Money by constructing your own photo equipment.

Photo Enlargers—1: Condenser lens type; simple vertical; horizontal.
Photo Printers & Dryer—25: Describes three practical printers, timer and negative dryer.
Photo Darkroom Equipment—96: Cabinets, light-tight box, timer, agitator, washer.
Picture Projector, Trick & Table Top Photography—97: Projectors that enlarge magazine illustrations and shop drawings. Tips for table toppers, photomontages, tricks.
Photo Kinks—98: 63 time and money-saving ideas you can use.

FORMULA BOOKLETS

Cleaning Preparations—11: Easy-to-make cleaners for walls, glass, etc. Removing fabric stains.
Cosmetic Formulas—12: Hand lotions, creams, rouge, bath salts, beauty clay, lipsticks, etc.
Re-Silvering Mirrors—70: Formulas for silvering and coloring.

MISCELLANEOUS BOOKLETS

Knots and Ropework—105.
Chemical Experiments—93: Easy-to-perform experiments. Inexpensive lab.
Taxidermy—9: How to prepare skins and obtain life-like poses.
Log Cabins & Tourists Cottages—14: Year-round log cabins; inexpensive tourists' cabin.
Magic for Everybody—29: Simple tricks to puzzle your friends.
Trapping Small Animals—33: How to lure fur bearers, prepare bait and traps, dress skins.
Tricks of Training Your Dog—35.
Small Furnaces—36: Build own gas or electric.
Telescopes—20: Design and construction.
Poultry Houses—108: Structures, brooders and incubators.
Guns and Decoys—109: Cleaning, shooting; making decoys.

POPULAR MECHANICS PRESS,
200 E. Ontario St., Chicago 11, Ill.

I enclose (U. S. bills may be mailed if carefully wrapped) for "Little Library" booklets numbers:

.....
.....
Name
Address Zone.....
City State.....

LOANS *by* MAIL

\$50 to \$300 *IN A HURRY*

CONFIDENTIAL

Salaried people, men or women, married or single, loans on your own signature, or your own security. NO personal interview. NO co-signers needed. NO wage assignments. You mail the application to us... we mail the money to you.

FOR A LOAN OF	YOU CAN REPAY MONTHLY			
	IN 15 PAYMENTS	IN 12 PAYMENTS	IN 9 PAYMENTS	IN 6 PAYMENTS
\$ 50		\$ 5.03	\$ 6.43	\$ 9.24
100	8.40	10.07	12.87	18.48
150	12.60	15.10	19.30	27.73
200	16.75	20.09	25.68	36.91
250	20.85	25.02	32.02	46.05
300	24.93	29.94	38.33	55.17

The above payments made at regular monthly intervals will repay the entire loan and all charges in the time indicated. Charges are based on the monthly rate of three per cent on unpaid principal balances to \$150.00 and two and one-half per cent on that portion of unpaid balances in excess of \$150.00 but not exceeding \$300.00. "Loans by Mail" may be repaid in larger amounts, more frequent payments or repaid in full at further savings to you.

CONVENIENT

Just write us how much money you need and how you wish to repay... there's no charge or obligation. Whatever your needs for cash now or in the future, write for your "Loans by Mail" plan, today.

MERCHANTS INVESTMENT CO.

819-G 1st Nat'l Bldg., Omaha, Nebr.

Without obligation, rush complete details and all papers necessary for a loan of \$_____ to be repaid at \$_____ on the _____ day of each month.

Name _____

Address _____

City _____ State _____

Occupation _____



COUNT TELEGRAPH WIRES IN DISTANCE
SUPER EYE \$15.00
20 Day Free Trial

An outstanding field glass. Precision ground, polished, matched 50 mm lenses give you wider view, clearer visibility. Sturdy metal construction. Has combination sunshade, lens guard! Ideal for all sports. **SEND NO MONEY!** Just pay postman \$15.00 plus 20% Federal tax and postage. Cash orders sent postpaid. United Products Co., 7941 S. Halsted, Dept. GC-105, Chicago 20, Ill.

As MODERN as the electric refrigerator, compared with the old ice box.

VERTROD—vertical models eliminate poles—insulators—lightning arresters—filters—hanging aerial wires—climbing.

VERTROD—20 models cover all wave reception—FM—AM and Television.

VERTROD—the most perfect scientific development approaching complete freedom from man made static.

Install an aerial

THE VERTROD WAY

The VERTROD way (with patented features) is the modern way. At most radio shops.

Write for folder 403

VERTROD CORPORATION

60 EAST 42nd STREET · NEW YORK 17, N. Y.



B-29 AIR FORCE GUN SIGHT

Convertible Into
SLIDE PROJECTOR
SLIDE VIEWER
BABY SPOT

Build all of the above items plus many others with the high grade top quality expensive parts in this. The double achromat lens system can with the lighting assembly be adapted to a variety of optical or photographic uses. A value for the parts alone.

FREE CONVERSION SHEET WITH EACH ORDER

Send for your gun sight now. Rush check or money **\$8.50** order. Postpaid.....

B & B PRODUCTS CO., Dept. B
 111 W. Jackson Blvd., Chicago



Profit by the Building Boom!

Start your own business manufacturing concrete building block and brick. Use Economy hand moulds. Make true, straight, easy-to-lay units which will pass any building code. Small investment, high production, big profits. One \$30.00 mould will make 1,000 5"x8"x12" blocks per day. Letters and repeat orders tell how pleased our customers are.

WRITE FOR FOLDER

Economy Manufacturing Company
 Dept. P Stone Mountain, Georgia

START FURNACE FIRE in 3 MINUTES WITHOUT PAPER, KINDLING!



Here's the quickest, easiest way you ever heard of to get a roaring furnace fire started—or bring it back to life in jig time. Don't bother with paper or kindling! Just turn on gas, light Rocket Furnace Lighter, and slide in ash pit. In 3 min. coal or coke is burning briskly. Saves hours of furnace drudgery. Rocket Lighter comes complete with metal tubing and gas cock both Approved by Amer. Gas Assn. Testing Lab. Attach to any gas outlet. Requires no more attention ever. Only \$5.95 prepaid. Sold on 10 day's free trial. You don't risk a penny to try a Rocket. Send

order today to **LOBAIN FURNACE LIGHTER CO., Dept. 17, 1794 E. 33rd St., Lorain, O.**

SAY YOU SAW IT IN POPULAR MECHANICS

FREE *Bikini Crossroads Patch*



Send only \$1.00 for our beautiful selection of 20 different Flight Squadron and Shoulder Insignia and receive the RARE BIKINI BOMBER leatherette breast patch absolutely FREE. Tremendous value. Colored insignia book with your order at no cost. Send to-day. Offer limited.

THE INSIGNIA MART, Dept. AA
 703 Broadway, New York 3, N. Y.

WAR SURPLUS

Lathes, Milling Machines, Drill Presses, Sawing Equipment, Motors and thousands of miscellaneous items. Information on Helicopters, Power Lawn Mowers, Trailers, Garden Tractors, Jet Impulsion etc.—Free Literature. If you want catalog sheets sent by return first class mail include \$1.00.

THE WAYNE ENGINEERING CO., Dept. 1009, Greenville, Ohio

CAR OWNERS

No more winter starting troubles when you install the new "Ideal Electric Engine Block Heater. Easily attached. Heats block in 20 minutes. SAFE. Plug in any electric outlet. Order today, only \$5.95 postpaid, with cord and instructions. 12 months guarantee. Specify make of car.

IDEAL SPECIALTY CO., Route 2, Box 45, Royal Oak, Mich.

USE Fine Walton Wheels to Make Your Own WAGONS—SHOPPING CARTS and RACERS



65¢

Each in Sets of 2 or 4—plus 10¢ ea. for postage. 4 1/2-inch with 3/8-in. bushing

Coaster wagons, scooters, shopping carts, bike trailers, golf bag carriers, etc., are easy to make. Use fine Walton DeLuxé Wheels! They're strong welded pressed steel construction. Ideal for making many things for use and play. Solid rubber tires. Red enameled. Send check or money order. No C.O.D.'s. Dealers write.

WALTON WHEEL COMPANY, Dept. J-1
 Plankinton Bldg. Milwaukee 3, Wis.

AMAZING MONEY SAVING OFFER **\$9.95** Plus Fed. Tax

Beautiful Swiss Watch



For Watch and Band

AND MATCHED

Stainless Expansion Band

No need now to pay high jewelry store prices—instead, you can save money and have a beautiful Swiss Watch and Stainless Expansion Band—Flexible From Tip to Tip—complete—ready for your wrist for only \$9.95, plus Fed. Tax. Think of it! Watch is a good time piece, has smart, white face, black numerals, and black hands. And the Band is a beauty. Highly durable for long wear service.

SEND NO MONEY—Just pay only \$9.95, plus 10% Fed. Tax and postage C.O.D. Or enclose \$10.95 (tax included) for postpaid delivery. Return in 5 days for refund if not delighted.

BAND EXPANDS TO FIT ANY WRIST

KENT JEWELERS, 105 N. Clark St., Dept. PM-10, Chicago 2, Ill.

Can You Thread That Special Nipple?

The Wing Nipple-guide and Pipe-chuck provide a simple, quick, accurate way to thread close nipples or long pipe on the job—somewhat faster. 1/8" thru 1"

Piping Time Is Costly

Making is faster than hunting for a nipple. Only 2 to 4 minutes for: first threads, measuring, cutting, burring, final threads. Dies move onto oil—a big advantage.

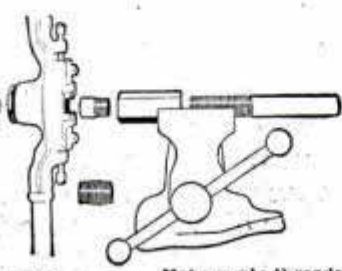

Make angle threads right on the job. Pipes out of line are easily connected—up to 15° per pair of threads.

Drop card for information and price circular. Dealers wanted. **WING LABORATORY (Manufacturer), 123 Water St., Grass Lake, Michigan.**

AGENTS SALES-MEN

FOR IMMEDIATE DELIVERY

\$2.40 Doz.

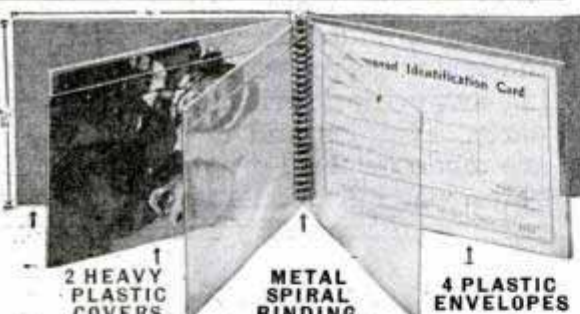

2 HEAVY PLASTIC COVERS

METAL SPIRAL BINDING

4 PLASTIC ENVELOPES

Timely fast selling Specialty—easy to carry. Everybody buys our Clear View Identico Case. The perfect Wallet Insert—fits into wallet, vest or blouse pocket and Ladies' purse. Sells like "Hot Cakes." Price 50c ea. Cost you \$2.40 Doz. Postpaid. Order trial Dozen today. **GUARANTEE** Sale of 1st order or money refunded for unsold portion. **FREE** 3 color display card, sample attached, with 1st order. **BEACON SALES CORP., Dept. PM-10, 37 S. Wabash, Chicago 3**

WINDOW SIGN LETTERS

For Store Fronts and Office Windows. Anyone can put them on. Samples furnished. Genuine Gold and Silver. **METALLIC LETTER CO., 430 N. Clark St., Chicago 10**

Cute stuff TO BUILD



Make a big hit with these **NEW and ORIGINAL IDEAS**

Easy to Make . . . Easy to Sell. (Christmas is coming). Full Size . . . Professional Plans

30c Each. Set of 8 for \$1.60

- Bird Door Knocker
- Turtle Flower Base
- Lobster Knife Rack
- Crocodile Game
- Ubangi Ash Tray
- Frog Pull Toy
- Duck Door Stop
- Chipmunk Nut Tray

Each item has some clever twist to the design to make it unusual and desirable.

PARKE PRODUCTS

78 Grand Street Coldwater, Michigan

USE AC's FOR UTMOST RELIABILITY

Factory-recommended AC's, of correct Heat Range for today's fuels and driving speeds, help millions to be punctual. Have your plugs checked to be sure that you have the right plugs for today's driving and fuels.



Look for this sign



Spark Plugs cleaned and adjusted "By the AC Method" may save as much gas as 1 gallon in 10

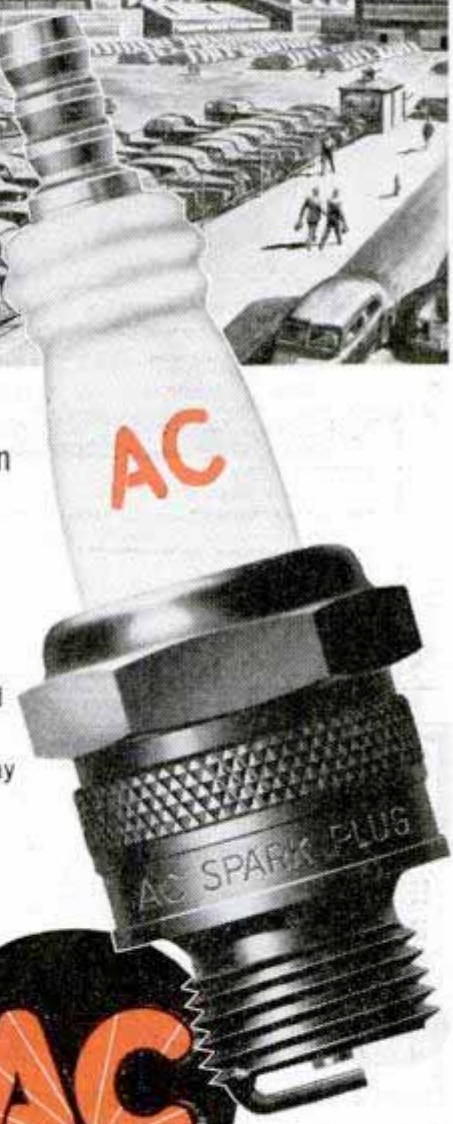

AC SPARK PLUGS

AC SPARK PLUG DIVISION • GENERAL MOTORS CORPORATION

At Last! THE NEW ATOMIC LIGHTER and CIGARETTE CASE Combination



A masterpiece of modern design—streamlined, chrome lighter top on handsome colored plastic case which holds full package of cigarettes.

\$2.50
complete

Rush your Order Today on this no-risk offer. You must be pleased or your money will be refunded in full.

WHOLESALE DISTRIBUTORS
4624 N. Sheridan Road, Chicago 40, Ill.

5 DAY TRIAL OFFER

WHOLESALE DISTRIBUTORS Dept. BN
4624 N. Sheridan Rd., Chicago 40, Illinois.

Please send me, at \$2.50 each, combination lighter and cigarette case as checked below.

I enclose \$ (check, cash or money order) in full for postpaid delivery.

Send C. O. D. I will pay charges plus postage.

Name.....

Address.....

City.....Zon.....State.....

SAY YOU SAW IT IN POPULAR MECHANICS

Pli-rench

SUPER POWER. LOCKING



IT'S ALL IN THE RED JAW

\$2.45
O. P. A.

SELF ALIGNING JAW

LOCKS WORK WITH TONS OF PRESSURE . . . HANDS FREE

This remarkable brand-new tool is a combination pliers, wrench, pipe wrench, clamp and hand vise. The self-aligning jaw fits itself to irregular shaped objects, giving a powerful, jaw-length grip, multiplying hand pressure at least fifty times. A whale of a tool!

If your dealer cannot supply you, order direct.

THE WHALE TOOL CORP.
1767 BROADWAY, NEW YORK 20, N. Y.

Faucets Having Nondrip Valves Close by Water Pressure

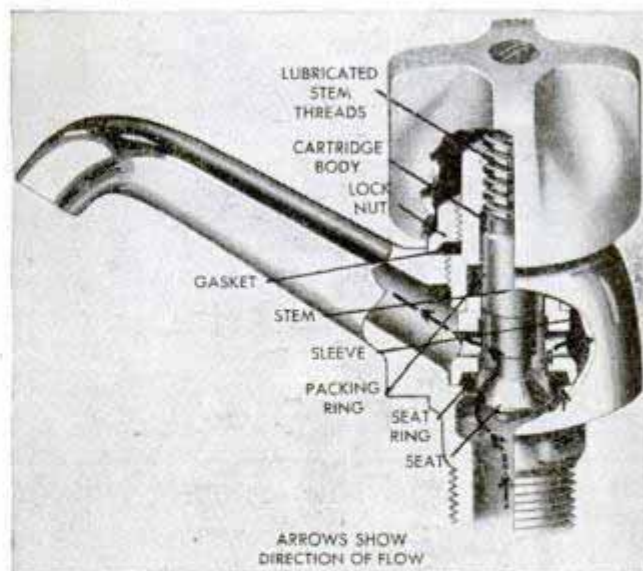

Nondrip faucets are shut off automatically by pressure of the water even if they are not closed tightly. Shutoff of the valve mechanism in the same direction as the flow of water makes the faucets as easy to operate as turning a radio dial. In conventional faucets the valve must be closed against the water pressure. Each of the new faucets contains a "cartridge" unit that houses the entire valve mechanism. A faucet that is worn out can be repaired simply by replacing the entire unit with a new one. Lubrication is provided inside the cartridge, preventing water from washing away the lubricant and corroding the parts. Handles and covers of the faucets are made of pearl-gray plastic, which provides enough insulation to prevent the parts from becoming uncomfortably hot.

Bolt Latch Has Gravity Handle

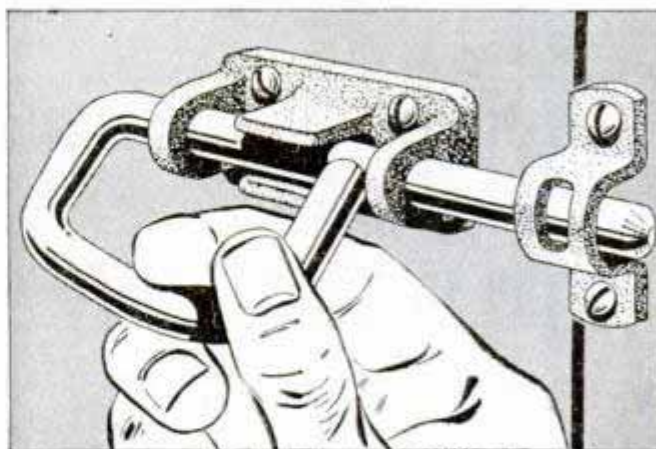

Open or closed, the weight of a large handle causes a latch bolt to fall into locking position. Its weight causes the handle to lie flat against the wall, making it difficult to jimmy from outside.

Logan

A NAME TO REMEMBER WHEN YOU THINK OF BETTER LATHES

AND SHAPERS

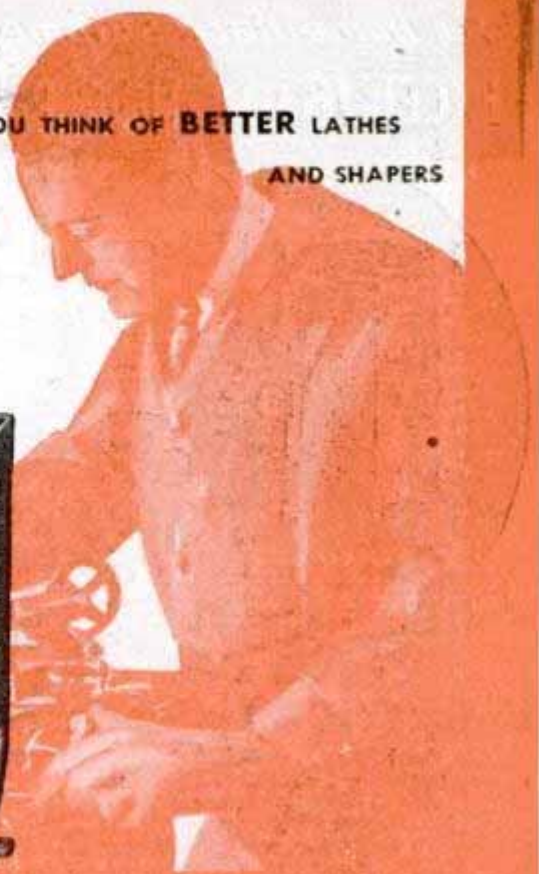
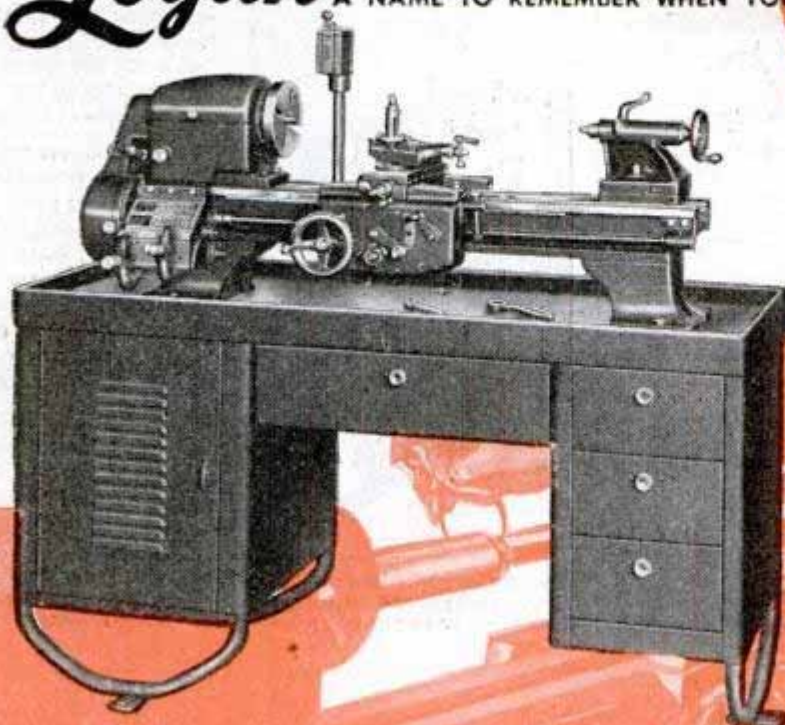

Your workshop

9 reasons why LOGAN Lathes are BETTER lathes

- 1 BALL BEARING HEADSTOCK**
for sustained accuracy.
- 2 RUGGED, ACCURATE BED**
within .0005" of parallelism.
- 3 SELF-LUBRICATING BEARINGS**
at vital points lengthen life.
- 4 BACK GEARS ENCLOSED IN HEADSTOCK**
with shifter rack safely and conveniently at your finger-tips.
- 5 RUBBER CUSHIONED COUNTERSHAFT**
for smoothness and accuracy in working area.
- 6 THREE POINT SUPPORT**
Steadies the countershaft, prevents rocking.
- 7 ENCLOSED BELTS, GEARS, PULLEYS**
Prevents accidents. Keeps lathe clean.
- 8 AUTOMATIC BELT TENSION RELEASE**
Makes belt changing easy and safe.
- 9 PRECISION BUILT THROUGHOUT**
For tool room accuracy in your shop.

can now have a Logan Lathe

Make a Logan Lathe the key machine in your workshop. When you install a Logan Lathe you work with the same fine tool that business has long recognized as a sound and profitable investment. Your Logan Lathe will have the same ball bearing mounted spindle, the same rugged bed with ways ground to within .0005" of parallelism, the same close tolerance construction throughout that has made Logan Lathes outstanding performers in the tool rooms, experimental shops and production lines of large and small industries. The simplicity and safety of operating this fine, industry-proven tool will further increase your satisfaction in owning a Logan Lathe.

WRITE FOR FREE CATALOG! Complete, illustrated descriptions of Logan Lathes, Shapers and Accessories.

LH-1

LOGAN ENGINEERING CO., 4921 LAWRENCE AVE., CHICAGO 30, ILL.

Now Available!
For Immediate Shipment!
EXCEL 16 MM. Movie Projector

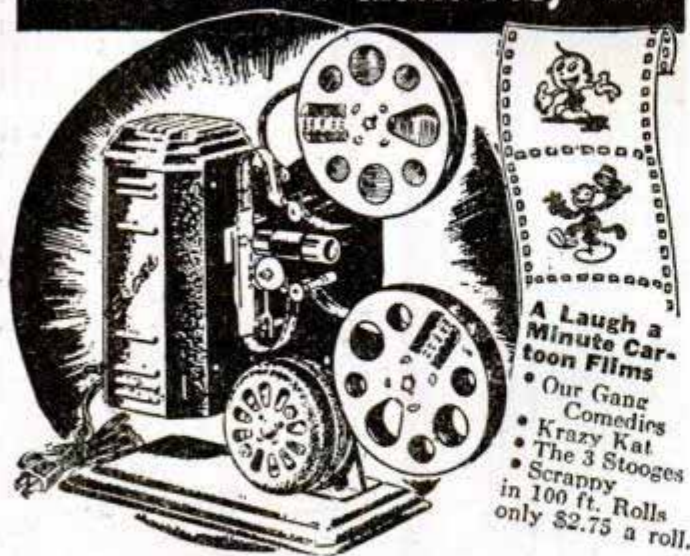

A Laugh a Minute Cartoon Films

- Our Gang Comedies
 - Krazy Kat
 - The 3 Stooges
 - Scrappy
- in 100 ft. Rolls only \$2.75 a roll.

Enjoy the Fun of Movies at Home

This is the Finest Low-Priced Motor-Driven Projector Available. Comes furnished with a 200 ft. Take-up Reel, 2-inch lens in focusing mount, tilting device, 120-watt lamp, accessible Spring Belt Drive, Motor Driven Rewind, Switch control Motor, Baked on Enamel Finish and Power-House Type Constant speed motor, A.C. only. Shipping wt. 7 lbs.

FOR ONLY

\$17⁵⁰ (Movie Projector)
 Plus Postage

MAIL COUPON NOW!

UTILITY STORES, 117 S. Wabash, Dept. KK-15, Chicago 3, Ill.

Please ship as indicated below:

Excel 16MM Movie Projectors at \$17.50 \$_____

100 ft. Rolls of "Laugh a Minute" \$_____

Cartoons at \$2.75 \$_____

Postage _____

for which I enclose \$_____

Check Films Wanted: Krazy Kat Scrappy

Our Gang Comedies The 3 Stooges

Name _____

Street or R.F.D. _____

City _____ State _____

THE
 NEW
 ELDEN

ELECTRIC WATER HEATER

HOT WATER IN 5 MINUTES

... WITH THE ELDEN ELECTRIC WATER HEATER. Simply place the heater in water, plug it into your electric light outlet. Complete with 6 feet rubber cord and plug. Act now! Send check or moneyorder. No C.O.D.'s—your money back if not satisfied.



CHROME PLATED CAN'T RUST

DEALERS: Write for discounts.

ELDEN PRODUCTS CO., Dept. A

7310 WOODWARD AVE.

DETROIT 2, MICH.

OIL BURNER

INFORMATION IN A HANDY FORM

JUST OUT!

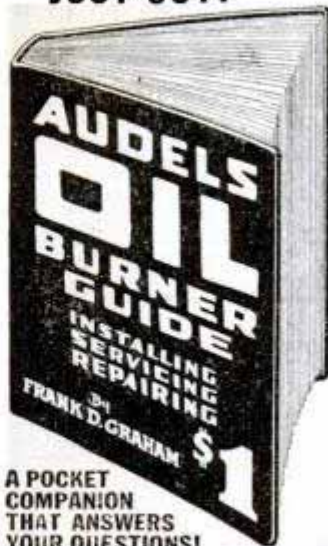

AUDELS OIL BURNER GUIDE

— A new practical, concise treatise, 384 pages—31 Chapters — 321 Diagrams and Illustrations — covering Domestic and Industrial Oil Burners.

New from Cover to Cover, for mechanics interested in Oil Burners. Gives practical inside working knowledge of theory, construction, installation, operation, testing, servicing and repair of all types of oil burners. Includes electrical hook-ups and wiring diagrams of automatic control systems.

PRICE \$1 POSTPAID

Get this information for yourself. Mail coupon today. No obligation unless satisfied.

ASK TO SEE IT

A POCKET COMPANION THAT ANSWERS YOUR QUESTIONS!

AUDEL, Publishers, 49 W. 23rd St., New York 10, N.Y.

Please mail AUDELS OIL BURNER GUIDE (Price \$1). If satisfactory, I will remit \$1 on its safe arrival, otherwise I will return the book.

Name _____
 Address _____
 Occupation _____
 Employed by _____ PM

Movie Projector Shows "Stills"

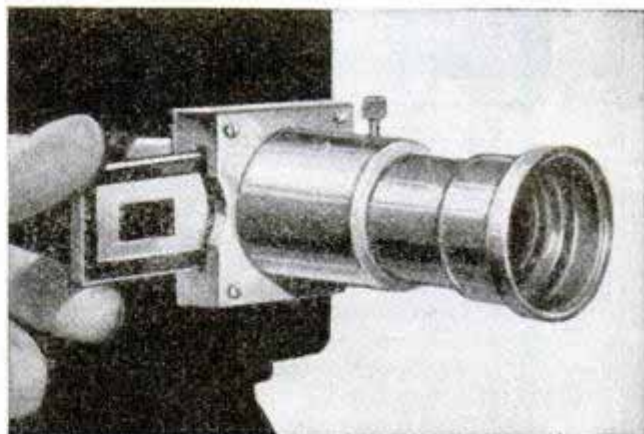

By fitting a 16-millimeter movie projector with a series of tubes and a slotted receptacle for slides it can be converted into a still projector. To install the slide holder the lens is removed from the projector and the long barrel of the slide holder inserted in its place. The lens then is inserted in the short barrel. The projector is kept in full operation with both the motor and lamp on when showing stills.

Paintbrush bristles made from casein, a milk by-product, have been developed by Department of Agriculture scientists.

MILL IT—on Your Lathe with a **PALMGREN** MILLING ATTACHMENT

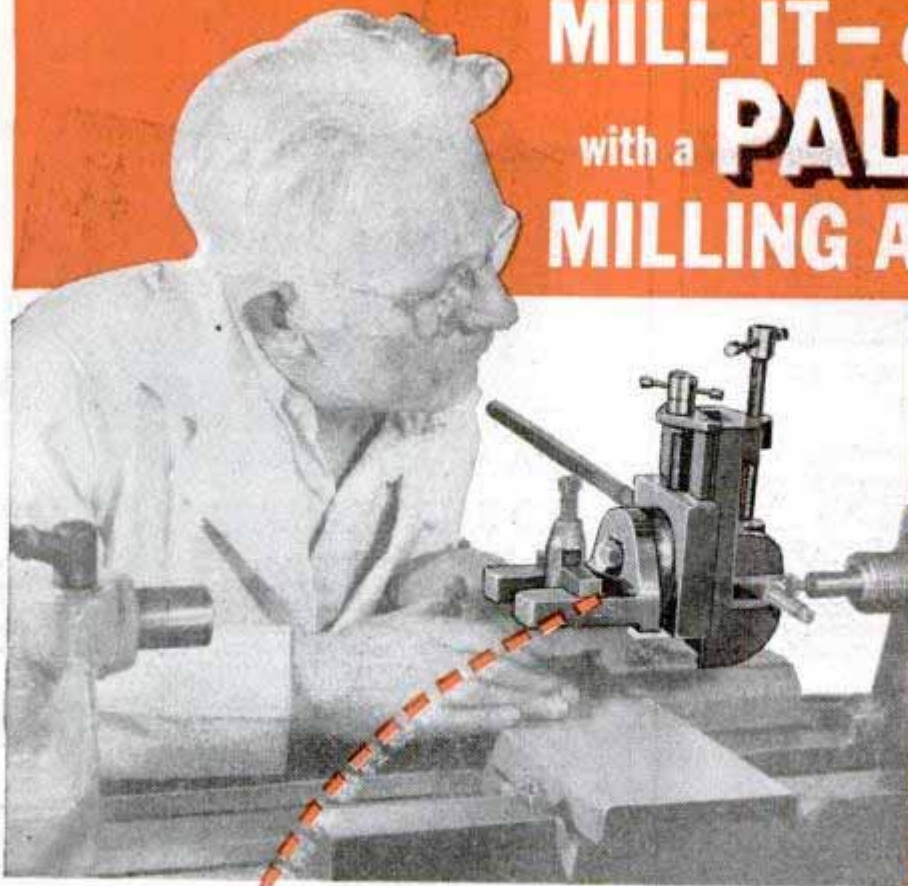

JUST A FEW OPERATIONS YOU
CAN DO ON YOUR LATHE!

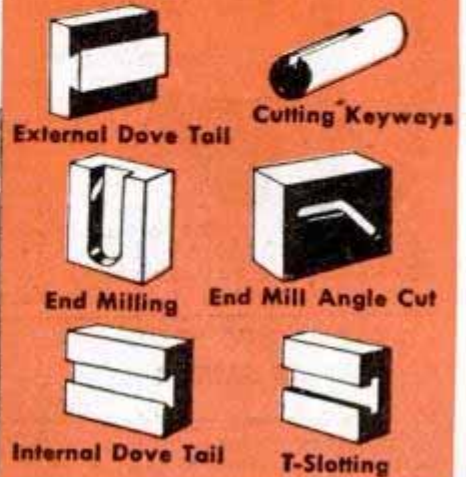

CONVERT LATHE in 10 SECONDS!

Now—in your own shop—on your lathe, you can Mill, Slot, Grind, Groove, Square Shafts, Saw at Angles, Recess, and do many other important jobs. Yes! In 10 seconds, you can convert your lathe—SAVE time and money by doing work you formerly had to send out. Lathe owners are amazed at the quality and variety of work that can be done with a PALMGREN MILLING ATTACHMENT. Don't overlook this important tool. Precision built, it has 360° graduation for rotary angle adjustments, also graduated vertical feed screw. Fits South Bend, Atlas, Craftsman, Logan, Sheldon and all other lathes. Easily mounted by straddling tool post. Thousands in use and highly valued in home work shops, small and large machine shops, repair shops, railroad shops, schools and experimental laboratories.

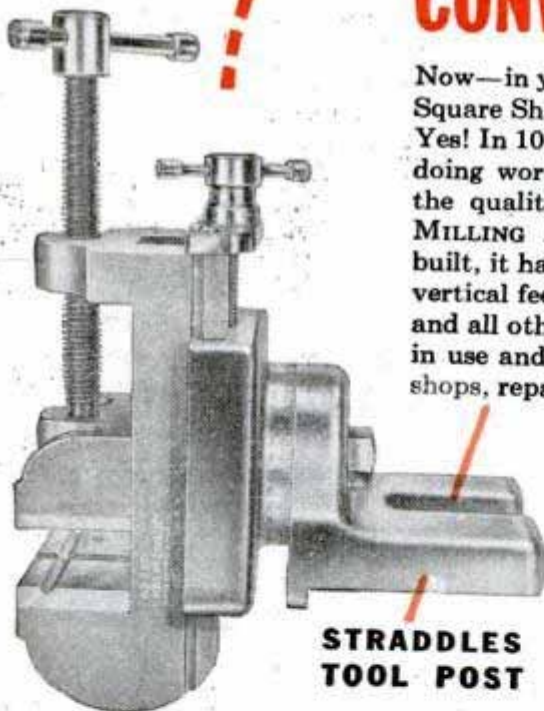

**STRADDLES
TOOL POST**

3 SIZES

Made in 3 convenient sizes to handle small, medium or large pieces of work. One trial will convince and delight you. It will quickly pay for itself and add to your profits for years to come. Don't delay! Order today!

Nos.	Width Jaws	Depth Jaws	Jaws Open	Weight Pounds	Fits Tool Post	Price F. O. B. Factory
150	1½ in.	1 in.	1½ in.	6½	1 in. dia.	\$18.75
250	2½ in.	1 7/16 in.	2½ in.	11	1¼ in. dia.	24.75
400	4 in.	1½ in.	4 in.	24	2 in. dia.	39.75

AVAILABLE IMMEDIATELY

Your dealer or jobber will gladly show you one. However, if he cannot supply you, fill out the coupon, attach your remittance and we will send postpaid.

Write for Circular No. 1106

CHICAGO TOOL AND ENGINEERING CO.

Mfrs. of PALMGREN PRODUCTS for over 28 years
8393 South Chicago Avenue • Chicago 17, Illinois

MAIL THIS COUPON TODAY!

Gentlemen:—

Enclosed find draft or money order for \$_____. Please send prepaid a No. _____ PALMGREN MILLING ATTACHMENT.

NAME _____

STREET _____

TOWN _____ STATE _____

Print Name and Address—Use margin if needed.

PRECISION BUILT WORK SHOP TOOLS FOR THE DRILL PRESS

● Try any Barron Tool at our expense. Shipped prepaid on receipt of check, money order, or C.O.D. Use it 10 days and if not satisfied—return for FULL REFUND.

FAMOUS MULTI-PURPOSE 5-in-1 ROTARY WOOD PLANER



Barron Planer offers exclusive workshop advantages found in no other tool. Not only surface planes all sizes of work pieces—but will rabbet, tenon, rout, panel, groove and bead. Used in any standard type chuck. Provides numerous plastic and woodworking features due to the exclusive horizontal "set" of its double edged hi-speed tool steel blades. Shipped prepaid on receipt of check, money order—or C. O. D.—Complete at..... **\$7.50**

ROTARY DRILL PRESS SURFACE SANDER

Here's a low cost, precision-built surface sander to fit any drill press. Comes complete with 20 cup sanding discs. No messy gluing of discs. Snap a new one on with the Barron spring clamp. You'll be amazed at its simplicity of operation, speed, perfection of finish. No waves, ripples, steps, circular striations or sanding marks. Any type plastic or wood—soft, hard, grainy, or knotty—will have a velvet smooth finish. Try it! Shipped prepaid for..... **\$5.95**



NEW STYLE SPIRAL FLUTE ROUTER BITS

Ground from finest hi-speed tool steel with special radial spiral flute design for faster chip clearance, smoother side and bottom routing, grooving, veining, carving and round-end mortising. Extra long cutting flutes. Available in individual sizes $\frac{1}{8}$ " to $\frac{1}{2}$ " or set of six sizes as illustrated. Shipped prepaid..... **\$9.50**

ALL-METAL AUXILIARY DRILL PRESS TABLE

Provides extra large, true working surface of 234 square inches—made of hard Alcoa aluminum alloy heavily ribbed. Fits any standard drill press in less than a minute. Equipped with pivoting steel fence and hi-speed clamp. Ideal with Barron Planer, Sander or Router Bits, many other drill press uses. Built for shaper fence operations. Blanchard ground to .0005. An out-standing value. Complete at..... **\$9.85**



See Your DEALER—Or Write for Free Descriptive CATALOG

Barron Tool Company, Inc.
369 Architects Bldg., Detroit 1, Mich.



USE OUR CAPITAL

NO SALES EXPERIENCE NEEDED

The biggest opportunity ever, to quickly establish a money-making, lifetime business, now awaits you as a McNess Dealer. Sell things farmers need and use up. Serve same families year after year. Pleasant work--no bosses--easy to do. We supply capital to work on. Also provide offers--advertising--premiums and trade secrets that bring sales.

First to apply get best trading areas. Don't wait--write us today for McNess proposition. Tell us county and state you want to serve. Ask for free McNess Book.

THE McNESS CO., 279 Adams St., Freeport, Ill.

GENUINE IMPORTED SWISS WRIST WATCH



\$8.49

plus 10% tax Below OPA Ceiling

Modern streamlined expansion watch band fits any wrist. Non-tarnishable silver finish, stainless steel. Regular \$2.50 value. Only \$1.00 Also Gold plated expansion Watch band, \$2.50



CEDO SALES SERVICE, Dept. P.M.52, P.O. Box 4, New York 51, N. Y.

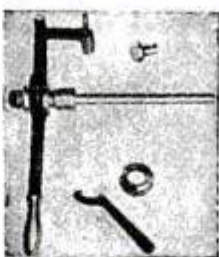

COLLET CHUCK ATTACHMENT

Hand Lever Type

Carried in stock for 9" South Bend, 10" Atlas, 10" Logan, 12" Craftsman Lathes. Price each.....\$45.00 Collets to fit, from stock, each.\$3.75

Send check or money order to

CENTER TOOL CO.

154 Centre St., New York 13, N. Y.

Is Your Rupture HERE?

Why continue to suffer with an uncomfortable truss if we can help you? Relief GUARANTEED or it costs you nothing. Send for the facts about my perfected truss invention—the Brooks Appliance for reducible rupture—with the patented AIR-CUSHION support that works silently with Nature to give protection. Thousands bought by doctors.

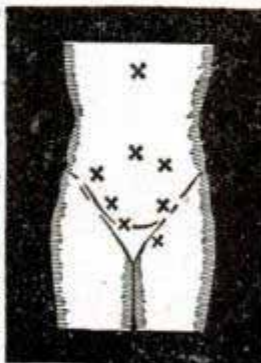

Sent on Trial—Made-to-measure, individual fitting for man, woman or child. Low-priced, sanitary, durable. No obnoxious springs or hard pads; no metal girdle to rust. Light weight, neat and comfortable. Not sold through stores or agents—beware of imitations. Write today for full information sent free in plain sealed envelope.

BROOKS APPLIANCE CO. 359-B State St. Marshall, Mich.

IDEAL FOR Auto-Home Appliance and Farm REPAIRS

Now A DYNAMIC HEAVY DUTY INDUSTRIAL WELDER

Available Now—Immediate Deliveries

Designed to Do High-Grade Welding *Inexpensively*

Maintenance men, farmers, mechanics, machine shops, foundries, auto, general repair and job welding shops using the DYNAMIC WELDER find it so indispensable and useful that they cannot afford to be without it. If inexperienced you can easily learn to do a variety of high-grade welding jobs by following the practical, simplified operating and welding instructions furnished.

WORKS ON IRON, STEEL, BRASS, BRONZE and OTHER METALS

Has eight metallic and carbon arc welding heat stages. Does work you would think only possible with a larger, more expensive machine.

READ WHAT USERS SAY...

Repair Shop Owner says, "It will do more than you say"

"I want to say I operate a repair garage and am more than satisfied with the welder. It will do more than you say." C. P., Butler, Ohio

It's the Greatest Portable Outfit

"Now I am equipped for all kinds of welding and I must say it's the greatest portable outfit for welding any man could ever wish to own. I wouldn't sell mine for the cost of plenty welders I have seen which were very high in cost but not in convenience. You may put me on file as a booster of your wonderful welding product." W. J. B., St. John, N. B., Canada

Better Than I Expected

"I have done quite a little welding with my welder and will say it is better than I expected. The price, convenience, and variety of work that can be done with the Dynamic are the attractive points." W. R. P., Portland, Ore.

EASY TO OPERATE!

DYNAMIC SUPERCHARGED WELDER

GET DETAILS ON OUR 10-DAY TRIAL OFFER!

Once you see a DYNAMIC in operation you won't want to be without it. Its simplicity will amaze you. In a year the DYNAMIC only costs you about 6c a day. Comes complete, ready to operate, with helmet, rods, cables, electrode holder and operating instructions, etc. Nothing else to buy. Write today for Free particulars. Act now and get details on our amazingly low priced Dynamic Welder and 10 day trial offer.

DYNAMIC WELDER CO.

13 East 23rd Street—FL

CHICAGO 16, ILLINOIS

FOR ONLY
\$23⁵⁰
COMPLETE

AMAZINGLY SIMPLE TO OPERATE!

This portable Dynamic Welder, easily carried right to the job, can be operated from any convenient, properly wired 110 Volt 60 cycle line. Can also be supplied for 220 Volt 60 cycle operation and for other voltages and cycles at slight additional cost.



SOUTH BEND LATHES

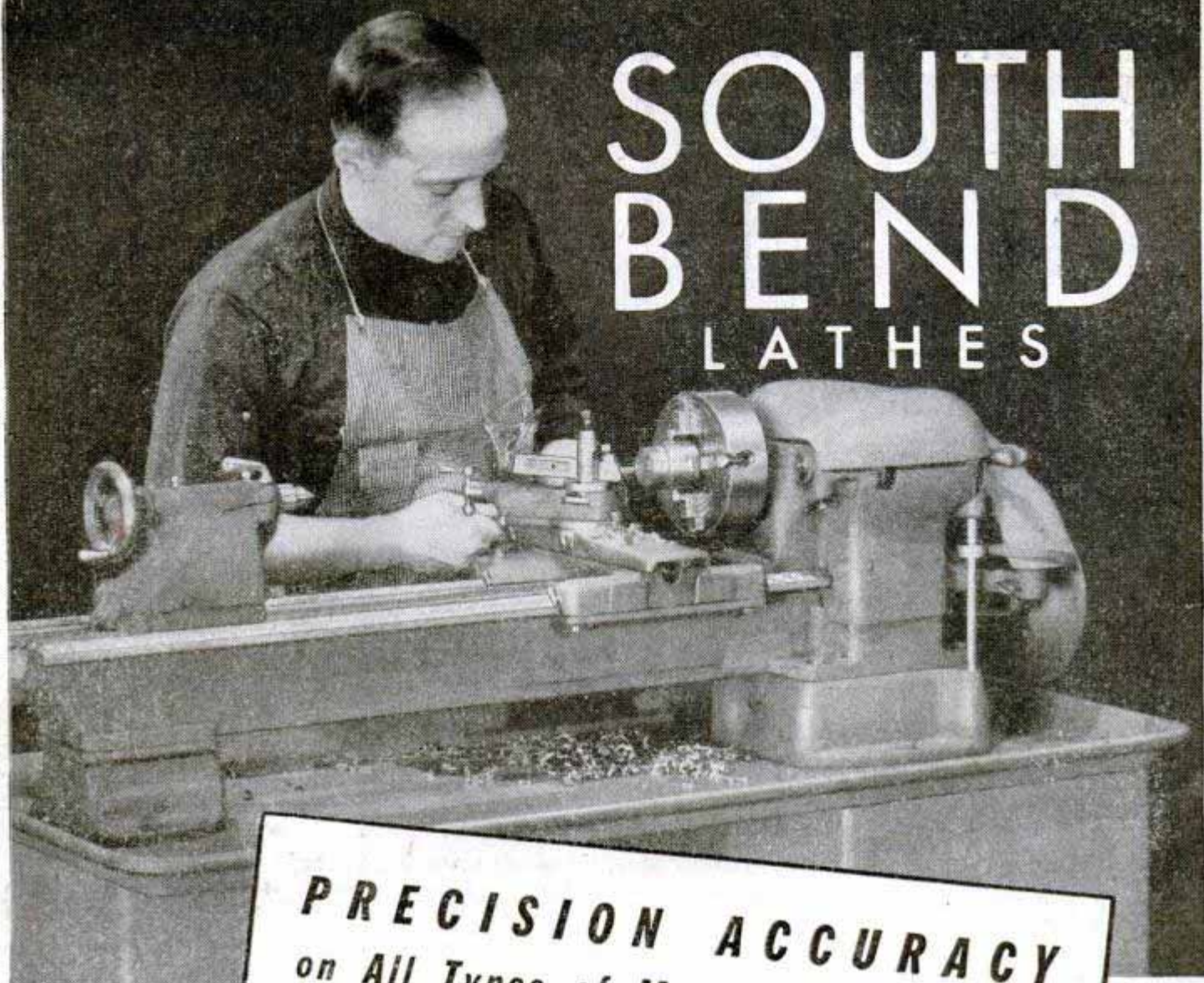

PRECISION ACCURACY
on All Types of Machining Operations

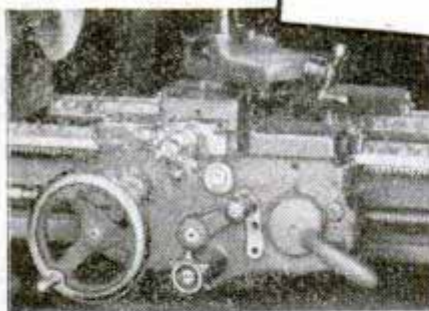

ACCURATE OPERATION is assured through large, graduated collars on cross-feed and compound rest screws, and through convenient apron controls.

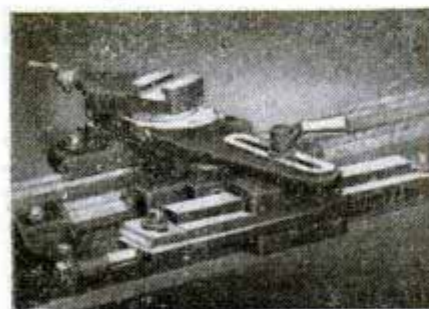

TAPER ATTACHMENT for 9-inch lathes, designed and built for accurate taper turning and boring. Features degree and taper-per-foot graduations.

South Bend Lathes bring to all machining operations the precision which makes fine craftsmanship possible. The ability to do fine work is further aided by the ease with which these lathes can be operated. Easy-to-read, accurately graduated micrometer adjustments, and smooth, positive action of easy-to-reach controls encourage operators to put forth their best efforts. These worthwhile features are important not only in large industrial toolrooms and manufacturing plants, but in the smallest shop. Investigate the many advantages which versatile South Bend Precision Lathes can give you.



FREE CATALOG—Write for it! It illustrates and describes all types, sizes, and models of South Bend Lathes. Specify size in which interested—9", 10", 13", 14-1/2", or 16" swing.

LATHE BUILDERS SINCE 1906

SOUTH BEND LATHE WORKS
455 E. MADISON STREET • SOUTH BEND 22, INDIANA



Printed by Popular Mechanics Company, Chicago, Ill., U. S. A.

A  of a lot more



\$2.65 PER GAL.

SAME PRODUCT - SAME PRICE

-but still not quite enough for every



● Today, any car that *runs* is a good car, whether it's a '46—or '36. It deserves protection from freeze-up—and the best is "Prestone" anti-freeze. One shot lasts all winter, because it doesn't boil away or foam off. Prevents rust and corrosion too.

There's a lot more "Prestone" anti-freeze this year...more than at any time since

1941. But, with demand exceeding supply, *some* motorists are going to be "left out in the cold." To avoid freeze-up damage, get your "Prestone" anti-freeze early.

NATIONAL CARBON COMPANY, INC.

30 East 42nd Street, New York 17, N. Y.
Unit of Union Carbide and Carbon Corporation



The words "Eveready" and "Prestone" are registered trade-marks of National Carbon Company, Inc.

WHY
there's still a
"Prestone" anti-
freeze shortage:

1 "Prestone" anti-freeze, like most other products, depends on the utilization of raw materials and equipment drawn from many fields. Recent industrial dislocations have affected our plant-expansion program, which was not authorized during the war. Planned for years, it is well advanced; but the real benefit will not be felt in 1946.

2 "Prestone" anti-freeze must be produced and *packaged* long before cold weather. Last spring and summer the food shortage diverted packaging materials to the need of starving millions, and adversely affected our ability to meet 1946 requirements. So your dealer may be selling "Prestone" anti-freeze from 5-gallon cans in addition to the familiar 1-gallon cans.

PRESTONE ANTI-FREEZE

TRADE-MARK

"YOU'RE SAFE AND YOU KNOW IT!"—ONE SHOT LASTS ALL WINTER