

POPULAR MECHANICS

MAGAZINE

WRITTEN SO YOU CAN UNDERSTAND IT



REG'D. TRADE MARK, GREAT BRITAIN, No. 1198

REG. U.S. PAT. OFF.



SEE PAGE 131

*An Amazing
Improvement!*



RAY-O-VAC

LEAKPROOF FLASHLIGHT BATTERIES

Stay Fresh
FOR YEARS

NO DATING NECESSARY

RAY-O-VAC COMPANY, MADISON 4, WIS.

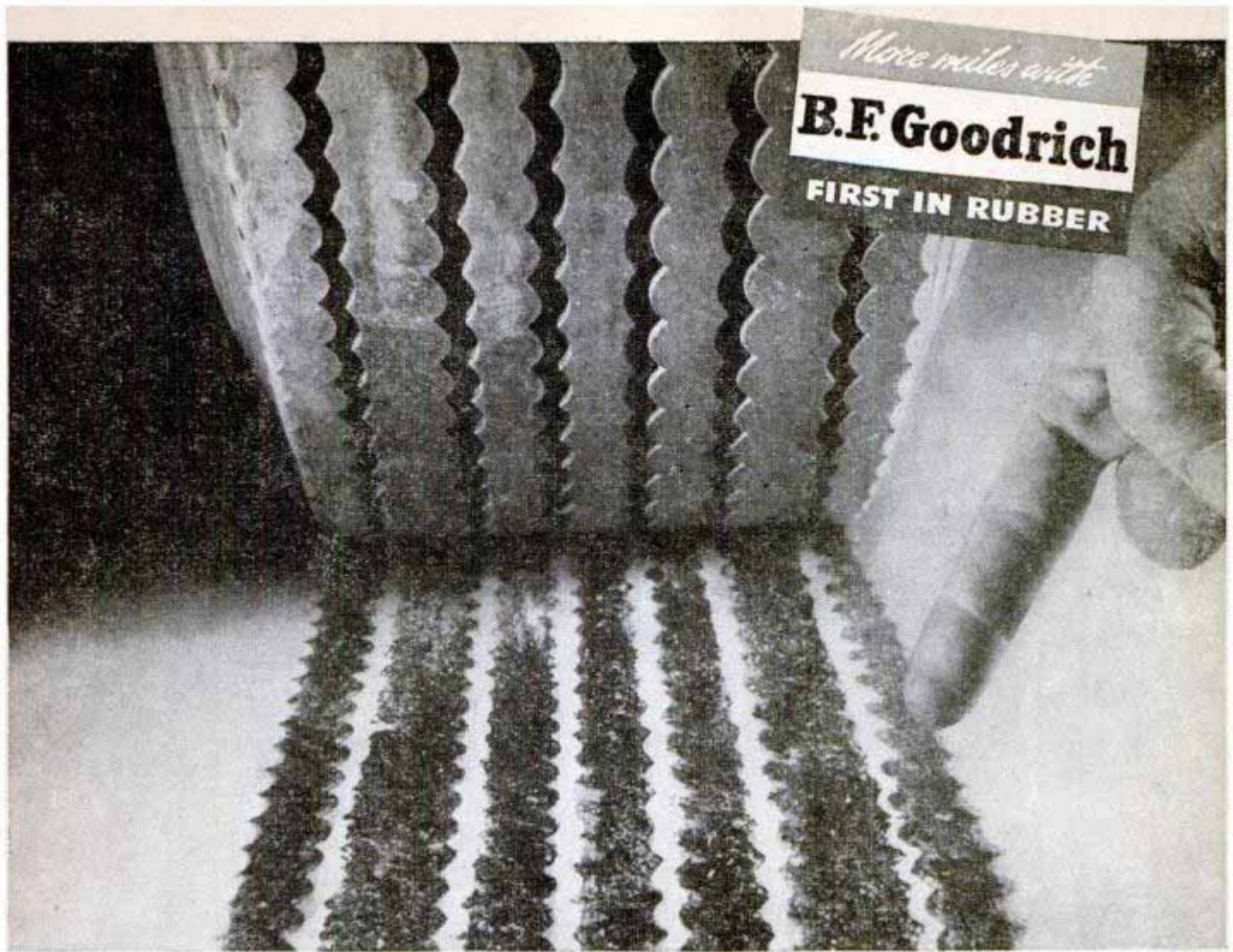

NEW, BROADER TREAD B. F. GOODRICH TIRE OUTWEARS PREWAR TIRES

Now you can order these new tires for your car!

IT'S EASY to understand why a tire with a thick, tough tread will last a long time. But did you know that by making that same tread wider and flatter—so it hugs the road and spreads the wear over a greater area—it will give you still more miles of trouble-free driving?

The new B. F. Goodrich Silvertown has a new type of wider, flatter tread. This longer-wearing tread was not practical on prewar tires because prewar tire bodies were not strong enough to withstand the extra strains set up by a wide, flat tread. By combining this type of tread with a tire body made with

tougher cords and more of them, Goodrich engineers have produced a tire that outwears prewar tires . . . a tire that has more than proved itself in 17 million miles of tests.

You can forget any misgivings you may have had about today's tires. If you get B. F. Goodrich tires, you will be getting tires that have passed the toughest tests anyone could give them in the labora-

tory or on the road. You can be sure they'll stand up better than the tires you bought in prewar days.

Remember, too, the sooner you see your B. F. Goodrich dealer, the sooner you'll have safe, new tires on your car. Supplies are still limited, of course, but we're making and shipping new B. F. Goodrich Silvertown tires every day and will have ever-increasing quantities in the hands of dealers soon. *The B. F. Goodrich Company, Akron, Ohio.*

B.F. Goodrich

FIRST IN RUBBER

TWA uses

CHAMPION

The Dependable Spark Plug



When TWA, "Trans World Airline," selects spark plugs, you can be certain that it is exercising expert judgment backed by experience. This outstanding air line uses dependable Champion Spark Plugs for the great majority of its domestic and international planes, including the famous TWA Constellations. Here again is conclusive proof that Champions are the choice of experts and make every engine—on land, water, or in the air—a better performing, more dependable engine. Champion Spark Plug Company, Toledo 1, Ohio.

TWA Constellation over Paris. Now on daily schedule, making stops at Gander, Newfoundland and Shannon, Ireland.

FOLLOW THE EXPERTS DEMAND CHAMPIONS

Popular Mechanics Magazine

Registered in U. S. Patent Office and Canada

H. H. WINDSOR, Founder

H. H. WINDSOR, Jr., Editor and Publisher



LOOK twice at this picture. It's an introduction to our new French edition, MECANIQUE POPULAIRE, now being read in France, Switzerland and Belgium.

Director of this first foreign edition is Major Adrien Albarranc, a hero of French resistance and widely known in France as an engineer and scientist. He thrice escaped the Nazis and was decorated with the Legion of Honor and other medals. The major determined to publish a French edition of the magazine when he noted the enthusiasm of his American companions for our overseas edition. Paper is scarce in France, but the major was allotted a run of 50,000 copies to stimulate mechanical and scientific activities.



NEXT MONTH you'll look through "Window to the Unknown" at a miniature wonderland—germs as big as sofa pillows and a sheet of paper nine feet thick. The story tells of unknown worlds being disclosed by the electron microscope.

THINK your dog should be in the movies? Then read how "Lassie" and other animals are trained to steal scenes from the stars, how studios acquire everything from a singing owl to a deodorized skunk.

THE CRAFTSMAN section will feature a story that'll bring a tingle of taste to your mouth—how to build a smokehouse of any size for meat and fish. For camera fans there's an article on putting foregrounds to work in salon shots.

RADIO control for model aircraft, available to licensed amateurs, will be described in the Radio section.

Volume 86

AUGUST 1946

Number 2

Managing Editor.....Roderick M. Grant
Assistant Managing Editor.....Wayne Whittaker
Shop Notes and Crafts Editor.....James R. Ward
Radio and Electronics Editor.....Frank L. Brittin
Aviation Editor.....Aubrey O. Cookman, Jr.
Associate Editor.....John R. Kinsey
Eastern Editor.....Bill Reiche
Western Editor.....Thomas E. Stimson, Jr.
Art Director.....Frank Beatty

Assistant Editors

Donald R. Brooks Clifford B. Hicks Maston M. Jacks Virgil T. Swanson

Assistant Editors, Shop Notes and Crafts

W. Clyde Lamme Wayne C. Leckey John F. Shrock A. E. Youngquist

In This Issue

Report From Bikini	73
Sailing in the Sky	82
Don't Pour Coal Up the Chimney	89
Clearer View Ahead	96
Tree Farms Restore an Empire	105
Putting Earth Waves to Work	117
The Bridge Born in a Wind Tunnel	122
They Die a Thousand Deaths	131
Elephants Are Good Pupils	137
Rabbit Hotel	144
The Fishing Fleet Goes Scientific	148
Drive to the Other Americas	154

For the Craftsman

Fireplace Circulates Warm Air	162
"Choosy" Sprays That Kill Weeds	170
Give Your Engine a Check-Up	180
Cash In on Garden Photography	190
Lathe Pinch Hits for Circular Saw	197
Spot Welders for Every Purpose	203
Radio and Electronics	213

Table of Contents Continued on Page 8

Published monthly by POPULAR MECHANICS COMPANY, 200 East Ontario Street, Chicago 11, Ill. H. H. Windsor, Jr., president; Paul H. Dunakin, vice president and general manager; D. F. Windsor, vice president and secretary-treasurer; William Harrison Pettridge, vice president and assistant to the publisher; Clover L. Perkins, advertising manager; Alan M. Deyoe, circulation manager. Single copy in the United States, 25 cents; subscription rates in United States and possessions, and countries of the Pan-American Postal Union, 1 year, \$2.50; 2 years, \$4.50; 3 years, \$6.00. Single copy in Canada, 30 cents; subscription rates, 1 year, \$3.00; 2 years, \$5.50; 3 years, \$7.50. To all other countries add \$1.00 a year over United States prices for overseas postage. If you plan to move, notify us at least 60 days in advance so you will not miss an issue. Give both old and new addresses. Entered as Second Class Matter, September 15, 1903, at the Post Office at Chicago, Illinois, under Act of March 3, 1879. Entered as Second Class Matter at Post Office Dept., Canada. Copyright 1946, by Popular Mechanics Company. Copyright under International Copyright Union. Copyright in France. All rights reserved under Pan-American Copyright Union. Printed in the United States of America.

BEST SELLER!

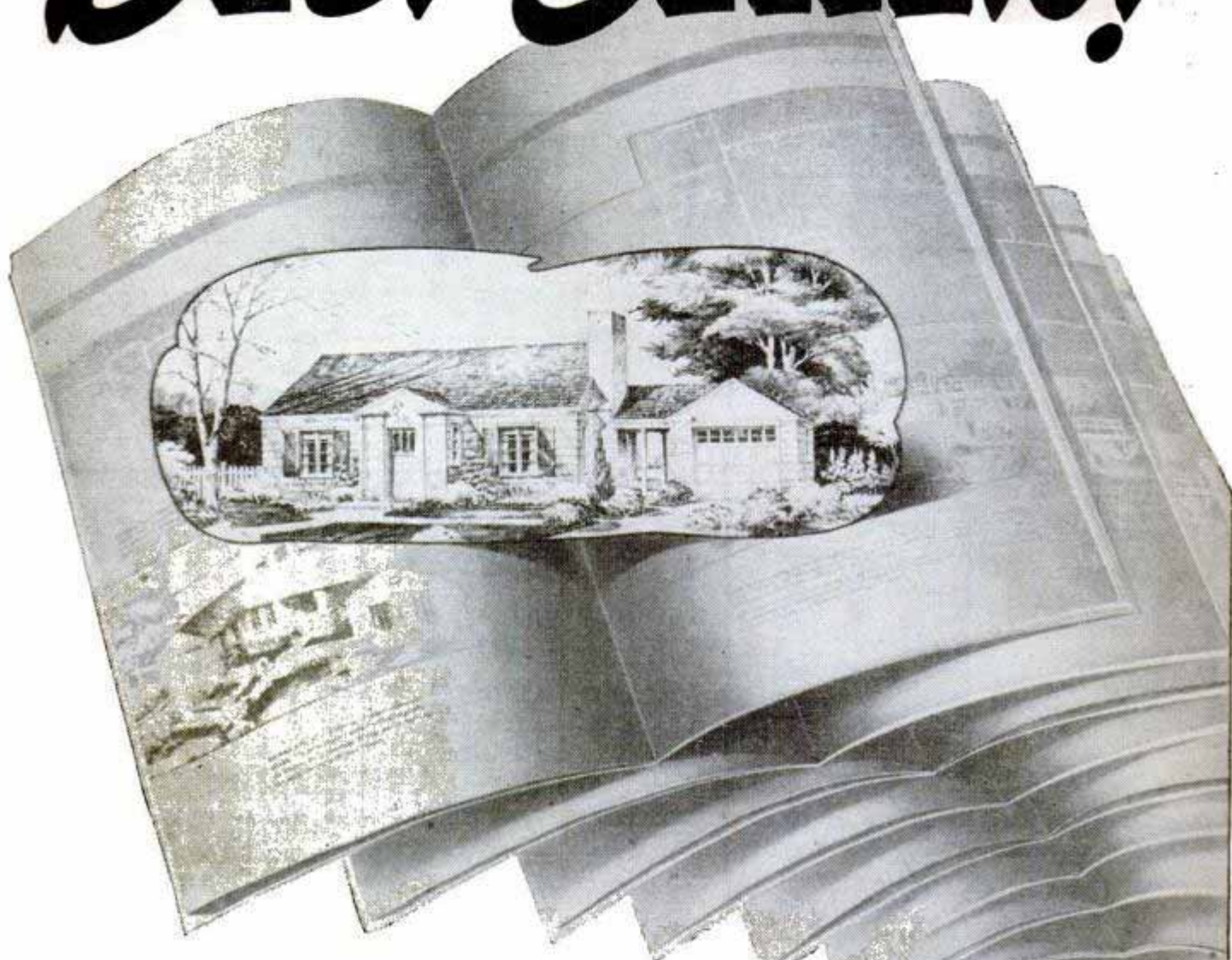

DEFOE is receiving thousands of requests for the descriptive brochure showing architect's drawings of several houses which can be built by the entirely new Defoe method of building permanent, comfortable and efficient homes. ✓ ✓ When the critical shortage of building materials, which is paralyzing home building, is over, Defoe will be able to offer you a home to fit your individual needs—at a price which will bring the savings made possible by advanced mass production methods. ✓ ✓ Send for your copy of Defoe's interesting and instructive brochure today so that you may better understand how the Defoe method works and how you will be able to obtain just the home you have always wanted, custom-built "To Your Measure," by Defoe's master craftsmen.

Illustrated above is the Cape Cod model now in limited production at Defoe's Bay City plant. The present housing emergency will restrict Defoe's output to homes of this single design and, for some time, all of them will go to ex-service men, under priority. But it will pay you to study Defoe's brochure now so that you can formulate your building plans and prepare to be one of the first to own a new Defoe home when unlimited production is once again possible.



HOUSING DIVISION
DEFOE SHIPBUILDING CO.
DEPT. PM-8
BAY CITY, MICHIGAN

Please send me the descriptive brochure on the new Defoe Homes. Enclosed is 10c for handling and mailing costs.

Name _____

Street _____

City and State _____

DEFOE SHIPBUILDING COMPANY... BAY CITY, MICHIGAN



look

SHARP

feel

SHARP

be

SHARP

use

Gillette

Blue Blades

with the **SHARPEST** edges ever honed!



You look **SHARP** because you get the best-looking shaves any man ever had!

You feel **SHARP** because Gillette Blue Blades give you the quickest, most refreshing shaves of your life!

You are **SHARP** when you buy Gillette Blue Blades with the **SHARPEST** edges ever honed, because you get more shaves per blade and save money!

Copyright, 1946, by Gillette Safety Razor Company.

GILLETTE'S CAVALCADE OF SPORTS presents the major boxing event of the week every Friday night over American Broadcasting Company stations coast to coast
Gillette Safety Razor Company, Boston 6, Mass.

THE GREATEST
POWER ON
EARTH!



The Magic of Mind

WERE the great personages of the past victims of a stupendous hoax? Could such eminent men of the ancient world as Socrates, Pericles, and Alexander the Great have been deluded and cast under the spell of witchcraft—or did the oracles whom they consulted actually possess a *mysterious faculty of foresight*? That *the human mind can truly exert an influence over things and conditions* was not a credulous belief of the ancients, but a known and demonstrable fact to them. That there exists a wealth of infinite knowledge just beyond the border of our daily thoughts, which can be aroused and commanded at will, was not a fantasy of these sages of antiquity, but a dependable aid to which they turned in time of need.

It is time you realized that the rites; rituals and practices of the ancients were not superstitions, but subterfuges to conceal the marvelous workings of natural law from those who would have misused them. Telepathy, projection of thought, the materializing of ideas into helpful realities, are no longer thought by intelligent persons to be impossible practices, but instead, *demonstrable sciences*, by which a greater life of happiness may be had.

One of America's foremost psychologists and university instructors, says of his experiments with thought transference and the powers of mind—"The successes were much too numerous to be merely

lucky hits and one can see no way for guessing to have accounted for the results." *Have you* that open-minded attitude of today which warrants a clear, positive revelation of the facts of mind which intolerance and bigotry have suppressed for years? *Advance with the times*; learn the truth about your inherited powers.

Let this free book explain

The Rosicrucians (NOT a religious organization) have been leaders in introducing the ancient wisdom of mental phenomena. Established throughout the world for centuries, they have for ages expounded these truths to those thinking men and women who sought to make the utmost of their natural faculties. Use the coupon below—avail yourself of a pleasing book of interesting information which explains how you may acquire this most *unusual* and *helpful knowledge*.

The ROSICRUCIANS (AMORC)

USE THIS COUPON

Scribe O.W.O.
The Rosicrucians, AMORC,
San Jose, California.

I am sincerely interested in knowing more about this unseen, vital power which can be used in acquiring the fullness and happiness of life. Please send me, without cost, the book, "THE MASTERY OF LIFE," which tells me how to receive this information.

Name _____

Address _____

State _____

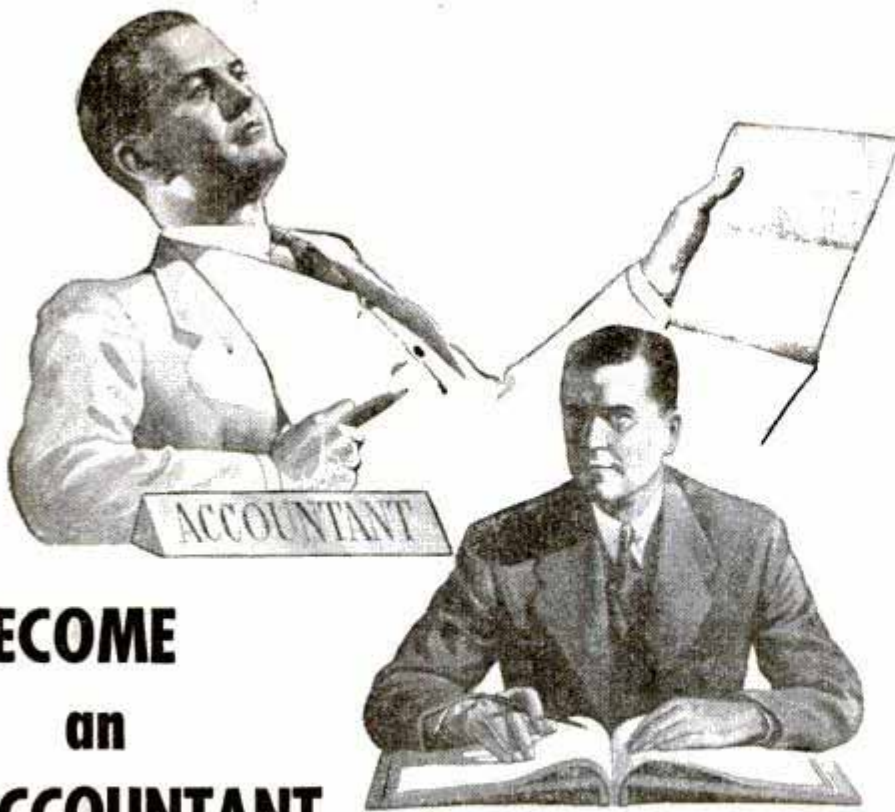

Are YOU doing bookkeeping "chores"?

CLIMB HIGHER!

BECOME an ACCOUNTANT

IF you are doing the "chore" work of accounting as a bookkeeper, ledger clerk, cost clerk, billing clerk, or in one of the other many record keeping jobs—

You should consider climbing higher—becoming an accountant.

Why be satisfied all your life with a small salary and an ordinary job when there is such a large future for the man or woman who understands accountancy in all its forms and phases?

One big difference between you and the successful accountant is that he doesn't do the chores. He bosses those who do the drudgery and he gets the money and prestige. And he does that because he knows the principles behind the records you keep—can plan those records and interpret them to management. He knows what you know—and a lot more.

There are two ways in which you can get this knowledge which will qualify you for an accountant's position.

First—the old way of day-by-day experience on the job. This is the long route—taking many, many years, sometimes a lifetime. Most people taking this way never get anywhere. Why sacrifice years of success—lose time and money—when there is a better and easier way?

Second, the LaSalle way of learning in your spare time—studying and preparing for the step ahead. You learn by doing—you study accounting principles and solve accounting problems. You cover accountancy from the basic principles right up through Accounting Systems and Income Tax Procedure—C.P.A. training if you so desire.

As you go along you absorb the principles of auditing, business law, statistical control, cost accounting, organization, management and finance, etc.

This way is not magic. It is not easy. It requires giving up certain spare time to serious study. How long will it take you to acquire

this accountancy training is strictly up to you—you can go as fast or as slowly as you choose. But after you have gone part way (you need not wait until you are clear through the training) you will find yourself stepping up to better positions.

And once you have mastered this fascinating profession—once you have become an accountant—then you will have the money and the standing to make your dreams come true. You will be a respected member of the best paying profession and equipped to go out into public accounting or to climb to a top management position.

Our free 48-page booklet, "Accountancy, the Profession That Pays," tells you what you must know to be an accountant and how you can prepare in your leisure time at moderate cost. The coupon below will bring this booklet quickly without cost or obligation. You already have a start in this field; now find out how you can go all the way. Do it today.

LASALLE EXTENSION UNIVERSITY A Correspondence Institution

Dept. 864-H, 417 S. Dearborn Street, Chicago 5, Illinois

I'd like to know more about your home study program to help me prepare for an accounting career. Please send me your free 48-page booklet, "Accountancy, the Profession That Pays."

Name

Present to

Address

City & State

This One



9BEY-17W-K6ST

**ADD LIFE TO
YOUR
CAR,
ADD**

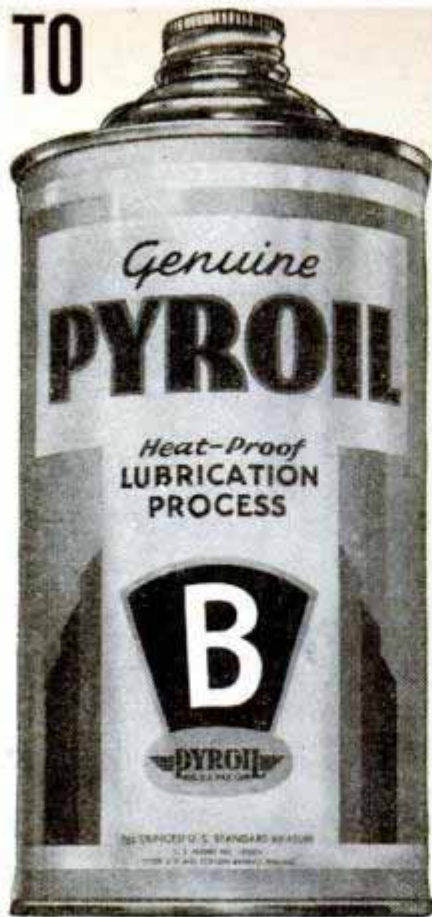

Ask your gas station attendant to add Pyroil. Provides constant film of lubrication on cylinder walls, prevents rust, corrosion, reduces friction wear, frees away sludges and gums and reduces carbon formation.

PYROIL FOR AIRCRAFT ENGINES—Use Aircraft Pyroil B for lubricating oil, Aircraft Pyroil A for gasoline.

Manufactured and Guaranteed by Pyroil Company, W. V. Kidder, Founder, 58 Pyroil Bldg., La Crosse, Wisconsin.

PYROIL COMPANY
58 Pyroil Bldg., La Crosse, Wisconsin

I want my car to last and run properly. Please tell me more about Pyroil and how it can accomplish this for me.

Name.....

Address.....

City or Town.....State.....



Jerry, the talking dog, is entertaining hospitalized veterans, by courtesy of the PYROIL Company. Picture of Jerry, sent on request.

TABLE OF CONTENTS (Continued)

AUTOMOTIVE

Car-top bag stores extra luggage.....113
Auto exhaust heats stove.....141
Hand-operated auto enables movie actress to drive despite handicap.....142
Car built from spare aircraft parts.....142

AVIATION

Speed planes.....78
Bomber tires fit tractor after exchanging rims.....81
High-wing feeder plane gives passengers better view.....81
Planes on deck turn carriers with propeller thrust.....88
Amphibian plane has large door in nose.....102
Transatlantic flying wing.....114
Navy blimp equipped with pontoons for water landings.....142
Thermometers gauge jet speed.....158

BOATS AND BOATING

Metal rack protects outboard motor during storage.....121
Boat has carrier attachment for hoisting to top of car.....121
Jet-propelled ocean liner of future to carry 10,000 passengers.....126
"Egg-beater" propeller boosts speed of test ship by one third.....147

HOUSE AND HOME

Netting shields baby from cold drafts.....94
Jig-time slab house.....95
Cracker removes nut from shell without crushing meat.....102
Midget fire fighter for the home.....113
Adhesive edges hold "sweat shirts" around perspiring water pipes.....116
Houses built of aircraft scrap metal ease shortage in England.....116
Four adjustable stones in sharpener permit grinding any knife.....121
Outdoor thermostatic control regulates building heat.....126
Davenport frames of aluminum.....127
Hollow garment hanger filled with moth balls protects clothing.....128
Electric frying pan can be immersed in water for cleaning.....128
Holder for hot soft-boiled eggs is easy on fingers.....128
Treated paper sheet makes polishing silver a simple job.....128
Electric unit in cover converts frying pan into broiler.....129
Snap-fasteners "sewed" in place with hammer and U-shaped tool.....129
Steel spring and rubber wheel muffle closing of screen door.....129
Agitator of mixer is small enough to slip into bottles.....129
Drop leaf on freezer serves as worktable.....129
Windows swing like doors on hinged channel device.....130
DDT "spider" on lamp kills insects.....141
Building house is child's play with British "prefab" home.....160

LAWN AND GARDEN

Mower with circular blades cuts grass of any height.....87
Grass trimmer operates by pushing down handle.....103
Weeder bites down into plant to remove roots.....103
Garden tool holder saves space.....103
Hose nozzle regulates flow of water by way it is held.....103
Pickup rake has teeth that open wide to gather leaves.....103
All-in-one garden pest killer combats rusts, blights and insects.....120

OUTDOOR RECREATION

Nonstag lure with hidden barbs exposes hooks when hit.....80
Jeep "retriever" chases golf balls.....113
Sleeper trailer for two has kitchen with icebox and gas stove.....120
Glass fishing rods rival bamboo.....141
Paprika makes brook trout wild—at least in color.....153
Cork disk for hook protects angler.....160

PHOTOGRAPHY

Foolproof photo solutions stop overdevelopment.....87
Platform atop mobile crane gives photos desired "angle".....143
Automatic microfilming camera photographs each side of check.....143
Silver reclaimed from hypo by use of wood waste.....143

TOOLS

Nonslip "torque-action" hook grips beams as it lifts.....77
Heat detector finds ship at sea or man ¼ mile away.....77
Carbide pencil writes on glass but leaves no mark on paper.....102
Robot "draftsman" saves time with electric pencil.....120
Lathe converter with universal head does many jobs.....130
Converter for manual saws makes operation automatic.....153

MISCELLANEOUS

Machine tests workers' eyes to help find right job.....77
Atom smashers launch war on disease.....80
Adjustable paper sun visor made from single sheet.....81
Shock cases treated by dry heat from chemical container.....81
Gas and smoke "detectives" find millionth parts in air.....87
High windows for strap hanger prevent riding past stop.....88
Dozer clips nine-inch trees to clear 2½ acres in hour.....88
Newspaper "piped" to home by facsimile broadcaster.....94
Mantelpiece longhorns.....104
Radiant energy roasts coffee.....113
Push-button bed provides self-nursing service for hospital patients.....116
Nudge with chin activates electric book-page turner.....126
Pinhead "shadows" are counted.....127
Robot tabulates and records bowling scores by electric impulses.....127
U. S. steps up machine gun fire.....136
British barrage balloon hoists lights in railroad yard.....136
Felt-pointed fountain brush has nonleak control valve.....136
Korean noodle factory.....140
Coal-burning locomotive model develops enough power to haul eight adults.....142
Ship's auto-carrying capacity increased by installing third deck.....142
Britain's Golden Arrow makes first postwar run.....142
Rotproof fabric buried 90 days retains full strength.....143
Portable hoist unloads cars where cranes are lacking.....147

(Continued to page 10)

HOW'S YOUR POST-WAR PROGRESS?



• Remember when you were going to prepare for the period of post-war opportunities? *This is it!* New industries are coming into being, established industries are expanding . . . and there are rewarding openings for *trained* men in all lines.

• If you failed to get ready for them, it still isn't too late to do something about it! You don't have to slip back . . . you don't have to content yourself with merely hanging to the same old job. The famous International Correspondence Schools can help you to catch up with the procession.

• But don't delay again . . . or it may be too late. Mail the coupon today for full information on I. C. S. training in the field of your interests. Thousands of leaders in American business and industry started up the ladder of success in just that way. It can be the beginning of your climb to higher pay and a more responsible position.

INTERNATIONAL CORRESPONDENCE SCHOOLS



BOX 5585-K, SCRANTON 9, PENNA.

Without cost or obligation, please send me full particulars about the course *before* which I have marked X:

- | | | | |
|---|--|---|---|
| <p>Business and Academic Courses</p> <ul style="list-style-type: none"> <input type="checkbox"/> Accounting <input type="checkbox"/> Arithmetic <input type="checkbox"/> Business Correspondence <input type="checkbox"/> Business Management <input type="checkbox"/> Certified Public Accounting <input type="checkbox"/> Commercial <input type="checkbox"/> Cost Accounting <input type="checkbox"/> Federal Tax <input type="checkbox"/> First Year College <input type="checkbox"/> Foremanship <input type="checkbox"/> Good English <input type="checkbox"/> Higher Mathematics <input type="checkbox"/> Illustrating <input type="checkbox"/> Postal Service <input type="checkbox"/> Salesmanship <input type="checkbox"/> Sign Lettering <input type="checkbox"/> Spanish <input type="checkbox"/> Traffic Management <p>Air Conditioning and Plumbing Courses</p> <ul style="list-style-type: none"> <input type="checkbox"/> Air Conditioning <input type="checkbox"/> Heating <input type="checkbox"/> Refrigeration | <p>Chemistry Courses</p> <ul style="list-style-type: none"> <input type="checkbox"/> Chemical Engineering <input type="checkbox"/> Chemistry, Analytical <input type="checkbox"/> Chemistry, Industrial <input type="checkbox"/> Chemistry, Mfg. Iron & Steel <input type="checkbox"/> Petroleum Refining <input type="checkbox"/> Pulp and Paper Making <p>Civil Engineering, Architectural and Mining Courses</p> <ul style="list-style-type: none"> <input type="checkbox"/> Architectural Drafting <input type="checkbox"/> Architecture <input type="checkbox"/> Building Estimating <input type="checkbox"/> Civil Engineering <input type="checkbox"/> Contracting and Building <input type="checkbox"/> Highway Engineering <input type="checkbox"/> Lumber Dealer <input type="checkbox"/> Reading Structural Blueprints <input type="checkbox"/> Sanitary Engineering <input type="checkbox"/> Structural Drafting <input type="checkbox"/> Structural Engineering <input type="checkbox"/> Surveying and Mapping <p>Communications Courses</p> <ul style="list-style-type: none"> <input type="checkbox"/> Electronics <input type="checkbox"/> Practical Telephony <input type="checkbox"/> Radio, General <input type="checkbox"/> Radio Operating | <p><input type="checkbox"/> Radio Servicing <p>Electrical Courses</p> <ul style="list-style-type: none"> <input type="checkbox"/> Telegraph Engineering <input type="checkbox"/> Electrical Drafting <input type="checkbox"/> Electrical Engineering <input type="checkbox"/> Electric Light and Power <input type="checkbox"/> Lighting Technician <input type="checkbox"/> Practical Electrician <input type="checkbox"/> Power House Electric <input type="checkbox"/> Ship Electrician <p>Internal Combustion Engines Courses</p> <ul style="list-style-type: none"> <input type="checkbox"/> Auto Technician <input type="checkbox"/> Diesel-Electric <input type="checkbox"/> Diesel Engines <p>Mechanical Courses</p> <ul style="list-style-type: none"> <input type="checkbox"/> Aeronautical Engineering <input type="checkbox"/> Aircraft Drafting <input type="checkbox"/> Flight Engineer <input type="checkbox"/> Forging <input type="checkbox"/> Foundry Work <input type="checkbox"/> Heat Treatment of Metals <input type="checkbox"/> Industrial Engineering <input type="checkbox"/> Industrial Metallurgy <input type="checkbox"/> Machine Shop <input type="checkbox"/> Machine Shop Inspection </p> | <ul style="list-style-type: none"> <input type="checkbox"/> Mechanical Drafting <input type="checkbox"/> Mechanical Engineering <input type="checkbox"/> Mold-Loft Work <input type="checkbox"/> Patternmaking—Wood, Metal <input type="checkbox"/> Reading Shop Blueprints <input type="checkbox"/> Sheet-Metal Drafting <input type="checkbox"/> Sheet-Metal Worker <input type="checkbox"/> Ship Drafting <input type="checkbox"/> Ship Fitting <input type="checkbox"/> Tool Designing <input type="checkbox"/> Toolmaking <input type="checkbox"/> Welding—Gas and Electric <p>Railroad Courses</p> <ul style="list-style-type: none"> <input type="checkbox"/> Air Brake <input type="checkbox"/> Car Inspector <input type="checkbox"/> Diesel Locomotive <input type="checkbox"/> Locomotive Engineer <input type="checkbox"/> Locomotive Fireman <input type="checkbox"/> Railroad Section Foreman <p>Steam Engineering Courses</p> <ul style="list-style-type: none"> <input type="checkbox"/> Boilermaking <input type="checkbox"/> Combustion Engineering <input type="checkbox"/> Engine Running <input type="checkbox"/> Marine Engineering <input type="checkbox"/> Steam Electric <p>Textile Courses</p> <ul style="list-style-type: none"> <input type="checkbox"/> Cotton Manufacturing <input type="checkbox"/> Rayon Weav'g <input type="checkbox"/> Textile Desig'ng <input type="checkbox"/> Woolen Manufacturing |
|---|--|---|---|

Name _____ Age _____ Home Address _____

City _____ State _____ Present Position _____

Working Hours _____ A.M. to _____ P.M. Length of Service in World War II _____

Special tuition rates to members of the Armed Forces. Enrollment under the G.I. Bill of Rights approved for War II Veterans.

Canadian residents send coupon to International Correspondence Schools Canadian, Ltd., Montreal, Canada.



FLEXIBLE CURVED TOOTH FILE design — for use in special holder shown in picture at left.

RIGID CURVED TOOTH FILE with tang for accommodating conventional file handle.



SUPER-SHEAR FILE with wide-spaced short-angle teeth at right for fast cutting; narrow-spaced, long-angle teeth at left for smoothing.



NEW FILING SPEED

The increased use of light-but-strong manufacturing materials—such as aluminum, magnesium, plastics and the softer alloys—means correspondingly greater demands for “shearing” type files.

These files reach their highest perfection in the newly designed Nicholson Super-Shear (exclusive with Nicholson) and the improved Nicholson Superior Curved Tooth. Both combine the qualities of *fast cutting* and *smooth finishing*.

Nicholson Superior Curved Tooth (top and middle)—Conventional design with extra-sharp milled teeth and long-lasting quality. Rigid type (with tang), and Flexible for use in special holder (see action view) on convex and concave surfaces. Also made in Narrow Flexible and Rigid Half Round Shell shapes.

Nicholson Super-Shear (bottom)—Its extremely sharp teeth are milled in an “off center” arc that varies the angles and spacing of the teeth to provide both fast cutting and smooth finishing when file is used with the overlapping right-toward-left stroke. Longitudinal serrations help break up chips.

● You can get these special-type files through good mill-supply and hardware houses.

NICHOLSON FILE CO.
22 Acorn St., Providence 1, R. I.
(In Canada, Port Hope, Ont.)



NICHOLSON FILES

FOR EVERY PURPOSE

(Continued from page 8)

Underwater canyon 600 feet deep.....	147
Homemade Tom Thumb tractor built to half-size scale.....	153
Plastic radiophone sifts sounds to pick up voice only.....	159
Family “furniture factory” grows wood in back yard.....	160

Craftsman and Shop Notes Index

ART AND ARTIST

Wire template transfers outline of intricate shapes.....	196
Paper-clip can be moved for convenience of draftsman.....	200
Pencil leads used in compass.....	200
Wedge corrects loss of spring in drafting instruments.....	202
Cleaning agent has many uses in the drafting room.....	210

AUTOMOTIVE

“Seal-beam” your old headlamps.....	179
Preventing waste of stored gasoline.....	184
“Sleeper” for your car.....	186
Battery cable is repaired easily.....	200
Flat-iron clip secures ladder to painter’s truck.....	202
Simple check for ignition lock.....	209
Converted oil drum holds tools and accessories.....	210

FARM

Pipe simplifies removal of posts from soggy ground.....	201
Reversed doubletree lifts weight from horses’ necks.....	202
Method of saving fence posts.....	212
Ladder secured by pitchfork wired to rungs.....	212

HOUSE AND HOME

Storm windows installed from inside house.....	165
Many uses for wetting agents.....	165
Solving home problems.....	166
Miniature shopping bags provide unusual party favors.....	168
Making wallpaper waterproof.....	168
Boxes are rolled for storage.....	176
Ruled lines printed by roller secure decorative effects.....	176
Flypaper is barrier to ants.....	176
Cellular rock used as lighter.....	178
Guard over blade of shoescraper prevents injury.....	184

OUTDOOR RECREATION

Picnic hamper opens to make a serving table.....	169
Hinged hoisting racks speed job of washing rowboats.....	175
Folding campfire grid packs flat for carrying.....	175
Fishing flies tied quickly with drill clamped in vise.....	176
Fishing reel made from typewriter spool.....	196
Conserving rubber bathing caps.....	196
Waterproofing minnow seines.....	211

PHOTOGRAPHY

Basic background can be altered for different effects.....	194
Short pieces of movie film stored in dental flat-tape boxes.....	194
Safelight for photographic paper.....	194
Protecting extra cable releases.....	194
Pipe cleaner will dust negatives without damaging emulsion.....	194

RADIO AND ELECTRONICS

Hams resume “calling CQ” on recently restored amateur bands.....	213
How to build an electron-coupled zero-beat metal detector.....	214
Replacement cabinet for table model receivers.....	216

TOOLS

From sewing machine to jigsaw.....	177
Work easily sawed at any angle without using miter box.....	178
Trouser hanger clamped to saw serves as depth gauge.....	184
Miter gauge used as protractor to scribe on wood.....	188
Stop on tap prevents breakage.....	188
Craft quiz.....	195
Use for broken or short drills.....	199
Guard on conveyor-belt roller prevents injury to hands.....	199
Carboly tip on steel scriber prolongs life of instrument.....	200
Knurled handle holds tool bits when grinding.....	209
How to use small drills in large drill press.....	210
Substitute wrench for disk nuts.....	210
Three tapping hammers useful to modelmakers.....	211
Adjustable guide bar on square is used to mark stringers.....	212
Notches in rule will speed work.....	212

MISCELLANEOUS

Spools guide workbench drawer and serve as support.....	165
Metal clip holds papers in tray.....	168
Easily made glass frame permits observation of plant root systems.....	168
Masonry “drive nails” improvised by using discarded bolts.....	176
Cotter pin makes attaching link on safety chain.....	178
Toothpicks form neat spokes in model wheels.....	178
Dowel used for sanding stick to remove glue from holes.....	178
Linotype slug impresses name on leather goods.....	184
Wire and bolt form hose clamp for emergency use.....	184
Quonset hut for your dog.....	185
How to make a small paper baler.....	188
Furniture bumpers made from rubber heel.....	188
Coins are patterns for cutting gaskets.....	188
Rustic wall rack has shelves of bracket fungi.....	189
Pipe steamer for modelmakers.....	189
“Flower basket” for lawn shrubs is built with barrel staves.....	196
Preventing frayed rope ends.....	196
Bristles taped for stencil brush.....	200
Ball-bearing turntable for assembly and repair.....	201
Bearing used to cut washers for electric motors.....	202
Blueprint record identifies keys.....	202
Lightweight sawhorse is carried to job in auto.....	209
Nail holds brush to rim of paste bucket.....	209
Warehouse hand truck is built of boards and pipe.....	210
Wallboard carried in rope sling by one workman.....	211
Rubber hose used to hold conduit clip.....	212

IMPORTANT NOTICE—It is the intention of this magazine to provide its readers with information regarding the latest developments in the mechanical arts. We take no responsibility as to whether the disclosures contained in our articles are covered by patents and advise readers to investigate this subject before making, using, or selling any of the products, machines, or processes described in order to avoid possible liability for patent infringements.

AUDELS REFRIGERATION & AIR CONDITIONING GUIDE.....\$4

New from Cover to Cover—1280 Pages, Fully Illus. Covering basic principles, servicing, operation & repair of household, commercial & industrial refrigeration & air conditioning. A gold mine of essential important facts for engineers, servicemen, users.

AUDELS CARPENTERS & BUILDERS GUIDES—4 Vols.\$6

A practical illustrated trade assistant on modern construction for carpenters, joiners, builders, mechanics and all woodworkers. 4 vols., 1600 pages, 3700 illustrations, flexible covers. Pocket size. Each volume sold separately \$1.50 a vol.

AUDELS AUTOMOBILE GUIDE.....\$4

A practical quick ready reference book for auto mechanics, service men, operators & owners. Explains theory, construction & servicing of modern motor cars, trucks, buses & auto type Diesel engines. 1540 pages, fully illustrated. 55 chapters. Indexed. A standard book for mechanics. New fluid drive covered.

AUDELS DIESEL ENGINE MANUAL.\$2

A practical, concise treatise with questions and answers on the theory, operation and maintenance of modern diesel engines including General Motors 2 cycle Diesel, 384 pages, fully illus., flexible binding, pocket size. All details plainly brought out, this book is of extreme value to engineers, operators & students.

AUDELS WIRING DIAGRAMS.....\$1

210 Pages. Illustrated. Gives practical facts on wiring of electrical apparatus. It shows clearly how to wire apparatus for practically all fields of electricity. Each diagram is complete & self-explanatory. Highly Endorsed Pocket Companion.

AUDELS PLUMBERS & STEAMFITTERS GUIDES—4 Vols.\$6

A Practical Trade Assistant & Ready Reference. Explains in plain language & by clear illustrations, diagrams, charts, graphs, pictures principles of modern plumbing practice including Marine Pipe Fitting and Air Conditioning. 4 Vols.—1670 Pages—3642 Diagrams. Pocket size. Each Vol. Sold Separately \$1.50 a Vol.

AUDELS SHEETMETAL WORKERS HANDY BOOK.....\$1

Practical inside information. Fundamentals of Sheet Metal Work. 388 pages. Illustrated. 11 sections. Clearly written. Essential & important facts, figures, pointers in everyday language. Ref. Index.

AUDELS SHEETMETAL PATTERN LAYOUTS.....\$4

Developed by Experts for Sheet Metal Workers, Layout Men & Mechanics. A Practical Encyclopedia in 10 Sections, size 7 x 10 x 2—1125 Pages—350 Layouts—1600 Illustrations. 1001 Key Facts. Fully indexed for ready reference in answering your layout problems. Covers all phases of sheet metal work including Pattern Cutting, Pattern Development & Shop Procedure.

AUDELS ANSWERS ON BLUE PRINT READING.....\$2

For Mechanics & Builders. Covers all types of blue print reading including ship & airplane. 376 pages, fully illustrated.

AUDELS NEW MACHINIST & TOOLMAKERS HANDY BOOK....\$4

Covers modern machine shop practice in all its branches. 5 practical books in 1. New from cover to cover. Tells how to set up & operate lathes, screw and milling machines, shapers, drill presses and all other machine tools. 1600 pages, fully illustrated, 5 x 8 1/2 x 2. Indexed. 5 sections. 1—Modern Machine Shop Practice. 2—Blue Print Reading & How to Draw. 3—Calculations & Mathematics for Machinists. 4—Shop Physics. 5—How to Use the Slide Rule. 60 chapters. Easy to read and understand. A shop companion that answers your questions.

AUDELS MATHEMATICS & CALCULATIONS FOR MECHANICS \$2

Mathematics for home study or reference. 700 pages, 550 illus. Practical mathematics from beginning. How to figure correctly. Easy, correct methods covering a complete review. Ill. & Indexed.

AUDELS HANDY BOOK OF PRACTICAL ELECTRICITY.....\$4

For maintenance engineers, electricians & all electrical workers. 1440 Pages, 2600 illus. Covers important electrical information in handy form—including Marine Wiring, Radio Principles, Welding. Indexed. A Key to a practical understanding of electricity.

AUDELS RADIOMANS GUIDE.....\$4

A key to the practical understanding of radio including Frequency Modulation, Television, etc., Aircraft & Marine Radio. For radio engineers, servicemen, amateurs. 772 pages. 400 Illustrations & Diagrams. Photos. Review Questions & Answers, Reference Index. Authentic, clear, concise.

AUDELS ELECTRONIC DEVICES...\$2

Tells What You Want to Know About Electric Eye. Easily Understood. Covers photo-electric cells & their applications. Amplifiers, illumination, frequencies, voltage, photocell, tubes, Ohm's Law, wiring diagrams, etc.

AUDELS WELDERS GUIDE.....\$1

A concise, practical text on operation & maintenance of all welding machines for all mechanics. Over 400 pages, illustrated. Covers all methods of electric and acetylene welding including airplane work.

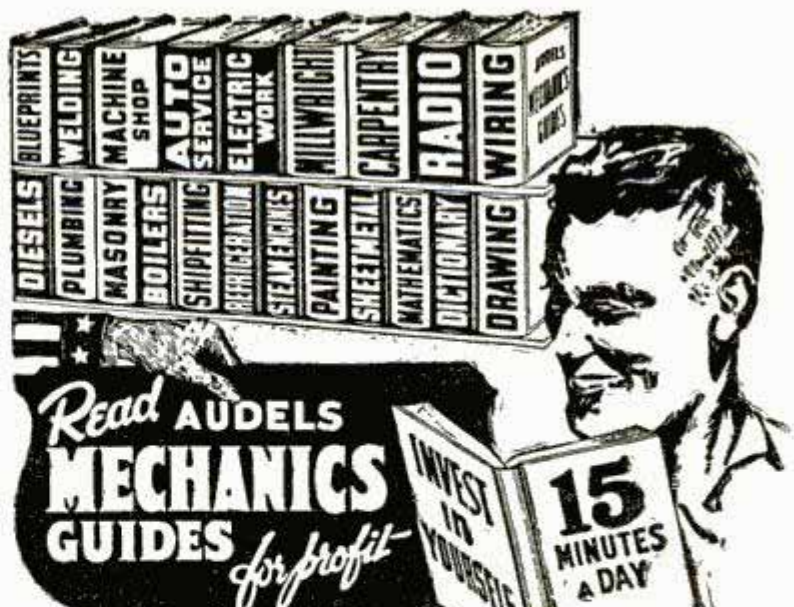

AN AUDEL GUIDE IS A GOOD FRIEND!

Use the brains and experience of others in these Guides of the Trades. Save time and money with right methods, short cuts, labor saving ideas. CHECK NOW! You can look over any Audel Guide in your home. Start the Easy Payments if satisfied.

CUT HERE MAIL ORDER

THEO. AUDEL & CO., 49 W. 23 St., New York 10, N.Y.

Please mail me for 7 days' free examination the books marked (X) below. I agree to mail \$1 in 7 days on each book or set ordered, and to further mail \$1 a month on each book or set ordered until I have paid purchase price.

If I am not satisfied with Guides I will return them.

- Audels OIL BURNER GUIDE \$1.
- Audels REFRIGERATION & Air Conditioning Guide. 4.
- Audels POWER PLANT ENGINEERS GUIDE 4.
- Audels PUMPS, HYDRAULICS & AIR COMPRESSORS 4.
- Audels WELDERS GUIDE 1.
- Audels BLUE PRINT READING 2.
- Audels SHEET METAL WORKERS Handy Book 1.
- Audels SHEET METAL PATTERN LAYOUTS 4.
- Audels AIRCRAFT WORKER 1.
- Audels MATHEMATICS and CALCULATIONS 2.
- Audels MACHINISTS & TOOLMAKERS Handy Book 4.
- Audels MECHANICAL Dictionary 4.
- Audels AUTOMOBILE GUIDE 4.
- Audels DIESEL ENGINE MANUAL 2.
- Audels MARINE ENGINEERS Handy Book 4.
- Audels SHIPFITTERS Handy Book 1.
- Gueths MECHANICAL DRAWING COURSE 1.
- Rogers DRAWING and DESIGN 2.
- Audels MILLWRIGHTS and Mechanics Guide 4.
- Audels CARPENTERS and Builders Guides (4 vols.) 6.
- Audels PLUMBERS and Steamfitters Guides (4 vols.) 6.
- Audels MASONS and Builders Guides (4 vols.) 6.
- Master PAINTER and DECORATOR 2.
- Audels GARDENERS & GROWERS GUIDES (4 vols.) 6.
- Audels ENGINEERS & FIREMANS EXAMINATIONS 1.
- Audels ENGINEERS and Mechanics Guides Nos. 1, 2, 3, 4, 5, 6, 7 and 8 complete 12.
- Audels Answers on Practical ENGINEERING 1.
- Audels ELECTRICIANS EXAMINATIONS 1.
- Audels WIRING DIAGRAMS 1.
- Audels Handy Book of PRACTICAL ELECTRICITY 4.
- Audels ELECTRICAL POWER CALCULATIONS 2.
- Audels ELECTRONIC DEVICES 2.
- Audels ELECTRIC Dictionary 2.
- Audels RADIOMANS GUIDE 4.
- Audels NEW ELECTRIC LIBRARY at \$1.50 a Volume Vols. I, II, III, IV, V, VI, VII, VIII, IX, X, XI, XII

Name _____
 Address _____
 Occupation _____
 Employed by _____ PM

LOANS *by* MAIL

IN A HURRY



OUR DOOR IS AS CLOSE AS YOUR MAIL BOX!

\$50 to \$300 ON YOUR SIGNATURE ALONE OR YOUR OWN SECURITY TO

SALARIED PEOPLE who are steadily employed in approved occupations. For men or women—married or single. You mail the application to us . . . we mail the money to you. The monthly payment plans shown below include all costs—no hidden charges. Up to 18 months to repay most loans.

**NO PERSONAL INTERVIEW
NO CO-SIGNERS NEEDED
NO WAGE ASSIGNMENTS**

CONVENIENT

"Loans by Mail" are completed quickly, confidentially and entirely by mail. Whatever your needs for cash—now or in the future . . . write for our "Loans by Mail" plan today. In our 20th year of installment financing . . . a guarantee of satisfaction.

FOR A LOAN OF	YOU CAN REPAY MONTHLY				
	In 18 Payments	In 15 Payments	In 12 Payments	In 9 Payments	In 6 Payments
\$ 50	—	—	\$ 5.03	\$ 6.43	\$ 9.24
100	7.29	8.40	10.07	12.87	18.48
150	10.94	12.60	15.10	19.30	27.73
200	14.53	16.75	20.09	25.68	36.91
250	18.08	20.85	25.02	32.02	46.05
300	21.60	24.93	29.94	38.33	55.17

Above payments, made at regular monthly intervals, will repay the entire loan in the time indicated . . . all charges are on unpaid principal balance based on 3% to \$150 and 2½% in excess thereof but not exceeding \$300. "Loans by Mail" may be repaid more rapidly, more frequently or repaid in full at further savings to you.

819-A **MERCHANTS INVESTMENT CO.**
1st Natl. Bk. Bldg., Omaha, Nebr.

Without obligation, rush complete details and all papers necessary for a loan of \$_____ to be repaid at \$_____ on the _____ day of each month.

Name _____

Address _____

City _____ State _____

Occupation _____

Clip this ad NOW for immediate or future use.

SAY YOU SAW IT IN POPULAR MECHANICS

IT'S EASY TO LEARN TO WRITE

The Magazine Institute offers an up-to-the-minute course in writing for magazines which makes it easy to get started in spare time at home. You may concentrate on either fiction or non-fiction. Send today for the FREE CATALOG describing the Magazine Institute method. No obligation.

THE MAGAZINE INSTITUTE, INC., Dept. 638-D
50 Rockefeller Plaza, Rockefeller Center, New York 20, N. Y.

BIG MONEY NOW IN LIQUID MARBLE

THREE wonderful new opportunities for your own big money-making business—regardless of your age, sex, or previous experience!

- 1. LIQUID MARBLE.** Make beautiful artificial Marble Slabs. Pour from liquid state. Glazed or unglazed. This marble may be mottled, veined, multi-colored or left in original snow-white state. The color is actually a part of the marble! Does not fade or wear away. Liquid Marble is unsurpassed on kitchen or bathroom walls. Easy to make and install.
- 2. PLASTIC FLOORING.** May be made in any color or combination of colors. Gives a lifetime of wear. Dustproof, Soundproof, Verminproof. Resilient to the tread. Lay out solid from wall to wall or in pattern design of various shaped blocks.
- 3. FLEXIBLE MOLDS.** For plaster casting. Make your own moulds for few cents each. \$1.00 in raw materials will make up to \$25.00 worth of finished goods. We furnish names of buyers. Write now for FREE information about our **BIG THREE** money-making opportunities! Get in on busy season just starting. Send penny postcard or letter. No obligation.

COMPO-TEX, Box 786-SG, ST. LOUIS 1, MO.

SHORTHAND in 6 Weeks at Home

Famous Speedwriting system. No signs or symbols; uses ABC's. Easy to learn; easy to write and transcribe. Fast preparation for a job. Surprisingly low cost. 100,000 taught by mail. Used in leading offices and Civil Service. Write for free booklet.

SPEEDWRITING, Dept. 1508-6, 55 West 42 St., N. Y. 18

PEPSI-COLA HITS THE SPOT

JUST OUT! NEW FROM COVER TO COVER

AUDELS REFRIGERATION and AIR CONDITIONING GUIDE



4 Books in One! Covering:

- Basic principles, Servicing, Operation, Repair of
- 1—Household Refrigeration
- 2—Special Refrigeration Units
- 3—Commercial & Industrial Refrigeration
- 4—Air Conditioning Systems

A gold mine of essential important facts for ENGINEERS, SERVICEMEN & USERS. A Good Book is a Good Friend! Here you have at your fingers' ends a Complete Library in ONE VOLUME, the necessary data you have been looking for on: MODERN UNITS, SYSTEMS & MACHINES, REFRIGERANTS, including Freon, Lockers, Water Coolers, Quick Freezing & Air Conditioning Systems.

1280 Pages, 46 chapters all Fully Illustrated & indexed for Ready Reference.

ANSWERS YOUR QUESTIONS

Get This Information for Yourself. Mail Coupon Today. No Obligation Unless Satisfied. ASK TO SEE IT.

\$4 COMPLETE • PAY ONLY \$1. A MONTH ←

AUDEL, Publishers, 49 W. 23rd St., New York 10, N.Y.

MAIL AUDELS NEW REFRIGERATION GUIDE for free examination. If O. K. I will send you \$1 in 7 days; then remit \$1 monthly until price of \$4 is paid. Otherwise I will return it.

Name _____

Address _____

Occupation _____

Employed by _____ PM



RADIO SERVICING pays good money for full time work. Many others make \$5, \$10 a week EXTRA fixing Radios in spare time.

**Building this
A. M. SIGNAL GENERATOR**

gives you valuable experience. Provides amplitude-modulated signals for test and experiment purposes.

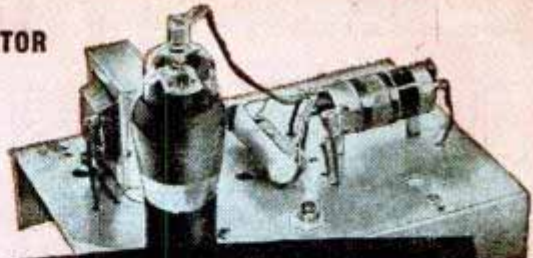

Learn RADIO by PRACTICING in Spare Time

with 6 Big Kits of Radio Parts I Send You

Do you want a good-pay job in Radio — or your own money-making Radio Shop? Mail Coupon for a FREE Sample Lesson and my FREE 64-page book, "Win Rich Rewards in Radio." See how N.R.I. gives you practical Radio experience at home—building, testing, repairing Radios with 6 BIG KITS OF PARTS I send!



You build this MEASURING INSTRUMENT yourself early in the course—use it for practical Radio work on neighborhood Radios to pick up EXTRA spare time money!

You build this SUPERHETERODYNE CIRCUIT that brings in local and distant stations. You get practical experience putting this set through fascinating tests!

Many Beginners Soon Make Good Extra Money in Spare Time While Learning

The day you enroll I start sending EXTRA MONEY JOB SHEETS. You LEARN Radio principles from my easy-to-grasp, illustrated lessons—PRACTICE what you learn with parts I send—USE your knowledge to make EXTRA money fixing neighbors' Radios in spare time while still learning! From here it's a short step to your own full-time Radio Shop or a good Radio job!

Future for Trained Men Is Bright in Radio, Television, Electronics

It's probably easier to get started in Radio now than ever before because the Radio Repair business is booming. Trained Radio Technicians also find profitable opportunities in Police, Aviation, Marine Radio, Broadcasting, Radio Manufacturing, Public Address work. Think of even greater opportunities as Television and Electronics become available to the public! Send for free books now!

Find Out What N.R.I. Can Do For You

Mail Coupon for Sample Lesson and my 64-page book. Read the details about my Course. Read letters from men I trained, telling what they are doing, earning. See how quickly, easily you can get started. No obligation! Just MAIL COUPON NOW in an envelope or paste it on a penny postal.—**J. E. SMITH, President, Dept. 6HP, National Radio Institute, Pioneer Home Study Radio School, Washington 9, D. C.**

**BE A SUCCESS in RADIO
I Will Train You at Home**

Sample Lesson FREE



Gives hints on Receiver, Servicing, Locating Defects, Repair of Loudspeaker, I.F. Transformer, Gang Tuner, Condenser, etc., 31 illustrations. Study it—keep it—use it—without obligation! Mail coupon NOW for your copy!



GET BOTH 64 PAGE BOOK SAMPLE LESSON FREE

Mr. J. E. SMITH, President, Dept. 6HP, National Radio Institute, Washington 9, D. C.
Mail me FREE, without obligation, Sample Lesson and 64-page book about how to win success in Radio and Television—Electronics. (No salesman will call. Please write plainly.)

Name.....Age.....
Address.....
City.....State.....

Approved for Training under GI Bill



My Course Includes Training in TELEVISION ★ ELECTRONICS

OFFERS LOW COST LIFE INSURANCE

Postal Life offers \$1724. in Protection for \$2.00 monthly (age 21). Other Ages in Proportion

THIS PREMIUM HALF PERMANENT RATE Policy Fully Paid-up in 30 years

NEW YORK, Saturday. Postal Life of New York, unique among important Old Line, Legal Reserve Life Insurance Companies, is again offering this special modified policy, already owned by thousands of American families. You pay half the permanent rate until the 6th year; \$2.00 monthly for substantial amounts of Protection, depending on age! \$2.00 monthly pays for \$1754. of life long protection at 20; \$1142. at 40; \$5.00 monthly buys \$3650. at 30, etc. Proportionate amounts at other ages. You pay no premiums after 30 years; policy fully paid-up and in force your entire life.

For your convenience we print below a coupon that can be clipped and sent to Postal Life. Full information, rates, etc., will be sent to you promptly. There is no obligation to buy but we advise immediate action. Life Insurance is vital to your future and your family's welfare. Postal Life Insurance Company, 511 Fifth Avenue, New York 17, N. Y.

Postal Life Insurance Company
511 Fifth Ave., Dept D-604, New York 17, N. Y.
Mail rates and full details about your "\$2.00-per-month", 30-Payment Life Policy at my age.

Name _____
Occupation _____ Date of Birth _____
Address _____

Include P. O. District Number, if any



HUNTING and FISHING

is a monthly magazine crammed full of hunting, fishing, camping, dog and boating stories and pictures, invaluable information about guns, fishing tackle, game law changes, best places to fish and hunt—countless ideas that will add more fun to your days afield.

Special Trial Offer

Send 25c in stamps or coin and we will send you Hunting & Fishing for six months.

HUNTING & FISHING MAGAZINE

251 Sportsmen's Bldg., Boston, Massachusetts

Train Your Own HORSES!

Colts — Stock Horses — Circus Horses
Gait Show Horses — Write for FREE BOOK
ANIMAL LOVERS' ASSOCIATION
Box KA-111, Tarzana, Calif.



SAY YOU SAW IT IN POPULAR MECHANICS

AIR RIFLES BENJAMIN AIR PISTOLS
ARE IN PRODUCTION

ORDER BENJAMIN AIR RIFLES & BENJAMIN AIR PISTOLS from your DEALER. Send for our FREE FOLDER and Complete Specifications TODAY. Both Calibre Benjamin H-C Pellets are available now.
BENJAMIN AIR RIFLE CO., 812 MARION ST., ST. LOUIS 4, MO.



59c



5 Extra Blades (Year's Supply) 25c

1734 Carew Tower

COMB-A-TRIM THE NEW QUICK TRIMMER

Something New! Trim your hair without any experience. It's easy! The excess hair comes off smoothly and easily by just pulling trimmer through hair like an ordinary comb. Also removes hair from legs—armpits. Save on hair-cut bills... Trim your own hair or the whole family's. Send 59c and your Comb-A-Trim will be sent at once.

SPECIAL OFFER
Send \$..00 for 2 Comb-A-Trims and save 18c. **2 for \$1**

COMB-A-TRIM CO.

Dept. R-9

Cincinnati, O.

FIX ANY RADIO

Amazing New Invention



PRICE ONLY \$1.50 COMPLETE

Learn quickly to repair all radio sets. New, different Comparison method. No previous radio knowledge needed. Introductory training included. Simple, picture suggestions tell you where to look for faults and how to make the repair. No testers needed for most jobs. Manual 8 1/2 x 11 in., 63 job-sheets, 24 blueprints. Many hints. New edition. Order manual 3-P. Price only \$1.50 postpaid. Money back guaranteed.

SUPREME PUBLICATIONS 9 S. Kedzie Ave. Chicago 12, ILL.

ANALYZE HANDWRITING

Qualify for Certified Grapho-Analyst Degree. New uncrowded, fascinating field of service. Gratifying earnings reported by graduates in Employment, Credit, Social Service, Police and Judicial, and Entertainment fields. Others have developed profitable private practice, full or spare time, as Personal Problem and Vocational Counselors. Send for 3000 word test lesson and Grapho-Analyst **FREE**

ADDRESS A. I. G. A. Inc. 120 NOEL, MO.



Arc Welded Design "Know-How"

Only \$2.50 each Each volume contains over 3 different volumes 100 welding designs. Write \$10.00 postpaid Hobart Bros. Co. Box M-561, Troy, O.

Good Handwriting

HELPS YOU WIN SUCCESS!

It's so important to write a good hand for business and social advancement. Poor illegible penmanship often causes costly errors and marks you for failure. Why write a poor hand? It's so easy to learn at home in spare time. Write for our new free booklet today. If you wish, send 10c for a permanent suitable for shaded writing and your name beautifully written.

THE TAMBLYN SCHOOL OF PENMANSHIP
In Business Since 1895 H-441 Ridge Bldg., Kansas City, Mo., U. S. A.

do you WORRY?

Why worry and suffer any longer if we can help you? Try a Brooks Patented Air Cushion. This marvelous appliance for most forms of reducible rupture is GUARANTEED to bring YOU heavenly comfort and security—day and night—at work and play—or it costs you NOTHING. Thousands happy. Light, neat-fitting. No hard pads or springs. For men, women, and children. Durable, cheap. Sent on trial to prove it. Not sold in stores. Beware of imitations. Write for Free Book on Rupture, no-risk trial order plan, and proof of results. All Correspondence Confidential.



Brooks Company, 359 State St., Marshall, Mich.

INVENTORS

The patent laws provide that any new and useful art, machine, article of manufacture, composition of matter, or design, or any new and useful improvement thereof, may be patented if the act of invention is involved. Therefore, every inventor with a valuable invention should take advantage of the patent laws and proceed for patent protection in order to safeguard his rights.

A patent gives the inventor the exclusive right to prevent others from making, using, or selling the invention claimed in the patent for a period of 17 years.

The patent laws were enacted for the benefit of the inventor to give him protection for the features of his invention which are patentable. These features must be properly and concisely set forth and claimed in a formal application for patent in order to comply with the requirements of the U. S. Patent Office. For that reason, the Patent Office advises the inventor to engage a competent registered patent attorney to prepare his application for patent and represent him before the U. S. Patent Office Examiner.

A specially prepared booklet containing detailed information with respect to patent protection and procedure will be forwarded to you without obligation upon request.

Patents
Trademarks
Copyrights

Registered Patent Attorneys

CLARENCE A. O'BRIEN & HARVEY B. JACOBSON
Registered Patent Attorneys
61-H Adams Building, Washington 4, D. C.

Please send me booklet containing information regarding patent protection and procedure. This request does not obligate me.

Name _____

Address _____

City _____ State _____

(Please write or print plainly.)

CLARENCE A. O'BRIEN
& HARVEY B. JACOBSON

61-H Adams Building + Washington 4, D. C.

LET ME TRAIN YOU

for RADIO ELECTRONICS & TELEVISION

I'll Supply a FULL RADIO SET

for SIMPLIFIED INSTRUCTION — PRACTICE & TESTING

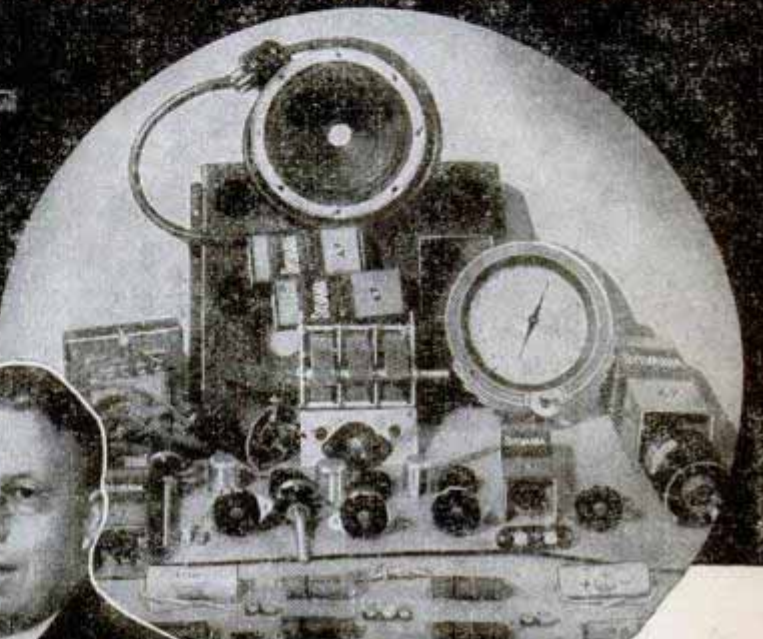
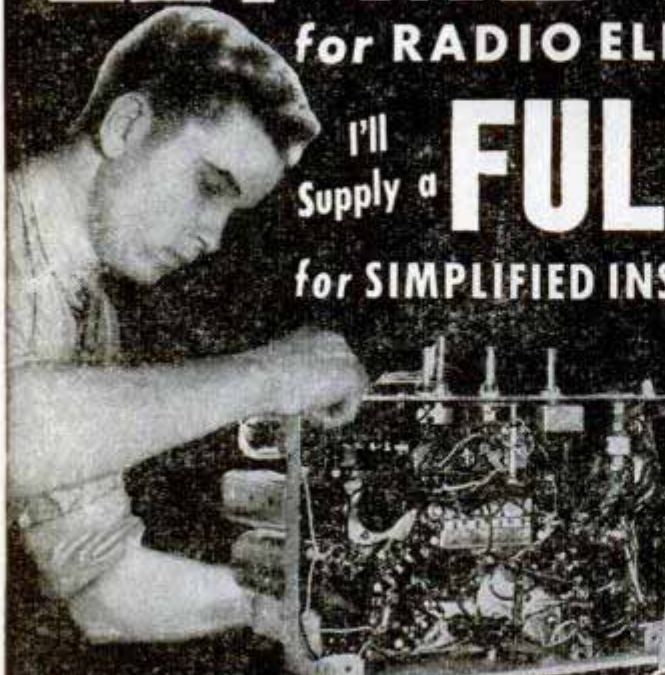

Beginners Learn FAST
START NOW! Big Developments
 Ahead in F. M., Radar, Television



MAKE GOOD MONEY IN
a Business of Your Own
...or a Good Radio Job.

The offer I make you here is the opportunity of a lifetime. It's your big chance to get ready for a wonderful future in the swiftly expanding field of Radio-Electronics INCLUDING Radio, Television, Frequency Modulation and Industrial Electronics. Be wise! NOW'S the time to start. Opportunities ahead are tremendous! No previous experience is necessary. The Sprayberry Course starts right at the beginning of Radio. You can't get lost. It gets the various subjects across in such a clear, simple way that you understand and remember. And, you can master my entire course in your spare time.

You Do Practical Experiments

There's only one right way to learn Radio Electronics. You must get it through simplified lesson study combined with actual "shop" practice under the personal guidance of a qualified Radio Teacher. It's exactly this way that Sprayberry trains you, supplying real Radio parts for learn-by-doing experience right at home. Thus, you learn faster, your understanding is clear-cut.

I'll Show You a New, Fast Way to Test Radio Sets Without Mfg. Equipment

The very same Radio Parts I supply with your Course for gaining pre-experience in Radio Repair work may be adapted through an

exclusive Sprayberry wiring procedure to serve for complete, fast, accurate Radio Receiver trouble-shooting. Thus, under Sprayberry methods, you do not have one cent of outlay for manufactured Test Equipment.

Succeed As a Radio-Electronician

My training will give you the broad, fundamental principles so necessary as a background, no matter which branch of Radio you wish to specialize in. I make it easy for you to learn Radio Set Repair and Installation Work. I teach you how to install and repair Electronic Equipment. In fact, you'll be a fully qualified RADIO-ELECTRONICIAN, equipped with the skill and knowledge to perform efficiently and to make a wonderful success of yourself.

Read What Graduate Says "One Job Nets About \$26.00"

"Since last week I fixed 7 radios, all good-paying jobs and right now I am working on an amplifier system. This job alone will net me about \$26.00. As long as my work keeps coming in this way, I have only one word to say and that is 'Thanks' to my Sprayberry training and I am not afraid to boast about it." — ADRIEN BENJAMIN, North Grosvenordale, Conn.

DON'T PUT IT OFF!

Get the facts about my training—now! Take the first important step toward the money-making future of your dreams. All features are fully along with another valuable FREE explained in my big, illustrated FREE Catalog which comes to you book you'll be glad to own.

FREE BOOKS

"How To Read Radio Diagrams and Symbols"

... a valuable new book which explains in simple English how to read and understand any Radio Set Diagram or circuit. Includes translations of all Radio symbols. Send for this FREE book now, and along with it I will send you another big FREE book describing my Radio-Electronic training.

RUSH COUPON for BOTH



SPRAYBERRY ACADEMY OF RADIO

F. L. Sprayberry, President
 Room 1086, Pueblo, Colorado

Please rush my FREE copies of "How to MAKE MONEY in RADIO, ELECTRONICS and TELEVISION," and "HOW to READ RADIO DIAGRAMS and SYMBOLS."

Name.....Age.....

Address.....

City.....State.....

(Mail in envelope or paste on penny postcard)

MAIL COUPON AT ONCE!

HOW "JACK THE WEAKLING" SLAUGHTERED THE "DANCE-FLOOR HOG"!

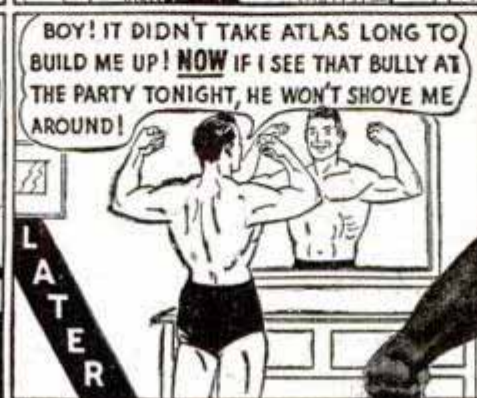
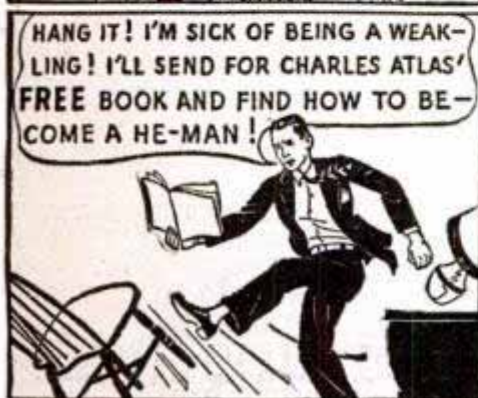

Charles Atlas

—actual photo of the man who holds the title, "The World's Most Perfectly Developed Man."

I Can Make YOU a New Man, Too —in Only 15 Minutes a Day!

HAVE YOU ever felt like Jack—absolutely fed up with having bigger, huskier fellows "push you around"? If you have, then give me just 15 minutes a day! I'll PROVE you can have a body you'll be proud of, packed with red-blooded vitality!

"Dynamic Tension." That's the secret! That's how I changed myself from a scrawny, 97-pound weakling to winner of the title, "World's Most Perfectly Developed Man."

"Dynamic Tension" Does It!

Using "Dynamic Tension" only 15 minutes a day, in the privacy of your own room, you quickly begin to put on muscle, increase your chest measurements, broaden your back, fill out your arms and legs. This easy, NATURAL method will make you a finer specimen of REAL MANHOOD than you ever dreamed you could be!

You Get Results FAST

Almost before you realize it, you will notice a general "toning up" of your en-

tire system! You will have more pep, bright eyes, clear head, real spring and zip in your step! You get sledge-hammer fists, a battering-ram punch—chest and back muscles so big they almost split your coat seams—ridges of solid stomach muscle—mighty legs that never get tired. You're a New Man!

FREE BOOK

Thousands of fellows have used my marvelous system. Read what they say—see how they looked before and after—in my book, "Everlasting Health and Strength."

Send NOW for this book—FREE. It tells all about "Dynamic Tension," shows you actual photos of men I've turned from puny weaklings into Atlas Champions. It tells how I can do the same for YOU. Don't put it off! Address me personally:

Charles Atlas, Dept. 8H,
115 East 23rd St., New York 10, N. Y.



CHARLES ATLAS, Dept. 8H
115 East 23rd St., New York 10, N. Y.

I want the proof that your system of "Dynamic Tension" will help make a New Man of me—give me a healthy, husky body and big muscular development. Send me your free book, "Everlasting Health and Strength."

Name.....
(Please print or write plainly)

Address.....

City..... State.....

Check here if under 16 for Booklet A

INVENTORS

The Rules of Practice of U. S. Patent Office advises—unless the inventor is qualified to handle such matters—that he employ the services of a competent Patent Attorney in the preparation of his Patent Application. We are Registered Patent Attorneys fully qualified to represent you at the Patent Office. Our long and varied experience in patent practice, we believe, enables us readily to understand inventors' disclosures, to advise what is probably patentable, after conducting preliminary patentability investigation of prior U. S. patents, and to draw your specifications and claims in such manner as to present clearly the novel features.

Patent Laws Favor the Inventor Who Acts Promptly

Remember, the details of your invention do not have to be 100% perfect before you can obtain patent. Unwise inventors often

devote considerable unnecessary time working on unimportant details of their devices. This is expensive, hazardous and unnecessary. First step is to have us conduct search for the prior U.S. patents and render a report as to its patentability. Our Search Report is very valuable to you in that it clears up the course you should take in regard to your invention. If our Report is favorable, this report of the patentability of your device shows that your chances of patent protection are in your favor.

Have Patent Protection First

Unless you safeguard your invention by obtaining a patent, thereby securing a monopoly on same, it may become "public property," free to be made, used and sold by anyone, or it may be patented by some other person.

McMORROW, BERMAN & DAVIDSON

Registered Patent Attorneys
135-V Atlantic Building, Washington 4, D. C.

McMORROW, BERMAN & DAVIDSON

Registered Patent Attorneys
135-V Atlantic Building, Washington 4, D. C.

Send me further particulars on how to protect my invention and "Invention Record" form at once. I understand that this request does not obligate me.

Name.....

Address.....

City..... State.....

-(Write or print name clearly)-

COPYRIGHTS

PATENTS

TRADE MARKS

G.I.'s

CORRESPONDENCE SCHOOL



*You learn while you **EARN!***

I. C. S. COURSES free to you! They're available now to honorably discharged World War II Veterans under the G. I. Bill of Rights. The U. S. Government pays for this training . . . and it is NOT to be deducted from any future bonus payments.

This is *your* personal reconversion program if you want to earn as you learn . . . to master a trade or profession and qualify for promotions and pay raises on the job!

Here, for your choosing, is famous I. C. S. education in any one of more than 400 technical and business vocations. Courses are

practical, authoritative, easy to understand. You study in your spare time. At work you prove and apply what you learn.

Thousands of successful students have demonstrated that today's I. C. S. student is tomorrow's leader. Here's your chance to join them — at no cost to you.

Act *now!* When you mark and mail the coupon on this page you've taken the first step to Success. We send you full details of the Course in which you're interested — and complete instructions on how to enroll with us under the G. I. Bill of Rights.

INTERNATIONAL CORRESPONDENCE SCHOOLS



BOX 5586-K, SCRANTON 9, PENNA.

Without cost or obligation, please send me full particulars about the course *before* which I have marked X:

- Air Conditioning and Plumbing Courses**
- Air Conditioning
- Heating Plumbing
- Refrigeration Steam Fitting
- Chemistry Courses**
- Chemical Engineering
- Chemistry, Analytical
- Chemistry, Industrial
- Chemistry, Mfg. Iron & Steel
- Petroleum Refining Plastics
- Pulp and Paper Making
- Civil Engineering, Architectural and Mining Courses**
- Architectural Drafting
- Architecture
- Bridge and Building Foreman
- Building Estimating
- Civil Engineering
- Coal Mining
- Contracting and Building
- Highway Engineering
- Lumber Dealer
- Reading Structural Blueprints
- Sanitary Engineering
- Structural Drafting

- Structural Engineering
- Surveying and Mapping
- Communications Courses**
- Electronics
- Practical Telephony
- Radio, General
- Radio Operating
- Radio Servicing
- Telegraph Engineering
- Electrical Courses**
- Electrical Drafting
- Electrical Engineering
- Electric Light and Power
- Lighting Technician
- Practical Electrician
- Internal Combustion Engines Courses**
- Auto Technician Aviation
- Diesel-Electric
- Diesel Engines Gas Engines
- Mechanical Courses**
- Aeronautical Engineering
- Aircraft Drafting
- Flight Engineer
- Foundry Work
- Heat Treatment of Metals

- Industrial Engineering
- Industrial Metallurgy
- Machine Shop
- Mechanical Drafting
- Mechanical Engineering
- Mold-Loft Work
- Patternmaking—Wood, Metal
- Reading Shop Blueprints
- Sheet-Metal Drafting
- Sheet-Metal Worker
- Ship Drafting Ship-Fitting
- Tool Designing
- Toolmaking
- Welding—Gas and Electric
- Railroad Courses**
- Air Brake Car Inspector
- Diesel Locomotive
- Locomotive Engineer
- Locomotive Fireman
- Railroad Section Foreman
- Steam Engineering Courses**
- Boilermaking
- Combustion Engineering
- Engine Running
- Marine Engineering
- Steam Electric Steam Engines

- Textile Courses**
- Cotton Manufacturing
- Rayon Weaving
- Textile Designing
- Woolen Manufacturing
- Business and Academic Courses**
- Accounting Advertising
- Arithmetic Bookkeeping
- Business Correspondence
- Business Management
- Certified Public Accounting
- Commercial
- Cost Accounting
- Federal Tax
- First Year College
- Foremanship French
- Good English High School
- Higher Mathematics
- Illustrating Motor Traffic
- Postal Service
- Salesmanship Secretarial
- Sign Lettering
- Spanish Stenography
- Traffic Management

Name _____ Age _____ Address _____
 City _____ State _____ Present Position _____

Working Hours _____ A.M. to _____ P.M. Length of Service in World War II _____

Special tuition rates to members of the Armed Forces. Enrollment under the G.I. Bill of Rights approved for War II Veterans. Canadian residents send coupon to International Correspondence Schools Canadian, Ltd., Montreal, Canada.

PATENT PROTECTION FOR INVENTORS

THE Constitution of the United States provides that "Congress shall have power . . . to promote the progress of science and useful arts, by securing for limited times to . . . inventors the exclusive right to their . . . discoveries."

A PATENT IS A VALUABLE RIGHT

On the basis of the constitutional provision Congress has established a system under which inventors may secure the exclusive right to prevent the unauthorized use, manufacture and sale of their inventions for periods of seventeen years. The inventor secures this protection by obtaining a patent from the United States Patent Office.

The United States Patent Office recommends in its Rules of Practice that "an applicant is advised, unless familiar with such matters to employ a competent registered patent attorney or registered patent agent, as the value of patents depends largely upon the skillful preparation of the specifications and claims."

The United States Supreme Court has high-lighted the same thought in this language:

"The specification and claims of a patent, particularly if the invention be at all complicated, constitute one of the most difficult legal instruments to draw with accuracy . . ."

Victor J. Evans & Co., established in 1898, has a staff of experienced registered patent attorneys, available to represent inventors in the preparation and prosecution of their cases before the Patent Office. Detailed information and the steps to be taken in obtaining patent protection will be furnished upon request.

VICTOR J. EVANS & Co.
Merlin M. Evans
 REGISTERED PATENT ATTORNEY

130-J Merlin Building, Washington 6, D. C.

Please forward to me detailed information regarding procedure to obtain Patent Protection.

Name.....

Address.....

City and State.....

PATENTS • TRADEMARKS • COPYRIGHTS

BE A

LANDSCAPE ARCHITECT

WORK OUTDOORS



Healthful, pleasant outdoor work in an uncrowded field.

The field of Landscape Gardening offers unusual opportunities for trained men . . . greatly augmented by the huge home-building and modernizing program ahead. We provide thorough, interesting home-training during your spare time . . . adapted to your regional conditions.

!APPROVED for VETERANS

BE YOUR OWN BOSS

A graduate says, "I finished the course about two months ago and now I average about \$2.00 per hour net for my time."

There are many employment opportunities in this profitable, uncrowded field or you can easily start your own business. Write today.

Service from Coast to Coast

NATIONAL LANDSCAPE INSTITUTE
 DEPARTMENT P 756 SOUTH BROADWAY — LOS ANGELES 14

LEARN MONEY-MAKING CARTOONING

IN SPARE TIME — by Easy Picture Chart Method

Same Simplified Method that has helped train creators of "Terry & Pirates," "Freckles," "Out Our Way," "Winnie Winkle," "Reg'lar Fellers," "Strange As It Seems," "The Neighbors," and many others. Earn while learning. Send 10c for Picture Chart (to test your ability), and full details. (State age.)



Landon School of Cartooning, Dept. 4608 Philadelphia (1) Pa.

ENGINEERING DEGREE IN 27 MONTHS

INDIANA TECHNICAL COLLEGE

Aeronautical, Chemical, Civil, Electrical, Mechanical, and Radio Courses, B.S. degree. 1-yr. diploma in Electrical, Mechanical, and Radio Service; Drafting. Prep. courses. Gov't. approved for GI's. Low rate. Earn board. Large industrial center. Demand for graduates. Enter Sept., Dec., March, June. Catalogue. 586 E. Washington Blvd., Ft. Wayne 2, Ind.



BOOKS FOUND FREE!

WHAT BOOKS DO YOU WANT?

We quote the lowest market prices. No charge for locating Hard-to-Find and Out-of-Print Books. All books, OLD or NEW, mailed POST-FREE. SEARCHLIGHT BOOK CLUB, 22 East 17th St., New York City

Learn Public Speaking

Learn theory and fundamentals at home—in spare time. Then acquire actual experience and practice. Send for FREE booklet "Power of Effective Speech."

North American School, Dept. 135-C
 1315 S. Michigan Ave., Chicago 5, Illinois

MAKE MONEY AT HOME

RUBBER MOLDS

Low as 6¢ EA.



Amazing rubber mold-making outfit makes perfect flexible molds of plaques, ash trays, bookends, etc. Molds cost 6c to 25c each. Each mold makes hundreds of novelties and gifts to sell for \$1.00 apiece and more! No experience necessary. Everything furnished. Quick and easy. Start profitable business in your home—sell to stores, gift shops, friends, resorts, road stands, by mail. Full or spare time. Write for complete FREE details and easy instructions.

SO-LO WORKS, Inc., Dept. J-800, Loveland, Ohio

Prepare for YOUR FUTURE Now

You'll Need "ALL-AROUND" Training to Meet New Conditions!

Get Ready QUICK—in 1 of these 2 Opportunity Fields!



ELECTRICITY in its Many Branches...

Electricity is vital to our progress during the years ahead. Prepare for the opportunities in such branches as Power Plant Work, Motors, Armature Winding, Industrial and House Wiring, Maintenance, etc., with COYNE shop training.



This big fire-proof building is occupied entirely by the Coyne Electrical School.

RADIO-ELECTRONICS... A great field now, even greater growth ahead. Prepare for a real Radio career. Learn construction, operation, trouble-shooting on Radio Receivers, Public Address Systems, Sound Picture Units, FM, Photo-Cells, Television—the practical COYNE way.

"LEARN-BY-DOING" IN A FEW WEEKS

Student Finance Plan

Conditions today are different. Many "one-operation" jobs that paid well in the past, no longer exist. Do you have a good job with a real future? Plan for steady pay and advancement by training NOW, while there's still time! Come to the big shops of COYNE in Chicago, for "all-around" training in Electricity or Radio-Electronics—the 2 great opportunity fields of today and tomorrow. I'll finance most of your tuition.

TRAIN ON ACTUAL EQUIPMENT!

My famous "Learn-by-Doing" method gives you practical experience on full-size equipment. Not by correspondence, but actual shop work. You are trained right here in the Coyne shops, that has been training men and young men for over 47 years.

START NOW—PAY LATER!

Don't let lack of money hold you back. My "Student Finance Plan" has helped thousands to get ahead. Coupon brings details. Many earn while learning, to help take care of living expenses while here. Men from 16 up to 40, with or without experience, Coyne training is for you!

LIFETIME JOB SERVICE TO COYNE GRADUATES

First I train you for a good job and future, then assist you in getting located. As a Coyne graduate, use this service whenever you need it—no charge. Also FREE review privileges at any time. Get the facts!

INDUSTRIAL ELECTRONICS and Electric Refrigeration Included With Either Course

Added training in these great fields of INDUSTRIAL ELECTRONICS and ELECTRIC REFRIGERATION makes you more valuable to employer, leads to opportunities for bigger pay. This valuable TRAINING now included with either my Electrical or Radio Course. We also have facilities for men with physical disabilities whether due to war or other causes. Check coupon for details if you have a physical disability of any kind.

VETERANS—

Coyne is also equipped to train those who qualify for training under G. I. Bill of Rights. Check coupon for our special G. I. Bulletin.

PICK FIELD YOU LIKE—
SEND FOR BIG BOOK

FREE



H. C. Lewis

Some men prefer Electricity, others Radio-Electronics. Whichever interests you most, we will train you in a few short weeks at Coyne—on full-size equipment, by my famous "Learn-by-Doing" method. I have a big, fully illustrated book on each course, and will send you the one you want, without the slightest cost or obligation. Simply check below, then mail coupon in envelope or paste on postcard. No salesman will call. You are the sole judge. Don't delay. Your future is at stake. Rush coupon to me—TODAY.



H. C. LEWIS, Pres.,
COYNE ELECTRICAL SCHOOL
500 S. Paulina St., Dept. C6-72H, Chicago 12, Ill.
Send me your BIG FREE BOOK — for the course checked below. Also full details of your "Student Finance Plan."

ELECTRICITY RADIO-ELECTRONICS
 Send special G. I. Bulletin Physical disability

NAME.....

ADDRESS.....

CITY..... STATE.....

COYNE ELECTRICAL SCHOOL

H. C. LEWIS, Pres.

Founded 1899

500 So. Paulina Street, Dept. C6-72H, CHICAGO 12, ILL.

"I'll show YOU how to make yourself COMMANDO-TOUGH

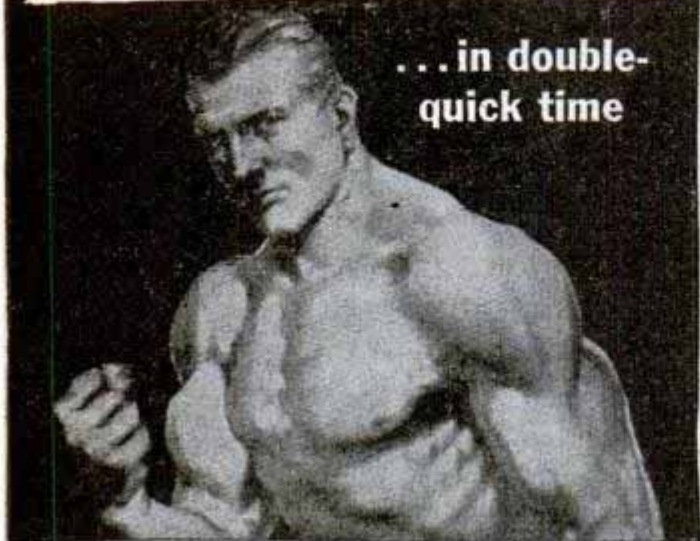

...in double-quick time

...OR IT WON'T COST YOU A CENT!"

says *George F. Jowett*

WORLD'S GREATEST BODY BUILDER

Let me prove to YOU that you can put inches of dynamic muscles on your arms! Add inches to your chest! Broaden your shoulders and power-pack the rest of your body. I can do for you what I've done for thousands the world over, including many officers and men now in the U. S. and British Armed Forces.

GIVE ME 10 MINUTES A DAY!

I'll Show You My Secrets Of Body Building

I'll help you learn the "Progressive Power Method" through which I rebuilt myself from a physical wreck to the holder of more strength records than any other living athlete or teacher! No matter how skinny or flabby you are, you can learn my methods right in your own home. Through my proved secrets I show you how to develop your power, inside and out, until YOU are fully satisfied that you are the man you want to be. "The Jowett System," says R. F. Kelly, Physical Director of the YMCA, Atlantic City, "is the greatest in the world!"

If you want a physique that will inspire respect from men, and admiration from women... **ACT LIKE A HE-MAN!** Decide at once! The famous book, "Nerves of Steel—Muscles Like Iron" will be included FREE! Priceless for the strength fan! Full of photos of marvelous power-bodied men who will show you what Jowett has done for them and how he can do the same for you. Reach out... Grasp this Special Offer today!

Jowett Institute of Physical Culture
230 Fifth Avenue
Dept. PM-68
New York 1, N. Y.

**PROVE TO YOURSELF
IN ONE NIGHT!**

Send only 25c for test, Course, "Molding a Mighty Arm." Read it the evening it arrives—learn from experience the thrill you can give your muscles!

SEND FOR THESE FIVE FAMOUS COURSES IN BOOK FORM

**ONLY 25c EACH
or ALL 5 for \$1.00**

*This
Book
Free!*



**BOOK WITH PHOTOS OF FAMOUS STRONG MEN
MAIL COUPON NOW**

FREE



Jowett Institute of Physical Culture
230 Fifth Avenue, Dept. PM-68, New York 1, N. Y.

George F. Jowett: Your proposition looks good to me. Send by return mail, prepaid, the courses checked below, for which I enclose (). Include FREE book of PHOTOS.

- George F. Jowett Champion of Champions
- All 5 courses for... \$1
 - Molding a Mighty Arm 25c
 - Molding a Mighty Back 25c
 - Molding a Mighty Grip 25c
 - Molding a Mighty Chest 25c
 - Send all 5 C.O.D. (\$1 plus postage.) No orders less than \$1 sent C.O.D.

NAME..... Age.....
(Print name)

ADDRESS.....



Be an ARTIST!

—Train at Home in Your Spare Time

The fascinating field of Art offers commercial opportunities to men and women. **COMMERCIAL ART, CARTOONING, DESIGNING** all in one complete course. We prepare you step-by-step. Trained Artists are capable of earning \$40, \$60, \$75 a week. Colorful **FREE BOOK**, "Art for Pleasure and Profit—" describes course and method of instruction. **TWO ART OUTFITS** included with training. **STATE AGE.**

Approved for training under "G.I." Bill.

**WASHINGTON SCHOOL OF ART, Studio 128 C
1115—15th St., N. W. WASHINGTON 5, D. C.**

FREE BOOK
gives
details

LEARN WATCH REPAIRING



AT HOME. By our modern and original system of instruction you can learn every part of the **WATCH REPAIRING TRADE AT HOME.** Prepare yourself for a well-paying position or start in business after completing our course of instruction. Good watch repairers are in demand and generally earn very good salaries. For particulars apply to the **Wisconsin School of Watch Repairing** 759 North Milwaukee St., Milwaukee 2, Wis.

FENCING World's Finest Sport Exciting Fun—Harmless



Just Out! Healthful, Clean, makes you Strong & Alert. **FREE BOOKLET** (with foils) teaches Quickly—Easily. **HARMLESS** 3 ft. Spring Steel Foils (swords) have Safety Rubber Buttons. Complete outfit, 2 foils (swords) with hand guards. Free Instructions. Now only \$1.98; Postpaid. Junior Masks only \$3 for two. \$1.69 for one Postpaid. Mail check or M. O. today. Add 28c for Foreign Postage.

LEE PRODUCTS CO., Dept. 3-1613 First Ave., New York 28, N. Y.

AUDELS Carpenters and Builders Guides



4 vols. \$6

Inside Trade Information for Carpenters, Builders, Joiners, Building Mechanics and all Woodworkers. These Guides give you the short-cut instructions that you want—including new methods, ideas, solutions, plans, systems and money saving suggestions. An easy progressive course for the apprentice and student. A practical daily helper and Quick Reference for the master worker. Carpenters everywhere are using these Guides as a Helping Hand to Easier Work, Better Work and Better Pay. To get this assistance for yourself, simply fill in and mail the **FREE COUPON** below.

Inside Trade Information On:

How to use the steel square—How to file and set saws—How to build furniture—How to use a mitre box—How to use the chalk line—How to use rules and scales—How to make joints—Carpenters arithmetic—Solving mensuration problems—Estimating strength of timbers—How to set girders and sills—How to frame houses and roofs—How to estimate costs—How to build houses, barns, garages, bungalows, etc.—How to read and draw plans—Drawing up specifications—How to excavate—How to use settings 12, 13 and 17 on the steel square—How to build hoists and scaffolds—skylights—How to build stairs—How to put on interior trim—How to hang doors—How to lath-lay floors—How to paint



THEO. AUDEL & CO., 49 W. 23rd St., New York City

Mail Audels Carpenters and Builders Guides, 4 vols., on 7 days' free trial. If O.K. I will remit \$1 in 7 days and \$1 monthly until \$6 is paid. Otherwise I will return them. No obligation unless I am satisfied.

Name

Address

Occupation.....

Reference

WHICH OF THESE *Opportunities* INTERESTS *You* MOST?

Accounting & C. P. A.
Air Conditioning
Architecture & Building
Automotive Engineering
Aviation—Practical
Aviation Drafting & Design
Better Foremanship
Bookkeeping
Business Management

Contracting
Diesel Engineering
Drafting & Design
Electrical Engineering
Electricity—Practical
Electronics, Industrial
High School Courses
Machine Shop Operations
Mechanical Engineering

Plastics Engineering
Plumbing—Practical
Private Secretary
Radio Operating & Servicing
Railway Training
Refrigeration
Sheet Metal Pattern Drafting
Shop Management
Tool Making

THINK! LOOK FORWARD!

Business is making big, new plans

Men and Women are preparing for the future

WHAT ARE YOU DOING ABOUT YOUR TOMORROWS?

● *Today*, choose the job you want—and prepare for it. Or if you are already engaged in the work you like best, start training *now* for quicker promotion. Acquire the knowledge that will help you to get ahead faster, make more money and have greater security.

Invest part of your spare time in more rapid progress. Start training now, in spare time in your own home. Be ready to grasp your opportunity and step out ahead of those who lack the ability you have attained.

American School, founded in 1897 as an educational institution *not for profit*, can help you to reach your goal just as it has helped others during the past forty-nine years. Give serious thought to the list above. Pick one or more subjects that interest you. Then check the coupon at right, add your name and address and mail it at once. The school will send you details on its training plan and outline of study prepared by specialists. There is no charge, no obligation, so send the coupon immediately.

PRACTICAL, EFFECTIVE HOME • STUDY TRAINING SINCE 1897

Take This First Easy Step

CHECK, CLIP AND MAIL COUPON NOW

AMERICAN SCHOOL, Dept. GC45, Drexel at 58th, Chicago 37, Ill.

Without obligation, Please send FREE and postpaid, bulletin and details of the Subject checked.

- | | | |
|--|--|--|
| <input type="checkbox"/> PLASTICS ENG'R | <input type="checkbox"/> Accounting & C.P.A. | <input type="checkbox"/> Drafting and Design for Men and Women |
| <input type="checkbox"/> Refrigeration | <input type="checkbox"/> Electrical Engr. | <input type="checkbox"/> Radio |
| <input type="checkbox"/> Architecture and Building | <input type="checkbox"/> Electricity-Pract. | <input type="checkbox"/> High School |
| <input type="checkbox"/> Contracting | <input type="checkbox"/> Electronics, Industr. | <input type="checkbox"/> Air Conditioning |
| <input type="checkbox"/> Practical Plumbing | <input type="checkbox"/> Bookkeeping | <input type="checkbox"/> Mechanical Eng. |
| <input type="checkbox"/> Automotive Engineering | <input type="checkbox"/> Private Secretary | <input type="checkbox"/> Shop Management |
| <input type="checkbox"/> Aviation Drafting | <input type="checkbox"/> Diesel Engineering | <input type="checkbox"/> Tool Making |
| <input type="checkbox"/> Aviation | <input type="checkbox"/> Sheet Metal | <input type="checkbox"/> Better Foremanship |
| <input type="checkbox"/> Business Mgmt | <input type="checkbox"/> Pattern Drafting | <input type="checkbox"/> Machine Shop Operations |
| <input type="checkbox"/> Railway Training | | |

Name..... Occupation.....

Address..... Age.....

City..... State.....

AMERICAN SCHOOL

Dept. GC45, Drexel at 58th Street, Chicago 37

It's YOUR future — Make the most of it!



Start now to earn the bigger pay in electrical repair

WAS there ever such an opportunity to get started in electrical maintenance and repair—and at top-notch wages? Are you ready—with experience and ability—to cash in on it? Others are getting just the sort of background needed—quick! practical!—to handle the great variety of electrical maintenance and repair work TODAY—from this well-known electrical library. You can too!

THE LIBRARY OF ELECTRICAL MAINTENANCE AND REPAIR

5 vols., 1826 pages, 1724 illustrations

Gives you the "know-how" to tackle any wiring or motor job. Five books show you HOW—to install all types of motor and generator units—to inspect and repair motor starters and generators—to diagnose motor and generator troubles—to figure new windings for old cores—DO and AC windings—to test armature windings—test induction motors, etc., etc. One book is full of trouble-shooting charts that show quickly symptoms, causes, specific remedies, etc.

Take the first step toward improving YOUR future—Mail this coupon TODAY

No money down—special price—easy payments—FREE trial

McGraw-Hill Book Co., 330 W. 42 St., New York 18, N. Y.

Send me for ten days' free examination the Electrical Maintenance and Repair Library. If satisfactory I will send you \$1.50 in 10 days and \$3.00 monthly until the price of \$16.50 is paid. If not wanted I will return books postpaid. (To insure prompt shipment write plainly and fill in all lines.)

Name

Home Address

City and State

Company

Position

P.L-8-46

OIL BURNER

INFORMATION IN A HANDY FORM

JUST OUT!



A POCKET COMPANION THAT ANSWERS YOUR QUESTIONS!

AUDELS OIL BURNER GUIDE
— A new practical, concise treatise, 384 pages—31 Chapters—321 Diagrams and Illustrations—covering Domestic and Industrial Oil Burners.

New from Cover to Cover, for mechanics interested in Oil Burners. Gives practical inside working knowledge of theory, construction, installation, operation, testing, servicing and repair of all types of oil burners. Includes electrical hook-ups and wiring diagrams of automatic control systems.

PRICE \$1 POSTPAID

Get this information for yourself. Mail coupon today. No obligation unless satisfied.

ASK TO SEE IT

AUDEL, Publishers, 49 W. 23rd St., New York 10, N. Y.

Please mail AUDELS OIL BURNER GUIDE (Price \$1). If satisfactory, I will remit \$1 on its safe arrival, otherwise I will return the book.

Name

Address

Occupation

Employed by

HOME-STUDY BRINGS BIGGER PAY

Don't be caught napping when Opportunity knocks. Prepare for advancement and more money by training now for the job ahead. Free 48-Page Books Tell How. Write for the book on the business field you like—or mail us this ad with your name and address in the margin. Now, please.

- | | |
|--|--|
| <input type="checkbox"/> Higher Accountancy | <input type="checkbox"/> Business Management |
| <input type="checkbox"/> Traffic Management | <input type="checkbox"/> Business Corres. |
| <input type="checkbox"/> Law—Degree of LL.B. | <input type="checkbox"/> Salesmanship |
| <input type="checkbox"/> Commercial Law | <input type="checkbox"/> Modern Foremanship |
| <input type="checkbox"/> Industrial Management | <input type="checkbox"/> Expert Bookkeeping |
| <input type="checkbox"/> Stenotypy | <input type="checkbox"/> C. P. A. Coaching |

LASALLE EXTENSION UNIVERSITY

A Correspondence Institution

Dept. 864-R 417 So. Dearborn St. Chicago 5



You can learn plain, rapid writing or fancy ornamental writing for social and business advancement, right in your own home during spare time by my Simplified Method. Write for my free book, "How to Become an Expert Penman," which shows what others have accomplished by taking my Courses. Send 10c for one of my favorite Pen Points and your name with a beautiful flourished bird written on a card. Write today. T. M. Tevis, Box 25K, Chillicothe, Mo.

What Every Mason Wants

We have important Masonic books for Blue Lodge, Chapter, Commandery, Scottish Rite, and Shrine.

Our Rituals Are Used the World Over. Send for free catalog of books and rituals for Masons, Odd Fellows, Knights of Pythias, Knights of Columbus, etc. EZRA A. COOK, Publisher, P. O. Box 796, PAT, Chicago 90, Ill.



RAYE BURNS will teach you HOW to CREATE ORIGINAL CARTOONS at home that you may SELL! Course contains 26 lessons and over 600 illustrations. All for Only.....

\$2.85

Send name and address for free details.

RAYE BURNS SCHOOL, Dept. M, Box 3583, CLEVELAND, OHIO

INVENTING

—FOR PROFIT! If you have an inventive turn of mind, write for free 28-page booklet explaining how the Institute of American Inventors is helping inventors pre-test the profit possibilities of proposed devices to fill today's unprecedented demand for useful new inventions.

INSTITUTE of AMERICAN INVENTORS

Dept. 4, 1926 Eye St., NW, Washington 6, D. C.

Free Book

MOUNT BIRDS, ANIMALS, FISH

Yes FREE. Explains Taxidermy. Tells how to learn at home by mail to mount birds, animals, heads... to TAN skins and furs. Great for MEN and BOYS. Fun! Also earn money in spare time. WRITE TODAY—NOW—for free book containing 100 game pictures, State AGE. N.W. School of Taxidermy, Dept. 337C, Omaha, Neb.



MONEY for MEN ALL FREE

THE PLASTEX Industry needs manufacturers on small scale and for big production of Lamp and Clock Stands, Art Goods and Novelties in Plastex and Marble imitation. Experience unnecessary, 1/2c material makes regular 10c store sellers. Rubber moulds furnished for speed production. Small investment brings good returns. Big chain store orders now being placed. Ambitious men have chance for real prosperity. Our Free booklet will interest and benefit you.

PLASTEX INDUSTRIES, Dept. P, 1085 Washington Ave., New York, N. Y.

See how readily YOU can train at home for BIGGER EARNINGS in RADIO ELECTRONICS



FREE KIT PACKET SHOWS HOW YOU CAN GET LOTS OF "LEARN-BY-DOING" RADIO EXPERIENCE AT HOME FROM DEFOREST'S THRILLING RADIO "Home Laboratory"

133 EXPERIMENTS

DeForest's Kit Packet shows how you can get real Radio experience from the many standard Radio parts furnished you with DeForest's Training. See how you may quickly build Radio Circuits that work... how you may experiment with Photo Electric Cell "Magic"... a 5-Tube Superheterodyne Receiver... a Radio Telephone and scores of other fascinating projects. See how you get actual "shop training" at home to give you the practical Radio experience you need.

VETERANS!

Big things are happening at DeForest's for veterans! See how we may prepare you without cost for a GOOD JOB or BUSINESS OF YOUR OWN in the vast Radio-Electronic opportunity field.

DeFOREST'S PROVIDES ALL 3 HOME TRAINING AIDS

- A** A 16 mm. Movie Projector and Learn-By-Seeing Movie Film
- B** Actual Radio Parts for working out 133 experiments
- C** 90 lessons prepared under the supervision of Dr. Leo DeForest—the "Father of Radio."



Now—you can see for yourself why DeForest's Training does such a grand job of preparing men for a bright future in one of America's most promising opportunity fields—Radio and Electronics. Send the coupon below for your free "Kit Packet" plus the big free book, "Victory For You!" that has helped so many to find the way to good pay jobs. You'll be surprised at the opportunities ahead of FM Radio, Aviation Radio, Broadcast Radio, a profitable Business of Your Own, Motion Picture Sound Equipment, and Electronics—plus the exciting future possibilities ahead of Television, Radar, etc. Train in your spare time at home—or get all of your training in our Chicago laboratories.

You Also Get EFFECTIVE EMPLOYMENT SERVICE

Upon completing your training, you get the full benefit of DeForest's Employment Service that has helped so many men to get started in the Radio-Electronic field.



DeFOREST'S TRAINING INCLUDES INSTRUCTION IN MOTION PICTURE SOUND EQUIPMENT, FM RADIO AND TELEVISION. RESIDENTIAL TRAINING IN OUR MODERN CHICAGO LABORATORIES ALSO AVAILABLE—ASK US FOR INFORMATION!

E. B. DeVry, President
DeFOREST'S TRAINING, INC.
2535-41 North Ashland Ave., Dept. PM-C8
Chicago 14, Illinois, U.S.A.

Send FREE RADIO KIT PACKET and "VICTORY FOR YOU!" BOOK.



Name _____ Age _____
Address _____ Apt. _____
City _____ Zone _____ State _____
 If under 16, check here for special information. If a discharged Veteran of World War II, check here.

DeFOREST'S TRAINING, INC.
CHICAGO 14, ILLINOIS



SO IT NEEDS FIXING

By S. T. CHRISTENSEN
the "Fix-it Man"

WELL, I guess I'm the fellow to see, for I've repaired thousands of refrigerators (home and commercial both), vacuum cleaners, radios, washing machines, irons, fans, lamps, mangles, motors, etc. In fact, many of my customers call me their "electrical appliance doctor." And, "doctoring," I might add, has paid me a good substantial income for quite a few years. Funny, in a way, how I got started. Always liked to tinker and by experimenting around I found that most electrical appliances had many things in common. That, regardless of what the appliance was used for, or who the manufacturer was, the basic principles were much the same. From fixing my own appliances to fixing friends' and then for strangers at a fee, seems now to have been but a small step.

What to Charge?

At first, I let the owner decide the charge and, frankly, I was amazed at what I earned per hour. But then, when one figures what initial costs are involved in buying most electrical appliances, one can readily see that spending extra dollars for repairs is well worth while. Before long I was making more in my spare time repairing than from my regular job. The result . . . I went into business for myself. When war came, business boomed, for new appliances were not available.

For a while, repair parts (needed on some

jobs) were a little difficult to get. But that situation quickly adjusted itself and many repair parts were given the high priority rating of AA2. After all, we had to provide for the health and well-being of our civilian population.

The Future Offers

Friends ask me about my future. And, I think I've got a grand one. Age is no handicap in repairing. I have in my files enthusiastic letters from repairmen ranging in age from 18 to 79 years. Now the war is over we are certain to see hundreds of new products on the market . . . products that the average person never dreamt of. These new products and our old appliances are all going to need at some time or other "fixing." Well, I'll still be the fellow to do it. The field open for appliance repairmen is unlimited. I don't worry at all about too much competition.

If You Are Ambitious

To the contrary, I've prepared a complete course, chuck full of simple, easy to understand photos and drawings and written in the same non-technical language as this article. I know the course is good, because I have hundreds of men all over the country writing to me telling me how the course has helped swell their pockets with cash. If you too want to prepare now for your future, I suggest you read the next page and send me the handy coupon."

Advertisement



**BIG MONEY
INDEPENDENCE**

*A PROFITABLE
LIFETIME
BUSINESS
OF
YOUR OWN!*

LEARN ELECTRICAL APPLIANCE REPAIRING

PREPARE NOW FOR THE FUTURE

If now employed, start your home appliance repair business NOW in your spare time and be set with a business of your own no matter what happens. You don't need elaborate fixtures or expensive equipment to be a successful repairman. Operate from your garage, basement, vacant store, etc. Work as many hours as you wish—the home appliance repairman is his own boss. It is a profitable occupation for on many types of repairs it is not unusual for a repairman to charge on the basis of \$5.00 to \$6.00 per hour. Don't gamble with your future—learn a trade that will always support you. Remember, as long as electrical appliances are used, there will be a need for electrical appliance repairmen.

If you are at all mechanically inclined—can hold and use tools—then you have all of the qualifications required for becoming a big money earning home appliance repairman. It does not matter if you have not had a great deal of schooling or had previous experience along these lines—**WE WILL TEACH YOU.** Age should be no barrier—nor should any minor physical handicap.

New Course Tells All

Profusely illustrated, our new course shows you in simple, easy to understand language and drawings how to make each repair on refrigerators, vacuum cleaners, washing machines, motors, etc. Explains and gives you a working knowledge of electricity, welding, nickel plating, etc. Shows you how to build the power tools you need and how to solicit and keep business coming to you. Not a theory course but an honest to goodness course written by and used by repairmen the country over. Price of course is so low that the savings on your own household appliance repairs will quickly pay for it. Act now! Mail the handy coupon below today.

----- Read What Our Students Say About Course -----

I really believe your course the best investment a mechanically minded man can make.—Claude E. Allen, Indianapolis, Ind.
I have received your Course in Appliance Repairing and I must say I am well pleased with same. I am only sorry I did not have said Course some years ago. I have learned so much more through this course I would not part with it.—Charles Schwarz, Hamilton, Ohio.

The Course in Appliance Servicing arrived a few days ago. Want to take out a few minutes of my valuable time to let you know that this is just what I have been looking for ever since I opened up my Fix-It shop. I must admit that you told the truth when you said that it contains quite a bit more information than I bargained for.—P. J. Brett, Sebring, Ohio.

I am a mechanic for the Western Union Telegraph Co. Three days after receiving the lessons in refrigeration I earned the exact cost of the course.—Henry S. Lee, Washington, D. C.
I work day times at the shipyard and after 4:00 P.M. I operate from my cellar and garage. I average \$10.00 to \$15.00 clear every day.—Walter Hanby, Brockton, Mass.

GET STARTED TODAY — MAIL THIS COUPON

CHRISTY SUPPLY CO.
2835 N. Central Ave., Dept. D-3603
Chicago 34, Illinois

Please send me free illustrated literature about America's Fastest Growing Industry — **ELECTRICAL APPLIANCE REPAIRING.**

Name.....

Address.....

City..... State.....

Do you want

- ..to go to College?
- ..or to enter a Profession?
- ..or get an Office Position?

(Such as Accounting, Architecture, Nursing, Dentistry, Teaching, Social Work, Osteopathy, Beauty Culture, Optometry, Embalming, Chiropody, Law, Medicine, etc.)

To get anywhere, you practically **MUST** finish High School **FIRST**. You can complete our simplified High School Course in **SPARE** time at home, as **FAST** as your time and abilities permit. Equivalent to resident school work—prepares you for college, pre-professional examinations, business, industry. Standard texts furnished. Diploma. Credit for H. S. subjects already completed. Single subjects if desired. Low tuition, easy terms. American School, Chicago, est. 1897—endorsed by educators. Finish your high school education **NOW**, Write **TODAY!**

High School Course at Home

Many Finish in 2 Years

American School, Dept. HC-45, Drexel Ave. at 58th St., Chicago 37, Ill.

Gentlemen: Send me **FREE** information covering special training in subjects checked below. No obligation on my part.

- | | |
|--|--|
| <input type="checkbox"/> High School Course | <input type="checkbox"/> Diesel Engineering |
| <input type="checkbox"/> Architecture and Building | <input type="checkbox"/> Drafting and Design for Men & Women |
| <input type="checkbox"/> Automotive Engineering | <input type="checkbox"/> Plastics |
| <input type="checkbox"/> Business Management | <input type="checkbox"/> Private Secretary |
| <input type="checkbox"/> Electrical Engineering | <input type="checkbox"/> Mechanical Engineering |
| <input type="checkbox"/> Elec. and Gas Refrigeration | <input type="checkbox"/> Aviation |
| <input type="checkbox"/> Air Conditioning | <input type="checkbox"/> Salesmanship |
| <input type="checkbox"/> Railway Training | <input type="checkbox"/> Radio |
| <input type="checkbox"/> Electronics, Industrial | |

Name.....

Address.....

AVIATION Career

MAXIMUM TRAINING IN MINIMUM TIME

CAL-AERO TECH TRAINING will add dollars to your pay check all the rest of your life. Specializing in **AERONAUTICAL ENGINEERING** and **MASTER AVIATION MECHANICS** since 1929, Cal-Aero Tech training is carefully designed for just one thing—**TO MAKE MORE MONEY FOR YOU**. An alumni of over 6000 successful graduates proves our career training is unsurpassed.

VETERANS —Write us about Aviation Training, as provided under "G.I. Bill of Rights."



CAL-AERO TECHNICAL INSTITUTE
 MAJOR C. C. MOSELEY PRES. SINCE 1929
 FORMERLY CURTISS-WRIGHT TECHNICAL INSTITUTE
 GRAND CENTRAL AIR TERMINAL
 GLENDALE 1, CALIFORNIA
 LOS ANGELES COUNTY

MAIL THIS COUPON TODAY!

Cal-Aero Technical Institute, Grand Central Airport, Glendale 1, California
 Please send full information on Aviation Training **FREE**—without obligation, Dept. PM-8

Name..... Birth Date.....

Street.....

City..... State.....

STUDY AT HOME

With An Educational Institution

Men with specialized training win higher positions, insure larger earnings, and are bigger successes in business and public life. Opportunities **NOW** greater than ever before. Send for our Catalog.

ARTS and SCIENCES

Courses in Philosophy; Education; Letters; Public Health; Medical Jurisprudence; Psychology; Sociology; Physics; Chemistry; Plastics; Geology; Political Science; Theology; Business and Commerce; Accounting; Mathematics; Statistics; Agriculture.

ENGINEERING

Courses in Electrical, Civil, Mechanical, Drafting, Architectural, Steam, Aeronautical, Radio, Structural, Mining, Industrial, Petroleum, Marine, Chemical, Diesel, Automobile, Refrigeration, and Air Conditioning Engineering.

LAW

Complete Professional Law Course includes 20 Hornbook Series college grade textbooks. Courses also in Commercial Law, Patent Law and Medical Jurisprudence.
 McKinley-Roosevelt Incorporated, 4610-K, Sheridan Rd., Chicago 40, Ill.

TRAIN for SUCCESS in the Poultry Business



Study at home in spare time. Earn extra while learning....

YOU CAN MAKE MORE MONEY from POULTRY. Proper management means profits ANY season, for life. Get latest scientific methods that avoid losses and mistakes. Our famous system of Home Study Training has helped thousands to success. Extra profits from the start. **FREE** Catalog; describes courses, methods, service. Write today to Dept. 50.

NATIONAL POULTRY INSTITUTE, Adams Center, N. Y.



LEARN REFRIGERATION at HOME

Simple, easy-to-understand directions for repairing household electric refrigerators. Complete details, diagrams, and photographs. Theory explained in simple terms. These books are authentic. Learn the **CORRECT** methods.

All yours in four volumes—neat flexible covers—handy size, 6 x 8 1/2 inches—544 pages—only \$4.00. Send cash with order or let us send your set C.O.D. Your money refunded if books are returned within ten days. Write to **BUSINESS NEWS PUBLISHING CO.**, Dept. 31, 450 W. Fort St., Detroit 26, Mich.

Send for **FREE** folder describing other books on refrigeration and air conditioning.

WHY DON'T YOU WRITE?

Writing short stories, articles on business, homemaking, gardening, shop crafts, local and club activities, etc., will enable you to earn extra money. In your own home, on your own time, the **New York Copy Desk Method** teaches you how to write—the way newspaper men learn, by writing. Our unique "Writing Aptitude Test" tells whether you possess the fundamental qualities essential to successful writing. You'll enjoy this test. Write for it, without cost or obligation.

Veterans: This course approved for Veterans' Training.

NEWSPAPER INSTITUTE OF AMERICA
 SUITE 559-M, ONE PARK AVENUE, NEW YORK 16, N. Y.

LEARN PORTRAIT PAINTING AT HOME



• Previous art training or talent **NOT** necessary. This new Stuart System teaches you, in 11 simple, easy-to-follow lessons, to make exact charcoal and oil likenesses. Guidance for your every step. Send for free book today.

STUART STUDIOS, Room 68
 121 Monument Circle Indianapolis 9, Ind.
 Please send me free book and outline of lessons.

Name.....

Street.....

City..... State.....

GET INTO RADIO

TELEVISION ELECTRONICS NOW!

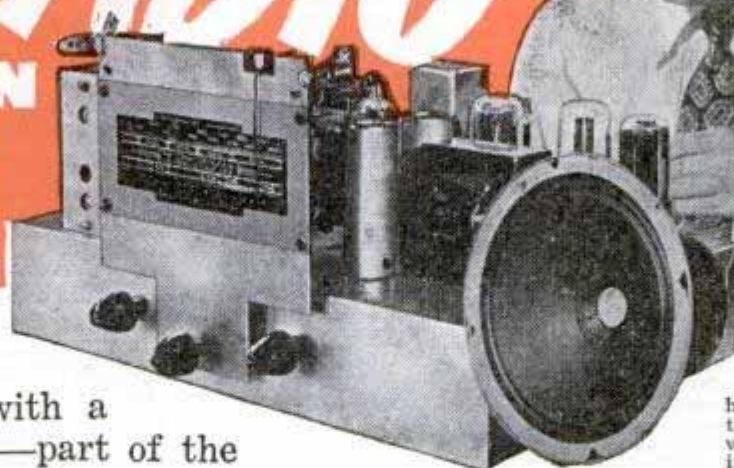

You build this complete, modern super-heterodyne receiver with the equipment that comes with your National Training at no extra cost.

This amazing new shop instruction system gives you actual experience with a Home Radio Laboratory—part of the

SHOP METHOD HOME TRAINING

FOR YOU—A REAL HOME LABORATORY IN MODERN RADIO

from one of the world's best established **Oldest and Largest Technical Trade Schools**

Send the coupon below, immediately. Learn how this **sensationally improved**, practical speed-up training can fit you, in a short time, for the **GREAT BUSINESS OF RADIO**—for the **NEW AND RAPIDLY EXPANDING FIELD OF FREQUENCY MODULATION (F.M.), TELEVISION AND ELECTRONICS.**

This is the thoroughly proved, quick and easy speed-up method used so extensively in wartime training—endorsed by the **success of National men everywhere**—a system by which you study in spare time—off hours, even minutes right in your home and yet have the **ADVANTAGE OF REAL SHOP EXPERIENCE** to back you up.

Trained Radio Men Wanted

The man who really **knows modern Radio** is in greater demand today than ever before—not only in Radio proper but in **Television and Electronics**—in **Aviation, Transportation, Communications.** **Good jobs**

are wide open, **WAITING FOR YOU**, in the production, operation and maintenance of modern electronic equipment—in radio stations, in hundreds of industries—in homes, theatres and studios. Good, sound training in this important field is absolutely necessary. And now, **National Schools** brings such training to you **no matter where you live or what you may be doing**—not only the fundamental theory but the **actual experience that comes with knowing shop practice and working with real equipment**—demonstrating each step with first-hand knowledge. This is true **“learning by doing”**—direct from the great shops and laboratories of **National Schools** where new developments in methods, equipment and applications are constantly going forward.

Only **National** can offer you such practical training because only **National** has the plant to back it up. **Sample this training yourself. MAIL THE COUPON FOR A FREE LESSON.**

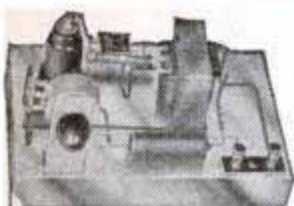

Your **National Training Kits** include equipment for hundreds of practical electronic experiments in your own home. You

have the genuine parts for this audio oscillator which you get to understand by building it yourself.

You learn modulation, beat frequencies, signal generation by actually building this small radio transmitter with your **National shop parts.**

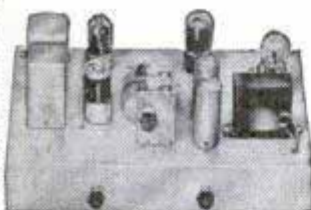

Your training outfits from **National** are made up of the most modern **radionic** equipment—much of it just out of the experimental laboratory. You learn new ways of handling equipment



by modern methods. Get the details by mailing the coupon.

POSTWAR SUCCESS and SECURITY FOR YOU

Radio is a Big Sound Well-Established Business. **Television** is just on the threshold of limitless expansion. When you hang up your uniform—when your war job folds up, will you step out proudly into an essential established industry? Perhaps into a business of your own? Answer these questions by reading the catalog sent you **FREE** from **National Schools.** Face realities now! Fill out and mail the coupon today.

Check the Job You Now Have With These Opportunities in RADIO

1. **Financial Security** Radio has grown from \$100 million to \$5 billion in past few years.
2. **Limitless Future** predicted by over 1,800 manufacturers of equipment.
3. **Television** promises over half a million jobs alone—experts estimate.
4. **Electronics** opens wide new fields in home and industrial use.
5. **Your Own Business** with little or no capital.

Get the details. Use the coupon!

FREE GET THESE 2 BIG BOOKS



NATIONAL SCHOOLS

LOS ANGELES 37, CALIFORNIA EST 1905

MAIL OPPORTUNITY COUPON FOR QUICK ACTION

National Schools, Dept. PM-8
4000 South Figueroa Street
Los Angeles 37, California

(Mail in envelope or paste on penny post card)

Mail me **FREE** the books mentioned in your ad including a sample lesson of your course. I understand no salesman will call on me.

NAME..... AGE.....

ADDRESS.....

CITY..... STATE.....

Check Here if Veteran of World War II. Include your zone number.

NATIONAL TRAINING WINS BIG JOBS

You, too, can share the success of **National** graduates. **Joseph Grumich**, Lake Hiawatha, N. J., writes: "My latest offer was for \$5,800.00 as **Radio Photo Engineer**, but I am doing well where I am. I am deeply indebted to **National.**"

Joseph Michel, Jr., Granite City, Illinois, writes: "I am enthused with **National** training. I am now earning \$225 a month as a **radio operator** and technician and \$20 a week more in my shop at home."



While still a student of **National** training, **I. Wilson of Vallejo, California**, writes: "My pay has jumped from \$52.18 a week to \$72.65, and the end is not in sight. I am proud of my **National Course.**"

10,000 HELPS TO BE YOUR OWN BOSS IN THIS BIG BOOK!



IF IT'S RESULTS YOU WANT—GET ACTION QUICKLY WITH THESE PRACTICAL IDEAS

Never before has a more helpful book been printed for those planning a business of their own. Gathered in this large illustrated volume are the formulas, recipes, facts and secrets that have contributed so largely to America's great industrial progress. Capitalize on this information for making most any conceivable product without experience, special equipment or previous knowledge of chemistry. Start at home, expand with profits—build for a profitable independence. The experts who compiled this book are authorities, and present this information in simple, understandable language. They also give you wholesale supply sources for needed materials, short cuts and economy methods for the most profitable results. Hundreds of good paying businesses have been built on a product made from a simple

recipe. Opportunities in this field exist everywhere. Choose from any of the 162,000 facts and 10,000 formulas of which the following are only a very few: Adhesives, Alloys, Anti-Freeze Solutions, Cosmetics, Beverages and Liquors, Candy, Gum, Casein, Celluloid, Ceramics, Cheese, Cleaning Preparations, Concrete, Copper, Cotton, Dentifrices, Depilatories, Dyes, Embalming Fluids, Enameling, Glass, Glazes, Household Formulas, Inks, Insecticides, Iron, Jewellers' Formulas, Lacquers, Laundry Preparations, Leather, Linoleum, Lubricants, Manicure Preparations, Marble (artificial), Metals, Mirrors,

INCLUDED

PITCHMAN'S GUIDE. Easily made big-profit items that go fast with crowds at Fairs, Carnivals etc. \$25 Net daily not exceptional.

Oils and Ointments, Paints, Paper, Perfumes, Photography, Polishes, Powders, Remedies for Man, Beast or Fowl, Rubber Products, Refrigerants, Soaps, Solder and Soldering, Tooth Cements, Transfers, Transparencies, Varnishes and Thousands of others for making all sorts of profitable and practical things.

FORTUNES MADE FROM A SINGLE IDEA!

This comprehensive book is an accepted authority by chemists, schools, industry, etc. and is the largest and most comprehensive book of its kind ever issued. Nothing else like it in existence. A single formula has been worth a thousand times this book's small cost to countless owners. Crammed with money-making ideas. Invaluable for reference. Ideal for Factory, Home, Farm, Office or Workshop. As necessary as the dictionary and more useful for manufacturers, chemists and salesmen who put up products for profit.

\$3.50 postpaid. Canada or Foreign, \$3.85 U. S. Funds. (C.O.D. shipments U.S.A. only.) Immediate Shipment—Safe Delivery Guaranteed.

**ADAMS BROWN COMPANY, Dept. 168
Chestnut Hill 67, Massachusetts, U.S.A.**

POSTPAID!
\$3.50
U.S.A.
\$3.85
FOREIGN

Keep that "Car TICKING"

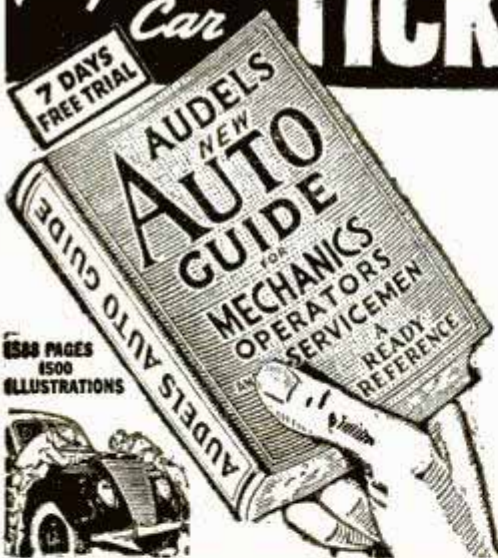

Every operator and mechanic needs AUDELS AUTO GUIDE.

This book saves time, money and worry. Highly endorsed. It presents the whole subject of auto mechanics:

- 1—Basic principles
 - 2—Construction
 - 3—Operation
 - 4—Service
 - 5—Repairs
- Handy Size. Easily understood.

NEW FLUID DRIVE, HYDRAULIC SHIFT AND DIESEL ENGINES FULLY COVERED

Over 1500 pages—1540 illustrations showing inside views of modern cars, trucks and buses with instructions for all service jobs.

4 COMPLETE • PAY ONLY \$1. A MONTH ←
ASK TO SEE IT!—To Get This Assistance for Yourself Simply Fill in and Mail Coupon Today.

AUDEL, Publishers, 49 West 23rd St., New York
MAIL AUDELS NEW AUTO GUIDE for free examination. If O.K. I will send you \$1 in 7 days; then remit \$1 monthly until price of \$4 is paid. Otherwise I will return it.

Name.....
Address.....
Occupation.....
Employed by..... P M



Follow This Man!

Secret Service Operator No. 38 is On The Job!

Follow him through all the excitement of his chase after the counterfeit gang. See how a crafty operator solves a murder with tell-tale finger prints! Thrills! Mystery!

FREE! The Confidential Reports No. 38 Made to His Chief Earn a Regular Monthly Salary

Write for reports and free "Blue Book of Crime." Learn how YOU can become a Finger Print Expert at home, in spare time, at small cost. 63% of all Identification

Bureaus in U. S. employ our students or graduates! Get list of all bureaus employing I. A. S. trained men. Write today! Literature sent only to persons stating age.

INSTITUTE OF APPLIED SCIENCE
1920 Sunnyside Ave., Dept. 135-C, Chicago 40, Illinois

MEN WANTED!

GOOD MONEY NOW and a Bright FUTURE for You

Veterans . . . office and factory workers . . . others!
If you want to enjoy a FINE INCOME NOW, with even greater opportunities in the future, **Write us Today!** We are a nationally known manufacturer of Fire Fighting equipment . . . featuring "AUTOFYR-STOP" the amazing combination fire extinguisher and alarm that holds unequalled records. Our products sell FAST and in QUANTITIES to factories, schools, stores, homes.

NO EXPERIENCE NEEDED. Write for FREE FACTS!
AUTOFYRSTOP CO., Dept. M-86 2035 Washington Ave., Philadelphia 46, Pa.

LEARN MEAT CUTTING

At Home—In Spare Time

Get into the vital meat industry. Concise, practical Home Training based on 25 years proven instruction methods used at National's famous resident school. Prepares you for bigger pay as Meat Cutter, Supervisor, market manager or more money in your own store. Go as rapidly as your spare time permits. Diploma. Start NOW to turn your spare hours into money. Send for FREE bulletin today. No obligation.

National School of Meat Cutting, Inc., Dept. U-72, Toledo 4, Ohio

ELECTRICAL TRAINING

Intensive 8 months residence course in fundamentals of industrial electrical engineering, including radio, electronics. Prepares for technician, engineering aides. Approved for veteran training. 53rd year. Catalog.

BLISS ELECTRICAL SCHOOL

7638 Takoma Ave., Wash. 12, D. C.

ARTISTS MAKE MONEY

Do you like to draw? Send name, address, age and occupation for FREE ART TEST, to find out your ability.

ART INSTRUCTION, Inc.
8136 ART INSTRUCTION BLDG., MINNEAPOLIS 15, MINN.

AVIATION TRAINING

Learn AERONAUTICAL ENGINEERING or AIRCRAFT and ENGINE MECHANICS (A & E)

Resident courses at famous Northrop Field

Northrop Aeronautical Institute
1527 E. BROADWAY (Division of Northrop Aircraft, Inc.) LOS ANGELES COUNTY CALIFORNIA
HAWTHORNE

★ SEND FOR ILLUSTRATED BOOK



INDUSTRIAL TRAINING INSTITUTE

AMERICA'S FOREMOST SCHOOL OF *PRACTICAL* TRAINING

WILL TRAIN YOU FOR A KEY JOB
OR A BUSINESS OF YOUR OWN IN

REFRIGERATION AND AIR CONDITIONING

A FIELD OF OPPORTUNITY

Here is an industry that offers every opportunity you could ask for. Good jobs—security—plenty of chance for advancement—a business of your own.

And here is a school equipped in every way to train you for Refrigeration and Air Conditioning work—the largest and most completely equipped school of its kind in America—a school that already has trained thousands of men for just such opportunities.

GET READY FOR YOUR BIG CHANCE

Learn Refrigeration and Air Conditioning—now, while the time is ripe. You don't need any advanced schooling or previous experience. If you are at all mechanically inclined and have gone to high school for at least one year or have equivalent education, we can teach you Refrigeration and Air Conditioning. Everything is made simple, fascinating and easy to grasp.

FACTS ABOUT THE INDUSTRIAL TRAINING INSTITUTE . . .

Founded in 1916. Has trained more than 400,000 men for practical work in industrial fields. From 1942 through 1945 trained specialized technicians, exclusively, for the Army, Navy, and Marine Corps. Now training thousands of veterans under the G. I. Bill, both in its Residence Schools and by home-study. Occupies five buildings of its own. Has over \$500,000 invested in training facilities, with an instruction staff of more than 100 men. Known everywhere as America's foremost school of practical training for industry.

AUTHORIZED TO ACCEPT
VETERANS FOR G. I. TRAINING



**REGISTRAR, P3U
INDUSTRIAL TRAINING INSTITUTE,
2150 LAWRENCE AVE., CHICAGO 25, ILL.**

Please send me, FREE, your "Camera Visit" booklet and information about the opportunities for trained men in Refrigeration and Air Conditioning. It is understood that I will be under no obligation.

NAME.....

ADDRESS.....

CITY..... STATE.....

ARE YOU A VETERAN:.....

GET THE FACTS WRITE FOR FULL DETAILS **TODAY**

READ THIS GREAT PRACTICAL BOOK

Learn How to
Climb to Success
in Business



Get this NEW and DIFFERENT Guide to a High Goal. Get it AT ONCE. Start now toward a BIGGER JOB at BIGGER PAY.

Here's a book you'll read again and again. It is the "how" book of successful living, interestingly written by a noted authority, gaily illustrated, and packed with sound facts which you can use every day in making faster progress. No preaching, no theorizing—just practical success know-how that can put you out ahead of the crowd. Make your wishes and day-dreams come true. Decide NOW that you want more than just the ordinary things in life and intend to do something about it. Send for this great book AT ONCE. Use the coupon below.

AMERICAN TECHNICAL SOCIETY

Vocational Publishers Since 1898

Dept. UC 19, Drexel Ave. & 58th St., Chicago 37, Ill.

Send RUSH copy of new book, THIS WAY UP. I enclose \$2.00, you pay postage. Send C.O.D. for \$2.00, plus postage. I may return book after 5 days for full refund if not satisfied.

Name.....

Address.....

City & State.....

Learn this Profitable Profession



IN 90 DAYS
AT HOME

Money-Making Career Open to Men and Women, 18 to 50

Hundreds of men and women between 18 and 50 make \$10 to \$20 in a single day giving scientific Swedish Massage and Hydro-Therapy treatments. There is big demand from doctors, hospitals, sanatoriums and clubs. Graduates earn large full time incomes from these or in private practice in their own offices. Others make good money from home treatments given in spare time. Learn this interesting, money-making profession in your own home, through our home study course. Same instructors as in our nationally known resident school. You can win independence and prepare for future security by qualifying for your Diploma. Course can be completed in 3 to 4 months. Many earn while they learn. Begin your training at once.



Anatomy Charts & Booklet FREE

Enroll now and we will include, at no extra cost, many needed supplies. Fit yourself to help meet growing demand for Scientific Swedish Massage. Send the coupon at once for complete details. Anatomy Charts and 32-Page Illustrated Booklet, FREE, postpaid.

THE COLLEGE OF SWEDISH MASSAGE
Dept. 664-K, 100 East Ohio St., Chicago 11, Illinois

Please send me FREE and postpaid, Anatomy Charts, 32-page Booklet and complete details on Home Training.

Name.....

Address.....

City..... State.....



New—Exciting! AAF Pictorial of your stay in the ETO. You'll thrill to over 250 pictures of air combat—fighters—bombers—flak—London—Norwich—Ipswich and many others. Post-paid \$3.00. Send check, money order or C.O.D. Now to Dept. G.



AAF PUBLICATIONS
6015 West Third St.
Los Angeles 36, Cal.

"How to Make Money With Simple Cartoons"

A book everyone who likes to draw should have. It is free; no obligations. Simply address
CARTOONISTS' EXCHANGE

Dept. 98-D Pleasant Hill, Ohio



MUSIC LESSONS

LEARN... PROGRESS... EARN MORE... SUCCEED... Your own achievement, popularity, success through music. Learn in your home. Check course: Piano, Violin, Cornet, Saxophone, Clarinet, Guitar, Harmony, Arranging, History. If juvenile, parent's signature must accompany inquiry. Low cost. Easy Terms. FREE catalog. Suite U405 765 Oakwood Bl. Chicago 18

UNIVERSITY EXTENSION CONSERVATORY

LAW STUDY AT HOME for PERSONAL SUCCESS and LARGER EARNINGS. 35 years expert instruction—over 108,000 students enrolled. LL.B. Degree awarded. All texts furnished. Easy payments. Send for FREE BOOK—"Law and Executive Guidance."
AMERICAN EXTENSION SCHOOL OF LAW
Dept. 68-M, 646 N. Michigan Ave., Chicago 11, Ill.

Now You Can Lick ANY AUTO REPAIR JOB!

Look up make, model, job in MoToR's AUTO REPAIR MANUAL—and go to work! Complete guide for every model built since 1935. 764 pages; 1000 illustrations; 450 charts; 200,000 repair facts. Index. After 7 days' Free Examination, send \$1; then \$1 monthly for 4 months, 35c postage. If not satisfied, return book, pay nothing. MoToR Book Dept., Desk 1J, 572 Madison Ave., New York 22, N. Y.



AMAZING DEVICE! Guides your hand—corrects poor penmanship in few days—big improvement in three hours, no failures. Complete Outline Free. Write, Mr. Ozment, 34, St. Louis, Mo.



CODE-RECEIVING SPEED

Learn to send and receive Radio Code with greater speed. Stop nervous tension. Have confidence. Be proficient. Same system used by radiotelegraph specialists. Thousands of operators needed. Rush name for FREE book.

CANDLER SYSTEM CO.
Dept. 5-J, Box 928, Denver 1, Colo., U. S. A.

FIX TYPEWRITERS

A Simplified Practical Homestudy Course. Many of our Students now have their own Business—Many Repair for others. Repair Shops Swamped. Health or Age no handicap.
WEBER TYPEWRITER MECHANICS SCHOOL
Box 269, Osborn, Ohio



Plasti-Liner TIGHTENS FALSE TEETH BEST



Guaranteed TO MAKE PINK PLATES FIT PERFECTLY PERMANENTLY!

● NOW, at home, you can quickly and safely relin your dentures with PLASTI-LINER—the original, professionally developed reliner that refits your plates perfectly and permanently. Unlike ordinary reliners that last for only a few months, PLASTI-LINER is guaranteed to last for the life of your plate! PLASTI-LINER is NOT a powder nor a paste; but a strip of genuine, fully guaranteed dental plastic. **PROVEN CONCLUSIVELY BY DENTISTS!** PLASTI-LINER (Methyl Methacrylate) consists of the same ingredients as that used by many dentists. Properly applied, you too will get professional results **QUICKLY — ECONOMICALLY! SAFE — EASY TO APPLY . . .** Pure, non-toxic, harmless, non-irritating, odorless, tasteless, smooth, molds to mouth. **WILL NOT HARM PLATES—** no heat necessary. Praised by thousands of satisfied users. Mr. H. McF. says—"I find that there is just nothing to compare with it . . . PLASTI-LINER is 100% all right."

SEND NO MONEY - ORDER BY MAIL TODAY
\$1 for upper or lower—\$2 for both. Sold on money-back guarantee. Save C.O.D. charges by enclosing money. **PLASTI-LINER CO., DEPT. 41C, 908 WALBRIDGE BUILDING, BUFFALO 2, N. Y.**

LEARN SHORTHAND AT HOME

Maude E. Frank's Perfected Copyrighted System of 20 lessons. Used Successfully 17 Years from Coast to Coast. Write—Maude E. Frank

Secretarial School, 2000 East Linwood Boulevard, Kansas City, Mo.

HOW TO CUT RAFTERS New vest pocket book gives lengths, Side cuts, Plumb cuts, forty feet wide. For all rafters for any building from one inch to four feet wide. Gives numbers to cut on squares. Also decrees for same cuts for Radial Saws. All standard pitches from 1/4 to 5/4. Just open book to pitch page and there are your lengths, side cuts, etc. Anyone who knows what a jack rafter is can frame a roof if he has this great book. Price one dollar prepaid.
BUILDERS' TOPICS, Dept. M, Med. Arts Bldg., Seattle 1, Wash. Original teachers of the square in five easy lessons by mail. Send for FREE list of plan books—Kamp Kabin to Mansions.

TRAIN Your VOICE!
Results GUARANTEED
We build, strengthen the vocal organs—**not** with singing lessons—but by sound, scientifically correct silent and vocal exercises and absolutely guarantee complete satisfaction with results. Write for Voice Book. **FREE.** Sent to no one under 17 years old unless signed by parent.
Perfect Voice Studios, Studio 135-C, Kimball Hall Bldg., Chicago 4, Ill.

Durn Your Hide!
Since 1938 we have published a magazine for you—and you've never seen a copy of it! Rustle of wings at dawn over the marshes, splash of a striking bass, roar of a charging grizzly—**Western Sportsman** is crammed full of articles, pictures and information about the New West, greatest outdoors country on earth! 7 issues, \$1. Write, Joe Austell Small, Editor, **WESTERN SPORTSMAN, Dept. E, 3303 Bridle Path, Austin, Texas.**

WAR SURPLUS
Lathes, Milling Machines, Drill Presses, Sawing Equipment, Motors and thousands of miscellaneous items. Information on Helicopters, Power Lawn Mowers, Trailers, Garden Tractors, Jet Impulsion etc.—Free Literature. If you want catalog sheets sent by return first class mail include \$1.00.
THE WAYNE ENGINEERING CO., Dept. 1004, Greenville, Ohio



Fix Your Own ALARM CLOCKS
New, practical home course. Just out. Makes interesting hobby—profitable too. Save money by doing your own repairing at home. Easy if you know how. Price now only \$1.00. Details **FREE.** Send postcard.
THIES JEWELRY STORE, Genoa 3, Illinois

for Everything in Radio

Get ALLIED'S 1946 RADIO CATALOG



Send for it **NOW**

LARGEST STOCKS OF RADIO AND ELECTRONIC EQUIPMENT

ALL THE LATEST, best values in Radio! New receivers, phono-radios, Ham sets and gear, parts, tubes, builders' kits, code apparatus, tools, books, test instruments, public address systems. More than 10,000 items. Leading makes. Guaranteed quality. Lowest prices. Fastest service from the world's largest and most complete stocks. Send for your **FREE** copy of Allied's new 1946 Buying Guide now!

HELPFUL RADIO BOOKS

- Radio Formulas & Data No. 37-752 . 10c
- Dictionary of Radio Terms No. 37-751 . 10c
- Radio Circuit Handbook No. 37-753 . 10c
- Radio Builders' Handbook No. 37-750 . 10c
- Simplified Radio Servicing No. 37-755 . 25c
- Radio Data Handbook No. 37-754 25c
- ALL SIX BOOKS No. 37-799 75c
- Parallel Resistance and Series Capacitance Calculator. No. 37-960 . . 25c
- R-F Resonance and Coil Winding Calculator. No. 37-955 25c

ALLIED RADIO

ALLIED RADIO CORP.
833 W. Jackson Blvd., Dept. 5-H-6
Chicago 7, Illinois

FREE CATALOG

Send **FREE** 1946 CATALOG
 Send Six Books No. 37-799
 Send Books checked above } \$...enclosed
 Send Calculators checked above }

Name.....
 Address.....
 City..... Zone.... State.....

Imagine! ONLY 7¢ A DAY TO LEARN MUSIC



Easy as A-B-C



Here's grand news! You can now learn your favorite instrument right at home, in spare time, for ONLY 7c A DAY! And it takes an amazingly short time this modern, easy as A-B-C, "Print and Picture" way.

It's real fun, too! No tiresome scales, no tedious exercises. Instead you play real tunes by note from the very start. The simple printed lessons tell you what to do... the large, clear pictures show you how to do it.

See How Easy It Is!

See for yourself how easy it is to learn music this short-cut, money-saving way. Send for Free Booklet and "Print and Picture" Sample. Mention favorite instrument. U. S. School of Music, 78 Brunswick Bldg., New York 10, N. Y.

FREE! Print and Picture Sample

U. S. School of Music

78 Brunswick Bldg., New York 10, N. Y.

Please send me Free Booklet and Print and Picture Sample. I would like to play instrument checked below.

Piano	Saxophone	Modern Elementary
Guitar	Trumpet, Cornet	Harmony
Hawaiian Guitar	Reed Organ	Mandolin
Violin	Tenor Banjo	Practical Finger Control
Piano Accordion	Clarinet	

Name Have You Instrument?

Address

City State

Save 2c—Stick Coupon on Penny Postcard



AUTO

BOOKS ON APPROVAL

SEND NO MONEY. Just mail the coupon for a complete set of Six Big Auto Books. 20th Edition. Whether you are a mechanic or helper, expert or apprentice, auto owner or driver, take immediate advantage of this FREE EXAMINATION OFFER.

MAKE GOOD MONEY NOW HOLD A PERMANENT JOB

America wants its automobiles kept in good repair. Men with "know how" are in demand, at big pay. These books will help you get and hold an important job, or give you a chance to go into business for yourself now or later. Any man who half tries to improve himself can learn auto servicing and repairing by this quick reference method. Use the JIFFY INDEX to find easily understood answer to any auto problem. These wonder books prepared by eleven of America's great automobile engineers. Many hundreds of valuable illustrations. Send the coupon TODAY.

A year's consulting privileges with our engineers now given with these books without extra charge.

Vocational Publishers Since 1898

CAN YOU FIX IT?

These wonder books tell step by step HOW to make difficult repairs and adjustments, how to keep a car at maximum efficiency, including latest improvements in car design and operation. Engine troubles and how to correct them well covered.

6 BIG VOLUMES
2800 pages, 2000 illustrations, wiring diagrams, etc., including Diesel engines. Beautiful modernistic, washable cloth binding.

AMERICAN TECHNICAL SOCIETY, Dept. AC-19
Drexel Ave. at 58th St., Chicago 37, Ill.

I would like to examine your Six-Volume Set of Auto Books. I will pay the delivery charges only, but if I choose I may return them express collect. If after 10 days' use I prefer to keep them, I will send you \$2 and pay the balance at the rate of only \$3 a month until \$24.80 has been paid. Please include consulting service as offered above.

Name

Address

City State

Please attach a letter stating your age, occupation, employer's name and address, and name and address of at least one business man as a reference. Men in service, also please give home address.

Do You Need More Money?

SELL FAMOUS SUNSHINE CHRISTMAS CARDS

EXTRA SPARETIME DOLLARS FOR YOU!
Take orders galore from friends for 25 SUPER VALUE CHRISTMAS FOLDERS \$1.25. With name. Others to \$2.50. 56 Designs. AMERICA'S LEADING \$1. BOX ASSORTMENT OF 21 FOLDERS. COSTS 50c. A complete box line: CURRIER & IVES, GLITTERS, OILYETS, GRAND-MA ROSES, Gift Wraps, Everyday's. Personal Line. 21 Asst. and Sunshine Notes on approval. FREE SAMPLES of Personal Cards. Write today. ORGANIZATIONS—Ask for "Sunshine Money-Making Plan" and Samples. SUNSHINE ART STUDIOS, 115 FULTON St. Dept. EP, NEW YORK 8, N. Y.

FREE SAMPLES PERSONAL CARDS

LEARN AT HOME TO MOUNT BIRDS



Animals, Heads, Fishes, Pets; to TAN. Be a Taxidermist. Profit and FUN.

Hunters, save your valuable TROPHIES. Mount ducks, squirrels, everything. Learn to TAN for leather and furs. Wonderful HOBBY Have a HOME MUSEUM.—BIG PROFITS mounting for others. INVESTIGATE NOW.

FREE BOOK With 100 fine game pictures. NOW absolutely FREE. Write TODAY.

Send Postal TODAY for FREE BOOK. State AGE. N.W. SCHOOL OF TAXIDERMY, Dept. 337C, Omaha, Neb.



WHY JOB WORRY? LEARN ELECTROPLATING

Highly paid, uncrowded, interesting business. Part or full time. Chromium, Nickel, Gold, Silver, etc. Send postcard for FREE booklet and proof. PLATER HYDE, Dept. S Post Office Box 176 National City, Calif.

LEARN MOVIE PROJECTION THEATRE MANAGEMENT

The Motion Picture Theatre Business offers big opportunities for trained men. Get into a fascinating field with a post-war future. Train at home in spare time. Free Catalog. Established 18 years.

THEATRE INSTITUTE, 370 Washington St., Elmira, New York

SAY YOU SAW IT IN POPULAR MECHANICS

60 POWER TELESCOPE \$2.95

VARIABLE EYEPIECE 20X-40X-60X
NEW! Three telescopes in one. 3 different magnifications. 20 power for ultra-bright images with 40 and 60 power for extra long range. Guaranteed to bring distant objects, people, sports events, ships, moon, stars, etc., 60 times as close.



Most powerful made for anywhere near the money. Closes to 1 ft. in length. Multiple lens system. 30 mm. objective lens. 5 sections. Can be used as a compound 4 lens microscope. American made. Prompt shipment guaranteed. We pay postage. Only \$2.95. BROWSCOPE CO., Dept. 8M, 24 W. 45th St., N. Y. 19, N. Y.



"The Book They're Talking About"

ART ANATOMY OF THE HUMAN FIGURE

For the amateur and professional artist. Contains over 350 illustrations, charts and notes, giving detailed study of every part of the body. \$1 POSED and IN ACTION. Price Only.....\$1 Outside U.S.A. Send \$1.25

Major Book Co. (Dept. 6-C), 241 E. Broadway, New York 2, N. Y.

Again Beltone reduces size of AMAZINGLY IMPROVED

ONE UNIT HEARING AID

NEW REVOLUTIONARY
Beltone
MONO-PAC

About 1/4 size and weight of
old-style Hearing Aids.

Amazing "X-Cell" outperforms units 5 times its size! All one unit—no cumbersome separate battery pack—no battery wire nuisance—no "harness." Comfort-Curv design—wafer-thin case! Increased power gives better hearing under all conditions. Range Selector to filter out annoying background noises. Ever-level full tones bring back clear, lifelike hearing. Find out WHY there are more Beltone one-unit Hearing Aids in use than all others combined.

BELTONE HEARING AID CO., 1450 W. 19th St., Chicago 8, Ill.



SO TINY! SO LIGHT!
YET EVERYTHING SOUNDS
CLEARER-TRUER

MAIL
COUPON
NOW
FREE
BOOKLET

BELTONE HEARING AID CO., Dept. PM-8
1450 W. 19th St., Chicago 8, Ill.
Gentlemen: Please send me FREE Beltone
Hearing Aid booklet. No obligation.

Name _____
Address _____
Town _____ State _____

BUILDING



Millions of homes needed. Nation wide call for builders. Big opportunities. Learn now in spare time. — at home. Practical training with blue prints. No books. Send for FREE Trial Lesson and blue print plans.

CHICAGO TECHNICAL COLLEGE

K-150 Tech. Bldg., 2000 S. Mich. Ave.
Chicago 16, Ill.

MAKE MONEY CASTING AT HOME FREE FACTS SENT



Make hundreds of Plaster Casts, quick, easy. Sell output to stores, novelty shops, etc. Enormous profits. No experience. Very little capital needed. Start in basement, garage or workshop. Complete, simple instructions anyone can follow. Start now while merchants are begging for merchandise to sell. Rush.

PLASTIC ARTS STUDIOS, R.R.5, Dept. 29, Muncie, Ind.

Collect U. S. Army Shoulder Patches

An interesting, fascinating hobby. From 20c to 50c each. Master set of 400 patches—\$97.50. Assortments \$1, \$5, \$10, \$25, \$50. Official patches available for every major Army and Air Corps Unit. Send \$1 for sample selection of patches and PATCH CATALOGUE. Orders from Canada—add 20%.

SPRINGER'S
286 San Francisco Street
EL PASO, TEXAS



SAY YOU SAW IT IN POPULAR MECHANICS

EVERY ELECTRICAL WORKER NEEDS THIS ELECTRICIANS 1946 HAND BOOK

**For Everyday Help
On The Job!**



Brand new... up to the minute. Contains over 5,000 electrical facts—wiring diagrams—essential electrical formulas—latest code rules, tables, charts and wiring methods. Includes Industrial Electronics data. It's a gold-mine of practical, down-to-earth helps and ideas to save you time and money. A book every Electrical Worker can use every day. Pocket size, 4 1/4 by 7 inches, flexible leatherette cover to stand hard usage.

400 Pages

Electrical Circuits
Reading Wiring
Diagrams
Wiring Methods
Motors
Switching & Control
Illumination
Industrial
Electronics, Etc.

SEE IT FREE!

See this book FREE for 7 days at my expense. If you decide you don't want to keep it, send it back and you owe nothing. If you keep the book you pay only \$3.25 after 7 days' FREE examination.

**FREE TRIAL
COUPON**

H. C. LEWIS, President
Coyne Electrical School, Dept. C6-R5
500 S. Paulina St., Chicago 12, Ill.

I want to see the New Coyne Electricians Handbook. Send me a copy for 7 days' FREE examination. If after 7 days I do not want the book I will return it and owe you nothing. If I keep it I will pay \$3.25 within 7 days and the book is mine.

NAME _____ Ago _____

ADDRESS _____

TOWN _____ Zone _____ STATE _____

If you prefer to pay postman cash price shown above on delivery, check here. Same FREE examination & money back guarantee.

LEARN PLASTICS

GET THIS COMPREHENSIVE, PRACTICAL KNOWLEDGE of Plastics—materials, designing, molding, fabricating, laminating, testing, etc. Plastics Institute's course can be of great value to you in obtaining the kind of a position you want in this growing industry. Send for free booklet now!

Approved for Veterans

Plastics
INDUSTRIES TECHNICAL INSTITUTE
NEW YORK CHICAGO LOS ANGELES
122 East 42nd St. 221 N. LaSalle St. 1601 S. Western Ave.

PLASTICS INDUSTRIES TECHNICAL INSTITUTE
Dept. PM6-8, 1601 S. Western Ave., Los Angeles 6, Calif.

NAME _____

ADDRESS _____

CITY _____ ST. _____

Veterans: Check for special information.

If under 18: Check for special booklet.

FREE BOOKLET



START

\$1756 to \$3025 YEAR

Unusual Number of Examinations expected soon

Prepare NOW for Next Examinations

MEN—WOMEN

Veterans get preference. FREE of charge, list of 32-Page Civil Service Book—FREE Mail Coupon Today—SURE

Gentlemen: Rush to me, U. S. Government big pay jobs. Send me FREE 32-page book describing salaries, vacations, hours, work, and full particulars telling how to qualify for one of these jobs.

FRANKLIN INSTITUTE

Dept. T79

Rochester 4, N. Y.

Name.....

Address..... Vet?.....

FOREIGN JOBS

Specific Foreign Job Listings

Engineers, Radio Operators, Technicians, Sales, Office Personnel, and many others, listed in our reference directory (revised monthly), together with necessary information on how to obtain Foreign Positions, and World-Wide Listings of Business organizations with Foreign interests. \$1.00, postpaid.

FOREIGN SERVICE REGISTER

DEPT. M

BALTIMORE 3, MD.

LEARN Accounting AT HOME - IN SPARE TIME

Bookkeepers, accountants, and secretaries are in great demand. Now is the time to prepare for the many opportunities open to business-trained men and women.

Write today for FREE copy of interesting new booklet, "Through Hill's To Success," which tells where the best positions are found and how you may train for them quickly at home in your spare time or in resident school.

Hill's is rated as one of America's leading business schools. Thousands of successful graduates. Nationwide Employment Service.

Hill's EXTENSION SCHOOL And Business University

619 West Main St. Oklahoma City 2, Okla.

THE NEW IMPROVED WATCH REPAIR COURSE

WRITTEN

By a Certified watchmaker with more than twenty-five years of experience at the bench. At present, Teaching the course in a vocational school. For the beginner with No previous experience. In a step for step style, with instructions easy to follow and profusely illustrated.

UNITS

{ LATHE WORK
BALANCE STAFFING
GENERAL WATCH CONSTRUCTION }

Just off the press at \$7.50 each. Three more Units soon to follow.

WRITE:

JOHN VAN PUFFELEN
POST OFFICE BOX-117, GRAND RAPIDS, MICH.

GET INTO

REFRIGERATION AND AIR-CONDITIONING

Build your future in fast-growing industry. Prepare for high pay jobs or get into your own business. M-8 Resident classes only.

Send ad with name and address for information. VETERANS Eligible for training under G. I. Bill, Check here

BOSTON TECHNICAL INSTITUTE
School of Refrigeration, 4707 Euclid Ave., Cleveland 3, Ohio



Begin today. Write now for our Free Book, "How to Become a Good Penman." It contains specimens and tells how others learned to write in spare time. Enclose 10c for your name beautifully written and a pen point suitable for shaded writing. Write today.

THE TAMBLYN SCHOOL OF PENMANSHIP
N-441 Ridge Building, Kansas City, Mo.

SELL BIBLE SOUVENIR

METAL COINS, LORD'S PRAYER, ONE SIDE: JOHN 3:16 on THE OTHER—Quick Easy Sales—Very attractive pocket piece. Quantity Price \$6.00 per 100; \$27.50 per 500; \$50.00 per thousand . . . Don't Wait . . . Order Today. Sample Order 15 Coins with Display Card, \$1 Postpaid. LOUIS LE VITE, 21 E. Van Buren St., Dept. P5, Chicago 5.

SILVER DOLLAR SIZE

INVENTORS

WITH GOOD INVENTIONS

Should write us without delay for FREE BOOKLET, Protective Disclosure Form and facts about The Inventor's Most Logical Markets. Patented, Unpatented inventions, all kinds, Cash, Royalty, needed by specific manufacturers. If your invention is for sale, write today for full particulars. A Post-Card will do! Address:

THE INVENTION REPORTER
5C-11106 South Longwood Drive Chicago 43, Illinois

POPULAR MECHANICS

WAR BARGAINS in LENSES and PRISMS

NOW! MAKE YOUR OWN BINOCULARS!

Complete Set of LENSES and PRISMS from Navy's 7X, 50 Model

Save Up to \$150.00



Here's an unusual opportunity to secure a fine set of Binoculars at a tremendous saving of money. Build them yourself with all of the very same optics contained in

the Navy's 7 Power Glasses. Or you can construct a Monocular (1/2 a Binocular) in which case exactly one half quantities of the Binocular Components will be furnished. All Lenses and Prisms are in excellent condition. Lenses are cemented and have the new low reflection coating. Complete assembly directions included for either project.

Stock #5102-H Binocular Set of Lenses and Prisms\$25.00 Postpaid

Stock #5103-H Monocular Set of Lenses and Prisms\$12.50 Postpaid

UNMACHINED LEFT AND RIGHT BODY AND COVER

PLATE CASTINGS. Stock #820-H.....\$2.50 Postpaid

35 MM. KODACHROME PROJECTING LENS SET—Consists of 2 Achromatic Lenses for projecting, plus 2 Condensing Lenses and piece of Heat Absorbing Glass with directions.

Stock #4029-H.....\$3.10 Postpaid

POLARIZING FILTER—Diam. 73 mm. Perfect condition.

Stock #637-H.....\$3.00 Postpaid

TANK PRISMS—90-45-45 deg., 5/8" long, 2 1/2" wide, finely ground and polished.

Stock #3004-H Silvered Prism (new & perfect).....\$2.00 Postpaid

Stock #3005-H Plain Prism (new & perfect).....\$2.00 Postpaid

Stock #3100-H Silvered Prism (Second).....\$1.00 Postpaid

Stock #3101-H Plain Prism (Second).....\$1.00 Postpaid

We have literally millions of war surplus lenses and prisms for sale at bargain prices. Write for Catalog "H"—Sent Free!

Satisfaction Guaranteed Order by Stock No.

EDMUND SALVAGE COMPANY

P. O. AUDUBON, NEW JERSEY

**V-8
DUALS
& SINGLES**

STEELS and ALUMINUMS with a motorboat tone

SINGLES \$5.50 to 8.00
V-8 DUALS 17.50 to 20.00

Reduce back pressure and increase engine performance. A Sandee is time proved and dependable. Aluminums are guaranteed for the life of your car.

DEALERS WANTED

SANDEE MUFFLER CO.
7523 S. WESTERN AVE., LOS ANGELES 44, CALIF.

SAY YOU SAW IT IN POPULAR MECHANICS

LEARN METAL PLATING—

Our complete production course will teach you the profitable business of metal-plating non-metallic articles such as baby shoes, plaster casts, molded plastics, etc. Personalized, step-by-step instruction—the only thing of its kind! Write now for full details.

MASTER METALLIZERS

3314 S. Grand Ave. Los Angeles, Calif.

FIGURE DRAWING WITHOUT A MODEL

This book brings famous art schools right to your easel! Over 300 "real-life" drawings in this new Cliff Young book. Only \$1 postpaid. Order Now; Art Books list included FREE.

HOUSE OF LITTLE BOOKS, 80-B East 11th St., N. Y. 3



DRILL-INDEX A compact container for indexing and filing twist drills. Eliminates search. Made entirely of steel in nine sizes. See your dealer or write to

HUOT MFG. CO.
Foot Schultz Bldg. St. Paul 1, Minn.

FREE TRIAL IN YOUR HOME!

HERE'S THE HELP YOU NEED FOR BEST JOBS—RIGHT NOW!



DO ANY JOB.. EASIER.. QUICKER
MAKE MORE MONEY in the
BIG OPPORTUNITY FIELDS

SEND NO MONEY
Select the Books YOU Need Now! We Ship C.O.D. Anywhere in U. S. and Will Refund Amount Paid if Not Satisfactory.

Get into one of these big opportunity fields. Big money and many other advantages await you if you prepare now. Here is the help you need—EASY—QUICK—AT LOW COST. Thousands of men have already used these famous books. Beginners and experienced men alike have doubled and tripled their earnings with this help. You too, can now get the special knowledge you need for top pay, better jobs, or a business of your own. This is your GOLDEN OPPORTUNITY.



Air Conditioning

Big air conditioning boom interrupted by war is getting into full swing again. Bigger opportunities ahead than ever before. Get this complete and practical book by an international authority and be ready for your share of millions to be spent. Covers whole field in simple, non-technical language. Shows you what to do; how to do it; how to make money. 450 pages. Illustrated. \$4.00

Welding Practice

When you know welding you are in a profession that is tops in all industries. Start learning now with this newest book on all types of welding and heat treatment of metals. Written by recognized specialists in training men for production jobs. Use it for complete study or a reference guide. Prepare now for best jobs. Price \$4.00



430 Pages
277 Illus.
Practical and Non-Technical



Auto Repairs

Car owners are spending big money to keep their good older cars looking like the new ones coming out. This practical, money-making guide shows you how to do it. Ideal for shop owners and every man who wants a share of the millions to be spent in keeping old cars looking new. Tells how to get a good job or start business of your own with small capital. 325 pages, 232 illustrations. \$3.50

SEND NO MONEY! Mail Coupon

GOODHEART-WILLCOX CO.,
2099 S. Michigan Ave., Dept. 1A, Chicago 16, Ill.

Send books checked, C.O.D. I will pay postman, plus few cents charges. If not satisfactory I will return books in 5 days and you will refund money paid. (Outside U.S. or possessions remit with order.)

Auto Body and Fender Repairs\$3.50 Modern Welding Practice, \$4.00
 Air Conditioning\$4.00

If remittance accompanies order we will pay all postage charges under same return privilege.

Name.....

Address.....

City.....State.....

HOW TO MAKE MONEY BY MAIL

Down-to-earth facts, directions (illustrated) for running business profitably, using expertly for YOUR good fortune the employees, trains, planes which Gov't places at your disposal CHEAP. Get orders by mail, ship by express or freight or mail, get out of the kindergarten . . . 14th edition, enlarged to 576 pages, now selling. It's YOUR winner. Make this year and the following years worth more. . . . THIS knowledge really PAYS OFF.

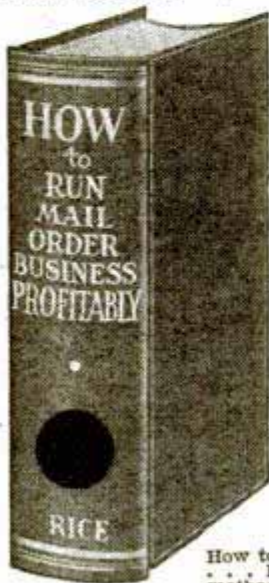

THE EASY WAY to start new or expand your present occupation. Do it NOW. Extraordinary plain, simple skill, know-how. No theory. Fact story of rich experience of author E. Rice day-by-day. How many times have we heard: "I wish I had some money, this patent would earn me a fortune," or "why can't my crop pay better?" or "I wish I knew how to sell this gadget myself," or "why should my boss alone do this when I too know how the money is made?" . . . Listen, YOU DO NOT NEED MONEY TO START THIS RICE WAY. His method automatically pays all bills same day rendered, no bank loans, pay as you go, no borrowing from relatives or friends, no salesmen. Also no worry, quickly a home of your own all paid for. Rice paid off \$5000 in mortgages a year after using this skillful idea.

46 Years of PROOF

Sounds fishy? Sure, but this has been done steadily for 46 years, depression or no depression, by the author; that is why he wrote this book, to pass the good word along. Make it go with anything you have which is salable, or with what you are now doing. Rice made his pay plan go from the start when living in one room in a city lodging house. Turn your city or country home, your work, your hobby, into money. How to get orders coming steadily at cost of only \$4 for each \$100 taken in. The popular error to avoid in trying for sales. Business won free while others have to pay for it.

How to conceive the money-getting advertisement. Profitable changes from ordinary ideas and methods. Not usual cut-and-dried pattern, 165 adventures, a dictated book in everyday talk by Rice

doing day by day what he discloses in his book can be done by his method. No dictionary writing. . . . Read how others are profiting big.

Take a chance on this book being worth a fortune to you and yours and send \$2.95. Book mailed same day order is received. Or ask two friends to chip in 98 cents each with your 99c to get this book. Hundreds of buyers whose letters we show you declare emphatically its superlative goodness. Follow its easy pattern for success. Cloth-bound, 576 pages, 8 1/2 by 5 1/2. Best seller, 14th edition now selling. Cut out the \$2.95 HOW BOX here, pin or stick it to sheet of paper bearing your name and address, mail in envelope with money order or check for \$2.95 to

HOWARD ST. HOUSE, Melrose 76d, Massachusetts

HOW
\$2.95

READY TO MOVE IN... A SIX ROOM HOUSE



2800 Complete
TWO BATHS • GARAGE
INSULATED FIRE RESISTANT

START BUILDING IMMEDIATELY!

This may answer your own personal housing problem. George W. Pearce's book is designed for ACTION! He reveals, in simple, easy-to-read language, PROVEN construction methods—unique, money-saving materials. EVERYTHING completely explained and illustrated. 10 folded 12" x 18" drawings showing details of construction, wiring, plumbing, heating, lighting. ABSOLUTE MONEY-BACK GUARANTEE.

Send check or money order. Your copy rushed postpaid.

MAIL NOW! 10 COMPLETE DRAWINGS
138 PAGES ILLUSTRATED

TECHNICAL PRESS
Box 42F Swampscott, Mass.

\$2
POST PAID

AGENTS EARNING UP TO \$300 A WEEK SELLING AMAZING NEW FLOOR FINISH REINFORCED WITH PLASTIC RESIN . . . REQUIRES NO WAXING OR LABORIOUS MAINTENANCE

FREE SALES KIT!

Get in on the ground floor of one of the biggest money makers ever put out! Every home, office, store, restaurant, beauty parlor, church and factory a red hot prospect. Sells on sight. Anyone can apply. Just mop it on. Send for free sales kit today. Exclusive territory. Write our Mr. Thomas today.

FAIRCHILD CHEMICAL & COATINGS CO., INC.
280 Madison Ave., New York 16, N. Y.

BIG MONEY FOR YOU IN PLASTICS

SEND 10¢ Offer includes 2 books: New Fabrication Manual & Giant Catalog, listing the most complete stock of Plastic Materials, Accessories, Tools.

BERTON PLASTICS, INC.
19 W. 21st St., N. Y. 10, N. Y.

REFRIGERATION AND AIR CONDITIONING SERVICE MECHANICS COURSE

Learn at home—how to start your own repair shop on little capital. No previous experience needed. Common school education sufficient. Splendid opportunity for older men. Prepare now for your future. FREE illustrated booklet.

MECHANICS TRAINING SCHOOL
7217 So. Broadway, Dept. P-8, Los Angeles 3, Calif.

LEARN MASTER MACHINIST MECHANICAL DRAFTING

Expert training on Lathes, Milling Machines, Shapers, Grinders, etc.—Mechanical Drafting, Blueprint Reading and Designing. Allied shops are completely equipped and modern. Approved for G. I. Training Days, Evenings.

ALLIED SCHOOL OF MECHANICAL TRADES
1330 South Michigan Avenue • Chicago 5, Illinois

SAY YOU SAW IT IN POPULAR MECHANICS

Correspondence Courses in **RADIO and ELECTRICAL ENGINEERING**

LOW AS \$25

ELECTRICAL ENGINEERING. Get good grasp of wide electrical field. Modern. Very understandable. Theory made easy.

RADIO ENGINEERING. Extra fine course in radio, public address, photo-electric work. Trains you to be super-service man, real vacuum tube technician. Tuition ONLY \$25, either course. Deferred payment plan. Servicemen needed badly.

FREE Write for free copies of school catalogs, student magazines, etc.

LINCOLN ENGINEERING SCHOOL, Box 931-P92, Lincoln, Nebr.

Thrilling Work COLORING PHOTOS

Fascinating vocation learned at home by those with aptitude. Thrilling pastime. National method brings out life-like colors. Free booklet.

NATIONAL PHOTO COLORING SCHOOL
1315 S. Michigan, Dept. 135-C, Chicago 5

NEW CHEAP OIL BURNER

FOR COOKING & HEATING STOVES-FURNACES
HEAT YOUR HOME, COOK YOUR MEALS
WITH CHEAP FURNACE OIL

NO MORE SHOVELING COAL OR ASHES. New Fuelizer Starter Vaporizing System turns Cheap 130 Flash Furnace Oil into Oil Gas heat without clogging up. LIFE-TIME GUARANTEE against defects. \$1.00-BONUS OFFER FOR TESTING. We will let you try it in your own stove or furnace for one month. Get Yours for introducing. Big profits. Be first. Send in your name today.

NORTHWEST MFG. CO. 561-K 5th Ave. Mitchell, So. Dak.

CAN YOU SELL?

DIRECT OR TO STORES

This is not an ordinary "agents wanted" ad. We are not interested in one-time salesmen. If you feel that your career really lies in selling, we have a worthwhile product backed by real sales promotion assistance from us.

**PLASTIQUE NU-FLO
AMAZING LINOLEUM FINISH**

is a quality product that does away with waxing and washing. It is not a one-sale product, but builds repeat business because it gives floors that wonderful like-new finish.

Retails for \$1.95 a quart on which you make \$1.00. Sell with a MONEY-BACK guarantee. If you think you can sell, investigate today.

WRITE FOR FREE SALES KIT OFFER

PLASTIQUE NU-FLO PRODUCTS CO.

506 S. FRANKLIN, DEPT. P. M. 8 CHICAGO 7, ILL.

**FREE 32-PAGE BOOKLET ABOUT
MODEL RAILROADING
THE WORLD'S MOST FASCINATING HOBBY**



FREE 32-PAGE BOOKLET tells all about this absorbing hobby for skilled tradesmen, business and professional men. Give yourself hours of satisfaction and relaxation building your own scale model railroad which performs and looks like the real thing. It's easy and relatively inexpensive. Get started now. Send at once for our free booklet "Your Model Railroad."

**MODEL RAILROADER MAGAZINE
DEPT. MR-8 MILWAUKEE 3, WISCONSIN**

Practical Electricity and House Wiring



Discusses common electrical devices, principles of circuits, wires and insulation, grounding, fuses and circuits, wiring methods, planning installations, installing switches, fixtures, etc., wiring houses after they are built, alterations and additions, wiring farm buildings, home repair, etc. 200 pp.....227 illust.

C.O.D. Send Today, Money Back Guarantee Postpaid \$2.25 \$2.00

The GATEWAY BOOK CO., Dept. PM-20
32 N. State — Chicago 2, Illinois

**Learn to Service and Repair
ELECTRICAL APPLIANCES**

Open your own electrical appliance service shop. Complete illustrated course covering house wiring, motor repairs, house appliance repair. Send today for FREE BOOKLET without obligation.

PACIFIC TRAINING SCHOOL

7217 So. Broadway, Dept. P-8, Los Angeles 3, Calif.

NEW OTTAWA SAW

BIG FREE BOOK World's Fastest 6 H.P. EASY TO MOVE Falls trees. Saws big logs, small logs, limbs. Pulley for belt work. Easy to handle, weighs less than lower powered units. FULLY GUARANTEED. Cash in on fuel shortage. Turn wood lots into cash.

OTTAWA MFG. CO., 827 Pine St., Ottawa, Kans.

Fit-Rite makes False Teeth TIGHT Makes loose dental plates fit snugly and comfortably. LASTS FOR MONTHS!

Simply squeeze on dental plate and put it in your mouth. Hardens and becomes part of plate. Money-back guarantee.

FREE Generous package of Dental Plate Cleanser with each order. Send \$1.00 or mailed parcel post collect.

Fit-Rite Co., 1573 Milwaukee Ave. Dept. 8-PM, Chicago, Ill.

**START NOW TOWARD A FUTURE IN
REFRIGERATION and
AIR CONDITIONING**

Refrigeration and Air Conditioning are among the giant Industries of America. Such industries need men who KNOW. Many men servicing and installing equipment are making large incomes.

Spare Time Training

If mechanically inclined, get the training you need to qualify for experience installing & servicing Refrigeration and Air Conditioning in stores, offices, homes.

Then you should have no difficulty getting started in these great industries. As experience, tools and a personal following are acquired; you may find it practical, later, to start your own REFRIGERATION and AIR CONDITIONING SHOP.



Rush Coupon Below Today!

Practical Interesting Training

You'll like our way of training—through capable home-study instruction followed by practice on actual equipment under watchful eyes of seasoned Refrigeration and Air Conditioning men in our shops. You'll get top-rate instructions—the easy way. So get the facts now—FREE of obligation. Write TODAY—SURE!

GET VALUABLE FACTS FREE

UTILITIES ENGINEERING INSTITUTE, Dept. 186
1314 W. BELDEN AVE., CHICAGO 14, ILL.

Please send me the Free FACTS about opportunities in Air Conditioning and Mechanical Refrigeration. I marked the one that interests me most.

Air Conditioning Mechanical Refrigeration

NAME _____ Age _____

ADDRESS _____

CITY _____ Zone _____ STATE _____

MAKE MORE MONEY

APPLYING OR SELLING

**CORKSTONE
PLASTIC FLOORING**

EASY TO APPLY

Here's your opportunity to get into business for yourself applying or selling Corkstone, the economical, top-grade plastic flooring. Plenty of profit. Act without delay!



Dealers & Agents Wanted

WRITE FOR DETAILS OF OUR PROPOSITION

We believe in teamwork and cooperation. We'll help you get started. No cost; no obligation. Act today!

LASTING PRODUCTS COMPANY
MANUFACTURERS OF PAINTS, PUTTIES, PLASTICS
FRANKLINTOWN ROAD PLANT, BALTIMORE 23, MARYLAND

ELECTROPLATING OUTFIT

BRUSH ON SILVER, COPPER



Only **\$3.95** COMPLETE



Comes Ready to Use—Nothing Else to Buy!

Here's the Handy ELECTRO-PLATER outfit for your home-workshop or business! Only \$3.95 complete! Puts a smooth, shining, silver or copper plating on silverware, toys, models, doorknobs, auto accessories, home fixtures . . . everything with a conductive surface! Simple, easy to use! Complete instructions furnished. Just brush on silver or copper plating! Comes complete—ready to use—with liberal jars of silver and copper plating materials, cleaner, two brushes, battery power unit . . . everything you need to start plating at once! Nothing else to buy.

SEND NO MONEY! GUARANTEED!

Just mail name and address today! Pay postman only \$3.95 plus few cents postage on delivery. Use electroplater for 10 days. If you are not completely satisfied, return outfit and your money will be refunded. Rush your order today!

HANDY ELECTRO-PLATER • Dept. D-400
259 Strader Avenue Cincinnati 26, Ohio

ELECTRICAL BOOKS

shipped for EXAMINATION



8 BIG BOOKS

SEND NO MONEY
MODERN ELECTRICITY
INCLUDING RADIO AND REFRIGERATION

Here's great news for anyone interested in Electricity. NEW, up-to-date 19th Edition of Applied Electricity with new subjects fully covered, including blueprint reading, electronics, F. M. radio, fluorescent lighting, 8 Big Books sent for examination!

NEW Edition for Beginners and Experts

Over 3700 pages, 2700 illustrations and 134 tables in most complete electrical work we have published. Dynamos, motors, diesel plants, power stations, transmission—everything explained for easy understanding.

BIG FIELD! Big Demand! Big Pay!

Men who understand electricity are needed now in all kinds of industries. Practically every business depends on electrical knowledge, and men who know this subject make big money. Learn easily with these new, interesting books. Send coupon for a set of books on approval. See how they will help you to get ahead faster.

SEND NOW

(A year's consulting privileges with our engineers now given to all buyers of this famous Cyclopaedia of Electricity.)

AMERICAN TECHNICAL SOCIETY
Vocational Publishers Since 1898

American Technical Society, Dept. EC19, Drexel at 58th St., Chicago 37
Send for 10 days' free use, 8 volume set of New 19th Edition, Applied Electricity, including a certificate entitling me to consulting privileges for one year. I will pay the delivery charges only on the books. If I wish I may return them in 10 days and owe you nothing, but if I keep them, I will send \$2.00 after 10 days, then \$3.00 a month until the total price of only \$34.80 is paid.

NAME.....

ADDRESS.....

CITY.....STATE.....

Please attach letter stating age, occupation, employer's name and address, and name and address of at least one business man as reference. Men in service, also please give home address.



NOW! EASY-TO-MAKE HOMECRAFT NOVELTIES

FOR PLEASURE AND PROFIT!

FREE! NEW 40-PAGE CATALOG

Our new free book is crammed with money-making facts about Leather Craft, Wood Carving, Clay Modeling, Lacing and Braiding, Wood Burning (Pyrography), Showcard Lettering, Ready-to-Finish Woodcraft and much more. Send for FREE copy TODAY!

SPECIAL! EASY MONEY-MAKER!

Newest fashion idea. Leather Link Belts. Very smart for both men and women. Kit including everything for six easy-to-make belts (2 white, 2 black, 1 brown, 1 natural) to sell at \$2 each (\$12 total) sent to you complete for only \$3.50 postpaid. Or C.O.D., you pay postage. (No Canadian or foreign shipments made.) Money back if not delighted.

- Make BEAUTIFUL Hand-Tooled
- BILLFOLDS
 - CLAY MODELS
 - WOOD CARVINGS
 - POTTERY
 - SPATTER CRAFT
 - BOOK ENDS
 - BRACELETS

DWINNELL CRAFT SHOP, Dept. P68, Elm Grove, Wheeling, W. Va.



Locksmithing AND KEY MAKING Now Made Easy!

Practical up-to-date course teaches you how to pick locks, de-code, make masterkeys, repair, install, service, etc. New self-instruction lessons for every handyman, a homeowner, carpenter, mechanic, service station operator, fix-it shop, hardware dealer, gunsmith. 65 easy illustrated lessons. Low price! Satisfaction! Free details, write NELSON CO., 1139 S. Wabash, Dept. 2H02, Chicago 5

Big Success—FREE Catalog yours

TATTOOING OUTFITS

Electric Machines, Designs, Inks, Etc. Price List Free!

MARSHALL STEELE

Apt. 108, 540 Leavenworth, San Francisco, Calif.

LIQUID MARBLE COLORED POTTERY

Different! Marvelous! Color-glazed. Brush, spray, mold tiles, table-tops, ornaments! **SANITARY COMPOSITION FLOORING**—Dustless, noiseless; put on like plaster, plain or tile designs; yielding as cork, lasting as stone. **RUBBERLASTIC Mold Compound**—For plaster casting, novelties, statuary, toys, plaques, dolls. **TILEX Colored Roofing**. Build Modern **PLASTIC HOMES**. Illustrated literature free. **RAPID MARBLEIZING SERVICE**, Dept. 10-A, Edwardsville, Illinois



CARTOON TO SUCCESS!

Learn to cartoon! Big pay! Easy, enjoyable work! Cartoon course, gag course, anatomy course and business course full of plans, markets, ideas. Drawing set and criticisms. All one low price! Rush card for details! **HARTMAN SCHOOL**, 2776 California Court, Lincoln 1, Nebraska

ACCOUNTING—BOOK-KEEPING made easy

New, practical, quick. No Study. No work. Just follow a few simple rules. Send 25c for sample Bulletin A. Money back if not satisfied.

EFFICIENCY INSTITUTE, P. O. Box 254, Evanston, Ill.

STAMMERER?

This new 128-page book, "Stammering, Its Cause and Correction," describes the Bogue Unit Method for scientific correction of stammering and stuttering—successful for 45 years. **Benj. N. Bogue**, Dept. 1839, Circle Tower, Indianapolis 4, Ind.



SIMPLE EASY INVENTION TRIMS HAIR AT HOME!

SAVES BARBER BILLS

Trims hair as it combs! Easy! Quick! Keeps men's, women's children's hair trim, neat, freshly-cut looking all the time! Trims, tapers, thins out uneven hair. Use like ordinary comb. Safe. Simple.



No experience required. Fine for legs, underarms! Sells like wild! **SAMPLES FOR AGENTS** Sample offer sent immediately to all who send name at once. A penny postal will do. **SEND NO MONEY**. Just your name. **KRISTEE CO.**, 684 Bar St., AKRON, OHIO

JET PROPULSION



GAS TURBINE Model Engine

★ ★ Be one of the first to build a real Turbo-Jet Model Engine. Single-stage centrifugal compressor and turbine. This is a real engine, easily made with ordinary home workshop equipment. Complete plans for construction . . . design formulas and curves for checking performance and testing.

\$2.00
Post paid

THE ROTOJET CO. Department 11
BOX 757 • LOS ANGELES 25 • CALIFORNIA



GOOD BAR BELLS

and EXERCISE Courses

Send for my free booklets with complete information and photos. Also forward to me, postpaid, the courses checked below.

- Fundamentals Of Exercise & Strength Building25c
- Body Conditioning And Midsection Course25c
- Advanced Abdominal Course Of Progressive Exercise25c
- Arm Developing Course (Weight Training)25c
- Shoulder Developing Course (Weight Training)25c
- All 5 courses only \$1.00. No stamps accepted.

GOOD BAR BELL CO., READING, PA.

LEARN TRIG QUICKLY—EASILY

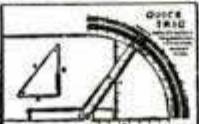

NEW QUICK TRIG SLIDE RULE, patent pending, solves trig, radio, electricity and carpentry problems FAST. Simply set the slides and read the answers for all three sides and angles of a triangle. Also gives degrees, sines, cosines and tangents of angles. Entirely automatic. No figuring on paper necessary. Easy instructions included. We will mail C.O.D. plus postage or enclose \$1.00, the full price, and we will mail postpaid. Send now for your QUICK TRIG, to **REED MFG. CO., 124-F W. 4th St., Los Angeles 13, Calif.**



RADIO TRAINER
Learn the theory and practical side of radio by building this simplified battery tube set. Experimental model teaches you to design larger radios, not just assemble them. Efficient, sensitive circuit brings in distant as well as local stations. Covers broadcast and short wave bands. Compact and portable. Can be used on camping trips and on farms without electricity. All parts furnished including Tube, Batteries, Double Earphones, Aerial and Ground Wire and Easy-to-follow illustrated instructions. No soldering required. Complete, postpaid, only \$9.95. Or send \$1.00—shipped C.O.D. for balance plus postage. Money-back guarantee. Order today!

B. G. FLEMING MFG. CO. Dept. 8-A, 906 Main St., Cincinnati 2, O.

Say You Saw It in
POPULAR MECHANICS

PLASTIC HOBBYCRAFT KIT

Kit contains 2 lbs. PLEXIGLAS and LUCITE sheets and strips, dye, cement, sandpaper, buffing compound and fabricating instructions. Send \$3.00 money order to Dept. S.

HOME CRAFTSMAN PLASTICS, 1945 W. Harrison St., Chicago 12, Ill.

TRI-STATE COLLEGE

B. S. Degree in 27 months in Engineering (all branches); Bus. Admin., Acc't and Sec. Science. 63rd year. School now filled to capacity. No applications can be accepted until further notice.

846 College Ave., Angola, Ind.

CRESCENT TOOLS
Give Wings to Work

ASK YOUR
**HARDWARE
DEALER**

ENSHRINE THEIR MEMORIES WITH

U. S. MONUMENTS **\$14. UP**

There is none better. Our free catalog is ready for you. Write today. A-18 U. S. Marble & Granite Co., Oneco, Fla.

NOW YOU CAN KNOW ABOUT



RADAR

Easily understood
**NON-TECHNICAL,
BUT AUTHENTIC**

The "mysteries" of Radar are revealed in this entertaining book written in non-technical language by John F. Rider, Lt. Colonel, Army Signal Corps (Ret.).

The author worked on Radar literature for the last three years of the war and in "Radar" explains in an easily understood and unique manner, the simple fundamentals and interesting applications of one of the most talked of scientific developments of the electronic age.

Learn About Radar in An Evening!

Anyone with a grammar school education will find "Radar" fun to read, will gain a conversational knowledge of a scientific subject that will be news for years.



Be the first in your group to get this book. Amaze your friends with your knowledge of this scientific development. You will be able to thrill them with authentic stories of how Radar helped win the war.

ORDER NOW
John F. Rider Publisher, Inc.
404 (p) Fourth Avenue
New York 16, N.Y.
Enclosed find \$1.00 for copy of your new book "Radar."

NAME

ADDRESS

CITY

"Jet" Propelled! SPEED BOAT



Actually sounds like a real speedboat!

No Springs!
No Gears!

\$1

Complete, Postpaid

Fuel Supply Included at no Extra Cost

Runs half an hour on a small piece of fuel. (Fuel included). Sounds like a real 2-cylinder speed boat. Easy to operate. Will delight both young and old. Order several. They make a wonderful gift.

All Metal!
No Moving Parts

MAIL ORDERS DIRECT TO
UTILITY STORES, 117 S. Wabash,
Depl. HH-22 CHICAGO 3, ILLINOIS

INVENTORS

The inventor who believes he has a new and useful invention, and finds himself in need of advice, should consult a competent registered patent attorney.

The question as to whether a subject matter is patentable can be substantially determined by a search of the United States Patent records.

Without obligation, write us for information as to what steps an inventor should take to secure a Patent.

RANDOLPH & BEAVERS

Registered Patent Attorneys

11-D Columbian Bldg., Washington 1, D. C.

RANDOLPH & BEAVERS

11-D Columbian Bldg., Washington 1, D. C.

Please send me full information on how to secure Patents & Trademarks.

Name.....

Street.....

City.....State.....

Here Is a Way YOU Can Get Ready for the BUILDING BOOM

Learn about Earning Opportunities in BUILDING CONTRACTING

FREE FACTS



Do you want to be on the inside in the building boom—where big money is made? Learn about opportunities for Building Contractors whether or not you have previous experience in this field. Millions of dollars are going to be made in home and farm buildings, in construction of stores, garages, small industrial buildings. The building industry uses men with organizing ability by thousands in construction, supervision, management, sales. Properly trained men needed in production, distribution, finance, installation, and marketing.

Use Our Training Plan to Learn at Home in Spare Time

Easy to Learn in Nationally Known School

Government estimates housing demand at 40 billion dollars! Others are preparing to get in now! Act immediately—get the facts!

HOME BUILDERS INSTITUTE, Dept. D-28
6312 No. Broadway — Chicago 40, Illinois

Fill Out, Cut Out, Mail Today

FACTS FREE for Men Who Want to Get Ahead

HOME BUILDERS TRAINING INSTITUTE, Dept. D-28
6312 No. Broadway—Chicago 40, Illinois

I am interested in the opportunities in the Building Industry. Please send me free information about getting a start as a building contractor.

Name.....

Address.....

City.....State.....

PATENTS AND TRADE MARKS

C. A. SNOW & CO.

Registered Patent Attorneys Since 1875
Write for Free Book and "Certification of Invention" form
427 SNOW BUILDING, WASHINGTON 1, D. C.

PATENT YOUR IDEAS

SEND FOR FREE BOOK HOW TO OBTAIN A PATENT

Written by Former Member Examining Corps (1922-24) U. S. Pat. Office.
CARL MILLER, Registered Patent Attorney
Former Member Examining Corps U. S. Patent Office
Woolworth Bldg., Dept. 86-A New York — Bond Bldg., Dept. 86-A Washington, D. C.

PATENTS

Free preliminary advice
E. E. VROOMAN, Patent Lawyer
Registered Patent Attorney Since 1902
871 Woodward Building, Washington 5, D. C.

AMAZING MYSTERY BUTTON

Startles Every body. With this Electronic Button you can make your own Telephone—Amplifier—Detectophone. Attach this button to piece of cardboard—transmit conversation to another room. Music also transmitted to distant places. Most interesting, electrical apparatus ever discovered. Enables you to perform hundreds of experiments. So tiny it can be concealed in dozens of places. A Pre-War Product. Electronic Button including 8000 word instruction booklet with 50 illustrated experiments postpaid only \$1.00.
Electronic Products Company, Saint Charles, Ill.

SAW YOU SAW IT IN POPULAR MECHANICS

AIR CONDITIONING and REFRIGERATION

New FREE BOOK

Be prepared to take your place in fast growing industries. Learn Refrigeration, Heating, Air Conditioning in our modern laboratories. Service course — 6 months; Technician — one year. Ideal for the man who wants his own business. Write NOW!

MILWAUKEE SCHOOL OF ENGINEERING "43rd Year"
P.M. 846A N. Broadway & E. State Milwaukee, Wis.

Become a Doctor of PSYCHOLOGY

Win the degree of Ps.D. Teach the secret of contentment, happiness. Solve mental worries. Experience the revelation of truth. Chartered college. Individual help. Write for FREE book. COLLEGE OF UNIVERSAL TRUTH, 5153-B North Clark St., Chicago.

YOU CAN MASTER MATHEMATICS

Key to the Electronic, Atomic age.
O - UNIVERSAL SCHOOL OF MATHEMATICS - O
623 Walter Story Bldg., Los Angeles, Calif.

Drawing Is Easy

—optical illusion makes any view or object you wish to draw appear right on the drawing paper in rich detail and full color. New, low-cost invention makes drawing simple tracing. Develops talent. Postcard brings details.
Dept. 21H, BEELER ENTERPRISES, No. Hollywood, Calif.

\$\$\$ if trained in arc welding

Big income jobs await you. Learn quickly and thoroughly. Enroll under G. I. Bill. Write today.
Hobart Trade School, Box M-563, Troy, O.

WATCHES WANTED Broken or Usable

—all kinds, even Ingersolls. Highest prices paid for jewelry, rings, spectacles, gold teeth, etc. Cash mailed promptly. Write for Free Shipping Container.
LOWE'S, Holland Bldg., Dept. PM, St. Louis 1, Mo.

FIBRE ARMS AND LEGS!

Light, correctly fitted, strong and comfortable. Natural appearance. Braces for all deformities. Scientific design. Fair Terms.
BUCHSTEIN-MEDCALF
223 S. 6th St., Minneapolis, Minn.

Floyd Clymers Popular MOTOR BOOKS

Send for FREE Motor Book Catalog

INDIANAPOLIS "500" RACE HISTORY BOOK

Just out! 1000 illustrations; 320 large pages; complete detailed data on every race held on Speedway since 1909. Foreign and U.S. cars and drivers shown. Enjoy for 10c a race year after year history. Complete book \$3.50; with De Luxe red Fabrikoil binding, \$5.00.



MOTOR RACING with MERCEDES-BENZ

Sensational book of Grand Prix Racing. 176 pages, includes 93 finest action photos. Famous speedways, cars described. See and read about Caracciola, Rosemeyer, Seaman, Ruesch, Mays, Nuvolari, Lang, others. Photos Mercedes-Benz, Auto-Union, Alfa-Romeo, Bugatti, Maserati, others. Graphic, thrilling race incidents. Postpaid, \$2.00; De Luxe clothbound \$3.00.

Ab Jenkins Race History Book, \$1.50 . . . Power & Speed, \$2.50 . . . Speed—How to Obtain It, \$1.50. All books postpaid. See our ad under Autos, Classified section. Pin check or M.O. to this ad—Mail Now to
CLYMER, Dept. A8, 2125 W. Pico, Los Angeles 6, Calif.

Get into Good Paying AUTO BODY and FENDER WORK



BIG DEMAND in Auto Body and Fender work. Start training now in your spare time at home for good pay work. Practical shop experience included. U.E.I. Training covers metal work, welding, painting, etc. Placement service—or we will show you how to start your own shop.

Behind U.E.I. TRAINING is a large national organization founded 1927.

Write today for Free Facts—No obligation

AUTO-CRAFTS DIVISION • UTILITIES ENGINEERING INSTITUTE
1314 BELDEN AVENUE, Dept. 186-X, CHICAGO 14, ILLINOIS

PHOTOGRAPHY

For Today's & Tomorrow's

BIGGEST OPPORTUNITIES

Nationwide opportunities, sound future career waiting for trained photographers. N.Y.I. graduates winning success from coast to coast. Success-proved home study courses. Also resident. Write today.
INSTITUTE OF PHOTOGRAPHY
10 West 33 St. New York 1, N. Y.

EASY TO LEARN CODE

Learn or increase speed with an Instructograph—the Code Teacher that takes the place of an operator-instructor and enables anyone to master code without further assistance. Available tapes from beginners alphabet to typical messages on all subjects. Speed range 5 to 40 WPM. Always ready—no QRM. Thousands have "acquired the code" with the Instructograph System. Write today for convenient rental and purchase plans.



INSTRUCTOGRAPH COMPANY
Dept. M, 4701 Sheridan Road, Chicago 40, Ill.

LEARN ACCOUNTING INCREASE YOUR EARNINGS
Streamlined Home Study Course Now Available—Prepared by Successful Accountant
WESTERN HOME STUDY INSTITUTE
P.O. Box 2506, San Francisco 26, Calif.

Learn BAKING At Home

Baking is one of America's high industries in wages. Nearly depression-proof. Thorough basic home course lays sound foundation. If you have aptitude, write for FREE BOOKLET, "Opportunities in Commercial Baking."
National Baking School, 1315 Mich. Ave., Dept. 135C, Chicago 5



MIKE Jr. NOW ONLY \$1.39
SING—TALK—AMUSE YOUR FRIENDS through your own radio set. Practice to become an announcer. Simple to install—Not a Toy.
SEND NO MONEY—WRITE TODAY
Just send your name and address and when your MIKE Jr. arrives, pay postman \$1.39 plus few cents postage. Sent postpaid if check or money order accompanies your order. No stamps.
MART DISTRIBUTORS, 1572 Sherman Ave., Evanston, Ill.

Invest 5 minutes a day in your future

Learn FOREMANSHIP Improve Your LEADERSHIP

With These Easy-to-read Booklets



Knowledge of human relations is the secret of success in supervision. Know how to direct workers—how to handle yourself, and others—for outstanding results. Get more cooperation and conscientious effort from those under your charge. The "Little Library of Good Foremanship" booklets—now in successful use by thousands of large plants and hundreds of thousands of men—give you the fundamentals of leadership, the very foundation of good foremanship. Easy to read and understand, they are not complicated text books. Pocket size, each dealing with one subject, each packed full of sound practical help. Five minutes a day with these booklets will give you a priceless knowledge of leadership principles with which you can be strikingly successful in your job—more confident of yourself—more valuable to your employer.

EXTRA Bonus Offer—With an order for \$3 or more we send you without charge a set of the six celebrated Personal Success booklets including the famous "Three Seeds of Success."

EXECUTIVES: Over 5000 top firms now using these booklets for better supervision—better handling of workers—better production. Order a full set and write for quantity prices.

USE THIS COUPON—ORDER NOW

4 for \$1—9 for \$2—14 for \$3—19 for \$4—24 for \$5
Send Check, Money Order or Cash. We prepay postage.

- | | |
|---|--|
| <ul style="list-style-type: none"> Teamwork Morale Job-Training The New Employee Use of Authority Planning Your Job Leadership The Foreman Makes Progress Getting Along With The Boss Persuasion Correction Methods How About Quality | <ul style="list-style-type: none"> What About Waste Safety Keeping Your Head Grievances Foreman & Good Housekeeping Care of Equipment System in Supervision The Good Manager Thoroughness in Supervision Salesmanship in Supervision Supervision and Cost Control Time & Supervision |
|---|--|

ACADEMY OF FOREMANSHIP TRAINING

35 East Wacker Drive, Dept. 18, Chicago 1, Ill.

Name _____
Address _____
City & State _____

SAY YOU SAW IT IN POPULAR MECHANICS

How to Start YOUR OWN BUSINESS

Amazing Postwar Development Now Gives You the Opportunity to Make Money Fast!
Startling scientific discovery, just now becoming available for general use, will enable you to start your own business and reap great profits! Plastics, one of the most revolutionizing and rapidly expanding industries, offers a great opportunity to all enterprising men and women. This is one of the few industries in which home manufacturers thrive and prosper. You can start even on a spare time basis in your own home, and expand rapidly into a full time business, paying good profits.
LIQUID MARBLE
Make LIQUID MARBLE the amazing Plastic, with a thousand uses. LIQUID MARBLE can be poured into FLEXIBLE MOLDS for casting all kinds of artistic and serviceable articles such as: ornaments, novelties, desk sets, paper weights, book-ends, souvenirs, statuary, toys, etc.
FLEXIBLE MOLDS
Make your own FLEXIBLE MOLDS. The cost is low—in fact, a large sized mold costs but a few cents. Hundreds of casts can be taken from a single mold.
NO EXPERIENCE NEEDED!
No skill or previous knowledge is necessary. All you do is follow our easy-to-understand instructions.
UNLIMITED MARKET
The market is literally unlimited. You will find steady year-round demand in your own community. Your problem will not be in selling but in supplying the huge pent-up demand. Moreover, we supply you with names of big buyers for your finished products.
WRITE TODAY
Bing Products will show you how to start with a small investment and build a permanent, independent, profitable business! Don't fail to grasp this opportunity! Write today for FREE CATALOG.

BING PRODUCTS Dept. A8, 88 Broad Street BOSTON 10, MASS.

Pay Is Good
in both these big Branches
of the Automobile Industry

Learn in a few weeks
in our big, modern
Training Shops

**AUTOMOTIVE
MECHANICS**

**BODY & FENDER
REBUILDING**

Now is the time to
prepare for your
place in a Giant In-
dustry

Automobile industry mak-
ing up for lost time! There may never
again be such opportunities for men who want better
jobs or business of their own to get in on ground floor
and go up fast!

Train on Actual Equipment

Chicago Motive Trades Institute makes rapid prog-
ress possible by Learn-By-Doing SUPERVISED SHOP
TRAINING. In motive trades our institute gained
nation wide fame training Auto Mechanics for U. S.
Army. Same quality training available to you now.
CONSULTATION AND PLACE-
MENT SERVICE WHETHER YOU
ARE INTERESTED IN WORTH-
WHILE JOB OR SETTING UP
YOUR OWN BUSINESS.



AUTOMOTIVE MECHANICS

Efficient auto mechanics get fine pay. Can service,
repair, install all mechanical and electrical parts of
autos. Learn to overhaul and repair engines, trans-
missions, differentials, and other assemblies. Good
pay, steady work, excellent opportunities for increased
earnings for properly trained auto mechanics.



BODY AND FENDER REBUILDING

Body and Fender Rebuilding
makes good profits in garages,
service stations. Get practical,
all-around Shop Training—
welding, aligning, mixing and

matching colors, spray painting, power and hand tools.
Values increased when used cars are made to "look
like new."

VETERANS — FREE INFORMATION

Write for free information telling how you can get
your training under "G.I. Bill."
A **NATIONALLY KNOWN AND
RECOGNIZED INSTITUTION**

CHICAGO MOTIVE TRADES INST.

Dept. B-28
Div. of Commercial Trades Inst.
1400 W. Greenleaf Ave., Chicago 26, Ill.

**FREE—Important Information
Telling How to Get Started**



Fill Out, Cut Out, Mail Today

FACTS FREE for Men Who Want to Get Ahead

CHICAGO MOTIVE TRADES INSTITUTE, Dept. B-28
1400 W. Greenleaf, Chicago 26, Ill.

Send free illustrated Brochures and other information about the
field I have checked below.

- Automotive Mechanics Body & Fender Rebuilding
 Check here if interested in G. I. Training

Name.....

Address.....

City..... State.....

NEW MIDGET ELECTRIC

ARC WELDER

RETAILS
ONLY
\$3.95

FULLY
GUARANTEED



**Plugs into Light
Socket—AC or DC**

It's new! It's handy! It's efficient! Use
the Midget Electric Arc Welder for hun-
dreds of light-metal jobs. Does compar-
able welding work with a 1/16 inch
welding rod on thin metal as that of
larger and higher priced welders. Oper-
ates on 15 ampere fuse, 110 volt, 60
cycle A.C. or D.C. current, by use
of our special standard-coated 1/16-
inch welding rods. Generous supply
of rods supplied with machine.
Recommended for all light welding
like automobile fenders, etc. Take
the Midget Arc anywhere to the
job. Sturdily built and fully guar-
anteed. Comes complete—ready to
use. Nothing else to buy. No pre-
vious welding experience needed to
strike an arc. In a short time, any-
one mechanically inclined can learn
to weld with this machine.

You'll find hundreds of money-saving, time-saving uses for
the Midget Arc around your home, garage, or workshop.
Also in garages, factories, repair shops, tin shops, mechan-
ics, farmers, inventors, etc. Order a Midget Electric Arc
Welder now! **SEND NO MONEY.** We'll rush one to you,
complete with rods and helmet (equipped with APPROVED welding
glass). Pay postman only \$3.95 plus postage charges. If not satis-
fied, return Midget Arc in 5 days from receipt and we'll refund your
money immediately. **RUSH YOUR ORDER NOW.**

MIDGET ARC WELDER CO., Strader Ave., Dept. L-202, Cincinnati 26, Ohio

**PRACTICAL
TECHNICAL
TRAINING FOR YOU**

Specialize in Electronics, Radio, Electricity, Refrigeration,
Heating and Air Conditioning, or Welding

Prepare in six or twelve months for position as Technician,
or in three years secure your **B.S. Degree in ELECTRICAL
ENGINEERING** with a Machinery or Electronics Major.

Write for booklet, "Career Building."

**MILWAUKEE
SCHOOL of ENGINEERING**
Institute of Electrotechnics

P. M. 846 North Broadway and E. State Milwaukee, Wis.

MERCHANDISE CATALOGUE

FREE Send name and address on penny post card and we'll
rush new bargain catalogue by return mail. Immediate
delivery on Electric Toasters, Heating Pads, Fountain
Pens, Cameras, Electric Hot Plates, Wool Sweaters,
Slacks, Chenille Robes, Jewelry and dozens of other scarce items.
No obligation! 1,000,000 satisfied customers. Rush post card today to
ILLINOIS MERCHANDISE MART, Dept. GG
510 N. Dearborn St. Chicago 10, Illinois

Be Your Own Boss — In Your Own Business

Start at home . . . small cap-
ital needed . . . prepare for
exciting plastics jobs or Your
Own Plastics Business. We
teach you Fabrication and
Casting right in your own
home. All materials furnish-
ed. Send ad with name and
address for information.
VETERANS: Eligible for resident
training under G. I. bill,
Check here

LEARN

PLASTICS

PLASTICS TECH

School of America, Inc.
5200 Euclid Avenue
Dept. M-8, Cleveland 3, Ohio

LENSES 500,000 OF THEM

Buy them for a fraction of their original cost.
U.S. ARMY & NAVY surplus lenses and prisms.
RIGHT ANGLE PRISM 23 m/m sq. face..... ea. \$ 1.25
5 POWER TANK TELESCOPE (M71) Brand New.
Coated Optics Completely Assembled, Value \$345.00 Perfect ea. 29.50
9 PERFECT LENSES to make 5X tank artillery scope. 10.00
Value \$140.00

**METAL PARTS TO MAKE A COMPLETE 5 POWER
TANK ARTILLERY SCOPE, Diagram included..... 7.50**

Send Money Order or Check—3 cent stamp for list
A. JAEGER, BOX 84 P, SO. OZONE PARK 20, N. Y.

**WORLD'S
BEST
WANT AD
MEDIUM**

CLASSIFIED Advertisements



Advertisements in this section 50 cents per word, each insertion, minimum 10 words, payable in advance
To be inserted under proper classification in September issue, copy should be in our office August 4th

September issue on sale September 1st

F. W. Johnson, Manager, Classified Advertising

Popular Mechanics Magazine, 200 East Ontario Street, Chicago 11, Illinois

YOU'LL PROFIT

By reading and answering the classified ads in this section. Hundreds of opportunities to make and save money.

Popular Mechanics Magazine,
200 East Ontario Street, Chicago, Illinois

Gentlemen: We have been using space in your classified section for a number of years and found the medium highly profitable. We have placed copy in other magazines with such poor results that we have come to complete agreement that the results obtained through your columns are by far the best. You may place our name upon your list of satisfied customers.

(Original letter on
file in our office)

Yours very truly,
PACIFIC PHOTO SERVICE

1251 CLASSIFIED ADVERTISEMENTS 1251 OPPORTUNITIES FOR YOU

AUTOMOBILES, MIDGET CARS

FOUR-WHEELED Motorized sidewalk automobile, simple complete plans, detailed material list, one dollar. Donald Kettleborough, Mendota, Illinois.

SCOOTER-CAR! A two passenger three wheeled, motorized runabout. More than a motorscooter. Simple construction from available second hand parts. Complete plans \$1.00. Universal, 2671 Algonquin, Toledo 6, Ohio.

SEE Our ad under motorcycles for midget racer bargains. Midget Motors Directory, Athens, Ohio.

OFFICIAL Photographs Indianapolis 500 mile classic, made by official photographers to Indianapolis Motor Speedway. All years, all cars, all drivers. Starts, finishes, pit scenes, track views, crashes. 8x10 glossy photos \$1 each—6 for \$5.65—30 for \$25. Tower Studios, Dept. C, 5454 East Washington, Indianapolis 1, Ind.

"STREAMLINE Your automobile"—beautiful, custom built, ten years newer by inexpensive, easy methods. Illustrated restyling manual \$1. Almqvist Engineering, 447-64th Street, Brooklyn 19.

SUPER Charge your automobile, by air-ramping. Free literature. Kokomo Enterprises, Box 270-M, Kokomo, Indiana.

500 MILE Indianapolis Automobile Racing History Book, just printed. Complete history detailed year by year results every Indianapolis race since 1909. 320 large pages, over 2000 illustrations, drawings, photographs describe foreign, American racing automobiles. Photographs world's famous drivers. View in your arm chair every mile of every event at 10c a race average cost. Complete book postpaid \$3.50. De luxe edition bound attractive red Du Pont Fabrikoid \$5.00. Limited number available—hurry! Clymer, Dept. A82, 2125 W. Pico, Los Angeles 6, Calif.

CUSTOMIZE Your automobile. Illustrated, new restyling ideas, instructions, suggestions, specific model changes by simple methods. Postpaid \$1. Speedwheel, Box 723-E, Arcadia, California.

INDIANAPOLIS, Motor Speedway winners parade. 26 official pictures, each 4 1/2 x 6 1/2 inches, only \$1. Famous cars and drivers, crashes, track scenes, 1946 winner included. Tower Studios, Dept. C, 5454 East Washington, Indianapolis 1, Ind.

BUILD Speedy Midget track racer from castoff parts! Plans, specifications, construction information, \$1.00. Motor Supply, Box 1682-CS, Toledo, Ohio.

MUFFLER Manual. Convert easily to Hollywood, Laguna, Westwood, duals, etc. Includes construction details, regulations, diagrams. Postpaid \$1. Mellotone, Box 723E, Arcadia, California.

FREE 1946 List photos, racing cars, drivers. Photographer, Midland Park, N. J.

MIDGET Racing car blueprint, 3 view professional layout, \$1.50. Sawin, Box 31, Seekonk, Mass.

DUALTONE Twin muffler sets for Fords and Mercurys. Instructions included \$20. Replacement mufflers, all automobiles. Prices quoted on request. Designed to eliminate back pressure, giving increased gas mileage and horsepower. Has deep mellow tones. Three inch chrome tailpipe extension \$3.00. Dualtone Mufflers, 2636C India Street, San Diego (1), Calif.

PROFESSIONAL Midget racer, motor-scooter, midget roadster, and midget motorcycle. Plans, specifications for all four contained in illustrated handbook, 25c. Big list bargain priced used motors, motorscooters, servicycles, etc., included free! Midwest, 3839 Drummond, Toledo, Ohio.

RACING Car fuel concentrate supercharges gasoline for all cars. More power, speed. \$1.00 pint. Free speed equipment literature. Lee Motorcraft, 1412-A Great Northern Bldg., Chicago 4, Illinois.

R & R Mfg. Co., marine and auto division, Anderson, Indiana, Robert M. Roof, \$1.00 for our new 1946 speed and power equipment catalogue with price sheet—showing racing cars, midgets, speed boats with recommendations how to rebuild your motors for racing. Dual ignition racing cylinder heads for V-60-100 and Mercury Ford engines. Dual intake manifolds, racing pistons, camshafts, compound valve springs, Lynite flywheels, quick change gear boxes and numerous other supplies.

AUTOMOBILE Racing book, fifth edition, well illustrated. Instructions on building bodies, frames, engines. Ford A and B conversions. Plans, AAA rules, specifications. Roadster racing. Indianapolis cars. \$1.00 postpaid, \$1.30 C.O.D. Ray Kuns, Dept. 47, Madisonville, Cincinnati 27, Ohio.

AUTO SUPPLIES AND EQUIPMENT

OLSON Motor breather. Reduces back pressure in crankcase and back main leaks. Keeps engine fumes out of the car. Reduces crankcase dilution. Improves power, mileage, idling, winter starting, upper engine lubrication and crankcase ventilation. Garages and mechanics wanted for distributors. Big profits! Free particulars! Olson Motor Breather Co., 3609 Motor Ave., Los Angeles 34, Calif.

McCULLOCH-FORD V8 supercharger wanted. 1940 or later model complete. P.O. Box 432, Quincy 69, Mass.

HYDRAULIC Brakes on Model A. Instructions \$1.00. G. Stade, 332 Davida, Victoria, B.C., Canada.

1946 **SUPER** Ignitioniter \$5.50. Fast starting, pep, mileage. EG Mfg. 355A East 149, New York 55.

AGENTS Wanted—Windshield cleaner. Saves 3 to 5 minutes cleaning any windshield. Removes bugs like magic. Send \$1.00 for five samples. Make 150% profit. American Model Engineers, Ft. Worth 5, Tex.

SAVE 1/3 Gas. Eliminate carbon. \$1. T. Brandner, 280 Station Road, Mineola, N. Y.

SALESMEN—Distributors with following among auto accessory stores, garages, filling stations. Ernie Airline Tire Inflator; eliminates flat tire worries. Send \$1.00 (refundable) for sample and free details—many other items. Kramer Industries, P.M. Box 3505, Cleveland 18, Ohio.

CONVERTIBLE Tops need not look shabby. Refinish with Converta-Top. Applied with brush, not a paint, waterproof, will not crack. Quart refinishes any top. Black, red, clear. Send \$2.65. Shipped prepaid. Eagle Chemical Coatings, Box 114, South Euclid, Ohio.

1000 MOTORISTS Needed to make gas saving test. Up to 30% savings. For trial test offer write Vacu-matic Carburetor Co., 7617-1285 W. State Street, Wauwatosa, Wis.

MCDOWELL Gasoline saving vacuum supercharger greatest invention in years, more speed, power, saves gasoline motors waste, self addressed stamped envelope for pamphlet, expect surprise. \$7.50 only until granted raise. McDowell Company, 2000 NE. Union, Portland 12, Oregon.

AIR Compressor outfits, complete with quart size spray guns, less motors. Use your own 1/2-horse power motor. Limited quantity. Write for details. Box 172, North End Station, Detroit 2, Michigan.

GASOLINE Saving device. Chevrolet, Ford 1932-1942, Dodge, Plymouth, 1933-1938. Walert Company, 3429 North 10th Street, Milwaukee 6, Wisconsin.

HAVING Car trouble? New, used, guaranteed auto, truck parts save money. Transmission specialists. Describe needs; immediate reply. Victory, 2930 1/2 North-western, Chicago 18.

AUTO Parts for all autos and trucks. Trans, motors, differentials, fenders, carburetors. Also body parts. Security Auto and Truck Parts, 1941 BJ Eddy, Chicago 13.

GRILES For all cars. Meyers Auto Parts, 820 Dryades, New Orleans, La.

OIL Pumping motors—Brought back to normal without ring job. Write for particulars. Joe Mullner, Box 3102, St. Paul 1, Minn.

PLATING Outfits for auto parts. Connect to a battery. No tanks used. Free particulars and proofs. Gunmetal Co., Ave. J. Decatur, Ill.

AUTO TRAILERS

AUTO-TRAILER Travel, monthly magazine, \$1 year. Kimbel, Plant City, Fla.

TRAILER Owners: Save tires by installing Laidlaw Save-A-Tires. Warning light on dash indicates soft tire. \$7.50 per set of two. P.O.B. Pasadena. Deliveries C.O.D. Shipping weight three pounds. Laidlaw Mfg. Co., Box 1108, Pasadena 20, Calif.

STREAMLINED Trailers. Has everything. Large manual full of drawings, instructions, etc. \$1.00. Illustrated circulars, dime. Craftsmann Books, Box 1153-P3, Milwaukee 1, Wis.

BUILD Your own trailer! Save money! Have every feature you want! Plans for house, sport, camp and utility trailers. Catalog describing 9 models 10c. 15c in Canada and overseas. Jim Dandy, Box 125-A, Wausau, Wisconsin.

MOTORCYCLES, BICYCLES, MOTOR-SCOOTERS AND SUPPLIES

MOTORSCOOTER \$10, motor \$3, tires \$2! Send 25c for big new catalog Number 934, just printed, listing scores of other sensational bargains in motors, wheels, motorscooters, motorbikes, servicycles, tires, etc. Associated, Box CS-1764, Toledo, Ohio.

FACTORY Built midget car \$65; Johnson motorbike \$45; Servicycle \$75; 3-wheel Cushman motorscooter \$65; homemade motorscooters \$15 up, complete; motors \$8 up. More than 4700 tires for motorscooters and midget cars \$1.50 up. Mailorder only. Send 25c for catalogue number 14 listing these and hundreds of other bargains in motorcycles, outboard motors, motorscooters, midget racers, parts, plans, etc., (35c by first class mail.) Midget Motors Directory, Athens, Ohio.

BICYCLES And accessories. Wholesale and retail. Send dime for price list. Century Cycle Company, 3447 Lawrence, Chicago 25, Illinois.

FLASH Light size rechargeable batteries, guaranteed—Write Kimley, 103 Highland, Williamsville 21, N. Y.

HARLEY-DAVIDSON New and used 45" motors, service, parts, accessories. Send \$2.25 for army motorcycle manual, 10c for bulletins. Knuth's (Harley-Davidson factory dealer), 2491 Fondulac, Milwaukee, Wis.

AMERICAN - Bicyclist - Motorcyclist, monthly magazine, \$2.00 year. Kimbel, Plant City, Fla.

MOTORCYCLE Cams ground for speed and power, carburetion. For information write Harold Schaller, 247 West Main, Turlock, Calif.

MOTORCYCLE Parts, new and used. List 10c. Ballak, 811 N. 9th, St. Louis 1, Mo.

GET Your copy of the new Ranger bicycle lubrication chart. A genuine check-chart which shows you how to service your bicycle. Only 10c. Mead Cycle Co., 4520 W. Madison Street, Chicago 24, Illinois.

BICYCLE Tools, 6 pieces, 3 assorted size open end wrenches, slip joint plier, 2 sizes screw drivers. Waterproof leatherette case. Only \$1.49 a real buy. Order today. Money back if not satisfied. LeNard Industries, 179-A W. Washington, Chicago.

WRITE For free literature about new five passenger (half ton), three wheel motorcycle made of Ford parts. Easy built, thrilling, handy. Build first in your locality. Show your genius. Nothing like it on earth. Instructions \$1.00 Motorcycle Wizard, 73 South Shirley, Pontiac 20, Mich.

GENUINE Moto-Scout parts. Amsco centrifugal clutch. Windshields, sidescars. All other parts and accessories. Write for parts list. Also genuine engine parts for Briggs and Stratton, Lauson. American Moto-Scout Co., 1313-23 Carroll Ave., Chicago 7, Ill.

MOTORBIKE Manual containing motorbike and scooter plans and motor tune-up information, \$1.00. Veco, P.O. Box 124, Evansville, Ind.

MIDGET Car \$18. Briggs motor \$5, tires \$1.00! Send 25c for new bargain catalog packed with money saving buys in motorscooters, motorbikes, midget cars, motors, wheels, tires and parts. Gail and Company, Nicholas Building, Toledo, Ohio.

WHEELS! Complete with rubber tires for wagons, scooters, trailers, wheelbarrows, mowers, 6 1/2" to 16". Free list. Trulsen Mfg. Co., 811 E. 31, Kansas City, Mo.

BICYCLE Book, how to buy, rebuild, sell used bicycles 50c. John Collett, Handley, Texas.

TIRES, Inner tubes, wheels, for small trucks, wheelbarrows, midget cars, power scooters, farm equipment, carts, etc. Sizes 8" to 18" o.d. in 2, 4, and 6 ply first-line quality tires, with removable inner tubes and heavy duty demountable wheels. Also caster forks, straight or swivel types. Free circular and prices. Experienced tire engineers to advise on your special equipment problems. Jahant Co., 626 East Exchange Street, Akron 6, Ohio.

TIRES And industrial wheels, suitable for scooters, wheelbarrows, farm equipment, etc. All sizes. Bicycles and accessories. Largest assortment in America. Send dime for list. Cycle Transport Company, 1241 So. Michigan Ave., Chicago 5, Illinois.

BUILD America's lowest priced motor-scooter speedster! Complete plans, specifications, \$1.00. Big list bargain priced used motors, etc., included free! Motor Supply, Box 1682-CS, Toledo, Ohio.

LARGE Stock Indian parts. Expert motor rebuilding. Indian Motorcycle Sales, Kansas City 1, Mo.

BOYS, Illustrated "Bicycle Repair Manual" teaches brake repairing, re-spoking wheels, etc. Dealers wanted, 65c. Robt. Klausner, Shelbyville, Ill.

AVIATION

PROPELLERS—Correct size for any motor. Exclusive 3 blade for sleds, boats. Shorter diameter, lower position, better thrust. Aircool motor diagrams 50c. Illustrated literature. Standard Aircraft, Ft. Worth.

WAR Surplus navy dirigible balloons. Ridiculous low price. Information. Details free. Rush name. Maupin, Tipp City 20, Ohio.

NEW Aviation wide-vision rocket goggles. Rubber mask, curved lens. Green, blue, clear. Only \$9.95 for this \$15 seller. Send for circular on other goggles, helmets. Knuth's, 2491 Fondulac, Milwaukee, Wis.

DUAL Carburetors. More speed, power. Simple, inexpensive. Blueprints \$1.00. Corcraft, 80 Maxwell, Rochester, N. Y.

VETERANS: Flight training under G.I. bill. Private, commercial, and flight instructor ratings. Write for information. Gottschalk School of Aeronautics, Adrian, Michigan.

AERONAUTICAL Maps, ideal hunters, fishermen. Your vicinity, six maps, \$1.00. No C.O.D. Flyer's boots, genuine leather-rubber, zipper, \$4.95. Goggles, \$4.95. Leather helmets, \$4.95. Aero Parts Supply, Municipal Airport, Houston, Texas.

JET Engine experiments. Impulse jet type included. Make experimental model in two hours. Circular on plans. Rush name. Maupin, Tipp City 53, Ohio.

140 M.P.H. On 40 h.p. Build, fly the Meteor. Blueprints \$2.00. Corcraft, 80 Maxwell, Rochester, N. Y.

PROPELLERS For ice-snow sleds, air boats, literature 5c. Banks Propellers, R.P.D. 7, Ft. Worth, Texas.

CUBS, Wacos, Taylorcrafts, Aerocars—\$125 and up! Big catalog, 25c, lists these and thousands of other sensational airplane bargains. Some are "easy to repair" crack-ups. National, Box 1682-CS, Toledo, Ohio.

FLYING Flea, plans \$1.00. Lightplane manual \$1.00. Illustrated circulars 20c. Craftsmann Books, Box 1153-P1, Milwaukee 1, Wis.

BATTERIES, GENERATORS, ETC.

EDISON Batteries. Light, Power. Fifteen year life. Unconditionally guaranteed. Complete lighting plants. Free literature. See-Jay Company, 321 Yonkers Avenue, Yonkers, New York.

ELECTRICAL SUPPLIES, EQUIPMENT

PRACTICAL Winding of a.c. motors. A course of instruction on winding, connecting, and testing single, two, and three phase motors. Clearly written in everyday non-technical language. Illustrated throughout. This book is recommended for beginners interested in learning motor re-winding and repair. Satisfaction guaranteed or remittance refunded. \$2.00 prepaid. Educational Advancement Co., Dept. Y, Lakewood, New York.

10,000 ALNICO Magnets available. Literature free. Eyrich, Box 849, Milwaukee 1.

BROKEN—Burned out electrical heating elements quickly repaired. Use new amazing Nichrome paste, simply overlap ends and turn on current. Family size \$1.00 bill. Satisfaction guaranteed. Armstrong Mfg., Box 861-X, Minneapolis, Minn.

BUILD Lamps. Shade holders (harps) 7" to 9", \$2.50 doz. 2" brass tips (finials) \$1.50 doz. postpaid. Lampcraft, 602 North St., Jackson, Miss.

RECORD Players, Hamilton electric. Own volume control, switch, metal case, removable top. \$33.77 postpaid. Gerridon Specialty Co., Box 125, Romoland, Calif.

TELEPHONES—New and rebuilt. Tell us your needs. The Telephone Shop, 542 So. Dearborn, Chicago 5, Ill.

NE-O-LITE Tester—locates instantly all defects in electrical appliances—motors—spark plugs—fuses. Discovers broken circuits "quick as a flash." Two of these amazing trouble shooters for only \$1.00, prepaid. Have one at home. Carry the other in your car. Sold on money-back guarantee. Neolite Manufacturing Company, Rockford, Illinois.

ELECTRIC Fans? Make your own. 16 in. correctly balanced aluminum fan blade. 1/2 in. bore, ideal on any size motor 1/6-1/3 h.p., \$3.50. 18 in. all welded guard adjusted to fit 4 stops on motor, \$3.00. Adjustable floor standard, 4-8 ft. height, rigid, sturdy, \$9.00. Table standard, universal, fits any motor base, \$3.75. Ted Riseman, 1461 No. 3rd St., Springfield, Ill.

NOW—Repair your own electrical appliances with Chanite Self-welding Electrical Heating Element Flux. Instructions delivered, price \$1.00. Stick form 25c ea., \$2.00 doz. Chanite Sales Company, 914 South Main, Fort Worth, Texas.

ELECTRIC Pencil: Writes-engraves all metals \$1.00 postpaid. Beyer Mfg., 4515-H Cottage Grove, Chicago 15.

WELDING, SOLDERING, PLATING

NEW Model electric welder 110 volt a.c.-d.c. will weld all metals; easy to use; full directions. Complete with power unit, flame and metallic arc attachments, carbons, fluxes, rods, mask; all for \$19.95. Used by the navy. Magic Welder Mfg. Co., 239-MP8 Canal St., New York City.

ACETYLENE Welding outfits like new; 80 amp. welder, 110 volt, \$46.00; welders book \$1.65. Eagle Welding, Dept. PM, 5085 Broadway, Chicago 40, Ill.

ARC Welders wanted by the thousands. Learn with 516 page lessons manual. Over 500 how-to-do-it photos. \$2.00 copy. Money-back guarantee. Hobartweld, Box M-864, Troy, Ohio.

"THUNDERBOLT"—Transformer welder, dial-control, 3 heat stages, 60 amps., 110 volts—ac. up to 3/32 rod, carrying case, accessories, instructions, \$39.50. Also "Super-Welder," 110 volts, ac-dc \$19.95. Save 20%, send check. Or order c.o.d. West of Mississippi \$5.00 deposit on Super-Welder, \$10.00 on Thunderbolt. Super-Welder Mfg. Co., Dept. PMC, 23 E. 20th St., New York 3, N. Y.

USED A.C. Welders, \$15.00 up. Frazee, Box 179, Santa Rosa, Calif.

"BUILD Your Own Arcwelder." Inquiries welcome. Welders Club, AB-3432, Chicago 54.

WELDING, Cutting, aircraft welding and soldering equipment. Electric arc welders. Superior Oxy-Acetylene Co., Hamilton, Ohio.

MACHINERY, TOOLS AND SUPPLIES

SPEED-LEVER—A hand lever for the tailstock of your bench lathe. Speeds up drilling, reaming, etc. Also use with tailstock turret. Has built in micrometer dial for precision work. Can be installed in one minute. All working parts hardened. A high quality tool. For Atlas, Craftsman, South Bend and Logan bench lathes. Specify make when ordering. Postpaid \$24.50. Earl Engineering Co., Box 52, Fresno, California.

MACHINE Screws, tools, brazing materials, plastics, bearings, electric drills, flexible shafts, etc. Catalogue 10c. Metall-plas Supply Co., 1420 S. 16th, Maywood, Ill.

WAR Surplus without bidding, new products, stock articles. How to buy, prices, addresses. Advance information. Catalog sheets, each week. Details free. Rush name. Maupin, Tipp City 36, Ohio.

CEMENT Mixers available. Also concrete block making forms. Low priced. Blue Square Enterprises, Excelsior, Minn.

KNIVES—Electricians with locking wire scraper, screwdriver, and 3" utility blade. Outdoor with leather sheath, stag handle and 5" blade. Each \$2.00 postpaid. Rondack Supply, Box 438, Glens Falls, New York.

BENCH Saws \$18.25, drill presses \$9.00, hack saws \$18.00, band saw blades 70c. Motor arbors 65c. Motor mounts \$2.00. Sunshine, Berkshire Heights, Penna.

LIMITED Quantity of machinist indicators. Free literature. Kokomo Enterprises, Box 270-M, Kokomo, Indiana.

TANKS, Stainless steel—9 gallon capacity. Internal pressure: 400 pounds. Diameter: 12". Length 24". Tapped both ends for 1/4" pipe connections. Prime coated ready for painting. Can easily be made into buoys, floats, pure water containers for boat, car, truck or camp. Ideal as a receiver for small air compressor unit. Also used to store air for emergency tire inflation. Complete "How to Make It" instructions with every order. Remember, this tank is pure stainless steel! Supply is limited. Order today! \$7.99 f.o.b. Ireland & Vice, 48 Chedell Place, Auburn, N. Y.

LOOK, Nearly new 1 1/2" wire scratch wheels, 1/4" hole, \$1.50 per doz., postpaid. Dunlap, 219 S. 17th, Philadelphia 3, Pa.

EQUIP Your home workshop quickly, efficiently, economically by building your own mill, shaper, drillpress, vise, jointer or other metal and woodworking tools. Lewis castings and materials are ready to finish, detailed blueprints show how. Send 10c to cover cost of mailing new catalog describing 23 items. Lewis Machine Tool Co., P.O. Box 116, Station A, Dept. M-67, Los Angeles 31, California.

MOTORIZED And modernize that old lathe. End aggravation and power losses due to inefficient installations. Guaranteed plans \$2.00. Southwestern, Box 1399, El Paso, Texas.

LOCKNUTS Don't come loose. Replacements, repairs on farm, household machinery, autos, toys, hobbyists. Assortment twenty locknuts 3/16 to 3/8 inch, coarse thread, \$1.00. Locknut Sales and Engineering Co., Box 209, Bronxville, N.Y.

EXPERIMENTERS—48-Pitch spur gears, pinions, worms, mixer sets, shaft assemblies, etc. 50 piece assortment, \$4.75; 100 pieces, \$8.50; postpaid. Scientific Construction Company, Box 438, Hackensack, New Jersey.

HIGH Speed drills, mills, reamers, rotary files. 122 Brunswick Blvd., Buffalo 8, N. Y.

DRILL Grinder for twist drills \$2.95, and other craftsman's tools. See ad on page 247.

DRILL Grinder—Grinds drills to factory accuracy. Calipers with direct reading scales. Circle cutters. New tool grinder. Lowest prices. Free literature. Factory; 811-B East 31st, Kansas City 3, Mo.

JOINTER Head for wood shaper. 2" wide, 2" cutting circle. Replaceable hardened tool steel blades. Precision ground. Immediate delivery, \$4.75 postpaid. State arbor diameter. Hurley, 14 Lone Oak, Bethesda 14, Md.

SHARPEN Dull pipe wrenches with new patent grinder. No competition. One operator made \$321 in one week. J. C. Moore Industries, Box 234 Fredonia, Penna.

SURFACE Plate 8"x14"x2 1/4" high, 20 ribs, wood handles included. Unfinished \$4.50, machine finished \$9.50, 25 lbs. Angle plate 4"x3"x3" ribbed, unfinished, 75c, machine finished \$2.00, 3 lbs. (Castings normalized.) Model Tool Service, Rock Falls, Ill.

TOOLS. Hardware, drills, taps, dies, pulleys, saw mandrels, jeweler saws, steel, brass, drill rod. Catalog 10c. Terek, 6304 Patterson, Chicago 34.

INDEX Heads for sale. Very inexpensive. Sixty-two different divisions. Used on small lathes, drill press, milling machines, etc. Make gears, hobbis, cutters, etc. Very accurate, and durable. Not a toy. Used by defense schools and hobbyists. Write for free folder. Long's Index Heads, 2117 East B St., Torrington, Wyo.

BOATS, OUTBOARD MOTORS, ETC.

TRAILER Coaches, boats, luggage and boat trailers and motors. All supplies, parts for trailers and boats. Contact Seilhorn's, Sarasota, Florida, or East Lansing, Michigan. We ship or deliver anywhere.

A HOUSEBOAT Is easy to build and you beat the rent problem. Complete all-season accommodations for six. Write for full free information. P.O. Box 575, Denton, Texas.

ALL Copper water-jacketed exhaust manifolds for marine conversions of automobile and aviation engines and marine engine replacements; any make, model or age. Joseph Van Blerck & Son, 392 Woodcleft Avenue, Freeport, N. Y.

10' OR 15' Folding Kayak plans \$1.00. Foldcraft, 4015-F Oketo, Chicago 34.

REBUILT Tachometers 0-5000 and 0-8000 r.p.m. 4 3/8" diameter face, \$8.00 each, specify rotation. Zakarian Engineering, Box 416, East San Diego, Calif.

RUBBER Boats. Get one of those marvelous inflatable light weight boats. Lots of fun at beach or lake. Large size, useful as dinghy or for gunning and fishing. One man capacity playboat, \$23.00 postpaid. Four-five man, sturdy boat, complete with pump, oars and bag, \$49.00. Shipping wt. 50 lbs. 50 h.p. new Evinrude outboard motors, \$410 f.o.b. Famous Mae West inflatable life preserver, \$2.00 postpaid. Other bargains. M & E Marine Supply Co., P.O. Box 601, Camden, N. J.

USED Boat buyers authoritative booklet by experienced boat repairman tells where to look for hidden dry rot, poor hull design and construction. \$1.00. Howard Barnes, 725 West Jackson St., Painesville, Ohio.

KAYAK—Easily built. Instructions, \$1. Gee, 1211 Frisco, Far Rockaway, N. Y.

USED Outboard motor parts. Outboard Exchange, 1194 Remsen Ave., Brooklyn, 12, N. Y.

FORD-Mercury-Zephyr marine conversions. Catalog 10c. Lehman Manufacturing Company, Dept. D, Newark 2, N. J.

BOAT Designers are highly paid professionals. Complete course by mail. Catalog. Westlawn, Montville, N. J.

NINE Plywood boat plans 50c. Catalog boat building plans 10c. The Rudder, 15 Murray Street, New York.

PULL Size, cut to shape boat patterns, blueprints. 7 1/2 - 38 feet. Illustrated "Build a Boat" catalog, 10c (coin). "How to Build Boats" book, \$1.00. Cleveland Boat Blueprints Co., Dept. A-66, Cleveland, Ohio.

USED Marine motors, propellers, marine fittings, conversion manifolds. Stokes Marine Supply, Coldwater, Michigan.

MARINE Power—Easily convert any Ford and Jeep motor (domestic and foreign) with Osco parts and kits. Complete catalogue 25c (coin). Osco Motors Corp., 2020 East Orleans Street, Dept. M, Philadelphia 34, Penna.

ENGINES, MOTORS, DYNAMOS

600 NEW Motor diagrams, tables, and controller connections for the practical electrician. Makes dual-voltage, multi-speed, star and Delta circuits clear and simple. Also includes all standard split-phase, repulsion induction, compensated series, two and three phase. Data for re-winding and reconnecting all types. Over 100 valuable tables. Money-back guarantee. Price \$2.75 prepaid. Educational Advancement Company, Dept. L, Lakewood, New York.

WIZZ Electric motor: Assembles in a jiffy. Flashlight cell operates. All parts, plus illustrated instructions 30c postpaid. Also smaller "Mighty Midget" 1" model, third size 25c. Eltro Company, 171E, Deer Park, New York.

150 AMPERE Generator for welding \$47.50. Extra flexible cable, 8 ft. lengths \$2.75. Other bargains. Butler Electric Company, 1885 Milwaukee, Chicago 47.

BIG Pay jobs in welding. Complete welding lessons and reference books, 516 pages, 41 lessons, \$2.00 copy. Money-back guarantee. Hobartweld, Box 865-M, Troy, Ohio.

MOTORS—For water, air, steam pressures. 250 lbs. or less. Built in 1/16 h.p. up to 5 h.p. Specials built to order. Stock motors 1/8 h.p. \$5.50; 1/4 h.p. \$7.50; 1/2 h.p. \$12.50 cash prepaid. Inventions developed ready for production. Duplex Motors, Burlington, Iowa.

FLEETWIND Gasoline engines for model airplanes, race cars, etc. Precision built, more power, faster starting. Bore 15/16 (.937) Stroke 7/8 (.875). R.P.M. 7,200 to 10,700. \$25.37 postpaid. Gerridon Specialty Co., Box 125, Romoland, Calif.

NEW Kohler electric plants a.c. and d.c. Other electric plants rebuilt. Write E. F. Schmaltz, 314 Wyoming Ave., Kingston, Penna.

WINDING Data, listing 225 motors, single and three phase, \$1.00. Motor Data Co., Box 7631, Kansas City 3, Mo.

ATHLETIC EQUIPMENT, BODY BUILDING COURSES

STRONGMAN Course \$1.00. (Guaranteed). Sid's System, PMM, Southgate, California.

EUREKA: Develop your arms, hands, fingers with this newest sensational pocket size exerciser for old, young, athletes, non-athletes. Strengthens muscles, stimulates circulation. Recommended by doctors. Eureka gripper, made of Neoprene, now available; lasts 7 ears. Sold on 10-day money-back guarantee. Postpaid only \$1.00. Eureka Gripper, 707 S. Broadway, Los Angeles, Calif.

EXPERT Instruction—Judo, boxing, wrestling, swimming, dancing. (Illustrated courses.) \$1.00 each. Variety House, Box 46-BH, Wall Station, New York City 5.

LEARN Scientific jitsu defense technique. Powerful. Book 200 photographs—\$1.00. Kogan, 1032-PB, New York 8.

BARBELLS, Exercise equipment. Courses. Special offers! Free booklet. Good Barbell Co., Reading, Penna.

SPORTING GOODS, GUNS, FISHING TACKLE, TRAPPING, ARCHERY

BOWS, Arrows for recreation, hunting, fishing. Beautiful Archery Instruction Book. 70 pages, 50 illustrations, only 50c. Illustrated catalogue 10c. Archery Sales Service, 617 So. State, Chicago.

FISHING Poles: Dealers only. Sample jointed native cane. Prepaid \$2.50. Bob Pace, Combs, Ark.

FISH Bite like hungry wolves. Amazing bait. Make it yourself for almost nothing. Guaranteed formula \$1.00. Baer, 1450 Elmdale, Chicago.

FLYER'S Boots, genuine leather-rubber, zippers, \$4.95. Aero Parts Supply, Municipal Airport, Houston, Texas.

FISHING Poles, fresh and salt water, simple construction. Complete plans and photograph, \$1.00. Charles Sullivan, 54 Alexander Ave., Yonkers 4, N. Y.

100% WEEDLESS Automatic lure. None other like it. Sold only direct, \$2.00 prepaid, taxes included. Write for free circular. Babcock Reel & Tool Mfg. & Sales Co., Oak Harbor, Ohio.

SHOOTERS—Gun bargains exclusively. Details free. Shotgun News, Columbus, Nebraska.

LUMINOUS Sure-Bait Fishing Kit—Ever-Glow. Makes any plug, lure, hook or spoon "Glow" in both fresh and salt waters. Attracts any specie of fish. Complete kit contains—1, adhesion primer; 2, Ever-Glow luminescent 3, waterproofing varnish; 4, safety solvent; 5, brush and spatulas. \$3 includes mailing and handling. O.P.A. approved. R-D Lab., Belmar, N. J., Box 226.

CHUM (Unattached bait) attracts food and game fish—from 6 or 7 miles—to your hooks. Fresh or salt water. Cheap! Easy! Make 6 Rigs. Learn 8 secrets. Use 10 methods. Know 55 best chums. Send \$1.00 for a U. S. Chumming Guide. Fish Research, 5912D Thompson, Philadelphia 31, Penna.

THE Tent-house solves housing and vacation problems. Sleeps eight. Radical features. Tested six years. Plans \$2.00. Box 293, Jamaica, N. Y.

USED Guns, bought, sold, exchanged. List stamp. Howe Fur Company, Coopers Mills, Maine.

3000 BARGAINS, Firearms, binoculars, war relics, catalog 30c. Smith Firearms, Runnemede, New Jersey.

"AMMUNITION"—New and used "shotguns," "rifles," "handarms." List 10c. Rudolph's, Atchison, Kansas.

SEND 10c For list 100 used guns. Frayseth's, Willmar, Minnesota.

FIELD GLASSES, MICROSCOPES, TELESCOPES, MAGNIFIERS

TELESCOPES, 15" Polished lens, \$1.00; 17 power—4 1/2", 3 lenses \$2.50. Compass, wrist-type, luminous, withstands heat, cold, \$2.50. All postpaid. Guaranteed. Gruenewald, 3837 Coolidge Ave., Oakland, California.

IT'S New. All aluminum microscope. Two properly focused lenses, 50 power. Complete \$1.98. Money refunded. (Factory representative.) Fred Roesch, 502-P First St., Hoboken, N. J.

ULTRA Powerful astronomical telescope easily made. Clear vision. Perfect lenses give 100, 200 and 400 diameters magnification. Complete set finished lenses and instructions \$6.00 postpaid. Unconditional 30 day money back guarantee. Carl Jamer, Manorville, N. Y.

REAL 17 Power telescopes with simulated leather covers \$2.90, \$1 deposit, balance c.o.d. United, 2309-P Lawrence, Toledo, Ohio.

60 POWER Telescope, \$2.95. 250 power microscope, \$2.45. Also bargains in binoculars and surplus lenses. Send for free catalog. Brownscope Company, 24 West 45th Street, New York.

REFLECTING Telescopes, complete. 3 1/2" diameter, equatorially mounted. View planets, stars, \$19.75. Write Sky-scope Company, 475-P 5th Ave., New York.

TELESCOPES 18 Inch 2-section 8-power precision ground polished lenses. Individually packed \$1.50. 36 inch 3-section 17 power precision ground polished lenses, including carrying case \$2.50 postpaid. Criterion Co., Dept. PM, 327 Trumbull St., Hartford, Conn.

BUILD Your own reflecting telescope. Copy of instructions 10 cents. Catalogue free. Mayfloor, Katonah, N. Y.

BINOCULARS. Telescopes, watches. Buy, sell, trade. Paul Schweer, Donnellson, Iowa.

TELESCOPES, Microscopes, cameras, binoculars: bought, sold, repaired. Lists 10c. Specify instrument wanted. Rasmussen and Reece, 41 Market, Amsterdam, N. Y.

DOGS, PETS, BIRDS, RABBITS

RAISE Guinea pigs. Make money at home. Big demand. Free booklet. Taylors Guinea Pig Farm, Hapeville, Georgia.

60 VARIETIES Pigeons, etc. Catalogue 10c. Jim Houck, Tiffin, Ohio.

DOG-KEY Tags 25c. Printing, rubber stamps. Quigley's, Cupertino, 932, Calif.

RAISE Angora rabbits for us. We buy every Angora you raise from our stock. Contract particulars free. Wilson Rabbit Farms, 1065 Shryer, St. Paul 8, Minn.

BEAUTIFUL Collie-shepherd pups, \$12. Paul Schultetus, New Liberty, Illinois.

SPORTSMEN: 200 Pointers, setters, straight cooners, combination hunters, rabbit and fox hounds. Reasonable. List free. Ramsey Creek Kennels, Ramsey 1, Illinois.

RAISE Guinea pigs. Profitable, low-cost feeding, small space required, small investment. Complete details 25c. Guinea Pig Farms, 3456 West 116th St., Chicago 43.

SAMPLE Copy "Rabbit Profits" magazine, information regarding revolutionary new hutch plans and literature telling how to make most money from rabbits. 10c. Reliable Fur Industries, Dept. PM, Montebello, Calif.

ZOOLOGICAL And pet animals for sale. Illustrated catalogue, literature, 25c. Trails End Zoo-5, St. Stephen, S. C.

ORIGINAL Chin-Chin giant chinchilla rabbits. Gorgeous fur. Delicious meat. Most prolific. Easily raised anywhere. Free booklet shows amazing profits. Willow Farm, R15, Sellersville, Penna.

ANGORA Rabbits, giant chinchillas—finest pedigree. Valuable wool \$15.00 pound; gorgeous two-tone furs. Raised anywhere. Literature free. Grinsteeds, Edwardsville, Illinois.

ST. BERNARD Pups: Champion sired beauties. Franklin Young, R4, Riverhead, Long Island, New York.

STANDARD Rabbit Journal, Milton, Pa. 3 years \$1.00, sample dime.

A LIVING With rabbits and cavies. Markets waiting. Magazine 10c. Book describing twenty breeds and magazine 25c. Book and magazine (monthly) one year 50c. Address Small Stock, Dept. 2, Pearl River, N. Y.

FARMS, FARM LANDS, REAL ESTATE

HOMESITES \$450—Low terms. California's finest garden spot. On Morro Bay's scenic shores. Wonderful fishing, hunting, boating, etc. Fertile soil, soft water, temperate climate, congenial community. Free literature. Richard M. Otto, 6560 Hollywood Blvd., Hollywood 28, Calif.

IF You want to buy, sell or trade a farm, home or business write Starks, 1715 N.E. 10th, Oklahoma City, Okla.

CHICKEN-FARM In Canada! Low-priced land and good markets make this an opportunity worth investigating. Farms available in most parts of the Dominion. Don't delay, write today for information (state province in which you are interested). Address H. S. Cresswell, Canadian Pacific, Montreal.

GOVERNMENT Land \$1.50 acre up. Information all states 25c. National Tax Service Bureau, 834A Majestic Bldg., Detroit.

\$5.00 MONTHLY Buys 40 acres near town; price \$200.00; free list. Box 425-P, Carthage, Mo.

OZARK Lands for all purposes. Actual river frontages. 5 acres \$90.00 and upwards. Free list and literature. Hubbard, 424-I, Minnesota Ave., Kansas City 4, Kansas.

OZARK Magazine, Eureka Springs, Arkansas. For homeseekers, sportsmen. Year, \$1.00.

OZARK Farms, resorts. Free list. Farmers, 111, Eureka Springs, Arkansas.

STROUT'S Green farm catalog—Over 1300 bargains—25 states—Maine to Florida, west to California, Oregon and Washington. Write today for this big book. Mailed free. Strout Realty, 255-P 4th Ave., New York 10, N. Y. 7 So. Dearborn St., Chicago 3, Ill. 453 So. Spring, Los Angeles 13, Calif.

FREE Catalog, farm bargains, 9 mid-west states. Many fully equipped for convenient quick start. Many pictures. Special service to help you locate quickly, if you state requirements, payment plan and general location desired in first letter. United Farm Agency, 1796-MP Arcade Bldg. 1, St. Louis, Mo.

OZARK Farm bargains, 5 to 5000 acres. Frank, Mountain View, Mo.

GOOD Farms—ranches. Washington, Minnesota, Montana, Idaho, Oregon, North Dakota. Dependable crops, favorable climate. Write for literature, lists describing typical postwar farm opportunities. Specify which state. J. W. Haw, 119 Northern Pacific Ry., St. Paul 1, Minn.

FARM MACHINERY

INEXPENSIVE Device to pick up pecans and edible nuts. Plans one dollar. Dallas McLean, 3115 Guadalupe, Austin, Texas.

POULTRY AND FARM SUPPLIES

KNOW How to raise poultry for profit. Read Northeastern Poultryman. Every issue packed with helpful hints and practical suggestions. Latest articles on breeding, feeding, and management. Read nationally. Subscribe now. 1 year 65c; 2 years \$1.00. Northeastern Poultryman, Dept. M, 376 Boylston St., Boston 16, Mass.

RAISE Turkeys the new way. Write for free information explaining how to make up to \$3000.00 in your own backyard. Address National Turkey Institute, Dept. 3, Columbus, Kansas.

PROFITABLE OCCUPATIONS

LEATHERCRAFT Supplies. Catalog 10c. Art Craft Supply Company, 1205 Throckmorton, Fort Worth, Texas.

ASTOUNDING Art discovery liberates hidden talent. Paint original pictures instantly. Inexpensive home study course. Inexperience no handicap. Particulars free. Weidler, 1321 Wellesley, Los Angeles 25, California.

WELDING Pays. Learn with 1942 trade school text manual, 516 pages. Over 500 photos. \$2.00 copy. Money-back guarantee. Hobartweid, Box 863, Troy, Ohio.

AMAZING Course. Mail selling, only \$5.00. Two volumes, telling art and science of successful mail selling. Gives methods, secrets and procedure. Free with course. Opportunity to establish profitable business selling "world's finest books." Parcel Market, 2701 S. Main, Elkhart, Indiana.

MONEY In rabbits! Spare-time, full-time. Interesting details, prices, literature, 25c coin. Odette Rabbitry, P.O. Box 5642-MP, Dallas 2, Texas.

MECHANICALLY Inclined men—Own and operate general appliance repair shop. Complete, illustrated course shows you how. Welding, refrigeration, motor repair, how to get business, etc., all phases covered. Free literature. Christy Supply, Dept. 467, 2835 N. Central Ave., Chicago.

BE A manufacturer of wall plaques, book ends, etc., large market waiting, easily learned, no expensive machinery or molds to buy. Use garage or basement, large profits. Write Plastex Products, 127 Clement, San Francisco 18, Calif.

SELL By mail. Interesting, profitable. Free details. W. Gillen, 33 18th Ave., Paterson 3, New Jersey.

SCRAP Metal costing 5c pound brings \$4.00 in finished castings. Lifetime opportunity. Information. Paul Fritz, Dept. 11, 622 N. Fulton, Allentown, Penna.

SMALL Investment, immediate returns. Sell punchboards. Full or spare time. Write for circular and prices. Galentine Novelty Company, 520 East Sample Street, South Bend 18, Indiana.

MIRRORS From window glass at 3c per foot. Formula and silvering data \$1.00. Tesco, P.O. Box 189-D Wilkes-Barre, Penna.

IMMEDIATE Earnings, independence! Learn exclusive, non-crowded, best-paying "insect-pest control" business. We teach you how and back you up with personal guidance. Details free. Manufacturers Advisory Service (Insecticide Div.), 350-A Stockton St., Brooklyn 6, N. Y.

PLAN Houses. Your own, others. Big fees. New, easy, model method eliminates drawings. Authentic, illustrated course \$2.00. Nothing else to buy. Modern Crafts, 302 Pine Street, Modesto, Calif.

"ALASKA"—The last frontier offers thousands of job and business opportunities in fur farming, mining, fishing, aviation, construction, lumbering, oil, including government homestead lands at 25c per acre. \$1 brings 1946 copyrighted booklet and official government map explaining how-when-where to apply. Transcontinental Research, Box 2147-PM Hollywood 28, California.

ENJOY Life, comfortable living on two acres. Be independent. Complete information \$1.00. Satisfaction guaranteed. Home Industries, A1514 Long, Columbus 3, Ohio.

TATTOOING—Electric machines, designs, inks. Steele, 540-G Leavenworth, San Francisco 9, California.

NOW—"New jobs in west coast lumber industry"—Permanent, year-round employment, indoors or outdoors, at good pay. \$1.00 brings copyrighted report listing 103 largest firms, with sample application letter and job qualifications. Experience not necessary. Immediate refund if not satisfied. Dept. 2L, Pacific Industrial Research Bureau, 907 Terminal Sales Building, Portland 5, Oregon.

IF You want a business of your own, write for free details. Hubbard, 293 Magnolia, Cranston 10, R. I.

PANNING Gold. Free literature, pictures. Old Prospector, Box 21R48, Dutch Flat, Calif.

"FREE Information!" Locates thousands scarce bargain merchandise. Chemist, Box 1279-P, Joliet, Ill.

PAINT Plaster plaques; statuary. Sell locally. Beautiful, clear detail. Strong, hard castings. Guaranteed quality. Fascinating! Popular! Profitable! List free. Samples \$3.00. Artists' brushes, paints, instruction books available. Pioneer, 394A8, Austin, Minnesota.

"MUNGOFUNGEO" Sprouting beans, free sample. Snyder, 406A West 47, New York 19.

RAISING Frogs for profit. Be independent, raise giant frogs for food, full time job. Send \$3.00 for complete illustrated book on frog raising. This book is factual, written by president of Texas Frog Industries, operator of large frog farm. Can supply breeder frogs. Address Robert B. Van Meter, Box 912, San Benito, Texas.

MUSHROOMS Grown: boxes: barrels. Illustrated instructions 50c. Spawn \$1.00. Gordons, 553 William, Winnipeg, Man.

SELL Names—the real truth about selling names by mail. Russell's Service, Grant 820, PM, Laredo, Texas.

INTERESTED In Latin American and foreign employment? \$1 brings 1946 copyrighted "Foreign Trade Research Report" listing 300 American firms with foreign interests, and explaining how-when-where to apply. L. J. Enterprises, Box 2549-PM, Hollywood 28, California.

WOULD You pay 3%—first \$350 made? Color-illustrated book "505 Odd, Successful Enterprises" free! Some offer occasional "day off". Start at home, office. Expect something odd! Pacific, 262 Drake, New Rochelle, N. Y.

ELECTRIC Clocks are every where you go, buildings, homes, parking lots, factories. Repairs increasing. Our easy to learn course with pictures and drawings teach you how to repair these clocks. Electronic Supply Co., P.O. Box 2350A, Houston 1, Texas.

GOLD-STAMPING Is fascinating and profitable. Free booklet. Home City Specialties, Dept. PM1273, Springfield, Mass.

STORY Writing simplified! Don't dream—try! Fascinating, complete home study. Handsome earnings. Circular free. New Simple Segment System, Postoffice Box 834, Spokane, Wash.

TYPEWRITER Repairmen urgently needed. Earn \$40 to \$50 weekly spare time. Our easy to learn home study course teaches how to repair typewriters. Write for free information. Houston Typewriter Repair Service, P.O. Box 5357A, Houston 12, Texas.

EXCELLENT Profits raising mink. Choice breeding stock available. Details furnished. Franklin Young, Riverhead, New York.

\$40.00 WEEKLY Made growing mushrooms, fresh, dried. Dominion patent 331583. Free spawn. North American, 169P Yonge, Toronto, Canada.

TYPEWRITER Repairing—Original course, simplified home study. Weber Typewriter Mechanics School, Box 269, Osborn, Ohio.

MAKE Beautiful costume jewelry at home for large profits, hobby or therapy. Free illustrated wholesale catalogue of sea shell, metal and plastic parts contains detailed instructions. Florida Supply House, Bradenton, Florida.

ANNOUNCING Home study course in commercial baking. Practical basic training. Good field for those with aptitude. Nearly depression proof. Send for free booklet, "Opportunities in the Baking Industry." National Baking School, 1315 Michigan Ave., Dept. 3432, Chicago 5, Ill.

LOCKSMITHING—Profitable business or hobby! New course teaches you how to pick locks, fit keys, de-code, masterkey, etc. Easy self-instruction lessons. Bargain price. Fascinating 100-page illustrated catalog free! Write—Nelson Company, Dept. 2-02, Chicago 5.

TADPOLES Make frogs, tremendous demand. Both make you money. 25c brings tell-how information. Chariton Corporation, Century Building, Chicago 4.

BOOKS, PERIODICALS, PICTURES, POSTCARDS

MAGAZINES—Business, trade, professional. Keep informed on developments, opportunities, etc. Current copies. Choice 763 publications. All fields. Free price-list. Commercial Engraving Publishing Co., 34C North Ritter, Indianapolis 1, Indiana.

HOBBYISTS, 18 Clear glossy snapshots, 3"x4 1/2", ranches, broncs, civic taken in and around Amarillo. Neat packet, send quarter. Star Drug, 619 N. Fillmore, Amarillo, Texas.

PICTURE Post cards from your photograph. For resorts, camps, hotels, advertising purposes. 4154 Fifth Street, Philadelphia 40.

WHAT Do you want from Honolulu or the South Sea Islands? Anything from ship, land or sea. Photos, souvenirs, or curios. Send stamp for list. Lutts, 729-15th, CHA-3, Honolulu, T. H.

ADVANCEMENT Slow? Try improving personality 3 quick ways. Users say "it works!" Free folder. Methods Research, 6235-F Eastwood, Kansas City 3, Mo.

WHAT Every Mason wants. We have Masonic books for Blue Lodge, Chapter, Commandery, Scottish Rite and Shrine. Our rituals are used the world over. Send for free catalog of books and rituals for Masons, Odd Fellows, Knights of Columbus, etc. Ezra A. Cook, Publisher, P.O. Box 796-PAT, Chicago 90, Ill.

BUILD Your own fortune! The rules of fortune building are infallible and have been followed by successful men and women ever since the days of ancient Babylon. These rules were not taught to you in school, nor taught to you in college. Building a fortune is explained fully in the book, "Seven Cures for a Lean Purse." Send \$1.00 for a postpaid copy. Satisfaction guaranteed. Bedard Publications, P.O. Box 637, Detroit 31, Michigan.

PHOTOS, Postcards, 8000 subjects. 50 assorted 50c prepaid. Jack's Hobby Shop, 591-12th St., Oakland 7, California.

BOOKFINDERS! (Scarce, out-of-print unusual books.) Quickly supplied. Send wants. Clifton, Box 1377PM, Beverly Hills, Calif.

STRANGE, Interesting and unusual books, also books to help you in your work, trade or business. Write for free interesting catalogue. Faller Company, 201 Dewey St., Newark 8, N. J.

ATOM Bombed Nagasaki, 5 photographs 25c. Makins Pictures, 538 1/2 Washington, Bremerton, Washington.

SELF-INSTRUCTION Shorthand booklet fifty cents, sample ten cents. All students learn in few hours. Elliott School, Established 1924, 4426 Carrollton, New Orleans.

"TRUE Christian Religion." To obtain a free copy of an 80-page digest of this remarkable work by the famous scientist, philosopher and theologian, Emanuel Swedenborg, send your name and address to Swedenborg Foundation, Inc., Room 1649, 51 East 42 Street, New York 17.

SENSATIONAL "Magic" shorthand and typing course. Easy, practical. 25c. R. G. Saunders, Box 1209, Winston-Salem, N. C.

PACIFIC Veterans! Now hear this! 20 glossy, sharp photos, size 4x5, of Philippine campaign and ruined Tokyo scenes. Descriptions included. See Manila burning, shelling, looting, Lingayen sky battle; Kamikaze attack; Americans surrender at Corregidor (Jap photo), 2 photos of Tokyo Rose apprehended. Other perfect shots. Send quarter for 2 samples. Price 20 photos \$2.00. Money back guarantee. Al Rosen Studio, Chester, Penna.

OPERATE Magazine subscription agency: wholesale catalog, complete supplies, 25c. Cassell Publishers Service, Westfield, New Jersey.

"100,000 POST-WAR Jobs Abroad"— South America, China, India, Burma, Japan, Russia, Malaya. How, when and where to apply. U. S. participation in world reconstruction and trade demands thousands of American-trained mechanics, salesmen, technicians, engineers, foremen, laborers and business representatives—every trade needed. Our 15,000-word copyrighted report—compiled from business, professional and government sources—lists over 200 big U. S. firms with foreign interests, gives job information, salary brackets, contract tips, application letters, passport information, climatic conditions, etc.—everything needed for your immediate application. \$1.00. Return for refund in 7 days if not satisfied. Pacific Industrial Research Bureau, 907-E Terminal Sales Building, Portland 5, Oregon.

"30,000 JOB And Business Opportunities in Alaska"—Based on two years' Alaskan experience, this 15,000-word copyrighted report gives latest facts on fur farming, mining, agriculture, lumbering, transportation, commercial fishing, construction, business opportunities. Special section on climate, homesteading, mineral resources, rights, etc. Private firms and government projects listed—tells how, when, where to apply. \$1.00. Return for refund in 7 days if not satisfied. Pacific Industrial Research Bureau, Dept. 2D, 907 Terminal Sales Building, Portland 5, Oregon.

SQUARE Dance calls, instructions, illustrated. \$1.00. Guide, Eureka Springs, Arkansas.

BIBLE Says, "Swords into Plowshares." When? Free booklet explains. Ketchum, 1848 S. 18th, Springfield, Illinois.

MAGAZINES (Back dated)—foreign, domestic, arts. Books, booklets, subscriptions, etc. Catalog 10c (refunded). Cicerone's, 863 First Ave., New York 17, N. Y.

GOOD "Used" self-instruction educational books on all subjects bought, sold, rented, exchanged. Satisfaction guaranteed. Complete information and 100-page illustrated bargain catalog free! Write—Nelson Company, Chicago 5.

SELF-EXPLAINING Bible: Illustrated circular free. Box 446-P, Minneapolis, Minn.

NATIONAL Geographic Magazines, 1888-1945, any issue. Periodical Service, Dept. PM, Swarthmore, Penna.

BOOKS, (Out-of-print, new, used) quickly supplied. Many 35c bargains. Catalogue. Mid-West Book Service, 18870 Marx Ave., Detroit 3, Mich.

BIG Profits taking subscriptions for all magazines. Agents' confidential catalog listing over 2500 periodicals and complete starting supplies free. Pines Subscription Agency, Flushing, New York.

GAMES AND ENTERTAINMENT

NEW Universal game. Can be played in any language. Develops the vocabulary, increases knowledge of mathematical and chemical formulas. Only \$1.98 postpaid. Lexigraph Co., 210 Post, Suite 915, Dept. 5, San Francisco 8, California.

"84 CARD Tricks," 25c! Free: "money-making opportunities!" Hirsch, Spring Valley 2, N. Y.

TARGET Balloons, 50c each, 12 for \$5.00. Write for quantity prices. S & P Novelty, 1733-P St. N.W., Washington 6, D. C.

JUST Out, a new game of skill. An ideal gift for your returned service man. \$2.15 postpaid or send post card for illustrated booklet and complete description. Hix Novelty Works, 1568 East 22nd Street, Los Angeles 11, Calif.

FASCINATING New card game. Free. P.O. Box 842, Denver 1, Colo.

MAGIC TRICKS, PUZZLES, JOKER NOVELTIES

PRECISION Wooden puzzles that defy efforts to disassemble. Three different puzzles \$1.00. Blake Industries, 2355 Guardian Bldg., Detroit 26.

BEWILDERING! Today's trickiest magical novelty! Magic eyes "change color" instantly! Uncanny, repeatable! Instructions 15c! Rush! Postways, Box 5325, Philadelphia 42, Penna.

DOLLAR Magic set free with gigantic catalog 25c. Mysto, 4462 Germantown, Philadelphia.

VANISHING Quarter trick 10c, catalog free. Tom DeLime, 30 Pershing Ave., Ridgewood, N. J.

RISING Cigarette trick. Cigarette magically rises from pack. Apparatus and instructions dime. Eastwood, Box 623, Parkersburg, W. Va.

THE New "miracle deck" of trick playing cards. No marks. Detect blindfolded, \$1.00. M. Brophy Co., Rentola Bldg., West Duluth 7, Minn.

MAGICAL Supplies—Card readers, trick dice, novelties, books. Catalog free. Vine, Hill & Co., Dept. P, Swanton, Ohio.

VALUE, Fun, magic. Mind reading exposed, 250 parlor tricks, 5 clever pocket tricks. Catalog, \$1.00. DeLuca's, 127D Pettis, Providence 4, R. I.

LARGE Illustrated professional catalog 10c. Williams, 900 Plymouth, Ellwood City, Penna.

FREE Big illustrated lists, magic tricks, illusions, mind reading, pocket, parlor, club or stage. Jokes, novelties of all kinds. Magician, 2463-M Kensington Ave., Philadelphia 25, Penna.

CHECKERBOARD Puzzle—keeps you working hours to solve. Tricky, hair-raising. Greatest funmaker ever invented. 35c. Money back if dissatisfied. Farris, 1364 N. Sedgwick, Chicago 10.

NEW Vanishing key and catalog 25c. Sterling Magic, Box 191, Royal Oak, Mich.

500 TRICKS You can do! Douglas' famous catalog of 500 tricks, now only 10c. America's fastest service on magic for pocket, parlor, stage, professional, amateur. Douglas Magic Shop, Box 274, Dallas, Texas.

VENTRILOQUISM Complete instruction only \$1. LeSueur, 77 Wellesley, Toronto, Canada.

FREE! Large catalog of magical apparatus if you remit 25c for "Magic Is Fun" magazine. Robbins Co., 152-F West 42nd Street, New York.

AMAZE And mystify your friends with highest quality magic. New catalogue 25c coin. Mazda Magic Co., Mt. Sterling, Ky.

ENTERTAIN! Mystify! New, bigger magic catalog and 4 secret tricks 25c. Herbert, P-192 N. Clark, Chicago 1.

MAGIC: Big 160 page Illustrated Catalog Latest Magic Goods, 25c. For over 1/3 century we have supplied Professional as well as Beginner. Chicago Magic Co., 2300 N. Mason, Chicago 39.

BE A magician. Large professional magic catalogue of latest tricks 25c. Ireland, C-109 North Dearborn, Chicago 2.

MAGIC Tricks, puzzles, books, cards, punch boards. Catalog 10c. Specialty, Box 671, St. Louis 1, Mo.

COINS, TOKENS, CURRENCY

OLD Money wanted. Will pay \$100.00 for 1894 dime, S. mint, \$50.00 for 1913 Liberty head nickel (not buffalo). Big premiums paid for all rare coins. Send 4c for large coin folder. May mean much profit to you. Numismatic Co., Dept. 20, Fort Worth, Texas.

WILL Pay \$10.00 each for certain Lincoln pennies! Indianheads \$50.00; dimes \$1,000.00. Catalogue 10c. Federal Coin Exchange, 8-PM, Columbus, Ohio.

FOREIGN Coins, paper money. Worldwide selection ten different odd unusual 30c postpaid. R. A. Webb, Box 843, San Bruno, Calif.

THIRTY Different coins and bills \$1.00. Oddehon, Box 482, St. Louis, Mo.

WORLD Coins—List free. Harry Elsholz, Box 9014, Pittsburgh 24, Penna.

WE Purchase Indianhead pennies. Complete coin catalogue 10c. Fairview, 277 Broadway, New York.

COMMEMORATIVE \$1 1/2. Oregon, Texas, Kentucky, Cleveland, Long Island, \$2.00 ea. Illustrated catalogue 25c. Norman Shultz, Salt Lake 9, Utah.

QUICK Service; reasonable prices. United States catalog 10c. Foreign catalog 10c. Ben's Coin Company, 72 West Washington, Chicago 2, Illinois.

FREE! Foreign coin, banknote and coin collectors illustrated catalog to approval service applicants. Send 3c postage. Tatham Coinco, Springfield-125, Mass.

GET Profit and pleasure in collecting old coins. Send 10c for 56-page illustrated coin catalog. You'll be delighted with it. Send for it now. B. Max Mehl, 370 Mehl Building, Fort Worth, Texas. Largest rare coin establishment in U. S. Established 46 years.

STAMP COLLECTING

UNITED States bargain. Here's an offer so stupendous that it is almost unbelievable: 50 different U. S. stamps ranging in age as far back as over sixty years and in face value as high as the dollar Wilson, composed entirely of face different postage, airmail and commemorative stamps, nothing else. In addition, we include 2 Japanese occupation stamps of the Philippines. We will send all these for 10c but only to sincere approval applicants. In asking for approvals please state whether you are interested in United States or foreign stamps or both. Approval headquarters, Globus Stamp Company, 268 Fourth Avenue, New York City 10, Dept. 217.

POSITIVELY Greatest free offer—Latest Scott's International \$5.00 stamp album—covering entire world, contains 36,000 illustrated descriptive spaces; Scott's 1946 standard \$5.00 catalogue "Philately's Encyclopedia"—absolutely free to applicants for foreign approvals becoming customers. Plymouth Specialty Company, Dept. A9, Bell, California.

NEW Zealand beauties! Peace issue 11 mint stamps \$1.20. Also bulletin with valuable information on new issue service. Deluxe Stamps, Box 997, Minneapolis, Minn.

FREE Bulletin "Colonial Collector" lists all new peace sets. Include 3c postage for mint Argentine Roosevelt commemorative. Glen M. Wilson, 711 North A Street, Tampa 6, Florida.

31 DIFFERENT With George Washington stamps from Brazil and Ecuador; Pirate Island; victory issue; medical set; others—all 4c with approvals. Grayson Company, Sherman, Texas.

150 STAMPS—Giant triangle, diamond shapes included. 5c to serious approval applicants only. Regent Stamp Company, 316 Flatbush Avenue, Dept. P, Brooklyn 17, New York.

FLASH! Amazing value! Djibouti, Bechuanaland, Camerouns, Dominica, others, all 6c, approval applicants only. Southwest Stamps, Box 117, Long Beach 1, Calif.

RARE Russian semi-postal set complete picturesque designs of workers and peasants, mammoth stamps including giant triangle. This set retails for \$3.00, but only 10c to serious applicants for our foreign approvals. West Coast Stamp Service, Box 344, Hollywood Station, Hollywood 28, California.

25 DIFFERENT Egypt, 10c with approval selection. Paul Rawden, Box 2920, Westville, New Haven, Conn.

GREECE Roosevelt memorial (3) 25c. Austria AMG (17) 75c. Vatican City Council of Trent (14) 45c. China C31-40 (10) 45c. Vatican City Christ (3) 10c. France AMG (10) 30c. Austria Russian occupation (23) 80c. Italy AMG (8) 30c. India victory (3) 60c. Italy Polish Legion (4) 45c. Salydad Co., Merchandise Mart Post Office Box 3930, Chicago, Ill.

FULL Japanese sheet 1-sen stamps (100) with copy 11,300 word commentary "G.I. in Japan." \$1.00. (Extra sheet 2-sen stamps, \$1.00 postpaid.) Lee Beal, 402 Grand, Oakland 10, California.

COLOSSAL! Stupendous! values. Hurry send today—25 different hard to get stamps. 10c in coin. Approval applicants. Leonard's Stamp Service, 2581 Elmhurst Avenue, Detroit 6, Michigan.

PACKAGE Of 250 all different U. S. and foreign \$1.00. Guaranteed over \$5.00 catalog value. To approval applicants. Barry Horenbein, 836 Espanola Way, Miami Beach, Fla.

HITLER 20 Values—50c. Swastika set 12 values 50c. Approvals if you wish. Sidney Dennerstein, 2032 Creston Avenue, Bronx 53, New York.

FAMOUS Washington bicentennials 10c with United States approvals. Jarr, Box 217-P, Madison Square Station, New York 10.

FREE—25 Different to approval buyers. Send 3c postage. Bennett's, 39 Arlington, Toronto, Canada.

VATICAN City—Ten different eye-filling pictorials, entire set 6c with approvals. Viking, 130-Z Clinton St., Brooklyn, N. Y.

BELGIUM, 225 Different \$2.00, 325, \$5.00. U. S. bills. Lecomte, Rue Frere-Orban, Jumet, Belgium.

FREE Colorful Greek Albania occupation pictorial set to approval applicants. "PG." 195 Park, Lewiston, Me.

FREE Foreign stamps with approvals. Kelly, 9544 Whitcomb, Detroit 27, Mich.

3000 WORLDWIDE \$2; Approvals. Griest, 619 W. 4th, Davenport, Iowa.

FIFTY Different, free. With approvals, any country. Purchase's, 210-B Virginia, Hillside 5, New Jersey.

BEAUTIFUL Nicaragua Roosevelt set free. Approvals. Steve Franks, Hendersonville, N. C.

SEND 100 Precancels for 100 foreign stamps. Peck, 2231 E. 18th, Tulsa, Okla.

AUSTRALIA, 50 Different, \$1.00. W. L. Bedard, P.O. Box 637, Detroit 31, Mich.

FREE! 18 Different Switzerland with approvals. Excel, Box 1315, Chicago 90.

FINE Approvals for general collections. Kress, Box 144, Hanover, Penna.

CHOICE Approvals—1c and up. Stamps, 1267 Tutwiler, Memphis 7, Tennessee.

AERO-PHILATELISTS. Send for current price list. Baker, East Setauket, N. Y.

FREE 100 Different, approvals. Kloster, 3883-47th St., San Diego 5, California.

55 DIFFERENT U. S. 10c. Approval applicants. Standard, 3817 Sackett, Cleveland 9, Ohio.

WHAT Have you to offer? A collection? A "shoe box" accumulation? Anything in stamps. We urgently need them. Spot cash paid. Cosmopolitan Stamp Co., 1457 Broadway, Dept. 8-E, New York.

RARE \$1.00, \$2.00, \$4.00, \$5.00, \$10.00 U. S. stamps. Special 5c with approvals. "PG." 195 Park, Lewiston, Me.

EXCHANGE Stamps, postcards universe. "Exchangers" Bry 226, pres Paris, France. Particulars free.

IRELAND, 12 Different for 3 cents. Swell approvals. Eric Kardell, 1175 Clay, San Francisco, California.

PENNY Approvals. Thousands different. Pictorials, airmails, commemoratives. Raymax, 123-Z William Street, New York City.

VATICAN "Trento Council", 10 values 20c with approvals. Postes-Timbres, 666 Dumont Ave., Brooklyn 7, N. Y.

FINE Foreign stamps sent on approval. Write for a selection today. Stamps, 6341 Dennis, Detroit 10, Michigan.

SAVE 20%. 10c sets 8c. 5c sets 4c. Send for attractive selection today. Enclose 3c postage and receive mint Ecuador airmail set free. Walt Sochor, 1508 Dickinson St., Philadelphia 46, Penna.

WRAP Up a dime now and get our 10-10 Sur-Prize Packet—10 different stamps from 10 different countries. Stamp World, 536 S. 30, Omaha 5, Nebraska.

FREE Packet foreign stamps when requesting pictorial approvals. Getche, 1040 N.E. Eighteenth, Minneapolis 13.

100 DIFFERENT 5c to approval applicants. Quality Stamp Company, Dept. S, Box 202, Sta. F, Buffalo 12, New York.

THREE Hitler heads free with approvals. Everglades Stamp Company, Box 3222, Station F, Atlanta, Georgia.

FREE! Complete Balkan aviation set with approvals. Beaman, Glenburnie 1, Maryland.

BRITISH, Spanish and French colonies, Vatican, Hitler heads and airmail packet, free with approvals. Pan-American Stamp Company, 615 West 173rd Street, New York.

SPAIN'S "Nude Goya" set complete 25c. Approvals. Royal Stamp Company, Tamaqua, Penna.

FREE! Scarce Medellin midget stamp with approvals. Seminole, Glenburnie 1, Maryland.

MINT British Colonies set only 5c to approval applicants. George Rogel, 5149 N. Lincoln Ave., Chicago 25, Illinois.

BARGAINS "Galore" to purchasers from our general approvals. Suburban Stamp Sales, St. Louis 14, Mo.

PORTUGUESE Colonies, 25 different 5c with approvals. Lorane Brown, Marion, Michigan.

BAVARIA, 17 Different 5c to approval buyers. Boerger Stamp Company, 206 Main, Toledo 5, Ohio.

PITCAIRN Mutiny stamp! Fabulous bird, sword and shield, schooner, pirate map, Kiwi, Russian music, Swedish commemorative and others for only 3c with approvals. Star Stamp Company, Dept. 1, Lakewood, New York.

MOST Fascinating innovation in stamp collecting history. Send silver dime for 50c worth samples. 25c extra secures stamp guaranteed President Roosevelt's collection. K. Bileski, Station B, Winnipeg, Canada.

STAMPS From 40 countries, including Mozambique, 10c. Elsea, Bowling Green, Ohio.

GORGEOUS Giant triangles! Six different, 5c. Approvals. Saylor Stamp Company, 2073½ Hillhurst, Los Angeles 27A, California.

LIBERAL Offer, thick packet with Seychelles, Fiji, U. S. commemoratives, Tete, Djibouti, Inini, Congo, Porto Rico, Philippines and multitude others. Everything only 10c to approval applicants. Burmaster, Box 1910 A, Los Angeles 53, Calif.

FREE Illustrated wholesale bargain list. Imperial Stamps, First National Bldg., Yonkers, N. Y.

FREE! Bechuanaland! Trinidad! Iran! assortment. Approvals. Stampco, Miami Springs, Florida.

FREE! A gift that will make the most interesting item in your collection! No matter if your collection is worth \$10,000, you will devote a full page of your album to it! Approvals included. Postage appreciated. George Wentz, San Marcos 5, Texas.

ITALY'S Lost Empire! Collection gorgeous mint pictorials, commemoratives, reflecting Mussolini's former glory. Cyrenaica, Somaliland, Italian East Africa, Eritrea, Libia, including beautiful semi-postals and bi-colors—cataloging over 50c—only 10c! Approvals included. Thole, Box 86P, Elmont, N. Y.

CUBA'S Latest retirement set shows aged couple receiving pension check. This set sent to approval applicants for only 5c. Bryson Stamp Company, Drawer F-2, Rossford, Ohio.

200 MIXED Fine used New Zealand cataloging \$7.00 including 35 varieties, \$1.00. Robert Webb, Jebb Place, Marblehead Neck, Massachusetts.

FOREIGN Packets, 100 diff. 25c, 500 diff. \$1.75, 1000 diff. \$3.50, 2000 diff. \$8.00. Mendelsohn Stamp Co., 5713 Euclid Ave., Cleveland 3, Ohio.

ARGENTINE FDR 3c to approval applicants. Larson, Box 134, Ventura, Calif.

COMPLETE Triangle set 15c, approvals. J. Durlak, 3229 W. Thomas St., Chicago 51, Illinois.

WORLD-WIDE Packet—Includes S. Africa, Colombia Midgets; Cocos Island; Guatemala Bi-Set; Bavaria; Persia; Palestine; George VI set; commemoratives; pictorials; etc. 6c approval applicants. Norman Baker Stamps, Farmington, Mich.

THE Bargain of your life includes Ascension, Basutoland, Cyprus, Nyassaland, 10c to approval applicants only. Excello Stamps, P.O. Box #95, Hackensack, N. J.

GORGEOUS Colors, scarce airmail, surcharges, charities, sets, etc. All in our big premium packet only 3c to approval buyers. Dixie Stamp Company, Dept. M, Milwaukee 3, Wisconsin.

1000 ASST. U. S. And foreign pictorial, commemoratives, air-mails from many countries \$1.00. 1000 asst. foreign \$1.00. 1000 asst. U. S. with regular and commemorative issues \$1.00. \$10.00 cat. foreign commemoratives \$1.00. Nu-Dell Stamp Co., 4339 Irving Park Rd., Chicago 41, Ill.

ADEN To Zanzibar! 40 different British Empire, including Cyprus, Malta, Dominica; 5c with approvals. Lyman Company, 95 Nassau Street, New York City 7.

TRADERS—Trade your duplicates for stamps from our approval books. Postcard brings full information. Comet, GPO Box 517P, Brooklyn, N. Y.

ARMY Navy set 10c. Foreign—U. S. approvals. Yokum, Box 1327, San Antonio 6, Texas.

BRAZIL Diamond shaped set 10c, with approvals. Vargo Stamps, 6044 South Fairfield, Chicago 29, Illinois.

1000 MIXED U. S. old and new 25c. Weatherby, Medina, Ohio.

UNITED States approvals. Fine quality. Klein, Box 22, Robinson, Illinois.

15 DIFFERENT Airmails with approvals 10c. Robert Ewing, Wapakoneta, Ohio.

60,000 VARIETIES Low priced approvals. Discounts. Scott, 30 Baker Ave., Lexington, Mass. 6.

5 TRIANGLES Free! Approvals. Gordon Davison, Box 1019B, Manchester, N. H.

U. S. Price list. Send postage. State Stamp Service, 1225 Park Building, Pittsburgh 22, Penna.

MINT George VI eight crown colony pictorials including bi-colors 10c to serious approval applicants. Mutual Stamp Service, 5145P Village Green, Los Angeles 16, California.

FREE Beautiful new issues. Greece, France, airmails. Triangle to approval applicants. Green & Company, Norwood 12, Ohio.

U. S. COLLECTION—Thirty different fine unused commemoratives before 1939 including Columbians, bicentennials, parks price \$1.00 approval applicants only. Fort Orange Stamps, Albany 7, New York.

FIVE Vatican City stamps free to approval applicants. Florida Stamp Company, Box 807, Miami 5, Florida.

25 DIFFERENT Swiss 10c—with 1/4, 1/2, 1c approvals. Carroll's, 4357A S. Hoover, Los Angeles 37, Calif.

CHINA. Every stamp with a historical meaning. Twenty of these colorful stamps offered approval applicants for 10c. Collins', 71 Coleridge, San Francisco 10, Calif.

175 U. S. Commemoratives, airmails, etc., 25c. Lloyd Johnson, Hawarden, Iowa.

OLD Scarce U. S. seconds on approval. Slightly defective, nice appearance, bargain prices. Hernfield, 551 Clinton, Newark 8, N. J.

EXCHANGE Duplicates. Swappers everywhere. List 10c. Particulars free. Box 2166-M, Denver 1, Colorado.

ONE, Two, four, five dollar U. S. stamps free to approval applicants. United Stamp Service, Box 1789-M, Miami 10, Florida.

ZANZIBAR, Palestine, Manchukuo, Azerbaijan, Haiti, Iraq, Siam, Victoria, Hitler stamp 5c. Approvals. Postzegel, Windham, New York.

U. S. Price list. Send postage. Stanley Gibbons, 38-P Park Row, New York.

APPROVAL Sheets, Frederick B. Driver, 909 Finance Building, Philadelphia 2, Pa.

PENNY Approvals, that satisfy. Neil Gronberg, Box 5441-P, Philadelphia 43, Penna.

MINT Pictorials free to approval applicants. Surf Stamp Co., Box 2296, Miami Beach 40, Florida.

UNITED Nations, scarce 5c U. S. commemorative and packet 30 different U. S., including airmail, commemoratives, revenues, etc. Catalogs 65c—to approval applicants for 5c. Curhan Stamp Company, Dept. H, Gloucester, Mass.

ZOWIE-E! A barrel of fun for only a dime. 500 United States stamps—absolutely unpicked and unsorted—just as received from church missions. Many varieties, including large commemoratives, airmails, high denominations up to \$5.00! Stampdom's biggest package of fun—and you might find something really valuable! Price only 10c to serious approval service applicants. Money back if not delighted. Illustrated bargain lists with each order. Mystic Stamp Company, Dept. 80, Camden, New York.

50 DIFFERENT United States, 10c. Price-list free. Seidenberg, Cassopolis, Mich.

CANADA—75c Diff. 25c. Approvals, Lists. Victoria Stamp Co., London 4, Canada.

FINE Approvals, freshly mounted. Fast, personal service. Tell me what countries you prefer and I'll send their stamps. Skinner, 438 Locust, Long Beach 2, Calif.

RICH Man's approvals, poor man's prices. Grand value packet containing five foreign sets, free with approvals. Stoll Stamp Service, 2630B West Burnett, Louisville 10, Kentucky.

FREE! Negro Triangle; Turks Islands "Cactus"; Dakar; Guinea; Palestine; "Fairy Tale," Pirate Chart, Map, Ship, Sea Lion and Snake stamps; French, British, Portugese Colonies, etc. Free for 3c postage. Approvals. Potomac Stamps, Washington 10, D. C.

WOW! \$10.00 Worth of fun only 10c. What a treasure hunt! Big package 500 foreign stamps—just as received from foreign missions other sources. Includes stamps from Africa, South America, Philippines. Free French, Cape Juby, Palestine, etc., including airmails, commemoratives, and stamps worth up to 50c and 75c. This amazing offer is given for 10c to serious approval applicants only. One to a customer, money back if not more than delighted. Jamestown Stamp Co., Dept. 22, Jamestown, New York. Stamps—valued up to 50c and 75c each.

UNITED States approvals complete coverage, fine quality, attractive prices. Seminole Stamps, Box 378, Coconut Grove, Florida.

FREE! Leeward Is., Cayman Is., Turks and Caicos plus 54 different mint World's Fair poster stamps, to approval service applicants sending 3c postage. Tatham Stamp Co., Springfield 30, Mass.

25 DIFFERENT India, 3c with approvals. Premiums with purchases. Brandwein Stamp Company, Box 92H, Bayonne, N. J.

EXOTIC Pictorial collection, including Tahiti Spear Fishing, Melanesian Idol, Carib Archer, Malagasian Farmer and many other scarce stamps from strange countries. Everything only 5c. Imperial Stamp Co., Yonkers, N. Y.

50 DIFFERENT Including scarce diamond-shaped airmail 3c to approval service applicants. Avalon Stamp Co., Dept.

19th CENTURY U. S. Commem., Civil War—Battleship revenues, \$5 and \$10 stamps free to U. S. approval applicants. Metropolitan Stamps, 198C Broadway, New York.

DANDY United States approvals. Write immediately. Sullivan, Endicott Building, St. Paul 1, Minn.

1000 GRABAGS 15c Each. Super bags 25c. Zandy, 630 Binghamman, Reading, Pa.

BOX Stamps containing hundreds all different, cataloging up to 25c each. Everything \$1.00. Longacre Shop, 108 West 42nd, New York City.

SCARCE "Pole to Pole" packet! Stamps from strange, mysterious countries only—Greenland (North Pole), Solomons, Spanish Morocco, Bhopal, Patiala, Siberia, Grahamland (South Pole), Djibouti, Zanzibar, etc., and including stamps cataloging up to 25c each! Our price only 5c to approval applicants. Big dime packet list free! Methuen Stamp Service, Inc., Dept. 136, Lawrence, Mass.

FREE U. S. price list. Postage 3c. Mark Hanna, 335 - 5th Avenue, Pittsburgh 22, Penna.

COMPLETE "United States" catalog with 1000 illustrations! Send 10c for mailing. Harris & Co., 137 Transit Building, Boston, Mass.

FREE—Pick 25c worth of stamps from our first U. S. approval selection. Approximately 100 stamps to choose from. Excellent value. No obligation to buy. Lists illustrating the most popular U. S. stamps—at prices you can afford—will be included. Don't miss this opportunity! Write today. S. C. Engel Co., 38 Park Row, New York City.

AMAZING Offer! Assortment each of giant stamps, midget stamps, flag stamps, airmail stamps, Free French Colonies, U. S. commemoratives and numerous others. Everything only 10c to approval applicants. Simon, Box 214, Iraan, Texas.

SCARCE 1880 U. S.—Hussey local carrier stamp listed at 15c. Also Costa Rica No. 65 listed at 40c. Both sent free to approval buyers sending 3c postage. Pladon Stamps, 1717-M Idaho, Toledo 5, Ohio.

WORLD'S Largest diamond and triangle stamps, free stamp magazine, stamps from fighting Free French, 20 stamps from 20 different countries, pictorials, airmails, big bargain 5c with approvals. Capital Stamps, Dept. 2, Little Rock, Ark.

FREE! Canadian sets, royal visit, George VI, George V, coronation, jubilee, others, to approval applicants. Ensign, Box 118-M, South Orange, N. J.

DEALERS—Wholesale list. Postage 3c. Frank, 5031 Queensberry, Baltimore 15, Md.

118 DIFFERENT Stamps including commemoratives, charities, airmail sets, etc., only 3c to approval buyers. We buy collections. Badger Stamp Co., Milwaukee 3, Wis.

VICTORY Packet free—Includes stamps from Tanganyika, British Cayman Islands, animal, scarce babyhead, coronation, early Victorian, airmail, map stamps, with big catalogue—all free. Send 5c for postage. Gray Stamp Company, Dept. PM, Toronto, Canada.

FREE! The Stamp Finder! Send today for the big new edition, fully illustrated, enabling you instantly to identify all difficult stamps! Also fine packet strange, fascinating stamps from Bosnia-Herzegovina, Monaco, Patiala, Cyprus, etc., including maps, ships, animals and strange scenes. All free to approval applicants enclosing 3c postage. Garcelon Stamp Company, Box 900, Calais, Maine.

42 ALL Different Ceylon stamps, 1887-1946 complete, Victorian-to-date \$6.00. Satisfaction guaranteed. Pius Gunawardena, Batagama, Kandana, Ceylon.

HOBBIES AND COLLECTIONS

FOREIGN Medal ribbon packet. United Nations, Axis, \$1.00, sample 20c. Insignia-craft, 236 28th Avenue N.W., Calgary, Canada.

FREE Hobby handicraft information. Postcard to Baker-Alexander, 1472 Broadway, New York 18, N. Y.

SELLING (10,000) Match-cover collection. 15 for 10c—100 for 75c—300 for \$2.00. Jack Gray, 1129 State St., Massillon, Ohio.

SWAPPER? Collector? Send 10c for sample copy Hobbyswap Contacts, 1326 South 27th, Omaha, Nebraska.

THE Hobby Directory for Men and Boys. Box 91, So. Orange, N. J.

MILITARY Insignias: 22 different for \$1.00 (value \$4.60.) Introductory offer, never before equalled. Prices and insignia guide 10c; sample 5c. Hobbyguild, P35

INVENTING Can be an interesting and profitable hobby. Write for complete particulars. Institute of American Inventors, Dept. 40-E, 1926-Eye St. N. W., Washington 6, D. C.

COLLECTING Hobbyists. Exchange duplicates. Swappers directory 10c. C. Bishop, Route 8, Kalamazoo 88, Michigan.

COLLECT Colorful Army patches. Pictures, prices and sample patch only 10c. Insignia Mart, 703 Broadway, N. Y.

UNUSED Match book covers. 100 all different \$1.00. 35 Royal Flash covers \$1.00. Free list. Charles Edelman, 1311C East 84, Cleveland 3, Ohio.

JEWELRY Stones removed from rings, etc., 100 assorted \$2.40; 50 large ones \$2.40. B. Lowe, Holland Bldg., St. Louis 1, Mo.

BOOK Matches—your name, address, or initials. 50—\$1.25. Press, 749 S. Plymouth, Rochester 8, N. Y.

ANTIQUES, RELICS, INDIAN GOODS, CURIOS

COINS, Minerals, glass, Indian relics. Catalogue 5c. Cowboy Lemley, Las Cruces, New Mexico.

INDIAN Relics, beadwork, coins, minerals. Catalog 5c. Sistersshop, Northbranch, Kansas.

SWORDS, Rapiers, daggers, pistols, armor. Illustrated catalog 50c. Robert Abels, 860-A Lexington Ave., New York.

4 FINE Ancient arrowheads, \$1.00. Stone Tomahawk, \$1.00. Flint knife, 50c. List free. Lear's, Box 569, Galveston, Texas.

MUSEUM Specimens. Indian relics, curios, den decorations. Illustrated catalogue, identification chart 25c. We also buy. Museum Supplies, 6601 Oshkosh, Chicago 31, Illinois.

MINERALS AND PRECIOUS STONES

"GENUINE" Arizona rubies (garnets). Send quarter for packet. Mineral Specimens Company, Box 2651, Phoenix, Ariz.

CAMERAS AND PHOTO SUPPLIES

NOW Available for immediate shipment: Univex No. C-15 Uniflash—Synchronized photoflash camera including photoflash reflector unit. Accurate flash timing. Magni-field telescopic view finder. Automatic flash bulb ejector. Uses Univex 00 film. Price: \$6.75. Conway Camera Company, 34 North Clark Street, Chicago 2, Illinois.

FILM! High speed military. Five rolls, eight exposures, postpaid: No. 127—\$1.45; 120—\$1.75; 620—\$1.75; 116—\$2.00; 616—\$2.00. Artex, Union, New Jersey.

CAMERAS! Hundreds! Direct from owners. Latest big directory 25c. Seymour, 101-M Sherman, New York 34.

BUILD Your own candid camera with our kit of parts. Only \$4.75 including federal tax. Free particulars. Seneca Sales Co., Box 53, East Pasadena, Calif.

PHOTO Printer kit \$1.00. L. Spada, 10 Lexington, Wethersfield 9, Conn.

FILMS, 5 Rolls, postpaid 127—\$1.40; 120 or 620—\$1.70; 116 or 616—\$1.95. We buy cameras, lenses, etc. "Cameramen," 542x Fifth Ave., New York 19.

REFLEX Type camera 57.5mm. Maester lens, precision shutter. Postpaid \$5.95. Davis Service, 32A W. Randolph St., Chicago 1, Ill.

CAMERAS, Enlargers, projectors. Lowest prices. Free catalog. Cavalier Camera, 1822 Center, Pittsburgh 19, Penna.

FILMS. All you desire, 6 rolls 127, \$1.65; 120-620, \$1.98; 116-616, \$2.30; 35mm. 36 exposure, 85c each, postpaid. Imperial Foto, 122 Sharon, Glendale, Ohio.

100 FT. Factory packed AGFA super speed 35mm. film \$3.00 postpaid. Camera Aids, 160 East 48th, New York.

ADVANCED Amateurs anticipating opening business, amazing details. Photographer, Midland Park, N. J.

PHOTO Finishers. \$15 per thousand cash paid for empty spools 127, 120, 620, 116 and 616. Write stating quantities available. Howard West, 3 W. 42nd St., New York 18, N. Y.

BASS Says: Trade cameras? For 36 years Bass has satisfied thousands everywhere! Finest equipment available. Always satisfaction guaranteed or your money back! Bass buys 'em, sells 'em, trades 'em. Bass Camera Company, Dept. AG, 179 W. Madison St., Chicago 2.

CASH! Spot cash for cameras, lenses, binoculars, movie and still equipment. Send full description for prompt cash offer. Over 36 years of dependability. Bass Camera Company, Dept. AG, 179 W. Madison St., Chicago 2.

PHOTOGRAPHY For pleasure or profit. Learn at home. Practical basic training. Long established school. Write for booklet. American School of Photography, 1315 Michigan, Dept. 3432, Chicago 5.

USED Camera Directory, Box 1031-M, Canton, Ohio—lists hundreds of war-bargain used cameras—35mm., Speed Graphics, Kodaks, Rolleiflex—many others. Send 25c for latest issue.

HAVE You a camera? Improve your hobby of photography and learn how to make better pictures. Write today for our latest book catalog and sample copy of American Photography, containing articles and pictures by the world's foremost writers and photographers. Camera House, 601, 353 Newbury St., Boston 15, Mass.

PHOTO FINISHING

ROLLS Developed with 8 enlarged prints— $3\frac{1}{2} \times 5$ inches 25c. Enlargement coupon free. Skrudland, 6444 23 Diversey, Chicago 35.

ROLLS Developed and printed 25c, or eight reprints for 25c plus double weight professional enlargement coupon free with each roll. Cut rate quality would cost you more elsewhere. Films for all cameras now available. Cut Rate Photo Service, Dept. S, Box 236, Regina, Sask.

1c PHOTO Sale! Order one 8x10-in. enlargement of your favorite snapshot at new low price of 39c, and get another for 1c. Send only 40c and negative (not print) for two 8x10 enlargements, and free literature—"How to Color Your Own Photos." Write today. Bostonian Photo Lab., Dept. 104, Uphams Corner, Boston 25, Mass.

FREE—Set of filters. Send names and addresses of four camera owners. Photocraft, Canton 1, Ohio.

ROLL Developed and printed only 20c. Skrudland, 6444M Diversey, Chicago.

6 OR 8 Exposure roll developed and printed, 25c. Printed double size 35c. Prompt service. Douglas Photo Service, Box 3352, Brentwood, Calif.

HALL-MARKED Oil colored photos, your negative. Write Scenic Oilcraft, 11319 Iowa Ave., Los Angeles 25, Calif.

FREE Snapshots! Free album! Mail this ad and two negatives for free snapshots complete in album! When you see these free samples you'll want more. Artist, Dept. 131, Drawer 220, Regina, Sask.

SPECIAL—50 Reprints \$1. Suburban Studio, 1410 Bond, Rockford, Illinois.

ROLL Developed, printed 20c. Reprints 50, \$1.00. Howard's, 3760 Fremont, Chicago 13.

ROLL Developed, 8 prints, 25c. Free enlargement coupon. Free mailer on request. Smith's Foto, 9621-A Dobson, Chicago 28, Ill.

THREE 8x10" Enlargements, \$1.00. Send negatives. Look Photo, Andover 1, Mass.

OVERNIGHT Service. Roll developed and 8 prints 30c. Finest quality guaranteed. Our 13th year. Tri-Plex Photo Service, Box 375-B, San Francisco 1, Calif.

CENTURY Delivers work and service that can't be beat. Sixteen famous Century-Tone prints each 8-exp. roll 30c. Free mailers. Century Photo Service, LaCrosse, Wis.

DELUXE Professional quality enlargements. 5x7—25c, 8x10—50c, 11x14—\$1.00. Beautifully toned free. Hand colored—\$1.00 extra. Dept. A-1, 6323 Elmwood Ave., Philadelphia 43, Penna.

48 YEARS of leadership in finer photo finishing. Genuine Moe-Tone quality, approved by thousands offers you prompt, efficient, artistic workmanship. 8 exposure roll film developed with 16 beautiful prints or 8 enlargements 25c. Developing Panchromatic film 5c extra. Let us help you take better pictures. Free mailers and helpful hints. Moe Photo Service, 452, LaCrosse, Wisconsin.

35 4x6 REPRINTS \$1.25. MacDonald's Photos, Box 28-A, Congress Park, Illinois.

INDIVIDUAL Attention each negative guarantees outstanding pictures. Roll developed and 8 prints 25c. 8 beautiful 6x4 enlargements 35c. Fresh film. Write for free mailers and other offers. 24-hour service. Universal Photo Service, Box 6120, LaCrosse, Wisconsin.

PROFESSIONAL 8x10 Oil colored enlargement \$2.00. Send negative and instructions. Johnson, 4006 West End, Chicago, Illinois.

MONEY Back guarantee—All this for 25c: Roll developed, 8 bigger deluxe prints, also 8 regular prints, plus two beautiful enlargements and tasteful Leathertone frame. Lifetone Photo Company, Dept. 839, Des Moines, Iowa.

SLIDES, Black and white, from your favorite snapshots, 6 for \$1 in standard 2x2 cardboard mounts. Send any pictures under 8x10 (returned). No negatives. Jane Sherer, 16 Victory St., Waukegan, Illinois.

YOUR Photo enlarged to 8"x10", beautifully hand colored in permanent oils, and mounted in a simulated leather album. Only \$2.98 plus postage. From any photo or snapshot. Specify coloring. Free circular. Kensey, B25, 211 W. 145th, New York 30.

SMITH For quality! Any 8 exposure roll developed, 8 prints and two enlargements, 25c. 8 double-size prints, 25c. 35mm. fine grain developed, 36— $3\frac{1}{4} \times 4\frac{1}{2}$ enlargements, 90c; 18—55c. Cartridge refilled, 36 exposures, 35c; 18—20c. Write for sample print, mailers and price list. Smith Studios, 8 Saint John Street, Plains, Penna.

8 HOUR Service. Your 8 exposure roll developed and printed jumbo or regular size 25c, deckled edge if requested, 12 exposure rolls 35c, 16 exposures 50c, 36 exposures \$1.00. Reprints jumbo or regular size 3c each. All film developed fine grain. Workmanship, materials and 8 hour service guaranteed throughout. Quality Photo Service, Box 468, San Francisco 1, Calif.

ROLL Or negatives developed, 16 pictures 25c. Dependable Photos, 2960 Gresham, Chicago 18, Illinois.

2 BEAUTIFUL Hi-Gloss prints each good negative and enlarging coupon with each 6 or 8 exposure roll developed 28c. Owlphoto Co., Weatherford, Oklahoma.

FILM 6 Or 8 exposure roll developed & printed plus 5x7 enlargement free—complete 25c. Mail film to Joy-Photos, G.P.O. Box 606, New York 1, N. Y.

ROLLS Developed and printed, 25c. Reprints, 2c; 5x7 enlargements, 15c; 8x10, 25c. Davis Studio, Guthrie, Oklahoma.

FAST Delivery. Satisfaction guaranteed. Eight exposure rolls with two prints of each exposure. 30c; or eight jumbo size prints, 35c, completely finished. Write for special reprint prices. Pioneer Photo Print Service, Box 123, Wichita, Kansas.

AT Last we have films: 116 and 616, 38c ea.; 120 and 620, 33c ea.; 127, 27c ea. Roll developed, all your snapshots hand-colored as beautiful as most actual colored photography 35c. Hand colored reprints 4c each, 12 for 45c. Midwest Photo, Janesville 26, Wisconsin.

ROLLS Developed and eight 4x6 single weight enlargements from any size roll 30c. Reprints 4c each. Mohart Film Service, West Salem, Wisconsin.

FILM Developed, 8 album size enlargements or 16 sparkling prints, 25c; 8 snappy 4x6 enlargements, 30c. Reprints each: contact prints, 2c; album enlargements, 3c; 4x6 enlargements 4c. Crystal Studios, 159-F, Rushford, Minn.

BIGGEST \$1.00 Value in 35mm. finishing today. 36 exposure fine grain $3\frac{1}{4} \times 4\frac{1}{2}$ enlargements; deckled, embossed margin and date. Eighteen exposures 75c; 16 exposure splits 55c; 36 exposure reloads 50c. Special: return this ad with \$2.00 and we will send five 36 exposure reloads. Free mailers. 8 exposure rolls in beautiful, deckled contact finish with embossed wide margin, 25c. Mailbag Film Service, Box 5440A, Chicago 80, Ill.

8 VELOX Prints and two professional enlargements 25c. Send roll or negatives for trial offer. Young Photo Service, 405-C, Albany 2, N. Y.

GLOSS Finish enlargements. 4 5x7 from negative 50c, 3 5x7 from photo 50c. Robert Renshaw, Jr., P.O. Box 478, Chester, Penna.

PHOTOGRAPHY For pleasure or profit. Learn at home. Practical basic training. Long established school. Write for booklet. American School of Photography, 1315 Michigan, Dept. 3451, Chicago 5.

8 EXPOSURE Rolls 25c, over 8 exposure 40c, for one Velox print each and free enlargement coupon. Reprints 3c, minimum 25c. Fred D. Eastman, Bode, Iowa.

BEAUTIFUL Double-size pictures $3\frac{1}{2} \times 6$ each, from 116 and 120 negatives, $3\frac{1}{4} \times 4\frac{1}{2}$ from all other sizes. All work guaranteed. Overnight service. Roll developed and 8 pictures 30c. Roll 12 pictures 45c. Roll 16 pictures 60c. Enlargements on double weight portrait paper 5x7—30c, 8x10—50c. Copies made from any picture 75c. Pacific Photo Service, Box 666, San Francisco, Calif.

EVERY Picture an enlargement! 8 sparkling deckle-edge enlargements and roll developed 25c coin; 116 size or smaller; enlarge reprints 3c. Enlarge Photo, Box 791D, Boston, Mass.

SENSATIONAL Introductory offer! Send snapshot or negative, this ad, and 3c. We'll send you a beautiful 7"x5" enlargement! Or, Kodak roll developed with 16 guaranteed deckle-edge velox fade-proof prints or 8 double-size prints, 25c! Special! From your negatives, 16 regular-size or 8 double-size reprints, 25c! Canidid rolls—36 exp. 35mm. developed, vaporated, enlarged to 3x4, \$1.00! 18 exp. 50c. Reprints, 3x4, 3c each. We have new, perfect 35mm. film. Low prices. Free mailers, details on request. American Studios, Dept. 279, LaCrosse, Wis.

6-8 EXPOSURE Rolls developed and enlarged mammoth size 30c. Reprints 3c. Thrifty Photos, Box 46, South Gate, Calif.

MOTION PICTURES AND SOUND EQUIPMENT

8—16MM. Film bargains. Sound, silent. Big catalog. Kodachrome sample 20 cents. Warrington Films, 1418 Knecht Ave., Halethorpe 37, Maryland.

16MM. SOUND Films. Complete subjects, good condition, \$1.95 per 400' reel, up. Write for list of over 200 available titles. Blackhawk Films, Dept. PM27, Davenport, Iowa.

NEW 1946 Model 35mm. twin s.o.f. projectors with amplifier and speaker, complete, ready for use. Suitcase type 2000 ft. film capacity straight feed, \$1245. Immediate delivery. Trades accepted. Many other good bargains in 16mm. and 35mm. projectors, films, cameras, rewinds, splicers and screens. Mogull's, 64 West 48th St., New York 19, N. Y.

"MISS America Pageant," Atlantic City beauty contest, 8mm., 50 ft., \$2.00, Kodachrome, \$7.50, 16mm., 100 ft., \$4.00, Kodachrome, \$14.75. Color sample, "Waikiki Hula," \$1.00. Catalog, 25c. World in Color, Box 392-F, Elmira, N. Y.

UNUSUAL 8-16 mm. Film subjects. Big catalog with sample film, 10c. National Film Exchange, Broadway, Sta. E, Toledo 9, Ohio.

"THE World's Greatest Passion Play," all sizes sound and silent. Write Hemenway Film, 33-F Melrose St., Boston 16, Mass.

NEW Motor driven 16mm. projectors \$16.00 postpaid. Sterling's, 679 Northampton, Easton, Penna.

FREE Illustrated catalogs. New 8-16 releases. Bryant Films, 264 Spring, Ossining, N. Y.

GUARANTEED Fresh movie film! Dalite loading! Processing free! Three spools double 8mm. \$3.45! Six single 8mm. for Univex, \$3.50! Postpaid. Eso-S, 828 West 39th, Kansas City 2, Missouri.

SOUND Silent projectors, hard to get films. Transcription players. Send dime for catalogs. Hallenbeck Riley, 562 Broadway, Albany, N. Y.

35 MM. Silent sound films, projectors. Bedner, 5300 So. Talman, Chicago.

PROJECTION Equipment bargains. 8-16mm. films. Catalogue 10c. Towers, 935 North Fortieth, Philadelphia 4.

NEW Projector. Shows slides, pictures, comic strips, etc. Projector, slides and electric cord, \$2.25. Send \$1 deposit, balance c.o.d. United, 2309-PD Lawrence, Toledo, Ohio.

TALKIES: Convert your silent 16mm. projector into sound with our guaranteed parts kit. Plays all 16mm. sound films. Quickly assembled at home. Special introductory offer: Send this ad now with \$19.95, check or money order, and we will include sound test film, instruction manual and full information on how to use with your radio, postpaid, or send \$1.50 for complete blue prints showing how to make adapter yourself. Soundtech, Box 3071, Hollywood 28, Calif.

1947 8MM-16MM. Catalog free! Eso-S, 828 West 39th, Kansas City 2, Missouri.

16MM. Sound film and equipment rental, sale, exchange. For home, club, church, school, road showmen. Kunz Motion Picture Service, 1319 Vine St., Philadelphia 7, Penna.; 432 N. Calvert St., Baltimore 2, Md.

"SURPRISE" Assortment 8-mm. colorful titles! \$1. Guaranteed. LeMoine Films, Nevada, Missouri.

FREE Movie catalog; cameras, projectors, films, 35mm. press cameras; photographic items. Goodwill Company, Jackson, Tennessee.

SINGLE Eight film for Univex 60c roll, 16mm. 100 foot \$2.50 including processing. Cine Products, Box 1134, A, Baltimore, Md.

35MM. Silent Holmes projector and medal DeBrie, all accessories, bargain. Edwards, 3054 Arunah Ave., Baltimore, Md.

OWNERS Of home movie projectors. Project the original authentic outstanding home movie production free. Send postal card today. Preferred Films, Hamilton 10, Ohio.

8MM.-16MM. Silent-sound—Black and white and colored film, sold, rented and exchanged. Most reasonable rates in the East. Free catalog. Home Movie Service, 1423 N. 15th St., Phila. 21, Penna.

LEARN Professional motion picture technique at home. Free catalog. Motion Picture Institute, Birmingham 4, Mich.

COMPLETE Stocks always of Castle, Official, Pictorial films, 8mm., 16mm., sound. Musicals, soundies, free catalogs. We exchange your films and equipment, or buy them for cash. Frank Lane, 5 Little Bldg., Boston, Mass.

16MM. MOTOR Driven projector \$16.00 postpaid. Selco Products, Danvers 1, Mass.

HOME Movies. All kinds. Catalogs, 10c. Box 337-A, Valley Stream, N. Y.

FRESH Movie camera films 100'—16mm. \$2.25, three rolls \$6.00, 25' double 8mm. \$1.25 developing included. Ambassador, 479-A Quincy Street, Brooklyn, N. Y.

HOME Movies. Rent, buy, swap 8mm.-16mm. silent and sound at money-saving rates. Details for a dime. Midland, Box 429, Oak Park 4, Ill.

BASS Says: 36 years of leadership in the motion picture equipment field. Sound projectors, 8 and 16mm. equipment, finest accessories. Bass buys 'em, sells 'em, trades 'em. Always satisfaction guaranteed or money refunded! Bass Camera Company, Dept. A, 179 W. Madison St., Chicago 2.

I BUY, Sell, swap, rent s.o.f., 8 and 16mm. films. List free. Harvey Iris, Box 539, Brockton, Mass.

MAKE \$8 To \$10 net profit daily with your 8mm. or 16mm. projector. Details free. Metcalf, 10806 Glenroy Ave., Chicago 43, Ill.

UNUSUAL Home movies—travel, adventure, sports, news, war films. Many film bargains. Big 1946 catalog and sample, dime. Audet, Box 6520-BG, Philadelphia 38, Penna.

LEARN Movie projection, management. Free catalog. Theatre Institute, Elmira, N. Y.

MOVIE Camera films, 100' 16mm. \$2.50, 25' double 8mm. \$1.25. Free developing. Better Films, 742 NewLots, Brooklyn 7, N. Y.

BEAUTIFUL Kodachrome slide and list. 25c. Art Slide Co., M-1, Canton, Ohio.

MUSIC AND MUSICAL INSTRUMENTS

HAWAIIAN Guitar chord chart \$1.00. Over 650 chords in A-E 7th-C#-B 11th—Notes and diagrams by Sol Hoopii and Dick McIntire. Best for arranging. Fator's, 3998 So. Vermont St., Los Angeles 37, Calif.

PLAYER Piano rolls. Two for 95c. Old favorites and newest hits. Send for free list of over 400 titles. The A. Bachand Co., Dept. 1, North Adams, Mass.

ACCORDIONS—Brand new. Just received from Italy. Also used accordions for sale. Del Principe, 307 So. Wabash, Chicago.

WE Want song poems and lyrics on all subjects. We offer the services of a noted Hollywood motion picture composer and arranger. Send your poem today for consideration and our liberal offer. Hollywood Melodies, P.O. Box 2168 PM, Hollywood 28, Calif.

MELODIES Or lyrics \$3. Copy my published song free. Edward Atwood, New Edinburg, Arkansas.

SONGWRITER'S Magazine! 10c copy, \$1 year. Songs published free. "Songwriter's Review," 111-M West 48th, New York.

FREE! Entertainer's script catalog. Kleinman, 25-31-B 30th Rd., Astoria 2, N. Y.

ORIGINAL Music composed to your words. Printing done by music type process. Reginald Belcher, Florham Park, New Jersey.

KEEP Your piano tuned. Tools, instructions, inexpensive. Particulars free. P. T. Crane, 272 North Mountain Avenue, Upper Montclair, N. J.

SWISS Musical movements \$4.50. Mail check with order. Also musical Lucite photo album and cigaret boxes. Lucite scrap available. Novelties of Distinction, 131 W. 42nd, New York City.

MUSIC Lovers. For five new songs send \$1.00. Art Music Co., 1658 Broadway, New York 19.

MUSIC Arranged. Songs printed. Frank Wildt, Music Publisher, Lancaster, Penna.

SONGWRITERS! Outstanding, ethical offer. Hibbler, C5, 2157 N. Avers, Chicago.

MUSIC Manuscripts photostatically duplicated, \$1.00. Clearprint, 118 Washington, Elizabethtown, Pa.

SONGWRITERS—Lyricists—poets. This is your chance! Send your name and address. Banner Music Publishers, Box 848, Grand Central Annex, New York 17, N. Y.

SONGWRITERS! A limited amount of songs wanted for radio distribution. Tin Pan Alley, Inc., 1650 Broadway, New York 19, New York.

SONG Poems. Send to established composer and learn truth about song writing. Vernon Leftwich, 659 So. Orange Drive, Los Angeles, Calif.

PRESENT Your songs professionally to publishers, recorders. You can win too. We set music to your poem, send you 10 prints with har-symb \$15.00. We made original copy of Cement Mixer. Holly Star Music, 6411 Hollywood Blvd., Hollywood 28, Calif.

HARMONICA Magic. Easy new system eliminates notes. Self instruction method includes 75 songs. Send only \$1.00. Money back guarantee. Harmonica Magic, Dept. PM-1, Box 3445, Merchandise Mart, Chicago 54.

SONGWRITERS. Have your songs completed by an honest, experienced arranger. Submit songs for free analysis. Tommy Kilbourne, Box 1253, Bakersfield, Calif.

THE 96 Page "The Complete Songwriter" tells how to write music, words, arrangements and publishing. Send \$2.00 M.O. Puritan Publishing Co., Inc., 343 So. Dearborn St., Chicago 4, Ill.

"GUITARS"—"Band and orchestra instruments"—"harmonicas." List free. Rudolph's, Atchison, Kansas.

SONG Writer's attention! The amazing demand for phonograph records, accelerated by more than 300,000 juke boxes and the hits popularized warrants your immediate consideration. We are offering song-poem writers the rare opportunity of having established composers collaborate on appealing material received this month. Recola Records, Box 987P, Hollywood 28, Calif.

POEMS Wanted for musical setting. Send poem for immediate consideration and free rhyming dictionary. Richard Brothers, 24 Woods Building, Chicago.

SONGWRITERS—Send poems for immediate examination and free book. "Your Future in Songwriting." Radio City Music Academy, 1674 Broadway, New York City 19.

WANTED! Lyrics, melodies for songs. We arrange, publish, sell. Superior Song Studios, Passaic, N. J.

ACCORDIONS. New and used at wholesale prices. Save up to \$100.00. Buy direct from factory. Del Principe, 307 So. Wabash, Chicago.

BEFORE Sending your poem to be set to music, know your composer. Free folder. Al. Moquin, 5333 La Cresta Court, Hollywood 38, Calif.

POEMS Wanted for musical setting. Send poem for immediate consideration. Five Star Music Masters, 630 Beacon Building, Boston.

SONG Poems wanted. Free examination. McNeil, Master of Music, 510-PM South Alexandria, Los Angeles, Calif.

WRITE Songs. Big money and reputation. Write for information. J. Gordon Pub Co., 201 N. Hoyne Ave., Chicago.

RADIOS AND SUPPLIES

CUSTOM Built electronic equipment built to any specifications. Estimates free. Modern Electronic Laboratory, Dept. E5, Box 353, Brunswick, Maine.

FLAT Rate schedules improve profits. Compiled from 500,000 jobs. Write for information. Radio Equipment Co., 1415 W. Franklin Ave., Minneapolis 5, Minn.

STEEL Shelves, adjustable, 6'x18"x36". Other sizes. Radios, record players, Automatic changers. Re-Ampliphone, Milwaukee 8, Wis.

RADIO Parts and supplies. Tremendous savings. List. Electronic Trading Post, Box 1076, Santa Fe, N. M.

BUILD Finest, extra-loud crystal set. Instructions, 15c. "All about crystal sets." booklet, 45c. Catalog free. Amorose Radio, R-4, Hungary Road, Richmond, Va.

REVISED Plans 18 long distance crystal sets, including "Radiobuilder"—25c. Laboratories, Box I-c, San Carlos, California.

WAR Surplus radio parts—IN21 Sylvaria crystal 98c, condensers, resistors. Free bargain lists. Erie Supply, 88 Exchange Street, Rochester, N. Y.

YOUR New free catalog is ready! Radionic's catalog lists hard-to-get radio parts and books. All available for immediate shipment. Send today to: Radionic Equipment Co., Dept. S8, 170 Nassau St., New York 7, New York.

RADIO, Electronic parts and equipment. New and used. Write for free list. Highbridge, 340 Canal Street, New York 13, New York.

HURRY! Hurry! If you want to become a radio service expert in a hurry. No previous experience required. Nothing else like it. Write Hazelton Enterprises, Dept. 2, 302 Temple Court Bldg., Chattanooga 2, Tenn. No obligation.

\$2 BRINGS You a one pound package of radio component parts, no screws or nuts included. Dunlap, 219 S. 17th, Philadelphia 3, Penna.

HAVE You a radio problem? Write for free estimate and include problem. Radio Consultant, 333 W. 87 St., New York 24.

MEMORIZE Morse code rapidly. 10 lessons 25c. Jayson, P.O.B. 1128 Church St. Station, New York 8.

AUTOPILOT Amplifier, seven locktal tubes, six plate relays, etc., \$5.75. Descriptive surplus list, 10c. Engineering Associates, Far Hills Branch Box 26, Dayton, Ohio.

THOUSAND Radio surplus bargains. Send 6c stamps for list. Campbell, 3800 Kinzie, Racine, Wisconsin.

TRANSFORMERS, 110-6.3 Volt cased, 6 amp. with terminal strip, \$3 each plus postage on 3 lbs., no c.o.d. Dunlap, 219 S. 17th, Philadelphia 3, Penna.

BUILD This world's smallest a.c.-d.c. radio with built in loudspeaker! Uses one tube! Easily fits in ladies' handbag or briefcase. Send 50c for plans, photos, instructions. Louis Toth, P.O. Box 110, Station H, New York 25, N. Y.

EXPERIMENTERS. Students, amateurs! Giant grab bag assortment of radio parts, tubes, speakers, transformers, coils, etc. 10 lbs. \$3.75; 25 lbs. \$8.50; 100 lbs. \$25.00. Radionic Salvage, 18518 Winthrop, Detroit 19, Mich.

BUILD Your own radio. 5 tube super het kit complete with tubes and cabinet. Using 50L6, 35Z5, 12SA7, 12SK7, 12SQ7. Easy to wire. Your cost \$16.95. McGee Radio Co., 1330 Broadway, Denver, Colo.

5 DISTANCE Getting radio diagrams, 50 cents. Having radio problems? Write for estimate including problem. Akerberg Radio, Stanley, North Dakota.

CATHODE Ray tubes 5CP1's brand new \$7.95, socket with tube 45c, otherwise 90c, include 5-lb. shipping postage in your remittance. 5CP1 steel shields 85c (3-lbs.). New 954-956 Acorn tubes, original cartons 89c each postpaid. Free electronic bargain list. Ohmeyer Engineering, Dept. D, Fairview Blvd., Hempstead, N. Y.

ANNOUNCERS Needed as radio industry expands. You may qualify. Write: Dept. A, P.O. Box 4703, Dallas, Tex.

BUILD Radio. Complete kit with tubes \$10.95. Details, Radio, 9418e Avenue "A," Brooklyn, N. Y.

POCKET Radio! Build new vacuum tube super-midget. Plans \$1.00. United Manufacturing Associates, 3316-4G, Fort Worth 5, Texas.

ONE Tube radio \$8.45. Complete with batteries, tube, phones, aerial. Clanin, 135 Crown Avenue, Dayton, Ohio.

LOUD Speaking crystal radio, improved design. Illustrated plans 25c. Radio Clinic, 10631-C Euclid, Cleveland 6, Ohio.

NAVY Surplus—Operator control box \$1.00 postpaid. TBY8 walkie-talkie 28-80Mc. with 8 tubes, headset, microphone, locker case, instruction book \$49.00. Van Sickle Radio, Indianapolis 6, Ind.

FAMOUS "Allen" Midget Semi-Fixed Crystal Detector, set building plans and 100 late crystal set distance reports all for 50c postpaid. Allen, 427-P, Clinton, Mo.

MAKE Simple, tubeless, batteryless, distance-getting crystal radios. Crystal and illustrated instructions 25c postpaid. Allen, 427-P, Clinton, Missouri.

FM Can now be heard on old radios! Very simple adaptor! Send postcard for free data! Topical Emprise Corporation, 1527 Highland, Box 42, Louisville 4, Ky.

RADIO Technician and radio service courses. Training for federal licenses. American Radio Institute, 101 W. 63 St., New York City. Approved under G. I. Bill of Rights.

BUILD It yourself. Laboratory designed, radio receiver, hi-fidelity amplifier, phono oscillators, volume expanders compressors. Drawings, literature 50c. Starestone Electronics, 608 Seneca Ave., Brooklyn, N. Y.

BUSINESS OPPORTUNITIES

MAILORDER Advertisement writing with "guts!" Letters, circulars, campaigns written to order. Reasonable! Finkle Advertising, 1201 1/2 South Ogden, Los Angeles 35.

OWN A mail-order paper products business. Sell envelopes, tags, bags, boxes by mail, wholesale. Tremendous demand. Steady profits. No capital necessary. Write Omaha Envelope Service, Dept. 154, 4721 California, Omaha 3, Nebr.

INCORPORATE Your business. Delaware laws. Many advantages, free details. Tax Research Bureau, Inc., Delaware Trust Building, Wilmington, Delaware.

MAKE Your own automatic electric water heater. Save 75%. Big profits selling to others. Write card to Crane Electric, Eugene 4a, Oregon.

SELL Religious goods by mail. Big profits. Work spare, full time. Small capital. Everything furnished. Cleveland, 243-B5 White, Clyde, Ohio.

START A mailing list business in spare time. Big profit. Steady demand. Details free. MacAndrews, 8 Buick Street, Calais, Maine.

START Home manufacturing business making Cleaning Compounds, Soaps, Insecticides (DDT), Cosmetics, Polishes. No machinery. Literature free. Kemix, Park Ridge, Ill.

OPERATE Profitable mail order business. Good opportunity. Details free. E. L. Dawson, Box 44, Summerdale, Penna.

UNPAINTED Wall plaques 2 1/2c up. Illustrated list free. Oman, 642-A Broadway, St. Paul 1, Minn.

MAKE Money making movies. Experience unnecessary. Book of plans, \$2.00. Information, stamp. World in Color Productions, Box 392X, Elmira, N. Y.

WAR Surplus without bidding. New products, stock articles. How to buy, prices, addresses. Advance information. Catalog sheets, each week. Details free. Rush name. Maupin, Tipp City 33, Ohio.

SUB-MANUFACTURERS, Dealers, many territories still open. Build and service wooden composting cabinets for our customers to convert garbage, organic wastes, into valuable fertilizer. Permanent post-war business. Western Compo, 3614 S. E. Ninth, Portland 2, Oregon.

AMAZE Others. Add faster than adding machine. Free details. Math Institute, Box 633, Mobile 4, Ala.

HOW To make money by mail. Easy way to start new or expand your present work. No capital needed. No loans. Astonishing, full particulars free. Granite Book House, Box 867, Portsmouth, New Hampshire.

MAKE Cuts from photos and drawings. Simple. Inexpensive. Both processes \$1.00. Lucius Dawson, Box 20-A Sta. "J," New York.

CARDED Nuts 24/10c. All kinds. Sample cards \$1.40. Altuck Distributing Co., 35 Hillview Ave., San Rafael, California.

YOUR Own business! Make money on the side. Manufacture "plastic novelties." Big profits. Free folder. Pinetree, 1037 Elm, Manchester, N. H.

WHOLESALE Distributors: Amazing patented screwholding screw drivers! Removes, holds, inserts screws instantly hard-to-get-at places! Counter displays, advertising literature, demonstrators furnished. Factories, mechanics, electricians, stores buy quantities. Big repeats! Refundable trial offer! -Millen Mfg., 312 Miller Building, Boston 10, Mass.

MECHANICALLY Inclined men - Own and operate general appliance repair shop. Complete, illustrated course shows you how. Welding, refrigeration, motor repair, how to get business, etc., all phases covered. Free literature. Christy Supply, Dept. 167, 2835 N. Central Ave., Chicago.

MAKE Liquid marble, flexible molds, statuary, art goods, novelties, artificial marble flooring. Literature free. Kemico, Park Ridge, 8M, Ill.

MONEY For you. Start home business. Free leaflet describes 137 plans. Specialty, Box 43, Station N, New York 23.

START Profitable business, sell amazing cleaners under your name. Sample 25c. Linnell Co., Box 1720A, Cleveland 5, Ohio.

COMFORTABLE Income, prestige and future, selling America's outstanding Bibles, religious and educational books by mail. Fast sellers including History World War II. Midwest Co., 745 N. Central Ave., Chicago 44, Illinois.

FREE. Mail order trade magazines and books. A. McCloy, 2261 Marquette, Detroit 8, Michigan.

ENJOY The profit, security and dignity of your own business. Less than \$5.00 needed. Midwest Drug Company, Columbus 15, Ohio.

EARN Money with textile painting course. Details free. George Gundrum, LeRoy, Michigan.

SUCCESSFUL Moneymaking mail order opportunities. Free literature. Geele, 3754 North Port Washington, Milwaukee 12, Wisconsin.

FREE Literature. Tested money making business ideals. Kelly, 9544-AE Whitcomb, Detroit 27, Michigan.

SOMETHING New! Super X red liquid molding rubber. Hot or cold castings. Sample jar 25c. Quart \$3.00. Gallon \$10.00. W. Wooley, 115-A Donald, Peoria, Ill.

CLASSIFIED Directory. Trade magazines. 3343 publications with complete addresses, \$1.00. Commercial Engraving Publishing Co., 34C North Ritter, Indianapolis 1, Indiana.

MEN, Women. "Everybody Likes Candy." Learn to manufacture professionally at home. (Our 35th year.) Ragsdale Candies, East Orange 2, N. J.

SPECIALTY Manufacturing, the big money business that can be operated anywhere, start on a very small capital; we supply dependable formulas and complete instructions; get interesting free booklet, "Moneymaking Opportunities in Specialty Manufacturing." Howard Robinson, Ph.G., 1300-A South Ohio Street, Sedalia, Mo.

WHOLESALE Catalog, directory 10c. Thousands of articles. Stafford Sales, 9611 1/2 N. Jefferson, Indianapolis 1, Ind.

FORTIFY Future, home mail order, \$5 required. Harry Punch, 1329 Grace, Cincinnati 8, Ohio.

1000 FRESH Names. Opportunity seekers. 10c. Amazing plan free. United, 305-West 8th, Los Angeles, Calif.

DOLLARS Daily! Start home mailorder businesses. Details free. Duffy, E-56, Covington, Ky.

RUBBER Molds \$1.00 up. Illustrated list free. Oman, 642 1/2 A Broadway, St. Paul 1, Minn.

OPERATE Profitable mail order business. Good opportunity. Write Walter Service, 4159 East 112th, Cleveland 5, O.

MAIL Order giant package books, plans. Amazing lifetime guaranteed income \$2.00. Robert Martin, P.M., 57 Hart Street, New Britain, Connecticut.

YOUR Own original, exclusive mail order business—built by nationally known consultant on tested, proved success principles. The way to big-time profits. Only few hundred dollars capital needed. Free bulletin, details, proof. Erol Slater, 707 S. Hill, Los Angeles 14, Calif.

LIQUID Marble—make in any color. Soundproof plastic flooring. Flexible molds. Cast novelties, plaques, statuary. Big money—your own business. Free catalog. Write Bing Products, 88-AT Broad Street, Boston 10, Massachusetts.

YOU Too can make beautiful mirrors from inexpensive window glass. Formula with complete working details for dollar bill. Tesco, P.O. Box 189-C Wilkes-Barre, Penna.

POSITIVELY Starts you in profitable mailorder business. Profitable business repeater. Free details. Skyland Specialties, 93 Cloyes Street, West Asheville, N. C.

AT Home—Your own manufacturing business; making popular \$1.00 novelties. Cost you 3c to 15c. Everything supplied. Write So-Lo Works, Dept. H-600, Cincinnati, Ohio.

DO It with sea shells. Attractive jewelry. Big profits. Free instructions. Werts, 1429-56th Ave., Oakland, Calif.

FREE Instructions with electroplating kits \$2.45 up plus postage. Plate baby's shoes, novelties, fishing spoons, etc. Anchor Sales and Service, 3519 Texas Ave., S.E., Washington 20, D. C.

OPERATE Profitable mail order business. Splendid opportunity. For details write West View Sales Co., 1241 6th Ave. North, Ft. Dodge, Iowa.

BIG Moneymaking opportunities. Free. Universal Sales, Box 1076, Peoria, Ill.

WHOLESALE Directory. Source 1/2 million articles. Free. United, 305-W. 8th, Los Angeles 14, Calif.

SELL By mail. Costs 10c, sells for \$1.00. Your profit 90c. Free particulars. Carl E. Edwards, 1351-28, Des Moines, Iowa.

MAKE Soap at home. No machinery. Profitable. Literature free. Kemico, Park Ridge, (8-SM), Ill.

RUBBER-LATEX Molding liquid. "Make your own flexible molds." Sample quart, directions \$2.95. Gallon \$9.00. Free Plasticwood model. Money back guarantee. Rubbercoat, 3873A California, San Diego, Calif.

LEARN Flameproofing and mothproofing. A new and growing business. Learning to treat rugs, carpets, curtains, mattresses, furniture and auto upholstery and fabrics of all kinds. Complete instructions for operating an application service plus enough of this new patented product to perform a \$12.00 job. Send \$3.00 to Flamort, 501 West Santa Clara, San Jose, Calif.

\$50.00 A WEEK Can be made by you, at home, in spare time, without personal selling or canvassing. 36 page book, "More Money for Ambitious People," shows you how. Sent for 10c. United Publications, Divisional Headquarters, Bosworth, Mo.

FLEXIBLE Mold \$1.00 postpaid. Make gifts, novelties. Scotty dog mold, full manufacturing information, illustrated mold and material catalogue. Money back guarantee. Rubbercoat, 3873A California, San Diego, California.

LATEST Giant information directory—Sources 500,000 articles wholesale, retail. Mail order opportunities, tips, \$1.00. National, 322 "A" Union Avenue, Brooklyn 11, New York.

GROW Bean sprouts for market in dark room without sun or soil. Pays well. An economical, vitamin rich food, high in minerals and proteins. Excellent substitute for meats, eggs, butter, cheese, etc. Free literature. Mrs. Nickell, Rt. 1, Box 456, Bend, Oregon.

SECRET Invention. Millions of car owners buy on sight. No competition. Huge profits. Easy made at home. Exclusive territory. Plans complete ready to go \$1.00. We cooperate. P. O. Box 201, Marion, Iowa.

WHY Job worry? Learn electro-plating, interesting, highly paid business. Postcard brings full details, free. Plater Hyde, Dept. MC, P.O. Box 176, National City, Calif.

WRITE Goldcraft Plastics, Box 228, Long Beach, Calif., for exclusive moneymaking opportunity.

OPERATE profitable mail order business. Splendid opportunity. For details write Rausch Service Bureau, 542 S. Broadway, R-701, Los Angeles 13, Calif.

LEARN How to metallize baby shoes. Quick easy method. Have a business of your own. Complete instructions by mail. Associated Industries, P.O. Box 184, Newark 1, N. J.

125 SUCCESSFUL Business plans. Broadside free. Crown Books, Charlotte, Mich.

MAKE Money operating mail order business. Good opportunity for ambitious people. Details free. Bryant Howell, Parkin, Arkansas.

SPECIAL Liquid molding rubber. Free sample. Quart \$3.00, gallon \$10.50. Free instructions. Universal Sales, Box 1076-A, Peoria, Ill.

BOOKKEEPERS: General ledger and tax report experience. Operate permanent, profitable accounting service for the smaller business. Part or full time. Simplified method. Write now! L. A. Bell, 1404 West 25th Street, Cleveland 13, Ohio.

START Costume jewelry business. Write Costume Jewelers, 264-5th Ave., New York.

SELL By mail to huge Negro market. This is over-prosperous field of prospects. Details free. Fredericks Books and Supplies, Box 1810-P, Houston, Texas.

EARTHWORM Culture. A home industry. Send postcard for valuable free bulletin on "Earthworms: Their Intensive Propagation and Use." Thos. J. Barrett, Earthmaster Farms, Box B-488, Roscoe, Calif.

LIQUID Rubber for flexible molds. The real stuff. Send for illustrated instructions on mold making 50c. Apex Plastic Products, 1740 Estes Ave., Chicago 26.

\$46 FROM Square foot plywood. Jigsaw necessary. Write, Woodarts, X-31, Bridge-water, Mass.

ACCOUNTANTS, Bookkeepers, operate our system. Forms furnished. Barnhart & Kennedy, Public Accountants, Chambersburg, Penna.

TYPISTS, Profitable business at home. Complete authentic information, 50c. C.O.D. 75c. Gaunt, 3521-y Broadway, Chicago 13, Ill.

MAKE Big money now, selling our beautiful plaques. Any snapshot, negative, photograph reproduced in plastic. Everyone wants one. Send for sample. No investment. Dale Specialty, 109 Hudson St., Dept. M, New York 13, N. Y.

RUBBER-COTE Latex makes perfect lasting flexible molds. \$3.00 quart, \$10.50 gallon. Rubber molds for sale. Morgan Art Co., 4923 Rockville Road, Indianapolis 8, Indiana.

10c BRINGS You hundreds of money-making propositions, plans, ideas, tips, wholesale supply sources, magazines—50c value. Gardenville Publishers, Gardenville 5, New York.

NYLON Tooth brushes sell fast. Good profit, samples 25c. Robert Frost, Inc., 120 Broadway, New York 5, N. Y.

PROFITS In plastics. Instruction 25c. Craft Co-op, Dept. 19, 3928 Dumaine, New Orleans, La.

REFINE Used oil without cost. Particulars free. Arthur Yesk, 17 Cuttermill Rd., Great Neck, N. Y.

CASH In your spare time at home. 150 new ideas free. Edgar Brinson, 312 W. 123rd St., New York 27, N. Y.

QUICK Money! "Repairing car batteries." At home! Easy too! Write. Batteryman, Grand Junction 5, Colorado.

GET In business for yourself. Open an office. No selling. We train you. Write for free details. Franklin Publishing Co., Dept. M, Roanoke 7, Va.

TWENTY Thousand customers. Listed on the Blue List. Write Addressee, Box 1251, Chicago 90, Illinois.

YOU Sell, we mail. One of best mail order courses, easy to sell. Big profits. Millions of prospects. Sample, dealers proposition \$2 (refundable). Limited. Hurry! Chapman, 416 Dillard, Winter Garden, Fla.

POSTAGE Vendors, top quality two column machines, two for \$35.00. Vanhise, 517 Birmingham St., Bridgeport, Conn.

MOULDS For lead toys. Sample mould and catalog \$1.00. Catalog 10c. Dandridge, 1557 Essex St., Rahway, N. J.

OPEN Up cleaning, dyeing, pressing shop. Instruction book \$1.00. Artie Barnes, Box 997 PM, Wichita, Kansas.

OPERATE Your own employment agency. Many make \$500 upwards monthly. Copyrighted manual reveals all. Small investment. Write for particulars. Hunt, Box 308, Burlingame, California.

MAIL Order profits and how to make them. Write us today asking for free information on what sells—who buys by mail and how to reach them. Help you every step of the way. No obligation. Joyce Distributing Co., 30 West Washington Street, Room 940, Dept. 54-A, Chicago 2, Illinois.

FELLOW Workers—Down with bosses—Start own business—Be independent—Booklet describing 137 tested plans, free. P. Padney, 307 York St., Jersey City, N. J.

MAKE \$200 Weekly selling new line of books. Details free. Leroy Harris, 310 W. 14th St., Cincinnati, Ohio.

LEARN Shell jewelry manufacturing. Complete, simplified home instruction course, beautifully illustrated, shows 45 styles pins, earrings, brooches, sprays, hair ornaments. Includes pearlizing, dyeing, golding, glow-in-dark methods. No tools needed! Learn-earn within a week. Only \$1 postpaid, including wholesale prices of all raw materials. House of Gifts, Box 4550-RF, Coral Gables, Fla.

START Home business making statuary, plaques, novelties, garden furniture, artificial marble flooring, liquid marble. Make your own flexible molds. Amazing profits. Folder free. Creative Publishers, Box 236-L, Winnetka, Illinois.

MINK Raising, information free. Complete. Lake Superior Mink Farm, Superior, EE, Wisconsin.

PROFITABLE Mailing merchandising business. Write Riegel, 1111 Harrison, Phila. (24), Penna.

START A mail order business. Free information. Kirk Sales, Box 84, Wellington, Ohio.

TADPOLES Make frogs, tremendous demand. Both make you money. 25c brings tell-how information. Chariton Corporation, Century Building, Chicago 4.

PROFITABLE Business opportunities. New, fascinating. Home or by mail. Get the facts. Deavenport Mail Service, 147A Roxboro, Rochester 11, N. Y.

MAIL Order beginner! Right start—means success. Free information. Russell's Service, PM, Grant 820, Laredo, Texas.

25c MAIL Seller. 800% profit. Sample, details 10c. Harvey Teeple, Decatur, Ind.

OPERATE Profitable mail order business. Good opportunity now. Details free. Post Office Box 7324, New Orleans 19, La.

ART Of gem cutting, 128 page book giving full instructions, with 32 page gem catalog \$1.60 postpaid. Hill Gem Co., Route 7, Salem, Oregon.

OPERATE Profitable mail order business. Details free. P.O. Box 5331, New Orleans, La.

EARN Up to \$2,000 year, inventing simple items for special cash markets. Ideas only. No patents. Hendrickson, Argyle 7, Wisconsin.

COPPERIZE Baby-shoes, complete instructions, tested sales plan. Metalloids, Box 8087-b, Pittsburgh 16, Penna.

MAKE Strange new plastic—1c pound. Makes durable, attractive floors, walls, roofs. Build for half. Bays Laboratory, Oklahoma City 9.

MAKE "DDT" Products. My ten master formulas show how. Literature free. Howard Robinson, Ph. G., 1302-A So. Ohio, Sedalia, Missouri.

GOT \$24,500 Using "schemes" from "Schemer" Magazine, Alliance, Ohio. 48th year, \$1.00; four samples, 30c.

START Your own business in one evening, without special equipment, make enough wonder product to net you up to \$100.00 profit. Send \$1.00 cash (C.O.D. \$1.21) for full details plus selling instructions. Lake Shore Laboratory, Dept. PM, 534 Surf Street, Chicago 14, Illinois.

SILVER Plating liquid you can make, for ten to twenty cents per ounce. Why pay up to one dollar? Send penny card for particulars. Gold liquid also. The Mirror Shop, Box 728, Seattle 11, Wash.

YOUR Circulars, folders, and small booklets mailed, 500 for \$1.00 to any desired name classification. Bourque, 3712 Fifth, Marrero 2, Louisiana.

FORTUNE From farming; less labor. "Nature's perfect system." Two great booklets—30 years study and experience gives fullest guarantee. Both \$1.00 postpaid. Agriculture Engineer, 281 Windsor Street, Hartford 5, Conn.

IF You would like to make \$5,000 yearly in an easily learned office business of your own, send for free details immediately. G. H. Cole, Pres., Syracuse 2, New York.

MAKE Flexible molds! Few cents each! Cast plaques, novelties, bookends! Free sample! H. Tooker, 630-A Chestnut, Hamiltion, Ohio.

BUILD Lifetime income at home. Books of instruction for ambitious people. Information free. News Specialty Company, 463 Daisy, Mansfield 1, Ohio.

\$565.00 PROFIT From every \$15.00 invested. Standard Service System, La Grange 1, Indiana.

LEARN Inlay work this new easy way. Beautiful inlay work of a thousand pieces. No limit to different designs, can be made in a short time. Copyrighted instructions mailed for 25c. No stamps. A. Emerson, 215, Jensen, Florida.

LIQUID Marble; snow-white, multi-colored. Glazed. Unglazed. Composition flooring. Lifetime wear. Any color. Flexible molds. Plaster casting. Get into the big money now. Full information given free. Write Compo-Tex, Box 786-R, St. Louis, Mo.

SPIN Lovely Angora wool into choice yarns, at home, everything furnished. House of Angora, Springfield, Illinois.

OPPORTUNITIES Galore! Fifty profitable mail order plans. Literature free. Priesing, Box 97, Jamaica Plain 30, Mass.

HOW To build your own mail order business. Creative ideas to make money. Rush 25c for booklet. Holden, 4903A Rhodes Ave., North Hollywood, Calif.

MAKE Big money preserving baby shoes in metal, bronze, pearl, gold and silver! Kiktavi Company, 8620 South Ruthelen, Los Angeles, 44, California.

SPECIALIZED Mail business earned \$1400 monthly. Copyrighted instructions \$1.00. Wm. Boyd, 331 Fourth, Pittsburgh 22, Penna.

START Moneymaking home mailorder business, sparetime. Interesting literature free. Goodrich, Edgewood Terrace, Longmeadow 6, Mass.

GUARANTEED Profits, your yard; basement; kitchen. Information 25c. Dillard, Box 2807, Kansas City 13, Missouri.

BRONZE Baby shoes! Big profits! New field! Details free. Write, Opportunity Center, Box 349, Long Beach 2, Calif.

SYNTHETIC Latex with Neoprene base for making flexible molds! Quick drying! Quart \$2.00. Gallon \$5.95. Full instructions. Plastercraft, 1406 East 43rd Street, Cleveland 3, Ohio.

HOW And where to obtain capital, small and large loans, free particulars. Star Service, Wapakoneta, Ohio.

EXTRA Profits 50 to 75% home mail order business. Details free. Campbell Service, 1626 E. 75, Cleveland 3, Ohio.

BIG Money silvering mirrors. Easiest method, best results. Rumfield, 5716 Junius, Dallas, Texas.

SMALL Capital starts your own advertising agency, at home in spare time. Complete operation exposed. No stock or equipment. Opportunity for large earnings. Stamp brings folder and proof. P. Snyder, Box 4907-A, Philadelphia 19, Penna.

MAIL Order business can be your future! Same as hundreds advertising in this and other publications. "How to Build Your Own Mail Order Business"—noted specialist's 10,000-word treatise—shows how to make it pay, on small, capital start. 25c postpaid. Satisfaction guaranteed. Maupin & Maupin, LaFayette 3, Ind.

HARDWARE Business is one of the most interesting and profitable of them all. Be independent. You can start your own retail store with small investment and no previous experience. 15,000-word, copyrighted booklet tells you how. \$1.00 postpaid. C. R. Divan, P.O. Box 325, Santa Monica, Calif.

CASH By mail. Either sex. 10c brings offers. Bargain. Specialty Company, Box 635BO, Modesto, California.

GO Into rug and upholstery cleaning and mothproofing business. Extra double profits selling these two professionally used products to stores and homes. Russell-Johnson Company, Clarkfield, Minn.

START A business of your own. Can put you next to new profitable business opportunities. Particulars free. Beiers, 837-A N. Hoffert St., Bethlehem, Penna.

RAISE Your salary. Amazing new plan works wonders. Write immediately. Good Supply, Potsdam 7, New York.

WE Start you in business, at home, sparetime, earning \$10-\$30 weekly selling by mail. Stamp appreciated but not necessary. Driscoll Sales Service, Box 2771-A, Denver, Colo.

COLORGLAZED Concrete pottery made without molds. New, low cost, patented method. Cemetery products, novelties, tiles, floors, etc. Basement leaksealing. Other moneymaking projects. Booklet, details free. Men only. National Potteries Company, Fergus Falls, Minnesota.

OPERATE Profitable mail order business. 75c profit each dollar. Powell Service, 5713 Euclid, Cleveland 3, Ohio.

ELITE Collection contains 137 practical money-making plans; local and mail order. New edition. Particulars free. Elite Co., 220-A Grand St., New York 13.

137 WAYS To make money, in home or office, business of your own. Full particulars free. Elite Co., 220-A Grand St., New York 13.

MANUFACTURE Costume jewelry at home for profit, hobby, therapy. Free wholesale supply catalogue. Instructions. Florida Supply House, Bradenton, Fla.

PUBLISHER Of seventy page trade magazine offers cooperative distributorships to men desiring advancement in mail order field. Splendid opportunity. Good earnings. Send 10c for handbook; application form Progressive Publications, Sheboygan, Wisconsin.

WANTED Unused U. S. postage stamps, small discount. Advance Stamp Company, 24 East 23rd Street, New York.

PLASTICS. Your own business at home. Make your own plastics, no expensive equipment needed, formula and molding instructions \$1.00. Box 224, Wickliffe 17, Ohio.

METALLIZE Baby shoes! Learn this money making business from nationally recognized consultant. Get "know how" from outstanding authority! See Kushner ad, page 250.

LIQUID Rubber, for making flexible molds, literature and sample free. H. Chaney, 1130 E. 16th St., Jacksonville 6, Fla.

PLASTIC Homes—Build yourself! Resurface old buildings! Wonderful building material. Particulars free. Marbleizing Service, Edwardsville, Illinois.

MAILING List! 5000 women mailorder buyers. \$25.00; 3000, \$15.00; 1000, \$6.00. Guaranteed accurate! Try them! Woods Remants, Bedford, Penna.

LIQUID Marble—Colorful, glazed! Molded, brushed, sprayed! Composition floors. Rubberlastic molds. Particulars free. Marbleizing Service, Edwardsville, Ill.

HANDY Men—Earn money home operating Community "Fix-It" Shop. Write Stanord, 708 Rawlings, Carbondale, Ill.

YOUR Own business. Big profits, very small capital. National organization teaches, helps, supplies everything. Interesting service business. Big demand everywhere. Americlean, 211 North 7th Street, St. Louis 1, Mo.

BOOKKEEPERS—Operate your own "Dollar-A-Week" bookkeeping and tax service. Full or spare time. Details free. Ellis, Box 200, Cedar Grove, No. Carolina.

MAIL Order business course shows you how to make money, spare or fulltime. Teaches professional mail order technique—not penny-snatching schemes. Fascinating 100-page illustrated success-catalog free! Write—Nelson Company, Dept. 4-02, Chicago 5.

BUILD Miracle homes. Yours. Others. Chamberlain, Fitzsimons Building, Pittsburgh 22, Penna.

LATEX For making flexible rubber moulds. Thoroughly tested. No shrinkage. Complete instructions with each order. Stoneham Rubber Co., Box 244, Stoneham 80, Mass.

"HOW To Make Simple Molds and Plaster Plaques." Profitable business or hobby! Instructive booklet 25c. Plastercraft, 1406 East 43rd Street, Cleveland 3, Ohio.

RUBBER Moulds for casting novelties. Latex for making moulds. Use thoroughly tested and approved products. Eastern Latex Laboratories, Box 153, Mattapan 26, Mass.

TYPEWRITER Repairing—Original course, simplified home study. Weber Typewriter Mechanics School, Box 269, Osborn, Ohio.

FLORIDA Opportunities—Pensacola offers exceptional opportunities for small industries, especially in the field of mahogany novelties and woodware, perfumes, soap, chemicals. Delightful year-round climate. Wonderful fishing, hunting, beach sports. For information write: Industrial Development Division, Municipal Advertising Board, Pensacola, Florida.

RECAST Old batteries into new. Latest achievements. Battery Laboratories, Minneapolis.

\$25 WEEKLY Working two hours daily. No canvassing. No manufacturing. Lycke, Box 2471, Cleveland 12, Ohio.

START Mailorder bookshop—Everything furnished; publisher cooperation. 25c brings booklet, exclusive setup, samples, exciting ideas. General Publications, Ossining, N. Y.

BECOME An "Attritionist Masseur." First improvement over Swedish massage in 100 years! Results unbelievable! Dr. Swearingen, 9128M, Station S, Los Angeles.

Big Money making Hollywood style pottery, bird baths, wishing-wells, benches, stucco-rock. New method. Clever designs. Color with chemicals, water-paints. Marbling, colored glaze effects. Dime brings samples, pictures, literature. Hollywood Cementcraft, 8527 Wonderland Ave., Hollywood 46, California.

BRUSH Plating outfits connect to a battery. No tanks necessary. Good paying business at home plating autoparts, bathroom fixtures, bicycles, reflectors, silvering mirrors. No shop or experience required. Outfits furnished. Free booklet. Gunmetal Co., Ave. H, Decatur, Ill.

AGENTS—To mail our literature. Good profits. Home business. Maywood, 1133 Broadway, New York.

START Paying mailorder business. Circulars mailed. Clark, Box 515, Schenectady, New York.

WE Show you how, in ten easy lessons, to succeed in roofing and siding unlimited, profitable business. No capital needed. Roy J. Peyton, Sr., 1611 South Kentucky Ave., Evansville (13), Ind.

BUILD Neon signs and neon lighting. Easy to learn. Very small capital required. McMaster Sign Co., 730 State St., Bellingham, Wash.

TREMENDOUS Profits mailing literature, dealers' information 3c. General-print. East Orange, N. J.

BABY Shoes preserved. Complete instructions. Exclusive rights. M. E. Watson, Bellefontaine, Ohio.

WOULD You pay 3%—first \$350 made? Color-illustrated book "505 Odd, Successful Enterprises" free! Some plans offer occasional "day off." Start at home, office. Expect something odd! Pacific, 262 Drake, New Rochelle, N. Y.

MONEYMAKING OPPORTUNITIES

FINANCIAL Success for you! "Mail Order Flashes"—64 pages of tips, plans, schemes and instructions. 25c. E. McCrow, 2261 Marquette, Detroit 8, Michigan.

MANUFACTURE Shell jewelry. Write for free instruction book. Supplies at wholesale. Russ Renaud Novelty, 7956 N.E. 2nd Ave., Miami 38, Fla.

BE Your own boss—Write today for free folder describing practical, tested money making plans. Donovan, Box 123-A, Jersey City 3, New Jersey.

GET The newest and best offers. New service brings complete, ready-to-start offers at low cost. Saves time, effort. Particulars free. Kelly, 9544-AF Whitcomb, Detroit 27, Michigan.

AT Last! Fifty prize plans for successful mail order operation. Be first! Write now for free particulars. P. A. Sheehan, 13 Pearl St., Amesbury, Mass.

INTERESTING Mail Journal 2 months 10c. "Direct-Mail Success," 7040 Woodward, Dallas 17, Texas.

FREE Literature describing many money making plans. Address: Joe N. Bolden, 409 Washington St., Bristol, Penna.

MECHANICALLY Inclined men—Own and operate general appliance repair shop. Complete, illustrated course shows you how. Welding, refrigeration, motor repair, how to get business, etc., all phases covered. Free literature. Christy Supply, Dept. 1167, 2835 N. Central Ave., Chicago.

"LUMINOUS Paint." Resilvering Mirror formulas 25c each. Soapmaking, (20 formulas) \$1.00. Ideal Service, 300, Park Ridge, Ill.

NOVELTY Manufacturers: Increase your sales with our snappy, outstanding designs for making your own molds. Large, illustrated catalog 25c. Plastex Products, 127 Clement, San Francisco 18, California.

DRAFTSMEN—Start spare time drawing service. Operating plan \$5.00. Critchfield & Associates, 1015 E. 75 Terrace, Kansas City 5, Missouri.

EARN Money by mail. Our books tell how. Literature 10c. Handy thousand fact booklet included. Harold Edlund, 577 Kensington, Los Angeles 26, California.

MONEY In domestic rabbits! Spare-time, full-time. Write for literature. John Edwin, P.O. Box 5642, Dallas 2, Texas.

START Your own business! Big money—manufacture novelties, plaques, statuary at home. Catalog free. Write Bing Products, 88-AU Broad Street, Boston 10, Massachusetts.

FREE "Prize Contest Bulletin" describes many contests. Money making opportunity. Cash Register-G, 210 Fifth Avenue, New York 10.

THOUSANDS Articles wholesale. "Supply Source Directory" 10c. Ideal Service, Park Ridge D-8, Illinois.

WANTED. Get the facts on how you can earn \$50 to \$100 per week right in your own home. Details free. G. W. Lowman & Sons, 363 Tulpehocken St., Reading, Pa.

YOUR Spare time is valuable. Make it pay. Particulars free. Garlen, Box 178, Richmond 1, Va.

PAINT Wall plaques at home. Big profits. No experience needed. My course tells how. Valuable information free. Alfred Novak, 2560-A Loop, Cleveland 13, Ohio.

"THERE'S Big money in junk!" Easy! Fascinating! Free circular! Batteryman, Grand Junction 5, Colorado.

LEARN How to permanize baby shoes in beautiful metallic finishes. No motors, tanks or equipment needed. Complete instructions by mail. Associated Industries, P.O. Box 184, Newark 1, N. J.

HOW To sell by mail. No guess work. You get facts. Sample dime. H. S. Smith, 3139 So. Mabbett Ave., Milwaukee 7, Wis.

START Your own mail order business! 50 profitable, small capital plans show how! Details free! Mailway, 620-A William, Winnipeg, Manitoba, Canada.

FREE Success details. Aviation, electricity, plastics, radio. Technibook, Box 261-C, Mt. Kisco, N. Y.

\$1 PROFIT Each 25c invested. R. T. Johnson, Brookport, Ill.

64 PAGE Dollar making book 50c. Free imprints; wholesale prices, home business. Easy! Louis Lant, 56 Teneyck Ave., Albany 2, New York.

CO-PUBLISH Magazine. Many profits. 16 page booklet 10c (refundable). Goldenberg, 5209-C Lindsay, Houston 3, Texas.

CANDID Camera given free to boy or girl in exchange for few hours easy work. Write G. West, Box 396, Pueblo, Colo., for information.

MONEY Making circular sent free. Write Orange Mfg. Co., 545 Fifth Ave., New York 17, N. Y.

WHOLESALE Anything imaginable. New guaranteed list 25c. Refundable. Lasalle Novelties, Box 2172, Waterloo, Iowa.

MAKE \$5000 Yearly, like I do. Guy Carylton, Bethany 1, Okla.

LET'S Swap! Whatcha got? Whatcha want? Send 25c for National Swappers Guide. It's full swappers, buyers, sellers coast to coast and opportunities to swap, buy and sell almost anything under sun. National Swappers Guide, P.O. Box 415, Evansville, Ind.

I MADE \$1000 From 1000 tomatoes using my unique methods. Detailed instructions, \$1.00. (Refundable). Alfred Dinsmore, Marlborough, Mass.

EARN Money at home—realize independence. Write Successful Income Builders, 508A, Hollywood 28, Calif.

MANUFACTURE Costume jewelry at home for profit, hobby, therapy. Free wholesale supply catalogue. Instructions. Florida Supply House, Bradenton, Fla.

UNPAINTED Figurines, plaques list. Progress Company, 4033 Chowen, Minneapolis 10, Minn.

EX-GI'S Wacs plan for your future security with proven plans. Literature free. Triare Books, Box 26, Pratt Station, Brooklyn, N. Y.

EARN Money evenings, copying and duplicating comic cartoons for advertisers. Adservice, Argyle (1), Wisconsin.

"FORTUNES In Formulas," 10,000 trade secrets, authentic, reliable, practical, moneymaking ideas galore. This 900 page book is a real bargain. \$2.95 postpaid. Stillman, 555 Kingston Ave., Brooklyn 3, New York.

10,000 FORMULAS, Receipts, secret profit ideas. Details free. Lumco, Kimball, Nebraska.

200 MONEY Making deals, Plans, Rare formulas. Schemes. Folio free. Formico Eng., Box 572, Dayton, Ohio.

PLASTIC Paint all colors easy and inexpensive to make. Detailed process \$1.00. L. Cantin, 6 1/2 Scott, Quebec, Canada.

MONEY Made in spare time from hobbies. Particulars free. Alfred Halteman, 314 Willowood Dr., Dayton 5, Ohio.

SELL Merchandise by mail. Profitable, lifetime business. Write today! Powell, Sampliner Bldg., Cleveland 3, Ohio.

MONEY-MAKING Opportunities, exclusive supply sources, personal guidance guaranteed. For complete information, remit 25c. American Mail Trade Association, 313-F East 21st, New York 10, N. Y.

WOULD You pay 3%—first \$350 made? Color-illustrated book "505 Odd, Successful Enterprises" free! Proven by "Little Fellows." Start at home, office. Expect something odd! Pacific, 262 Drake, New Rochelle, N. Y.

BUY Articles wholesale. Make money by mail. Formulas, trade secrets. Free literature. Massey, 64 Sterling, Franklin, New Jersey.

GUARANTEED Giant Chinchilla rabbits. Prolific. Profitable. Most valuable fur. Markets furnished. Details free. Willow Brook Farm, R 15, Sellersville, Pa.

THOUSANDS Of alarm clocks need repairing. Jewelry stores swamped. Our simplified course teaches you how to repair these clocks. Necessary tools and supplies furnished with course. Alarm Clock Repair Service, P.O. Box 2350A, Houston 1, Texas.

"HOW To Write Advertising," absolutely free! Dudley Bunn, 126-PM Lexington Avenue, New York 16.

EARN Money at home! Thousands do! "Home Worker Magazine" tells how. Sample, 25c. Sizemore, Box 7, 4917 North Kostner, Chicago.

FORTIFY The future! Start own business; home, office. Booklet describing "Collection of 137 Tested Plans" free. Elite Co., 220-A Grand St., New York 13.

PUBLISH Your own magazine. Hand-some 52 page format, well edited, illustrated. Cost low as \$1.00 month. Brings you prestige, profits. 25c brings sample, details. National Ord. Nebr.

I MAKE Big money in the mail-order business. You can do the same at home with my copyrighted system. Write me. I'll tell you how. P. Little, Box 8, Glen-shaw P.O., Pittsburgh, Penna.

START Plating business at home. Amazing profits. Make own outfit. Inexpensive. Illustrated instruction booklet 25c. Popular Mechanics Press, (C-43), 200 E. Ontario, Chicago.

FORMULAS, PLANS, ETC.

NEED Chemists? Formulas. Analyses. Ideas. Consulting Scientific Company, Swarthmore, Pennsylvania.

REAL Manufacturing formulas. Lists free. Cummings, Chemist, Gordon Ave., Syracuse, N. Y.

FORMULAS — Latest, best. Analysis. Literature free. Belfort, Engineering Building, Chicago.

BUBBLE Formula and valuable list 10¢ (coin). Worth dollars. Taulman, 3316-G-6, Fort Worth 5, Texas.

MANUFACTURE Cleaners, flavors, cosmetics. Formula catalog free. Kemico, Park Ridge 16, Illinois.

COUNTLESS Profitable opportunities as own boss! 924 page giant illustrated instruction book contains 10,000 helps, scientific formulas, secrets. Earn immediately! \$2.89 postpaid. (C.O.D. accepted.) Continental Publications, 79-02m Woodside, Elmhurst, New York.

DISCOVERED. Time, dollar saving method of self hair cutting. New Winner. (Stamp). Engineering, Box 342, Cambridge, Mass.

ALL-PURPOSE Formulas, most modern, opportunity-building. Personal guidance. Details free. Manufacturers Advisory Service, 350-A Stockton St., Brooklyn 6, N. Y.

METALLIZING Baby shoes formula, \$1.00. No special equipment needed. Nunn, 659 E. Oxnard, Calif.

PLASTICS

PLASTICS And supplies—New Plexiglas, Lucite, Catalin, sheets, rods, tubes, etc. Exceptional kits \$2.00, \$5.00, \$8.00. Attractive prices. We pay postage. Free list. Plas-Met Sales and Engineering, 4648 Shirley Place, St. Louis 15, Mo.

Clear Plastic glue (cement) for Lucite, Plexiglas, Acetate. Repair broken china, furniture, toys. Half pint \$1.00; quart \$3.00. Great Lakes Plastic Chemical Co., Leaf River, Illinois.

PLEXIGLAS Sheets and supplies. Free price list. Thomas Cavaliere, 2141 So. Beechwood St., Philadelphia 45, Penna.

ZIMCOLITE — Platin — Mold without equipment, novelties, etc. Trial 1/2# with instructions—\$1.00. Plastic Products Co., 211 7th S.E., Canton, Ohio.

BEAUTIFUL Articles easy to make with the Jacaso Kits and instructions. Plexiglas, Lucite, Lumarith. We have in stock any plastic materials you need, including dyes, cements, buffing compounds. Send card today for complete catalog 1A. Beginners experimental kit \$2.00. Jacaso Company, Box 180, Lakewood, New Jersey.

COLORED Lucite — Plexiglas cement. Five colors \$2.25. Dealers wanted. National Plastic Products Co., 5 W. Larned St., Detroit 26, Mich.

PRESERVE Your favorite photo, photostatic discharge, fishing or drivers license, etc.! Let us laminate them between crystal clear plastic, making them waterproof, glossy, durable—ideal to carry in billfold. Anything up to 3"x5". 35¢—enclose money with article, we'll return it laminated promptly. Bircraft, Belleville, Illinois.

PLASTICS. Make yours at home. Formula and moulding instructions \$1.00. Forester, Zone 84, Station K, Toronto, Canada.

COLORED Plastics — mottled colors; sheets and rods. Free price list. Hanson Plastics, Dept. J, 7625 South Park Ave., Chicago 19.

25 PROJECTS! Complete plans and instructions. Beautiful, salable Lucite novelties. Warde, 1248 Neil, Columbus 1, Ohio.

\$1100 IN Cash prizes for your plastic projects. Write today for full information to: Allcraft Products Co., P.O. Box 212, Hempstead, New York.

PLASTER Workers. Just created a new Christmas plaque. Don't be late on this one, every home a prospect. Model only \$1.00. You will make money on this one. Order early. Walter G. Williams, 3525 Ave. O., Galveston, Texas.

PLEXIGLAS Sheets, rods, dyes, cements, Vibro tools, findings. Free listings. Craft Plastics, Box 129-P, Somerville, N. J.

PLASTICS. Plexiglas, Lucite, Catalin. Jewelry craftsman supplies, including 48 page illustrated catalogue 10¢. Douglas Homecraftsman, Box 34 B, Stamford, Connecticut.

POLYSTYRENE Polished, 1/2" round rod—half priced! Six feet, \$1.00. Technicraft (Distributors — plastics, supplies, tools), 1156 Commonwealth, Boston 34, Mass.

ANYTHING Made to order in plastics. Nick Iamarino, Route 2, Quakertown, Penna.

"FORMALIN" Quicksetting liquid plastic. Literature free. Dealers wanted. Formalin Works, 5 W. Larned, Detroit 26, Michigan.

PLEXIGLAS, Clear, masked, 12"x12", 1/16"—\$1.50; 1/8"—\$2.00; 1/4"—\$2.75, postpaid. Dyes, 16 colors; dye concentrate; cements, colored, clear. List free. G. Baker Company, 685 Center Avenue, River Edge, New Jersey.

LUCITE—Complete illustrated fabricating instructions, used in craft classes throughout the world, price list on lucite, dyes, complete supplies. Booklet 10¢, with sample. 35¢. "Gem-O-Lite" P.O. Box 686-B North Hollywood, California.

BIGGEST \$1.00 Plastic value transparent plexiglas and lucite sheets and strips in irregular shapes and thicknesses. Useful for many projects and experimental work—big package by return mail, no waiting. Double size package with dye and cement included \$2.00. Send money order to HomeCraftsman Plastics, 1945 W. Harrison Street, Chicago 12, Illinois.

CHEMISTRY

THE House of Winn, home of supplies for amateur chemists. See Winn's New Idea chemical kits and apparatus outfits for home experimenting. Send 10¢ for retail catalog. Established 1931. John H. Winn, Dept. 508, 124 West 23rd St., New York 11, N. Y.

FREE Catalog: Chemicals, apparatus, bargains. Colonial Chemical, DPM-4, Brockton 28, Mass.

LABORATORY Supplies. Chemicals and apparatus all descriptions. 36 page book 10¢. Standard Science Supply Co., 1232 N. Paulina St., Chicago 22, Illinois.

STUDENTS' Laboratory supplies. Send 5¢ for catalog. Mel-Glo Chemical Co., 258 Fourth Ave., Brooklyn, N. Y.

HYDROGEN! 10 Charges \$1.00. Inflate balloons, etc. Miles Specialties, Kokomo, Indiana.

CHEMICALS And apparatus for industrial, analytical, and private laboratories. Complete supply service for correspondence school students. Send 3¢ for catalog. Dept. M-43, Biological Supply Co., 1176 Mt. Hope Ave., Rochester 7, New York.

HANDBOOK For chemical experimenters, illustrated, hundreds of experiments, 50¢. Experiment booklet 15¢. Chemistry catalog 5¢. Reading Scientific Company, Reading, Penna.

FREE Catalog. Chemistry, mineralogy, biology, optics. Tracey Laboratories, Evanston, Illinois.

HELP WANTED

PARAMOUNT Atmospheric conversion gas burners. Quickly installs into any heating plant. Absolutely guaranteed. Sell and install. Peerless Sales, 4322 Sheridan, Lincoln 6, Nebraska.

CREATOR. Paper specialties. Man equipped by training and experience to create, produce and merchandise a line of paper specialties, as albums, games, diaries, etc. This offer by one of country's largest paper converters, located in New York, who will give right man 100% co-operation. Full details in letter to precede interview. M. D. Hammer, 345 Hudson St., New York City.

OILFIELDS Offer good paying pleasant jobs from Boomtown to city office. Names, addresses, 100 companies, list jobs and pay rates. Research, Box 559, Victoria, Texas.

AGENTS WANTED

UP To 100% profit selling friends outstanding \$1.00 Christmas card assortment. Costs you 50¢ up per box. Also religious, gift wrapping, birthday assortments 35¢ up. Extra bonus. Request sample \$1.00 Christmas box on approval. Free sample 50 for \$1.00. 25 for \$1.00 personal Christmas card and stationery portfolios. Special offers. Elmira Greeting Card Co., M-151, Elmira, N. Y.

HERE It is—Make lots of extra dollars selling complete line of California perfume beads. Write: P. J. Healy Co., 111 West Jackson Blvd., Chicago 4, Ill.

IMMEDIATE. Amazing large profits. Complete line plexiglas ornaments, costume jewelry. Send two dollars for sample bracelets. Details free. Keystone Sales, 622 Penfield Bldg., 1328 Chestnut St., Philadelphia, Penna.

SILVER Plating Liquid: (Improved formula). You can see it silverplate instantly right before your eyes. Simply rub-on with a cloth, or, immerse articles in the liquid and see them silverplated. Remove and rub-up and they are done. About 1 minute. Renews silverplated ware like new. Cleans, silverplates, polishes, (3-results) from one application. Silverplates before your eyes onto sterlingware, plated silverware, also onto articles of brass, copper, bronze, zinc, nickel-silver, german-silver and all affinitive metals. Puts on genuine 1000 Fine silverplate. Guaranteed lasting finish. Won't rub off, boil off or brush off. Has many adaptable uses throughout the automotive, refrigeration, radio, jewelry, research and experimentation, musical instrument, surgical and dental instrument, beauty shop equipment, antiques, art goods, hobbies, hardware, and many other lines. Working sales-distributors needed for many areas not being worked now. Details by letter mailed free. NuProcess Products Laboratories, Dept. 238, Aurora, Illinois.

"OUR Flag"—famous picture. Four colors. 500,000 sold. Sample print—free. Our Flag Sales Corp., Dept. C1076, Excelsior Springs, Mo.

NEW. Extra money plan. Up to 100% profit showing friends unusual personal Christmas cards, box assortments, gift wrappings, humorous, all occasion, birthdays, social notes, personalized stationery. Extra bonus. Request free 50 for \$1, 25 for \$1.25 for \$1.95 name imprinted Christmas cards and personalized stationery folder. Special offer. Thomas Terry Studios, 257 Union Avenue, Westfield, Mass.

EASY Money now to Christmas. Up to 100% profit selling friends, others marvelous new 1946 Christmas and year round box assortments—30 boxes 35¢ up. Odd cards 2 1/2¢ up. Extra bonus. Request special feature \$1.00 Christmas assortment on approval. Send today for free samples of our fast selling 50 for \$1.00, 25 for \$1.00 personal Christmas cards and personal stationery lines. Special offers. New England Art Publishers, North Abington, Mass.

AT Last! Something new and sensational in Christmas cards. Amazing "Oil-ette" cards. Like costly oil paintings. Designs never before offered. Gets orders fast. Beautiful 25 for \$1 cards, name imprinted. Many other assortments. Big profits. Samples on approval. Puro Co., 2801 Locust, Dept. 640-K, St. Louis, Mo.

GOLD Lacquered window sign letters. Large sizes penny each. New foils. Absolutely beautiful. Free samples. Atlas, 544 W. 79th, Chicago 20.

FLASH. The beautiful Doehia Christmas cards are ready. Request samples today. Zweifel's Shut-In Agency, Dept. R-3, Freeport, Illinois.

TRIM Hair at home. Save barber bills. New invention. Simple. Easy. Lightning seller. Samples sent on trial. Kristee, 125, Akron, Ohio.

SELL Famous "Federal" spark plugs to dealers. Repeat business. Four easy orders daily pay you \$71.40 weekly. Federal Distributors, Pittsfield Bldg., Chicago 2, Ill.

POWER Mower. Cuts-trims. Agents-dealers. Farm Products, M-2007, Excelsior Springs, Mo.

CHRISTMAS And everyday greeting cards, gift wrappings, correspondence notes, stationery, novelties. 4154g Fifth Street, Philadelphia 40.

PLAN Now to make more money through profitable spare time work. Fall best selling season. Our helps build business. Wholesale catalog free. Write McGregor Magazine Agency, Dept. PM6, Mount Morris, Illinois.

FASCINATING Income building plan. Take easy orders from friends, fellow workers, church organizations for fast-selling Christmas, all occasion, gift wrapping, birthday, get-well, correspondence notes assortments. Sell for \$1.00 each—cost you 50¢ up. Extra bonus. Experience unnecessary. Request foremost \$1.00 Christmas box on approval. Special offers. Bluebird Studios, Dept. 16-J, Fitchburg, Mass.

SELL Christmas cards. Easy money showing exquisite Christmas, everyday, wrapping assortments, stationery. Over 100 quick sellers. Request \$1.00 Christmas box on approval. Free samples of 50 for \$1.00 Christmas cards. Special offers. Hedenkamp, 343 Broadway, Dept. A-22, New York 13.

SELL Needed eyeglass cleaner, prevents steaming. 8 25¢ tubes \$1.00. Shurberg, Box 1514, Hartford 1, Conn.

EXCLUSIVE Agents each county, take orders ornamental house markers and weather vanes, twenty six designs. Easy sellers. Don R. Bartels Co., McAllen, Texas.

SCHOOL Seniors! A postal will bring you our Kwick-Sell Cardalog of graduation name cards. Hot selling everywhere! Big profits! Hurry! Craftcards, Box 235-L, Pittsburgh 30, Penna.

MIRACLE Wax for home, auto. The all purpose polish in powder form. Cleans, polishes, waxes in one operation. Send \$1.00 for two pint cans. (Regular price \$1 each.) 25c for sample size. Satisfaction guaranteed. Bless Chemical Company, 4806 North Drake, Chicago 25, Ill.

AGENTS, Distributors—Our polish sells to car owners and housewives. Big profits. Details free. Visco Brothers, Box 4705, Philadelphia 34, Penna.

NEW Precision printer! Postcards, tickets, tags. Automatic inking. No adjustments. Retail \$9.50 complete in sturdy case. Trial deal. Hasko Company, 17 West 60th, New York 23, N. Y.

WORLD'S Greatest Bible buy, \$3.95. Up to \$2.00 per copy profit. Religious Educators Association, 311 Church St., Nashville 11, Tennessee, Dept. C.

REPRESENT Us in your territory. Future of state distributorship. Safeguard for mothproofing. Cannon's Compounding Co., P.O. B. 246, Doylestown, Penna.

EARN \$1-\$2 Hour spare time, selling Magic Needle Threaders, world's fastest seller at 10c. Every woman buys one or more on sight. Just print your name and address on postcard and send at once for 50 on approval. E.Z.C. Co., P., 82 St. Paul, Rochester 4, N. Y.

MAKE 100% Profit, easy mass sales demonstrating "Ingersoll" dollar stropping outfits for all types razors. Sample demonstrator \$1.00. Walber's, A132 Monitor, Jersey City 4, New Jersey.

CHRISTMAS Cards. Earn \$5.00 with every ten \$1.00 21-in card assortments you sell. Also wrappings and 25 for \$1.00 imprinted cards. Write for samples today. Howard P. Ellis, Dept. PM-8, Pitman, New Jersey.

WE Pay you \$25 for selling fifty \$1.00 boxes. Think of it! 50 beautiful assorted Christmas cards sell for only \$1.00, your profit 50c. Write today for free samples. It costs nothing to try. Cheerful Card Co., Dept. 224, White Plains, New York.

NEW Exterminating business. Nets you big profits first day. We help you start your own fine business with revolutionary, completely automatic Insecto-Death Vaporizer process that kills dangerous insects and even destroys their eggs. Harmless to humans, pets, foods. Write now for exciting details. Kundra Laboratories, 2950 N. Halsted St., Dept. B, Chicago 14.

BE First! Beat competition! Monthly New Products Bulletin Service brings last minute listings, 100 newest products and sources! Latest release, \$1.00. Particulars free. Coates, 46-L King, Dorchester, Mass. Propper Products, Box 758, Milwaukee, Wisc.

\$20 DAILY. Nameplates for homes, offices. Beautifully machine-engraved black and white bakelite, \$1.95. Sample, your name, dollar bill. Alexander, 1813 East Fifth, Pomona 2, Calif.

SELL Hand painted china novelties, very nice. One dollar for sample of six assorted. Prepaid. Frank Einsel, Struthers, Ohio.

REAL Live Mexican jumping beans. 20, 25c; 125, \$1.00; 500, \$2.50; 1000, \$4.00. J. J. Frank, P525 Palm, Rockford, Illinois.

AMAZING Brownie Dri-Rite Brush Pen making big income for agents. Sensational quick demonstration. Write P. Brown, 195 William St., New York 7.

OUR Solid brass flanging tool for tavern beer pipe repairs, sells on sight. Agents make \$15.00 daily. Exclusive territory. Sample \$1.00. Kelly Johnson, 172 Washington St., Newark, N. J.

CASH In—Novel ideal—leather items; quick sales, big profits; fascinating—fun for customers to lace. Send \$1.00 sample wallet. Yale Leather, P.O. Box 1938P, New Haven, Conn.

QUICK Cash profits. Sell friends big value Christmas and year 'round greeting card assortments. Cost you only 30c up. Up to 100% profit. Extra bonus. Request fast selling new 1946 \$1.00 Christmas card box on approval. Free samples 50 for \$1.00, 25 for \$1.00 name imprinted Christmas cards and personal stationery. Special offers. Tom-Wat Studios, Dept. PM, Bridgeport, Conn.

500% PROFIT Selling comic novelty cards. Samples, prices 25c. Jack Blades, Box 944, Altoona 6, Penna.

CHRISTMAS Cards. Earn big money. Take orders galore from friends. 25 exquisite folders with name \$1.25. Free samples 10 designs. America's fastest selling 21 Christmas folder box. Costs 50c. Sells \$1. Request samples today. Sunshine Art, Dept. E, 115 Fulton St., New York City.

JUST Out! History of World War II. Huge volume. Popular price. Authentic text. Official photographs. Big profits. Riverside Book Company, Iowa Falls, Iowa.

\$5,000 YEARLY Possible, selling books by mail. Distributors proposition. Nichols Publishers, Box 831, Pine Bluff, Arkansas.

1 LB. 50% DDT. Just add water, makes 1 to 3 gallons, \$1.50. Get facts. Kohlen, 506 West 45th, Chicago 9.

AGENTS—300 % Profit selling genuine gold window letters; stores and offices. Free samples. Metallic Letter Co., 438-B North Clark, Chicago.

LUMINOUS Pictures that glow in the dark. Large manufacturer wants factory representatives; wonderful new item; fast seller; free sample. Madison Mills, 303 Fourth Ave., New York City.

SELL Full, part time, individualized belts, buckles, cap badges, tie holders. Thousand emblems. Every veteran prospect. Fast profits. Repeats. Write today special outfit offer. Hook-Fast, PM, Box 1425, Providence, R. I.

BIG Bargains for big profits. Over 100 sensational values. Men's used suits \$2.00, pants 35c, topcoats \$1.25, overcoats \$2.00, shoes 20c. Experience unnecessary. Free wholesale catalog. Superior, 1250-FB Jefferson, Chicago 7.

AGENTS Wanted. Our service puts you in contact with hundreds of firms anxious to hire you. Agents National Service, 1311 Linden Avenue, Lima, Ohio.

200 MONEY Making deals. Plans, rare formulas. Schemes. Folio free. Formico Service, Box 572, Dayton, Ohio.

MEXICAN Feather pictures. Unusual novelty. 50c (stamps) bring \$2.00 worth samples, details. Refunded if unsatisfied. Aztec Art, Apartado 762, Mexico City.

100% PROFIT On famous, popular Pines birthday, Christmas and all-occasion greeting cards. Wonderful 12 to 24 card, boxed assortments sell on sight for \$1.00. Write today for information and extra bonus distributors' plan. R. Pines, Box 32, Flushing, N. Y.

137 COMPLETE Plans for starting own business: local—mail order. Particulars free. Elite Co., 220-A Grand St., New York 13.

MAGIC Cleaner and laundry soap deal. Hotter than a firecracker. Big profits. Sample free. Bestco, 5007 Irving Park, Chicago.

\$3 FIRE Extinguisher; quick sales, wholesale or direct; liberal profits. "Fire-Killer," 109 N. Franklin, Syracuse 1, N. Y.

SELL "Petite picture notes." Something really different in greeting cards. Sample free. Dunbar Cards, New Brunswick 20, N. J.

AGENTS: Stamping names on pocket-key protectors. Sample check with your name, address, 25c. Stamping outfits. Emblem checks, check-fobs, name plates. Hart Mfg. Co., 303 Degraw St., Brooklyn, N. Y.

WHOLESALE Sources. 500,000 articles. Free directory. Maywoode, 1133 Broadway, New York.

PLATING Outfits for autoparts, reflectors. Connect to a battery. No tanks necessary. Free booklet and particulars. Gunmetal Co., Ave. N, Decatur, Ill.

EXCELLENT Sideline for printing salesmen. Decalcomania name plates in small quantities. Also, make money applying initials on automobiles. Free samples. "Ralco," X-164, Boston (18), Mass.

FREE Water and our concentrates, makes flavors, lotions, shampoos, 72 products, labels, bottles furnished. Qualco, E-20030 Russell, Detroit.

HIGH-GRADE SALESMEN

NOW You can sell nationally famous industrial product just made available for home use. Unique safe anti-slip floor wax sells on half-minute demonstration. Also amazing cleaner that lifts old wax and dirt right off. Rush postal today for free details, dramatic demonstration outfit, and territory reservation. Franklin, Dept. 9J, 5134 Lancaster, Philadelphia, Penna.

SALES Slow? Try improving personality 3 quick ways. Users say "it works!" Free folder. Methods Research, 6235-R Eastwood, Kansas City 3, Mo.

START Your own business on our capital. Always your own boss. Hundreds average \$6,000 to \$25,000 annual sales year after year. We supply stocks, equipment on credit. 200 home necessities. Selling experience unnecessary to start. Wonderful opportunity to own pleasant, profitable business backed by world wide industry. Write Rawleigh Co., Dept. H-U-PPM, Freeport, Illinois.

AMAZING New zipper shoe sells on sight. Big profits for salesmen. Leads line 200 splendid styles. Territories open. Get free sample outfit. Write Consolidated Shoe, Dept. S-200, Chippewa Falls, Wis.

FIVE To ten thousand dollar a year men wanted to sell complete line chemical cleaning supplies to institutions and industry. Write Sanitary Chemicals, Rochester, Indiana.

AMERICA'S Biggest hand truck value. All steel welded construction. Heavy duty rubber tires. Every store and factory a prospect. Wm. Kane, 1019 North Dearborn, Chicago 10, Illinois.

PAPER Signs—Restaurants, fountains, markets—big demand—big sample package \$1.00. Cotley Signs, Sandusky, Ohio.

BIG Commissions—selling to stores celluloid pricing tickets, metal shelf moulding. To restaurants, menu covers, signs. P. Pricing Press, 124 White St., New York 13, N. Y.

QUICK, Sure money. Tested. Annie Blain flavors. George S. Parker, New Brunswick, N. J.

SELL Greeting cards, display signs, pictures, books, novelties. Big profits. Bulletin free. Elfco, 432 North Wells, Chicago 10.

FREE! Latest issue Opportunity Magazine. Salesman's Guide. Inspiring, constructive. Shows how to earn money selling for others or in your own business. Hundreds postwar opportunities. Send name and describe what you have sold or are selling. Illustrated copy sent free. Opportunity Magazine, 620 N. Michigan, Dept. 17, Chicago 11, Ill.

AGENCIES WANTED

WOULD Represent oil burner and space heater manufacturer. J. Provost, 531 1/2 Sussex St., Ottawa, Ontario, Canada.

EDUCATIONAL AND INSTRUCTION

BE A radio-television expert. Excellent opportunities. Broadcasting stations, airlines, police departments, radio servicing, offer sound futures at fine salaries to properly trained men. Extension or resident training. Special course in radio and in household electrical appliance servicing (including house wiring) available at resident school. Our nation-wide employment service is highly successful in placing graduates in good positions. Resident training approved for veterans. Age or previous education no drawback, we have a training program which fits your needs. Write today for full information. Please indicate if you are a veteran. Address: "Chief Registrar" Central Radio & Television Schools, 17th and Wyandotte Sts., Kansas City 8, Missouri.

WELDING—Electric arc. Learn profitable trade quickly through actual practice. Individual welder instructions at bare cost of materials. Full particulars free. Valuable welding lessons book 50c. Hobart Welding School, Box M-862, Troy, Ohio.

TIRE Technicians in big demand. Become expert. Earn from \$60.00 to \$100.00 per week. Simplified course makes it possible for you to operate while learning. Written by an expert instructor in plain, easy-to-understand style. Illustrated complete course only \$2.00. Tech Tire Engineering, 329 South Ave., Westfield 3, N. J.

"HOW To Break and Train Horses"—a book every farmer and horseman should have. It is free; no obligation. Simply address Beery School of Horsemanship, Dept. 1108, Pleasant Hill, Ohio.

LEARN Foot correction. Permanent, dignified, profitable profession. Six weeks training. Tunis Corrective Foot System, 3041 S. Double Dr., El Monte, Calif.

SWIFTEST Alphabet free. Most legible. Jesse L. Cook, Bartow, Florida.

REMEMBER Anything you want to—through quick, sure Super-Memory. Write for information. M-1, Thor Books, Box 1210, Chicago.

USED Educational and technical books on all subjects bought, sold, rented. Catalog free. Educational Exchange, Hensgar, Ala.

LEARN Paperhanging. Make \$20.00 per day. Complete instructions only \$3.00. F. Station, 184 W. Mound, Columbus 15, O.

BEGINNERS Instructed for positions in southern winter hotels. Lee's Hotel Institute, 714 Winthrop Building, Boston 9.

\$125-\$220 MONTH! Permanent Gov't. jobs, men-women! Prepare at once for early examinations. 32 page Civil Service book with sample coaching—list positions free. Write today. Franklin Institute, Dept. T24, Rochester, New York.

SHORTHAND 4 To 6 weeks. Modern A.B.C. method. Simple, interesting, inexpensive. Sample lesson, full details free. DeLuca's Service, 127D Pettis, Providence 4, R. I.

MENTAL Science course. Revealing. Helpful. Booklet free. Write Clark, 125B West 7th Avenue, Cheyenne, Wyoming.

TYPEWRITING Learned in 10 lessons guaranteed (your home); Also: shorthand, bookkeeping including accounting—ninety hours each; low rates (Osborne-Chilcoat "Psycho-Methods"). Osborne College of Short System, 212 West Third Street, Los Angeles 13, California.

INTERPRET: The Slide Rule. Instructions for sharp calculations. Reference list, \$1.00. Calculator, Box 342, Cambridge, Mass.

NO Advance payment! Study Automatic Sew Machine Engineering at home. Complete from machine elements to cam layout. Pay as you learn. Warren's School of Engineering, 9 S. Kedzie Ave., Dept. 308, Chicago 12, Illinois.

USED Mechanical self instruction courses. Send card for free list. Mechanics Press, P.O. Box 1043A, Houston, Tex.

REGULAR Railway mail clerks start \$2300 yearly. Prepare now for exam. Veterans get preference. Write, Ozment School, 75, St. Louis, Mo.

SCREW Machine men! Warren's book will help you. Over 300 pages, simplifying estimating, feeds, speeds, tooling, cam layout. Five-day return privilege. \$10.00 plus small c.o.d. fee. Alhar-Warren Co., 9 S. Kedzie Ave., Dept. 38, Chicago 12, Ill.

HOME Bible course. Simple, helpful, instructive. Total cost \$3.00 includes textbooks, examinations, certificate. \$1.00 starts you, or simply request prospectus. The Bible Study School, Reverend Leslie Marshall, Secretary, 382 Van Houten Street, Paterson 1, N. J.

PREPARE Your own home study course on any vocational subject. Free bulletin. DeVoto Schools, 35 Vicente, San Francisco 16, Calif.

HOME Study course, drugless therapy. Free literature. Institute of Drugless Therapy, Tama, Iowa.

SELECT Your career easily with scientific testing method. Write Vocational Service, 735 Bank of America Bldg., San Diego, Calif.

MASSO-PHYSIO-THERAPY. Chiropody. Evans natural therapeutics home study courses. P.O. Box 1195, San Antonio 6, Texas.

GOOD "Used" self-instruction educational books on all subjects bought, sold, rented, exchanged. Satisfaction guaranteed. Complete information and 100-page illustrated bargain catalog free! Write—Nelson Company, Chicago 5.

29 LANGUAGES By Linguaphone. Russian, Spanish, Portuguese—Direct conversational method for mastering any language quickly, easily, correctly at home. Send for free book. Linguaphone Institute, 83 RCA Bldg., New York.

LEARN Photo-engraving at home or in oldest, largest school in America. Work for newspaper or establish own profitable business. New Tasope Photo-Engraving equipment available soon. Write for information. Veterans ask about G.I. training. The Aurora School of Photo-Engraving, Tasope' Bldg., Aurora, Mo.

INVESTIGATOR Training. Phillips Secret Service, 1917B North Kenneth, Chicago 39, Illinois.

LOCKSMITH Course. Lock picking, key fitting, etc. \$1.00 prepaid. Locksmith, Canadian, Texas.

MEDICAL Laboratory technicians in great demand. We train you in your spare time, in your own home. You can practice while studying. Write for free catalogue. Imperial Technical Institute, Box 973-E, Austin, Texas.

SECRET Investigation. Experience unnecessary. Investigators particulars free. George Wagner, M 125 West 86th, New York.

USED Educational books on all subjects sold, rented, also bought and exchanged. Moneyback guarantee. Write today for free catalog and details. Lee Mountain, Pisgah, Alabama.

PLAYS, STORIES, MANUSCRIPTS

I WANT New writers to cash hundreds of checks for \$1 to \$100, offered each month. The easiest way to write for pay. No previous experience necessary. Send for free details. No obligation. Saunders M. Cummings, 467-M Independence Bldg., Colorado Springs, Colo.

NEW Writers needed to rewrite ideas in newspapers, magazines and books. Splendid opportunity to "break into" fascinating writing field. May bring you up to \$5.00 per hour spare time. Experience unnecessary. Write today for free details. No obligation. Postcard will do. Comfort Press, Inc., 210-P South Seventh St., St. Louis 2, Missouri.

BUSINESS SERVICE

TO Whom it may concern: We will represent you in all principal cities of the world. Personal or business assignments \$1 per hour. James W. Farley, Citizens Bldg., Cleveland 14, Ohio. Note: Would appreciate hearing from someone who wishes to enter this business in your city. Will send you assignments immediately. References exchanged. State qualifications.

\$3.00 MONTHLY Maintains Washington, D. C. "capital" address. Your business, personal mail reforwarded when wanted. Hawks, (established 1917), 1300 Taylor, (102j).

NORFOLK, Va. Mail address 15c each letter or \$1.50 month. 3 postcard views 20c. I remail. Personal assignments. James, 739 Burkesdale Road.

BUSINESS And personal representation, appraisal, and adjustments. 25 years experience. J. E. Rumfield, 5716 Junius, Dallas, Texas.

1,000 MAILING Names on perforated gummed labels \$2.50. Labeloft, Box 47, Springfield, Mass.

SPECIAL SERVICES

NEW YORK Newspapers sent anywhere. Daily News, World Telegram, etc. Prompt service. Twenty cents each, limit five. J. Ares, 43-40 40th Street, Long Island City 4, New York.

CALIFORNIA Business agent; for information, advice, services. Retainer fee \$1. Percy Gaugh, 817 W. 23rd St., Los Angeles 7.

DO You have trouble enlarging plan drawings in magazines to proper size? Large drawing or 2 or 3 small drawings enlarged. \$2.00. Send drawings and desired size to Jack Rothbart, R.F.D. 4, New Brunswick, N. J.

SCENES Of historical Philadelphia. 10 postcards 25c. Reforwarding; postcards 5c each. Letters 25c each. Fredric, 3312 Germantown Ave., Philadelphia 40, Pa.

ENGINEERING Service—plans, research, design (electrical, civil, mechanical) at a price you can afford. Free estimate. William H. Jacques & Associates, Consulting Engineers, Zobel Bldg., Red Bank, N. J.

GOOD "Used" self-instruction educational books on all subjects bought, sold, rented, exchanged. Satisfaction guaranteed. Complete information and 100-page illustrated bargain catalog free! Write—Nelson Company, Chicago 5.

CARTOONING, COMMERCIAL ART, SHOWCARD WRITING, SIGN PAINTING

PERSPECTIVE Charts simplify drawing products, architecture. Set of four with instructions, \$1.00. Domestiercraft, P.O. Box 73, New York 16, N. Y.

"HOW To Make Money With Simple Cartoons."—A book everyone who likes to draw should have. It is free; no obligation. Simply address Cartoonists' Exchange, Dept. 98-C, Pleasant Hill, Ohio.

NEW Show card lettering course. Illustrated. Postpaid \$2. Art Instructions Studios, 47-23rd Ave., Paterson 3, N. J.

NOW Make signs in six months, daily practice, simplified fundamentals, \$1.00. Jantzen, 252 West New York, New Jersey.

LEARN Showcard writing at home in spare time. Fascinating, lifetime business of your own. No special skill needed. Free information. Sherwood Publishing Co., Irvington 11, New Jersey.

BARGAINS—Quick landscape painting, poster art, lettering, art studies, supplies. Free literature. Art Book Shop, Arnold 6, Mo.

ARTISTS—Students: Auto-scale saves half time copying, enlarging, reducing drawings. Guaranteed. \$3. Particulars free. Disco, Box 761, Glendale 5, Calif.

CARTOONING. Draw comic characters instantly. Complete charts, instructions, \$1. Cartoonist Felix, Box 337, Duluth, Minnesota.

CHALK Talks. Laugh producing program. \$1.00. Catalog 10c. Balda The Cartoonist, Oshkosh, Wisconsin.

CARTOON Course—22 easy lessons. 200 figure sketches. 25c coin postpaid. Snack-Pack Co., 32 E. Georgia, Indianapolis 4.

MAKE Signs, letters, stencils. 9 complete alphabet pattern sets. 3 complete numeral pattern sets and catalog \$1.00. Sign Letter Distributors, P.O. Box 101, Mineola, N. Y.

ADVERTISING AGENCIES, LETTER WRITERS, FOR ADVERTISERS

ADVERTISING Placed everywhere lowest rates. Reliable guidance on publications, expert assistance on ads without charge. Newspaper, magazine, mailing-list ratebook free. Chicago Advertising Agency, 20-P West Jackson, Chicago 4.

CARTOON Advertising. Complete service. 50% of insertion cost. Alvin Bantien, Armada, Michigan.

25 WORDS. 32,000 readers, 2 months \$5.00. Renick, Holland, N. Y.

MAILING Lists—accurate, inexpensive. Indicate type needed. Charles, Box 232, Station A, Manchester, Conn.

ORDER—Pulling sales letters written, \$2 page. Twenty years' experience. Satisfaction guaranteed. Dudley Bunn, 126-PM Lexington Avenue, New York 16.

ADVERTISING. Art work, sales letters. C. F. Sanford, 5029 Maple Ave., St. Louis.

MAILING Lists, certified, productive, inexpensive, \$5.00 1000. Homeworkers, agents, buyers, etc. Write Dixie Service, King, N. C.

ADVERTISERS! 6,000,000 Circulation 25 Sunday national key newspapers. 18 words. \$40.79. "Terrific pullers" 20 popular newspapers \$8. "Free booklet." Newmarks Advertising Agency, 217-7th Ave., New York.

FREE! 1946 Advertisers Rate & Data Directory. 52 pages! E. H. Brown Advertising Agency, 20 N. Wacker, Chicago 6.

ADVERTISE: 24 Words. 40 newspapers \$3.50. List free. Advertising Bureau, 4515-C Cottage Grove, Chicago 15.

24 WORDS in 64 weeklies \$4.96. H. J. Darnell, 730 Hays, Jackson, Tenn.

ADS Placed in out of town newspapers and magazines. Low rates. Catalogue free. Ideas that pay. Baker Advertising Agency, Successors Ankrum Agency, 189 W. Madison, Chicago 2.

TYPEWRITERS, DUPLICATORS, OFFICE DEVICES

PRINT Your own postal cards, paper, or anything on "Printomatic Self-feeding Rotary Postal Card Stencil Duplicator." Only \$9.50 with \$2.35 worth of supplies, stencils, ink, etc. Literature free. Pittsburgh Typewriter Supply, 336-RE Fourth Ave., Pittsburgh 22, Penna.

RUBBER STAMPS, OFFICE SUPPLIES

3 LINES 35c; Signatures \$1.50. Pads 25c. Stamprite, Wauwatosa, Wis.

PRINTING, MULTIGRAPHING, MIMEOGRAPHING, GUMMED LABELS

200 HAMMERMILL Letterheads \$1.00. Other printing. Samples. Parker Press, 479 Main, Groveland, Mass.

QUALITY Printing: Business, personal stationery. Prepaid delivery. Samples free. Mero Products, 100 Morrison, Punxsutawney, Penna.

LETTERHEADS, Envelopes, statements or billheads—150. \$1.00 postpaid. Benneville Printing, Box 1931, Pittsburgh 30, Penna.

BETTER Printing, attractively priced! Letterheads, envelopes, booklets, cards, labels. Samples, estimate free. Lonelm Publishers, Paulding, Ohio.

500 6³/₄ ENVELOPES \$2.00. Mango, 555-A South 20th, Newark 3, N. J.

QUALITY Printing, lowest cost. Samples free. National, 4012-B Drexel, Chicago 15.

CIRCULARS, Letters, advertising matter, forms, etc., lithographed economically. Duplicraft Service, 930 F St. N.W., Washington 4, D. C.

LETTERHEADS—250 Red, white and blue air mail and 250 regular, \$5.00 postpaid. We print anything. Send for prices. Postal Press, 7600 North 30th, Omaha 12, Nebraska.

SEND 10c Now, for our 36-page 1946 pricelist—refunded first order. McCall Press, 1326 South 27th, Omaha, Nebraska.

NOW! Try our printing—samples. Mail Printing, P-93, Danvers, Mass.

HONEST Value. Letter heads, envelopes, business cards, \$1.00 per hundred. W. B. Musson, 11 Chambers Street, Phillipsburg, New Jersey.

• 500 **LETTERHEADS**; Envelopes; 5½x 8½ statements; \$2.00 each postpaid. Ledlin Press, 3635 So. 87th St., West Allis, Wis.

100 **EMBOSSED** Panel cards printed. Name, address, phone, \$1.00 postpaid. Free sample. Frank Michalucine, 3206 Eastwood, Chicago 25, Ill.

COLLEGE Stationery personalized with your name. Samples 10c. Details free. 1040 Main Press, Clinton, Mass.

1000 **PROFESSIONAL** Business cards \$2.50 postpaid. Hamilton, 4341P Meade, Chicago 34.

FINE Printing reasonable, send copy for estimates. White, 526 Brooks, Dallas, Texas.

BOND Letterheads \$2.95 for 500. Send stamp for samples. Ranney, The Printer, Sheldon, N. Dak.

150—8½x11 **HAMMERMILL** Letterheads, printed, postpaid, \$1.00. Envelopes same. Race Printing, Hudson, New York.

100 **LETTERHEADS**, 100 Envelopes, \$1.25 postpaid. Tucker, P.O. Box 45, Indianapolis.

ATTRACTIVELY Mimeographed letters, 100—\$1.00. Haynescraft, 706 Eighth, Washington 1, D. C.

PRINTING. Multigraphing, mimeographing: Low prices, high quality workmanship. Write for samples, Bay Printing Co., 24404-A Oakland Road, Bay Village, Ohio.

BETTER Grade printing reasonable. Estimates on anything. Economic Press, Leonia, N. J.

MIMEOGRAPHING—Any copy. Reasonable. Mailers Service, Box 606-A, Chicago 90, Ill.

500 3½x2¼ **FOUR** Line gummed stickers, 25c. Moritz Printery, Saginaw, Mich.

MIMEOGRAPHING—Letters, pricelists, formulas, instructions. Lowest prices. Lem's Letter Shop, 5710 Stanton, Detroit 8.

PRINTING OUTFITS AND SUPPLIES

PRESSES. Type, cabinets, supplies. List for stamp. Lincoln Press Co., 220-W Hartwell, Fall River, Mass.

PRINTERS. Make cuts the Quick Etch method. Details free. Charles P. Medlock, Box 256C, Goodland, Indiana.

6x9 **MOTORIZED** Printing press, hand feed, 3 chases, year old, complete, \$160.00 cash, \$170.00 crated. F.O.B. Mail Products, Mendota, Illinois.

HOME-MADE Presses. Proofs free. Riegel, 1111 Harrison, Phila. (24), Penna.

PRINTING Press plans, \$1.00. Details, samples of work, free. Homer DeSellier, 10 Stebbins St., Springfield, Mass.

CUTS—Make real halftones, line cuts yourself! Samples 25c. Particulars free. Rapid Chemical Service, Edwardsville, Ill.

PRINTING Equipment, type and supplies. Send stamp for details or dime for complete illustrated supply book. Kelsey Inc., X-11, Meriden, Conn.

PRINT At home—Send 10c for catalogue—presses, type, supplies. Barnhard Co., 6 Columbia St., Newark 5, N. J.

INEXPENSIVE Home-made printing press. Details free. Novelty Shop, Downsville, Louisiana.

PATENT ATTORNEYS

INVENTORS. Have patent protection first. Remember, the details of your invention do not have to be 100% perfect before you can obtain patent. First step is to have us conduct search of prior U. S. patents and render a report as to its patentability. Send at once for further particulars and "Invention Record" form. Request does not obligate you. McMorro, Berman & Davidson, Registered Patent Attorneys, 134-Y Atlantic Building, Washington 4, D. C.

PATENTS And trade marks. Wilfred E. Lawson, 1524 K Street N.W., Washington 5, D. C.

PATENT Protection—The U. S. Patent Office recommends "an applicant is advised, unless familiar with such matters, to employ a competent registered Patent Attorney as the value of patents depends largely upon the skillful preparation of the specifications and claims." Steps to be taken in obtaining patent protection available upon request. Victor J. Evans & Co., established 1898, 131-J Merlin Building, Washington 6, D. C.

PATENTS—U. S. and foreign patents secured. Trade-marks and copyrights registered. Searches made to determine patentability and validity. Patent, trademark and unfair competition causes, Lancaster, Allwine & Rommel, Registered Patent Attorneys, Suite 411, 815-15th St., N. W., Washington 5, D. C.

INVENTORS: Without obligation, write us for information as to what steps an inventor should take to secure a patent. Randolph & Beavers, Registered Patent Attorneys, 21-C Columbian Bldg., Washington 1, D. C.

INVENTORS: Learn now—without obligation—how to protect and sell your invention. Write for free "Record of Invention" form and complete information for making disclosure and establishing date of your invention. We also send our new free "Patent Guide for the Inventor," containing complete information about patent procedure and how to sell inventions; giving illustrations of many successful inventions; over 150 basic mechanical movements. We assure you prompt, confidential service. Delays may be dangerous. Write today for your free "Patent Guide" and "Record of Invention" form. Clarence A. O'Brien & Harvey Jacobson, Registered Patent Attorneys, 61B-G Adams Building, Washington, D. C.

PATENTS. Free preliminary advice. E. E. Vrooman, Patent Lawyer, Registered Patent Attorney, 871 Woodward Building, Washington 5, D. C.

"**INVENTOR'S** Guide." 100 mechanical movements, free; advises on patenting, selling inventions. Frank W. Ledermann, 154 Nassau Street, New York 7.

PATENTS—Trade marks. Irving L. McCathran, 315 McLachlen Bldg., Washington 1, D. C. Registered Patent Attorney.

PATENTS Obtained; selling service, information, recording forms free. Labiner, World Building, New York.

C. A. SNOW & Co., M-427 Snow Bldg., Washington 1, D. C. Registered patent attorneys. Established 1875. Literature mailed on request.

FOR INVENTORS

INVENTORS. Have patent protection first. Remember, the details of your invention do not have to be 100% perfect before you can obtain patent. First step is to have us conduct search of prior U. S. patents and render a report as to its patentability. Send at once for further particulars and "Invention Record" form. Request does not obligate you. McMorro, Berman & Davidson, Registered Patent Attorneys, 134-X Atlantic Building, Washington 4, D. C.

INVENTORS—Victor J. Evans and Co., established 1898, has a staff of registered patent attorneys, available to represent inventors in the preparation and prosecution of their cases before the Patent Office. Detailed information and the steps to be taken to obtain patent protection will be furnished upon request. Victor J. Evans & Co., 132-J Merlin Building, Washington 6, D. C.

DRAWINGS of your ideas—inventions, by college draftsmen. Drawings approved by patent attorneys. Chrisman, College Box 375, Manhattan, Kansas.

PATENTS. Free preliminary advice. Confidential service. Send sketch and description. John D. & Son, 140 Spruce St., Box 3213, Dept. PM-846, Bridgeport 5, Conn.

WE Make drawings for you to safeguard, sell or explain your ideas. Jepsco, 940 Harvard Blvd., Dayton, Ohio.

MACHINES. Mechanical inventions designed and built. Louis, 86 Walthery Avenue, Ridgewood, N. J.

INVENTORS! Have you a good patentable idea? Write Mr. Metzler, 11 West 42nd, New York.

RELIABLE Patent Office searches \$5.00. Sketches and descriptions returned promptly with patentability report. Registered mail recommended. Address Raymond L. Smith, Patent Searcher, 410-M Bond Building, Washington 5, D. C. (Former U. S. Patent Office employee.)

HOBBY Books. Latest titles. Catalog free. Popular Mechanics Press, (C-43), 200 E. Ontario, Chicago.

SELL Inventions without investing your money. Write internationally known inventor, C. H. Taylor, 53 Wilbraham Rd., Springfield, Mass.

AIM Your invention for "bull's-eye" success. Inventors' Manual gives concise, unbiased instructions and inspiration. \$1.00. Guaranteed. Ric-Craft, Box 1466-C, Tampa 1, Florida.

"**INVENTOR'S** Guide." 100 mechanical movements, free; advises on patenting, selling inventions. F. W. Ledermann, 154 Nassau Street, New York 7.

WANTED: Practical inventions. Inventors Exchange, Research Division, B6, Hartford 1, Connecticut.

I **SELL** Patents. Established in 1900. Charles A. Scott, 773PM Garson Ave., Rochester, N. Y.

INVENTIONS Having profit possibilities in demand by specific manufacturers, cash or royalty. Free descriptive booklet, protective disclosure form, references, and how to safely disclose an invention for sale, upon request. Invention Reporter, 5A-11106 So. Longwood Dr., Chicago 43.

CASH For practical ideas and inventions. Mr. Ball, AB-9441 Pleasant, Chicago.

INVENTORS: Avoid unnecessary expense. Write for free booklet explaining how our consulting and advisory service can assist you in deriving greatest profit from inventing. Institute of American Inventors, Dept. 40-A, 1926-Eye St. N.W., Washington 6, D. C.

INVENTORS: Learn now—without obligation—how to protect and sell your invention. Write for free "Record of Invention" form and complete instructions for making disclosure and establishing date of your invention. We also send our new free "Patent Guide for the Inventor," containing complete information about patent procedure and how to sell inventions; giving illustrations of many successful inventions; over 150 basic mechanical movements. We assure you prompt, confidential service. Delays may be dangerous. Write today for your free "Patent Guide" and "Record of Invention" form. Clarence A. O'Brien & Harvey Jacobson, Registered Patent Attorneys, 61A-G Adams Building, Washington, D. C.

RUBBER—Everything in rubber. Patents developed. Dept. P.M. Broadway Rubber Mfg. Co., Louisville 2, Ky.

PATENT Models developed and built. The Thompson Engineering Co., 206-C Winchester Bldg., Grand Rapids 2, Mich.

INVENTORS: We have a market for worthwhile products. Write for our sales plan. Visioneering, Inc., Dept. B, Security Bldg., West Bend, Wisconsin.

THE Inventor who believes he has a new and useful invention, and needs advice, should consult a competent registered patent attorney. Without obligation, write for full information on how to secure patents and trademarks. Randolph & Beavers, Registered Patent Attorneys, 11-E-Columbian Bldg., Washington 1, D. C.

INVENTIONS WANTED

INVENTIONS Wanted—Patented or unpatented. Preferably in mechanical, electrical, sports or home appliance fields, by well financed manufacturing executive looking for additional interests with good future possibilities. Outright purchase preferred but other arrangement possible. Give enough details to establish advisability of further investigation. Whitman, P.O. Box 1159, Chicago 90, Ill.

SELL Your invention, now. Let us market your invention as only we know how. Patented or unpatented. Send sketch and description. John D. & Son, 140 Spruce St., Box 3213, Dept. PM-8, Bridgeport 5, Conn.

CASH For inventions, patented, unpatented. Mr. Ball, A-9441 Pleasant, Chicago.

WANTED—Paper product, idea or invention, patented or unpatented, having profit possibilities. Make-up principally of paper, all kinds. Sell or royalty. Reply immediately. L. H. Symons Associates, 345 Hudson St., New York 14.

EARN Up to \$2,000 year, inventing simple items for special cash markets. Ideas only. No patents. Hendrickson, Argyle (7-B), Wisconsin.

INVENTORS: Hundreds of manufacturers have requested our assistance in locating marketable new products. Complete information, free. Institute of American Inventors, Dept. 40-D, 1926-Eye St. N.W. Washington 6, D. C.

WANTED—Patented, unpatented inventions having profit possibilities, all kinds. If will sell, reply immediately. Descriptive booklet, references, free. Invention Reporter, 5B-11106 So. Longwood Drive, Chicago 43.

PATENTS FOR SALE

CARD Protector for outdoor playing. Manufactured in plastic. Very different. Have patent. Will sell part cash and royalty basis. K. McGinty, 830-40 St., Miami Beach 40, Fla.

BEAUTY Supply manufacturers, all difficulties of spiral winding long hair, solved by new Bell Winder. Contact Margaret R. Bell, Federal Hotel, Great Falls, Montana.

PATENT For sale: roller guard for automobiles to prevent wrecks. Dennis James Cunningham, 731 Abnor Court S.E., Washington 3, D. C.

PLASTIC Animated novelty animal. William Fentress, 8339 Jadwin, Cincinnati 15, Ohio.

CIGARETTE Case: dial locking, time unlocking, makes the doctors order to heavy smokers to minimize or quit easy. "Breaks that force of habit." Light one, then set dial for any predetermined period of time and case will not open till time is up. Patent pending. Small mechanism, outright or royalty. Ward Leatherman, 610 Portage St., Barberton, Ohio.

INVENTORS: Test the commercial value of your patented or unpatented inventions, quickly and inexpensively. Write for free information. Institute of American Inventors, Dept. 40-B, 1926-Eye St. N.W., Washington 6, D. C.

MANUFACTURING

PLASTIC Molding and fabricating. Small or large quantities. Complete manufacturing facilities. Plastic Products Co., Dept. PM-4, 211 7th St. S.E., Canton 2, O.

MOULDS And dies for glass and plastics. Send blueprints for quotations. Unamit Mould & Machine Shop, Bunker Hill, Ill.

PLASTIC Molding and fabricating—Any item or quantity. Reasonable. Plastic Products Co., Dept. PM3, 211 7th St. S.E., Canton, Ohio.

FOR Estimates, send sketch. Machinists, 114-111 229th Street, St. Albans 11, New York.

INVENTORS—Market study; developing; manufacturing models. J. M., Burlington, Kentucky.

MODELS—Small lot manufacturing. Metals, plastics, etc. Milburn, Burlington, Kentucky.

MODELS AND MODEL SUPPLIES

SHIP Models and yacht supplies complete. Large 64 page catalogue 30c. Bill Wild's, 510 East 11 St., New York City 9.

WIZZ Electric motor: Assembles in a jiffy. Flashlight cell operates. All parts, plus illustrated instructions 30c postpaid. Also smaller "Mighty Midget" 1" model, third size 25c. Eltro Company, 171B, Deer Park, New York.

MODEL Rail News—5c brings your copy. New, used Lionel, Gilbert and scale railroad equipment. Hoxie, 150-P Stewart, Providence 3, Rhode Island.

FLY The biplane "Bullet"! Assembled in one hour! All balsa parts cut. 17½" wingspan. \$1.15. Complete line of hobby supplies. Hobby Shop, Oriental Bldg., Mattapan 26, Mass.

BUILD Complete miniature circus 1/8" scale. Easily assembled wagon kits. Cage wagons, baggage, pole, water, band wagons, calliope wagons, ticket wagons, 75c to \$1.25. Cast metal horses, drivers, lions, tigers, camels, giraffes, elephants, 15c to 50c. Main tents, sideshow tents, circus railroad cars. Send 35c today for booklet Building Miniature Circus and catalog. Bathgate, 32 Main, E. Orange, N. J.

WHY Not have fun building and flying a control line model. Kits \$3.95 up. Motors \$18.00 up. Send 10c stamps or coin for detail folder. Johnnie Casburn, Ameco, Dept. PA, Fort Worth 5, Texas.

MARINE And stationary gasoline and steam model engines: bench tested working models, casting kits and drawings. Circular 25c. Tecco, 206-C Winchester Bldg., Grand Rapids 2, Mich.

LANDLOCKED Sailors! Here's a beautiful, richly illustrated, fully descriptive catalogue of famous model ships—whalers, slavers, corvettes, etc., authentic in every detail. Send for it today. Only 10c. Marine Model Company, Inc., Dept. C-17, Halesite, Huntington, N. Y.

FLY - POWERED Plane—real model plane uses housefly for engine. Simple instructions with complete plans \$1. Earl Enterprises, Box 9204M, Los Angeles 5, Calif.

ENGINE Castings, Supplies, Catalogue 10c. Howard A3, 2417 N. Ashland, Chicago, Ill.

RAILWAY Models, complete line, 128 page catalog, HO and O gauge 25c. Walters, 247 Erie, Milwaukee 2, Wis.

MODEL Engine catalog, railroad supplies, 25c refunded. Simonsen, A-3054 Greenview, Chicago 13.

SHIP And yacht model fittings and blueprints. Hundreds of items to choose from. Send 25c for new illustrated catalog. A. J. Fisher, 1002 Etowah Ave., Dept. M, Royal Oak, Mich.

BIG Illustrated model engine catalog 10c. Active Products & Supply Co., 53 W. Jackson, Chicago 4.

SHIP Model kits and fittings. Complete line Fisher model yacht equipment. All Boucher, Fisher, Marine Model and Ideal kits, fittings and blueprints at standard prices. Most complete stock in New England. Send 10c for price list. James Bliss & Co., Inc., 220 State St., Boston, Mass.

MINIATURE Steam locomotives, 1/4" 1/2", 3/4" scales. Castings, parts, rail! Thorough drawings with instructions. Catalog 25c. Little Engines, Wilmington, Cal.

CATALOGS (Illustrated) for modellers! Airplanes, 60 page book on solids. Features construction data, specifications, camouflage, 15c; railroads: 128 page "HO" guide. Equipment, accessories, fittings. 25c (includes refund coupon). Send coin or stamps for each profusely illustrated catalog desired. Polk's, "Nation's Leading Hobby House," 314-PM Fifth Ave., New York City 1.

HOME CRAFTSMEN

FREE Turning brass rods, rounds, squares, hexagons, sheets, tubes and circles. Also bronze bearings and bushings. All sizes, any quantity. Free catalogue and prices. Richards Industries, Postoffice Box 362-E, Jamaica, New York.

WALLET, Make your own! Lady's or man's. Pigskin or Morocco goat. Red, brown, black. Complete kit \$2.00. No tools needed. Kit Kraft, Box 2868, Los Angeles 53, Calif.

PATTERNS Two lawn chairs, settee, picnic benches and Table 60c. Doll house and Furniture 30c. 70 lawn ornaments and novelty \$1.00. Five new hanging shelf \$1.00. Doll stroller, Colonial cradle, table and chairs, circus group \$1.00. All patterns \$3.50. Modern Woodcraft, Saginaw, Michigan.

HARD Paint brushes softened. Patented outfit uses new vapor process. Works like a charm. Brushes like new. One brush saved pays for it. Satisfaction guaranteed. Keeps brushes always ready. Stores brushes safely. \$2.50 postpaid. Distributors wanted. Wisconsin Laboratories, 2324 West Wisconsin, Milwaukee 3, Wisconsin.

COOL Your house! Use these plans to build a husky exhaust fan to ventilate your home. Proved design, plywood blades, quiet, efficient. Easily built with wood-working tools by home craftsmen at cost of few dollars for lumber and metal shaft, bearings, V-pullies, (1/4 h.p. motor required). Send \$1.00 for plans and instructions to Warren Crafts, Box 5952-M, Bethesda, Maryland.

JEWELRY Accessories, Findings. Plastic and metal pinbacks, screw eyes, ear wires, clasps, chains, rings, pearls, cameos, stones, etc. Prompt shipping service. Lists 10c. Doremby Co., Chisholm 1, Me.

SOLDER Aluminum with ordinary soft solder and soldering iron! Send \$1.00 for a generous supply of our new flux. Warhane Industries, RD#3, East Aurora, N. Y.

FELT Instruction booklet—patterns and designs for boleros, knitting bags, novelties, 25c. Nine 12 inch felt squares—assorted colors and grades, \$1.25 postpaid. Send 10c for color chart on yard goods. The Felt Crafters, Plaistow 10, N. H.

FREE, Hobby and handicraft information. Postcard to Baker-Alexander Co., 1472 Broadway, New York 18, N. Y.

SPEEDING Up machining operations is like finding money. Free circular explains how. Elcraft, P8, Box 8184, Portland 7, Oregon.

MAKE Beautiful copper wall hanging scoop with simple tools for home or profit. Genuine copper, brass parts. Complete directions \$1.30. Pair \$1.80. Lewis Metalcrafts, Box 755, West Los Angeles Station, Los Angeles 25, California.

SHELLCRAFT Supplies wholesale: (complete line) plastic animal shapes; discs; pinbacks; etc. Pkgs. or gal.; doz. or gross quantities; (catalogue). P.O. Box 279, Bradenton, Florida.

BUILD, Sell—Rocking lawn chairs. Detailed plans 50c. Simple economical construction. Hajicek & Co., 5405 West 25th Street, Cicero 50, Illinois.

TWO To one, speed reducer \$3.75. Craftsmans instruction handbook \$2.00. Machinists, 114-111 229th Street, St. Albans 11, New York.

EXPERIMENTERS! Many interesting items available from war surplus. Write for description. P. Siefke, P.O. Box 18, Station E, Buffalo 11, N. Y.

BALSA Wood—Ideal for modelers, craftsman. Price list free. Sanlader, Manitowoc, Wis.

LAMPS—Build or repair. Profitable hobby. All parts. Illustrated catalog 10c, refund first order. Gyro Lamps, 5416 Clark, Chicago 40.

SHELL Jewelry supplies. Wholesale only. McFarland Plastic Co., Sarasota, Fla.

MAKE Shell jewelry—for gifts, as a hobby or start a business. Free catalogue and price list. Complete illustrated book of instructions 75c. Florida Shellcraft Company, Box 1840, Sarasota, Florida.

PLANS, 30 Toys, 10 puzzles, 10 lawn ornaments, \$1.00. Winfield Hess, Dover 1, Penna.

BULLDOZER. Power shovel, earthmover. Prints and specifications of above original toy designs in wood \$1.00. Others available. Earthmover Toys, East Lansing, Mich.

ARTISTS' Brushes, paints, instruction books available. Pioneer, 394AH8, Austin, Minnesota.

SHELLCRAFT Kits for beginners—shells and complete supplies for making pins, earrings, combs and novelties. Instructions free. Kits \$2.00 and \$5.00. Herbert Diamond & Co., 1121 North East First Avenue, Miami 36, Florida.

MAKE Shell jewelry! Profit! Pleasure! Shellcraft book free! 450 Caribbean shells, including findings for making \$6 worth, \$1. Satisfaction guaranteed. Shell Company, Miami 36, Florida.

CERAMIC Jewelry supplies, bar pins, ear screws, for ceramic and woodworkers; also glass and seashell assemblers. Free catalog. Philadelphia Badge Co., 1007 Filbert St., Philadelphia, Penna.

CRAFTSMEN—Fast selling, make childrens and adults lawn chairs. Plans and instructions \$1.00. Summercraft Studio, 42 Vernon St., Newton 58, Mass.

MANUFACTURE Costume jewelry at home for profit, hobby, therapy. Free wholesale supply catalogue. Instructions. Florida Supply House, Bradenton, Fla.

35 PATTERNS Of action pull toys, trucks, carts, toy furniture, etc., \$1.00. Continental Homecrafter, 907 Birch, Eau Claire, Wisconsin.

SHELL Jewelry supplies. Wholesale only. McFarland Plastic Co., Sarasota, Fla.

BUILD And sell lawn chairs. Plans \$1.00. We tell you how and where we sell. The Woodcraft Shop, Danby, Vermont.

CATALOG: Patterns plywood novelty furniture, letters, numerals, plaques, frames, weathervanes, silhouettes, lawn ornaments, 100 books and booklets on crafts and hobbies, picture frame mouldings, tools, large line decal transfers. Other lines. Hundreds articles finely illustrated. Write Wo-Met Shop, Ashburn, Ga.

KNOCKDOWN Cedar chest lumber veneers. Free price list. Giles-Kendall, Huntsville, Ala.

MAKE IT YOURSELF

WHEELS For your own construction of wagon, scooter, racer, wheelbarrow and bicycle trailer. Drawings 25c each. 8x2" and 10x1.75" all-metal wheels with puncture-proof tires and ball bearings. \$2.25 per 8" wheel. \$3.25 per 10" wheel. F.O.B. Akron. Send orders to Jim Brown's Toy Co., 868 East Tallmadge Avenue, Akron, Ohio.

BUILD Concrete block machine, mixer, electric weed cutter, flame weeder, blue prints 50c each. Portable sawmill, blue prints \$3.00. 12" planer, tree saw, edger, \$1.00 each. Electric blueprinter, acetylene generator, burning machine, \$2.00 each. Nichols Equipment Co., Purvis, Miss.

CEDAR Chests knockdown and completed. Free price list. Sims Mfg. Co., Box 485, Malakoff, Texas.

FLUORESCENT Tubes—How to re-light them. Use indefinitely—\$1.00. Steele, 1817D San Pablo, Oakland, Calif.

BUILD Motor vibrator, concrete block machine or hand tamp, in two days for \$10 (exclusive of motor). Makes a standard block per minute. Complete, plans, photos, and instructions for building machine \$3.50 postpaid. Order from this advertisement or write for details. Clyde Lee, Dept. A, Mountain View, Okla.

ATTENTION Experimenters: Plans for a one tube walkie talkie, battery charger, photo electric cell, and a small arc welder, also—ingredients to make your own luminous paint, all for one dollar. Wm. Gable, P.O. Box 7, Avondale, Arizona.

PLANS Of bench jigs for making clothes hangers. Price \$10.00. Jesse Snyder, 1924 W. Delaware, Evansville 12, Ind.

PHONOGRAPHS. Make your own, easily, economically. We supply all mechanical parts, mounted, ready to play. Suggested cabinet plans, 25c. Circular free. Partnership Products, Box PM-141, Hamden, Conn.

KEEP Food cool without ice, electricity. Build Fogwood cooler, chimney draft operates. Plans 25c coin. Fogwood Company, King, Ontario, Canada.

ATTIC Fan ventilation can be yours now! Build the Davis designed "wind tunnel" fan yourself and enjoy seashore comfort for years to come. Save up to \$200.00. Only ordinary carpenter tools needed. Wood and fibreboard construction. Complete instructions with necessary easy-to-read drawings, bill of material, costs, installation procedure, etc. \$5.00. Davis Plans, 4314 Duval, Austin 22, Texas.

BUILD 18" Ball bearing band saw. Economically but durably constructed, easy to build. Detailed drawings, step by step assembly plans, \$1.00. N. G. Blackard, 110 Shepherd St., Raleigh, N. C.

"CONCRETE Block machine." Simple, low cost, modern design. Start your own plant. Drawings and information \$2.00. Hartley, 311 S. Norton, Los Angeles.

BURGLARIES May be prevented. Protect your bedrooms with Burglar Resistant Window Guards. Drawings, photos and instructions \$1.00. Hamco Products Company, Box 1466, Alexandria, Louisiana.

HOME? Want yours soon? Better learn to build it yourself now! Years showing beginners! Your labor saves up to 60%! Valuable circular 25c. Get the original: William Jackson, A. B., 1713 Howard, Port Huron, Michigan.

BUILD Concrete block machine. Vibration and hand operated types. 100 blocks per hour. Easy, inexpensive. Sell blocks, build home, garage, barn at low cost. Free details. Horne, 206 West Wilder, Tampa 3, Florida.

HOW To build a box kite. Complete plans, instructions. 25c stamps or coins. Zeis, 728 Lesley, Rockford, Illinois.

AUTO And farm plans, that can be made for \$1.00. List free. P. Lessard, 716 Tyler St., Oakland, California.

BUILD Your home as a hobby. No rent. No mortgage. Save 50%. Use spare time. No special skill required. Amazing facts sent free. H. C. Lightfoot, Civil Engineer, Richboro 1, Penna.

FLUORESCENT Lights. How to make your own 20 watt lights for less than \$1.00 each. Materials available. Complete, guaranteed, detailed instructions \$1.00 cash or money order. Checks \$1.10. Specialty Sales, Box 1086, Muncie, Indiana.

WATCHES, OLD GOLD, JEWELRY, PRECIOUS STONES

LADIES Three tone gold filled on sterling silver lockets. Hold two pictures. Complete with chain \$5.50, including tax. Dale Finney Jewelry Shop, Humboldt, Ia.

WHOLESALE Costume jewelry. Assortments for retailers only. \$25.00 up. Vas-sar-co, 4653 East 94, Cleveland 5, Ohio.

AMERICAN Horologist, watchmakers monthly magazine, \$2 year. Kimbel, Plant City, Fla.

IDEAL Beginners jeweled pocket watch movements "as is" \$2.00 each. Wm. Bez-ko-r, 1491 Metropolitan Avenue, New York 62.

MAKE Jewelry. 12 beautiful pieces in each kit. Plastics \$2.00. Shellcraft \$2.00. Both \$3.00. Craft Co-op, 3928 Dumaine, New Orleans 19, La.

GEMS, Precious and semi-precious, all genuine, from world wide sources. Deal direct, no overhead, save money. Catalog 10c. Hill Co., Route 7, Salem, Oregon.

WATCH Repairing easy learned by our home study course. Watch repairers are in demand and are among the highest paid craftsmen today. Write for free information. Houston Chronometer & Watch Co., P.O. Box 1140A, Houston 1, Texas.

WANTED—Old or broken jewelry. Cash paid immediately. Mail gold teeth, watches, rings, silverware, diamonds, spectacles. Satisfaction guaranteed or merchandise returned. Information free. Rose Smelting Co., 29 East Madison, Chicago, Dept. A.

WATCH And clock repairing—complete practical course in modern horology. 66 illustrated self-instruction lessons. Just out! Low price. Fascinating 100-page illustrated catalog free! Write—Nelson Company, Dept. 8-02, Chicago 5.

TOBACCO, SMOKERS' SUPPLIES

CIGARETTES—Popular brands; minimum 3 cartons. Price \$1.40 per carton; postpaid. Send check or money order. Ace Mail Order Co., East Orange 84, N. J.

SURE-FIRE Cigarette lighters, stylish block aluminum; round \$1.50, square \$1.50, \$2.50; Flame-Master 75c. Gruenewald, 3837 Coolidge, Oakland 2, Calif.

SURVEYING INSTRUMENTS

GUARANTEED Factory rebuilt transits and levels for sale (cash or terms) or rent (with purchase option). We will repair, trade, or buy old instruments. Ship prepaid for estimate and valuation. For complete information. Write for list M-28, Warren-Knight Co., (Manufacturers of Transits and Levels), 136 N. 12th St., Philadelphia 7, Penna.

RAZORS, BLADES, SHARPENING

100—NEW Double edge blades, only \$1.25. Ace Company, 3518-32nd Street, Union City, New Jersey.

BEST Quality handsome ivory plastic dry shavers now available. Complete with cord, travel case and guarantee \$5.95. 10 day trial. Midwest Distributors, Box 253, Hebron, Nebr.

100 DOUBLE Edge blades, \$1.00 postpaid. Free razor, Doroff Sales, 38 Mkt. Sq., Newport, R. I.

"PIGSKIN Safety Blade Sharpener." Latest patent. Enclose 25c. Address C. P. Martin, Comstock Park, Mich.

RAZOR Blades, single or double edge \$1.95 per 100 postpaid. Sample free. Specify type. MSB Co., P.O. Box 27, Brooklyn 8, New York.

FOR SALE OR EXCHANGE

GOLD Plated lapel crosses, dozen \$1.80, gross \$17.28. Quarter brings sample. Box 459-A, Hackensack, N. J.

FOR SALE MISCELLANEOUS

RECONDITIONED Army clothing bargains. Army pants all wool serge, \$3.95; Army raincoats, \$1.75; Navy rain jackets or pants, each \$1.00; shop aprons (new) \$1.00; blankets, 40"x80", all wool, like new to \$6.50; Army shirts, all wool worsted (new) \$5.50, satisfaction guaranteed. New York Clothing Co., Dept. PM, 2079 Second Ave., New York 29, N. Y.

GIANT Plastic reducing lens, 15 inches diameter, weighs over 8 pounds, \$5.00. Some slightly scratched \$4.00. Leo's Studio, Opportunity, Washington.

FOR Sale mechanical drawing instruments—Veeco, 4 piece, compact, precision set, brand new in lined case, value \$12.50, Special, \$7.25, \$10.00—Charvos 9 piece set, \$8.50. Army surplus slide rules, slightly used, 75c each. Hull auto compass, for accurate road direction, brand new, \$2.50. Brand new folding valise knapsacks made of heavy olive green duck, heavily bound and reinforced, repellent to fire or water. Inside 3 large snap fastened pockets, heavy webbed straps, hand and shoulder handles, size opened 22" x 54", closed 22" rolled. Useful to hunters, Boy Scouts, hikers and for all traveling use. A \$7.50 value, special \$2.25 postpaid. Prisms for 6 x 30 or 8 x 30 binoculars brand new \$1.50 each. Offset prisms to be attached to 7 x 50 B. & L. binoculars gives double the field of the ordinary 7 x 50 binocular. Cost \$98.00, special \$25.00. Forward money with order. No C.O.D. shipments. Public Sport Shops, 13 S. 16th, Philadelphia, Pa.

NEW Curtiss electric motors, 10,000 to 1 reduction gears complete \$19.75. Varney, Tipp City, Ohio.

CLOTHESPINs, Clothespins, millions. Get dealer prices, sample. Scheall, Box 263 Duluth, Minnesota.

ARMY Goods (used) canteens, mess sets, helmets, life preservers, raincoats, knapsacks \$1, cartridge belts, holsters, gas mask bags 50c. Life rafts \$7.50, bunks \$5, rubber suits \$5. N. Y. Salvage, 144 Chamber St., N. Y. C.

FOR THE HOME

WASHING Machine parts, wringer rolls, belts, etc. Send old parts for duplication. Prices free. General Washer, 7203 Lozier, Van Dyke, Mich.

SAVE Money. Prefabricated homes. List of 109 manufacturers \$1.00. Fabrication Service, Box 804, Battle Creek, Mich.

WIGWAM Flue Doctor stops down draft, permanently cleans creosoty chimneys. Wig, Abington, Mass.

WANTED MISCELLANEOUS

WANTED—Used stamps. Bulk, on paper, mixtures. Write. C. Ritchie, Watertown, So. Dakota.

SWAPPERS Hobby Bulletin. What'cha got? Want? Dime trial. Royal Oak, Mich.

"THE Swappers Bible." issued monthly, copy dime. "Michigan Trader," Box 642P, Gobles, Michigan.

WANTED: 65 Note electric rewind piano rolls. Norman M. Baird, 2140 Waterman Ave., San Bernardino, California.

JUSTICE Buys almost anything! List free. 9762 Santa Monica, Beverly Hills, California.

MERCURY—Highest prices. Free containers. Write. Wholesale Terminal, Norwood, Mass.

MERCURY (Quicksilver). Write for quotation stating quantity. Metallurgical Products Co., 35th and Moore Sts., Philadelphia, Penna.

PERSONAL

HOW To recognize rare books. Complete instructions, prices, etc., \$1. Robert Cannon, 37-50 86th St., Jackson Heights, N. Y.

PHOTOSTAMPS. Details free. Pera, Dept. A1, 165 Chattanooga, San Francisco 14, Calif.

ABILITY Not recognized? Try improving personality 3 quick ways. Users say "It works!" Free folder. Methods Research, 6235-S Eastwood, Kansas City 3, Mo.

VISIT Miami by proxy. Three views 25 cents. Address and return. Collomb, Box 1495, Miami 9, Fla.

2500 ADVERTISING Book matches \$10.95. Rev. Otho DeWitt, Corunna, Mich.

RUPTURED? Positive comfort, no under-traps, no steel, no elastic. Write Smith Manufacturing Company, Preston, Ont.

SPEED Ahead financially. Four quick ways. Dr. Tibolt, 18M, Philadelphia 20.

MAIL Forwarded. Reliable. 25c each letter. Box 536, Anaheim, Calif.

HOW You can find out! Information discreetly developed, any matter, person, problem, anywhere. Personal-business assignments, representations, undertaken. Nation-wide. Officially licensed and bonded service established 1922. Reasonable. All inquiries confidential. William Herman, 170 Broadway, New York.

FALLING Hair, its cause and prevention. An informative and educational pamphlet entitled "How To Keep Your Hair Till Ninety" mailed free. James Hilton, 4819 A Fourth Ave., Brooklyn 20, N. Y.

NERVOUS. Self-conscious, fears? Be courageous, self-confident, magnetic. Sensational psychology course. Only \$1.00. Dr. Malcolm Smith, 1104 Union Ave., Montreal 3, Canada.

MEXICAN Law practice, L. Gonzalez, Box 236, El Paso, Texas.

POOR Penmanship corrected—few hours. New-way. Ozment, 9, St. Louis, Mo.

HAIR Falling? Dandruff? Write Trichologist, 137 Lewis St., Phillipsburg, N. J.

MISCELLANEOUS

ILLUMINATED House numbers connect to doorbell button terminals. Bulbs last indefinitely, draw practically no current. Postpaid \$3.50. Send check or money-order. State numerals wanted. F. N. Sues Mfg. Co., 1050 Florida Ave., Akron 14, O.

BILLFOLDS, Men's, ladies'. Genuine leather. Four window inserts. Allround zipper. Name lettered in gold. \$5.00 value. Only \$2.98 postpaid. Selby Sales, 145 N. Clark, Chicago 2.

CREATE In modeling clay. Five pounds \$3.00 postpaid. Self-hardening into permanent stone. Kendakraft, 82 New Jersey Ave. Brooklyn 7, New York.

SOUVENIRS Of Washington, D. C. Drop me a card for your list. W. E. Thompson, 1213 H. St. N. E.

NEW Powerful Goldak locators for minerals and metals and with wartime improvements now available. Screen grid and beam power tubes. Moneyback guaranteed detect buried gold and silver at greater depths than any competitive device. Write Goldak Co., 1544 W. Glenoaks Blvd., Glendale 1, Calif.

SELECT Mailing list of agents and specialty salesmen. Just completed, nationwide, with names and addresses on individual gummed labels ready for mailing \$6 per thousand. C. H. Keeley, 14417 Victory Blvd.-A. Van Nuys, Calif.

FIREWORKS—Any time—any quantity—newest ideas—highest quality—best values. Giant salutes, aerial bombs, sky-scramblers, battle-in-the clouds, new jet-propulsion plane rocket. 150-piece combination offer \$4.95. Satisfaction guaranteed. Write for big new catalog. Banner Fireworks, Dept. 32, Toledo, Ohio.

"RECEIVE Mail." Money-making offers, opportunities, catalogs. Name listed 10c. Ideal Service, 100, Park Ridge, Ill.

USEFUL, Reliable mail-purchasing merchandise! Free information! Postways, Box 5325, Philadelphia 42, Penna.

FILTER All acids, corrosives, photo-solutions, baby formulas, etc. quickly. Ultrafine stainless steel filter mounted in special plastic transparent funnel, cleans instantly. \$1.00 postpaid. Larsen-Bowen Products, Villa Park, Ill.

DREAM Book explaining 500 dreams 10c. Kaybee, Crescent Beach, B.C. Canada.

HOBBIES In Hollywood. Movie stars collect stamps, coins, guns, books, pipes, dolls, china, jade, antiques, etc. List of the hobby and home address of 60 famous stars \$1. Originators Service, Room 1119X, 210 West Seventh St., Los Angeles 14, Cal.

DOG Identification tags 50c. Send for illustration. Frank Michalucine, 3206 Eastwood Ave., Chicago 25, Ill.

EMBOSSE Ink kit \$1.00 L. Spada, 10 Lexington, Wethersfield 9, Conn.

A THOUSAND Laughs. Unique Jackass Cigarette Dispenser. Holds 10 cigarettes. Simply press donkey's head down, tail rises—presto—out—slips cigarette. Satisfaction guaranteed. Sent postpaid for \$1.00 with order or \$1.10 C.O.D. Sanimo Industries, Dept. C-9, Spencer, Ind.

RECEIVE Money-making opportunities, mails, samples, catalogs, magazines. Your name in thousand mailing lists, 25c. Glassmink, 1654-MX Amsterdam Avenue, New York 31.

USED Comic magazines bought and sold. Ed. Wilkins, Beeville, Texas.

LOW Cost spray equipment for the home, farm or shop. No expensive compressor needed. Uses compression of car or tractor engine without harm. Sturdy, professional type spray gun sprays paint, insecticides, weed killers, etc. Will inflate tires and pressure grease. For complete information write PowerAire Corporation, 332 S. Michigan, Chicago 4, Ill., Dept. PM1.

SCOUTS—Army signal flags and case—50 cents. Model Shop, 818 North Highland Avenue, Atlanta, Georgia.

PAINT Crackles forming designs while drying. Circular free. Mapco, Hapsbrunck Heights, New Jersey.

WEEDETTE Kills ragweed, poison ivy, plantain, etc. 50c package covers 1,200 square feet. Order now. D.D.T. Service Company, Waterbury, Conn.

ELECTROPLATING Free estimates. Describe fully and finish desired. Platers supplies. Anchor Sales and Service, 3519 Texas Ave. S.E., Washington 20, D. C.

CONCRETE, Building blocks or tile, any size or shape, easy to make on simple, patent mold. Plans \$1.00. W. Denham, Box 265, Murray, Ky.

KILL All weeds with 2000 degree flame. Famous fire gun sprays, sterilizes, incinerates, disinfects. Works like plumber's blow torch, burns kerosene, mostly air. Endorsed by agricultural experts. Immediate shipment 4 gal. tank, burner, hose \$22 express collect. Descriptive literature free. Sine Equipment, P376, Quakertown, Penna.

PETER Pelican—Ashtray, cigarette-match dispenser! 8" high; decorated cocoa, yellow, blue, white, gold. Matches in hat, cigarettes in pouch, striker in beak. Hard plaster composition; felt bottom. \$3.50 postpaid or send \$1.00; balance c.o.d. charges. Orange Mfg. Co., 1350 Madison Ave., New York 28, N. Y.

HOMES, Pre-cut, prefabricated. Get on manufacturer's list. Mail \$1.00 for names of over 100 firms, and other vital information. Midwest, Box 298, Streator, Ill.

CALENDAR 1753 to 2152. 35 cents postpaid. Tracy Newton, Decatur, Georgia.

FOR Executives and superior white-collarites only. Bag-o'-tricks that landed \$24,000 position, 25c. Andrea, Barnegat, N. J.

BOOK Of 300 useful, helpful, time-money saving household hints—25c. Harold C.B. Brown, Sullivan, Indiana.

ARTIST Addresses envelopes—beautifully lettered and colored. Send \$1.00 for 8. D.A.C., 1730 N. Lima, Burbank, Calif.

DADDIES—Have fun. Send up toy balloons. Mix three kitchen items. Tie on your address. Instructions \$1.00. J. P. Turner, 67 Lake Forest Parkway, Wilmington, N. C.

MEXI-MOLLY, Patented animated novelty animal. Three for dollar. The Tinker Shop, 8339 Jadwin, Cincinnati 15, Ohio.

DEVELOPMENTS Undertaken. We will solve your problems if they are mechanical or electrical. Custom-built devices and apparatus of all types constructed, redesigned, repaired. Guaranteed results. Reasonable. Alko Labs, 335 E. 94 St., New York City.

INTERESTING Scenes of Okinawa. Filmed by navy photographer. 4x5 high quality glossy prints. 20 for \$1.00. Send 10c (coin) for sample photos. Kadef Sales Co., Box 875, Atlantic City, New Jersey.

SKULL, Other novelties, key chain, identification tag 50c. Quigley, Cupertino, California.

POOL Your friends. Pretend you are in Atlantic City. You write message, address, we mail from Atlantic City. 3 post cards sent 25c. Kadef Sales Co., Box 875, Atlantic City, New Jersey.

EXPERIMENTER'S Special offer. 8 Alnico magnets, \$2.00. 100 diagrams and uses, 25c. Eljay, Box 891, Newark 1, N. J.

TAILORED Homes. 69 sketches one-story houses styled Colonial, English, Spanish and moderne. Price \$1.00. H. P. Jones, 486K Brandeis Th. Bldg., Omaha 2, Nebraska.

MAKE Delicious caramels, marshmallows, cheesecorn, three guaranteed formulas. \$1.00. Frank Shilling, 1017-P Dueber, Canton 6, Ohio.

MAKE Your own Plastoplate printing cuts. Simple, easy process. Plastoplate, Argyle (1), Wisconsin.

MEXICAN Miniature pottery. Oaxaca and Guadalajara. Bulletin. Mexican Products Co., 128 N. Main, Tulsa 3, Okla.

KEYS Duplicated 25c, by code 45c. Fitted to any lock \$1.00. Lock, key, or safe problems or questions answered \$1.00. Box 6, Riverside Station, Miami 35, Fla.

LUMINOUS Paint. Best quality. Glows bright blue in dark. 1 oz. each paint and sealer only \$1.59 f.o.b. Chicago. Black Light Products, 67 E. Lake St., Chicago 1, Ill.

MEXICAN Jumping beans. Dozen 25c, hundred \$1.00, thousand \$5.00. Mexican Products Co., 128 N. Main, Tulsa 3, Okla.

SOMETHING To swap? Advertise in Green Mountain Trader. National circulation. Sample, dime. Henshaw, Bondville 13, Vermont.

YOURS For better buying through the "Product of the Month." Free informative folders. Selected Products, Box 56-K Kensington, Brooklyn 18, N. Y.

EVERLASTING Calendar! Attractive, practical. Illustrated circular free. James Dollar, Grand Place, Vancouver, Wn.

TATTOOING Outfits, designs, colors. Write today. Zeis Studio, 728 Lesley, Rockford, Illinois.

GOOD "Used" self-instruction educational books on all subjects bought, sold, rented, exchanged. Satisfaction guaranteed. Complete information and 100-page illustrated bargain catalog free! Write—Nelson Company, Chicago 5.

BIGGEST Money in tattooing now! No experience required. Complete instructions with outfits. Send for free literature. Tatuco, 651 South State, Chicago.

"BIBLE Studies." 70 lessons 25c. Bulletin, Box 87, Station H, New York 25.

MEDICAL Laboratory technicians in great demand. We train you in your spare time, in your own home. You can practice while studying. Write for free catalogue. Imperial Technical Institute, Box 973-J, Austin, Texas.

METAL, Mineral locators latest 1946 electronic type ready for immediate shipment. Fisher Research Laboratory manufactured 2 million dollars worth of electronic equipment for the U. S. Army, including some of the finest metal-locators. Experience gained is yours in the best metal, mineral locator. Free 16 page booklet upon request. Fisher Research Laboratory, Palo Alto, California.

FREE—"Amazing New Book"—"Profits From Classified Advertising." Tells how and what to advertise. Be sure to read this book before you invest one cent in advertising. Remember—it's free! Write for your copy now. F. W. Johnson, Classified Advertising Manager, 200 East Ontario Street, Chicago 11, Illinois.

**Money Making
Pay Raising
BOOKS
Catalog
FREE**

SEND NAME AND ADDRESS TODAY—Selected books covering all trades, office helps, home workshop, spare time work, hobbies, etc. Learn how to earn more. 1946 edition. Popular Mechanics Press 200 E. Ontario St., Chicago 11



New 1946 WHAT TO MAKE out now!

Our annual reprint of articles selected from our "CRAFTSMAN" Department is better than ever. It contains hundreds of ideas you can use around the home and in your workshop. 208 pages. 400 illustrations. Get the 50c paper edition from your News Dealer. We shall not sell this edition at all this year. In December we shall have it and the six previous volumes bound in good-looking, durable library cloth at \$1.25 each or \$8.00 for the complete set. A wonderful addition to any craftsman's library!

POPULAR MECHANICS PRESS

Dept. 617 200 E. Ontario St. Chicago 11

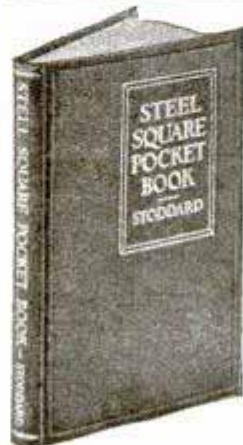

**THIS BOOK SHOWS
HOW TO DO IT**

STEEL SQUARE POCKET BOOK

Completely Revised

This concise and handy little book illustrates and describes the best methods of using the carpenter's steel square in laying out all kinds of carpentry work. It is easy to understand as a picture of the square laying directly on the work shows exactly how the various cuts are made. Its compact and handy size makes it convenient to carry in the pocket for quick reference.

Price \$1.00 Postpaid

POPULAR MECHANICS PRESS

DEPT. 627

200 E. ONTARIO, CHICAGO 11, ILL.

LEARN Automobile Styling



Be a **HIGHLY PAID**
AUTOMOBILE
DESIGNER

STUDY AT HOME:—

The era of new-style cars throws the doors of unlimited opportunity wide open for future automobile stylists. Now, for the first time, you can learn this highly paid, fascinating profession at home from schooling that originates in the heart of the industry—dynamic Detroit.

This home-study course is personally directed by Harley J. Earl, responsible for the design of twenty million cars here and abroad. Lessons are scientifically planned and tested to give you a concentrated knowledge of styling techniques and each project you submit gets detailed frank evaluation by a staff of experienced designers. Enrollments are accepted at any time.

WRITE AT ONCE FOR FREE FULL PARTICULARS

DETROIT INSTITUTE OF AUTOMOBILE STYLING

Operated by the Harley Earl Corporation
Dept. 8-P, 5533 Woodward Avenue • Detroit 2, Michigan

Now for EVERY WORK SHOP!

NEW
Invention

Electroplates by BRUSH

**Easy to Plate CHROMIUM
GOLD, SILVER, NICKEL, COPPER
... For Pleasure and Profit!**

If you have a workshop—at home or in business—you need this new Warner Electroplater. At the stroke of an electrified brush, you can electroplate models and projects—you can replate worn articles, faucets, tools, fixtures, silverware, etc. with a durable, sparkling coat of metal... Gold, Silver, Chromium, Nickel, Copper or Cadmium. Method is easy, simple, quick. Everything furnished—equipment complete, ready for use. *By doing a bit of work for others, your machine can pay for itself within a week.* So make your shop complete by getting a Warner Electroplater right away. Send today for **FREE SAMPLE** and illustrated literature. **ACT AT ONCE! Mail Coupon.**

**WARNER ELECTRIC CO., DEPT. J-8
663 North Wells, Chicago 10, Illinois**

FREE Details & Sample!

WARNER ELECTRIC CO., 663 North Wells, Chicago 10, Dept. J-8
Gentlemen: Send Free Sample and Details to:

Name _____
Address _____
City _____ State _____



RADIO PHONES

Made to U. S. Army Specifications, passed by Signal Corps Inspectors. Dynamic Microphone and dynamic receiver of finest quality—Water, shock, weather and altitude proof, used on tank and aircraft (B19) intercom systems. For recording, for battery-less telephone, talk through your radio set or use earphones for pocket-size set or use loud speaker.

Complete two receiver, cord set, head band, and dynamic hand microphone including special connecting cord set. Less than regular cost of dynamic mic. **\$9.95** Postpaid

King of ELECTRIC SWITCHES

**Versatile Switch of a Thousand Uses
Millions in Post War Applications**

Floodlights your porch when the door is opened—sounds alarm when window is opened—signals arrival of mail—controls heating of furnace—filling of water tank, these and many other services are performed by this versatile switch. Shipped with instruction sheet showing numerous illustrated uses for this device at the low price of **\$1.00** Postpaid



KING PRODUCTS COMPANY

BATAVIA 2, ILLINOIS



Get Started in Radio TEN "HOW-TO-DO-IT" BOOKS

Get a solid foundation in radio by means of these 10c timely text books. Each clearly written, profusely illustrated, contains over 15,000 words. You'll be amazed at the wealth of information packed into these handy books. Excellent for reference—ideal for technical library. Your money back if not satisfied.

5 Books for 50c—10 Books for \$1
SENT TO YOU POSTPAID

- No. 1—How To Make Four Doerle Short Wave Sets
 - No. 2—How To Make The Most Popular All-Wave 1 and 2 Tube Receivers
 - No. 3—Alternating Current for Beginners
 - No. 4—All About Aerials
 - No. 5—Beginners' Radio Dictionary
 - No. 6—How To Have Fun With Radio
 - No. 7—How To Read Radio Diagrams
 - No. 8—Radio for Beginners
 - No. 9—Simple Electrical Experiments
 - No. 10—Television
- Remit by check or money order—register letter if you send cash or stamps.
RADIO PUBLICATIONS, 23K West Broadway, New York (7)



THE GEM MAKER

Amateurs or professionals... hobbyists or jewelers... Polish your own gems with a B&I Gem Maker. You will find this a profitable adventure. All necessary lapidary equipment is furnished, including a super-charged diamond blade for sawing, and all wheels for grinding, shaping and polishing, also complete instructions. The complete equipment as shown, less motor and belt, for only \$29.50, f.o.b., Burlington, Wis. Write today for information and literature on the Gem Maker and accessories.

B&I MFG. CO., Dept. S, Burlington, Wis.



Balance 4" x 9" Base. With either **\$6.00** Metric or Avoirdupois Weights...

Catalog with 3000 illustrations of laboratory apparatus sent for 75 cents. Catalog listing 10,000 chemicals, drugs, minerals, etc. and 1500 scientific books sent for 25c. Catalog of 100 books 10c.
**LABORATORY MATERIALS CO.
7321 Vincennes Ave. Chicago 21, Ill.**



MACHINE SHOP EQUIPMENT

Every man who owns a workshop should have a copy of this new, authentic catalog of Machine Shop Equipment... the latest tools made by the biggest manufacturers in the United States. Replete with illustrations, descriptions, prices. Prompt delivery on most tools listed in this catalog. Available at the cost of printing—50c a copy—Get yours today! Price of Catalog Refunded on First Order over \$5.00. Send check or Money Order to

**CENTER TOOL CO.
154 Centre St., New York 13, N. Y.**

OTTAWA TRACTOR SAW



FREE BOOK
and
Price List

350 CUTS PER MINUTE

Make money sawing wood. Use Ottawa—fastest cutting. Cuts large, small logs easiest way. Fells trees. One man operates. Thousands in use. Built to last with heavy, stiff saw blade. Positive safety clutch control: uses power take-off any tractor.
OTTAWA MFG. CO., D827 Forest Ave., Ottawa, Kan.

ATOMIC!

**IN ITS POWER
TO CREATE PROSPERITY
AND RICHES — FOR YOU!**

HERE IS A
NEW BOOK THAT
WILL START YOU
AT ONCE ON THE
PATH TO PROSPERITY



YES, IN LESS THAN
AN HOUR FROM THE TIME
YOU START READING THIS
BOOK, YOU WILL KNOW THE
SECRETS OF HOW TO OBTAIN
ANYTHING YOU WANT.

"THE FINER THINGS OF LIFE"
HOW TO OBTAIN THEM

**DO YOU WANT MONEY? A NEW HOME?
A FARM? A NEW CAR? A NEW POSITION?
TO INCREASE YOUR BUSINESS?**

Young men and women just out of the Service,
businessmen, salesmen, farmers, housewives, etc. all
will want this book regardless of present occupation.

We guarantee you will be delighted with "THE FINER
THINGS OF LIFE" or your money refunded in ten days.
GET YOUR COPY NOW! Print plainly, your name and
address. Send \$1.00 direct to: — **SUCCESS FORMULA** —
4348 Broadway, Dept. M. P., Chicago 13, Ill.

SAY YOU SAW IT IN POPULAR MECHANICS

PLEXIGLAS COLORED and TRANSPARENT

Our warehouse guarantees you savings on Grade 'A' Plexiglas
Orders Promptly Filled

CLEAR PLEXIGLAS SHEETS, NEW PER SQ. FOOT			
1/16	\$1.24	3/16	\$1.97
1/8	\$1.61	1/4	\$2.31

Colored Plexiglas Sheets: 10% Additional
For free literature on Plastics and how to work them, price lists on
rods, sheets, tubing, odd shapes in all types of plastics, dyes, cements,
buff compounds, send 10c to cover packaging & mailing. Prices subject
to change without notice.

**HOUSE OF PLASTICS, Dept. LW-11X
7604 FENKELL DETROIT 21, MICHIGAN**

COLOR CONCRETE WITH CHEMICALS

A business of your own. Big money making Hollywood style pottery and
birdbaths without moulds. Washing-wells, stucco-rock, benches. Mar-
bling and cement water-paints. 10c brings sample, literature, pictures.
Hollywood CementCraft, 8529 Wonderland Ave., Hollywood 46, California

INVENTIONS WANTED

— Patented or Unpatented —

Preferably in mechanical, electrical, sports or
home appliance fields, by well financed manu-
facturing executive looking for additional in-
terests with good future possibilities. Outright
purchase preferred but other arrangement pos-
sible. Give enough details to establish advisa-
bility of further investigation.

WHITMAN, P.O. BOX 1159, CHICAGO 90, ILL.

Give Yourself the Backing of a
Great Growing Industry



REFRIGERATION AIR CONDITIONING

Refrigeration and Air Conditioning have leading
place in fast growing fields of our time. Trained
men paid well to service, install, maintain, repair,
rebuild household and commercial refrigerators.
Important new developments such as Frozen Foods
and many new industrial uses. De-
mand for commercial installations in
restaurants, butcher shops, taverns,
florists, bakeries, etc.—air condition-
ing in homes, offices, shops.



Start Now---Full and Part Time Earnings

There may never again be such opportunities for
men who want better jobs or business of their own
to get in on ground floor and go up fast! If over 17
and under 60 learn how you can get started. CON-
SULTATION AND PLACEMENT
SERVICE WHETHER YOU ARE
INTERESTED IN WORTH-
WHILE JOB OR SETTING UP
YOUR OWN BUSINESS.



**Begin Training at Home
or Come Directly
to Shops**

Begin your training at home
in spare time, finish in our big,
modern shops, or come directly
to shops. At home you get
C.T.I.'s SHOP PROVED.
HOME STUDY instruction —
actual shop experience has gone
into the practical lesson assignments. That is why it is easy
for mechanically inclined men to learn by our Home Study
training and start on actual refrigeration work.



A NATIONALLY KNOWN INSTITUTION

C.T.I. was only civilian school selected by
Army to train service men for refrigeration.
Same quality training available to you now.

VETERANS

Write for free information telling
how you can get your training under
"G.I. Bill."

COMMERCIAL TRADES INSTITUTE
Dept. A-28
1400 W. Greenleaf, Chicago 26, Ill.



→ Fill Out, Cut Out, Mail Today ←

FACTS FREE for Men Who Want to Get Ahead
COMMERCIAL TRADES INSTITUTE, Dept. A-28
1400 W. Greenleaf, Chicago 26, Ill.

Send free Illustrated Brochures and other information about
Refrigeration and Air Conditioning.

Check here if interested in G.I. Training.

Name.....
Address.....
City..... State.....

PLEASURE AND
PROFIT IN

Photography



IMPROVE YOUR
SKILL — STUDY
AT HOME

Whether you wish
to make a career
of photography or
want to gain ad-

ditional skill as an amateur, the American School of Photography offers practical basic training, which requires only spare time study.

With proper aptitude and application, this Course should provide you with a fundamental background which may open the door to valuable professional experience . . . or add fascination and zest to your hobby.

OLD ESTABLISHED SCHOOL. Backed by years of experience, our training covers every phase of Modern Photography through spare time study at home. Basic photographic principles are taught by inspiring "learn-by-doing" method, step-by-step, under the supervision of a qualified instructor.

GET FREE BOOKLET! Send coupon today for free booklet, "Opportunities in Modern Photography," and full particulars.



AMERICAN SCHOOL OF PHOTOGRAPHY
1315 S. Michigan Ave. Dept. 1350
Chicago 5, Illinois

AMERICAN SCHOOL OF PHOTOGRAPHY
1315 S. Michigan Ave., Dept. 135C, Chicago 5, Ill.
Please send me without obligation your free booklet, "Opportunities in Modern Photography," and full particulars.

NAME.....AGE.....
ADDRESS.....
CITY.....ZONE.....STATE.....

CARTOONING Made Easy

Drawing and Animation

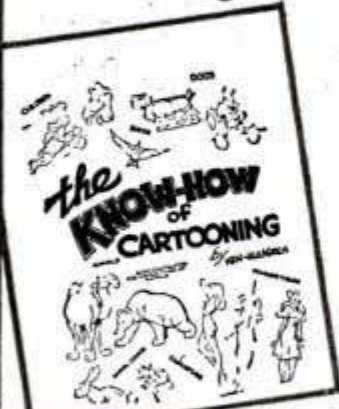

In 400 step-by-step illustrations by Ken Hultgren, top-notch comic artist.

Research Books
126 West Third St.
Los Angeles 13, Calif.

\$1.00
POSTPAID

Name _____
Address _____
City _____ Zone _____ State _____

PAY-RAISING — EXTRA MONEY BOOKS

Use these books to prepare for a better job—bigger pay—to start a profitable spare time or full time business of your own, improve your home, start a hobby. Popular Mechanics specializes in supplying outstanding self-help books on many subjects. Send for our FREE catalog.

- How to Remodel a House** Nothing is omitted...\$4.75
- Painting, Furniture Finishing & Repairing** New self-help book for craftsmen, home owners...\$1.50
- Shop Notes for 1946** Now ready. For every man who uses tools...\$.60c
- Shop Notes Library** 5 Vols.—1946, 45, 44, 42, 41. (No Dup. Mat.)...\$3.00
- Welding, Brazing & Soldering** How to build own equipment and use it effectively...\$1.25
- Garden Book** Build own trellises, lawn furniture, fireplaces, ornaments, etc...\$1.00
- Forty Power Tools** Build own saw, drill, lathe, sander, etc., from scraps—save money...\$1.25
- Rewinding & Servicing Electric Motors (No. 75)**...\$.25c
- Turn Scrap Into Money** Convert old auto generators into motors, welders, etc...\$1.00
- House Wiring (No. 89)** All information needed to do complete job...\$.25c
- Modern Refrigeration** Electric, Gas. Be service expert...\$5.00
- Dyke's Auto Ency.** (includes Diesels, airplane engines) New 20th Ed. World's greatest book for mechanics...\$7.00
- Sheet Metal Work** Self instruction in all phases...\$2.50
- Tool & Saw Sharpening (No. 92)**...\$.25c
- Armature Winding** Construction, winding, repairing AC & DC Motors, generators...\$2.00
- Build Your Own Boat** Describes 17 popular boats—rowboats, sailboats, plywood outboard, etc. 192 pages...\$1.50
- Forging Practice**...\$1.50
- Toys You Can Make of Wood**...\$2.50
- Carpentry** Learn modern methods...\$2.00
- Foundry Work**...\$2.00
- Pattern Making** Wood, metal...\$2.00
- Action Toys (No. 66)** Plans for 21 easy-to-make toys...\$.25c
- The Young Craftsman** Over 450 things boys can make...\$1.50
- Five Acres and Independence** How to make money on small farm...\$2.50
- Modern Welding Practice** Useful data on welding of all kinds. Simplified, non-technical, easy-to-understand...\$3.50
- How to Plan a House** Every detail carefully explained. 525 pages...\$4.50
- A Small Store and Independence** Guide to successful retailing...\$2.00
- Modern Gas Turbine** Complete up-to-date information on uses as supercharger and prime mover. Includes jet propulsion...\$4.00
- A.B.C. of Poultry Raising**...\$2.50
- How to Build Violin, Pipe Organ, Banjo-Uke**...\$1.00
- Knots, Ties, Splices** For everyone who uses rope...\$1.25
- Plastics** Latest information on manufacture and use...\$4.00
- Workbenches & Tool Cabinets You Can Build (No. 47)**...\$.25c
- Concrete Handbook** New book on using concrete around home, garden, farm...\$1.50
- Oil Burner Handbook**...\$2.50
- Photo Guide** Construct own equipment, gadgets. Make better photos...\$1.50
- Welding, Electric**...\$1.25
- Welding, Oxy-Acetylene** Welding, cutting...\$1.25
- Metallurgy**...\$2.50
- Ropp's Calculator** Figuring made easy...\$.50c
- Plumbing Installation & Repair** For those without previous training...\$1.50
- Judo, 30 Lessons in Modern Jiu-Jitsu**...\$1.89
- Tool Making**...\$3.50
- Tool Design**...\$4.50
- Mechanism**...\$3.50
- Air Conditioning—Heating and Ventilating.** Principles and general applications of steam, hot water, vapor and vacuum heating...\$4.00
- Audels Sheet Metal Pattern Layout**...\$4.00
- Estimate for the Building Trades** How To: Material and labor costs for masonry, plumbing, electricity, carpentry, heating, hardware, painting, etc. 629 pp...\$4.75
- Audels Masons and Builders Guides** For Bricklayers, Cement workers, Plasterers, Tile Setters and Stone Masons. 4 Vols...\$1.50 each
- Lejay Manual of Homemade Electric Equipment** How to construct 100 items that are scarce and valuable...\$1.50
- Drake's Refrigeration Service Manual**...\$2.00
- Slide Rule Simplified**...\$2.50
- Mathematics for Ready Reference** Covers all phases of mathematics...\$2.00
- Mechanical Drawing Self-Taught** With 21 simple step-by-step exercises, 56 pages of illustrations showing how to do it...\$1.00
- Audel's New Automobile Guide** 1600 pages...\$4.00
- New Small Homes** 62 practical and popular designs...\$.50c
- The Vegetable Growing Business**...\$3.50
- Rabbits for Food and Fur**...\$2.50
- Furniture Joinery**...\$2.50
- Principles of Woodworking** Tools, processes, materials, projects...\$2.00
- Pottery Made Easy**...\$2.50
- The Art of Wood Turning**...\$2.00
- Essentials of Upholstery**...\$2.75
- Radio Physics Course**...\$5.00
- A thorough training in radio fundamentals.**
- Bookkeeping for Personal and Business Use**...\$2.25
- The Art of Inventing and What to Invent**...\$3.00



MAIL THIS COUPON TODAY

Check the books you want, write your name and address below, and mail this advertisement with money order or check. Outside U. S. A. include 15% additional for shipping charges.

Books selected will be mailed promptly on our "money back if you're not entirely satisfied" guarantee.

Name _____
Address _____
City _____ State _____

Mail to **POPULAR MECHANICS PRESS.**
Dept. 604—200 East Ontario St., Chicago 11, Ill.

THE WORLDS' ONLY
'SKY-FLYER'
GIANT 4 FT. PLANE TRAVELS WITHOUT A MOTOR

STAYS IN THE AIR FOR HOURS
 OVER 1000 FT. ALTITUDE
 STUNTS

THRILLS... FUN GALORE FOR YOUNG & OLD

Price Per Plane **\$100** POSTPAID

U. S. PAT. 2032228 OTHER PATENTS PENDING

MAIL YOUR ORDER NOW
 Write Name Plainly and Enclose \$1.00

READY CUT & COLOR MARKED VERY SIMPLE TO ASSEMBLE
 LIMIT—2 TO EACH CUSTOMER

AGENTS WANTED

SKY-FLYER SALES CO., NEW HYDE PARK, L. I., N. Y.

Is it worth \$1000⁰⁰ TO YOU TO READ THIS?

It can be worth much more—yes, it can be worth thousands of dollars to you each year. Vocational and aptitude tests will find the career for which you are best suited and put you onto the RIGHT road to business and financial success. Should you be in accounting, radio, salesmanship, copywriting or elsewhere? Before taking a job or starting a course of study KNOW what you should do. Save weeks, maybe years, of work. Why postpone success? Vocational tests are SURE—they can be taken in your own home. Satisfaction is guaranteed. Write today for complete information.

DEPT. PM VOCATIONAL TESTING LABORATORY 2019, Main St. Dallas 1, Texas

SELL MERCHANDISE BY MAIL
 Operate profitable home business selling merchandise by mail. 75c profit on fast selling \$1 items. Write TODAY.
POWELL CO., Dept. A, Sampliner Bldg., Cleveland 3, Ohio

SAY YOU SAW IT IN POPULAR MECHANICS

RAISED WOOD SIGN LETTERS
 MADE OF THE BEST IDAHO WHITE PINE.
 ALL SIZES. FACTORY PRICES.
 Send 10c for Catalog

SIGN LETTER DISTRIBUTORS, P.O. Box 101, Mineola, N. Y.

LAW STUDY AT HOME for PERSONAL SUCCESS and LARGER EARNINGS. 35 years expert instruction—over 108,000 students enrolled. LL.B. Degree awarded. All texts furnished. Easy payments. Send for FREE BOOK—"Law and Executive Guidance."

AMERICAN EXTENSION SCHOOL OF LAW
 Dept. 68-M, 646 N. Michigan Ave., Chicago 11, Ill.

TRAILER AXLES, HITCHES, AND PARTS

• If you are interested in purchasing trailer axles, hitches, and other trailer parts, contact us promptly. Write for free literature.

HAMMER BLOW TOOL COMPANY, Dept. 108, WAUSAU, WIS.

CHANITE SELF-WELDING FLUX
 REPAIRS ALL ELECTRIC HEATING ELEMENTS

So simple anyone can make repairs in your broken or burnt-out electrical appliances—irons, toasters, stoves, etc. Guaranteed nothing like it. From our mines to your appliances. \$1.00 per package. \$7.50 per doz. Stick form 25c. \$2.00 per doz.

CHANITE SALES COMPANY, 914 So. Main, Fort Worth 4, Texas

LARGE GENUINE ANCIENT ROMAN COIN — \$1.00

20 different coins 15 countries.....\$1.00
 50 different coins allied nations.....\$5.00
 40 different coins defeated nations.....\$5.00

Lists — Approvals
 DEL MONTE • 40 West 18 • New York 11

HELPFUL BOOKS
 Send post card asking for FREE catalog
 Popular Mechanics Press, 200 E. Ontario, Dept. 601, Chicago 11

HOBART Arc Welding
Starts you in Business

BE YOUR OWN BOSS!
 How many times have you said to yourself, "I'm tired of working for someone else, I'm going into business for myself"? Here's your chance—a Hobart Arc Welder starts you in your own business, with minimum investment.

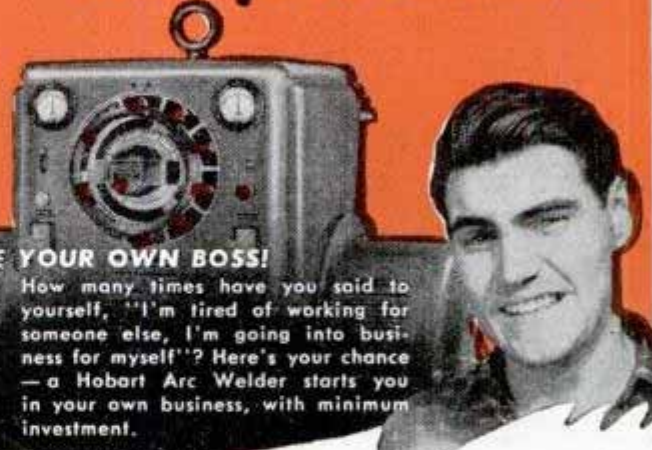

GET THE BIGGER PROFITS!
 Arc Welding is one of the most profitable trades open today—everyone brings their work to you—auto and farm machinery repairs, construction work. And with Hobart Arc Welders, you get the bigger profits because Hobart lets you get high quality welds faster, at lower cost.



A.C. Arc Welder

EASY TO OPERATE!
 There's nothing complicated in producing the high quality welds that bring extra profits, if you have a Hobart. Exclusive operation features let you weld faster and easier, with greater profit. You get the exact welding heat for every job!

"BUILD YOUR OWN" ARC WELDER!
 With the Hobart Generator, a used auto engine and chassis, you can build your own gasoline drive arc welder and save hundreds of dollars. Towed behind your auto, it goes after the profitable jobs in the field.



Generator Only

HOBART SCHOOL OF ARC WELDING
 You can learn welding at Hobart's famous School of Arc Welding, in an intensive course that makes you a competent arc welder. Individual instruction by experts. School qualified under G.I. Bill. Write for details.
HOBART BROS. CO., BOX M-86, TROY, OHIO



HOBART
 Get full details without obligation

"One of the World's Largest Builders of Arc Welders"

free

HOBART BROS. CO., BOX M-86, TROY, OHIO

Send me my FREE copy of "Welder's Pocket Guide" and details on items checked below:

Electric Drive Generator Only
 A.C. Welder Welding School

"Welder's Vest Pocket Guide"

Name _____
 Address _____



Little Library of Useful INFORMATION

5 for \$1.00
12 for \$2.00
25¢ Each

Here at amazingly low cost is the practical help and information you have always wanted. Articles in previous issues of Popular Mechanics have been classified according to subject and are now available in these handy reprint booklets. Check Titles wanted, clip ad and mail today.

BOOKLETS ON WORKSHOP EQUIPMENT

Power-Driven Saws—74: Complete details on scrollsaw, two circular saws, sliding cut-off saw, bandsaw.
Drill Presses, Plane, Grinders—79.
Sanders—80: Complete constructional details on 8 useful machines.
Wood & Metal-Turning Lathes—81: Two wood lathes, small metal-turning lathe.
Filing Machine, Hacksaw, Cutoff Wheel, Shaper—82.
Metal Lathe Tools You Can Make—101.
Workbenches & Tool Cabinets—47.
Spray Painting—94: Constructing spray guns, compressor, using spray gun.
From Pattern to Casting—91: How to make your own patterns and small castings.

BOOKLETS ON SHARPENING—USING TOOLS

Correct Measurement—106: How to use micrometers, gauges, calipers, etc.
Tool and Saw Sharpening—92.
Using & Sharpening Drills & Wood Bits—90.
Successful Wood Turning—32: All the information you need to master this art.
How to Read Blueprints—71: Tells you how to understand signs, symbols, and lines.
Metal Turning Lathe Kinks—99: Simple homemade tools, time and labor-saving shortcuts you can use.
Operating a Metal Turning Lathe—100.
Heat Treating & Case Hardening—102.
Working with Glass—103: Cutting, drilling, etching, blowing.

ELECTRICAL BOOKLETS

Rewinding & Servicing Electric Motors—75: Repairing and rewinding a.c. and d.c. motors. Locating trouble. Converting auto generators into 110 v. a. c. motors.
House Wiring—89: All the information you need to do a complete wiring job or install extra outlets.
Electromagnets & Solenoids—44: Designing and building.
Transformer Construction—41: Easy-to-understand instructions for all kinds of transformers.
The Boy Electrician—43: Easy-to-build motors, experiments.
Soldering & Brazing—17.
Arc & Spot Welders—5: Building and operating 110 v. a. c. arc and spot welders.
Treasure Finders—13: Build your own treasure finder and metal locator. Details for both large and small radio types.

ELECTROPLATING BOOKLETS

Electroplating with Copper, Nickel, Chromium, Lead, Zinc, Cadmium—86.
Plating Leather & Other Non-Metallic Objects—Plating with Gold, Silver, Alloys—87.

HOME IMPROVEMENT BOOKLETS

Simple Home Improvements—104: Modernizing; making storm sash, ironing boards, etc.
Building Extra Rooms in Attic—23.
Attractive Basement Playrooms—24.
Lower Your Fuel Cost—31: Practical kinks that will save you hundreds of dollars.
Hanging Wallpaper—38: Tricks of hanging wallpaper, removing old paper, etc.
Curing Leaky Basements—45:
Fitting Home Game Room—55: Construct own game & tennis tables, shuffleboard court, action game, portable playrooms.

Ridding the Home of Insect Pests—107: Exterminating and protecting against moths, flies, termites, mosquitoes, etc.
Built-In Fixtures—78: Step and space-saving kitchen units, built-in beds, corner cabinets, vanities, linen chest.
Constructing Indoor & Outdoor Fireplaces—88: Stone fireplaces, portable mantels, garden fireplaces.

GARDENING BOOKLETS

Backyard Gardening—39: Selecting, planning and getting the best results.
Lawn & Garden Novelties—72: Jig-sawed ornaments, parkway numbers, sundials, flower boxes.
Trellises, Pergolas, Fences—76.
Lawn & Garden Furniture—77: Modern bent-tube furniture, arbor and seat combinations, swings, lawn chairs.
Playground Equipment—73: Two playhouses, ferris wheel, roller coaster, treadmill, play store, slide, two merry-go-rounds.
Colored Concrete Garden Furniture—6: Garden benches, pottery, flower boxes, bird baths and sundial pedestals in colored concrete. How to build small concrete mixer.
Bird Houses—7: Easy to build homes for all kinds of birds.
Farm & Garden Tractors—8: Two tractors you can build from old automobile parts.

CRAFT WORK—HOBBY BOOKLETS

Complete how-to-make-it instructions for hundreds of practical projects.

Working with Plastics—61: Using brilliant-colored plastics in craftwork.
Magazine Racks—49: Ten attractive racks.
Clock Cases—50: Large Hall, Colonial wall and mantel, ship's wheel, miniature grandfather, desk, Spanish style banjo.
Serving Trays for Every Occasion—53: Fourteen different designs.
Children's Room Furniture—51: Twelve attractive pieces.
Book Ends—52: Ten designs offer good selection.
Small Tables—54: Modern and colonial styling.
Smoking Stands—56: Seven designs given.
Jigsawed Novelties—57: Sewing kits, string holders, place-card holders, plywood kitchenware, plant and flower holders, coin banks, door stops, drawer pulls.
Desks—58: Colonial writing desk, two modern-type desks, student's study desk of plywood, combined chest and writing desk.
Book Cases—59: Eight designs.
Doll House & Doll Furniture—60.
25 Shelves You Can Make—64.
Novelties Turned on Lathe—62.
Inlay Pictures—Veneering—63.
Whittling and Wood & Soap Carving—65.
Action Toys—66: 21 easy-to-make toys.
High Flying Kites—67.
Windmills & Weathervanes—68.
Lamps in Wood, Metal, Plastic—69: Selection of 14 designs.
Metal Craft—28: Brass tapping and making of novelties both decorative and useful.
Small Looms—37: Building hand looms for weaving rugs, etc.; leather novelties.
Plain & Novelty Wood Finishing—40.
Gem Cutting—42: How to cut and polish semi-precious stones.

BOAT BUILDING BOOKLETS

Build a boat at home—you can do it

14 Ft. Outboard Runabout—2: Here is a fast 14 foot V-bottom boat. Suitable for motors of 4 to 24 hp., estimated cost, \$30 to \$40.
14 Ft. Sailing Dinghy—26: This 14-foot boat combines strength and light weight. It carries 140 sq. ft. of canvas and weighs about 350 pounds. Actual photographs and diagrams illustrate every detail.
21 Ft. Sloop—46: Every fact needed by the amateur boat builder to construct this craft which carries eight to ten persons.
Rowboats, Bicycle Boat, Small Dinghy—83: All the information you need to construct four low-cost boats.
Small Sail Boats—84: 12-ft. sailing dinghy, 6-ft. "training ship" for young sailors, how to sail a boat.
Two Outboard Runabouts—85: 14-Ft. family outboard weighs about 400 lbs. and 12-ft. plywood outboard weighs about 110 lbs. Both are V-bottom type.
Build Your Own Canoe, Kayak, Surfboard—30: Complete details on 16-ft. Canadian-type canoe, 17-ft. kayak, and 12-ft. hollow surfboard.
Fast Class-E Ice Yacht—22: Build your own Class-E ice yacht. Every detail of construction carefully explained.

AUTOMOBILE BOOKLETS

Automobile Kinks and Shortcuts—10: Money-saving hints on upkeep and operation.
Building Trailers—27: Small Streamlined house trailer; several utility trailers.
Motor-Driven Midget Car & Scooter—34: Both use gas engine of washing machine type.
Curing Auto Electrical Troubles—95.

PHOTOGRAPHY BOOKLETS

Save Money by constructing your own photo equipment.
Photo Enlargers—1: Condenser lens type; simple vertical; horizontal.
Photo Printers & Dryer—25: Describes three practical printers, timer and negative dryer.
Photo Darkroom Equipment—96: Cabinets, light-tight box, timer, agitator, washer, trimmer.
Picture Projector, Trick & Table Top Photography—97: Projectors that enlarge magazine illustrations and shop drawings. Tips for table toppers, photomontages, tricks.
Photo Kinks—98: 63 time and money-saving ideas you can use.

FORMULA BOOKLETS

Transform simple ingredients into useful products
Cleaning Preparations—11: Easy-to-make cleaners for walls, glass, etc. Removing fabric stains.
Cosmetic Formulas—12: Hand lotions, creams, rouge, bath salts, beauty clay, lipsticks, etc.
Re-Silvering Mirrors—70: Formulas for silvering and coloring.

MISCELLANEOUS BOOKLETS

Knots and Ropework—105.
Chemical Experiments—93: Easy-to-perform experiments. Inexpensive lab.
Taxidermy—9: How to prepare skins and obtain life-like poses.
Log Cabins & Tourists Cottages—14: Year-round log cabins; inexpensive tourists' cabin.
Magic for Everybody—29: Simple tricks to puzzle your friends.
Trapping Small Animals—33: How to lure fur bearers, prepare bait and traps, dress skins.
Tricks of Training Your Dog—35.
Small Furnaces—36: Build own gas or electric.

POPULAR MECHANICS PRESS,

200 E. Ontario St., Chicago 11, Ill.

I enclose (U. S. bills may be mailed if carefully wrapped) for "Little Library" booklets numbers:

.....
.....
Name
Address Zone
City State



Make Your Own RUBBER MOLDS

with **RED LATEX MOLDING COMPOUND**

Earn money, have fun; make your own molds for plater objects. Produce novelties and gifts for home and to sell to friends. RED LATEX MOLDING COMPOUND (60% density) now available in quart and gallon quantities. Gives perfect results, easy to apply. Send for complete information and prices.

OHIO SUPPLY CO., Dept. J-2, 474 Lilly Ave., Columbus 5, Ohio

New Designs in **FRANZITE GRIPS**

Modernize Your Gun! Improve Your Score!
Most durable grips made. Positively unbreakable! For Colt, Smith & Wesson, Hi-Standard, Ortgies, Luger & Mausers in a wide choice of beautiful designs in Ivory, pearl, walnut, onyx, etc. Low prices. FREE CATALOG. Dealers Wanted.

SPORTS, INC., (Mfrs.) 5501 Broadway, Dept. P-8, Chicago 40, Ill.

HOME STUDY OR SHOP TRAINING

Learn Plastics, Refrigeration or Diesel. Study at home, shop work later. Also shop courses in Body and Fender, Machine Shop, Tool and Die. 41,000 graduates. Established 1902. Free booklet. Specify trade.

GREER SHOP TRAINING, Dept. 186, 460 S. State St., Chicago

START HOME MAIL ORDER BUSINESS

Start small — grow big. Amazing new course shows you the way. Rush your name and address today for full particulars. No obligation.

BELFORT (Dept. A) Engineering Bldg. Chicago 6, Ill.

ACCOUNTING

STUDY AT HOME for C.P.A. and BIG PAY Accounting opportunities with 42 year old school. No previous training needed. Texts furnished. EASY PAYMENTS. Send for FREE BOOK.

Mac CORMAC EXTENSION SCHOOL
Dept. 8-B, 1170 East 63rd St., Chicago 37, Ill.

PHOTO DEVELOPING & PRINTING

Work and Service that can't be beat. Sixteen Famous Century-Tone prints each 8-exp. roll 30c. FREE MAILERS. Send roll and money.

CENTURY PHOTO SERVICE Dept. X La Crosse, Wis.

RADIO

ENGINEERING, Broadcasting, Servicing, Electronics, Aviation, Marine & Police Radio taught thoroughly. 48 weeks' Engineering course equivalent to 3 years' college radio work. Approved Veteran Training. Co-educational. Catalog free.

VALPARAISO TECHNICAL INSTITUTE, Dept. D, Valparaiso, Ind.

BRUSH PLATING OUTFITS

for re-plating articles in the home and shop. No tanks necessary. Free particulars.

GUNMETAL CO., AVE. M, DECATUR, ILLINOIS

Say You Saw It in **POPULAR MECHANICS**

WINDOW SIGN LETTERS

For Store Fronts and Office Windows. Anyone can put them on. Samples furnished. Genuine Gold and Silver. METALLIC LETTER CO., 430 N. Clark St., Chicago 10

arc welding manual and text book...\$2.00 Teaches you how to become an arc welding operator — one of highest paid trades today. Write today!
Hobart Bros. Co., Box M-562, Troy, Ohio

BOWS & ARROWS

Write for 94 page Illustrated Instruction Hand Book 50c; 20 page catalog 5c; stamps or coin.
LE STEMMLER CO. QUEENS VILLAGE, N.Y.

WHEN YOU BUY FLASHLIGHT BATTERIES ASK FOR **"EVEREADY" FRESH DATED BATTERIES**

The word "Eveready" is the registered trade-mark of National Carbon Co., Inc.

BOYS! MEN! now you can MOLD PLASTICS AT HOME!

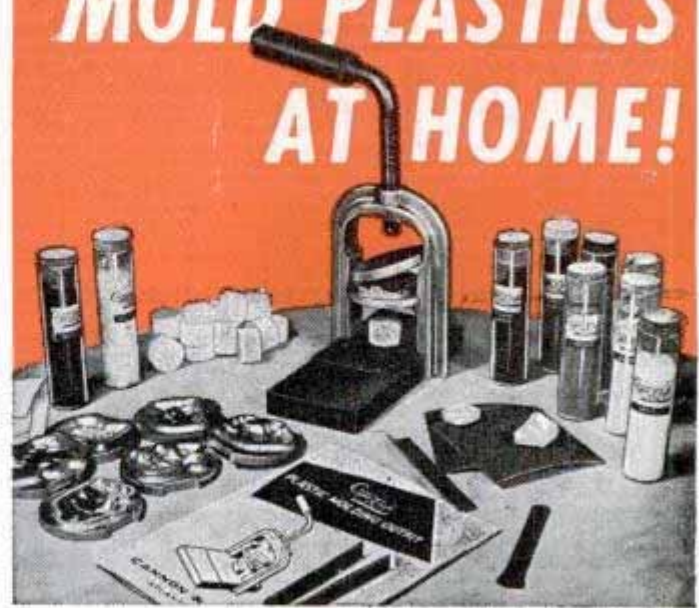

Get in on the newest hobby craze! Make beautiful buttons, pins, ornaments, etc. of colorful plastics. Fascinating! Modern! And so EASY with



PLASTIC MOLDING SETS

Designed by expert Plastic Chemists and Engineers. Contain everything the home craftsman needs to start this absorbing pastime—assorted plastics in various colors, a practical, easy-to-use press, assortment of die-cast aluminum molds, fuel tabs, finishing materials, complete instructions—all packed in a sturdy metal box.

The Number 1 Outfit costs only..... \$2.60
Number 2 Outfit (illustrated) — more different kinds and colors of plastics in larger quantity, more and larger molds..... \$4.85

If your dealer cannot supply you, use coupon and send money order or check direct.

(DEALERS: Write for particulars)

CANNON & COMPANY
216 Elliott Street, N. W., Atlanta, Ga.

CANNON & COMPANY,
216 Elliott Street, N. W., Atlanta, Ga.

Please send me, postpaid, Cannon Craft Plastic Molding Outfit Number..... Remittance of \$..... is enclosed.

Name.....

Address.....



**NOW IS THE TIME
for a Business of your own**

MODERN SHOP TRAINING

APPLIANCES

SERVICE—REPAIR—INSTALL

**GET ALL-AROUND
TRAINING FOR
THE EFFICIENCY
YOU WANT.**

**A FEW SHORT WEEKS MAKE
ALL THE DIFFERENCE
LEARN-BY-DOING IN OUR
WELL EQUIPPED SHOPS**

Tremendous demand for washers, mangles, electric stoves, irons, mixers, appliances of all kinds in homes, on farms—rural development bringing electricity to thousands of more homes. Practical shop training—polishing, plating, welding, motor repair, how to use precision and power tools. Trained men get good pay repairing, maintaining, servicing, installing, selling electric appliances. From small start you may build good, growing business. **CONSULTATION AND PLACE-MENT SERVICE WHETHER YOU ARE INTERESTED IN WORTHWHILE JOB OR SETTING UP YOUR OWN BUSINESS.**

EASY TO LEARN IN NATIONALLY KNOWN SCHOOL

Rapid progress possible by learn-by-doing **SUPER-VISED SHOP TRAINING**. C.T.I. only civilian school engaged to train enlisted men in Refrigeration and Air Conditioning. Training of same quality available to you. **VETERANS**—Write for free information telling you how you can get your training under "G.I. Bill".



APPLIANCE TRAINING SCHOOL
Dept. C28
Div. of Commercial Trades Institute
6312 No. Broadway, Chicago 40, Ill.

Fill Out, Cut Out, Mail Today

FACTS FREE for Men Who Want to Get Ahead
APPLIANCE TRAINING SCHOOL, Dept. C28
Div. of Commercial Trades Institute
6312 No. Broadway, Chicago 40, Ill.
Send free illustrated brochures and other information about Electric Appliance Maintenance, Service and Repair.
 Check here if interested in G.I. Training.

Name

Address

City State

SAY YOU SAW IT IN POPULAR MECHANICS

NOW! Build Your Future On



DIESEL Opportunities

LOOK around you. See the way tractors, trucks, buses, railroads, ships, power plants and equipment of many kinds are "going Diesel." Every day new opportunities are opening—in industrial and farming communities—for trained men who can install, maintain, operate and repair Diesel engines. Plan now to build your future in this growing field.

Diesel Knowledge is Earning Power

You don't have to give up your present job. Now, you can begin learning DIESEL in spare time at home. UEI practical training teaches you, step by step, how Diesel engines operate, how fuel systems work, repairs, accessories and auxiliary equipment; a world of Diesel "know how." Includes actual practice on Diesel equipment in our shop under expert guidance. UEI training methods are successful. For 20 years they have helped mechanically inclined men better themselves.

NOW IT'S UP TO YOU!

Coupon below brings you all the facts without cost or obligation. Get going today! **MAIL COUPON NOW.**

UTILITIES ENGINEERING INSTITUTE
Diesel Division
1314 W. Belden
Dept. 18-D
Chicago 14, Ill.

Founded 1927



Send Coupon for **FREE FACTS**

UTILITIES ENGINEERING INSTITUTE, Diesel Division
1314 W. Belden Ave., Dept. 18-D, Chicago 14, Ill.
Please send me Free Facts about Diesel opportunities and training.

NAME Age

ADDRESS

CITY Zone or County STATE

Check here for special information if you are under 17.
 Check here if Veteran of World War II.

LEARN

WATCH REPAIRING AT HOME



Construction, repair, adjustment. New complete "PRACTICAL COURSE" for beginners and repairmen. All essential steps. Theory, operation. Many test cases. Full coverage of tools, materials. Fully illustrated. **\$2.95** Only. (If C.O.D. plus postage fee.) **Post Paid**
Money Back Guarantee

We Supply Tools, Materials at Lowest Cost
Write for illustrated catalogue of tools, materials. We specialize in all books on Watchmaking, Jewelry, Metalcraft, Gem Cutting, Optics.

MODERN TECHNICAL BOOK CO., Dept. MMC
55 WEST 42ND ST. NEW YORK 18, N. Y.

JOIN our new TECHNICAL BOOK CLUB—free

Members receive current literature, guidance on all book problems, premiums. No obligation. **ALL BOOKS:** Tech-nics, Chemistry, Physics, Plastics, Refrigeration, Air-conditioning, Building, Construction, Electricity, Radio, Television, Electronics, Automobiles, Mathematics, Wood-working, Homecraft, Business, Languages, Farming, Sports, Photography, etc. — Write for free literature, please specify subject.



BUILD a BOAT

- Row Boat—12 Foot
- Dinghy—8 Foot
- Dinghy—14 Foot Sailing
- Training Ship—6 Foot
- Sea Sled—5 Foot
- Outboard—12 Foot
- Cruiser—18 Foot
- Bicycle Boat—Kayak
- Row Boat—Sectional
- Dinghy—Sailing
- Canoe—16 Foot
- Sailing—12 Foot
- Outboard—12 Foot
- Outboard—Runabout
- Pontoons Ice Yacht

**FOR PLEASURE OR PROFIT
DESCRIBES 17 LOW COST BOATS**

Get this outstanding book and build a boat at home for your own use or to sell at a profit. You can do it. Just the boat you've always wanted—power, sail or row boat—17 different kinds and sizes.

Order **BUILD A BOAT** on postal card and pay only \$1.50 plus postage on delivery. Return in 5 days if not pleased and get money back. Or send \$1.50 with order and we'll pay postage. (Outside U. S. \$1.70 with order.) Order today.

POPULAR MECHANICS PRESS
Dept. 598, 200 E. Ontario, Chicago, 11



PRACTICAL BOOKS ON HOME PLANNING BUILDING · REPAIRS

MAIL ORDER TODAY

Plan Now—Build When You Can
Books Sent C.O.D. Anywhere in U.S.A.

Select from this list of helpful books. In U. S. books sent postpaid if remittance accompanies order. Outside U. S. include 15% extra for shipping charges.

- How to Plan a House..\$4.50
- House Construction Details\$3.00
- Painting, Decorating....\$1.50
- Carpentry\$2.00
- Painting, Furniture Finish-ing and Repairing
Includes floor renewal\$1.50
- How to Remodel a House
Complete, practical..\$4.75
- Building Insulation.....\$3.50
- Concrete Handbook
Do work for yourself, others\$1.50
- Blueprint Reading for Building Trades.....\$1.25
- Practical Bricklaying..\$1.75
- Simplified Carpentry Esti-mating\$3.00

FAMOUS PLAN BOOKS
Books contain floor plans, photos, descriptions of homes.

AMERICA'S BEST LOW COST HOMES.
125 designs.\$1.00

DE LUXE SMALL HOMES. 210 designs.\$1.00

OUR FUTURE HOME.
Wide selection of residences, summer homes, garage apartments. \$1.00

MODERN HOME & GARDENING. 42 popular designs. Improve-ments, garden short-cuts, etc.50c

Set of **Four Books**
\$3.50

Stair Building
\$2.00



POPULAR MECHANICS PRESS
Dept. 000 • 200 E. Ontario St., Chicago 11

POPULAR MECHANICS

ELECTRICIANS!

Free!

Get This Book of 150 Valuable Wiring Diagrams

ACCEPT THIS AMAZING BOUND VOLUME AS MY GIFT TO YOU! . . .

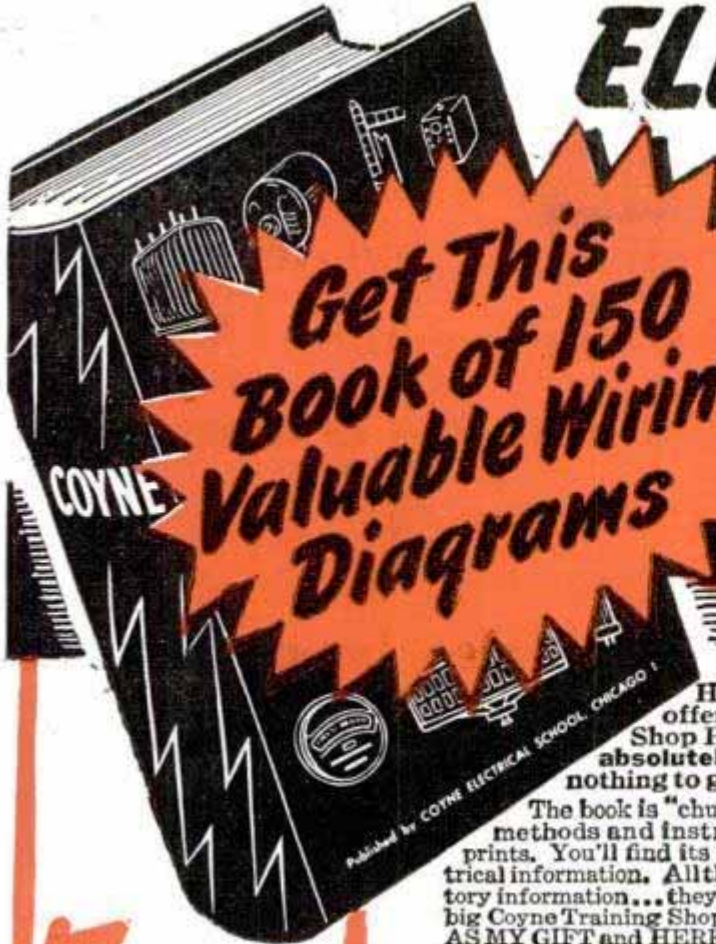

Here's one of the greatest "get acquainted" offers ever made. This book of 150 Electrical Shop Prints and Wiring Diagrams is YOURS—absolutely FREE. IT'S an outright gift—you pay nothing to get it. and nothing to keep it.

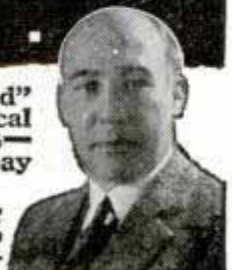

H. C. Lewis

The book is "chuckful" of valuable charts, diagrams, wiring methods and instructions for reading and using wiring shop prints. You'll find its pages packed with up-to-the-minute electrical information. All the shop prints are full size with full explanatory information... they have all been developed and pretested in the big Coyne Training Shops. I WANT YOU TO HAVE THIS BOOK AS MY GIFT and HERE'S ALL YOU HAVE TO DO TO GET IT:

Examine My New 7 Volume Set Get This Book of 150 Shop Prints Free!

To get your FREE copy of this Shop Print book all you have to do is to let me send you my complete new 7 volume set of electrical books—COYNE PRACTICAL APPLIED ELECTRICITY for 7 days FREE examination. Here's a set of books written for the "beginner" or "oldtimer" in electrical work who is anxious to get ahead. This 7 volume set covers everything electrical from house wiring to advanced DC & AC motors and equipment. Thousands of "show how" diagrams and photos.

SEND NO MONEY!

The new 7 volume set of practical electrical books is so NEW, so DIFFERENT and so UNIQUE that you have to see the set to really appreciate how much it can mean to you and your future. So here's what I'll do—I'll send you the complete set of 7 volumes (pictured below) at my risk, postpaid for 7 days FREE Examination. I'll also send you the New Coyne Book of 150 Shop Prints & Motor Diagrams as my FREE gift to you TO KEEP REGARDLESS OF WHETHER OR NOT YOU DECIDE TO KEEP THE 7 VOLUME SET COYNE PRACTICAL APPLIED ELECTRICITY.

Keep ALL the books 7 days. If not 100% pleased with the 7 volume set just return it and you owe nothing. If you keep the 7 volumes you can pay for them at the special low rates shown here in the coupon at right.

Coupon Is Not An Order —UNLESS You Decide to Keep the Books

YOU'RE NOT BUYING THIS SET WHEN YOU SEND THIS COUPON, you're merely asking to see them FREE for 7 days. The coupon becomes an order only if you decide to keep the 7 vol. set after 7 days' examination. SEND COUPON NOW!



FREE BOOK COUPON

H. C. Lewis, Pres., Coyne Electrical School, Dept. C6-R6
500 South Paulina St., Chicago 12, Illinois

Send me the NEW 7 volume set COYNE APPLIED PRACTICAL ELECTRICITY. Also send me the bound volume of 150 Shop Prints which I am to keep FREE WHETHER I KEEP THE 7 VOL. SET OR NOT I'll either return the 7 volume set in 7 days and keep the 150 Print book and owe nothing or I'll keep the 7 vol. set and pay \$3.00 in 7 days and \$3.00 per month until \$21.00 is paid or send \$19.75 cash. You include FREE one year consultation service and Technical Bulletins.

NAME _____ Age _____

ADDRESS _____

CITY _____ Zone _____ STATE _____

Check here if you want to pay postman cash price of \$19.75 (you save \$1.25) delivered. Same 7-day examination privilege and Money-Back Guarantee.

Cover everything from home wiring to DC-AC Motors and Equipment. Over 3000 subjects—2000 illustrations—5000 facts.

VOL. 1 Electrical Principles & circuits—signal systems—telephony; 450 pages.

VOL. 2 Wiring for Light, Power—Neon, Fluorescent, Aviation Lighting—Household Appliances—Farm Electricity; 460 pages.

VOL. 3 D. C. Motors and Controls, installation, operation and Maintenance, Welding—620 pages.

VOL. 4 A. C. Motors and Controls—Electronics—700 pages.

VOL. 5 Armature & Stator Winding and Repair—350 pages.

VOL. 6 Refrigeration & Air Conditioning; Radio—510 pages.

VOL. 7 Automotive, Diesel and Battery 420 pages.



COYNE ELECTRICAL SCHOOL
Dept. C6-R6 500 S. Paulina St., Chicago 12, Ill.

The **A B C** of **MODUFLOW***



HEAT LOSS is continuous, but the rate of loss varies with the weather. When it is cold  heat loss is more rapid than when the weather is warmer.

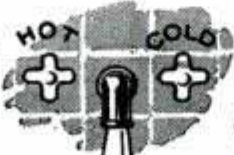

HEAT SUPPLY should also be continuous, but modulated  to whatever temperature is required to  offset the heat loss.

MODUFLOW . . . maintains a continuous balance  between heat loss and heat supply.

RESULT . . . "Comfort Unlimited" 

FOR YOUR PRESENT HOME... You, too, can have the "comfort unlimited" that Moduflow has brought to thousands of homes. You don't have to wait until you build a new home. Moduflow can be easily and inexpensively installed on practically any type of automatic heating plant.

FOR YOUR NEW HOME... Of course, if you are planning to build, you will want your heating plant to be efficient and the last word in

heating comfort. There isn't room to explain here just how Moduflow can be applied to the various types of heating systems, whether warm air, hot water or steam. It is completely described in the booklet "Comfort Unlimited" which has just been released. Attractively illustrated with pictures and diagrams, it will be especially interesting to readers of *Popular Mechanics*. So, mail the coupon today for your free copy of "Comfort Unlimited."

* **MODUFLOW** is the name of Honeywell's newest heating control system. It means *modulated* heat with continuous *flow*. Moduflow will be a "must" in the better homes and apartments of tomorrow.

MODUFLOW

The New **HONEYWELL** Heating Control System

Minneapolis-Honeywell Regulator Co.
2754 Fourth Avenue South
Minneapolis 8, Minnesota
Please send my free copy of
"Comfort Unlimited"



FREE!

Name _____

Address _____

City _____ State _____

For an eyewitness account of what happened at Bikini, *Popular Mechanics* sent its Aviation Editor, Aubrey Cookman, to the atoll aboard the USS *Appalachian*. During the war Mr. Cookman was a lieutenant colonel, U. S. Army Air Forces. Further accounts of the atomic bomb tests, how they were documented by the scientists, and their significance, will appear in future issues.

Here we present our first

Report From BIKINI

By Aubrey O. Cookman, Jr.

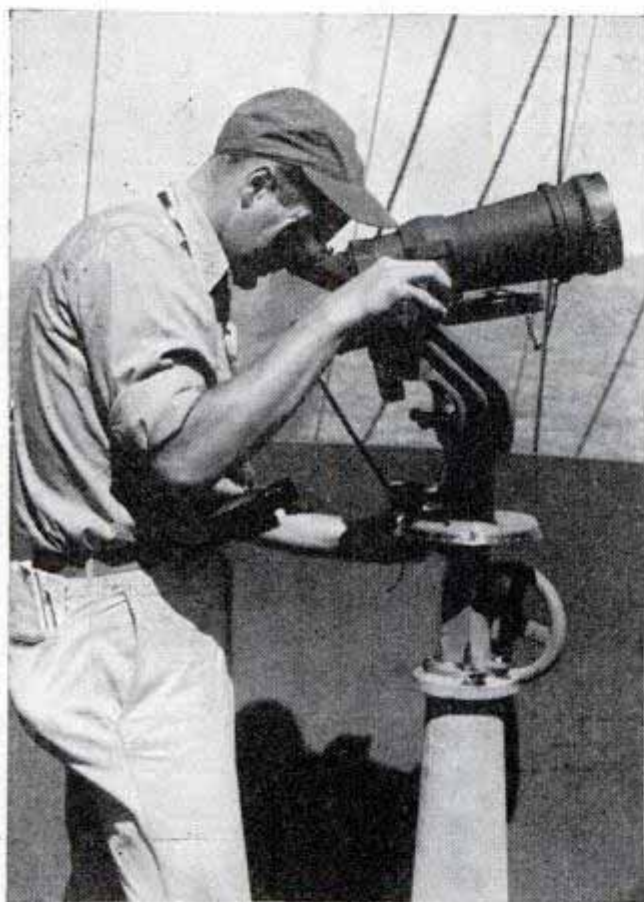

Official Photograph, Joint Army-Navy Task Force One
Here Mr. Cookman, acting as a special observer for Joint Task Force One, watches the atomic bomb burst over target on phosphor screen of Navy's Icaroscope

POPULAR AUGUST
1946
MECHANICS

WRITTEN SO YOU CAN UNDERSTAND IT
VOL. 86 NO. 2

BIKINI, Marshall Islands (By Navy Radio)—It has been a month since a single atomic bomb sank five ships and crippled a half dozen more, but the most important results from the initial Bikini test are only now beginning to fit together into a complete picture.

Precise score cards in the form of 10,000 measuring instruments, aided by the volunteer activities of scientific stations all over the world, are still rolling in for interpretations. Questions posed by scientists, militarists and John Q. Public since the first atomic explosion in the New Mexico desert more than a year ago are finally nearing experience-proven answers. The bomb, without losing prestige as the world's most powerful agent of mass destruction, is being eased out of the myth class and into the realm of human comprehension.

Considerably more is expected to be learned from the shallow water experiment and the deep underwater blast planned for later this year and next. The latter may also be held at Bikini, off the lee side of the island where the atoll shelf slopes sharply into the ocean. Both are potentially more significant than the first Bikini drop, particularly from the standpoint of influence on naval architecture. They also are expected to do greater damage to target ships.

As one of the first to enter the target area after the overwater explosion, I can testify to the terrific pressure of an air blast that

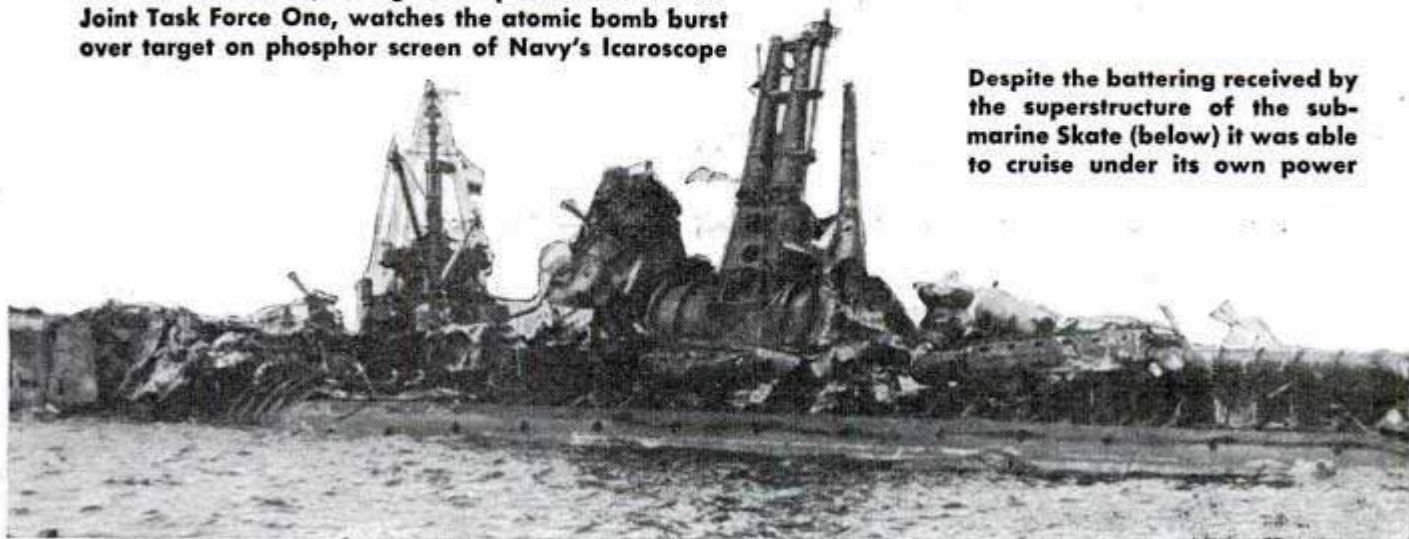

Despite the battering received by the superstructure of the submarine *Skate* (below) it was able to cruise under its own power

wrecked steel superstructures 1000 yards from the detonation point.

Two attack transports, a cruiser and two destroyers had already plunged to the bottom and at least six others were in no condition to fight. Of one, the badly battered and smoking USS Independence, Task Force Commander Admiral Blandy tersely commented: "She is no longer a carrier."

Tonnage totaling almost the equivalent of three of our largest new battlewagons had been laid low by a single bomb. Even vessels at the target's rim, 3000 yards away, in some freakish instances experienced minor damage. Estimates of the casualty toll from blast and radiation, had the ships been manned, ran upwards from 50 percent.

The bursts over Japan killed and injured over 300,000. How much the presence of crews to control the damage would have helped the stricken vessels is still a debatable point. Although the same type as the one used at Nagasaki, the bomb dropped at Bikini was described as proving less explosive than the blast at Nagasaki but more powerful than those at Hiroshima and New Mexico. It has thus far been impossible to make two atomic bombs of exactly the same strength.

I had the good fortune to be able to witness the bomb drop through the Navy's Icaroscope, one of the most important and newest instruments used by the scientific observers at Bikini. It was developed late in the war to spot enemy planes attacking from the direction of the sun.

To eliminate glare, the direct image of the bomb burst was formed on a phosphor screen while the screen was hidden from the eye. This is accomplished by a double rotating shutter which permits outside light to reach the screen while the eye is shut off from the view, then permits the eye to view the screen from behind while the outside light is shut off. This operation takes about one hundredth second, so that the scene is viewed as though in a high-speed motion picture camera. A 110-volt 60-cycle motor drives the shaft on which the disks rotate. The image always appears a yellow-green. I watched the drop through the Icaroscope as a special observer for Joint Army-Navy Task Force One.

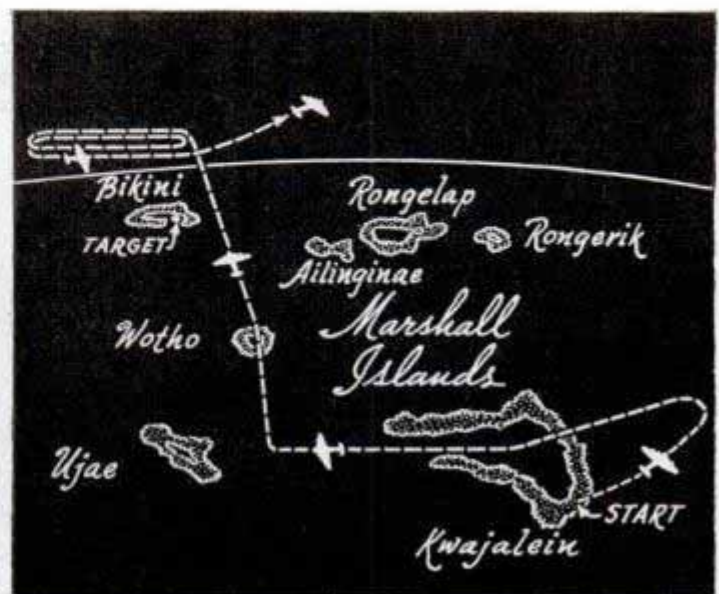
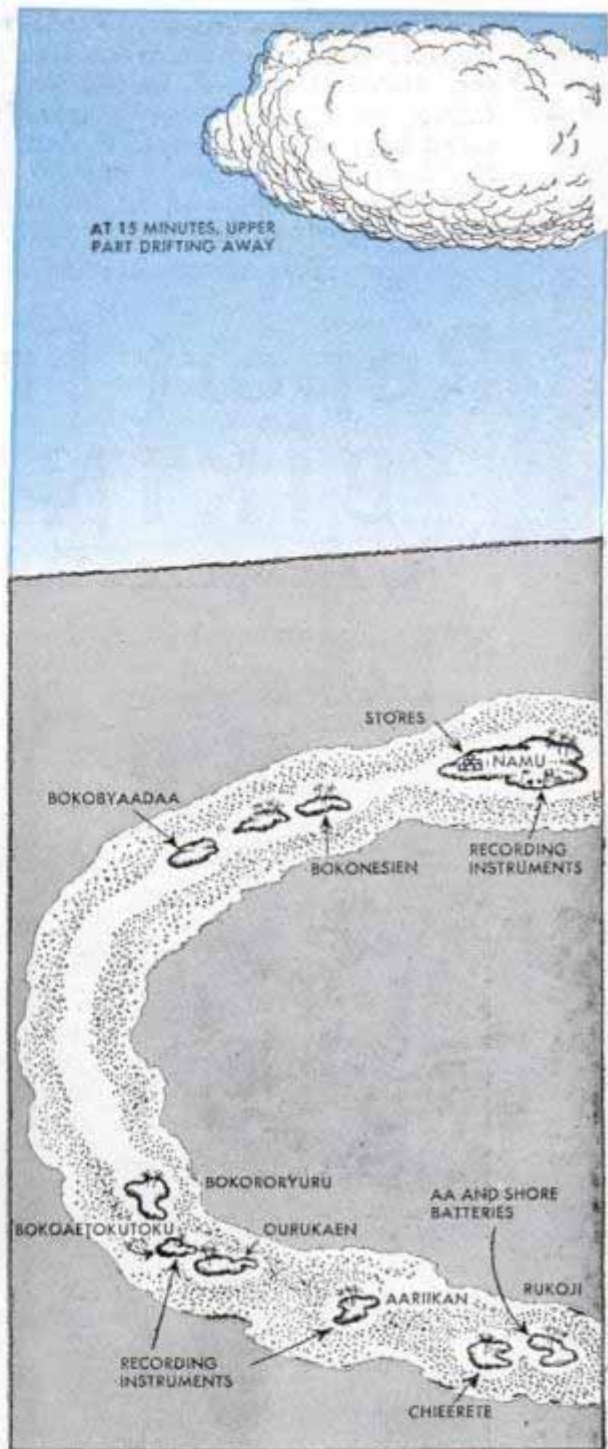

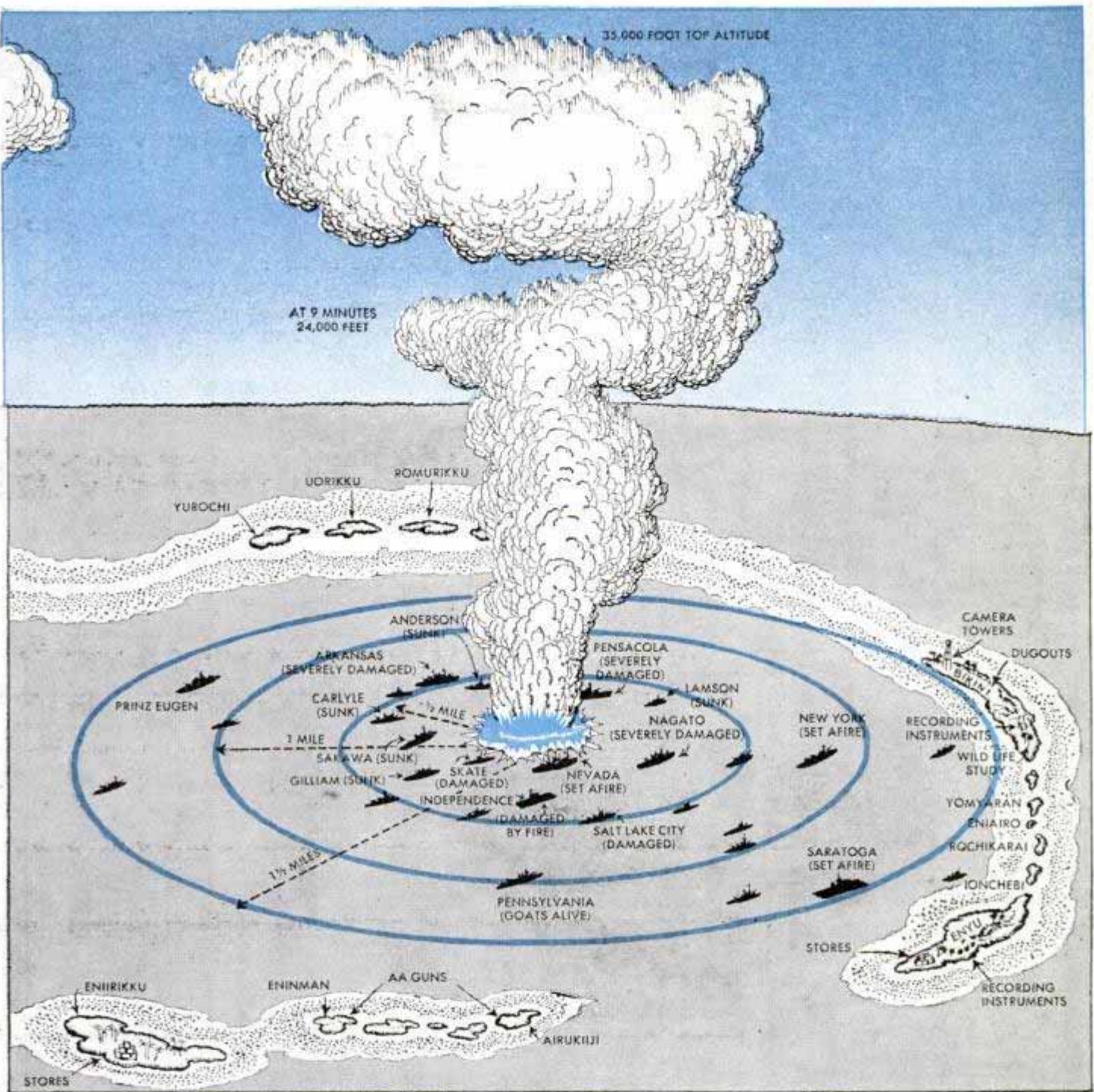

No. 2 EXPLOSION ON SURFACE

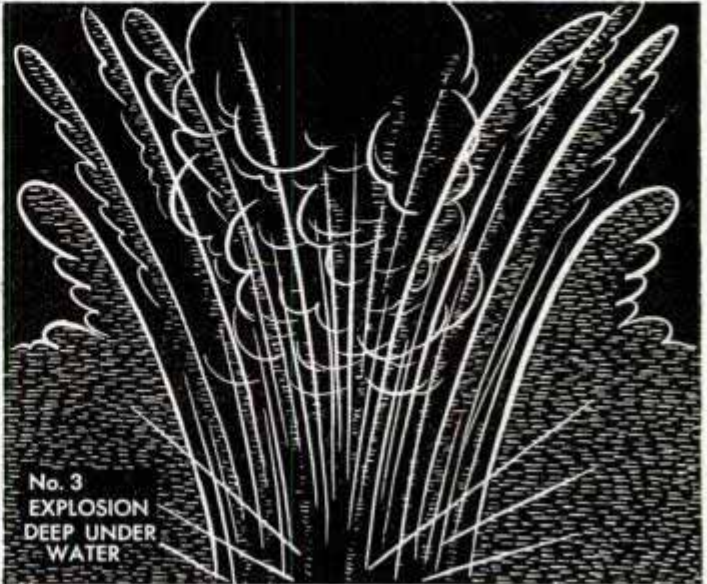

No. 3 EXPLOSION DEEP UNDER WATER

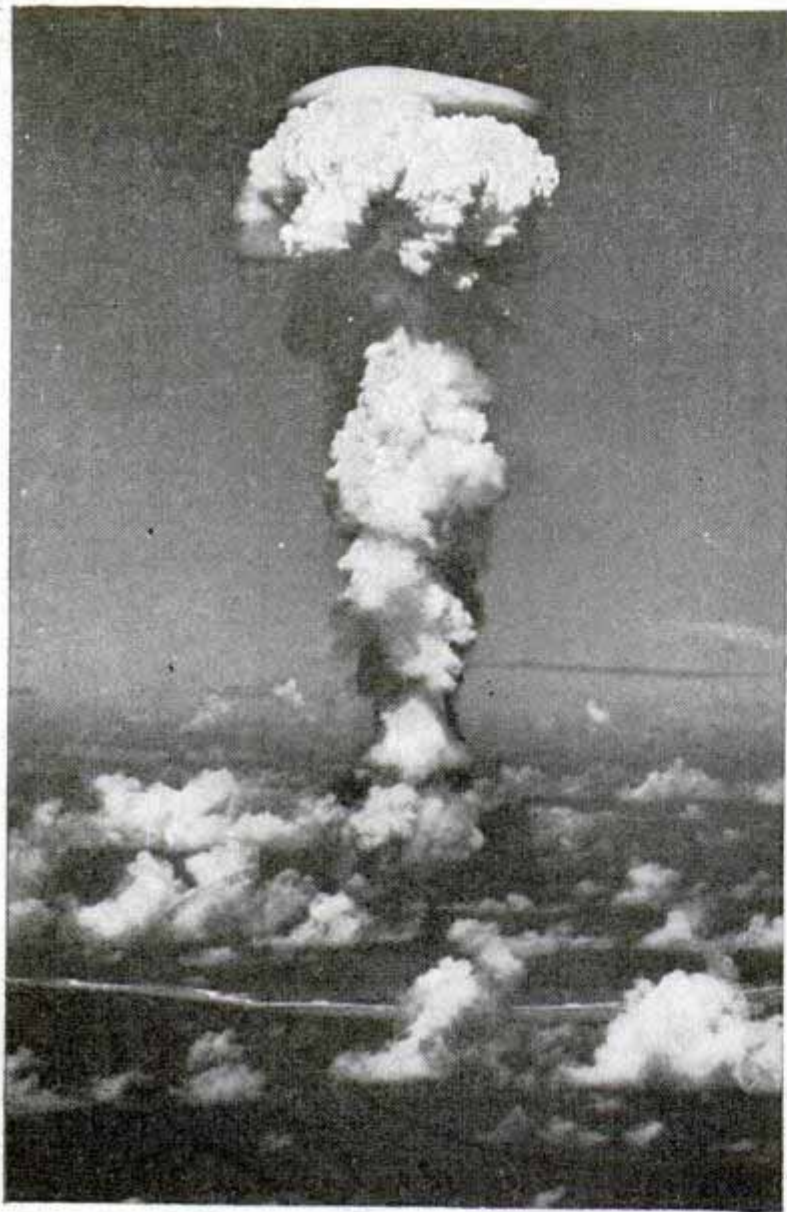

Over cumulus clouds and Bikini shore, atomic cloud mushrooms



The battered bow of the carrier Independence shows the crushing effect of the blast

While no official figure was given it is believed the bomb exploded about 500 feet above the water. The avowed purpose of the Bikini experiments is to test the effect of one atomic bomb against naval vessels in order to gain information on possible required changes in ship design, tactical formations at sea and anchoring distances in port, the number and location of operating bases and repair yards, and strategic disposition of ships. Secondary aims are to test the bomb against air and ground forces materiel, learn more about its effects on humans, compare the relative value of vessels and other types of bomb targets, and find out more about the phenomena accompanying atomic explosions.

While the bulk of the technical findings particularly linked with the elaborate instrumentation program, that in itself is costing between two and four million dollars, cannot yet be revealed for security reasons, some of the results were apparent. Before the smoke cleared from fires on the target ships, pressure gauges and heat-seared scars on the targets indicated the blast had a terrific straight-on effect but did considerably less damage just around the corner. In many places the hot blast left the imprints of chains and railings on surfaces several feet behind, and in one instance the sharp outline of a light bulb appeared on the background.

Two means used to test a human's ability to stand the blast pressure registered encouraging performances. Both the pigs, with a chest cavity similar to that of man, and empty five-gallon tin cans capable of withstanding the same proportionate pressure as the human chest, came through better than expected. Altogether, 150 goats, the same number of pigs and 3101 rats were left above and below decks on 22 of the targets, in place of humans, for medical experimentation which is not yet completed. About 10 percent were killed outright by the blast, and some predict eventual mortality from the after effects may be up to 75 percent. Even the initial effects, however, pointed to the need for improved protection of personnel, especially on transports.

(Continued to page 252)

Machine Tests Workers' Eyes to Help Find the Right Job

Visual performance of a worker's eyes is tested by a machine developed by the Bausch & Lomb Optical Company in co-operation with Purdue University's Division of Education and Applied Psychology. As a result of the tests, workers can be classified and placed in jobs for which they are visually fitted. Although two men both may have "good" eyesight, one may have visual ability well suited to the work of a watchmaker, the other a crane operator. A dye mixer requires still another type of vision, skill in color discrimination.

The new machine is intended solely for the measurement of such visual performance and is not used for refraction or diagnosis.

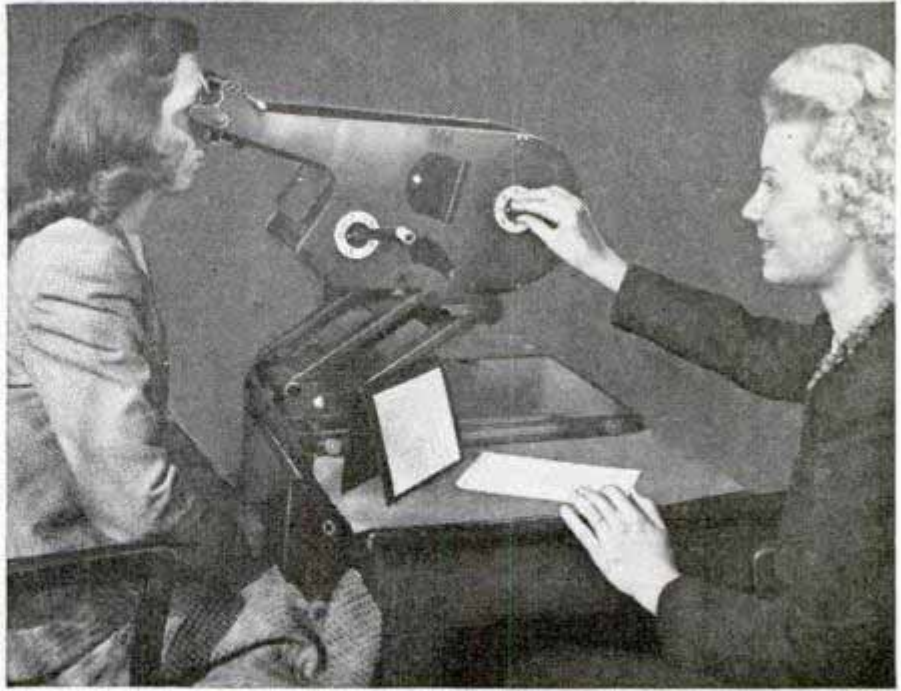

Heat Detector Finds Ship at Sea Or Man 1/4 Mile Away



Super-sensitive heat detectors whose main part is no larger than a pin head "feel" the warmth from a man's body a quarter of a mile away or pick up the heat radiated by a ship far out at sea at night. Developed at the end of the war as a new secret weapon, the device is built around tiny elements called thermistors (thermal resist-

ors) which have such sensitivity to heat that they detect temperature variations as small as one millionth degree Centigrade. The Bell Telephone Laboratories originally developed the unit for use in telephone networks to control fluctuating speech levels. Metallic oxides and other chemical compounds are used for the "heart" of the detector and sealed in a glass bead. They vary their resistance to electricity in accordance with the heat radiation picked up from various objects. So fine is the perception that from high altitudes the instruments can indicate the pattern of rivers by the difference in heat radiation between land and water.

Nonslip "Torque-Action" Hook Grips Beams as It Lifts

As the load becomes greater the grip of a "torque-action" hook becomes tighter when lifting beams, girders and channel irons. The hook is anchored to a hoisting ring and slipped over the object to be raised. When the lifting power is applied the torque action causes the hook to bite against the surface with increasing force so the object cannot slip from the hook's grasp.

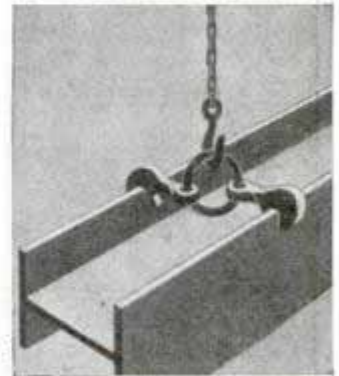

Names and addresses of manufacturers of new products featured in this issue will be supplied promptly by the Bureau of Information, Popular Mechanics Magazine, 200 East Ontario Street, Chicago 11, Illinois

SPEED PLANES



They go by so fast all you hear is a "whoosh" of the jet engines. Above, two views of the AAF's P-80, one with wing tanks on jet-assisted takeoff, the other without tanks. Below, Navy Phantom



NEW world speed records, far faster than the British-held mark of 606 miles an hour, are likely over the Labor-Day weekend during the National Air Races at Cleveland. Racing pilots will be chasing gold

as well as glory. The richest pot of prize money in race history, nearly \$110,000, will be split among the winners. Stripped of heavy armament, souped-up versions of the fastest combat planes of the war will fly in competition, as will the newest and fastest jets of the services. Start of the speed trials comes in Los Angeles August 30 when pilots take off on the 2200-mile Bendix Trophy dash to Cleveland.



The British Gloster Meteor, below, holds the present world's record of 606 m.p.h. Left, the De Havilland Swallow is the first British jet-powered flying wing

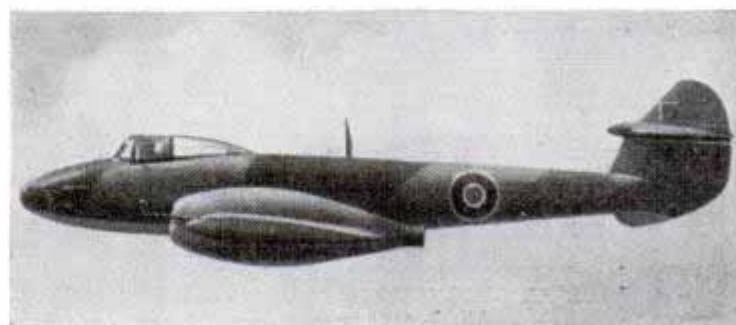



When AAF added P-51 to P-51 it came up with faster, more powerful twin, the P-82, above, In 500-m.p.h. twin-jet flying wing XP-79, below, pilot lies prone to avoid "blackout"

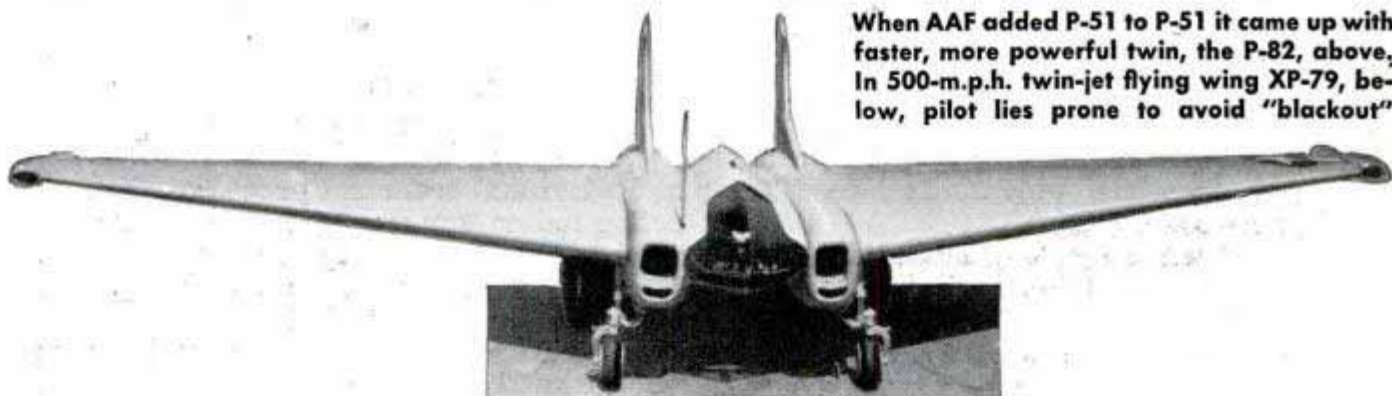

↓ New Thunderjet has speed of more than 590 m.p.h., service range of 1000 miles, ceiling above 40,000 feet

↓ Stripped of armament, with souped-up engines, P-38s will be among top contenders in National Air Races



↓ Recent addition to AAF line-up is twin-jet Bell P-83

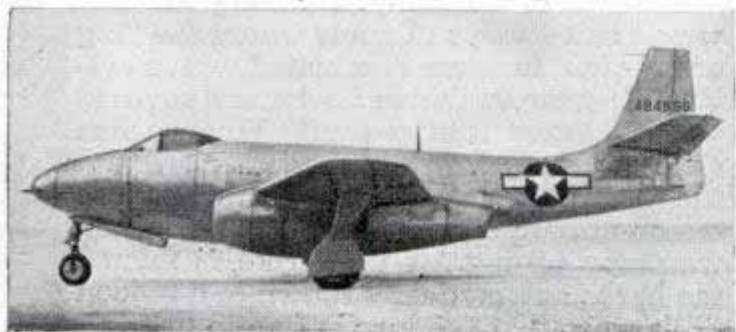

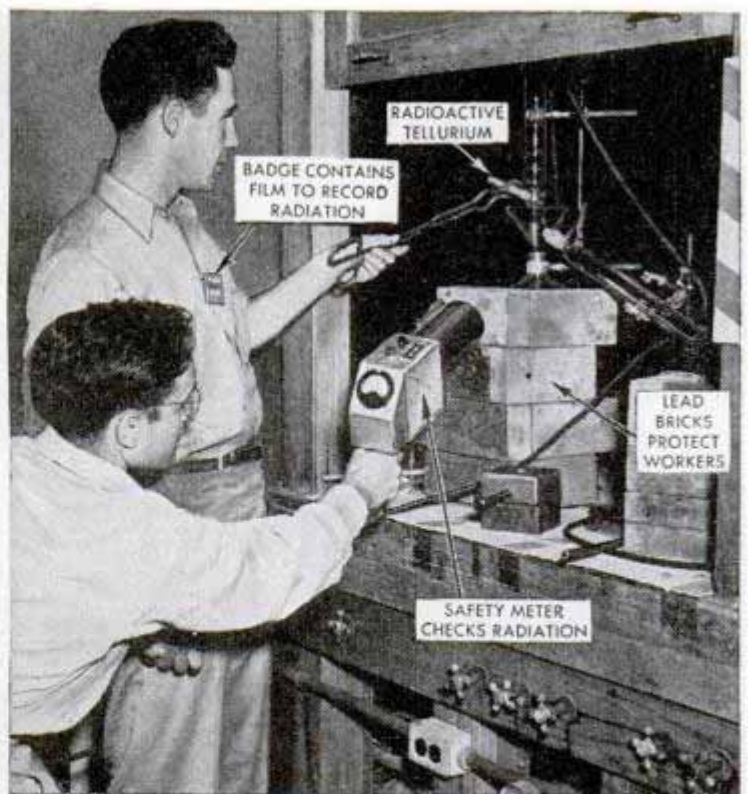

Great advances in unlocking mysteries of human diseases and in treatment of certain ailments are expected to result from the War Department's decision to supply radioactive isotopes to accredited hospitals, universities, research laboratories and clinics.

As announced by the Manhattan Engineer District, the isotopes will be produced from the uranium chain-reacting "atom pile" of the Clinton Laboratories at Oak Ridge, Tenn., which conducted basic research in the development of plutonium atom bomb material. Distribution of radioactive isotopes constitutes the first peacetime benefits to result from the atom bomb program. Radioisotopes are radioactive

Atom Smashers Launch War On Disease

forms of common elements with the same chemical properties of the

element but with a different atomic weight.

They will be used in two important ways. The first is as "tracer" atoms in chemical, biological and technical processes. Radioactive iodine, for example, can be used to measure the functioning of a thyroid gland. The second use will be as therapeutic agents for treatment of diseases.

Approximately 100 radioactive isotopes will be available. They include Carbon 14, Sulphur 35, Phosphorus 32 and Iodine 131. Since carbon is one of the principal elements found in organic material, the isotope Carbon 14 is expected to give great impetus to the study of all organic processes including the mechanism and growth of normal and abnormal tissues.

Phosphorus also is expected to reveal many biological secrets through experimental use of its isotope. Sulphur 35 may be used in tracing reactions to sulfa drugs.

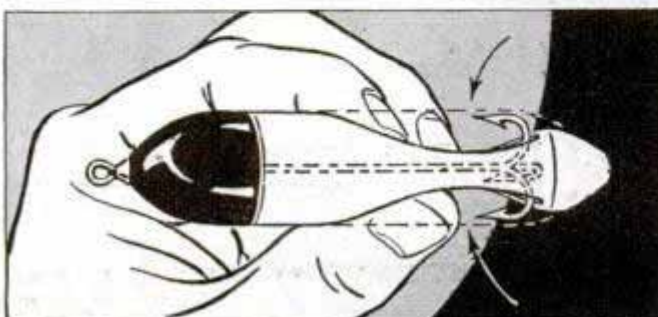
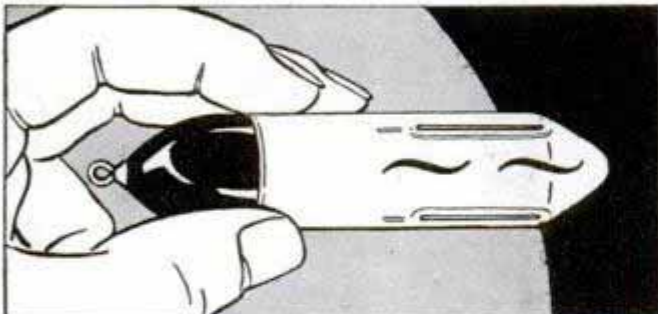

Nonsnag Lure With Hidden Barbs Exposes Hooks When Hit

Hazards of snagging a fishing lure on weeds and stumps in pools where the "big ones" often lurk are eliminated with a collapsible guard. Treble hooks are covered with a slotted rubber shell. When a fish strikes, the rubber shell is compressed and the barbs are exposed. The hooks are mounted on a sliding shaft and move forward for setting. If the strike is missed the barbs automatically return to a hidden position so that the lure is free to drift.

High-Wing Feeder Plane Gives Passengers Better View

For short-range intercity schedules connecting with trunk-line flights, Boeing is building a high-wing twin-engine transport designed to carry 20 to 24 passengers. It is powered by 800-horsepower Wright Cyclone engines. It has a wing span of 86 feet, is approximately 60 feet long, has thermal anti-icing of wing and tail surfaces and dual-wheel tricycle landing gear. Greater visibility is provided by the high-wing construction.

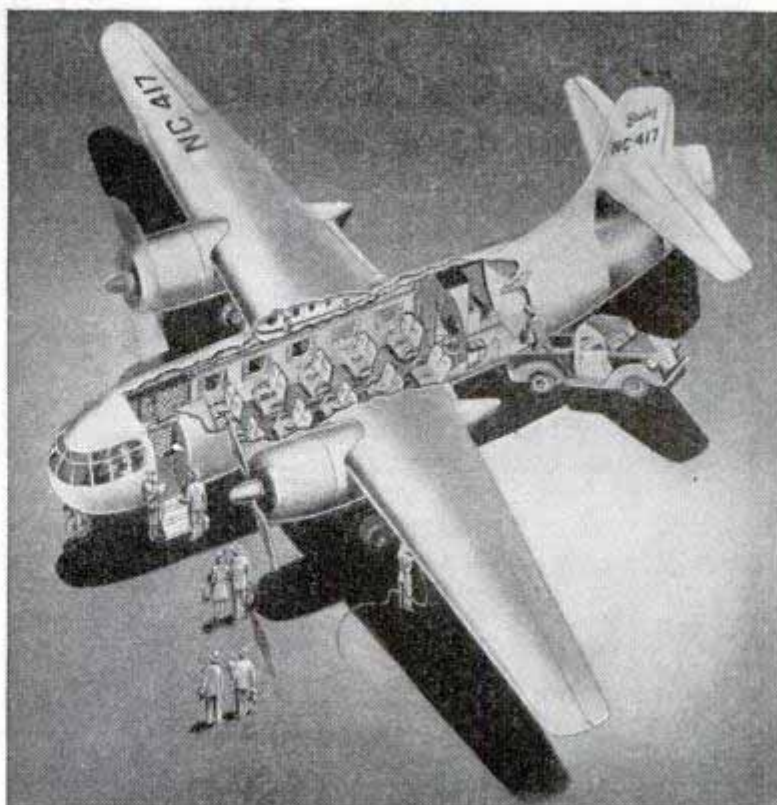

Bomber Tires Fit Tractor After Exchanging Rims

With a simple rim-welding job, surplus tires once destined for bombers and fighters now are filling equally important roles on earthmovers, hay balers, tractors and other farm vehicles. After the size to be used is determined, the original rim is cut away from the spokes or disk and the airplane rim is welded on. Tires intended for planes with 14-inch rims can be adapted for Fords, Plymouths, Chevrolets and other cars with

16-inch wheels. In some instances entire steel wheels, including the contact surface, have been changed over to make use of the largest size bomber tires.

Adjustable Paper Sun Visor Made From Single Sheet

While entertaining his young son by making paper boats and hats, a Chicago advertising man recently hit on an idea to make adjustable sun caps from a single piece of heavy paper. Starting with a paper about nine inches wide and 16 inches long and curved at one end for the bill of the cap, the inventor made perforated mark-

ings as guides for removing two sections from the paper. With these sections gone, there remain the bill, a strip for over the head and a strip for each side. The strips are joined together in a slot at the back. The caps, which are patented, are expected to be distributed as advertising novelties at baseball games and other outdoor events.

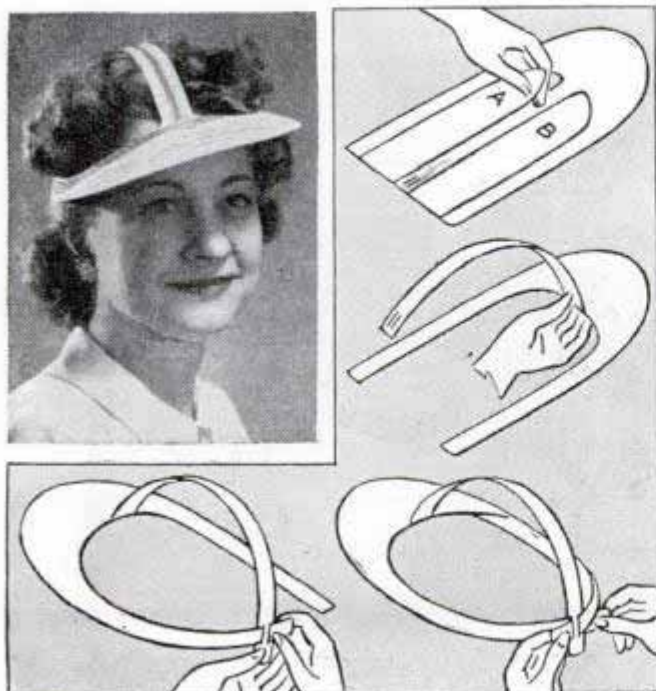

Shock Cases Treated by Dry Heat From Chemical Container

Dry heat for emergency treatment of accident victims is supplied in a minute by a special chemical compound in a small metal container. Heat is generated by releasing a spring lever, creating a chemical reaction which maintains warmth for an hour. The heat block, 1½ by 3½ by 4 inches and weighing 22 ounces, is wrapped in a towel or blanket for first-aid treatment of shock cases. A cylinder filled with the heat chemical fits inside the metal case and can be easily and quickly filled.



Sailing in the Sky

SAILORS are riding the heat waves above Elmira, N. Y., this month, intent on bringing to America some of the international records long held by European pilots of gliders and sailplanes.

This is the time of thermals, of cumulus clouds and warm updrafts along the hillsides of south central New York state, scene of the National Soaring Contests. More than 100 gliders and sailplanes and twice as many pilots are searching out air currents to give them a lift in a sport where motors are generally scorned.

Its military pilot-training program restricted after the first world war, Germany took to the air in sailplanes. Interest in

America lagged, but now it is a growing hobby for men and women from the teens to the 70s.

A fraction the weight of an airplane and without its expensive engine, a glider can carry a man nearly 500 miles or gracefully ease him through clouds 20,000 feet high. A sailplane recently sped 37 miles at an average of 111 miles an hour. Add to this a comparatively low cost for the craft and no fuel expense or engine maintenance.

Such advantages are rapidly swelling the glider ranks. Many converts are young wartime airmen who've found even the light powered planes a notch beyond their civilian means, but who still want to enjoy

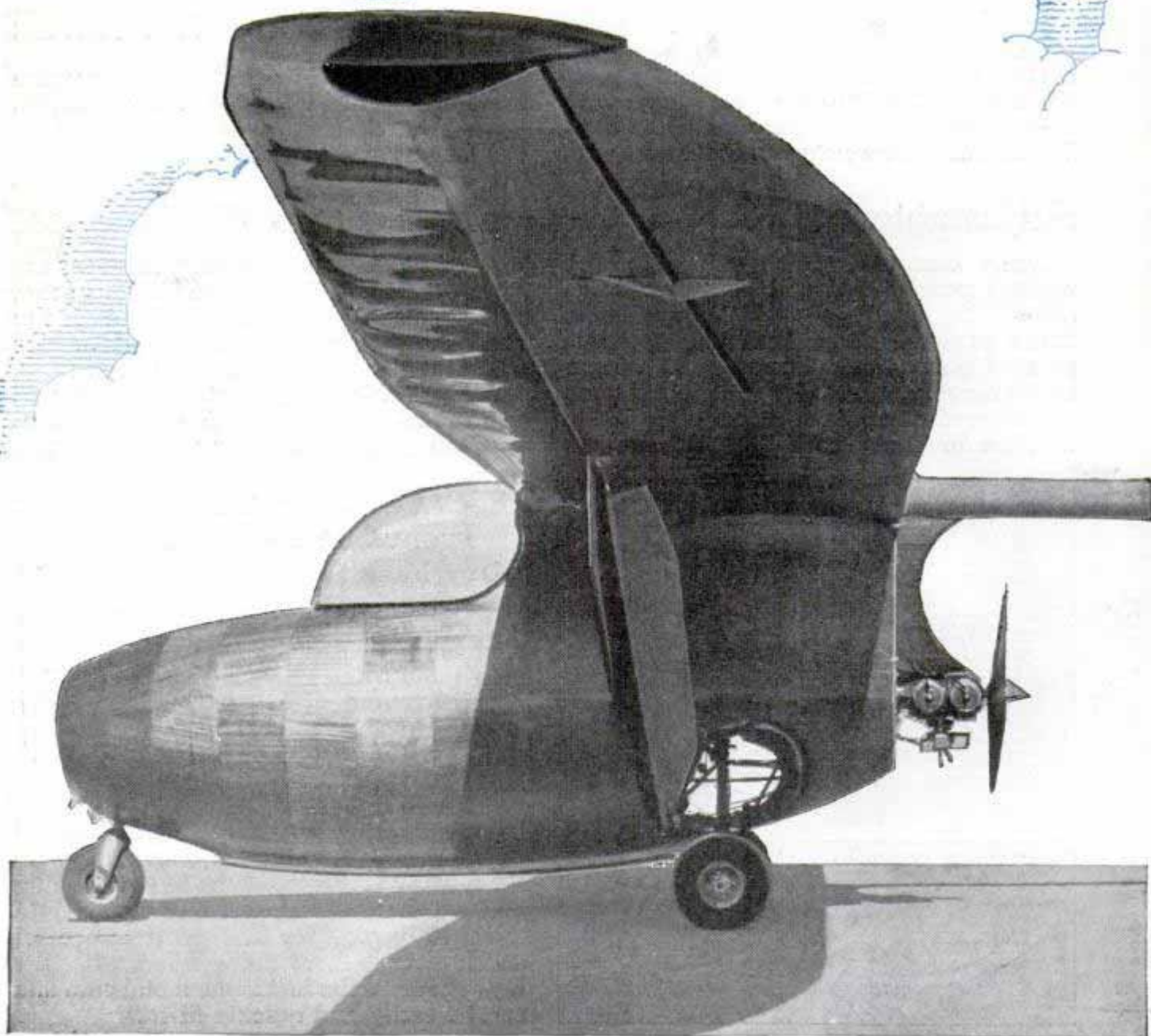

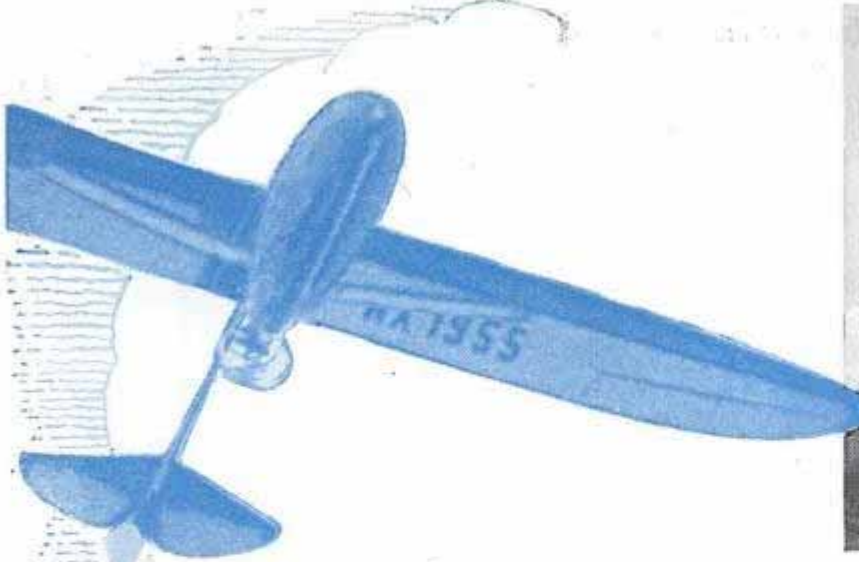

the thrills of flying. Many pilots recommend it for aviation training, pointing out that it gives the student confidence and a more intimate understanding of the art of flying.

The terms gliding and soaring are not interchangeable despite frequent misuse. Gliding is flying a motorless plane in a steady downward flight or glide. Soaring is an advanced form, using wind, heat currents, thermals and any energy of the atmosphere to prolong flight and gain altitude.

Primary gliders are comparatively crude

Latest development in gliders is this cabin craft with engine for power takeoffs

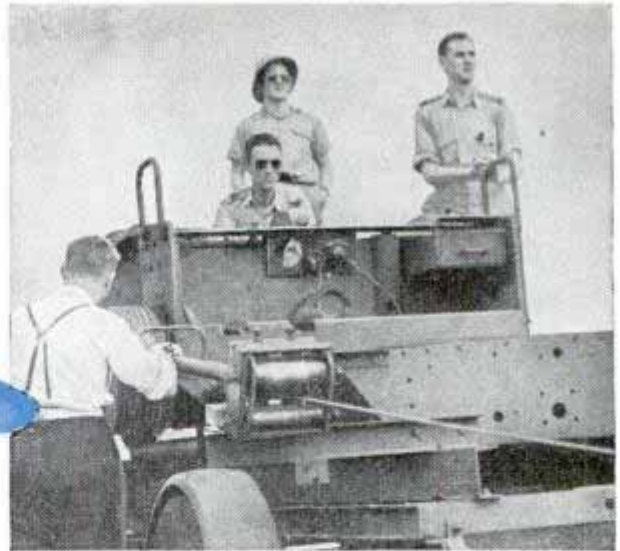

Drum of this winch revolves at constantly increasing speed to wind up towrope and launch the glider



H. A. Provisor photos
View from cab of the winch just before the glider becomes airborne. Below, operator of winch has hand on the accelerator lever to increase speed

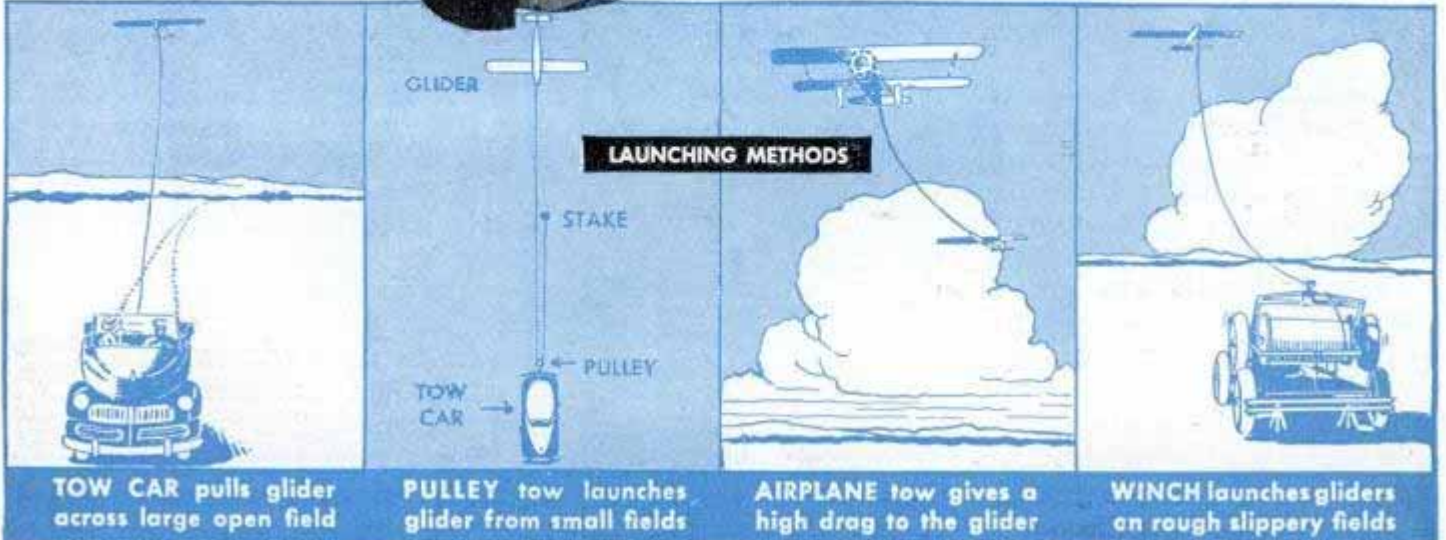
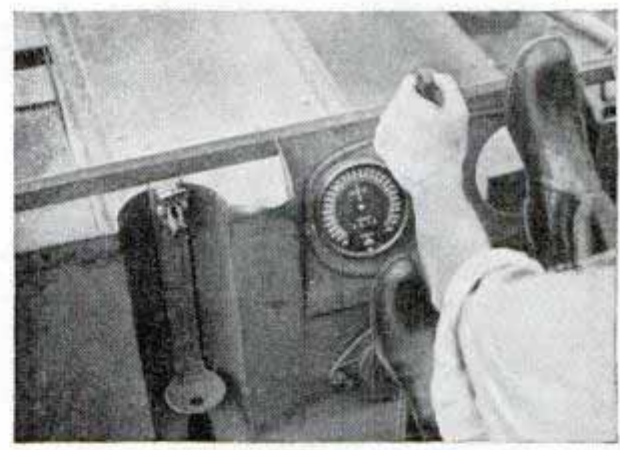

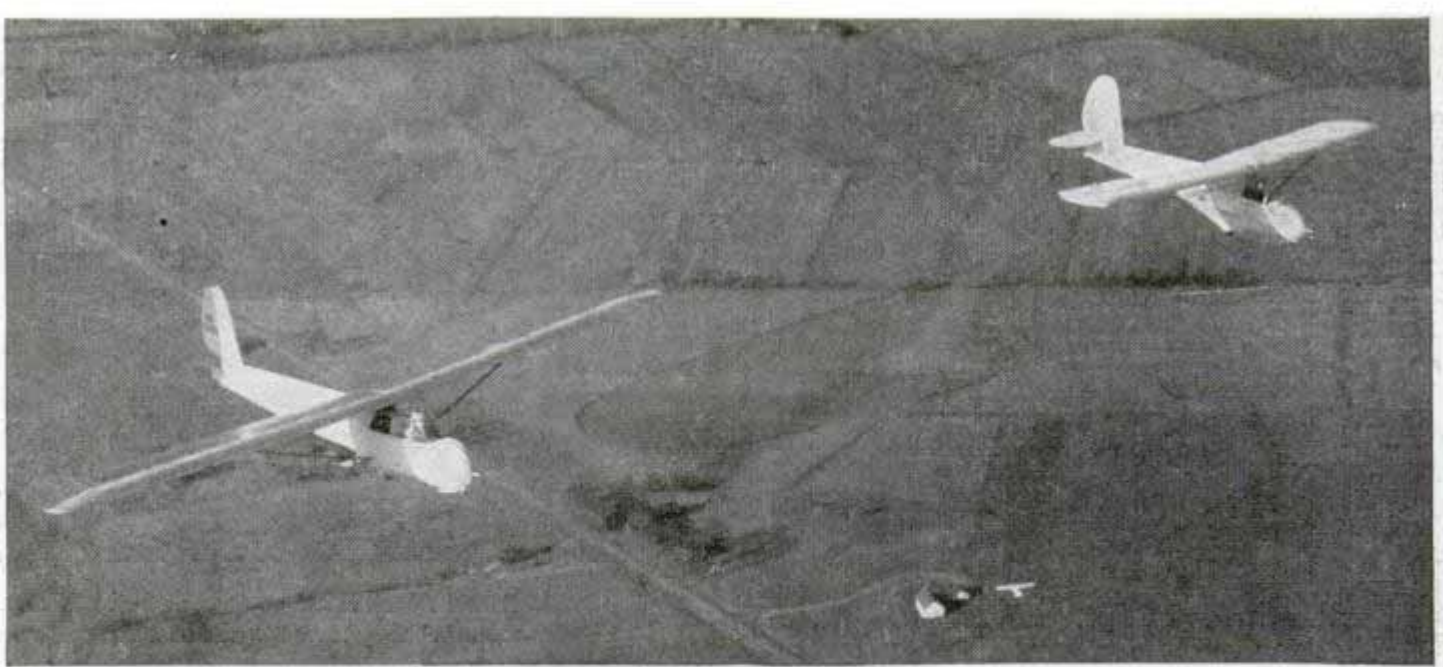

Schweizer Aircraft Corporation photo
 ↑ Left plane of these two ships is two-place sailplane, craft at right is glider

and simple, while the high-performance soaring or "sail" plane is streamlined and efficient. Between the extremes are utility gliders and intermediate sailplanes.

The average glider has a wingspan of 34 to 36 feet, weighs about 200 pounds empty and is built on a wooden skeleton. Sailplanes weigh 400 to 500 pounds and have a wingspan of more than 50 feet, almost twice that in some experimental models. Some are all-metal construction, all have enclosed cockpits.

Sailplanes have a higher stalling speed, 34 miles an hour in one new model, and a much slower sinking speed. They are much more sensitive to control than gliders. Primary gliders have no instruments, but a high-performance sailplane has an air-speed indicator, a climb indicator, an altimeter, turn-and-bank indicator, compass, thermometer and rubber-tired landing wheels with brakes.

Both types normally carry only one or two persons, though the military troop-carrying versions transported 20 or more fully-equipped soldiers. Conventional sailplanes and gliders are available either assembled or in kit form, with prices ranging from around \$200 for a primary to

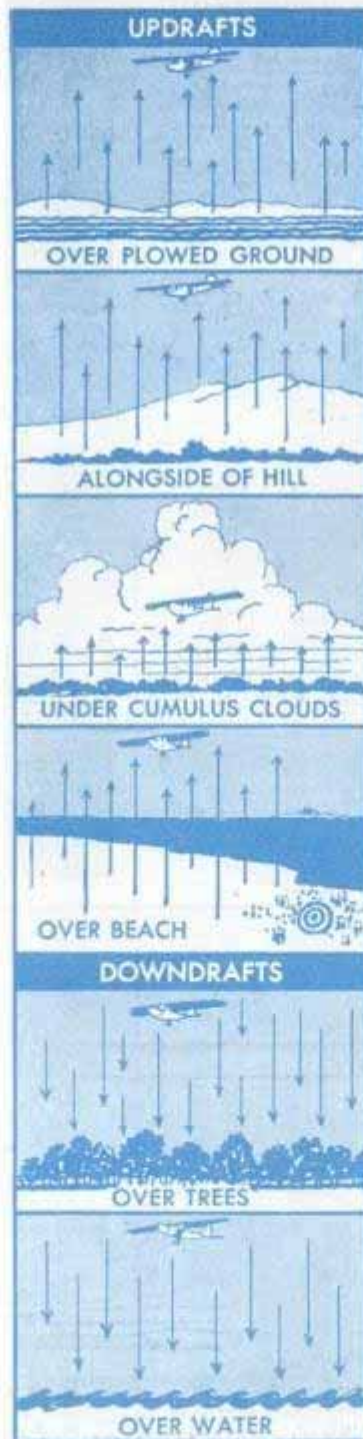

← Pilots must be masters at finding these updrafts, avoiding down currents

several thousand for a top-flight sailplane.

A glider stays in the air principally because it has lift, which in turn depends on the speed of the craft and the size and shape of the wings. Glider designers are constantly working to increase wing efficiency, with the better wings carrying the glider farthest with the least descent.

In the sport's early days slope winds were relied on almost entirely for duration flights. As a result most of the sites were in hilly rolling country like that around Elmira, the "Glider Capital of America." As the understanding of thermals grew, however, gliding shook its dependence on topography. Now there are popular sites on the plains of Texas and Illinois, as well as in western mountain and desert areas.

Thermals, or air bumps, result from unequal heating of the earth's surface. For example, the sun's rays striking a plowed field are radiated directly into the atmosphere above. Since hot air rises, this air breaks away from the surface in the form of a series of thermal bubbles when sufficiently heated. They rise until their temperature reaches equilibrium with the atmosphere above.

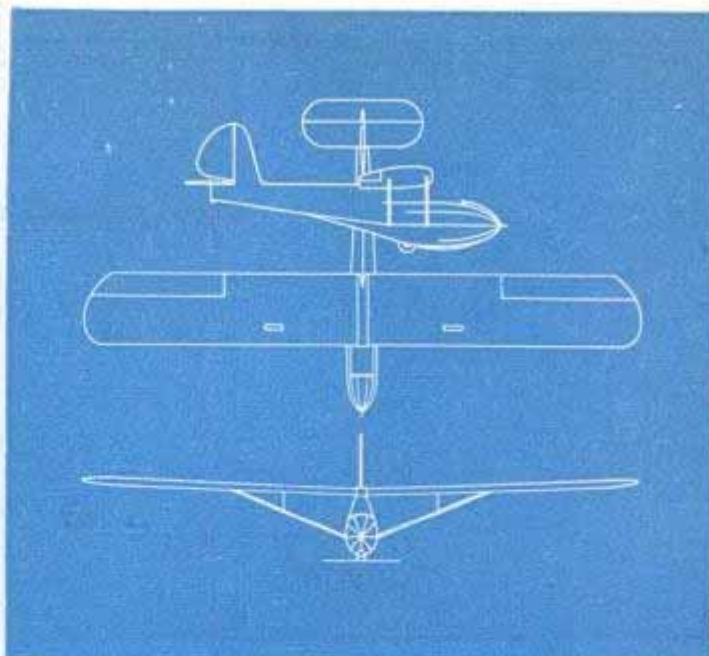
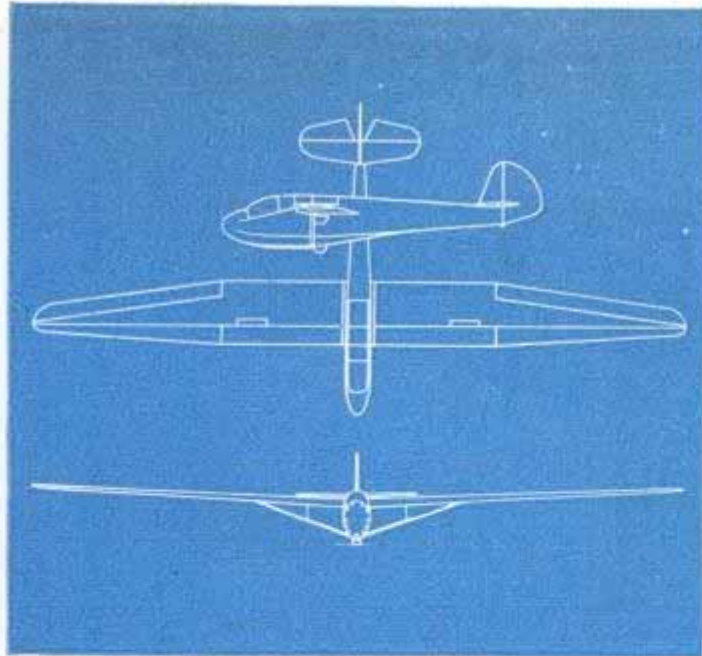

Two-place sailplane sketched above has 52-foot wingspread. At upper right is one-place glider. Method of coasting up thermals is shown at right

Woods or water will not radiate as much heat as a plowed field. As a result, air above these areas will be relatively cooler and flow downward, creating a downdraft. By careful use of thermals, or upcurrents, and by dodging downdrafts, a pilot can maneuver to great heights and sail long distances. Good thermals are generally not found on windy days because the wind scatters the rising air currents.

Storm flying in towering cumulonimbus clouds has boosted sailplanes over 15,000 feet. Now pilots are studying dynamic soaring, using the difference in wind velocity at various altitudes to promote lift, as another possibility for sustaining flight.

In launching gliders the four towing

Utility glider soars in the wake of its tow plane
Schweizer Aircraft Corporation photo

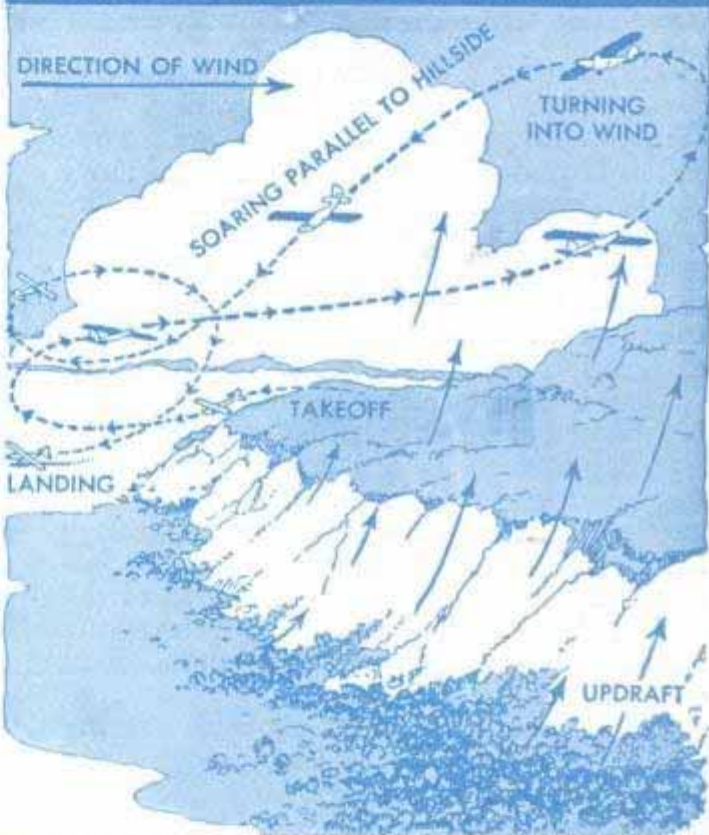

13755 Paton
San Fernando, California
"Bumblebee" made by Nelson Aircraft Co

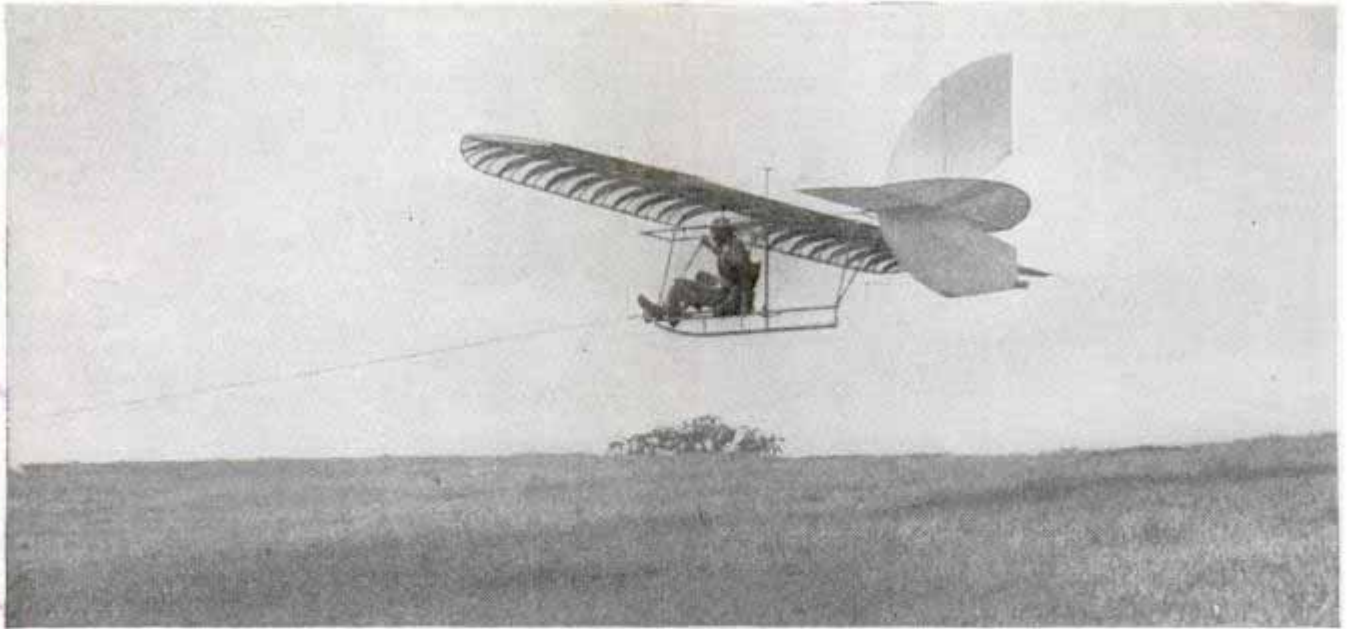

Model of an 1883 glider struggles into the air during filming of a movie depicting life of early glider pilot

methods most generally used are the airplane, winch, auto and auto-pulley. The common towline is a strong manila rope several hundred feet long with metal rings at each end. Airplanes are used with the heaviest gliders or whenever a high tow is needed. The auto is most effective on a large field where there is a smooth path for the tow car, while the winch method is best on a rough or slippery launching area.

With the auto-pulley technique, the line is attached to a stake and threaded through a pulley at the rear of the car. The ring at the other end attaches to the glider. The auto-pulley works best on small, rough fields, or when wind velocity is low because the pulley doubles the speed of the glider. A wartime development, the flying "pickup" may prove especially valuable in cargo roles.

Development of a two-place soaring plane with a small auxiliary engine for takeoffs is exciting glider fans. Designed by William Hawley Bowlus, glider pioneer,

the Bumblebee is built of plywood, with a hollow duralumin tail boom. A small propeller at the rear is driven by a 16-horsepower air-cooled 4-cylinder two-cycle engine. The glider takes off under its own power at 38 miles an hour and climbs 300 feet a minute. Once aloft, the engine is switched off and it performs like a glider.

The glider's controls are the elevators, rudder and ailerons. Up or down direction is achieved by tilting the elevators, which normally lie in a horizontal plane at the rear of the fuselage. When they are raised, the tail goes down and the nose up, or just the opposite when they are lowered.

Ailerons are the two horizontal surfaces hinged to the trailing edge of each wing. They operate like the elevators, except that when one is raised the other drops to lower the wing on the raised side. Both elevators and ailerons are operated by a control stick. The rudder is worked by a rudder bar or pedals. A push with the left foot, for example, turns the plane left.

Built primarily as an aerial freighter, this Army glider carries several tons
Official U. S. Army Air Force photo

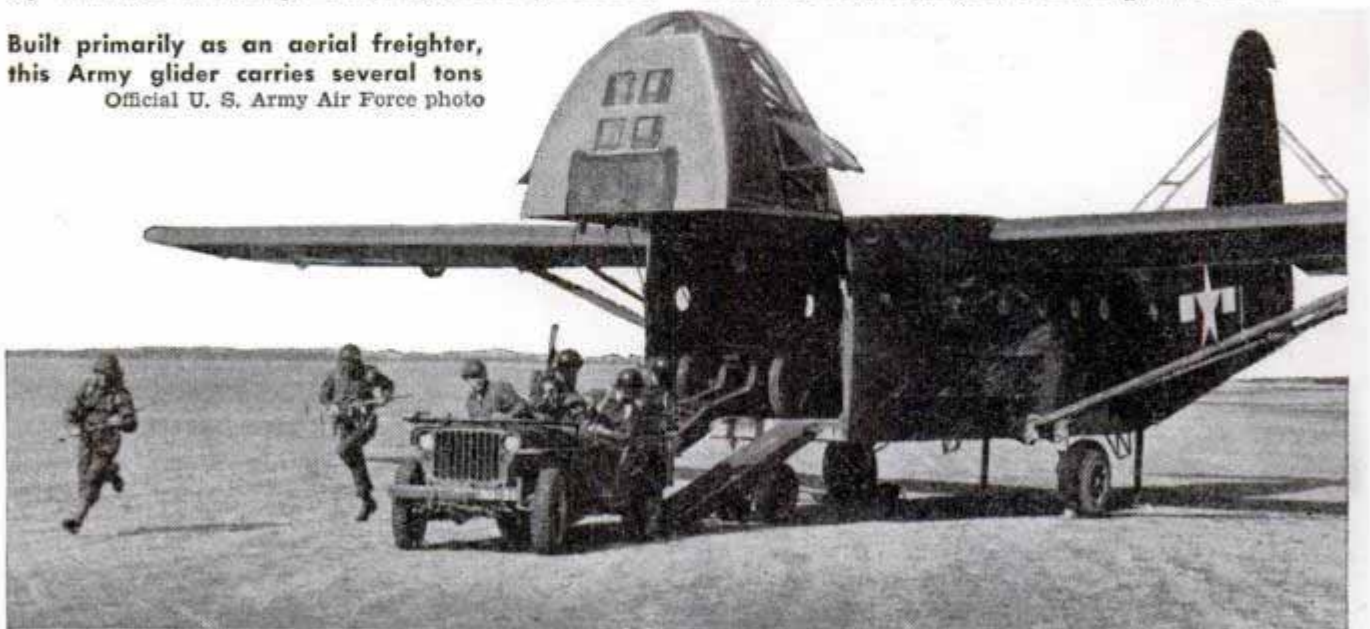

Gas and Smoke "Detectives" Find Millionth Parts in Air

Two new instruments, more sensitive for detecting minute quantities of gas or smoke than any ever devised, have been announced by Northwestern University. Both instruments were designed during the war in connection with the development of a more efficient gas mask. The "ultraviolet photometer" detects the presence of gases by means of ultraviolet light. It will find peacetime use in the measurement of toxic vapors in factories and mines. The instrument, capable of discovering as little as one part of gas in a million parts of air, was developed by Dr. Irving J. Klotz and Dr. Malcolm Dole, professors of chemistry. Another device, the "photoelectric smoke penetrometer," can detect 1/100,000 ounce of smoke in a room 30 feet square and gives similar readings of the amount of dust in the air. A puff of ciga-

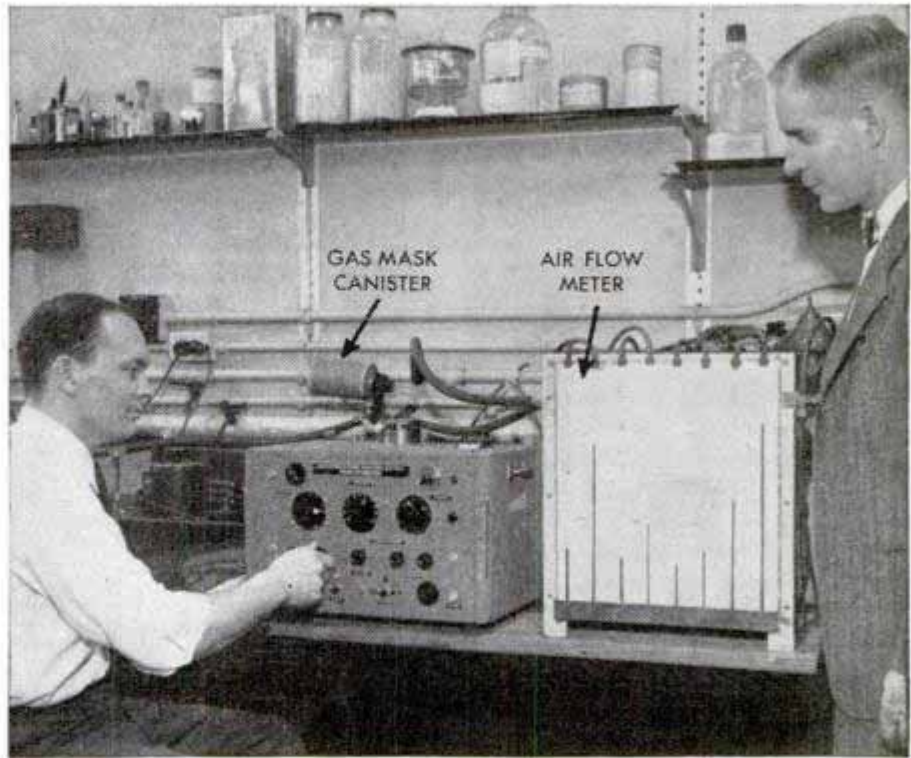

rette smoke in a huge auditorium will deflect the indicator. The instrument will be used in studies of smoke elimination and air purification. It was developed by Dr. Hugh B. Pickard, Prof. Frank T. Gucker, Jr., and Chester T. O'Konski.

Mower With Circular Blades Cuts Grass of Any Height

Circular blades that whirl horizontally enable a new power mower to trim the edges of a lawn at the same time it cuts the



grass. The blades reach to the edges of posts and trees. The machine's rotary action is similar to that of two electric fans placed side by side face down above the grass. Because the blades are horizontal the machine will cut a 30-inch strip through grass or weeds of almost any height. An automatic safety clutch disengages the wheels and blades from the motor whenever the handle is released. The height of the blades is adjustable in quarter-inch intervals from 1¼ to 2½ inches. The handle can be collapsed and folded for convenient storage during the winter.

Foolproof Photographic Solutions Stop Overdevelopment

It's impossible to overdevelop photographic prints or negatives with new chemical solutions which eliminate the need for hypo or stop bath. The solutions develop negatives in 20 minutes and prints in two minutes. Prints and negatives can be left in the solutions for any length of time without danger. Also, prints can be exposed to light as soon as the image starts to appear. Two solutions are available, one for prints and one for negatives.

High Windows for Strap Hanger Prevent Riding Past Stop

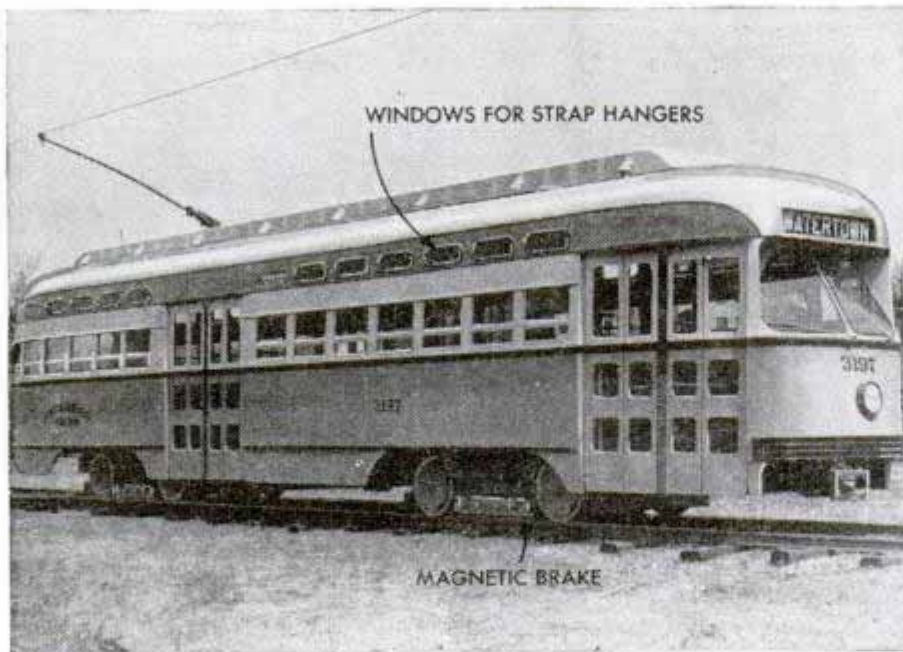

Eye-level windows are built into each side of an all-electric street car so the strap hanger can pick out distinguishing landmarks to keep him from riding beyond his stop. No compressed air is used in the car. Electric motors open and close the doors and operate windshield wipers. The magnetic brakes are controlled from a 32-volt battery. For greater safety, windshield area has been increased so that the motor-man may have a better view of boarding and alighting passengers.

Planes on Deck Turn Carriers With Propeller Thrust

Carrier planes can maneuver their mother ship in confined areas by employing the thrust of whirling propellers to turn the floating base in a tight circle. Planes lined up crosswise at one end face the direction of turn and aircraft crosswise at the other end face the opposite direction. The forward tug exerted by the propellers of each group revolves the ship like a wheel. By facing the planes in the same direction, the ship can be moved sideways. Conceivably, the ship's speed could be increased by facing both groups of planes forward and racing their engines.

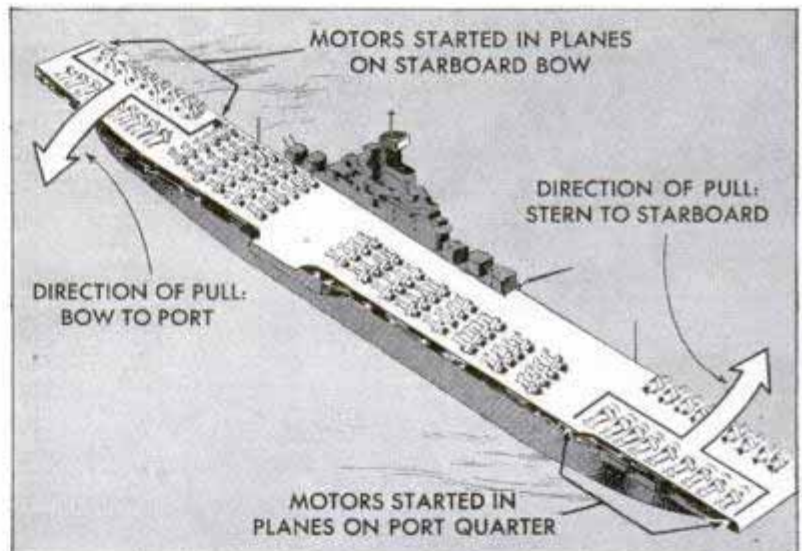

Dozer Clips Nine-Inch Trees to Clear 2½ Acres in Hour



With a giant Caterpillar tree dozer and brush cutter, brush and trees up to nine inches in diameter are cleared from 2½ acres of wooded land per hour. The machine, operated by the Iron Range and Rehabilitation Commission, Hibbing, Minn., is used for opening new areas for mineral development in the Iron Range area.

☐ In order to cool the engine of a tank in battle, a ton of air per minute was blown through the engine compartment at a velocity of a mile a minute. The amount of heat thus removed from the tank's power train was fantastic—enough to heat 20 homes on a cold day.

DON'T POUR *Coal* UP THE CHIMNEY



The University of Illinois has found how to "stretch" coal further and heat homes better

By Aubrey O. Cookman, Jr.

WHEN Mrs. Julian R. Fellows excitedly called her professor-husband home from class to fix a smoking furnace she didn't know she was inspiring one of the first major improvements in hand-fired home heating since Benjamin Franklin invented his stove more than 200 years ago. But from that summons, and a decade of research since, came the Illinois smokeless furnace, capable of burning any soft coal without smoke, providing even heat, and saving as much as 30 percent of the fuel pile.

Professor Fellows, a mechanical engineering instructor at the University of Illinois, shifted all his spare time attention to whipping the vexing soft coal smoke problem. He finally found the answer in a furnace built around a "downdraft coking principle."

This is a method for directing smoke and gases from newly added coal through an area of already burning coals. There they are heated to igniting temperature and mixed



Thermostats should be in the sitting zone, not at eye level, for comfortable heating

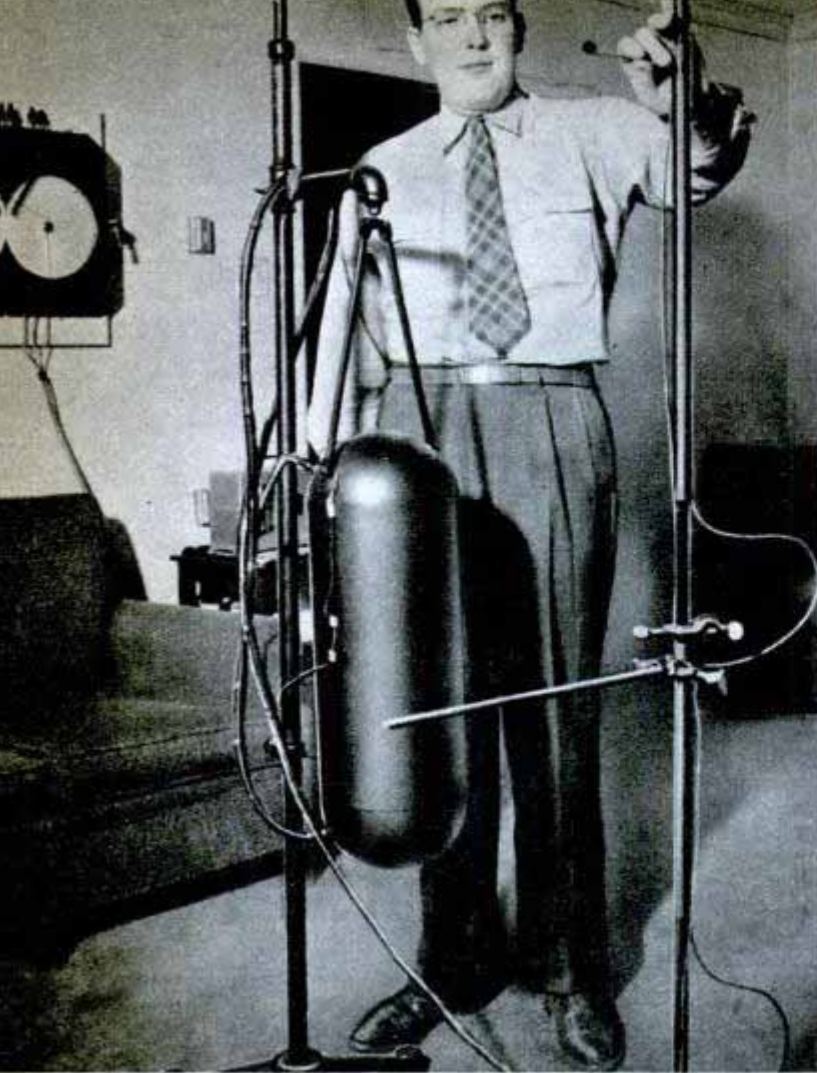

Thermometers record temperatures at high and low positions in University of Illinois heat-test home

with preheated auxiliary air coming in through a passage over the coking chamber. The gases burn completely. This releases much heat formerly lost and eliminates the smoke nuisance.

Tests of nearly 100 samples of soft coal indicate that virtually all kinds can be burned without smoke in the Illinois smokeless furnace. This opens the way to banish the smoke nuisance in cities without banning the use of plentiful and inexpensive soft coal. The benefits to health and cleanliness are as important as fuel saving.

A hundred "pilot" models of the Fellows furnace are under further test in private

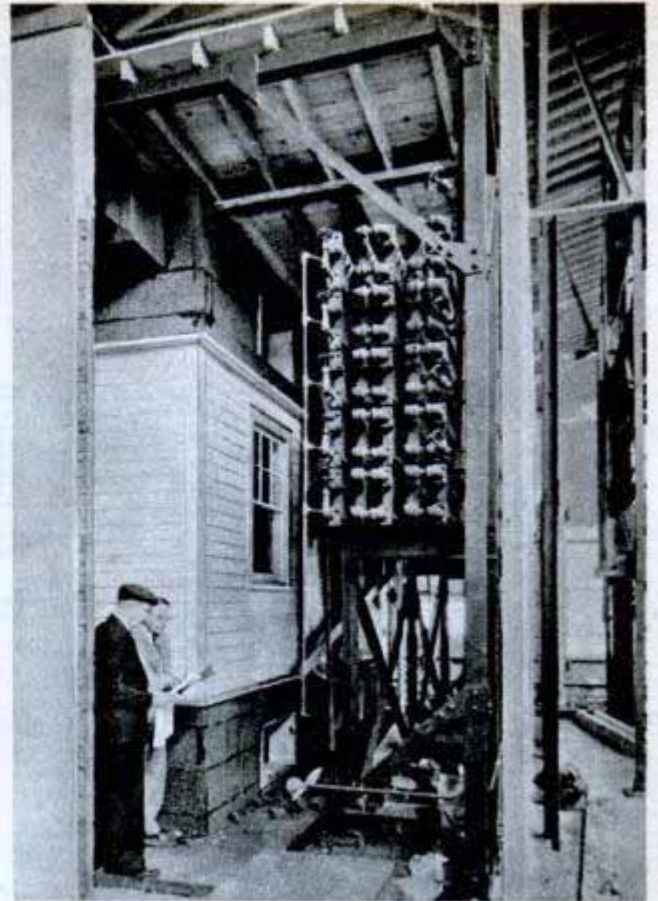

Small house built in climate laboratory is subjected to temperatures from 5 below to 100 above zero

homes. A typical user reported a season's fuel consumption of eight tons, compared with 12 tons of the same kind of coal burned the previous year in a conventional furnace. The same operating principle applied by Fellows in furnaces is applicable to stoves.

The smokeless furnace is a recent development in the heating research program that started at the university in the early 1920s. This research was instigated by Professor Arthur Cutts Willard, then a member of the mechanical engineering department, but recently retired as president of the university. Willard was amazed by the lack of standards in heating equipment when he was in charge of purchasing for army cantonments during the first World War. Up until then furnaces were sold by the pound, without regard to their capacity to do a specific heating job. Willard saw no reason why a scientific yardstick couldn't be applied to gauging heating equipment.

Largely through his efforts, the National Warm Air Heating and Air Conditioning Association put up a two-story 10-room frame residence on the university campus in 1924. This was the first house ever built expressly for

Moisture in any part of a home is measured by electrical apparatus with a plug-in detector



Radiant baseboards made of hollow cast iron distribute hot water heat evenly throughout a home

scientific research in home heating. A second home for heating research, built by the Institute of Boiler and Radiator Manufacturers, was dedicated in 1941. It is a six-room brick veneer house, typical of the trend to small homes. In each instance the industry provides the house and the equipment, and engineers from the university's staff conduct the tests. In charge of the warm air research house is Professor S. Konzo, authority in this field, while Professor Warren Harris supervises tests conducted in the boiler and radiator heating research home at the university.

Few subjects are of more general concern than heating, involving the comfort and well-being of all of us either directly or indirectly. The most recent national housing census showed that more than 16,000,000 dwelling units were stove heated, almost 7,500,000 heated by steam or hot water and 7,000,000 by warm air furnaces. About 11 percent were reported using other kinds of heating or none.

Both research homes are fully equipped with all sorts of strange looking measuring instruments. One is the thermocouple, a wire device for measuring temperatures. Some 300 are in the radiator house alone. The thermocouples are attached to walls, ceilings and supports to measure air temperatures at various



Smokeless furnace, fired by its developer, Prof. Julian R. Fellows of the University of Illinois, directs smoke and gases from new coal through coal already burning. Diagram below shows how the furnace operates

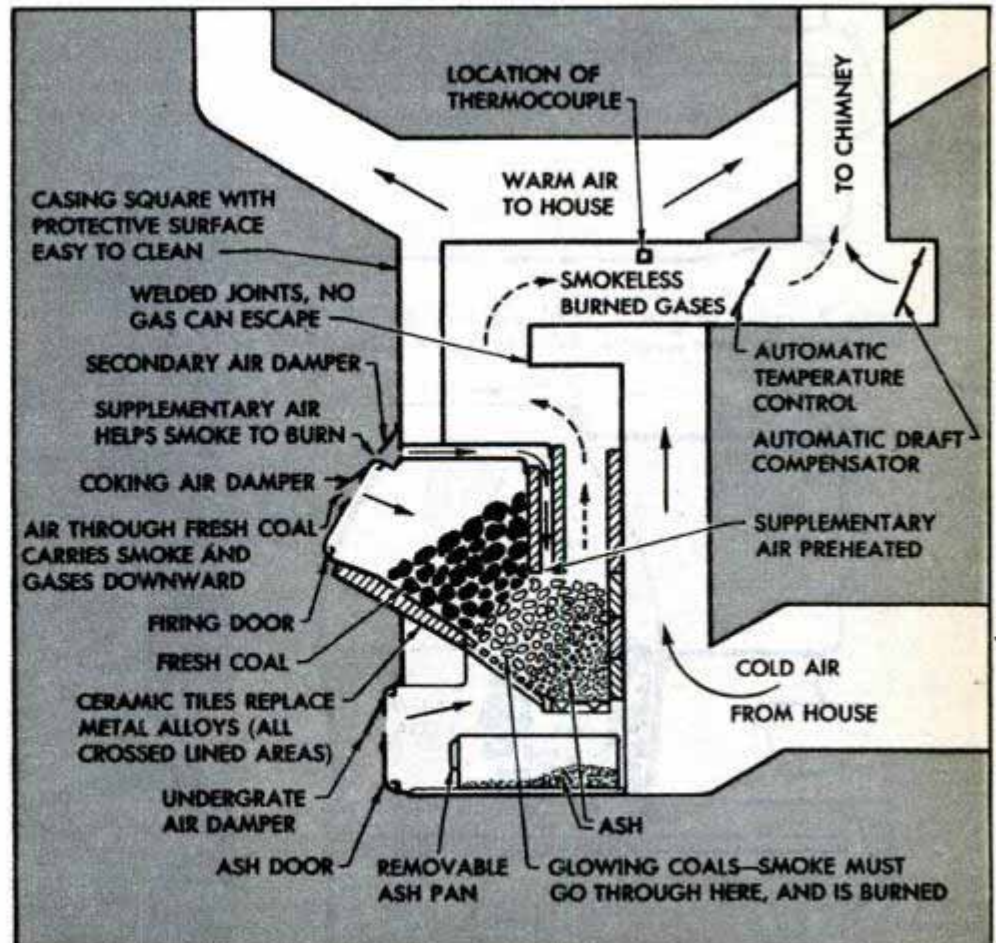

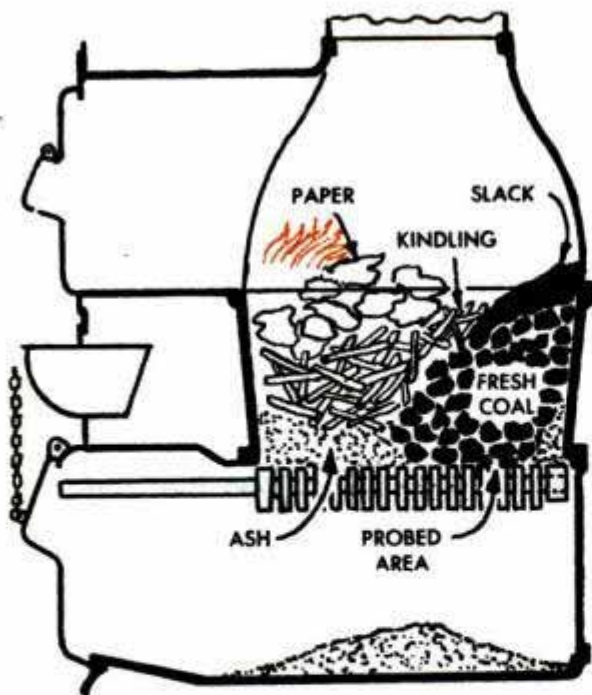

↑ Here's how to start furnace fire with soft coal

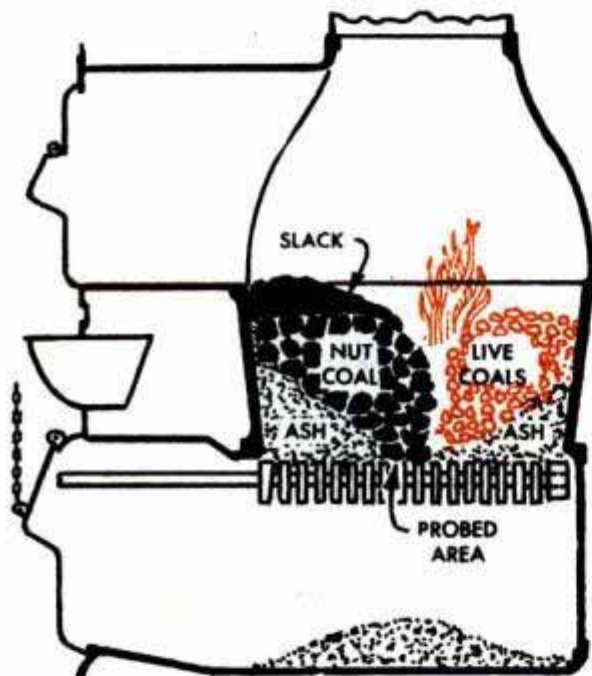

Keep it under control i mild weather by ash bed (above). Cold weather firing is shown below

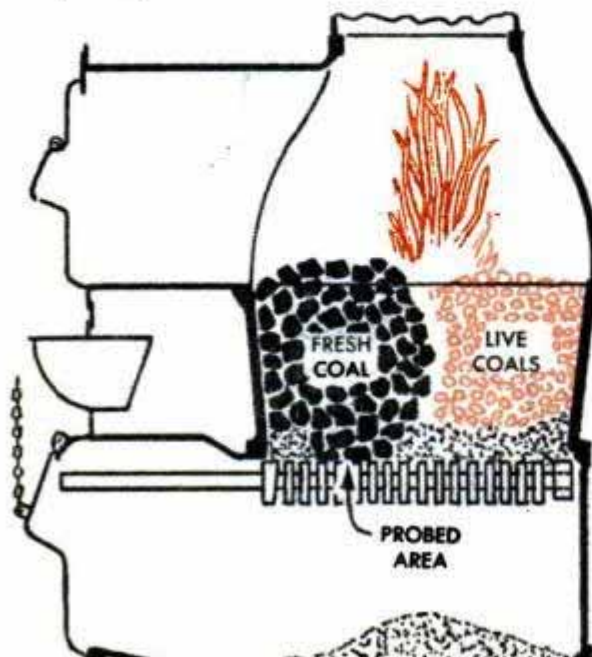

heights in the rooms. In some locations nine of them are grouped on and in a wall to measure the temperature at points three inches from the inside wall of the house, then at progressive stages through the wall structure, and finally ending at three inches outside the wall.

Recording thermometers in each room register a constant report of the air temperatures in the house at the floor, ceiling and in the "living zone" of a seated person. A bulky sausagelike instrument called a thermo-integrator reacts to the radiant energy, or lack of it, in the walls as well as to the air temperatures to indicate the comfort conditions of a room. Still other instruments measure moisture. Most of the equipment is connected to a central control board in the basement which can supply 100 to 125 readings every six hours.

The university's aim in this research is to improve home heating, set standards for heating equipment and pass along this information to those concerned. This includes manufacturers, the installers who are the industry's point of contact with the public, and the public.

Much educational work for the public is being done through the university's Small Homes Council, a coordinating agency to assemble and distribute, in popular form, information affecting the small home, from advice on selecting a lot and financing it to selecting a heating plant, planning the kitchen or installing storm windows. Thus far the council has prepared 12 nontech-

Hot water pipe $\frac{1}{2}$ or $\frac{3}{4}$ inch in diameter serves as well as $1\frac{1}{4}$ -inch pipe, university experts found

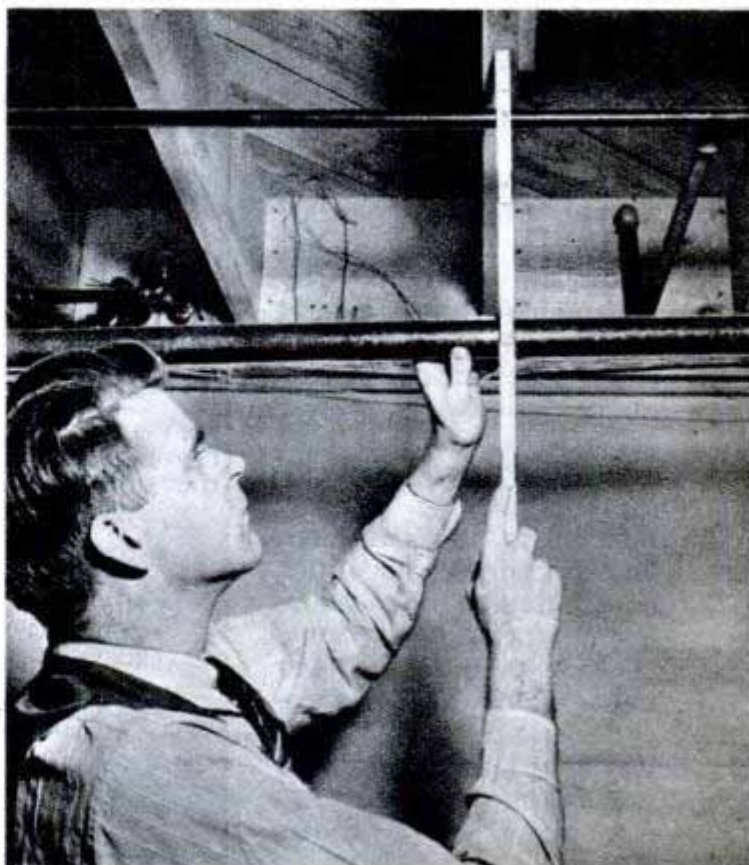

nical pamphlets on various phases of housing.

Authorities agree that good house construction is the first essential for efficient heating. The perfect heating plant will do only a fair job in a poorly built house, while even a mediocre unit performs fairly well in a tightly constructed home.

Experiments have shown, for example, that a plaster ceiling has high heat conductivity, and you can accomplish heat savings as high as 15 percent by insulating the attic floor above. Wall insulation can save 20 percent of the remainder, while tight storm windows and doors will slash away another 20 percent. Another recommendation for greater comfort is to locate heat-controlling thermostats 30 inches from the floor, in the living zone of seated persons, instead of at the 60-inch eye-level mark usually practiced.

University research has shown, on the basis of exhaustive tests, that the sizes of hot water pipes from boilers often can be reduced from 1¼ inches to ¾ or ½ inch, saving both materials and space with no loss in heating efficiency. They found, too, that when radiators are located along exposed walls there is no perceptible floor draft, but when they are placed next to inside walls the floor to ceiling temperature difference jumps three to five degrees.

With recessed radiators, where some of the normal wall insulation has been sacrificed to gain the space for the recess, they learned that by insulating the recess with one inch of rigid

(Continued to page 248)

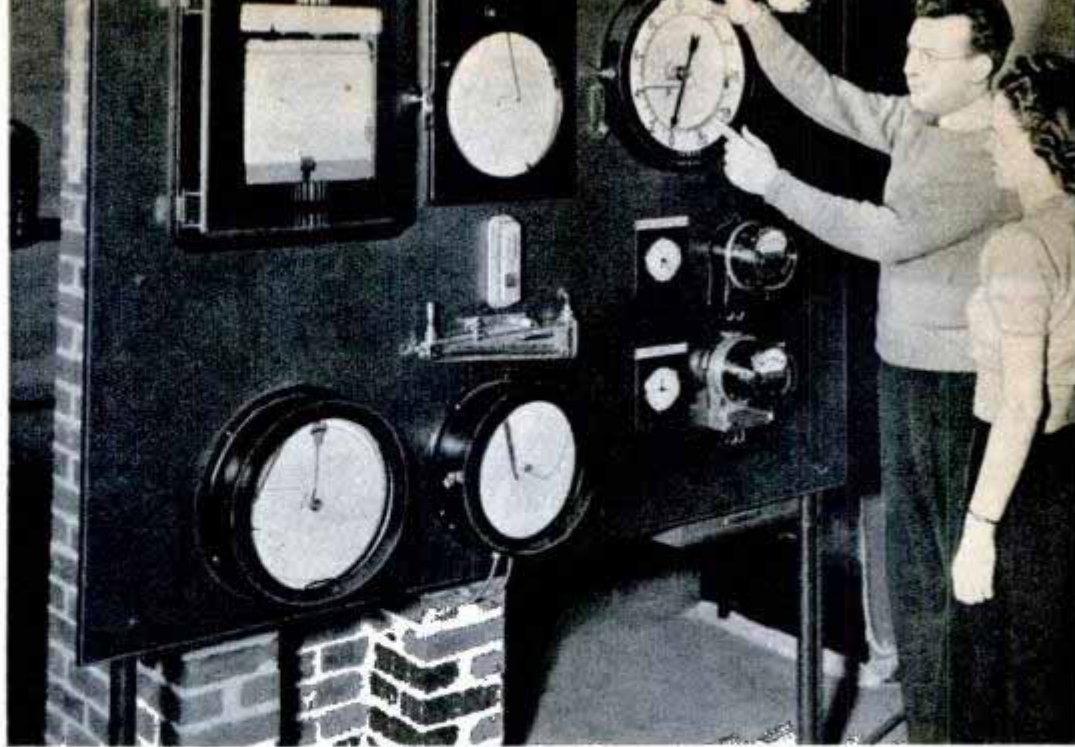

Instrument board in basement of test home registers performance of boiler and circulator and notes flue gas temperatures and current consumption. Below, drawings indicate efficient and inefficient designs for duct systems. Diagram at bottom itemizes heat lost from average two-story frame house

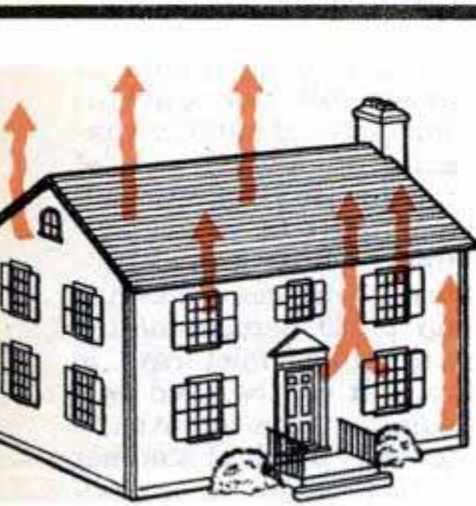
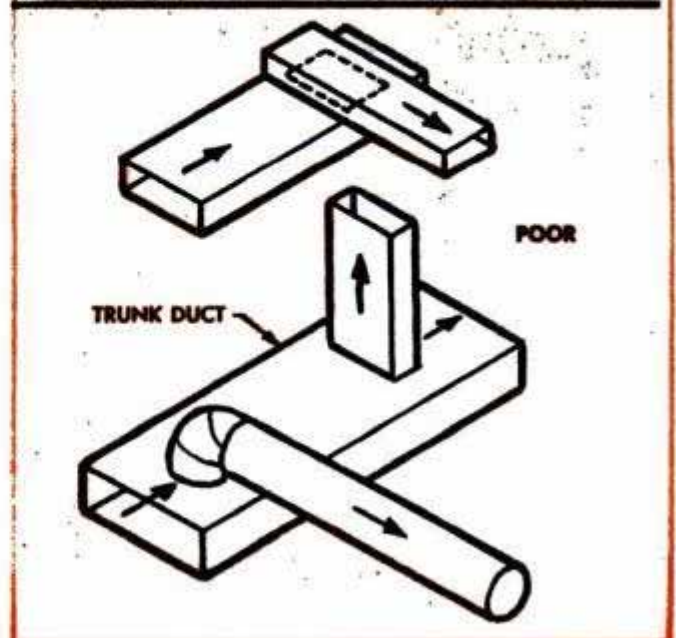
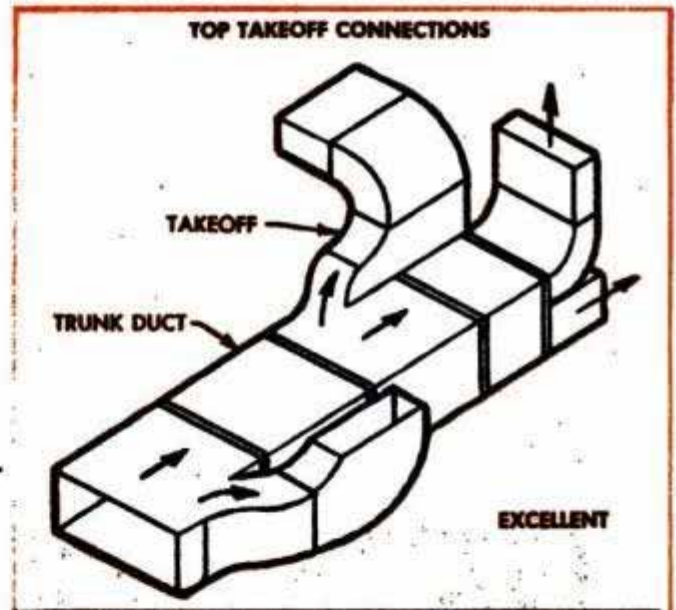

ROOF	16%
WALLS	27%
GLASS	26%
INFILTRATION	25%
DOORS	4%
FLOORS	2%
TOTAL	100%

Newspaper "Piped" to Home by Facsimile Broadcasting Equipment

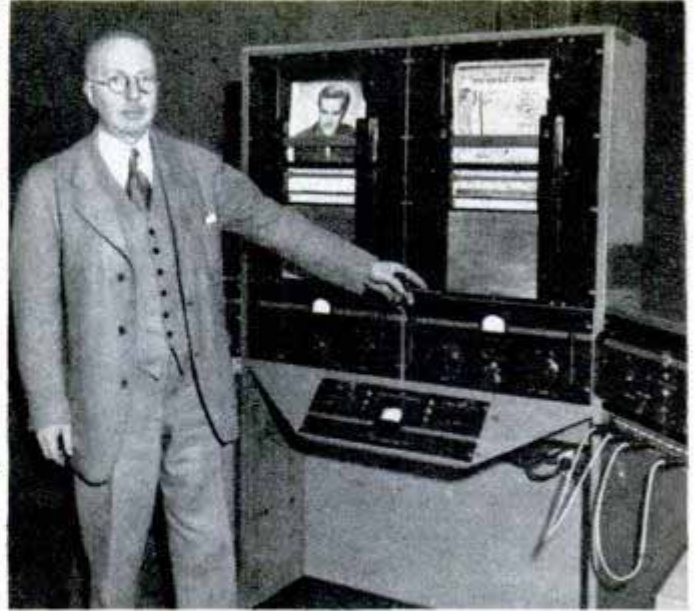

Four 9½ by 12-inch pages of text or photographs are printed by radio in 15 minutes by facsimile broadcasting equipment designed for home use. The recorder is built in two types: one to be attached to existing radio sets, and the other to be mounted in a radio console by manufacturers. Printed pages emerge from a slot in the top surface of the set at the rate of 28 square inches per minute, and a transparent window enables the owner to see the page as it is being recorded. In a recent demonstration, news and photographs were transmitted, in addition to such material as maps, charts, cartoons and crossword puzzles. At the broadcasting station, copy to be transmitted is placed on a revolving drum equipped with a scanning head. An electric eye scans each detail of the copy and

translates each graduation of black into an electrical impulse, which in turn is converted into a sound signal and sent over the air by an FM radio station. The signal is picked up by any standard FM radio receiver and relayed to the facsimile recorder connected to the radio set. A roll of white paper, chemically treated to make it electrosensitive, feeds through the recorder. The recorder (or printer), synchronized with the scanner at the radio station, passes an electrical impulse through the sensitized paper at every point where black appears in the original copy. The action of the electrical impulse on the electrolytic paper turns it black, and in this way an exact reproduction of the original copy is obtained. Radio Inventions, Inc., of New York developed the equipment.

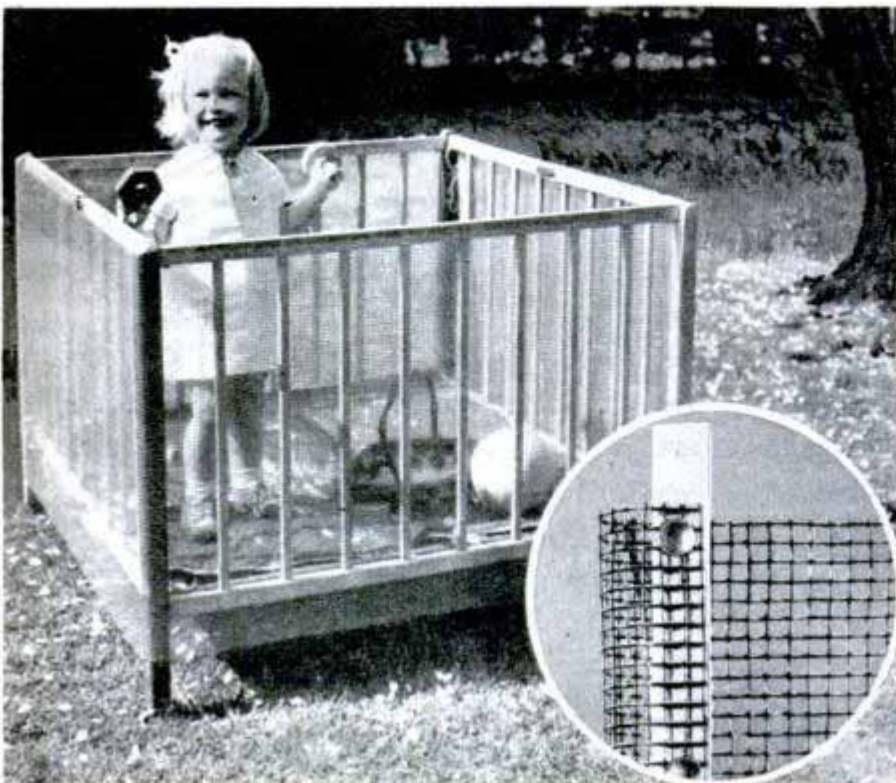

Netting Shields Baby From Cold Drafts

Wrapped around your baby's play pen, a transparent plastic-coated netting keeps out cold drafts, dust, dirt or stray animals and enables him to get his full quota of outdoor sunshine. Double layers of tough, clear plastic are laminated to cotton netting to form the wind-break. Since it permits up to 60 percent of the sun's ultraviolet rays to pass, it can be used as a window glass substitute for sun porches, summer cottages, hotbeds or poultry houses. It can be cut with a pair of scissors.

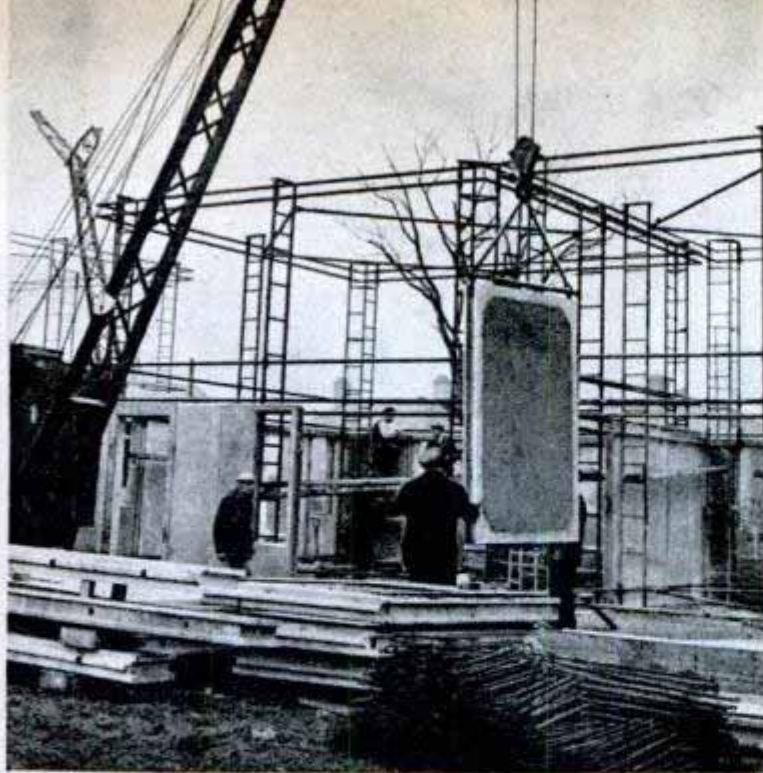

JIG-TIME SLAB HOUSE



In England builders are using modified prefabrication to speed house construction. A skeleton of steel pipe is raised first, above, and mobile cranes lower concrete wall panels, delivered from the factory, into place in frames. Interlocking joints of the panels form a cavity which is filled with liquid concrete, left, to make a solid wall containing windows and doors

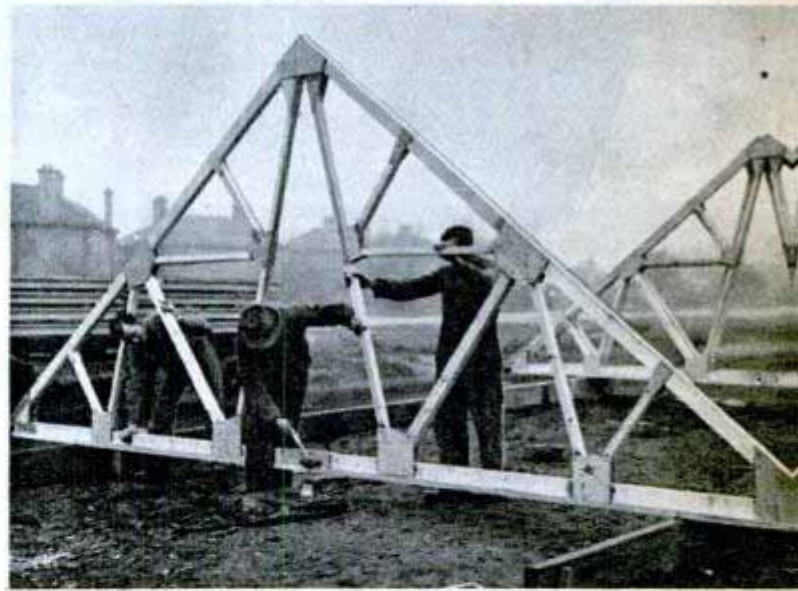

Sections forming the roof trusses, above right, are assembled on the ground and then the entire roof frame, below left, is hoisted into position. Steel-pipe skeleton then is dismantled, removed and erected again on another foundation. Wall panels are available in a variety of shapes adaptable to attractive small house design

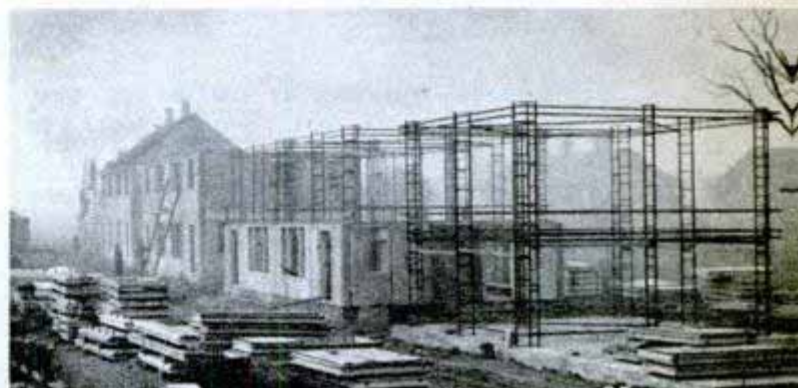

Immune to shock from exploding depth charges, submarine binoculars provide sharp vision even through rain

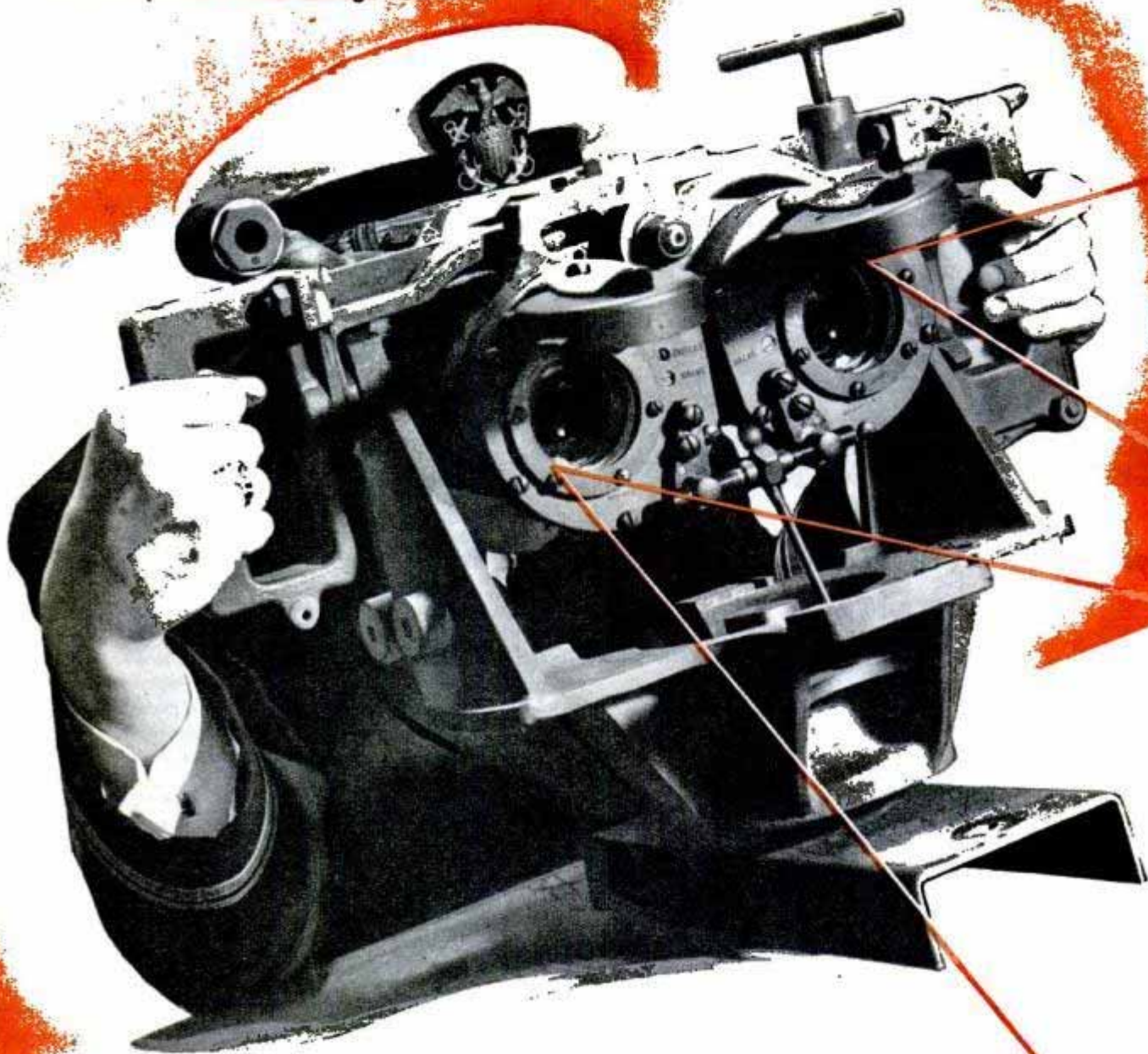

By John R. Kinsey

Clearer VIEW AHEAD

★

Science is making it easier to see things. Better glass has been developed for lenses. And chemical "over-coats" make the lenses reflection-free

★

YOU'RE scooting down the highway in your car on a nice clear day. Your windshield is clean, yet you have to duck your head from time to time to dodge light reflections in order to see well.

Suddenly it starts to rain and your windshield wiper begins spreading a thin layer of water across the glass surface. Immediately you can see much better.

What happens is that the film of water makes the windshield more "transparent" by letting through about two percent more light and reducing the amount of reflection.

Science today is applying this principle to lenses for spectacles, cameras, movie projectors, binoculars and telescopes. But instead of water a chemical coating is used that stays put.

The results are amazing. By adding a four-millionth-inch invisible film of me-

tallic fluoride—so thin it would take 4000 coats to equal a hair's breadth—camera lenses produce sharper photographs, movie projector lenses step up illumination 15 to 30 percent, spectacle lenses eliminate 80 percent of all reflections.

This, however, is only one of many improvements in optics. Better sunglasses are being made. Glare-removing visors are available for automobiles. A heat-absorbing, color-transmitting glass for projectors and floodlights improves color pictures and provides cooler working conditions for motion picture and television actors. A "sight checking machine" accurately measures factory workers' vision and establishes what jobs they are best fitted for. Advances also have been made in contact lenses that fit under a person's eyelids to take the place of glasses.

But of all the develop-



Bausch & Lomb photos
Placing optical parts on racks (above) for chemical treatment in chamber (left) which will make them reflection-free

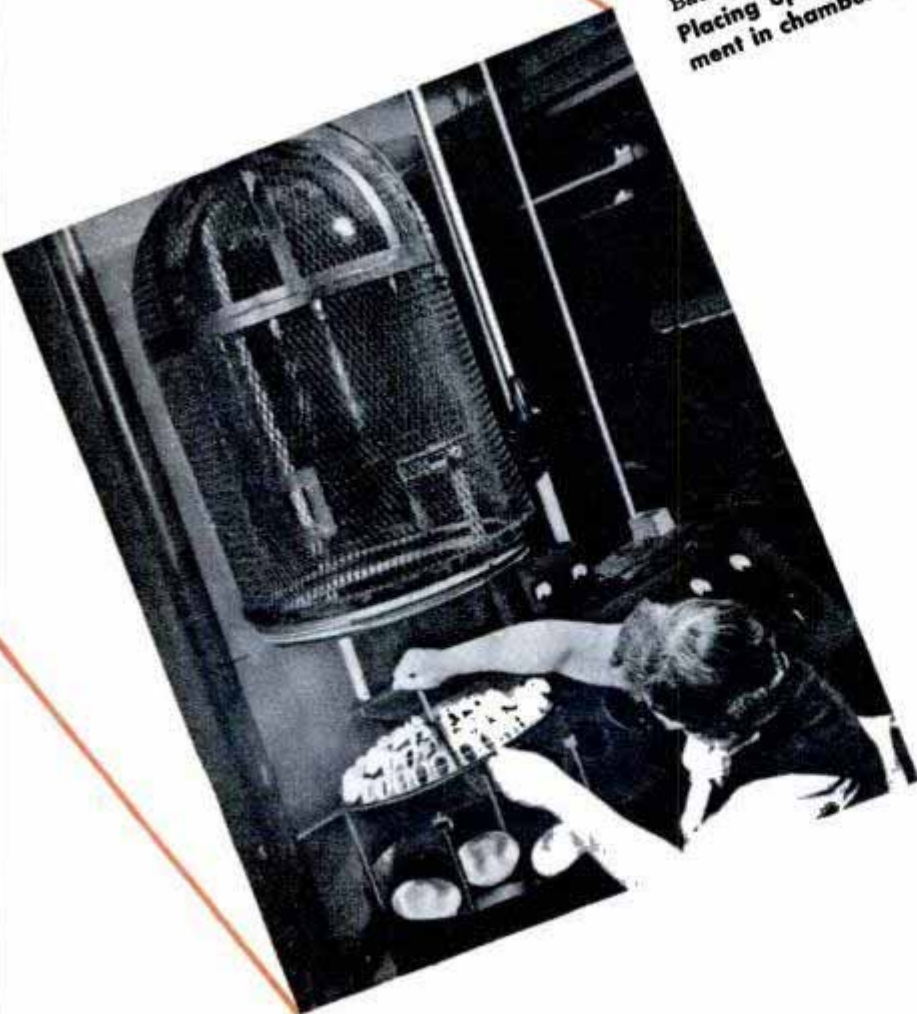

ments, the chemical coating process promises the most diversified benefits. For example, in addition to present uses, glass manufacturers predict that as soon as it is economical the reflection "killer" will be applied to auto windshields, framed pictures and windows for stores, trains, busses, cars, buildings and homes.

The history of chemical "overcoats" for lenses goes back as far as 1852 to Grove's work on cathodic sputtering of metals in a vacuum. But a more tangible step was taken in 1892 when H. Dennis Taylor, British lens designer, discovered that certain types of photographic lenses were actually "faster" when tarnished through age than when newly polished.

In 1936 John Strong of California Institute of Technology demonstrated that a coating of metallic fluoride deposited on an optical surface reduced the amount of light reflected from



From a 379-pound piece of optical glass was produced a prism for an immense telescope at Puebla, Mexico, observatory. Below, new sunglasses absorb glare and dangerous light rays

the surface and increased the transmission by that amount.

Two years later C. H. Cartwright and A. F. Turner, while doing research work at Massachusetts Institute of Technology, developed this process further, finding more materials to use and pointing out the relationship between the effectiveness and the thickness of the film.

The first commercial application of the antireflection coatings came in 1939 when the Bausch & Lomb Optical Company coated projection lenses in many movie theaters throughout the nation for the first showing of the Technicolor production, "Gone With the Wind." This application of the chemical coating to projector lenses increased "on the screen" illumination about 30 percent and at the same time heightened the image contrast to produce the "snap" for which photographers are constantly striving.

During the war great improvements were made in controlling the thickness of reflection-reducing coatings and in increasing their durability. The microscopically thin film applied to lenses today is virtually as tough as the glass itself. It is as hard but no harder than the glass, which means that both the glass and the coating are subject to scratching.

Metallic fluoride is applied to lenses in vapor form under high vacuum. After

being thoroughly cleaned in detergents, chemicals and distilled water and spun dry in a centrifuge, the lenses are placed in a specially designed jig which holds them by the edges. Then the jig is placed in an

American Optical Co. photo



evaporator from which air is pumped to create a vacuum. The metallic fluoride, heated electrically to a temperature between 2700 and 2800 degrees Fahrenheit, turns into vapor which attaches itself to the lenses.

In some parts of the country you can buy "reflection-cured" glasses for about \$4.50 above the regular price. Or you can have old glasses treated for \$6.

If you talk to someone whose glasses have this coating, you'll never have any trouble seeing his eyes clearly. Undoubtedly you've had the annoying experience of chatting with a friend whose eyes at times were almost completely obscured by reflections dancing on his glasses. If you wear coated glasses, you'll no longer be bothered by "ghost images" because the treated lenses will reduce the brightness of the reflections.

The amount of light reflected from ordinary lenses is approximately eight percent; from properly coated lenses the reflection is less than three percent.

Since only two independent lenses are involved in spectacles, the increase in light transmission that results from reflection-reducing treatment obviously is a minor thing compared to the improvement that occurs in complex optical systems equipped with six or eight lenses. In such applications, coated lenses increase light transmission by 50 percent or more.

In World War II the coating process was a valuable fighting tool. Gun sights and range finders on tanks were treated to combat desert reflections. Binoculars used aboard ships were made reflection-free. By D-day all types of military optics had been given this protection.

To improve the efficiency of aerial cameras and flyers' sun glasses, Bausch & Lomb developed a process of applying a thin coating of stainless steel to serve as a shield against intense sunlight. For cameras, the coating is deposited on a special filter glass in front of the lens. Hot spots thus are eliminated and the resulting negative has uniform density. When applied in various thicknesses to sunglasses, the stainless steel coating enables the flyer to enjoy comfortable vision while looking directly at, or just off the edge of, the sun.

As mentioned earlier, metallic fluoride treatment of lenses for movie projectors adds greatly to the clarity and illumination of objects shown on a screen. A second development has further improved projection of pictures, particularly color pictures.

A new heat-absorbing, color-transmitting glass developed by the American Optical Company makes possible not only better projection of color pictures but also cooler working conditions.

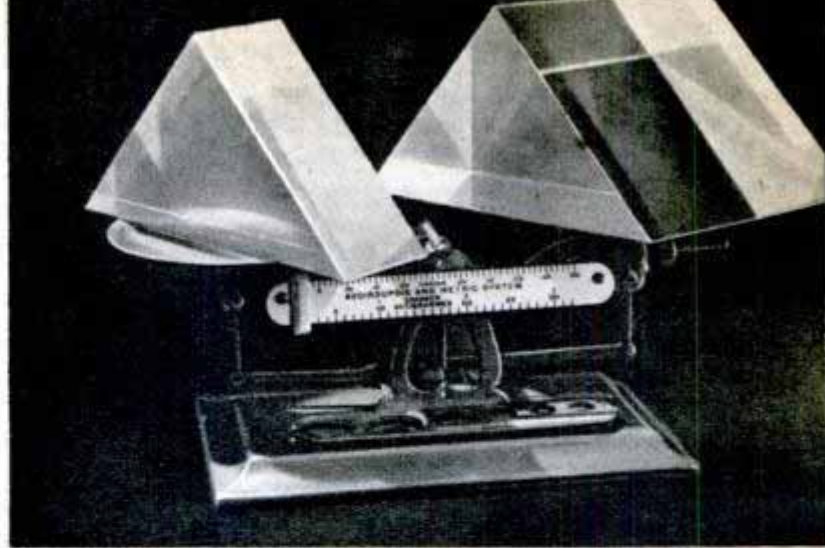

Plastic (right), weighing no more than piece of glass half its size, is used for optical elements in aircraft



Polaroid Corp. photos

Parts for some telescopes are made of plastic, as the spherical mirror (above) and the reflector below (rear). In front of the reflector is a gun-sight part



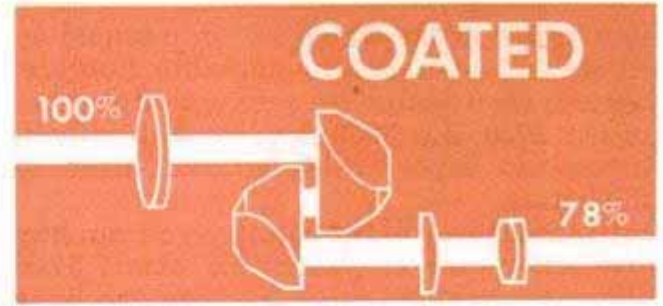
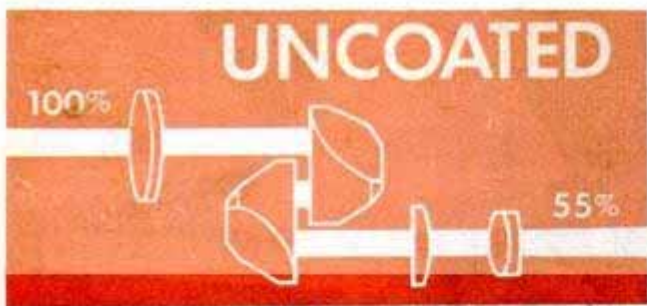

A lot of light is reflected by ordinary lenses, resulting in limited vision through spectacles and obscured photographs by some cameras. But by coating lenses with invisible metallic fluoride the amount of light lost by reflection is cut. Diagram above shows coated lenses admit 78 percent of light, uncoated only 55 percent



Photographers often blame themselves for fuzzy pictures when the trouble sometimes is a lens reflecting too much light. Look at the reflection in the lens (left) and the absence of reflection in the chemically treated lens (right). Then observe the photos below, taken by an untreated lens (left) and a coated lens (right)



When used as a heat screen in a projector, the new glass permits the projection of motion and still pictures in their original colors, with the result that pictures reproduced on the screen have the true colors of the original scene.

At the same time, the glass absorbs heat emitted by the light source, protecting films and slides against damage or burning. This insulating property enables film

editors and educators to study a specific projected scene by stopping the projector and relying on the glass to protect the film.

Another use for the glass is in spotlights and floodlights as a heat screen to protect actors against scorching heat generated by the powerful lights. Approximately 90 percent of the present almost unendurable heat is absorbed by the glass.

Dr. E. D. Tillyer, American Optical re-

search director, predicts the glass will make possible improved, safe color projection on an extended scale in homes, schools, theaters and stores. As a result of the glass, he believes projection of films, slides, printed works and color reproductions of art will become as common in schools and homes as radio broadcasts.

The new glass absorbs approximately 90 percent of infrared (heat) radiations and transmits about 85 to 90 percent of the light. It transmits colors accurately, is chemically stable, resists weathering without requiring a surface treatment, and can be molded, ground, polished and fabricated like ordinary glass. It is formed from carefully balanced proportions of phosphorus, aluminum and silicon oxides, supplemented by various conditioning ingredients, together with a ferrous compound as the heat-absorbing agent.

Before the war, most heat screens for color picture projectors were imported from Germany. Today, this new American-made glass is considered superior.

(Continued to page 228)

Left half of scene (right) was projected through improved glass; right half through ordinary glass. Below, Polaroid car visor eliminates sun glare from windshield

Film protected by heat-absorbing glass (left) withstands heat from projector, but film at right, shielded by ordinary glass, bursts into flame

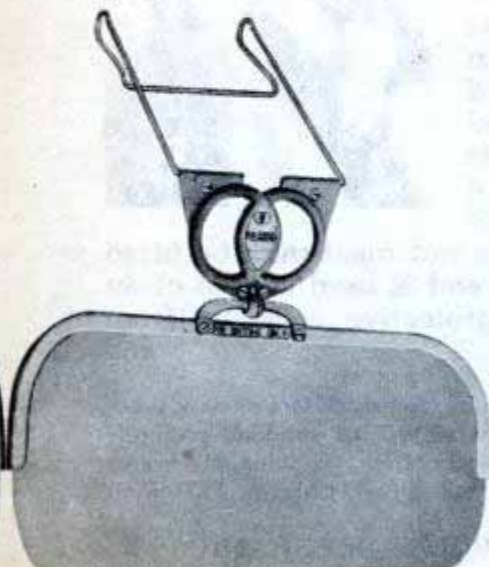
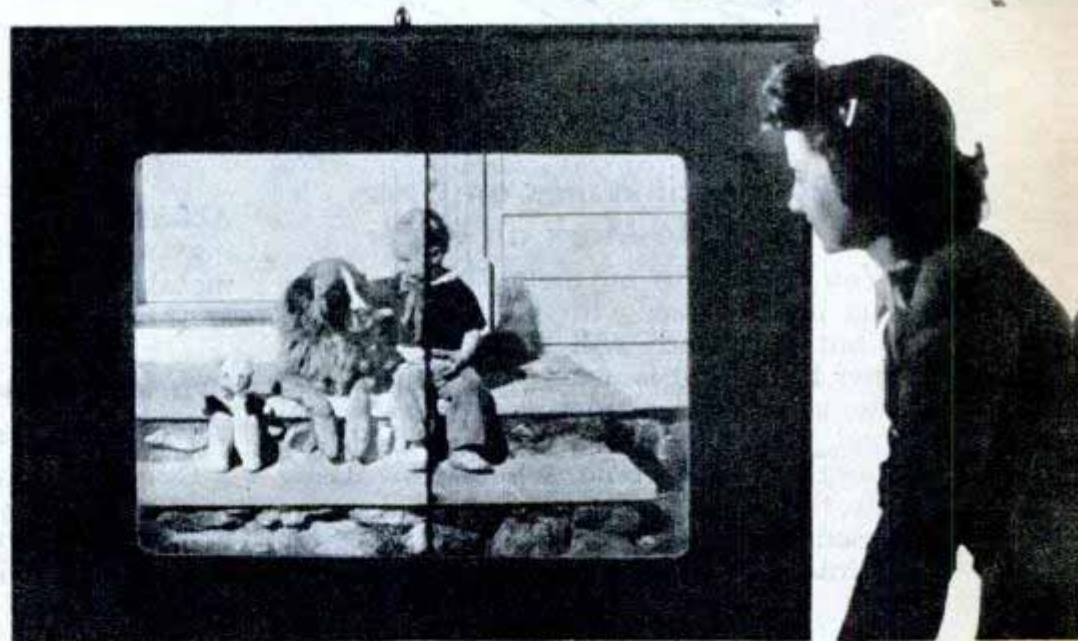
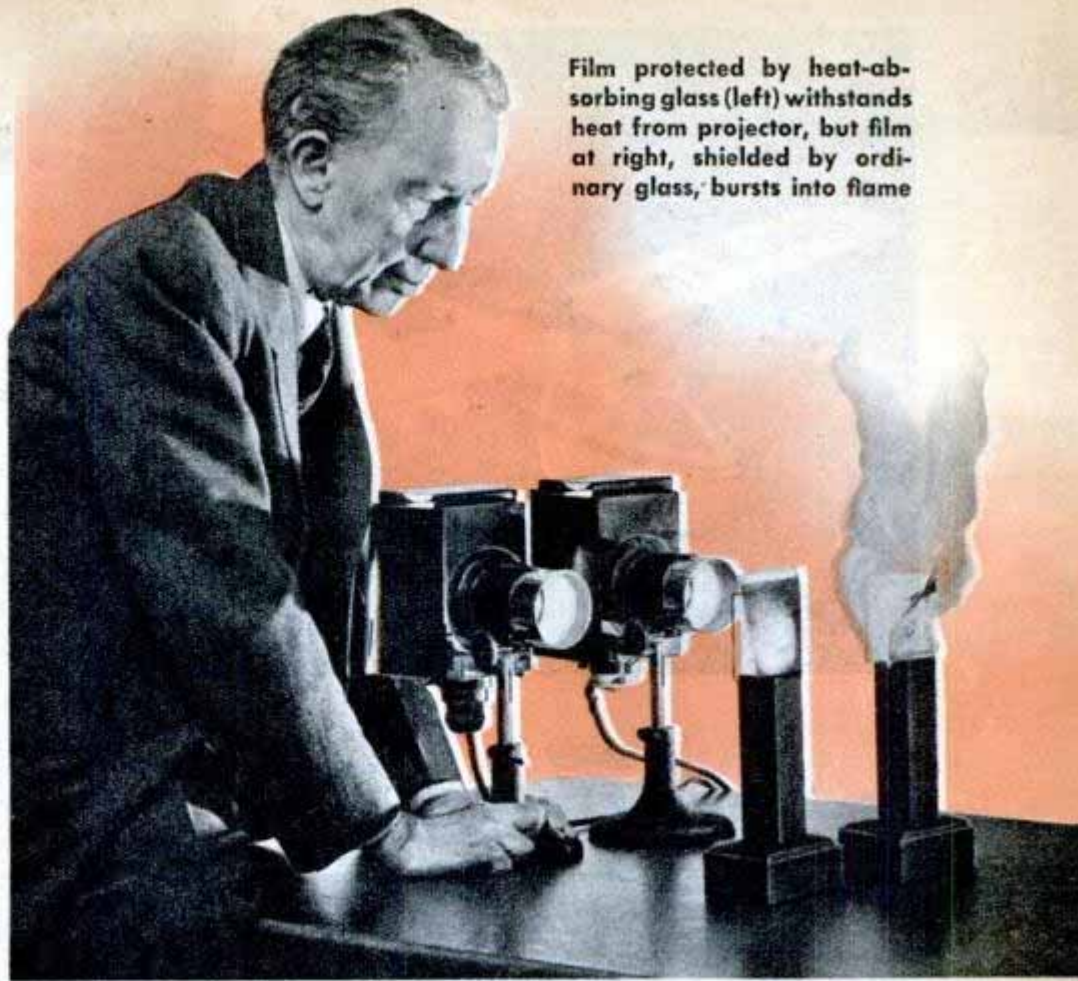



Amphibian Plane Has Large Door In Nose

Greater ground safety and less noise for passengers is claimed for a four-place Republic Seabee amphibian plane, with both propeller and engine mounted above and behind the cabin. The new model also features a full-size nose door for unloading and anchoring, or fishing from within. The landing gear wheel wells have been eliminated. Equipped with a 215-horsepower Franklin engine, it has a range of 560

miles and cruises at 103 miles an hour. About 700 feet is required for water landings and less than 400 on land. The all-metal Seabee is 28 feet long and has a wing spread of 37 feet 8 inches.



Carbide Pencil Writes on Glass But Leaves No Mark on Paper

You can write on metal, glass or any other hard surface with an automatic pencil but the "lead" will leave no mark on paper because it is made of cemented carbide, a material almost as hard as a diamond. The Carboloy "lead" is made by squeezing the carbide, while in a plastic state, through a die. A silicon carbide stone is used to sharpen the point because it will cut into a grinding wheel or metal file.



Cracker Removes Nut From Shell Without Crushing Meat

Cracker and sheller are combined in a nut-cracker constructed like a pair of pliers to avoid crushing the nut meat. The nut is cracked between the heavy arms of the cracker and the bladed end is used to cut the shell around the center so that the nut meat may be lifted out. The bladed end is used also to clean the thin inner protective covering from the meat.



Names and addresses of manufacturers of new products featured in this issue will be supplied promptly by the Bureau of Information, Popular Mechanics Magazine, 200 E. Ontario Street, Chicago 11, Illinois



GRASS TRIMMER for tufts missed by mower operates by pushing down handle

WEEDER with a tooth that bites down into the plant easily removes weed roots



GARDEN TOOL HOLDER saves space and keeps tools conveniently at hand. It stores five tools or can be used to hold brooms, brushes and mops

HOSE NOZZLE regulates the flow of water by the way it is held. A short length of hose which contains a long pin is provided with the nozzle. When the hose is bent, the pin pushes against the inner wall to open the valve and permit passage of water

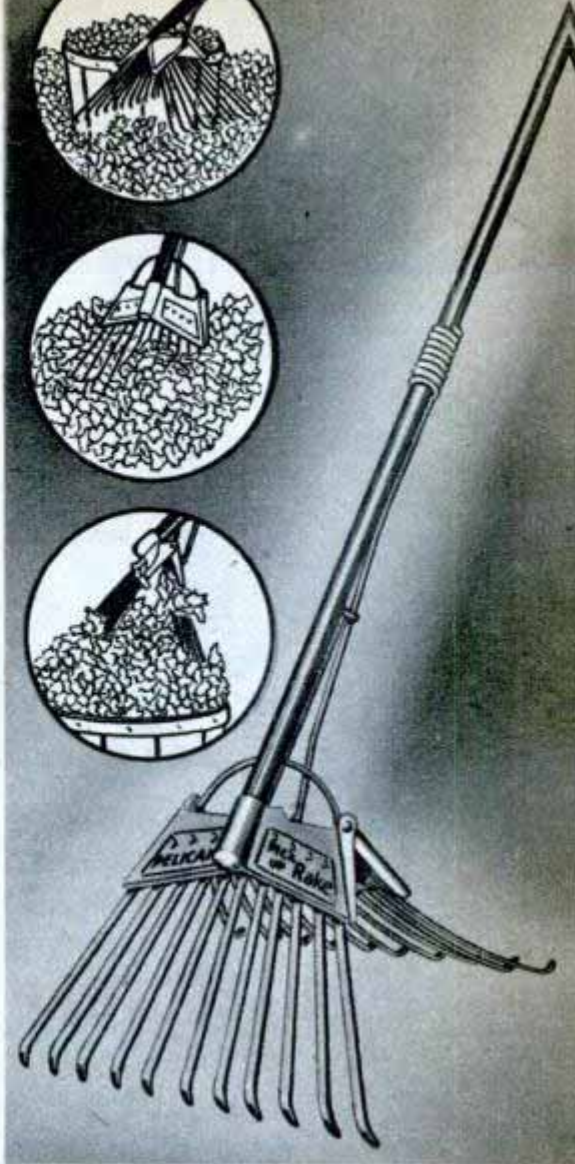

PICKUP RAKE has teeth that open wide to gather leaves, clamp down on them, then release over basket

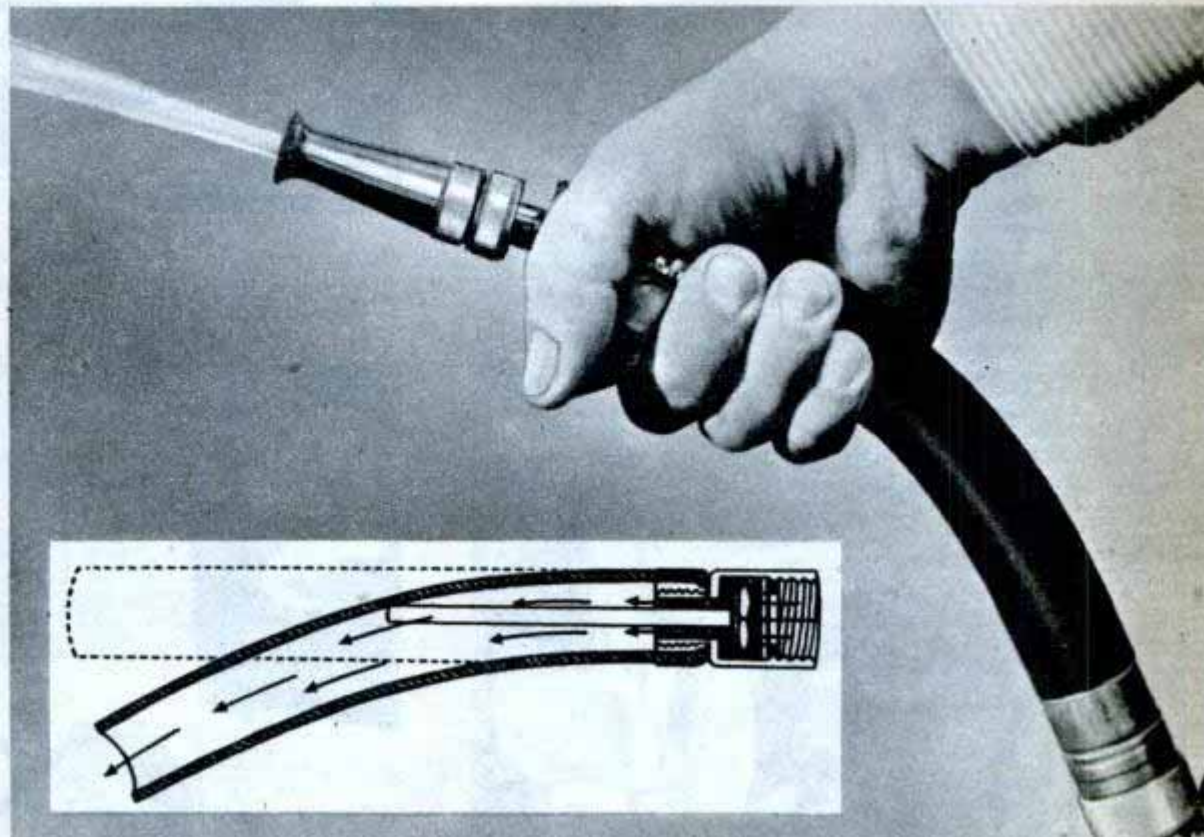



After sandpapering, Mayor Kimbrough polishes the horns on an electric buffer, above

Mantelpiece Longhorns

In Benson, Ariz., Mayor Val Kimbrough continues an old western custom of polishing and mounting steer horns. The horns he uses were taken years ago from Texas longhorns which once roamed western cattle ranges. A good sized pair may span six feet. Modern cowboys still like to hang them over either the entrance or mantel of many of their bunkhouses.

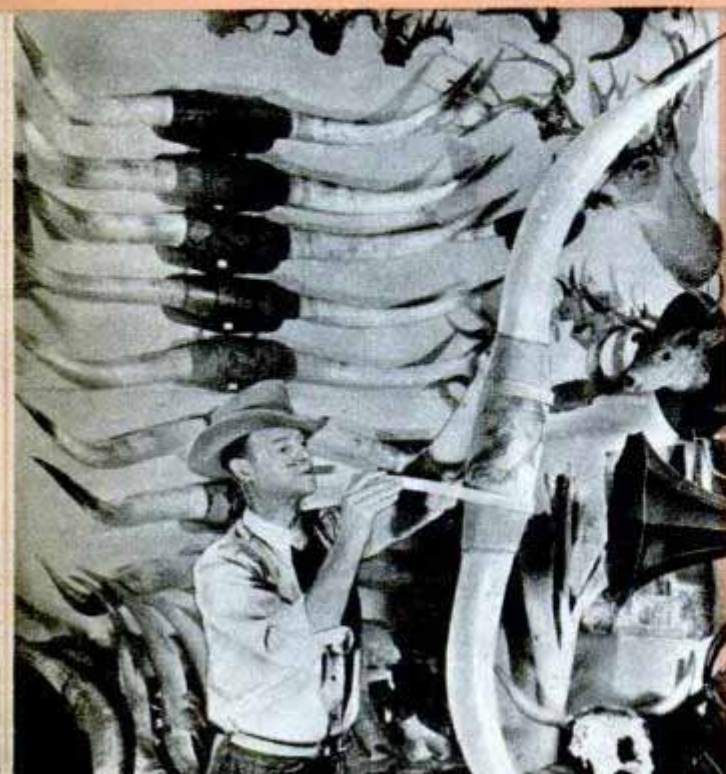

First step is to scrape the weather-beaten surface and uncover the delicate black and white pattern near the tip of the horn



Holes are drilled and the horn attached to a wood core, above, cut the breadth of a steer head. Hand-tooled leather covers the core, below. He adds final decorative leather strips, left



TREE FARMS

Restore an Empire

By Charles F. A. Mann

AMERICAN farmers are cultivating a crop as vital to our life as wheat and corn from the plains of the Middle West, as essential to the national economy as coal and iron from the nation's mines. They are turning to the serious business of growing trees as a crop—like corn or wheat.

Modern pioneer farmers are looking beyond their own lives. There will be no harvest of the tree crop, even a preliminary one, for 15 or 20 years. And

Loggers spare sturdy seed pines to perpetuate the forest. Below, a husky youth totes seedlings to the planting area



St. Paul and Tacoma
Lumber Co. photo

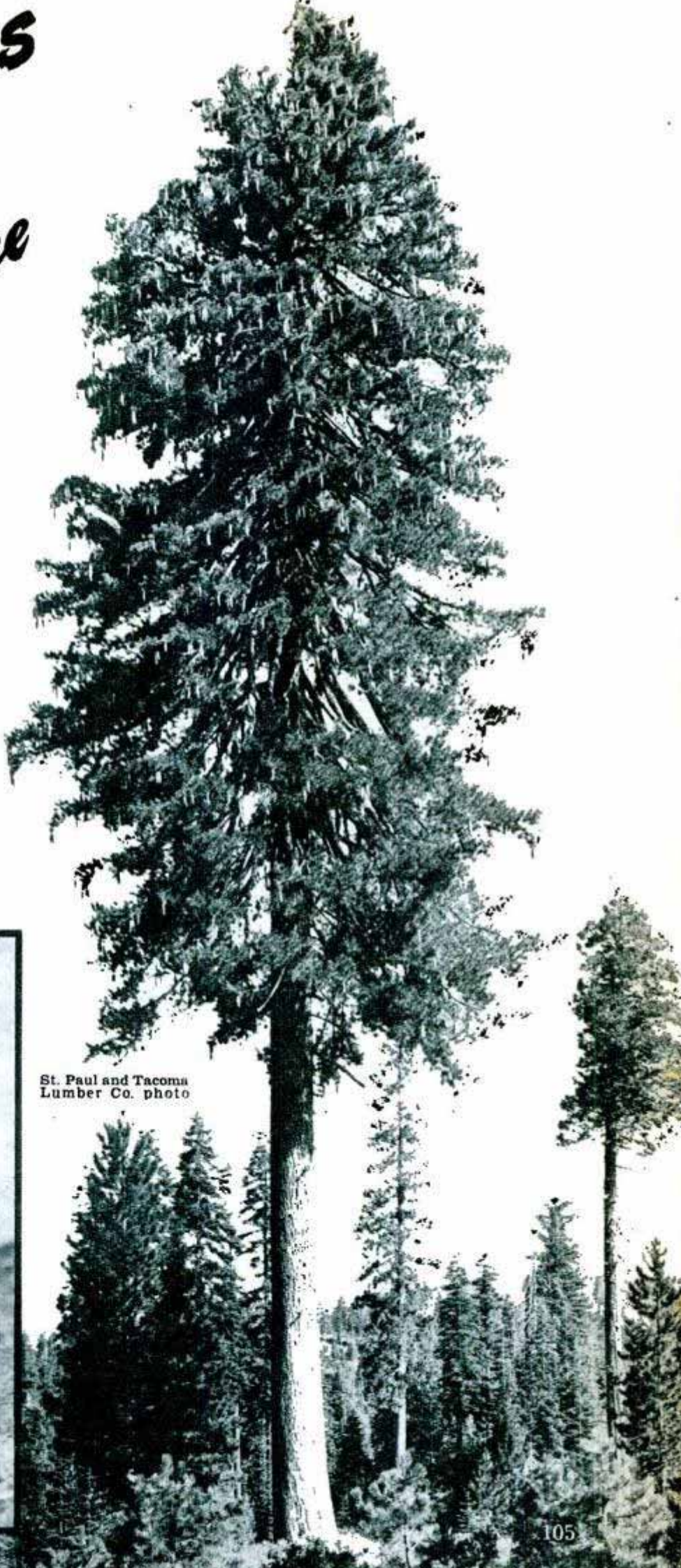



↑ A young planter examines delicate root system of a two-year-old seedling
↓ Planting crew works on exposed knoll that has been burned over repeatedly
K. S. Brown photos



the farmer's grandson likely will cut the full crop when it matures—about 80 years from now. The farming of trees requires business vision measured in decades, courage to work in forest fields now in anticipation of a heavy yield a couple of lifetimes later.

Tree farming has evolved as slowly as the growth of its wonderful crop. Before 1900 vast forests stretched across the United States in an unlimited sweep from Maine to Washington and through the South from the Potomac to the Mississippi. Trees were an obstacle to agricultural expansion. Lumber was cheap and apparently inexhaustible. America was housed by wood, the houses were heated by wood, and even cities with their miles of brick exteriors were built of sturdy wood construction beneath the brick. It was the material of furniture and bridges, toothpicks and telegraph poles.

Then came the realization that the nation was digging too deeply into its storehouse of timber, that the old forests were disappearing. The era of iron and steel did little to cut down the waste of the nation's lumber. American industry ate into the iron and steel supply—and demanded still more wood. The storehouse was becoming barren in spots and little was being done to turn the wastelands into crop lands where trees could grow to replenish the nation's timber. Lumber had been cut to the shores of Puget Sound, last stand



Chet Ullin photo

Here in the rolling foothills of mighty Mt. Rainier are four examples of what tree farming can do. The foreground is a logged-off section that has been restocked by seed trees. The middle is an area recently planted by hand, the upper middle a logged-off strip, and on the distant foothills is a stand of old-growth fir

of the mightiest softwood forest known on earth, the fir belt of the Northwest.

In 1903 the late George S. Long, Weyerhaeuser Timber Company's fabled manager, sensed that America might some day be lumber-poor. He decided that huge areas of the Douglas-fir forest in western Washington would be far more useful if the old overripe sections were carefully cleared. He was convinced that with proper slash burning and spacing of seed trees an even heavier crop of new trees could be grown. So he began developing huge areas of hillside land, most of it unfit for anything but trees, into workable blocks lying above the river valleys.

A campaign was inaugurated to tell the public the disastrous effects of over-taxation and the "cut-and-get-out" theory that had made parts of America's original forest an unproductive waste. In those days the new theory was called "conserva-

tion." Later it became "reforestation" and after the first World War it was "sustained yield" or "selective logging"—catchwords that slowly caught the imagination of the American people.

Pine grows rapidly in the South, land is cheap and so are the taxes. It was there that tree farming by individuals started. Then in 1934 the state of Washington noticed the movement. The government realized at long last that its real-estate tax policies had forced hundreds of small loggers and sawmills to redouble their reckless cutting. Rough lumber or "Japanese squares" (logs with but four slabs of bark

This stand of seed-bearing timber was left purposely on the knoll to reseed the logged-off land





Cultivating the seedlings is a delicate job. Trees from this plot are destined for areas where fire has destroyed seed stands

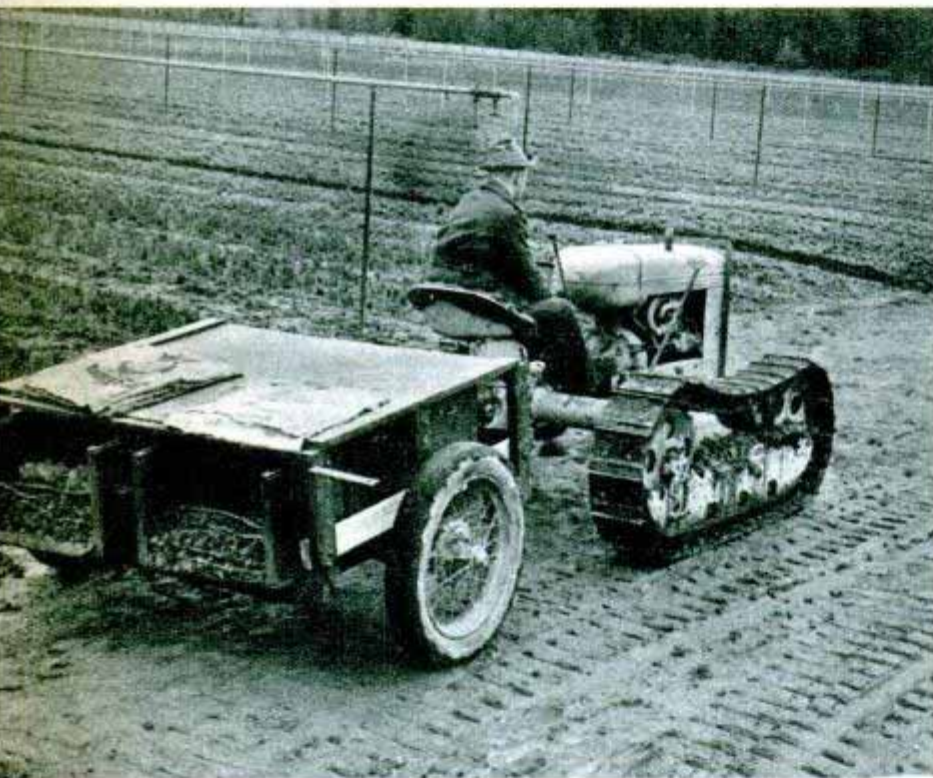

↑ Tomorrow's trees are hauled from the nursery. The sprinkler system is turned on during the dry season in July and August
↓ High school girls riding "weed buggies" keep the plots clean



removed, leaving a square to fit the hold of a ship) were being dumped at ruinously low prices on the world export market. The state, seeing its basic wealth float away in exports, decided to revamp its policies.

Washington passed a law that became a model for the nation—the Reforestation Act of 1934. The law gave a concrete incentive to any honest logger who wanted to keep his logged-off lands in production. The stimulant came in the form of low taxes—\$1 per acre—and a harvest or crop tax of 12½ percent only when the timber is cut, 50 to 100 years from now.

Immediately thousands of acres of logged-off lands went back on the tax rolls. Markers were erected throughout the state. Fire roads built by private companies penetrated hundreds of miles of young forests to connect with national or state forest service roads.

In the 12 years that have followed, over half of the logged-off lands, the wastelands of Washington, were put to work again. Sturdy Douglas firs, a new generation, climbed skyward from 12 to 30 inches each year.

The first actual farm, the great Clemons Tree Farm near Montesano, Wash., was born in 1940. The Weyerhaeuser Timber Company owns 65 percent of the farm. School districts, the state and individuals own the rest. The farm's 130,000 acres blanket a rich rolling hill country near the Chehalis River valley.

But the movement is not confined to large lumber companies. In Snohomish County, Washington, a dozen ranchers with a few acres of land behind their pastures, ideal for a tree crop but worthless for conventional farming, are now "Registered Tree Farmers." Eighty of these small operators have banded together to form the Washington Forest Products Cooperative Association. They plan to cultivate and market their crop of trees just as the cops handle dairy products.

All that was needed to convince the nation that trees can be made to grow like corn, that the annual yield per acre can be reckoned in dollars in the bank, was the magic of the name "tree farm." It has stimulated public interest in the

movement far more than any other factor.

In the short space of three years 10,690,000 acres of American forest land have been registered as American Tree Farms. More than 800 owners in 12 states have gone into the business of growing trees as a commercial crop. Each owner contracts to maintain a specified area for growing trees. He must provide roads and fire protection, prevent damage from disease and insects and cut or harvest the crop to maintain continuous forest growth. These foresters no longer relentlessly seek newer and bigger stands of old-growth timber. They have become farmers instead of loggers.

There are 461,000,000 acres of commercial forest land in the United States. Private industry owns about 202,000,000. Nearly half is in sound private forest management.

In the prolific Douglas-fir belt of western Oregon and Washington about 2,100,000 acres are now included in tree farms. There are 32 industrial forests and 17 small tree farms of about 120 acres each. The average annual production from cautious cutting is 600 to 700 board feet per acre.

There are 52 registered tree farms totaling 2,112,000 acres in the western pine belt that covers a vast area in 11 western states. All these farms are operated on a selective logging basis—only the mature trees are harvested.

But only a relatively small percentage of the nation's timber now grows on tree farms. The movement is young and great areas of forests are still being slashed away on the "cut-and-get-out" theory. Add to this the tremendous drain of the war on the gross visible lumber supply. Then include the vast cuttings made necessary by the housing shortage and the essential commercial building that was dammed up during the war. The total drain paints a sobering picture. Tree farms and a more intelligent harvest of timber by big operators are the only factors that can salvage our lumber reserves.

Although the American tree farms idea jelled only six years ago, it has spread like a forest fire



↑ Despite his age this lad is an expert at "heeling in" a seedling with the aid of a mattock. He plants about 540 trees each day

↓ Second stand of western hemlock and Sitka spruce dwarfs the stumps of the old harvest. These trees are about 50 years old
Stan Spiegle photo





↑ With modern logging practices this heavy forest of Douglas fir will reseed itself naturally and produce a perpetual lumber harvest
 ↓ Seedlings are sorted and packed at a nursery for shipment to a burned-over area. Roots must be kept moist or the plants will die



across the nation. Farm sizes range from 22 acres of Christmas trees near Kalispell, Mont., to the huge industrial tree farm at Klamath Falls, Ore., and a spreading Texas farm that covers nearly 700,000 acres.

Three organizations, the West Coast Lumbermen's Association, the Western Pine Association and the Pacific Northwest Loggers' Association, certify the farms and encourage the owners. Public dedications of new farms are impressive. West Coast schools and colleges are teaching the need for stewardship on the part of every citizen if the program is to be a success.

In the Great Lakes region and the South, tree farming by paper mill operators is a pronounced success even though the rate of growth varies widely. Many operators started too late to make their crop equal their annual consumption—but at least they have started.

Huge new areas now classified as logged-off lands soon will be embraced in the scientific plan. Farmers have distributed literature, exchanged ideas and tabulated statistics. Thousands of individuals are trained in forest-fire fighting. Sportsmen's groups learn the value of fire prevention. The public is being taught the folly of over-taxation and wasted forests. There is a personal interest in fire prevention in our wooded areas.

The end-objective of all tree farms is to grow annually an amount of timber that at least equals the total demands of industry. That objective is expected to be reached in about 15 years.

Tree farming, plus the exploitation of timber formerly considered worthless and the elimination of all waste, will give America an adequate annual supply of timber. No one doubts that tree farming will pay off as a business venture. In 15 years the timber harvest will be worth three times per acre the value of a cotton crop.

Harvesting that mythical crop of "second-growth forest"—the former name for "junior

forest"—has been going on for years. Half the paper, probably this very page, and a lot of pretty fair lumber on the market right now, comes from trees that were seedlings at the time of the gold rush to Alaska in 1899.

Let's visit a typical tree farm where both old and new-growth trees are systematically harvested. Some of the great-grandchildren of the lads in the accompanying photographs may visit the full-grown forest on the farm 100 years from now!

The vast farm of the St. Paul and Tacoma Lumber Company is an example. The company began cutting down trees in the heart of what is now the Allenmore Golf Course in the center of Tacoma, Wash., in 1888. It still is the largest of the "independents" of western Washington and with one possible exception the oldest. Through wise management and foresight the company has some second-growth timber from 50 to 125 feet high which will reach maturity in another 20 years. The farm spreads over some 200,000 acres at the foot of Mt. Rainier between the White River and Nisqually River watersheds. This wild foothill country can be reached by car in 50 minutes from downtown Seattle or Tacoma. Sons and grandsons of workmen who came to the coast in 1888 to work for the company still work and live on the farm.

Goal of the farm's operations is eventually to grow from 125 to 150 million feet of fir annually to balance the company's anticipated cutting. Odd tracts purchased at random are being consolidated with Northern Pacific land grants so they can be managed as an integrated unit.

Roads honeycomb the forests, largely rebuilt from railroad grades that were slashed through the timber. Snags and leftovers have been cut and burned. Some areas where the war rush for high timber left a lot of excellent wood on the ground that was later swept by fire are being relogged for salvage. Gates and markers have been constructed. The company has mapped and indexed all sections as to slope, soil, moisture, wind conditions and other vital factors. Seed blocks—groups of seed trees on high ground spared by the logger—reseed 90 percent of the ground naturally. The other 10 percent, mostly high knolls and hillside areas swept by repeated fires, poses a problem. These sections must be replanted by hand and carefully watched until the young trees cover

AUGUST 1946



Speed is essential in fighting forest fires. These back-pumps fight small blazes in virtually inaccessible places
American Forest Products Industries photos



↑ Standing guard over his second-growth forest, this tree farmer has a tank truck as insurance against fire damage

↓ Fire-control plans contemplate extinguishing small fires with water before they grow to a sweeping curtain of flame





Western Pine Association photo.

Pine grows fast to make tree farming profitable. One year's growth is shown above the hand of this logging superintendent

the ground with their spreading branches to keep the sun from drying out the thin topsoil. The company has had a forester at work on this problem for 20 years.

In areas where natural restocking has been a success, 12 to 30-inch trees are growing, 38 years after the original logging.

The company organized a planting system in 1944 that attracted boys from nearby high schools. They work in groups, 10 or 15 youths to a crew, under a trained foreman. The system has become a model for all other tree farmers and is receiving enthusiastic support from teachers and parents. The U. S. Forest Service can find nothing wrong with the plan.

Seedlings for planting come from a nursery that draws its seed from healthy 16-year-old trees carefully selected as to altitude. Trees that will be grown near sea level must come from sea-level parents, while those destined for the top of a 4500-foot mountain come from an equally high peak. One pound of Douglas-fir seed will produce 30,000 seedlings.

The West Coast Lumbermen's Association tree nursery at Nisqually grows the seedlings. High school girls operating specially designed "weed buggies" do most of the weeding and cultivation. Seedlings are packed 50 to a bundle in moist moss and wrapped in heavy oiled

(Continued to page 240)

Fire swept across this ridge years ago, leaving in its wake only a fringe of timber on the top. From these few trees came all the seeds that reforested the thick slopes. Note the skeleton trunks left by the fire





Jeep "Retriever" Chases Golf Balls

Protected by an enveloping wire netting, an Army jeep has been converted for use in peacetime sports at Camp Hood, Tex. It is used to retrieve golf balls on a driving range. The screens protect the jeep driver and make it unnecessary for golfers to stop practicing while the balls are collected.



Midget Fire Fighter for the Home

Small fires such as might start in a wastebasket can be stopped quickly with a small extinguisher which is nine inches long and weighs only 10 ounces. Its fire quenching chemicals are contained under 90 pounds pressure. It is simple to operate and its charge can be released by turning a hand screw at one end. About eight small fires can be extinguished before refilling.

Radiant Energy Roasts Coffee

You may get your coffee fresh-roasted at the corner grocery store while you wait. Radiant energy produced by radio waves, already used to cook hamburgers and hot dogs in coin operated vending machines, will roast coffee completely and uniformly in just two minutes in an electronic roaster devised by August S. Torres of Medellin, Colombia, South America. The ordinary roasting process takes about 15 minutes.



Car-Top Bag Stores Extra Luggage

Extra luggage space for vacation-bent travelers is provided in a new luggage carrier that is attached to the top of the car. The carrier is a waterproof, dustproof canvas bag that closes with a slide fastener along one side. It can be fastened easily to any size coach or sedan and will not mar the finish of the car, according to the manufacturer. When not in use, the bag can be removed and packed into a small box.

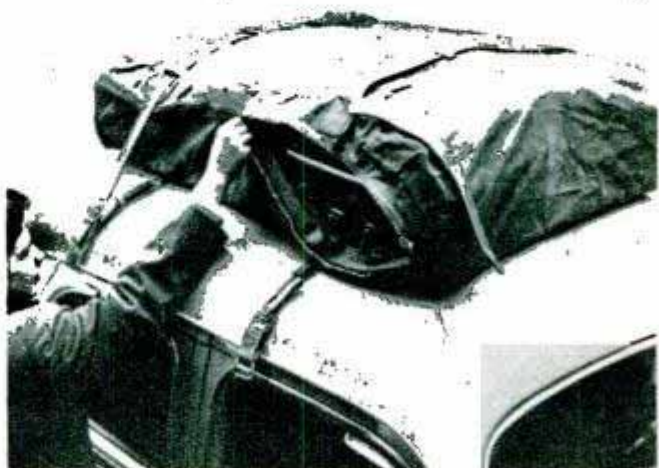

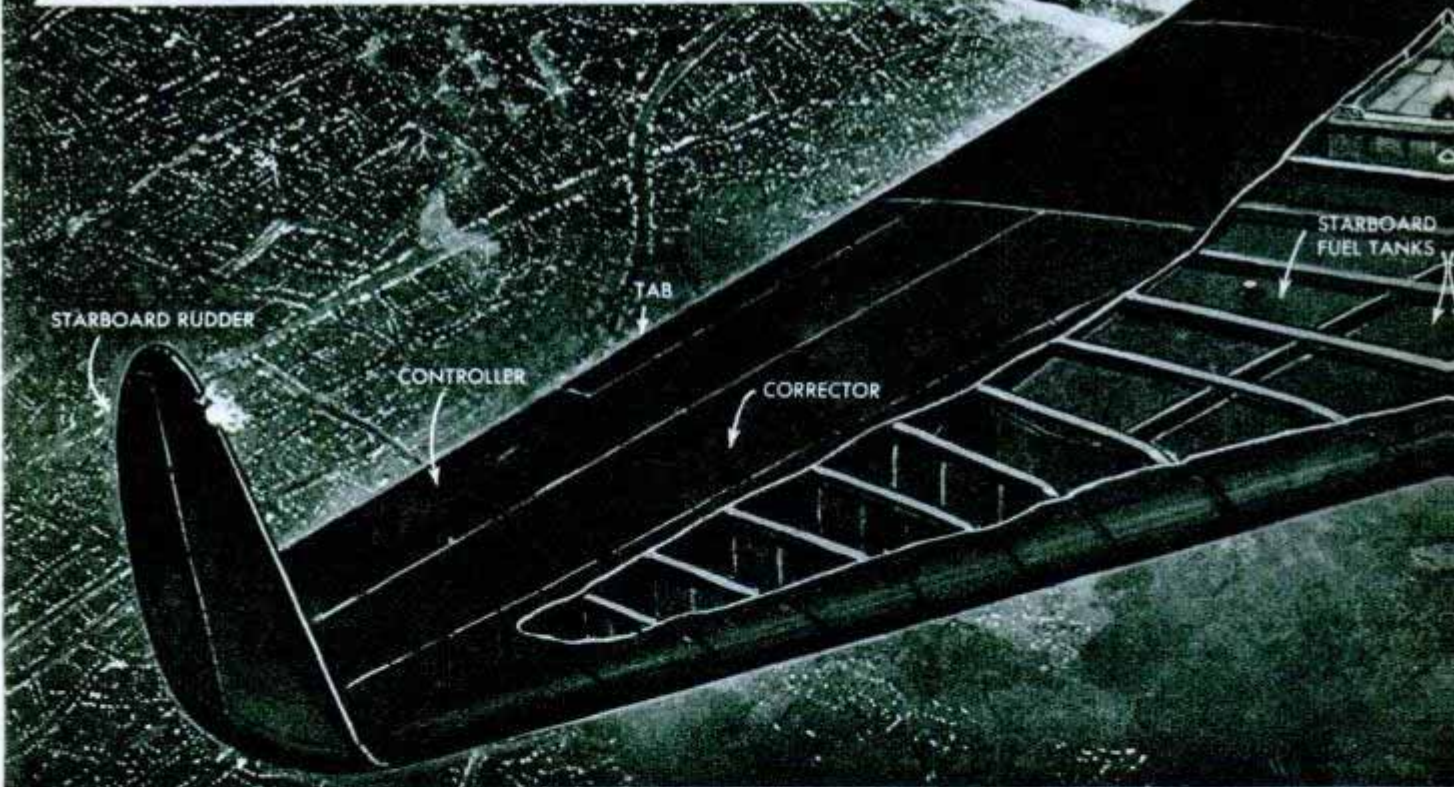
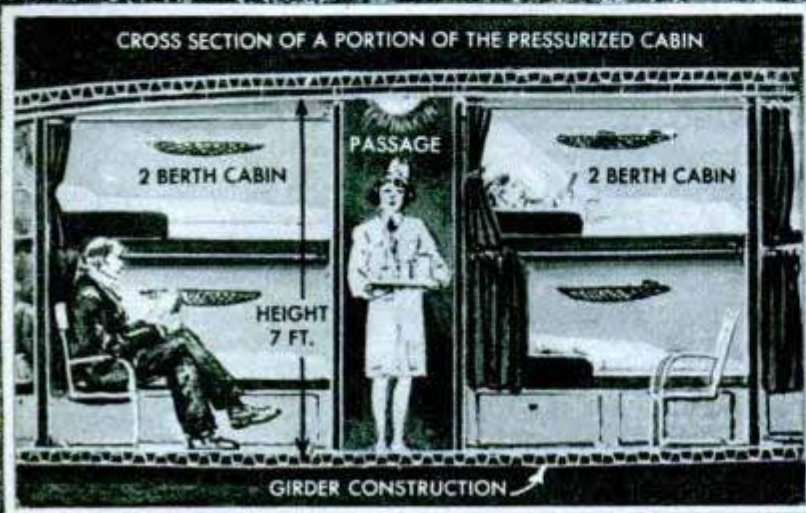
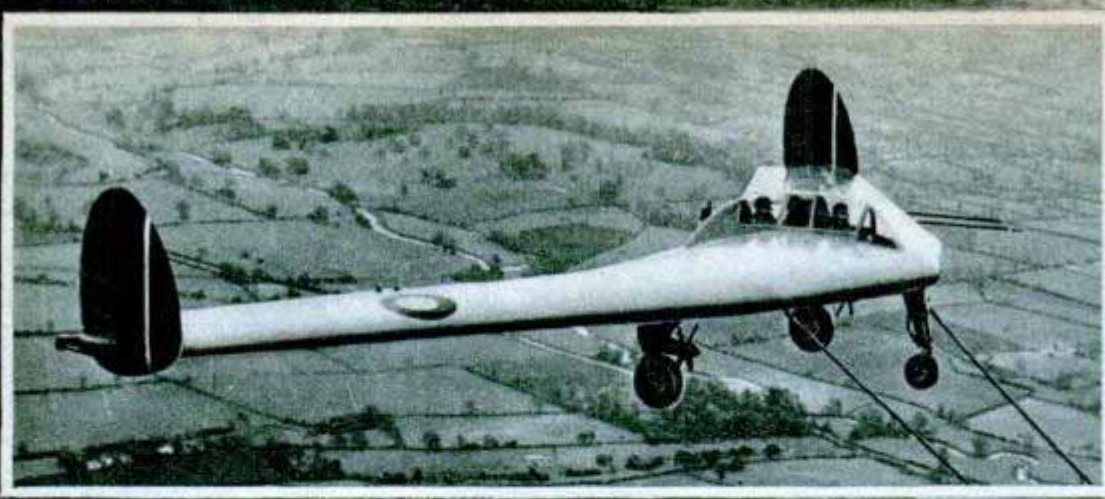

Transatlantic Flying Wing

PASSENGERS who want to drop off to sleep in their berths in England and awoken in America the next morning may soon flash across the Atlantic in a British-designed flying wing. The huge V-shaped

plane will be jet-propelled and will carry from 24 to 28 passengers, part of a pay load of 29,000 pounds. Top speed will be more than 400 miles an hour. Both the cabin and the cargo compartments will be pressur-

Push-Button Bed Provides Self-Nursing Service for Hospital Patients

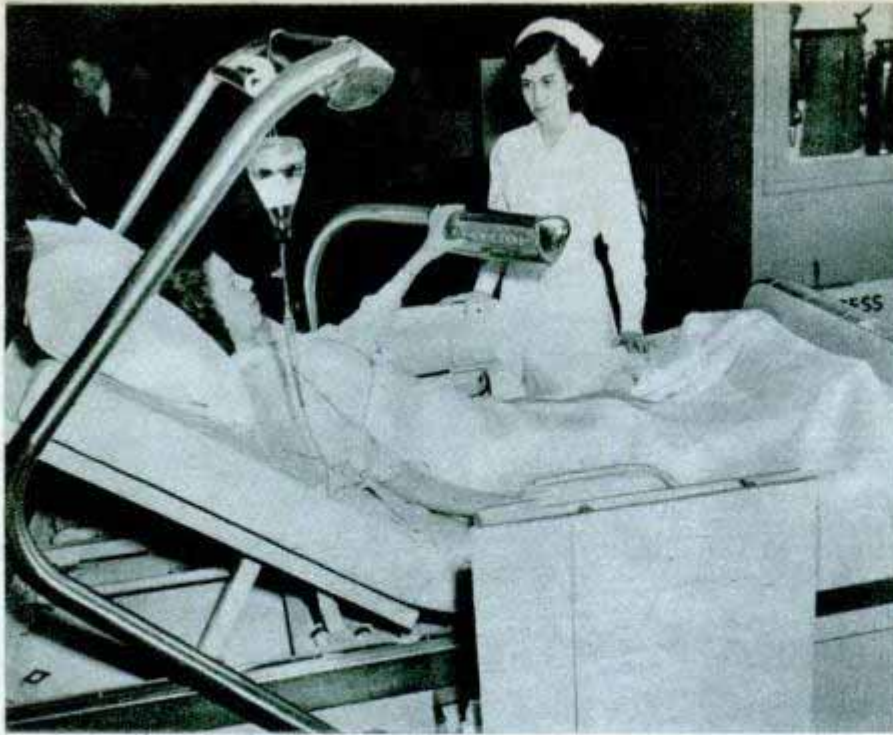

If a hospital patient has the use of his arms, he can accomplish most routine nursing duties for himself with a push-button-controlled self-service bed. One set of push-button controls is located on an arm extending over the bed. By pushing them the patient can raise or lower the head of the bed, adjust the overhead trapeze bar and its ultraviolet lamp or raise or lower the built-in toilet and wash basin. A second control board at the foot of the bed can be operated by the nurse. The bed was invented by Dr. Marvel Beem of Los Angeles.

Adhesive Edges Hold "Sweat Shirts" Around Perspiring Water Pipes

Condensation of vapor on exposed cold water pipes, which causes them to sweat and drip during humid weather, can be stopped by covering them with an insulating jacket held to the pipe by adhesive edges. The blanket of thick, pliable insulating material has a moisture-proof outer backing which is a positive vapor barrier. It can be cut to fit with a pair of scissors.

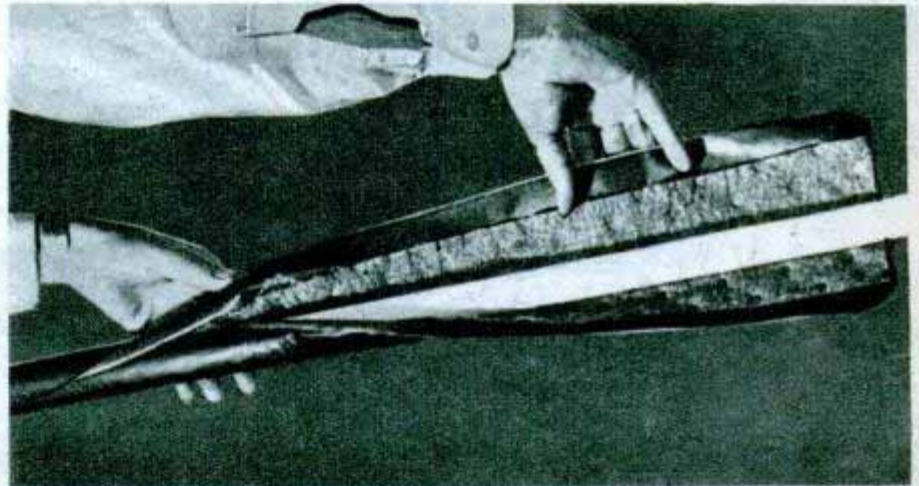

Houses Built of Aircraft Scrap Metal Ease Shortage in England



Four British aircraft companies are answering the challenge of England's housing shortage with aluminum homes. The plants convert scrap aluminum, much of it from crashed warplanes, into bungalows at the rate of one every three minutes. Each house is built in three prefabricated sections and it can be erected in only 45 minutes after its delivery at the homesite. The kitchen includes aluminum built-in cupboards, a modern gas range and a boiler for washing.

Putting EARTH WAVES to Work

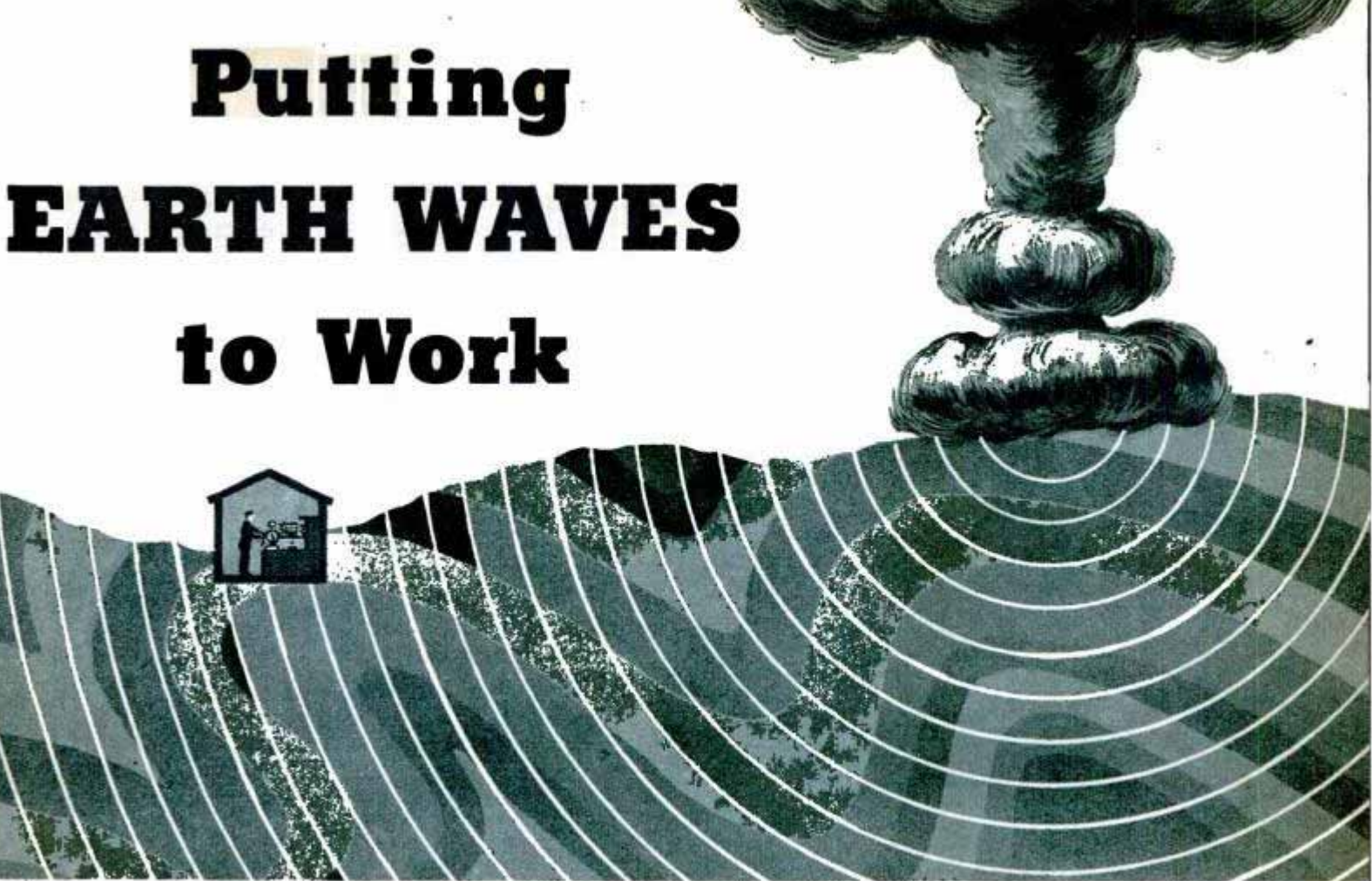

Artist's sketch of atom-bomb tests in New Mexico interprets findings of seismological observatory (left). Downward concussion of bomb created earth waves (white circular lines). Wavy patterns represent rock strata

By Nathaniel Nitkin

THE JULY 6, 1945, test in Jordana del Muerto, New Mexico, accomplished more than to introduce the atom bomb. It provided seismologists—students of earth movements—with a controlled laboratory to test their theories of earth waves. Many old ideas went overboard. The results led to the discovery that earth waves come in two types: coupled waves which were predicted in 1939 by Dr. L. Don Leet of Harvard University, and hydrodynamic waves.

Whenever there is a disturbance on or below the earth's crust such as an earthquake, hurricane or explosion of dynamite, energy generates earth waves. They rush through the earth's strata at terrific speed, often following the warped contours of bedrock. Seismographs at scattered stations record these tremors. There is always a time interval between arrival of pre-

liminary and main waves at the seismograph. However, the first and second waves are sometimes reflected and refracted so that they are superimposed on the graph before the main waves arrive. Using a precision device to time incoming waves, scientists can locate the center of disturbance as accurately as radar.

Here lies a way of harnessing earth

Removing seismograph record bearing wavy lines tracing big and little quakes

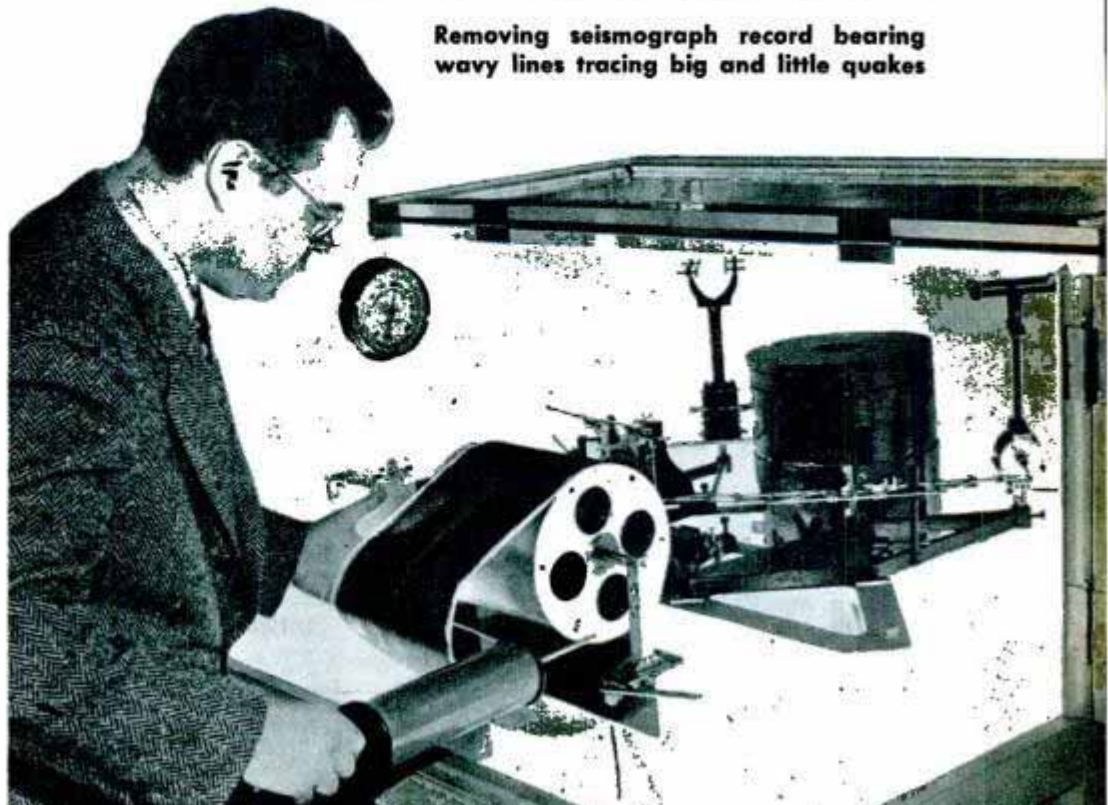

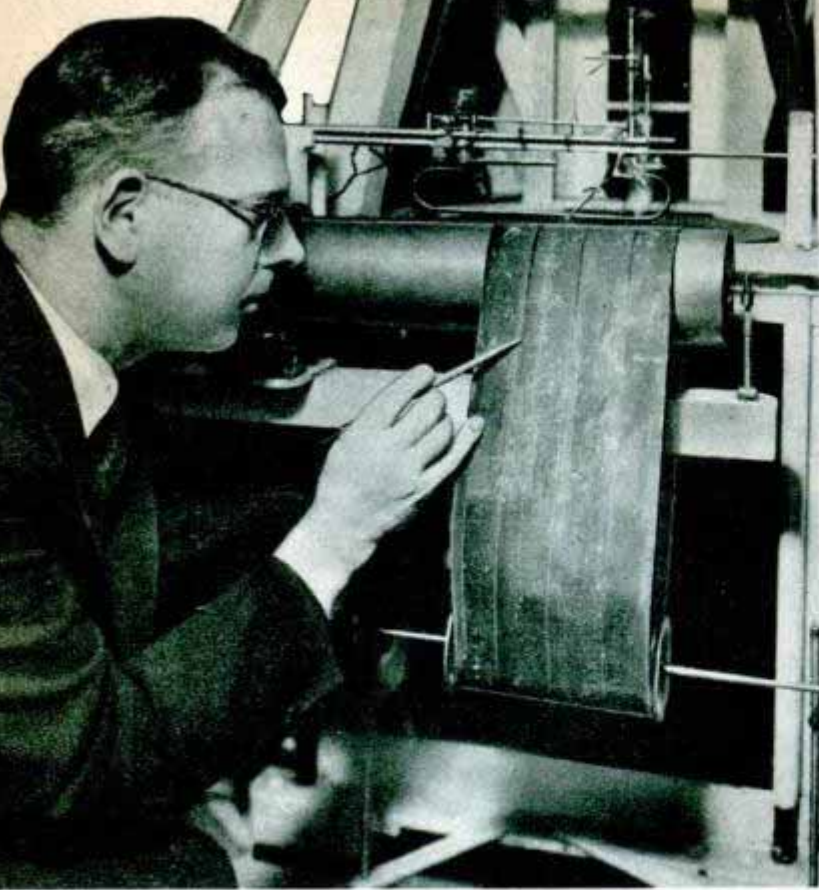

American Museum of Natural History photo
Zigzag lines recorded during ocean bed earthquake
in 1934 were similar to graph of April tidal wave

waves, just as we have utilized electromagnetic waves in radio and other electronic instruments. Major earth waves are not necessary. Microseisms—small waves—will do just as well.

For instance, a hurricane originates off the Cape Verde coast of equatorial Africa. As the storm moves and gathers strength, it transmutes some of its violent energy into earth waves which race through the ocean floor to seismological stations. Man learns of the hurricane when it is still 1000 miles away and he traces its course. By the time the storm hits shipping lanes or inhabited areas, he is prepared for it.

Perhaps a better knowledge of coupled and hydrodynamic waves might have forewarned Hawaii and the west coast before the April 1946 tidal waves hit them. As a matter of fact, the U. S. Coast and Geodetic Survey had an advance warning of the sub-

marine earthquake in the Aleutian deep but it could not predict such destructive tidal waves accurately.

Hurricane warning is not the only possible use of microseisms. Geologists use portable seismographs in prospecting for oil and minerals. A few miles away a scouting party detonates dynamite, creating little waves. Since the geological structure and composition of rocks write their own record on the seismograph, the scientific prospectors know at once whether they struck a mother lode or a dud. In the same way, bedrock can be mapped for whatever engineering structure is planned for a site.

Little is known about earth waves, since most of our knowledge has come through the study of earthquakes. Though there are more than 10,000 minor earthquakes per year, they are bad subjects for scientific research since they cannot be controlled. The New Mexico atom-bomb test was the most important laboratory experiment in this field. Previously, controlled tests were confined to rock quarry blasts.

A seismological observatory looks like a small one-car garage. The basement houses the recording instruments. In a larger station like the Harvard University Oak Ridge, there is a lower level for the sensitive parts of the seismographs. They rest on a concrete pier anchored to bedrock. The pier is insulated from the building so that the house vibrations do not affect it. Observatory walls and roof are banked and insulated so that atmospheric conditions do not affect the instruments.

Since earth waves are mostly directional, the standard station has seismographs arranged at right angles to each other. In this manner, no tremor passes the station without etching its record on the graphs.

The principle of the seismograph is easy to grasp. Make a model gallows without the noose and set it on any table. Attach a long string and weight—a pendulum—to the model arm, so that it hangs loosely. In the standard seismograph, the pendulum is the so-called steady mass and since, like all pendulums it has an independent movement, it is steadied by a damping device.

Now strike the side of the table horizontally with a hammer or mallet to simulate

This seismogram, recorded at the University of Chicago, tells the story of the catastrophic tidal wave April 1

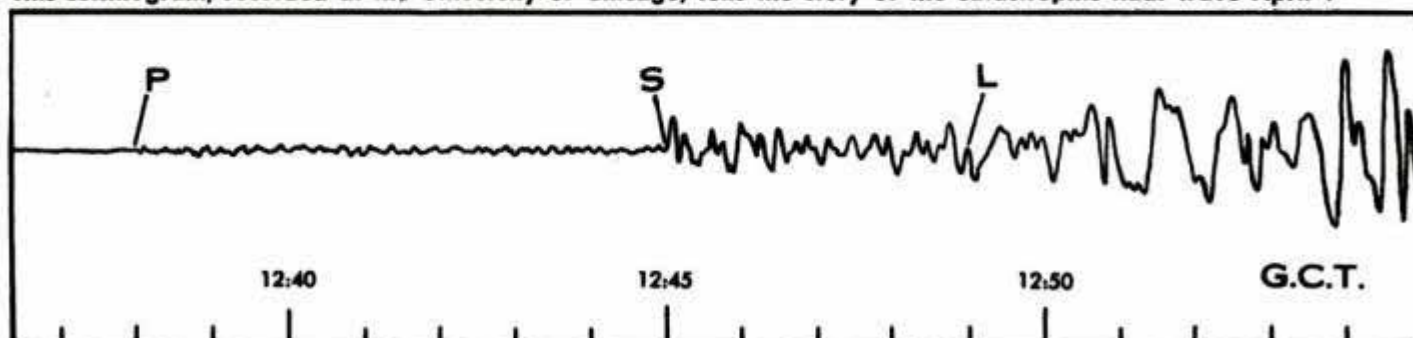

an earthquake. The stationary structure of your model will vibrate but your pendulum will not, especially if it is damped. An arm extending from the structure to the pendulum without touching it will magnify the vibrations. This is the basic principle of the intricate seismograph.

Suppose an earthquake stirs up a tidal wave. In one of the station seismographs, the needle begins to move slightly, registering the first or primary wave. It continues its small nervous movements until the secondary wave arrives. The speeds of primary and secondary waves are known; the primary is entirely directional and faster than the longitudinal secondary. The difference in time interval between them tells the distance of the disturbance from the station. Then the main wave hits the pier and the needle becomes violent. The direction of earth wave plus the time lapse between the primary and secondary waves locate the center of the earth's misbehavior.

A new type of seismograph is being built to record small earth waves such as those set in motion by hurricanes, typhoons and large storm areas. Once out of experimental stage, it will locate these violent storms long before they strike inhabited centers, saving many lives and millions of dollars.



Applying lamp black (above) to paper roll for use in a seismograph. Below, essential parts of a home-made seismograph which will trace earthquakes

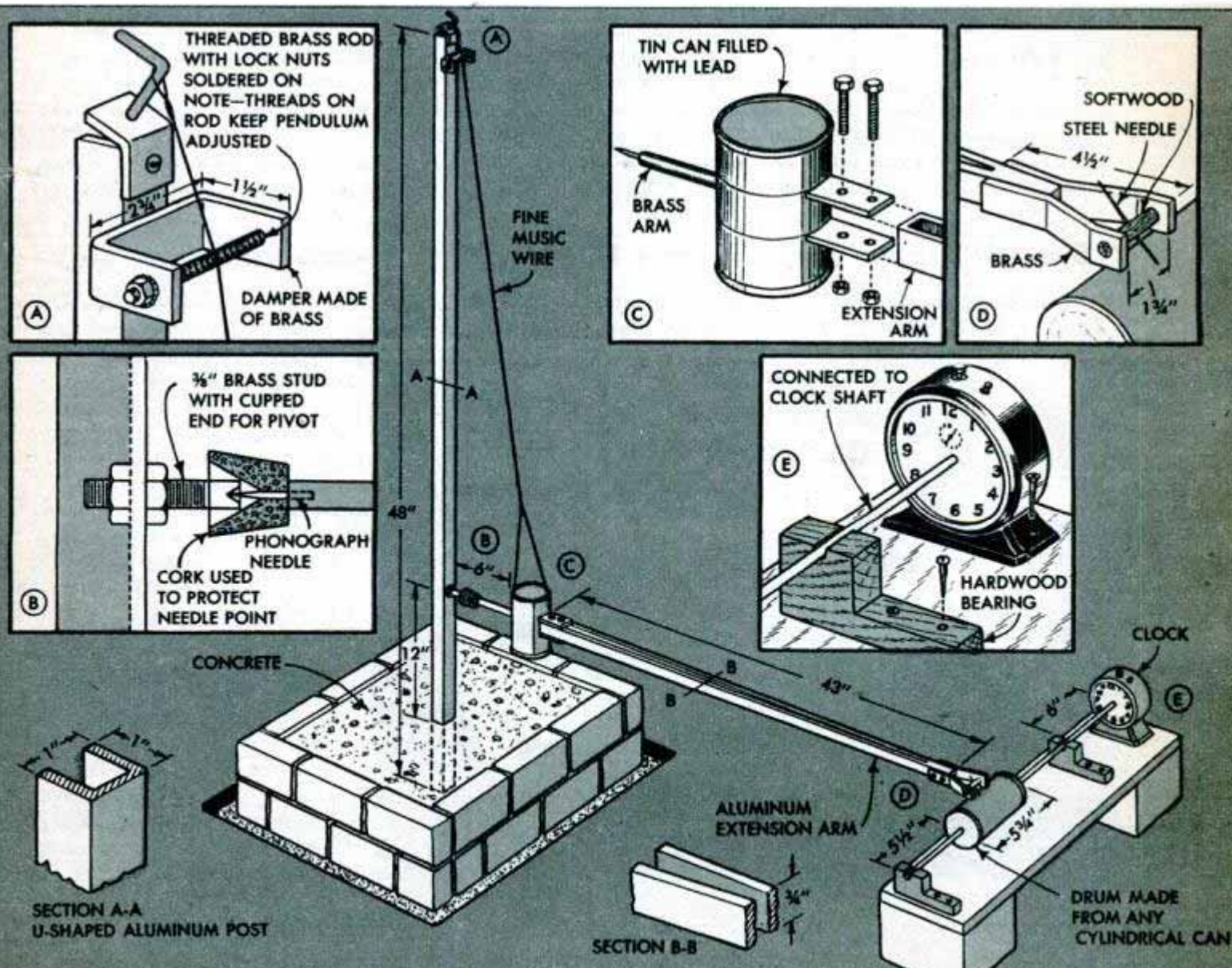

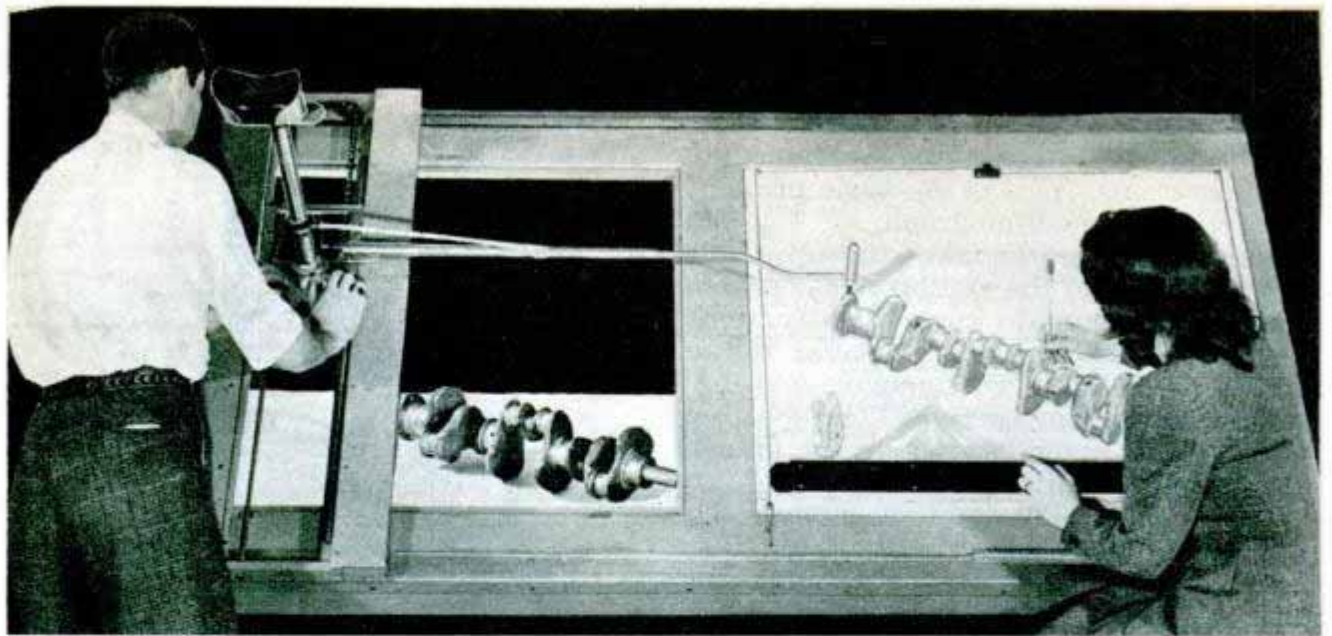

Time required to make mechanical drawings is greatly reduced by a robot "draftsman" equipped with an electrically operated pencil point. Drawings are made by following the contours of an object or design with cross hairs in a sighting instrument. Each time the operator centers on a

Robot "Draftsman" Saves Time With Electric Pencil

point to be recorded he presses a control button and the pencil makes a dot on the drawing board. Dots are joined later and hand shading is applied, if necessary. Studebaker used drawing instruments of this type to speed the job of launching its 1947 model automobiles.

All-in-One Garden Pest Killer Combats Rusts, Blights and Insects

Two-way ammunition for the gardener is supplied with a chemical that kills both insects and such plant pests as rusts, blights and mildews. The mixture, concocted by Du Pont chemists, contains DDT and rotenone to combat insects in addition

to the necessary amounts of fungicides. This new pest control, known as Du Pont Garden Dust, can be applied in dust form or mixed with water and sprayed on plants. Applications are recommended every week or two until 30 days before harvest.

Sleeper Trailer for Two Has Kitchen With Icebox and Gas Stove

Sleeping space for two and a streamlined galley are included in a pleasure trailer that is covered with a sheet aluminum skin.

The trailer weighs only 525 pounds. The undercarriage is made of welded steel tubing and is so light that one man can lift it.

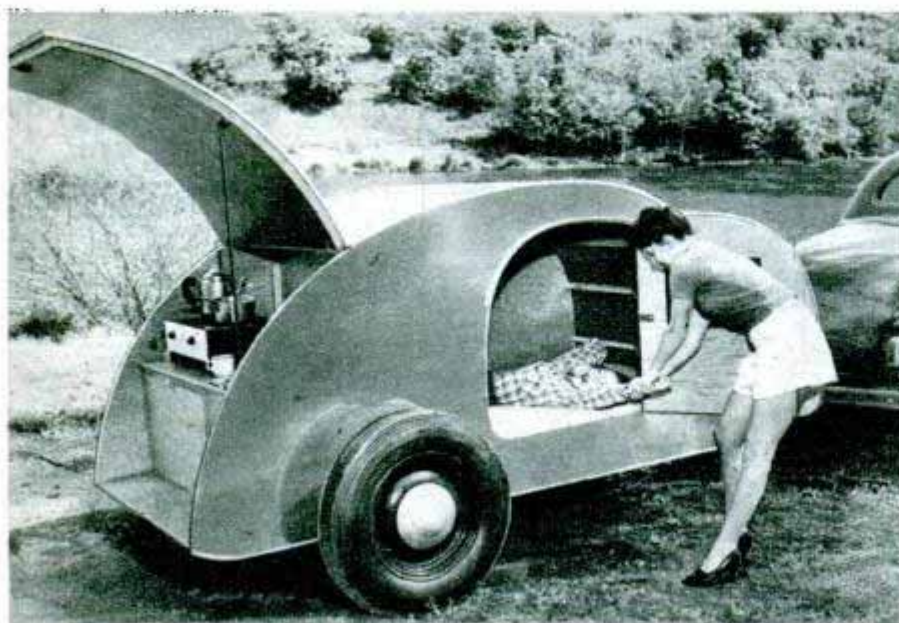

Shock absorbers and springs are eliminated through use of individual torque-bar suspension. The inside of the trailer is constructed of plywood and sealed with lacquer to make it dustproof. The sleeping compartment features a full-length innerspring mattress and a built-in hamper for clothing. A section of the roof swings open to reveal the galley with cupboard and drawer space, a 25-pound icebox and a gas stove. Screened windows in the bedroom can be opened from the inside.

Boat Has Carrier Attachment for Hoisting to Top of Car

Makeshift methods of strapping a boat to the top of a car are unnecessary when sportsmen use a new unit that includes both boat and carrier. The boat's molded hull is made of laminated plastic and special fabric. It is 18½ inches deep amidships, has a 52-inch beam and 12-foot gunwales and weighs only 110 pounds. The carrier can be fastened to the rear bumper of any automobile. Hinged supports on the carrier permit the boat to be

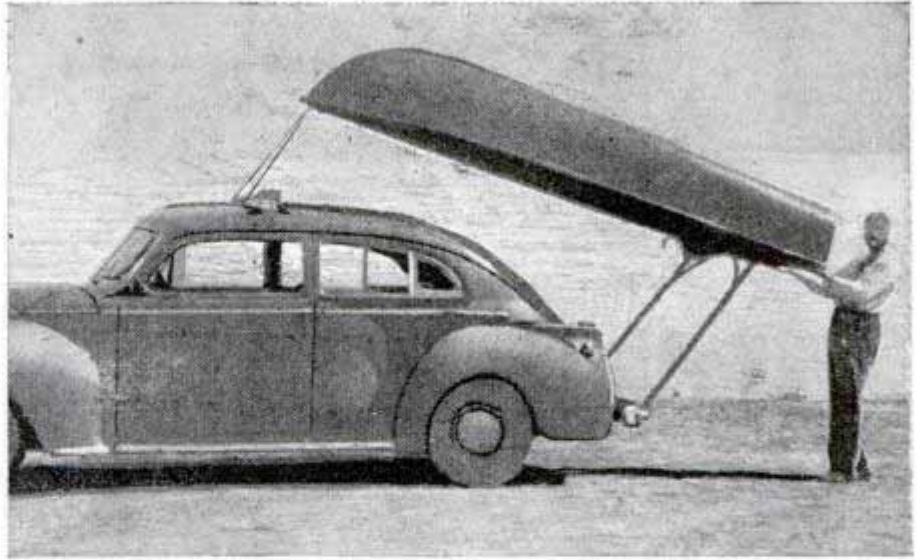

swung completely over after the bow lines are unfastened. The boat can be disconnected from the car and ready for the water

in about 15 seconds. The carrying device does not interfere with use of the car's trunk, doors, windows or rear-view mirror.

Metal Rack Protects Outboard Motor During Storage

Outboard motors can be transported or stored on a rack that guards them against dents, punctured gas tanks or other abuse.

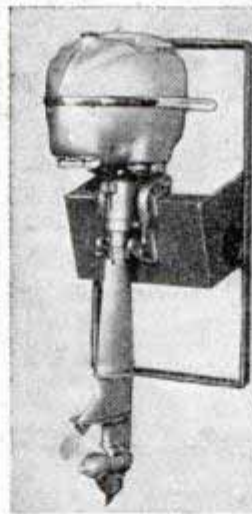
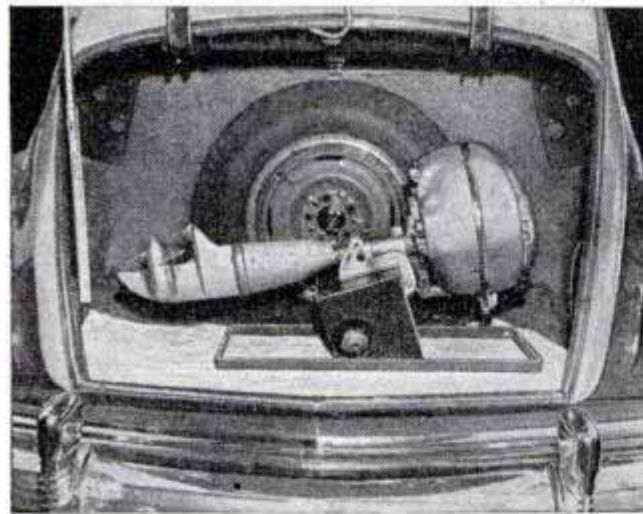

The metal rack weighs only nine pounds. It consists of a rectangular frame to which a U-shaped projection is electrically spot-welded. The motor clamps over one side of the projection. The dimensions are 27 by 12 by 7½ inches, small enough so the rack takes up no more room than the motor itself. Any motor up to 10 horsepower can be clamped to the frame. Grease, tools and other requirements fit into a built-in compartment. When the motor is to be stored, the rack can be hung on the wall or placed on the floor.

Four Adjustable Stones in Sharpener Permit Grinding Any Knife

Four separate abrasive stones are used to grind the cutting edge of a knife blade in a new electric knife sharpener. The four stones are mounted on two wheel sections that rotate to bring the abrasive surfaces in contact with the knife blade 6000 times a minute. Because of the space between the stones, air circulates over the blade to prevent the knife from becoming hot and thereby weakening the edge. The angle at which the stones grind the blade can be adjusted to four different positions to fit the edge of any knife. A special device that holds the blade permits grinding of the edge as far back as the handle. The 120-grit abrasive carborundum stones can

be replaced easily. The sharpener gives a convex edge to a blade which is superior in strength to a concave or "hollow-ground" edge, according to the manufacturer.

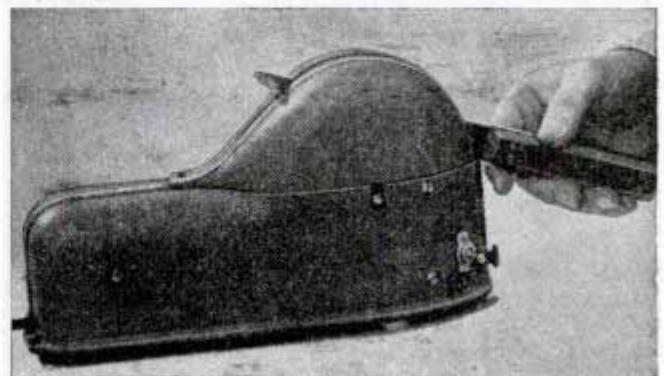

THE BRIDGE

By Reinhart Knudsen

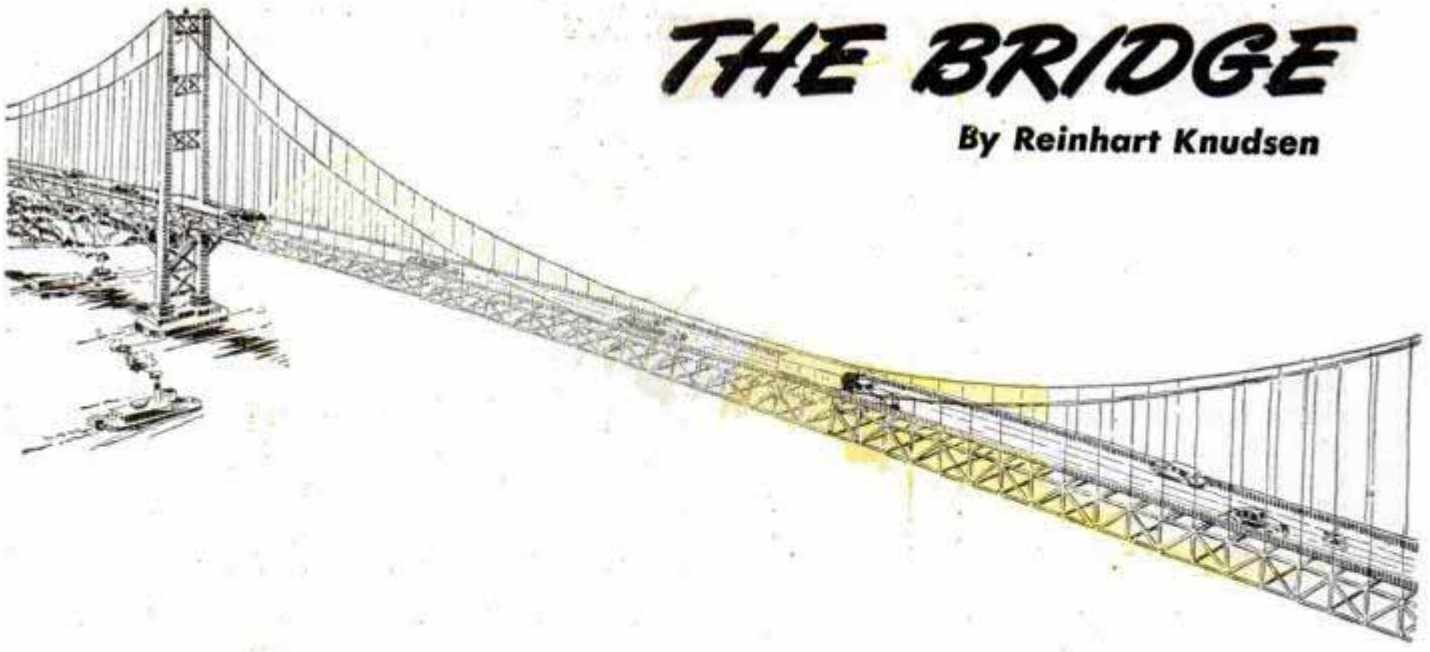

THE new Tacoma Narrows bridge, to link Tacoma and Bremerton, Washington, will be the world's first aerodynamically designed and shock absorber-equipped suspension bridge.

When the original span, built along traditional suspension bridge designs, dramatically collapsed on November 7, 1940, it carried down with it all ideas that the design of suspension bridges could ever again be made in terms of static forces alone. From now on, aerodynamic forces as well, and their resultant vibrations, must also be considered. Ever since that disastrous day, Washington State engineers, in cooperation with the federal Public Roads Administration, have carried on original research and continuous wind tunnel tests in an experimental laboratory at the Uni-

versity of Washington to arrive at a design for a new bridge which would not blow down. Last March these plans were approved by the Washington Toll Bridge authority. The new structure is expected to be built and in use by 1948.

The original 5979-foot span was exceeded in length only by the Golden Gate bridge and the George Washington bridge in New York. It cost \$6,618,138.53 and held up just four months and seven days. During that time, however, it became famous for its rising and falling motion and earned the name of "Galloping Gertie." When the winds swept across Puget Sound, tourists came out to watch the roadway rise and fall as much as 40 or 50 inches. The end came during a roaring 45-mile-an-hour wind when the roadway "galloped" up and down as much as five feet.

In its last agonizing moments the pavement was heaving in nine waves at the rate of 37 times a minute. When the center diagonal stays could stand it no longer the span began to twist and shake to pieces. In a little while only the towers and main cables remained standing and they were severely damaged.

To find out exactly why the old bridge fell and to make accurate designs for a new one, a wind tunnel 100 feet long with a four-

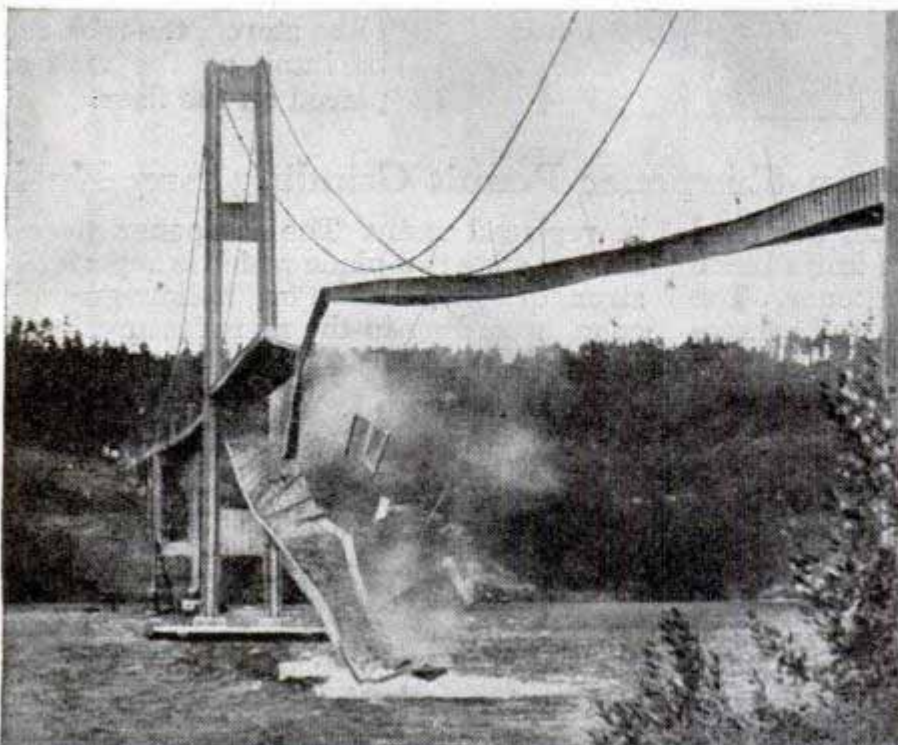

Copyright Bashford-Thompson from Acme
Collapse of the four-month-old Tacoma bridge in 1940 demonstrated the need for new design

BORN IN A WIND TUNNEL

Let the wind blow. It won't topple over the new Tacoma bridge equipped with shock absorbers and air slots in the floor

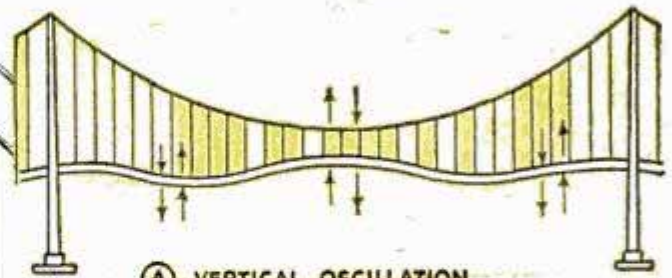

(A) VERTICAL OSCILLATION

Drawings show three types of vibrations studied by engineers in designing the bridge

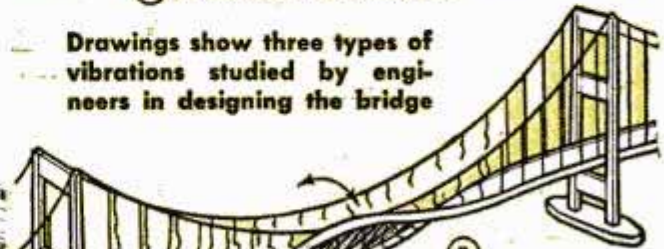

(B) TORSIONAL OSCILLATION

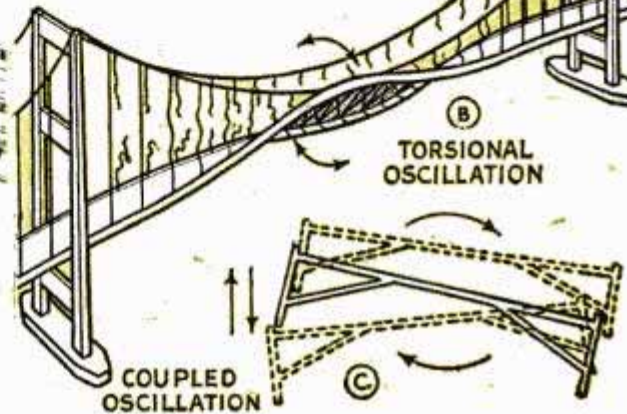

(C) COUPLED OSCILLATION

Wind tunnel tests with 118-mile-an-hour air blasts whipping through models of bridges showed engineers how to construct an aerodynamically designed bridge

foot throat was built at the University of Washington. In this tunnel full scale models of proposed designs were built and tested. There was some doubt, however, as to the accuracy with which scale models could be used to tell what would happen to the real thing. Inasmuch as records were already available as to the exact actions of the original span in various winds during its brief life, a model of this original bridge was built first. When it reacted in precisely the same manner under the same types of winds, the engineers knew they were on the right track. Knowing their tests would be accurate they went ahead and built a model of the proposed new design. It was constructed to scale, one foot to 50 feet of the actual bridge, structurally, mechanically and aerodynamically.

In their studies the engineers produced the first organized data on various types of oscillations that might cause a bridge to collapse. With this knowledge they were able to incorporate changes in the design of the new bridge which would minimize

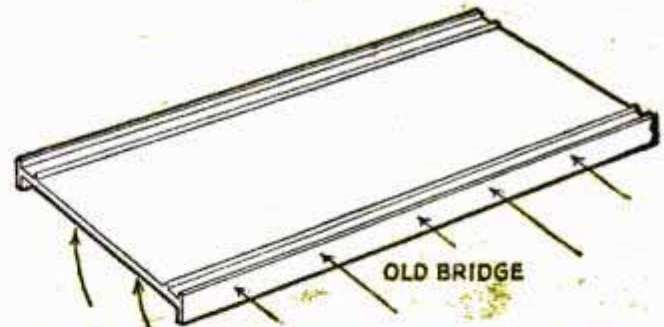

Unlike the solid roadway of the old bridge, the new structure will have a slotted floor to permit rising air currents to pass through

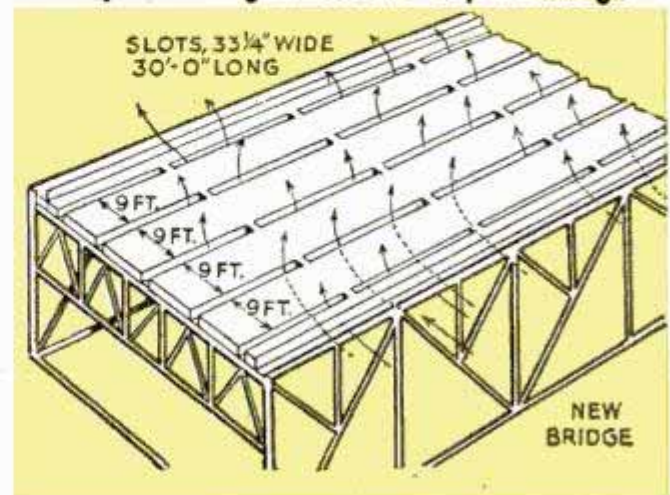

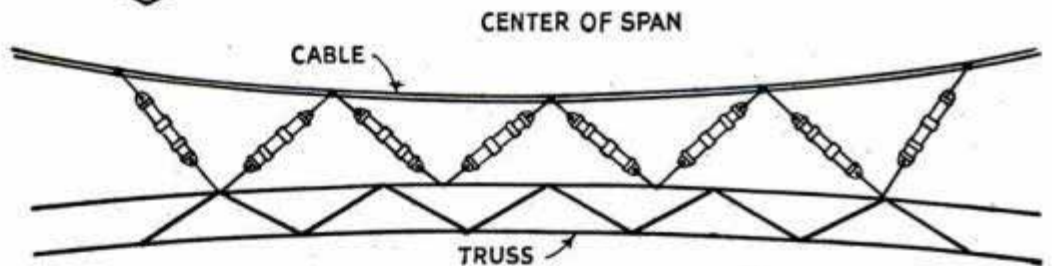
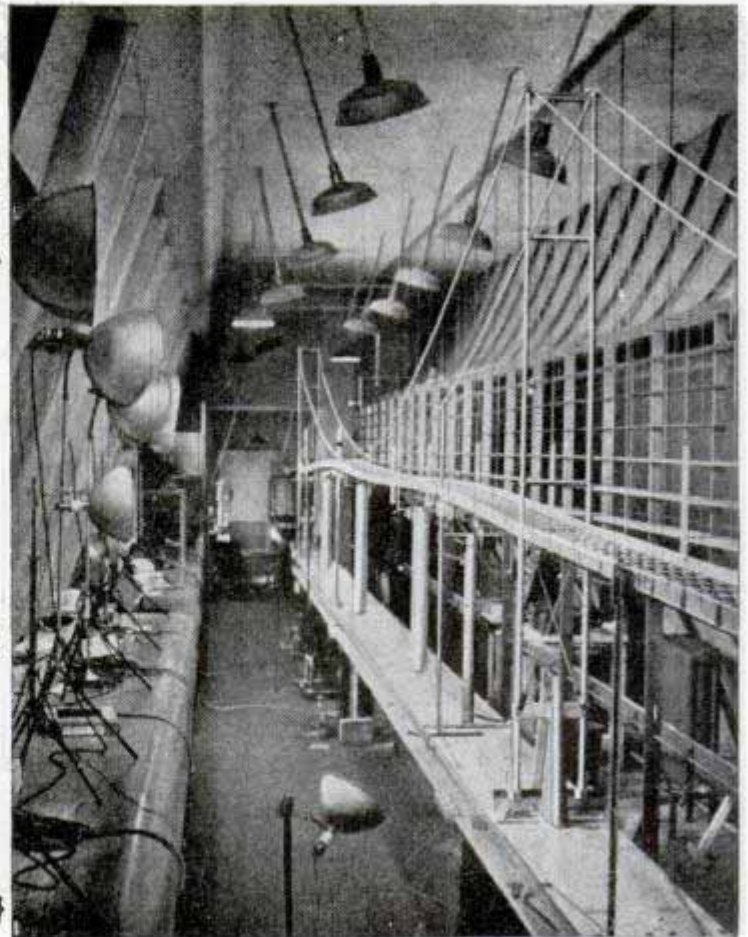
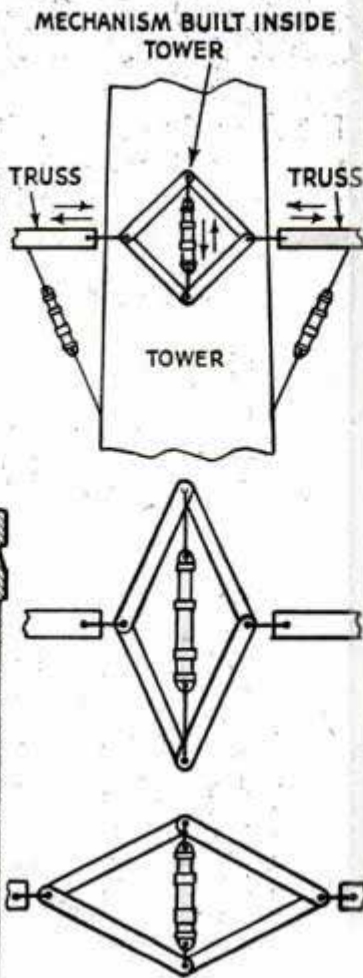
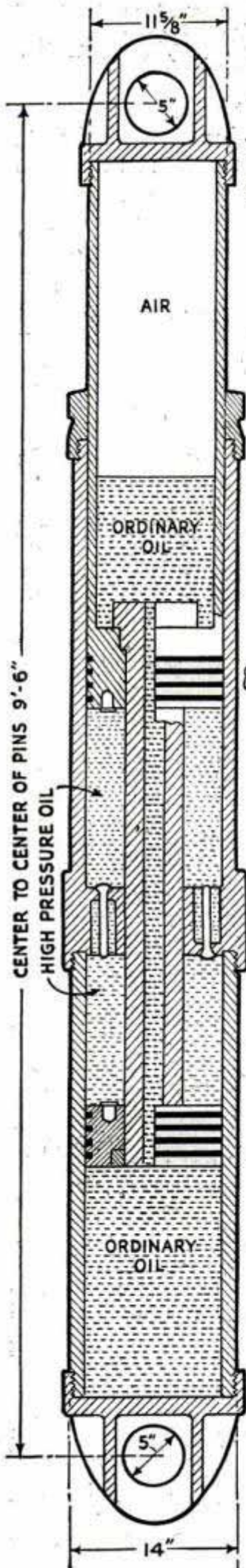

Installed at various points throughout the structure, 24 hydraulic jacks (cross-section shown at left) will absorb shock. Above, tests in the wind tunnel

such oscillations and then by use of the model and wind tunnel to actually test their design changes. Among the different types of oscillations that had to be minimized were the steady wavelike oscillations common to all suspension bridges, the twisting oscillations which brought about the collapse of the Narrows bridge, coupled oscillations which are a combination of both the steady and twisting types, and restricted oscillations, steady wavelike movements which develop at a certain wind velocity but tend to disappear at a higher velocity. None of these movements is exclusive in bridges. They are found in mechanical devices such as automobiles, railway cars and airplanes. They are readily observed in "wing flutter" and "galloping transmission lines."

Both the laboratory tests and the demands of a growing area required that the new bridge be larger and heavier than its slender predecessor. It must carry four lanes of traffic instead of two. The increased weight contributes substantially to absorbing wind shock and increasing resistance to various types of vibrations. Engineers call this "damping."

An immediately noticeable design feature of the new bridge is its openness of construction. Whereas the former span used an eight-foot solid girder to support the main deck, the new structure will be built with a 33-foot open-type truss. This will reduce wind resistance and also break up air currents which might start

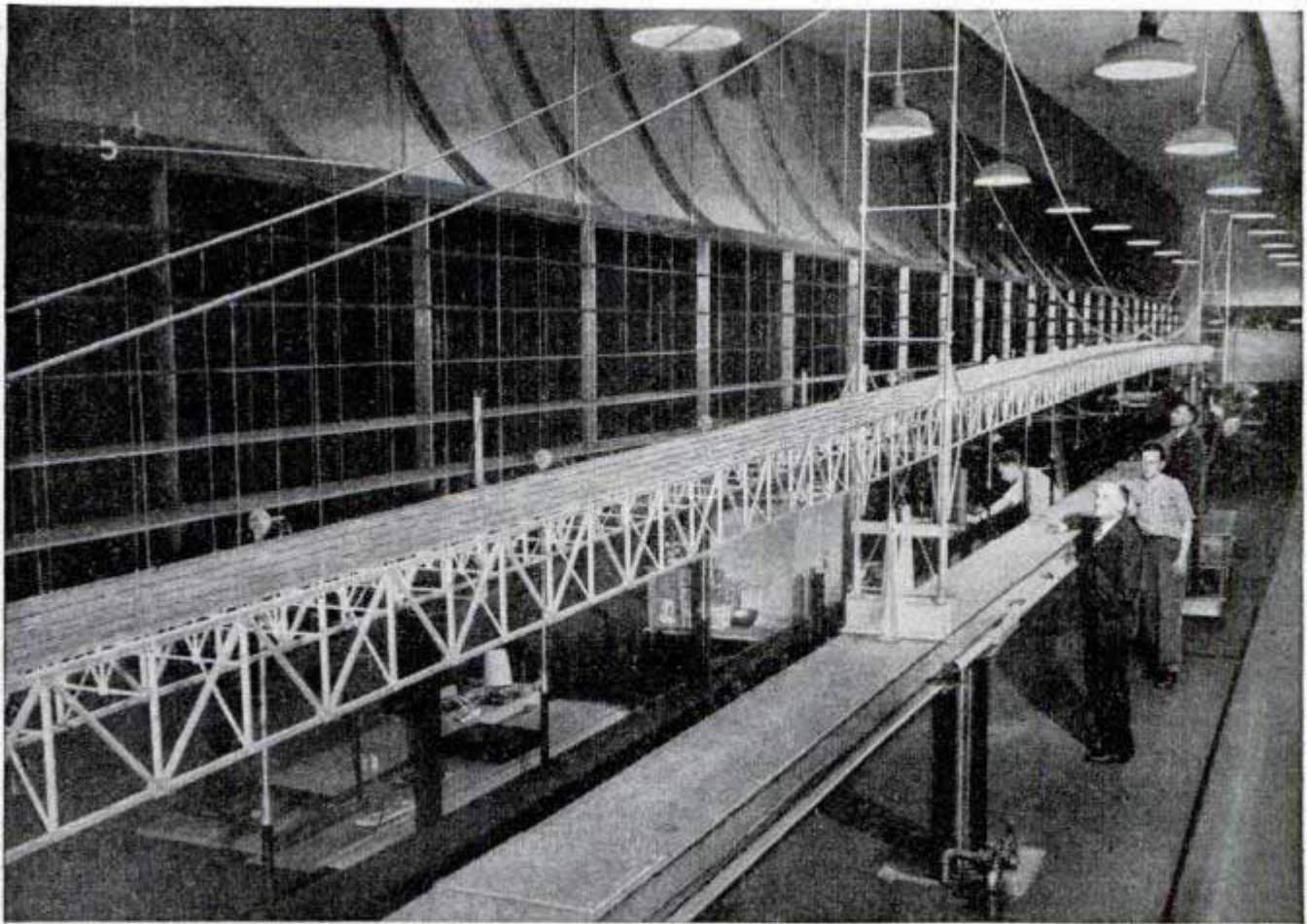

A 100-foot model at the University of Washington withstood rugged tests leading to design of Tacoma bridge

oscillations. Floor beams will also be of open-type truss design, and a double-lateral bracing system has been incorporated to add to the stiffness of the structure.

The new bridge will be the first such structure ever to come equipped with "shock absorbers." These will be huge hydraulic cylinders similar to the recoil system of battleship guns, located at the centerline of the bridge where the cables come down to the roadway and at each tower. They will permit slow motion, such as might be caused by a heavy load of traffic on the bridge, but will resist rapid motion such as wind oscillations.

When engineers built their model of this preliminary design and subjected it to the wind tunnel test it worked perfectly in a steady horizontal wind stream. A gale equivalent to 118 miles an hour was whipped up by 10 big propellers and the bridge stood firm. However, when the wind stream was tilted upward at an angle of two degrees

serious oscillations developed at 78 miles an hour. Due to bluffs along the shore such upward slanting winds are quite common at the bridge site although not at such great velocities.

Nevertheless the engineers were not satisfied. They promptly built and tested a sectional model for the study of roadways

(Continued to page 224)

Measuring oscillations to test the roadway of a sectional bridge model

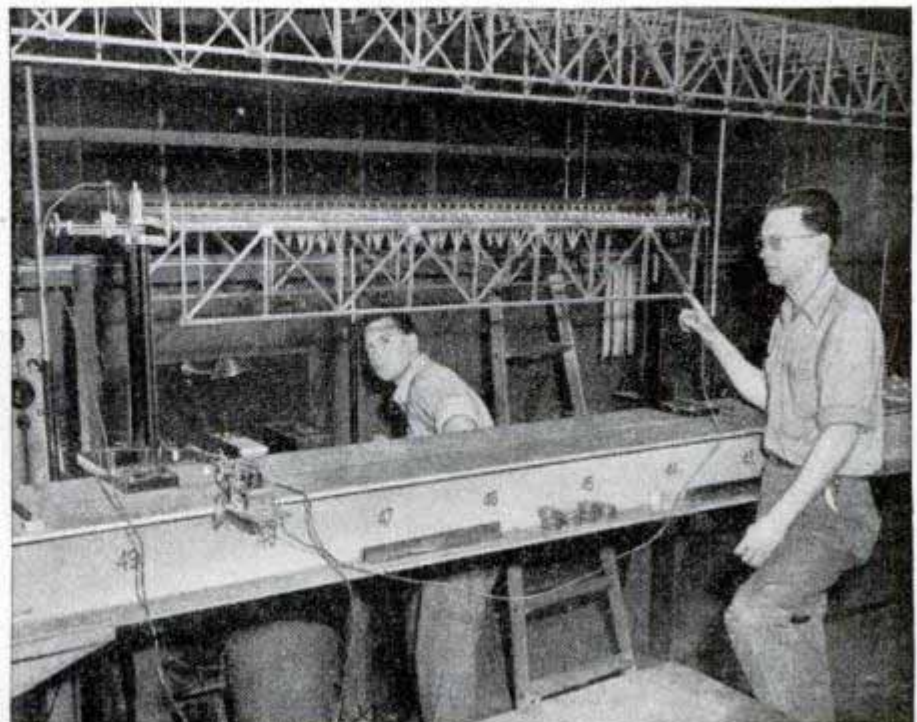

Nudge With Chin Activates Electric Book-Page Turner



After nurse attaches thread to book pages, an automatic page turner enables incapacitated boy and woman in iron lung to read the books

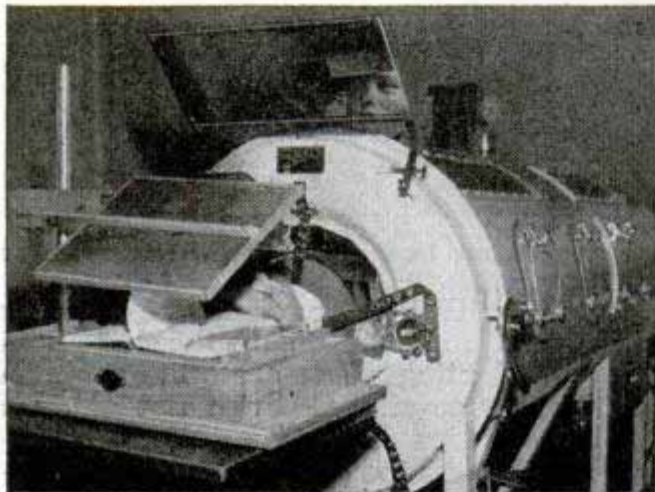

Armless persons and hospital patients unable to use their hands can turn the pages of a book with the aid of a motor-driven spool which pulls thread attached to the various pages by metal clips. The switch can be hung from a cord around the patient's neck and operated by a nudge from his chin or it can be placed near the foot of the bed for foot operation. R. F. Mallina of the Bell Telephone Laboratories designed the equipment at the suggestion of the American Red Cross.

Outdoor Thermostatic Control Regulates Building Heat

Outside rather than inside temperatures actuate an automatic thermostat which regulates heat for homes, apartments, commercial and industrial buildings. Used to operate all types of heating systems, the outdoor thermostat shuts off all heat when the outside temperature rises to 65 degrees Fahrenheit. Continuous heating is supplied, night or day, if the outdoor tempera-

ture drops below zero. The times at which heating starts in the morning and stops at night are determined automatically in accordance with actual weather conditions. During the day, constant building temperatures are maintained by producing heat at regularly spaced intervals, with the length of heating periods automatically changing as the weather changes.

Jet-Propelled Ocean Liner of Future to Carry 10,000 Passengers

Jet engines will power passenger liners and merchant vessels of the future, according to designer J. Tomadelli. He has designed a scale model of a 1487-foot 10,000-passenger liner to be powered by four jet engines, two on each side of the hull. Estimated cost of such a 116,000-ton displacement vessel is \$60,000,000.

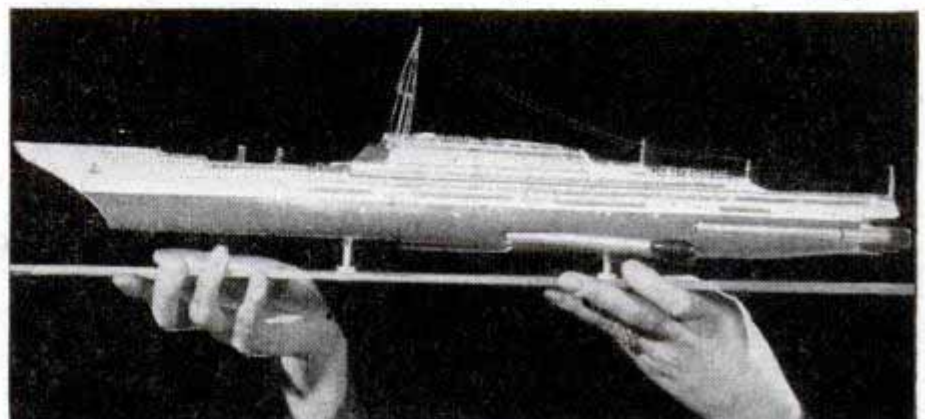

Davenport Frames of Aluminum

Frames of aircraft aluminum, one third lighter than the conventional wood, are being used in upholstered living room furniture. They are termiteproof, fireproof and cannot warp. To permit compact shipping and quick change of zipper-fastened covers, the pieces are built in four units, the back, two arms, base and cushions, which can easily be separated.

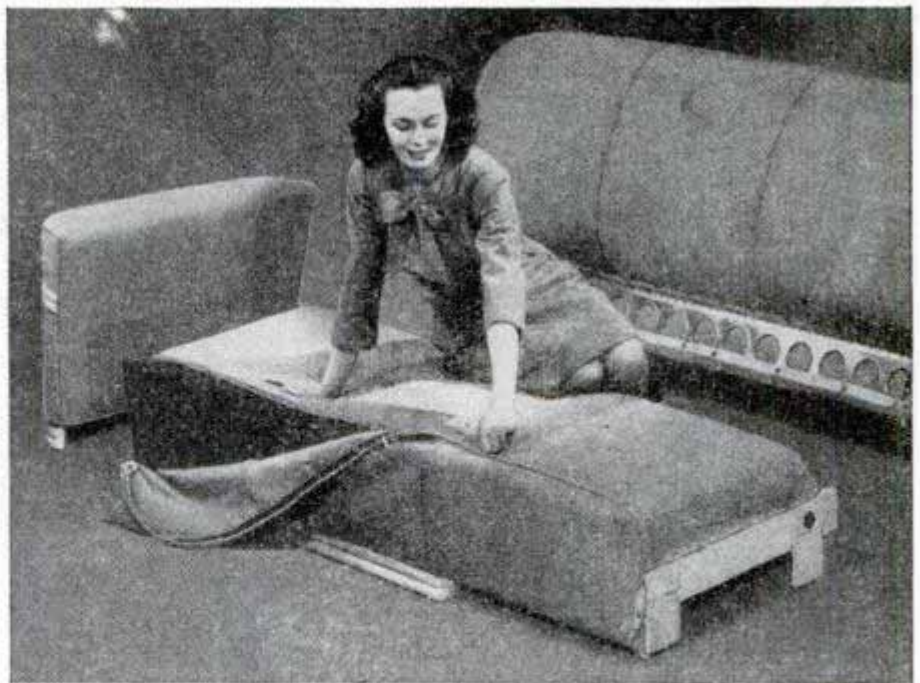

Pinhead 'Shadows' Are Counted

Objects as small as $\frac{1}{32}$ inch in diameter can be counted accurately at 1000 per minute with a counting device utilizing a short light beam sharply focused through an aperture in a perpendicular guide tube. As small objects drop through the tube they break the beam. A high speed electronic circuit counts the interruptions or shadows and actuates the machine.

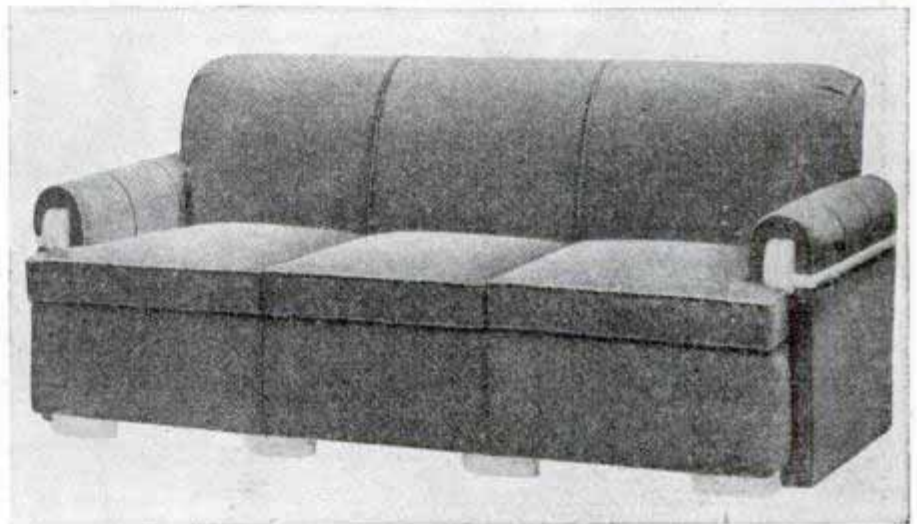

Robot Tabulates and Records Bowling Scores by Electric Impulses

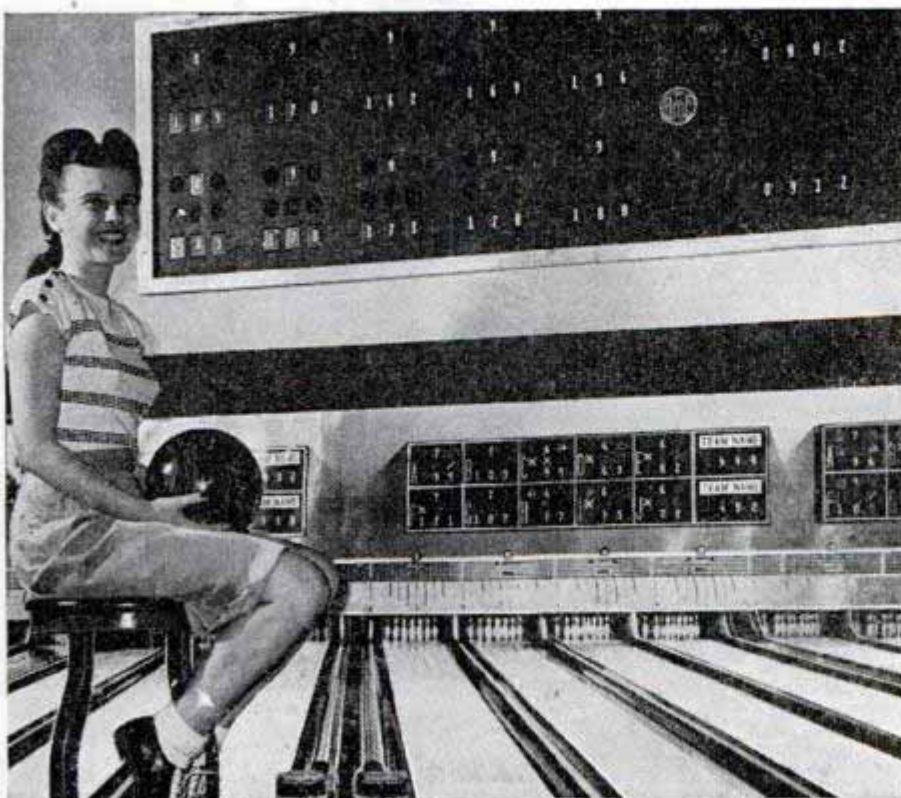

Bowling scores are tabulated and recorded automatically by an electrical scorekeeper used in conjunction with a mechanical pinspotter. Pins knocked into the pit are picked up by the robot spotter which creates electrical impulses, the number dependent upon the number of pins knocked down. These impulses are translated into running bowling scores—individual, team or both—which are posted on scoreboards facing the bowlers. The electrical scorekeeper has symbols representing strikes and spares which light up when a bowler makes one or the other.



"Inside Stubb"

for Your Home



Hollow plastic garment hanger, filled with moth crystals, left, protects clothing. Below, electric frying pan is a one-piece cast aluminum unit and it can be immersed in water for cleaning

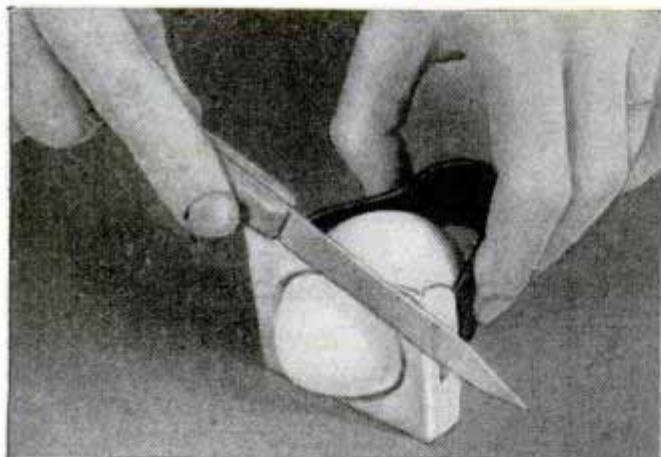

Holder for hot soft-boiled eggs is easy on fingers; squeezing end of loop holds egg firmly. Below, polishing silver is simple job with treated paper sheet

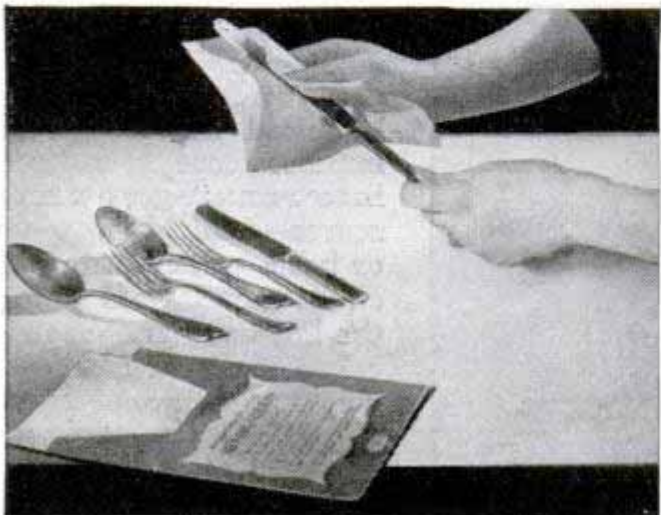



Electric unit in cover converts frying pan into broiler. Inverted on table base it becomes electric stove

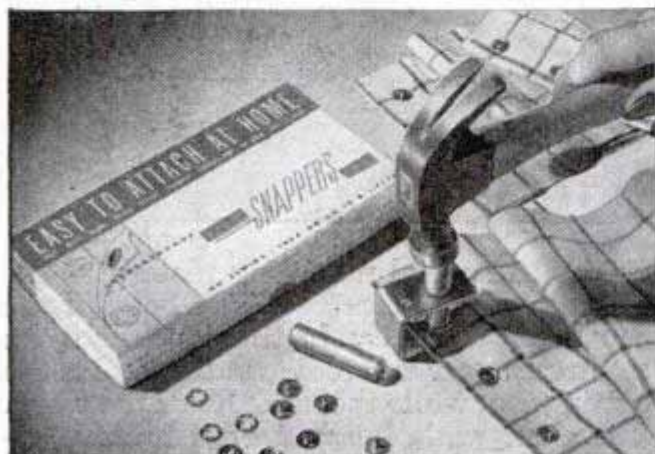

Snap-fasteners are "sewed" in place with hammer and U-shaped tool with hole for punch. Below, steel spring and rubber wheel muffle closing of a screen door



Agitator of this handy lightweight mixer is small enough to slip into bottles or glasses. Drop leaf on home freezer, below, serves as worktable or dinette



Lathe Converter With Universal Head Does Many Jobs

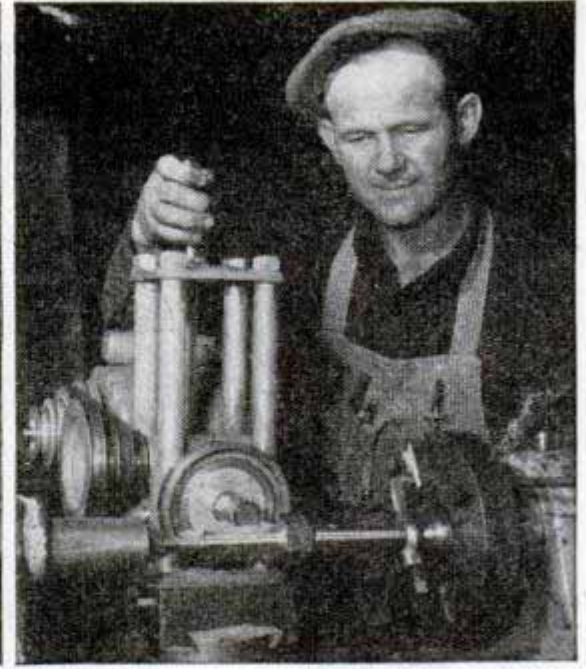
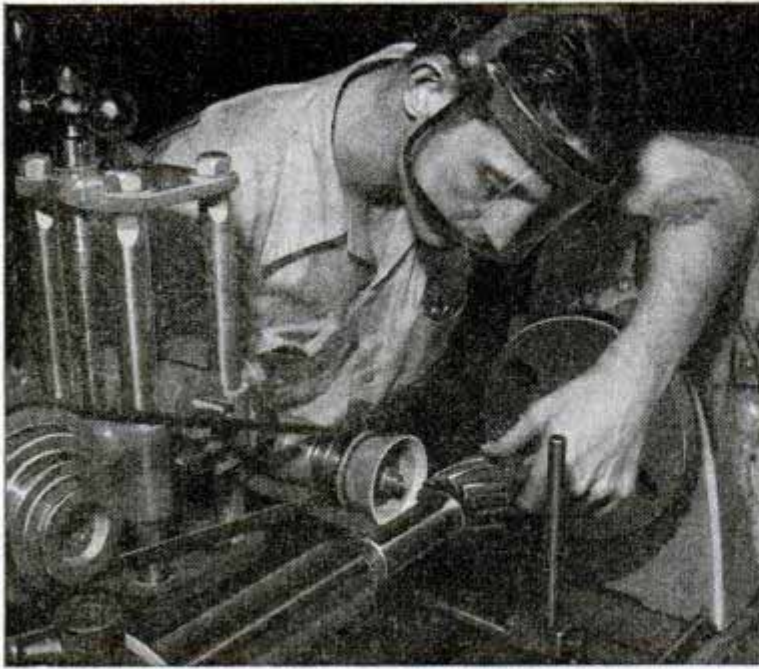

Ordinary lathes will perform almost any type of metal-working operation when used in conjunction with a lathe converter equipped with a universal head. The converter, which was used by the armed services in portable machine shops in combat zones, is available in three models that can be adapted to lathes from 9 to 36-inch

swing. A special mounting plate attaches to the tool-post carriage. The head of the converter, which can be tilted for such jobs as thread, gear and tool grinding, holds the cutting tool while the lathe holds the work. Interchangeable heads permit milling operations, various types of grinding, internal keyseating, routing, drilling and indexing.

Windows Swing Like Doors on Hinged Channel Device

Double-hung windows can be swung into the room like a door with a hinge and retainer channel device that can be attached to any wooden or metal window jamb. Windows already in service can easily be equipped with the device. A rolled metal channel is screwed to the window jamb.

The trim on the opposite side of the window frame is cut at an angle so that it can be removed and replaced easily. The hinge is fastened to the window, one end forming a slide which fits into the retainer channel. When the window is to be opened, the pre-cut trim is lifted out and the window

swings into the room on its hinges. The rope or cable on the opposite side of the window is fastened to the jamb when the window is opened. Both sections of a double-hung window can be equipped with the device, doubling the ventilation and making window washing an easy job. The attachment has no effect on the up-and-down movement of the windows, and weatherstripping may be used.

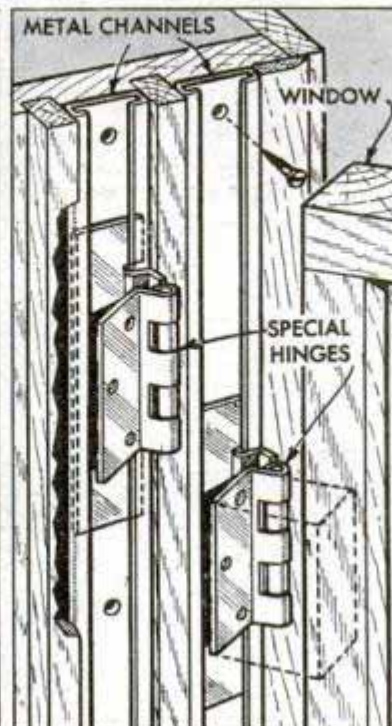
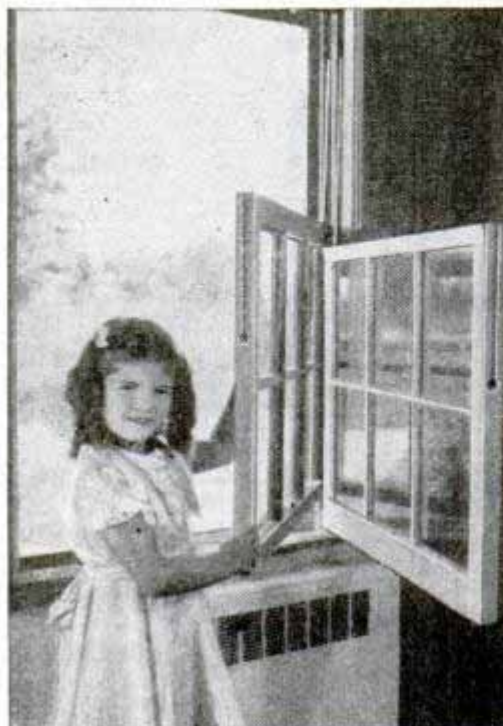

⚠ Danger of shocks from electrical outlets is eliminated by transparent plastic safety caps which are plugged in when outlets are not in use.



They Die a Thousand Deaths

MOST Hollywood stunt actors would have been killed years ago if it were not for elaborate precautions to protect them from injury. Accidents rarely happen even in the production of western movies that call for violent action every minute.

Men and horses shot down in a wild chase in the morning are ready to rehearse the next scene after lunch. Men and animals that participate in the spectacular smashup of a covered wagon will do it again with another wagon if the cameras missed the first shot. All such scenes are so carefully planned that hazards are at a minimum.

When "Pop" Sherman, veteran producer of westerns, is preparing a thrilling sequence for a picture he is apt to put in a call for Fred Kennedy, stunt actor who has reduced

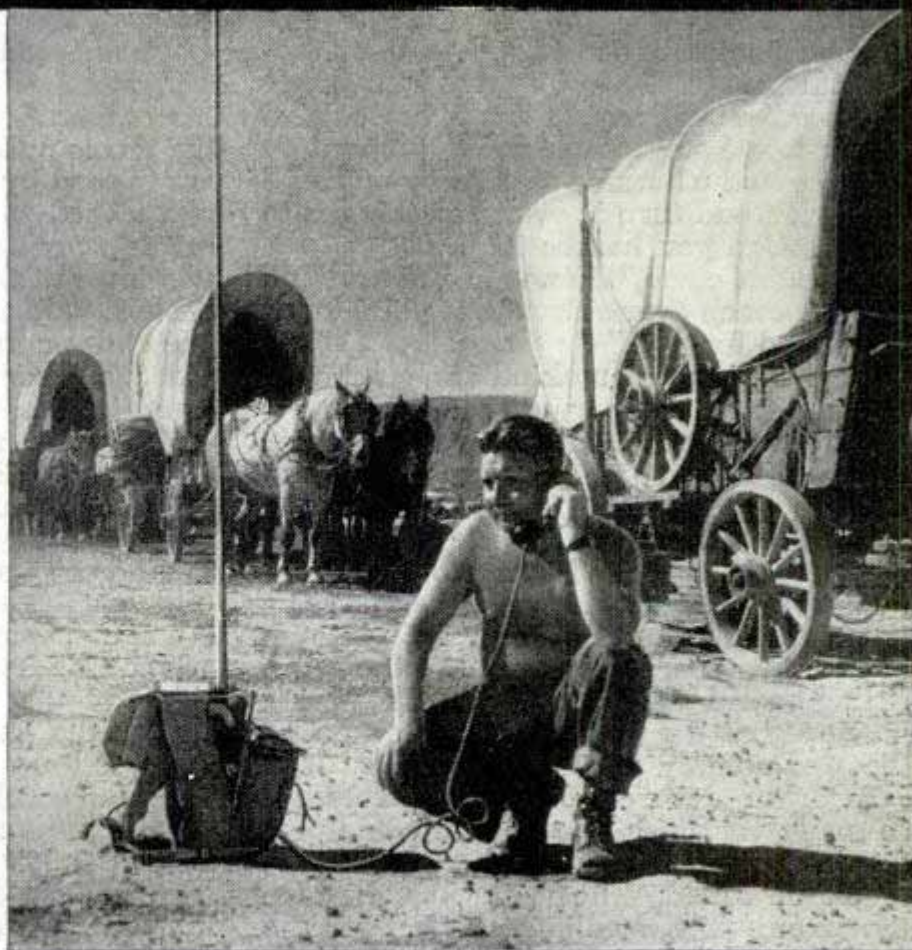

Stunt men performing in Hollywood westerns (top) fall from fast-moving horses and wagons but scientific precautions minimize the dangers. Below, walkie-talkie radio receives instructions from distant cameraman



Harry Sherman Productions photo

Camera mounted on a truck moves along a smooth road to photograph cowboys chasing a gang of cattle thieves

the mechanics of smashups to a mathematical basis.

"Fred," he will say, "I want you to drive a four-horse stagecoach down a mountain road, have the horses break away and spill the coach and turn it over, smashing it to pieces. Can you handle it?"

"That's a cinch," Kennedy replies. "I'll roll the coach over sideways if you like or flip it end for end."

Kennedy stages any kind of a crash that the scenario writers can dream up, from a collision involving two stagecoaches driven at a full gallop to a simple thing like wrecking a buggy against a boulder.

Usually he rides the vehicle all the way, unless the script calls for him to jump clear at the last minute. If the driver is to be thrown headfirst out of the wagon into an adjacent ravine, a dummy takes the reins, sitting over a powerful spring. The spring is tripped at the moment of the crash and flips the dummy through the air.

In an "unprepared" crash there would be so many variables that no one could predict just what would happen. Someone might be killed. The vehicle might turn the wrong way, spoiling the shot for the cameras, or it might not turn over at all. Kennedy makes the crash occur according to a predetermined pattern.

In preparing to roll a stagecoach on a

mountain road, for instance, the stunt actor first attaches special crash equipment to the coach. The wooden tongue by which the teams pull the vehicle is removed and is replaced by a special iron tongue. This is attached to the vehicle by means of a break-away device that is controlled by a trip-lever at the driver's seat. A long steel cable is laid across the top of the coach, one end secured to the rear of the vehicle and the other end attached to the break-away tongue.

Ready for action, Kennedy drives the stage at a gallop toward the cameras and at the right instant trips the lever that releases the horses and the vehicle's tongue. The horses and the tongue pull away from the vehicle and this action releases an automatic mechanism that immediately cramps the front wheels of the coach to one side. By now the horses have reached the end of the long overshot cable and have tightened up on it. This automatically pulls the coach over in a terrific crash.

During the confusion Kennedy dives into a steel safety box alongside the driver's seat, padded inside with sponge rubber. Five seconds elapse from the start to the finish of an ordinary crash and the stunt actor needs only three seconds to get into his safety box, out of the way of flying debris. Kennedy spent months in working

out the mechanics of his crashes, towing vehicles behind automobiles at speeds up to 25 miles per hour to perfect the equipment.

For an end-over-end crash the stunt actor rebuilds the vehicle so that the horses can pull the front axle and wheels from under the wagon when a lever is tripped. The front end of the wagon falls to the ground and two steel bars beneath the wagon bed dig their points into the ground, bringing the vehicle to a halt. The horses automatically complete the crash as they move ahead by tightening up on an overshot cable attached to the rear of the vehicle. The wagon somersaults through the air and slams to earth upside down. Kennedy in the meantime dives free of the wreckage or jumps into his safety box.

Special equipment, too, saves the life of the stunt actor when he is called upon to fall or be thrown down between the horses from the driver's seat of a moving vehicle. Without some protection the actor would be sure to be trampled by the horses or run over by a heavy wheel. The safety equipment consists of a long platform, called an "ironing board," that is firmly attached to the tongue between the two horses, out of sight of the camera. Pretending to be shot from his seat, the actor falls unharmed on this safety platform and hangs onto it while he lowers his body into the dust between the two horses, allowing his dragging heels to be caught by the camera.

Extraordinary precautions are taken to avoid injuring animals in the making of a western. Teams of horses are turned loose by means of break-away devices just before something happens to the vehicle that the teams are hauling. Run-aways are staged under the control of a hidden driver concealed in the vehicle who has a small window in front of him through which he can watch the horses and guide them by special reins. A vehicle that has lost its horses and careens down a slope apparently out of control actually is steered by a hidden stunt man along the exact path the director desires.

The horses that take spills in a western movie are valuable animals trained to fall realistically for the camera. The ground on which

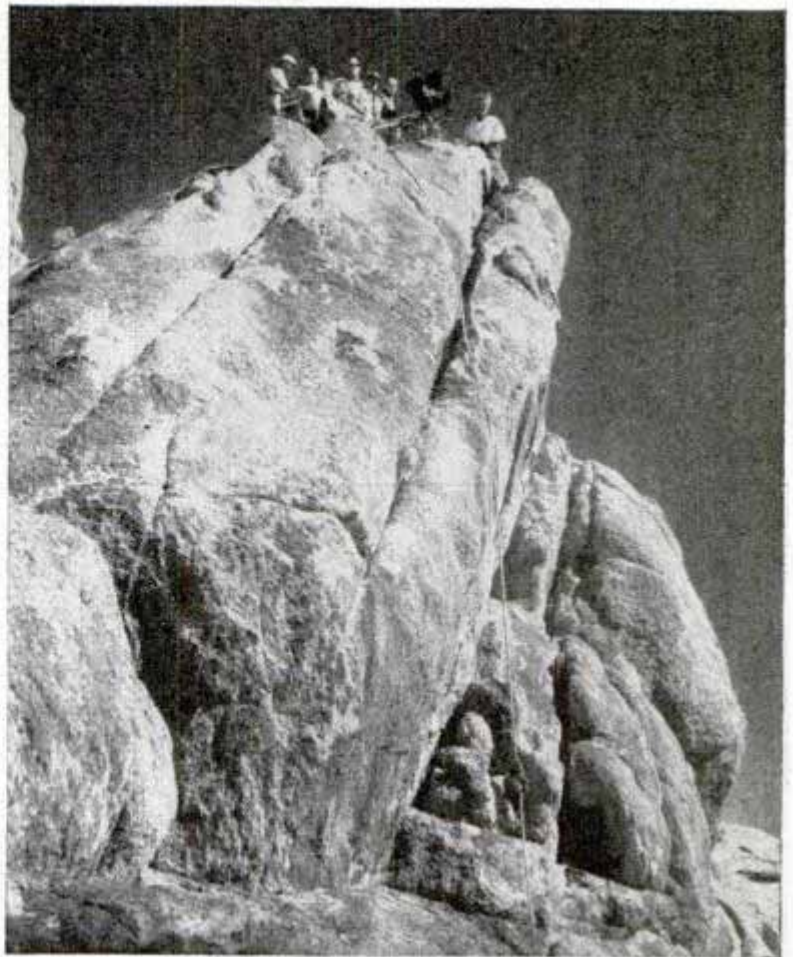

After hoisting their equipment by ropes to the top of a towering rock, a camera crew gets ready to shoot a movie sequence. Below, concealed steering wheel guides a runaway coach



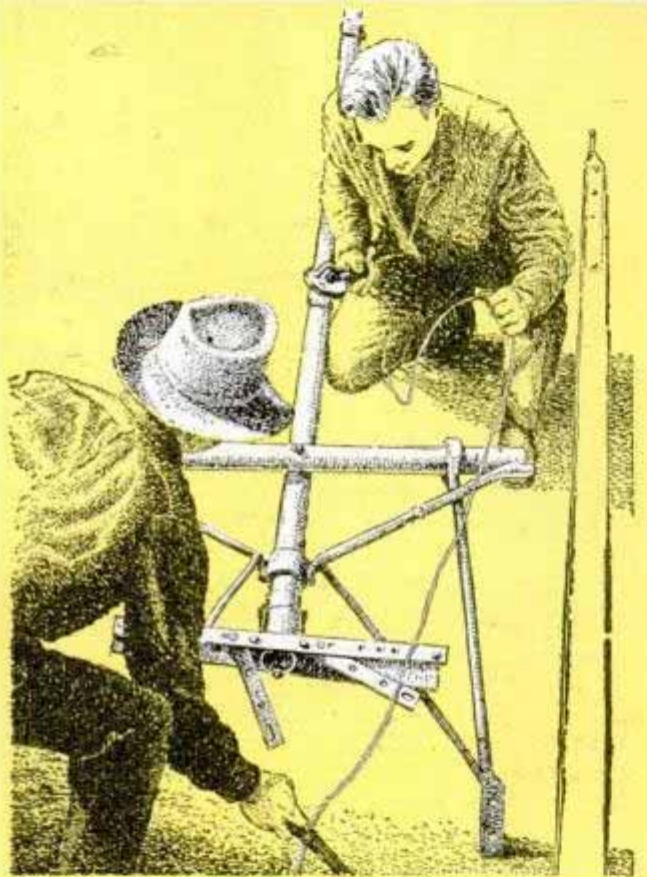

the fall is to occur is dug up and padded with hay or straw.

On the screen you may watch a horse and rider apparently being shot down by an outlaw's bullet, with the rider then crawling away and leaving his horse as dead. Actually, when the scene was filmed the camera continued to roll until the horse was allowed to regain its feet and walk away. This full scene is viewed by the S.P.C.A. as proof that the animal was uninjured by the fall; after the film is inspected it then is cut to conform to the story.

Shooting scrapes are fought with blank cartridges that produce only smoke and noise. Bullets that appear to land uncomfortably close to an actor usually consist of gelatin capsules filled with colored earth, aimed from a slingshot or air gun out of camera range. The capsule smashes realistically when it hits a rock, giving a convincing imitation of a bullet that has hit the rock and glanced off.

Chairs, bottles and guns used as clubs in a brawl are composed of break-away materials that do no damage. Chairs are usually made of balsa wood, bottles ordinarily of thin plasterlike material, and guns are usually of rubber. Even natural rocks and boulders are imitated in paper, cloth and paint when they are to be used as missiles in a picture.

The universal appeal of a wild west picture is based on its violent actions, thrills and scenic backgrounds. Generally the plots are simple and involve such things as the capture of villainous cattle rustlers or

Stunt actor Fred Kennedy (top) rehearses trick horse to fall and play dead. Break-away tongue (center) is used on wagon (below) occupied by a lifelike dummy

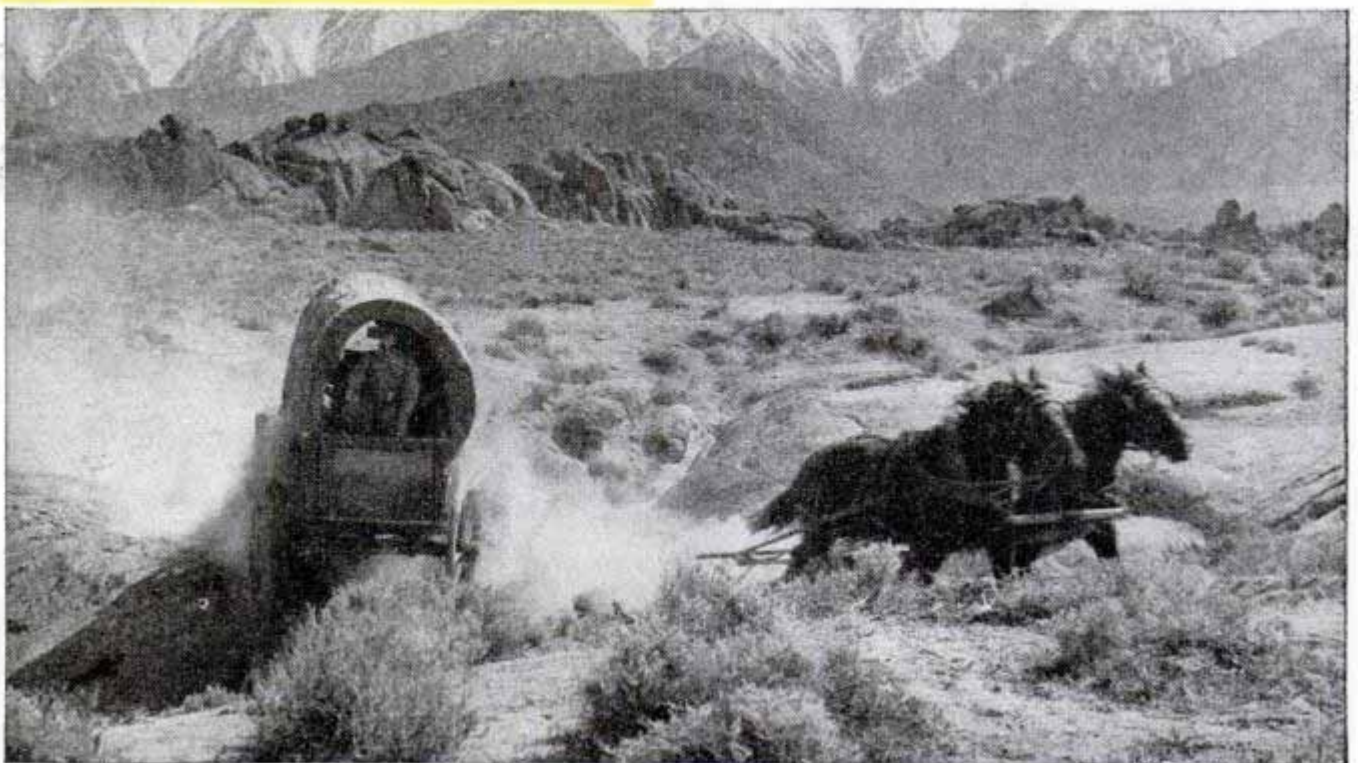

the winning of a gold mine from claim jumpers. Saddle horses and teams are invariably used and such vehicles as airplanes or automobiles rarely appear, even though the story is laid in the present. One minor Hollywood industry consists of riding stables specializing in western equipment and properties for the studios. Such a stable has barns crammed with buggies, surreys, coaches, wagons and miscellaneous vehicles and is ready to provide everything from saddles and harness to a score of horses and a herd of cattle upon demand.

Roughly one fourth of all Hollywood motion pictures are westerns, most of them produced by small companies and costing in the neighborhood of \$50,000. Superduper westerns, usually written around some famous historical episode, cost as much as \$3,000,000. In Paramount's "California," 1000 actors performed and in one scene 600 horses pulled a 150-wagon train.

Western pictures are as popular in foreign countries as they are in the United States and a good western picture may continue to run a full decade after it was first filmed. Tom Mix and Bill Hart were among the early western stars; Roy Rogers and Gene Autry are two of half a dozen or more modern cowboy heroes.

Padded stunt man (top) takes a spill. Safety platform (center) catches driver who falls between team. Below, a crackup

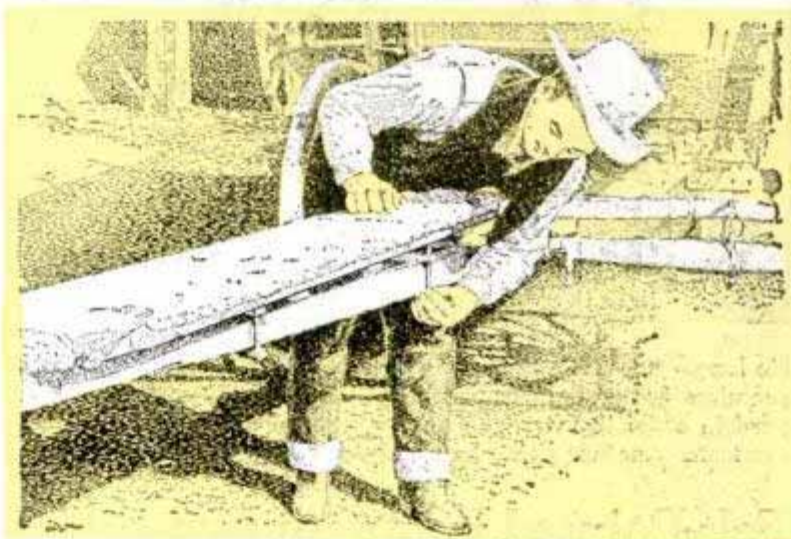

British Barrage Balloon Hoists Lights in Railroad Yard

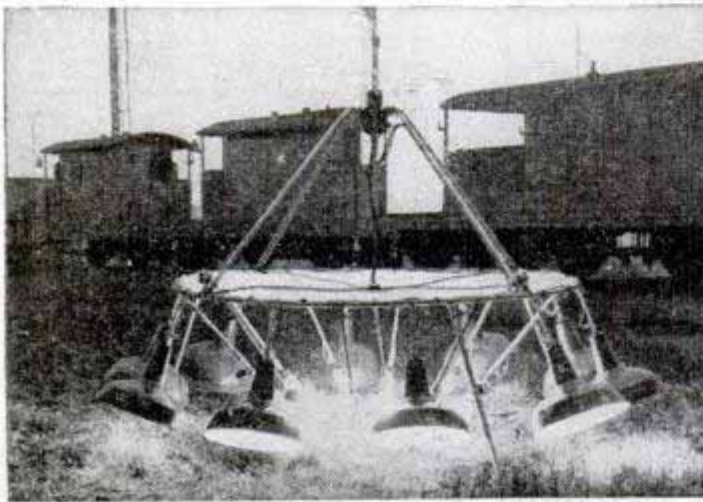
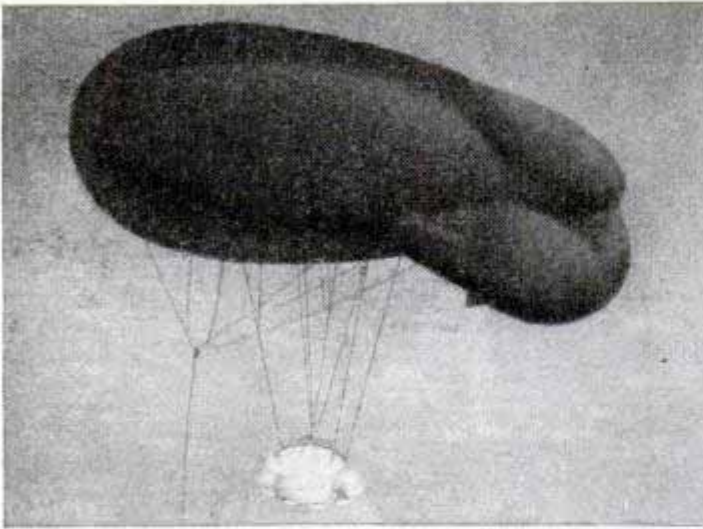

No longer needed for air protection in England, a barrage balloon has been used in a lighting experiment that promises better light for railroad workers. Twenty 1000-watt lamps were hoisted 150 feet above a rail yard in order to increase visibility throughout the area. Permanent structures may be erected as a result of the tests. Another possible use of the balloon-supported lights is in illuminating the scene of railroad wrecks

Felt-Pointed Fountain Brush Has Nonleak Control Valve

Hard felt is used as the point of a new aluminum fountain brush designed to letter hard-to-mark surfaces such as glass,

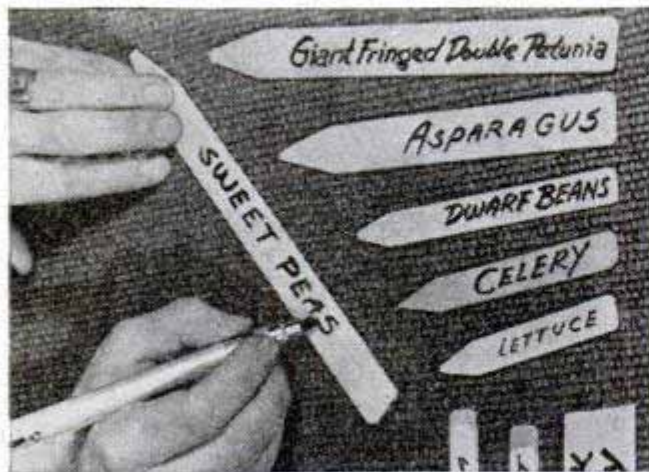

wax and Cellophane. The brush, no larger than an ordinary fountain pen, has an automatic control valve that opens only when pressure is exerted on the felt point. This prevents flooding or leaking. A variety of points are available and each point can be cut with a knife to change the width or shape of the line that is to be drawn. Special quick-drying waterproof marking colors are used in the brush.

U. S. Steps Up Machine Gun Fire

If all the forward-bearing .50-caliber machine guns on a B-25 bomber were to be fired at once they would hurl 280 two-ounce slugs in one second. Rate of fire of the Army's .50-caliber aircraft weapon has been stepped up 50 percent by the use of improved metals and technical changes since the end of the war. The improved .50-caliber fires 1250 rounds per minute as compared with 850 for the wartime model.



Elephants ARE GOOD PUPILS



herd, once halted a stampede and probably saved the lives of hundreds of circus fans.

Big John, decked out in spangled headgear and harness, was at the head of the column as the band blared into the march for the grand entry. "Tailed up" behind him, trunks and tails swaying, came the rest of the herd. The whole procession, from the clowns to the royalty of the high trapeze, moved rhythmically along the track.

Suddenly, two young male elephants became panicky, frightened perhaps by a bit of paper or by a woman's queer hat. They charged trumpeting from the line. One of them brushed Big John and pushed his headgear down over one eye. The bull-boss shouted. Hastily the procession halted. Some-

how, the two crazed bulls had to be stopped before the herd ran amuck.

Big John seemed undisturbed. He moved over to the high railing around the arena and used it to shove his headgear back. Then he turned and faced head-on the charge of the runaways, now pounding the track on their second lap.

They collided with a thud. The youngsters were stunned and Big John was knocked through a half dozen already-emptied rows of seats. The stampede was over before it started.

Elephant trainers say the fabulous stories about their ability to remember are fiction. Most elephants would forget their routines from one season to the next if

ELEPHANT actors of the big top were not hiding in the jungle when brains were passed around. This is proved every day by the big gray wagon-pushers and star performers, most popular of all the multitude of circus attractions.

The important job of training elephants must be completed before they are 10 years old. Pachyderms abide by the canine axiom that an old-timer can't be taught new tricks. The average young elephant, who starts to school when he is three or four, is smart and adaptable. He takes a back seat in his "books" only for the chimpanzee and the orangutan.

An elephant can act quickly in an emergency, too. Big John, leader of a circus

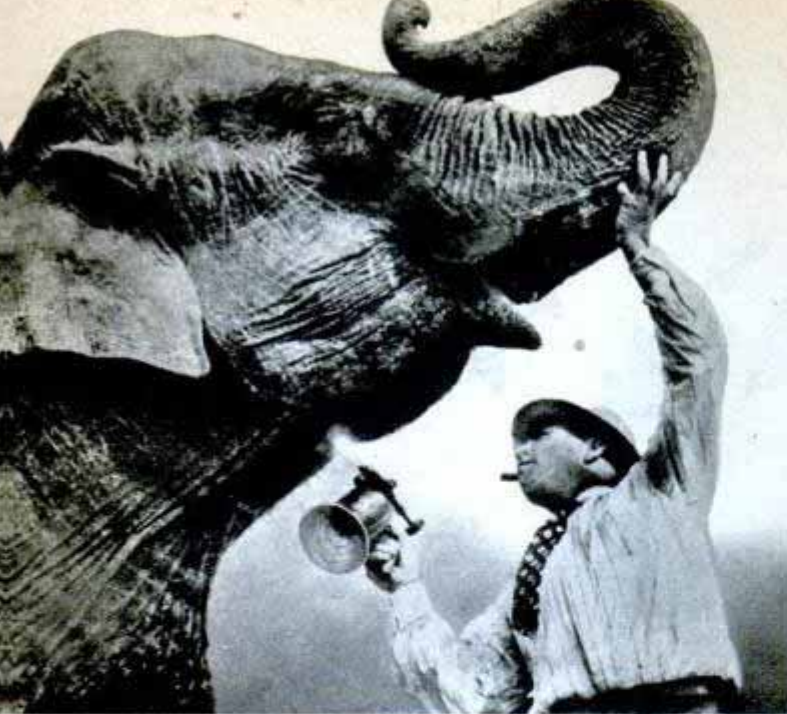

The well-groomed elephant has no worries with five o'clock shadow. His barber tenderly burns off his whiskers with blowtorch, above, while manicurist does his nails with drawknife, below, before ring appearances



it were not for review in winter quarters. Like humans, all elephants do not have the same I. Q. This also applies to size. The Asiatic elephant, which can be identified by ears which resemble a map of India, is usually larger and more tractable than its African cousin. Few weigh more than four tons. The biggest and most famous was Jumbo, who was exhibited by P. T. Barnum. He was almost 11 feet tall and could reach to a height of 26 feet with his trunk. Incidentally, in that long proboscis there are 40,000 individual muscles and so sensitive is it that an elephant can pull a cork from a bottle with it. Jumbo died following a head-on collision with a freight train which derailed the engine and two cars. His hide alone, mounted after his death, weighed 1400 pounds.

All circus elephants come from the jungles. Only 12 have been born in captivity in this country since the first one was unloaded at Salem, Mass., in 1796, and none has lived as long as a year. The Ringling Bros. and Barnum and Bailey Circus owns half the elephants in the United States and carries about 40 on tour with the show.

Edward Allen, famous elephant trainer, says that patience and kindness pay big dividends to an elephant tutor. Simple commands are repeated over and over and the trainer must not permit his charges to be hurt or lose confidence. One elephant, frightened once by an unsteady ring tub,

Spectacular perhaps, but easy for an elephant because the trunk acts as an extra leg helping him to balance



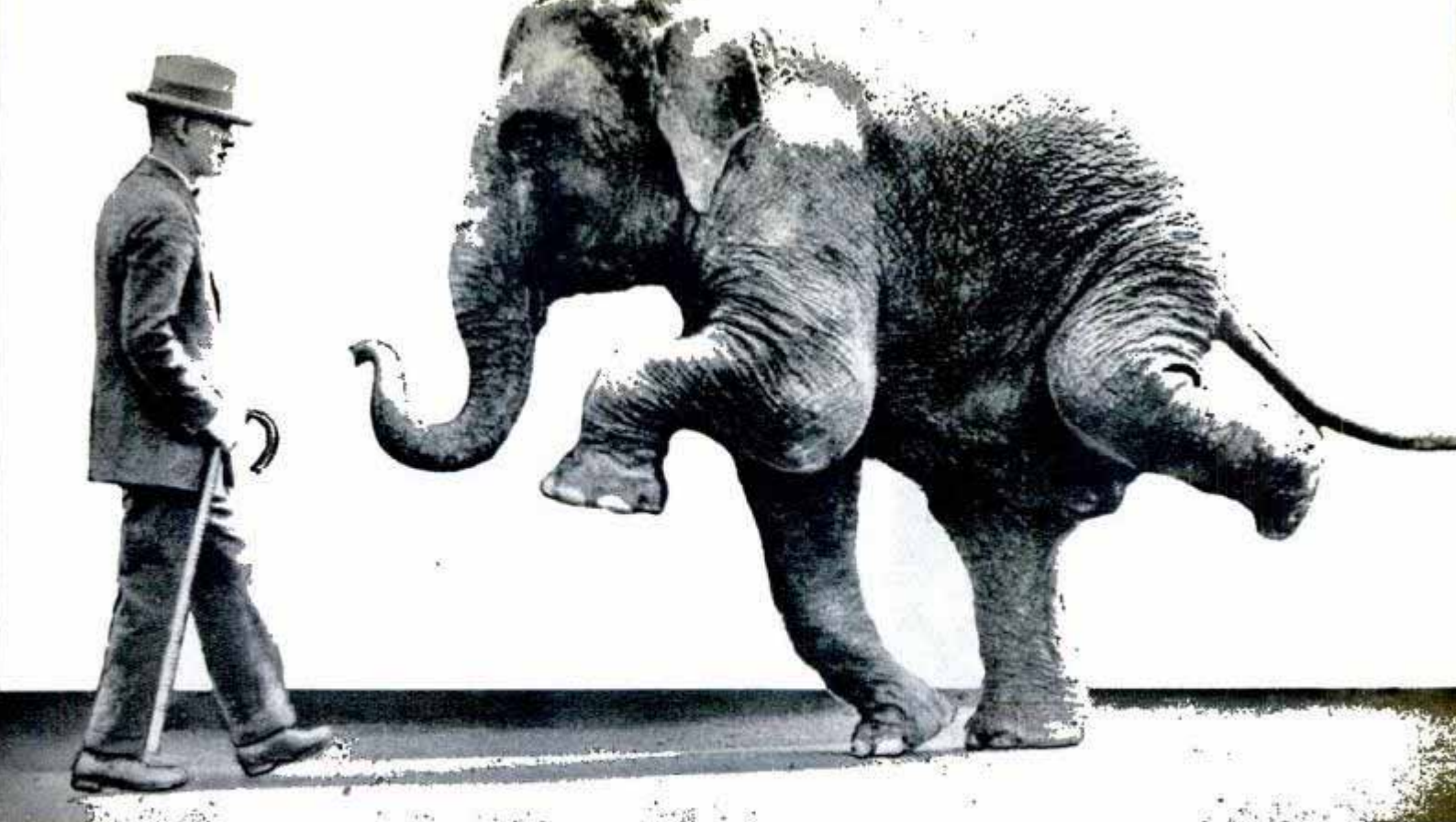

Dance steps are taught with a harness. When the trainer tugs on it the elephant is forced to lift its legs. As soon as the beast gets the idea it will go into its routine when the trainer signals with the bull-hook

would assume the required sitting-down position when performing but invariably she would hold herself an inch or two above the tub-seat.

Hoists and swings help in teaching basic tricks. First the beast is taught to stand on its hind legs, a difficult feat because the stand requires the development of unused muscles and a high degree of balance. Ropes are looped around each foreleg and through an overhead pulley. At the trainer's command, an assistant pulls on the ropes and the elephant is hauled into posi-

tion. A tub-seat supports the beast, helps it balance and lessens its fear of falling. Similar rigging pulls the elephant's trunk into saluting position. Soon the elephant learns to respond unaided to the command.

(Continued to page 244)

It takes as much training to break an elephant to working harness, below, as it does to teach it to go through its ponderous performance in the circus ring, right



AUGUST 1946



139

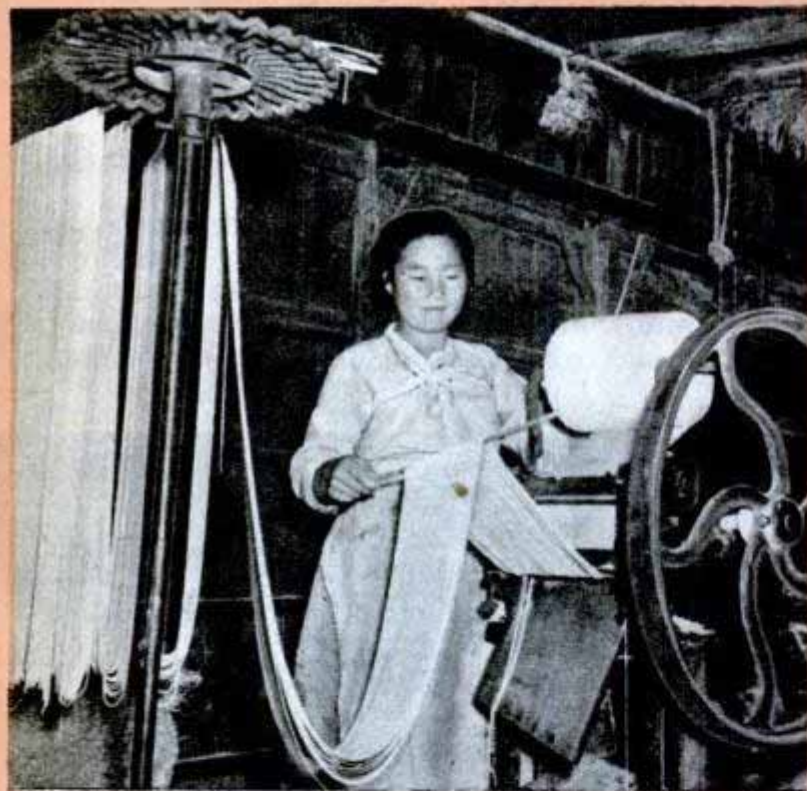
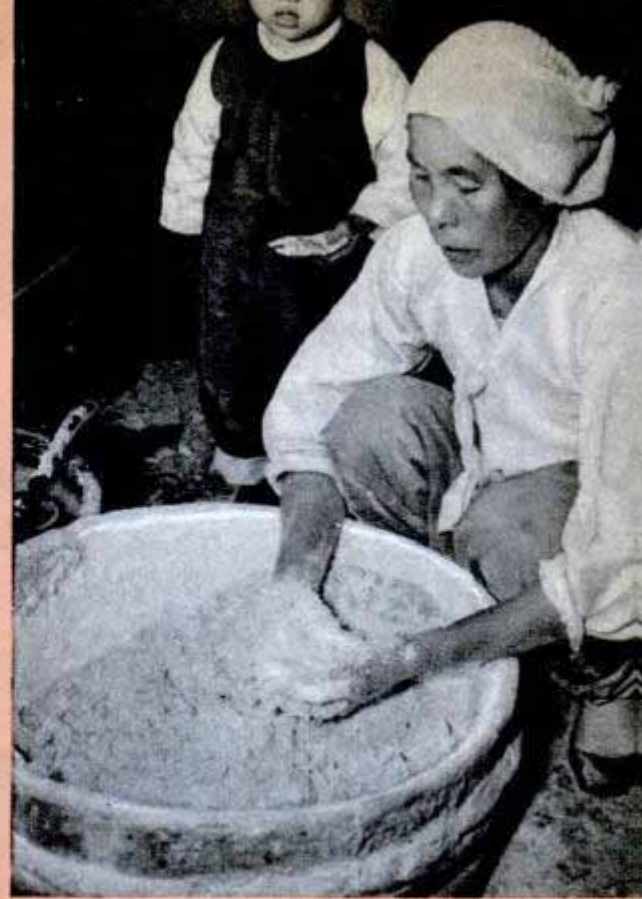

Korean Noodle Factory

In Korea rice cakes, pastries, bread and noodles are produced in small household factories where most of the work is done by hand. But the first traces of the machine age can be found even in these one-family shops. In this small factory at Fusan the family makes noodles to be sold on a local street corner. Dough of flour and water is first mixed (above) in a great bowl and kneaded to the proper consistency. Then it is fed into the machine shown at the upper left—the most valuable piece of property in the household. Wringerlike rollers flatten the dough into a continuous strip that is wound on a spindle. At left the dough is fed into the rear of the machine where an attachment slits the roll into noodles several yards long. The noodles are cut into smaller lengths and hung in the sun to dry (lower left). Below, a woman cuts the noodles into one-foot lengths and ties them into bundles for the market



Auto Exhaust Heats Stove

Exhaust from an automobile supplies the heat for an outdoor cookstove invented by an Army ordnance man and now available for civilians. The stove fits over the rear bumper and a curved pipe hooks onto the exhaust pipe of a car to catch the heat which approximates 212 degrees Fahrenheit. Exhaust fumes are dissipated from the bottom of the unit. The small stove is fitted with a cover, hot plate, grate and oven to provide all types of cooking for campers.



Glass Fishing Rods Rival Bamboo

Fly rods made of glass fibers have been developed that show even greater elastic qualities than bamboo. The rods are constructed by placing long fibers over a tapered wood core, then bonding them with synthetic resins. Toward the tip of the rod the fibers are cut at varying intervals to give the pole taper and elasticity. The glass is highly elastic

because of the extremely small diameter of each strand and is therefore ideal for making fishing rods. An estimated 538,000 individual fibers are used in making each rod. Advantages claimed for the new pole over bamboo rods are lighter weight, greater elasticity, higher breaking strength and immunity to the effects of salt water.

☞ You may wish to obtain additional information about the new products that are described each month in Popular Mechanics. If you want to know the name and address of the manufacturer or the distributor, just write to Bureau of Information, Popular Mechanics, 200 East Ontario Street, Chicago 11, Ill. Your letter will be answered promptly upon receipt.

DDT "Spider" on Lamp Kills Insects

Flies, moths, mosquitoes and other insect pests are killed by a spider-shaped wire frame coated with active DDT crystals. Inside the frame are two wire clips similar to those that fasten a lamp shade to a light bulb. At night the "spider" may be clipped to a bulb to kill moths and mosquitoes. During the day a piece of fly bait may be placed between the clips.



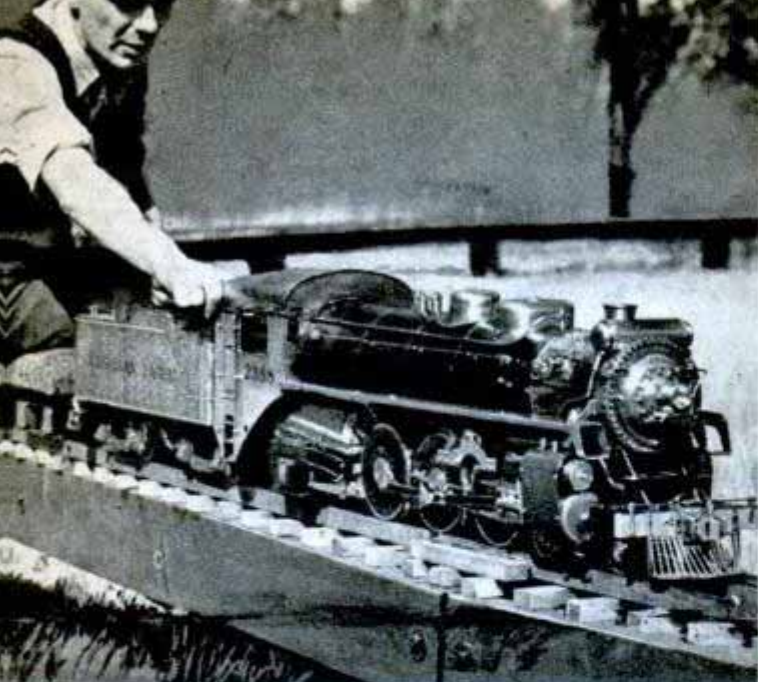

COAL-BURNING STEAM LOCOMOTIVE MODEL built by Charles Montgomery of Toronto, Canada, develops power enough to haul eight adults on a small track



THIRD DECK installed on Great Lakes Steamer Charles Donnelly increases ship's auto-carrying capacity by 90 cars. Now 432 cars are transported on three decks



SEAGOING NAVY BLIMP is equipped with rubber pontoons for water landings. After coming to rest, the craft can be moored by throwing out a sea anchor



HAND-OPERATED AUTOMOBILE enables movie actress Susan Peters to drive despite the fact she lost the use of her legs in a hunting accident a year ago

STREAMLINED CAR built from spare aircraft parts attains a speed of over 130 miles-per hour. Assembled by Jack Norvell of Los Angeles, it is 18 feet long

GOLDEN ARROW, one of Great Britain's finest trains, recently made its first postwar run and now is on schedule between London's Victoria Station and Dover

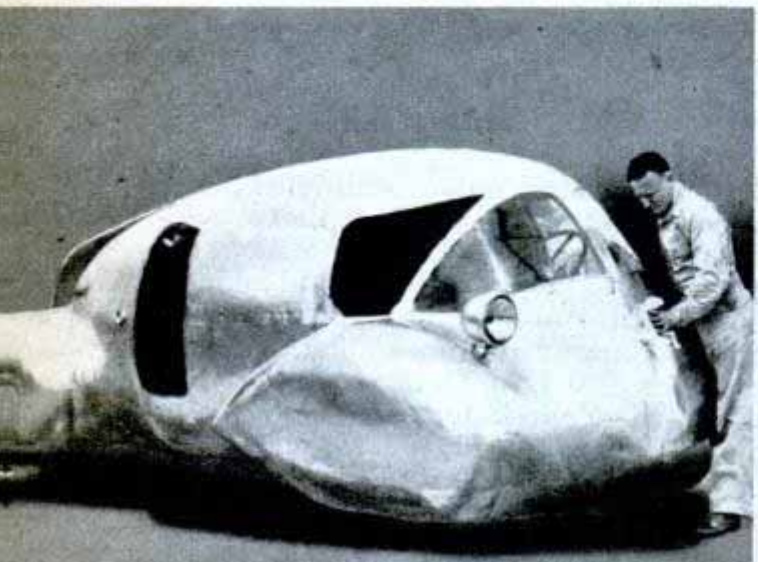

Automatic Microfilming Camera Photographs Each Side of Check

Both sides of bank checks are photographed simultaneously by a microfilming machine. The lengthwise images of the checks appear side by side across the narrow width of 16-millimeter film. Reduced photographically 35 times, both sides of 10,500 checks can be photographed on 100 feet of film, or 100 checks per foot. The machine also endorses and face-stamps all checks, eliminating a separate operation in busy banks. Face-stamping proves that the check has been photographed and is on a microfilm file. The machine, developed by Recordak Corporation, subsidiary of Eastman Kodak Company, is expected to have wide application in offices where inactive file cards and record sheets occupy valuable floor space in file cabinets.



Silver Reclaimed From Hypo By Use of Wood Waste

Valuable silver floating around in used photographic hypo can now be reclaimed through the use of a wood waste product called lignin. Treated with an alkali, lignin is poured into the hypo solution to cause the silver to settle to the bottom of the tray along with the lignin. Next, the liquid hypo is poured off, the lignin is

burned and only silver is left. Firms that develop many films are expected to realize substantial savings by this method.

Platform Atop Mobile Crane Gives Photographs Desired "Angle"

To get proper elevation for a picture of new freight cars coming off an assembly line of the Pullman-Standard Car Manufacturing Company a photographer mounted his cameras on a four-foot-square platform and then commandeered a mobile crane to lift him into shooting position.

Rotproof Fabric Buried 90 Days Retains Full Strength

Improved chemical preservative protects fabrics against rot-causing fungi, prolonging the life of fish nets and lines, tents, tarpaulins, awnings, shoe liners, fire and garden hose and such clothing as overalls and military uniforms. Reformulated by the Monsanto Chemical Company, the long-lasting fungicide first was developed by a German chemist 66 years ago but its potentialities were discovered only recently. Known technically as copper 8-quinolinolate, the preservative is applied to fabrics at textile mills. In one test, treated and untreated strips of cloth were buried in a greenhouse where soil swarmed with destructive organisms. The untreated fabrics were destroyed in from five to seven days, while the treated samples retained full tensile strength after 90 days.



RAISING rabbits by the ton is the avocation of a Chicago oil man whose ultramodern "rabbit hotel" provides all the comforts of home for its 800 tenants and pays off in profits from fur and meat.

Whether it's meat for your own table or a money-making small business that happens to be your incentive, an efficiently operated rabbitry can pay dividends. Sheldon Clark, chairman of the executive committee of Sinclair Refining Company and a noted yachtsman, started his rabbitry as a hobby on his 87-acre suburban estate, then let the multiplication tables work for him. His 125 doe rabbits produce four litters a year, usually eight to the litter, and in 10 weeks each rabbit is a three-pound package of meat ready for market. Mr. Clark finds a ready sale for frozen rabbit, and a mail-order house absorbs his harvest of hides.

Rainbow Farm is one of the most efficiently designed and equipped rabbitries in the country, with running water and all the mechanical conveniences conceivable

Live rabbits, frozen meat and hides constitute big business at Chicago's model Rainbow Farm rabbitry

for operation by a two-man crew which also has time to perform the maintenance work around the suburban farm home.

The GI starting a small rabbit farm can choose from a number of breeds according to the type of business that interests him. He can raise Angora rabbits to produce fluffy wool, or he can specialize in any of five other breeds (White Satin, Rex, Chinchilla, New Zealand, Flemish Giant) depending upon whether he wishes to concentrate on producing meat, felt for hats or fur for coats.

On the Clark farm New Zealand whites are the specialty. Charles Zundel, No. 1 maintenance man, designed the rabbit houses and the automatic and semiautomatic equipment so that a minimum of labor keeps the quarters clean and the rabbits well fed, watered, clean and healthy. Built on a grade so that the concrete floors slope to the rear, the houses have recessed concrete pits under each row of hutches. Daily washing by hose keeps the entire place spotlessly clean. Blowtorches re-

Double-deck hutches with wire-mesh bottoms house the rabbits. Concrete pits below are washed every day

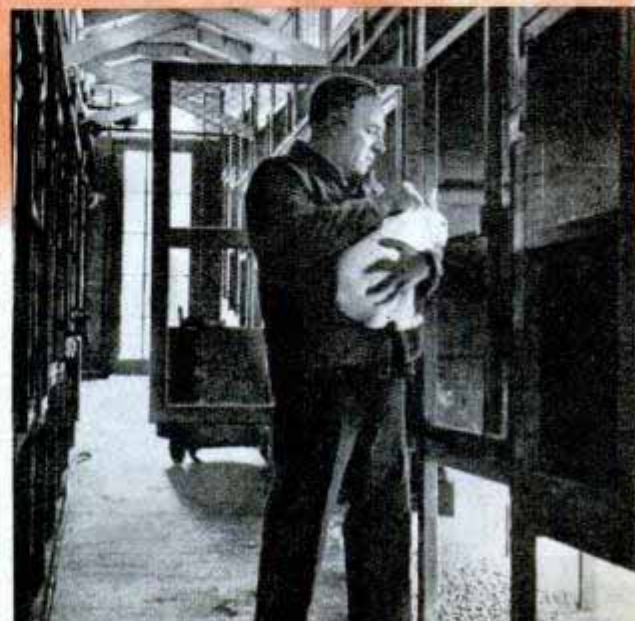

Rabbit Hotel

move rabbit hair from the wire mesh used for the bottom of each hutch.

Wire mesh is used for two reasons: (1) rabbits kept off the ground provide tender meat, and (2) wire construction insures cleanliness and proper ventilation. Since the hutches—132 per house—are erected in double-deck fashion, a slanting sheet of metal separates the top and bottom hutches and directs droppings into the pit to be collected for fertilizer.

Automatic drinking fountains satisfy the rabbits' thirst. In each hutch a water pipe with a nipplelike valve emits drops of water when touched by a rabbit's mouth. Gravity-feed tanks at the top of the house supply the water.

Feed (a mixture of alfalfa pellets, oats and soybeans) pours out from a gravity-type storage bin when a small vertical gate is raised. A rubber-tired feed cart is used to wheel food from one hutch to another.

Oil stoves and long pipes keep the building warm in the winter, while fresh air is brought in by spinning ventilators turning



From a gravity storage bin, rabbit feed pours automatically. It's a mixture of alfalfa, oats, soybeans

Bunnies get water from drinking fountain that has nipplelike valve. Below, star boarder greets feeder





Placed on wire shapers, rabbit hides dry in about two days. Then they're sold for \$2 a pound for fur garments

on oiled ball bearings. In mild weather additional air and sunshine are admitted by lifting hinged wall boards on the side of a rabbitry opposite the direction from which the wind is blowing.

Eight to 10-week-old rabbits are butchered and the meat—about three pounds per rabbit—is kept fresh in an electric freezing cabinet. The meat sells for about 50 cents a pound.

Hides are stretched and dried on wire shapers with the bottom of each skin held tight by clothespins. The skins dry in two days and are sold for approximately \$2 a pound, or 35 to 90 cents per hide, depending on the size and quality. The fur is used to line gloves, helmets and other garments and for some types of coats.



Tattoo box (left) holds rabbit securely while identification marks are applied to inside of his ears (right) which stick through slots in the box top. Above, rabbit meat is put in Cellophane-topped box and frozen

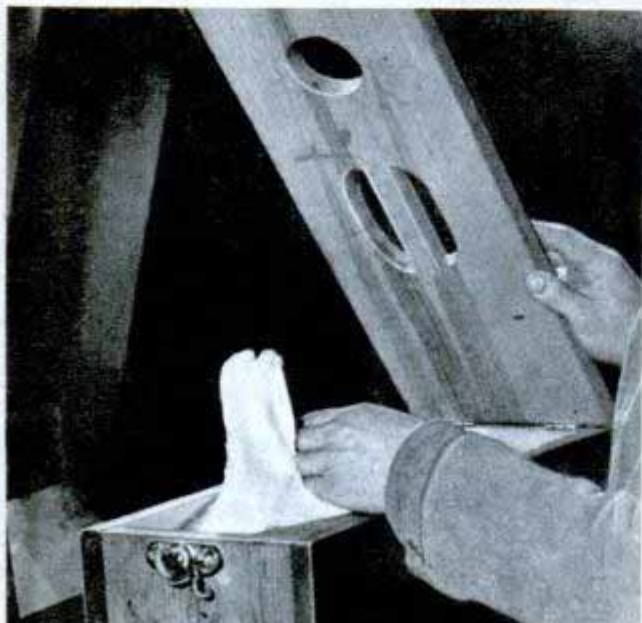



"Egg-Beater" Propeller Boosts Speed of Test Ship by One Third

Six-bladed propellers of revolutionary design were recently installed on a Navy landing craft and tests show promise that they may become standard on all vessels. The cycloidal propellers were developed by Prof. Frederick K. Kirsten of the University of Washington. They consist of giant rotors seven feet in diameter from which the blades project vertically into the water. Each of the blades revolves twice on its own axis during one revolution of the en-

tire rotor. Rudders have been removed from the test ship, as the angle of the blades can be changed to steer the ship. Tests show that the speed of the ship has been increased more than a third by the elimination of rudders and struts beneath the hull. Maneuverability is greatly increased, according to Navy officials. The test craft can spin in a complete circle without fore and aft movement, or can move directly sideways under its own power.

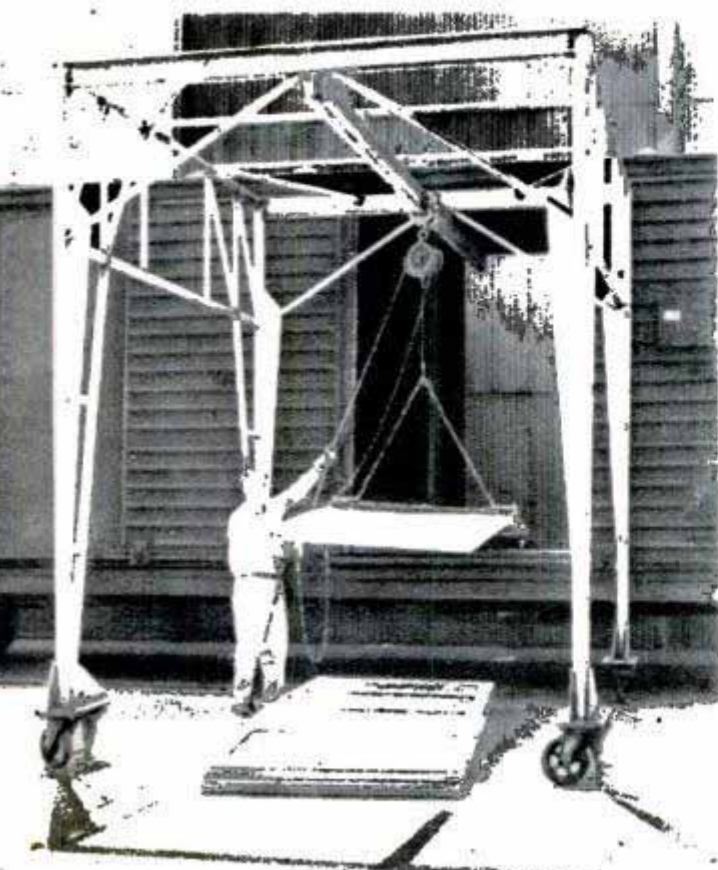

Portable Hoist Unloads Cars Where Cranes Are Lacking

Loading and unloading freight with a monorail hoist extended into the doorway of a boxcar is a technique devised by a Douglas Aircraft Company employee to speed operations and cut demurrage costs when cranes are not available. It also reduces the danger of heavy material falling on a worker inside the car. The monorail beam is mounted on a mobile metal frame.

Underwater Canyon 600 Feet Deep

Far beneath the surface of the lower Mississippi River is a mud-filled canyon five miles wide with walls 600 feet high. This underwater "Grand Canyon" was discovered by Walter J. Osterhoudt of the Gulf Research and Development Company, Harmarville, Pa., while studying the geological structure of the area south of Timbalier Bay in Louisiana.

THE FISHING FLEET

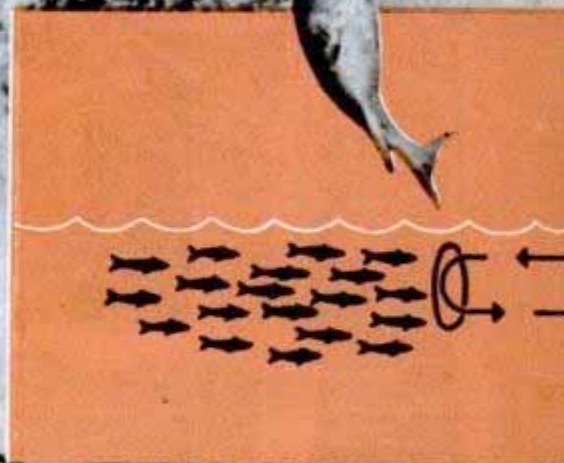

GOES *Scientific*

By Thomas E. Stimson, Jr.

DEEP-SEA fishing fleets of the Pacific are returning to port with bulging holds, hulls riding low in the water. Scientific methods of exploring the ocean are giving the ranging skippers "underwater eyes" for spotting bigger and better schools of succulent fish.

"Thar she blows!" is still the signal to the crew that a whale has been sighted. But next year the whaling fleet that works out of British Columbia expects to use sonar instruments as mechanical lookouts to detect a whale several miles away—while it's still submerged!

Developed during the war as a method of finding and tracking enemy submarines, sonar uses sound waves under water the same way radar uses radio beams above the surface. The new echo-ranging gear will make it possible for a whaling vessel to track a submerged leviathan until the crew can look straight down the spout when the beast comes up to blow.

Even the lowly sardine is now caught by applied science. Formerly purse seiners were always limited by their ability to spot schools of fish that happened to be at or near the surface after dark. Lookouts detected the presence of a school by peculiar phosphorescence that follows in its wake.

Now the skipper of a purse seiner can spot fish that are far below the surface. Watching the dial of the Fathometer in the wheelhouse, he may observe that a flashing dot of light indicating a depth of 400 fathoms is being interrupted by flashes much higher up the scale.



Navigator on a far-ranging tuna clipper swings the loop of his radio compass to "fix" a shore station

"There's a 'false bottom' at 100 fathoms," he tells his mate. "Might be sardines. We'll use the floodlights to try to bring them to the surface."

The Fathometer was a forerunner of the more complicated sonar instruments. It projects a sound signal down through the water from the hull of a vessel, measures the time required for the signal to strike bottom and be reflected back to the hull, and translates this interval into fathoms of depth. Fishermen use the Fathometer in place of the old lead line for ordinary navigation and for finding just the right depths at the fishing banks. A "false bottom" reading on the Fathometer simply may indicate a current of water of extremely different temperature or salinity some distance below the vessel. But similar indications are obtained when the signals are

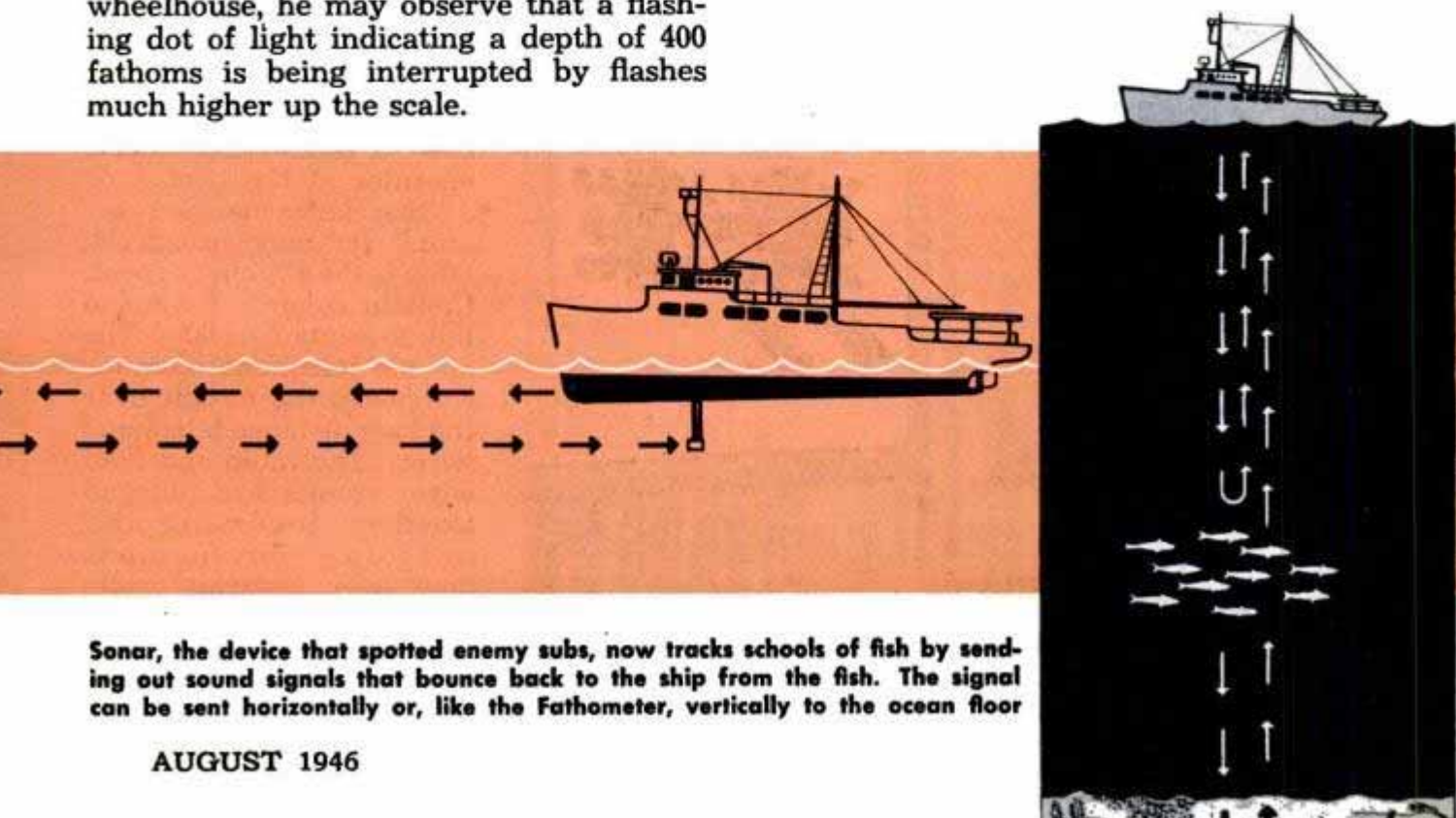

Sonar, the device that spotted enemy subs, now tracks schools of fish by sending out sound signals that bounce back to the ship from the fish. The signal can be sent horizontally or, like the Fathometer, vertically to the ocean floor



Complex tuna clippers like this modern ship can range far from home port and quick-freeze as much as 500 tons of fish during each trip
 Courtesy Van Camp Sea Food Co.

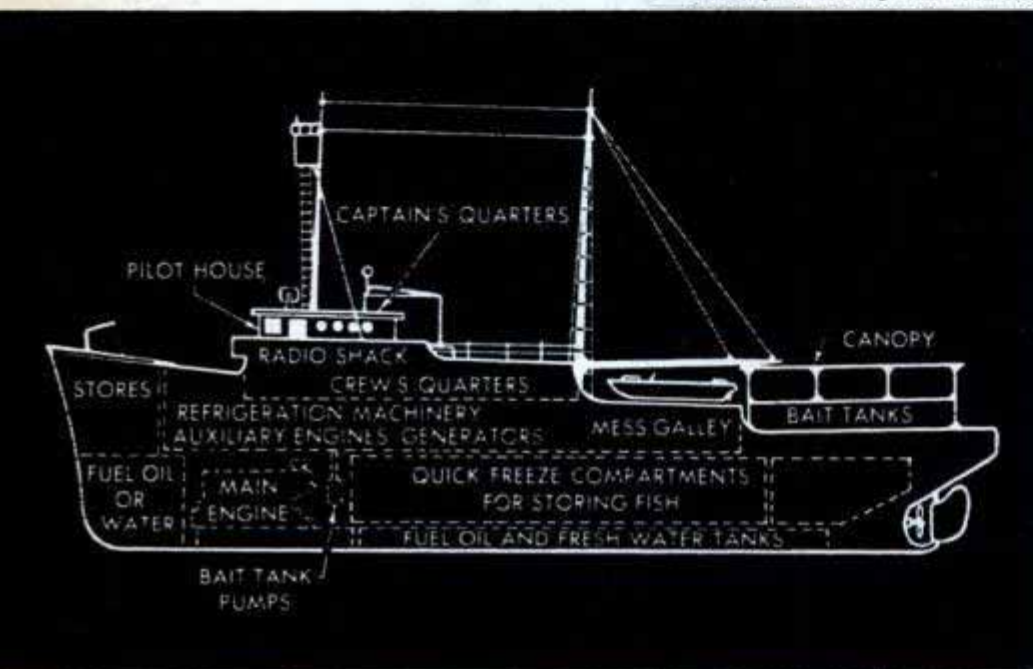

↑ Diagram of clipper shows freezing compartment where catch is stored
 ↓ Fathometer dial tells depth of the ocean floor and intervening fish

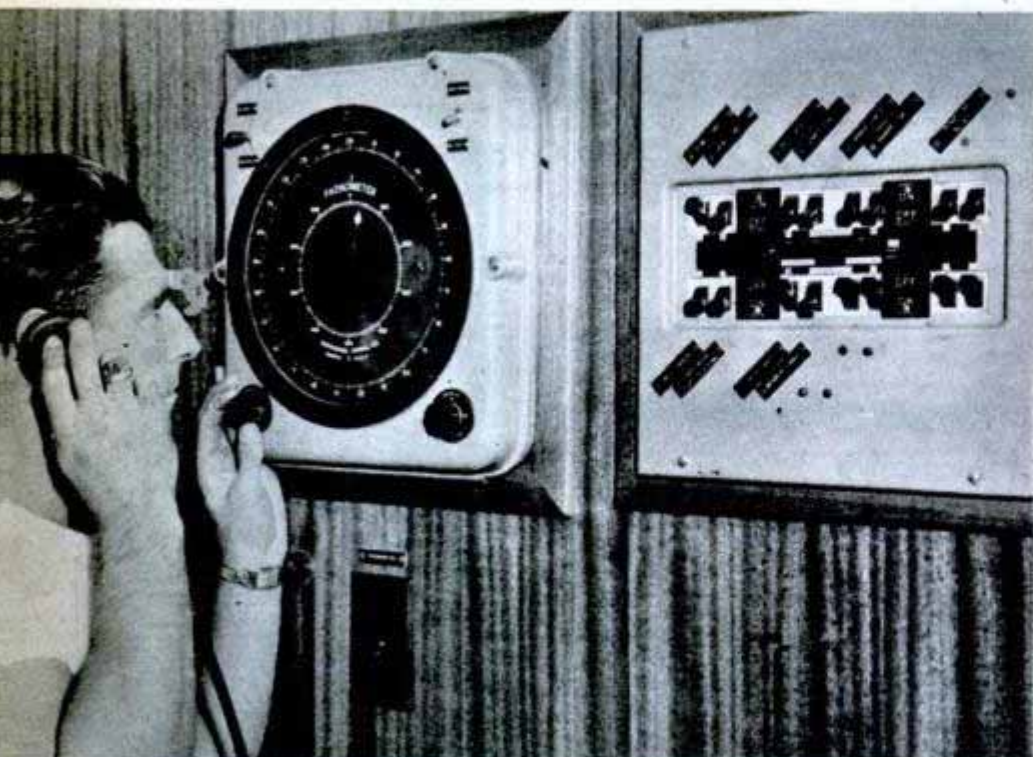

reflected from closely packed schools of sardines or mackerel or even from a whale.

Purse seiners employ floodlights as an attraction to keep a school of sardines close to the surface while a quarter-mile-long net is being drawn around the school. Another favorite trick is to use an underwater flashing beacon to prevent the school from escaping while the ends of the net are being closed. Hanging at the end of a 150-foot insulated cable below the boat, the beacon frightens the fish back into the enclosed area.

Commercial fishermen have used short-wave radiophones for a number of years for sending distress messages when the ship breaks down, and for reporting their positions and loads to shore stations. Gossiping back and forth with other boats over the radiophone, a fishing skipper learns what boats are having good luck and what boats are finding no fish. From their locations he decides where he should go to find his load.

Recently this phone facility has been hooked up to telephone circuits ashore. A fisherman who wants to report his load to his cannery or call his home to tell his family when he will return merely broadcasts a call to the marine operator at the port.

"San Pedro marine operator," he may broadcast, "this is the Flying Serpent, Captain Adams. I want to talk to Santa Ana 000." The marine telephone operator completes the circuit over the long distance telephone wires. The radio and land wire circuits are plugged together. Incoming and outgoing conversations flow over separate radio frequencies, each of which is "guarded" when not in use by intermittent tone signals similar to the busy

signal you hear on a telephone when the circuit is in use. This radio busy signal warns other stations off the frequencies and prevents interference.

During the war Navy blimps and Coast Guard aircraft often assisted the fishing fleet by reporting the locations of large schools of fish sighted from the air. This impromptu spotting service is to be continued by scout aircraft provided by some of the canneries themselves. One plane is to be based on the Galapagos Islands, two at Costa Rica. They will search hundreds of square miles of ocean daily, radioing to the clippers the latitude, longitude, size and direction of travel of the schools.

Most complex of all the Pacific fishing craft are the tuna clippers that cruise for



Various "teasers" and lures are used in commercial deep-sea fishing. This fisherman is examining a huge wrought iron hook and wire leader for catching sharks

although the hull at the stern may have a draft of 15 feet. The after deck is practically awash because the heavy fish are caught from the stern of the vessel and must be raised from the water. The low deck makes for easier, faster work.

Fishing crews stand on low metal racks that are swung outboard from the hull. Usually they receive involuntary baths when the vessel rolls and occasionally a man is swept overboard. He must be rescued at once because sharks may be in the area preying on the school of fish.

Live bait is thrown into the water from a large bait tank to attract the tuna to the boat. The fishermen use sturdy bamboo poles, short lines and feather lures that hide a barbless hook. When a fish strikes the lure a heave on the pole lands the tuna,

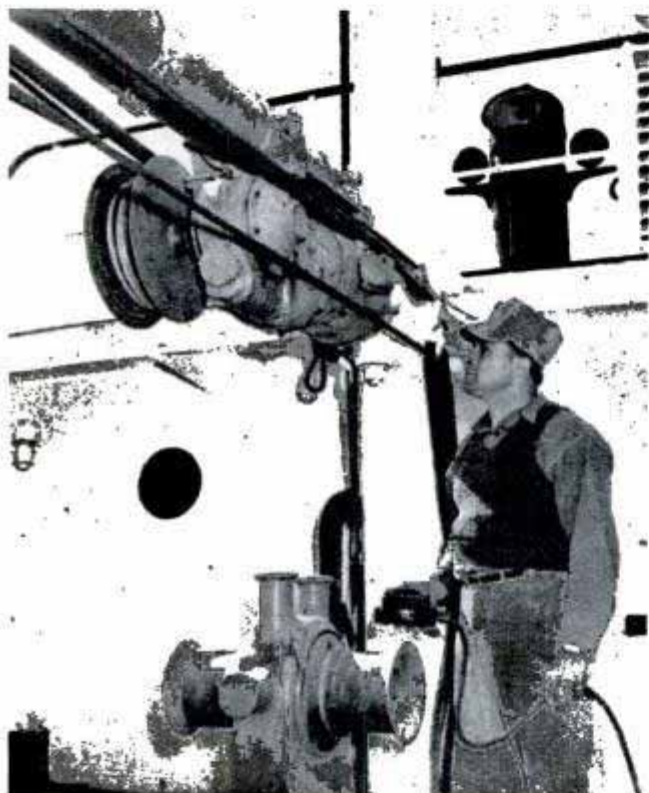

Portable switchbox in fisherman's hand controls a rugged electric motor on cargo boom. Right, wheelhouse governor permits remote control of main engine

thousands of miles in search of fish. Depending on the season of the year a clipper may get its load almost within sight of its home port or it may follow the fish all the way to the coast of South America, below the equator. The tuna pack, which had a value of \$50,000,000 last year, is the most valuable fishery on either coast. One record catch delivered recently in San Diego by the "Espirito Santo" after a 57-day round trip to the Galapagos Islands consisted of 445 tons of yellow-fin tuna. The prize load was valued at \$88,950.

Modern tuna clippers, because of their peculiar needs, look like no other craft in the world. A typical vessel has a high forward deck, with very little freeboard aft



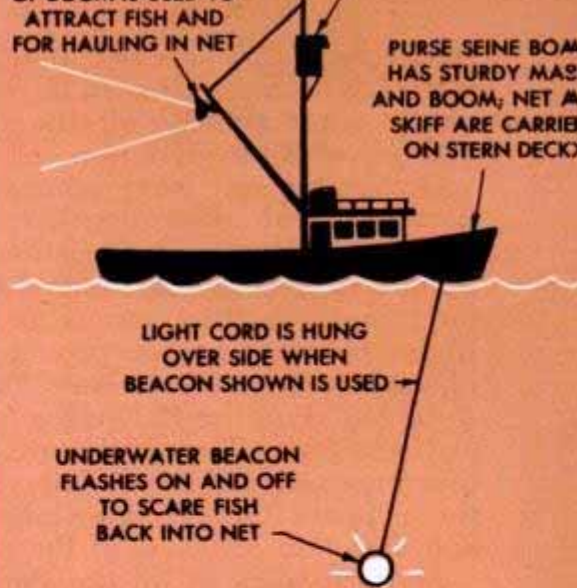
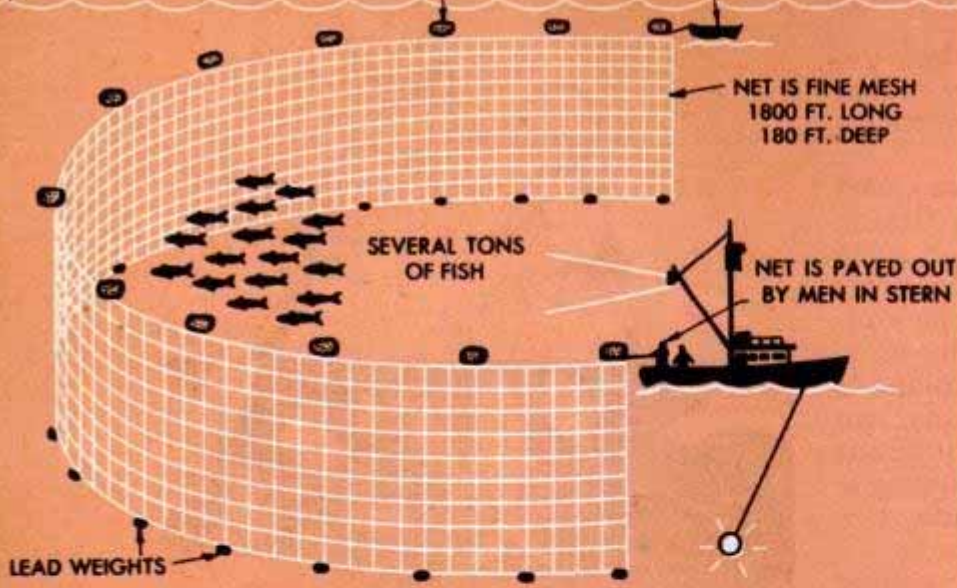

Sardines for your table are trapped in cork-floated nets payed out in a great circle by the purse seiners

the hook flies free and the fisherman casts the lure back into the water.

Tuna vary greatly in weight. The fish in a school may average 20 pounds, 30 pounds or even as much as 60 pounds. The fishermen form "three pole" or "four pole" teams for catching the larger fish, working simultaneously with all the lines of a team attached to a common leader and hook.

Before the war freshly caught fish were iced down in the fish holds or stored in refrigerated brine tanks. Postwar clippers are equipped with quick-freeze units that spot-freeze the fish and keep them at below-freezing temperatures during the return trip. The fish must be thawed at the cannery before they can be cut up, cooked and canned, but this extra step in the canning process is more than offset by a lack of spoiled fish that formerly were found in most loads.

From the mechanical standpoint a modern tuna boat rivals an ocean liner in equipment. No expense is spared to provide every



Light on the boom attracts fish while undersea beacon shown at left frightens them into net

navigational device and working aid. A tuna clipper may cost as much as a quarter of a million dollars, one third spent on the hull and two thirds on equipment.

Typical of the latest clippers is the "Chicken of the Sea" that fishes for the Van Camp Sea Food Company of San Diego and San Pedro.

This 142-foot vessel is powered by a 1560-horsepower Diesel engine and has two 265-horsepower auxiliary Diesels that drive 175-kilowatt generators. Aside from its engines the boat is all-electric in operation. Electric motors operate the sharp-freeze refrigeration plant and drive the large pumps that circulate fresh sea water through the bait tanks. The vessel can carry 250,000 sardines or other small bait fish and is equipped with small boats and nets for collecting this bait.

The vessel has an automatic fire alarm system with carbon dioxide extinguisher

(Continued to page 236)

Left, lookout in this protected station on the mast can guide the steersman by telephone toward a school of fish. Right, fishermen of a "two-pole team" join forces to swing a tuna heavyweight aboard the clipper

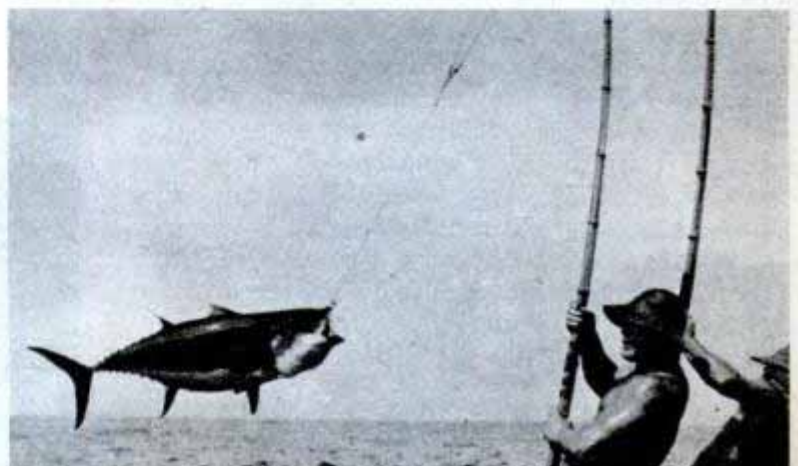

Converter for Manual Saws Makes Operation Automatic

Manually operated metal cutoff saws can be converted to automatic operation with a device that is installed in a few hours. The converted unit will cut any length stock from $\frac{3}{16}$ inch up with a consistency of accuracy to .010 inch. The controlling element of the new device is a supersensitive air valve that is located at the length control stop, the block of metal that governs the length of pieces that are to be cut. When the saw cuts through a piece of stock, the piece falls, releasing the air valve which activates an air cylinder. The cylinder raises the head of the saw until the stock is cleared. At the same time the clamp that holds the stock during the sawing operation is released, and a chain operated by a friction clutch pulls the stock forward until it is again in position against the length control stop. This closes the air valve and lowers the blade to complete the cycle of operation. The saw can be changed back to manual operation simply by turning off the air valve. The life of the saw blade is said to be prolonged as much as 50 percent by an oversize oil-check cylinder that lowers the blade gently into the stock. Special units are built to fit each of the more widely used makes of metal cutoff saws.

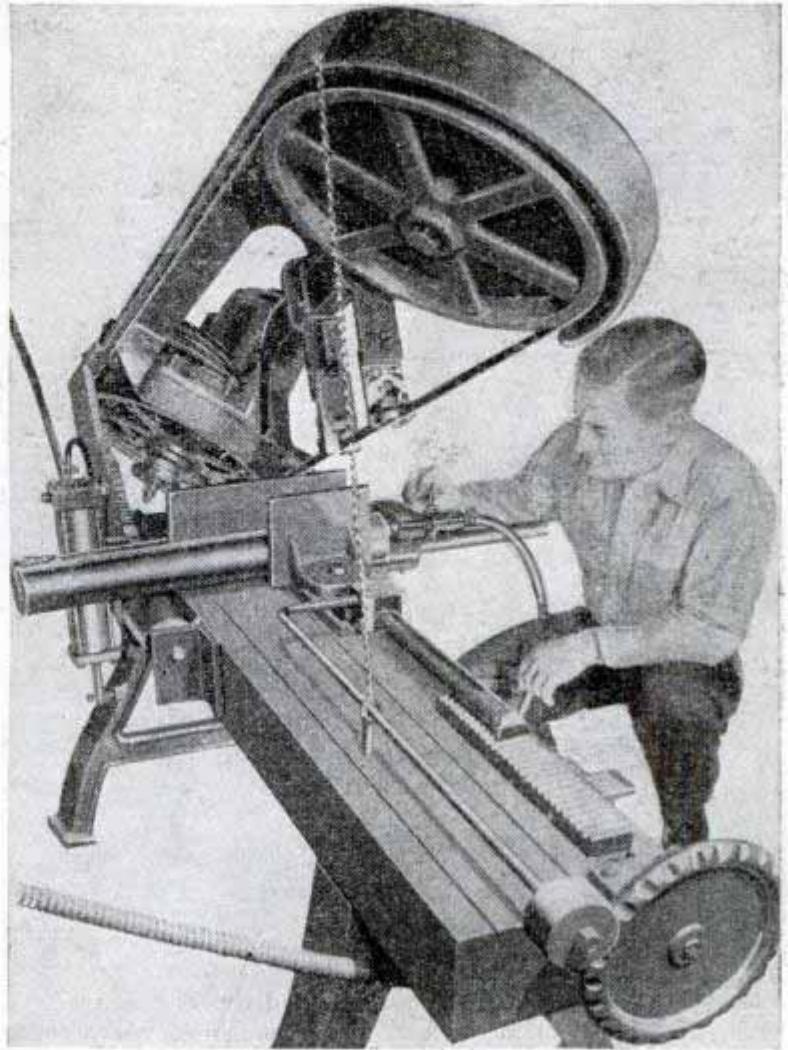

Homemade Tom Thumb Tractor Built to Half-Size Scale

Children enjoy cultivating make-believe farms with a real though pint-size tractor built by Carl Huber of Colfax, Washington. Huber estimates that he spent 1500 leisure hours and about \$100 for materials in



building the model, which was started five years ago. The tractor is built to a half-size scale of a real tractor and contains individual steering clutches, a master clutch, gas throttle, greasing system and leather upholstered seat cushion. Most of the parts are constructed of wood. The track shoes are made of masonite, the cleats of maplewood and the track chain of rubber belting. The machine weighs about 200 pounds, is 48 inches long, 33 inches wide and 28 inches high. Top speed of the tractor is five miles an hour.

Paprika Makes Brook Trout Wild —At Least in Color

Hatchery-reared brown or brook trout are getting paprika in their diet. This brightens their normally pale pigmentation to the same color as wild trout. The diet is being fed by the U. S. Fish and Wildlife Service. Controlled experiments revealed that coloration of hatchery trout similar to that of wild trout could be produced by using two percent of paprika in food. The paprika colors only the exterior of the fish and does not affect the taste of the flesh. Anglers had objected to hatchery trout because of their pale coloration.

DRIVE TO THE



Signal Corps photo

Motorists, take your pick—from pines and snowy peaks of the Pacific Northwest to Mexican village near Pan-American route
Mexican Tourist Association photo



By Andrew Hamilton

NOW that the family car is rolling again you'll want to explore the possibilities of driving to the other Americas.

The international highways to adventure beckon whether you're the proud owner of a spanking new 1946 model or the driver of a patched-up vehicle whose vintage dates back to the '30s.

There's real news for the motor-ing vacationist in what lies ahead in 1947, 1948 and the 1950s. Get out your atlas and check these exciting prospects:

(1) By 1947 or 1948, the Pan-American Highway—almost all 13,000 miles of it—should be completed and you will be able to drive to Argentina or Brazil.

(2) An auto ferry is planned from Florida to the West Indies.

(3) A new round-trip highway into mysterious Lower California will be completed soon.

(4) Improvements should be well under way on the southern section of the Pacific International Highway down the west coast of Mexico.

OTHER AMERICAS

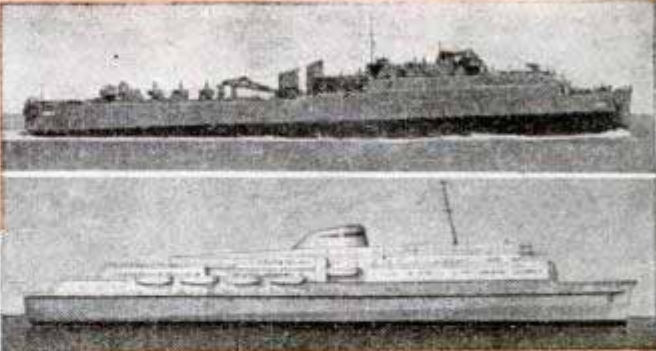
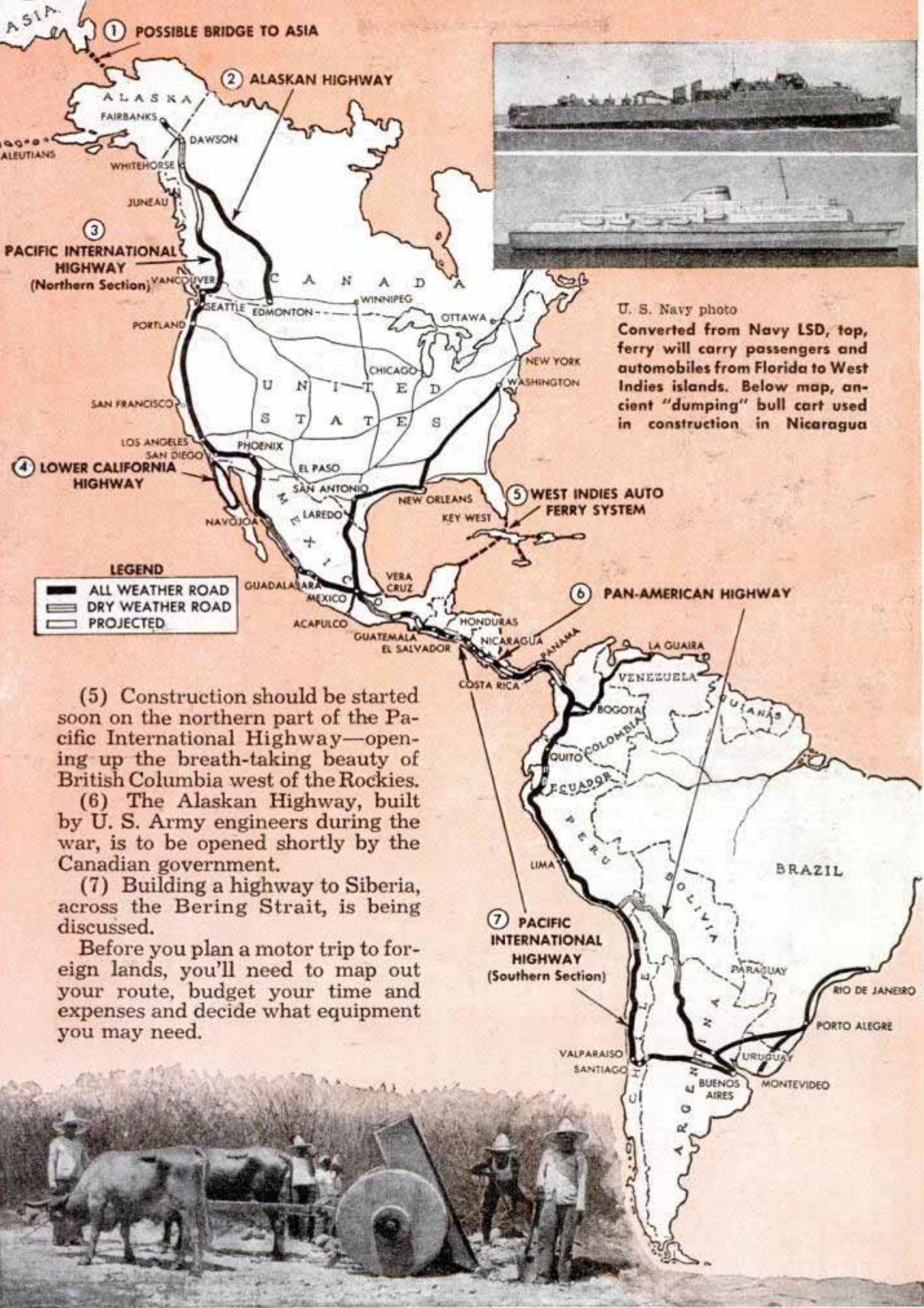

U. S. Navy photo
 Converted from Navy LSD, top, ferry will carry passengers and automobiles from Florida to West Indies islands. Below map, ancient "dumping" bull cart used in construction in Nicaragua

(5) Construction should be started soon on the northern part of the Pacific International Highway—opening up the breath-taking beauty of British Columbia west of the Rockies.

(6) The Alaskan Highway, built by U. S. Army engineers during the war, is to be opened shortly by the Canadian government.

(7) Building a highway to Siberia, across the Bering Strait, is being discussed.

Before you plan a motor trip to foreign lands, you'll need to map out your route, budget your time and expenses and decide what equipment you may need.



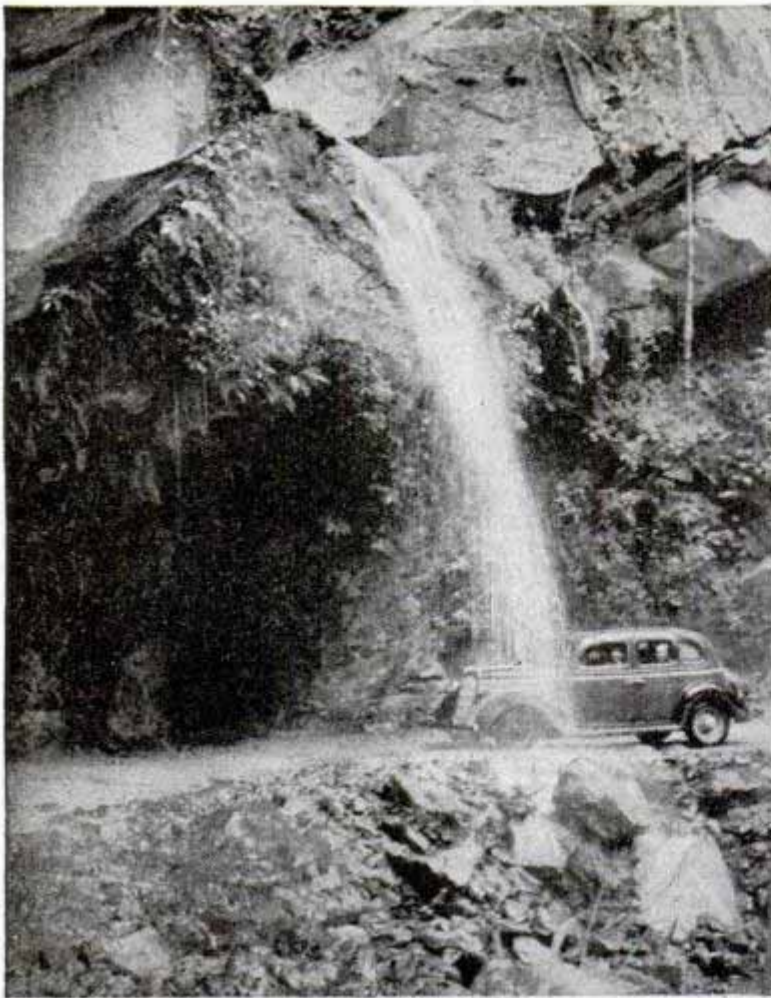

Construction of the new international highways was speeded by the war. In 1942 and 1943, when Nazi subs were sinking our ships and the Japs were making landings in the Aleutians, it looked as if our only link with Alaska and the Panama Canal might be overland highways. Army engineers performed herculean tasks on both the Alaskan and Pan-American Highways which now will tie the peoples of 21 nations closer together economically, socially and culturally.

The Public Roads Administration is carrying on where the army left off. American money, engineering skill and equipment have been poured into construction.

Waterfall over main highway, left, near Bogota in Colombia. Below, Pan-American route winds through the mountainous jungle



However, it's a two-way proposition because the countries of Central and South America are furnishing labor and materials—and they'll send their tourists to the United States.

As construction proceeds, gas stations, garages, motor courts and restaurants are beginning to flank the highways. Chile, Argentina and Peru have already embarked upon a program of hotel-building to accommodate the expected increase in auto travelers.

Safety has been carefully considered. The Pan-American Highway Congress, for example, has recommended a system of road signs and markers similar to those in the United States. The only difference is that of language. The highway signs of the near future will contain easily translated examples of "stop", "go", "steep grade" and "dangerous curve" signs in Spanish and Portuguese as well as English.

International highways will promote economic exchange of goods. Already, over incomplete portions of the Pan-American Highway in Central America, commercial trade is picking up.

Fine cattle raised in Costa Rica can be hauled to market in a few hours whereas before the long trip overland resulted in a 20 percent loss in weight. Guatemala will be able to produce rice and camphor superior to that of the Orient. There will be a "market road" for pineapples, hemp,



Mexican Govt. Tourist Dept. photo
Colorfully garbed caballeros greet visitors at a hotel in Mexico City

cashew nuts, coconut oil, cacao and other tropical products.

These are the international highways that you will be able to drive over in the near future:

Pan-American Highway—Greatest of all is this highway which begins at Laredo, Tex., and extends for 3200 miles to the Panama Canal, continues another 6000 miles to Buenos Aires and then turns north for another 1900 miles to Rio de Janeiro.

This magnificent highway was the inspiration of a group of U. S. and Latin-American engineers meeting in Washington, D. C., in 1924. Built over trails and roads used by Aztecs, Mayans and Incas, it links the capitals of 17 nations and penetrates the last frontiers of the Western Hemisphere.

Work on the Pan-American Highway has averaged about 600 miles a year. Most of the South American part and much of the Mexican have been completed and are already in use. Between

Shy Bolivian natives in colorful dress turn their backs to camera



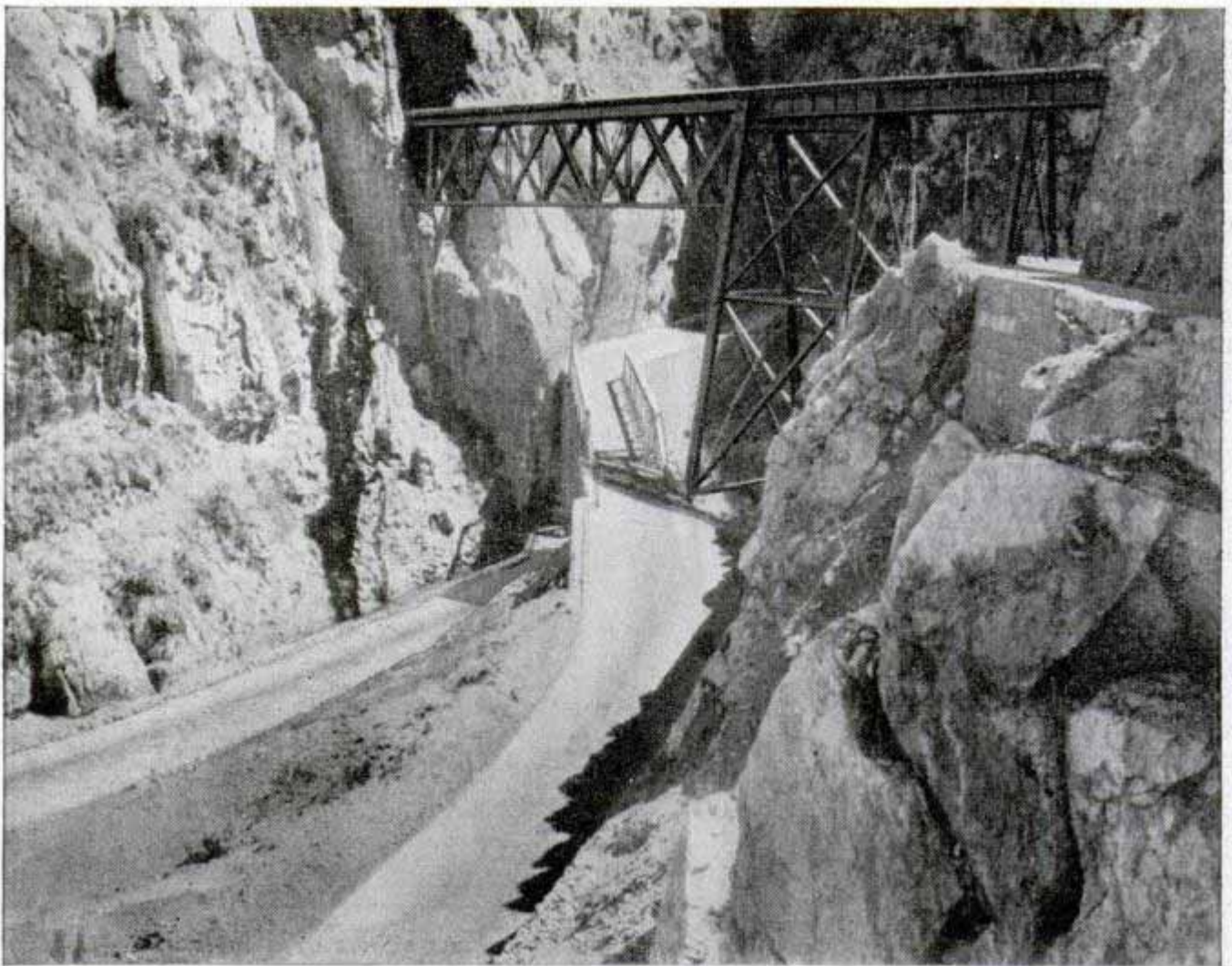

Three levels of winding highway and railroad bridge fill narrow gorge on Pan-American Highway between Lima and Oroya, Peru. Below, tourists awaiting U. S. customs inspection jam one of the many gateways to the south



is the stubborn "missing link" of Central America. Here, rank jungle, high mountains and tropical rains have presented engineering problems that are almost impossible to solve.

Costa Rica offers an example. Some 71 miles of construction required the handling of 17,000,000 cubic yards of excavation. This is nearly 240,000 yards per mile—as compared with 15,000 yards per mile on the Alaskan Highway. Most of the excavation is rock and many tunnels must be built.

Still under construction are some 400 miles from Oaxaca to Mexico's southern border, 150 miles in Costa Rica, 50 miles in northern Panama and 200 miles in southern Panama and Colombia. This latter stretch may not be completed for eight or 10 years and may be served by ferry.

West Indies Ferry-Highway System—Harold G. Williams, a Florida barge operator, has the blueprints and \$2,000,000 for a

superferry between Key West and Havana. This ferry, which may be in operation soon, will carry 300 automobiles and 900 passengers across the 90-mile Florida Straits in about six hours. Average cost will be around \$20 per car.

This is just the start of an ambitious plan to open up all the West Indies to automobile traffic. Other ferries will run between Cuba and Haiti (fare, \$40), and between the Dominican Republic and Puerto Rico (fare, \$30). A route between Cuba and Jamaica is also planned.

Still another ferry will run from Cuba to the Yucatan peninsula when a spur of the Pan-American Highway has been built into that area. This will save 800 miles of driving for motorists on the Atlantic seaboard who may wish to visit Mexico City.

Lower California Highway—Work on a round-trip highway, starting at San Diego and making a 500-mile loop into Lower California, is under way. Construction of this road began early in 1942 when it seemed possible that the Japs might land on the desolate coast of Lower California and march on San Diego or Los Angeles.

Originally a military necessity, this new international highway will become a popular tourist road into the mysterious, little-known peninsula that has seldom been seen by white men since black-robed Jesuit missionaries built a string of adobe-walled churches there 250 years ago.

Pacific International Highway—Not as well-known as the Pan-American Highway is the Pacific International Highway. It begins in Alaska and hugs the Pacific slope all the way down to Chile. From Mexico City to Vitor, Peru, it becomes a part of its better known relative, the Pan-American Highway.

The Mexican section of this highway begins at Nogales, Ariz., and follows the west coast of Mexico through Guaymas and Guadalajara to Mexico City. The road has been completed south to Guaymas where California and Mexican anglers go for what is said to be "the best deep-sea fishing in the world."

As far back as 1930, a party of highway engineers, representing the Southern California Automobile Club, drove the entire 600 miles of the projected highway to Mexico City. Their cars followed cow-paths, forded streams without bridges and crept over the mountainous country of Mexico's "barrancas."

But they got through and pioneered the road that you some day will be speeding along at 50 miles an hour. Money for the construction of this highway has been appropriated. It is expected that construction will get under way soon.

(Continued to page 220)

Plastic Radiophone Sifts Sounds To Pick Up Voice Only

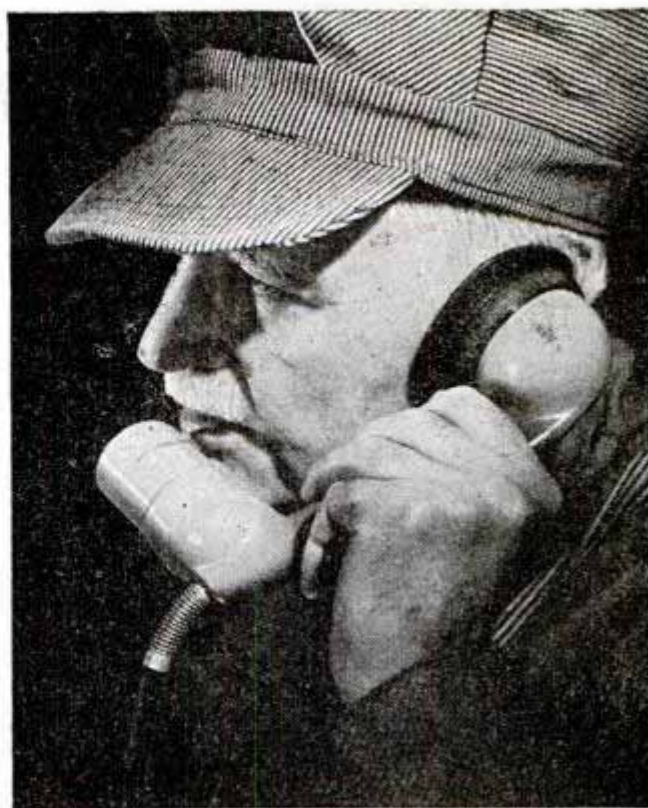

Two narrow slits on the cylindrical mouthpiece of a Tenite plastic radiotelephone handset pick up only the voice of the speaker and eliminate distracting sounds. The set is designed for two-way radio communication on railroads. The earpiece is fitted with a rubber attachment which cups tightly over the ear to aid reception. A red button on the middle section of the set operates the transmitter; it is pressed for speaking and released for listening.

Thermometers Gauge Jet Speed

New instruments have been developed to measure the extremely high speeds of jet planes and the slow movement of helicopters. Dr. Theodore Shedlovsky of Rockefeller Institute developed a method of using two thermometers to measure the speeds of jet planes. With two thermometers mounted on the outside of the plane—one shielded and the other exposed to full air flow—an electrical device records changes in temperature in the two thermometers as the plane's speed is stepped up. A comparison of the figures reveals the actual speeds. For measuring the speeds of helicopters and other slow-moving aircraft the National Bureau of Standards developed lightweight anemometer cups mounted on bearings which start rotating in less than two knots of wind.

Names and addresses of manufacturers of new products featured in this issue will be supplied promptly by the Bureau of Information, Popular Mechanics Magazine, 200 East Ontario St., Chicago 11, Illinois

Family "Furniture Factory" Grows Wood in Backyard

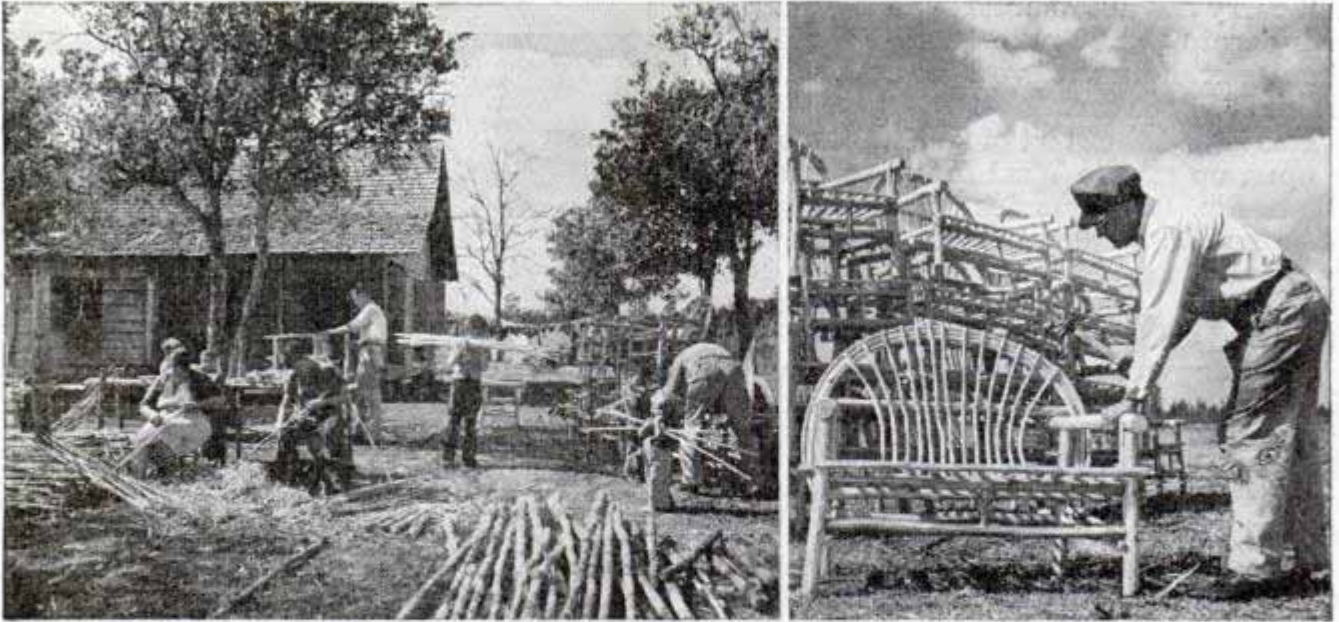

Raw materials are no problem in a furniture "factory" near Polk City, Fla. The nine-member family of J. H. Wilson cuts sturdy cypress poles in quantity from a

nearby swamp and turns them into three-piece sets of strong rustic furniture. All of the family participate in the enterprise. The sets are shipped to northern markets.

Building House Is Child's Play With British 'Prefab' Home

Even children are helping erect homes in England to solve the critical housing shortage. Aluminum prefabricated houses have been designed that are so simple in construction that children aid in assembling them. Each house is built in four sections. The lightweight sections are shoved together and bolted in place to form one unit.



Cork Disk for Hook Protects Angler

Cork disks are now available as a solution to the fisherman's age-old problem of how to prevent his fishhooks from snagging fingers when not in use. The disks are marketed in kits which contain

corks of various sizes from large ones for deep-sea hooks to smaller ones for lake and stream fishing. Disks with large holes in the center are included for hooks with feather lures. Both lures and plugs may be carried in the pocket safely when the points are imbedded in the guards. By pushing the disks onto a dowel, floats and bobbins can be improvised quickly.

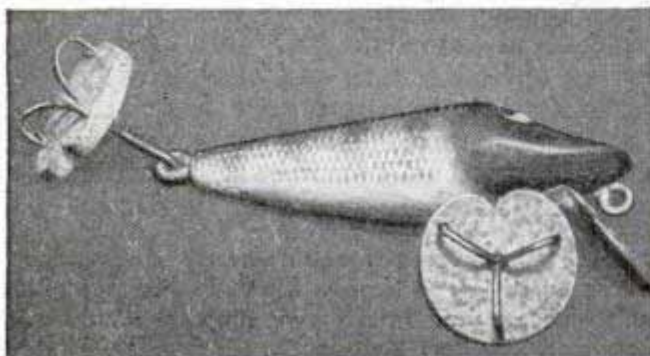

Names and addresses of manufacturers of new products featured in this issue will be supplied promptly by the Bureau of Information, Popular Mechanics Magazine, 200 East Ontario Street, Chicago 11, Ill.

The Craftsman

"Fine thing," your back-seat driver will say, "you get us halfway up Pikes Peak and then let the engine conk out. A fine thing! Didn't I tell you to take Popular Mechanics' advice and tune up the motor before we left home?" And so on and on. It may happen to you on the Pikes Peak road or in Death Valley or halfway through the Holland Tunnel. Wherever it happens it will be embarrassing, it will delay your trip, it will be—shall we say—a nuisance. So take a tip from the Old Craftsman and read about motor tune-ups on page 180 . . . The ancient jalopy is not the only hazard facing 1946 tourists; there is the matter of crowded hotels. On page 186 is one solution: convert the rear of your car into a comfortable roadside "sleeper." Here are other highlights of the pages following: a timely article on chemical weed controls (page 170) . . . an insulated "Quonset hut" for your dog (page 185) . . . and, for shop men, an article (page 203) tells how to build spot welders in three sizes



INSULATED DOGHOUSE

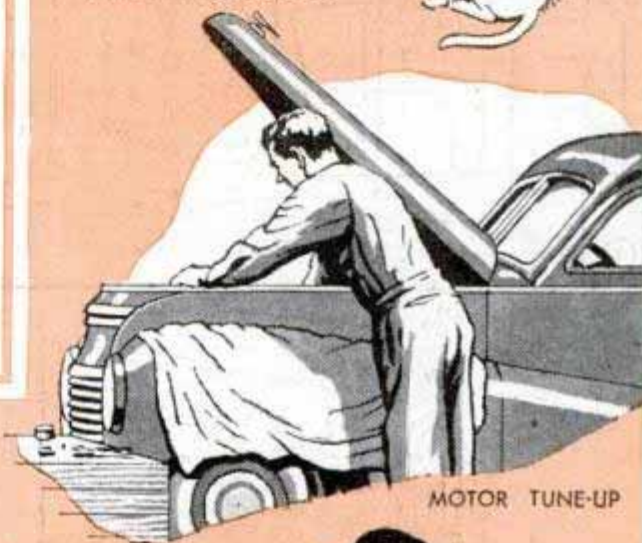

MOTOR TUNE-UP

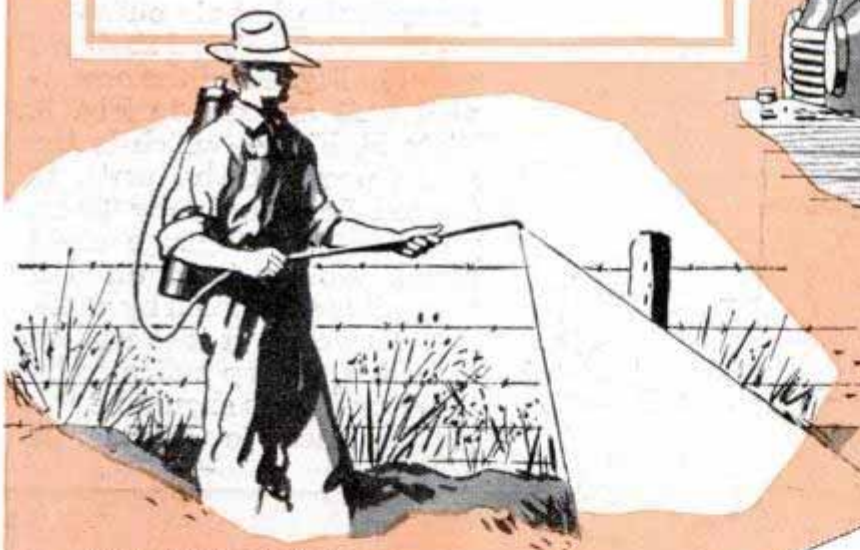

WEED-KILLING SPRAYS



COUPE BED

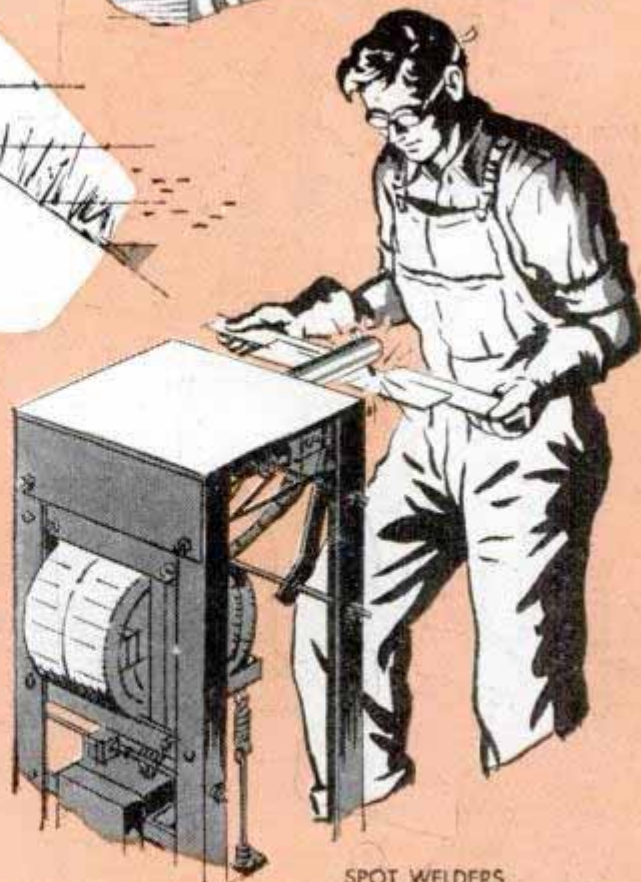

SPOT WELDERS

Fireplace

By J. B. Temple

THERE'S no need to worry about chilly evenings at your cottage or camp if you have this circulating fireplace. It's also equally effective in your home for cool evenings during late spring and early fall so you won't have to start the heating plant. And during the winter it will lessen the load on your furnace considerably on extremely cold days. Because it recirculates the air instead of sending most of the heat up the chimney, this fireplace is an efficient unit. The path which the air follows is shown in Fig. 2; it enters the cold-air intake, passes through the space formed by the metal shell and the masonry, where it is heated, and finally is discharged through the hot-air outlet.

Details of the steel shell are given in Fig. 4 and the assembled unit appears in Fig. 3. Plate E, Fig. 4, which is the main part of the unit, is formed from a 36 by 60-in. piece of No. 12-gauge sheet metal. No lap is required if the unit is assembled by welding. However, if it is riveted or bolted, the lap indicated by the dotted lines should be followed. These joints must be

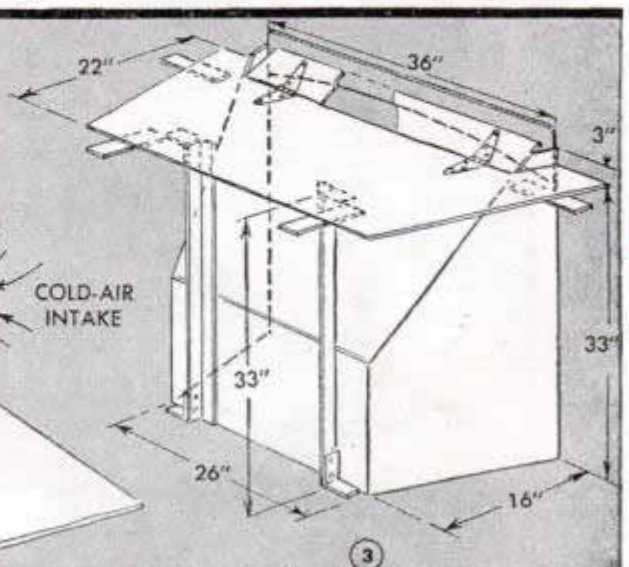
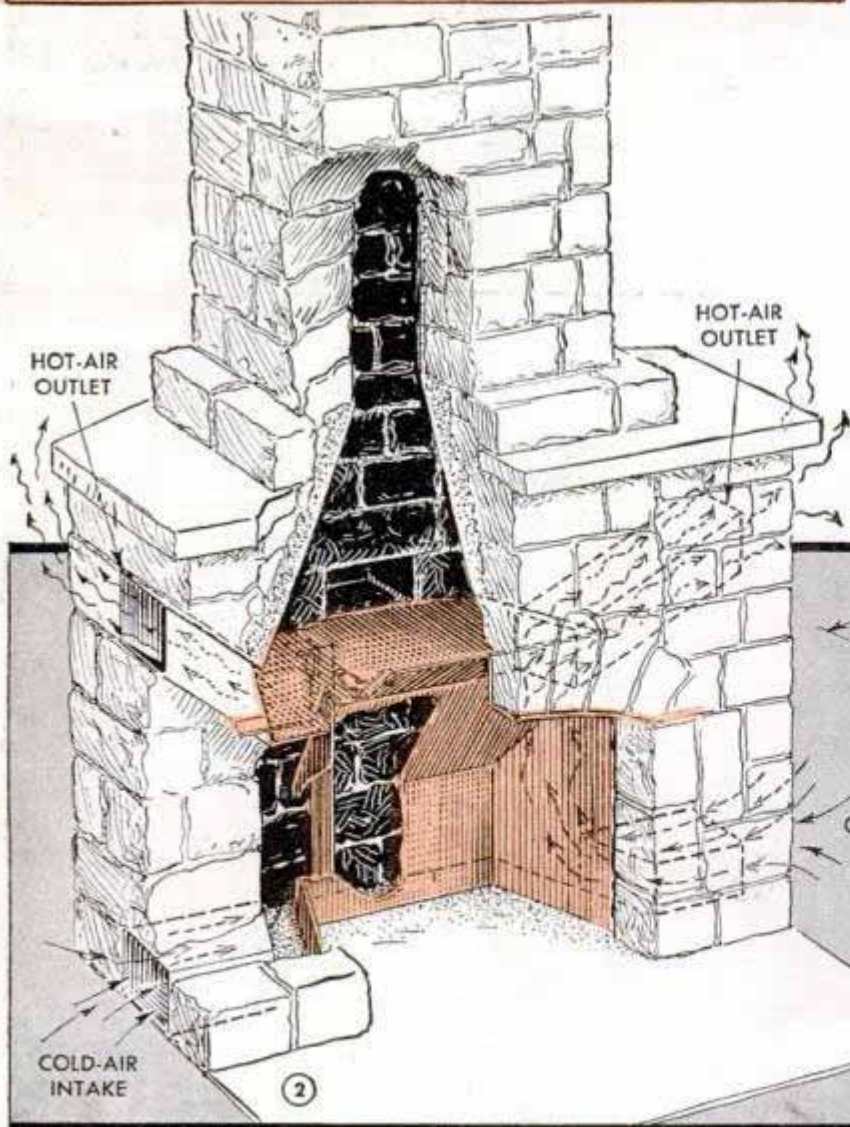
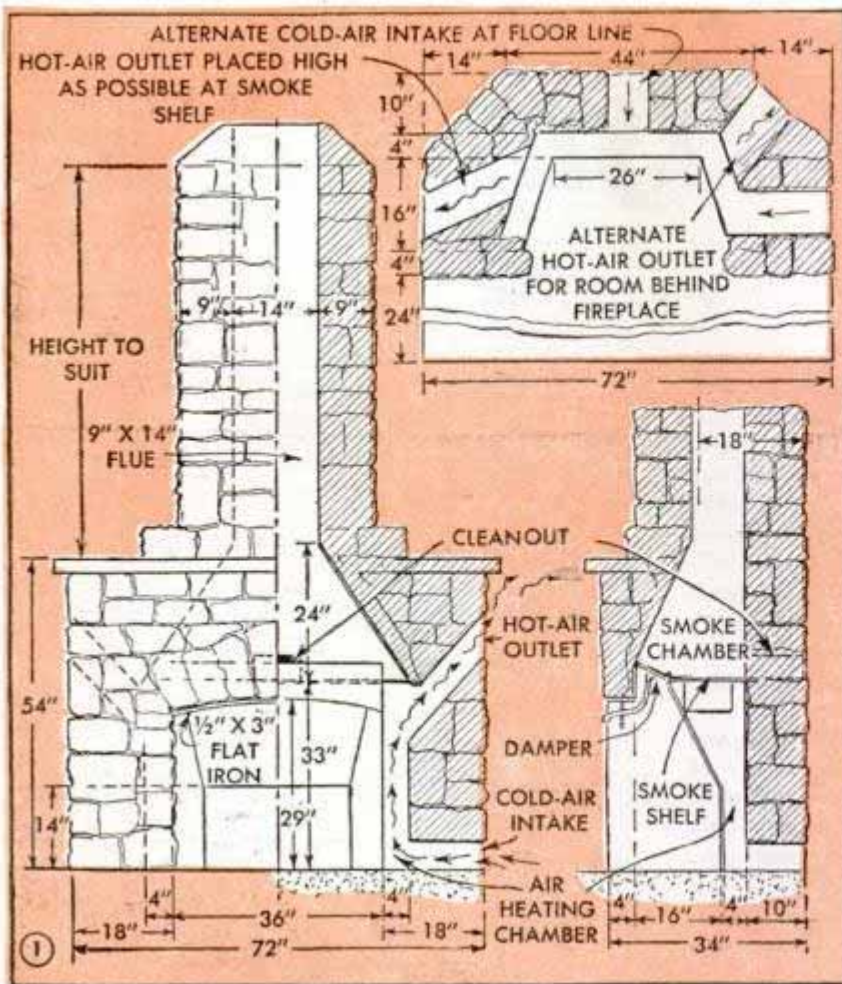

Circulates Warm Air

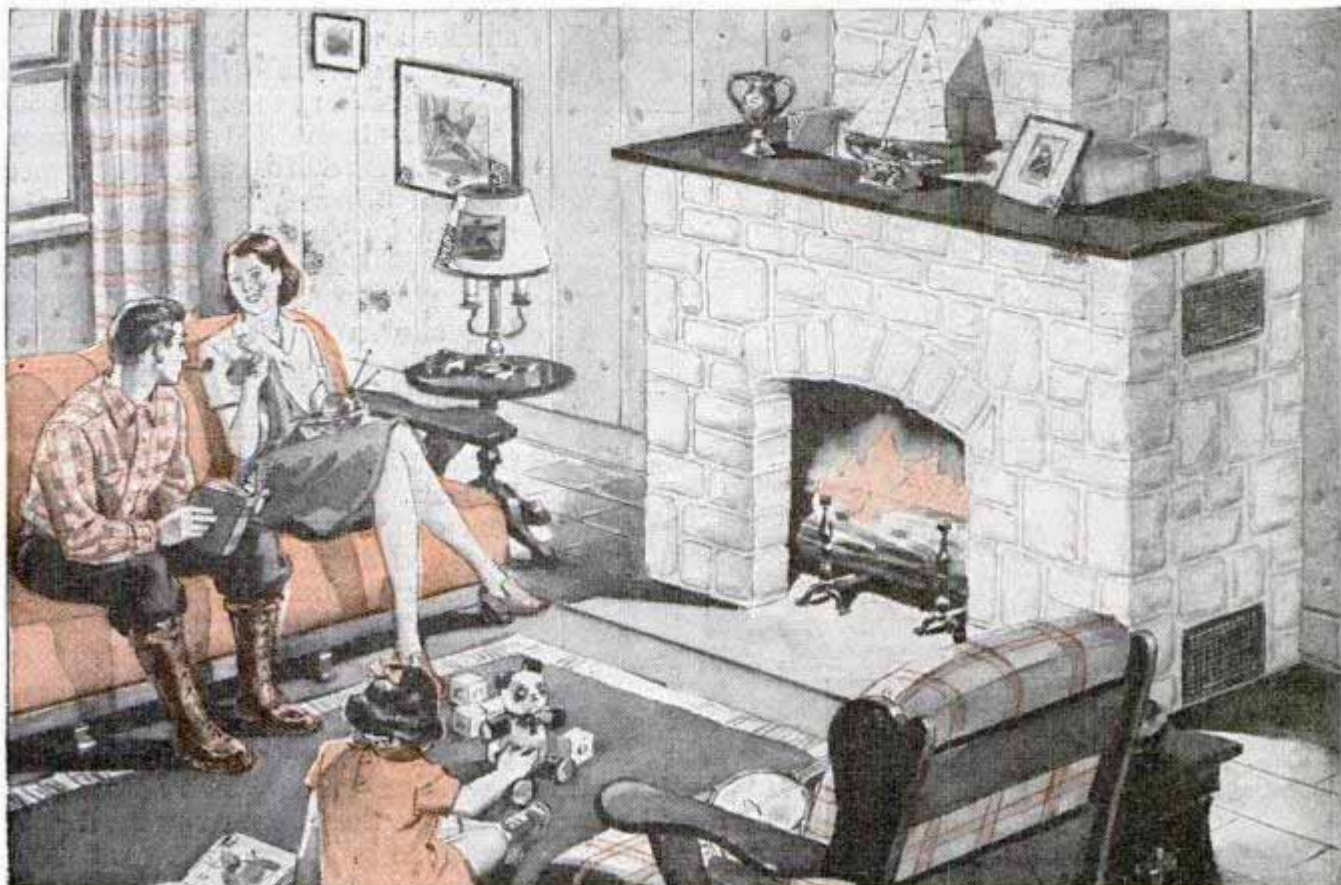

smoketight and may require the use of furnace cement. Plate A, Fig. 4, is cut from a 9 by 36-in. sheet and is hinged to the top front of the shell to act as a damper. The smoke shelf, Plate D, is a piece of No. 10-gauge metal 22 by 48 in. This is welded or bolted to the shell, Fig. 3, and supported at the rear by two $\frac{1}{4}$ by $1\frac{1}{2}$ by $1\frac{1}{2}$ -in. angles cut and assembled as shown in Plate C, Fig. 4. The edges of this plate are set into the masonry about $1\frac{1}{2}$ in., and, to give further support, flat-iron lugs are welded to the underside of the shelf.

The damper control, lower right-hand detail, Fig. 1, is a piece of flat iron cut in the shape of a gooseneck and hinged to the damper. Adjustment of the damper is obtained by engaging notches in the gooseneck with a catch set in the masonry. A $\frac{1}{2}$ by 3 by 48-in. bar is used to make the arch, Plate B, Fig. 4.

A stone, rubble and concrete foundation is carried to solid ground below the frost line. If the house has a basement, the floor is broken up and the foundation carried down in the same manner. When the foun-

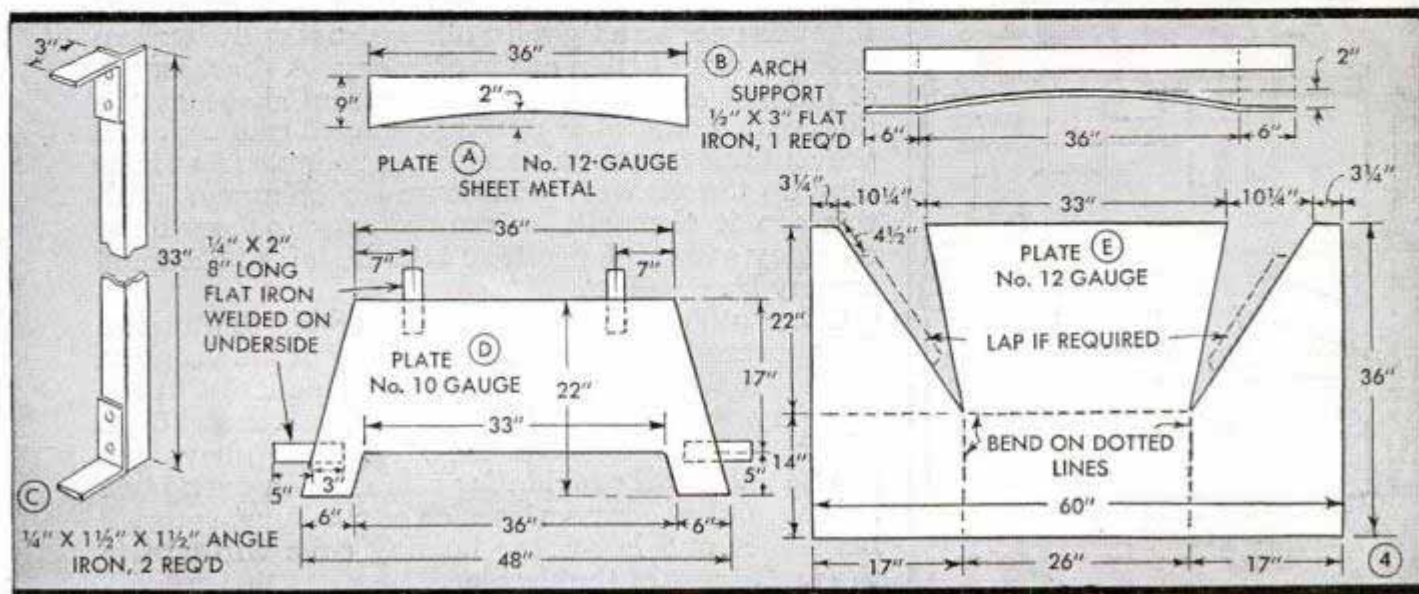

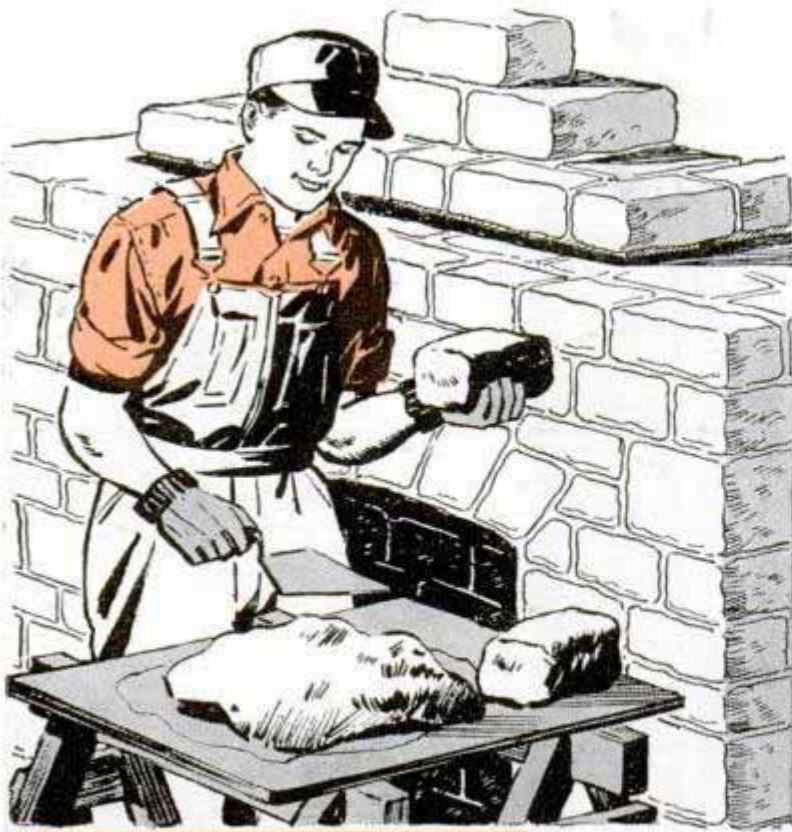

dition has been completed to the level of the hearth, the steel shell is set in place. The masonry is built up 4 in. away from the sides and the back of the shell, with the smoke shelf, as mentioned previously, sealed into the stonework. When building the masonry, allow for cold-air intakes at the bottom, Fig. 2. The hot-air outlets are slanted upward, beginning under the smoke shelf. These are either standard 6 by 8-in. ductwork or 7-in. stovepipes. Besides the outlets shown in Fig. 2, additional outlets are suggested in the upper right-hand detail of Fig. 1. This would apply when the fireplace is not against an outside wall and it is desirable to heat a room at the rear of the unit. For every outlet installed there is a cold-air intake.

However, before the outlets are completed, the arch bar, Plate B, Fig. 4, is installed. This is done when the masonry has been carried

to the height of the damper. The smoke chamber part of the flue has a slope of about 60 degrees. It is built around a wooden frame which is knocked down and removed before the chimney is built. No attempt should be made to burn the frame out. The inside dimensions of the flue are given as 9 by 14 in., but these dimensions can be varied somewhat as long as the cross sectional area is over 100 sq. in.

Fig. 5 shows an alternate masonry design when it is desirable to have the chimney outside the house. This avoids cutting out a portion of the wall and roof of the house, but requires wider and heavier masonry at the base and a higher smoke chamber to obtain the proper bevels. In this case, since the chimney is not seen from inside the house, it can be built of brick.

There are many refinements and conveniences that may be added to this basic fireplace. A cleanout door can be located above the smoke shelf at the back of the fireplace so that accumulations of soot can be cleaned out from time to time. It is important that this door be a tight fit; otherwise it will interfere with the draft action of the chimney. A short length of galvanized duct the same size and shape as the flue, with a conical or pyramid-shaped rain cap, will prevent mice, squirrels and other rodents from running up the masonry and down the chimney. With this cap it also will be unnecessary to board the chimney over if the cottage is to be left unoccupied for any length of time.

Other attachments that may be added to improve the appearance and add to the utility of the fireplace include a swinging arm or crane. This is set in the masonry at the front of the fireplace. A metal oven which extends through the stonework above the smoke shelf will provide for some Dutch oven style baking. Other accessories such as revolving spits for barbecues and hot-water heating coils will add to the usefulness of the fireplace.

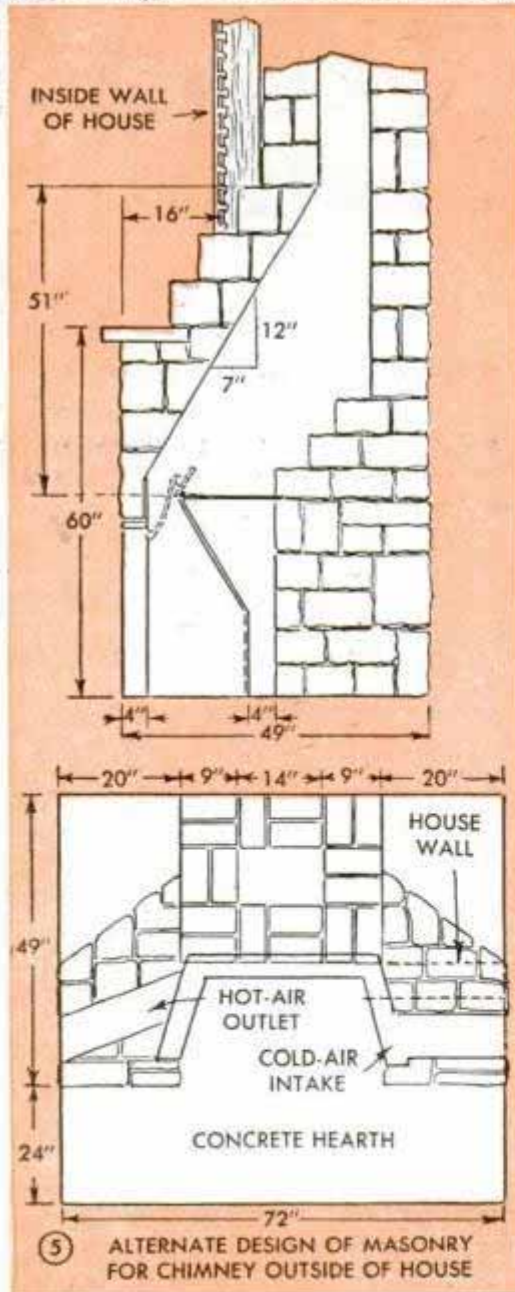

Storm Windows Installed From Inside House

The difficult way of installing second-floor storm windows from the outside with an extension ladder can be eliminated by using a pulley and rope which attaches to fasteners on the window and sash. The hardware for each window consists of 12 screw eyes, 4 steel pins and 4 screw hooks. The assembly of the pins and the handle is shown in the center detail. Another hook at the top of the frame will aid in hoisting. To install a window, place a pulley on a hook that is in the top of the window frame and pass a rope through the pulley. Attach a window to the rope and hoist into position. Using the handle to hold the window in place, insert the pins and the job is done. If it is found that the window does not fit tightly against the frame, the screw eyes on the window are given

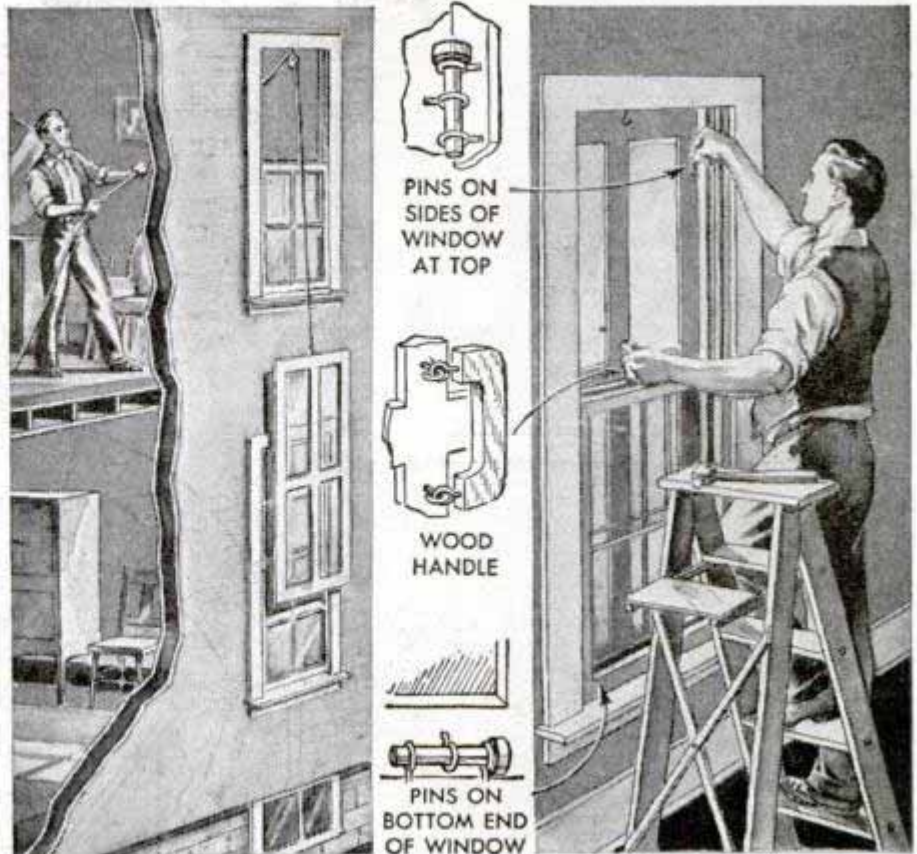

a turn or two. Care must be taken to keep all of the screw eyes concentric.

Frank H. Sutz, Chicago.

Spools Guide Workbench Drawer and Serve as Support

A drawer that rides smoothly on thread spools and an angle-iron track can be installed in a bench or worktable with little effort. For support, two spools are re-

quired. One is cut in two with halves pivoted on nails at the sides of the drawer opening in the bench apron so that the lower edge slides on them. The back of the drawer is cut out for a track, which is a length of angle iron attached beneath the bench top by means of corner brackets as indicated. Flanges or ends are cut off a second spool, which then is pivoted to a hardwood block screwed to the back of the drawer so the spool will ride on the track.

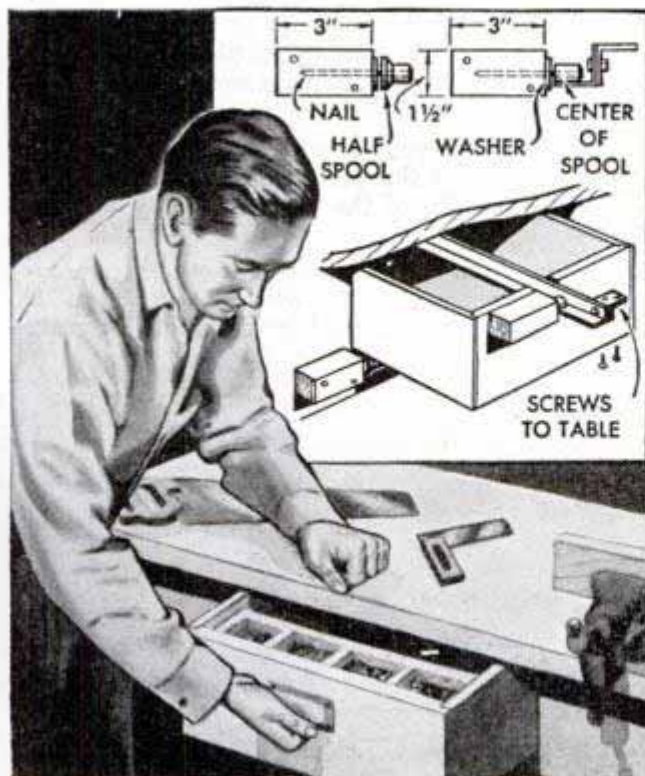

Many Uses for Wetting Agents

Beside their use in the darkroom, wetting agents have many other applications. The labels can be soaked off bottles more quickly if a little of the material is added to water. To prevent mirrors and spectacles from steaming, wipe them off with a rag to which a few drops of the agent have been added. The same treatment applied to car windows will prevent their steaming.

Hugh M. Gordon, Millgrove, Ont., Can.

☞ Before laying linoleum, always place it in a warm room or in the sun for a few hours. This makes the material much easier to cut and more flexible in handling.

Solving Home Problems

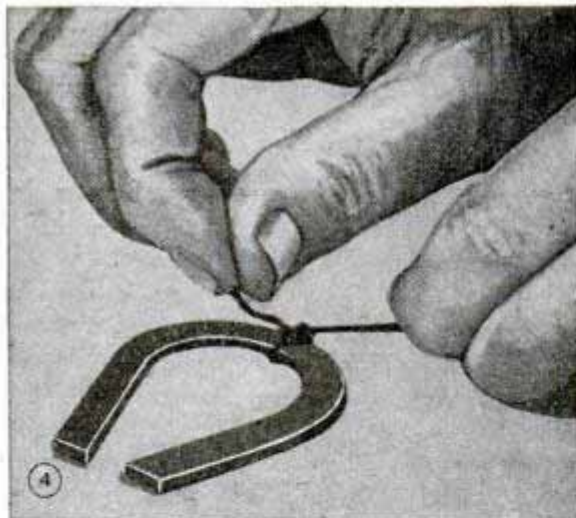
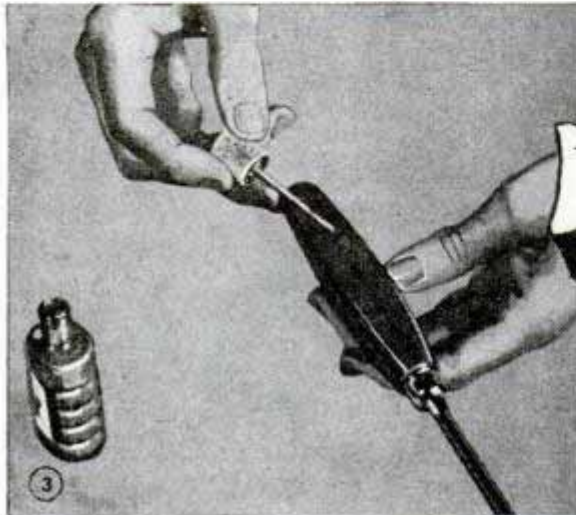
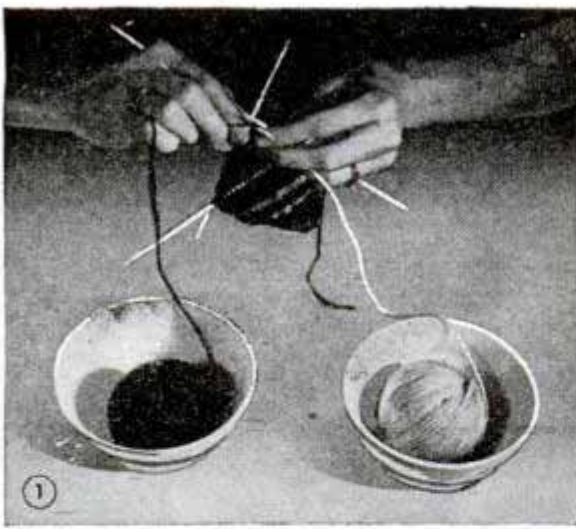

- ① When knitting with different-colored balls of yarn, it is difficult to keep the strands from tangling. If each ball is placed in a bowl, this will not happen
- ② Jar rubbers glued to the underside of a breadboard at each corner will keep the board from "skidding" when kneading dough or pastries on a smooth table
- ③ If colorless nail polish is applied to the painted handles of kitchen utensils, the enameled finish will not chip off, nor will the colors lose their luster
- ④ A small horseshoe magnet tied to your sewing basket is always at hand for picking up pins and needles. This arrangement is especially convenient for invalids
- ⑤ Put lids on all of your empty fruit jars. This will keep the inside of the jar free of dust, and also will protect the rim of the jar from being chipped
- ⑥ Cut to shape from small scraps of oilcloth, these easy-to-make labels are attached with rubber bands. If permanent paint is used, the labels will last for years





7 There's no need to worry about plants being pushed off your window sill if you build an attractive fence like the one shown here. It is made of light wood and painted in a color to match the trim of the building

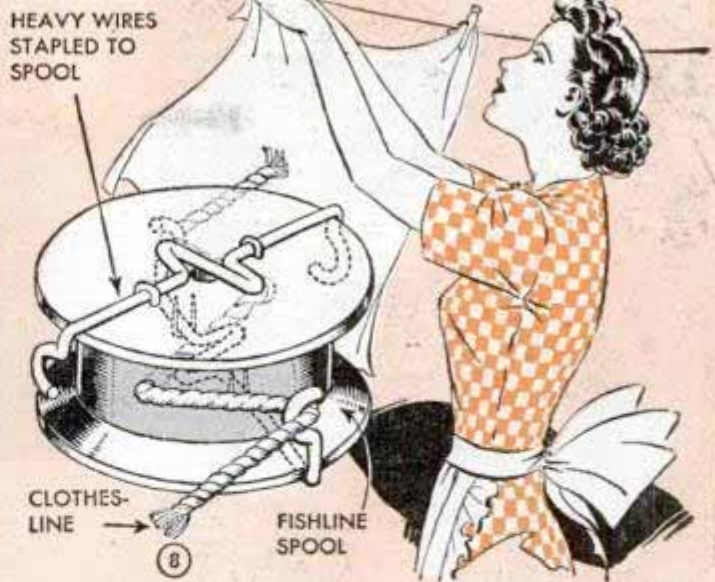

8 To take up slack in a rope clothesline, one housewife uses a reel made from a fishline spool. Hooks are formed as shown and stapled to the spool. The line is wound around the reel and caught by the hooks

9 Illumination in a bedroom at night is obtained by mounting the light beneath the headboard of the bed with a toggle switch on top of the headboard. Such a light will not disturb anyone who is in bed asleep

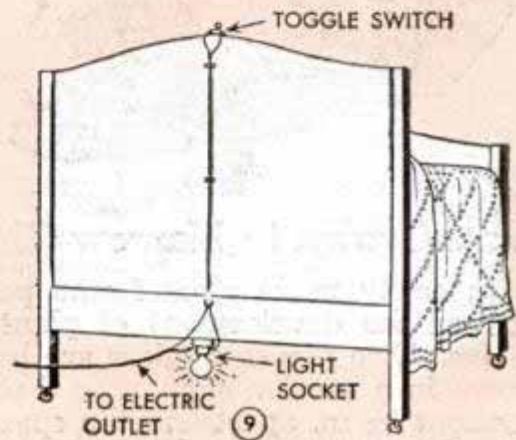

10 Protective tubing, inserted over the cords of metal venetian blinds, will prevent fraying due to the cutting action of the metal when the blind is raised or lowered. Tape wound around the tubing fastens it to the cord

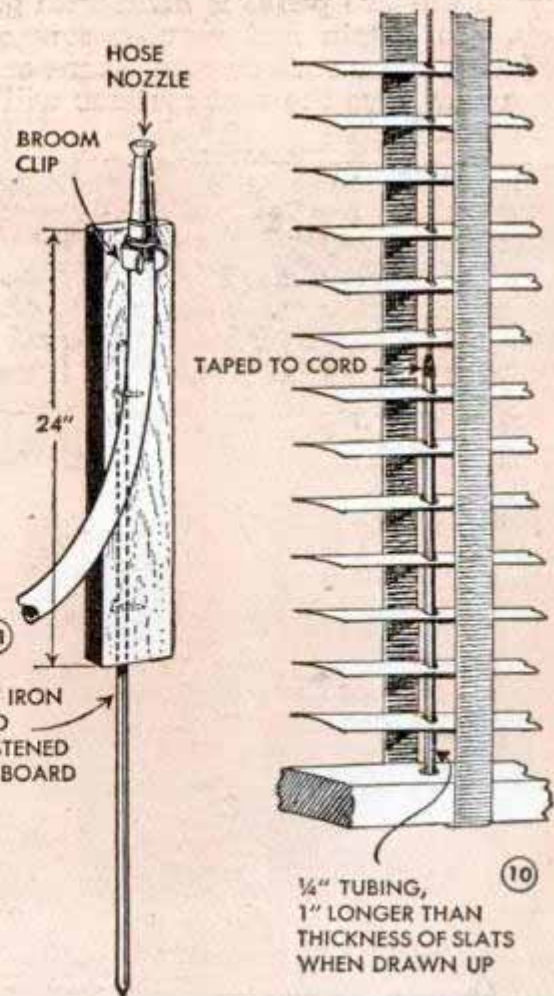

11 Better coverage by a lawn spray will result if the nozzle is raised some distance from the ground. A board is fastened to a rod which is driven into the ground and the nozzle is held securely in place with a broom clip

12 Spices and flavorings are always easy to find when kept in this shelf which is screwed to the inside of the kitchen cabinet door. If stainless steel is available, it is an ideal material from which to make the shelf

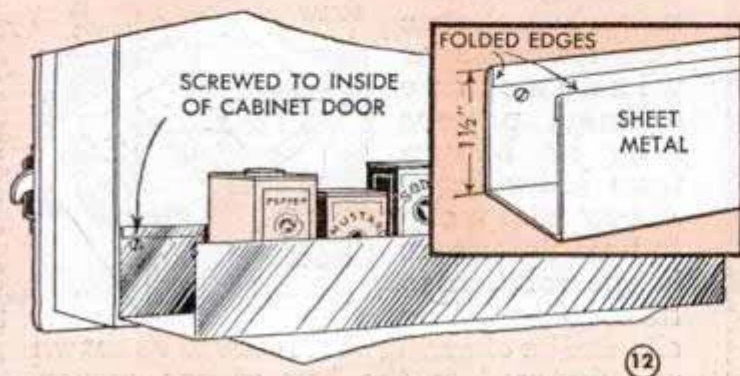

Miniature Shopping Bags Provide Unusual Party Favors

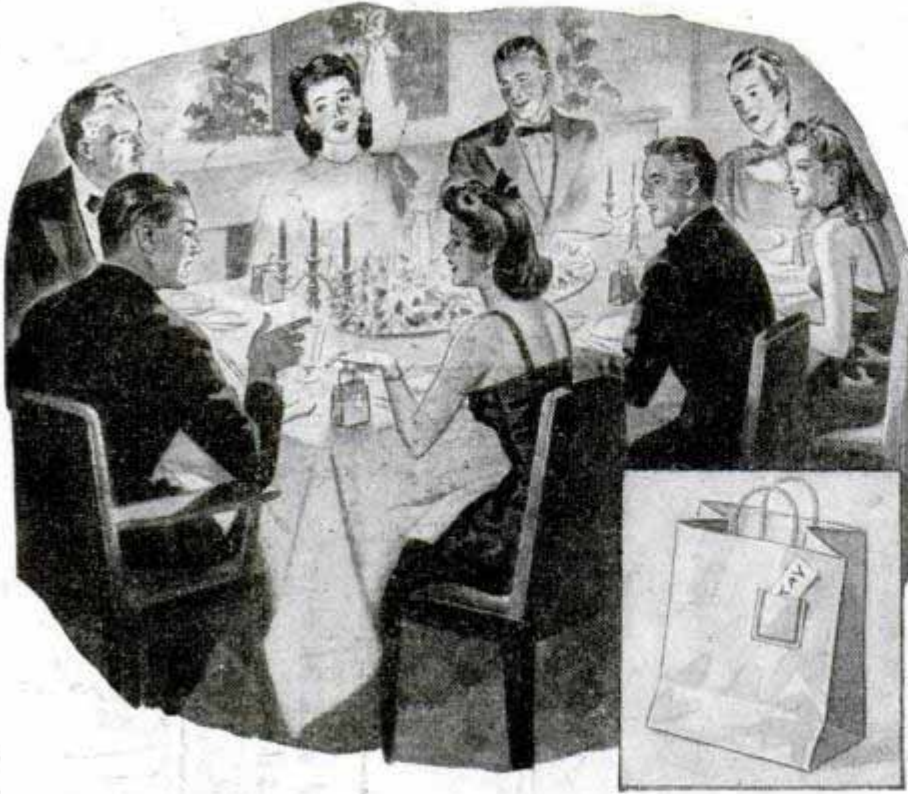

Inexpensive and easy to make, this clever place favor will add an unusual touch to your dinner party. To make it, use the smallest size brown paper bag available and cut down or turn under the tops to secure the right proportion. Cutting with pinking shears will give a novel and attractive edge. Then attach string handles to the inside of the bag with gummed tape. The miniature pocket which usually holds a shopping list is, in this case, a card holder for the guest's name. Candies, nuts or a small gift may be placed in the bag as a favor.—Benj. Nielsen, Aurora, Nebr.

Plants Grown in Narrow Glass Frames to Observe Growth of Roots

This easily made glass frame permits study of the development of plant root systems. Two pieces of glass are held in grooves in a wooden support so that they are about $\frac{1}{2}$ in. apart and the space between the two panes is filled with garden soil. To obtain fast results, sow quick-growing seeds such as corn, beans or peas. In a few days the root systems will have

developed enough to be observed and studied. One peculiarity of roots is that, unlike leaves, they avoid the light. Therefore, to get the roots to grow along the glass surface, it is best to keep the glass covered except when the cover is removed for observation. The plants shown in the illustration are bunch beans. The plant is one week old.—Paul Hadley, Philadelphia, Pa.



Making Wallpaper Waterproof

Wallpaper is rendered washable if you coat it first with sizing and then with clear shellac. This treatment is especially helpful in the kitchen, bath and children's room. It should be remembered, however, that the shellac will change the appearance of the paper somewhat. It may be best to try the treatment on a sample piece.

Joseph G. Cleveland, Minneapolis, Minn.

Metal Clip Holds Paper in Tray

During the summer when electric fans are used or windows are opened, papers may be blown from letter trays. A tray with a clip to hold the papers is one solution to this problem. The clip can be of spring brass curved as shown and fastened to the box at one corner.

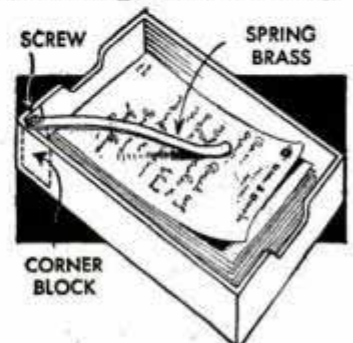

The clip can be of spring brass curved as shown and fastened to the box at one corner.

Picnic Hamper Opens to Make a Serving Table

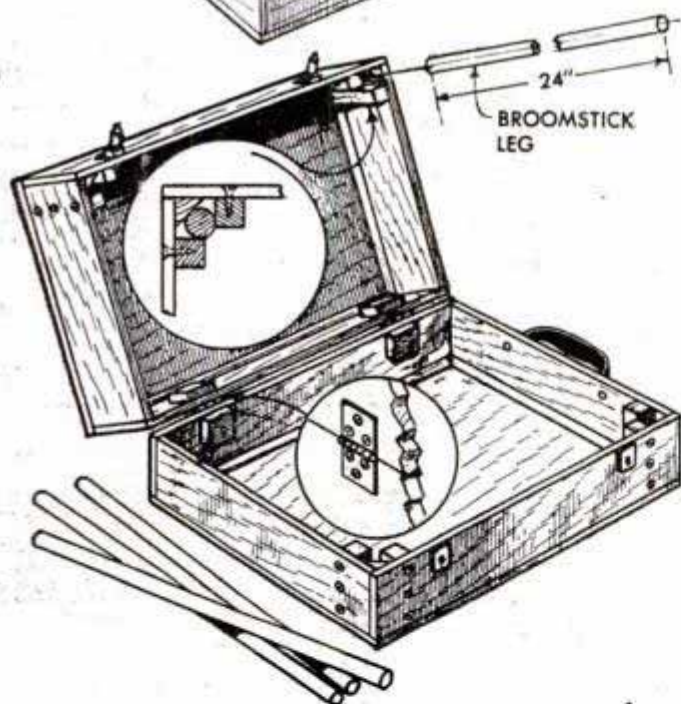
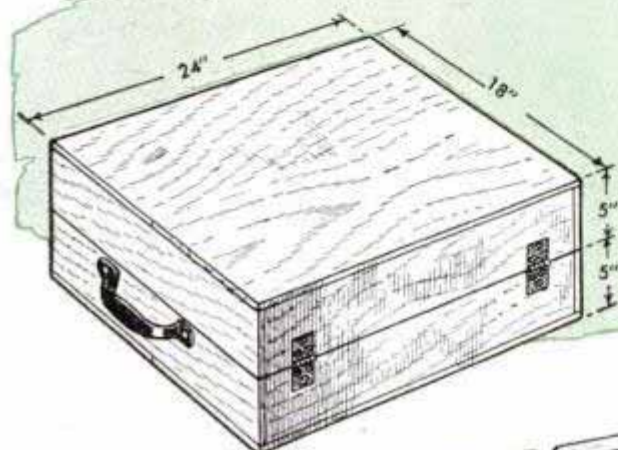

When closed this picnic hamper is carried like a suitcase. Open it up, fit the four detachable legs, turn it over and you have a rigid, sturdy table. It's made of plywood in two thicknesses, $\frac{1}{4}$ -in. for the side panels and $\frac{1}{2}$ -in. for the ends, top and bottom. The halves are built as separate "boxes" with ends, sides and bottoms and then are hinged together with medium-sized brass butt hinges. Metal clasps of the type used on suitcases are provided for locking the

hamper closed and a leather or metal handle is attached to one end for carrying. All these parts are fastened with small screws or rivets. Triangular blocks are screwed in two corners of each half as indicated and then square blocks or cleats are screwed to the sides and ends as shown in the circular detail. This arrangement forms a socket into which the leg is inserted when the hamper is set up as a table. The dimensions given are only a suggestion. They can be altered to suit most any special requirement. Although fir plywood will serve for all practical purposes, the hamper will finish much better if birch plywood is used. Very little sanding will be necessary except across the ends of the pieces to eliminate saw marks and to round the outer corners slightly. Heads of all exposed screws should be turned in flush with the wood. Countersink the holes to prevent splitting. Then, to finish in the natural color, apply a prepared sealer and follow with a coat of spar varnish or use clear lacquer over a lacquer undercoater.

P. B. Horsley, Pembroke, Ont., Canada.

☐ A short drive over dirt or graveled roads is often much more wearing on tires and requires more gasoline than a much longer run on a smooth hard surface.



"Choosy" Sprays

New selective herbicides that promise complete control of some of nature's worst plant pests can be applied by anyone with the most inexpensive equipment

By W. Clyde Lamme

① How Weeds Spread

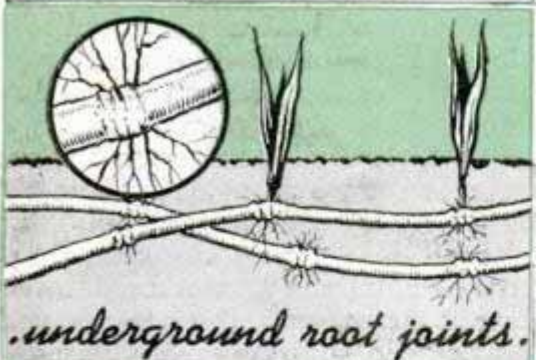
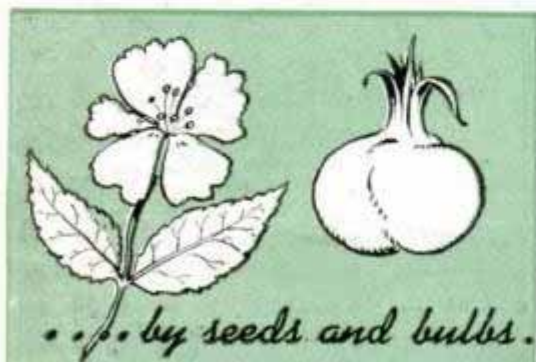

MIX a solution according to simple directions and then spray 'em—that's the new, sure way of killing weed pests on the lawn, in driveways and on farms and country estates. Not only the common weeds but such persistent perennial pests as poison ivy, poison oak, bindweed, dandelion, ragweed, plantain and many others of wide distribution are usually killed outright with just one application of the powerful herbicides which recently have been developed. Many of these new chemical killers are selective in action, which means that under favorable conditions certain weeds can be killed in a field of growing grain without damaging the crop, and dandelion plants can be eradicated from lawns without injuring the grass. Moreover, certain of the chemicals do not act as soil sterilants when applied as sprays in the solutions recommended for specific purposes. Others are only temporary soil sterilants, the time varying with the soil. Most of the solutions are free from fire or explosion hazards, many of them actually possessing fire-resistant properties. Residues from the spray solutions have not been found harmful to grazing stock, pets or humans. Some of the solutions have a slow corrosive action on galvanized metals, others do not. In any case it's always best to wash out the sprayer with soap and water or kerosene after the solutions have been used in it. If the same sprayer is used for applying insecticides to plants and shrubs all traces of the chemical must be removed.

Weeds spread over large areas by several natural processes, Fig. 1. Perennials, such as wild garlic and others, reproduce by seed and by bulbs; others, such as chickweed, by creeping above ground, still others by new growth from underground root joints. Johnson grass and quack grass perpetuate in this manner. Dandelion and others reproduce by seed and by a vegetation process. The latter method of perpetuation takes place when a root section is cut away in some manner, such as by hoeing, disk-harrowing or plowing. This piece, although cut away from the plant and perhaps carried some distance, sends out roots and stems and thus establishes itself as a new plant. Roots of some of the rapidly spreading perennial weed pests, such as bindweed, have been found to extend as much as 25 ft. into the subsoil. Eradicating these pernicious weeds over large areas by ordinary methods of soil tillage and cultivation has in many instances been proven hopeless. Once they become

That Kill Weeds



firmly established, there is no getting rid of them by common soil-tillage methods.

However, certain solutions of the selective weed killers administer a knockout punch to the most hardy of these pests of both the deep and shallow-rooted varieties. After the chemical has been applied as a solution to the foliage by spraying or, in some cases simply by sprinkling, it not only kills the plant tissues with which it comes in contact but it moves slowly downward throughout the root system of the plant by following the tiny conducting tubes in the stems and roots. The process is known as translocation and is shown diagrammatically in Fig. 4, although, of course, the drawing is purposely exaggerated. On certain plants this process may take several weeks, but the end result is a 100 percent kill. It should be remembered, however, that not all herbicides perform in this manner. Some effect a kill only by contact, others by a translocation process, and only certain of these are selective in action. Some still are being distributed only for experimental purposes. There are others that kill by diffusion of vapors, Fig. 3. On small areas the chemical is forced into the

soil by means of an applicator especially made for the purpose. The same type of applicator also is used to inject a soil fumigant lethal to insects such as nematodes, millipedes and others which inhabit the lower portion of the surface soil. One diffusion-type weed killer, carbon disulphide, acts as an effective weed eradicator and also is toxic in its effect on such soil organisms as nematodes, wire worms and certain other bacteria. It is only a temporary, partial soil sterilant and, inasmuch as the residues are eventually decomposed and oxidized to sulphates, it tends to correct any excess alkalinity, a process which usually favors the subsequent growth of higher plants, such as the grasses and cereals. Although very effective as a herbicide, carbon disulphide and carbon-disulphide emulsions find more widespread use in localities where large quantities are required. This chemical must be handled





carefully, as the vapor is highly inflammable.

Herbicides applied as spray solutions usually are of more value to the individual user because of the ease of application and the inexpensive equipment required. Any light hand or power sprayer will do, even a sprinkling can will serve for very small areas, although sprinkling is not as effective as spraying. Most of these preparations contain varying amounts of the chemical, 2,4-dichlorophenoxyacetic acid, more popularly known as 2,4-D. These herbicides now are supplied in tablet, powder and liquid form. Another chemical, ammonium sulfamate, is coming into widespread use along with preparations containing 2,4-D to kill poison ivy and other woody plants and in the control of many common weed pests on lawns and golf fairways. Due to the extensive research now being carried on by manufacturers, the U. S. Department of Agriculture and state experiment stations, it is very likely that new weed-killing chemicals will be discovered, also new and more widespread uses for those already well known.

Fig. 5, A, and Figs. 6 and 7 suggest methods and precautions to be used in ridding your lawn of weeds with weed killers of the selective plant-growth-regulant type, such as those containing 2,4-D, in the various forms in which these are now supplied. A single tablet dissolved in a quart of water will make sufficient solution to cover about 100 sq. ft. when applied with a small sprayer of the hand-operated type shown in Fig. 6. Use soft water if available, or, if you must use hard water, warm it slightly. The temperature should be above 70 deg. F. for best results with the spray. The sprayer used should produce sufficient pressure to break the solution into a drenching spray. The solution should not be reduced to a mist. A nozzle that can be adjusted to produce a fan-shaped spray is best for most jobs. Always follow the manufacturer's directions for mixing the solution in any quantity as the recommended proportions vary somewhat for the various forms in which the chemicals are regularly supplied.

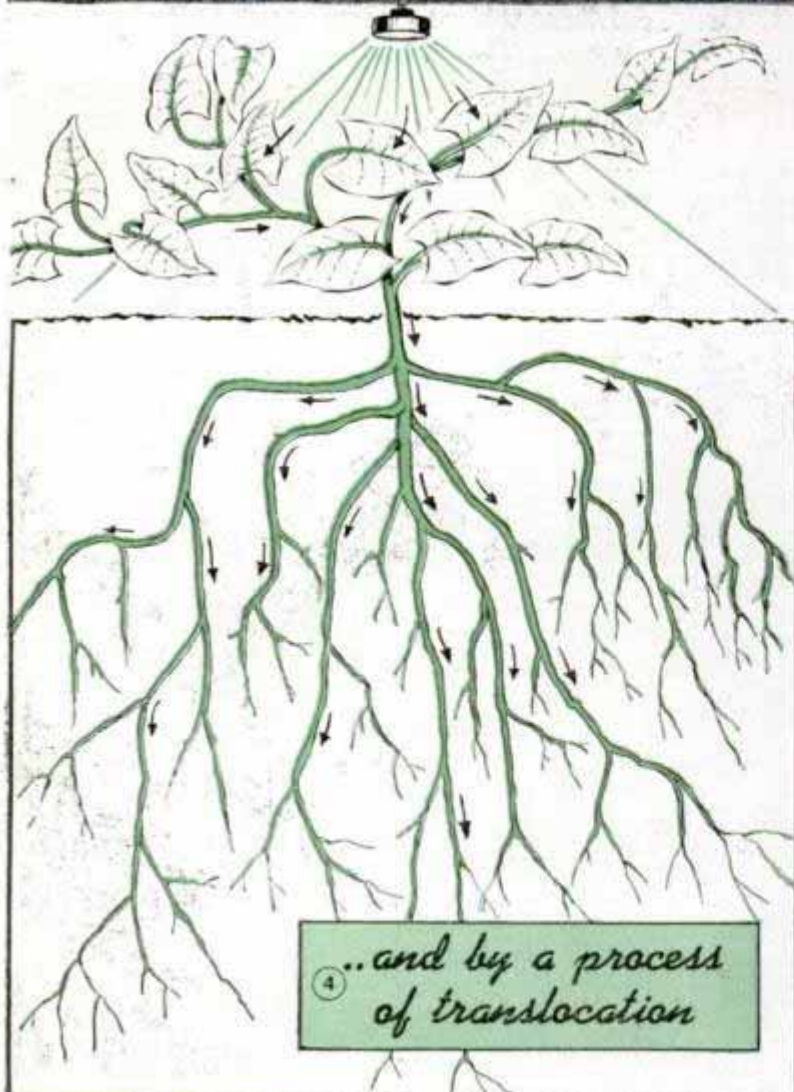

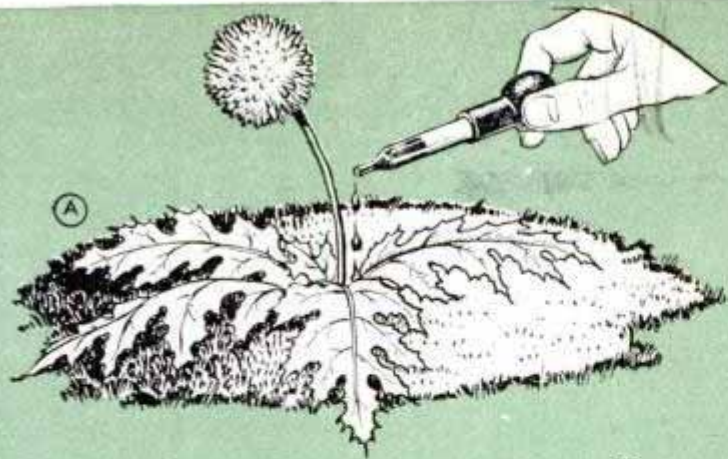

A

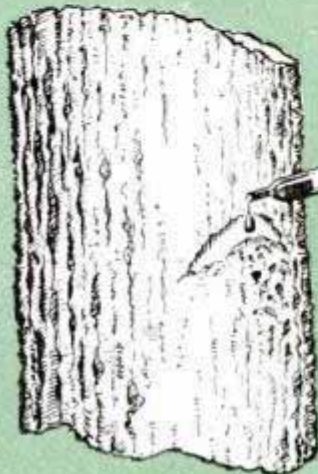

B

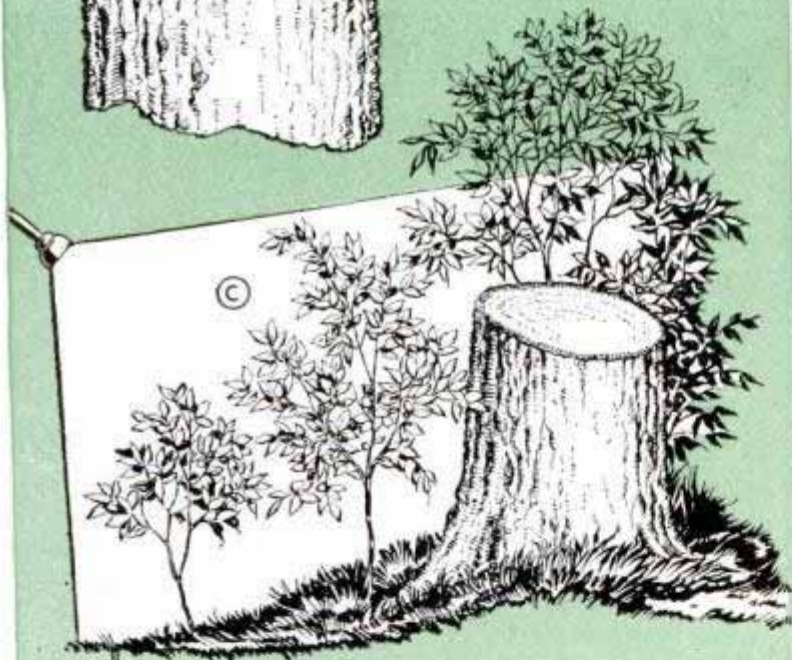

C



D

Spot spraying of lawns is effective where weeds are found in clusters. This treatment saves both time and material

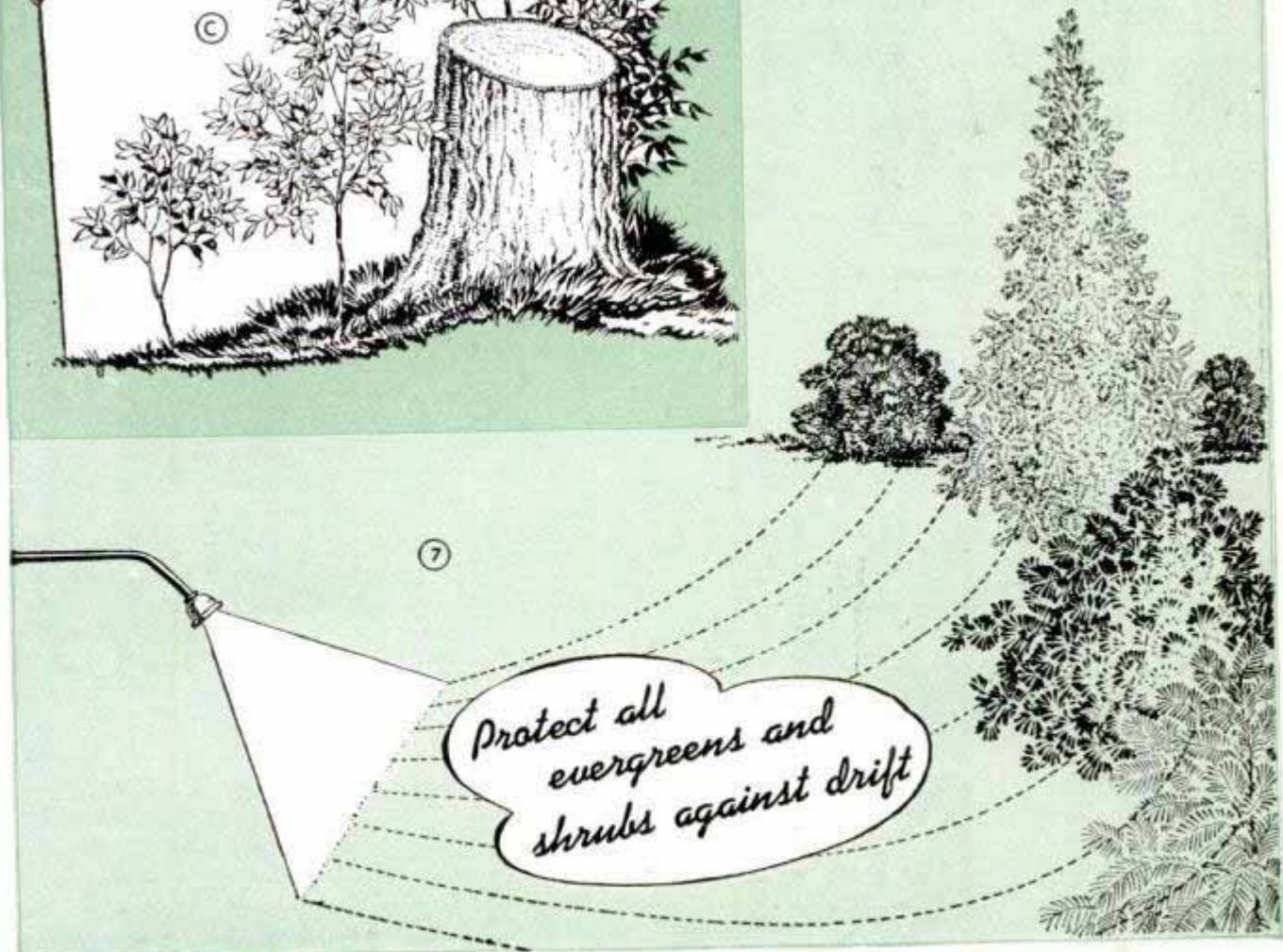

E

Protect all evergreens and shrubs against drift



Yards and grounds



Ditch banks

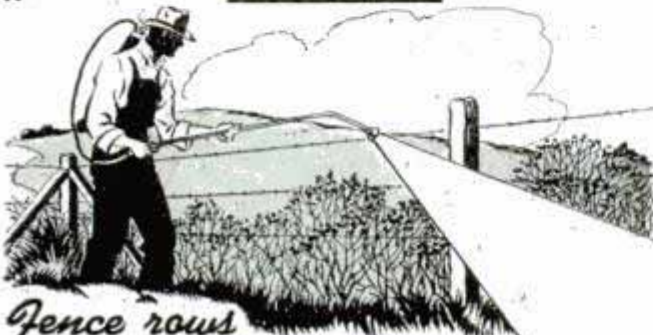

Fence rows



Farm roads

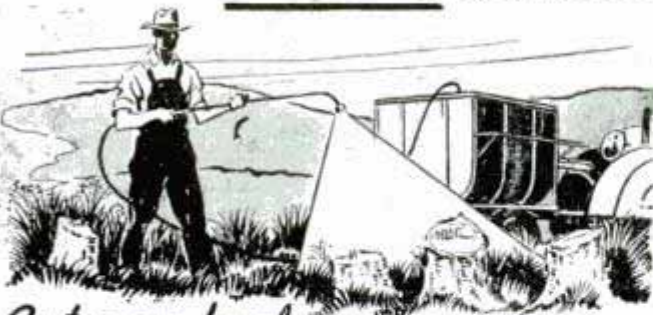

Cut-over land

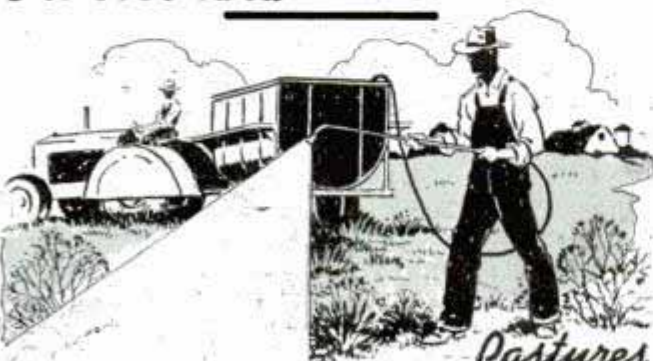

Pastures

Where weeds are in small patches or clusters, Fig. 6, spot spraying of lawns is more effective and saves considerable material. Where the weeds are scattered, only a few individual plants here and there, then the method shown in Fig. 5, A, is best. Here the chemical is used full strength. Only a single drop is required for most plants, such as dandelion, plantain, dock, etc. Certain kinds of trees in undesirable locations can be killed by gashing the trunk in several places with a hatchet or axe and applying a few drops of the chemical as in Fig. 5, B. Although under some conditions weed-killing preparations containing the chemical 2, 4-D will temporarily discolor the common lawn grasses, there is no permanent damage if the spray is uniformly applied in the solution recommended. However, concentrations sufficient to kill some common weeds that infest lawns will injure bent grass under certain conditions and also will kill white clover. With a solution of 1 to 100 there usually is no permanent injury to bent grass. If you wish to preserve a seeding of white clover, then the weeds can be killed by the method shown in Fig. 5, A. This procedure is far easier than digging out the plants one by one. In all-over spraying of a lawn, it is essential to protect flowers and shrubbery against drift of the spray solutions, Fig. 7. This can be done with heavy paper or some similar covering, but it's better to work on a quiet, windless day, or at night when there is no wind. Keep the spray nozzle close to the ground and avoid concentrating the spray. Newly fertilized lawns should not be sprayed for a period of two to four weeks.

Weed-killing sprays are fully effective only when the leaves are green and the plant is in active growth. Remember the temperature should be at least 70 deg. F. Cover the leaves of the plant thoroughly, especially larger growth such as the giant ragweed, Fig. 2, also poison ivy, poison oak, sumac and others. In spraying farm pastures, along fences and ditches, and along roads, keep in mind the precautions to be taken against drift of the spray. On cutover land the sprays are most effective in killing sprouts, Fig. 5, C, and Fig. 8, which may grow up from the stumps, also noxious weeds which infest cleared areas. In pastures, sprays containing the chemical 2, 4-D will not permanently damage the common forage grasses such as bluegrass, redtop and the various fescues but will damage the clovers common in pasture lands. However, where weed infestation is heavy spot spraying can often be done effectively without unduly injuring the forage crop.

Folding Campfire Grid Packs Flat for Carrying

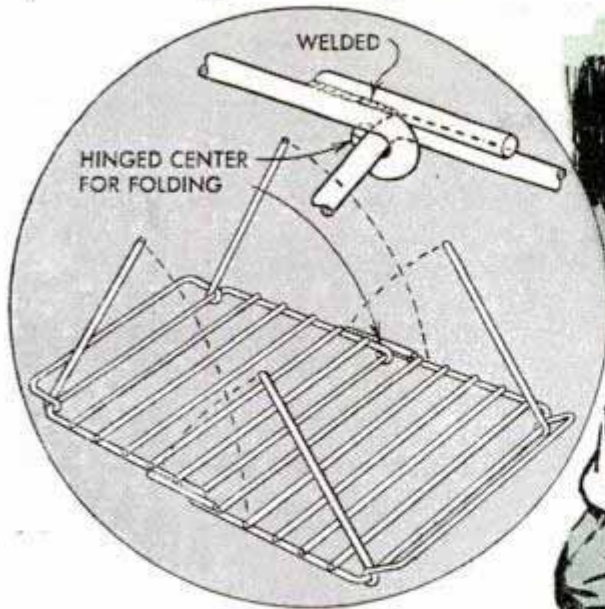

The legs of this campfire grid, which is made of $\frac{3}{16}$ -in. wire, fold flat against the top, the latter being hinged in the center. When folded, the grid takes little space. No dimensions are given as they can be determined best by the builder.

When the unit is set up, a short length of wire welded to one of the halves rests against the other half to hold the top rigid, as shown in the detail. All joints should be

welded and the legs should be long enough to support the grid at the proper height from the fire when pushed firmly into the ground.—D. E. Horn, River Forest, Ill.

Hinged Hoisting Racks Speed Job of Washing Rowboats

The backbreaking job of cleaning, hosing and draining rowboats by tipping them on their sides is eliminated with this hinged hoist. The unit consists of two racks which are fastened to the dock. An electric motor mounted overhead raises and lowers the boats through a pulley and cable arrangement. In the upper view both racks are shown partially raised, while in the lower illustration, one rack is submerged so a boat can be floated in and the other rack is fully raised.—Ormal I. Sprungman, San Diego, Calif.

☐ A whisk broom will remove the silks from sweet corn. After removing the husks, just brush the ears toward the stem ends.



Masonry 'Drive Nails' Improvised By Using Discarded Bolts



Good use can be made of discarded bolts by converting them into masonry "drive nails." As the drawing shows, the threaded portion is slit and then expanded in the hole by placing a small steel wedge so that it spreads the halves when the bolt is driven in place.

Boxes Are Rolled for Storage

Whenever she gets cardboard clothing boxes of the kind that are collapsible, one housewife takes them apart and rolls them into a cylinder. Kept thus, they require little space for storage and are easily identified.—D. S. Bucher, Philadelphia, Pa.

Ruled Lines Printed With Roller Secure Decorative Effects

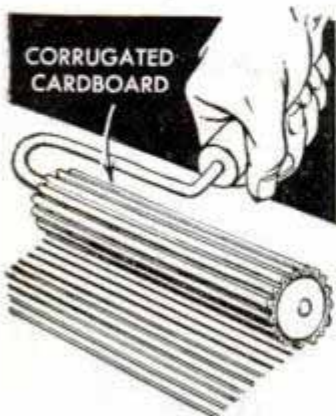

Decorative borders are imprinted easily and quickly by means of this simple roller. It can be used also to apply glue when the latter is intended only to "tack" two pieces together. Secure a piece of single-faced corrugated cardboard with ei-

ther large or small corrugations, depending upon the distance between the lines you wish to print. The cardboard is

wrapped around the roller and the joint is glued. Ink the roller by passing it over a sheet of glass or smooth wood on which the desired paint or glue has been spread in an even film; then transfer it to the surface to be treated.—Kenneth Murray, Colon, Mich.

Flypaper Is Barrier to Ants

If ants have been getting into your kitchen cabinet or other kitchen furniture, wrap narrow strips of flypaper around the legs with the sticky side out. The strips present

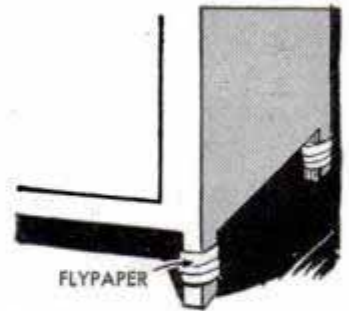

a barrier across which the ants cannot pass. When it becomes necessary, the strips of paper can be replaced.

Fishing Flies Are Tied Quickly With Drill Clamped in Vise

To speed the time required to wind the bodies on fishing flies, one sportsman uses a breast drill clamped in a vise. The hook is held in the chuck of the drill and the shank and eye are left free. The shank of the hook should be centered so that it does not wobble. After the body has been wound in the manner shown, the drill is dropped down in the vise so the crown gear cannot rotate. Then the other parts of the fly can be tied on the hook while it is still being held in a convenient position.

H. Leslie Thompson, Sarnia, Ont., Can.



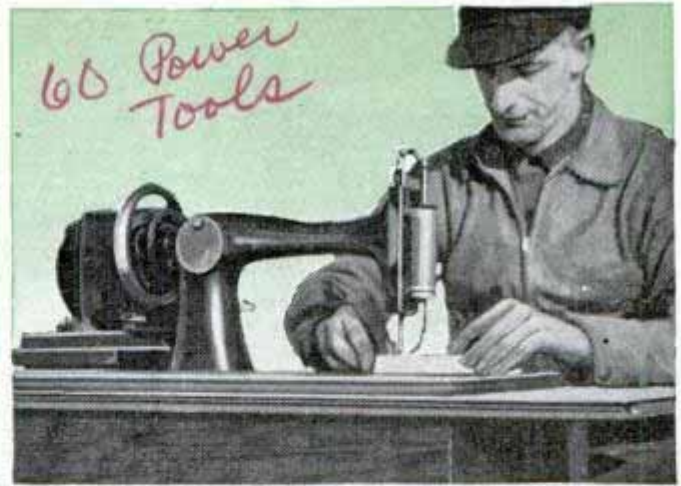
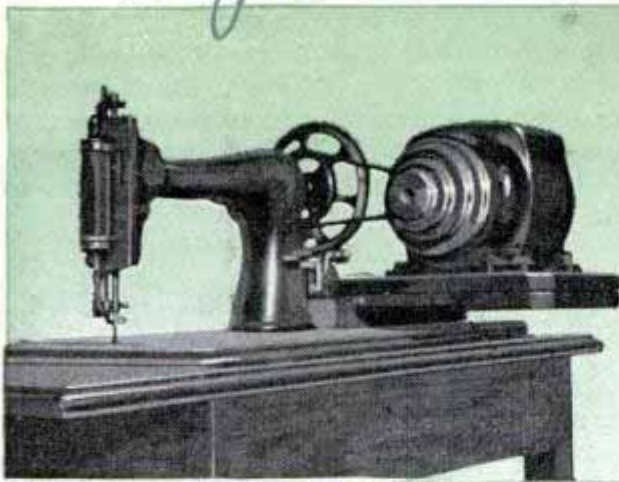

From SEWING MACHINE to JIG SAW

By GUST M. LARSON

THAT old sewing machine long relegated to the attic can be converted into an excellent motor-driven jig saw at practically no cost. All you have to do is strip the machine of its shuttle mechanism, located on the underside of the base, and install the blade-tension device shown at the right. Thickness of the stock that the saw will handle depends upon the stroke of the machine at hand, although it is possible to increase the stroke of most machines simply by raising the needle bar in the head. Drive is by a $\frac{1}{2}$ or $\frac{1}{8}$ -hp. motor mounted on a hinged base to bring it in line with the pulley on the handwheel. A small insect sprayer, attached by brackets to the cover plate, is operated by the needle bar to provide an efficient sawdust blower.

The machine can be left on its original stand, or you can set the head and base flush in the top of a sturdy bench. In either case, a board must be installed, as shown in the cutaway view, so that the tensioner can be screwed to it, directly below and in line with the needle bar. The tension device consists of a floor flange threaded to a slotted tube in which slides a spring-loaded shaft. The tension of the spring is adjusted by a nut at the end to suit the blade being used. A cross pin keeps the shaft from turning in the tube, and a collar and setscrew, soldered to the upper end of the shaft, form a blade clamp. The needle clamp will hold jeweler's blades but will require enlarging for saber-type blades.

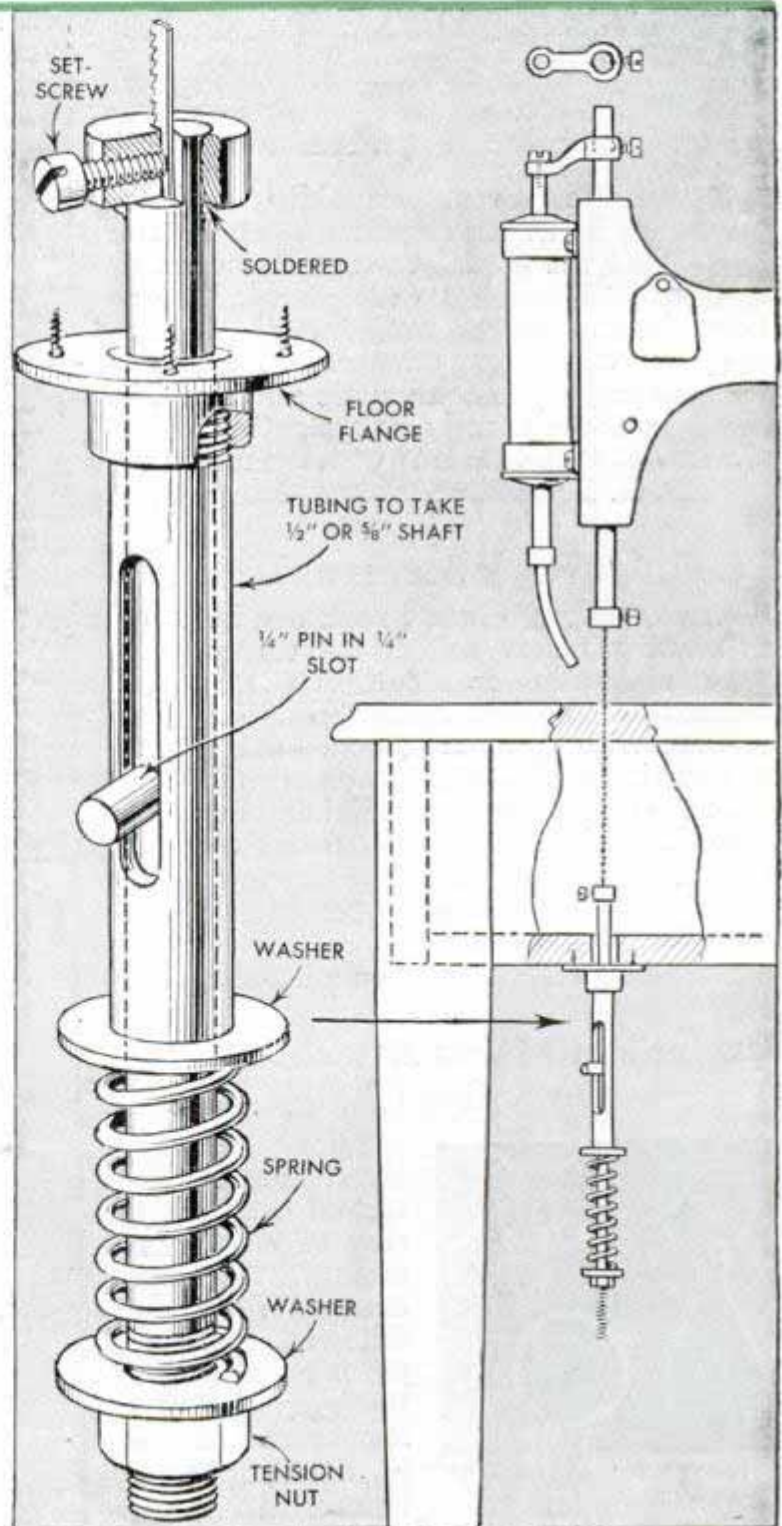

Work Easily Sawed at Any Angle Without Using Miter Box

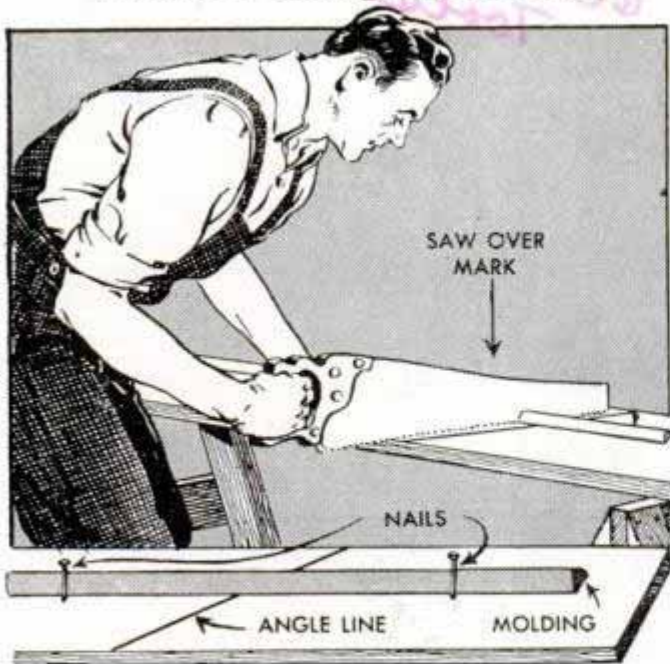

If you want to miter molding and no miter box is at hand, you can improvise one. Draw the angle at which the wood is to be sawed across a wide piece of scrap board and drive two nails into the board, parallel with the long dimension. Then hold the molding against the nails and saw directly over the pencil mark, sighting along the saw to keep it in line with the mark.

D. R. Brizendine, Forest Grove, Ore.

Cellular Rock Serves as Lighter

Any cellular, volcanic rock can be used to make a handy lighter for stoves, furnaces and fireplaces. The rock should be about the size of an egg or an apple. It is secured with wire and fastened to a length of dowel for a handle. To use the lighter, soak the head in kerosene, light it and place it in the fuel to be burned. Because of the porous nature of the rock, it will hold a fairly large amount of the fluid and will burn for some time.

Robert K. Smith, Klamath Falls, Ore.

Cotter Pin Makes Attaching Link On Safety Chain

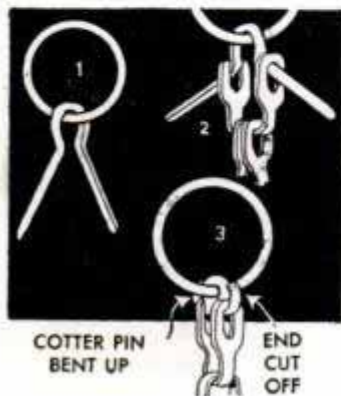

Safety or sash chain can be attached neatly to a ring or other fastening if the steps detailed here are followed. A cotter pin is hooked over the ring and the legs spread slightly, detail 1; then the chain link,

which has also been spread slightly, is slipped onto the legs of the cotter pin, detail 2. Finally, the legs are bent upward and over the head of the pin and the two ends cut off, detail 3. This makes a strong, as well as small and neat, attachment to hold the chain.

Toothpicks Form Neat Spokes In Model Wheels

Modelmakers can save time and do realistic work when turning out miniature wheels with spokes by using round toothpicks and cutting them to the correct length. As the toothpicks are fairly uniform in length and perfectly round, little time is required to make spokes by this method and the work will be accurate and satisfactory.

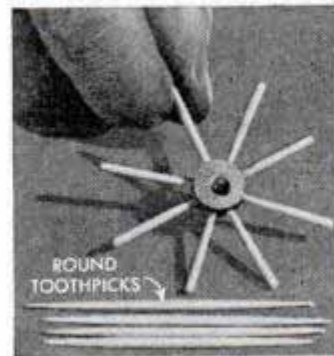

Dowel Is Used for Sanding Stick To Remove Glue From Holes

When replacing the lower rail on a chair, the hole into which the round piece fits must be cleaned of glue so the new rail will fit properly. To do this make a sanding stick by wrapping a small piece of sandpaper around the end of a dowel which is slightly smaller than the hole to be cleaned. The stick is chucked in a brace. It is not necessary to cement the sandpaper to the dowel. It can be held until started and will stay on during the sanding operation.

Herman Klein, Pittsburgh, Pa.

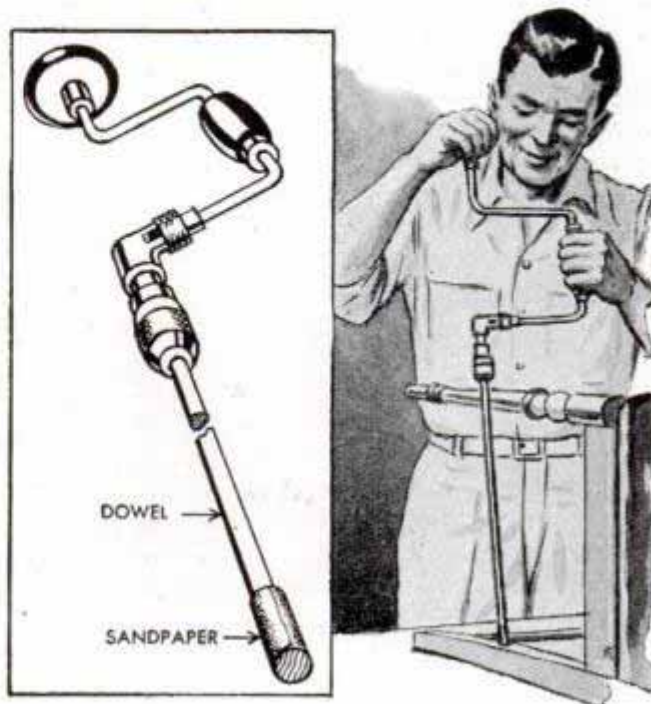

"Seal-Beam" Your Old Headlamps

By Edward Zychal

USING parts of the original reflectors and a little ingenuity it's no trick at all to fit sealed-beam units in the headlamps of an older-model car. The first step is to check the outside diameter of the reflector with the diameter of the sealed-beam unit. This must be done carefully, using dividers to transfer the measurement to several points on the back of the reflector. Then the reflector is placed face down on a flat surface as in Fig. 1 and a line scribed with a pencil as shown. In most cases, the diameter of the scribed circle will be about $6\frac{5}{8}$ in., the diameter of the lens step on the sealed-beam unit. This should be stepped carefully with dividers to assure that the measurement is correct. Then the thin metal is cut through on the line with a 3-cornered file as in Fig. 2. After cutting around the reflector, burr off the rough edge with a file or emery cloth and round over smooth. Only the rim is used.

Next, the unit must be provided with a narrow cork gasket. This is attached with a quick-setting cement or shellac. Make a trial assembly to determine the distance from the rear curvature of the original headlamp housing to the rear curvature of the sealed-beam unit. Either a large coil spring of light tension, such as a chair-cushion spring, or a section of rubber hose, Fig. 3, must be fitted in the space between the unit and the housing so that there will always be sufficient pressure to prevent the sealed-beam unit from rotating. A section of $2\frac{3}{4}$ -in. radiator hose with one end slit at spaced points about the circumference as in Fig. 3 will serve this purpose. With old wiring, you'll get better lights if relays are used. Also, it may be necessary to take current direct from the battery.

Necessary plugs to fit the prongs of the sealed-beam units may be purchased from auto-supply stores. In assembling, the common lead is hooked up first. On many cars this corresponds to the ground connection so it will be necessary to bolt or solder a ground wire to the headlamp housing. The other two wires then are connected to the plug. Be careful to follow the wiring color code so that the high and low beams will work together. In assembling the sealed-beam units in the housings make sure that the tension is sufficient to prevent the unit from turning. After assembling the headlamps on the car, Fig. 4, they should be set, or aimed, in the usual way.



First, reflector is marked by holding pencil steadily and rotating reflector face down



After rechecking diameter marked, reflector is cut through with a three-cornered file



Slitted piece of radiator hose provides pressure to keep the sealed-beam unit in place

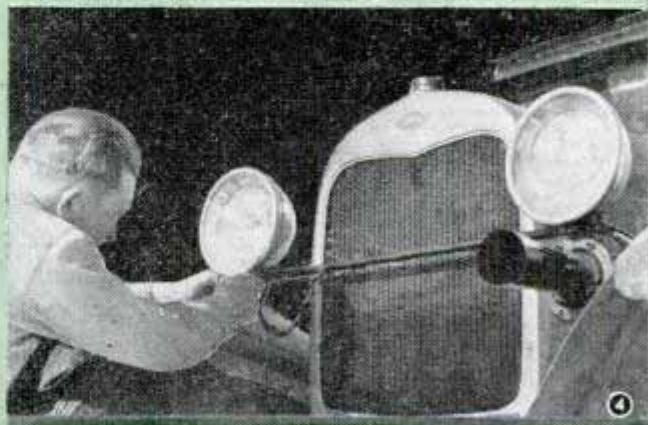

Reassembling the headlamps and fastening the retaining rims securely completes the work

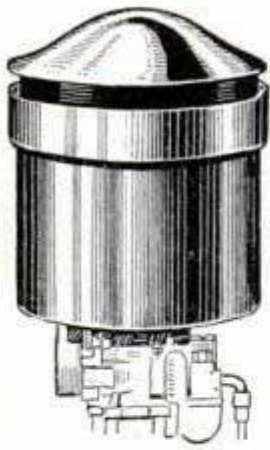

Give Your Engine

AIR CLEANER choked with dirt saps engine power and wastes gas. Remove the filter element and wash thoroughly in gasoline. Then dip it in light oil and allow it to drain before replacing. Make sure connections from cleaner to carburetor are leakproof. Watch oil level in oil-bath type cleaners

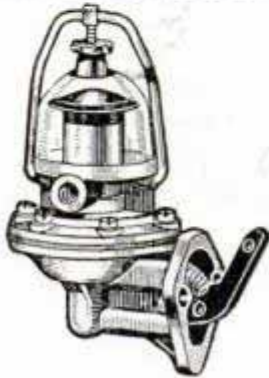

FUEL PUMP sediment bowl must be emptied of water and dirt regularly. Check the pump diaphragm, too. Sudden increase in oil consumption may indicate broken diaphragm is sucking engine oil from crankcase. If flow of fuel is weak, blow out the line with an air hose held at fuel pump (remove tank filler cap first), and check the line back to the tank for flattened spots

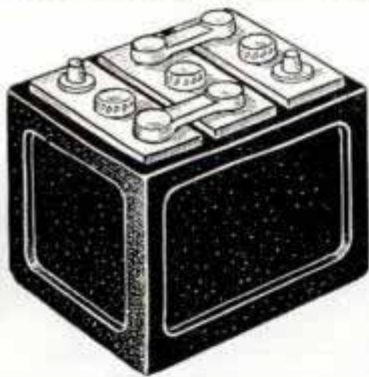

BATTERY neglect means short life. Check regularly at least once every two weeks and even more often in hot weather. Inspect each cell to see that water level is above plates at all times, and add only pure distilled water when needed. If terminals are corroded, scrape them clean and coat with vaseline. Soda-water application neutralizes acid on top of battery



DISTRIBUTOR check should cover inspection of housing for cracks that may retain moisture and develop shorts; cleaning sockets where high-tension wires enter the cap, and smoothing pitted points. Remove oil deposits, if any, and locate source, as oil on breaker points will cause excessive point burning. Over-oiled rotor wick or oil from grease cup may be the trouble

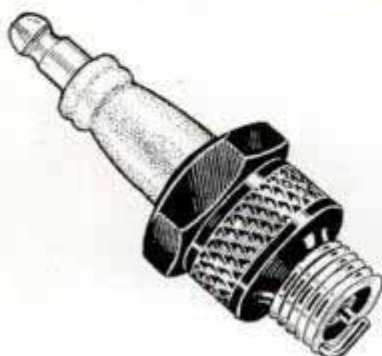

SPARK PLUGS fail in four ways: normal wear, broken insulators, dirty electrodes and excessive gap. Do not screw plugs tightly in place; future removal of a "frozen" plug may result in cracking the insulator. Scrape accumulated carbon from electrodes and check for excessive gap between them. In regapping, use a feeler gauge and always bend side electrode



a "Physical" Check-up!

Minor things that you can do yourself to save both time and money and keep your car operating at top efficiency

By Phil Ruskin

AN HOUR or two spent occasionally in making minor adjustments and repairs on your car engine not only will be repaid in the pleasure of driving a car that gives peak performance, but also will help delay the time for a major overhaul job. Efficient fuel and ignition systems, Fig. 4, are a must if an engine is to deliver its power smoothly and economically, so start the check with the fuel system.

Fuel pump: This is the heart of the system and should be checked first. Disconnect the fuel line on the discharge side of the pump. Then turn the engine over a few times with the ignition off to see if the pump is delivering sufficient gas. If the flow is insufficient, blow out the fuel line and clean the pump sediment bowl. Be sure the tank vent is open. A weak flow of gas may indicate that the trouble is in the fuel pump itself.

Carburetor: Aside from fuel pump failure, improper functioning of the carburetor is another primary cause of poor engine performance. Check the float and needle valve to see that the latter seats properly and that the fuel level is maintained at the correct height in the float chamber. This varies with the different cars. The correct level recommended for each individual make of car can be had by consulting a dealer or manual. However, in the absence of this information, the correct level can be determined, to some extent, in the following way: When the fuel level is too high, the carburetor will be flooded when the engine is not running. If it is too low, the engine will perform poorly, especially when attempting rapid acceleration. Be sure that all vents and jets in the carburetor are open and in working condition. Set all manual adjusting screws to give the best engine rhythm when it is idling at a speed equivalent to 20 m.p.h. If the engine has an automatic choke, be sure that it remains closed when the engine is

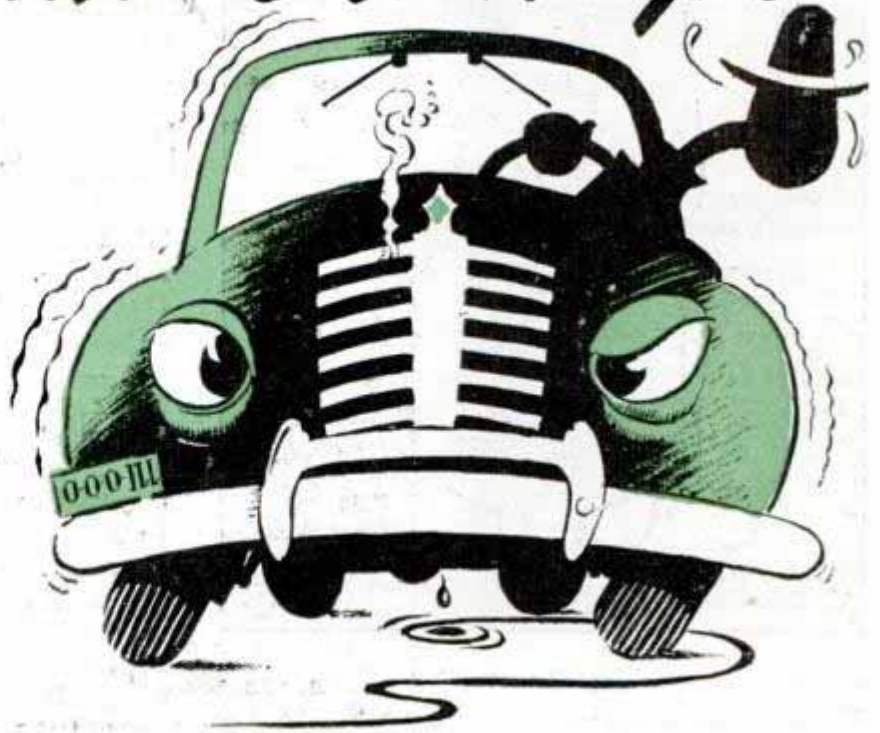

cold, and open when the engine is warm. All gaskets around the carburetor must be leakproof. Engine idling should be adjusted to the lowest speed at which the engine will turn over smoothly. Some carburetors have a screen in the inlet pipe that requires periodic cleaning.

Air cleaner: A partially blocked air cleaner causes excessive fuel consumption and may be the cause of a sluggish engine. Remove the cleaner and wash all parts in gasoline. Reoil the copper-gauze filter and allow it to drain before replacing. If the air cleaner is an oil-bath type, refill the reservoir to the level mark. This usually requires about a pint of oil.

Battery: A faulty ignition system will cause an otherwise good engine to run poorly. Test the battery and see that the electrolyte covers the plates at least $\frac{3}{8}$ in. A fully charged battery should have a specific gravity reading of 1.280 and should never be allowed to fall below 1.250. Clean the corrosion from the terminals with a wire brush and wash the top of the battery with a solution of baking soda, rinse off with warm water and wipe dry. An application of grease or petroleum jelly to the terminals will help prevent corrosion. It's especially important that the ground cable connections be tight and clean. Replace broken and frayed battery cables. With the battery in good shape, ample voltage is assured. Next comes the ignition coil. It's best to have it tested at a garage, but you can make a fair test by pulling the high tension wire from the center of the

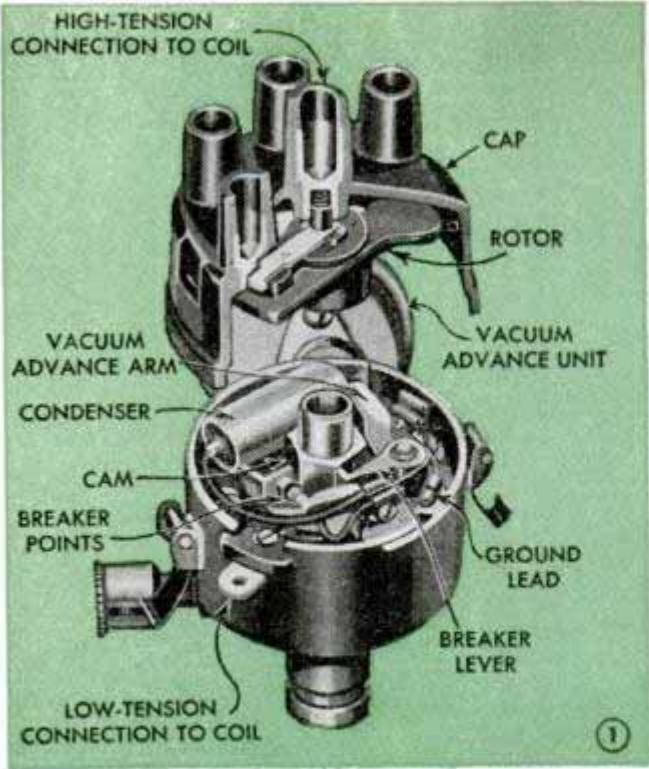

distributor and holding it $\frac{3}{8}$ to $\frac{1}{2}$ in. from the motor. If a spark jumps to the motor when the distributor points are broken, likely the coil is all right.

Distributor: Check to see that it is clean, that all parts are lubricated, Fig. 1, that the casing is not cracked and that the springs are in good condition. Also see that the breaker points are not unduly pitted and are timed perfectly. If the points are pitted slightly, use a coil file to smooth them. Or, better still, replace them. Badly pitted points that produce a long, hot arc when they break with the ignition on usually indicate a weak condenser. If this condition is apparent, both the points and condenser should be replaced. A mark on the flywheel of most cars permits timing the points to a close degree of approximation without the use of an instrument. When the mark is centered in an index hole in the housing, the points should begin to break for firing the No. 1 cylinder. Check with a dealer to obtain the correct firing order of the engine and the gap required between the breaker points when they are wide open. Use a regular feeler gauge to test the clearance. If the timing of the cam in the distributor is off, it can be adjusted by loosening the distributor on its shaft and turning it until the correct moment of "point breaking" is found. Check the ignition wires for breaks in the insulation, wipe them clean of oil and dirt and see that they do

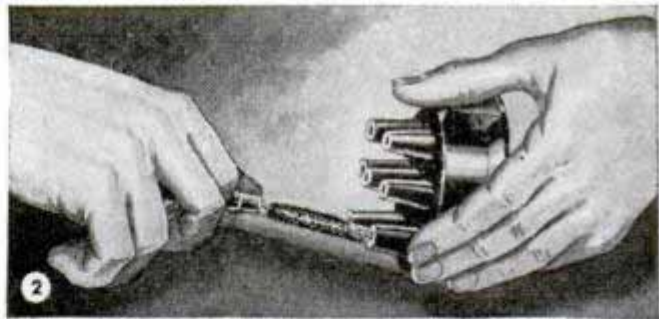

not come in contact with hot engine parts. Also, it's a good idea to clean and polish the wire sockets in the distributor as in Fig. 2.

Spark plugs: Before removing the spark plugs, clean the walls around them so that dirt will not fall into the cylinder. Look for cracks in the porcelain insulation and adjust the electrodes, Fig. 3, to a gap of .025 to .029 depending on the maker's instructions. Adjust only the side electrode, never the center one. If the electrodes are badly burned, or if the plugs are very dirty and rusted, replace them. In replacing the plugs tighten them just snugly, do not draw them up tightly. The right type plug to install is important. Where you notice that the insulators of the plugs become a brownish color quickly and the electrodes burn away, they should be replaced with a cooler running plug having a short shank. If the plugs are wet, sooty and fouled all the time, a hotter running plug—one with a long shank—is needed.

Road test: When the tests so far have been made, give the car a road test. You may find the carburetor needs adjusting. If the engine "rolls" or it seems sluggish and black smoke pours from the exhaust following rapid acceleration, the carburetor mixture is probably too rich, that is, too much fuel in proportion to air. On the other hand, if the engine "spits" and lacks power, the mixture is perhaps too lean. During the road test, try hill climbing. Here you may find that the spark is

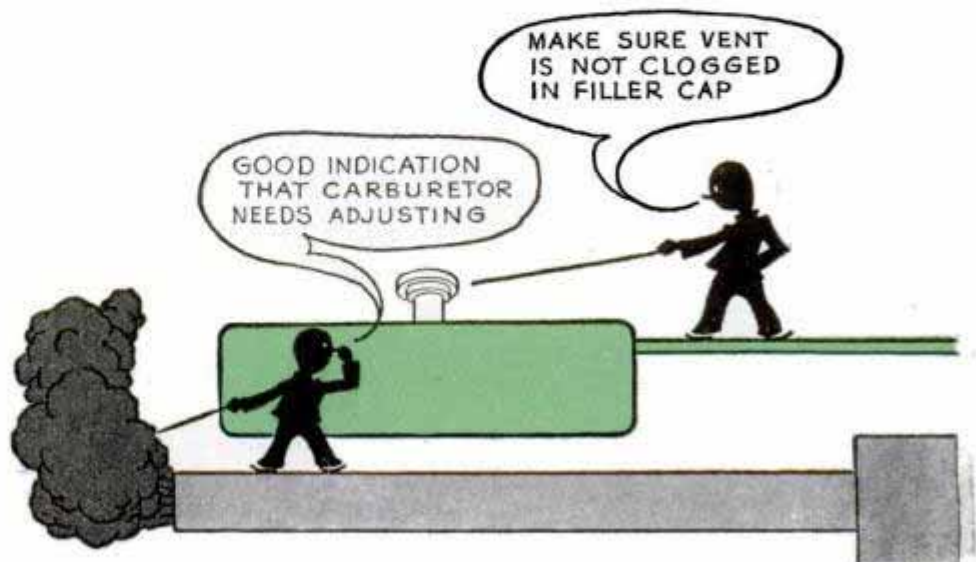

advanced too much for the type of fuel being used, causing the engine to knock and lose power. Recheck distributor and spark plug gap. Also, check engine compression by letting the engine idle downhill in high gear. Good compression should hold the car back fairly well. On level grade a good six-cylinder engine should be able to pull evenly at less than 5 m.p.h. in high gear. Another thing to check is the condition of the piston rings and cylinder walls. If blue smoke is observed from the exhaust during fast acceleration, it indicates that lubricating oil is passing the pistons, and the rings or cylinder walls need attention.

Engine compression: If the engine still performs poorly, look for faulty compression. First check the valve clearance with a feeler gauge placed between the valve stem and the actuating mechanism when the valve is fully closed on its seat. Examine the condition of the valve springs too. Testing engine compression accurately requires a special gauge, but by removing the plugs, one at a time, and holding the hand over the plug opening while the engine is being turned over, you'll be able to detect a weak cylinder. Another way is to "short" one or a pair of spark plugs while the engine is running. A weak cylinder will show very little if any decrease in engine speed when it is shorted out, which indicates that it is doing little work. A

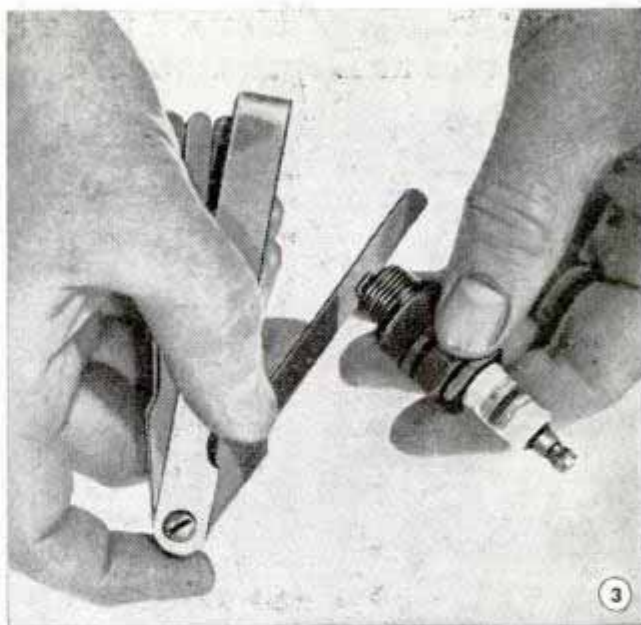

third method of finding a weak cylinder is to crank the engine over slowly by hand, and count each cylinder as it comes up on its compression stroke. Less compression in cranking will be noted if a cylinder is weak. If regrinding the valves makes no appreciable improvement in compression, the pistons and cylinder walls need attention. This, however, amounts to a major overhaul job which should be done by a competent mechanic. Finally, it's a good idea to check the engine temperature during tests. If the cooling system is in good condition it will remain fairly constant.

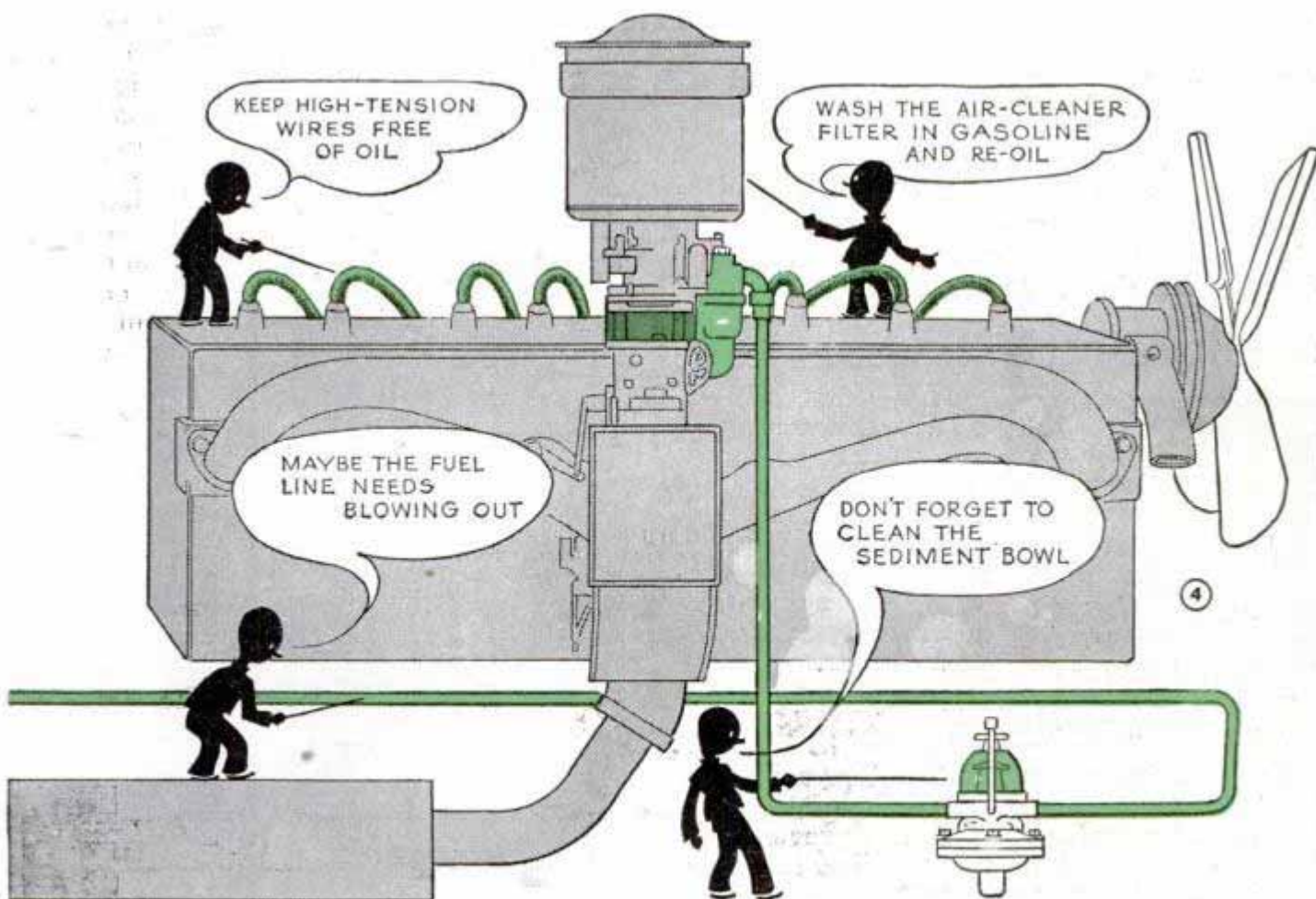

Trouser Hanger Clamped to Saw Serves as Depth Gauge

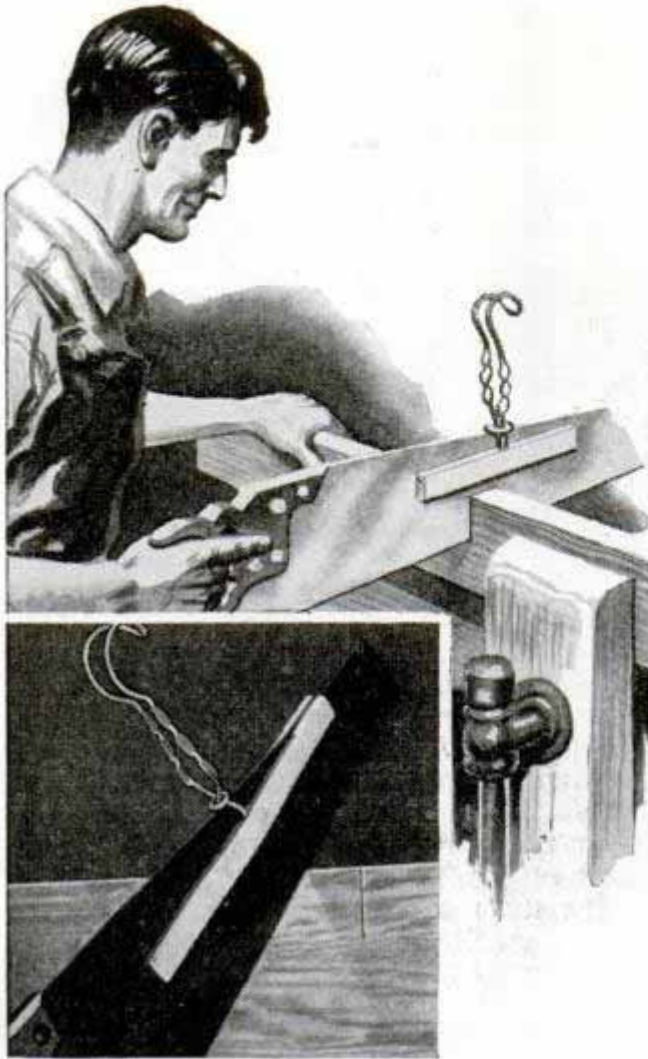

When you must make a saw cut in from the edge of a board to an exact depth and there's no suitable depth gauge at hand, just clamp a trouser hanger on the saw blade and measure the distance from the points of the teeth to the bottom edge of the hanger. Then adjust until the distance corresponds to the depth of cut you require.—William Swallow, Brooklyn, N. Y.

Guard Over Blade of Shoe Scraper

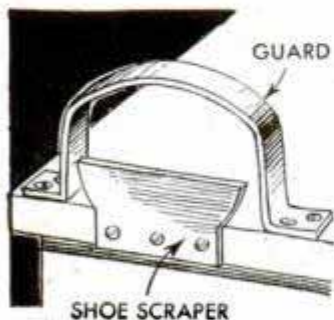

If a guard is placed over a shoe scraper, it will prevent injury should anyone trip and fall on it. The guard must be large enough to permit insertion of footwear.

Saving Gasoline in Storage

You'll increase your auto mileage and tractor acreage from a given drum of gasoline by the simple precaution of preventing its evaporation in storage. The sun's heat will volatilize gasoline even in mild

weather and waste much of the fuel. To avoid this, the storage tank should be shaded. Any kind of a simple shelter will do—just a roof is sufficient as long as it is wide enough to keep direct sunlight away from the tank.

Linotype Slug Impresses Name On Leather Goods

Personal articles made of leather may be stamped with a linotype slug bearing your name to identify them. Use the slug as you would a metal stamp and tap it with a hammer lightly to make a good impression. The slug can be obtained from any job printer for a nominal fee. A fairly large type should be used, and preferably a Gothic face, so that the impression is clean cut.—H. P. Cesary, Syracuse, N. Y.



Wire and Bolt Form Hose Clamp For Emergency Use

An emergency hose clamp having great strength can be made from a length of soft wire and a stove bolt. The two ends of the wire are twisted together to form a loop which is flattened. Then the double strand is twisted, with eyes left in each end to receive the bolt. In application the clamp is wrapped around the hose twice and pulled up tight with a screwdriver as shown.

John Krill, Youngstown, Ohio.



QUONSET HUT for your Dog

By Hi Sibley

IT may be that every dog has his day but until that time he should have a home of his own and it should be snug, warm, well ventilated and clean. If you think as much of your pet as he does of you, just any place won't do. So his home will have to be something extra special and here's a good suggestion—a house patterned after the well-known Quonset hut and retaining the essential features of the full-sized structure. The double walls are sheathed inside and out with $\frac{1}{8}$ -in. hard-pressed board. Linoleum can be used but is not so durable for this purpose. Space between the double walls is filled with $\frac{3}{4}$ -in. soft-pressed insulating board cut to fit between the supporting strips as in Fig. 2. Ends are triple thickness: $\frac{1}{2}$ -in. wood, two thicknesses, with insulating board inside, as in Fig. 1. Note that the ends are shaped to form a $\frac{7}{8}$ -in. step which takes the $\frac{1}{8}$ -in. inner wall plus the thickness of the insulating board.

Dimensions given in Figs. 1 and 2 are about average. The house can be made larger but not much smaller due to the shortened radius of the curved top. Hard-pressed board will not take the bend satisfactorily on a radius much less than 12 in. as given. Make the ends first, using strips of solid stock nailed or screwed together with the grain at right angles as indicated. Or use $\frac{1}{2}$ -in. waterproof plywood if available. No size is given on the door opening, as this is optional. Size of the ventilator opening and the sliding sheet-metal cover are given in Fig. 2, B.

Assemble by nailing the inner wall to the ends. Space the nails about 1 in. apart. Then follow with the strips and the insulation. Outside sheathing should be cut so that it overhangs the ends and lower edges about $\frac{1}{8}$ in. This will prevent water working underneath and onto the floor. It's a good idea to coat all joining edges with paste white lead or waterproof glue before nailing the outer sheathing in place. Bottom construction is very simple. Ends of the hut should overhang the ends of the bottom boards about $\frac{1}{8}$ in. when the parts are assembled. The canvas curtain, A in Fig. 2, and the visor of $\frac{1}{8}$ -in. hard-pressed board or light sheet metal finish the job ready for painting.

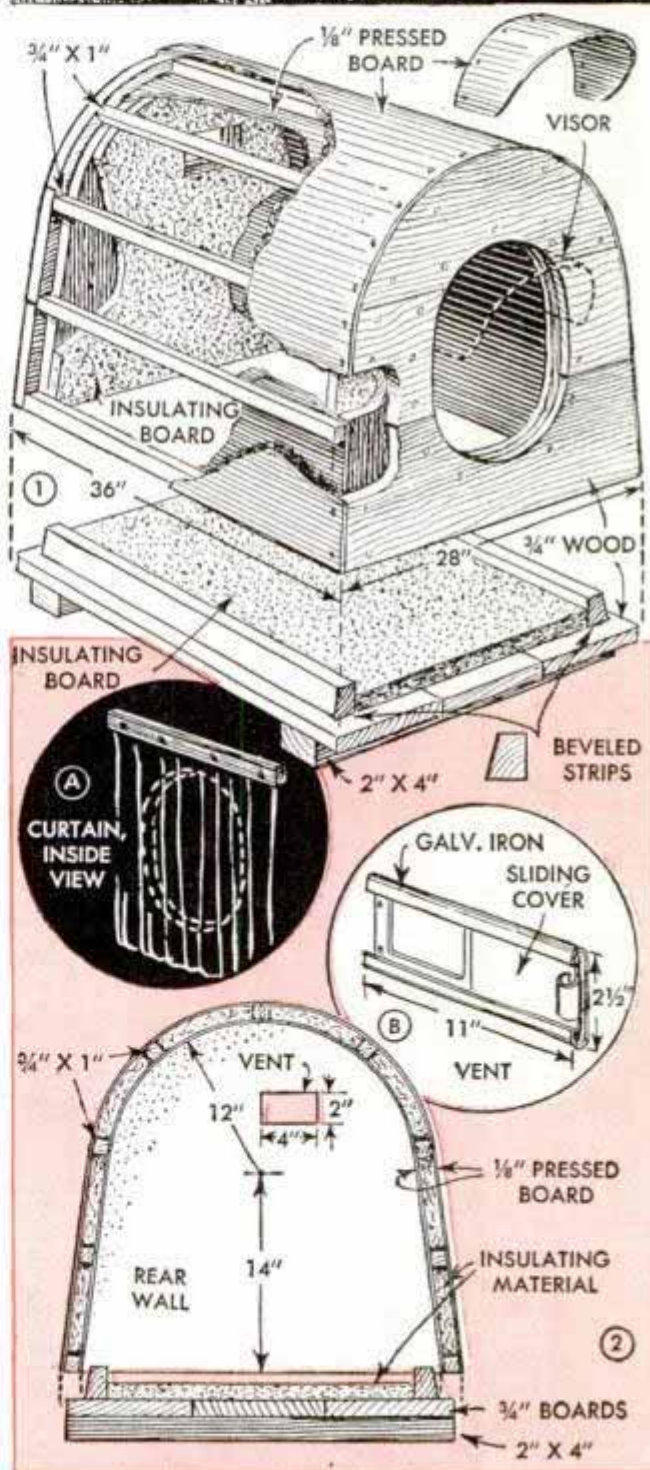

"Sleeper"

Rear-deck extension provides a comfortable bed for two, and a tarpaulin gives privacy. The entire outfit is stored in a small space in the rear of your car

By Jim Robinson

THE roadside is your bedroom when your car is equipped with this rear-deck "sleeper". The rear-deck compartment on most coupes and even some sedan-type cars is roomy enough so that, if a short extension board is added, it can accommodate a double mattress. Since the dimensions of the extension will vary with different cars, it might be well to cut a paper pattern first, being sure it fits and is large enough to support part of the mattress. Both the extension board, Fig. 1, and the tailboard can be cut from $\frac{3}{4}$ -in. plywood. Note in Fig. 2 that the curved side of the board follows the curvature of the car closely. If necessary, hinge a support at the rear of the extension board to keep it in place. As a precaution, make a wood brace that can be wedged between the rear-deck door or cover and the bumper guard, Fig. 3. Figs. 4 and 5 show the completed bed. Finally, a tarpaulin, Fig. 6, is thrown over the rear deck and lashed down.

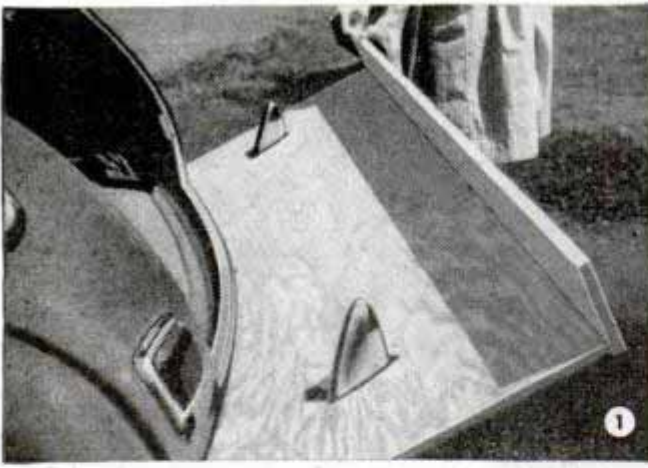

Slipped over the bumper guards to rest on the rear bumper, this extension board serves as support for the lower end of the double mattress

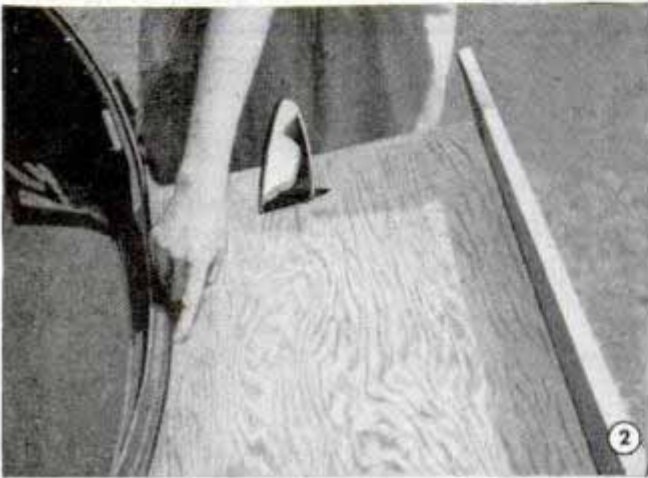

Although it is not necessary that the board carry a heavy load, for strength it should be a tight fit against the rear deck of the car



As a safety precaution, a wooden brace supports the rear-deck door. The base of the support is wedged tightly into the bumper guard

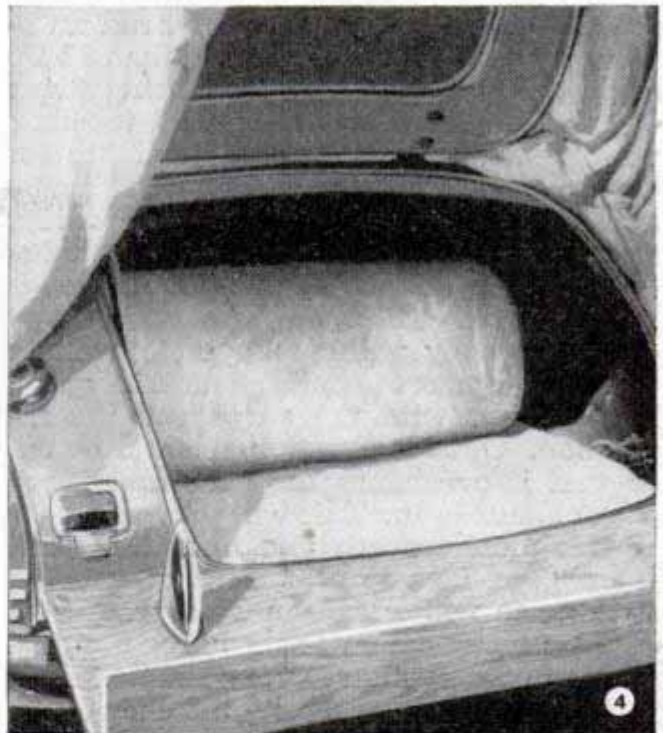

A pad placed on the floor of the rear deck protects the mattress, after which the latter is unrolled and the bed is ready to be made

for Your Car

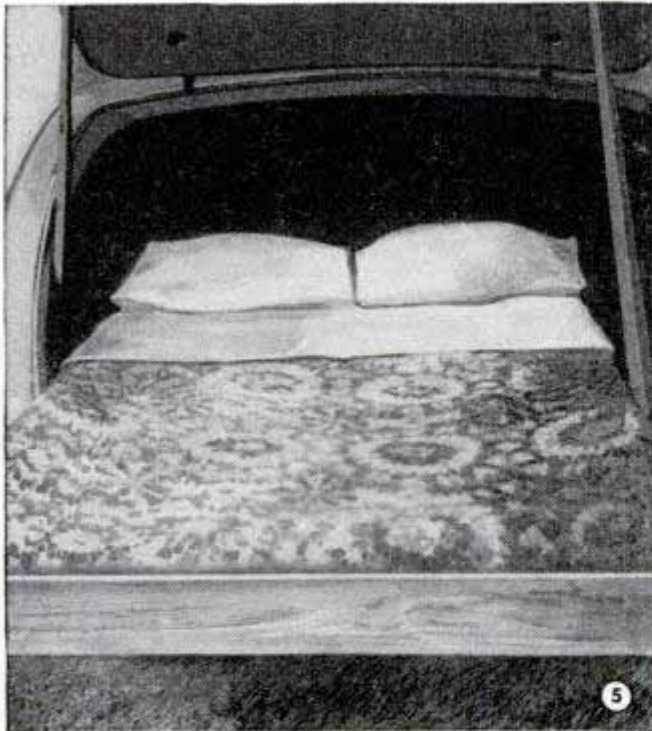
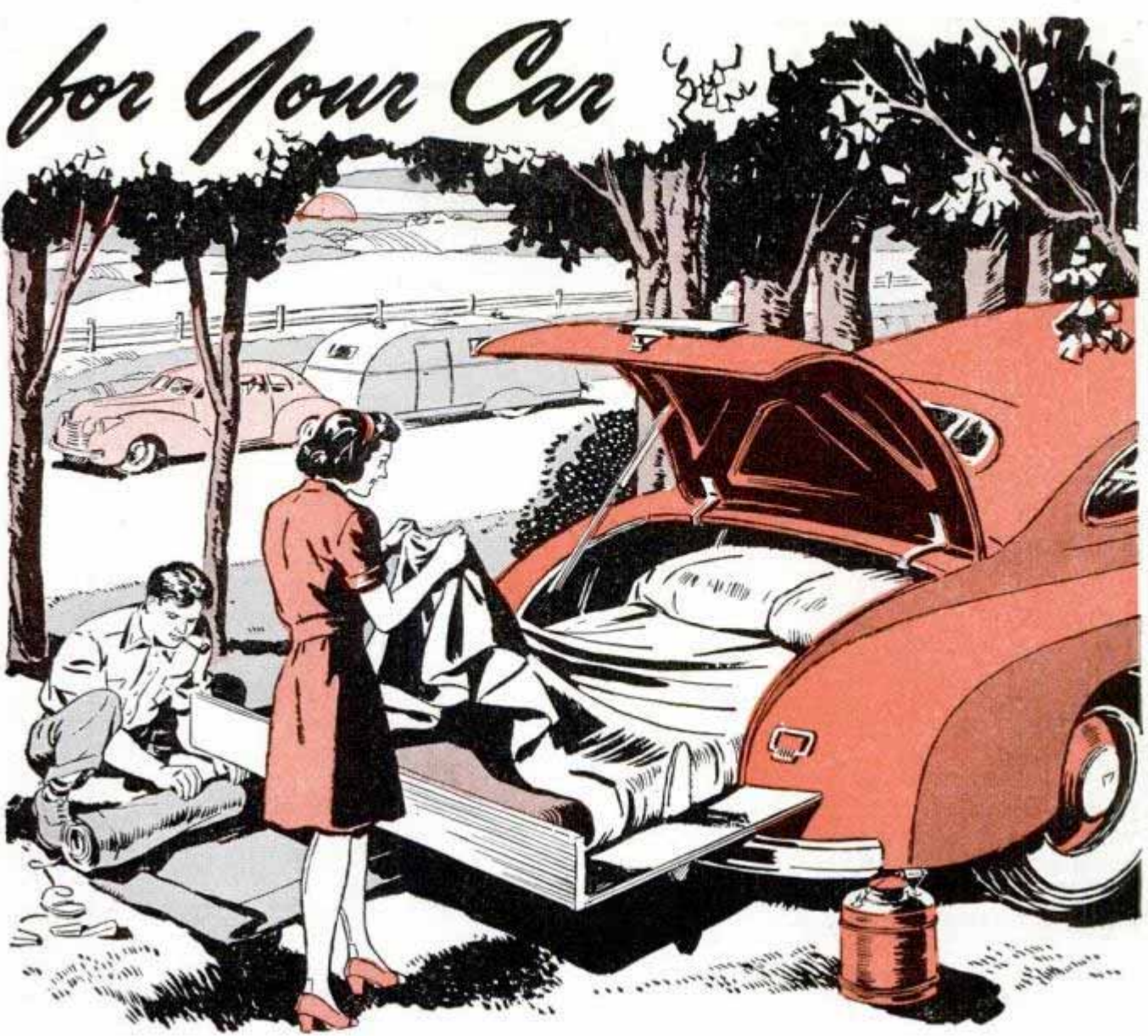

5

Bed is made up and ready for occupancy. The tailboard, fastened to the extension board, is an aid in keeping the mattress in position

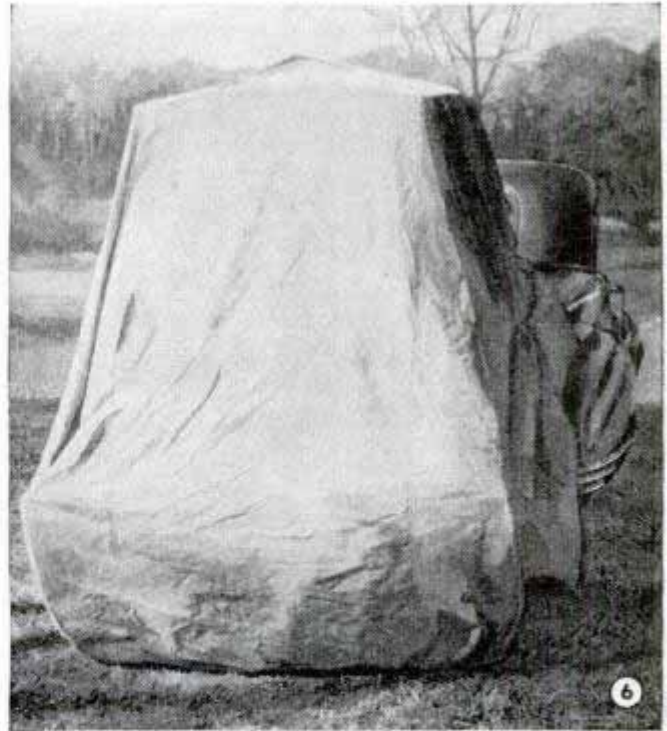

6

As protection against weather and to insure privacy, a tarpaulin is thrown over the rear deck and tied to the bumper and door handles

Miter Gauge Used as Protractor For Marking Angles

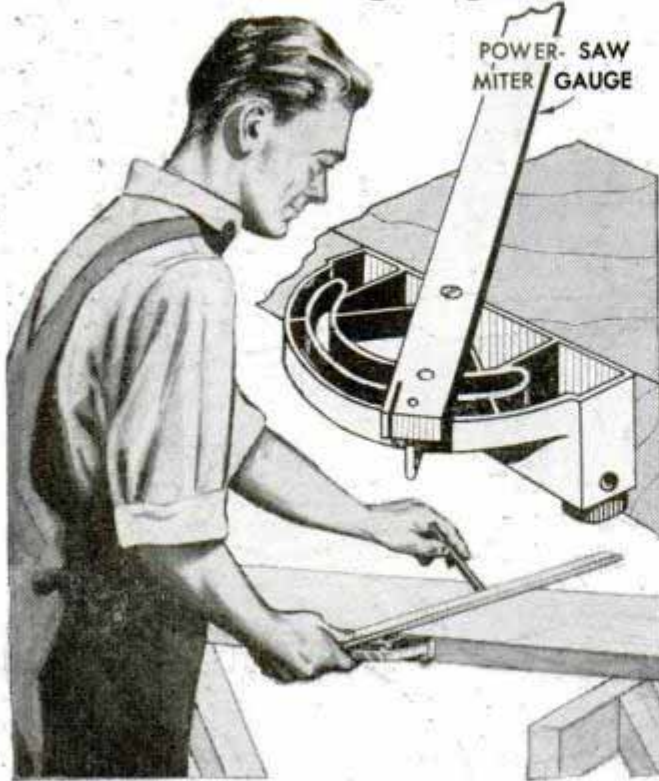

To use a power-saw miter gauge as a protractor, turn the gauge upside down with the face against the piece to be scribed. Then scribe the lines along the face of the bar that fits into the table groove. The angle to be drawn is set on the angle scale.

Robert J. Lux, East Aurora, N. Y.

How to Make Small Paper Baler

Constructed from odds and ends of lumber and an old auto jack, this paper baler will produce neat and compact bundles of scrap paper. Although width and depth

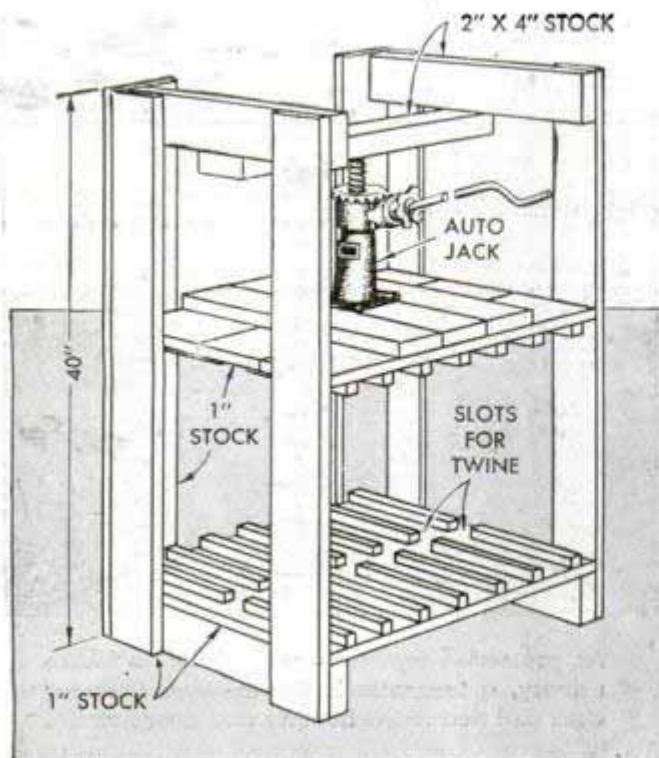

are not dimensioned and can vary to suit individual requirements, a width of 22 in. and a depth of 15 in. would be about average. Note that provision is made for slots in the top and bottom platforms so that twine can be passed around the paper when it is ready to be tied and taken from the press. The jack, which furnishes the pressure, is placed between the top platform and a 2 by 4-in. piece which is fastened to the side members.

E. A. Rerucha, Franklin Park, Ill.

Bumpers Cut From Rubber Heel

If you are unable to obtain rubber bumpers of the type used to protect furniture, they can be cut from a rubber heel. Using a razor blade, cut the heel into cubes so that a nail hole is in the

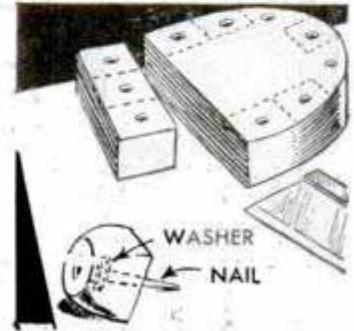

center of each cube. Each hole is fitted with a small washer through which a small nail is driven with a nail set for attaching the bumpers to the furniture.

Coins Used as Gasket Patterns

Whenever you want a round gasket of thin rubber, leather or heavy paper, hold the material between two coins of the same denomination and cut around them with a pocket knife. The diameters of coins are as follows: dollar, $1\frac{1}{2}$ in.; half dollar, $1\frac{3}{16}$ in.; quarter, $\frac{15}{16}$ in.; nickel, $\frac{13}{16}$ in.; penny, $\frac{3}{4}$ in., and dime, $\frac{11}{16}$ in. The hole in smaller gaskets can be punched and in larger gaskets it can be made by cutting around one of the smaller coins that is nearest the desired diameter.

Bob Hewitt, West Hartford, Conn.

Stop on Tap Prevents Breakage

Threading blind holes with an ordinary tap is a risky business because breakage is almost sure to result if the tap strikes the bottom of the hole. In most cases a



bottom tap is used for this purpose. But you can thread blind holes with an ordinary tap without danger of breakage if you first run lock nuts over the tap thread and adjust them so that the tap will cut the thread to the desired depth.

M. E. Frick, Evansville, Ind.

Rustic Wall Rack Has Shelves of Bracket Fungi



Everyone who vacations in the woods is familiar with the shelflike fungi often found growing on the trunks of large trees. When dry, these plant growths are of such a hard and woody nature that they can be carved, sawed and nailed without breakage. Most of the parasitic plants of this particular species, known as bracket fungi, are of a grayish-white color but some, more rare, are colored a brilliant red. Any of these growths can be made into attractive and novel wall shelves, or racks, for the summer home or woods camp. Fig. 1 offers one suggestion, using a small tree crotch as a supporting frame. The back of the crotch frame is planed flat so that it will fit neatly



against the wall. The shelves are fitted and nailed to the opposite side. Fig. 2 shows a combination wall plaque and tie holder. The flat surface of the dried fungus plant is decorated with an oil painting, which is protected by a coat of copal varnish after the oil colors are dry.

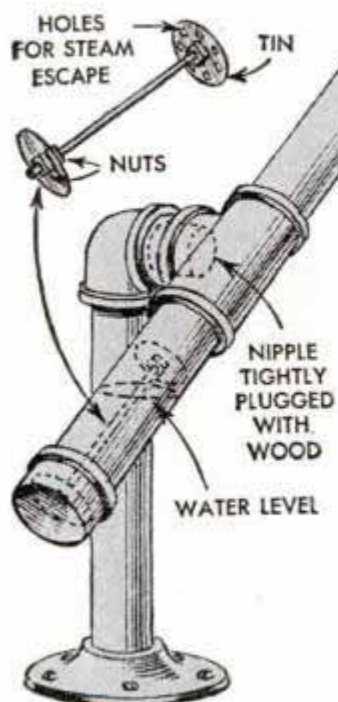

Steamer From Pipe For Modelmakers

Constructed of 1 or 1½-in. pipe and heated with a blowtorch, this compact steamer will be welcomed by modelmakers as a solution to their bending problems. Note that the upper pipe is removable and various lengths can be used to accommodate wood of different lengths. The unit which is shown in the upper left-hand detail keeps the wood out of the water. To keep steam out of the support, the nipple which connects the tee to the elbow is plugged.



White hollyhocks photographed against a blue sky, using a dark yellow filter. Such flowers always are good subjects for close-up photos

By Paul Hadley

REGARDLESS of size or kind, almost any garden—the one right in your own back yard—is full of interesting and lively subjects from which you can make salable pictures if the lighting and composition are right at the instant you trip the shutter. To be of interest and use to editors of farm and garden publications, photos of these subjects must have good composition. Composition gives a photo life, interest, action—tells a simple story at a glance, without words. Photos offered for sale must be crisp, sharp and clear, of good contrast in the light and dark areas, and above all they must be interesting. Take as examples the two simple shots, Figs. 1 and 8. There is nothing especially unusual about the composition of the photo in Fig. 1, except that it shows how onion sets are planted in the small home garden, but that is of interest to a great many people. The same is true of the photo, Fig. 8. It shows exactly how sweet potatoes are bedded, the first step in the propagation of the plants. Moreover, these two shots attract attention simply because they show people doing something.

On the other hand, Figs. 2, 3, 4 and 5 are examples of photo stills of familiar garden-plant blossoms. The important points to notice about these four shots are the crisp detail and the bold quality brought out by close-up focusing combined with unusual angles and a careful timing of the exposure.

One, Fig. 4, is taken with flash lighting and instantaneous exposure, the lighting being so arranged that the undersides as well as the top sides of the leaves are illuminated. Thus the subject is made to stand out in bold outline against a dark background. Essentially the same effect can be achieved by using floodlights, Fig. 9 being a good example of the results that can be obtained by a careful prearrangement of camera and floodlighting.

Figs. 2 to 7 inclusive are examples of close-ups of garden subjects, literally hundreds of which are possible in any vegetable or flower garden. The two photos, Figs. 6 and 7, were taken on a table top, using a background of dark cloth. Notice how these shots give the feeling of a bountiful harvest of perfect specimens. This effect is achieved by the number and arrangement of the vegetables and the fact that the photos are taken with the camera close to the subject in each case. For this type of photography a view camera with a long bellows is usually best. Mounted on a steady tripod and equipped with the proper lens, a view camera can be focused at very short distances. The large image on the ground glass can be carefully studied for the most effective composition and placement of the subject before the picture is taken. A reflex camera of the long-bellows type also is useful for this close work. In the reflex camera the image is reproduced on the ground glass right side up. You see the subject just as it will

On GARDEN PHOTOGRAPHY



Low-angle shot of onion seed heads, using a dark yellow filter to strengthen color values. The photograph was taken against a cloud background

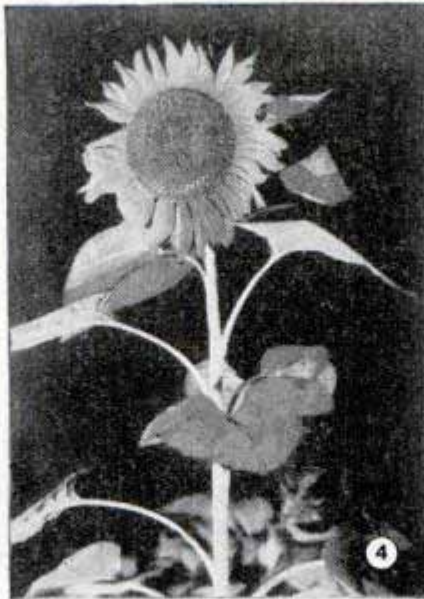

This flash shot of a sunflower was taken at night. In night photos taken by flash, detracting background detail is usually eliminated



Flower of the lowly pumpkin given an unusual orchidlike delicacy by a close-up shot. The camera must always be supported on a steady tripod

appear on the print. In order to get fine detail in close-ups of such subjects as those in Figs. 6 and 7 you use a comparatively slow shutter speed and a small stop, and for extreme close-ups it often is necessary to use an auxiliary or portrait lens. This is simply an attachment that slips over the regular lens and makes it possible to focus on small objects only a few inches from the camera.

Film to be used on close-ups of the kind already described, in fact, any ordinary outdoor work, should be moderately fast and color corrected for best results. This means a fairly fast panchromatic film of the press type which generally gives better rendition of the red and yellow values. Size of the film is largely a matter of choice, but 4 by 5, 5 by 7 or 8 by 10-in. sizes give acceptable contact prints without enlarging. Many professional photographers prefer to work with the larger film sizes as a matter of speed, economy and quality of prints. Others regularly use the smaller film sizes and enlarge from the negatives to the print size desired. This method has the advantage that slightly under or over-exposed negatives can be corrected in the process of enlarging to give a final, large-



Above and below: Close-ups of vegetables are of interest to farmers and gardeners. These photos are typical dark-background shots that leave the impression of bounteous yields

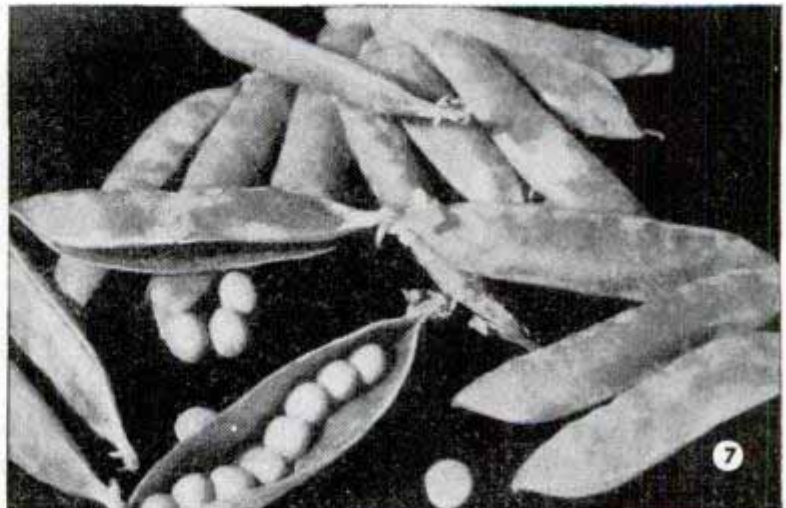



This photo is interesting because it shows how sweet potatoes should be bedded for propagation of plants in a hotbed. Note sidelighting

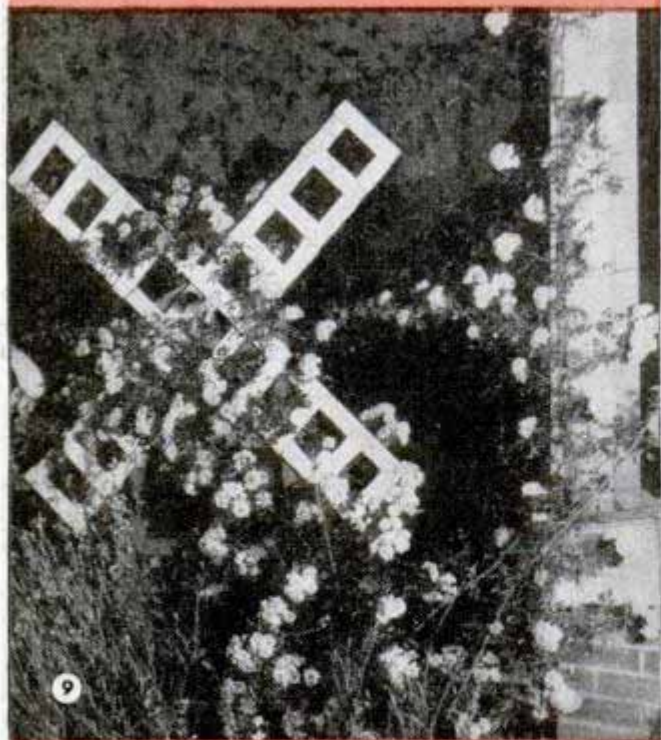

Another night shot having the effect of throwing the subject into bold relief against a dark background. Taken with floodlights and time exposure

size print of acceptable quality. Also, by using the various common grades of enlarging papers, other minor defects of the negative can be corrected or modified.

Close-up shots of insects are quite easy to make with the camera equipment described. They fit in well with stories on the control of garden pests. Figs. 10 and 12 are examples. Sharp focusing and correct timing of the exposure are the first essentials in insect photography. Careful selection of the subject and its surroundings—composition—is equally important to success. Although artificial lighting can be used, as a rule daylight is best. The large spider shown in Fig. 10 is quite brightly colored—hence it will be necessary to take careful note of the background. The camera must be placed so that there are no vines or edges of leaves which closely parallel the legs or follow the outline of the body of the insect. Such defects in the composition will spoil the picture. Use a camera with a long bellows extension and, if necessary, a portrait attachment on the lens so that the subject can be focused close up and the image enlarged several diameters. In this way the image covers the greater part of the ground-glass area and most or all of the unnecessary adjacent detail can be eliminated from the picture. If necessary to use direct sunlight, try to maneuver the subject or camera into a position where the former will be sidelighted or high lighted in such a way as to bring out the contrasting body colors in their true values.

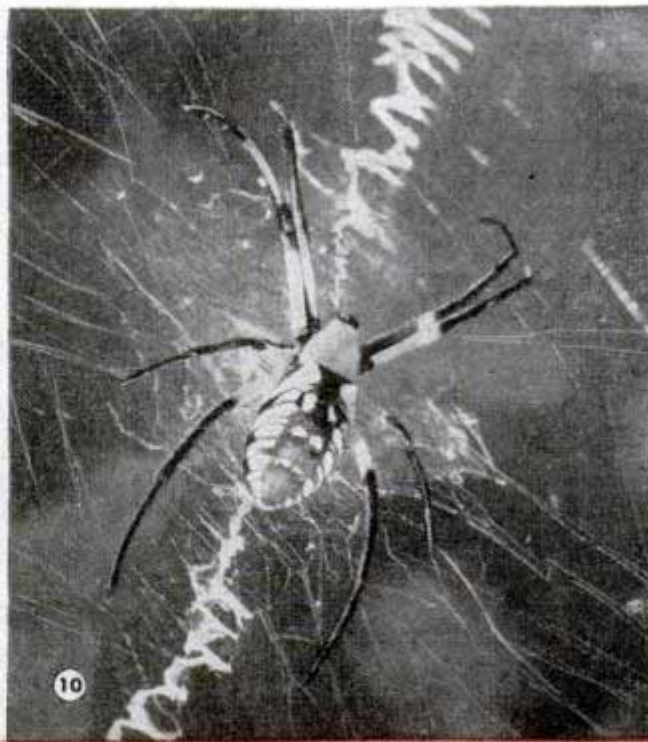

Although harmless to humans and plants, this garden spider seems none too pleased about having his picture taken in such a close-up fashion

Fig. 12 presents another problem along the same line. Here the subject must be photographed with parts of large plant leaves in close proximity. An enlarged image and needle-sharp focus are the first considerations. Then the camera is moved about by trial settings until the available light highlights the subject in sufficiently clear outlines. Proper location of the image on the ground glass and the correct exposure time complete the essential details preliminary to taking the picture. A good quality exposure meter is helpful in accurately measuring the available light and determining the proper exposure time. Be sure that the meter is set to the speed rating of the film you are using.

The photos in Figs. 11 and 13, like those in Figs. 1 and 8, effectively picture the human-interest angle of garden photography. The first, Fig. 11, emphasizes action and is taken fairly close with the purpose of registering fine detail and giving the feeling of movement. Often it is well to have the subject rehearse the action several times so that when the picture is finally taken the pose will be natural. In Fig. 13 the shot is taken at a low angle to emphasize height of the vine which is the point of pictorial interest. Notice that the figure has been purposely posed in the act of reaching upward, another detail serving to direct attention to the unusual feature of the picture. The composition of such photos as that in Fig. 13 should be carefully planned with these points in mind.



People like to see pictures of other people and this shot of the little girl gathering roasting ears is of interest to everyone, including editors

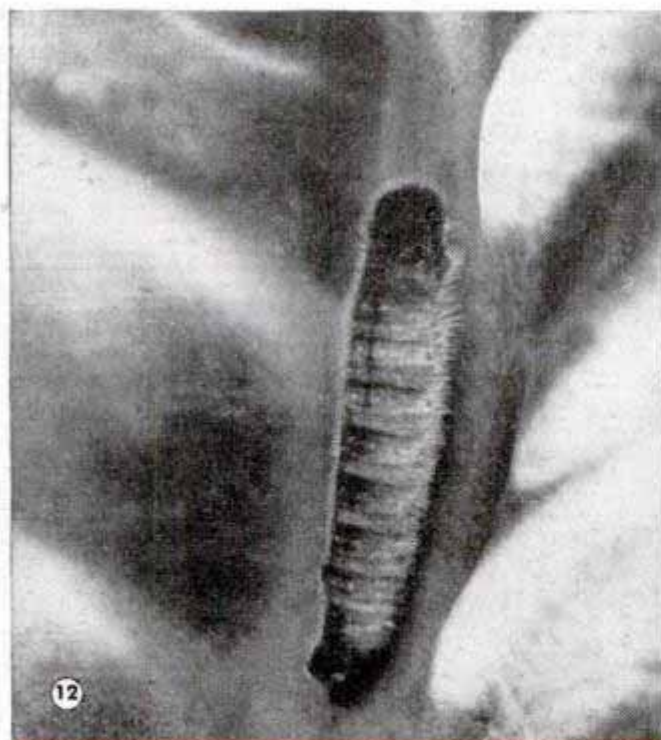

Entomologists rate this fellow a serious pest. Although he appears shy here, he's a voracious feeder and no gardener can overlook his depredations



Tomato vines 10 ft. tall don't grow in every garden. Anyone boasting a "green finger" will instantly feel the challenge of such a photo as that above

Basic Background Can Be Altered For Different Effects

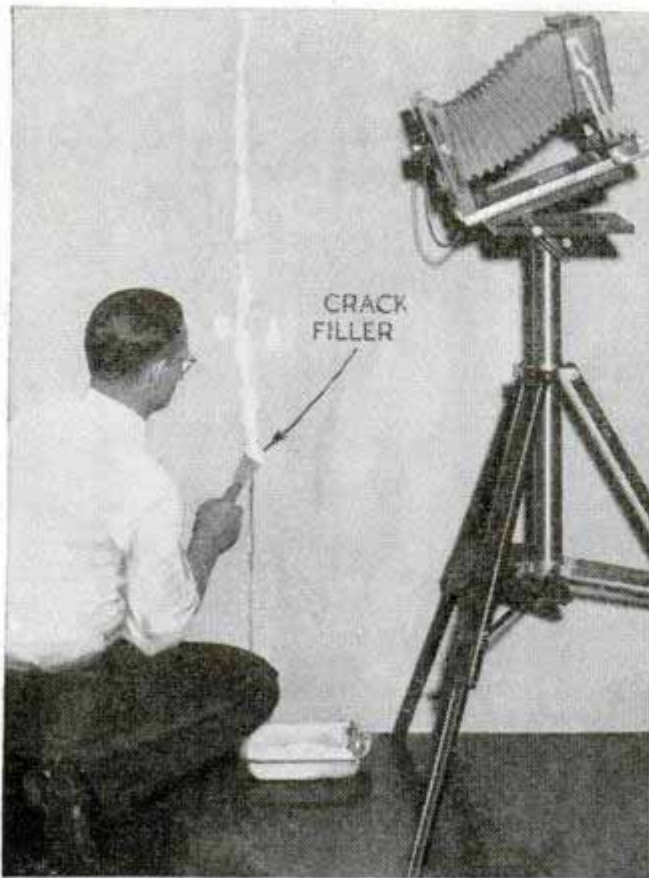

A background that can be altered to obtain a number of different effects is a welcome addition to the photographer's studio. Panels of heavy insulating board are used and should be nailed to furring strips that are fastened to the wall. The panels should be flush with the floor and ceiling. An aqua-colored water paint is ideal as a finish and a paste made of the paint should be applied before the second coat to fill cracks and nail holes. This color makes a proper background for most subjects, but variety can be obtained by attaching different colors of cloth, paper, netting, etc., with push pins.

Ivan Grosvenor, Richmond, Ind.

Short Pieces of Movie Film Stored In Dental Flat-Tape Boxes

I find that empty dental flat-tape boxes make excellent storage cans for titles and other short film cuts. In editing a reel, shots cut out can be stored for future use. When splicing on titles, just enough of the film is fed from the can to make the splice and the rest is not handled, eliminating the possibility of fin-

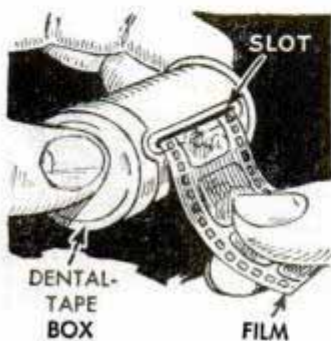

ger prints. A piece of adhesive tape wrapped around the can will seal it and the tape is marked for identification.

C. W. Philpot, Laurens, S. C.

Safelight for Photographic Paper

Here's a safe-light that is made easily by using a small bottle in which photographic chemicals are kept. Cut a 1 1/8-in. hole in the cover and solder an extension socket in this hole. With a 7 1/2-watt bulb in the jar, and with the light properly placed in the darkroom, good illumination will be secured.



Protecting Extra Cable Releases

Because cable releases that have been kinked sharply are apt to be unreliable in operation, extras that you carry in your case should be protected. One way of doing this is to glue a strip of corrugated paper inside the lid of the camera case and coat the paper with clear lacquer. One cable release will fit snugly inside each corrugation.

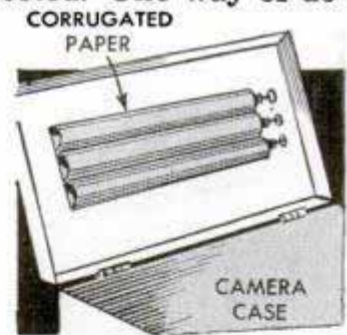

Pipe Cleaner Will Dust Negatives Without Damaging Emulsion

If nothing else is available for the purpose, pipe cleaners can be used to remove the dust from film negatives. The cleaner will not scratch the emulsion, as might be the case if the fingers were used.

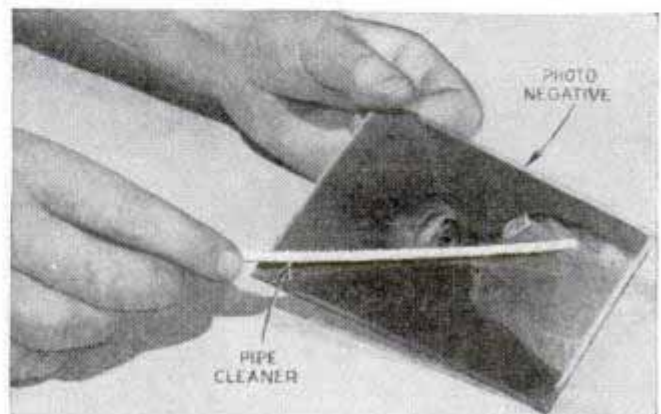

CRAFT QUIZ



1. This wood turner is—
 (a) Indexing (c) Cutting off
 (b) Making sizing cuts (d) Inletting

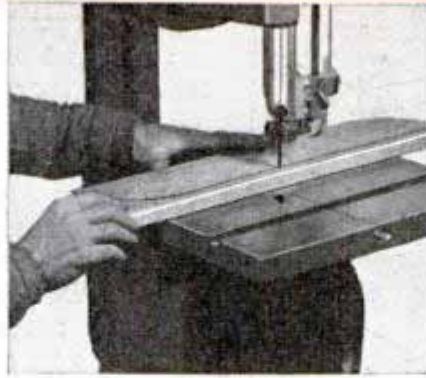

2. What's wrong here?
 (a) Hand position (c) Guide
 (b) Start of cut (d) Wood grain

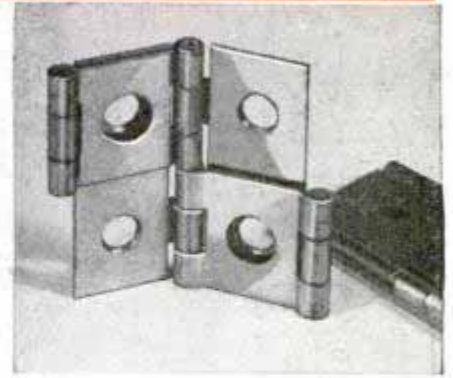

3. You'll find these on—
 (a) High chairs (c) Folding screens
 (b) Desk lids (d) Drop-leaf tables

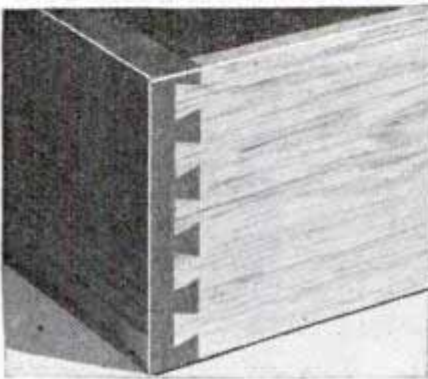

4. This joint is named from a—
 (a) Tree (c) Fish
 (b) Flower (d) Bird

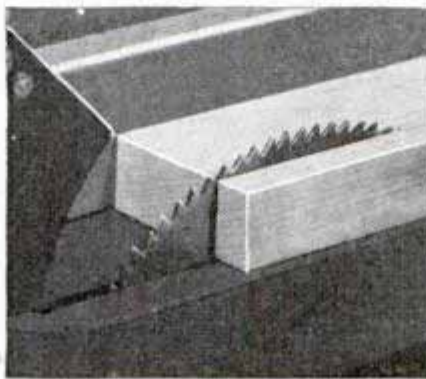

5. What's wrong here?
 (a) Grain of wood (c) Saw height
 (b) Kind of saw (d) Table insert

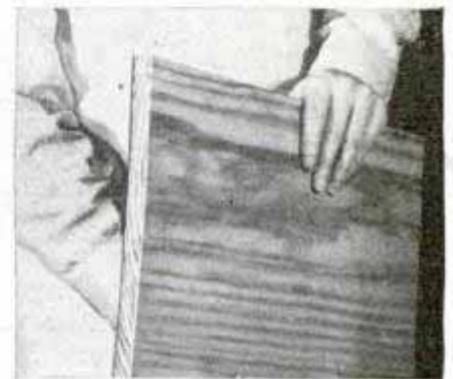

6. Heart side of this board is—
 (a) Top edge (c) Rear side
 (b) Face side (d) Bottom edge



7. Mast of this boat is—
 (a) Walnut burl (c) Snakewood
 (b) Spruce (d) Crotch maple

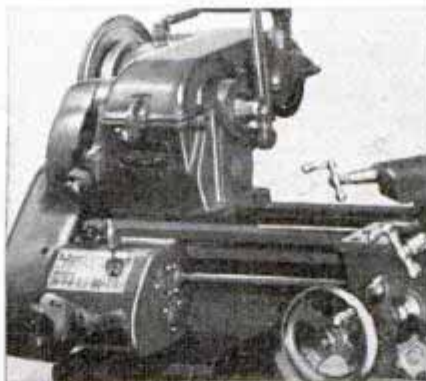

8. This lathe is called—
 (a) Gap bed (c) Quick change
 (b) Turret (d) Automatic



9. Motor of this electric drill is—
 (a) Constant speed (c) AC only
 (b) Universal (d) Split-phase



ANSWERS: 1—b; 2—b (work will strike column at end of cut); 3—c (double action hinge); 4—d (joint is a dovetail); 5—b (crosscut saw used for ripping—a would also be correct); 6—b; 7—b; 8—c; 9—b; 10—a; 11—a

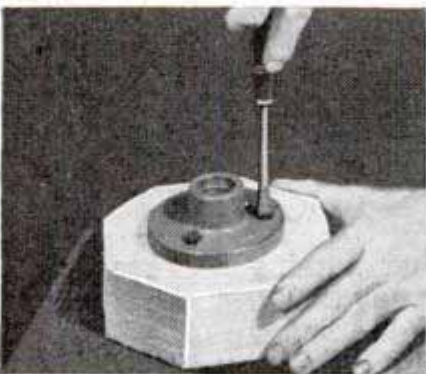

10. Soon he will be—
 (a) Scraping (c) Knurling
 (b) Cutting (d) Tapering

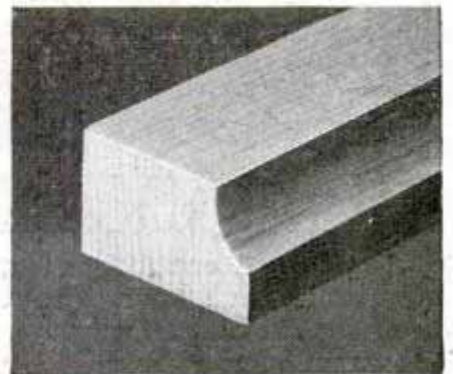

11. This molding is a—
 (a) Cove (c) Dentil
 (b) Bead (d) Flute

Wire Template Transfers Outline Of Intricate Shapes



Made from a few lengths of wood, a strong rubber band and a number of light wire rods, this adjustable template can be used for such jobs as fitting linoleum into awkward corners by transferring the outline of the corner to the linoleum. Or it can be used by artists and draftsmen to make drawings of unusual shapes without taking intricate measurements. The method of assembly is shown in the detail. To insure best operation of the template, the rods must be perfectly straight.

C. L. Meehan, Lakeview, Ont., Can.

Preventing Frayed Rope Ends

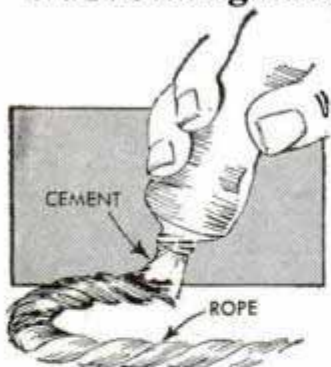

Rope ends may be prevented from unraveling by coating them with a cellulose china cement. Treated in this manner, the ends will withstand wear without chipping the cement.

Conserving Rubber Bathing Caps

To prevent cracking of rubber bathing caps that have been stored over winter, they should be rubbed between the hands in warm soapy water to which a small amount of household ammonia has been added. This treatment will make the rubber soft and pliable and prevent splitting,

which may occur if the cap is forced over the head while dry and brittle.

Mrs. Virginia Arral, New York City.

Fisherman Uses Typewriter Spool As an Emergency Reel

One fisherman used an old typewriter spool as a temporary reel. For a crank he turned a shoulder on a short length of rod and soldered it in a hole drilled in the spool, which was attached to the pole by a bolt, a nut and washer being used as a spacer between the spool and pole.

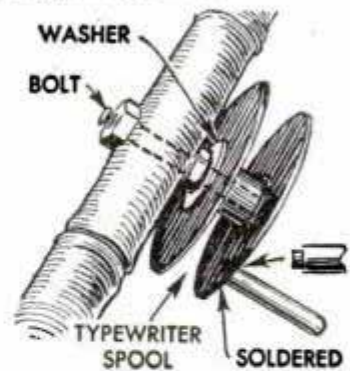

H. Byt Werk, Grand Rapids, Mich.

"Flower Basket" for Lawn Shrubs Is Built With Barrel Staves

Unusual and attractive, this "flower basket" will command attention from passers-by. It is made with barrel staves which are turned outward and held together with bands of pliable wood. The handle is of similar material. The basket, minus a bottom, is filled half full of rich dirt. A rambling rose is ideal for the basket, but other plants can be used to obtain a "bouquet" effect.—R. Lee Sharpe, Carrollton, Ga.





LATHE Pinch hits for CIRCULAR SAW

By EARL D. TELLIN

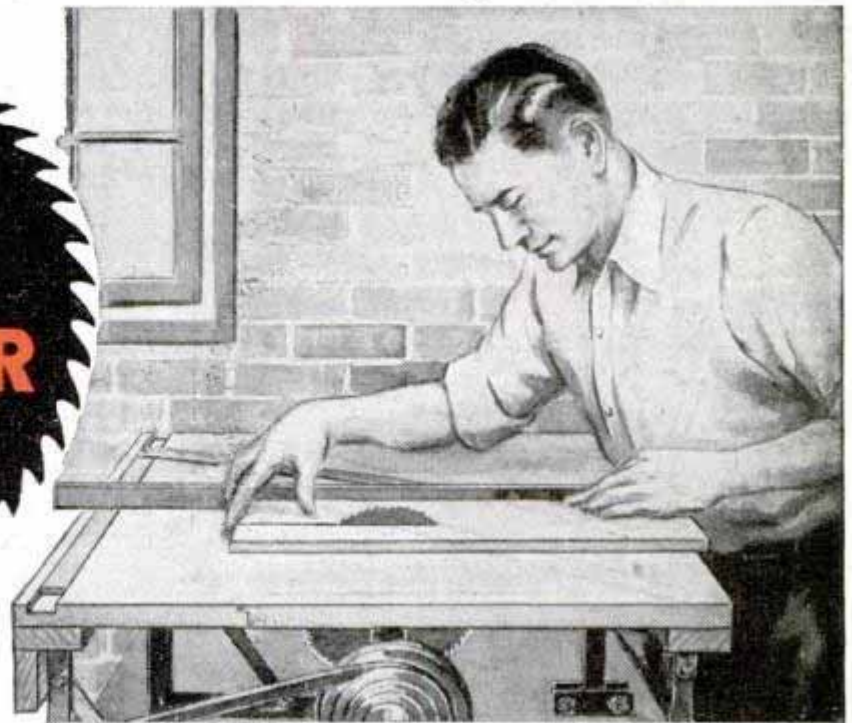

YOUR woodturning lathe is quickly converted to a bench saw when equipped with this setup. All you do is mount an arbor and saw between the lathe centers as in Fig. 1, lower the table over the blade and you're ready to start sawing. When not in use, the table swings back out of the way against the wall as in Fig. 8. Such a setup naturally requires that the lathe be mounted on a stand or bench which can be pulled out into the center of the room to permit ripping long stock.

The original saw was made for a lathe having a 9-in. swing, although with a few changes in dimensions the idea is adaptable to any size lathe. The first step in construction is to make the saw arbor detailed in Fig. 2. This is machined from a length of $1\frac{3}{8}$ -in. cold-rolled steel to accommodate the bore of the saw blade. One end of the arbor is bored and threaded internally to screw onto the threaded lathe spindle, and the other end is fitted with a bronze bushing which is pressed in place to receive the tailstock center. In use, the hole in

Hinged table that lowers over saw blade mounted between centers will convert a lathe into an efficient bench saw

the bushing is filled with grease before the center is engaged. If you wish, a ball-bearing "live" center in the tailstock can be substituted for the bronze bushing. For best results, the lathe speed should be approximately 4000 to 5000 r.p.m. for an 8-in. blade and proportionately faster or slower for a smaller or larger one. The saw blade should be mounted near the tailstock end of the arbor to reduce whipping and vibration to a minimum.

Fig. 3 shows the rear support to which the saw table is hinged. The support consists of two angle-iron brackets, of a size

Fig. 3 shows the rear support to which the saw table is hinged. The support consists of two angle-iron brackets, of a size

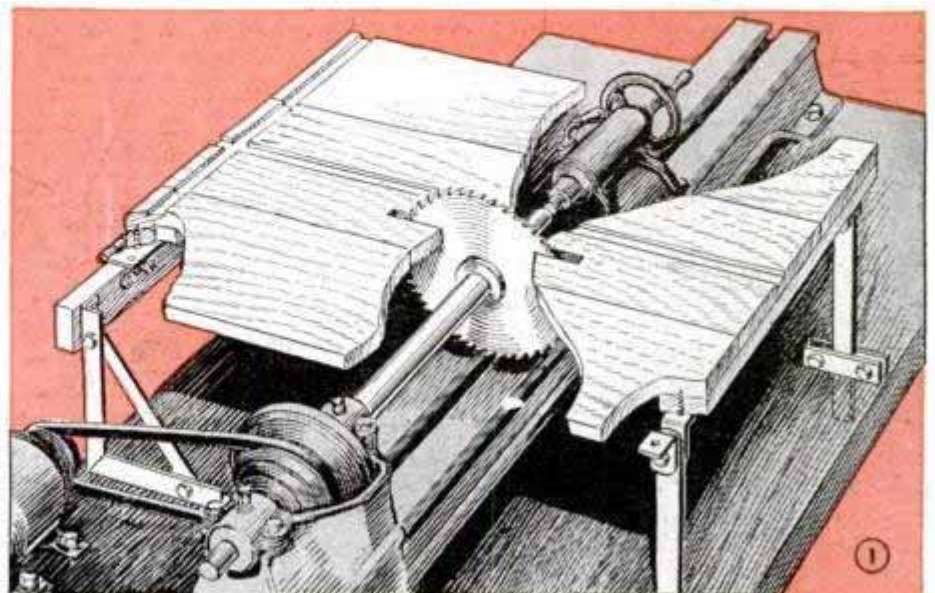

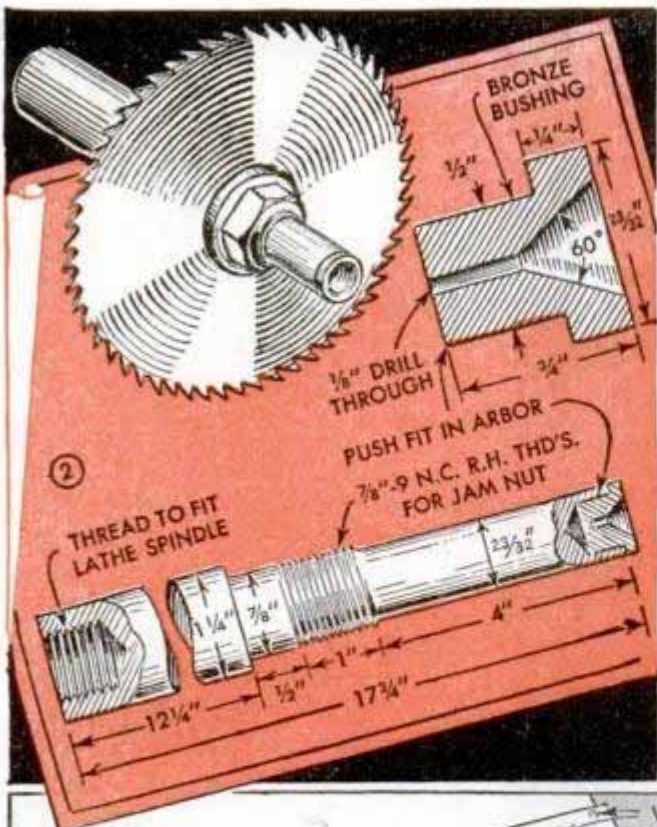

to suit the lathe at hand, bolted to a 1-in. hardwood strip, the brackets being bolted permanently to the bench top. The saw table is built up from three hardwood boards $\frac{3}{4}$ by 10 by 30 in., which are doweled and glued together edgewise as shown in Fig. 5. Several bar clamps are used to draw the pieces together tightly. Cleats 3 in. wide are screwed to the underside of the top at the front and rear edges to keep the surface flat. If you are able to obtain $\frac{3}{4}$ -in. plywood, the table can be from a single piece, 30 in. square, or a stock drawing board or a breadboard of a suitable size can be purchased and used for the table. Still another method, in some respects the best, is to rip 30 1-in.-wide strips from 1-in. hardwood and glue these together with waterproof glue. A top made in this way is exceptionally rigid and will not warp. Where it is desired to use the saw to make shoulder cuts, grooves, etc., the depth of cut is regulated by two flat-iron

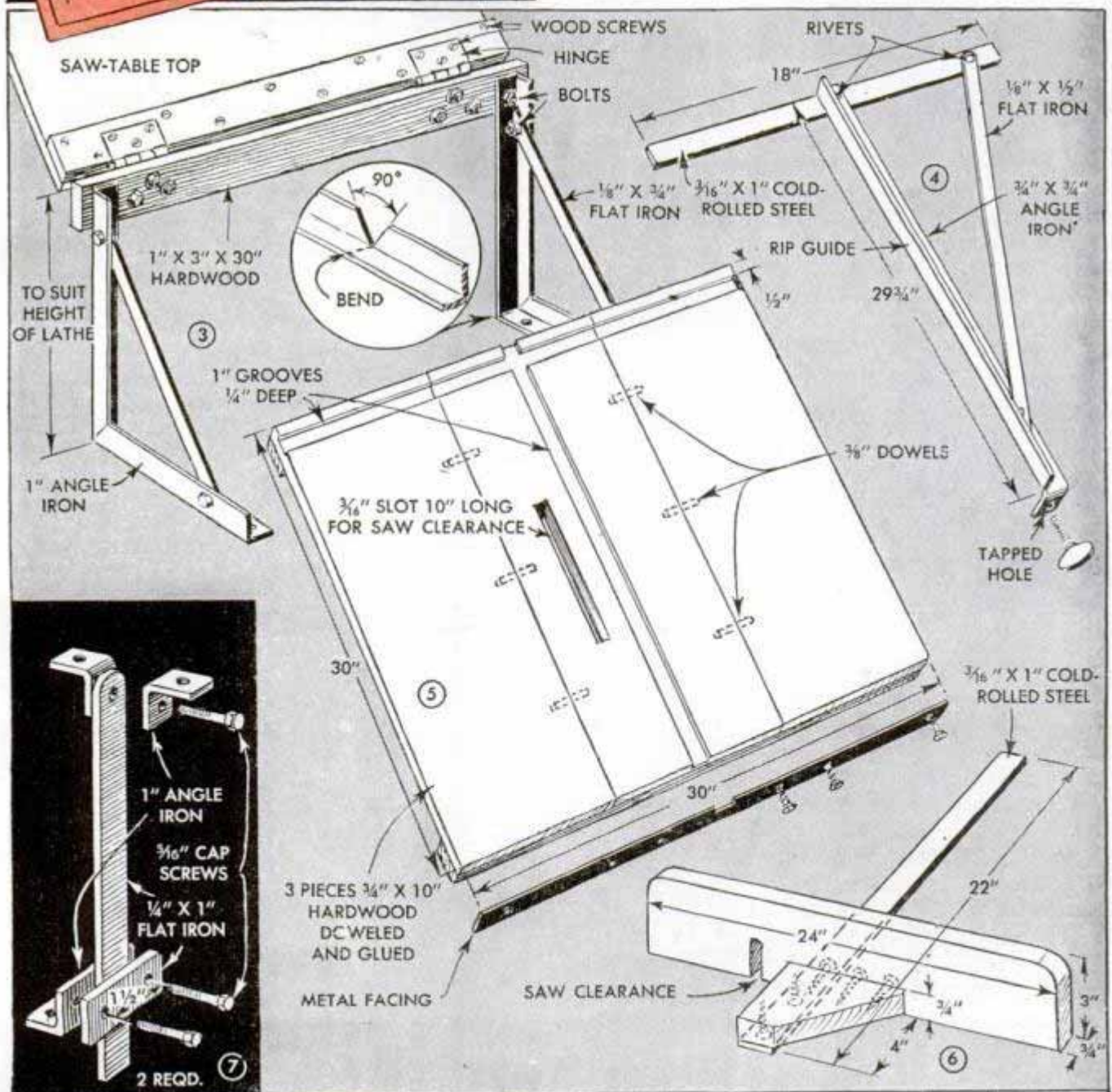

legs as in Fig. 7. These extend through holes in the bench top and are made adjustable by a clamping device which consists of a section of angle iron fastened to the bench top and tapped to receive short cap screws and a plate. Tightening the screws locks the table at any set position and loosening them allows the legs to be withdrawn and moved with the table when not in use. The legs are pivoted to the front edge of the table with brackets of angle iron in the manner shown in Fig. 7.

The rip fence, Fig. 4, operates in a groove across the rear of the table, and is locked in position with a setscrew which bears against a metal facing strip attached to the front edge of the table. A groove for the crosscut guide is run parallel to the saw slot and on the right-hand side of it. If you wish, the slot can be enlarged and provided with an insert so that a dado head can be mounted on the arbor. Both grooves should be cut about $\frac{1}{4}$ in. deep so that the guide bars are slightly below the table surface. The fence on the rip guide is a length of angle iron braced as shown. The crosscut guide is made according to Fig. 6, and it is important that the head be attached to the metal bar at 90 degrees. While its use is restricted to crosscutting only, miter cuts

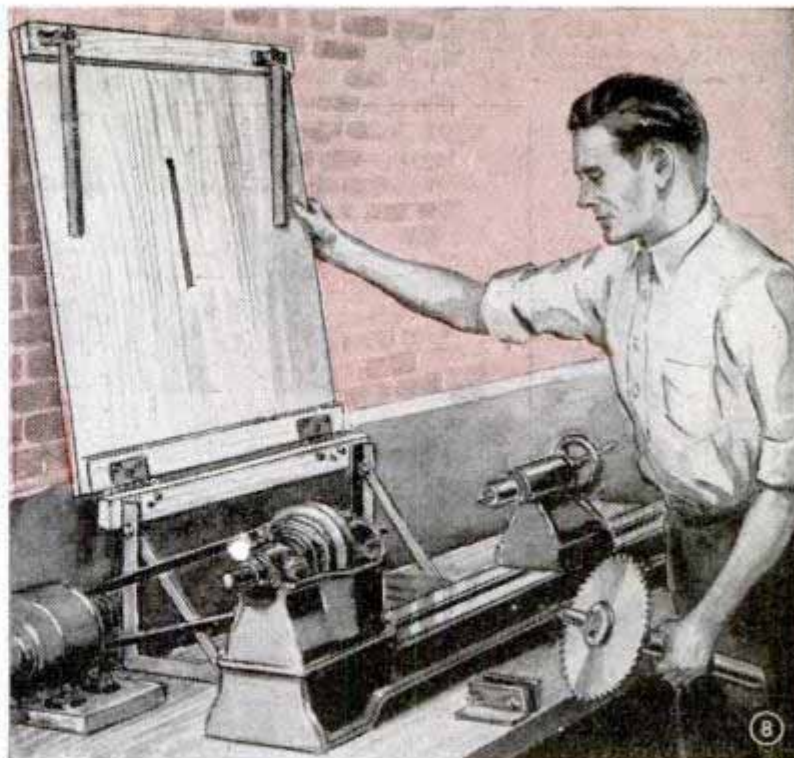

Two tools in one—simply mount the arbor between lathe centers, lower the table and, presto!—you have an excellent circular saw

can be made with it by using a template block of the desired angle between the work and the guide. Or a trunnion of metal or wood, patterned after a commercial guide, can be attached to make the head adjustable for angle cutting. You even may be able to purchase a regular cutoff gauge and cut the groove in the table to fit it. Complete the job by sanding the table and applying a coat of thinned shellac. Then sand lightly and wax.

Guard on Conveyor-Belt Roller Prevents Injury to Hands

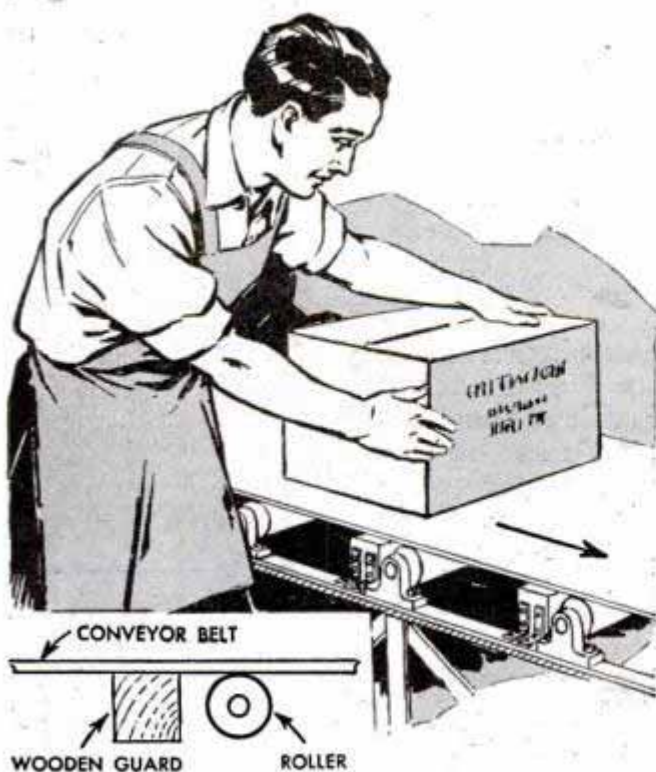

To prevent injury to his workers, one plant manager had wooden guards installed ahead of the rollers on the conveyor-belt system. Previous to this, several workmen had been injured by catching their hands between the roller and the belt. With the addition of this safeguard, such accidents were eliminated.

W. F. Schaphorst, Newark, N. J.

Use for Broken or Short Drills

For the mechanic who has a small high-speed grinder, here is a way to use short and broken drills, sizes 30, 31, 32, $\frac{1}{8}$ in., 41, 42, 43 and $\frac{3}{32}$ in. The 30, 31, 32 and $\frac{1}{8}$ -in. drills will fit the $\frac{1}{8}$ -in. collet while the other four will take a $\frac{3}{32}$ -in. collet. First grind the drills off square and then grind to give the cutting edge clearance. These altered drills will do well as cutting tools. The high-speed type drills will, of course, give the best service.

O. A. Nitz, Helena, Mont.

Battery Cable Is Repaired Easily With Copper Wire and Solder



If battery cables become frayed or broken, they can be repaired by winding the ends together and wrapping the exposed area with bare copper wire of a medium gauge. Following this, flow solder onto the joint and then wrap with friction tape.

Jack Bronte, Grass Valley, Calif.

Paper-Clip Hooks Can Be Moved As Convenience to Draftsman

The draftsman who likes to work with his board set at a steep angle will find that these paper-clip hooks hold his instruments and triangles so they will not slide off onto the floor. The hook is formed by bending the clip and the short end is in-

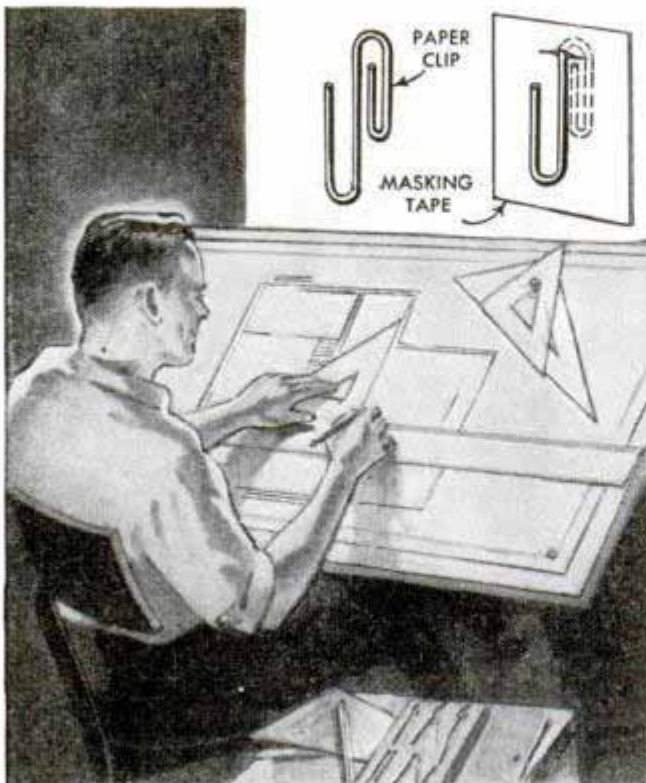

serted in a small square of masking tape. The tape holds the hook on the board, and since there would be no damage to the paper, when convenient the hooks may be placed on the drawing.

Louis Gilbert, Philadelphia, Pa.

Pencil Leads Used in Compass

When I experienced difficulty in obtaining leads of suitable hardness for my compass, I found pencil leads made an excellent substitute. Leads having a hardness of HB and H are good for outline drawing and 2H does well for construction lines. Pencils that are too short for drawing can be used to obtain the leads.

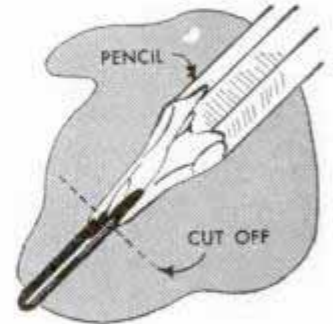

Peter Shour, Montreal, Que., Can.

Carboloy Tip on Steel Scriber Prolongs Life of Instrument

A dull scriber on the layout bench could be the cause of a costly error. When your scriber slides over the surface without cutting a clean, true line, make a new one by using a length of $\frac{3}{16}$ -in. rod. Saw a slot on one end wide enough to hold a small piece of carboloy; pinch the rod to prevent the carboloy from dropping out, and then braze and grind the tip to a point. Dividers may be tipped in the same way by grinding the points down so the slot can be cut.—H. Peterson, North Troy, N. Y.

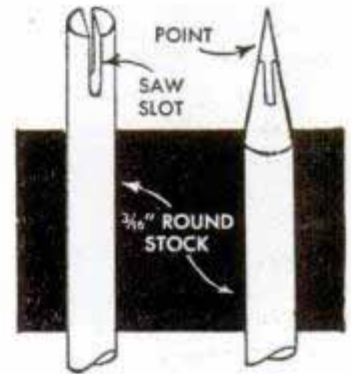

Bristles Taped for Stencil Brush

An ordinary paint brush can be used as a stencil brush if the bristles are bound with paper adhesive tape. This leaves only a short length of the bristles exposed and gives the necessary rigidity for stenciling. Since most brushes have a tapered point, the bristles should be trimmed evenly. The paper is removed by soaking the brush in water.

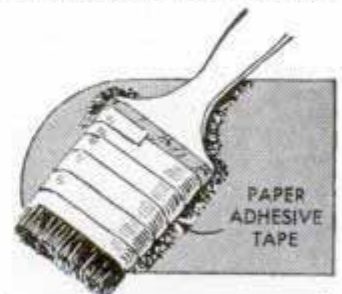

Frank Shore, New York City.

Ball-Bearing Turntable for Assembly and Repair

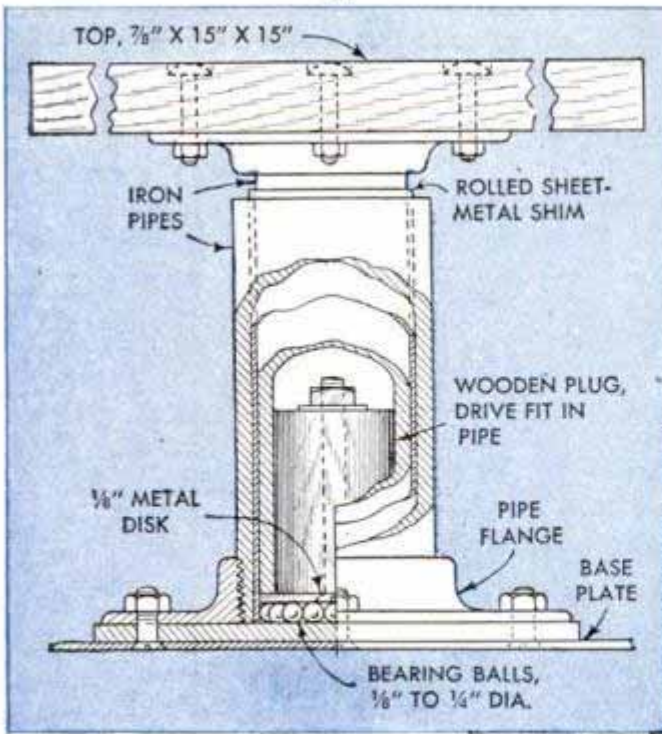

The turntable top, or platform, can be turned easily in either direction because it's mounted on ball bearings



When repairing motors, typewriters, household equipment or other intricate mechanisms where it is necessary to get at all sides of the assembly, a bench turntable saves a lot of labor and time. With the type detailed above the motor or other unit to be disassembled is simply placed on the hardwood top and, if necessary, bolted or clamped in place so that it cannot shift.

Once in position all parts of the work can be reached by rotating the top in either direction. The turntable stand is made from pipe and fittings. All the weight is carried on an improvised ball bearing as will be seen from the cutaway view above. The column can be any length for either floor or bench mounting and the diameter of the column can be large or small.

Pipe Vent Simplifies Removal of Posts From Soggy Ground

Pulling posts from soggy ground often is difficult because of the suction created by the vacuum at the bottom of the post. However, if a length of pipe is plugged and drilled as shown and driven into the ground beside the post, removal will be easier because air admitted through the pipe will tend to break the vacuum.

The tip of a soldering iron can be reshaped or cleaned on a coarse-grit disk or belt sander. This is faster than hand filing, and no time is wasted cleaning a file which has been used on copper.

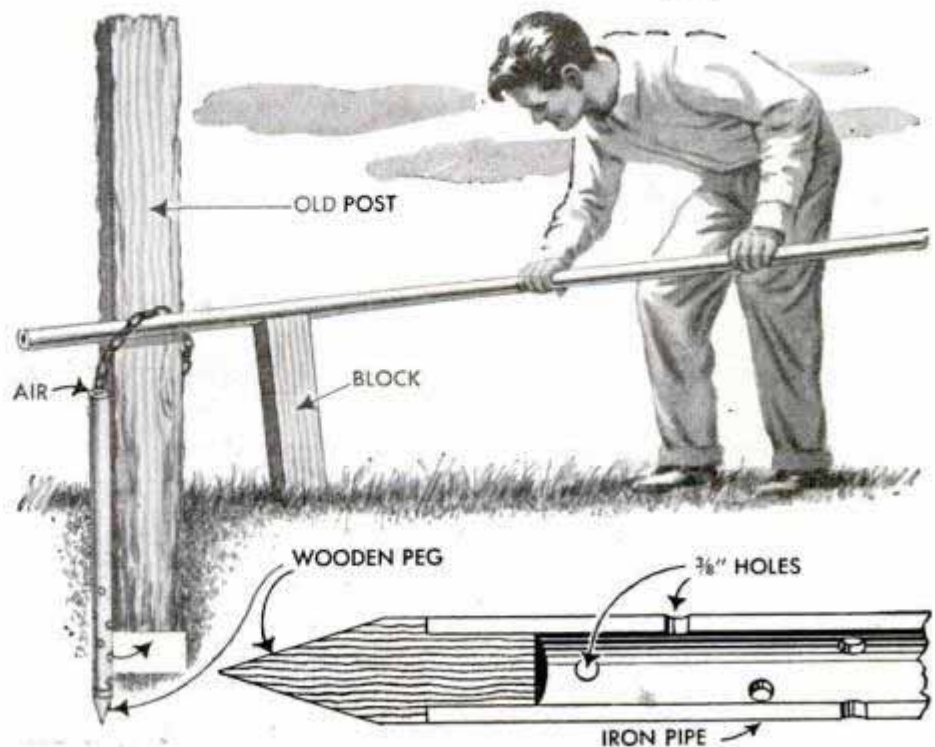

Reversed Doubletree Lifts Weight From Horses' Necks

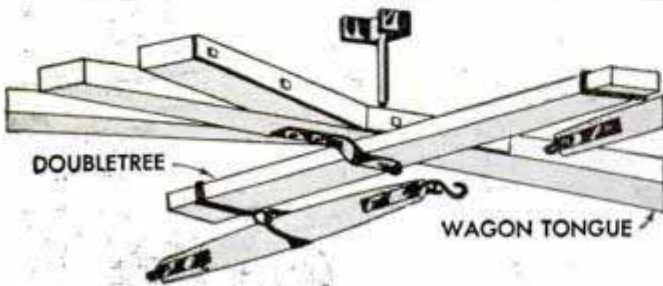
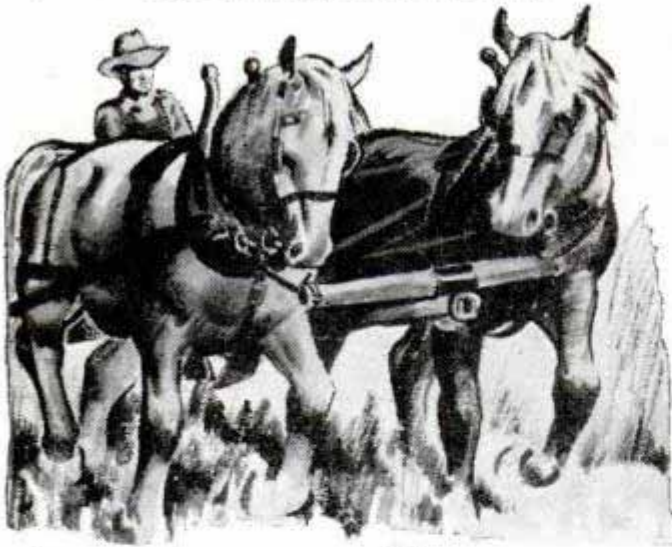

To prevent the weight of a heavy field wagon or implement tongue from resting on the horses' necks, a frequent cause of sores and chafing, one farmer places the doubletree under the tongue instead of on top of it. In this position, the pull of the team on the traces produces a slight lift of the tongue, sufficient to remove weight from the animals' necks.

Flat-Iron Clip Secures Ladder On Painter's Truck

One painter keeps his light ladder from bouncing around or being lost from his truck by bending a strip of flat iron into a

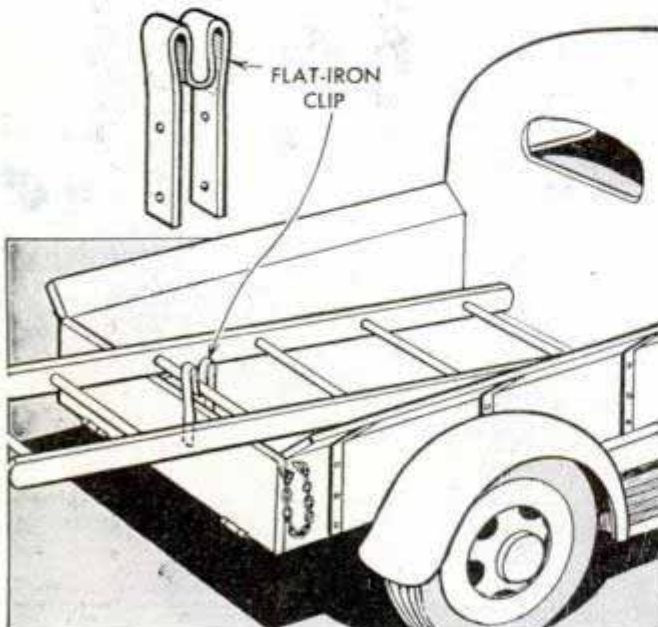

clip and bolting this onto the tail gate. When the ladder is in place, one round is forced into the clip and held safely. After the ladder has been removed, the tail gate is swung down and the clip is out of the way.

Wedge Corrects Loss of Tension In Drafting Instruments

Over a period of time bow spring compasses and dividers will lose their tension and will not open to the full width. To put new life in such an instrument, insert a wedge cut from a rubber eraser in the fork. This will keep the compass or divider in excellent working order.—G. L. Schrum, Akron, Ohio.

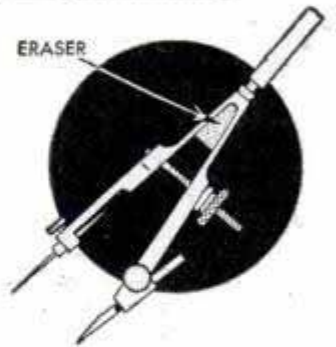

Easy Way to Cut Thrust Washers For Electric Motors

Washers for electric motors or similar equipment are cut quickly by using a sleeve bearing that is a few thousandths larger than the shaft over which the washer is to fit. The fiber material for the washer is placed on the shaft and the bearing is driven down over it to punch out the center. The outside diameter is cut with a pair of tin snips.

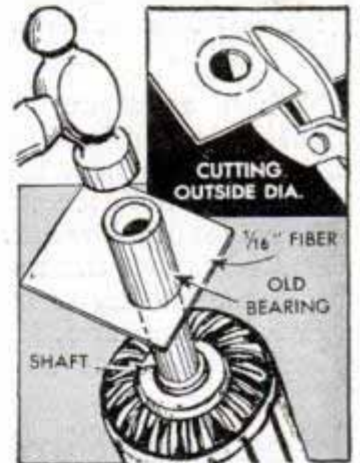

Neal Winchester, Kansas City, Mo.

Blueprint Record Identifies Keys

Identification of keys is easy when their outline is drawn on tracing paper and prints of the drawing are distributed to the operating personnel. Anyone new to the plant, such as a watchman or guard, will be able to identify the keys by studying the print. If end sections of the keys were drawn on the tracing also, locksmiths would be able to replace any lost keys by referring to the print on file.



TABLE A—APPROXIMATE ELECTRICAL CHARACTERISTICS

	Large 6.6 K.V.A.	Medium 3.3 K.V.A.	Small 2.3 K.V.A.
For 220 Volt Operation			
Power From Line	8250 Watts	4125 Watts	3290 Watts
Line Current (Max.)	37.5 Amp.	18.8 Amp.	15 Amp.
Line Fuses	60 Amp.	30 Amp.	30 Amp.
Welding Voltage	2.8 to 2.0 V.	2.8 to 2.0 V.	2.8 to 2.0 V.
Welding Current (Max.)	Over 2000 Amp.	Over 1000 Amp.	Over 750 Amp.
Power Factor	80%	80%	70%
For 110 Volt Operation			
Power From Line		4125 Watts	3290 Watts
Line Current (Max.)		37.6 Amps.	30 Amp.
Line Fuses		60 Amps.	30 Amp.
Welding Voltage	Do Not Operate on 110 Volts	2.8 to 1.6 V.	2.8 to 1.6 V.
Welding Current (Max.)		Over 1000 Amp.	Over 750 Amp.
Power Factor		80%	70%

**SPOT
WELDERS**
*for light or
heavy-duty
work*

By C. A. Crowley

BUILDING a spot welder of the type shown in Fig. 1 is not difficult and is a good way to acquire one inexpensively. The three sizes described in this article are efficient, will operate on either 110 or 220 volts a.c., and can be made for 25, 50 or 60-cycle current. One for 60 cycles will operate satisfactorily on 50 cycles. Information relative to line current, fusing and other electrical characteristics of the welders is given in table A.

The first step is to decide the size of welder you need. The 6.6 k.v.a. size, which means 6.6 kilovolt amperes, is the largest, and is capable of delivering a welding current in excess of 2000 amperes. This size will handle sheet steel and equivalent parts up to $\frac{3}{16}$ in. thick. The medium size is useful where the thickest stock to be welded is not over $\frac{1}{8}$ in., and the small welder is for the thin gauges of sheet metal. All three machines are built alike except that some of the dimensions differ with the size of unit being built. Where a dimension is indicated by a letter, the exact size will be found under a corresponding letter opposite the welder size in the various tables.

Start construction with the transformer. The core iron or plates are cut to the sizes indicated in the center detail and table B of Fig. 2. The lower detail and table C of Fig. 2 give complete assembly information for the transformer core. When assembled, the center leg of the core is taped tightly together, after which the other laminations are removed, thus leaving the center leg free for winding the coils.

First the leg is gripped tightly in a vise and rebound with a second layer of friction tape. The circular detail of Fig. 2 shows the appearance of the

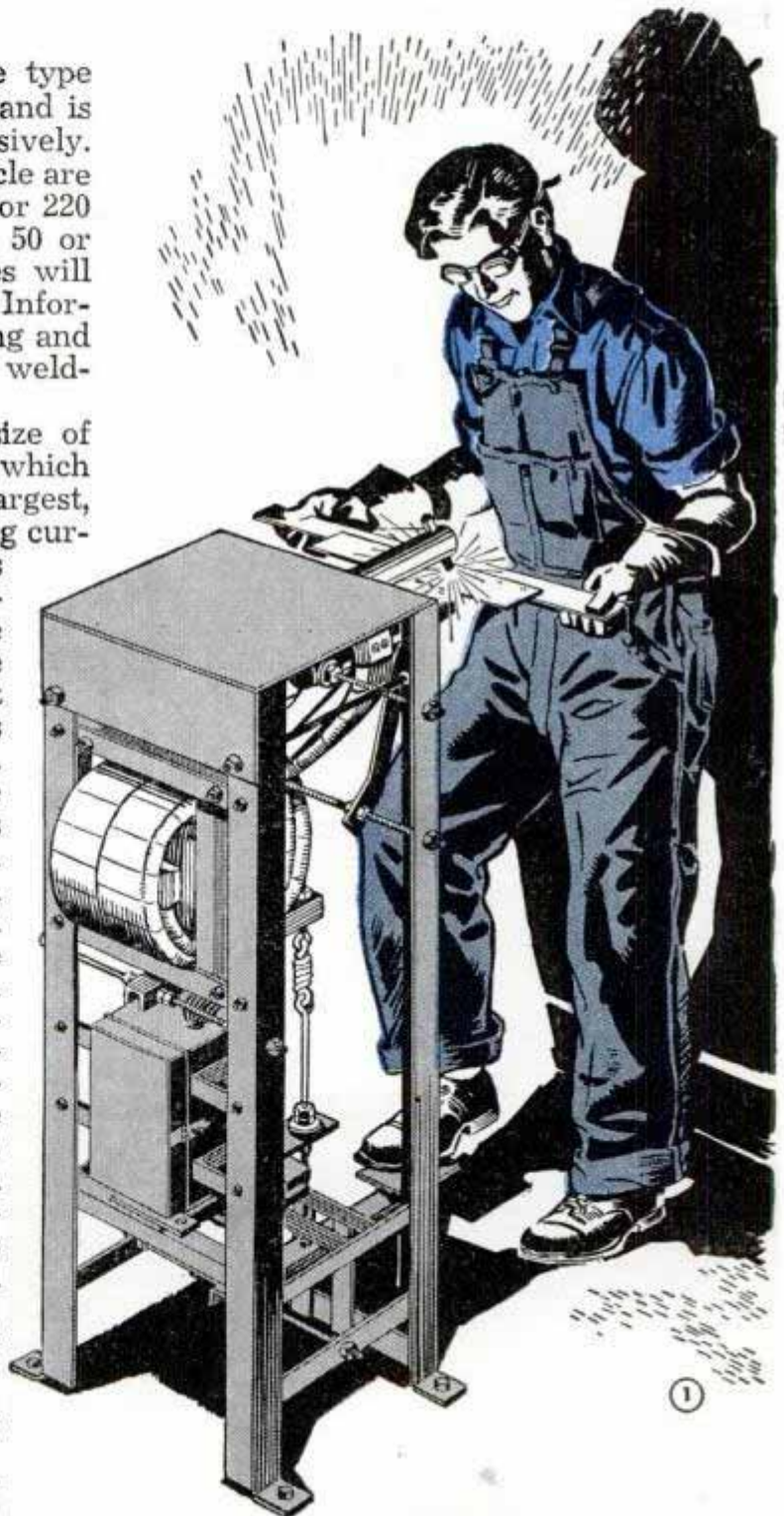

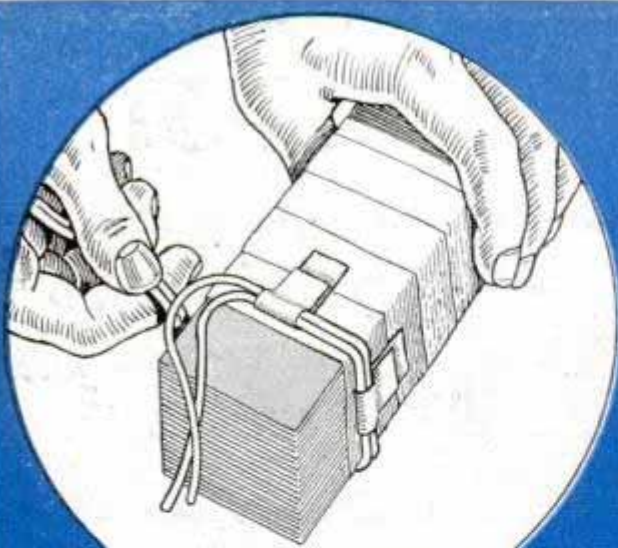

TWO WIRES ARE WOUND TOGETHER

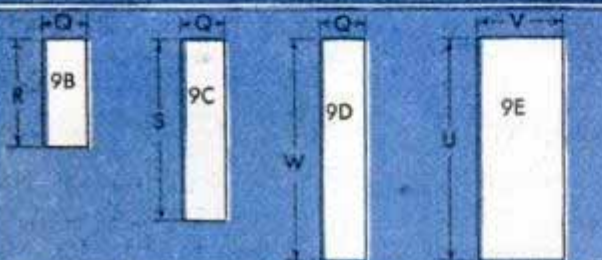

TRANSFORMER PLATES (No. 26-GAUGE SILICON STEEL)
TABLE B

Welder Size	Q	R	S	U	V	W
6.6 K.V.A.	1½"	4½"	6¾"	6¾"	3"	8¼"
3.3 K.V.A.	1¾"	3½"	5¾"	5¾"	2¾"	7¼"
2.3 K.V.A.	1¼"	3"	4¾"	4¾"	2½"	6"

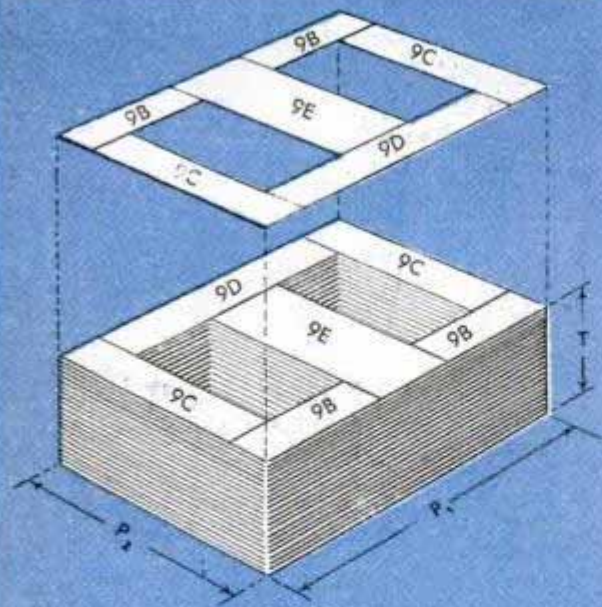

TABLE C

Welder Size	Cycles	Core Thickness (T)	Pile Thickness				P ₁	P ₂
			9B	9C	9D	9E		
6.6 K.V.A.	25	5"	10"	10"	5"	5"	11¼"	8¼"
	60	3¼"	6½"	6½"	3¼"	3¼"	11¼"	8¼"
3.3 K.V.A.	25	4"	8"	8"	4"	4"	10"	6¾"
	60	2¾"	5¼"	5¼"	2¾"	2¾"	10"	6¾"
2.3 K.V.A.	25	4"	8"	8"	4"	4"	8½"	6"
	60	2½"	5"	5"	2½"	2½"	8½"	6"

leg at the start of winding the wire onto it. Details for wire size and number of turns are given in table D. To start winding, procure two spools of wire of the proper size to wind the line coils. Mark the two start ends of wires 1 and 3 and then proceed to wind the indicated number of turns, two wires at a time, placed neatly side by side. In order to prevent the turns from slipping out of place when a second layer is wound on, use the taping method shown by three steps in one of the details of Fig. 2. After the required number of turns have been wound, the ends of the two wires should be left as long as indicated by the leads in table D and unmarked. How to identify these two ends for numbering when you are ready to make final connections is explained in Fig. 14.

Next, the coil which is identified as the tap coil in table D is wound. The start of this coil is labeled No. 4. It should be wound in the same direction as the line coils. After winding sufficient turns, the tap connection is made as shown in detail A of Fig. 3 and labeled No. 5. It is important that this connection, as well as all others, be soldered carefully and taped thoroughly. After the tap has been made, the winding is continued until the required total number of turns have been wound into place. The finish end of the tap coil is labeled No. 6. The coils must be wound evenly and tightly in order to fit inside the assembled core. After completing these coils, they are covered with two layers of fiber board, which should be taped down tightly to hold them in place.

TABLE D—COIL-WINDING DATA			
LINE COILS			
6.6 K.V.A.	3.3 K.V.A.	2.3 K.V.A.	
2 Coils 115 Turns Each	2 Coils 115 Turns Each	2 Coils 115 Turns Each	
No. 10 D.C.C. Magnet Wire	No. 10 D.C.C. Magnet Wire	No. 12 D.C.C. Magnet Wire	
Leads 36" Long	Leads 36" Long	Leads 36" Long	
TAP COILS			
1 Coil 90 Turns No. 6 D.C.C. Magnet Wire Tapped At 38 Turns Leads 36" Long	1 Coil 90 Turns No. 6 D.C.C. Magnet Wire Tapped At 38 Turns Leads 36" Long	1 Coil 90 Turns No. 8 D.C.C. Magnet Wire Tapped At 38 Turns Leads 36" Long	
WELDING COILS			
3 Full Turns 9 Strips 12 Ga. Copper 2¼" X 70"	3 Full Turns 9 Strips 14 Ga. Copper 1½" X 70"	3 Full Turns 7 Strips 14 Ga. Copper 1½" X 70"	

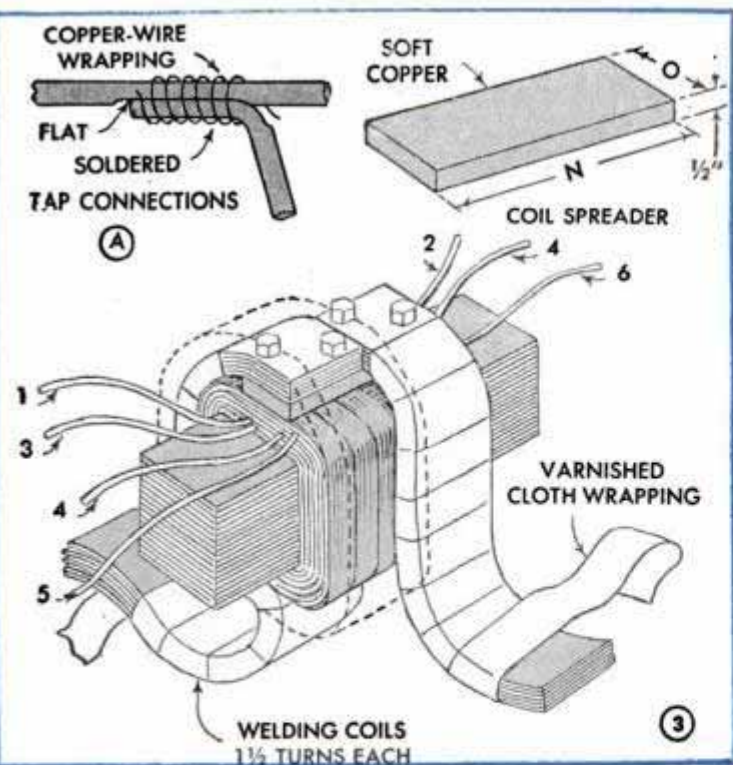

The welding coil is next and is wound from strips of sheet copper, the dimensions and number of strips being given in table D. Fig. 3 shows how the two sets of copper strips are spliced to the soft-copper coil-spreading bar. The strips must be tinned and sweat-soldered together and then screwed and soldered to the copper bar as in Fig. 4. A poor connection here will prevent the welder from working. Each half of the welding-coil unit is wound exactly 1 1/2 turns, making a total of three turns for both. As the winding progresses, varnished cloth in tape form should be wound around

the two groups of copper strips and the spreader bar to assure complete insulation. It is best to wrap the varnished tape around the strips as the winding progresses since bending of the composite bundle of strips will cause slippage and deformation of the bundle. After completing the welding coil, it is tied securely in place with strong cord and the entire assembly coated thoroughly with shellac or impregnating varnish. When dry, laminations previously removed should be woven back into place so that the core is reassembled as shown in Fig. 6. Two sets of core clamps are required.

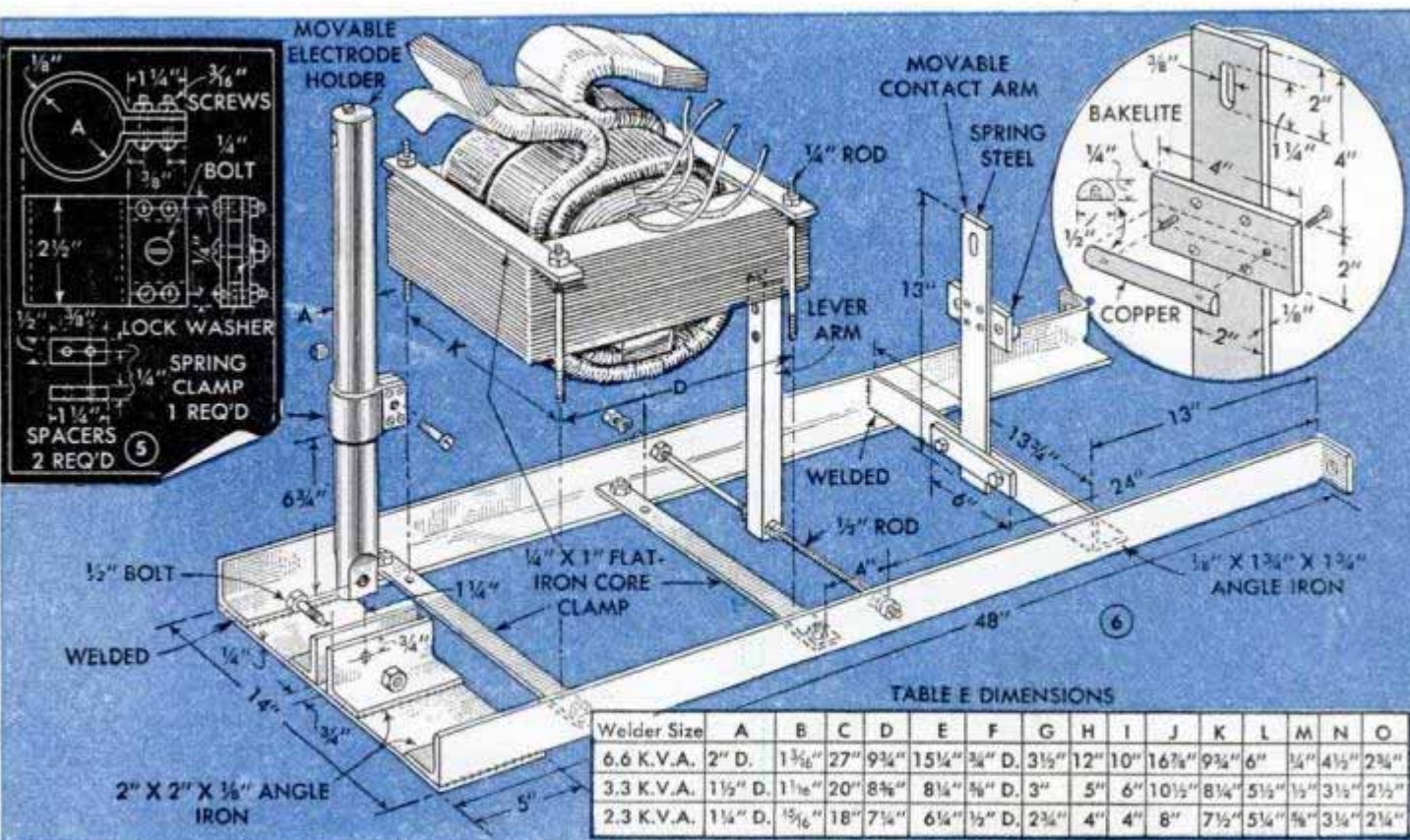

These are assembled on the core as in Fig. 6 and the unit later mounted on the two back angle irons of the frame. Studs with lock washers and nuts should be used to fasten the transformer in position.

The movable electrode holder is detailed in Fig. 7. One of the welding leads from the transformer is carefully formed around this holder, and both sides of each strip in the lead are tinned for a distance of 3 in. of its length. The electrode holder also is tinned where the copper strips will contact it. Then two holes are drilled through the strips and corresponding holes are drilled and tapped in the holder for brass machine screws. After attaching the lead, soften the solder with a blowtorch and, while the solder is still soft, tighten the screws and apply clamps to assure perfect contact between all the strips and between the strips and the electrode holder. It is important that this joint be made carefully, otherwise it will heat.

After completing the coil, make the frame members. These are mostly angle iron as indicated in Figs. 6 and 13, although some

of the braces are rods, channel iron and steel plate. A study of Figs. 6 and 13 will determine the location of each brace and cross member. After the angle irons have been cut and drilled, a 1/4-in. steel plate, 5 in. by 14 in., and an angle-iron support for the movable electrode holder are welded in position on the back of the two rear angle-iron legs of the frame. For this job, as well as the other welded joints indicated, ordinary gas welding will be found satisfactory. If an electric arc welder is available, it may be used with equal satisfaction. On the other hand, bolts may be substituted for welding if more convenient. The 1/8 and 1/4-in. flat-iron strips, which support the lower switch contact plate, are then welded in place 11 in. from the floor end of the rear legs as shown in Fig. 13. Two 1/2 by 15-in. threaded tie rods are next installed 4 in. from the top end of the legs. The front legs are then placed in the assembly, nuts tightened on the rods, and welds made at the other joints to complete the frame assembly. Before welding the parts together, the dimensions should

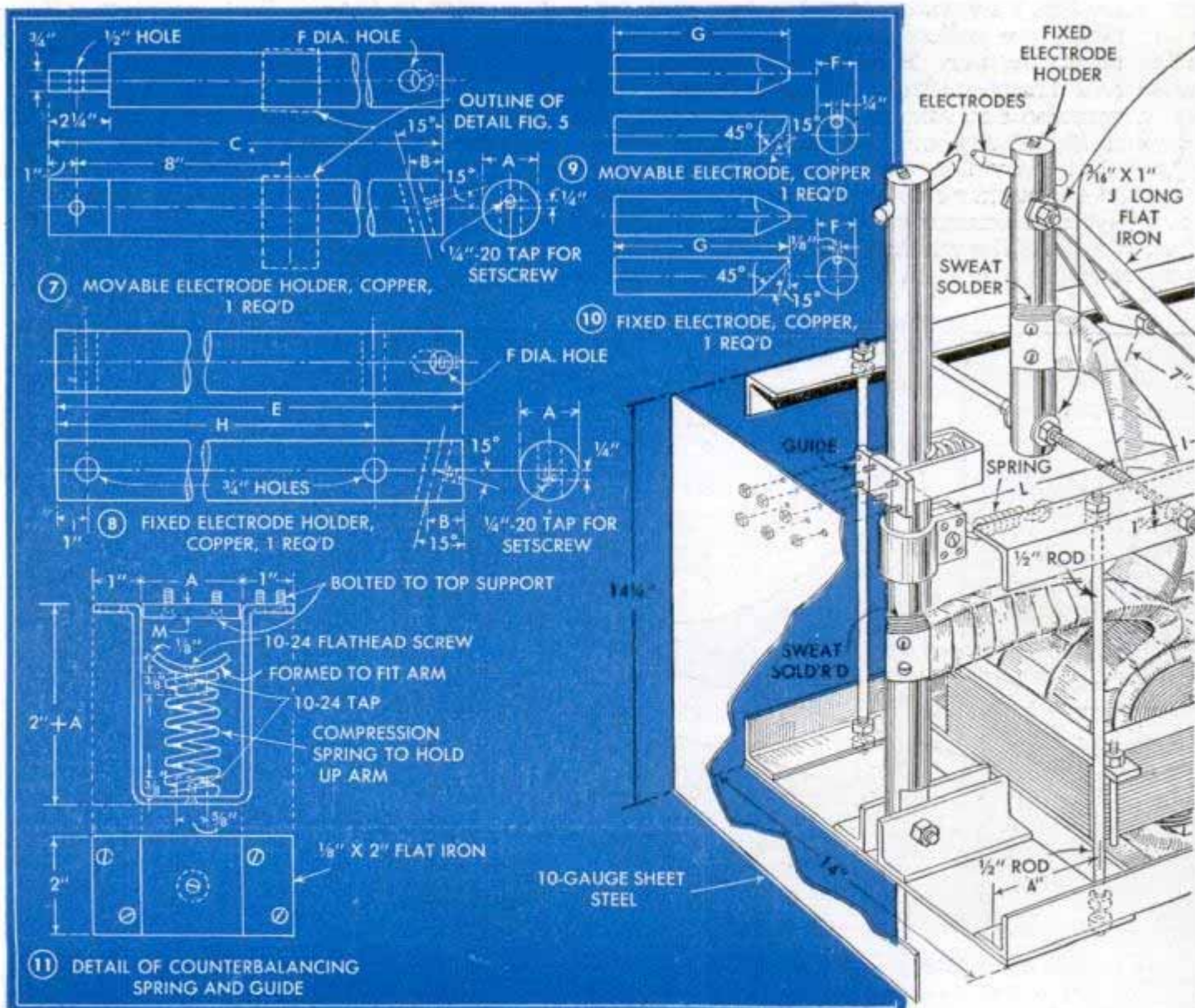

be checked carefully to make certain that the entire unit is exactly 14 in. on each side.

After completing the frame, weld on the $\frac{3}{16}$ by 2-in. flat-iron strips which support the treadle. These are shown located $6\frac{1}{2}$ in. from the floor end of the frame. The fixed electrode holder, Fig. 8, is installed as indicated in Fig. 13. Note that this holder is completely insulated from the frame with fiber tubing and washers as indicated in the enlarged circular detail of Fig. 13. The remaining end of the welding coil is sweat-soldered to the fixed electrode holder by the same method as previously explained for the movable holder. When both of the welding leads have been sweat-soldered into place they should be wrapped their entire length with friction tape, or, better still, with varnished cloth.

Next the lever arm shown in Figs. 6 and 13 and the treadle are installed. The movable contact arm shown in the circular detail of Fig. 6 is mounted on the rear angle iron directly above the switch contact plate detailed in Fig. 12. The $\frac{1}{4}$ and $\frac{1}{2}$ -in. pull rods and springs are now installed along with the spring clamp detailed in Fig. 5.

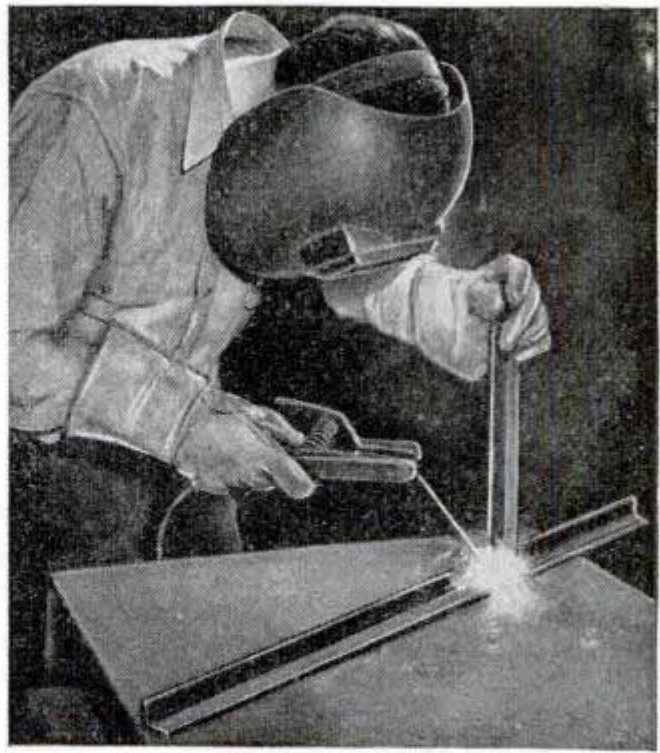

Although the welder frame can be assembled with bolts it is better to weld all the parts together and thus produce a rigid unit that will never loosen

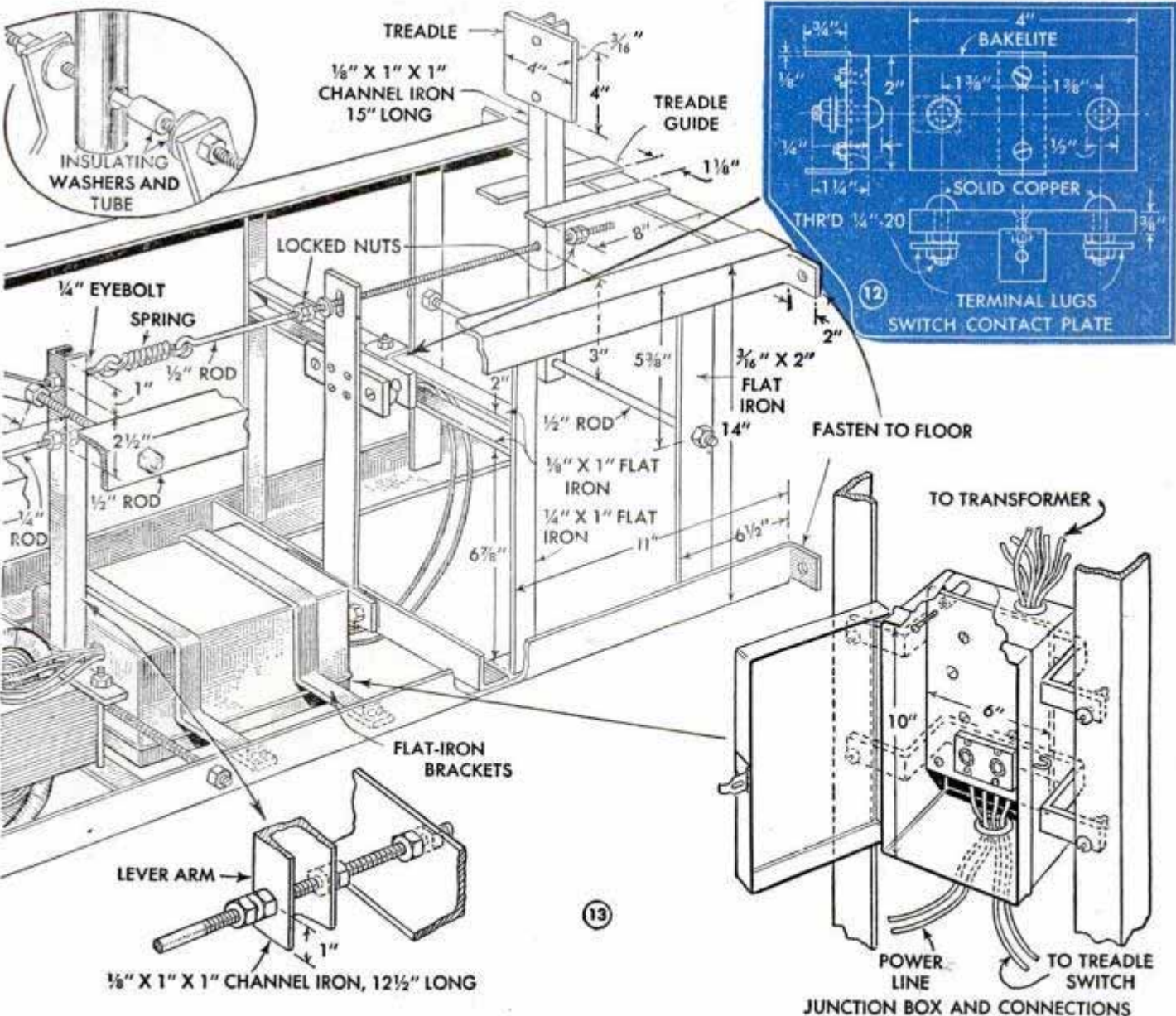

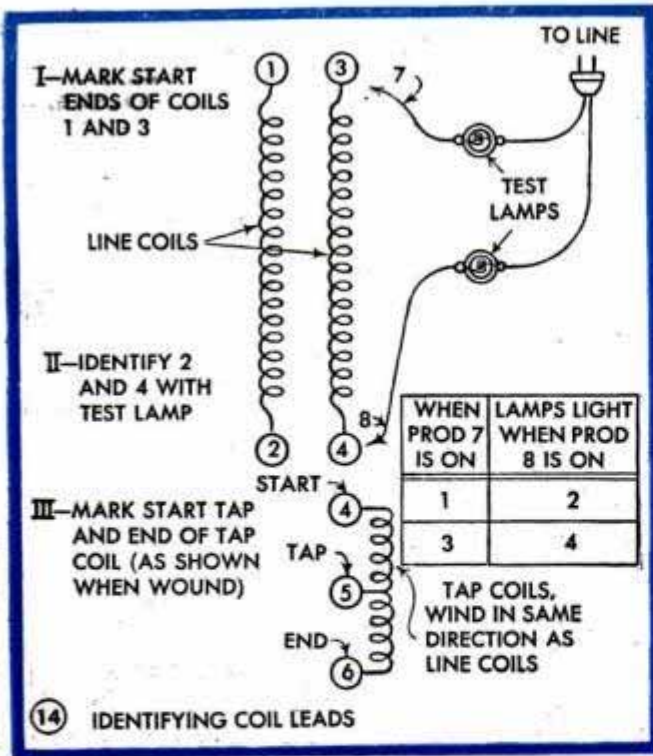

The electrode arm guide and counterbalance detailed in Fig. 11 is bolted to the top plate which is welded to the frame. This is shown pulled apart in Fig. 13. The electrodes as detailed in Figs. 9 and 10 are then installed in their respective holders. The pull rods should be adjusted so that the foot end of the treadle is approximately 3 in. higher than the supported end of this member with the electrodes apart. It is important that the spring in Fig. 11 be strong enough for this purpose so that there is no possible chance of the electrodes coming together when there is no work between them. On the other hand, the spring should not be excessively strong as this would make the switch control unnecessarily hard to operate.

To adjust the treadle switch so that it closes properly, the treadle is depressed

slowly until the electrodes just close on a $\frac{3}{16}$ -in. spacer held between them. Then the treadle is depressed $\frac{1}{2}$ to $\frac{3}{4}$ in. farther and the lock nuts, just above the flat-spring switch member, are turned down against it until the copper bar or upper half of the switch, which is screwed to the underside of the spring member near the outer end, just makes a contact with two round-head copper bolts. These serve as the lower part of the switch and the two power-line wires from the junction box are connected to them. In making this adjustment, it is important that the electrodes close tightly on the work before the switch closes. This means that when the treadle is released the current will be turned off before the electrode pressure is released from the work. This is necessary to prevent arcing.

The wires from the transformer and the two from the switch are next run through porcelain bushings into the junction box as in Fig. 13. The two wires without labels should be tested as explained in Fig. 14 and labeled. Connections are made to the terminal board as indicated in Fig. 15. Jumper wires are placed on the front terminal connections to adapt the unit to 110 or 220-volt operation as required. The fuse block in the junction box is used for controlling the voltage at the welding electrodes. For the small units, one 30-amp. fuse is placed in either the fuse opening marked H for high current or in the opening marked L for low current. Under no condition should a fuse be placed in both of these receptacles. For the larger welding units, an ordinary 30-amp. fuse should be opened up and a heavy copper wire inserted in place of the fuse wire normally present. The line fuses give adequate protection, the only purpose of this block being to serve as a switch in changing from high to low current for welding purposes.

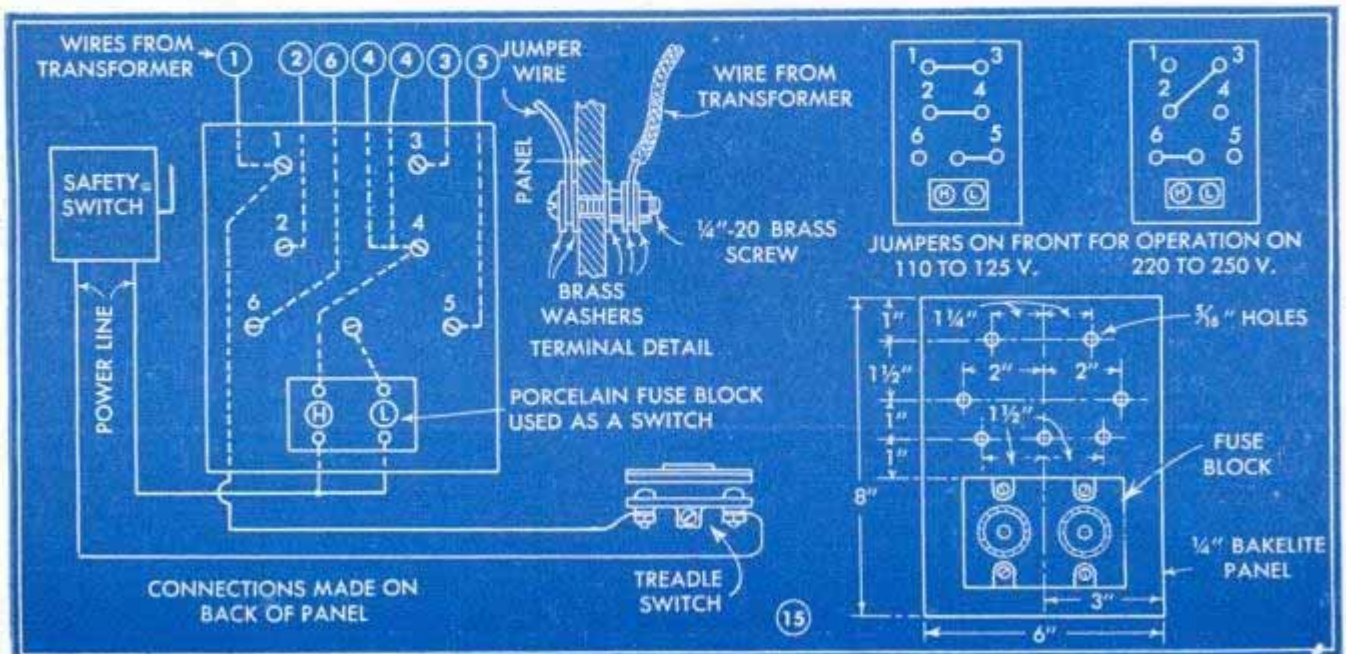

Knurled Handle Holds Tool Bits When Grinding

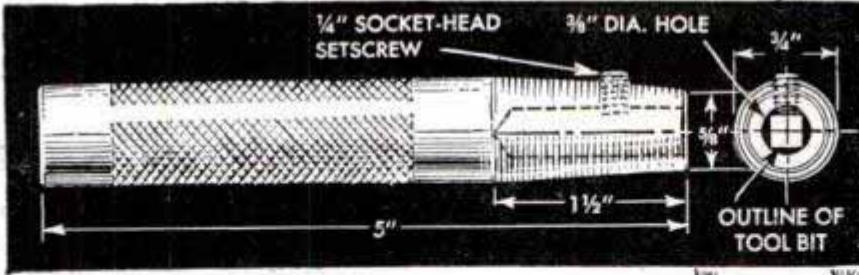

It's not necessary to discard lathe tool bits that are too short to hold in the fingers for grinding if you use this turned and knurled handle. It is made from a 5-in. length of $\frac{3}{4}$ -in. steel rod. A $\frac{3}{8}$ -in. hole is drilled in lengthwise from one end for a distance of $1\frac{1}{2}$ in. Then a second hole is drilled and tapped into the first for a $\frac{1}{4}$ -in. socket-head setscrew. The exact degree of taper on the handle is of no importance as this merely makes it easier to hold the handle. A deep, sharp knurl on the straight portion of the handle provides a secure grip. To use, simply insert the square tool bit in the hole and tighten the setscrew on one of the flat sides of the tool.—Fremont Wood, Ashtabula, Ohio

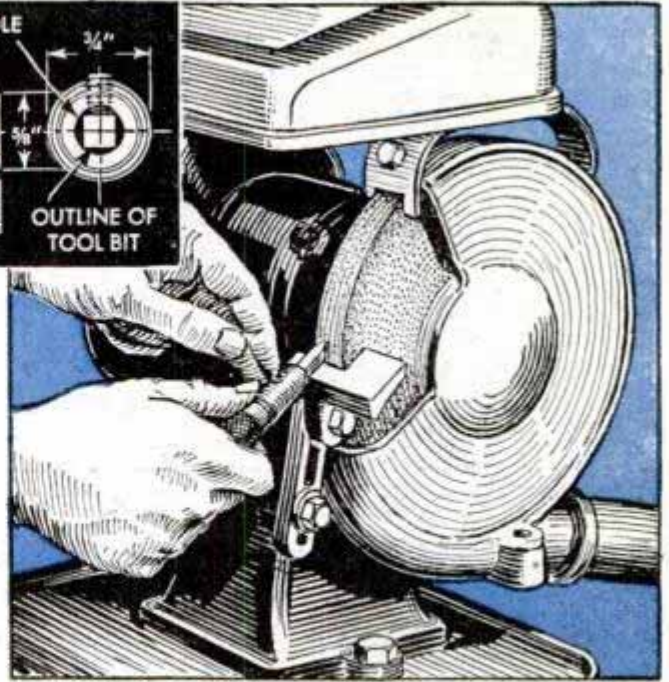

Sturdy Sawhorse Is Small Enough to Be Hauled in Your Car

Small and light enough in weight to be carried in a passenger car, this sturdy sawhorse has many uses. The lower shelf provides a handy tray to keep tools and small parts conveniently at hand, and the sawhorse is low and strong enough to be used as a support to stand on when working in places above your head. When used for this purpose, the shelf serves as a step to

reach the top member. The dimension for the width of this member can be varied, and for that reason is indicated by a blank arrow. If it is made about 6 in. wide it will provide a place to lay saws and similar tools as well as a flat working surface.

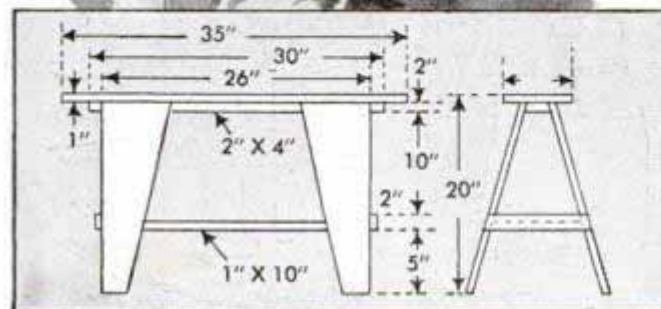

Simple Check for Ignition Lock

If your car is equipped with a lock that turns on the gasoline, temperature and other gauges as well as the ignition, the condition of the lock can be checked by noting whether or not the key has to be forced to its extreme position to turn on the gauges. If this is necessary, the switch is failing and should be replaced. The job is a minor one, and you may have the old ignition lock installed in the new switch, thus making it unnecessary to carry two keys.

Nail in Handle Supports Brush On Paste-Bucket Rim

Here's a stunt one paperhanger used to hook his paste brush to the rim of his paste bucket each time he was through using it. He drove a nail through the brush handle edgewise about $\frac{1}{2}$ in. from the base as shown. Held in this manner, the brush need not be removed when the bucket is carried about.—Harry M. Childs, Crichton, Ala.



Converted Oil Drum Holds Tools And Truck Accessories

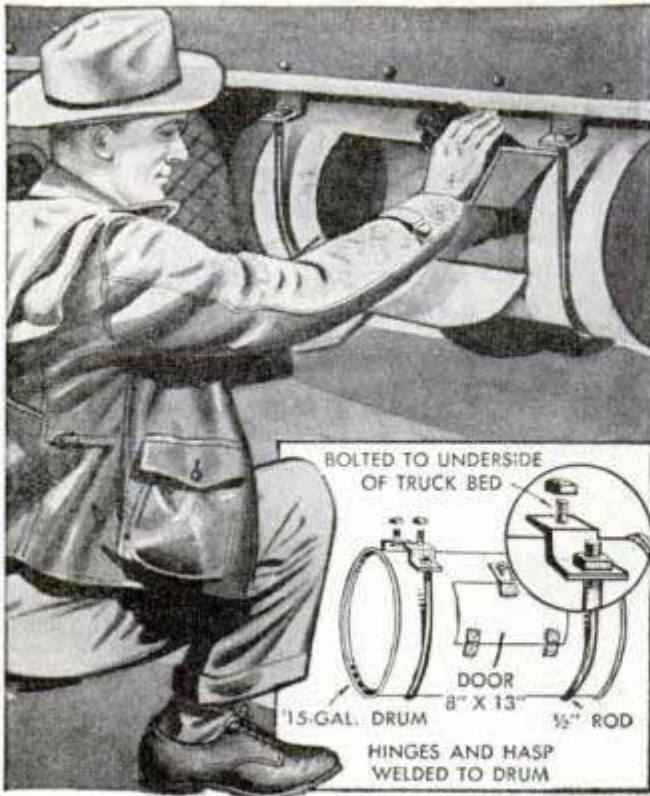

An old oil drum suspended from underneath the truck body at one side makes a convenient container in which to carry tire chains, wheel jack and road flares on a truck. A door is cut in one side of the drum, the hinges and hasp for the door being welded in place.

Cleaning Agent Has Many Uses In Drafting Room

Ordinarily used as a dry cleaner, carbon tetrachloride has many applications in the drafting room. It can be used to erase guide lines after a drawing has been inked. It also will remove the gummy substance that is left by masking tape. Carbon tetrachloride also cleans scales and drawing instruments.—H. Schlossberg, Washington, D. C.

Extra Chuck Takes Small Drills



The mechanic who uses small-size drills occasionally and does not have a small press can use a regular drill press for No. 40 to 80 drills by fitting a $\frac{1}{4}$ -in. or smaller chuck with a straight shank that will slip into the larger chuck.

Since the larger presses are not designed for small drills, the highest speed should be used and the drill should be fed with care, using only a light pressure.

Wm. Riederich, Flint, Mich.

Substitute Spanner for Disk Nuts

Round disk-type nuts often are found on balances and other laboratory instruments. Usually they are made with two blind holes, one on each side of the center, which engage two pins on a special key for turning them. When the proper tool is not at hand, they may be loosened or tightened by using a pair of long-nosed pliers.



D. E. Kerr-Lawson, Swastika, Ont., Can.

Warehouse Hand Truck Is Built With Low Platform

A light hand truck with a low, flat platform is always handy in a warehouse, shipping room, or wherever there are smooth concrete floors. Little work is required to make this one and the only materials needed are a few boards, some sheet metal, two lengths of pipe, two casters and a few bolts and nuts. The pipes are bent and flattened, as shown, and the two casters are fastened to the pipe. Then the boards are laid across the flattened portion and bolted on. A lip for the platform and cross braces on the handles are added to complete the truck.



Three Small Hammers Useful to Modelmakers

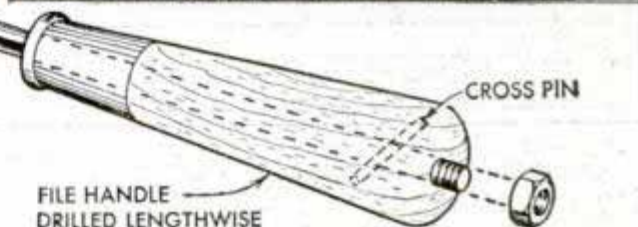
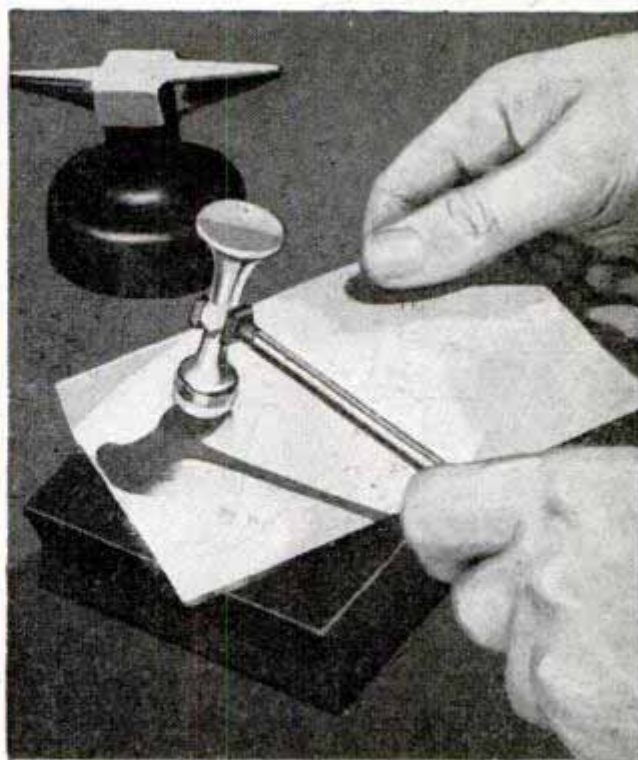
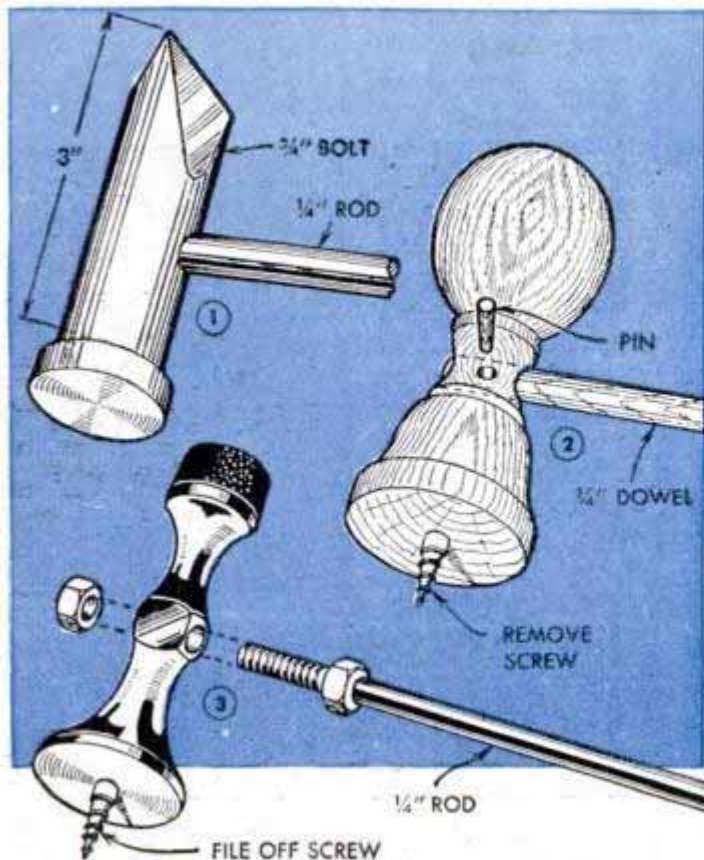

Small hard and soft-faced hammers and wooden mallets are always handy in model-making for driving small wooden pins, brads, etc. Of the three hammers detailed above, two have heads made from ordinary doorstops of the type that screw into the baseboard. The third, Fig. 1, is shaped from a $\frac{3}{4}$ by 4-in. bolt having a hexagon head. This is ground to the rounded shape shown and the face is crowned slightly. The threaded section is cut off the opposite end, which then is ground wedge-shaped for light peening and riveting operations. Handles for the hammers in Figs. 1 and 3 are

made in the same way except that one is not threaded, but is forced into the head after the latter has been heated. The handle of the mallet, Fig. 2, consists of a $\frac{1}{4}$ -in. dowel fitted with a file-handle grip as in Fig. 3, the grip being glued to the dowel. Overall length of the finished hammers and the mallet should be about 9 in.

Simon S. Palestrant, Bronx, N. Y.

Large Wallboard Sheets Carried in Sling by One Workman

By using this sling, one workman is able to carry sheets of wallboard that are much larger than any he could ordinarily handle alone. In use the board is set in the grooved strip, a guide rope is thrown over the top of the wallboard and the sling is lifted to the shoulder. The guide rope serves to prevent the board from tipping.

Waterproofing Minnow Seines

Minnow seines and landing nets can be waterproofed if green cedar bark is available. The net or seine should be boiled for about an hour in a solution that contains this bark. This is not only a waterproofing treatment, but also it will serve to prevent rot and keep the threads of the net soft and pliable.

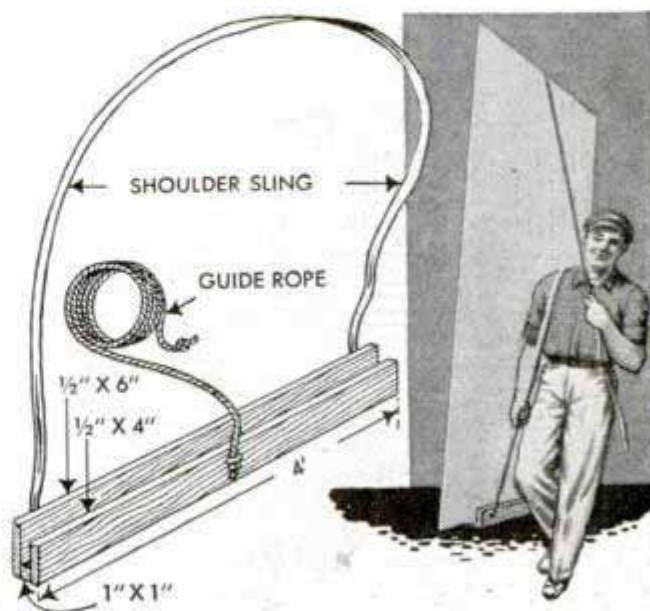

Adjustable Guide Bar on Square Aids in Marking Stringers



Once this guide bar is set, it's no trick to lay out stringers quickly and accurately with a steel square. Dressed lumber about 22 in. long is used and slotted to slip over the legs of the square. Two carriage bolts with wing nuts are used to clamp the bar in place after it has been set.

Ladder Secured by Pitchfork Fastened to Rungs

When you have occasion to use a ladder on a surface where the feet might slip, you can utilize a pitchfork in an emergency to

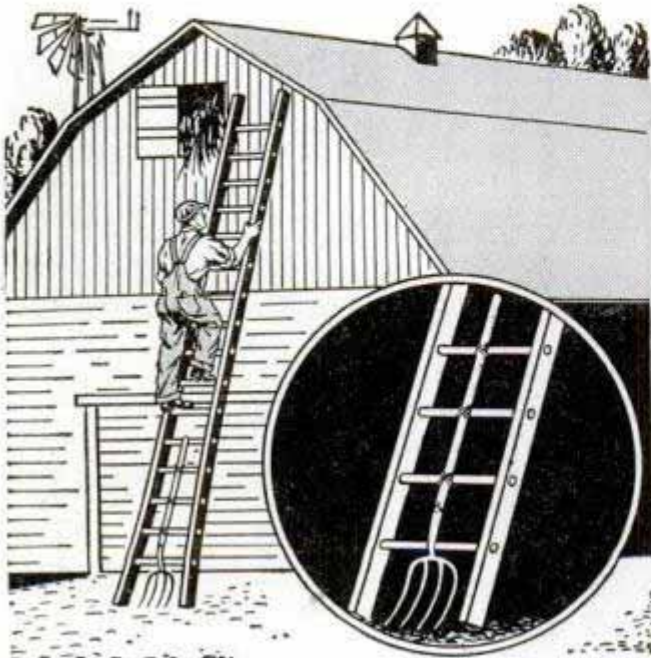

keep the ladder from sliding. The fork is wired to the ladder rungs with the tines set on the ground and bowed outward.

Hose Will Hold Conduit Clip

One electrician who found it difficult to hold metal clips over conduit when nailing it to overhead joists used a clamp made of garden hose to overcome this trouble. A short section of the hose is split lengthwise and one end is trimmed to leave a projecting tongue.

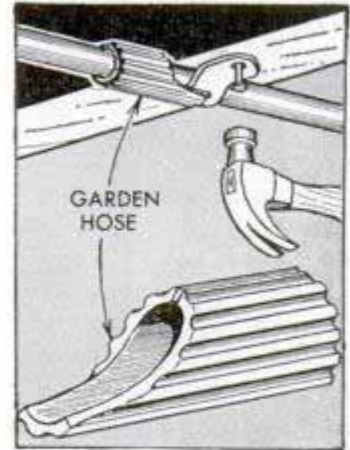

In use, the clamp is slipped over the conduit and the tongue slides over the clip to hold it for nailing.

Notches in Steel Rule Speed Work

Notches may be made in a steel rule at convenient intervals if you have occasion to mark off duplicate measurements repeatedly.



Work of this nature will go faster, fewer mistakes will be made and there will be less eyestrain. A triangular file should be used to make the notches in the ruler.

Method of Saving Fence Posts

If fence posts are impregnated with creosote from the inside out, their life is increased greatly. To do this bore a $\frac{3}{4}$ -in. hole from the bottom to above the place where the ground line will be. Then drill from the outside of the post down at an angle to meet the hole in the center. Plug the bottom hole and set the post. Then fill the prepared cavity with creosote and plug it. Several fillings may be required to saturate the wood thoroughly and the creosote level should be watched. Post braces are similarly treated. —R. H. Fischer, Sterling Junction, Mass.

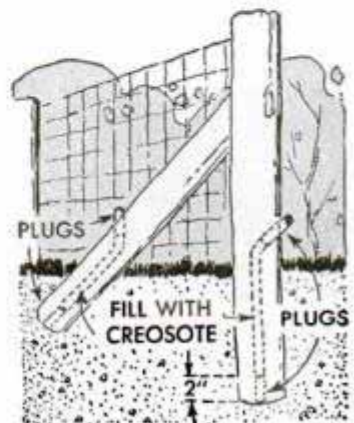

Radio and Electronics



HAMS RESUME—"CALLING CQ"

By F. L. Brittin—W9DCX

IF your receiver includes the recently restored amateur short-wave bands, you have again heard radio "hams" calling CQ. You may also hear the amateurs in California, New York, Canada or Mexico answer; they usually do if conditions are favorable. Prewar "air" acquaintances are being renewed and new friends made. About 60,000 hams were listed in the "Call Book" before the war; the publisher says there will be 100,000 by December. Nearly 35,000 went into the armed forces; today there are 250,000 veterans with radio training ready to qualify for FCC tickets. Amateurs have served in peacetime during many emergencies. Their outstanding value as a source of skilled radio personnel in time of war has now been recognized.

Annual prewar ham and would-be ham purchases amounted to a peak of about 20 million dollars; typical communications receivers are illustrated in photos A and C. Photo B shows a homemade two-way "rig" for the new ultra-high radio band. Arthur R. Koch (W9WHM/2), adjusting the tube, made the parabolic reflector from ordinary mesh screen; the bottom of a tomato can serves as a reflector on the end of the radar-type antenna. The mobile installation in photo D consists of a compact 2-meter transceiver powered with a new 6-volt vibrator-type unit.



ELECTRON-COUPLED ZERO-BEAT

By Harry A. Fore

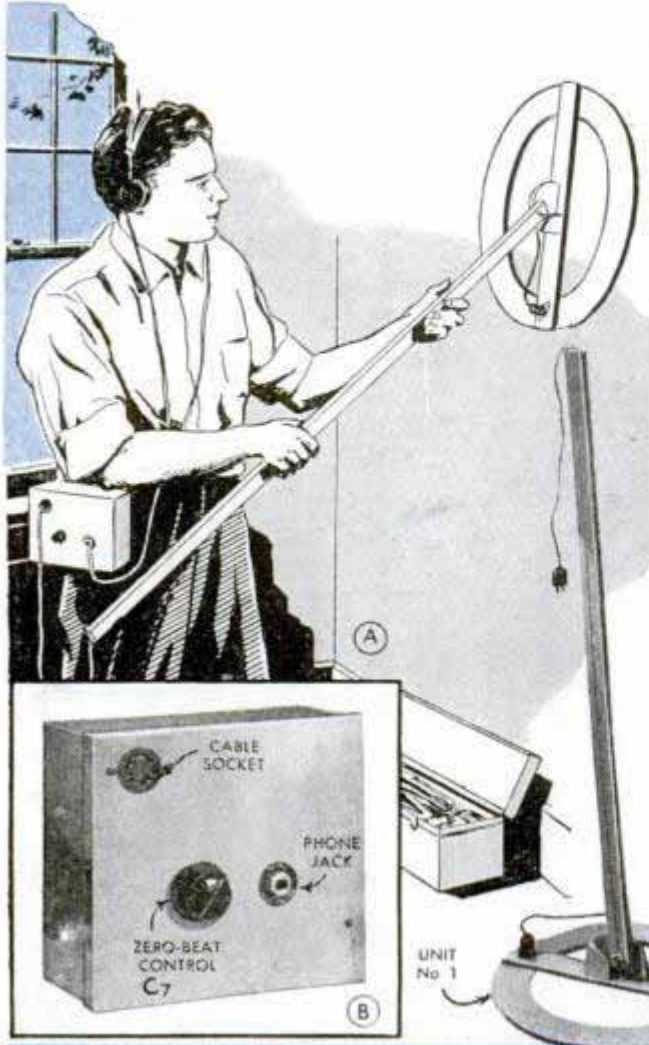

TREASURE finder enthusiasts looking for a "zero-beat" metal-detecting device that is an improvement over prewar instruments will find this electron-coupled unit definitely better. Designed especially for the readers of Popular Mechanics Magazine by the same engineers that built mine detectors used by the British Army in Africa, this compact model is intended primarily for the advanced experimenter, and as a replacement for the original zero-beat treasure finder that was described in the January 1940 issue. Although not as "sharp" as precision commercial locators,

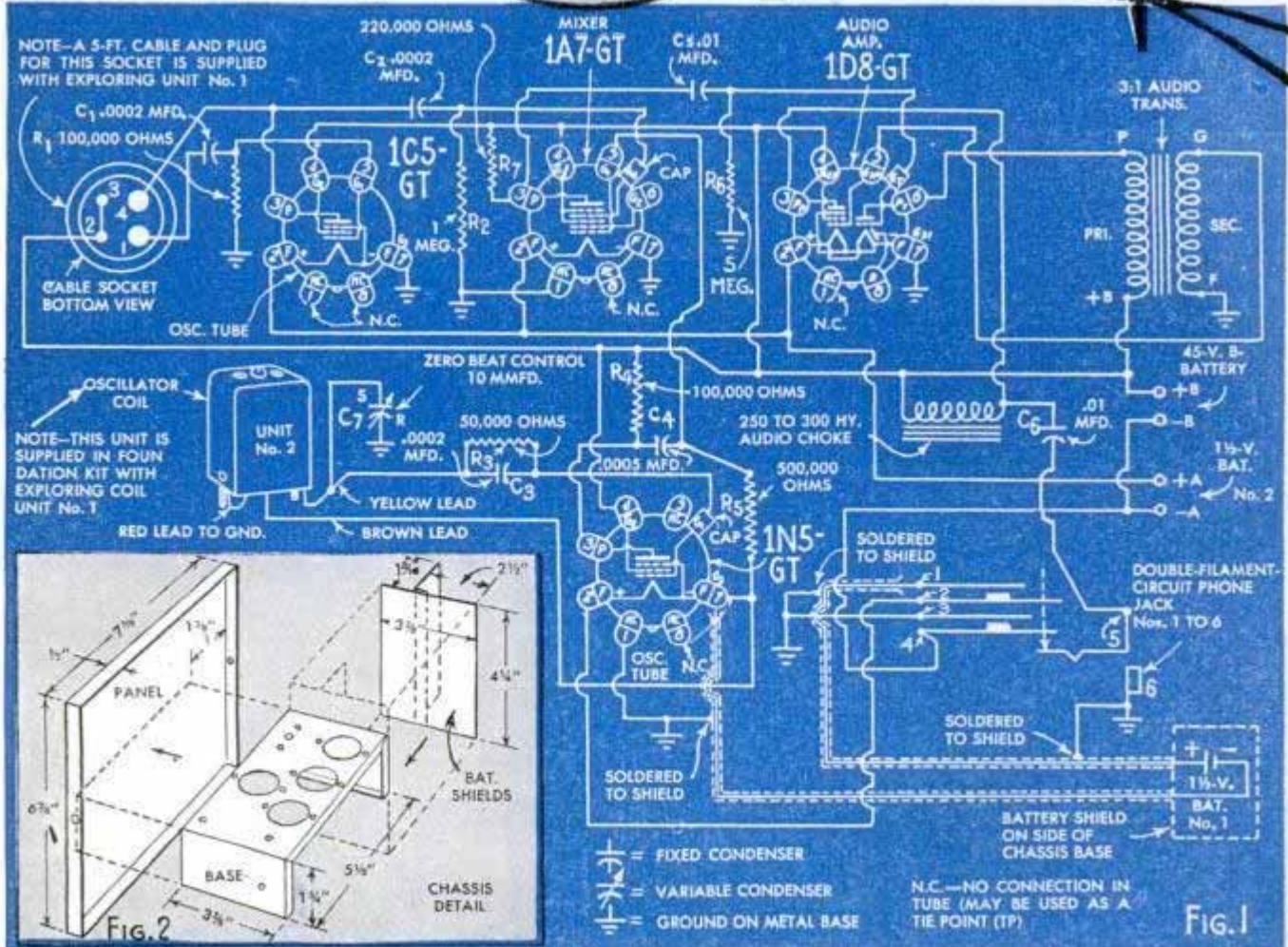
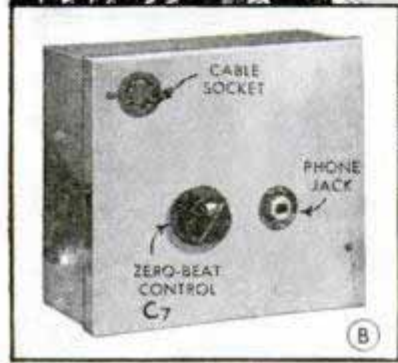

METAL DETECTOR

it retains all the excellent points of the original "Chilson" type metal detector, with many added refinements. Ideal for locating buried metallic objects, it also has other practical applications such as locating and tracing pipes in walls and masonry as illustrated in sketch A.

All parts specified are standard radio types with the exception of the exploring loop, unit No. 1, and the oscillator-mixer coil, No. 2. The manufacturer has made these units available through mail-order radio-parts houses in kit form.

A schematic circuit diagram is given in Fig. 1; the panel and chassis are detailed in Fig. 2. Photos B, C, E, F, and G show various views of the instrument. Filament battery No. 1, for the 1N5-GT tube, must be in the shielded compartment, and its leads are shielded as indicated in the pictorial wiring diagram Fig. 3. The case is 3 $\frac{3}{4}$ in. deep, 6 $\frac{1}{2}$ in. high and 7 $\frac{1}{4}$ in. wide.

An audible note will be heard in a pair of 4000-ohm headphones when the phone plug is inserted in the "Yaxley" type

(Continued to page 220)

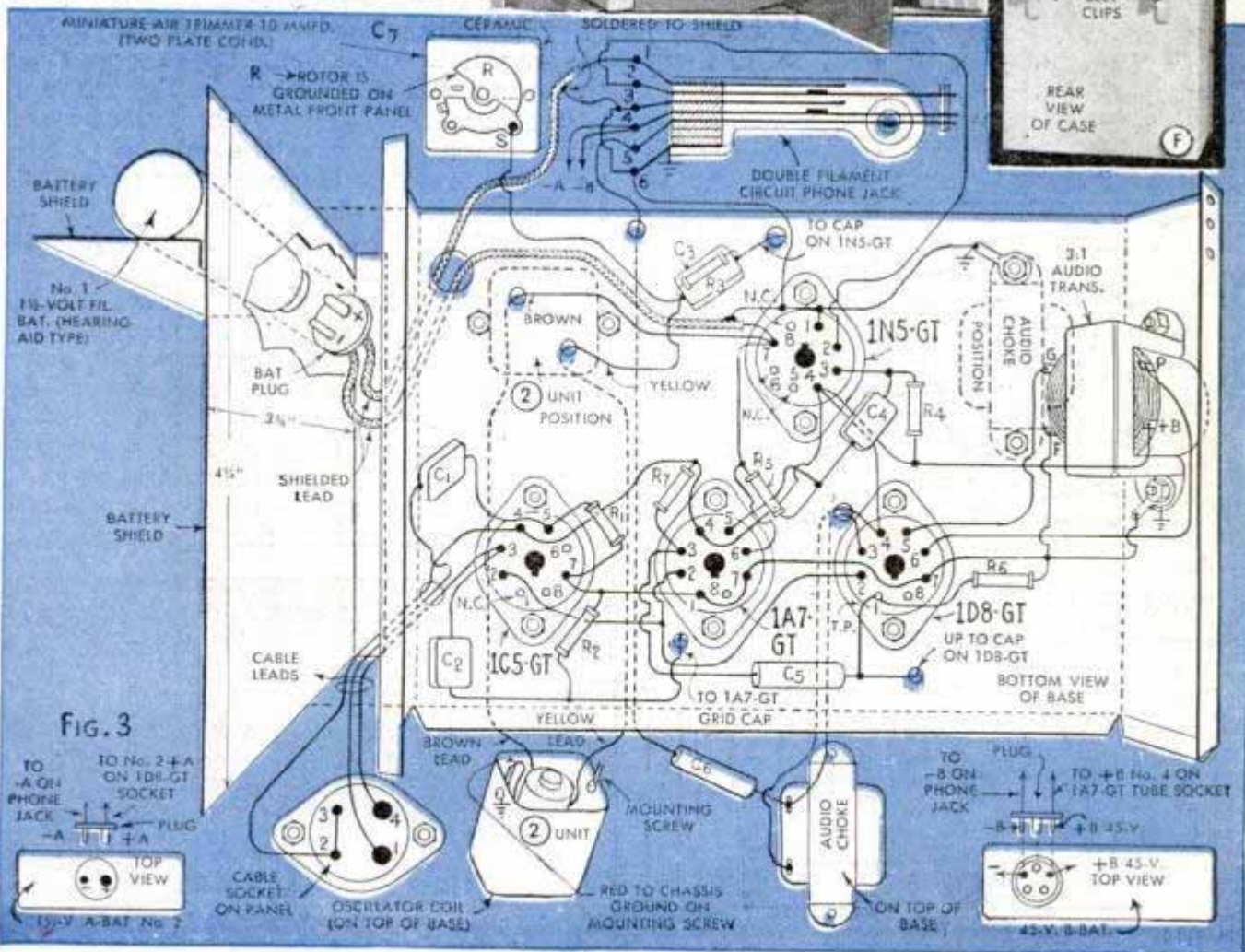

Replacement Cabinet for Table Model Receivers

By D. W. Damrow

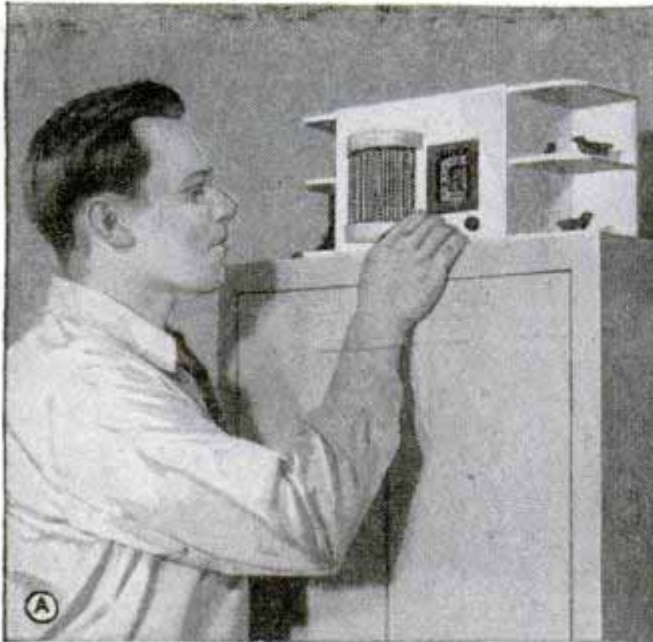

AS REPLACEMENTS for many of the plastic radio cabinets in use today are extremely difficult to obtain, it is quite likely that you may have a set that is not in service because "little Rollo" knocked it off the table and the cabinet is broken beyond repair. If the radio chassis is still in good condition the receiver can be put back in operation with this attractive wooden cabinet. It may be placed on a table or large cabinet, and also looks well on a wall as the shelves provide space for displaying small knickknacks or figurines.

Complete construction details are given in Figs. 1 and 2. The top and bottom pieces "A" are cut from $\frac{3}{8}$ -in. fir plywood and these are fastened to the $\frac{1}{2}$ -in. pine stock uprights "B" with brads after glue has been applied to all joints. Both pieces "A" should extend $\frac{3}{8}$ in. at the rear to provide room to nail the $\frac{3}{8}$ -in. plywood back pieces "C" in position. Shelves "D" are cut from $\frac{3}{8}$ -in. fir plywood and inserted in the $\frac{1}{4}$ -in.-deep and $\frac{3}{8}$ -in.-wide grooves cut in uprights "B". These shelves are glued in position and then carefully tacked at the rear to the back pieces "C".

Front panel "E" also is made from $\frac{3}{8}$ -in. fir plywood and holes are cut for the speaker grille and dial plate, or escutcheon. The speaker hole should be slightly smaller than the speaker and is covered at the rear with coarse-mesh grille cloth. The unusual grille dowel rods and the dial plate are painted a bright red before they are mounted on the front panel which is white in common with the cabinet. A good grade of white and red enamel was used and the pleasing result is shown in photos A and B; the control knobs also are bright red.

It will be noted in Fig. 3 that there is no back cover as it is necessary to provide ventilation for the set. If the cabinet is mounted on a wall, a half-inch space between the wall and cabinet should be provided. Spacers made by cutting small wooden spools in half may be employed.

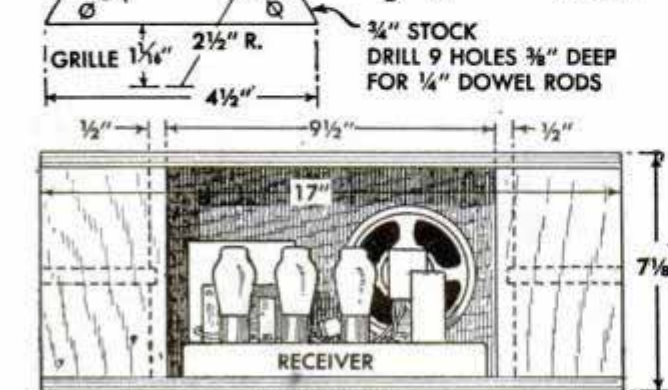
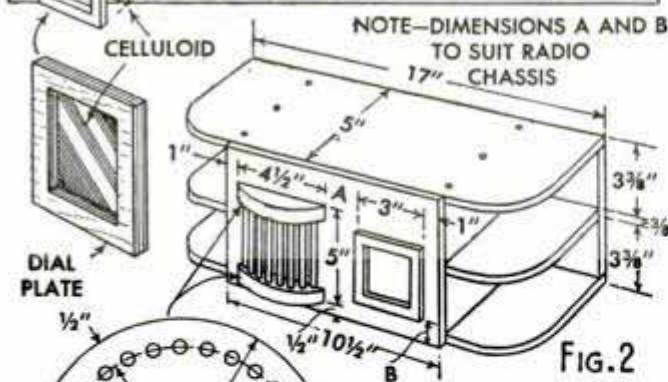
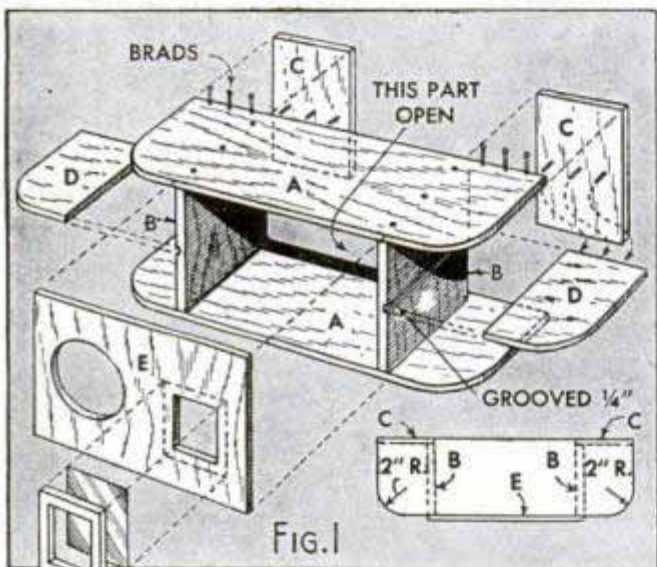
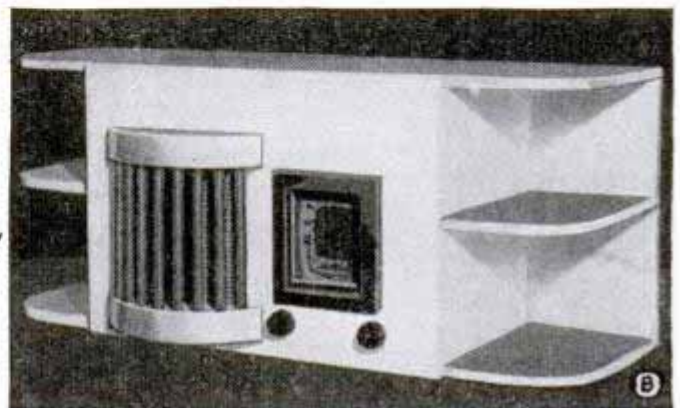
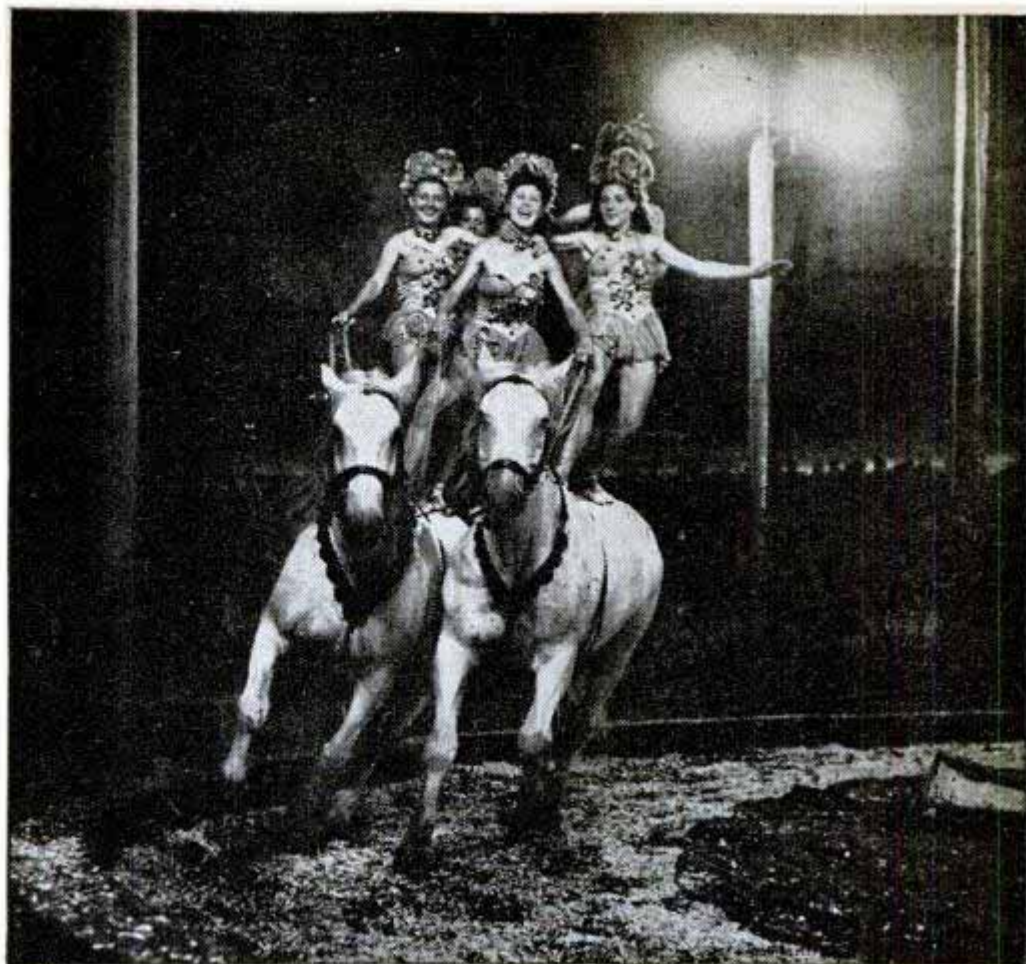

FIG. 3 BACK VIEW





Poor light,
no flash—

but a good picture

Film, Kodak Super Panchro-Press, Sports Type



It gets the shots you'd expect to miss . . . indoors with the light as is, outdoors when the light's "impossible." You can use relatively high shutter speeds; you can set for extensive depth of field . . . and when under-exposure seems certain, you can save your picture by prolonged development. Sheets only—and in limited quantities . . . Eastman Kodak Company, Rochester 4, N. Y.

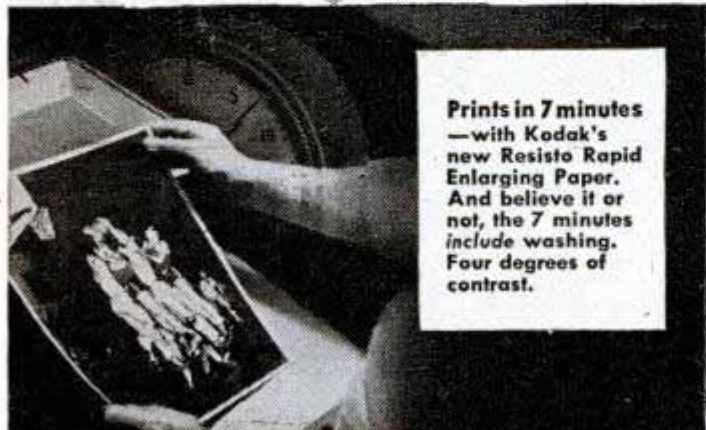

Prints in 7 minutes
—with Kodak's
new Resisto Rapid
Enlarging Paper.
And believe it or
not, the 7 minutes
include washing.
Four degrees of
contrast.

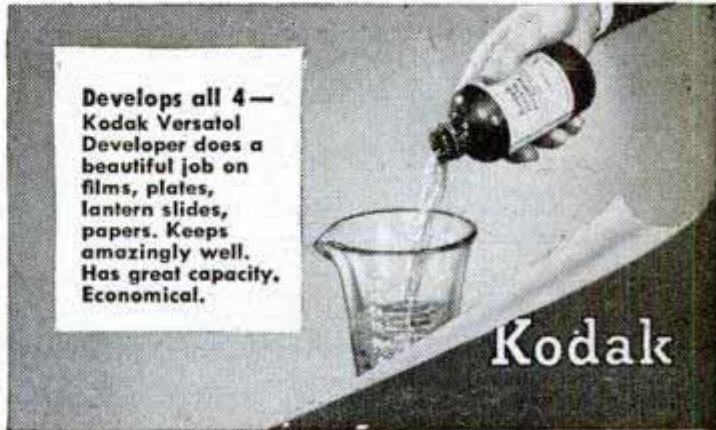

Develops all 4—
Kodak Versatol
Developer does a
beautiful job on
films, plates,
lantern slides,
papers. Keeps
amazingly well.
Has great capacity,
Economical.

Kodak

Modest Texan Gets Bass With HAWAIIAN WIGGLERS



Jim Lowry with bass taken on Hawaiian Wiggler.

"Dear Fred:

"I'm just a mediocre fisherman who doesn't get to fish often enough and I certainly don't know much about baits. It happens that the Hawaiian Wiggler was recommended to me several years ago, I tried it with good results and, being naturally lazy, I seldom change to anything else.

"Maybe I miss a lot of fish that way, but the times I have tried others I didn't catch anything, so I would end up with the Hawaiian Wiggler. Of course if the fish aren't biting, it won't perform a miracle. But several times I've had other fellows laugh at me for using only one lure, then put one on their own line after I'd snag a bass right out from under them."—**James H. Lowry, Fort Worth, Texas.**



**Shallow Running
No. 2 Hawaiian Wiggler \$1.10**
(Sorry — No Mail Orders)

Write for Free Catalog

FRED ARBOGAST & CO., 1608 North St., Akron 3, Ohio

Ingenious New Technical Methods

To Help You with Your
Reconversion Problems

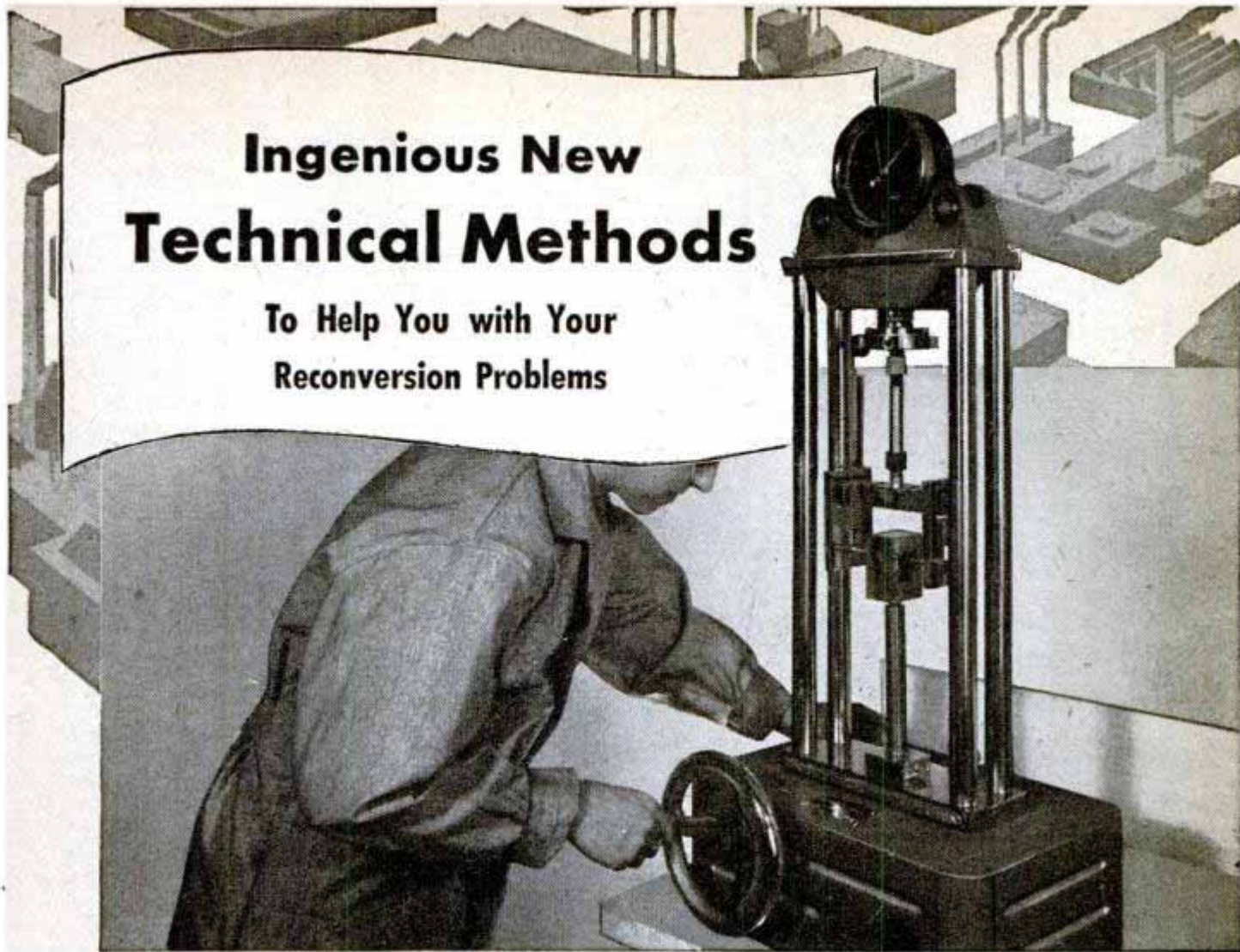

Portable Tester Checks Tensions Up To 10,000 lbs.—Right at the Workbench!

Standing only 37" high, weighing but 137 lbs., the Dillon Universal Tester checks wire, copper, aluminum, fabrics, steel, etc. for tensile, transverse, compression and shear strengths. Available in 7 capacities, with interchangeable dynamometers, the Universal will test from 0 to 10,000 lbs. Special gripping jaws are made for every requirement.

The Universal Tester may be either hand or motor operated. No special training is needed to record accurate results instantly on the dynamometer. It is compact, simple, inexpensive—designed for small shops and plants everywhere.

Tests prove that workers, too, undergo strain and nervous tension on the job. That's why many factories urge workers to chew gum. Workers can chew Wrigley's Spearmint Gum right on the job—even when hands are busy. And the act of chewing helps relieve monotony—helps keep workers alert, thus aiding them to do a better job with greater ease and safety.

You can get complete information from *W. C. Dillon & Company, Inc.*
5410 W. Harrison St., Chicago 44, Illinois

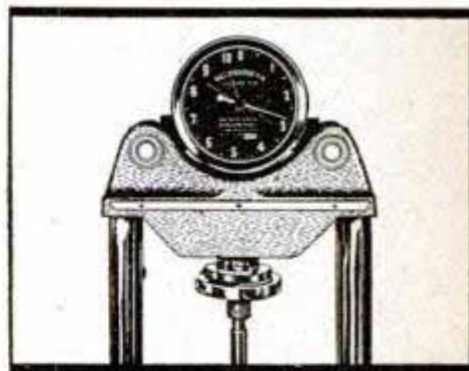

Interchangeable Dynamometer



AA-82



Fly and Buy THE WORLD'S LEADING PERSONAL PLANE

More Piper Cubs have been sold than all other light planes combined. That's partly because Piper's modern mass production methods bring you a good, safe plane for less cost than any other—\$665 down, with economy of operation to match. A free flying course goes with every new Piper Cub. Ask your dealer for a free flight demonstration now.



HERE ARE 3 FINE AVIATION
BOOKS FOR
Your Library!

Our printers are working overtime to keep up with the demand for these popular Piper books. Hundreds of thousands have come off the press already—and requests are still pouring in. Get yours now!

1. **Piper Cub Brochure.** Brand new! Beautiful full-color airplane illustrations, suitable for framing. Complete specifications of Piper Cubs.
2. **"How to Fly" Book.** Takes you on a typical flying lesson with 53 step-by-step photos and descriptions. Many other interesting facts.
3. **"What Your Town Needs" Book.** Will help you plan an inexpensive landing area now.

Get these books from your Piper Cub Dealer now. Or, if you prefer, send us 10c per book or 25c for all three. Use stamps or coins. Specify which books you desire. Write Dept. PM86.

PIPER AIRCRAFT CORPORATION
LOCK HAVEN, PENNA.

PIPER

Electron-Coupled Zero-Beat Metal Detector

(Continued from page 215)

double filament circuit-control phone jack, then final adjustments can be made.

Turn C₇ variable condenser half in and make slight screwdriver adjustments of the screws in the top of unit No. 2 through holes in top of case to produce an approximately zero-beat note.

Place the exploring coil on a wooden table and adjust the C₇ control knob to

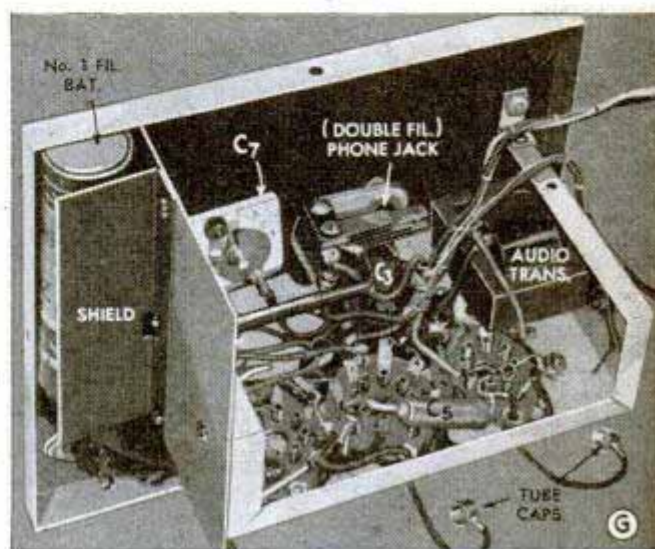

give the slowest "clucking" sound. Over average soil, as in photo D, its detection depth should be at least 12 inches on a 1-ft.-square metal sheet; greater depth range depends upon the bulk of the buried metal. Actual detection can be made with either increase or decrease of the clucking rate. Detailed student material list and blueprint number is R-346.

Drive to the Other Americas

(Continued from page 159)

Another section of the Pacific International Highway which is receiving much attention is a projected route from Vancouver to Whitehorse. At the present time it is completed as far north as Hazelton, but from there on is a 600-mile stretch still to be built.

Such a link, whose construction has been endorsed by President Truman and the governors of Alaska and Washington, could be built for about \$13,000,000. It would open up virgin land which is begging for settlement.

The Alaskan Highway—On the eastern side of the Rockies is the Alaskan Highway (formerly called the Alcan Highway). This 1600-mile stretch, from Great Falls, Mont., to Whitehorse, was built by Army

(Continued to page 224)

13 Different Blade Shapes

X-acto is always right—always ready!



"Like my good right hand..."

That's how much X-acto Knives mean to Martin Prehn, professional artist and expert whittler of Freeport, Long Island. He has used them for years, he says, for both his work and his hobby . . . and finds them *always* sharp, with *always* the needed blade contour."

Just look at them — there to the right are the thirteen scientifically designed blade shapes which make X-acto the ideal knife for every art and craft. Each of fine surgical steel, ground scalpel-sharp. With X-acto's three firm-grip, all-metal knives, and an assortment of these versatile, interchangeable blades, even an amateur can tackle any hobby job with confidence and gusto.

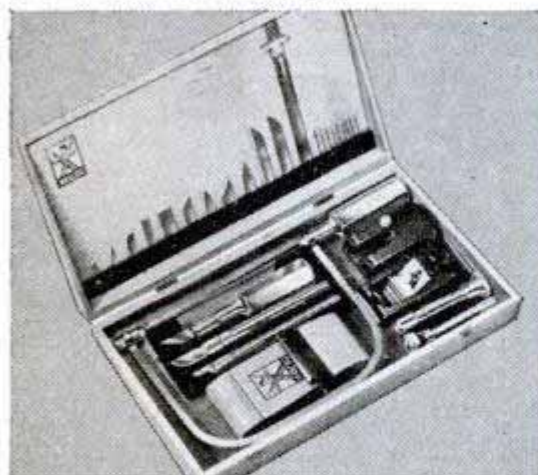

"Small Tools Are a Big Help," says Mr. Prehn. "There are so many small jobs that *only* small tools do well. X-acto Tools fit the hobby, and the hand, perfectly." No. 85 X-acto Tool Chest: 3 all-metal Knives; complete blade assortment; planer; sander; stripper; saw; drills; holders; ruler; complete in handy desk-drawer-size wooden chest, \$12.50.



No. 10 — For all small, fine general work, including small concave or convex surfaces.



No. 11 — For fine angle cutting and deep cuts in narrow places, with less danger of splitting. Also for stencils.



No. 16 — For small holes or notches. Ideal for templates, friskets, or stencils in thin materials, even tracing paper.

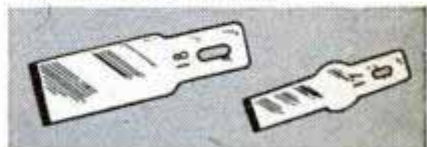

No. 17 — A chisel blade, 1/4-inch wide, for working those hard-to-get-at flat surfaces. No. 18 — Same, 1/2-inch wide.



No. 22 — For long cuts along a template, or close corners. For whittling concave or convex surfaces.

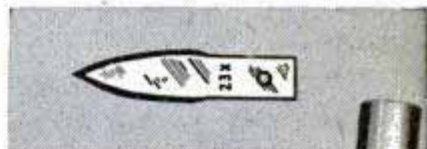

No. 23X — Ideal for acute-angled corners. All purpose blade with 2 cutting edges.



No. 25 — The ideal blade for general carving and all outside heavier cutting. Use it with No. 2 or No. 6 Knife.

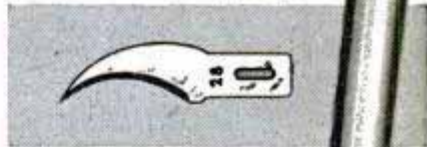

No. 28 — Hooked, for outside curved shaping. For leather, linoleum, whittling.



No. 24 — For light chiseling, close corners. Templates and mats of cardboard, paper, celluloid. Cross grain trims, etc.



No. 19 — A broader blade for general roughing, deep scoring and cross cutting.



No. 26 — 3-inch whittler's blade. No. 27 — 3-inch saw blade.

ALL-METAL No. 2 X-acto Knife — 50¢ With 5 assorted blades, \$1. Other Knives, Tools, Chests, 50¢ to \$12.50.

A complete series of V- and U-shaped gouges coming soon!



x-acto
KNIVES & TOOLS



At hardware, hobby and gift shops

X-acto Crescent Products Co., Inc., 440 Fourth Ave., New York 16, N.Y. In Canada: Handicraft Tools, Ltd. Hermant Bldg., Toronto.

*Reg. U. S. Pat. Off.

WORKSHOP WISDOM

A model glue for model boats

To ensure a strong hull, use CASCAMITE for bulkhead, keel, and deck joints.

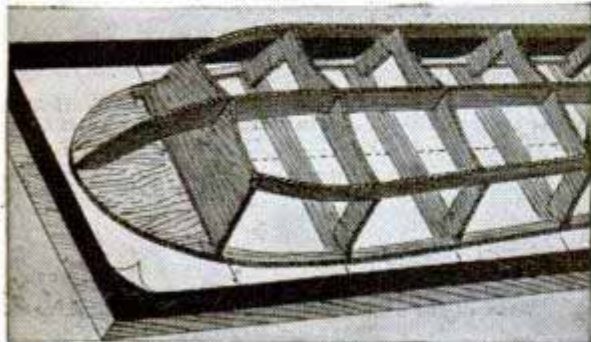

Also fasten deck planks down with CASCAMITE.

Cross braces determine the strength and shape of your ship. CASCAMITE will glue them snugly into place and prevent warping and springing of seams.

And for that "shipshape" look, use CASCAMITE for cabins, masts, hurricane decks, superstructure, and all your fittings. Makes neater joints because it's stain-free.

Why you will prefer CASCAMITE:

Easy to use. Just add CASCAMITE to cold water and stir.

Strong. CASCAMITE glue joints are stronger than the wood itself.

Thrifty too! No waste. You mix CASCAMITE as you need it.

For actual sailing models, use CASCO-PHEN, the new, completely waterproof resorcinol-resin glue.

Get CASCAMITE—and CASCO—the standard casein household repair glue—at your hardware store, in 10¢, 25¢ and larger sizes.

FREE GLUING GUIDE containing household repair and gluing hints, plus helpful information on household repairs. Address a post card to: Casein Co. of America, Dept. PM-86, 350 Madison Avenue, New York 17, N. Y.



CASCAMITE

Dry Powder Urea Resin Glue

SAY YOU SAW IT IN POPULAR MECHANICS

"YANKEE" HANDYMAN TOOLS



No. 133H—
"Quick Return"
Spiral Ratchet
Screw Driver

Works like a charm.
Simply push either to
drive or draw screws.
Hidden "quick return"
spring returns handle for
another push. Great value.

NORTH BROS. MFG. CO.
Phila. 33, U. S. A.
Division of The Stanley Works

Thompson BEATS the World on BOATS



**Better Built
Lower Prices**



**Safe Boats With
Full Length Spray Rails**
Keep passengers perfectly
dry—even at high speeds.
Catalog also shows two new
models of "Take-Along"
Boats. Two big factories—
save you freight.

CATALOG FREE
Write for your copy. State kind of
boat in which you are interested.

THOMPSON BROS. BOAT MFG. CO.
213 Ann St.
PESHIGO, WIS.

Light Boat for Auto
THOMPSON BROS. BOAT MFG. CO. (161)
113 Elm St.
CORTLAND, N. Y.

Merrily You Roll
Happy, carefree motoring, in
new measure, is yours with the
**HULL STREAMLINE AUTOMOBILE
COMPASS.** No more worry, confusion,
lost directions, wrong-way travel. Insist
on a Hull for time-proved accuracy,
dependability. At your dealer's.
Price \$3.95.

HULL MFG. CO.
P.O. Box 246-D9, Warren, Ohio



STOP THAT DRIP



New—for homes! A sure cure for condensation drip from cold water pipes. Pliable, cork-filled NoDrip Tape eliminates wet floors, makes idle space usable!

Quick, Clean, Easy to Wrap on—No tools needed. Covers joints as well as straight pipes. **\$1.25**

At hardware, dept. stores, lumberyards.
Roll, enough for 7 feet of 1/2" pipe.

Higher west of Rockies and Canada
Write for free NoDrip Tape Circular
J. W. MORTELL CO. 522 BURCH ST.,
KANKAKEE, ILL.





An old horse is old for keeps— but an engine can be made young again

YOU can't look an engine in the teeth, but you can tell its age by its performance—and new Sealed Power Piston Rings can knock years off its age, increasing horsepower by as much as 20% to 25%, saving oil, saving gas, and lengthening engine life.

Whatever the make, model, or degree of cylinder wear in your car, truck or tractor, there is a Sealed Power Piston Ring Set specifically engineered to do the best possible job. These rings are made with the same pride, precision and quality that have made Sealed Power the choice of leading engine builders for over a third of a century. See your Sealed Power franchise dealer and ask him for the new booklet "What Causes Excessive Oil Consumption." Or write direct to Sealed Power Corporation, Muskegon, Michigan, and Stratford, Ontario.

KEEP YOUR WAR BONDS! GET \$4 FOR \$3!

© 1946, Sealed Power Corp.

For better results 26 Basic Ring Designs

No one piston ring design can meet all replacement needs. Sealed Power Individually Engineered Ring Sets are made up from twenty-six (26) basic ring designs, which permit each set to be specifically engineered to do the best possible job in a particular make of engine.

These ring sets are engineered to save gas without sacrifice of oil economy, to save oil without inducing friction and cylinder wear. Each set gives balanced performance in a particular engine.

*Piston Rings
Pistons
Cylinder Sleeves
Valves
Water Pumps
Chassis Parts*



SEALED POWER PISTON RINGS

BEST IN NEW CARS! ★ BEST IN OLD CARS!

Now! tests prove-

BRIGHT STAR BATTERIES



give more
bright light
longer

Here is your proof!

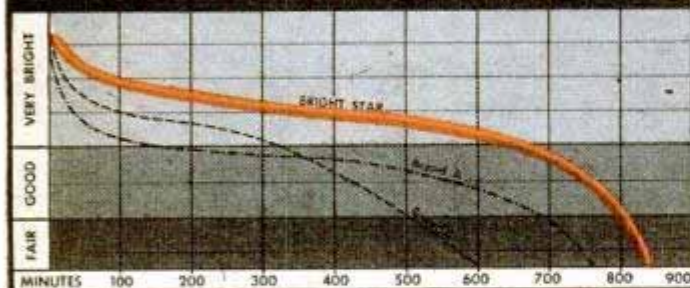

These results of vital service tests* prove that Bright Star batteries give you more *bright light* longer than the two other leading brands tested. Insist on the best—it's Bright Star by test!

*Chart based on laboratory tests conducted under government standards.

BRIGHT STAR BATTERY COMPANY, CLIFTON, NEW JERSEY

engineers straight through raw forest wilderness, muskeg swamps and towering mountains. It is still a military road under the jurisdiction of the Joint Traffic Control Board. However, it is being widened for two-way traffic—in both winter and summer—and is expected to be declared open to tourists and civilians soon.

The America-Asia Bridge—Most intriguing international highway—even though not more than an engineering dream at the moment—is one which would link Alaska and Siberia by bridge or tunnel across Bering Strait.

This is not an impossibility. Bering Strait is only about 50 miles across and the water is quite shallow. A survey was made in 1916-17 by Army engineers. The feasibility of putting a railroad bridge across Bering Strait was favorably reported upon.

What may come of this idea awaits development of other international highways in the Western Hemisphere and the swing of political tides between Russia and the United States.

One of these days a major portion of the world may be linked by means of automobile highways across the Bering Strait.

The Bridge Born in a Wind Tunnel

(Continued from page 125)

alone. As a result, instead of the solid roadway originally proposed, the new bridge will have a slotted roadway. These slots are continuous longitudinal strips of open steel grating 33¼ inches wide running between the four traffic lanes. They will permit air currents to come through from beneath the bridge, thus breaking them up and reducing opportunity for oscillations to develop. The slots will also serve as lane markers for motorists.

Though the new bridge will be considerably heavier than its predecessor, existing piers, anchorages and one approach will be used with some alterations. Under maximum pressures the new structure is expected to produce an increase of only one ton per square foot on the piers, and this is considered safe. The towers will be of the same cellular-type construction but will be 60 feet wide all the way up instead of 50 at the bottom and 39 at the top as in the old bridge. Engineers claim the wider tower actually gives a better load distribution on the pier than before. The towers will also be 502 feet tall instead of 425 feet as in the old bridge. This is to allow for the increased cable sag caused by the greater weight.

(Continued to page 228)

ONLY 50¢

for a whole year's supply
of exciting woodworking
plans and projects

... brought to you in
the popular, plan-packed
hobbyists' magazine —

the DELTAGRAM

Delivered to your
home six times a year!

ONE RECENT
ISSUE OF THE
DELTAGRAM CON-
TAINED ALL THIS:

- Plans and photographs for making a modern cellaret.
- Plans and instructions for making a reading table.
- Plans and numerous illustrations of a child's novel rocker.
- Clear instructions for building a toy bus.
- A Delta Craftsheet showing how to make your own wheels.
- Photographs of six interesting projects made by Deltagram readers.
- Much other practical information.

Remember, this is just
ONE issue out of SIX!

... Page after page of tested
ideas on what to make and
how to make it!

Not one — not two — but *six*
big issues of The Deltagram!
Enough plans, projects, designs,
news for a *whole year* of fun—
building furniture, toys, novel-
ties, lamps, etc. All this for 50¢!

Easy to Understand

The Deltagram leaves nothing to
guesswork. Step-by-step instructions
are clear and complete. Even a be-
ginner can follow them without
waste of time and costly materials.

You get useful, *shop-tested* infor-

mation that's a big help in produc-
ing beautiful objects your friends ad-
mire . . . in performing operations
more easily, more quickly, more safely.

Get Your Subscription In!

New subscriptions start with the
September-October issue. To be sure
you don't miss a single issue, sub-
scribe to The Deltagram right now.

Paper shortages limit the number
of subscriptions we can accept. So
to avoid disappointment, fill out the
coupon below and mail *today* with
50 cents in coin, postal note, or
money order.

TEAR OUT COUPON
AND MAIL TODAY!

HM-39

DELTA
MILWAUKEE
REG. U. S. PAT. OFF.

HOMECRAFT
REG. U. S. PAT. OFF.
POWER TOOLS



Subsidiary of
Rockwell Manufacturing Co.

*Trade Mark Reg. U. S. Pat. Off.

THE DELTA MANUFACTURING CO.
681H E. Vienna Ave., Milwaukee 1, Wis.

Enclosed is 50¢ in payment for a whole
year's subscription to The Deltagram.

Name.....

Address.....

City..... (.....) State.....

ADVENTURE IS CALLING
YOU!



**RIDE A
HARLEY-DAVIDSON**

The present tremendous demand for Harley-Davidsons confirms motorcycling as the "world's greatest sport!" And its popularity is hitting new peaks! Enthusiastic motorcycling "fans" are buying Harley-Davidsons faster than we can ship them to our dealers. We're doing our best to keep up with the demand. But we urge you to see your Harley-Davidson dealer EARLY, if you want the adventure—the fun and thrills—that come with owning a Harley-Davidson! Newest models pack so much power, speed and stamina they're well worth waiting for until your dealer can deliver YOUR Harley-Davidson!



**HARLEY-
DAVIDSON
MOTORCYCLES**

HARLEY-DAVIDSON MOTOR CO.
Department P, Milwaukee 1, Wisconsin
Please send free copy of 24-page
"Enthusiast" Magazine, filled with
motorcycle action pictures and stories.

Name.....
Address.....
City.....State.....

SAY YOU SAW IT IN POPULAR MECHANICS

**FINE TOOLS
NEED
FINE OIL!**



- Lubricates
- Prevents Rust
- Cleans • Polishes

SOLD EVERYWHERE

3-IN-ONE Oil

**Sand Casting—Forging—Heat Treating—Case Hardening
BRONZE FOUNDRY**



is again available in limited quantity without priority. Orders filled in sequence as received. INVENTORS—SCHOOLS—CRAFTSMEN use FOUNDRYETTE for making castings quickly for new inventions, for instruction, and general purpose. Order now for early delivery. Three sizes are available capable of making bronze castings of 1½, 3, and 6 pounds weight, aluminum, copper, brass, etc., \$17.50, \$24.00, \$34.50, f.o.b. Kansas City. Domestic gas supply and 110 volt AC or DC energy required for operation. Write for circular.

KANSAS CITY SPECIALTIES CO.
Box 6022, Dept. P-69 Kansas City, Mo.

NEW THOR "B" ENGINE—\$9.95

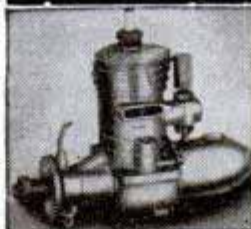

The new THOR "B"—Sensational miniature gasoline engine that really works. Super-power performance. Smooth, velvety power that roars into action with a "twist of the wrist." Over 10,000 already sold this year. 1/6 H.P. Complete with coil, condenser, and fully illustrated instructions, only \$9.95. Ready to run, guaranteed. No technical knowledge required. Powers all models. Send \$1.00—shipped collect same day C.O.D.

FREE Just off the Press. Send for big 40-page illustrated hobby catalog with over 300 illustrations and over 1,000 listed items. The "Bible" of wide-awake modelers. Write for it now—no obligation, naturally!



AMERICA'S HOBBY CENTER, INC.
Dept. B86, 156 W. 22nd St., N. Y. 11, N. Y.

SPONGE-AWAY



**Checks
Scratching**

You give your scratching dog quick comfort when you sponge him with (or dip him in) Sponge-Away solution. It allays itching; kills any fleas, lice, ticks. Also promotes healing, regrowth of hair. Don't let your pet scratch himself into a worse condition or continue suffering. Get 25c bottle (makes 2 quarts) from pet, drug or department store today.

A PULVEX QUALITY DOG PRODUCT

The case of the Chipped Chisel

One chisel is as good as another, the buyer thought. But now, still shiny and new, this one has a chipped edge that gives it away. It was a "bargain counter" tool. It couldn't do its job.

The importance of quality in tools and hardware ... the sheer wastefulness of spending good money on a poor product ... is an old story to any *Popular Mechanics* reader.

And your hardware dealer is just as quality-minded as you are. His business success *depends* on quality. He's the man to see for tools and hardware that will not let you down.



YOUR HARDWARE DEALER
Sells QUALITY Tools and
Hardware. Buy from HIM.

✓ **POPULAR MECHANICS**



**"A '40...and just as
BEAUTIFUL
AS EVER!"**



SIMONIZ Restores Showroom Beauty to Even the Dullest Finish

Why drive a car that looks its age? **SIMONIZ** the finish and it glistens like new again. Bring back the sparkle quickly, safely with Simoniz Kleener. Then apply **SIMONIZ** to protect it against damage by gritty mud, corrosive airborne chemicals and scorching sun rays. For longer lasting beauty . . . for keeping the finish sparkling clean by wiping with a dry cloth. If your car's worth driving, it's worth Simonizing. Get Simoniz and Simoniz Kleener, liquid or paste, today!

THE SIMONIZ CO., Chicago 16, Ill.
Recognized for over thirty years as authorities on preservation of fine finishes

Sold by grocery, hardware, variety, drug, paint, 5 cents to \$1, auto accessory and department stores—and by linoleum dealers everywhere



Cables will be 20 $\frac{1}{8}$ inches in diameter instead of 17 $\frac{1}{4}$ inches.

Despite the fact that no new piers will have to be built, resulting in an estimated savings of \$2,500,000, the new bridge's estimated cost of construction is set at \$7,560,000 compared to \$6,618,138.53 for the old one. Incidental and financing expense will require a bond issue of \$8,500,000. The cost of operation of the bridge, maintenance and insurance is estimated at between \$55,000 and \$60,000 a year depending on the insurance rates.

Research work on the new design was carried on by an engineering consulting board headed by Charles F. Andrew, Tacoma bridge engineer. Wind tunnel experiments were directed by Professor F. B. Farquharson of the University of Washington. Altogether, the cost of the wind tunnel and the various models tested came close to \$100,000, of which almost 60 per cent was shared by the Public Roads Administration.

Because of the importance and pioneering nature of these studies, inquiries have come in from all over the world. As far away as Russia and Australia, bridge construction is being withheld until the results of these experiments are made known.

Clearer View Ahead

(Continued from page 101)

Silica sand, used for centuries in glass making, is left out of several new types of glass which may become increasingly important for use in optics, photography, special colored glasses and material which is transparent to ultraviolet rays.

The sandless glass is made from phosphates, borates or fluorides. It resembles silica glass but has different chemical and physical properties. Nonsilica glass has already proved its value in the photographic field, and Dr. Frank L. Jones of Bausch & Lomb says it offers certain advantages in optical instruments.

If and when beryllium glass is made more stable (at present it collapses into a puddle when exposed to air), it may be ideal for lenses. This is because it permits light to pass through it faster than through any other glass. Tests by the American Optical Company revealed that light travels through beryllium fluoride glass at 146,000 miles per second. Light goes through spectacle glass at 122,000 miles per second. Also, if this glass could be used in a lens it would produce less color aberrations.

With scientists probing into mysterious chemical mixtures to produce new kinds of

(Continued to page 232)



STOP LEAKS!



**Cooling Systems
Made Leak-Proof QUICKLY**

WARNER LIQUID SOLDER—Non-Metallic—Deposits Tiny Fibers to Repair Leaks Anywhere in Cooling Systems. Simply pour in! Finds and REPAIRS every crack or hole. Do it yourself—or see your service man.

Warner-Patterson Co., 920 S. Michigan Ave., Chicago 5



MODEL: Gasoline Engine Ready to Run

A precision built and engineered single cylinder FOUR-CYCLE model gasoline engine; adjustable valves; steel pinion and cam gears; a real ignition system; speed 300 to 3,000 rpm; develops approximately 1/2 hp. Bench tested and ready to run. Available with stationary or marine engine base. Full instructions. Lots of fun. Price \$40.00 complete, with coil, condenser and starting rope. Immediate delivery.

The THOMPSON ENGINEERING CO.

7 3/4" high—3" wide
Cyl. 1" dia.; stroke 1" 206 Winchester Place, Grand Rapids 2, Mich.

REPAIR FURNITURE

WITH THE GLUE THAT
MANUFACTURERS USE

FRANKLIN GLUE

GENUINE LIQUID HIDE GLUE

READY-TO-USE

Makes joints stronger than the wood itself. No mixing — No heating — No unpleasant odor — No chilled joints.

THE FRANKLIN GLUE CO., COLUMBUS 15, OHIO

AT YOUR HARDWARE DEALER



What keeps the pages
nice and neat
And guarantees the
set's complete?



Dennison
GUMMED REINFORCEMENTS
At Stationery Departments Everywhere

Dependable Bike Light MEANS SAFETY

GOOD LIGHT
EVEN AT A WALK
WITHOUT BATTERIES

CAN'T
BLOW BULBS



MAKE-A-LITE BICYCLE LIGHT Generator

MAKES night cycling safe! Run-down batteries and dim lights account for numerous accidents. Make-A-Lite provides bright, unfailing light, even at a walk, without batteries! Generates electricity, cost-free.

Automatic voltage control generator prevents blowing of bulbs at high speed. Separate circuits for head and tail lamps prevent damage of one from affecting the other. Both lamp bulbs interchangeable.

At Your Bicycle, Hardware
or Sporting Goods Store



Easy TO
INSTALL

MAKE-A-LITE DIVISION
Chefford Master Mfg. Co., Inc., Fairfield, Ill.

SAY YOU SAW IT IN POPULAR MECHANICS

SWIVEL-HEAD FLASHLIGHT

nothing else like it!

**HEAD TURNS
LIGHT AT
ANY ANGLE**



Greatest advance in flashlight design in a generation. Turn powerful pre-focused beam where you want it . . . stand it up . . . clip it on . . . both hands are free. A handsome, durable, all-purpose flashlight for everyone. Ask your dealer.



**\$2 LESS
BATTERIES**



No. SW-22
Patented

No. 75 Heavy-Duty Dated
Cell. Fresh
Lasts longer. 10¢

Flashlights & Batteries

If dealer cannot supply, send \$2.00 to Dept. P
UNITED STATES ELECTRIC MFG. CORP., New York 11, N. Y.

*USALITE Red-Head Safety Flashlight -
a "MUST" for the motorist.

SAY YOU SAW IT IN POPULAR MECHANICS

Test-O-Lite the MODERN TROUBLE SHOOTER



THE NEON GLOW

. . . LOCATES TROUBLE INSTANTLY in electric circuits, fuses, cut-outs, motors, radios, appliances. Tests everything electrical from 100 to 550 volts. Indicates hot or grounded wires. Tells AC from DC. Engineers prefer it because it has patented safety features.

↑ PUTS "FINGER" ON THE TROUBLE SPOT -- QUICKLY

Far superior to ordinary clumsy test bulb. Saves precious time. Indispensable in shop or home. Vest pocket size. Lifetime guarantee. List \$1.50 (Pat. No. 1,778,883) Purchase through regular electrical dealers.

L. S. BRACH MFG. CORP.

200 Central Ave. Newark, N. J.



FUSES



MOTORS



OUTLETS



HUNTER'S COMPASS

Hunting Case, Watch
Type, All Metal, **\$2.50**
Jeweled Longines

**Engineers All Metal Army
Type Hand-Sighting**

LEVELS

\$1.50



PUBLIC SPORT SHOPS

13 S. 16th St., Phila. 2, Pa.

No COD's

YOUR ELECTRIC DRILL

Has 100 Other Uses

when used with K-Jax attachments

METAL SAWING . . . SHEARING

RIVETING ATTACHMENTS

Write for illustrated circular

K-JAX, 2600 Canton St., Dallas, Texas

AMAZING MODEL AUTOGIRO

Really flies!
Chupp

ROTOR-FLYER

CAPTIVE AUTOGIRO

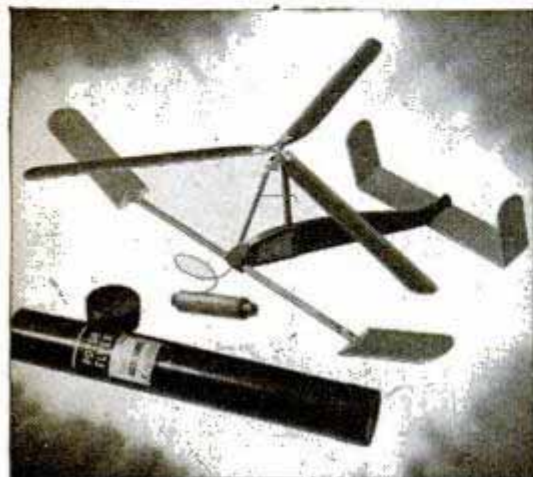

Be first in your neighborhood to own and fly the sensational new ROTOR-FLYER. This captive autogiro needs only an 8-mile breeze. Enthusiastic owners report flights over 2000 feet! More than a toy—an amazing scientific model—designed by an experienced aeronautical engineer. The ROTOR-FLYER is based on the same patents . . . embodies the same principles . . . as full-size autogiros. Sturdily constructed of the best materials.

Send name and address for
INTERESTING FREE BOOKLET

and name of nearest dealer.

Address: ROTOR-FLYER,
Dept. P-10, Room 202,
230 Fifth Ave., New York 1, N. Y.



Electrically Welded Endless

Paramount

BAND SAW BLADES



Made in widths from 1/8" to 1-3/4"

Make your band saw do more work for you. The proper width of blade will extend the scope of this important machine. Burrill's Paramount Blades are made from tough Nickel Alloy Steel properly tempered. Teeth accurately set and filed, and all saws carefully straightened. Send order and check today. Delivery will be made as promptly as conditions permit, from a few days to a week or two. You can obtain these saws at the following prices:

1/4"-3/16"-1/4"-3/8" wide, 5'6" long.....\$.90 each
 1/2"-3/16"-1/4"-3/8" wide, 6'6" long..... .95 each
 3/4"-3/16"-1/4"-3/8" wide, 7'6" long..... 1.10 each

Other sizes at proportional prices

ALSO METAL CUTTING BAND SAWS

Made in widths from 1/8" to 3/4"

Your satisfaction is guaranteed

BURRILL SAW & TOOL WORKS

407 E. Main St., Iilon, N.Y.



AN EXTRA HAND- FOR PAINTING

Paint stays level - can't swing or spill. "Painter's Pal" clamps on pail, hangs securely on ladder. Fits quart to gal. pails. Stamped and welded steel construction. Holds 100 pounds. For right or left hand. Satisfaction guaranteed.

"Painter's Pal" For Brush and Pail
 At Your Dealer
 Or \$1.25 prepaid, from



GENERAL ENGINEERING CORP.

CHARLOTTE MICHIGAN U. S. A.

Sampsel

AUTOMATIC CONTROLS for Hand-Fired FURNACE or BOILER

Thermostat, Limit Control and Electric Damper Motor automatically operate draft and damper maintaining even temperatures—saving fuel. Package sets include everything needed for easy installation. Order from your local furnace dealer. For free literature write . . .

SAMPSEL TIME CONTROL, INC.
 618 Strong Ave. Spring Valley, Ill.



PULVEX DDT FLEA POWDER

now also contains
 GUARANTEED BY
 GOOD HOUSEKEEPING
 IN DETECTION OF
 NOT AS ADVERTISED THEREIN

Kills the fleas
 QUICKLY!
 Keeps others off
 for days!
 Still 25¢ and 50¢



A Better Bit Brace

WILL HELP YOU DO BETTER WORK

Every craftsman knows that better tools produce better work. And that's what a Stanley Bit Brace does. It puts skill in your hands and it represents the ultimate in material, design and performance.

Look at Stanley Bit Brace No. 923 - head of fine tropical hardwood, steel clad-bronze bushing in head to minimize wear, with end thrust carried against ball bearings - heavy steel rod - chuck with steel shell and hardened, forged jaws to hold bit or drill securely for true boring.

A word to the wise craftsman is - buy Stanley.

STANLEY

Trade Mark

HARDWARE · HAND TOOLS · ELECTRIC TOOLS

Here are two books well worth owning

The first book is free . . . "The Joy of Accomplishment", a brief introduction to tools and their uses. The second is the famous textbook . . . "How to Work with Tools and Wood", recently revised, fully illustrated. The cost is only \$1.

Stanley Tools, 186 Elm St., New Britain, Conn.

Please send by return mail

- FREE booklet: "The Joy of Accomplishment."
- 188-page book: "How to Work with Tools and Wood." \$1.00 enclosed.

(In Canada: Send order to Stanley Tool Co. of Canada, Ltd., Roxton Pond, Quebec.)

Name

Address

City State

SAY YOU SAW IT IN POPULAR MECHANICS

THE FAITHFUL
HEART
OF YOUR FUEL
SYSTEM



AC FUEL PUMPS

Pulsing steadily, hundreds of times a mile, your AC Fuel Pump is the strong, reliable heart of your fuel system. It has given you long, faithful service because of its inbuilt quality and scientific design.

You can prolong that faithful service indefinitely, if you insist upon an AC when you replace your present pump with a new or rebuilt one.

AC SPARK PLUG DIVISION • GENERAL MOTORS CORPORATION

glass, improved spectacles, sunglasses and lenses of all types are appearing on the market constantly.

There are new sunglasses which prepare eyes during daytime for speedy adaptation to the dark. This development should make night driving and flying somewhat safer. Developed by American Optical, the new lens transmits only 15 percent of visible light and absorbs glare and dangerous invisible ultraviolet and infrared rays. Thus, the glasses enable a person's eyes to adapt themselves to darkness within 30 minutes, the normal time required for complete adaptation to darkness. War pilots wore the glasses during daytime flights to condition their eyes for night missions. Lenses are a rose shade instead of the standard green previously worn by the Army Air Forces.

Another type of glare-reducing goggles developed by Professor Walter R. Miles of Yale University is useful for observing welding operations and for studying the sun. While most of the lens is coated with a "light smoke" color, a darker narrow patch covers the center, directly in front of the eye's pupil. By making the patches oblong and setting them at right angles to each other, both pupils are given complete glare protection, yet objects that appear close to the sun can be observed by at least one eye.

Use of special goggles is one way to protect a person's eyes. American industry is now going a step further by carefully checking workers' vision in order that they may be assigned to jobs for which their vision qualifies them. Both of two men may have good eyesight, but one may have the type of vision best suited for close inspection work while the other is a "long distance see-er" who would make an expert crane operator.

An eye testing instrument designed by Purdue University and Bausch & Lomb scientists supplies the information needed for assigning jobs to fit a worker's vision. Called an Ortho-Rater, the eye checker is a type of stereoscope which employs test slides in the form of transparencies mounted on rotating drums and illuminated by a centrally located lamp. A separate drum is used for the distance and near tests. Looking through the eyepiece, a worker views a wide variety of charts and pictures in both black and white and color. Results of the test give the job placement director a pretty accurate picture of the worker's capabilities with respect to his eye "power."

Glasses pose a serious problem for some workers whose jobs are such that lenses

(Continued to page 236)

Thrilling 4-cylinder outboards



SPEEDIFOUR



BIG FOUR

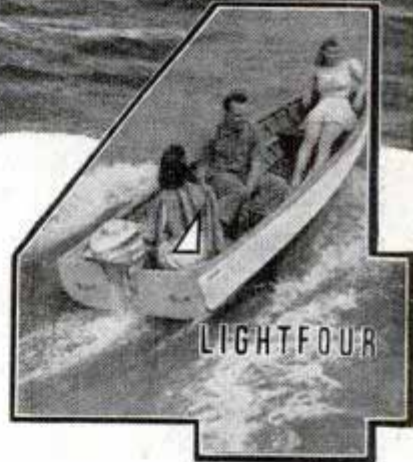

LIGHTFOUR



ZEPHYR

Only Evinrude builds them!
Four superb models —
5.4 to 50 horsepower*

Only one choice . . . it's an Evinrude "four" — if you'd like to enjoy the last word in outboard performance. *There's nothing like a "four"* — for fast fishing craft, family boats and swiftest runabouts. *Matchless smoothness* . . . a thrilling flow of velvet power that rolls back the miles with effortless ease. Instant responsiveness—zooming pick-up and rugged stamina that means years of carefree service.

Even for boats of modest size there are "fours" just right in power and weight. The Zephyr — "light as a twin and smooth as an eight" — develops 5.4 horsepower*, weighs only 46 pounds. The popular Lightfour, 9.7 horsepower*, 63 pounds.

See your Evinrude dealer — look for his name under "Outboard Motors" in your classified telephone directory. Catalog of the complete Evinrude line of 8 models sent on request. Write for it today — address, EVINRUDE MOTORS — 5344 N. 27th St., Milwaukee 9, Wisconsin.

In Canada: Evinrude Motors, Peterboro, Ontario.



*
Zephyr, 5.4 h.p. at 4000 R.P.M.
Lightfour, 9.7 h.p. at 4000 R.P.M.
Speedifour, 33.4 h.p. at 4000 R.P.M.
Big Four, 50 h.p. at 5000 R.P.M.

*All ratings are O.B.C. certified
brake horsepower ratings.*

FREE

ALLIED'S 1946 RADIO CATALOG

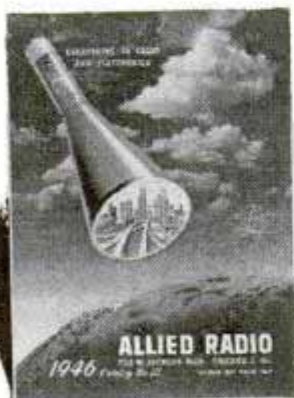

Send for it
NOW

**LARGEST STOCKS
OF EVERYTHING
IN RADIO . . .**

SERVICEMEN! Dealers! Soundmen! Amateurs! Builders! Experimenters! Send for the handiest, most complete 1946 Buying Guide for Everything in Radio! Features latest radios, sound systems, amateur and builders' gear, thousands of radio and electronic parts—world's largest and most complete quality stocks—at lowest prices. Fastest service; expert help!



**NEW RADIO SETS
COMPLETE SOUND SYSTEMS
LATEST HAM GEAR
ALL SERVICE EQUIPMENT
BUILDERS' SUPPLIES
RADIO BOOKS**



MORE THAN 10,000 ITEMS

Everything for every radio use: New model home radios, phono-radios, recorders, communication receivers, Hamkits, code apparatus, radio parts, tubes, tools, test instruments, public address equipment, low-cost easy-to-build kits, diagrams and matched parts lists, largest selection of instructive books—all at lowest prices!



ALLIED RADIO

ALLIED RADIO CORP.
833 W. Jackson Blvd., Dept. 5-HH-6
Chicago 7, Illinois



Rush new FREE 1946 CATALOG.

Name.....

Address.....

City.....Zone.....State.....

SAY YOU SAW IT IN POPULAR MECHANICS



SPECIFICATIONS

TYPE — Resonating Jet
WEIGHT—16 oz. (Approx.)
DIAMETER — 2 in.
LENGTH — 27 1/2 in.
THRUST — 2 lbs. (plus)
CG FROM NOSE—5 1/4 in.
STARTING — Hand fire pump
SPARK PLUG — Champion V-3
FREQUENCY—
210-230/sec.

A modern jet propulsion motor scaled down to fit the design requirements of model building enthusiasts. Can become an integral part of model planes, speed boats and cars. Extremely low frontal area and 27" length allow speed model designs with exceptionally low drag—speed being limited by aerodynamic cleanliness of model construction.

See your dealer now to insure receiving your MINIJET early. Be ready to compete in the new super-speed jet class.

MINIJET MOTORS

161 East California St.
Pasadena 5, Calif., U. S. A.

NEW TOOL READY

**QUICKLY SHAPES, SANDS, CARVES, PROFILES, BANDSANDER
GRINDS, BEVELS, SMOOTHS, POLISHES, CLEANS!**

War industry's most versatile machine—now available to hobbyists, craftsmen, model makers, pattern makers, home workshops—cuts fast and clean on wood, metal, plastics! Works equally well on inside cut-out openings or irregular outside edges, on intricate scrolls, curves. Saves hours of tiresome hard work—does better job. Nothing else like it. IDEAL TO GIVE OR GET FOR WORKSHOP! Sold on 5 Day's Trial, money back GUARANTEE.



FREE!

Write for free, lavishly illustrated Circular describing how Bandsander—the machine that amazed the experts—saves time, money, trouble. Write now—a post card will do!



MEAD SPECIALTIES CO.
4114 N. Knox Ave., Dept. 18, Chicago 41, Ill.

BUILD THESE PROJECTS

For garden or lawn. Easy to build. Easy to sell. Detailed Blueprints Model B-25 Dutch Windmill 50c; Model OM-60 Old Mill, 85c. Lawn Figure Patterns—Sunbonnet Girl, Dutch Boy, Tulip Girl, Holland Pair, 35c each, all 4—\$1. Catalog illustrating many models, send 10c, today.

CRAFTSMAN'S MODEL CO., Dept. P-94, 2030 N. 41st St., Milwaukee, Wis.

DIE-LESS DUPLICATING

Many small parts can be formed without dies, to duplicated accuracy of .001" with DI-ACRO Precision Machines,—Benders, Brakes, Shears. Save die expense and time delay. Ideal for experimental and research work, making samples, models, etc., as well as regular production runs. Write for descriptive literature.

O'Neil-Irwin Mfg. Company
341 8th Ave. South
Minneapolis 15, Minn.



POPULAR MECHANICS



AMAZING NEW BATTERY

Needs water only 3 times a year...

IN NORMAL CAR USE

Lasts longer, too!

The Auto-Lite "Sta-ful" Battery has more than 3 times the liquid reserve of ordinary batteries. In normal car use the plates are kept submerged to help deliver full life and power long after the plates in ordinary batteries are exposed and inactive.

In addition, oversize electrical capacity, plus Fibre-glass insulation, gives longer life than batteries without the Auto-Lite "Sta-ful" features.

Be sure your next battery is an Auto-Lite "Sta-ful."

AUTO-LITE BATTERY CORPORATION TOLEDO 1 OHIO

Manufacturing Plants at:

Niagara Falls • Indianapolis • Atlanta
Oakland • Oklahoma City • Toronto



Switch to AUTO-LITE

Tune in the Auto-Lite Radio Show Starring
Dick Haymes HELEN FORREST • GORDON JENKINS'
ORCHESTRA & CHORUS
Thursdays 9:00 p. m., E. T., CBS



Unique new design and construction gives Auto-Lite "Sta-ful" more than 3 times the liquid reserve of ordinary batteries.

Both Batteries Filled

Liquid Level After Equal Evaporation

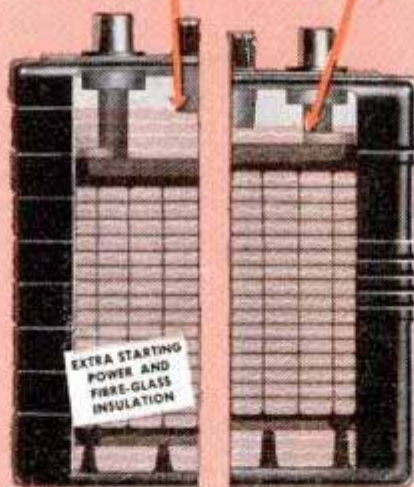

Auto-Lite "Sta-ful" Ordinary Type

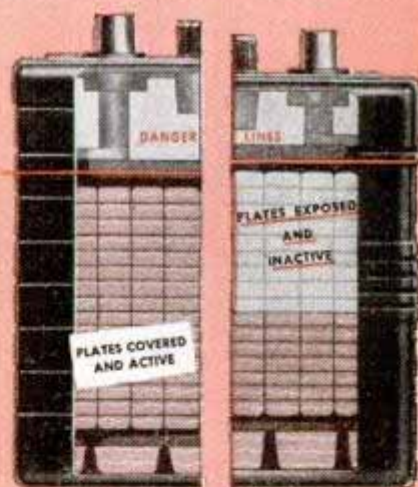

Auto-Lite "Sta-ful" Ordinary Type

Illustrations above show the result of equal evaporation in the Auto-Lite "Sta-ful" Battery and other batteries. As shown by illustration on the far right, plates of ordinary batteries are exposed sooner by water loss and then become inactive faster.

For sale by Auto-Lite battery dealers everywhere



AUTO-LITE

AGAIN AVAILABLE

Luther
HAND AND POWER GRINDERS



FAMOUS FOR 50 YEARS
Luther Grinders — manufactured to the most exact specifications and chosen by those who insist on quality tools — are again available. Select your new hand or power grinders from Luther's complete line.

LUTHER
GRINDER & TOOL CO.
ESTABLISHED 1896
SHEBOYGAN, WISCONSIN

become covered with steam, fog, or perspiration, with the result that vision is clouded. One answer has been contact lenses—thin, saucer-shaped plastic lenses that fit under the wearer's eyelids.

So much improvement has occurred in the design, manufacture and fitting of contact lenses that today an estimated 85 percent of all persons wearing glasses can successfully use contact lenses.

Worn on and moving with the eyeball, the contact lens is invisible. It becomes part of the refracting system of the eye and produces the same correction regardless of the position of the eye. Some people wear them 18 to 20 hours at a stretch, others three or four. The average is about eight hours, according to a survey.

Dorothy Parker once said, "Men seldom make passes at girls who wear glasses." Makers of contact lenses like to quote this wisecrack.

The Fishing Fleet Goes Scientific

(Continued from page 152)

pipied to all vital parts. Motor-driven ventilation fans force fresh air throughout the ship, and various stations are connected by an intercommunication phone system. All deck winches and cargo hoists are powered by electric motors operated with push-button switches.

Traditional watches need not be stood in the engine room except for performing maintenance work. Normally the main engine is operated by remote control. From the wheelhouse the engine can be started, speeds changed ahead or astern, and stopped. Auxiliary controls on each bridge wing permit "remote remote" control of the engine so the vessel can move to keep up with a school of tuna while the man on watch stands outside.

Steering is performed by a "metal mike" gyro pilot that can be disengaged to permit electromechanical maneuvering in close waters. The entire steering apparatus is hooked to a large gyro compass below deck.

For smaller ships, the Sperry Gyroscope Company developed a compass combining features of a gyroscope and magnetic compass. This device allows the standard magnetic compass to be installed on the part of the ship that has the least magnetism—usually high on the mast. Deviation errors are minimized. A gyroscopic control averages the compass readings and transmits them to a repeater compass in the wheelhouse. The readings on the repeater are free from swing, regardless of rolling and pitching. The gyro magnetic compass can

(Continued to page 240)

SMOOTH HORSEPOWER

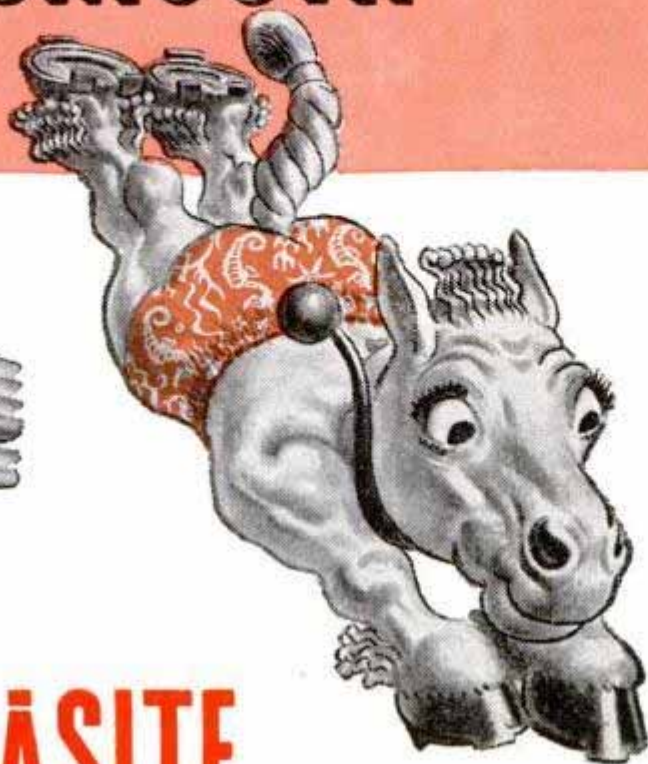

CASITE GUARANTEES BETTER AND SMOOTHER PERFORMANCE OR DOUBLE-YOUR-MONEY-BACK

★ New or old—your car will run better and last longer with Casite. Casite protects stiff new motors during the critical break-in period . . . gives older motors new smoothness, pick-up and power.

Casite carries oil quickly to the tight spots . . . reduces engine wear . . . retards formation of sludge and gum . . . *cleans motors—keeps them clean.*

Millions of motorists use Casite all the time. Service stations, garages and car dealers everywhere sell it.

Put a pint in the crankcase every oil change and a pint through the air intake every three months for *guaranteed* better and smoother performance all-year-round.

THE CASITE CORPORATION, HASTINGS, MICHIGAN • In Canada: Hastings Ltd., Toronto

NEW RADIO SHOW: "RIGHT DOWN YOUR ALLEY"
AMERICAN BROADCASTING CO. • EVERY SUNDAY AFTERNOON



GUARANTEE

Add Casite to crankcase and run through air intake according to instructions, then drive your car 100 miles or for 60 days, whichever is first. If not convinced that Casite gives you better and smoother performance, you get double-your-money-back by filling out guarantee certificate and mailing it to The Casite Corporation, Hastings, Michigan. Maximum refund is \$1.30 per pint, twice the nationally advertised price of Casite.

Tuffy POWER-ARM DRIVER

FOR LOOSENING TIGHT, RUSTED SCREWS

Tuffy's tremendous EXTRA LEVERAGE loosens tight, rusty screws easy; tightens screws so they stay put! Power-Arm closes for regular driving. Strong aluminum handle, forged steel blade. In 3 popular sizes from \$1.95 up; Kit Box of all 3 sizes, no extra charge. Ask your tool dealer or write us for free folder.

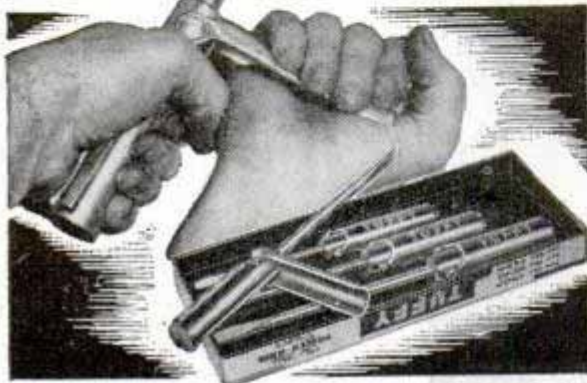

DEALERS: Write for complete merchandising details.
SWALLOW AIRPLANE CO., Inc., Wichita 7, Kansas

IF YOU HAVE A HAND FINISHING OPERATION

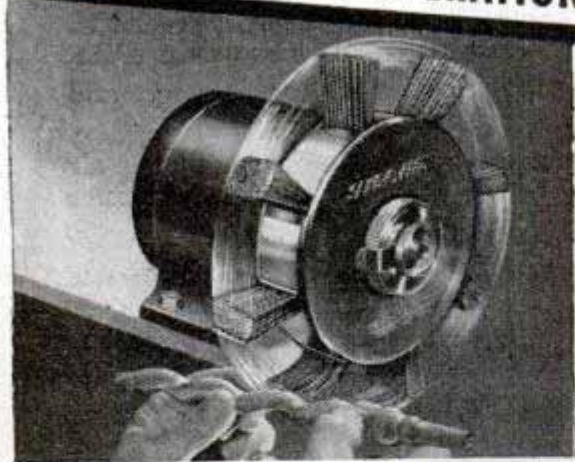

USE A SAND-O-FLEX

Trade-Mark Reg. U. S. Pat. Off.

The new Sand-O-Flex Contour Sander gets in and around curved surfaces. Replaces hand sanding, filing and scraping. The central magazine houses a strip abrasive that threads out in front of brushes. The brushes cushion the abrasive and force it into the hard-to-get-at places. Abrasives come in a wide variety of grits—one for every purpose. Sand-O-Flex adapts to any motor shaft, and now comes in three sizes for every type of home or production use. For complete information, write to

SAND-O-FLEX CORPORATION

4373 Melrose Avenue • Los Angeles 27, California

WELD

ANYTHING ANYWHERE ANYTIME

ALL PURPOSE ARC WELDER
 9 Models . . . 32 Volt D.C., 110 to 440 A.C.

A complete workshop in itself! Weld, cut, braze or solder any type metal; iron, castings, aluminum, steel, bronze . . . in any gauge or weight, with equal ease. Compact, complete, sturdy as the Rockies. Formed steel and cast aluminum case, welded steel base, 4" cast wheels. Built with voltage control. Better on R.E.A. lines. No training needed. Sold throughout the world. Unconditionally guaranteed for 2 years. Fully equipped—ready to use.

FORNEY MFG. CO.
 FORT COLLINS 2, COLORADO

BUILD Your Own SCOOTER WAGON or WHEELBARROW

—Shopping Cart—Golf Cart or Toys. Sturdy Rubber Tired Pressed Steel Wheels. Bright red enameled. Hundreds of uses. Build a bassinet, portable play pen, doll carriage, baby cradle cart etc. Sent postpaid in U. S. on receipt of price. Immediate shipment.

CIRCLE METAL MFG. CO.
 4266 E. Pacific Way
 Los Angeles 23, Calif.

4 inch; 3/4 inch bushing	75 ^c
	each
6 inch; 3/8 inch bushing	1 ⁰⁰
	each

FIND UNDERGROUND MINERALS and METALS with M-SCOPE

Employs same principle as Army Mine Detector. Unsurpassed in Efficiency. Write for Free 16 page booklet.



FISHER RESEARCH LABORATORY
 PALO ALTO CALIFORNIA

Write for Free Catalog of 45 Kits Today

MEIER BRASS & COPPER CO.
 1320 E. Larned, Detroit 7, Mich.

BRASS RODS

For Home Work Shops

For use on model boats, airplanes, etc., keep a supply of these free-turning brass rods on hand. Each kit contains a complete assortment of sizes.

SHARPER CUTTING EDGES

Easy • Accurate • Quick

It's easy to hone keen cutting edges on your chisels and plane blades. Precision adjustment for ANY ANGLE of bevel. Roller glide makes every stroke uniform across oil stone. Light, strong—ideal for home craftsmen, hobbyists, carpenters, cabinet makers.

check or money order
\$2.95
 POST PAID

McLAREN INDUSTRIES, INC., Box 606, TROY, N. Y.

Simplified Shaves

ENDERS



Speed SHAVER
Easy does it

Men who like to do things the simple, easy way, fall in love with Enders their first shave. Easier, quicker from start to finish. That's because of Enders clever simplicity of design and action. Gives pressureless shaving. Gets the hard-to-reach whiskers. Shaves close with safety, comfort. Get an Enders today.

because double thick deluxe blades clicks in like magic nothing to take apart streamlined action new safety

Blades 5 for 25¢ Dept. R

49¢
with 6 BLADES

DURHAM-ENDERS RAZOR CORP. Mystic, Conn.

ALARM CLOCKS



Two inch watch type, Swiss movement, with luminous hands and dial. Husky bell alarm will outlast ordinary alarms many years, \$6.65. Musical alarms too, \$17.95.

ONLY **\$6.65**
PREPAID

HARLEY CLOCK SHOP
Dept. P
425 Aitman Bldg.
Kansas City 6, Mo.

PHOTO ENLARGEMENTS



Is Photography your hobby? Do you want a profitable easy business at home? Make PHOTO ENLARGEMENTS for yourself and others. Your cost 5¢ each and less. The AU-TO-MATIC requires no experience. Also COPIES any picture. \$9.60 COMPLETE. Interesting circular FREE.

5¢
ANY SIZE

PHOTO-SPHERE, Dept. B, Long Island City 3, New York

MARCOT KEY MACHINE

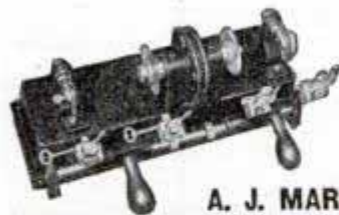

Marcot No. 8 Key Machine Mounted on Cabinet... \$ 75.00
Book on Modern Locksmithing 3.95
Auto Code Book and Auto Depth Key 12.50
162 Doz. popular Key Blanks 77.75
Set Key Files, Tools, Pins, Springs, Thimble 10.50

\$179.71

A. J. MARCOTTE CO., 1200 N. Kedzie Ave. CHICAGO 51, ILL.

SHEATH WAR-BORN WONDER OIL

Eliminates Cause of Rust

[A CHEMICAL DEVELOPMENT OF SCIENTIFIC WARFARE]

—Here's a jungle proven rust preventive that actually eliminates the cause of rust. Now you can keep tools and equipment—everything you own—free from rust with Sheath.

EVERY HOME WORKSHOP NEEDS SHEATH—Sweaty hands soon ruin unprotected precision instruments. Damp basements play havoc with your tools and equipment. Sheath ends all such rust troubles—protects forever.

Cleaves to wet or dry metal surfaces giving an amazing film of protection that displaces water, finger prints, all the causes of rust—Not messy or greasy—a light, free-flowing oil that acts like magic. You've never seen anything like it!

SPECIAL INTRODUCTORY OFFER—Your dealer may not yet have Sheath, so to those who act at once we will send our regular full 8-oz. \$1.00 bottle direct with all postage paid. Simply enclose one dollar bill or money order and forget your rust worries.

BROWNELL INDUSTRIES, Dept. 10, Montezuma, Ia.

IT'S TRUE! YOUR RUST WORRY'S OVER

A TOOLSHOP IN YOUR HAND!

- GRIND • DRILL • ROUT
- POLISH • ENGRAVE
- CUT • SAND • SAW, etc.

Make Things From Wood—Plastics—Metals—Glass—Linoleum—Leather—Alloys—Horn—Stone—Bone, etc.

HANDEE TOOL OF 1001 USES

Smooth, steady power at your fingertips! Perform precision operations not possible with any other portable tool! With a Handee you can turn out professional looking projects for pleasure or profit—ship, plane and train models, costume jewelry, wood carvings, puppets, initialed tumblers, etc. AC or DC. 25,000 r.p.m. Wt. 12 oz.

USE THE RIGHT ACCESSORIES! Choose them from the most complete line . . . more than 300 made right in the Handee plant.

GET A GOOD START GET THE HANDEE KIT

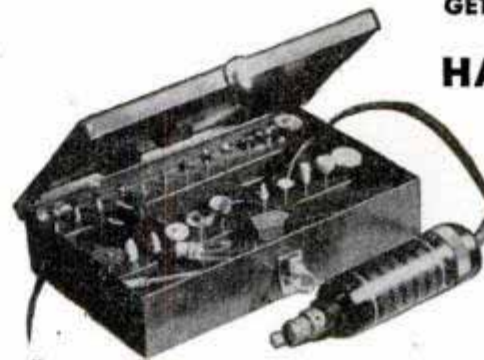

HANDEE Tool and 45 most popular accessories packed in compact steel carrying case. You'll be amazed at what you can accomplish!

Postpaid, \$25.00

Handee only, \$18.50

FOR YOURSELF OR A FRIEND... THE GIFT OF A LIFETIME!

NEW PRECISION ATTACHMENTS

Fit Handee only; enable novice or craftsman to do perfect work. Magically, easily, your offhand carving, routing, shaping will be exact as to depth of cut, accuracy of line. Set of 6 attachments with instructions, postpaid, \$7.95



ORDER NOW. SATISFACTION GUARANTEED!

FREE! NEW 52-PAGE MANUAL

CHICAGO WHEEL & MFG. CO.
1101 W. Monroe St., Dept. PM
Chicago 7, Ill.

Send Handee Kit Handee Tool Precision Attachments C.O.D. Remittance enclosed Send Manual

Name.....

Address.....

SAY YOU SAW IT IN POPULAR MECHANICS

"DUSTLESS" SWEEPING SIMPLE AS THIS



Fill the Dustless brush reservoir with Arbitrin

sweeping fluid. In the process of sweeping, this fluid filtering through the tufts makes sweeping compound out of dust on



The result:



Germ culture after ordinary sweeping



Germ culture after "Dustless" sweeping

the floor. The result: You eliminate up to 97% of the dust in the air between sweepings. You also have cleaner floors and cut sweeping costs. Thousands of factories, shops, stores, and schools now use "Dustless"

sweeping. Write for complete facts today.

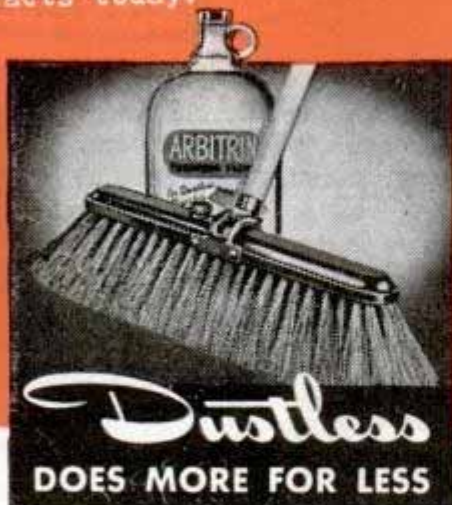

- Dustless
- Speed Sweep
- Speed Wash brushes

MILWAUKEE DUSTLESS BRUSH COMPANY

528 N. 22nd Street - Milwaukee 3, Wisconsin

be hooked to automatic steering equipment.

Like the rest of the postwar tuna clipper, the "Chicken of the Sea" is equipped with a supersonic Fathometer that indicates bottom at depths to 1000 fathoms. The vessel has a radio loop compass for taking navigational bearings. Its radio equipment also includes a world-wide code transmitter and a radiophone for short distance conversations and for communicating with scout aircraft.

Tree Farms Restore an Empire

(Continued from page 112)

paper to prevent drying. These are crated 1600 to 2000 per crate and cost \$4.26 per 1000 at the nursery. Anyone, an individual, commercial forest operator or small tree farmer, can purchase seedlings there. The Nisqually nursery raises about five million seedlings each year.

Trucks haul the seedlings to the remote end of a forest trail where planting operations are scheduled. Another truck picks up the boys at their homes. High school teachers who have been taught the work are sometimes called in as foremen. The boys are paid 75 cents an hour and are allowed one hour travel time from home and back daily. Men are paid 90 cents an hour with time-and-a-half if they are foremen. Each boy carries either a planting bag with two bundles of 50 seedlings strapped to his back, or a double-bit mattock—the sole and highly effective planting tool. Planting starts about the first of February and ends the last of April, depending on the weather. If the dry season starts earlier, planting must end earlier.

The trees are spaced eight feet from each other. Tall guide-poles keep rows straight and prevent spotty planting. Seedlings are planted in the shade of snags or rocks to protect them from sun and wind. The average boy plants 540 trees per day.

The boys planted 1324 acres on the Mowich Lake road in 1944, working only on Saturdays and during spring vacation. An additional 285 acres were planted by foremen. All told, the boys set out 572,550 trees and earned \$6400 in wages. It cost less than two cents per tree to plant the area. The men earned more per hour but did very little more work than the 15 to 17-year-olds. The slight difference proves the value of the boys to the program.

Daily planting records are kept for each boy and each crew. Down at forester Norman Jacobson's office at Tacoma Tidelands these records are transferred to maps, indexed and filed in a vault. Forty years

(Continued to page 244)

**FOR EVERY HOBBYIST
FOR EVERY WORKSHOP**

1002



Pat.
Pend.

THE NELSON Precision VISE

Here's what you've been waiting for. A finer Precision Vise enabling you to work to a fine degree of accuracy. Nothing quite like it before. Carry in any tool box—fasten anywhere. Ways precision milled...V shaped design...Hardened steel jaws... Each Vise checked with a go and a no go gage...Jaw width 1-3/16"... Opening 3/4"... Weight 1 lb. Sent post paid on receipt of \$5.75. Cavalier Sales Co., 4221 Beverly Blvd., Los Angeles 4, California. Dep't B.

Now AVAILABLE!



CROSMAN Silent RIFLES

America's favorite compressed air rifles for indoor or outdoor shooting are back again! Available in .22 cal. single shot and Magazine Loading Types. At your dealer—or order direct. Ask for Crosman SUPER-PELLS too—the better ammunition for all compressed air rifles.

CROSMAN ARMS CO., INC. ROCHESTER 7, N. Y.



**MASTER CHAMPION
LAWN MOWER SHARPENER**

Also Mfg., Saw Sharpening
& Key Machines

FRANK'S MFG. CO.

LUCAS 6929
Dept. PM2, 3312 Tweedy Bl.
SOUTHGATE, CALIF., U.S.A.

AERO-DRY



The perfect line drier. Metal fingers neoprene coated for protection. Collapses to 4 1/2 x 4" for tackle box. Holds up to 200 yards of line. Priced \$1.50. Larger size \$3.00. Mail order today. Enclose check or money order. Hall Line Corporation.

7611 Park Avenue, Highland Mills, N. Y.

"WONTWIST" ANIMAL TETHER



SAFE FOR ALL
ANIMALS, BALL
REVOLVES IN ALL DIRECTIONS.

Send Check or Money Order \$2.95 DEPT. P-6
Price Includes Delivery Charges

THE HAYDEN CO., Bryn Mawr, Pa.

STRONG
EFFICIENT

DEPT.
P-6



**RIGHT NOW is
the right time
to . . .**



That dripping pipe . . . that crack in the furnace . . . those loose door hinges . . . casters and handles that fall out . . . all those little repair jobs—get after them NOW with Smooth-On No. 1 Iron Repair Cement, famous since 1895 for stopping leaks, sealing cracks, tightening loose parts.

No heat required—applied like putty. Smooth-On repairs are inexpensive, too—cost vastly less than a repair man's bill . . . and are lasting. Get Smooth-On No. 1 in 1 3/4-oz., 7-oz. or larger size at your neighborhood hardware store. If they haven't it, write us.

**Get This 40-Page
Repair Handbook FREE**

Clear, simple, practical directions. 170 diagrams, Pocket size. Dozens of short-cut repairs. Just send the coupon.

—SIGN AND MAIL NOW—

**SMOOTH-ON
CEMENTS**



For the
Motor Car and Boat,
Home, Factory and
Power Plant

Smooth-On Mfg. Co., Dept. 37

570 Communipaw Avenue, Jersey City 4, N. J.

Please send me a Smooth-On Handbook.

Name.....

Address.....

8-46.....

Do it with SMOOTH-ON
The Iron Repair Cement of 1000 Uses

IT'S GOOD NEWS WHEN YOU GET A BURGESS vibro-tool

Trade Mark Reg. U.S. Pat. Off.



Whether you purchase the Vibro-Tool alone, for \$7.50, or the De Luxe Kit and sharpening stone with 22 accessories for all types of engraving on metals, plastics, glass; wood carving; leather tooling; cardboard cutting, etc., you are on your way to new thrills and new ability to do hundreds of craft and home workshop jobs easier and much faster. (110V., A.C., 60 cycles)

SEE YOUR DEALER or order direct

(HANDICRAFT DIVISION)
BURGESS BATTERY COMPANY

166 N. Wabash Avenue Chicago I, Ill.



SET
T-52
**Deluxe
Electrical
Ignition
and
Radio Set**

All For \$13.00
List Price

See your dealer or write us

SPINTITE SET

A Positive Need in Every RADIO, HOME and ELECTRICAL SHOP.

Contains Chuck Type Handle, Reamawl, 3 Screw Drivers, 2 Pliers, 7 SPINTITES and Insulated, Neutralizing Alignment Wrench.



STEVENS WALDEN, INC.

WORCESTER 4, MASSACHUSETTS

ELECTRICITY FOR ANY JOB ANYWHERE

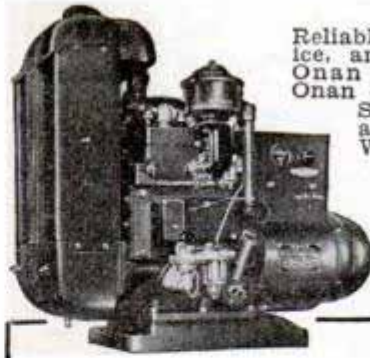

Reliable, economical electric service, anywhere, anytime, with an Onan Electric Plant. Driven by Onan 4-cycle, gasoline engines. Single-unit, compact design and sturdy construction. Water or air cooled.

Capacity range: 350 to 35,000 watts; 115 to 660 volts A.C., 50 to 800 cycles; 6 to 800 volts D.C. Combination A.C.-D.C. types. 65 different models

WRITE FOR FOLDER

ONAN

D. W. Onan & Sons, 2520 Royalston Ave., Minneapolis 5, Minn.

Power Sprayer only \$5.95



The Mars Power Sprayer illustrated uses any gas engine as the air compressor. Can be operated from spark plug of your automobile or truck. Sprays paint, varnish, shellac, insecticide or any finely mixed, free flowing liquid. Complete with a trigger controlled sprayer, pint jar, spark plug air check valve, compression tank, adaptors for all size spark plugs and 12 feet of hose.

Engine Driven Tire Pump and Compressor complete with adaptors for all cars with 12 feet of hose and tire connection at only \$4.50.

MARS PRODUCTS COMPANY

DEPT. C, 1170 BROADWAY, NEW YORK, N. Y.



Made From IMPORTED BRIAR

BULLDOG SADDLE



Enjoy unmatched sweet smoking quality, outstanding fine grains, in modern designs.

Write for FREE illustrated booklet. \$3.50 to \$10

C. B. WEBER & CO., 141 Cafor Ave., Jersey City 5, N. J.

BUILD ARC WELDER PLANS 35C

We Show You How to build this new powerful welder without rewinding. For light or heavy work. Uses coils taken from old auto generators. Works on 110 or 220 volts A. C. Has 20 different heats. Send 35c for complete PLANS and valuable Catalog. Write today. LEJAY MFG. CO., 1347 LeJay Bldg., Minneapolis 8, Minn.



Appliance \$10⁹⁵ Tester

LOCATES TROUBLE INSTANTLY IN ALL ELECTRICAL DEVICES

In this single unit are all the necessary tests for examining every appliance. Checks thermostats under working conditions. Tells instant it opens or closes. Controls heat on soldering irons. Prevents over-heating. Tests continuity, open circuits, automatic irons, vacuum cleaners, motors, coin machines, bulbs, 3-way switches, etc. Great time, and money saver! ONLY \$10.95 COMPLETE. No C.O.D.'s, shipping wt. 3 lbs.

Pat. Pend.

FREE with each Tester. New, Complete Practical Course in electrical appliance repairing. WRITE FOR CIRCULAR. HANLAN CO., 1419-A, West Jefferson, Los Angeles 7, Calif.

A TOOL... NOT A BRUSH



\$1.00 POST PAID

PAINTERS' STRIPING TOOL

Easy to use as a pencil! Draws parallel lines, straights, curves, circles with paint, enamel, lacquer, etc. Do your own striping on autos, furniture, toys, bikes, model planes, signs, linoleum... make wall board look like tile. Painters—craftsmen, order today! Type "M" Master Painters' Striping Tool complete with tip for 1/16" stripe, \$1.00. Extra tips 1/64", 1/32", 3/64", 1/16", 5/64", 3/32", 1/8" - 75c each. Tool with complete set of 7 tips \$5.00. (C.O.D. orders 25c extra.) Dealers write!

WENDELL MFG. CO.
4234-B Lincoln Ave., Chicago 18, Illinois

NOW! PAINT STRIPING MADE EASY!

Build Your Own RADIO RECEIVER



And listen to your own radio programs—this Kitcraft Radio Set brings them in clear as a bell. Easy to build; works anywhere. Complete with mica condenser, tested galena crystal and 20-page illustrated manual containing diagrams, theory and step-by-step building and operating instructions. Base of "Lucite" plastic; no soldering or batteries required. Uses any type earphone. Thousands in use. **MONEY BACK GUARANTEE.** Sent prepaid or C.O.D. plus postage. **ORDER TODAY!** Dept. PM-8

KITCRAFT INC. 614 North San Vicente, Los Angeles 46, California

only \$2.95 complete less phones

SPINIT—GAS MODEL STARTER
Ideal For Model Plane Builders



Gas model fans, this is IT! "If it will run—a SPINIT will start it!" Sturdily built. Finger tip release. Makes model flying more fun. Available at dealers. Standard model, \$4.00. Write for folder!

STREED ELECTRIC CO.
1315-A Harmon Pl., Minneapolis 3, Minn.

STEEL SPRING POWERED
AUTOMATIC SAFETY RELEASE
RUBBER CUSHIONED DRIVE
PAT. APPLIED FOR

FOR BIGGER PROFITS FROM SMALL LATHES!

UNIQUE BENCH LATHE TOOLS ARE BUILT RIGHT... THEY ARE "TOPS" FOR DOING ALL PRODUCTION JOBS BETTER AND FASTER!

UNIQUE BED TURRET...TAPER ATTACHMENT...TAIL STOCK TURRET...ADJUSTABLE KNURLING TOOL... AND OTHER UNIQUE PRODUCTION EQUIPMENT WILL MAKE YOUR BENCH LATHES PAY OFF BETTER.

UNIQUE MFG. CO., 4807 N. 31st Ave., Omaha, Neb.

SEND FOR **FREE** DESCRIPTIVE CIRCULAR AND NAME OF NEAREST DEALER

Unique PRODUCTION EQUIPMENT

MAKE YOUR OWN COSTUME JEWELRY BIG EARNINGS AT HOME



YOU can make costume earring and pin sets, brooches, necklaces, dress clips, cameos, etc.

WE supply the jewelry findings; bar pins, ear screws, jump rings, chains, screws, stone sets, sequins, shells, boxes, cement, cards, etc.

WRITE FOR FREE CATALOGUE

PHILADELPHIA BADGE, 1007 FILBERT ST., PHILA. 7, PA.

This famous

RIGID

gives you most pipe wrench for your money...



Only RIGID offers you this money-saving guarantee

UNCONDITIONAL GUARANTEE
If this Housing ever Breaks or Distorts we will replace it Free

CO. PA. 1957
THE RIDGE TOOL CO.
ELYRIA, O.

● You get powerful I-beam handle so comfortable you can give it all the pull you've got—*barehanded*. Precision-cut alloy jaws take-hold and let-go instantly—full-floating hookjaw has handy pipe scale, heeljaw is replaceable. Adjusting nut won't bind, spins freely in all sizes. And the guaranteed housing means long expense-free service—most for your money. Buy **RIGID** at your Supply House.

RIGID

WORK-SAVER PIPE TOOLS

THE RIDGE TOOL COMPANY · ELYRIA, OHIO, U. S. A.

1 SCREW
DRIVER
does the work
of **3**

MILLERS FALLS *Automatics* can handle any job

With only one screw driver—the Millers Falls Spiral Ratchet—you can do *any* screw driving job quickly and easily. It can be used as a regular rigid screw driver, a right or left hand ratchet, or as a complete automatic. Changes are made simply by shifting the knurled control sleeve and the spiral lock nut.

Smooth, powerful action and tested dependability are built into Millers Falls Automatic Screw Drivers. They will give you long-lasting satisfaction in your home workshop or light production assembling. Ask your dealer to show you these fine Millers Falls tools.

One Thing in Common—QUALITY!



MILLERS FALLS COMPANY
GREENFIELD, MASSACHUSETTS



from now, when the boy is a middle-aged man, the company will invite him to return to the forest at the company's expense to see what he did in his youth!

Alder is being cut off old lands at present and thinning cuts will be made in the fir stands in 15 and 30 years. All logging roads are now permanent. In 1994, when the company starts cutting trees planted in 1944, about 70 percent of the trees probably will be utilized instead of today's 50 percent and yesterday's 3 to 35 percent. The new hydraulic barker adopted in 1944 by the northwest pulp mills raises visible northwest pulpwood supply by 20 percent. In 1890 Douglas fir brought 50 cents per 1000 board feet on the stump in the woods. Today it is from six to ten times that expensive. Tomorrow it may be twice today's values. Some authorities claim an acre of growing trees, by 1960, will be worth \$25 each year as a source of plastics and chemicals alone.

The owner of a tree farm of 640 acres can look forward to a comfortable old age, utilizing his carefully managed timber crop as a source of permanent income, like the milk from a dairy farm. If he can't realize a return on the work during his lifetime his son will harvest the profit.

Elephants Are Good Pupils

(Continued from page 139)

Because many elephants remain standing even when asleep (one elephant did not lie down in nearly 20 years) a rigging may be used to pull them off balance and to teach them to "hit the dirt" upon command. Sitting up is simple as the beasts need only to roll to a sitting position with the front feet held up.

The headstand, most spectacular of the elementary tricks, is quite easy because in that position the trunk serves as an extra leg helping the elephant to balance.

Trainers teach circus elephants to "tail up" trunk to tail to keep them in line. It also keeps them from using their trunks to belabor the cash customers in the front rows. The "shimmy" is another popular trick, easy because elephants have naturally loose skin. To teach it the trainer ties a rope loosely around the animal's body. At the command the trainer and his assistant shake the rope. Another way to teach this trick is to place a sack of sand on the elephant's back. All elephants like to throw objects on their backs and then shake them off. Soon the beast shakes upon command.

A famous circus elephant, Rajah, learned to read. His trainer put a blackboard in

(Continued to page 248)

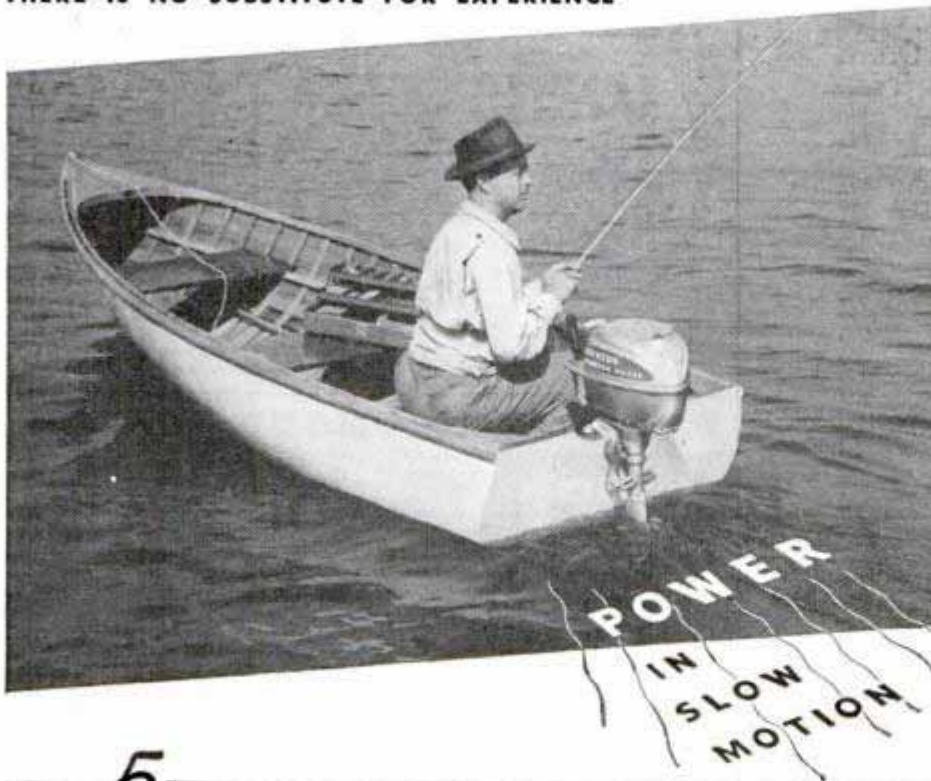

There's *power* under that hood. But as long as you want to go slow, *you go slow!*

That's control—the result of Johnson Dual Carburetion and Johnson precision. A rotary valve cuts in automatically at low throttle and you purr along as sweetly as at full speed.

Dual Carburetion, Reverse with 360° Steering and Perfected Alternate Firing (for liquid power flow) are the "big three" of outboard motoring. You get them all in a "Sea-Horse."

And just as important as any feature is Johnson SERVICE. With Johnson's experienced, nation-wide dealer-service organization, you *know* that you can always keep your "Sea-Horse" in tip-top condition.

JOHNSON MOTORS, 400 Pershing Rd., Waukegan, Illinois

5
GREAT
MODELS

Small Alternate Firing Twin	31 lbs.	2.5 H.P.
Medium Alternate Firing Twin	44 lbs.	5.0 H.P.
Large Alternate Firing Twin	70½ lbs.	9.8 H.P.
Super Alternate Firing Twin	92½ lbs.	16.0 H.P.
Heavy Duty Opposed Twin	115¼ lbs.	22.0 H.P.

All ratings are O.B. C. Certified brake horsepower at 4000 r.p.m.

JOHNSON
SEA-HORSES
for DEPENDability

Write for your copy of the new "Sea-Horse" Handy Chart of motors and specifications. Look for the name of your Johnson Dealer under "Outboard Motors" in your classified phone book.

Johnson Makes "SEA-HORSE" Motors Only—No Others

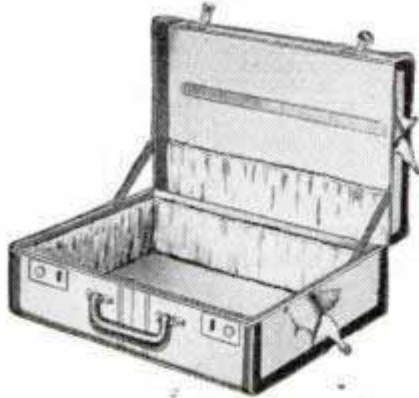

MENDS
LUGGAGE, BOOKS

... also china, glassware, toys and furniture. Makes models, too. It's waterproof, transparent, flexible.



DUOCO CEMENT
REG. U. S. PAT. OFF.

Now you see it—Now you don't

FOLD-HORSE

(Patented)

—folds away into most any out-of-the-way corner in a jiffy when you are not using it. You'll want this sturdy saw-horse if your home workshop has only limited room, because the Fold-Horse folds down to the neat, compact size of only 8" x 9" x 42" in a matter of seconds. And—it's built to last a lifetime. It's so simple to assemble and much stronger than most horses. All

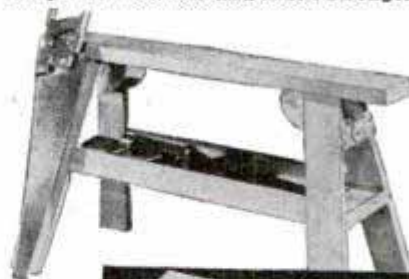

metal parts are 14 gauge steel, cadmium plated to prevent rust. The top is standard 2" x 6" x 42" and made of clear pine. Tool tray is 9" x 36". Only a limited number can be manufactured for a while—so, get your order in today!



Lists at \$9.95 each

Jobbers Note: a few select territories still open—inquire.

UNIQUE TOOL PRODUCTS COMPANY

4634 N. Clark Street, Chicago 40, Illinois

Gentlemen:

Your patented "Unique Fold-Horse" is not available from my local jobber, so please send me.....for which I enclose my check for \$.....

Name.....Title.....

Firm Name.....

Street.....

City and Zone.....State.....

IS SKIN BETWEEN TOES—CRACKED ITCHY, PEELING?

Watch out for Athlete's Foot!



Don't delay—apply Zemo—a Doctor's fast acting agent—so wonderfully soothing yet so *powerfully effective* that first applications promptly relieve itching soreness and aid healing. Zemo actually kills on contact the germs that cause and spread Athlete's Foot. It helps guard against re-infection. That's why Zemo has such an amazing record of *continuous* success! First trial convinces. Buy at any drugstore.

ZEMO



GERSTNER Tool Chests
Outstanding Chests because of better construction and finer finish. Free catalog for Tool, Die and Pattern Makers.

GERSTNER TOOL CHESTS
446 Columbia St., Dayton 7, Ohio

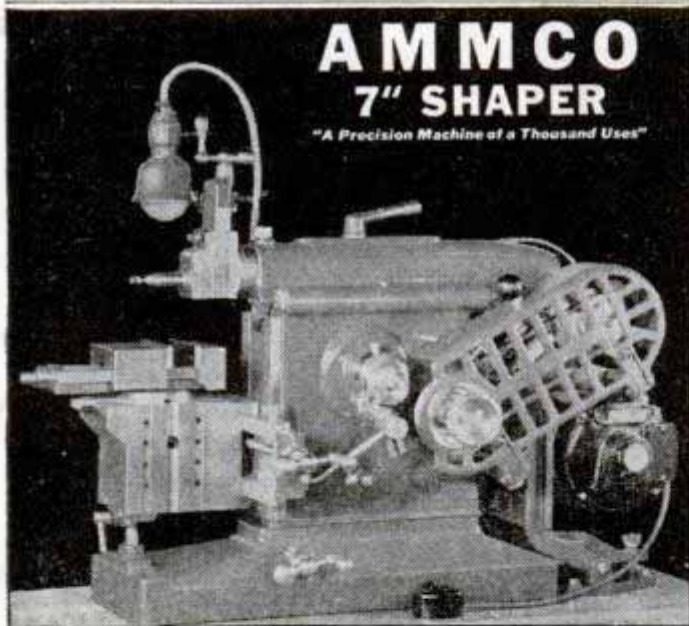

AMMCO 7" SHAPER

"A Precision Machine of a Thousand Uses"

A wide variety of jobs can be done accurately, quickly, easily, and economically on the AMMCO Shaper (7" stroke). Construction incorporates many features you would expect to find only in larger, more expensive machines... For example: WAYS of ram, tool head, and front face of the main frame are of the "VEE" type, hand scraped to insure accuracy and long life. Available for stationary installation or as portable unit.

Write today for specifications and prices

AMMCO

2140 Commonwealth Ave. North Chicago, Ill.



VET'S TIE CHAIN

Fine quality tie chain that makes an ideal gift for an honorably discharged veteran. Packaged in neat gift box. Chain holds actual reproduction of Honorable Discharge emblem!

\$1.50

X175—Gold Plated

\$1.50

X176F—

1/20 12K Gold Filled

\$3.50

Price Includes

Postage & Tax
NO C.O.D.

H. J. SALES

P. O. Box 361, Chicago 90, Ill.

BUILDING CONSTRUCTION



with composition cement and cheap wood builds 3 room house low as \$250, farm buildings low as \$50. Homemade forms make blocks, panels and tiles in color, and wallboard of sawdust and other compositions. Wall-high blocks, insulated, with finished sides. Stream-lined roof and walls. Cement gutters, troweled roofs and floors. Ten formulas. Cabins, stores and sectional. 100 money and labor saving ideas. Mixer and saw easily made from an old auto. Make doors and windows. 50 proved ways to earn \$10.00 to \$15.00 a day. Guaranteed, book, 100 illustrations, \$1.00.

MAKE FURNITURE OF COMPOSITION cement, sawdust, asbestos, paper. Some part scrap wood and metal. Illustrated instructions to make tables, cabinets, chests, racks, shelves, inclosed sinks, lawn novelties and toys. 500 per cent profit. 50c.
HOW TO MAKE ACCURATE SHOP MACHINES: Band, jig, and circular saws, electric drills, sanding wheels, forge, tools, electric weed cutters and many other things from old auto parts and washing machine motors. Illustrated. 50c.
HOME MFG. ENTERPRISES. 50 selected home shop projects, illus., 50c. Special: All four booklets described above, \$2.00 postpaid. No C.O.D.
HOME INDUSTRIES, 1318 So. 30th Ave., Dept. PM, Omaha 5, Nebr.

SAY YOU SAW IT IN POPULAR MECHANICS

SAVE MONEY ON GASOLINE

FITS ALL CARS

Now you can get up to **30%** extra gasoline mileage with a Vacu-matic on your car. Quicker pick-up, smoother running, added power saves money every day. Guaranteed. **Automatic Supercharge Principle** Vacu-matic is *entirely different!* Operates on the Supercharge principle. Saves gas. Automatically provides a better gas mixture. Guaranteed to give up to **30%** extra gas mileage, more power and better performance.



SALESMEN WANTED

Big profits. Every Car a Prospect. Send name and address for **FREE PARTICULARS** and how you get yours for introducing.

Vacu-matic Co., 7617-1286 W. State St., Wauwatosa 13, Wis.

Power Hacksaw \$35⁷⁰ Cap. 4" x 4" Swivel Vise



F.O.B. Kalamazoo, Mich.
NO OTHER SAW LIKE IT for the price. Also Die Filing Machines, Arc Welders, Milling Machines, Shapers, Arbor Presses, Angle Vises, Punch Presses.

JOHN E. KANDLER—Machinery

Write for free literature

214 N. Rose St., Kalamazoo 12, Mich.

SHAW and "Peppy-Pal" GARDEN TRACTORS

1 to 9 H.P. Circulars on request. Building more now. We supply repairs for all SHAW Tractors sold in our 42 years in business.

BUILD YOUR OWN RIDING TRACTOR—"WAR HORSE"

using old auto parts, powered by 2 H.P. or larger air-cooled engine; or walking type Garden Tractor 1/2 to 3 H.P. or convert truck or auto into Farm Tractor. Each with steel or rubber tires; will plow, cultivate. Plans for building, in few hours, any one of above, postpaid for \$1.00 (state which wanted) or all 3 for \$2.00. Money Back Guarantee.

SHAW MFG. CO., 4508 Front St.

Galesburg, Kansas

668G North 4th St.,

Columbus, Ohio

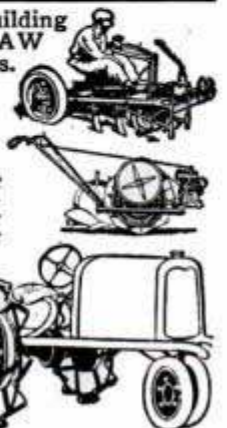

make your own
WORK BENCHES



BENCH LEGS

An arc welded rigid assembly steel bench legs providing support for storage platforms, wood tables and steel benches.

\$2.95 EACH
F.O.B. NEW YORK

WHOLESALE HARDWARE CO., Inc.

761 Tenth Ave., New York 19, N. Y.



Model
BX

\$10.85
LIST

A HONEY OF A MIKE TURNER Challenger

High performance at low cost. Reproduces voice or music crisp and clear. Precision built with moisture sealed crystal. Works indoors or out. Rich bronzed enamel finish. 7 ft. cable. Ideal for hams and home recording. Ask your dealer. Write for Free literature describing Turner Microphones

THE TURNER COMPANY

921 17th St N. E., Cedar Rapids, Iowa

WOOD WORKERS

LUMBER—PLYWOOD AVAILABLE
Harold Hunt wants to send new No. 15 catalog. Over 124 pages of woodworking ideas. **UNEQUALED BARGAINS** in imported and American woods, supplies, hard-to-find hardware. Send only 15c to cover postage and handling.

CRAFTSMAN WOOD SERVICE CO.
2729 S. Mary St., Dept. A-72, Chicago 8, Ill.

only
15¢



ALUMINUM RODS

FOR HOME CRAFTSMEN

Use these free-turning aluminum rods on model engines, planes, etc. Two typical kits below. Send postcard today for complete list.

KIT 1.....\$1.00 plus postage, 7 pcs. 12" long, 3/8" to 1/2" diameter by 1/16ths.
KIT 2.....\$4.00 plus postage, 5 pcs. 12" long, 1/2" to 1" diameter by 1/8ths.



THE PLEASANT CO., Aluminum Div., 13032 E. Jefferson, Detroit 15, Mich.



BLOWERS HEATING COOLING

Blowers and Cooling Supplies. Gas and Oil Burning Furnaces, Conversion Burners. Good Profits. Wanted — men to sell and install.

PEERLESS SALES, 4318 Sheridan, Lincoln 6, Nebr.

A Fine, Precision
EXPOSURE METER

\$13.95

COMPLETE WITH
LEATHER CASE
Including Tax
on Meter



The Sign of Precision

Make your camera take better, sharper photos. Eliminate guess-work, lost pictures and wasted film with a precision-built SKAN Exposure Meter. A *must* for color—still or movies. Be right in *any* light—day or night. Simple to use.

Sold at camera counters everywhere. For free literature write: G-M Laboratories Inc., 4290 N. Knox Ave., Chicago 41, Ill.



EXPOSURE METER

SAY YOU SAW IT IN POPULAR MECHANICS

YOU NEED THESE CRAFTSMAN'S TOOLS

SUPER DRILL GRINDER

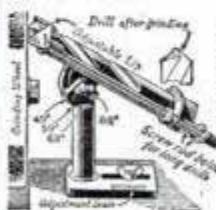

Sharpens round shank drills from 3/32" to 1/16" diameter. Grinds Old Drills like new in 4 different drill point angles. Grinds Short, Medium and Long Twist Drills from 1/4" up to 1 1/2" long, for hand or power grinding wheels.

100,000 IN USE!

Grinds your drills like factory in 25 seconds. Gives perfect center and clearance. Saves drills, time and money. No shop should be without the Super Drill Grinder. Guaranteed to do the work or money back. The Grinder that gives a round point!

Only
\$2.95

SUPER ARBOR

(PATENT PENDING)

A combination drilling or grinding wheel attachment. For 3/8" motor shafts. Will take grinding wheel with 1" hole on shaft and 3/8" hole on small end. Extension can be used for rag or wire wheel, or 3/8", 24-thread drill chuck which holds drills from No. 60 to 3/8" in diameter. Right hand thread only.

Price Only

\$1.50

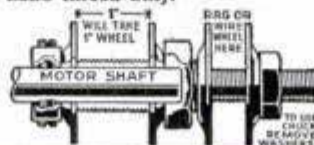

SUPER HACKSAW

AND FLAT DIE FILE HOLDER



The tool with 100 uses! Holds broken hacksaw blades—used by mechanics, electricians, plumbers, auto mechanics, hobbyists and repairmen. Perfect for all-round household needs; ideal for difficult close-quarter work. Nothing like it for tool and die men. Price, without saw blade.

Only
95¢

At Your Dealer's or Postpaid
CRANDALL MFG. CO.
1512 West Stauson, Dept. FA-8
Los Angeles 44, Calif.

3 REASONS

WHY YOU MAY NEED
NEW SPARK PLUGS

BETTER GAS
GREATER MILEAGE
NORMAL SPEEDS

Often the *types* of spark plugs that gave best results with low octane gas, low speed driving, and limited mileage, won't do today. They should be changed to the factory-recommended types—or to "cooler" types if preignition or rapid electrode wear are being experienced.

Your AC dealer has the improved AC Spark Plugs, of correct Heat Range for *your* engine, built to meet today's driving conditions—built for quicker starting, longer life, less fouling. They may save you up to 1 gallon of gas in 10.

More than 2 out of every 4 new cars and trucks built since 1932 were factory-equipped with AC's—because AC's give *utmost reliability* in performance. Try the new, improved AC's in *your* car.

AC Spark Plug Division • General Motors Corp.

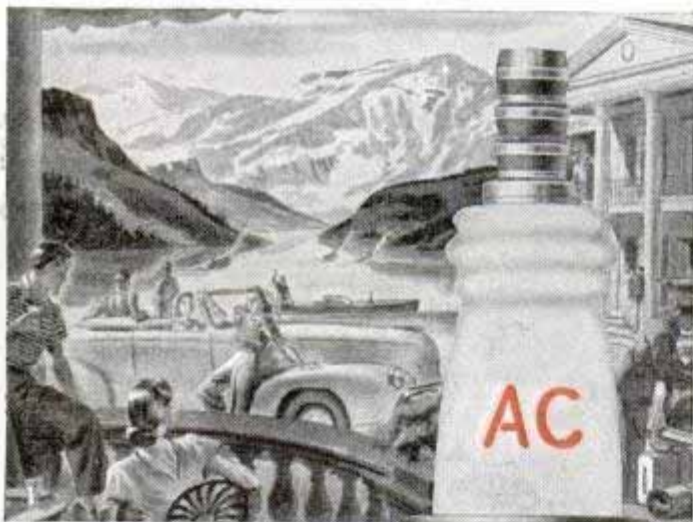

UTMOST RELIABILITY

AC
SPARK PLUGS

front of him and chalked on it the word "March." As he completed lettering the word, he shouted the command at Rajah. Before long Rajah would start to march as soon as his trainer completed printing the word. Rajah also learned to read "Stop."

Elephants like to play and sometimes bedevil their keepers. One Sunday afternoon while on tour, keepers let their herd plunge into a small lake near the circus grounds. Soon it was time to get the animals back to the lot but the elephants played on, squirting water at their frantic keepers. Only when they were completely exhausted did they emerge and permit themselves to be taken back to the show grounds.

Don't Pour Coal Up the Chimney

(Continued from page 93)

insulation and one thin metal reflective surface the heat loss through the recess is reduced to a value corresponding to that of a fully insulated brick veneer wall back of a free-standing radiator. The new radiators, incidentally, take up about 40 percent less space than those made a few years ago.

Another interesting discovery was that less than 50 percent of the required heat is supplied by the radiators. The remainder comes from the chimney, uninsulated pipes and the boiler, with a small amount supplied by lights and occupants. Long ago the university proved that oil paint increases the heat transmission of radiators by 10 percent as compared with metallic paints which provide unwanted insulation.

They found also that the ducts of warm air furnaces are best left clean and shiny. The once-common practice of placing a single layer of asbestos paper over the ducts actually increases heat loss. A half inch of air-cell asbestos is necessary to restore the heat-turning qualities of the bare metal.

Another recommendation is to utilize streamlined ducts offering low resistance to air flow. Narrow, abrupt turnoffs are frowned upon and, where sharp-angled elbows do occur, engineers urge turning vanes as helpers.

Since 1943 studies have been made with radiant baseboards, long, low panels containing hot water. Their heat is spread along the bottom of outside walls, in the coldest part of the room, and the result is warmer floors and less difference between floor and ceiling temperatures than with any other type of heating. This is particularly important for the growing number of basementless houses. Radiant baseboard is easy to clean, it facilitates better furniture placement and eliminates dirt streaks on walls and drapes.



5CP1 CATHODE RAY TUBE BARGAIN

A cathode ray tube buy if there ever was one! 5" medium persistence, green fluorescence. 4 electrostatic deflecting elements led to four terminals in the base. Sensitivity of electrodes near gun is 0.34 mm/volt d.c. Maximum anode voltage 4400 v. 12 pin diheptal base. 17 1/8" overall 5 11/32" diam.

\$7.40

SOCKET FOR TUBE — 99c each
SHIELD FOR TUBE — \$1.98 each

HIGHBRIDGE RADIO TELEVISION & APPLIANCE SERVICE CO.

340 CANAL ST. NEW YORK 13, N. Y.
Send for FREE Monthly Bulletin

THIS TOOL HOLDER GRIPS 4 SIZES OF TOOL BITS!

Same Clark Tool Holder that set production records in industry. Securely grips 1/8, 3/16, 1/4, or 3/16" round, square or dual narrow tool bits or boring bars. Tool bits last longer, do better work. Order 60-L for left-hand, 60-R for right-hand standard 15° cutter channel. Write Dept. PM-8-TH

Either model, shipped prepaid or C.O.D., only **\$6.55**
Money Back Guarantee!

Robert H. Clark Company
9330 Santa Monica Blvd., Beverly Hills, Calif.

Ball-Bearing SPEED WHEELS



Build Your Own—

- Coaster Wagons
- Racers
- Scooters
- Bike Trailers

ORDER NOW FOR PROMPT DELIVERY

8 in. Wheel with Tire \$2.25 each
10 in. Wheel with Tire \$3.25 each

JIM BROWN TOY COMPANY
869 E. Tallmadge Ave. Akron 10, Ohio

GET THE BEST IN MUFFLERS V-8 DUALS & SINGLES

Finest Norman custom-built muffler sets — steel pack — torpedo type — heavy, perforated steel cores — chrome enamel finish — mellow, deep tone (improves with use) — designed to fit — all ways superior — double economy.

DUALS.....\$17.50 SINGLES.....\$7.00
V-8 Ford-Mercury Buick, Olds., Chry.
SINGLES.....\$5.50 ORDER TODAY! Will outlast three ordinary mufflers.
Chev., Ford, Plym. Distributors — Write for Full Details

NORMAN'S MUSICAL MUFFLERS
Dept. PM-5, 1216 W. Slouson Ave., Los Angeles 44, Calif.

Amazing New Way TO TRIM HEDGES—SHRUBBERY!

LA RENE HEDGE TRIMMER



Cuts 100 feet of Hedge in 20 Minutes!

Attaches to 1/4" PORTABLE ELECTRIC DRILL

So Light a Woman Can Operate

Now you can take all the drudgery out of trimming hedges, shrubbery, or ornamental trees with the marvelous new La Rene Hedge Trimmer. This precision instrument attaches easily to any standard 1/4" electric drill (operating at 1,000 to 2,500 RPM) and makes 60,000 cuts per minute.

Made of steel. No nuts, bolts, or screws. No intricate parts to get out of order. Guaranteed for one year against mechanical defects.

Go to your dealer today. If he cannot supply you, order direct. State make and model of drill you own. Send either check, money order, or sent C.O.D.

ONLY **\$16.90**

Write for Descriptive Booklet K

JOHN L. JAMES CO.
Manufacturers

Sales Office: 307 FIFTH AVENUE, NEW YORK 16, N. Y.



New! Complete! RADIO CATALOG

READY NOW! Send For Your FREE Copy!

Radio sets...radio kits (including 19 Popular Mechanics Kits)...radio parts...electronic equipment...amplifiers...complete, standard lines of post-war designed equipment and supplies; pages and pages of what you've been waiting for...in the new Concord Catalog, ready now! Rush coupon for your copy...sent FREE!

CONCORD RADIO CORP.

LAFAYETTE RADIO CORPORATION
CHICAGO 7, ILL. 901 W. Jackson Blvd. • 265 Peachtree St. ATLANTA 3, GA.

CONCORD RADIO CORPORATION, Dept. P-86
901 W. Jackson Blvd., Chicago 7, Ill.
Rush FREE copy of new, complete Concord Catalog.

Name.....
Address.....
City..... State.....

This Exquisite
Marquetry
Cigarette Box
Sells For \$11.00



Make It Yourself
For \$3.55

Catalogue Now Ready Contains ten (10) photographs with shop drawings and instructions for finishing. Includes Silent Butlers, Bookends, Tobacco Humidors and other useful items. Catalogue price 25c

WOODCRAFT MARQUETRY KITS CO., 302 Oakland St., Brooklyn 22, N. Y.

Now . . . Something Brand New for Hobbyists!

WOODCRAFT Marquetry KITS

Each Kit Includes:—brass nickel polished piano hinge and screws . . . genuine black American walnut lumber for box . . . mahogany and porcelain lining . . . felt for bottom . . . shop drawing and instructions . . . and A COMPLETELY LAMINATED MARQUETRY TOP PANEL, 1/4 inch thick!

Subjects:—Mallard—Pheasant—Horse—Dog—Bomber. All in natural and colored woods from all parts of the world.

FULL KIT — \$3.55

(Add 20c for Postage and Insurance)

Now!
A Better Soldering Tool...
THE
VANATTA
KWIKHEAT

THERMOSTATIC SOLDERING IRON

Has Built-in
Thermostat
Control!



6 TIP STYLES

- #0—\$1.25
- #1—\$1.25
- #2—\$1.25
- #3—\$1.25
- #4—\$1.75

#5—Melting Pot
for tinning—\$1.25

HOT, READY FOR USE ONLY 90 SECONDS after plugging in! Kwikheat is the only soldering iron with a thermostat built into the tool itself*—maintaining the proper level of heat for most efficient, economical operation. **SAFE!** . . . Cannot overheat—**ECONOMICAL!** . . . Lasts longer—saves tips and requires less retinning. **POWERFUL!**—225 watts—yet exceptionally light weight (14 oz.). Well-balanced with cool protecting plastic handle. Modern streamlined design. Six interchangeable tip styles adapt one Kwikheat Iron to all your soldering jobs. You will be proud to own America's finest and most versatile soldering tool . . . from tip to plug Kwikheat is in a class by itself. Ask your dealer to demonstrate the quick-heating feature now!

*patented
Kwikheat Iron with choice of any one tip . . . \$11.00
Set of 5 Tips, consisting of #0, 2, 3, 4, and 5 . . . \$5.50



Dept. PM-8, Kwikheat Division of
SOUND EQUIPMENT CORP., 3903 San Fernando Rd., Glendale, 4 Calif.



**MINIATURE
ENGINES**

Gasoline—Steam
Air—Locomotive



THE WORLD'S
MOST FASCINATING HOBBY

Build them yourself — In your own shop
With your own tools



Send 10 cents for my illustrated catalogue listing the world's largest selection of miniature engine castings and drawings.

WAYNE MILLER

Suite 201
Engineering Bldg., Chicago 6, U.S.A.

ATTENTION AUTO OWNERS!

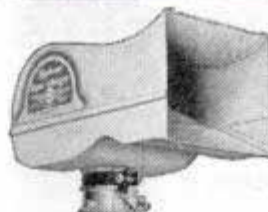

New Power, Pickup, Pep!

Amazing **TYPHOON SUPERCHARGER** is back again, ready to put new life into old motors, add to power, pickup, pep! 41,000 users find gas economy, you will, too. Motor knock vanishes, oil bath air cleaning keeps harmful dust out. Takes 5 minutes to install on carburetor, replacing old air cleaner. Order today, mention make and model of car. Only \$5.95.

(Ohio orders add 3% sales tax, West of Rockies, add 10%.)

TYPHOON PRODUCTS CO. 507-C Engineers Bldg. Cleveland 14, Ohio

METALLIZE BABY SHOES

Learn this easy, money making business from nationally recognized consultant. Small investment; perpetual market. For free details write Joseph B. Kushner, B.S. Ch.E., Metal Finishing Consultant, Stroudsburg, Pennsylvania, R.D. 3N.

WRITE FOR YOUR FREE COPY OF THE NEW KRW HYDRAULIC PRESS BOOK

Describes all manner of Production and Shop Work on KRW Hydraulic and Bench Type Arbor Presses. 32 pages illustrating the new KRW Hand-operated, Electric-operated and Air-operated Hydraulic Presses.
Write for your copy today.



K. R. WILSON, DEPT. 17, 215 MAIN ST., BUFFALO 3, N. Y.

Builders of Shop Equipment for Ford Dealers Since 1916



LOOK! SERVICEMEN — CIVILIANS TOO!
PRECISION BUILT MILITARY WRIST WATCH
THE WATCH YOU'VE BEEN WAITING FOR!



Swiss Movement
 Precision Made by
 Expert Swiss Craftsmen

**SUPPLY LIMITED
 RUSH YOUR ORDER**

A fortunate purchase makes this amazing offer possible. Latest military styling, red sweep second hand, Easy to read Extra Fancy Dial. Comes complete with Leather Strap. A watch you'll be proud to wear or give as a gift. Below O.P.A. Price.

ONLY
\$8.49
 plus 10% Fed. Tax

SEND NO MONEY—Pay Postman \$8.49 plus 85c Fed. Tax, and C.O.D. charges, or, send \$9.34 with order and we pay postage. Return within 5 days if not delighted, providing watch has not been tampered with.

Hurry — Order Now — Supply Limited!

AMERICAN MERCHANDISING CO., INC., Dept. PMW-2
 12 Adams Ave. MONTGOMERY 4, ALA.



DON'T LET GRAY HAIR STOP YOU

Duzz-It will soften the shade and gradually blend your gray hair into its natural color within two to four weeks if used as directed. Sold on a money back guarantee.

\$1.75
 INC. TAX

DUZZ-IT CHEMICAL WORKS
 1912 S. DRAKE AVE. CHICAGO 23, ILL.

PICNIC STOVE and TRASH BURNER

Tree stump of durable reinforced Haydite concrete with grill, charcoal pan, grate. Burns trash safely.

Only \$29.45

Freight prepaid east of Rockies

For descriptive circular write to
W. O. JOHNSON CO., Dept. PM, Omaha 6, Neb.



CASTINGS

SMALL MACHINE TOOLS AND ATTACHMENTS

Many of these castings previously described in Popular Mechanics may be ordered either rough or semi-finished. High Speed Drill Press; Tool Post Grinder; Adjustable-Jaw Vice for Milling, Shaping, and Lathe Face Plate work; Step Collet; Boring Bar Holder; 3" and 4" Tool Post Turrets; V-Blocks; Angle Plates; Face Plates 6" and 9"; Chuck Back Plates 4", 5", and 6". We make castings and patterns for special projects—send blue prints or write us. Also equipped to machine small metal parts in limited quantities for experimenting, small production items, etc.

T-P Manufacturing Company, P. O. Box 7024, Dallas, Texas

Low Price The OTTAWA "Buzz" Master

CLEARs LAND FAST! Powerful 6-HP motor with friction clutch for safe operation. Cuts down timber, brush, hedge; turn blade vertically and saw logs to length. Can be equipped to fell largest trees. Clutch pulley for belt work. Guaranteed.

FREE Details

OTTAWA MFG. CO., 827 Brush Ave., Ottawa, Kansas

CASCO ELECTRI-CRAFT

EXCLUSIVE FINGER-GRIP BRINGS HAND CLOSER TO THE WORK—PERFECT FOR FINE DETAILS

\$22.50 COMPLETE
 \$31.75 value if bought separately

WORKS

- WOOD
- METAL
- GLASS
- PLASTICS



GRINDING



DRILLING



CARVING



ROUTING



POLISHING and 10,000 other uses

MAKE IT BETTER

WITH THE NEW

CASCO ELECTRI-CRAFT TOOL KIT

A whole shopful of tools, complete with 35 accessories—for Hobbyists—Craftsmen—Mechanics.

Casco leads again with the new 1946 Electri-Craft Hand Power Tool Kit to increase your skill, and widen the scope of work you can do in home or shop. It's dynamically balanced, sturdy, safe. Precision-engineered to run in excess of 20,000 RPM on AC or DC. Tools won't wobble. Fan-cooled, air-vented and positively insulated. Vibrationless on ball bearings. Guaranteed. In one economical buy you get a complete portable power workshop: Hand Tool and 35 accessories in dual-use, fitted steel chest. The greatest value ever offered in this field.

Available soon in limited quantities. Watch for it at leading appliance, hobby, department, electrical, jewelry and hardware stores.

watch

CASCO

FOR NEW AND UNUSUAL CONTRIBUTIONS TO BETTER LIVING

CASCO PRODUCTS CORP., BRIDGEPORT 2, CONN.

If you're Modern...

U-DIAL-IT

for any cutting job around
home, office, school, shop and camp!

**JUST LOOSEN THE KNOB AND
SELECT CUTTING POSITION**

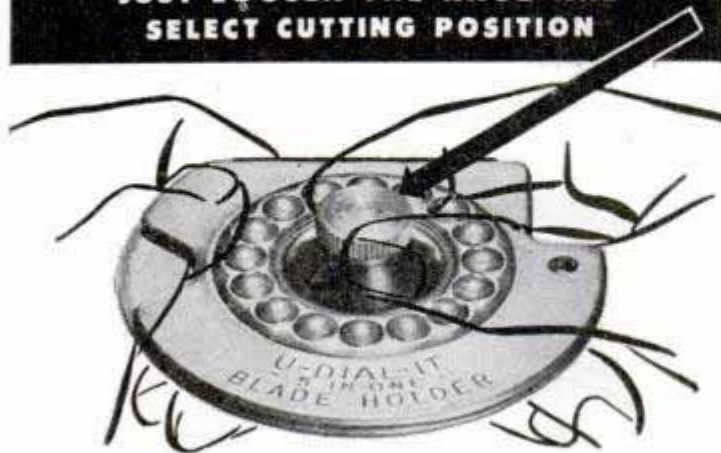

You'll find dozens of uses every day for the U-Dial-It. This sensational, new blade cutter has only 3 parts... aluminum, light but sturdy... plus double edge razor blade.



SCRAPER

DIAL 1-IT SCRAPES

Wonderful for removing putty, paint, stickers, labels, etc.



CORD CUTTER

DIAL 2-IT SLICES

Just right for cardboard, heavy paper, mats, textiles, thin wood, etc.

DIAL 3-IT CUTS

So handy for cutting cord, string, thread, fishing line, leaders, etc.



PAPER CUTTER

DIAL 4-IT RIPS

The best tool you've tried for ripping out stitches and basting quickly, neatly.

DIAL 5-IT CUTS

Amazing for shallow cuts... you can cut out clippings without spoiling other pages of magazine or newspaper.

DIAL CL-IT'S CLOSED

Blade is fully guarded, cutter safe to carry in pocket.



SLICER



RIPPER



CLOSED

Some territories still open for
distributors and jobbers.

DON'T DELAY · ORDER TODAY · YOU'LL WANT SEVERAL!
H. R. BASFORD COMPANY
425 SECOND STREET, SAN FRANCISCO 7, CALIF.

30¢ ea.
POSTAGE PAID
SEND COIN OR
MONEY ORDER

Gentlemen:

Please RUSH today, postpaid;
U-DIAL-IT Blade Cutter(s),
each complete with blade.
I enclose coin or money order.

Name _____

Address _____

City _____ State _____

Report From Bikini

(Continued from page 76)

Incidentally, one tough porker found swimming in the radioactive waters 24 hours later was identified as the lone survivor of a sunken cruiser.

The light steel construction of the radar and radio gear topside on the ships offered little resistance to the blast. Twisted and toppled stacks gave additional evidence along the same lines, adding momentum to present plans to redesign superstructures in view of the heavy wartime damages wrought by kamikazes. The explosion also exerted a surprisingly strong downward pressure, crumpling light steel deck sections hundreds of yards distant. In one of these instances it oddly left a nearby Teletype machine, a comparatively delicate instrument, unscathed, perhaps because of the equality of the blast pressure from all sides.

Oceanographers reported no perceptible disturbance of the lagoon's floor from the first test and there was no wholesale extinction of marine life, according to preliminary studies. Nor was there any major effect on birds in the area.

The most fruitful phases of the oceanographic study are expected from the second and third bomb tests. Knowing the point of release for the bomb, its detonation time and the amount of energy released, scientists will be able to make measurements of the heights of the waves, their movement, their action in shallow water and their effect on the sea bottom and the beaches, in terms of both time and distance. Supersonic echo sounders or fathometers on 16 ships scattered throughout the target fleet will record large waves through the rise and fall of the ships. Eleven fathometers on buoys will monitor the shorter waves. There also will be maximum water height recorders and water level meters on the nearest islands. The water height indicator consists of a pipe, a contractor strip and a dry cell and a series of fuses which burn out as the water passes up the pipe. An alternative and simpler type employed in the air burst test used water-sensitized paper. Photographs made serially from just prior, to several minutes after the explosion, when analyzed will provide measurements of the height, length, velocity and position of the waves at precisely recorded times. The necessary stopwatch timing for the operation will be effected by radio controlling links consisting of transmission equipment in one of the aircraft and ground installations. As each control pulse is received cameras will make an exposure and cycle forward ready for the next pulse.

Famous Barron DRILL PRESS Accessories . . .

Multi-Purpose WOOD PLANER..\$7.50

Fits ANY drill press. Planes, panels, rabbets, routs, tenons, beads, grooves. Machined and balanced. Hi-Speed tool steel cutter knives. Thousands now in use. 10 Day Money Back Guarantee.

Rotary Surface SANDER . . . \$5.95

Fits chuck of drill press. Unexcelled for smooth, even surface sanding of woods and plastics. Original in design and a great labor saver. Complete with 20 sanding discs. 10 Day Money Back Guarantee.

Spiral Flute ROUTER BITS

Special radial shaped flutes for faster, smoother, easier routing, grooving, carving, round-end mortising. Extra long cutting flutes for deeper work. Available in individual sizes. Complete set of 6 sizes . . . \$9.50

Auxiliary Drill Press TABLE \$8.85

Hard Alcoa aluminum 234 sq. inch table. Fits on standard drill press table to give greater working area. Precision ground. Heavily ribbed. With Barron steel fence. A "must" for every drill press.

Write for FREE Catalog

BARRON TOOL CO., INC.

369 Architects Bldg.

Detroit 1, Mich.

BARRON PRECISION WORK SHOP TOOLS

Do YOU Own A Scratching Dog?

Does your dog constantly scratch, dig, rub and bite himself—often until his skin is raw and sore? He may be perfectly clean and flea free, but suffering from an intense itching irritation that has centered in the nerve endings of his skin. He is in torment and can't help scratching—unless you try to help him. Try giving him Rex Hunters Dog Powders, once each week, and note the quick improvement. One owner writes: "If my dog could talk I know he would say thanks for Rex Hunters Dog Powders. He was raw and sore from scratching and just lay around. Now he plays and is full of pep." Ask for Rex Hunters Dog Powders at any good drug store, pet or sport shop. Only 25c. Economy size box only \$1. If dealer can't supply send 25c or \$1 to J. Hilgers & Co., Dept. 218, Binghamton, N. Y.

Keep Your Outboard Motor

FREE OF WEEDS



"KUTWEED" DOES IT. Spins with propeller, chews weeds into shreds BEFORE they can clog propeller. Fits all outboard motors, operating either clockwise or counter-clockwise. Has keen double cutting edges. To attach, remove nut holding propeller, put on "KUTWEED," replace nut. Bend "Kutweed" so tip is 1/4-inch from shaft. Done! ONLY 50 CENTS. If your dealer hasn't "Kutweed," order direct from

KUTWEED SALES COMPANY
Dept. A., 2324 Harriet Ave., Minneapolis 5, Minn.

SAY YOU SAW IT IN POPULAR MECHANICS

BUILD YOUR OWN FAST FREEZER PLANS \$1.00

It's easy to build this household appliance and profitable to use. Save up to 75%. Operates on 110 or 32 volts. Plans show 5 sizes and are easy to follow. ENJOY MAKING ONE of these freezers from new or used parts. No expert knowledge needed. Mail \$1.00 bill or check for complete plans and catalog.

LE JAY MFG., 447 LeJay Bldg., Minneapolis 8, Minn.



1 New - Improved OIL FOR ALL . . .
HOUSEHOLD-SPORTSMAN-MECHANIC
Lubricates - Prevents Rust - Cleans Metal

3 oz. 40c

FIENDOIL



... for SPORTSMEN · BOY SCOUTS FOREST RANGERS · SEAMEN · AVIATORS

Catch a sunbeam and signal accurately to a distant objective on the horizon or in the air with this pocket-size (4" x 5") mirror of tempered resistant-to-shock plate glass. With the cross-shaped aperture in the center, a beam of cross-marked light can be aimed at the target by facing the mirror between the sun and the objective. The thin mirroring film of vaporized aluminum makes it effective through the widest angle from the sun.

Full instructions clearly printed on the opaque lacquered back surface of the mirror. Convenient lanyard, easily suspended from the neck, attached through a hole in one of the rounded corners. Easy to carry—resistant to corrosion—hard to lose or break.

Designed for life-saving purposes for the Armed Forces by General Electric Company in cooperation with the National Bureau of Standards.

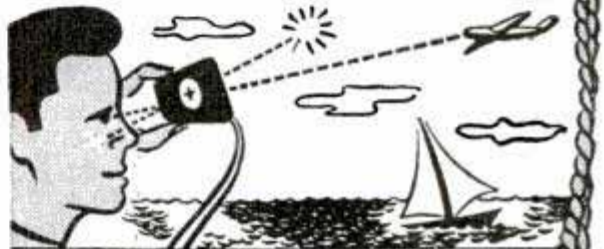

FOR SAFER, SUNNIER WORK OR PLAY,
ORDER YOUR SIGNALING MIRROR TODAY!
Send \$1 with your name and address to Dept. P

ALL-STATE BOX CORPORATION
949 BROADWAY NEW YORK 10 N Y

JUST OUT! GOV'T SURPLUS SOLID BRASS 12 FT. PORTABLE RADIO ANTENNAS

Real \$15 Value Now Only \$3.95 Postpaid
FOR HOMES, BOATS OR AUTOS

Same as used on Army tanks. These telescopic rustproof antenna have a tremendous pickup and eliminate dangerous wiring. Solid Brass throughout practically insures NOISE FREE RECEPTION.

**12 EXCEPTIONALLY RUGGED SECTIONS
COMPRESS INTO 1 FT. 4 IN.**

Handy for Camping Trips, also Useful for Transmitting, FM and Television sets.

Each antenna comes with clamps, nut, lug, and wire. Easy to install anywhere.

QUANTITY LIMITED

MAIL ORDER TODAY. A real \$15 value for only \$3.95 Postpaid. Send check or money order now or mailed C.O.D. plus postage. Money back in 10 days if not satisfied.

RADIO HOSPITAL 1113 LEXINGTON AVE.
Dept. A
New York 21, N. Y.

Atlas DRILL PRESS

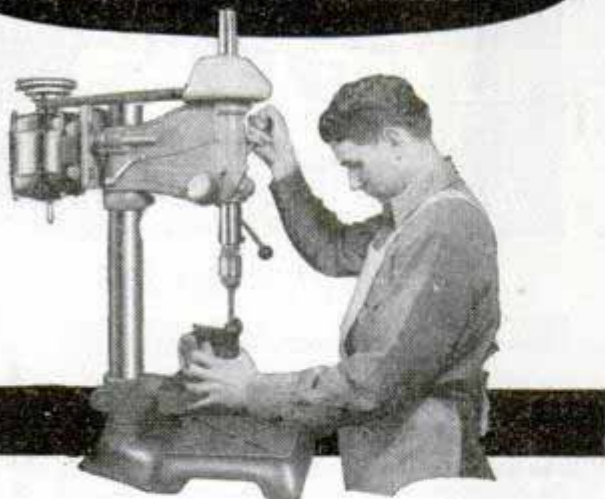

**BROADENS SCOPE OF YOUR SHOP . .
.. SAVES HOURS OF TIME**

With an Atlas and its low-cost accessories, you can handle all kinds of sensitive drilling, tapping, and routing and get real "professional" results on mortise-and-tenon joints for tables, chairs, doors, bookcases, cabinets, storm windows, screens. Ask your Atlas distributor for full details.

LOOK FOR THIS SIGN



ATLAS PRESS COMPANY
843 North Pitcher Street, Kalamazoo 13D, Michigan

NEW SOLDERING GUN

WELLER SPEED IRON* HEATS INSTANTLY



USE SPEED IRON FOR, Home Workshop, Radio Service, Telephone Installation, Electronic and Sound Maintenance, Appliance Repair, Laboratory Work.

New gun type soldering tool produces heat instantly by induction principle in soldering tip. Built-in transformer provides 400 ampere heating current when trigger switch is closed. Fast 5 second heating saves power, saves time, saves tip dressing and burning. Loop type tip is adjustable, gets into corners, lets you see where you are working. Short pistol grip gets you close to work, good balance makes tool very easy to handle. Can solder with aluminum solder or tin-lead solder.

The soldering gun gives you for the first time really fast induction generated heat combined with real convenience of use. For the finest and most advanced soldering tool that money can buy, order a Speed Iron today! Price Complete \$14.95 Postpaid 110 Volt A.C.-60 cycle
ORDER DIRECT *T. M. U. S. Reg. Pat. Off.

WELLER MFG. CO.

522 Northampton St.
Easton, Pa.



WHEELS AT BARGAIN PRICES

BUILD YOUR OWN—
Wagons—Scooters—Mowers—Wheelbarrows—Grocery Carts—Baby Carts—Play Pens—Etc.

We have a quantity of the below size **WHEELS WITH TIRES COMPLETE**, on which we can offer **SPECIAL PRICES**.

- 10 x 1 1/4" wheel and solid tire 1/2" steel bore, . \$2.75 each
 - 10 x 1.75 wheel complete 1/2 or 5/8" bore, argon oil-less bearing, \$3.20 each
 - 8 x 4.00 wheelbarrow wheel, 3/4" oilite bearing, complete with 2 ply tire and tube, \$1.75 each
 - 8 x 2" wheel and tire 7/16" bore—ball bearing, \$2.75 each
 - 10 x 1.75 wheel and tire 7/16" bore, ball bearing, \$3.75 each
 - 10 x 2.75 wheel Semi-Pneumatic tire, 3/8" bronze bore, \$5.75 each
 - 6" scooter wheel, solid tire 5/16" steel bore, . \$0.85 each
 - 4" wheel and tire, sleeve bearing with hub cap, . \$0.55 each
- Write number wheels wanted in space provided, tear out and mail this ad. with check or money order and your name and address.
TRULSON MFG. CO., 809 E. 31 St., Kansas City 3, Mo.

EXPERIMENT WITH BLACK LIGHT!

FUN! THRILLS! PROFITS! See seven page article on this fascinating science in June 1945 issue of Popular Mechanics. We furnish all supplies. Trial Kit of 8 lacquers only \$6.25. Black bulb for testing, \$2.00. Lamps, lacquers, crayons, fabrics, etc. Write for descriptive list and full details today!

BLACK LIGHT PRODUCTS, 67 East Lake Street Chicago 1, Illinois

BIG BARGAINS IN RADIO

FREE! BARGAIN FLYER C-37

Hundreds of dollar-saving values in Lafayette's new Bargain Flyer of radio and electronic parts—just out. Get yours now! Are you on our list for our big, new super-catalog? Lists everything in radio, electronics, P.A. amateur gear. You can't afford to miss it. Write today—we'll send you Flyer C-37 and reserve your copy of the super-catalog.

LAFAYETTE RADIO Dep't. LH-6, 100 Sixth Ave., New York 13

SAY YOU SAW IT IN POPULAR MECHANICS

Fishing Worms

ALWAYS AVAILABLE WITH THIS UNIQUE ELECTRICAL APPLIANCE WHICH BRINGS DOZENS TO THE SURFACE IN SECONDS, MAIL A DOLLAR FOR COMPLETE SET WITH INSTRUCTIONS.

AMERICAN ELECTRO BAIT CO. DEPT. A,
P. O. BOX 6495 WASHINGTON 17, D. C.



Up to \$600 WEEKLY

with new 5 min. photo equipment. *No experience necessary.* Write:

FEDERAL IDENTIFICATION CO.
Dept. HB 1012 N.W. 17
Oklahoma City, Okla.



MOTOR ARBOR AND COMBINATION V-PULLEY
1/2" right .65c 1/2" left .75c
5/8" & 3/4" R & left. \$1.00
Add 10c postage U.S.A. Trade discounts.
F. ROESCH
502P-1st St. Hoboken, N. J.

ONE-MAN SAWMILL LESS THAN \$200

Easy To Turn Trees Into Money

Makes lumber, ties, shingles, crates, lath, studding, siding.

Belsaw Models in 10, 14, 20, 24 ft. sawing lengths Patented Mechanical Feed, accurate set works and positive dogs. Use tractor or old auto engine for low cost power. Thousands used for commercial sawing. Pays for itself quickly. Send post card today for FREE booklet, "How To Make Lumber" and Catalog of Woodworking Equipment.

BELSAW MACHINERY COMPANY
3542 Main Street, Kansas City, Mo.
Dept. 2811-B

12 NORTON GRINDING WHEELS

ASSORTED WAR SURPLUS STOCK



ONLY \$2.00 POST PAID

SIZES 2" to 4" Incl.

This is a splendid value in genuine Norton abrasives—valuable for home work shops or industry. These were used during war production. Please order promptly as supply is limited. Send check or money order today.

A-Y MANUFACTURING CO.
2710 Bay Street Saginaw, Michigan

ELECTRICAL TEST EQUIPMENT

VARIAC General Radio Type 200 CU, 115 Volt A. C. Input; Output variable from 0 to 135 volts A. C. at a maximum current of 7½ amperes. Shipped complete with knob, less dial, in original G. R. carton. ONLY \$12.00.

VOLTMETER Westinghouse NA 33 2½", panel mounting, 0-150 volts A. C., surplus new. \$1.98.

AMMETER Weston Model 528 Portable. Dual range 0-3 Amp. and 0.15 Amp. A. C. full scale. The ideal instrument for all commercial, industrial, experimental home, radio, motor, and general repair shop testing. Comes complete with a genuine leather, push-lined carrying case and a pair of test leads. Your cost only \$12.50.

All orders F.O.B. New York City; 25% deposit on C.O.D. orders. We carry complete line of electrical instruments. Send for free circular.

MARITIME SWITCHBOARD

Dep't. PM1, 336 Canal Street, NEW YORK 13, N. Y.

RACER

HIGHLY POLISHED CAST ALUMINUM

8½ inches long. Heavy single unbreakable casting. Free running rubber wheels. Can't rust. Trim, sleek lines. Looks like models selling up to \$12.00. Form a racers' club today! Every youngster wants one.



Send \$2.98

Postpaid in U.S.A.

Dealer Inquiries Invited
POST OFFICE BOX 43
CHICAGO 17, ILLINOIS

BARTON INDUSTRIAL PRODUCTS CORP., Dept. 8

You CAN'T WORM WRONG

for tape, hook, whip, round (ascaris) worms when you worm your dog as directed with Pulvex

Worm Capsules, a combination treatment which insures your worming right. Used by leading breeders. Packaged 2 ways: for puppies, for dogs. Either, 50¢; double-size, 75¢
At pet, drug, department stores.



PULVEX
★ COMBINATION TREATMENT
WORM CAPSULES

AUGUST 1946



LUXURIOUS LIVING
•
MODEST COST

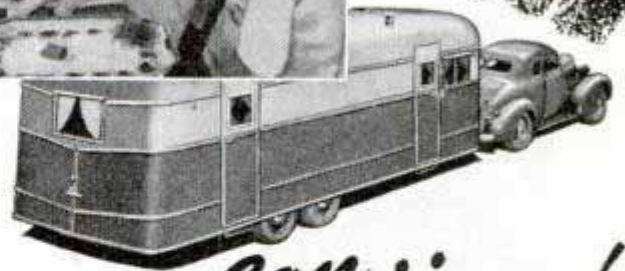

You Can take it with you!

• Yes, you can take this mobile home wherever you need it for living or playing. Every facility of a 2-bedroom house, plus the mobility of your car.

FURNISHED!

Complete kitchen includes oven range, refrigerator, double sink, ample

food storage space. Plenty of drawers, closets; 3 wardrobes. Luxurious double bed built into the bedroom; sofa-bed in living room converts into extra double bed.

See these trailer coaches at your Schult dealer, or send for catalog featuring 1946 Schult Luxury Liner

SCHULT CORPORATION, Dept. 3208, Elkhart, Ind.

MEMBER: TCMA

SCHULT Trailer Coaches



Repairing tail gate band of truck with New "Fleet-Arc Jr." A 15-minute job. Income \$2.00.

MORE PROFITS with this NEW LINCOLN WELDER

Exclusive "Arc Booster" of the new low-priced "Fleet-Arc Jr." A.C. welder provides the easiest striking arc ever developed for repair shops and farms... simplifies repair, hard-facing, fabrication and construction welding. Welds thin sheets, heavy plates and structural members. Increases your opportunities for profits in repair and construction work.



Continuous Current Control provides smooth, accurate adjustment of arc heat over range of 20 to 180 amps. . . . eliminates plug shifting and tap changing. Maximum input current of 37 amps., meets power company and REA requirements. Write for free Bul. 365 today.

THE LINCOLN ELECTRIC COMPANY
Dept. 512 • Cleveland 1, Ohio

Largest Manufacturer of Arc Welding Equipment in the World

RIDE ONE

and you'll
buy one!



**Make Your Bike a Motor Bike
With a WHIZZER Motor!**

The modern idea in dependable, low-cost transportation. Thoroughly proved through eight years of service. Fits any balloon-tired bike. Opens up thrilling new adventure and travel opportunities. Use it on your vacation, for errands, shopping, recreation, business, work. 2½ h.p.—drives through V-belt, unaffected by road or weather conditions. Speeds up to 35 m.p.h. 125 miles per gallon of gas. Plenty of power for hills. Does not interfere with normal pedaling of bike. Put a Whizzer on your bike now! Easily installed. Complete, except bike. See your dealer or mail coupon. Available now. **WHIZZER MOTOR COMPANY, Pontiac 15, Michigan.**

FACTORY PRICE
\$97.55
PLUS TAX

Precision-designed, precision-built by automotive craftsmen in the heart of the auto industry. And auto-type assembly line production has brought its price within reach of all!

IF NO LOCAL DEALER, USE COUPON

WHIZZER MOTOR COMPANY
Dept. 168, Pontiac 15, Mich.

I enclose \$99.97, which includes \$2.42 Federal Excise Tax, () check or () money order. Send me one Whizzer motor, complete, tax paid, with full installation instructions. Written guarantee with every motor.

If descriptive literature only is desired, check here ().

NAME _____

ADDRESS _____

CITY _____ STATE _____

DDT Applicator for Screens Fits Bottle Top

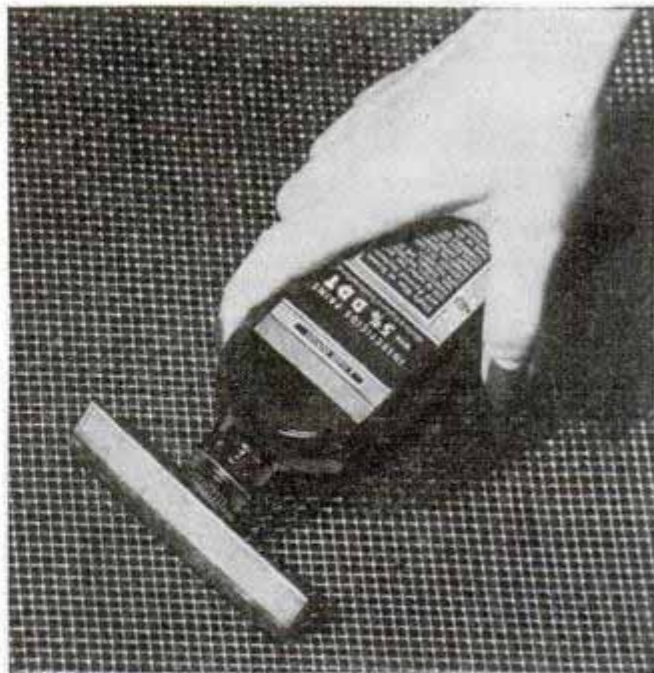

DDT solution can be painted on window or door screens with a bottle fitted with an applicator which fits over the top of the bottle and prevents skin contact with the chemical. Flies and mosquitoes are killed if they come in contact with screens coated with the solution.

DDT Plus Fluorine Equals DFDT —Less Harmful to Animals

Fluorine atoms substituted for two of the five chlorine atoms in the basic structure of DDT produce DFDT which is said to be more effective as an insecticide than DDT. It is less harmful to warm-blooded animals. The chemical cousin was reported by Prof. H. L. Bradlow of the University of Kansas. Somewhat more expensive than DDT, DFDT killed all insects in a controlled test while DDT killed 90 to 95 percent.

Chemical Elements 95 and 96 Called Americium and Curium

Latest chemical elements discovered—95 and 96—have been named americium and curium, respectively, by their co-discoverer, Dr. Glenn T. Seaborg, professor of chemistry at the University of California who has been "on loan" to the University of Chicago for atomic-bomb research. Element 95 was named after the Americas, and 96 in honor of Pierre and Marie Curie, leaders in the study of radioactivity.

☛ Transparent gloves made from compar, vinyl resin derivative, protect workers' hands from all organic fluids.



**Build and Fly
CLEVELAND
MODELS**

30" LOCKHEED SHOOTING STAR
Flying Contest Model. Kit
IT-90 **\$1.00**
Other 30" Flying Contest Models—
Ryan Fireball, Globe Swift,
Stinson 150, per Kit.... **\$1.00**



36" BLACK WIDOW
Industrial Training
Model, Kit T-155... **\$1.50**
Also 36" Industrial Training
Piper Cub, Spitfire, **\$1.50**
Mustang, per Kit..



P-51 MUSTANG
27 3/16" Scale Flying
Model. MFM Kit SF-91. **\$3.00**
SEE your dealer first. In or-
dering direct, include 20c ex-
tra for packing-postage. Complete
Cleveland Catalog (Kits from
25c to \$15.00)..... **5c**

CLEVELAND MODEL & SUPPLY CO.

4512H21 Lorain Ave. Cleveland 2, Ohio, U.S.A.

CLOSE-OUT BARGAINS



**POWERFUL
ALL PURPOSE
INDUCTION
MOTOR**

Sturdily construct-
ed to precision
standards, this
self-starting, shad-
ed pole A.C. in-
duction motor is
ideal for experi-
menters—101 uses.
Consumes about 15 watts of
power and has a speed of 3,000
r.p.m. When geared down, will
constantly operate an 18-inch
turntable loaded with 200 lbs.
dead weight.
3" high by 2" wide by 1 3/4"
deep; 4 convenient mounting
studs; shaft 3/8" long by 3/16"
diameter; runs in self-aligning
oil retaining bearings. Designed
for 110-20 volts, 50-60
cycles. A.C. only. **\$2.95**
Wt. 2 lbs.
Send Money Order or Check. (No
HUDSON SPECIALTIES COMPANY

**WESTERN
ELECTRIC
BREAST
MIKE**



Fine light-weight air-
craft carbon micro-
phone. Weighs only
1 lb. Comes with
breastplate mounting
and has 2-way swiveling adjust-
ment so that it can be adjusted
to any desired position. 2 woven
straps; one goes around neck,
the other around chest. Can be
snapped on and off quickly by an
ingenious arrangement.
Mike can be adapted for home
broadcasting or private commu-
nication systems. By dismantling
breastplate, it can be used as
desk mike. Comes complete with
6-foot cord and hard rubber plug.
Finished in sherardized
plate, non-rustable. Shp. **\$1.95**
Wt. 2 lbs.
Include Shipping Charges.
INTERNATIONAL PLASTIC CORPORATION
40 West Broadway, Dept. PM 846,
New York 7, N. Y.



Don't
tie
it—

taypit!

You make a neat, secure package in a
jiffy—with this new, crystal-clear tape. It's
strong and quick to use; comes off the roll
without a tussle; sticks instantly. Use no
water—just press on.



**THE CRYSTAL-CLEAR
TRANSPARENT TAPE**

100" for 10c
300" for 25c

Also look for Taypit Write-On
and a wide variety of Taypit
Gift-Wrap tapes in gay colors
and designs.

INTERNATIONAL PLASTIC CORPORATION
10 Park Place, Morristown, N. J.

MAKE BIG MONEY!



Be a floor surfacing contractor and sand both new and old
floors. Sanders are easy to operate and better still, you're
your own boss. Write for latest "tell-all" booklet entitled
"Opportunities in Floor Surfacing", enclosing 25 cents
in coin or stamps to cover handling.

AMERICAN
FLOOR SURFACING MACHINE CO.
535 So. St. Clair Street - Toledo 2, Ohio

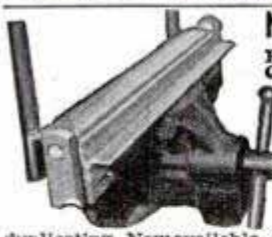

New! 12" Sheet Metal Brake Only \$12

Fits in bench vise.
Quickly, easily forms
all kinds of angles
in sheet metal, strap
iron and aluminum,
wire and plastic.
Use it to make use-
ful articles, experi-
mental research
work, patent models,
etc. Simple gauges
made for quantity
duplicating. Now available. Send for details, or or-
der direct. \$12 p.p. C.O.D. \$2 deposit. Wt. 9 lbs.

SAMPLES OF WORK



WISE BRAKE MFG. CO., Dept. P. M., 1318 So. 30th Ave., Omaha 5, Nebr.

AUTOMOTIVE HEAT OR TEMP. INDICATORS
Repaired Like New—Any Condition—Guaranteed
AUTOMOTIVE INSTRUMENT SERVICE
2836 Montrose Ave. Chicago 18, Ill. **1.50**
PLUS POST

SAY YOU SAW IT IN POPULAR MECHANICS

**Big Money for Workers
In Home or Shop**



Licensed Concrete Specialists wanted. No experience
needed. Make *Colorglazed* concrete pottery without
molds. New, low cost, patented method. Cemetery
products, novelties, tiles, etc. Basement leaksealing.
Other big pay projects. Booklet, details free. Men only.
NATIONAL POTTERIES COMPANY
542 Lincoln Avenue Fergus Falls, Minnesota

"Press the Button"

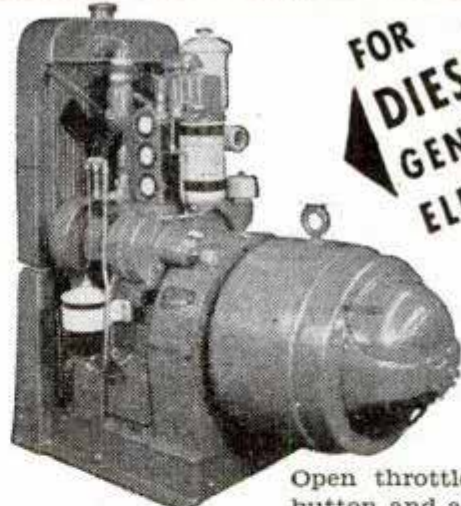

FOR
**DIESEL
GENERATED
ELECTRICITY**

Generating Sets
2,000 to 36,000
watts

Open throttle, press starter
button and a Sheppard Diesel
Generating Set is in operation.

Close throttle and it stops. Can be serviced by any
average mechanic. Uses ordinary domestic furnace oil
for fuel. Generates electricity at about 1c per K. W.
hour. That's why "Diesel's the Power . . . Sheppard's
the Diesel." Write for complete information.

Power Units, 3/4 to 56 H.P. • Marine Engines, 3/4 to 62 H.P.
R. H. SHEPPARD COMPANY, INC., 48 Middle St., Hanover, Pa.

DIESEL'S THE POWER - Sheppard's THE DIESEL!

"Spar" All-Metal MICROSCOPE



50 Power—2 Lenses

Adjustable eye tube and reflecting mirror

FREE SPECIMEN SLIDES AND DESCRIPTIVE BOOKLET

Observe the intimate wonders and secrets of nature invisible to the naked eye. Ideal for amateur chemists, scientists and bacteriologists. Order now as a Xmas gift.

This sturdy, practical microscope can be yours for only \$2.98, postage prepaid in U.S.A. Send check or money order. Don't Delay—Order Today.

ONLY \$2.98

SPECIAL PRICE TO SCHOOLS AND CLUBS IN QUANTITY

MART DISTRIBUTORS

DEPT. M, P. O. BOX NO. 6, EVANSTON, ILLINOIS

CHARCOAL BROILER

by Searles



\$19.95
F.O.B. CHICAGO

Fun Eating Anywhere Under The Skies—Backyards, picnics, hunting, fishing trips, camps, summer spots or across the andirons in your fireplace.

A Completely Portable Charcoal Broiler
Eight simple, all welded parts, assembled in less than two minutes. Grill locks for easy adjustment. Ash pan provides draft control. Expanded durable metal grate. "Snap on" side tables, one wood-backed for cutting. Nickel finished Grill and Spit. Red heat resistant fire box, black frame. **Folds into Compact Carrying Box**
You can store or carry the Searles Broiler anywhere. Shipped express charges collect. Price \$19.95, P. O. B. Chicago.

Ask your dealer or order direct from

H. M. P. PRODUCTS COMPANY,
Dept. P.M. 8
810 Clark Street, Evanston, Illinois

ELECTRIC MOTORS

NOW AVAILABLE! LIMITED QUANTITY! A top quality, powerful, compact, electric motor made to highest specifications. Ball Bearing both ends 1500 R.P.M., 1/50 H.P., 110 Volt A.C. D.C. 50-60 cycles. Series wound, 7 poles. Send \$5.00. **DUPEROY CO., 1360 Fifth Ave., New York 29, N. Y.**

Prompt Delivery!

Model 000-UI

WYCOFLEX
"Universal"
HIGH SPEED GRINDER

COMPLETE WITH G. E. MOTOR, AC-DC 10,000 R.P.M. — SIX ASSORTED ACCESSORIES COMPLETE IN HANDLING METAL CASE
ONLY \$31.25

GRINDER ONLY — \$24.75

Stands on aluminum base or hangs anywhere, even on belt! Best helper in home workshop. Unequaled for grinding, burring, filing, sanding, polishing. All accessories available. Exclusive, Patented Inner-liner, Shaft—vibrationless. True-running, long life. Ball-bearing handpiece and 1/4" collet. Order from dealer or write direct today. Supply limited.

only \$31.25

WYZENBEEK & STAFF, INC. 838 W. HUBBARD ST. CHICAGO 22, ILLINOIS

Makers of famous WYCO Flexible Shaft Machines

WAR'S TOP SECRET

WEIGHT 165 LBS.

COST U.S.GOV'T \$6000.00

YOURS FOR \$35.00 F.O.B. CHICAGO

B-17 Bomb Sight with automatic computers. High precision mechanical instruments for engineers, technical schools, inventors, and model makers. Use for study—demonstration—parts. Hundreds of gears, gyros, metal bellows, pressure switches, lenses, motors, spirals, levers, etc.

SEND MONEY ORDER TODAY

WEIS, 2929 Pulaski Road, Chicago 41, Illinois

Amazing Money-Saving Offer

2-Pc. SOLID ALUMINUM Flexible **ROD & REEL \$4.98**

INCLUDING Leather-Base Heavy Canvas Bag with snap-button flap for rod, and Leatherette Bag with snap-button flap, and loops for attaching to your Belt—for your reel, sinkers, floats, hooks, flies, lures, etc.

Rod measures 55 inches overall length assembled. Its smartly designed wooden handle will fit any reel. The Aluminum Reel is all-purpose, free wheeling, single action and detachable.

Send \$4.98

for Complete Set post-paid. Immediate Delivery.

Rod and canvas Bag only.. \$2.98

Reel and leatherette bag only.. \$2.29

\$1.00 deposit required on C.O.D. orders. Pay postman balance plus postage.

Rush Your Order Today!

Satisfaction Guaranteed or Money Refunded (Dealers Inquiries Invited)

R. B. ENTERPRISES, Dept. P

Factory Office: 30 W. Washington, Chicago 2, Ill.

Handy Mail Order List

Little Library of Useful INFORMATION

5 for \$1.00
12 for \$2.00
25¢ Each

Here at amazingly low cost is the practical help and information you have always wanted. Articles in previous issues of Popular Mechanics have been classified according to subject and are now available in these handy reprint booklets.

How to Use Measuring Tools—Micrometers, Calipers, etc.—106.

Power Driven Saws—74.
Drill Presses, Grinders, Etc.—79.
Wood, Metal Turning-Lathes—81.
Filing Machine, Hacksaw, Cutoff Wheel, Shaper—82.

Lathe Tools You Can Make—101.
Workbenches—Tool Cabinets—47.
Spray Painting—94.

From Pattern to Casting—91.
Tool and Saw Sharpening—92.
Sharpening Drills, Wood Bits—90.

Successful Wood Turning—32.
How to Read Blueprint—71.
Metal Turning Lathe Kinks—99.

Operating a Metal Lathe—100.
Heat Treating, Hardening—102.
Working With Glass—103.

Servicing Elec. Motors—75.
Electromagnets & Solenoids—44.
Transformer Construction—41.

The Boy Electrician—43.
Soldering and Brazing—17.
Arc and Spot Welders—5.

Electroplating With Nickel, Chromium, Cadmium, Etc.—86.
Plating Leather, Wood, etc.—87.

Lower Your Fuel Costs—31.
Curing Leaky Basements—45.
Fitting Home Game Room—55.

Indoor & Outdoor Fireplaces—88.
Backyard Gardening—39.
Lawns and Garden Novelties—72.

Trellises, Pergolas, Fences—76.
Lawn and Garden Furniture—77.
Playground Equipment—73.

Concrete Garden Furniture—6.
Making Serving Trays—53.
Sanders—80.

House Wiring—89.
Treasure Finders—13.
Hanging Wallpaper—38.

Built-in Fixtures—78.
Bird Houses—7.
Magazine Rack—49.

Clock Cases—50.
Book Ends—52.
Small Tables—54.
Smoking Stands—56.

Desks—58.
Book Cases—59.
Action Toys—66.
High Flying Kites—67.

Telescopes—20.
Metal Craft—28.

Knots and Ropework—105.
Working With Plastics—61.
Simple Home Improvements—104.

Ridding Home of Insect Pests—107.
Children's Room Furniture—51.
Jigsawed Novelties—57.

Doll House & Doll Furniture—60.
25 Shelves You Can Make—64.
Novelties Turned on Lathe—62.

Inlay Pictures—Veneering—63.
Wood, Soap Carving—65.
Windmills & Weathervanes—68.

Lamps from Wood, Metal—69.
Home Work Opportunities—19.
Wood Finishing—40.

Boats—14 ft. Outboard—2.
Boats—14 ft. Sail Dinghy—26.
Boats—21 ft. Sloop—46.

Rowboats, Small Dinghy—83.
Small Sail Boats—84.
Two Outboard Runabouts—85.

Build Own Canoe, Kayak—30.
Build Class-E Ice Yacht—22.
Auto Kinks, Shortcuts—10.

Building Trailers—27.
Motor-Driven Midget Cars—34.
Stop Auto Elect. Troubles—95.

Photo Printers and Dryers—25.
Photo Darkroom Equipment—96.
Trick and Table Top Photos—97.

Cosmetic Formulas—12.
Food Products Formulas—15.
Metal Plating and Coloring—21.

Re-Silvering Mirrors—70.
Chemical Experiments—93.
Log Cabins, Tourist Houses—14.

Trapping Small Animals—33.
Farm and Garden Tractors—8.
Building Extra Attic Rooms—23.

Attractive Basement Rooms—24.
Small Looms—37.
Gem Cutting—42.

Photo Enlargers—1.
Photo Kinks—98.
Cleaning Formulas—11.

Taxidermy—9.
Magic—29.
Training Dogs—35.

Small Furnaces—36.

Check Titles Wanted, Clip, Mail with Remittance to

POPULAR MECHANICS PRESS, Dept. 605, 200 E. Ontario, Chicago, 11

POPULAR MECHANICS

THE
NEW
ELDEN

ELECTRIC WATER HEATER

HOT WATER IN 5 MINUTES

... WITH THE ELDEN ELECTRIC WATER HEATER. Simply place the heater in water, plug it into your electric light outlet. Complete with 6 feet rubber cord and plug. Act now! Send check or money order. No C.O.D.'s—your money back if not satisfied.



\$6.50
Add 25c for Postage

CHROME PLATED
CAN'T RUST

DEALERS: Write for discounts.

ELDEN PRODUCTS CO., Dept. A

7310 WOODWARD AVE.

DETROIT 2, MICH.

Here's a New POWER CUTTER KIT

with a cutting range of 5/8" to 2 1/2"

Two Bruno Adjustable Hole Cutters in one convenient kit for home users, mechanics, farmers, technicians! High speed steel blade cuts clean, fast holes in metal, wood, plastics. Quickly adjustable and easily sharpened. For drill press, portable drill or hand brace. Money back guarantee!



Only
\$7.85
Complete

POWER CUTTER KIT CONTAINS

MODEL	SHANK SIZE	EXPANSION	PRICE
100	1/4" st. shank	5/8"—1 1/2"	\$3.00
101	3/8" st. shank	1"—2 1/2"	\$5.00
790 KIT		5/8"—2 1/2"	\$8.00*

At all hardware stores or write direct, Dept. PM-8

*Fair Trade Minimum \$7.85



BRUNO TOOLS

9330 Santa Monica Blvd.
Beverly Hills, Calif.

PLASTIC KITS

Amazingly LOW Prices

Grade 1 stock—fully factory masked—no seconds—no scraps—big full sheets. Kit No. 2 has 360 sq. in.: 2 pcs. 1/16"—4 x 23, 1 pc. 1/8"—4 x 20, 1 pc. 1/4"—4 x 24 plus 2 oz. cement and instructions. Enough for a large number of fine projects. Big bargains. Kit No. 2, \$3.95; Kit No. 3, \$5.70; Kit No. 5, \$9.20. Perhaps you are now paying twice as much. Order your kits now. Send check or money order today. Add 10% for postage and handling.

JACKSON STUDIOS, 5441 N. Shoreland Ave., Milwaukee 11, Wis.

TWO PIECE STEEL FISHING ROD \$7.95



53 1/2" overall length assembled. High quality spring steel. Rust resisting. Stainless steel guides, screw reel seat lock. Packed in telescopic tube suitable as carrying case.

F.O.B. Chicago

Money Back Guarantee. Dealer inquiries invited.

MARKO SUPPLY CO., Dept. P.M., 2924 Logan Blvd., Chicago, Ill.

SAY YOU SAW IT IN POPULAR MECHANICS



STEELS and ALUMINUMS with a motorboat tone

SINGLES \$5.50 to 8.00

V-8 DUALS 17.50 to 20.00

Reduce back pressure and increase engine performance. A Sandee is time proved and dependable. Aluminums are guaranteed for the life of your car.

DEALERS WANTED

SANDEE MUFFLER CO.

7523 S. WESTERN AVE., LOS ANGELES 44, CALIF.

ANCO RAIN-MASTER

"Dead-Locker"

WINDSHIELD WIPER ARMS and BLADES

BLADE SNAPS ON... STAYS PUT

FINGER-TIP RELEASE

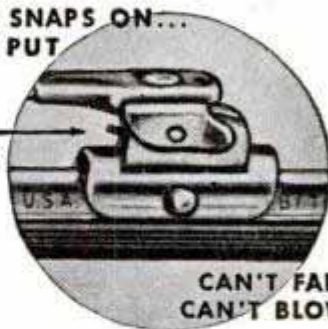

CAN'T FALL OFF
CAN'T BLOW OFF

(A war-born invention—by ANCO—first) for military aircraft—now for your car.)

DON'T SHOOT YOUR GAS-PUMP MAN!

He's doing the best he can. Sure, he knows how dangerous it is for you to drive your car... in stormy weather... with your dull old windshield wipers that smear and smear. He'd gladly put on for you quickly a pair of keen new ANCO RAIN-MASTER Wiper Blades and Arms. He has them—Newest Models! But he forgets to remind you? Too busy? You can't shoot him for that!



PATENTS MAKE JOBS

After all, it's *your* car to protect. So you remind *him*. Get RAIN-MASTERS... patented features... original equipment on many makes of high grade cars and trucks... used in war—on our fighting tanks and trucks and ships and bombers too... because ANCO RAIN-MASTERS clean quicker, clean cleaner... last longer. May save you a costly smashup.

Ask for RAIN-MASTER Windshield Wiper Arms and Blades next time you buy gas.

THE ANDERSON COMPANY

Established 1918

GARY, INDIANA

WALTON PRECISION-BUILT WHEELS



FOR MAKING . . .
RACERS • SCOOTERS
COASTER WAGONS • SAILMOBILES
BOAT CARRIERS • BIKE CARRIERS
MARKET CARRIERS
GOLF BAG CARRIERS, ETC.

THRILLING FUN!

Speed to spare! Walton Wheels roll like "sixty"! Strong and sturdy. Velvet glide bearings. Make barbecue carts, garden wheel barrows, mobile lawn furniture . . . 101 things for fun and practical use.

AUTO-STYLE JUMBO BALLOON TIRES

Extra heavy deep tread, semi-pneumatic tires. Inner Air-cushion for soft, speedy riding.



PERFECT GIFT!

Just what every boy wants! MAKE HIM HAPPY with a set of Walton Wheels . . . help him build a thrilling racer, pushmobile, barbecue cart or other house and garden items. He'll be the proudest, happiest kid in town.

COMPLETE KITS

WK1 Four 8 x 2 Wheels, 2-20" x 1/2" dia. axles, 4 heavy hangers, washers and cotter pins ready for use. **ONLY \$13.25**

WK2 Four 10 x 1.75 Wheels, 2-24" x 1/2" dia. axles, 4 heavy hangers, washers and cotter pins ready for use. **ONLY \$15.95**

REMIT WITH ORDER
 To Save C.O.D. Charges

\$275 EACH
 In Sets of Two

IN 8 x 2 SIZE
 Single Wheel, \$3.25
\$10.80 FOR FOUR

10 x 1.75 SIZE
 Single Wheel, \$3.75
\$12.80 FOR FOUR

SAFE SAILING!

WALTON WHEEL COMPANY

PLANKINGTON BLDG., MILWAUKEE 3, WISC.

SHIP TO—

FREE suggestion sheet with every order!

NAME.....

STREET NUMBER.....

CITY.....STATE.....

WHEEL KIT NO.....@ \$.....

.....8 x 2 WHEELS @.....

.....10 x 1.75 WHEELS @.....

Small Drill With Foot Control Operates by Elevating Table

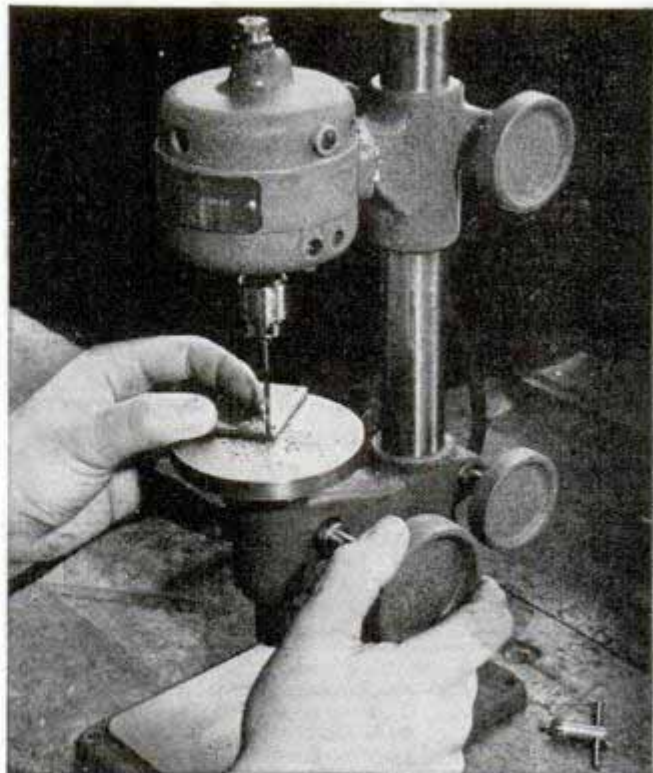

Foot-operated to leave both hands free, a small drill has been designed for the fabrication of small parts made of wood, plastic or metal. The tool accommodates 1/8-inch drills or smaller. A 1/30-horsepower motor gives the drill a range of 2000 to 15,000 revolutions per minute with speed controlled by a foot rheostat. The drill head is firmly held on a steel column and the drilling operation is accomplished by elevating the table to the drill with a hand control geared to the table. The drill, which permits a 360-degree radius of action, weighs only 15 pounds.

Jack-of-All-Work Repair 'Dope' Serves as Putty or Paint

Asphalt powder is the base of a versatile new repair material that can be used as a paint, caulking compound, plastic coating or joint compound. The powder can be mixed in any consistency and worked into joints like putty or applied with a brush like paint. Any oil solvent such as kerosene is used in mixing the compound. The powder is available in three colors, black which can be mixed as a compound or a paint, and aluminum or red which are used only as paint.

Shipping containers for photographs are made of thin sheets of aluminum which are sealed with viscose tape to prevent pictures from being bent and to keep out dust, dirt and moisture.

**JUST OUT — WAR SURPLUS — BRAND NEW
DIAMOND SAW BLADES**

With Actual Diamond Dust on Cutting Edge

Formerly Sold up to \$30 each!

Now at greatly reduced prices

6 inch \$3.60 — 8 inch \$4.70 — 10 inch \$5.80 ^{POST PAID}
(All have 5/8 inch arbor hole)

Useful for cutting of any hard material such as tile, glass, ruby, plastics, slate, stone, marble or quartz. Ideal for Hobbyists, Mechanics, Jewelry, Glass and Porcelain Workers, Marble Cutters and all who need a fast, true cutting saw blade for hard substances.

Fit Skill saws and any ordinary motor shaft. Especially treated steel disks—original packing—Quantity Limited.

Mail order today. Enclose check or Money Order today. All prices are postpaid. Sent C.O.D. plus cost, if you wish.

DIAMOND DISKS Dept. A—140 West 42 St. New York 18, N. Y.

**KROIL LOOSENS
RUSTY FROZEN PARTS**

creeps in

Frozen bolts, pipe threads, bearings, etc., yield to KROIL, the new chemical lubricant that creeps into millionth inch spaces and dissolves rust and dried grease. Fastest penetrating oil known. Now used by 5000 industrial plants for emergencies. Use it on money back basis—AT YOUR DEALER or send \$1 for two 8-oz. spout cans, postpaid. Send dealer's name.

KANO LABS., 3028 Lincoln Tower, CHICAGO 1, ILL.

SINGLE PHASE COIL HEAD

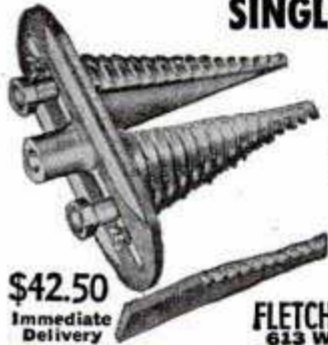

A fast and simple setup for winding single phase stator coils. Winds any length coils for motor slot length up to 6 inches, with 15 various widths. For motors up to 1 and 2 horse power.

The head is made of aluminum, weighing less than eight pounds. Has one inch hole and key-way for mounting on drive.

FLETCHER ELECTRICAL SPECIALTY CO.
613 W. Pico Blvd., Los Angeles 15, Calif.

\$42.50
Immediate Delivery

MAKE-A-LITE

LIGHT UP YOUR BIKE

Automatic voltage control. Mount generator on either front or rear fork.

GENERATOR, HEAD LAMP AND TAIL LIGHT OUTFIT \$5.50

As shown—complete with brackets, extension cords and instructions.

Dealers write Postage prepaid in U.S.A.
G. & E. EQUIPMENT SUPPLY
400 N. Sangamon, Chicago 22, Illinois

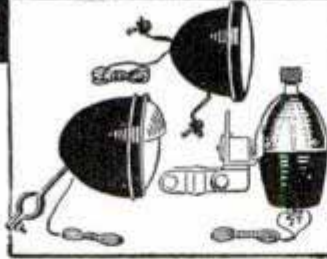

BUILD THIS FREEZER

FOR LESS THAN \$50!

SAVE FOOD

SAVE MONEY

Zero temperature freezes and stores 170 lbs. of meat, fruit, etc. Easy to build from steel barrels and other available material. Complete instructions and \$2.00

14 view detail photo sent for.....
MASON FREEZERS, Dept. PM, Geneva, N. Y.

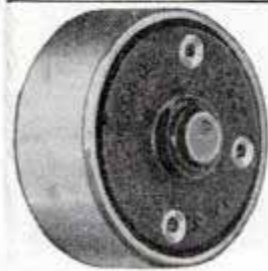

SUPER MYSTERY BUTTON

Many times as sensitive as our regular mystery button. Can be used for the same experiments and uses as the mystery button but with far better results. Needs no diaphragm of any kind. Ideal for musical instruments, intercommunication, recording, talking thru radio, and many other uses. When used with small head phone it makes an ideal inexpensive hearing aid. Shipped with 5000 word, 12 page booklet showing diagrams for dozens of uses, postpaid \$2.00.

Electronic Products Company
Saint Charles, Ill.

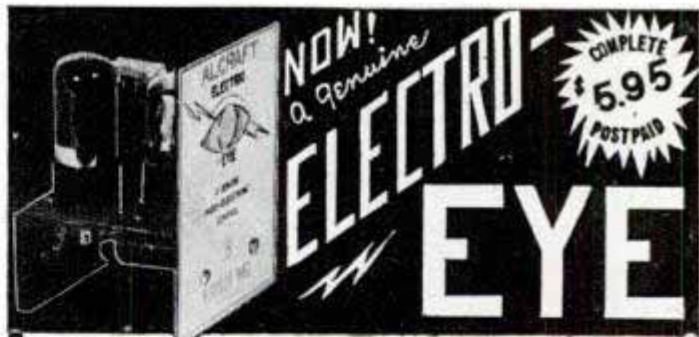

NOW!
a genuine
ELECTRO-EYE
COMPLETE \$5.95 POSTPAID

**OPEN DOORS, TURN ON LIGHTS, RING BELLS!
AMAZING STUNTS PERFORMED ON LIGHT BEAM**

You can assemble this unique electronic control in one hour! This photo relay comes complete with all parts including steel panel and chassis, RCA Photo-tube, Electronic tube, GE Relay, etc. The *Alcraft Electro-Eye* is a postwar development of the makers of Algonquin precision aircraft parts. Due to material shortages, supply of kits is limited. Order your *Alcraft Electro-Eye* now! Sent prepaid for only \$5.95.

ALGONQUIN PARTS, Inc.

BOX A

DARIEN, CONN.

**THE SAWS YOU NEED...
Now!**

These two Precision machines are sturdily constructed for fast, accurate work, with "sealed for life" ball bearings.

MODEL 95—12" floor type tilting arbor saw. Cast steel base. Low maintenance cost. No die castings. Weight 350 lbs. Depth of cut 4-1/8".

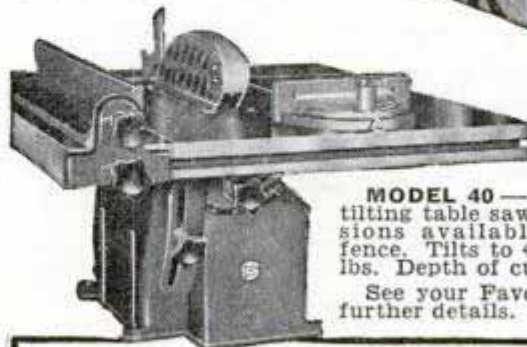

MODEL 40—7" bench type tilting table saw. Three extensions available. Reversible fence. Tilts to 45°. Weight 27 lbs. Depth of cut 2-3/16".

See your Favorite dealer for further details.



Darra-James CORP.
WATERBURY 14 CONNECTICUT

AT LAST IT'S
big chance to

HERE - YOUR
learn about the

V-2 ROCKET BOMB

Be first in your neighborhood to own and fly this miniature V-2 ROCKET BOMB! Watch it soar into the sky with sizzling jet speed! Most amazing model you ever saw! Scientifically designed to perform along lines of Nazi V-2 ROCKET BOMB!

Absolutely harmless! Complete unit: V-2 bomb, launching platform, with 12 extra rocket chargers, price only \$2.95. Mail check or money order, we pay postage. Or send your name and address and pay postman, plus C.O.D. costs. Order NOW!

WALSH PRODUCTS, Inc.
209 N. Maple Ave., East Orange, N. J.

MAKE UP TO \$10
ON EVERY SALE!

AIR
CORPS
TYPE
**SUN
GLASSES**



\$5.00
SELLS
EVERYWHERE
UP TO \$15 and MORE!

Just released for civilian use! Here are genuine 12 Karat gold filled, Air Corps Type SUN GOGGLES complete with "Mother of Pearl" sweat bar, brow rest and rocking pads, scientific ray-absorbent "No Glare" ground and polished sage green lenses, dropped before curving, and self-adjusting comfortable ear pieces. Genuine leather crush-proof case included. Will protect eyes from glare, sun, wind, dust and exposure. Wonderful for auto drivers, policemen, golfers, gardeners, farmers and all outdoor workers and sportsmen. Sold on 10 day no risk trial money-back guarantee. You can easily sell 3 or more pairs a day. Send for your sample pair of these fine Sun Goggles—only \$5.00, postage prepaid. Or send no money. Just deposit \$5.00 with your own postman, plus postage—your money back if not delighted.

MIDWEST SCIENTIFIC CO. Dept. 35B, 1148-1160 W. Chicago Ave. CHICAGO 22, ILL.

SpeedWay

Each month, more SpeedWay Drills come off the production line; are being shipped each day. But, frankly, though we are beginning to cut into our mountainous pile of back orders, there's a deal of waiting still for a lot of people who are ordering SpeedWay Tools today. However, because they are worth waiting for, we suggest that you place your order now with your local SpeedWay dealer for earliest possible delivery.

SPEEDWAY MFG. CO.
1863 S. 52nd Ave.
Chicago 50, Ill.
No. 89 equipped with Snap-Release Chuck
No. 89-J with Jacob chuck (as illustrated) \$5.00 extra

IMMEDIATE DELIVERY



New Post War 5 Tube A.C. /D.C. Superhetrodyne Radio Kit. Built-in Loop Antenna, Automatic Volume Control. Complete, including full instructions for assembling. Beautiful Plastic Cabinet. Approx. Size 9"x5"x6". \$13.75 Net, less tubes.

Kit of 5 matched tubes for above (12SA7, 12SK7, 12SQ7, 50L6, and 35Z5) \$4.95.
3 Tube Completely Assembled Phono-Amplifier (Approx. Size 5 1/4" x 3 1/2" x 1 1/4") \$4.75 less tubes.

Kit of 3 matched tubes for above (12SQ7, 50L6, 35Z5) \$2.95
To Expediate Delivery, send Cash, Check or Money Order
Write for Free Catalog

NATIONAL RADIO DISTRIBUTORS, 1029M E. 163 St., New York 59, N. Y.

★ ★ ★

MAKE YOUR OWN POWER TOOLS at Low Cost

from old Auto Parts, etc.

A New Edition Featuring TOOLS of WOOD

Now you can have a good lathe, drill press, circular and band saw and other power tools in your home workshop, at a cost of only a few dollars each. Make them yourself from old auto parts, discarded sewing machines and other odds and ends that cost little or nothing. Get this new book—"Forty Power Tools You Can Make." Costs only \$1.25 postpaid. This book gives every detail in plain language you can understand and follow. Hundreds of pictures and plans show every step to follow in making the power tools you want. Actual photographs of finished machines included. Send \$1.25 today. Money back if not satisfied.

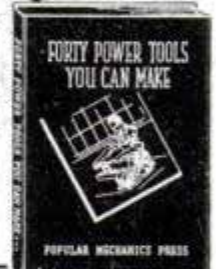

MAKE EVERY POWER TOOL NEEDED IN YOUR HOME WORKSHOP

- Some of the power tools you can make are:
- | | |
|--------------------|------------------------------|
| 2 Band Saws | 2 Drill Presses |
| 0 Sanding Machines | 1 Scroll Saw |
| 2 Circular Saws | 2 Wood Turning Lathes |
| 1 Metal Lathe | 3 Grinders |
| 1 Power Hack Saw | 1 Shaper or Moulding Machine |
| 1 Jig Shears | 1 Vibrating Pencil |
| 1 Cut-Off Wheel | and others |

Information too, about pulleys, belts, motors and drive methods. Just published. No other book like it. Order today.

POPULAR MECHANICS PRESS

Dept. 621

200 E. Ontario Street, Chicago 11



- Test ALL Home Outlets
- Find Open Circuits

STAR TEST-PLIERS

- Locate Blown Fuses
- Remove Fuses SAFELY

A must tool for electricians, maintenance men, home owners. Made of a transparent, shock-proof Plastic. Replaceable lamp inside Plier tests 110 to 250 Volts. Plier pulls fuses from 10 to 100 Amperes. Requires the use of only one hand. Can be obtained from General Electric or Westinghouse stores, or

from local electrical dealers. Order one TODAY.

Price \$2.75 without Leads, \$1.50 additional for Leads which provide greater reach and more flexibility.

STAR FUSE CO., 233 Canal St., New York 13, N. Y.

SAY YOU SAW IT IN POPULAR MECHANICS

REPAIR YOUR OWN ELECTRIC APPLIANCES WITH NEW AMAZING NICHROCITE



Simply overlap ends, apply Nichrocite paste and turn on the current—a perfect weld results. Used by big utility companies and repair shops. Just the thing for that broken or burned out heating element in your electric iron, stove, toaster or heater. Does the job in a jiffy. Trial order, \$1; 4 ozs., \$2.50; 1 lb., \$8.00.



Handy for Home or Industrial Use

ARMSTRONG ELECTRIC CO., Box 861-MP, Minneapolis, Minn.

FIVE ACRES AND INDEPENDENCE

A Practical Guide to the Selection and Management of the Small Farm

By M. G. Kains

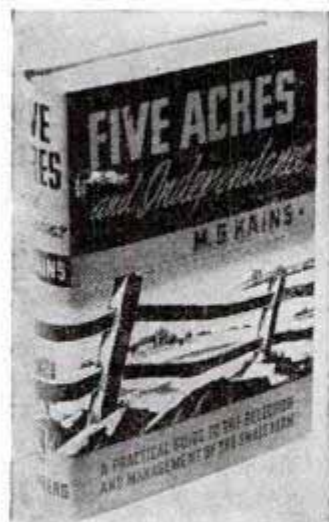

This book is a complete, practical guide to the selection and management of a small farm. It explains how a small farm can be self-supporting. What farms not to buy. How to choose the right farm, based on proper soil, location, irrigation, elevation, climate, etc. Then a detailed explanation of what crops to plant and how to make them yield results, sure-fire methods of grafting, rotation, transplanting, etc. Finally, how to make a profit by selling your excess crops, livestock and preserves. Written by an expert who has made a

real success with many small farms. Revised, enlarged edition. 413 pages, profusely illustrated. Price \$2.50

Only \$2.50, Postpaid in U. S. A. (Outside U. S. \$2.75). Order Today

POPULAR MECHANICS PRESS Room 490 • 200 East Ontario St., Chicago

MYSTIK *Self-Stik*



STOPS DRIP

FAST, EASY, CLEAN TO APPLY!

Now anyone can insulate cold water pipes in no time. DRI-PIPE fastens to pipe by "self-stik" edges... no fuss, no mess, no tools. Stops condensation drip positively. Clean up basement playroom, store room, or anywhere you have sweating pipes. Get DRI-PIPE at hardware or department store now. Mystik Adhesive Products, 2653 North Kildare, Chicago 39.

Applies lengthwise, sticks by own adhesive. Water-proof backing doesn't require painting.

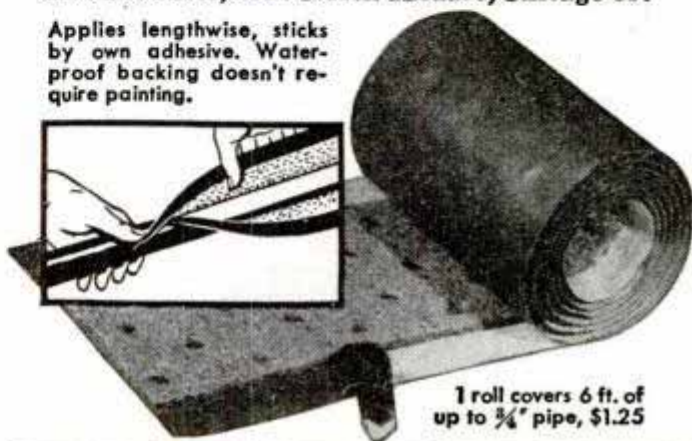

1 roll covers 6 ft. of up to 3/4" pipe, \$1.25

ARE YOU INVENTIVE?



What would you do with an Army Aviation Formation-Stick Kit? It contains two stick assemblies, two Arm Rests, Function Selector, Switch and Control Box, packed in moisture proof manner for overseas shipping. Take the units apart and you have transformers, condensers, relay and magnetic switches, silver and gold contact points, expensive 4-way switch, and enough parts to cover the top of a good sized workbench.

COST TO U. S. GOV'T OVER \$500

The set, as packed, cost the government over \$500. Manufactured by Minneapolis-Honeywell and Jack & Heintz. Every part is precision manufactured to the high standards demanded by the government's war inspector.

A CHALLENGE TO INGENUITY

This is really a parts "grab-bag." The readers of Popular Mechanics are the type who can capitalize on this surplus war materials bargain. Some will find value in the parts alone—others will want to keep the units assembled for experimental purposes. Whatever it is, here is a "grab-bag" opportunity. Shipped to you in sealed containers just as they were delivered to the government—ready for overseas shipment. Sent, express collect, on receipt of remittance.

\$14.95

ALL OFFICE MACHINE CO. 4636 W. WASHINGTON BLVD. CHICAGO, ILL.

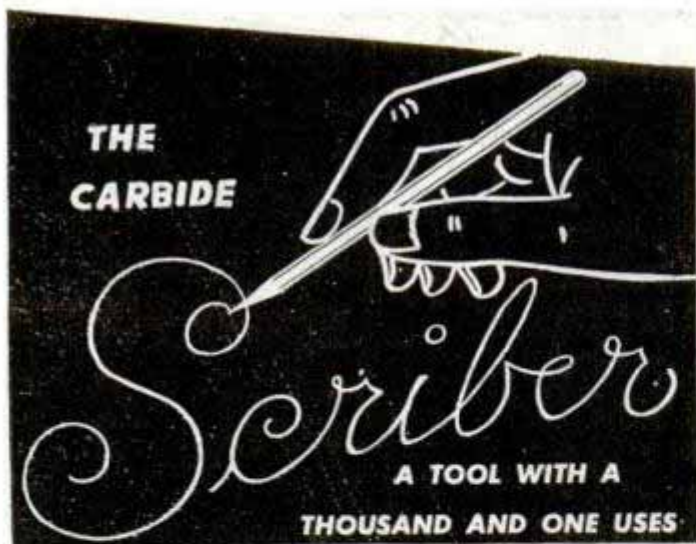

AT LAST — SCIENCE HAS FOUND THE PERFECT WAY TO:

**ENGRAVE
ETCH
EMBOSS
CUT
MARK
and WRITE**

ON ANY KNOWN SURFACE, SUCH AS:

**Steel (and its alloys), Soft Metals, Glass, Wood,
Plastics, Ceramics, Minerals, Precious Metals.**

AN INDISPENSABLE TOOL FOR:

CRAFTSMEN, HOBBYISTS, ENGRAVERS AND WATCH-
MAKERS, INDUSTRIAL WORKERS, SHOP OWNERS,
GLAZIERS, SIGN WRITERS, AUTOMOTIVE WORKERS,
MEDICAL AND DENTAL PROFESSIONS.

For marking and identifying tools, materials, parts and supplies.

For manufacturing fine jewelry and small precision parts.

For cutting, engraving or writing on glass and ceramics.

For engraving and etching by artists and home craftsmen.

Latham's Tungsten Carbide Scribes are made from dia-
mond-lapped, solid tungsten carbide, which is tapered
to a sharp point after being inserted $\frac{1}{4}$ inch into an
octagan shaped stainless steel handle.
The overall length of the scriber is 6
inches. This tool will give service for
an indefinite period.

\$1.25

Sent postpaid in U.S.A. for \$1.25 each.

Money-back guarantee.

**LATHAM MACHINE CO., DEPT. P.M.
40 N. MAIN STREET, PITTSBURGH 15, PA.**

Please send me.....Latham Scribes at
\$1.25 each. I enclose \$.....

Name.....

Address.....

City.....State.....

ADD ADDITIONAL POSTAGE FOR CANADA AND FOREIGN

Aids for Handicapped Children Designed in Hobby Shop



Building toys and training aids for hand-
icapped children is the heart-warming bus-
iness of Joseph Block of Chicago, who first
built the devices as a hobby. His first
corrective aids were toys for his eight-year-
old daughter, a spastic victim whose hips
are dislocated. Parents of other handi-
capped children heard about his work and
requested many special devices from Block
for their own youngsters. He soon quit his
job as an aircraft worker to devote his full
time to making the appliances. Each cor-
rective aid is designed after a close con-
sultation with the physician attending the
child for whom it is intended. Walking skis
invented by Block impart the correct mo-
tion to a paralytic's legs and provide play
for the child at the same time. Another
device is a tricycle with special leg clamps
fitted to the pedals that force the legs into
correct movements, while a high-backed
seat corrects posture. A Chicago school
recently installed Block's equipment in a
special nursery for handicapped children.

Sponge Rubber Carpet Cushion Anchors Rugs to Slick Floors

To prevent rugs from sliding on highly
polished floors, a cause of many home ac-
cidents, a protective sponge-rubber under-
lay cushion has been developed to anchor
them in place. Green in color, the cushion
is made in various widths and can be cut
to fit any size rug. It can be cleaned with a
damp cloth and will not mark the floor.

U. S. GOVERNMENT SURPLUS New Westinghouse Generator



200 AMPS.
5700 WATTS
28 VOLTS
\$895

F.O.B. CHICAGO

Makes an ideal welder, electro-plater, fast battery charger, auxiliary power unit. Government inspected and O.K'd. Value over \$100. In original factory crate. Shipping weight 58 lbs.

Dealers: Write for Quantity Prices

Generator Sales, Dept. P.M., 1627 N. Damen Ave., Chicago 47, Ill.

200 PIECE GRINDING KIT ASSORTMENT

- 10 ass'td. Grinding wheels with such famous names as NOR-TON-CARBURUNDUM, etc.
- 5 Cut off wheels ass'td. sizes
- 5 Felt polishing wheels ass'td. sizes 1 to 2 inch
- 5 Round steel brushes with handles—ass'td. widths
- 10 Abrasive cloth cones ass'td. sizes and grits
- 2 Rotary files finest high speed steel
- 5 Mounted grinding points ass'td. on 1/8" shank
- 50 3-inch round crocus cloths
- 100 Paper abrasive disks 7/8"
- 2 Steel Mandrels 3/32 and 1/8"
- 6 Felt Bobs square & pointed

FOR INDUSTRY & HOME SHOP
WAR SURPLUS-ALL NEW

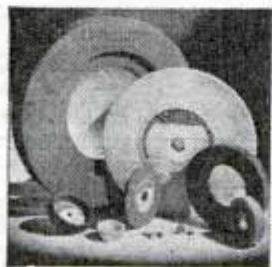

GROBAN SUPPLY CO.

1522 S. Michigan Ave.
Dept. M, Chicago 5, Ill.

\$6.95

Postpaid
in U.S.A.

BIG OPPORTUNITY BUILDING BLOCKS of CONCRETE-CINDERS

Men of vision and Modest Capital see prosperity and independence in this big field today. Everywhere every kind of building to be done—residence construction biggest of all. Big demand for quality blocks at low cost. Our Blocker Vibrator produces high quality blocks from sand and gravel, limestone screenings, or any light weight aggregates. All steel construction—will make 800 to 1200 blocks every 8 hours.



WRITE for details and "How to Start and Operate a Concrete and Cinder Block Plant—a New Local Business Rich in Opportunity." Rush name, address today.

CONCRETE BLOCK EQUIPMENT CO.

920 CENTRAL, DEPT. 100

KANSAS CITY 6, MO.

RADIO PARTS GRAB BAG!!

\$25 original value assortment of Coils, Condensers, Transformers, Resistors, Controls, etc. An experimenter's dream. While they last, only.....

\$3.98

MARKO SUPPLY, Dept. P.M. 8

2924 Logan Blvd.

Chicago 47, Ill.

SAY YOU SAW IT IN POPULAR MECHANICS

DRILLS

what the home work shop owner has been waiting for.
A COMPLETE SET OF HIGH SPEED DRILLS
FOR SHOP, INVENTORS, HOBBY WORK, ETC.

- 60 DRILL SET SIZES NO. 1 to 60 \$14.95
- 29 DRILLS 1/16" to 1/2" by 64ths. \$17.75
- 21 DRILLS 1/16" to 3/8" by 64ths. \$ 8.95

PRODUCTS—INDUSTRY

STAND FREE

122 SOUTH LA SALLE STREET, CHICAGO 3, ILLINOIS

\$14.95

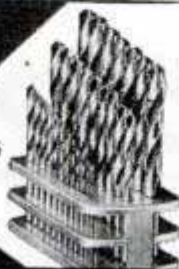

Back Again! PICTURE MAKER



Here's news to please all - Adults and Youngsters alike! PICTURE MAKER, the complete photo-printing kit that enables the most inexperienced to obtain excellent photo prints, is back! Prints your favorite negatives on PAPER, CARDBOARD, CLOTH, SILK, SHIRTS, TIES, KERCHIEFS, HANDKERCHIEFS, ETC.

HARMLESS to negatives; prints INDOORS and OUTDOORS. Each set contains sufficient materials for 150 excellent prints.

EASY to use; no darkroom or additional equipment necessary. Complete directions enclosed.

Order your set now and begin printing beautiful, PERMANENT, coppers tones of your favorite snapshot. Order as many as you like. Interested dealers also write.

Price 75c. per kit, postpaid. All C.O.D. orders, plus postage. Send check or money order to

QUAKER BRAND PRODUCTS

BOX No. 7, Sta. R, New York 55, N. Y.

you'll do faster, better work with this
EFFICIENT SHOP TOOL

THE
Bantam
GRINDER



Polishing
Grinding
Carving
Drilling
Buffing
Plastic
Glass
Metal
Wood
Bone

You'll enjoy doing many shop jobs with the Bantam Grinder. Correctly balanced for easy handling. Precision-built of quality materials for dependable, long-life service. Operates on 110-115 Volt AC-DC. Speed approx. 20,000 R.P.M. Internal ventilating fan. Fingertip switch. Weight—15 oz. With 8-ft. cord and plug, 23 accessories, substantial gift box... **\$25**



If your dealer doesn't have it, write us.

Small Motors, Inc.

Dept. 80, 53 W. Jackson Blvd. • Chicago 4
Manufacturers of special small universal, fractional H. P. motors, shaded pole motors, heater motors for industrial and appliance uses.

GENUINE A.C. DELCO MOTORS Only \$5.25

Send Check or Money Order Plus Postage

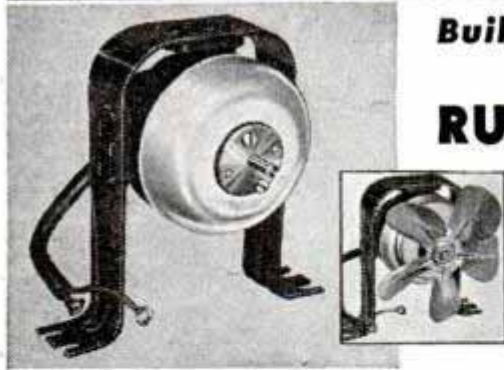

110 volts, 60 cycle A.C. Complete as illustrated. Shipping weight 5 pounds.

Build Your Own Electric Workshop With a Genuine, Factory Tested Guaranteed

RUBBER MOUNTED DELCO MOTOR

can be used for electric fans, small grinding work, buffing, hand tools, drilling, and a thousand and one other uses. Complete with 5-blade fan, 1/4" shaft, overall dia. 7 1/2", 2-wire rubber covered cord, rubber mounted with horse-shoe stand. Perfect quiet operation guaranteed.

G. & E. EQUIPMENT SUPPLY CO. Dept. P11, 400 N. Sangamon St. CHICAGO 22, ILLINOIS
WRITE FOR FREE CATALOG WITH MANY OTHER BARGAINS

World Radio Leads in

READY NOW! AMATEUR Sensation of the Year! WRL Globe Trotter TRANSMITTER KIT

SAVINGS

Complete including all parts, chassis panel, streamlined cabinet, less tubes, coils, and meter.
Cat. No. 70-300 \$59.95
Cat. No. 70-312 Kit same as above wired by our engineers \$75.00
All necessary accessories \$13.85 Extra
Here is the latest most outstanding transmitter value on the market today. Capable of 40 watts input on C.W. and 25 Watts input on phone on all bands from 1500 KC through 28 Megacycles. Incorporates Tritet Oscillator using a 20 meter X-tal; three bands; 10, 20, and 80 meters; two power supplies.
National Headquarters for Ham Needs. FOR EARLIEST DELIVERY on your favorite receiver place your order now with World Radio. All makes and models.



Formerly Wholesale Radio Laboratories
Address DEPT. PM-8, COUNCIL BLUFFS, IOWA

FREE!
OUR LATEST FLYER OF RADIO PARTS
Giant Radio Reference Map 3 1/2 x 4 1/2 ft...15c
Tube Base Calculator25c

EXPERIMENT WITH LUMINOUS PAINT

Complete kit of Luminous Paints in colors. Paint artificial flowers, lamp ornaments, novelties, house numbers, light switches, etc. Kit of one oz. each of 3 lasting colors, Lumi-Blue, Gardenia and Chartreuse, one ounce Sealer. Guaranteed best quality.

COMPLETE KIT WITH 3 COLORS AND SEALER \$4.25
F.O.B. Chicago

New Address
BLACK LIGHT PRODUCTS • 67 E. Lake St. • Chicago 1, Illinois

WOODWORKERS ... Get this!
CONSTANTINE MASTER MANUAL

Get the Most Fun From Your Hobby Indispensable to woodworkers. Newest, biggest edition, more pages, more color, helpful how-to-do-it articles, pre-war and new items, more bargains. Send 25c today and we will include **FREE! FULL YRS. SUBSCRIPTION** to Chips and Chats, published bi-monthly. Keeps you up-to-date on everything in woodworking, offers big money-saving bargains. Send now.
ALBERT CONSTANTINE & SON, Inc.
791-W, 135th Street, New York 54, N. Y.

SING-TALK thru your own Radio with Radio MICROPHONE

Put on your own broadcast at home with this Radio Mike. Sing, Talk from any room in the house. Make announcements. Lots of fun! It's wonderful voice practice. Easily attached to any radio. **SEND NO MONEY.** Pay postman \$1.98 plus postage. Send check or money order and save postage.
DISCO SALES, INC. (Dept. PM-5), 154 Nassau St., New York 7, N. Y.

SAY YOU SAW IT IN POPULAR MECHANICS

LAWN ORNAMENT-NOVELTY PATTERNS

28 Lawn Ornament Patterns, 25c. Other patterns; 15-20" high; Dutch Girl, Dutch Boy, Pirate, Bull Terrier, Mexican Girl, Mexican Boy, Dwarf, Penguin, Flower Girl, 10c each. 25 Novelty Patterns, 30c. All 62 Full Size Patterns, \$1.00 Postpaid. Strother Pattern Service, Dept. K-8, Box 383, Belington, W. Va.



'QUICK-CHANGE' GEAR BOX
CUT THREADS — 4 TO 224 PER INCH

Approximately .003 feed, for fine turning. New reverse furnished with box for Atlas. Bronze bearings throughout entire unit. Aluminum casting — All steel gears. Maintained accuracy. Speeds up production. Easy to install. Simple to set. Immediate delivery.

Only \$75.00
F.O.B. Chicago Guaranteed

FOR-Atlas, Logan, Craftsman and Power-Kraft Lathes

Write for information or order direct. Full instructions with shipment.
O'BRIEN MACHINE CO., Dept. 8, 1620 Highland Ave., Chicago, Ill.

Pli-rench

SUPER POWER, LOCKING

IT'S ALL IN THE RED JAW

SELF ALIGNING JAW

LOCKS WORK WITH TONS OF PRESSURE . . . HANDS FREE

This remarkable brand-new tool is a combination pliers, wrench, pipe wrench, clamp and hand vise. The self-aligning jaw fits itself to irregular shaped objects, giving a powerful, jaw-length grip, multiplying hand pressure at least fifty times. A whale of a tool! OPA ceiling price \$2.45. If your dealer cannot supply you, order direct.

THE WHALE TOOL CORP.
1767 BROADWAY, NEW YORK 20, N. Y.



REST EASY

You can make it!

Build this new lawn chair in your own workshop. Patented design has adjustable back and folds flat for winter storage. Send \$1.00 for plans now!



UNITED INDUSTRIES
3321 40th Ave. So.
Minneapolis 6, Minn.

4 IN 1

UNIVERSAL Fence Tool

TAKES UP SLACK
STRETCHES, SPLICES, ETC.

It's a **STRETCHER, STAPLE PULLER, SLACK TAKER AND SPLICER** combined all in One Tool for only **\$3.95**

If your hardware, implement or lumber dealer can't supply you, order direct. Prompt shipment. Check with order, or C.O.D., postpaid. Complete instructions with each tool.

INTERNATIONAL STEEL COMPANY

2828 (Dept. D.) Lyndale Ave. South Minneapolis 8, Minn.

ENJOY YOUR VACATION

Fishing, picnicking or sport events. Relax with the comfortable **KROMER BACK REST**. Strong semi-spring steel frame. Heavy canvas back support. Lightweight—folds flat for carrying. Green Duco finish. Price \$2.35 F.O.B. Minneapolis, Minn.

If your dealer cannot supply order direct, adding 15c for mailing. 25c west of Rocky Mts.



O. W. KROMER CO.

1423 Washington Avenue South, Minneapolis, Minn.

SAY YOU SAW IT IN POPULAR MECHANICS

LAW

STUDY AT HOME for PERSONAL SUCCESS and LARGER EARNINGS. 35 years expert instruction—over 108,000 students enrolled. L.L.B. Degree awarded. All texts furnished. Easy payments. Send for FREE BOOK—"Law and Executive Guidance."

AMERICAN EXTENSION SCHOOL OF LAW
Dept. 68-M, 646 N. Michigan Ave., Chicago 11, Ill.

GOOD NEWS FOR FARMERS!

SOLVE YOUR TILLAGE PROBLEM With The

SPECTACULARLY IMPROVED SEAMAN Triple TILLER

Make a better seedbed . . . faster! . . . with a Seaman Farm-Size Triple Tiller. With a single implement, you can prepare a complete seedbed in one operation under average conditions. Handles shallow or surface mulching, or deeper tillage, as required. Fertilizer or surface vegetation is thoroughly milled into seedbed. Promotes increased yields, eradicates quack-grass, provides better weed control.

NEW, SPECTACULAR IMPROVEMENTS INCLUDE: Drastic reduction in horsepower requirements, permitting successful operation of a 3-ft. Seaman Tiller from power take-off of top-rated 2-plow tractors; wheel position (in front) eliminates tiller wheel tracks; new type Pilot Disc assures better operation in average cover crops; new type tines permit more effective penetration; greatly improved Rotor Assembly, with heavier carrier plates and long-life clutch facings, assures drastic cut in maintenance costs.

All the above **PLUS VALUES** now available **AT NO INCREASE IN PRICE!** And here's **MORE** good news! Increased production makes power take-off model **SEAMAN TRIPLE TILLERS** available **NOW!**

PRICE:
3-FT. MODEL
\$525
f.o.b.
Milwaukee

SEE YOUR LOCAL IMPLEMENT DEALER ABOUT A SEAMAN TILLER AT ONCE! . . . or write us for detailed information.

SEAMAN MOTORS

341 NORTH 25th STREET, MILWAUKEE, WIS., U. S. A.

DEALERS: If we are not represented in your locality, write, phone or wire for details regarding the Seaman Dealer Franchise.

SAFE-T-PLANE

CUTS WOOD, METAL, PLASTICS
FITS ANY DRILL PRESS!

Positive cutting action eliminates scraping or tearing in hard, medium or soft woods, including balsa, irrespective of grain position. A special cutter is available for making square-shouldered cuts, another for work in non-ferrous metals and many plastic products.

Features: single cutting blade; "one-spot" blade adjustment; polished bell guard protects eyes and hands, directs flying chips downward; vibrationless precision operation, rugged strength, versatility and long working life.

Only **\$5.95** fully guaranteed.

At Your Dealer—or Postpaid. Literature available

A. D. McBURNEY, 939 W. SIXTH STREET, DEPT. PM-8, LOS ANGELES 14, CALIF.

BOICE-CRANE POWER TOOLS

for shop men and
homecraftsmen.



BAND SAWS



JIG SAWS



DRILL PRESSES



THICKNESS PLANERS



SPINDLE SANDERS

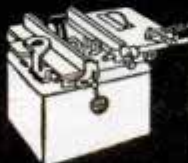

SAW-JOINTERS



LATHES



SPINDLE SHAPERS



BELT SANDERS

Write for literature on this
versatile, low-cost,
sturdy line.

BOICE-CRANE COMPANY
943 Central Ave., Toledo 6, Ohio

WORLD'S LOWEST PRICED ADDING MACHINE

VEST POCKET SIZE

IDEAL FOR BUSINESS OR PERSONAL USE

FREE TRIAL
ONLY \$2.50
TOTAL COST
SEND NO MONEY

Each Baby Calculator in Beautiful, Rich-looking Leatherette case—at no extra cost. **FREE!!**



Fits vest pocket or purse. Guaranteed accurate. Operated as easily, and as reliable, as machines costing many times as much. Not a toy. Substantially made of 28-gauge steel—guaranteed for life against defects in construction. You positively can't buy a calculator of equal quality for as little money. **ACCEPTED AS THE FINEST LOW PRICED CALCULATOR FOR OVER 30 YEARS!** Operates with a flick of your finger. Adds, subtracts, multiplies, divides—counts up to ten million. Pays for itself over and over in mistakes avoided, and time saved. **MAKES IDEAL GIFT.**

Sold on a positive money back guarantee. Send only \$2.50. Calculator sent postpaid, or send name and address and pay postman \$2.50 plus postage. **MONEY BACK IN 10 DAYS IF NOT DELIGHTED!** (If outside U. S. send \$3.00.) **AGENTS WANTED.**

CALCULATOR MACHINE CO. (Mfrs.)
Dept. 181, P. O. Box 248, Glenview, Illinois

Nongrease Kitchen Ventilator Stops Condensation in Ducts

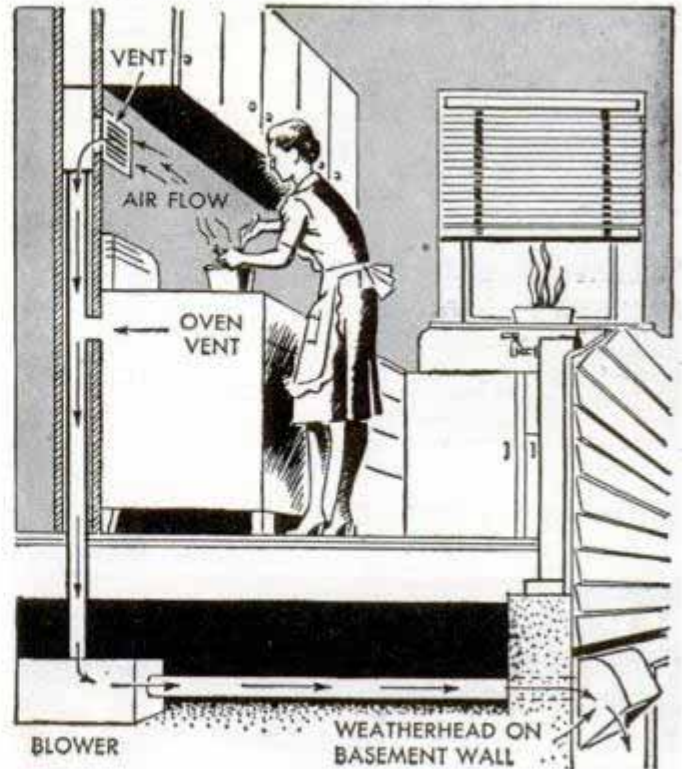

Kitchens are free of heat, odors, and grease-bearing vapors with ventilating systems designed for new or old homes. The secret of kitchen ventilation, according to engineers of the Rochester, N. Y., Gas and Electric Corporation who devised the systems, is to carry cooking vapors away before they have an opportunity to condense on cool kitchen walls and deposit grease. Each of the installations provides for a wall grille above the range where cooking vapors and excess heat are picked up. Another outlet is connected to the oven and broiler if the range is designed for such ventilation. The outlets lead into a ventilating duct made of material that retains heat and prevents vapors from condensing until they are blown out of the building. This keeps the ductwork and blower-fan blades clean. The outlet, equipped with an automatic back-draft damper, may be located either in the basement or the attic depending on the construction of the home. One of the outstanding features of the system is the way cupboards or shelves are used to guide cooking vapors into the grille.

Farmers Boost Hay Food Value By Cutting Young Grass

Grass cut and quick-cured while young contains three times as much protein as it does when cut at the usual hay-making stage, according to C. F. Schnabel of Research Products, Inc., of Kansas City, Mo. Grass cut in the spring, he reports, contains 40 percent protein on a dry-weight basis.

SMALL EFFICIENT SPEED REDUCER

Sturdy, compact (see dimensions). Proved in thousands of industrial installations. Case of heat treated aluminum. Gears, SAE 65 (British Gear) Bronze. Worm of case hardened steel. Timken Bearings throughout. Available in 4 different assemblies (shown below) and in these standard ratios:

4-1	25-1	64-1	200-1
8-1	30-1	75-1	300-1
10-1	40-1	80-1	400-1
16-1	50-1	100-1	600-1
20-1	60-1	150-1	800-1

Torque capacity 100 inch pounds. Especially suited for bench work, home work shops, light production, animated displays, etc. When ordering be sure to specify assembly and ratio required. Shipping weight in carton, 8 lbs. Full money back guarantee. Prompt deliveries.



\$15.12

Ceiling Price
F. O. B. Cleveland

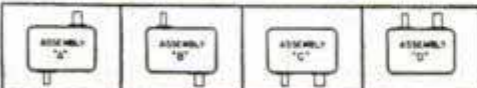
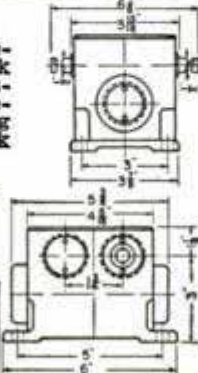

THE OHIO GEAR CO.
1408 EAST 179th ST. • CLEVELAND 10, OHIO

TELEVISION KIT

Easy to assemble—No knowledge of television required—complete easy to assemble instructions. Kit includes a \$30.00 7 inch Picture Tube. For information write

TRANSVISION, INC.

BOX 364 NEW ROCHELLE, N. Y.

PLASTICS!

Fabricating plastics offers you a fascinating hobby or a profitable business. New Carmen-Bronson Plastics Handbook tells you how; gives construction plans. New Carmen-Bronson Catalog lists all needed materials—Plexiglas, Lucite, Bakelite, Lignolite, Tenite II, Lumarith in sheets, rods, tubes, special shapes—clear and glowing colors. Also plastics dyes, cements, accessories and supplies. 10c brings you both catalog and handbook. Send for them today.

CARMEN-BRONSON COMPANY
165 EAST 3RD STREET, DEPT. 8-B, MOUNT VERNON, N. Y.

Save a Thousand Hours Hard Labor



\$16.50
postpaid

Build a whirlblade power lawnmower with this lightweight construction KIT and mow your lawn the easy way. Electric motor or gasoline engine bolts on aluminum base.

Kit contains: Aluminum alloy permanent mold die casting with engine base and 3/4" OILITE bearings; 16", 18" or 20" width cutter bar; two extra blades; two pulleys—all beautifully finished. Sent \$16.50 postpaid. 10" rubber tired wheels to match \$3.25 each. Dealers and mfrs. write for discount.

THE WEBB MFG. CO., 703 E. Poplar Avenue, Arkansas City, Kans.

SAY YOU SAW IT IN POPULAR MECHANICS

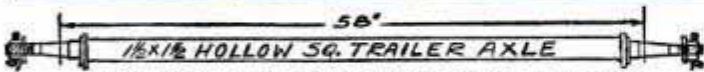

CAP.—2000 LBS.—\$6.75 EACH F.O.B. DETROIT

STRONG MACHINE & AXLE COMPANY
9710 Lumpkin Hamtramck 12, Michigan

Drawings

Inventors Note

Your Sketches Prepared for Patenting, Selling and Manufacturing

Come First

Our drawings accepted and approved by Patent attorneys for filing in Patent Office, Washington, D. C.

Notarized Protection

CHRISMAN DRAFTING LABORATORY

Drawings by College Engineers 317 South West 17th, Manhattan, Kansas

AUTO ENGINE SPEED CONTROL GOVERNORS

(REGULADORES)

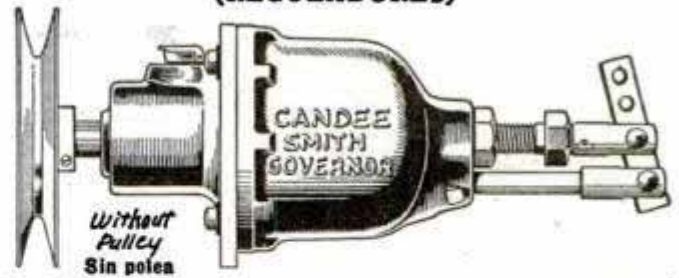

Without Pulley
5in polea

Give constant or changeable speed to any auto or truck engine, when used for power. Guaranteed. Instructions. Oil ring bearing, \$14.25. Full ball bearing, \$21.75. Postage west of Miss., 50c; east of Miss., 85c. Sent COD or—Postage to any country in the world \$1.00 each.

Pulleys to 3", \$1.00, wt. 1 lb.; to 6", \$1.50, wt. 1 1/2 lb. Governor speed 1400 to 2400 rpm. Figure your pulley size.

Agents Wanted: Parts and Implement Dealers, Garages, Welders, Wreckers, Catalog and Mailing List Houses, etc.



These valves used where carburetors have outside attachments.

State size of opening and distance between bolt holes. 1", \$3.75; 1 1/4", \$5.25; 1 1/2", \$6.50; 1 3/4", \$7.50; V8, \$8.00. Mailing weight, 3 lbs. If remitting, enclose for postage. You may order from this ad, or we will send circulars. Stocks carried: In Montreal 15, Canada: 7546 Wiseman St. In Skaneateles, N. Y.: Horie Welding Supply.

CANDEE, Dept. N, 2641 S. Hill, Los Angeles 7, Calif.



CUSTOMER:
"That's a beautiful job, Pete."
PETE: "Yes, you can't beat the Foley for turning out a perfect cutting saw."

is a Good Business

With the Foley Automatic Saw Filer you can have a fine cash business with steady customers and make a good living. The Foley automatically joints the saw, making all teeth even in size, shape, spacing. The Foley is the only machine that files all hand saws, also band and cross-cut circular saws.

SEND FOR FREE PLAN—Shows how to start a saw repair shop. No canvassing. Send coupon today.

FOLEY Automatic SAW FILER

FOLEY MANUFACTURING CO.
816-6 Foley Bldg., Minneapolis 13, Minnesota
Send Free Plan on Saw Filing business, no obligation

Name _____

Address _____





MOTO-TOOL ★ THE "POCKET-SIZE" MACHINE SHOP



PUT THIS "WAR VETERAN" TO WORK

Tough grinding and polishing jobs in tool rooms and machine shops fade away under the speed and versatility of Dremel Moto-Tools. Thousands of Moto-Tools helped establish production records in plants such as General Electric, Westinghouse, Remington Arms, Ford, Nash-Kelvinator, Consolidated Aircraft, Northrop, and Douglas. Others earned the respect of the armed forces in far flung repair depots.

Only Moto-Tools Have All These Features

A Model 2 Moto-Tool develops a speed of approximately 27,000 rpm. Weighs only 13 oz. Shaped to fit the hand. Sturdily built. Has shock-proof bakelite housing. Balanced for vibrationless operation. Uses 110-120 A.C. or D.C. current. Patented automatic chuck lock pin makes removal of accessories easy. Pin disengages automatically . . . prevents accidental burning-out of motor.



A few of the jobs that can be done better and faster with a Moto-Tool.

- | | | |
|--------------------------------------|-------------------------------------|-----------------------------------|
| <input type="checkbox"/> Sharpening | <input type="checkbox"/> Burring | <input type="checkbox"/> Cleaning |
| <input type="checkbox"/> Finishing | <input type="checkbox"/> Grinding | <input type="checkbox"/> Routing |
| <input type="checkbox"/> Touching Up | <input type="checkbox"/> Polishing | <input type="checkbox"/> Cutting |
| <input type="checkbox"/> Sanding | <input type="checkbox"/> Burnishing | <input type="checkbox"/> Rasping |
| <input type="checkbox"/> Drilling | <input type="checkbox"/> Inlaying | <input type="checkbox"/> Carving |
| <input type="checkbox"/> Mortising | <input type="checkbox"/> Sawing | <input type="checkbox"/> Brushing |
| <input type="checkbox"/> Engraving | <input type="checkbox"/> Scoring | <input type="checkbox"/> Dressing |

27,000 R.P.M.

MOTO-TOOL KIT

Kit No. 2 with 23 high grade accessories and Model 2 Moto-Tool, in hardwood case. \$23.50
Model 2 Moto-Tool, with 1 accessory . . . \$16.50

MONEY-BACK GUARANTEE

Ask your Dealer about Dremel Moto-Tools and accessories. If he does not handle them, send direct to factory. We send prepaid if cash in full accompanies order. \$2.00 brings Moto-Tool C.O.D. for balance, plus postage. Write for FREE CATALOG.

MOTO-SAW COMING!

Dremel Moto-Saw . . . the sensational electric scroll saw . . . will be back as soon as materials are available.

DREMEL MFG. CO., Dept. 116-H, RACINE, WISCONSIN

HERE'S GOOD NEWS...AGES 3 TO 7

RUBBER WHEEL ROLLER SKATES BY Multi-Kwik



Perfect companion to the original 16-disc wheel skate but may be used indoors, too!

Sleek and shining in rust-proof steel - quiet SOLID RUBBER WHEELS...and safe for beginners...ages 3 to 7...adjustable.

ONLY 2.75 pr. (Plus freight some localities)

AT LEADING STORES EVERYWHERE
MULTI-KWIK CO. A Division of Radiobar Company of America
WEST LOS ANGELES 25, CALIFORNIA

Say You Saw It in POPULAR MECHANICS

MIDGET BURNER OF A HUNDRED USES

WAR SURPLUS BARGAIN



Use this amazing midget alcohol burner in your home, workshop, garage, camp, etc. Excellent for sterilizing, experimenting, soldering, heating. Hinged metal case houses burner, sterilizing tray. 1 1/2" x 1 1/8" x 2 3/8". All brass, bright nickel finish. Sterilizing trough is STERLING SILVER.

POSTPAID ONLY 60c COMPLETE

U. S. METAL PRODUCTS CO., INC.
1045 ATLANTIC AVENUE, BROOKLYN 16, N. Y.

LOW COST HANDY WHEELBARROW



Makes Hauling Easy Because It's Lighter and Better Balanced. Costs Less Than "Old Fashioned" Wheelbarrow. Takes hickache out of hauling. New principle—simply slip bushelbasket, washtub in frame—hauls anything ordinary wheelbarrow will—more too. Lasts a lifetime. Write For FREE Information And Trial Offer. CONSOLIDATED SALES, 8th & Oak, Dept. P.1, Kansas City, Mo.

FREE RADIO CATALOG

Latest radio and electronic parts and devices, newest ham gear, gadgets, war surplus items. All in this new FREE catalog. Don't delay.



BURSTEIN-APPLEBEE CO.
1012M McGee, Kansas City 6, Mo.

Now A DYNAMIC HEAVY DUTY INDUSTRIAL WELDER

IDEAL FOR AUTO - HOME APPLIANCE AND FARM REPAIRS

DESIGNED TO DO HIGH GRADE WELDING INEXPENSIVELY—Maintenance Men; Farmer's Mechanics; Machine Shops; Foundries; Auto, General Repair and Job Welding Shops; all using the DYNAMIC find it so indispensable and useful that they cannot afford to be without it. If inexperienced, you can easily learn to do a variety of high grade welding jobs by following the practical, simplified operating and welding instructions furnished. Once you see a DYNAMIC in operation, you won't want to be without it. Its simplicity will amaze you. In a year the DYNAMIC only costs you about 6¢ a day. Helmet, rods, cables, holder and operating instructions, etc., furnished.

SAVES YOU VALUABLE TIME AND MONEY!

This portable DYNAMIC WELDER—easily carried to the job—can be operated from any convenient, properly wired 110 volt, 60 cycle line. Can also be supplied for 220 volt, 60 cycle operation and for other voltages and cycles at slight additional cost. Works on IRON, STEEL, BRASS, BRONZE, AND OTHER METALS—has 8 metallic and carbon arc welding heat stages—does work you would think only possible with larger more expensive machine.

DYNAMIC WELDER CO. • 13 East 23rd St., FH, Chicago 16, Ill.

FOR ONLY \$23.50 COMPLETE...

AVAILABLE NOW WITHOUT PRIORITIES!

WRITE TODAY FOR PARTICULARS
Get details on our 10 day trial offer.

Member Chicago Association of Coasmerce



7 LB. EXPERIMENTER PARTS ASSORT. KIT



A "gold mine" for the radio serviceman. Hundreds of valuable radio parts, new valvar and electronic parts and sub-assemblies, coils, resistors, trimming condensers—worth many times this low **\$1.79** price. A130R—7 lbs.

G.I. RUCKSAKS



Straps over your back for toting luggage, camping equipment, etc. Has tubular steel frame. Made of heavy duty U.S. ARMY duck with adjustable shoulder and waist straps. Has four compartments. A real value for campers, hikers, etc. Wgt. 7 lbs. R501—Used, Each Only **\$2.15** Fed. Tax

Total Cost **\$2.48**

AIR CORP. BOMB. SIGHT



For inventors, experimenters, research workers, etc. This delicate instrument consists of hundreds of accurately machined parts, including eye objective, reflecting mirror prism, many fine calibrated adjustments, electric bulbs, polaroid filter, calibrated scales for its many adjustments, etc. Packed in all metal box 15x21 x12 inches with lock. Weight 100 lbs. **\$35.00** Stock No. 214—Ea.

AIR CORP. GUN SIGHT



Worth many times this low price. Consists of a polaroid filter, top surfaced prism mirror, actuating motor, compensating adjustments, calibrated dial for air speed, drift, straining range, etc. Inventors and experimenters will find many valuable parts in this assembly. All brand new in orig. export packing. Weight 7 lbs. No. 215—... **\$18.50** Each only

LIFE PRESERVER BELTS

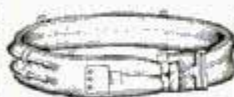

Right from the invasion beaches. Consists of two air chambers. May be inflated automatically with "sparklet" cartridges or manually by attached hose. Adjustable in waist size. One air chamber guaranteed air tight—other may need a tire patch. All belts are used and slightly soiled but a bargain at this low price.

No. 1261 **\$1.00** Each

WAR SURPLUS AND HUNDREDS OF OTHER BARGAINS

SPECIALS FOR BOY SCOUTS, CAMPERS, HUNTERS



MESS KITS
Regulation two-piece Army Mess Kits with folding handle. Used, but perfect. Weight 2 lbs. No. A116—Ea. **69c**

ARMY BANDOLEERS
Eleven pocket army bandoleer. Big pockets with snap button fasteners—shoulder and waist straps. NEW. Wgt. 1 lb. No. 129—Each **49c**

MICROPHONE BUTTON
Brand new. For radio, electronics and other experiments. Full 2 1/2 inch diameter. Wgt. 1 lb. No. 512—Each **98c**

MOSQUITO TENTS
Army cot size. Fine mesh netting, taped seams. Set-up rods included. New. Wgt. 8 1/2 lbs. No. A104—Each **\$5.95**

NEW ARMY COTS
Brand new. Folding type, opens to 27x78 inches. Heavy canvas top. Wgt. 26 lbs. No. 232—Each **\$5.95**

WOOL ARMY BLANKETS
100% wool, regulation O.D. Army blankets. Class B—perfect. Used but renovated for re-issue. Wgt. 5 lbs. No. 233—Ea. **\$4.89**

MOSQUITO HEAD NETS
Fine mesh netting. Fits over hat. Draw string at neck. Brand new. Wgt. 1 1/2 lb. No. 509—Each **89c**

MCCLELLAN SADDLES
Brand new! Of fine top grain cow hide with hair girth. Complete. Guar. value. Wgt. 22 lbs. No. 145—Each.. **\$13.95**

SADDLE BAGS
Of fine top grain leather. Each bag measures 12x13 inches. Makes fine motorcycle pouch. Used, but perfect. Wgt. 6 lbs. No. 151—Each **\$6.95**

POPULAR RECORD ASSORTMENT
Fifty records of modern dance, race, blues and hillbilly selections. No two alike. Famous name bands and artists included. Used in juke boxes, but guar. perfect. Shipped exp. collect only—no exchanges or refunds. Wgt. 28 lbs. No. A303—50 records **\$9.64**



CANTEENS
Reg. U. S. issue canteens. Plastic screw top chained to body. Slightly used but perfect. Wgt. 1 lb. 117—Metal **69c** 118—Plastic—Ea.

CANTEEN CUPS, COVERS
All metal with folding handle. Fits over canteen listed above. Wgt. 1 lb. No. A120—Each **69c**

CANTEEN COVERS
Of heavy O.D. canvas with taped edges and snap button fasteners. Wgt. 1/2 lb. NEW A530—Ea. **35c** USED A119—Ea. **25c**

PUP TENTS
Army regulation pup tents of heavy brown canvas. Fine for boy scouts, campers, etc. Used but perfect. Wgt. 5 lbs. No. 100—Each **\$5.95**
Brand new pup tents with extended flies. No. A110—Each **\$7.95**
Poles, stakes, etc. for Pup Tents listed above. No. 101—Set **\$1.00**

G.I. POCKET BELTS
Regulation G.I. Belt with snap button fasteners on all pockets. New! Adjustable size. Wgt. 3 lbs. No. 109—Each **98c**

TANK PRISMS
Sighting Prism for tank gunner. Reflects images at right angles. Used but perfect. Wgt. **\$2.95** 2 lbs. No. 234—Each..

CAVALRY SPURS
U.S. Cavalry Spurs. Bright metal. Wgt. 2 lbs. No. 102—Pair **98c**
Set of 4 leather straps for above. No. 103—Per set... **50c**

SHIPS LANTERNS
Navy type ships lantern, 22 1/2 in. high. Burns oil—may be wired for electricity. New. Wgt. **\$12.50** 15 lbs. No. 516—Each

RUBBER BOAT



Purchased from U.S. Gov't. Has 5 man or 1000 pound capacity. Used but guaranteed perfect. Furnished complete with pump for inflating and oars. Shipping wgt. 70 lbs. **\$49.50** No. 811—Each ..

ONE MAN BOATS
Similar to above but smaller. Designed for one man use. Each boat complete—packed in a special parachute bag. Wgt. 15 lbs. No. 526—Each .. **\$17.95**

G.I. PISTOL BELTS



Of heavy canvas webbing. Adjustable. Eyelleted all around. Used but perfect. Wgt. **98c** 2 lbs. No. 131—Each..

ANTENNA UNITS



Purchased from U.S. Gov't. Eliminates radio interference. Improves reception. New. Wgt. 4 lbs. No. 637—Each **\$2.95**

AERO TURN CONTROL

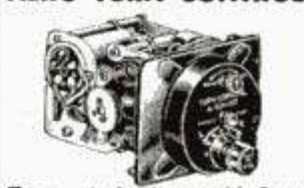

Turn control unit assembly from an airplane, consisting of a valuable assortment of gears, switches, mechanical and electrical parts. Fine for experimenters, inventors, etc. Illus. shows unit with cover removed. Shp. wgt. 10 lbs. **\$7.95** No. A264—Each ...

SERVO TURN CONTROL



Part of automatic pilot. Accurately machined gears and fittings worth many times this low price. Many valuable parts usable by experimenters of other purposes. Shp. Wgt. 30 lbs. No. A263—Each..... **\$17.50**

MOISTURE ABSORBENT



Protex-Sorb. A protective absorbent that eliminates moisture damage. In cloth bags of 1 oz. No. 138—Doz. 4 oz. bags... **\$1.00**

STILLS



Distill your own water with one of these fine portable stills. Purchased from the Gov't. Completely self contained. Has 1 gallon capacity; output 1 1/2 gal. per hour. Fitted with genuine Coleman double burner stove. Operates 5 to 7 hrs. on one filling. Heat output 20,000 BTU's. Stove alone is worth this price. All new and guaranteed. Instr. included. Weight 100 lbs. No. 206 **\$59.50** Each ..

ORDER DIRECT FROM THIS AD

Values galore! Hundreds of hard-to-find items for home, shop and outdoors. Make remittances by money-order, bank draft or personal check. Send 25% deposit on C.O.D. orders. No C.O.D.'s on orders for less than \$3.00. Include sufficient postage on parcel-post orders—any average will be promptly refunded. All quotations F.O.B. Chicago. Used items and materials are guaranteed serviceable and as described. Your money back if not more than satisfied.

BIG ILLUSTRATED CATALOG FREE

STARK'S Dept. PM846
509 So. State St.
CHICAGO 5, ILL.

SOUTH BEND

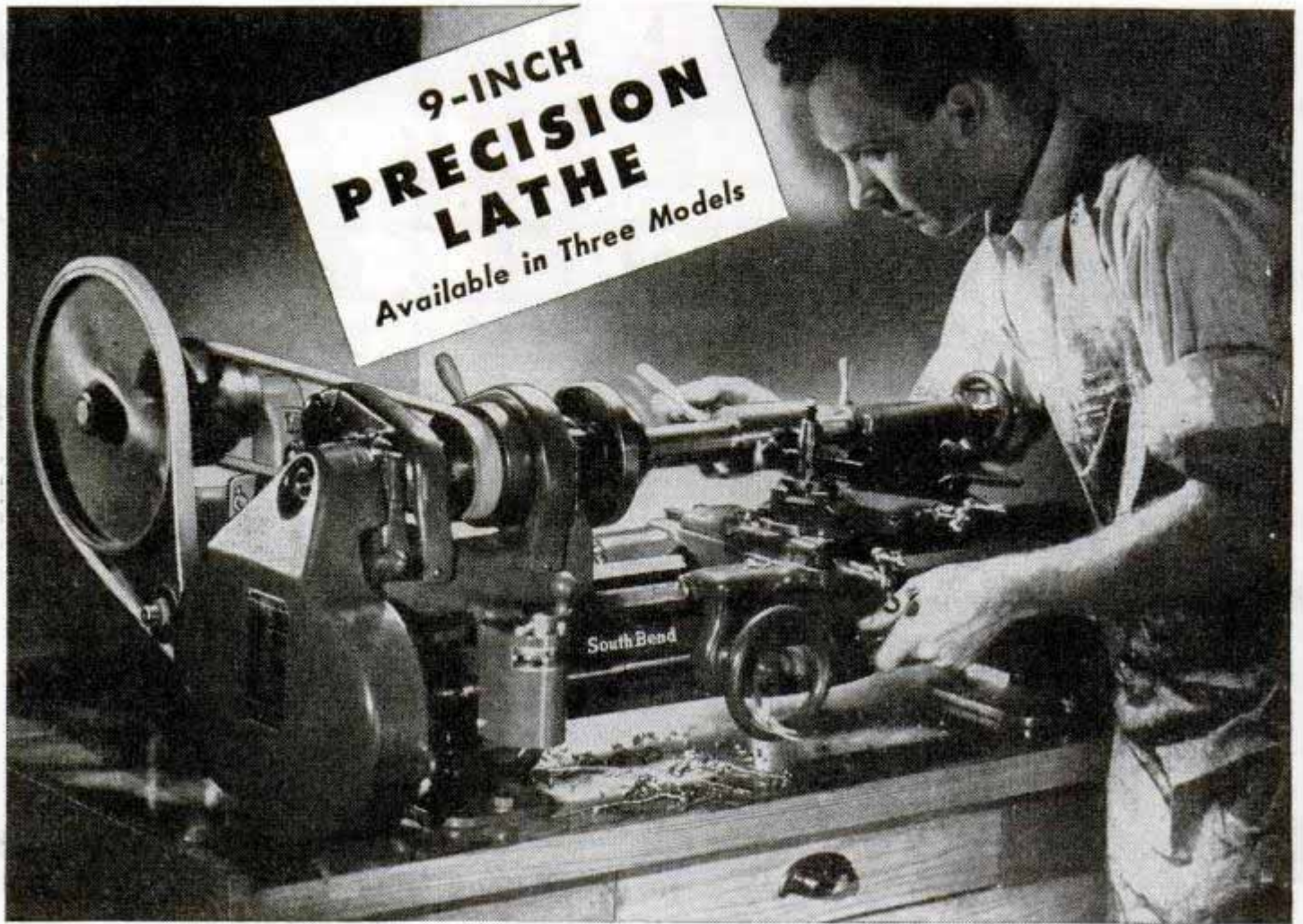

PLAN YOUR SHOP AROUND THIS LATHE

9-INCH LATHE FEATURES

- Fine workmanship by highly experienced machine tool craftsmen
- Superfinished spindle with large bearings
- Belt drive for smooth, quiet operation at high speeds
- Back-gear drive for power and low speeds
- 6, 8, 12 or 16 spindle speeds
- Thread cutting range (Model A)—4 to 224 per inch, 48 pitches
- Precision lead screw for thread cutting
- Worm drive and friction clutch for power longitudinal and cross feeds
- Three hand-scraped V-ways and a flat way on bed insure perfect alignment of headstock, saddle and tailstock

The South Bend 9-Inch Lathe is basic equipment for all kinds of accurate machine work—precision manufacturing operations, auto, radio and appliance repair, tool and instrument work, model building, pattern making, and wood turning. A fine precision tool capable of machining work to exacting tolerances, it performs a wide variety of operations on metals of all kinds, wood, plastics, and similar materials. It is used for turning, boring, drilling, cutting screw threads, milling, grinding, polishing and many other machining jobs.

The 9-inch South Bend Lathe is practically a shop in itself as the addition of a few practical attachments will increase its versatility beyond the usual scope of lathe work. Write today for catalog giving complete information on this and other types and sizes of South Bend Lathes.

LATHE BUILDERS SINCE 1906

SOUTH BEND LATHE WORKS

455 EAST MADISON STREET, SOUTH BEND 22, INDIANA



Printed by Popular Mechanics Company, Chicago, Ill., U. S. A.

MILL IT—on Your Lathe with a **PALMGREN** MILLING ATTACHMENT

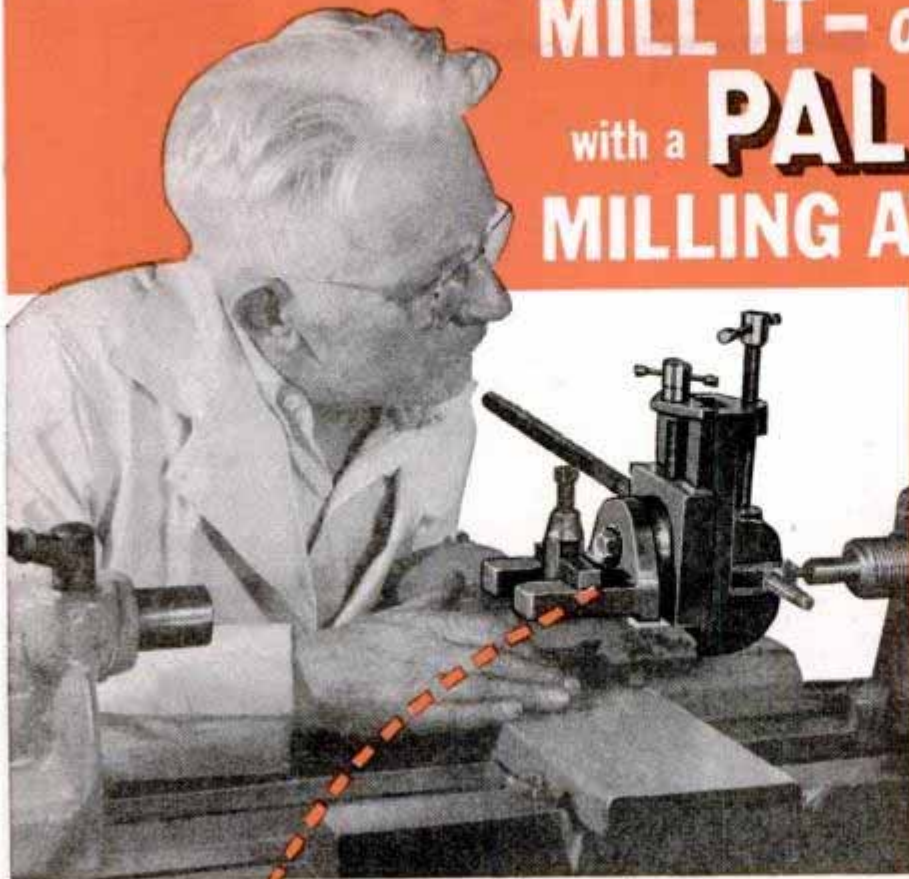

JUST A FEW OPERATIONS YOU
CAN DO ON YOUR LATHE!

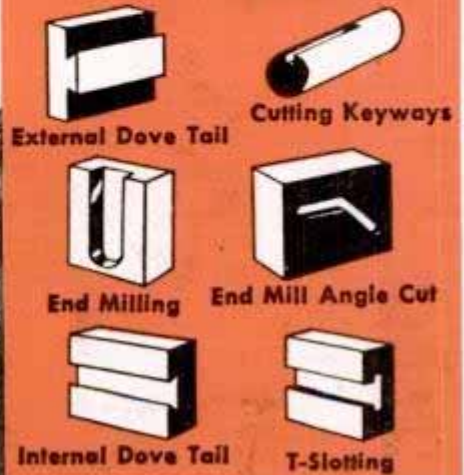

CONVERT LATHE in 10 SECONDS!

Now—in your own shop—on your lathe, you can Mill, Slot, Grind, Groove, Square Shafts, Saw at Angles, Recess, and do many other important jobs. Yes! In 10 seconds, you can convert your lathe—SAVE time and money by doing work you formerly had to send out. Lathe owners are amazed at the quality and variety of work that can be done with a PALMGREN MILLING ATTACHMENT. Don't overlook this important tool. Precision built, it has 360° graduation for rotary angle adjustments, also graduated vertical feed screw. Fits South Bend, Atlas, Craftsman, Logan, Sheldon and all other lathes. Easily mounted by straddling tool post. Thousands in use and highly valued in home work shops, small and large machine shops, repair shops, railroad shops, schools and experimental laboratories.

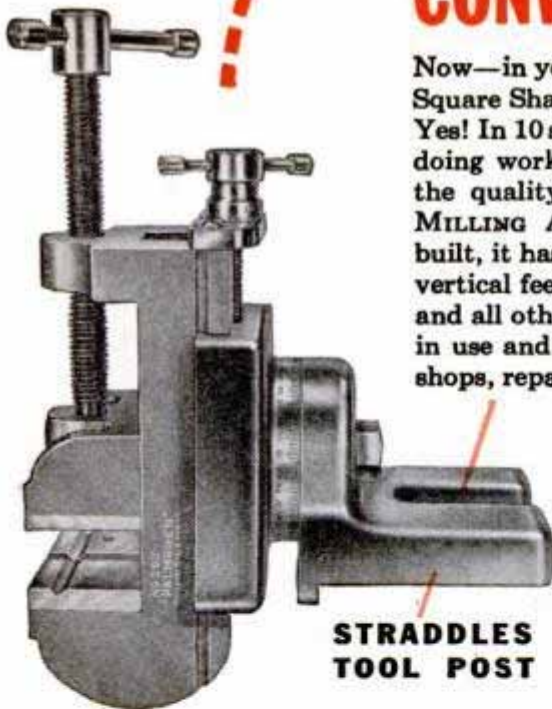

**STRADDLES
TOOL POST**

3 SIZES

Made in 3 convenient sizes to handle small, medium or large pieces of work. One trial will convince and delight you. It will quickly pay for itself and add to your profits for years to come. Don't delay! Order today!

Nos.	Width Jaws	Depth Jaws	Jaws Open	Weight Pounds	Fits Tool Post	Price F. O. B. Factory
150	1½ in.	1 in.	1 ¾ in.	6½	1 in. dia.	\$18.75
250	2½ in.	1 7/16 in.	2½ in.	11	1½ in. dia.	24.75
400	4 in.	1½ in.	4 in.	24	2 in. dia.	39.75

AVAILABLE IMMEDIATELY

Your dealer or jobber will gladly show you one. However, if he cannot supply you, fill out the coupon, attach your remittance and we will send postpaid.

Write for Circular No. 186

CHICAGO TOOL AND ENGINEERING CO.

Mfrs. of PALMGREN PRODUCTS for over 28 years

8365 South Chicago Avenue • Chicago 17, Illinois

MAIL THIS COUPON TODAY!

Gentlemen:—

Enclosed find draft or money order for \$_____. Please send prepaid a No. _____ PALMGREN MILLING ATTACHMENT.

NAME _____

STREET _____

TOWN _____ STATE _____

Print Name and Address—Use margin if needed.



Restful Writing

BECAUSE OF "TRIUMPH" DESIGN

Color Photograph by
John Paul Pennebaker

Easier writing stems from better basic design, better materials—hand formed, fitted and finished by master craftsmen. That's the background of "TRIUMPH." The result challenges comparison—defies "equals"! Prove this for yourself. A test of all points up the superiority of one—Sheaffer's! Beauty, balance, features of function—not fad—instant response to any writing style—and writing action that glides with easy eagerness across the paper. Once you try—you'll buy Sheaffer's!

VALIANT pen, \$12.50; pencil, \$5; complete set, \$17.50. Other sets, \$3.95 and up. Complete range of Colors.

The
Lifetime
POINT

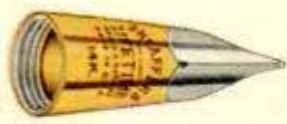

Unconditionally Guaranteed For First User's Lifetime Without Repair Charges if sent to Sheaffer factory!

New
Fineline



SLEEVE TIP[®]
Reduces
Lead Breakage!

Copyright 1940, W. A. Sheaffer Pen Co. *Trademark
Reg. U. S. Pat. Off. *Licensed U.S. Patent No. 2170734

SHEAFFER'S

Listen Every Sunday to Sheaffer's Parade with Carmen Cavallaro—NBC Complete Network, 2 p.m. Eastern Standard Time; 3 p.m. Eastern Daylight Time