

POPULAR MECHANICS

MAGAZINE

WRITTEN SO YOU CAN UNDERSTAND IT

REG. TRADE MARK GREAT BRITAIN NO. 410428

REG. U.S. PAT. OFF.

JULY
1946
25 CENTS
30c IN CANADA

GARDEN IN THE DESERT
PAGE 92





Delco batteries are sold by more
than 37,000 Delco battery dealers.
Wherever you go, you will find
Delco batteries in the right size
and type for your car.

DELCO-REMY... WHEREVER WHEELS TURN OR PROPELLERS SPIN

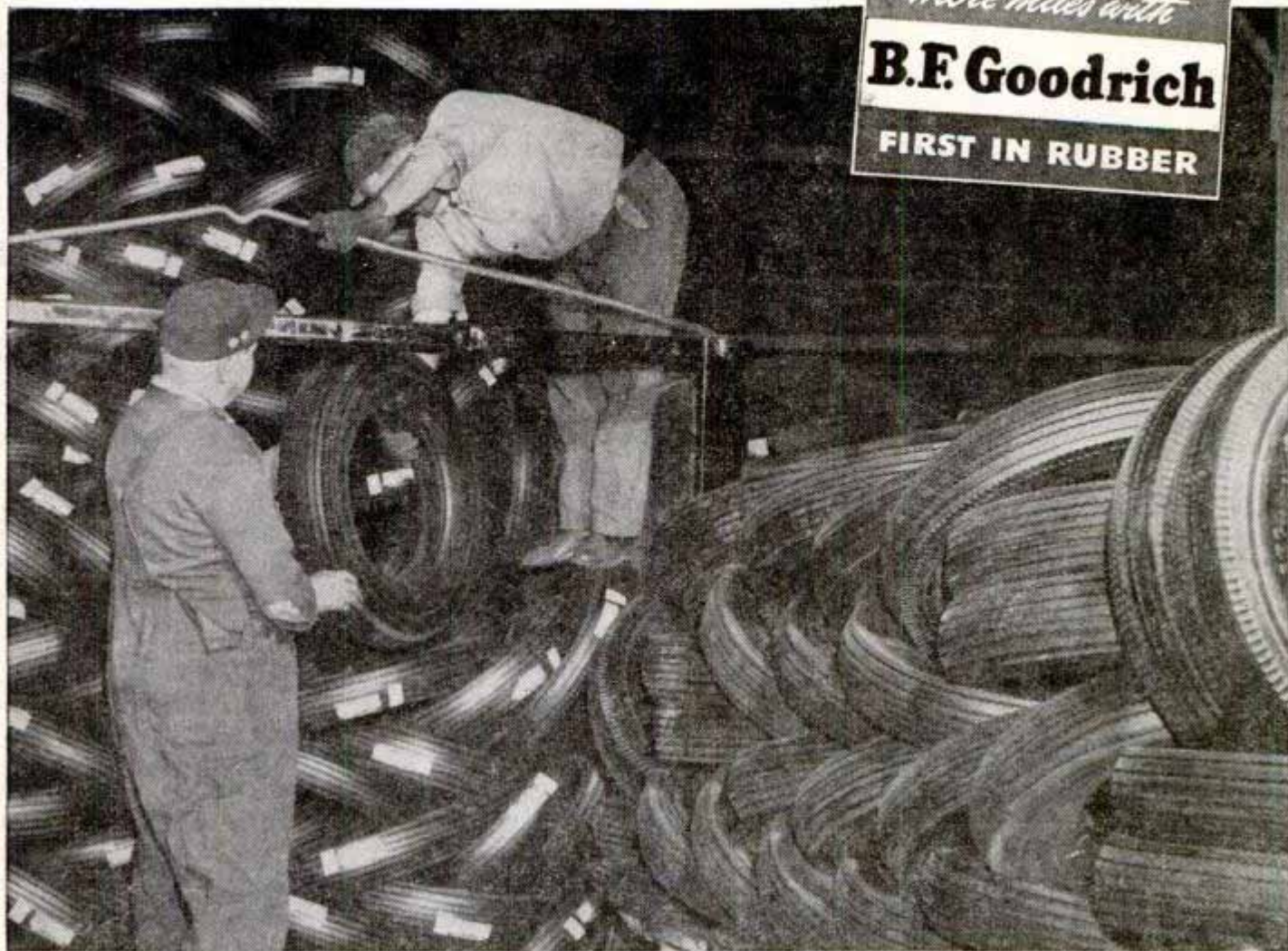

THOUSANDS ON THEIR WAY—THE NEW TIRES THAT OUTWEAR PREWAR TIRES

You can order a set of these tires for your car now

RIGHT NOW the nation's tire dealers are getting more passenger-car tires than ever before in history—75 per cent more for the first six months this year than the first six months of 1940, the last normal prewar year. This is in addition to the thousands of tires being supplied to automobile manufacturers for use on new cars.

But there's more demand for some than others and big extra demand for B. F. Goodrich. Naturally people want the tire that outwears prewar tires. So it's well to order a little in advance.

The B. F. Goodrich Silvertown is a better tire—that's why there is a bigger demand for it. It has a new tread design, slightly wider and flatter, that puts more rubber on the road—gives extra miles of service because it wears longer and more evenly. This longer wearing tread is backed up by a strong tire body—better cords and more of

them—for resistance to bruising and damage from accident.

If you need new tires, or may need them soon, the thing to do is to check with your dealer now. He may have tires for your car in stock. If not, it will be well worth your while to place your order and wait a little longer to be sure of getting the new B. F. Goodrich Silvertowns that outwear prewar tires. *The B. F. Goodrich Company, Akron, Ohio.*

B.F. Goodrich

FIRST IN RUBBER

electrical pipe-line →

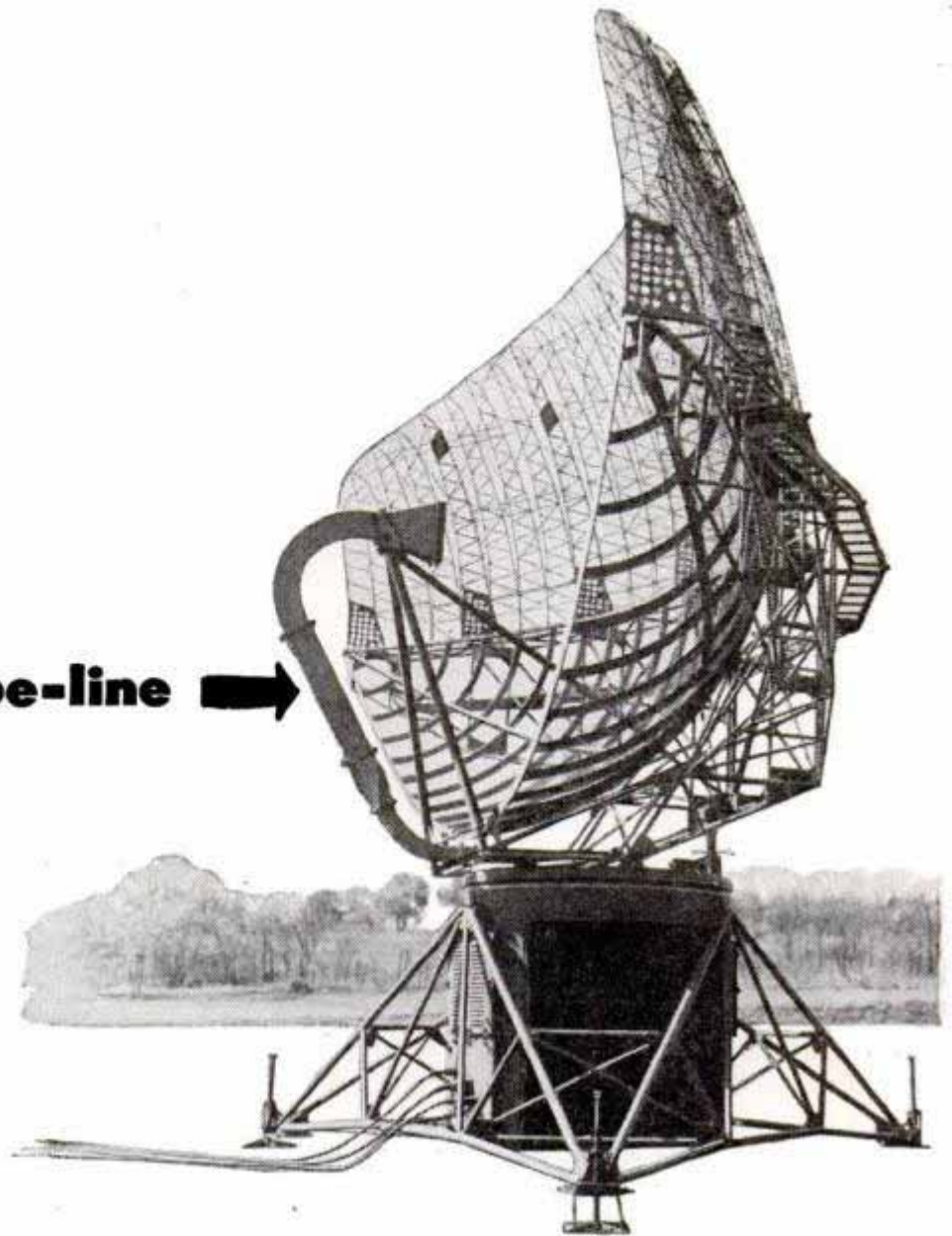

Microwaves make their journey from apparatus to antenna not by wire, cable, or coaxial—but by waveguide.

Long before the war, Bell Laboratories by theory and experiment had proved that a metal tube could serve as a pipe-line for the transmission of electric waves, even over great distances.

War came, and with it the sudden need for a conveyor of the powerful microwave pulses of radar. The metal waveguide was the answer. Simple, rugged, containing no insulation, it would operate unchanged in heat or cold. In the radar shown above, which kept track of enemy and friendly planes, a waveguide conveyed microwave pulses be-

tween reflector and the radar apparatus in the pedestal. Bell Laboratories' engineers freely shared their waveguide discoveries with war industry.

Now, by the use of special shapes and strategic angles, by putting rods across the inside and varying the diameter, waveguides can be made to separate waves of different lengths. They can slow up waves, hurry them along, reflect them, or send them into space and funnel them back. Bell Laboratories are now developing waveguides to conduct microwave energy in new radio relay systems, capable of carrying hundreds of telephone conversations simultaneously with television and music programs.

EXPLORING AND INVENTING, DEVISING AND PERFECTING FOR CONTINUED IMPROVEMENTS AND ECONOMIES IN TELEPHONE SERVICE



BELL TELEPHONE LABORATORIES

Popular Mechanics Magazine

Registered in U. S. Patent Office and Canada

H. H. WINDSOR, Founder

H. H. WINDSOR, Jr., Editor and Publisher



WE ARE sitting at the ringside of the greatest show on earth this month. The scene is Bikini, and our Aviation Editor, Aubrey O. Cookman, is there to watch the atom bomb hit the target fleet. He is

one of the 200 press and radio representatives chosen from among more than 6000 who sought permission to witness the event. He will bring you his ringside report in a forthcoming issue.

WE HAVE an eyewitness report in this issue from White Sands, N. M., where Tom Stimson, our Western Editor, saw the V-2 rocket take off for the ionosphere. He also tells of a visit to the place where rockets are born—at California Tech.

OUR waterfront reporter brings the comforting assurance that if you can't get beef, there still is fish. For, he says in an August feature, the fleet has "gone scientific" and scouts for schools of fish with sonar and fathometer.

BIRTH and death department—in one August feature you'll watch the wind-tunnel birth of one of the world's longest suspension bridges. And "They Die a Thousand Deaths" tells an exciting story of Hollywood's stunt men.

THE CRAFTSMAN section will give one easy lesson in building three versatile spot-welders that operate on 110 or 220-volt current. The largest size handles $\frac{3}{16}$ -inch stock, the smallest, sheet metal. Then there's an article on how to construct a fireplace for cold winter months that heats the air, then circulates it through the room.

LOST treasure, or even pipes in a wall, can be located with a home-made metal detector described in the August Radio section.

Volume 86 JULY 1946 Number 1

Managing Editor.....Roderick M. Grant
Assistant Managing Editor.....Wayne Whittaker
Shop Notes and Crafts Editor.....James R. Ward
Radio and Electronics Editor.....Frank L. Brittin
Aviation Editor.....Aubrey O. Cookman
Associate Editor.....John R. Kinsey
Eastern Editor.....Bill Reiche
Western Editor.....Thomas E. Stimson, Jr.
Art Director.....Frank Beatty

Assistant Editors

Donald R. Brooks Clifford B. Hicks Maston M. Jacks Virgil T. Swanson

Assistant Editors, Shop Notes and Crafts

W. Clyde Lammey Wayne C. Lecky John F. Shrock A. E. Youngquist

In This Issue

Ears of the Sub Killers	73
"Prep School" for Rocket Warfare	81
Garden in the Desert	92
What Kind of a House Do You Want?	100
Your National Parks Are Ready	106
Repeating Eye of the Navy	113
Rough Riders on Water Skis	117
Mechanics of Golf by Byron Nelson	122
Pitching the President's Game	130
Forecasting the Ocean Waves	137
Telling the World	148
Putting a Madcap River to Work	154

For the Craftsman

Utility Serving Cart	162
"Know How" of Log Cabin Building	170
Air Filters for Your Windows	181
Crop the Photo Before You Shoot!	188
Build Your Own Air Compressor	197
Simplified Sheet-Metal Layout	202
Precision Sine Bar Vise	209
Radio and Electronics	213

Table of Contents Continued on Page 8

Published monthly by POPULAR MECHANICS COMPANY, 200 East Ontario Street, Chicago 11, Ill. H. H. Windsor, Jr., president; Paul H. Dunakin, vice president and general manager; D. F. Windsor, vice president and secretary-treasurer; William Harrison Petridge, assistant to the publisher; Clover L. Perkins, advertising manager; Alan M. Deyoe, circulation manager. Single copy in the United States, 25 cents; subscription rates in United States and possessions, and countries of the Pan-American Postal Union, 1 year, \$2.50; 2 years, \$4.50; 3 years, \$6.00; Single copy in Canada, 30 cents; subscription rates, 1 year, \$3.00; 2 years, \$5.50; 3 years, \$7.50. To all other countries add \$1.00 a year over United States prices for overseas postage. If you plan to move, notify us at least 60 days in advance so you will not miss an issue. Give both old and new addresses. Entered as Second Class Matter, September 15, 1903, at the Post Office at Chicago, Illinois, under Act of March 3, 1879. Entered as Second Class Matter at Post Office Dept., Canada. Copyright 1946, by Popular Mechanics Company. Copyright under International Copyright Union. All rights reserved under Pan-American Copyright Union. Printed in the United States of America.



The custom yacht interiors shown in the photographs are typical of Defoe's fine workmanship. \ \ For more than forty years, Defoe's rule has been that everything must be made to look well, to perform perfectly and to give the buyer top value for his money.

LET DEFOE SHOW HOW
You Can Afford
The Very Best

- • in design and workmanship
- • in comfort and convenience

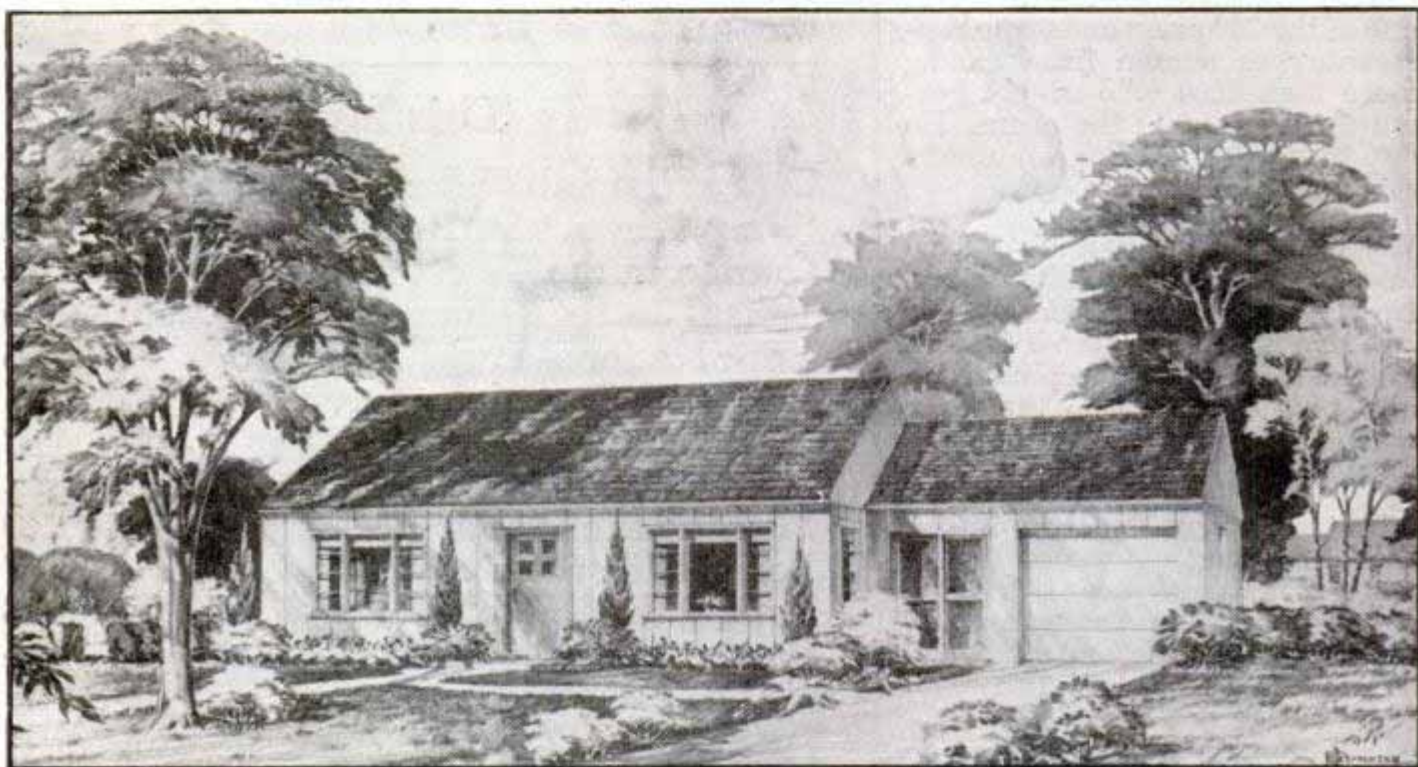

WHEN you buy Defoe you will acquire a fine heritage of beauty and common sense in design brought into being by workmen skilled in a traditionally fine craft. And remember, Defoe builds homes—the kind that fit naturally into any American couple's scheme of living. No trend toward freak design has been permitted and there will be no compromise materials or construction methods employed.

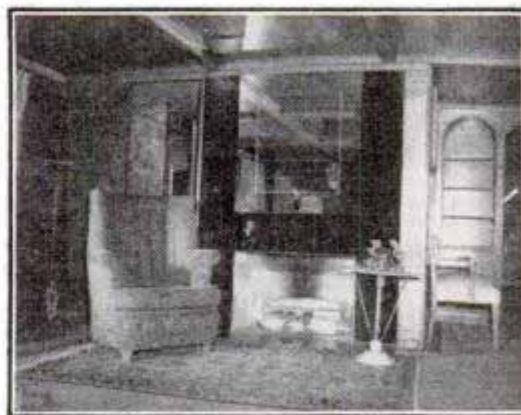

HOUSING DIVISION
 DEFOE SHIPBUILDING COMPANY Dept. PM-7
 BAY CITY, MICHIGAN

Please send me the descriptive brochure on the new Defoe Homes. Enclosed is 10c for handling and mailing costs.

Name _____

Street _____

City and State _____



The Federal Government has just announced details of a nation-wide emergency housing program which will necessitate changes in the original program for the construction of Defoe Homes. The brochure offered in the attached coupon shows architect's drawings of several houses which can be built by the Defoe system. It also explains how the Defoe method works and pictures some of the unique features which Defoe will offer.

"A tip for your trip..."

MIRROR LAKE, YOSEMITE NATIONAL PARK

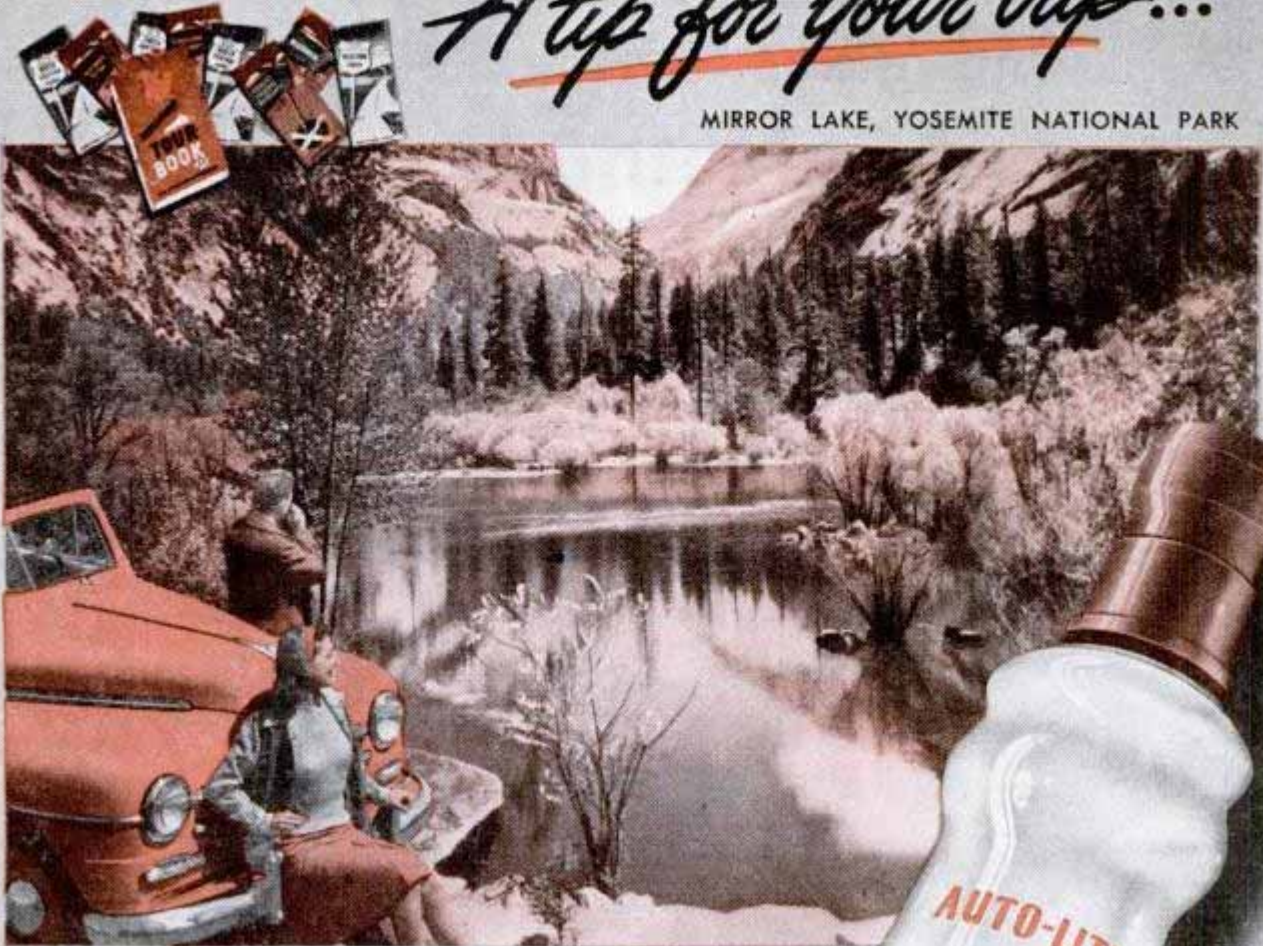

WHEN YOU NEED NEW SPARK PLUGS

Switch to —
AUTO-LITE

MOUNTAINS, seashore or National Parks— wherever you go—a smooth running engine will add much to the pleasure of your trip. So if your present plugs are faulty, switch to Auto-Lite Spark Plugs . . . engineered by the same engineers who design complete ignition systems for many of America's finest cars, trucks and tractors.

Remember the name . . . Auto-Lite. Money cannot buy a better spark plug. See your friendly Auto-Lite Spark Plug dealer today.



THE ELECTRIC AUTO-LITE COMPANY
Toronto, Ontario Toledo 1, Ohio

Tune in the Auto-Lite Radio Show starring Dick Haymes, Thursdays, 9:00 P.M.—E.T. on CBS.



Money cannot buy a better Spark Plug

AUTO-LITE SPARK PLUGS
"Ignition Engineered"

Ingenious New Technical Methods

To Help You with Your
Reconversion Problems

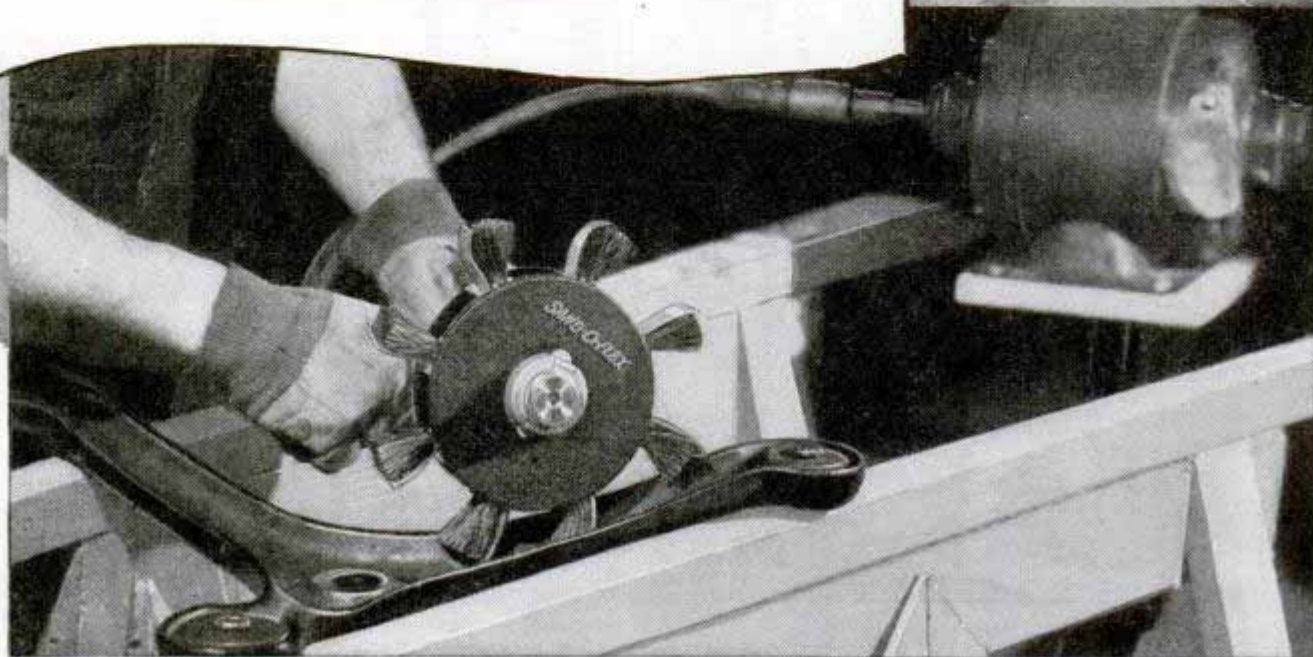

New Brush-Backed, Strip-Fed Abrasive Wheel Deburrs, Sands Any Surface!

For sanding in and around the most irregular contours—for deburring parts too large to be tumbled—for removing rust, paint and imperfections from wood, plastics, rubber, earthenware and metals—the new Sand-O-Flex brush-backed abrasive wheel is MOST PRACTICAL.

The central magazine houses a strip abrasive cartridge, to be fed out as needed in front of the eight brushes which "cushion" the abrasive, and force it evenly over the most difficult surfaces. The Sand-O-Flex comes in 3 sizes, and is adaptable to any stationary or portable motor shaft, with speeds up to 1750 RPM. Abrasives are available in grits for every need.

To help speed production in dry, dusty work atmosphere, many mills and factories urge workers to chew gum to help relieve dry throat. *The reason:* Because dust causes throat irritation and dryness—but chewing Wrigley's Spearmint gum helps keep workers' mouths moist and fresh. *The result:* Reduced work interruptions and "time outs" to the drinking fountain. Even when workers' hands are busy, they can refresh as they work "on the job." And the chewing action helps keep workers alert and wide-awake.

*You can get complete information from the Sand-O-Flex Corporation
4373 Melrose Ave., Los Angeles, 27, California*

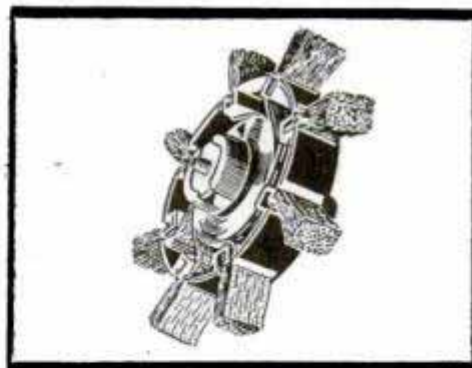

Abrasive Cartridge Shown Open



AA-77



If YOU were Boss would YOU promote "YOU"?

Be honest now—

suppose that a better job had opened up in your company—carrying with it promotion and more money—could you qualify?

If you were boss, would you select "YOU" for that better job?

Consider before you answer.

First of all, could you *fill* the job? Has your experience fitted you for the step forward—have you been preparing for promotion apart from experience gained on the job?

Or have you just been filling a niche, doing daily tasks well but making no real and intelligent effort to learn and qualify for the job ahead so that if an opening should occur you would be ready to fill it?

The man who gets real promotion is the one who makes his own breaks—the man who slaves in the ordinary job at low pay just wishes and dreams of promotion and more money. Which are you?

Business is always willing to pay the man who knows—and pay him well. The man who is ready and willing to take responsibilities—and capable of

directing the efforts of other men is a valuable asset to any business organization. He never wants for a good job and above average earnings. He gets ahead.

We have helped thousands of men achieve promotion and more money—success sometimes beyond their dreams—a success that was started by a coupon similar to the one below.

Get out of that rut—don't be satisfied with a mediocre job at small pay—be a success in business—this coupon may be your first step.

So send it today—right now—tomorrow never comes for the man who consistently puts things off.

La Salle Extension University A Correspondence Institution

Dept. 764-R

417 S. Dearborn, Chicago 5

If you can help me get the ability and knowledge for real promotion, I want to know it. Please send me your free 48 page booklet telling how I can succeed in the field I have checked below. I understand you will send this without obligation to me.

- | | |
|--|--|
| <input type="checkbox"/> Accounting | <input type="checkbox"/> Law: LL.B. Degree |
| <input type="checkbox"/> C. P. A. Coaching | <input type="checkbox"/> Foremanship |
| <input type="checkbox"/> Bookkeeping | <input type="checkbox"/> Industrial Management |
| <input type="checkbox"/> Business Management | <input type="checkbox"/> Traffic Management |
| <input type="checkbox"/> Effective Speaking | <input type="checkbox"/> Business English |
| | <input type="checkbox"/> Stenotypy |

Name

Position

Address

City and State

This One



CBAF-837-0H99

Insulate against wear with PYROIL

Pyroil insulates your motor against wear due to friction by providing a constant film of lubrication on cylinder walls. This same film prevents rust and corrosion. When you step on the starter, there is no heavy battery drain to overcome metal-to-metal contact.

For better driving and for extra motor life, ask your gas station attendant to add Pyroil A to your gasoline and Pyroil B to your crankcase.

PYROIL FOR AIRCRAFT ENGINES

Use Aircraft Pyroil B for lubricating oil, Aircraft Pyroil A for gasoline.

Manufactured and Guaranteed by Pyroil Company, W. V. Kidder, Founder, 57 Pyroil Building, LaCrosse, Wis.



PYROIL COMPANY
57 Pyroil Building,
LaCrosse, Wisconsin

I want my car to last and run properly. Please tell me more about Pyroil and how it can accomplish this for me.

Name.....
Address.....
City or Town..... State.....



Jerry, the talking dog, is entertaining hospitalized veterans, by courtesy of the Pyroil Company. Picture of Jerry, sent on request.

TABLE OF CONTENTS (Continued)

AUTOMOTIVE

Nonscratch clamp for car top holds fish poles or oars (R. C. Cheney Co., 501 Gillette St., La Crosse, Wis.).....	78
"Steam-fit" upholstery is free of wrinkles.....	78
Pump engine drives midget auto.....	91
Floor outlet for auto exhaust (Kent-Moore Organization, Inc., 485 W. Milwaukee, Detroit 2, Mich.).....	116
Two-passenger three-wheel car has engine in rear (B & B Specialty Co., Rossmoynne, Ohio).....	142
Trailer hitch has universal joint (C & R Mfg. Co., 1317 N. State St., Los Angeles 33, Calif.).....	146

FARM AND GARDEN

Tank dons "civies" to pull stumps.....	78
Flame gun burns weeds or thaws frozen pipes (D. B. Smith & Co., Smith Bldg., Utica 2, N. Y.).....	116
Combine for harvesting potatoes digs, sacks and loads.....	121
Swords into plowshares—Australian version.....	135
Driverless tractor stops if it jumps furrow.....	142
Foot-operated selector on cultivator gives choice of tools (Aircraft Mechanics, Inc., Colorado Springs, Colo.).....	146
Walnut harvester catches nuts knocked down by men (Max E. Phillips, Stockton, Calif., inventor).....	146
Power spray attached to garden tractor (Ellinwood Industries, Los Angeles, Calif.).....	146

HOUSE AND HOME

DDT tape to kill houseflies (Insecticide Tape Co., Box 2927, New Haven 15, Conn.).....	80
Quick-lock hose coupling (E. B. Wiggins Oil Tool Co., 3424 E. Olympic Blvd., Los Angeles 23, Calif.).....	87
Washing machine makes butter with churn attachment (Churn Device Co., 1316 Hutton St., Des Moines 16, Iowa).....	88
Tenants share subzero locker (Cliff Dwellers Frosted Food Co., 134 N. LaSalle St., Chicago).....	112
Outside plug seals boiler leaks (Rolyan Metal Products, 2322 W. 58th St., Chicago 36).....	112
Adjustable lawn sprayer sprinkles square plots (Joseph H. Wiley, 14101 Merchandise Mart, Chicago 54).....	128
Molded chairs mounted on rubber can't be tipped.....	129
Levers on lawn mower control height of cutting (Reo Motors, Inc., Lansing, Mich.).....	136
Plastic-coated plywood cabinet has hamper compartment (Decorative Cabinet Corp., 261 5th Ave., New York 16).....	144
Clamp-on seats fit youngsters too big for high chairs (Griffin Mfg. Co., Pasadena, Calif.).....	144
Grips on spoon handle hold knife and fork as single unit (Post Mart, 475 5th Ave., New York 17).....	144
Pressure cooker also used as serving dish (Ekco Products Co., 1949 N. Cicero Ave., Chicago).....	144
Paint chart contains 1000 color shades (Frank Crawley, Martin Senour Co., Chicago 1).....	145
Plastic mold to make frozen "sticks" in refrigerators (Gartel Co., 475 5th Ave., New York 17).....	145
Three-burner electric range cooks complete meal on table (Camco Products, Inc., 57 William St., New York 5).....	145
Can opener also serves as handle to empty contents of can (Ekco Products Co., 1949 N. Cicero Ave., Chicago).....	145
Steel armchair folds into compact bundle (W. F. Meyer & Sons, Inc., Merchandise Mart, Chicago 54).....	153

INDUSTRY

"Canned" freight for flatcar saves handling of cargo (Reynolds Metal Co., 2500 S. 3rd St., Louisville, Ky.).....	80
Scoop makes tractor one-man earth mover (Stockland Road Machinery Co., 2653 34th Ave. S., Minneapolis, Minn.).....	99
Portable packaging machine seals odd-shaped articles (Good-year Tire and Rubber Co., Akron, Ohio).....	99
Sun-ray dial for architects helps in planning windows (R. W. Justice, Box 122, Belvedere, Calif.).....	112
Solution renews sandpaper by removing wood dust (Massie Mfg. Co., 558 40th Ave. N. E., Minneapolis 13, Minn.).....	121
Machine makes oysters "yawn" for quick processing.....	147
Strongest material of its weight has cloth or paper core.....	147
Voiceless communication system for factories (Simplex Time Recorder Co., Gardner, Mass.).....	158
Cork tree farms boost new U. S. industry.....	159

OUTDOOR RECREATION

"Minnow" hooks spring open when struck (Schallman Sales, 3223 W. Montrose Ave., Chicago 18).....	80
Dummy tests "charging power" of football linesmen.....	87
Mechanical caddy for golfers includes comfortable chair.....	91
Production methods for PT boats used for pleasure cruiser.....	98
Novel rod and pole holder (Klamerus & Co., 914 N. Rockwell St., Chicago 22).....	111
Noiseless fishing reel powered by rubber (Virginia Reel Co., 1313 University Ave., Madison, Wis.).....	128
Fishing boat seat is also lawn chair (W. C. Lincoln Co., 113 E. 75th St., Chicago 19).....	135
Three-point suspension principle used in pleasure boat (Don R. Hill, 512 E. Fairview Blvd., Inglewood, Calif.).....	136
Pleasure float for bathers can't capsize or sink (Aqua Float Co., 153 E. 116th St., New York).....	160
Pencil meter helps golfer judge distance to green (Golf-Meter Co., Kalamazoo 99, Mich.).....	160
Outboard motor "toter" combines dolly and support (Pearson, Inc., 2842 W. Grand Blvd., Detroit 2, Mich.).....	160
Collapsible live-bait container saves space in car or boat (Schallman Sales, 3223 W. Montrose Ave., Chicago 18).....	160

TOOLS

One-unit welder and battery charger (Hobart Brothers Co., Motor Generator Corp. Division, Troy, Ohio).....	89
Midget power screwdriver starts work automatically (Aro Equipment Corp., Bryan, Ohio).....	105

(Continued to page 10)

SEE YOURSELF 10 YEARS FROM NOW!



No Time Machine required. All you have to do is look around you. The routine worker of 10 years ago who failed to prepare himself for larger responsibilities is a routine worker today. But the man who mastered technical or business subjects is collecting substantial rewards.

You count yourself among the ambitious today. Prove it—if you expect to find yourself among the successful. The proof, of course, rests on whether you are taking special training that will qualify you for a better position.

This is the training in which the International Correspondence Schools have specialized for more than 50 years. I. C. S. Courses cover more than 400 technical and commercial subjects. You're in a class by yourself . . . study in your own home . . . progress just as fast as your ability and ambition permit.

Thousands of successful graduates demonstrate that today's I. C. S. student is tomorrow's leader. Mail the coupon *today* for complete information.

INTERNATIONAL CORRESPONDENCE SCHOOLS



BOX 5582-K, SCRANTON 9, PENNA.

Without cost or obligation, please send me full particulars about the course *before* which I have marked X:

- Air Conditioning and Plumbing Courses
- Air Conditioning
- Heating Plumbing
- Refrigeration Steam Fitting
- Chemistry Courses**
- Chemical Engineering
- Chemistry, Analytical
- Chemistry, Industrial
- Chemistry, Mfg. Iron & Steel
- Petroleum Refining Plastics
- Pulp and Paper Making
- Civil Engineering, Architectural and Mining Courses**
- Architectural Drafting
- Architecture
- Bridge and Building Foreman
- Building Estimating
- Civil Engineering
- Coal Mining
- Contracting and Building
- Highway Engineering
- Lumber Dealer
- Reading Structural Blueprints
- Sanitary Engineering
- Structural Drafting

- Structural Engineering
- Surveying and Mapping
- Communications Courses**
- Electronics
- Practical Telephony
- Radio, General
- Radio Operating
- Radio Servicing
- Telegraph Engineering
- Electrical Courses**
- Electrical Drafting
- Electrical Engineering
- Electric Light and Power
- Lighting Technician
- Practical Electrician
- Internal Combustion Engines Courses**
- Auto Technician Aviation
- Diesel-Electric
- Diesel Engines Gas Engines
- Mechanical Courses**
- Aeronautical Engineering
- Aircraft Drafting
- Flight Engineer
- Foundry Work
- Heat Treatment of Metals

- Industrial Engineering
- Industrial Metallurgy
- Machine Shop
- Mechanical Drafting
- Mechanical Engineering
- Mold-Loft Work
- Patternmaking—Wood, Metal
- Reading Shop Blueprints
- Sheet-Metal Drafting
- Sheet-Metal Worker
- Ship Drafting Ship Fitting
- Tool Designing
- Toolmaking
- Welding—Gas and Electric
- Railroad Courses**
- Air Brake Car Inspector
- Diesel Locomotive
- Locomotive Engineer
- Locomotive Fireman
- Railroad Section Foreman
- Steam Engineering Courses**
- Boilermaking
- Combustion Engineering
- Engine Running
- Marine Engineering
- Steam Electric Steam Engines

- Textile Courses**
- Cotton Manufacturing
- Rayon Weaving
- Textile Designing
- Woolen Manufacturing
- Business and Academic Courses**
- Accounting Advertising
- Arithmetic Bookkeeping
- Business Correspondence
- Business Management
- Certified Public Accounting
- Commercial
- Cost Accounting
- Federal Tax
- First Year College
- Foremanship French
- Good English High School
- Higher Mathematics
- Illustrating Motor Traffic
- Postal Service
- Salesmanship Secretarial
- Sign Lettering
- Spanish Stenography
- Traffic Management

Name _____ Age _____ Address _____

City _____ State _____ Present Position _____

Working Hours _____ A.M. to _____ P.M. Length of Service in World War II _____

Special tuition rates to members of the Armed Forces. Enrollment under the G.I. Bill of Rights approved for War II Veterans, Canadian residents send coupon to International Correspondence Schools Canadian, Ltd., Montreal, Canada.

Ink reservoir on stencil brush holds supply for 500 prints (Marsh Stencil Machine Co., Belleville, Ill.).....105
 Electric printing machine types lettering into large drawings (Underwood Corp., 1 Park Ave., New York 16).....116
 Railroad maintenance drill (The Buda Co., Harvey, Ill.).....153

TOYS AND NOVELTIES
 Plastic toys made at home in toy molding press (N. R. K. Mfg. and Eng., 5646 N. Western Ave., Chicago 45).....105
 Radio tubes operate toy organ (Electronic Laboratories, Inc., Indianapolis, Ind.).....111
 Dual-propelled model plane uses jet and rubber band.....129



MISCELLANEOUS
 Eyes on Bikini.....79
 Photos made without camera by electrical charge.....88
 Tailored for Tom Thumb.....89
 Sharper beam for radio relay aids phones and television.....90
 Mechanical waiter lifts food from kitchen.....90
 British "jungle airborne buggy" pulls floating trailer.....99
 "Mathematician" for heating systems (Heat-O-Meter, 424 W. 42nd St., New York 18).....111
 Armor-plated "battle sleds" towed to position by tanks.....121
 Repeater flash bulb for photographers (Wabash Photolamp Corp., 335 Carroll St., Brooklyn, N. Y.).....128
 Coal conveyor on dump truck is powered by engine.....142
 Square-tip "windmill" props boost airplane speeds (Hamilton Standard, East Hartford 8, Conn.).....143
 British locomotive named after Eisenhower.....147
 "Snap-on" fluorescent shield reduces light glare (Camfield Mfg. Co., Grand Haven, Mich.).....160

Craftsman and Shop Notes Index



AUTOMOTIVE
 Locating slow leak in inner tube.....168
 Reflector and flag are warning to approaching motorist.....184
 Handy tray for auto parts fits over strut rod.....205



HOUSE AND HOME
 Wire springs hold cut flowers.....165
 Ironing board with folding legs is made easily.....165
 Solving home problems.....166
 Attractive flower pots made with tin cans and putty.....178
 Cracked joist can be reinforced with channel-iron support.....180
 Sheet of aluminum with handles makes a good griddle.....180
 Clean-out door in cold-air duct provides easy access.....186
 Rubber bumper prevents screen door from slamming.....187

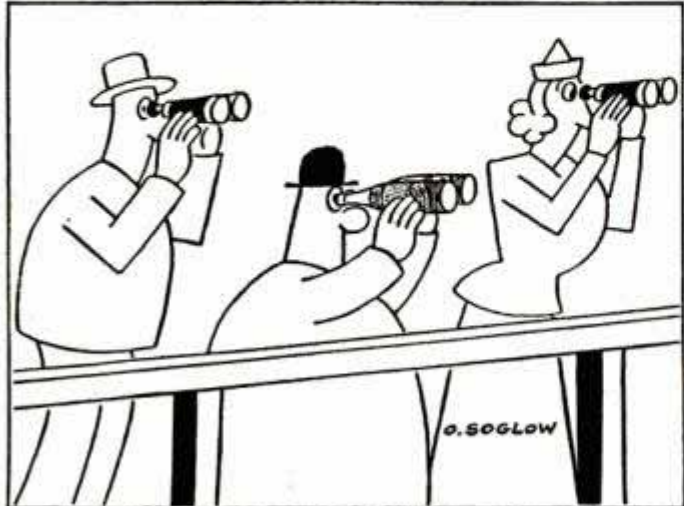

LAWN AND GARDEN
 Imitation water wheel at side of house is flower garden.....168
 Portable barbecue pit has motor-driven spits.....179
 Wind indicator yard ornament adds decorative touch.....184
 Kitchen broom skims fish ponds.....186
 Sprag arrangement holds gate in any open position.....208

OUTDOOR RECREATION
 Palm reel attached to old glove simplifies flying kite.....165
 Telltale float glows to signal night angler.....169
 Improvised fishing raft is transported easily.....177
 Bicycle tire used as bow guard on kayak.....180
 Quick adjustment for bicycle seat.....184

PHOTOGRAPHY
 Inner-tube band on tripod legs makes compact bundle.....193
 Typewriter eraser brush used to clean camera.....194
 Focusing card aid for dim light.....194
 Ferrotypes held in drawer.....194
 Information recorded on negative during exposure of film.....194
 Accurate weighing of chemicals.....194
 Control unit gives wide range in photo lighting.....195

RADIO AND ELECTRONICS
 Radio circuits "printed" on ceramic plates.....213
 Built-in radio receiver with hookups for extension speakers.....214
 Helpful hints for home set service.....216

TOOLS
 Easy way to sand narrow slots.....168
 Wooden plugs cut rapidly with bandsaw setup.....168
 Tool "suitcase" fits over table for temporary workbench.....178
 C-clamp used to make vise for small hobby work.....180
 Vise clamped to drill-press table.....184
 Magnets used as soldering jig.....186
 Craft quiz.....196
 Railroad rail makes shop anvil to handle light work.....200
 Lathe milling attachment.....201
 Bending tool forms wire clamp around rubber hose.....201
 Lathe tool centered with scale.....206
 Holes drilled in steady rest jaws lubricate work in lathe.....206
 Hand grip spliced to shovel repairs broken handle.....206
 Reversed holder prevents tool digging into work.....212

TOYS AND NOVELTIES
 Lawn "lake" keeps little tois in bounds.....185
 Dart holder is cut from broomstick.....186
 Toothpicks at finger tip with this dispenser.....187

MISCELLANEOUS
 Candle rubbed over inked address will prevent smearing.....169
 Best way to mount a knife switch.....177
 Shelf surface tilted with siding to keep contents in place.....178
 Bottle caps used to fasten handles to pails and cans.....178
 Notch in drawer provides holder for letter-file folders.....206
 Undercut walls eliminate roof flashings.....207
 Cardboard strips form holders for display cards.....208
 Modified oil pump lifts water.....208
 Filing jig for channels and angles.....208
 Light on edge of welding helmet aids when inspecting work.....212
 Holders for prints and tracings make handling easier.....212
 Flowerpot makes poultry fountain for emergency use.....212

IMPORTANT NOTICE—It is the intention of this magazine to provide its readers with information regarding the latest developments in the mechanical arts. We take no responsibility as to whether the disclosures contained in our articles are covered by patents and advise readers to investigate this subject before making, using, or selling any of the products, machines, or processes described in order to avoid possible liability for patent infringements.

AUDELS REFRIGERATION & AIR CONDITIONING GUIDE.....\$4

New from Cover to Cover—1280 Pages, Fully Illus. Covering basic principles, servicing, operation & repair of household, commercial & industrial refrigeration & air conditioning. A gold mine of essential important facts for engineers, servicemen, users.

AUDELS CARPENTERS & BUILDERS GUIDES—4 Vols.\$6

A practical illustrated trade assistant on modern construction for carpenters, joiners, builders, mechanics and all woodworkers. 4 vols., 1600 pages, 3700 illustrations, flexible covers. Pocket size. Each volume sold separately \$1.50 a vol.

AUDELS AUTOMOBILE GUIDE.....\$4

A practical quick ready reference book for auto mechanics, service men, operators & owners. Explains theory, construction & servicing of modern motor cars, trucks, buses & auto type Diesel engines. 1540 pages, fully illustrated, 55 chapters, Indexed. A standard book for mechanics. New fluid drive covered.

AUDELS DIESEL ENGINE MANUAL.\$2

A practical, concise treatise with questions and answers on the theory, operation and maintenance of modern diesel engines including General Motors 2 cycle Diesel. 384 pages, fully illus., flexible binding, pocket size. All details plainly brought out, this book is of extreme value to engineers, operators & students.

AUDELS WIRING DIAGRAMS.....\$1

210 Pages, Illustrated. Gives practical facts on wiring of electrical apparatus. It shows clearly how to wire apparatus for practically all fields of electricity. Each diagram is complete & self-explanatory. Highly Endorsed Pocket Companion.

AUDELS PLUMBERS & STEAMFITTERS GUIDES—4 Vols.\$6

A Practical Trade Assistant & Ready Reference. Explains in plain language & by clear illustrations, diagrams, charts, graphs, pictures principles of modern plumbing practice including Marine Pipe Fitting and Air Conditioning. 4 Vols.—1670 Pages—3642 Diagrams. Pocket size. Each Vol. Sold Separately \$1.50 a Vol.

AUDELS SHEETMETAL WORKERS HANDY BOOK.....\$1

Practical inside information. Fundamentals of Sheet Metal Work. 388 pages, Illustrated, 11 sections. Clearly written. Essential & important facts, figures, pointers in everyday language. Ref. Index.

AUDELS SHEETMETAL PATTERN LAYOUTS.....\$4

Developed by Experts for Sheet Metal Workers, Layout Men & Mechanics. A Practical Encyclopedia in 10 Sections, size 7 x 10 x 2—1125 Pages—350 Layouts—1600 Illustrations. 1001 Key Facts. Fully Indexed for ready reference in answering your layout problems. Covers all phases of sheet metal work including Pattern Cutting, Pattern Development & Shop Procedure.

AUDELS ANSWERS ON BLUE PRINT READING.....\$2

For Mechanics & Builders. Covers all types of blue print reading including ship & airplane. 376 pages, fully illustrated.

AUDELS NEW MACHINIST & TOOLMAKERS HANDY BOOK...\$4

Covers modern machine shop practice in all its branches. 5 practical books in 1. New from cover to cover. Tells how to set up & operate lathes, screw and milling machines, shapers, drill presses and all other machine tools. 1600 pages, fully illustrated, 5 x 6 1/2 x 2. Indexed, 5 sections. 1—Modern Machine Shop Practice. 2—Blue Print Reading & How to Draw. 3—Calculations & Mathematics for Machinists. 4—Shop Physics. 5—How to Use the Slide Rule. 60 chapters. Easy to read and understand. A shop companion that answers your questions.

AUDELS MATHEMATICS & CALCULATIONS FOR MECHANICS \$2

Mathematics for home study or reference. 700 pages, 550 illus. Practical mathematics from beginning. How to figure correctly. Easy, correct methods covering a complete review. Ill. & Indexed.

AUDELS HANDY BOOK OF PRACTICAL ELECTRICITY.....\$4

For maintenance engineers, electricians & all electrical workers. 1440 Pages, 2000 Illus. Covers important electrical information in handy form—including Marine Wiring, Radio Principles, Welding. Indexed. A Key to a practical understanding of electricity.

AUDELS RADIOMANS GUIDE.....\$4

A key to the practical understanding of radio including Frequency Modulation, Television, etc., Aircraft & Marine Radio. For radio engineers, servicemen, amateurs. 772 pages, 400 Illustrations & Diagrams. Photos. Review Questions & Answers, Reference Index. Authentic, clear, concise.

AUDELS ELECTRONIC DEVICES...\$2

Tells What You Want to Know About Electric Eye. Easily Understood. Covers photo-electric cells & their applications. Amplifiers, illumination, frequencies, voltage, photocell, tubes, Ohm's Law, wiring diagrams, etc.

AUDELS WELDERS GUIDE.....\$1

A concise, practical text on operation & maintenance of all welding machines for all mechanics. Over 400 pages, illustrated. Covers all methods of electric and acetylene welding including airplane work.

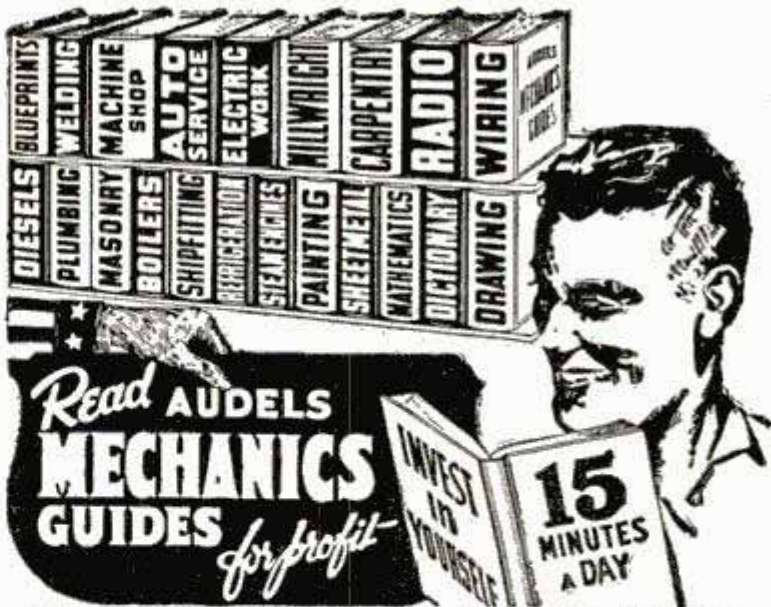

AN AUDEL GUIDE IS A GOOD FRIEND!

Use the brains and experience of others in these Guides of the Trades. Save time and money with right methods, short cuts, labor saving ideas. CHECK NOW! You can look over any Audel Guide in your home. Start the Easy Payments if satisfied.

CUT, HERE MAIL ORDER

THEO. AUDEL & CO., 49 W. 23 St., New York 10, N.Y.

Please mail me for 7 days' free examination the books marked (X) below. I agree to mail \$1 in 7 days on each book or set ordered, and to further mail \$1 a month on each book or set ordered until I have paid purchase price.

If I am not satisfied with Guides I will return them.

- Audels OIL BURNER GUIDE \$1.
- Audels REFRIGERATION & Air Conditioning Guide. 4.
- Audels POWER PLANT ENGINEERS GUIDE 4.
- Audels PUMPS, HYDRAULICS & AIR COMPRESSORS 4.
- Audels WELDERS GUIDE 1.
- Audels BLUE PRINT READING 2.
- Audels SHEET METAL WORKERS Handy Book 1.
- Audels SHEET METAL PATTERN LAYOUTS 4.
- Audels AIRCRAFT WORKER 1.
- Audels MATHEMATICS and CALCULATIONS 2.
- Audels MACHINISTS & TOOLMAKERS Handy Book 4.
- Audels MECHANICAL Dictionary 4.
- Audels AUTOMOBILE GUIDE 4.
- Audels DIESEL ENGINE MANUAL 2.
- Audels MARINE ENGINEERS Handy Book 4.
- Audels SHIPFITTERS Handy Book 1.
- Gueths MECHANICAL DRAWING COURSE 1.
- Rogers DRAWING and DESIGN 2.
- Audels MILLWRIGHTS and Mechanics Guide 4.
- Audels CARPENTERS and Builders Guides (4 vols.) 6.
- Audels PLUMBERS and Steamfitters Guides (4 vols.) 6.
- Audels MASONS and Builders Guides (4 vols.) 6.
- Master PAINTER and DECORATOR 2.
- Audels GARDENERS & GROWERS GUIDES (4 vols.) 6.
- Audels ENGINEERS & FIREMANS EXAMINATIONS 1.
- Audels ENGINEERS and Mechanics Guides Nos. 1, 2, 3, 4, 5, 6, 7 and 8 complete 12.
- Audels Answers on Practical ENGINEERING 1.
- Audels ELECTRICIANS EXAMINATIONS 1.
- Audels WIRING DIAGRAMS 1.
- Audels Handy Book of PRACTICAL ELECTRICITY 4.
- Audels ELECTRICAL POWER CALCULATIONS 2.
- Audels ELECTRONIC DEVICES 2.
- Audels ELECTRIC Dictionary 2.
- Audels RADIOMANS GUIDE 4.
- Audels NEW ELECTRIC LIBRARY at \$1.50 a Volume Vols. I, II, III, IV, V, VI, VII, VIII, IX, X, XI, XII

Name _____
 Address _____
 Occupation _____
 Employed by _____ PM

AUDEL, Publishers, 49 W. 23 St., N. Y. 10

STRANGE

things happen here!



The Dark Continents of Your Mind

DO YOU struggle for balance? Are you forever trying to maintain *energy, enthusiasm,* and the *will to do?* Do your personality and power of accomplishment ebb and flow — like a stream controlled by some unseen valve? Deep within you are minute organisms. From their function spring your emotions. They govern your *creative ideas* and *moods* — yes, even your enjoyment of life. Once they were thought to be the mysterious seat of the soul — and to be left unexplored. Now cast aside superstition and learn to direct intelligently these *powers of self.*

Accept this *Free Book*

Let the Rosicrucians, an age-old fraternity of thinking men and women (not a religion), point out how you may fashion life as you want it — by making the fullest use of these little-understood *natural faculties* which you possess. This is a challenge to make the most of your heritage as a human. Write for the Free Book, "The Mastery of Life." Address: Scribe E.D.V.

The ROSICRUCIANS

San Jose (AMORC) California

"A Six Room House, \$2800

Complete, Ready for You
to Move In"

BY GEORGE W. PEARCE

The author, a mechanical engineer, reviews the history of housing and shows how building costs have risen in the last 150 years until few families can buy a house adequate for their needs.

He then describes how, by the use of various money-saving building methods, a large, modern, 6-room, thoroughly insulated, fire resistant, 2-bath bungalow with garage can be had most anywhere in the United States for \$2800.00.

Included with the book are 10 folded drawings, 12" wide x 18" long. These drawings by Mr. Pearce show all the details of construction for this house—the wiring, the plumbing, the automatic oil heating system and the fluorescent lighting. The book is devoted to showing how similar savings can be made on any house of any style, size or floor plan.

A very readable and interesting book. Every prospective home owner should have a copy. 138 6" x 9" pages, 26 illustrations, leatherette bound. 10 large drawings.

Send \$2.00 to TECHNICAL PRESS, Box 6 G, Swampscott, Mass., and your copy will be rushed to you postpaid. Distributed solely by Technical Press—Not sold in book stores.

TRAIN NOW

AUTO MECHANICS and BODY & FENDER WORK

ENGINE OVERHAUL
REPAIR SERVICE
TROUBLE SHOOTING
IGNITION
CARBURETION
TRANSMISSION
ETC., ETC.

MOST COMPLETE TRAINING PROGRAM OF ITS KIND

This old established shop training organization inaugurates a new all inclusive training program in advanced auto mechanics and modern Body and Fender work. Big, modern, fully equipped shop and expert instructors get you into practical do-it-yourself training immediately. Low tuition fee. Veterans, ask for "G.I." Bulletin. Write today for free Booklet No. 90.

Chicago MOTIVE TRADES Institute

DIV. COMMERCIAL TRADES INSTITUTE

1400 W. GREENLEAF AVE. • CHICAGO 40, ILL.



AMAZING DEVICE! Guides your hand—corrects poor penmanship in few days—big improvement in three hours, no failures. Complete Outline Free. Write, Mr. Ozment, 34, St. Louis, Mo.

LARGE GENUINE ANCIENT ROMAN COIN — \$1.00

20 different coins 15 countries.....\$1.00
50 different coins ailed nations.....\$5.00
40 different coins defeated nations.....\$5.00

Lists — Approvals
DEL MONTE • 40 West 18 • New York 11

LEARN MASTER MACHINIST MECHANICAL DRAFTING

Expert training on Lathes, Milling Machines, Shapers, Grinders, etc.—Mechanical Drafting, Blueprint Reading and Designing. Allied shops are completely equipped and modern. Approved for G. I. Training Days, Evenings.

ALLIED SCHOOL OF MECHANICAL TRADES
1330 South Michigan Avenue • Chicago 5, Illinois

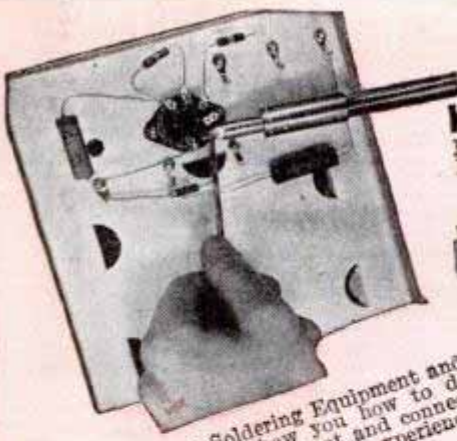

KIT 1 I send you Soldering Equipment and Radio Parts; show you how to do Radio Soldering; how to mount and connect Radio parts; give you practical experience.

KIT 2 Early in my course I show you how to build this N.R.I. Tester with parts I send. It soon helps you fix neighborhood Radios and earn EXTRA money in spare time.

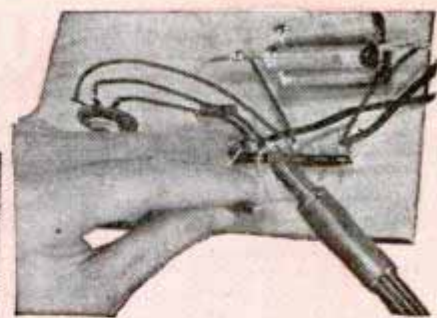

KIT 3 You get parts to build Radio Circuits; then test them; see how they work; learn how to design special circuits; how to locate and repair circuit defects.

Learn RADIO by PRACTICING in Spare Time

with **6 BIG KITS** of **RADIO PARTS** I send you

Do you want a good-pay job in the fast-growing Radio Industry—or your own Radio Shop? Mail the Coupon for a Sample Lesson and my 64-page book, "Win Rich Rewards in Radio," both FREE. See how I will train you at home—how you get practical Radio experience building, testing Radio circuits with 6 BIG KITS OF PARTS I send!



Many Beginners Soon Make Extra Money in Spare Time While Learning

The day you enroll I start sending EXTRA MONEY JOB SHEETS that show how to make EXTRA money fixing neighbors' Radios in spare time while still learning! It's probably easier to get started now than ever before, because the Radio Repair Business is booming. Trained Radio Technicians also find profitable opportunities in Police, Aviation, Marine Radio, Broadcasting, Radio Manufacturing, Public Address work. Think of even greater opportunities as Television, FM, and Electronic devices become available to the public! Send for FREE books now!

Find Out What NRI Can Do For You

Mail Coupon for Sample Lesson and my FREE 64-page book. Read the details about my Course; letters from men I trained; see how quickly, easily you can get started. No obligation! Just MAIL COUPON NOW in envelope or paste on penny postal. J. E. SMITH, President, Dept. 6GP, National Radio Institute, Pioneer Home Study Radio School, Washington 9, D. C.

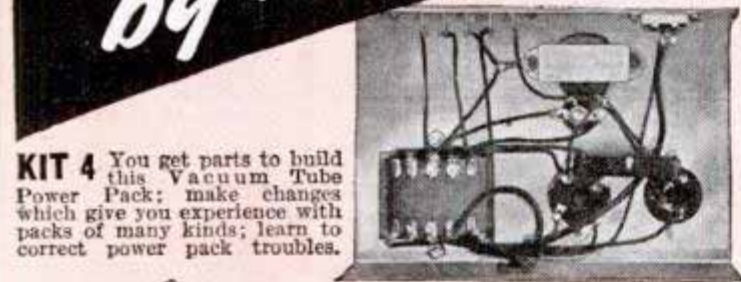

KIT 4 You get parts to build this Vacuum Tube Power Pack; make changes which give you experience with packs of many kinds; learn to correct power pack troubles.

KIT 5 Building this A.M. Signal Generator gives you more valuable experience. It provides amplitude-modulated signals for many tests and experiments.

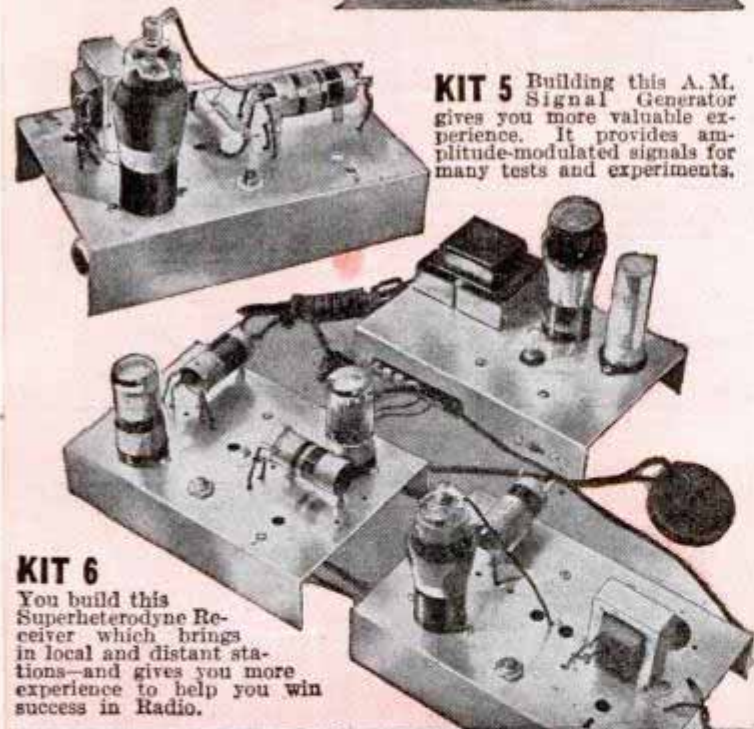

KIT 6 You build this Superheterodyne Receiver which brings in local and distant stations—and gives you more experience to help you win success in Radio.

My Course Includes Training in **TELEVISION • ELECTRONICS**
Frequency Modulation

Sample Lesson **FREE**
64 Page Book



Mr. J. E. SMITH, Pres., Dept. 6GP
National Radio Institute
Washington 9, D. C.

Mail me FREE, without obligation, Sample Lesson and 64-page book. (No salesman will call. Please write plainly.)

Name.....Age.....

Address.....

City.....State.....

(Please include Post Office zone number)

Approved for Training under GI Bill

Do you want

- ..to go to College?
- ..or to enter a Profession?

(Such as Accounting, Architecture, Nursing, Dentistry, Teaching, Social Work, Osteopathy, Beauty Culture, Optometry, Embalming, Chiropody, Law, Medicine, etc.)

- ..or get an Office Position?

To get anywhere, you practically **MUST** finish High School **FIRST**. You can complete our simplified High School Course in **SPARE** time at home, as **FAST** as your time and abilities permit. Equivalent to resident school work—prepares you for college, pre-professional examinations, business, industry. Standard texts furnished. Diploma. Credit for H. S. subjects already completed. Single subjects if desired. Low tuition, easy terms. American School, Chicago, est. 1897—endorsed by educators. Finish your high school education **NOW**, Write **TODAY!**

High School Course at Home

Many Finish in 2 Years

American School, Dept. HB45, Drexel Ave. at 58th St., Chicago 37, Ill.

Gentlemen: Send me **FREE** information covering special training in subjects checked below. No obligation on my part.

- | | |
|--|--|
| <input type="checkbox"/> High School Course | <input type="checkbox"/> Diesel Engineering |
| <input type="checkbox"/> Architecture and Building | <input type="checkbox"/> Drafting and Design for Men & Women |
| <input type="checkbox"/> Automotive Engineering | <input type="checkbox"/> Plastics |
| <input type="checkbox"/> Business Management | <input type="checkbox"/> Private Secretary |
| <input type="checkbox"/> Electrical Engineering | <input type="checkbox"/> Mechanical Engineering |
| <input type="checkbox"/> Elec. and Gas Refrigeration | <input type="checkbox"/> Aviation |
| <input type="checkbox"/> Air Conditioning | <input type="checkbox"/> Salesmanship |
| <input type="checkbox"/> Railway Training | <input type="checkbox"/> Radio |
| <input type="checkbox"/> Electronics, Industrial | |

Name

Address

AUDELS Carpenters and Builders Guides

4 vols. \$6



Inside Trade Information for Carpenters, Builders, Joiners, Building Mechanics and all Woodworkers. These Guides give you the short-cut instructions that you want—including new methods, ideas, solutions, plans, systems and money saving suggestions. An easy progressive course for the apprentice and student. A practical daily helper and Quick Reference for the master worker. Carpenters everywhere are using these Guides as a Helping Hand to Easier Work, Better Work and Better Pay. To get this assistance for yourself, simply fill in and mail the **FREE COUPON** below.

Inside Trade Information On:

How to use the steel square—How to file and set saws—How to build furniture—How to use a mitre box—How to use the chalk line—How to use rules and scales—How to make joints—Carpenters arithmetic—Solving mensuration problems—Estimating strength of timbers—How to set girders and sills—How to frame houses and roofs—How to estimate costs—How to build houses, barns, garages, bungalows, etc.—How to read and draw plans—Drawing up specifications—How to excavate—How to use settings 12, 13 and 17 on the steel square—How to build hoists and scaffolds—skylights—How to build stairs—How to put on interior trim—How to hang doors—How to lay floor—How to paint



THEO. AUDEL & CO., 49 W. 23rd St., New York City

Mail Audels Carpenters and Builders Guides, 4 vols., on 7 days' free trial. If O.K. I will remit \$1 in 7 days, and \$1 monthly until \$6 is paid. Otherwise I will return them. No obligation unless I am satisfied.

Name

Address

Occupation

Reference

Make Your Own RUBBER MOLDS

Amazing New Method!....

Now, an amazing new method to make your own flexible rubber molds to recast sculptured models or subjects. Duplicate singly or in quantity, expensive original subjects at amazing low cost. Reproduce statuettes, plaques or any other models—any surface—with this new liquid rubber material. Hundreds of other uses.



PROFITABLE HOBBY!

Start this fascinating hobby that can lead to beginning of your own business. For only a few cents each, make hundreds of castings to resell at big profit prices. Easy to start. Big list of subjects you can reproduce.



SEND NO MONEY!

Just your name and address for **BIG INTRODUCTORY KIT** containing 14 different items; everything you need to work with including famous Indian model. Pay postman only \$1.49 plus C.O.D. postage. Money back if not satisfied. Or save C.O.D. by sending \$1.49 with order and we pay postage. Write for **FREE CATALOGUE!**

RUBBER-FOR-MOLDS • 521 W. Monroe, Dept. 49-J • Chicago 6, Ill.

LEARN AT HOME TO MOUNT BIRDS



Animals, Heads, Fishes, Pets; to **TAN**. Be a Taxidermist. Profit and FUN.

Hunters, save your valuable **TROPHIES**. Mount ducks, squirrels, everything. Learn to **TAN** for leather and furs. Wonderful **HOBBY** Have a **HOME MUSEUM**.—**BIG PROFITS** mounting for others. **INVESTIGATE NOW.**

FREE BOOK With 100 fine game pictures. **NOW** absolutely **FREE**. Write **TODAY.**

Send Postal **TODAY** for **FREE BOOK**. State **AGE**. **N.W. SCHOOL OF TAXIDERMY, Dept. 337B, Omaha, Neb.**



Learn Public Speaking

Learn theory and fundamentals at home—in spare time. Then acquire actual experience and practice. Send for **FREE** booklet "Power of Effective Speech."

North American School, Dept. 135-B
1315 S. Michigan Ave., Chicago 5, Illinois



MUSIC LESSONS

LEARN . . . PROGRESS . . . EARN MORE . . . SUCCEED . . . Your own achievement, popularity, success through music. Learn in your home. Check course: Piano, Violin, Cornet, Saxophone, Clarinet, Guitar, Harmony, Arranging, History. If juvenile, parent's signature must accompany inquiry. Low cost. Easy Terms. **FREE** catalog. Suite U398 765 Oakwood Bl. Chicago 15

UNIVERSITY EXTENSION CONSERVATORY

ACCOUNTING

STUDY AT HOME for C.P.A. and **BIG PAY** Accounting opportunities with 42 year old school. No previous training needed. Texts furnished. **EASY PAYMENTS**. Send for **FREE BOOK**.

Mac **CORMAC EXTENSION SCHOOL**
Dept. 7-B, 1170 East 63rd St. Chicago 37, Ill.



COMB-A-TRIM THE NEW QUICK TRIMMER

Something New! Trim your hair without any experience. It's easy! The excess hair comes off smoothly and easily by just pulling trimmer through hair like an ordinary comb. Also removes hair from legs—armpits. Save on hair-cut bills . . . Trim your own hair or the whole family's. Send 59c and your Comb-A-Trim will be sent at once.



59c

SPECIAL OFFER
Send \$1.00 for 2 Comb-A-Trims and save 18c. **2 for \$1**

5 Extra Blades (Year's Supply) 25c **COMB-A-TRIM CO.**
1734 Carew Tower Dept. R-8 Cincinnati, O.

INVENTORS

The patent laws provide that any new and useful art, machine, article of manufacture, composition of matter, or design, or any new and useful improvement thereof, may be patented if the act of invention is involved. Therefore, every inventor with a valuable invention should take advantage of the patent laws and proceed for patent protection in order to safeguard his rights.

A patent gives the inventor the exclusive right to prevent others from making, using, or selling the invention claimed in the patent for a period of 17 years.

The patent laws were enacted for the benefit of the inventor to give him protection for the features of his invention which are patentable. These features must be properly and concisely set forth and claimed in a formal application for patent in order to comply with the requirements of the U. S. Patent Office. For that reason, the Patent Office advises the inventor to engage a competent registered patent attorney to prepare his application for patent and represent him before the U. S. Patent Office Examiner.

A specially prepared booklet containing detailed information with respect to patent protection and procedure will be forwarded to you without obligation upon request.

Patents
Trademarks
Copyrights

Registered Patent Attorneys

CLARENCE A. O'BRIEN
& HARVEY B. JACOBSON

61-G Adams Building + Washington 4, D. C.

CLARENCE A. O'BRIEN & HARVEY B. JACOBSON
Registered Patent Attorneys
61-G Adams Building, Washington 4, D. C.

Please send me booklet containing information regarding patent protection and procedure. This request does not obligate me.

Name _____

Address _____

City _____ State _____

(Please write or print plainly.)

LET ME TRAIN YOU

for RADIO ELECTRONICS & TELEVISION

I'll Supply a FULL RADIO SET

for SIMPLIFIED INSTRUCTION — PRACTICE & TESTING

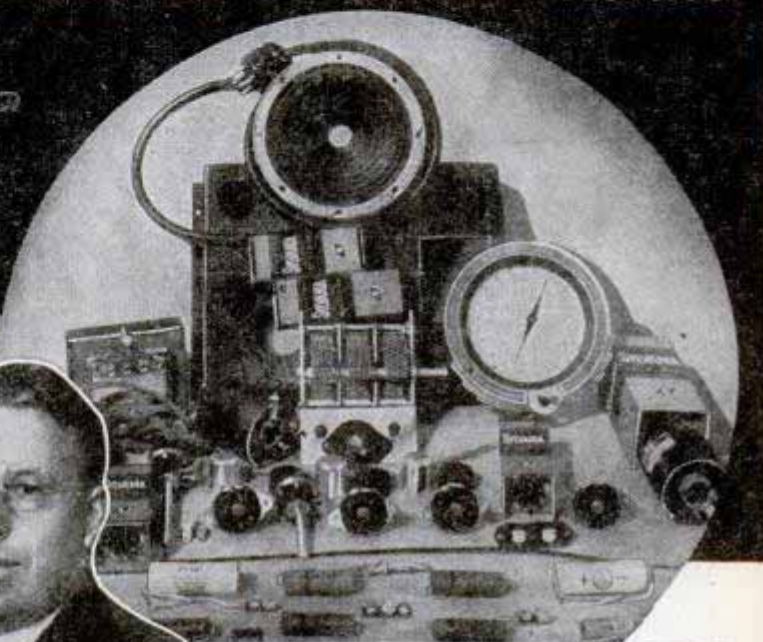
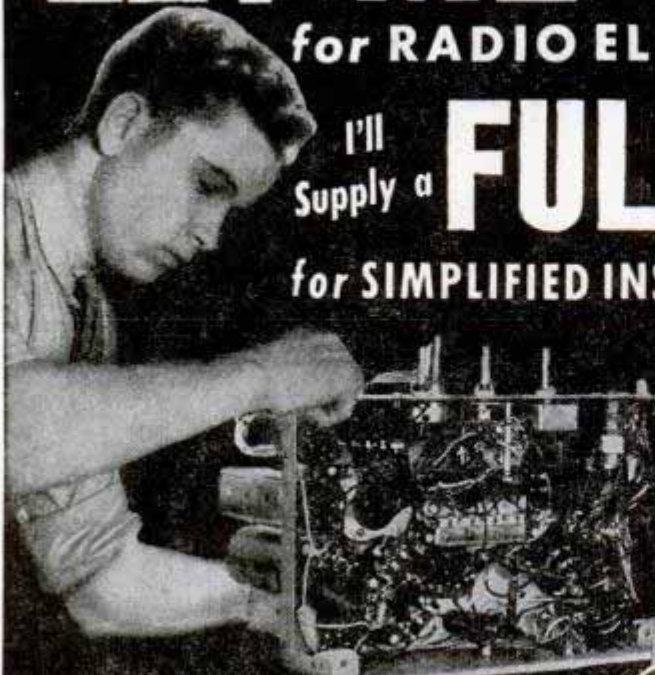

Beginners Learn FAST
START NOW! Big Developments
Ahead in F. M., Radar, Television



MAKE GOOD MONEY IN
a Business of Your Own
...or a Good Radio Job.

The offer I make you here is the opportunity of a lifetime. It's your big chance to get ready for a wonderful future in the swiftly expanding field of Radio-Electronics INCLUDING Radio, Television, Frequency Modulation and Industrial Electronics. Be wise! NOW'S the time to start. Opportunities ahead are tremendous! No previous experience is necessary. The Sprayberry Course starts right at the beginning of Radio. You can't get lost. It gets the various subjects across in such a clear, simple way that you understand and remember. And, you can master my entire course in your spare time.

You Do Practical Experiments
 There's only one right way to learn Radio Electronics. You must get it through simplified lesson study combined with actual "shop" practice under the personal guidance of a qualified Radio Teacher. It's exactly this way that Sprayberry trains you . . . supplying real Radio parts for learn-by-doing experience right at home. Thus, you learn faster, your understanding is clear-cut.

I'll Show You a New, Fast Way to Test Radio Sets Without Mfg. Equipment
 The very same Radio Parts I supply with your Course for gaining pre-experience in Radio Repair work may be adapted through an

exclusive Sprayberry wiring procedure to serve for complete, fast, accurate Radio Receiver trouble-shooting. Thus, under Sprayberry methods, you do not have one cent of outlay for manufactured Test Equipment.

Succeed As a Radio-Electronician
 My training will give you the broad, fundamental principles so necessary as a background, no matter which branch of Radio you wish to specialize in. I make it easy for you to learn Radio Set Repair and Installation Work. I teach you how to install and repair Electronic Equipment. In fact, you'll be a fully qualified RADIO-ELECTRONICIAN, equipped with the skill and knowledge to perform efficiently and to make a wonderful success of yourself.

Read What Graduate Says
"One Job Nets About \$26.00"
 "Since last week I fixed 7 radios, all good-paying jobs and right now I am working on an amplifier system. This job alone will net me about \$26.00. As long as my work keeps coming in this way, I have only one word to say and that is 'Thanks' to my Sprayberry training and I am not afraid to boast about it." — ADRIEN BENJAMIN, North Grosvenordale, Conn.

DON'T PUT IT OFF!
 Get the facts about my training—now! Take the first important step toward the money-making future of your dreams. All features are fully along with another valuable FREE explained in my big, illustrated FREE Catalog which comes to you book you'll be glad to own.

FREE BOOKS

"How To Read Radio Diagrams and Symbols"

. . . a valuable new book which explains in simple English how to read and understand any Radio Set Diagram or circuit. Includes translations of all Radio symbols. Send for this FREE book now, and along with it I will send you another big FREE book describing my Radio-Electronic training.

RUSH COUPON for BOTH



SPRAYBERRY ACADEMY OF RADIO
 F. L. Sprayberry, President
 Room 1076, Pueblo, Colorado

Please rush my FREE copies of "How to MAKE MONEY in RADIO, ELECTRONICS and TELEVISION," and "HOW to READ RADIO DIAGRAMS and SYMBOLS."

Name Age
 Address
 City State
 (Mail in envelope or paste on penny postcard)

MAIL COUPON AT ONCE!

HOW JUST TWO WORDS TURNED MAC INTO A HE-MAN!

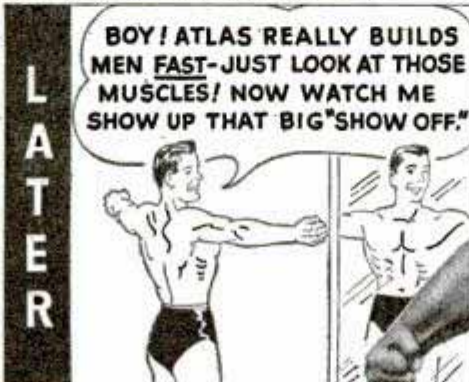

Charles Atlas
— actual photo of Charles Atlas, winner and holder of the title, "The World's Most Perfectly Developed Man."

I Can Make YOU a New Man, Too —in Only 15 Minutes a Day!

If you (like Mac) are fed up with being "pushed around"—if you're sick and tired of having the kind of a body that people PITY instead of ADMIRE—then give me just 15 minutes a day! That's all I need to PROVE I can make you a NEW MAN!

I know what I'm talking about. I was once a thin, peepless, 97-pound "bag of bones" myself. Then I discovered my now-famous secret, "Dynamic Tension." It turned me into "The World's Most Perfectly Developed Man." And I have used this secret to rebuild thousands of other scrawny, half-alive weaklings into perfect, red-blooded specimens of real HE-MANHOOD. Let me prove that I can do the same for YOU!

"Dynamic Tension" Does It!

Using "Dynamic Tension" only 15 minutes a day, in the privacy of your own room, you quickly begin to put on muscle, increase your chest measurements, broaden your back, fill out your arms and legs. This easy, NATURAL

method will make you a finer specimen of REAL MANHOOD than you ever dreamed you could be!

I don't care how old or young you are, or how ashamed of your present physical condition you may be. If you can simply raise your arm and flex it I can add SOLID MUSCLE to your biceps—yes, on each arm—in double-quick time!

FREE BOOK

Thousands of fellows have used my marvelous system. Read what they say—see how they look before and after—in my book, "Everlasting Health and Strength."

Send NOW for this book—FREE. It tells all about "Dynamic Tension." Shows you actual photos of men I've turned from puny weaklings into Atlas Champions. It tells how I can do the same for YOU. Don't put it off! Address me personally. Charles Atlas, Dept. 8G, 115 East 23rd Street, New York 10, N. Y.



CHARLES ATLAS, Dept. 8G
115 E. 23rd Street, New York 10, N. Y.

I want the proof that your system of "Dynamic Tension" will help make a New Man of me—give me a healthy, husky body and big muscular development. Send me your free book, "Everlasting Health and Strength."

NAME.....
(Please print or write plainly)

ADDRESS.....

CITY..... Zone No. (if any)..... STATE.....

Check here if under 16 for Booklet A.

INVENTORS

● **T**he Rules of Practice of U. S. Patent Office advises—unless the inventor is qualified to handle such matters—that he employ the services of a competent Patent Attorney in the preparation of his Patent Application. We are Registered Patent Attorneys fully qualified to represent you at the Patent Office. Our long and varied experience in patent practice, we believe, enables us readily to understand inventors' disclosures, to advise what is probably patentable, after conducting preliminary patentability investigation of prior U. S. patents, and to draw your specifications and claims in such manner as to present clearly the novel features.

Patent Laws Favor the Inventor Who Acts Promptly

Remember, the details of your invention do not have to be 100% perfect before you can obtain patent. Unwise inventors often

devote considerable unnecessary time working on unimportant details of their devices. This is expensive, hazardous and unnecessary. First step is to have us conduct search for the prior U.S. patents and render a report as to its patentability. Our Search Report is very valuable to you in that it clears up the course you should take in regard to your invention. If our Report is favorable, this report of the patentability of your device shows that your chances of patent protection are in your favor.

Have Patent Protection First

Unless you safeguard your invention by obtaining a patent, thereby securing a monopoly on same, it may become "public property," free to be made, used and sold by anyone, or it may be patented by some other person.

McMORROW, BERMAN & DAVIDSON

Registered Patent Attorneys

135-T Atlantic Building, Washington 4, D. C.

●
COPYRIGHTS

PATENTS

TRADE MARKS
●

McMORROW, BERMAN & DAVIDSON

Registered Patent Attorneys

135-T Atlantic Building, Washington 4, D. C.

Send me further particulars on how to protect my invention and "Invention Record" form at once. I understand that this request does not obligate me.

Name.....

Address.....

City..... State.....

-(Write or print name clearly)-

SCHOOL for VETERANS!

Learn while you earn!

**You're in a class
by yourself with
I.C.S.—and Courses
are free to you
under the G.I. Bill
of Rights!**



- I. C. S. Courses, paid for by the Government, are now available to honorably discharged World War II Veterans. And the Government's investment in your training will NOT be deducted from any future bonus.
- Get started now on your studies for success in business or industry! With I. C. S. you can do this in your spare time *while holding down a job!* You're in a class by yourself. There's no one to

- hold you back . . . you progress just as fast as your abilities and ambition permit!
- Courses cover more than 400 commercial and technical subjects—many listed below. Check the subject that interests you—or write it in. We'll send you full information on the Course—and complete instructions on how to enroll with us under the G.I. Bill of Rights. Act now!

INTERNATIONAL CORRESPONDENCE SCHOOLS



BOX 5583-K, SCRANTON 9, PENNA.

Without cost or obligation, please send me full particulars about the course *before* which I have marked X:

- Air Conditioning and Plumbing Courses**
- Air Conditioning
- Heating Plumbing
- Refrigeration Steam Fitting
- Chemistry Courses**
- Chemical Engineering
- Chemistry, Analytical
- Chemistry, Industrial
- Chemistry, Mfg. Iron & Steel
- Petroleum Refining Plastics
- Pulp and Paper Making
- Civil Engineering, Architectural and Mining Courses**
- Architectural Drafting
- Architecture
- Bridge and Building Foreman
- Building Estimating
- Civil Engineering
- Coal Mining
- Contracting and Building
- High Way Engineering
- Lumber Dealer
- Reading Structural Blueprints
- Sanitary Engineering
- Structural Drafting

- Structural Engineering
- Surveying and Mapping
- Communications Courses**
- Electronics
- Practical Telephony
- Radio, General
- Radio Operating
- Radio Servicing
- Telegraph Engineering
- Electrical Courses**
- Electrical Drafting
- Electrical Engineering
- Electric Light and Power
- Lighting Technician
- Practical Electrician
- Internal Combustion Engines Courses**
- Auto Technician Aviation
- Diesel-Electric
- Diesel Engines Gas Engines
- Mechanical Courses**
- Aeronautical Engineering
- Aircraft Drafting
- Flight Engineer
- Foundry Work
- Heat Treatment of Metals

- Industrial Engineering
- Industrial Metallurgy
- Machine Shop
- Mechanical Drafting
- Mechanical Engineering
- Mold-Loft Work
- Patternmaking—Wood, Metal
- Reading Shop Blueprints
- Sheet-Metal Drafting
- Sheet-Metal Worker
- Ship Drafting Shipfitting
- Tool Designing
- Toolmaking
- Welding—Gas and Electric
- Railroad Courses**
- Air Brake Car Inspector
- Diesel Locomotive
- Locomotive Engineer
- Locomotive Fireman
- Railroad Section Foreman
- Steam Engineering Courses**
- Boilermaking
- Combustion Engineering
- Engine Running
- Marine Engineering
- Steam Electric Steam Engines

- Textile Courses**
- Cotton Manufacturing
- Rayon Weaving
- Textile Designing
- Woolen Manufacturing
- Business and Academic Courses**
- Accounting Advertising
- Arithmetic Bookkeeping
- Business Correspondence
- Business Management
- Certified Public Accounting
- Commercial
- Cost Accounting
- Federal Tax
- First Year College
- Foremanship French
- Good English High School
- Higher Mathematics
- Illustrating Motor Traffic
- Postal Service
- Salesmanship Secretarial
- Sign Lettering
- Spanish Stenography
- Traffic Management

Name _____ Home Address _____

City _____ State _____ Present Position _____

Working Hours _____ A.M. to _____ P.M. Length of Service in World War II _____

Special tuition rates to members of the Armed Forces. Enrollment under the G.I. Bill of Rights approved for War II Veterans. Canadian residents send coupon to International Correspondence Schools Canadian, Ltd., Montreal, Canada.

PATENT PROTECTION FOR INVENTORS

THE Constitution of the United States provides that
 "Congress shall have power . . . to promote the progress of science and useful arts, by securing for limited times to . . . inventors the exclusive right to their . . . discoveries."

A PATENT IS A VALUABLE RIGHT

On the basis of the constitutional provision Congress has established a system under which inventors may secure the exclusive right to prevent the unauthorized use, manufacture and sale of their inventions for periods of seventeen years. The inventor secures this protection by obtaining a patent from the United States Patent Office.

THE UNITED STATES PATENT OFFICE

recommends in its Rules of Practice that "an applicant is advised, unless familiar with such matters to employ a competent registered patent attorney or registered patent agent, as the value of patents depends largely upon the skillful preparation of the specifications and claims."

PATENT DECISION OF U. S. SUPREME COURT

The United States Supreme Court has highlighted the same thought in this language:
 "The specification and claims of a patent, particularly if the invention be at all complicated, constitute one of the most difficult legal instruments to draw with accuracy. . . ."

VICTOR J. EVANS & CO., established in 1898, has a staff of experienced registered patent attorneys, available to represent inventors in the preparation and prosecution of their cases before the Patent Office. Detailed information and the steps to be taken in obtaining patent protection will be furnished upon request.

FORM BELOW FOR MAILING CONVENIENCE

VICTOR J. EVANS & Co.

Merlin M. Evans
 REGISTERED PATENT ATTORNEY

130-H Merlin Building, Washington 6, D. C.

Please forward to me detailed information regarding procedure to obtain Patent Protection.

Name.....

Address.....

City and State.....

PATENTS • TRADEMARKS • COPYRIGHTS

BE A

LANDSCAPE ARCHITECT

WORK OUTDOORS



The field of Landscape Gardening offers unusual opportunities for trained men . . . greatly augmented by the huge home-building and modernizing program ahead. We provide thorough, interesting home-training during your spare time . . . adapted to your regional conditions.

Healthful, pleasant outdoor work in an uncrowded field.

!APPROVED for VETERANS

BE YOUR OWN BOSS

A graduate says, "I finished the course about two months ago and now I average about \$2.00 per hour net for my time."

There are many employment opportunities in this profitable, uncrowded field or you can easily start your own business. Write today.

Service from Coast to Coast

NATIONAL LANDSCAPE INSTITUTE
 DEPARTMENT P 756 SOUTH BROADWAY — LOS ANGELES 14

LEARN MONEY-MAKING CARTOONING

IN SPARE TIME — by Easy Picture Chart Method
 Same Simplified Method that has helped train creators of "Terry & Pirates," "Freckles," "Gut Our Way," "Winnie Winkle," "Reg'lar Fellers," "Strange As It Seems," "The Neighbors," and many others. Earn while learning. Send 10c for Picture Chart (to test your ability), and full details. (State age.)



Landon School of Cartooning, Dept. 4607 Philadelphia 1 Pa.

ACCOUNTANT

BECOME AN EXPERT

Executive Accountants and C. P. A.'s earn \$2,000 to \$10,000 a year. Thousands of firms need them. We train you thoroughly at home in spare time for C. P. A. examinations or executive accounting positions. Previous experience unnecessary. Personal training under supervision of staff of C. P. A.'s. Placement counsel and help. Write for free book, "Accountancy, the Profession That Pays."
LASALLE Extension University, 417 So. Dearborn St.
 A Correspondence Institution Dept. 764-H Chicago 5, Ill.

AVIATION TRAINING

Learn **AERONAUTICAL ENGINEERING** or **AIRCRAFT and ENGINE MECHANICS (A & E)**

Resident courses at famous Northrop Field

Northrop Aeronautical Institute

1527 E. BROADWAY (Division of Northrop Aircraft, Inc.) LOS ANGELES COUNTY
 HAWTHORNE CALIFORNIA

+ SEND FOR ILLUSTRATED BOOK

STAMMER?

This new 128-page book, "Stammering, Its Cause and Correction," describes the Bogue Unit Method for scientific correction of stammering and stuttering—successful for 45 years. **Benj. N. Bogue**, Dept. 1838, Circle Tower, Indianapolis 4, Ind.

GET THIS FREE BOOK!

MAKE MONEY AT HOME

RUBBER MOLDS *Low as 6¢ EA.*

Amazing rubber mold-making outfit makes perfect flexible molds of plaques, ash trays, book-ends, etc. Molds cost 6c to 25c each. Each mold makes hundreds of novelties and gifts to sell for \$1.00 apiece and more! No experience necessary. Everything furnished. Quick and easy. Start profitable business in your home—sell to stores, gift shops, friends, resorts, road stands, by mail. Full or spare time. Write for complete FREE details and easy instructions.



SO-LO WORKS, Inc., Dept. H-800, Loveland, Ohio

Prepare for YOUR FUTURE Now

You'll Need "ALL-AROUND" Training to Meet New Conditions!

Get Ready QUICK—in 1 of these 2 Opportunity Fields!

ELECTRICITY OR **RADIO ELECTRONICS TELEVISION**



ELECTRICITY in its Many Branches...
Electricity is a permanent necessity in war or peace. Be ready for the opportunities in such branches as Power Plant Work, Motors, Armature Winding, Industrial and House Wiring, Maintenance, etc., with COYNE shop training.



This big fire-proof building is occupied entirely by the Coyne Electrical School.

RADIO-ELECTRONICS...A great field now, even greater growth ahead. Prepare for a real Radio career. Learn construction, operation, trouble-shooting on Radio Receivers, Public Address Systems, Sound Picture Units, FM, Photo-Cells, Television—the practical COYNE way.

"LEARN-BY-DOING" IN A FEW WEEKS

Student Finance Plan

Conditions today are different. Many "one-operation" jobs that paid well in the past, no longer exist. Do you have a good job with a real future? Plan for steady pay and advancement by training NOW, while there's still time! Come to the big shops of COYNE in Chicago, for "all-around" training in Electricity or Radio-Electronics—the 2 great opportunity fields of today and tomorrow. I'll finance most of your tuition.

TRAIN ON ACTUAL EQUIPMENT!

My famous "Learn-by-Doing" method gives you practical experience on full-size equipment. Not by correspondence, but actual shop work. You are trained right here in the Coyne shops, that has been training men and young men for over 47 years.

START NOW—PAY LATER! LIFETIME JOB SERVICE TO COYNE GRADUATES

Don't let lack of money hold you back. My "Pay-Tuition-after-Graduation" plan has helped thousands. Coupon brings details. Many earn while learning, to help take care of living expenses while here. Men from 16 up to 40, with or without experience, Coyne training is for you!

First I train you for a good job and future, then assist you in getting located. As a Coyne graduate, use this service whenever you need it—no charge. Also FREE review privileges. Get the facts!

PICK FIELD YOU LIKE—
SEND FOR BIG BOOK



FREE *H.C. Lewis*

Some men prefer Electricity, others Radio-Electronics. Whichever interests you most, we will train you in a few short weeks at Coyne—on full-size equipment, by my famous "Learn-by-Doing" method. I have a big, fully illustrated book on each course, and will send you the one you want, without the slightest cost or obligation. Simply check below, then mail coupon in envelope or paste on post-card. No salesman will call. You are the sole judge. Don't delay. Your future is at stake. Rush coupon to me—TODAY.



INDUSTRIAL ELECTRONICS and Electric Refrigeration Included With Either Course

Added training in these great fields of INDUSTRIAL ELECTRONICS and ELECTRIC REFRIGERATION makes you more valuable to employer, leads to opportunities for bigger pay. This valuable TRAINING now included with either my Electrical or Radio Course. We also have facilities for men with physical disabilities whether due to war or other causes. Check coupon for details if you have a physical disability of any kind.

VETERANS—

Coyne is also equipped to train those who qualify for training under G. I. Bill of Rights. Check coupon for our Special G. I. Bulletin.

COYNE ELECTRICAL SCHOOL

H. C. LEWIS, Pres. Founded 1899

500 So. Paulina Street, Dept. B6-72H, CHICAGO 12, ILL.

H. C. LEWIS, Pres.,
COYNE ELECTRICAL SCHOOL
500 S. Paulina St., Dept. B6-72H, Chicago 12, Ill.

Send me your BIG FREE BOOK—for the course checked below. Also full details of your "Student Finance Plan."

- ELECTRICITY RADIO-ELECTRONICS
 Send special G. I. Bulletin Physical disability

NAME.....

ADDRESS.....

CITY.....STATE.....

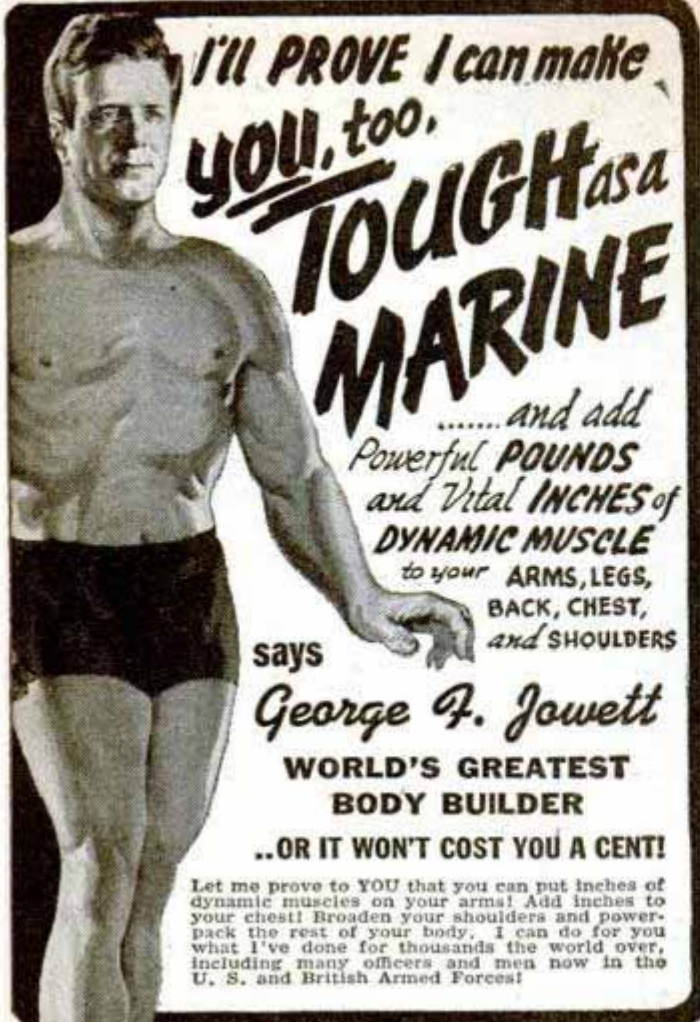

I'll PROVE I can make
you, too,
**TOUGH as a
MARINE**

..... and add
Powerful POUNDS
and Vital INCHES of
DYNAMIC MUSCLE
to your ARMS, LEGS,
BACK, CHEST,
and SHOULDERS

says
George F. Jowett
WORLD'S GREATEST
BODY BUILDER

..OR IT WON'T COST YOU A CENT!

Let me prove to YOU that you can put inches of dynamic muscles on your arms! Add inches to your chest! Broaden your shoulders and power-pack the rest of your body. I can do for you what I've done for thousands the world over, including many officers and men now in the U. S. and British Armed Forces!

GIVE ME 10 MINUTES A DAY!
I'll Show You My Secrets Of Body Building

I'll help you learn the "Progressive Power Method" through which I rebuilt myself from a physical wreck to the holder of more strength records than any other living athlete or teacher! No matter how skinny or flabby you are, you can learn my methods right in your own home. Through my proved secrets I show you how to develop your power, inside and out, until YOU are fully satisfied that you are the man you want to be. "The Jowett System," says R. F. Kelly, Physical Director of the YMCA, Atlantic City, "is the greatest in the world!" If you want a physique that will inspire respect from men, and admiration from women... ACT LIKE

A HE-MAN! Decide at once! The famous book, "Nerves of Steel—Muscles Like Iron" will be included FREE! Priceless for the strength fan! Full of photos of marvelous power-bodied men who will show you what Jowett has done for them and how he can do the same for you. Reach out... Grasp this Special Offer today!

PROVE TO YOURSELF IN ONE NIGHT!

Send only 25c for test Course, "Molding a Mighty Arm." Read it the evening it arrives—learn from experience the thrill you can give your muscles!

SEND FOR THESE FIVE FAMOUS COURSES IN BOOK FORM ONLY 25c EACH or ALL 5 for \$1.00

Jowett Institute of Physical Culture
230 Fifth Avenue
Dept. PM-67
New York 1, N. Y.

This Book Free!



BOOK WITH PHOTOS OF FAMOUS STRONG MEN FREE MAIL COUPON NOW



Jowett Institute of Physical Culture
230 Fifth Avenue, Dept. PM-67, New York 1, N. Y.
George F. Jowett: Your proposition looks good to me. Send by return mail, prepaid, the courses checked below, for which I enclose (), include FREE book of PHOTOS.

- George F. Jowett Champion of Champions
- All 5 courses for... \$1
 - Molding a Mighty Arm 25c
 - Molding a Mighty Back 25c
 - Molding a Mighty Grip 25c
 - Molding a Mighty Chest 25c
 - Send all 5 C.O.D. (\$1 plus postage.) No orders less than \$1 sent C.O.D.

NAME..... Age.....
(Please print plainly. Include Zone Number.)

ADDRESS

BECOME A SERVICE EXPERT

REFRIGERATION and AIR CONDITIONING

Millions of Older Units Need Expert Service. Big After-the-War Expansion Will Create Even More Opportunities

Approved for Veterans "G.I." Training

Now, not "next week," is the time to start training for a top-pay job in this vital field. A drastic shortage of trained service experts exists. Many thousands more will be needed for big post-war expansion caused by new industrial uses. Train NOW to get your pick of best jobs. We will give you the practical training you need. For 2 years we trained men and women for the Army and Navy only, in fine-precision aircraft instrument work. So our methods must be right. Common schooling is all you need. Our unique system makes everything easy to grasp. You can train at home and in our big Chicago shops. Write for full facts TODAY, without obligation.

INDUSTRIAL TRAINING INSTITUTE
2150 Lawrence Avenue, Dept. PIT, Chicago 25, Illinois

Learn Penmanship

You can learn plain, rapid writing or fancy ornamental writing for social and business advancement, right in your own home during spare time by my Simplified Method. Write for my free book, "How to Become an Expert Penman," which shows what others have accomplished by taking my Courses. Send 10c for one of my favorite Pen Points and your name with a beautiful flourished bird written on a card. Write today. T. M. Tevis, Box 25K, Chillicothe, Mo.

SILK SCREEN PROCESS A PROFITABLE BUSINESS OF YOUR OWN



PRACTICE in your spare time!
We Send You Complete Kit of Supplies

Silk Screen Processed signs & displays needed everywhere. A lucrative future for you in the great advertising boom. Easy to do—quick to learn—you may make more than course costs before it's completed. BOOKLET with 3-color Silk Screen Processed Cover and samples sent FREE... Write now, California School Screen Process, Dept. PM 2710 S. Spaulding, Los Angeles 16, Calif. 746

A High Profit Business — or a Thrilling Hobby

Your Future in PHOTOGRAPHY

Nationwide opportunities sound future waiting. Photographers needed by studios, newspapers, advertisers, in business, industry, science. Qualify through success-proved home study courses. Also resident instruction. Write for full details.
N. Y. INSTITUTE OF PHOTOGRAPHY,
Dept. 49, 10 W. 33 St., New York 1, N. Y.

Free Book

MOUNT BIRDS, ANIMALS, FISH
Yes FREE. Explains Taxidermy. Tells how to learn at home by mail to mount birds, animals, heads... to TAN skins and furs. Great for MEN and BOYS. Fun! Also earn money in spare time. WRITE TODAY -- NOW -- for free book containing 100 game pictures, State AGE, N.W. School of Taxidermy, Dept. 337B, Omaha, Neb.



LAW

STUDY AT HOME for PERSONAL SUCCESS and LARGER EARNINGS. 35 years expert instruction—over 108,000 students enrolled. LL.B. Degree awarded. All texts furnished. Easy payments. Send for FREE BOOK—"Law and Executive Guidance."
AMERICAN EXTENSION SCHOOL OF LAW
Dept. 67-M, 646 N. Michigan Ave., Chicago 11, Ill.



LEARN MEAT CUTTING At Home — In Spare Time

Get into the vital meat industry. Concise, practical Home Training based on 25 years proven instruction methods used at National's famous resident school. Prepares you for bigger pay as Meat Cutter, Supervisor, market manager or more money in your own store. Go as rapidly as your spare time permits. Diploma. Start NOW to turn your spare hours into money. Send for FREE bulletin today. No obligation.

National School of Meat Cutting, Inc., Dept. U-71, Toledo 4, Ohio

WHICH OF THESE *Opportunities* INTERESTS *You* MOST?

Accounting & C. P. A.
Air Conditioning
Architecture & Building
Automotive Engineering
Aviation—Practical
Aviation Drafting & Design
Better Foremanship
Bookkeeping
Business Management
Contracting

Diesel Engineering
Drafting & Design
Electrical Engineering
Electricity—Practical
Electronics, Industrial
High School Courses
Machine Shop Operations
Mechanical Engineering
Plastics Engineering
Plumbing—Practical

Private Secretary
Radio Operating & Servicing
Railway Training
Refrigeration
Sheet Metal Pattern Drafting
Shop Management
Surveying & Topographical
Drafting
Tool Making

THINK! LOOK FORWARD!

Business is making big, new plans

Men and Women are preparing for the future

WHAT ARE YOU DOING ABOUT YOUR TOMORROWS?

● *Today*, choose the job you want—and prepare for it. Or if you are already engaged in the work you like best, start training *now* for quicker promotion. Acquire the knowledge that will help you to get ahead faster, make more money and have greater security.

Invest part of your spare time in more rapid progress. Start training now, in spare time in your own home. Be ready to grasp your opportunity and step out ahead of those who lack the ability you have attained.

American School, founded in 1897 as an educational institution *not for profit*, can

help you to reach your goal just as it has helped others during the past forty-nine years. Give serious thought to the list above. Pick one or more subjects that interest you. Then check the coupon at right, add your name and address and mail it at once. The school will send you details on its training plan and outline of study prepared by specialists. There is no charge, no obligation, so send the coupon immediately.

PRACTICAL, EFFECTIVE HOME - STUDY TRAINING SINCE 1897

Take This First Easy Step

CHECK, CLIP AND MAIL COUPON NOW

AMERICAN SCHOOL, Dept. GB45, Drexel at 58th, Chicago 37, Ill.
Without obligation, Please send FREE and postpaid, bulletin and details of the Subject checked.

- | | | |
|--|---|--|
| <input type="checkbox"/> PLASTICS ENG'R | <input type="checkbox"/> Accounting & C.P.A. | <input type="checkbox"/> Drafting and Design for Men and Women |
| <input type="checkbox"/> Refrigeration | <input type="checkbox"/> Electrical Engr. | <input type="checkbox"/> Radio |
| <input type="checkbox"/> Architecture and Building | <input type="checkbox"/> Electricity-Pract. | <input type="checkbox"/> High School |
| <input type="checkbox"/> Contracting | <input type="checkbox"/> Electronics, Industr. | <input type="checkbox"/> Air Conditioning |
| <input type="checkbox"/> Practical Plumbing | <input type="checkbox"/> Bookkeeping | <input type="checkbox"/> Mechanical Eng. |
| <input type="checkbox"/> Automotive Engineering | <input type="checkbox"/> Private Secretary | <input type="checkbox"/> Shop Management |
| <input type="checkbox"/> Aviation Drafting | <input type="checkbox"/> Diesel Engineering | <input type="checkbox"/> Tool Making |
| <input type="checkbox"/> Aviation | <input type="checkbox"/> Surveying & Topographical Drafting | <input type="checkbox"/> Better Foremanship |
| <input type="checkbox"/> Business Mgmt | <input type="checkbox"/> Sheet Metal Pattern Drafting | <input type="checkbox"/> Machine Shop Operations |
| <input type="checkbox"/> Railway Training | | |

Name..... Occupation.....
Address..... Age.....
City..... State.....

AMERICAN SCHOOL

Dept. GB45, Drexel at 58th Street, Chicago 37



AUTO

BOOKS ON APPROVAL

SEND NO MONEY. Just mail the coupon for a complete set of Six Big Auto Books, 20th Edition. Whether you are a mechanic or helper, expert or apprentice, auto owner or driver, take immediate advantage of this FREE EXAMINATION OFFER.

MAKE GOOD MONEY NOW HOLD A PERMANENT JOB
America wants its automobiles kept in good repair. Men with "know how" are in demand, at big pay. These books will help you get and hold an important job, or give you a chance to go into business for yourself now or later. Any man who half tries to improve himself can learn auto servicing and repairing by this quick reference method. Use the JIPPY INDEX to find easily understood answer to any auto problem. These wonder books prepared by eleven of America's great automobile engineers. Many hundreds of valuable illustrations. Send the coupon TODAY.

A year's consulting privileges with our engineers now given with these books without extra charge.
Vocational Publishers Since 1898

CAN YOU FIX IT?

These wonder books tell step by step HOW to make difficult repairs and adjustments, how to keep a car at maximum efficiency, including latest improvements in car design and operation. Engine troubles and how to correct them well covered.

6 BIG VOLUMES
2800 pages, 2000 illustrations, wiring diagrams, etc., including Diesel engines. Beautiful modernistic, washable cloth binding.

AMERICAN TECHNICAL SOCIETY, Dept. AB19
Drexel Ave. at 58th St., Chicago 37, Ill.

I would like to examine your Six-Volume Set of Auto Books. I will pay the delivery charges only, but if I choose I may return them express collect. If after 10 days' use I prefer to keep them, I will send you \$2 and pay the balance at the rate of only \$3 a month until \$24.80 has been paid. Please include consulting service as offered above.

Name

Address

City..... State.....

Please attach a letter stating your age, occupation, employer's name and address, and name and address of at least one business man as a reference. Men in service, also please give home address.

PLUMBERS & STEAM FITTERS

Audels Plumbers and Steamfitters Guides



4 Vols. \$6

A practical, illustrated, Reference Library and Study-Course for Master Plumbers, Journeymen and Apprentice Steamfitters, Gas Fitters and Helpers, Sheet Metal Workers, Draughtsmen, Master Builders, Engineers and all Building Trade Students. This valuable set of handy, pocket-size Guides explains in practical concise language and well-done illustrations all the principles, advances and short cuts of the Plumbing and Heating trade—based on modern practice. Contains careful, detailed instructions

on how to figure and estimate various jobs. Use FREE COUPON below to examine, without obligation, this valuable work.

INSIDE TRADE INFORMATION ON:

Soldering, tinning. Joint wiping, bending, beating. Pipe—iron—steel, threading. Mathematics, tables, physics. Materials—iron, steel, copper, brass, lead, tin, antimony, etc. Sheet metal—galvanized—plate. Sanitation, syphonage, tanks. Drainage, sewage, purification. Fixtures—bath—kitchen. Pipe fittings, soil pipe tools. Laying out work. Roughing. Screwed fittings, flanges, joints. Pipe bending, examples. Elbows. Heating, ventilation, air conditioning, refrigeration. Water supply, mains, wells, tanks. Gas-fittings. Sheet metal work, problems, methods. Bracing, heating, lead burning. Welding, various welds, methods. Blacksmithing, forges, tools. Air Conditioning.

THEO. AUDEL & CO., 49 W. 23rd St., New York City

Mail Audels Plumbers Guides, 4 vols., on 7 days' free trial. If O. K. I will remit \$1 in 7 days, and \$1 monthly until \$6 is paid. Otherwise I will return them. No obligation unless I am satisfied.

Name.....

Address.....

Occupation.....

Reference..... PM



BIG PROFITS!



A few hours fun in your spare time at home with **PLASTICS** WILL BRING YOU THE EXTRA MONEY YOU'VE BEEN NEEDING!

Don't waste time! Be your own boss! Our sets teach you plastic fabrication. Send for our sensational special introductory kit complete with plastics, jigs, and simple instructions... makes two picture frames, a smart cigarette box, and card and pencil holder.

Only \$3.95... we pay the postage.
Other countries, \$4.60. PLUS.

THERMO-PLAST CO.
737 Venice Blvd., Los Angeles 15, Calif.

"YOU ARE UNDER ARREST!"



Help Bring Crooks to Justice Through Scientific CRIME DETECTION!

I have taught thousands this exciting, profitable, pleasant profession. Let me teach you in your own home. Learn Finger Printing, Firearms Identification, Police Photography, Criminal Investigation thoroughly, quickly, at small cost. 53% of all American Bureaus of Identification employ I. A. S. students or graduates. I can prepare you for this fascinating work, during spare time. Write today, stating age, for "Blue Book of Crime."

Institute of Applied Science, 1920 Sunnyside Ave., Dept. 135-B, Chicago 40, Ill.

ENGINEERING DEGREE IN 27 MONTHS

INDIANA TECHNICAL COLLEGE

Aeronautical, Chemical, Civil, Electrical, Mechanical, and Radio Courses. B.S. degree. 1-yr. diploma in Electrical, Mechanical, and Radio Service; Drafting. Prep. courses. Gov't. approved for GI's. Low rate. Earn honor. Large industrial center. Demand for graduates. Enter Sept., Dec., March, June. Catalogue. 576 E. Washington Blvd., Ft. Wayne 2, Ind.

WORK WITH LEATHER!

Get this simplified "here's how" book; develop real skill in leather craft. Scores of stimulating illustrations show professional techniques, tricks, short-cuts. Order your copy of "WORKING IN LEATHER" today. \$1.00 pp.

Complete list FREE

HOUSE OF LITTLE BOOKS, 80-C E. 11th St, New York 3



THERE'S MONEY IN CARTOONS!

RAYE BURNS will teach you HOW to CREATE ORIGINAL CARTOONS at home that you may SELL! Course contains 26 lessons and over 600 illustrations. All for Only.....

\$2.85

Send name and address for free details.

RAYE BURNS SCHOOL, Dept. M, Box 3583, CLEVELAND, OHIO

Big Money for Workers In Home or Shop



Licensed Concrete Specialists wanted. No experience needed. Make Colorglazed concrete pottery without molds. New, low cost, patented method. Cemetery products, novelties, tiles, etc. Basement leaksealing. Other big pay projects. Booklet, details free. Men only.

NATIONAL POTTERIES COMPANY
542 Lincoln Avenue Fergus Falls, Minnesota

See how readily YOU can train at home for BIGGER EARNINGS in RADIO ELECTRONICS



FREE KIT PACKET SHOWS HOW YOU CAN GET LOTS OF "LEARN-BY-DOING" RADIO EXPERIENCE AT HOME FROM DEFOREST'S THRILLING RADIO "Home Laboratory"

133 EXPERIMENTS

DeForest's Kit Packets show how you can get real Radio experience from the many standard Radio parts furnished you with DeForest's Training. See how you may quickly build Radio Circuits that work... how you may experiment with Photo Electric Cell "Magic"... a 5-Tube Superheterodyne Receiver... a Radio Telephone and scores of other fascinating projects. See how you get actual "shop training" at home to give you the practical Radio experience you need.

VETERANS!

Big things are happening at DeForest's for veterans! See how you can prepare yourself without cost for a GOOD JOB or BUSINESS OF YOUR OWN in the vast Radio-Electronic opportunity field.

DeFOREST'S PROVIDES ALL 3 HOME TRAINING AIDS

- A** DeVry Movie Projector and Learn-By-Seeing Movie Film
- B** Actual Radio Parts for working out 133 experiments
- C** 90 lessons prepared under the supervision of Dr. Lee DeForest—the "Father of Radio."

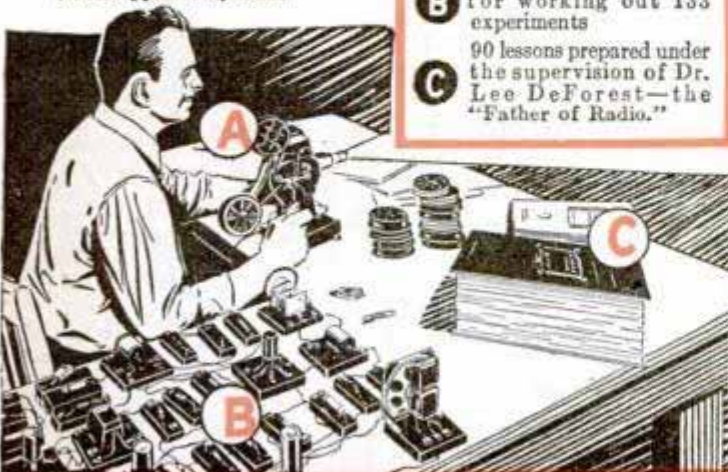

Now—you can see for yourself why DeForest's Training does such a grand job of preparing men for a bright future in one of America's most promising opportunity fields—Radio and Electronics. Send the coupon below for your free "Kit Packet" plus the big free book, "Victory For You!" that has helped so many to find the way to good pay jobs. You'll be surprised at the opportunities ahead of FM Radio, Aviation Radio, Broadcast Radio, a profitable Business of Your Own, Motion Picture Sound Equipment, and Electronics—plus the exciting future possibilities ahead of Television, Radar, etc. Train in your spare time at home—or get all of your training in our Chicago laboratories.

You Also Get EFFECTIVE EMPLOYMENT SERVICE

Upon completing your training, you get the full benefit of DeForest's Employment Service that has helped so many men to get started in the Radio-Electronic field.



DeFOREST'S TRAINING INCLUDES INSTRUCTION IN MOTION PICTURE SOUND EQUIPMENT, FM RADIO AND TELEVISION. RESIDENTIAL TRAINING IN OUR MODERN CHICAGO LABORATORIES ALSO AVAILABLE—ASK US FOR INFORMATION!

E. B. DeVry, President
DeFOREST'S TRAINING, INC.
2535-41 North Ashland Ave., Dept. PM-C7
Chicago 14, Illinois, U.S.A.

Send FREE RADIO KIT PACKET and "VICTORY FOR YOU!" BOOK.



Name _____ Age _____

Address _____ Apt. _____

City _____ Zone _____ State _____

If under 16, check here for special information. If a discharged Veteran of World War II, check here.

DeFOREST'S TRAINING, INC.
CHICAGO 14, ILLINOIS



SO IT NEEDS FIXING

By S. T. CHRISTENSEN
the "Fix-it Man"

"WELL, I guess I'm the fellow to see, for I've repaired thousands of refrigerators (home and commercial both), vacuum cleaners, radios, washing machines, irons, fans, lamps, mangles, motors, etc. In fact, many of my customers call me their "electrical appliance doctor." And, "doctoring," I might add, has paid me a good substantial income for quite a few years. Funny, in a way, how I got started. Always liked to tinker and by experimenting around I found that most electrical appliances had many things in common. That, regardless of what the appliance was used for, or who the manufacturer was, the basic principles were much the same. From fixing my own appliances to fixing friends' and then for strangers at a fee, seems now to have been but a small step.

What to Charge?

At first, I let the owner decide the charge and, frankly, I was amazed at what I earned per hour. But then, when one figures what initial costs are involved in buying most electrical appliances, one can readily see that spending extra dollars for repairs is well worth while. Before long I was making more in my spare time repairing than from my regular job. The result . . . I went into business for myself. When war came, business boomed, for new appliances were not available.

For a while, repair parts (needed on some

jobs) were a little difficult to get. But that situation quickly adjusted itself and many repair parts were given the high priority rating of AA2. After all, we had to provide for the health and well-being of our civilian population.

The Future Offers

Friends ask me about my future. And, I think I've got a grand one. Age is no handicap in repairing. I have in my files enthusiastic letters from repairmen ranging in age from 18 to 79 years. Now the war is over we are certain to see hundreds of new products on the market . . . products that the average person never dreamt of. These new products and our old appliances are all going to need at some time or other "fixing." Well, I'll still be the fellow to do it. The field open for appliance repairmen is unlimited. I don't worry at all about too much competition.

If You Are Ambitious

To the contrary, I've prepared a complete course, chuck full of simple, easy to understand photos and drawings and written in the same non-technical language as this article. I know the course is good, because I have hundreds of men all over the country writing to me telling me how the course has helped swell their pockets with cash. If you too want to prepare now for your future, I suggest you read the next page and send me the handy coupon."

Advertisement



**BIG MONEY
INDEPENDENCE**

*A PROFITABLE
LIFETIME
BUSINESS
OF
YOUR OWN!*

LEARN ELECTRICAL APPLIANCE REPAIRING

PREPARE NOW FOR THE FUTURE

If now employed, start your home appliance repair business NOW in your spare time and be set with a business of your own no matter what happens. You don't need elaborate fixtures or expensive equipment to be a successful repairman. Operate from your garage, basement, vacant store, etc. Work as many hours as you wish—the home appliance repairman is his own boss. It is a profitable occupation for on many types of repairs it is not unusual for a repairman to charge on the basis of \$5.00 to \$6.00 per hour. Don't gamble with your future—learn a trade that will always support you. Remember, as long as electrical appliances are used, there will be a need for electrical appliance repairmen.

If you are at all mechanically inclined—can hold and use tools—then you have all of the qualifications required for becoming a big money earning home appliance repairman. It does not matter if you have not had a great deal of schooling or had previous experience along these lines—**WE WILL TEACH YOU.** Age should be no barrier—nor should any minor physical handicap.

New Course Tells All

Profusely illustrated, our new course shows you in simple, easy to understand language and drawings how to make each repair on refrigerators, vacuum cleaners, washing machines, motors, etc. Explains and gives you a working knowledge of electricity, welding, nickel plating, etc. Shows you how to build the power tools you need and how to solicit and keep business coming to you. Not a theory course but an honest to goodness course written by and used by repairmen the country over. Price of course is so low that the savings on your own household appliance repairs will quickly pay for it. Act now! Mail the handy coupon below today.

----- Read What Our Students Say About Course -----

I really believe your course the best investment a mechanically minded man can make.—Claude E. Allen, Indianapolis, Ind.

I have received your Course in Appliance Repairing and I must say I am well pleased with same. I am only sorry I did not have said Course some years ago. I have learned so much more through this course I would not part with it.—Charles Schwarz, Hamilton, Ohio.

The Course in Appliance Servicing arrived a few days ago. Want to take out a few minutes of my valuable time to let you know that this is just what I have been looking for ever since I opened up my Fix-It shop. I must admit that you told the truth when you said that it contains quite a bit more information than I bargained for.—P. J. Bretl, Sebring, Ohio.

I am a mechanic for the Western Union Telegraph Co. Three days after receiving the lessons in refrigeration I earned the exact cost of the course.—Henry S. Lee, Washington, D. C.

I work day times at the shipyard and after 4:00 P.M. I operate from my cellar and garage. I average \$10.00 to \$15.00 clear every day.—Walter Hanly, Brockton, Mass.

GET STARTED TODAY — MAIL THIS COUPON

CHRISTY SUPPLY CO.
2835 N. Central Ave., Dept. D-3503
Chicago 34, Illinois

Please send me free illustrated literature about America's Fastest Growing Industry — **ELECTRICAL APPLIANCE REPAIRING.**

Name.....

Address.....

City..... State.....

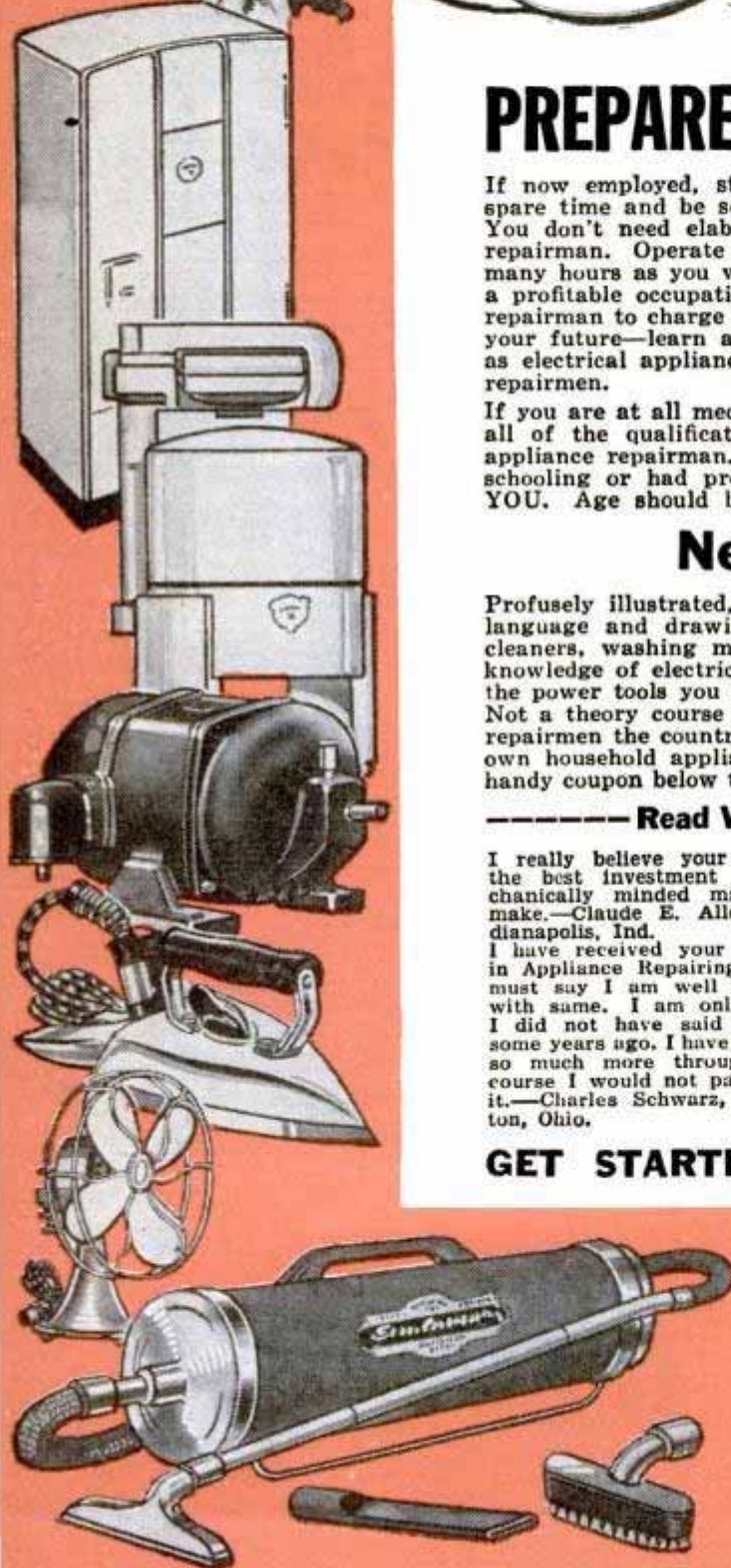

START NOW TOWARD A FUTURE IN REFRIGERATION and AIR CONDITIONING

Refrigeration and Air Conditioning are among the giant industries of America. Such industries need men who KNOW. Many men servicing and installing equipment are making large incomes.

Spare Time Training

If mechanically inclined, get the training you need to qualify for experience installing & servicing Refrigeration and Air Conditioning in stores, offices, homes.

Then you should have no difficulty getting started in these great industries. As experience, tools and a personal following are acquired; you may find it practical, later, to start your own REFRIGERATION and AIR CONDITIONING SHOP.



Rush Coupon Below Today!

Practical Interesting Training

You'll like our way of training—through capable home-study instruction followed by practice on actual equipment under watchful eyes of seasoned Refrigeration and Air Conditioning men in our shops. You'll get top-rate instructions—the easy way. So get the facts now—FREE of obligation. Write TODAY—SURE!

GET VALUABLE FACTS FREE

UTILITIES ENGINEERING INSTITUTE, Dept. 176
1314 W. BELDEN AVE., CHICAGO 14, ILL.

Please send me the Free FACTS about opportunities in Air Conditioning and Mechanical Refrigeration. I marked the one that interests me most.

Air Conditioning Mechanical Refrigeration

NAME _____ Age _____

ADDRESS _____

CITY _____ Zone _____ STATE _____

Learn this Profitable Profession



IN 90 DAYS AT HOME

Money-Making Career Open to Men and Women, 18 to 50

Hundreds of men and women between 18 and 50 make \$10 to \$20 in a single day giving scientific Swedish Massage and Hydro-Therapy treatments. There is big demand from doctors, hospitals, sanatoriums and clubs. Graduates earn large full time incomes from these or in private practice in their own offices. Others make good money from home treatments given in spare time. Learn this interesting, money-making profession in your own home, through our home study course. Same instructors as in our nationally known resident school. You can win independence and prepare for future security by qualifying for your Diploma. Course can be completed in 3 to 4 months. Many earn while they learn. Begin your training at once.

Anatomy Charts & Booklet FREE

Enroll now and we will include, at no extra cost, many needed supplies. Fit yourself to help meet growing demand for Scientific Swedish Massage. Send the coupon at once for complete details. Anatomy Charts and 32-Page Illustrated Booklet, FREE, postpaid.



THE COLLEGE OF SWEDISH MASSAGE
Dept. 664H, 100 East Ohio St., Chicago 11, Illinois

Please send me FREE and postpaid, Anatomy Charts, 32-page Booklet and complete details on Home Training.

Name _____

Address _____

City _____ State _____

Do You Need More Money?

SELL FAMOUS SUNSHINE CHRISTMAS CARDS

EXTRA SPARE TIME DOLLARS FOR YOU!
Take orders galore from friends for 25 SUPER VALUE CHRISTMAS FOLDERS \$1.25. With name. Others to \$2.50. 58 Designs. AMERICA'S LEADING \$1. BOX ASSORTMENT OF 21 FOLDERS. COSTS 50c. A complete box line. CURRIER & IVES, GLITTERS, OILLETES, GRAND-MA ROSES, Gift Wraps, Everyday's. Personal Line. 21 Asst. and Sunshine Notes on approval. FREE SAMPLES of Personal Cards. Write today. ORGANIZATIONS—Ask for "Sunshine Money-Making Plan" and Samples. SUNSHINE ART STUDIOS, 115 FULTON ST. Dept. EP, NEW YORK 8, N. Y.

FREE SAMPLES PERSONAL CARDS

"How to Make Money With Simple Cartoons"

A book everyone who likes to draw should have. It is free; no obligations. Simply address
CARTOONISTS' EXCHANGE

Dept. 97-D

Pleasant Hill, Ohio

SHORTHAND in 6 Weeks at Home

Famous Speedwriting system. No signs or symbols; uses ABC's. Easy to learn; easy to write and transcribe. Fast preparation for a job. Surprisingly low cost—100,000 taught by mail. Used in leading offices and Civil Service. Write for free booklet. **SPEEDWRITING, Dept. 1507-6, 55 West 42 St., N. Y. 18**

What Every Mason Wants



We have important Masonic books for Blue Lodge, Chapter, Commandery, Scottish Rite, and Shrine.

Our Rituals Are Used the World Over. Send for free catalog of books and rituals for Masons, Odd Fellows, Knights of Pythias, Knights of Columbus, etc. **EZRA A. COOK, Publisher, P. O. Box 796, PJ, Chicago 90, Ill.**

arc welding manual and text book...\$2.00

Teaches you how to become an arc welding operator — one of highest paid trades today. Write today!

Hobart Bros. Co., Box M-562, Troy, Ohio

INVENTING

—FOR PROFIT! If you have an inventive turn of mind, write for free 28-page booklet explaining how the Institute of American Inventors is helping inventors pre-test the profit possibilities of proposed devices to fill today's unprecedented demand for useful new inventions.

INSTITUTE of AMERICAN INVENTORS

Dept. 4, 1926 Eye St., NW, Washington 6, D. C.

Fit-Rite makes False Teeth TIGHT

Makes loose dental plates fit snugly and comfortably. **LASTS for MONTHS!**

Simply squeeze on dental plate and put it in your mouth. Hardens and becomes part of plate. Money-back guarantee. **FREE** Generous package of Dental Plate Cleanser with each order. Send \$1.00 or mailed parcel post collect. **Fit-Rite Co., 1573 Milwaukee Ave. Dept. 7 PM, Chicago, Ill.**



GET INTO RADIO

TELEVISION ELECTRONICS NOW!

This amazing new shop instruction system gives you actual experience with a Home Radio Laboratory—part of the



You build this complete, modern super-heterodyne receiver with the equipment that comes with your National Training at no extra cost.

SHOP METHOD HOME TRAINING

FOR YOU—A REAL HOME LABORATORY IN MODERN RADIO

from one of the world's best established **Oldest and Largest Technical Trade Schools**



Your National Training Kits include equipment for hundreds of practical electronic experiments in your own home. You

have the genuine parts for this audio oscillator which you get to understand by building it yourself.

You learn modulation, beat frequencies, signal generation by actually building this small radio transmitter with your National shop parts.

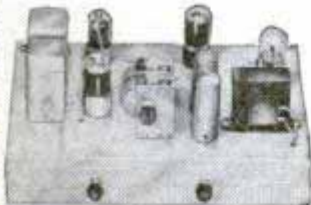

Your training outfits from National are made up of the most modern radionic equipment—much of it just out of the experimental laboratory. You learn new ways of handling equipment

by modern methods. Get the details by mailing the coupon.

Send the coupon below, immediately. Learn how this **sensationally improved**, practical speed-up training can fit you, in a short time, for the **GREAT BUSINESS OF RADIO**—for the **NEW AND RAPIDLY EXPANDING FIELD OF FREQUENCY MODULATION (F.M.), TELEVISION AND ELECTRONICS**.

This is the thoroughly proved, quick and easy speed-up method used so extensively in wartime training—endorsed by the **success of National men everywhere**—a system by which you study in spare time—off hours, even minutes right in your home and yet have the **ADVANTAGE OF REAL SHOP EXPERIENCE** to back you up.

Trained Radio Men Wanted

The man who really **knows modern Radio** is in greater demand today than ever before—not only in Radio proper but in Television and Electronics—in Aviation, Transportation, Communications. **Good jobs**

are wide open, WAITING FOR YOU, in the production, operation and maintenance of modern electronic equipment—in radio stations, in hundreds of industries—in homes, theatres and studios. Good, sound training in this important field is absolutely necessary. And now, National Schools brings such training to you **no matter where you live or what you may be doing**—not only the fundamental theory but the **actual experience that comes with knowing shop practice and working with real equipment**—demonstrating each step with first-hand knowledge. This is true **"learning by doing"**—direct from the great shops and laboratories of National Schools where new developments in methods, equipment and applications are constantly going forward.

Only National can offer you such practical training because only National has the plant to back it up. **Sample this training yourself. MAIL THE COUPON FOR A FREE LESSON.**

POSTWAR SUCCESS and SECURITY FOR YOU

Radio is a Big Sound Well-Established Business. **Television is just on the threshold of limitless expansion.** When you hang up your uniform—when your war job folds up, will you step out proudly into an essential established industry? Perhaps into a business of your own? Answer these questions by reading the catalog sent you **FREE** from National Schools. **Face realities now!** Fill out and mail the coupon today.

Check the Job You Now Have With These Opportunities in RADIO

1. **Financial Security** Radio has grown from \$100 million to \$5 billion in past few years.
 2. **Limitless Future** predicted by over 1,800 manufacturers of equipment.
 3. **Television promises** over half a million jobs alone—experts estimate.
 4. **Electronics opens** wide new fields in home and industrial use.
 5. **Your Own Business** with little or no capital.
- Get the details. Use the coupon!

FREE GET THESE 2 BIG BOOKS



NATIONAL SCHOOLS

LOS ANGELES 37, CALIFORNIA EST 1905

MAIL OPPORTUNITY COUPON FOR QUICK ACTION

National Schools, Dept. PM-7
4000 South Figueroa Street
Los Angeles 37, California

(Mail in envelope or paste on penny post card)

Mail me **FREE** the books mentioned in your ad including a sample lesson of your course. I understand no salesman will call on me.

NAME..... AGE.....

ADDRESS.....

CITY..... STATE.....

Check Here if Veteran of World War II. Include your zone number.

NATIONAL TRAINING WINS BIG JOBS

You, too, can share the success of National graduates. Joseph Grumich, Lake Hiawatha, N. J., writes: "My latest offer was for \$5,800.00 as Radio Photo Engineer, but I am doing well where I am. I am deeply indebted to National."



While still a student of National training, I. Wilson of Vallejo, California, writes: "My pay has jumped from \$52.18 a week to \$72.65, and the end is not in sight. I am proud of my National Course."

Joseph Michel, Jr., Granite City, Illinois, writes: "I am enthused with National training. I am now earning \$225 a month as a radio operator and technician and \$20 a week more in my shop at home."

AVIATION Career

MAXIMUM TRAINING IN MINIMUM TIME

CAL-AERO TECH TRAINING will add dollars to your pay check all the rest of your life. Specializing in AERONAUTICAL ENGINEERING and MASTER AVIATION MECHANICS since 1929, Cal-Aero Tech training is carefully designed for just one thing—TO MAKE MORE MONEY FOR YOU. An alumni of over 6000 successful graduates proves our career training is unsurpassed.

VETERANS —Write us about Aviation Training, as provided under "G.I. Bill of Rights."



MAIL THIS COUPON TODAY!

Cal-Aero Technical Institute, Grand Central Airport, Glendale 1, California
 Please send full information on Aviation Training FREE—without obligation. Dept. PM-7

Name _____ Birth Date _____
 Street _____
 City _____ State _____

JUST OUT! NEW FROM COVER TO COVER

AUDELS REFRIGERATION and AIR CONDITIONING GUIDE

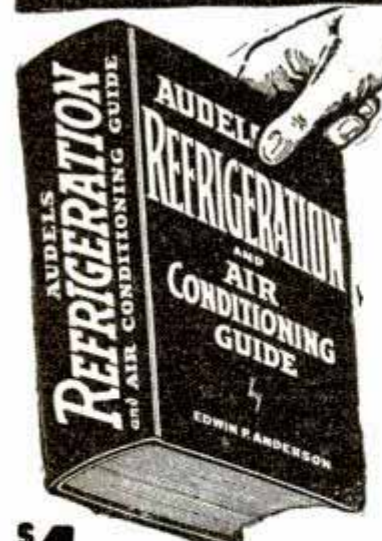

4 Books in One! Covering:
 Basic principles, Servicing, Operation, Repair of
 1—Household Refrigeration
 2—Special Refrigeration Units
 3—Commercial & Industrial Refrigeration
 4—Air Conditioning Systems
 A gold mine of essential important facts for ENGINEERS, SERVICEMEN & USERS.
 A Good Book is a Good Friend! Here you have at your fingers' ends a Complete Library in ONE VOLUME, the necessary data you have been looking for on: MODERN UNITS, SYSTEMS & MACHINES, REFRIGERANTS, including Freon, Lockers, Water Coolers, Quick Freezing & Air Conditioning Systems.
 1280 Pages, 46 chapters all Fully Illustrated & indexed for Ready Reference.

\$4 COMPLETE • PAY ONLY \$1. A MONTH ←

AUDELS, Publishers, 49 W. 23rd St., New York 10, N.Y.
 MAIL AUDELS NEW REFRIGERATION GUIDE for free examination. If O.K. I will send you \$1 in 7 days; then remit \$1 monthly until price of \$4 is paid. Otherwise I will return it.

Name _____
 Address _____
 Occupation _____
 Employed by _____ PM

Get into Good Paying AUTO BODY and FENDER WORK



Men 18 to 60. If you are mechanically inclined, start now to learn to become an auto body mechanic and fender repair man. U. E. I. spare time, home-study training combined with actual shop practice gives you sound, basic knowledge of practical methods so you may get the experience which may bring you big pay. Course includes acetylene welding, spray painting, use of hand and power tools.

WRITE FOR FACTS

THOROUGH, RELIABLE TRAINING
 Auto body and fender repairing is one of the best profit-makers in any garage or service station. Employment placement service included, or we'll show you how to go about to get started in your own shop. Get the facts FREE today!

AUTO-CRAFTS DIVISION • UTILITIES ENGINEERING INSTITUTE
 1314 BELDEN AVENUE, Dept. 176X, CHICAGO 14, ILLINOIS

ELECTRICAL TRAINING

Intensive 8 months residence course in fundamentals of industrial electrical engineering, including radio, electronics. Prepares for technician, engineering aides. Approved for veteran training. 53rd year. Catalog.

BLISS ELECTRICAL SCHOOL
 7636 Takoma Ave., Wash. 12, D. C.

"The Book They're Talking About"

ART ANATOMY OF THE HUMAN FIGURE

For the amateur and professional artist. Contains over 350 illustrations, charts and notes, giving detailed study of every part of the body. **POSED and IN ACTION. Price Only \$1**
 Outside U.S.A. Send \$1.25

Major Book Co. (Dept. 12-B), 241 E. Broadway, New York 2, N. Y.

CODE SPEED SHORT CUT

Be an expert. Learn to be a Telegraph or Radio Operator. Thousands of men needed. Intensely interesting work—good pay. Learn at home or wherever you are, quickly, easily with the famous Candler Speed System. Book of particulars Free.

CANDLER SYSTEM CO., Dept. 5-H, Box 928, Denver 1, Colo., U.S.A.

PLASTIC HOBBY CRAFT KIT

Kit contains 2 lbs. PLEXIGLAS and LUCITE sheets and strips dye, cement, sandpaper, buffing compound and fabricating instructions. Send \$3.00 money order to Dept. S.

HOME CRAFTSMAN PLASTICS, 1945 W. Harrison St., Chicago 12, Ill.

SAY YOU SAW IT IN POPULAR MECHANICS

Learn PHOTOGRAPHY at Home

Splendid opportunities. Prepare in spare time. Practical basic training. Long-established school. Send for free book, "Opportunities in Photography." No obligation.

American School of Photography, 1315 S. Michigan Ave., Dept. 135B, Chicago 5, Ill.

Learn to Write

Begin today. Write now for our Free Book, "How to Become a Good Penman." It contains specimens and tells how others learned to write in spare time. Enclose 10c for your name beautifully written and a pen point suitable for shaded writing. Write today.

THE TAMBLYN SCHOOL OF PENMANSHIP
 N-441 Ridge Building, Kansas City, Mo.

FALSE TEETH

KLUTCH holds them tighter

KLUTCH forms a comfort cushion; holds dental plates so much firmer and snugger that one can eat and talk with greater comfort and security; in many cases almost as well as with natural teeth. Klutch lessens the constant fear of a dropping, rocking, chafing plate. 25c and 50c at druggists. . . If your druggist hasn't it, don't waste money on substitutes, but send us 10c and we will mail you a generous trial box. © I. P. INC.

KLUTCH CO. Box 4693-G ELMIRA, N. Y.



DO YOU BELONG

in the new world?

THERE'S a *new* world opening all around you . . . a world of Electronics, Plastics and other *new* industries . . . a world of *new* developments in Aviation, Building, Chemistry, Engineering, Business.

With opportunities and rewards coming faster than ever, you can't afford to be a back number. The advancements are going to the *trained* men and women. And if you're as smart as we think you are, you're planning now to join them.

That's where the world-famous International Correspondence Schools come in. The 23 Schools of I. C. S. are Schools for Moderns. There's an Aviation School and an Automobile School . . . Schools of Air Conditioning, Chemistry, Radio, Accountancy and Management . . . Schools in virtually every field of modern industry and commerce.

There are Courses on Plastics . . . Diesel Engines . . . Electronics . . . a Course for Private Pilots and a Course for Commercial Pilots. And constant revision keeps the Courses in other subjects just as up to the minute. Here's tomorrow's training for you *now*. Mail the coupon *today!*



INTERNATIONAL CORRESPONDENCE SCHOOLS



BOX 5584-K, SCRANTON 9, PENNA.

Without cost or obligation, please send me full particulars about the course *before* which I have marked X:

Air Conditioning and Plumbing Courses

- Air Conditioning
- Heating Plumbing
- Refrigeration Steam Fitting

Chemistry Courses

- Chemical Engineering
- Chemistry, Analytical
- Chemistry, Industrial
- Chemistry, Mfg. Iron & Steel
- Petroleum Refining Plastics
- Pulp and Paper Making

Civil Engineering, Architectural and Mining Courses

- Architectural Drafting
- Architecture
- Bridge and Building Foreman
- Building Estimating
- Civil Engineering
- Coal Mining
- Contracting and Building
- Highway Engineering
- Lumber Dealer
- Reading Structural Blueprints
- Sanitary Engineering
- Structural Drafting

- Structural Engineering
- Surveying and Mapping

Communications Courses

- Electronics
- Practical Telephony
- Radio, General
- Radio Operating
- Radio Servicing
- Telegraph Engineering

Electrical Courses

- Electrical Drafting
- Electrical Engineering
- Electric Light and Power
- Lighting Technician
- Practical Electrician

Internal Combustion Engines Courses

- Auto Technician Aviation
- Diesel-Electric
- Diesel Engines Gas Engines

Mechanical Courses

- Aeronautical Engineering
- Aircraft Drafting
- Flight Engineer
- Foundry Work
- Heat Treatment of Metals

- Industrial Engineering
- Industrial Metallurgy
- Machine Shop
- Mechanical Drafting
- Mechanical Engineering
- Mold-Loft Work
- Patternmaking—Wood, Metal
- Reading Shop Blueprints
- Sheet-Metal Drafting
- Sheet-Metal Worker
- Ship Drafting Ship Fitting
- Tool Designing
- Toolmaking
- Welding—Gas and Electric

Railroad Courses

- Air Brake Car Inspector
- Diesel Locomotive
- Locomotive Engineer
- Locomotive Fireman
- Railroad Section Foreman

Steam Engineering Courses

- Boilermaking
- Combustion Engineering
- Engine Running
- Marine Engineering
- Steam Electric Steam Engines

Textile Courses

- Cotton Manufacturing
- Rayon Weaving
- Textile Designing
- Woolen Manufacturing

Business and Academic Courses

- Accounting Advertising
- Arithmetic Bookkeeping
- Business Correspondence
- Business Management
- Certified Public Accounting
- Commercial
- Cost Accounting
- Federal Tax
- First Year College
- Foremanship French
- Good English High School
- Higher Mathematics
- Illustrating Motor Traffic
- Postal Service
- Salesmanship Secretarial
- Sign Lettering
- Spanish Stenography
- Traffic Management

Name _____ Age _____ Address _____

City _____ State _____ Present Position _____

Working Hours _____ A.M. to _____ P.M. Length of Service in World War II _____

Special tuition rates to members of the Armed Forces. Enrollment under the G.I. Bill of Rights approved for War II Veterans. Canadian residents send coupon to International Correspondence Schools Canadian, Ltd., Montreal, Canada.

NEW peacetime production plans mean



BIGGER PAY FOR MACHINISTS

Master shop work quickly with these books

This big home-study and reference course gives you the practical facts on machines and methods you need to advance in machine shop work. Take advantage of the other man's experience as found in books, to solve your problems, increase your efficiency, with

The AMERICAN MACHINISTS' LIBRARY

6 volumes—2368 pages—2516 illustrations
(A combined home-study course and reference library)

This library of machine shop practice was written for practical men. It gives you the best methods for every kind of machine shop work. It fully explains lathes, drills, and other machine tools and their operation, automatic screw machines, speeds and feeds, gear design and production, jigs and fixtures, punch and die work, metal surfacing, etc., etc. Plainly written—completely illustrated—the best kind of help to the machine shop man who wants to advance himself.

No money down—special price—easy payments.

EXAMINATION COUPON

McGRAW-HILL BOOK CO., 330 W. 42nd St., N. Y. 18

Send me for ten days' examination the American Machinists' Library. If satisfactory I will send you \$4.00 in 10 days and \$4.00 monthly until the price of \$20.00 is paid. If not wanted, I will return the books postpaid. (To insure prompt shipment write plainly and fill in all lines.)

Name
Home Address
City and State
Company
Position PM 7-46

8 BIG BUILDING BOOKS

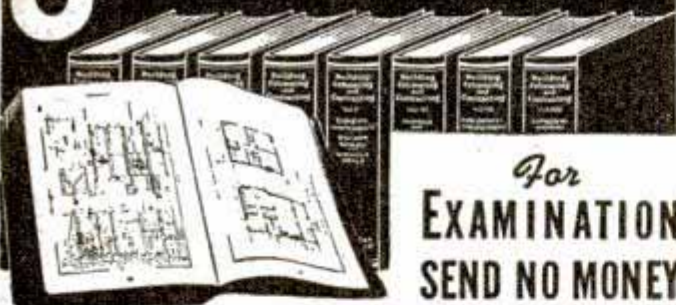

For
EXAMINATION
SEND NO MONEY

Learn to draw plans, estimate, be a live-wire builder, do remodeling, take contracting jobs. These 8 practical, profusely illustrated books cover subjects that will help you to get more work and make more money. Architectural design and drawing, estimating, steel square, roof framing, construction, painting and decorating, heating, air-conditioning, concrete forms and many other subjects are included.

BETTER JOBS — BETTER PAY UP-TO-DATE EDITION

The postwar building boom is in full swing and trained men are needed. Big opportunities are always for MEN WHO KNOW HOW. These books supply quick, easily understood training and handy, permanent reference information that helps solve building problems.

These books are the most up-to-date and complete we have ever published on these many subjects.

Coupon Brings Eight Big Books For Examination

AMERICAN TECHNICAL SOCIETY Vocational Publishers since 1898
Dept. GB19 Drexel at 58th Street Chicago 37, Ill.

You may ship me the Up-to-Date edition of your eight big books, "Building, Estimating and Contracting," without any obligation to buy. I will pay the delivery charges only, and if fully satisfied in ten days, I will send you \$2.00, and after that only \$3.00 a month, until the total price of only \$34.80 is paid. I am not obligated in any way unless I keep the books.

Name
Address
City State

Please attach a letter stating your age, occupation, employer's name and address, and name and address of at least one business man as a reference. Men in service, also please give home address.

STUDY AT HOME

With An Educational Institution

Men with specialized training win higher positions, insure larger earnings, and are bigger successes in business and public life. Opportunities NOW greater than ever before. Send for our Catalog.

ARTS and SCIENCES

Courses in Philosophy; Education; Letters; Public Health; Medical Jurisprudence; Psychology; Sociology; Physics; Chemistry; Plastics; Geology; Political Science; Theology; Business and Commerce; Accounting; Mathematics; Statistics; Agriculture.

ENGINEERING

Courses in Electrical, Civil, Mechanical, Drafting, Architectural, Steam, Aeronautical, Radio, Structural, Mining, Industrial, Petroleum, Marine, Chemical, Diesel, Automobile, Refrigeration, and Air Conditioning Engineering.

LAW

Complete Professional Law Course includes 20 Hornbook Series college grade textbooks. Courses also in Commercial Law, Patent Law and Medical Jurisprudence.
McKinley-Roosevelt Incorporated, 4610-K, Sheridan Rd., Chicago 40, Ill.



Get Started in Radio TEN "HOW-TO-DO-IT" BOOKS

Get a solid foundation in radio by means of these 10c timely text books. Each clearly written, profusely illustrated, contains over 15,000 words. You'll be amazed at the wealth of information packed into these handy books. Excellent for reference—ideal for technical library. Your money back if not satisfied.

5 Books for 50c - 10 Books for \$1
SENT TO YOU POSTPAID

- | | |
|--|-------------------------------------|
| No. 1—How To Make Four Doerle Short Wave Sets | No. 4—All About Aerials |
| No. 2—How To Make The Most Popular All-Wave 1 and 2 Tube Receivers | No. 5—Beginners' Radio Dictionary |
| No. 3—Alternating Current for Beginners | No. 6—How To Have Fun With Radio |
| No. 7—How To Read Radio Diagrams | No. 8—Radio for Beginners |
| No. 8—Simple Electrical Experiments | No. 9—Simple Electrical Experiments |
| No. 10—Television | |
- Remit by check or money order—register letter if you send cash or stamps.
RADIO PUBLICATIONS, 23H West Broadway, New York (7)

Now You Can Lick ANY AUTO REPAIR JOB!

Look up make, model, job in MoToR's AUTO REPAIR MANUAL—and go to work! Complete guide for every model built since 1935. 764 pages; 1000 illustrations; 450 charts; 200,000 repair facts. Index. After 7 days' Free Examination, send \$1; then \$1 monthly for 4 months, 35c postage. If not satisfied, return book, pay nothing. MoToR Book Dept., Desk 1H, 572 Madison Ave., New York 22, N. Y.

Drawings INVENTORS Note

Drawings are protection. We give you drawings plus notarized protection.

Come First
CHRISMAN DRAFTING LABORATORY
317 South West 17th Manhattan, Kansas

BY COLLEGE ENGINEERS WRITE TODAY

\$\$\$ if trained in arc welding
Big income jobs await you. Learn quickly and thoroughly. Enroll under G. I. Bill. Write today.
Hobart Trade School, Box M-563, Troy, O.

ARTISTS MAKE MONEY

Do you like to draw? Send name, address, age and occupation for FREE ART TEST, to find out your ability.

ART INSTRUCTION, Inc.
7136 ART INSTRUCTION BLDG., MINNEAPOLIS 15, MINN.

FIX TYPEWRITERS
A Simplified Practical Homestudy Course. Many of our Students now have their own Business—Many Repair for others. Repair Shops Swamped. Health or Age no handicap.
WEBER TYPEWRITER MECHANICS SCHOOL
Box 269, Osborn, Ohio



BIG MONEY NOW IN LIQUID MARBLE

THREE wonderful new opportunities for your own big money-making business—regardless of your age, sex, or previous experience!

1. LIQUID MARBLE. Make beautiful artificial Marble Slabs. Pour from liquid state. Glazed or unglazed. This marble may be mottled, veined, multi-colored or left in original snow-white state. The color is actually a part of the marble! Does not fade or wear away. Liquid Marble is unsurpassed on kitchen or bathroom walls. Easy to make and install.

2. PLASTIC FLOORING. May be made in any color or combination of colors. Gives a lifetime of wear. Dustproof, Soundproof, Verminproof. Resilient to the tread. Lay out solid from wall to wall or in pattern design of various shaped blocks.

3. FLEXIBLE MOLDS. For plaster casting. Make your own moulds for few cents each. \$1.00 in raw materials will make up to \$25.00 worth of finished goods. We furnish names of buyers. Write now for FREE information about our BIG THREE money-making opportunities! Get in on busy season just starting. Send penny postcard or letter. No obligation.

COMPO-TEX, Box 786-SG, ST. LOUIS 1, MO.



BUILDING HUMAN STATURE

"I grew 6 inches in a year through following instructions given in 'BUILDING HUMAN STATURE,'" says the younger man at left. "Now I am a head taller than my father."

If you wish you were taller send for FREE outline of this remarkable book loaded with practical information.

CARILLON BOOKS, Dept. 32, Boerne, Texas

WHY JOB WORRY? LEARN ELECTROPLATING

Highly paid, uncrowded, interesting business. Part or full time. Chromium, Nickel, Gold, Silver, etc. Send postcard for FREE booklet and proof.

PLATER HYDE, Dept. M Post Office Box 176 National City, Calif.

EASY TO LEARN CODE

Learn or increase speed with an Instructograph—the Code Teacher that takes the place of an operator-instructor and enables anyone to master code without further assistance. Available tapes from beginners alphabet to typical messages on all subjects. Speed range 5 to 40 WPM. Always ready—no QRM. Thousands have "acquired the code" with the Instructograph System. Write today for convenient rental and purchase plans.



INSTRUCTOGRAPH COMPANY

Dept. M, 4701 Sheridan Road, Chicago 40, Ill.

ANALYZE HANDWRITING

Qualify for Certified Grapho-Analyst Degree. New uncrowded, fascinating field of service. Gratifying earnings reported by graduates in Employment, Credit, Social Service, Police and Judicial, and Entertainment fields. Others have developed profitable private practice, full or spare time, as Personal Problem and Vocational Counselors. Send for 3000 word test lesson and Grapho-Analyst

FREE

ADDRESS A. I. G. A. Inc. 120 NOEL, MO.

MONEY for MEN ALL DATA FREE

THE PLASTEX Industry needs manufacturers on small scale and for big production of Lamp and Clock Stands, Art Goods and Novelties in Plastex and Marble imitation. Experience unnecessary. 1/2c material makes regular 10c store sellers. Rubber moulds furnished for speed production. Small investment brings good returns. Big chain store orders now being placed. Ambitious men have chance for real prosperity. Our Free booklet will interest and benefit you.

PLASTEX INDUSTRIES, Dept. P, 1085 Washington Ave., New York, N.Y.

REPAIR RADIOS

Easily and TWICE as FAST

A Complete Modern Guide for LOCATING & REPAIRING RADIO SET TROUBLES

Let Alfred A. Ghirardi show you the "secret" of repairing radio receivers fast and profitably—in half the usual time, and without elaborate test equipment! His famous RADIO TROUBLESHOOTER'S HANDBOOK is not a study book. It goes to work the minute it arrives. Just look up the radio's Make, Model and Trouble Symptom and go to work!

"TEST" IN 2 MINUTES

Clear instructions tell exactly what the trouble is—exactly how to fix it. No guesswork. No needless testing. Nine times out of ten, the HANDBOOK gives all the detailed data you require—in 2 minutes or less! A real money-maker for anyone who likes to do radio work. Pays for itself first time you use it. Weighs 4 1/2 lbs. Has 744 big, manual-size pages. Covers specific repair data for practically every radio in use today. In addition, there are hundreds of pages of helpful repair charts; tuning alignment data; transformer servicing hints; color codes; tube data, etc.—all designed to help you repair any radio ever made—easier, better, faster. Order today. ONLY \$5 COMPLETE. Our UNRESERVED 5-DAY MONEY-BACK GUARANTEE is your absolute protection.

COVERS OVER 4,800 models of home and auto receivers of 202 manufacturers! ONLY \$5



BE A PROFESSIONAL RADIO SERVICE EXPERT

Prepare at Home for Big Money in Scientific Radio-Electronic Servicing

Who is going to repair the millions of new radios, F-M and Television Receivers and complicated industrial Electronic Equipment? Only men with real professional Know-How can do the job—and nowhere can you get the needed training easier, quicker and at less cost than in Ghirardi's famous MODERN RADIO SERVICING. Explains test instruments, how to interpret their readings, how to troubleshoot circuits scientifically; how to test, repair and replace faulty components, installation, etc., etc. Complete course—easy to understand. 1300 pages; 706 illustrations; 720 self-test review questions. Only \$35—and our 5-DAY MONEY-BACK GUARANTEE means you don't really risk a cent!



SPECIAL OFFER

Let the Handbook save time on common jobs. Let Modern Radio Servicing train you for PROFESSIONAL work. Get BOTH big books at only \$9.50 for the two. See coupon.

COMPLETE COURSE IN BASIC \$5 RADIO-ELECTRONICS... Only \$5

FOR BEGINNERS . . . 36 COURSES IN ONE



No matter what phase of Radio-Electronics-Television work you plan to enter, a knowledge of the basic fundamentals is essential. Ghirardi's Big 3 1/2-lb. 972-page RADIO PHYSICS COURSE book gives just the training you need—ALL YOU NEED—at a price you can afford. Many beginners have completed it at home in a few weeks. More widely used for Home Study and by more Signal Corps, Navy and civilian schools than any similar book or course. Study it for 5 full days. Our MONEY-BACK GUARANTEE protects you!

5-DAY MONEY-BACK GUARANTEE

Dept. PM-76, MURRAY HILL BOOKS, INC., 232 Madison Ave., New York 16, N.Y.

Enclosed find \$. . . for books checked; or send C.O.D. (U.S.A. only) plus postage. If not fully satisfied, I may return books within 5 days and get my money back.

- RADIO TROUBLESHOOTER'S HANDBOOK \$5 (\$5.50 foreign)
- MODERN RADIO SERVICING \$5 (\$5.50 foreign)
- RADIO PHYSICS COURSE \$5 (\$5.50 foreign)
- MONEY-SAVING OFFER, Modern Radio Servicing AND Troubleshooter's Handbook, \$9.50 for the two. (\$10.50 foreign)

Name.....

Address.....

City & Dist. No..... State.....
(Please write or print plainly)

STOP WORKING for the OTHER FELLOW

BE YOUR OWN BOSS — OPERATE YOUR OWN PROFITABLE BUSINESS IN

HOME AND INDUSTRIAL

APPLIANCES



MODERN SERVICE-REPAIR AND INSTALLATION WORK

NEW! DIFFERENT! . . . Gives you practical shop training on real appliances including washing machines, heat control systems, vacuum sweepers, electric motors, circuits and controls, plating processes, welding, etc. Start work immediately on actual machines under trained instructors.

ACTUAL SHOP TRAINING ON APPLIANCES

Thousands of appliances need expert repairs now. New ones coming off the assembly lines must be installed and serviced. It's fascinating, profitable work. Jobs are everywhere! Investigate this opportunity now. Let us show you the money-making possibilities—the need for trained men—how easy it is to open your own shop and be your own boss. Veterans, ask for special G.I. plan. Act now!

RUSH COUPON FOR FULL DETAILS

OLD EST. SCHOOL MOST COMPLETE TRAINING COURSE OF ITS KIND

APPLIANCE TRAINING SCHOOL, Dept. M 23
Div. of Commercial Trades Institute
6312 N. Broadway, Chicago 40, Ill.

Gentlemen:
Please send Free Details.
Name.....
Address.....
City.....State.....

Check here for G.I. plan.

WAR BARGAINS in LENSES and PRISMS

NOW! MAKE YOUR OWN BINOCULARS!

Complete Set of LENSES and PRISMS from Navy's 7X, 50 Model

Save Up to \$150.00



Here's an unusual opportunity to secure a fine set of Binoculars at a tremendous saving of money. Build them yourself with all of the very same optics contained in

the Navy's 7 Power Glasses. Or you can construct a Monocular (1/2 a Binocular) in which case exactly one half quantities of the Binocular Components will be furnished. All Lenses and Prisms are in excellent condition, Lenses are cemented and have the new low reflection coating. Complete assembly directions included for either project.

- Stock #5102-H Binocular Set of Lenses and Prisms \$25.00 Postpaid
- Stock #5103-H Monocular Set of Lenses and Prisms \$12.50 Postpaid
- UNMACHINED LEFT AND RIGHT BODY AND COVER PLATE CASTINGS. Stock #820-H \$2.50 Postpaid
- 35 MM. KODACHROME PROJECTING LENS SET—Consists of 2 Achromatic Lenses for projecting, plus 2 Condensing Lenses and piece of Heat Absorbing Glass with directions. Stock #4029-H \$3.10 Postpaid
- POLARIZING FILTER—Diam. 73 mm. Perfect condition. Stock #637-H \$3.00 Postpaid
- TANK PRISMS—90-45-45 deg., 5 1/4" long, 2 1/8" wide, finely ground and polished.
- Stock #3004-H Silvered Prism (new & perfect) \$2.00 Postpaid
- Stock #3005-H Plain Prism (new & perfect) \$2.00 Postpaid
- Stock #3100-H Silvered Prism (Second) \$1.00 Postpaid
- Stock #3101-H Plain Prism (Second) \$1.00 Postpaid

We have literally millions of war surplus lenses and prisms for sale at bargain prices. Write for Catalog "H"—Sent Free! Satisfaction Guaranteed Order by Stock No.
EDMUND SALVAGE COMPANY
P. O. AUDUBON, NEW JERSEY

BUILD YOUR OWN SUMMER COTTAGE THIS EASY, LOW-COST WAY!



No experience necessary. This book contains full instructions and 14 complete plans for building your own summer camp, cottage or guest house in the woods or at the seashore. Easy-to-follow, step-by-step directions tell you

everything you need to know for every type of vacation house: location, materials, foundations, framing, paints, trim, concrete, shingling, outdoor furniture, fireplaces. Over 100 detail drawings. Every point fully covered. Save one third to half the cost by building yourself. Get this new book now for only \$3.00. Money back if not satisfied.

CAMPS and COTTAGES

How to Build Them • By CHARLES D. WHITE
THOMAS Y. CROWELL CO., 432 Fourth Avenue, New York 16, N. Y.

TRAIN for SUCCESS in the Poultry Business



Study at home in spare time. Earn extra while learning.

YOU CAN MAKE MORE MONEY from POULTRY. Proper management means profits ANY season, for life. Get latest scientific methods that avoid losses and mistakes. Our famous system of Home Study Training has helped thousands to success. Extra profits from the start. FREE Catalog; describes courses, methods, service. Write today to Dept. 50.

NATIONAL POULTRY INSTITUTE, Adams Center, N. Y.

INVENTORS

WITH GOOD INVENTIONS

Should write us without delay for FREE BOOKLET, Protective Disclosure Form and facts about The Inventor's Most Logical Markets. Patented, Unpatented inventions, all kinds, Cash, Royalty, needed by specific manufacturers. If your invention is for sale, write today for full particulars. A Post-Card will do! Address:

THE INVENTION REPORTER
5C-11106 South Longwood Drive Chicago 43, Illinois

BOOKS FOUND FREE!

WHAT BOOKS DO YOU WANT?
We quote the lowest market prices. No charge for locating Hard-to-Find and Out-of-Print Books. All books, OLD or NEW, mailed POST-FREE.
SEARCHLIGHT BOOK CLUB, 22 East 17th St., New York City

FENCING World's Finest Sport Exciting Fun—Harmless



Just Out! Healthful, Clean, makes you Strong & Alert. FREE BOOKLET (with foils) teaches Quickly—Easily. HARMLESS 3 ft. Spring Steel Foils (swords) have Safety Rubber Buttons. Complete outfit, 2 foils (swords) with hand guards. Free Instructions. Now only \$1.98; Postpaid. Junior Masks only \$3 for two. \$1.69 for one Postpaid. Mail check or M. O. today. Add 28c for Foreign Postage.

LEE PRODUCTS CO., 1613 Y-First Ave., New York 26, N. Y.

WATCHES WANTED Broken or Usable

—all kinds, even Ingersolls. Highest prices paid for jewelry, rings, spectacles, gold teeth, etc. Cash mailed promptly. Write for Free Shipping Container.

LOWE'S, Holland Bldg., Dept. PM, St. Louis 1, Mo.



CARTOON TO SUCCESS!

Learn to cartoon! Big pay! Easy, enjoyable work! Cartoon course, gag course, anatomy course and business course full of plans, markets, ideas. Drawing set and criticisms. All one low price! Rush card for details!
HARTMAN SCHOOL, 2776 California Court, Lincoln 1, Nebraska

Train Your Own HORSES!

Colts — Stock Horses — Circus Horses
Gait Show Horses — Write for FREE BOOK
ANIMAL LOVERS' ASSOCIATION
Box KA-111, Tarzana, Calif.



Floyd Clymer's Popular MOTOR BOOKS

Send for FREE Motor Book Catalog

INDIANAPOLIS "500" RACE HISTORY BOOK

Just out! 1000 illustrations; 320 large pages; complete detailed data on every race held on Speedway since 1909. Foreign and U.S. cars and drivers shown. Enjoy for 10c a race year after year history. Complete book \$3.50; with De Luxe red Fabrikoid binding, \$5.00.



MOTOR RACING with MERCEDES-BENZ

Sensational book of Grand Prix Racing. 176 pages, includes 93 finest action photos. Famous speedways, cars described. See and read about Caracciola, Rosemeyer, Seaman, Ruesch, Mays, Nuvolari, Lang, others. Photos Mercedes-Benz, Auto-Union, Alfa-Romeo, Bugatti, Maserati, others. Graphic, thrilling race incidents. Postpaid. \$2.00; De Luxe clothbound \$3.00.

Ab Jenkins Race History Book, \$1.50 . . . Power & Speed, \$2.50 . . . Speed—How to Obtain It, \$1.50. All books postpaid. See our ad under Autos, Classified section. Pin check or M.O. to this ad—Mail Now to

CLYMER, Dept. A7, 2125 W. Pico, Los Angeles 6, Calif.

Correspondence Courses in RADIO and ELECTRICAL ENGINEERING

LOW AS \$25

ELECTRICAL ENGINEERING. Get good grasp of wide electrical field. Modern. Very understandable. Theory made easy.
RADIO ENGINEERING. Extra fine course in radio, public address, photo-electric work. Trains you to be super-service man, real vacuum tube technician. Tuition ONLY \$25, either course. Deferred payment plan. Servicemen needed badly.
FREE Write for free copies of school catalogs, student magazines, etc.
LINCOLN ENGINEERING SCHOOL, Box 931-P91, Lincoln, Nebr.

LEARN WATCH REPAIRING



AT HOME. By our modern and original system of instruction you can learn every part of the **WATCH REPAIRING TRADE AT HOME.** Prepare yourself for a well-paying position or start in business after completing our course of instruction. Good watch repairers are in demand and generally earn very good salaries. For particulars apply to the **Wisconsin School of Watch Repairing 759 North Milwaukee St., Milwaukee 2, Wis.**

Get U.S. Gov't Job

Splendid salaries, vacations, pension when retired. My low-priced, home-study practice tests help one make higher grade in Gov't Exam. Write today, **OZMENT SCHOOL, 80, St. Louis, Mo.** (Veterans given preference)

TRI-STATE COLLEGE

B. S. Degree in 27 months in Engineering (all branches); Bus. Admin., Acc't and Sec. Science. 63rd year. School now filled to capacity. No applications can be accepted until further notice.
746 College Ave., Angola, Ind.

DRAW for MONEY



BE AN ARTIST!

Trained Artists Are Capable of Earning \$40, \$60, \$75 a week
Use Your Spare Time to Prepare for a Profitable Art Career! **COMMERCIAL ART, DESIGNING and CARTOONING**
—all in **ONE** complete home study course
No previous Art experience necessary—we teach you step by step—hundreds have profited by our practical method. **TWO ART OUTFITS FURNISHED. Colorful, FREE BOOK, "Art for Pleasure & Profit"**—tells all about our course, service and commercial opportunities for you in Art. Mail coupon today. Training approved under "G.I." Bill.

FREE BOOK gives details!

WASHINGTON SCHOOL OF ART
Studio 127C, 1115 15th St., N. W., Wash. 5, D. C.
Send me your booklet and full particulars about your course.

Name.....AGE.....
Address.....
City.....Zone.....State.....

FREE TRIAL IN YOUR HOME!

HERE'S THE HELP YOU NEED FOR BEST JOBS—RIGHT NOW!



DO ANY JOB.. EASIER.. QUICKER MAKE MORE MONEY in the BIG OPPORTUNITY FIELDS

SEND NO MONEY
Select the Books YOU Need Now! We Ship C.O.D. Anywhere in U. S. and Will Refund Amount Paid if Not Satisfactory.

Get into one of these big opportunity fields. Big money and many other advantages await you if you prepare now. Here is the help you need — **EASY — QUICK — AT LOW COST.** Thousands of men have already used these famous books. Beginners and experienced men alike have doubled and tripled their earnings with this help. You too, can now get the special knowledge you need for top pay, better jobs, or a business of your own. This is your **GOLDEN OPPORTUNITY.**



Air Conditioning

Big air conditioning boom interrupted by war is getting into full swing again. Bigger opportunities ahead than ever before. Get this complete and practical book by an international authority and be ready for your share of millions to be spent. Covers whole field in simple, non-technical language. Shows you what to do; how to do it; how to make money. 450 pages. Illustrated. \$4.00

Welding Practice

When you know welding you are in a profession that is tops in all industries. Start learning now with this newest book on all types of welding and heat treatment of metals. Written by recognized specialists in training men for production jobs. Use it for complete study or a reference guide. Prepare now for best jobs. Price \$4.00



Auto Repairs

Car owners are spending big money to keep their good older cars looking like the new ones coming out. This practical, money-making guide shows you how to do it. Ideal for shop owners and every man who wants a share of the millions to be spent in keeping old cars looking new. Tells how to get a good job or start business of your own with small capital. 325 pages, 232 illustrations. \$3.50

430 Pages
277 Illus.
Practical and Non-Technical

SEND NO MONEY! Mail Coupon

GOODHEART-WILLCOX CO.,
2009 S. Michigan Ave., Dept. 17, Chicago 16, Ill.

Send books checked, C.O.D. I will pay postman, plus few cents charges. If not satisfactory I will return books in 5 days and you will refund money paid. (Outside U.S. or possessions remit with order.)

- Auto Body and Fender Repairs\$3.50
- Modern Welding Practice.....\$4.00
- Air Conditioning\$4.00

If remittance accompanies order we will pay all postage charges under same return privilege.

Name.....
Address.....
City.....State.....

THIS FASCINATING HOBBY PAYS OFF QUICKLY!

TRY THE EASY ROEHRIG WAY TO HAND COLOR PHOTOGRAPHS!

● Start with the best colors money can buy . . . ROEHRIG. Follow simple ROEHRIG instructions included in every set. No artistic talent needed! Soon you too will be happily hand coloring photographs for your own enjoyment . . . coloring the favorite prints of others at a neat profit . . . THE ROEHRIG WAY!

ROEHRIG Colors are bright, beautiful, natural for landscapes and portraits alike. No fuss . . . No mess. Colors come off easily until the right effect is obtained . . . then they last as long as the print itself.

Use matte or semimatte paper.

ROEHRIG OIL PHOTO colors come in complete sets and single tubes. Special Military Khaki (summer and winter shades) and Navy Blue sold in separate tubes only. See your nearest photo dealer. Write Dept. M for free descriptive folder.

THIS COMPLETE SET ONLY **\$4.00** plus postage

ROEHRIG-BIELENBERG CO.

39 Henry Street
Brooklyn 2, New York



REMEMBER ROEHRIG FOR TRUE COLORS . . . Since 1912!

REFRIGERATION AIR CONDITIONING

MODERN SHOP TRAINING

**TRAIN WHERE THE ARMY TRAINED
IN THE SHOP OR AT HOME**

approved

GI

training

This new, fast growing industry needs trained men now! It's fascinating work—easy to learn in our big shops—or train at home on special assignments and finish with practical intensive shop training. G.I. approved for home study, too. Same course and instructors from Army Training program attests the thoroughness and professional level of this long established institute in modern refrigeration and air conditioning.



LEARN BY DOING — WORK ON REAL MACHINES

Proven training methods and expert instructors get you into the heart of this work immediately. Work with tools on actual machines right from the start. It's practical, interesting and it gives you the "know-how" and the "know-why" that distinguishes CTI graduates in the field today. Investigate this opportunity now! Certificate issued.

STUDY AT HOME IN YOUR SPARE TIME FINISH IN OUR BIG SHOPS

FREE BIG 16 PAGE BOOK OF VITAL INFORMATION
Tells you the true facts . . . gives you vital information on CTI approved training.

RUSH COUPON TODAY FOR FULL DETAILS

ACT NOW!
LEARN IN YOUR SPARE TIME AT HOME

Commercial Trades Institute, Dept. M27
209 W. Jackson Blvd., Chicago 6, Ill.

Gentlemen:—
Without obligation, please send me the facts. Let me judge for myself the opportunities and post-war security this training offers.

Check here if interested in GI training.

Name

Address

City State

HOME & CABIN PLAN BOOK



Exteriors with Floor Plans
Low Cost Cabins
Modern Homes
Pre-Fabricated Houses
Fire Place Construction
Built-in Furniture, Row Boats,
and Docks

87 FLOOR PLANS
39 EXTERIORS

Send **\$2.00**

WOODBEEK PUBLISHING COMPANY
206 Winchester Place, Grand Rapids, Michigan

MAKE MONEY CASTING AT HOME "FREE FACTS SENT"



Make hundreds of Plaster Casts, quick, easy. Sell output to stores, novelty shops, etc. Enormous profits. No experience. Very little capital needed. Start in basement, garage or workshop. Complete, simple instructions anyone can follow. Start now while merchants are begging for merchandise to sell. Rush.

PLASTIC ARTS STUDIOS, R.R. 5, Dept. 29, Muncie, Ind.



Gem Cutting!

A fascinating, profitable business or hobby . . .

Cut and polish valuable gem stones from inexpensive rough Jade, Opal, Agate, Tiger Eye, etc. Make rings, bracelets, pendants, etc! It's easy with our Compact Lapidary Unit. WRITE NOW!

Lapidary EQUIP. CO.

Dept. S, 2020 Westlake, Seattle 1, Wash.



FREE CATALOG
Illustrates the 4 simple steps of cutting and polishing a selection gem, and gives other helpful information
SEND NOW!



TRAIN Your VOICE!

Results GUARANTEED

We build, strengthen the vocal organs—not with singing lessons—but by sound, scientifically correct silent and vocal exercises and absolutely guarantee complete satisfaction with results. Write for Voice Book, FREE. Sent to no one under 17 years old unless signed by parent.

Perfect Voice Studios, Studio 135-B, Kimball Hall Bldg., Chicago 4, Ill.

SELL BIBLE SOUVENIR

METAL COINS, LORD'S PRAYER, ONE SIDE; JOHN 3:16 on the OTHER—Quick Easy Sales—Very attractive pocket piece. Quantity Price \$6.00 per 100; \$27.50 per 500; \$50.00 per thousand . . . Don't Wait . . . Order Today. Sample Order 15 Coins with Display Card, \$1 Postpaid. LOUIS LE VITE, 21 E. Van Buren St., Dept. PS, Chicago 5.

SILVER DOLLAR SIZE



YOU CAN MASTER MATHEMATICS

Key to the Electronic, Atomic age.
O - UNIVERSAL SCHOOL OF MATHEMATICS - O
623 Walter Story Bldg., Los Angeles, Calif.

LEARN



PORTRAIT PAINTING AT HOME

● Previous art training or talent NOT necessary. The Stuart System teaches you, in 11 easy-to-follow lessons, to (1) locate features exactly to correspond to model's features, (2) outline head and face to correspond to model's outline, (3) make each feature a true portrait of that feature in the model, (4) produce shadows and shading that exactly correspond to that of model's face, (5) mix flesh paint tints that are like living flesh. You, too, can make exact charcoal and oil likenesses. Send for free booklet today.

STUART STUDIOS

121 Monument Circle, Room 676, Indianapolis 9, Ind.

Please send me free book and outline of lessons.

Name

Street

City State

Again Beltone reduces size of AMAZINGLY IMPROVED ONE UNIT HEARING AID

NEW REVOLUTIONARY
Beltone
MONO-PAC

About 1/4 size and weight of
old-style Hearing Aids.

Amazing "X-Cell" outperforms units 5 times its size! All one unit—no cumbersome separate battery pack—no battery wire nuisance—no "harness." Comfort-Curv design—wafer-thin case! Increased power gives better hearing under all conditions. Range Selector to filter out annoying background noises. Ever-level full tones bring back clear, lifelike hearing. Find out WHY there are more Beltone one-unit Hearing Aids in use than all others combined.

BELTONE HEARING AID CO., 1450 W. 19th St., Chicago 8, Ill.



SO TINY! SO LIGHT!
YET EVERYTHING SOUNDS
CLEARER-TRUER

MAIL
COUPON
NOW
FREE
BOOKLET

BELTONE HEARING AID CO., Dept. PM-7
1450 W. 19th St., Chicago 8, Ill.
Gentlemen: Please send me FREE Beltone
Hearing Aid booklet. No obligation.

Name _____
Address _____
Town _____ State _____

FIX ANY RADIO

Amazing New Invention

PRICE ONLY \$1.50 COMPLETE

Learn quickly to repair all radio sets. New, different Comparison method. No previous radio knowledge needed. Introductory training included. Simple, picture suggestions tell you where to look for faults and how to make the repair. No testers needed for most jobs. Manual 8 1/2 x 11 in., 63 job-sheets, 24 blueprints. Many hints. New edition. Order manual 3-P. Price only \$1.50 postpaid. Money back guaranteed.

SUPREME PUBLICATIONS
9 S. Kedzie Ave.
Chicago 12, ILL.

Learn BAKING At Home

Baking is one of America's high industries in wages. Nearly depression-proof. Thorough basic home course lays sound foundation. If you have aptitude, write for FREE BOOKLET, "Opportunities in Commercial Baking." National Baking School, 1315 Mich. Ave., Dept. 135B, Chicago 5

LEARN MOVIE PROJECTION THEATRE MANAGEMENT

The Motion Picture Theatre Business offers big opportunities for trained men. Get into a fascinating field with a post-war future. Train at home in spare time. Free Catalog. Established 18 years.

THEATRE INSTITUTE, 370 Washington St., Elmira, New York

Fix Your Own ALARM CLOCKS

New, practical home course. Just out. Makes interesting hobby—profitable too. Save money by doing your own repairing at home. Easy if you know how. Price now only \$1.00. Details FREE. Send postcard.

THIS JEWELRY STORE, Genoa 3, Illinois

IT'S REALLY FUN



Learned Quickly at Home
"I learned more music in a few months than I hoped to in two years. Your lessons are practical." *W. S., Johnson City, Ill.



Well Worth It
"The money I spent on the course is well worth it. I do not know how the school can put out a course for so small a fee." *I. S., Heron Bay, Ontario, Can.

LEARNING MUSIC WITHOUT A TEACHER —this easy way

OVER 850,000 students have enrolled for this home study method. Many didn't know one note from another—yet they started in learning simple tunes by note. For this wonderful method makes it easy as A-B-C to learn music at home, without expensive private lessons. No tedious study and practice. Every step is right before your eyes in print and pictures. You can't go wrong. Soon you're actually playing popular pieces on your favorite instrument.

FREE Print and Picture Sample

See how easily you may learn to play your favorite instrument in spare time at home at amazingly low cost. Mail coupon today. Address: U. S. School of Music, 77 Brunswick Bldg., New York 10, New York.

SUCCESSFUL 48TH YR.

U. S. School of Music, 77 Brunswick Bldg., New York 10, N. Y. Please send me FREE Print and Picture Sample and Illustrated Booklet. I am interested in the instrument checked below.

- | | | |
|--------|-----------------|---------------------------|
| Piano | Piano Accordion | Tenor Banjo |
| Guitar | Saxophone | Modern Elementary Harmony |
| Violin | Trumpet, Cornet | Other Instrument |

Name.....
Street.....
City..... State.....
*Actual pupils names on request. Pictures by professional models.

OFFERS LOW COST LIFE INSURANCE

Postal Life offers \$2000. in Protection for \$1.78 monthly (age 21). Other Ages in Proportion

THIS PREMIUM HALF PERMANENT RATE

NEW YORK, Saturday. Postal Life of New York, unique among the important Old Line, Legal Reserve Life Insurance Companies, is again offering this special modified policy, already owned by thousands of American families. You pay half the permanent rate until the 5th year; as little as 89c per \$1000.00 of Solid Protection at age 21. You pay only \$1.13 per \$1000. at 30; \$1.56 monthly at 40; proportionate amounts at other ages. At these low rates, \$1500. is the minimum amount that can be offered.

For your convenience we print below a coupon form that can be clipped out and sent to Postal Life in New York. Full information, rates, etc., will be sent to you promptly. There is no obligation to buy but we advise immediate action. Life Insurance is vital to your future and your family's welfare. Postal Life Insurance Company, 511 Fifth Avenue, New York 17, New York.

Postal Life Insurance Company
511 Fifth Ave., Dept. M-595, New York 17, N. Y.

Mail me complete information about your low-cost Modified "4" Policy at my age.

Name _____
Occupation _____ Date of Birth _____
Address _____

Include Postal Zone, if any

Are You Starting a Business? Then you MUST keep complete, accurate records to protect your investment, assure profits, comply with government requirements. Don't guess. KNOW your business progress with RAMSAY SIMPLIFIED BOOK-KEEPING SYSTEMS. Complete instructions make bookkeeping experience unnecessary. Gives systematic control—automatic Profit-Loss Statement. Stop leaks—cut overhead!—with this vital business aid. SPECIAL OFFER: 2-Year APEX System, \$22.50. Write for illustrated folder. RAMSAY SYSTEMS, Inc., 192 Lexington Ave., N. Y. 16, N. Y. (Agents Wanted.)

AIR RIFLES BENJAMIN AIR PISTOLS
ARE IN PRODUCTION

ORDER BENJAMIN AIR RIFLES & BENJAMIN AIR PISTOLS from your DEALER. Send for our FREE FOLDER and Complete Specifications TODAY. Both Calibre Benjamin H-C Pellets are available now.
BENJAMIN AIR RIFLE CO., 812 MARION ST., ST. LOUIS 4, MO.



HUNTING and FISHING is a monthly magazine crammed full of hunting, fishing, camping, dog and boating stories and pictures, invaluable information about guns, fishing tackle, game law changes, best places to fish and hunt—countless ideas that will add more fun to your days afield.

Special Trial Offer
Send 25c in stamps or coin and we will send you Hunting & Fishing for six months.

HUNTING & FISHING MAGAZINE
251 Sportsmen's Bldg., Boston, Massachusetts



MAKE YOUR OWN COSTUME JEWELRY BIG EARNINGS AT HOME

YOU can make costume earring and pin sets, brooches, necklaces, dress clips, cameos, etc.

WE supply the jewelry findings; bar pins, ear screws, jump rings, chains, screws, stone sets, sequins, shells, boxes, cement, cards, etc.

WRITE FOR FREE CATALOGUE

PHILADELPHIA BADGE, 1007 FILBERT ST., PHILA. 7, PA.

Learn to Service and Repair ELECTRICAL APPLIANCES

Open your own electrical appliance service shop. Complete illustrated course covering house wiring, motor repairs, house appliance repair. Send today for FREE BOOKLET without obligation.

PACIFIC TRAINING SCHOOL
7217 So. Broadway, Dept. P-7, Los Angeles 3, Calif.

BRIGHT LIGHT AT ALL RIDING SPEEDS with GOOD LIGHT EVEN AT A WALK

MAKE-A-LITE
BICYCLE LIGHT GENERATOR

SEE NEXT MONTH'S AD FOR DETAILS

Burpee Crocus 12 BULBS 25¢

All Colors Mixed
Blue, purple, yellow, white, striped.
Choice bulbs, guaranteed to bloom. Postpaid:
12 Bulbs 25¢; 50 for \$1. Order right away!
Dutch Bulbs Are Back! Hyacinths, Tulips, Daffodils, etc., to plant this fall. Send postcard today for Burpee Bulb Book.

BULB BOOK FREE

W. Atlee Burpee Co.
155 Burpee Building Philadelphia 32, Pa. OR 155 Burpee Building Clinton, Iowa

Thrilling Work COLORING PHOTOS

EASY TO LEARN

Fascinating vocation learned at home by those with aptitude. Thrilling pastime. National method brings out life-like colors. Free booklet.

NATIONAL PHOTO COLORING SCHOOL
1315 S. Michigan, Dept. 135-B, Chicago 5

GOLFERS

Why make hard work of your golf swing? Learn the easy new method that gives unbelievable power and accuracy to your shots. Read **The Straight-Line Golf Swing**, \$1.00 postpaid. R. A. PETTITT, 1414 McLish, Ardmore, Oklahoma.

LEARN ACCOUNTING INCREASE YOUR EARNINGS

Streamlined Home Study Course Now Available—Prepared by Successful Accountant

WESTERN HOME STUDY INSTITUTE
P.O. Box 2506, San Francisco 26, Calif.

FIBRE ARMS AND LEGS!

Light, correctly fitted, strong and comfortable. Natural appearance. Braces for all deformities. Scientific design. Fair Terms.

BUCHSTEIN-MEDCALF
223 S. 6th St., Minneapolis, Minn.

The GLENWOOD MEMORIAL

Freight Paid Anywhere in U.S.A.

In all its beauty and durability is pictured in our free catalog of genuine Marble and Granite. Write for yours today.

U. S. MARBLE & GRANITE CO., A-18, Oneco, Fla.



**NOW! EASY-TO-MAKE
HOMECRAFT NOVELTIES**
FOR PLEASURE AND PROFIT!

FREE! NEW 40-PAGE CATALOG

Our new free book is crammed with money-making facts about Leather Craft, Wood Carving, Clay Modeling, Lacing and Braiding, Wood Burning (Pyrography), Showcard Lettering, Finger Painting, Spatter Craft, Textile Coloring, and much more. New low prices on all kinds of tools, findings, crayons, art paper, modeling sets, and ready-to-finish woodcraft. Send for FREE copy TODAY!

Make
BEAUTIFUL
Hand-Tooled
BILDFOLDS
CLAY MODELS
WOOD CARVINGS
POTTERY
SPATTER CRAFT
BOOK ENDS
BRACELETS

DWINNELL CRAFT SHOP, Dept. P67, Elm Grove, Wheeling, W. Va.

BUILDING



Millions of homes needed. Nation wide call for builders. Big opportunities. Learn now in spare time, — at home. Practical training with blue prints. No books. Send for FREE Trial Lesson and blue print plans.

CHICAGO TECHNICAL COLLEGE
H-150 Tech. Bldg., 2000 S. Mich. Ave.
Chicago 16, Ill.

LEARN WATCH REPAIRING AT HOME



Construction, Repair adjustment. New, complete "PRACTICAL COURSE" for beginners and professional repairmen. All essential steps. Theory, operation. Many test cases. Full coverage of tools, materials. Fully illustrated. Only \$2.95 postpaid. Money back guarantee.

We Supply Tools, Materials at Lowest Cost
FREE CATALOGUE

Modern Technical Book Co., Dept. MMC, 55 W. 42nd St., New York 18

Arc Welded Design "Know-How"



Only \$3.50 each Each volume contains over
3 different volumes 100 welding designs. Write
\$10.00 postpaid Hobart Bros. Co. Box M-561, Troy, O.

COLOR CONCRETE WITH CHEMICALS

A business of your own. Big money making Hollywood style pottery and birdbaths without moulds. Washing-wells, stucco-rock, benches. Marbling and cement water-paints. 10c brings sample, literature, pictures. Hollywood CementCraft, 8529 Wonderland Ave., Hollywood 46, California

NEW OTTAWA Wood Saw



FOR TRACTORS Makes wood sawing fast; easy. Cuts enough wood to pay for itself quickly. Easily moved while attached. Big blade; send for FREE details. **OTTAWA MFG. CO.,/W727 Oak Ave., Ottawa, Kans.**

do you WORRY?

Why worry and suffer any longer if we can help you? Try a Brooks Patented Air Cushion. This marvelous appliance for most forms of reducible rupture is GUARANTEED to bring YOU heavenly comfort and security—day and night—at work and play—or it costs you NOTHING. Thousands happy. Light, neat-fitting. No hard pads or springs. For men, women, and children. Durable, cheap. Sent on trial to prove it. Not sold in stores. Beware of imitations. Write for Free Book on Rupture, no-risk trial order plan, and proof of results. All Correspondence Confidential.



Brooks Company, 359 State St., Marshall, Mich.

NEW and Ready for you

**ALLIED'S 1946
CATALOG**
of Radio and
Electronic Supplies

FREE
Send for it
NOW



BRINGS YOU LATEST, finest values in Radio! New receivers, phono-radios, Ham gear, parts, tubes, kits, code apparatus, tools, books, test instruments, public address—all types of equipment. Over 10,000 items. Leading makes. Guaranteed quality. Fastest service from the world's largest and most complete stocks under one roof. Send for your free copy of Allied's new 1946 Buying Guide now. *Save time and money.*



HELPFUL RADIO BOOKS

- Radio Formulas & Data No. 37-752. 10c
- Dictionary of Radio Terms No. 37-751. 10c
- Radio Circuit Handbook No. 37-753. 10c
- Radio Builders' Handbook No. 37-750. 10c
- Simplified Radio Servicing No. 37-755. 10c
- Radio Data Handbook No. 37-754... 25c
- ALL SIX BOOKS No. 37-799..... 75c
- Parallel Resistance and Series Capacitance Calculator. No. X37-960. 25c
- R-F Resonance and Coil Winding Calculator. No. 37-955.... 25c

ALLIED RADIO

ALLIED RADIO CORP.
833 W. Jackson Blvd., Dept. 5-GG-6
Chicago 7, Illinois

Date.....

- Send FREE 1946 CATALOG
- Send . . . Books/Calculator No. . . . } \$. . . enclosed
- Calculator No. . . . }

Name.....

Address.....

City..... Zone..... State.....

Keep that "TICKING" Car

7 DAYS FREE TRIAL



1588 PAGES
1500 ILLUSTRATIONS



Every operator and mechanic needs AUDELS AUTO GUIDE.

This book saves time, money and worry. Highly endorsed. It presents the whole subject of auto mechanics:

- 1—Basic principles
 - 2—Construction
 - 3—Operation
 - 4—Service
 - 5—Repair
- Handy Size, Easily understood.

NEW FLUID DRIVE, HYDRAULIC SHIFT AND DIESEL ENGINES FULLY COVERED

Over 1500 pages—1540 illustrations showing inside views of modern cars, trucks and buses with instructions for all service jobs.

4 COMPLETE • PAY ONLY \$1. A MONTH ←

ASK TO SEE IT!—To Get This Assistance for Yourself Simply Fill in and Mail Coupon Today.

AUDEL Publishers, 49 West 23rd St., New York
MAIL AUDELS NEW AUTO GUIDE for free examination. If O.K. I will send you \$1 in 7 days; then remit \$1 monthly until price of \$4 is paid. Otherwise I will return it.

Name.....

Address.....

Occupation.....

Employed by..... PM

"Jet" Propelled! SPEED BOAT



Actually sounds like a real speedboat!

No Springs!
No Gears!

\$1 Complete, Postpaid

Runs half an hour on a small piece of fuel. (Fuel included). Sounds like a real 2-cylinder speed boat. Easy to operate. Will delight both young and old. Order several. They make a wonderful gift.

.... Fuel Supply Included at no Extra Cost

All Metal! No Moving Parts

MAIL ORDERS DIRECT TO UTILITY STORES, 117 S. Wabash,

Dept. GG-25

CHICAGO 3, ILLINOIS



Collect U. S. Army Shoulder Patches



An interesting, fascinating hobby. From 20c to 50c each. Master set of 400 patches—\$97.50. Assortments \$1, \$5, \$10, \$25, \$50. Official patches available for every major Army and Air Corps Unit. Send \$1 for sample selection of patches and PATCH CATALOGUE. Orders from Canada—add 20%.



SPRINGER'S
286 San Francisco Street
EL PASO, TEXAS



MAKE MORE MONEY

Applying or Selling Lasting ROOF COATING

Extra profitable, easy to apply. Exclusive new formula makes this America's best roof coating for felt, composition, steel, slag, iron, gravel, concrete and metal roofs. Definitely superior in all climates, at all temperatures. Act at once!

DEALERS & AGENTS WANTED
Write for Details of Our Proposition

LASTING PRODUCTS COMPANY
MANUFACTURERS OF PAINTS, PUTTIES, PLASTICS
FRANKLINTOWN ROAD PLANT. BALTIMORE 23. MARYLAND

Get Started QUICK in DRAFTING

I Will Train You Until You Get a GOOD PAY JOB And I'll furnish all WORKING TOOLS

Get a better job with more pay and pleasant working conditions. Get into Drafting—where all products start. I will train you at home—give you experience—on the same kind of jobs you will do with the best paying firms. I furnish instruments, and all equipment when you start. Write today for vital facts and FREE Book. Give age.

ENGINEER DOBE, Div. 17, Libertyville, Ill.

TATTOOING PLEASURE PROFIT

\$ \$ \$ \$ \$ \$ \$ \$

Make Money—Have Fun! "TATTOOING." Profitable, Interesting, Fascinating Business. Write to-day! Full particulars, 3c Stamp.

MARSHALL STEELE
540-T LEAVENWORTH, SAN FRANCISCO 9, CALIF.

Low Price The OTTAWA "Buzz" Master



CLEAR LAND FAST! Powerful 6-HP motor with friction clutch for safe operation. Cuts down timber, brush, hedge; turn blade vertically and saw logs to length. Can be equipped to fell largest trees. Clutch pulley for belt work. Guaranteed.

FREE Details

OTTAWA MFG. CO., 727 Brush Ave., Ottawa, Kansas



SWISS MADE WATCHES

Wear 10 Days at Our Risk!
Swiss made watches are renowned for accurate time-keeping. This men's watch has a sturdy, finely-constructed chrome case, an open figure dial, genuine leather strap. SEND NO MONEY! Just pay postman for wristwatch \$8.50 plus few cents postage and 10% Federal excise tax. Wear for 10 days on our money-back if not satisfied guarantee! Rush orders today—supply is limited. UNITED PRODUCTS CO., 7941 S. Halsted, Dept. MM-404, Chicago 20, Ill.

VETS!

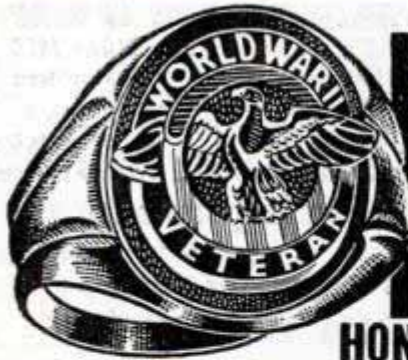

Only
\$1.98

HONORABLE DISCHARGE RING

Genuine Sterling Silver Gold Finish
HERE'S A VALUE! Handsome, hefty Genuine Sterling Silver HONORABLE DISCHARGE RING, yellow gold finish, for only \$1.98 plus tax. Handsome scrolled mounting. OFFICIAL DISCHARGE EMBLEM. A beautiful ring you'll wear for life.

SEND NO MONEY Mail your name, address, and ringsize today. Your Genuine Sterling Gold Finish Discharge Ring will be sent to you AT ONCE. Pay your postman only \$1.98 plus tax and postage. Wear the ring 10 days, and if not delighted, return it and your money will be refunded at once. Yes, your satisfaction guaranteed! **ORDER TODAY.** Send strip of paper for size.
CHARLES STEWART, 616 Walnut St.
Dept. C-203 CINCINNATI 2, OHIO

HOW TO CUT RAFTERS New vest pocket book gives lengths, side cuts, Plumb cuts, Deductions. For all rafters for any building from one inch to forty feet wide. Gives numbers to cut on square. Also decrees for same cuts for Radial Saws. All standard pitches from 1/4 to 5/8. Just open book to pitch page and there are your lengths, side cuts, etc. Anyone who knows what a jack rafter is can frame a roof if he has this great book. Price one dollar prepaid.

BUILDERS' TOPICS, Dept. M, Med. Arts Bldg., Seattle 1, Wash. Original teachers of the square in five easy lessons by mail. Send for FREE list of plan books—Kamp Kabins to Mansions.

BOWS & ARROWS

Write for 94 page Illustrated Instruction Hand Book 50c; 20 page catalog 5c; stamps or coin.
LE STEMLER CO. QUEENS VILLAGE, N.Y.



DRILL-INDEX A compact container for indexing and filing twist drills. Eliminates search. Made entirely of steel in nine sizes. See your dealer or write to
HUOT MFG. CO.
Foot Schultz Bldg. St. Paul 1, Minn.

IF  **FALSE TEETH**
SLIP OR DROP

USE **REFIT MAGIC** **PLASTI-LINER**

MAKES ALL PLATES FIT PERFECTLY PERMANENTLY OR **MONEY BACK**

ONE APPLICATION LASTS FOR LIFE OF PLATE

PLASTI-LINER is a professionally developed re-liner for home use that ends forever the mess and bother of temporary applications that last for only a few hours or a few months. It is NOT a paste, nor a powder; but a strip of genuine dental plastic!

SAFE AND EASY TO USE

PLASTI-LINER is non-toxic, pure, non-irritating, harmless, odorless, tasteless, smooth, molds to mouth. No heat necessary. Just 3 easy steps.

"Excellent Results" say users

"I bought your product over a year ago. Have had no trouble with my plates since. I have told my friends and now all of us with false teeth use **PLASTI-LINER**. It really works." Mrs. E. S., Brooklyn, N. Y.

FREE! Our competent staff dentist will answer all your plate problems.

SEND NO MONEY — ORDER TODAY

PLASTI-LINER CO., Dept. 120
Walbridge Bldg., 43 Court St., Buffalo 2, N. Y.

Rush **PLASTI-LINER** with complete directions. I will pay Postman \$_____ plus postage charges. I may return package for refund if I am not satisfied.

\$1 for UPPER or LOWER **\$2** for Both

Name.....

Address.....

City..... Zone..... State.....

You Save Postage by Enclosing Money

SAY YOU SAW IT IN POPULAR MECHANICS

★ GET ON "UNCLE SAM'S" PAYROLL ★

\$1506 TO \$2650 FIRST YEAR

Veterans Get Special Preference

Railway Postal Clerks—Mail Carriers—Mail Clerks — Patrol Inspectors — Storekeeper Gaugers—Positions at Washington, D. C. — Etc. Mail Coupon immediately — **32-Page Civil Service Book—FREE**

FRANKLIN INST., Dept. S79, Rochester 4, N. Y.

Gentlemen: Rush to me, without charge, 32 page book with list of U. S. Government big paid positions. Advise me also regarding salaries, hours, work, vacations, etc. Tell me how to qualify for a position.

Name.....

Address.....

Net?.....

INVENTORS

The inventor who believes he has a new and useful invention, and finds himself in need of advice, should consult a competent registered patent attorney.

The question as to whether a subject matter is patentable can be substantially determined by a search of the United States Patent records.

Without obligation, write us for information as to what steps an inventor should take to secure a Patent.

RANDOLPH & BEAVERS

Registered Patent Attorneys

11-D Columbian Bldg., Washington 1, D. C.

RANDOLPH & BEAVERS

11-D Columbian Bldg., Washington 1, D. C.

Please send me full information on how to secure Patents & Trademarks.

Name.....

Street.....

City.....State.....



FUN AND MONEY IN PLASTICS

You'll like to make things with BELLCO Plastics! Bellco kits include cigarette boxes, crystal clear trays, wall shelves, etc., of sparkling Plexiglas and Lucite. Profitable bulk assortments, sheets, dyes, cements, etc. Send 10¢ for complete catalog.

BELLCO PLASTICS, Inc.
147 W. Sidney St., Mt. Vernon, N. Y., Dept. E 7



CASH LOANS by MAIL

You can borrow \$25 to \$300 by mail from Postal Finance if you can make small monthly payments. Loans made to employed men and women. No need to take time off work or go downtown for a loan. It's more private—more satisfactory—to BORROW BY MAIL. QUICK SERVICE—LOW RATES—No fees—No commissions—No insurance. Fill in and mail coupon today for FREE information.

POSTAL FINANCE COMPANY

Desk 6, Sioux City, Iowa.

Without obligation, tell me how to BORROW BY MAIL.

Name.....

Address.....

City.....State.....

Occupation.....

PATENTS

AND TRADE MARKS

C. A. SNOW & CO.

Registered Patent Attorneys Since 1875
Write for Free Book and "Certification of Invention" form
427 SNOW BUILDING, WASHINGTON 1, D. C.

INVENTORS • MODELS

accurately made

IMPROVEMENT • SUGGESTIONS — FREE
Mail Blue Print or Sketch to

LYNN DAWSON

124 SUNSET DRIVE

SO. MIAMI, FLA.

PATENT YOUR IDEAS

SEND FOR FREE BOOK

HOW TO OBTAIN A PATENT

Written by Former Member Examining Corps (1922-24) U. S. Pat. Office.

CARL MILLER, Registered Patent Attorney
Former Member Examining Corps U. S. Patent Office

Woolworth Bldg., Dept. 76-A New York — Bond Bldg., Dept. 76-A Washington, D. C.

PATENTS

Free preliminary advice

E. E. VROOMAN, Patent Lawyer

Registered Patent Attorney Since 1902
871 Woodward Building, Washington 5, D. C.



SHEET METAL PROJECTS

OLD SNIPS' BEST SELLERS

34" x 44" Blueprints

#103 Colonial Post-Top Lamp
Hinged door for relamping. Makes beautiful copper project. . . . \$1.00

#427 Plate Girder & Box Truss Bridges
with inverted deck type. NO Scale . . . \$1.00

#865 Fishing Tackle Box . . . 3 trays, sinker bin, sand-spike, hook holder, reel compartment. . . . \$1.00

#951 Executive's Desk Lamp . . . Modern fluorescent, built-in picture frame for 5 x 7 Portrait. . . . \$1.00

DRAFTSMEN ASSOCIATES
3300-2 Aldine St. Philadelphia 36, Pa.

THE NEW IMPROVED WATCH REPAIR COURSE

WRITTEN

By a Certified watchmaker with more than twenty-five years of experience at the bench. At present, teaching the course in a vocational school. For the beginner with NO previous experience. In a step for step style, with instructions easy to follow and profusely illustrated.

UNITS

LATHE WORK
BALANCE STAFFING

Just off the press at \$2.50 each. Other Units soon to follow.

WRITE:

JOHN VAN PUFFELEN

POST OFFICE BOX NO. 183, KALAMAZOO, MICH.

Be independent. Be your own boss. BE A WATCHMAKER . . . Let an experienced practicing staff of watchmakers teach you this lucrative trade. Course includes necessary tools and jeweled timepiece. Write for complete facts:

TERRE HAUTE SCHOOL OF WATCHMAKING
POST OFFICE BOX 1048, TERRE HAUTE, INDIANA

REFRIGERATION

AND AIR CONDITIONING

SERVICE MECHANICS COURSE

Learn at home—how to start your own repair shop on little capital. No previous experience needed. Common school education sufficient. Splendid opportunity for older men. Prepare now for your future. FREE illustrated booklet.

MECHANICS TRAINING SCHOOL

7217 So. Broadway, Dept. P-7, Los Angeles 3, Calif.

WINDOW SIGN LETTERS

For Store Fronts and Office Windows. Anyone can put them on. Samples furnished. Genuine Gold and Silver. METALLIC LETTER CO., 430 N. Clark St., Chicago 10

100 ASSORTED NORTON SANDING BANDS ONLY \$1.95 POST PAID

WAR SURPLUS STOCK

For Industry and Home shop, used on hand drill for internal sanding and sanding of small places on wood, metal etc. Bands are all new NORTON abrasives—sizes 1/2" x 1/2" to 2" x 1 1/4".

A rare buy—these bands regularly sell for \$3.50 to \$7.50 per 100. Order today while supply lasts. Send check or money order to



4 ASSORTED—PENCIL TYPE \$1.00 GRINDING WHEELS

AA LEATHER CRAFT & HOBBY SUPPLIES 11850 JOSEPH CAMPAU • DETROIT 12, MICHIGAN

BUILDING CONSTRUCTION



with composition cement and cheap wood builds 3 room house low as \$250, farm buildings low as \$50. Homemade forms make blocks, panels and tiles in color, and wallboard of sawdust and other compositions. Wall-high blocks, insulated, with finished sides. Stream-lined roof and walls. Cement gutters, troweled roofs and floors. Ten formulas. Cabins, stores and sectional. 100 money and labor saving ideas. Mixer and saw easily made from an old auto. Make doors and windows. 50 proved way to earn \$10.00 to \$15.00 a day. Guaranteed, book, 100 illustrations, \$1.00.

MAKE FURNITURE OF COMPOSITION cement, sawdust, asbestos, paper. Some part scrap wood and metal. Illustrated instructions to make tables, cabinets, chests, racks, shelves, inclosed sinks, lawn novelties and toys, 500 per cent profit. 50c.

HOW TO MAKE ACCURATE SHOP MACHINES: Band, jig, and circular saws, electric drills, sanding wheels, forge, tools, electric weed cutters and many other things from old auto parts and washing machine motors. Illustrated, 50c.

HOME MFG. ENTERPRISES. 50 selected home shop projects, illus., 50c.

Special: All four booklets described above, \$2.00 postpaid. No C.O.D.

HOME INDUSTRIES, 1318 So. 30th Ave., Dept. PM, Omaha 5, Nebr.

TRIG SLIDE RULE

Patent Pending

EASY TO USE

● Fits the pocket. Quickly solves trigonometry, radio, and electricity problems. Simply set the slides and read the answers for all three sides and angles of a triangle. Gives degrees, sines, cosines, and tangents of angles. Entirely automatic. No figuring on paper necessary. Easy instructions included. Price only \$1.00 or we will mail C.O.D. plus postage. Send for yours, NOW, To

REED MFG. CO., 124-D W. 4th St., Los Angeles 13, Calif.

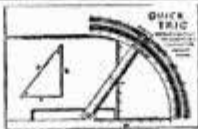

RADIO TRAINER

Learn the theory and practical side of radio by building this simplified battery tube set. Experimental model teaches you to design larger radios, not just assemble them. Efficient, sensitive circuit brings in distant as well as local stations. Covers broadcast and short wave bands. Compact and portable. Can be used on camping trips and on farms without electricity. All parts furnished including Tube, Batteries, Double Earphones, Aerial and Ground Wire and Easy-to-follow Illustrated Instructions. No soldering required. Complete, postpaid, only \$9.95. Or send \$1.00—shipped C.O.D. for balance plus postage. Money-back guarantee. Order today!

B. G. FLEMING MFG. CO. Dept. 7-A, 906 Main St., Cincinnati 2, O.

START HOME MAIL ORDER BUSINESS

Start small—grow big. Amazing new course shows you the way. Rush your name and address today for full particulars. No obligation.

BELFORD (Dept. A) Engineering Bldg. Chicago 6, Ill.

WHEN YOU BUY FLASHLIGHT BATTERIES ASK FOR

"EVEREADY" FRESH DATED BATTERIES

The word "Eveready" is the registered trade-mark of National Carbon Co., Inc.

OTTAWA Post Hole Driller

A high speed, one-man driller equipped with fast new type auger. For any row crop tractor. Easy to operate from driver's seat. Make big money doing custom digging. Guaranteed. Write for details.

OTTAWA MFG. CO., 727 Elm St., Ottawa, Kans.

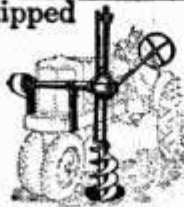

10,000 HELPS TO BE YOUR OWN BOSS IN THIS BIG BOOK!



IF IT'S RESULTS YOU WANT—GET ACTION QUICKLY WITH THESE PRACTICAL IDEAS

Never before has a more helpful book been printed for those planning a business of their own. Gathered in this large illustrated volume are the formulas, recipes, facts and secrets that have contributed so largely to America's great industrial progress. Capitalize on this information for making most any conceivable product without experience, special equipment or previous knowledge of chemistry. Start at home, expand with profits—build for a profitable independence.

The experts who compiled this book are authorities, and present this information in simple, understandable language. They also give you wholesale supply sources for needed materials, short cuts and economy methods for the most profitable results. Hundreds of good paying businesses have been built on a product made from a simple

recipe. Opportunities in this field exist everywhere. Choose from any of the 102,000 facts and 10,000 formulas of which the following are only a very few: Adhesives, Alloys, Anti-Freeze Solutions, Cosmetics, Beverages and Liquors, Candy, Gum, Casein, Celluloid, Ceramics, Cheese, Cleaning Preparations, Concrete, Copper, Cotton, Dentifrices, Depilatories, Dyes, Embalming Fluids, Enameling, Glass, Glazes, Household Formulas, Inks, Insecticides, Iron, Jewelers' Formulas, Lacquers, Laundry Preparations, Leather, Linoleum, Lubricants, Manicure Preparations, Marble (artificial), Metals, Mirrors, Oils and Ointments, Paints, Paper, Perfumes, Photography, Polishes, Powders, Remedies for Man, Beast or Powl, Rubber Products, Refrigerants, Soaps, Solder and Soldering, Tooth Cements, Transfers, Transparencies, Var-nishes and Thousands of others for making all sorts of profitable and practical things.

INCLUDED—PITCHMAN'S GUIDE. Easily made big-profit items that go fast with crowds at Fairs, Carnivals etc. \$25 Net daily not exceptional.

FORTUNES MADE FROM A SINGLE IDEA!

This comprehensive book is an accepted authority by chemists, schools, industry, etc. and is the largest and most comprehensive book of its kind ever issued. Nothing else like it in existence. A single formula has been worth a thousand times this book's small cost to countless owners. Crammed with money-making ideas. Invaluable for reference. Ideal for Factory, Home, Farm, Office or Workshop. As necessary as the dictionary and more useful for manufacturers, chemists and salesmen who put up products for profit.

POSTPAID! \$3.50 U.S.A. \$3.85 FOREIGN

\$3.50 postpaid. Canada or Foreign, \$3.85 U. S. Funds. (C.O.D. shipments U.S.A. only.) Immediate Shipment—Safe Delivery Guaranteed.

ADAMS BROWN COMPANY, Dept. 167 Chestnut Hill 67, Massachusetts, U.S.A.

BE PREPARED FOR SICKNESS or ACCIDENT



THIS HOSPITALIZATION PLAN PROTECTS YOU AND YOUR FAMILY

Costs only 3¢ A DAY • EACH ADULT 1 1/2¢ A DAY • EACH CHILD

Benefits begin the day you enter a hospital
FOR SICKNESS OR ACCIDENT
 Hospital Expenses paid, up to \$540.00
FOR ACCIDENT
 Doctor Expense paid, up to \$135.00
 Loss of Wages reimbursed, up to \$300.00
 Loss of Life by Accident \$1000.00

WAR COVERAGE AND EXTRA BENEFITS
 Childbirth Expense paid, up to \$75.00

● It's easy to run into debt when sickness or accident hit. Under the Family Mutual Plan, you'll be able to pay your hospital bills. And in case of accident, you'll be reimbursed for your doctor expenses, for loss of time from work. You can enter any hospital in the United States. Your family doctor may attend you. Benefits applying to children are 50% of those paid adults.

MAIL COUPON TODAY—No Agent Will Bother You

FAMILY MUTUAL LIFE INSURANCE CO., WILMINGTON 99, DEL

Family Mutual Life Insurance Co. PM-14
 601 Shipley St., Wilmington 99, Del.
 Please send me, without obligation, complete information on your Economical Hospitalization Plan.

NAME _____
 ADDRESS _____
 CITY _____ STATE _____

ANCO RAIN-MASTER

"Dead-Locker"

WINDSHIELD WIPER ARMS and BLADES

BLADE SNAPS ON...
STAYS PUT

FINGER-TIP
RELEASE

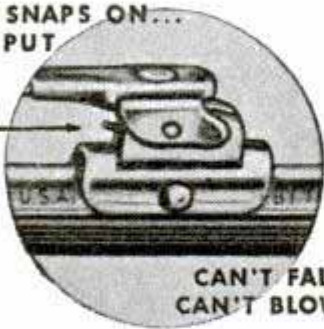

CAN'T FALL OFF
CAN'T BLOW OFF

(A war-born invention—by ANCO—first)
for military aircraft—now for your car.)

DON'T SHOOT YOUR GAS-PUMP MAN!

He's doing the best he can. Sure, he knows how dangerous it is for you to drive your car... in stormy weather... with your dull old windshield wipers that smear and smear. He'd gladly put on for you quickly a pair of keen new ANCO RAIN-MASTER Wiper Blades and Arms. He has them—Newest Models! But he forgets to remind you? Too busy? You can't shoot him for that!



After all, it's *your* car to protect. So *you* remind *him*. Get RAIN-MASTERS... patented features... original equipment on many makes of high grade cars and trucks... used in war—on our fighting tanks and trucks and ships and bombers too... because ANCO RAIN-MASTERS clean quicker, clean cleaner... last longer. May save you a costly smashup.

Ask for RAIN-MASTER Windshield Wiper Arms and Blades next time you buy gas.

THE ANDERSON COMPANY
Established 1918
GARY, INDIANA

SAY YOU SAW IT IN POPULAR MECHANICS

Practical Electricity and House Wiring



Discusses common electrical devices, principles of circuits, wires and insulation, grounding, fuses and circuits, wiring methods, planning installations, installing switches, fixtures, etc., wiring houses after they are built, alterations and additions, wiring farm buildings, home repair, etc. 200 pp.....227 illust.

C.O.D. Send Today, Money Back Guarantee Postpaid \$2.25 \$2.00

The GATEWAY BOOK CO., Dept. PM-19
32 N. State — Chicago 2, Illinois



WHY WEAR DIAMONDS

When diamond-dazzling Zircons from the mines of far-away mystic Blam are so effective and inexpensive! Thrilling beauty, stand acid, true backs, full of FIRE! Exquisite mountings. See before you buy. Write for FREE catalog.

National Zircon Co., Dept. 20
Wheeling, W.Va. **Catalog FREE!**

WAR SURPLUS

Lathes, Milling Machines, Drill Presses, Sawing equipment, Motors and thousands of miscellaneous items. Also information on Helicopters, Sleeper Trailers, Garden Tractors, Power Lawn Mowers, Welders, Jet Impulsion for Cars and Tractors etc. RUSH name for free literature. THE WAYNE ENGINEERING CO., Dept. 1002, Greenville, Ohio

HOME STUDY OR SHOP TRAINING

Learn Plastics, Refrigeration or Diesel. Study at home, shop work later. Also shop courses in Body and Fender, Machine Shop, Tool and Die. 41,000 graduates. Established 1902. Free booklet. Specify trade. GREER SHOP TRAINING, Dept. 176, 460 S. State St., Chicago



BUILD THESE PROJECTS

For garden or lawn. Easy to build. Easy to sell. Detailed Blueprints Model B-25 Dutch Windmill 50c; Model OM-60 Old Mill, 85c. Lawn Figure Patterns—Sunbonnet Girl, Dutch Boy, Tulip Girl, Holland Pair, 35c each, all 4—81. Catalog illustrating many models, send 10c, today.

CRAFTSMAN'S MODEL CO., Dept. P-93, 2030 N. 41st St., Milwaukee, Wis.



Balance 4" x 9" Base. With either Metric or Avoirdupois Weights ... \$6.00

Catalog with 3000 Illustrations of Laboratory Apparatus sent for 75 cents. Catalog listing 10,000 chemicals, drugs, minerals, etc. and 1500 scientific books sent for 25c. Catalog of 100 books 10c. LABORATORY MATERIALS CO. 7321 Vincennes Ave. Chicago 21, Ill.

LOANS by MAIL



IN A HURRY

FROM \$50

TO \$300 ON YOUR SIGNATURE ONLY

... OR YOUR OWN SECURITY

NO PERSONAL INTERVIEW
CO-SIGNERS NEEDED
WAGE ASSIGNMENTS

To salaried people - men or women - married or single. You mail the application to us - we mail the money to you. QUICK - CONVENIENT - CONFIDENTIAL. Satisfaction guaranteed. In our 20th year of installment financing.

MERCHANTS INVESTMENT CO.
 819-G 1st Natl. Bk. Bldg., Omaha, Nebr.
 At no charge or obligation, send information for a loan of \$_____ to be repaid at \$_____ per mo.
 NAME _____
 ADDRESS _____
 CITY _____ STATE _____
 OCCUPATION _____

**WORLD'S
BEST
WANT AD
MEDIUM**

CLASSIFIED Advertisements



Advertisements in this section 50 cents per word, each insertion, minimum 10 words, payable in advance
To be inserted under proper classification in August issue, copy should be in our office July 3rd

August issue on sale August 1st

F. W. Johnson, Manager, Classified Advertising
Popular Mechanics Magazine, 200 East Ontario Street, Chicago 11, Illinois

YOU'LL PROFIT

By reading and answering the classified ads in this section. Hundreds of opportunities to make and save money.

Popular Mechanics Magazine, Chicago, Illinois

Gentlemen: We do not want to miss any issues of Popular Mechanics Magazine because we feel that it is positively the best pulling medium that we have ever tried and even with display items being used, we would never cease to advertise in the classified section, because not only is it the best pulling medium that we know, but also the cheapest. We have had 25 years of experience in the direct selling field and we feel that we have a right to know by this time which is the best advertising medium in the direct selling field.

(Original letter on file in our office)

Very truly yours,
HOOK-FAST SPECIALTIES, INC.

1361 CLASSIFIED
ADVERTISEMENTS

1361 OPPORTUNITIES
FOR YOU

AUTOMOBILES, MIDGET CARS

BUILD Speedy Midget track racer from castoff parts! Plans, specifications, construction information, \$1.00. Motor Supply, Box 1682-CS, Toledo, Ohio.

MUFFLER Manual. Convert easily to Hollywood, Laguna, Westwood, duals, etc. Includes construction details, regulations, diagrams. Postpaid \$1. Mellotone, Box 723E, Arcadia, California.

500 MILE Indianapolis Automobile Racing History Book, just printed. Complete history detailed year by year results every Indianapolis race since 1909. 320 large pages, over 1000 illustrations, drawings, photographs describe foreign, American racing automobiles. Photographs world's famous drivers. View in your arm chair every mile of every event at 10¢ a race average cost. Complete book postpaid \$3.50. De luxe edition bound attractive red Du Pont Fabrikoid \$5.00. Limited number available—hurry! Clymer, Dept. A72, 2125 W. Pico, Los Angeles 6, Calif.

SCOOTER-CAR! A two passenger, three wheeled, motorized light scooter-car. Use second hand material. Easily built. Efficient. Fun. Also, inexpensive, easily constructed two passenger midget "Jeep." Detailed working plans for both, only \$1.00! Universal, 2671 Algonquin, Toledo 6, Ohio.

BLUE Prints for regulation midget race car \$1.00. M & M Machine Co., 207 S. Henrietta Ave., Rockford, Ill.

MIDGET Racing car blueprint, 3 view professional layout, \$1.50. Sawin, Box 31, Seekonk, Mass.

FREE 1946 List photos, racing cars, drivers. Photographer, Midland Park, N. J.

DUALTONE Twin muffler sets for Fords and Mercurys. Instructions included \$20. Replacement mufflers, all automobiles. Prices quoted on request. Designed to eliminate back pressure, giving increased gas mileage and horsepower. Has deep mellow tones. Three inch chrome tailpipe extension \$3.00. Dualtone Mufflers, 2636C India Street, San Diego (1), Calif.

FOR Midget car bargains, see our ad under Motorcycles. Midget Motors Directory, Athens, Ohio.

STREAMLINE Your automobile—beautiful, custom built, ten years newer by inexpensive, easy methods. Illustrated restyling manual \$1.00. Almqvist Engineering, 447-64 St., Brooklyn 19.

STUTZ Bearcat, H.C.S. or Stutz phaeton wanted. Box 1014, Shelby, N. C.

PROFESSIONAL Midget racer, motor-scooter, midget roadster, and midget motorcycle. Plans, specifications for all four contained in illustrated handbook, 25¢. Big list bargain priced used motors, motorscooters, servicers, etc., included free! Midwest, 3839 Drummond, Toledo, Ohio.

RACING Car fuel concentrate supercharges gasoline for all cars. More power, speed. \$1.00 pint. Free speed equipment literature. Lee Motorcraft, 1412-A Great Northern Bldg., Chicago 4, Illinois.

R & R Mfg. Co., marine and auto division, Anderson, Indiana, Robert M. Roof, \$1.00 for our new 1946 speed and power equipment catalogue with price sheet—showing racing cars, midgets, speed boats with recommendations how to rebuild your motors for racing. Dual ignition racing cylinder heads for V-60-100 and Mercury Ford engines. Dual intake manifolds, racing pistons, camshafts, compound valve springs, Lynite flywheels, quick change gear boxes and numerous other supplies.

AUTOMOBILE Racing book, fifth edition, well illustrated. Instructions on building bodies, frames, engines. Ford A and B conversions. Plans. AAA rules, specifications. Roadster racing. Indianapolis cars. \$1.00 postpaid, \$1.30 C.O.D. Ray Kuns, Dept. 47, Madisonville, Cincinnati 27, Ohio.

CUSTOMIZE Your automobile. Illustrated, new restyling ideas, instructions, suggestions, specific model changes by simple methods. \$1. Speed Wheel, Box 723-E, Arcadia, California.

AUTO SUPPLIES AND EQUIPMENT

MCDOWELL Gasoline saving vacuum supercharger greatest invention in years, more speed, power, saves gasoline motors waste, self addressed stamped envelope for pamphlet, expect surprise, \$7.50 only until granted raise. McDowell Company, 2000 NE Union, Portland 12, Oregon.

EMERGENCY Unit to put out incipient fire, or inflate flat tires. Odorless carbon dioxide gas in pressure cylinder. Light, safe, easy to use, and inexpensive refilling. Money back guarantee. Price \$7.50. Will refill for 75¢. Morrison, 322½ S. 6th St., Springfield, Ill.

VETERANS World War II bronzed auto emblem. Same as your lapel button \$1.00 we pay postage. Emblematic Co., Dept. "B," 784 Garden Street, Hartford, Conn.

1000 MOTORISTS Needed to make gas saving test. Up to 30% savings. For trial test offer write Vacu-matic Carburetor Co., 7617-1283 W. State Street, Wauwatosa, Wis.

REPLACE Your own automobile glass. Complete easy instructions, 50¢. Send model type and year of car. D. Axelrod, 8798 21st Ave., Brooklyn, N. Y.

CRANKSHAFT Refacing. Instructions \$1.00. John Richard, 3208 So. Hoynes Ave., Chicago 8, Ill.

BUG Screens: for car, truck or tractor. Prewar made. Highest quality. State make, year, model. \$1.25 value. 50¢ each. Postpaid. Allen Co., Clinton, Missouri.

GRILLES For all cars. Lowest prices. Wagner Grille Co., Bernville, Route #2, Penna.

ATTENTION Gas and garage attendants. Modern motor tune up, simplifies and analyzes car's the time saving way. Rush \$1.10 for yours. Modern Motor Charts, Box 602, Trenton 4, New Jersey.

"BUMPER-JACKS." Now available for civilian use. Ingenious design and patented action provides greater safety and trouble-free operation. Over 2,000,000 used by U. S. Army. Easily lifts 6000 pound loads. Height closed: only 10¾". Extends to 27¾". Fully guaranteed. \$2.98 postpaid anywhere in United States. Send check or money order to Auto Products Co., 540 W. Lake St., Chicago 6.

1946 SUPER-IGNITIONER \$5.50. Fast starting, mileage pep. EG Mfg., 355A East 149th, New York 55.

AIR Compressor outfits, complete with quart size spray guns, less motors. Use your own ¼-horse power motor. Limited quantity. Write for details. Box 172, North End Station, Detroit 2, Michigan.

WATER Injection!—Install your own—extra power—extra savings. Rush postcard. Milage, 620 Adams, Ottawa, Ill.

AMAZING Typhoon super-charger available again! 41,000 satisfied motorists enjoy new power, pickup, pep. It's easily installed, replacing old-type air cleaner. Operates on "air booster" principle—packs air currents into carburetor, gives sensationally smoother power, saves gasoline, increases car resale value. Order yours today. Mention car make and model. Only \$5.95. West of Rockies, add 10%. Ohio orders add 3% sales tax. Quantities limited, prompt shipment. Typhoon Products Co., 507-A Engineers Bldg., Cleveland, Ohio.

MAGIC At your finger tips, with the new push button plastic key case, which automatically opens and selects your car key! Available in two colors, red or black. Send no money, \$1.00 C.O.D. Satisfaction guaranteed or money back. Flippo Mfg., P.O. Box 73, Oakland 8, Emeryville Branch, California.

GASOLINE Saving device. Chevrolet, Ford 1932-1942, Dodge, Plymouth, 1933-1938. Walert Company, 3429 North 10th Street, Milwaukee 6, Wisconsin.

HAVING Car trouble? New, used, guaranteed auto, truck parts save money. Transmission specialists. Describe needs; immediate reply. Victory, 2930½ Northwestern, Chicago 18.

AUTO Parts for all autos and trucks. Trans., motors, differentials, fenders, carburetors. Also body parts. Security Auto and Truck Parts, 1941 BJ Eddy, Chicago 13.

GRILLES For all cars. Meyers Auto Parts, 820 Dryades, New Orleans, La.

OIL Pumping motors—Brought back to normal without ring job. Write for particulars. Joe Mullner, Box 3102, St. Paul 1, Minn.

PLATING Outfits for auto parts. Connect to a battery. No tanks used. Free particulars and proofs. Gunmetal Co., Ave. J, Decatur, Ill.

AUTO TRAILERS

TRAILER Owners: Save tires by installing Laidlaw Save-A-Tires. Warning light on dash indicates soft tire. \$7.50 per set of two. F.O.B. Pasadena. Deliveries C.O.D. Shipping weight three pounds. Laidlaw Mfg. Co., Box 1108, Pasadena 20, Calif.

BUILD Woodsmann camping trailer. Sleeps 2, carries boat on top. Easy to tow. Large manual, working drawings, instructions, parts list, etc. \$1.00. Illustrated circular, dime. Craftsmann Books, Box 1153-P6, Milwaukee 1, Wis.

STREAMLINED Trailers. Has everything. Large manual full of drawings, instructions, etc. \$1.00. Illustrated circulars, dime. Craftsmann Books, Box 1153-P3, Milwaukee 1, Wis.

BUILD Your own trailer! Save money! Have every feature you want! Plans for house, sport, camp and utility trailers. Catalog describing 9 models 10c. 15c in Canada and overseas. Jim Dandy, Box 125-A, Wausau, Wisconsin.

MOTORCYCLES, BICYCLES, MOTOR-SCOOTERS AND SUPPLIES

MOTORSCOOTER \$10, motor \$3, tires \$2! Send 25c for big new catalog Number 916, just printed, listing scores of other sensational bargains in motors, wheels, motorscooters, motorbikes, servicycles, tires, etc. Associated, Box CS-1764, Toledo, Ohio.

GENUINE Moto-Scot parts. Amsco centrifugal clutch. Windshields, sidecars. All other parts and accessories. Write for parts list. Also genuine engine parts for Briggs and Stratton, Lauson. American Moto-Scot Co., 1313-23 Carroll Ave., Chicago 7, Ill.

MOTORBIKE Manual containing motorbike and scooter plans and motor tune-up information, \$1.00. Veco, P.O. Box 124, Evansville, Ind.

GOVERNMENT Surplus Harley 45" motors brand new \$75 and up. New bicycle motors \$75. Gerald Baughman, Wadsworth, Ohio.

HARLEY-DAVIDSON Service, parts, accessories. Send \$2.25 for Army Motorcycle Manual, 10c for bulletins. Knuth's (Harley-Davidson Factory Dealer), 2491 Fond-du-Lac, Milwaukee, Wis.

RETREADING—Only mid-west plant equipped to tread motorcycle tires (all sizes) in famous Zook Armor Tread. All non-skid design. Substantial dealer discount. Send tires direct to Zook Tire Company, Denver, Colorado.

MOTORCYCLE Cams ground for speed and power. For information write Harold Schaller, 247 West Main, Turlock, Calif.

MIDGET Car \$18, Briggs motor \$5, tires \$1.00! Send 25c for new bargain catalog packed with money saving buys in motorscooters, motorbikes, midget cars, motors, wheels, tires and parts. Galed and Company, Nicholas Building, Toledo, Ohio.

FACTORY Built midget car \$65; Johnson motorbike \$45; Servicycle \$75; 3-wheel Cushman motorscooter \$65; home-made motorscooters \$15 up, complete; motors \$8 up. Tires for motorscooters and midget cars \$1.50 up. Mailorder only. Send 25c for new Directory Number 14 just out listing these and hundreds of other bargains in motorcycles, outboard motors, motorscooters, midget racers, parts, plans, etc. (35c by first class mail.) Midget Motors Directory, Athens, Ohio.

BICYCLES Schwinn and Monark. Just received from factory. Send dime for list. Century Cycle Company, 3447 Lawrence Avenue, Chicago 25, Illinois.

TIRES, Inner tubes, wheels, for small trucks, wheelbarrows, midget cars, power scooters, farm equipment, carts, etc. Sizes 8" to 18" o.d. in 2, 4, and 6 ply first-line quality tires, with removable inner tubes and heavy duty demountable wheels. Also caster forks, straight or swivel types. Free circular and prices. Experienced tire engineers to advise on your special equipment problems. Jahant Co., 626 East Exchange Street, Akron 6, Ohio.

WHEELS! Complete with rubber tires for wagons, scooters, trailers, wheelbarrows, mowers, 6 1/2" to 16". Free list. Trulsen Mfg. Co., 811 E. 31, Kansas City, Mo.

CHANGE Your bicycle to electric or gas motorcycle. T. M. McDonald, 837 Magnolia, Beaumont, Calif.

WHEELS! Steel disc rubber tired for toys, wagons, scooters, etc. Sizes 5", 7", 8" available. United Wheels Mfg. Co., 11727 Lafayette Ave., Chicago 28, Illinois.

BUILD America's lowest priced motor-scooter speedster! Complete plans, specifications, \$1.00. Big list bargain priced used motors, etc., included free! Motor Supply, Box 1682-CS, Toledo, Ohio.

LARGE Stock Indian parts. Expert motor rebuilding. Indian Motorcycle Sales, Kansas City 1, Mo.

BOYS, Illustrated "Bicycle Repair Manual" teaches brake repairing, re-spoking wheels, etc. Dealers wanted, 65c. Robt. Klausner, Shelbyville, Ill.

BICYCLE Book, how to buy, rebuild, sell used bicycles 50c. John Collett, Handley, Texas.

TIRES And industrial wheels, suitable for scooters, wheelbarrows, farm equipment, etc. All sizes. Bicycles and accessories. Largest assortment in America. Send dime for list. Cycle Transport Company, 1241 So. Michigan Ave., Chicago 5, Illinois.

AVIATION

PROPELLERS—Correct size any motor. Airliner 3 blade, shorter diameter, lower center position, better thrust, for sleds, boats. Illustrated literature. Aircoo motor conversion 50c. Standard Aerocraft, Ft. Worth, Tex.

CUBS, Wacos, Taylorcrafts, Aeroncas—\$125 and up! Big catalog, 25c, lists these and thousands of other sensational airplane bargains. Some are "easy to repair" crack-ups. National, Box 1682-CS, Toledo, Ohio.

JET Propulsion experiments. New principle to drive boats, bicycles, model helicopters. Circular on plans. Rush name. Houston Maupin, Tipp City 53, Ohio.

PROPELLERS, For ice-snow sleds, air facts, literature 5c. Banks Propellers, RFD 7, Ft. Worth, Texas.

NYLON Rope 1/4" 300 ft. coil \$12.00—1/2" 75 ft. coil \$12.00—3/4" 350 ft. coil \$51.00—all F.O.B. New Orleans, Freeland Products Company, 1019 Alta St., New Orleans 20, La.

AIRPLANES—Used \$125 up. Engines, wings, parts. Send 25c for list. Aircraft, 2300 West Flagler, Miami 35, Florida.

FLYING Flea, plans \$1.00. Lightplane manual \$1.00. Illustrated circulars 20c. Craftsmann Books, Box 1153-P1, Milwaukee 1, Wis.

JET Propulsion circular sent builders bikes, airplanes. Byrum, Buffalo, Okla.

BATTERIES, GENERATORS, ETC.

EDISON Batteries. Light Power. Fifteen year life. Unconditionally guaranteed. Complete lighting plants. Free literature. See-Jay Company, 321 Yonkers Avenue, Yonkers, New York.

ELECTRICAL SUPPLIES, EQUIPMENT

AMAZING Electrical insulating assortment! Mica, fibre, plastic, laminates washers and plates. Ceramic, glass, bushings. Flexible tubing. Rubber mounts. 1400 pieces \$1.00. 3000 piece assortment \$1.98. Sylvania Industries, 4800 North Lawndale, Chicago 25.

ALNICO Magnets, immediate delivery. Terry Sales Company, 3726 South Detroit Avenue, Toledo 9, Ohio.

TRANSFORMERS, Sturdy 110-6 volt, 100 VA, uncased, fine for trains, etc. \$3.50 each postpaid no C.O.D. Dunlap, 219 S. 17th, Phila. #3, Penna.

NE-O-LITE Tester—locates instantly all defects in electrical appliances—motors—spark plugs—fuses. Discovers broken circuits "quick as a flash." Two of these amazing trouble shooters for only \$1.00. prepaid. Have one at home. Carry the other in your car. Sold on money-back guarantee. Neolite Manufacturing Company, Rockford, Illinois.

PISTOL Flashlight. Beautiful useful novelty. Postpaid \$1.00. Quentin Plastics, 2134 Flatbush Avenue, Brooklyn 10, N. Y.

QUICK Way to test bells, fuses, bulbs, toasters, irons, motors, electric appliances. Amazing device. Easy to use. Accuracy guaranteed. Literature free. Hawco Products, 444 Hart, Brooklyn 21, N. Y.

LAMPSHADE Holders 6" to 10" \$2.50 doz. Brass tips that screw on top \$1.50 doz. postpaid. Lampcraft, 602 North St., Jackson, Miss.

FERNAL Electrical laboratory furnaces, pyrometers, thermocouples, rheostats from \$14.75 upward. Write, Fernal's, 12449 State, Chicago 28.

ELECTRIC Fans? Make your own. 16 in. correctly balanced aluminum fan blade. 1/2 in. bore, ideal on any size motor 1/6-1/3 h.p., \$3.50. 18 in. all welded guard adjusted to fit 4 stops on motor, \$3.00. Adjustable floor standard, 4-8 ft. height, rigid, sturdy, \$9.00. Table standard, universal, fits any motor base, \$3.75. Ted Riseman, 1461 No. 3rd St., Springfield, Ill.

BROKEN—Burned out electrical heating elements quickly repaired. Use new amazing Nichrome paste, simply overlap ends and turn on current. Family size \$1.00 bill. Satisfaction guaranteed. Armstrong Mfg., Box 861-X, Minneapolis, Minn.

ELECTRICAL Pencil: Writes and engraves all metals, professional size, precision built \$1.00 postpaid. Reb. Industries, Box 265-X, Elmhurst, Illinois.

ELECTRICAL Appliance repair. Open your own shop. Learn house wiring; electric motors, vacuum cleaners, washers, etc. Complete illustrated course shows how. Free booklet. Pacific Training School, Dept. AP-2, 7217 So. Broadway, Los Angeles 3, Calif.

NOW—Repair your own electrical appliances with Chantite Self-welding Electrical Heating Element Flux. Instructions delivered, price \$1.00. Stick form 25c ea., \$2.00 doz. Chantite Sales Company, 914 South Main, Fort Worth, Texas.

ELECTRIC Pencil: Writes-engraves all metals \$1.00 postpaid. Beyer Mfg., 4515-H Cottage Grove, Chicago 15.

REFRIGERATION

"REFRIGERATION Service Manual"—domestic, commercial, construction, operation, installation, testing, trouble shooting, replacement, repair, etc. 300 pages; fully illustrated, \$2.25 postpaid. Money back guarantee. All books on technics, radio, television, homecrafts. Free catalogue. Modern Technical Book Co., Dept. MMC, 55 West 42nd St., New York 18.

WELDING, SOLDERING, PLATING

NEW Model electric welder 110 volt a.c.-d.c.; will weld all metals; easy to use; full directions. Complete with power unit, flame and metallic arc attachments, carbons, fluxes, rods, mask; all for \$19.95. Used by the navy. Magic Welder Mfg. Co., 239-MP7 Canal St., New York City.

ARC Welders wanted by the thousands. Learn with 516 page lessons manual. Over 500 how-to-do-it photos. \$2.00 copy. Money-back guarantee. Hobartweld, Box M-764, Troy, Ohio.

WONDERFUL invention, 20-250 amps, using auto storage batteries, welds anything perfectly, build your own plans \$1. Battweldco, Santa Barbara, Calif.

WE Do nickel and chromium plating. Globe Company, Fitzgerald, Georgia.

ACETYLENE Welding outfits like new; 80 amp. welder, 110 volt, \$46.00; welders book \$1.65. Eagle Welding, Dept. PM, 5085 Broadway, Chicago 40, Ill.

"BUILD Your Own Arcwelder." Inquiries welcome. Welders Club, AB-3432, Chicago 54.

THUNDERBOLT—Transformer welder, dial-control, 3 heat stages, 60 amps, 110 volts-a.c., takes up to 3/32 rod, carrying case, all accessories, illustrated instructions. Professional heavy duty welding, brazing outfit, \$39.50. Also "Super-Welder" for light work, 110 volts, a.c.-d.c. \$19.95. Save 2%, send check. Or order C.O.D. west of Mississippi. \$5.00 deposit required on Super-Welder, \$10.00 on Thunderbolt. Super-Welder Mfg. Co., Dept. PMC, 23 E. 20th St., New York 3, New York.

WELDING, Cutting, aircraft welding and soldering equipment. Electric arc welders. Superior Oxy-Acetylene Co., Hamilton, Ohio.

MACHINERY, TOOLS AND SUPPLIES

SPEED-LEVER—A hand lever for the tailstock of your bench lathe. Speeds up drilling, reaming, etc. Also use with tailstock turret. Built in micrometer dial for precision work. Can be installed in one minute, no drilling. All working parts hardened. A high quality tool. For Atlas, Craftsman, South Bend and Logan bench lathes. Specify make when ordering. Postpaid \$24.50. Earl Engineering Co., Box 52, Fresno, California.

DRILL Grinder—Grinds drills to factory accuracy. Calipers with direct reading scales. Circle cutters. New tool grinder. Lowest prices. Free literature. Factory; 811-B East 31st, Kansas City 3, Mo.

MACHINE Shop tools released for private industry. Wilson Wasp 150 amp. arc welders, also 150 amp. Lincoln vertical type. 220 volt, 24 ampere, 3 phase, 60 cycle. \$160; belt driven pedestal grinders \$16; 18" double disc grinder \$110; 16"x5 1/2" manufacturing lathe not screw cutting \$140; small hand screw machines \$70; 24"x12" engine lathe, compound rest, taper attachment, \$530; medium size turret lathes \$70. Conversion Parts Co., 278 Adams St., Boston 22, Mass.

CASTINGS—Aluminum, in the rough or finished, for inventors, experimenters or small manufacturers; no order too small for us to handle. Send your pattern or print for our low prices. W & D Mfg. Co., Stuttgart, Ark.

SINE Bars. Simplified, accurate. Instructions included, \$8.75. Capanna, 552 Morgan, Akron 11, Ohio.

GRAB This, 50—assorted new grinding wheels, 1/2" to 4" diameter, would cost over \$50 retail, yours for \$9.00 plus express charges—no C.O.D. Dunlap, 219 S. 17th, Phila. #3, Penna.

MACHINISTS—Free information on selecting proper machining speeds. Elcraft, P7, Box 8184, Portland 7, Oregon.

BUILD Quickchange gear box for Craftsman 12", Atlas 10" lathes. Adaptable to others. No castings required. Complete drawings \$3.00. Stevens Engineering, 2604 Military, Los Angeles 34.

WORK Arbor slips on any 1/2 inch shaft motor to make power grinder or polisher. Takes wheel with 1/2" hole. Money back guarantee. See check or money order to Greenleaf Mfg. Co., Paoli 1, Penna. Thousands in use. Agents wanted.

TEMPERING Chisels, dies, etc. Dollar brings proven formula and instructions. Struve, 308 West 6th, Fremont, Nebr.

USED Knu-Lok toggle clamps \$15 doz.; friction tape 1/2 lb. rolls \$1.80 doz.; 6" stainless scratch wheels \$10 doz.; plain wheels \$7 doz. plus express chgs., no C.O.D. Dunlap, 219 S. 17th, Phila. 3, Pa.

CONCRETE Block mach., semiauto. 2 men, up to 350 blocks per day comp. with 100 steel pallets, \$149.50 at factory. Also 1/2 and 1 bag mixers for blocks or mortar, \$185 and up, plus freight. Prompt shipment. Madison Equip. Co., Madison, Tenn.

JOINTER Head for wood shaper. 2" wide. 2" cutting circle. Replaceable hardened tool steel blades. Precision ground. Immediate delivery, \$4.75 postpaid. State arbor diameter. Hurley, 14 Lone Oak, Bethesda 14, Md.

SHARPEN Dull pipe wrenches with new patent grinder. No competition. One operator made \$321 in one week. J. C. Moore Industries, Box 234 Fredonia, Penna.

IT'S Easy to build your own metal and woodworking tools from Lewis castings, materials and blueprints—and at savings up to 80%! Lewis mills, shapers, drill-presses and other shop tools have ample capacity and performance for home workshop jobs. New catalog—sent on receipt of 10c to cover mailing—describes 23 Lewis tools. Address Lewis Machine Tool Co., P.O. Box 116, Station A, Dept. M-63, Los Angeles 31, California.

LATHE Owners—Genuine "Accur-Craft" die and tap holders. Designs, 25c each. Accur-Craft, 128 Hewitt St., Santa Rosa, California.

EXPERIMENTERS—100 Assorted 48-pitch spur gears, pinions, worms, miter sets, shaft assemblies, etc. Postpaid, \$8.50. Scientific Construction Company, Box 438, Hackensack, New Jersey.

8" BENCH Saws, post drills, power hack saws, motor mounts. Circular free. Sunshine, Berkshire Heights, Penna.

"TWELVE-IN-ONE" Precision tool. Fine tempered steel. Fits in vest pocket. Includes adjustable nut wrench, alligator wrench, screw driver, file, glass cutter, wire stripper, staple and tack puller, straight edge, magnet, rule, knife sharpener, bottle-opener—all in one unit. \$1.00, postpaid, guaranteed. Bishop Tools, 111 West Washington, Chicago 2.

SURFACE Plate 8"x14"x2 1/4" high, 20 ribs, wood handles included. Unfinished \$4.50, machine finished \$9.50, 25 lbs. Angle plate 4"x3"x3" ribbed, unfinished, 75c, machine finished \$2.00, 3 lbs. (Castings normalized.) Model Tool Service, Rock Falls, Ill.

COMPLETE Blue prints for power-operated concrete tile machine, capacity 2,500 per day; builds easy; materials cost less than \$100. Send \$10 for plans. Designers, Box 222, Gainesville, Texas.

TOOLS, Hardware, drills, taps, dies, pulleys, saw mandrels, jeweler saws, steel, brass, drill rod. Catalog 10c. Terek, 6304 Patterson, Chicago 34.

DRILL Grinder for twist drills \$2.95, and other craftsman's tools. See ad on page 251.

INDEX Heads for sale. Very inexpensive. Sixty-two different divisions. Used on small lathes, drill press, milling machines, etc. Make gears, hobs, cutters, etc. Very accurate, and durable. Not a toy. Used by defense schools and hobbyists. Write for free folder. Long's Index Heads, 2117 East B St., Torrington, Wyo.

BOATS, OUTBOARD MOTORS, ETC.

PROPELLERS: Three blade polished manganese bronze, new, Army surplus; 12 in. dia.; 10 in. pitch; 7/8 in. hub bore; wt. approx. 5 lbs.; made for U. S. Army's famous assault boat motors (Johnson POLR 15-22 hp. outboard). Can be modified to fit other engines. Can also be made into everlasting mementoes of World War 2. Immediate delivery. Extremely low price of \$5.00 each until limited supply is exhausted—\$1.00 deposit on C.O.D. orders, balance parcel post collect. Baker Bros. Mfg. & Supply House, Palatine (Cook County) Ill.

TACHOMETERS Recalibrated 0 to 5000 or 0 to 8000 rpm. 4 3/8 diameter face, \$8.00 each, specify rotation. Zakarian Engineering, Box 416, East San Diego, Calif.

A Houseboat is easy to build and you beat the rent problem. Complete all-season accommodations for six. Write for full free information. P.O. Box 575, Denton, Texas.

ICE Skate and ice boat sails. Canvas for boats, trailers, artists, automobiles, seat cushions. Alan-Clarke Company, 96 Chambers, New York City.

BOATS And all about them. How to select, build, repair and operate. For 40 years the leading practical boating magazine. Half price trial subscription. 12 issues for \$1.00. Motor Boat, 62 Gold Street, New York 7.

PONTOON Dock with built-in swimming basin. Safe, practical. Childrens delight. Easily built. Plans \$1.00. Lidemark, 226 Potomac, Buffalo, N. Y.

PLASTIC Boats now! Make your own for pleasure or sale with streamlined 9'x4' one-piece reinforced molded hulls. Weight 50 lbs. Makes Adirondack car-top boat, sailing dinghy; ten other craft. Won't leak. Won't crack. Won't rot. Plastic Boats, Box 187, Lake Placid, N. Y.

KAYAK—Easily built. Instructions, \$1. Gee, 1211 Frisco, Far Rockaway, N. Y.

USED Outboard motor parts. Outboard Exchange, 1194 Remsen Ave., Brooklyn, 12, N. Y.

FORD-Mercury-Zephyr marine conversions. Catalog 10c. Lehman Manufacturing Company, Dept. D, Newark 2, N. J.

BOAT Designers are highly paid professionals. Complete course by mail. Catalog. Westlawn, Montville, N. J.

NINE Plywood boat plans 50c. Catalog boat building plans 10c. The Rudder, 15 Murray Street, New York.

FULL Size, cut to shape boat patterns, blueprints, 7 1/2 - 38 feet. Illustrated "Build a Boat" catalog, 10c (coin). "How to Build Boats" book, \$1.00. Cleveland Boat Blueprints Co., Dept. A-66, Cleveland Ohio.

USED Marine motors, propellers, marine fittings, conversion manifolds. Stokes Marine Supply, Coldwater, Michigan.

MARINE Power—Easily convert any Ford and Jeep motor (domestic and foreign) with Osco parts and kits. Complete catalogue 25c (coin). Osco Motors Corp., 2020 East Orleans Street, Dept. M, Philadelphia 34, Penna.

ENGINES, MOTORS, DYNAMOS

PRACTICAL Winding of a.c. motors. A course of instruction on winding, connecting, and testing single, two, and three phase motors. Clearly written in everyday non-technical language. Illustrated throughout. This book is recommended for beginners interested in learning motor re-winding and repair. Satisfaction guaranteed or remittance refunded. \$2.00 prepaid. Educational Advancement Co., Dept. Y, Lakewood, New York.

ELECTRIC Motors—6000 r.p.m.—96 amp. 24v series—\$3.95. Westinghouse 5/8 hp.—3ph.—60 cycle 230v—3450 r.p.m. O. Ball bearing enclosed frame \$42.50. O. Kitz, Morris Heights Station, Box 51, New York.

BIG Pay jobs in welding. Complete welding lessons and reference books. 516 pages. 41 lessons. \$2.00 copy. Money-back guarantee. Hobartweld, Box 765-M, Troy, Ohio.

ELECTRIC Motors 110 volt ac-dc high speed—1/4 h.p. \$6.50, limited quantity. B. Price, 1394 Fulton Ave., 56, Bronx, N. Y.

GENERATORS New, made by Leland Electric Co. 2500 watts 110 volts 60 cycle. Ac. single phase. Self excited. 1800 r.p.m. Regular price \$132.00. Our price \$67.50 F.O.B. Chicago. Send check or money order. Sold with money back guarantee. See advertisement page 259. J. & H. Equipment Co., 1132 S. Canal St., Chicago 7, Illinois.

MOTORS, Water, air, steam driven. 3" novelty \$3.50, 4" novelty \$5.50, prepaid. Specials 1/8 h.p. \$5.50, 1/4 h.p. \$7.50, 1/2 h.p. \$9.50, 1 h.p. \$16.50, prepaid. Duplex Motors, Burlington, Iowa.

WIZZ Electric motor. Assembles in a jiffy. Flashlight cell operates. Parts complete, plus illustrated instructions 30c postpaid. Eitro Company, 171E, Deer Park, New York.

600 NEW Motor diagrams, tables, and controller connections for the practical electrician. Makes dual-voltage, multi-speed, star and Delta circuits clear and simple. Also includes all standard split-phase, repulsion induction, compensated series, two and three phase. Data for re-winding and reconnecting all types. Over 100 valuable tables. Money-back guarantee. Price \$2.75 prepaid. Educational Advancement Company, Dept. L, Lakewood, New York.

NEW Kohler electric plants a.c. and d.c. Other electric plants rebuilt. Write E. F. Schmaltz, 314 Wyoming Ave., Kingston, Penna.

WINDING Data, listing 225 motors, single and three phase, \$1.00. Motor Data Co., Box 7631, Kansas City 3, Mo.

ATHLETIC EQUIPMENT, BODY BUILDING COURSES

EUREKA: Develop your arms, hands, fingers with this newest sensational pocket size exerciser for old, young, athletes, non-athletes. Strengthens muscles, stimulates circulation. Recommended by doctors. Eureka gripper, made of Neoprene, now available; lasts years. Sold on 10-day money back guarantee. Mail \$2.00 for pair. Eureka Gripper, 707 So. Broadway, Los Angeles, Calif.

NOW Available rubber chest expanders. Get all the muscles only \$2.00. Shipped immediately. Order now. Marcy Co., 1519 Riverside Dr., Los Angeles 31, Calif.

HEALTH Acrobat booklet "free!" Become professional acrobat. Mc Knoff, Peawaukee, Wisconsin.

LEARN Scientific jitsu defense technique. Powerful. Book 200 photographs—\$1.00. Kogan, 1032-PB, New York 8.

DEADLY Judo—Fiercest fighting technique. Complete course (186 photographs). Particulars free. Variety House, Box 46-BG, Wall Station, New York City.

SUPER Strength hand balancing exercise. \$1.00 complete. Burgo, 1008 Grandview, Dallas, Texas.

BARBELLS, Exercise equipment. Courses. Special offers! Free booklet. Good Barbell Co., Reading, Penna.

SPORTING GOODS, GUNS, FISHING TACKLE, ARCHERY, ETC.

FISHERMEN. Get worms the easy way. Make your own electric bait getter. Operates from a car battery, dry cells or house current. Parts from dime store. Easy to make. Send \$1.00 for complete illustrated plans. Cromer, 6533 Penrod, Detroit 10, Mich.

ARCHERS: We specialize big game and target arrows, double tapered, custom made from finest materials, matched or standard sets. Write—C. F. Coonrad, 720 Linden Street, Riverside, California.

FISHING Poles: Dealers only. Sample jointed native cane \$2.50. Bob Pace, Combs, Ark.

CHUM (Unattached bait) attracts food and game fish—from 6 or 7 miles—to your hooks. Fresh or salt water. Cheap! Easy! Make 6 Rigs. Learn 8 secrets. Use 10 methods. Know 55 best chums. Send \$1.00 for a U. S. Chumming Guide. Fish Research, 5912D Thompson, Philadelphia 31, Penna.

LIVELY Fishing worms. 200—\$1.00, 100—\$.10. Harry Dean, Milford, Mich.

THE Tent-house solves housing and vacation problems. Sleeps eight. Radical features. Tested six years. Plans \$2.00. Box 293, Jamaica, N. Y.

SILENCER For .22 cal. rifle or pistol. Sounds like air-gun! Simple plans \$1.00. Singer, 1014 College Ave., Bronx 56, N. Y.

USED Guns, bought, sold, exchanged. List stamp. Howe Fur Company, Coopers Mills, Maine.

ARCHERY, Free factory price list. Sheboygan Archery Co., Sheboygan 5, Wis.

3000 BARGAINS, Firearms, binoculars, war relics, catalog 30c. Smith Firearms, Runnede, New Jersey.

"AMMUNITION"—New and used "shot-guns," "rifles," "handarms." List 10c. Rudolph's, Atchison, Kansas.

SEND 10c For list 100 used guns. Frayseth's, Willmar, Minnesota.

FIELD GLASSES, MICROSCOPES, TELESCOPES, MAGNIFIERS

TELESCOPES, 15" polished lens, \$1—17 power; 41", 3 lenses \$1.98. Compass, wrist-type, luminous, withstands heat, cold, \$1.98. All postpaid. Guaranteed. Gruenewald, 3937 Coolidge Ave., Oakland, California.

60 POWER Telescope, \$2.95. 250 power microscope, \$2.45. Also bargains in binoculars and surplus lenses. Send for free catalog. Brownscope Company, 24 West 45th Street, New York.

TELESCOPES, Real 17 power telescopes \$2.90. Send \$1 deposit balance C.O.D. United, 2309-PM Lawrence, Toledo, Ohio.

MAKE Telescopes, binoculars, lenses, prisms. New catalog lists lens grinding equipment, tools, abrasives, optical glass. Reflector kits, mountings. David Wolf, 334 Montgomery St., Brooklyn, N. Y.

FREE Instructions. Make powerful astronomical telescope. Trifling cost. Carl Jamer, Manorville, N. Y.

TELESCOPES 18 Inch 2-section 8-power precision ground polished lenses. Individually packed \$1.50. 36 inch 3-section 17 power precision ground polished lenses, including carrying case \$2.50 postpaid. Critterion Co., Dept. PM, 327 Trumbull St., Hartford, Conn.

REFLECTING Telescopes, complete. 3 1/2" diameter, equatorially mounted. View planets, stars. \$19.75. Write Sky-scope Company, 475-P 5th Ave., New York.

BUILD Your own reflecting telescope. Copy of instructions 10 cents. Catalogue free. Mayfloor, Katonah, N. Y.

PORRO Prisms 1 3/8" x 15/16" oval face. Manufactured by world-famous opticians for army and navy 8 x 50 binoculars. Rejected for slightly chipped edges. Outstanding bargain! 30c ea., 4 for \$1.00 postpaid. No c.o.d. Remit with order. Ross, 70 West Broadway, New York 7, N. Y.

BINOCULARS, Telescopes, watches. Buy, sell, trade. Paul Schweer, Donnellson, Iowa.

TELESCOPES, Microscopes, cameras, binoculars: bought, sold, repaired. Lists 10c. Specify instrument wanted. Rasmussen and Reece, 41 Market, Amsterdam, N. Y.

DOGS, PETS, BIRDS, RABBITS

SPORTSMEN: 200 Pointers, setters, straight cooners, combination hunters, rabbit and fox hounds. Reasonable. List free. Ramsey Creek Kennels, Ramsey 1, Illinois.

CAT Owners. Big illustrated monthly magazine, 5 months \$1; sample 25c. Cats Magazine, Room 701, 751 State, Utica, New York.

RAISE Angora rabbits for us. We buy every Angora you raise from our stock. Contract particulars free. Wilson Rabbit Farms, 1065 Shryer, St. Paul 8, Minn.

CHINCHILLA Breeding does. Willow Brook strain. Fifteen dollars each. R. Whittington, Ysleta, Texas.

RAISE Rabbits, guinea pigs. Big demand. Winfield Harrison, Fitzgerald, Ga.

RAISE Guinea pigs. Profitable, low-cost feeding, small space required, small investment. Complete details 25c. Guinea Pig Farms, 3456 West 116th St., Chicago 43.

SAMPLE Copy "Rabbit Profits" magazine, information regarding revolutionary new hutch plans and literature telling how to make most money from rabbits, 10c. Reliable Fur Industries, Dept. PM, Montebello, Calif.

ZOOLOGICAL And pet animals for sale. Illustrated catalogue, literature, 25c. Trails End Zoo-5, St. Stephen, S. C.

RAISE Moneymaking Angora rabbits. Wool \$14.50 pound. Plenty markets. Cash income. Future prospects bright. Particulars free. White's Rabbitry, Lawrence, Kansas.

ORIGINAL Chin-Chin giant Chinchilla rabbits. Gorgeous fur. Delicious meat. Most prolific. Easily raised anywhere. Free booklet shows amazing profits. Willow Farm, R15, Sellersville, Penna.

ANGORA Rabbits, giant chinchillas—finest pedigree. Valuable wool \$15.00 pound; gorgeous two-tone furs. Raised anywhere. Literature free. Grinsteads, Edwardsville, Illinois.

MONEY Raising rabbits. Investigate. Folder 10c. Close Rabbitry, Tiffin, Ohio.

CHINCHILLA Giants, real. Most profitable. Prolific, easily raised anywhere. Breeders supplied reasonable. Satisfaction guaranteed. Free literature. Large illustrated catalogue, 25c. Fur samples, 25c. Chin-Chin Farms, Melvin Behrens, Gen-Mgr., Dept. 4, 44 Chester Pike, Darby, Pa.

PIGEONS, Rabbits, 30 varieties. Catalogue 10c. Jim Houck, Tiffin, Ohio.

ST. BERNARD Pups: Champion sired beauties. Franklin Young, R4, Riverhead, Long Island, New York.

RAISE Guinea pigs. Make money at home. Big demand. Free booklet. Taylors Guinea Pig Farm, Hapeville, Georgia.

STANDARD Rabbit Journal, Milton, Pa. 3 years \$1.00, sample dime.

A LIVING With rabbits and cavies. Markets waiting. Magazine 10c. Book describing twenty breeds and magazine 25c. Book and magazine (monthly) one year 50c. Address Small Stock, Dept. 2, Pearl River, N. Y.

FARMS, FARM LAND, REAL ESTATE

HOMESITES \$450—Low terms. California's finest garden spot. On Morro Bay's wooded shores. Wonderful fishing, hunting, boating, etc. Fertile soil, soft water, temperate climate, congenial community. Free literature. Richard M. Otto, 6560 Hollywood Blvd., Hollywood 28, Calif.

OZARK Lands for all purposes. Actual river frontages, 5 acres \$90.00 and upwards. Free list and literature. Hubbard, 424-I, Minnesota Ave., Kansas City 4, Kansas.

MEN, Women! Live in the country—be your own boss—have your own business right at home! My "Have-More" plan shows you how! More than 150,000 copies sold. Price \$1.00, postpaid. Triple your money back if you want to return plan in ten days! That's how sure I am you'll like it! Mail \$1.00 now to Ed Robinson, Box 275, Noroton, Conn.

ILLINOIS, Missouri, Florida lands, cheap, easy terms. List. Williams Realty, Mt. Vernon, Illinois.

HERE'S A plan for your future! Write today for complete information on farming opportunities in Canada. Farms of all types, sizes... at low prices. Favorable terms. Be sure to indicate kind of farm and what province you are interested in. Address H. S. Cresswell, Canadian Pacific, Montreal.

WEST'S Summer catalogue: brand new, just off the press, 100 pages of farm and business bargains; free copy write West's Farm Agency, HE-1, Pittsburgh 16, Pa.

\$5.00 MONTHLY Buys 40 acres near town; price \$200.00; free list. Box 425-P, Carthage, Mo.

FARMS, Businesses, listed and sold. Particulars, lists free. Willson, Broker, Albia, Iowa.

OZARK Magazine, Eureka Springs, Arkansas. For homeseekers, sportsmen. Year, \$1.00.

OZARK Farms, resorts. Free list. Farm-finders, 111, Eureka Springs, Arkansas.

STROUT'S Green farm catalog—Over 1300 bargains—25 states—Maine to Florida, west to California, Oregon and Washington. Write today for this big book. Mailed free. Strout Realty, 255-P 4th Ave., New York 10, N. Y. 7 So. Dearborn St., Chicago 3, Ill. 453 So. Spring, Los Angeles 13, Calif.

FREE Catalog, farm bargains, 9 mid-west states. Many fully equipped for convenient quick start. Many pictures. Special service to help you locate quickly, if you state requirements, payment plan and general location desired in first letter. United Farm Agency, 1796-MP Arcade Bldg. 1, St. Louis, Mo.

OZARK Farm bargains, 5 to 5000 acres. Frank, Mountain View, Mo.

GOOD Farms—ranches. Washington, Minnesota, Montana, Idaho, Oregon, North Dakota. Dependable crops, favorable climate. Write for literature, lists describing typical postwar farm opportunities. Specify which state. J. W. Haw, 119 Northern Pacific Ry., St. Paul 1, Minn.

POULTRY AND FARM SUPPLIES

MEN, Women! Raise turkeys in spare-time—new way fits even a small backyard—make \$100.00 to \$300.00 a year! My "Have-More" plan starts you right—more than 150,000 copies sold! Price \$1.00 postpaid. Triple your money back if you want to return plan in ten days! That's how sure I am you'll like it. Mail \$1.00 now to Ed Robinson, Box 275, Noroton, Conn.

KNOW How to raise poultry for profit. Read Northeastern Poultryman. Every issue packed with helpful hints and practical suggestions. Latest articles on breeding, feeding, and management. Read nationally. Subscribe now. 1 year 65c; 2 years \$1.00. Northeastern Poultryman, Dept. M, 376 Boylston St., Boston 16, Mass.

RAISE Turkeys the new way. Write for free information explaining how to make up to \$3000.00 in your own backyard. Address National Turkey Institute, Dept. 3, Columbus, Kansas.

PROFITABLE OCCUPATIONS

MAKE Big money. Train horses, cattle, etc., using secret methods circuses employ. Make \$100 daily with trick horse, mule, or bull at fairs, rodeos, etc. Buy horses \$50 to \$150, sell them \$300 to \$1500. Information free. American Horse Training Institute, Dept. 10, Columbus, Kans.

MECHANICALLY Inclined men—Own and operate general appliance repair shop. Complete, illustrated course shows you how. Welding, refrigeration, motor repair, how to get business, etc., all phases covered. Free literature. Christy Supply, Dept. 466, 2335 N. Central Ave., Chicago.

BE A novelty manufacturer, fascinating, interesting work. Make large profits. No expensive equipment needed, easily learned. Use garage or basement, inexpensive materials. Successful manufacturer shows how at small cost. Orders waiting. Write today. Plastex Products, 127 Clement, San Francisco 18, Calif.

WELDING Pays. Learn with 1942 trade school text manual. 516 pages. Over 500 photos. \$2.00 copy. Money-back guarantee. Hobartweld, Box 763, Troy, Ohio.

MUSHROOMS Grown: boxes: barrels. Illustrated instructions 50c. Spawn \$1.00. Gordons, 553 William, Winnipeg, Man.

TADPOLES Make frogs, tremendous demand. Both make you money, 25c brings tell-how information. Chariton Corporation, Century Building, Chicago 4.

SELL Names—the real truth about selling names by mail. Russell's Service. Grant 820, PM, Laredo, Texas.

CHEMICAL Gardening. Illustrated instructions 50c. Chemical \$1.00. Gordon, 553 William, Winnipeg, Manitoba.

"12,000 ALASKAN Job And Business Opportunities." \$1 brings 1946 copyrighted booklet explaining how-when-where to apply for potential job opportunities in the construction, fishing, and aviation fields. Included are tips on excellent business opportunities and government home-stead land at 25c per acre to approved applicants. Transcontinental Research, Box 2147-PM, Hollywood 28, Calif.

INTERESTED In Latin American and foreign employment? \$1 brings 1946 copyrighted "Foreign Trade Research Report" listing 300 American firms with foreign interests, and explaining how-when-where to apply. L. J. Enterprises, Box 2549-PM, Hollywood 28, California.

TYPISTS, Profitable business at home. Complete information, 50c. Gaunt, 3521-C Broadway, Chicago, Ill.

LEATHERCRAFT Supplies. Catalog 10c. Art Craft Supply Company, 1205 Throckmorton, Fort Worth 2, Texas.

WHAT Could be more fun than opening letters containing money? Find out how by writing Quivira Mail Service, 207-D North Pioneer, Lyons, Kansas.

WOULD You pay 3%—first \$350 made? Color-illustrated book "505 Odd, Successful Enterprises" free! Some offer occasional "day off". Start at home, office. Expect something odd! Pacific, 262 Drake, New Rochelle, N. Y.

YOUR Refrigerator will bring you dollars. Manage simple business at home. Full instructions, 25c. White's, Box 45-A, Cambridge, Massachusetts.

PAINT Plaster plaques: statuary. Sell locally. Beautiful, clear detail. Strong, hard castings. Guaranteed quality. Fascinating! Popular! Profitable! List free. Samples \$3.00. Artists' brushes, paints, instruction books available. Pioneer, 394A7, Austin, Minnesota.

ELECTRIC Clocks are every where you go, buildings, homes, parking lots, factories. Repairs increasing. Our easy to learn course with pictures and drawings teach you how to repair these clocks. Electronic Supply Co., P.O. Box 2350A, Houston 12, Texas.

SHELL Jewelry supplies. Wholesale only. McFarland Plastic Co., Sarasota, Fla.

GOLD-STAMPING Is fascinating and profitable. Free booklet. Home City Specialties, Dept. PM1273, Springfield, Mass.

STORY Writing simplified! Don't dream—try! Fascinating, complete home study. Handsome earnings. Circular free. New Simple Segment System, Postoffice Box 834, Spokane, Wash.

TYPEWRITER Repairmen urgently needed. Earn \$40 to \$50 weekly spare time. Our easy to learn home study course teaches how to repair typewriters. Write for free information. Houston Typewriter Repair Service, P.O. Box 5357A, Houston 12, Texas.

GUARANTEED Investment. Immediate profits. Free details how, twenty dollars start. Agud Company, P.O. Box 861, Seattle 11, Washington.

YOU Too can make beautiful mirrors from inexpensive window glass. Formula with complete working details for dollar bill. Tesco, P.O. Box 189, Wilkes-Barre, Penna.

MAKE Beautiful costume jewelry at home for large profits, hobby or therapy. Free illustrated wholesale catalogue of sea shell, metal and plastic parts contains detailed instructions. Florida Supply House, Bradenton, Florida.

EXCELLENT Profits raising mink. Choice breeding stock available. Details furnished. Franklin Young, Riverhead, New York.

ANNOUNCING Home study course in commercial baking. Practical basic training. Good field for those with aptitude. Nearly depression proof. Send for free booklet, "Opportunities in the Baking Industry." National Baking School, 1315 Michigan Ave., Dept. 3432, Chicago 5, Ill.

LOCKSMITHING—Profitable business or hobby! New course teaches you how to pick locks, fit keys, de-code, masterkey, etc. Easy self-instruction lessons. Bargain price. Fascinating 100-page illustrated catalog free! Write—Nelson Company, Dept. 2-02, Chicago 5.

PAINTING Flagpoles often pays \$50.00 daily. Particulars free. The Skyline Co., P.O. Box 1601 B, Uniontown, Penna.

\$40.00 **WEEKLY** Made growing mushrooms, fresh, dried. Dominion patent 331583. Free spawn. North American, 169P Yonge, Toronto, Canada.

TYPEWRITER Repairing — Original course, simplified home study. Weber Typewriter Mechanics School, Box 269, Osborn, Ohio.

BOOKS, PERIODICALS, PICTURES, POSTCARDS

PACIFIC Veterans! Now hear this! 20 glossy, sharp photos, size 4x5, of Philippine campaign and ruined Tokyo scenes. Descriptions included. See Manila burning, shelling, looting, Lingayen sky battle; Kamikaze attack; Americans surrender at Corregidor (Jap photo); 2 photos of Tokyo Rose apprehended. Other perfect shots. Send quarter for 2 samples. Price 20 photos \$2.00. Money back guarantee. Al Rosen Studio, Chester, Penna.

ALASKA! Learn about this great land of opportunity! Send 25c for copy pictorial magazine with true stories of life on the last frontier. The Alaska Sportsman, PM 118, Ketchikan, Alaska.

TRADE Magazines. Current single copies. Choose from 747 publications—all fields. Free price-list. Commercial Engraving Publishing Company, 34C North Ritter, Indianapolis 1, Indiana.

OPERATE Magazine subscription agency: wholesale catalog, complete supplies, 25c. Cassell Publishers Service, Westfield, New Jersey.

WHAT Every Mason wants. We have Masonic books for Blue Lodge, Chapter, Commandery, Scottish Rite and Shrine. Our rituals are used the world over. Send for free catalog of books and rituals for Masons, Odd Fellows, Knights of Columbus, etc. Ezra A. Cook, Publisher, P.O. Box 796-PJ, Chicago 90, Ill.

"100,000 **POST-WAR** Jobs Abroad"—South America, China, India, Burma, Japan, Russia, Malaya. How when and where to apply. U. S. participation in world reconstruction and trade demands thousands of American-trained mechanics, salesmen, technicians, engineers, foremen, laborers and business representatives—every trade needed. Our 15,000-word copyrighted report—compiled from business, professional and government sources—lists over 200 big U. S. firms with foreign interests, gives job information, salary brackets, contract tips, application letters, passport information, climatic conditions, etc.—everything needed for your immediate application. \$1.00. Return for refund in 7 days if not satisfied. Pacific Industrial Research Bureau, 907-E Terminal Sales Building, Portland 5, Oregon.

INSIDE Mexico, the magazine of Mexican news, brings—valuable information for businessmen, particulars. Year 12 issues \$1.00. Apdo. (P.O. Box) 1791, Mexico City.

INTERESTING, Informative books. Various subjects; instruction, formulas, self-improvement. Write for free literature. Walter Gillen, 33 18th Ave., Paterson 3, New Jersey.

TRULY Amazing book reveals new way to become successful! Contains astonishing information. Satisfaction guaranteed. Send \$1.00. Redmont Company, P.O. Box 9264, Los Angeles 5, California.

INDIA—Strange, unusual photos. Snake charmers, burning ghats, fakirs, etc. Set of 12—\$1.00. India Pic Photo Co., 1362 Ratliff St., Richmond, Indiana.

BOOKFINDERS! (Scarce, out-of-print, unusual books) quickly supplied. Send wants. Clifton, Box 1377-PM, Beverly Hills, Calif.

"30,000 **JOB** And Business Opportunities in Alaska"—Based on two years' Alaskan experience, this 15,000-word copyrighted report gives latest facts on fur farming, mining, agriculture, lumbering, transportation, commercial fishing, construction, business opportunities. Special section on climate, homesteading, mineral resources, rights, etc. Private firms and government projects listed—tells how, when, where to apply. \$1.00. Return for refund in 7 days if not satisfied. Pacific Industrial Research Bureau, Dept. 2D, 907 Terminal Sales Building, Portland 5, Oregon.

HALL-MARKED Oil color prints. Your choice scenic negatives. Write for prices and mailing instructions. Scenic Oilcraft, 11319 Iowa Ave., Los Angeles 25, Calif.

SQUARE Dance calls, instructions, illustrated. \$1.00. Guide, Eureka Springs, Arkansas.

BIBLE Says, "Swords into Plowshares." When? Free booklet explains. Ketchum, 1848 S. 18th, Springfield, Illinois.

BOOKS. Know yourself, be successful. Box 254M, San Francisco, Calif.

READ Character! Everyone! Types for over 100 occupations! Educational! Only \$1.00. Louis Lant, 56 Teneyck Ave., Albany 2, New York.

ATOM Bombed Nagasaki Japan. 5 authentic photographs. 25c. Makins Pictures, 538 1/2 Washington, Bremerton, Wash.

USED Correspondence courses, books, bought and sold. Free literature! Spotlight, 141 Broadway, New York.

10 **INDIVIDUAL** Stars photos \$1.00. Stan Cutter, 4974 Melrose, Hollywood 27, California.

VISIT Historic Philadelphia by mail. 3 postcard views 20c. Address, return, I remail. Letters 25c each. Fredric, 3312 Germantown Ave., Phila. 40, Penna.

FIGUROLOGY. Vest pocket mathematical short-cuts 25c. Figurology, Box 222, Chicago 90.

BOOKWORMS—Send for my bargain list of used books—all subjects. Fox's, Second and Walnut, Lexington 34, Ky.

WORLD War II history. Amazing book. Over 1,100 pages, 200 pictures. Illustrated circular free. Flegel, 726 First Ave. N., Great Falls, Mont.

JOIN New technical book club—free! Members receive current literature, guidance on all book problems, premiums. No obligation. All technical, scientific, home-craft, farming, sports, etc. Specify subject for free information. Modern Technical Book Co., Dept. M2MC, 55 West 42nd St., New York 18.

ATOMIC Age shorthand. Learn in 5 lessons, 10c each. Elliott School, 4426 Carrollton 19, New Orleans.

MAGAZINES (Back dated)—foreign, domestic, arts. Books, booklets, subscriptions, etc. Catalog 10c (refunded). Cicero's, 863 First Ave., New York 17, N. Y.

BOOKS You'll prize! Catalog free. Carleton, Box 643-E, Ann Arbor, Michigan.

MAGAZINE Export Sales Company, 2084 First Avenue, New York 29, N. Y. U. S. A. Over-issue popular American magazines and pocket-size novels. Comics, fashions, pictorials, romances, screens, pulps, many others. Export only.

GOOD "Used" self-instruction educational books on all subjects bought, sold, rented, exchanged. Satisfaction guaranteed. Complete information and 100-page illustrated bargain catalog free! Write—Nelson Company, Chicago 5.

SELF-EXPLAINING Bible: Illustrated circular free. Box 446-P, Minneapolis, Minn.

NATIONAL Geographic Magazines, 1888-1945, any issue. Periodical Service, Dept. PM, Swarthmore, Penna.

BOOKS. (Out-of-print, new, used) quickly supplied. Many 35c bargains. Catalogue. Mid-West Book Service, 18870 Marx Ave., Detroit 3, Mich.

BIG Profits taking subscriptions for all magazines. Agents' confidential catalog listing over 2500 periodicals and complete starting supplies free. Pines Subscription Agency, Flushing, New York.

BEAUTIFUL Photos, South America, Panama Canal, Hawaii, including Wakiki, world's most beautiful beach. Ten \$1. Jerome Jones, 2830 North Eleventh Street, Philadelphia, Penna.

GAMES AND ENTERTAINMENT

JUST Out, a new game of skill. An ideal gift for your returned service man. \$2.15 postpaid or send post card for illustrated booklet and complete description. Hix Novelty Works, 1568 East 22nd Street, Los Angeles 11, Calif.

"84 **CARD** Tricks," 25c! Free "Money-making Opportunities!" Hirsch, Spring Valley 2, N. Y.

FASCINATING New card game. Free. P.O. Box 842, Denver 1, Colo.

MAGIC TRICKS, PUZZLES, JOKER NOVELTIES

PRECISION Wooden puzzles that defy efforts to take apart. Three for \$1.00. Blake Industries, 2355 Guardian Building, Detroit 26.

MAGNETIC Tricky dogs. Amusing, unusual, instructive, mounted on strong Alnico magnets. \$1.00—four pair. Gross \$21.60. Auerbach, 14 East 34, New York City.

FASCINATING Woodcraft puzzle 25c. Homecraft Projects, Lovers Lane, Gainesville, Texas.

VENTRILOQUIST'S 8 Lesson course \$1. Gotberg, 4207 Grandriver, Detroit 8, Mich.

EIGHT Different magic books, \$1.00. Monarch, 38 Jefferson, Auburn, New York.

ELECTRIC Fun! 200 stunts, 110 volts, \$1. Kutting, Campbell, Calif.

ESCAPE Handcuffs, trunk, vault, rope, etc. Instructions 50c. Illington's, 418 W. 64th, Los Angeles 3.

BECOME Ventriloquist. Throw your voice. Eight lessons, three monologues, \$3. Bowen, 5500 Morelo Road, Baltimore 14, Maryland.

DOLLAR Magic set free with gigantic catalog 25c. Mysto, 4462 Germantown, Philadelphia.

FA-KO Deck, \$1.00. Professional catalog, 10c. Williams, 900 Plymouth, Ellwood City, Penna.

MAGICAL Catalog, over 300 wonders of pocket, parlor, club and stage tricks, sensations, mental acts, escapes for amusement, entertainment or profit. Big illustrated catalog 25c refunded first order. "The Magician," 2463-M, Kensington Ave., Phila. 25, Penna.

MAGIC: Complete act for sale. For details write Delbert Eubank, 1816 19, Lubbock, Texas.

SPIRIT Effects, mind reading and hand-cuff escapes. Descriptive literature for stamp. Frank Wilbur, 1048 Dickens, Chicago 14.

PICTURE Puzzle, 10c. L. A. Jessen, 3260 Maypole Ave., Chicago 24, Illinois.

MYSTIFYING—Age and money trick, 25c. Mathmagic, Box 222, Chicago 90.

MAGIC Tricks, books, jokes, novelties. Rex Magic Shop, 741 Poydras St., New Orleans 12, La. Free catalog.

NEW Vanishing key and catalog 25c. Sterling Magic, Box 191, Royal Oak, Mich.

THAYERS! Quality magic since 1907. Send 25c for current catalog. Free lists. Secrets Twelve Illusionettes \$1.00. Sample Genii magic magazine 30c. Thayer Mfg. Co., 812 South LaBrea Ave., Los Angeles 36, Calif.

500 TRICKS You can do! Douglas' famous catalog of 500 tricks, now only 10c. America's fastest service on magic for pocket, parlor, stage, professional, amateur. Douglas Magic Shop, Box 274, Dallas, Texas.

FLOATING Cigarette—cigarette floats in midair—with instructions—ten cents. J. Eastwood, Box 623, Parkersburg, W. Va.

VENTRILQUISM Complete instruction only \$1. LeSueur, 77 Wellesley, Toronto, Canada.

FREE! Large catalog of magical apparatus if you remit 25c for "Magic Is Fun" magazine. Robbins Co., 152-F West 42nd Street, New York.

AMAZE And mystify your friends with highest quality magic. New catalogue 25c coin. Mazda Magic Co., Mt. Sterling, Ky.

ENTERTAIN! Mystify! New, bigger magic catalog and 4 secret tricks 25c. Herbert, P-192 N. Clark, Chicago 1.

WORLD'S Largest professional magic shop keeps you in touch with latest tricks. To receive mailings send 25c for new catalog. Holden, 220M W. 42nd St., New York.

MAGIC: Big 160 page illustrated Catalog Latest Magic Goods, 25c. For over 1/3 century we have supplied Professional as well as Beginner. Chicago Magic Co., 2300 N. Mason, Chicago 39.

EARN Money in any crowd. Call names of strangers, tell unspoken questions. Professional course mind reading, faked spiritualism, etc., \$1. Henderson, Box 341, San Bernardino, Calif.

LEARN Ventriloquism, 3c stamp brings particulars. Smith, 801 Bigelow, Peoria, Ill.

BE A magician. Large professional magic catalogue of latest tricks 25c. Ireland, C-109 North Dearborn, Chicago 2.

MAGIC Tricks, puzzles, books, cards, punch boards. Catalog 10c. Specialty, Box 671, St. Louis 1, Mo.

COINS, TOKENS, CURRENCY

FOREIGN Coins, paper money. World-wide selection ten different odd unusual 30c postpaid. R. A. Webb, Box 843, San Bruno, Calif.

WILL Pay \$10.00 each for certain Lincoln pennies! Indianheads \$50.00; dimes \$1,000.00. Catalogue 10c. Federal Coin Exchange, 7-PM, Columbus, Ohio.

OLD Money wanted. Will pay fifty dollars for nickel of 1913 with Liberty head (no buffalo). We pay cash premiums for all rare coins. Send 4c for large coin folder. May mean much profit to you. Numismatic Co., Dept. 20, Fort Worth, Texas.

20 DIFFERENT Foreign coins, 10 different foreign notes. All \$1.00. Tapp, Greer, S. C.

THIRTY Different coins and bills \$1.00. Oddehon, Box 482, St. Louis, Mo.

\$2.00 TO \$500 Each paid for hundreds of old-odd coins. Indian, Lincoln cents, foreign etc. wanted. Keep all until posted. Send 10c for illustrated coin book, 4x6. Coin Establishment, (40 years in business), Le Roy, N. Y.

FREE! Dutch East Indies invasion bill free with order for mammoth assortment of Japanese Philippine invasion currency. Over \$1,000.00 face value guaranteed. Price \$1. Stewart Byers, Box 187, Rayville, La.

WILL Pay twice the value for gold coins. Private collector wants U. S. gold coins in good condition. Write complete description. Willing to pay good price. B. Chadkin, 39-P West 60th St., New York City.

FREE! Coin collectors send for our monthly lists. DuBose, Box 993, Atlanta 1, Georgia.

INDIAN Head penny with list 10c. Charles Banker, Salina, Kansas.

GENUINE Ancient Roman silver coin, before Christ, fine, \$1.65. Tapp, Greer, South Carolina.

WORLD Coins—List free. Harry Elsholz, Box 9014, Pittsburgh 24, Penna.

CIRCULATED And uncirculated, U. S. and foreign coins. Write for price on dates and condition wanted. Special on Indian cents, 10—1900 to 1909, G. to F. \$1.00. 20—1890 to 1909, G. to F. \$2.75. 30—1880 to 1909, G. to F. \$5.25. 10c extra for postage and insurance under \$5.00. Elmer B. Ray, 825 W. North, Lima, Ohio. A. N. A. 10264.

SENSATIONAL Offer! Japanese-Philippine invasion currency; varied assortment 25 for \$1. Peter Winfield, 2516 Georgetown, Toledo, Ohio.

WE Purchase Indianhead pennies. Complete coin catalogue 10c. Fairview, 277 Broadway, New York.

COMMEMORATIVE 1/2, Oregon, Texas, Kentucky, Cleveland, Long Island, \$2.00 ea. Illustrated catalogue 25c. Norman Shultz, Salt Lake 9, Utah.

QUICK Service; reasonable prices. United States catalog 10c. Foreign catalog 10c. Ben's Coin Company, 72 West Washington, Chicago 2, Illinois.

FREE! Foreign coin, banknote and coin collectors illustrated catalog to approval service applicants. Send 3c postage. Tatham Coinco, Springfield-125, Mass.

GET Profit and pleasure in collecting old coins. Send 10c for 56-page illustrated coin catalog. You'll be delighted with it. Send for it now. B. Max Mehl, 370 Mehl Building, Fort Worth, Texas. Largest rare coin establishment in U. S. Established 46 years.

STAMP COLLECTING

FREE—Liberia Triangle, Hitler stamps, half-stamp triangle, Devil's Island, others. Approvals. Postage 3c. Pilgrim Co., 6406 Old Hartford, Baltimore 14, Md.

POSITIVELY Greatest free offer—Latest Scott's International \$5.00 stamp album—covering entire world, contains 36,000 illustrated, descriptive spaces; Scott's 1946 Standard \$5.00 catalogues "Philately's Encyclopedia" — absolutely free to applicants for foreign approvals becoming customers. Bargain Stamp Service, Palm Springs 1, California.

STAMPS From 40 countries including Mozambique, 10c. 25 Egypt, 20c. 25 Russia, 20c. No approvals. Elsea, Bowling Green, Ohio.

WORLD-WIDE Packet—Includes S. Africa, Colombia Midgets; Cocos Island; Guatemala Bi-Sect; Bavaria; Persia; Palestine; George VI set; commemoratives; pictorials; etc. 6c approval applicants. Norman Baker Stamps, Farmington, Mich.

SPECIAL Offer—10 different guaranteed to catalogue 10 to 25 cents each—15c. Clayton Doll, 85 Audubon Avenue, New York 32, New York.

THE Bargain of your life includes Ascension, Basutoland, Cyprus, Nyassaland, Tangier and 25 different other countries—10c to approval applicants only. Excello Stamps, P.O. Box #95, Hackensack, N. J.

HOT Tips. Valuable information. Penny postal brings free bi-weekly bulletin. Tells what to buy. New issues etc. Deluxe Stamp Company, Box 997, Minneapolis, Minn.

BARGAIN—1,000 Mixed United States only 50c! Plenty commemoratives, airmails. Free—Hitler banknote with order. Grant Hastie, 1520 Dale, San Diego, California.

50 DIFFERENT Inexpensive short and complete sets, singles, to approval applicants, references. Bengston, 3439 South Michigan Ave., Chicago, Illinois.

WHAT Have you to offer? A collection? A "shoe box" accumulation? Anything in stamps. We urgently need them. Spot cash paid. Cosmopolitan Stamp Co., 1457 Broadway, Dept. 7-E, New York.

GORGEOUS Colors, scarce airmail, surcharges, charities, sets, etc. All in our big premium packet only 3c to approval buyers. Dixie Stamp Company, Dept. M, Milwaukee 3, Wisconsin.

SEND Name and address for price lists issued every two weeks. Singles, sets, new and old issues. Also approvals. Walter Kotowski, 5864 St. Aubin, Detroit 11, Mich.

1000 ASST. U. S. And foreign pictorial, commemoratives, air-mails from many countries \$1.00. 1000 asst. foreign \$1.00. 1000 asst. U. S. with regular and commemoratives issues \$1.00. \$10.00 cat. foreign commemoratives \$1.00. Nu-Dell Stamp Co., 4339 Irving Park Rd., Chicago 41, Ill.

NICE Clean U. S. approvals, numbered and classified; mounted with peelable hinges; postpaid both ways. Jess T. Green, Bonita Ave., Route 2, Box 111, Mountain View, California.

DOLLAR'S Worth for a dime! 50 stamps from 50 countries cataloguing dollar or more—to approval applicants sending ten cents. Wm. Thiem, Cape Vincent, N. Y.

ADEN To Zanzibar! 40 different British Empire, including Cyprus, Malta, Dominica; 5c with approvals. Lyman Company, 95 Nassau Street, New York City 7.

TRADERS—Trade your duplicates for stamps from our approval books. Postcard brings full information. Comet, GPO Box 517P, Brooklyn, N. Y.

FREE—Iceland codfish comm. set to approval applicants. West Stamp Co., Box 154, La Mesa, Calif.

ARMY Navy set 10c. Foreign—U. S. approvals. Yokum, Box 1327, San Antonio 6, Texas.

AGENTS Wanted, sell stamps, no investment. William Waugh, 2140 N St., N. W., Washington 7, D. C.

"NUDE Duchess" set complete 25c. Approvals. Royal Stamp Company, Tamaqua, Penna.

FREE Packet all different, no approvals. Karr Ross, DeRidder, Louisiana.

BRAZIL Diamond shaped set 10c, with approvals. Vargo Stamps, 6044 South Fairfield, Chicago 29, Illinois.

100 DIFFERENT 5c To approval applicants. Quality Stamp Company, Department M, Box 202, Sta. F, Buffalo 12, N. Y.

1000 MIXED U. S. old and new 25c. Weatherby, Medina, Ohio.

FREE Argentine "Roosevelt issue". Request approvals. Blatt's, 1015 Pine St., Phila. 7, Penna.

STAMP Magazine—full year 25c. P.O. Box 1151, Worcester, Mass.

SAAR GEBIET Packet. Send 50c coins. TK Stamps, 1156 8th St., Manhattan Beach, California.

12 ISSUES Clifford's Stamp Bulletin, 10c. Clifford, 581 W. 161 St., New York 32.

FREE! Airmail packet with approvals. Deane Stamp Co., Box 1002, Miami Beach 39, Florida.

GUATEMALA 75 Different one dollar, 10 India free. Murray, 438 Melbourne, Mamaroneck, N. Y.

50 DIFFERENT United States 10c to approval applicants. Standard, 3817 Sackett, Cleveland 9, Ohio.

OUTSTANDING Packet containing many unusual items. 3c to approval applicants. Longhorn Stamp Company, 2021M Red River, Austin, Texas.

UNITED States approvals. Fine quality. Klein, Box 22, Robinson, Illinois.

FOREIGN Grabbags, 50c, \$1.00, \$1.50. Slotin, 328 Bannerman, Winnipeg, Man.

FREE Stamps, catalog to approval applicants. Long Beach Stamp Co., Box 555, Long Beach, New York.

U. S. PACKETS, 50 Diff. 25c, 100 diff. 45c, 125 diff. 85c, 200 diff. \$1.50. Mendelsohn Stamp Co., 5713 Euclid Ave., Cleveland 3, Ohio.

FLAG Stamp free with U. S. approvals. Wenigman, 929 Oakdale, Chicago.

UNSORTED Treasure packet, catalog value over \$1.00, 3c with approvals. Beaver Stamps, Medway, Mass.

15 DIFFERENT Airmails with approvals 10c. Robert Ewing, Wapakoneta, Ohio.

AMERICAN Used commemoratives and inexpensive foreign stamps sent on approval by paralyzed shut-in. Rose Krenz, 823 So. Covell, Sioux Falls, South Dakota.

CHARKHARI—India: Beautiful temple issue. Complete set, 10c with approvals. Walbeth, R.D. #2, Troy, N. Y.

FREE 100 Different, approvals. Kloster, 3883-47th St., San Diego 5, California.

FREE! 3 Different Hitler heads to approval applicants. Riverside Stamp Co., Box 1565, Miami 35, Florida.

MEXICAN Airmail packet, 5 cents to approval applicants. Bierhorst, 1659 N. Dupre St., New Orleans 19, La.

1000 U. S. Mission mixture 25c. Monjar, 1750 Fairmount, Cincinnati, Ohio.

WORLD Album 10c. Fine approvals. Kress, Box 144, Hanover, Penna.

CAPE Juby set 15c with approval to applicants. Sweeper, 141 A West St., Newark 3, New Jersey.

CHOICE United States approvals. Wallace Mageau, 1104-4 Ave., Virginia, Minn.

ST. LUCIA, Ceylon, South Seas, Levant, Caucasus, all 3c with approvals. Hall, 610 Brackenridge, Corpus Christi, Texas.

25 JAPANESE Stamps 5c with approvals. Frank, 177 Elmcraft, Rochester 9, N. Y.

60,000 VARIETIES Low priced approvals. Discounts. Scott, 30 Baker Ave., Lexington, Mass. 6.

3,000: 50 COUNTRIES \$2: Approvals: Griest, 409 Oak, Davenport, Iowa.

FREE! Bechuanaland! Iran! Tobago! Assortment. Approvals. Stampco, Miami Springs, Florida.

FREE! A gift that will make the most interesting item in your collection! No matter if your collection is worth \$10,000, you will devote a full page of your album to it! Approvals included. Postage appreciated. George Wentz, San Marcos 4, Texas.

5 TRIANGLES Free! Approvals. Gordon Davison, Box 1019B, Manchester, N. H.

JUST A postcard—your name and address will bring you a pleasant surprise. Stamp World, 536 S. 30, Omaha 5, Nebr.

MINT George VI eight crown colony pictorials including bi-colors 10c to serious approval applicants. Mutual Stamp Service, 5145P Village Green, Los Angeles 16, California.

BIG Premium, packet free to approval applicants. 3c postage. Oedamer's, 1738 Arlington, Corpus Christi, Texas.

75 U. S. Airmails, commemoratives 25c. Corryville Exchange, 119 St. Clair, Cincinnati, Ohio.

HOT Dogs! 21 different super stamps 10c with approvals. Carlson, 312½ Riverdale, Glendale 4, Calif.

EXCHANGE Your duplicates. Send 50 and 20c, receive 100-150 different, catalog value \$3.00. Hobbyland, Box 435, Nashua, New Hampshire.

FREE Mint Philippine first foreign trade week issue sent, with approvals. 20th Century, P. O. Box 3413, Phila. 22, Penna.

NETHERLANDS Admirals complete. 17 mint beauties \$1.40. List. Vic and Ethan's Stamp Company, R.F.D. 6, Jackson, Mich.

5 BEAUTIFUL Sets 10c with personalized approval selections. Hintz, R-1, West DePere, Wis.

400 BRITISH Empire mixture 25c. U. S. foreign approvals. Box 448, Anoka, Minn.

APPROVALS. Scarce foreigners 5c—\$2.50 each. Bargains. References. Coelho, Spivak, Colorado.

ELEVEN Beautiful Maoriland peace mint set, \$1.00. Ditto first-day official covers \$2.00. Nine, Cook Islands, Samoa, F/D covers, superbly cancelled, \$2.00. Singles, 80c. Scarce! Charity healths. "Princesses" 1944 mint set, 30c. 1945 "Peter Pan" 25c. Mint. Page, Tokomaru Bay, E. C., New Zealand.

"STAMP Post"—Chock-full news, bargain ads! 15 issues 25c. Station A, Pasadena, Calif.

175 U. S. Commemorative, etc. 10c. 500—25c. P.O. Box 457, Newark 1, N. J.

CHINA. Every stamp with a historical meaning. Twenty of these colorful stamps offered approval applicants for 10c. Col-lins', 71 Coleridge, San Francisco 10, Calif.

TURKS, Caicos, Grenada, Solomon Islands, Dominica, Caymans; everything 3c with approvals. Viking, 130(Z) Clinton St., Brooklyn, N. Y.

RUSSIAN "Grinning Bear" stamps for conquered Berlin. 4 different 5c. Approvals. Fields, Box 36, Brookhill 22, Va.

U. S. Price list. Send postage. State Stamp Service, 1225 Park Building, Pittsburgh 22, Penna.

NEW Zealand. 50 scarce varieties including rare mints, \$1. W. L. Lovell, Tauri-piri, New Zealand.

FREE Beautiful new issues, Greece, France, airmails. Triangle to approval applicants. Green & Company, Norwood 12, Ohio.

U. S. COLLECTION—Thirty different fine unused commemoratives before 1939 including Columbians, bicentennials, parks price \$1.00 approval applicants only. Fort Orange Stamps, Albany 7, New York.

FIVE Vatican City stamps free to approval applicants. Florida Stamp Company, Box 307, Miami 5, Florida.

25 DIFFERENT Swiss 10c—with ¼, ½, 1c approvals. Carroll's, 4357A S. Hoover, Los Angeles 37, Calif.

FREE! 25 Different British Colonies with approvals. Stamphouse, 7235-A Sheridan, Chicago 26.

175 U. S. Commemoratives, airmails, etc., 25c. Lloyd Johnson, Hawarden, Iowa.

5,713 DIFFERENT Stamps from 147 countries—many pictorials, commemoratives, and airmails—only one cent each on our collection building penny approvals. Pima Stamp Company, Sells, Arizona.

OLD Scarce U. S. seconds on approval. Slightly defective, nice appearance, bargain prices. Hernfield, 551 Clinton, Newark 8, N. J.

EXCHANGE Duplicates. Swappers everywhere. List 10c. Particulars free. Box 2166-M, Denver 1, Colorado.

ONE, Two, four, five dollar U. S. stamps free to approval applicants. United Stamp Service, Box 1789-M, Miami 10, Florida.

FREE St. Helena pictorial and big surprise packet to approval applicants. Pioneer, Box 414A, Pasadena 18, Calif.

ZANZIBAR, Palestine, Manchukuo, Azerbaijan, Haiti, Iraq, Siam, Victoria, Hitler stamp 5c. Approvals. Postzegel, Windham, New York.

125 DIFFERENT U. S. Stamps, 30c. Frank Stroskey, Box 55, Perth Amboy, New Jersey.

U. S. Price list. Send postage. Stanley Gibbons, 38-P Park Row, New York.

APPROVAL Sheets, Frederick B. Driver, 909 Finance Building, Philadelphia 2, Pa.

PENNY Approvals, that satisfy. Neil Gronberg, Box 5441-P, Philadelphia 43, Penna.

MINT Pictorials free to approval applicants. Surf Stamp Co., Box 2296, Miami Beach 40, Florida.

UNITED Nations, scarce 5c U. S. commemorative and packet 30 different U. S., including airmail, commemoratives, revenues, etc. Catalogs 65c—to approval applicants for 5c. Curhan Stamp Company, Dept. H, Gloucester, Mass.

ZOWIE-E! A barrel of fun for only a dime. 500 United States stamps—absolutely unpicked and unsorted—just as received from church missions. Many varieties, including large commemoratives, airmails, high denominations up to \$5.00! Stamp-dom's biggest package of fun—and you might find something really valuable! Price only 10c to serious approval service applicants. Money back if not delighted. Illustrated bargain lists with each order. Mystic Stamp Company, Dept. 80, Camden, New York.

50 DIFFERENT United States, 10c. Price-list free. Seidenberg, Cassopolis, Mich.

CANADA—75c Diff. 25c. Approvals, Lists. Victoria Stamp Co., London 4, Canada.

FINE Approvals, freshly mounted. Fast, personal service. Tell me what countries you prefer and I'll send them stamps. Skinner, 438 Locust, Long Beach 2, Calif.

RICH Man's approvals, poor man's prices. Grand value packet containing five foreign sets, free with approvals. Stoll Stamp Service, 2630B West Burnett, Louisville 10, Kentucky.

FREE! Negro Triangle; Turks Islands "Cactus"; Dakar; Guinea; Palestine; "Fairy Tale." Pirate Chart, Map, Ship, Sea Lion and Snake stamps; French, British, Portugese Colonies, etc. Free for 3c postage. Approvals. Potomac Stamps, Washington 10, D. C.

WOW! \$10.00 Worth of fun only 10c. What a treasure hunt! Big package 500 foreign stamps—just as received from foreign missions other sources. Includes stamps from Africa, South America, Philippines, Free French, Cape Juby, Palestine, etc., including airmails, commemoratives, and stamps worth up to 50c and 75c. This amazing offer is given for 10c to serious approval applicants only. One to a customer, money back if not more than delighted. Jamestown Stamp Co., Dept. 22, Jamestown, New York. Stamps—valued up to 50c and 75c each.

UNITED States approvals complete coverage, fine quality, attractive prices. Seminole Stamps, Box 378, Coconut Grove, Florida.

FREE! Leeward Is., Cayman Is., Turks and Caicos plus 54 different mint World's Fair poster stamps, to approval service applicants sending 3c postage. Tatham Stamp Co., Springfield 30, Mass.

25 DIFFERENT India, 3c with approvals. Premiums with purchases. Brandwein Stamp Company, Box 92H, Bayonne, N. J.

EXOTIC Pictorial collection, including Tahiti Spear Fishing, Melanesian Idol, Carib Archer, Malagasian Farmer and many other scarce stamps from strange countries. Everything only 5c. Imperial Stamp Co., Yonkers, N. Y.

50 DIFFERENT Including scarce diamond-shaped airmail 3c to approval service applicants. Avalon Stamp Co., Dept. M, Springfield 8, Mass.

19th CENTURY U. S. Commem., Civil War—Battleship revenues, \$5 and \$10 stamps free to U. S. approval applicants. Metropolitan Stamps, 198C Broadway, New York.

DANDY United States approvals. Write immediately. Sullivan, Endicott Building, St. Paul 1, Minn.

1000 GRABAGS 15c Each. Super bags 25c. Zandy, 630 Bingham, Reading, Pa.

BOX Stamps containing hundreds all different, cataloging up to 25c each. Everything \$1.00. Longacre Shop, 108 West 42nd, New York City.

SCARCE "Pole to Pole" packet! Stamps from strange, mysterious countries only—Greenland (North Pole), Solomons, Spanish Morocco, Bhopal, Patiala, Siberia, Grahamsland (South Pole), Djibouti, Zanzibar, etc., and including stamps cataloging up to 25c each! Our price only 5c to approval applicants. Big dime packet list free! Methuen Stamp Service, Inc., Dept. 136, Lawrence, Mass.

FREE U. S. price list. Postage 3c. Mark Hanna, 335 - 5th Avenue, Pittsburgh 23, Penna.

COMPLETE "United States" catalog with 1000 illustrations! Send 10c for mailing. Harris & Co., 137 Transit Building, Boston, Mass.

FREE—Pick 25c worth of stamps from our first U. S. approval selection. Approximately 100 stamps to choose from. Excellent value. No obligation to buy. Lists illustrating the most popular U. S. stamps—at prices you can afford—will be included. Don't miss this opportunity! Write today. S. C. Engel Co., 38 Park Row, New York City.

AMAZING Offer! Assortment each of giant stamps, midget stamps, flag stamps, airmail stamps, Free French Colonies, U. S. commemoratives and numerous others. Everything only 10c to approval applicants. Simon, Box 214, Iraan, Texas.

SCARCE 1880 U. S.—Hussey local carrier stamp listed at 15c. Also Costa Rica No. 65 listed at 40c. Both sent free to approval buyers sending 3c postage. Pladon Stamps, 1717-M Idaho, Toledo 5, Ohio.

WORLD'S Largest diamond and triangle stamps, free stamp magazine, stamps from fighting Free French, 20 stamps from 20 different countries, pictorials, airmails, big bargain 5c with approvals. Capital Stamps, Dept. 2, Little Rock, Ark.

FREE! Canadian sets, royal visit, George VI, George V, coronation, jubilee, others, to approval applicants. Ensign, Box 118-M, South Orange, N. J.

DEALERS—Wholesale list. Postage 3c. Frank, 5031 Queensberry, Baltimore 15, Md.

118 DIFFERENT Stamps including commemoratives, charities, airmail sets, etc., only 3c to approval buyers. We buy collections. Badger Stamp Co., Milwaukee 3, Wis.

VICTORY Packet free—Includes stamps from Tanganyika, British Cayman Islands, animal, scarce babyhead, coronation, early Victorian, airmail, map stamps, with big catalogue—all free. Send 5c for postage. Gray Stamp Company, Dept. PM, Toronto, Canada.

FREE! The Stamp Finder! Send today for the big new edition, fully illustrated, enabling you instantly to identify all difficult stamps! Also fine packet strange, fascinating stamps from Bosnia-Herzegovina, Monaco, Patiala, Cyprus, etc., including maps, ships, animals and strange scenes. All free to approval applicants inclosing 3c postage. Garcelon Stamp Company, Box 900, Calais, Maine.

HOBBIES AND COLLECTIONS

"GEM Cutting" profitable, interesting hobby. Instructive illustrated booklet, one dollar. Mineral Specimens Company, Box 1191, Santa Monica, Calif.

BOOK Matches—your name, address, or initials. 50—\$1.25. Press, 749 S. Plymouth, Rochester 8, N. Y.

WANTED:—Old cigarette cards. Write Charles Bray, East Bangor, Penna.

SWAPPY - Hobby bulletin. What'cha got? want. Dime trial. Royal Oak, Mich.

SIGNATURES (47) Nazi war leaders—exact facsimile on real parchment—\$1.00. Warden Robert Bock, 507 North 61st, Milwaukee 13, Wisconsin.

MILITARY Insignias: 22 different for \$1.00 (value \$4.60.) Introductory offer, never before equalled. Prices and insignia guide 10c; sample 5c. Hobbyguild, P35 West 32nd Street, New York.

INVENTING Can be an interesting and profitable hobby. Write for complete particulars. Institute of American Inventors, Dept. 40-E, 1926-Eye St. N. W., Washington 6, D. C.

NEW—15 Different match covers 10c. Box 202, Rochester 1, N. Y.

FOREIGN Decoration ribbons, list, sample, 20c. Foreign insignia packet, booklet, \$1.00. Insigniacrafts, 236-238th Ave. N.W., Calgary, Canada.

COLLECTING Hobbyists. Exchange duplicates. Swappers directory 10c. C. Bishop, Route 8, Kalamazoo 88, Michigan.

COLLECT Colorful Army patches. Pictures, prices and sample patch only 10c. Insignia Mart, 703 Broadway, N. Y.

UNUSED Match book covers. 100 all different \$1.00. 35 Royal Flash covers \$1.00. Free list. Charles Edelman, 1311C East 84, Cleveland 3, Ohio.

JEWELRY Stones removed from rings, etc., 100 assorted \$2.40; 50 large ones \$2.40. B. Lowe, Holland Bldg., St. Louis 1, Mo.

ANTIQUES, RELICS, INDIAN GOODS, CURIOS

MOUNTED Birds, animals, guns, coins, relics, list 10c. Saulsbury, Spicer, Minn.

FINE Indian beadwork, stone relics. Catalog 5c. Sistershop, Northbranch, Kansas.

GIMBELS Clears gun collection: 25% off. Send for 134-page illustrated catalog (\$1.00). Several thousand weapons, including modern shooter's items, antique guns, swords, daggers, armor, cannons, powder flasks, molds, etc. Special bargain, Canadian cavalry sword, shiny basket guard complete with scabbard by Wilkinson, British court swordmakers, originally \$19.95 now \$8.95. Gimbel's, 33rd and Broadway, New York 1, New York.

SWORDS, Rapiers, daggers, pistols, armor. Illustrated catalog 50c. Robert Abels, 860-A Lexington Ave., New York.

4 FINE Ancient arrowheads, \$1.00. Stone Tomahawk, \$1.00. Flint knife, 50c. List free. Lear's, Box 569, Galveston, Texas.

MUSEUM Specimens. Indian relics, curios, den decorations. Illustrated catalogue, identification chart 25c. We also buy. Museum Supplies, 6601 Oshkosh, Chicago 31, Illinois.

MINERALS AND PRECIOUS STONES

AGATES From atom bomb city \$1.35 pound. Vik, Box 724, Richland, Wash.

GEM Cutters, jade, \$1.00 oz. 2 moss agate 25c. Algae chalcedony agate turritella Jasper \$1.00 lb. Gem House, Casper, Wyoming.

CUTTERS, Collectors, mixed, pound. Agates, Jasper, wood \$1.00. Smith, Box 422F, Albany, Oregon.

12 ROUGH Red garnets 36 gram for only \$2.40. Brilliant cut genuine Australia green garnet \$3.00. Finest cut optical prism 1 3/4 inch \$3.00. Federal tax included. Ernest Meier, Church St. Annex, Post Office Box 302, New York 8, N. Y.

CAMERAS AND PHOTO SUPPLIES

TALKIES! Convert your silent 16mm. projector into sound with our guaranteed parts kit. Plays all 16mm. sound films. Quickly assembled at home. Special introductory offer: send this ad now with \$19.95, check or money order, and we will include sound test film, instruction manual and full information on how to use with your radio, postpaid. Soundtech, Box 3071, Hollywood 28, Calif.

CAMERAS! Hundreds! From private owners. Free details: Seymour, 101-M Sherman, New York 34.

ADVANCED Amateurs anticipating opening business, amazing details. Photographer, Midland Park, N. J.

PHOTO Printer kit \$1.00. L. Spada, 10 Lexington, Wethersfield 9, Conn.

GET Clean scratchless negatives. Ultra-fine stainless steel filter stops developer sludge, lint, tapwater, grit. Fast and effective. \$1.75 postpaid. Larsen-Bowen, Box 107, Villa Park, Ill.

HILDEBRAND Theodolite for sale. P.O. Box No. 373, Lawrence, Mass.

FILM! High speed. Five rolls, eight exposures, postpaid: No. 127, \$1.45; 120, \$1.75; 620, \$1.75; 116, \$2.00; 616, \$2.00. Artex, Union, New Jersey.

PHOTO Finishers. \$15 per thousand cash paid for empty spools 127, 120, 620, 116 and 616. Write stating quantities available. Howard West, 3 W. 42nd St., New York 18, N. Y.

FILMS. Fresh, dated 1948, outdoor type. 127—\$4.09 dozen. 120 or 620—\$4.81 dozen. 116 or 616—\$5.41 dozen, postpaid. "Camaraman," 542-5th Ave., New York 19.

ENLARGERS—Build your own. Kit of parts, \$6.00. Free particulars. Krescent Engineering, Box 586, North Hollywood, Calif.

BASS Says: Trade cameras? For 36 years Bass has satisfied thousands everywhere! Finest equipment available. Always satisfaction guaranteed or your money back! Bass buys 'em, sells 'em, trades 'em. Bass Camera Company, Dept. AG, 179 W. Madison St., Chicago 2.

CASH! Spot cash for cameras, lenses, binoculars, movie and still equipment. Send full description for prompt cash offer. Over 36 years of dependability. Bass Camera Company, Dept. AG, 179 W. Madison St., Chicago 2.

CAMERAS, Enlargers, projectors. Free catalog. Cavalier Camera, 1822 Center, Pittsburgh (19), Penna.

PHOTOGRAPHY For pleasure or profit. Learn at home. Practical basic training. Long established school. Write for booklet. American School of Photography, 1315 Michigan, Dept. 3432, Chicago 5.

USED Camera Directory, Box 1031-M, Canton, Ohio—lists hundreds of war-bargain used cameras—35mm., Speed Graphics, Kodaks, Rolleiflex—many others. Send 25c for latest issue.

HAVE You a camera? Improve your hobby of photography and learn how to make better pictures. Write today for our latest book catalog and sample copy of American Photography, containing articles and pictures by the world's foremost writers and photographers. Camera House, 601, 353 Newbury St., Boston 15, Mass.

DARKROOM Supplies. Federal enlarger \$35.30. Papers, chemicals, tanks, printers, dryers, washers, etc. Free price list, bulletin, listing scarce items. Photo-Craft, Box 470-Q, Jamaica 1, New York.

ARGUS 35 MM. R.F. And flash model C3 new \$65.98. Malena Co., 616 Market St., Phila. 6, Penna.

PHOTO FINISHING

SMITH For quality! Any 8 exposure roll developed, 8 prints and two enlargements, 25c, 8 double-size prints, 25c. 35mm. fine grain developed, 36—3 1/4 x 4 1/2 enlargements, 90c; 18—55c. Cartridge refilled, 36 exposures, 35c; 18—20c. Write for sample print, mailers and price list. Smith Studios, 8 Saint John Street, Plains, Penna.

GENUINE Moen-Tone finishing approved by thousands since 1898. 8 exposure roll developed with 16 prints or 8 enlargements—25c. Moen Photo Service, 452 La Crosse, Wisconsin.

8 HOUR Service. Your 8 exposure roll developed and printed jumbo or regular size 25c, deckled edge if requested. 12 exposure rolls 35c, 16 exposures 50c, 36 exposures \$1.00. Reprints jumbo or regular size 3c each. All film developed fine grain. Workmanship, materials and 8 hour service guaranteed throughout. Quality Photo Service, Box 468, San Francisco 1, Calif.

NEW Amazing Plastik-Prints. Secret process. Post war invention. Nothing like it. Sharper, clearer, fade-proof, water resistant prints. Lifetime guarantee. 6 or 8 exposure roll finished 30c. Reprints 3c. World Photo, Joplin 9, Mo.

INDIVIDUAL Attention each negative guarantees outstanding pictures. Roll developed and 8 prints—25c. 8 beautiful 6x4 enlargements—35c. Fresh film. Write for free mailers and other offers. 24-hour service. Universal Photo Service, Box 612-O, La Crosse, Wisconsin.

ROLL Developed, 8 prints, 25c. Free enlargement coupon. Free mailer on request. Smith's Foto, 9621 Dobson, Chicago 28, Ill.

CENTURY Delivers work and service that can't be beat. 8 exp. roll 25c with two professional enlargements free. Century Photo Service, LaCrosse, Wisconsin.

15c AND This ad. Trial roll developed and printed only 15c. Box 5, River Grove, Illinois.

ROLL Or negatives developed, 16 pictures 25c. Dependable Photos, 2960 Gresham, Chicago 18, Illinois.

COLOR Prints from any transparency. Write for additional information. Ross Color Lab., 46 Westmore Rd., Mattapan, Mass.

FREE—Set of filters. Send names and addresses of four camera owners. Photo-Craft, Canton 1, Ohio.

VETERANS' Special offer—5% discount on orders over \$5.00. For yourself and members of your family desiring expert developing and printing of 35mm. film. Color film—35mm.—your color transparencies made on prints with exclusive white borders. Size 2 1/4" x 3 1/2", only \$1.00; size 3 1/4" x 4 1/2", only \$1.25; size 5" x 7", only \$2.50; size 8" x 10", only \$3.75. These color prints are beautiful—Black and white film—35mm. Free cartridge refill with each order. Your films developed (fine grain processed) and enlarged to beautiful prints Size 3 1/4" x 4 1/2". 36 exposure roll developed and enlarged \$1.75, 18 exposures \$1.25. Prompt service. Postpaid. Your order given careful attention by expert photographic technicians. Send postal money order with films by air mail. Harton's, Mainland Station, Box 1291, Daytona Beach, Florida.

PHOTOGRAPHS Expertly oil colored, 50c. Barton, Sta.-B. 6205, Miami, Fla.

MONEY Back guarantee—All this for 25c: Roll developed, 8 bigger deluxe prints, also 8 regular prints, plus two beautiful enlargements and tasteful Leathertone frame. Lifetone Photo Company, Dept. 739, Des Moines, Iowa.

5x7 DELUXE Quality enlargements 25c each. 8x10 50c each. Beautifully toned free. Dept. A, 6323 Elmwood Ave., Phila. 43, Penna.

ROLL Developed and 8 beautiful enlargements 2 to 6 times larger. Deckled edge—high gloss. Any 8 exposure roll 25c coin. 12 ex. 35c—16 ex. 50c—36 ex. \$1.00. Reprint enlargements 3c each. Aiden Photos, 94-3 Astor Sta., Boston, Mass.

2 BEAUTIFUL Hi-Gloss prints each good negative and enlarging coupon with each 6 or 8 exposure roll developed 28c. Owipphoto Co., Weatherford, Oklahoma.

ROLL Developed, eight sparkling 4x6 glossy enlargements, 35c. MacDonald's Photos, Box 28-A, Congress Park, Illinois.

FILM 6 Or 8 exposure roll developed & printed plus 5x7 enlargement free—complete 25c. Mail film to Joy-Photos, G.P.O. Box 606, New York 1, N. Y.

ROLLS Developed and printed, 25c. Reprints, 2c; 5x7 enlargements, 15c; 8x10, 25c. Davis Studio, Guthrie, Oklahoma.

FAST Delivery. Satisfaction guaranteed. Eight exposure rolls with two prints of each exposure, 30c; or eight jumbo size prints, 35c, completely finished. Write for special reprint prices. Pioneer Photo Print Service, Box 123, Wichita, Kansas.

AT Last we have films: 116 and 616, 38c ea.; 120 and 620, 33c ea.; 127, 27c ea. Roll developed, all your snapshots hand-colored as beautiful as most actual colored photography 35c. Hand colored reprints 4c each, 12 for 45c. Midwest Photo, Janesville 26, Wisconsin.

ROLLS Developed and eight 4x6 single weight enlargements from any size roll 30c. Reprints 4c each. Mohart Film Service, West Salem, Wisconsin.

FILM Developed, 8 album size enlargements or 16 sparkling prints, 25c; 8 snappy 4x6 enlargements, 30c. Reprints each: contact prints, 2c; album enlargements, 3c; 4x6 enlargements 4c. Crystal Studios, 159-F, Rushford, Minn.

BIGGEST \$1.00 Value in 35mm. finishing today. 36 exposure fine grain 3 1/4 x 4 1/2 enlargements; deckled, embossed margin and date. Eighteen exposures 75c; 16 exposure splits 55c; 36 exposure reloads 50c. Special: return this ad with \$2.00 and we will send five 36 exposure reloads. Free mailers. 8 exposure rolls in beautiful, deckled contact finish with embossed wide margin, 25c. Mailbag Film Service, Box 5440A, Chicago 80, Ill.

8 VELOX Prints and two professional enlargements 25c. Send roll or negatives for trial offer. Young Photo Service, 405-C, Albany 2, N. Y.

50 REPRINTS \$1.00. No limit. Studio, 1408-M Bond, Rockford, Ill.

GLOSS Finish enlargements. 4 5x7 from negative 50c. 3 5x7 from photo 50c. Robert Renshaw, Jr., P.O. Box 478, Chester, Penna.

PHOTOGRAPHY For pleasure or profit. Learn at home. Practical basic training. Long established school. Write for booklet. American School of Photography, 1315 Michigan, Dept. 3451, Chicago 5.

8 EXPOSURE Rolls 25c, over 8 exposure 40c, for one Velox print each and free enlargement coupon. Reprints 3c, minimum 25c. Fred D. Eastman, Bode, Iowa.

6-8 EXPOSURE Rolls developed and enlarged mammoth size 30c. Reprints 3c. Thrifty Photos, Box 46, South Gate, Calif.

EVERY Picture an enlargement! 8 sparkling deckle-edge enlargements and roll developed 25c coin; 116 size or smaller; enlarge reprints 3c. Enlarge Photo, Box 791D, Boston, Mass.

BEAUTIFUL Double-size pictures 3 1/2 x 4 1/2 each, from 116 and 120 negatives, 3 1/4 x 4 1/2 from all other sizes. All work guaranteed. Overnight service. Roll developed and 8 pictures 30c. Roll 12 pictures 45c. Roll 16 pictures 60c. Enlargements on double weight portrait paper 5x7—30c, 8x10—50c. Copies made from any picture 75c. Pacific Photo Service, Box 666, San Francisco, Calif.

SENSATIONAL Introductory offer! Send snapshot or negative, this ad, and 3c. We'll send you a beautiful 7" x 5" enlargement! Or, Kodak roll developed with 16 guaranteed deckled-edge velox fade-proof prints or 8 double-size prints, 25c! Special! From your negatives, 16 regular-size or 8 double-size reprints, 25c! Candid rolls—36 exp. 35mm. developed, vaporated, enlarged to 3x4, \$1.00! 18 exp. 50c. Reprints, 3x4, 3c each. We have new, perfect 35mm. film. Low prices. Free mailers, details on request. American Studios, Dept. 279, LaCrosse, Wis.

8 PRINTS. All enlarged to nearly postcard size, from your roll or negative, 25c. Willard Studios, Box 3535A, Cleveland 18, Ohio.

DELUXE Photo finishing. Rolls developed and printed. 8 exposures 25c. 12-35c. 16-50c. Enlargements 5"x7", 25c. 8"x10" 40c each. Kensey, B25, 211 W. 145th, New York 30.

TRIAL Offer—Eight exposure rolls developed including sixteen Hyglos prints—29c. Free \$1.00 framed enlargement coupon. Hollytints, P-1350, Hollywood, Calif.

MOTION PICTURES AND SOUND EQUIPMENT

8MM.-16MM. Silent-sound—Black and white and colored film, sold, rented and exchanged. Most reasonable rates in the East. Free catalog. Home Movie Service, 1423 N. 15th St., Phila. 21, Penna.

LEARN Professional motion picture technique at home. Free catalog. Motion Picture Institute, Birmingham 4, Mich.

"SURPRISE" Assortment 8-mm. color film titles \$1. Guaranteed. LeMoine Films, Nevada, Missouri.

COMPLETE Stocks always of Castle, Official, Pictorial films, 8mm., 16mm., sound. Musicals, soundies, free catalogs. We exchange your films and equipment, or buy them for cash. Frank Lane, 5 Little Bldg., Boston, Mass.

FRESH Movie films 100' 16mm. \$2.25. Three rolls \$6.00. 25' double 8mm. \$1.25, developing included. Ambassador, 479-A Quincy Street, Brooklyn, N. Y.

16MM. MOTOR Driven projector \$16.00 postpaid. Selco Products, Danvers 1, Mass.

35MM. SOUND Film—bought, sold, lists. Edward Elwell, Brockport, N. Y.

KODACHROME Movies. 8mm., 16mm. Projection length sample "Waikiki Hula," \$1.00. Catalog, 25c. World in Color, Box 392-F, Elmira, N. Y.

MOVIE Projectors and binoculars bought and sold. List 10c. Refundable. United, 2309-A Lawrence, Toledo, Ohio.

VANISHING Titles with Craft-X "Fade-o-Film." Fadeouts, fadeins, simplified. 20"x40" sheets \$1.00. Satisfaction guaranteed. Major, 3510 Palmer, Chicago 47.

LATEST Movies, 8-16 mm., S.O.F. save! 1946 projectors, cameras! Free details! Charlie Poorman, Dept. PM1, Schuylkill Haven, Penna.

GUARANTEED Fresh movie film! Dalite loading! Six spools single 8mm. for Univex cameras, \$3.50! Three spools double 8mm., \$3.45! Processing free! (Give camera make.) Catalog. C.O.D.'s shipped. ESO-S, 828 West 39th, Kansas City 2, Missouri.

HOME Movies. All kinds. Catalogs, 10c. Box 337-A, Valley Stream, N. Y.

16MM. SOUND Films. Complete subjects, good condition, \$1.95 per 400' reel, up. Write for list of over 200 available titles. Blackhawk Films, Dept. PM26, Davenport, Iowa.

FILM, Free processing 100 ft. 16mm. Weston 6, \$2.50; Weston 24, \$4.90; Weston 64, \$4.95; 25 ft. double 8, Weston 6, \$1.35; Weston 24, \$1.89; Weston 64, \$1.99. Free circulars. Fromader Genera, Davenport 7, Iowa.

FRESH Movie camera films 100'—16mm. \$2.25, three rolls \$6.00. 25' double 8mm. \$1.25 developing included. Ambassador, 479-A Quincy Street, Brooklyn, N. Y.

8MM.-16MM. Silent-sound film. Complete rental library. All latest subjects. Free catalogue. (Sample film 10c.) Garden Film, 317 West 50th, New York 19.

8MM.-16MM. Films bought, sold, exchanged. Complete sound subjects \$2.00 up. Catalogues, end title 10c. International-M, 2120 Strauss, Brooklyn.

HOME Movies. Rent, buy, swap 8mm.-16mm. silent and sound at money-saving rates. Details for a dime. Midland, Box 429, Oak Park 4, Ill.

BRAND New 8mm. motor driven projectors \$36.25 postpaid. Sterling's, 679 Northampton, Easton, Pennsylvania.

FINEST Movie screens, inexpensive, make them yourself. Free literature. Snow White Screen Company, Danville, Illinois.

BASS Says: 36 years of leadership in the motion picture equipment field. Sound projectors, 8 and 16mm. equipment, finest accessories. Bass buys 'em, sells 'em, trades 'em. Always satisfaction guaranteed or money refunded! Bass Camera Company, Dept. A, 179 W. Madison St., Chicago 2.

I BUY, Sell, swap, rent s.o.f., 8 and 16mm. films. List free. Harvey Iris, Box 539, Brockton, Mass.

MAKE \$8 To \$10 net profit daily with your 8mm. or 16mm. projector. Details free. Metcalf, 10806 Glenroy Ave., Chicago 43, Ill.

35MM. Sound westerns, features, shorts. C. Rogers, Box 26, East Atlanta, Ga.

UNUSUAL Home movies—travel, adventure, sports, news, war films. Many film bargains. Big 1946 catalog and sample, dime. Audet, Box 6520-BG, Philadelphia 38, Penna.

8MM., 16mm., 35mm. films. Samples 10c. Lists free. Paramount Films, Monmouth, Illinois.

35MM. Sound features, projectors. A Savarese, Woodcliff Lake, New Jersey.

LEARN Movie projection, management. Free catalog. Theatre Institute, Elmira, N. Y.

MOVIE Camera films, 100' 16mm. \$2.50. 25' double 8mm. \$1.25. Free developing. Better Films, 742 NewLots, Brooklyn 7, N. Y.

SPECIAL Movie film, 8mm., 25 feet double-Weston 8, \$2.00. Super double X, Pan indoor 60, outdoor 100, 16 mm.—\$6.50. Super X Pan indoor 24, outdoor 50, \$5.75. Pan Weston 12, \$5.00. 16 mm. 100 feet Weston 6, \$4.00. Free developing. Exhibitors Film Exchange, 630 9th Ave., New York 19, N. Y.

BEAUTIFUL Kodachrome slide and list. 25c. Art Slide Co., M-1, Canton, Ohio.

PROJECT-O-COLOR The new sensational accessory for movie projectors available now! Information free. Write Project-O-Color, Palatine 3, Ill.

OWNERS Of home movie projectors. Project the original authentic outstanding home movie production free. Send postal card today. Preferred Films, Hamilton 5, Ohio.

8MM. FILMS Exchanged. Projection equipment. Bargain bulletins 10c. Towers, 935 North Fortieth, Philadelphia 4.

RENT 8MM.—16mm. and sound films by week. New catalogs. Lowest rates. Dayton Film, 2227 Hepburn, Dayton 6, Ohio.

MUSIC AND MUSICAL INSTRUMENTS

ACCORDIONS: All sizes and makes. Wholesale prices. Free catalogue. American Accordion Center, 89 S. Kedzie, Chicago 12, Ill.

SONGWRITERS! Outstanding, ethical offer. Hibbler, C5, 2157 N. Avers, Chicago.

HAWAIIAN—Spanish and ukelele course \$1.00 only. Catalogue on request. Golden Gate Publications, 5464 Foothill Blvd., Oakland 1, Calif.

ENORMOUS Stock of instruments and pianos. Lower prices. Enough said. We buy, trade and sell. Dept. M. Harden's Music Store, 179 S. Main St., Marion, Ohio.

ACCORDIONS Wholesale new or used, all makes. Free circular. Monarch Accordion, 44 North Albany, Chicago.

MUSIC Manuscripts photostatically duplicated, \$1.00. Clearprint, 118 Washington, Elizabethtown, Pa.

PLASTIC Harmonicas \$1.25. 50,000 copies of music. Harden's Piano Store, 179 S. Main St., Marion, Ohio.

SONGWRITERS—Lyricists—poets. This is your chance! Send your name and address. Banner Music Publishers, Box 848, Grand Central Annex, New York 17, N. Y.

SONGWRITERS! A limited amount of songs wanted for radio distribution. Tin Pan Alley, Inc., 1650 Broadway, New York 19, New York.

WE Offer the services of a noted Hollywood motion picture composer and arranger. Recordings made by NBC singer. Send your poem on any subject today for consideration and our liberal offer. Hollywood Melodies, P.O. Box 2168PM, Hollywood 28, Calif.

SONGWRITERS: Collaborate with successful composer. Turner, Box 2201-M, Bridgeport 8, Conn.

GUITARISTS' Dream chart. Names; readings; symbols; diagrams; fingerings; positions; all chords. New. Original, sensational \$1.00. Carol Sales, Box 21, Lefterts, Brooklyn 25, N. Y.

HIGH-GAIN Ac-dc amplifier, for guitar, phonograph, etc., \$5.00. less tubes. Michel, 1018 E. Fairmount, Milwaukee 11, Wis.

SONG Poems. Send to established composer and learn truth about song writing. Vernon Leftwich, 659 So. Orange Drive, Los Angeles, Calif.

"ACTIONS Speak louder than words." Hit song of love. 20c per sheet music copy. 2 for 35c. Cost at your music dealer—35c per copy. Henry J. Sommers, 1629 Que St., N. W., Washington 9, D. C.

PLAYER Piano rolls 2 for 95c. Send for free list of 400 titles. Old favorites and newest hits. The A. Bachand Co., N. Adams, Mass.

PRESENT Your songs professionally to publishers, recorders. You can win too. We set music to your poem, send you 10 prints with har-symb \$15.00. We made original copy of Cement Mixer. Holly Star Music, 6411 Hollywood Blvd., Hollywood 28, Calif.

HARMONICA Magic. Easy new system eliminates notes. Self instruction method includes 75 songs. Send only \$1.00. Money back guarantee. Harmonica Magic, Dept. PM-1, Box 3445, Merchandise Mart, Chicago 64.

POPULAR Piano instruction by Boston's famed Phil Saltman. Nineteen lessons \$1.00. Kenmore Music, 581 Boylston, Boston.

SONGWRITERS, Have your songs completed by an honest, experienced arranger. Submit songs for free analysis. Tommy Kilbourne, Box 1253, Bakersfield, Calif.

POEMS Wanted for musical setting. Composers' Guild of America, 545 Fifth Avenue, New York 17, N. Y.

SONGWRITERS. We publish good songs without payment. Write for details. McGinty Music, 34 West Flagler, Miami, Fla.

USED Jukebox records, off my machines. State your requirements. Olin Milner, 335 McDaniel St., Atlanta, Ga.

PLAY Piano the "Berry Way." Play melodies right away. Send \$1.00 for your copy of "A New Approach To Piano Playing." Earl Berry Music Studio, 11 State St., Meriden, Conn.

SONGWRITERS—Send best poems today for our offer, or request free booklet "Getting Ahead In Songwriting." Song Service, 331-C, West 46th, New York.

THE 96 Page "The Complete Songwriter" tells how to write music, words, arrangements and publishing. Send \$2.00 M.O. Puritan Publishing Co., Inc., 343 So. Dearborn St., Chicago 4, Ill.

"GUITARS"—"Band and orchestra instruments"—"harmonicas." List free. Rudolph's, Atchison, Kansas.

MUSIC Composed to song-poems. Address: Frank Wildt, Lancaster, Penna.

SONG Writer's attention! The amazing demand for phonograph records, accelerated by more than 300,000 juke boxes and the hits popularized warrants your immediate consideration. We are offering song-poem writers the rare opportunity of having established composers collaborate on appealing material received this month. Recola Records, Box 987P, Hollywood 28, Calif.

POEMS Wanted for musical setting. Send poem for immediate consideration and free rhyming dictionary. Richard Brothers, 24 Woods Building, Chicago.

SONGWRITERS—Send poems for immediate examination and free book, "Your Future in Songwriting." Radio City Music Academy, 1674 Broadway, New York City 19.

WANTED! Lyrics, melodies for songs. We arrange, publish, sell. Superior Song Studios, Passaic, N. J.

ACCORDIONS. New and used at wholesale prices. Save up to \$100.00. Buy direct from factory. Del Principe, 307 So. Wabash, Chicago.

BEFORE Sending your poem to be set to music, know your composer. Free folder. Al. Moquin, 5333 La Cresta Court, Hollywood 38, Calif.

POEMS Wanted for musical setting. Send poem for immediate consideration. Five Star Music Masters, 630 Beacon Building, Boston.

SONG Poems wanted. Free examination. McNeil, Master of Music, 510-PM South Alexandria, Los Angeles, Calif.

WRITE Songs. Big money and reputation. Write for information. J. Gordon Pub Co., 201 N. Hoyne Ave., Chicago.

SONGS And poems arranged, published, sold. Free melody—examination. National Songwriters, Hollywood, Calif.

MUSIC Composed, orchestrated, arranged, music printed by church organist 35 years experience. All work carefully edited by my daughter, graduate Juilliard with masters' degree in theory and composition. Reginald Belcher, Florham Park, New Jersey.

ONE Needle—Plays up to and over 5,000 records. Excellent for automatic record players and ordinary phono-graphs. While they last, \$1.50. Adam Cuches, 145 So. 4th St., Brooklyn 11, New York.

HOBBY Books. Latest titles. Catalog free. Popular Mechanics Press, (C-43), 200 E. Ontario, Chicago.

RADIOS AND SUPPLIES

YOUR New free catalog is ready! Radionic's catalog lists hard-to-get radio parts and books. All available for immediate shipment. Send today to: Radionic Equipment Co., Dept. S7, 170 Nassau St., New York 7, N. Y.

RADIOS: Scarce tubes. Record players. Automatic changers. Hagedorn, 2250 North 27 St., Milwaukee 8, Wisconsin.

BOOKS Of all radio publishers. Same-day shipment. C.O.D. orders accepted. Catalog for stamp. Editors and Engineers, 1304 Kenwood, Santa Barbara, Calif.

EXPERIMENTERS Look, uncased, new, genuine Radiosonde C-W transmitters complete with tube, less battery and mike, \$2.50 each p. pd. no C.O.D.. Dunlap, 219 S. 17th, Phila. #3, Penna.

RADIO Tubes 20% off. Specify. Spada, 10 Lexington, Wethersfield 9, Conn.

POCKET Radio! Build new vacuum tube super-midget. Plans \$1.00. United Manufacturing Associates, 3316-4G, Fort Worth 5, Texas.

RADIO, Electronic parts and equipment. New and used. Write for free list. Highbridge, 336 Canal Street, New York 13, New York.

SIMPLIFIED Instructions, a.c. d.c. phono-osc kit with tubes \$7.50. Transmits recordings, voice, to radio without wires. Immediate delivery. Constant Electric, 112 Cornelia Street, Brooklyn, N. Y.

HURRY! Hurry! If you want to become a radio service expert in a hurry. No previous experience required. Nothing else like it. Write Hazelton Enterprises, Dept. 2, Radio Division, 601 Temple Court Bldg., Chattanooga 2, Tenn. No obligation.

ONE Tube radio \$8.45. Complete with batteries, tube, phones, aerial. Cianin, 135 Crown Avenue, Dayton, Ohio.

BUILD Newest, extra-loud crystal set. Instructions, 20c. "All About Crystal Sets," booklet, 45c. Amorose, R-4, Hungary Road, Richmond, Virginia.

ELECTROLYTIC Trickle chargers \$1.50 each prepaid. Satisfaction guaranteed. Write Kimley, 103 Highland, Williamsville 21, N. Y.

LOUD Speaking crystal radio, improved design. Illustrated plans 25c. Radio Clinic, 10631-C Euclid, Cleveland 6, Ohio.

100 ASSORTED Paper and mica condensers \$1.00. Cash, check or m. o. P. Balizer, 19 Micieli Pl., Brooklyn 18, N. Y.

3 TUBE Phono amplifiers including tubes \$9.54; less tubes \$7.74 including tax. Victoria Electronics & Supply Co., 1039 Memorial Avenue, West Springfield, Mass.

NAVY Surplus—Operator control box \$1.00 postpaid. TBY8 walkie-talkie 28-80Mc. with 8 tubes, headset, microphone, locker case, instruction book \$49.00. Van Sickle Radio, Indianapolis 6, Ind.

RADIO Surplus. Bargain prices. Thousand items. List for nickel. Campbell, 3800 Kinzie, Racine, Wisconsin.

FAMOUS "Allen" Midget Semi-Fixed Crystal Detector, set building plans and 100 late crystal set distance reports all for 50c postpaid. Allen, 427-P, Clinton, Mo.

REVISED Plans 18 long distance crystal sets, including "Radiobuilder"—25c. Laboratories, Box I-C, San Carlos, Calif.

LEARN Code. Simplified method. 25c. Tesco, P.O. Box 189, Wilkes-Barre, Penna.

BUILD Radio. Complete kit with tubes \$10.95. Details. Radio, 9418e Avenue "A," Brooklyn, N. Y.

RADIO Dealers and service men write for latest low price parts circular. Mc Gee Radio Co., 1330 Broadway, Denver, Colo.

BUILD Your own radio. All kits complete, including speaker, 4 tubes and full instructions, \$10.95. Details and latest parts catalog. National Radio Distributors, 1029-M E. 163rd St., New York 59, N. Y.

MAKE Simple, tubeless, batteryless, distance-getting crystal radios. Crystal and illustrated instructions 25c postpaid. Allen, 427-P, Clinton, Missouri.

FM Can now be heard on old radios! Very simple adaptor! Send postcard for free data! Topical Emprise Corporation, 1527 Highland, Box 42, Louisville 4, Ky.

RADIO Service flat rate schedules solve pricing problems. Compiled from 20 years experience. Write for information. Radio Equipment Co., 1415 W. Franklin Ave., Minneapolis 5, Minn.

MEMORIZE Morse code rapidly. 10 lessons 25c. Jayson, 333 W. 87th, N. Y. 24.

RADIO Technician and radio service courses. Training for federal licenses. American Radio Institute, 101 W. 63 St., New York City. Approved under G. I. Bill of Rights.

BUILD It yourself, laboratory designed, radio receiver, hi-fidelity amplifier, phono oscillators, volume expanders compressors. Drawings, literature 50c. Staretone Electronics, 608 Seneca Ave., Brooklyn, N. Y.

"**TWELVE-IN-ONE**" Tool. See Bishop tool ad under "Machinery."

CATHODE Ray tubes 5CP1's brand new \$7.95, socket 45c, include 4-lb. shipping postage in your money order. New 954 Acorn tubes, not rejects, 89c postpaid in U. S. Free electronics bargain list. Ohmeyer Engineering, Dept. D, Fairview Blvd., Hempstead, N. Y.

HAVE You a radio problem? Write for free estimate and include problem. Radio Consultant, 333 W. 87 St., N. Y. 24.

BUSINESS OPPORTUNITIES

LEARN Shell jewelry manufacturing. Complete, simplified home instruction course, beautifully illustrated, shows 45 styles pins, earrings, brooches, sprays, hair ornaments. Includes pearling, dyeing, gilding, glow-in-dark methods. No tools needed! Learn-earn within a week. Only \$1 postpaid, including wholesale prices of all raw materials. House of Gifts, Box 4550-RF, Coral Gables, Fla.

START Home business making statuary, plaques, novelties, garden furniture, artificial marble flooring, liquid marble. Make your own flexible molds. Amazing profits. Folder free. Creative Publishers, Box 236-L, Winnetka, Illinois.

MALE Bookkeepers, accountants everywhere earn big money posting journal entries spare time at home. For details write National Bookkeeping Service, Porter Bldg., Room 401, Kansas City, Mo.

WHOLESALE Distributors: Amazing patented screw-holding screw drivers; removes, hold, inserts screws instantly hard-to-get-at places; 7 models; tremendous market stores, factories, big profits; returnable trial order. Write now. Millen Mfg., 93E Federal, Boston, Mass.

HAVE An office. Many earn up to \$5,000-\$15,000 annually. Learn credit-collection agency business by home study course. Write for free bulletin. Franklin Credit School, Dept. P.M., Roanoke 7, Virginia.

BOOKKEEPERS: General ledger and tax report experience. Operate permanent, profitable accounting service for the smaller business. Part or full time. Simplified method. Write now! L. A. Bell, 1404 West 25th Street, Cleveland 13, Ohio.

SUB-MANUFACTURERS Wanted everywhere. Build and supply wooden composting cabinets for our customers, to convert garbage, organic wastes, into valuable fertilizer. Request regular literature, or manufacturer-dealer proposition. Western Compo, 3614 S. E. 9th., Portland 2, Oregon.

DON'T Throw it away! There could be a fortune in your attic or cellar. Free information. Write Research Enterprises, P.O. Box 5296, Highlandtown Station, Baltimore, Md.

1000 FRESH Names—opportunity seekers—only 10c. Profit Builders, 305-West 8th., Los Angeles 14, Calif.

POSTWAR Security! The greatest legitimate plan ever devised to secure a big mailing list and a stream of dimes. Free particulars. Jack Killion, Box 3096, Terminal Annex, Los Angeles 54, California.

CIGARETTE Lighters. Sample \$2.50. Write for circular and quantity prices. Liberty, Box 3797, Portland 8, Oregon.

MINK Raising, information free. Complete. Lake Superior Mink Farm, Superior, EE, Wisconsin.

SELL Religious goods by mail. Big profits. Work spare, full time. Small capital. Everything furnished. Cleveland, 243-B4 White, Clyde, Ohio.

THOUSANDS Articles wholesale. "Supply Source Directory" 10c. Ideal Service, Park Ridge D-7, Illinois.

INCREASE Your earnings! Operate profitable mail order business from your home. Full or part time. Details free. Fletcher Products, 2922 West Vernon, Los Angeles 43, California.

PROFITABLE Mailing merchandising business. Write Riegel, 1111 Harrison, Phila. (24), Penna.

START A mail order business. Free information. Kirk Sales, Box 84, Wellington, Ohio.

OPERATE Profitable mail order business. Good opportunity. Write. Walter Service, 4159 East 112th, Cleveland 5, Ohio.

PROFITABLE Business opportunities. New, fascinating. Home or by mail. Get the facts. Deavenport Mail Service, 147A Roxboro, Rochester 11, N. Y.

MAIL Order beginner! Right start—means success. Free information. Russell's Service, PM, Grant 820, Laredo, Texas.

OPERATE Profitable mail order business. Good opportunity now. Details free. Post Office Box 7324, New Orleans 19, La.

OPERATE Mail order business, \$5 capital; write Harry Punch, 1329 Grace Ave., Cincinnati 8, Ohio.

MEN, Women! If you have half an acre of land or more you can make equivalent of \$1.00 an hour in sparetime—right at home! My "Have-More" plan shows you how! More than 150,000 copies sold. Triple your money back if you want to return plan in ten days! That's how sure I am you'll like it! Mail \$1.00 to Ed Robinson, Box 274, Noroton, Conn. for your copy of the "Have-More" plan.

GET The facts. Sell names by mail. Spare time. Big money making opportunity. Rush name for free details. Forest Book Co., Box 297 North Hollywood, Calif.

MAKE Liquid marble, flexible molds, statuary, art goods, novelties, artificial marble flooring. Literature free. Kemico, Park Ridge, 7M, Ill.

PROFITABLE Business at home in your spare time. Hustlers write Eagle Ink Company, Forest Hills, N. Y.

NEW 1946 Information directory \$1.00. Tells you where to buy. Box 6900, Pittsburgh 12, Penna.

ART Of gem cutting, 128 page book giving full instructions, with 32 page gem catalog \$1.60 postpaid. Hill Gem Co., Route 7, Salem, Oregon.

BIG Money-making opportunities. Free. Fine Arts, Donald Street, Peoria, Ill.

MECHANICALLY Inclined men—Own and operate general appliance repair shop. Complete, illustrated course shows you how. Welding, refrigeration, motor repair, how to get business, etc., all phases covered. Free literature. Christy Supply, Dept. 166, 2835 N. Central Ave., Chicago.

EARN Money with textile painting course. Free details. George Gundrum, LeRoy, Michigan.

OPERATE Profitable mail order business. Details free. P.O. Box 5331, New Orleans, La.

SOMETHING New! Super X red liquid molding rubber. Hot or cold casting. Sample jar 25c, quart \$3.00, gallon, \$10.00. W. Wooley, 115-A Donald, Peoria, Ill.

EARN Up to \$2,000 year, inventing simple items for special cash markets. Ideas only. No patents. Hendrickson, Argyle 7, Wisconsin.

OPERATE Profitable mail order business. Good opportunity. Details free. E. L. Dawson, Box 44, Summerdale, Penna.

25c MAIL Seller, 800% profit. Sample, details 10c. Harvey Teeple, Decatur, Ind.

OPERATE Profitable home business. Folio 10c. Lisbon Service, R-4, Lisbon, Ohio.

AGENTS—Real profits, repeat sales, sell the beautiful Doehla greeting cards, free details. Zweifel's Shut-In Agency, R. 3, Freeport, Illinois.

COPPERIZE Baby-shoes, complete instructions, tested sales plan. Metalloids, Box 8087-b, Pittsburgh 16, Penna.

SELL Big-profit religious items. Every home a prospect. Send \$1.00 (refundable) for samples to Bella Products Company, 26 East 17th Street, New York 3, N. Y.

FREE Details describing many money-making plans. Ernest Coop, Box 452, Sumner, Wash.

DISTRIBUTOR For cigarette lighters. Investment required. Box 9X, Tarzana, California.

MOULDS (Rubber) made for your model—\$3.00 up. Also original models and moulds. Vallance Art Products, 1873-A East 70 St., Cleveland 3, Ohio.

HOME Business Monthly, copy 50c. Alvin, 553 William, Winnipeg, Manitoba.

FREE Literature—Tested money making business ideas. Kelly, 1080-P Casgrain, Detroit 9, Michigan.

TADPOLES Make frogs, tremendous demand. Both make you money. 25c brings tell-how information. Chariton Corporation, Century Building, Chicago 4.

PLASTICS-MOLDING, Casting, forming easily learned. 40 worksheets (70 illustrations) teach reliable home and shop methods. \$1. Circular free. Plastics Digest, 3937M Tracy, Kansas City 4, Mo.

MAIL Dealers or beginners—"Wonder" plan pulls substantial orders, big profit! You can do it. Instructions—25c. Julian Bach, Box 776, Columbus, Ohio.

A PROFITABLE Business of your own. Fast selling Glow In The Dark novelties. Samples. Progressive, 2160 Bleecker, Ridgewood 27, N. Y.

GET Our book! Chock full of money-making ideas. Free literature. Frank Cuny, 726 Anson, Gretna, Louisiana.

LIQUID Marble—Make it any color. Soundproof plastic flooring. Flexible molds. Cast novelties, plaques, statuary. Big money—your own business. Free information. Write—Bing Products, 88-AR Broad Street, Boston 10, Massachusetts.

MAKE Strange new plastic—1c pound. Makes durable, attractive floors, walls, roofs. Build for half. Bays Laboratory, Oklahoma City 9.

MAKE "DDT" Products. My ten master formulas show how. Literature free. Howard Robinson, Ph. G., 1302-A So. Ohio, Sedalia, Missouri.

AT Home—Your own manufacturing business; making popular \$1.00 novelties. Cost you 3c to 15c. Everything supplied. Write So-Lo Works, Dept. G-600, Cincinnati, Ohio.

MAKE Soap at home. No machinery. Profitable. Literature free. Kemico, Park Ridge, (7-SM), Ill.

MAKE Money making movies! Details, stamp. Jenkins, Box 392X, Elmira, N. Y.

GOT \$24,500 Using "schemes" from "Schemer" Magazine, Alliance, Ohio. 48th year, \$1.00; four samples, 30c.

PLASTICS Directory lists wholesale-retail dealers in all kinds of materials, plastics, molds, machinery, supplies. \$1. Plastics Digest, 3937P Tracy, Kansas City 4, Missouri.

START Your own business. In one evening, without special equipment, make enough wonder product to net you up to \$100.00 profit. Send \$1.00 cash (C.O.D. \$1.21) for full details plus selling instructions. Lake Shore Laboratory, Dept. PM, 534 Surf Street, Chicago 14, Illinois.

SILVER Plating liquid you can make, for ten to twenty cents per ounce. Why pay up to one dollar? Send penny card for particulars. Gold liquid also. The Mirror Shop, Box 728, Seattle 11, Wash.

YOUR Circulars, folders, and small booklets mailed, 500 for \$1.00 to any desired name classification. Bourque, 3712 Fifth, Marrero 2, Louisiana.

DOES \$1,500 Yearly "on the side" by mail, interest you? Write Eljay Publishers, Herrin 4, Illinois.

WAR Surplus without bidding—new products—stock items. How to buy. Prices and addresses. Information service. Catalog sheets monthly. Details free. Rush name. Maupin, Tipp City 33, Ohio.

"FOR Best agency and mail order opportunities, be sure to get our literature first." D. Deaton, 659 Oakford Dr., Los Angeles 22, Calif.

FORTUNE From farming; less labor. "Nature's perfect system." Two great booklets—30 years study and experience gives fullest guarantee. Both \$1.00 postpaid. Agriculture Engineer, 281 Windsor Street, Hartford 5, Conn.

IF You would like to make \$5,000 yearly in an easily learned office business of your own, send for free details immediately. G. H. Cole, Pres., Syracuse 2, New York.

\$6.30 STARTS You. Suite cleaning business. Earnings \$100 week up possible. Write Gansler Specialties Bridgeport 1, Ohio.

YOUR Opportunity. Nationally known mail order consultant—25 year success record—offers original, exclusive, profitable propositions. Many to choose from. Small capital. Or expert advertising, development your own mail order idea or business. Free bulletin, details, proof. Write Erol Slater, 701 Foreman Bldg., Los Angeles 14, Calif.

EARN Cash at home with "Money Making Business Starters," sample booklet 25c. Louis Gianakos, (PM-13), 1150 N. 12th St., Milwaukee 3, Wis.

MAKE Flexible molds! Few cents each! Cast plaques, novelties, bookends! Free sample! H. Tooker, 630-A Chestnut, Hamilton, Ohio.

START Profitable business, package, sell amazing cleaner under your name. Sample 25c. Linnell Company, Box 1720A, Cleveland 5, Ohio.

BUILD Lifetime income at home. Books of instruction for ambitious people. Information free. News Specialty Company, 463 Daisy, Mansfield 1, Ohio.

\$565.00 PROFIT From every \$15.00 invested. Standard Service System, La Grange 1, Indiana.

LATEST Postwar products—concentrated—1000% profits! Gerard, Distributors, Fairmont, West Virginia.

FINANCIAL Success in your own business or profession. The art of knowing how. \$1.00. Altone's, Houseman Building, Dept. C, Grand Rapids, Michigan.

LEARN Inlay work this new easy way. Beautiful inlay work of a thousand pieces. No limit to different designs, can be made in a short time. Copyrighted instructions mailed for 25c. No stamps. A. Emerson, 215, Jensen, Florida.

LIQUID Marble; snow-white, multi-colored. Glazed. Unglazed. Composition flooring. Lifetime wear. Any color. Flexible molds. Plaster casting. Get into the big money now. Full information given free. Write Compo-Tex, Box 786-R, St. Louis, Mo.

SPIN Lovely Angora wool into choice yarns, at home, everything furnished. House of Angora, Springfield, Illinois.

ORIGINAL Genuine rubber mold liquid. Mix ingredients cold! Kitchen beater! Enormous profits. Guaranteed formula \$3.00. Toms, Chemist, Park Road, Peoria, Illinois.

FORGE Ahead: New arrangement starts you in mail order. Inquiries swamping us. Letters, only. Tait-Douglas, 5345-B, Harper, Chicago 15.

OPPORTUNITIES Galore! Fifty profitable mail order plans. Literature free. Priesing, Box 97, Jamaica Plain 30, Mass.

HOW To build your own mail order business. Creative ideas to make money. Rush 25c for booklet. Holden, 4903A Rhodes Ave., North Hollywood, Calif.

OWN A mail-order paper products business. Sell envelopes, tags, bags, boxes by mail, wholesale. Tremendous demand. Steady profits. No capital necessary. Write Omaha Envelope Service, Dept. 152, 4721 California, Omaha 3, Nebr.

RAISE Fishworms; 100 breeders, instructions \$2. M. Stoner, Chattanooga 6, Tenn.

SELL By mail interesting, profitable. Free details. W. Gillen, 33 18th Ave., Paterson 3, New Jersey.

RUBBER Molds rented, made, sold. \$1.50 pint. Arts, 15 Carl St., Dayton 3, Ohio.

CASH From your own business. My new folio of ten projects, sent for \$1.00 with advisory service tells you how. Ralph Morey, 087 Somerset, Springfield 8, Mass.

PANNING Gold. Free literature, pictures. Old Prospector, Box 21R48, Dutch Flat, Calif.

SECURITY Acres! 30 profitable business opportunities for a city lot. Free details. Gardenville Publishers, Gardenville 11, N. Y.

\$10 DAILY As your own boss. No products to sell. Practical business plans. Write Linthurst, Box 261-P, Chambersburg, Penna.

START Moneymaking home mailorder business, sparetime. Interesting literature free. Goodrich, Edgewood Terrace, Longmeadow 6, Mass.

GUARANTEED Profits, your yard: basement; kitchen. Information 25c. Dillard, Box 2807, Kansas City 13, Missouri.

SPECIALIZED Mail business earned \$1400 monthly. Copyrighted instructions \$1.00. Wm. Boyd, 331 Fourth, Pittsburgh 22, Penna.

FIFTY Plans! Newest; tested; guaranteed; money makers. Duffy, D54, Covington, Ky.

MAKE Big money preserving baby shoes in metal, bronze, pearl, gold and silver! Kiktavi Company, 8620 South Ruthelen, Los Angeles, 44, California.

METALLIZE Baby shoes! Learn this moneymaking business from nationally recognized consultants. See Kushner ad, page 251.

GIANT Big mail! Hundreds of moneymaking propositions, home work offers, including big magazine, all for a dime. Gardenville Publishers, Gardenville 11, N. Y.

POWERFUL Prescription for achieving personal and business success, works without expense or guess work. You can use it. Free details. Lyman, 622 Penfield Bldg., Philadelphia 7, Penna.

HOW To make molds for plaques, statuettes, figurines, bookends, with rubber or glue. Practical, workable instructions 25c. Oman, 642-P Broadway, St. Paul, Minn.

10c BRINGS You hundreds of moneymaking propositions, plans, ideas, tips, wholesale supply sources, magazines. Gardenville Publishers, Gardenville 4, N. Y.

LIMITED, Exclusive territories open for distributors selling our nationally advertised automobile accessories, gives live wires grand opportunity to have own highly profitable steady, repeat business. Most complete line available. We can deliver. World wide distribution. Our established dealers making handsome profits weekly with own business. \$500-\$600 investment—week or 10 day supply. Puts right man with good transportation on road to big profits. Send complete information first letter, age, experience, three business references. Prompt reply. Catalogue, full information to follow. Knicks Mend-Rite Co., No. Kansas City, Mo.

POCKET Up to 40% of nationally advertised price. Radios, household appliances, sporting goods, etc. Buyers' Ring, Landover, Maryland.

BRONZE Baby shoes! Big profits! New field! Details free. Write, Opportunity Center, Box 349, Long Beach 2, Calif.

HOW And where to obtain capital, small and large loans, free particulars. Star Service, Wapakoneta, Ohio.

DOLLARS In your mail:—You keep 90c out of each dollar. Send 10c for literature, or \$1.00 for complete information. Shure Industries, 813 First National Bank Bldg., Memphis 3, Tennessee.

EXTRA Profits 50 to 75% home mail order business. Details free. Campbell Service, 1626 E. 75, Cleveland 3, Ohio.

SUCCEED In business with our illustrated business plans. Complete details free. Home-Art Supply, Box 732-A, Warren, Ohio.

BIG Money silvering mirrors. Easiest method, best results. Rumfield, 5716 Junius, Dallas, Texas.

HOME Mail order business opportunities for you. Big profits, small capital starts you. Particulars free. National, Route 4, Box 1508G, Tampa, Fla.

1946 GIGANTIC Directory of opportunities, advertisers supplies, sources, trade information, mail order ideas, products, wholesalers, valuable tips—just published! Descriptive literature free. Wilkin & Co., 118-AP East Main St., Hillsboro, Ohio.

QUICK Money! "Repairing car batteries." At home! Easy too! Write, Batteryman, Grand Junction, Colorado.

315 GOLDEN Money-making opportunities now ready for you, selling by mail! Details free! Mailway Agency, 10-620P, William, Winnipeg, Manitoba, Canada.

SMALL Capital starts your own advertising agency, at home in spare time. Complete operation exposed. No stock or equipment. Opportunity for large earnings. Stamp brings folder and proof. P. Snyder, Box 4907-A, Philadelphia 19, Penna.

SYNTHETIC Latex with Neoprene base for making flexible molds! Quick drying! Quart \$2.00. Gallon \$5.95. Full instructions. Plastercraft, 1406 East 43rd Street, Cleveland 3, Ohio.

MAIL Order business can be your future! Same as hundreds advertising in this and other publications. "How to Build Your Own Mail Order Business"—noted specialist's 10,000-word treatise—shows how to make it pay, on small, capital start. 25c postpaid. Satisfaction guaranteed. Maupin & Maupin, LaFayette 3, Ind.

HARDWARE Business is one of the most interesting and profitable of them all. Be independent. You can start your own retail store with small investment and no previous experience. 15,000-word, copyrighted booklet tells you how. \$1.00 postpaid. C. R. Divan, P.O. Box 325, Santa Monica, Calif.

CASH By mail. Either sex. 10c brings offers, Bargain. Specialty Company, Box 635BO, Modesto, California.

GO Into rug and upholstery cleaning and mothproofing business. Extra double profits selling these two professionally used products to stores and homes. Russell-Johnson Company, Clarkfield, Minn.

START A business of your own. Can put you next to new profitable business opportunities. Particulars free. Beiers, 837-A N. Hoffer St., Bethlehem, Penna.

RAISE Your salary. Amazing new plan works wonders. Write immediately. Good Supply, Potsdam 7, New York.

RAISE Bean sprouts in dark room. Pays well. Free information. Mrs. Nickell, Route 1, Box 456, Bend, Ore.

WE Start you in business, at home, sparetime, earning \$10-\$30 weekly selling by mail. Stamp appreciated but not necessary. Driscoll Sales Service, Box 2771-A, Denver, Colo.

COLORGLAZED Concrete pottery made without molds. New, low cost, patented method. Cemetery products, novelties, tiles, floors, etc. Basement leaksealing. Other moneymaking projects. Booklet, details free. Men only. National Pottery Company, Fergus Falls, Minnesota.

MAIL Order opportunities. Read oldest trade journal. Copy 25c. Mail Order News, Somerville 35, N. J.

OPERATE Profitable mail order business. 75c profit each dollar. Powell Service, 5713 Euclid, Cleveland 3, Ohio.

CONCRETE Brick are a profitable product with a well established consumer demand. This is your opportunity to enter the concrete products field with the minimum equipment expenditure. R. S. Reed Company, Three Rivers, Mich.

ELITE Collection contains 137 practical money-making plans; local and mail order. New edition. Particulars free. Elite Co., 220-A Grand St., New York 13.

137 WAYS To make money, in home or office, business of your own. Full particulars free. Elite Co., 220-A Grand St., New York 13.

MANUFACTURE Costume jewelry at home for profit, hobby, therapy. Free wholesale supply catalogue. Instructions. Florida Supply House, Bradenton, Fla.

PUBLISHER Of seventy page trade magazine offers cooperative distributorships to men desiring advancement in mail order field. Splendid opportunity. Good earnings. Send 10c for handbook; application form Progressive Publications, Sheboygan, Wisconsin.

WANTED Unused U. S. postage stamps, small discount. Advance Stamp Company, 24 East 23rd Street, New York.

PLASTICS. Your own business at home. Make your own plastics, no expensive equipment needed, formula and molding instructions \$1.00. Box 224, Wickliffe 17, Ohio.

LIQUID Rubber, for making flexible molds, literature and sample free. H. Chaney, 1130 E. 16th St., Jacksonville 6, Fla.

PLASTIC Homes—Build yourself! Resurface old buildings! Wonderful building material. Particulars free. Marbleizing Service, Edwardsville, Illinois.

MAILING List! 5000 women mailorder buyers. \$25.00; 3000, \$15.00; 1000, \$6.00. Guaranteed accurate! Try them! Woods Remnants, Bedford, Penna.

LIQUID Marble—Colorful, glazed! Molded, brushed, sprayed! Composition floors. Rubberlastic molds. Particulars free. Marbleizing Service, Edwardsville, Ill.

ELECTRICAL Appliance repair. Open your own shop. Learn house wiring; electric motors, vacuum cleaners, washers, etc. Complete illustrated course shows how. Free booklet. Pacific Training School, Dept. AP-1, 7217 So. Broadway, Los Angeles 3, Calif.

HANDY Men—Earn money home operating Community "Fix-It" Shop. Write Stafford, 708 Rawlings, Carbondale, Ill.

YOUR Own business. Big profits, very small capital. National organization teaches, helps, supplies everything. Interesting service business. Big demand everywhere. American, 211 North 7th Street, St. Louis 1, Mo.

BOOKKEEPERS—Operate your own "Dollar-A-Week" bookkeeping and tax service. Full or spare time. Details free. Ellis, Box 200, Cedar Grove, No. Carolina.

MAIL Order business course shows you how to make money, spare or fulltime. Teaches professional mail order technique—not penny-snatching schemes. Fascinating 100-page illustrated success-catalog free! Write—Nelson Company, Dept. 4-02, Chicago 5.

BUILD Miracle homes. Yours. Others. Chamberlain, Fitzsimons Building, Pittsburgh 22, Penna.

LATEX For making flexible rubber moulds. Thoroughly tested. No shrinkage. Complete instructions with each order. Stoneham Rubber Co., Box 244, Stoneham 80, Mass.

MEN — Women — "Everybody Likes Candy." Learn to manufacture professionally at home. (Our 35th year.) Ragsdale Candies, East Orange 2, N. J.

AMAZE Others. Add columns instantly. Add faster than adding machine. Free details. Math Institute, Box 633, Mobile 4, Ala.

"HOW To Make Simple Molds and Plaster Plaques." Profitable business or hobby! Instructive booklet 25c. Plastercraft, 1406 East 43rd Street, Cleveland 3, Ohio.

RUBBER Moulds for casting novelties. Latex for making moulds. Use thoroughly tested and approved products. Eastern Latex Laboratories, Box 153, Mattapan 26, Mass.

TYPEWRITER Repairing—Original course, simplified home study. Weber Typewriter Mechanics School, Box 269, Osborn, Ohio.

FLORIDA Opportunities—Pensacola offers exceptional opportunities for small industries, especially in the field of mahogany novelties and woodware, perfumes, soap, chemicals. Delightful year-round climate. Wonderful fishing, hunting, beach sports. For information write: Industrial Development Division, Municipal Advertising Board, Pensacola, Florida.

RECAST Old batteries into new. Latest achievements. Battery Laboratories, Minneapolis.

\$25 WEEKLY Working two hours daily. No canvassing. No manufacturing. Lycke, Box 2471, Cleveland 12, Ohio.

START Mailorder bookshop—Everything furnished; publisher cooperation. 25c brings booklet, exclusive setup, samples, exciting ideas. General Publications, Ossining, N. Y.

BECOME An "Attritionist Masseur." First improvement over Swedish massage in 100 years! Results unbelievable! Dr. Swearingen, 9128M, Station S. Los Angeles.

BIG Money making Hollywood style pottery, bird baths, wishing-wells, benches, stucco-rock. New method. Clever designs. Color with chemicals, water-paints. Marbling, colored glaze effects. Dime brings samples, pictures, literature. Hollywood Cementcraft, 8527 Wonderland Ave., Hollywood 46, California.

BRUSH Plating outfits connect to a battery. No tanks necessary. Good paying business at home plating autoparts, bathroom fixtures, bicycles, reflectors, silvering mirrors. No shop or experience required. Outfits furnished. Free booklet. Gunmetal Co., Ave. H. Decatur, Ill.

AGENTS—To mail our literature. Good profits. Home business. Maywood, 1133 Broadway, New York.

MONEY For you. Start home business. Free leaflet describes 137 different plans. Specialty Sales, Box 43-PM, Station N, New York 23, New York.

EXPORT, Import, represent manufacturers. Deal with South America, Africa, China, Europe. War-peace time big business. Uncrowded fields. Unlimited opportunities. Deposit one dollar for two bulletins. Money back if unsatisfied. P. Benko, 246 Fifth Avenue, New York 1.

HOW I started successful business on 25c. Box 254M, San Francisco, Calif.

START Paying mailorder business. Circulars mailed. Clark, Box 515, Schenectady, New York.

GREAT Opportunity. Operate profitable mail order business. Free details. Florida Service, Box 328, Miami, Florida.

FOR An extremely profitable lifetime occupation operate a commercial employment agency, easily learned. Details free. Hunt, Box 308, Burlingame 1, Calif.

WE Show you how, in ten easy lessons, to succeed in roofing and siding unlimited, profitable business. No capital needed. Roy J. Peyton, Sr., 1611 South Kentucky Ave., Evansville (13), Ind.

DISTRIBUTORS—Franchise basis. Guaranteed 100% plastic polish for automobiles, floors, woodwork. Demonstration will convince anyone. The results are amazing. Nothing like it anywhere. Apply in person or write Resin-Nu Products, Inc., 11 Niagara St., Buffalo, N. Y.

INCREASE Your income. Spare, full time business in own home or office. Free literature describing deluxe edition "Illustrated Collection of 137 Successful Business Plans." Send post card inquiry to R. C. Chelf, 1126 S. Belmont, Indianapolis 3, Ind.

START Right. Develop profitable mail order business. Free literature. Jay Peterson, Box 752, Minneapolis 1, Minnesota.

PROFITABLE Business of your own. Big profit in photo-printing post cards. Make advertising, souvenir and personal post cards. Work in your kitchen. No experience needed. Automatic machine complete with supplies to make 50 cards \$5.98 tax paid post-paid. Send for folder. Craftex Laboratory, 4615 Elston Ave., Dept. PC, Chicago 30, Ill.

REACH And sell the colored trade by mail. An over-prosperous market. Details free. Elmer Swanson, Niagara, N. Dak.

BUILD Neon signs and neon lighting. Easy to learn. Very small capital required. McMaster Sign Co., 730 State St., Bellingham, Wash.

TREMENDOUS Profits mailing literature, dealers' information 3c. General-print, East Orange, N. J.

BUY Now unpainted plaques, book ends novelties and animal figures. Free list. Woody, 3715 Pillsbury Avenue, Minneapolis 8, Minnesota.

BE Your own boss. Sell by mail from your own home. Learn the how, why, when. Free details. L. Black, 2917 High, Des Moines 12, Iowa.

1918 24c AIRMAIL Stamp sold for \$4,000. Send 50c and learn about investment possibilities of U. S. postage stamps. Vaughn, 2207 Van Buren, Chicago 12.

PHILADELPHIA Mail or branch office address. Business, personal, assignments. Mail forwarded. Capable, experienced, confidential. E. J. Lyman, 622 Penfield Building, Philadelphia 7, Penna.

"MONEY! Money! Money! Need any? Then investigate mail order work! Details free! Quivira Mail Service, 207-e North Pioneer, Lyons, Kansas.

BABY Shoes preserved. Complete instructions. Exclusive rights. M. E. Watson, Bellefontaine, Ohio.

WORK Evenings at home collecting names and addresses. Sell them by mail. Details free. MacAndrews, 8 Buick Street, Calais, Maine.

WOULD You pay 3%—first \$350 made? Color-illustrated book "505 Odd, Successful Enterprises" free! Some plans offer occasional "day off." Start at home, office. Expect something odd! Pacific, 262 Drake, New Rochelle, N. Y.

FREE Literature giving details of several profitable home work plans. Webb, 1512 Buena Vista, Detroit 6, Michigan.

PERCENTAGE Mark-ups. Vest pocket chart 25c. Percent-o-Meter, Box 222, Chicago 90.

LIQUID Rubber for flexible molds. Professionals use it. Quick drying. Fast build-up. Less coats. Send for illustrated booklet on simple mold making 50c. Apex Plastic Products, 1740 Estes Ave., Chicago 26.

MONEYMAKING Instruction books on approval. Free literature. Upham and Son, 939-x Ravine Drive, Cleveland 12, Ohio.

VENDING Machines. Be independent. Own a big money business operating coin machines. Earn as high as \$7.00 weekly on machines costing as low as \$10.75 each. Car and experience unnecessary. Routes can be operated either in your spare or full time. Act quickly. Write for details and catalogue showing our amusement games, postage machines, candy-gum-nut vendor, scales, and stationery machines. Parkway Machine Co., 3046P Tioga Parkway, Baltimore 15, Maryland.

HOW Much capital do you need to start a mail order business of your own? I'll tell you all the facts on what to start, and how to start it. Information free. Rollick's Distributing Service, P.O. Box 564-B, Yonkers 1, N. Y.

10c BRINGS Offers of moneymaking plans, ideas, mailorder magazines. Reamy, Box 174-K, Staten Island 1, N. Y.

JIGSAW Owners: Square foot plywood yields \$46. Write: Woodarts, X-39, Bridgewater, Mass.

DO-IT-YOURSELF! Quick independence and fame! Earn money by mail from all parts of the world! Positive, tested and successful system reported now greatest business in the world! Easy, fascinating, desirable, tremendous Mail Order work! Lifetime work that dignifies! Expansion unlimited! Satisfaction guaranteed. Airmail dollar (seal envelope). Results or refund. Zigzag Corporation, Box 101-W, Guatemala City, Central America.

MONEYMAKING OPPORTUNITIES

MECHANICALLY Inclined men—Own and operate general appliance repair shop. Complete, illustrated course shows you how. Welding, refrigeration, motor repair, how to get business, etc., all phases covered. Free literature. Christy Supply, Dept. 1166, 2835 N. Central Ave., Chicago.

FOOD Sanitation. Learn for profit, protection, career. Certificate awarded. Free details. Sanitary Science, 2385G, Edgewater, Los Angeles 26, Calif.

TURN Your spare time into money making channels. We have hundreds of plans. Write Severance, 220A Garden Ave., Knoxville 18, Tenn.

GET The newest and best offers. New service brings complete, ready-to-start offers at low cost. Saves time, effort. Particulars free. Kelly, 1080-N Casgrain, Detroit 9, Michigan.

UNPAINTED Figurines, plaques list. Progress Company, 4033 Chowne, Minneapolis 10, Minn.

START Your own business! Big money—manufacturing novelties, plaques, statuary at home. Catalog free. Write—Bing Products, 88-AS Broad Street, Boston 10, Massachusetts.

"THERE'S Big Money in Junk!" Easy! Fascinating! Free circular! Write, Batteryman, Grand Junction, Colorado.

"LUMINOUS Paint." Resilvering Mirror formulas 25c each. Soapmaking, (20 formulas) \$1.00. Ideal Service, 307, Park Ridge, Ill.

EX-GI'S Wacs plan for your future security with proven plans. Literature free. Triare Books, Box 26, Pratt Station, Brooklyn, N. Y.

EARN Money evenings, copying and duplicating comic cartoons for advertisers. Adservice, Argyle (1), Wisconsin.

MONEY In domestic rabbits—interesting literature, information, prices, 25c coin. Odette Rabbitry, P.O. Box 5642-P, Dallas 2, Texas.

START Manufacturing business in your own home. No cheap novelties. Vallance Art Products, 1873-A East 70 St., Cleveland 3, Ohio.

"FORTUNES In Formulas," 10,000 trade secrets, authentic, reliable, practical, moneymaking ideas galore. This 900 page book is a real bargain. \$2.95 postpaid. Stillman, 555 Kingston Ave., Brooklyn 3, New York.

10,000 FORMULAS, Receipts, secret profit ideas. Details free. Lumco, Kimball, Nebraska.

200 MONEY Making deals. Plans. Rare formulas. Schemes. Folio free. Formico Eng., Box 572, Dayton, Ohio.

50 MAIL Order opportunities. Booklet 25c. Modern Mails, 102 West 15th, Bloomington, Indiana.

"HOW To Sell by Mail." 40-page book—40 mailorder subjects, 25c. Eljay Publishers, Herrin 4, Illinois.

SALES Outlook terrific for "money"—new dollar book golden opportunities, moneymaking ideas, small businesses, strange patents. Most unusual book 6x9, thrilling, inspirational. Distributors wanted, full or part time, every city, county. Rush \$1 for copy with exclusive big money sales plan. Pyramid Press, 218P Flatiron Bldg., Denver 2, Colorado.

SELL Stores home popsicle maker \$1. Ster. 828 N. Gardner, Hollywood 46, Calif.

OPERATE Profitable home mail-order business. Dime brings details. Billings, 210 Fifth Avenue, New York.

FREE Catalogs every month for everyone. Best nationally advertised sporting goods, radios, everything. Argent and Ross, Landover, Maryland.

INVESTIGATE Mail selling! What's the one best thing to sell, happily, honestly, profitably? We know! Get free particulars, free samples. What-To-Do Shop, Box 1082, Tacoma, Wash.

PLASTIC Paint all colors easy and inexpensive to make. Detailed process \$1.00. L. Cantin, 6½ Scott, Quebec, Canada.

MONEY Made in spare time from hobbies. Particulars free. Alfred Halteman, 314 Willowwood Dr., Dayton 5, Ohio.

FORTUNES In your hobbies. Details, dime. William Stamp, Clarkston, Mich.

GET Dollar orders by mail—Keep 90c. Easy! Pleasant! Everything furnished. New four-way plan shows how! Particulars, 40 page money making magazine, 25c. Genmerco, Box 142B, Dorchester Center, Mass.

SELL Merchandise by mail. Profitable, lifetime business. Write today! Powell, Sampliner Bldg., Cleveland 3, Ohio.

MONEY-MAKING Opportunities, exclusive supply sources, personal guidance guaranteed. For complete information, remit 25c. American Mail Trade Association, 313-F East 21st, New York 10, N. Y.

18,000 PATENTS, Royalty free. See "Bishop Tools" ad under "Patents."

HOMEWORKERS — Assemble colorful handmade jewelry! Profitable sideline. Free details. Beginner's outfit, \$1 (refundable). Hughes, 712 Kimball, Danville 3, Ill.

MAKE Money anywhere. 64-page book describes 300 mailorder plans; business ideas, secrets; formulas—25c. Moneyback guarantee. R-J Publications, Box 1651, Milwaukee.

"PROFITABLE Mail Selling." Idea-book for beginners, mail dealers. Air-mailed, quarter, no stamps. Greb, 10029 85th Ave., Edmonton, Alberta, Canada.

NEW Advertising scheme—A supplement to your magazine advertising. Every mail order beginner should have it. 25c. Murray's, 196 Circle St., Forestville, Conn.

BIG Mail free—Your name printed free in big mail directory. Send 25c for 3 mo. subscription to Progressive Mail Trade magazine. Vallis Mail Service, 3201 Harrison, Brookfield, Illinois.

OPPORTUNITY Seekers—72 page magazine listing hundreds of concerns offering you their latest money-making opportunities. 25c copy. Pleased or refund. Opportunity Bureau, Whaleyville, Va.

MONEY! Money! Money! Have you too much? Then don't write us for free details about mail order work, because you will only make more! Quivira Mail Service, 207-f North Pioneer, Lyons, Kansas.

WOULD You pay 3%—first \$350 made? Color-illustrated book "505 Odd, Successful Enterprises" free! Proven by "Little Fellows." Start at home, office. Expect something odd! Pacific, 262 Drake, New Rochelle, N. Y.

ENJOY Financial success. Details free. Write Success Foundation, 30 West Washington, Suite 900, Chicago 2, Illinois.

LEARN Aviation, electricity, plastics, radio, at home for less. Details free. Technibook, Box 261, Mt. Kisco, N. Y.

101 GOLDEN Opportunities, \$1.00 book. Start home business. Other books, courses. Write Research, Magnolia St., Malden, Mass.

BUY Articles wholesale. Make money by mail. Formulas, trade secrets. Free literature. Massey, 64 Sterling, Franklin, New Jersey.

GUARANTEED Giant Chinchilla rabbits. Prolific. Profitable. Most valuable fur. Markets furnished. Details free. Willow Brook Farm, R 15, Sellersville, Pa.

OPERATE Your own health service. Small investment to start. Many earn \$75 to \$125 per week. Work part or full time. Free booklet. Stanley Physical Therapy Supply & Equipment Co., 162 No. State St., Chicago 1, Ill.

THOUSANDS of alarm clocks need repairing. Jewelry stores swamped. Our simplified course teaches you how to repair these clocks. Necessary tools and supplies furnished with course. Alarm Clock Repair Service, P.O. Box 2350A, Houston 1, Texas.

AT Home—profitable business painting wall plaques. Experience unnecessary. Big demand. Free details. Alfred Novak, 2560-A Loop, Cleveland 13, Ohio.

1001 MONEY Making ideas for everybody. Write Neuway Institute, Box 5463, Chicago, Ill.

TATTOOING—Pleasure! Profit! Particulars free! Steele, 1138-S Market, San Francisco 2, California.

"HOW To Write Advertising," absolutely free! Dudley Bunn, 126-PM Lexington Avenue, New York 16.

PROFITABLE Ideas \$1.00. Free literature. Michael's Business Enterprises, 715 Lorimer St., Brooklyn, 11, N. Y.

CO-PUBLISH Magazine. Many profits. 16-page booklet free! Goldenberg, 5209-A Lindsay, Houston 3, Texas.

MAKE Popular, fast-selling stainless steel bracelets at home, full or spare time. Easy 300% profit. Special introductory kit makes work quick, easy. Facts free. Ar-Clo Guild, 2055 W. Summerdale, Chicago 25, Ill.

FREE. Money making opportunities. George Simon, 6843-A Jonathon, Dearborn, Michigan.

EARN Money at home! Thousands do! "Home Worker Magazine" tells how. Sample, 25c. Sizemore, Box 7, 4917 North Kostner, Chicago.

FORTIFY The future! Start own business: home, office. Booklet describing "Collection of 137 Tested Plans" free. Elite Co., 220-A Grand St., New York 13.

LEARN Battery repairing, rebuilding. Engineer offers money making methods. Battery Bureau, 2225 North 44th St., Milwaukee, Wis.

PUBLISH Your own magazine. Hand-some 52 page format, well edited, illustrated. Cost low as \$1.00 month. Brings you prestige, profits. 25c brings sample, details. National, Ord. Nebr.

I MAKE Big money in the mail-order business. You can do the same at home with my copyrighted system. Write me. I'll tell you how. F. Little, Box 8, Glenshaw P.O., Pittsburgh, Penna.

LEARN Metascience. Remarkable drugless healing. No manipulation, No apparatus. Unbelievable simplicity and results. Inexpensive correspondence course. Write Metascience, De Land, Florida.

EARN Money at home—realize independence. Write Successful Income Builders, 508A, Hollywood 28, Calif.

500,000 ARTICLES—Wholesale directory, dime. National, 322P Union Avenue, Brooklyn 11, N. Y.

MANUFACTURE Costume jewelry at home for profit, hobby, therapy. Free wholesale supply catalogue. Instructions. Florida Supply House, Bradenton, Fla.

FORMULAS, PLANS, ETC.

MANUFACTURE Cleaners, flavors, cosmetics. Formula catalog free. Kemico, Park Ridge 16, Illinois.

GIANT Formula; opportunity catalog free! Wilborn, 2719-P Jefferson Blvd., Los Angeles 16.

MODERN Manufacturing formulas. Everything including plastics, compositions, mold materials. 20c up. Catalog free. Houdelette, E. Wareham, Mass.

BUBBLE Formula and valuable list 10c (coin). Worth dollars. Taulman, 3316-6-G, Fort Worth 5, Texas.

10,000 TRADE Secrets, recipes, etc. Fortunes in formulas for home, farm and workshop. (Henley's Twentieth Century Book of Ten Thousand Formulas, Processes and Trade Secrets.) (Originally \$4.00.) Only \$1.49 postpaid. Send for free book catalog No. 341P. Union Library Association, 121 East 24th Street, New York 10, N. Y.

MODERN Specialties from formulation to packaged product. Gerard, Consultant, Fairmont, W. Va.

COUNTLESS Profitable opportunities as own boss. Giant illustrated instruction book contains 10,000 helps, scientific formulas, secrets. Earn immediately. \$2.99 postpaid. (C.O.D. accepted). Continental Publications, 79-02m Woodside, Elmhurst, New York.

MAKE Magic bubble solution. Two formulas, source supplies, \$1.00. Robinson, 315 North West, York, Penna.

MAKE 25 Pounds soap for 25c in about 25 minutes. Three ingredients. No lye or grease. Also bubble liquid. Carpet cleaner. Soap substitute. Garment cleaning soap. All 25c coin. Smart circular free. Teycer, Chemist, Box 1287½, Chicago 90.

NEED Chemists? Formulas. Analyses. Ideas. Consulting Scientific Company, Swarthmore, Pennsylvania.

REAL Manufacturing formulas. Lists free. Cummings, Chemist, Gordon Ave., Syracuse, N. Y.

FORMULAS—Latest, best. Analysis. Literature free. Belfort, Engineering Building, Chicago.

SELECTED Scientific formulas, processes, trade secrets. \$1.00. Fields, Empire, Colorado.

PLASTICS

PLASTICS And supplies—new Plexiglas, Lucite, and Catalin—sheets, rods, tubes, etc. Plexiglas and Lucite sheets per sq. ft. 1/16" \$1.60; 1/8" \$2.00; 3/16" \$2.25; 1/4" \$2.75; 3/8" \$3.75; 1/2" \$4.75; 3/4" \$7.50; etc. 5% discount over 5 sq. ft., 10% over 10 sq. ft. Kits \$2.00; \$5.00; and \$8.00. Swiss musical units—\$3.95 postpaid. List free. Send money order. Plas-Met Sales and Engineering, 4648 Shirley Pl., St. Louis, 15, Mo.

PLASTICS—10c Brings complete catalog containing profitable, fascinating ideas! Special kits and bulk assortments. Full line of plastics. Details about free offer! Fast, reliable service! Write Bello Plastics, Inc., Dept. L-7, 147 W. Sidney Ave., Mt. Vernon, New York.

CELLULOID—New postwar, beautiful assortment. Mottles, opaques, onyx, pearls. Used by ring makers everywhere. One pound assortment—pieces approximately 30 sq. in. each. Price \$1.00. Please add 10c for postage. Craft Service, 337 University Ave., Rochester 7, New York.

COLORLED Plastics—mottled colors; sheets and rods. Free price list. Hanson Plastics, Dept. G, 7625 South Park Ave., Chicago 19.

SELL Lucite hobbycraft supplies! Co-operative agency plan. Technicraft, 1156 Commonwealth, Boston 34.

PLEXIGLAS—Supplies prime grades 10% discount from Craft Plastics. Free listing. Box 129, Somerville, N. J.

"FORMALIN" Quicksetting liquid plastic. Literature free. Dealers wanted. Formalin Works, 5 W. Larned, Detroit 26, Michigan.

"LUCITE" Clear transparent plastics, new material. You save when buying 24"x36" sheets, 1/16" thick \$8.00. 1/8" \$10.00. 3/16"—\$11.10. 1/4" \$12.18. "Lucite" cement 6 oz. \$1.00. We pay shipping to points in U. S. on orders over \$100.00. Hamilton Plastics Corp., 717 Cedar Lane, Teaneck, N. J.

25 PROJECTS! Complete plans, instructions. Beautiful, salable Lucite novelties. \$1.00. Warde, 1248 Neil, Columbus, Ohio.

IF interested in plastics see the Jacaso advertisement on page 251.

MOLDED Plastic egg holder. (1 dozen) 8x10x1 1/2"—\$1.25 each. FOB Fernal's, 12449 State, Chicago 28, Ill.

WANTED—Plastics craftsman to make small ornament. R. D. Hudson, 100 Broad Street, Martinsville, Va.

YOUR Name, beautifully machine engraved, 1/2" letters on two inch lucite, 15c letter. \$1.50 minimum. A. C. Alexander, 1813 E. 5th, Pomona Calif. 1

PLEXIGLAS, Clear, approximately 8x12", 12x15", 1/8", 3/16", assorted. Irregular salvage sheets 3 1/2 lbs. \$1.90. 72" vinyl tubing included. 3 assortments \$4.70. Amer. Standard, 1208 North 13th, Philadelphia 22, Penna.

SPECIAL Sale of catalin unmasked sheets, 1/8" to 3/8", 6"x8" or larger. Assorted colors and thicknesses, 10 pounds \$7.50 postpaid. Under 10 pounds 75c pound, express collect. Send 10c for price lists of cameos, catalin, plexiglas. Craftsman Supply House, Scottsville 2, N. Y.

PLEXIGLAS, Clear, masked, 12"x12", 1/16"—\$1.50; 1/8"—\$2.00; 1/4"—\$2.75, postpaid. Dyes, 16 colors; dye concentrate; cements, colored, clear. List free. G. Baker Company, 685 Center Avenue, River Edge, New Jersey.

PLEXIGLAS Any size, any amount, cheap. Free price list. Thomas Cavaliere, 2141 So. Beechwood St., Phila. 45, Pa.

LEARN At home "Working With Plastics." Full information on sheets, blocks, rods, tubes. Trade names, sizes, colors for fabrications, designing, tooling, bending, cementing, polishing. Also for home workshop. Only \$1.25 postpaid. Money back guarantee. Modern Technical Book Co., Dept. M4MC, 55 West 42nd Street, New York 18.

PLASTIC, Plexiglas sheets new; 144 square inches following thicknesses: 1/16" \$1.60; 1/8" \$1.85; 3/16" \$2.00; 1/4" \$2.50; 3/8" \$3.50; 1/2" \$4.50; 3/4" \$7.25; 1" \$9.25. 5% discount over 5 square feet, 10% discount over 10 square feet. Sent prepaid. Send money order. Plastic Supply Company, 2618 St. Louis Ave., St. Louis 6, Mo.

LUCITE—Complete illustrated fabricating instructions, used in craft classes throughout the world, price list on lucite, dyes, complete supplies. Booklet 10c, with sample, 35c. "Gem-O-Lite," P. O. Box 686-B North Hollywood, California.

BIGGEST \$1.00 Plastic value transparent plexiglas and lucite sheets and strips in irregular shapes and thicknesses. Useful for many projects and experimental work—big package by return mail, no waiting. Double size package with dye and cement included \$2.00. Send money order to HomeCraftsman Plastics, 1945 W. Harrison Street, Chicago 12, Illinois.

CHEMISTRY

THE House of Winn, home of supplies for amateur chemists. See Winn's New Idea chemical kits and apparatus outfits for home experimenting. Send 10c for retail catalog. Established 1931. John H. Winn, Dept. 507, 124 West 23rd St., New York 11, N. Y.

STUDENTS' Laboratory supplies. Send 5c for catalog. Mel-Glo Chemical Co., 258 Fourth Ave., Brooklyn, N. Y.

FREE Catalog: Chemicals, apparatus, bargains. Colonial Chemical DPM-3, Brockton 28, Mass.

HANDBOOK For chemical experimenters, illustrated, hundreds of experiments, 50c. Experiment booklet 15c. Chemistry catalog 5c. Reading Scientific Company, Reading, Penna.

APPARATUS, Chemicals, ounce quantities, catalog 5c. Fleischer's Laboratories, Everett 49, Mass.

FREE Catalog. Chemistry, mineralogy, biology, optics. Tracey Laboratories, Evanston, Illinois.

NEW 36 Page chemical apparatus order book. Complete line of chemical glassware, apparatus and chemicals. Send 10c for this book. Standard Science Supply Co., 1232 N. Paulina St., Chicago.

CHEMICALS And apparatus for industrial, analytical, and private laboratories. Complete supply service for correspondence school students. Send 3c for catalog. Dept. M-43, Biological Supply Co., 1176 Mt. Hope Ave., Rochester 7, New York.

HELP WANTED

OILFIELDS Offer good paying pleasant jobs from Boomtown to city officer. Names, addresses, 100 companies, list jobs and pay rates. Research, Box 559, Victoria, Texas.

MAN Over 30 with car to travel in smaller cities calling on men's and women's patriotic and civic organizations; we book for them a dignified fund raising plan requiring no investment; no merchandise involved; permanent position; earnings \$90 to \$100 weekly plus quarterly bonus averaging \$400 to \$600. Write Sales Manager, 704 Waittower Bldg., Kansas City 6, Mo.

BIG Money conversion burners, furnaces, blowers. Peerless, 4322 Sheridan, Lincoln 6, Nebr.

AGENTS WANTED

MILLIONS Need this link to life and will pay you big profits. The new Safety Glide can be quickly and easily hooked to a bed leg, radiator foot or fastened to the wall. A child can operate it—the heaviest adult can rely on its strength in sliding to safety from a fire. Big profits all year 'round. Hotels, public buildings, schools, factories, apartment houses, homes and hosts of other places all eager prospects. Don't miss this opportunity of a big steady income. Write for full details today! Morrissey Manufacturing Company, Box 143, Dept. PM, Auburn, N. Y.

IMMEDIATE Profits! Take orders for new amazingly beautiful life-time laminated plastic reproductions of any pictures, snap-shot or negative. Build a profitable full or part-time business without investment. Write for details today. Gotham Products Co., Dept. G, 215 E. 149th Street, New York 51, N. Y.

TAKE Orders for famous patented "Re-Zil-Arch" supports. Men, women, operate own business. Exclusive established item. No cold canvassing. No competition. No investment. Excellent spot commission. Will instruct by mail. Write Lynn Foot Cushion Company, Lynn, Massachusetts.

CHRISTMAS Cards. Earn big money. Take orders galore from friends. 25 exquisite folders with name \$1.25. Free samples 10 designs. America's fastest selling 21 Christmas folder box. Costs 50c. Sells \$1. Request samples today. Sunshine Art, Dept. E, 115 Fulton St., New York City.

SILVER Plating liquid. Simply rub-on with a cloth. Cleans, silverplates, polishes, one rubbing. Puts on genuine 1000 fine silverplate. Renews silverplated ware like new. Silverplates onto brass, copper, bronze, etc. Lasting finish, won't come off. Sales representatives wanted. Details free. NuProcess Products, Dept. 232, Aurora, Ill.

AGENTS—Salesmen—solicitors—pitchmen—promoters desiring outstanding profits. Hawaway's interesting proposition pyramids your chances. Write Hawaway, 635C Mills Building, San Francisco, Calif., else miss opportunities!

GOLD Lacquered window sign letters. New foils, styles, absolutely beautiful. Free samples. Atlas, 544 W. 79th St., Chicago.

JUST Out! History of World War II. Huge volume. Popular price. Authentic text. Official photographs. Big profits. Riverside Book Company, Iowa Falls, Iowa.

SELL Housewives patented gadgets. Landan, P. O. Box 6553, Washington, D. C.

\$5,000 YEARLY Possible, selling books by mail. Distributors proposition. Nichols Publishers, Box 831, Pine Bluff, Arkansas.

EVERYDAY Cards. Make \$5.00 with every ten \$1.00 assortments you sell. Also fancy note paper and everyday wrappings. Send for samples today. Howard P. Ellis, Dept. PM-7, Pitman, N. J.

SURE Hit. Hot seller everyone uses. Big profits. Trim Rite hair trimmer. Trims hair as it combs. Sample 25c. Dozen \$1.75. Gross \$15.00. Trim Rite Co., New Kensington 449, Penna.

IRON Board cover holders—fast seller. Sample \$1.00—10 clips per set. Special distribution prices. J. G. Specialty, 1430 East 82 St., Cleveland 3, Ohio.

MAKE Money in your spare time! Helps furnished. Easy sales. Voluntary repeat orders. Liberal commissions. Send for free wholesale price list today! Write McGregor or Magazine Agency, Dept. PM6, Mount Morris, Ill.

25 WAYS To make money with luminous paint. (Shines in dark). Send 25c for profitable folio and luminous color sample. Lite-Saver, 97C, Saybrook, Conn.

SELL Suntan and other lotions. Exclusive territory. Permanent connection. Excellent sideline. 100% profit. Bonny Fair, 53 State, Boston, Mass.

AGENTS, Distributors, and saleswomen: highest commissions, noncompetitive field, free details. M. E. M. Specialties, 3044 Jackson, Dept. 56, Chicago 12, Illinois.

AGENTS: Sell fast moving cosmetics. Big profits! Bernal Sales, One Union Square, New York 3, N. Y.

SPECIALS—Greeting cards, Box 61, Times Square Station, New York 18.

1 LB. 50% DDT. Just add water, makes 1 to 3 gallons, \$1.50. Get facts. Kohen, 506 West 45th, Chicago 9.

AGENTS—300 % Profit selling genuine gold window letters; stores and offices. Free samples. Metallic Letter Co., 438-B North Clark, Chicago.

NEW, Extra money plan. Up to 100% profit showing friends unusual personal Christmas cards, box assortments, gift wrappings, humorous, all occasion, birthdays, social notes, personalized stationery. Extra bonus. Request free 50 for \$1, 25 for \$1, 25 for \$1.95 name imprinted Christmas cards and personalized stationery folder. Special offer. Thomas Terry Studios, 221 Union Avenue, Westfield, Mass.

SELL Shampoos, creams, lotions, tonics, in bulk to barbers, beauty shops. Gerard Specialties, Fairmont, W. Va.

SELL Greeting cards with true Christian sentiments. We feature twenty different assortments. Commission up to 100%. Shepherd's Town Card Company, Shepherdstown 57, Penna.

LUMINOUS Pictures that glow in the dark. Large manufacturer wants factory representatives; wonderful new item; fast seller; free sample. Madison Mills, 303 Fourth Ave., New York City.

BE First!—Monthly new products bulletin service brings last-minute listings, 100 newest products and sources! Latest release, subscription offer, \$1.00. Literature free. Proper Products, Box 758, Milwaukee, Wis.—Coates, 46-L King, Dorchester, Mass.

SELL Stores—pocket knives, nail files, nail clippers, scalp massagers. Carded samples \$2. Sibert Co., East Orange 40, New Jersey.

POWER Mower, cuts, trims. User agents-dealers. Farm Products, M-2004, Excelsior Springs, Mo.

LAUNDRY Soap powder, 100 lb. drum \$11.00. Farrand Chemical, Tyrone, Penna.

ENGRAVED Brass plate on rest room wall keeps floor dry. Everyone buys for \$2. Sample \$1. Satisfaction guaranteed. A. C. Alexander, 1813 E. 5th, Pomona, Calif. 1.

"TWELVE-IN-ONE" Tool. See Bishop Tool ad under "Machinery."

SELL Full, part time, individualized belts, buckles, cap badges, tie holders. Thousand emblems. Every veteran prospect. Fast profits. Repeats. Write today special outfit offer. Hook-Fast, PM, Box 1425, Providence, R. I.

SENSATIONAL Lanite makes paint brushes washable in plain water. Agents, dealers, 50 cents silver brings liberal sample. Lanite, 1925 South Dupont, Minneapolis, Minnesota.

HOUSE Numbers, adjustable, permanent. Sells on sight. Small assortment starts you. Geringer Supply Co., 7205 S. Morgan St., Chicago 21, Ill.

AUTOMOBILE Polish. Fast deal. Big profits. \$1.00 brings sample. Master Products Company, 125 S. E. 30th Place, Portland 15, Oregon.

WONDER Silver plating liquid. Applied with cloth. Deposits permanent silverplate on all silverware, brass, bronze, zinc, etc. Good carded item for stores. Wonderful demonstration. Big profits. Full details by mail. Wonder Products, 1265D Broadway, New York 1, N. Y.

BIG Bargains for big profits. Over 100 sensational values. Men's used suits \$2.00, pants 35c, topcoats \$1.25, overcoats \$2.00, shoes 20c. Experience unnecessary. Free wholesale catalog. Superior, 1250-FB Jefferson, Chicago 7.

PICTURES For framing. Samples and lists 10c. Curtis, Box 1916A, Denver 1, Colo.

AGENTS Wanted. Our service puts you in contact with hundreds of firms anxious to hire you. Agents National Service, 1311 Linden Avenue, Lima, Ohio.

SELL Needed eyeglass cleaner, prevents steaming. \$1.00 for 8 25c tubes. Shurberg, Box 1514, Hartford 1, Conn.

200 MONEY Making deals. Plans, rare formulas. Schemes. Folio free. Formico Service, Box 572, Dayton, Ohio.

MEXICAN Feather pictures. Unusual novelty. 50c (stamps) bring \$2.00 worth samples, details. Refunded if unsatisfied. Aztec Art, Apartado 762, Mexico City.

SELL Books by mail. Mammoth sales and huge profits. Everything furnished. Send 10c for complete details. Business Plans Foundation, Box 56-R, New York 10.

100% PROFIT On famous, popular Pines birthday, Christmas and all-occasion greeting cards. Wonderful 12 to 24 card, boxed assortments sell on sight for \$1.00. Write today for information and extra bonus distributors' plan. R. Pines, Box 32, Flushing, N. Y.

137 COMPLETE Plans for starting own business: local—mail order. Particulars free. Elite Co., 220-A Grand St., New York 13.

MAKE Quick clean-up selling perfume beads. Particulars free. Mission, 2328 W. Pico, Los Angeles 6, Calif.

ELECTRIC Ironing cords with indicator light. Iron-So-Ezee Company, Mt. Washington, Ohio.

MAGIC Cleaner and laundry soap deal. Hotter than a firecracker. Big profits. Sample free. Bestco, 5007 Irving Park, Chicago.

\$3 FIRE Extinguisher; quick sales, wholesale or direct; liberal profits. "Fire-Killer," 109 N. Franklin, Syracuse 1, N. Y.

SELL "Petite picture notes." Something really different in greeting cards. Sample free. Dunbar Cards, New Brunswick 20, N. J.

AGENTS: Stamping names on pocket-key protectors. Sample check with your name, address, 25c. Stamping outfits. Emblem checks, check-fobs, name plates. Hart Mfg. Co., 303 Degraw St., Brooklyn, N. Y.

WHOLESALE Sources. 500,000 articles. Free directory. Maywoode, 1133 Broadway, New York.

PLATING Outfits for autoparts, reflectors. Connect to a battery. No tanks necessary. Free booklet and particulars. Gunmetal Co., Ave. N. Decatur, Ill.

EXCELLENT Sideline for printing salesmen. Decalomania name plates in small quantities. Also, make money applying initials on automobiles. Free samples. "Ralco," X-164, Boston (18), Mass.

FREE Water and our concentrates, makes flavors, lotions, shampoos, 72 products, labels, bottles furnished. Qualco, E-20030 Russell, Detroit.

HIGH-GRADE SALESMEN

PAPER Signs—Restaurants, fountains, markets—big demand—big sample package \$1.00. Cotley Signs, Sandusky, Ohio.

LOOK Here! Wanted—Men and women to start in business on our capital. Sell some 200 farm-home products. Thousands our dealers now make quick sales, big profits. For particulars write Rawleigh Co., Dept. G-192-PPM, Freeport, Ill.

BIG Commissions—selling to stores celluloid pricing tickets, metal shelf moulding. To restaurants, menu covers, signs. P. Pricing Press, 124 White St., New York 13, N. Y.

PUNCHBOARDS Really sell and there's big money in ours. From more than 300 sources, we test and find winners! If your locality permits punchboards, and if you can make a small outlay (guaranteed refundable), write us today! Jay Wico & Co., Box 271, Logansport, Ind.

SALES Managers needed in every city. Every investigator given an opportunity. Post Office Box 4967 Florence Branch, Los Angeles, California.

SELL Full or part time, individualized belts, buckles, caps, cap badges, tie holders. Thousand emblems to choose from. Fast profit. Repeats. Write today. Special outfit offer. Hook-Fast Company, Roanoke, Virginia.

QUICK, Sure money. Tested. Annie Blain flavors. George S. Parker, New Brunswick, N. J.

SALESMEN, Sell plastic merchandise and abrasives wholesale. Profitable full time. Sample kit, photos, catalogs. \$12.00 investment required. Turner Bros., P.O. Box 174, Alhambra, California.

FAMOUS Picture—in four colors. 500,000 sold. Permanent opportunity. State experience. Sample print free. Our Flag Sales Corp., Dept. C-1074, Excelsior Springs, Mo.

SELL Greeting cards, display signs, pictures, books, novelties. Big profits. Bulletin free. Elfco, 432 North Wells, Chicago 10.

SALES Representatives—Sell Pre-Eze penetrant. Tunes, desludges and breaks-in motors; loosens rusty parts quicker. Nothing like it. Nationally advertised. Build own exclusive profitable business. Pre-Eze Chemical Corp., Box 439, Atlanta, Ga.

FREE! Latest issue Opportunity Magazine. Salesman's Guide. Inspiring, constructive. Shows how to earn money selling for others or in your own business. Hundreds postwar opportunities. Send name and describe what you have sold or are selling. Illustrated copy sent free. Opportunity Magazine, 620 N. Michigan, Dept. 17, Chicago 11, Ill.

EDUCATIONAL AND INSTRUCTION

WIN A well-paid job in travel—step into a new world of glamorous opportunity! Today more Americans are "going places" than ever before in history. As a result—the hotel and institutional field is surging ahead to new prosperity. Successful Lewis graduates "making good" everywhere in luxurious hotels, fashionable resorts, smart restaurants, and clubs. Free book explains how to qualify at home for a well-paid position in this ever-growing business where you are not dropped because you are over 40—shows how you are registered free of extra cost in the Lewis National Placement Service. Write today. Room HP-395, Lewis Hotel Training School, Washington 7, D. C. (Now in its 30th year.)

"HOW To Break and Train Horses"—a book every farmer and horseman should have. It is free; no obligation. Simply address Beery School of Horsemanship, Dept. 1107, Pleasant Hill, Ohio.

"PRINTING Is Progress." Pays big! Prepare to get ahead. Write for free sample lesson today. International School of Printing, Dept. MC-76, Box 334, Dayton, Ohio.

WELDING—Electric arc. Learn profitable trade quickly through actual practice. Individual welder instructions at bare cost of materials. Full particulars free. Valuable welding lessons book 50c. Hobart Welding School, Box M-762, Troy, Ohio.

WORK For "Uncle Sam!" Commence \$125-\$220 month. Prepare now for next examinations. Vets get preference. Full particulars—sample coaching free! Write today. Franklin Institute, Dept. S24, Rochester, N. Y.

CAN'T Remember? Stop worrying! Facts, figures, faces at your command through Supermemory. A-17, Thor Books, Box 1210, Chicago.

WHY Don't you write? Writing short stories, articles, etc., will enable you to earn extra money. In your spare time we teach you to write the way newspapermen learn—by writing. Free "Writing Aptitude Test" tells whether you possess the fundamental qualities essential to successful writing. Veterans: This course approved for veterans' training. Write today! Newspaper Institute of America, Suite 570-L, One Park Avenue, New York 16, N. Y.

HOME Bible course. Simple, helpful, instructive. Total cost \$3.00 includes textbooks, examinations, certificate. \$1.00 starts you, or simply request prospectus. The Bible Study School, Reverend Leslie Marshall, Secretary, 382 Van Houten Street, Paterson 1, N. J.

BECOME A Doctor of Psychology or Metaphysics. Teach secret of contentment, happiness. Win degree of Ps.D. or Ms.D. Solve mental worries. Free book. College of Universal Truth, 5153-B North Clark, Chicago.

FIND Your real opportunity. Advance "years in months." Dr. Tibolt, 16M, Phila. 20.

LEARN Typewriting in 10 lessons guaranteed (your home); Also: shorthand, bookkeeping including accounting—ninety hours each; low rates (Osborne-Chilcoat "Psycho-Methods"). Osborne College of Short Methods, 212 West Third Street, Los Angeles 13, California.

NO Advance payment! Study automatic screw machine engineering at home. Complete from machine elements to cam layout. Pay as you learn. Warren's School of Engineering, 9 S. Kedzie Ave., Dept. 307, Chicago 12, Ill.

PREPARE Your own home study course on any vocational subject. Free bulletin. DeVoto Schools, 35 Vicente, San Francisco 16, Calif.

"FREE Educational opportunities" (directory) lists hundreds of free books, correspondence courses, etc. All 1946 sources! \$1.00. Also "personal success book" free! Landry, Box Q-101, Hyde Park Station, Los Angeles 43, Calif.

HOME Study course, drugless therapy. Free literature. Institute of Drugless Therapy, Tama, Iowa.

SCREW Machine men! Warren's book will help you. Over 300 pages, simplifying estimating, feeds, speeds, tooling, cam layout. Five-day return privilege. \$10.00 plus small C.O.D. fee. Alhar-Warren Co., 9 S. Kedzie Ave., Dept. 37, Chicago 12, Ill.

TUNE Pianos scientifically. Lesson and diagram, \$1.00. Oscar Fylling, 841 Robinson, Oroville, Calif.

COMPLETE Course radio announcing \$5.00. Ryan Studio, 2888 Westshire Drive, Hollywood 28, Calif.

SHORTHAND In 4 to 6 weeks. Modern A.B.C. method. Simple, interesting, low cost. Sample lesson. Full particulars free. DeLuca's Service, 127D Pettis Street, Providence 4, R. I.

SELECT Your career easily with scientific testing method. Write Vocational Service, 735 Bank of America Bldg., San Diego, Calif.

MATH-O-METER Vest pocket graphic calculator 25c. Math-O-Meter, Box 222, Chicago 90.

UNISCRIP Universal shorthand alphabet free. Textbook 25c. Guaranteed success \$5.00. Jesse L. Cook, Bartow, Fla.

GET Government job: Good salaries, permanent. Service men given preference. Low priced home study practice lessons help you make good grade. Write, Ozment's School, 75, St. Louis, Mo.

LEARN Radio announcing. Send 50c. Ryan Studio, 502 17th North, Seattle 2, Wash.

LEARN Shoe rebuilding. State, gov't. Approved for GI training. Modern Shoe Rebuilding School, 2935 Belmont, Chicago.

MASSO-PHYSIO-THERAPY, Chiropody. Evans natural therapeutics home study courses. P.O. Box 1195, San Antonio 6, Texas.

GOOD "Used" self-instruction educational books on all subjects bought, sold, rented, exchanged. Satisfaction guaranteed. Complete information and 100-page illustrated bargain catalog free! Write—Nelson Company, Chicago 5.

USED Educational and technical books on all subjects bought, sold, rented. Catalog free. Educational Exchange, Henagar, Ala.

29 LANGUAGES By Linguaphone. Russian, Spanish, Portuguese—Direct conversational method for mastering any language quickly, easily, correctly at home. Send for free book. Linguaphone Institute, 83 RCA Bldg., New York.

LEARN Photo-engraving at home or in oldest, largest school in America. Work for newspaper or establish own profitable business. New Tasope' Photo-Engraving equipment available soon. Write for information. Veterans ask about G.I. training. The Aurora School of Photo-Engraving, Tasope' Bldg., Aurora, Mo.

INVESTIGATOR Training, Phillips Secret Service, 1917B North Kenneth, Chicago 39, Illinois.

LOCKSMITH Course. Lock picking, key fitting, etc. \$1.00 prepaid. Locksmith, Canadian, Texas.

MEDICAL Laboratory technicians in great demand. We train you in your spare time, in your own home. You can practice while studying. Write for free catalogue. Imperial Technical Institute, Box 973-E, Austin, Texas.

SECRET Investigation. Experience unnecessary. Investigators particulars free. George Wagner, M 125 West 85th, New York.

USED Educational books on all subjects sold, rented, also bought and exchanged. Moneyback guarantee. Write today for free catalog and details. Lee Mountain, Pisgah, Alabama.

PLAYS, STORIES, MANUSCRIPTS

WRITERS. Create original plots from published stories without plagiarizing. Folio shows how. Guaranteed. Price 50c. Information free. Writecraft, Box 202-M, Chicago Heights, Ill.

WIN Fame, success, security writing short stories, newspaper features. New, easy plan shows you how. Write today for exclusive details. Writer's Institute, 4-M So. 15th St., Philadelphia 2, Penna.

WE Pay high fees for stories and articles. Submit manuscripts: Writer's Bureau, P.O. Box 2629, Cape Town, South Africa.

NEW Writers needed to rewrite ideas in newspapers, magazines and books. Splendid opportunity to "break into" fascinating writing field. May bring you up to \$5.00 per hour spare time. Experience unnecessary. Write today for free details. No obligation. Postcard will do. Comfort Press, Inc., 210-P South Seventh St., St. Louis 2, Missouri.

I WANT New writers to cash hundreds of checks for \$1 to \$100, offered each month. The easiest way to write for pay. No previous experience necessary. Send for free details. No obligation. Saunders M. Cummings, Box 609-M, Colorado Springs, Colo.

BUSINESS SERVICE

BUSINESS And personal representation, appraisal, and adjustments. 25 years experience. J. E. Rumfield, 5716 Junius, Dallas, Texas.

\$3.00 MONTHLY Maintains Washington, D. C. office address. Your business, personal mail reforwarded when wanted. Hawkins, (Established 1917), 1300 Taylor, (102h).

TO Whom it may concern: We will represent you in the principal cities of the United States; Alaska; Bahamas; Canada; Cuba; Europe; Hawaii; Mexico; Newfoundland; New Zealand; Nova Scotia; Panama; Philippines; Puerto Rico; South Africa and South America. Personal or business assignments \$1 per hour. James W. Farley, Citizens Bldg., Cleveland 14, Ohio. Note: Would appreciate hearing from someone who wishes to enter this business in your city. Will send you assignments immediately. References exchanged. State qualifications.

NEW Things to buy, sell, FTC regulation items. The Products Review, Spotlight Trade Service, Copy 50c. Chaffee, 308 Washington, Chicago 6.

INTERNATIONAL Personal and business representation—all cities of United States, Mexico, Canada, Panama. Reasonable rates—interested in being our representative? Write Secretariat Services, 239 Bleecker St., New York City (14G.)

1,000 MAILING Names on perforated gummed labels \$2.50. Labeloft, Box 47, Springfield, Mass.

BUSINESS Stationery. Your personal representative. Samples. Ace Printing, Brentwood, Maryland.

SPECIAL SERVICES

ENGINEERING Service—plans, research, design (electrical, civil, mechanical) at a price you can afford. Free estimate. William H. Jacques & Associates, Consulting Engineers, Zobel Bldg., Red Bank, N. J.

COMMERCIAL Art, letterheads, advertising illustrations, color designs. Engraving service furnished. Send 25 cents for samples and estimates—refunded first order. James Burroughs, Conway, S. C.

INFORMATION Furnished, many subjects, reasonable fee. Bert Research, 1516 Jackson, New Orleans 13.

VISIT Historical Philadelphia by proxy. Send 15c for 3 post cards. You address, return, we mail. Dept. B, 6323 Elmwood Ave., Phila. 43, Penna.

MECHANICAL Equipment designed. Bevan Engineering Service, 355 Keystone Drive, New Kensington, Penna.

MECHANICAL Construction engineer desires represent American firm in Belgium or all Europe. Formerly director general for important Belgium firm. Pinget, 282 Rue Du Noyer, Brussels, Belgium.

TRANSLATIONS Half cent word. 478 East 25th, Paterson, N. J.

REPRESENTATION—Business, personal. Frank Dumond, Box 1989, Las Vegas, Nev.

VISIT Atlantic City by mail. 3 postcard views 20c. Address, return, I mail. Letters mailed 15c. Muriel Koler, 1111 Atlantic Ave., Atlantic City, N. J.

GOOD "Used" self-instruction educational books on all subjects bought, sold, rented, exchanged. Satisfaction guaranteed. Complete information and 100-page illustrated bargain catalog free! Write—Nelson Company, Chicago 5.

FREE—"Amazing New Book"—"Profits From Classified Advertising." Tells how and what to advertise. Be sure to read this book before you invest one cent in advertising. Remember—it's free! Write for your copy now. F. W. Johnson, Classified Advertising Manager, 200 East Ontario Street, Chicago 11, Illinois.

CARTOONING, COMMERCIAL ART, SHOWCARD WRITING, SIGN PAINTING

"HOW To Make Money With Simple Cartoons."—A book everyone who likes to draw should have. It is free; no obligation. Simply address Cartoonists' Exchange, Dept. 97-C, Pleasant Hill, Ohio.

SHOWCARD Writing—Learn—new easy method—complete instructions. Now \$2.50. Sign Service, Box 435, Ansonia, Conn.

ENJOY Painting beautiful pictures quickly, easily, inexpensively. Free literature. Art Book Shop, Arnold 4, Mo.

ARTISTS—Students: Auto-scale saves half time copying, enlarging, reducing drawings. Guaranteed. \$3. Particulars free. Disco, Box 761, Glendale 5, Calif.

DRAFTSMEN And artists new mechanical pencil. Postal secures details. Collet Instruments, 695 East 17th Street, Brooklyn 30, New York.

ARTWORK; Stationery designs, headings, title-lines, \$1.35. 200 colorful samples \$1.10. Major Designs, 3510 Palmer, Chicago 47.

CARTOONING, Draw comic characters instantly. Complete charts, instructions, \$1. Cartoonist Felix, Box 337, Duluth, Minnesota.

CARTOONING Course:—30 illustrated lessons, over 500 sketches, complete \$1.00. Rex Cartoons, Box 892, Pasadena, Calif.

CHALK Talks. Laugh producing program, \$1.00. Catalog 10c. Balda The Cartoonist, Oshkosh, Wisconsin.

CARTOON Course—22 easy lessons. 200 figure sketches. 25c coin postpaid. Snack-Pack Co., 32 E. Georgia, Indianapolis 4.

MAKE Signs, letters, stencils. 9 complete alphabet pattern sets. 3 complete numeral pattern sets and catalog \$1.00. Sign Letter Distributors, P.O. Box 101, Mineola, N. Y.

ADVERTISING AGENCIES, LETTER WRITERS, FOR ADVERTISERS

ORDER—Pulling sales letters written, \$2 page. Twenty years' experience. Satisfaction guaranteed. Dudley Bunn, 126-PM Lexington Avenue, New York 16.

ADVERTISE Profitably: \$20.00 reaches 5,000,000 Sunday newspaper readers with 24-word ad. Newspaper, magazine, mailing-list ratebook free. Chicago Advertising Agency, 20-PA W. Jackson, Chicago 4.

ADVERTISING, Art work, sales letters. C. F. Sanford, 5029 Maple Ave., St. Louis.

MAILORDER Advertisement writing! Powerful sales letters, circulars, complete campaigns. Investigate! Finkle Advertising, 1201½ South Ogden, Los Angeles, 35.

25 WORDS 32,000 Readers \$2.00, magazines 20c. Renick, Holland 4, New York.

NATIONAL Advertising agency needs representatives. If you can control good advertising accounts we can pay liberal commissions. Write Horan, Two Eleven North Seventh, St. Louis, one, Missouri.

SAVE Money on magazine advertising. Write for rate folder. The E. J. Eller Advertising Agency, Dept. 12, 803 Curtis Street, Albany 6, California.

MAILING Lists, certified, productive, inexpensive, \$5.00 1000. Homeworkers, agents, buyers, etc. Write Dixie Service, King, N. C.

ADVERTISERS! 6,000,000 Circulation 25 Sunday national key newspapers. 18 words, \$40.79. "Terrific pullers" 20 popular newspapers \$8. "Free booklet." Newmarks Advertising Agency, 217-7th Ave., New York.

ADVERTISING: Placed in any publication, anywhere. Write for mail-order rate sheet "M." LeGrand Advertising Agency (established 1923) Floral Park, N. Y.

MAILING Lists!—Fresh, reliable, names, addresses; \$10 thousand. Loyalton Service, 868 Woodward Ave., Brooklyn 27, N. Y.

FREE! 1946 Advertisers Rate & Data Directory. 52 pages! E. H. Brown Advertising Agency, 20 N. Wacker, Chicago 6.

ADVERTISE: 24 Words, 40 newspapers \$3.50. List free. Advertising Bureau, 4515-C Cottage Grove, Chicago 15.

ADVERTISERS Service—For men going in business. Put our experience in merchandising and advertising back of your products. Write Van De Mark, Times Star Bldg., Cincinnati 2.

24 WORDS In 64 weeklies \$4.96. H. J. Darnell, 730 Hays, Jackson, Tenn.

ADS Placed in out of town newspapers and magazines. Low rates. Catalogue free. Ideas that pay. Baker Advertising Agency, Successors Ankrum Agency, 189 W. Madison, Chicago 2.

TYPEWRITERS, DUPLICATORS, OFFICE DEVICES

RECONDITIONED Typewriters, mimeograph, multigraph printing devices, appliances, supplies. Catalog. Dixiegraph Service, King, N. Carolina.

PRINT Your own postal cards, paper, or anything on "Printomatic Self-feeding Rotary Postal Card Stencil Duplicator." Only \$9.50 with \$2.35 worth of supplies, stencils, ink, etc. Literature free. Pittsburgh Typewriter Supply, 336-RB Fourth Ave., Pittsburgh 22, Penna.

RUBBER STAMPS, OFFICE SUPPLIES

3 LINES 37c; Signatures \$1.75; pads 25c. Stamprite, Wauwatosa, Wis.

KNOB Handle, 1 line 35c. 2—40c, 3—50c. Stamp Works, Centerport, N. Y.

PICTORIAL Rubber stamps for children, 10c each. Catalog free. Stamporium, 2660P Rochester, Detroit 6, Mich.

BETTER Rubber stamps. "Ezy-Order" literature free. Lee-Vall Press, Box 1242, Indianapolis 6, Indiana.

THREE Lines, cushioned, indexed, knob handle, \$1.00. Additional lines 25c each. Ideal Rubber Stamp Co., Detroit 8, Mich.

PRINTING, MULTIGRAPHING, MIMEOGRAPHING, GUMMED LABELS

2000 8½x11 BOND Letterheads and 2000 6¼ envelopes \$15.00. 2000 business cards \$6.00. 5000 6¼ envelopes \$14.00. Send check or money order. John Adams, 240 East 119th St., New York City.

BETTER Printing—lower cost! Letterheads, envelopes, booklets, folders, labels, statements. Estimate free. Loneim Publishers, Paulding, Ohio.

1000 BUSINESS Cards—\$1.49. Agents wanted. Excelsior Press, Hampton, Va.

FINE Printing reasonable, send copy for estimates. White, 528 Brooks, Dallas, Texas.

BUSINESS Cards, "special" items, reasonable. Knutson, 316-M Pleasant, Mankato, Minnesota.

BOND Letterheads \$2.95 for 500. Send stamp for samples. Ranney, The Printer, Sheldon, N. Dak.

500 ENVELOPES \$2.00 F.O.B. Mango, 555-A South 20th, Newark 3, N. J.

OFFICE Forms—all printing reasonable. Catalog, estimates free. Bagley Printers, 9956 Burgard, Portland, Oregon.

CUTS Made to order, art work. Photo-engraver, 5130 Cedarsprings, Dallas, Tex.

NOW Is the time to get your printing needs. 1000 business cards \$2.50. 1000 envelopes \$4.50. 1000 letterheads 8½x11 \$4.95. 1000 letterheads 5½x8½ \$3.25. All above on good grade of paper. Cosme Press, P.O. Box 6, New Bedford, Mass.

150—8½x11 HAMMERMILL Letterheads, printed, postpaid, \$1.00. Envelopes same. Race Printing, Hudson, New York.

100 LETTERHEADS, 50 Envelopes, personal \$1.25. Ripple finish bond. Send money order. Specific Products, 119 North Water Street, Rochester 4, N. Y.

75 BOND Letterheads and 75 envelopes \$1.00. Benneville Printing, Box 1931, Pittsburgh 30, Penna.

1000 PROFESSIONAL Business cards postpaid \$2.50. Hamilton, 4341 N. Meade, Chicago 34.

MODERN Mimeographing. Form letters, booklets, price lists, etc. Dupli-Press, 164 Hudson St., Cornwall-on-Hudson, N. Y.

50 WEDDING Invitations \$4.00. Samples sent. 24 hour service. Scholler, 530 Dunloe, Pittsburgh 12, Penna.

100 LETTERHEADS, 100 Envelopes, \$1.25 postpaid. Tucker, P.O. Box 45, Indianapolis.

CIRCULARS, Letters, advertising matter, forms, etc., reproduced by lithography. Duplicraft, 930 F St., N. W., Washington 4, D. C.

ATTRACTIVELY Mimeographed letters, 100—\$1.00. Haynescraft, 706 Eighth, Washington 1, D. C.

500 NOTEHEADS, 5½x8½. Postpaid \$2.00. Samples. Hurst Printing, 621 East 31st, Kansas City 3, Mo.

1000 BUSINESS Cards, neatly printed, 2-color, \$3.00 postpaid. Globe Print Shop, High Point, N. C.

LETTERHEADS, Envelopes, statements, cards, 200 \$1.00. Samples, dime. Adams, Box 187, Chillicothe, Illinois.

NAME And address on 300 postcards, 3¼x5½. \$1.00 postpaid. Horace Coats, Borden, Indiana.

100 MONARCH Or 8 1/2 x 11 letterheads and envelopes, \$2.00. 200 business cards, \$1.00. Limit four lines. Postpaid. To satisfy, we try. Richmond Printers, Box 179, Buffalo 1, N. Y.

NICER Printed stationery cheaper. Free samples. Whiteoak Valley, Couchatta, La.

MIMEOGRAPHING. Offset printing. Rush service. Duplicraft, 930 F Street, N.W., Washington 4, D. C.

100 LETTERHEADS Or envelopes, \$1.00 postpaid. Hawkins Printery, 926 South Fifth Street, Louisville, Kentucky.

HAMMERMILL Letterheads, envelopes, 200 each \$2.00. Samples. Parker Press, 479 Main, Groveland, Mass.

PRINTING. Mimeographing, highest quality, low cost. Samples free. National Printers, 4012 Drexel Blvd., Chicago 15.

QUALITY Printing prepaid: Business, personal stationery. Letterheads, envelopes, statements. Prices reasonable. Samples. Mero Products, 100 Morrison, Punxsunawney, Penna.

PRINTING. Multigraphing, mimeographing: Low prices, high quality workmanship. Write for samples. Bay Printing Co., 24404-A Oakland Road, Bay Village, Ohio.

350 BUSINESS Cards \$1.00 postpaid. Artcraft, 40-06 97th, Corona 1, N. Y.

SEND 10c Now, for our 36-page 1946 pricelist—refunded first order. McCall Press, 1326 S. 27th, Omaha, Nebraska.

BETTER Grade printing reasonable. Estimates on anything. Economic Press, Leonia, N. J.

MIMEOGRAPHING—Any copy. Reasonable. Mailers Service, Box 608-A, Chicago 90, Ill.

500 3/4 x 2 1/4 FOUR Line gummed stickers, 25c. Moritz Printery, Saginaw, Mich.

MIMEOGRAPHING—Letters, pricelists, formulas, instructions. Lowest prices. Lem's Letter Shop, 5710 Stanton, Detroit 8.

PRINTING OUTFITS AND SUPPLIES

PRINTING Supplies, new, used. Equipment bought, sold. Boyle, Clinton, N. Y.

HOME-MADE Presses. Proofs free. Riegel, 1111 Harrison, Phila. (24), Penna.

PRINTING Press plans, \$1.00. Details, samples of work, free. Homer DeSillier, 19 Stebbins St., Springfield, Mass.

PRESSES, Type, cutters, supplies, exchanges invited. Bulletins 3c. Box 918, New York 8.

CUTS—Make real halftones, line cuts yourself! Samples 25c. Particulars free. Rapid Chemical Service, Edwardsville, Ill.

PRINTING Equipment, type and supplies. Send stamp for details or dime for complete illustrated supply book. Kelsey Inc., X-11, Meriden, Conn.

PRINT At home—Send 10c for catalogue—presses, type, supplies. Barnhard Co., 6 Columbia St., Newark 5, N. J.

INEXPENSIVE Home-made printing press. Details free. Novelty Shop, Downsville, Louisiana.

PATENT ATTORNEYS

PATENT Protection—The U. S. Patent Office recommends "an applicant is advised, unless familiar with such matters, to employ a competent registered Patent Attorney as the value of patents depends largely upon the skillful preparation of the specifications and claims." Steps to be taken in obtaining patent protection available upon request. Victor J. Evans & Co., established 1898, 131-H Merlin Building, Washington 6, D. C.

INVENTORS: Without obligation, write us for information as to what steps an inventor should take to secure a patent. Randolph & Beavers, Registered Patent Attorneys, 21-C Columbian Bldg., Washington 1, D. C.

INVENTORS: Learn now—without obligation—how to protect and sell your invention. Write for free "Record of Invention" form and complete information for making disclosure and establishing date of your invention. We also send our new free "Patent Guide for the Inventor," containing complete information about patent procedure and how to sell inventions; giving illustrations of many successful inventions; over 150 basic mechanical movements. We assure you prompt, confidential service. Delays may be dangerous. Write today for your free "Patent Guide" and "Record of Invention" form. Clarence A. O'Brien & Harvey Jacobson, Registered Patent Attorneys, 61B-G Adams Building, Washington, D. C.

INVENTORS—Take prompt steps to protect your invention. Delays are dangerous. Get new free book, "Protect, Finance and Sell Your Invention," and "Invention Record" form. Preliminary information free. Reasonable fees. Conscientious counsel. Easy payment plan. Learn how to protect and sell your invention. Write us today. McMorro, Berman & Davidson, Patent Attorneys, 134-W Atlantic Building, Washington 4, D. C.

DAVIES & Son, patents-trade marks, 7240 Wisconsin Ave., Washington 14, D. C.

PATENTS. Free preliminary advice. E. E. Vrooman, Patent Lawyer, Registered Patent Attorney, 871 Woodward Building, Washington 5, D. C.

"INVENTOR'S Guide." 100 mechanical movements, free; advises on patenting, selling inventions. Frank W. Ledermann, 154 Nassau Street, New York 7.

PATENTS And trade marks. Wilfred E. Lawson, 1524 K Street N.W., Washington 5, D. C.

PATENTS—Trade marks. Irving L. McCathran, 315 McLachlen Bldg., Washington 1, D. C. Registered Patent Attorney.

INVENTORS—Before disclosing your invention to anyone send for form "Evidence of Conception"; Schedule of Government and Attorneys' Fees and instructions. Sent free. Lancaster, Allwine & Rommel, Registered Patent Attorneys, 411 Bowen Building, Washington 5, D. C.

PATENTS Obtained; selling service, information, recording forms free. Labiner, World Building, New York.

C. A. SNOW & Co., M-427 Snow Bldg., Washington 1, D. C. Registered patent attorneys. Established 1875. Literature mailed on request.

SELL Your patent through a small classified ad in Popular Mechanics. Many inventors have found buyers in this way. Ask me for proof—I'll gladly send it to you. F. W. Johnson, Manager Classified Advertising, 200 E. Ontario St., Chicago.

FOR INVENTORS

INVENTORS: Learn now—without obligation—how to protect and sell your invention. Write for free "Record of Invention" form and complete instructions for making disclosure and establishing date of your invention. We also send our new free "Patent Guide for the Inventor," containing complete information about patent procedure and how to sell inventions; giving illustrations of many successful inventions; over 150 basic mechanical movements. We assure you prompt, confidential service. Delays may be dangerous. Write today for your free "Patent Guide" and "Record of Invention" form. Clarence A. O'Brien & Harvey Jacobson, Registered Patent Attorneys, 61A-G Adams Building, Washington, D. C.

INVENTORS—Take prompt steps to protect your invention. Delays are dangerous. Get new free book, "Protect, Finance and Sell Your Invention," and "Invention Record" form. Preliminary information free. Reasonable fees. Conscientious counsel. Easy payment plan. Learn how to protect and sell your invention. Write us today. McMorro, Berman & Davidson, Patent Attorneys, 134-V Atlantic Building, Washington 4, D. C.

INVENTORS—Victor J. Evans and Co., established 1898, has a staff of registered patent attorneys, available to represent inventors in the preparation and prosecution of their cases before the Patent Office. Detailed information and the steps to be taken to obtain patent protection will be furnished upon request. Victor J. Evans & Co., 132-H Merlin Building, Washington 6, D. C.

RUBBER—Everything in rubber. Patents developed. Dept. P.M. Broadway Rubber Mfg. Co., Louisville 2, Ky.

DRAWINGS For manufacturers and inventors. Notarized protection. Chrisman Drafting Laboratory, Manhattan, Kan.

PATENT Models developed and built. The Thompson Engineering Co., 206-C Winchester Bldg., Grand Rapids 2, Mich.

INVENTORS: We have a market for worthwhile products. Write for our sales plan. Visioneering, Inc., Dept. B, Security Bldg., West Bend, Wisconsin.

THE Inventor who believes he has a new and useful invention, and needs advice, should consult a competent registered patent attorney. Without obligation, write for full information on how to secure patents and trademarks. Randolph & Beavers, Registered Patent Attorneys, 11-E-Columbian Bldg., Washington 1, D. C.

INVENTORS: We design, build working models and market your idea or product. Gadget Designer, 725 Walnut, Room 23-D, Philadelphia 6, Penna.

SELL Inventions without investing your money. Write internationally known inventor. C. H. Taylor, 53 Wilbraham Rd., Springfield, Mass.

AIM Your invention for "bull's-eye" success. Inventors' Manual gives concise, unbiased instructions and inspiration. \$1.00. Guaranteed. Ric-Craft, Box 1466-C, Tampa 1, Florida.

DEPENDABLE Patent searches \$5.00—complete with patent copies. Protection form free. Write Raymond L. Smith, Patent Searcher, 410-M Bond Building, Washington 5, D. C. (Former U. S. Patent Office employee.)

INVENTORS! Have your good patentable ideas? Write Mr. Metzler, 11 West 42nd, New York.

"INVENTOR'S Guide." 100 mechanical movements, free; advises on patenting, selling inventions. F. W. Ledermann, 154 Nassau Street, New York 7.

WANTED: Practical inventions. Inventors Exchange, Research Division, B6, Hartford 1, Connecticut.

I SELL Patents. Established in 1900. Charles A. Scott, 773PM Garson Ave., Rochester, N. Y.

INVENTIONS Having profit possibilities in demand by specific manufacturers, cash or royalty. Free descriptive booklet, protective disclosure form, references, and how to safely disclose an invention for sale, upon request. Invention Reporter, 5A-11106 So. Longwood Dr., Chicago 43.

CASH For practical ideas and inventions. Mr. Ball, AB-9441 Pleasant, Chicago.

INVENTORS: Avoid unnecessary expense. Write for free booklet explaining how our consulting and advisory service can assist you in deriving greatest profit from inventing. Institute of American Inventors, Dept. 40-A, 1926-Eye St. N.W., Washington 6, D. C.

INVENTIONS WANTED

FREE Booklet for inventors, only. "How To Find A Buyer For Your Invention." John D. & Son, 140 Spruce St., Box 3213, Bridgeport 5, Conn.

EARN Up to \$2,000 year, inventing simple items for special cash markets. Ideas only. No patents. Hendrickson, Argyle (7-B), Wisconsin.

INVENTORS: Hundreds of manufacturers have requested our assistance in locating marketable new products. Complete information, free. Institute of American Inventors, Dept. 40-D, 1926-Eye St. N.W., Washington 6, D. C.

WANTED—Patented, unpatented inventions having profit possibilities, all kinds. If will sell, reply immediately. Descriptive booklet, references, free. Invention Reporter, 5B-11106 So. Longwood Drive, Chicago 43.

CASH For inventions, patented, unpatented. Mr. Ball, A-9441 Pleasant, Chicago.

PATENTS FOR SALE

CLOTHESLINE Cleaner and pulley, also molded automobile anti-glare visor. Patented. Colburn Olsen, 28-70 Street, Brooklyn, New York 11.

SUN Visor to cut glare and direct reflection of sun from hood of automobiles. Patent 2,305,677. Cash or royalty. A. P. Cotton, St. Matthews, S. C.

CAPTURED German and Jap patents, 18,000 enemy alien formulas, patents, ideas; plans, drawings. Use immediately, royalty free. Particulars, 10c. Bishop Tools, 111 West Washington, Chicago 2.

FLASHLIGHT With built-in streamlined mounting clamp. Can mount in few seconds on object or projection up to 3" thick, or on flat surface. Holds light beam where you want it. Has spherical radius of nearly 300 degrees from any mounted position. Extremely practical for motorist, mechanics and professional men. Also companion handle and guard for extension cord light, new and better. L. B. Pierce, 516 W. Jackson St., Medford, Ore.

INVENTORS: Test the commercial value of your patented or unpatented inventions, quickly and inexpensively. Write for free information. Institute of American Inventors, Dept. 40-B, 1926-Eye St. N.W., Washington 6, D. C.

FREE—"Amazing New Book"—"Profits From Classified Advertising." Tells how and what to advertise. Be sure to read this book before you invest one cent in advertising. Remember—it's free! Write for your copy now. F. W. Johnson, Classified Advertising Manager, 200 East Ontario Street, Chicago 11, Illinois.

MANUFACTURING

ZIMCOLITE. Platin, mold without equipment, novelties, etc. Trial $\frac{1}{2}$ lb. with instructions—\$1.00. Plastic Products Co., 211 7th S. E., Canton, Ohio.

MANUFACTURING. Any amount. Models. Developing. Industrial diamonds mounted \$1.50. Slightly used roller bearings. Specialty Machine, 2821 Mitchell, Racine, Wis.

INVENTORS—Market study; developing; manufacturing models. J. M., Burlington, Kentucky.

MODELS—Small lot manufacturing. Metals, plastics, etc. Milburn, Burlington, Kentucky.

MODELS AND MODEL SUPPLIES

MARINE And stationary gasoline and steam model engines; bench tested working models, casting kits and drawings. Circular 25c. Teco, 206-C Winchester Bldg., Grand Rapids 2, Mich.

LANDLOCKED Sailors! Here's a beautiful, richly illustrated, fully descriptive catalogue of famous model ships—whalers, slavers, corvettes, etc., authentic in every detail. Send for it today. Only 10c. Marine Model Company, Inc., Dept. C-17, Halesite, Huntington, N. Y.

FLY-POWERED Plane—real model plane uses housefly for engine. Simple instructions with complete plans \$1. Earl Enterprises, Box 9204M, Los Angeles 5, Calif.

MODEL Ford cars and other makes. Catalog 25c. Model Autos, Box 133, Hemingway, S. C.

ENGINE Castings, Supplies. Catalogue 10c. Howard A3, 2417 N. Ashland, Chicago, Ill.

RADIO Control, 10 tube midget unit, revolutionary design. Write for details. Box 1097, New York 8, N. Y.

MINIATURE Circus-wagon kits, performers, tents, animals. $\frac{1}{8}$ " scale. Free catalog. Haledon Hobby Center, 389 Belmont Ave., Paterson 2, N. J.

JET Propulsion. Latest plans motor drive model boats, planes, cars, etc. New book, plans \$3.00 postpaid. Phil Hopkins, Union 5, N. Y.

"**TWELVE-IN-ONE**" Tool. See Bishop Tool ad under "Machinery."

SKILKO Model planer 75c. Get our monthly "Nobletter." Nobil Hobbycraft, P. O. Box 3527, Philadelphia 22, Pa.

AIRPLANE Models, complete line, 68 page Master Model Airplane and Gas Model catalogue 25c (includes refund coupon). General Modelcraft Company, 91-17, M7, 173rd Street, Jamaica 3, New York.

"S" Gauge the new practical size for trouble free model railroading. 10c (refunded with order) for information and illustrated catalog. Midgagge Models, Inc., Portsmouth, R. I.

WIZZ Electric motor. Assembles in a jiffy, flashlight cell operates. Parts complete, plus illustrated instructions 30c postpaid. Eltro Company, 171B, Deer Park, New York.

MODEL Exchange service. For information write Model Exchange, 5721 Leland Ave., Chicago 30, Ill.

RAILWAY Models, complete line, 128 page catalog, HO and O gauge 25c. Walters, 247 Erie, Milwaukee 2, Wis.

MODEL Engine catalog, railroad supplies, 25c refunded. Simonsen, A-3054 Greenview, Chicago 13.

TINY Power model steam engines and boilers. Finished ready-to-run. Circulars for dime. Chas. V. Arnold, Philomath, Oregon.

SHIP And yacht model fittings and blueprints. Hundreds of items to choose from. Send 25c for new illustrated catalog. A. J. Fisher, 1002 Etowah Ave., Dept. M, Royal Oak, Mich.

SHIP Models and yacht supplies complete. Large 64 page catalogue 25c. Bill Wild's, 510 East 11 St., New York City.

BIG Illustrated model engine catalog 10c. Active Products & Supply Co., 53 W. Jackson, Chicago 4.

BRASS, Copper, aluminum, stainless steel, monel. List 10c. Hobby Supply House, Box 2014, Pittsburgh 30, Penna.

SHIP Model kits and fittings. Complete line Fisher model yacht equipment. All Boucher, Fisher, Marine Model and Ideal kits, fittings and blueprints at standard prices. Most complete stock in New England. Send 10c for price list. James Bliss & Co., Inc., 220 State St., Boston, Mass.

MINIATURE Steam locomotives, $\frac{1}{4}$ " $\frac{3}{8}$ " $\frac{1}{2}$ " scales. Castings, parts, rail! Thorough drawings with instructions. Catalog 25c. Little Engines, Wilmington, Cal.

CATALOGS (Illustrated) for modelers! Airplanes, 60 page book on solids. Features construction data, specifications, camouflaging, 15c; railroads: 128 page "HO" guide. Equipment, accessories, fittings, 25c (includes refund coupon). Send coin or stamps for each profusely illustrated catalog desired. Polk's, "Nation's Leading Hobby House," 314-PM Fifth Ave., New York City 1.

HOME CRAFTSMEN

RARE Woods for home workshops. Turnings, carvings, etc. Cherry, mahogany, walnut, magnolia, hackberry, etc. Solids, veneers, etc. Giant grab assortment. Each box 60 lbs. or more, only \$2.49. Order yours today. Rare Woods, 1144 W. Superior, Chicago 22, Ill.

TIME And labor-saving motor driven tools. These versatile tools quickly shape, grind, carve, sand and polish wood, metal, plastics, glass, stone, bone, etc. Work equally well on inside and outside irregular surfaces. Indispensable to hobbyists, and craftsmen. Built to fit Handee, Dremel, Casco, Speedway, etc. motor tools. Write for free illustrated catalogue. Hobby Outfitters, 600 Washington Street, Boston, Massachusetts.

LAWN Furniture, child chair, larger chair, settee, picnic benches and table, 60c. Doll house and furniture, 30c. 80 lawn ornaments and novelty patterns, \$1.25. 6 new hanging shelf patterns, \$1.25. Doll stroller, colonial cradle, table and chairs, circus group, \$1.00, all patterns \$4.00. Modern Woodcraft, Saginaw, Michigan.

LEATHER Kits, coin purse 50c, comb case 35c. Bulletin 71 lists kits, supplies. Kit Kraft, Box 2868, Los Angeles 53, Calif.

BUILD Ships in a bottle. Complete easy to follow, illustrated, instruction book—25c. Steiner Publishing Company, Rockwell Road, Danbury, Connecticut.

SHELLCRAFT Kits for beginners—shells and complete supplies for making pins, earrings, combs and novelties. Instructions free. Kits \$2.00 and \$5.00. Herbert Diamond & Co., 1121 North East First Avenue, Miami 36, Florida.

MAKE Childrens lawn shower. Fast selling. Buy parts from hardware store. Complete plans 50c. Detroit Drafting Service, 18461 Ferguson Ave., Detroit 19, Michigan.

JIG Saw patterns! 50 assorted \$2.00. Sample 10c. Northwoods Specialties, 432-P Detroit, Royal Oak, Michigan.

MAKE Shell jewelry! Profit! Pleasure! Shellcraft book free! 450 Caribbean shells, including findings for making \$6 worth, \$1. Satisfaction guaranteed. Shell Company, Miami 36, Florida.

CERAMIC Jewelry supplies, bar pins, ear screws, for ceramic and woodworkers; also glass and seashell assemblers. Free catalog. Philadelphia Badge Co., 1007 Filbert St., Philadelphia, Penna.

NEW Nylon parachutes, quilting materials. Samples free. Rainbow, Decherd, Tenn.

MASONITE Mill ends 5 lbs. \$1.00 plus postage. Carl Sign Co., Wooster, Ohio.

HOMECRAFTSMAN'S Club helps you sell your products. Send dime for copy of homecraft magazine and membership particulars. Stewart, 616 2nd, Columbus, Ind.

HOUSEWIFE Helpers—Build them for your wife or mother. Cookbook stand—holds book open at an angle for easy reading. Spice rack—holds approximately sixteen containers. Eliminates searching. Full size patterns. 25c each. Woodcraft Plans, P.O. Box 136, Sedalia, Missouri.

PANTOGRAPH. Accurately traces any picture, comes ready to use with heavy card base, instructions. Postpaid anywhere. Send \$1.00. Stamps accepted. Science Toy Co., 1261 Union Street, Brooklyn, N. Y.

SCRAP Metal costing 5c pound brings \$4.00 in finished castings. Lifetime opportunity. Information. Paul Fritz, 622 N. Fulton, Allentown, Penna.

DON'T Use "squares." Enlarge drawings with Enlargo. Faster, more accurate than "graphsquares." Generous supply 50c. Particulars free. Enlargo, 80 Putnam Circle, Springfield 4, Mass.

WOODWORKING Craftsmen, spare time profits 100%; full details free. Powers, 6059 Woodland, Philadelphia, Penna.

JEEP Scale wheels for your boy's car \$5.00. 10 inch semi-pneumatic tires. Stamp for list other parts. Gesco, Box 880, Inglewood, Calif.

"**TWELVE-IN-ONE**" Tool. See Bishop Tool ad under "Machinery."

ENLARGE Workshop drawings automatically. Eliminate graphsquares. Illustrated literature dime. Pantographs, Munising 1, Michigan.

NEW Gear box, 2 to 1 ratio, four roller bearings, Boston gears, sealed lubrication, \$30.00 value for \$3.75 postpaid. Craftsman's Instruction Handbook \$2.00. 100 Alphabet beads \$3.00. Craftsman's Supplies, 114-111 229th Street, St. Albans 11, New York.

10c **BRINGS** Our booklet with illustrations, project suggestions, instructions on Lucite, Catalin, Plexiglas and Bakelite. Douglas Home Craftsman, Box 34C, Stamford, Conn.

SUEDE-COAT! Luxurious art finish. Introductory kit—three colors, applicator, adhesive, directions, \$1.00. Craftsman's catalog, 10c. Technicraft, 1156 Commonwealth, Boston 34.

JEWELRY Accessories and findings. Plastic and metal pinbacks, screw eyes, clasps, chains, rings, etc. Prompt shipping service. Complete lists 10c. Doremby Company, Chisholm 1, Maine.

CRAFTSMEN—Fast selling, make childrens and adults lawn chairs. Plans and instructions \$1.00. Summercraft Studio, 42 Vernon St., Newton 58, Mass.

MANUFACTURE Costume jewelry at home for profit, hobby, therapy. Free wholesale supply catalogue. Instructions. Florida Supply House, Bradenton, Fla.

35 **PATTERNS** Of action pull toys, trucks, carts, toy furniture, etc., \$1.00. Continental Homecraft, 907 Birch, Eau Claire, Wisconsin.

SHELL Jewelry supplies. Wholesale only. McFarland Plastic Co., Sarasota, Fla.

BUILD And sell lawn chairs. Plans \$1.00. We tell you how and where we sell. The Woodcraft Shop, Danby, Vermont.

CATALOG: Patterns plywood novelty furniture, letters, numerals, plaques, frames, weathervanes, silhouettes, lawn ornaments, 100 books and booklets on crafts and hobbies, picture frame mouldings, tools, large line decal transfers. Other lines. Hundreds articles finely illustrated. Write Wo-Met Shop, Ashburn, Ga.

KNOCKDOWN Cedar chest lumber veneers. Free price list. Giles-Kendall, Huntsville, Ala.

MAKE Shell jewelry—for gifts, as a hobby or start a business. Free catalogue and price list. Complete illustrated book of instructions 75c. Florida Shellcraft Company, Box 1840, Sarasota, Florida.

LEATHERCRAFT Kits, supplies. Leather samples and catalog 10c. Leroy Buckley, 2539 Devon, Chicago 45.

MAKE IT YOURSELF

POWER Lawnmower—convert any hand lawnmower. Complete, instructions, photographs showing easy, cheap way, simple clutch. Have made and sold over 250 powermowers from ordinary hand mowers and any make washing machine motors. No theories, but a practical copyrighted system that gets the job done. \$1.00 money order. Woodridge Lawnmower Co., 744 McConnell, Memphis, Tenn.

FOUR-WHEELED Motorized sidewalk automobile, simple complete plans, detailed material list, one dollar. Donald Kettleborough, Mendota, Illinois.

BUILD Farm type, portable sawmill, blueprints \$3.00. Edger prints \$1.00. 12" planer prints \$1.00. Gasoline engine tree saw prints \$1.00. Nichols Equipment Company, Purvis, Miss.

HOME? Want yours soon? Better learn to build it yourself now! Years showing beginners! Your labor saves up to 60%! Valuable circular 25c. Get the original: William Jackson, A. B., 1713 Howard, Port Huron, Michigan.

ARCOMETER. Protractor locating automatically over round holes. Blueprints \$1. Peterson Instrument Co., 1102 So. Park St., Madison, Wis.

FREE Hot water from sunshine. Build Solar systems. Big money. Virgin territory. No competition. Write for details. Miami Solar Water, Box 175, Dept. J, Coral Gables, Florida.

BUILD Concrete block machine, mixer, electric weed cutter, flame weeder, blueprints 50c each. Nichols Equipment Company, Purvis, Miss.

BUILD Concrete block machine. Vibration and hand operated types. 100 blocks per hour. Easy, inexpensive. Sell blocks, build home, garage, barn at low cost. Free details. Horne, 206 West Wilder, Tampa 3, Florida.

BUILD It yourself. Backyard foundry for making castings up to 65 lbs. Easily available materials. Plans \$1.00. Sylvester Kruse, 1504 Madison St., Madison, Wis.

BUILD Your own home. Save expensive labor. Get our individual service, complete building instructions, list of materials. Use your plans. L. F. Post, Estimator, Box 1225, Clearwater, Florida. Details 3c stamp.

BUILD Electric blueprinting machine, plans \$2.00. Nichols Equipment Company, Purvis, Miss.

BUILD Handy lathe from pipe fittings. Three unique plans everything explained. All for one dollar. Al's Appliance Repair Shop, 501 South Navajo, Denver, Colorado.

BLUEPRINTS And instructions to make adjustable angle plate, tool makers vise, magnetic parallels, angle plate, each 40c. All \$1.35. Gaunt, 3521-Z Broadway, Chicago 13, Ill.

HOW To build a box kite. Complete plans, instructions. 25c stamps or coins. Zeis, 728 Lesley, Rockford, Illinois.

WIZZ Electric motor. Assembles in a jiffy, flashlight cell operates. Parts complete, plus illustrated instructions 30c postpaid. Eltro Company, 171K, Deer Park, New York.

AUTO And farm plans, that can be made for \$1.00. List free. P. Lessard, 716 Tyler St., Oakland, California.

BUILD Motor vibrator, concrete block machine or hand tamp, in two days for \$10 (exclusive of motor). Makes 300 blocks per day. Complete, plans, photos, and instructions for building machine \$3.50 postpaid. Order from advertisement or write for details. Clyde Lee, Dept. A, Mt. View, Okla.

ARC Welders, power mowers, automatic hacksaw, supplies. Holgeron, B319, Canton, Kansas.

LOOSE False teeth can be made to fit tight, snug, with entirely new dental plate liner—made by a dentist. Do it yourself. One application lasts. New discovery—not a paste or powder. Guaranteed to make loose dental plates fit perfectly. Write for 15 day trial offer. Send no money. C. N. Reese, D.D.S., Box 268J, Winnetka, Ill.

BUILD Your home as a hobby. No rent. No mortgage. Save 50%. Use spare time. No special skill required. Amazing facts sent free. H. C. Lightfoot, Civil Engineer, Richboro 1, Penna.

INEXPENSIVE Jigsaw; circle saw; plans 25c each. Jeffery, 2214 Wolcott, Flint 4, Michigan.

CONCRETE Mixer, efficient hand power, inexpensive from oil drum. Plans \$2.00. A. Mitkos, 8802 Corwin, St. Louis 21, Mo.

FLUORESCENT Lights. How to make your own 20 watt lights for less than \$1.00 each. Materials available. Complete, guaranteed, detailed instructions \$1.00 cash or money order. Checks \$1.10. Specialty Sales, Box 1086, Muncie, Indiana.

JIGSAW—Build production machine, hardwood, auto parts. Photographs, plans, instructions 25c (coin). Bruvolds, Hebron, North Dakota.

ELECTRIC Tester. Make it yourself. Tests motors, electrical appliances. Easily made. Plans \$1.00. Hawco Electric, 444 Hart, Brooklyn 21, N. Y.

WATCHES, OLD GOLD, JEWELRY, PRECIOUS STONES

GENUINE Diamonds, out-of-pawn low prices, wonderful values. Unredeemed loans and big buying power enable us to offer beautiful gems at prices far less than original cost. Shipped free for inspection, appraisal. Send for big free list showing fine diamonds at startling low prices. Lloyd J. Butler, President, Prudential Loan Association, 133-VG North Clark St., Chicago 2.

GEMS, Precious and semi-precious, all genuine, from world wide sources. Deal direct, no overhead, save money. Catalog 10c. Hill Co., Route 7, Salem, Oregon.

BARGAIN—Watch expansion band, also bracelet and barrette set, classy, rich looking, dural metal, \$1 postpaid. Pioneer, Box 243, St. Louis 3, Mo.

1947 BULOVA—"Excellency" 21 jewels, \$52.50, unsurpassable. Midland, 116 Vista, Staten Island 4, N. Y.

JEWELRY Job lots, mfgs. Samples \$9.00. Demeo, Box 64, Elmwood Station, Providence, R. I.

WATCHES And clocks repaired, guaranteed. Correct Time, P.O. Box 102, Brooklyn (Sta. P.) 2, New York.

WHY Not employ the convenient, easy mail method of having your watch repaired. Work guaranteed for one year. Write to Geo. Banks, 55 years at 3 Maiden Lane, New York 7, N. Y.

WATCH Repairing easy learned by our home study course. Watch repairers are in demand and are among the highest paid craftsmen today. Write for free information. Houston Chronometer & Watch Co., P.O. Box 1140A, Houston 1, Texas.

"JEWELRY, Gem Cutting, Metalcraft." Fascinating designs for hobbies and money-making opportunities. New, complete illustrated book covers cutting, polishing, mounting gems, metal, jewelry work, etc. 287 pages, \$2.95 postpaid. Money back guarantee. We supply tools, materials at lowest cost. Modern Technical Book Co., Dept. M3MC, 55 West 42nd St., N. Y. 18.

WANTED—Old or broken jewelry. Cash paid immediately. Mail gold teeth, watches, rings, silverware, diamonds, specialties. Satisfaction guaranteed or merchandise returned. Information free. Rose Smelting Co., 29 East Madison, Chicago, Dept. A.

WATCH And clock repairing—complete practical course in modern horology. 66 illustrated self-instruction lessons. Just out! Low price. Fascinating 100-page illustrated catalog free! Write—Nelson Company, Dept. 8-02, Chicago 5.

TOBACCO, SMOKERS' SUPPLIES

SURPRISINGLY Low prices. Havana cigars. S. Kelley, 2302 Ontario St., Ft. Wayne 6, Ind.

CIGARS, 50—Choice quality. \$3.00—postpaid. Check or money order. S. & E. Co., Dept. PM, Red Lion, Penna.

RAZORS, BLADES, SHARPENING

100—NEW Double edge blades, only \$1.25. Ace Company, 3518-32nd Street, Union City, New Jersey.

FOR SALE OR EXCHANGE

WILL Exchange microscope for centrifuge. Address S. S. Sharpe, c/o General Delivery, Little Rock, Ark.

FOR SALE MISCELLANEOUS

MECHANICAL Drawing instruments—Veeco, 4 piece, compact, precision set, brand new in lined case, value \$12.50, special \$7.25—Deitzgen 11 piece set, \$10.00—Charvos 9 piece set, \$8.50. Army surplus slide rules, slightly used, 75c each. Hull auto compass, for accurate road direction, brand new, \$2.50. Brand new folding valise knapsacks made of heavy olive green duck, heavily bound and reinforced, repellent to fire or water. Inside 3 large snap fastened pockets, heavy webbed straps, hand and shoulder handles, size opened 22" x 54", closed 22" rolled. Useful to hunters, Boy Scouts, hikers and for all traveling use. A \$7.50 value, special \$2.25 postpaid. Forward money with order. No C.O.D. shipments. Public Sport Shops, 13 S. 16th, Philadelphia, Penna.

ARMY Clothing bargains—USN gabardine raincoats 34-40 \$5.75; Army shirts, all wool worsted 14-16, \$5.50; all wool serge pants, \$7.95; heavy twill coveralls 34-40, \$5.50. Satisfaction guaranteed. New York Clothing Company, Dept. PM, 2079 2nd Ave., New York 29, N. Y.

U. S. ARMY'S Famous assault boat propellers. New, three blade, polished manganese bronze, wt. approx. 5 lbs.—use for making everlasting mementoes of World War 2. Immediate delivery. Extremely low price of \$5.00 each until limited supply is exhausted—\$1.00 deposit on C.O.D. orders, balance parcel post collect. Baker Bros. Supply House, Palatine (Cook County), Ill.

SOLID Gold discharge emblems \$3.00—gold filled \$2.00. Mimeograph machines \$9.95, \$22.50, \$32.50. 7 column adding machines \$12.95. Expansion watch bands \$1. Art, 820A Sheridan, Chicago 13.

VETERANS Beautiful campaign bar bracelet. Sturdy Plexiglas bracelet with bars and stars sealed inside. Something new, five year guarantee. Sent postpaid, \$5.00. Name your bars. Merritt Novelties, 2408 E. Exeter, Ft. Worth, Texas.

OFFICIAL USN Raincoats, navy blue gabardine, single breasted, half belt, sizes 34 to 38, \$5.50. New York Clothing Company, Dept. PM, 2079 2nd Ave., New York 29, N. Y.

BLACKSMITH Shop, equipped. Wide territory, large trade. Low cash price. Sistershop, Northbranch, Kansas.

11 1/2 MILES Of wire for \$4.95. Dozens of uses. 8 lbs. breaking strain, rustproof Bethanized steel, government surplus. Orders filled immediately. The A. Bachand Co., No. Adams, Mass.

MERCHANDISE And vending machine closeouts. Best Machine, 2629 Joseph, New Orleans, La.

ETCHED Aluminum decimal chart. Attaches to drafting machines. Large, legible, convenient, \$1.00 postpaid. Enterprise Products, 15 1/2 South Vanburen, Freeport, Illinois.

REVOLUTIONARY Garden-lawn sprinkler; amazing rainlike low pressure irrigation; adjustable. Write AAA Engineering, Salem 5, Oregon.

BRAND New army saddles, \$19.95; Texas bridle complete, \$4.95; both for \$23.95. Refund if dissatisfied. Free circular. Schafner, West Copake 3, N. Y.

CLOTHESPINS, Clothespins, millions. Get dealer prices, samples. Scheall, Box 263, Duluth, Minnesota.

HANDMADE Mexican tablecloths sent postpaid. Two sizes \$5.00, \$6.00. Check or postal money order to Jose Bernardo, Mar Mediterraneo, No. 120-1, Mexico City.

ARMY Goods (used) canteens, mess sets, helmets, life preservers, raincoats, knapsacks \$1, cartridge belts, holsters, gas mask bags 50c. Life rafts \$7.50, bunks \$5, rubber suits \$5. N. Y. Salvage, 144 Chamber St., N. Y. C.

WANTED MISCELLANEOUS

HAVE You an idea? Have plant—need something we can make, liquids, pastes or powders for institutional or industrial use. Will finance and protect to your satisfaction. Rubber City Mfg. Co., 9511 Cassius Avenue, Cleveland 5, Ohio.

DO You want to trade-buy-sell guns, watches, cameras, movie projectors, binoculars, musical instruments, books, jewelry, antiques printing equipment or anything of value? Send 25c for copy Swappers Guide. It's crammed full with traders-buyers-sellers, coast to coast, who list what they want, and opportunities to trade-buy-sell almost anything under sun. Your "wants" listed free. National Swappers Guide, P. O. Box 415, Evansville, Ind.

JOBS Lots miscellaneous merchandise. Paul, 1461 North Third, Springfield, Ill.

JUSTICE Buys almost anything! List free. 9762 Santa Monica, Beverly Hills, California.

WANTED: Unusual, practical, profitable gift items. Give details. M. Clark, 2538 N. Taibot, Indianapolis 5.

MERCURY—Highest prices. Free containers. Write. Wholesale Terminal, Norwood, Mass.

MERCURY (Quicksilver). Write for quotation stating quantity. Metallurgical Products Co., 35th and Moore Sts., Philadelphia, Penna.

WANTED: Set of blue prints for 1 to 5 H.P. four cycle stationary air-cooled gasoline engine. Also interested in patterns, if available. Hartman Manufacturing, Salamanca, New York.

FOR THE HOME

VETERAN Homes! Particulars free. Hale, 544 Russ Building, San Francisco 4, California.

FIREPOTS—Grates, linings craxmend wringer rolls guaranteed. Majprudax, Royal Oak, Mich.

WIGWAM Flue Doctor stops down draft, permanently cleans creosoty chimneys. Wig, Abington, Mass.

PREFABRICATED Homes; list of 101 manufacturers \$1.00. Fabrication Service, 67 W. Columbia Ave., Battle Creek, Mich.

INTERESTING, Informative household book. Free literature. Gassmann, 17162 Gallagher, Detroit 12.

PERSONAL

PERSONAL Stationery. Send stamp for sample printed with your name, address. Andrew Peck, Box 428-D, Battle Creek 100, Michigan.

NEW York City postmark on your mail. Confidential 25c each. Box 316, New York 8.

HAIR Falling out? Use scalp stimulator. Amazing new method helps promote hair growth. Particulars free. L. Shields, 1024 Cavalry, Detroit 9, Mich.

HOW You can find out! Information discreetly developed, any matter, person, problem, anywhere. Personal-business assignments, representations, undertaken. Nation-wide. Officially licensed and bonded service established 1922. Reasonable. All inquiries confidential. William Herman, 170 Broadway, New York.

FALLING Hair, its cause and prevention. An informative and educational pamphlet entitled "How To Keep Your Hair Till Ninety" mailed free. James Hilton, 4819 A Fourth Ave., Brooklyn 20, N. Y.

DISCOVER Yourself! Your best abilities, talents. Newest methods. Helpful information free. Hervey Richer, 36 State, Albany 7, New York.

SOUVENIR Postcards, letters forwarded from Mexico, Chicago, three for 30c. \$2 month. Avery, 331 N. Hillside, Wichita 8, Kans.

MEXICAN Law. General practice atty. J. Cenicerros, 1203 Arizona St., El Paso, Texas.

RARE Book formula! Circular free. Robert Cannon, 37-50 86th St., Jackson Heights, N. Y.

MASTER-KEY To promotion, better job, larger pay. Unique, result producing technique, \$2.00. Ask for free sample lesson. Andree, Barnegat, N. J.

MEN! Do you want a professional title and earn while learning? Not a school or correspondence course. All information in personal letter for one dollar. William L. Keifer, Opt., 1301 Elm St., Lebanon, Pa.

AMPUTES! Get facts on artificial limbs. Send for "John Silver, Twentieth Century" authoritative, unbiased, excellent gift 50c. Donald Baish, R. 3, Irwin, Pa.

LEATHER Jackets scientifically cleaned, refinished like new, \$3.50. G.I. trousers dyed \$2.50. Lawrence Jacobson, 2825 N. Broad Street, Philadelphia 32, Penna.

SWAPPERS' Gazette—"Catalog of Swaps"—25c. 2836-PM Slevin, Louisville 12, Ky.

LIVE Longer, feel better, enjoy life. Free information. Fairchild Company, Mt. Vernon, Ohio.

INTERESTING Poem, "A Glimpse of The West" 20c. Lewis Vikla, Lonsdale, Minnesota.

NERVOUS, Self-conscious, fears? Be courageous, self-confident, magnetic. Sensational psychology course. Only \$1.00. Dr. Malcolm Smith, 1104 Union Ave., Montreal 3, Canada.

MEXICAN Law practice, L. Gonzalez, Box 236, El Paso, Texas.

POOR Penmanship corrected—few hours. New-way. Ozment, 9, St. Louis, Mo.

HAIR Falling? Dandruff? Write Trichologist, 137 Lewis St., Phillipsburg, N. J.

MISCELLANEOUS

ALNICOV "Magic Magnets," most powerful steel, defy gravity, through wood, glass. Useful tool, stunts, gift, 1" long, 2 for \$1.00. Also "Toothpick Magnets," 8 for \$1.00; "Magic Wand" 2 for \$1.00. Eljay, Box 891, Newark 1, N. J.

DECALS—Name plates, instruction plates, trademarks. Made in Detroit. Fast delivery. Bayard Kurth Company, decal manufacturers, 1421 Springwells Avenue, Detroit 9, Michigan.

ILLUMINATED House numbers connect to doorbell button terminals. Bulbs last indefinitely, draw practically no current. Postpaid \$3.50 or shipped C.O.D. State numerals wanted. Frank N. Sues Co., 1050 Florida Ave., Akron 14, Ohio.

"STORY Of Prefabricated Houses," brief factual book prospective owners of new homes should have. Tells about materials, methods with factory made houses. Read it 5 days free, then remit \$1.25 or send only one dollar and receive book with our guarantee money back in 5 days. Research, Columbus 8B, Indiana.

SUN Glasses, Air Corps goggle style. Ground and polished lenses, sweatbar, yellow gold-filled frame, \$12 value for \$7. Star Optical Company, Dept. 33, Butler, Penna.

BEAUTIFUL Oil colored 8x10 enlargement from your negative—returned unharmed. \$2.00. Lakes Photo Studio, Round Lake, Illinois.

DON'T Worry about your septic tank. Read the facts in our 12-page pamphlet on "What To Do and What Not To Do With Your Septic Tank" by Reuben Selfridge. Order now. \$1.00 per copy. Selfridge Printing Co., Dept. M, Clymer, N. Y.

TAILORED Homes, 69 sketches one-story houses styled Colonial, English, Spanish and moderne. Price \$1.00. H. P. Jones, 486K Brandeis Th. Bldg., Omaha 2, Nebraska.

LADIES Beautiful alligator skin handbags \$12.00. Box 25 bestbrand Havana cigars \$3.50 postpaid. Particulars. Anthony Prado 109, Havanacuba.

FIREWORKS—Any time—any quantity—newest ideas—highest quality—best values. Giant salutes, aerial bombs, sky-screamers, battle-in-the clouds, new jet-propulsion plane rocket, 150-piece combination offer \$4.95. Satisfaction guaranteed. Write for big new catalog. Banner Fireworks, Dept. 31, Toledo, Ohio.

TRADE Magazines. Current single copies. Choose from 747 publications—all fields. Free price-list. Commercial Engraving Publishing Company, 34C North Ritter, Indianapolis 1, Indiana.

"RECEIVE Mail." Moneymaking offers, opportunities, catalogs. Name listed 10c. Ideal Service, 107, Park Ridge, Ill.

LOCATE Valuable mineral deposits with amazing new Mineralight. Easy to carry. Free catalog. A. R. Wallin, Rep., 4039 N. La Porte Ave., Chicago, Ill.

MAKE Delicious caramelcorn, marshmallows, cheesecorn, three guaranteed formulas. \$1.00. Frank Shilling, 1017-P Dueber, Canton 6, Ohio.

MAKE Your own Plastoplate printing cuts. Simple, easy process. Plastoplate, Argyle (1), Wisconsin.

"FREE Information!" Locates thousands scarce bargain merchandise. Chemist, Box 1279-P, Joliet, Ill.

HOBBY And novelty catalogue 10c (stamps). Barrington Smith Co., Halfwaytree, Jamaica BWI (Postage Jamaica 5c).

HOMES. Build your own. With blocks or tile. Build in your reinforcing. Make your buildings storm proof. Plans and instructions \$1.00. W. Denham, Box 265, Murray, Ky.

DOG Identification tags 50c. Send for illustration. Frank Michalucine, 3206 Eastwood Ave., Chicago 25, Ill.

MEXICAN Miniature pottery. Oaxaca and Guadalajara. Bulletin. Mexican Products Co., 126 N. Main, Tulsa 3, Okla.

WESTERN Belts. Texas made. 3/4"—\$1.1"—\$1.80. 1 1/4"—\$2.15. Postpaid. Waist measurement. Satisfaction or money back. Free price list. Southwestern Import Company, P.O. Box 5052, Beacon Hill Station, San Antonio 1, Texas.

NOW. The visible shave—with "U-X." Shave in two minutes, without soap, cream, lather or brush. See what you're shaving. Just rub U-X stick on face, wash off and shave—for the cleanest, smoothest shave you've ever had. Unbelievable? Send \$1.00 for two sticks—6 months supply. Money-back guarantee if not completely satisfied. Sloan Sales Service, Dept. PM-1, Staten Island 6, N. Y.

AQUARIUM Thermostat, highest quality, superior performance. Free circular. Enterprise Products, 15 1/2 South Vanburen, Freeport, Illinois.

BETTER Ink cheaper with guaranteed ink powder 402 size 10c. Pint twenty five. Quart forty. Staff, 1430 Cuyler, Chicago 13.

GIGANTIC Mails, magazines, catalogs, directory listing 10c, three times 25c. Marvin Waddell, 341 East 76th, New York 21.

MEXI-MOLLY. A real action toy; patented. Thirty-five cents, postpaid. The Tinker Shop, 8339 Jadwin Avenue, Cincinnati 15, Ohio.

BOOK Of 300 useful, helpful, time-money saving household hints 25c. Harold C. B. Brown, Sullivan, Indiana.

KEYS Duplicated 25c, by code 45c. Fitted to any lock \$1.00. Lock, key, or safe problems or questions answered \$1.00. Box 6, Riverside Station, Miami 35, Fla.

NAME Plates, 2" x 4" brass, beautifully machine engraved 15c letter. \$1.50 minimum. Prepaid. A. C. Alexander, 1813 E. 5th, Pomona, Calif. (1).

SEND 35c For sample. Sensational toy plane, works on new principle. 100% profit. Particulars with sample. Industries, Inc., Box 322, Station A, Boston, Mass.

RECEIVE Moneymaking opportunities, mails, samples, catalogs, magazines. Your name in thousand mailing lists, 25c. Glassmine, 1654-MX Amsterdam Avenue, New York 31.

LUMINOUS Paint. Best quality. Glows bright blue in dark. 1 oz. each paint and sealer only \$1.59 f.o.b. Chicago. Black Light Products, 67 E. Lake St., Chicago 1, Ill.

SQUARE Dance calls, instructions, forty dances. "Handbook of American Square and Folk Dances," \$1.00 postpaid. Wesley Rader, YMCA Educational Dept., 25-E. 16th Ave., Denver, Colorado.

VICTORIAN Type furniture—for the home also metal furniture. Send list of needs for circular and prices. L. E. Peterson Agency, 3417 Adams Ave., San Diego, California.

FLASH Light size rechargeable batteries, guaranteed—Write Kimley, 103 Highland, Williamsville 21, N. Y.

MEXICAN Jumping beans. Dozen 25c, hundred \$1.00, thousand \$5.00. Mexican Products Co., 126 N. Main, Tulsa 3, Okla.

SOMETHING To swap? Advertise in Green Mountain Trader. National circulation. Sample, dime. Henshaw, Bondville 13, Vermont.

KILL All weeds with 2000 degree flame, famous fire gun sterilizes, thaws, incinerates, disinfects. Works like blow torch, burns kerosene, mostly air. Economical, safe, sure. Free literature tells how. Write Sine Equipment, P376, Quakertown, Pa.

YOURS For better buying through the "Product of The Month." Free informative folders. Selected Products, Box 56-K Kensington, Brooklyn 18, N. Y.

EVERLASTING Calendar! Attractive, practical. Illustrated circular free. James Dollar, Grand Place, Vancouver, Wn.

THE Lord's coming! Get dozens free proofs. Write quickly. International Evangelism, Box 263, Duluth, Minnesota.

TATTOOING Outfits, designs, colors. Write today. Zeis Studio, 728 Lesley, Rockford, Illinois.

GOOD "Used" self-instruction educational books on all subjects bought, sold, rented, exchanged. Satisfaction guaranteed. Complete information and 100-page illustrated bargain catalog free! Write—Nelson Company, Chicago 5.

BIGGEST Money in tattooing now! No experience required. Complete instructions with outfits. Send for free literature. Tatuco, 651 South State, Chicago.

"BIBLE Studies." 70 lessons 25c. Bulletin, Box 87, Station H, New York 25.

MEDICAL Laboratory technicians in great demand. We train you in your spare time, in your own home. You can practice while studying. Write for free catalogue. Imperial Technical Institute, Box 973-J, Austin, Texas.

PHOTO Enlargers—Four types you can make. Illustrated instruction book 25c. Popular Mechanics Press, (C-43), 200 E. Ontario, Chicago.

METAL, Mineral locators latest 1946 electronic type ready for immediate shipment. Fisher Research Laboratory manufactured 2 million dollars worth of electronic equipment for the U. S. Army, including some of the finest metal-locators. Experience gained is yours in the best metal, mineral locator. Free 16 page booklet upon request. Fisher Research Laboratory, Palo Alto, California.

New 1946 WHAT TO MAKE out now!

Our annual reprint of articles selected from our "CRAFTSMAN" Department is better than ever. It contains hundreds of ideas you can use around the home and in your workshop. 208 pages. 400 illustrations. Get the 50c paper edition from your News Dealer. We shall not sell this edition at all this year. In December we shall have it and the six previous volumes bound in good-looking, durable library cloth at \$1.25 each or \$8.00 for the complete set. A wonderful addition to any craftsman's library!

POPULAR MECHANICS PRESS

Dept. 617 200 E. Ontario St. Chicago 11

Money Making
Pay Raising
BOOKS
Catalog
FREE

SEND NAME AND ADDRESS TODAY—Selected books covering all trades, office helps, home workshop, spare time work, hobbies, etc. Learn how to earn more. 1946 edition. Popular Mechanics Press 200 E. Ontario St., Chicago 11



JET PROPULSION



GAS TURBINE Model Engine

★ ★ Be one of the first to build a real Turbo-Jet Model Engine. Single-stage centrifugal compressor and turbine. This is a real engine, easily made with ordinary home workshop equipment. Complete plans for construction . . . design formulas and curves for checking performance and testing.

\$2.00
Post paid

THE ROTOJET CO. Department 11
BOX 757 • LOS ANGELES 25 • CALIFORNIA



APTITUDE TESTS for men, women, boys, girls, discover the kind of work or studies best for your success! You get a personal report—a guide for life—more happiness—more prosperity. Write for complete facts.

D. L. Beck
Man. Dir.

VOCATIONAL COUNSELING INSTITUTE
956 Maccabees Bldg., Detroit 2, Michigan



Make Your Own RUBBER MOLDS

with **RED LATEX MOLDING COMPOUND**

Earn money, have fun; make your own molds for plater objects. Produce novelties and gifts for home and to sell to friends. **RED LATEX MOLDING COMPOUND** (80% density) now available in quart and gallon quantities. Gives perfect results, easy to apply. Send for complete information and prices.

OHIO SUPPLY CO., Dept. H2, 474 Lilly Ave., Columbus 5, Ohio

LENSES 500,000 OF THEM

Buy them for a fraction of their original cost. **U.S. ARMY & NAVY** surplus lenses and prisms. **RIGHT ANGLE PRISM** 23 m/m sq. face.ca. \$ 1.25
5 POWER TANK TELESCOPE (M71) Brand New.
Coated Optics Completely Assembled. Value \$345.00 Perfect. ea. 29.50
9 PERFECT LENSES to make 5X tank artillery scope. Value \$140.00. 10.00
METAL PARTS TO MAKE A COMPLETE 5 POWER TANK ARTILLERY SCOPE. Diagram included. 7.50

Send Money Order or Check—3 cent stamp for list

A. JAEGER, BOX 84 P, SO. OZONE PARK 20, N. Y.



Veteran's Discharge Ring \$3.95 Plus Fed. Tax

A beautiful and massive Sterling Silver ring with Gold plated Discharge Emblem that every ex-serviceman will love. It will make an ideal gift. **SEND NO MONEY.** Pay postman on delivery \$3.95 plus tax and postage.

CLARK RING CO., Dept. 387
Box 5151, Chicago 80, Ill.



"WONDER" ELECTRIC BUTTON

Most interesting electrical apparatus ever discovered. Make your own Telephone-Amplifier Detectophone. Transmit your voice or music to distant rooms. Perform hundreds of fascinating experiments. So tiny it can be concealed in dozens of places. Send \$1 now for button and free 5,000 word instruction booklet with 59 illustrated experiments. **SPECIAL OFFER** 6 buttons and booklets sent post-paid for \$5.

BUCK MFG. COMPANY, Box A-28, No. Aurora, Ill.

RAISED WOOD SIGN LETTERS

MADE OF THE BEST IDAHO WHITE PINE.

ALL SIZES. FACTORY PRICES.

Send 10c for Catalog

SIGN LETTER DISTRIBUTORS, P.O. Box 101, Mineola, N. Y.

STANLEY NEW PLAN SET (of Five Plans)—10c

FIVE New Plans for Small Colonial Furniture, including: Book Stand, Magazine Case, Magazine Stand, Bench. Postpaid for 10c. Stanley Tools, 176 Elm St., New Britain, Connecticut.

HOW TO MAKE MONEY BY MAIL

Down-to-earth facts, directions (illustrated) for running business profitably, using expertly for **YOUR** good fortune the employees, trains, planes which Gov't places at your disposal **CHEAP**. Get orders by mail, ship by express or freight or mail, get out of the kindergarten. . . . 14th edition, enlarged to 576 pages, now selling. It's **YOUR** winner. Make this year and the following years worth more. **THIS** knowledge really **PAYS OFF**.

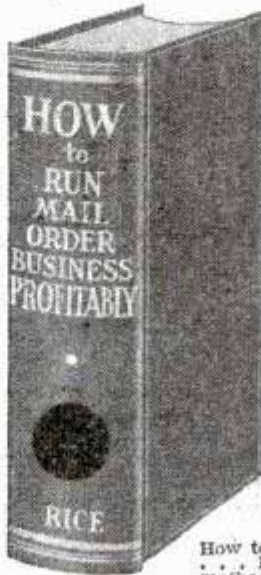

THE EASY WAY to start new or present occupation. Do it NOW.

Extraordinary plain, simple skill, know-how. No theory. Fact story of rich experience of author E. Rice day-by-day. How many times have we heard: "I wish I had some money, this patent would earn me a fortune," or "why can't my crop pay better?" or "I wish I knew how to sell this gadget myself," or "why should my boss alone do this when I too know how the money is made?" . . . Listen, you do not need money to start this Rice way. His method automatically pays all bills same day rendered, no bank loans, pay as you go, no borrowing from relatives or friends, no salesmen. Also, no worry, quickly a home of your own, all paid for. Rice paid off \$5000 in mortgages a year after using this skillful idea.

45 Years of PROOF

Sounds fishy? Sure, but this has been done steadily for 45 years, depression or no depression, by the author; that is why he wrote this book, to pass the good word along. Make it go with anything you have which is salable, or with what you are now doing. Rice made his pay plan go from the start when living in one room in a city lodging house. Turn your city or country home, your work, your hobby, into money. How to get orders coming steadily at cost of only \$4 for each \$100 taken in. The popular error to avoid in trying for sales. Business won free while others have to pay for it.

How to conceive the money-getting advertisement. . . . Profitable changes from ordinary ideas and methods. Not usual cut-and-dried pattern, 165 adventures, a dictated book in everyday talk by Rice

doing day by day what he discloses in his book can be done by his method. No dictionary writing. . . . Read how others are profiting big.

Take a chance on this book being worth a fortune to you and yours and send \$2.95. Book mailed same day order is received. Or ask two friends to chip in 98 cents each with your 99c to get this book. Hundreds of buyers whose letters we show you declare emphatically its superlative goodness. Follow its easy pattern for success. Cloth-bound, 576 pages, 8 1/2 by 5 1/2. Best seller, 14th edition now selling. Cut out the \$2.95 **HOW BOX** here, pin or stick it to sheet of paper bearing your name and address, mail in envelope with money order or check for \$2.95 to

HOW
\$2.95

HOWARD ST. HOUSE, Melrose 76d, Massachusetts

NEW MIDGET ELECTRIC ARC WELDER



FULLY GUARANTEED

RETAILS ONLY
\$3.95

Plugs into Light Socket—AC or DC

It's new! It's handy! It's efficient! Use the Midget Electric Arc Welder for hundreds of light-metal jobs. Does comparable welding work with a 1/16 inch welding rod on thin metal as that of larger and higher priced welders. Operates on 15 ampere fuse, 110 volt 60 cycle A.C. or D.C. current, by use of our special standard-coated 1/16-inch welding rods. Generous supply of rods supplied with machine. Recommended for all light welding like automobile fenders, etc. Take the Midget Arc anywhere to the job. Sturdily built and fully guaranteed. Comes complete—ready to use. Nothing else to buy. No previous welding experience needed to strike an arc. In a short time, anyone mechanically inclined can learn to weld with this machine.

You'll find hundreds of money-saving, time-saving uses for the Midget Arc around your home, garage, or workshop. Also in garages, factories, repair shops, tin shops, mechanics, farmers, inventors, etc. Order a Midget Electric Arc Welder now! **SEND NO MONEY.** We'll rush one to you complete with rods and helmet (equipped with APPROVED welding glasses). Pay postman only \$3.95 plus postage charges. If not satisfied, return Midget Arc in 5 days from receipt and we'll refund your money immediately. **RUSH YOUR ORDER NOW.**

MIDGET ARC WELDER CO., Strader Ave., Dept. K-202, Cincinnati 26, Ohio

BOYS! MEN!

now you can

MOLD PLASTICS AT HOME!



Get in on the newest hobby craze! Make beautiful buttons, pins, ornaments, etc. of colorful plastics. Fascinating! Modern! And so EASY with



PLASTIC MOLDING SETS

Designed by expert Plastic Chemists and Engineers. Contain everything the home craftsman needs to start this absorbing pastime—assorted plastics in various colors, a practical, easy-to-use press, assortment of die-cast aluminum molds, fuel tabs, finishing materials, complete instructions—all packed in a sturdy metal box.

- The Number 1 Outfit costs only **\$2.60**
- Number 2 Outfit (illustrated) — more different kinds and colors of plastics in larger quantity, more and larger molds **\$4.85**

If your dealer cannot supply you, use coupon and send money order or check direct.

(DEALERS: Write for particulars)

CANNON & COMPANY
216 Elliott Street, N. W., Atlanta, Ga.

CANNON & COMPANY,
216 Elliott Street, N. W., Atlanta, Ga.
Please send me, postpaid, Cannon Craft Plastic Molding Outfit Number Remittance of \$ is enclosed.

Name

Address

PAY-RAISING — EXTRA MONEY BOOKS

Use these books to prepare for a better job—bigger pay—to start a profitable spare time or full time business of your own, improve your home, start a hobby. Popular Mechanics specializes in

supplying outstanding self-help books on many subjects. Send for our FREE catalog.

- How to Remodel a House**
Nothing is omitted... **\$4.75**
- Painting Furniture Finishing & Repairing**
New self-help book for craftsmen, home owners... **\$1.50**
- Shop Notes for 1946**
Now ready. For every man who uses tools... **.60c**
- Shop Notes Library**
5 Vols.—1946, 45, 44, 42, 41. (No Dup. Mat.)... **\$3.00**
- Welding, Brazing & Soldering**
How to build own equipment and use it effectively... **\$1.25**
- Garden Book**
Build own trellises, lawn furniture, fireplaces, ornaments, etc. **\$1.00**
- Forty Power Tools**
Build own saw, drill, lathe, sander, etc., from scraps—save money **\$1.25**
- Rewinding & Servicing Electric Motors (No. 75)** **.25c**
- Turn Scrap Into Money**
Convert old auto generators into motors, welders, etc. **\$1.00**
- House Wiring (No. 89)**
All information needed to do complete job **.25c**
- Modern Refrigeration**
Electric, Gas. Be service expert **\$5.00**
- Dyke's Auto Ency. (includes Diesels, airplane engines)**
New 20th Ed. World's greatest book for mechanics. **\$7.00**
- Sheet Metal Work**
Self instruction in all phases **\$2.50**
- Tool & Saw Sharpening (No. 92)** **.25c**
- Armature Winding**
Construction, winding, repairing AC & DC Motors, generators **\$2.00**
- Build Your Own Boat**
Describes 17 popular boats—rowboats, sailboats, plywood outboard, etc. 192 pages **\$1.50**
- Forging Practice** **\$1.50**
- Toys You Can Make of Wood** **\$2.50**
- Carpentry**
Learn modern methods. **\$2.00**
- Foundry Work** **\$2.00**
- Pattern Making**
Wood, metal **\$2.00**
- Action Toys (No. 66)**
Plans for 21 easy-to-make toys **.25c**
- The Young Craftsman**
Over 450 things boys can make **\$1.50**
- Five Acres and Independence**
How to make money on small farm **\$2.50**
- Modern Welding Practice**
Useful data on welding of all kinds. Simplified, non-technical, easy-to-understand. **\$3.50**
- How to Plan a House**
Every detail carefully explained. 525 pages... **\$4.50**
- A Small Store and Independence**
Guide to successful retailing **\$2.00**
- Modern Gas Turbine**
Complete up-to-date information on uses as supercharger and prime mover. Includes jet propulsion **\$4.00**
- A.B.C. of Poultry Raising** **\$2.50**
- How to Build Violin, Pipe Organ, Banjo-Uke** **\$1.00**
- Knots, Ties, Splices**
For everyone who uses rope **\$1.25**
- Plastics**
Latest information on manufacture and use **\$4.00**
- Workbenches & Tool Cabinets You Can Build (No. 47)** **.25c**

- Concrete Handbook**
New book on using concrete around home, garden, farm **\$1.50**
- Oil Burner Handbook** **\$2.50**
- Photo Guide**
Construct own equipment, gadgets. Make better photos **\$1.50**
- Welding, Electric** **\$1.25**
- Welding, Oxy-Acetylene**
Welding, cutting **\$1.25**
- Metallurgy** **\$2.50**
- Ropp's Calculator**
Figuring made easy... **.50c**
- Plumbing Installation & Repair**
For those without previous training **\$1.50**
- Judo, 30 Lessons in Modern Jiu-Jitsu** **\$1.89**
- Tool Making** **\$3.50**
- Tool Design** **\$4.50**
- Mechanism** **\$3.50**
- Air Conditioning—Heating and Ventilating.** Principles and general applications of steam, hot water, vapor and vacuum heating **\$4.00**
- Audels Sheet Metal Pattern Layout** **\$4.00**
- Estimate for the Building Trades**
How To: Material and labor costs for masonry, plumbing, electricity, carpentry, heating, hardware, painting, etc. 629 pp. **\$4.75**
- Audels Masons and Builders Guides**
For Bricklayers, Cement workers, Plasterers, Tile Setters and Stone Masons.
4 Vols. **\$1.50 each**
- Lejay Manual of Homemade Electric Equipment**
How to construct 100 items that are scarce and valuable **\$1.50**
- Drake's Refrigeration Service Manual** **\$2.00**
- Slide Rule Simplified** **\$2.50**
- Mathematics for Ready Reference**
Covers all phases of mathematics **\$2.00**
- Mechanical Drawing Self-Taught**
With 21 simple step-by-step exercises, 56 pages of illustrations showing how to do it **\$1.00**
- Audels' New Automobile Guide**
1600 pages. **\$4.00**
- New Small Homes**
62 practical and popular designs **.50c**
- The Vegetable Growing Business** **\$3.50**
- Rabbits for Food and Fur** **\$2.50**
- Furniture Joinery** **\$2.50**
- Principles of Woodworking**
Tools, processes, materials, projects **\$2.00**
- Pottery Made Easy** **\$2.50**
- The Art of Wood Turning** **\$2.00**
- Essentials of Upholstery** **\$2.75**
- Radio Physics Course** **\$5.00**
A thorough training in radio fundamentals.
- Bookkeeping for Personal and Business Use** **\$2.25**
- The Art of Inventing and What to Invent** **\$3.00**



MAIL THIS COUPON TODAY

Check the books you want, write your name and address below, and mail this advertisement with money order or check. Outside U. S. A. include 15% additional for shipping charges.

Books selected will be mailed promptly on our "money back if you're not entirely satisfied" guarantee.

Name

Address

City State

Mail to **POPULAR MECHANICS PRESS.**
Dept. 604—200 East Ontario St., Chicago 11, Ill.

SPONGE-AWAY

KILLS TICKS



Sponge your dog with (or dip him in) Sponge-Away solution; you kill the ticks which are making your dog miserable. Sponge-Away also kills fleas, lice; allays itching, checks scratching; promotes healing, hair regrowth; helps dog get over Summer Eczema from fleas. Get 25c bottle (makes one quart) from pet, drug or department store and free your dog of ticks without delay.

A PULVEX QUALITY DOG PRODUCT

ANYONE CAN DO THIS IF THEY HAVE OUR CHART

SPECIAL OFFER FOR AGENTS

Blue Print 27" x 36" now printed on both sides showing squares full size. Shows how to find length of any rafter, find any angle in degrees, frame any polygon 3 to 16 sides, read the board foot and brace tables, octagon scales, rafter tables, many other uses can be scaled down for model work as well as full scale framing. Also chart changing pitches to degrees. For use with radial saws. About 13 square feet of printed copy. Sent post paid for \$1. Money order or check—no stamps. MASON ENGINEERING SERVICE, 2031 N. Burdick St., Dept. 7, Kalamazoo, 81, Mich.

LEARN REFRIGERATION at HOME

Simple, easy-to-understand directions for repairing household electric refrigerators. Complete details, diagrams, and photographs. Theory explained in simple terms. These books are authentic. Learn the CORRECT methods. All yours in four volumes—neat flexible covers—handy size, 6 x 8 1/2 inches—544 pages—only \$4.00. Send cash with order or let us send you set C.O.D. Your money refunded if books are returned within 15 days. Write to BUSINESS NEWS PUBLISHING CO., Dept. 31, 450 W. Fort St., Detroit 26, Mich. Send for FREE folder describing other books on refrigeration and air conditioning.

Your Lighter Will WORK ... better—with RUMIN

Gold Coated FLINTS and LIGHTER FLUID

ROCK FLINT CO., 123 Doughty Boulevard, Far Rockaway, N. Y.

"For The SPARK That NEVER Falls"

At drug and cigar stores, PX and Ship's Service.

BRUSH PLATING OUTFITS

for re-plating articles in the home and shop. No tanks necessary. Free particulars.

GUNMETAL CO., AVE. M, DECATUR, ILLINOIS

CHANITE SELF-WELDING FLUX

REPAIRS ALL ELECTRIC HEATING ELEMENTS

So simple anyone can make repairs in your broken or burnt-out electrical appliances—irons, toasters, stoves, etc. Guaranteed nothing like it. From our mines to your appliances. \$1.00 per package. \$7.50 per doz. Stick form 25c. \$2.00 per doz. CHANITE SALES COMPANY, 914 So. Main, Fort Worth 4, Texas

LAWN ORNAMENT-NOVELTY PATTERNS

28 Lawn Ornament Patterns, 25c. Other patterns; 15-20" high; Dutch Girl, Dutch Boy, Pirate, Bull Terrier, Mexican Girl, Mexican Boy, Dwarf, Penguin, Flower Girl, 10c each. 25 Novelty Patterns, 30c. All 62 Full Size Patterns, \$1.00 Postpaid. Strother Pattern Service, Dept. H-8, Box 383, Belington, W. Va.

NEW CHEAP OIL BURNER

FOR COOKING & HEATING STOVES-FURNACES
HEAT YOUR HOME, COOK YOUR MEALS
WITH CHEAP FURNACE OIL

NO MORE SHOVELING COAL OR ASHES. New Fuelizer Starter Vaporizing System turns Cheap 130 Flash Furnace Oil into Oil Gas heat without clogging up. LIFE-TIME GUARANTEE against defects. \$1.00-BONUS OFFER FOR TESTING. We will let you try it in your own stove or furnace for one month. Get Yours for introducing. Big profits. Be first. Send in your name today.

NORTHWEST MFG. CO. 561-J 5th Ave. Mitchell, So. Dak.

LEARN PLASTICS

GET THIS COMPREHENSIVE, PRACTICAL KNOWLEDGE of Plastics—materials, designing, molding, fabricating, laminating, testing, etc. Plastics Institute's course can be of great value to you in obtaining the kind of a position you want in this growing industry. Send for free booklet now!

Approved for Veterans

Plastics
INDUSTRIES TECHNICAL INSTITUTE
NEW YORK CHICAGO LOS ANGELES
122 East 42nd St. 221 N. LaSalle St. 1601 S. Western Ave.

PLASTICS INDUSTRIES TECHNICAL INSTITUTE
Dept. PM6-7, 1601 S. Western Ave., Los Angeles 6, Calif.

NAME _____

ADDRESS _____

CITY _____ ST. _____

Veterans: Check for special information.

If under 18: Check for special booklet.

FREE BOOKLET



MAKE UP TO \$10 ON EVERY SALE!

AIR CORPS TYPE SUN GLASSES



\$5.00 SELLS EVERYWHERE UP TO \$15 and MORE!

Just released for civilian use! Here are genuine 12 Karat gold filled, Air Corps Type SUN GOGGLES complete with "Mother of Pearl" sweat bar, brow rest and rocking pads, scientific ray-absorbent "No Glare" ground and polished sage green lenses, dropped before curving, and self-adjusting comfort cable ear pieces. Genuine leather crush-proof case included. Will protect eyes from glare, sun, wind, dust and exposure! Wonderful for auto drivers, policemen, golfers, gardeners, farmers and all outdoor workers and sportsmen. Sold on 10 day no risk trial money-back guarantee. You can easily sell 3 or more pairs a day. Send for your sample pair of these fine Sun Goggles—only \$5.00, postage prepaid. Or send no money. Just deposit \$5.00 with your own postman, plus postage—your money back if not delighted.

MIDWEST SCIENTIFIC CO. Dept. 35-A, 1148-1160 W. Chicago Ave. CHICAGO 22, ILL.

Let the Popular Mechanics Garden Book Help You!

MAKE YOUR OWN GARDEN FURNISHINGS

Here is the practical and handy guide that thousands of home owners are using to improve their yards and gardens and save money. It shows how you can make, at small cost, easily and quickly, attractive outdoor furniture, fences, trellises, fireplaces, pools, lawn ornaments, playthings for children, window boxes, etc., plus helpful and vital information on the making of lawns and flower and vegetable gardens. A most unusual book. Suitable for all localities and climates.

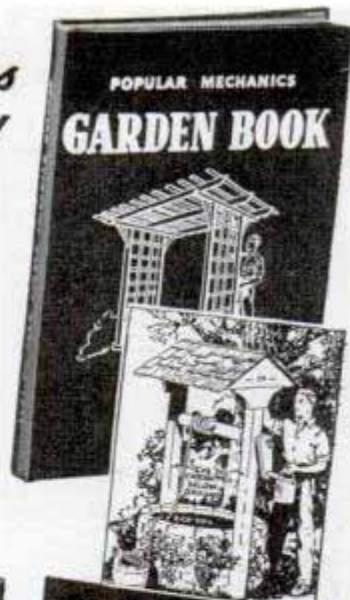

How to Make Lawn Furniture . . . Trellises . . . Gates . . . Fences . . . Outdoor Fireplaces . . . Bird Houses . . . Etc.

PARTIAL CONTENTS: Window Boxes—Bar-B-Q Fireplaces—Fencing for the Home Grounds—Pergolas to Beautify Your Garden—Backyard Screens and Trellises—Porch Furniture—Colonial Lawn Chair—Hammock on Wheels—Barrow Chair—Single and Colony Bird Houses—Bird Baths and Sun Dials from Colored Concrete—Concrete Garden Furniture—Swimming Pool for Youngsters—Playhouses—Portable Screened Porch—Outdoor Living Rooms—Weathervanes—Ornaments—Etc. **OTHER FEATURES:** Secrets of Backyard Vegetable Gardening—Better Gardens With Better Watering—Lighting Gardens at Night—Landscaping—Growing Creeping Bent—Growing Roses—and other articles. **HUNDREDS OF PHOTOS, DIAGRAMS, PLANS.**

Order from **POPULAR MECHANICS PRESS . . . \$1.00**

GIANT PLASTICS CATALOG and FREE FABRICATION MANUAL 10¢

Tells you how to drill, saw, rout, form, machine, finish, Plastics. A money maker guide. **BERTON PLASTICS, Inc., 19 WEST 21st ST., NEW YORK 10, N. Y.**

How to Make LIQUID MARBLE

And BIG PROFITS In Your Own Business

Amazing Liquid Marble can be made at home without machinery. It requires no expensive equipment to apply. Needs no heat or pressure. Can be sprayed, brushed or troweled onto any surface; or poured into molds for casting expensive novelties. It produces a smooth, highly glazed marble effect on concrete, wood, wallboard, iron, stone, etc., without rubbing or polishing. Liquid Marble can be made in any color. It is even more beautiful than genuine marble because of its highly glazed finish. Costs far less.

OTHER MONEY-MAKING OPPORTUNITIES

PLASTIC FLOORING: Make lifetime floors in any color or shade. Can be laid over wood, concrete, brick, cement, etc. Work out beautiful patterns in contrasting and harmonious colors.

FLEXIBLE MOLDS: Make your own FLEXIBLE MOLDS; cast novelties, statuary, desk sets, book-ends, etc., out of Liquid Marble, plaster and many other molding compositions. A large sized mold costs but a few cents. Hundreds of casts can be taken from a single mold.

UNLIMITED MARKET

You will find steady year-round demand in your own community. No selling problem. We supply names of **BIG BUYERS** for your finished products.

Let **BING PRODUCTS** show you how to start with a small investment and build a permanent, independent, profitable business! Don't fail to grasp this opportunity! Write now for **FREE CATALOG!**

BING PRODUCTS Dept. A7, 88 Broad St. BOSTON 10, MASS.

BOOKKEEPER-ACCOUNTANTS Double Your Income

Be your own boss, operate a profitable bookkeeping service part or full time. For details write:

THE TAX-SAVER SYSTEM

DEPT. D-19

FORT WORTH, TEXAS

PLASTIC HOMES



New Building Material! Resurface old homes; build new ones. Colorful, Beautiful! **LIQUID MARBLE—**Color-glazed! Molded, brushed, sprayed. **SANITARY COMPOSITION FLOORING—**Dustless, noiseless; put on like plaster; resilient—yielding as cork; lasts like stone; plain or marked in tile design. **RUBBERLASTIC Mold Compound—**Mold novelties, statuary, toys, gifts, plaques, plaster animals. **COLORS POTTERY—**Birdbaths, garden furniture, vases. **TILEX** colored roofing. Illustrated literature **FREE.** **RAPID MARBLEIZING SERVICE, Dept. 10-B, Edwardsville, Illinois**

CRESCENT TOOLS

Give Wings to Work

ASK YOUR HARDWARE DEALER

TRAILER AXLES, HITCHES, AND PARTS

● If you are interested in purchasing trailer axles, hitches, and other trailer parts, contact us promptly. **Write for free literature.**

HAMMER BLOW TOOL COMPANY, Dept. 107, WAUSAU, WIS.

ONE-MAN SAWMILL LESS THAN \$200.00

Easy To Turn Trees Into Money

Makes lumber, ties, shingles, crates, lath, studding, siding.

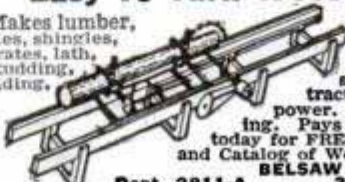

Belsaw Models

In 10, 14, 20, 24 ft. sawing lengths. Patented Mechanical Feed, accurate

set works and positive dogs. Use tractor or old auto engine for low cost power. Thousands used for commercial sawing. Pays for itself quickly. Send post card today for **FREE** booklet, "How To Make Lumber" and Catalog of Woodworking Equipment.

BELSAW MACHINERY COMPANY Dept. 2811-A 3542 Main Street, Kansas City, Mo.

FIVE ACRES AND INDEPENDENCE

A Practical Guide to the Selection and Management of the Small Farm

By M. G. Kains



This book is a complete, practical guide to the selection and management of a small farm. It explains how a small farm can be self-supporting. What farms not to buy. How to choose the right farm, based on proper soil, location, irrigation, elevation, climate, etc. Then a detailed explanation of what crops to plant and how to make them yield results, sure-fire methods of grafting, rotation, transplanting, etc. Finally, how to make a profit by selling your excess crops, livestock and preserves. Written by an expert who has made a

real success with many small farms. Revised, enlarged edition. 413 pages, profusely illustrated. Price \$2.50

Only \$2.50, Postpaid in U. S. A. (Outside U. S. \$2.75). Order Today

POPULAR MECHANICS PRESS Room 490 • 200 East Ontario St., Chicago

Handy Mail Order List

Little Library of Useful INFORMATION

5 for \$1.00
12 for \$2.00
25¢ Each

Here at amazingly low cost is the practical help and information you have always wanted. Articles in previous issues of Popular Mechanics have been classified according to subject and are now available in these handy reprint booklets.

- How to Use Measuring Tools—Micrometers, Calipers, etc.—106.
- Power Driven Saws—74.
- Drill Presses, Grinders, etc.—79.
- Wood, Metal Turning—Lathes—81.
- Filing Machine, Hacksaw, Cutoff Wheel, Shaper—82.
- Lathe Tools You Can Make—101.
- Workbenches—Tool Cabinets—47.
- Spray Painting—94.
- From Pattern to Casting—91.
- Tool and Saw Sharpening—92.
- Sharpening Drills, Wood Bits—90.
- Successful Wood Turning—32.
- How to Read Blueprint—71.
- Metal Turning Lathe Kinks—99.
- Operating a Metal Lathe—100.
- Heat Treating, Hardening—102.
- Working With Glass—103.
- Electromagnets & Solenoids—44.
- Transformer Construction—41.
- The Boy Electrician—43.
- Soldering and Brazing—17.
- Arc and Spot Welders—5.
- Electroplating With Nickel, Chromium, Cadmium, Etc.—86.
- Plating Leather, Wood, etc.—87.
- Lower Your Fuel Costs—31.
- Curing Leaky Basements—45.
- Fitting Home Game Room—55.
- Indoor & Outdoor Fireplaces—88.
- Backyard Gardening—39.
- Lawn and Garden Novelties—72.
- Trellises, Pergolas, Fences—76.
- Lawn and Garden Furniture—77.
- Playground Equipment—73.
- Concrete Garden Furniture—6.
- Making Serving Trays—53.
- Sanders—80.
- House Wiring—89.
- Treasure Finders—13.
- Hanging Wallpaper—38.
- Built-in Fixtures—78.
- Bird Houses—7.
- Magazine Racks—49.
- Clock Cases—50.
- Book Ends—52.
- Small Tables—54.
- Smoking Stands—56.
- Decks—88.
- Book Cases—59.
- Action Toys—66.
- High Flying Kites—67.
- Telescopes—20.
- Metal Craft—28.
- Knots and Ropework—105.
- Working With Plastics—61.
- Simple Home Improvements—104.
- Ridding Home of Insect Pests—107.
- Children's Room Furniture—51.
- Jigsawed Novelties—57.
- Doll House & Doll Furniture—60.
- 25 Shelves You Can Make—64.
- Novelties Turned on Lathes—62.
- Inlay Pictures—Veneering—63.
- Wood, Soap Carving—65.
- Windmills & Weather-vanes—68.
- Lamps from Wood, Metal—69.
- Home Work Opportunities—19.
- Wood Finishing—40.
- Boats—14 ft. Outboard—2.
- Boats—14 ft. Sail Dinghy—26.
- Boats—21 ft. Sloop—46.
- Rowboats, Small Dinghy—83.
- Small Sail Boats—84.
- Two Outboard Runabouts—85.
- Build Own Canoe, Kayak—30.
- Build Class-E Ice Yacht—22.
- Auto Kinks, Shortcuts—10.
- Building Trailers—27.
- Motor-Driven Midget Cars—34.
- Stop Auto Elect. Troubles—95.
- Photo Printers and Dryers—25.
- Photo Darkroom Equipment—96.
- Trick and Table Top Photos—97.
- Cosmetic Formulas—12.
- Food Products Formulas—15.
- Metal Plating and Coloring—21.
- Re-Silvering Mirrors—70.
- Chemical Experiments—93.
- Log Cabins, Tourist Houses—14.
- Trapping Small Animals—33.
- Farm and Garden Tractors—8.
- Building Extra Attic Rooms—23.
- Attractive Basement Rooms—24.
- Small Rooms—37.
- Gem Cutting—42.
- Photo Enlargers—1.
- Photo Kinks—98.
- Cleaning Formulas—11.
- Taxidermy—9.
- Magic—29.
- Training Dogs—35.
- Small Furnaces—36.

Check Titles Wanted, Clip, Mail with Remittance to

POPULAR MECHANICS PRESS, Dept. 605, 200 E. Ontario, Chicago, 11

LEARN WATCH & CLOCK REPAIRING At Home



STEADY WORK • SECURITY • HIGH PAY

Prepare yourself now for this fascinating high-grade occupation. You can earn while you learn. This UP-TO-DATE COURSE IN HOROLOGY shows you how to get the practical working experience you need for big-time success. THOROUGH SELF-INSTRUCTION TRAINING in American and Swiss watches, clocks, etc. Interesting LEARN-BY-DOING teaching method makes lessons easy. No previous experience necessary. Watchmaking is BASIC TRAINING for many scientific and mechanical precision jobs. Amazing low price. Satisfaction or money-back guarantee. Get into this fast-growing field NOW... big opportunities. Mail coupon for free information.

LOCKSMITHING & Key Making

Practical modern course for self-instruction. How to picklocks, de-code, make masterkeys, repair, install, service, etc., etc. For carpenter, fix-it shop, service station operator, hardware dealer, gunsmith, mechanic, home-owner, 53 easy illustrated lessons. Mail coupon for free details.

Practical ELECTRICITY

Quick course for men who demand how-to-do-it practical facts. Covers house-wiring, generators, storage batteries, telephones, lighting equipment, telegraphy, welding, etc. 55 lessons at surprisingly low price. Satisfaction guaranteed. Mail coupon below for complete interesting details.

SHORT-CUT Mathematics

How to be a "master mind!" This 2-in-1 self-study course teaches how to juggle figures, do baffling tricks with numbers. Also teaches practical mechanics... for every technically minded man who wants to get ahead. Used by stage magicians, expert accountants, etc. Only \$1. See coupon.

FREE! 100-PAGE BOOK! Mail this Now

NELSON CO., Dept. 2602, 1139 S. Wabash Ave., Chicago 5, Ill.

Please send me—free and without obligation—big illustrated Success-Catalog containing complete information about subject (subjects) checked below. (No salesman will call).

- Watch & Clock Repairing
- Practical Electricity
- Locksmithing & Key making
- Short-Cut Mathematics

Name _____

Address _____

Now for EVERY WORK SHOP!

NEW INVENTION Electroplates by BRUSH



Easy to Plate CHROMIUM GOLD, SILVER, NICKEL, COPPER

... For Pleasure and Profit!

If you have a workshop—at home or in business—you need this new Warner Electroplater. At the stroke of an electrified brush, you can electroplate models and projects—you can replate worn articles, faucets, tools, fixtures, silverware, etc. with a durable, sparkling coat of metal... Gold, Silver, Chromium, Nickel, Copper or Cadmium. Method is easy, simple, quick. Everything furnished—equipment complete, ready for use. By doing a bit of work for others, your machine can pay for itself within a week. So make your shop complete by getting a Warner Electroplater right away. Send today for FREE SAMPLE and illustrated literature. ACT AT ONCE! Mail Coupon.

WARNER ELECTRIC CO., DEPT. J-7
663 North Wells, Chicago 10, Illinois

FREE Details & Sample!

WARNER ELECTRIC CO., 663 North Wells, Chicago 10, Dept. J-7
Gentlemen: Send Free Sample and Details to:

Name _____

Address _____

City _____ State _____

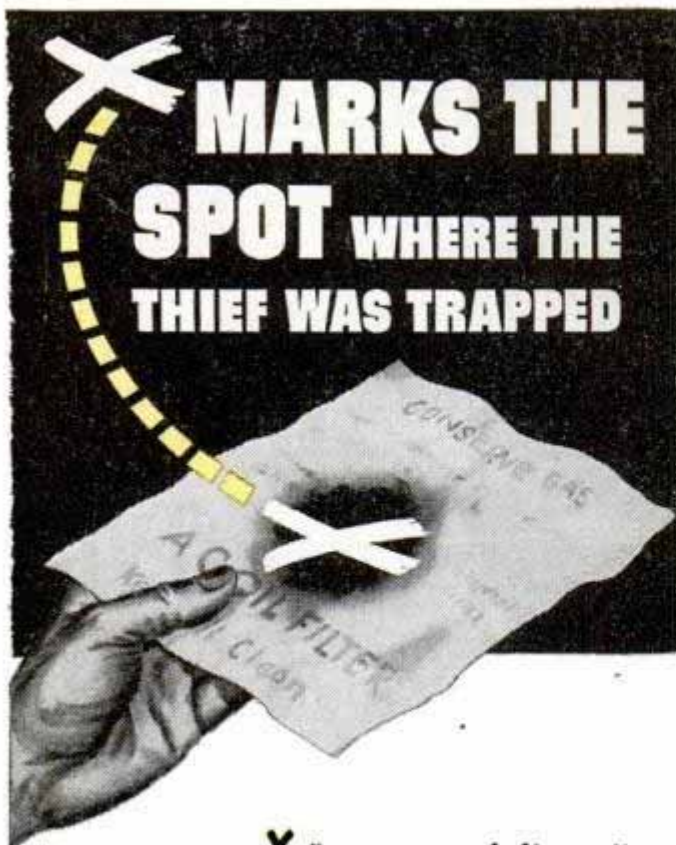

X MARKS THE SPOT WHERE THE THIEF WAS TRAPPED

X is a smear of dirty oil on an AC Oil Test Pad—oil from a car whose owner didn't know he needed an oil filter. The evidence shows clearly on the white pad.

You can get this oil test FREE—and in a jiffy—at any official AC Oil Filter Service Station. The attendant simply wipes the dipstick on the Pad, instead of a rag, and you can see for yourself whether your oil is safe to use.

Dirty oil is a power thief. It clogs piston rings and slots—makes valves stick—hastens engine wear—wastes fuel and oil—steals more and more power as the days go by.

Every engine needs an oil filter. The AC oil test will show you why. And the AC Oil Filter Service Station will show you why the AC Oil Filter gives you tops in protection—and why the AC Replacement Element is the one you should use in your present filter. AC makes quality replacement elements for nearly all filters.

So see your AC Official Oil Filter Service Station today and trap the thief that's stealing your power. Look for the sign shown below.



AC SPARK PLUG DIVISION—GENERAL MOTORS CORPORATION

Turn Your Home Workshop into a PAYING BUSINESS!

● Have you a small wood working shop in your basement or garage? How would you like to earn \$100.00 a week making items for us? Write for Free information—

AMERICAN WOOD WORKS

Subsidiary of American Builders Supply Co., Inc.

6359 YUCCA • LOS ANGELES 23, CALIF.
OFFICES IN ALL PRINCIPAL CITIES OF THE WEST



OUTDOOR KING BINOCULAR

20 Days FREE TRIAL

Postpaid **\$4.75**
or C.O.D.

Comes complete with case and straps. Easy to focus. Adjustable for all eye widths. Metal construction. Optically ground lenses. Ideal for spotting planes, ships, hunting, indoor-outdoor sports. Precision built. SEND NO MONEY. Just pay postman \$4.75 plus Federal tax and postage. Itemit and we ship prepaid. United Products Co., 7941 S. Halsted, Dept. FG-105, Chicago 20, Illinois.



New Designs in
FRANZITE GRIPS

Modernize Your Gun! Improve Your Score!
Most durable grips made. Positively unbreakable! For Colt, Smith & Wesson, Hi-Standard. Ortgies, Luger & Mausers in a wide choice of beautiful designs in ivory, pearl, walnut, onyx, etc. Low prices. FREE CATALOG. Dealers Wanted.

SPORTS, INC., (Mfrs.) 5501 Broadway, Dept. P-7, Chicago 40, Ill.

BECOME A MANUFACTURER'S AGENT

Engage in this highly profitable field. Be a substantial business man with little or no capital or investment. Information supplied on methods of securing lines and companies to represent with details of operations. Digest and instructions on How to Become a Manufacturer's Agent sent postpaid for \$2.00.

VIMAR COMPANY, 536 Andrus Building, Minneapolis 2, Minnesota

LAW STUDY AT HOME for PERSONAL SUCCESS and LARGER EARNINGS. 35 years expert instruction—over 108,000 students enrolled. LL.B. Degree awarded. All texts furnished. Easy payments. Send for FREE BOOK—"Law and Executive Guidance."

AMERICAN EXTENSION SCHOOL OF LAW
Dept. 67-M, 646 N. Michigan Ave., Chicago 11, Ill.

RADIO ENGINEERING, Broadcasting, Servicing, Electronics, Aviation, Marine & Police Radio taught thoroughly. 48 weeks' Engineering course equivalent to 3 years' college radio work. Approved Veteran Training. Co-educational. Catalog free.

VALPARAISO TECHNICAL INSTITUTE, Dept. D, Valparaiso, Ind.

SHAW and "Peppy-Pal" "DU-ALL" GARDEN TRACTORS

1 to 9 H.P. Circulars on request. Building more now. We supply repairs for all SHAW Tractors sold in our 42 years in business.

BUILD YOUR OWN RIDING TRACTOR—"WAR HORSE"

using old auto parts, powered by 2 H.P. or larger air-cooled engine; or walking type Garden Tractor 1/2 to 3 H.P. or convert truck or auto into Farm Tractor. Each with steel or rubber tires; will plow, cultivate. Plans for building, in few hours, any one of above, postpaid for \$1.00 (state which wanted) or all 3 for \$2.00. Money Back Guarantee.

SHAW MFG. CO., 4507 Front St.
Galesburg, Kansas
668G North 4th St., Columbus, Ohio

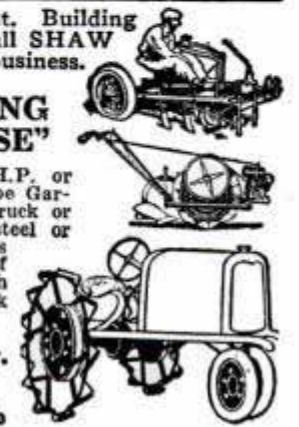

Little Library of Useful INFORMATION

5 for \$1.00
12 for \$2.00
25¢ Each

Here at amazingly low cost is the practical help and information you have always wanted. Articles in previous issues of Popular Mechanics have been classified according to subject and are now available in these handy reprint booklets. Check Titles wanted, clip ad and mail today.

BOOKLETS ON WORKSHOP EQUIPMENT

Power-Driven Saws—74: Complete details on scrollsaw, two circular saws, sliding cut-off saw, bandsaw.
Drill Presses, Plane, Grinders—79.
Sanders—80: Complete constructional details on 8 useful machines.
Wood & Metal-Turning Lathes—81: Two wood lathes, small metal-turning lathe.
Filing Machine, Hacksaw, Cutoff Wheel, Shaper—82.
Metal Lathe Tools You Can Make—101.
Workbenches & Tool Cabinets—47.
Spray Painting—94: Constructing spray guns, compressor, using spray gun.
From Pattern to Casting—91: How to make your own patterns and small castings.

BOOKLETS ON SHARPENING—USING TOOLS

Correct Measurement—106: How to use micrometers, gauges, calipers, etc.
Tool and Saw Sharpening—92.
Using & Sharpening Drills & Wood Bits—90.
Successful Wood Turning—32: All the information you need to master this art.
How to Read Blueprints—71: Tells you how to understand signs, symbols, and lines.
Metal Turning Lathe Kinks—99: Simple homemade tools, time and labor-saving shortcuts you can use.
Operating a Metal Turning Lathe—100.
Heat Treating & Case Hardening—102.
Working with Glass—103: Cutting, drilling, etching, blowing.

ELECTRICAL BOOKLETS

Rewinding & Servicing Electric Motors—75: Repairing and rewinding a.c. and d.c. motors. Locating trouble. Converting auto generators into 110 v. a. c. motors.
House Wiring—89: All the information you need to do a complete wiring job or install extra outlets.
Electromagnets & Solenoids—44: Designing and building.
Transformer Construction—41: Easy-to-understand instructions for all kinds of transformers.
The Boy Electrician—43: Easy-to-build motors, experiments.
Soldering & Brazing—17.
Arc & Spot Welders—5: Building and operating 110 v. a. c. arc and spot welders.
Treasure Finders—13: Build your own treasure finder and metal locator. Details for both large and small radio types.

ELECTROPLATING BOOKLETS

Electroplating with Copper, Nickel, Chromium, Lead, Zinc, Cadmium—86.
Plating Leather & Other Non-Metallic Objects—Plating with Gold, Silver, Alloys—87.

HOME IMPROVEMENT BOOKLETS

Simple Home Improvements—104: Modernizing; making storm sash, ironing boards, etc.
Building Extra Rooms in Attic—23.
Attractive Basement Playrooms—24.
Lower Your Fuel Cost—31: Practical kinks that will save you hundreds of dollars.
Hanging Wallpaper—38: Tricks of hanging wallpaper, removing old paper, etc.
Curing Leaky Basements—45:
Fitting Home Game Room—55: Construct own game & tennis tables, shuffleboard court, action game, portable playrooms.

Ridding the Home of Insect Pests—107: Exterminating and protecting against moths, flies, termites, mosquitos, etc.
Built-In Fixtures—78: Step and space-saving kitchen units, built-in beds, corner cabinets, vanities, linen chest.
Constructing Indoor & Outdoor Fireplaces—88: Stone fireplaces, portable mantels, garden fireplaces.

GARDENING BOOKLETS

Backyard Gardening—39: Selecting, planning and getting the best results.
Lawn & Garden Novelties—72: Jig-sawed ornaments, parkway numbers, sundials, flower boxes.
Trellises, Pergolas, Fences—76.
Lawn & Garden Furniture—77: Modern bent-tube furniture, arbor and seat combinations, swings, lawn chairs.
Playground Equipment—73: Two playhouses, ferris wheel, roller coaster, treadmill, play store, slide, two merry-go-rounds.
Colored Concrete Garden Furniture—6: Garden benches, pottery, flower boxes, bird baths and sundial pedestals in colored concrete. How to build small concrete mixer.
Bird Houses—7: Easy to build homes for all kinds of birds.
Farm & Garden Tractors—8: Two tractors you can build from old automobile parts.

CRAFT WORK—HOBBY BOOKLETS

Complete how-to-make-it instructions for hundreds of practical projects.

Working with Plastics—61: Using brilliant-colored plastics in craftwork.
Magazine Racks—49: Ten attractive racks.
Clock Cases—50: Large Hall, Colonial wall and mantel, ship's wheel, miniature grandfather, desk, Spanish style banjo.
Serving Trays for Every Occasion—53: Fourteen different designs.
Children's Room Furniture—51: Twelve attractive pieces.
Book Ends—52: Ten designs offer good selection.
Small Tables—54: Modern and colonial styling.
Smoking Stands—56: Seven designs given.
Jigsawed Novelties—57: Sewing kits, string holders, place-card holders, plywood kitchenware, plant and flower holders, coin banks, door stops, drawer pulls.
Desks—58: Colonial writing desk, two modern-type desks, student's study desk of plywood, combined chest and writing desk.
Book Cases—59: Eight designs.
Doll House & Doll Furniture—60.
25 Shelves You Can Make—64.
Novelties Turned on Lathe—62.
Inlay Pictures—Veneering—63.
Whittling and Wood & Soap Carving—65.
Action Toys—66: 21 easy-to-make toys.
High Flying Kites—67.
Windmills & Weathervanes—68.
Lamps in Wood, Metal, Plastic—69: Selection of 14 designs.
Metal Craft—28: Brass tapping and making of novelties both decorative and useful.
Small Looms—37: Building hand looms for weaving rugs, etc.; leather novelties.
Plain & Novelty Wood Finishing—40.
Gem Cutting—42: How to cut and polish semi-precious stones.

BOAT BUILDING BOOKLETS

Build a boat at home—you can do it

14 Ft. Outboard Runabout—2: Here is a fast 14 foot V-bottom boat. Suitable for motors of 4 to 24 hp., estimated cost, \$30 to \$40.
14 Ft. Sailing Dinghy—26: This 14-foot boat combines strength and light weight. It carries 140 sq. ft. of canvas and weighs about 350 pounds. Actual photographs and diagrams illustrate every detail.
21 Ft. Sloop—46: Every fact needed by the amateur boat builder to construct this craft which carries eight to ten persons.
Rowboats, Bicycle Boat, Small Dinghy—83: All the information you need to construct four low-cost boats.
Small Sail Boats—84: 12-ft. sailing dinghy, 6-ft. "training ship" for young sailors, how to sail a boat.
Two Outboard Runabouts—85: 14-Ft. family outboard weighs about 400 lbs. and 12-ft. plywood outboard weighs about 110 lbs. Both are V-bottom type.
Build Your Own Canoe, Kayak, Surfboard—30: Complete details on 16-ft. Canadian-type canoe, 17-ft. kayak, and 12-ft. hollow surfboard.
Fast Class-E Ice Yacht—22: Build your own Class-E ice yacht. Every detail of construction carefully explained.

AUTOMOBILE BOOKLETS

Automobile Kinks and Shortcuts—10: Money-saving hints on upkeep and operation.
Building Trailers—27: Small Streamlined house trailer; several utility trailers.
Motor-Driven Midget Car & Scooter—34: Both use gas engine of washing machine type.
Curing Auto Electrical Troubles—95.

PHOTOGRAPHY BOOKLETS

Save Money by constructing your own photo equipment.
Photo Enlargers—1: Condenser lens type; simple vertical; horizontal.
Photo Printers & Dryer—25: Describes three practical printers, timer and negative dryer.
Photo Darkroom Equipment—96: Cabinets, light-tight box, timer, agitator, washer, trimmer.
Picture Projector, Trick & Table Top Photography—97: Projectors that enlarge magazine illustrations and shop drawings. Tips for table toppers, photomontages, tricks.
Photo Kinks—98: 63 time and money-saving ideas you can use.

FORMULA BOOKLETS

Transform simple ingredients into useful products
Cleaning Preparations—11: Easy-to-make cleaners for walls, glass, etc. Removing fabric stains.
Cosmetic Formulas—12: Hand lotions, creams, rouge, bath salts, beauty clay, lipsticks, etc.
Re-Silvering Mirrors—70: Formulas for silvering and coloring.

MISCELLANEOUS BOOKLETS

Knots and Ropework—105.
Chemical Experiments—93: Easy-to-perform experiments. Inexpensive lab.
Taxidermy—9: How to prepare skins and obtain life-like poses.
Log Cabins & Tourists Cottages—14: Year-round log cabins; inexpensive tourists' cabin.
Magic for Everybody—29: Simple tricks to puzzle your friends.
Trapping Small Animals—33: How to lure fur bearers, prepare bait and traps, dress skins.
Tricks of Training Your Dog—35.
Small Furnaces—36: Build own gas or electric.

POPULAR MECHANICS PRESS,

200 E. Ontario St., Chicago 11, Ill.

I enclose (U. S. bills may be mailed if carefully wrapped) for "Little Library" booklets numbers:

.....
.....
.....
.....
Name
Address Zone
City State

Guide Sealed Beam Units Insure Headlighting at its Best

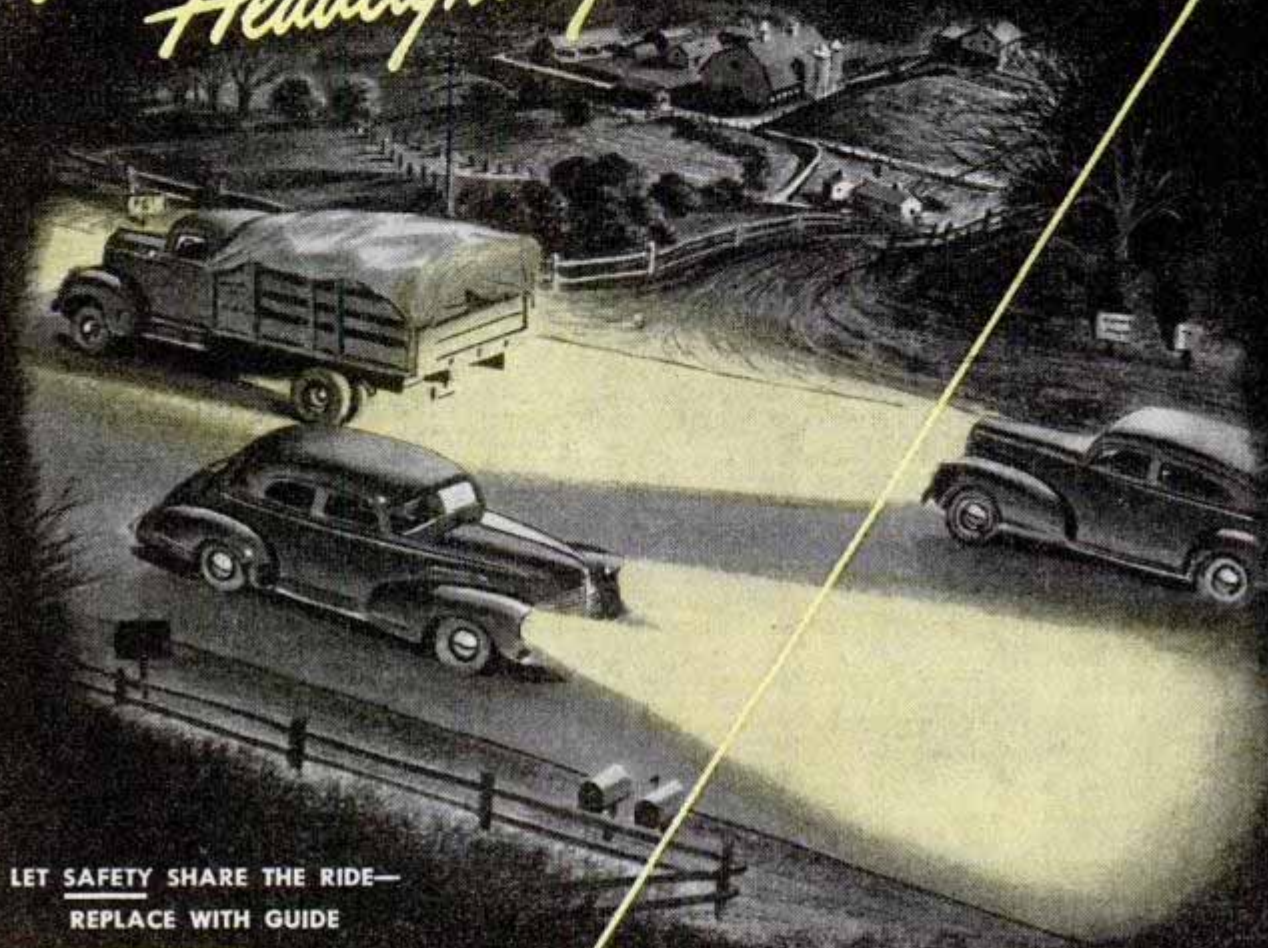

LET SAFETY SHARE THE RIDE—
REPLACE WITH GUIDE



Driving at night is safer and more fun behind Guide Sealed Beam units. Without strain or fatigue, you see the road stretching ahead clearly and sharply, far beyond your safe-stopping distance. In country or city, you have the *best* auto lighting that science has yet devised.

Guide Sealed Beam units won't grow dim—won't burn out when the lens is cracked. Tell your service man you want Guide units, and get this *double* protection—no dim-out, no black-out. It costs no more.

NO DIM-OUT—Because Guide Sealed Beam units are sealed against dirt, dust and traffic film, they stay bright for the life of the unit—do not lose their efficiency, as earlier-type headlamps do.

NO BLACK-OUT—Because there is a separate bulb within the sealed unit, your Guide Sealed Beam unit will not fail in case of a cracked lens—will light the way safely until the damaged unit can be replaced.

GUIDE LAMP DIVISION OF GENERAL MOTORS CORPORATION

SAFE HEADLAMPS ARE "CORRECTLY AIMED" HEADLAMPS—HAVE YOURS CHECKED TODAY

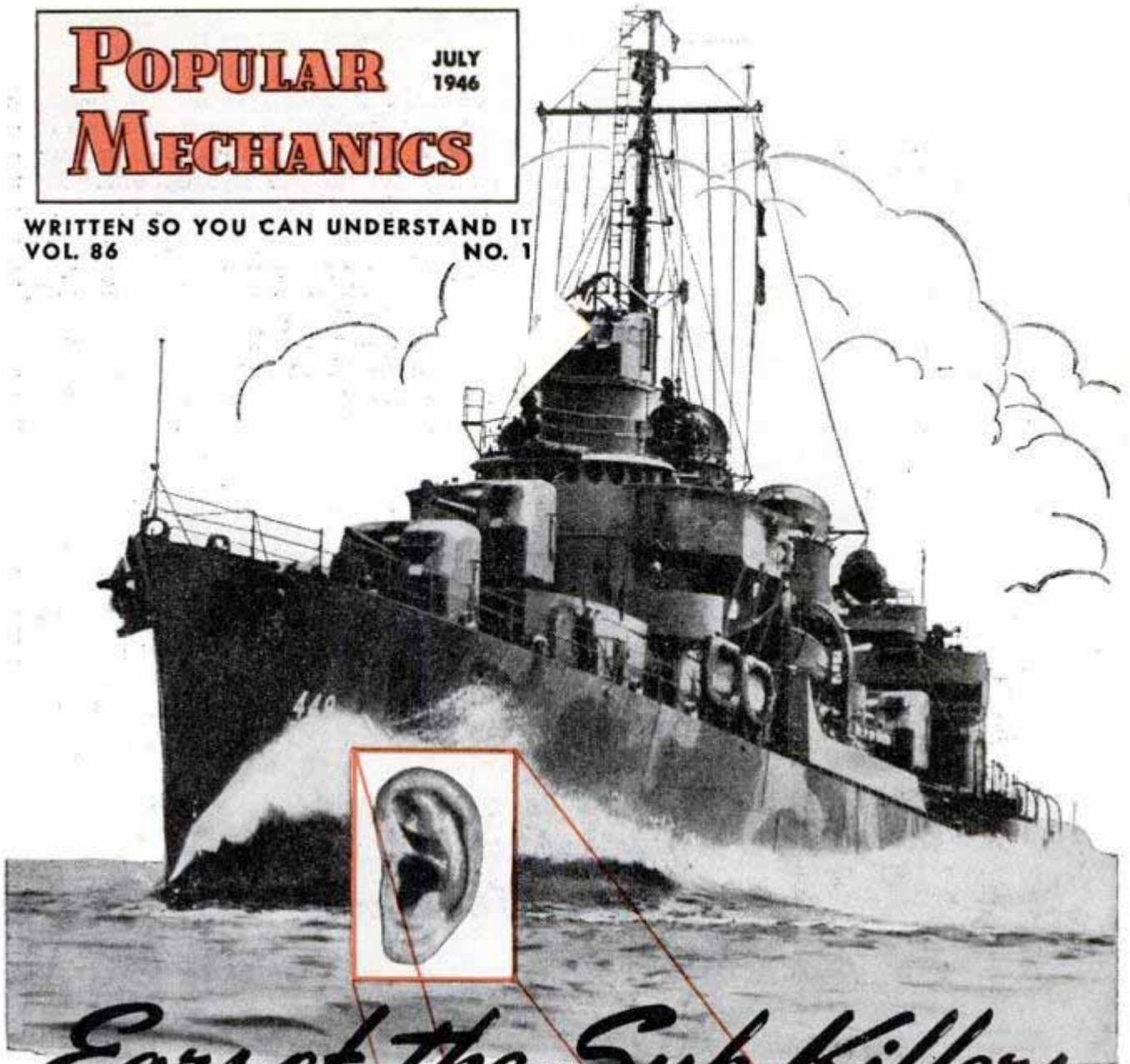

Ears of the Sub Killers

ONE single technical invention by our enemies," said Hitler in 1943, "has checked our U-boats."

That was not exactly the case; a combination of new devices and tactics was responsible, and high on the list of antisubmarine devices was sonar. Sonar is the official Navy term covering all aspects of underwater sound detection. The operators are called sonarmen.

Let's step into the shoes of a sonarman and slip on his jacket with its distinctive headphone insignia. As a sonarman you've had months of training at the U. S. Navy Sound School at San Diego, New London or Key West. Now you have come aboard. Maybe it's a DD (destroyer) or a DE (destroyer escort) or an SS (submarine). There are two sides to this sonar business—prosubmarine and antisubmarine. If you're on a destroyer or a ship of that type you're

By William T. Adams

out to murder subs. If you are assigned to a sub your job is to detect enemy targets.

Subsurface warfare resembles a battle between two gunmen in a pitch-black cellar. They feel their way through the dark listening for every sound. The first who sneezes or bangs a washtub is probably a dead duck.

Suppose you are aboard a destroyer as sonarman, first class. Your ship is convoying troop transports well out on the port flank of the convoy. You're sitting on a

Sonar is the ears of the Fleet just as radar is its eyes. Here is the graphic story of our undersea listening posts and how they ended the U-boat menace

hard chair listening to pulses of sound—pings—tossed every second or two from the loud-speaker over the “stack” before you. You watch dials that record the true and relative bearings of your ship. In your hand is a small metal wheel. Slowly you turn it from port to starboard and back. As the pings go out steadily without an echo, you report to the conning officer on the bridge: “No Contact!”

Sonar is the amazing twin of radar—but less well known. Radar is the Fleet’s “eyes” and sonar its “ears.”

Basically, radar is a device which projects a beam of electrical energy through the air until it strikes an object that bounces back part of the electrical energy.



Checking sonar driver — source of the sound signal

Similarly, sonar transmits an electrical impulse of sound through water. If the sound wave strikes an object, an echo is reflected which is caught up by a powerful receiver. Both devices—radar and sonar—reveal range (distance) and bearing (direction).

Like all complex electronic devices, sonar is the newest expression of multiple experiments begun years ago. During World War I, the Allies developed a new instrument for detecting undersea sound called the hydrophone. This was strictly a listening device and functioned like a doctor’s stethoscope. The intensity of sound indicated a sub’s distance, and by skillful maneuvering the listening vessel could be brought over the sub for attack by depth charges. Soon ships began carrying two hydrophones so that U-boats could be located as to bearing as well as distance.

Of course, submarines could avoid hydrophone detection by shutting off their

engines and resting quietly on the bottom. Also, submarines soon had hydrophones of their own which aided them in spotting surface craft.

Next step leading to sonar was the application of the newly invented vacuum-tube amplifier to the hydrophone. This made possible an enormous gain in sensitivity. If a number of patrol ships closed on a U-boat, the direction of the sub from each ship was radioed over and plotted by the patrol leader.

Then the American inventor Fessenden produced a new idea in underwater sound detection—the electromagnetic oscillator and receiver which was able to generate powerful sound waves in the sea. These



Sonar control “stack” guides beam, listens for echo

waves radiated outward several miles in all directions like ripples from a stone cast into a pond. If the waves struck any object—an iceberg, rocky coast, submarine—part of the waves would be reflected back to the sending ship. A pickup device measured the time lag of the echo and thus gave the range of the target.

After the Armistice, several countries simultaneously developed the first modern type of echo-ranging gear.

Before the start of World War II, many of America’s leading physicists, inventors and engineers plunged into the task of further extending the value of underwater sound gear. The result is present-day sonar.

Let’s step back into the shoes of the sonarman to see how he operates. The room in which you work is the sonar hut—usually located on the bridge or just off it.

You’re still turning the wheel on the stack slowly from port to starboard and

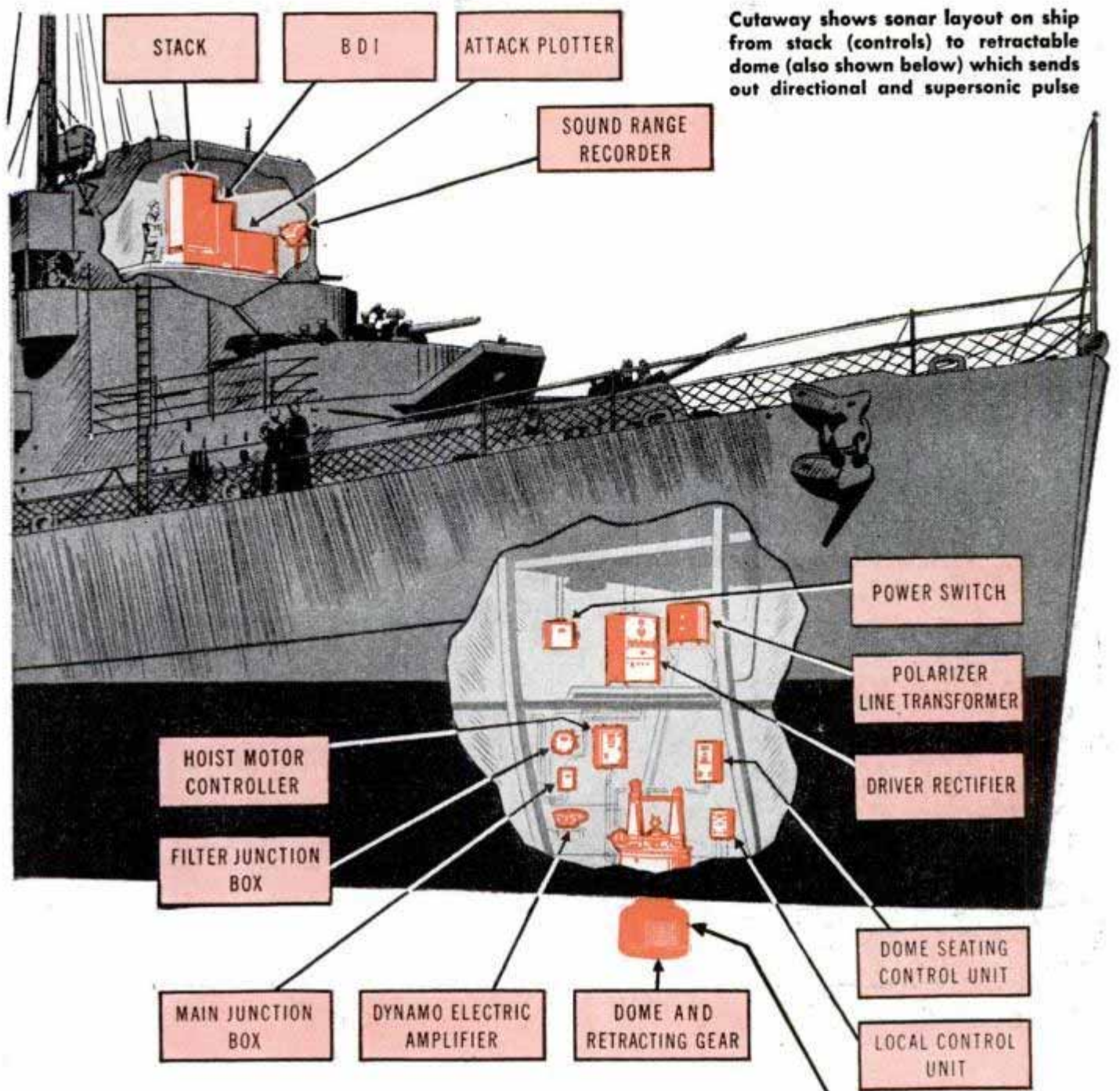

Cutaway shows sonar layout on ship from stack (controls) to retractable dome (also shown below) which sends out directional and supersonic pulse

back, calling out "No Contact" from time to time. You know that down under the hull of your ship, swirling along in the water, is a streamlined "dome" which contains a most important part of your equipment—the directional supersonic oscillator, or projector.

A far cry from Fessenden's early device, your projector concentrates its high-frequency pulse in a narrow cone or beam. The oscillator is really a large sandwich made of steel and layers of quartz or Rochelle crystals through which electrical currents are transmitted by the driver. This sets up frequencies over a range extending up to thousands of vibrations per second. The sound impulses carried out by the beam are supersonic. Your sending and receiving equipment change these supersonic sounds into sounds you can hear easily. The wheel in your hand and the stack which houses all controls are both connected with the projector so that, as the wheel turns, the narrow beam of sound turns with it. Since you are moving forward at fair speed, you swing (or search with) your sound beam over the two forward quarters. There is little chance of a slow-moving sub coming up on your stern quarters.

If seas are moderate and echo-ranging conditions good, you know your beam will detect objects in the water ahead. But

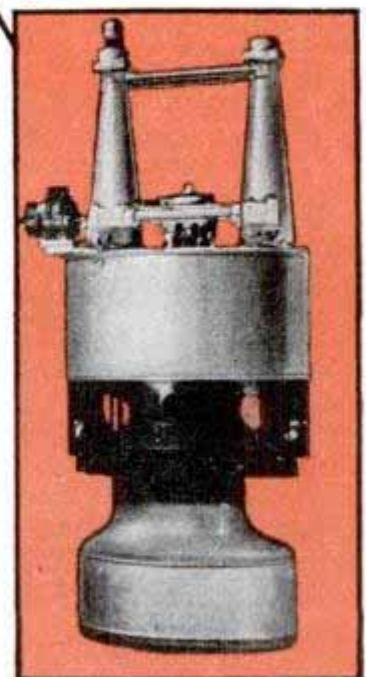

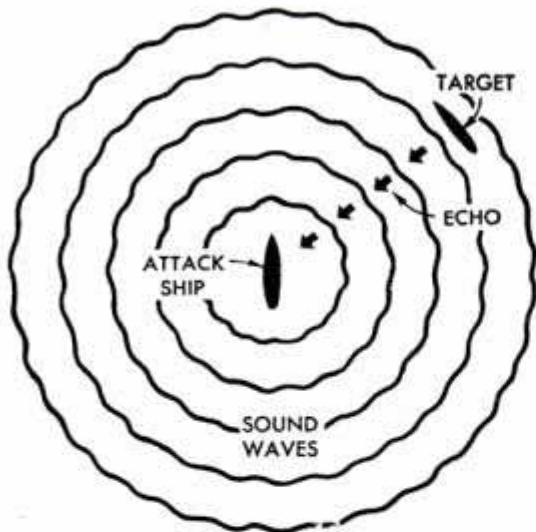

Early Fessenden oscillator sent sound waves out in all directions and returned echo was weak

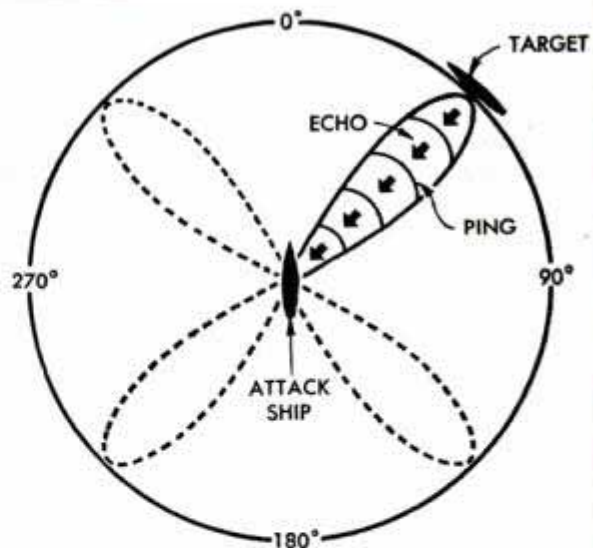

Modern sonar sends powerful directional beam; time lag between ping and echo gives the range

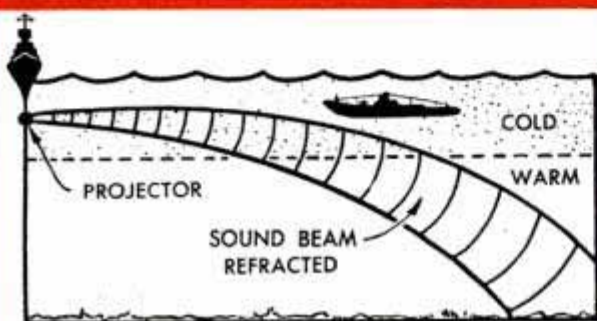

Layer of warm water "bends" sound beam downward—missing submarine only 500 yards away

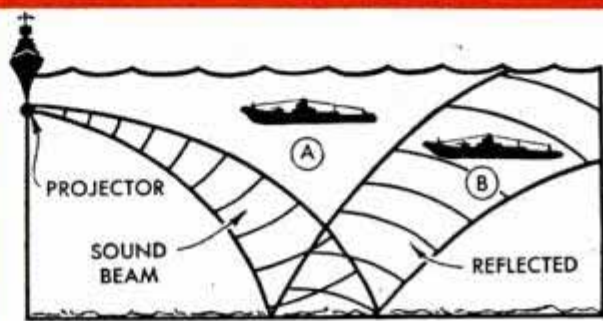

Here sound beam has hit bottom and reflected upward, catching sub B; sub A is in dead spot

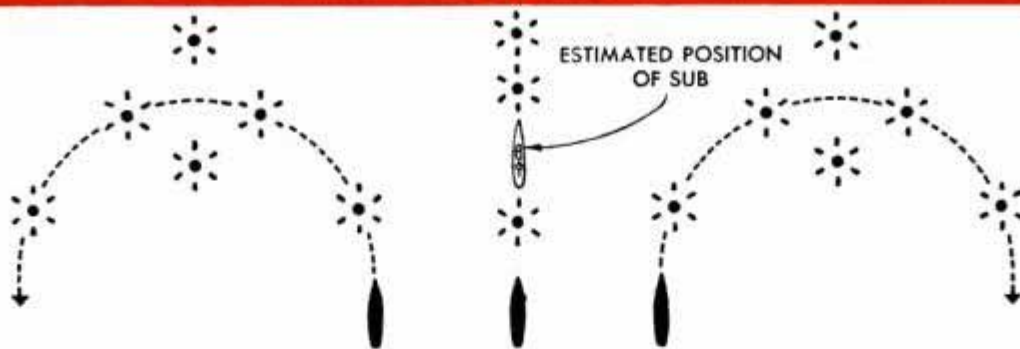

Pattern of depth charges is laid over sub by three attacking destroyers according to set plan in order to bottle up U-boat for the kill; a depth dive is the sub's only hope

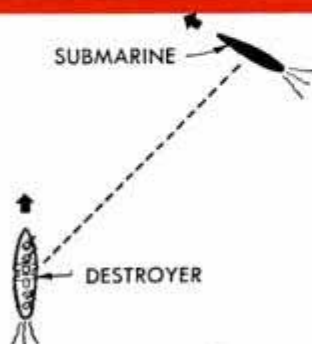

"Up Doppler" (rising pitch of echo) means destroyer and submarine are getting closer

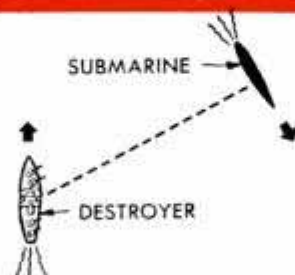

"Down Doppler" (falling of pitch in echo) means ships are gradually drawing apart

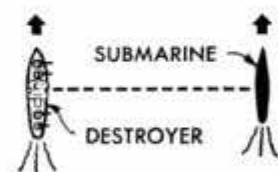

"No Doppler" (no change in pitch of echo) occurs when ships are running parallel



Sonar has done its work in locating a target for this Coast Guard crew and a depth charge churns the sea

you also know that sound transmitted in water is apt to do queer things. The sea is composed of layers of cold and warm water that reflect and refract (bend) sound waves. You learned in sound school that certain sea areas abound in crustacea, such as snapping shrimp, that raise Old Ned with echo-ranging. Charts of echo-ranging conditions for different seasons and localities are used and also readings from a device called a bathythermograph that records temperatures at various depths. If conditions turn bad the beam may be effective out to only 300 or 400 yards. You sit there straining your ears, your eyes on the control stack. The loud-speaker pings repeatedly. You turn the wheel—over and back . . . over and back . . . searching the seas . . . ever alert.

Then it comes—a faint echo between pings. "Contact!" you shout into the intercom. "Bearing zero-six-seven!"

"Verify contact," orders the conning officer. He knows, as you do, that every contact may not be a submarine. Perhaps it's a whale or a playful school of porpoise or a mass of seaweed.

Painstakingly you swing your sound beam back and forth over the narrow segment where you picked up the first echo. The ship is alerted as it heels to port. Every man is at battle station. By your side your fellow sonarman stand at the sound range recorder. Everything now depends on you—you are the brains, the heart, of the ship. On your skill rests the fate of many.

"Contact. Bearing zero-five-zero," you call out. The echo is stronger now and you add, "Up Doppler."

This ability to recognize the Doppler effect in echoes is a vital part of your mental equipment. Without it you would never have qualified as a sonarman. Doppler effect, named for the man who discovered this phenomenon of sound, is the change in pitch of sound as you approach or draw away from the sound source. When you report "Up Doppler" it means ping echoes are rising in pitch and you are getting nearer the target. "Down Doppler" means you are losing distance. "No Doppler" means distance remains the same.

Now, at your elbow, the sonarman at the sound range recorder announces, "Range four double O." The conning officer knows that the target is 400 yards away. Another officer locates the target in relation to the convoy. If other attacking ships are combining in the operation, they are notified and a set pattern for the attack adopted according to definite rules. A constant stream of radio information is exchanged between ships since there is no danger of interception by the submerged target.

"Bearing zero-three-zero, up Doppler, believe it's a sub, sir," you report. Now you are headed 30 degrees to starboard of the target, and the range is narrowing. By the metallic quality of the echo and the Doppler effect, you feel sure this is a submarine.

"Range closing to two-five-zero," calls the sonarman at the range recorder. Next to him his companion studies the BDI (Bearing Deviation Indicator). This is a scope like the scope of a television set. On it a beam of light travels up and down a center line. Targets are represented on the

(Continued to page 244)



Nonscratch Clamp Holds Oars

Rubber-faced at contact points so that it cannot scratch the finish, a clamp fastens to the drip-mold and holds fishing poles, skis, oars and other long objects in place on a car top. It does not interfere with the closing of car doors and can be put on or taken off quickly by tightening or loosening one wing nut. Once attached the metal clamp will not be shaken loose by wind or vibration.

Steamed Upholstery Is Wrinkle-Free

Much as a tailor uses steam in pressing a suit of clothes, an automobile manufacturer is employing it to achieve a glove-like fit of the upholstery in his 1946 closed models. As the automobile bodies come along the Hudson production line at the factory in Detroit, steam under 400 pounds pressure is fed into the closed body for 12 seconds. When the doors are opened the "steam-fitted" seat covers are smooth fitting and wrinkle-free.

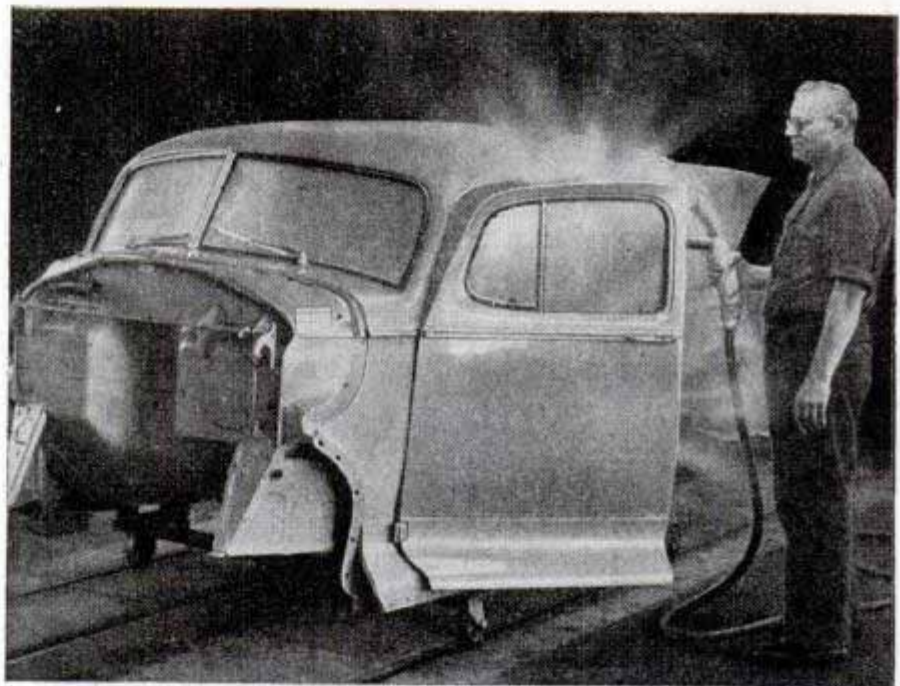

Tank Pulls Stumps

When the Army declared a group of tanks surplus, Kamile Dupre purchased one at the Rock Island arsenal. He uses it to pull huge tree stumps from the fields on his farm near Geneseo, Ill., and for other heavy farm chores.

One million children in the United States, not including the totally deaf, are suffering from some form of poor hearing, according to estimates of the American Society for the Hard of Hearing.

EYES ON BIKINI

PROBABLE POSITION OF RISING CLOUD AT INTERVALS AFTER EXPLOSION

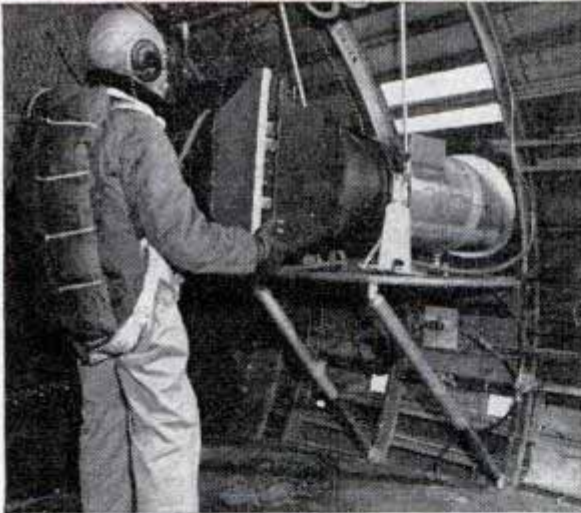
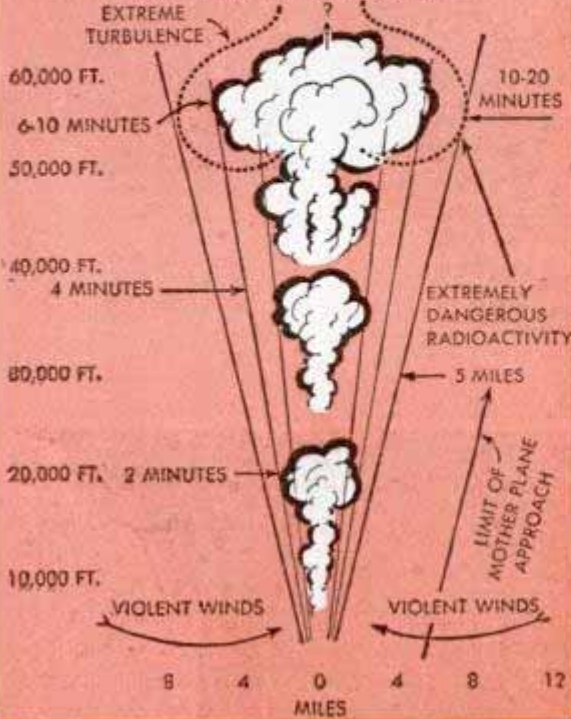

Batteries of cameras like those above are expected to give "Operation Crossroads" at Bikini Atoll this month the greatest aerial photographic coverage of all time. More than 250 movie cameras alone will be airborne for the event. A cluster of six high-speed cameras can be seen in the center background. At left is the largest single camera ever used on an operational mission, a modified K-18 with a specially designed 48-inch telephoto lens. Object of much study are the atomic clouds which will arise after the bomb explodes. The sketch, upper left, released by Joint Army-Navy Task Force One, shows the expected behavior, with violent winds at the bottom of the mushroom and extremely dangerous radioactivity at 50,000 feet. Crewless and manned only by radio waves from a "mother" vessel, Navy LCVPs like the one below will be sent into the bombed area to gather test data immediately after the explosion

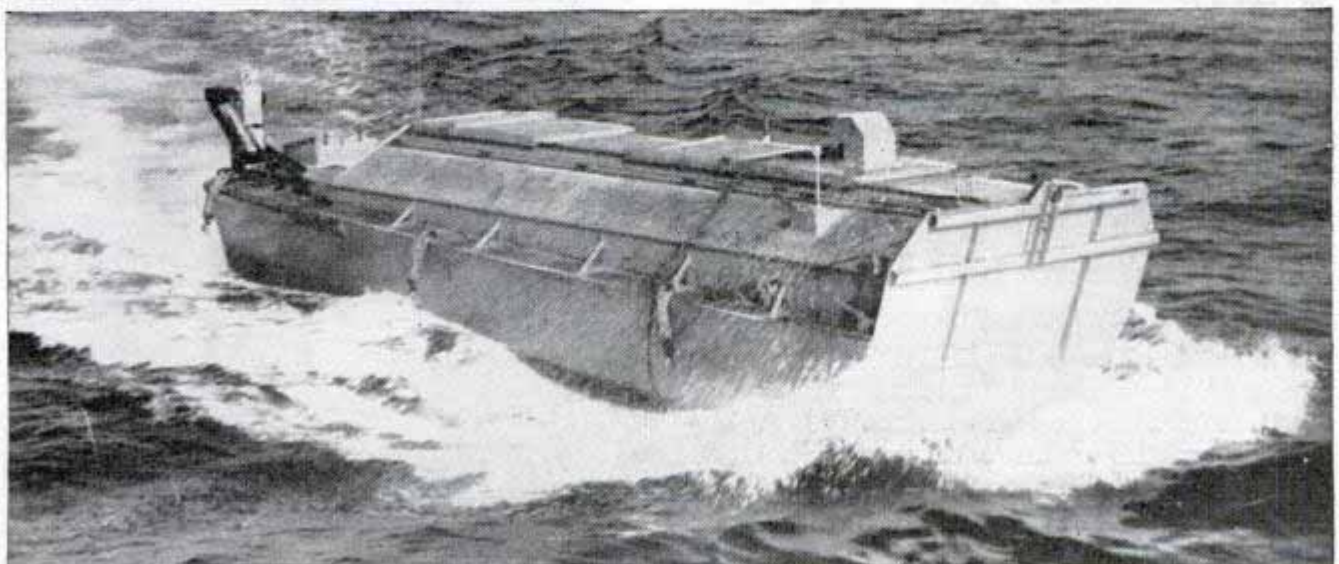

"Canned" Freight Is Transferred From Flatcar to Truck

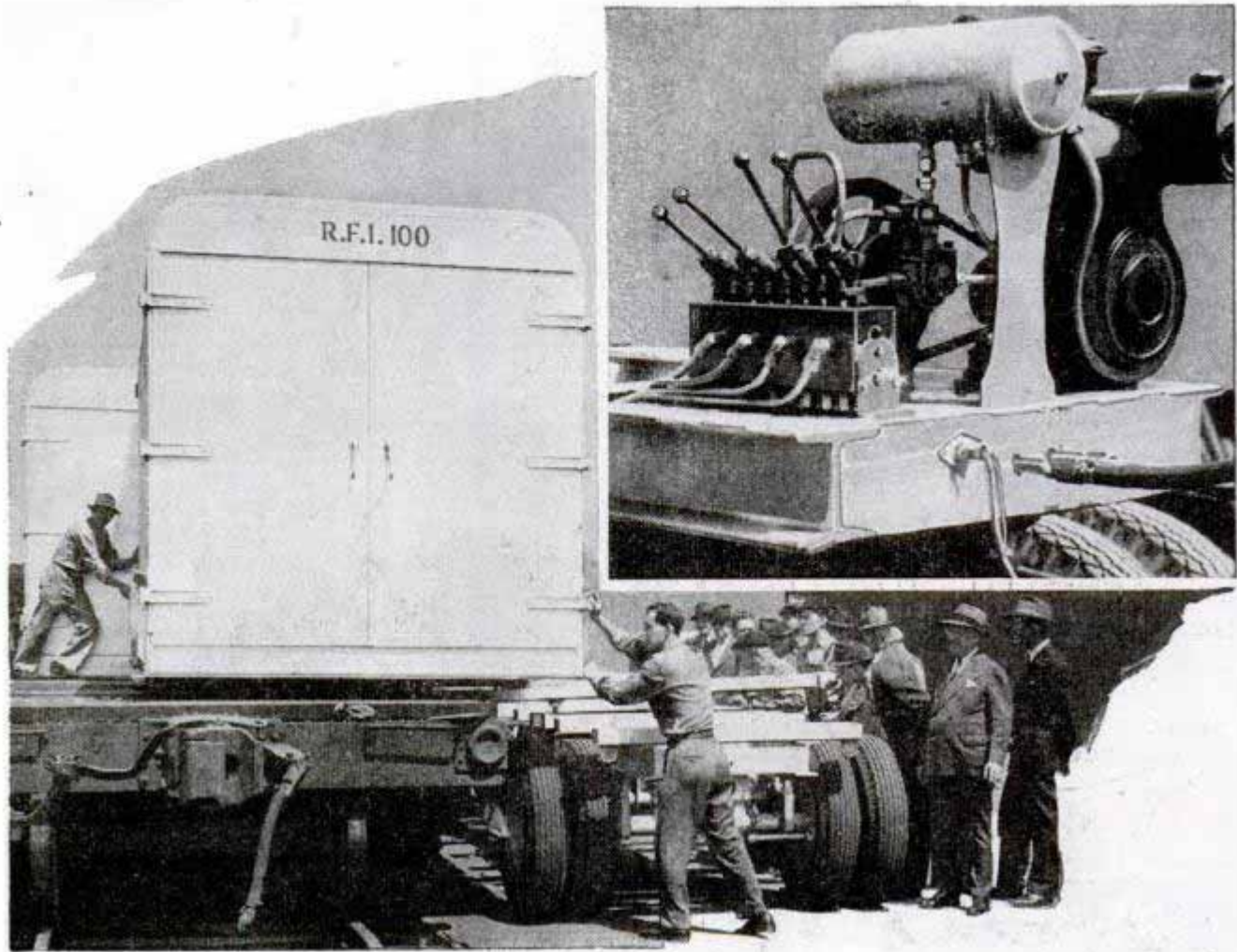

Preloading of railroad freight cars is possible with all-aluminum containers of half-boxcar capacity. The containers are loaded in manufacturing plants and hauled by semitrailer truck to a railroad siding. Built-in hydraulic jacks, powered by the truck engine, and roller bearings shift the half-boxcar "package" to a flatcar or vice versa in just three minutes. Two 20-foot-

long containers or three 13-foot containers, designed for air or rail transport, can be fitted on a flatcar. Use of the metal package eliminates rehandling of cargo between the factory and final destination. The unit, produced by the Reynolds Metal Company, can be built as a refrigerated container which holds a zero temperature for 36 hours without re-icing.

Fish Are Fooled by 'Minnow' Hooks Which Spring Open When Struck

Three camouflaged hooks on a minnow-like, nonspin, weedless spoon spring open when a fish strikes, increasing the fisherman's chances for a catch. The all-metal, chromium-plated spoon is available in two sizes— $\frac{1}{2}$ -ounce with a $2\frac{1}{4}$ -inch blade and $\frac{3}{4}$ -ounce with a 3-inch blade.

DDT Tape to Kill Houseflies Retains Potency for Months

Paper strips coated with DDT compound are useful in killing houseflies. The strips are gummed at one end to simplify hanging them from the ceiling. Flies absorb DDT on contact and die shortly after. The tapes are effective for several months if kept out of direct sunlight.

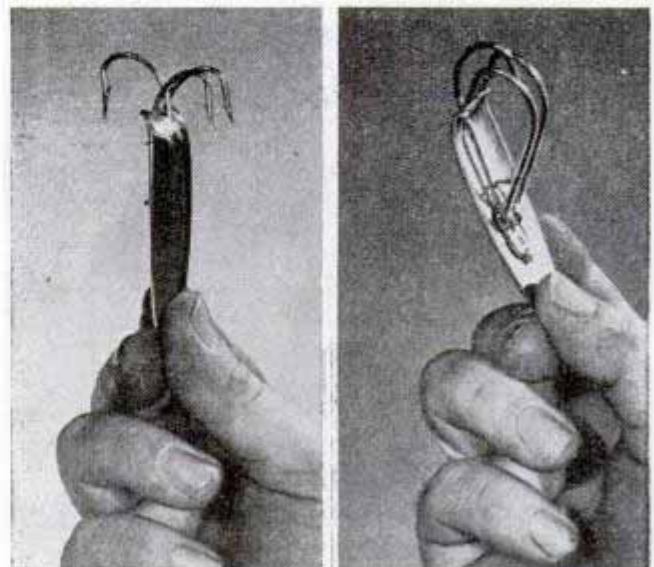

RADIO-STEERED "city busters" of the war that must never happen may be the "next generation" of those skyscraping rockets that are trying their primitive fins high above the New Mexico desert.

Jet-driven underwater missiles are swimming along a test channel in California, grimly promising to make the torpedo a firecracker by comparison.

The giant rocket—which may eventuate in the most terrible of atomic weapons boring thousands of miles through space, or in an interplanet ship or an intercontinental freight carrier or a scientific explorer of the skies—is in its infancy. The race is on for its development, and imaginative American scientists and war-schooled military men are pooling theory and experience to keep the United States to the fore in a field where German supremacy almost won the war.

We were not asleep while the V-2s—now captives serving us as laboratory tools—were flattening city blocks in England. Rockets played their part in our own victory. But the "V" weapons nearly changed the final score, and the Allies were fortunate that time was

"PREP SCHOOL" FOR ROCKET WARFARE



V-2 on New Mexico firing platform is fueled by liquid oxygen-alcohol blend carried in two 1000-gallon tanks

CONCRETE BLOCKHOUSE WHERE CONTROLS FOR FIRING ALL GIANT ROCKETS ARE LOCATED

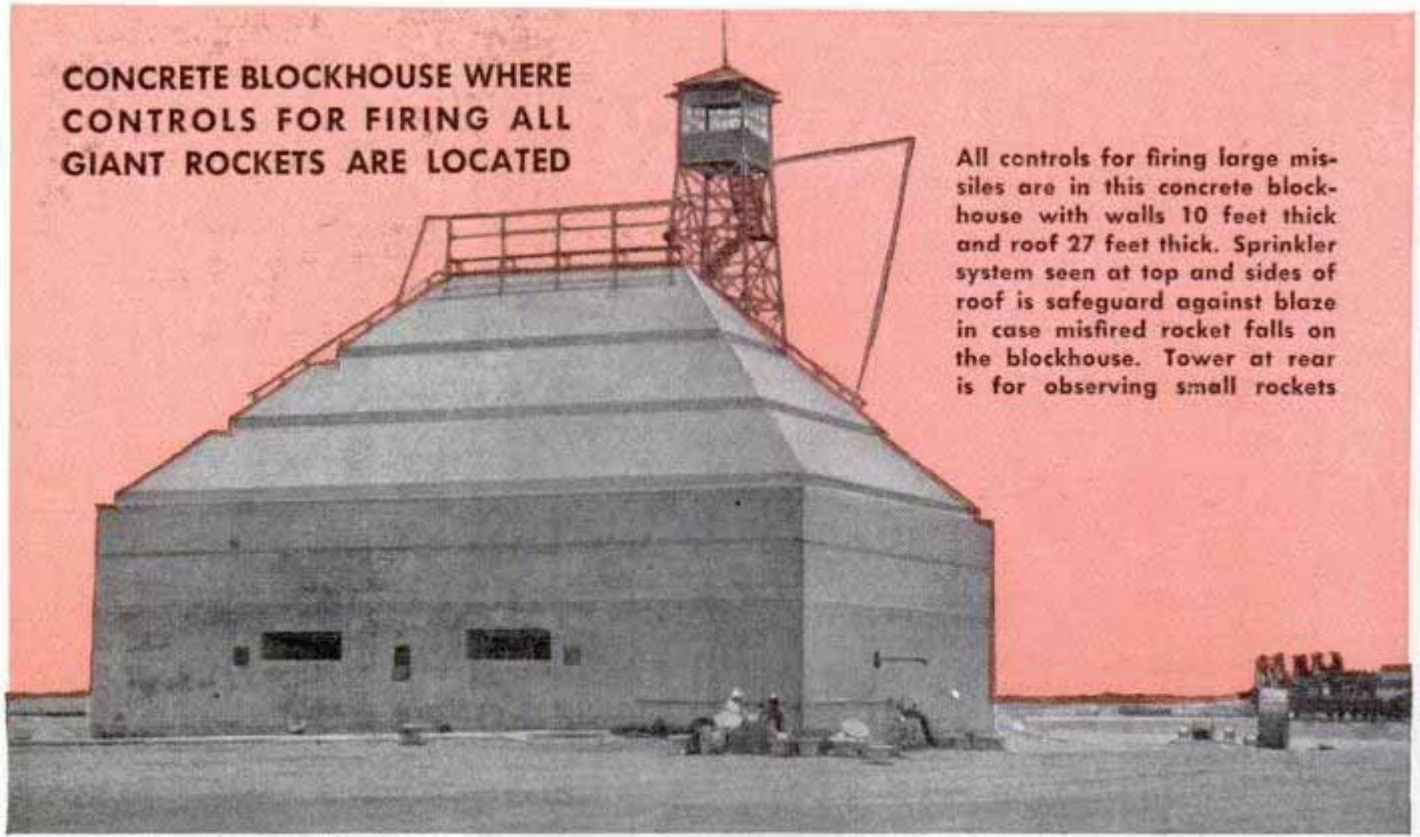

All controls for firing large missiles are in this concrete blockhouse with walls 10 feet thick and roof 27 feet thick. Sprinkler system seen at top and sides of roof is safeguard against blaze in case misfired rocket falls on the blockhouse. Tower at rear is for observing small rockets

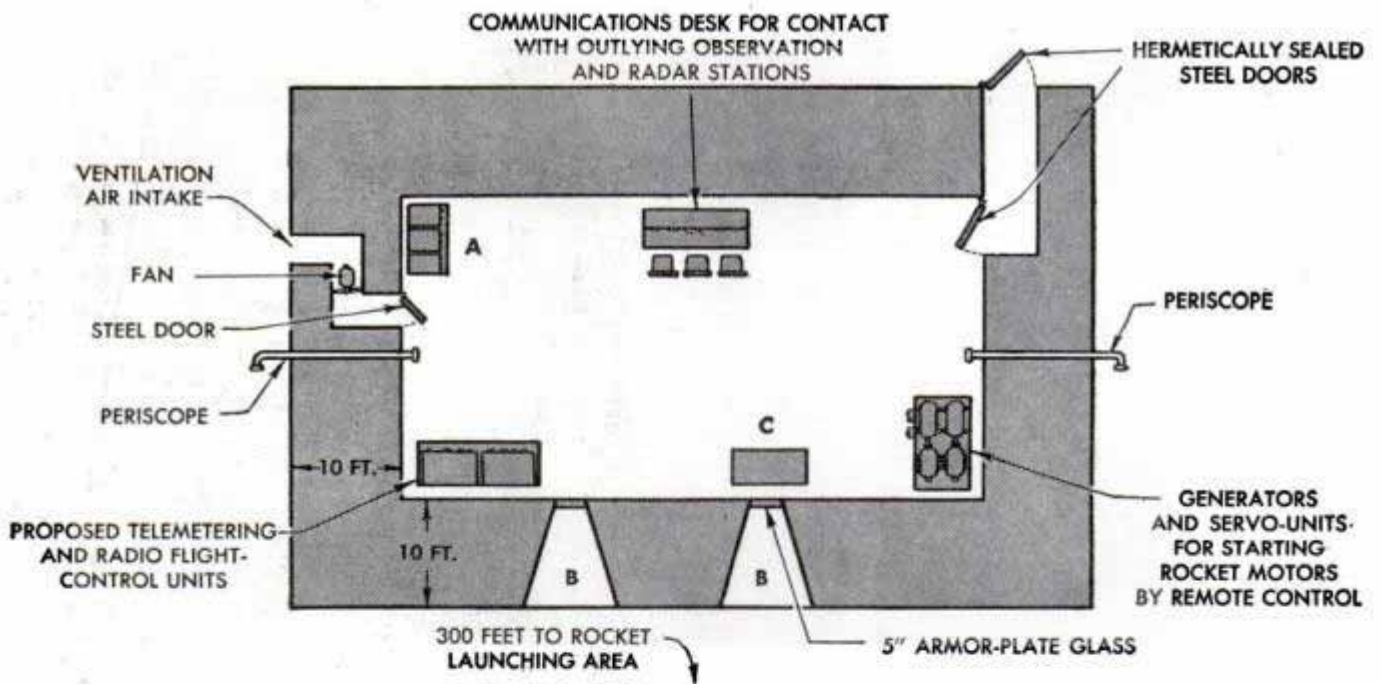

A Apparatus to establish time base for all stations observing rocket's flight in trial

B Soldier peers from outside at five-inch-thick armored glass protecting an observation slit

C Firing of all large missiles is directed by operators at this panel in the blockhouse

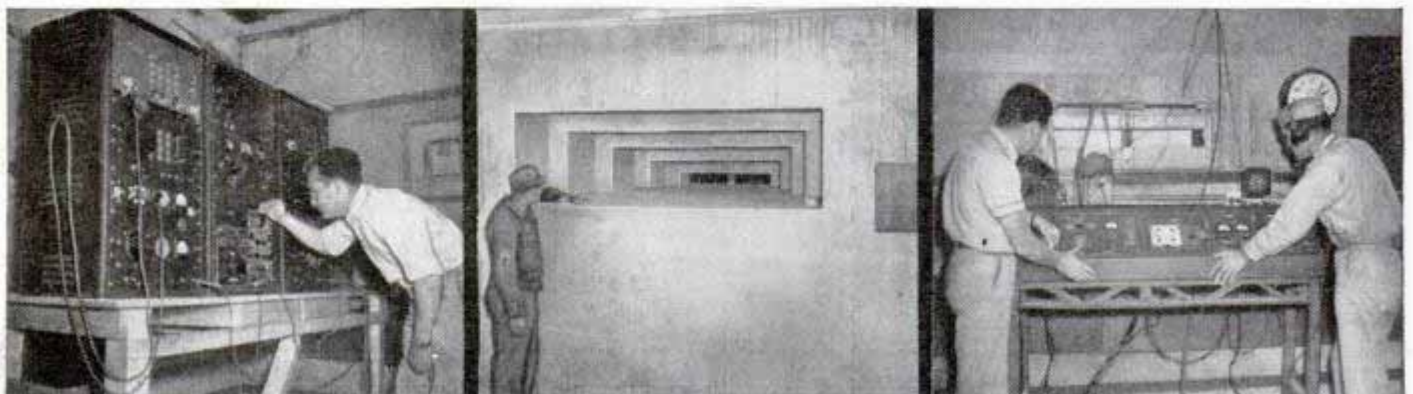

too short for the Nazis to learn all that we now are learning of long-range missiles.

Already we have plans for static test stands to try the motors for 150-ton rockets that are being conceived in current research programs. Other rockets that can race to the upper limits of the atmosphere and relay weather information back to earth, supersonic "test tubes" that will investigate new airfoil shapes, radar-tracked and radio-guided rockets all are close to realization.

Before he relinquished leadership of the AAF, General H. H. Arnold warned Congress of the need for an intensive research program: "If we fail to keep not merely abreast but ahead of technological development, we needn't bother to train any force and we needn't make any plans for emergency expansion. We shall be totally defeated before any expansion could take place!"

This summer at White Sands, New Mexico, Proving Grounds the Army Ordnance Department is experimentally firing a series of German V-2s up to the 100-mile level above the earth, well beyond the heights their inventors achieved. These nearly 14-ton giants, pointed skyward on a concrete launching platform, emit fire like a blast furnace and leave the ground with the roar of 100 express trains.

The rocket takes off slowly at the speed of a building elevator but accelerates rapidly and is moving 3000 miles per hour within a minute. It reaches maximum velocity of 3800 miles an hour at a point about three quarters of the way in its path of descent, finally crashing in the impact area, 30 to 40 miles away, its fuel explosion alone gouging a crater 35 feet across and 25 feet deep.

Controls for the firing are located in a concrete blockhouse some 300 feet away, with walls 10 feet thick and a 27-foot-thick roof. The rest of the area is cleared and a rocket shell fired from the blockhouse signals the outlying observation stations two minutes before the hulking V-2 is sent on its way. Painted a glaring yellow and black to aid observation, the finned cylinder is as high as a three-story building.

The giant V-2 missiles and rocket air-

"WAC Corporal" in position at bottom of 102-foot steel launching tower. The rocket weighs nearly 700 pounds and is 16 feet long. Standing alongside is Dr. Frank J. Malina, Cal Tech scientist who developed fuel now used to fire it nearly 50 miles up

RADIOSONDE PARACHUTE

RADIOSONDE

GYROSCOPE

FUEL

ROCKET MOTOR

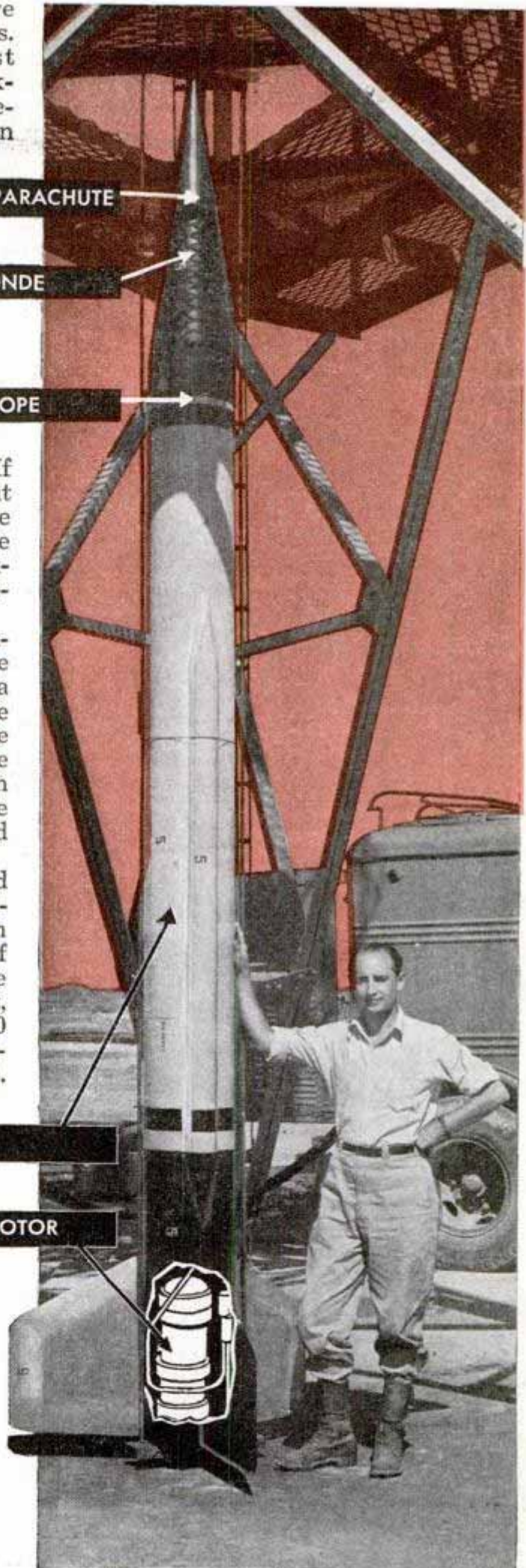

craft were two of Germany's major jet propulsion achievements during the war. The United States, meanwhile, concentrated on short-range artillery and aircraft rockets that were most suitable to our immediate military needs. But all the while, under wraps, we were working on advanced types in the longer-range categories.

Much of this research was centered at a secret 40-acre laboratory area near Pasadena, Calif., operated by the Jet Propulsion Laboratory of the Guggenheim Aeronautical Laboratory of the California Institute of Technology. Here scientists invented and perfected the JATO (jet-assisted takeoff) units by which heavily-loaded military aircraft are boosted into the air after very short runs. Here, too, they developed the various GALCIT solid grain propellants for a variety of propulsion purposes. Cal Tech also is experimenting with new liquid propellants and with various kinds of radio controls.

The institute's jet propulsion program for the armed services was initiated by Dr. Theodore von Karman. At present Dr. C. B. Millikan is acting chairman of the executive board and Dr. Frank J. Malina is acting director of the Jet Propulsion Laboratory.

Three million dollars have been spent for explosionproof observation rooms, concrete firing pits in which rockets are anchored for stationary tests, a towing channel for the study of underwater jet-propelled missiles, and other special equipment.

The project personnel operate a test station for the Ordnance Department of the AAF Muroc Army Air Base, Calif., where a firing pit large enough for the testing of liquid propellant rocket motors of up to 20,000

V-2 being readied on launching platform for firing test. It is more than 46 feet long and 5.41 feet in diameter. At present its maximum range is about 230 miles and its greatest vertical distance between 75 and 100 miles. Descending, it attains 3800 miles an hour. Relative trajectories of both the V-2 and the WAC Corporal are shown

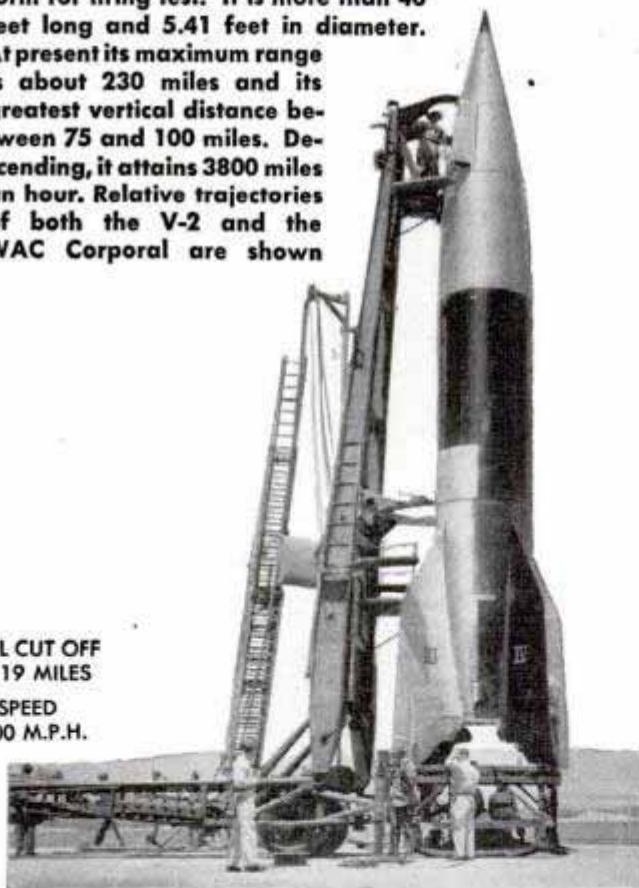

FUEL CUT OFF AT 19 MILES
SPEED 3000 M.P.H.

V-2 ROCKET OVER 13 TONS



WHITE SANDS IS 4000 FT. ABOVE SEA LEVEL

WAC CORPORAL 665 POUNDS

6 MILES 2400 M.P.H. AT IMPACT POINT

38 MILES

75 MILES —

IONOSPHERE (68.7 MILES) —

60 MILES —

50 MILES —

40 MILES —

MAXIMUM VELOCITY 3800 M.P.H.

30 MILES —

20 MILES (Highest meteorological balloons)

13 MILES (Highest manned balloon)

10 MILES (Highest clouds)

7 MILES (Bottom of stratosphere)

43.5 MILES

10.6 MILES (Highest plane)

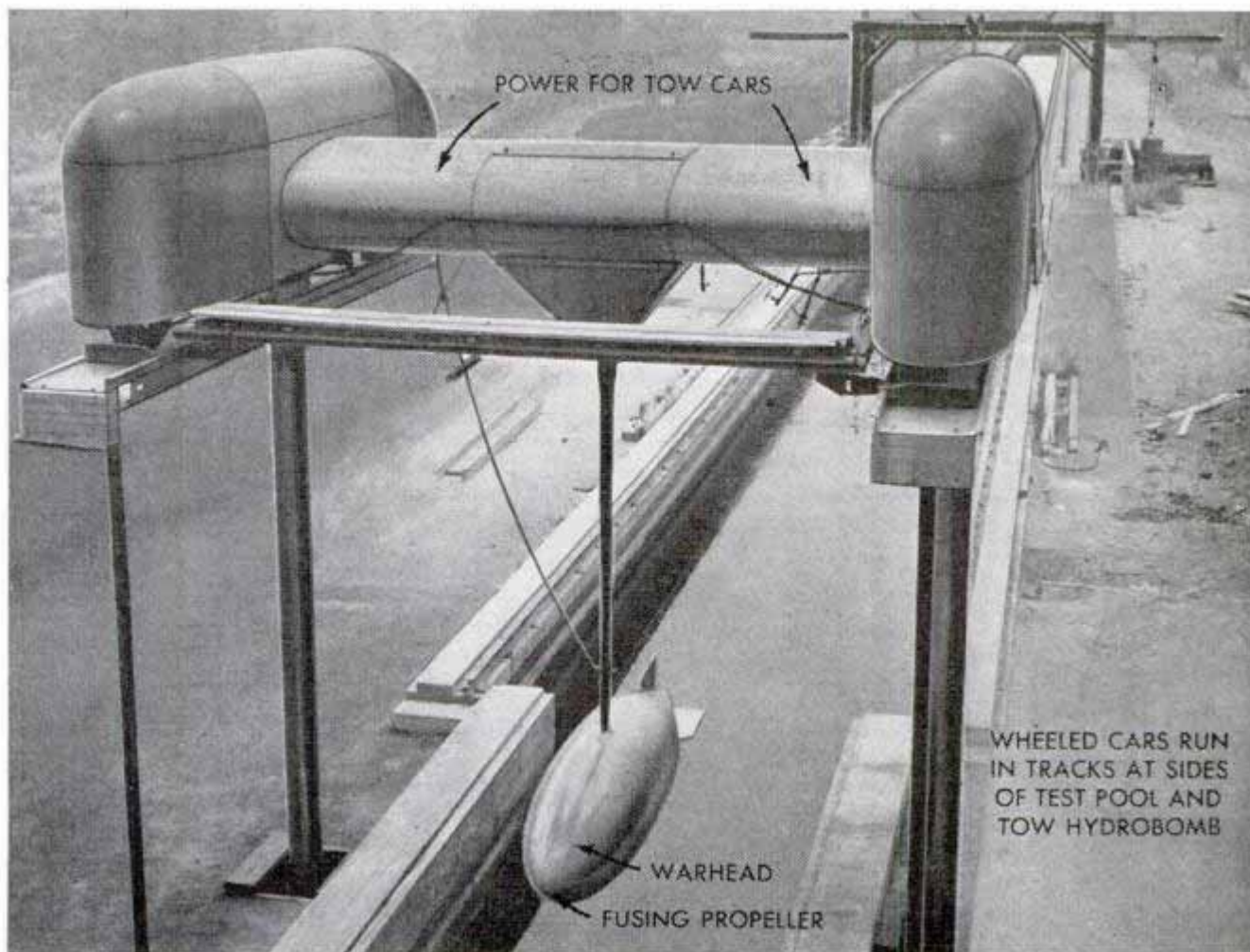

Hydrobomb tests are made in this 500-foot tank with underwater observation windows. The electric-powered tow car is lowered to the tracks at either side of the tank, completely straddling it when in operation. Still experimental, this plane-borne supertorpedo can carry a heavier charge twice as fast as current types

pounds thrust has been constructed. A motor of this size consumes propellants at the rate of three tons per minute.

Among the moderate-range experimental missiles developed at Cal Tech were the eight-foot-long needle-nosed "Private A" that has a range of 11.3 miles, and the "Private F," similar to "A" but equipped with horizontal lifting tail surfaces of nearly five feet span plus stubby nose wings of less than three feet span. They were designed for studying guided missiles.

For the Ordnance Department the project built the "WAC Corporal," code name for an upper-air sounding rocket that has been tracked by radar to an altitude of 43.5 miles. It carries meteorological instruments in its long needle-point nose.

The WAC Corporal is 16 feet long, a foot in diameter and weighs less than 700 pounds. It is launched vertically inside three guide rails contained in a 102-foot-tall steel tower. Initial acceleration comes from a booster unit that delivers 50,000 pounds of thrust for a little more than half a second. An inertia-operated valve then turns on the main motor that delivers 1500 pounds of thrust for a total of 45 seconds. This drives the missile almost 50 miles up.

The booster unit consists of an adapted

motor of a "Tiny Tim" rocket, originally designed to be launched from an airplane and delivering the punch of a 12-inch naval shell. It was developed at Cal Tech and was used at Okinawa.

The propellant mixture in the WAC Corporal consists of a fuel and an oxidizer, each in a separate tank, that combust spontaneously when brought together in the combustion chamber. Aniline is used as the fuel and nitric acid is used as the oxidizer. This combination, developed under Dr. Malina, automatically ended ignition, combustion and "throbbing" problems earlier encountered with liquid propellants.

Compressed air pressure feeds the propellants into the combustion chamber. The jacketed chamber is cooled by the flow of the aniline en route from its storage tank.

Much work is being done on liquid propellants. The present acid-aniline combination is superior to an earlier nitric acid and gasoline mixture that was ignited by a spark plug in the combustion chamber. New discoveries in turn may supersede acid-aniline. One oxidizer that has promise is a high-strength hydrogen peroxide. A nitromethane monopropellant, too, is being used experimentally in small rocket motors for periods as long as five minutes.

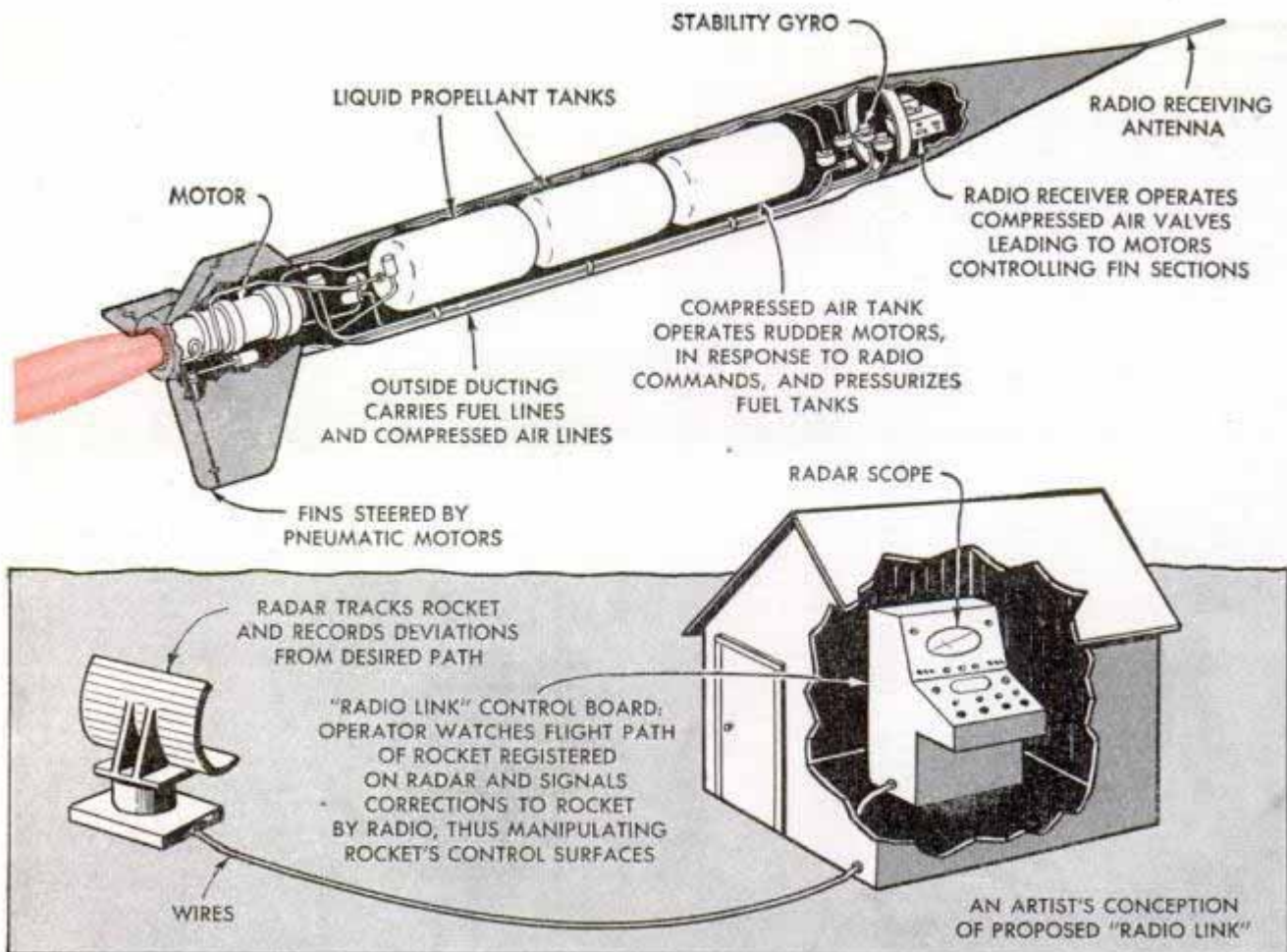

One American technique has been to force the propellants from their tanks to the combustion chamber by means of compressed air. The Germans used this and also developed the turbo-rocket system, used in the V-2, by which gas obtained from hydrogen peroxide operates a turbine that pumps the propellants from their tanks. Research is continuing on these systems and also on a way of manufacturing pressurizing gas from chemicals placed in the rocket.

Cooling the rocket motor is another problem. The best method so far has been to circulate the liquid propellant around the motor to absorb the heat. Under investigation is a proposed "film cooling" method by which the walls of the combustion chamber and exhaust nozzle are coated with a film of liquid. It may be that the evaporation of this film during combustion will keep the walls at a satisfactorily low temperature.

Another weapon that Cal Tech is working on experimentally is the hydrobomb, designed to be dropped from an airplane and to travel under water like a super-torpedo. A jet propulsion motor gives the hydrobomb an underwater speed of 70 miles per hour, twice the speed of the usual Navy torpedo. It carries a much heavier charge than a torpedo but has a shorter underwater range.

The hydrobomb is almost 10 feet long and has a diameter of 28 inches. Its motor is similar to a JATO unit.

For testing the hydrobomb a water tank 500 feet long, 12 feet wide and 16 feet deep was built at the experimental area. The tank has an underwater window through which the performance of the missiles may be watched and recorded. A rocket-propelled tow car was placed astride the channel. Electric motors that give the tow car

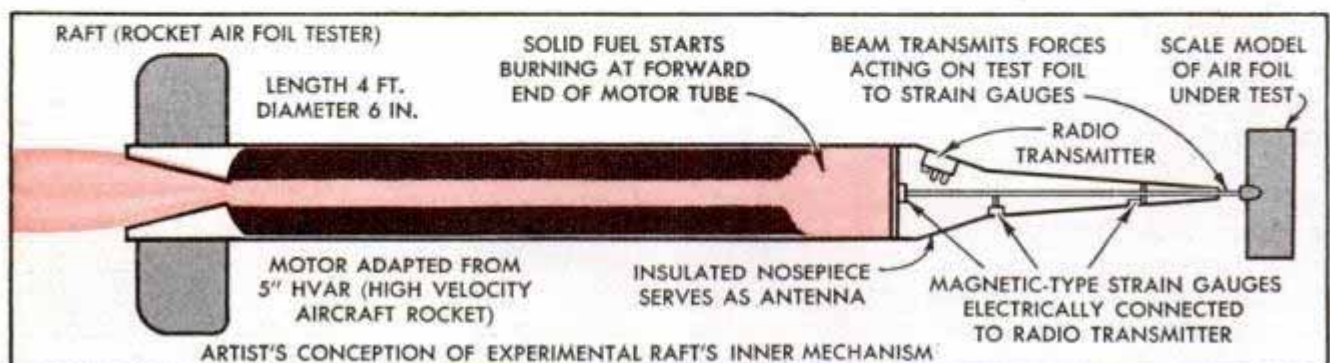

a speed of 40 miles per hour have since replaced the rocket power.

Another of the Cal Tech projects is the RAFT, a rocket apparatus intended to move an experimental airfoil at the speed of sound, or at supersonic speeds, in order to measure its aerodynamic characteristics and report them by radio. Its name is taken from the initials of the designation "Rocket Air Foil Tester." It will augment and check wind tunnel studies on new wing shapes by actually flying them at speeds approximating those for which they are designed.

Present experimental RAFTs consist of standard five-inch High Velocity Aircraft Rockets fitted with a special type of nose. Almost six feet long, the standard HVAR rocket travels just under 1000 miles per hour without an airfoil attached.

The airfoil under test is supported in front of the rocket's nose by means of a rod or beam. The other end of this beam is supported at three points inside the nose of the rocket. Lift, drag, and moment that act on the airfoil in flight are registered at these three points by magnetic strain gauges.

A novel radio hookup relays this information to the ground. Each of the strain gauges controls the frequency of an audio-oscillator circuit. Variations in strain thus create comparable variations in frequency. The nose of the rocket, insulated from the motor, serves as a half-wave-length antenna to transmit variations to the ground, where they are received and recorded.

To keep their huge V-2 missiles on their intended courses the Germans provided automatic pilots with three gyroscopes to control the pitch, yaw and roll.

At Cal Tech, ORDCIT men (Ordnance Department and California Institute of Technology), in conjunction with the Sperry Gyroscope Company, are working on automatic pilots of greater accuracy and more positive control. They are experimenting with telemetering systems by which a rocket reports information about itself to the ground, and on "radio link" control apparatus by which a missile may be maneuvered and directed during flight.

A typical automatic rocket pilot consists of three air-operated gyroscopes connected to pneumatic motors that are geared to the steering segments of the rocket fins. When the rocket veers from its course the gyro mechanism signals the motors, which then operate the rudders sufficiently to bring the missile back on course. The gyros, amplifiers and motors all are driven by compressed air from the tank supplying pressure to the propellant tanks.

Telemetering is new and complex. It reports 10 conditions continuously to a ground station during the flight of the rocket.

(Continued to page 260)

Dummy Tests "Charging Power" Of Football Linesmen

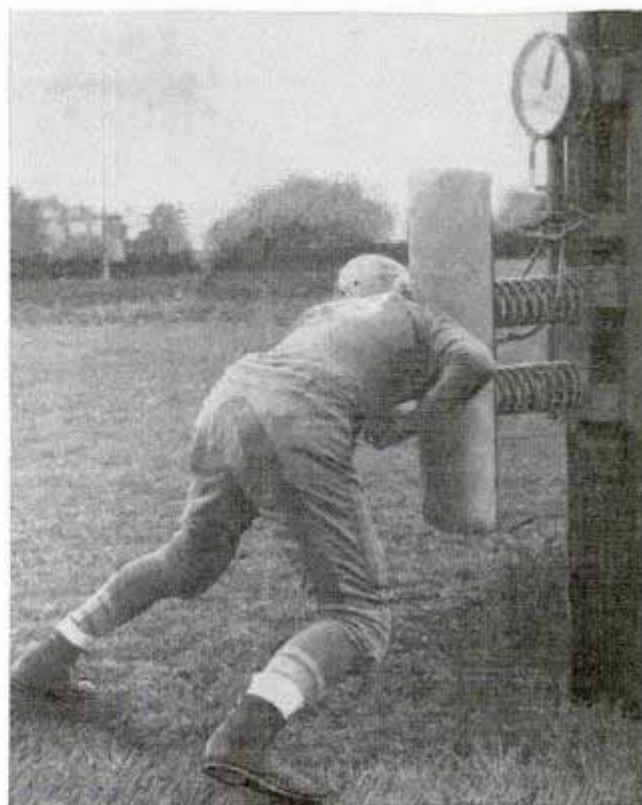

Football coaches can measure in pounds the charging power of linesmen with a practice dummy devised by Ed Ryan, coach at Klamath Falls, Ore. It is a cross between a conventional dummy and a carnival punching bag that tests your "hay maker." The machine has springs and levers connected with a meter to measure the force with which the dummy is hit.

Quick Lock Hose Coupling Is Held Tight by Spring

Hose couplings that any housewife can handle with ease are made of solid bar aluminum that resists wear and corrosion. The threaded section is attached permanently to any standard threaded faucet. The section attached to the hose has a knurled ring instead of threads. When the ring is moved, a set of hinged dogs swings open and grips the faucet section. Moving the ring back against the pressure of a spring releases the dogs for uncoupling the hose. Standard types of gaskets can be used with the new coupling.



Photographs Made Without Camera by Electrical Charge

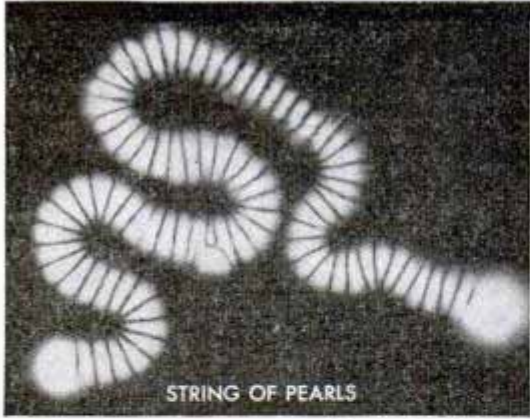

STRING OF PEARLS

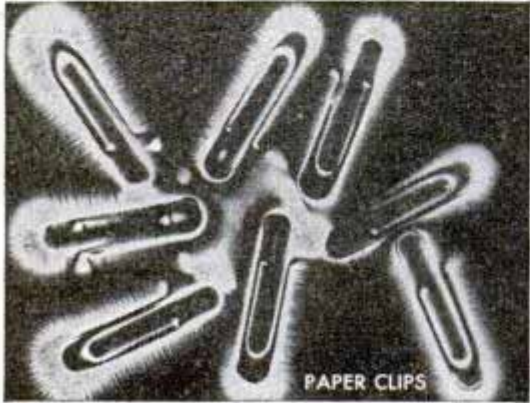

PAPER CLIPS

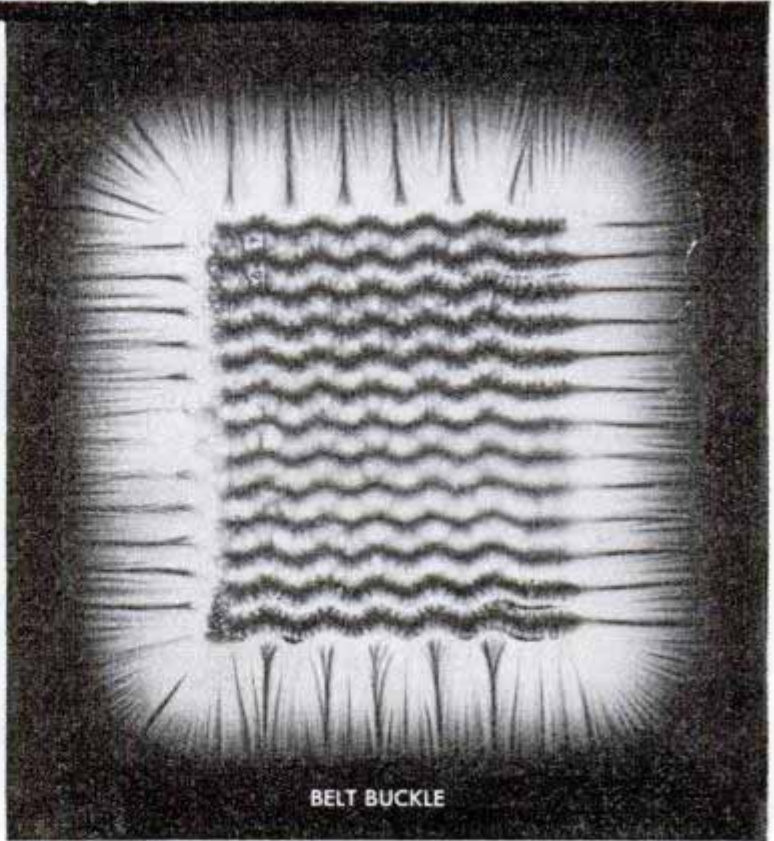

BELT BUCKLE

Weird looking photographs can be taken without a camera. An object, such as a necklace, is placed on a photographic plate in a darkened room. Electric wires are attached to each end of the object and the

current is switched on. The electricity passes through the object, creating an aura of light which registers on the photographic plate in the form of a strange pattern. In a recent experiment, 100,000 volts was used.

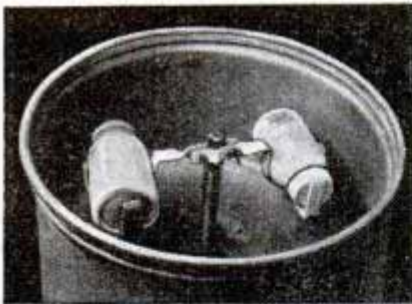

Home Churn Attachment Makes Butter in Washer

Butter now can be churned in the washing machine. A churning device clamps on either a round or square-type washing machine agitator. It holds two one-quart canning jars. The jars are partly filled with cream and the machine turned on. The rest of the process is automatic and requires no attention until the freshly churned butter is removed.

Welder Charges Battery

Battery charger and arc welder are combined in one unit designed to service railway coaches. One model is equipped with a 400-ampere electric motor-driven welder and circuits for charging batteries on two coaches at a time at a maximum rate per battery of 150 amperes at 50 volts d.c. The unit is adaptable to any shop where batteries are charged and electric arc welding is done.

Tailored for TOM THUMB



Kitchen match is big timber in tiny miter box. The pipes can be smoked

6117 N. Wentworth Chgo 40.

If you need a complete set of carpenter's hand tools all carefully made from the finest materials you can find them at the home of Joseph H. Gray in Chicago. But you'll have to be less than a foot tall or you will not be able to use any of them. Just how many thousands of miniatures he has in his collection, Mr. Gray himself doesn't know, for he is still collecting. But he could furnish a home for an undersized Tom Thumb with fine period furniture, carpets and original etchings, even including folders of tiny safety matches for lighting the half-inch candles in the inch-high candlesticks he is arranging carefully on the table below



It's a midget hammer, not a nail, alongside regular hammer, left. Every tool in miniature chest will work

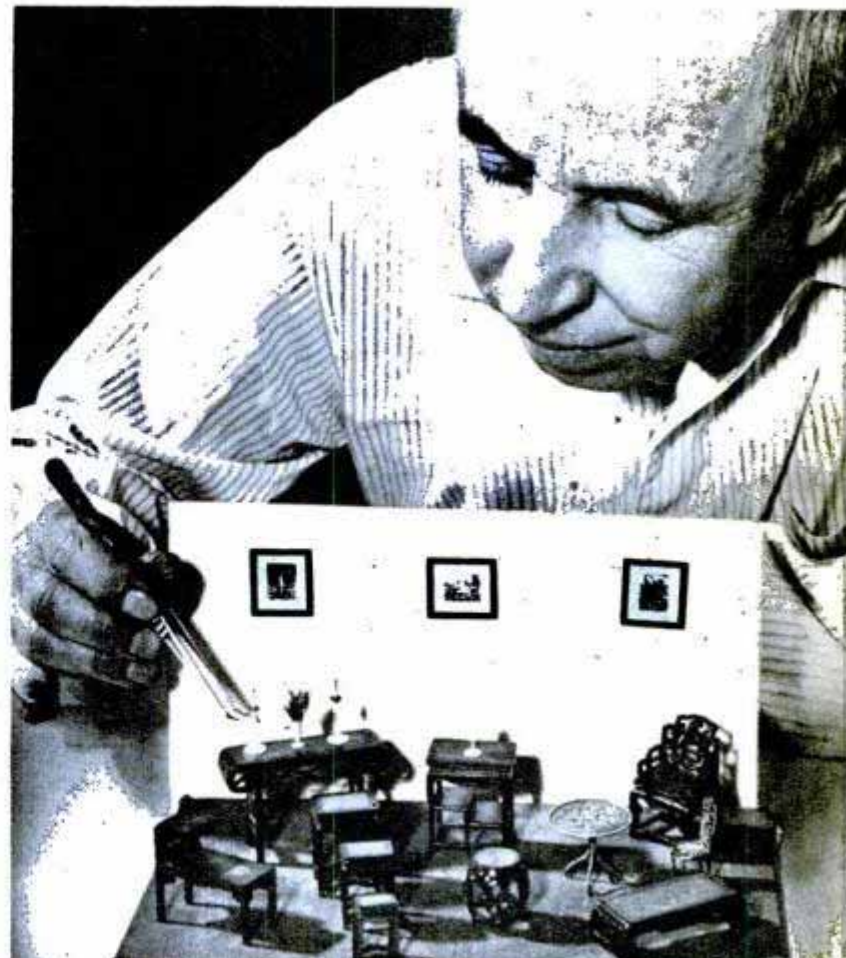

100 Cooper St. N.Y. 34, N.Y.
Mechanical Waiter in Restaurant Table Lifts Food From Kitchen



Waiters in a New York restaurant are never tipped—because they're machines. Mechanical service tables have been installed that are connected by miniature elevators with the floor below. The diner writes his order on a slip of paper and drops it through a slot in the table to the kitchen. There a chef prepares the order and places it on the elevator. It then is raised to the diner through a hole in the center of the table.

Penicillin Output Increased

Greater yield through improved methods of production has caused the wholesale price of penicillin to be reduced from \$20 per dose in June 1943 to its present level of about 60 cents. During the first six months of 1943 only about 400 million units were produced, enough for about 400 cases. In the last six months of 1945 production each month was 677 billion units. Money value of this lifesaving drug produced last year is estimated by the Department of Agriculture at \$100,000,000.

Sharper Beam for Radio Relay Aids Phone Systems and Television

Ultrashort radio waves are focused into a sharp beam by a metal lens which is expected to have widespread application in microwave radio relay systems such as the

New York to Boston channel now under construction. The lenses, varying from 18 inches to 20 feet in diameter, were designed primarily for long distance telephone transmission. They also will be used in transmitting wire photos, for radio broadcasts and television programs and as an aid to radar for sea and air navigation. Developed by Dr. Winston E. Kock and his associates at Bell Telephone Laboratories, the lens improves the transmission and receiving of wave energy in the form of a narrow beam necessary for short-range transmission between relay stations. The lens operates on a principle somewhat akin to that of a simple magnifying glass focusing the sun's rays to burn a hole in a sheet of paper. An array of metal plates receives radio waves from a hornlike shield and focuses them into a pencil beam.

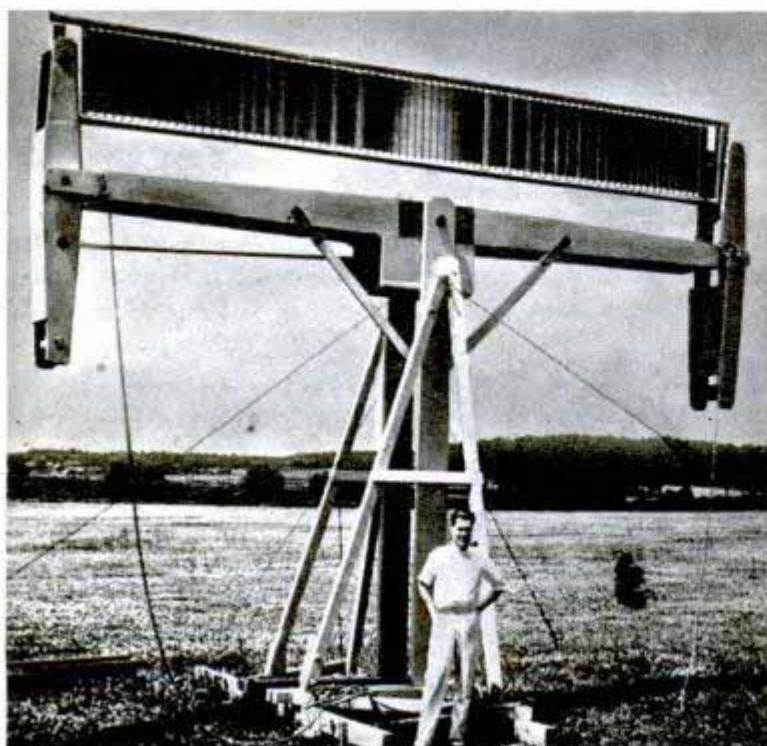

Information about products described in this issue may be obtained by writing to Bureau of Information, Popular Mechanics, 200 East Ontario Street, Chicago 11, Ill.



Bathers can lie back, float and relax under the sun-shading canopy of a nonsinkable pleasure raft. Built in various sizes to accommodate up to four persons, the raft is made of a cork compound in two sections joined to form the horseshoe-shaped outer shell. The body rest is of canvas tape which can be replaced by a waterproof canvas sheet if the user desires to stay dry. A gum rubber head-

Pleasure Float for Bathers Can't Capsize or Sink

rest is placed at the rudder end. It is so designed that additional

body rests can be attached, turning the pleasure craft into a double decker. It can be propelled by oar or outboard motor or the detachable canopy can be used as a sail. The outer shell sections can be separated quickly and the entire raft can be carried in a canvas bag. Overall weight of the craft is 55 pounds.

Square-Tip "Windmill" Propellers Designed to Boost Airplane Speeds

Resembling a windmill vane, the first square-tipped propeller blade since the days of the Wright brothers is now in production. Its builders maintain that the square tip, carrying the airfoil section for

the blade's entire length, performs more efficiently because it is unnecessary to distort airfoil design at the tip as with the present blade. Width added at the tip also affords the greatest gain in blade power absorption with minimum weight increase, permitting lighter blades. A slightly rounded early version of the square-tipped blade was first used on the P-51 Mustang and new models are slated for the Martin 202 and the Consolidated-Vultee 240.



Sound "Radar" Probes Skies To Predict Weather

Meteorologists now aim machine-made sounds at the sky and study the echoes in an electrical instrument to learn more about approaching weather conditions. The sound maker, called "sodar," creates a low-power noise that can be heard as it heads straight up into the atmosphere. The same device, developed by Bell Telephone Laboratories, "catches" the returning echoes and changes them into visible oscilloscope patterns. Changes in temperature overhead are detected when the sound bouncing back is louder than when it started. This indicates that hot and cold air are mixing violently, presaging a storm.

Garden in the



Derelict house is silent evidence of the earth's thirst. Scene at top shows how water will cause the arid region to bloom

A mighty river will lift itself uphill and change a million acres of wasteland into 17,000 fertile, individually owned farms

By Thomas E. Stimson, Jr.

GRAND COULEE DAM, busy creating power for the Northwest, is being readied for its other prime task—that of manufacturing millions of tons of food every year.

When its new power tools are ready the dam and the Columbia River that it controls will be responsible for the production of vast stores of wheat and cereals, many thousands of tons of milk, butter, cheese and eggs, tremendous quantities of meat and an untold tonnage of fresh vegetables.

It will create all this by bringing under irrigation more than a million acres of rich land that is now too arid to be farmed. This amounts to adding to the useful lands of the country an area comparable to Denmark.

Administered by the Bureau of Reclamation, the \$277,000,000 Columbia Basin irrigation project is planned ultimately to provide permanent occupations for more than a quarter of a million people. An estimated 80,000 will operate the 17,000 or more 40 to 160-acre new farms, and 200,000 more will work in new towns and industries.

Desert

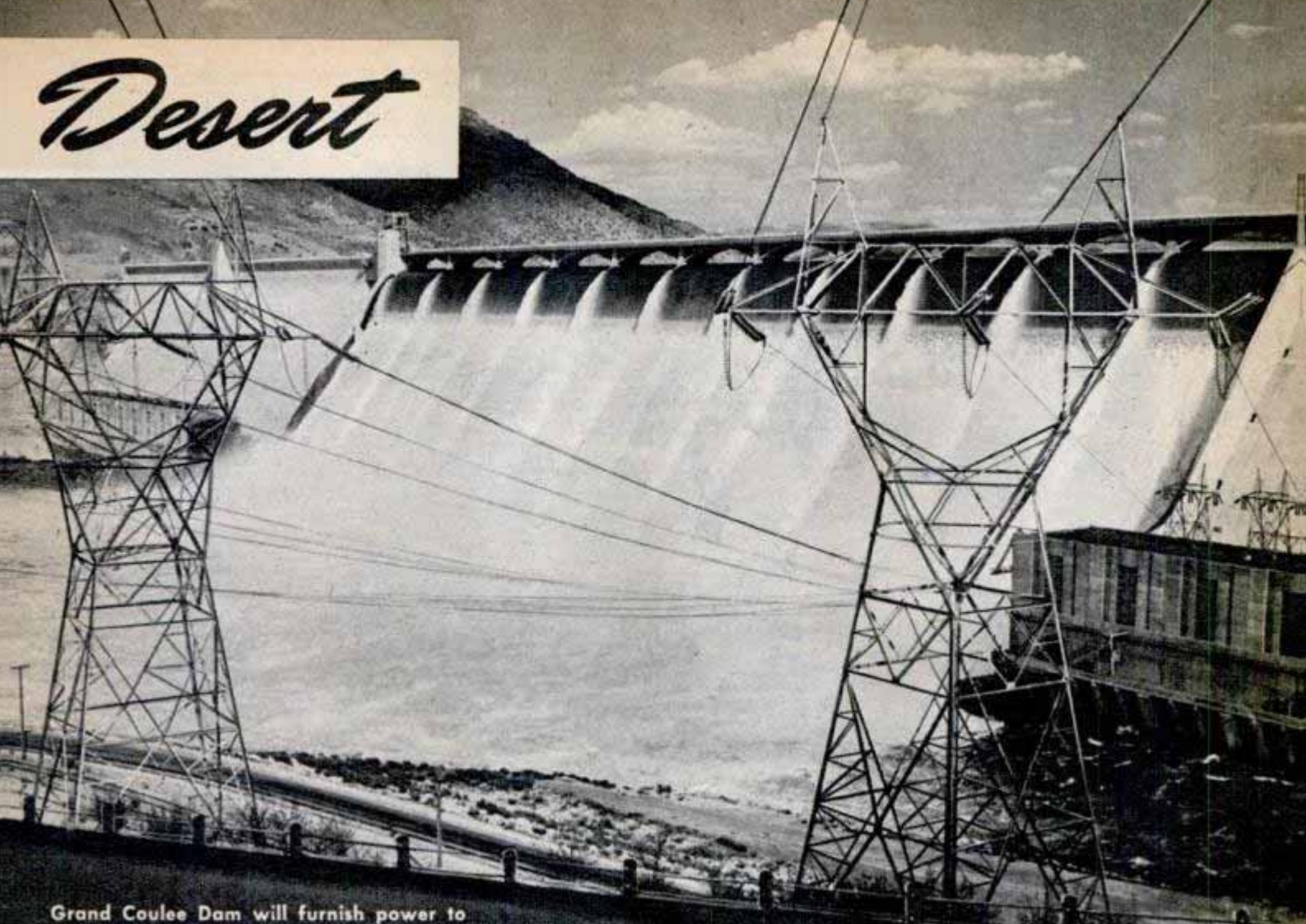

Grand Coulee Dam will furnish power to lift part of the river to a balancing reservoir

Plans call for the nation's largest postwar construction program to complete the reclamation job in 10 years.

The project area in south central Washington is 50 miles wide and 80 miles long. The soils are deep, fertile sandy loams and silt loams. Not all the land can be farmed because several mountain ranges interrupt the area. In summer it is hot with a period between frosts of from 135 to 190 days, depending on location. Winters are generally mild with minimum temperatures of 20 degrees above zero. Rainfall varies from less than six to a maximum of nine and a half inches a year. The land will receive an average of four acre feet of irrigation water each year.

In comparable irrigation districts apples, peaches, cherries, alfalfa, cereals and forage crops, potatoes, asparagus and sugar beets all flourish along with dairy and beef cattle, hogs and sheep. Farming that



combines livestock and crops seems to have greatest promise.

Before this desert can be irrigated the Columbia must be tricked into making some of its water flow uphill. This will be done by using a portion of the river's own



Farmer adjusts the head gate of canal sluice box to control amount of flow of life-giving water to dry fields

hydroelectric power to pump part of its flow up to a gigantic reservoir. From there the water will be diverted to the irrigation district many miles away.

Two factors make this engineering stunt practical. The first was a glacier which

once blocked the Columbia at about the spot now occupied by Grand Coulee Dam. This forced the water to carve out a high channel through one canyon wall, at right angles to its old streambed. Eventually the glacier melted and the river resumed

Grand Coulee, prehistoric river bed carved out and then abandoned by the Columbia, will become huge reservoir



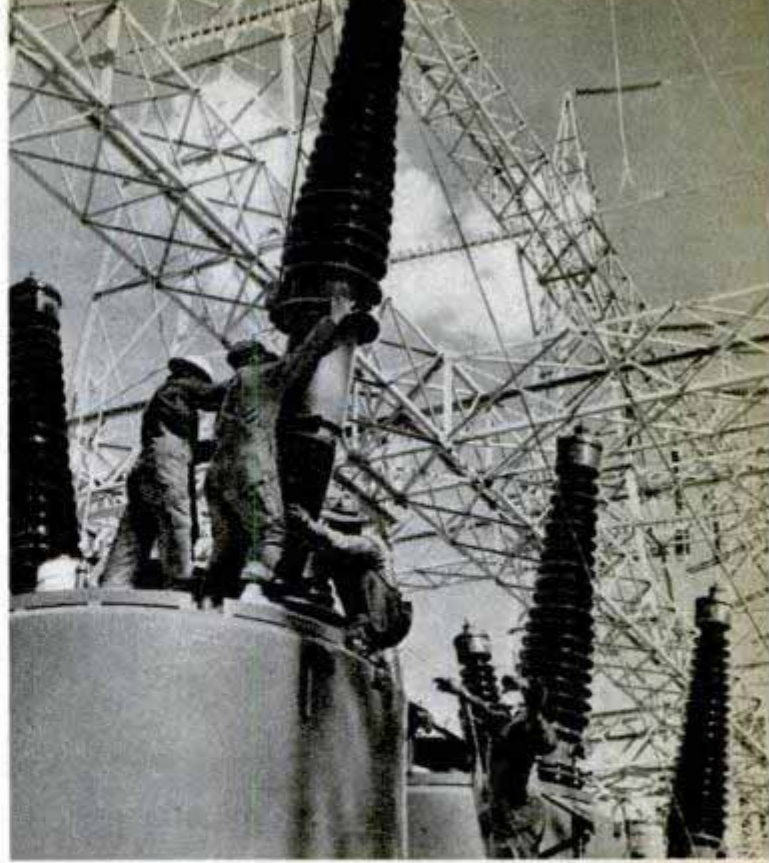

A half mile away, a cableway operator guides the controls which launch a 22-ton Bureau of Reclamation tug, left, in the waters below Grand Coulee Dam. Right, power switchboard through which power is fed to pumps

its original, and present, course. Its temporary channel was left as a huge, high and dry gulch through the tableland.

This old trench is Grand Coulee. It is to be closed at each end by earth dams 27 miles apart. It will be filled by pumping water up from the reservoir behind Grand Coulee Dam, 280 feet below. Then it will be used both as an equalizing reservoir and as a channel for conducting water part way to the irrigation district.

The second factor is that the high-water period on the Columbia occurs during the summer months. This happens because the river's water comes from Canadian ice and snow fields melted only by the summer sun. Thus adequate water for irrigation plus the power to pump it uphill can be extracted from the river's surplus flood water just at the time it is needed. This will reduce neither the power generated at the dam nor the amount of river flow at periods of low water.

Part of the pumping plant was built concurrently with Grand Coulee Dam because much of the construction is below the water level of the reservoir behind the dam. Water is to be pumped from the main reservoir up to the balancing reservoir through a dozen 12-foot-diameter steel pipes, sections of which are now in place. Six of the 108,000 kilowatt generators at the dam will supply power to operate twelve 65,000-horsepower synchronous motors. Each motor will drive one single-

stage pump in one of the intake pipes. Each pump will deliver in 24 hours a little more than a billion gallons of water, more than the requirements of the seven million inhabitants of Greater New York. The pumps, which will be the largest in the world, have not yet been built.

The irrigation system when completed will include 488 miles of canals and laterals, five miles of tunnels, 66 siphons to carry water across depressions, and a number of storage dams, the largest of which will be three miles long with an estimated volume of 12 million cubic yards of earth and rock fill. Seepages from the canal system and from the irrigated areas will be recovered and returned to use.

Ninety percent of the land in the area is privately owned. Appraised values on a dry land basis range from \$5 to \$30 an acre, depending on soil, slope and other features. These dry land values will be the basis of the price to be paid by settlers who purchase blocks of land from present owners or from the government, which expects to purchase privately owned land, divide it into family-sized farm units and resell it.

Purchase of these tracts will be an orderly procedure and there is no advantage in hurriedly buying land before the water is available. Stringent rules have been set up to prevent speculation. No homesteads are available.

An average charge of \$85 per acre, depending on its productivity, will be levied



Through 12 huge tunnels, shown under construction above and below, 50 tons of water per second will be lifted 280 feet over canyon walls from the lake to fill the irrigation reservoir

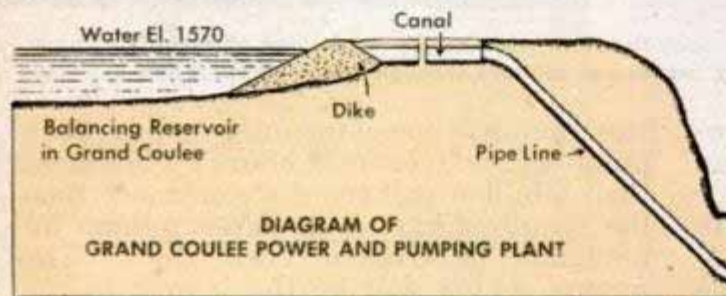

against the land by the government to repay part of the cost of the irrigation development. This sum will be divided into annual payments without interest over a 40-year period. These annual payments plus operation and maintenance charges for delivering water to the land will average less than \$5 per acre per year, according to present estimates.

Each family may purchase only one farm unit to which water will be delivered. The average farm unit probably will not exceed 80 acres although some lands may be available in 160-acre blocks. Generally, applicants to the government for the purchase of family tracts will be considered on the basis of general health, at least two years of actual farming experience, and the possession of \$2000 or more in cash, livestock, equipment or other assets suitable for carrying on farm operations.

Purchasers of land from private owners need not meet these qualifications although health, experience and

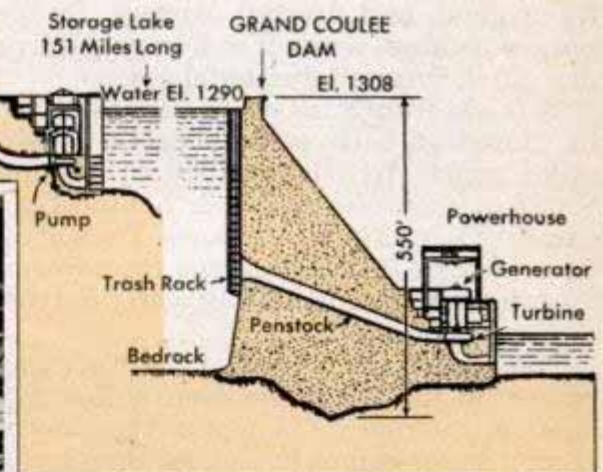

money for farm operations are considered necessary for success. The Bureau of Reclamation plans only to furnish irrigation water and oversee the orderly settlement of the region. There are no provisions for providing houses, domestic water or electricity. Cheap power will be available from Grand Coulee Dam and it is expected that settlers will dig wells to provide themselves with domestic water.

Anyone who is interested in the project and especially in the purchase of specific tracts of land should apply to the Bureau of Reclamation, Coulee Dam, Washington, for free information before incurring any obligation.

Related service industries which will come into being along with the

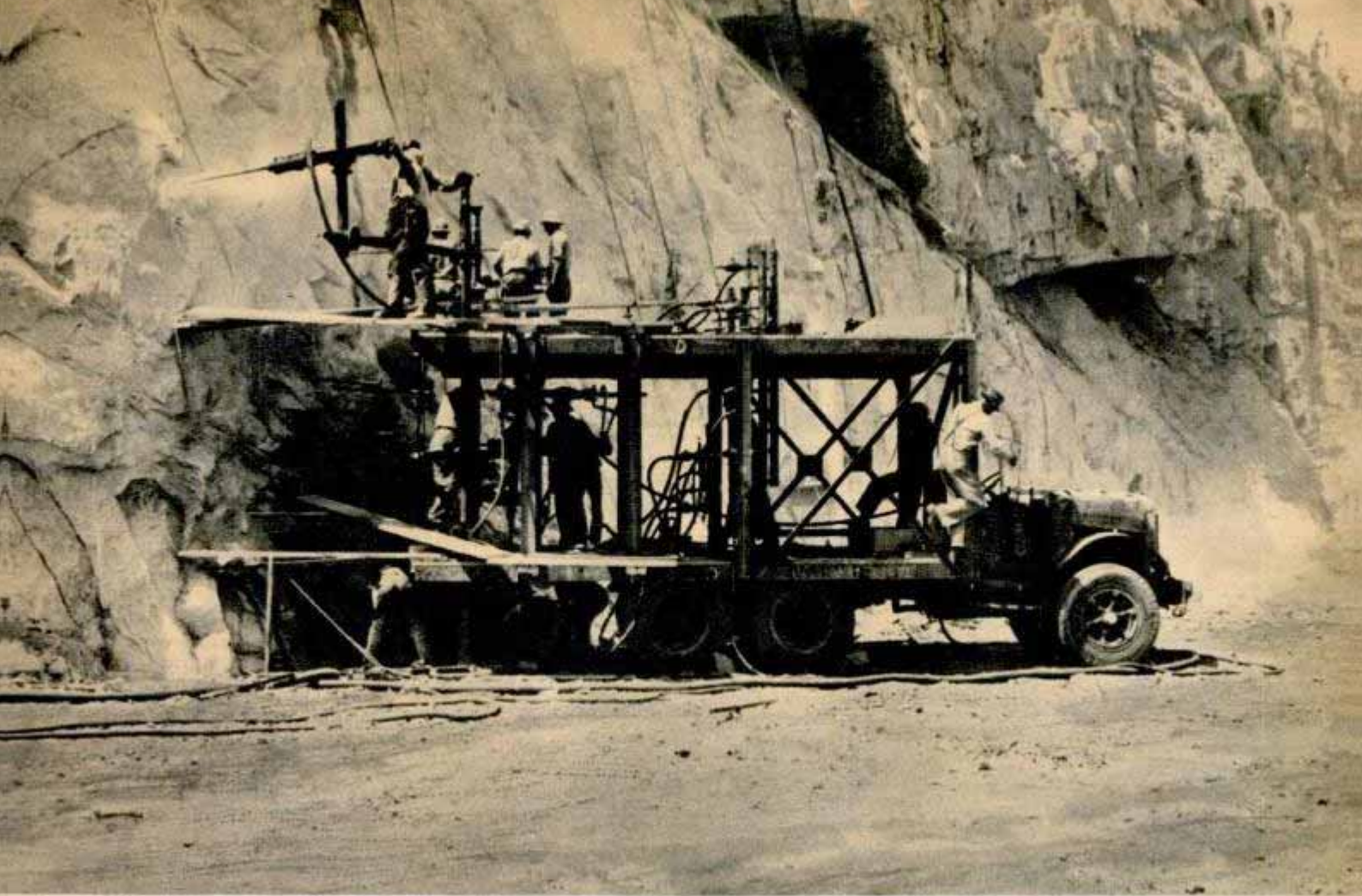

Cliff where power drills, above, opened pumping tunnels is now under water. Right, view inside the steel case surrounding one of the hydroelectric power units

farms are certain to attract many more thousands of persons. Power for these industries will be produced by the utilization of the economic assets of the Columbia River. In its 600-mile course from the Canadian border to tidewater it falls 1290 feet and the tremendous weight of its flow can generate millions of kilowatts of electricity.

In the long-range development program a series of 10 dams is planned for the Columbia. Only two, Bonneville and Grand Coulee, have been built. The dams will convert the river into a series of gigantic steps and will utilize for power and other purposes about 92 percent of the river's fall. Barge locks for river commerce and fish ladders for Columbia River salmon will be provided at each dam, right up to the massive bulk of Grand Coulee.

If related projects such as dams on the Snake River and other tributaries are included it is estimated that the waters of the Columbia basin can be made to develop more than eleven and one half million kilowatts of power. Such a construction program will require 20 years and will cost in excess of one billion dollars. With Columbia River power the Pacific Northwest may become one of the richest and most productive areas in the world.

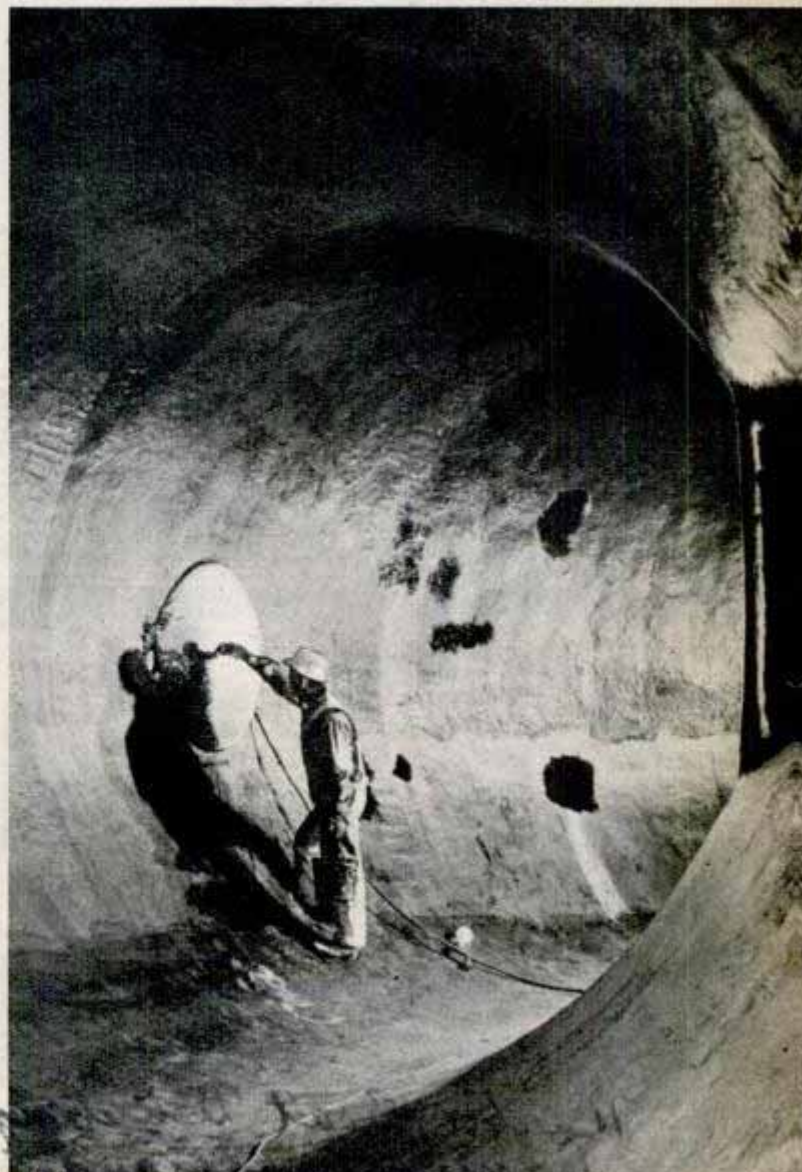

From
PT BOAT
To
**SPORT
CRUISER**



Ideas and mass production methods that were developed for the PT boats and aircraft rescue craft (above) are now being incorporated into a 40-foot pleasure cruiser. Sleek, war-matured lines give the boat a top speed of 40 miles per hour. The Harbor Boat Building Company of Los Angeles is building the craft on the same jigs and assembly lines that turned out the power-packed PTs. At lower left is shown the testing tank where scale models of the pleasure cruiser are checked for speed, resistance and flotation factors. Turnover assembly line below makes it possible to reach any part of the hull. The high chine (bilge) construction in the hull cushions the boat against buffeting in rough water

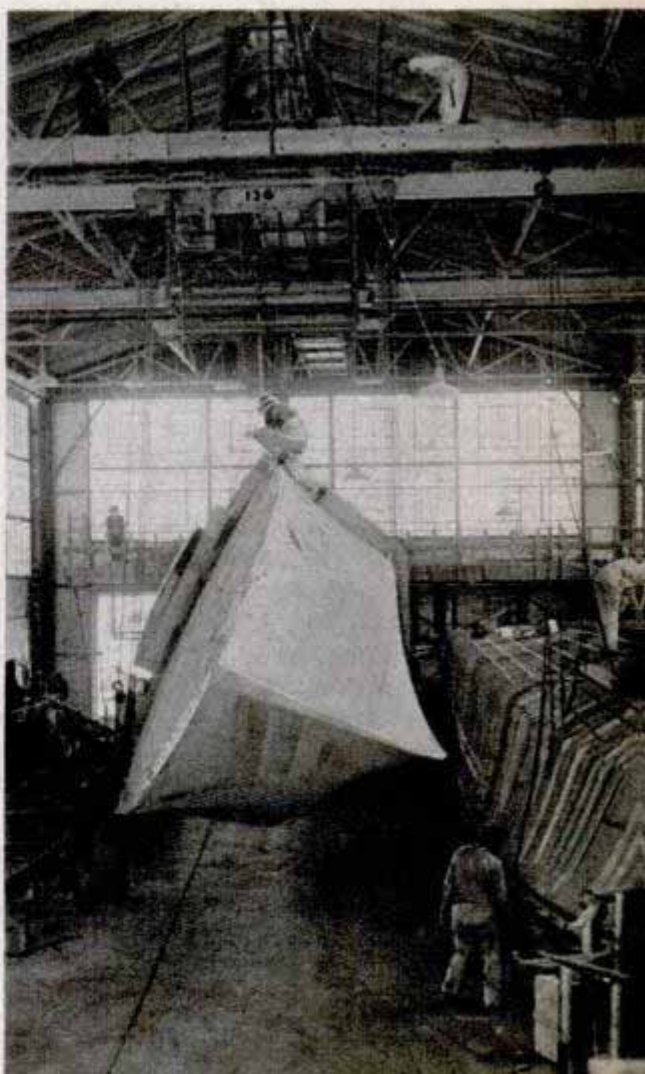
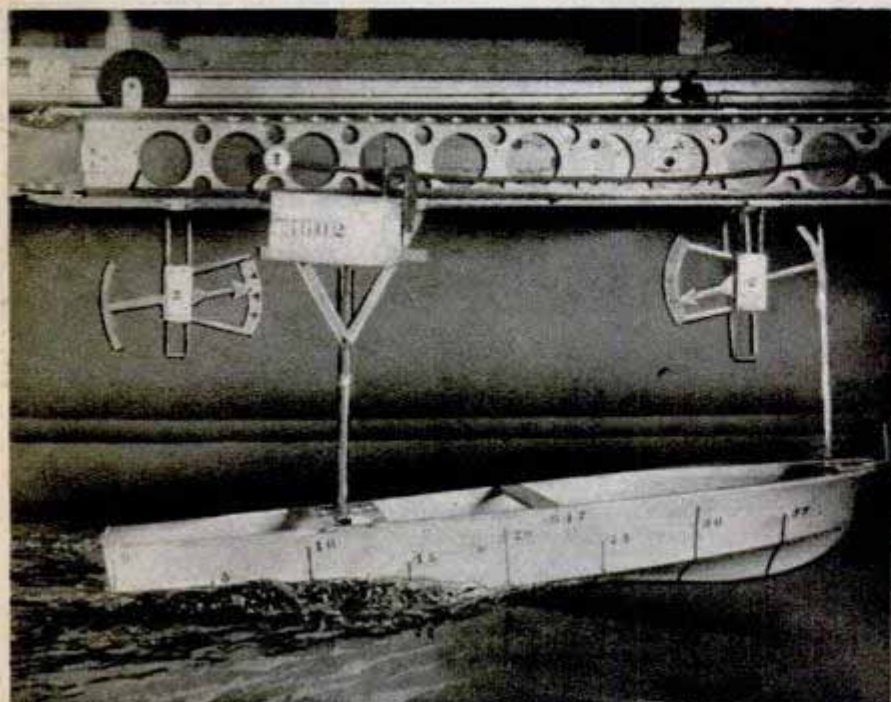

With Power Scoop Attached Tractor Becomes Earthmoving Machine

Power provided by a hydraulic pump operated by the tractor engine drives an earthmoving scoop which will dig, carry, dump and spread its loads. The scoop cuts from one to 12 inches into the ground. It holds about 10 cubic feet of earth and fills itself in three to four feet of travel, depending on the depth of the cut. After it is filled, the scoop is raised to permit forward or backward movement of the tractor. The unit is available for several makes of tractors.



Portable Packaging Machine Seals Odd-Shaped Articles in Pliofilm

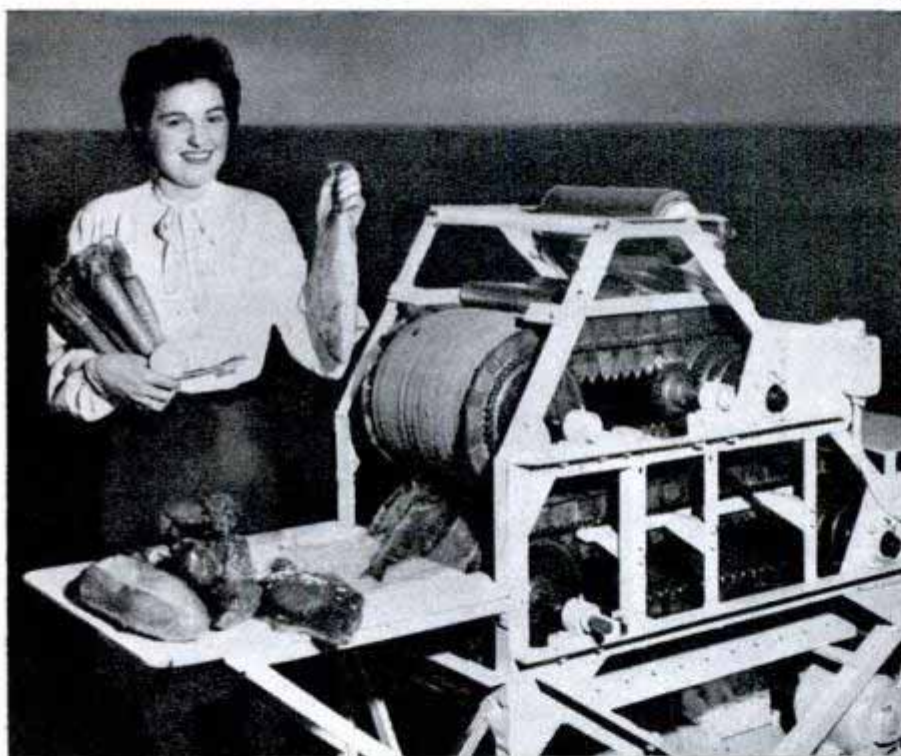

Steaks or chops, poultry or fish, vegetables or bread, hardware or precision instruments all are wrapped in individual airtight Pliofilm containers by a versatile packaging machine developed by the Goodyear Tire and Rubber Company. The machine passes Pliofilm over electrically heated rollers and between two high-speed Airfoam belts which cushion the Pliofilm tightly around surfaces of the object, at the same time forcing all air from within the formed enclosure. The machine is portable and can be taken into the field to wrap vegetables.

British "Jungle Airborne Buggy" Pulls Detachable Floating Trailer

"Jab" is short for Jungle Airborne Buggy, the proper name of a military car which is a British version of the American jeep. Like the jeep, the jab has four-wheel drive but it is smaller, lighter in construction and has less power. The jab can climb a sharp grade. It is powered by an eight-horsepower engine and has a floating trailer designed for ferrying over streams.



What kind of a House do you want?

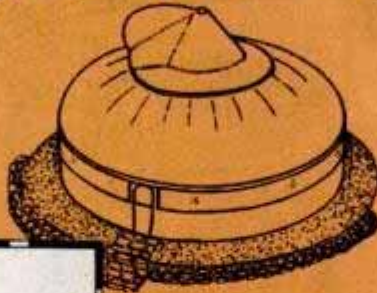
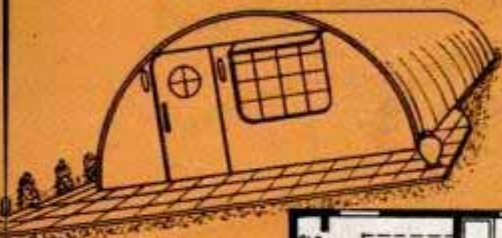

By Wayne Whittaker

THERE will be 2,700,000 new houses along the highways and byways of the U. S. A. within the next couple of years if everything goes according to the well-laid plans of national housing experts. Wilson W. Wyatt, national housing administrator, estimates the shortage of homes at three million and the National Housing Agency says 10 million houses now standing are in such bad shape they should be torn down.

What will the bulk of the new houses be like? Flat-roofed and modern? Colonial? One-story ranch type? Wood, brick, aluminum, stucco or concrete? Prefabricated? With or without basement? With or



English-type house hews to conventional design; floor plan is shown above

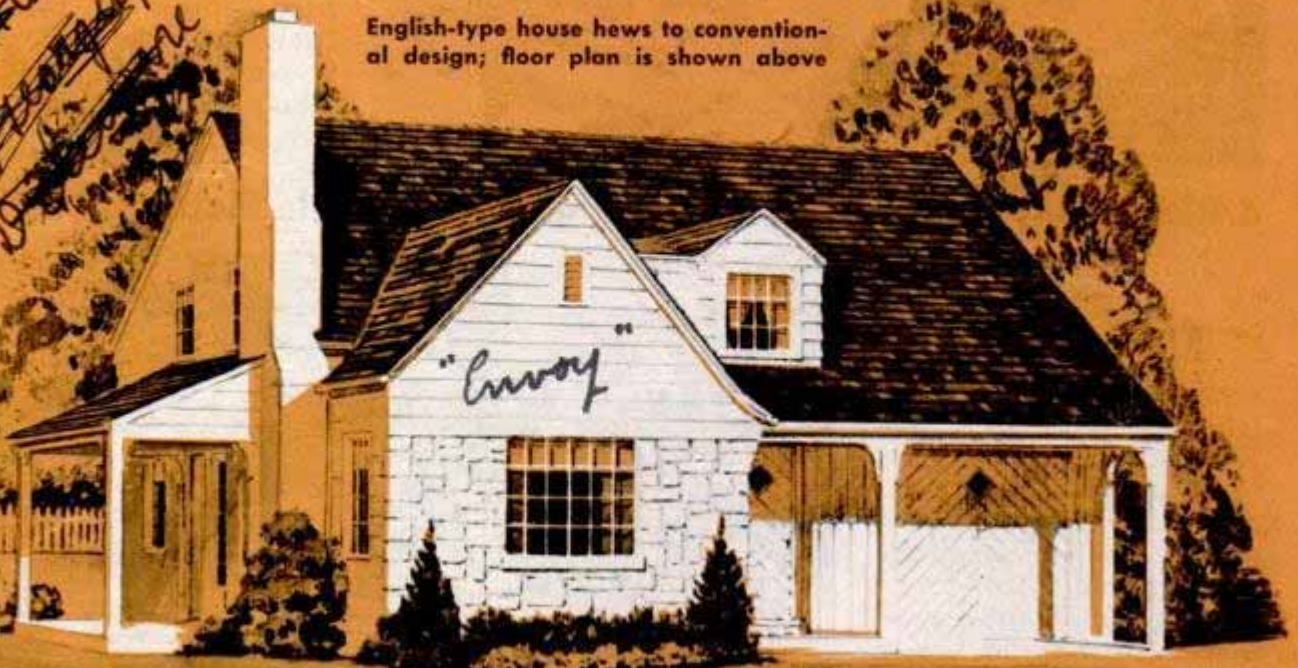

National Plan Service, Inc.
1315 W. Congress St.

Handwritten notes:
A plan for a
2-story house
with a garage
and a porch
on the side
of the house



Spreading ranch-type home features outdoor living or dining room shown in sketch and in floor plan below



without radiant heat and air conditioning?

Out of the general confusion that has accompanied the country's awakening to the worst housing shortage in history has emerged the following conclusion: The dream era in housing is over and there's no time to wait for the House of Tomorrow. Returning servicemen and other thousands of would-be home builders are asking, "What about the House of Today?"

Since the turn of the century there have been five predominant fads in the design of houses in this country. The "gingerbread" style of architecture of the '90s carried over into the early 1900s. From 1910 to 1913 Frank Lloyd Wright houses with many horizontal windows and skylights and projecting eaves came into vogue, and after World War I (1919-1924) the English and colonial types (Dutch, Cape Cod, New England) prevailed. The fad from 1926 until the stock market went kerplunk was the Spanish house of stucco and tile with much interior iron grille work.

If any fad can be said to exist today it favors the one-story spreading type of dwelling, popularly called the ranch-type house. One of the most popular houses of this design is shown on this page. Modified colonial houses are also popular. Among the away-with-tradition builders—a loud-spoken minority—architects are setting out to prove the merits of the "functional modern" or contemporary house.

In regard to interior planning, wise builders are more and more concerned with laying out the house in accordance with the particular needs of their families than in following conventional lines. A popular innovation in many house plans is a hobby-workshop all-purpose room on the first floor, particularly in the home with children of high school age and under. It

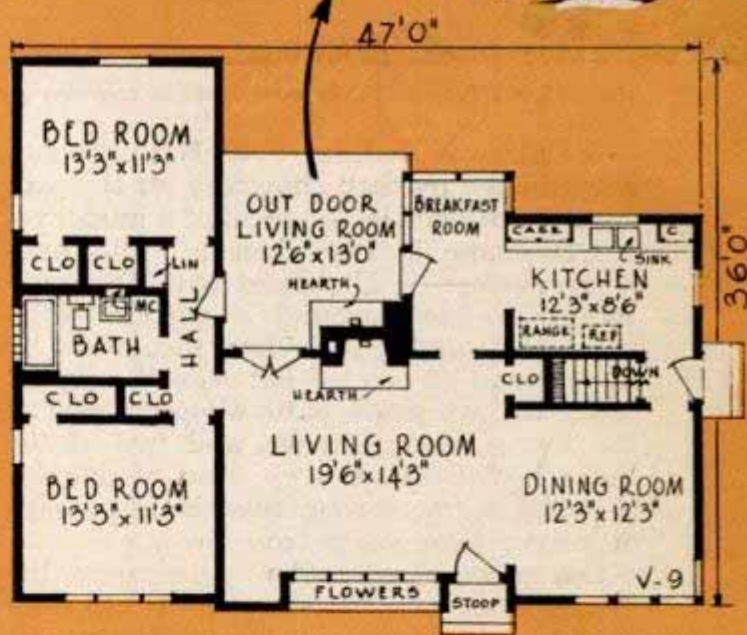

is a refinement of the basement rumpus room and provides facilities beyond the scope of a living room.

Regardless of the type of architecture they decide upon, prospective homeowners are alert to new materials, metals, plastics, wall coverings, dual glass for windows or entire walls, and to improvements for the kitchen, bathroom, lighting and heating.

Will you build a modern or contemporary type of house? This includes the solar house that puts the sun to work to help cut down heating bills, and the "true" modern with low horizontal lines in which every architectural feature has a special function.

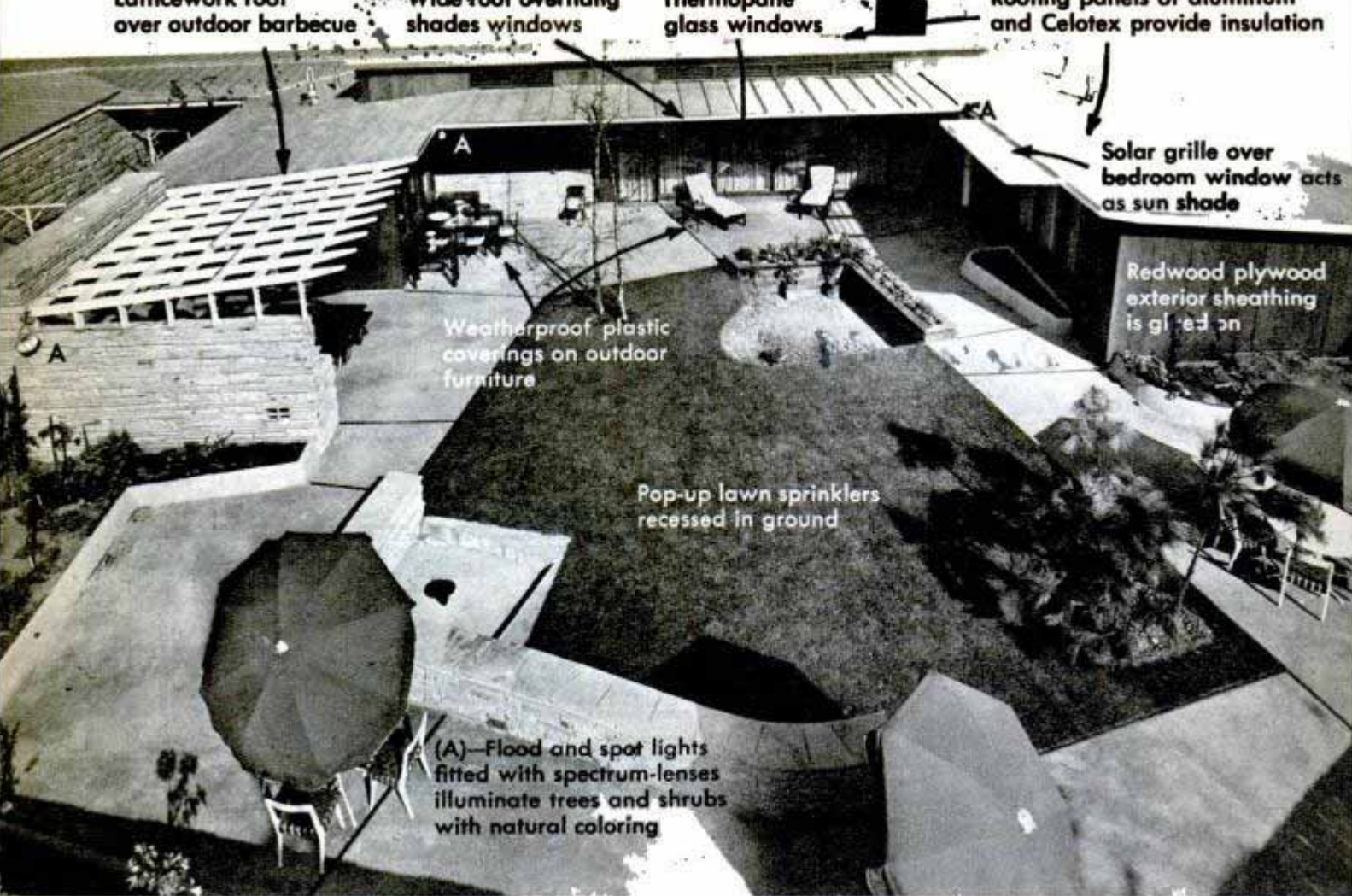

The \$75,000 Fritz B. Burns model house contains scores of innovations in design, materials and appliances

A California builder, Fritz B. Burns, has assembled a modern showcase for the prospective builder in the form of a model research home in Los Angeles. This one-story modern is U-shaped with the main rooms grouped around a garden patio. Dual glass walls, providing insulation by dehydrated air sealed between the panes, make the attractive patio almost a part of the living room, kitchen and two of the three bedrooms. A new kind of double-paned glass in one room retards the passage of radiant heat waves from the sun.

Designed along solar principles, the Burns house has broad eaves to keep out the high-riding summer sun and admit its rays during the winter season when the sun is low in the sky. A new type of metal roofing consists of panels one foot wide and eight feet long formed by molding sheets of aluminum around insulation board. The exterior walls are plywood panels four by eight feet joined together with splines and fastened to horizontal strips mortised into the studs which do not penetrate into the outside face of the plywood.

Ceilings of the house are covered either with acoustical plaster or perforated tile, and the doors are soundproof as well as warp-proof. The bedroom walls are covered with a rubberized plastic material resembling wallpaper with designs im-

pregnated into it. These walls are easily cleaned with a damp sponge. The "packaged" bathroom is made of enameled and highly polished wood and plastic, but later on it may be stamped out of metal. The pear-shaped tub provides a wide end for the shower which is partitioned with a revolving turret-type door of Plexiglas.

The house is completely air-conditioned and thermostats assure an even temperature. The bathroom has a full-length infrared gas heater. Dust is collected by a Westinghouse Precipitron. The house is filled with electrical appliances ranging from a vibrating electric toothbrush to a sun-tan lamp in the bathroom ceiling. A continuous electric outlet strip installed in the baseboards permits plugging in of appliances at any point. Every room has radio reception with dials offering a choice of standard radio, FM, phonograph recordings or music over telephone wires.

Innovations in lighting include a new type of flush installation which utilizes the principle of sealed-beam headlights on automobiles. The living room is illuminated with indirect fluorescent lighting, and there are neon tubes in the bookcases which can be regulated to low, medium or bright by turning a dial.

Linen closets and kitchen cabinets are lighted by continuous strips of either



Kitchen of Burns house has picture window and plastic walls; bedside cabinet controls all lights in house

fluorescent or neon tubes. Floodlights outside the house contain bulbs with spectrum colors in the glass which give a natural "technicolor" effect at night. These floodlights, as well as all the lights in the house and the adjoining "carport" with workshop and storage room to the rear, are controlled by a master switch in a cabinet in the master bedroom. This bedside cabinet also contains a radio receiver and an intercommunication instrument which permits talking to various parts of the house and patio.

The kitchen, a wonderland for housewives, has one wall devoted to an all-electric laundry complete with a machine that washes, rinses and damp-dries clothes, an ironer and mangle. Other kitchen features are rotating circular shelves for pots and pans, an electric sewing machine on a swinging door, a table-high console-type refrigerator, dishwasher, and garbage disposal unit which electrically disposes of waste including bones.

Frankly built to demonstrate the optimum in modern living equipment, the house and its appliances cost around \$75,000. As far as the modern house is concerned, the Burns house answers the with-or-without basement problem by the simple process of elimination. The heating unit, water heater, air conditioner and

Precipitron are housed in a small space on the first floor near the kitchen.

Most architects who specialize in the house of modern design say that the basement is a thing of the past. Confronted with the stubborn public reaction that "a house is not a home without a cellar," they often effect a compromise on a part-basement to house the heating unit and possibly a workshop or storeroom. In the past, it was generally conceded that a house built in a northerly climate had to have a basement to accommodate a gravity system heating plant. Now we have fans and pumps which make it possible to place the heating unit on room level. The old argument that houses without basements are damp is refuted by the best architects. Those who favor a basement for the small home say that the utility it affords cannot be duplicated for the same price above ground. The fact remains that an FHA survey in 1940 revealed that 30 percent of the houses under construction were being built without basements.

Are you among those who want a house traditional in architecture with modern improvements?

Recently, in a Chicago suburb, a house of this type built in 1939 was placed on the market for a price well over twice its original cost. It was snapped up by an eager

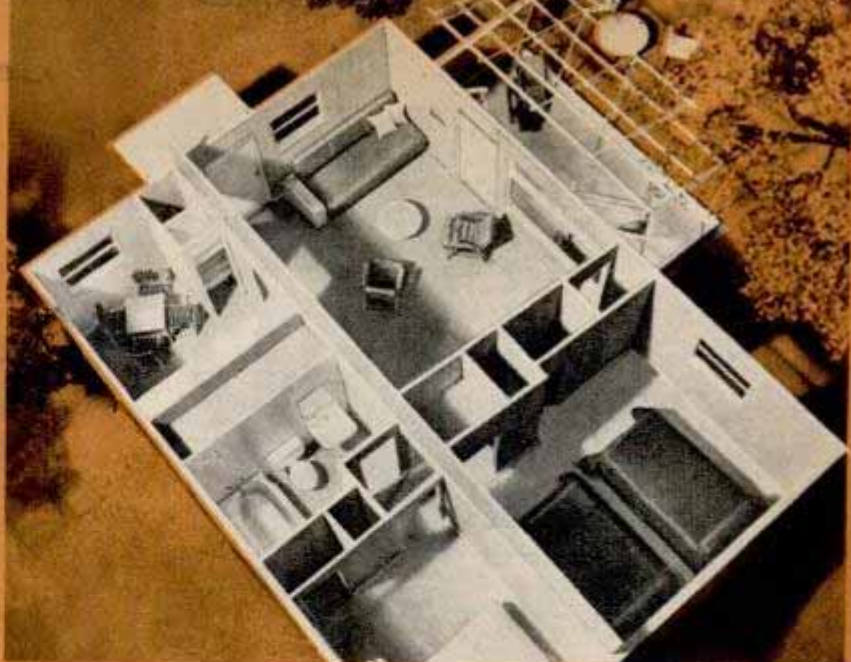
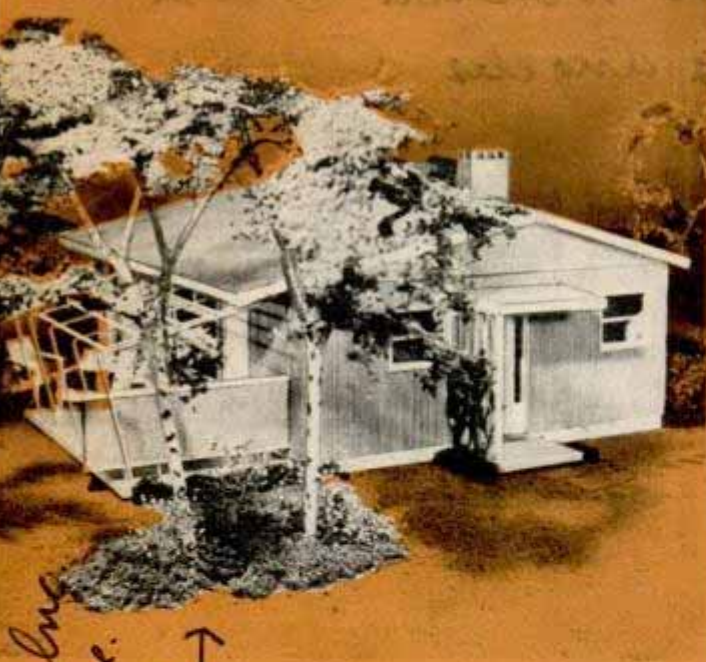

*Shelley Lyndyst. Ave
430 54th Ave.
N.Y. 20, N.Y. ↑*

This two-bedroom prefab has a factory price of only \$4685; roof-off view shows compact layout of house

buyer. The agent who handled the deal attributes its quick sale to two factors. One, of course, is the housing shortage with boom-era prices; the other is the fact that the house is an excellent example of what the public is looking for today. It embodies a pleasant blending of conventional design and modern improvements.

This particular house is colonial with white-painted brick walls, but effective use is made of two of modern architecture's prime contributions—the picture window

Model of "featherweight" plywood prefab made in four sections, each with built-in fixtures including beds

*Carmy Annot
1819 Broadway
N.Y. 11*



and glass blocks. The kitchen, contrary to conventional design, is at the front of the house and the living room at the rear with a picture window overlooking a beautifully landscaped back yard. As in the Burns house, this small home incorporates the landscaping as an integral part of the house itself. One landscaping feature is an elevated rock garden and pool directly in line with the big window. Across an expanse of lawn the rock garden gives the effect of being held up to the viewer in the window. This raised garden also hides a more prosaic vegetable garden.

Features of the house include a terrace with outdoor fireplace backed up to the one in the living room, a wall of glass blocks in the dining room, plenty of roomy closets, air-conditioning equipment and many other modern improvements. An important consideration is its compactness and ease of maintenance. The house was built to accommodate a family of three adults and two children with the housewife doing all her own work.

The contention that this type of house—a combination of the traditional and the contemporary with the accent on a conventional exterior—is the House of Today is advanced by J. M. Wright, president of National Plan Service, and Howard J. Uebelhack, one of the firm's leading architects. This organization, which keeps an ear to the ground through lumber dealers from coast to coast, reports that 75 percent of the postwar houses building for \$10,000 or less will be conservative in design.

Contrary to what the

(Continued to page 236)

Plastic Toys Made at Home With Small Injection-Molding Machine

Youngsters can mold their own plastic toys at home with an electrically heated injection-molding machine. Molds are provided for cowboys, Indians, animals, train cars, club pins, buttons, buildings and even golf tees. Operation of the machine is simple. Plastic pellets are fed into the electrically heated loading chamber at the top of the molding cylinder. A hand-operated plunger forces the molten plastic into the mold located at the bottom of the machine. The plastic hardens in the mold in a faithful reproduction of the design. The machine, constructed on the same principle as the giant machines used in industry, is 12 inches high and weighs about 17 pounds. A rubber pad on the base prevents it from scratching furniture.

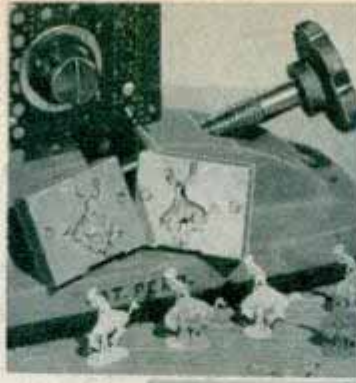

Midget Power Screwdriver Starts Work Automatically

About the size of a cigar, a midget pneumatic screwdriver is designed especially for driving small screws. The fully automatic tool starts work when it is applied to the screw. As the blade is pressed harder against the screw, the air power is increased and the blade is driven faster. A

rotary type motor, negligible in air consumption, provides power. The chrome-finished tool has bits to handle screws ranging in size from number 1 to number 6. A socket adapts the tool for tightening nuts.

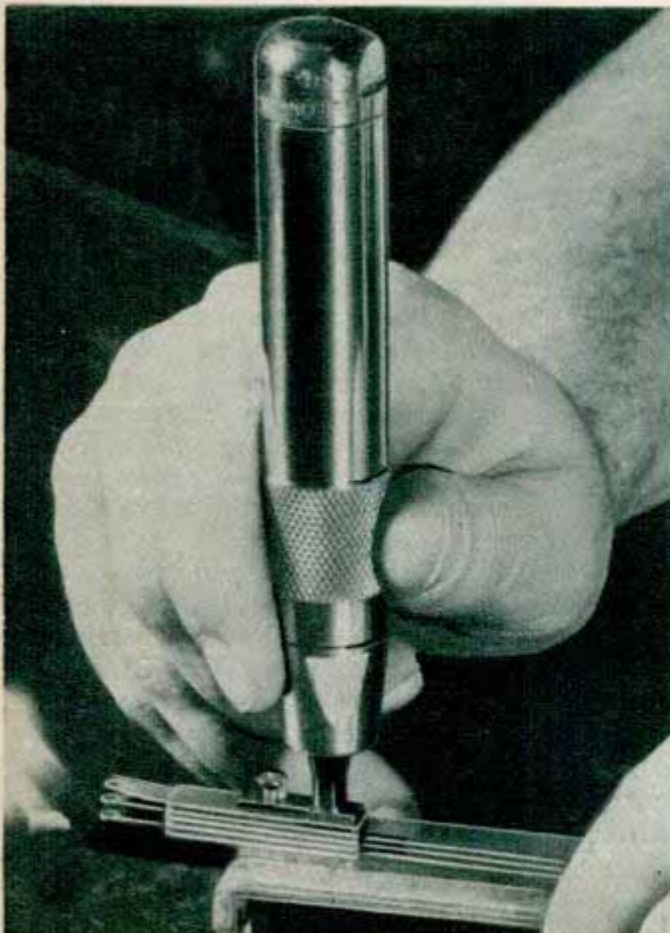

Ink Reservoir on Stencil Brush Holds Supply for 500 Prints

Enough ink to mark 500 shipping stencils is contained in a "fountain" brush with a T-shaped hollow aluminum handle that serves as the ink reservoir. The lightweight brush can be used in either a vertical or horizontal position, as the flow of ink is regulated by a valve. A button to operate the valve is located in a convenient position just below the handle.



Waterproof Plastic-Wool Hats

Wool combined with a plastic fiber produces waterproof felt hats that are said to retain their shape and size permanently. The new material looks like ordinary felt. In hat-making the plastic is "set" by heat treatment and fuses with the wool fibers.

The DeWitt Co 350 5th Ave N.Y.C. N.Y.

materials from:
Am. Viscose Co. N.Y.C. N.Y.
Eme. State Bldg.



Your National Parks Are Ready

All roads lead to vacation lands this year. Millions of people are rediscovering good times in outdoor America

RIGHT NOW the national parks are bulging. Millions of veterans and stay-at-homes who were starved for the open spaces through the war years are jamming the 27 national parks with jalopies and trailers in the first postwar mass pilgrimage to the outdoors.

The National Park Service saw what was coming in the closing months of the 1945 vacation season. When gasoline rationing ended suddenly after V-J day Yellowstone's bears and the Kaibab deer must have noticed the surge of motorists that brought attendance in the parks to 4,000,000 for the year, a million and a half above the total for 1944. The rangers and lodge keepers began early to "clean house" for an anticipated record guest register in 1946.

From rock-bound Acadia to tropical Hawaii, the parks have everything to offer except the artificial entertainment of the city. Here the only signs of civilization are the roads and the lodges and camp grounds maintained for

the convenience of the visitors. There are still lakes abundant with game fish, towering canyons of multicolored stone, deep gorges cut by swift streams. All the grandeur of nature is being conserved for future generations of Americans, and can be changed only by Nature herself.

You can fish in every park. There is exceptionally good trout fishing in Yellowstone, Yosemite and Glacier. You can camp in every park and most of them have facilities for swimming.

You can climb the skyscraping peaks of California and Colorado and the glacial mountains of Montana or descend into the earth at Carlsbad Caverns or Wind Cave or Mammoth Cave. These three parks have caverns with many miles of underground galleries and numerous chambers of stalagmites and stalactites, resulting from the action of water upon soluble minerals.

Or take a trip to Zion, Bryce Canyon or Grand Canyon. Grand Canyon is regarded as the greatest ex-

By John L. Kent

1946
1945
1944
1943
1942
1941
1940
1939
1938
1937
1936
1935
1934
1933
1932
1931
1930
1929
1928
1927
1926
1925
1924
1923
1922
1921
1920
1919
1918
1917
1916
1915
1914
1913
1912
1911
1910
1909
1908
1907
1906
1905
1904
1903
1902
1901
1900



Pack burros carry camp supplies for hikers leisurely exploring the high country of Yosemite. Below left, the natural bridge at Bryce Canyon. Right, proof of good fishing below the Wyoming Tetons, a nine-pound trout



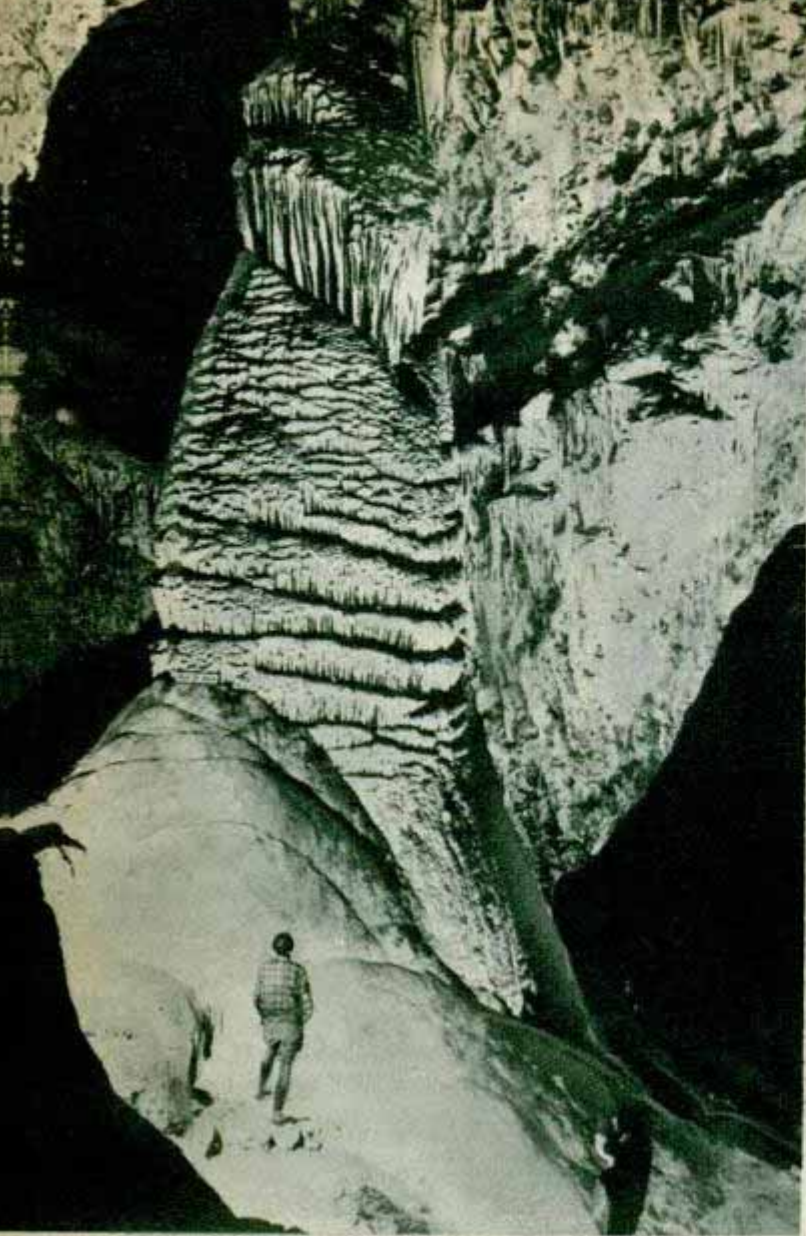

Underground fantasies like Rock of Ages at Carlsbad, above, stagger the imagination. Below, Santa Elena Canyon on the Rio Grande in the new Big Bend Park

Park Directory

All National Park areas are open to motorists whenever the roads are accessible. The following schedule shows approximate periods during which tourist facilities, including lodges, hotels and stores, are open. Park Service officials counsel visitors to make reservations well in advance or be prepared to camp.

Park	Season
Acadia, Maine	June 15 to Oct. 15
Big Bend, Texas	All year (no hotel accommodations in park area)
Bryce Canyon, Utah	May 30 to Sept. 25
Carlsbad Caverns, New Mexico	All year (overnight accommodations at Carlsbad, N. M., or other nearby cities)
Crater Lake, Oregon	June 15 to Sept. 19
Glacier, Montana	May 1 to Oct. 15
Grand Canyon, Arizona	South rim, all year; north rim, May 25 to Oct. 15
Grand Teton, Wyoming	May 15 to Oct. 15
Great Smoky Mountains, North Carolina and Tennessee	All year
Hawaii National Park, Hawaii, T. H.	All year
Hot Springs, Arkansas	All year
Isle Royale, Michigan	June 18 to Sept. 21
Kings Canyon, California	All year
Lassen Volcanic, California	Summer, May 1 to Sept. 30; winter, Dec. 15 to March 31
Mammoth Cave, Kentucky	All year
Mesa Verde, Colorado	May 15 to Oct. 15
Mount McKinley, Alaska	June 10 to Sept. 1
Mount Rainier, Washington	Paradise Valley and Longmire sections open all year; other sections during summer, June 27 to Sept. 2
Olympic, Washington	April 15 to Sept. 15
Platt, Oklahoma	All year (overnight accommodations at Sulphur, Okla.)
Rocky Mountain, Colorado	All summer; limited winter accommodations at Estes Park and Grand Lake
Sequoia, California	May 25 to Sept. 9
Shenandoah, Virginia	April 4 to Nov. 2
Wind Cave, South Dakota	June 1 to Sept. 20 (overnight accommodations at Hot Springs, S. D.)
Yellowstone, Wyoming	May 31 to Oct. 15
Yosemite, California	All year
Zion Park, Utah	All year

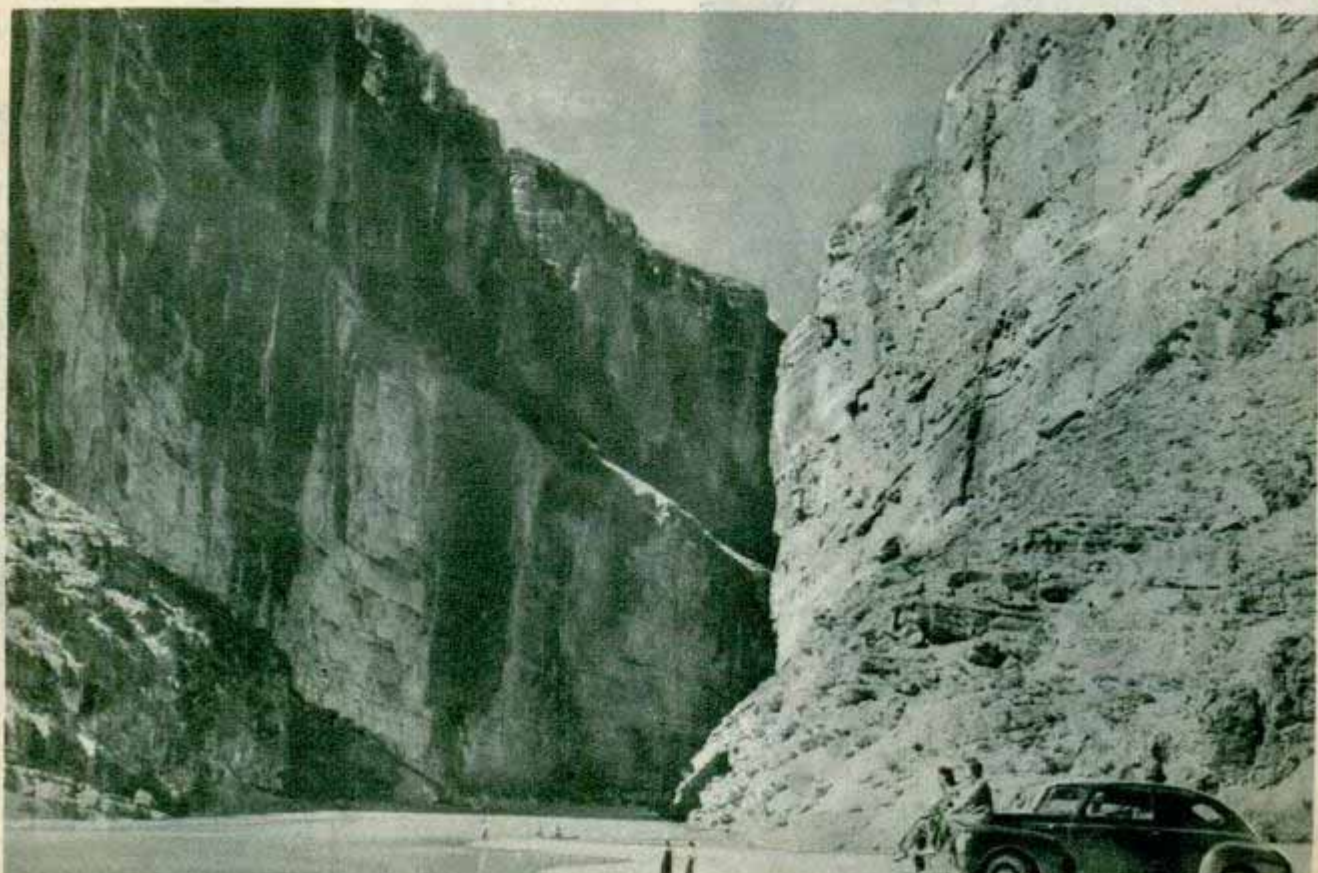



Twenty-one million people visited parks in 1941 and enjoyed recreation like this wiener roast at Yosemite

ample of erosion and the most sublime spectacle in the world. Zion Canyon is from 1500 to 2500 feet in depth with precipitous walls of great beauty.

In Bryce Canyon, in eastern Utah, one may see spectacular results of chemical weathering or decomposition. This differs from mechanical weathering caused by the alternate freezing and thawing of water or by plants growing in openings in the rocks which by a wedging action break down the stone. Bryce Canyon was carved by the ac-

tion of air and water on limestone, largely composed of the mineral calcite. When limestone weathers, a soluble compound, calcium carbonate, is produced. Water dissolves this compound and removes it in large quantities, creating the startling topography of the canyon.

To enable more of the public to see the wonders of Zion, Grand Canyon and Bryce Canyon, the Union Pacific Railroad, which operates facilities in these parks, is this year spending a half million dollars on im-

Riding party stops to watch Old Faithful, world-famous among 10,000 geysers and hot springs at Yellowstone





Giant tropical ferns flank entrance to Lava Tube at Hawaii National Park

provements on its properties and services.

Biggest and oldest national park is Yellowstone, located in northwestern Wyoming. The 3350-square-mile park is a land of geysers. The world-famous "Old Faithful" can be depended upon to stage its almost hourly show for your benefit, sending boiling water and steam 200 feet into the air. This old favorite has kept up its show despite wars, strikes and scanty audiences.

Officials of the four railroads serving Yellowstone have announced that the standard 2½-day sightseeing tour, suspended during the war, again is available during the 1946 season until September 10.

Not all the parks are in the West. There are Acadia National Park in Maine, the Great Smoky Mountains Park in Tennes-

Fertile valleys, heavily wooded Blue Ridge Mountains beautify Shenandoah



see and North Carolina, and Shenandoah in the Blue Ridge Mountains of Virginia.

Shenandoah, one of the most scenic, is located only 50 miles from Washington, D. C. It is within one day's ride of about 50 million people yet most of it is still wilderness. In places only two miles wide, Shenandoah stretches along the top of the Blue Ridge for a distance of about 75 miles. It is among our most recently created parks. It was opened on Christmas Day of 1935.

The newest and 27th national park, opened in 1944, is Big Bend, a 700,000-acre park located in southern Texas where the

Rio Grande, forming the boundary between the United States and Mexico, makes a big U-shaped bend in its course. It lies about 200 miles east of El Paso and 330 miles west of San Antonio. It consists primarily of semiarid plains characterized by gravel-colored slopes, arroyos and washes.

Big Bend is a new, undeveloped park for those who enjoy roughing it. Lodge accommodations are not as yet available and the Park Service warns, "Bring your own food, bedding and tents and be prepared to camp."

At Crater Lake in Oregon there is a possibility that the country may gain a new, active volcano. Crater Lake, six miles wide and nearly 2000 feet deep, is surrounded by the walls of the old crater of Mount

Mazama which rise above it 500 to 2000 feet. Thousands of years ago, before the period of volcanic activity which may have caused its peak to collapse, Mount Mazama is thought to have had an altitude of some 12,000 feet. Later activity after the lake was formed created the cone known as Wizard Island which rises 780 feet above the water near the western rim.

On four separate occasions during 1945 observers saw a bluish-gray smoke or gas cloud over Crater Lake. Park Ranger Kenneth A. Hulbert said

that the cloud was 300 to 400 feet wide, 400 to 500 feet high, and diamond-shaped—narrow at bottom and top, wide in the middle.

E. P. Leavitt, superintendent of the park, says that the only plausible explanation is that a blurb of smoke or gas was released from some of the vents which undoubtedly exist on the floor of the extinct or dormant crater and passed through the water to escape to the air above. The Park Service is keeping watch and may place a seismograph near the crater's rim to record any earth shocks which could be interpreted as signs of revival in Mount Mazama.

The Park Service is operating all parks on full schedule. During the war the number of employees of the service dropped from 5145 in 1941 to 1577 in 1945, but there was a compensating drop in visitors. Attendance rose in 1945 and surged sharply upward after V-J day.

Now, with many employees back from military service, the Park Service is engaged in a program of rehabilitation of roads, structures and facilities. The Park Service looks upon itself as the guardian of a great public trust whose funds of unsurpassed natural grandeur minister to the human mind and spirit.

If you want to see America, start with your national parks.

'Mathematician' for Heating Systems

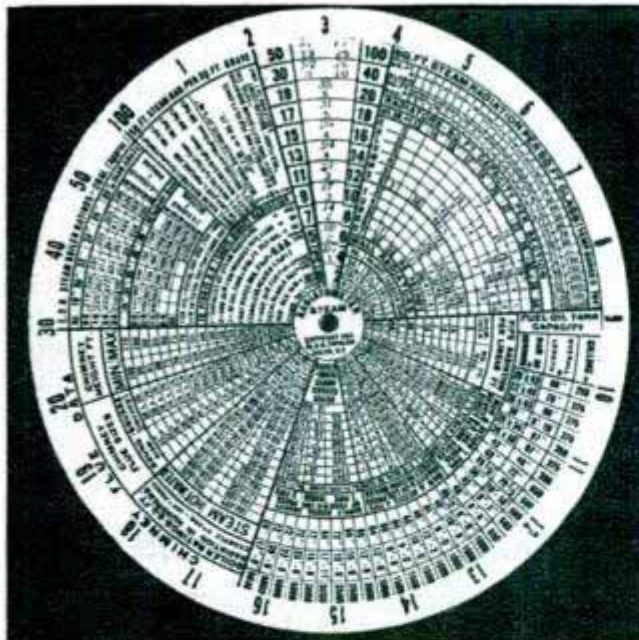

Consisting of a round dial and tables printed on three concentric celluloid disks, a calculating instrument quickly supplies radiation data necessary to set up steam or hot water heating systems. Eliminating involved figuring, the "mathematician" provides such information as required sizes for mains, returns, risers, radiators, chimney flues and fuel tanks.

Radio Tubes Operate Toy Organ With "Grown-Up" Tone



Operated by ordinary radio tubes, a toy organ sounds like a full-size electronically operated instrument. The range of the toy organ is an octave and a half starting with middle C. It can be plugged into any household electrical outlet.

Adjustable Fishing Pole Holder Permits Free Use of Hands

Fishermen can keep their hands free while awaiting a strike with a pole holder that clamps to the boat or dock. The device can be adjusted to hold the pole at any angle. When the fish makes a strike at the bait, the tip end of the pole should be raised first to set the hook in the fish's mouth. Two styles of fasteners are available, a clamp for boat or dock and a screw type for pushing into the ground or screwing into logs, stumps and railings. As many as three poles can be held in each device.

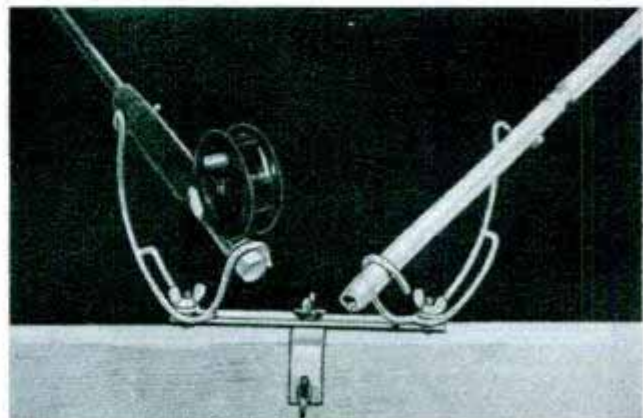



Tenants Share Subzero Locker

Each tenant of an apartment building can now store perishable foods in his own refrigerated compartment. A large deep-freeze locker divided into compartments has been devised for apartment buildings.

Outside Plug Seals Boiler Leaks

Leaks in tanks, boilers and water heaters can be sealed permanently by an all-metal repair plug that is inserted from the outside with a screwdriver and pair of pliers. A soft stem of lead alloy on the plug flows into irregularities on both inside and outside walls when it is tightened. The plug is said to be unaffected by tank contents, pressure serving only to seal it tighter.

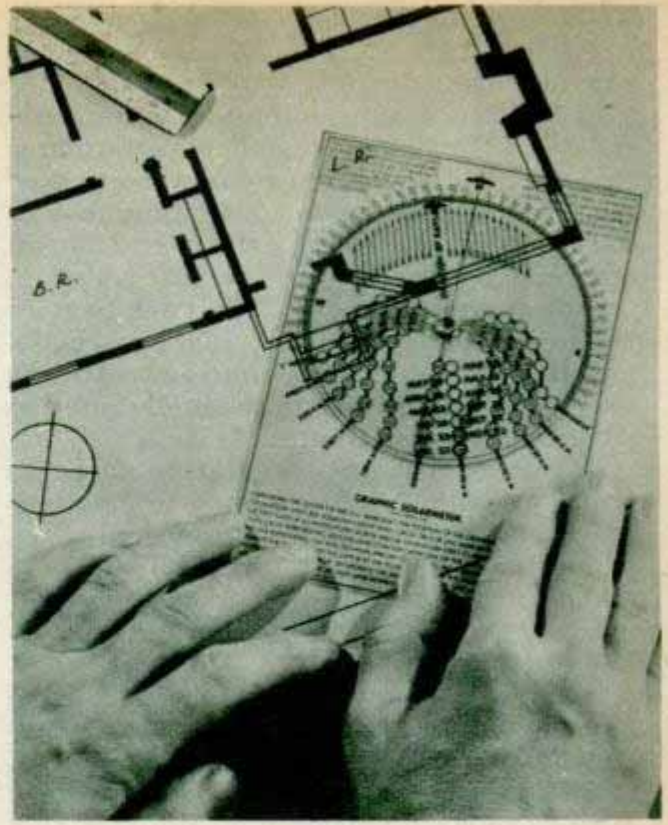

Sun Ray Dial for Architects Helps in Planning Windows

Architects, draftsmen and gardeners will find a new instrument of value in determining the direction and inclination of the sun's rays at any hour throughout the year. The "Solarmeter," as the instrument is called, is a transparent plastic dial marked with dates, mounted over a sheet of similar material that is divided into hours and degrees. When the device is oriented with the north indicator on a house or building plan, successive settings of the dial show the dates and the time of day when any wing, wall or window will receive direct sunlight. The angle at which the sun is shining also is shown so that the operator can compute how far into a room the sunlight will reach. Gardeners may find use for the device in planning their gardens. Separate instruments are available for each $2\frac{1}{2}$ -degree band of latitude.

Uranium Glass Wards Off Rays

Rescuers are protected from the deadly radioactive rays of exploded atomic bombs by glass manufactured from uranium, the basic element used in making the bombs. Garments made of uranium spun-glass and helmets lined with the glass permit safe entry into the bombed area, according to Prof. Alexander Silverman of the University of Pittsburgh. Oxygen respirators with uranium-glass-insulated high-frequency precipitators keep radioactive dust out of the lungs of the rescue squads.

REPEATING "Eye" OF THE NAVY



Sharp action shots are assured with the Navy-modified K-20 camera (above) and the K-25 shown below with cover removed

By Lieut. Comdr. Cecil C. Snyder, USNR

PHOTOGRAPHERS who have been longing for a fast-operating camera to record a rapid sequence of action pictures may find it in the K-20 and K-25 aircraft cameras adapted by the Navy for ground use. Both have been combat-tested and will produce a series of 4x5 negatives with excellent detail. Each exposure consumes only a fraction of a second.

Photographer's mates, early in the war, began using the Fairchild K-20 for other than aerial assignments. The fast operation of the camera made it highly adaptable for photographing flight deck activities aboard carriers. Its only drawback for ground work was that it could not be focused. Since it was manufactured for aerial use the lens was permanently mounted in the infinity position.

The standard f:4.5 lens for the K-20 has a $6\frac{3}{8}$ -inch focal length. With the lens wide open at infinity

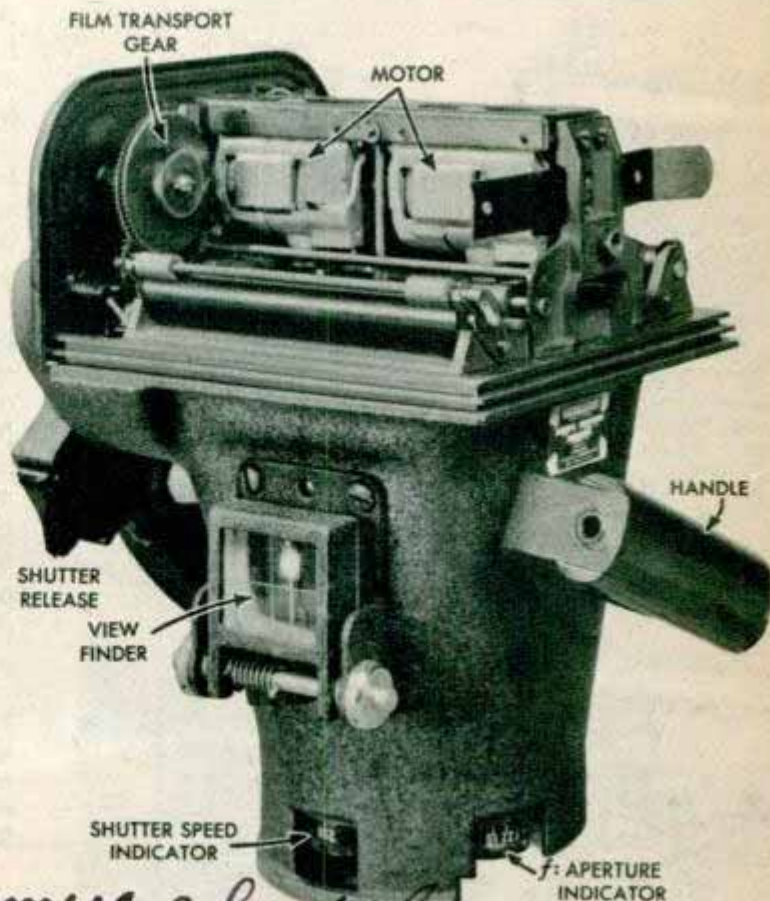

JULY 1946

*Fairchild Camera • Inst. G.
88-06 Van Wink Blvd.*

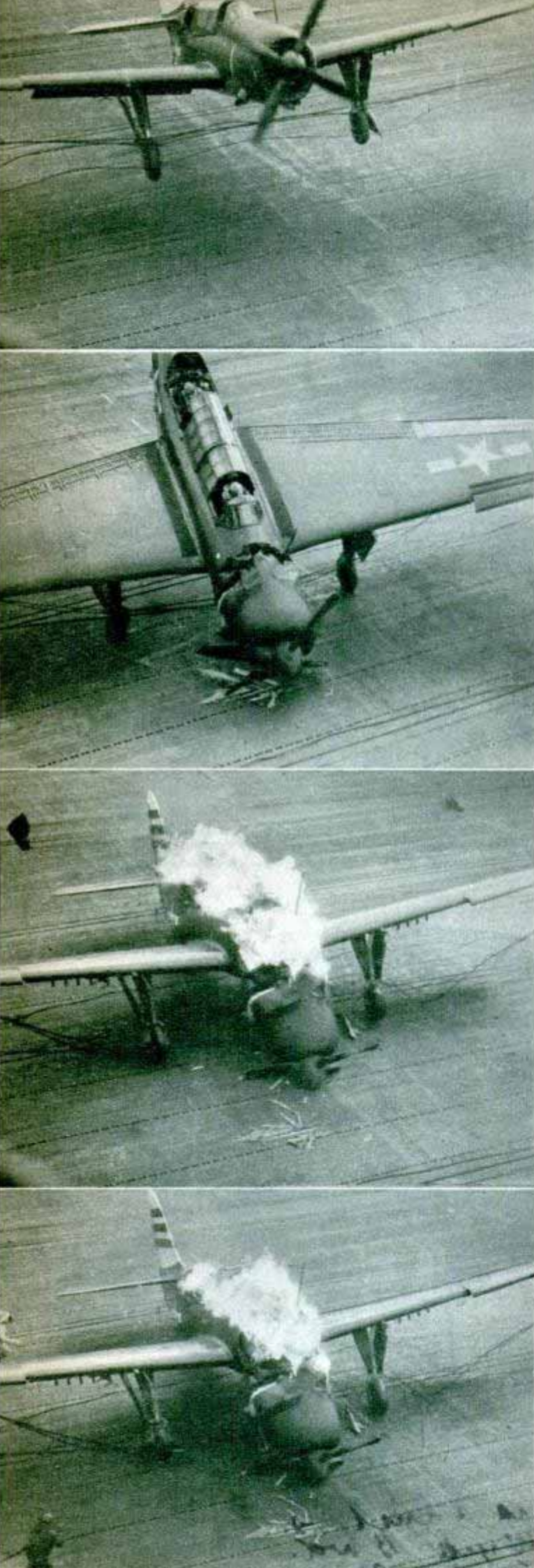

any object within 188 feet will not be sharp. Stopped down to $f:11$ the hyperfocal distance is 77 feet. Thus the fixed infinity focus of the lens gave the camera a limited application in ground photography.

Realizing that the K-20 would be far more valuable for general use if a focusing arrangement could be devised, Earl J. Hackethorn, PhoM. 1/c, stationed aboard an escort carrier on antisubmarine patrol in the Atlantic, went to work on an idea. With only the tools and material available aboard ship, Hackethorn designed and built a focusing attachment which was accepted by the Navy. Aeroflex Laboratories, Long Island, N. Y., was awarded the contract for production.

The K-20 is simple to operate, rugged and easy to handle. The lens and shutter assembly is set in a cone, to the back of which is attached a roll-film magazine. A hand grip is fastened to the left of the cone and a trigger release handle on the right. Through a series of gears and wind and trip rods, the film is advanced and the shutter set by merely pushing the trigger handle forward 50 degrees and bringing it back into position. The winding operation is carried out on both movements.

In other words, a simple wrist movement which does not necessitate moving the camera advances the film and sets the shutter. Within a split second the cameraman is ready for his next exposure. The elapsed time between shots depends upon the proficiency of the photographer.

The task of modifying the camera to allow focusing was not particularly difficult. A means had to be devised for moving the lens forward for close-up work. This was accomplished by mounting a threaded ring permanently on the nose flanges of the camera. A second ring, also threaded, was fastened to the lens and shutter assembly which, when screwed into the permanently mounted outer ring, racks the lens in and out of the cone.

One other engineering problem was encountered. The wind and trip rods for the shutter, operating from the gear mechanism in the magazine, had to be made adjustable to lengthen or shorten as the lens assembly is moved. The redesigned rods are made from two pieces of metal, one fitting inside the other. A spring, inserted in the open section, brings the rod to the proper length as the lens is focused. With this modification, the K-20 can be focused at any point from 15 feet to infinity.

Taken by an electrically operated K-25 camera, sequence of action pictures shows a Navy Helldiver crash-landing on carrier; the engine breaks off, plane catches fire, pilot and gunner are rescued and fire fighters go into action all within a few seconds

As the war progressed, a need developed for an electrically operated aircraft camera, to be remotely controlled by the pilot, for photographing attacks on enemy submarines and shipping. It was necessary that the camera have rapid rewind and fast shutter action as most of the attacks were high-speed runs at low level.

The aerial camera most suitable was the K-20 with shutter speeds of 1/125, 1/250 and 1/500 second. A small motor was installed within the magazine to operate directly on the gears of the camera. The first cameras produced, known as K-25s, provided 2.5 exposures every second, which was varied slightly in some of the later models. Both Fairchild and Graflex were given production contracts.

Here, again, photographer's mates saw the advantages of this camera for ground use, especially in rapid combat action. Experiments were carried out to install a trigger handle like that of the K-20, for hand-held use. The focusing attachment developed for the K-20 also fits the K-25.

Before the war most fast action sequences were made with 35-mm. single-frame or motion picture cameras where it is difficult to maintain detail in enlargements of sufficient size for good reproduction. Now, with the focusing models of the K-20 and K-25 cameras, sequence photographs of football, baseball, track and field competition and other sports are possible.

Film for these cameras comes in 19½-foot rolls giving 50 exposures without reloading. The camera can also be reloaded in subdued light.

Eastman Kodak Company supplies two panchromatic emulsions, Super XX and Tri-X, for use with the K-20 and K-25 cameras. Aero Kodatolor is also available and may be utilized for ground photography, offering the possibility of fast color shots.

It is unnecessary to expose the entire roll of film before developing the negatives. The magazine may be opened in the dark-room and the exposed length of film cut from the feed roll. The balance is reloaded in the camera. Development may be carried out by tray or roll-film tank method.

It is an easy matter to install a 110-volt motor in place of the 24-volt system used for aircraft operations so the camera may be plugged into any standard electrical outlet. It also is possible to synchronize the camera with a high-frequency flash unit, as was demonstrated by the Navy.

Although both the K-20 and K-25 are constructed entirely of metal they are not excessively heavy, each weighing approximately 11 pounds fully loaded. They measure 12 inches long, 8½ inches wide and 7 inches thick. Both are equipped with a Newtonian optical oblique viewfinder.



Electric Printing Machine Types Lettering Onto Large Drawings



Typists instead of highly paid engineers and draftsmen can letter large drawings, plans and charts with an electric lettering machine that is operated like a typewriter. The drawing is placed over a large flat platen that permits an unobstructed view of 396 square inches of surface, enabling the operator to type letters with pinpoint accuracy within the area. The keys can be adjusted to produce lettering of any desired density. A special "blueprint" ribbon is used. There are no feed rollers on the machine to smear or mar the drawing. The device does the lettering at typewriter speed with mechanical neatness and accuracy.

Flame Gun Burns Weeds Or Thaws Frozen Pipes

Weeds and brush can be destroyed easily with a peacetime "flame thrower" that shoots a flat flame of 2000 degrees Fahrenheit. The gun consists of a four-gallon steel tank with an air pump, an oil-resistant hose and a nozzle device that controls the flat flame. It burns kerosene, range oil or light furnace oil at an average rate of one gallon each hour. Proposed uses include destroying green weeds, backfiring safety strips to restrict forest fires, disinfecting poultry houses and thawing frozen pipes.



Floor Outlet for Automobile Exhaust Protects Garage Workers

Carbon monoxide gas that endangers the health of garage and filling station employees is piped out of buildings by a floor outlet for exhaust systems. The gas emerging from automobile exhaust pipes is drawn through an eight-foot flexible hose into the floor outlet and then blown out of the building. A double socket for installation between stalls permits two cars to be serviced by the same outlet. The hose is attached to the car's exhaust pipe with a snap-type opening in which attachments may be inserted for analysis of an automobile's exhaust gas.



*Kent-Moore Engineering
Gen Motors Tech Body
Detroit 2, Mich*

WINSTON DONALD
208 N. D. HENRY DR
BEVERLY HILLS
CALIF.

Rough Riders on Water Skis

FOR plain and fancy thrills on the water there's nothing that can compare with water skiing behind a speedboat.

At 40 miles an hour the sensation of speed is terrific. You swoop out to one side at the end of the tow line, boosting your speed 10 miles above that of the boat. Crossing back behind the boat to the other side, you jump the boat's wake instead of smashing through it, straightening up just as you hit the uplift of the wake. The impetus sends you 10 or 15 feet through the air, six feet above the water.

You do all this while standing on two varnished slabs of wood, six inches wide and half a dozen feet long. When you become proficient, you'll do a lot of skiing on one ski, leaving the other ski in the boat.

Water skiing is exciting but safe, an easy-to-learn

In these three pictures Bruce Parker of Miami demonstrates the difficult feat of changing tow lines from a speed launch to an airplane while he cuts through the water at 70 miles an hour

JULY 1946



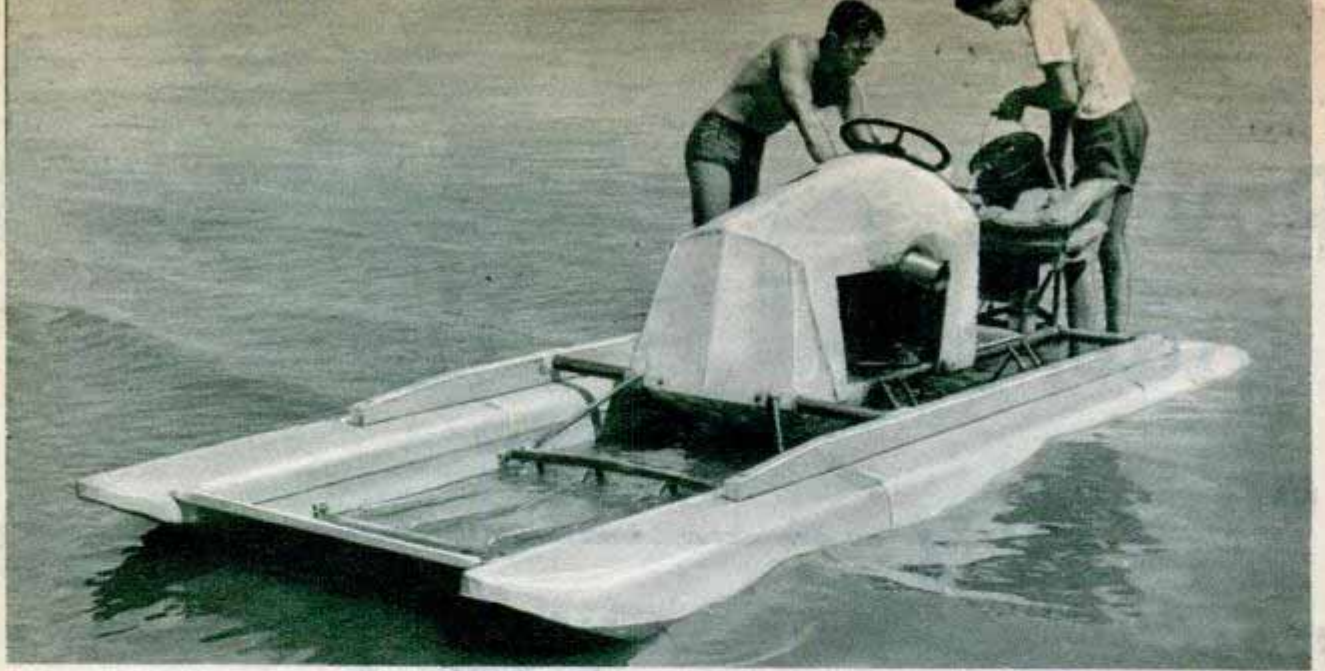

Ideal boat for towing water skiers on quiet lakes is this pontoon rig made of automobile gasoline tanks

sport. The average beginner gets the hang of it and can stand up for a ride of several minutes after only four or five starts. Later, when he learns to relax and his muscles acquire strength he can ski for much longer periods. Win MacDonald of Hollywood, one of the world's finest water skiers, once spent seven hours on one ski while being towed round trip from San Pedro to Catalina Island, nonstop.

One of MacDonald's stunts is to fish as he skis up the faces of deep-water ocean breakers. Carrying a harpoon, he looks for sharks or swordfish that may be basking on the surface. His approach is practically noiseless, out to one side of the speedboat, and he slides right up alongside the fish, aiming the harpoon. The harpoon is attached by means of a light line to a buoy that is carried in the speedboat. The buoy is tossed overboard when a fish is speared. The ski fisherman is picked up by the boat, the floating buoy is retrieved and the fish is hauled in.

MacDonald advises a beginner to start on an aquaplane, a broad board surface, until he gains balance and confidence. Then he may graduate to skis. The correct ski

posture is a crouch similar to the crouch used in snow skiing. Bent knees absorb the shocks caused by small waves.

You may start out from deep water or, wearing one ski, you may make a flying start from the beach. In a deep-water start you put on your skis, bring your legs up under you and signal the speedboat to move ahead. Holding the tow line, you are dragged up through the water until your skis are riding on the surface. From your squatting position you can then rise to a well-balanced crouch.

For an experienced skier a flying start on one ski is a faster way to get going. He stands on one leg in water that is half way to his knee, his other foot and the ski resting on the surface. At the instant the tow line becomes taut he makes a one-legged jump from the bottom. He's off in a swirl of spray, riding one ski.

The easiest way for the skier to stop is to signal the speedboat to slow down, then release the tow line after he starts to sink. He can also pull himself up the tow line to the boat and climb aboard. Experts ski right into the shallows and step ashore practically dry. The boat pulls a proficient

No ghost pilots the boat that is pulling this skier. He's rigged up remote controls operated by his tow line!



Right, adjustable bindings are made of wood and rubber. Below, keels fastened to bottom improve stability

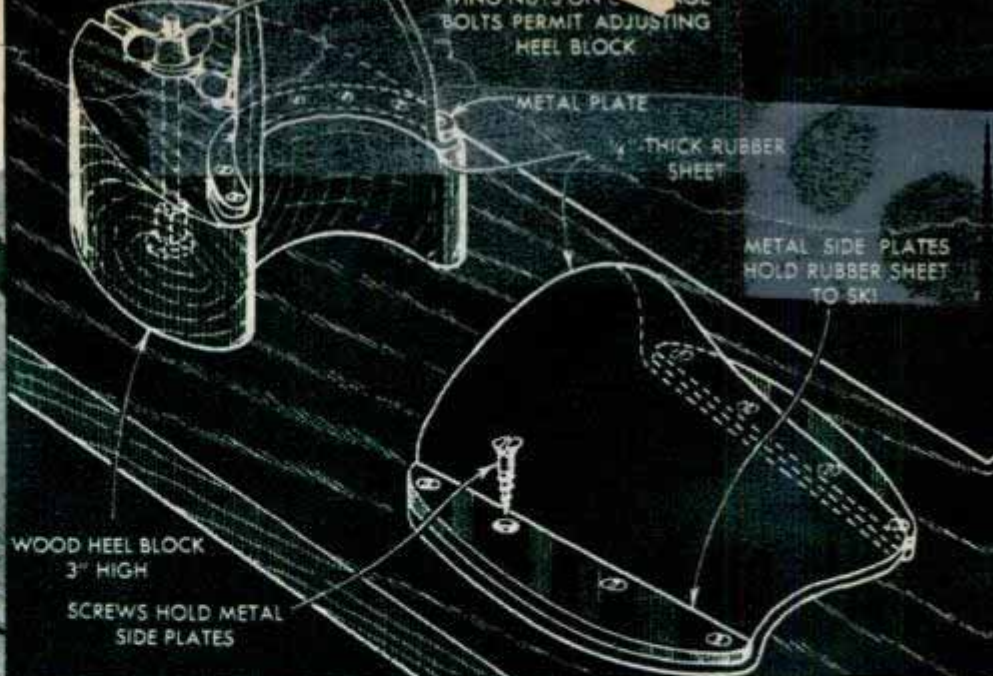

skier close to shore at full speed. When the skier lets go of the tow line, his momentum carries him in 100 feet or more. As he reaches shallow water he digs in with his heel, braking to a perfect stop.

Water skiing apparently started on the French Riviera about 15 years ago after water sport enthusiasts decided ordinary aquaplaning was too tame. The first skis were a foot wide and nine feet long.

About 10 years ago smaller skis were tried out at Lake Arrowhead, California, and other parts of the United States. Some experts whittled their skis down until they were doing stunts on "splinters" only three feet long and four inches wide. Skis like these are skittish and hard to control except at high speeds.

Oddly enough, it's almost impossible to get hurt in a spill. Your feet slip out of the

Right, experts demonstrate spectacular stunts at high speeds. Diagram shows how boat was rigged for remote control

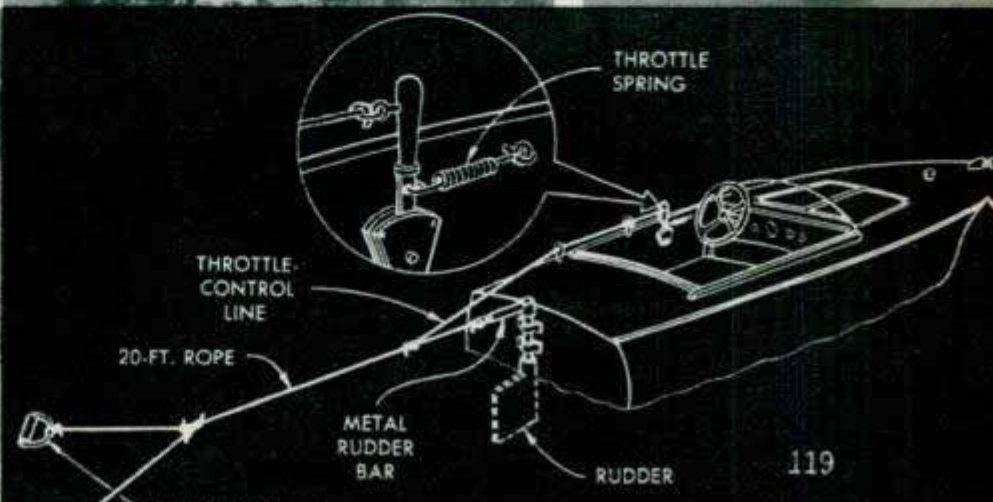

bindings and you slide across the water to a gradual stop. Southern California and Florida have thousands of ski enthusiasts and the sport has spread to many large lakes and rivers. Ocean skiing usually requires the most skill. The test of an accomplished skier is his ability to hang on in rough ocean water.

Skis six feet long and six inches wide are about right for people of average weight. These will support you at 20 miles an hour and are perfectly maneuverable at 40 miles an hour and up. The most pleasant skiing speeds are from 30 to 35 miles an hour but the more proficient you become the faster you usually want to go.

Because most skiers build their own skis there is considerable latitude in design. A pair of flat boards, six feet by six inches and $\frac{3}{4}$ inch thick, of vertical grain spruce, mahogany or ash is the usual raw material. One end of each board is tapered, rounded and bent upward to form the toe. The bending may be done by steam or by immersing the end of the board in boiling water for 20 minutes, then placing it in a form that provides an upward bend of four inches on a one-foot radius. Width of the after end of the ski may be reduced by tapering each side $\frac{1}{4}$ inch. This will allow the toe to ride higher in the water.

The binding in which you place your foot may consist simply of an old shoe with the laces removed. It is attached to the ski with half a dozen screws around the edges of the sole plus a longer screw through the heel. The binding is located about midway on the ski. It should balance at the point where the ball of your foot will rest.

Instead of using old shoes, most skiers prefer bindings that can be adjusted to fit different sizes of feet. A sheet of $\frac{1}{4}$ -inch-thick live rubber is cupped upward so it fits snugly over the front part of the foot. It is fastened by metal plates that are screwed tightly to the ski. The wooden heel block, rounded and padded with live rubber, is adjustable. It contains a slot through which two carriage bolts project that are anchored to the bottom of the ski. Wing nuts clamp the heel block in place.

Some skiers attach an "island" board two feet long to the center of each ski and fasten their bindings to the board. Others taper the bottoms to give a slight V effect but this seems to have no effect on performance in the water. A two-inch wooden keel, screwed to the after end of the ski, contributes to stability and control, especially if the ski is of short length.

Bruce Parker of Miami recently traveled 70 miles an hour on water skis by hooking a ride behind a seaplane. He started out behind a speedboat. When the boat was traveling at peak speed he grabbed a tow line that was dropped from the seaplane as it roared past. He hung on while the plane built up its speed. At 70 miles an hour his skis were practically out of water.

Win MacDonald, similarly, set a water ski record of 81 miles an hour several years ago while being towed behind a seaplane. At high speed the spray beat against his legs like gravel and the terrific rush of air almost blinded him. But that experience wasn't as bad as an earlier one. He was being towed by a blimp for a motion pic-

(Continued to page 224)

Left, 6-year-old learns to ski by practicing on aquaplane. Right, Florida beauties zip through boat's wake

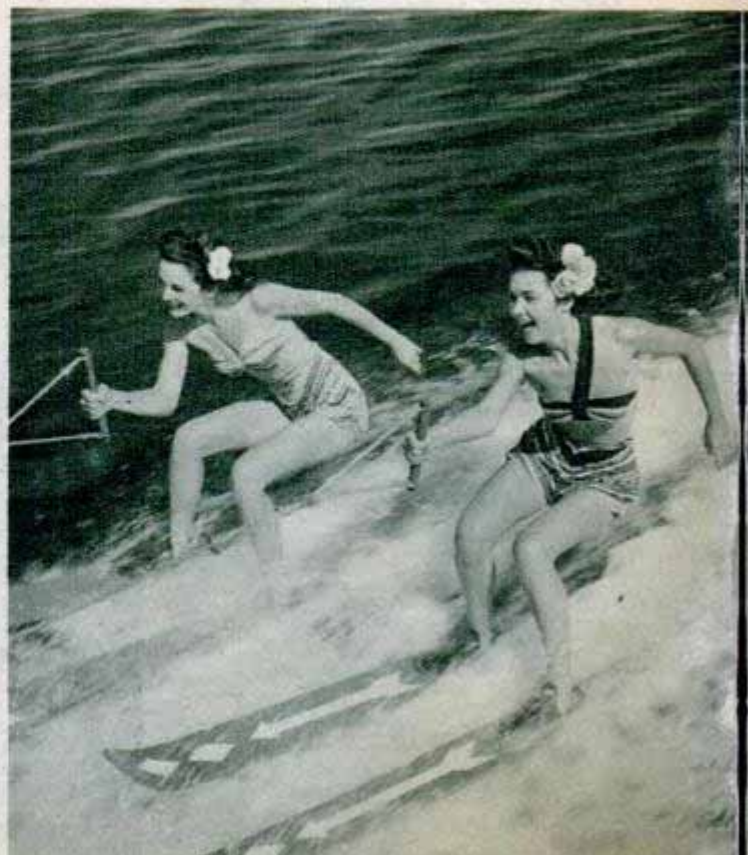

Armor Plated "Battle Sleds" Towed to Position by Tanks

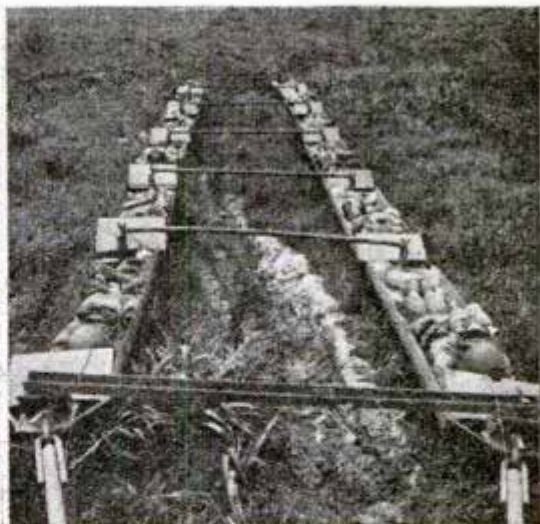

U. S. Signal Corps photos

Another battle-born gadget recently revealed by the War Department is the "battle sled," used to protect infantrymen while they were transported to advance positions to knock out enemy guns. The nine-foot sleds were made of $\frac{1}{8}$ -inch armor plate and mounted on $\frac{1}{4}$ -inch steel runners. Twelve of them, attached in pairs, were pulled

snakelike behind a tank, which protected them against mines. The group of sleds was flexible enough to turn with the tank. One infantryman with his equipment was carried on each sled. The sleds were designed by Brigadier General John W. O'Daniel of the 3rd Division, and were used by that unit in Italy in 1944.

Combine for Harvesting Potatoes Digs, Sacks and Loads

In one continuous operation, a potato combine devised by an Oregon farmer digs, sacks and loads. Manned by a nine-man crew, including the driver of the truck which carries the sacked potatoes from field to market, the combine will harvest and process 1226 sacks of potatoes per day—enough to feed 1000 persons for one year. The combine, powered by a Caterpillar Diesel tractor, is in operation on Robert H. Miller's 600-acre farm near Gresham, Ore. It digs the potatoes from the ground and lifts them to a sorting rack where they are brushed, graded and processed by crewmen. They are then placed on a conveyor which lifts them to sackers who move the loaded sacks to trucks traveling along in the field at the side of the combine.

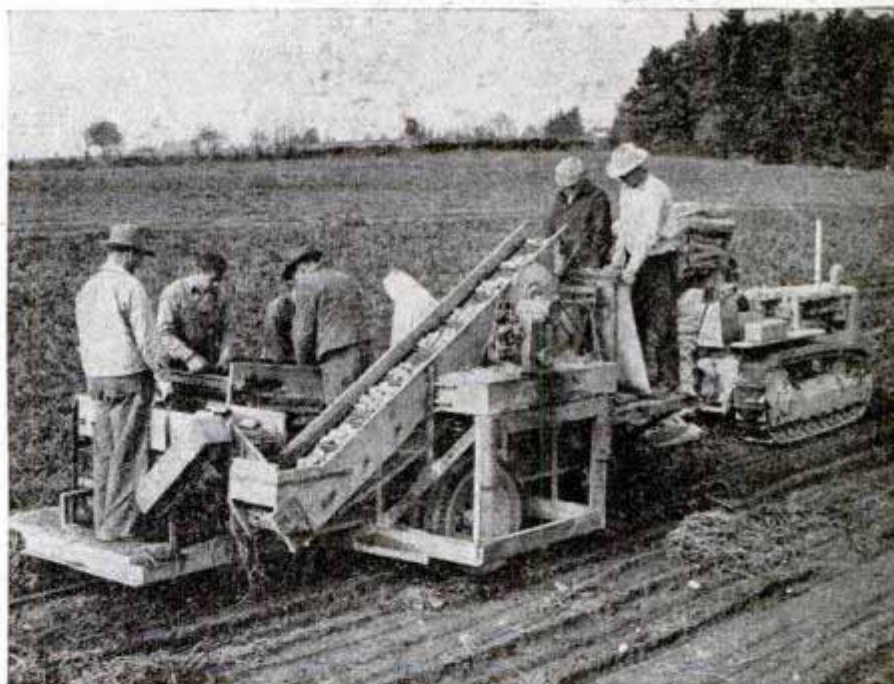

Solution Renews Sandpaper By Removing Wood Dust

Used sandpaper that is filled with wood dust, paint or varnish can be restored to life with a solution that is brushed onto the paper. The solution is allowed to impreg-

nate the abrasive for about five minutes. Then the paper is rubbed with a fine steel brush to remove all particles that clogged the cutting surface. The solution can be used also on cloth sanding belts, buffing wheels and disks and files. It is said to be nontoxic, nonirritating to the skin and will not corrode metal machine parts.

Three 5400-horsepower Diesel-electric freight locomotives have hauled Baltimore & Ohio trains over 850,000 miles in two years without a breakdown or a missed trip.

Designed by: Miller Bros.
 Route 2
 Gresham, Oregon

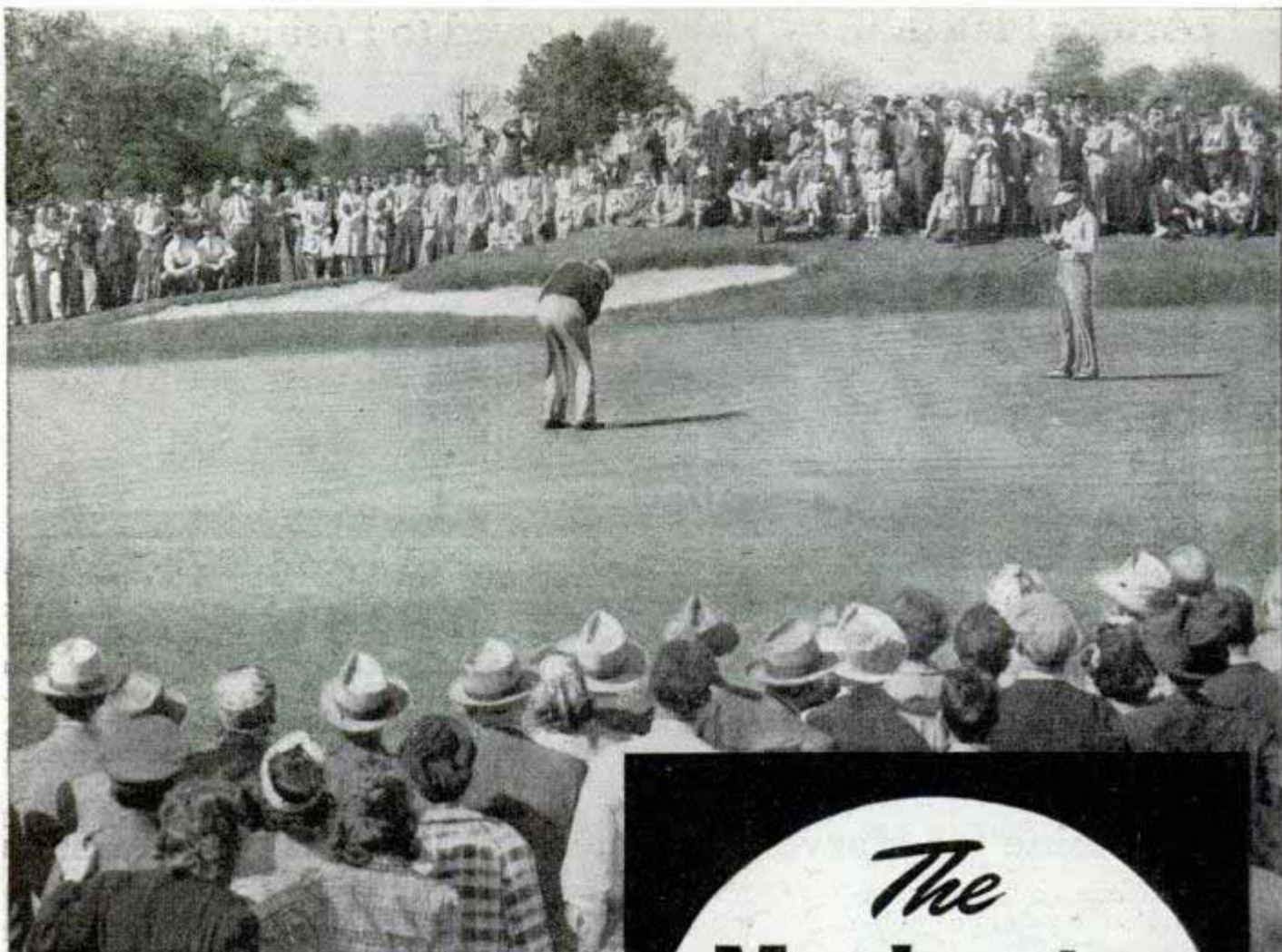

Nelson putting in the Masters', which he's twice won

YOUR primary concern in playing a short iron (Nos. 7, 8, 9) shot is accuracy. Thus, complete control of the club and a fine "touch" are of supreme importance.

I shorten the grip on my club when playing a shot with a short iron, placing the little finger of my left hand about 1½ inches below the top of the shaft. In this way I get better "feel" of the clubhead, and this is an aid to accuracy.

Too many people have a tendency to let foolish pride get the better of their good judgment in playing shots with short irons. When I hear someone say, "I always use a No. 9 iron for a 125-yard shot to the green," I know that person has the wrong idea. Ability to hit a ball beyond the normal hitting range of any one club is not a criterion of a good golfer. It's just plain nonsense.

Successful tournament players have none of this false pride. They use a club with which they can take a normal, smooth stroke and get the ball to the objective. In the case of the short irons, this objective is usually the cup on the green. For the average golfer I recommend a No. 7 or 8 iron for a shot of approximately 120 yards. It is a shot of this length I am playing in photos 1 through 8 on page 123.

The Mechanics of GOLF

Part 3

By Byron Nelson

For your third lesson, study the short irons, chipping and putting —then play two holes with Nelson

What difference does it make if you can boast that you hit a No. 9 iron, for instance, a few yards farther than someone else? The point with the short irons is to get the ball right up close to the hole, or in it.

A common impression is that you need not follow through with the short irons. As you see in photo 8, this is not the case.

No. 8 IRON

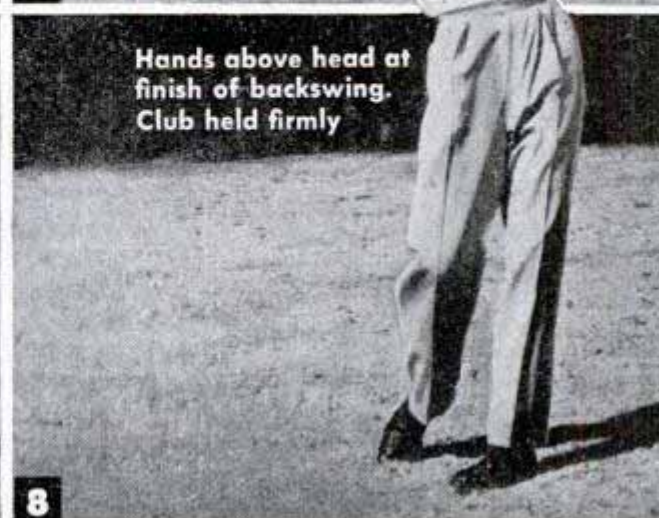
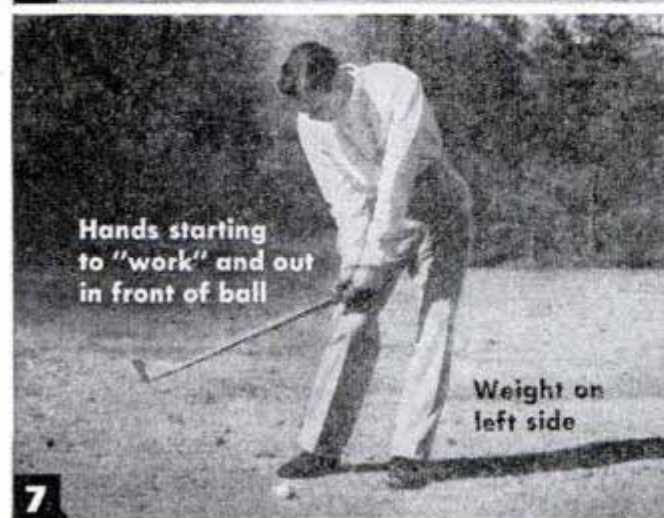
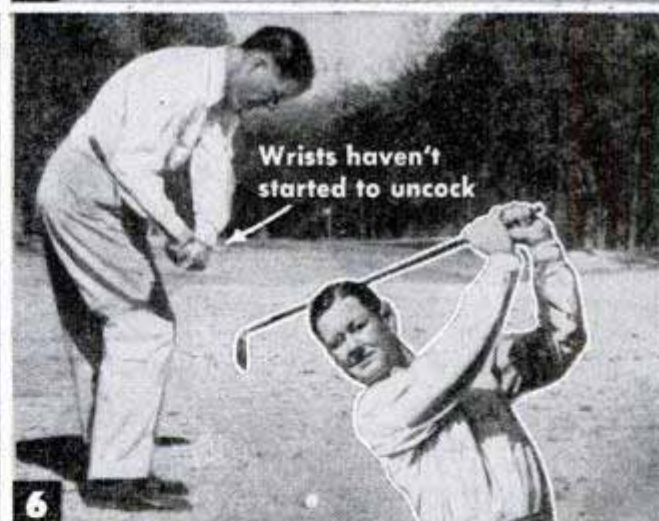
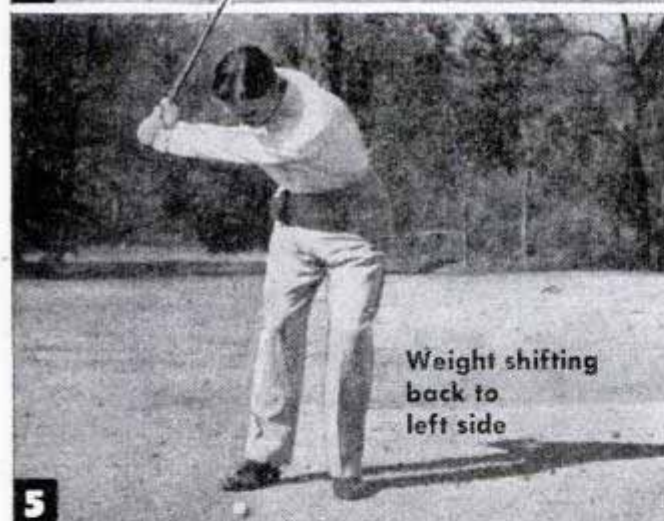
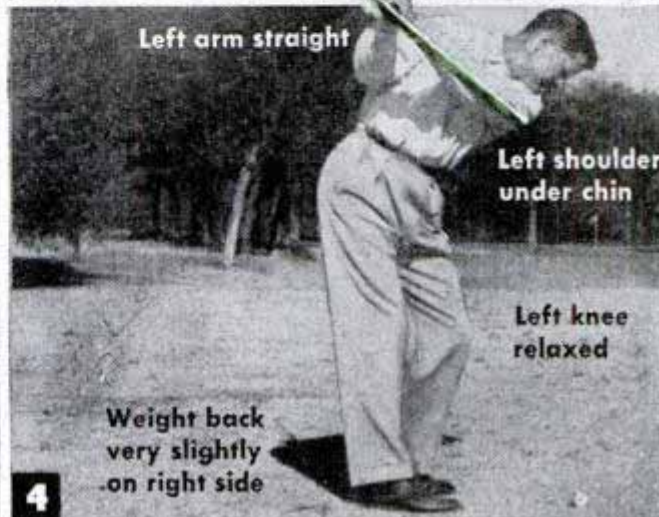
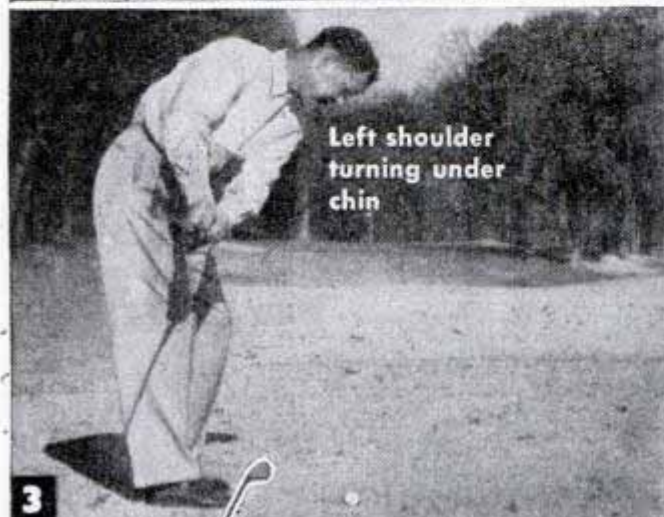
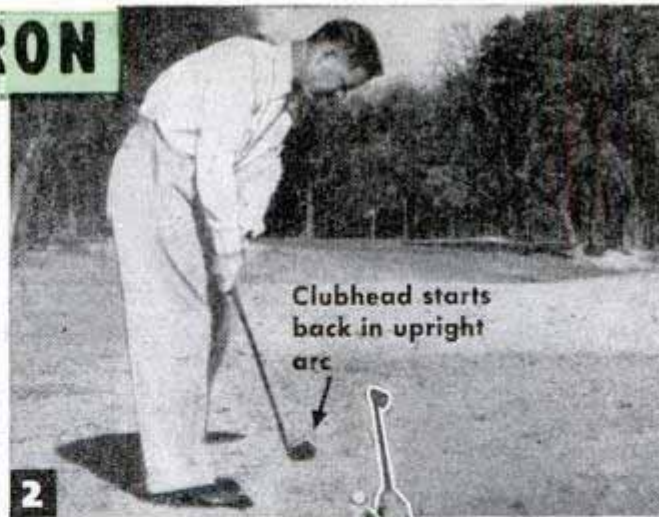



Champ's eyes follow ball he just blasted from trap

The principal differences to be observed between the way you play a short and a medium iron are, for the short irons, (1) feet closer together, (2) hands closer to body, (3) bent over a little more at the waist because of shorter shaft, (4) standing nearer to ball, (5) more upright arc to swing, (6) more hand and arm motion.

Photos 1 through 8, plus accompanying explanatory matter, illustrate clearly the mechanical details of the swing for a shot to a green approximately 120 yards distant.

If you have ambitions to be a low-score golfer, remember that skillful use of Nos. 7, 8 and 9 irons is of great importance.

As I mentioned earlier in this series of articles, many golfers who can hit a ball tremendous distances with woods and long irons may never be winners for the principal reason that they cannot hit short irons accurately. It is finesse in the use of these clubs that really pays off.

To make my point more clear, almost any day on any golf course you may observe two men of apparently comparable abilities with woods and long irons, yet one may come in with a 75, while the other has an 85. Chances are that the player with the 75 hit his short irons up closely enough for two putts at the most on some greens and for a single putt on others. The 85 player probably missed the green altogether more often than he hit it with a full 7 or 8 iron shot. Most courses are built so that a poorly aimed shot at the green winds up in a trap, bunker or in long grass.

I usually shoot my lowest rounds on the days I am hitting my medium and short irons up frequently to where I can get into the cup in one putt.

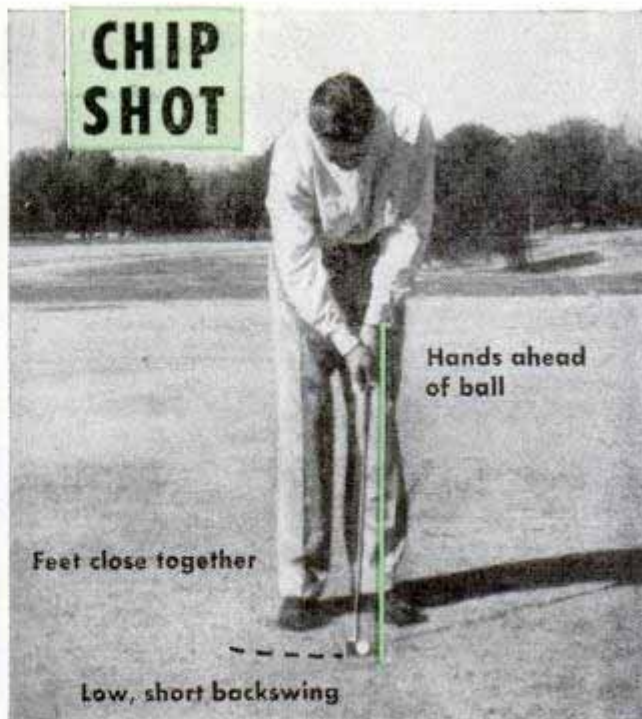

The author prefers a four or five iron for this shot

The short irons are great scoring equalizers. One day I witnessed a golf match between a powerfully built former All-American football player and a short, slightly built young chap.

The big fellow was booming his drives out 20 and 30 yards beyond his pint-sized opponent. But, while the big one was getting into all kinds of trouble with his short irons, the small one was "knocking 'em stiff" with his medium and short irons. It was no contest. The long-hitting "Goliath" was completely mastered by accurate-shooting "David."

CHIP SHOTS

The short chip shot from within a few yards of the edge of the green is another invaluable asset in cutting down your scoring total.

The photo above illustrates the stance for such a shot. You needn't grip the club as firmly as for full iron shots.

I will take the clubhead back away from the ball fairly close to the turf and on a straight line running from the objective back through the ball. The clubhead will follow through on the same line. This stroke puts overspin on the ball and tends to hold it on the intended line of flight.

I prefer a No. 4 or 5 iron for this shot.

SAND TRAP SHOTS

Most golfers go down into a sand trap with their No. 9 iron or double-duty niblick as though they were doomed, and quake in their shoes as they prepare to try to play the ball out of the heavy sand.

It's really not as bad as that. In fact, there is a wide allowance for error in blast-

TRAP SHOT

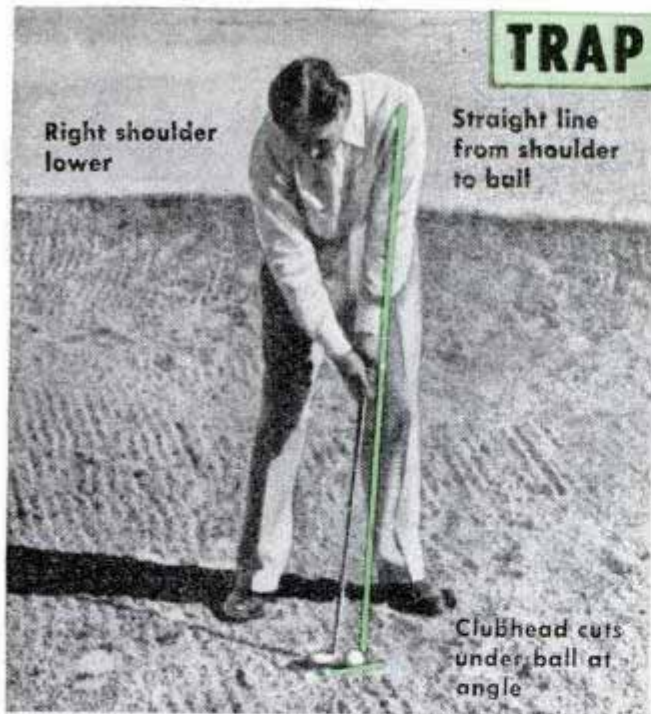

Right shoulder lower

Straight line from shoulder to ball

Clubhead cuts under ball at angle

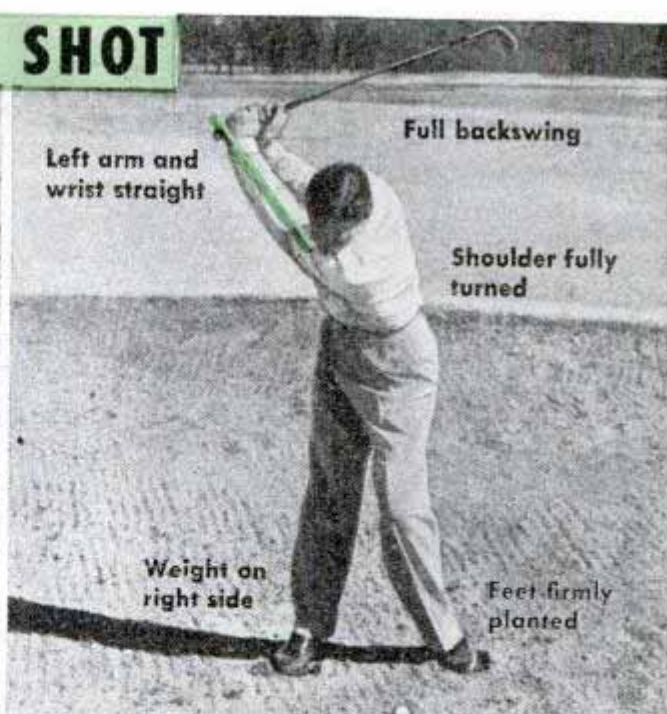

Left arm and wrist straight

Full backswing

Shoulder fully turned

Weight on right side

Feet firmly planted

Apply plenty of power behind this shot to avoid having your clubhead stop in the sand, Golf's No. 1 star urges

GRIP, STANCE AND STROKE FOR PUTTING



Index finger pointing down



Thumbnail stuck into club

Index finger overlaps



Underside view of grip

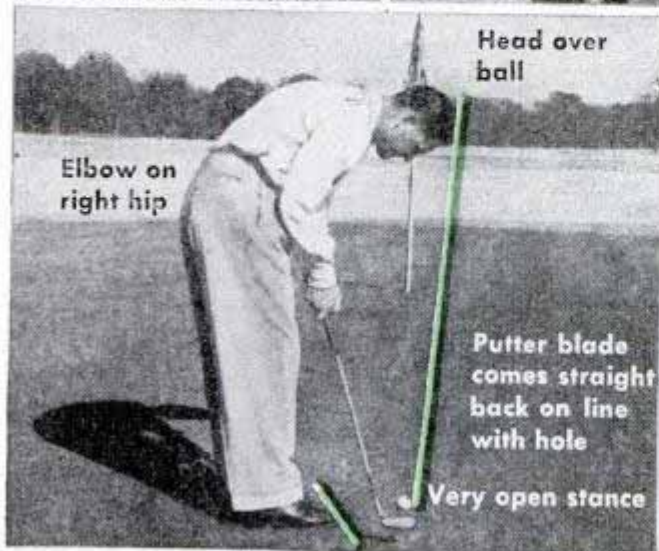

Elbow on right hip

Head over ball

Putter blade comes straight back on line with hole

Very open stance

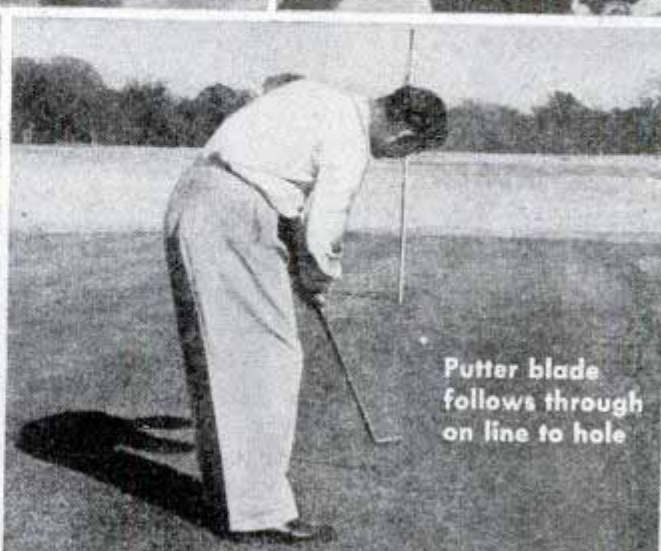

Putter blade follows through on line to hole



"Lord Byron" driving in a professional tournament at Miami. McSpaden and Byrd, left foreground, await turns

NELSON SHOTS A BIRDIE ON HOLE No. 1

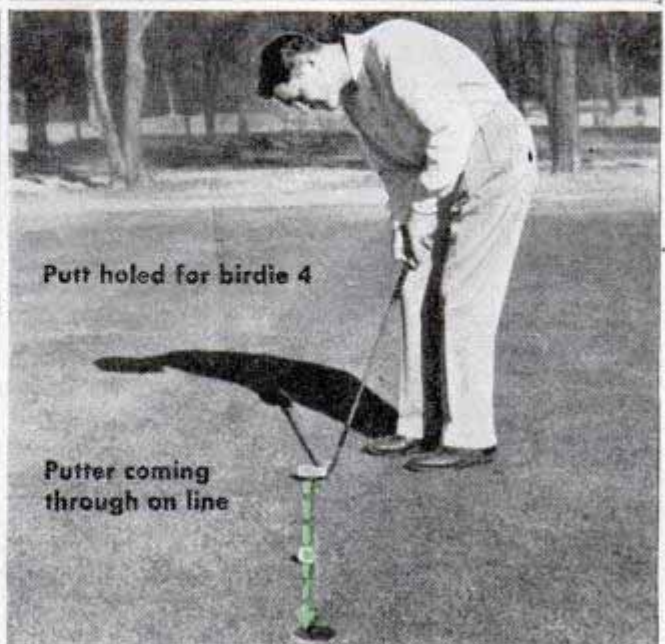
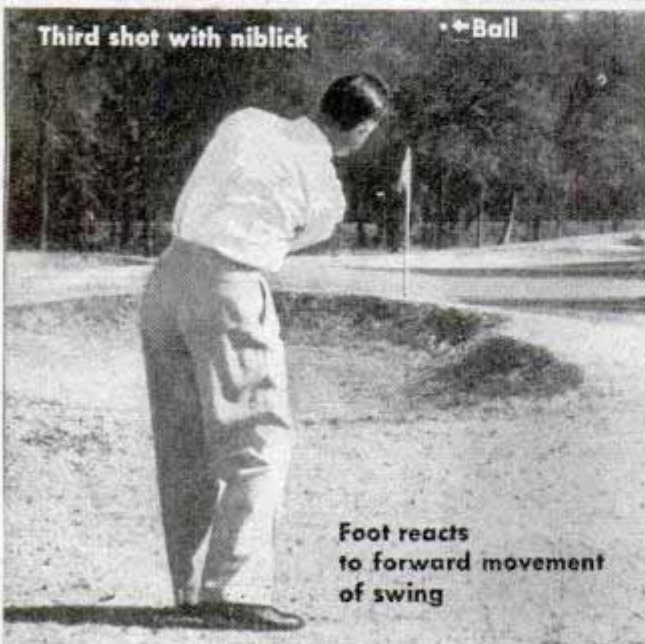
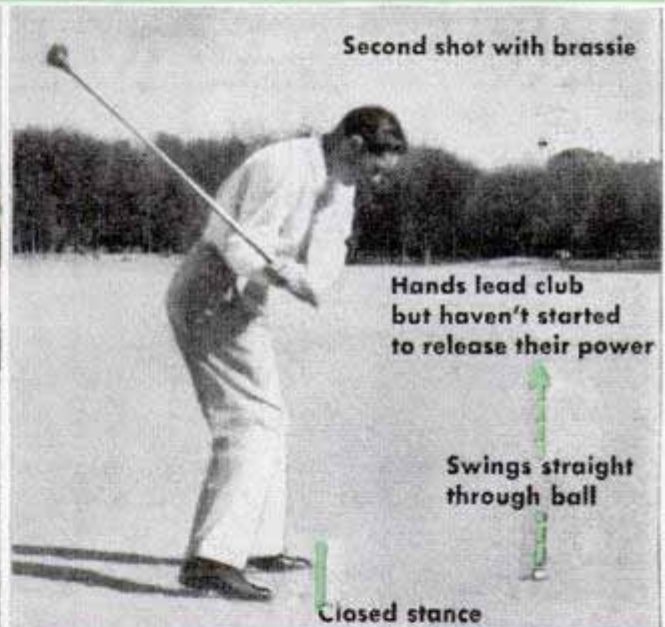
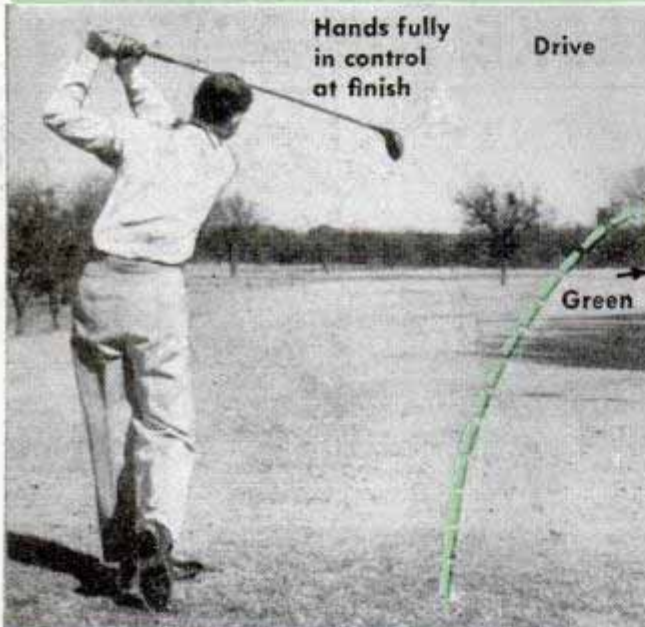

ing the ball out of a sand trap. Your clubhead may cut down into the sand anywhere from a half inch to three inches behind the ball; if you swing all the way through in a full stroke, chances are the ball will carry out of the trap.

To get set take an open stance with your feet, and work them down into the sand so that you have a firm foundation.

In starting the clubhead back for this shot you take it up in an arc outside the imaginary line of flight (in other words, away from your body). This is to enable you to swing the clubhead through under the ball at an angle cutting across the ball from outside the line of flight to inside the line of flight. This stroke gets the ball well up in the air and puts so much spin on it that it stops practically where it lights.

The ball is played from opposite a point just a little in from the left heel.

For any ordinary shot, I try to cut the clubhead down into the sand about two inches behind the ball, and not more than two inches deep at the bottom of the swing. The distance the ball will travel is determined by the amount of sand between the spot at which the clubhead enters and the ball. The less sand, the longer the flight of the ball. I never try to hit any closer than a half inch.

The clubhead is laid back nearly flat, as the first trap shot photo on page 125 illustrates. As you can see in the next photo, I take a full backswing for this shot. You must apply enough power to make sure your clubhead does not stop in the sand.

PUTTING

My putting grip is the result of a great deal of experimentation aimed at incorporating into it (1) a maximum of coordination between hands, (2) feel. I wanted my hands to work together as a single unit.

The comment has often been made, "If Nelson could only putt..."

As a matter of fact, I consider this one of the stronger features of my game. I have had a comforting number of putts of from six to 30 feet roll into the cup at times when the pressure was really on. Like any other human, I miss an occasional four or five-footer, but not enough to cause me special concern.

(Continued to page 228)

PAR FOUR ON No. 2



Drive

No waste motion in wrist

Head center of movement

Green

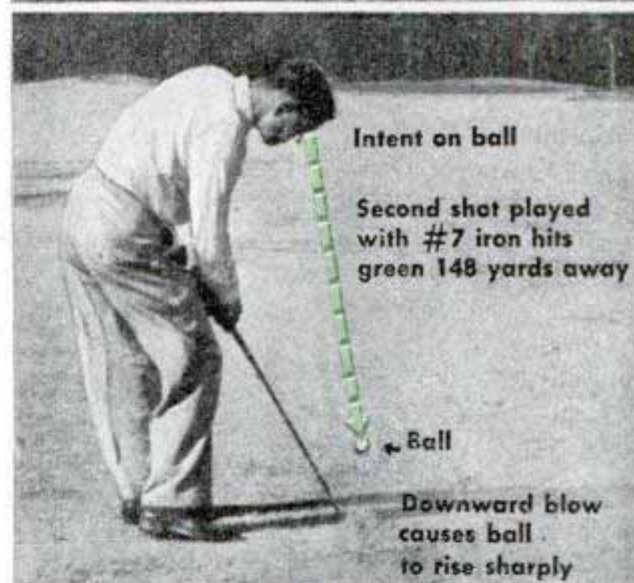

Intent on ball

Second shot played with #7 iron hits green 148 yards away

Ball

Downward blow causes ball to rise sharply

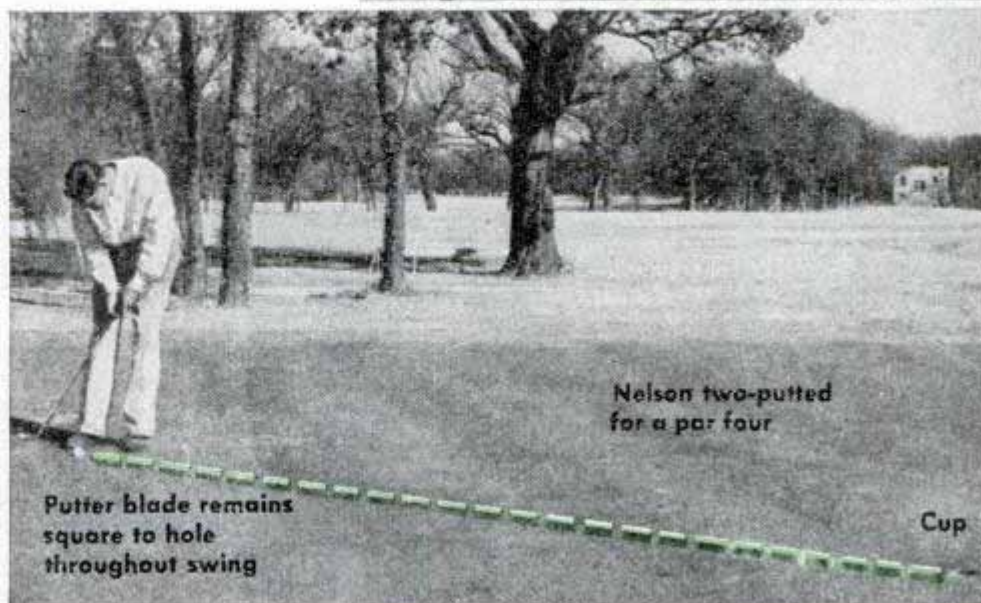

Nelson two-putted for a par four

Putter blade remains square to hole throughout swing

Cup

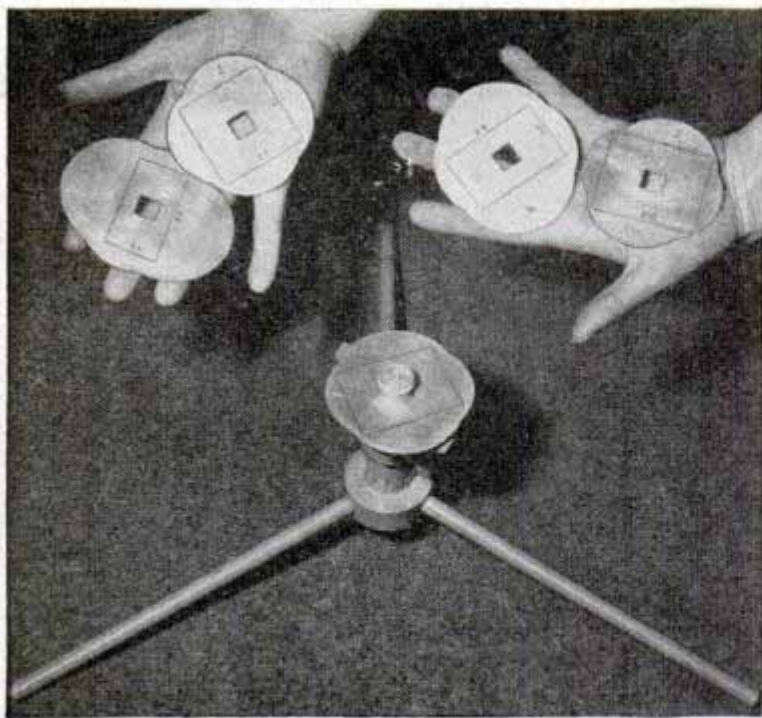

Adjustable Lawn Sprayer Sprinkles Square Plots

Sprinkling the entire surface of a square or rectangular lawn without spraying adjoining sidewalks is the fascinating feat performed by a new lawn sprinkler. Five disks control the shape of the spray from a long narrow rectangle to a square. The maximum area the device will spray depends upon the water pressure. The sprinkler will cover a 32-foot square under the average water pressure of 35 pounds. Reducing the pressure by closing the faucet restricts the size of the area that will be sprayed. The sprinkler distributes the water evenly without soaking particular areas with too much water.

Repeater Flash Bulb for Photogs

Several thousand individual flashes of daylight photographic illumination are provided by one repeating photoflash bulb. The bulb is 50 times faster than an ordinary flash bulb. Color tests indicate its light is the same as normal daylight so no filters are required for indoor use with daylight-type color film. The bulb has a porcelain three-prong base. Inside the bulb is a gas-filled coiled glass tubing. Power discharged through this coil provides the illumination.

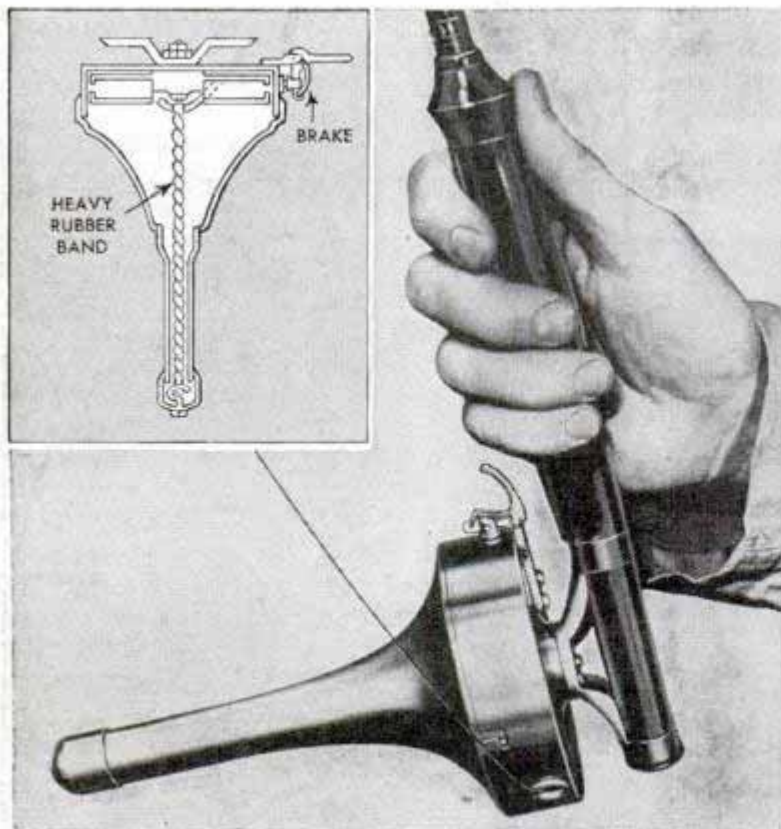
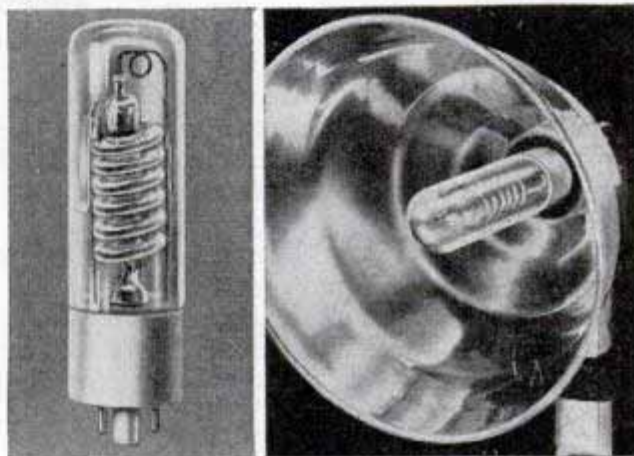

Noiseless Fishing Reel Powered by Rubber

Noiseless automatic fishing reels employ a block or band of rubber to retrieve the line. As the line is payed out, the rubber is twisted tightly. When the reel brake is released, the rubber untwists, reeling in the line without jerking. The new type reel is said to eliminate cleaning and repair problems encountered with the conventional reel.

☐ Many of the products described in this issue are available or are ready to be marketed. Popular Mechanics is prepared to give you additional information on these products, including the name and address of the manufacturer or distributor. Simply write to Bureau of Information, Popular Mechanics, 200 East Ontario Street, Chicago 11, Illinois.

Dual-Propelled Model Plane Uses Jet and Rubber Band

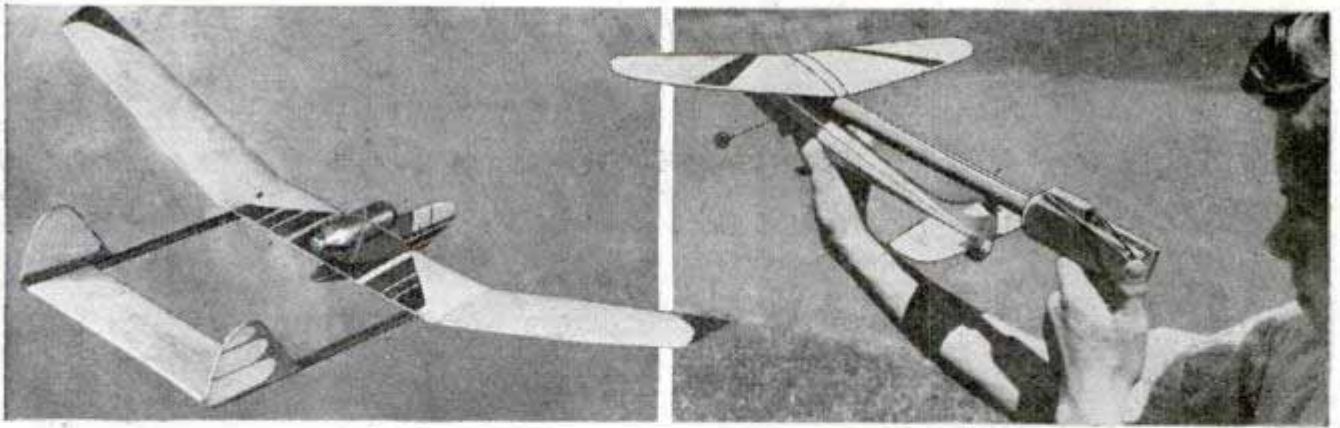

Dual propulsion—rubber bands plus jet action supplied by carbon dioxide cartridges—is the latest development in model planes. With the cartridge attached to the plane, a wooden launching gun equipped with a strong rubber band and a needle-pointed plunger sends the miniature aircraft zooming into the air. The rubber band releases the plunger which breaks a small hole in the cartridge to expel the carbon dioxide gas and provide the jet power. Planes with propellers have the added power supplied by “wound-up” props. The person launching a dual-propelled ship winds the prop, positions the plane on the cartridge-holding launching gun and releases the trigger and prop at the same time. Designed by

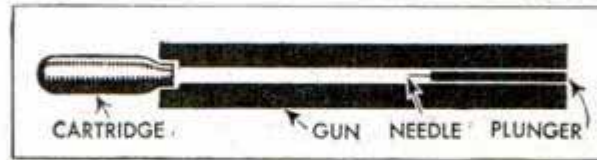

engineers of Aircraft Products Company at West Chester, Pa., the planes are available in various models,

including a miniature replica of the Ryan Fireball. Scientific principles of flight, weight and air control were followed. For example, the weight change that occurs due to carbon dioxide discharge does not unbalance the plane since the cartridge is prepositioned to maintain its proper center of gravity. The carbon dioxide cartridge—the same type used in siphon bottles—is powerful enough to give a plane a fast lift but is not dangerous to use, the manufacturer explains, and contains no fire or explosives. Carbon dioxide was decided on after experiments showed powder was difficult to handle and sometimes dangerous.

Molded Chairs Mounted on Rubber Cannot Be Tipped

Shock-mounted chairs which are molded to fit the contours of the body, and which have a rear leg to defy the most relaxed sitter to fall over backward, soon will be on the market. Shock-mounting of this molded plywood furniture is achieved by joining the seats and backs to the frames with live rubber disks which are bonded to wood surfaces by high-frequency heating. Natural finish, upholstered and stained models are offered, the stain applied by a new process said to soak the color deep into the plies without blurring the natural surface and markings. Companion pieces for living room, dining room and outdoor use also have been designed

by Charles Eames, who showed them at New York's Museum of Modern Art. It is planned to produce the pieces this year.

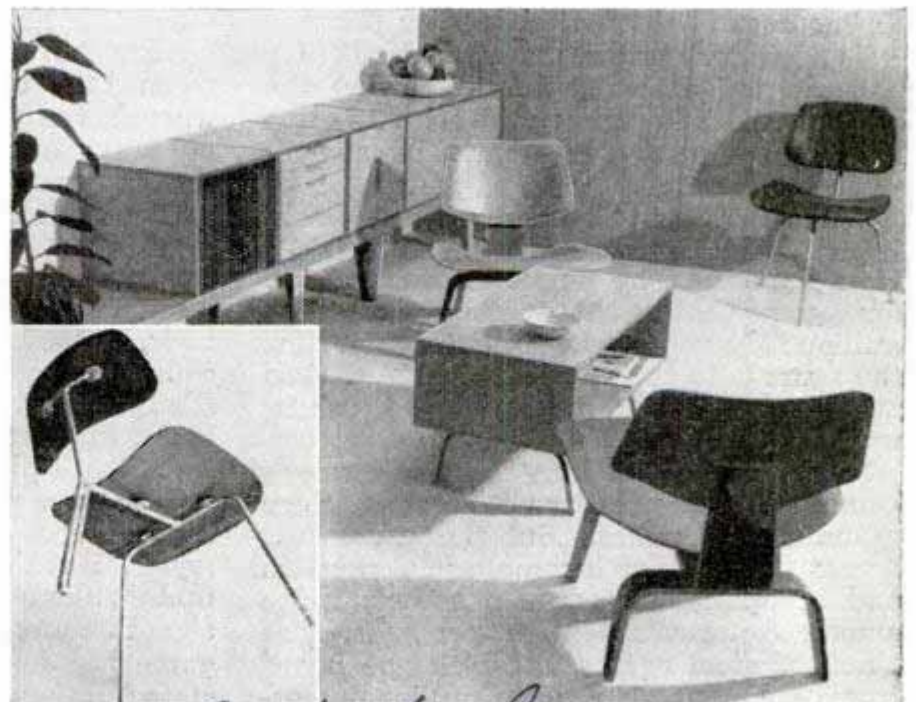

*Eames Products Co.
15310 Tullerton Ave.*

Pitching the President's Game



When Mr. Truman brought horseshoes to the White House lawn, the sport hit the headlines. Here's the pitch on playing the game



BY RICHARD W. EMERY

PHOTOGRAPHS BY ED LUNDBERG

IF someone tells you horseshoe pitching is a farmer's game, don't believe it! It's a soldier's game. Farmers learned the game from soldiers when the soldiers came home from the wars—back in ancient Greece, a couple of thousand years ago!

When President Truman recently established a horseshoe court on the White House grounds, he pitched a dead ringer for a game that has between two and three million followers in the United States. Now the sport is in the national spotlight. And many a foresighted statesman is brushing up on horseshoe pitching, just in case!

No, horseshoe pitching is not a farmer's game. It's been popular with farmers since grandpa was a kid. But the game cuts across the lines of income, social position and occupation to carve a homely niche among America's popular pastimes. The clank of steel against steel can be heard from tenement districts to millionaire es-

tates. The game is especially popular with factory workers, who flip horseshoes between bites of their noonday lunch. And where's the village firehouse that has no pitching court just around the corner from the hooks and ladders?

Chief reason for the popularity of the sport is the simplicity of the equipment and the small area needed for a court. Secure a couple of steel pegs in properly prepared beds, buy a few horseshoes and you have a court. One set of shoes will last a lifetime. It's inexpensive entertainment that pays a bonus in muscle building. It's easy-moving sport that's played in outdoor air.

There are ways and more ways to pitch a horseshoe. The experts have their own styles. But the game itself is standardized under rules adopted by the National Horseshoe Pitchers Association of America. The game has its local, regional, state, interstate, national and world championship

213 S. Everett Ave
 Monterey Park ~~Calif.~~
 Calif.

Each player has a favorite method of holding shoe. Here are three of the most popular grips. Note the number of turns each shoe makes as it rotates in flight

National Champion Isais keeps his arm straight at the peak of the backswing, shoe held high above his head, weight on right foot

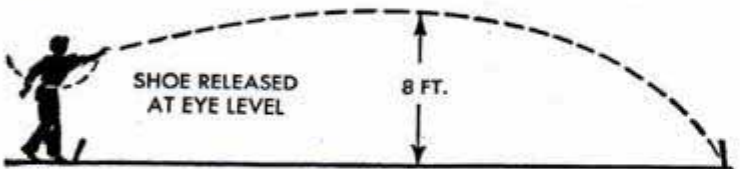
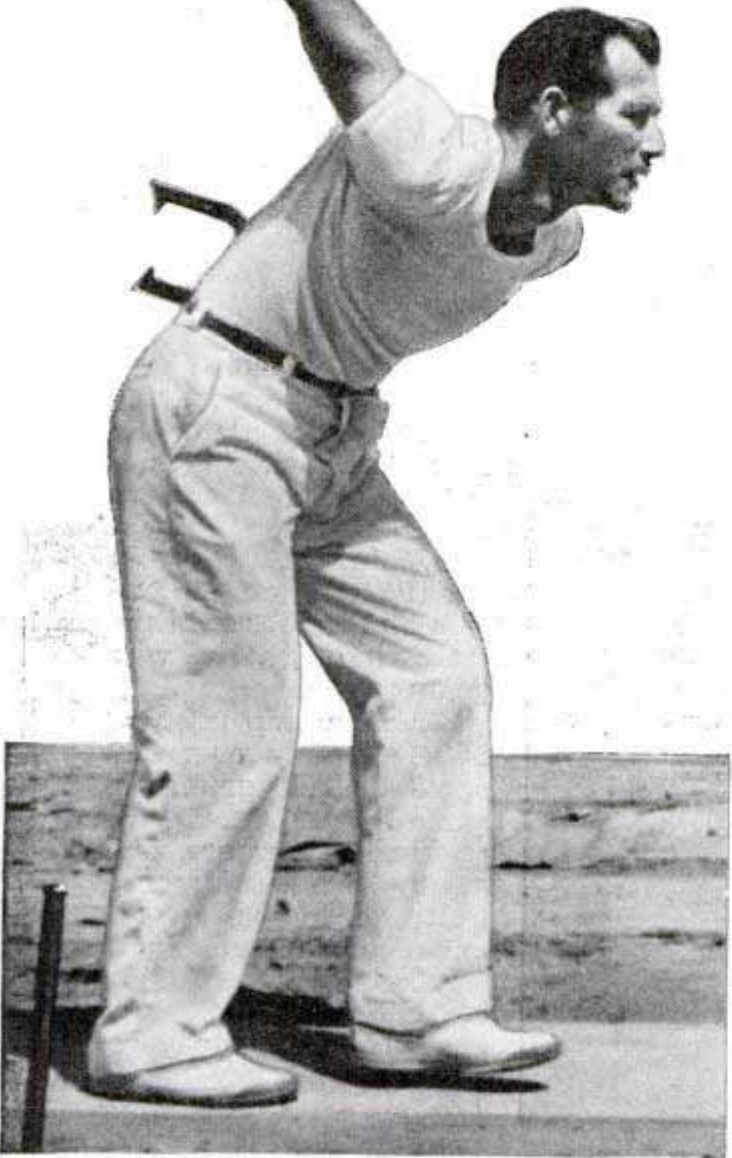
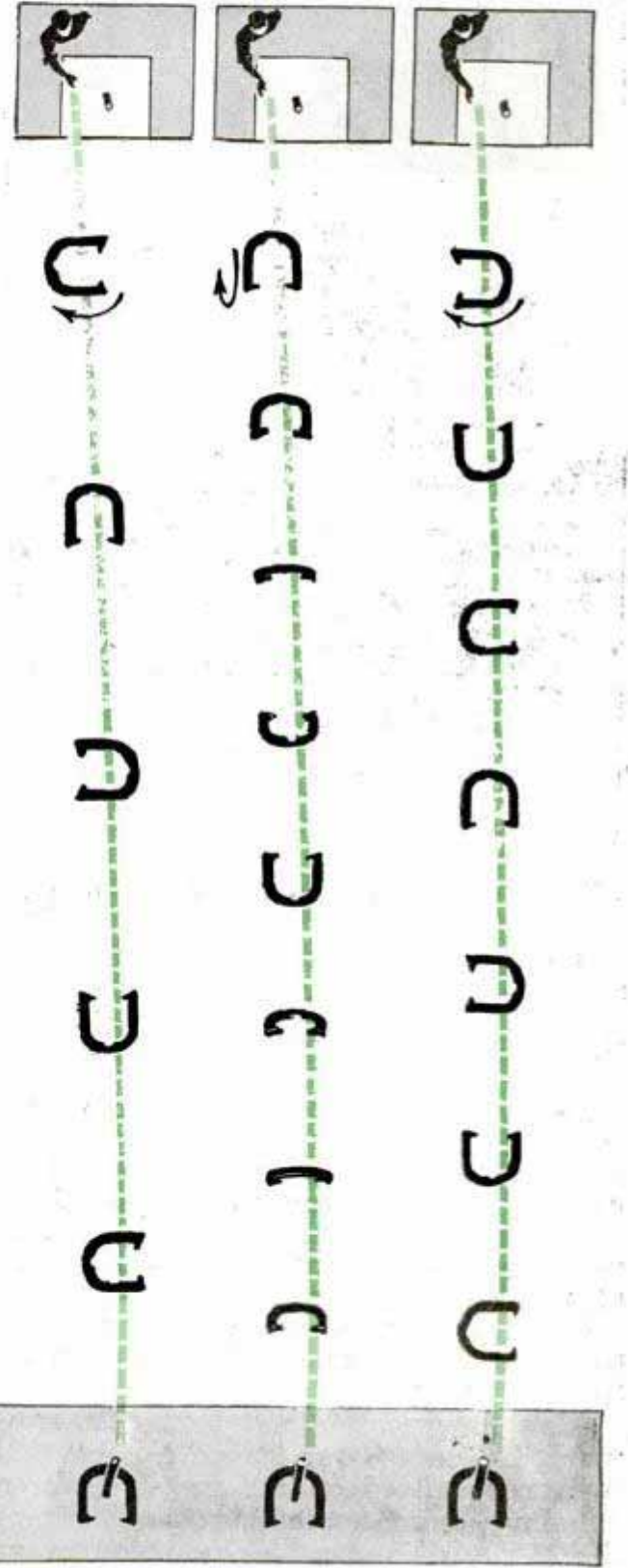
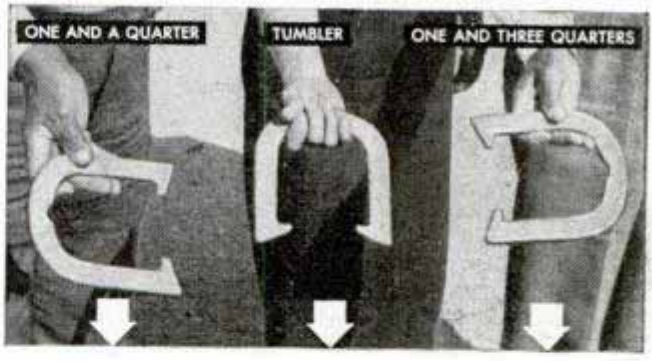

This trajectory of the champion's pitch shows that the shoe travels fairly low to the ground. It is still moving forward when it lands at base of stake

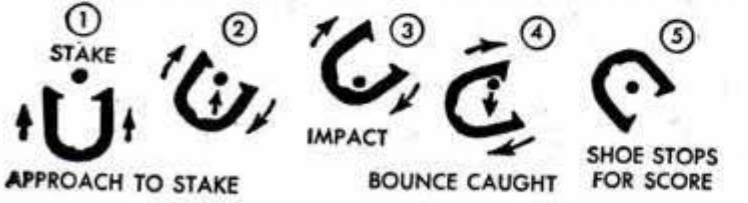

In a good toss, the horseshoe "opens" straight into the stake, then locks itself there on the rebound



Note the champion's finger position as he aims at the opposite stake. The little finger gives positive control to the shoe's rate of rotation

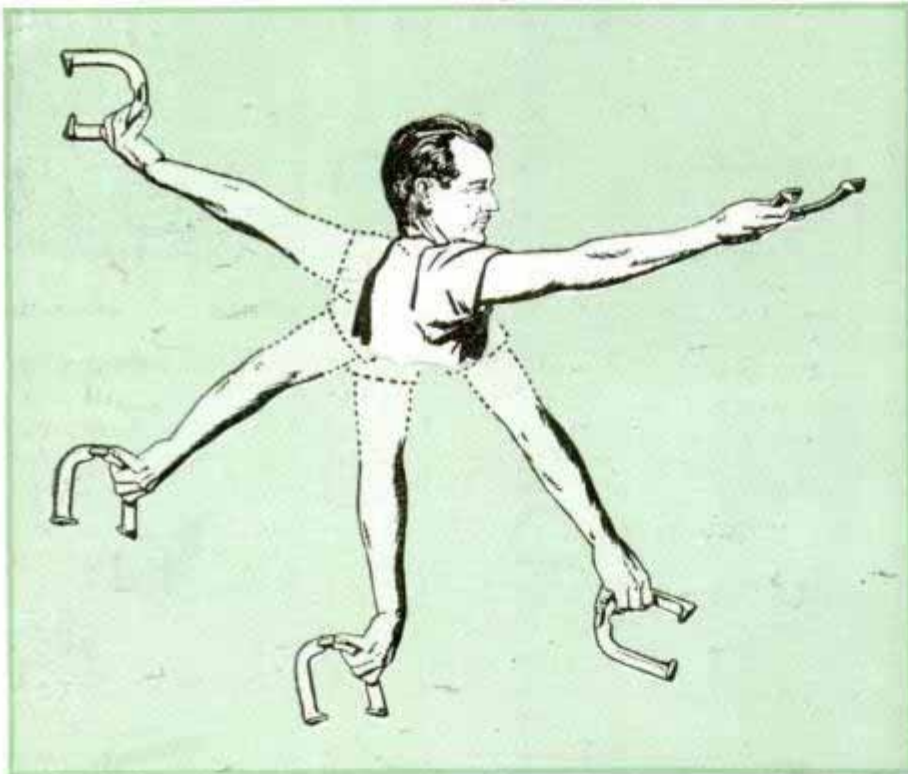

Shoe remains on a vertical plane until it clears the leg. Then it is turned horizontally and given a clockwise twist as it leaves the hand at eye level

tournaments. And champions of the sport are real athletes.

How does a champion pitch a horseshoe? Take a look at Fernando Isais in action. He's a husky 32-year-old Californian who was born in the fishing village of La Paz, in Baja California, Mexico. He's of Spanish Basque descent, and that last name is pronounced "ee-sah-ees" with the accent on the middle syllable.

He's a horseshoe champion extraordinary, but he's never ridden a horse and he's never lived on a farm. He's been winning horseshoe pitching championships for 15 years. He was the champion tennis

player in the Mexican Southern California tournament for 1946, and he averages a husky 186 as a bowler in league play. Between tournaments he manufactures Venetian blinds at Ventura, Calif.

Soon after Isais started pitching horseshoes he won the California championship. That was in 1931. He has held the state title eight or nine times and has been interstate champion of Arizona, Indiana, Utah, Iowa and Oregon. In 1934 and 1935 he toured the country with Ted Allen, national title holder at that time, giving exhibitions of plain and fancy "hoss shoe" pitching. He whipped Allen at the Iowa State Fair at Des Moines in 1941 to win the national championship and he has held the title through the war years.

Championship pitching is not a lazy everyday sport. It's a gruelling game that calls for great physical endurance and steady nerves. Many a contender drops out because of fatigue. Isais trains for a tournament by putting himself in top condition with four hours of practice a day for at least six weeks before the tournament. "It's like any other sport," he says. "Practice counts!"

Isais started out as a "1¼" pitcher. That is, he first pitched a horseshoe that turned one and one fourth revolutions in mid-air.

"But I found I could do better with a shoe that turns faster," he says. "Now I throw a one and three quarter shoe. It grabs the peg better. It doesn't bounce back as easily."

In action, Isais has the precision and grace of motion that mark a fine athlete. And if you want to learn his style of pitching, here's the way to toss the shoe:

With your left hand, hold the shoe with caulks down, open end toward your right. Grip the shoe with your right hand, thumb on top with three fingers reaching under

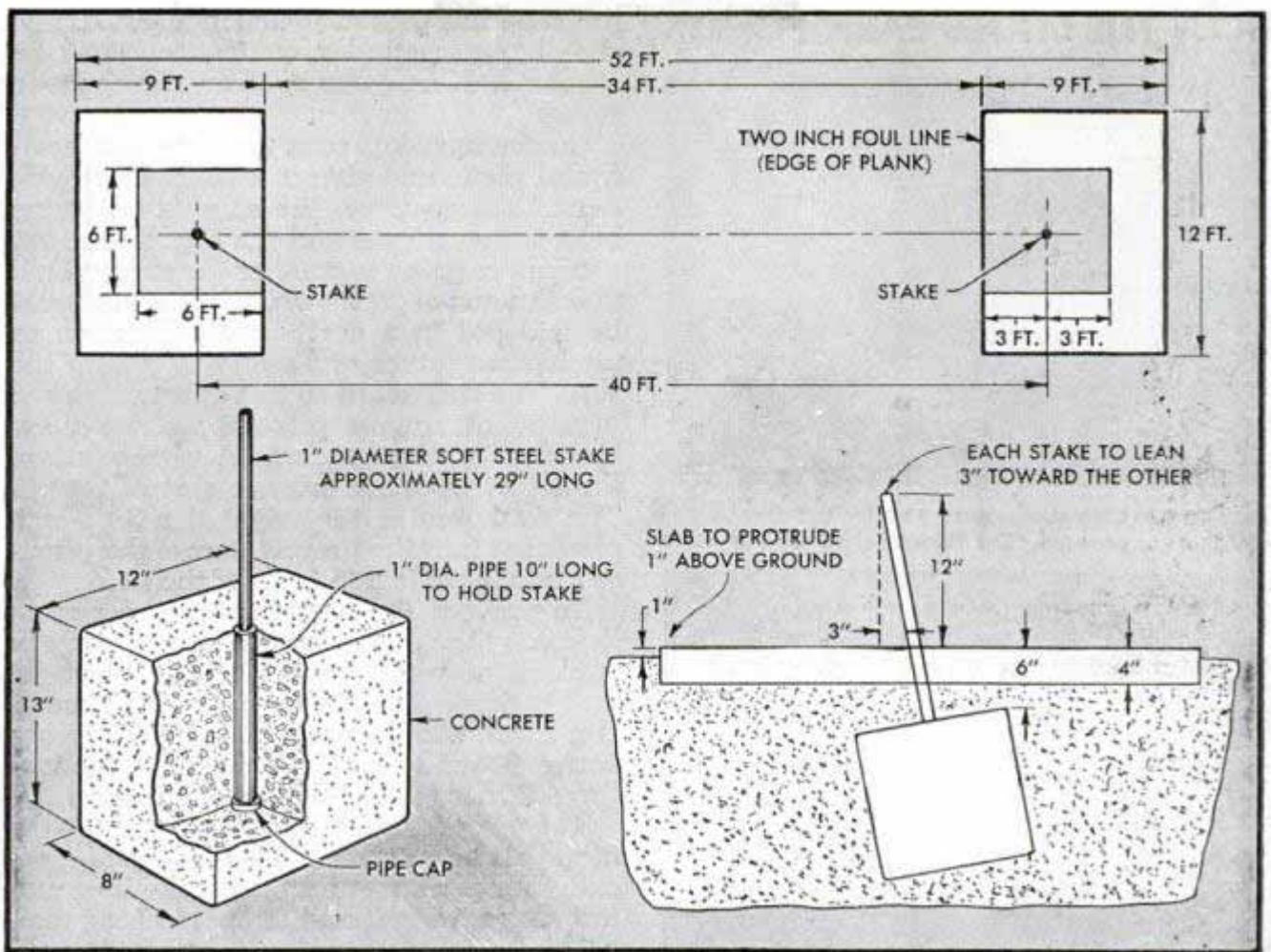

Drawing from National Horseshoe Pitchers Association of America
Here are dimensions for building your own horseshoe court. The equipment and materials are inexpensive

the shoe and gripping its inner edge. Brace your little finger against the toe caulk—that's the one on the round end of the shoe.

"Bracing your little finger like that will always give you exactly the same hold on the shoe," Isais says. "The whole purpose of your grip, your stance and your delivery is to standardize your movements so that every pitch will be exactly alike. Then you

should work to improve your accuracy."

Stand in the pitcher's box, about even with the stake, feet close together, with your weight mostly on your right leg. Raise the shoe to "sighting" or "aiming" position, at full arm's length ahead of you. Swing the shoe back and drive your arm high up behind you, keeping elbow and wrist straight.

Left, clay that is too dry should be sprinkled thoroughly and covered with wet burlap. Right, when court is not in use it should be sheltered by a wooden or metal cover to keep the clay at puttylike consistency

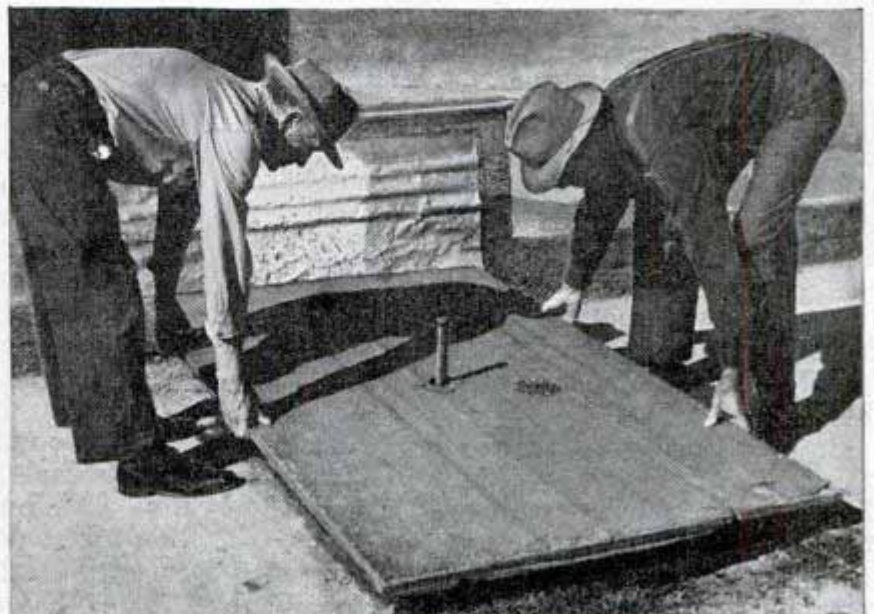

HOW THE SHOES EARN POINTS

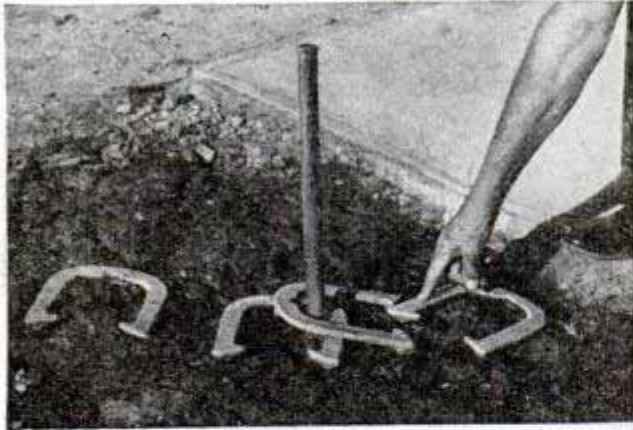

↑ Tie scores, such as these ringers by opposing players, are not counted. But "close" shoe wins a point



↑ Here only the single ringer counts. All the other horseshoes are more than six inches from the stake

↓ The shoe at the left is a "leaner." It has no more point value than a shoe that barely touches the stake



When Isais makes this backswing, he leans sharply forward from the hips. His hand and the horseshoe are high above his head.

In this position, you are ready to start the forward swing, which will send the 2½-pound steel shoe sailing 40 feet to ring the opposite stake—you hope.

Bring the shoe downward and forward without turning it off a vertical plane, until

the shoe has passed your right leg. If the shoe bumps your leg, your pitch can't be accurate. Keep your eyes on the opposite stake.

On the upswing, turn the shoe to a horizontal plane and give it a slight clockwise twist. Let go when the shoe is on a line between your eyes and the opposite stake.

If you're going to practice the game you'll need a court of your own. The court should be laid out in a north-south direction so pitchers at either end won't be facing the sun. The stakes are 40 feet apart, centered in six-foot square pits topped with six inches of puttylike clay. A pitcher's box three feet wide lies on each side of the pit. The foul line is the edge of a two-inch plank set into the ground across the pitcher's box three feet in front of the stake.

To prevent the hard-hitting shoes from loosening the stake, set the stake firmly in a block of wood and bury the block 18 inches deep. The stake, of one-inch-diameter steel, should project about 12 inches above ground level. Each stake inclines three inches toward the opposite stake.

The shoes aren't real horseshoes—the kind that horses wear. They're made especially for pitching and they come in standard shape, weight and tempers. Isais likes a "dead soft" temper shoe for tournaments, because it has less bounce. A soft shoe soon gets full of dents, however, and if you use one you'll need a file to remove sharp edges.

Standard shoes must not exceed 7½ inches in length, 7 inches in width or 2½ pounds in weight. The opening between the heel caulks—the open end of the U—cannot exceed 3½ inches.

For purposes of scoring a game is divided into innings. When each contestant has pitched two shoes, that's one inning. A tournament game is played for 50 points, but league games usually are played for 21. A regulation contest between two players consists of the best six out of eleven games.

To earn any points the shoe must lie within six inches of the stake after all four shoes have been pitched. The closest shoe within six inches of the stake scores one point. A ringer scores three points. All equal scores by opponents in any one inning are ties and are not tallied. In each inning, a player may gain in score only by superior pitching. Tournament games have gone to 130 shoes per player before one player could win 50 points.

"That's when training counts," says Fernando Isais. "Training gives you confidence. When the game gets tough, you don't lose your nerve. The crowd doesn't upset you. You are sure of your delivery. And with luck—you win!"

"Swords Into Plowshares"—Australian Version

Australian inventors, who submitted more than 20,000 ideas to aid the Allied war effort, are working now to convert military equipment to peacetime use.

Thousands of ideas for utilizing enormous quantities of military equipment are being submitted by civilians and servicemen to the Australian Army Inventions Directorate. Each idea is tested to prove or disprove its practicability. Occasionally the ideas are improved during the tests.

One idea that has already found application is the conversion of millions of square feet of steel mesh to the manufacture of prefabricated packing crates. The mesh was used during the war to provide a solid surface on the soft soil of beaches and jungles. The idea to make crates from the mesh was suggested by a soldier who had seen many smashed wooden packing cases. The mesh crates are collapsible, being held in shape by clips, and are easily transported when empty. More than 50,000 crates have been made from the unused mesh at base depots alone.

Millions of feet of rusty barbed wire, erected at many strategic points along the Australian coast when Japanese invasion was imminent, have been reconditioned for farm use by a "pickling" process. The method is the least expensive ever devised. The wire is dipped in a phosphatic pickling bath, then coated with a bituminous protective mixture. The bath first

makes shining metal of the badly rusted rolls, then the protective treatment gives it a dark brown finish.

Bren carriers have been stripped of armor plate and their controls modified in testing their use as farm tractors. More than 20,000 of the vehicles are idle in tractor-poor Australia, where wheat growers face a serious power shortage.

Thousands of 40-gallon steel drums are being used as fat reclaimers at army camps and hospitals. New uses are being proposed for thousands of tons of leftover explosives, which may be used to improve harbors and railroads, to reclaim forests and swamp areas and even to excavate deep waterholes in thirsty desert regions.



Seat for Fishing Boat Also Is Lawn Chair

For use either as a lawn seat or fisherman's arm chair, a dual purpose, all steel sportsman's seat can be folded into a compact bundle for easy carrying. The chair, which has a cushioned seat and canvas back, will fit any boat seat or it can be detached and fitted over legs for use on land.

Three-Point Suspension Principle Used in Pleasure Boat

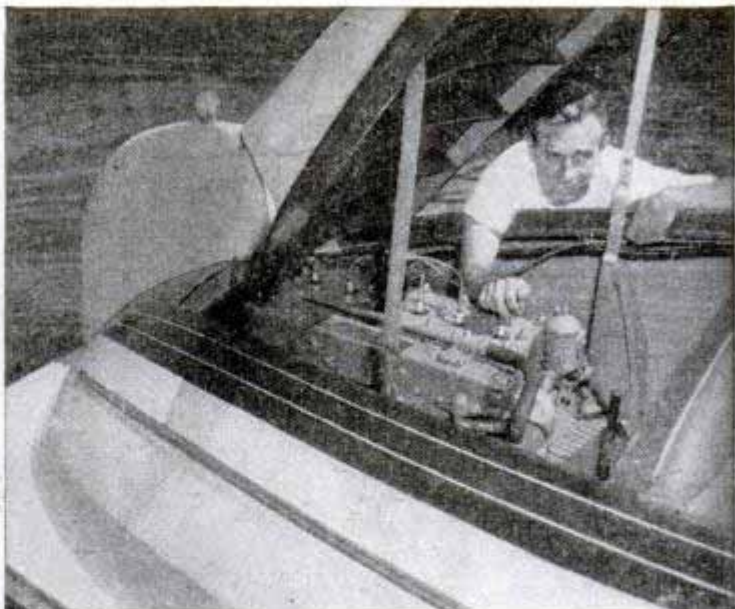

Using the three-point suspension principle widely employed by racing boats to develop greater speed, a new 19-foot stock runabout carries six people at speeds up to 60 miles per hour. At high speeds the boat planes on two underwater sponsons lo-

cated amidships and on its flat stern. The runabout has a glass-plastic laminated hull, is powered by a 175-hp. marine engine and weighs 2000 pounds. The engine is located in a compartment in the stern and is readily accessible through a rear deck that is raised like the hood of an automobile. The seats are upholstered in waterproof plastic materials and the instrument board carries a clock and push-button radio receiver. The hull is of streamline design. A 21-foot, eight-passenger version of the same design, powered by twin 275-hp. engines, travels up to 70 miles per hour.



Levers on Lawn Mower Control Height of Cutting

Equipped with two levers on the handle for height and blade control, a power lawn mower makes it possible to cut grass to a desired height. One of the levers controls an automatic leveling device to fix the height of the cut. The other adjusts the proper clearance between the cutting blades and the bottom knife. This can be controlled with micrometer accuracy to within .001 inch, which is said to give more efficient cutting and quieter operation. Both levers can be set without using a wrench or screwdriver. The 21-inch cutting blades on the mower extend three inches beyond the driving wheels on each side to make it easy to trim around trees, flower beds, rocks and other obstructions. A 17-inch hand mower with similar controls also is available.



Forecasting *THE OCEAN WAVES*

By Andrew Hamilton

THE sea played a grim and ghastly joke upon the world last April Fool's Day. Powerful tidal waves, started by an underwater earthquake near the Aleutian Islands, battered seacoasts in the Hawaiian Islands, Peru, California and Alaska. More than 100 lives were lost and property worth \$10,000,000 was destroyed.

Could this disaster have been prevented?

"Probably not," says Dr. Harald U. Sverdrup, director of the University of California's Scripps Institution of Oceanography and one of the world's authorities on ocean currents.

"Tidal waves are started by earth slippages—and as yet science has not been able to predict earthquakes. It is true that earth shocks were recorded by seismographic instruments within a few minutes whereas it took the tidal waves, traveling at 400 miles an hour, four hours to reach Hawaii and eight hours to reach southern California.

"However, earth shocks are recorded every day and there is no way of determining accurately which ones set off these rare tidal waves. The factor of tide and swell also must be taken into consideration. At low tide, little or no damage may be done; at high tide and with a high swell, considerable damage may be expected."

Machine-made waves are measured and studied at the Woods Hole, Mass., Oceanographic Institution. Tripod marker (below) guided landings on Okinawa



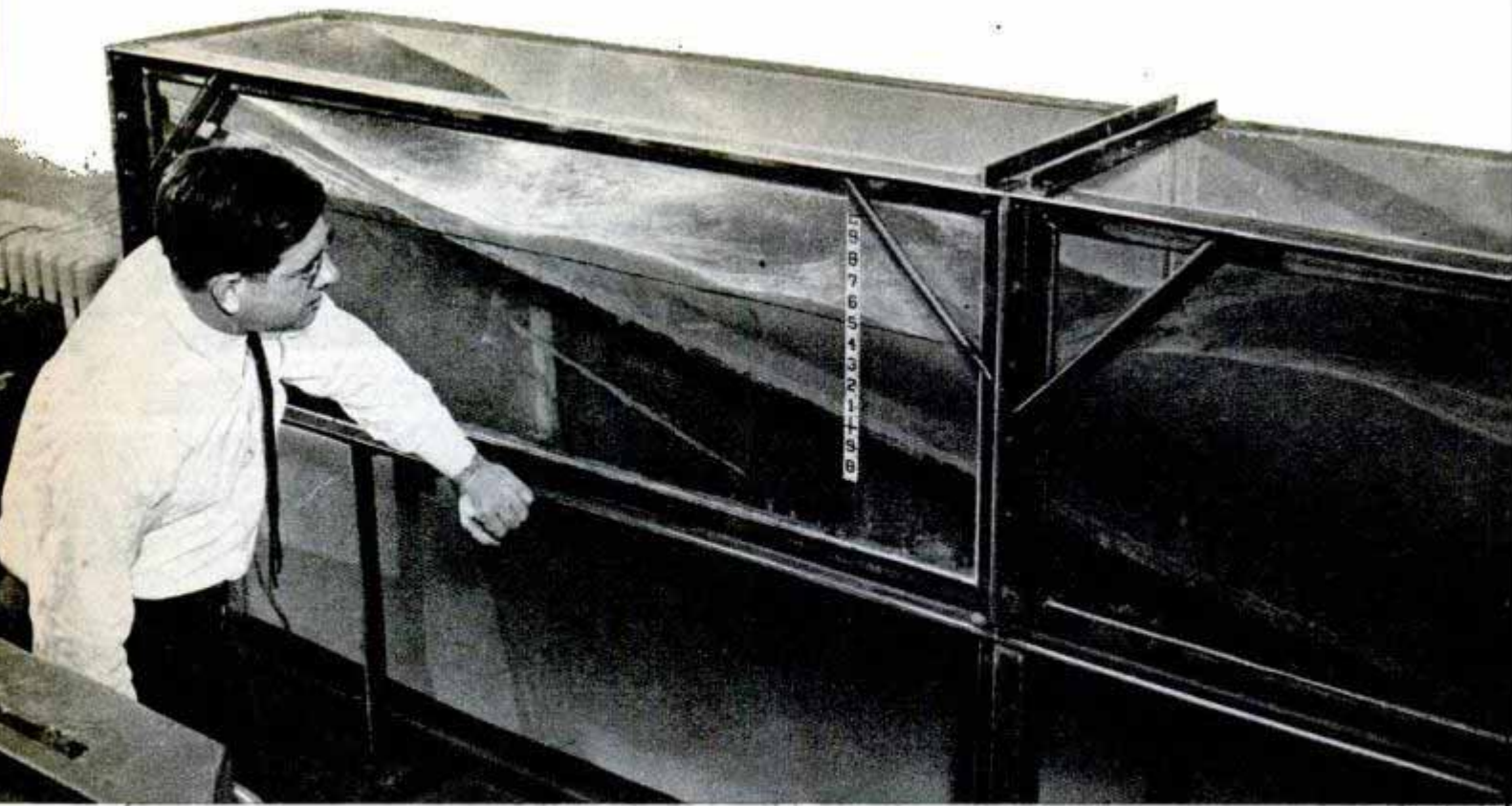

Relation between wave speeds and water depths was studied in a glass case to aid amphibious warfare

Dr. Sverdrup says the April 1 wave may have been caused by a block of the sea bottom, several square miles in area, slipping a couple of feet. The effect produced was like throwing a rock into a pond. Giant ripples radiated in all directions. In the open sea, these huge ripple-waves could not have been seen. No ship captain or transpacific plane pilot reported them. The crests may have been 100 miles apart.

"Greatest damage occurred when the waves reached land—especially in the vicinity of Hilo, Hawaii," Dr. Sverdrup explains. "The sea level rose 15 or 20 feet. In passing over a reef, such as existed there, it took on the characteristics of a 'bore.' The tide came in as a wall of water and smashed stores, piers and homes.

"We are never going to be able to prevent disasters such as earthquakes and tidal waves, but what we learned about the sea in the study of amphibious warfare will enable us to cope better with waves, swell and surf. A network of swell and tide stations throughout the Pacific would help us control the destructiveness of the sea."

A major factor in the success of American amphibious warfare was that our troops and commanders knew about tides, swell, depth, surf and wave conditions before the men hit the beaches.

Back in 1942 Dr. Sverdrup was charged by the Navy with assembling information on the ocean. He was asked to develop a quick method of predicting wave and surf conditions from aerial photographs im-

Tidal waves that struck Hawaii may have been caused by sudden vertical movement of a huge sea-bottom section

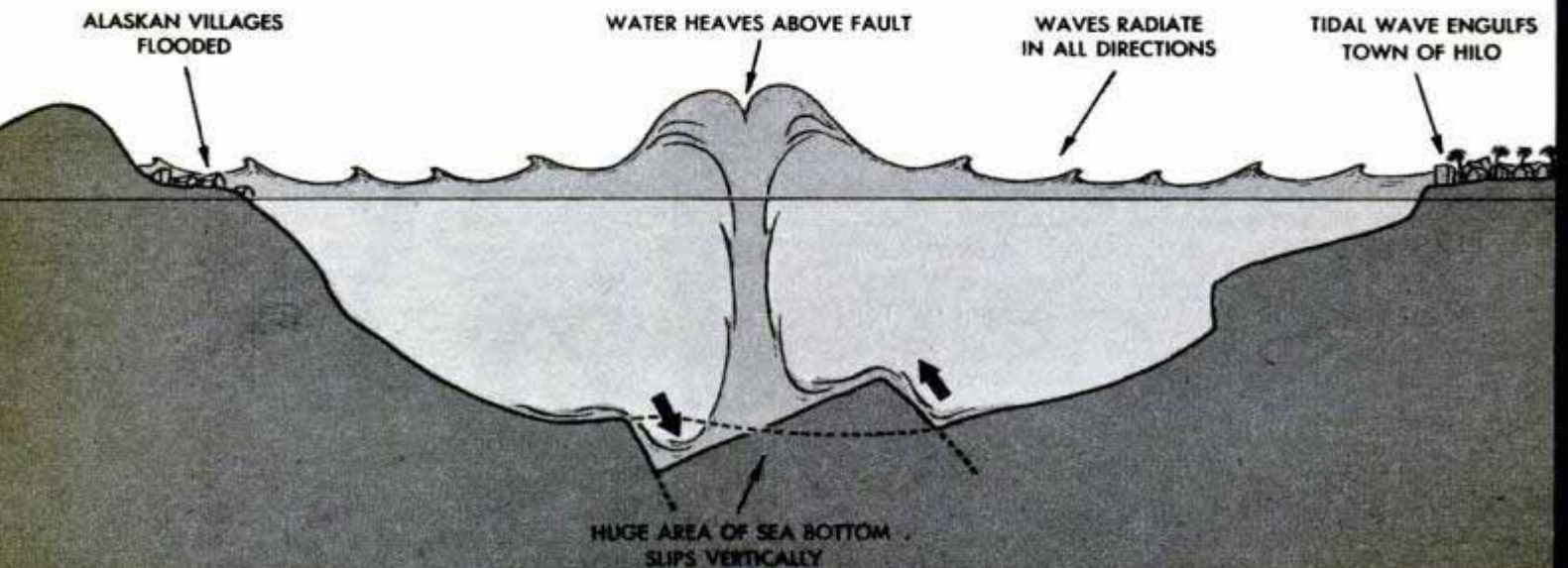



Schooled on California beaches, landing craft skippers learned to take advantage of breakers to ride ashore

mediately prior to a landing, and was asked to establish a school to teach Army, Navy and Marine Corps weather officers the science of forecasting sea, swell and surf.

Working in cooperation with the Woods Hole Oceanographic Institution and the department of mechanical engineering on the Berkeley campus of the University of California, Dr. Sverdrup and his assistants laid out a program to help make amphibious warfare successful for the Allies. This meant (1) prediction of sea and swell conditions from weather maps, (2) forecasting breakers and surf when the swell was known and (3) determining surf conditions and offshore depths from aerial photos.

The program paid off in victories. More than 200 Army, Navy and Marine Corps officers, after attending classes at the Scripps Institution, predicted accurately the conditions of sea and surf in amphibious landings at Sicily, Normandy, Saipan, Guam, Tinian, Palau, the Philippines, Iwo Jima and Okinawa.

More than 100 years ago, the classic theory of waves had been formulated: "in deep water the speed in knots is three times the period in seconds," thus a 10-second wave travels in deep water with a speed of 30 knots; and "the length of a wave is five times the square of the period," thus a 10-second wave has a length five times 10 squared or about 500 feet.

This was the basis on which amphibious landing research was conducted. In spite of the confused, checkerboard pattern of

waves in the sea it was found possible to establish a definite relationship between higher waves, wind velocity and the stretch of water over which the wind was blowing (the fetch) or the length of time the wind was blowing, (the duration). The formulation of these relationships in 1943 represents, according to Dr. Sverdrup, the greatest single achievement of the project—a quiet scientific achievement, not as sensational as an atom bomb or a jet fighter, but in its own way quite important.

From weather maps of ocean areas, meteorologists were trained to compute the wind velocity at the sea surface and to determine the fetch of the wind and its duration. With these values they read off from simple graphs the height and period of the significant waves present. Thus, with an 18-knot wind and a fetch of 300 miles they found significant waves were 8 feet high with a period of 6.3 seconds, whereas with a 32-knot wind and the same fetch the waves were 20 feet high with a period of 8.4 seconds.

Aerial photographs were invaluable to the science of forecasting surf and wave conditions. Wave patterns in a single aerial photo would give an experienced observer a mental picture of the ocean bottom. And a series of pictures, taken at a few seconds' interval, would allow him to determine depths to an accuracy of one foot.

When the landings on Sicily were imminent, the Allied fleet ran into a severe storm in the strait between Tunisia and

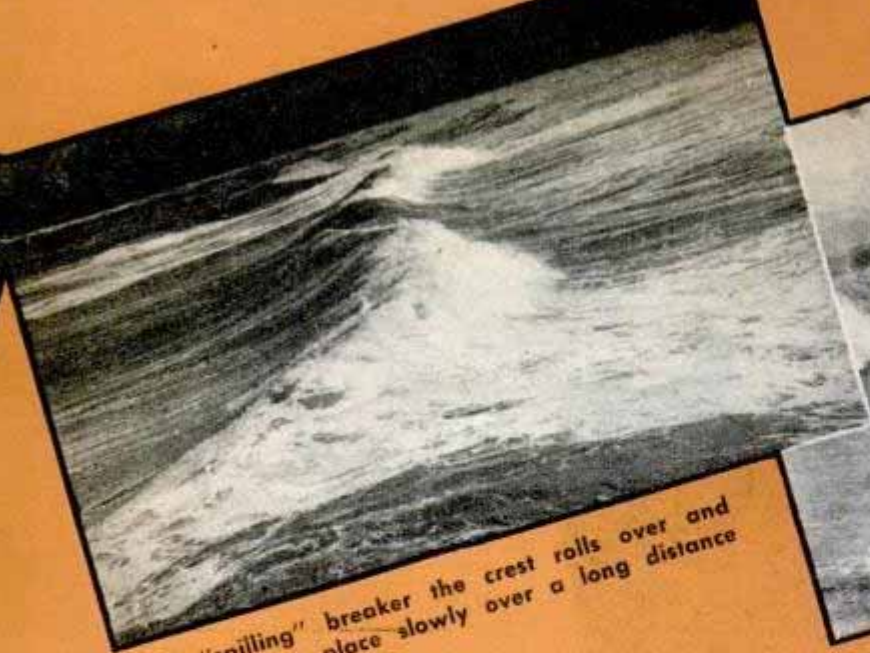

In a "spilling" breaker the crest rolls over and breaking takes place slowly over a long distance



This is a "plunging" breaker which breaks quickly and over shorter distance than "spilling" breakers

Sicily. On the afternoon of D-minus-1 day it appeared that the fleet might have to turn back and the operation be postponed. However, the Navy aerologist attached to Admiral Hewitt's flagship forecast that the wind would die before midnight and that only moderate surf would be encountered the next morning at H-hour. Operations were continued on schedule and the prediction turned out correct in every detail.

Before the Normandy landings extensive preparations were made to provide correct forecast of surf conditions on the French invasion beaches. The weather situation was unsettled when the great second-front invasion took place but the forecasts were reliable and there was no loss of life from incorrect estimate of weather and surf.

In the western Pacific, meteorologists, however, frequently could use in reverse their knowledge of the relationship be-

tween wind and waves. By observing sea and swell they could draw conclusions as to the character of the winds and could improve their weather maps and forecasts.

At Iwo Jima the steepness of the beach contributed to the hazards of the operation. Moderate and high waves broke directly against the steep bench and made the handling of landing craft a tricky task. But this feature had been foreseen and taken into account.

At Okinawa alternate beaches had been selected in order that D-day landings could be made on beaches least exposed to the surf. However, weather conditions on that sunny Easter morning were favorable and landings were made on the beaches which had been considered first choice.

With the end of the war, efforts have been made to forge this war-born science

(Continued to page 232)

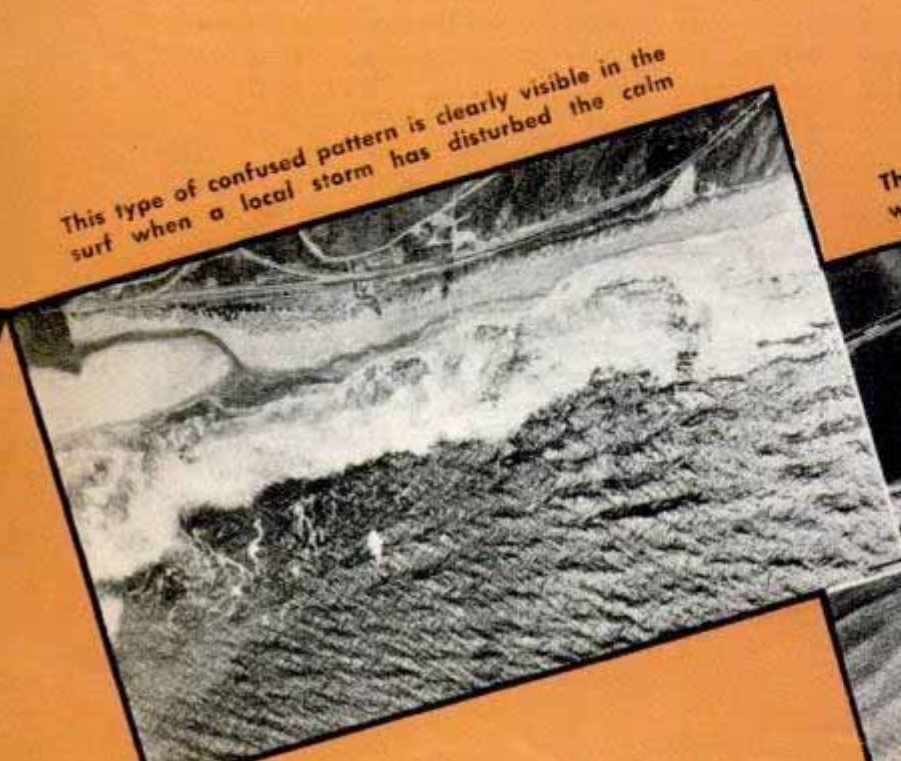

This type of confused pattern is clearly visible in the surf when a local storm has disturbed the calm

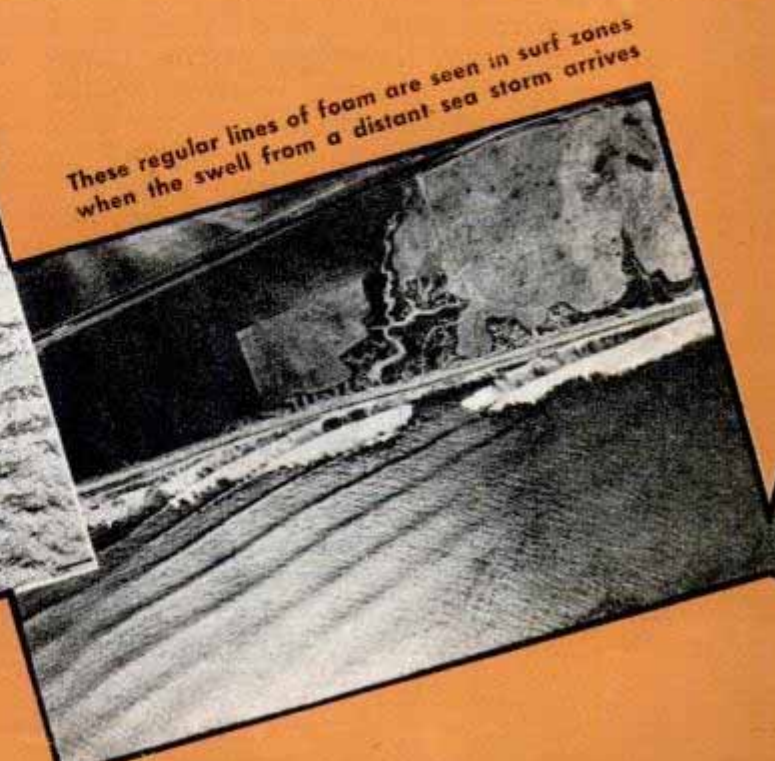

These regular lines of foam are seen in surf zones when the swell from a distant sea storm arrives



Waves breaking in this manner warned our landing crews of the obstacle of an extremely steep beach



Gentle waves of this kind signify a flat beach, the type amphibious troops chose for their landings

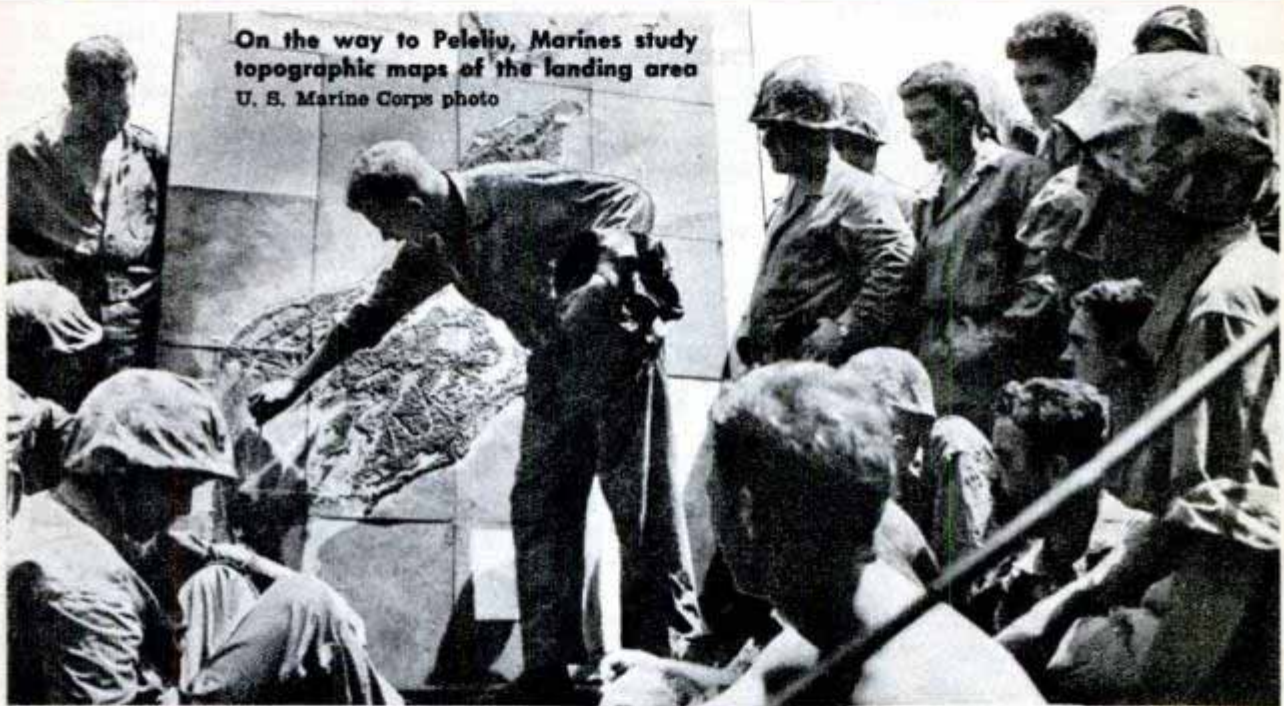

On the way to Peleliu, Marines study topographic maps of the landing area
U. S. Marine Corps photo

Waves tend to swing together when passing over a submarine ridge. High breakers result

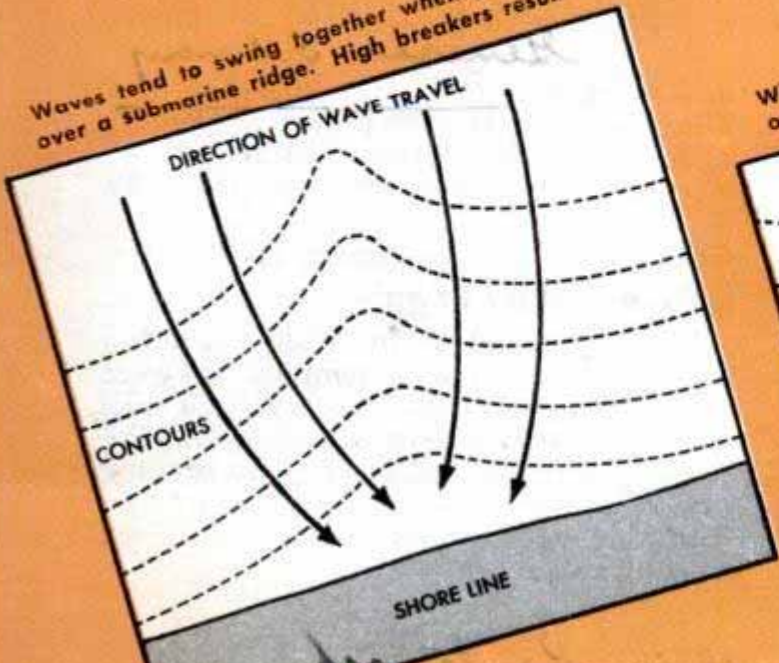

When passing over a deep channel, waves fan out, crests are stretched, breakers are low

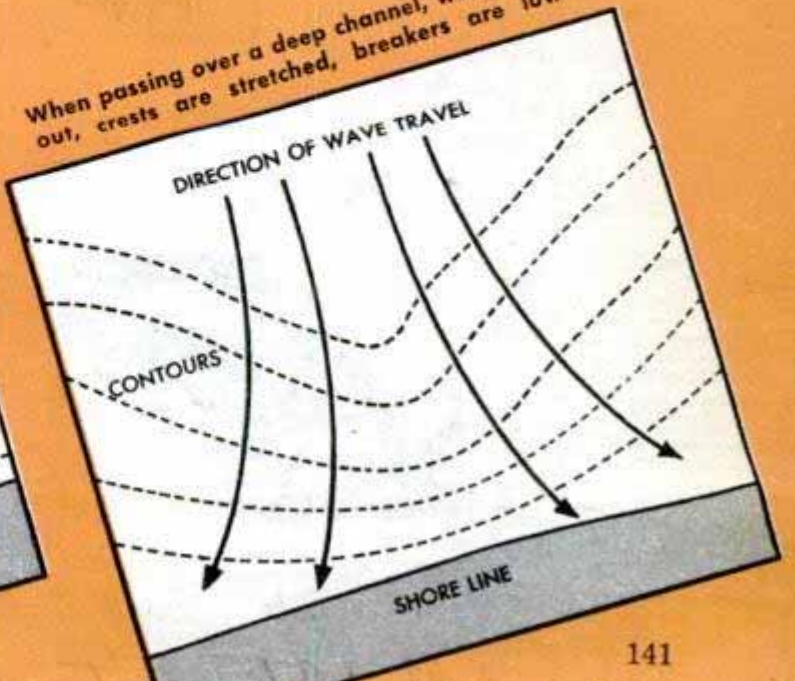



Room for two passengers to ride comfortably is provided in a three-wheel car powered by a 10-horsepower engine mounted over the rear wheels. The same company also builds one and two-passenger motor scooters driven by smaller engines of the same type. Overall length of the car is 80 inches. The

Two-Passenger Three-Wheel Car Has Engine in Rear

The 450-pound car will run up to 50 miles per hour and will deliver 65 to 70 miles per gallon of gasoline. Both engine and wheels are spring mounted. The scooters run approximately 100 miles on a gallon of gas and can travel at speeds up to 40 miles per hour.

wheelbase is 66 inches and the width 40 inches.

Driverless Tractor Stops Automatically If It Jumps Furrow While Plowing

Tractors used for plowing can be equipped with a two-wheel guide on the front which eliminates the need for a driver. The guide keeps the machine following a furrow around and around a field. It consists of an old-type tractor wheel guide and disk coupled to a bar about three feet ahead of the front tractor wheels. If the tractor does jump a furrow the power is shut off automatically and the tractor stops. When this happens the tractor must be started again by an attendant, but use of the device allows one man to keep several tractors in operation at the same time. The guide was



General Delivery

developed by F. O. Masten of Sudan, Tex. The driverless tractor pulled a plow 24 hours a day and reduced the man-hours needed to plow 420 acres from 1180 to 35.

Coal Conveyor on Dump Truck Is Powered by Engine

Power supplied by the engine drives a conveyor which quickly empties coal from a dump truck. It consists of a trough with an endless belt conveyor fastened to the truck bed. When the truck body is tilted the conveyor remains level, connecting with a delivery trough which also utilizes an endless belt conveyor.



Mr. James L. ... B. ...

10 Oil Pantograph

Pump Engine Drives Midget Automobile

Working without plans, Emory Kent of Wichita Falls, Tex., built a handsome midget automobile which travels 55 miles on a gallon of gas and speeds up to 50 miles per hour. It is powered by a five-horsepower pump engine. Its chassis is made from steel bed frames. Overall weight is 500 pounds. The car measures 86 inches from bumper to bumper and is 51 inches wide.

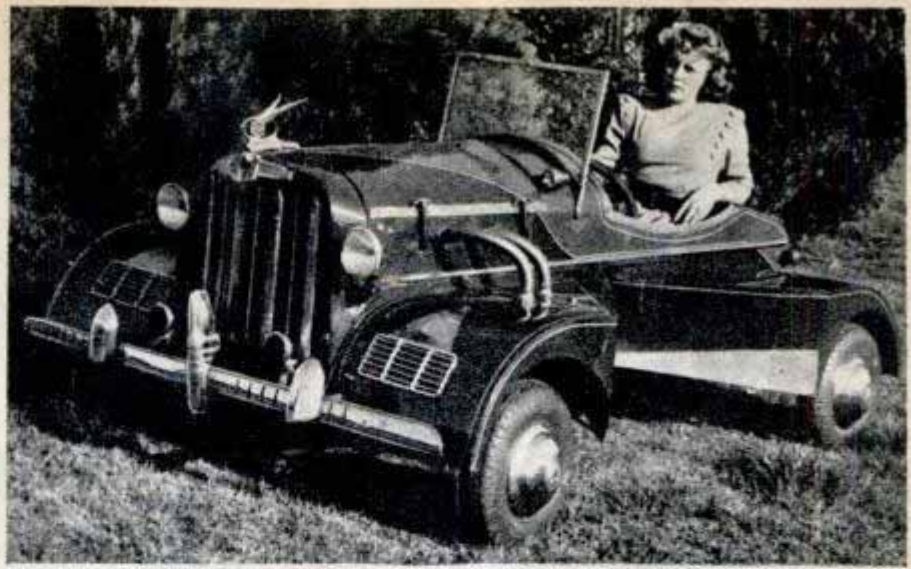

Giant Magnets Used To Make Atom Bomb

Electromagnets 250 feet long are used in atomic bomb production to separate U-235 from uranium compound. The compound first is vaporized, then ionized or electrified by passing through an electric arc. Then the electrified atoms are given a forward acceleration by passing through more "potent" electric fields. The accelerated atoms move at high speeds in a strong magnetic field which causes them to travel in a circular path. The lighter U-235 atoms travel in a smaller orbit than the

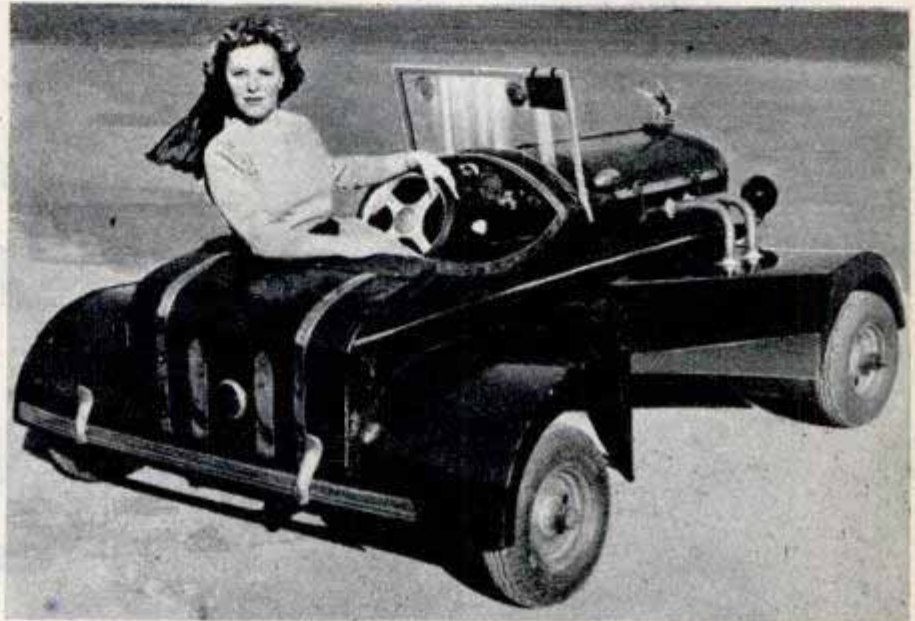

heavier U-238 atoms. At the proper point separate containers are placed to receive the U-235 and U-238 atoms.



Mechanical Caddy for Golfers Includes Comfortable Chair

Golfers can loaf over the course with a combination mechanical caddy and comfortable chair invented by Henry R. Sutphen of New York. The golfer's boon has been dubbed the "Takeitezy." Golf clubs are carried in a bag mounted on two wheels. An extension of the aluminum-tubing framework forms an adjustable seat. The inventor has patented another feature of the mechanical caddy—an adjustable handle that can be locked in any desired position to provide perfect balance regardless of the number of clubs in the golf bag.

☐ Popular Mechanics is always ready to supply further information to readers about various products described in any issue. Just write to Bureau of Information, Popular Mechanics, 200 East Ontario Street, Chicago 11, Ill., for a prompt reply.



*"Inside
Stubb"*
for
Your Home





3

- 1 Pressure cooker becomes a service dish when regulator lid is replaced by serving lid (inset)
- 2 Small grips on the handle of a spoon hold a knife and fork as a single unit in picnic baskets
- 3 Can opener turns the lid upward and also serves as a handle to empty contents of can into pan
- 4 Complete meal can be cooked on the dining room table with three-burner, fold-up electric range
- 5 Youngsters too big for high chairs can find the right fit in clamp-on seats attached to chairs
- 6 Plastic-coated plyboard cabinet has a ventilated hamper compartment and two small drawers
- 7 Chocolate or fruit-juice frozen "sticks" are made at home in plastic mold for use in refrigerators
- 8 Charts that contain 1000 color shades make it easy to select proper paint to match fabrics



4

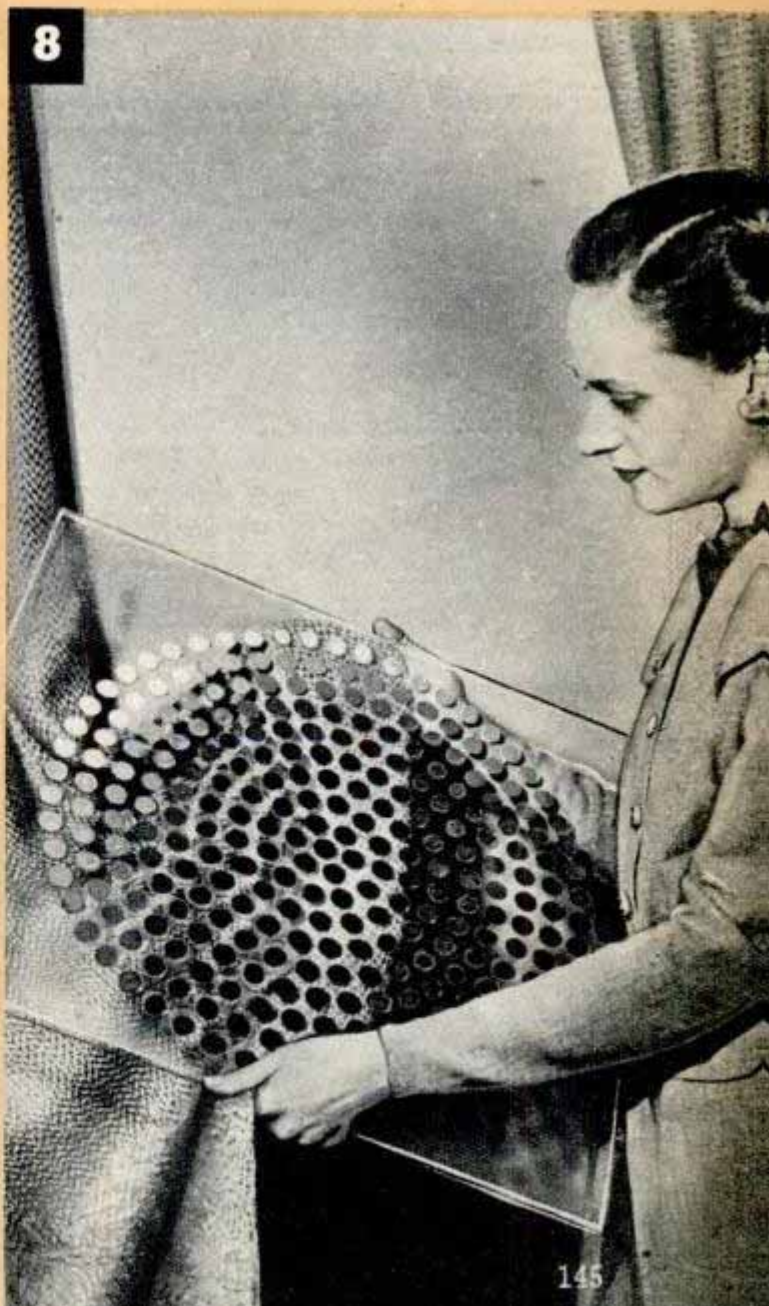

8

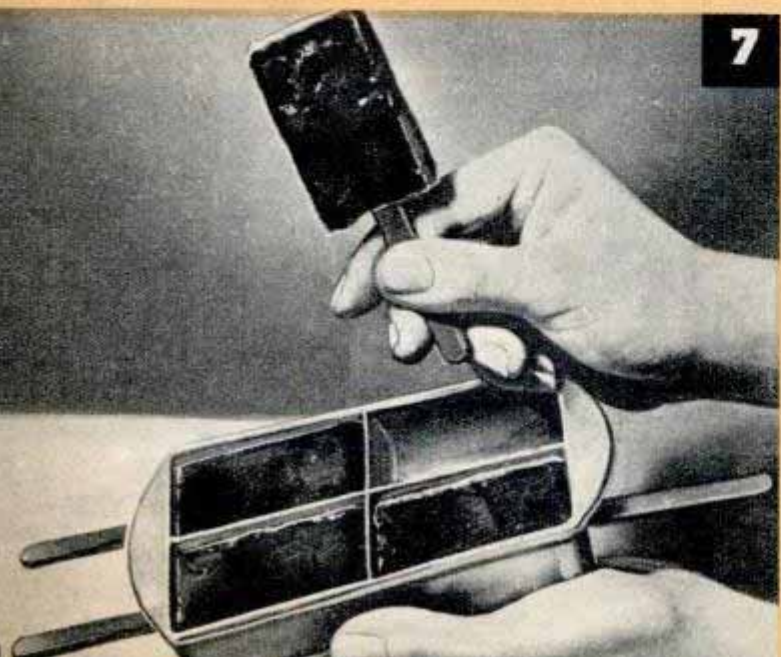

7



WALNUT HARVESTER has steel and canvas apron which catches nuts knocked down by men on attached towers

TRAILER HITCH has a universal joint which prevents overturning by providing swivel in all directions

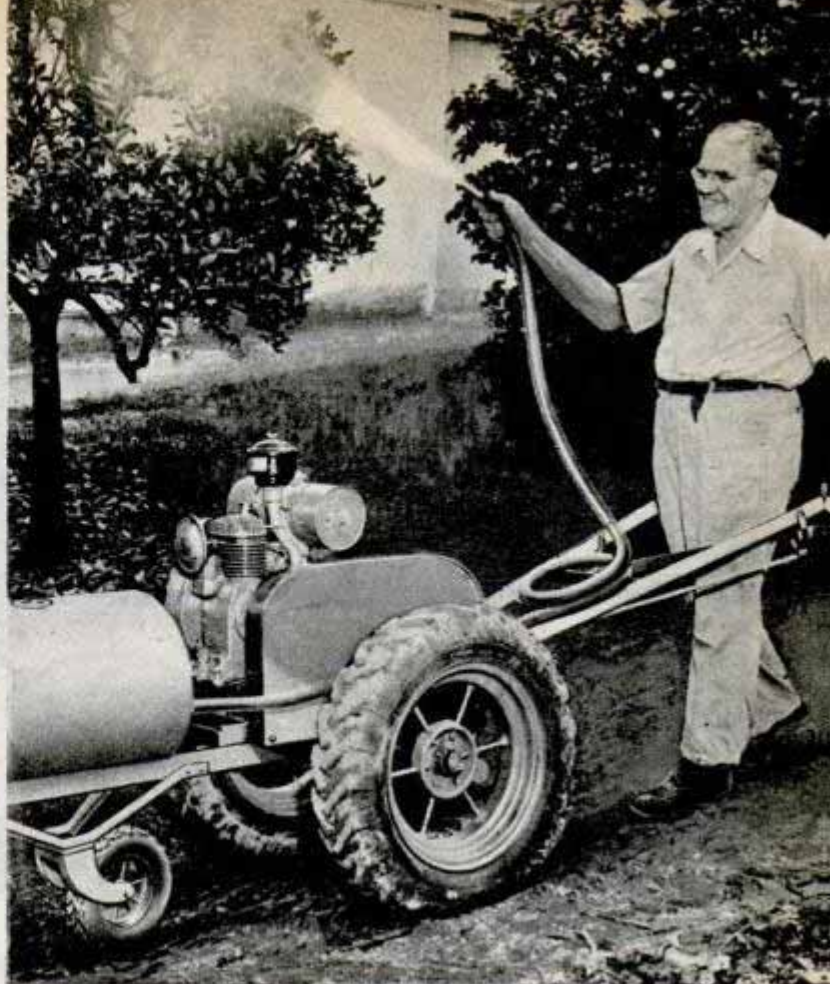

POWER SPRAY attached to garden tractor combats insects on trees and plants, develops 300-lb. pressure

FOOT-OPERATED tool selector on garden cultivator gives choice of plow, weeder, cultivator and hiller

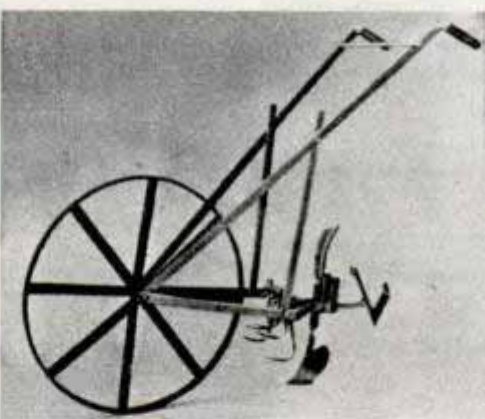
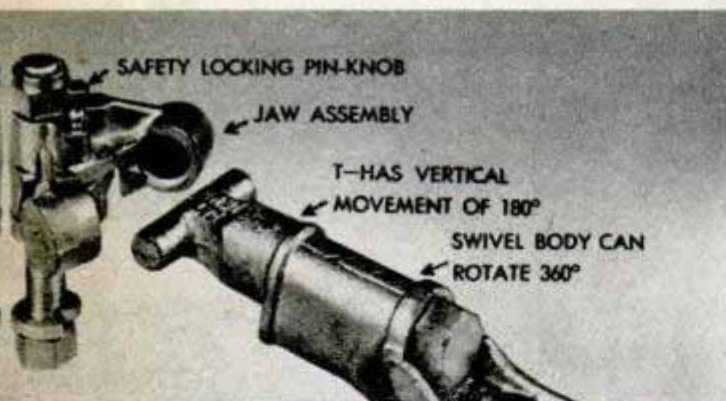

'Honeycomb' Structural Material Has Cloth or Paper Core

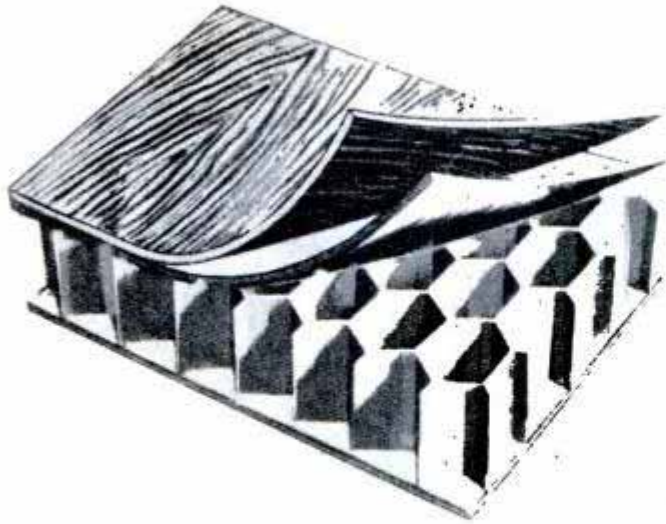

Resin-impregnated cloth or paper, formed into a "honeycomb" and covered with thin sheets of metal, wood veneer or plastic, has been made into what is described as the strongest structural material of its weight ever developed. Produced by the Glenn L. Martin Company and the U. S. Plywood Corporation, the material may be made with a core thickness of one eighth inch upwards and with width and length limited only by the size of the skin material and the dimensions of presses. Thickness of core and type of skin may be varied with load requirements. Wood veneer may be used alone when little stress is expected or it may be combined with a metal facing where load is greater. The material will be used both as flooring and in structural members of a new transport plane, and is expected to have wide use for walls, ceilings and partitions of railroad cars, in auto and motor truck bodies, and possibly in the home as doors, wall panels or furniture.

Machine Makes Oysters 'Yawn' For Quick Processing



Oysters "yawn" when placed in a machine that tumbles them about, sprays them with water and dunks them in a soda water bath to prepare for quick shucking. This process, developed by Dr. Herbert F. Prytherch, head of the U. S. Fisheries Laboratory at Beaufort, N. C., is patterned after the starfish practice of wrapping five arms around an oyster and injecting into its shell a natural anesthetic to cause the oyster to open up and permit easy access to its "meat." The "yawn" machine is said to save 25 percent of processing costs.

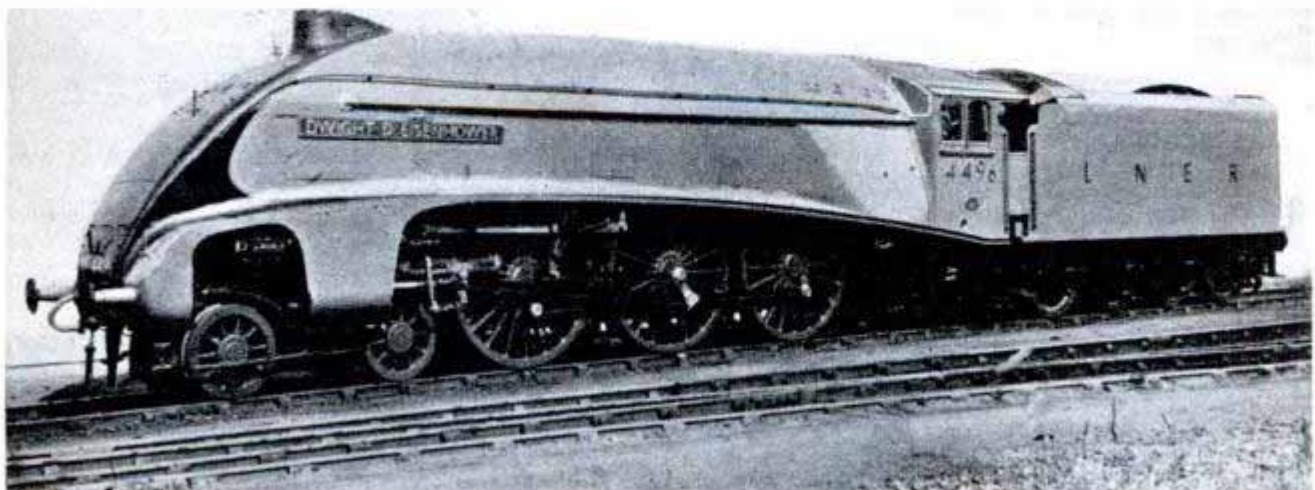

Associated British & Irish Railways photo

BRITISH TRIBUTE is paid to General Dwight D. Eisenhower by naming a locomotive in his honor. The locomotive is the first postwar streamlined engine to be placed in service by the London and Northeastern Railroad

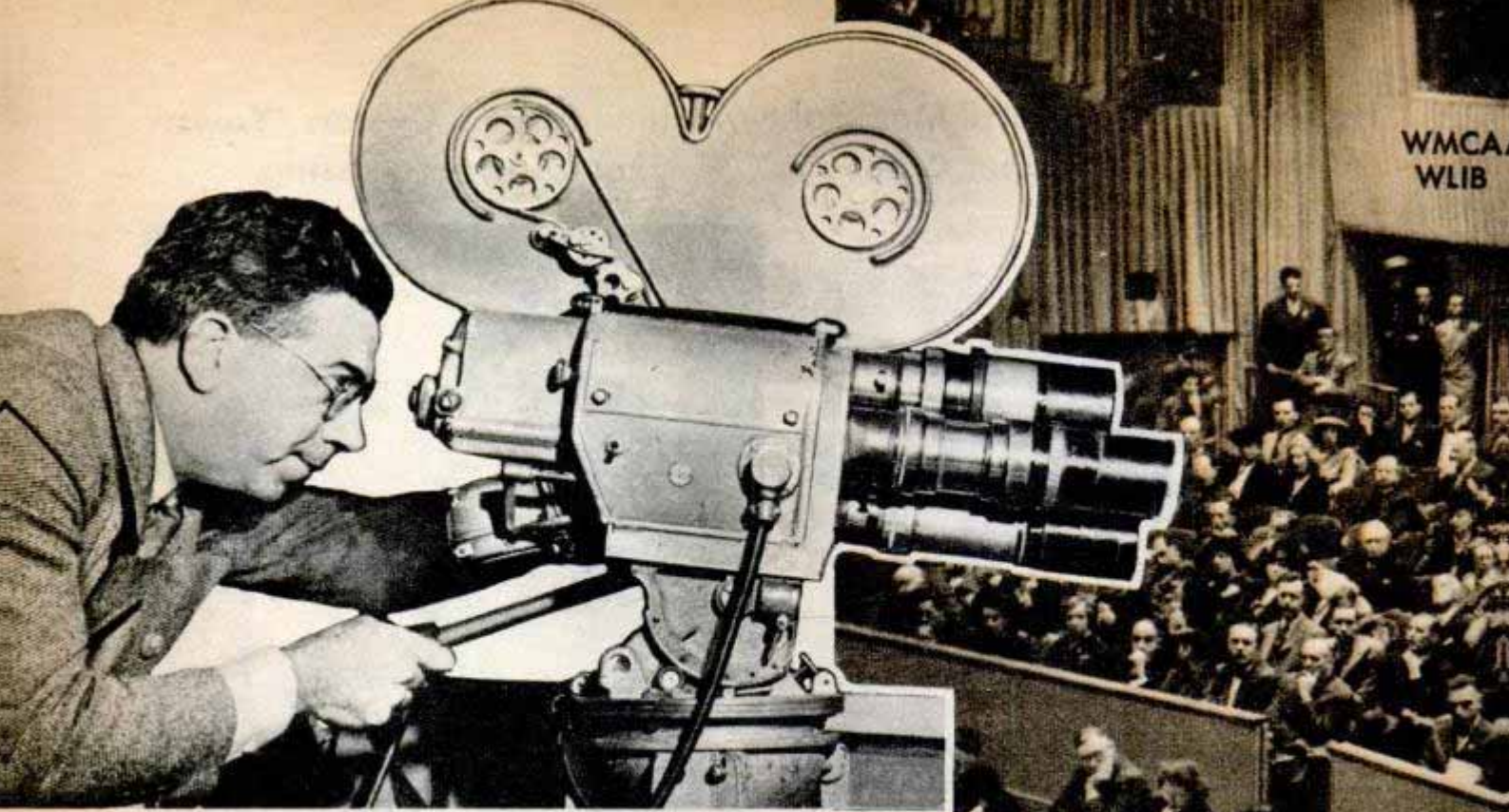

From Brooklyn to Bombay, the whole world receives day-to-day reports on the United Nations' deliberations via a vast communications network

TELLING

ELEVEN men sit around a boomerang-shaped table making world history. What they say and do may affect the lives of every man, woman and child alive today—from Salem, Mass., to Sydney, Australia.

But do they, members of the United Nations Security Council, perform their

By Bill Reiche

fateful chores in privacy befitting so solemn a proceeding? They do not! Joe DiMaggio hitting a climactic World Series home run is practically unnoticed compared to the intense concentration accorded the council by the news and communications organizations.

More than 700 correspondents were ac-

Edward R. Stettinius and James F. Byrnes, U.S.A.



Andrei A. Gromyko U.S.S.R.



Henri Bonnet France





THE WORLD

Official United Nations photos
Spectators, reporters, newsreel cameramen, newspaper photographers and radio announcers train their eyes on United Nations delegates

credited to the council, representing such diverse publications as the Sydney (Australia) Morning Herald, and Variety, the bible of show business, which conducts its operations from the fringe of New York's Times Square. The significantly named Ultima Hora—The Final Hour—of Bolivia was represented at the capital of the world,

temporarily set down in the gymnasium of Hunter College in the Bronx. Writers representing newspapers in Calcutta, Jerusalem, Tunis and Scranton, Pa., rubbed elbows with the representative of Vogue.

Radio—local, national, international and foreign—went all out to bring the council proceedings and reports of its actions to a

Trygve Lie
Norway

Sir Alexander Cadogan
Great Britain

Francisco Castillo Najera
Mexico





Monitor of sound control at the conference is Major G. R. Vincent. ACR antennas (below) at Brentwood, L. I., beam messages to the world



Communications flashed from the American Cable & Radio operations room (right) via transmitter (below) reach Europe in 10 minutes. Transmitting and receiving equipment handles 38 overseas circuits

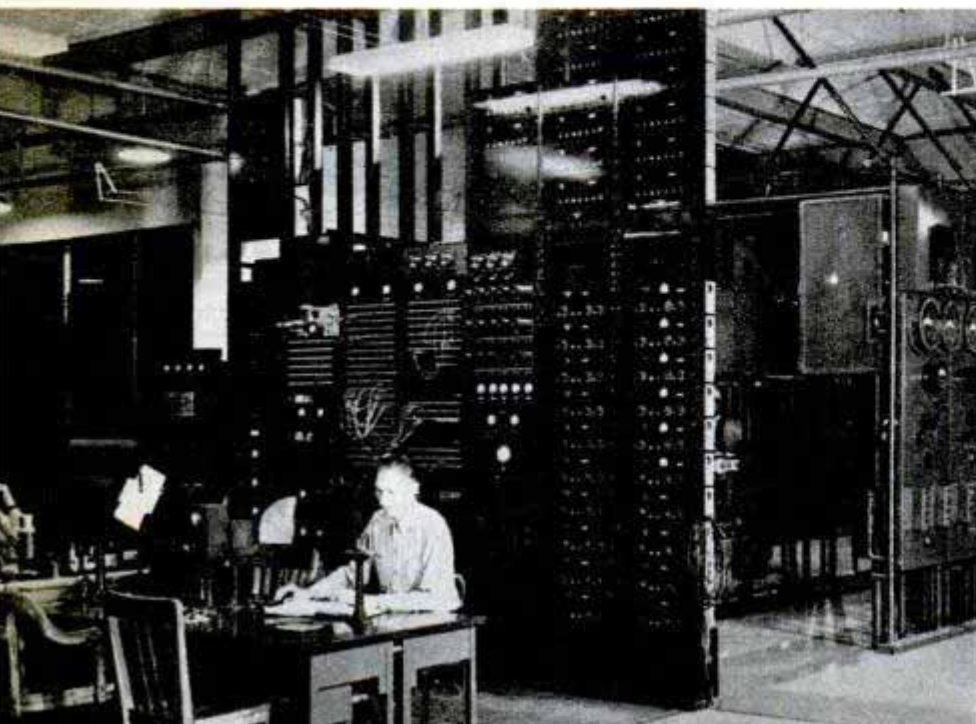

vast majority of the world's homes that have receivers.

Four national networks, three international broadcasting systems, three foreign networks, eight stations in the New York metropolitan area and 25 independent broadcasters throughout the nation provided radio coverage never exceeded and perhaps never equaled in history.

This accounts for the readers and the listeners. For those who wish to look at the proceedings there are five newsreels on deck and NBC television.

But even as an army is no better than its communications, a newspaper writer outside of his own city room is helpless without a sure link which keeps him in touch with his office—be it in Brooklyn or Bombay. For this outside corps of correspondents a vast network of telegraph and cable circuits covers the globe like a giant spider web; multiple radio channels for radiophone and radiotelegraph lace the world tightly.

Work horse of the team of communications organizations doubtless is Western Union, whose telegraph and cable facilities at the Security Council meeting are capable of handling more than a million words a day. Thirty-six wires, 20 teletypers and 16



lines for international Morse code link the former college swimming pool, where the press room is situated, to WU's telegraph and cable offices in lower Manhattan.

The copy can be transcribed and relayed from either office or a direct circuit can be established to the ultimate destination in instances where arrangement has been made to transmit a considerable volume of copy.

Let's follow a piece of copy from the moment it is completed by a Scandinavian correspondent sitting in the press gallery. He waves his copy and a Western Union messenger darts down the aisle and snatches it. With a few quick strides he is at the pneumatic tube that drops to the press room several floors below, beside which stands another messenger. He rushes the yellow sheets to an operator, who starts the message on its way to the cable office, many miles south near the tip of Manhattan Island. Transfer to the operator handling the wire to Sweden is swiftly accomplished and then the electrical impulses start their long journey under the north Atlantic.

Within an hour—frequently less—the foreign editor of the Stockholm paper is reading the dispatch his colleague wrote thousands of miles away.



Using a supersensitive image orthicon camera, an NBC television technician focuses his camera on the statesmen at the UN meeting



Calls from 500 telephones at the Hunter College headquarters of UN are handled on 12-position switchboards. Below, newsmen working in the press room. Left, radio commentator views a television screen





Newspapermen reach for copies of statement on Spanish situation by Poland's Dr. Oscar Lange

William H. Watts, Western Union chief at Hunter College, reported that the meeting had produced the heaviest cable file on a single subject in American history and that, as usual, the installation of equipment had to be finished in less than enough time.

"When we started to put our machines in here," he said, "there still was water in the swimming pool," and he tapped the temporary floor that covers the "old swimmin' hole" of the collegiate nymphs.

He said the press and communications setup had been so well arranged that there had been few untoward happenings. He did recall that one correspondent came to grief because he knew too many languages.

When Andrei Gromyko, the Soviet representative, made his historic withdrawal from the meeting over the Iranian question, he did not actually depart when he said he would. He waited for his words to be translated into English and French before making his exit. Apparently only one newsman understood Russian and he was off like a rabbit as the words fell from Gromyko's lips.

He might have had a beat of several minutes on all his colleagues of the press, but his locomotion was not as

skilled as his linguistics and he fell down an entire flight of stairs. By the time he pulled himself together his time advantage had been considerably narrowed.

RCA Communications is prepared to transmit 200,000 words a day via the air waves—chiefly to European newspapers and press services—but seldom reaches that quota since the maximums are set to handle earth-shaking events which will have every writer pounding his typewriter into a white heat.

This organization boasts that it has transmitted stories from the press gallery to Gothenburg, Sweden, in 10 minutes, but human fallibility sometimes slows down the process. A European correspondent filed his dispatch after obtaining his information from an English language transcript of the day's proceedings. Then he discovered a discrepancy in the French translation. The message was practically stopped in midair, with its extremities in two continents, while the harried reporter figured out which version was correct.

The RCA routine is much the same as Western Union's: correspondent to messenger, to teleprinter, to downtown office. There the message is put on the

(Continued to page 248)

Steel Armchair Folds Into Compact Bundle

By merely detaching two clamps and a cross bar, a full-size spring-steel armchair designed for either porch or outdoor use can be folded into a small compact bundle for easy carrying. Only four thumb bolts need be loosened to take the chair apart for folding. The frame is of white enamel and the posture-form seat, finished in Chinese red, apple green or canary yellow, is shaped for comfort. It is light in weight and its finish is rust-resistant. It can be assembled just as quickly as it can be folded.

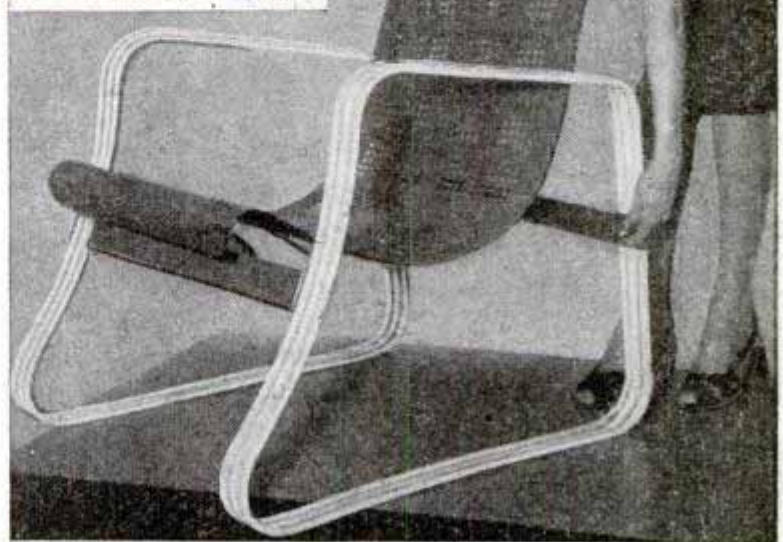

Positive Cure for Malaria Reported by Scientists

Positive cure for malaria in white patients is now said to exist. Designated only as SN13276, the new drug's value as a cure for Negroes, Chinese and other dark-skinned people must be tested, it is reported to the American Chemical Society, before it can be used for their treatment. It is chemically related to a previously known drug, pamaquin, which had curative properties but could not be used because it was too poisonous. The new cure is more effective and less toxic to human beings. In the same campaign against malaria, tests with young chicks have revealed a new

group of synthetic chemical compounds, known as alpha-aminocresols, one of which is 75 times more effective than quinine. Approximately 100 compounds in this group have been tested. While bird malaria is not identical with the disease in man, it is similar enough for testing purposes.

Parke Davis, Squibb

Power Drill That Rides the Rails Can Be Operated by Only One Man

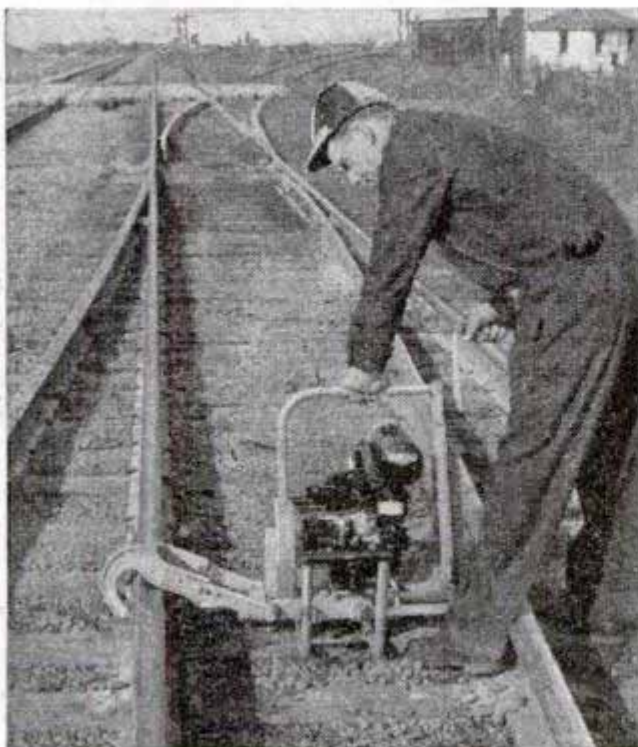

One man can operate a new 130-pound power drill for railroad track maintenance that bores bolt holes in rails of any weight. The drill uses less than one quart of gasoline in eight hours of operation. Because it rides directly along the rail, one man can easily push or pull it into position. The bit can be raised or lowered for accurate drilling, while a crank controls the direction and speed. A spindle chuck is available for drilling holes $\frac{3}{4}$ to $1\frac{1}{2}$ inches in diameter. Tests show a saving over manually operated drills of 20 cents for each bolt hole that is bored, according to the manufacturer.

Every day new products for homes and workshops, farms and factories, are appearing on the nation's markets, and every month you'll find them described in Popular Mechanics. For additional information about these products, write to Bureau of Information, Popular Mechanics, 200 East Ontario Street, Chicago 11, Illinois.



From this pipe line spews forth land-building sand scooped from the mountains of Southern California. Below, giant rock is lifted into place atop dike that is pushing land farther out into Long Beach Harbor



PUTTING A *MADCAP RIVER* TO WORK

By **RICHARD W. EMERY**

Photos by Ray Chapin

FLOOD-CONTROL experts were the only ones who took the zany Los Angeles River seriously until Long Beach Harbor engineers put the temperamental stream to work.

From the hills above Hollywood where the river originates to its mouth along the ocean shore at Long Beach the stream bed lies empty, dry and sun-baked most of the year, lizards dozing on its sandy bottom. Easterners look at the dry channel and laugh.

"Some river!" they say.
"Where's the water?"

When Southern California's rainless summer ends, flood-control experts inspect the 60-mile winding channel. They fret about the next flood. They know the river's Hollywood temperament.

Ordinary California rainstorms have little effect on the river. Even a downpour won't fill the dry banks. Only a hard, driving rain that falls steadily, day after day, until the earth won't absorb another drop will transform the sandy river bed into a roaring, turbulent flood.

Then muddy water spills down the slopes of the Santa Monica and Verdugo Mountains, the San Rafael Hills. Storm drains funnel the flood into the river channel. The Los Angeles River comes to life. From its sodden banks spectators respectfully eye the sweeping milk-chocolate current. Down through Movieland the river churns, scooping mud from around Studio City, Universal City and the

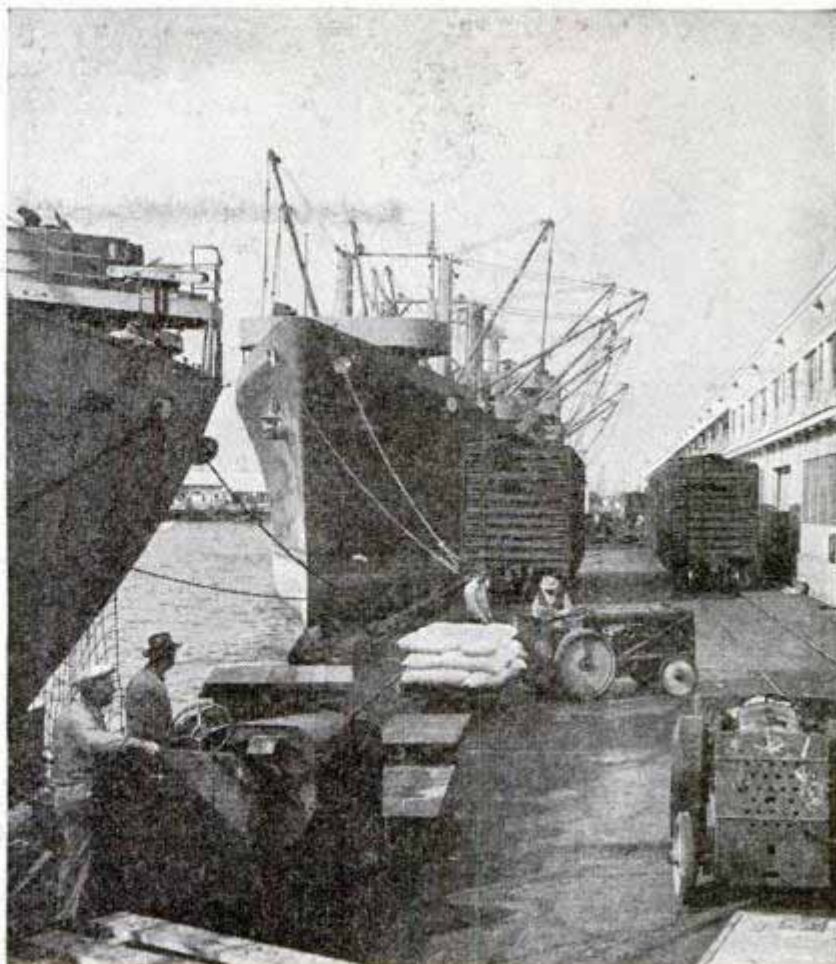

Ships unload at a completed pier in the harbor. The land was built of silt from the Los Angeles River. Below, sandy channel of the river (foreground) sweeps past the harbor



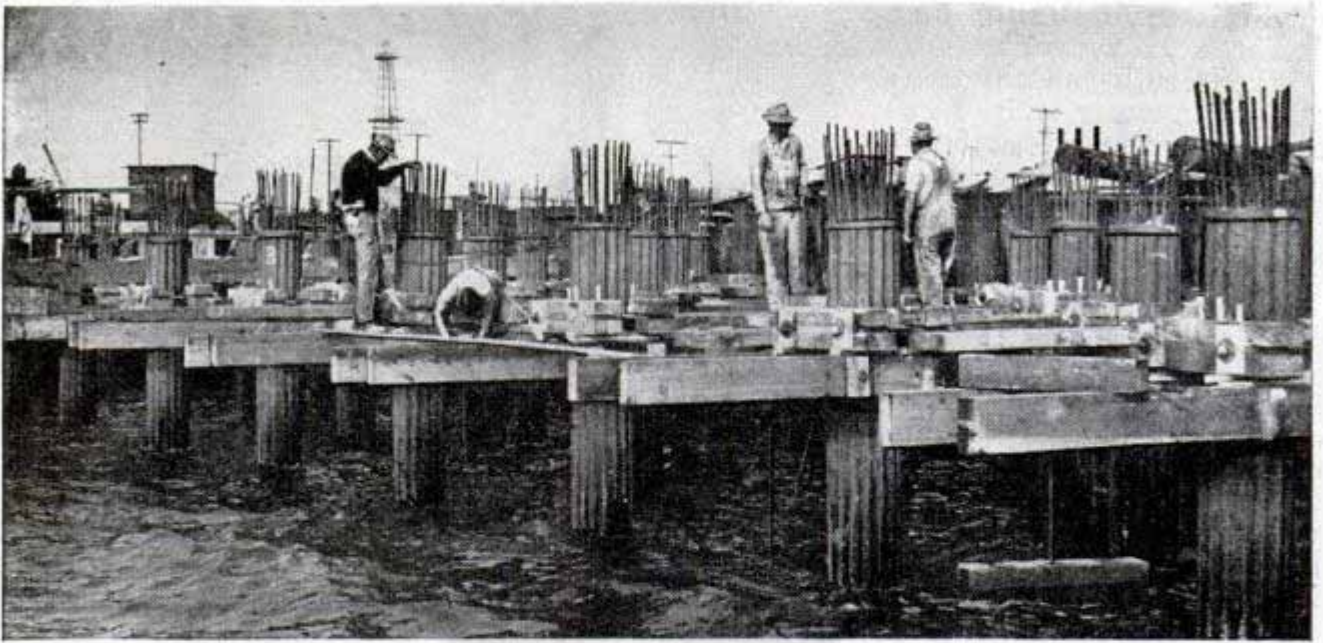

Reinforcing rods for pier are placed in tubular piles that sink deep into the earth 40 feet beneath water surface

Walt Disney Studios. Southward, around Mount Hollywood, it strikes a foaming curve. Then, right through the heart of Los Angeles, the West Coast's most populous area, it hisses, eager to reach the sea.

At times the rampaging river has borne on its crest such trophies as bridge timbers and chicken coops, shingle roofs and palm trees. When the water subsides, beachcombers have found rattlesnakes, pigs, dogs and chickens along the river bottom.

But derelict debris is not all that the madcap river carries at flood time. It hauls sand. Sand by the millions of cubic yards. Sand from Hollywood hills and lowland suburbs, from Van Nuys, Burbank, Glendale, Los Angeles and Long Beach.

A few years ago the stream dumped its load far and wide into the ocean, where currents swept the sand away. Now Long Beach Harbor engineers are transforming the sand into dikes and harbor areas.

The Port of Long Beach is the east section of a crescent-shaped harbor several miles long. It is protected from the open sea by federal breakwaters lying three miles offshore in 50 feet of water. The Port of Los Angeles occupies the west section. In the early months of the war the Navy acquired a mile and a half of the Long Beach waterfront and built the \$100,000,000 Roosevelt Base. The Port of Long Beach had counted on the land for future growth. After losing it to the Navy, the port faced

Ten million cubic yards of sand carried by the capricious river were poured into these moles and piers

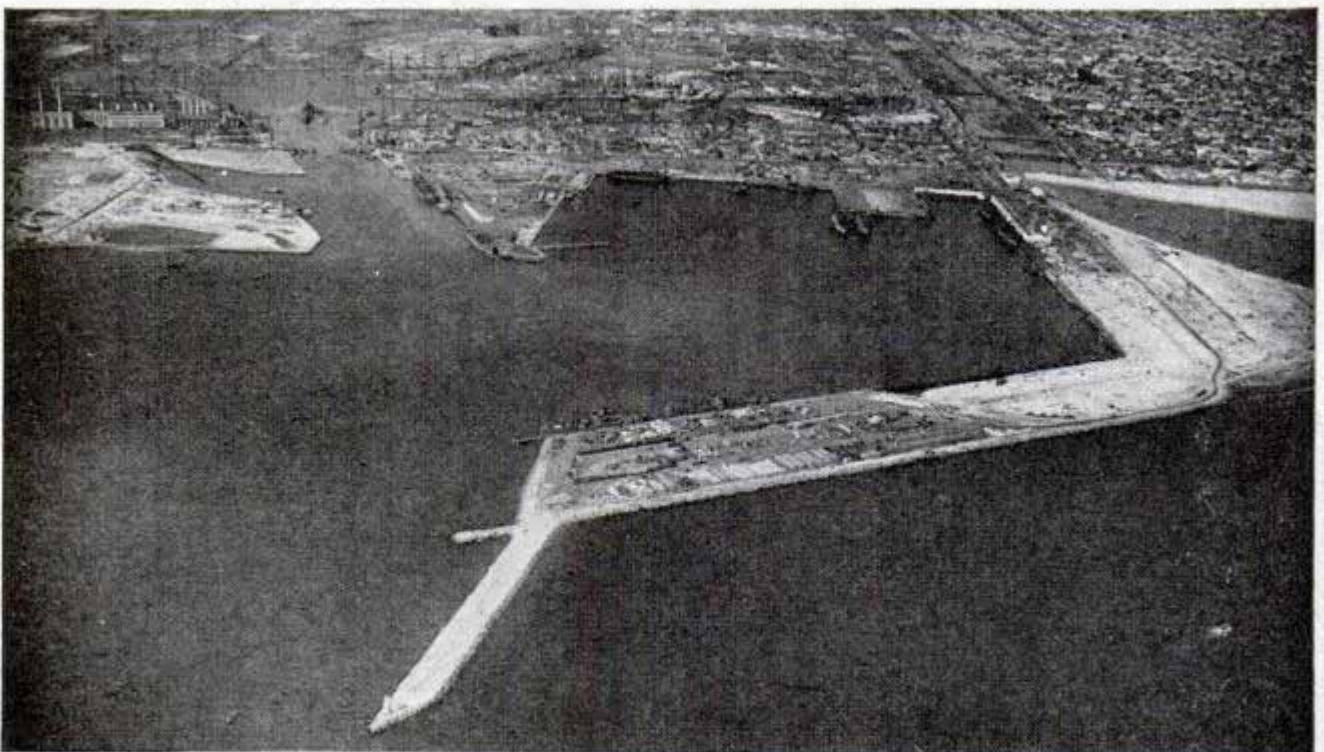

the task of building new land in outer harbor depths.

Back in 1937 the Port of Long Beach struck oil on its own land. By 1938 oil revenue was pouring into its harbor development fund at the rate of \$3,500,000 per year. The Board of Harbor Commissioners fostered a plan for creating huge land fills. Upon the fills would be built the most modern marine terminals and harbor facilities that could be designed. The board laid out a \$59,000,000 "Comprehensive Plan."

But problems faced Port Manager Alois J. Amar and his chief engineer, Robert R. Shoemaker. The Army wanted to keep the river mouth open to prevent inland floods. Both the Army and the Navy wanted harbor facilities.

The Port of Long Beach, with oil wells bristling from its land, naturally pushed land-building operations. New land would provide port facilities and space for more oil wells. And here in the river was sand for land-building—sand which would be replenished every time the river went on a rampage.

While the river dozed through the hot

summer, workmen constructed a curved jetty of granite, leading southeast into the harbor from the river's west bank. The next time the river came foaming out into the ocean, sand-laden and angry, it bumped headlong into the jetty. The current whirled and eddied—then dropped its sand.

Big dredges came to eat into the silt on the harbor bottom, driving it through pipe lines to areas enclosed by new dikes. The areas became solid land and the port builders constructed wharves, warehouses and railways.

Through the war years, the port invested \$7,000,000 in new construction. Ten million cubic yards of sand carried by the Los Angeles River went into the construction of moles and piers. The Army took over many of the new facilities for its port of embarkation. On June 30, 1945, the port launched its \$14,735,000 "Five-Year Plan" for constructing the next units projected in the "Comprehensive Plan," which looks forward some 20 or 25 years.

Future construction will require 30,000,000 more cubic yards of sand. But the Los

(Continued to page 220)

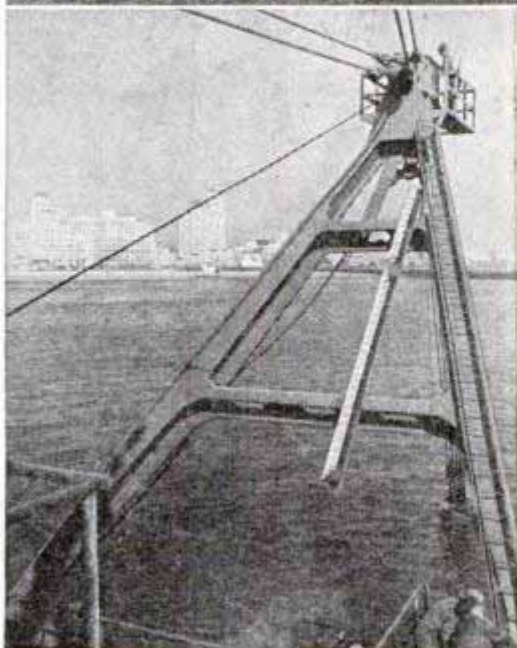
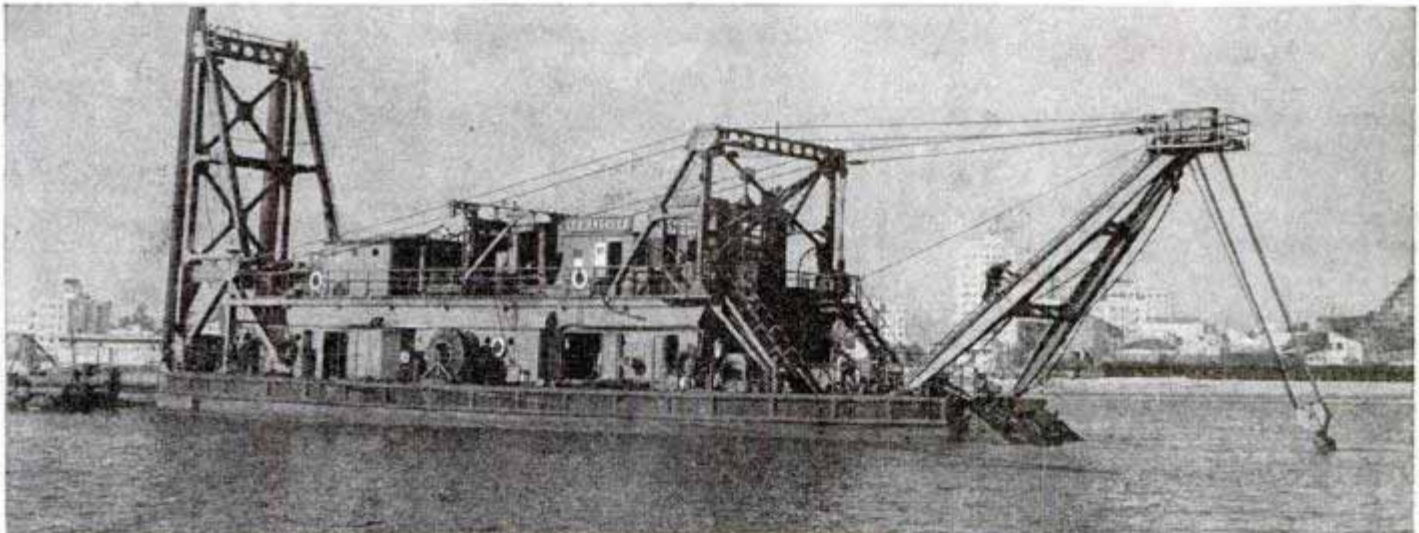

Fifty feet beneath this giant dredge its cutter is biting into the sandy floor of the ocean, boosting silt through a pipe line to new land fills

★ ★ ★

Left, giant A-frame supports the five-bladed rotary cutter on dredge that eats into the sandbanks. Numbered scale tells depth of cutter

★ ★ ★

Right, levorman's problem is to keep a steady flow of solid material in suction line. Overloading with solids may stop flow, cause delay





"Party Line"... In Code

BBETTER control of production and record keeping is made possible with a voiceless communication system for factories. To eliminate possible errors in voice transmission, messages are sent in easily remembered code simply by dialing letters and numbers on a dial similar to that used on telephones. One central unit is employed with as many substations as are needed. As the message is dialed it remains recorded until cleared at both stations. This system is highly flexible and can be used to show when new orders are received, the quantity and products for which the order calls and its progress through the factory until its shipment. The system also can be employed to keep a check on raw materials, machine breakdowns, time and cost records and other data. When an operation is finished, the data can be sent to the central station to provide a complete picture of operations.

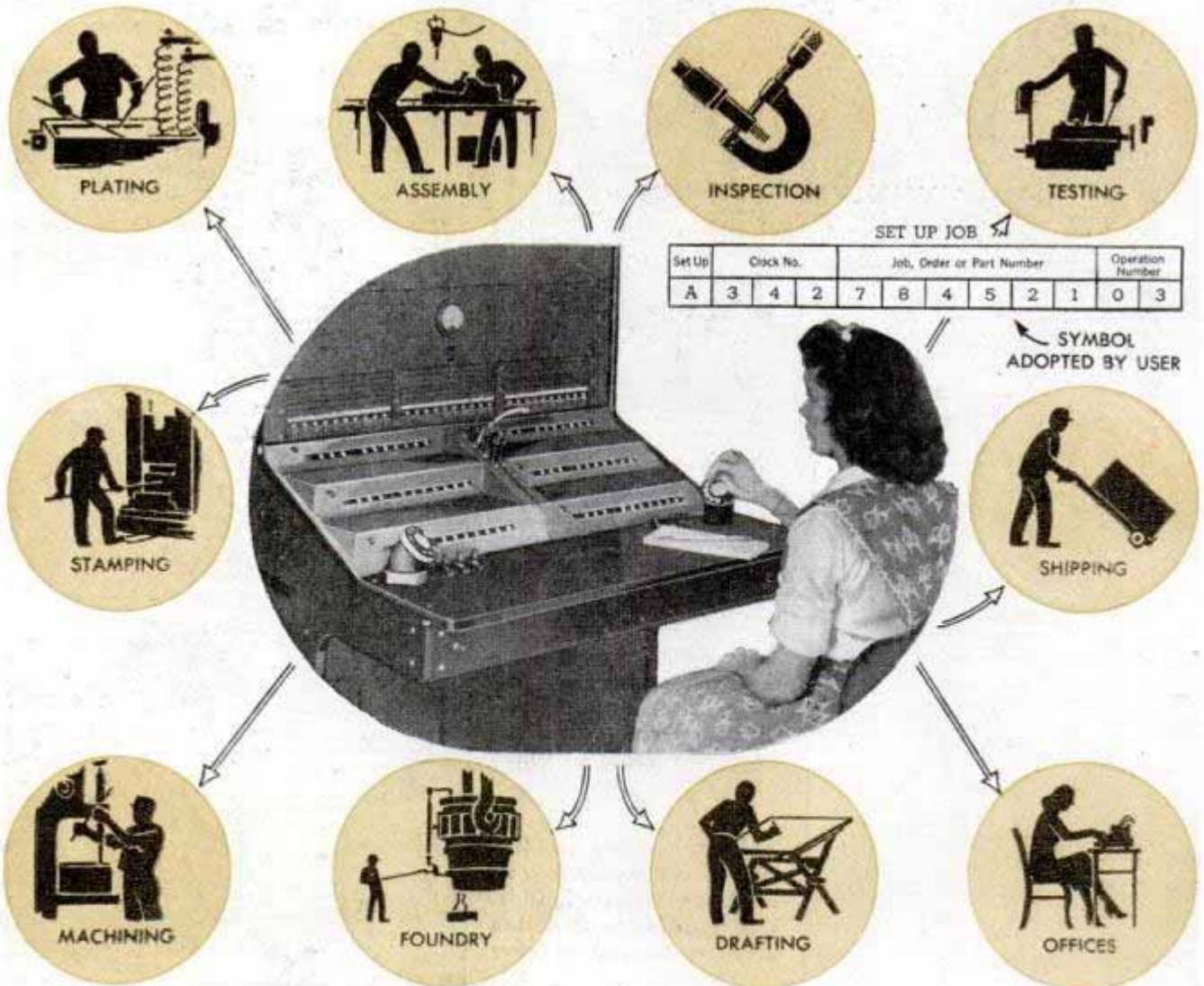

Cork Oak Tree Farms Boost New U. S. Industry *Cal.*

Production of cork for a thousand or more useful tasks is fast becoming a big American industry although the Mediterranean was our chief source of supply a few years ago. In California alone more than 4000 mature cork oak trees, some dating back to the days of the Spanish settlement, supply bark from which many tons of cork are produced. Since 1940, countless acorns and more than half a million seedlings have been distributed, free of charge, by the Western Crown Cork and Seal Company so more and more

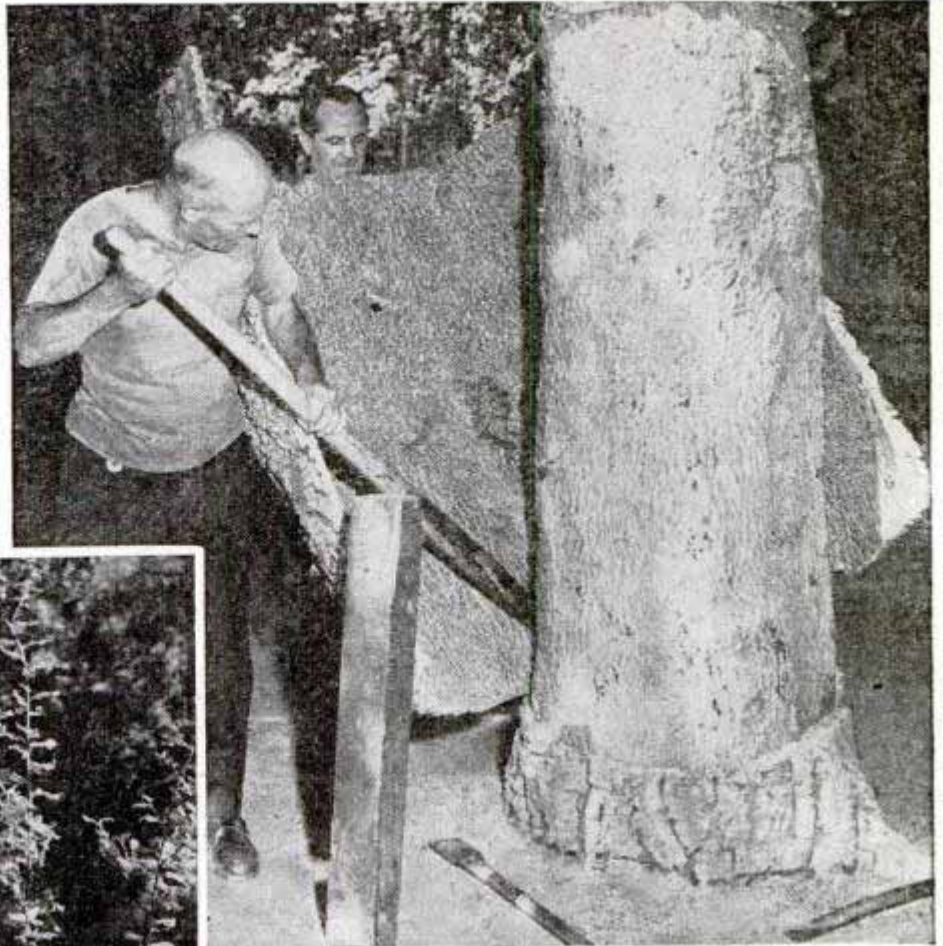

From seedlings (left) grow cork oak trees which are stripped every 10 years to yield a rich harvest of cork bark. Strippers use Portuguese ax to remove the tough bark



cork oak trees will be grown. It requires about 15 years for a tree to reach the productive stage, but the trees live 150 to 400 years. Some huge trees yield as much as 1050 pounds of good quality cork. In preparing cork for commercial use, slabs are removed from trees and allowed to season in the sun for two weeks. Then the slabs are placed in vats where the bark is softened and dirt, sap and tannic acid are removed. Then the bark is dried and made into bales weighing from 250 to 500 pounds

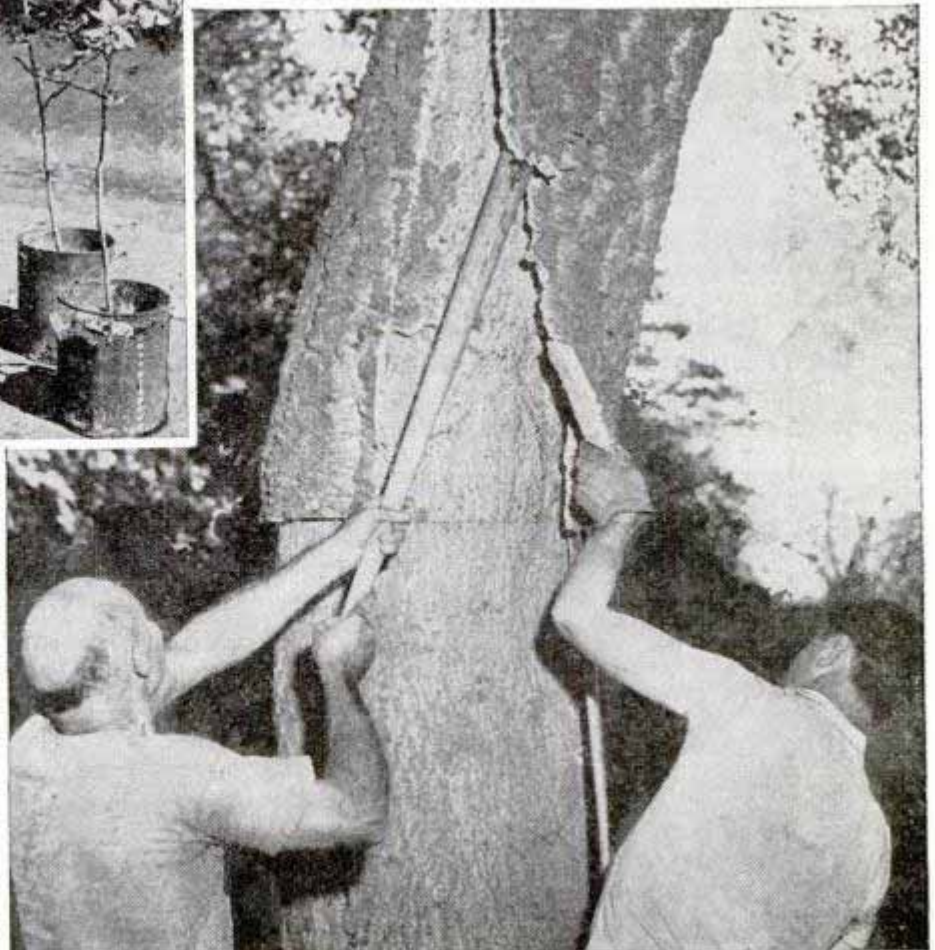

Pencil-Meter Is Help to Golfer Approaching Green

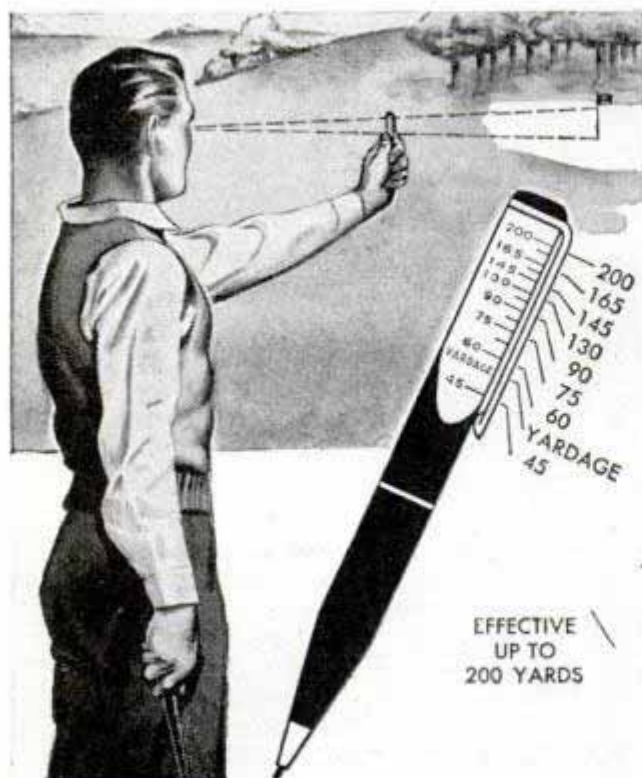

Guesswork in judging distances is avoided with a pencil having a graduated scale designed to aid golfers. The golfer, when approaching the green, holds the pencil at arm's length and sights over it to the flag. The place where his line of sight to the base of the flagpole crosses the built-in scale will tell him the distance to the cup and the proper club to use for shots of that distance.

Collapsible Live-Bait Container Saves Space in Car or Boat

When collapsed for carrying in a luggage compartment or boat, a rustproof, portable live-bait box occupies less than a cubic foot of space. When assembled, the rustproof box is 20 inches in diameter and 12 inches high. It can be collapsed or assembled in less than one minute without tools.

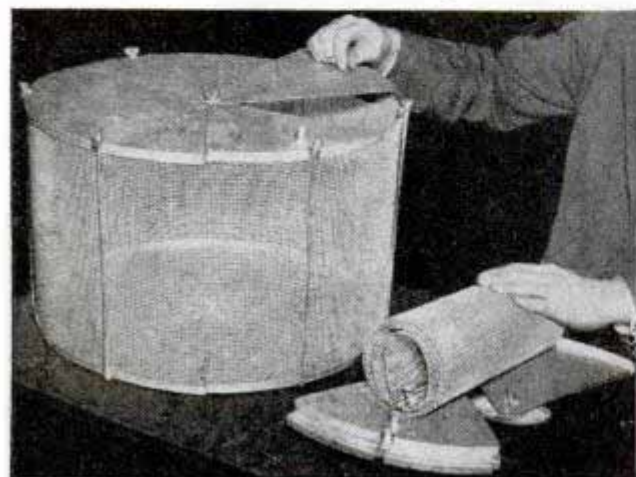

"Snap-On" Fluorescent Shield Reduces Glare From Tube



Glare from fluorescent lights is eliminated by a shield which diffuses the light evenly and reduces eyestrain. Made of aluminum, the decorative white enamel fixture fits over fluorescent tubes and is clamped on with snap-on clips that require no screws or bolts. The shields are available in 20-inch lengths for 20-watt lights and 48-inch lengths for 40-watt lights.

Dolly "Totes" Outboard Motor

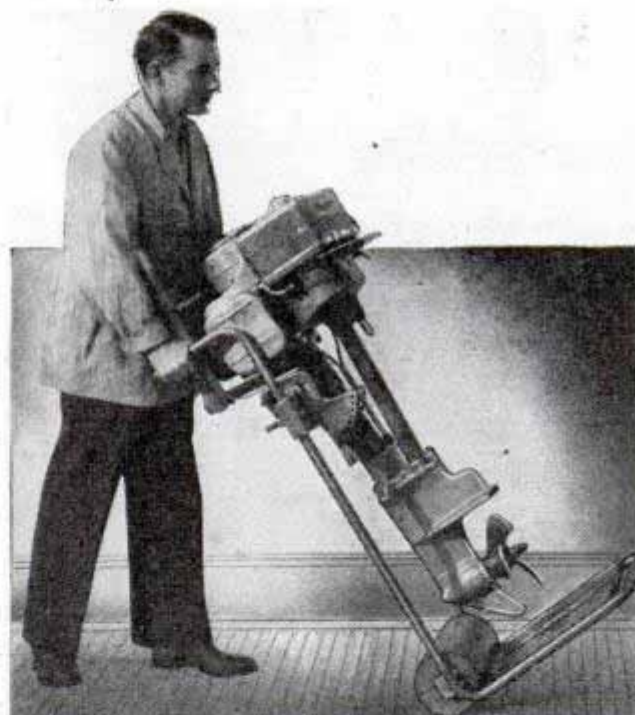

Outboard motors can be transported to and from the waterfront by a combination dolly and motor support. Providing a support in upright position for adjusting motors, the unit can be tipped over to hold the motor in position for servicing. While in upright position the motor cannot be tipped over accidentally. A removable drip pan catches leaking oil and a large steel roller prevents sinking in soft ground. The unit is available in two sizes to handle up to 60-horsepower motors.

The Craftsman

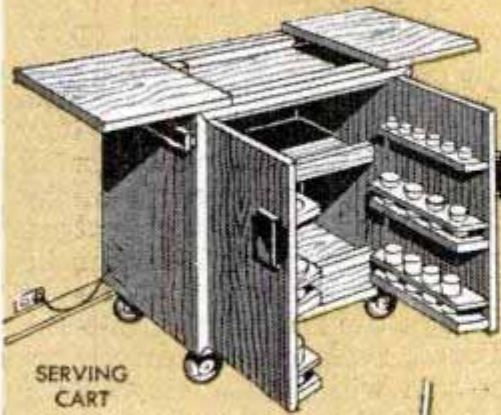

SERVING CART

Are you looking for a place to live, at least temporarily? Then turn to page 170. We're not suggesting that you start chopping away at your neighbor's favorite elm, but the log-cabin story may present a partial solution for your housing need. It tells how you can build an attractive cabin from various types of logs, some field stone and odd pieces of used lumber. Of course, when it's finished you'll want to take a picture of it to show around—one that has good composition—so try "shooting" through a mask as told in a photo yarn on page 188. There'll be days, too, when you'll have to take a rain check on outdoor activities and that will be the time to get going on the unusual serving cart described on page 162. It's a kind of rolling "butler" from which to serve buffet style at mealtime. Also along the shop line, a feature on page 202 acquaints you with a short cut in laying out sheet-metal patterns, and on page 181 there's an excellent article on making air filters for your windows. Besides these feature stories, there are many other practical ideas to keep you going till we come around next month

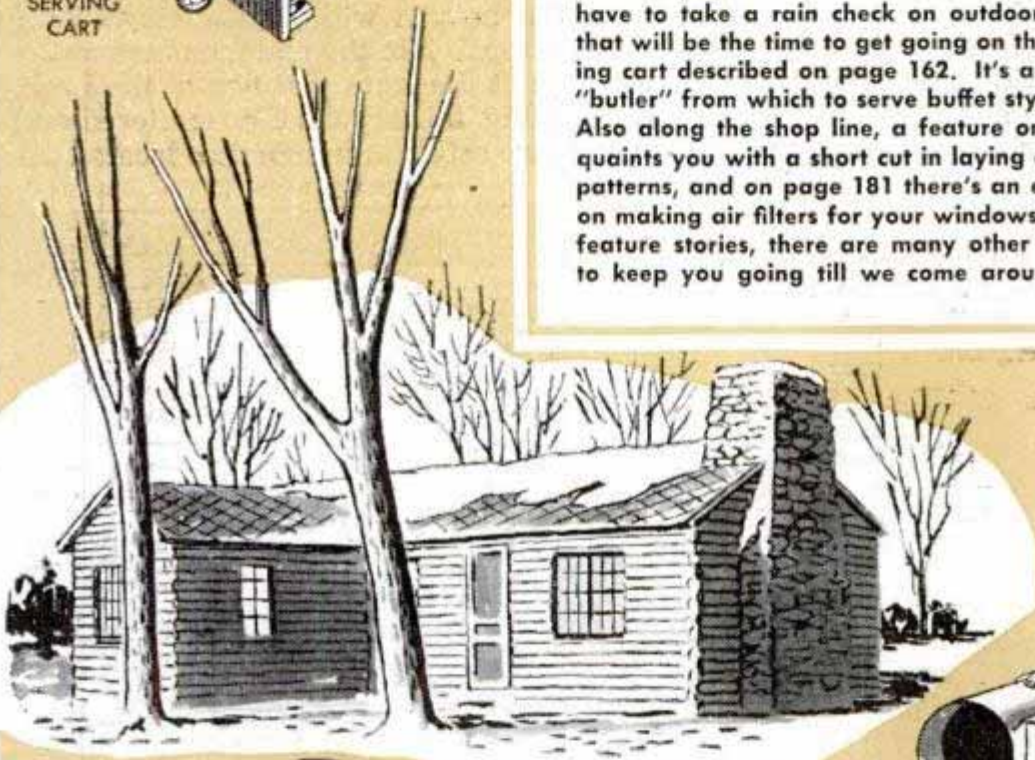

LOG CABINS



SHEET-METAL LAYOUT



ROOM DUST FILTER



PHOTO COMPOSITION

Utility *SERVING CART*

WHETHER it's your turn to entertain at bridge or you're just having the neighbors in—that's when you'll want to wheel out this smart looking serving cart. It's just the thing beside the bridge table for coffee and light snacks, or to assist in serving at a small dinette table. There's plenty of space for dishes and glassware as indicated in Fig. 4, and the divided top slides back to reveal a metal tray and an outlet to plug in a toaster and electric plate as shown in Fig. 3. The whole thing closes up into the neat little cabinet in Fig. 2 which can be pushed into a corner out of the way when not in use.

Construction is a fairly simple joining job as detailed in Fig. 1. Although standard $1\frac{1}{16}$ -in. solid stock is called for, which allows $\frac{1}{16}$ in. for dressing, construction can

Streamlined version of the tea wagon is wired for toaster and electric plate. Has plenty of room for dishes and glassware

By Gene Russell

be of $\frac{3}{4}$ -in. plywood if the dimensions are changed and minor alterations are made in the assembly. Panels for the sides and bottom of the cabinet are built up in width from several pieces

doweled and glued edgewise. From the pull-apart view in Fig. 5 you can see how the pieces go together. Note that a small beading is run on the inner edges of the panels. If the mitered corners specified are difficult for you to cut, the pieces can be butted and fastened with screws driven at an angle through the bottom and into the side. If mitered, nails can be driven up from the bottom without showing. Four rabbeted rails join the end members at the top, two at the front and two at the back. Note in Fig. 5 that rails J are mitered and rails L are set flush in mortises located ac-

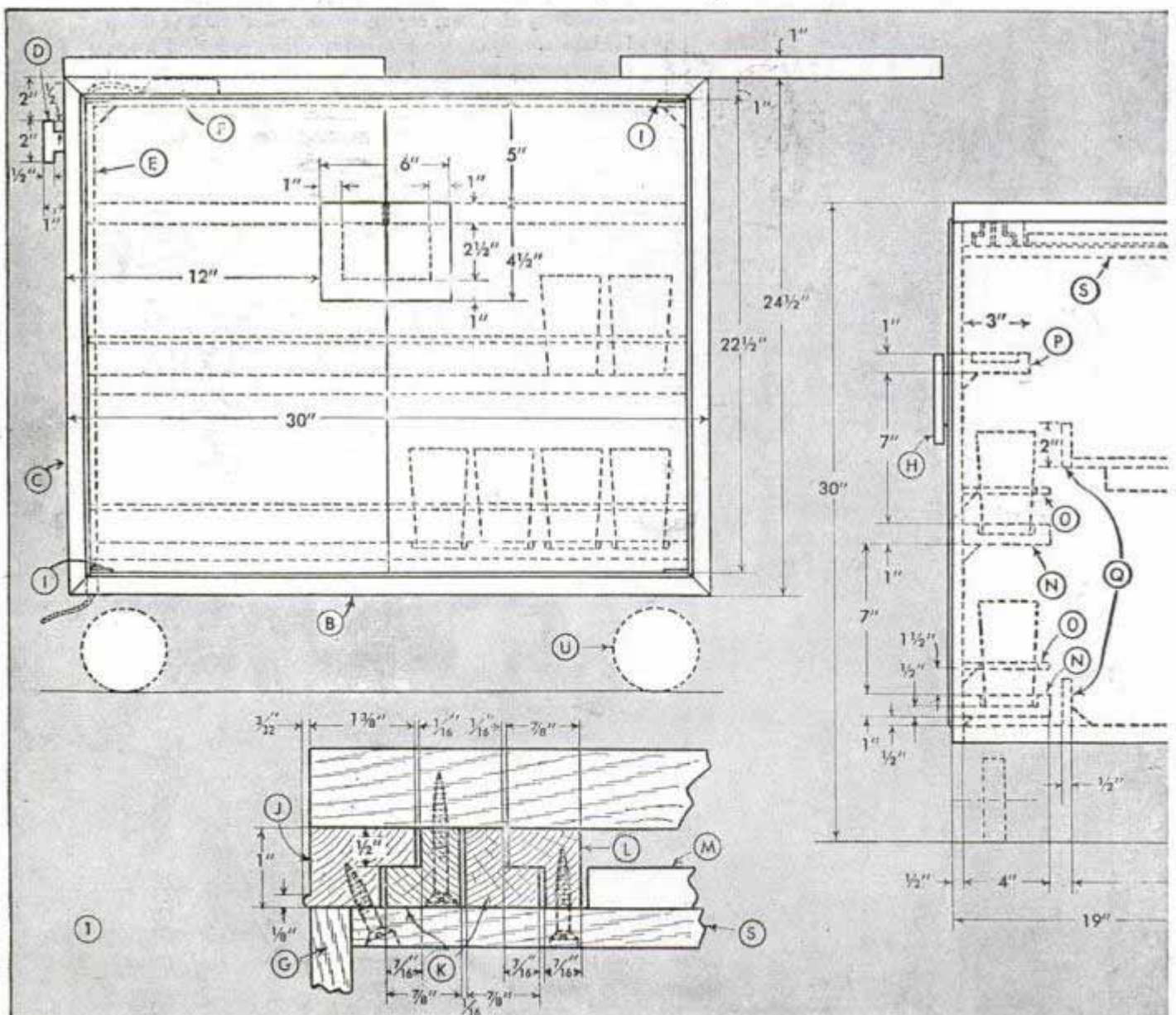

is Smartly Styled

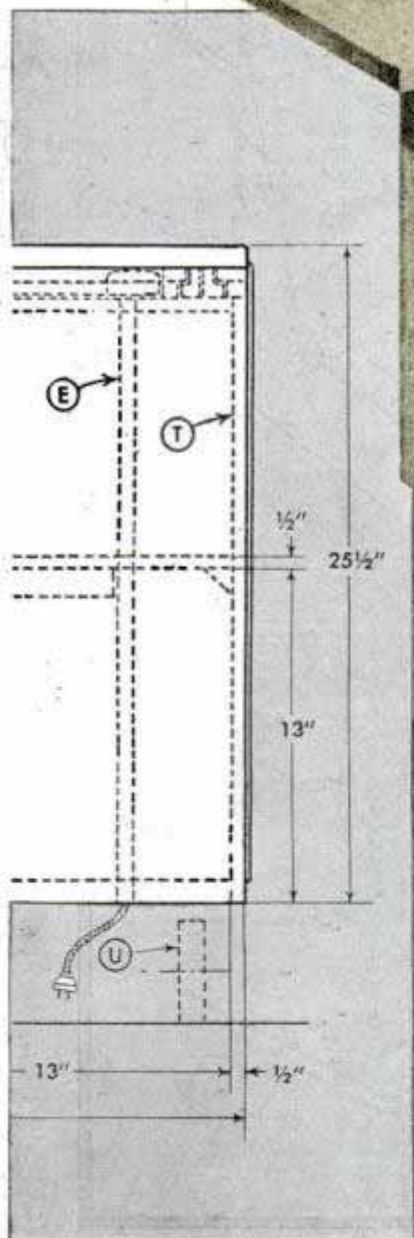
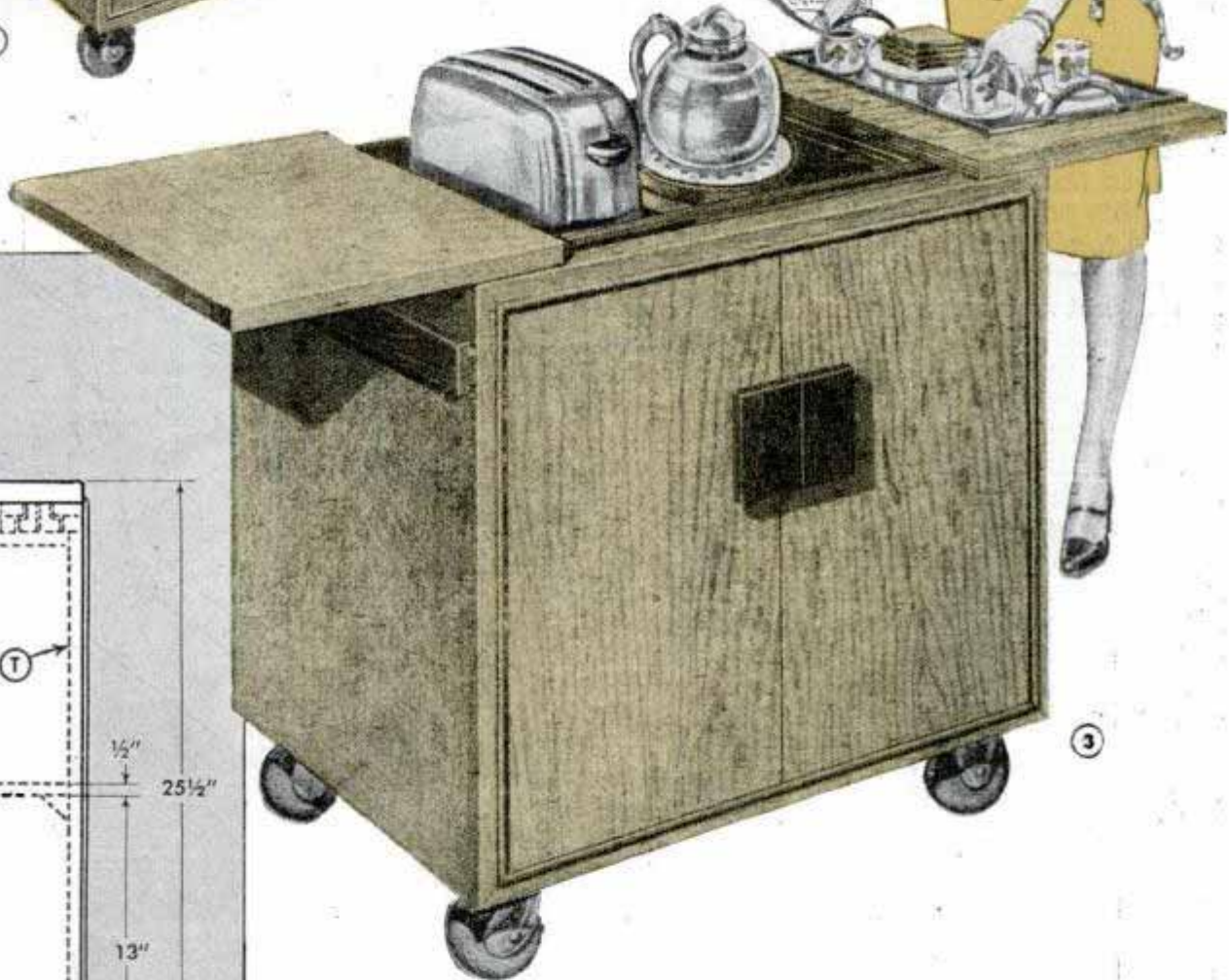

MATERIAL LIST

Part	Required	Size (Finished dimensions)	Name
A	2 pcs.	1 x 15 x 19 in.	Top
B	1 pc.	1 x 19 1/4 x 30 in.	Base
C	2 pcs.	1 x 19 1/4 x 24 1/2 in.	Sides
D	1 pc.	1 x 2 x 19 in.	Push handle
E	1 pc.	1/2 x 23 1/2 in.	Thin-wall conduit
F	1	Extension cord and double receptacle	Extension cord and double receptacle
G	2 pcs.	1/2 x 14 x 22 1/2 in.	Doors
H	2 pcs.	3/4 x 3 x 4 1/2 in.	Door handles
I	4 prs.	Concealed hinges (type shown)	Concealed hinges (type shown)
J	2 pcs.	1 x 1 1/2 x 30 in.	Outer guide
K	4 pcs.	1 x 7/8 x 16 3/4 in.	Slides
L	2 pcs.	1 x 7/8 x 29 in.	Inner guide
M	1	20-ga. sheet-metal tray (removable)	20-ga. sheet-metal tray (removable)
N	4 pcs.	1 x 4 x 14 in.	Shelves (glasses)
O	4 pcs.	1/4 x 4 x 14 in.	Retainer strips
P	2 pcs.	1 x 3 x 14 in.	Upper shelf (door)
Q	2 pcs.	1/2 x 2 x 28 in.	Bottle shelf (front)
R	1 pc.	1/2 x 13 x 28 in.	Bottle shelf
S	1 pc.	1/2 x 18 x 28 in.	Tray baseboard
T	1 pc.	1/2 x 22 1/2 x 28 in.	Back
U	4	4-in.-dia. rubber wheels (2 swivel type)	4-in.-dia. rubber wheels (2 swivel type)

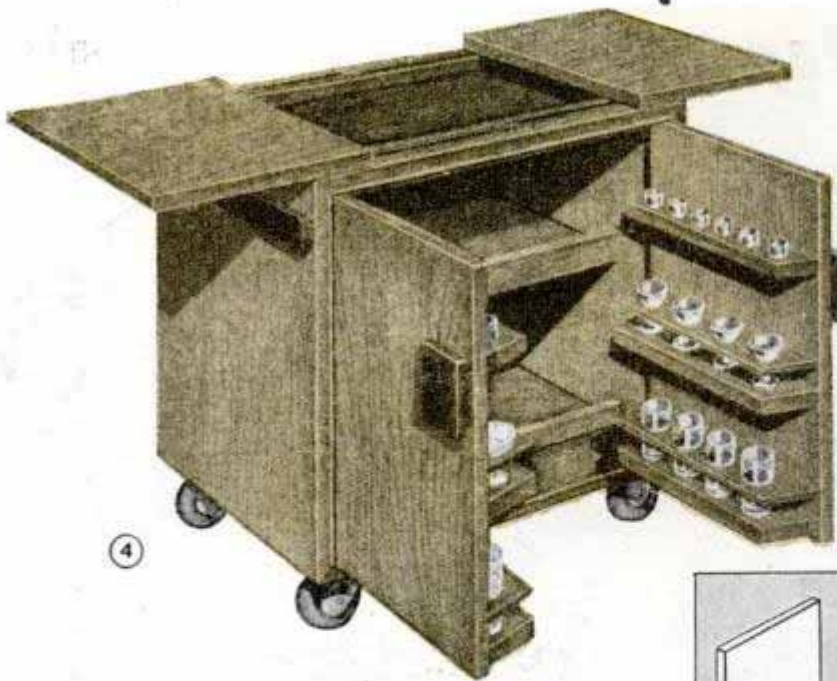

④

according to the sectional detail in Fig. 1. When these are in place, the back is fitted to set-in the thickness of the beading.

At this point the sliding top must be attached to slides K, each half of the top being fastened to one set of slides. Notice in Fig. 5 that one set extends past the other to provide a stop so that they cannot be pulled all the way out. Pieces of thin cardboard inserted between the slides and guides before the former are screwed to the top will prevent binding. Next, panel S, which forms a recess for the tray detailed in Fig. 7, is installed. This is screwed to rails J and L as in Fig. 1 and is cut to allow the doors to fit flush when they are hinged. A two-plug receptacle is located as in Fig. 6 and is wired with an extension cord that runs down through a length of conduit and out the bottom of the cabinet.

This leaves the doors to be fitted and hinged. Like the back, the doors are set-in the thickness of the beading. Fig. 5 shows

the type of concealed hinge to use. Finally, counterbored racks are attached to the inside of the doors for small glasses, and a two-part knob, built up of two blocks, is attached with screws from the back, one half to each door. A handle for guiding the cart is attached to the left-hand end near the top. Any suitable rubber-tired truck casters, about 4 in. in diameter, will do, although two of them should be of the swivel type to make the cart easy to steer.

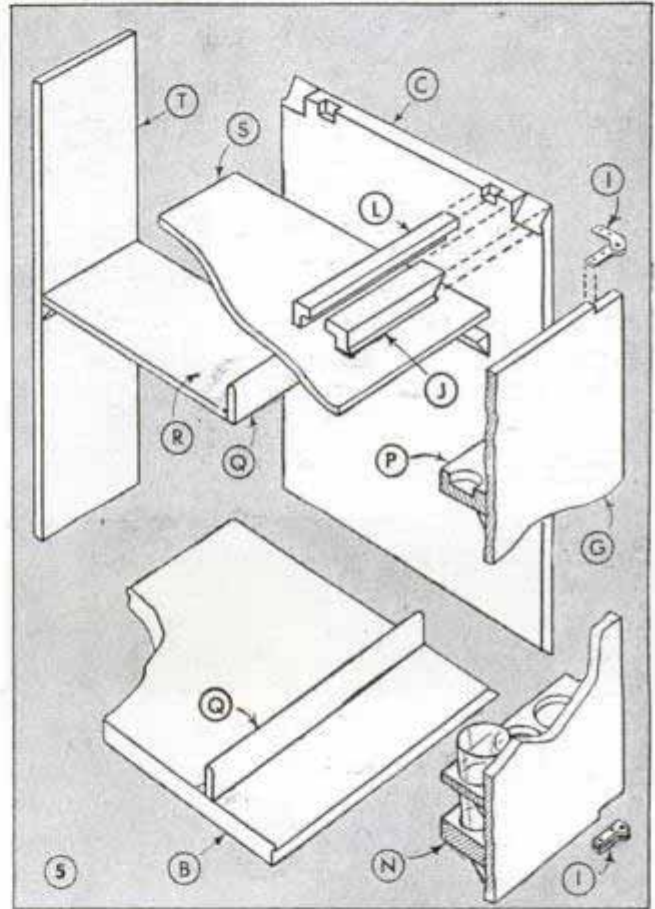

⑤

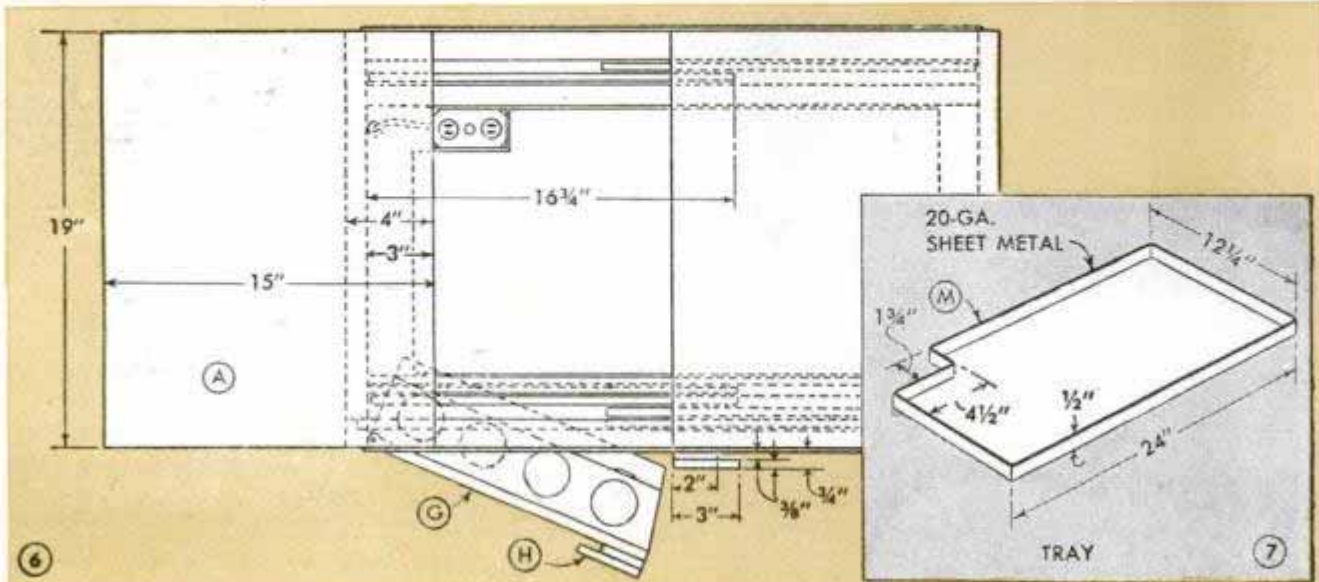

⑥

⑦

Ironing Board With Folding Legs Is Made Easily

Permanently attached to an ironing board, this half stand unfolds to support one end of the board while the other end rests on the edge of a table, counter or laundry tub. The board can be made from odds and ends of lumber, five hinges and a short length of stiff wire. The pieces of the leg assembly may be joined with screws, dowels or tenons. If the dimensions given are followed, the stand will fold flat against the board. To allow for final adjustment, cleat A should be mounted after all the folding members have been joined. A hook made from stiff wire holds the leg brace in position to prevent the stand from collapsing.—J. Modroch, Danbury, Conn.

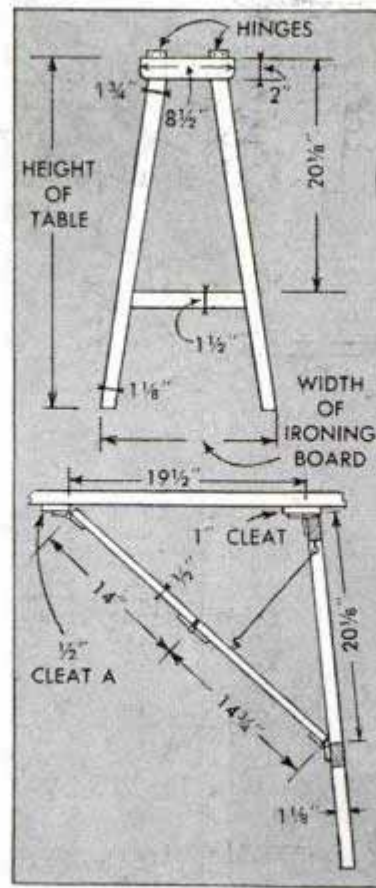

Palm Reel Attached to Old Glove Simplifies Flying Kite

You won't get cord burns on your fingers if you use this "reel" which is attached to a leather glove. The reel is simply a wooden cleat riveted to the glove and secured with copper washers inside the palm. Or the ends of the rivets can be peened against a

strip of sheet metal. Any hardwood will do for the cleat. In use, the glove is worn on the left hand and the string is wound or unwound with the right hand.



Wire Springs Hold Cut Flowers

For short-stemmed flowers, or to even up short and long-stemmed flowers, use coiled springs similar to the ones shown. These are fastened to the edge of the vase and the stems are slipped through them, then adjusted to the desired height.



Safety Glass for Playroom

For youngsters who pound on playroom windows with their hands, some protection is obtained by shatterproofing the windows. Several thicknesses of Cellophane may be applied to both sides of the window to obtain this effect. For divided or small panes, the Cellophane will have to be cut to size.—E. L. Stone, Hopkinton, Mass.

Solving Home Problems

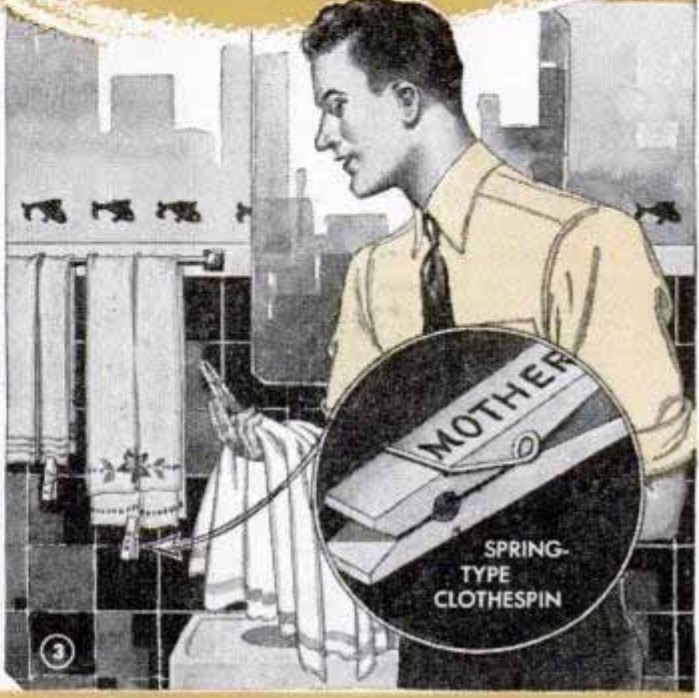
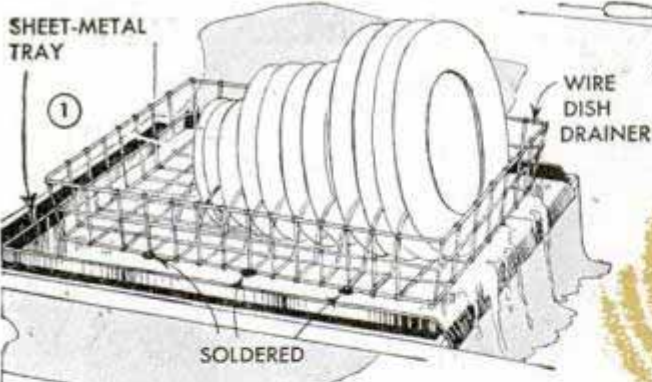

- ① Sheet-metal tray furnishes protection for linoleum-covered drainboards. One side of the tray forms a lip for water to drain into the sink. A dish drainer is soldered to the tray
- ② To keep a mirror from fogging, apply a film of soap with a slightly moistened finger and then polish the glass with a cloth or cleansing tissue. This will keep a mirror clear for some time
- ③ As a means of identifying individual towels hanging from the same rack, one woman clips spring-type clothespins to the towels. Each pin has the name of a member of the family on it

- ④ Instead of using a silver spoon to measure out bleaching solutions, which may discolor the silverware, use a plastic-type measuring spoon. Attach it to the bottle with a poultry leg band
- ⑤ When exposed to air, cut grapefruit soon becomes dry and hard. To prevent this next time you have half a grapefruit left, place it face down on a plate and store in the refrigerator
- ⑥ A yardstick or other flat stick wrapped with a length of oil-treated cheesecloth makes it easy to clean dust from under a bookcase, piano or other furniture that is too heavy to move easily

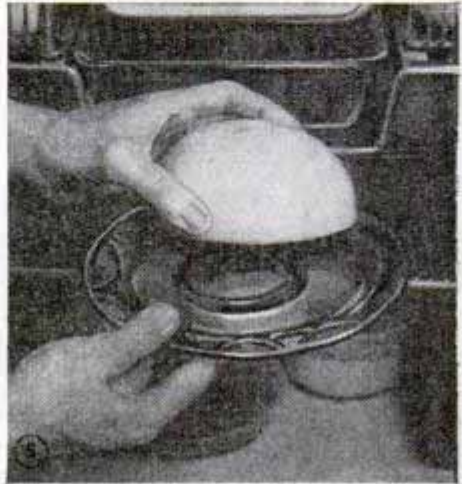

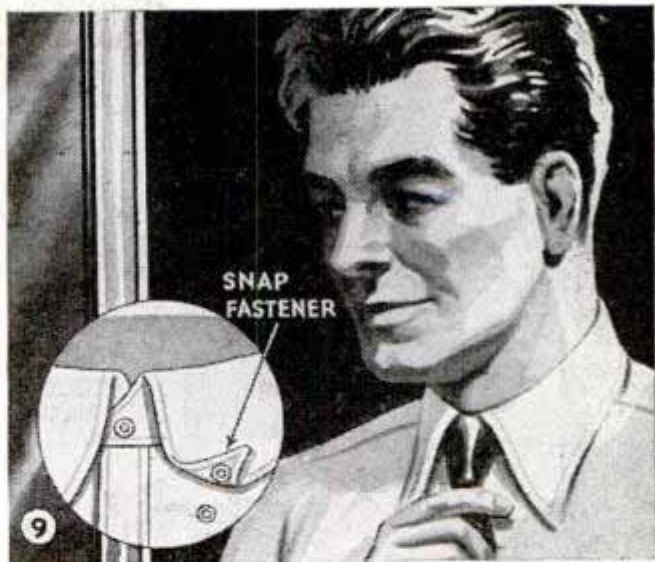
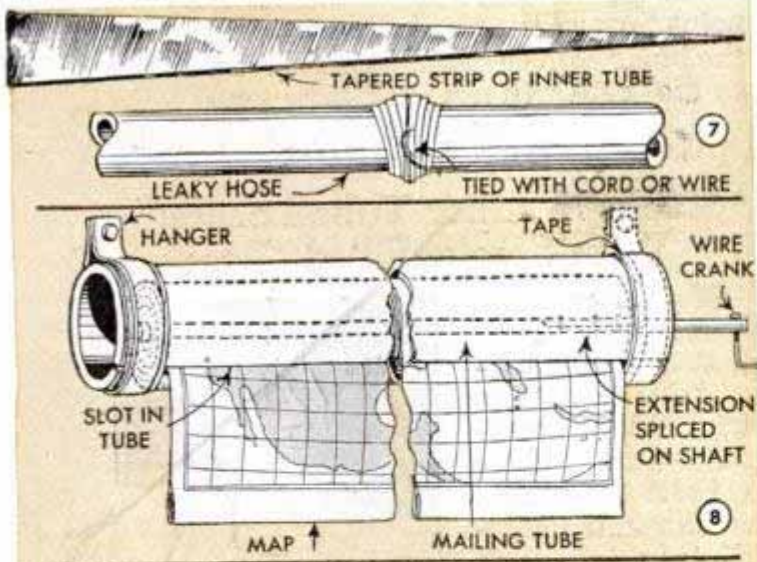

7 When a garden hose develops a leak a good temporary repair is made by wrapping a tapered strip of inner tube over the hole. The strip is stretched as it is wound and tied with wire

8 Slotted lengthwise and hung by tape at each end, a mailing tube provides protection for a large wall map. A dowel handle spliced to the map shaft serves as a crank to roll up the map

9 The ends of a shirt collar will remain neatly in place and not curl if each one is held down with a small snap fastener. Sew one half of the fastener to the collar and the other half to the shirt

10 Elevating a revolving lawn sprinkler on a stepladder will permit watering a greater area with less danger of damaging tender plants. Also, the sprinkler will require moving less often

11 Filled with light oil, an atomizer provides a simple way of oiling a clock without dismantling. Squirted oil through a hole in the case will deposit a fine mist on hard-to-reach parts

12 There's less chance of your stepladder tipping sideways if you fit it with broomstick braces as shown. The ends are capped with rubber crutch tips and pivoted at the upper end to fold flat

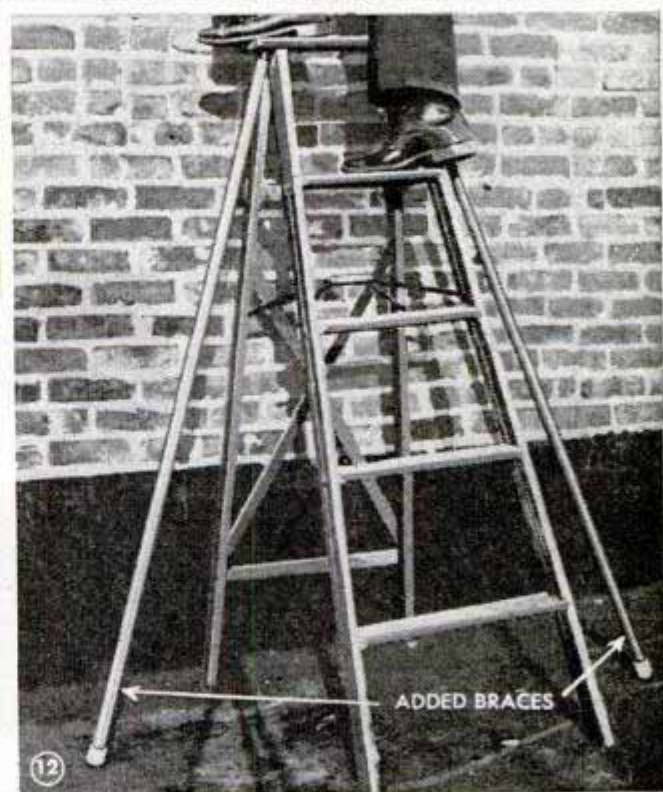
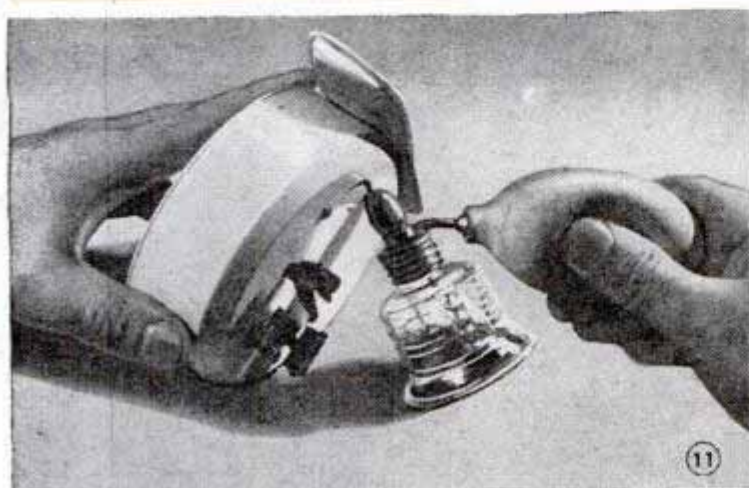
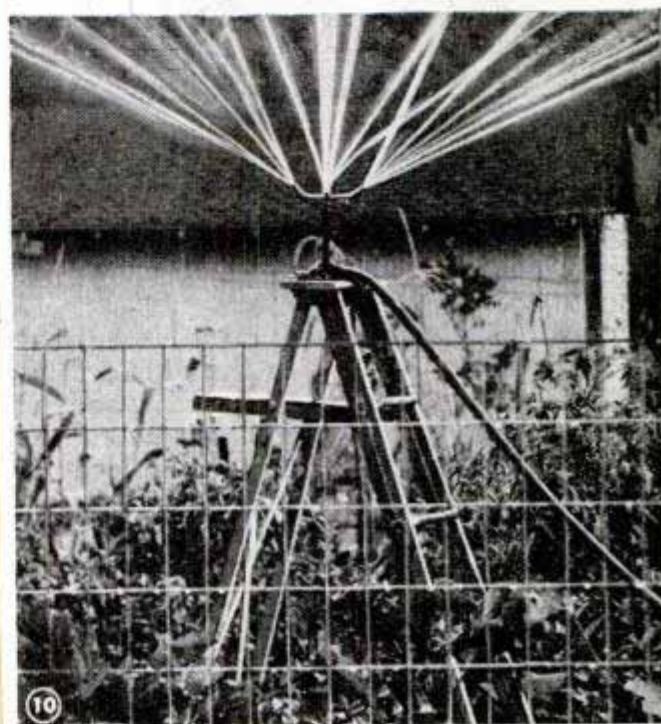

Wooden Plugs Cut on Bandsaw By Using Simple Jig

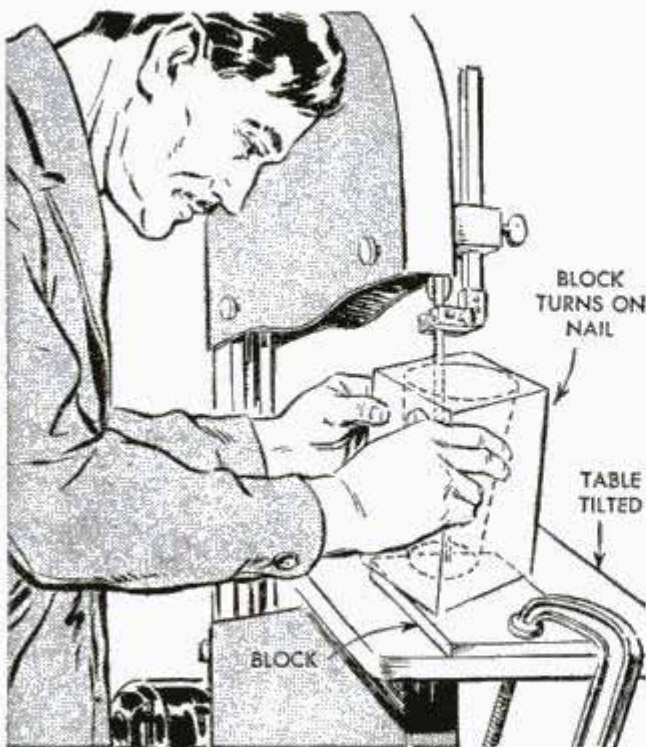

Instead of shaping them on a lathe, one craftsman found that with the aid of this jig a number of large, tapered wooden plugs could be cut on a bandsaw more easily. A nail is driven through a piece of wood near one edge and the block is centered on this. The board then is clamped to the bandsaw table which is tilted to get the correct taper. The plug is cut by rotating the block on the nail. Note that the nail is near the edge of the board so the bottom of the plug will clear it when being cut.—E. H. Morrill, San Rafael, Calif.

Steel Wool Cleans Stove Burners

Aluminum burners in domestic gas ranges are kept clean and bright by using steel wool to polish them at weekly intervals. Pipe cleaners will remove steel-wool waste that is caught in the burner holes. Any small bits of steel that may drop into cracks or on flat surfaces of the stove can be picked up with a magnet.

Jack A. Bristol, Portland, Ore.

Easy Way to Sand Narrow Slots

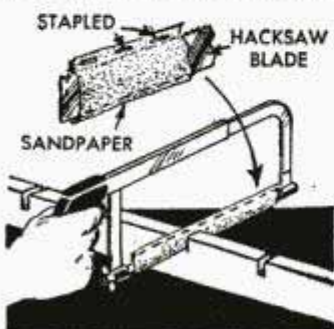

Narrow slots are easily sanded with sandpaper which is fastened around a hacksaw blade. The blade is removed from the saw and the paper is stapled over it so that the teeth

point toward the stapled part. When used, the blade is inserted in the reverse position so the teeth will not cut the paper.

Opie Read, Jr., Chicago.

Leaks in Inner Tube Located With Smoke-Filled Glass

If an inner tube has a slow leak that cannot be located, try this trick. Fill an ordinary glass tumbler with tobacco smoke and immediately invert it over the tube, keeping the tumbler and tube in close contact. Then slowly slide the glass over the surface of the tube.

When the tumbler passes over the leak turbulence will be noticed in the smoke.

Tommy Laird, Waverly, Ia.



"Water Wheel" at Side of House Is Used as Flower Garden

Built against the side of a house, this imitation water wheel, which is made of 2-in. lumber, will transform the house into an old mill. To add to the decorative effect, the wheel can be used as a novel flower garden, the "paddles" being filled with soil for plants.

Paul Hadley, Philadelphia, Pa.



Illuminated Night Float Glows When Fish Bites

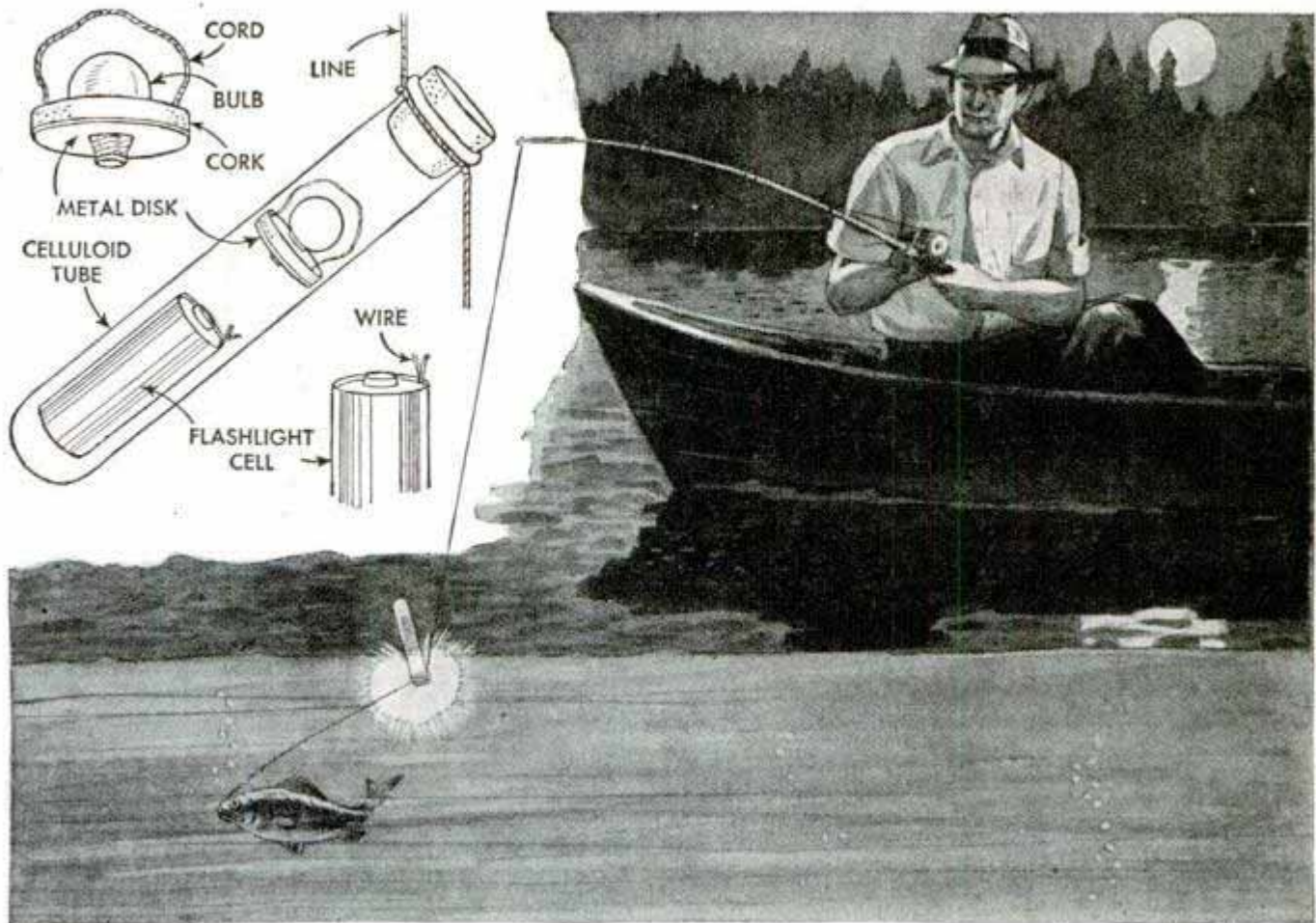

Fishermen who work the ponds, lakes and river backwaters where night fishing for catfish, bullheads and other night feeders is permitted will appreciate this illuminating fishing float. He's hooked in a flash, so to speak, because the float flashes a light at the slightest nibble. It consists of a pen-light cell which slides inside a glass or celluloid tube to make contact with a bulb when the tube is tipped. Any test-tube type of vial will do—an envelope moistener makes a good one. The bulb is held in a cork disk which is cut to wedge inside the tube and then is faced with a metal disk

through which the bulb is screwed. A cord handle permits removal of the cork. The cell makes contact with the metal disk by a piece of lamp cord, stripped of its insulation and inserted between the cell and its paper covering. The amount the wire should extend is determined by actual test. It must permit the bulb to make contact with the positive or center element of the cell to complete the circuit. The float is attached to the line at the neck of the tube as shown so that a pull on the hook will tip it and cause the cell to slide against the bulb. The tube, of course, is corked tightly.

Candle Rubbed on Inked Address Will Prevent Smearing

During the winter, or during rainy weather, the ink-written address on a package may become smeared by snow or rain so the writing is illegible. One way to prevent this is to rub a candle over the writing to form a protective surface that is waterproof.

☞ If hot plates and dishes have left disfiguring marks on a dining-room table or other polished wood surface, use spirits of camphor to remove the spots. Rub lightly with a soft cloth and when the stain disappears, polish with a soft duster.

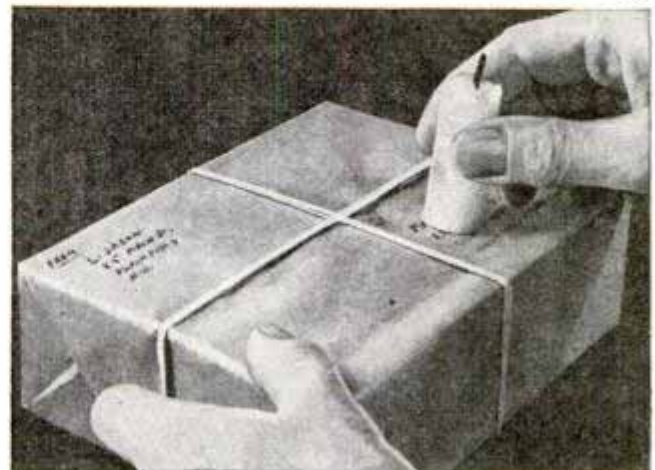

for Boys

Rep. with to

print 0

X403 The "KNOW HOW"

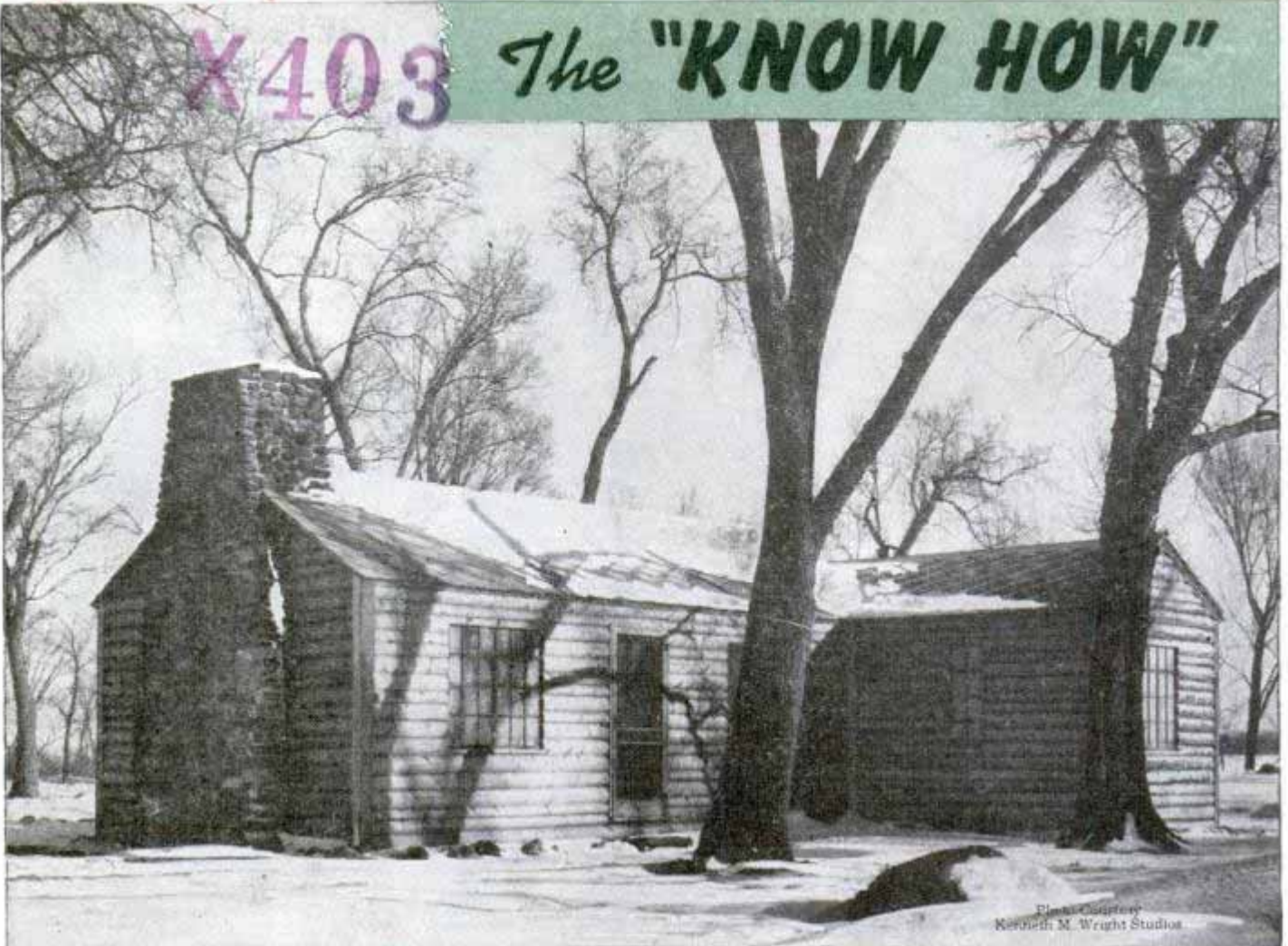

Photo Courtesy Kenneth M. Wright Studios

By Hi Sibley

MOST of us enjoy working out the plans for a new home, even the rather drab business of cost accounting, figuring material lists and so on, but the thrill of construction is lost as this usually is done by skilled tradesmen, and to them it's just another house. But a log cabin of your own in the woods or on a lake shore or near some secluded stream—that's something else. There's one sure way to get a real thrill out of owning a log cabin—start from scratch and build it yourself. It's true that it's going to take some work before you get to that last nail in the shingles and that last stone in the fireplace chimney, but once completed, the pride of ownership and the satisfaction of a job well done make it worth while.

Where there is plenty of standing timber the construction of a log cabin is a matter of labor rather than expense, and if the prospective owner builds it himself the outlay will be negligible, the cost of any special work depending, of course, on the type of structure. If you build in a heavily wooded area, first get the advice of the local forester and then select trees that are



Slab siding and conventional construction make this type of cabin suitable for year 'round living. It can be fitted with all modern conveniences, and insulated walls and ceilings make it snug and warm

straight and of minimum taper. It's best to avoid all hardwoods because of weight and toughness when cutting. Pine, cedar, hemlock, tamarack and balsam are suitable, but birch, willow, aspen, basswood and cottonwood are

unsatisfactory. If you wish to remove the bark and preserve it for decorative effects, peel it off, lay it flat on boards and weight it to dry as in Fig. 5. It is best to cut the trees in the fall and stack the logs loosely, as in Fig. 4, to season until the following spring or summer—longer if possible. They will be easier to handle if well dried. For trimming the logs, such as when squaring or making one side flat, a broadaxe is best, although an ordinary ax may be used. An adze also is handy in roughing-out work.

Foundations: The simplest foundation is a stone pier at each corner of the cabin. Use two flat stones as in details B and C, Fig. 6, to keep the logs well up from the moist ground. Do not cement the stones together. Support them on a concrete base poured in a hole in the ground as in detail

of LOG CABIN BUILDING

B. It also is permissible to set the sills up on posts, cedar or redwood preferred, digging the hole below the frost line and setting the post on a rock in the bottom, detail A. All posts or logs in contact with the ground should be thoroughly creosoted, working the liquid into all cracks.

Corner joints: Several methods of forming corners are illustrated in Fig. 7. One of the simplest methods is to cut away half of each log end, as at A, and drive spikes as you build up. To many builders the method shown at B makes a more attractive corner as the whole end of each log is exposed. Corners of the types detailed at C, E, G and H in Fig. 7 also are widely used in cabin construction, but the two types D and F are perhaps more generally favored by woodsmen because in both cases the joint will shed water more effectively. These joints are the strongest of all because of the interlocking V-cuts. The dovetailed corner, Fig. 7, E, is equally good but requires very careful fitting. Chipping and notching can be eliminated by making corners as in details G and H, but the con-

struction is not as strong or durable. These two methods are recommended only for temporary construction.

Log-cabin siding: Ready-cut slabs, which resemble logs on the outside, Fig. 1, simplify construction greatly, and having a ship-lap joint, Fig. 3, they do not require caulking. These are nailed to conventional framing in the same manner as any lapped siding. Ready-cut slabs usually are mitered at the corners or a corner piece is fitted as in the upper left-hand detail of Fig. 3.

For a year 'round cabin, a hunting lodge or clubhouse where expense is shared and warmth is essential, an insulated wall can be made as in the lower detail of Fig. 3. In this the slab siding is used inside and out, with insulating board between, forming a double air space. This construction includes a concrete subfloor, giving another air space beneath the wood flooring.

Sills: A simple way to install sills is to support joists on a 2 by 8-in. support spiked to the bottom log, detail C, Fig. 6. The joists are spaced as in standard construction, with bridging between. Another

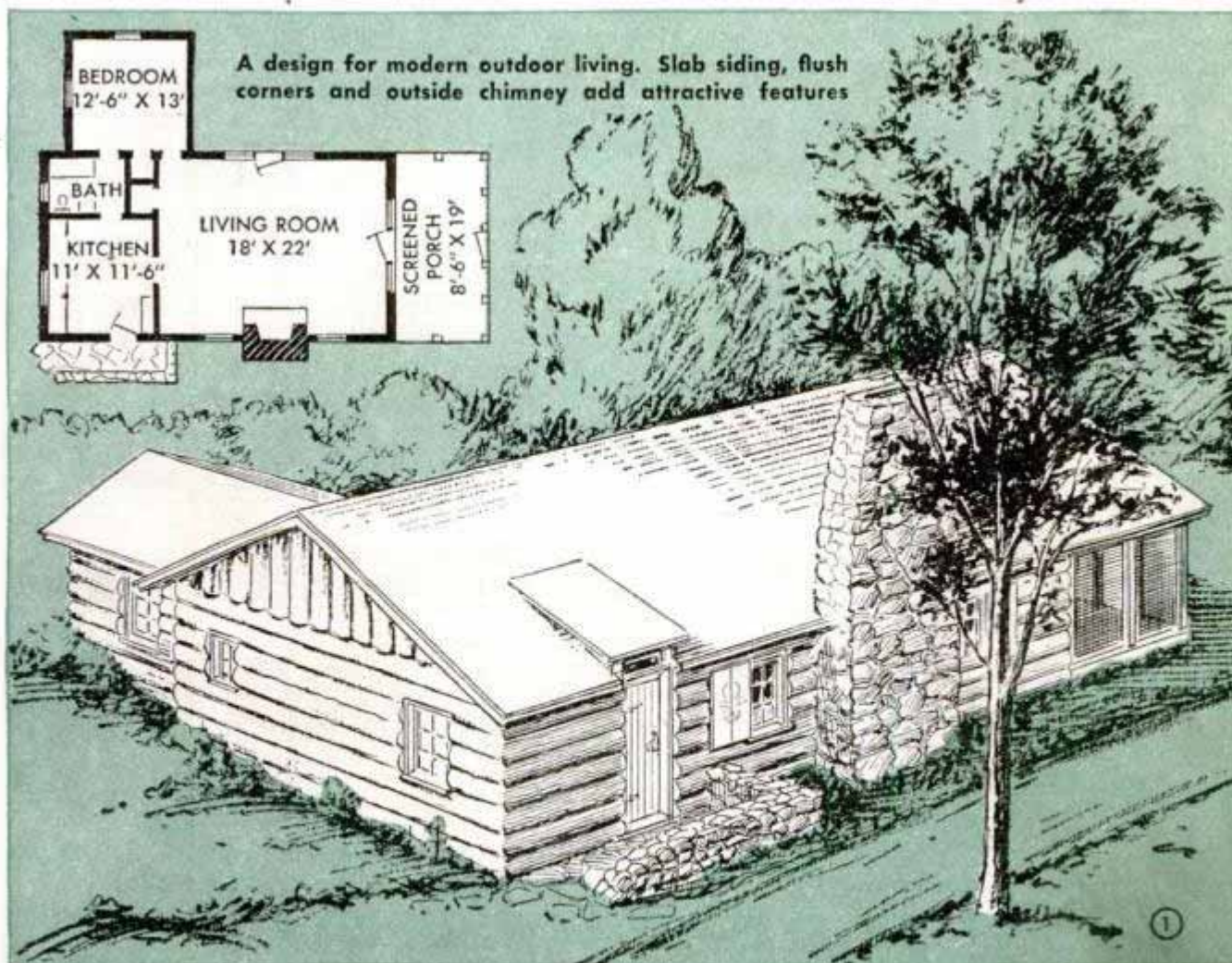

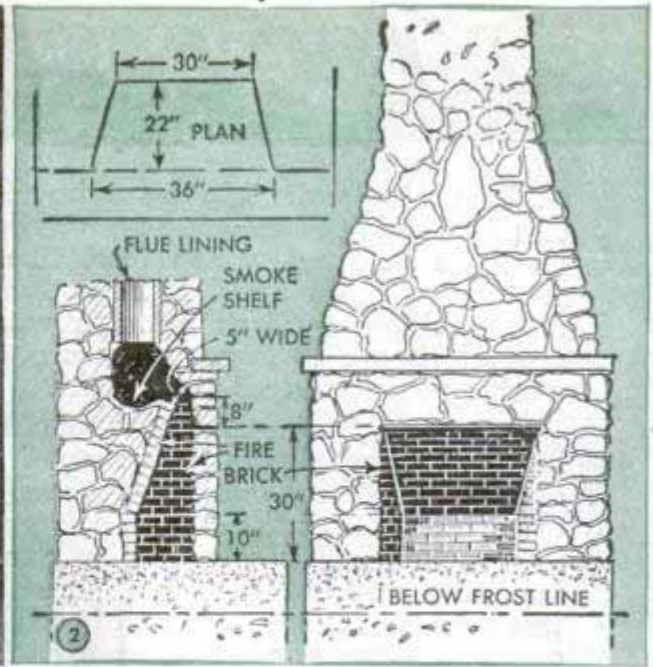

Properly made, a fireplace can give both atmosphere and comfort. Structural details above at the right show the proper throat construction to give maximum efficiency. The dimensions should be followed quite closely

method is to notch the sill log for the ends of log joists, which have been trimmed as indicated in detail D, Fig. 7. Tops of the logs are trimmed flat to make a suitable bearing for the flooring.

Rafters and roofing: Logs of 4-in. diameter and larger are often used for rafters as shown at C in Fig. 8. These are notched into the end logs and should be as straight as possible, as well as trimmed flat to support the sheathing which is laid edge to edge for roofing paper. For a shingle roof, and conventional 2 by 4-in. rafters, detail B, the sheathing boards may be spaced 2 to 4 in. apart. Slabs over roofing paper and sheathing make a rain-tight and picturesque treatment as in detail A, and bark also can be used in a similar manner over the roof boards as in detail C.

Likewise there are three or four interest-

ing ways to treat gables, three of them shown in Fig. 8, A, B and C. Vertical lines relieve the monotony of horizontal logs or board-and-batten construction in the gables. Shingles, laid irregularly, also are popular. In each case the gable material should extend down over the plate log.

Slab shack: Reduced to the simplest and least expensive construction is the slab shack shown in floor plan in Fig. 10 and in detail in Figs. 11, 12, 13 and 14. This can be put up in a hurry to serve as a shelter until a more substantial cabin is completed, when it may be used as a rustic garage.

The slabs usually can be had for the hauling if there is a sawmill nearby. The shack is a one-room affair with one single and one double bunk, Fig. 10. A sheet-iron stove, kitchen workbench and shelves complete the furnishings. Although there is no



Photo Courtesy Graphic Arts Studio

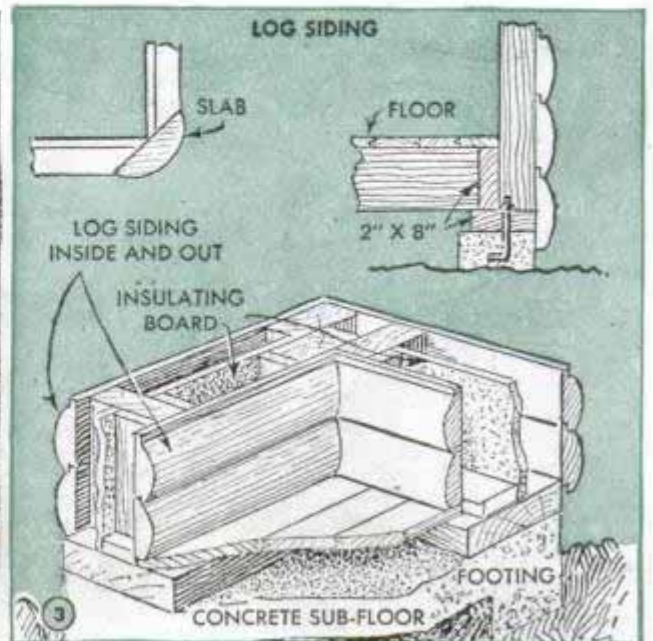

4 SEASONING LOGS



LOGS STACKED LOOSELY AND SEASONED 8 TO 12 MONTHS

5 PREPARING BARK

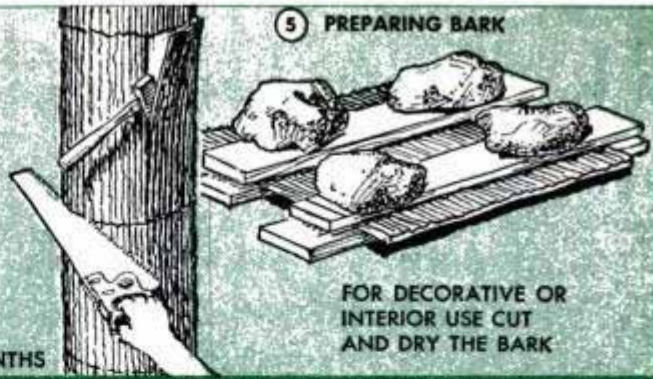

FOR DECORATIVE OR INTERIOR USE CUT AND DRY THE BARK

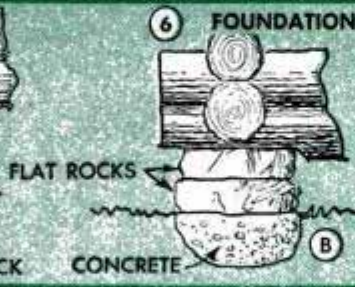
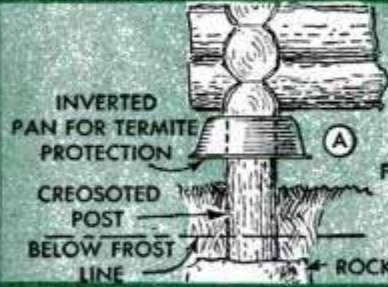

6 FOUNDATIONS, SILLS AND FLOOR JOIST

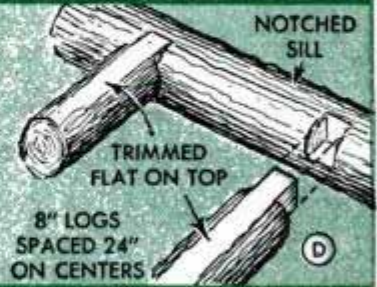
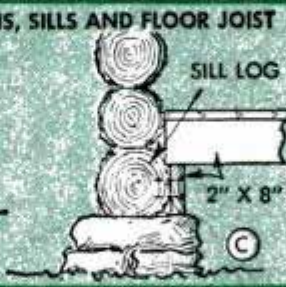

7 TYPES OF CORNER JOINTS

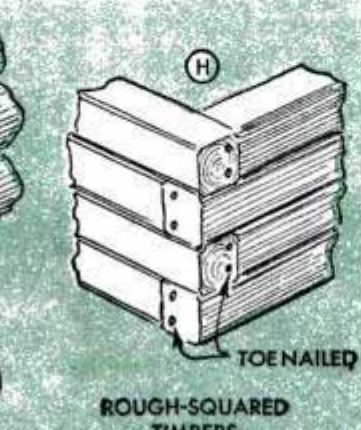
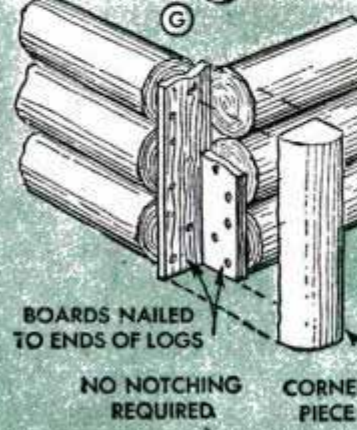
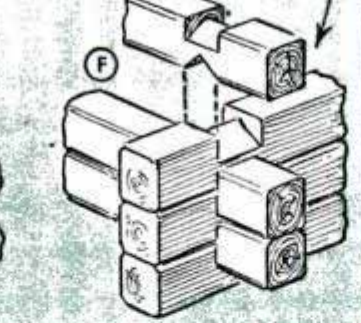
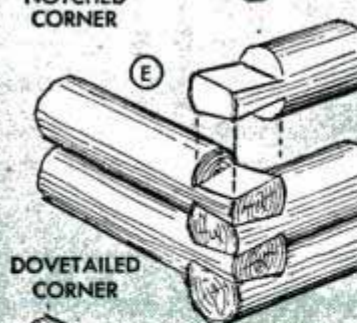
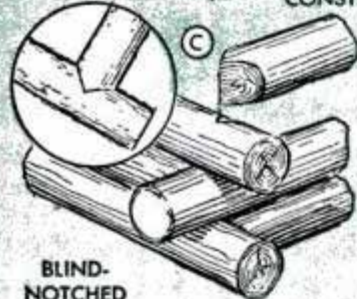
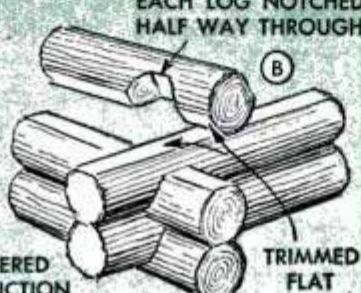
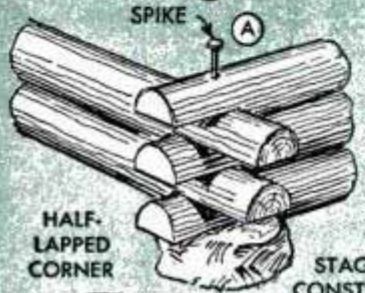

8 TYPES OF ROOFS

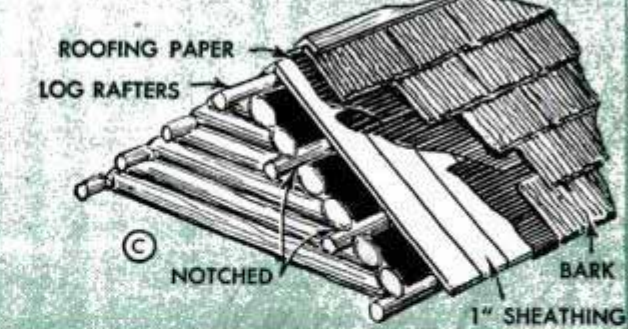
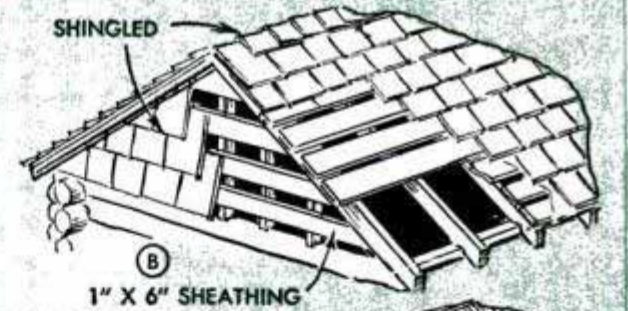

9 CAULKING CHINKS

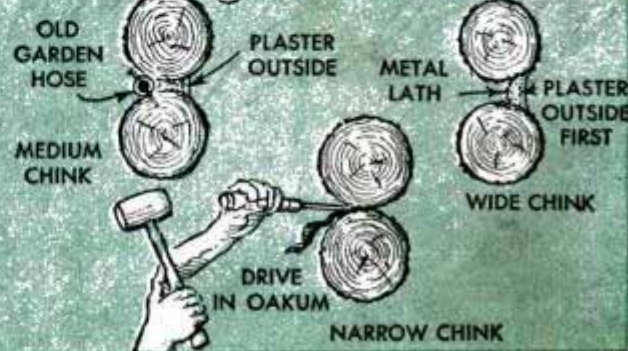

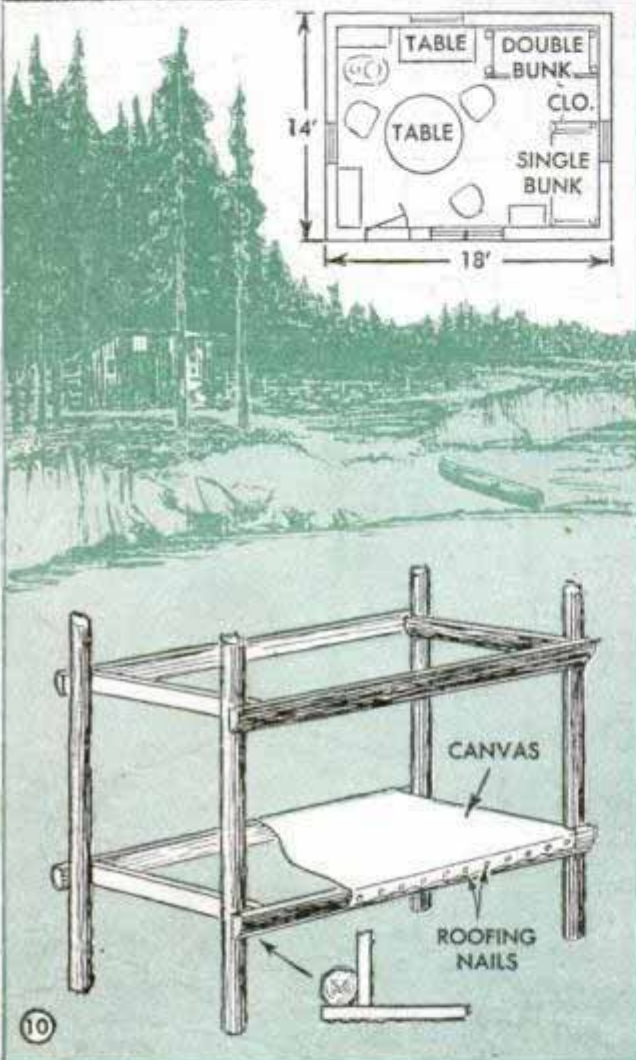

running water or other plumbing, it is much more comfortable and roomy than a tent. It has a puncheon floor, that is, slabs laid with the bark side down directly on the soil. The bottom logs of the walls are creosoted. Stovepipe is carried through a square of galvanized sheet iron nailed over an opening in the wall as in Fig. 12. By ripping the slabs down the center, two straight sides are formed on each, making them useful in building bunks, headers, roof sheathing over log rafters, etc. Canvas is stretched over the bunk frames and tacked along the edges with galvanized roofing nails as in Fig. 10. This makes a bunk more comfortable than an ordinary cot because of the greater width.

General construction is illustrated in Fig. 11. Note how corner posts and log studs are set directly on the sill logs, which should be large in diameter and thoroughly creosoted, as they will be banked with earth inside, and the puncheon floor laid upon the earth. Wall slabs are squared on both edges and extend up to the roof. All corners should be braced diagonally, otherwise this shack might fold up in a high wind, or at least be forced out of plumb. As a slab floor laid directly on the soil will deteriorate in a few years, if you wish the shack to be a more permanent structure leave an air space below and support the floor with a log at right angles mounted on flat rocks midway between the sills.

Typical small log cabin: A conventional design of the small cabin is presented in Figs. 16 and 17. This has a rectangular floor plan, solid log walls, casement windows, slab door and composition roofing. It includes a small cookstove, two swing-up bunks and the usual shelves and kitchen

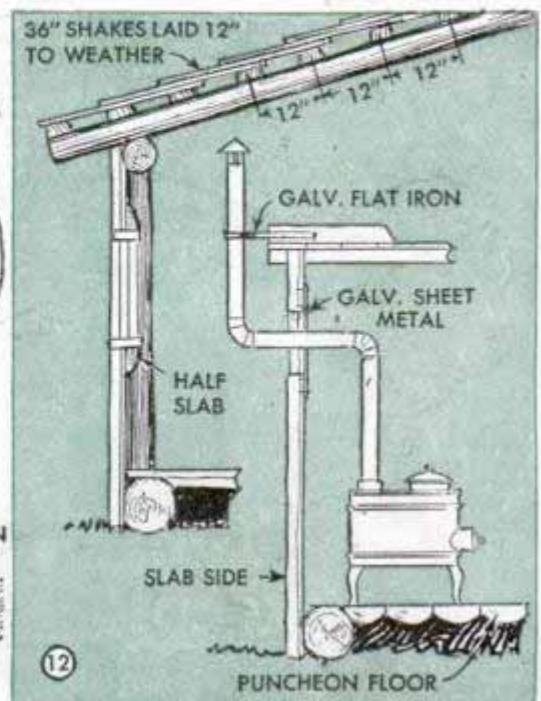
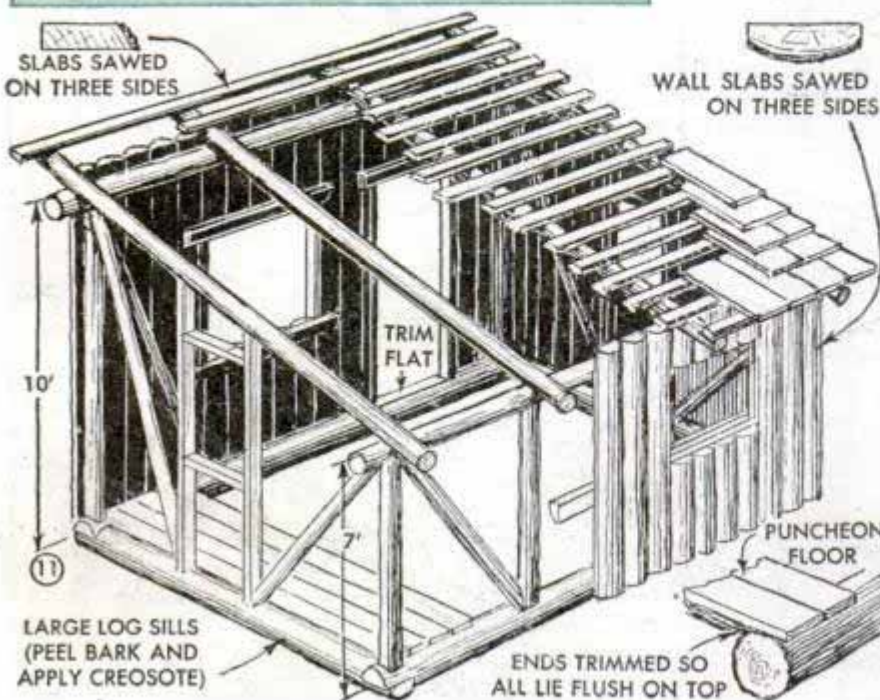

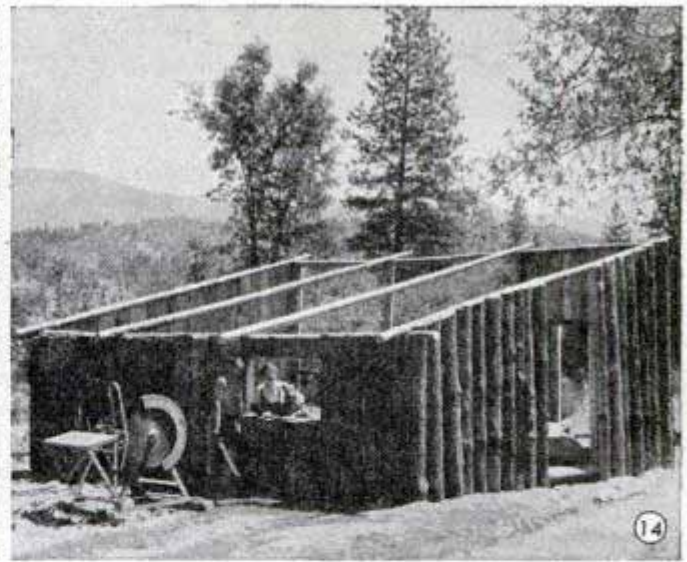
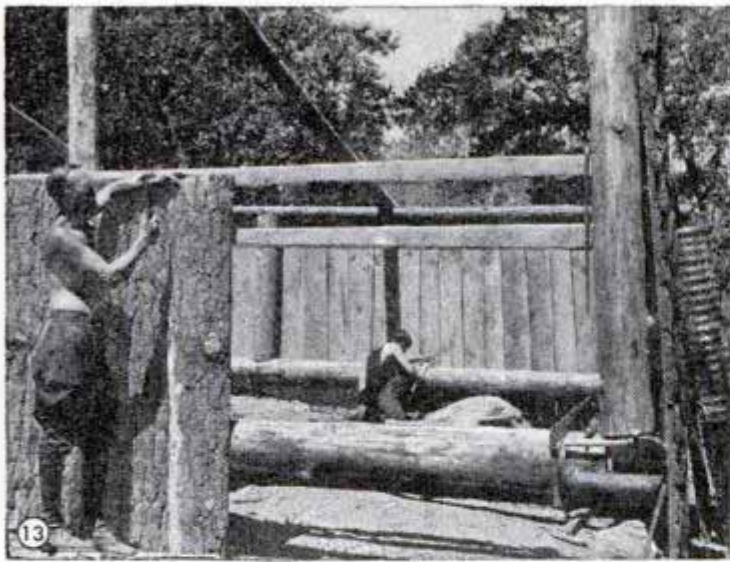

workbench. In the sectional view, note the arrangement of flooring on log joists, which are set into the field-stone foundation. The outside chimney eliminates the fire hazard of a pipe through the roof and also its tendency to leak around the opening. Method of truing up the joists with a center support is shown in the upper left-hand detail, Fig. 16, while alternate construction with dimensioned lumber is shown at the lower right, the sill being supported on a ledge of the foundation wall. Any of the corner joints shown in Fig. 7 will do for the two other corner constructions of the cabin, those detailed at B and D being preferred. The dovetail corner, Fig. 7, E, also is satisfactory. Roof framing in this cabin is standard practice unless the builder prefers one of the special types shown in Fig. 8. This will mean some changes in the roof framing and the slab-sided walls will require regular door and window frames.

Interior details: Slabs make attractive and inexpensive interior walls. They should be assembled with the flat sides together and staggered, those against the 2 by 2-in. strips at top and bottom nailed first, the others nailed to the first row.

Fireplace and chimney: A fireplace is always desirable in a cabin, summer or winter, but unless properly constructed, it will surely smoke. The secret of proper design is to have the narrow throat 8 in. above the opening and the latter not quite as high as its width, Fig. 2. There must be a smoke shelf, as shown in the sectional drawing, to direct down-drafts away from the throat. The flue should be smooth and preferably round to accommodate spiraling gases. Round tile is satisfactory and the area of the cross section of the flue should be 16 sq. in. to every sq. ft. of fireplace opening. Throat area should be no

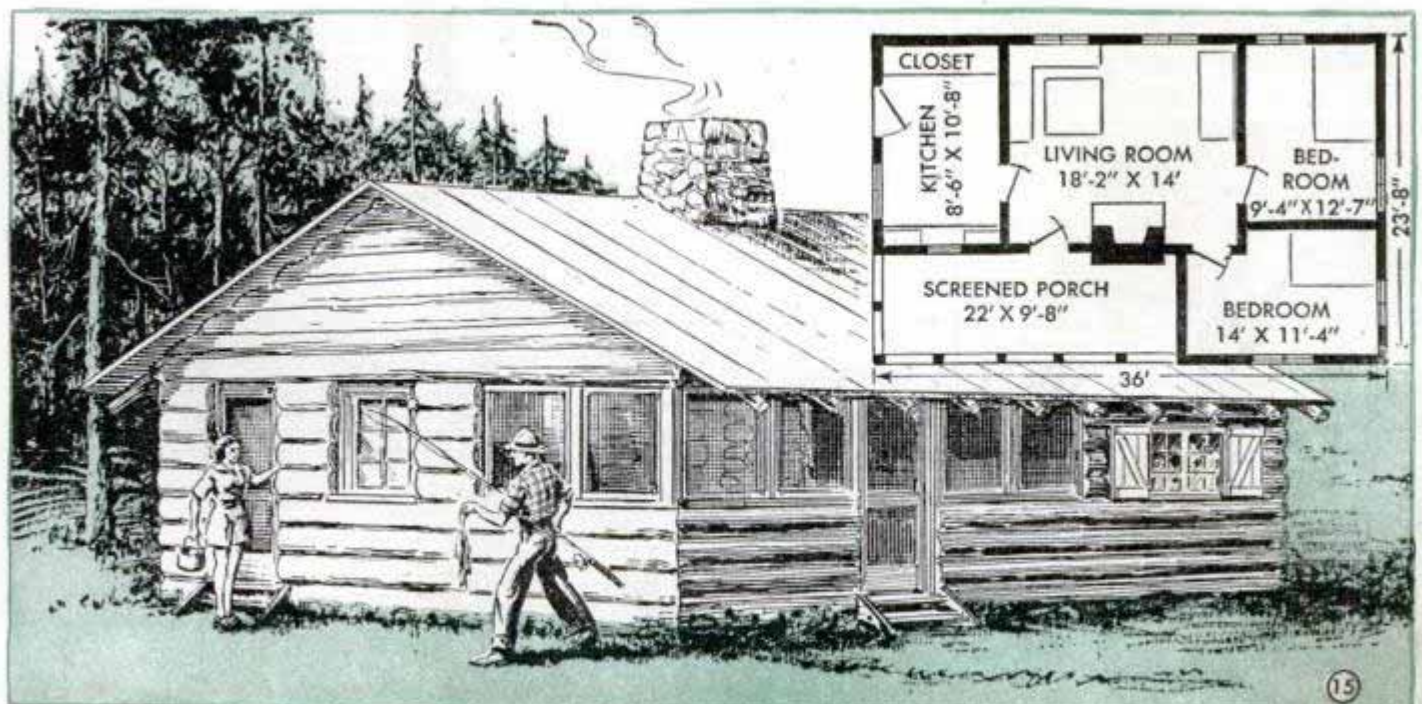

This design, suitable for a hunting or fishing lodge, has a combination living and dining room and bedrooms for modern furnishings. Walls are slab-sided over conventional construction and window framing is regular

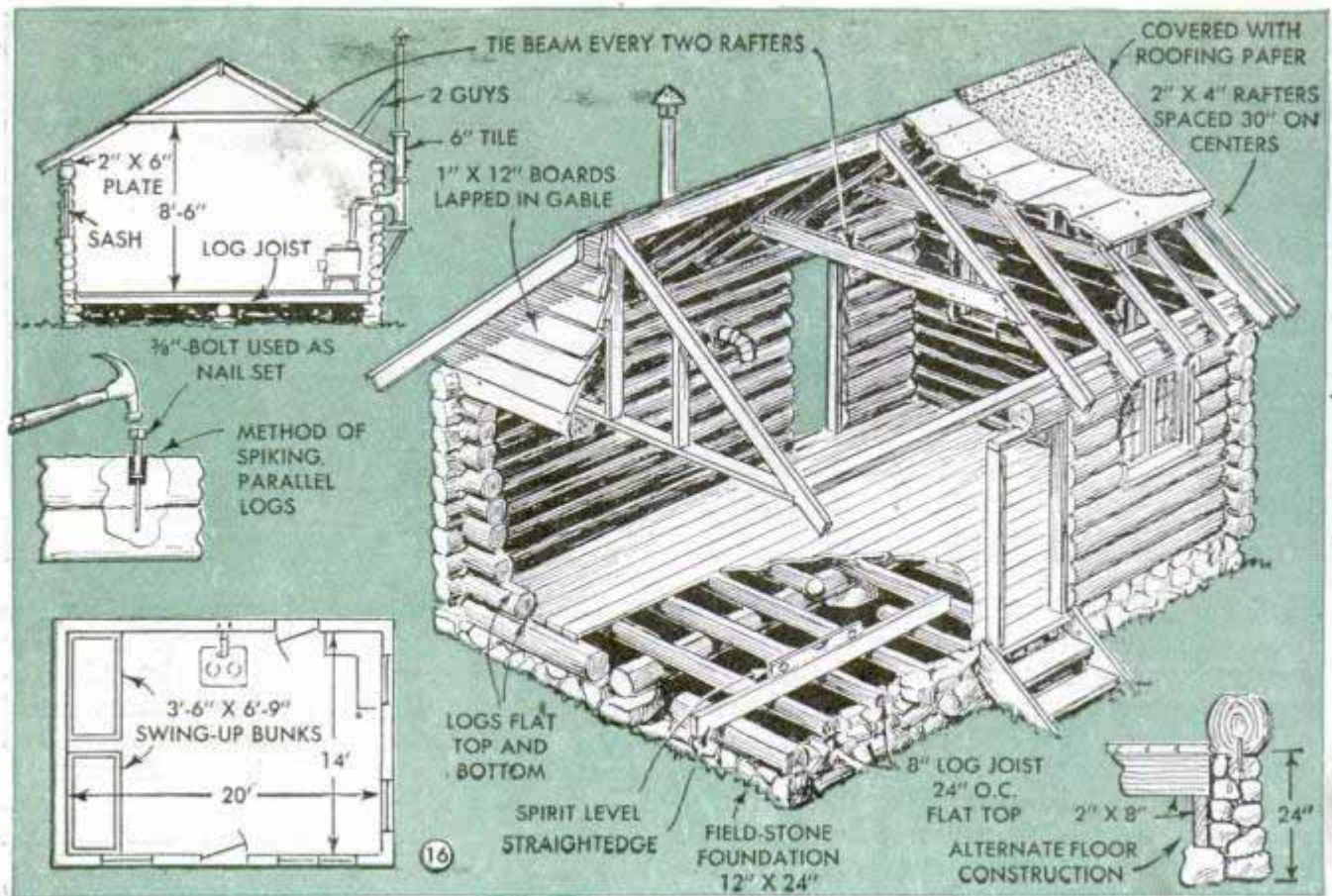

less than that of the flue and it should extend the width of the fireplace opening.

Caulking chinks: Openings between the logs are inevitable, no matter how carefully fitted, except in the case of ready-cut log-cabin siding. For medium-width chinks, a length of old garden hose can be temporarily nailed along the seam inside the cabin, fitted in snugly, and plaster applied against it from the outside, making a neat joint when the hose is removed. See Fig. 9. For wider chinks, bend a strip of metal lath to a V-shape and nail it in the chink on the outside. Plaster over this, using a small

trowel, and when the plaster has set, finish from the inside. Caulk narrow cracks with oakum and a blunt-nosed chisel.

Additional cabins: Based on a rectangular plan, a design for a roomy cabin to accommodate a sizeable family is shown in Fig. 15. This is built of log-cabin siding and construction is pretty much standard. No plumbing is included, except for running water in the kitchen when a source is available. Fig. 1 gives plan and view of a more elaborate cabin with bath and other conveniences, which can be added to as required by extending the bedroom wing.

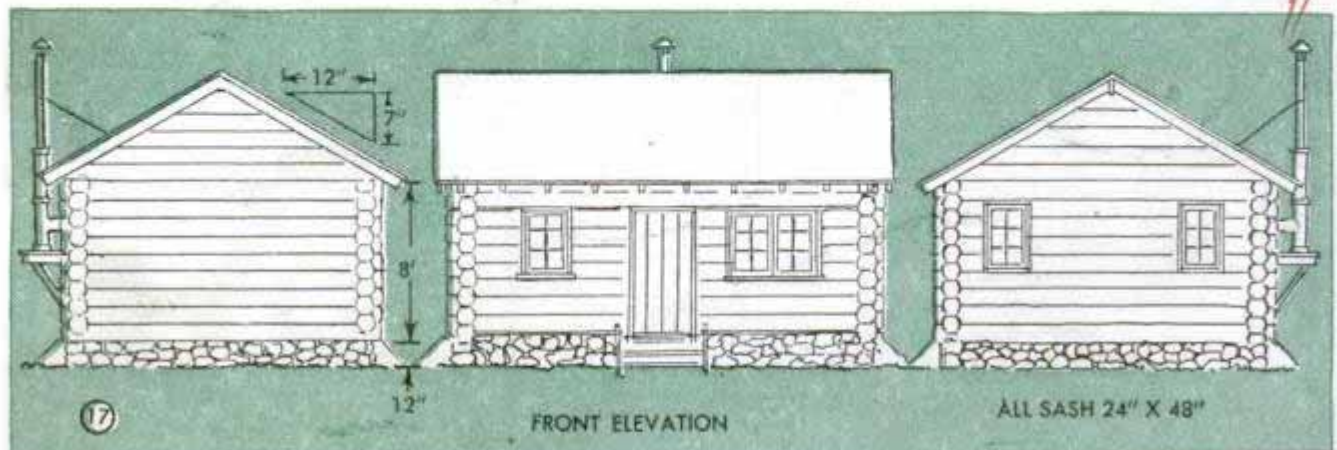

Here's a design that comes about the nearest to being the all-around log-cabin type. Detailed at the top of the page and shown in elevation above, it's cheap to build and can be fitted out for simple living comfort

Improvised Fishing Raft Is Transported Easily

With four inner tubes, some rope, two straps, a ski and a light wooden platform you can improvise a fishing raft that will get you out where the fish are biting. And when you have your catch, it's an easy matter to disassemble the craft and stow it in your car. Three of the inner tubes are lashed together to support the platform that serves as a seat while the fourth is tied to the tip of a ski that serves as a longitudinal member for the raft. The platform is bolted to the ski and can be taken apart for ease in transportation. Although not shown on the drawing, a stabilizing fin attached to the ski at the tip and

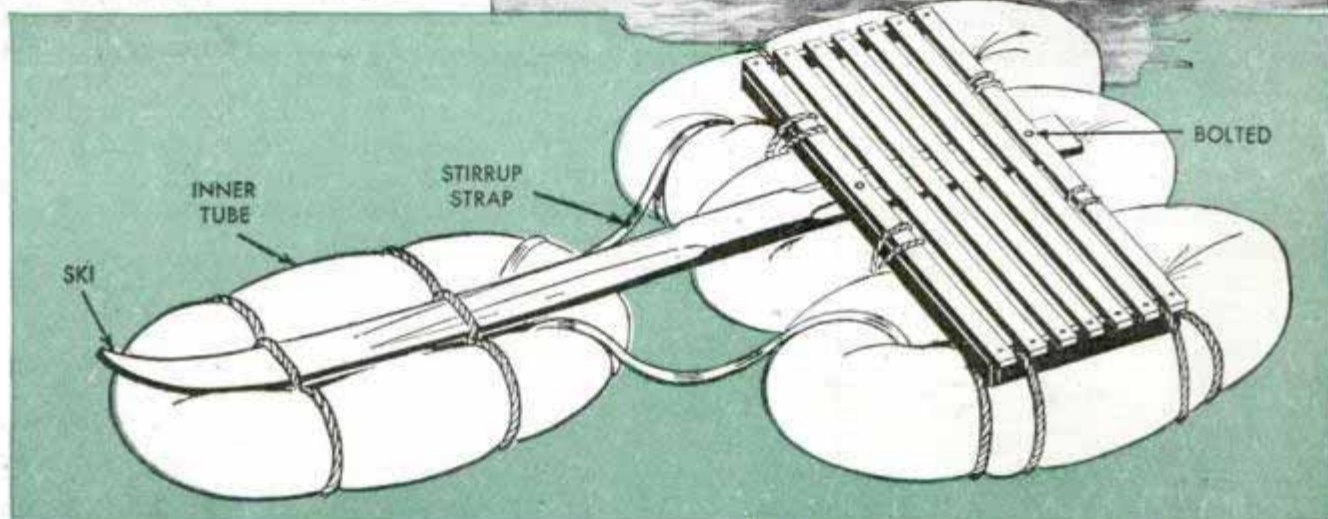

another at the rear will add to the craft's maneuverability. The two stirrup straps are used as foot rests should the water be

a bit chilly. The raft will handle best if a double canoe paddle is used, but a single paddle will do.—Robert F. Sear, Chicago.

Reversed Knife-Type Switch Will Not Jar Shut

If a knife switch is mounted on a wall in the vertical position, the contacts to which the knife is hinged should be on the bottom. When mounted as shown at the left, the switch may tend to close if the pivot joint of the knife is loose. This undesirable feature is eliminated when the mounting is reversed because if the knife is loose the contacts will hold the switch closed when desired, and when the switch is opened gravity will not cause it to close.

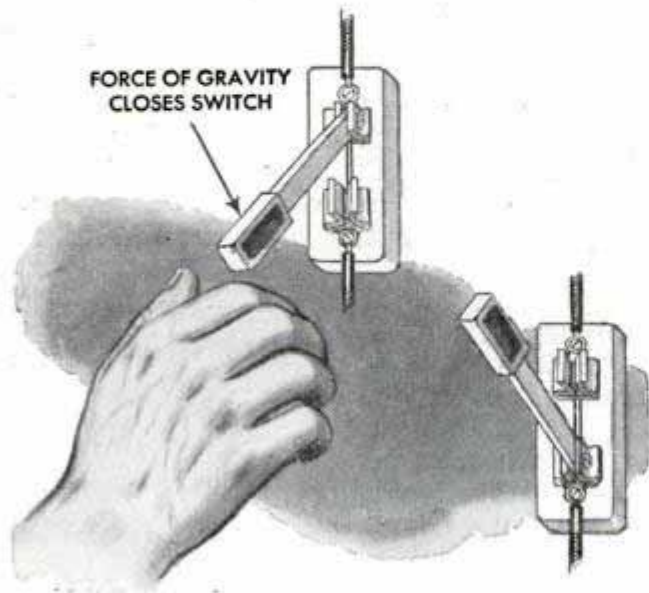

☐ The life span of a roof can be lengthened greatly by patching it at the first indication of a stain in the attic.

Tool Case That Fits Over Table Provides Temporary Workbench

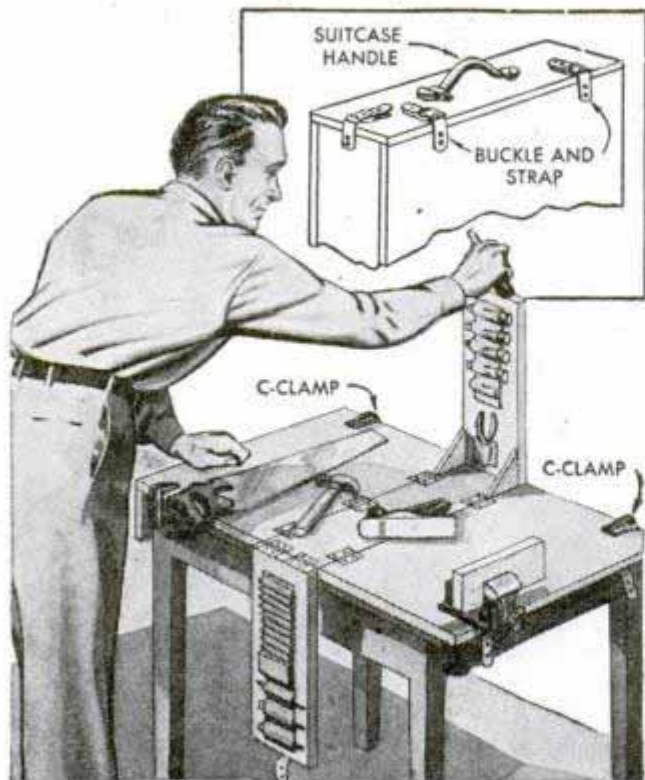

Constructed in the shape of a suitcase, this kit is made of wood and held together with hinges, buckles and straps. When opened, one end remains upright and provides a holder for small tools, bits and taps. The other end folds down over the table and has similar accommodations for other tools. The top is removed and the bottom and two sides lie flat on the table to protect its surface. A vise and C-clamps serve to hold the case in place on the table.

Shelf Surface Tilted With Siding Keeps Contents in Place

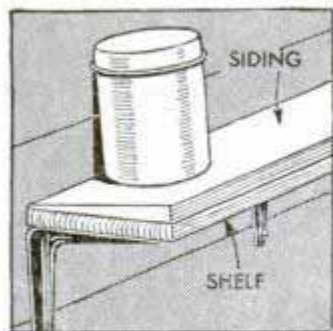

Jars of bolts and screws that are placed on shelves near power tools often are shaken off the shelf due to vibration of the machinery. If a length of beveled siding is nailed to each shelf with the

wide edge outward, any shaking will move the containers back toward the wall.

Ronald Eyrich, Milwaukee, Wis.

Preparing Rawhide From Pelts

To make rawhide from the pelt of an animal, soak the pelt in a pail or tub of water to which a few handfuls of wood ashes have been added. Let it soak for sev-

eral days, or until the hair comes off easily. Using a dull-edged tool such as a skate blade or the edge of a file, scrape off all the hair so that the pelt is clean. Then turn over the pelt and "flesh" it by scraping off all the fat until it is white and uniform in thickness. During the scraping operation rub in dry sawdust or cornmeal to help absorb the fat. After scraping, stretch the hide and tack it to a flat surface in a shady place away from flies. When thoroughly dry, the hide is softened by rubbing in a mixture consisting of equal parts of tallow and neatsfoot oil. To finish the rawhide, work the skin back and forth over the edge of a board until it is soft and pliable.

R. A. Jenkins, St. Louis, Mo.

Attractive Flower Pots Are Made Of Tin Cans and Putty

Attractive flower pots for your house plants are made inexpensively by using discarded tin cans, some putty and a little ingenuity. The cans are painted with an oil paint which is allowed to dry. Then a layer of putty is spread over the outside and the surface is worked into rough designs with the hands. After the putty has dried, it is covered with an oil paint and decoratively embellished.

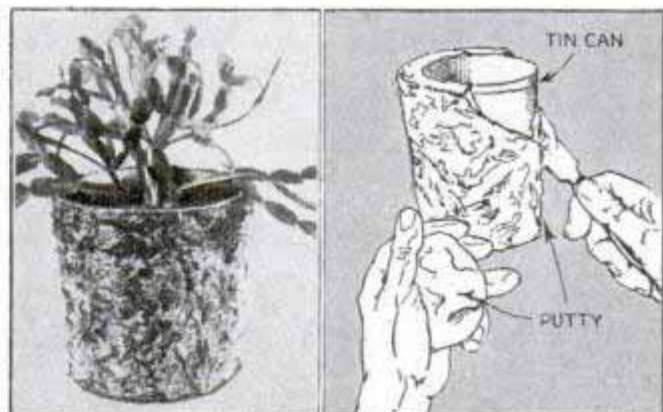

Screw Caps Used to Fasten Bails On Buckets or Cans

Screw caps can be used to attach a bail to a tin can and they also are used to replace broken handles on pails. The metal caps are cleaned and a hole is punched in the center of each cap. Next, the ends of the wire are bent and slipped through the holes in the caps. Then flow a layer of solder on the container and sweat the caps in place.—Richard Verbrugge, Grosse Pointe Park, Mich.

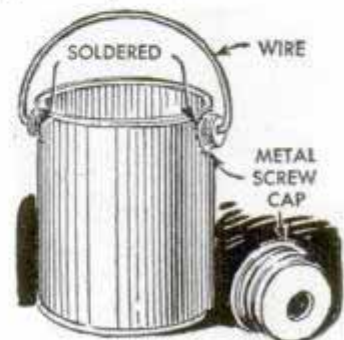

Printed Under Kitchen
Portable Barbecue Pit Has Motor-Driven Spits



By Dorothy A. Brockhoff

It's not only portable but it's equipped with two electrically driven spits, which is something new in home barbecue stands. The frame is built of pipe and fittings in various sizes as called for in Figs. 1 and 2. A $\frac{1}{8}$ -in. steel plate, firebrick and a grille or screen of heavy hardware cloth are assembled as shown to form the firebox. Rubber-tired wheels make the unit easy to move about. The motor drive is of the integral gear-reduction type giving about $1\frac{1}{2}$ r.p.m. This can be further reduced by a reduction to the lower spit as will be seen from Figs. 1 and 2. In this particular design the speed of the upper spit is still further reduced by using a larger-diameter sprocket. However, if desired, both spits can be made to rotate at the same speed if sprockets of equal diameter are used. Most any light drive chain and matching sprockets will serve as the drive, which, of course, must be of metal because of the heat from the firebox. Although shown on only one in Fig. 2 each spit should be provided with two meat clamps. Some light brazing will be necessary on this assembly.

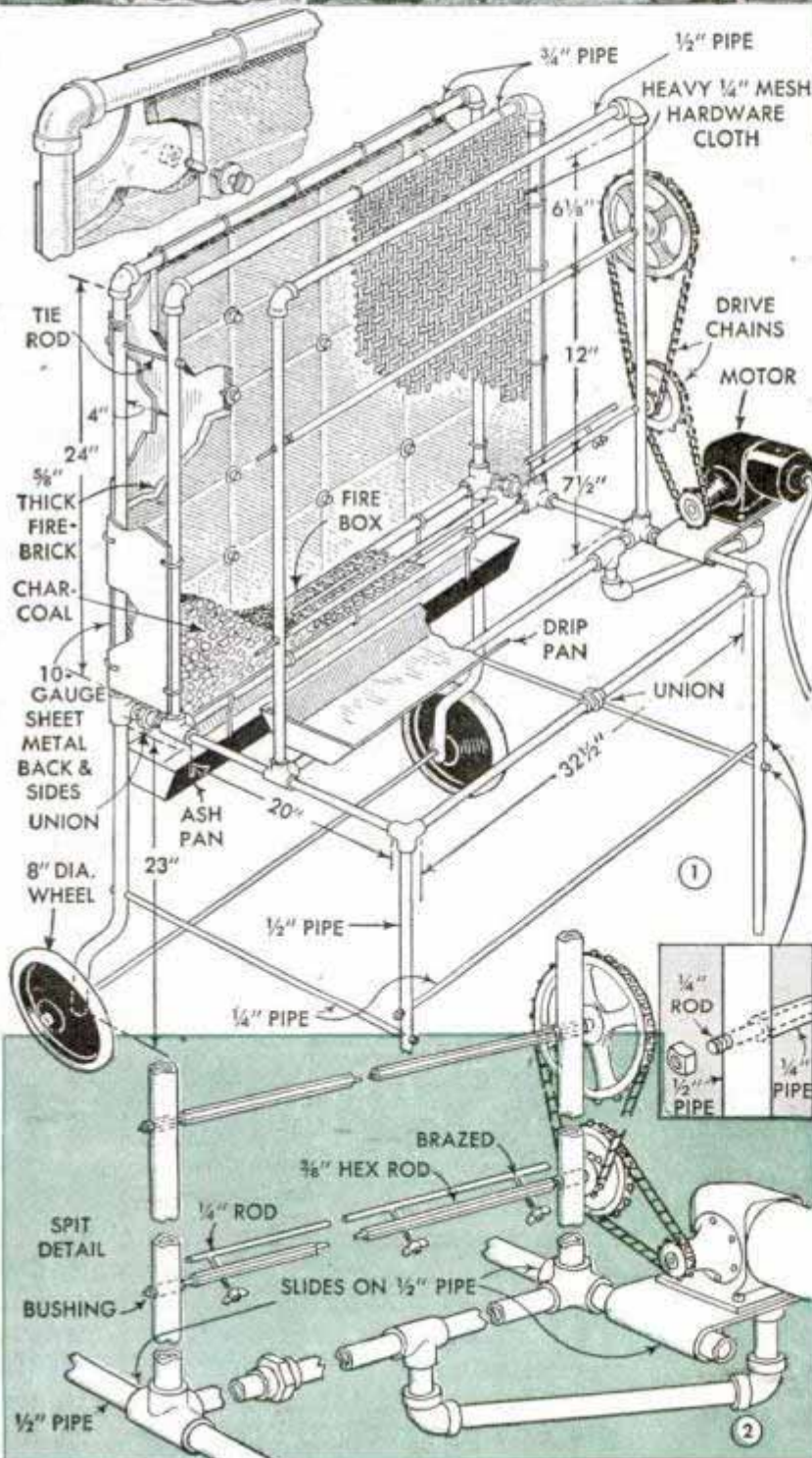

Sheet of Aluminum With Handles Makes a Good Griddle



When frying eggs, pancakes and other grilled foods, a sheet of $\frac{1}{4}$ -in. aluminum makes an excellent griddle that will accommodate much more than the ordinary frying pan. The metal is cut to a size that will fit your stove and metal handles are fastened to the ends. Before using the griddle, it should be heated and "burned" with suet. This precaution will keep food from sticking.

Cracked Joist Can Be Reinforced By Channel-Iron Support

Cracked and sagging joists are easily reinforced with a channel-iron support like the one shown. Cut the channel to the proper dimensions and drill a $\frac{1}{2}$ -in. hole in

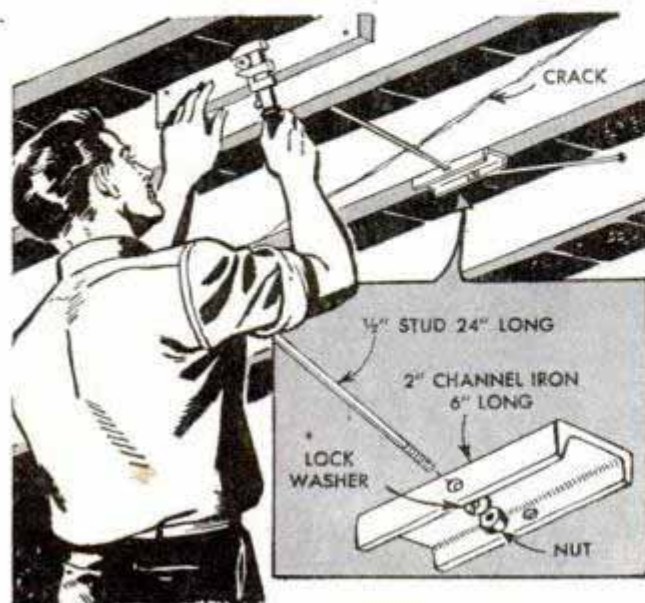

the center of each leg equidistant from the ends. Then reinforce the joist on each side of the sagging member with heavy wood strips and drill $\frac{1}{2}$ -in. holes through the joists. Hold the channel in place and connect it to the joist on either side with a stud. Tighten until the cracked member no longer sags.—D. E. Horn, River Forest, Ill.

C-Clamp Used to Make a Vise For Small Hobby Work

It's often difficult to work on small parts held in standard vise jaws because the width of the jaws interferes with filing and cutting operations. For this kind of close-in work a vise made

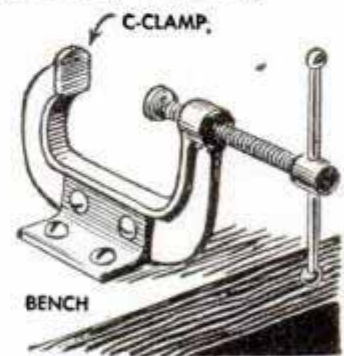

from a small C-clamp and a short piece of angle iron is just right. Drill two $\frac{1}{4}$ -in. holes in the C-clamp and four through the angle iron, as shown. Then attach the clamp to the angle and screw the angle to the bench top as indicated.

E. J. Wiczorek, Chicago.

Wall Plaque From Cutting Board

For unique kitchen and dinette pictures, use a cutting board of either the small or regular size. Lacquer one side to blend with your color scheme, or, if you prefer, leave the wood in its natural color. Paste on a bright fruit or flower print, shellac the entire surface and hang by the hole that is in the top of the board. These are especially attractive when used in pairs.

Ruth C. Buck, Jackson, Miss.

Bicycle Tire Serves as Boat Guard

The bow on a kayak and similar frail craft is damaged easily when used in shallow water where it may strike stones or submerged logs. To prevent this, one boating enthusiast uses a guard

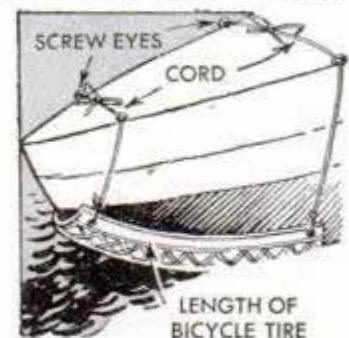

made from a length of bicycle tire. The piece is a foot or so long and is punched at each end so that cords, which fasten it to the boat, can be attached. Screw eyes are driven into the deck of the craft and the cords are slipped through these to hold the guard in place.—E. Miller, Linden, N. J.

AIR FILTERS for your windows



NO matter where you live, an open window anywhere in the house lets in all kinds of airborne dust, soot and plant pollens. Homemakers, always beset with the dust problem, and especially hay-fever sufferers and those confined to the sick-room will appreciate these efficient air filters which use filtering units of the spun-glass and honeycombed fiber type. They are easily made to fit in any double-hung window. The first type, detailed in Figs. 1 to 4 inclusive, is fitted with an electric fan and three spun-glass filter units of the type used in warm-air heating plants equipped with circulators. The fan is hooded for greater efficiency and is housed in a neat cabinet which projects only a few inches

beyond the window stool inside the room. Since the filter units come in standard sizes it's a good idea to have these at hand before you make the cabinet. Width of the filter units must be less than the width of the window. Also, it should be noted that dimensions given in Fig. 3 are only suggestions. They must be altered to suit the window frame and the fan and filter units at hand. The cabinet should be made of material that can be finished to match the woodwork. Birch plywood in $\frac{1}{2}$ -in. thickness is a good choice as it can be painted or stained and varnished to match almost any interior finish. However, for a painted finish, $\frac{1}{2}$ -in. fir plywood will do very well.

First, measure the window to determine

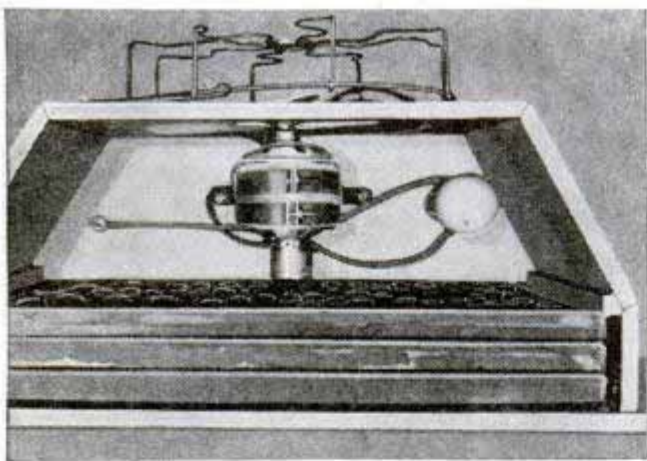
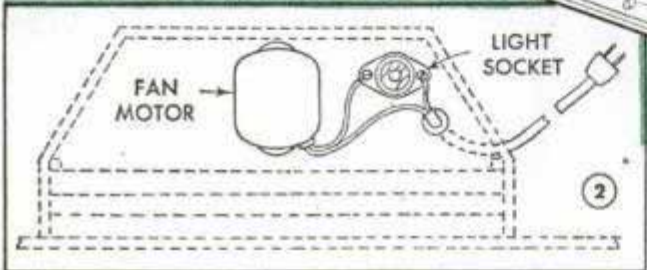
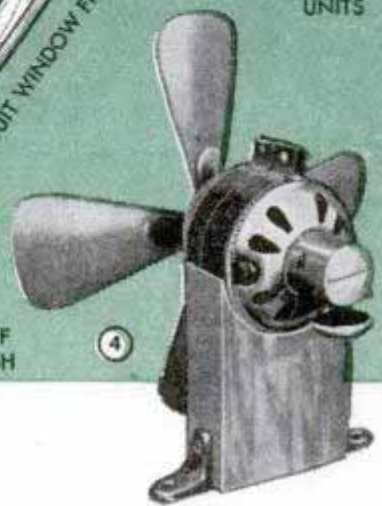
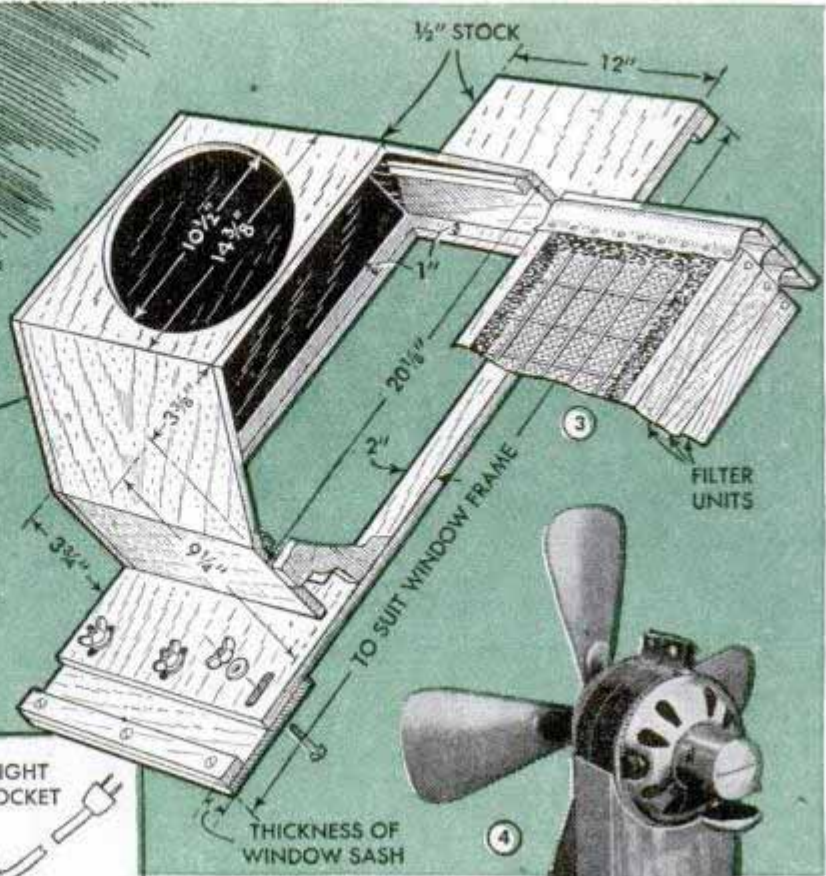

the length of the panel that fits under the raised sash. This measurement should be the same as the width of the lower sash. Note that this panel is made in two parts with a width adjustment so that it can be set in the opening between the inside sash stops and then widened to fit snugly in the sash grooves and against the pulley stiles. The extension piece, Fig. 3, is held in place with three small bolts which pass through slots cut in both members as shown. Wing nuts are used to provide a quick and easy adjustment. The outer ends of both members are built out to the thickness of the sash with cleats so that they fit snugly in

the sash grooves. The panel should be about 4 in. wider than the filter unit, and the opening should be about 1 in. smaller each way than the overall size of the unit. This provides a ledge or stop against which the outer unit fits when the cabinet is assembled. See Fig. 3.

Building the five-sided fan housing is mostly a matter of getting the angle joints cut to fit properly. If you don't have a circular saw, the best way to do this is to make the cuts outside the dimension lines with a handsaw and then finish with a plane to a perfect fit. The circular opening in the front member should be about $\frac{1}{2}$ in. larger in diameter than the circle described by the fan blades. The opening can be covered by a fine-meshed wire grille or with the wire guard which is removed from the fan. Usually the guard is just about the right size and makes an attractive finishing detail as well as affording protection from the whirling fan blades. Generally it is necessary to alter the fan unit by removing the regular base and substituting another sawed from hardwood as in Fig. 4. Two sheet-metal compression bands, tightened with stove bolts, are used to hold the motor in place on the wooden base. This is anchored to the bottom of the cabinet with

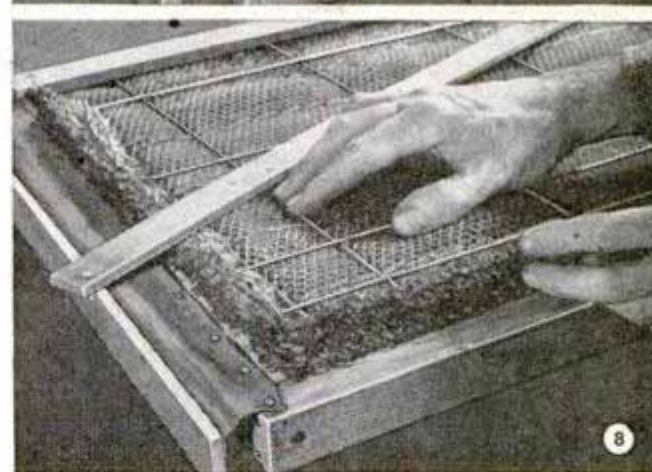
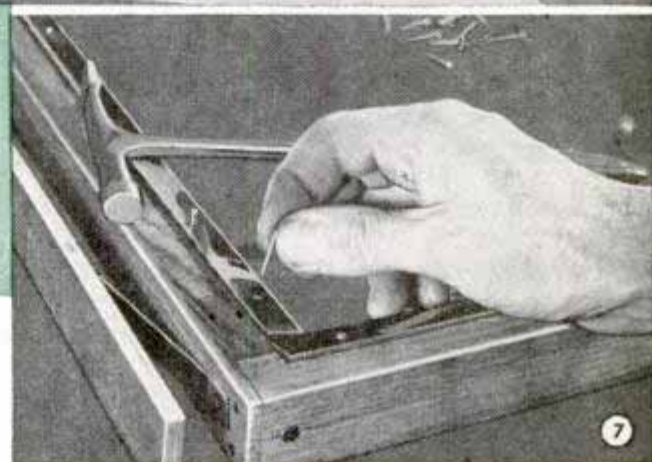
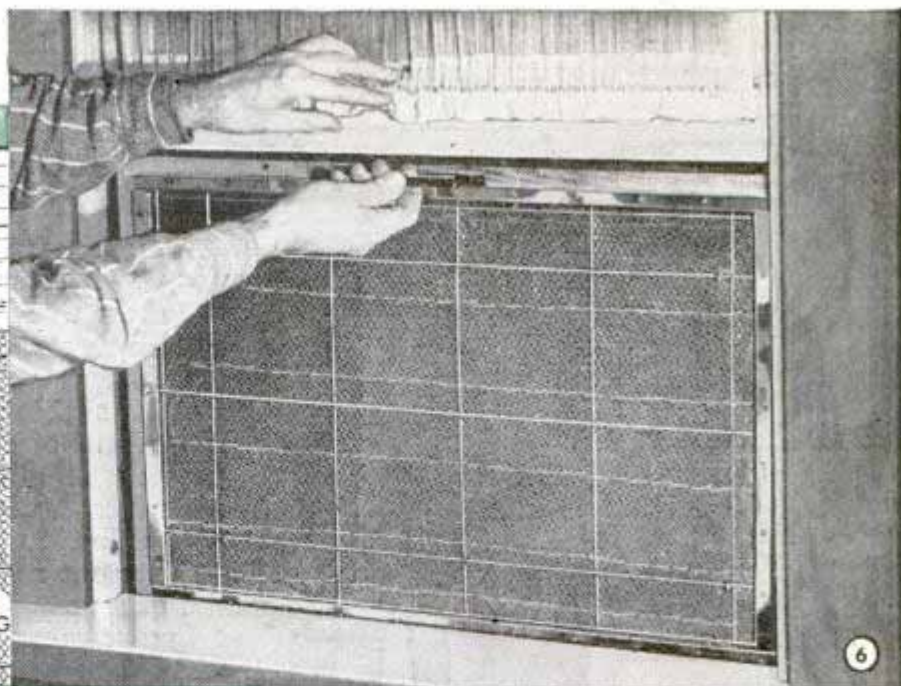
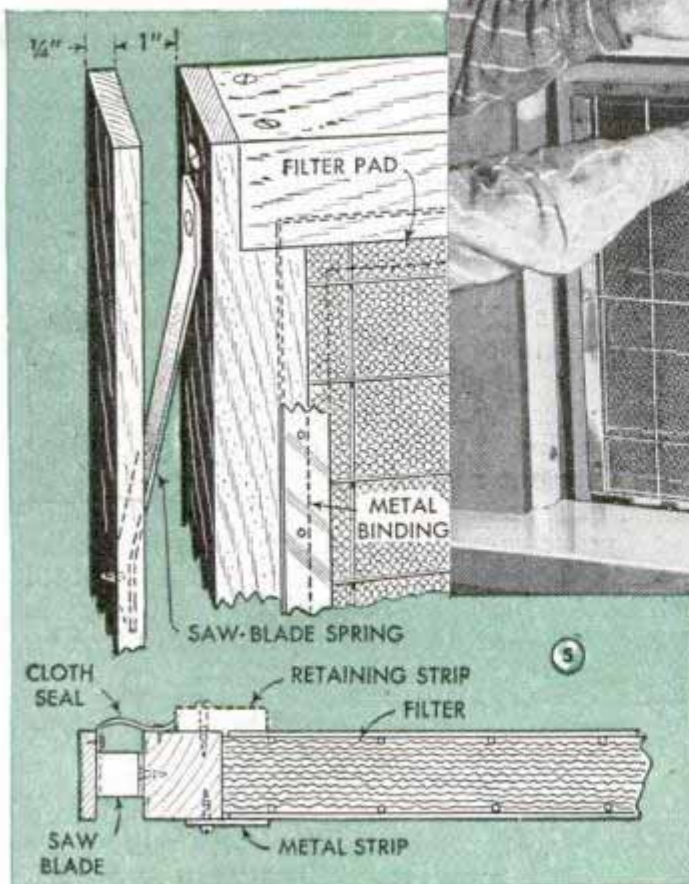

two small steel angles as indicated. If a heavy rubber band cut from an inner tube is slipped over the motor frame before clamping it in place, the fan will be practically noiseless, and if you want a constant-speed fan to run slower than its normal speed, you can connect a porcelain light socket in the motor circuit as in Fig. 2. A 50-watt lamp in the socket will reduce the speed of a universal-type fan motor sufficiently for the purpose. The completed cabinet should have a snug-fitting cover.

Another type of air filter, detailed in Figs. 5 to 8 inclusive, utilizes the less expensive honeycombed fiber filter unit or pad. This comes in standard sizes, usually 2 by 16 by 20 in., 2 by 16 by 25 in. and 2 by 20 by 20 in. overall. The 25-in. length can be framed to fit nicely in the average window frame. Fig. 5 suggests one way of framing the filter unit so that it will be dust-tight yet can be removed easily. Note in Figs. 5 and 8 that a strip of cloth covers the space between the spring-mounted strips and the frame, thus forming an effective seal. The spring-mounted strip allows the assembled unit to be telescoped slightly so that it can be inserted in the window frame past the inside sash stops. The springs can be made from hacksaw blades, although any flat spring of sufficient strength will do. The inside of the frame is finished with linoleum seam binding as in Fig. 7. The

filter unit bears against a retaining strip screwed to the outside of the wood frame as in the lower detail, Fig. 5. A small metal handle attached to the top of the unit aids in removal. Where the unit is left in the window throughout the season it's a good idea to provide a cover to prevent driving rain from entering the filters. A strip of sheet metal screwed to the top member of the frame will serve this purpose. It should be about 4 in. wide and 1 in. shorter than the frame and should be bent down at an angle so that it sheds the water. Paint the metal strip to match the trim color.

Reflector and Flag Are Warning To Approaching Motorists

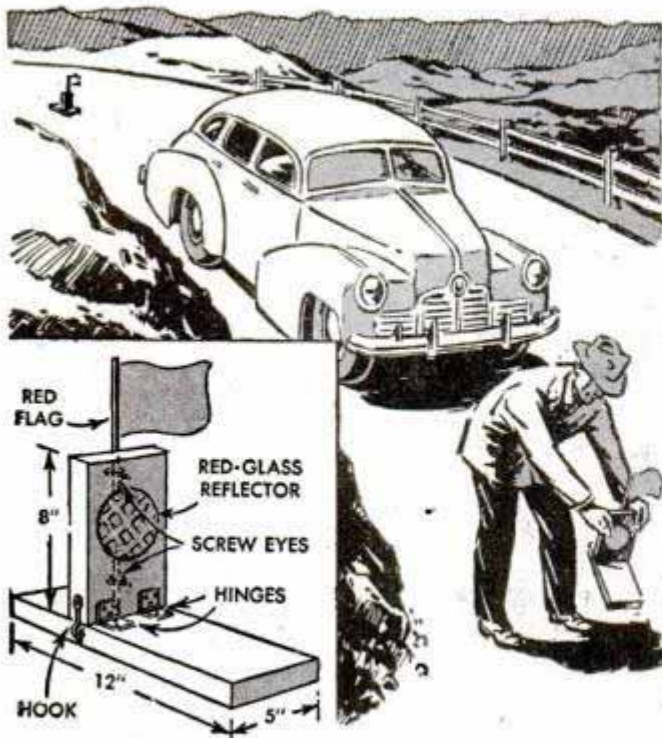

If you have a flat tire or your car stalls on the highway, especially on sharp grades and curves, a combination reflector and red flag assembled as shown will serve to warn approaching motorists and prevent collision. Two pieces of lumber of the size indicated in the detail are fitted together with hinges. A screen-door hook is fastened to one side to keep the upright in position. The staff of the flag slips into screw eyes which are on the back of the vertical panel. During the day, the flag serves as warning to approaching motorists and at night the reflector performs the same function.

Joel R. Huffstutter, Fort Riley, Kans.

Vise Is Fastened With Clamp

You won't have any trouble keeping a small vise in position on a drill press if it is clamped in place. A simple clamp for this purpose is made as diagrammed in the circular detail. It consists of a bolt turned to

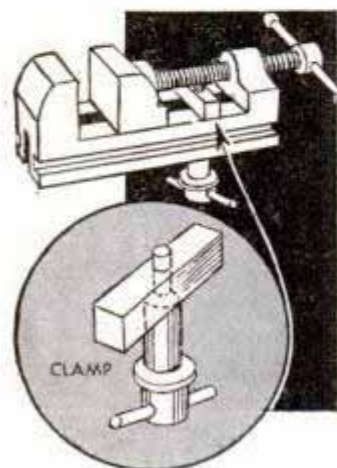

shape and threaded at the small end to screw into a small metal bar. This is of a size to slip between the table slot and the guides of the vise. In use, place the vise in the approximate position desired, then slip the clamp up through the table and vise, turn the metal bar

crosswise and tighten the bolt. Loosening the bolt a turn or two will permit it to be readjusted as required.

H. W. Holt, San Gabriel, Calif.

Quick Adjustment for Bike Seat

When several people of different heights use the same bicycle, it is necessary to adjust the seat to suit the height of each person. If a sillcock-handle wheel is welded to the adjustment nut of the seat post, lowering or raising the seat will be an easier task; you won't have to search for a tool and the likelihood of skinned knuckles is avoided.—Andrew Vena, Philadelphia, Pa.

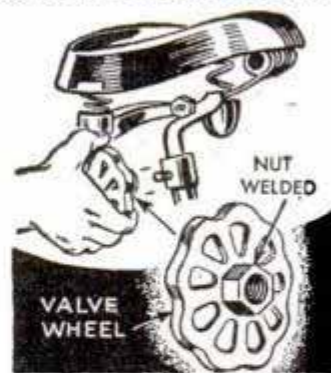

Phone Number on Drifting Boat Helps Locate Owner

One lakeside resort owner who has a number of rowboats for rent paints his telephone number on the transom of each boat. If a boat should be cast adrift or blown out on the lake during a high wind, a person finding it can call the owner on the telephone instead of trying to discover where the resort is located. By this means the boats are located without loss of time.

William E. Davies, Flint, Mich.

Wind Indicator Yard Ornament Adds Decorative Touch

Here's a wind indicator that is made by using odds and ends found around the house. The base is a discarded floor lamp, which will have to be anchored if not sufficiently weighted to withstand high winds. Sheet aluminum is used for the letters N, S, E and W as well as for the directional arrow. Both the arrow and the anemometer vanes, which indicate wind velocity, are mounted on roller skate wheels so they will turn easily. As the drawing shows, the cups on the anemometer are salad molds welded to light pieces of rod.—C. W. Philpot, Laurens, S. C.

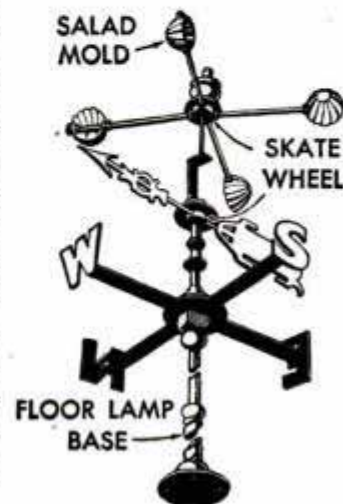

This Lawn "Lake" Keeps Little Tots in Bounds

Small children will be so interested in exploring the possibilities of this tiny "pond" that there'll be no time for experimenting with improvised playthings that might cause injury, or for wandering away as they so often do. The unit is built like a sandbox except that the bottom and corner joints are taped and marine-glued. Waterproof plywood is best for the sides and bottom, although solid wood can be used for the sides. All exposed edges are rounded. Since children like bright colors, the box or tank may be painted lemon yellow with the seats in Chinese red and the sunshade column finished in the natural color of the wood

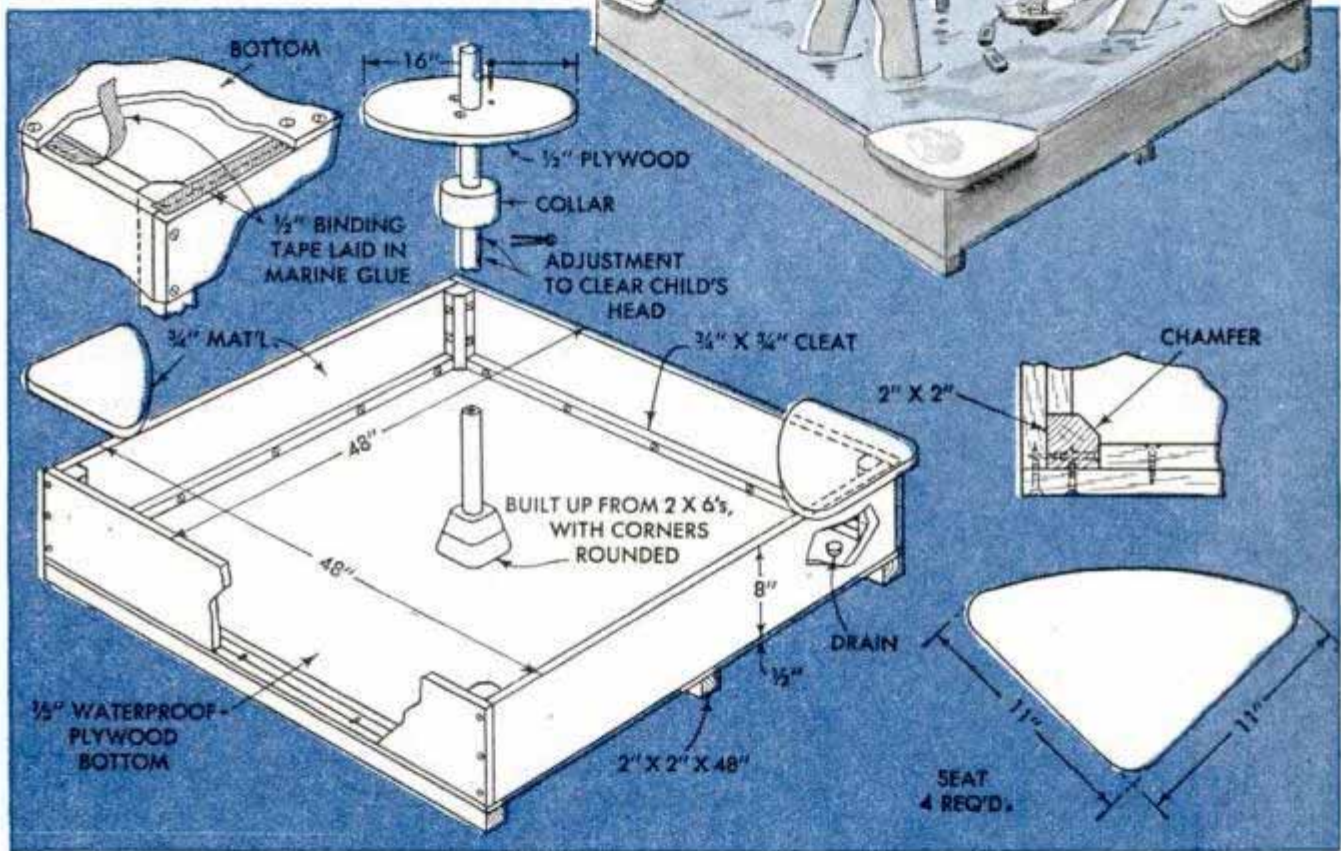
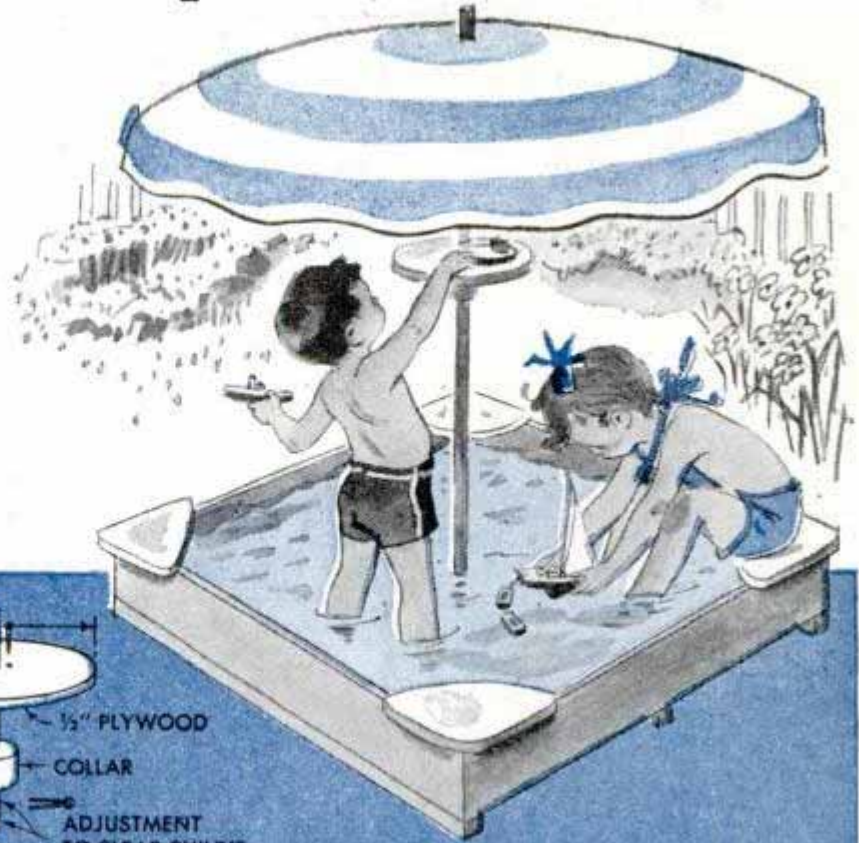

Re-Covering Old Card Table Gives It New Lease on Life

Old card tables with worn coverings will take a new lease on life when repainted and re-covered with a bright, new cover. The materials needed are one sq. yd. of leatherette and the same amount of flannel blanket or a similar material. The old covering and padding should be stripped off the table with the aid of a pointed—but not too sharp—tool. Pry the material out of the slot running around the edge of the table; you will find that in most cases there are no nails to hold the cover in place. After this has been done, sand the table with a fine grade of sandpaper, tighten all screws and make certain that all nails on the top surface are countersunk. Repaint

the table in either its original color or some color that contrasts well with the new cover. Next, the padding should be placed over the table and pressed into the slot with the rounded end of a bevel gauge or some similar instrument. The leatherette for the top then is placed on the table and trimmed so that it will extend about $\frac{3}{4}$ in. beyond the slot in all directions. This is fastened in the same way as the padding; in both cases care should be taken to avoid wrinkles and creases.—Lieut. Comdr. John David Howell, West Orange, N. J.

☐ If paste is not available, the white of an egg can be used as an adhesive.

Surface of Fishpond "Skimmed" With Kitchen Broom



To remove dead leaves and insects from the surface of a fishpond or lily pond, an ordinary kitchen broom can be used as illustrated. When the broom is immersed in the water under the material to be removed and then lifted up, the skimmings will adhere to the straws, which allow the water to drain through.

A. H. Waychoff, Phoenix, Ariz.

Clean-Out Door in Cold-Air Duct Provides Easy Access

This small clean-out door in the cold-air return of your furnace will provide easy access when removing accumulated dirt.

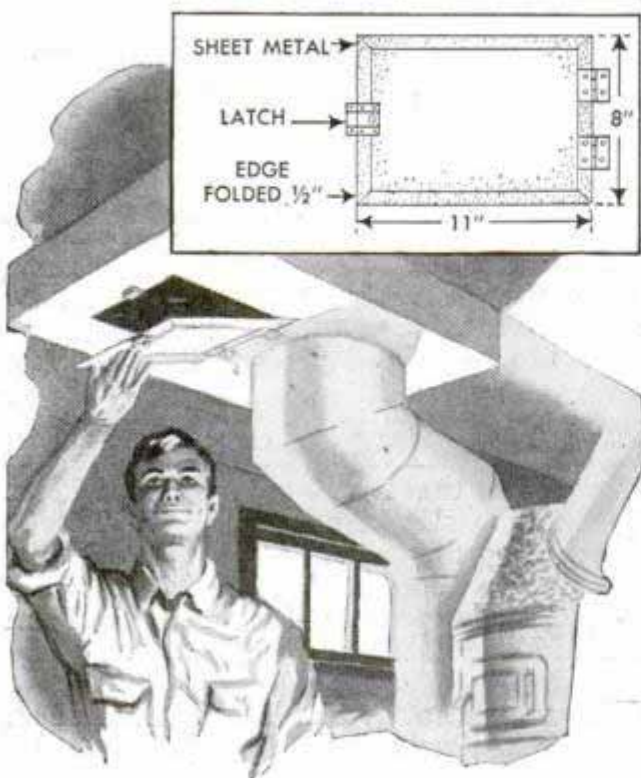

The opening in the duct should be $\frac{1}{2}$ -in. smaller all around than the dimensions given for the door so that the door will overlap the edges to provide a seal and prevent basement air from entering the duct and lessening the recirculating effect of the sealed return. Hinges for the door are soldered or bolted in place and a latch opposite the hinges keeps the door closed.

Thomas J. Mahan, East St. Louis, Ill.

Magnets Used as Soldering Jig

A pair of horse-shoe magnets can be used to hold light steel and iron objects in position for soldering. The magnets are slipped over the edge of the work table and the objects to be soldered are laid on the magnets in the proper position. This leaves both hands free and also lessens the possibility of burning the bench.

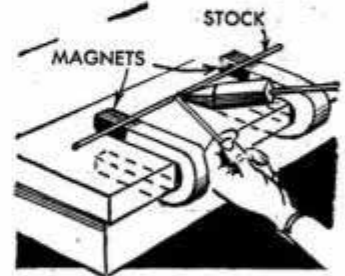

Paul Criton, Jr., Kayville, Sask., Can.

Substitute for Wood Putty

For an emergency repair, a good substitute for wood putty may be obtained by using collodion cement and wood dust. Using a fairly coarse wood rasp, scour some dust from the underside of the piece to be repaired, or from a similar piece, so that the coloring will match closely. Mix the dust with the cement and when it reaches the right consistency work it into the damaged place. The "fill" should project slightly so that when it dries and shrinks there will still be a raised portion which can be sanded down level with the surrounding surface.—H. G. Kurtz, Columbus, Ohio.

Dart Holder Cut From Broomstick

Followers of dart throwing will appreciate this compact holder. An 8-in. length of broomstick is planed so that it can be fastened to a back board. The holes in which the darts fit are $\frac{1}{8}$ in. in dia. and $\frac{1}{2}$ in. deep and are spaced on 1-in. centers. They are drilled at an angle of 45 deg. After the holder is sanded and finished, it can be mounted on a wall of the game room.

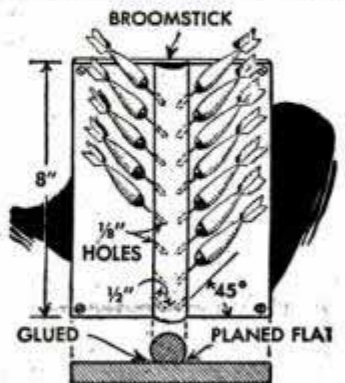

D. I. Naughton, Mt. Vernon, N. Y.

Dispenser Delivers Toothpicks One at a Time

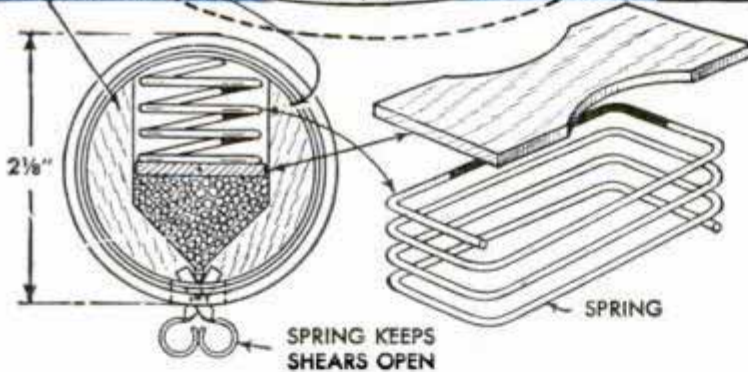
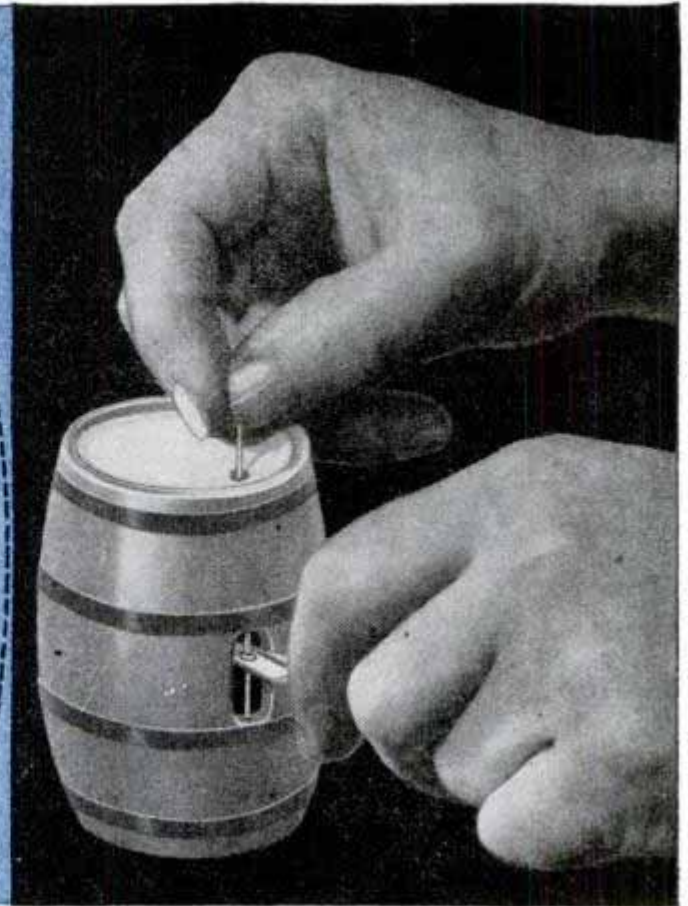
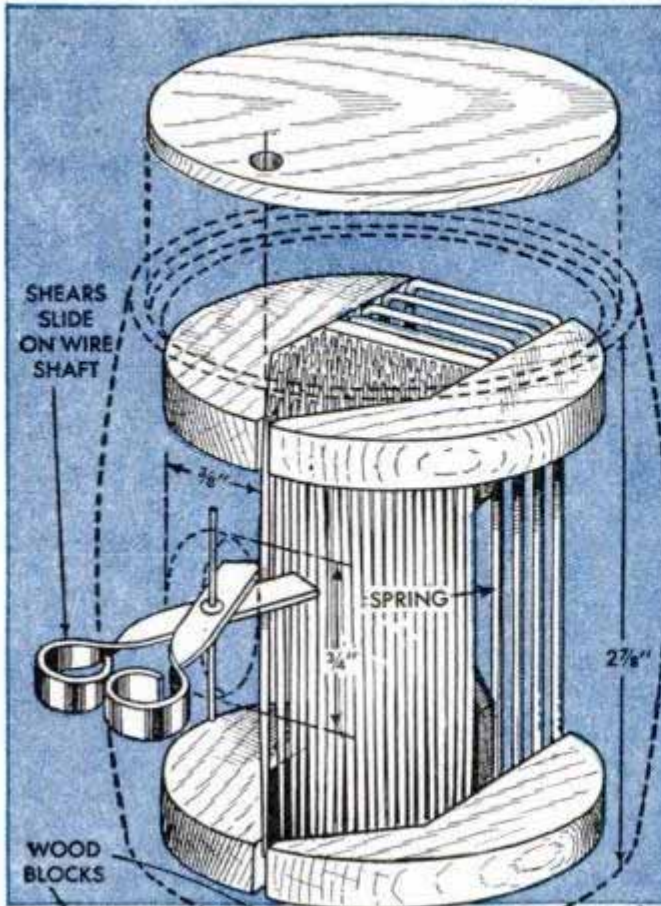

Squeeze the handle, lift up and out pops a toothpick. That's how this dispenser works. It's done by a plunger which reloads the scissorlike handle each time a toothpick is removed. The detail shows how V-shaped pieces, glued at both ends of a turned barrel, form a hopper for the toothpicks. Ends of the barrel are fitted with heads, the top one being removable. A hollow rivet holds the handle together and provides a bushing for a pin which allows it to pivot in an opening in the side of the barrel

Rubber-Hose Bumper Keeps Screen Door From Slamming

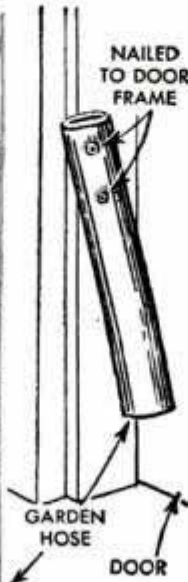

To prevent a screen door from slamming, nail 5-in. lengths of garden hose to the door frame so that the free end of the hose will extend out from the frame slightly. This will prevent the door from banging, but at the same time it will permit the door to be closed fully so that it can be locked.

Hi Sibley, Nuevo, Calif.

Rain Kept Out of Ventilators By Fine Mesh Screen

Strong winds will not blow rain through ventilator louvers if the outside of the ventilator is covered with a very fine mesh screen which breaks up the drops and prevents their entering. The screen should be painted to match the ventilator and improve its appearance.

Clarence Breitenfeldt, Marathon, Wis.

"FRAME" *the* PICTURE



Here the scene was viewed from a point to exclude the road and hedge and take advantage of the natural border formed by the overhanging branches. Note how branches and shadow fill empty corners of the picture. Golfers add theme and human interest

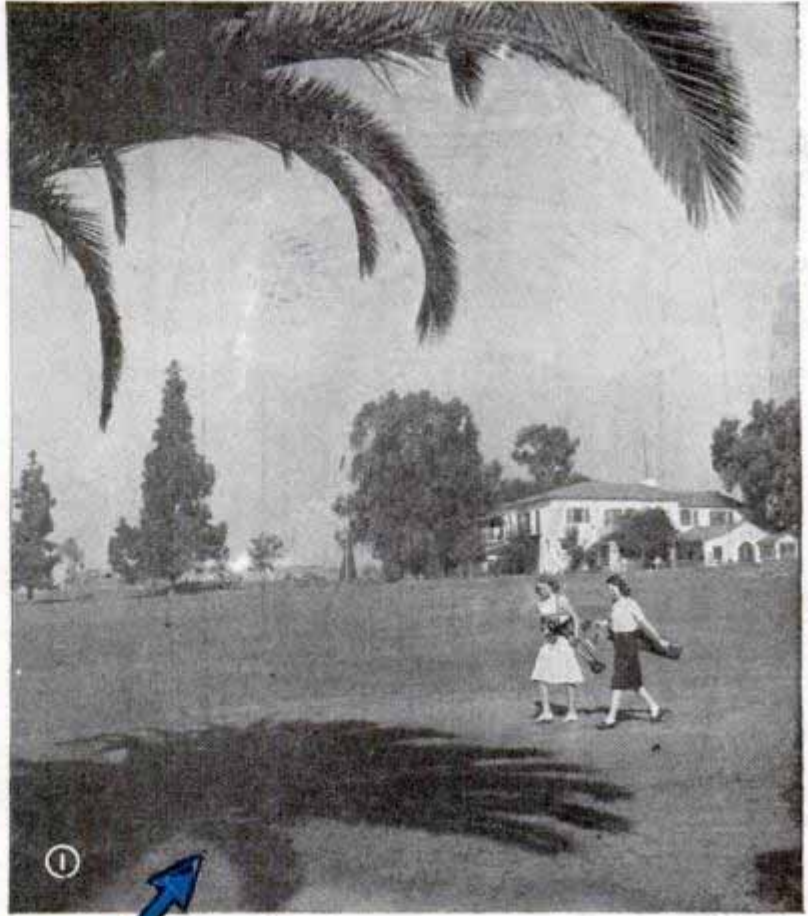

Before YOU SHOOT!

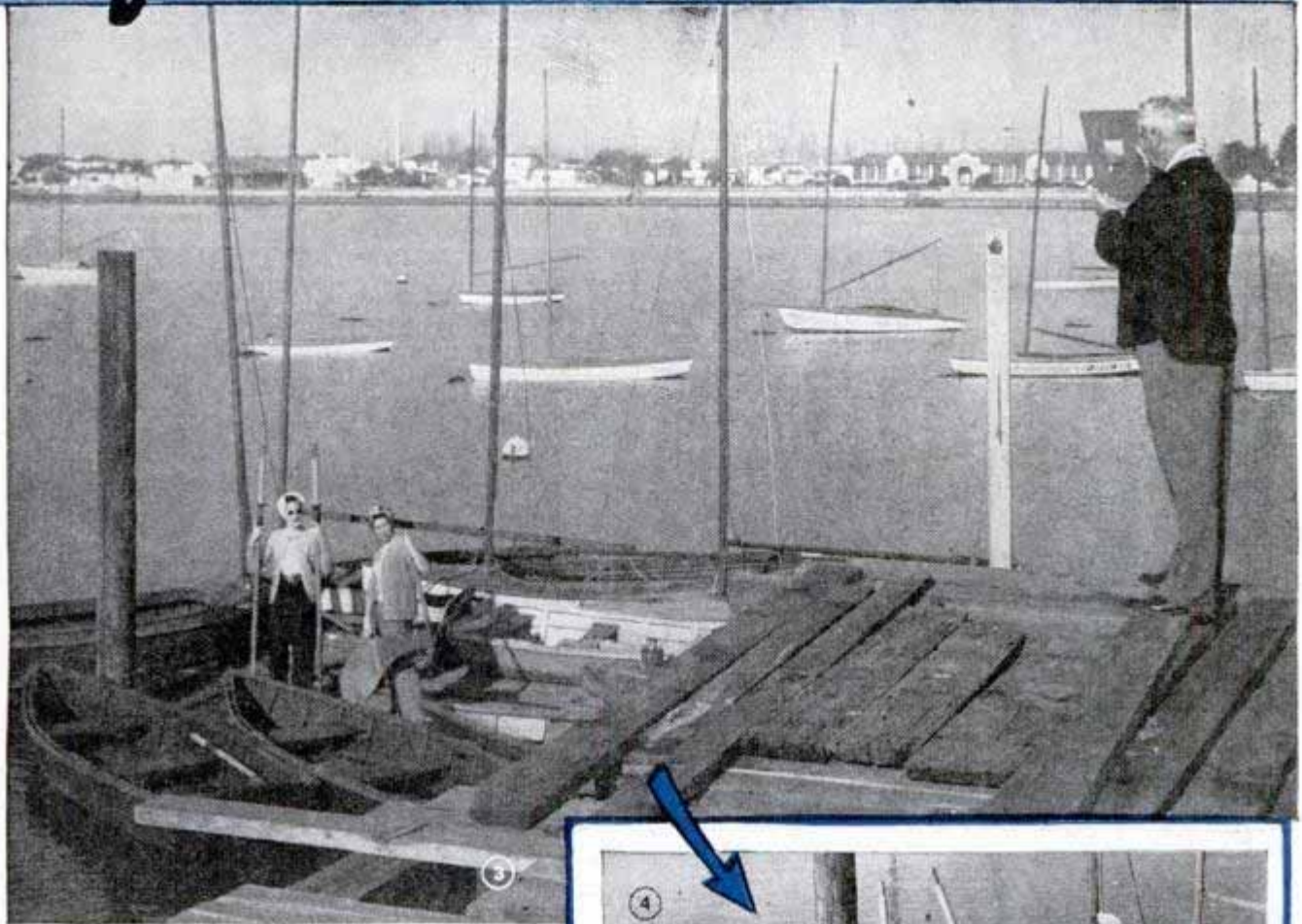

Confining action improves composition without sacrificing theme. Here the interest is centered by selecting a shooting spot which crops the picture of uninteresting background

By Richard W. Emery

TAILORED shots are yours when you "shoot" in advance through a mask. You pick the spot to take the shot. Framing pictures beforehand can be likened to cropping when enlarging—only here it is done before the picture is ever taken. While it is true that you more-or-less frame the picture when you sight through the camera view finder, the small image makes it difficult to study composition and see all the little things that go to make a good picture something that didn't just happen. Careless handling of composition, such as allowing part of a house in the background when you could have moved to avoid it, getting distracting landscape in a cloud shot, failing to include people or neglecting to let foreground add depth to the picture, can be controlled to a great extent by viewing the scene first through a simple cardboard mask. Holding the mask close to the face and look-

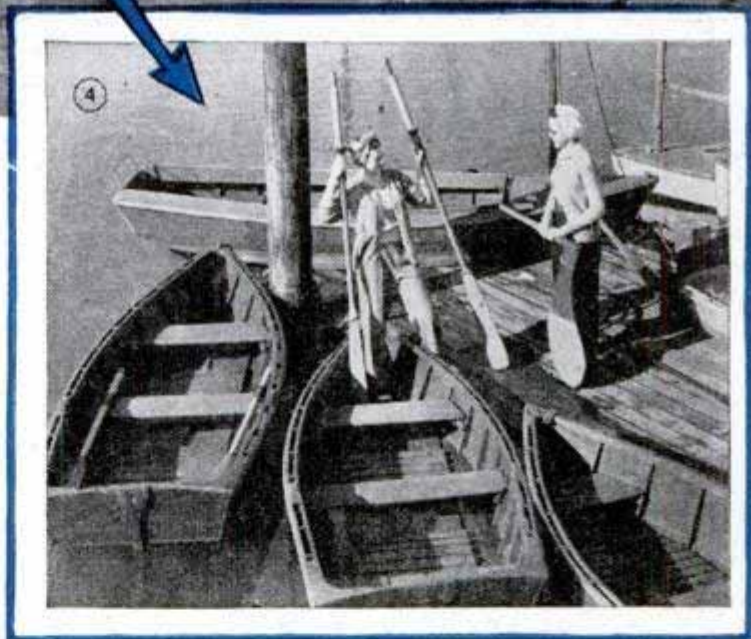

ing through it with one eye enables you to see the finished print, so to speak, and to study the proposed shot carefully from the standpoint of composition and shooting angle. Primarily it's a case of viewing the scene from many angles and distances until a vantage or shooting point is found that will produce the picture you want. To get the most out of the mask, you should know for sure if the camera "sees" the same amount of area as seen through the view finder. You can determine this by making a few test shots at various depths of field and noting

Photographs by Ray Chapin



These three pictures illustrate the value of using a mask in studying proposed shots beforehand. As viewed from the pier railing the skyline appears cluttered, with buildings in the background apparently sprouting from the tops of others

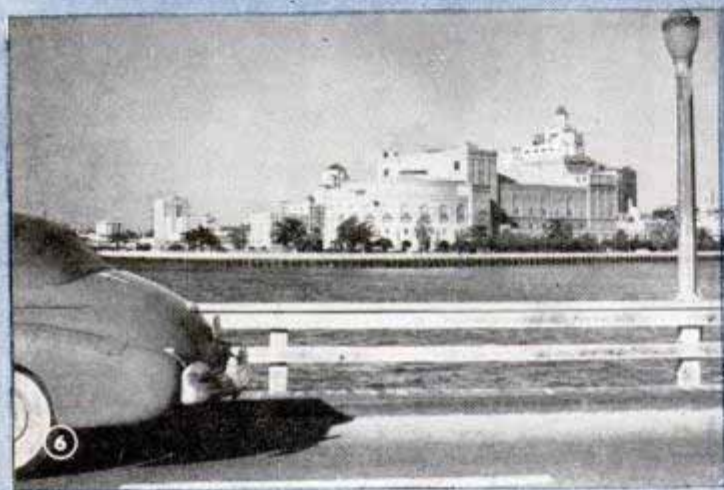

The same scene viewed from a point more distant shows very bad composition. The railing, car and lamppost are distracting elements. The skyline is unbalanced and the buildings appear mushroomed. Select a position to exclude these



Changing the position and viewing the scene from different angles produced this well balanced and defined picture. The skyline is uncluttered and the water, unbroken by distracting objects, adds depth and quality to the picture

Check these points for good composition:

1. General pictorial qualities
2. Theme
3. Lighting (shadow masses and high lights)
4. Background, foreground and sky
5. People
6. Focal point
7. Color and exposure

whether or not the width of vision is equal to that recorded on the film.

Figs. 1, 2, 3 and 4 are good examples of what framing will do to improve composition. By eliminating the road and hedge in Fig. 2 and allowing the tree and its shadow to fill empty areas, the resulting picture in Fig. 1 is interesting and has depth. The introduction of people, in this case golfers, adds human interest and gives the picture a definite theme. The same is true in Fig. 4. By "cropping" the typical boat scene in Fig. 3 of distracting and uninteresting elements, the result is dynamic and uncluttered.

All you need for a mask is a piece of dark cardboard about 12 in. square with an opening cut in the center equal to the size of negative or picture that is to be taken. For example, if your camera takes No. 120 or 620 film, the opening in the mask should measure $2\frac{1}{4}$ by $3\frac{1}{4}$ in.; if No. 116 film is used, the opening should be $2\frac{1}{2}$ by $4\frac{1}{4}$ in., etc. Larger openings, such as 5 by 7 in. and 8 by 10 in., require a mask having a margin sufficient to block off vision of surrounding area. Vertical and horizontal crosslines, which will aid in centering the subject, can be attached to the opening in the manner detailed in Fig. 10. Not only will the mask allow you to view the scene full size but also right side up, which is a distinct advantage when using a camera having a ground glass.

In locating the best shooting point you should consider a number of factors, such as general pictorial qualities or composition, theme, lighting (shadow masses and high lights), background, foreground and

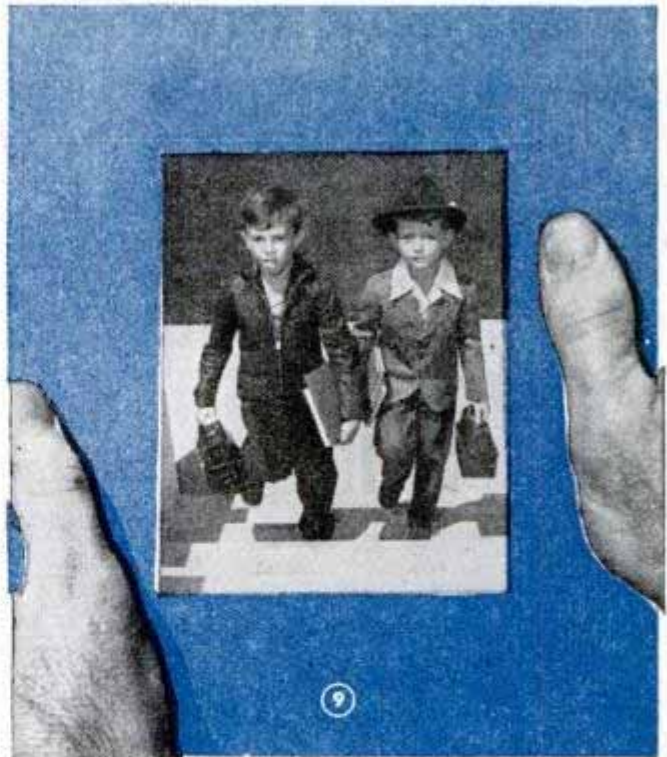
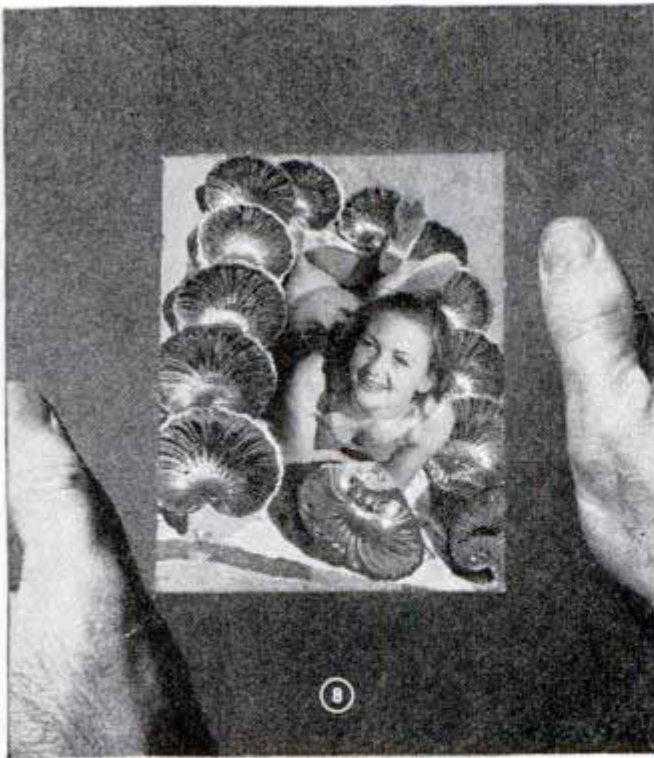

A mask is helpful in arranging compact composition in close-up shots as shown in the views above and below. Viewing the picture directly above from a point closer will fill empty corners and give better composition. Viewing shots beforehand will eliminate waste space and permit greater detail to be had

sky. In most instances, people in the scene will mean the difference between just another snapshot and one that is outstanding. Select a view that is free of objects that tend to distract from the central subject. An example of how such objects can rob a picture of good composition is shown in Figs. 5, 6 and 7. Shooting the skyline from the railing as shown in Fig. 5 produced the shot shown in Fig. 7, which is far better pictorially than the view in Fig. 6, taken from a more distant position. Not only do the railing, car and lamppost detract from the central subject, but the skyline is cluttered

by buildings appearing to be sprouting from the tops of others. A shift in the camera angle corrected this, as you see in Fig. 7. Study your scenes with the mask held one way and then the other to see if the picture would be better taken vertically instead of horizontally or vice versa. Also, view the scene from different angles to see if a change of position will improve composition. Don't be satisfied with the easiest way out; the picture you want may require shooting from a roof top or tree.

Knowing your camera field and working close-in for shots such as those in Figs. 8, 9 and 11 adds punch to your pictures. Here you can see how a mask will aid in arranging compact composition. Fig. 8 could be improved further by allowing the shells to fill empty corners of the picture or by taking a position somewhat nearer. When

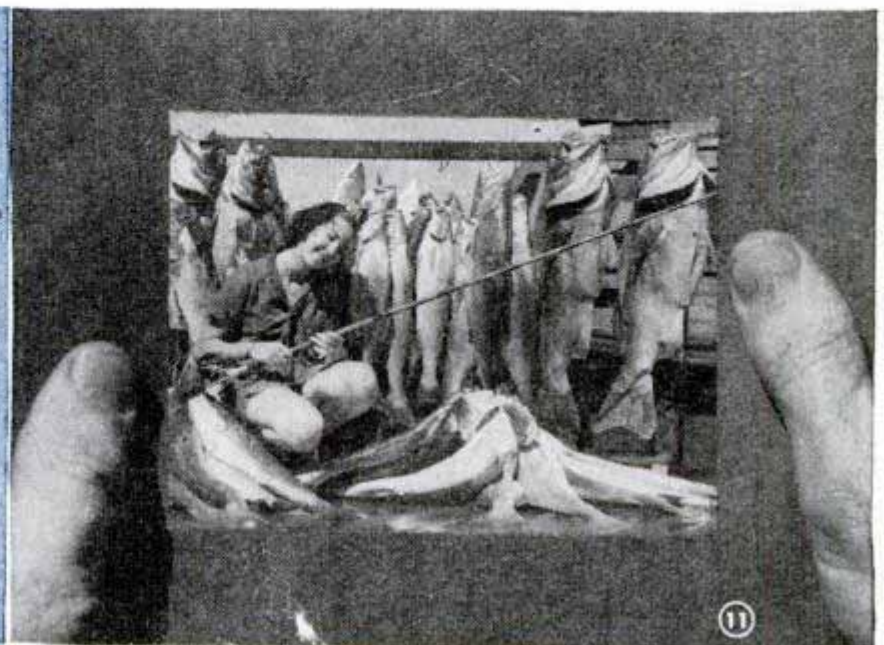
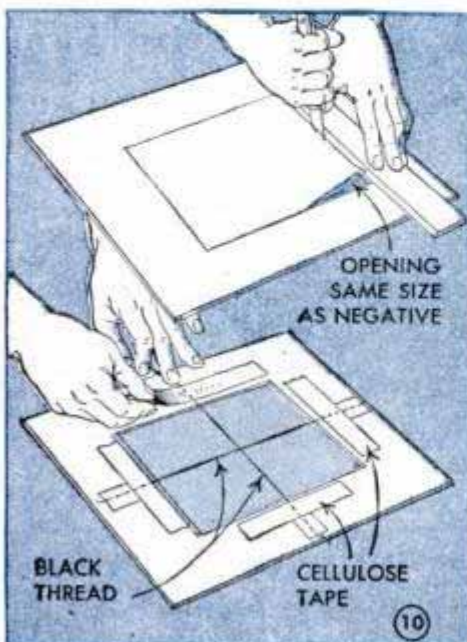

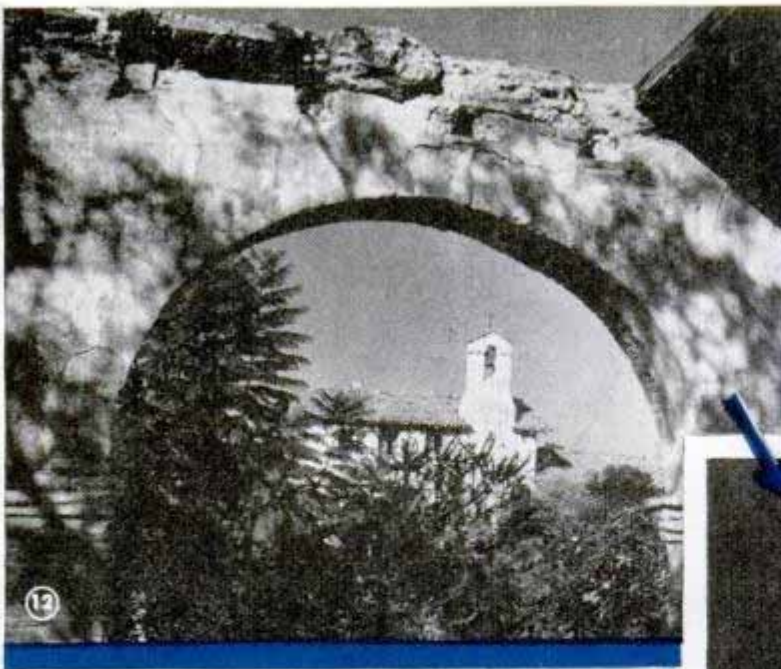

How shooting close-up and from a different angle improves composition is shown in these two shots of an old Spanish mission. In the picture at the left the photographer was able to balance general composition nicely with shadow masses covering the arch, but the same shot taken close-up from a different position produced a more pleasing picture of compact arrangement which confines the theme to a central point of interest as shown below



parallel lines run in line with the camera, you must allow for the foreshortening effect of the lens. Continued use of the mask soon will sharpen your eye to recognize good composition, and you'll become aware of the fact that a picture is not all center but has edges too. Figs. 12 and 13 show how an archway can be used to form a natural frame for the picture by shooting through the arch. Notice, too, in Fig. 12 how shadows covering the face of the arch balance the general composition of the picture. Comparing the two pictures you will see in Fig. 13 how a change of shooting angle produced compact arrangement without robbing the picture of its general theme. Narrowing the field of vision to the portion

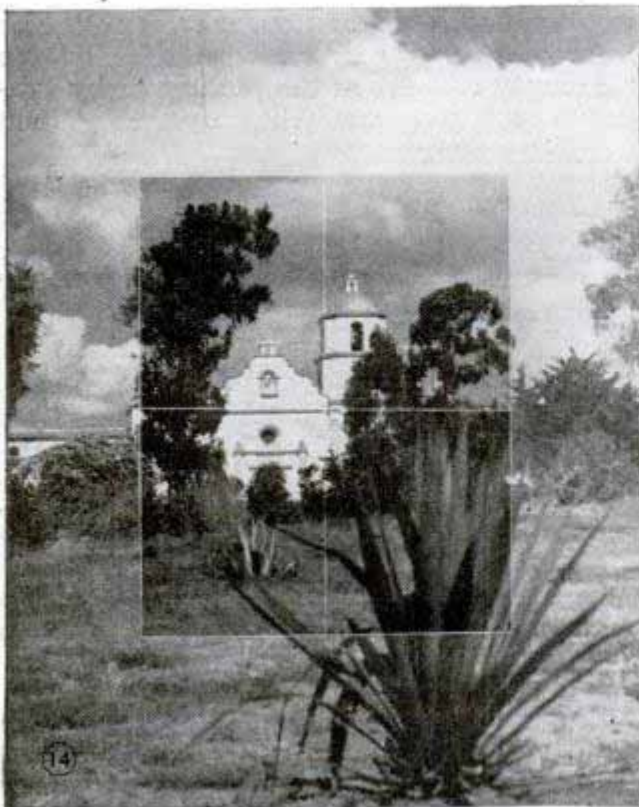

indicated in Fig. 14 shows how composition is improved without sacrificing theme. Selecting a shooting spot near the subject naturally increases detail and permits greater enlargement.

For your first effort in using the mask, pick a subject that is stationary, such as a landscape or a lake scene. If you have a definite theme in mind—trees, distant shoreline with perhaps a hilltop against the skyline—start prospecting for these “props” with your mask. Locations that look good to the eye are not always good pictorially when viewed through the mask. By imagining that you are looking at the finished print you can determine easily if composition will be improved any by raising the mask to include the skyline in the upper third of the picture. Or perhaps it will be still better if you swing to one side

Here's a good example of how narrowing the field of vision improves composition without sacrificing the theme of the picture. The area in the margin of the mask (shown transparent for the sake of illustration) is unimportant and detracts from the central subject

Right: This picture of a girl in a beach costume illustrates how theme is planned by careful use of minor elements expressing the same idea. The girl is the major element, but her costume, the pier planking and railing, the breaking waves and the hotels in the background all express the idea of beach and vacation. Studying a picture from various angles helps to establish harmony between major and minor elements so that they tell the same story

a little to have an overhanging branch or other object fill an empty spot in the picture or to provide a natural frame.

Fig. 15 illustrates how minor elements can be used to emphasize theme in a picture. The girl in the swimming costume alone conveys the thought of vacation and beach fun. But by introducing minor elements, such as the railing, pier, waves and hotels, the theme is accentuated. However, unless careful thought is used, minor elements can kill the main idea of the picture by having no direct relation to the main or major element. Studying a picture through a mask before shooting helps to establish harmony so that both elements tell the same story. Building up the composition in a picture requires a systematic routine of considering each point individually and checking it with the mask. Where a shot is planned to include a person or a group, select the



location first, choosing a background that will contrast well with the color of the clothing, then concentrate on placing the subjects to best advantage within the area confined by the mask.

Inner-Tube Band on Tripod Legs Makes Compact Bundle



To keep the legs of an old camera tripod from spreading when you're carrying it, snap a 2-in. band cut from an inner tube around the ends as shown. The rubber band holds the ends in place so that the tripod may be carried easily. If the band is large, it may be looped over the legs several times, as indicated in the circular detail.—Duke D'Ambra, Lawrence, Kans.

Color Filter Made From Key Tag

A satisfactory and inexpensive color filter can be made by substituting a disk of colored Cellophane for the cardboard disk in a metal-rimmed key tag. To hold the paper in place, apply a little colorless nail polish around the rim and allow it to thicken. Then flatten the rim in a vise. Holding the filter in a draft of warm air will draw the Cellophane taut after the cement has dried. If the right size tags are used, they will fit many filter adapters. To clean the filter, wipe it gently with a soft, dry cloth.

Typewriter Eraser Brush Is Used To Clean Camera

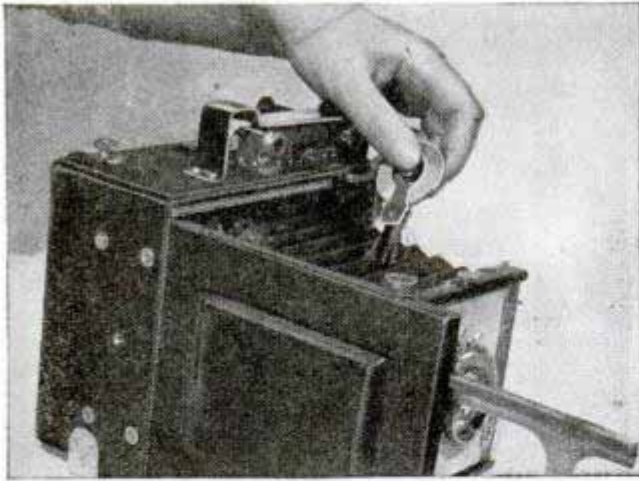

A worn typewriter eraser of the kind shown takes little room in a camera case but is handy when used to brush away dust that accumulates in hard-to-reach corners of a camera. However, the brush should never be used to clean the lens, filters, viewers or range finders.

Focusing Card Aid for Dim Light

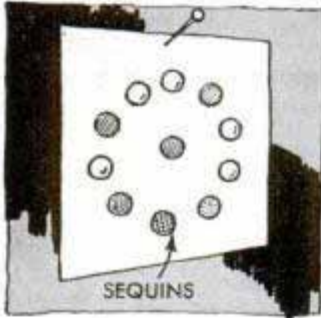

To overcome the difficulty of focusing a camera in dim light, use a card on which a few colored sequins have been glued. These small disks have high reflecting power and are easily seen on

the ground-glass screen. The card should be placed on or slightly to one side of the subject to obtain the best results.

Ferrotypes Held in Drawer

If ferrotypes are held in a curved position while photoprints are drying on them, the prints will be less likely to curl. A length of string or wire often is used to hold the tins in the curved position, but I



have discovered another method. I place my tins in one of the small drawers in my buffet. An added advantage to this arrangement is that when the prints dry and fall off, they drop into the drawer where they are gathered easily.

William Swallow, Brooklyn, N. Y.

Data Recorded on Negative When Exposing Film

Owners of cameras using cut film and plate holders can record information on the negative at each exposure. A strip of clear celluloid is cut to fit in the back of the camera at the bottom as indicated. The information is written or printed on the strip with a black marking pencil. When the film is exposed the information is re-

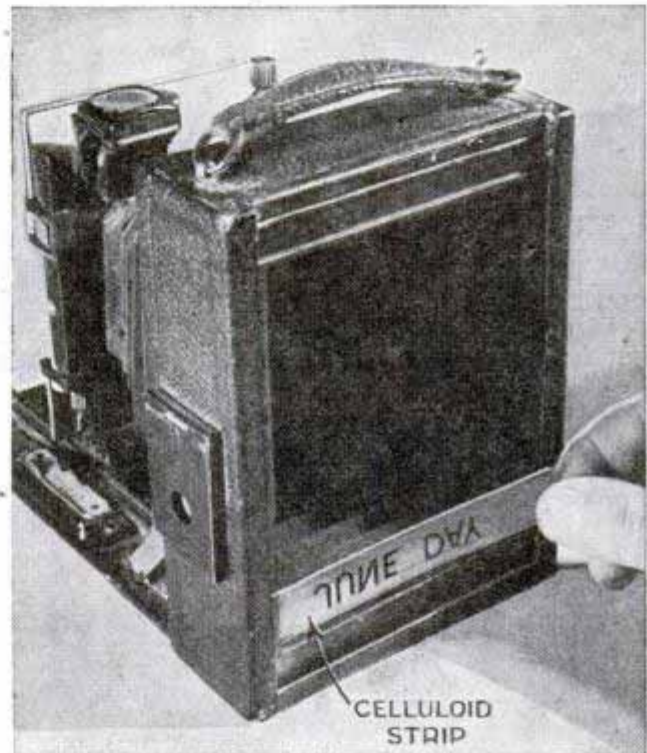

corded at the top of the picture. The celluloid is cleaned easily with a dry cloth. This method is most effective for outdoor scenes which include the sky.

Accurate Weighing of Chemicals

By controlling the flow of photographic chemicals from wide-mouth bottles onto the scale pan, weighing can be done more accurately; none will be spilled and it will not be necessary to return any of the chemical to the bottle. To do this hold a card over the bottle mouth so the flow will be uniform at all times.

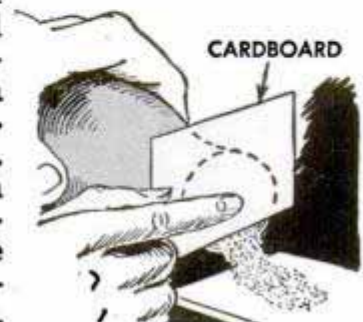

Control Unit Gives Wide Range in Photo Lighting

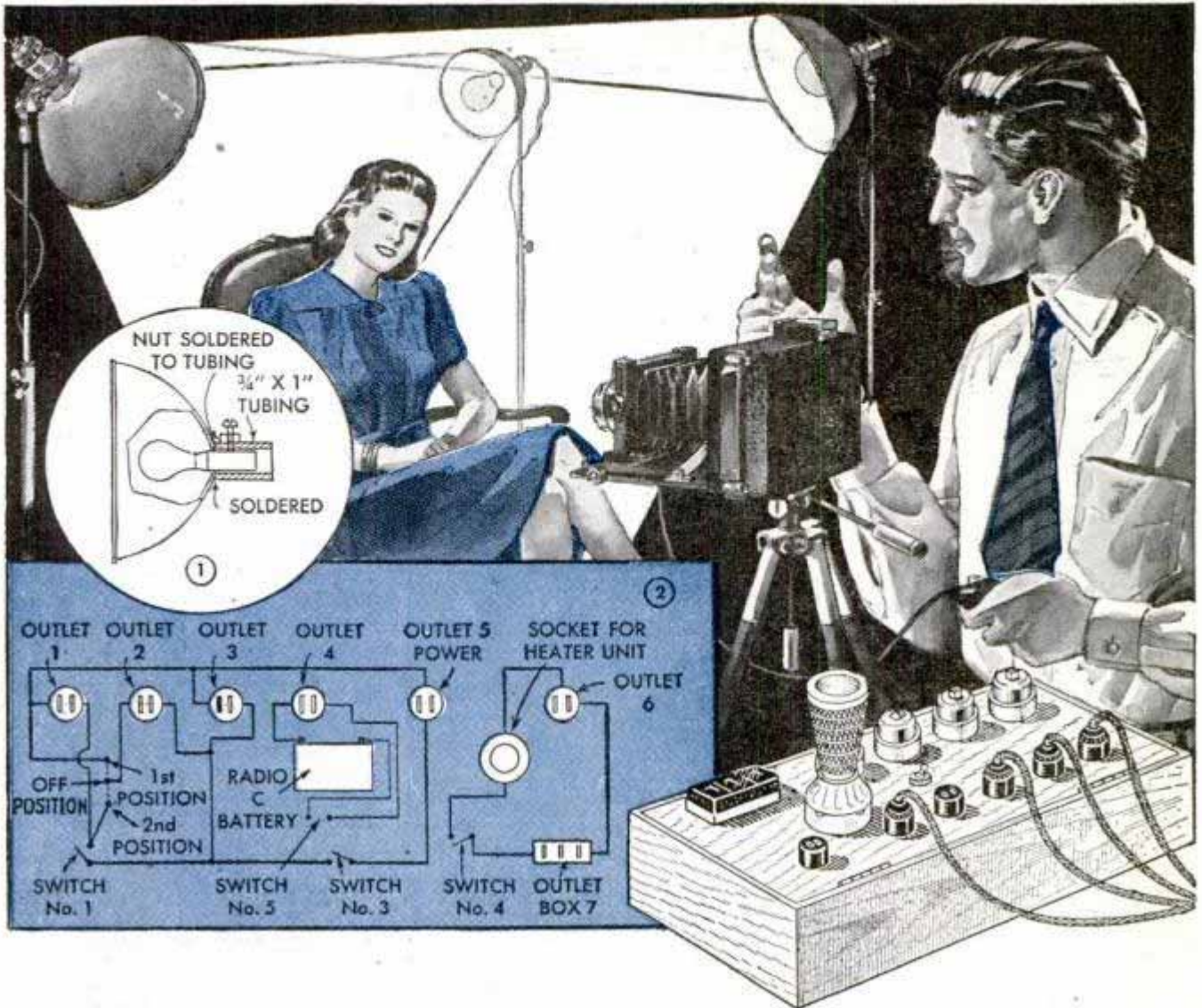

WITH this multiple-outlet unit you can control photo lamps for focusing, flash and flood lighting from one control panel. The unit consists of a battery of outlets and switches conveniently arranged on the cover or lid of a small wooden box of suitable size and depth to house the wiring and connections. The box lid serves as a panel on which the switches, plugs and a socket for a 600-watt porcelain heater unit are mounted. The box should be made from 1/2-in. hardwood.

Six-volt focusing and flash: Reflectors from 1937 Ford headlights are altered as in Fig. 1 by soldering a 3/4-in. length of copper tubing to the back of the reflector in the position shown. A setscrew and nut hold the midget bulb adapter in place. By moving the adapter back and forth the light can be focused for both spot and flood. As many as six reflectors can be used. To operate, turn heater unit into the socket and plug the 110-volt line into outlet No. 6, Fig. 2. Plug reflectors, with 32-candle-power headlight bulbs, into outlet No. 7. Turn on switch No. 4 to focus and arrange lights.

Turn off switch No. 4 and substitute midget flash bulbs. When switch No. 4 is turned on, bulbs will flash.

Floodlight: Plug 110-volt line into outlet No. 5 and plug floodlights into outlets Nos. 1 and 2. Then turn off switch No. 1 and turn switch No. 2—designated by 1st, 2nd and off positions in Fig. 2—to the second position which dims the lights for focusing. Turn on switch No. 1 and turn No. 2 to the first position for bright.

Flash on floodlight circuit: Turn off switches Nos. 1, 2 and 3 and plug the 110-volt line into outlet No. 5. Turn on switch No. 3 and plug lights into No. 3 outlet and focus. Then turn off switch No. 3 and remove flood lamps from outlet No. 3 and replace with flash bulbs. Turn on switch No. 3 and bulbs will flash.

Battery flash: Outlet No. 4 is connected to a 6 1/2-volt radio C battery and by plugging into this outlet with flash bulbs and closing switch No. 5, the bulbs will flash. You can use any voltage C battery and flash any reasonable number of bulbs.

CRAFT QUIZ

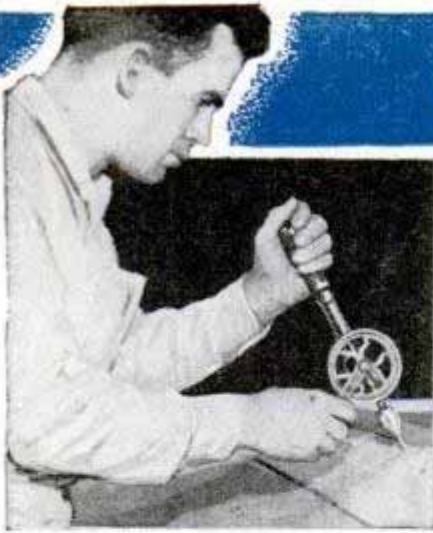

1. He is using a—
 (a) Hand drill (c) Ratchet drill
 (b) Brace (d) Post drill

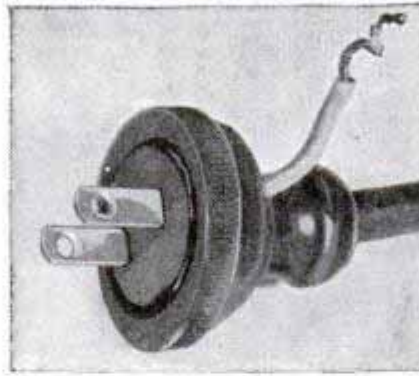

2. Extra wire on this plug is for—
 (a) Three phase (c) Better contact
 (b) Ground (d) Special motor

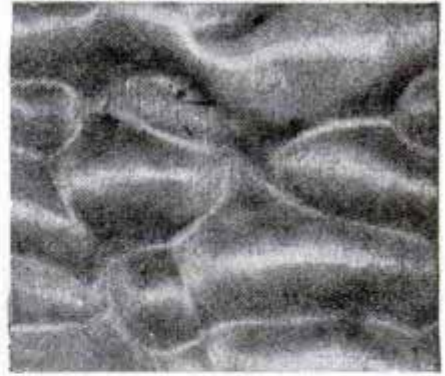

3. Plain to see, this wood is—
 (a) Dappled (c) Quilted
 (b) Mottled (d) Flake figure

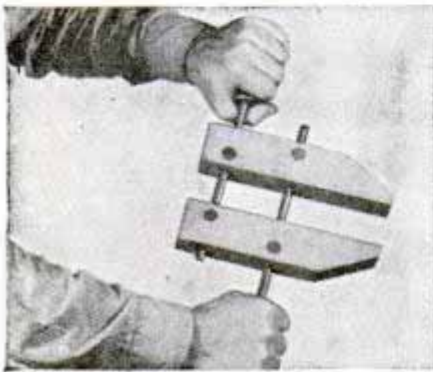

4. Wrong in this picture is—
 (a) Hands (c) Size
 (b) Jaw opening (d) Handles



5. He works in a—
 (a) Pattern shop (c) Foundry
 (b) Gear shop (d) Cabinet shop



6. Interior panels in this trailer are—
 (a) No. 2 Common (c) Holly
 (b) Birch (d) Hemlock

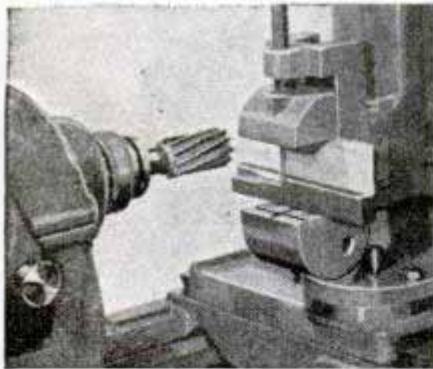

7. Cutting tool here is—
 (a) Spiral reamer (c) End mill
 (b) Broach (d) Skiving tool

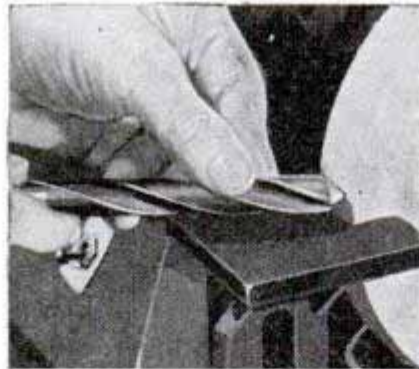

8. He hopes to be—
 (a) On the 59 (c) At the gate
 (b) On top (d) Swaging



9. This worker is—
 (a) Stenciling (c) Offset printing
 (b) Silk screening (d) Block printing

ANSWERS: 1—a; 2—b; 3—c; 4—a (for proper balance, right hand must grasp end spindle of handscrew); 5—a; 6—b; 7—c; 8—a (referring to point angle of drill); 9—b; 10—a (cup center is used only for wood turning); 11—c

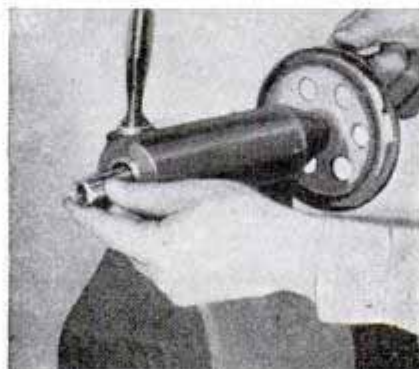

10. Getting ready to—
 (a) Turn wood (c) Taper
 (b) Turn metal (d) Use faceplate



11. Metal used here is—
 (a) Cast iron (c) Wrought iron
 (b) Foundry pig (d) Point 95 carbon



Shop Notes



Reprinted
Shop Notes 48

out of print

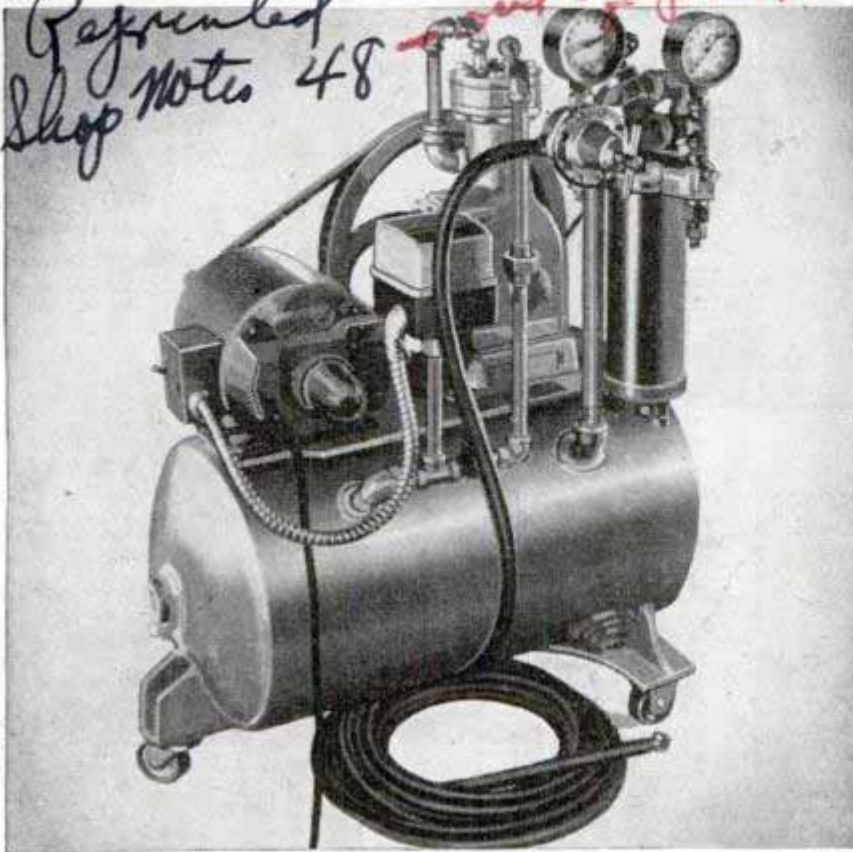

Build Your Own Air Compressor

Homeowners, farmers and small business contractors will find this highly efficient air compressor a time and labor-saving device

By Arthur Youngquist

HERE is an air compressor that anyone can make inexpensively as it utilizes an old household refrigerator compressor of the piston type. It will handle any job requiring up to 65 lbs. per sq. in. pressure, such as paint spraying, sand blasting, air-blast cleaning, running portable pneumatic tools, etc.

Building a machine of this type is principally a job of assembling various purchased parts. However, some machine work will be necessary if the compressor unit is of the type that has the valve in the piston. If the valve is in the compressor head, the valve mechanism may be used without change. The compressor used in this unit is the valve-in-piston type. To convert it for use as an air compressor, the cylinder head and piston are removed and all the valve parts taken out of the piston. The valve hole is closed with a solid pipe plug and faced off flush with the top of the piston, which then is re-installed. A new valve body, cylinder head and valve retainers, as detailed in Figs. 1 to 5 inclusive, are turned from cold-rolled steel to hold the original flipper valve disks and valve springs. Care should be taken to provide smooth finished surfaces



PAINT SPRAYING



SAND BLASTING



CLEANING SHOP TOOLS



OPERATING FORGE



PNEUMATIC TOOLS



① VALVE BODY

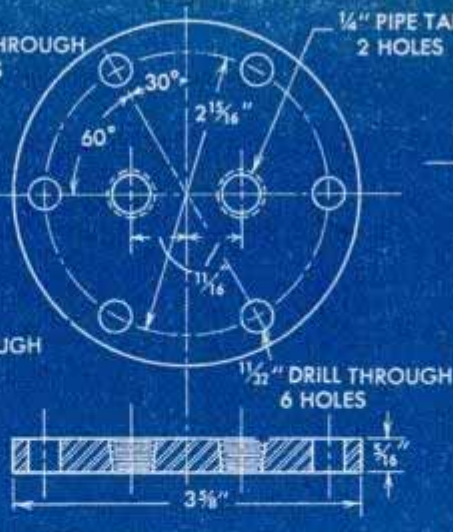

② CYLINDER HEAD

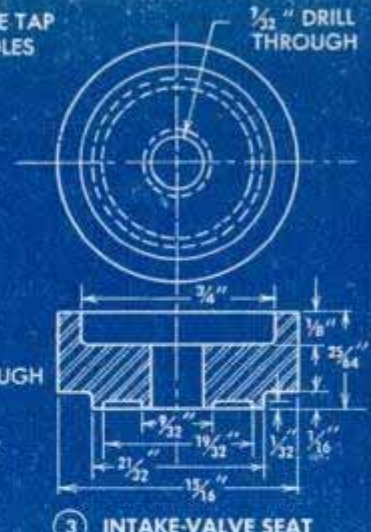

③ INTAKE-VALVE SEAT

1/8" DRILL THROUGH
9 HOLES

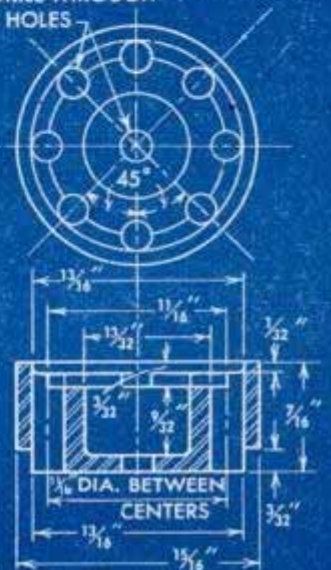

④ INTAKE-VALVE
RETAINER

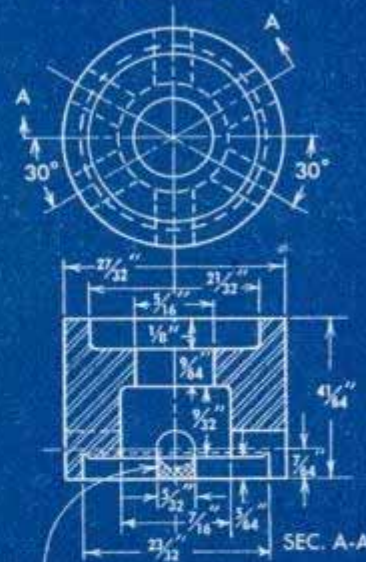

3/32" DRILL THROUGH,
THEN FILE TO
REMOVE SHADED PART

⑤ EXHAUST-VALVE
RETAINER

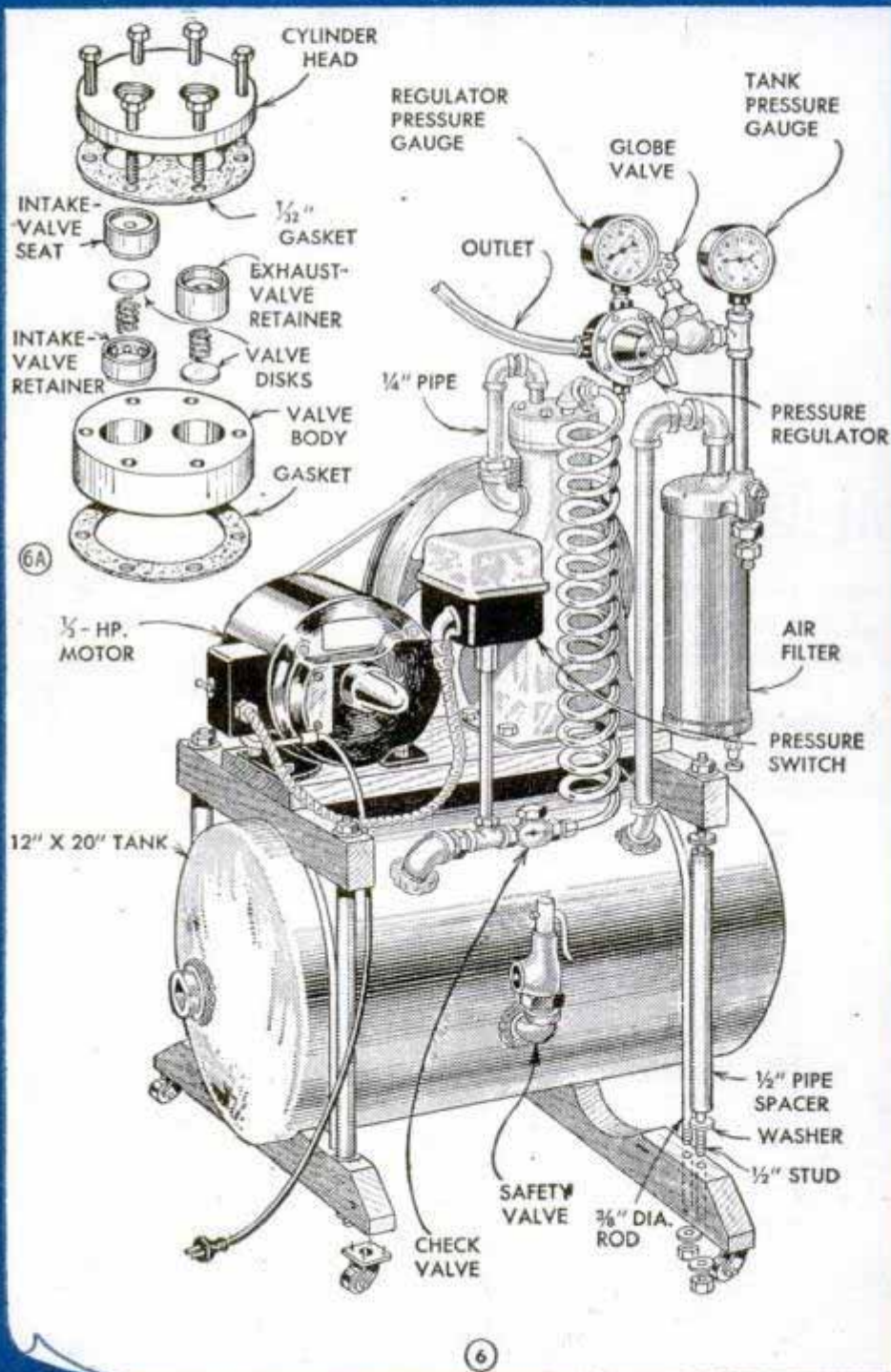

⑥

for the valve disks to seat against. Note in Fig. 3 how two narrow surfaces or rings are turned on the valve seat to contact the valve. These narrow surfaces provide better seals than one wide surface, and the center ring helps to prevent the valve disk from buckling under the increased pressure to which the compressor will be subjected. Two gaskets and longer head bolts complete the valve change-over. The parts are assembled as shown in the exploded view, Fig. 6A, and bolted to the compressor. The valve retainers are dimensioned to provide a $\frac{1}{64}$ -in. projection above the top surface of the valve body to assure an airtight seal and keep the retainers snug against the valve body. Fig. 7 illustrates how these valves operate on the intake and exhaust strokes. A pressure of 65 lbs. per sq. in. was obtained with a $\frac{1}{3}$ -hp. motor operating the compressor at about 550 to 600 r.p.m.

If your compressor unit is of a different make or model than the one shown, carefully measure the length of the valve springs as assembled in the piston and make the new valve head accordingly. This is important, as the strength of these springs has been calculated carefully by the manufacturer, and their compression in the new head must be the same as it was in the original installation.

When purchasing the tank be sure that it conforms to the American Society of Mechanical Engineers code for unfired pressure vessels of 150 lbs. per sq. in. In mounting the machine shown in the photographs a welded steel base and mounting plate were used. However, for those who do not have access to welding and cutting equipment, the arrangement shown in Fig.

VARIABLE AIR REGULATOR
CONTROLS PRESSURE FOR
A WIDE VARIETY OF USES



6 will hold the parts equally as well. Two $\frac{3}{8}$ -in.-dia. rods threaded on both ends encircle the tank and anchor it to the lower cross members. The four pipe spacers all should be the same length and slightly undersize so the cross members will clamp the tank securely. The motor and compressor then are mounted on the baseboard which is bolted to the upper cross members. The compressor intake is piped with a 90-deg. elbow turned toward the cylinder wall as indicated in Figs. 6 and 8 to prevent clothing or hands coming in contact with the intake opening when the machine is running. Although not shown in the photos, the input line to the tank should be of high-pressure tubing coiled as shown in Fig. 6. This will cool the air before it reaches the tank and avoid fracture of the line due to vibration. A check valve permits air to pass through in the direction indicated by the arrows in Figs. 6 and 8 and prevents

INTAKE

EXHAUST

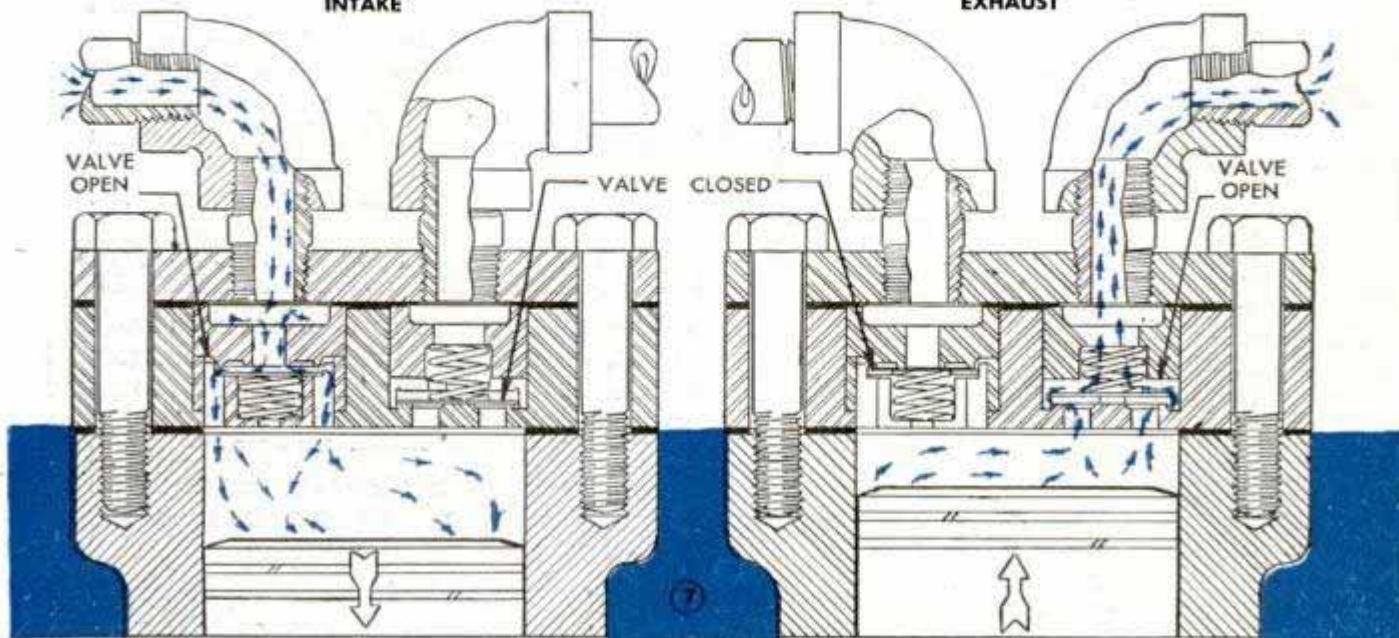



the air in the tank from escaping through the compressor when it is not running. The adjustable pressure switch shuts off the motor when the desired pressure has been reached. A safety valve is a must and can be connected to the tank at any convenient outlet. If the compressor is to be used for paint spraying, an air filter should be installed in the outlet line to remove any water, oil or dirt that would contaminate the paint. A pressure gauge, globe valve and air regulator with pressure gauge then is fitted to the outlet line. All of the parts are standard and may be purchased in whatever types and sizes are needed to suit the requirements of the builder.

The piping arrangement shown in Fig. 6 need not necessarily be followed; however,

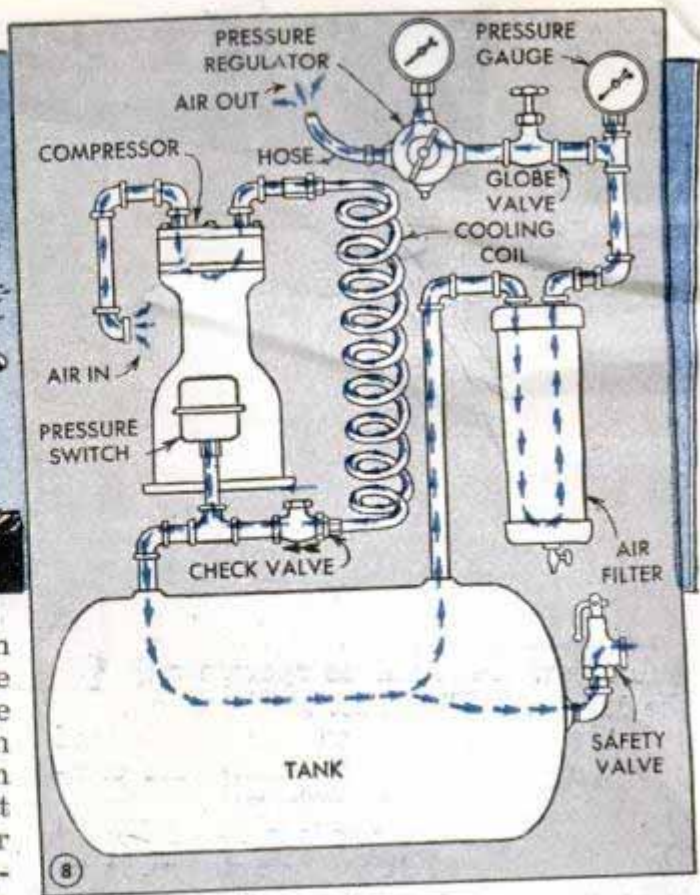

it is important that the relative position of the various parts be similar to that indicated in Fig. 8.

As a safety measure when the compressor and air-driven equipment are not in use, close the globe valve, loosen the thumbscrew of the pressure regulator and drain off the air in the line until the gauge on the regulator drops to zero.

Shop Anvil From Railroad Rail Will Handle Light Work

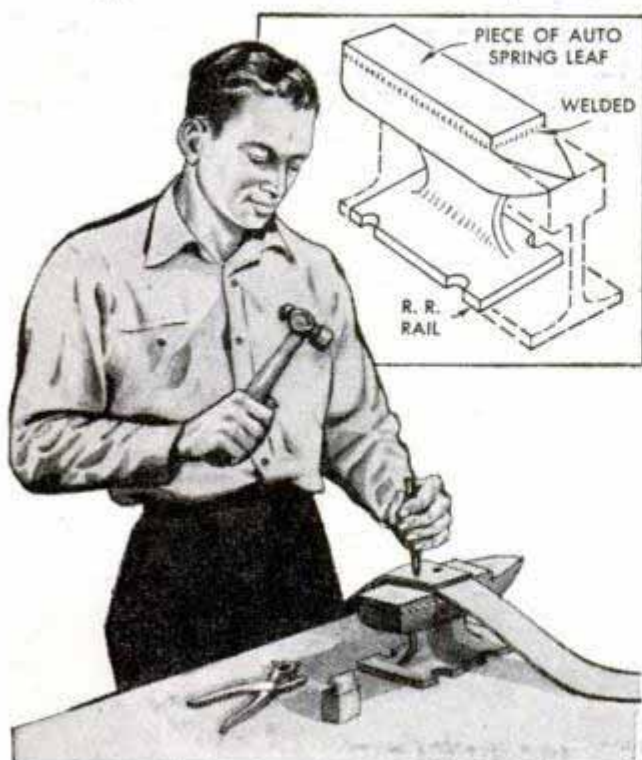

One mechanic finds a small steel anvil cut from a piece of railroad rail one of the most useful tools in his shop. The rail is cut with a torch along the solid lines as shown in the drawing. A piece of auto spring leaf is welded to the top to secure a flat surface that is harder than rail steel. To weld, use an austenitic stainless-steel, or similar, rod. Being small, the anvil is moved about the shop easily.

Phillip Wilson, Streator, Ill.

Two-Sided Brush for Mechanics

By securely tying two toothbrushes back to back, an efficient brush for mechanics can be made. Since the bristles of a toothbrush are stiff, this brush is excellent for cleaning keyways, gears, etc., in milling machines, lathes and other machinery. The fact that the brush has two sides makes it useful for cleaning the inside of bored shafts, counterbores and inside threads.

Henry S. Galus, New Bedford, Mass.

Shopmade Milling Attachment Fits Any Lathe

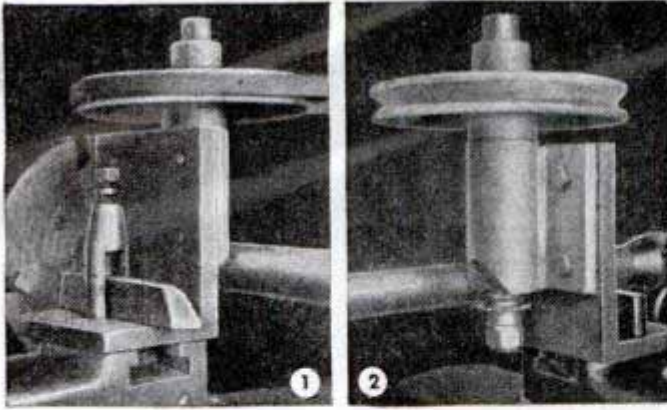

When the amount of milling work in a small shop does not justify investment in an expensive milling attachment, this homemade one for a lathe will prove satisfactory. It has been used successfully in various gear-cutting operations as well as for regular milling work. The attachment consists of a heavy angle casting, a cast bearing and a spindle. The angle casting is drilled on the lower side to fit the lathe tool post and on the vertical side to take four bolts, which attach the bearing. A pulley is keyed to the upper end of the spindle, the lower end of which is threaded to take various cutters. An angle bracket bolted to the lathe carriage at the rear carries a motor which drives the spindle. Figs. 1 and 2 show general construction. The type of lathe will determine the size of the parts used. The tool post provides horizontal



movement, and shims inserted beneath the attachment vary the height. Collars of various thicknesses above or below the cutters will serve the same purpose.

Bending Tool Forms Wire Clamp Around Rubber Hose

A tool to form neat wire clamps around rubber hose is made easily from a short length of $\frac{5}{8}$ -in. drill rod. The rod is turned and three holes are drilled in it as illustrated, the size of the holes being determined by the size of the wire. To use the tool, bend the wire double and wrap it around the hose twice. Then insert the ends under the doubled end and in the holes in the tool. Draw the clamp tight, using a spike for added leverage, turn the ends over and cut off the excess length. A finished clamp, which fastens a piece of hose to metal tubing, is shown in the circular detail.—Benj. Neilson, Aurora, Nebr.

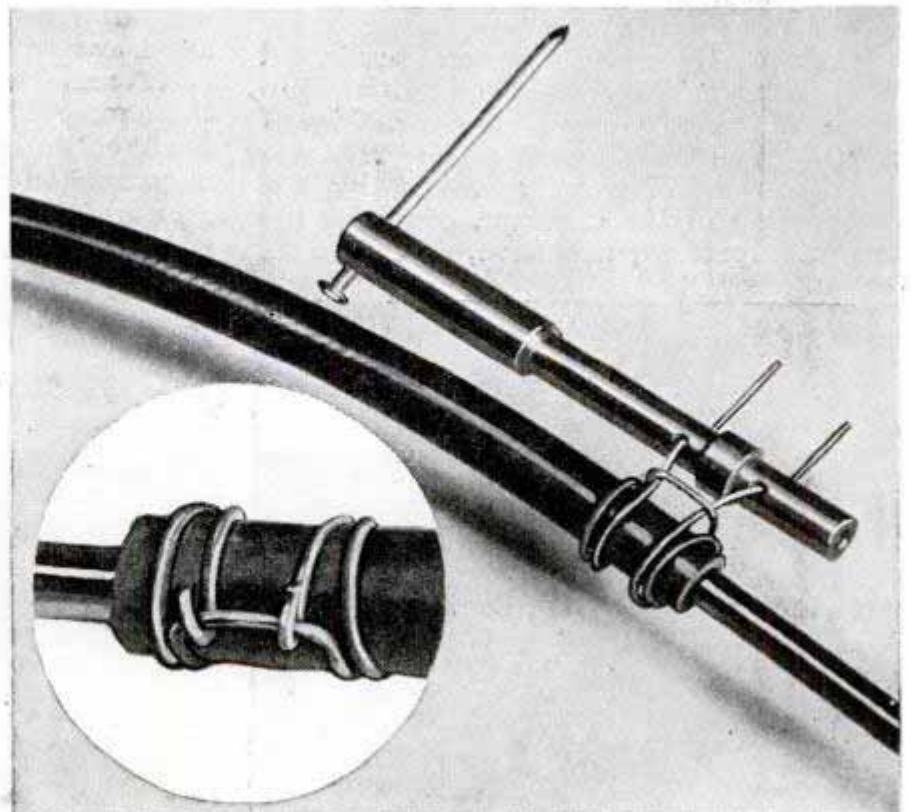

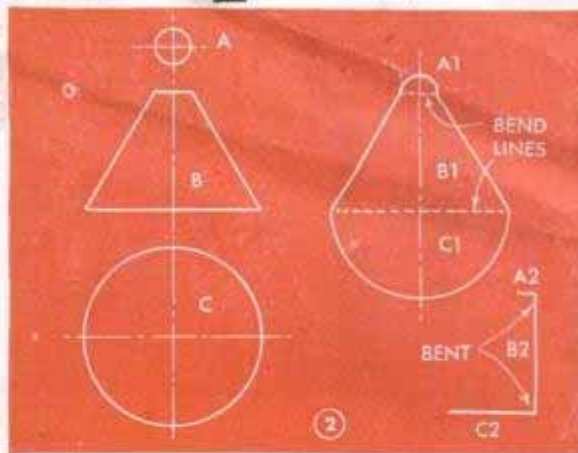
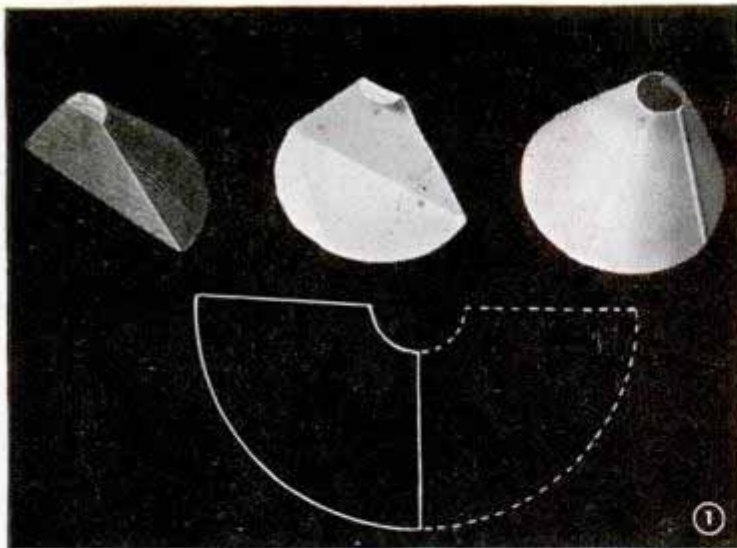

WHILE not entirely new to the trade, this simplified method of laying out sheet-metal patterns without an exhaustive knowledge of mathematics will be of value to the home owner who may undertake installing his own furnace duct work and similar sheet-metal jobs. It's a case of visualizing a sheet-metal form as being the surfaces of a solid, and making a metal template to duplicate on paper the exact outline of the shape simply by rotating it in the manner shown in Fig. 7.

Known as the "rollation" method, this trick-of-the-trade short cut, developed by Ralph W. Poe, Canton, Ill., is a time-saver in laying out accurate sheet-metal patterns. Detailed knowledge of geometry or drafting is not required

By Charles T. Pearson

Round-to-round transition: The basic principle of the method is explained in Fig. 1, which compares a sheet-metal cone, as an example, to an identical solid one of wood sliced exactly in half. By rotating one of the halves over a piece of paper and tracing the outline of its edges, you have an accurate pattern of half the cone. Two of these half patterns, one being reversed and matched edgewise as indicated by the dotted line in the diagram, comprise the complete pattern, exclusive, of course, of

allowance for seams. In actual use, a metal template is substituted for the wooden form and is chalked as in Fig. 6 and rolled over a piece of black paper to transfer its contour. The use of carbon paper, Fig. 7,

provides another way of making an impression. Ink and paint can be used, too.

Determining the shape of the template is very easy, and the method given in Fig. 2 for laying out a cone (round-to-round transition) applies to all fittings regardless of shape. Referring to Fig. 2, B represents the side view or cross section. The circles above and below it, A and C, correspond to the diameter of the small and large ends. As only half of the cone is required to form the pattern, only half of diameters A and C are drawn. Scribe B first, full size, and then add A and C to each end as shown. Lay out the template on 24 or 26-ga. metal and cut it out carefully as in Fig. 5. The template is completed except for bending the ends A1 and C1 at right angles to B1, Fig. 2. It is important to bend these exactly 90 de-

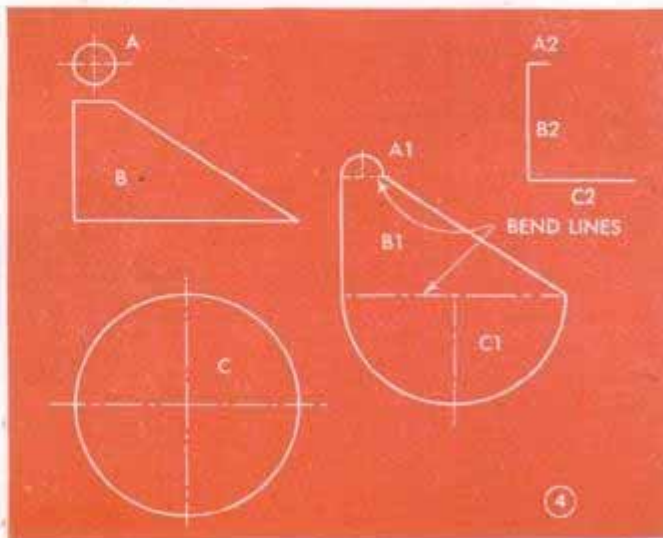
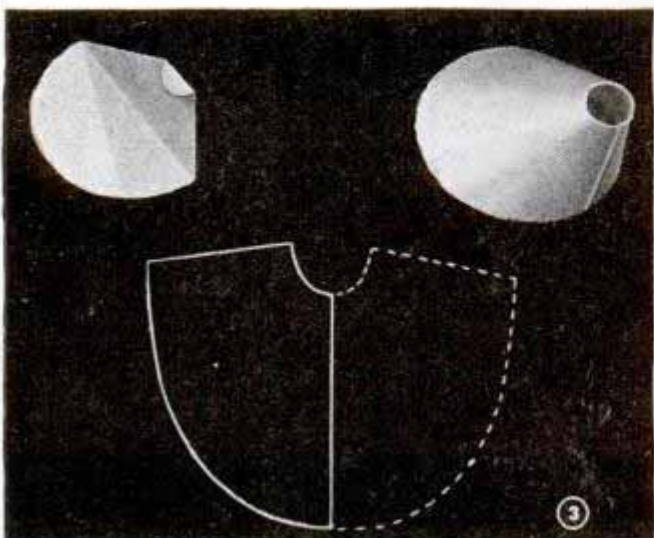

SHEET-METAL LAYOUT

Company, Middletown, Ohio

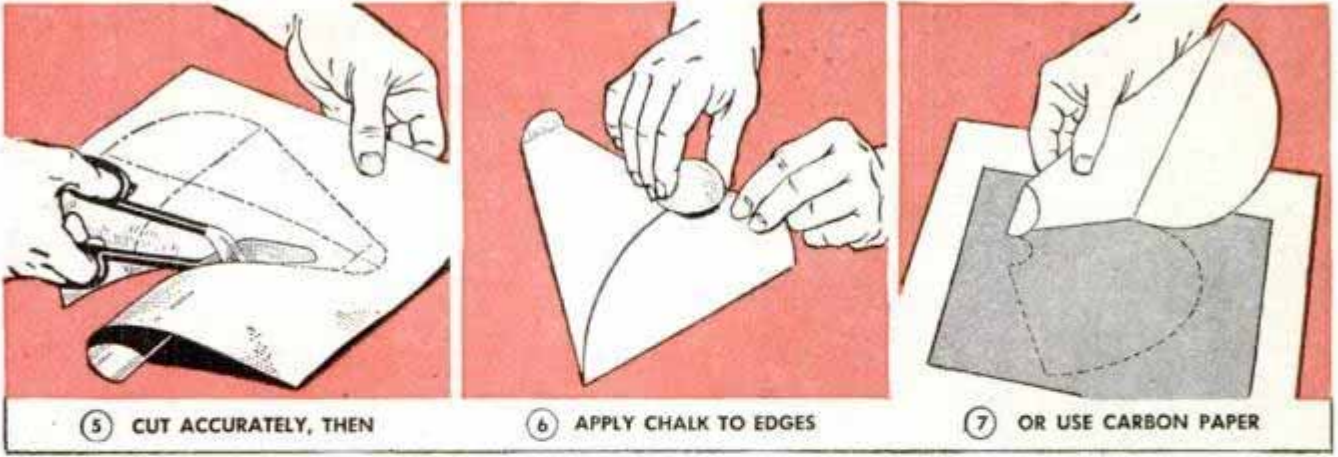

5 CUT ACCURATELY, THEN

6 APPLY CHALK TO EDGES

7 OR USE CARBON PAPER

grees, A2 and C2, to insure an accurate pattern. Any deviation from a right angle will produce a corresponding irregularity in the actual pattern. Where the template is quite large, the ends should be braced with a wooden spacer or made rigid by metal braces soldered in place. The completed template should look like the one shown at top center in Fig. 1.

Figs. 3 and 4 give another similar example of a round-to-round (off-center) fitting where one side is at a right angle to the large end and thereby requiring an irregular pattern. Here you proceed practically the same as before. What the template actually looks like can be seen at the upper left in Fig. 3, and also the shape of the pattern it will form. The solid line represents the first pattern, the dotted one being the same pattern reversed. Remember that the pattern as it is does not allow for seams. Fig. 4 shows how the template is laid out, and by comparing it with Fig. 2 you can note readily how the two differ. Oval-to-oval fittings are laid out in the same manner.

Square-to-round transition: The square-to-round (funnel-type) fitting in Fig. 9 is a common one encountered in most duct

work and similar installations, and as a rule is a difficult item to form, especially by conventional cut-and-try methods. The template required is a very simple one. Fig. 8 gives the steps to follow in making it, which here again follow the same fundamental principle as before. The diameter of the small end is seen at A, the cross section at B and the large end at C. Where a fitting as large as a stove hood or a hopper is to be made, it is obvious that the template will have to be braced to keep the ends rigid and at right angles while rolling the pattern. The pattern is formed by the same process as before, coating the edges first with chalk or ink. In rolling the template you must be careful to hold it firmly and not allow it to shift during the operation.

Oval-to-round transition: Oval-to-round fittings, Fig. 10, frequently are required to connect the oval collar on a furnace to the round smoke pipe, and generally there is quite a difference in the size of the two ends. While such a fitting is ordinarily difficult to lay out, this method makes it quite simple. Fig. 11 gives the shape of the template pattern required. You'll notice that it amounts to just another funnel pattern,

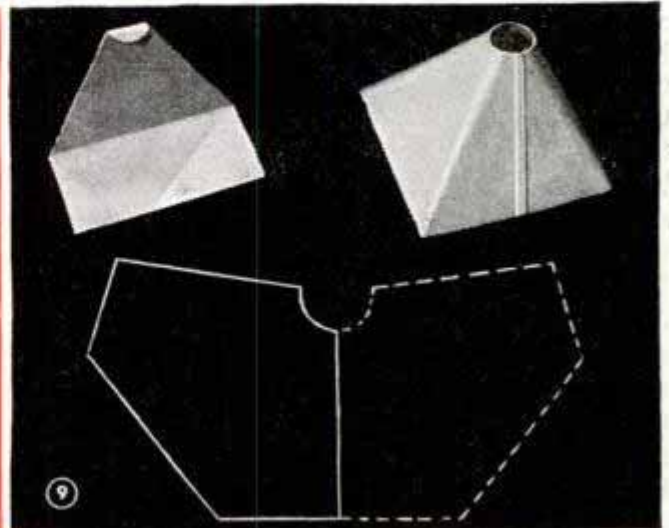
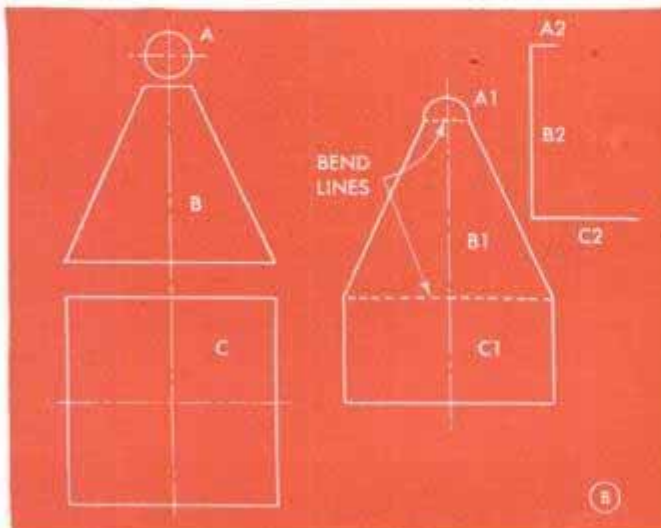

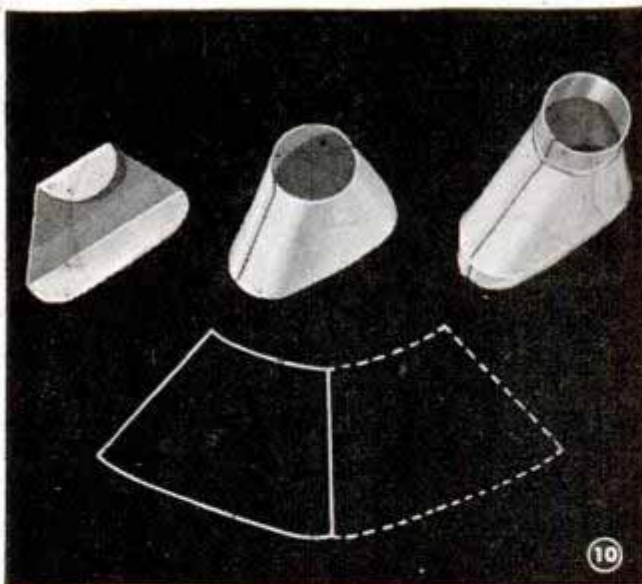

10

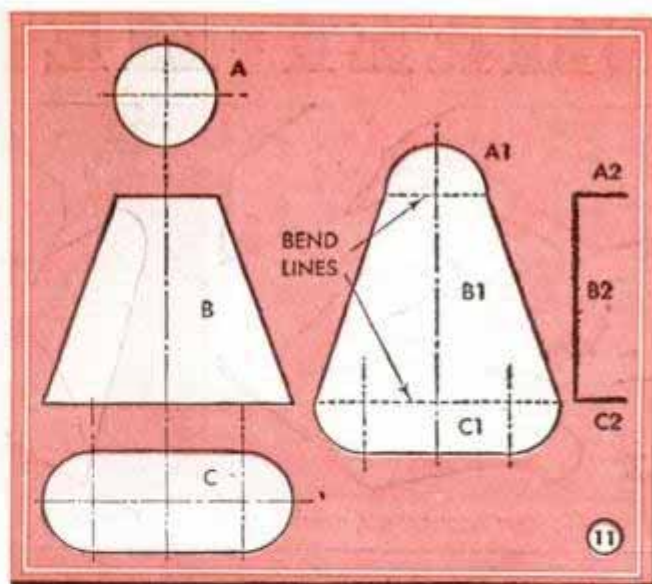

11

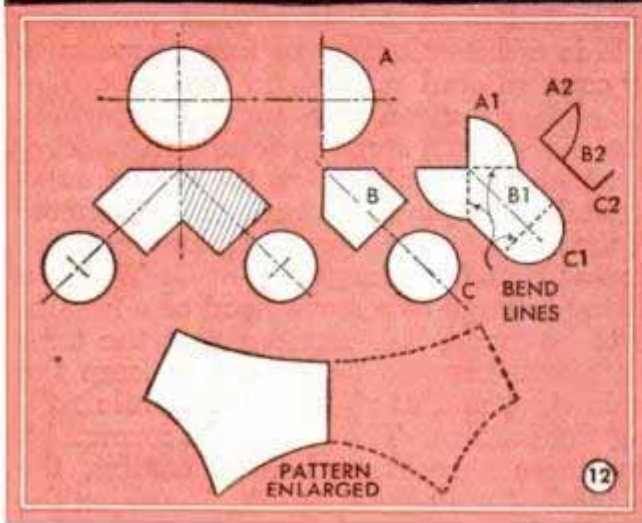

12

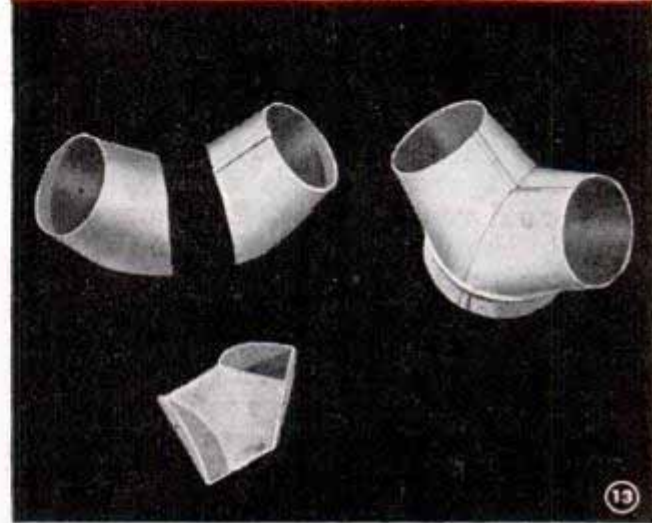

13

differing only in that C, in this particular case, is oval instead of round. Affixing collars, which is simply a case of adding bands, is done after the fitting is formed.

Y-fitting: Here you have what is called a multi-section transition. Fig. 13 shows the odd shape of the template required to produce the pattern for an ordinary Y-type fitting. First you must visualize the fitting and lay it out on paper according to the drawing at the upper left in Fig. 12. The cross sections B are purposely tapered slightly to facilitate installing and also to aid in joining the two parts together. Both branches of the fitting are identical and therefore only one template is required. Going through the steps as before, one section (shown shaded) is laid out full size. The half circle, A, establishes the size and shape of the top opening of each branch, while C is the shape of the small opening. Half the diameter of C is added to B1, as before and the half circle, A, is added in two quarter segments as shown at A1. After this, the ends are bent 90 degrees. The pattern produced by the template is symmetrical and need not be reversed when drawing the full pattern. In providing for seams, make allowance on the original pattern,

then in cutting make a second allowance for joining the two branches.

Square-to-round elbow: Another multi-section fitting is the elbow shown in Fig. 14. This type of fitting is commonly used in gravity furnace leads where a rectangular-to-round transition is required to connect cold-air registers. Such elbows are generally made up of three or more sections. The cross section of the complete elbow, parts X, Y and Z, is shown at the upper left in Fig. 15, with the size and shape of the connecting runs indicated by the rectangle and the circle projected at the top and bottom. Section X requires no template to make its pattern; it is laid out according to the diagram to equal the size of the projected rectangle.

The shaded section, Y, is laid out to correspond with A, B and C, A and C being identical in size and shape with the openings of the finished piece. Half of A and C are joined to B1 and the template is cut and bent as before. Note that C is slightly oval in shape, a transition from A. The finished template is shown in Fig. 14, and the shape of the pattern it forms is given in Fig. 15. Section Z requires making a second template which is developed by following the

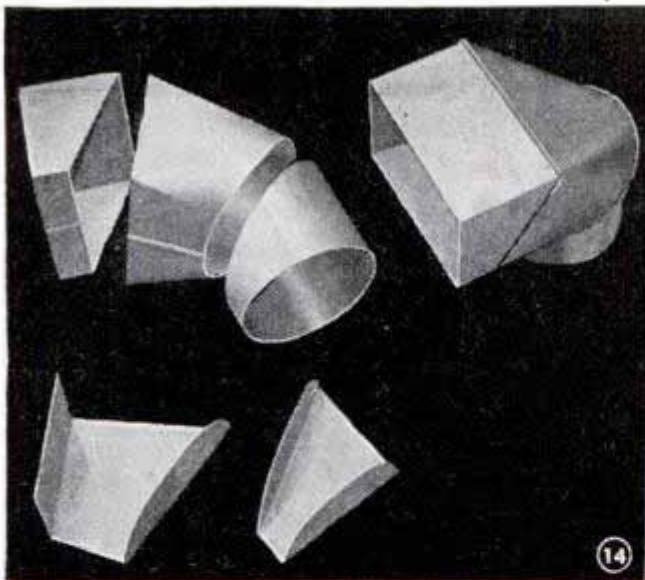

14

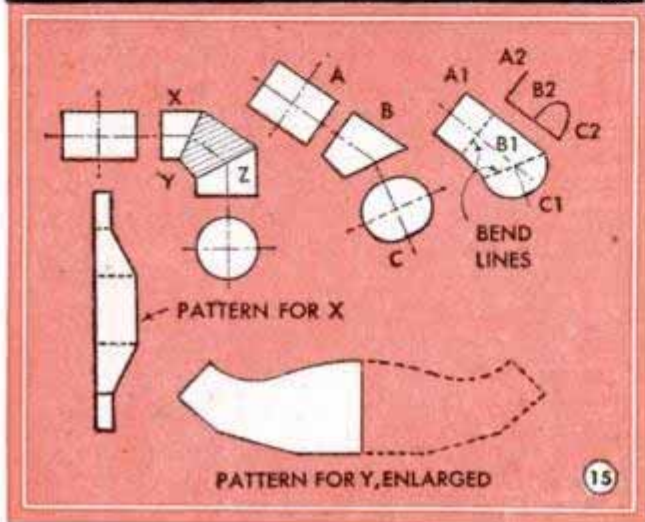

15

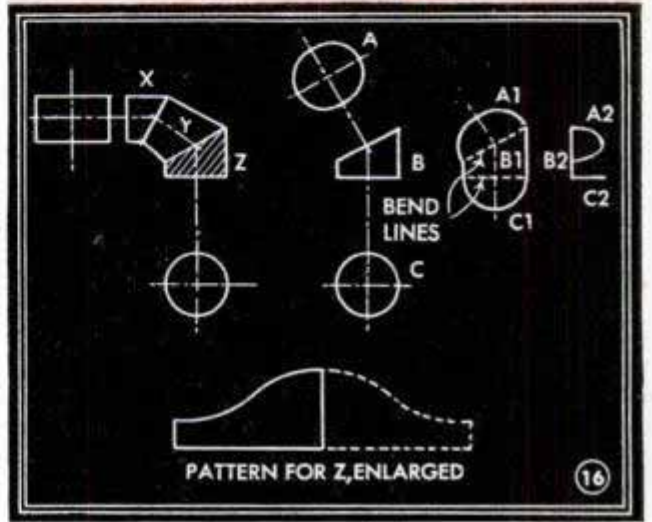

16

same steps as previously described. A, B and C in Fig. 16 represent the size and shape of the two ends and the cross section. Note here that A is oval shaped now as was C in Fig. 15 and that it is the same size. Half of A and C are added to B, after which the template is cut and the ends are

bent 90 degrees. The shape of the pattern for Z is shown in the diagram.

Remember in laying out a template there are just two things required. First, you must determine the cross section of the fitting and second, the exact size and shape of the two ends. It's as simple as that.

Courtesy American Rolling Mill Co.

Handy Tray for Automobile Parts Fits Over Strut Rod

If a quart or half-gallon oil can is cut and bent as shown, it will make a handy two-compartment tray for small automobile parts. The tray fits over a strut rod. Care will have to be taken to see that the two compartments balance.

Waterproofing Boots

Leather boots which are worn outdoors in all kinds of weather should be waterproofed for comfort and best wear. One waterproofing formula which is used is composed of equal parts of beeswax, neatsfoot oil and pine tar. These are melted in a double boiler, applied to the boots with a brush and then rubbed by hand.

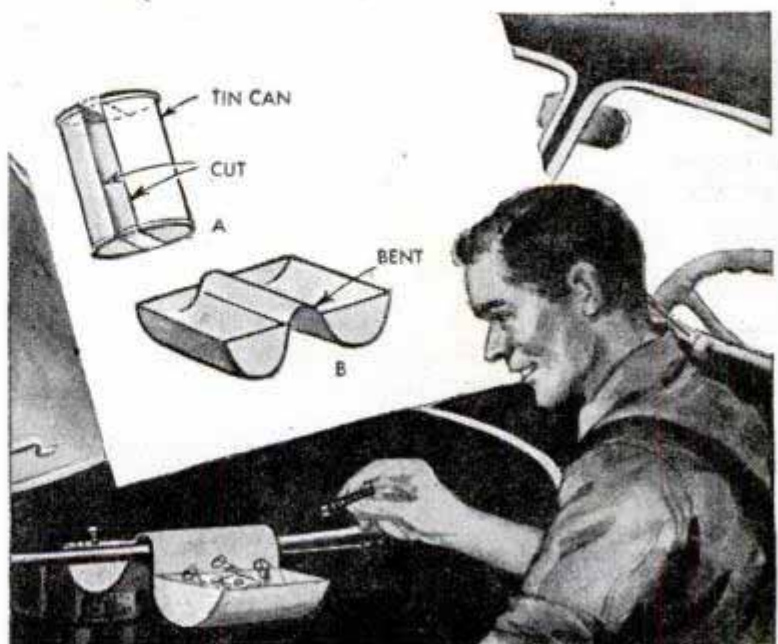

Notch in Drawer Provides Holder For Letter-File Folders



By notching one of the drawers in your desk, you can provide a handy holder for letter-file folders. Any letter in the file is accessible instantly for copying or reference, and it is not necessary to go through the file and pull out the letter you are looking for.—G. E. Hendrickson, Argyle, Wis.

Holes Drilled in Steady-Rest Jaws Lubricate Work in Lathe

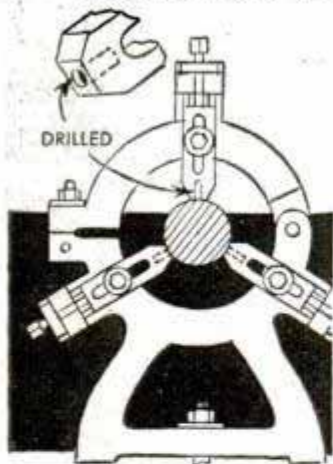

To lubricate work in a steady rest, one mechanic drills the jaws as shown, using a fairly large drill, and fills the holes with tailstock lubricant, such as white lead in oil. This lubricates work in the rest.—W. S. Kals, Vancouver, B. C., Can.

It's Less Effort to Time Ignition Before Assembling Engine

New pistons, rings and bearings "stiffen" an engine and make it difficult to turn over by hand when timing the ignition. Actually the crankshaft is all you need in place for this operation, so just make a partial assembly, omitting pistons and connecting rods and leaving the main bearing caps a

little slack. Then after the ignition is timed and the valves adjusted, the engine can be completely assembled and tested.

Lathe Tool Centered Using Scale

When using this simple trick, you can set a lathe tool on the horizontal center line of round work quite accurately. Hold a 6-in. steel rule or scale alongside the work as shown and run the lathe tool up against it lightly. If the top of the scale cants toward you even slightly the tool is too low. But if the top end of the scale cants in the opposite direction the tool is set too high. When the rule stands perpendicular to the bed of the lathe with the tool bearing against it, then the cutting tool is on the center line of the work.

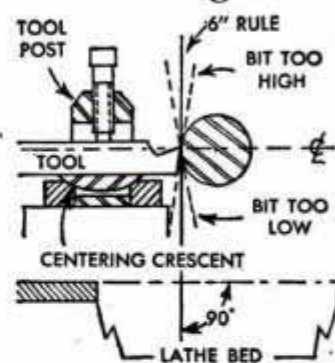

Robert A. Ridout, New Castle, Ind.

Hand Grip Spliced to Shovel Repairs Broken Handle

If the grip on your shovel is damaged, and you have a broken shovel with a good handle, you can make a very satisfactory repair. Cut the broken grip off at a diagonal and cut the replacement part at a matching angle so the two will fit properly. Then cut a tongue-and-groove joint and after fitting the two together drill holes for two horizontal and one vertical bolt. When assembled, you will have a sound handle.

R. E. Murray, Fremont, Ohio.

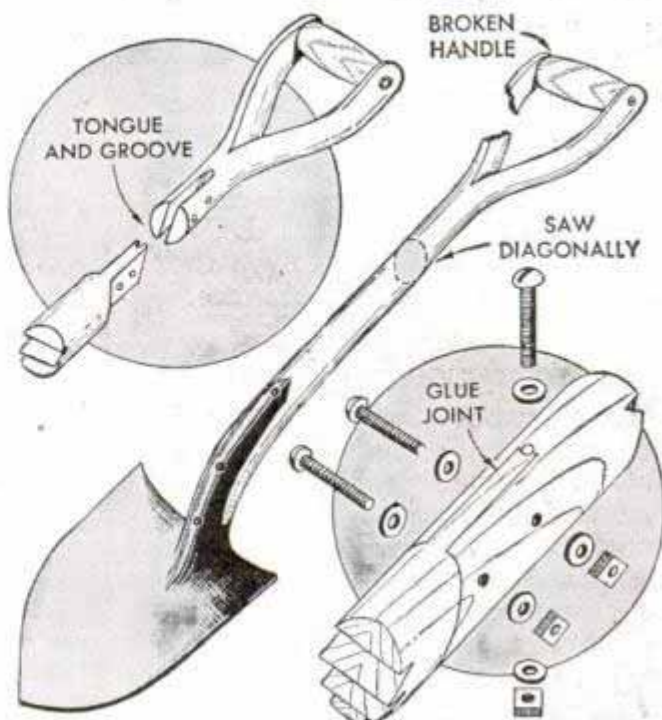

Undercut Walls Eliminate Metal Roof Flashing

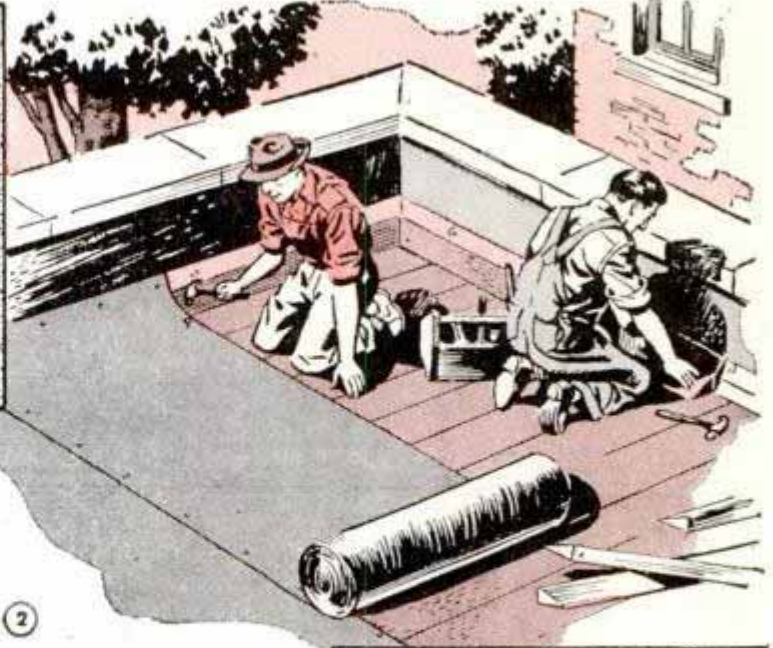
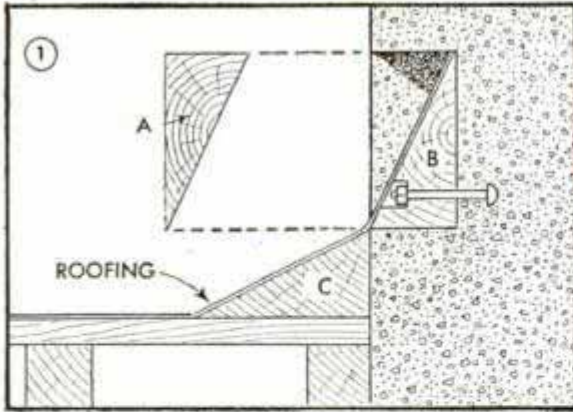

By Duane I. Hurd

HERE'S a practical roofing kink which is especially suited to flat-roof garages, Fig. 2, and similar structures having either brick or concrete walls.

It consists of a wood-lined undercut or recess cast in the wall at the time of pouring or formed in the brickwork by means of a wooden pattern the parts of which later are used as a nailing base for the roof covering. After the concrete forms are up, 2 by 4-in. stock is ripped diagonally lengthwise as in Fig. 3, forming the pieces A and B as shown. The latter piece is fitted with 6-in. bolts, spaced 2 ft. apart and set flush. Then the piece A is nailed to it as shown in Fig. 4. The top edge of the piece A should be coated with grease so it will not stick to the concrete or mortar. After this, the whole thing is nailed or screwed to the inside of the form, Fig. 7, screws being better for this purpose as the piece A is easily removed later and saved. The two pieces should be merely tacked together lightly so that they will part easily when the form is removed, Fig. 5. A third piece, C, is now ripped from 2 by 4-in. stock as already described and nailed to the roof boards in the position shown in Fig. 6. Finally, roofing is laid as in Fig. 1, part A being renailed to part B as the finishing operation which brings the recess flush with the wall. A coating of roofing tar worked into the joint finishes the job.

②

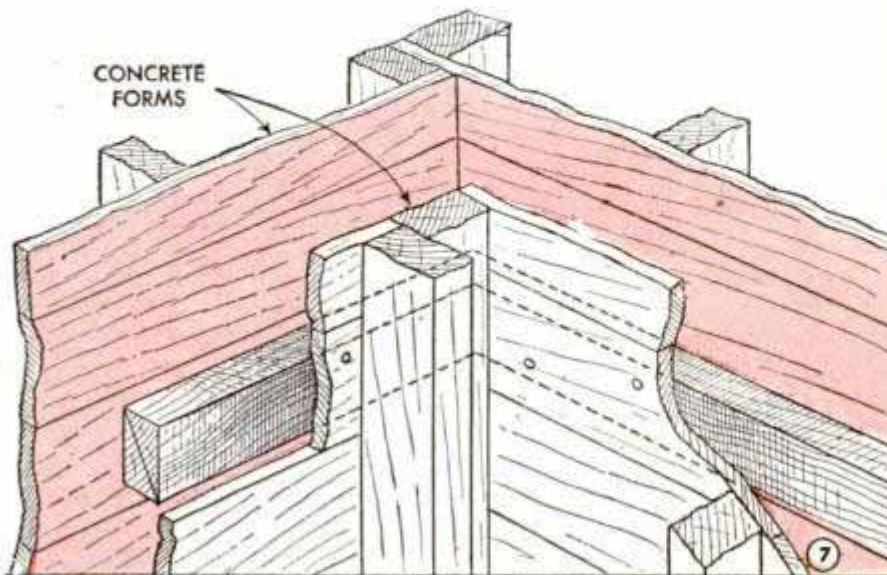
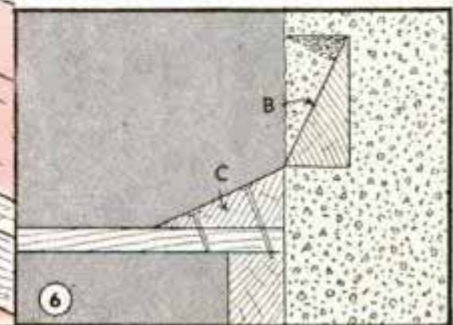
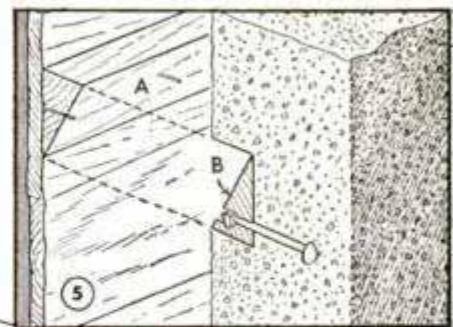
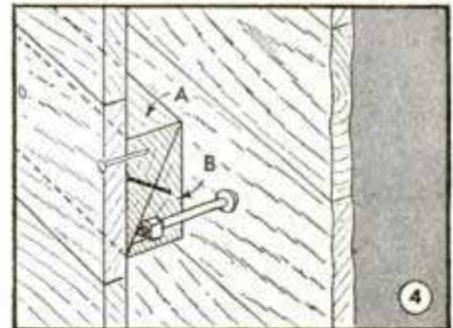
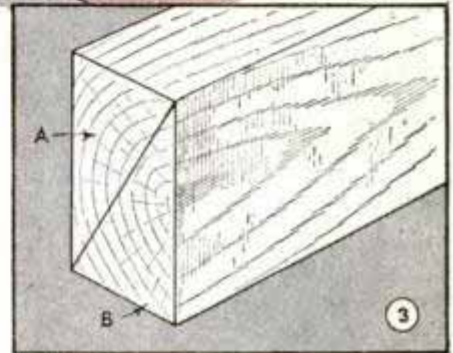

Strips of Cardboard Form Holders To Support Display Cards



The window trimmer in one store makes holders for display cards by using a strip of heavy cardboard about 3 or 4 in. wide. Slits are cut in the ends which then are folded over and bent up. The display card fits into the two slits.

"Sprag" Arrangement Holds Gate In Any Opened Position

To hold a farm or driveway gate open while carrying something or driving through it, the sprag illustrated is ideal. A piece of rod is sharpened at one end and an eye is formed at the other. The sprag is at-

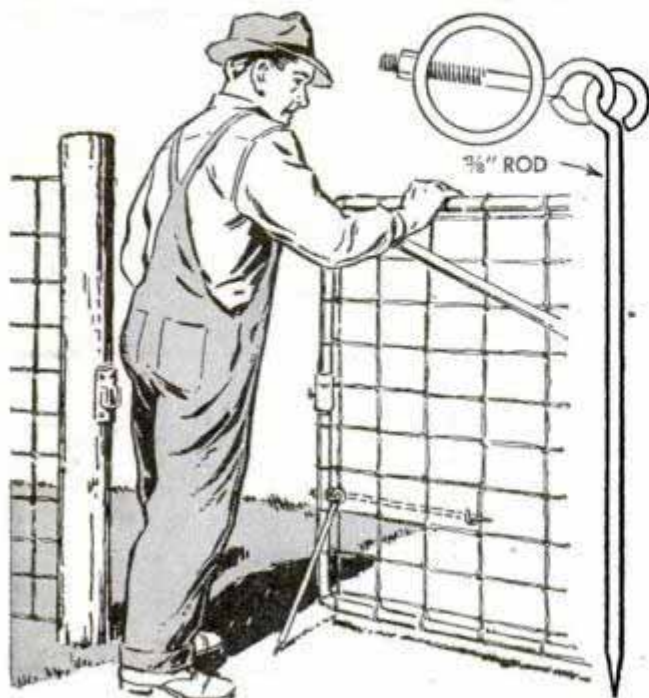

tached to the frame of the gate with a bolt and a hook is fastened to the wire mesh of the gate to hold the sprag out of the way when not in use.

Modified Oil Pump Lifts Water

With a few changes, the oil pumps used on some cars can be used to pump water from flooded basements, springs, ponds or other shallow depressions. The pump will perform best when the intake end of the pump is directly in the water or near it. In order to make an outlet connection for this particular pump, a short piece of radiator hose was slipped over the body and clamped at each end. Then a connection was made to this hose in much the same manner that a car heater is connected. A belt drive transmits power to the pump. Pvt. Burrel P. Wilburn, Wichita Falls, Tex.

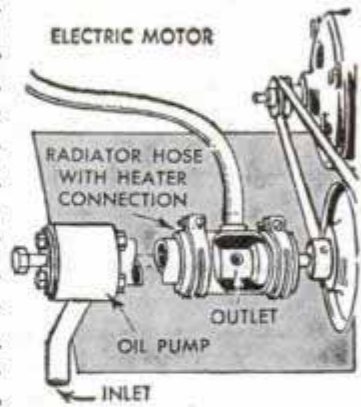

Heat Will Remove Plastic Stock That Is Frozen to Tool

When machining some plastics, too fast a cutting speed or too much pressure on the tool will soften the plastic with the result that part of the stock removed freezes on the cutting tool. If gentle heat is applied by means of a flame or soldering iron, the plastic will soften and can be wiped from the tool. Care should be exercised not to draw the temper of the tool.

Filing Jig for Channels and Angles

Short sections of channels and angles can be held firmly for filing or grinding by using the jig shown. A slot in one end makes it adjustable for various lengths of material. The hold-down clamps are made of flat-iron stock and are tightened with wing nuts. Three-quarter-inch plywood or pressed board makes the best base, and the bolts should be $\frac{3}{16}$ in. in dia. with the hole and slot large enough to accommodate them.

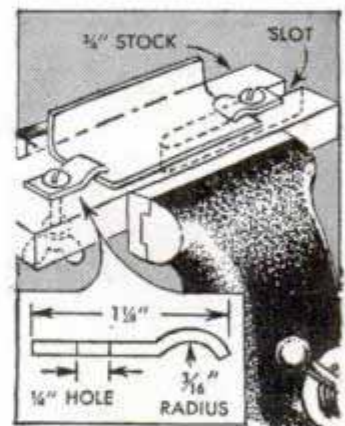

Wallace H. McClay, Pasadena, Calif.

Approved S. N. 10

Precision SINE BAR VISE

By Walter F. Debold

FOR the shop machinist who likes to make his own precision tools, the sine bar vise is a neat piece of machine work calling for close tolerances—a precise and versatile tool that can be used in such operations as checking, layout, drilling, reaming, jig boring, surface grinding or almost any machine-shop job requiring a high degree of accuracy on both angular and straight work. With this vise and the aid of planer gauge blocks any angle can be set up within plus or minus 5 minutes of a degree. Also, it can be used as an ordinary toolmaker's vise on a wide variety of precise work.

Most machinist's handbooks will give the sine of the angle for 1 in., which, in ordinary calculations, is multiplied by 5, the distance between the two vise pins. As an example, to set up an angle of 30 deg., the sine of the angle is found to be .5000. Then .5000 times 5 will equal 2.5000. The planer gauge is set to this dimension with a micrometer and is placed under one vise pin. This setup gives an accurate angle of 30 degrees for angle drilling, surface grinding and other operations requiring angular setups of the work.

All parts of the vise can be made from machine steel, carburized and hardened, or they can be made from tool steel and heat treated. Probably most machinists would choose the latter method because of the superior wearing qualities and the finer finish that can be obtained on tool steel. Fig. 2 shows the finished vise with the body in a raised position. Parts of the vise that are to be hardened should be finish-ground after heat treating, on all surfaces affecting accuracy, as these operations in turn determine the accuracy of the vise. It is necessary to allow $\frac{1}{64}$ in. all around for finish grinding after hardening. The detail drawings in Figs. 3, 5 and 6 show the finish sizes. The most important dimension to hold is 5.000 in., Fig. 3, as the accuracy of this dimension determines the accuracy of the angles. The steps that anchor the pins are

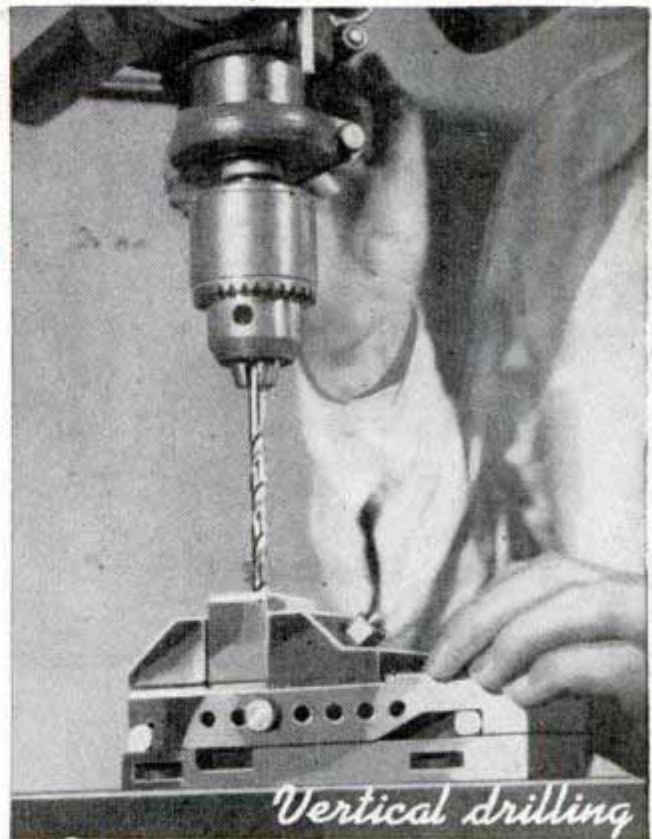

Here the sine bar vise is being used as an ordinary drill vise to hold work for a common drilling operation

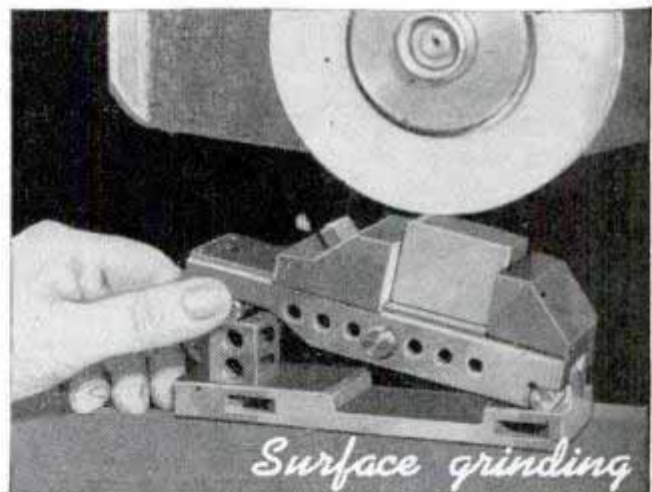

With the aid of precision gauge blocks any angle can be set up within plus or minus 5 minutes of a degree

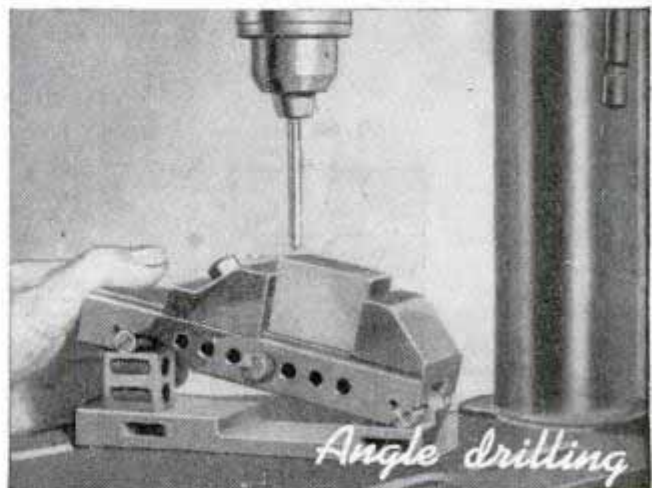

Angle setup for drilling on an ordinary drill press. Drill must be properly ground to prevent drifting

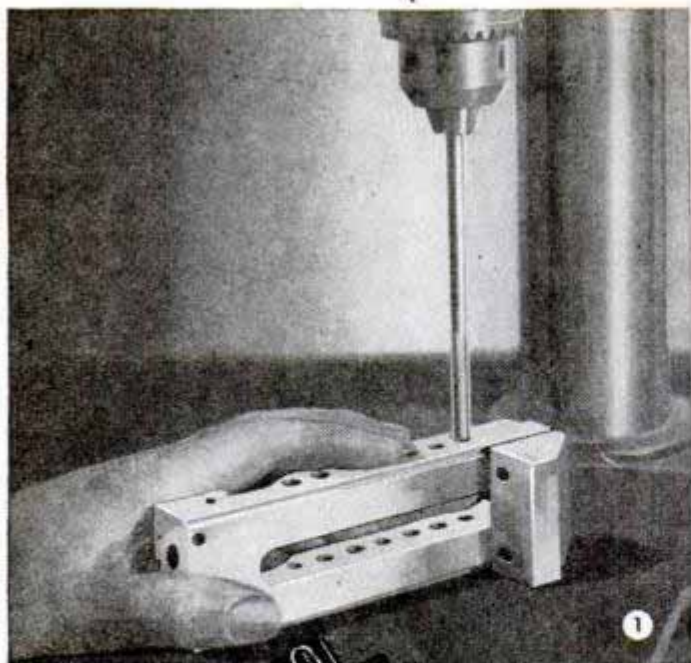

1

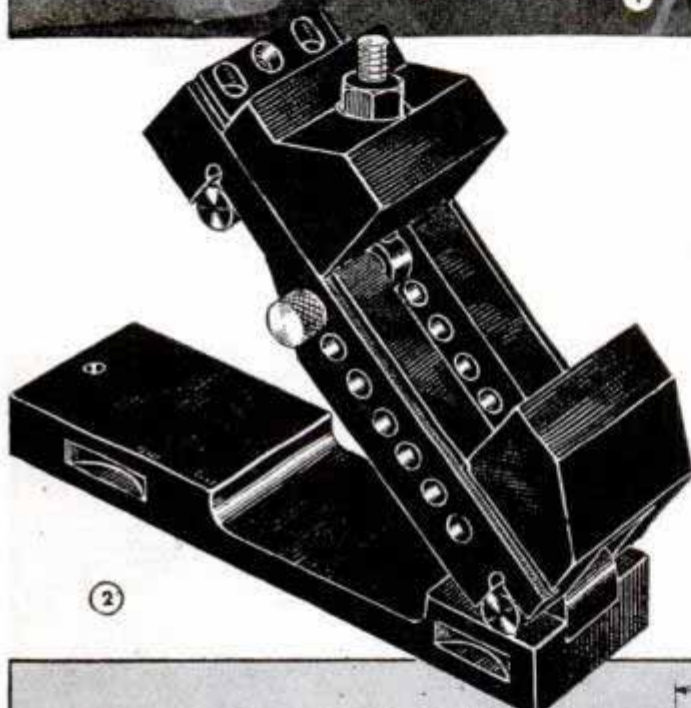

2

so designed that it's easy to bring the distance between the parallel faces to the exact measurement.

As a rule it's best to start construction with the vise body, Fig. 3. This is roughed out on the milling machine or shaper, allowing $\frac{1}{64}$ in. for finish grinding. Next, holes are drilled, reamed and counterbored, Fig. 1, to the various sizes indicated in Fig. 3. In this work it is necessary that the drill bits be ground to the proper angle to minimize the possibility of inaccuracies due to drifting of the bit. Notice that there are three chip-clearance holes in the vise body, although actually only one hole serves this specific purpose. For this reason the exact diameter of the holes is of no particular importance. Milling cuts for forming the ways for the guides milled on the sliding jaw are run straight through the thickness of the fixed jaw. This avoids the necessity of stopping the cuts within definite limits and adds something to the appearance of the finished job. The locking pin, Fig. 6, is a part of the body assembly and may be made at this time. The pin is simply a rough-turn, finish-grind-and-knurl job which can be done in the lathe.

Next comes the sliding jaw, detailed at the upper left in Fig. 3. After roughing out to the required shape, there remain the end-milling cuts and one counterbored hole at an angle of 45 deg. to finish the machine operations on this part. The counterbore takes the swivel screw and nut detailed in Fig. 6. The

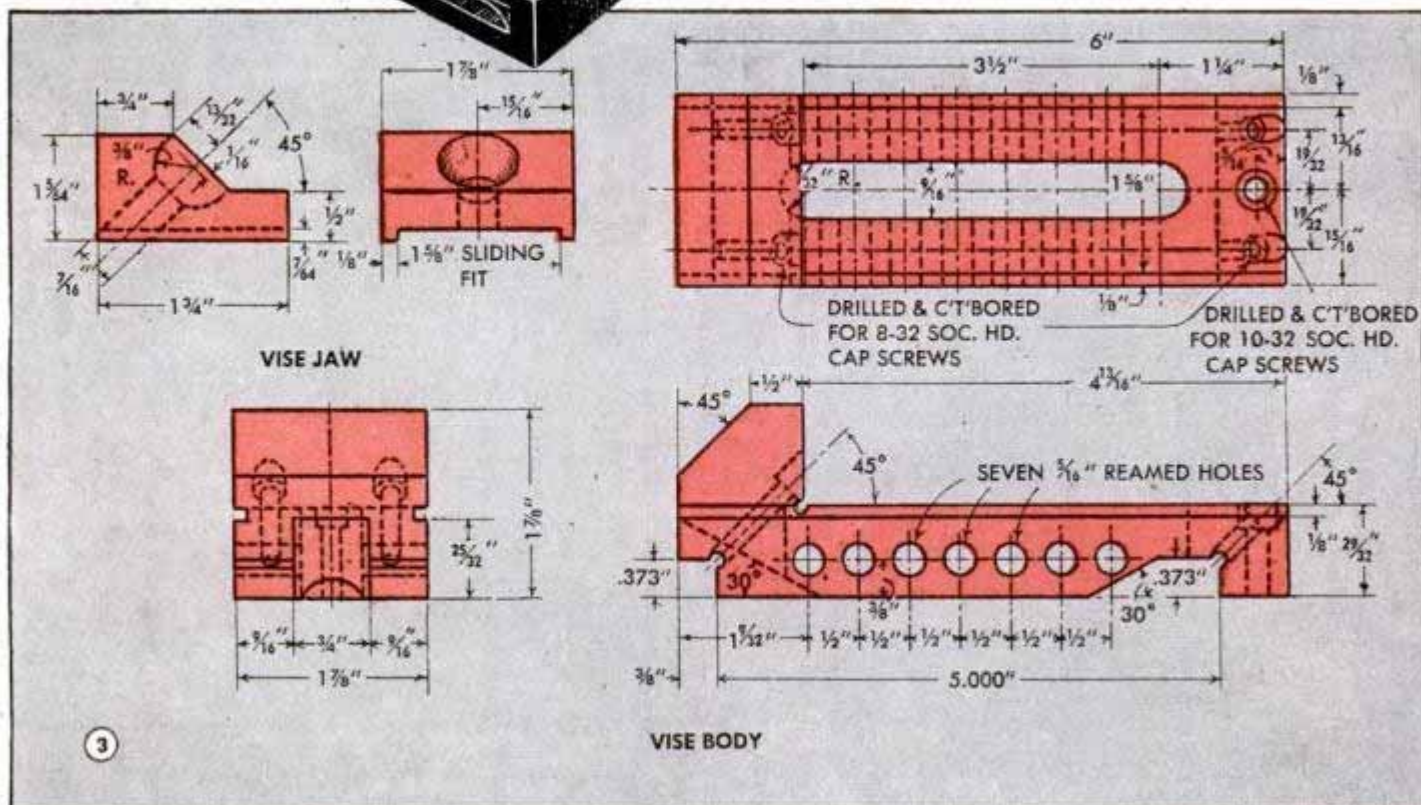

3

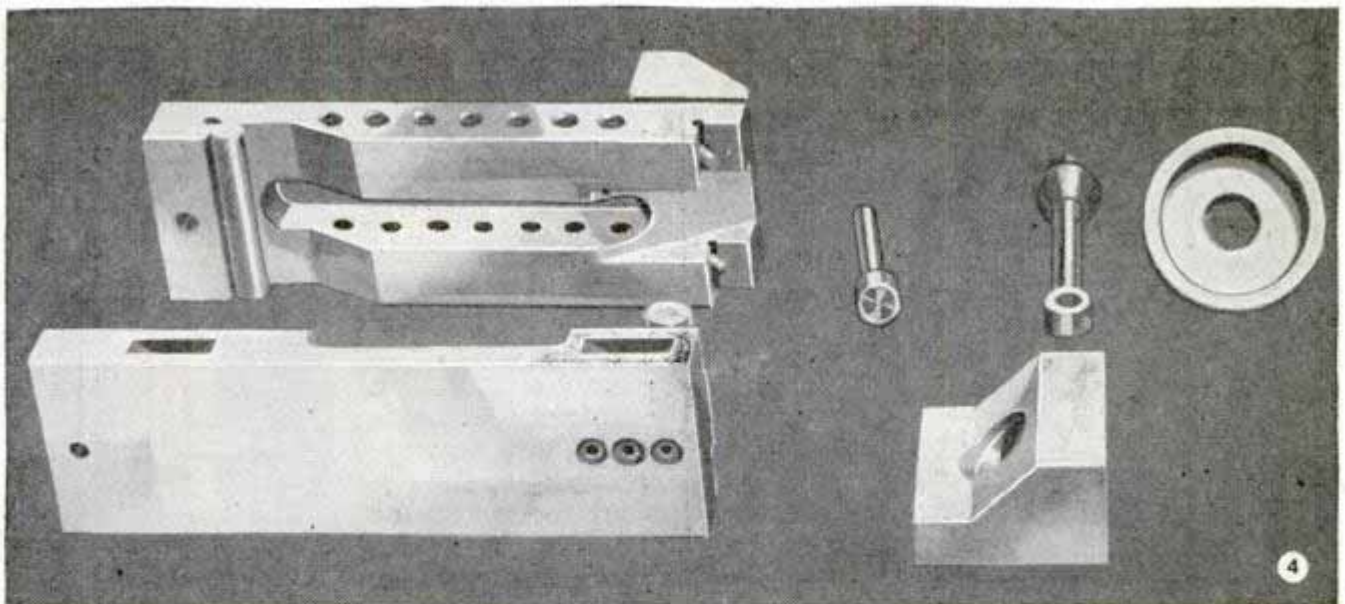

swivel screw pivots on the locking pin, and the swivel nut and wrench, Fig. 5, provide a fine adjustment on the sliding jaw. The hexagon socket of the adjusting wrench is really a broaching job, but because of the through-hole it is possible to do a creditable job with an ordinary hand file.

Finally, there's the roughing out of the base and the quadrant block. The machine operations on these two parts require working to "hold" dimensions. Cuts made on both sides of the base with a 1/4 by 1-in. Woodruff cutter provide openings for clamps. The slot milled in the base for the quadrant block must be held to exact depth in the finish grind, likewise the finish grind on the quadrant block must bring it to a smooth push fit in the slot. The hold dimensions on the two parts provide .0005 in. less than theoretical clearance when the parts

are assembled. This gives a velvet-smooth hinge action between the body and the base when the vise is being set in the angular positions. Turning out the two pins, upper right-hand detail in Fig. 6, finishes the parts ready for heat treating and finish grinding. This done, you have the set of parts shown disassembled in Fig. 4. The assembly is quite simple.

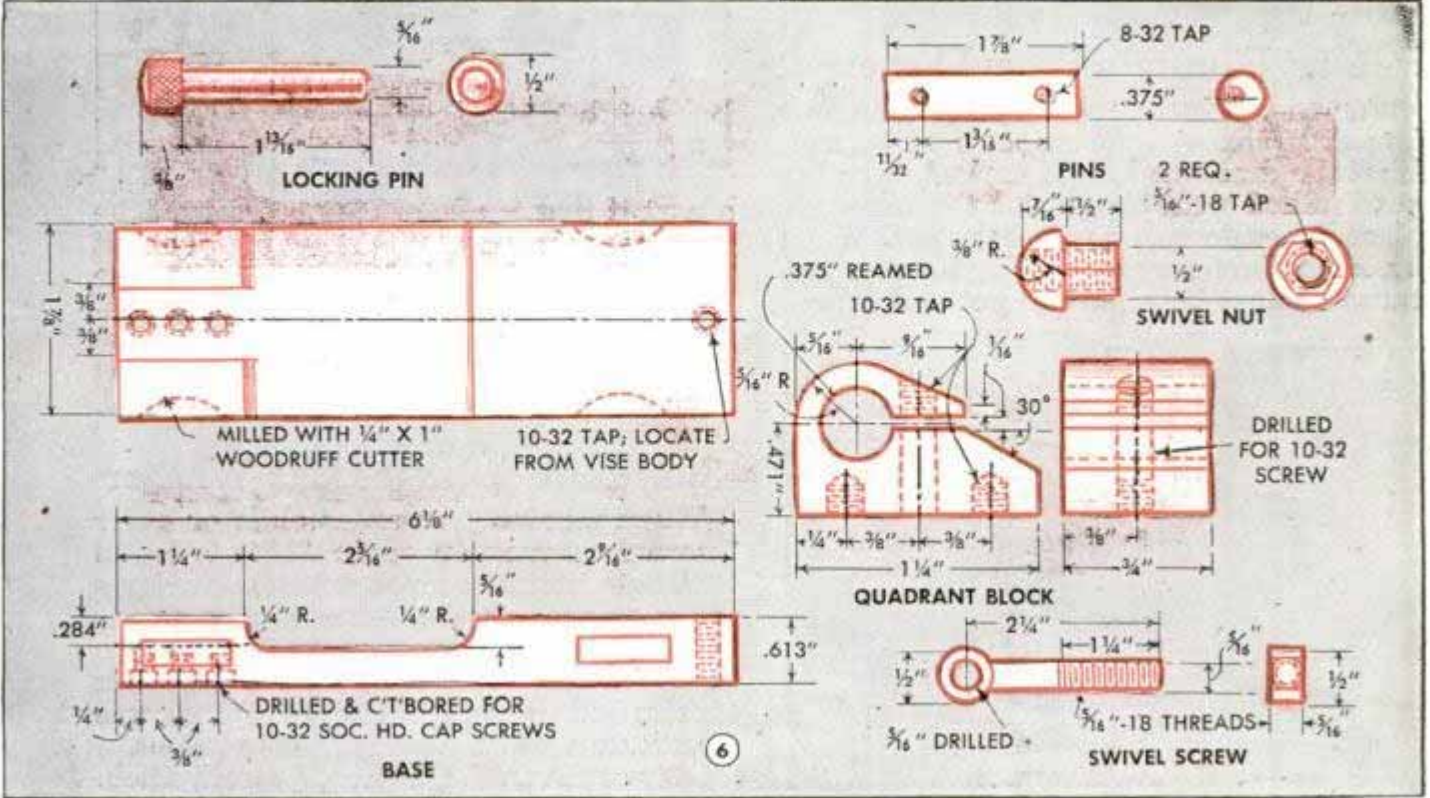
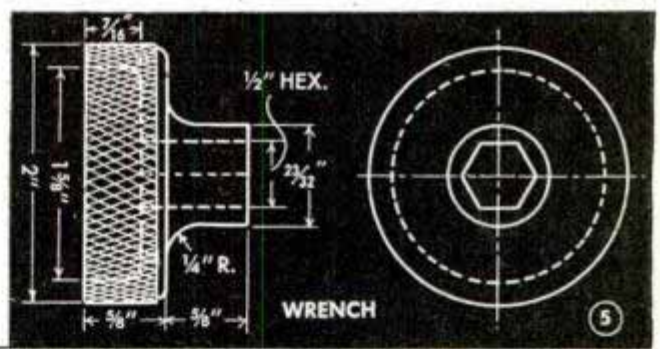

Light on Edge of Welding Helmet Aids When Inspecting Work

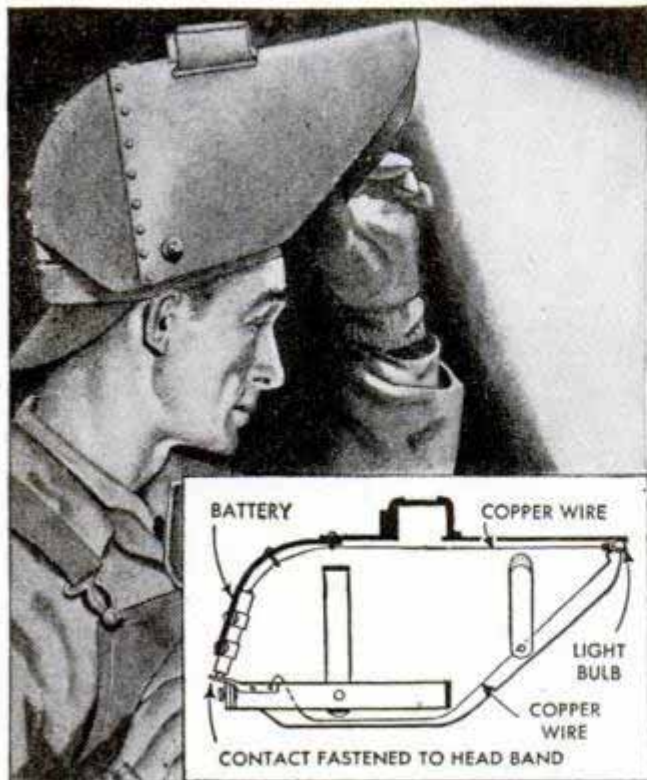

As an aid when inspecting work done in locations where the light is poor, one welder fastened a flashlight bulb to the lower edge of his helmet so that it would illuminate the work when the helmet was raised. The battery is fastened to the top of the helmet in such a way that it will touch a contact and close the circuit to the bulb when the helmet is raised. When the helmet is down, the circuit is broken and the light is off.

Norman W. Radcliffe, El Sobrante, Calif.

Poultry Fountain From Flowerpot

For an emergency poultry fountain, one farmer utilizes a flowerpot and saucer. First the drainage hole is corked, then the pot is filled with water and the saucer is placed, face down, on top of the pot. When inverted, the fountain is ready for use. Because contact between the pot and saucer

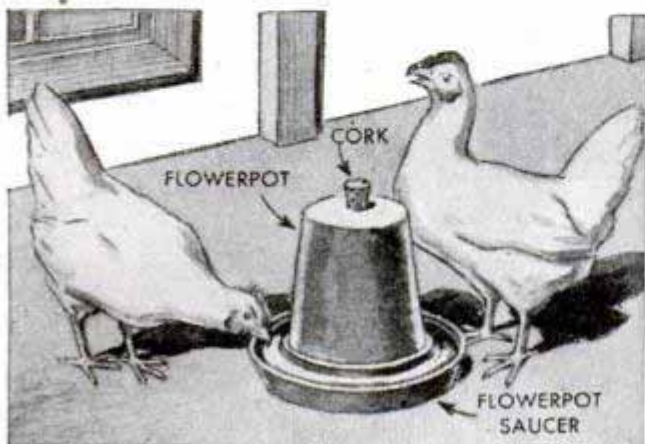

is not perfect, water will escape into the saucer. The saucer should be at least 2 in. larger in diameter than the pot.

Reversed Holder Prevents Tool Digging Into Work

In shaper work, difficulty sometimes is experienced when taking heavy cuts with a straight tool holder. There may be a tendency for the tool to chatter or to dig into the work. If the holder is reversed, tendency of the tool to dig in will force the point away from the work rather than into it.

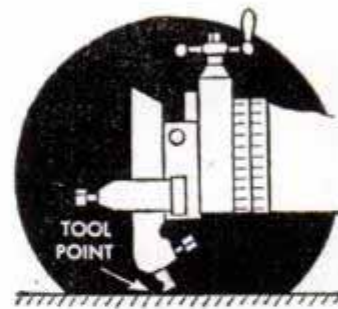

Emil Wittmann, Philadelphia, Pa.

Holders for Prints and Tracings Permit Easier Handling

Draftsmen will appreciate these holders for rolled blueprints and tracings since they will enable them to handle large drawings without weighting down the corners. The drawing can be entirely unrolled, or only

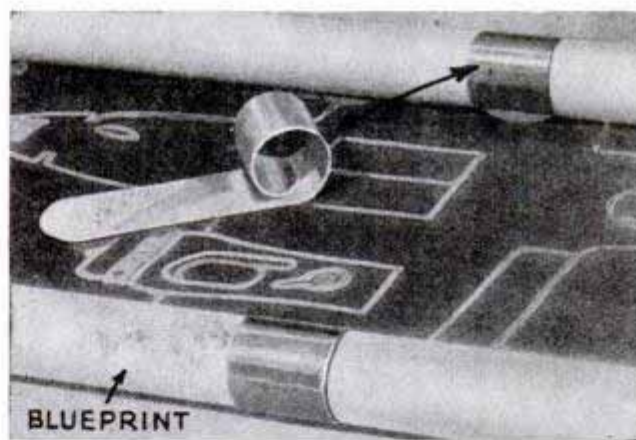

a part if that is all that is necessary. The holders are made of thin sheet metal about 1½ to 2 in. wide and 10 in. long. After the curve is formed, the flat part should measure about 6 in. The ends should be rounded and the edges beveled for convenience in handling.—Peter A. Bono, Springfield, Ill.

Substitute Asbestos Car Washer

When repairing an automobile or other internal combustion engine, if it is found that any of the copper-asbestos washers are no longer usable, asbestos string may be substituted. Three or four turns of the string should be sufficient. If the washer is of an odd size and difficult to replace, this substitute will be especially convenient.

Ivan J. Stretten, Detroit, Mich.



"PRINTED" RADIO CIRCUITS

SILVER lines replace copper wires in the "printed wiring" method for radio circuits that employed tiny tubes used in the proximity fuse, one of the secret war weapons. Developed by the engineers of Globe-Union, Inc., Milwaukee, Wis., this "printed hookup wire" solved a difficult construction problem as it was necessary to design a radio transmitter and receiver small enough to fit on the end of a mortar shell. Tubes about an inch long and slightly larger in diameter than a lead pencil are employed in these circuits that were "printed" on flat ceramic plates.

The lines of "silver ink" are painted over a stencil to form two-dimensional wiring. Carbon resistors are painted in with a carbon solution to complete the circuit, after which the plate is reheated to burn off the solvents. This idea of using carbon lines for a resistor is not new as many early radio experimenters used the same idea for making "resistors" with a lead pencil on a piece of paper. The young lady in photo A is using a small pen-type soldering iron to fasten the tube leads to the silver leads on the ceramic plate. Photo B shows by actual comparison what is accomplished with this method. The schematic diagram for both units appears in Fig. 1. All fixed condensers are small paper-thin ceramic disks silvered on both sides. The silk screen stencil-making process is illustrated in photo C. Manufacturers may decide to employ the new development for tiny receivers and electronic devices.

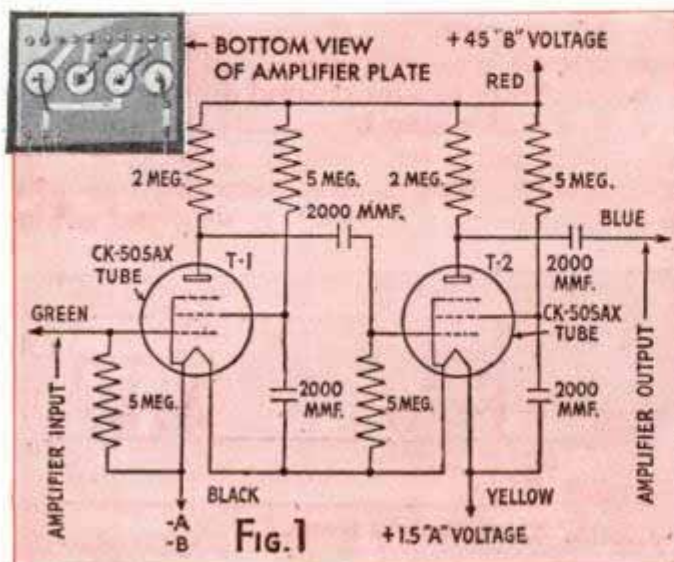

BUILT-IN RADIO

By W. H. Blankmeyer



NEARLY every home has at least one suitable location for a built-in receiver. When properly installed in a wall, library shelf or cupboard, the set is out of the way and there are no trailing wires. The permanent installation has several other advantages; for example, the loud-speaker may be mounted in a wall which provides a nearly infinite baffle for improving tone. The object is to separate the speaker front from the back by as much wall, or baffle, distance as possible, thus preventing low-note cancellation. It is also a simple matter to install remote PM speakers controlled from switches near the receiver panel.

A typical way of installing a radio chassis on a shelf in a built-in bookcase is illustrated in sketch Fig. 1. A neat and modern appearance is obtained by using a front panel which simulates a row of books. The speaker may be mounted several shelves higher and is provided with a grille of the same description backed with an appropriate cloth as detailed in Fig. 2. Decorating the set panel or speaker grille offers an opportunity for originality; however, the background color should harmonize with the other bookbindings. The vertical lines representing spaces between the books can be black; the book titles, gilt.

The bookshelf installation, Fig. 1, clearly shows the method by which proper ventilation is obtained. A space above the panel permits the heated air from the chassis to escape. To permit circulation, a dozen or more holes about 1½ in. in diameter are drilled in the shelf. The new control panel is supported on each end by wood strips and is made of plywood or other suitable material. In many cases it will be necessary to use extension shafts to bring out the controls.

All wiring to the chassis must be of the approved type and concealed for appearance. Antenna and ground outlets and the power outlet may be mounted at any convenient point on the side or rear of the bookshelf. Easy accessibility must always be considered. A speaker plug and cable

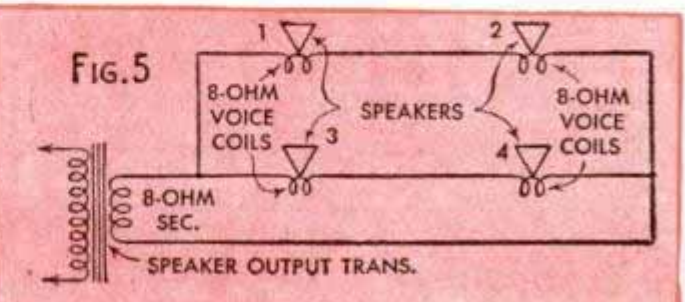
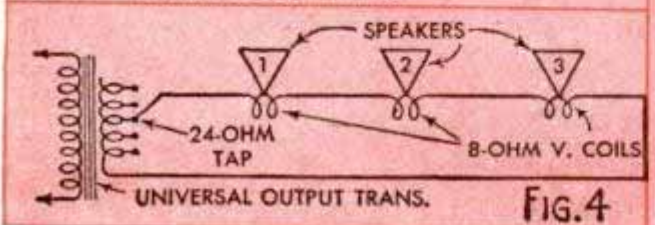
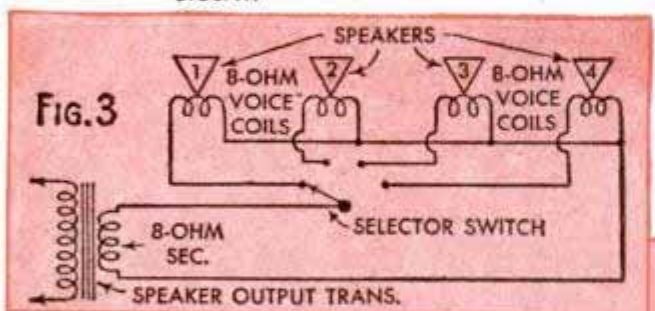
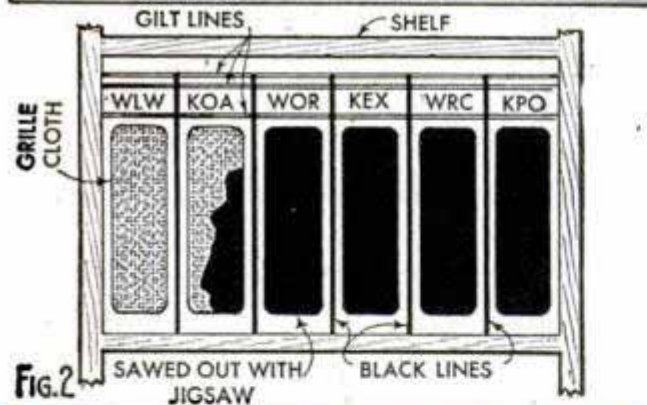
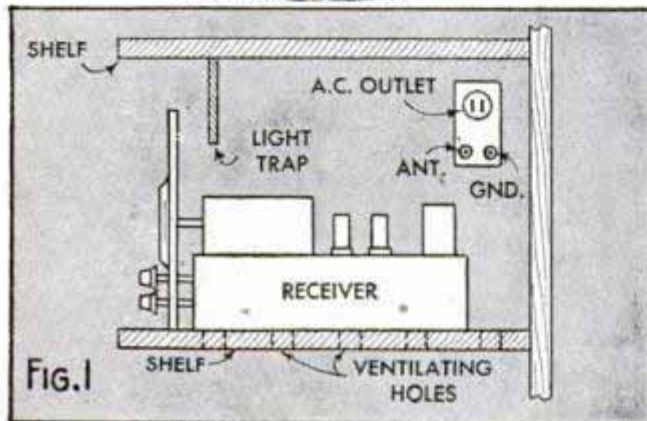

with EXTENSION SPEAKERS

hookup from the set chassis to the remote speaker, or to a small control panel near the receiver if more than one speaker is employed, completes the installation. Sketch A and photos B and C illustrate practical built-in receiver suggestions.

When several remote speakers are employed a simple selector switch is used to feed the audio power from the set output transformer to the desired PM speaker voice coil as detailed in Fig. 3. If several speakers are to be used simultaneously a universal output matching transformer is required as shown in diagram Fig. 4. The 8-ohm voice coils are connected in series, making the total impedance match at the 24-ohm tap. The universal output transformer will replace the one you have in your set and will match almost any speaker combination. If your speaker impedances are unknown try several different output taps for the best results.

Fig. 5 shows an idea for connecting several speakers without a matching transformer. This series-parallel combination matches an output winding intended for one voice coil when the number of speakers in series is the same number as those in parallel. Any installation using several speakers simultaneously divides the audio power output among the speakers, therefore your set must have sufficient output or the volume will not be satisfactory. To control the volume level of a speaker in any of the above arrangements separately, either at the remote speaker location or from any point along the connecting wires, a constant impedance control is necessary. The 8-ohm "L" pad, a dual resistance unit, shown in diagram Fig. 6 will serve to do this without disturbing the volume control setting at the receiver. The "L" pad must have the same impedance rating as the controlled speaker voice coil. The pad is merely connected in the leads to any individual speaker to be controlled. There is no blueprint for this article.

Wire for connecting extension speakers may be No. 18 annunciator, 2-conductor rubber-covered wire such as flat lamp cord, or regular No. 14 duplex in conduit.

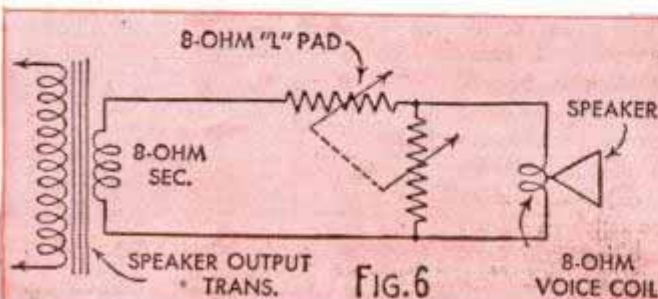
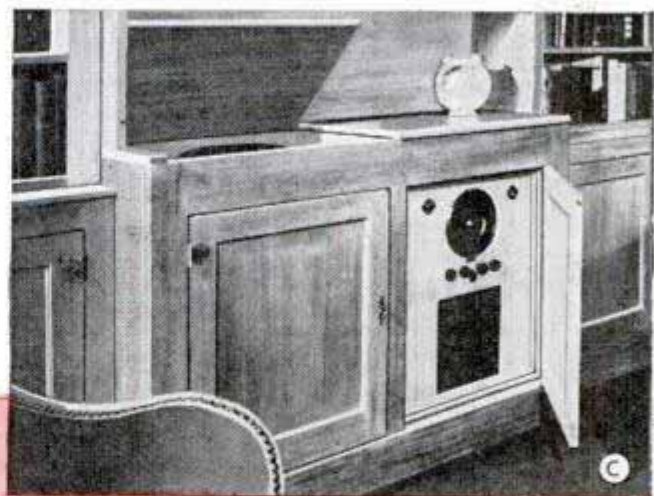

Blueprints covering radio construction articles in recent issues are available for 25 cents each; detailed student material lists, and additional information, can be obtained from our Radio and Electronics Department without charge on receipt of ordinary letter postage

Helpful SERVICE HINTS



(A) When removing tubes for checking purposes make sure that each socket is clearly marked for identification. Some manufacturers paste tube lineup charts on the inside or bottom of the cabinet instead of marking each tube socket; if the cabinet is changed or the chart is damaged, tubes may be inserted in the wrong sockets. Always turn off the set or disconnect it from the line supply before changing tubes. (B) Cardboard guide for starting screws in hard-to-reach locations. The screw, with washer in place, is inserted through the thin strip of cardboard which is easily pulled away after the screw is threaded into position. This idea is especially useful when repairing compact table-model receivers where the wiring partially covers mounting screw holes

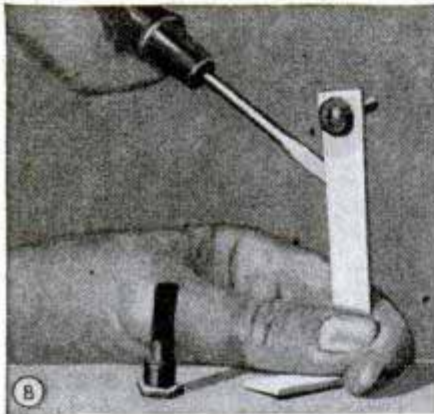

(C) Unless you have a detailed circuit diagram do not remove a volume control or other part from a radio receiver without first making a sketch of the wiring to such parts, showing the color coding of the wires, to insure correct replacement. (D) A marble bag or tobacco pouch saves knobs and screws during service operations. One misplaced screw or small part is often the cause of delay and many lost programs

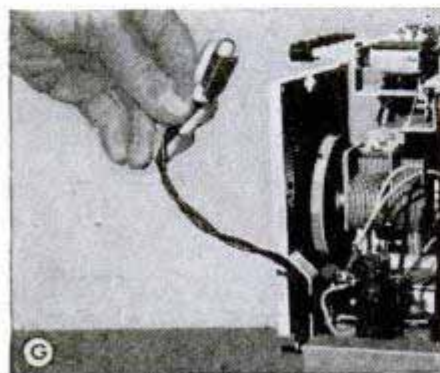
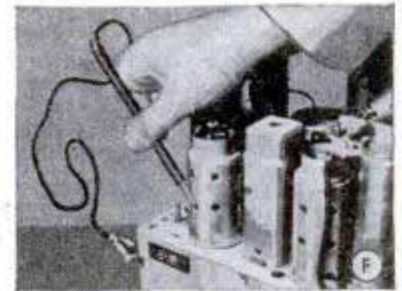

(E) Headphones in series with a small B or C-battery for continuity checking; if circuit is complete a distinct click is heard. (F) Loose tube shields make poor chassis ground contact and cause noise. (G) Twist pilot light leads to reduce hum. (H) Spring clips on ohmmeter leads leave hands free for checking intermittent short or break in line-cord resistor



For finer pictures,
KODAK
 from start to
 finish

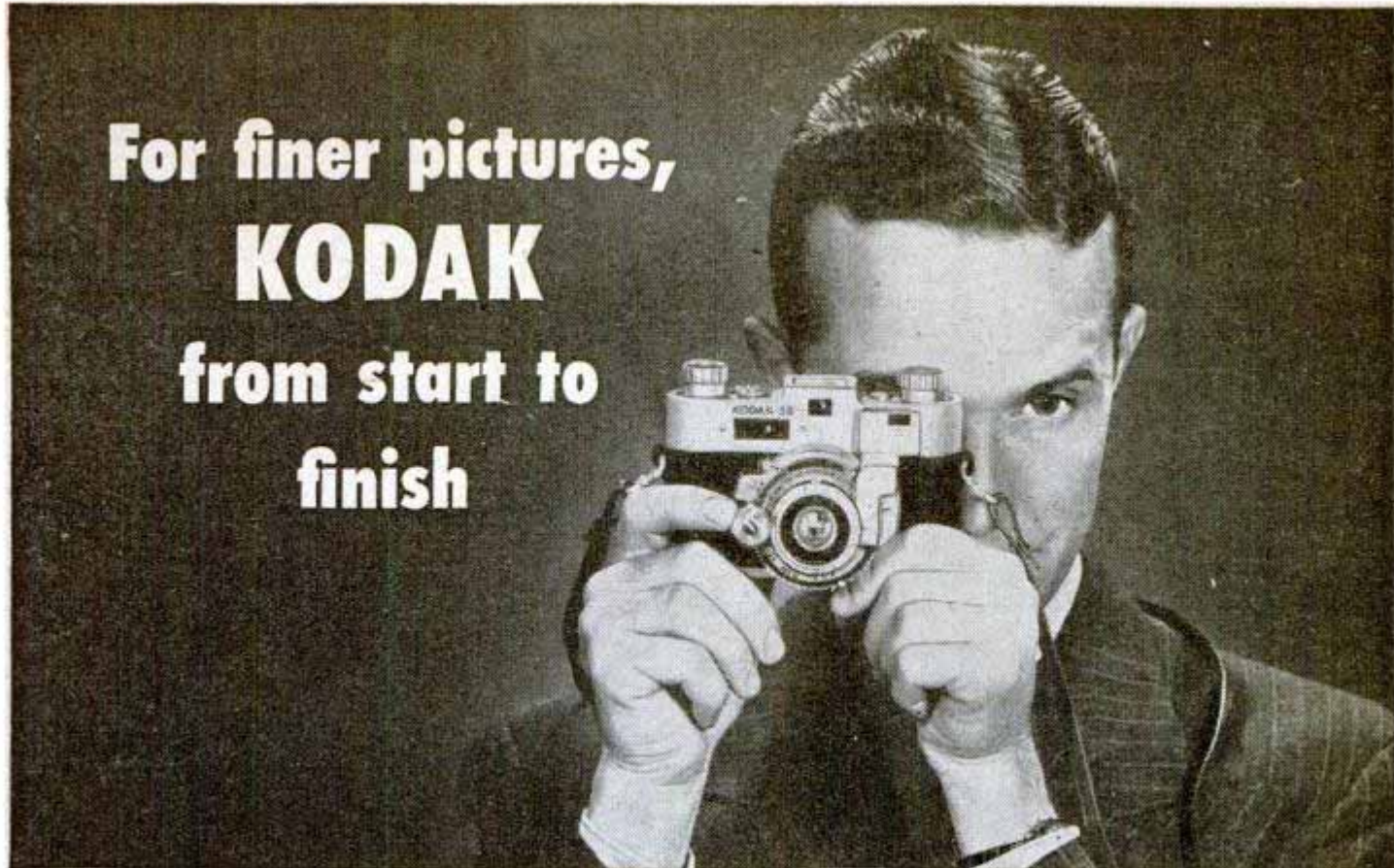

Above: **KODAK 35** (f/3.5 with range finder), a precision-built 35mm. camera well worth waiting for.



For extra emulsion speed, fine grain, general high quality—**Kodak Plus-X**, the all-round "pan" film. Rolls and packs.



For day-in-and-day-out picture making—**Kodak Verichrome**, America's favorite snapshot film by a wide margin. Rolls, packs.

Kodak's new **UNIVERSAL M-Q DEVELOPER**, in the handiest "chemical package" yet—only 5 cents. Two metal foil envelopes, clipped together in a match-book-style folder. Contents make solution sufficient to process 3 rolls of 620 film, 12 sheets of 5x7 film, or 72 sheets of 2½x3½ paper.



For best enlargements from any negative, with any enlarger—**KODABROMIDE**, all-purpose enlarging paper. Rich blacks, clean whites, delicate gradations. Five contrast grades. Wide latitude. At your Kodak dealer's . . . Eastman Kodak Co., Rochester 4, N. Y.

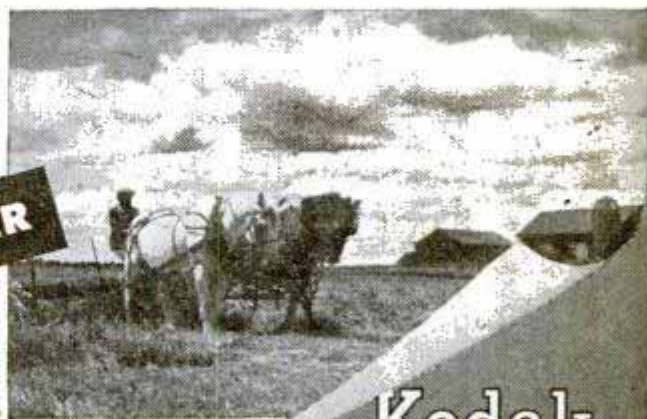

Kodak

"JITTERBUG, Tops As Killer of Bass!"

Angler Reports Several Catches from Michigan Lake



Dear Fred:

"Here's a picture of three nice bass and a Northern Pike I caught from Otsego Lake in Michigan. This is one of several nice catches I have taken on the Jitterbug from this same lake. The Jitterbug is certainly tops as a killer of bass. My lucky Jitterbug is shown rather indistinctly in this picture. It is directly under my chin."—F. E. Schulz, Akron 3, Ohio.

F. E. Schulz, of Akron, with a catch made on the Jitterbug

Send For Free Catalog

It has all the latest information on Jitterbug, famous surface bait, Hawaiian Wigglers and my new Hula Dancer. Copy is yours for the asking. (Sorry cannot accept mail orders. Please see your dealer.)

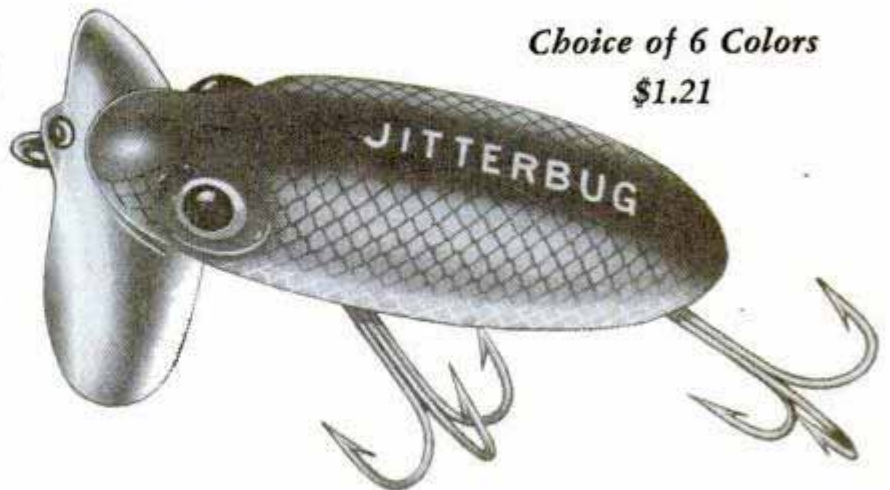

Choice of 6 Colors
\$1.21

FRED ARBOGAST & CO. • 1627 North St. • Akron 3, Ohio

IT'S A GRAND FEELING
TO DISCOVER A
NEW STAMP VARIETY



IT'S A GRAND FEELING, TOO,
WHEN YOUR CAR IS
CUSHIONED WITH MARFAK
CHASSIS LUBRICATION

MARFAK is scientifically designed to give your car that "cushiony" feeling . . . not for a few hundred miles, but for a thousand and more.

And remember that comfortable feeling is positive assurance that *Marfak* — Texaco's superior chassis lubricant — is on the job protecting the life of your bearings.

The special adhesive and cohesive qualities of *Marfak* resist wash-out, jar-out and squeeze-out. *Marfak* clings to bearing surfaces and seals out dirt and grime. That's why *Marfak* means longer riding comfort and reduced bearing wear.

So, see your Texaco Man today, and say: "*Marfak*, please."



With ordinary grease . . . you're taking the road shocks again after a few hundred miles.



Marfak stays on the job hundreds of miles longer — means more velvet smooth riding.

You're welcome at

TEXACO DEALERS



FIRE-CHIEF
GASOLINE



SKY CHIEF
GASOLINE



HAVOLINE AND TEXACO
MOTOR OILS



MARFAK
LUBRICATION



THE
TEXAS
COMPANY

Tune in the **TEXACO STAR THEATRE** starring **JAMES MELTON** Sunday nights. See newspapers for time and station.

"PLINK"... or ... "PLUNK"?

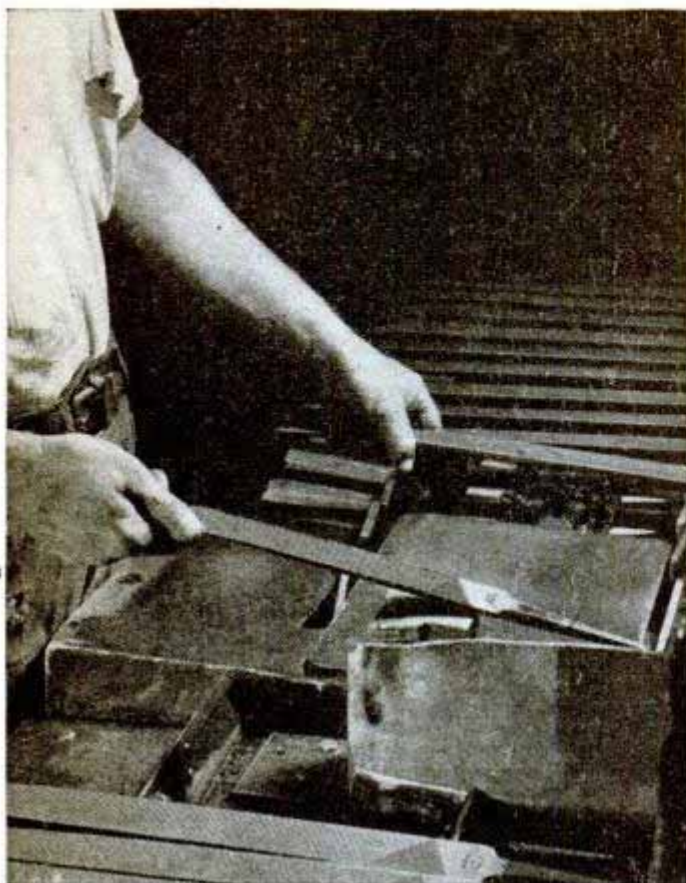

HERE'S one of the many tests or inspections Nicholson and Black Diamond files go through before they're permitted to face the world under the guarantee of *Twelve perfect files in every dozen.*

It's the "ringing" test for soundness. The inspector taps the file on a metal block. If its ring is a clear "plink," the verdict is "okeh." If a dull "plunk," most likely there's an invisible "water crack" somewhere, and the file is rejected.

Every Nicholson and Black Diamond file is given the "ringing" test. In fact, every important step in its manufacture is closely watched. As a result, these famous files come to you with unsurpassed uniformity—in shape, dimensions, cut, hardness and soundness. Good hardware and mill-supply houses sell them.



NICHOLSON FILE CO.
22 Acorn St.
Providence 1, R. I.
(In Canada, Port Hope, Ont.)



NICHOLSON FILES FOR EVERY PURPOSE

Putting a Madcap River to Work

(Continued from page 157)

Angeles River isn't tired of its part in the job. The port has used 10,000,000 cubic yards for terminals and has had enough left over to widen Long Beach's eight-mile bathing beach.

The dredges used in the construction look like top-heavy scows. The "Los Angeles" is a typical boat. The vessel is 130 feet long with a draft of seven feet. A giant A-frame supports a 70-foot ladder upon which is mounted a six-foot, five-bladed rotary cutter and a 30-inch suction pipe.

"Walking" slowly across the sand-filled sea, the dredge eats a 225-foot arc from the deposit of sand on the bottom, going as deep as 50 feet to find its food. A three-ton impeller in the 1500-horsepower electric turbine thrusts the dredged material through a mile of 27-inch pipe at 21 feet per second. Only about six percent of this material is solid, the rest water. But 1000 cubic yards of solid sand are moved through the pipe line each hour.

Through hot summer months the dredges work fast to clear a place for the river's winter and spring load of silt. From the rusty throats of huge pipe lines muddy water gushes into diked areas. Seagulls by thousands scream over the muddy fills, feeding on minced shellfish.

Costs of dredging sand from the river and depositing it in land fills range from 12½ to 32 cents per cubic yard, depending on the volume, location and depth and the distance the material must be pumped.

The harbor's future facilities will include a huge ultramodern base for seaplanes. The Port of Long Beach is determined that its future construction will meet the needs of modern world commerce. Shoemaker, the chief engineer, is removing all obsolete designs from the plans. Structures along the new piers will have built-in wartime im-

(Continued to page 224)

Model Builders Attention!

	V	V-2	V-3
Hex	½"	¾"	⅝"
Thread	⅜"-24	¼"-32	¼"-32
Thread Length	7/32	7/32	5/32
Weight, Grams	8	3½	2½

Actual Size V-Plug

Champion spark plugs for model gas engines give the same dependable performance as regular Champions. Sillment sealed. Sillimanite insulator. Alloy needlepoint electrodes for easy starting. One piece construction.

CHAMPION

SPARK PLUG COMPANY • TOLEDO 1, OHIO

Here's why most boat owners prefer Champion Spark Plugs

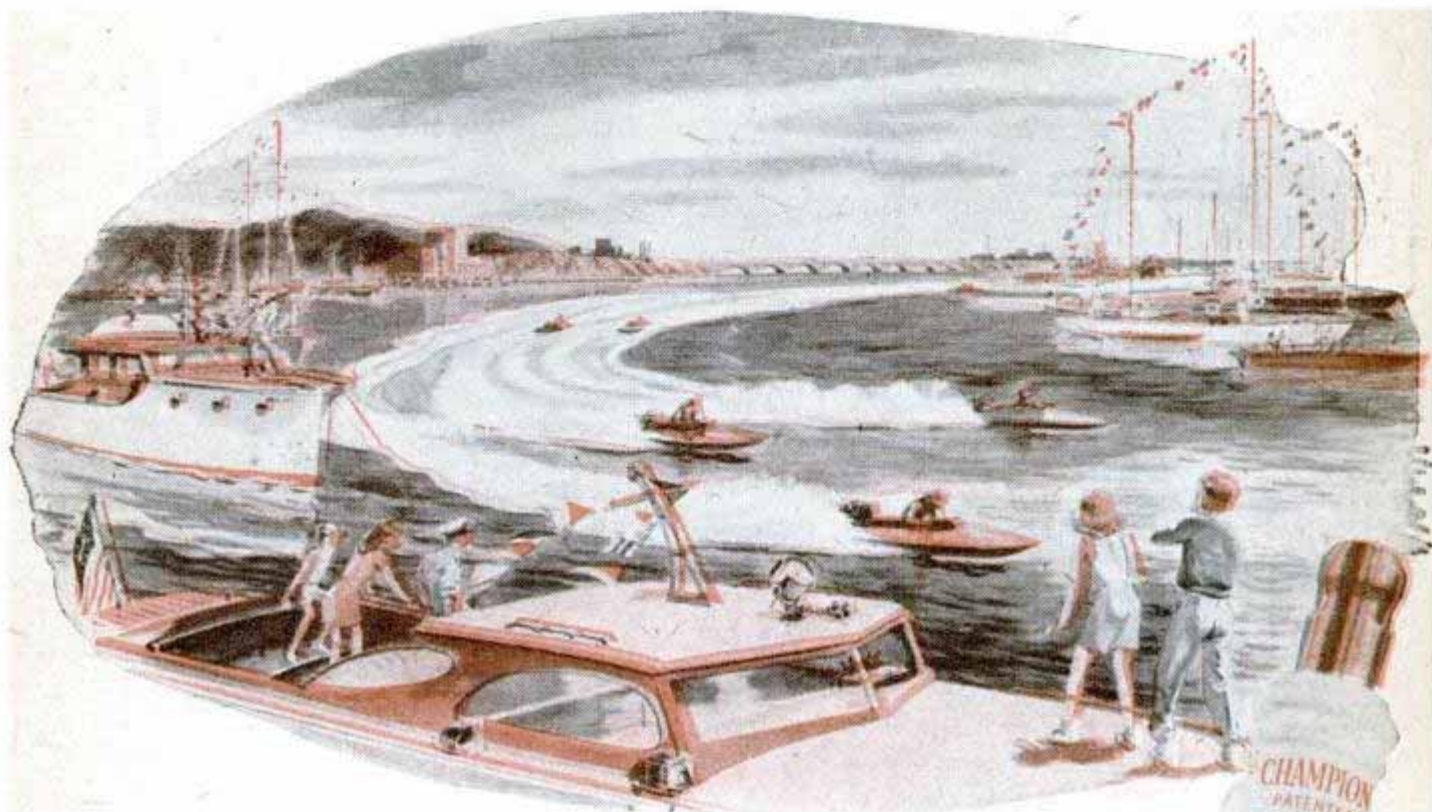

THEY'RE DEPENDABLE!

Owners of power boats of all sizes and types take deep pride in the performance of their craft. As a class they are experts on engine performance, and to them spark plugs are a matter of primary importance. That's why it's worthy to note that these experts—in both racing and cruising—prefer dependable Champion Spark Plugs in overwhelming majority. This preference is also expressed by most motorists. Champion Spark Plug Company, Toledo 1, Ohio.



FOLLOW THE EXPERTS . . . DEMAND DEPENDABLE CHAMPIONS

MEASURING ACCURACY..

\$2⁰⁰
EACH



Streamline's accuracy is unsurpassed by any steel tape on the market today. Its extra long tip for holding tape steady, its compact chrome plated case and lever brake to hold readings—are only some of the features which make Streamline the rule to carry at all times. Fits easily into any pocket and is ready to use at an instant's notice.

Can be used for direct inside measuring as well as a caliper, height gauge or scribe.

Get yours today at your local hardware store or building supply dealer or use coupon.

Streamline 8 ft. size \$2.25
8 ft. replaceable blade 70¢

MASTER

WOOD AND TAPE RULES
TRADE MARK

MASTER RULE MFG. CO., INC.
815 E. 136th St., New York 54, N. Y., Dept. F-7
Branch: P.O. Box 1587, Oakland, Cal.
Enclosed find \$2.00 for the new 6 ft. "Streamline"
(Spare blade 65¢ extra.)

NAME _____
ADDRESS _____
CITY _____ STATE _____

STOP LEAKS!

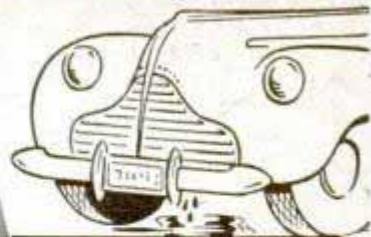

Cooling Systems
Made Leak-Proof QUICKLY

WARNER LIQUID SOLDER—Non-Metallic—Deposits Tiny Fibers to Repair Leaks Anywhere in Cooling Systems. Simply pour in! Finds and REPAIRS every crack or hole. Do it yourself—or see your service man.

Warner-Patterson Co., 920 S. Michigan Ave., Chicago 5

More Work in Less Time with
HOLD-E-ZEE

AUTOMATIC GRIP SCREWDRIVERS

Hold-E-Zees do the job better, faster. They excel wherever screwdrivers are used. Gripper instantly released by spring action, sliding out of way when not in use. Highest quality materials throughout.

UPSON BROS., INC., 65 Exchange St., Rochester 4, N. Y.



All
Leading Dealers
Everywhere

MODEL: Gasoline Engine Ready to Run

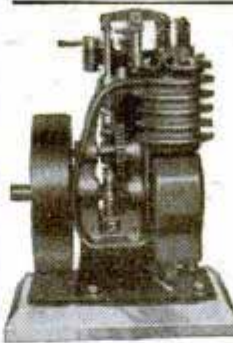

A precision built and engineered single cylinder FOUR-CYCLE model gasoline engine; adjustable valves; steel pinion and cam gears; a real ignition system; speed 300 to 3,000 rpm; develops approximately 1/2 hp. Bench tested and ready to run. Available with stationary or marine engine base. Full instructions. Lots of fun. Price \$40.00 complete, with coil, condenser and starting rope. Immediate delivery.

7 3/4" high—3" wide
Cyl. 1" dia.; stroke 1"

The THOMPSON ENGINEERING CO.
206 Winchester Place, Grand Rapids 2, Mich.

WRITE
For
FREE
Literature

BUILD YOUR OWN POWER LAWN MOWER

WHY BREAK YOUR BACK
MOWING FIELD OR LAWN?

Now anyone can save time and effort mowing field or lawn, by building their own whirl type power mower.

We furnish complete information, and whirl type blade attachment. Write today.

THE RITE-WAY
MOWER ATTACHMENT

T & H Mfg. Co.

811 E. 31, Dept. GP-5, Kans. City 3, Mo.

YOU WERE WRONG

THE TIME YOU FORGOT YOUR WEDDING ANNIVERSARY

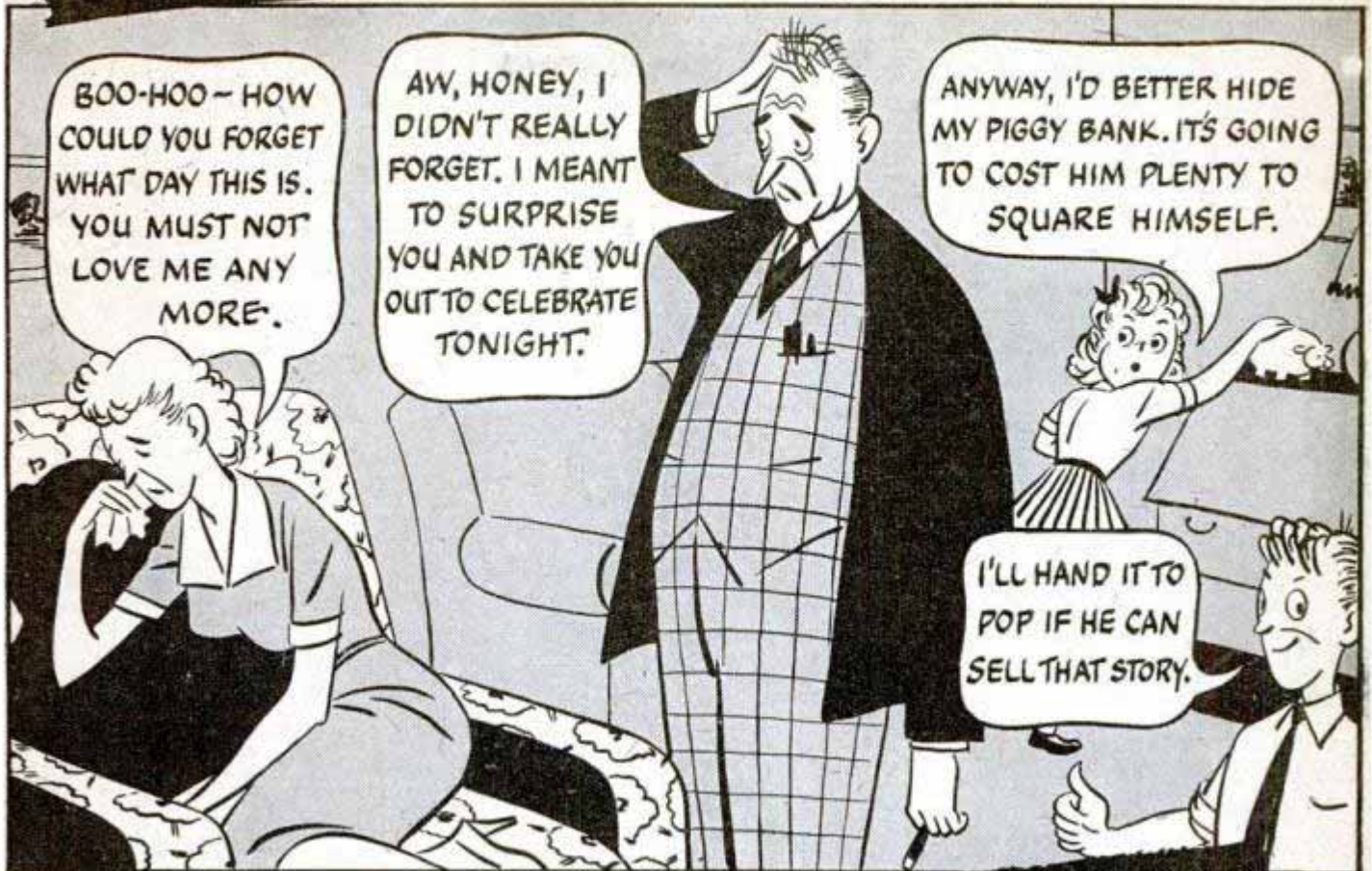

Well, a man can't always remember *everything*. But smart motorists *never* forget this: Replacing worn-out spark plug wires with Packard Four-Forty ignition cable keeps cars powerful, peppy, and economical to run.

Thanks to an especially tough outer sheath, Packard Four-Forty provides lasting protection against heat, cold, oil, moisture, corona and abrasion. And because of this special Packard feature, Four-Forty maintains full efficiency while your speedometer clicks off the thousands and thousands of miles. Regardless of driving conditions, you can be sure there are no voltage "leaks" when Packard Four-Forty is on the job.

**But... YOU'RE RIGHT
with
PACKARD CABLE!**

More new cars are originally equipped with Packard cable than with any other kind. Most leading service stations and garages have made Packard Four-Forty their replacement choice. Take it from these automotive leaders—you're *right* when you use Packard spark plug wires, lighting wires, battery cables and ground straps!

— PACKARD —
CERTIFIED RE-WIRING SERVICE

This sign means cable service at its best—the right Packard cable and the right methods. Thousands of dealers provide better electrical service as a result of the Packard Certified Re-Wiring Program.



Packard

REG. U.S. PAT. OFF.
TRADE MARK
PACKARD ELECTRIC DIVISION
GENERAL MOTORS CORPORATION
WARREN, OHIO



FOREMOST BUILDER OF AUTOMOTIVE AND AVIATION WIRING

This is the LIFE!

Ride a HARLEY-DAVIDSON



THE popularity of motorcycling — "the world's greatest sport" — is surging to new highs! Thousands and thousands of enthusiasts — old and new — want Harley-Davidsons. Our production rate is at an all-time peak—but dealers are selling Harley-Davidsons faster than we can ship them. If you want the thrill of Harley-Davidson ownership—and all the fun and thrills of motorcycling—see your Harley-Davidson dealer EARLY! Latest models give you so much in power, speed and stamina, they're well worth waiting for until your dealer can deliver your Harley-Davidson.



HARLEY-DAVIDSON MOTORCYCLES

HARLEY-DAVIDSON MOTOR CO.
Department P, Milwaukee 1, Wisconsin
Please send free copy of 24-page "Enthusiast" Magazine, filled with motorcycle action pictures and stories.

Name.....

Address.....

City.....State.....

provements that have enormously increased the efficiency of cargo handling.

Shoemaker estimates the future frontage of the Port of Long Beach at 25 to 30 miles. When that potential has been reached, the port will have used nearly 50,000,000 cubic yards of sand—carried free by the temperamental Los Angeles River.

Rough Riders on Water Skis

(Continued from page 120)

ture. The blimp, moving along at good speed, struck an uprising current and jumped high into the air. MacDonald was pulled off the water. In a few seconds he was dangling 150 feet from the surface. He had stirrup-type grips on the tow line and hung on until the blimp was brought down and placed him back on the water.

Competent skiers often work in pairs behind a fast boat, changing sides by ducking under one another's tow lines. One man, skiing beside his partner, can drop one ski, step on his partner's and then drop his other ski so that both are riding the same pair. Ski enthusiasts have ski-jumped off ramps at 40 miles an hour.

Any fast and maneuverable boat makes a good tow boat. Some enthusiasts build their own utility runabouts, from 15 to 20 feet long with enough power for speeds up to 45 miles an hour. The most popular inexpensive boat is the "crackerbox" type, so-called because it consists of plywood panels that are easily assembled. A practically flat bottom and straight vertical sides make it easy to build in a back yard. Usually a crackerbox is powered by an automobile engine. Tow lines are of stout half-inch cord from 30 to 50 feet long with a wooden crossbar or individual stirrup-type hand grips at the end.

The pay-off in ingenuity goes to one California enthusiast who didn't always have a partner to man the boat. He rigged up remote controls so he can ski at 30 miles an hour with no one aboard the boat. His tow line is secured to the end of a metal bar attached to the top of the rudder shaft. When he swings to one side and holds his tow line at arm's length he moves the rudder to one side, turning the boat in that direction. Another cord leads to the engine throttle. A spring normally holds the throttle closed, but tension of the tow line pulls the throttle open. When the ski rider takes in a few feet of tow line and then slacks off on it momentarily, the throttle is pulled shut by its spring, slowing down the engine. By repeatedly taking in line and then slacking off, the boat's speed can be brought down to 10 miles an hour.

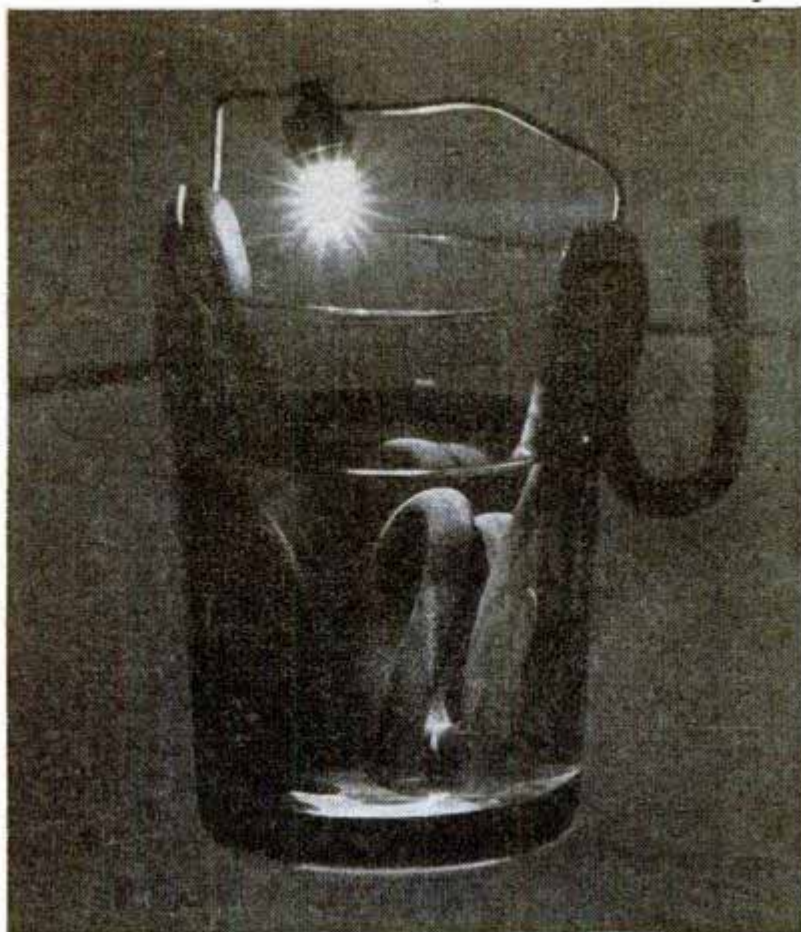

HOW YOU CAN MAKE A SIMPLE STORAGE BATTERY

Put two small pieces of scrap lead in an ordinary glass partly filled with a weak solution of sulphuric acid and water... pass direct current from a battery charger through the unit for about a half hour... then reverse the direction for the same length of time. You have a storage battery... of very low capacity and very short life... yet it embodies the basic theory of storage battery construction.

Between this home-made battery and one that will give dependable service, stretches a wide gap. Between it and an Exide Battery

this gap is bridged by 58 years of battery research, development and manufacturing experience. These are some of the reasons why so many millions of people say Exide is the world's finest storage battery. They know that—

"WHEN IT'S AN EXIDE YOU START"

Would you like to know how batteries function, and how to get the best results from them? Just mail a postal card to Exide and ask for FREE booklet, "The Storage Battery—Its Fundamentals, Use and Maintenance."

Exide

BATTERIES

THE ELECTRIC STORAGE BATTERY COMPANY, Philadelphia 32

Exide Batteries of Canada, Limited, Toronto

HANDY KIT of TOOLS in ONE TOOL!

- Adjustable End Wrench
- Lock-on Wrench
- Pipe Wrench
- Gripping Tool
- Pliers
- Hand Vise
- Clamp



Thousands of uses
in the home,
car, shop, garage
or on the farm.

BMC PRESSURE LOCK WRENCH

Fits as it Grips . . . and it HOLDS!

At last — a wrench, pliers, vise and clamp all in one tool. Gives a tight, slip-free grip — without fussy adjustment — on any shape piece that you can get hold of . . . nuts, studs, pipe, short, broken or irregular pieces. More than a ton gripping power . . . applied and locked with one hand, and released with the flick of a finger. Stays locked until you release it. Serves as a vise or clamp . . . or as a toggle press for gluing, welding, straightening, etc.

JAWS ALWAYS PARALLEL

BMC Pressure Lock Wrench will take a locking grip on any size piece up to 1" — with the jaws always parallel. That exclusive, patented feature prevents rounding of nuts . . . assures even pressure and a firm grip when used as a vise or clamp. Ideal for the tool kit of your car.

On sale at leading hardware, auto equipment and mill supply stores. Three sizes:

- No. 7 - Max. jaw opening $\frac{3}{4}$ " - \$2.75
- No. 9 - Max. jaw opening 1" - \$3.50
- No. 11 - Max. jaw opening $1\frac{1}{2}$ " - coming soon

BMC MANUFACTURING CORP.
BINGHAMTON, N. Y.

**STRIPE
WITH
PAINT
EASY
AS
USING
A
PENCIL**

PAINTERS' STRIPING TOOL

NOW you can do your own expert striping on furniture, bikes, model planes, bulletins, autos, toys, signs, linoleum, wall board . . . make plain walls look like tile! It's easy to paint straight, curved, circular, even parallel lines with any color. Handiest paint tool in your workshop! Type "M" Master Painters' Striping Tool complete with tip for 1/16" stripe, \$1.00. Extra tips 1/64", 1/32", 3/64", 1/16", 5/64", 3/32", 1/8" - 75c each. Tool with complete set of 7 tips \$5.00. (C.O.D. orders 25c extra.) WENDELL MFG. CO., 4234 -B Lincoln Ave., Chicago 18, Ill.

**A TOOL . . .
NOT A BRUSH**

Dealers
Write
Today!



**\$1.00
POST
PAID**

BUILD YOUR OWN TRAILER



For Traveling
Camping - Hunting

Or a REAL HOME OF YOUR OWN

Write for BIG FREE CATALOG

Complete stock of everything for the trailer-builder and trailer-owner—the best of parts and supplies. Rock bottom prices. Drop us a card or letter. Will send catalog promptly.

NATIONAL TRAILER STORES

Dept. 10— Box 2353
Terminal Annex Los Angeles 54, Calif.



A HONEY OF A MIKE TURNER Challenger

High performance at low cost. Reproduces voice or music crisp and clear. Precision built with moisture sealed crystal. Works indoors or out. Rich bronzed enamel finish. 7 ft. cable. Ideal for hams and home recording. Ask your dealer. Write for Free literature describing Turner Microphones

THE TURNER COMPANY
921 17th St N E., Cedar Rapids, Iowa

Thompson BEATS the World on BOATS



Better Built Lower Prices



Safe Boats With Full Length Spray Rails

Keep passengers perfectly dry—even at high speeds. Catalog also shows two new models of "Take-Along" Boats. Two big factories—save you freight.

CATALOG FREE
Write for your copy. State kind of boat in which you are interested.
THOMPSON BROS. BOAT MFG. CO. (161)
213 Ann St. PESHTIGO, WIS. Write to 113 Elm St. CORTLAND, N.Y.

Light Boat for Auto (161)
113 Elm St. CORTLAND, N.Y.

John J. Hall and Herman S. Burgess, famous ship model experts, at work on a 60-inch model of Robert Fulton's "Claremont". In background, four-foot model of the old "Constitution". Note they're using X-acto tools.

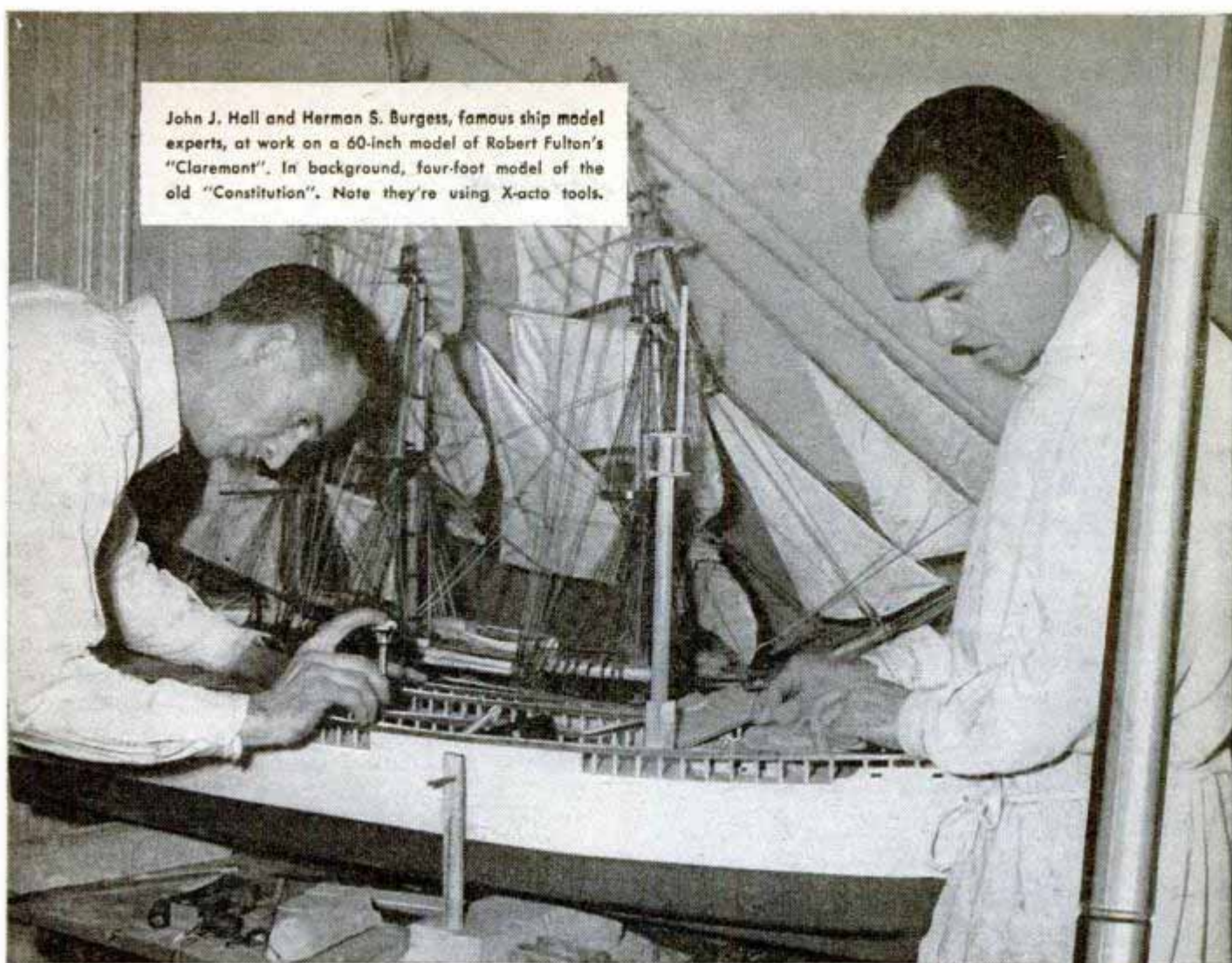

"You'll build better models with X-acto!"

"WE'VE used X-acto Knives and Tools for years . . . and we recommend them highly to all model builders," say President Burgess and Commodore Hall of New York's Model Schooner Club.

And that's advice worth heeding, for Hall and Burgess boats are consistent winners at the annual Model Yacht Regatta in Central Park.

Whether you are an amateur or a professional . . . a model builder, whittler, or the family Mr. Fix-it, you'll do a slicker job, and *quicker*, with these removable blade hobby knives. And now that the war is over, X-acto Knives are *all-metal*—no more substitute plastics!

X-acto is sharp as a surgeon's scalpel, easy to use as a pencil. Designed for safe, sure control, it adds skill to your wrist, zip to your work.

13 Blade Shapes Quickly Interchangeable!

With 13 blades, and 3 solid duraluminum handles, X-acto cuts smooth as a whistle . . . paper, leather, solid wood . . . with or across the grain, into hard-to-reach places, round sharp curves and corners. A special chuck collet locks blades firmly so they can't fold under.

Experts call it *the wonder knife* . . . once you've used X-acto you wonder how you ever worked without it!

ALL METAL
X-acto No. 2 solid
duraluminum
Knife . . . **50c**
With 5 assorted blades,
\$1. Other X-acto
Knives, Tools, Chests,
50c to \$12.50.



It's Got Everything! No. 85 X-acto Tool Chest—3 all-metal knives; full assortment of blades and X-acto hobby tools; complete in wooden chest, \$12.50. Also No. 84 Set, \$7.50

X-acto
KNIVES & TOOLS



At hardware, hobby and gift shops

X-acto Crescent
Products Co., Inc.,
440 Fourth Ave.,
New York 16, N. Y.
In Canada: Handi-
craft Tools, Ltd. Har-
mant Bldg., Toronto

*Reg. U. S. Pat. Off.

NEXT TIME SAY BRIGHT STAR

and you will get a
FLASHLIGHT & BATTERIES
famous since 1909
for QUALITY,
STYLE and
SERVICE

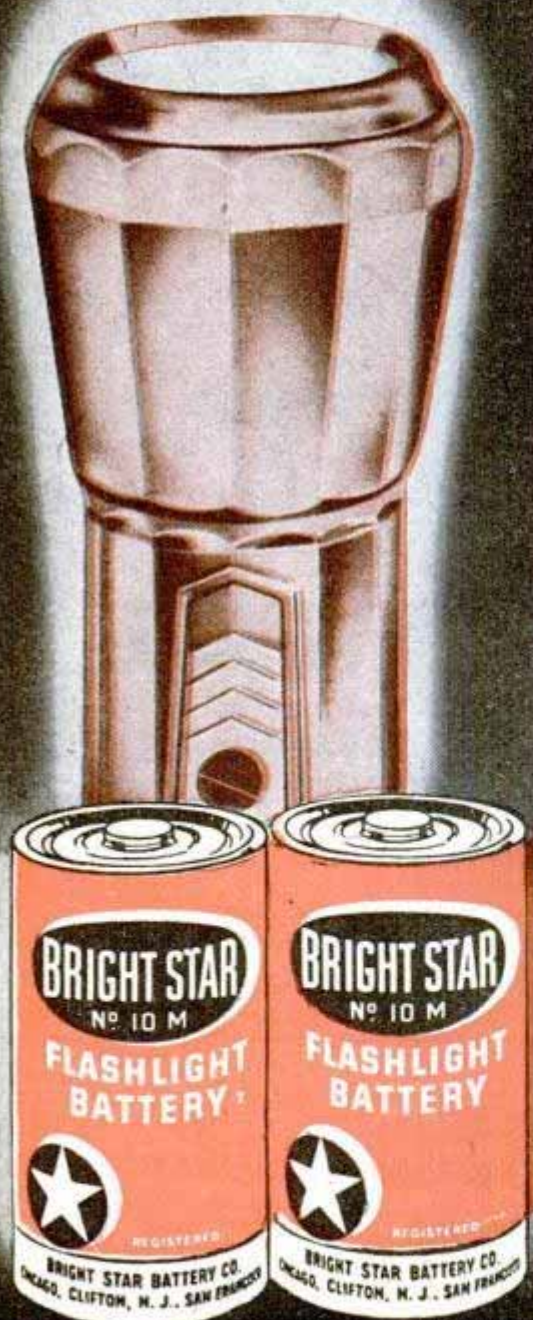

BRIGHT STAR BATTERY CO. CLIFTON N. J.

The Mechanics of Golf

(Continued from page 127)

Of course there is always room for improvement, but my putting results have been satisfactory enough so that I am content to continue with the grip I have been using. I feel that the principal hope for improvement lies in additional practice.

Photos on page 125 show how I grip my putter. Many golfers unnecessarily make hard work of putting. The proper putting stroke is very simple. The most important items to remember in putting are (1) keeping the blade of the putter perfectly square to the hole, (2) taking the blade back from the ball exactly on a line from intended direction of ball back through the ball, (3) keeping clubhead low throughout backswing, (4) stroking the blade through on line with intended direction of ball.

Because it is necessary to follow through with the clubhead on the longer putts, my right elbow slides off my right hip and toward the pin after the ball has been hit.

Now that we have studied in detail the technique of hitting all the shots commonly used, let's step out and play two holes together. (Photos on pages 126 and 127.)

Our locale is the beautiful Colonial Country Club at Fort Worth, Tex.

The first hole is a 561-yard par 5 dog-leg to the right. The green lies below the point indicated by the arrow. I want to hit the ball between the two trees at the right, for that is the shortest way to the green.

My drive travels 273 yards, leaving me still 288 yards from the green. This means I can hit a full brassie (No. 2 wood) for my second shot. This shot is good for 256 yards and brings the ball within 42 yards of the green. But there is a trap looming up between the cup and me.

Oh well, let's not worry too much about that. We'll take a double-duty niblick out of the bag so we can hit the ball high and put backspin on it. This will make it stop where it lights. My pitch to the green finds the ball stopping four feet from the cup.

My putt is good. I score a birdie four.

As I drive for the second hole—a 395-yard par 4—I try to make the ball slice (curve to the right) around the left side of the tree looming up before me.

To get an intentional slice I first take an open stance such as we studied in Part 1 of this series. As I start the backswing, I force my hands and the club away from my body so the clubhead will follow an upward arc outside the line of flight. As the clubhead follows this arc down to the ball, it cuts across the ball from outside to inside the

(Continued to page 232)

Tough..

but oh so gentle

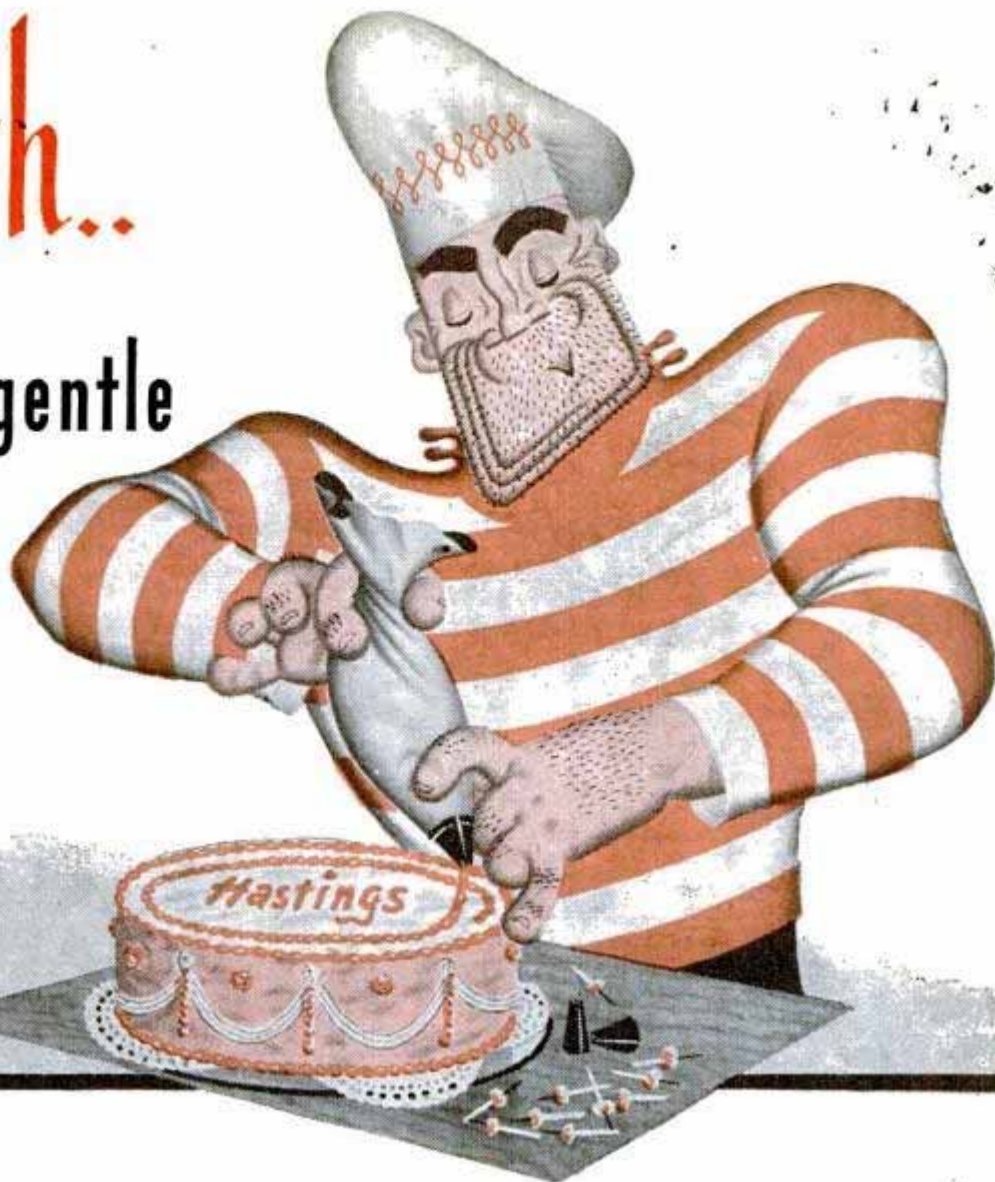

When you install new piston rings, it will pay you to get Hastings rings. They *stop* oil-pumping, *check* cylinder wear, *restore* engine performance. Ask your motor specialist.

HASTINGS MANUFACTURING COMPANY • HASTINGS, MICHIGAN

Hastings Ltd., Toronto

HASTINGS STEEL-VENT

PISTON RINGS



TOUGH ON OIL-PUMPING GENTLE ON CYLINDER WALLS

SWIVEL-HEAD

FLASHLIGHT

nothing else like it!

**HEAD TURNS
LIGHT AT
ANY ANGLE**

Greatest advance in flashlight design in a generation. Turn powerful pre-focused beam where you want it . . . stand it up . . . clip it on . . . both hands are free. A handsome, durable, all-purpose flashlight for everyone. Ask your dealer.

**\$2 LESS
BATTERIES**



No. SW-72
Patented

No. 75 Heavy-Duty Dated Cell. Fresh Lasts longer. 10c



Flashlights & Batteries

If dealer cannot supply, send \$2.00 to Dept. P UNITED STATES ELECTRIC MFG. CORP., New York 11, N. Y.
*USALITE Red-Head Safety Flashlight—a "MUST" for the motorist.

SAY YOU SAW IT IN POPULAR MECHANICS



Save Fingers with Steel-Grip Finger Guards

Hundreds of factories are saving time and protecting workers with Steel-Grip Finger Guards. Used for handling rough, sharp articles, buffing, grinding, sanding, polishing, punch press work, many other jobs. Wear on fingers or thumb, front or back. Durable leather, elastic web back for snug, cool, comfortable fit. Easy on and off. One size fits all, men or women. Send 10c each for samples or trial order box of 50 at \$4.25 less 10%.

Catalog of Steel-Grip Safety Apparel free on request

INDUSTRIAL GLOVES CO.
649 Garfield, Danville, Ill.
(In Canada: Safety Supply Co., Toronto)

Famous Industrial guards Since 1910

Famous Barron DRILL PRESS Accessories . . .

Multi-Purpose WOOD PLANER..\$7.50

Fits ANY drill press. Planes, panels, rabbets, routs, tenons, beads, grooves. Machined and balanced. Hi-Speed tool steel cutter knives. Thousands now in use. 10 Day Money Back Guarantee.

Spiral Flute ROUTER BITS

Special radial shaped flutes for faster, smoother, easier routing, grooving, carving, round-end mortising. Extra long cutting flutes for deeper work. Available in individual sizes. Complete set of 6 sizes \$8.50

Rotary Surface SANDER . . . \$5.95

Fits chuck of drill press. Unexcelled for smooth, even surface sanding of woods and plastics. Original in design and a great labor saver. Complete with 20 sanding discs. 10 Day Money Back Guarantee.

Auxiliary Drill Press TABLE \$8.85

Hard Alcoa aluminum 234 sq. inch table. Fits on standard drill press table to give greater working area. Precision ground. Heavily ribbed. With Barron steel fence. A "must" for every drill press.

Write for FREE Catalog
BARRON TOOL CO., INC.
369 Architects Bldg. Detroit 1, Mich.

BARRON PRECISION WORK SHOP TOOLS

FIND UNDERGROUND MINERALS and METALS with M-SCOPE

Employs same principle as Army Mine Detector. Unsurpassed in Efficiency. Write for Free 16 page booklet.



FISHER RESEARCH LABORATORY PALO ALTO CALIFORNIA

Sand Casting—Forging—Heat Treating—Case Hardening
BRONZE FOUNDRY



is again available in limited quantity without priority. Orders filled in sequence as received. INVENTORS—SCHOOLS—CRAFTSMEN use FOUNDRYETTE for making castings quickly for new inventions, for instruction, and general purpose. Order now for early delivery. Three sizes are available capable of making bronze castings of 1½, 3, and 6 pounds weight, aluminum, copper, brass, etc., \$17.50, \$24.00, \$34.50, f.o.b. Kansas City. Domestic gas supply and 110 volt AC or DC energy required for operation. Write for circular.

KANSAS CITY SPECIALTIES CO.
Box 6022, Dept. P-68 Kansas City, Mo.

PULVEX FLEA POWDER DDT



Kills the fleas QUICKLY!
Keeps others off for days!
Still 25c and 50c



POPULAR MECHANICS



W W W = 5 H.P.

W W W W W W W W = 5 H.P.

You don't have to be an "Old Salt" to maneuver a Johnson powered boat. Johnson's 360° Steering and Reverse make it easy to get in and out of tight places.

With Johnson's Dual Carburetion you can throttle down to a crawl and get the same sweet performance as at high speed. Rotary valve operation takes over automatically.

Third port operation at high speed lets you really step out when your throttle is open. Power... smooth power... without fussing. Hour after hour, you GO!

Two power impulses per revolution instead of one—a liquid flow of 8,000 impulses a minute in a Sea-Horse! That's Alternate Firing, developed and perfected by Johnson.



There is No Substitute for Experience

This is the famous Johnson Sea-Horse Model TD—the outboard motor that "has everything"... It develops 5.0 O.B.C. CERTIFIED brake horsepower at 4000 r. p. m. It is built with all the major refinements (27 of them) that make for outboard quality. It is prized above all for its DEPENDABILITY. And, of course, it is the motor that gives you "The Big Three" of outboard motoring—Johnson Perfected Alternate Firing, Reverse and Dual Carburetion.

FREE HANDY CHART. Write for your copy of the new Sea-Horse Handy Chart which gives complete specifications on the 5 great models of the 1946 Sea-Horse line.

JOHNSON MOTORS, 400 Pershing Rd. Waukegan, Illinois

JOHNSON BUILDS SEA-HORSE MOTORS ONLY—NO OTHERS



It took many years and many dollars to build the nationwide dealer organization that sells AND SERVICES Johnson motors. When you buy a Sea-Horse you know you've got a motor that can be kept in tip-top condition.



The new Sea Green Sea-Horses are being shipped—but the demand is the biggest in history. List your name with your Johnson dealer. Look under "Outboard Motors" in your classified phone book.

HUNTER'S COMPASS
Hunting Case, Watch Type, All Metal, Jeweled Longines **\$2.50**

Engineers All Metal Army Type Hand-Sighting LEVELS
\$1.50

PUBLIC SPORT SHOPS
13 S. 16th St., Phila. 2, Pa. No COD's



STOP THAT DRIP

NoDrip TAPE

EFFECTIVE IMMEDIATELY

New—for homes! A sure cure for condensation drip from cold water pipes. Pliable, cork-filled NoDrip Tape eliminates wet floors, makes idle space usable! **Quick, Clean, Easy to Wrap on**—No tools needed. Covers joints as well as straight pipes. **\$1.25**

At hardware, dept. stores, lumberyards. Roll, enough for 7 feet of 1/2" pipe.

Higher west of Rockies and Canada
Write for free NoDrip Tape Circular
J. W. MORTELL CO. 522 BURCH ST., KANKAKEE, ILL.



Just the saw horse for your workshop

The FOLD-HORSE
(Patented)

Folds away to 8" x 9" x 42" for storage

Jobbers—write immediately, a few select territories still open.



There's no longer any need for your saw horses eating up valuable workshop or storage space—just fold them down to a neat 8" x 9" x 42" package and slip them into a corner. Then too, the Fold-Horse probably is more rigid than most one-piece horses. It is assembled with 14 gauge, cadmium plated steel hardware. It's easy to assemble—easy to knock-down! Top is standard 2" x 6" x 42" and tool tray measures 9" x 36". Place your order right away to assure prompt delivery. Lists \$9.95 each.

UNIQUE TOOL PRODUCTS COMPANY
4634 N. Clark Street, Chicago 40, Illinois

Name.....
Address.....
City..... State.....

"DUSTLESS" SWEEPING SIMPLE AS THIS



Fill the Dustless brush reservoir with Arbitrin

sweeping fluid. In the process of sweeping, this fluid filtering through the tufts makes sweeping compound out of dust on



The result:



Germ culture after ordinary sweeping



Germ culture after "Dustless" sweeping

the floor. The result: You eliminate up to 97% of the dust in the air between sweepings. You also have cleaner floors and cut sweeping costs. Thousands of factories, shops, stores, and schools now use "Dustless"

sweeping. Write for complete facts today.

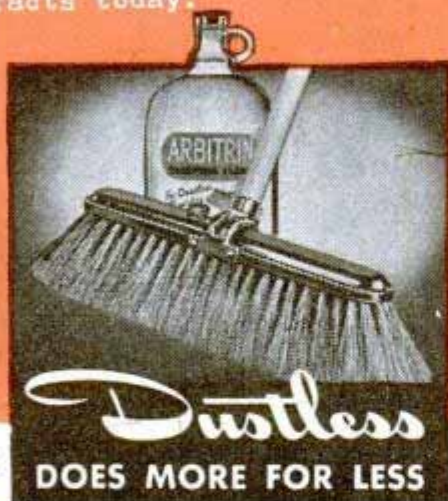

- Dustless
- Speed Sweep
- Speed Wash brushes

MILWAUKEE DUSTLESS BRUSH COMPANY

528 N. 22nd Street - Milwaukee 3, Wisconsin

line of flight and causes it to spin in such a manner that it curves to the right.

Because I have sliced the drive, the ball won't travel as far as a normal shot with a driver. My drive is out about 247 yards.

For my next shot I take a No. 7 iron, with which I place the ball on the green, 148 yards away. You can see the blade cutting through the turf, and the ball just starting to rise. The shot rolled about 12 feet past the cup, so I have quite a putt "coming back." No! They don't all go in. I missed this one and must settle for a par four on the hole. After all, if we made every putt, it might get monotonous. Guess none of us ever has to worry about this!

I've been so busy playing in tournaments that I don't very often get around to talking over the technique and mechanics of golf any more. I'm sure it has done me a lot of good to check up with you on what it takes to hit a ball well, and to go over my game at the same time.

I can't guarantee you that you'll go out now and break the record at your favorite course. The final result is up to you. If you study the various details of these three lessons closely, and then practice diligently, I feel certain you can improve your golfing form and get better scoring results—that is, unless you are already an expert.

My personal feeling is that there is always room for improvement in this fascinating, healthful game. If you will pardon a final personal reference—in 1944 I averaged 69.67 strokes per round for 85 rounds of official tournament golf to win the Radix trophy. At the time I thought this was as low as I could ever get.

However, I continued to study intently and practice intensively. My average score for 120 rounds of play in P.G.A. sanctioned tournaments during 1945 was 68.33, an improvement of more than a stroke per round.

I want to thank you for your attention and indulgence. Until we meet on the fairways, "So long, and better golfing!"

Forecasting the Ocean Waves

(Continued from page 140)

into a plowshare of peace. Dr. Sverdrup says that a large program under development calls for a world-wide network of scientific stations to record sea swell. The British already have a station on the west coast of England and it is expected that the U. S. Navy or some university will set up facilities on our side of the Atlantic.

A station for observing swells has been set up at Humboldt Bay on the Pacific Coast and a second station will be estab-

(Continued to page 236)

a Whole Year's Supply

of photographs, working drawings,
and step-by-step directions . . .

for more woodworking fun, making fur-
niture . . . lamps . . . toys and games . . .
novelties . . . other interesting projects

Only 50¢!
—delivered to your
home six times a year in

THE *Deltagram*

**Popular, plan-packed
hobbyist's magazine**

Every
issue full of
how-to-do-it
information
that is help-
ful to you!

What a bargain! Page after page of plans, projects, and ideas — enough for a *whole year of fun* in your woodworking shop. All for only 50¢!

A Gold-Mine of Information
You receive six big issues of The Deltagram. And in each issue you get the latest tips on how to perform operations more easily, more quickly, more safely. You get useful information that's a big help in producing beautiful objects your friends admire.

The Deltagram leaves nothing to guesswork. Everything is *detailed and specific*. Com-

plete, step-by-step instructions are in common, every-day language. Even a beginner can follow them without costly waste of time and materials.

Subscribe Now

Don't miss a single issue of The Deltagram. Get your subscription *now* for a year of enjoyment from this pleasure-packed magazine.

Paper shortages limit the number of subscriptions we can accept. So to avoid disappointment, fill out the coupon below and mail it today with 50¢ in coin, postal note, or money order.

Tear out coupon and mail today!

THE DELTA MANUFACTURING CO.

HM-38

681G E. Vienna Ave., Milwaukee 1, Wisconsin

Enclosed is 50¢ in payment for a whole year's subscription to The Deltagram.

Name.....

Address.....

City..... (.....) State.....

DELTA
MILWAUKEE
REG. U. S. PAT. OFF.
MECHANICAL
HOMECRAFT
REG. U. S. PAT. OFF.
POWER TOOLS



Subsidiary of Rockwell Manufacturing Co.

*Trade Mark Reg. U. S. Pat. Off.

A Fine, Precision EXPOSURE METER



\$13⁹⁵

COMPLETE WITH
LEATHER CASE
Including Tax
on Meter



The Sign of Precision

Make your camera take better, sharper photos. Eliminate guess-work, lost pictures and wasted film with a precision-built SKAN Exposure Meter. A *must* for color—still or movies. Be right in *any* light—day or night. Simple to use.

Sold at camera counters everywhere. For free literature write: G-M Laboratories Inc., 4290 N. Knox Ave., Chicago 41, Ill.

SKAN

EXPOSURE METER

SMALL EFFICIENT SPEED REDUCER



\$1512

Coiling Price
F. O. B. Cleveland

Sturdy, compact (see dimensions). Proved in thousands of industrial installations. Case of heat treated aluminum. Gears, SAE 65 (British Gear) Bronze. Worm of case hardened steel. Timken Bearings throughout. Available in 4 different assemblies (shown below) and in these standard ratios:

4-1	25-1	64-1	200-1
8-1	30-1	75-1	300-1
10-1	40-1	80-1	400-1
16-1	50-1	100-1	600-1
20-1	60-1	150-1	800-1

Torque capacity 100 inch pounds. Especially suited for bench work, home work shops, light production, animated displays, etc. When ordering be sure to specify assembly and ratio required. Shipping weight in carton, 8 lbs. Full money back guarantee. Prompt deliveries.

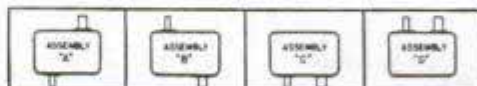

THE OHIO GEAR CO.

1407 EAST 179th ST. • CLEVELAND 10, OHIO

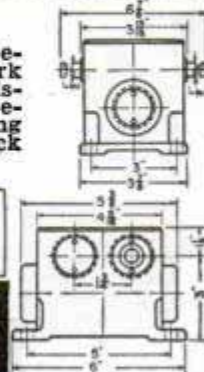

COMMANDO TYPE Hunting Knife in Leather Sheath



The Perfect Utility Knife for Sportsmen

Length over-all, 10-3/4", blade 6 1/4". Blade and tang are one piece high carbon special cutlery steel. Blade is bevelled, blood grooved, expertly hardened and tempered, ground to a good cutting edge. Handle of leather and colored fibre discs. Steel guard and cast zinc butt. Sheath of oak tanned leather reinforced and snap fastener loop. No C.O.D.'s. Send check or money order at special cash price today.

\$3⁷⁵
Post-paid

CHARLES NOVELTY CO.

510 N. Dearborn St., Dept. A, Chicago 10, Ill.



SPECIAL!

Delco Permanent Magnet Motor 27V (D.C.). Runs off a 6V. battery. For miniature or model \$3.00 trains, boats etc.....
Diamond Dressing Tool (used) for grinding wheels or cutting glass. 4/5 of diamond still use-\$1.50 able.....
Eye Levels (Govt. Surplus). Well constructed. Handy for \$1.00 many uses.....

All Prices Include Packing & Postage! Send Check or M.O.

Holland Hardware Co., Inc.
24 VESEY ST., New York 7, N. Y.

WRITE FOR YOUR FREE COPY OF THE NEW KRW HYDRAULIC PRESS BOOK

Describes all manner of Production and Shop Work on KRW Hydraulic and Bench Type Arbor Presses. 32 pages illustrating the new KRW Hand-operated, Electric-operated and Air-operated Hydraulic Presses.

Write for your copy today.



K. R. WILSON, DEPT. 17, 215 MAIN ST., BUFFALO 3, N. Y.

Builders of Shop Equipment for Ford Dealers Since 1916



Easy, boy — here's our Vacation!

Easy is right! This is no year to be careless with anything as precious as an Evinrude!

Whether it is a sparkling new '46 model — or a faithful old-timer — what really counts in vacation plans is the fact that *it's an Evinrude!* That means the assurance of satisfying performance wherever you go. It means rugged stamina and power you can bank on . . . finger touch handling ease and starting sureness *built right in!* It means a happier vacation, more fun on every trip.

Complete range of models . . . the right motor for every boat, every service. Light "singles" for smallest craft, powerful "twins" and four thrilling four-cylinder models. **See Your Evinrude Dealer!** Look for his name in your classified phone directory under "Outboard Motors". Catalog free — address EVINRUDE MOTORS, 5326 N. 27th St., Milwaukee 9, Wis.

*In Canada:
Evinrude Motors,
Peterboro, Ontario*

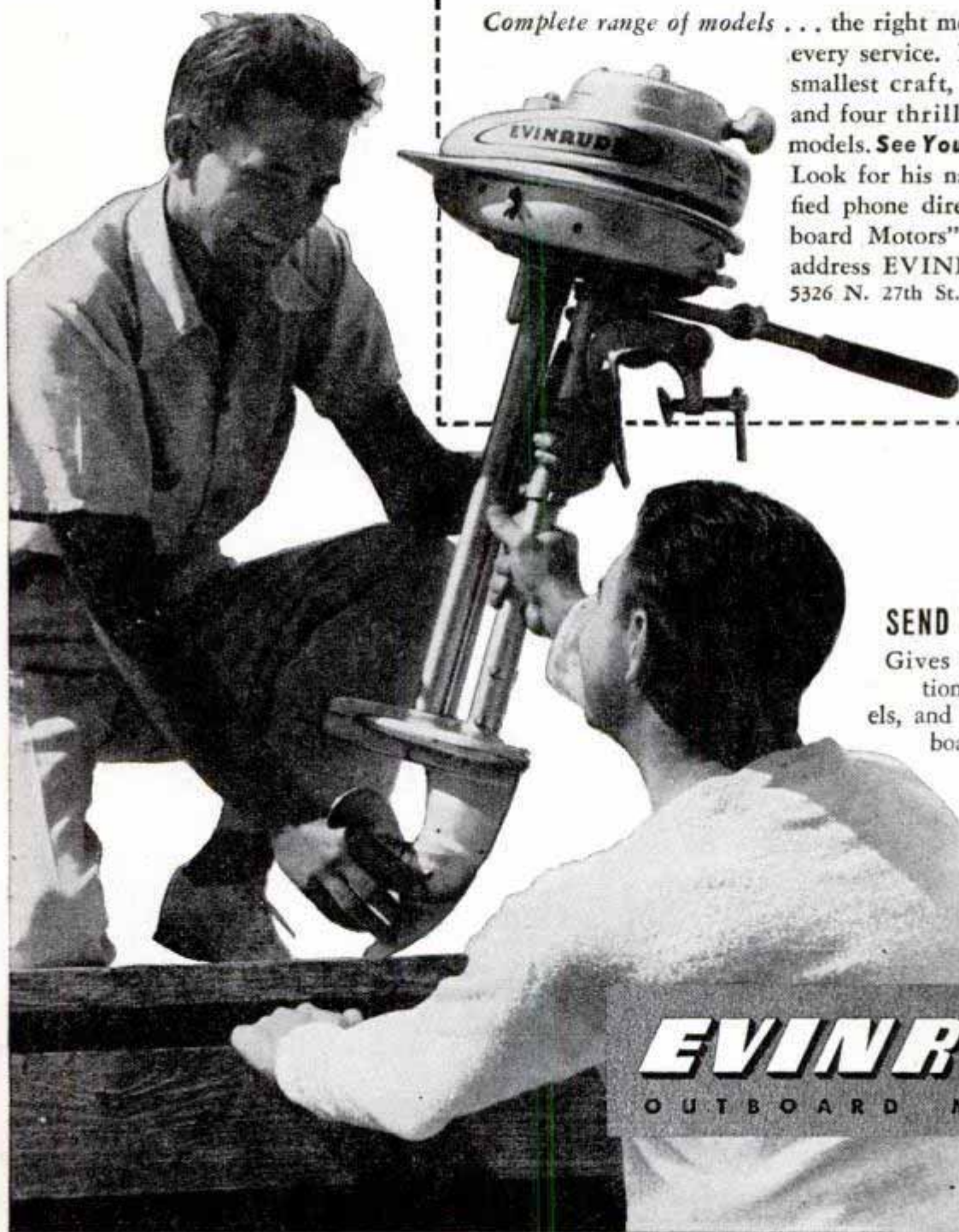

SEND FOR FREE CATALOG!

Gives features and specifications on all Evinrude models, and helpful information on boats, speeds, etc. It's free . . . write for it today.



EVINRUDE

OUTBOARD MOTORS



*So Inconspicuous

What are You Shouting for ?

• I can hear you now that I wear a Zenith Hearing Aid.

Best part—my friends are as tickled as I am about my wearing an aid. They don't have to shout to make me hear—and I'm not embarrassed when I'm with them, now.

Yes—I did my friends and myself a favor when I put on this Zenith. I'm getting a lot more fun out of life, too—really living for the first time in years.

Try the New **ZENITH**
Super-powered Hearing Aid



• Exclusive 4-Position Tone Control—adjusts *instantly* to your individual hearing needs with the flick of your finger.

• Neutral-color Earphone and Cord—actually as little noticeable as eyeglasses.

• Only \$50 complete, ready-to-wear.

Also Available: The New Zenith Bone Conduction Hearing Aid. \$50

FREE! A new, informative booklet which frankly discusses the problem of impaired hearing—and how it may be helped without needless embarrassment. Send for your free copy, today.

PASTE ON PENNY POSTCARD AND MAIL

ZENITH RADIO CORPORATION, Dept. PM-7B
6001 Dickens Avenue, Chicago 39, Illinois
Please send Free Booklet in plain envelope.

Name _____

Address _____

City _____ State _____

• COPYRIGHT 1946, ZENITH RADIO CORPORATION •

lished in La Jolla this spring. A third may be set up on the tip of Lower California.

Special instruments have been developed for these swell-recording stations. Instruments near the shore record the pressure exerted by each passing wave, thus measuring the size of the wave.

Deep-water instruments are more complex but highly efficient. Attempts now are being made to fit a deep-water instrument with a small radio transmitter which could be dropped from a weather ship in mid-ocean to report its findings by radio.

Many peacetime applications of the new knowledge of the sea gained in four years of amphibious warfare are foreseen by Dr. Sverdrup:

(1) Tankers that take on oil from pipe lines some distance from the beach can be warned when heavy swells are expected.

(2) The Coast Guard can give small craft better warning when swells approach a coast.

(3) Warnings can be issued to bathers and beach homeowners.

(4) Knowledge of surf can be used in studies of how piers, breakwaters and other man-made structures affect beach erosion.

(5) Pilots of commercial planes flying over ocean areas can at all times be kept informed as to the state of the sea. If forced down, they will know what to expect.

(6) When rescue operations of planes and ships have to be made, knowledge of the sea conditions will be indispensable in saving lives.

(7) Finally, adequate observation of sea and swell can supplement weather information and lead to improved weather forecasting. Tropical storms may be located by means of the swell which spreads out from the storm area and typhoons and hurricanes can be tracked.

What Kind of a House Do You Want?

(Continued from page 104)

public may have been led to expect, they contend that the average builder today (particularly the ex-serviceman who has saved toward a home) wants a conventional house as he knows it. He is not satisfied with a converted streetcar, a concrete-clad igloo or a hut-type dwelling even if it is made of platinum. He wants the kind of a home that he has dreamed about at odd moments for years, a place to be proud of where he can raise his family and enjoy life. If he finds he doesn't have enough money to build the kind of house he wants,

(Continued to page 240)

ONLY ONE WAY TO *Correctly* Tension A STUD OR BOLT



Snap-on TORQOMETERS

**insure accuracy - tell
tension as bolt
is tightened...**



WHERE specifications call for accurate, *uniform* stud or bolt tension, Torqometers should *always be used*. "Guesswork" tightening is an open invitation to all the troubles that follow mechanical distortion . . . wasted power, dangerous wear, breakage of parts. Even highly skilled mechanics cannot be expected to approximate specified pressures.

With Snap-on Torqometers any worker can tighten bolts to the exact foot-pound of tension *every time* . . . and on delicate mechanisms, to the *exact inch pound*.

He sees the applied torque as the bolt is tightened . . . as easily as reading a watch.

Throughout industry, Snap-on Torqometers are being adopted as standard wrench equipment for precision assembly and maintenance operations. Available in a complete range of sizes from zero to 30 in. lbs., up to 2,000 ft. lbs. Torqometers are part of the complete line of more than 3,000 Snap-on tools, available everywhere through Snap-ons nation-wide direct-to-user tool service.

SNAP-ON TOOLS CORPORATION

8062-G 28th AVENUE

KENOSHA, WISCONSIN



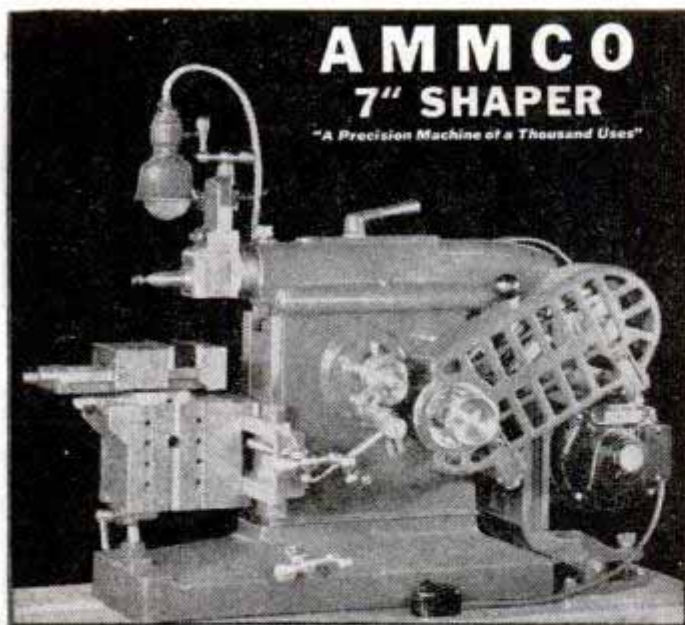

A wide variety of jobs can be done accurately, quickly, easily, and economically on the AMMCO Shaper (7" stroke).

Construction incorporates many features you would expect to find only in larger, more expensive machines... For example: WAYS of ram, tool head, and front face of the main frame are of the "VEE" type, hand scraped to insure accuracy and long life. Available for stationary installation or as portable unit.

Write today for specifications and prices

AMMCO

2140 Commonwealth Ave. North Chicago, Ill.



Have YOUR OWN Business

SAW FILING

You can have a good, steady, cash business of your own reconditioning saws with the Foley Automatic Saw Filer, which makes old saws cut like new again. The Foley is the ONLY machine that files all hand saws, also band and circular saws. Easy to operate—no eyestrain.

SEND FOR FREE PLAN—shows how to start in spare time—no canvassing. Send coupon today—no salesman will call.

FOLEY Automatic SAW FILER

FOLEY MANUFACTURING CO.
716-6 Foley Bldg., Minneapolis 13, Minnesota
Send Free Plan on Saw Filing business, no obligation

Name _____

Address _____



WE HAVE MANY OTHER **PRECISION GEARS** WRITE FOR CIRCULAR

NO.	MATERIAL	PICTER	O.D.	HOLE	TYPE	PRICE	NO.	MATERIAL	PICTER	O.D.	HOLE	TYPE	PRICE
A	CAST	32	3"	3/16"	SPUR	35¢	H	BRASS	48	1 1/2"	3/16"	SPUR	10¢
B	BRASS	48	3"	5/16"	SPUR	39¢	I	BRASS	48	1 1/2"	3/16"	SPUR	12¢
C	BRASS	26	2 1/4"	1/4"	BEVEL	39¢	J	FIBROID	48	1 1/2"	3/16"	SPUR	12¢
D	STEEL	48	1 1/4"	1/4"	BEVEL	39¢	K	FIBROID	30	1 1/2"	3/16"	SPUR	19¢
E	STEEL	48	1 1/2"	3/16"	SPUR	19¢	L	ALUMINUM	32	1 1/2"	3/16"	SPUR	12¢
F	BRASS	48	3/16"	3/16"	BEVEL	12¢	M	DURAL	48	1 1/2"	3/16"	SPUR	19¢
G	BRASS	48	1/4"	1/4"	MITER	12¢	COMPLETE SET OF ALL THE ABOVE GEARS 12.99						

ALNICO MAGNETS - JUST RELEASED

N1 BAR 8 1/2" x 1/4" x 1/8" 39¢ EACH
 N2 IN SHORTER LENGTHS 12¢ PER INCH
 N3 FACE 1 1/4" x 1 1/4" x 1/8" HIGH 35¢ EACH
 N4 3 HEAVY DUTY BAR 2 1/2" x 1 1/4" x 1/4" 11.99 EACH
 N5 4 FACE 1/2" x 1/2" x 1/8" HIGH 39¢ EACH
 N5 5 POLISHED 7/8" x 7/8" x 1/8" HIGH 35¢ EACH

WRITE FOR BETTER PRICES ON QUANTITY PURCHASES
LEOTONE RADIO CO. NEW YORK 7, N.Y.
 20% DEPOSIT REQUIRED ON ALL ORDERS - PLEASE ADD SUFFICIENT POSTAGE

V-8 DUALS & SINGLES

A GENUINE PACKED MUFFLER WITH A BEAUTIFUL DEEP TONE...

Reduces back pressure and increases engine performance. Sandee time proven dependable mufflers are available in sturdy steel or durable aluminum. Savings in gasoline will usually pay for one of these new mufflers.

Ford V-8 and Mercury Duals **17.50** Aluminum \$20.00

Singles fit in place of regular mufflers. Chevrolet, V-8, Plymouth to '42—Steel \$5.50, Aluminum \$6.50. Chrysler, Oldsmobile, Buick, etc.—Steel \$7.50, Aluminum \$8.50. Sandee steel mufflers will outlast two regular stock replacements. Sandee "Aluminums" are guaranteed for the life of the car.

SANDEE MUFFLER CO.
7523 S. WESTERN AVE., LOS ANGELES 44, CALIF.

DO YOU WANT a permanent business profession of your own? Then BECOME A FOOT CORRECTIONIST. Earnings in this greatly needed profession run as high as \$50-\$100 weekly after a few weeks home training—not medical or chiropody—no further capital needed, no goods to buy. 50th year. Write for free booklet.

Stephenson System of Foot Correction
28 Back Bay, Boston, Mass.

SHARPER CUTTING EDGES

Easy • Accurate • Quick

It's easy to hone keen cutting edges on your chisels and plane blades. Precision adjustment for ANY ANGLE of bevel. Roller glide makes every stroke uniform across oil stone. Light, strong—ideal for home craftsmen, hobbyists, carpenters, cabinet makers.

check or money order **\$2.95**
POST PAID
McLAREN INDUSTRIES, INC., Box 606, TROY, N. Y.

The case of the Twisted Screwdriver

It *looked* like a good screwdriver. The price looked good, too . . . only 19 cents. But it didn't have the tempered toughness it takes to loosen a rust-frozen screw. So now, like most "bargain counter" tools, it's a total loss.

As a *Popular Mechanics* reader and long-time user of tools and hardware, you know that nothing takes the place of quality.

Whatever you need in the hardware line—a screwdriver, saw, drill, can of paint or complete equipment for a home workshop—buy it from the man who has built his business on quality . . . your hardware dealer.



**YOUR HARDWARE DEALER
Sells QUALITY Tools and
Hardware. Buy from HIM.**

✓ **POPULAR MECHANICS**



SAFETY
for your
SPORTS AFLOAT



Ta-pat-co

LIFE-SAVE VEST

New Features

That Give New Comfort and Safety

Government Approved

Light, easy to wear Ta-pat-co Life-Save Vests are back. Back with new safety and comfort features developed on war's testing ground. Topcoat flexibility - sit down, bend, twist, there is no binding action when you wear a Ta-pat-co. Unbelievable buoyancy - filled with finest new Java Kapok (five times more buoyant than cork), your Ta-pat-co can't lose air or come off in the water - even bullets couldn't sink it.

See the new Ta-pat-co Life-Save Vests and Life Preserver Cushions at your sporting goods store.

Ta-pat-co Sleeping Bags are back. Outdoor men everywhere are ready to hit the trail once more. When you see the new, lighter, warmer, and more compact Ta-pat-co you'll say "That's the bag for me".



The AMERICAN PAD & TEXTILE CO.

GREENFIELD

OHIO

he prefers to rent one or live in an apartment for \$45 or \$55 a month, according to Mr. Wright and his researchers. (Sidelight: 30 percent of the people living in cities in 1940 occupied apartments.)

Will you decide upon a prefabricated house, either of conventional or modern design, and in the price bracket from \$4,000 to \$10,000? The federal housing administrator is expecting big things from the prefabrication industry which has been experimenting for years with various kinds of materials: plywood, concrete, metals, plastics, gypsum board and other kinds of wallboard. During the war the industry constructed more than 200,000 prefabs, mostly emergency housing. The FHA is calling upon the industry to supply 250,000 housing units this year and 600,000 in 1947. This came as a surprise to a young industry that had expected to produce only about 30,000 units in 1946.

The prefabricators are or soon will be offering houses that range from the circular Fuller house made of aluminum and suspended by cables from a central steel mast (see Popular Mechanics, June '46, page 118) to the conventionally attractive Defoe and Gunnison homes. The cost of the Gunnison house includes foundation, erection, wiring, plumbing, bathroom equipment, heating, sidewalks and landscaping. The financing is arranged so that monthly payments do not exceed one week's pay per month—the generally accepted rule for financing any type of house.

Two advantages to which the prefabrication industry points with pride are (1) the quoted price for the complete house eliminates the "extras" that often boost costs above what the builder had expected to pay, and (2) speed of construction. Most prefabricators can get the house under roof in a single day and finish the job in a week.

Builders of the nonprefabrication school insist that America is a nation of individualists, that the public demands custom-built houses and will not be satisfied with superficial changes which often distinguish one prefab from another. Prefabricators merely smile and point to the row upon row of nearly identical houses in thousands of subdivisions. With building costs averaging 50 percent higher than before the war (the highest since 1920) the public taste as in the past is largely dictated by its pocketbook.

One thing is certain: Regardless of the type of house you build today, there should be a rich harvest for the builder in new and better materials and advanced thinking along architectural lines.

Do fine craft work,
faster, with a

**BURGESS
vibro-tool**

Trade Mark Reg. U.S. Pat. Off.

The Vibro-Tool complete with 22 accessories for engraving on steel, jewelry; decorating glass and plastics, carving on wood; cutting out patterns from cloth, rubber and cardboard, tooling and embossing leather, and many other jobs; plus sharpening stone, conveniently fitted into handsome hardwood, natural **\$16.50** finish, hinged box.



The Vibro-Tool operates by vibration... 120 vertical strokes per sec.; 60 cycles AC. 110 V.

The Vibro-Tool may be purchased separately, with engraving needle for **\$7.50**



See Your Dealer or
Order Direct

HANDICRAFT DIVISION

BURGESS BATTERY COMPANY

166 N. WABASH AVE., CHICAGO 1, ILLINOIS

Now AVAILABLE!



CROSMAN Silent RIFLES

America's favorite compressed air rifles for indoor or outdoor shooting are back again! Available in .22 cal. single shot and Magazine Loading Types. At your dealer—or order direct. Ask for Crosman SUPER-PELLS too—the better ammunition for all compressed air rifles. .177 Cal.—\$1.80 per M. .22 Cal.—\$2.00 per M.

CROSMAN ARMS CO., INC. ROCHESTER 7, N. Y.

**Do a Better Job
WITH ONE OF THESE
EMPIRE LEVELS**

EMPIRE TORPEDO LEVEL
Smallest, most handy and accurate Level made. "Cigar-shaped"—no sharp corners to tear pocket. Aluminum stock. Only 3 oz. wgt. 9" long. Has Level, Plumb, 45° Vials.
No. 26.....\$1.75



ALUMINUM LEVEL — No. 151
Cast and Machined, a Beautiful Tool, with Patented, Removable Level and Vial.
With 2 Plumb, 2 Levels, 2 — 45° Vials. 18".....\$5.00
24".....\$5.50 28".....\$6.25

Order EMPIRE LEVELS from your local dealer.
Write direct for literature.

EMPIRE LEVEL MFG. CO.
717 S. 6th St. Dept. P-241 Milwaukee 4, Wis.

**HOW TO GET THE MOST
FROM TODAY'S**

- ★ BETTER GASOLINE
- ★ INCREASED DRIVING
- ★ NORMAL DRIVING SPEEDS



If your spark plugs were changed to the *type* of plug which was necessary with "lower octane" fuel, restricted driving, and low speeds, it is time to change back to the factory recommended type, — or to a "cooler" type in the case of preignition or rapid electrode wear.

Today's AC Spark Plugs are built for today's gas, mileages, and driving. They give you quicker starting. They last longer and stay clean longer. And new AC's save up to 1 gallon of gas in every 10 you buy.

AC Spark Plugs have been original equipment on more than 2 of every 4 new cars, buses, and trucks built since 1932. With today's improvements, AC is more than ever the plug for *utmost reliability*.

AC SPARK PLUG DIVISION
GENERAL MOTORS CORPORATION



SPARK PLUGS



Be the authority on accuracy

in your shop! A man's work is only as good as his measurement. You can be the "accuracy man" in your shop. Learn to work with genuine Ford "Jo-Blocks," guaranteed accurate to within 2, 4

WRITE FOR THESE FREE BOOKLETS!

An absorbing story of the search for precision. A new De Luxe Catalog of Ford Jo-Blocks and Accessories.

or 8 millionths of an inch, plus or minus. For a small investment, you can own fine working set of Jo-Blocks—keep your mikes and gages at millionth-inch precision. There is only ONE true American-made Jo-Block, made only by—

FORD MOTOR COMPANY
Johansson Division
Dept. 710, Dearborn, Michigan



Exclusive! Ready Now From Leo

WRL GLOBE TROTTER TRANSMITTER KIT



40 WATT INPUT KITS \$59.95

Complete including all parts, chassis panel, streamlined cabinet, less tubes, coils, and meter. Cat. No. 70-300.

Cat. No. 70-312 Kit same as above, wired by our engineers \$75.00 All necessary accessories\$13.85 extra

Here is the latest, most outstanding transmitter value on the market today. The WRL Globe Trotter is capable of 40 Watts input on C.W. and 25 watts input on phone on all bands from 1500 KC through 28 Megacycles. Incorporates the Tritet Oscillator using a 20 meter X-tal and providing sufficient drive at 10 meters for the 807 final; Heising choke modulation; three bands, all pretuned; 10, 20, and 80 meters; metering provided for both oscillator and final stages; two power supplies, one for 807 final and modulator tubes, and one for the speech amplifier and oscillator stage.

FOR EARLIEST DELIVERY on your favorite receiver place your order now with Leo. All makes and models. Liberal trade-in. Easy Terms.

FREE!

Our Latest FLYER of radio parts.
Giant Radio Reference Map 3 1/2 x 4 1/2 ft. . . . 15c
Tube Base Calculator 25c



Formerly Wholesale Radio Laboratories
Address Dept. PM-7, Council Bluffs, Iowa

GET THE SET—SAVE 15%

Complete Set of 4
Clark Lever-Lock BORING BARS
Packed in Sturdy Wood Box

4 precision boring bars, 3/16", 1/4", 3/8", 1/2" hardened drill rod. Each with the exclusive Clark Lever-Lock that grips tool bit at extreme end to bore or thread to bottom of blind hole with full clearance; 4 precision ground thread tool bits and 4 boring bits tempered by deep freeze process. Extra round bits available, ground or unground. **MONEY BACK GUARANTEE.**
Order today! Dept. PM-7-LLB

Immediate Delivery
\$10.20

Robert H. Clark Company
9330 SANTA MONICA BOULEVARD • BEVERLY HILLS, CALIFORNIA

REPAIR FURNITURE WITH THE GLUE THAT MANUFACTURERS USE

FRANKLIN GLUE
GENUINE LIQUID HIDE GLUE
READY-TO-USE

Makes joints stronger than the wood itself. No mixing — No heating — No unpleasant odor — No chilled joints.

THE FRANKLIN GLUE CO., COLUMBUS 15, OHIO
AT YOUR HARDWARE DEALER

You CAN'T WORM WRONG

for tape, hook, whip, round (ascarid) worms when you worm your dog as directed with Pulvex Worm Capsules, a combination treatment which insures your worming right. Used by leading breeders. Packaged 2 ways: for puppies, for dogs. Either, 50¢; double-size, 75¢
At pet, drug, department stores.

PULVEX
★ COMBINATION TREATMENT
WORM CAPSULES

The Modern PLASTIC for lasting Home Repairs

Durham's Rock Hard WATER PUTTY
WILL NOT SHRINK
STICKS AND STAYS PUT

PERMANENTLY mends cracks or holes in wood, tile, stone or plaster. Sticks and stays put—Does not chip, shrink or fall out. Easy to use. Economical. Mold it, chisel it, polish or paint it. If unobtainable from your lumber, paint or hardware dealer, the big 4-lb. can will be sent you post-paid (in U.S.) for only \$1. Full money-back guarantee, order now.

DONALD DURHAM CO.
Box 804-K, Des Moines, Iowa

DON'T SCRUB AND RUB

TILL FINGERS BLISTER



FOR A QUICK, EASY SHINE

JUST USE THIS, MISTER



**The easiest
and quickest way**

to get rid of dull traffic film is to use Du Pont No. 7 Polish. It saves time—saves work—and makes a wonderful improvement in the car's appearance. Try a can today.



Better Things for Better Living
...Through Chemistry

NO. 7 POLISH

**SEND FOR THIS
TIME SAVING OHMITE
Ohm's Law Calculator**

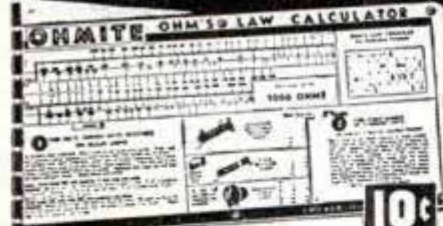

**Figures Ohms,
Watts, Amperes
Volts ... Quickly!**
Any Ohm's Law
Problem solved
with one setting

10c

of slide. All values direct reading. (4 1/8" x 9")
Send only 10c in coin to cover cost of handling.
OHMITE MFG. CO., 4931 Flournoy St., Chicago 44, Ill.

NEW TOOL READY

QUICKLY SHAPES, SANDS, CARVES, PROFILES, BANDSANDER, GRINDS, BEVELS, SMOOTHS, POLISHES, CLEANS!
War industry's most versatile machine—now available to hobbyists, craftsmen, model makers, pattern makers, home workshops—cuts fast and clean on wood, metal, plastics! Works equally well on inside cut-out openings or irregular outside edges, on intricate scrolls, curves. Saves hours of tiresome hard work—does better job. Nothing else like it: **IDEAL TO GIVE OR GET FOR WORK-SHOP!** Sold on 5 Day's Trial, money back GUARANTEE.



FREE!
Write for free, lavishly illustrated Circular describing how Bandsander—the machine that amazed the experts—saves time, money, trouble. Write now—a post card will do!

MEAD SPECIALTIES CO.
4114 N. Knox Ave., Dept. 17, Chicago 41, Ill.

**\$/ RIDS YOUR LAWN
OF UGLY WEEDS!**



WEED-NO-MORE
Magic Weed Killer

Destroys Ugly Weeds but Won't Harm Common Lawn Grasses!

NO MORE back-breaking digging! Destroy ugly leafy weeds with **WEED-NO-MORE!**

The 8-ounce lawn-size package treats 1600 square feet! Now you can enjoy a beautiful weed-free lawn for only \$1!

WEED-NO-MORE kills dandelion, plantain and other ugly weeds—yet won't injure soil.

Get it today! Rid your lawn of ugly weeds for only \$1. Just spray on... **WEED-NO-MORE!**

On Sale at Paint, Hardware, Garden Supply, Department and Drug Stores

WEED-NO-MORE

THE AMAZING NEW WEED KILLER

Made by **THE SHERWIN-WILLIAMS Co.** Cleveland, Ohio

Hobart Arc Welding

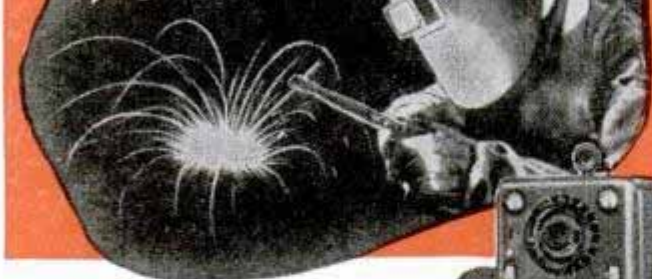

It's Profitable!

Your own arc welding job shop never had a brighter future! It's so easy to start, too, with Hobart Arc Welders because they handle all construction and repair jobs faster with greater profit. Everybody brings their work to you.

It's Easy. It's Simplified

Only Hobart can offer you the welding power you need for high quality welds—and get the exact welding heat so quickly and easily. A choice of 1000 combinations of welding heat; volt-amp adjustments made by Remote Control.

It's Economical

Hobart Arc Welders are economical to operate and to own. They last many years longer because they're sturdy and tough. Year in and year out, your Hobart is a steady money-maker—use the convenient coupon for more details.

Build Your Own. Save \$\$\$

It's so easy to build your own gasoline drive arc welder with the Hobart Generator and a used auto engine and chassis—and you save hundreds of dollars. This equipment gets the profitable jobs in the field—check coupon!

The Hobart Arc Welding School

Fully authorized under G. I. Bill. Complete and intensive course in welding in all its phases. Modern building. Expert instructors give individual instruction. Graduates quickly employed. Check coupon.

Hobart Bros. Co., Box M-76
Troy, Ohio



Electric
Portable



A. C. Arc
Welder



"Build
Your Own"
Generator



HOBART

"One of the World's
Largest Builders of Arc Welders."

Get full
details
without
obligation

HOBART BROS. CO., BOX M-76
TROY, OHIO

Send FREE copy of "Welder's Pocket
Guide" and details on items below:

- Electric Portable Welding School
 A. C. Arc Welder Generator Only

NAME _____

ADDRESS _____

Free!
"Welder's
Vest
Pocket
Guide"



Ears of the Sub Killers

(Continued from page 77)

scope by blobs of light. This is a visual check on the sound beam and indicates range and bearing.

As you continue to report bearing of the target and related information, the crucial action now shifts to the sound range recorder. This device is hooked up to the sound projector and to instruments indicating the ship's speed and course, and positions the target in terms of time and distance. Carefully worked out in advance are the seconds necessary to fire depth charges or ahead-thrown weapons.

Now you are almost "on" the sub. Echoes are coming back almost as powerfully as pings. There is strong "Up Doppler." This is to be an attack with depth charges. "Bearing zero-one-two," you cry. "Range zero-five-zero," calls the recorder. Only 50 yards between you and the sub. "Come right to zero-four-zero," orders the skipper. The helmsman gentles the wheel, "Right to zero-four-zero, sir!"

Green seas curling from your bow, you move across the path of the oncoming sub. Ash cans of TNT roll off your stern and Y guns toss others to each side to form a pattern around the enemy raider. Geysers of water shoot up with a thunderous roar.

But your job is not finished. This is only the first phase—unless you have made a successful hit. If pools of oil and bits of wreckage come to the surface, you can usually "scratch" one U-boat. Once in a blue moon the enemy sub itself may be forced to the surface to be pulverized by your deck guns.

As the tumult dies away and your ship circles, you're at it again—pinging in every direction for you don't know which way the sub has turned. He's probably dived deep or headed for a colder or warmer layer of water to make your job even tougher. Or he's making sharp turns that produce "knuckles" in his wake which throw back an echo almost like the hull of the sub itself. Or he's throwing out supersonic minelike noisemakers to jam your gear and return false echoes.

These are only a few of the tricks submariners employ to evade sonar detection. U-boats used them against us and we used them against the Japs.

The Battle of the Atlantic was largely one of antisubmarine warfare. Teamed up with carrier-based and land-based aircraft, surface craft equipped with sonar proved effective in reducing the number of Allied ships sunk to a very few. In contrast, Allied

(Continued to page 248)

Simplified Shaves



ENDERS

Speed SHAVER
Easy does it

Save time! Switch to this new, gracefully-fashioned razor. The simplest, easiest shaving imaginable. Easy to get ready, easy to use, easy to clean and put away. Scientifically designed for cleaner, pressureless shaves, with greater skin protection. Join the parade to simpler shaving. Get Enders today.

because
double thick deluxe blade
clicks in like magic
nothing to take apart
streamlined action
new safety

Blades 5 for 25¢

49¢
with 6 BLADES

DURHAM-ENDERS RAZOR CORP. - Mystic, Conn.

Utica Tools

U T I C A



Pliers for Every Need

ASK YOUR DEALER

UTICA DROP FORGE & TOOL CORPORATION
UTICA 4, NEW YORK

Sampsel

AUTOMATIC CONTROLS for Hand-Fired FURNACE or BOILER

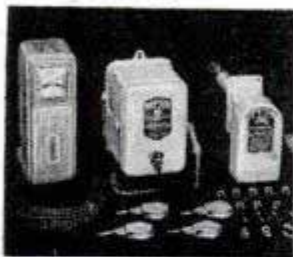

Thermostat, Limit Control and Electric Damper Motor automatically operate draft and damper maintaining even temperatures—saving fuel. Package sets include everything needed for easy installation. Order from your local furnace dealer. For free literature write . . .

SAMPSEL TIME CONTROL, INC.
618 Strong Ave. Spring Valley, Ill.

Supercharge YOUR CAR



Patented by U.S. Foreign Pat.

HIGH-FREQUENCY TRANSFORMER

Makes Motor Start Quicker — Run Smoother
ELECTRIC SUPERCHARGER is a patented high-frequency transformer designed for POWER, ECONOMY and SUPER PERFORMANCE in motors. Car owners, mechanics and fleet owners report amazing results, even on new cars. NOTHING LIKE IT ON THE MARKET. Gives engine New Life — Increased Power — a 60% Longer and Hotter Spark—more Complete Combustion—less Spark Plug Fouling and Longer Life. Fits all cars except Ford V8 and Mercury. Order Model V Supercharger for 1942-46 Ford or Mercury. ELECTRIC SUPERCHARGER is sold on a 15 DAY TRIAL—MONEY BACK GUARANTEE FOR ONLY \$3.95 in U. S.

HOLTHOUSE LABORATORY
3918 W. Grand Ave., Dept. A-3, Chicago 51, Ill.

"Nobody loves a Drip"

SOBBED REGGIE THE RADIATOR

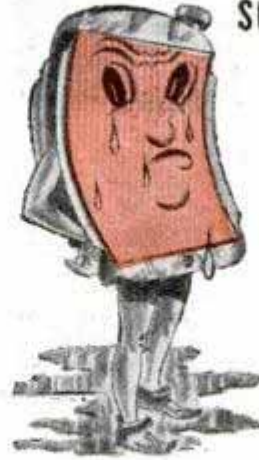

"Holy smoke," moaned Reggie, "is all that rust and sludge coming out of me?" "Sure is," the service man replied. "One bottle of K & W Radiator & Block Cleaner is knocking all the corruption out of your system. Now if you'll open wide and say 'ah-h', I'll use K & W Radiator Seal."

"What'll K & W Radiator Seal do?" Reggie asked. "It will fix you up in 30 minutes," the service man answered. "If one bottle doesn't stop every one of those leaks, nothing but repair shop surgery can take care of you!" A cautious radiator at heart, Reggie asked, "Do you guarantee that?" "Absolutely," the service man shot back.

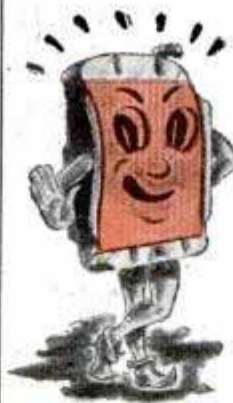

"Gee," Reggie smiled, "that K & W Radiator Seal really hit the spot. It's not even 30 minutes and I'm not leaking a drop." "Of course not," the service man grinned. "Now the clincher. A K & W Rust Inhibitor treatment and your cooling system is all set for a long, trouble-free season." "That's right," Reggie agreed, "Rust Inhibitor is the product that's famous for keeping rust and scale from forming!"

K & W

MORAL: Prevent and correct cooling system trouble by using K & W products: K & W Radiator and Block Cleaner, K & W Radiator Seal, K & W Rust Inhibitor—all sold with a money back guarantee

Other K & W products are K & W Metallic Seal and the patented K & W Mechanical Method—used by engine builders and modern repair shops for making fast, guaranteed repairs to cracked engine heads and blocks.



For name of nearest K & W Mechanical Method station wire or write Kerkling & Company, Burbank, California.

**Do Expert Welding
At Home
WITH THE HANDY
Magic Wand
WELDER**

*"The Welder in
the Carrying Case"*



JUST plug the Magic Wand in on any standard 110-V, 60-cycle AC outlet and do welding and brazing jobs like a professional. Heavy-duty transformer with 6 stages of welding heat. Electrode holders adaptable for electric flame and metallic arc welding, brazing and soldering. Special polarized outlet plug. Built into a strong, shock-proof carrying case, weighing less than 30 lbs. packed. Kit includes welding, brazing and soldering rods and fluxes, extra carbon electrodes, comfortable welding helmet, valuable Instruction Manual. Quickly pays for itself. Sold by hardware dealers and automotive jobbers.

For Descriptive Folder, address:

JOHN H. GRAHAM & CO., INC.
General Sales Agent
Dept. D, 105 Duane St., New York 8, N. Y.

**COMPLETE
\$34.50
F. O. B. FACTORY**

Magic Wand WELDER

MADE BY PATENT SPECIALTIES, INC., NEW YORK, N. Y.

**AUTO ENGINE SPEED CONTROL
GOVERNORS**

(REGULADORES)



Without Pulley
Sin polea

Give constant or changeable speed to any auto or truck engine, when used for power. Guaranteed. Instructions. Oil ring bearing, \$14.25. Full ball bearing, \$21.75. Postage west of Miss., 50c; east of Miss., 85c. Sent COD or—Postage to any country in the world \$1.00 each. Pulleys to 3", \$1.00, wt. 1 lb.; to 6", \$1.50, wt. 1½ lb. Governor speed 1400 to 2400 rpm. Figure your pulley size.

Agents Wanted: Parts and Implement Dealers. Garages, Welders, Wreckers, Catalog and Mailing List Houses, etc.

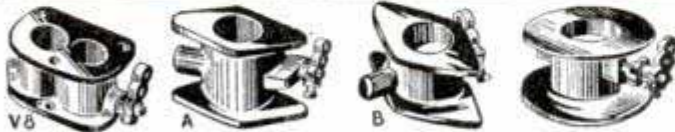

These valves used where carburetors have outside attachments. State size of opening and distance between bolt holes. 1", \$3.75; 1¼", \$5.25; 1½", \$6.50; 1¾", \$7.50; V8, \$8.00. Mailing weight, 3 lbs. If remitting, enclose for postage. You may order from this ad, or we will send circulars. Stocks carried: In Montreal 15, Canada: 7546 Wiseman St. In Skaneateles, N. Y.: Horle Welding Supply.

CANDEE, Dept. M, 2641 S. Hill, Los Angeles 7, Calif.

• Test ALL Home Outlets
• Find Open Circuits

STAR TEST-PLIERS

• Locate Blown Fuses
• Remove Fuses SAFELY

A must tool for electricians, maintenance men, home owners. Made of a transparent, shock-proof Plastic. Replaceable lamp inside Plier tests 110 to 250 Volts. Plier pulls fuses from 10 to 100 Amperes. Requires the use of only one hand. Can be obtained from General Electric or Westinghouse stores, or

from local electrical dealers. Order one TODAY.

Price \$2.75 without Leads, \$1.50 additional for Leads which provide greater reach and more flexibility.

STAR FUSE CO., 233 Canal St., New York 13, N. Y.



3-I-Q TAP GUIDES, DRILL AND TAP STAND

SAVES TIME SAVES MATERIAL
PREVENTS BROKEN TAPS

Holds set of drills, taps and tap guides. Drills located next to the taps. Tap guides help start taps straight.

TAP DRILL SIZES

National Tap	Coarse Drill Size
8-32	29
10-24	25
12-24	16
1/4-20	7
5/16-18	F
3/8-16	5/16
7/16-14	U
1/2-13	27/64

National Tap	Fine Drill Size
1/4-28	3
5/16-24	1
3/8-24	Q
7/16-20	25/64
1/2-20	29/64

Pipe Tap	Drill Size
1/8	11/32
1/4	7/16



465

SEE YOUR DEALER OR WRITE

ASHTON MACHINE WORKS

ARVADA, COLORADO



MINIATURE ENGINES

Gasoline—Steam
Air—Locomotive



THE WORLD'S MOST FASCINATING HOBBY
Build them yourself — In your own shop
With your own tools



Send 10 cents for my illustrated catalogue listing the world's largest selection of miniature engine castings and drawings.

WAYNE MILLER
Suite 201
Engineering Bldg., Chicago 6, U.S.A.

ARMSTRONG TOOL HOLDERS

enabled American Industry to change to war production "over night." For they are the permanent, multi-purpose tools used by 96 per cent of the machine shops and tool rooms, on lathes, planers and shapers—the tools used to make dies and jigs, to build production machines. They are the tools you will want for your own shop—ARMSTRONG TOOL HOLDERS for industry, ACE Tool Holders for home work shops.

ARMSTRONG BROS. TOOL CO.

"The Tool Holder People"

368 N. Francisco Ave., Chicago 12, U.S.A.



Amazing Ever Popular Scene-in-Action

Forest Fire Lamp

is Back Again

Copyright 1946 by Rapid Speculation Co.



COMPLETE
WITH PLUG
AND CORD

\$4⁹⁵

Same price as before the war! Improved model, 9 1/2" high; 17" circumference. Base and top made of sturdy plastic.

MOTION! . . . REALISTIC COLORS! . . . EXCITING!

So real it defies ready detection. Only technicolor rivals the beauty of moving flames sweeping through a pine forest. Makes everyone who sees it gasp with wonder.

Here's the most amazing lamp ever created. A gorgeous scenic table lamp that actually shows a pine forest being swept by moving flames. Has so much action and color . . . is so realistic you can almost hear the cracking of burning pines. But you will actually have to see this spectacular lamp to really appreciate it . . . that's why we are making this generous trial offer.

SEND FOR LAMP ON APPROVAL—Test 10 Days at Our Risk

Fill in coupon and mail today. Send no money. When your gorgeous Forest Fire Lamp arrives just deposit \$4.95 plus postage through postman. Show it to your family and friends. Use it yourself in your home for ten days at our risk. Then if you aren't so delighted with your bargain that you won't want to give it up for all the world, return and get your money back. **DON'T WAIT BUT WRITE TODAY!**

MAIL 10-DAY TRIAL COUPON NOW

SCENE-IN-ACTION LAMP COMPANY, Dept. F-1905
Grand Rapids, Michigan

Send order checked below. I will pay postman on arrival of lamp (s) on guarantee that I may use 10 full days and return if not satisfied and get full refund. (Send money with order—Scene-In-Action Lamp Co. will pay postage.)

Forest Fire Lamp, \$4.95 Niagara Falls Lamp, \$4.95

NAME.....

ADDRESS.....

CITY.....ZONE.....STATE.....

Niagara Falls Lamp Also Available

Imagine a lamp that portrays Niagara Falls in all its scenic splendor. Will bring back those romantic memories of your honeymoon.

FREE FOR PROMPT ACTION

Amazing Wonder Leaf . . .

If you act now you will receive absolutely FREE as a reward for promptness, a marvelous WONDER LEAF, so startling, so beautiful that it causes comment wherever seen. Simply pin the WONDER LEAF to curtain, it lives on air alone . . . grows unique, amazing plants! Act now . . . offer may be withdrawn at any time because of limited supplies.

why not use a DIAMOND?

ALL PURPOSE GRINDING
WHEEL DRESSER
FOR ALL DRESSING
OPERATIONS



\$2.50

POST PAID

SEND CHECK OR
MONEY ORDER TO

KOEBEL DIAMOND TOOL CO.
9454 GRINNEL AVE., DETROIT 13, MICH.

SAVE MONEY ON GASOLINE

FITS ALL CARS

Now you can get up to 30% extra gasoline mileage with a Vacu-matic on your car. Quicker pick-up, smoother running, added power saves money every day. Guaranteed. **Automatic Supercharge Principle** Vacu-matic is entirely different! Operates on the Supercharge principle. Saves gas. Automatically provides a better gas mixture. Guaranteed to give up to 30% extra gas mileage, more power and better performance.



SALESMEN WANTED

Big profits. Every Car a Prospect. Send name and address for FREE PARTICULARS and how you get yours for introducing.

Vacu-matic Co., 7617-1282W. State St., Wauwatosa 13, Wis.

BUILD ARC WELDER PLANS

We Show You How to build this new powerful welder without rewinding. For light or heavy work. Uses coils taken from old auto generators. Works on 110 or 220 volts A. C. Has 20 different heats. Send 35c for complete PLANS and valuable Catalog. Write today. **LEJAY MFG. CO., 1347 LeJay Bldg., Minneapolis 8, Minn.**



6 handy tools in ONE!

- 1 MITERING GUIDE
- 2 DIAMETER GAGE
- 3 ACCURATE SQUARE
- 4 MARKING GAGE
- 5 CENTER FINDER
- 6 CONVENIENT RULER

\$1⁵⁰

POSTPAID

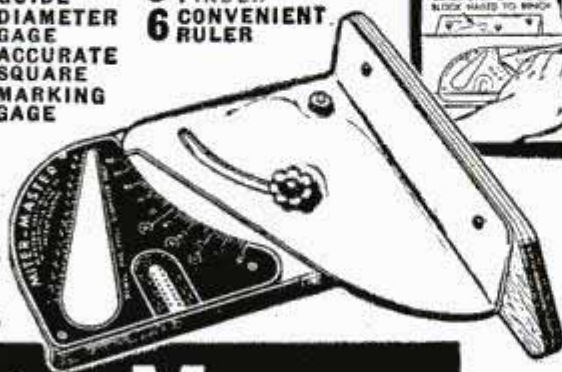

Miter Master takes the place of an expensive miter box accurately set to any angle. Scale marked for mitering 5, 6, and 8-sided frames. Steel construction. Built to last a

lifetime. If your dealer can't supply you we will send it postpaid anywhere in the U. S. for \$1.50. (Foreign \$1.75.) Unconditional guarantee. If not satisfied within ten days for any reason whatsoever, your money will be refunded.

MITER-MASTER

MASTER SPECIALTY COMPANY

3018 EAST LAKE ST. • MINNEAPOLIS 6, MINN.

YOU NEED THIS

FAST-ACTING AGENT TO
relieve misery and kill cause* of

ATHLETE'S FOOT

Helps
Guard
Against
Re-infection!



Here's a product that *really* does what it claims. It's a Doctor's wonderfully soothing yet powerfully medicated liquid called Zemo. First applications relieve itching and burning between cracked, peeling toes and aid healing. Zemo actually kills on contact the vicious germs* that cause and spread this trouble. That's why Zemo has such an amazing record of *continuous* success. First trial convinces. All drugstores.

ZEMO



GERSTNER Tool Chests

Popular with Machinists and Toolmakers because of better construction and finer finish. Free catalog.

GERSTNER TOOL CHESTS
446 Columbia St., Dayton 7, Ohio

NEW-ALL QUICK CHANGE GEAR BOX
Increases Production up to 1000%

NEW IMPROVED MODEL!



**PAYS
FOR
ITSELF
in
30
DAYS!**

30-DAY Money-Back Guarantee!

Drastically Cuts LABOR COSTS!

NO TIME LOST FINDING GEARS! Inexperienced workmen easily produce top output. Easy to install. You simply drill and tap four holes. **Guaranteed Accuracy!**

IS GUARANTEED TO CUT ACCURATE THREADS from 4 to 224 per inch with approximately 3/1000 feed for fine turning. It safeguards entire production in process throughout the complete operation. **Precision Constructed**

PRECISION CONSTRUCTED THROUGHOUT with gears of quality hobbled steel. Gear Box housing is made of high grade aluminum alloy casting—with replaceable bronze bearings.

NEW LOW PRICE . . . \$75.00 F.O.B. Los Angeles
For ATLAS, CRAFTSMAN, LOGAN, POWERKRAFT and SOUTH BEND 9-in., B & C.—Use Your Own Lead Screw.

Write Div. PM6

WESTERN AIRCRAFT TOOL CO.
650 No. Hoover St. Los Angeles 4, Calif. NOrmandy 2-4711

forces succeeded in destroying 996 German, Italian and Japanese submarines before V-J day.

While not a primary weapon, as in the case of the antisub vessel, sonar also constituted an effective part of U. S. submarine equipment. In most cases when stalking an enemy surface craft a submarine relies on its hydrophones and periscope. Sonar sets up sound waves which may be detected by the enemy.

However, sonar was extremely helpful to submariners when approaching hostile shores, especially when invading enemy harbors while submerged. Low-power projectors and BDI warned of antisubmarine nets and other barriers and, conversely, indicated open channels for passage into inner harbors. Sonar also proved valuable in evasive tactics, enabling the submariner to ping back and jam surface craft sonar.

The battle of sonar goes on—in the laboratories. For the realm of supersonic sound remains largely unexplored. With peace, the scientists are seeking new ways to utilize these mysterious electrical impulses. Among them are such projects as the precipitation of smoke, homogenization of milk, fine emulsification—giving smoother ice cream or mayonnaise—acceleration of aging wines and spirits, the treatment of seeds to stimulate plant growth, the mixing of metals to produce alloys and the detection of imperfections in castings.

Already supersonic echo-ranging gear is being used successfully to detect fish at sea. On the Pacific coast, for instance, the sardine industry is locating schools of fish by sound waves. As an aid to navigation, the Submarine Signal Company of Boston has perfected an echo-sounding device that records instantly the exact depth of water beneath the keel of a ship.

Thus from the crucible of war has come another great technical advance—sonar—the amazing “ears of the sub killers.”

Telling the World

(Continued from page 152)

wire to its Long Island short-wave transmitter, which handles 488 words a minute.

The UN operators transmit in eight or 10 foreign languages and pay little attention to what they are feeding to the teleprinters. In this respect they differ from the Western Union men who pride themselves on being connoisseurs of copy and take judicial notice of every paragraph they send.

The only direct service to Denmark and Madagascar is provided by the American Cable and Radio Corporation, which com-

(Continued to page 252)

It's Safe, Quick,
Simple, Efficient

**NEW
KUT-RITE
LAWN MOWER
SHARPENER**

Grinding wheel
principles applied.
Actually self
sharpening. Takes
only 3 minutes—
costs less than
one professional
sharpening, and
equally as good.

14" \$1.25 F.O.B.
16" \$1.35 F.O.B.
18" \$1.50 F.O.B.

Send Check or Money Order
Postage for mailing twenty cents.

ACCURATE

SHARPENER MFG. CO.
2230-A N. Hubbard Street,
Dept. P.M. 7, Milwaukee 12, Wis.

**BUSINESS OPPORTUNI-
TY** offered—small invest-
ment—earn big money—
Order yours today. Deal-
ers and agents wanted.

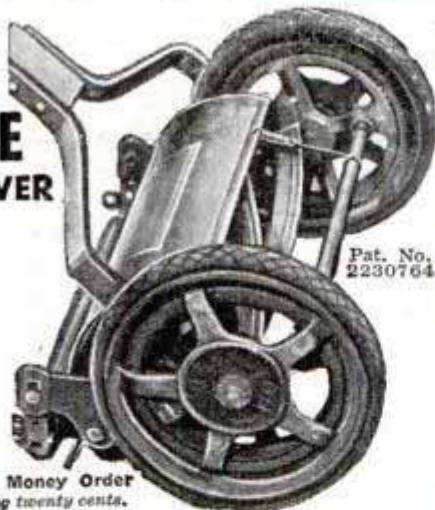

Pat. No.
2230764

**WISE-GRIP
WRENCH**

**Does More
Things Easier,
Quicker,
Than Any
Other Tool!**

Remains locked to the work with
hands removed. Holds anything,
any shape, with a grip that never
slips. Built with strength to back up
its power. Made of fine alloy steel.
Electroplated. Two sizes. 7" and 10".

Sold thru Tool Jobbers and Dealers

Invented, Developed and Made World Famous by
PETERSEN MFG. CO., DEPT. P-76, DeWitt, Nebr.



"Double Lever"
gives 1 Hand
TON GRIP

**REPAIR CRACKED
BLOCKS AND HEADS—**

External and internal leaks in blocks,
cylinders and valve ports quickly and
easily with **LUSCO PLASTIC SEAL**.
90 day Service Guaranteed or your money
back. Send money order or **\$3.00**
check for full pint—more than
sufficient for average repair... Postpaid

C. F. LUSK CO., 4607 EUCLID AVE., CLEVELAND 3, OHIO

PLASTICS!

Fabricating plastics
offers you a fasci-
nating hobby or a
profitable business.
New Carmen-Bronson Plastics Handbook tells you how; gives
construction plans. New Carmen-Bronson Catalog lists all needed mate-
rials—Plexiglas, Lucite, Bakelite, Lignolite, Tenite II, Lumarith in
sheets, rods, tubes, special shapes—clear and glowing colors. Also
plastics dyes, cements, accessories and supplies. 10c brings you both
catalog and handbook. Send for them today.

CARMEN-BRONSON COMPANY
165 EAST 3RD STREET, DEPT. 7-B, MOUNT VERNON, N. Y.

MAKE BIG MONEY!

Be a floor surfacing contractor and sand both new and old
floors. Sanders are easy to operate and better still, you're
your own boss. Write for latest "tell-all" booklet entitled
"Opportunities in Floor Surfacing", enclosing 25 cents
in coin or stamps to cover handling.

AMERICAN
FLOOR SURFACING MACHINE CO.
135 So. St. Clair Street - Toledo 3, Ohio



**Anybody can be a candid camera
expert almost overnight with the new**

MERCURY II (It's a *UNIVERSAL*)

**ESPECIALLY
DESIGNED
FOR COLOR**

MERCURY II will take
the blush out of your
family album. Now,
anyone can take
striking portraits or
split-second action
shots. Its amazing
simplicity and foolproof features make this pre-
cision instrument perfect for both camera rookie and
camera star. Check Mercury II before choosing a
new camera.

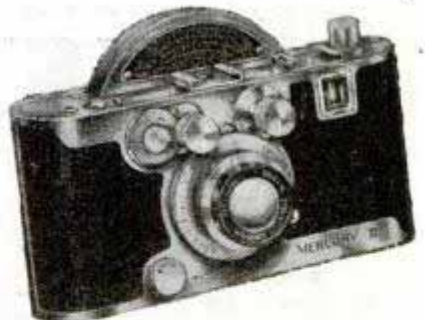

NEW YORK • CHICAGO • HOLLYWOOD
Manufacturers of Mercury, Cinémaster, Corsair Cameras
and Photographic Equipment

ELECTRICITY

**AT ALL
TIMES**

...and
**Economically,
too!**



Generating Sets
2,000 to 36,000 Watts

Many hatcheries, frozen food plants, service stations and factories are guarding against power curtailments and interruptions by installing a Sheppard Diesel Generating Set. They know a Sheppard on the job insures a steady supply of electricity at all times. That's why they all say "Diesel's the Power . . . Sheppard's the Diesel."

Power Units • 3/4 to 56 H.P. Marine Engines • 3/4 to 62 H.P.
R. H. SHEPPARD COMPANY, INC., 48 Middle St., Hanover, Pa.

DIESEL'S THE POWER -

Sheppard's
THE DIESEL!

MAKE MORE MONEY

APPLYING OR SELLING

CORKSTONE PLASTIC FLOORING

**EASY
TO
APPLY**

Here's your opportunity to get into business for yourself applying or selling Corkstone, the economical, top-grade plastic flooring. Plenty of profit. Act without delay!



Dealers & Agents Wanted

WRITE FOR DETAILS OF OUR PROPOSITION
We believe in teamwork and cooperation. We'll help you get started. No cost; no obligation. Act today!

LASTING PRODUCTS COMPANY
MANUFACTURERS OF PAINTS, PUTTIES, PLASTICS
FRANKLINTOWN ROAD PLANT, BALTIMORE 23, MARYLAND

AN EXTRA HAND- FOR PAINTING

Paint stays level - can't swing or spill. "Painter's Pal" clamps on pail, hangs securely on ladder. Fits quart to gal. pails. Stamped and welded steel construction. Holds 100 pounds. For right or left hand. Satisfaction guaranteed.

"Painter's Pal" For Brush and Pail
At Your Dealer
Or \$1.25 prepaid, from

GENERAL ENGINEERING CORP.
CHARLOTTE MICHIGAN U. S. A.

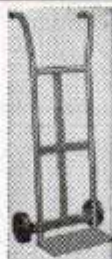

All Steel TRUCK

Order Monday—Get Friday—\$14.95 for 1... Lots of 3 \$13.95. "Handee" nat. adv. Thousands in use. 5x2 rub. trd. whls. 600 lb. cap. 48" ht. 14" nose width. Easy handling. Wt. 28 lbs. For all purp. 1% 10 da. Return express collect if not 100% satis. FOB. Order from **HANDEES CO., Dept. 230B, Bloomington, Ill.**

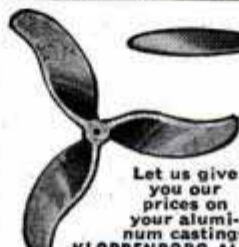

BUILD YOUR OWN FAN

with that old motor
One piece cast aluminum propellers used for cooling and ventilating. Also available to dealers at discount.

Size	Polished	Unpolished	Bore
1 1/2 in. 2 Bl.	\$2.50	\$2.00	5/8, 3/4
2 in. 3 Bl.	\$3.50	\$3.00	5/8, 3/4
2 1/2 in. 4 Bl.	\$4.00	\$3.50	5/8, 3/4
3 in. 5 Bl.	\$4.25	\$3.75	5/8, 3/4
3 1/2 in. 6 Bl.	\$5.00	\$4.25	5/8, 3/4
4 in. 8 Bl.	\$5.00	\$4.00	5/8, 3/4, 1

KLOPPENBORG ALUMINUM FOUNDRY, Dept. SM3, Davenport, Iowa

MARCOT KEY MACHINE

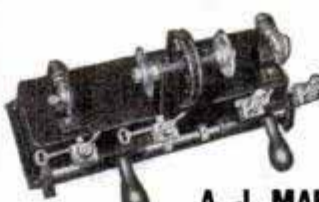

Marcot No. 8 Key Machine
Mounted on Cabinet.....\$ 75.00
Book on Modern Locksmithing 3.95
Auto Code Book and Auto
Depth Key 12.50
162 Doz. popular Key Blanks 77.76
Set Key Files, Tools, Pins,
Springs, Thimble 10.50

\$179.71
A. J. MARCOTTE CO., 1200 N. Kedzie Ave. CHICAGO 51, ILL.

RADIO PARTS GRAB BAG!!

\$25 original value assortment of Coils, Condensers, Transformers, Resistors, Controls, etc. An experimenter's dream. While they last, only.....
MARKO SUPPLY, Dept. P.M. 7
2924 Logan Blvd. Chicago 47, Ill.

\$3.98

LIKE WINGS ON YOUR CAR

This powerful inexpensive impeller supercharger can be yours—will fit any automobile—adds up to eight horsepower—has gas saving qualities—complete plans for easy building—send for free literature. **AIRCHIEF SUPERCHARGER CO., P.O. Box 1102, Dept. 14, San Diego 12, Calif.**

BLOWERS HEATING COOLING

Blowers and Cooling Supplies. Gas and Oil Burning Furnaces. Conversion Burners. Good Profits. Wanted—men to sell and install.
PEERLESS SALES, 4318 Sheridan, Lincoln 6, Nebr.

New - Improved OIL FOR ALL ---

HOUSEHOLD-SPORTSMAN-MECHANIC
Lubricates - Prevents Rust - Cleans Metal

FIENDOIL

3 oz. 40c

GRAPHITE GUS ASKS:

KNOW YOUR GRAPHITE AS A FINE TOOL



Does a craftsman-like lubricating job on bearings and metal surfaces operating under severest conditions of temperature, pressure, speed and solvents.

Nothing else even approaches dry lubricating graphite for use on absorptive materials like wood, leather, fibre textiles and rubber.

Write today for your free copy of Dixor's Data Sheet Directory, an entrance way to volumes of use knowledge about this amazing mineral.

The complete line of Dixon's products into which graphite is processed is stocked by Mill, Hardware, Automotive, Marine, Sporting Goods, Plumber and Janitor Supply stores everywhere.



30¢

DIXON'S GRAPH-AIR GUN

Filled with Microfyne powdered graphite, it's the slickest gadget you ever saw for lubricating locks and hard-to-reach mechanisms, in shop, office, car, boat, home. Will not leak or gum. Described on Data Sheet #8.



15¢

DIXON'S GRAPHITE SLIPSTIK

For rub-on lubrication. Easy to use as a lip stick. Fine for fire arms, sticking doors and windows, bicycle chains—1001 mechanisms in shop, office, car, boat, home. Keep one near you. Described on Data Sheet #23.



20¢ 1 Oz. Tube

DIXON'S GRAPHITE LATHE-CENTER LUBRICANT

Used in thousands of plants for one of the toughest lube jobs known—lathe dead centers—under severest conditions of heat, pressure and speed. Use wherever "hot spot" lubrication is needed. Described on Data Sheet #15.

Joseph **DIXON** Crucible Company • Div. 26C7 • Jersey City 3, N. J.



In Cylinders



On Pumps



On Bearings



On Chains



On Hoists



On Gears



On Pipe Threads



On Gaskets



On Packing

METALLIZE BABY SHOES

Learn this easy, money making business from nationally recognized consultant. Small investment; perpetual market. For free details write Joseph B. Kushner, B.S. Ch.E., Metal Finishing Consultant, Stroudsburg, Pennsylvania, R.D. 3J.

Get Into Plastics

Beautiful articles easy to make with the JACASO KITS and instructions. PLEXIGLAS, LUCITE, LUMARITH. We have in stock any plastic materials you need, including dyes, cements, buffing compounds.

Send card today for complete catalog H. Beginners experimental kit\$2.00

JACASO COMPANY

Box 180

Lakewood, New Jersey

12 ASSORTED { NEW HIGH SPEED ROTARY FILES } ONLY \$6.00
 1/4 Inch Shank
 SEND FOR CIRCULAR
 POSTAGE PREPAID

VICTOR MACHINERY EXCH., Inc., 251 Centre St., N. Y. 13, N. Y.

ALUMINUM CIGARETTE LIGHTERS

Agents Wanted!

SENSATIONAL SELLER

Slim and trim, this lighter sells on sight. Attractively finished in non-tarnishing satin aluminum with streamlining accentuated in brilliant red. A sure-fire light every time. *Ceiling price \$4.50 each, new low price to you only \$9.40 per dozen.* Sample \$1.00 prepaid. Sell through jewelry, drug, cigar, gift and novelty shops—also to friends. A most profitable side line. Literature free.



SAMPLE \$1.00

Your price \$9.40 per doz. Send trial order now!

PLANNED SPECIALTIES CO., Mfgs. P. O. Box 231 Pittsburgh, Pa.

Say you saw it in Popular Mechanics

YOU NEED THESE CRAFTSMAN'S TOOLS

SUPER DRILL GRINDER

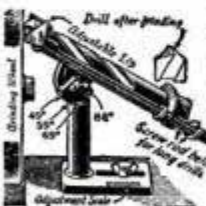

Sharpens round shank drills from 3/32" to 1 1/16" diameter. Grinds Old Drills like new in 4 different drill point angles. Grinds Short, Medium and Long Twist Drills from 1 1/2" up to 11" long, for hand or power grinding wheels.

100,000 IN USE!

Grinds your drills like factory in 25 seconds. Gives perfect center and clearance. Saves drills, time and money. No shop should be without the Super Drill Grinder. Guaranteed to do the work or money back. The Grinder that gives a round point!

Only \$295

SUPER ARBOR

(PATENT PENDING)

A combination drilling or grinding wheel attachment. For 3/4" motor shafts. Will take grinding wheel with 1" hole on shaft and 3/4" hole on small end. Extension can be used for rag or wire wheel, or 3/4", 24-thread drill chuck which holds drills from No. 60 to 3/8" in diameter. Right hand thread only.

Price Only \$150

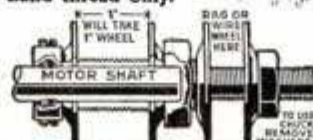

SUPER HACKSAW

AND FLAT DIE FILE HOLDER



The tool with 100 uses! Holds broken hacksaw blades—used by mechanics, electricians, plumbers, auto mechanics, hobbyists and repairmen. Perfect for all-round household needs; ideal for difficult close-quarter work. Nothing like it for tool and die men. Price, without saw blade.

Only 95¢

At Your Dealer's or Postpaid
CRANDALL MFG. CO.
 1512 West Slauson, Dept. FA-7
 Los Angeles 44, Calif.

A TOOLSHOP IN YOUR HAND!

- GRIND • DRILL • ROUT
- POLISH • ENGRAVE
- CUT • SAND • SAW, etc.

Make Things From
Wood—Plastics—Metals—Glass—Linoleum
—Leather—Alloys—Horn—Stone—Bone, etc.



HANDEE TOOL OF 1001 USES

Smooth, steady power at your fingertips! Perform precision operations not possible with any other portable tool! With a Handee you can turn out professional looking projects for pleasure or profit—ship, plane and train models, costume jewelry, wood carvings, puppets, initialed tumblers, etc. AC or DC. 25,000 r.p.m. Wt. 12 oz.

USE THE RIGHT ACCESSORIES! Choose them from the most complete line . . . more than 300 made right in the Handee plant.



**GET A GOOD START
GET THE
HANDEE KIT**

HANDEE Tool and 45 most popular accessories packed in compact steel carrying case. You'll be amazed at what you can accomplish!

Postpaid, \$25.00
Handee only, \$18.50

**FOR YOURSELF OR A FRIEND . . .
THE GIFT OF A LIFETIME!**

NEW PRECISION ATTACHMENTS

Fit Handee only; enable novice or craftsman to do perfect work. Magically, easily, your offhand carving, routing, shaping will be exact as to depth of cut, accuracy of line. Set of 6 attachments with instructions, postpaid, \$7.95

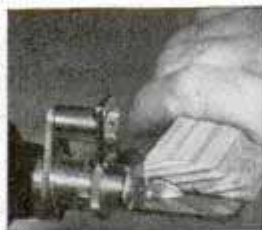

ORDER NOW. SATISFACTION GUARANTEED!

FREE! NEW 52-PAGE MANUAL

CHICAGO WHEEL & MFG. CO.
1101 W. Monroe St., Dept. PM
Chicago 7, Ill.

Send Handee Kit Handee Tool Precision Attachments
 C.O.D. Remittance enclosed Send Manual

Name.....

Address.....

prises two cable and one radiotelegraph service. All America Cables serves Latin and South America, Commercial Cables links the U. S. with Great Britain and Europe and Mackay Radio covers most of the civilized world.

ACR's teleprinters transmit 75 words a minute to its downtown office and from there it is forwarded by cable and radio. For radio transmission the Kleinschmidt tape is used—a paper strip which operates on the same principle as a player piano roll. The message is "written" on the strip by means of variously positioned punches and is "read" off onto the transmitter either by mechanical feelers which penetrate the punches or by an electric eye. The message comes off the receiving machine at the destination in wavy lines which are interpreted by the operator and transcribed on a typewriter or teleprinter.

Even more streamlined than the ultra-efficient telegraph and cable service is the setup arranged by the Associated Press, United Press, International News Service and the New York Post. These four have silent sounders—noiseless Morse code senders—right in the press galleries and their correspondents can whisper their flashes to the operators and have them in their local offices in a matter of seconds.

From 5000 to 6000 calls a day are handled by the New York Telephone Company in and out of the world capital. Equipment includes a 500-phone system with 100 trunks handled by 30 operators and four information clerks. The telephone people look for an ultimate installation of 1500 phones, but this doubtless will wait for the fall move to Lake Success, Long Island.

One company employee is sure he was made the victim of a global practical joke. An installation foreman, he returned from the armed services and selected his former Bronx territory as a quiet beat in which a man could gradually accustom himself to the rigors of civilian life. Two days later the UN moved in on him and he didn't get home before midnight for a month.

The contractors who refurbished the college gymnasium for the council meetings also met up with a telephonic joker. One of the first instruments was assigned to them and placed in a small, unoccupied room. One morning the builders arrived to find the room filled with furniture, locked and protected by a very determined armed guard. The guard was adamant and the contractor loath to attempt to complete such a rush assignment while incommunicado, so the phone company persuaded the guard to put his pistol down long enough

(Continued to page 256)



RADIO PHONES

Made to U. S. Army Specifications, passed by Signal Corps Inspectors. Dynamic Microphone and dynamic receiver of finest quality—Water, shock, weather and altitude proof, used on tank and aircraft (B19) intercom systems. For recording, for battery-less telephone, talk through your radio set or use earphones for pocket-size set loud speaker.

Complete two receiver, cord set, head band, and dynamic hand microphone including special connecting cord set. Less than regular cost of dynamic mic.

\$9.95

Postpaid

King of ELECTRIC SWITCHES

**Versatile Switch of a Thousand Uses
Millions in Post War Applications**

Floodlights your porch when the door is opened—signals arrival of mail—controls heating of furnace—filling of water tank, these and many other services are performed by this versatile switch. Shipped with instruction sheet showing numerous illustrated uses for this device at the low price of **\$1.00** Postpaid



BATAVIA 2, ILLINOIS

NEW THOR "B" ENGINE—\$9.95

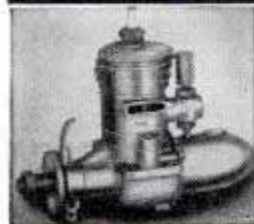

The new THOR "B"—Sensational miniature gasoline engine that really works. Super-power performance featuring new presto starting device, larger crank shaft, better fuel control, improved Cam and Timer, Wear-Proof rod. Smooth, velvety power that roars into action with a "twist of the wrist." Over 10,000 already sold. 1/6 H.P. Complete with coil, condenser, and fully illustrated instructions, only \$9.95. Bench tested, ready to run, guaranteed, Powers all models. Send \$1.00—shipped collect same day C.O.D.

FREE Just off the Press. Send for big 40-page illustrated hobby catalog with over 300 illustrations; over 1,000 listed items. The "Bible" of wideawake modelers. Write for it now—no obligation, naturally!



AMERICA'S HOBBY CENTER

Dept. B76, 156 W. 22nd St., New York 11, N. Y.

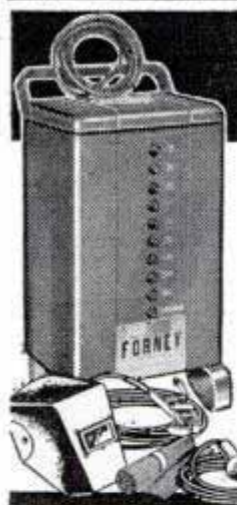

WELD ANYTHING ANYWHERE ANYTIME



ALL PURPOSE ARC WELDER

9 Models . . . 32 Volt D.C., 110 to 440 A.C.

A complete workshop in itself! Weld, cut, braze or solder any type metal; iron, castings, aluminum, steel, bronze . . . in any gauge or weight, with equal ease. Compact, complete, sturdy as the Rockies. Formed steel and cast aluminum case, welded steel base, 4" cast wheels. Built with voltage control. Better on R.E.A. lines. No training needed. Sold throughout the world. Unconditionally guaranteed for 2 years. Fully equipped—ready to use.

FORNEY MFG. CO.
FORT COLLINS 2, COLORADO

EXPERIMENT WITH BLACK LIGHT!

FUN! THRILLS! PROFITS! See seven page article on this fascinating science in June 1945 issue of Popular Mechanics. We furnish all supplies. Trial Kit of 8 lacquers only \$6.25. Black bulb for testing, \$2.00. Lamps, lacquers, crayons, fabrics, etc. Write for descriptive list and full details today!

BLACK LIGHT PRODUCTS, New Address 67 East Lake Street Chicago 2, Illinois

no more BATTERY BOTHER

Get a MAKE-A-LITE BICYCLE LIGHT GENERATOR

WATCH FOR AD IN NEXT MONTH'S ISSUE



OLD CARS GET NEW PEP WITH BURD "GRAF-FLOX" PISTON RINGS

You'll be amazed by the quick acceleration and new-car power of your engine after a re-ring job with Burd "Graf-Flox" Piston Rings. You'll get new pleasure out of driving and, what's more, you'll make worthwhile fuel and oil savings. What makes the difference? First of all, Burd Piston Rings are made of electric furnace iron, which produces castings of uniform strength and tension. Second, each ring is precision-ground and finished. Third, Burd's exclusive "Graf-Flox" process assures quicker-seating, longer-wear . . . prevents scoring or seizing. If your car "smokes" or acts sluggishly, have your serviceman install a set of Burd "Graf-Flox" Piston Rings without delay. Send the coupon today for the two FREE booklets described below.

BURD PISTON RING CO., DEPT. PM, ROCKFORD, ILL.



THIS COUPON BRINGS FREE BOOKS

BURD PISTON RING CO., DEPT. PM
Rockford, Illinois
Gentlemen:

I'd like a FREE copy of your "Handy Handbook" which tells how to keep my car in good working order. Also send a "Car Economy Record Book."

Name.....
Address.....
City..... State.....



PRECISION DRIVES for Your POWER EQUIPMENT



CONGRESS PULLEYS & COUPLINGS

Available in a large range of sizes, CONGRESS DRIVES increase the performance of your workshop. They are the same precision drives that are being used as standard equipment by many of the worlds largest manufacturers of high priced precision machinery.

Better hardware, hobby shop and farm equipment dealers are selling CONGRESS DRIVES. They are available in all popular sizes with diameters ranging from 1 1/2" to 14". You pay no more for CONGRESS than for ordinary drives.

LOOK FOR THIS DISPLAY

It identifies the dealer selling superior CONGRESS pulleys and couplings.

CONGRESS DIE CASTING DIVISION
Detroit 12, Michigan

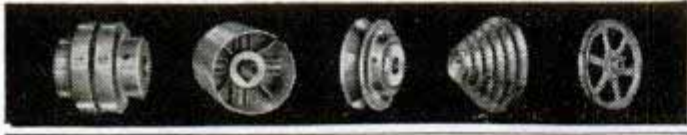

Appliance \$10.95 Tester

LOCATES TROUBLE INSTANTLY IN ALL ELECTRICAL DEVICES

In this single unit are all the necessary tests for examining every appliance. Checks thermostats under working conditions. Tells instant it opens or closes. Controls heat on soldering irons. Prevents over-heating. Tests continuity, open circuits, automatic irons, vacuum cleaners, motors, coin machines, bulbs, 3-way switches, etc. Great time and money saver! ONLY \$10.95 COMPLETE. No C.O.D.'s, shipping wt. 3 lbs.

FREE with each Tester. New, Complete Practical Course in electrical appliance repairing. WRITE FOR CIRCULAR. HANLAN CO., 1419-A, West Jefferson, Los Angeles 7, Calif.

FINE TOOLS NEED FINE OIL!

3-IN-ONE OIL

- Lubricates
- Prevents Rust
- Cleans • Polishes

SOLD EVERYWHERE

3-IN-ONE Oil

RAYON PARACHUTES

Strong and sturdy—new and different! Brand new white heavy rayon fragmentation bomb parachutes, complete with reinforced corded rayon shroud lines, and packed in metal cylinder 15 inches long, 4 inches in diameter. Chute measures over 7 feet in diameter, 22 feet around the outer edges. Use them for tents for the youngsters, swing hammocks, beach umbrellas, costumes. Complete chute only \$1.98, including shroud lines and metal container. Rush your order—send check or money order (add 50c each to cover postage and handling), or order C.O.D. Immediate delivery—satisfaction guaranteed.

HUGH CLAY PAULK
Dept. 8

49 FALMOUTH ST. BOSTON 15, MASS.



BRASS RODS For Home Work Shops

For use on model boats, airplanes, etc., keep a supply of these free-turning brass rods on hand. Each kit contains a complete assortment of sizes.

Write for Free Catalog of 45 Kits Today

MEIER BRASS & COPPER CO.
1320 E. Larned, Detroit 7, Mich.

BUILD Your Own SCOOTER WAGON or WHEELBARROW



—Shopping Cart—Golf Cart or Toys. Sturdy Rubber Tired Pressed Steel Wheels. Bright red enameled. Hundreds of uses. Build a bassinet, portable play pen, doll carriage, baby cuddle cart etc. Sent postpaid in U. S. on receipt of price. Immediate shipment.

CIRCLE METAL MFG. CO.
4266 E. Pacific Way
Los Angeles 23, Calif.

4 inch; 1/4 inch bushing	75¢ each
6 inch; 3/8 inch bushing	\$1.00 each

ELIMINATE WATER WASTE

WITH AUTOMATIC GARDEN HOSE NOZZLE VALVE SAVES WATER SAVES MONEY



\$3.50
POSTPAID

Flow of water is controlled by your hand. INSTANTLY. On or Off. NOTHING TO TURN OR ADJUST. NO PARTS TO WEAR OUT. Made of brass and high grade rubber water hose. Money back guarantee. **PHILLIPS TOOL CO., 62 Mt. Vernon Ave., Mt. Vernon, N. Y.**

YOUR ELECTRIC DRILL

Has 100 Other Uses

when used with K-Jax attachments
METAL SAWING . . . SHEARING
RIVETING ATTACHMENTS

Write for illustrated circular

K-JAX, 2600 Canton St., Dallas, Texas

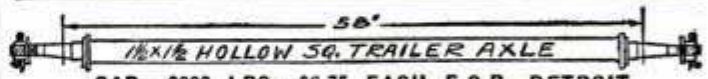

CAP.—2000 LBS.—\$6.75 EACH F.O.B. DETROIT

STRONG MACHINE & AXLE COMPANY
9710 Lumpkin Hamtramck 12, Michigan



FREE RADIO CATALOG

Latest radio and electronic parts and devices, newest ham gear, gadgets, war surplus items. All in this new FREE catalog. Don't delay,

BURSTEIN-APPLEBEE CO.
1012M McGee, Kansas City 6, Mo.



When you want to fix things fast . . . remember Weldwood Glue. It's quick to mix . . . easy to use . . . tremendously strong . . . stain-free . . . rot-proof . . . and permanent. At hardware stores, lumber yards, chain stores.



WELDWOOD PLASTIC RESIN WATERPROOF GLUE

UNITED STATES PLYWOOD CORPORATION, New York 18, N. Y.

Machine Tools & Machine Shop Equipment

DRILLS
TAPS
DIES
REAMERS
CUTTERS
SLEEVES
ARBORS

We can supply all your machine shop needs with fine tools made by leading U. S. manufacturers. Mail orders will be promptly dispatched. We invite you to send for our complete and illustrated catalogue—40c—which sum will be refunded on first order of \$10. Write to the

Veteran Tool & Supply Co., Dept. A
88 Baxter Street, New York, N. Y.

ELECTRIC TOOLS
GRINDERS
COLLETS
VISES
CHUCKS
MICROMETERS
SURFACE PLATES

FLUORESCENT FIXTURES

SALESMEN—AGENTS

No experience necessary

Earn \$500.-\$10,000. selling very latest type FLUORESCENT FIXTURES TO HOME, OFFICE, DEPARTMENT STORES and INDUSTRIAL USERS

Free literature—Rush your name to:

TRUTONE PRODUCTS COMPANY
303 West 42nd St., Dept. F, New York City



Army-Navy Type HEADPHONES

TYPE HS-23

Genuine U. S. Signal Corps headphones, better \$10.00 type. Leather-covered headband, detachable rubber cushions, lt. wt., imped-
ance 8000 ohms. Ea. . . . \$2.95

TELEGRAPH KEY

Genuine U. S. Signal Corps key with cutout switch, silver contacts 95c

3 1/2" G. E. AUTOMATIC TIME METER

60 cycle 110 volts. This time meter consists of a cyclometer driven by a telechron synchronous motor. Connect to an electric circuit; it will measure and indicate the number of hours, tenths of hours or minutes that the circuit is in use. Ship-
ping wt. 6 lbs.—list \$17.00. Your Cost. \$4.95

2500 mfd. 3 volt F. P. condensers, each 49c

Write for our illustrated literature of radio parts.
Plus shipping charges.

Arrow Radio Co., Dept. G, 2205 W. Division St., Chicago 22, Ill.



MILL IT ON YOUR LATHE



WITH A PALMGREN

MILLING ATTACHMENT

Now — you can do milling, slotting, grinding, grooving, squaring shafts, sawing at angles, and many other important operations on your lathe. PALMGREN MILLING ATTACHMENT is a necessary fixture for small shops, schools and emergency work in large plants. Fits South Bend, Atlas, Craftsman, Logan, Sheldon and all other makes. It has 360° graduation for rotary angle adjustments, also graduated feed and adjustment screw. Easily mounted by straddling lathe's regular tool post. Try one—it will quickly pay for itself.



IMMEDIATE DELIVERY

No.	Width Jaws	Depth	Jaws Open	Weight Pounds	Base Opening	Price F. O. B. Factory
150	1 1/4"	1"	1 5/8"	6 1/2	1"	\$18.75
250	2 1/2"	1 1/2"	2 1/2"	11	1 1/4"	24.75
400	4"	1 3/4"	4"	25	2"	39.75

Order from your dealer or jobber. Write for circular No. 349

CHICAGO TOOL AND ENGINEERING CO.

Mfrs. of PALMGREN PRODUCTS for Over 28 Years

8365 South Chicago Avenue • Chicago 17, Illinois

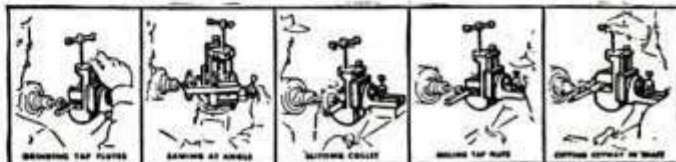

**Amazing New Way
TO TRIM HEDGES—SHRUBBERY!**

**LA RENE
HEDGE TRIMMER**



**Cuts 100 feet of Hedge
in 20 Minutes!**

Attaches to 1/4"

PORTABLE ELECTRIC DRILL

So Light a Woman Can Operate

Now you can take all the drudgery out of trimming hedges, shrubbery, or ornamental trees with the marvelous new La Rene Hedge Trimmer. This precision instrument attaches easily to any standard 1/4" electric drill (operating at 1,000 to 2,500 RPM) and makes 60,000 cuts per minute.

Made of steel. No nuts, bolts, or screws. No intricate parts to get out of order. Guaranteed for one year against mechanical defects.

Go to your dealer today. If he cannot supply you, order direct. State make and model of drill you own. Send either check, money order, or sent C.O.D.

**ONLY
\$16⁹⁰**

Write for Descriptive Booklet K

JOHN L. JAMES CO.

Manufacturers

Sales Office: 307 FIFTH AVENUE, NEW YORK 16, N. Y.

Now Available

**Electric Portable
PHONOGRAPHS**

Now—at Less
Than O.P.A. **36⁸⁰**
Ceiling Price

- Plays 10 or 12 inch records
- Full variable tone control
- 3-tube amplifier - Volume control
- Large P.M. Dynamic speaker
- Lid closes to eliminate surface noise
- AC current only
- In handsome brown simulated leather carrying case with sturdy handle
- With Automatic Record Changer **59.70**



Automatic Electric Irons

With Thermostat Control

Below O.P.A. **595 to 845**
Ceiling Prices

Non-Automatic Electric **495**
Irons as low as.....

Send for illustrated circular for hard to get merchandise in radios, and small electrical appliances.

If paid in advance mdse. will be sent prepaid of all charges; otherwise send 25% deposit, balance C.O.D.



ROBERT SCOTT CO.

**916 W. Belmont Ave.
Chicago 14, Illinois**

for them to retrieve the telephone and install it elsewhere.

The four radio networks, NBC, Columbia, American and Mutual, stand ready every moment that the council is in session to jettison the soap opera or other program of the moment and bring the UN deliberations to millions of American homes.

The International Division of NBC broadcasts news of the council in English, Spanish, Portuguese, German, French, Italian, Danish and Swedish, using 22 to 24 transmitters a day. Almost every day UN news is included in these daily broadcasts beamed to Latin and South America, Europe and Africa.

The Columbia Broadcasting System's international network operates on a daily seven-hour schedule in English, French, Italian, German, Dutch, Polish, Czech, Serbo-Croatian, Spanish and Portuguese. Its 112-station Latin American network is giving listeners south of the border thorough coverage of the meeting.

The most comprehensive international radio coverage ever achieved is claimed by the International Broadcasting Division of the State Department, which has a schedule of 64 broadcast hours a day in 18 languages—including Tagalog and Bulgarian. This service adheres strictly to straight factual reporting.

The British Broadcasting Company, Canadian Broadcasting Company and Radio Belgium serve their national audiences, the volume depending on the importance of the day-to-day news.

For the 80-odd million weekly moviegoers five newsreels cover the meetings in a pool arrangement. Fox Movietone, MGM News of the Day, Paramount News, Pathe News and Universal Newsreel take turns in occupying the camera booth almost directly opposite the center of the Council table and all footage is made available to all services. This is for the sound coverage; the silent footage is shot almost entirely by Universal.

NBC television not only brings sight and sound of the council into the homes of owners of video receivers but has proved a valuable adjunct to press coverage as well. Since only a third of the correspondents accredited to the UN can be accommodated in the press galleries and other reserved space at one time, this meant that approximately 500 newsmen and women were out in the cold.

This problem was solved by the installation of television receivers in the press lounge, where the meetings could be covered "first hand" in considerably more

(Continued to page 260)

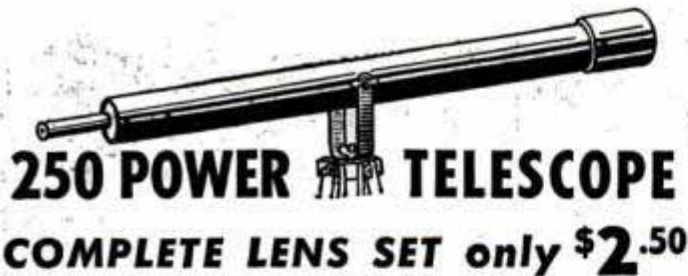

250 POWER TELESCOPE

COMPLETE LENS SET only \$2.50

See the mountains and craters on the moon, the ringed planet Saturn, the moons of Jupiter, distant ships, people, and hundreds of other interesting sights. Make your own high powered telescope in one evening of easy work. All optical parts for 6 ft. long refracting telescope completely finished. Set consists of 3 inch diameter 75 inch focal length ground and polished objective lens and all eyepiece lenses needed to give magnifications of 50X, 100X, 150X, 200X, and 250X as an astronomical telescope, and 50X, 100X, and 150X as a terrestrial telescope. Complete lens set with full directions for mounting, only \$2.50 postpaid.

BROWSCOPE CO., Dept. 7M, 24 W. 45th St., New York 19, N. Y.



SING-TALK thru your own Radio with Radio MICROPHONE

Put on your own broadcast at home with this Radio Mike. Sing, Talk from any room in the house. Make announcements. Lots of fun! It's wonderful voice practice. Easily attached to any radio. **SEND NO MONEY.** Pay postman \$1.98 plus postage. Send check or money order and save postage.

DISCO SALES, INC. (Dept. PM-4), 154 Nassau St., New York 7, N. Y.

CASTINGS

SMALL MACHINE TOOLS AND ATTACHMENTS

Many of these castings previously described in Popular Mechanics may be ordered either rough or semi-finished.

High Speed Drill Press; Tool Post Grinder; Adjustable-Jaw Vice for Milling, Shaping, and Lathe Face Plate work; Step Collet; Boring Bar Holder; 3" and 4" Tool Post Turrets; V-Blocks; Angle Plates; Face Plates 6" and 9"; Chuck Back Plates 4", 5", and 6".

We make castings and patterns for special projects—send blue prints or write us. Also equipped to machine small metal parts in limited quantities for experimenting, small production items, etc.

T-P Manufacturing Company, P. O. Box 7024, Dallas, Texas



SUPER MYSTERY BUTTON

Many times as sensitive as our regular mystery button. Can be used for the same experiments and uses as the mystery button but with far better results. Needs no diaphragm of any kind. Ideal for musical instruments, intercommunication, recording, talking thru radio, and many other uses. When used with small head phone it makes an ideal inexpensive hearing aid. Shipped with 5000 word, 12 page booklet showing diagrams for dozens of uses, postpaid \$2.00.

Electronic Products Company
Saint Charles, Ill.

RUBBER BOAT—Build Your Own

Anyone can build a rubber boat, suitable for fishing, sailing, duck-hunting, outboard motor. Your basement or spare room is your workshop. No special tools required. Little expense. Booklet entitled "How to Build Your Own Rubber Boat" gives design for 2 person and 4 person boats, including pattern details, step by step construction, and information on materials.

Booklet will be sent postpaid on receipt of Check or Money Order for.....\$1.50

BOAT ACCESSORIES

P.O. Box 349, Times Square Station, New York 18, N. Y.



MOTOR ARBOR AND COMBINATION V-PULLEY

1/2" right .65c 1/2" left .75c
5/8 & 3/4 R & left.....\$1.00
Add 10c postage U.S.A. Trade discounts.

F. ROESCH
502P-1st St. Hoboken, N. J.

NEW OTTAWA SAW

World's Fastest 6 H.P. EASY to MOVE

BIG FREE BOOK

Fells trees. Saws big logs, small logs, limbs. Pulley for belt work. Easy to handle, weighs less than lower powered units. FULLY GUARANTEED. Cash in on fuel shortages. Turn wood lots into cash.

OTTAWA MFG. CO., 727 PINE ST., OTTAWA, KANS.

HINGES or other fixtures LOOSE ?

Tighten them for good

this way!

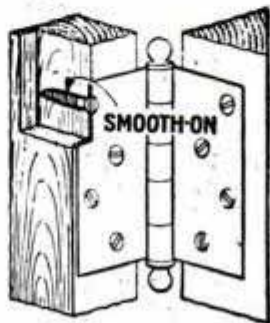

Remove the screws and fill in the holes and any unevenness under hinge or other loose fixture with Smooth-On No. 1 Iron Repair Cement mixed with water to form a soft paste. Insert the screws in the soft Smooth-On and turn up tight. Overnight the Smooth-On will harden like metal and hold the part tightly in place.

Simple, isn't it? And just as simple to seal cracks, stop leaks, tighten loose parts in heating and plumbing systems with this half-century-old home repair necessity. Keep it on hand for emergencies. Get it in inexpensive 1 1/4-oz., 7-oz. or larger sizes at your hardware dealer's. If he hasn't it, write us.

FREE REPAIR HANDBOOK SAVES YOU MONEY

40 pages, 170 diagrams. Clear, simple, tested directions for dozens of useful home repairs.

—SIGN AND MAIL NOW—

SMOOTH-ON CEMENTS



Smooth-On Mfg. Co., Dept. 37
570 Communipaw Avenue, Jersey City 4, N. J.

Please send me a Smooth-On Handbook.

Name.....

Address.....

T-46.....

For the Motor Car and Boat, Home, Factory and Power Plant

Do it with SMOOTH-ON

The Iron Repair Cement of 1000 Uses

PATTERN PORTFOLIO

FREE!



Each of these four decorative stencils, easy to reproduce with every

BURGESS
electric
vibro-tool kit

complete with all 22 attachments. Carves and engraves metal, wood, plastics. Can be used on any surface or material. Thrilling gift for anyone—a MUST for your workshop!



1650
postpaid

For you who want JUST the VIBRO-TOOL and one standard hard needle—
\$750
postpaid

EASTERN
HARDWARE
PRODUCTS
P. O. BOX 2080
PHILA. PA.

GYRO-MASTER

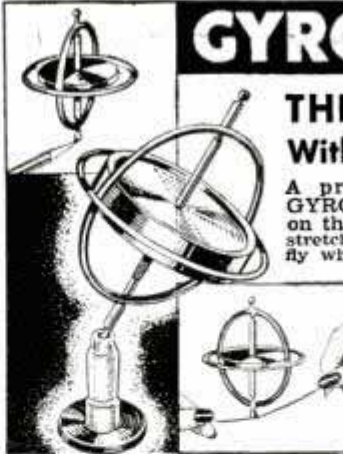

THE SCIENTIFIC TOY
With Handsome Pedestal

A precision-balanced high-speed GYRO which will balance at any angle on the tip of a needle, pencil, or on a stretched string. Has a gleaming metal fly wheel with red trim. Pedestal made of highly polished aluminum, with red base. Gives a scientific demonstration of the principle underlying the Gyro-compass, the Automatic Pilot and other secret war machines. Individually packed in box with full instructions. Sent postpaid anywhere in the U.S.A. for

\$100

DEALERS: SEND FOR QUANTITY PRICES
SCIENTIFIC PRODUCTS, Dept. 7A, 5491 University, Chicago 15, Ill.

Fire-Out Extinguisher

Heavy waterproof, fibre, pump type, containing "DIOBON," a chemical which turns into Sulfa Gas on contact with flame. Sulfa Gas is 5 times heavier than air. It forces out the oxygen and blankets the fire. Won't harm food, fabrics, metal or moving parts. A MUST IN EVERY HOME, WORKSHOP, GARAGE, CAR, BOAT, ETC. Shipped postpaid anywhere in U.S.A.

\$3⁵⁰

THE FIRE-OUT EQUIPMENT CO.
1243 N. HARDING AVE. CHICAGO 51, ILL.

EXPERIMENT WITH LUMINOUS PAINT

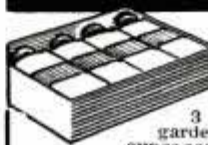

Complete kit of luminous paints in colors. Paint artificial flowers, lamp ornaments, novelties, mouse numbers, light switches, etc. Kit of one oz. each of 3 lasting colors, bright blue, gardenia and chartreuse, one ounce sealer. Guaranteed best quality.

COMPLETE KIT WITH 3 COLORS AND SEALER

\$4²⁵

New Address **F.O.B. Chicago**
BLACK LIGHT PRODUCTS • 67 E. Lake St. • Chicago 1, Illinois

A GENUINE

RADIO

ASSEMBLY KIT



A thrill to assemble, fun to use. No batteries or electric plug-in required—light and portable. You get all parts including screws and nuts and a full size standard ear-phone. Simple-to-follow instructions make the fundamentals of radio easy to learn. Sent, postpaid anywhere **\$3.49** in the U.S.A. for

Special—A Complete Outdoor Antenna Included for Only \$1 extra

APPLIANCE MART
1572 Sherman Ave. Evanston, Ill.

WRIST WATCHES



\$890

TAX INCLUDED

Genuine Swiss make, highly polished chrome case, genuine sturdy leather strap, "swiss" second hand, for Men and Women. Send check or money order we pay postage, or we'll ship C.O.D. plus postage. Order today! Immediate delivery!

CEDO SALES CO., 1165 BROADWAY, ROOM 305, NEW YORK 1, N. Y.

SPINIT—GAS MODEL STARTER



Ideal For Model Plane Builders

Gas model fans, this is IT! "If it will run—a SPINIT will start it!" Sturdily built. Finger tip release. Makes model flying more fun. Available at dealers. Standard model, \$4.00. Write for folder:

STREED ELECTRIC CO.
1315-A Harmon Pl., Minneapolis 3, Minn.

SAY YOU SAW IT IN POPULAR MECHANICS

If They'll Bite You Can **CATCH 'EM** With The **FISHING GADGET** Sets Hook Automatically



The greatest fishing invention since the fish-hook! Automatically sets the hook on fish that bite. First day's results insure lifetime use. Will last for years. Made of non-corrosive metal. Use on any line . . . for any kind of fishing. See your dealer or send coupon and \$1 bill for your Fishin' Gadget. . . Now! **MONEY-BACK GUARANTEE**

Send Coupon and \$1 Bill

Sent Postpaid Get Yours Now!

GRAHAM-CAMPBELL CO.
1405-7 Walnut St., Kansas City 6, Mo.

Here is a \$1 Bill. Send me a Fishin' Gadget quick!

NAME _____
STREET _____
TOWN _____ STATE _____

RADIO Assembly Kit



Only **\$3.49**

FREE

With each set we send booklet on Radio Theory and Trouble Shooting

Think of it! Now you can build a radio that really works! No batteries, no electric plug-in. You'll be thrilled with the results. Comes complete with all parts and standard earphones. Sent C.O.D. plus postage or send \$3.49 and we ship postpaid.

DISCO SALES, INC., Dept. PR3
154 Nassau St., N. Y. 7, N. Y.

HELPFUL BOOKS

Send post card asking for **FREE catalog**
Popular Mechanics Press, 200 E. Ontario, Dept. 601, Chicago 11

30 PIECE GRINDING WHEEL ASSORTMENT

FOR INDUSTRY & HOME SHOP

WAR SURPLUS ALL NEW!



Known names—NORTON—CARBURUNDUM—MACKLIN—MANHATTAN includes assortment of sizes invaluable for industry and home-workshop. If wheels were bought singly, value would be over \$30.00. Amazingly low price for complete assortment of 30 new grinding wheels only \$4.95 postpaid in U. S. Send check or money order today.

ONLY \$4.95 POST PAID

MOUNTED GRINDING POINTS— all new! Special "Hurry-up" offer gets you SEVEN mounted grinding points. ONLY \$1.00 paid

GROBAN SUPPLY CO.

1522 So. Michigan Avenue, Dept. M, Chicago 5, Ill.

"WONTWIST" ANIMAL TETHER



SAFE FOR ALL ANIMALS, BALL REVOLVES IN ALL DIRECTIONS.

Send Check or Money Order \$2.95 DEPT. P-6 Price Includes Delivery Charges

THE HAYDEN CO., Bryn Mawr, Pa.

AT LAST YOU CAN TIE-OUT YOUR ANIMAL SAFELY!

STRONG EFFICIENT



Save a Thousand Hours Hard Labor



\$16.50 postpaid

extra blades; two pulleys—all beautifully finished. Sent \$16.50 postpaid. 10" rubber tired wheels to match \$3.25 each. Dealers and mfrs. write for discount.

THE WEBB MFG. CO., 703 E. Poplar Avenue, Arkansas City, Kans.

POCKET TOOL



Handy, useful, something you need many times during the day. Regardless of where you work—in the factory—around the home—on the farm—this patented "Lucky 7" pocket tool will be worth its small cost many times over. Made of case-hardened steel— $\frac{1}{8}$ " thick—1" wide and $3\frac{1}{2}$ " long. Screw driver, rule, square, wrench, wire splicer, tack puller, bottle opener, friction top can opener, wire insulation stripper and other uses. Send only 25c in coins at once—and get yours, postpaid, while they last. Satisfaction guaranteed or your money back. YATES MFG. CO., 611 MAIN ST., LAKE GENEVA, WIS.

WOOD WORKERS

LUMBER—PLYWOOD AVAILABLE

Harold Hunt wants to send new No. 15 catalog. Over 124 pages of woodworking ideas, UNEQUALLED BARGAINS in imported and American woods, supplies, hard-to-find hardware. Send only 10c to cover postage and handling.

CRAFTSMAN WOOD SERVICE CO. 2729 S. Mary St., Dept. A-71, Chicago 8, Ill.

only 10¢



OTTAWA TRACTOR SAW



350 CUTS PER MINUTE

Make money sawing wood. Use Ottawa—fastest cutting. Cuts large, small logs easiest way. Fells trees. One man operates. Thousands in use. Built to last with heavy, stiff saw blade. Positive safety clutch control: uses power take-off any tractor.

OTTAWA MFG. CO., D-727 Forest Ave., Ottawa, Kan.

FREE BOOK and Price List

AIR COMPRESSORS

CURTIS TWO STAGE AIR COOLED 5 1/4 H.P. BRIGGS & STRATTON ENGINE

\$348.00

F.O.B. CHICAGO OR YOUNGSTOWN, OHIO

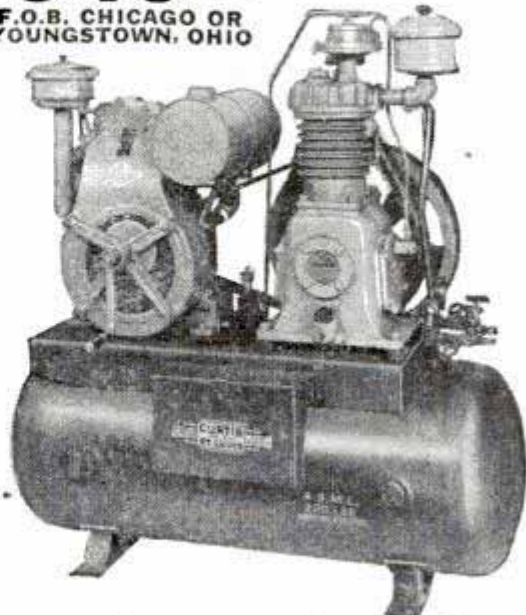

Regular \$475.00 Value for \$348.00

Compressor two stage, size low cylinder, Bore 4 3/16, Stroke 3 1/2 High cyl. 2 1/8 x 3 1/2. Air cooled. Displacement—17 C.F.M. at 200 lb. pressure. 24 C.F.M. at 100 lb. pressure. Engine Briggs & Stratton 5 1/4 H.P. Air Cooled Model Z. Air receiver size 16 x 44 A.S.M.E. Complete with centrifugal unloader, (unit idles when maximum pressure reached). Safety valve, pressure gauge, draincock, 4 air discharge outlets, 50 ft. air hose. Manufactured by Curtis Compressor Co., St. Louis, Mo. Brand new in original factory crates. Shipping weight 700 lbs.

Can be operated with 3 or 5 H.P. electric motor.

LELAND A.C. GENERATORS

Special Low Price

\$67.50

F.O.B. CHICAGO



2500 watts, 110 volt, 60 cycle, A.C. single phase, 1800 R.P.M. self-excited. Mfg. by Leland Electric, Dayton, Ohio. Brand new in original factory crates. Shipping weight 135 lbs. Regulator.

\$132.00 Value for \$67.50 F.O.B. Chicago, Ill.

Guaranteed as represented. Sold with money back guarantee. In stock for immediate delivery. Send check or money order.

Write for Dealer's Quantity Prices

J & H EQUIPMENT CO.

1132 S. CANAL ST., DEPT. P 7, CHICAGO 7, ILL.

FREE

Send for it
NOW



New 1946 Radio Parts
and Equipment

CATALOG

SERVICEMEN! Dealers! Soundmen! Amateurs! Builders! Here's your handiest, most complete 1946 Buying Guide for Everything in Radio! Features latest sets, parts, equipment of nationally known quality at lowest prices. Assures fastest service from world's largest and most complete stocks under one roof. Expert staff ready to help you.



**NEW RADIO SETS
COMPLETE SOUND SYSTEMS
LATEST HAM GEAR
ALL SERVICE EQUIPMENT
BUILDER'S SUPPLIES
RADIO BOOKS**



OVER 10,000 ITEMS

Everything for every radio use. New model radio sets, phonoradios, recorders, communication receivers, Ham kits, code apparatus, parts, tubes, tools, test instruments, public address equipment and accessories, low-cost easy-to-build kits, diagrams, matched parts lists, leading technical and non-technical books—at lowest prices.



ALLIED RADIO

ALLIED RADIO CORP.
833 W. Jackson Blvd., Dept. 5-G-6
Chicago 7, Illinois

Date.....

Rush new FREE 1946 CATALOG

Name.....

Address.....

City..... Zone..... State.....

comfort than the press galleries afforded.

This report would be incomplete without a mention of the one man who is literally indispensable to the entire communications setup. He is Major G. Robert Vincent, on leave from the Signal Corps for this vital assignment, who directed the installation of all the sound equipment and who sits in the control room, monitoring every word that is spoken in the meetings.

Seventeen microphones at the council table and four on the interpreters' table lead into his control panel and thence to the wide world. The public address system, radio, television, newsreels and recording devices—all are dependent on Major Vincent.

They could hardly be in better hands. Vincent, who has been working with sound for 34 of his 46 years, installed the equipment for the San Francisco Conference in two days and devised the amazing system for the Nuremberg trials by which a spectator may follow the proceedings in any one of four languages. Compared to that little job the Major considers the Security Council meeting a pushover—from the sound standpoint, anyway.

"Prep School" for Rocket Warfare

(Continued from page 87)

These include the angular rates around each of the three axes of the missile, position of each of the four control rudders, hinge movement on one control surface and longitudinal and transverse acceleration.

Small instruments in the rocket are actuated by these conditions and each of these mechanical quantities is made the frequency-controlling element of an audio-frequency oscillator. Five of the oscillators modulate a radio-frequency carrier wave of about 100 megacycles. The 10-channel instrument system consists of two five-channel groups, with the two transmitters using a common antenna that projects from the nose. The various frequencies are screened by filters on the ground and are separately transcribed on mechanical recorders.

Still under development, too, is a "radio link" that will permit a flight control operator on the ground to watch the flight of a rocket on a radar screen and signal corrections if the rocket appears to be veering away from its desired course. These corrections, picked up by a radio receiver in the nose of the missile, would be automatically applied to the air-operated rudder motors. All the details of this remote control system have not been worked out as yet but the general principles are well understood.

NOW READY!

Little Giant
5-TUBE SUPERHET
AC-DC LATEST MODEL

Immediate shipment. LITTLE GIANT-RADIO with latest in electronic development. 530 to 1730 KC. Permanent Magnet Speaker, New Sliding Pointer Dial with illumination. Handsome Walnut or Ivory neo-plastic cabinet. Brings in the stations you want sharp and clear. Send remittance or send \$5.00 deposit and we will ship C.O.D. for balance plus delivery charges. **AGENTS WANTED.** Make money on this and other models, also electric phonographs and record changers. Write for Agents plan.



\$22⁹⁵

O.P.A. Ceiling

ONE-A-LUX RADIO & TELEVISION CO.

Dept. 7PM, 303 W. 42nd St., New York 1, N. Y.

WAR SURPLUS BARGAINS!

LIFE VESTS RUBBER BOATS OUTBOARD MOTORS SHIPS BELLS



The famous "MAE WEST" inflatable life preserver. Light weight, folds flat. Good condition. . . \$1.85. Please add 15c for postage and handling.

RUBBER BOATS—marvelous, inflatable light weight boats. Pump easily, fold into small space. Lots of fun for beach, sports, useful as dingey. Five man capacity, \$49.00.

SPEED—35 H.P. OUTBOARD MOTORS made by Evinrude to Army specifications. 5,500 RPM, wt. 198 lbs. Brand new—\$410.00 FOB.

SHIPS BELLS—Genuine Navy 10" bell, excellent tone. Boats, farms, camps, etc. \$10.00 postpaid. Check or Money Order • Other Bargains

M & E MARINE SUPPLY COMPANY

P.O. BOX 601, CAMDEN, N. J.

NEW ALL PURPOSE SCISSOR JACK

- Takes "Headache" Out of Flats.
 - Auto Won't Slip Off Jack.
 - Saves Time and Money.
- Lifts 2 tons like it was "feather weight." Gets under hard to get places as low as 4 3/4". Lifts as high as 13". For autos, farm machinery, buildings, etc. Lasts a lifetime. Satisfaction guaranteed. Send check or M. O.

Only **\$7.50**

Jumbo Products Co.
Dept. 107, Mission, Kansas.

Write For FREE Literature



BURNING-PEN ELECTRIC, COOL HANDLE BURN, ETCH, EMBOSS, WRITE, TRACE in gold beautiful designs, cartoons, etc. on WOOD, leather, metal, cloth. **\$2.50** for all—2 points, 10 plaques, gold-foil, instruction course. American Standard Labs. 1208 N. 13th St., Philadelphia, Pa.

NEW DDT APPLICATOR

TREATS A SCREEN
in 60 seconds
with supply of
N&K INSECTICIDE PAINT

Both for **49c**

Use 2-WAY REPELLENT • 4 TIMES BETTER
NASH & KINSELLA LABS., INC. • ST. LOUIS 4, MO.

WOODWORKERS... Get this

CONSTANTINE MASTER MANUAL
Get the Most Fun From Your Hobby Indispensable to woodworkers. Newest, biggest edition, more pages, more color, helpful how-to-do-it articles, pre-war and new items, more bargains. Send 25c today and we will include **FREE! FULL YRS. SUBSCRIPTION** to Chips and Chats, published bi-monthly. Keeps you up-to-date on everything in woodworking, offers big money-saving bargains. Send now. **ALBERT CONSTANTINE & SON, Inc.** 791-L, 135th Street, New York 54, N. Y.



SAY YOU SAW IT IN POPULAR MECHANICS

Emergency SIGNAL MIRROR

...WITH A
10-MILE SIGNALING RANGE!

... for SPORTSMEN • BOY SCOUTS
FOREST RANGERS • SEAMEN • AVIATORS

Catch a sunbeam and signal accurately to a distant objective on the horizon or in the air with this pocket-size (4" x 5") mirror of tempered resistant-to-shock plate glass. With the cross-shaped aperture in the center, a beam of cross-marked light can be aimed at the target by facing the mirror between the sun and the objective. The thin mirroring film of vaporized aluminum makes it effective through the widest angle from the sun.

Full instructions clearly printed on the opaque lacquered back surface of the mirror. Convenient lanyard, easily suspended from the neck, attached through a hole in one of the rounded corners. Easy to carry—resistant to corrosion—hard to lose or break.

Designed for life-saving purposes for the Armed Forces by General Electric Company in cooperation with the National Bureau of Standards.

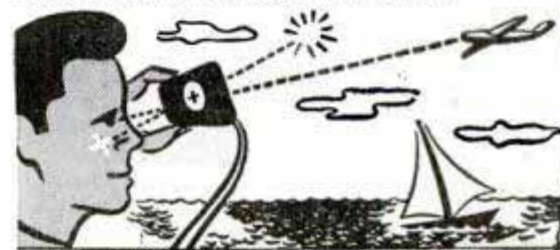

FOR SAFER, SUNNIER WORK OR PLAY,
ORDER YOUR SIGNALING MIRROR TODAY!
Send \$1 with your name and address to Dept. P

ALL-STATE BOX CORPORATION
949 BROADWAY NEW YORK 10 N Y

WE INVITE AMBITIOUS INDUSTRIAL SALESMEN

who want a permanent connection with a real future, with one of America's recognized leaders* in the industrial stoker and combustion engineering field to write us. In certain locations, we can help an alert energetic individual get started as a dealer, in business for himself, by selling our engineering and equipment. A good salesman or dealer who applies himself, should net from \$6000 up annually. **ADDRESS: MANAGER, BOX 879, CHICAGO, ILL.**

GET THE BEST IN MUFFLERS V-8 DUALS & SINGLES



Finest Norman custom-built muffler sets — steel pack — torpedo type — heavy, perforated steel cores — chrome enamel finish — mellow, deep tone (improves with use) — designed to fit — all ways superior — double economy.

DUALS.....\$17.50 **SINGLES.....\$7.00**
V-8 Ford-Mercury Buick, Olds., Chrys.
SINGLES.....\$5.50 ORDER TODAY! Will outlast three ordinary mufflers.
Chev., Ford, Plym.

Distributors — Write for Full Details

NORMAN'S MUSICAL MUFFLERS

Dept. PM-5, 1216 W. Stauson Ave., Los Angeles 44, Calif.

NEW SOLDERING GUN

WELLER SPEED IRON* HEATS INSTANTLY



USE SPEED IRON FOR, Home Workshop, Radio Service, Telephone Installation, Electronic and Sound Maintenance, Appliance Repair, Laboratory Work.

New gun type soldering tool produces heat instantly by induction principle in soldering tip. Built-in transformer provides 400 ampere heating current when trigger switch is closed. Fast 5 second heating saves power, saves time, saves tip dressing and burning. Loop type tip is adjustable, gets into corners, lets you see where you are working. Short pistol grip gets you close to work, good balance makes tool very easy to handle. Can solder with aluminum solder or tin-lead solder. The soldering gun gives you for the first time really fast induction generated heat combined with real convenience of use. For the finest and most advanced soldering tool that money can buy, order a Speed Iron today! Price Complete \$14.95 Postpaid 110 Volt A.C.-60 cycle ORDER DIRECT *T. M. U. S. Reg. Pat. Off.

WELLER MFG. CO.

522 Northampton St.
Easton, Pa.

SMOKE IN BED?



DON'T—unless you use the sensational new **6 IN 1 CIG-SMOKER**. Designed scientifically for safe-clean-filtered cigarette smoking. See the Cig burn inside this miracle, durable Silverglas creation. It combines a Holder, Filter, Fire Shield, Ash Guard, Smoke Cooler and Automatic Snuffer. **PREVENTS** fires, burns, ash mess, accidents, and irritating smoking. It's weather and windproof. New thrills in smoking . . . nothing else like it. Sample Cig-Smoker \$1.00 post-paid A Guaranteed 100 Cig-Filters Product

Agents, Dealers,
Exporters, Write

Pat. & Mfr., **SAFE-GARD MFG. CO.**
21 Perry-Payne Bldg. Cleveland 13, Ohio



New! Complete!
RADIO
CATALOG

READY NOW! Send For Your FREE Copy!

Radio sets...radio kits (including 19 Popular Mechanics Kits)...radio parts...electronic equipment...amplifiers...complete, standard lines of post-war designed equipment and supplies; pages and pages of what you've been waiting for...in the new Concord Catalog, ready now! Rush coupon for your copy...sent FREE!

CONCORD RADIO CORP.

LAFAYETTE RADIO CORPORATION
CHICAGO 7, ILL. 901 W. Jackson Blvd. • 265 Peachtree St. ATLANTA 3, GA.

CONCORD RADIO CORPORATION, Dept. P-76
901 W. Jackson Blvd., Chicago 7, Ill.
Rush FREE copy of new, complete Concord Catalog.

Name
Address
City State

Now You Can Make Quick Easy Sales

EARN BIG MONEY

Here is one of those unique devices that pop up in a BIG DEMAND MARKET that is an INSTANT SUCCESS... Housewives just cannot be without this Automatic Clothes Prop... In use it is perfect for the proper length... when not in use it is easily put away 'n little space... Strong, Durable and Automatic.

AGENTS, DISTRIBUTORS WANTED EVERYWHERE

SALES EVERYWHERE... HOUSEWIVES AMAZED

Sales are Quick, simply show it and the sale is made... Each sale sells many more in the same locality... Dealers are also enthusiastic buyers to supply their demand... If you are ambitious this is a natural MONEY-MAKER.

New Kind of Clothes Prop — AUTOMATIC —

Housewives like every feature of this AMAZING INVENTION; even the safety catch that holds the line to the Clothes Prop... The stronger the wind the more efficient; it takes up the slack in the line.

ADJUSTS LENGTH
from 4½ to 9 feet

TREMENDOUS DEMAND

Be The First in Your Territory

IVANHOE SPORTING AND MFG. CO. Sample \$1.50 Prepaid
318 SO. JAMES ST., DEPT. P-7, LUDINGTON, MICH.



DON'T LET GRAY HAIR STOP YOU

Duzz-It will soften the shade and gradually blend your gray hair into its natural color within two to four weeks if used as directed. Sold on a money back guarantee.

\$1.75
INC. TAX

DUZZ-IT CHEMICAL WORKS
1912 S. DRAKE AVE. CHICAGO 23, ILL.



MODEL MOTORS

AC: Shaded Pole Induction Type; Model Builders! Here is a Midget Motor that will fill your requirements as a power source in your model building. Motor is equipped with magnetic clutch action to obtain instant stop of slow speed shaft and is reversible in rotation.

Performance and Specifications: Voltages: 6-12-24 and 110 volts, 60 cycles AC, R.F.M., 3000 without gear reduction, 1-6-15-26 or 87 with gear reduction. Dimensions: 3-7/16-1 1/4-2 in., with gear reduction. 2-1 1/4-1 1/2 without gear reduction.

PRICE: Unit with gear reduction.....\$9.75
PRICE: Motor without gear reduction.....\$5.75
Other model motors available. Write to:

F. M. Macken, Model Motors, 4824 W. Kinzie St., Chicago, Ill.



New! 12" Sheet Metal Brake Only \$12

Fits in bench vise. Quickly, easily forms all kinds of angles in sheet metal, strap iron and aluminum, wire and plastic. Use it to make useful articles, experimental research work, patent models, etc. Simple gages made for quantity duplicating. Now available. Send for details or order direct. C.O.D. \$2.00 deposit. Wt. 9 lbs.

WISE BRAKE MFG. CO.

1318 So. 30th Ave., Omaha 5, Nebr.



Beautiful brass Social Security plates (illustrated 1/2 actual size), priced at only 50c. Please print your name & number plainly.

ACME

Stamping Service
Box 836
Davenport, Iowa



MACHINE SHOP EQUIPMENT

Every man who owns a workshop should have a copy of this new, authentic catalog of Machine Shop Equipment... the latest tools made by the biggest manufacturers in the United States. Replete with illustrations, descriptions, prices. Prompt delivery on most tools listed in this catalog. Available at the cost of printing—50c a copy—Get yours today! Price of Catalog Refunded on First Order over \$5.00. Send check or Money Order to

CENTER TOOL CO.

154 Centre St., New York 13, N. Y.

Now Make Your Own FROZEN SUCKERS



**QUICK, EASY, INEXPENSIVE
USE**

- Soft Drinks • Fruit Juices
- Beverage Powder
- Your Favorite Drink

For a real treat make wholesome refrigerator suckers at home in a specially treated rubber mold.

WILCA SPECIALTY CO.
Box 229 • Akron, Ohio

\$100
POSTPAID
Money
Back
Guarantee

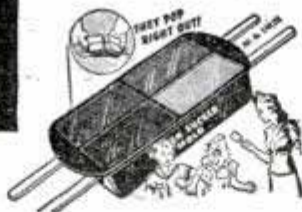

BE A WEATHERSTRIP CONTRACTOR



DOUBLE SEAL
Trademark

Windows and doors need weatherstripping. Demonstrate and install the best. Our elaborate mounted sliding samples on panel give you a quick-selling demonstration. Our Double Seal Weatherstrip has many exclusive features which eliminate competition. There are three types for windows and two types for doors. Easy to sell. Easy to install. Stops rattle, dust, cold air. Saves fuel. Permits free working window. For Demonstration Panel send \$2 which will be credited to your first order. Write for list of wholesale prices and details.

Act now. Write to-day!

DOUBLE SEAL CO., 2725 Ross Ave., WACO, TEXAS

BURN YOUR NAME ON TOOLS

WITH THE ARKOGRAF

PROTECT YOUR TOOLS FROM THEFT
Write with electricity any name or design on the hardest and finest tools and instruments or any metal, like writing on paper with pen or pencil. Thousands used by mechanics, garages, machine shops. **Complete Outfit \$3.50—Prepaid Anywhere**. Interesting illustrated circulars free. **Write today.** ARKOGRAF PEN CO., 3927 S.E. Stark, Portland 15, Ore.

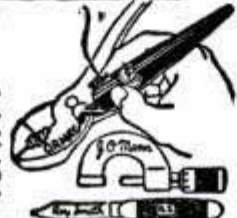

REPAIR YOUR OWN ELECTRIC APPLIANCES

WITH NEW AMAZING NICHROCITE



Simply overlap ends, apply Nichrocite paste and turn on the current—a perfect weld results. Used by big utility companies and repair shops. Just the thing for that broken or burned out heating element in your electric iron, stove, toaster or heater. Does the job in a jiffy. Trial order, \$1; 4 ozs., \$2.50; 1 lb., \$8.00.



Handy for Home or Industrial Use

ARMSTRONG ELECTRIC CO., Box 861-MP, Minneapolis, Minn.

New BULL-DOG Tractor Lift

Made by
OTTAWA Mfg. Co.
Our 42nd Year

Replaces Pitch
Forks & Shovels



Hay Rake and Stacker Attachment Also Available
The BULL-DOG Tractor Lift makes easy, fast moving of manure, dirt, sand, gravel, snow, barrels, etc. Builds ponds. Lifts machinery for loading. Latest hydraulic engineering features. Does a thousand jobs on farms, parks, highways. Guaranteed. Write today for details.

OTTAWA MFG. CO., 727 Allen St., Ottawa, Kansas

RIDE ONE and you'll buy one!



Make Your Bike a Motor Bike With a **WHIZZER** Motor!

The modern idea in dependable, low-cost transportation. Thoroughly proved through eight years of service. Fits any balloon-tired bike. Opens up thrilling new adventure and travel opportunities. Use it on your vacation, for errands, shopping, recreation, business, work. 2½ h.p.—drives through V-belt, unaffected by road or weather conditions. Speeds up to 35 m.p.h. 125 miles per gallon of gas. Plenty of power for hills. Does not interfere with normal pedaling of bike. Put a Whizzer on your bike now! Easily installed. See your dealer or mail coupon now. **WHIZZER MOTOR COMPANY, Pontiac 15, Michigan.**

**FACTORY
LIST PRICE**

\$89.50
PLUS
TAX

Precision - designed, precision - built by automotive craftsmen in the heart of the auto industry. And auto-type assembly line production has brought its price within reach of all!

Price Subject to Change Without Notice

IF NO LOCAL DEALER, USE COUPON

WHIZZER MOTOR COMPANY
Dept. 167, Pontiac 15, Mich.

I enclose \$91.60, including \$2.10 Federal Excise Tax, () check or () money order. Send me one Whizzer motor, complete, tax paid, with full installation instructions. Written guarantee with every motor.

If descriptive literature only is desired, check here ().

NAME _____

ADDRESS _____

CITY _____ STATE _____

SPEED TO SPARE!

WALTON Streamlined WHEELS

LEAD THE FIELD with speedy, rugged WALTON WHEELS. Cold rolled, electric welded steel hub. Oil smooth bearings for 1/2" axle. Extra rubber for longer wear. Inner air-cushion for velvet smooth, silent riding. Nifty appearance. TOP QUALITY!

**HUSKY
8x2**
Jumbo Balloon
**PUNCTURE PROOF
TIRE**
complete with wheel

MAKE SPEEDY COASTER WAGONS

**SCOOTERS • RACERS
PUSHMOBILES
WHEELBARROWS • CARTS
SAILMOBILES
and Other Vehicles**

WALTON WHEELS give you speed to spare! Popular 8x2 size ideal for making delivery carts, Hot Dog Wagons, canoe carriers, etc. You can make many things for practical use and play with these wheels.



\$2.75
EACH

COMPLETE
Including Tire
and Bearings

IN SETS OF TWO
Single Wheels \$3.25
\$10.80 for Four

Walton Wheels are completely assembled ready to use, including bearings. Axles and other parts are obtainable locally.

CASH WITH ORDER or Parcel Post C. O. D.
Instruction plans FREE with every order for making coaster wagon, scooter, wheelbarrows, etc. SEND YOUR ORDER TO

WALTON WHEEL COMPANY
Plankington Bldg., Milwaukee 3, Wis.

**NEW! AUTOMATIC
4 INCH C CLAMP**

Sensational war-development. The Gordon Automatic "C" clamp now available for you!

CLOSING ADJUSTMENTS:

Push screw handle forward, give it a quarter turn insuring a bull-dog grip on the work that cannot open.

FOR AUTOMATIC INSTANTANEOUS RELEASE:

Release tension by quarter turn of screw handle, press "magic release button," presto! clamp is open.

SPECIFICATIONS:

Special steel alloy construction. Drop forged! Indestructible tool hardened thread! Four inch opening with wide throat capacity! Patented Gordon automatic close and release feature!

If your dealer doesn't carry Gordon Automatic Clamps, order today by mail. Send Cash, Money Order or C.O.D. \$4.50 each, post paid. If you live west of the Mississippi add thirty-five cents additional for postage.

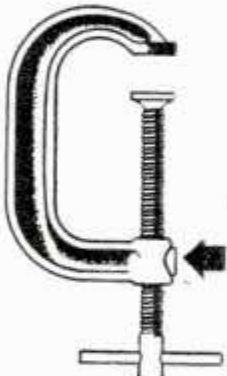

SATISFACTION GUARANTEED OR MONEY CHEERFULLY REFUNDED.

GORDON AUTOMATIC TOOL CORP.
50 Hamilton Avenue, Paterson 1, N. J.
DEALERS AND DISTRIBUTORS WANTED

BRIGHT EYES

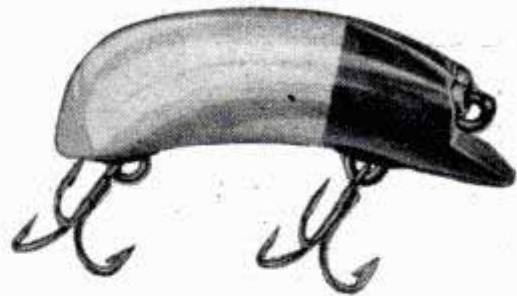

The sweetest casting lure you've ever used. Its ultra modern design—its exciting, whip-like action—its appeal to ALL game fish—its bright staring eyes that literally bore a path through the water—make it a must for the coming fishing season. Either a deep running, or surface lure, depending on speed of retrieve. Made of tenite, with two #1 P & K American made, nickel plated, treble hooks with extra sharp ground points. In 8 flashing color combinations. No. 44RW (Red & White), 44WL (Black body with white lateral line), 44YP (Yellow Perch), 44F (Frog), 44P (Pike), 44R (Rainbow), 44GS (Green Scallo), 44PR (Pearl). \$1.10 each.

We prefer that you buy P & K at your favorite dealer—BUT, if he hasn't it, you can order direct.

"ADVENTURES IN FISHING"

Just off the press. 32 pages—articles by Cal Johnson, famous outdoor writer and fishing authority—pictures in full color of P & K Lures and Accessories—hunting and fishing photos, etc. A regular 10c package of Raparound, the Invisible Ribbon Sinker, a MUST for Fly Fishermen, and this booklet, for only 10c, mailed postpaid. SEND YOUR DIME TODAY!



PACHNER & KOLLER, INC.

3428 Archer Ave.

Chicago 8, Ill.

TESTED AND PROVED LURES AND FISHING ACCESSORIES

**Science Introduces a New Toy
ROTOSPHERE GYROSCOPE**



Does Tricks:
Walks on a Wire
Spins in a Box, Balances on a Pencil Point—other interesting stunts

Here's destiny's toy—an adaptation of the scientific principles employed in Gyroscope used for steering torpedoes, stabilizing ships, automatic pilots, other ultra-modern devices. The Rotosphere Gyroscope top demonstrates principles of the law of gravity and centrifugal force. You can perform many scientific experiments and have a world of fun with this captivating toy that's scientifically precision built. A toy children love—as good as a circus—more fun than a barrel of monkeys.

SPECIAL INTRODUCTORY OFFER:

For 30 days, we offer readers of Popular Mechanics 2 Rotosphere tops complete with spinning cord and full directions, together with a scientific kit containing a new booklet on the physics of the Gyroscope, stunt pedestal, fine wire for balancing experiments—all for only \$2.98 Prepaid. Single top without kit and extras \$1.49 Postpaid. To avoid disappointment or delay, send for yours today. Sent C.O.D. if preferred. AGENTS: Big profits, quick sales. Good territory still open. Order 100—\$60.00 F.O.B. K. C., Mo. 25% cash. Balance C.O.D.

ROTO-SPHERE COMPANY Dept. C, 620 Wyandotte Street
KANSAS CITY 6, MISSOURI

PLEXIGLAS

**The Crystal-Clear Versatile Plastic
COLORED AND TRANSPARENT**

Our complete warehouse facilities afford you great savings on guaranteed Grade 'A' Plexiglas.

ORDERS PROMPTLY FILLED

CLEAR PLEXIGLAS SHEETS, NEW PER SQ. FOOT:

1/16 \$1.24 3/16 \$1.97
1/8 \$1.61 1/4 \$2.31

COLORED PLEXIGLAS SHEETS: 10% ADDITIONAL
Add 10% for packaging on orders under \$10.

Write for free literature on Plastics and how to work them. Price lists on request for complete line of rods, sheets, tubes, odd shapes in all types of Plastics. Also dyes, cements, buffing compounds.

All Prices subject to change without notice.

HOUSE OF PLASTICS

7604 Fenkell

Detroit 21, Mich.

Aluminum Bottle-Cap Remover Operates Like Pair of Pliers



Operated like a pair of pliers, a new bottle-cap remover has two handles that are squeezed to lift the cap free, minimizing the danger of breaking the bottle. A bell-shaped dome fits over the cap and the neck of the bottle, preventing the contents from foaming over. The opener is made of polished aluminum.

Transparent Plastic Saw Guard



Eyes of workers at the Douglas Aircraft plant are protected from flying pieces of metal by a transparent guard which fits over a spinning saw. The transparency of the shield gives operators a full view of their work. It can be quickly adjusted to fit evenly over the saw blade and also to the proper height to clear work pieces of varying thickness.

☐ In his first flight at Kitty Hawk in 1903 Orville Wright was airborne 120 feet, less than the wing span of today's superbomber.

Sensational New Blade Cutter

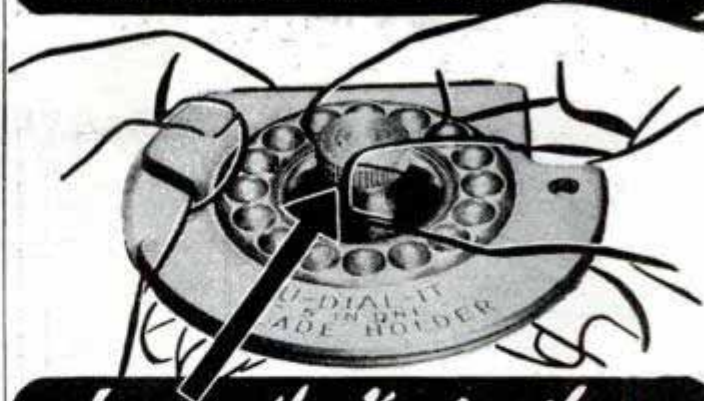

Loosen the Knob - then
U-DIAL-IT
to any desired cutting position
DOZENS OF USES
Around Home, Office, School, Shop and Camp!



DIAL 1-IT SCRAPES

Wonderful for removing putty, paint, stickers, labels, etc.

SCRAPER



DIAL 2-IT SLICES

Just right for cardboard, heavy paper, mats, textiles, thin wood etc.

CORD CUTTER

DIAL 3-IT CUTS

So handy for cutting cord, string, thread, fishing line, leaders, etc.



DIAL 4-IT RIPS

The best tool you've tried for ripping out stitches and basting quickly neatly.



DIAL 5-IT CUTS

Amazing for shallow cuts... you can cut out clippings without spoiling other pages of magazine or newspaper

PAPER CUTTER

DIAL CL-IT'S CLOSED

Blade is fully guarded, cutter safe to carry in pocket.



SLICER



RIPPER



CLOSED

30¢
eg.
POSTAGE PAID
SEND COIN OR
MONEY ORDER

The U-Dial-It consists of only 3 parts...made of aluminum, light but sturdy... plus double edge razor blade. Each U-Dial-It comes complete with blade and instruction card. Some territories open for distributors and jobbers.

DON'T DELAY · ORDER TODAY · YOU'LL WANT SEVERAL!

H. R. BASFORD COMPANY
425 SECOND STREET, SAN FRANCISCO 7, CALIF.

ELECTRICITY FOR ANY JOB ANYWHERE

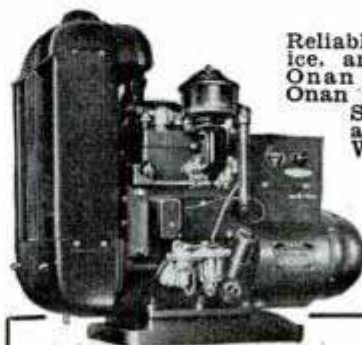

Reliable, economical electric service, anywhere, anytime, with an Onan Electric Plant. Driven by Onan 4-cycle, gasoline engines. Single-unit, compact design and sturdy construction. Water or air cooled.

Capacity range: 350 to 35,000 watts; 115 to 660 volts A.C., 50 to 800 cycles; 6 to 800 volts D.C. Combination A.C.-D.C. types. 65 different models

WRITE FOR FOLDER

ONAN

D. W. Onan & Sons, 2519 Royalston Ave., Minneapolis 5, Minn.

minijet



A modern jet propulsion motor scaled down to fit the design requirements of model building enthusiasts. Can become an integral part of model planes, speed boats and cars. Extremely low frontal area and 27" length allow speed model designs with exceptionally low drag — speed being limited by aerodynamic cleanliness of model construction.

See your dealer now to insure receiving your MINIJET early. Be ready to compete in the new super-speed jet class.

SPECIFICATIONS

- TYPE — Resonating Jet
- WEIGHT — 16 oz. (Approx.)
- DIAMETER — 2 in.
- LENGTH — 27 1/2 in.
- THRUST — 2 lbs. (plus)
- CG FROM NOSE — 5 1/4 in.
- STARTING — Hand fire pump
- SPARK PLUG — Champion V-3
- FREQUENCY — 210-230/sec.



MINIJET MOTORS

161 East California St.
Pasadena 5, Calif., U. S. A.

ELECTRIC DOOR OPENER



for the Home

Let the youngsters in or out of doors without leaving your work. ELECTRELEAVE opens garage, cellar or other doors without going out or downstairs.

Great, too, for den or workshop when you don't want to leave your work. Operates on house current through transformer or batteries. Easy to install. Guaranteed. Opener supplied with buzzer.

Send check or money order to
ARROW METAL PRODUCTS
2 Depot Plaza, White Plains, N. Y.
Territories are open for distributors

\$2.95

PHOTO ENLARGEMENTS



Is Photography your hobby? Do you want a profitable easy business at home? Make **PHOTO ENLARGEMENTS** for yourself and others. Your cost 5c each and less. The **AU-TO-MATIC** requires no experience. Also **COPIES** any picture. \$9.60 COMPLETE. Interesting circular **FREE**.
PHOTO-SPHERE, Long Island City 3, New York

5¢
ANY SIZE

PICNIC STOVE and TRASH BURNER

Tree stump of durable reinforced Haydite concrete with grill, charcoal pan, grate. Burns trash safely.



Only \$29.45

Freight prepaid east of Rockies

For descriptive circular write to
W. O. JOHNSON CO., Dept. PM, Omaha 6, Neb.

THE GEM MAKER



Amateurs or professionals . . . hobbyists or jewelers . . . Polish your own gems with a B&I Gem Maker. You will find this a profitable adventure. All necessary lapidary equipment is furnished, including a super-charged diamond blade for sawing, and all wheels for grinding, shaping and polishing, also complete instructions. The complete equipment as shown, less motor and belt, for only \$29.50, f.o.b., Burlington, Wis. Write today for information and literature on the Gem Maker and accessories.
B&I MFG. CO., Dept. S, Burlington, Wis.

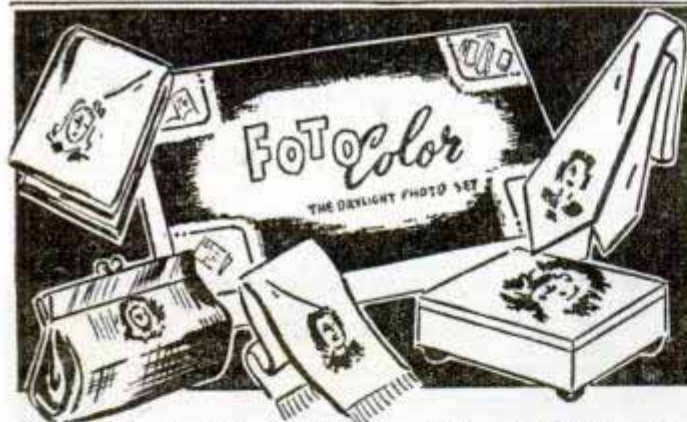

Print Pictures from Your Own Negatives at Home in 2 Minutes. Your Snapshot in Natural Color on Any Surface at Less Than 1c Each, with

FOTO COLOR The Magic Day-light Photo Set

● REPRODUCE YOUR PHOTOS AT HOME on ● SCARFS ● NECKTIES ● HANDKERCHIEFS ● STATIONERY ● PURSES, ETC. **\$1.95**

This MAGIC LIQUID Simplifies Photography. Simply take one drop of FOTO COLOR fluid, spread thinly on surface, place your negative over top and expose to light. Presto! you're finished. Anyone can become an expert. (Complete directions included)

ORDER DIRECT—TODAY . . . PROMPT SHIPMENT

UTILITY STORES

117 So. Wabash Ave., Dept. GG-23, Chicago 3, Illinois
I enclose \$ Ship at once FOTO-COLOR Sets at \$1.95 a set.

Name
PLEASE PRINT NAME AND ADDRESS
St. or R.F.D.
City State

FISH WORMS WITHOUT DIGGING



Get worms the easy way! Spend your time fishing, not digging worms. By using this new electric appliance worms shoot to the surface in seconds. This sturdy rod, handy and convenient, pays for itself. \$1.50 postpaid, with instructions. ORDER NOW! Agents wanted.

WIGGLE-OUT BAIT CO.
P.O. Box 126, Milwaukee Jct., Detroit, Mich.



MASTER CHAMPION LAWN MOWER SHARPENER

Also Mfg., Saw Sharpening & Key Machines

FRANK'S MFG. CO.

Lucas 6929
Dept. PM1, 3312 Tweedy Bl.
SOUTHGATE, CALIF., U.S.A.

Atlas
6"-10"
LATHES

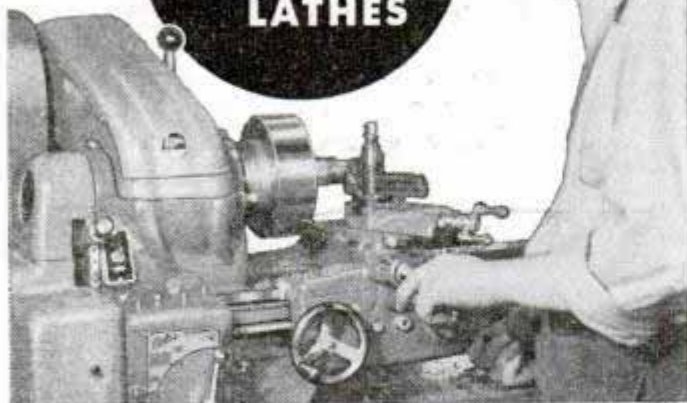

MANY MEN DO THEIR BEST SHOP WORK IN SUMMER

With a cool basement to invite them, thousands of men complete some of their best projects during hot summer evenings — and make plans for the busier months ahead. Atlas machine tools — lathes, drill presses, milling machines, shapers — vastly enlarge the scope of practical shop projects that you can undertake.

LOOK FOR THIS SIGN



ATLAS PRESS COMPANY
743 North Pitcher Street, Kalamazoo 130, Michigan

HULL AUTOMOBILE COMPASS



A travel companion that knows directions anywhere, any time.

Write for Circular

At your dealer's.

Price \$3.95

HULL MFG. CO., P. O. Box 246-D8, Warren, Ohio



You can Easily Install this

UNDERGROUND SPRINKLING SYSTEM



with **AQUASpray**
PATENT PENDING
SPRINKLER HEADS

DEPENDABLE • PERMANENT
SPRAY ADJUSTABLE TO 1/2 FOR SIDES
1/4 FOR CORNERS

Self-draining spray heads fit standard 1/2" pipe installed 3" below lawn surface.

For greener lawns—finer vegetables—less work. See your hardware dealer or write us for full information

Cost Complete, as Low as **\$35⁰⁰**

THE AQUA-SPRAY CO.

439 EAST FORT STREET • DETROIT 26, MICHIGAN

IT'S FUN to BUILD THE NEW LEJAY FAST-FREEZER

ENJOY BUILDING THIS HANDY FREEZER

When you consider how necessary such equipment is to the modern household, you will realize what these complete plans mean to men, like yourself, who enjoy making such things and get a big kick out of saving money in doing so. Its sturdy simplicity and ease of construction appeal to all handy men and amateurs.

PLANS ONLY

\$1⁰⁰



NO KNOWLEDGE OF REFRIGERATION REQUIRED

Plans are easy to follow and you may have much of the material at hand. FAST FREEZERS made from these plans have been in use since 1938.

MILK COOLER PLANS, TOO

are included at no extra cost. Send only \$1.00 for the complete plans. Canada, \$1.10.

LEJAY MFG. CO.

447 LeJay Building
Minneapolis 8, Minn.

FROZEN STORAGE
from 5° above to 10° below zero

For Fish, Meat, Game, Fruit etc.
5 Sizes
8-40 Cu.Ft. capacity

LAW

STUDY AT HOME for PERSONAL SUCCESS and LARGER EARNINGS. 35 years expert instruction—over 108,000 students enrolled. LL.B. Degree awarded. All texts furnished. Easy payments. Send for FREE BOOK—"Law and Executive Guidance."

AMERICAN EXTENSION SCHOOL OF LAW
Dept. 67-M, 646 N. Michigan Ave., Chicago 11, Ill.

WORLD'S LOWEST PRICED ADDING MACHINE

VEST POCKET SIZE

IDEAL FOR BUSINESS OR PERSONAL USE

FREE TRIAL
ONLY \$2⁵⁰
TOTAL COST
SEND NO MONEY

Each Baby Calculator in Beautiful, rich-looking Leatherette case—at no extra cost. **FREE!!**



Fits vest pocket or purse. Guaranteed accurate. Operated as easily, and as reliable, as machines costing many times as much. Not a toy. Substantially made of 28-gauge steel—guaranteed for life against defects in construction. You positively can't buy a calculator of equal quality for as little money. **ACCEPTED AS THE FINEST LOW PRICED CALCULATOR FOR OVER 30 YEARS!** Operates with a flick of your finger. Adds, subtracts, multiplies, divides—counts up to ten million. Pays for itself over and over in mistakes avoided, and time saved. **MAKES IDEAL GIFT.**

Sold on a positive money back guarantee. Send only \$2.50, Calculator sent postpaid, or send name and address and pay postman \$2.50 plus postage. **MONEY BACK IN 10 DAYS IF NOT DELIGHTED!** (If outside U. S. send \$3.00.) **AGENTS WANTED.**

CALCULATOR MACHINE CO. (Mfrs.)
Dept. 180, P. O. Box 248, Glenview, Illinois

Now Every Boy Can OWN A RACER

10 Inch ALL PURPOSE WHEELS for 1/2 in. AXLE

With GOODYEAR 10.00x1.75 SEMI-PNEUMATIC TIRES

BUILD YOUR OWN!

RACER—FOUR WHEEL TRUCK—WHEEL BARROW—GOLF BAG CARRIERS—MARKET CARRIERS—PUSHMOBILES—GARDEN TRUCKS—SCOOTERS—WAGONS—BEACH SAIL BOATS—TRAILERS FOR BIKES—GARDEN & PORCH FURNITURE—SERVICE STATION OIL or DISPLAY CASES, ETC. Will not injure plaster or linoleum floors.

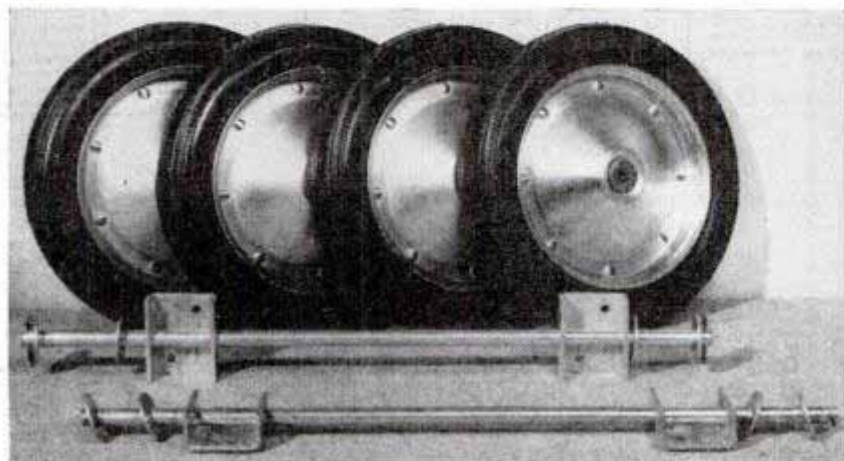

SHOWING 4 COMPLETE WHEELS, AXLES, ETC.

EXTRA HEAVY DEEP RIB TREAD STYLE 19 10" O.D. x 6 1/2" I.D. x 1 3/4" WIDE. MOUNTED ON 2 HEAVY STEEL DISCS. TIRE AND BEARING HELD FIRMLY TOGETHER WITH 8-3/16" RIVETS. THIS ASSURES PERFECT ALIGNMENT. EQUIPPED WITH GENUINE ARGUTO OILLESS BEARINGS—the bearing with the BUILT-IN Film of oil. UN-AFFECTED BY DUST or DIRT.

REAL FUN—SPEED GALORE

HERE THEY ARE — Just what every boy wishes for . . . GIVE HIM A REAL THRILL! MAKE HIM HAPPY! . . . Help him BUILD A RACER or one of the practical carriers that every boy likes . . . He'll be the talk of the neighborhood . . . Kit "B" and Kit "C" each contain 4 complete wheels, 4 tires, 2 axles, 4 hangers, etc. . . . Ready to use . . . In a few minutes he has a racer . . . The best kind of a gift . . . one he will enjoy.

A REAL GIFT FOR ANY BOY OR GIRL
Be First . . . Start a Soap Box Derby

NOTE THESE LOW PRICES

. . . Better Hurry!

1 COMPLETE 10" WHEEL WITH 10x1.75 TIRE \$2.90
2 COMPLETE 10" WHEELS (without axle) \$5.50
4 COMPLETE 10" WHEELS (without axle) \$10.00

Kit "A"—2 COMPLETE 10" WHEELS . . . 1-20" LONG x 1/2" dia.
AXLE—2 HEAVY HANGERS—4 WASHERS & 2 COTTER PINS—ALL PLATED—READY FOR USE . . . ONLY—\$7.50

Kit "B"—4 COMPLETE 10" WHEELS . . . 2-20" LONG x 1/2" dia.
AXLES—4 HEAVY HANGERS—8 WASHERS & 4 COTTER PINS—ALL PLATED—READY FOR USE . . . ONLY—\$13.50

Kit "C"—4 COMPLETE 10" WHEELS . . . 2-24" LONG x 5/8" dia.
AXLES—4 HEAVY HANGERS—8 WASHERS & 4 COTTER PINS—ALL PLATED—READY FOR USE . . . ONLY—\$16.00

F.O.B. Doylestown

Buy Direct from Manufacturer

BIG PRODUCTION — DIRECT SALES — YOU SAVE 50%

NOW any Boy or Girl can own a set of these MARVELOUS WHEELS AT THESE LOW PRICES . . . It has been many months since wheels of any kind have been available . . . The old type of wheel is gone! . . . In its place is this NEW 10 inch PRECISION BUILT WHEEL with GENUINE GOODYEAR RIB TREAD SEMI-PNEUMATIC TIRE . . . And Smooth Running BEARINGS . . . The best and YOU SAVE 50% . . . Better order at once for PROMPT SHIPMENT . . . Remit with order.

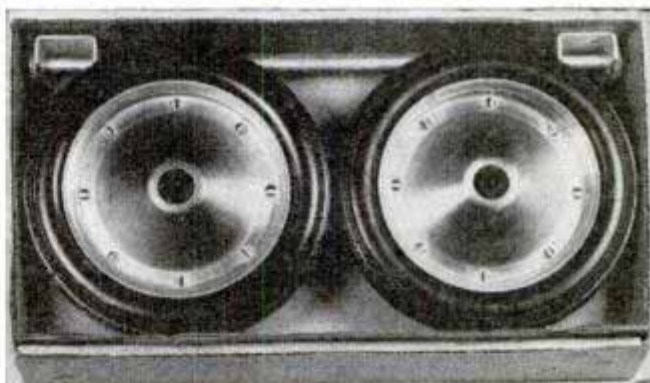

SHOWING 2 COMPLETE WHEELS, AXLE, ETC.

BUILT BY PRECISION AIRCRAFT PARTS MANUFACTURER . . .

These are not toy wheels . . . they are good, strong and precision built wheels in perfect alignment with the famous ARGUTO OILLESS BEARINGS . . . they spin like a top . . . good for SPEED . . . Letters and repeat orders tell how pleased our customers are . . . REAL BEST QUALITY . . . PRECISION BUILT WHEELS. Each wheel weighs approximately 3 1/2 lbs. . . . Axles and Hangers are designed for HEAVY DUTY like the wheels . . . All parts are bright Cadmium Plated . . . Each Kit neatly packed . . . An Ideal GIFT for Young or Old.

RUSH YOUR ORDER TODAY Write for Prices and Information for Our 12" DE LUXE ALUMINUM STEERING WHEEL
OSBORN WHEEL COMPANY, Dept. P-7, 115 So. Main St., Doylestown, Pa.



MOTO-TOOL ★ THE "POCKET-SIZE" MACHINE SHOP

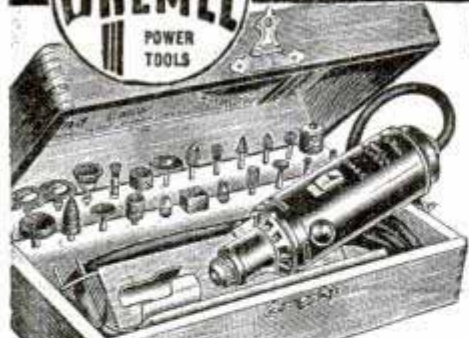

PUT THIS "WAR VETERAN" TO WORK

Tough grinding and polishing jobs in tool rooms and machine shops fade away under the speed and versatility of Dremel Moto-Tools. Thousands of Moto-Tools helped establish production records in plants such as General Electric, Westinghouse, Remington Arms, Ford, Nash-Kelvinator, Consolidated Aircraft, Northrop, and Douglas. Others earned the respect of the armed forces in far flung repair depots.

Only Moto-Tools Have All These Features
 A Model 2 Moto-Tool develops a speed of approximately 27,000 rpm. Weighs only 13 oz. Shaped to fit the hand. Sturdily built. Has shock-proof bakelite housing. Balanced for vibrationless operation. Uses 110-120 A.C. or D.C. current. Patented automatic chuck lock pin makes removal of accessories easy. Pin disengages automatically . . . prevents accidental burning out of motor.



A few of the jobs that can be done better and faster with a Moto-Tool.

MOTO-TOOL KIT
 Kit No. 2 with 23 high grade accessories and Model 2 Moto-Tool, in hardwood case. \$23.50
 Model 2 Moto-Tool, with 1 accessory . . . \$16.50

MONEY-BACK GUARANTEE
 Ask your Dealer about Dremel Moto-Tools and accessories. If he does not handle them, send direct to factory. We send prepaid if cash in full accompanies order. \$2.00 brings Moto-Tool C.O.D. for balance, plus postage. Write for FREE CATALOG.

MOTO-SAW COMING!
 Dremel Moto-Saw . . . the sensational electric scroll saw . . . will be back as soon as materials are available.

- 27,000 R.P.M.**
- | | | |
|--------------------------------------|-------------------------------------|-----------------------------------|
| <input type="checkbox"/> Sharpening | <input type="checkbox"/> Burring | <input type="checkbox"/> Cleaning |
| <input type="checkbox"/> Finishing | <input type="checkbox"/> Grinding | <input type="checkbox"/> Routing |
| <input type="checkbox"/> Touching Up | <input type="checkbox"/> Polishing | <input type="checkbox"/> Cutting |
| <input type="checkbox"/> Sanding | <input type="checkbox"/> Burnishing | <input type="checkbox"/> Rasping |
| <input type="checkbox"/> Drilling | <input type="checkbox"/> Inlaying | <input type="checkbox"/> Carving |
| <input type="checkbox"/> Mortising | <input type="checkbox"/> Sawing | <input type="checkbox"/> Brushing |
| <input type="checkbox"/> Engraving | <input type="checkbox"/> Scoring | <input type="checkbox"/> Dressing |

DREMEL MFG. CO., Dept. 116-G, RACINE, WISCONSIN

BLACK on WHITE for BETTER SIGHT

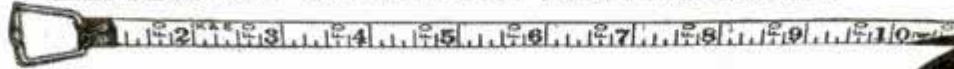

WYTEFACE Steel Tapes have black graduations on a crack-proof white surface. Easy to read in any light, from any angle. Faster measurements with fewer errors. Designed for hard service. Resists abrasion from rails, pipe, rocks, concrete. Protected against rust.



WYTEFACE
 TRADEMARK
STEEL MEASURING TAPES

KEUFFEL & ESSER CO.
 EST. 1867

NEW YORK • HOBOKEN, N. J.
CHICAGO • DETROIT • ST. LOUIS
SAN FRANCISCO • LOS ANGELES
MONTREAL



Drafting
 Reproduction
 Surveying Equipment
 and Materials
 Slide Rules
 Measuring Tapes

SILVER SOLDER KITS! For Silver Soldering ALL METALS



SOMETHING NEW. For Electricians, jewelers, dentists, garages, field service repair men, plumbers, farmers, refrigerator, and all types of brazing and fix-it-shops. **\$2.00 POST-PAID**

KIT INCLUDES:
 One 3 oz. Tube XCEL-FLUX "SS" Silver Solder Paste. Twenty 5-inch lengths (total 100 inches) of SILFOS and EASY-FLO Silver Brazing Alloy—1/8" - 1/16" and 1/32" wires, and one EASY-FLO .005" x 1" strip. **TRIAL SIZE with 45 in. Silver Solder Wire \$1.00.** (Jobbers write for Quantity Discounts)

PREST-O-LITE "4-in-1" TORCH OUTFITS
 For very fine to heavy Brazing & Silver Soldering, complete with carrying case \$6.50. Type MC gas tanks, 10 cu. ft. \$6.50, Type B, 40 cu. ft. \$12.50. Prices F.O.B. shipping point. Cash with order.
AMERICAN PRODUCTS CORP., 816 Lowell Bldg., Chicago 5, Ill.

SAY YOU SAW IT IN POPULAR MECHANICS

ELECTROPLATE by Brush IN YOUR OWN WORKSHOP

Complete plans with which anyone can make their own Electroplater, postpaid for \$1.00. All parts necessary can be purchased for under \$2.00. We give you source of supply. At the stroke of a brush you can Electroplate models, replate fishing tackle, worn articles, tools, fixtures, etc., with durable coat of metal, gold, nickel or silver. Send \$1.00 for your plans to
HART SALES ASSOCIATES, Dept. A, 1924 4th Ave. So., Minneapolis, Minn.

C-THRU-MIRRORS

Can be used wherever you want to watch others without being seen yourself. Framed in your front door, it allows you to see visitors thru what appears to them as a perfect mirror. Lasts indefinitely. 2" x 6" or 3" x 4" sizes. Money Back Guarantee. \$2.95 Postpaid. Send U.S. cash, check, or m.o. No C.O.D.

Dept. 21G, BEELER ENTERPRISES, No. Hollywood, Calif.

Now A DYNAMIC HEAVY DUTY INDUSTRIAL WELDER



IDEAL FOR AUTO - HOME APPLIANCE AND FARM REPAIRS
 DESIGNED TO DO HIGH GRADE WELDING INEXPENSIVELY—Maintenance Men; Farmers; Mechanics; Machine Shops; Foundries; Auto, General Repair and Job Welding Shops; all using the DYNAMIC find it so indispensable and useful that they cannot afford to be without it. If inexperienced, you can easily learn to do a variety of high grade welding jobs by following the practical, simplified operating and welding instructions furnished. Once you see a DYNAMIC in operation, you won't want to be without it. Its simplicity will amaze you. In a year the DYNAMIC only costs you about a day. Helmet, rods, cables, holder and operating instructions, etc., furnished.

SAVES YOU VALUABLE TIME AND MONEY!

This portable DYNAMIC WELDER—easily carried to the job—can be operated from any convenient, properly wired 110 volt, 60 cycle line. Can also be supplied for 220 volt, 60 cycle operation and for other voltages and cycles at slight additional cost. Works on IRON, STEEL, BRASS, BRONZE, AND OTHER METALS—has 8 metallic and carbon arc welding heat stages—does work you would think only possible with larger more expensive machine.

DYNAMIC WELDER CO. • 13 East 23rd St., FG, Chicago 16, Ill.

FOR ONLY \$23.50 COMPLETE...

AVAILABLE NOW WITHOUT PRIORITIES!

WRITE TODAY FOR PARTICULARS
 Get details on our 10 day trial offer

Member Chicago Association of Commerce

WAR

SURPLUS BARGAINS

* * * * *

SENSATIONAL VALUES FOR QUICK LIQUIDATION

BOMB PARACHUTES



Of fine white nylon fabric 5 x 8 feet in diameter with split seam for directional dropping. Designed for dropping fragmentation bombs, emergency rations, etc. Each packed in a metal container. Weight 13 lbs. No. R-162 Each only.. **\$1.95**

AIR CORPS PLASTIC FLASK SETS



Two handy, transparent plastic flasks with canvas case. Used by the U. S. Air Corps. Holds any kind of liquid. Each flask measures 4 1/4 x 1 1/4 inches. Has clamp-on top plus screw cap. Fine for use on camping trips, picnics, etc. Weight 1 lb. No. R-179—Set only **\$1.49**

POPULAR RECORD ASSORTMENT

This assortment of 50 records includes current dance, race, blues and hillbilly selections. These records have been used in juke boxes—but all are guaranteed perfect and playable. No two alike. Many famous name bands and artists included. Shipped express collect only—no exchanges, trades or refunds at this low price. Wgt. 28 lbs. No. A-303—50 records..... **\$9.64**



DIRECTIONAL COMPASS

For all outdoorsmen, boy scouts, etc. Liquid type, free acting and accurate. Gives direct reading. Tells you immediately what direction you are traveling. Plastic body measures 3 1/4 x 1 1/4 inches. Has waterproof compartment for matches. No. R-208 Each only **\$1.49**



BOOBY TRAP FIRING PIN



Consists of trigger and trip arrangement with cord for remote firing control. Has powerful spring action. Ejects a pencil 8 to 10 feet. Has many uses such as burglar alarms, etc. Brand new! No. R-178 Each..... **49c**

DECORATIVE CHROME STRIPS



For your car, boat, furniture, etc. Highly polished chrome finished strips with clinched edges for flush mounting to any surface. The 3 pound kit provides approx. 43 pieces in lengths from 4 inches to 3 feet and 1/4 to 3/4 inches wide. Wgt. 4 lbs. No. R-224—3 lb. Assort. only.. **\$2.00**

NEW SATCHEL POUCHES

Brand new shoulder type duffel bag pouches, ideal for luggage, school books, lunches, etc. Measures 11 x 12 inches. Of heavy canvas duck with taped edges. Weight 2 lbs. No. X-113 Each **98c**



MESS KITS

Regulation Army Mess Kits. Ideal for campers, boy scouts, etc. Slightly used but guaranteed perfect. Two pieces. Folding handle. A-116—Each..... **69c**



G I BELTS

Of heavy canvas webbing. Adjustable in size. Snap-on buckle. Eyelets all around. Used, but guaranteed. A131—EACH..... **98c**

7-LB. EXPERIMENTER PARTS ASSORT.



A "gold mine" for the radio serviceman. Hundreds of valuable radio parts, new radar and electronic parts and sub-assemblies, coils, resistors, trimming condensers, —worth many times this low price. A130R—7 LBS. **\$1.79**

CANTEENS, CUPS & COVERS

Regular U. S. Gov't issue canteens. Plastic screw top cap chained to body. Slightly used. A117—METAL BODY. Each.. **69c**



A118—PLASTIC BODY. Each..... **69c**
A109—Canteen Covers. New. Each..... **69c**
A119—Canteen Covers. Used. Each..... **35c**
A120—Canteen Cups. Used. Each..... **25c**

MICROPHONE BUTTON



Brand new! For experiments in radio, electronics and other electrical apparatus. Used in telephone, amplifier and detectaphone work. Diameter 2 1/2 inches. New. A512—EACH..... **98c**

AMMUNITION BOX

Fine for storing valuables, carrying lunches, etc. Of heavy gauge 7 1/2 x 11 x 4 inches. Fireproof. Hinged lid with folding handle. Olive drab finish. Used, but perfect. Shipping wt. 4 lbs. A525—EACH..... **25c**

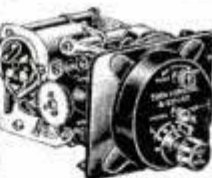

AERO TURN CONTROL

Turn control unit assembly from an aeroplane, consisting of a valuable assortment of gears, switches, mechanical and electrical parts. Fine for experimenters, inventors, etc. Illus. shows unit with cover removed. Shp. Wght. 10 lbs. No. A264—EACH..... **\$3.95**



U.S. Govt. BOLO KNIFE

Extra heavy. For farm, home or jungle use. Blade of Gov't. formula cutlery steel. Walnut riveted handle. 3 1/2 inch butt. 10 1/2 inch blade. You'll find hundreds of uses for a Bolo knife. Blade will take and hold a keen cutting edge. Wt., 2 lbs. A112—with Army Sheath..... **\$4.95**

A212—Leather Sheath, extra..... **\$1.50**



PUP TENTS

Regulation Army Pup Tents of durable, brown canvas. Used, but in good condition. Fine for campers, outdoorsmen, boy scouts, etc. Grand Xmas gift for children. Wgt. 5 lbs. A100—Tent Only..... **\$3.95**
A110—Tent, new..... **\$7.95**
A101—Ropes, wooden poles and stakes for above. Per set..... **\$1.00**



BIG SHIPS BELLS

Purchased from U. S. Maritime Comm. Measures 10 inches high, 9 3/4 inch flare. Big 6 inch clanger. Weight 15 lbs. Fine for farms, clubs, estates, etc. All new. Shp. wt. 10 lbs. A541—ONLY..... **\$9.85**

CAVALRY SPURS



Genuine wish-bone type cavalry spurs. Nickered brass. A102, Pair.. **98c**
A103 Spur straps per set of four..... **50c**

MEDICAL STERILIZER



Consists of alcohol burner and sterilizing tray in hinged metal case 1 1/4 x 1 1/4 x 2 1/4 inches. Burner may be used separately. Bright nickel finish. All brand new. A125—Each..... **98c**

SERVO PLANE ASSEMBLY

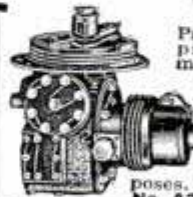

Part of automatic pilot. Accurately machined gears and fittings worth many times this low price. Many valuable parts usable by experimenters of other purposes. Shp. Wght. 30 lbs. No. A263—Each..... **\$12.50**

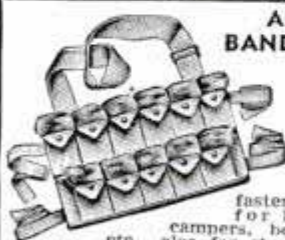

ARMY BANDOLEERS

Of fine heavy khaki. Big roomy pockets with button fasteners. Fine for hunters, campers, boy scouts, etc. also for shop work in carrying small parts, etc. Material alone is worth this price.

11 Pocket Type No. 129 **49c** | 5 Pocket Type No. 110 **29c**

ORDER DIRECT FROM THIS AD

Values galore! Hundreds of hard-to-find items for home, shop and outdoors. Make remittances by money-order, bank draft or personal check. Send 25% deposit on C.O.D. orders. No C.O.D.'s on orders for less than \$5.00. Include sufficient postage on parcel-post orders—any overage will be promptly refunded. All quotations F.O.B. Chicago. Used items and materials are guaranteed serviceable and as described. Your money back if not more than satisfied.

BIG ILLUSTRATED CATALOG FREE

STARK'S

Dept. PM746
509 So. State St.
CHICAGO 5, ILL.

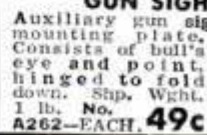

Auxiliary gun sight with mounting plate. Consists of bull's eye and point, hinged to fold down. Shp. Wght. 1 lb. No. A262—EACH. **49c**

SOUTH BEND LATHES

FOR PRECISION WORK

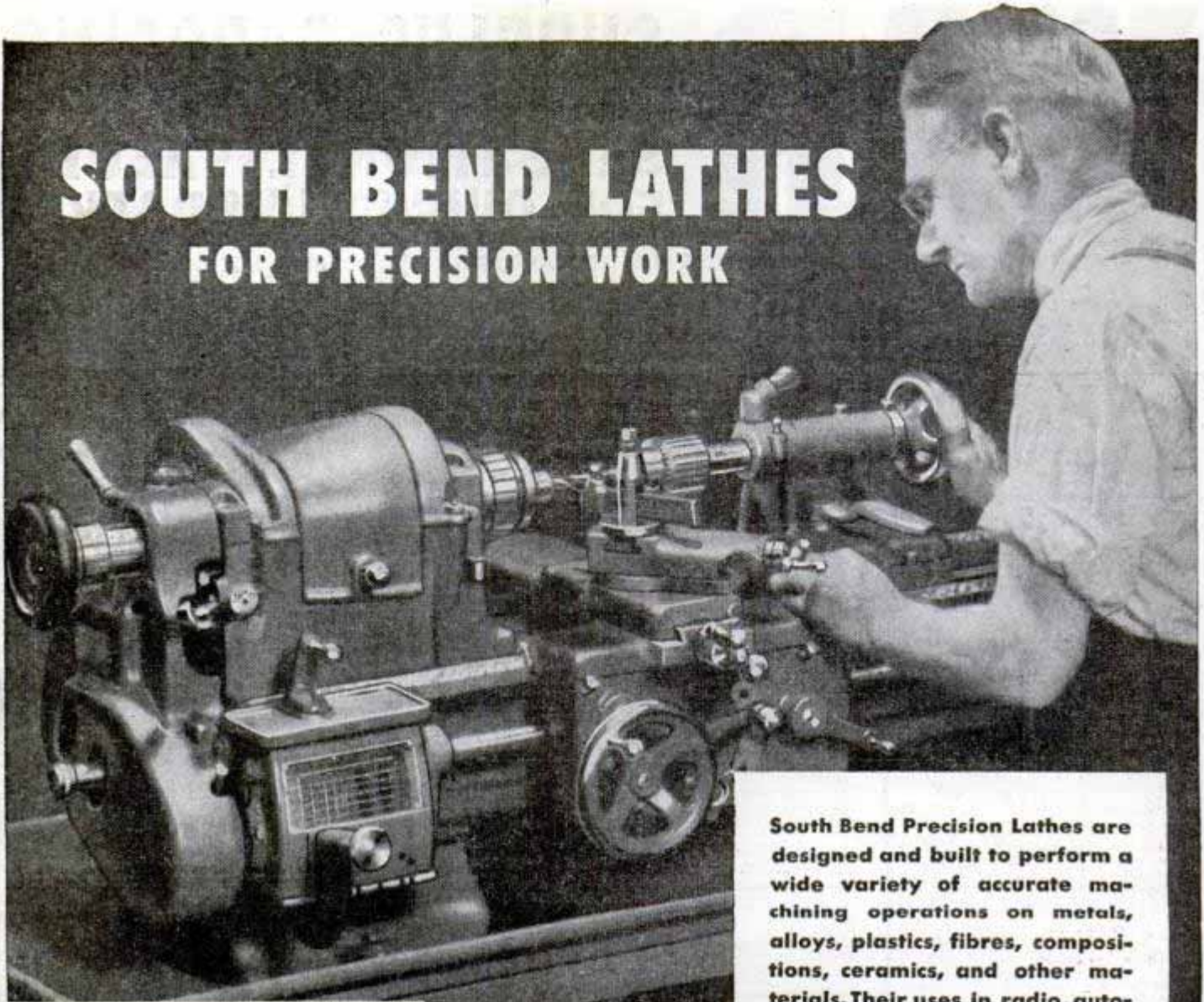

South Bend Precision Lathes are designed and built to perform a wide variety of accurate machining operations on metals, alloys, plastics, fibres, compositions, ceramics, and other materials. Their uses in radio, automobile, appliance, and other repair work, tool and model making, and maintenance are practically unlimited.



10" South Bend Quick Change Gear Precision Bench Lathe.

Handwheel Draw-in Collet Attachment
Unsurpassed for small diameter precision work. Speeds work and assures accuracy in making small tools, in the manufacture of parts for watches, radios, and instruments of all kinds, and in general service work.

WRITE FOR FREE CATALOG



Illustrates in full color and describes all types and models of South Bend Lathes in 9", 10", 13", 14½", and 16" sizes. Please mention size in which interested.

South Bend Precision Lathes bring to the small workshop the same split-thousandth accuracy, versatility, and dependability for which they long have been famous in industry. Practical attachments simplify many operations and add to the variety of work that can be done. Prices are moderate because plant facilities are geared to the efficient, large-scale production of these versatile machine tools. It will pay you to investigate the many advantages which South Bend Lathes have to offer before you buy any lathe for your shop. Write today for free catalog.

LATHE BUILDERS SINCE 1906

SOUTH BEND LATHE WORKS
455 EAST MADISON STREET SOUTH BEND 22, INDIANA



Printed by Popular Mechanics Company, Chicago, Ill., U. S. A.



look

SHARP

You look **SHARP** because you get the best-looking shaves any man ever had!



feel

SHARP

You feel **SHARP** because Gillette Blue Blades give you the quickest, most refreshing shaves of your life!



be

SHARP

You are **SHARP** when you buy Gillette Blue Blades with the **SHARPEST** edges ever honed, because you get more shaves per blade and save money!



use Gillette

5 for 25¢

Blue Blades with the SHARPEST edges ever honed!

Copyright, 1946, by Gillette Safety Razor Company.

GILLETTE'S CAVALCADE OF SPORTS presents the major boxing event of the week every Friday night over American Broadcasting Company stations coast to coast

Gillette Safety Razor Company, Boston 6, Mass.



Everybody
knows him...

Early or late, he's a familiar figure to every policeman on the street —he's the Doctor—he's on an emergency call!

● A Doctor's life isn't his own to live as he chooses. There are interrupted holidays and vacations and nights of broken sleep. Emergencies require his presence for long, exacting hours... with somewhere a pause and perhaps the pleasure of a cigarette. Then back to his job of serving the lives of others.

According to a recent Nationwide survey: **MORE DOCTORS SMOKE CAMELS THAN ANY OTHER CIGARETTE**

THE "T-ZONE"—T FOR TASTE AND T FOR THROAT

The "T-Zone" is your own proving ground for any cigarette. For only *your* taste and *your* throat can decide which cigarette tastes best to *you*... and how it affects *your* throat.



THE MAKERS of Camels are naturally proud of the fact that, out of 113,597 doctors who were asked recently to name the cigarette they preferred to smoke, more doctors named Camel than any other brand. This survey was nationwide, covered doctors in every branch of medicine — nose and throat specialists too. Three nationally known independent research agencies made and vouch for the findings.

Try Camels. Make the "T-Zone" (see left).

R. J. Reynolds Tobacco Co., Winston-Salem, N. C.

CAMELS *Cosette*
Tobacco