

POPULAR MECHANICS

MAGAZINE

SO YOU CAN UNDERSTAND IT



REG. U.S. PAT. OFF.

JUNE
1946
25 CENTS
30c IN CANADA



"SPEEDWAY IN A SAUCER"
PAGE 134

*An Amazing
Improvement!*



RAY-O-VAC

LEAKPROOF FLASHLIGHT BATTERIES

Stay Fresh

FOR YEARS

NO DATING NECESSARY

RAY-O-VAC COMPANY, MADISON 4, WIS.

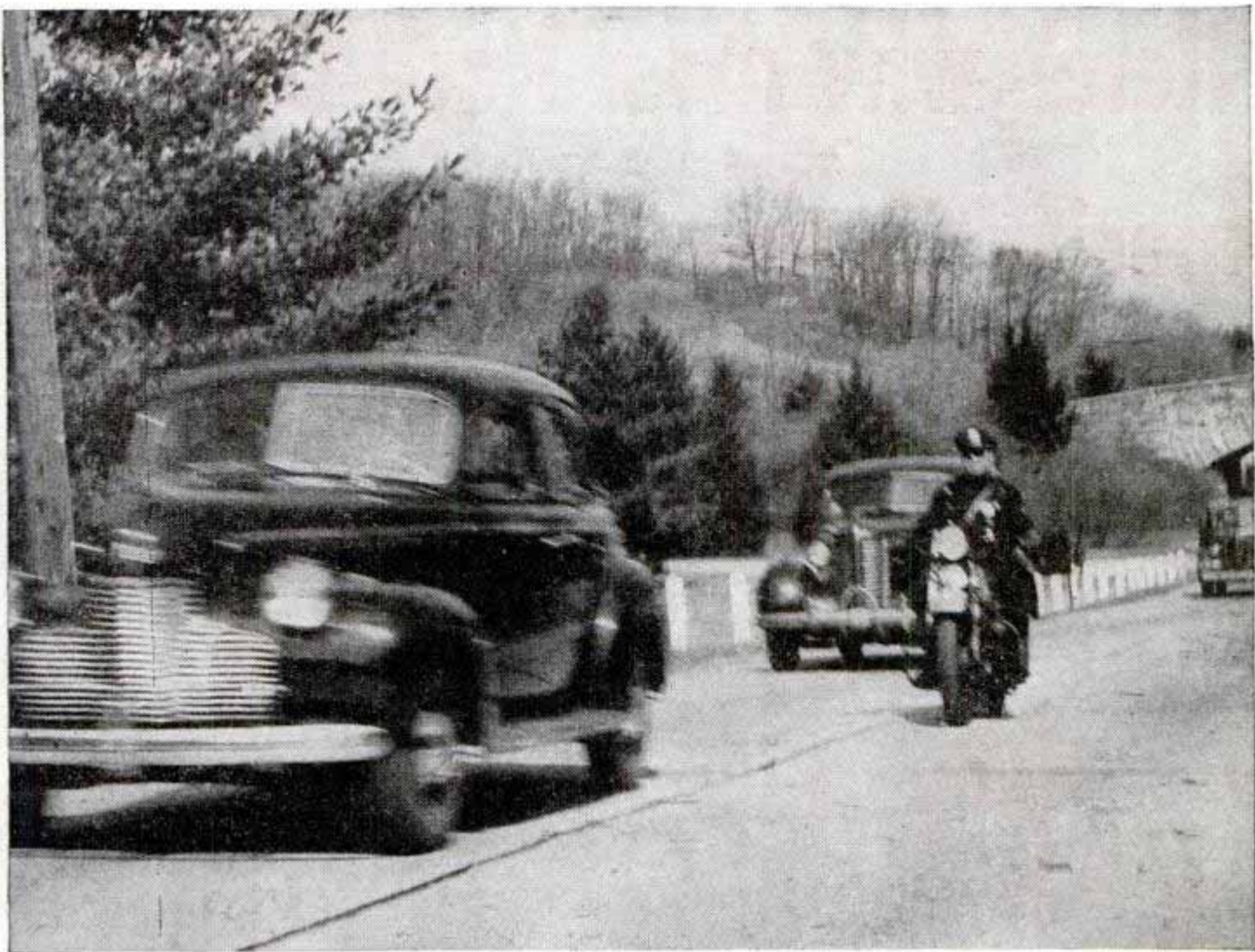

EVEN AT 60 MILES PER HOUR NEW TIRE OUTWEARS PREWAR TIRES

Now you can order these tires for your car

HERE'S your answer to "Will today's tires stand up under a long grind at high speed?"

In a test of the new B. F. Goodrich tire, test cars were driven steadily at sixty miles per hour, hour after hour, averaging over a thousand miles a day in all kinds of weather. Side by side on the wheels of these cars were prewar tires and the new B. F. Goodrich tires. Tires were shifted from wheel to wheel so that both took the same beating.

The new B. F. Goodrich Silvertowns outran the prewar tires—showed less tread wear—were good for thousands of extra miles.

Why? Because the new tire has a wider, flatter tread that puts more rubber on the ground, spreads the wear over a greater area. The tire body, or carcass, is stronger, too... made that way by using tougher cords and more of them. There are your reasons why the new B. F. Goodrich tire has stood up better both in test runs and in actual service on taxi fleets and police cars.

Your tire worries are definitely over when you get a set of new B. F. Goodrich Silvertowns—the tires that have proved they will outwear prewar tires.

Supplies are still a bit limited, but we're making and shipping these new B. F. Goodrich tires in greater volume every day and will have much larger quantities in the hands of most dealers soon. Place an order with your dealer today. *The B. F. Goodrich Company, Akron, Ohio.*

B.F. Goodrich

FIRST IN RUBBER

Here's why most Race Drivers specify Champion Spark Plugs

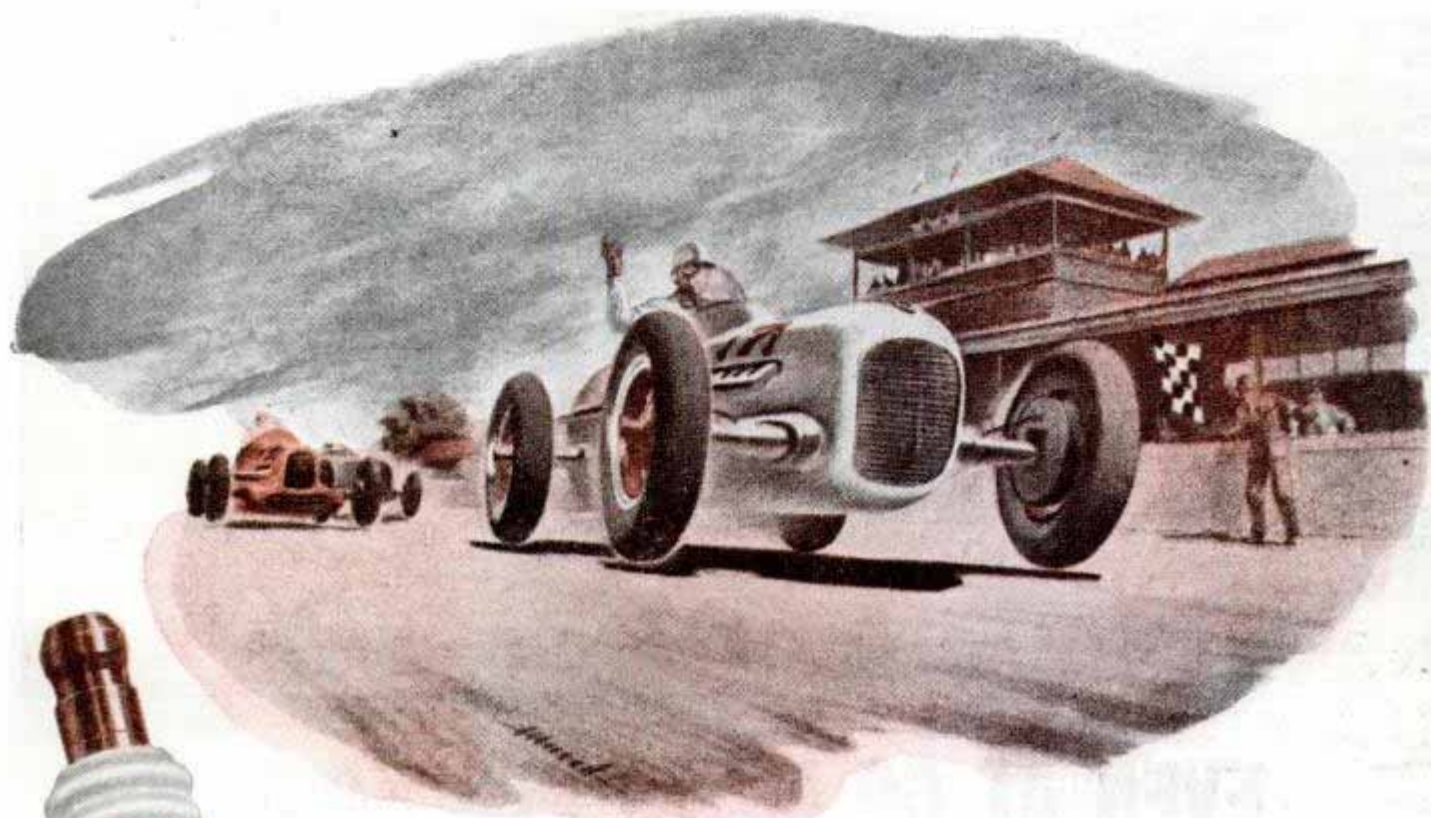

THEY'RE DEPENDABLE!

The vast majority of racing drivers use Champion Spark Plugs because they can depend upon them to give championship performance. There are many reasons why this is so, but the end results are contained in the record books on racing—on land, water and in the air. They show that Champions are true champions, in fact as well as in name—a fact worth remembering when you need spark plugs for your car. Champion Spark Plug Company, Toledo 1, Ohio.

FOLLOW THE EXPERTS . . . DEMAND DEPENDABLE CHAMPIONS

Popular Mechanics Magazine

Registered in U. S. Patent Office and Canada

H. H. WINDSOR, Founder

H. H. WINDSOR, Jr., Editor and Publisher

This Month and Next

THERE'S a thick slice of meat in your Popular Mechanics "sandwich" this month. Packed between covers is the story of the gigantic new flying wing that can tour 10,000 miles on a tankful of gasoline . . . Part II of Byron Nelson's series of golf lessons . . . and on page 88 we present the 1947 Studebaker cars—first of the "old line" to put on a new dress and new engineering. In the opening article by Aubrey Cookman, Aviation Editor, the coming system of landing airplanes "blind" by radar is described in pictures and text . . . and a full-color section starting on page 113 introduces Eastman's process of color photo printing for amateurs.

NEXT MONTH we offer a full ration in features, starting off with sonar—the magic "ears" of the sub-chasers. Then there's "Rough Riders on Water Skis," which will win many converts to a sport famed for plain and fancy thrills. Another headliner tells the story of ocean currents from a ripple to a tidal wave.

MADE to order for vacationers is a feature on our 27 national parks, and many a GI will grow thoughtful over "Garden in the Desert," the story of a vast irrigation project in the Northwest.

THE CRAFTSMAN section will present the ABCs of log-cabin construction . . . also a dust-and-pollen filter for homes that knocks the sneeze out of hay fever. An article for camera fans tells how the fellows who crash the roto pages frame a picture before they shoot. Another timely feature for the Craftsman tells how to build a portable barbecue.

"MEAT" for radio fans will be served up in the form of a built-in set that serves various rooms with extension speakers.

Volume 85 JUNE 1946 Number 6

Managing Editor.....Roderick M. Grant
Assistant Managing Editor.....Wayne Whittaker
Shop Notes and Crafts Editor.....James R. Ward
Radio and Electronics Editor.....Frank L. Brittin
Aviation Editor.....Aubrey O. Cookman
Associate Editor.....John R. Kinsey
Eastern Editor.....Bill Reiche
Western Editor.....Thomas E. Stimson, Jr.
Art Director.....Frank Beatty

Assistant Editors

Donald R. Brooks Clifford B. Hicks Maston M. Jacks Virgil T. Swanson

Assistant Editors, Shop Notes and Crafts

W. Clyde Lamney Wayne C. Leckey John F. Shrock A. E. Youngquist

In This Issue

Radar Lands Them Blind	81
The 1947 Studebaker	88
Mechanics of Golf by Byron Nelson	90
Mr. Watt, Farm Hand	97
Aladdin Was a Piker	108
Print Your Own Color Photos	112
Have We Outgrown Panama Canal?	120
10,000-Mile Flying Wing	129
Speedway in a Saucer	134
"Tracers" on the Trail of Cancer	144
Stock Up for the Outdoors	150
Mud-Slingers Bring Up Oil	156
Lithium, the Hungry Metal	161
Toehold on a Mountain	166

For the Craftsman

Pennsylvania Dutch Cupboard	174
Costume Jewelry From Buttons	182
Hormones in the Garden	192
Fluorescent Photo Lamp	201
How to Build a Midget Farm Truck	210
It Glows in the Dark	214
Radio and Electronics	225

Table of Contents Continued on Page 8

Published monthly by POPULAR MECHANICS COMPANY, 200 East Ontario Street, Chicago 11, Ill. H. H. Windsor, Jr., president; Paul H. Dunakin, vice president and general manager; D. F. Windsor, vice president and secretary-treasurer; William Harrison Pettridge, assistant to the publisher; Clover L. Perkins, advertising manager; Alan M. Deyoe, circulation manager. Single copy in the United States, 25 cents; subscription rates in United States and possessions, and countries of the Pan-American Postal Union, 1 year, \$2.50; 2 years, \$4.50; 3 years, \$6.00. Single copy in Canada, 30 cents; subscription rates, 1 year, \$3.00; 2 years, \$5.50; 3 years, \$7.50. To all other countries add \$1.00 a year over United States prices for overseas postage. If you plan to move, notify us at least 60 days in advance so you will not miss an issue. Give both old and new addresses. Entered as Second Class Matter, September 15, 1903, at the Post Office at Chicago, Illinois, under Act of March 3, 1879. Entered as Second Class Matter at Post Office Dept., Canada. Copyright 1946, by Popular Mechanics Company. Copyright under International Copyright Union. All rights reserved under Pan-American Copyright Union. Printed in the United States of America.

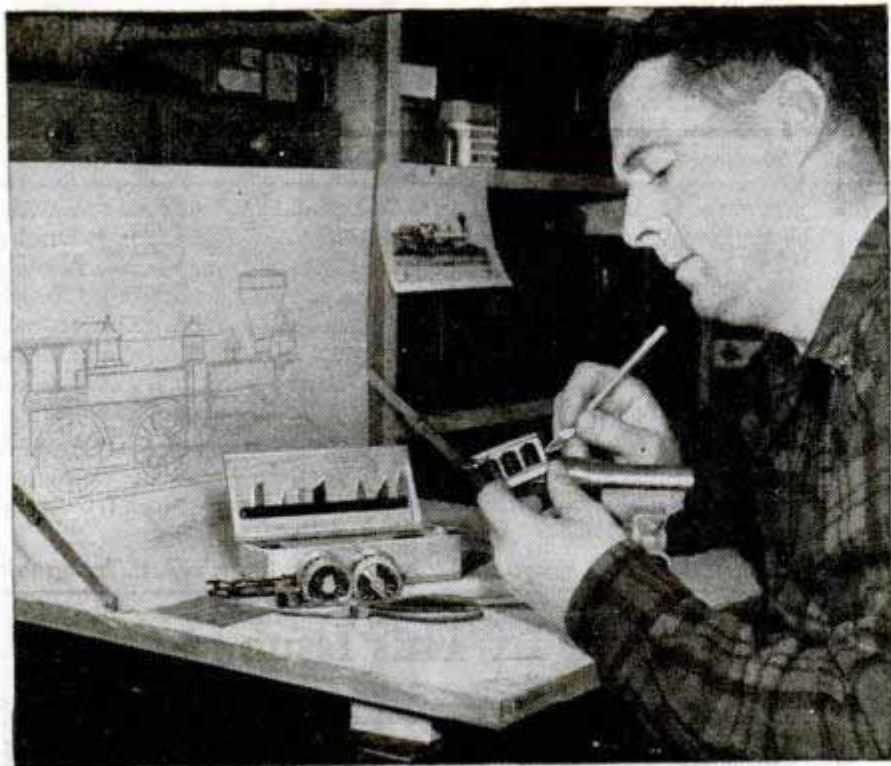

BURBANK DOES IT!...SO CAN YOU!

How Expert Model Builder Gets Topnotch Results

James W. Burbank, of Narrowsburg, N. Y., builds scale models of famous old locomotives. He's a perfectionist. When he finishes a model, it looks real enough to chug off under its own steam.

Here you see him finishing the inlaid walnut cab for his model of the Erie's old George C. Bernard, speed demon of the 1870's. You see, too, three good reasons why he turns out such beautiful work, i.e., the picture of the original engine; his own accurate scale design; and his *indispensable* X-acto Knife Set.

"X-acto Knives are tops," says hobby crafter Burbank. "They're so versatile. I can find a blade-handle combination for the toughest or most delicate jobs . . . And those little pin vises . . . their heads fit my hands

perfectly. I recommend X-acto to every model builder!"

Be Expert At Your Hobby!

X-acto adds skill to your wrist. Smooth-cutting, easy to use as a pencil, X-acto is the indispensable tool for whittlers, wood carvers, artists, photographers.



No. 85 X-acto Tool Chest - 3 all-metal knives; full assortment of blades; saw; sander; stripper; planer; 2 drill holders; 10 drills; 6" steel ruler; Complete in wooden chest, \$12.50. Also #84 Set, \$7.50.

Buy where you see this sign. At better hardware, hobby and gift shops - or if not available write direct to X-acto Crescent Products Co., Inc., 440 Fourth Avenue, New York 16, N. Y.

*Reg. U. S. Pat. Off.



x-acto*

KNIVES & TOOLS

X-acto Knives & Knife Chests From 50c to \$5.00

V is for Versatile

... as in

X-ACTO!



X-acto's 3 handle styles and 13 blade shapes fit every type of cutting job. But if you're a one-knife man, we recommend for all-round work . . .



X-ACTO No. 2 KNIFE, with solid duraluminum handle, made with new improved chuck collet. Knife alone, 50c. With 5 assorted blades, in #52 Set, \$1.

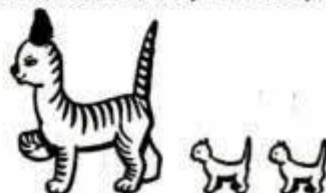

WHITTLE A LITTLE? Send 10c for a copy of "Whittling Is Easy with X-acto!" You'll be an expert in no time.



YOU'LL BE VERSATILE, TOO. Send for these helpful booklets, 10c each.

(1) Building Your First Flying Model. (2) The Knife As a Drawing Instrument. (3) Commercial Artists Handbook. (4) How To Build Scale Model Planes.



SAVES CUT FINGERS - X-acto is designed for firm grip and sure control. Blades lock in, can't fold under. So much handier and safer than razor blades.



OK, JUNIOR! Here's your X-acto Junior Knife, shaped like a Spitfire fuselage, with a two-edged blade. All-metal. Only 25c.

Send for this
Booklet



A Nest CONCEPT IN HOME HEATING

Comfort
Unlimited
WITH
MODUFLOW

COMFORT UNLIMITED—that's what you'll get when your home is equipped with Honeywell's remarkable new heating control system. It is called MODUFLOW*.

And, "Comfort Unlimited" is the title of Honeywell's brand new booklet that tells all about Moduflow. Attractively illustrated in color, it is both interesting to read and easy to understand. Discover how Moduflow eliminates the up-and-down temperatures of ordinary on-or-off heating systems; how it reduces wasteful overheating at the ceiling and eliminates the unhealthy drafts and cold floors caused by intermittent heat supply.

* MODUFLOW is the name of Honeywell's newest heating control system. It means *modulated* heat with a continuous *flow*. Moduflow will be a "must" in the better homes and apartments of tomorrow.

Learn, too, how Moduflow can maintain different temperatures in different sections of your home; for example, 72 degrees in your living room, 65 degrees in your bedrooms and 50 degrees in your built-in garage.

Best of all, learn how Moduflow can be easily and inexpensively installed on your present automatic heating system. You don't have to wait until you build a new home.

All of this, and more, is told in this fascinating booklet. Whether you are planning to build, or modernize your present heating system, you should investigate Moduflow. So, mail the coupon today, for your free copy.

MODUFLOW

the new HONEYWELL heating control system

It's
Free!

Minneapolis-Honeywell Regulator Co.
2753 Fourth Avenue South
Minneapolis 8, Minnesota
Please send my free copy of
"Comfort Unlimited"

Name _____

This One



8BT3-CKK-LXS5

Ingenious New Technical Methods

To Help You with Your
Reconversion Problems

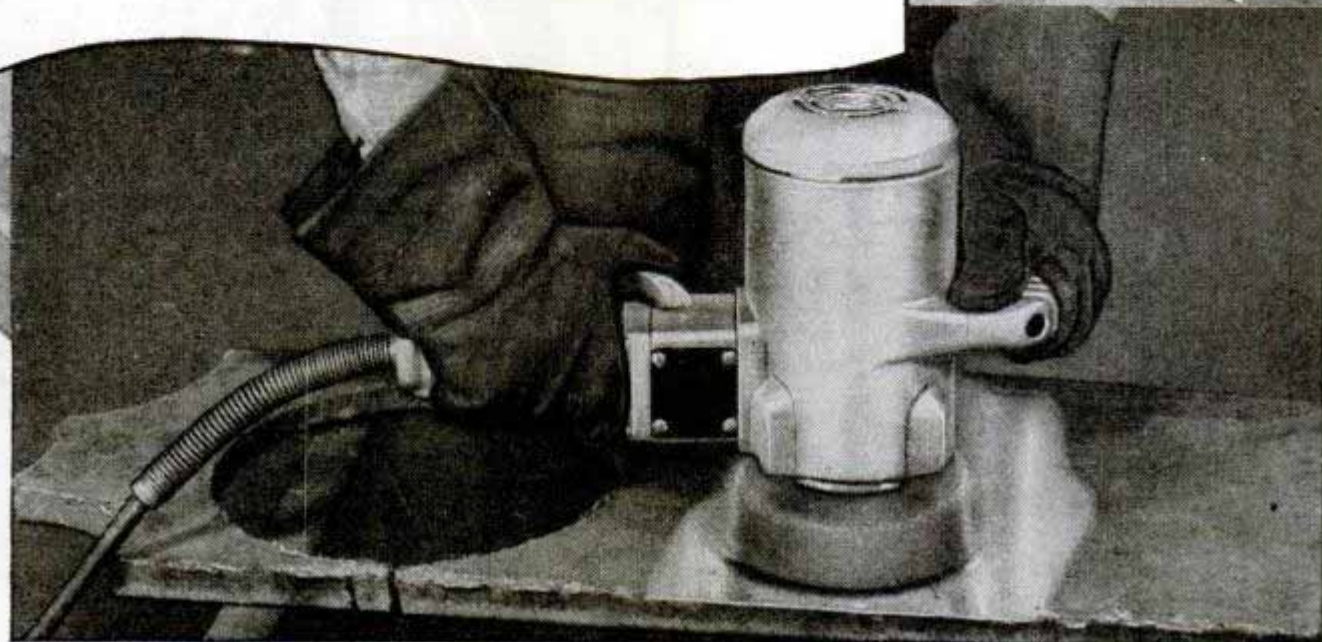

New Portable Grinder Lasts Longer ... Increases Production

The **Portable Gaston Grinder** is designed for the grinding and sanding of metal—also, with wire brushes, for paint and rust removal. Because it is powered by a 3-phase motor, without brushes, commutators or gears, the Gaston will give long service.

The Gaston Grinder starts at full speed. Its speed remains constant regardless of extra pressure by the operator. This controlled speed under heavy load, eliminates glazing of the grinding wheel; produces a better ground surface.

Three sizes of dust-tight Gaston Grinders are available. Furnished in either "cup-wheel" or "edge-wheel" type, as desired.

In a dusty work atmosphere, that causes throat irritation and dryness, chewing Wrigley's Spearmint Gum helps keep workers' mouths moist and fresh—thereby reducing work interruptions—and "time out" to the drinking fountain.

Workers can stay at their machine, while chewing Wrigley's Spearmint—even when their hands are busy. There is no lost time. And the pleasant chewing helps keep them alert and wide-awake. One Connecticut manufacturer with a dust problem reports group production up about 3% over normal, when workers were given chewing gum. Other plants and factories everywhere, claim stepped-up efficiency when chewing gum is made available to all.

*You can get complete information from William H. Howland,
2533 East 73rd Street, Chicago 49, Illinois*



The Portable Gaston Grinder



AA-72

What keeps YOU from making more MONEY?



Just what is the matter—why aren't you making more money? Look around you. Probably many of the people you know are doing a lot better than you are.

What's the reason?

Your own native ability is probably just as good as theirs—probably nothing wrong with your personality and appearance.

But—they *have something you lack*. The fact that they have a better job and more money proves that. Success in business today is measured by the dollar sign.

The secret is this—the man who prepares himself for the job ahead—is the one who gets advancement and more money. He doesn't need "pull." The man who really has something on the ball—"push" enables him to get what he wants.

Ambitious men and women have found in LaSalle the way to get ahead in business. This has been going on for 38 years. Hundreds of thousands of students have enrolled—our files are full of grateful letters from people who have bettered their earnings and position through LaSalle.

Perhaps we can help you. You should at least find out. The coupon below will bring full information. Just check the field of your choice and we'll send you full information, without obligation—the money making possibilities in that field, and how you can prepare in your spare time at moderate cost.

For a brighter future in the business world—more money and a better job—send the coupon today. Tomorrow you might forget.

LA SALLE Extension University a Correspondence Institution Dept. 664-R Chicago, Ill.

I want to better my position—make more money. Send me your free booklet on the field I have checked below.

- | | |
|--|--|
| <input type="checkbox"/> Higher Accountancy | <input type="checkbox"/> Expert Bookkeeping |
| <input type="checkbox"/> Foremanship | <input type="checkbox"/> Industrial Management |
| <input type="checkbox"/> Executive Management | <input type="checkbox"/> Traffic Management |
| <input type="checkbox"/> Law: I.L.B. Degree | <input type="checkbox"/> Salesmanship |
| <input type="checkbox"/> Stenotypy (Machine Shorthand) | |

Name..... Age.....
Present Position.....
City, Zone and State.....





Keep Rolling along with

PYROIL! The insignificant cost of Pyroil is low maintenance insurance on your automobile. Pyroil reduces wear by providing a constant film of lubrication on cylinder walls. It prevents rust and corrosion. It reduces friction wear. It frees away sludges and gums and reduces carbon formation.

Keep rolling along . . . ask your station attendant to add Pyroil next time you stop for gas or oil.

PYROIL FOR AIRCRAFT ENGINES

Use Aircraft Pyroil B for lubricating oil, Aircraft Pyroil A for gasoline.

Manufactured and Guaranteed by Pyroil Company, W. V. Kidder, Founder, 56 Pyroil Bldg., La Crosse, Wisconsin



PYROIL COMPANY

56 Pyroil Bldg., La Crosse, Wisconsin

I want my car to last and run properly. Please tell me more about Pyroil and how it can accomplish this for me.

Name.....

Address.....

City or Town.....State.....



Jerry, the talking dog, is entertaining hospitalized veterans, by courtesy of the PYROIL COMPANY. Picture of Jerry sent on request.

TABLE OF CONTENTS (Continued)

AUTOMOTIVE

Midget French automobile accommodates four people..... 86
 Jap copy of jeep lacks power.....106
 Midget convertible holds gas for 500-mile trip.....120
 Kart prevents baby rolling off rear seat of auto (General Tire & Rubber Co., 1703 Englewood Ave., Akron 9, Ohio).....141
 Blowout-proof rubber rivet for tires (J. W. Speaker Corp., Milwaukee 12, Wis.).....154

AVIATION

Patients see airborne movies on A/C hospital planes..... 87
 Light plane is fast climber (Call Aircraft Co., Aiton, Wyo.)... 95
 Gyro keeps its "head" in spins.....106
 "Flying Aalcar" to speed airmail service.....124
 Fresh developments in aircraft.....125
 XP-81 combines turbine-driven prop with jet thrust at rear..126

HOUSE AND HOME

Canvas cover on framework makes one-room cottage..... 87
 Cold food locker has 60 drawers (Iceberg Refrigerated Locker Systems, Inc., Empire State Bldg., New York).....107
 Pouch for baby frees mother's arms.....117
 At home in a "round house".....118
 Utility unit eliminates basement (Ingersoll Steel Division, Borg-Warner Corp., 310 S. Michigan Ave., Chicago).....127
 Kits for erecting model homes aid prospective buyers (Plan-A-Home Model Co., Elkhart, Ind.).....127
 Plastic "top" keeps ball of yarn in order (Allied Appliance & Plastic Co., 1014 N. La Brea Ave., Los Angeles 38, Calif.)...140
 Detachable mop wringer fits any size pail (John T. Leadstone, 1482 Merchandise Mart, Chicago).....140
 Window ventilator filters dust from air (Salmonson & Co., 1107 Broadway, New York).....140
 Fireplace grill fits over andirons for home barbecue (Wait Mig. Co., 415 N. Euwood, Tulsa, Okla.).....140
 Soap dish prevents "jelly" formation (Robert A. Hunter, Dudley Rollinson Co., Empire State Bldg., New York 1)....141
 Nonslip clothesline tightener (John T. Leadstone, 1482 Merchandise Mart, Chicago).....141
 Home electric polisher (Regina Corp., Rahway, N. J.).....141
 Faucet replacement insert stops leaks (Superior Valve Mig. Co., 1469-70 W. 9th St., Cleveland 13, Ohio).....141
 Portable washer cleans and dries three-pound load (John Tjaarda & Associates, 818 Fisher Bldg., Detroit 2, Mich.)...141
 Light metal house trailer contains complete kitchen (Aero Flite Co., Metropolitan Airport, Van Nuys, Calif.).....142
 Clamp holder for paint can (T. G. Persson Co., 224 Glenwood Ave., Bloomfield, N. J.).....171

INDUSTRY

"Deminerallizer" purifies water (Barnstead Still & Sterillizer Co. Inc., 2 Lanesville Terrace, Boston 31, Mass.).....117
 Crossbar holds brush in liquid (Kindt-Collins Co., 12651 Elmwood Ave., Cleveland 11, Ohio).....119
 Anti-foam makes oil bubble-free.....123
 Mud jacks up walk (Koenring Co., Milwaukee, Wis.).....133
 "Cushion-meter" test for packages (Meter & Instrument Div., General Electric Co., West Lynn, Mass.).....154
 Coil inserts replace stripped or worn threads (Aircraft Screw Products Co. Inc., 47-23 35 St., Long Island City 1, N. Y.)...164
 Precision adjustment nut permits pinpoint settings (Polizzi Products Co., 11127 Magnolia Blvd., N. Hollywood, Calif.)...164
 Split ball bearings that permit easy installation in "impossible" locations (Split Ballbearing Corp., Lebanon, N. H.)...164

OUTDOOR RECREATION

Nonsinkable boat (Reynolds Metals Co., Louisville, Ky.)..... 90
 Combination sun dial and compass (E. F. L. Sales Co., 185 Madison Ave., New York).....123
 Chemical preservative for fishing line permits storage when wet (Cuprinol Inc., 7 Water St., Boston 9, Mass.).....128
 Twin-tube float for swimmer folds into small package (Chandler Industries, Inc., Buffalo 7, N. Y.).....138
 Sun bathing shelter keeps insects out (Chandler Industries, Inc., Buffalo 7, N. Y.).....142
 "Butterfly" nets capture ducks at Japanese-style hunt.....155

PHOTOGRAPHY

Photos printed in daylight (Peerless Photo Products, Inc., 50 Broadway, New York 4)..... 86
 "Stereo" camera range finder focuses both lenses (David White Co., Milwaukee 12, Wis.)..... 95
 Sound-film movie projector for desk (Movie-Mite Corp., 1105 E. 15 St., Kansas City 6, Mo.).....132

RADIO AND ELECTRICAL

Phone talks and records messages (Telephone Answering & Recording Corp., 342 Madison Ave., New York 17).....106
 Walkie-talkie for baseball.....138
 Truck drivers "talk back".....149
 Radio steers "seeing bomb".....165
 Radio-phonograph with record slot (Philco Corp., Tioga & C Sts., Philadelphia, Pa.).....225
 Phono-radio combination in plastic cabinet (Garod Electronics Corp., 70 Washington St., Brooklyn 1, N. Y.).....225
 Chairside phono-radio (Farnsworth Television & Radio Corp., Fort Wayne, Ind.).....225
 Automatic record changer with built-in amplifier (Audio Industries, Michigan City, Ind.).....225
 Code practice oscillator (Allied Radio Corp., 833 W. Jackson Blvd., Chicago).....228
 Universal relay with interchangeable coils (Guardian Electric Co., 1625 W. Walnut St., Chicago 12).....230
 R. F. antenna change-over relay (Gordon Specialties Co., 823 S. Wabash Ave., Chicago).....238
 Dial-lock and tuning indicator (Radio Craftsman, 1341 S. Michigan Ave., Chicago 5).....238
 Crystal processing kit (Allied Radio Corp., 833 W. Jackson Blvd., Chicago).....238

TOOLS

"Spinning" wrench turns bolts (Patrick-McDermott Co., 415 W. Pico Blvd., Los Angeles 15, Calif.).....119
 Plastic ruler (Parva Products Co., West Haven 16, Conn.)...143
 (Continued to page 10)

"Why, he knows all about me!"

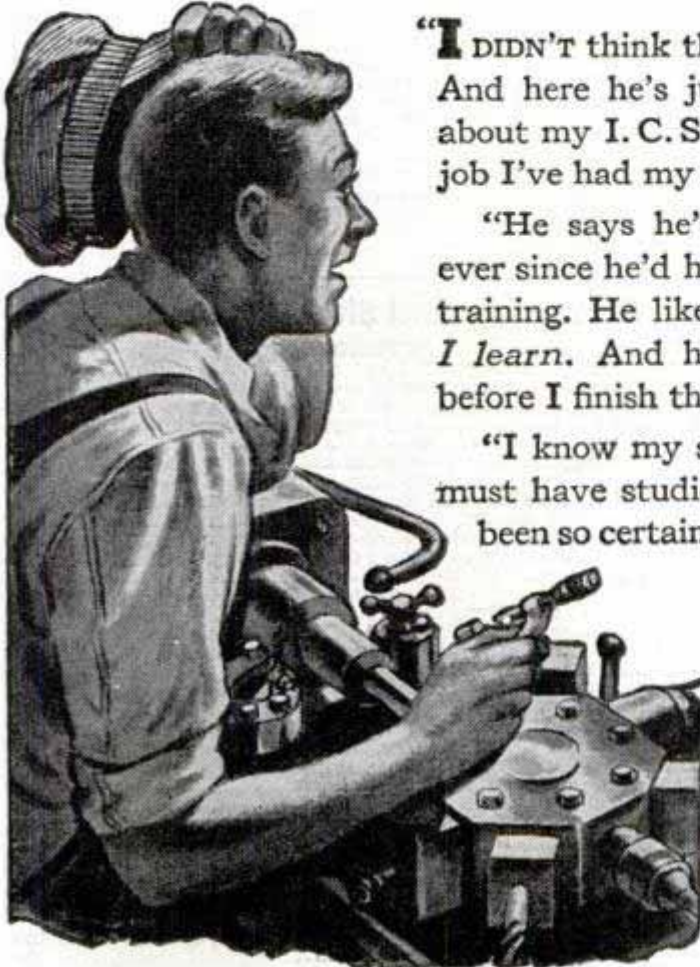

"I DIDN'T think the boss knew my name. And here he's just stopped by to talk about my I. C. S. Course and the bigger job I've had my eye on.

"He says he's had *his eye* on me ever since he'd heard I was getting that training. He likes the idea of my applying what I learn as I learn. And he says there'll be good news for me even before I finish the course.

"I know my studies showed in my work. But I guess he must have studied with I. C. S. himself or he couldn't have been so certain about just where I was getting my training."

Quite possibly the boss *is* an I. C. S. graduate. Thousands of employers are. Whether he is or isn't, however, he knows about your studies. I. C. S. regularly reports student progress to superiors. Letters of employer appreciation for this service are a regular part of our mail. So are student and graduate letters telling us of advancements—600 a month on an average. There *must* be a connection. Mail the coupon for full information.

INTERNATIONAL CORRESPONDENCE SCHOOLS



BOX 5580-K, SCRANTON 9, PENNA.

- Without cost or obligation, please send me full particulars about the course *before* which I have marked X:
- | | | | |
|---|--|---|--|
| <p>Air Conditioning and Plumbing Courses</p> <ul style="list-style-type: none"> <input type="checkbox"/> Air Conditioning <input type="checkbox"/> Heating <input type="checkbox"/> Plumbing <input type="checkbox"/> Refrigeration <input type="checkbox"/> Steam Fitting <p>Chemistry Courses</p> <ul style="list-style-type: none"> <input type="checkbox"/> Chemical Engineering <input type="checkbox"/> Chemistry, Analytical <input type="checkbox"/> Chemistry, Industrial <input type="checkbox"/> Chemistry, Mfg. Iron & Steel <input type="checkbox"/> Petroleum Refining <input type="checkbox"/> Plastics <input type="checkbox"/> Pulp and Paper Making <p>Civil Engineering, Architectural and Mining Courses</p> <ul style="list-style-type: none"> <input type="checkbox"/> Architectural Drafting <input type="checkbox"/> Architecture <input type="checkbox"/> Bridge and Building Foreman <input type="checkbox"/> Building Estimating <input type="checkbox"/> Civil Engineering <input type="checkbox"/> Coal Mining <input type="checkbox"/> Contracting and Building <input type="checkbox"/> Highway Engineering <input type="checkbox"/> Lumber Dealer <input type="checkbox"/> Reading Structural Blueprints <input type="checkbox"/> Sanitary Engineering <input type="checkbox"/> Structural Drafting | <ul style="list-style-type: none"> <input type="checkbox"/> Structural Engineering <input type="checkbox"/> Surveying and Mapping <p>Communications Courses</p> <ul style="list-style-type: none"> <input type="checkbox"/> Electronics <input type="checkbox"/> Practical Telephony <input type="checkbox"/> Radio, General <input type="checkbox"/> Radio Operating <input type="checkbox"/> Radio Servicing <input type="checkbox"/> Telegraph Engineering <p>Electrical Courses</p> <ul style="list-style-type: none"> <input type="checkbox"/> Electrical Drafting <input type="checkbox"/> Electrical Engineering <input type="checkbox"/> Electric Light and Power <input type="checkbox"/> Lighting Technician <input type="checkbox"/> Practical Electrician <p>Internal Combustion Engines Courses</p> <ul style="list-style-type: none"> <input type="checkbox"/> Auto Technician <input type="checkbox"/> Aviation <input type="checkbox"/> Diesel-Electric <input type="checkbox"/> Diesel Engines <input type="checkbox"/> Gas Engines <p>Mechanical Courses</p> <ul style="list-style-type: none"> <input type="checkbox"/> Aeronautical Engineering <input type="checkbox"/> Aircraft Drafting <input type="checkbox"/> Flight Engineer <input type="checkbox"/> Foundry Work <input type="checkbox"/> Heat Treatment of Metals | <ul style="list-style-type: none"> <input type="checkbox"/> Industrial Engineering <input type="checkbox"/> Industrial Metallurgy <input type="checkbox"/> Machine Shop <input type="checkbox"/> Mechanical Drafting <input type="checkbox"/> Mechanical Engineering <input type="checkbox"/> Mold-Loft Work <input type="checkbox"/> Patternmaking—Wood, Metal <input type="checkbox"/> Reading Shop Blueprints <input type="checkbox"/> Sheet-Metal Drafting <input type="checkbox"/> Sheet-Metal Worker <input type="checkbox"/> Ship Drafting <input type="checkbox"/> Ship Fitting <input type="checkbox"/> Tool Designing <input type="checkbox"/> Toolmaking <input type="checkbox"/> Welding—Gas and Electric <p>Railroad Courses</p> <ul style="list-style-type: none"> <input type="checkbox"/> Air Brake <input type="checkbox"/> Car Inspector <input type="checkbox"/> Diesel Locomotive <input type="checkbox"/> Locomotive Engineer <input type="checkbox"/> Locomotive Fireman <input type="checkbox"/> Railroad Section Foreman <p>Steam Engineering Courses</p> <ul style="list-style-type: none"> <input type="checkbox"/> Boilermaking <input type="checkbox"/> Combustion Engineering <input type="checkbox"/> Engine Running <input type="checkbox"/> Marine Engineering <input type="checkbox"/> Steam Electric <input type="checkbox"/> Steam Engines | <p>Textile Courses</p> <ul style="list-style-type: none"> <input type="checkbox"/> Cotton Manufacturing <input type="checkbox"/> Rayon Weaving <input type="checkbox"/> Textile Designing <input type="checkbox"/> Woolen Manufacturing <p>Business and Academic Courses</p> <ul style="list-style-type: none"> <input type="checkbox"/> Accounting <input type="checkbox"/> Advertising <input type="checkbox"/> Arithmetic <input type="checkbox"/> Bookkeeping <input type="checkbox"/> Business Correspondence <input type="checkbox"/> Business Management <input type="checkbox"/> Certified Public Accounting <input type="checkbox"/> Commercial <input type="checkbox"/> Cost Accounting <input type="checkbox"/> Federal Tax <input type="checkbox"/> First Year College <input type="checkbox"/> Foremanship <input type="checkbox"/> French <input type="checkbox"/> Good English <input type="checkbox"/> High School <input type="checkbox"/> Higher Mathematics <input type="checkbox"/> Illustrating <input type="checkbox"/> Motor Traffic <input type="checkbox"/> Postal Service <input type="checkbox"/> Salesmanship <input type="checkbox"/> Secretarial <input type="checkbox"/> Sign Lettering <input type="checkbox"/> Spanish <input type="checkbox"/> Stenography <input type="checkbox"/> Traffic Management |
|---|--|---|--|

Name _____ Age _____ Home Address _____
 City _____ State _____ Present Position _____
 Working Hours _____ A.M. to _____ P.M. Length of Service in World War II _____

Canadian residents send coupon to International Correspondence Schools Canadian, Ltd., Montreal, Canada.
 British residents send coupon to I. C. S., 71 Kingsway, London, W. C. 2, England.



**This is
the
FINISH!**

It's the kind of perfect-fit finish that usually results when human skill and *The right file for the job* get together. A Nicholson Long Angle Lathe File is shown removing the last few thousandths inch from a shaft. The same file will do the final smooth-finishing.

Because of the 45° angle of its teeth, it will, under light pressure, remove metal faster than a regular Mill file used as a "lathe" file. This long angle overcomes filling up—keeps file cutting and avoids scratching the surface of the work. Chips slide down the gullets and are forced out by the motion of the work—making file self-clearing, clean-shearing, non-chattering. Excellent for lathe-using hobbyists, as well as for industrial mechanics. Purchasable through mill-supply houses. Your hardware store also can get this special-purpose file for you.

FREE BOOK, "FILE PHILOSOPHY," on kinds, use and care of files—48 interesting illustrated pages.



NICHOLSON FILE CO.
22 Acorn St., Providence 1, R. I.
(In Canada, Port Hope, Ont.)



**NICHOLSON
FILES** FOR EVERY PURPOSE

(Continued from page 8)

Multipurpose grinding wheel (Wilson Foundry & Machine Co., 1417 Elysian St., Houston, Tex.).....	164
Tool flares tubing (Penn Brass & Copper Co., Erie, Pa.).....	164
Dot-dash rule helps draftsmen (The C-Thru Ruler Co., 385 Capital Ave., Hartford, Conn.).....	171
Hand-operated oiler has transparent barrel (Midwest Production Machine Co., Columbus, Ohio).....	172

MISCELLANEOUS

"Strato" gun shoots 12 miles and has radar director.....	86
Hot-box alarm for train emits smoke and odor.....	95
Giant self-propelled howitzer.....	96
Harness race gate moves with horses.....	96
Sections of Paris re-created in clay.....	103
An artist "paints" with wood.....	104
Dolls modeled after world-famous people.....	107
Single-valve mask aids firemen.....	119
Infrared sighting device spots enemy in dark.....	128
Radar spots enemy artillery by tracking shells.....	138
Electronic numerical integrator and computer.....	139
Power unit for bicycle replaces rear wheel (Don L. Fox Sales Co., 216 Randolph St., Detroit 26, Mich.).....	143
Pins on pipe carry off heat (Cy Benz Pipes, 4990 Melrose Ave., Los Angeles 27, Calif.).....	147
"Homemade" forest-fire fighting plow.....	154
Fish-eating garden.....	160

Craftsman and Shop Notes Index

AUTOMOTIVE

Punch marks position shaft key.....	186
Small cap to hold sun visor in proper position.....	188
Stand to hold transmission case is made of pipe fittings.....	209
Split garden hose fastens flag on projecting truck load.....	213
Spark-plug tester made from a lead pencil.....	220
Extension on truck bed increases carrying capacity.....	224

FARM AND GARDEN

Knotted cord tie prevents chafing of staked plants.....	180
Barn windows controlled by auto differential.....	209
How to build an irrigation head-gate frame.....	213
Brooder lights wired in series furnish proper intensity.....	220
Spray gun applies fly killer in liquid form.....	222

HOUSE AND HOME

Rack for tubes of tooth paste.....	176
Solving home problems.....	178
Handles provide firm grip on window screen.....	180
Outdated records form backgrounds for novel pictures.....	186
Turned fruit bowl makes beautiful centerpiece.....	189
Screened baby crib.....	197
Hand-driven churn converted to electric-motor drive.....	222

OUTDOOR RECREATION

Marker locates fishing rods accidentally dropped in water.....	177
Back rest to increase fishing comfort.....	180
Paddle holder stabilizes canoe.....	186
Protective holder for fishhooks prevents damage to tackle.....	186
All-weather tent for two.....	187
Turtle traps that "catch 'em".....	191
Fly-line retriever works like a tree trimmer.....	199
Telltails give sailboat skippers exact direction of wind.....	199

PHOTOGRAPHY

Data pasted on camera case for quick reference.....	200
Flash reflector made from sauce pan.....	200
Finishing inside of lens shade.....	200
Clamp-on photoflood reflector.....	200
Line level helps "set" camera.....	200
Flash bulb data given on reflector.....	205
"Brushes" for coloring prints.....	205
Acid fixing solution tested with old film.....	205
Photo timer and enlarger operated together.....	205

RADIO AND ELECTRONICS

Record players of advanced design.....	225
How to build transceiver for new two-meter amateur band.....	226
Now you can grind your own transmitting crystals.....	228
R.M.A. color code for fixed resistors.....	228
Fuse clips used to support rod antenna.....	228
How to mount antenna relays for quiet operation.....	228
Dial lock maintains tuning adjustments.....	228
Universal relay adjustable for many uses.....	228
Code-practice oscillator has built-in key.....	228

TOOLS

Scrollsaw switch mounted on front of stand.....	190
Shaft hangers from pipe fittings and generator bushings.....	204
Craft quiz.....	206
Angle guides for cutting-off on bandsaw.....	207
Lightweight tongs for handling small pieces of hot metal.....	212
Hacksawing in close quarters.....	213
Improved method of soldering.....	220
Jig centers round stock for drilling operation.....	220
"Baby pile driver" center punch.....	221
Quick-change motor mount serves all machines.....	223

TOYS AND NOVELTIES

Play catapult throws stones high and far.....	177
Sidewalk sailboat for "dryland skippers".....	181
Game board set in driveway for amusement of children.....	190

MISCELLANEOUS

Bicycle seat for extra passenger fits over crossbars.....	180
Substitute handle for lawnmower made from radius rod.....	190
Pivoted straightedge is aid when drawing in perspective.....	208
Guide pulley for short, quarter-turn belt drives.....	220
Cursor on slide rule cleaned by using a cigarette paper.....	222
Combination circuit tester and soldering iron connection.....	224

IMPORTANT NOTICE—It is the intention of this magazine to provide its readers with information regarding the latest developments in the mechanical arts. We take no responsibility as to whether the disclosures contained in our articles are covered by patents and advise readers to investigate this subject before making, using, or selling any of the products, machines, or processes described in order to avoid possible liability for patent infringements.

AUDELS REFRIGERATION & AIR CONDITIONING GUIDE.....\$4

New from Cover to Cover—1280 Pages, Fully illus. Covering basic principles, servicing, operation & repair of household, commercial & industrial refrigeration & air conditioning. A gold mine of essential important facts for engineers, servicemen, users.

AUDELS CARPENTERS & BUILDERS GUIDES—4 Vols.\$6

A practical illustrated trade assistant on modern construction for carpenters, joiners, builders, mechanics and all woodworkers. 4 vols., 1600 pages, 3700 illustrations, flexible covers. Pocket size. Each volume sold separately \$1.50 a vol.

AUDELS AUTOMOBILE GUIDE.....\$4

A practical quick ready reference book for auto mechanics, service men, operators & owners. Explains theory, construction & servicing of modern motor cars, trucks, buses & auto type Diesel engines. 1540 pages, fully illustrated, 55 chapters. Indexed. A standard book for mechanics. New fluid drive covered.

AUDELS DIESEL ENGINE MANUAL.\$2

A practical, concise treatise with questions and answers on the theory, operation and maintenance of modern diesel engines including General Motors 2 cycle Diesel. 384 pages, fully illus., flexible binding, pocket size. All details plainly brought out, this book is of extreme value to engineers, operators & students.

AUDELS WIRING DIAGRAMS.....\$1

210 Pages, Illustrated. Gives practical facts on wiring of electrical apparatus. It shows clearly how to wire apparatus for practically all fields of electricity. Each diagram is complete & self-explanatory. Highly Endorsed Pocket Companion.

AUDELS PLUMBERS & STEAMFITTERS GUIDES—4 Vols.\$6

A Practical Trade Assistant & Ready Reference. Explains in plain language & by clear illustrations, diagrams, charts, graphs, pictures principles of modern plumbing practice including Marine Pipe Fitting and Air Conditioning. 4 Vols.—1670 Pages—3642 Diagrams. Pocket size. Each Vol. Sold Separately \$1.50 a Vol.

AUDELS SHEETMETAL WORKERS HANDY BOOK.....\$1

Practical inside information. Fundamentals of Sheet Metal Work. 388 pages. Illustrated. 11 sections. Clearly written. Essential & important facts, figures, pointers in everyday language. Ref. Index.

AUDELS SHEETMETAL PATTERN LAYOUTS.....\$4

Developed by Experts for Sheet Metal Workers, Layout Men & Mechanics. A Practical Encyclopedia in 10 Sections, size 7 x 10 x 2—1125 Pages—350 Layouts—1600 Illustrations. 1001 Key Facts. Fully Indexed for ready reference in answering your layout problems. Covers all phases of sheet metal work including Pattern Cutting, Pattern Development & Shop Procedure.

AUDELS ANSWERS ON BLUE PRINT READING.....\$2

For Mechanics & Builders. Covers all types of blue print reading including ship & airplane. 376 pages, fully illustrated.

AUDELS NEW MACHINIST & TOOLMAKERS HANDY BOOK....\$4

Covers modern machine shop practice in all its branches. 5 practical books in 1. New from cover to cover. Tells how to set up & operate lathes, screw and milling machines, shapers, drill presses and all other machine tools. 1600 pages, fully illustrated, 5 x 6 1/2 x 2. Indexed. 5 sections. 1—Modern Machine Shop Practice. 2—Blue Print Reading & How to Draw. 3—Calculations & Mathematics for Machinists. 4—Shop Physics. 5—How to Use the Slide Rule. 60 chapters. Easy to read and understand. A shop companion that answers your questions.

AUDELS MATHEMATICS & CALCULATIONS FOR MECHANICS \$2

Mathematics for home study or reference. 700 pages, 550 illus. Practical mathematics from beginning. How to figure correctly. Easy, correct methods covering a complete review. Ill. & Indexed.

AUDELS HANDY BOOK OF PRACTICAL ELECTRICITY.....\$4

For maintenance engineers, electricians & all electrical workers. 1440 Pages, 2600 illus. Covers important electrical information in handy form—including Marine Wiring, Radio Principles, Welding. Indexed. A Key to a practical understanding of electricity.

AUDELS RADIOMANS GUIDE.....\$4

A key to the practical understanding of radio including Frequency Modulation, Television, etc., Aircraft & Marine Radio. For radio engineers, servicemen, amateurs. 772 pages. 400 Illustrations & Diagrams. Photos. Review Questions & Answers, Reference Index. Authentic, clear, concise.

AUDELS ELECTRONIC DEVICES....\$2

Tells What You Want to Know About Electric Eye. Easily Understood. Covers photo-electric cells & their applications. Amplifiers, illumination, frequencies, voltage, photocell, tubes, Ohm's Law, wiring diagrams, etc.

AUDELS WELDERS GUIDE.....\$1

A concise, practical text on operation & maintenance of all welding machines for all mechanics. Over 400 pages, illustrated. Covers all methods of electric and acetylene welding including airplane work.

AUDEL, Publishers, 49 W. 23 St., N. Y. 10

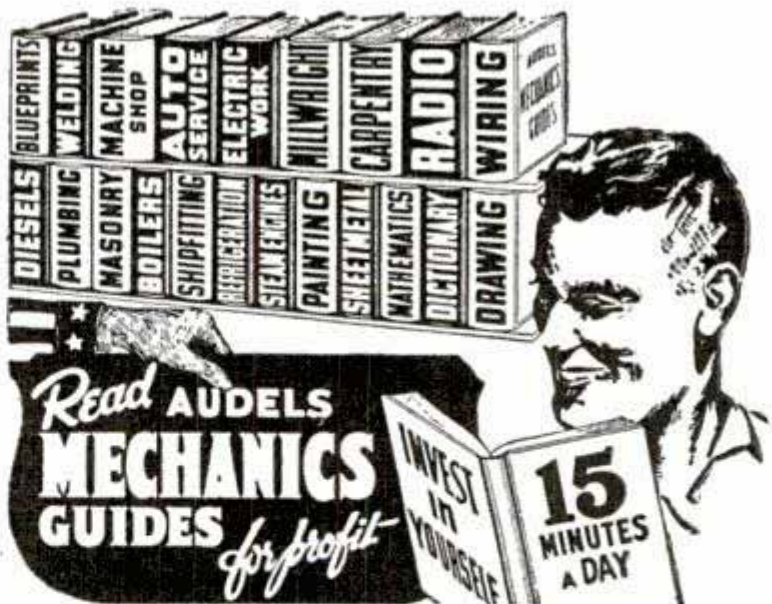

AN AUDEL GUIDE IS A GOOD FRIEND!

Use the brains and experience of others in these Guides of the Trades. Save time and money with right methods, short cuts, labor saving ideas. CHECK NOW! You can look over any Audel Guide in your home. Start the Easy Payments if satisfied.

CUT HERE MAIL ORDER

THEO. AUDEL & CO., 49 W. 23 St., New York 10, N.Y.

Please mail me for 7 days' free examination the books marked (X) below. I agree to mail \$1 in 7 days on each book or set ordered, and to further mail \$1 a month on each book or set ordered until I have paid purchase price.

If I am not satisfied with Guides I will return them.

- Audels REFRIGERATION & Air Conditioning Guide . \$4.
- Audels POWER PLANT ENGINEERS GUIDE . 4.
- Audels PUMPS, HYDRAULICS & AIR COMPRESSORS . 4.
- Audels WELDERS GUIDE . 1.
- Audels BLUE PRINT READING . 2.
- Audels SHEET METAL WORKERS Handy Book . 1.
- Audels SHEET METAL PATTERN LAYOUTS . 4.
- Audels AIRCRAFT WORKER . 1.
- Audels MATHEMATICS and CALCULATIONS . 2.
- Audels MACHINISTS & TOOLMAKERS Handy Book . 4.
- Audels MECHANICAL Dictionary . 4.
- Audels AUTOMOBILE GUIDE . 4.
- Audels DIESEL ENGINE MANUAL . 2.
- Audels MARINE ENGINEERS Handy Book . 4.
- Audels SHIPFITTERS Handy Book . 1.
- Gueths MECHANICAL DRAWING COURSE . 1.
- Rogers DRAWING and DESIGN . 2.
- Audels MILLWRIGHTS and Mechanics Guide . 4.
- Audels CARPENTERS and Builders Guides (4 vols.) . 6.
- Audels PLUMBERS and Steamfitters Guides (4 vols.) . 6.
- Audels MASONS and Builders Guides (4 vols.) . 6.
- Master PAINTER and DECORATOR . 2.
- Audels GARDENERS & GROWERS GUIDES (4 vols.) . 6.
- Audels ENGINEERS and Mechanics Guides Nos. 1, 2, 3, 4, 5, 6, 7 and 8 complete . 12.
- Audels Answers on Practical ENGINEERING . 1.
- Hawkins Aids to ENGINEERS EXAMINATION . 2.
- Audels ELECTRICIANS EXAMINATIONS . 1.
- Audels WIRING DIAGRAMS . 1.
- Audels Handy Book of PRACTICAL ELECTRICITY . 4.
- Audels ELECTRICAL POWER CALCULATIONS . 2.
- Hawkins ELECTRICAL Guides at \$1. each . 10.
- Audels ELECTRONIC DEVICES . 2.
- Audels ELECTRIC Dictionary . 2.
- Audels RADIOMANS GUIDE . 4.
- Audels NEW ELECTRIC LIBRARY at \$1.50 a Volume Vols. I, II, III, IV, V, VI, VII, VIII, IX, X, XI, XII.

Name

Address

Occupation

Employed by

NEW and Ready for you

ALLIED'S 1946 CATALOG

of Radio and Electronic Supplies

FREE
Send for it
NOW



BRINGS YOU LATEST, finest values in Radio! New receivers, phono-radios, Ham gear, parts, tubes, kits, code apparatus, tools, books, test instruments, public address—all types of equipment. Over 10,000 items. Leading makes. Guaranteed quality. Fastest service from the world's largest and most complete stocks under one roof. Send for your free copy of Allied's new 1946 Buying Guide now. *Save time and money.*

HELPFUL RADIO BOOKS

- Radio Formulas & Data No. 37-752.10c
- Dictionary of Radio Terms No. 37-751.10c
- Radio Circuit Handbook No. 37-753.10c
- Radio Builders' Handbook No. 37-750.10c
- Simplified Radio Servicing No. 37-755.10c
- Radio Data Handbook No. 37-754...25c
- ALL SIX BOOKS No. 37-799.....75c
- Parallel Resistance and Series Capacitance Calculator. No. X37-960.25c
- R-F Resonance and Coil Winding Calculator. No. 37-955...25c

ALLIED RADIO

ALLIED RADIO CORP.
833 W. Jackson Blvd., Dept. 5-FF-6
Chicago 7, Illinois

Date

- Send FREE 1946 CATALOG
 Send: ... Books/Calculator No. } \$..... enclosed
 Calculator No. }

Name

Address

City Zone State

10,000 HELPS TO BE YOUR OWN BOSS IN THIS BIG BOOK!



IF IT'S RESULTS YOU WANT—GET ACTION QUICKLY WITH THESE PRACTICAL IDEAS

Never before has a more helpful book been printed for those planning a business of their own. Gathered in this large illustrated volume are the formulas, recipes, facts and secrets that have contributed so largely to America's great industrial progress. Capitalize on this information for making most any conceivable product without experience, special equipment or previous knowledge of chemistry. Start at home, expand with profits—build for a profitable independence.

The experts who compiled this book are authorities, and present this information in simple, understandable language. They also give you wholesale supply sources for needed materials, short cuts and economy methods for the most profitable results. Hundreds of good paying businesses have been built on a product made from a simple recipe. Opportunities in this field exist everywhere. Choose from any of the 162,000 facts and 10,000 formulas of which the following are only a very few: Adhesives, Alloys, Anti-Freeze Solutions, Cosmetics, Beverages and Liquors, Candy, Gum, Casein, Celluloid, Ceramics, Cheese, Cleaning Preparations, Concrete, Copper, Cotton, Dentifrices, Depilatories, Dyes, Embalming Fluids, Enameling, Glass, Glazes, Household Formulas, Inks, Insecticides, Iron, Jewelers' Formulas, Lacquers, Laundry Preparations, Leather, Linoleum, Lubricants, Manicure Preparations, Marble (artificial), Metals, Mirrors,

INCLUDED—

PITCHMAN'S GUIDE. Easily made big-profit items that go fast with crowds at Fairs, Carnivals etc. \$25 Net daily not exceptional.

Oils and Ointments, Paints, Paper, Perfumes, Photography, Polishes, Powders, Remedies for Man, Beast or Fowl, Rubber Products, Refrigerants, Soaps, Solder and Soldering, Tooth Cements, Transfers, Transparencies, Varnishes and Thousands of others for making all sorts of profitable and practical things.

FORTUNES MADE FROM A SINGLE IDEA!

This comprehensive book is an accepted authority by chemists, schools, industry, etc. and is the largest and most comprehensive book of its kind ever issued. Nothing else like it in existence. A single formula has been worth a thousand times this book's small cost to countless owners. Crammed with money-making ideas. Invaluable for reference. Ideal for Factory, Home, Farm, Office or Workshop. As necessary as the dictionary and more useful for manufacturers, chemists and salesmen who put up products for profit.

POSTPAID!
\$3.50
U.S.A.
\$3.85
FOREIGN

\$3.50 postpaid. Canada or Foreign, \$3.85 U.S. Funds. (C.O.D. shipments U.S.A. only.) Immediate Shipment—Safe Delivery Guaranteed.

ADAMS BROWN COMPANY, Dept. 166
Chestnut Hill 67, Massachusetts, U.S.A.

AUDELS Carpenters and Builders Guides 4 vols. \$6



Inside Trade Information for Carpenters, Builders, Joiners, Building Mechanics and all Woodworkers. These Guides give you the short-cut instructions that you want—including new methods, ideas, solutions, plans, systems and money saving suggestions. An easy progressive course for the apprentice and student. A practical daily helper and Quick Reference for the master worker. Carpenters everywhere are using these Guides as a Helping Hand to Easier Work, Better Work and Better Pay. To get this assistance for yourself, simply fill in and mail the FREE COUPON below.

Inside Trade Information On:

How to use the steel square—How to file and set saws—How to build furniture—How to use a mitre box—How to use the chalk line—How to use rules and scales—How to make joints—Carpenters arithmetic—Solving mensuration problems—Estimating strength of timbers—How to set girders and sills—How to frame houses and roofs—How to estimate costs—How to build houses, barns, garages, bungalows, etc.—How to read and draw plans—Drawing up specifications—How to excavate—How to use settings 12, 13 and 17 on the steel square—How to build hoists and scaffolds—skylights—How to build stairs—How to put on interior trim—How to hang doors—How to lath-lay floors—How to paint



THEO. AUDEL & CO., 49 W. 23rd St., New York City

Mail Audels Carpenters and Builders Guides, 4 vols., on 7 days' free trial. If O.K. I will remit \$1 in 7 days, and \$1 monthly until \$6 is paid. Otherwise I will return them. No obligation unless I am satisfied.

Name

Address

Occupation

Reference PM



I Will Show You How to Learn RADIO by Practicing in Spare Time

**I Send You
6 Big Kits
of Radio Parts**



KIT 1

I send you Soldering Equipment and Radio Parts; show you how to do Radio soldering; how to mount and connect Radio parts; give you practical experience.



KIT 2

Early in my course I show you how to build this N.R.I. Tester with parts I send. It soon helps you fix neighborhood Radios and earn EXTRA money in spare time.

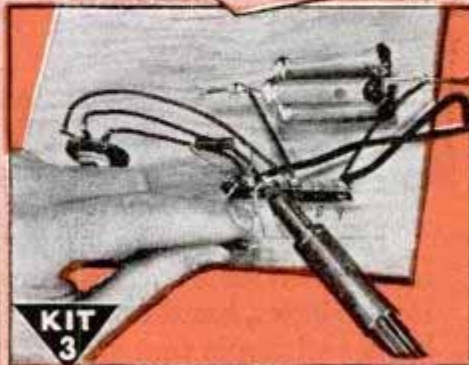

KIT 3

You get parts to build Radio Circuits; then test them; see how they work; learn how to design special circuits; how to locate and repair circuit defects.

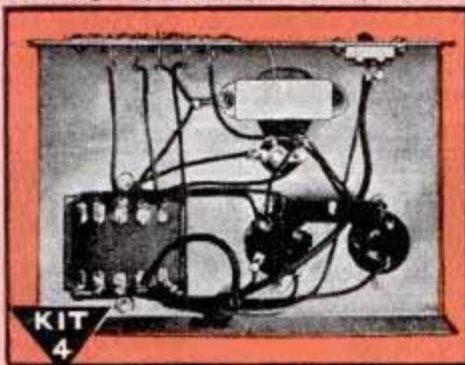

KIT 4

You get parts to build this Vacuum Tube Power Pack; make changes which give you experience with packs of many kinds; learn to correct power pack troubles.

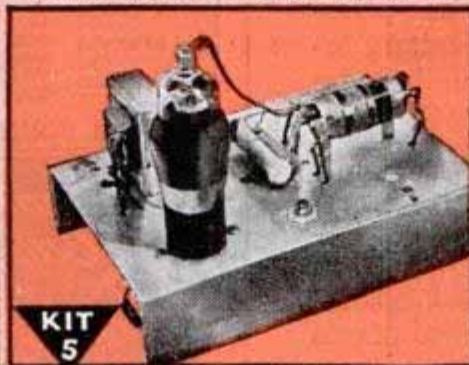

KIT 5

Building this A. M. Signal Generator gives you more valuable experience. It provides amplitude-modulated signals for many tests and experiments.

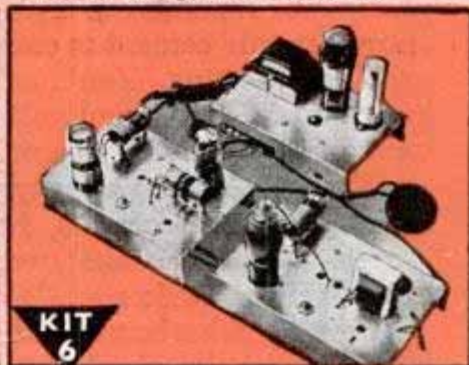

KIT 6

You build this Superheterodyne Receiver which brings in local and distant stations—and gives you more experience to help you win success in Radio.

KNOW RADIO - Win Success **I Will Train You at Home - SAMPLE LESSON FREE**

Send coupon for FREE Sample Lesson, "Getting Acquainted with Receiver Servicing," and FREE 64-page book, "Win Rich Rewards in Radio." See how N.R.I. trains you at home. Read how you practice building, testing, repairing RADIOS with SIX BIG KITS of Radio parts I send you.

Future for Trained Men is Bright in Radio, Television, Electronics

The Radio Repair business is booming NOW. Fixing Radios pays good money as a spare time or full time business. Trained Radio Technicians also find good pay opportunities in Police, Aviation, Marine Radio, in Broadcasting, Radio Manufacturing, Public Address work, etc. Think of the boom coming now that new Radios can be

made! Think of even greater opportunities when Television and Electronics are available to the public!

Many Beginners Soon Make \$5, \$10 a Week EXTRA in Spare Time

The day you enroll I start sending EXTRA MONEY JOB SHEETS to help you make EXTRA money fixing Radios in spare time

while learning. MAIL COUPON for sample lesson and 64-page book FREE. It's packed with facts about opportunities for you. Read about my Course. Read letters from men I trained, telling what they are doing, earning. MAIL COUPON in envelope or paste on penny postal. J. E. SMITH, President, Dept. 6FP, National Radio Institute, Pioneer Home Study Radio School Washington 9, D. C.

Our 32nd Year of Training Men for Success in Radio

**My Course Includes Training in
TELEVISION - ELECTRONICS**

Good for Both - FREE

MR. J. E. SMITH, President, Dept. 6FP, National Radio Institute, Washington 9, D. C. Mail me FREE, your sample lesson and 64-page book. (No salesman will call. Please write plainly.)

Name.....Age.....

Address.....

City.....Zone.....State.....4FP

Approved for Training Under G. I. Bill



FOR DOZENS OF REPAIR JOBS



Leaks and cracks in plumbing and heating systems . . . dripping joints . . . loose hinges, handles, casters . . . screws, bolts and rivets that won't stay tight . . .

YOU can fix them yourself with Smooth-On No. 1 without waiting for plumber or repair man. This time-proven iron repair cement is convenient, inexpensive, lasting. You'll actually get a kick out of using it, and noting its effectiveness. Smooth-On is a metallic powder that you mix to a putty with water and apply into cracks, holes, loose spaces. It hardens like iron, and stays put—for it expands slightly as it sets.

Most neighborhood hardware stores have Smooth-On No. 1 in 1 $\frac{3}{4}$ -oz., 7-oz. and larger sizes. If yours hasn't it, order from us.

FREE 40-PAGE REPAIR HANDBOOK

40 pages. 170 diagrams. Clear, easy-to-follow, practical, short-cut directions for countless metal repairs in house and garage—all tested. Pocket size. Handily indexed. Just send coupon.



—SIGN AND MAIL NOW—

Smooth-On Mfg. Co., Dept. 37
570 Communipaw Avenue, Jersey City 4, N. J.

Yes—please mail me my Smooth-On Handbook.

Name.....

Address.....

6-46.....

Do it with **SMOOTH-ON**
The Iron Repair Cement of 1000 Uses

STUDY AT HOME

With An Educational Institution

Men with specialized training win higher positions, insure larger earnings, and are bigger successes in business and public life. Opportunities NOW greater than ever before. Send for our Catalog.

ARTS and SCIENCES

Courses in Philosophy; Education; Letters; Public Health; Medical Jurisprudence; Psychology; Sociology; Physics; Chemistry; Plastics; Geology; Political Science; Theology; Business and Commerce; Accounting; Mathematics; Statistics; Agriculture.

ENGINEERING

Courses in Electrical, Civil, Mechanical, Drafting, Architectural, Steam, Aeronautical, Radio, Structural, Mining, Industrial, Petroleum, Marine, Chemical, Diesel, Automobile, Refrigeration, and Air Conditioning Engineering.

LAW

Complete Professional Law Course includes 20 Hornbook Series college grade textbooks. Courses also in Commercial Law, Patent Law and Medical Jurisprudence.
McKinley-Roosevelt Incorporated, 4610-K, Sheridan Rd., Chicago 40, Ill.

★ TRAIN for SUCCESS in the Poultry Business



Study at home in spare time. Earn extra while learning.

YOU CAN MAKE MORE MONEY from POULTRY. Proper management means profits ANY season, for life. Get latest scientific methods that avoid losses and mistakes. Our famous system of Home Study Training has helped thousands to success. Extra profits from the start. FREE Catalog; describes courses, methods, service. Write today to Dept. 50.

NATIONAL POULTRY INSTITUTE, Adams Center, N. Y.

Keep that "Car" TICKING



Every operator and mechanic needs AUDELS AUTO GUIDE.

This book saves time, money and worry. Highly endorsed. It presents the whole subject of auto mechanics:

- 1—Basic principles
 - 2—Construction
 - 3—Operation
 - 4—Service
 - 5—Repair
- Handy Size. Easily understood.

1588 PAGES
1500 ILLUSTRATIONS

NEW FLUID DRIVE, HYDRAULIC SHIFT AND DIESEL ENGINES FULLY COVERED

Over 1500 pages—1540 illustrations showing inside views of modern cars, trucks and buses with instructions for all service jobs.

ASK TO SEE IT!—To Get This Assistance for Yourself Simply Fill in and Mail Coupon Today.

4 COMPLETE • PAY ONLY \$1. A MONTH ←

AUDEL, Publishers, 49 West 23rd St., New York
MAIL AUDELS NEW AUTO GUIDE for free examination. If O.K. I will send you \$1 in 7 days; then remit \$1 monthly until price of \$4 is paid. Otherwise I will return it.

Name.....

Address.....

Occupation.....

Employed by..... PM

INVENTORS

Get **FREE BOOK**

NOW IS THE TIME TO PATENT AND SELL YOUR INVENTION

Now, more than ever before, is the right time to patent and sell your invention. Why? Because manufacturers everywhere, in striving to keep ahead of competition, are looking for new inventions and buying up the patent rights thereon so that they will have better and more attractive items to make and sell. Hence, the wise thing for you to do is also to act at once. Protect your invention—and yourself—by applying for a patent now.

FREE "PATENT GUIDE" EXPLAINS WHAT TO DO

Our Free 48-page "Patent Guide for the Inventor" contains complete information about patent procedure and selling inventions. It tells what details, drawings, etc. are necessary to apply for a Patent; how to protect your invention and safeguard your rights; and countless other facts that every inventor will want to know. In addition, it contains over 150 illustrations of basic mechanical movements. The Patent Laws were enacted for your benefit—to give you protection for the features of your invention which are Patentable. But these features must be legally and concisely set forth in the form of "claims". This phase of the procedure is so complex that the U.S. Patent Office advises the Inventor to engage a competent Registered Patent Attorney. We maintain a large staff—carefully trained registered patent attorneys—expert draftsmen—experienced searchers—to serve you.

TAKE FIRST STEP NOW

With the "Patent Guide" you will receive also Free a "Record of Invention" form which will enable you at once to establish the date of your invention, before you file your Patent application. This step costs you nothing yet may be vital to your success. Remember—in Patent Matters, ACTION IS IMPORTANT. Delay can be costly. Write for a free copy of our "Patent Guide" today. Clarence A. O'Brien & Harvey B. Jacobson, Registered Patent Attorneys, 61-F, Adams Building, Washington 4, D. C.

**CLARENCE A. O'BRIEN
& HARVEY B. JACOBSON**

REGISTERED PATENT ATTORNEYS

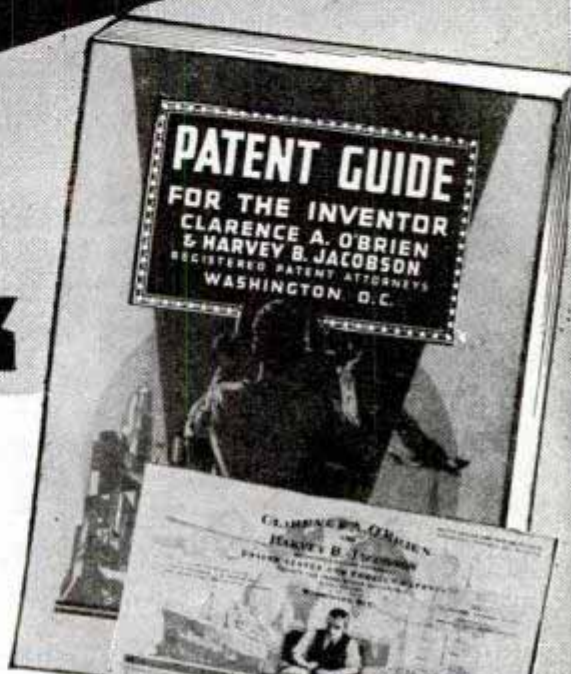

**48
PAGES**
*Over 150
Mechanical
Movements*

MAIL THIS COUPON TODAY

CLARENCE A. O'BRIEN & HARVEY B. JACOBSON
Registered Patent Attorneys before the United States Patent Office
61-F, Adams Building, Washington 4, D. C.

Please send me your 48-Page "Patent Guide for the Inventor" and your specially prepared "Record of Invention" form FREE. This request does not obligate me.

Name.....

Address.....

City..... State.....

(Please write or print plainly.)

LET ME TRAIN YOU

for RADIO ELECTRONICS & TELEVISION

I'll Supply a **FULL RADIO SET**

for SIMPLIFIED INSTRUCTION — PRACTICE & TESTING

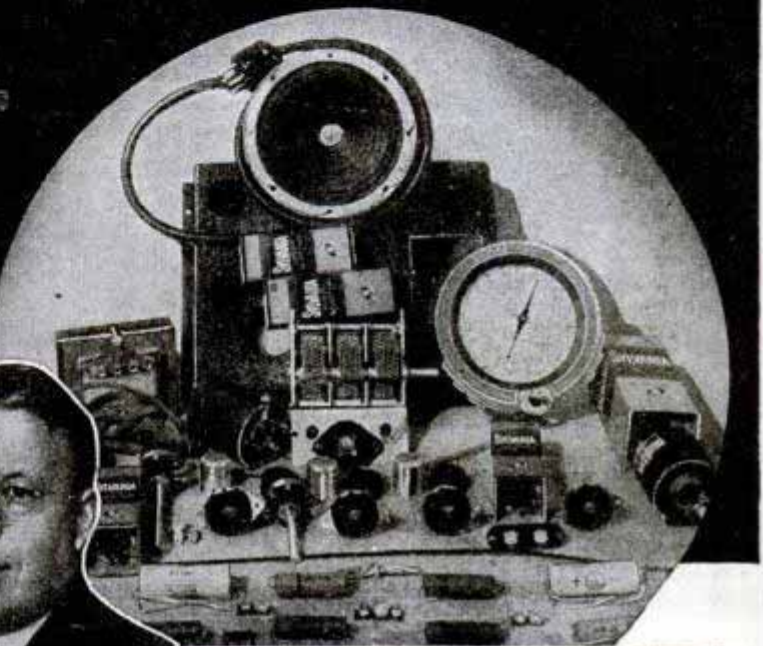
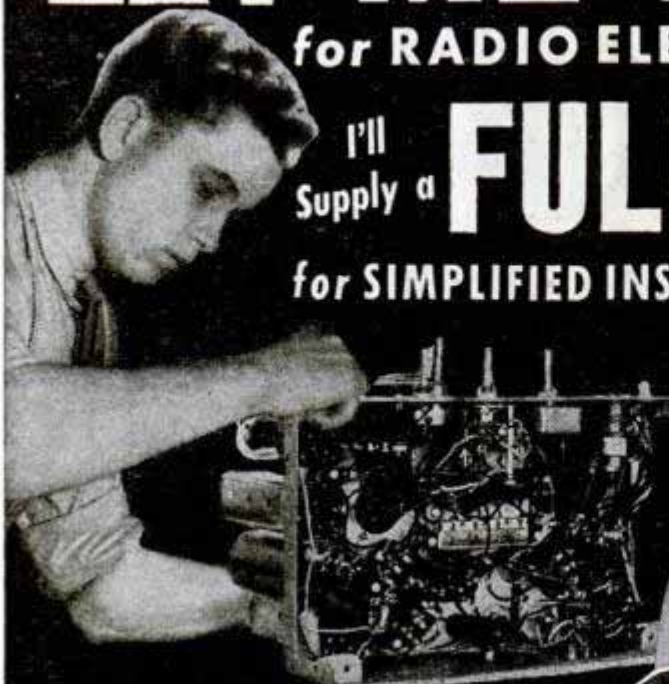

Beginners Learn FAST
START NOW! Big Developments
Ahead in F. M., Radar, Television



MAKE GOOD MONEY IN
a Business of Your Own
...or a Good Radio Job.

The offer I make you here is the opportunity of a lifetime. It's your big chance to get ready for a wonderful future in the swiftly expanding field of Radio-Electronics INCLUDING Radio, Television, Frequency Modulation and Industrial Electronics. Be wise! NOW'S the time to start. Opportunities ahead are tremendous! No previous experience is necessary. The Sprayberry Course starts right at the beginning of Radio. You can't get lost. It gets the various subjects across in such a clear, simple way that you understand and remember. And, you can master my entire course in your spare time.

You Do Practical Experiments
 There's only one right way to learn Radio Electronics. You must get it through simplified lesson study combined with actual "shop" practice under the personal guidance of a qualified Radio Teacher. It's exactly this way that Sprayberry trains you . . . supplying real Radio parts for learn-by-doing experience right at home. Thus, you learn faster, your understanding is clear-cut.

I'll Show You a New, Fast Way to Test Radio Sets Without Mfg. Equipment
 The very same Radio Parts I supply with your Course for gaining pre-experience in Radio Repair work may be adapted through an

exclusive Sprayberry wiring procedure to serve for complete, fast, accurate Radio Receiver trouble-shooting. Thus, under Sprayberry methods, you do not have one cent of outlay for manufactured Test Equipment.

Succeed As a Radio-Electronician
 My training will give you the broad, fundamental principles so necessary as a background, no matter which branch of Radio you wish to specialize in. I make it easy for you to learn Radio Set Repair and Installation Work. I teach you how to install and repair Electronic Equipment. In fact, you'll be a fully qualified RADIO-ELECTRONICIAN, equipped with the skill and knowledge to perform efficiently and to make a wonderful success of yourself.

Read What Graduate Says
"One Job Nets About \$26.00"

"Since last week I fixed 7 radios, all good-paying jobs and right now I am working on an amplifier system. This job alone will net me about \$26.00. As long as my work keeps coming in this way, I have only one word to say and that is 'Thanks' to my Sprayberry training and I am not afraid to boast about it."—ADRIEN BENJAMIN, North Grosvenordale, Conn.

DON'T PUT IT OFF!

Get the facts about my training—now! Take the first important step toward the money-making future of your dreams. All features are fully explained in my big, illustrated FREE Catalog which comes to you along with another valuable FREE book you'll be glad to own.

FREE BOOKS

"How To Read Radio Diagrams and Symbols"

. . . a valuable new book which explains in simple English how to read and understand any Radio Set Diagram or circuit. Includes translations of all Radio symbols. Send for this FREE book now, and along with it I will send you another big FREE book describing my Radio-Electronic training.

RUSH COUPON
for BOTH



SPRAYBERRY ACADEMY OF RADIO

F. L. Sprayberry, President
 Room 1066, Pueblo, Colorado

Please rush my FREE copies of "How to MAKE MONEY in RADIO, ELECTRONICS and TELEVISION," and "HOW to READ RADIO DIAGRAMS and SYMBOLS."

Name Age

Address

City State

(Mail in envelope or paste on penny postcard)

MAIL COUPON AT ONCE!

What's My Job? - I Manufacture Weaklings into **MEN!**

Charles Atlas

Actual Photograph of the man who holds the title "The World's Most Perfectly Developed Man."

GIVE ME a skinny, pepless, second-rate body—and I'll cram it so full of handsome, bulging new muscle that your friends will grow bug-eyed! . . . I'll wake up that sleeping energy of yours and make it hum like a high-powered motor! Man, you'll *feel* and *look* different! You'll begin to **LIVE!**



Let Me Make YOU a NEW MAN —IN JUST 15 MINUTES A DAY!

You wouldn't believe it, but I myself used to be a 97-lb. weakling. Fellows called me "Skinny." Girls snickered and made fun of me behind my back. I was a flop. THEN I discovered my marvelous new muscle-building system — "Dynamic Tension." And it turned me into such a complete specimen of MANHOOD that today I hold the title "THE WORLD'S MOST PERFECTLY DEVELOPED MAN."

That's how I traded in my "bag of bones" for a barrel of muscle! And I felt so much better, so much on top of the world in my big, new, husky body, that I decided to devote my whole life to helping other fellows change themselves into "perfectly developed men."

What Is "Dynamic Tension"? How Does It Work?

When you look in the mirror and see a healthy, husky, strapping fellow smiling back at you—then you'll be astounded at how short a time it takes "Dynamic Tension" to GET RESULTS!

"Dynamic Tension" is the easy, NATURAL method you can practice in the privacy of your own room—JUST 15 MINUTES EACH DAY—while your scrawny shoulder muscles begin to swell, ripple . . . those spindly arms and legs of yours bulge . . . and your whole body starts to feel "alive," full of zip and go!

One Postage Stamp May Change Your Whole Life!

As I've pictured up above, I'm steadily building broad-shouldered, dynamic MEN—day by day—the country over.

2,000,000 fellows, young and old, have already gambled a postage stamp to ask for my FREE book. They wanted to read and see for themselves how I'm building up scrawny bodies, and how I'm paring down fat, flabby ones—how I'm turning them into breath-taking human dynamos of pure MANPOWER.

Take just a few seconds NOW to fill in and mail the coupon at right, and you will receive at once my FREE book—"Everlasting Health and Strength" that PROVES with actual snap-shots what "Dynamic Tension" has done for others—what it can do for YOU! Address: CHARLES ATLAS, Dept. 8F, 115 East 23rd St., New York 10, N. Y.

FREE

Mail the coupon below right now for my FREE illustrated book, "Everlasting Health and Strength." Tells all about "Dynamic Tension" methods. Crammed with pictures, facts! Address me personally: CHARLES ATLAS, Dept. 8F, 115 E. 23rd St., New York 10, N. Y.



CHARLES ATLAS, Dept. 8F
115 East 23rd St., New York 10, N. Y.

I want the proof that your system of "Dynamic Tension" will help make a New Man of me—give me a healthy, husky body and big muscular development. Send me your free book, "Everlasting Health and Strength."

Name.....
(Please print or write plainly)

Address.....

City..... Zone No. (if any)..... State.....

Check here if under 16 for Booklet A.

INVENTORS

LEARN HOW TO
PROTECT and SELL
YOUR INVENTION

GET NEW **FREE BOOK**



FREE

Invention Record
Know How Successful
Inventors Protect and
Sell Their Inventions

Our new **FREE Book** is a book every inventor should have. Mail the coupon today for "How to Protect, Finance and Sell Your Invention" and learn . . .

- How to know if there is a prior U. S. patent on your invention.
- How to save steps in getting patent action.
- How to prepare your application for presentation to the Patent Office.
- How you may patent an improvement on something in use now.
- How to obtain funds to patent and promote your invention.
- How to find a buyer or backer for your invention.
- How to protect yourself in making royalty agreements.

MODERN BUSINESS WANTS INVENTIONS
Practical and novel inventions are in big demand today. The opportunity for quick money is enticing. Sales sources are many if your invention has merit. But, be *sure*—before you place your device in strange hands—that it is fully protected. A United States Patent gives you this protection. *The first step toward inventive success always is—and always has been—the application for a U. S. Patent. There is no other way to protect your invention in accordance with the laws of this country.*

MAKE THIS RECORD NOW If you have an invention, and wish to secure it for the future, act at once. Have it dated now and recorded in our office. We will send you this **FREE Invention Record Form** for the purpose. Fill out the Invention Record Form fully describing the nature of your invention. Make a sketch of its main features. Mail it to us and we will record the date it was received in our office. **The earlier the date the better your chance of combating rival inventors who may lay claim to your idea later. Don't delay a single minute in taking this important step. Your whole future may depend upon it. Mail the coupon for our FREE Invention Record Blank and New FREE Book today!**

HOW WE SERVE YOU AS REGISTERED PATENT ATTORNEYS

The U. S. Patent Office strongly recommends—unless the inventor is familiar with such matters—that he employ the services of a Registered Patent Attorney in the preparation of his Patent Application. We are Registered Patent Attorneys fully qualified to represent you at the Patent Office. We have had long experience in studying hundreds of types of inventions. This gives us the ability to judge your invention and to describe it accurately and convincingly in technical language. It gives us the perception to center arguments upon those details of your invention which, in our judgment, will be looked upon most favorably by the Patent Office Examiner.

Mail the coupon today for our new **FREE Book**, "How to Protect, Finance and Sell Your Invention," and our **FREE Invention Record Form**—maybe this step will pave the way to future security for you and your family. Act Today!

McMORROW, BERMAN & DAVIDSON

REGISTERED PATENT ATTORNEYS

135-S ATLANTIC BUILDING, WASHINGTON 4, D. C.

Send me your new **FREE book**, "How to Protect, Finance and Sell Your Invention"—and "Invention Record" form at once. I understand that this request does not obligate me.

NAME

ADDRESS

CITY..... STATE.....

(Write or print name clearly)

McMORROW, BERMAN & DAVIDSON
Registered Patent Attorneys

135-S Atlantic Building, Washington 4, D. C.

THIS COUPON IS FAMOUS



for putting people in touch with Success

INTERNATIONAL CORRESPONDENCE SCHOOLS



BOX 5581-K, SCRANTON 9, PENNA.

Without cost or obligation, please send me full particulars about the course *before* which I have marked X:

Air Conditioning and Plumbing Courses

- Air Conditioning
- Heating Plumbing
- Refrigeration Steam Fitting

Chemistry Courses

- Chemical Engineering
- Chemistry, Analytical
- Chemistry, Industrial
- Chemistry, Mfg. Iron & Steel
- Petroleum Refining Plastics
- Pulp and Paper Making

Civil Engineering, Architectural and Mining Courses

- Architectural Drafting
- Architecture
- Bridge and Building Foreman
- Building Estimating
- Civil Engineering
- Coal Mining
- Contracting and Building
- Highway Engineering
- Lumber Dealer
- Reading Structural Blueprints
- Sanitary Engineering
- Structural Drafting

- Structural Engineering
- Surveying and Mapping

Communications Courses

- Electronics
- Practical Telephony
- Radio, General
- Radio Operating
- Radio Servicing
- Telegraph Engineering

Electrical Courses

- Electrical Drafting
- Electrical Engineering
- Electric Light and Power
- Lighting Technician
- Practical Electrician

Internal Combustion Engines Courses

- Auto Technician Aviation
- Diesel-Electric
- Diesel Engines Gas Engines

Mechanical Courses

- Aeronautical Engineering
- Aircraft Drafting
- Flight Engineer
- Foundry Work
- Heat Treatment of Metals

- Industrial Engineering
- Industrial Metallurgy
- Machine Shop
- Mechanical Drafting
- Mechanical Engineering
- Mold-Loft Work
- Patternmaking—Wood, Metal
- Reading Shop Blueprints
- Sheet-Metal Drafting
- Sheet-Metal Worker
- Ship Drafting Ship Fitting
- Tool Designing
- Toolmaking
- Welding—Gas and Electric

Railroad Courses

- Air Brake Car Inspector
- Diesel Locomotive
- Locomotive Engineer
- Locomotive Fireman
- Railroad Section Foreman

Steam Engineering Courses

- Boilermaking
- Combustion Engineering
- Engine Running
- Marine Engineering
- Steam Electric Steam Engines

Textile Courses

- Cotton Manufacturing
- Rayon Weaving
- Textile Designing
- Woolen Manufacturing

Business and Academic Courses

- Accounting Advertising
- Arithmetic Bookkeeping
- Business Correspondence
- Business Management
- Certified Public Accounting
- Commercial
- Cost Accounting
- Federal Tax
- First Year College
- Foremanship French
- Good English High School
- Higher Mathematics
- Illustrating Motor Traffic
- Postal Service
- Salesmanship Secretarial
- Sign Lettering
- Spanish Stenography
- Traffic Management

Name _____ Age _____ Home _____ Address _____

City _____ State _____ Present Position _____

Working Hours _____ A.M. to _____ P.M. Length of Service in World War II _____

Canadian residents send coupon to International Correspondence Schools Canadian, Ltd., Montreal, Canada.
British residents send coupon to I. C. S., 71 Kingsway, London, W. O. 2, England.

THIS is probably the most famous coupon in all the world. Millions of ambitious persons like you have made it that. Some of them are people you know.

It is with this coupon that the International Correspondence Schools seeks out capable, far-sighted men and women who can be trained for Success in industry and business.

Behind I.C.S. today are 54 years of experience in Vocational Education. More than 5 million men and women have studied practical, authoritative, personalized I.C.S. Courses. More than 100,000 are receiving such training this very minute.

Included in the roll call of those who mailed the coupon are leaders in every technical and commercial line . . . presidents, production managers, chief engineers, senior and junior executives of world-famous airplane, railroad, steel, publishing, chemical, electric and other enterprises.

In recent 30-day periods, I.C.S. has received as many as 635 letters from students and graduates

testifying to advancements. In a period of 120 days, 1920 such letters were received . . . most of them from currently active students.

You know how many times you have seen the I.C.S. Coupon. Each time you were looking at Opportunity. It keeps on returning . . . but you're penalizing yourself if you continue to postpone the day of doing something about it.

Yesterday is gone beyond recovery. But today—right now—you can get started on the road to the position you want. In mailing the coupon for full information on an I.C.S. Course, you take the first step toward advancement.

Whatever the technical or commercial subject in which you're interested, you'll find it covered in one of the more than 400 I.C.S. Courses. Each has its long list of successful graduates. What they achieved in their spare time, you can do in yours. Mark and mail the coupon as they did. This can be the turning point of your career. Act Now!

INTERNATIONAL CORRESPONDENCE SCHOOLS

Scranton 9, Penna.

INVENTORS

THE TIME IS RIPE FOR



● You men . . . and women . . . with ideas for patentable inventions — OPPORTUNITY IS KNOCKING! American industry WANTS your ideas for new products, new processes, time and labor saving devices to offer to a public with the money to buy them. . . MANUFACTURERS ACTUALLY ARE ADVERTISING FOR IDEAS! And they want them NOW. Don't wait! Have your patent application prepared and prosecuted just as quickly as you can—and be in position to cash in before someone beats you to it. Remember—most manufacturers will consider an idea ONLY if you have taken steps to protect it with a patent . . . and with the U. S. Patent Office it's first come . . . first served.

HOW WE HELP INVENTORS

For 48 years, Victor J. Evans & Company, has helped inventors secure strong patents. We do all the work for you—make the search, prepare the drawings for submission to the United States Patent Office, prepare all necessary papers, push the prosecution of your claim to a speedy conclusion. And—report to you every step of the way . . . just as we have done for thousands of successful inventors.



First . . . GET THESE FREE BOOKS THEY WILL TELL YOU JUST WHAT TO DO!

64 pages of facts which tell you just how to go about getting your patent—how to sell your invention . . . show 115 Mechanical Movements which may be just what you need to complete your invention. With the books, we'll also send FREE, a valuable "Evidence of Invention" form that may help you establish your claim. MAIL THE COUPON TODAY for QUICK ACTION!

VICTOR J. EVANS & Co.

Patents—Trade Marks—Copyrights for Nearly 50 Years

130-G Merlin Building, Washington 6, D. C.

Please send me your books—"Patent Protection" and "When and How to Sell Your Invention"—also important "Evidence of Invention" form without cost or obligation.

Name

Address

City and State

EASY to
PLAY



Order
Yours TO-DAY

The New Luellen HARMONICA

Most wonderful pocket instrument ever made is the harmonica. Easy to master, fun for Everyone. The Luellen has 10 holes, 20 notes. Key of C. Beautiful tone. Now ready. Postpaid Only..... **\$2.10**

INSTRUCTION BOOK. Simple for youngest child. No notes, scales nor exercises. Ten lesson charts show everything. Includes 75 popular songs. Price \$1.00. Here's our special introductory offer: The Instructor and the Harmonica, both postpaid, both for \$2.69. Send Check or Money Order Today.

JOHN LUELLEN & CO., 17034 Page Avenue, Dept. 603, Hazelcrest, Ill.



**\$1,506 TO
\$2,650
A YEAR!**

U.S.
GOVERNMENT
JOBS



Men, women. Common education often sufficient. Veterans get preference. Write immediately for FREE 32-PAGE BOOK with list of positions and full particulars telling how to prepare for them.

FRANKLIN INSTITUTE, Dept. R86, Rochester 4, N. Y.

LEARN MONEY- MAKING CARTOONING

IN SPARE TIME — by Easy Picture Chart Method

Same Simplified Method that has helped train creators of "Terry & Pirates," "Freckles," "Out Our Way," "Winnie Winkle," "Regular Fellers," "Strange As It Seems," "The Neighbors," and many others. Earn while learning. Send 10c for Picture Chart (to test your ability), and full details. (State age.)

Landon School of Cartooning, Dept 4606 Philadelphia (1) Pa.



LEARN MEAT CUTTING At Home — In Spare Time



Get into the vital meat industry. Concise, practical Home Training based on 25 years proven instruction methods used at National's famous resident school. Prepares you for bigger pay as Meat Cutter, Supervisor, market manager or more money in your own store. Go as rapidly as your spare time permits. Diploma. Start NOW to turn your spare hours into money. Send for FREE bulletin today. No obligation.

National School of Meat Cutting, Inc., Dept. U-70, Toledo 4, Ohio

PEPSI-COLA HITS THE SPOT

MAKE MONEY AT HOME

RUBBER MOLDS *Low as*
6¢ EA.



Amazing rubber mold-making outfit makes perfect flexible molds of plaques, ash trays, bookends, etc. Molds cost 6c to 25c each. Each mold makes hundreds of novelties and gifts to sell for \$1.00 apiece and more! No experience necessary. Everything furnished. Quick and easy. Start profitable business in your home—sell to stores, gift shops, friends, resorts, road stands, by mail. Full or spare time. Write for complete FREE details and easy instructions.

SO-LO WORKS, Inc., Dept. G-800, Loveland, Ohio

If You're Now Working in ELECTRICITY or RADIO



you need **COYNE'S** New
1946 "Electrical and Radio
TROUBLE SHOOTING
MANUAL"

The trouble shooter is the plant's essential man! This practical new 612 page Coyne Electrical and Radio Trouble Shooting Manual shows **you** how to shoot trouble on motors, appliances, radio and electrical circuits, electrical refrigeration and air conditioning equipment. Covers automotive and diesel equipment, too! Giant 8½ x 11" handsomely bound volume. Includes 500 up to date shop prints with facts on "how to use them"—plus many other features. **Not a text book.** Every subject indexed and covered in practical, down-to-earth language. You don't have to read the whole book for the information you need. Turn to the index—look up the subject you want—and immediately you'll find the facts you need to "trouble shoot."

FREE WITH . . . "TROUBLE SHOOTING MANUAL"

With your "Trouble Shooting Manual" I'll include one full year of personal consultation from the Coyne staff—technical advice on any electrical and radio problem. A real help in your daily work. Also **FREE!** One year's subscription to **COYNE'S TECHNICAL NEWS**—with latest facts on electrical and radio progress illustrated and explained.

Examine! Read 7-DAY FREE TRIAL THIS BOOK on

Send no money. Coyne will send you big new "Electrical and Radio Trouble Shooting Manual" on 7 days' Free Trial to read, examine and use. If you don't want the "Trouble Shooting Manual" after 7 days send it back and you will owe nothing. The risk is all ours. But remember, this offer is limited—so mail your **FREE** examination coupon today. Immediate action will also bring you a **FREE** copy of "Starting and Operating a Profitable Radio or Electrical Shop" as described at the left.

FREE IF YOU ACT NOW!

New Book! "Starting and Operating a Profitable Electrical or Radio Shop." Tells you how to open your own full or part time shop on little capital! Packed with money making ideas and information. For a limited time this amazing new book absolutely "**FREE**" . . . just for examining the sensational new 1946 "Electrical and Radio Trouble Shooting Manual" for 7 days at Coyne's expense. Act now—this offer may be withdrawn at any time.



MAIL TODAY FOR 7 DAY FREE TRIAL

H. C. Lewis, Pres., **COYNE ELECTRICAL SCHOOL, Dept. AG-R6, 500 South Paulina Street, Chicago 12, Illinois.**
O. K. — Send me the new Coyne "Electrical and Radio Trouble Shooting Manual," postpaid. Within 10 days after the book comes I'll either return the "Trouble Shooting Manual" and **OWE YOU NOTHING** or send \$3.00 and \$3.00 a month until \$9.95 is paid.
FREE (FOR LIMITED TIME) New book "Starting and Operating a Profitable Radio or Electrical Shop" will be sent you with Coyne's compliments for merely examining the "Trouble Shooting Manual" on 7 days' **FREE** trial.

Name _____
Address _____
Town _____ Zone _____ State _____
Occupation _____

COYNE ELECTRICAL SCHOOL
500 SOUTH PAULINA ST.
DEPT. AG-R6 CHICAGO, ILL.

SAVE 10% Send cash price, \$9.95—you save over 10%. Same 7 day Free trial and Money Back Satisfaction Guarantee.

WHICH OF THESE *Opportunities* INTERESTS *You* MOST?

Accounting & C. P. A.
Air Conditioning
Architecture & Building
Automotive Engineering
Aviation—Practical
Aviation Drafting & Design
Better Foremanship
Bookkeeping
Business Management
Contracting

Diesel Engineering
Drafting & Design
Electrical Engineering
Electricity—Practical
Electronics, Industrial
High School Courses
Machine Shop Operations
Mechanical Engineering
Plastics Engineering
Plumbing—Practical

Private Secretary
Radio Operating & Servicing
Railway Training
Refrigeration
Sheet Metal Pattern Drafting
Shop Management
Surveying & Topographical
Drafting
Tool Making

THINK! LOOK FORWARD!

Business is making big, new plans

Men and Women are preparing for the future

WHAT ARE YOU DOING ABOUT YOUR TOMORROWS?

● *Today*, choose the job you want—and prepare for it. Or if you are already engaged in the work you like best, start training *now* for quicker promotion. Acquire the knowledge that will help you to get ahead faster, make more money and have greater security.

Invest part of your spare time in more rapid progress. Start training now, in spare time in your own home. Be ready to grasp your opportunity and step out ahead of those who lack the ability you have attained.

American School, founded in 1897 as an educational institution *not for profit*, can help you to reach your goal just as it has helped others during the past forty-nine years. Give serious thought to the list above. Pick one or more subjects that interest you. Then check the coupon at right, add your name and address and mail it at once. The school will send you details on its training plan and outline of study prepared by specialists. There is no charge, no obligation, so send the coupon immediately.

PRACTICAL, EFFECTIVE HOME - STUDY TRAINING SINCE 1897

Take This First Easy Step

CHECK, CLIP AND MAIL COUPON NOW

AMERICAN SCHOOL, Dept. GA45, Drexel at 58th, Chicago 37, Ill.
Without obligation, Please send FREE and postpaid, bulletin and details of the Subject checked.

- | | | |
|--|---|--|
| <input type="checkbox"/> PLASTICS ENG'R | <input type="checkbox"/> Accounting & C.P.A. | <input type="checkbox"/> Drafting and Design for Men and Women |
| <input type="checkbox"/> Refrigeration | <input type="checkbox"/> Electrical Engr. | <input type="checkbox"/> Radio |
| <input type="checkbox"/> Architecture and Building | <input type="checkbox"/> Electricity-Pract. | <input type="checkbox"/> High School |
| <input type="checkbox"/> Contracting | <input type="checkbox"/> Electronics, Industr. | <input type="checkbox"/> Air Conditioning |
| <input type="checkbox"/> Practical Plumbing | <input type="checkbox"/> Bookkeeping | <input type="checkbox"/> Mechanical Eng. |
| <input type="checkbox"/> Automotive Engineering | <input type="checkbox"/> Private Secretary | <input type="checkbox"/> Shop Management |
| <input type="checkbox"/> Aviation Drafting | <input type="checkbox"/> Diesel Engineering | <input type="checkbox"/> Tool Making |
| <input type="checkbox"/> Aviation | <input type="checkbox"/> Surveying & Topographical Drafting | <input type="checkbox"/> Better Foremanship |
| <input type="checkbox"/> Business Mgmt | <input type="checkbox"/> Sheet Metal Pattern Drafting | <input type="checkbox"/> Machine Shop Operations |
| <input type="checkbox"/> Railway Training | | |

Name..... Occupation.....
Address..... Age.....
City..... State.....

AMERICAN SCHOOL

Dept. GA45, Drexel at 58th Street, Chicago 37



REFRIGERATION AIR CONDITIONING

Air Conditioning and Refrigeration are among the great industries of today and tomorrow. Installations everywhere—in restaurants, shops, homes, etc., need service. Thousands of businesses are waiting for new installations. Today, more and more homes are being air conditioned. The Refrigeration and Air Conditioning industries are headed for greater prosperity and men who have the "know how" and experience should ride along.

Train Now Before the Expected EXPANSION Begins

Experts predict large demand for men to install and service Air Conditioning and Refrigeration equipment... Rise to the kind of job which requires a competent, trained man who can carry the responsibilities of installing costly equipment and maintaining it. If he knows the answer when he is called in for consultation, his reputation grows and his pay should grow also.

Follow This Way to Knowledge

If over 17, and under 60, here's all it takes to get you ready for experience in this modern industry. Just invest a limited amount of your spare time—while you are still on your present job. Through our balanced training, you learn first through home study, how to handle Installation, Maintenance & Service Work on Refrigeration and Air Conditioning equipment. Then you can get practical training in our big shops under capable instructors—experienced men who'll take a personal interest in helping you learn. When you're through you should have knowledge that enables you to get started in this vast industry.

WANT YOUR OWN REPAIR SHOP?

UEI training is easily understood by mechanically inclined men. You gain experience when you complete your course. Equipment, tools and personal following can accumulate as you progress. Soon you may find it wise to set up your own shop.

GET FREE FACTS RIGHT NOW!

It costs you nothing to get all the facts about this great field. Simply mail the coupon below and we'll tell you, without obligation the whole, sensational story of what's ahead in Refrigeration and Air Conditioning. Mail the FREE coupon now.

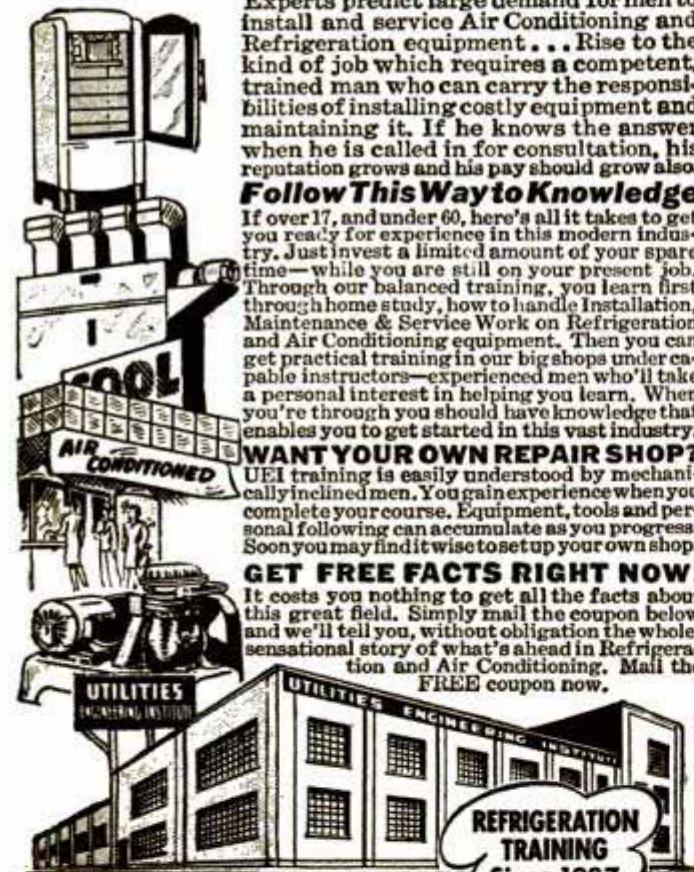

UTILITIES ENGINEERING INSTITUTE

1314 W. Belden Avenue, Dept. 166, Chicago 14, Ill.

Please send me the FREE FACTS about opportunities in Air Conditioning and Mechanical Refrigeration. I have marked the one that interests me most.

Air Conditioning Mechanical Refrigeration

NAME _____ AGE _____

ADDRESS _____

CITY _____ ZONE _____ STATE _____

SAY YOU SAW IT IN POPULAR MECHANICS

BIG MONEY NOW IN LIQUID MARBLE

THREE wonderful new opportunities for your own big money-making business—regardless of your age, sex, or previous experience!

1. **LIQUID MARBLE.** Make beautiful artificial Marble Slabs. Pour from liquid state. Glazed or unglazed. This marble may be mottled, veined, multi-colored or left in original snow-white state. The color is actually a part of the marble! Does not fade or wear away. Liquid Marble is unsurpassed on kitchen or bathroom walls. Easy to make and install.

2. **PLASTIC FLOORING.** May be made in any color or combination of colors. Gives a lifetime of wear. Dustproof, Soundproof, Verminproof. Resilient to the tread. Lay out solid from wall to wall or in pattern design of various shaped blocks.

3. **FLEXIBLE MOLDS.** For plaster casting. Make your own moulds for few cents each. \$1.00 in raw materials will make up to \$25.00 worth of finished goods. We furnish names of buyers. Write now for FREE information about our **BIG THREE** money-making opportunities! Get in on busy season just starting. Send penny postcard or letter. No obligation.

COMPO-TEX, Box 786-SG, ST. LOUIS 1, MO.

TRAIN

Your VOICE!

Results GUARANTEED

We build, strengthen the vocal organs—not with singing lessons—but by sound, scientifically correct silent and vocal exercises and absolutely guarantee complete satisfaction with results. Write for Voice Book, FREE. Sent to no one under 17 years old unless signed by parent.

Perfect Voice Studios, Studio 135-A, Kimball Hall Bldg., Chicago 4, Ill.

ANALYZE HANDWRITING

Qualify for Certified Grapho-Analyst Degree. New uncrowded, fascinating field of service. Gratifying earnings reported by graduates in Employment, Credit, Social Service, Police and Judicial, and Entertainment fields. Others have developed profitable private practice, full or spare time, as Personal Problem and Vocational Counselors. Send for 3000 word test lesson and Grapho-Analyst

FREE

ADDRESS A. I. G. A. Inc. 120 NOEL, MO.

What Every Mason Wants

We have important Masonic books for Blue Lodge, Chapter, Commandery, Scottish Rite, and Shrine. Our Rituals Are Used the World Over. Send for free catalog of books and rituals for Masons, Odd Fellows, Knights of Pythias, Knights of Columbus, etc. EZRA A. COOK, Publisher, P. O. Box 796, PJE, Chicago 90, Ill.

Train Your Own HORSES!

Colts — Stock Horses — Circus Horses
Gait Show Horses — Write for FREE BOOK
ANIMAL LOVERS' ASSOCIATION
Box KA-111, Tarzana, Calif.

BRUSH PLATING OUTFITS

for re-plating articles in the home and shop. No tanks necessary. Free particulars.

GUNMETAL CO., AVE. M, DECATUR, ILLINOIS

MONEY MEN ALL FREE

THE PLASTEX Industry needs manufacturers on small scale and for big production of Lamp and Clock Stands, Art Goods and Novelties in Plastex and Marble imitation. Experience unnecessary. 1/2c material makes regular 10c store sellers. Rubber moulds furnished for speed production. Small investment brings good returns. Big chain store orders now being placed. Ambitious men have chance for real prosperity. Our Free booklet will interest and benefit you.

PLASTEX INDUSTRIES, Dept. P, 1085 Washington Ave., New York, N.Y.

See how readily YOU can train at home for BIGGER EARNINGS in RADIO ELECTRONICS



FREE KIT PACKET SHOWS HOW YOU CAN GET LOTS OF "LEARN-BY-DOING" RADIO EXPERIENCE AT HOME FROM DEFOREST'S THRILLING RADIO "Home Laboratory"

133 EXPERIMENTS

DeForest's Kit Packet shows how you can get real Radio experience from the many standard Radio parts furnished you with DeForest's Training. See how you may quickly build Radio Circuits that work... how you may experiment with Photo Electric Cell "Maglo"... a 5-Tube Superheterodyne Receiver... a Radio Telephone and scores of other fascinating projects. See how you get actual "shop training" at home to give you the practical Radio experience you need.

VETERANS!

Big things are happening at De Forest's for veterans! See how we may prepare you without cost for a GOOD JOB or BUSINESS OF YOUR OWN in the vast Radio-Electronic opportunity field.

DEFOREST'S PROVIDES ALL 3 HOME TRAINING AIDS

- A** DeVry Movie Projector and Learn-By-Seeing Movie Film
- B** Actual Radio Parts for working out 133 experiments
- C** 90 lessons prepared under the supervision of Dr. Lee DeForest—the "Father of Radio."

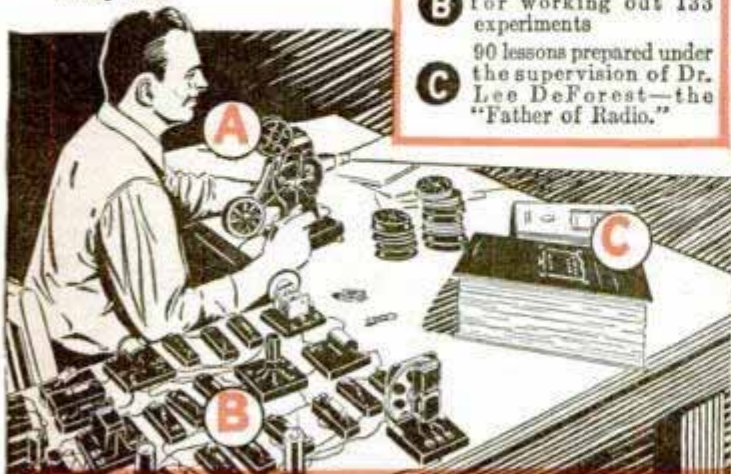

Now—you can see for yourself why DeForest's Training does such a grand job of preparing men for a bright future in one of America's most promising opportunity fields—Radio and Electronics. Send the coupon below for your free "Kit Packet" plus the big free book, "Victory For You!" that has helped so many to good pay jobs. You'll be surprised at the opportunities ahead of FM Radio, Aviation Radio, Broadcast Radio, a profitable Business of Your Own, Motion Picture Sound Equipment, and Electronics—plus the exciting future possibilities ahead of Television, Radar, etc. You can train in your spare time at home—or you may get all of your training in our Chicago laboratories.

You Also Get EFFECTIVE EMPLOYMENT SERVICE

Upon completing your training, you get the full benefit of DeForest's Employment Service that has helped so many men to get started in the Radio-Electronic field.



DEFOREST'S TRAINING INCLUDES INSTRUCTION IN MOTION PICTURE SOUND EQUIPMENT, FM RADIO AND TELEVISION... RESIDENTIAL TRAINING IN OUR MODERN CHICAGO LABORATORIES ALSO AVAILABLE —ASK US FOR INFORMATION!

E. B. DeVry, President
DEFOREST'S TRAINING, INC.
2535-41 North Ashland Ave., Dept. PM-C6
Chicago 14, Illinois, U.S.A.

Send FREE RADIO KIT PACKET and "VICTORY FOR YOU!" BOOK.



Name _____ Age _____

Address _____ Apt. _____

City _____ Zone _____ State _____

If under 16, check here for special information. If a discharged Veteran of World War II, check here.

DEFOREST'S TRAINING, INC.
CHICAGO 14, ILLINOIS



SO IT NEEDS FIXING

By S. T. CHRISTENSEN
the "Fix-it Man"

WELL, I guess I'm the fellow to see, for I've repaired thousands of refrigerators (home and commercial both), vacuum cleaners, radios, washing machines, irons, fans, lamps, mangles, motors, etc. In fact, many of my customers call me their "electrical appliance doctor." And, "doctoring," I might add, has paid me a good substantial income for quite a few years. Funny, in a way, how I got started. Always liked to tinker and by experimenting around I found that most electrical appliances had many things in common. That, regardless of what the appliance was used for, or who the manufacturer was, the basic principles were much the same. From fixing my own appliances to fixing friends' and then for strangers at a fee, seems now to have been but a small step.

What to Charge?

At first, I let the owner decide the charge and, frankly, I was amazed at what I earned per hour. But then, when one figures what initial costs are involved in buying most electrical appliances, one can readily see that spending extra dollars for repairs is well worth while. Before long I was making more in my spare time repairing than from my regular job. The result . . . I went into business for myself. When war came, business boomed, for new appliances were not available.

For a while, repair parts (needed on some

jobs) were a little difficult to get. But that situation quickly adjusted itself and many repair parts were given the high priority rating of AA2. After all, we had to provide for the health and well-being of our civilian population.

The Future Offers

Friends ask me about my future. And, I think I've got a grand one. Age is no handicap in repairing. I have in my files enthusiastic letters from repairmen ranging in age from 18 to 79 years. Now the war is over we are certain to see hundreds of new products on the market . . . products that the average person never dreamt of. These new products and our old appliances are all going to need at some time or other "fixing." Well, I'll still be the fellow to do it. The field open for appliance repairmen is unlimited. I don't worry at all about too much competition.

If You Are Ambitious

To the contrary, I've prepared a complete course, chuck full of simple, easy to understand photos and drawings and written in the same non-technical language as this article. I know the course is good, because I have hundreds of men all over the country writing to me telling me how the course has helped swell their pockets with cash. If you too want to prepare now for your future, I suggest you read the next page and send me the handy coupon."

Advertisement



**BIG MONEY
INDEPENDENCE**
*A PROFITABLE
LIFETIME
BUSINESS
OF
YOUR OWN!*

LEARN ELECTRICAL APPLIANCE REPAIRING

PREPARE NOW FOR THE FUTURE

If now employed, start your home appliance repair business NOW in your spare time and be set with a business of your own no matter what happens. You don't need elaborate fixtures or expensive equipment to be a successful repairman. Operate from your garage, basement, vacant store, etc. Work as many hours as you wish—the home appliance repairman is his own boss. It is a profitable occupation for on many types of repairs it is not unusual for a repairman to charge on the basis of \$5.00 to \$6.00 per hour. Don't gamble with your future—learn a trade that will always support you. Remember, as long as electrical appliances are used, there will be a need for electrical appliance repairmen.

If you are at all mechanically inclined—can hold and use tools—then you have all of the qualifications required for becoming a big money earning home appliance repairman. It does not matter if you have not had a great deal of schooling or had previous experience along these lines—**WE WILL TEACH YOU.** Age should be no barrier—nor should any minor physical handicap.

New Course Tells All

Profusely illustrated, our new course shows you in simple, easy to understand language and drawings how to make each repair on refrigerators, vacuum cleaners, washing machines, motors, etc. Explains and gives you a working knowledge of electricity, welding, nickel plating, etc. Shows you how to build the power tools you need and how to solicit and keep business coming to you. Not a theory course but an honest to goodness course written by and used by repairmen the country over. Price of course is so low that the savings on your own household appliance repairs will quickly pay for it. Act now! Mail the handy coupon below today.

----- Read What Our Students Say About Course -----

I really believe your course the best investment a mechanically minded man can make.—Claude E. Allen, Indianapolis, Ind.

I have received your Course in Appliance Repairing and I must say I am well pleased with same. I am only sorry I did not have said Course some years ago. I have learned so much more through this course I would not part with it.—Charles Schwarz, Hamilton, Ohio.

The Course in Appliance Servicing arrived a few days ago. Want to take out a few minutes of my valuable time to let you know that this is just what I have been looking for ever since I opened up my Fix-It shop. I must admit that you told the truth when you said that it contains quite a bit more information than I bargained for.—P. J. Brett, Sebring, Ohio.

I am a mechanic for the Western Union Telegraph Co. Three days after receiving the lessons in refrigeration I earned the exact cost of the course.—Henry S. Lee, Washington, D. C.

I work day times at the shipyard and after 4:00 P.M. I operate from my cellar and garage. I average \$10.00 to \$15.00 clear every day.—Walter Hanby, Brockton, Mass.

GET STARTED TODAY — MAIL THIS COUPON

CHRISTY SUPPLY CO.
2835 N. Central Ave., Dept. D-3403
Chicago 34, Illinois

Please send me free illustrated literature about America's Fastest Growing Industry — **ELECTRICAL APPLIANCE REPAIRING.**

Name.....

Address.....

City..... State.....

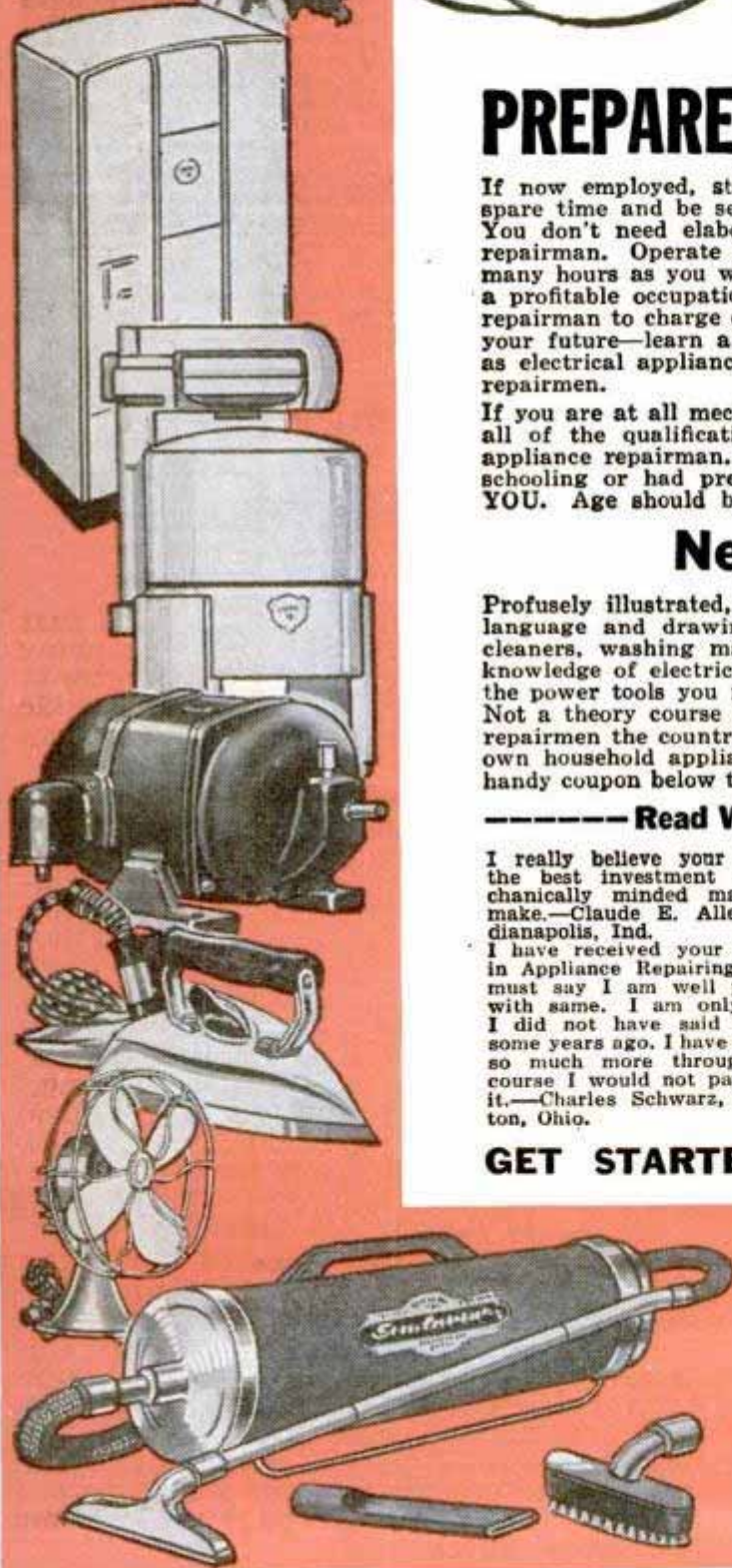

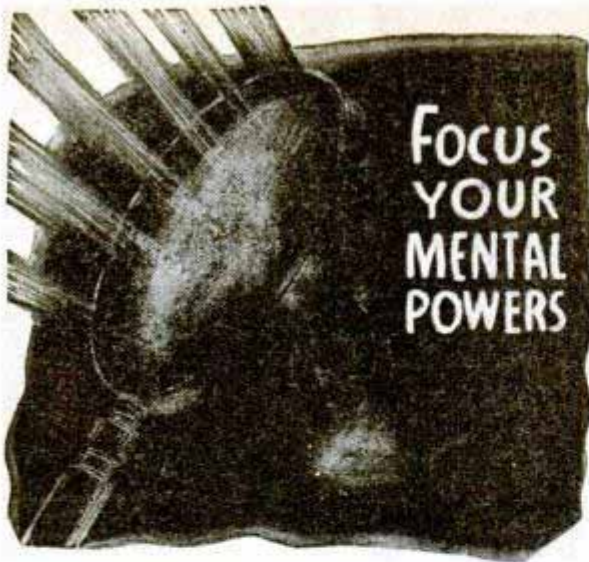

**FOCUS
YOUR
MENTAL
POWERS**

DO YOU THINK IN CIRCLES?

Do you ask yourself, "How shall I begin; what shall I do next?" Have you a confusion of ideas? Mastery in life, success in any enterprise, comes from the subtle ability to marshal your thoughts, to call to the fore, when an emergency arises, the proper mental powers. Mentally, you are an aggregate of forces. Why dissipate them because of lack of knowledge of how to properly use them? Learn to unite them, and you will have at your command, a *tremendous power* for accomplishment.

SEND FOR FREE BOOK

The Rosicrucians have preserved for centuries knowledge of the secret method for the development of mind power and the direction of man's unused inner faculties. This wisdom, not strange or mysterious, has changed the course of life for many men and women throughout the world. Write for the free, sealed book which explains how you may obtain this helpful information. Address: Scribe C. S. T.

The **ROSICRUCIANS**
[AMORC]

San Jose California

— USE THIS COUPON —

Scribe C. S. T.
The Rosicrucians
San Jose, California

I am sincerely interested in an intelligent method for attaining a mastership of life. Send me without obligation, your **FREE** Book which explains how I may receive and use your age-old method.

Name.....
Address.....
City.....

SAY YOU SAW IT IN POPULAR MECHANICS

MOTORISTS!

**BREEZO
KAR KOOLERS**



**DIRECT COOLING
BREEZE WHERE YOU
WANT IT IN YOUR CAR**

**\$1.25
PAIR
POSTPAID**

Send cash or
Postal Money
Order. \$1.50
in Canada

DEALERS: Car-owners buy Breezo on 10-second demonstration. Write for BREEZO "Extra Profits" OFFER!

INSTANTLY attached to any General Motors or Chrysler-made car, 1939-46. Snaps on or off. Extension for other makes or older models. Triple adjustment feature permits accurate control of cool air flow to feet, lap or chest area, as you desire. Don't suffer — get this hot weather driving aid now. Set of two BREEZO Kar Koolers only \$1.25 postpaid anywhere in U.S.A. \$1.50 in Canada. *Money back if not pleased.* Give name and model of car when ordering.

ECONOMY SPECIALTIES CO. 407 SOUTH 4TH STREET, BOX 67, STURGIS, MICH.

EASY TO LEARN CODE

Learn or increase speed with an Instructograph — the Code Teacher that takes the place of an operator-instructor and enables anyone to master code without further assistance. Available tapes from beginners alphabet to typical messages on all subjects. Speed range 5 to 40 WPM. Always ready—no QRM. Thousands have "acquired the code" with the Instructograph System. Write today for convenient rental and purchase plans.



INSTRUCTOGRAPH COMPANY
4713 Sheridan Road, Chicago 40, Illinois

**HOME
BIBLE
COURSE**

Simple, helpful, instructive. Study entire Bible under personal guidance of experienced instructors.

TOTAL COST \$3

includes textbooks, all supplies, regular examinations, certificate upon completing course.
\$1.00 starts you, or simply request Prospectus

The Bible Study School 382 VAN HOUTEN STREET PATERSON 1, NEW JERSEY

Learn BAKING At Home

Baking is one of America's high industries in wages. Nearly depression-proof. Thorough basic home course lays sound foundation. If you have aptitude, write for **FREE BOOKLET**. "Opportunities in Commercial Baking."



National Baking School, 1315 Mich. Ave., Dept. 135A, Chicago 5

FIBRE ARMS AND LEGS!

Light, correctly fitted, strong and comfortable. Natural appearance. Braces for all deformities. Scientific design. Fair Terms.

BUCHSTEIN-MEDCALF

610-3rd Av. S., Minneapolis, Minn.

do you WORRY?

Why worry and suffer any longer if we can help you? Try a Brooks Patented Air Cushion. This marvelous appliance for most forms of reducible rupture is **GUARANTEED** to bring **YOU** heavenly comfort and security—day and night—at work and play—or it costs you **NOTHING**. Thousands happy. Light, neat-fitting. No hard pads or springs. For men, women, and children. Durable, cheap. **Sent on trial** to prove it. Not sold in stores. Beware of imitations. Write for Free Book on Rupture, no-risk trial order plan, and proof of results. All Correspondence Confidential.



**ABOUT
RUPTURE**

Brooks Company, 359 State St., Marshall, Mich.

NOTICE: Over 125,000 ambitious men have been helped to higher paying jobs with the aid of books listed on this page.



Which of these books can help you GET A BETTER JOB AND MAKE MORE MONEY

knowledge the easy GATEWAY way. Our Money Back Guarantee appears elsewhere on this page. Study this list of popular books now.

Beat job competition and insure yourself of a prosperous future. Gateway Books help you tackle those tough jobs you've always had your eye on. They show you how to do the HARDEST jobs the EASIEST way in LESS time. Gateway Books are written by men who are experts in their particular field . . . men who have worked themselves up the hard way. Take advantage of their

Order From This List

PAINTING

1. **SPRAY PAINTING.** Spraying technique and operating instructions on paints, materials, finishes. 125 fully illust. pages. \$2.00
2. **INTERIOR WALL DECORATION.** Practical working methods for plain and decorative wall finishes. 185 illus., 491 pages. \$3.75
3. **THE MIXING OF COLORS AND PAINTS.** How to mix colors for interior decorating, arts, crafts, general mixing methods. \$2.75
4. **CYCLOPEDIA OF PAINTING AND DECORATING.** Covers methods, tools and materials for the home and workshop, including every branch of painting and decorating. Any particular job is fully explained with large illustrations to clarify text. 350 pages. \$3.75
5. **PAPER HANGING.** A practical book that shows you how to do your own papering and save many times the cost of this book. Plenty of illustrations. Over 200 pages. \$2.50
6. **FURNITURE, FURNITURE FINISHING, DECORATION AND PATCHING.** Practical new book that covers Period Furniture, Furniture Decoration, Patching, Finishing and many special finishes. 580 pages. \$5.00

WOODWORKING

7. **CARPENTRY CRAFT PROBLEMS.** 320 pages explain and illustrate hundreds of practical solutions to all types of carpentry problems met by the amateur and professional woodworker. Complete in every detail. \$2.75
8. **BUILDING—FORMS, STAIRS, ROOFS.** Latest information on how to build forms, staircases, roofs, etc., correctly. For carpenters and their helpers. 250 pages, illus. \$2.75
9. **WOODEN BOAT and SHIP BUILDING.** Solves every type of problem in building wooden boats and ships. 244 pp., illust. \$2.75
10. **HOW TO MAKE RUSTIC FURNITURE.** Hundreds of ideas and plans on making all types of rustic furniture for the home. Completely illust., thoroughly described. \$2.00
11. **WOOD TURNING.** An excellent book for every home craftsman. Tells and shows how to do the most artistic work. Numerous photos and many detailed drawings. \$2.50
12. **MODERN HOMECRAFT.** 240 pages of ideas for modern home furniture and how to make it. Scale drawings, fully illust. \$4.50
13. **BLUE PRINT READING.** A practical book that shows how to read and interpret blue prints. 111 pages, 69 illust. \$1.50
14. **CONCRETE DESIGN and CONSTRUCTION.** 508 pages, 251 illust. A new and enlarged edition covering all phases of concrete work and how to do it. \$5.00
15. **HOME REMODELING.** An excellent book for those planning remodeling. Gives hundreds of ideas that save money and add beauty to the finished job. 528 pages, illust. \$5.00
16. **HOW TO PLAN A HOUSE.** Here's a book for every person who ever intends to build their own home. This book shows how to design every single part of a modern house to save you the most money. 525 pages. \$5.00

Guarantee

Gateway Books are guaranteed to be absolutely satisfactory in every respect, or your money will be cheerfully refunded. **The GATEWAY BOOK CO., Dept. PM-18 32 N. State — Chicago 2, Illinois**

REFRIGERATION - PLUMBING AIR CONDITIONING

17. **REFRIGERATION SERVICE MANUAL.** Domestic and Commercial refrigeration used in markets, milk depots, soda fountains, home refrigerators are all covered so you can service any of these and many other units easily. Fully illustrated. \$2.50
18. **PLUMBING INSTALLATION and REPAIR.** Practical 236 page book tells how to repair leaky faucets, clogged toilets, drains, pipes, traps, vents, etc. 153 illust. \$2.50
19. **HEATING COOLING and AIR CONDITIONING.** 706 pages on heating of all types, cooling, Air Conditioning, equipment, furnaces, controls, etc. 64 charts, 351 illus. \$4.50

HOBBIES

20. **TIN CAN PROJECTS.** Tells how to turn tin cans into objects of beauty that command high prices and praise. This handy book has all the working patterns and designs. \$1.50
21. **LEATHER WORKING.** Tells of tools, materials and equipment needed. Gives working drawings of key holders, billfolds, book marks, coin purses, belts, frames, etc. \$2.00
22. **HOW TO WHITTLE and CARVE.** Complete directions for all types of whittling and carving of toys, jewelry, and novelties, etc. Illustrations simplify the work. \$2.75
23. **CREATIVE CRATE CRAFT.** Tells how to make clever and useful pieces of furniture from discarded crates and boxes. \$2.00
24. **IDEAS FOR THE YARD.** Novel book that gives hundreds of suggestions and plans for things you can make for your yard. \$1.50

DEALERS: Write today for our attractive discounts on these titles.

SPORTS

25. **TAXIDERMERY MADE EASY.** A handy book that brings this fascinating hobby within the reach of every sportsman. Explains tools, materials and methods. Profusely illus. \$2.50
26. **THE AMERICAN RIFLE.** A basic book on the rifle and its use for hunting and target shooting. Includes practical information on guns and equipment. Illust. \$3.00
27. **PISTOL AND REVOLVER.** Detailed information on the care of, types, accessories and uses of handguns. Regional shoots described. \$3.50
28. **SAILING CRAFT.** One of the most complete works ever printed on sailing and racing. All types of boats are discussed and illustrated. Over 400 illustrations, nearly 800 pages, size 7 1/2 x 10. Original cost was \$12.00. Now it's yours for. \$5.00
29. **SMALL BOAT BUILDING.** An excellent handbook giving specific information on small boat building. Many boats fully described with large line drawings and working blueprints. Now . . . build your own boat. \$3.00

METAL WORKING

30. **WELDING.** Arc, spot, butt and electric welding, etc. 280 pages, illust. \$2.50
31. **SHEET METAL WORKERS MANUAL.** Complete instructions and information on every phase of sheet metal working. Includes many tables. 552 pages, 375 illust. \$3.50
32. **METAL SPINNING.** A new art of proven popularity. Step-by-step descriptions of the various phases of the craft show you how to make the most out of your metal work. \$1.75
33. **METAL SPINNING PROJECTS.** Tells how to make bowls, lamps, serving dishes, book ends, candle sticks, etc. Complete working patterns and instructions. \$2.75

ELECTRICITY

34. **PRACTICAL ELECTRICITY and HOUSE WIRING.** An ideal book for around the home because it debunks all the mysteries of electricity and shows you how you can save plenty by doing all of your own wiring. \$2.25
35. **ARMATURE and MAGNET WINDING.** The construction of armatures and their repairs are fully covered with illust. \$2.00

AUTOMOTIVE SERVICE MANUALS

- The newest and most authoritative books published. Originally made for the U. S. Armed Forces Institute. Covers every make of automobile. Hundreds of illust. to explain text.
36. **THE ENGINE** . . . \$1.50
 37. **COOLING, LUBE and FUEL SYSTEMS** . . . \$1.50
 38. **AUTOMOTIVE ELECTRICITY** . . . \$1.50
 39. **THE POWER FLOW** . . . \$1.50
 40. **CHASSIS UNITS** . . . \$1.50
 41. **COMBINATION PRICE:** Above five volumes bound in paper, app. 300 pages each. Special money-saving price of only \$6.75

CHECK, CLIP AND MAIL THIS COUPON NOW

THE GATEWAY BOOK CO., 32 N. State St., Dept. PM-18, Chicago 2, Illinois O.K. Send the books I've circled. If C.O.D., I'll pay postman cost of books plus a few cents postage and handling charge. If prepaid, Gateway pays all shipping charges. If any book is not entirely satisfactory, I will return it in 10 days and you will refund my money. No C.O.D.'s outside the U. S.

1 2 3 4 5 6 7 8 9 10 11 12 13 14 15 16 17 18 19 20 21
22 23 24 25 26 27 28 29 30 31 32 33 34 35 36 37 38 39 40 41
(Please print name clearly)

Name.....
Address.....
City.....Zone.....State.....

8 BIG BUILDING BOOKS

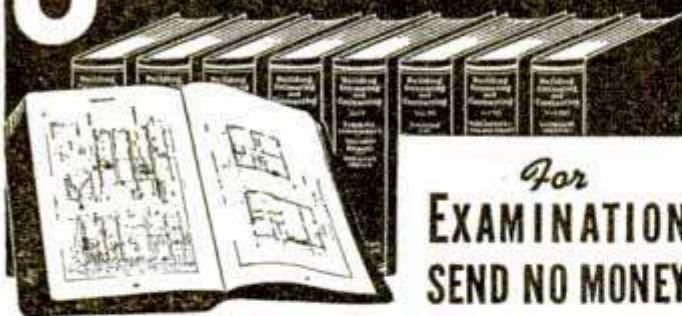

For
EXAMINATION
SEND NO MONEY

Learn to draw plans, estimate, be a live-wire builder, do remodeling, take contracting jobs. These 8 practical, profusely illustrated books cover subjects that will help you to get more work and make more money. Architectural design and drawing, estimating, steel square, roof framing, construction, painting and decorating, heating, air-conditioning, concrete forms and many other subjects are included.

BETTER JOBS — BETTER PAY UP-TO-DATE EDITION

Keep busy now at good pay, and be prepared for after-war building boom. Big opportunities are always for MEN WHO KNOW HOW. These books supply quick, easily understood training and handy, permanent reference information that helps solve building problems.

These books are the most up-to-date and complete we have ever published on these many subjects.

Coupon Brings Eight Big Books For Examination

AMERICAN TECHNICAL SOCIETY Vocational Publishers since 1898
Dept. GA-19 Drexel at 58th Street Chicago 37, Ill.

You may ship me the Up-to-Date edition of your eight big books, "Building, Estimating and Contracting," without any obligation to buy. I will pay the delivery charge only, and if fully satisfied in ten days, I will send you \$2.00, and after that only \$3.00 a month, until the total price of only \$34.80 is paid. I am not obligated in any way unless I keep the books.

Name

Address

City.....State.....

Please attach a letter stating your age, occupation, employer's name and address, and name and address of at least one business man as a reference. Men in service, also please give home address.

AVIATION Career

MAXIMUM TRAINING IN MINIMUM TIME

CAL-AERO TECH TRAINING will add dollars to your pay check all the rest of your life. Specializing in AERONAUTICAL ENGINEERING and MASTER AVIATION MECHANICS since 1929, Cal-Aero Tech training is carefully designed for just one thing—TO MAKE MORE MONEY FOR YOU. An alumni of over 6000 successful graduates proves our career training is unsurpassed.

VETERANS —Write us about Aviation Training, as provided under "G.I. Bill of Rights."



CAL-AERO INSTITUTE
MAJOR C. C. MOSLEY PRES. SINCE 1929
FORMERLY CURTISS-WRIGHT TECHNICAL INSTITUTE
GRAND CENTRAL AIR TERMINAL
-GLENDALE 1, CALIFORNIA
LOS ANGELES COUNTY

MAIL THIS COUPON TODAY!

Cal-Aero Technical Institute, Grand Central Airport, Glendale 1, California
Please send full information on Aviation Training FREE—without obligation. Dept. PM-6

Name..... Birth Date.....

Street.....

City..... State.....

Get into Good Paying AUTO BODY and FENDER WORK



Men 18 to 60. If you are mechanically inclined, start now to learn to become an auto body mechanic and fender repair man. U. E. I. spare time, home-study training combined with actual shop practice gives you sound, basic knowledge of practical methods so you may get the experience which may bring you big pay. Course includes acetylene welding, spray painting, use of hand and power tools.

WRITE FOR FACTS

THOROUGH, RELIABLE TRAINING
Auto body and fender repairing is one of the best profit-makers in any garage or service station. Employment placement service included, or we'll show you how to go about to get started in your own shop. Get the facts FREE today!

AUTO-CRAFTS DIVISION • UTILITIES ENGINEERING INSTITUTE
1314 BELDEN AVENUE, Dept. 166X, CHICAGO 14, ILLINOIS



—PHOTOGRAPHY—

for
PROFIT

Whether you are interested in photography for fun or as a career—get the facts as to how America's largest, best-equipped school can qualify you for success in leisure time thru success-proved home study courses. Also resident training. Write for full details.

N. Y. INSTITUTE OF PHOTOGRAPHY
Dept. 49, 10 West 33 St., New York 1, N. Y. (Founded 1910)

"YOU ARE UNDER ARREST!"



Help Bring Crooks to Justice Through Scientific CRIME DETECTION!

I have taught thousands this exciting, profitable, pleasant profession. Let me teach you in your own home. Learn Finger Printing, Firearms Identification, Police Photography, Criminal Investigation thoroughly, quickly, at small cost. 53% of all American Bureaus of Identification employ I. A. S. students or graduates. I can prepare you for this fascinating work, during spare time. Write today, stating age, for "Blue Book of Crime."

Institute of Applied Science, 1920 Sunnyside Ave., Dept. 135-A, Chicago 40, Ill.

LEARN WATCH REPAIRING



AT HOME. By our modern and original system of instruction you can learn every part of the WATCH REPAIRING TRADE AT HOME. Prepare yourself for a well-paying position or start in business after completing our course of instruction. Good watch repairers are in demand and generally earn very good salaries. For particulars apply to the Wisconsin School of Watch Repairing 759 North Milwaukee St., Milwaukee 2, Wis.



WONDERFUL INVENTION — Corrects poor penmanship in few hours. Guaranteed. No failures. Increases prestige. Helps one get better job. Write Ozment, 34, St. Louis, Mo.

RUPTURED?

Get Relief This Proven Way

Why try to worry along with trusses that gouge your flesh—press heavily on hips and spine—enlarge opening—fail to hold rupture? You need the Cluthe. No leg-straps or cutting belts. Automatic adjustable pad holds at real opening—follows every body movement with instant increased support in case of strain. Cannot slip whether at work or play. Light. Waterproof. Can be worn in bath. Send for amazing FREE book, "Advice To Ruptured," and details of liberal truthful 60-day trial offer. Also endorsements from grateful users in your neighborhood. Write:

CLUTHE SONS, Dept. 31, Bloomfield, New Jersey

GET INTO RADIO

TELEVISION ELECTRONICS NOW!

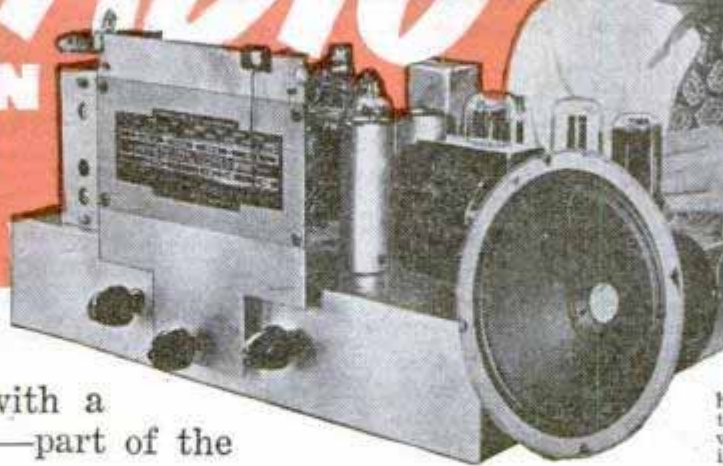

You build this complete, modern super-heterodyne receiver with the equipment that comes with your National Training at no extra cost.

This amazing new shop instruction system gives you actual experience with a Home Radio Laboratory—part of the

SHOP METHOD HOME TRAINING

FOR YOU—A REAL HOME LABORATORY IN MODERN RADIO

from one of the world's best established Oldest and Largest Technical Trade Schools

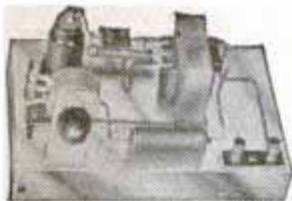

have the genuine parts for this audio oscillator which you get to understand by building it yourself.

You learn modulation, beat frequencies, signal generation by actually building this small radio transmitter with your National shop parts.

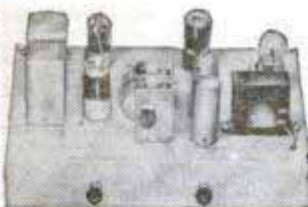

Your National Training Kits include equipment for hundreds of practical electronic experiments in your own home. You

Send the coupon below, immediately. Learn how this **sensationally improved**, practical speed-up training can fit you, in a short time, for the **GREAT BUSINESS OF RADIO**—for the **NEW AND RAPIDLY EXPANDING FIELD OF FREQUENCY MODULATION (F.M.), TELEVISION AND ELECTRONICS.**

This is the thoroughly proved, quick and easy speed-up method used so extensively in wartime training—endorsed by the **success of National men everywhere**—a system by which you study in spare time—off hours, even minutes right in your home and yet have the **ADVANTAGE OF REAL SHOP EXPERIENCE** to back you up.

Trained Radio Men Wanted

The man who really **knows modern Radio** is in greater demand today than ever before—not only in Radio proper but in **Television and Electronics**—in **Aviation, Transportation, Communications.** **Good jobs**

are wide open, **WAITING FOR YOU**, in the production, operation and maintenance of modern electronic equipment—in radio stations, in hundreds of industries—in homes, theatres and studios. Good, sound training in this important field is absolutely necessary. And now, National Schools brings such training to you **no matter where you live or what you may be doing**—not only the fundamental theory but the **actual experience that comes with knowing shop practice and working with real equipment**—demonstrating each step with first-hand knowledge. This is true **"learning by doing"**—direct from the great shops and laboratories of National Schools where new developments in methods, equipment and applications are constantly going forward.

Only National can offer you such practical training because only National has the plant to back it up. **Sample this training yourself. MAIL THE COUPON FOR A FREE LESSON.**

POSTWAR SUCCESS and SECURITY FOR YOU

Radio is a Big Sound Well-Established Business. **Television is just on the threshold of limitless expansion.** When you hang up your uniform—when your war job folds up, will you step out proudly into an essential established industry? Perhaps into a business of your own? Answer these questions by reading the catalog sent you **FREE** from National Schools. **Face realities now!** Fill out and mail the coupon today.

Check the Job You Now Have With These Opportunities in RADIO

1. **Financial Security** Radio has grown from \$100 million to \$5 billion in past few years.
 2. **Limitless Future** predicted by over 1,800 manufacturers of equipment.
 3. **Television promises** over half a million jobs alone—experts estimate.
 4. **Electronics opens** wide new fields in home and industrial use.
 5. **Your Own Business** with little or no capital.
- Get the details. Use the coupon!

FREE GET THESE 2 BIG BOOKS



NATIONAL SCHOOLS

LOS ANGELES 37, CALIFORNIA EST 1905

MAIL OPPORTUNITY COUPON FOR QUICK ACTION

National Schools, Dept. PM-6
4000 South Figueroa Street
Los Angeles 37, California

(Mail in envelope or paste on penny post card)

Mail me **FREE** the books mentioned in your ad including a sample lesson of your course. I understand no salesman will call on me.

NAME..... AGE.....

ADDRESS.....

CITY..... STATE.....

Include your zone number

NATIONAL TRAINING WINS BIG JOBS

You, too, can share the success of National graduates. Joseph Grumich, Lake Hiawatha, N. J., writes: "My latest offer was for \$3,800.00 as Radio Photo Engineer, but I am doing well where I am. I am deeply indebted to National."

Joseph Michel, Jr., Granite City, Illinois, writes: "I am enthused with National training. I am now earning \$225 a month as a radio operator and technician and \$20 a week more in my shop at home."



While still a student of National training, I. Wilson of Vallejo, California, writes: "My pay has jumped from \$52.18 a week to \$72.65, and the end is not in sight. I am proud of my National Course."



AUTO

BOOKS ON APPROVAL

SEND NO MONEY. Just mail the coupon for a complete set of Six Big Auto Books. 20th Edition. Whether you are a mechanic or helper, expert or apprentice, auto owner or driver, take immediate advantage of this FREE EXAMINATION OFFER.

MAKE GOOD MONEY NOW HOLD A PERMANENT JOB

America wants its automobiles kept in good repair. Men with "know how" are in demand, at big pay. These books will help you get and hold an important job, or give you a chance to go into business for yourself now or later. Any man who half tries to improve himself can learn auto servicing and repairing by this quick reference method. Use the JIFFY INDEX to find easily understood answer to any auto problem. These wonder books prepared by eleven of America's great automobile engineers. Many hundreds of valuable illustrations. Send the coupon TODAY.

[A year's consulting privileges with our engineers now given with these books without extra charge.]
Vocational Publishers Since 1898

CAN YOU FIX IT?

These wonder books tell step by step HOW to make difficult repairs and adjustments, how to keep a car at maximum efficiency, including latest improvements in car design and operation. Engine troubles and how to correct them well covered.

6 BIG VOLUMES

2800 pages, 2000 illustrations, wiring diagrams, etc., including Diesel engines, beautiful modernistic, washable cloth binding.

AMERICAN TECHNICAL SOCIETY, Dept. AA-19
Drexel Ave. at 58th St., Chicago 37, Ill.

I would like to examine your Six-Volume Set of Auto Books. I will pay the delivery charges only, but if I choose I may return them express collect. If after 10 days' use I prefer to keep them, I will send you \$2 and pay the balance at the rate of only \$3 a month until \$24.80 has been paid. Please include consulting service as offered above.

Name

Address

City

State

Please attach a letter stating your age, occupation, employer's name and address, and name and address of at least one business man as a reference. Men in service, also please give home address.



Save 1/2

MAKE YOUR SPARE TIME PAY!

Assemble These Beautiful Home Furnishings Yourself NO TOOLS... NO WORKSHOP NEEDED!

Your spare time is worth money! Make these smart, modern furnishings for your home... or as luxurious gifts for your friends! Styled by Paul Hudson Stanley, nationally known designer, these ultra-near accessories combine the natural beauty of clear-grained Harvest Oak and the trim lines of sparkling Lucite!

IT'S EASY AND IT'S FUN!

A tabletop Hobby! Each beautiful accessory comes in complete Kit form. All parts and materials of selected woods and gleaming Lucite are accurately pre-cut and ready for assembly. Nothing to cut, carve or shape... NOTHING ELSE TO BUY! Step-by-step instructions guarantee easy assembly, beautiful results!

HERE'S HOW YOU SAVE ONE-HALF!

Leading stores now feature identical items at assembled retail prices exactly DOUBLE your cost for complete Hobby Kits! You SAVE ONE-HALF... make your spare time PAY by building these articles with your own hands! For Pleasure and Profit... write today for free details of this enjoyable new Hobby!

HEMOCRAFTERS GUILD Dept. F3
360 N. MICHIGAN AVENUE • CHICAGO 1

Tomorrow's MONEY MAKING OPPORTUNITY IS HERE Today

Returning Veterans! Office and factory workers. All Men looking to the FUTURE! Get set for life with one of America's greatest industries. Quick cash profits are yours demonstrating AUTOFYRSTOP, the new combination automatic and manual fire extinguisher and alarm that holds unequal records. Sells fast to factories, schools, homes. Write for FREE facts. No experience necessary.

AUTOFYRSTOP CO., Dept. M-66
2035 Washington Ave., Philadelphia 46, Pa.



KILLS FIRE BY ITSELF

BOOKS FOUND FREE!

WHAT BOOKS DO YOU WANT?
We quote the lowest market prices. No charge for locating Hard-to-Find and Out-of-Print Books. All books, OLD or NEW, mailed POST-FREE.
SEARCHLIGHT BOOK CLUB, 22 East 17th St., New York City

PLAY GUITAR LIKE THE COWBOYS DO... 8 1/2\$ A LESSON



Just out—very latest guaranteed, simple, easy method. Play cowboy songs the Western way in a few minutes by ear. Surprise and amaze your friends. Be in big demand at parties, camps, public entertainments, on the radio, etc. 12 Complete Lessons. **SEND NO MONEY.** Pay postman only \$1.00 plus postage and C.O.D. charges, or send \$1.00 and get EXTRA SONGS all postpaid. (Canada, \$1.25 money order only.) Nothing else to buy. Positive money back guarantee. Rush order today.

WESTERN RANGER STUDIOS, Dept. 156, Hutchinson, Kans.

ENGINEERING DEGREE IN 27 MONTHS

INDIANA TECHNICAL COLLEGE

Aeronautical, Chemical, Civil, Electrical, Mechanical, and Radio Courses. B.S. degree, 1-yr. diploma in Electrical, Mechanical and Radio Service; Drafting. Prep. courses. Gov't. approved for GI's. Low rate. Earn board. Large industrial center. Demand for graduates. Enter June, Sept., Dec., March. Catalogue. 566 E. Washington Blvd., Ft. Wayne 2, Ind.

Learn LANDSCAPE GARDENING!

A thorough, constructive, interesting home-training, covering your regional conditions, for those who wish to become LANDSCAPERS, DESIGNERS, GARDENERS, etc., for profit or pleasure. Write today for FREE INFORMATION, without obligation, to

NATIONAL LANDSCAPE INSTITUTE
Dept. P-6 756 So. Broadway Los Angeles 14, California

Learn Public Speaking

Learn theory and fundamentals at home—in spare time. Then acquire actual experience and practice. Send for FREE booklet "Power of Effective Speech."

North American School, Dept. 135-A
1315 S. Michigan Ave., Chicago 5, Illinois

INVENTORS

WITH GOOD INVENTIONS

Should write us without delay for FREE BOOKLET, Protective Disclosure Form and facts about The Inventor's Most Logical Markets. Patented, Unpatented inventions, all kinds, Cash, Royalty, needed by specific manufacturers. If your invention is for sale, write today for full particulars. A Post-Card will do! Address:

THE INVENTION REPORTER
50-11106 South Longwood Drive Chicago 43, Illinois

JUST OUT! NEW FROM COVER TO COVER

AUDELS REFRIGERATION and AIR CONDITIONING GUIDE

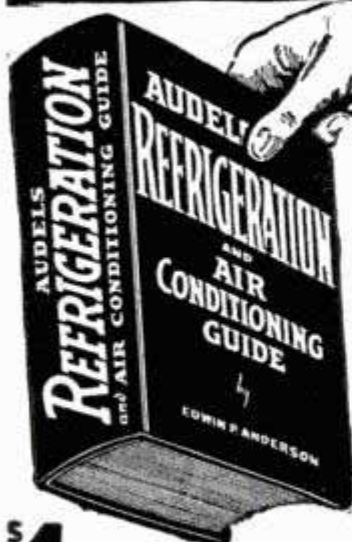

4 Books in One! Covering:

- Basic principles, Servicing, Operation, Repair of
- 1—Household Refrigeration
- 2—Special Refrigeration Units
- 3—Commercial & Industrial Refrigeration
- 4—Air Conditioning Systems

A gold mine of essential important facts for ENGINEERS, SERVICEMEN & USERS.
A Good Book is a Good Friend! Here you have at your fingers' ends a Complete Library in ONE VOLUME, the necessary data you have been looking for on: MODERN UNITS, SYSTEMS & MACHINES, REFRIGERANTS, including Freon, Lockers, Water Coolers, Quick Freezing & Air Conditioning Systems.
1280 Pages, 46 chapters all Fully Illustrated & indexed for Ready Reference.

ANSWERS YOUR QUESTIONS

Get This Information for Yourself. Mail Coupon Today. No Obligation Unless Satisfied. ASK TO SEE IT.

4 COMPLETE • PAY ONLY \$1. A MONTH ←

AUDELS, Publishers, 49 W. 23rd St., New York 10, N.Y.
MAIL AUDELS NEW REFRIGERATION GUIDE for free examination. If O. K. I will send you \$1 in 7 days; then remit \$1 monthly until price of \$4 is paid. Otherwise I will return it.

Name _____
Address _____
Occupation _____
Employed by _____ PM

NORTHROP Aeronautical Institute (Division of Northrop Aircraft, Inc.) 1 and 2 Year Courses AERONAUTICAL ENGINEERING

The two-year Aeronautical Engineering course at Northrop gives you a thorough working knowledge of aeronautics, including all fundamentals as well as advanced theory. A one-year course in Aeronautical Engineering is also available. After completing your training at Northrop Field, in the midst of one of the world's great aircraft engineering and research organizations, you can enter upon your career in commercial aviation with the confidence of a trained practical aeronautical engineer.

Other Courses Offered—The Aircraft and Engine (A&E) Mechanics courses are thorough and modern. Special methods of presentation, developed for the exclusive use of Northrop students, are utilized.

Veterans—The institute is approved for the training of veterans under the G. I. Bill of Rights.

NORTHROP AERONAUTICAL INSTITUTE
1527 E. Broadway, Hawthorne, California

SEND COUPON FOR COMPLETE INFORMATION

NORTHROP AERONAUTICAL INSTITUTE
1527 E. Broadway, Hawthorne, California

Please send me your free, illustrated booklet and information, including starting dates and tuition rates, on the training courses checked below.

- Aeronautical Engineering Master Aircraft & Engine Mechanic (A&E)

Name _____

Address _____ Age _____

City _____ Zone _____ State _____

- Check one: Veteran In Service Civilian

Make Your Own RUBBER MOLDS

Amazing New Method!....

Now, an amazing new method to make your own flexible rubber molds to recast sculptured models or subjects. Duplicate singly or in quantity, expensive original subjects at amazing low cost. Reproduce statuettes, plaques or any other models—any surface—with this new liquid rubber material. Hundreds of other uses.



PROFITABLE HOBBY! Start this fascinating hobby that can lead to beginning of your own business. For only a few cents each, make hundreds of castings to resell at big profit prices. Easy to start. Big list of subjects you can reproduce. **SEND NO MONEY!**

Just your name and address for **BIG INTRODUCTORY KIT** containing 14 different items; everything you need to work with including famous Indian model. Pay postman only \$1.49 plus C.O.D. postage. Money back if not satisfied. Or save C.O.D. by sending \$1.49 with order and we pay postage. Write for **FREE CATALOGUE!**

RUBBER-FOR-MOLDS • 521 W. Monroe, Dept. 49-H • Chicago 6, Ill.

LEARN AT HOME TO MOUNT BIRDS

Animals, Heads, Fishes, Pets; to TAN. Be a Taxidermist. Profit and FUN.

Hunters, save your valuable **TROPHIES**. Mount ducks, squirrels, everything. Learn to TAN for leather and furs. Wonderful **HOBBY** Have a **HOME MUSEUM**. **BIG PROFITS** mounting for others. **INVESTIGATE NOW.**

FREE BOOK With 100 fine game pictures. **NOW absolutely FREE. Write TODAY.** Send Postal **TODAY** for **FREE BOOK**. State **AGE**. **N. W. SCHOOL OF TAXIDERMY, Dept. 337A, Omaha, Neb.**



BUILDING

Millions of homes needed. Nation wide call for builders. Big opportunities. Learn now in spare time. — at home. Practical training with blue prints. No books. Send for **FREE Trial Lesson** and blue print plans.

CHICAGO TECHNICAL COLLEGE
G-150 Tech. Bldg., 2000 S. Mich. Ave.
Chicago 16, Ill.

FENCING World's Finest Sport

Just Out! Healthful, Clean, makes you Strong & Alert. **FREE BOOKLET** (with foils) teaches Quickly & Easily. **HARMLESS** 3 ft. Spring Steel Foils (swords) have Safety Rubber Buttons. Complete outfit, 2 foils (swords) with hand guards. Free Instructions. Now only \$1.98; Postpaid. Junior Masks only \$3 for two. \$1.69 for one Postpaid. Mail check or M.O. today. Add 28c for Foreign Postage.

LEE PRODUCTS CO., 1613 N-FIRST AVE., NEW YORK 28, N. Y.

CODE-RECEIVING SPEED

Learn to send and receive Radio Code with greater speed. Stop nervous tension. Have confidence. Be proficient. Same system used by radiotelegraph specialists. Thousands of operators needed. Rush name for **FREE** book.

CANDLER SYSTEM CO.
Dept. 5-G, Box 928, Denver 1, Colo., U. S. A.

NEW OTTAWA Wood Saw

FOR TRACTORS Makes wood sawing fast; easy. Cuts enough wood to pay for itself quickly. Easily moved while attached. Big blade; send for **FREE** details. **LOW PRICE** **OTTAWA MFG. CO., V. 627 Oak Ave., Ottawa, Kans.**

Good Handwriting HELPS YOU WIN SUCCESS!

It's so important to write a good hand for business and social advancement. Poor illegible penmanship often causes costly errors and marks you for failure. Why write a poor hand? It's so easy to learn at home in spare time. Write for our new free booklet today. If you wish, send 10c for a pinpoint suitable for shaded writing and your name beautifully written.

THE TAMBLYN SCHOOL OF PENMANSHIP
In Business Since 1895 H-441 Ridge Bldg., Kansas City, Mo., U. S. A.



IT'S FUN! BE YOUR OWN MUSIC TEACHER!

YES, it's a great pastime learning music this short-cut, Print and Picture way, right at home. You learn to play by playing real tunes by note with the very first lesson.

No boresome exercises. No lengthy, baffling explanations. Instead of hard work, learning to play becomes a genuine pleasure. You start with simple melodies. As you improve, you take up more difficult pieces. And soon you're amazed to find that you can pick up many popular tunes and play them right off.

And that's not all. You can take up any instrument this easy, home-study way for only 7c a day. That covers everything, valuable sheet music, printed instructions, diagrams, and our Personal Advisory Service.

If interested, send for our Free Booklet and Print and Picture Sample which explain all. U. S. School of Music, 76 Brunswick Bldg., New York 10, N. Y.

*Actual name on request. Picture by professional model.

It's easy as A-B-C!

Yet it's from that stirring favorite of the South, "Dixie"



Diagrams like this explain everything

Follow the dotted lines from the notes to the piano keyboard and before you know it you're playing the famous "Dixie".



PLAYS ON RADIO . . .

"As a proud student I can't keep from telling you that as a result of my course I have a good position playing from KTHS every morning."

* J. S. Heavener, Okla.

POCKET WATCHES

SWISS MOVEMENTS



Now available "EXPERT" watches. Swiss made watches are known the world over for their accurate time-keeping and quality construction because they are made by master watch craftsmen. This handsome men's pocket watch has a sturdily-constructed chrome case and open figure dial. A timepiece you will be proud to own. SEND NO MONEY. Simply pay postman \$8.50 plus 10% tax and postage. Wear 10 days on our money back if not satisfied guarantee. United Products Co., 7911 S. Halsted, Dept. P-327, Chicago 20, Ill.

SAY YOU SAW IT IN POPULAR MECHANICS



—TRAIN AT HOME IN YOUR SPARE TIME

The fascinating field of Art offers commercial opportunities to men and women. COMMERCIAL ART, CARTOONING, DESIGNING all in one complete course. TWO ART OUTFITS furnished. Learn to draw step-by-step. Trained Artists are capable of earning \$40, \$60, \$75 a week. Write today for full information and FREE BOOK, "Art for Pleasure and Profit." Mail coupon now.

FREE BOOK gives details

WASHINGTON SCHOOL OF ART, Studio 126C, 1115-15th St., N. W., Washington 5, D. C.

Name.....AGE.....

Address.....

City.....Zone.....State.....



LEARN PLASTICS

GET THIS COMPREHENSIVE, PRACTICAL KNOWLEDGE of Plastics—materials, designing, molding, fabricating, laminating, testing, etc. Plastics Institute's course can be of great value to you in obtaining the kind of a position you want in this growing industry. Send for free booklet now!

Approved for Veterans

Plastics
INDUSTRIES TECHNICAL INSTITUTE

NEW YORK CHICAGO LOS ANGELES
122 East 42nd St. 221 N. LaSalle St. 1601 S. Western Ave.

PLASTICS INDUSTRIES TECHNICAL INSTITUTE
Dept. PM6-6, 1601 S. Western Ave., Los Angeles 6, Calif.

NAME.....

ADDRESS.....

CITY.....ST.....

Veterans: Check for special information.

If under 18: Check for special booklet.

FREE BOOKLET



OFFERS LOW COST LIFE INSURANCE

Postal Life offers \$1724. in Protection for \$2.00 monthly (age 21). Other Ages in Proportion

THIS PREMIUM HALF PERMANENT RATE

Policy Fully Paid-up in 30 years

NEW YORK, Saturday. Postal Life of New York, unique among important Old Line, Legal Reserve Life Insurance Companies, is again offering this special modified policy, already owned by thousands of American families. You pay half the permanent rate until the 6th year; \$2.00 monthly for substantial amounts of Protection, depending on age! \$2.00 monthly pays for \$1754. of life long protection at 20; \$1142. at 40; \$5.00 monthly buys \$3650. at 30, etc. Proportionate amounts at other ages. You pay no premiums after 30 years; policy fully paid-up and in force your entire life.

For your convenience we print below a coupon that can be clipped and sent to Postal Life. Full information, rates, etc., will be sent to you promptly. There is no obligation to buy but we advise immediate action. Life Insurance is vital to your future and your family's welfare. Postal Life Insurance Company, 511 Fifth Avenue, New York 17, N. Y.

Postal Life Insurance Company

511 Fifth Ave., Dept D—586, New York 17, N. Y.

Mail rates and full details about your "\$2.00-per-month", 30-Payment Life Policy at my age.

Name _____

Occupation _____

Date of Birth _____

Address _____

Include P. O. District Number, if any

AIR RIFLES

BENJAMIN

AIR PISTOLS

ARE IN PRODUCTION

ORDER BENJAMIN AIR RIFLES & BENJAMIN AIR PISTOLS from your DEALER. Send for our FREE FOLDER and Complete Specifications TODAY. Both Calibre Benjamin H-C Pellets are available now.

BENJAMIN AIR RIFLE CO., 812 MARION ST., ST. LOUIS 4, MO.

arc welding manual and text book...\$2.00

Teaches you how to become an arc welding operator - one of highest paid trades today. Write today!

Hobart Bros. Co., Box M-562 Troy, Ohio

HUNTING and FISHING



HUNTING and FISHING

is a monthly magazine crammed full of hunting, fishing, camping, dog and boating stories and pictures, invaluable information about guns, fishing tackle, game law changes, best places to fish and hunt—countless ideas that will add more fun to your days afield.

Special Trial Offer

Send 25c in stamps or coin and we will send you Hunting & Fishing for six months.

HUNTING & FISHING MAGAZINE

251 Sportsmen's Bldg., Boston, Massachusetts



Collect U. S. Army Shoulder Patches



An interesting, fascinating hobby. From 20c to 50c each. Master set of 400 patches—\$27.50. Assortments \$1, \$5, \$10, \$25, \$50. Official patches available for every major Army and Air Corps Unit. Send \$1 for sample selection of patches and PATCH CATALOGUE. Orders from Canada—add 20%.



SPRINGER'S

286 San Francisco Street
EL PASO, TEXAS



INVENTING - FOR PROFIT!

If you have an inventive turn of mind, write for free 28-page booklet explaining how the Institute of American Inventors is helping inventors pre-test the profit possibilities of proposed devices to fill today's unprecedented demand for *useful* new inventions.

INSTITUTE of AMERICAN INVENTORS

Dept. 4, 1926 Eye St., NW, Washington 6, D. C.



ONE GOOD IDEA MEANS SUCCESS

Here's 10,000 formulas, recipes, plans, trade secrets, many of which have built fortunes. This massive 890-page volume in its 14th edition is an accepted scientific and industrial authority. Very simply written and may hold the key to your success. Only \$2.50 postpaid. C.O.D. PAID slightly higher.

\$2.50

C. H. BREWER CO., Dept. B
138 VINE ST., HARRISBURG, PA.

Now You Can Lick ANY AUTO REPAIR JOB!

Look up make, model, job in MoToR's AUTO REPAIR MANUAL—and go to work! Complete guide for every model built since 1935. 764 pages; 1000 illustrations; 450 charts; 200,000 repair facts. Index. After 7 days' Free Examination, send \$1; then \$1 monthly for 4 months, 35c postage. If not satisfied, return book, pay nothing. MoToR Book Dept., Desk 1G, 572 Madison Ave., New York 22, N. Y.



Thrilling Work COLORING PHOTOS

Fascinating vocation learned at home by those with aptitude. Thrilling pastime. National method brings out life-like colors. Free booklet.

NATIONAL PHOTO COLORING SCHOOL
1315 S. Michigan, Dept. 135-A, Chicago 5

HOME STUDY OR SHOP TRAINING

Learn Plastics, Refrigeration or Diesel. Study at home, shop work later. Also shop courses in Body and Fender, Machine Shop, Tool and Die. 41,000 graduates. Established 1902. Free booklet. Specify trade.



Begin today. Write now for our Free Book, "How to Become a Good Penman." It contains specimens and tells how others learned to write in spare time. Enclose 10c for your name beautifully written and a pen point suitable for shaded writing. Write today.

THE TANSBYN SCHOOL OF PENMANSHIP
N-441 Ridge Building, Kansas City, Mo.

Study ACCOUNTING

NOW—For Top-Pay Career

Fewer have trained for Accounting in recent years. Yet government regulations and taxes demand more book-keepers and accountants. Good opportunity now to enter this growing, well-paying field. After short period of spare-time training, you can take accounting position and continue study on the job. Interesting, free 48-page booklet describes opportunities and requirements in Accounting and tells how you can prepare quickly and at moderate cost. Write for "Accountancy, The Profession That Pays."

LASALLE EXTENSION UNIVERSITY A Correspondence Institution

417 S. Dearborn St., Dept. 664-H Chicago 5, Ill.

TRAIN FOR KEY JOB OR BUSINESS OF YOUR OWN

REFRIGERATION and AIR CONDITIONING

Millions of Older Units Need Expert Service. Big After-the-War Expansion Will Create Even More Opportunities. Approved for Veterans "G. I." Training

A key job—a successful business of your own—you can have either in this vital, war-hit industry. A serious shortage of service-experts exists in every branch. Big post-war boom will open thousands of new opportunities. Get ready for your big chance. We'll give you the practical training you need—at home—and in our big Chicago shops, largest and most completely equipped in the country. No advanced schooling needed. Our unique methods make everything easy to grasp. We've trained thousands. Pay as you go. Quit when you want to. Get the full facts without obligation. Write TODAY.

INDUSTRIAL TRAINING INSTITUTE

2150 Lawrence Avenue, Dept. P15, Chicago 25, Ill.

"How to Make Money With Simple Cartoons"

A book everyone who likes to draw should have. It is free; no obligations. Simply address
CARTOONISTS' EXCHANGE

Dept. 96-D

Pleasant Hill, Ohio

ELECTRICAL TRAINING

Intensive 8 months residence course in fundamentals of industrial electrical engineering, including radio, electronics. Prepares for technician, engineering aides. Approved for veteran training. 53rd year. Catalog.

BLISS ELECTRICAL SCHOOL

7634 Takoma Ave., Wash. 12, D. C.



GENUINE PRE-WAR QUALITY
FIREWORKS!
OH-BOY

Banner has always been right there with the newest and best in fireworks. Now we give you JET PROPULSION... an amazing rocket plane that can be used over and over again. Write quick for details of this newest sensation in fireworks. It's astounding. It's colossal.

BIG SPECIAL OFFER \$4.95

Giant assortment of over 150 pieces, including 2-3-5 inch salutes, star shells, aerial bombs, flower pots, skyscreamers, battle-in-the-clouds, Roman candles, tubular salutes, and many others... regular \$8.15, retail value for only \$4.95. Rush your order. Supply limited. Catalog FREE.

BANNER FIREWORKS MFG. CO., INC.
DEPT. 109 TOLEDO 12, OHIO

THE FAITHFUL
HEART
OF YOUR FUEL
SYSTEM



AC FUEL PUMPS

Pulsing steadily, hundreds of times a mile, your AC Fuel Pump is the strong, reliable heart of your fuel system. It has given you long, faithful service because of its inbuilt quality and scientific design.

You can prolong that faithful service indefinitely, if you insist upon an AC when you replace your present pump with a new or rebuilt one.

AC SPARK PLUG DIVISION • GENERAL MOTORS CORPORATION

REFRIGERATION AIR CONDITIONING

MODERN SHOP TRAINING

approved **GI** training

TRAIN WHERE THE ARMY TRAINED IN THE SHOP OR AT HOME

This new, fast growing industry needs trained men now! It's fascinating work—easy to learn in our big shops—or train at home on special assignments and finish with practical intensive shop training. G.I. approved for home study, too. Same course and instructors from Army Training program attests the thoroughness and professional level of this long established institute in modern refrigeration and air conditioning.



LEARN BY DOING — WORK ON REAL MACHINES

Proven training methods and expert instructors get you into the heart of this work immediately. Work with tools on actual machines right from the start. It's practical, interesting and it gives you the "know-how" and the "know-why" that distinguishes CTI graduates in the field today. Investigate this opportunity now! Certificate issued.

FREE BIG 16 PAGE BOOK OF VITAL INFORMATION
Tells you the true facts . . . gives you vital information on CTI approved training.

RUSH COUPON TODAY FOR FULL DETAILS

ACT NOW!
LEARN IN YOUR SPARE TIME AT HOME

Commercial Trades Institute, Dept. M26
209 W. Jackson Blvd., Chicago 6, Ill.

Gentlemen:—
Without obligation, please send me the facts. Let me judge for myself the opportunities and post-war security this training offers.

Check here if interested in GI training.

Name.....
Address.....
City..... State.....

Learn this Profitable Profession



IN 90 DAYS AT HOME
Money-Making Career Open to Men and Women, 18 to 50

Hundreds of men and women between 18 and 50 make \$10 to \$20 in a single day giving scientific Swedish Massage and Hydro-Therapy treatments. There is big demand from doctors, hospitals, sanatoriums and clubs. Graduates earn large full time incomes from these or in private practice in their own offices. Others make good money from home treatments given in spare time. Learn this interesting, money-making profession in your own home, through our home study course. Same instructors as in our nationally known resident school. You can win independence and prepare for future security by qualifying for your Diploma. Course can be completed in 3 to 4 months. Many earn while they learn. Begin your training at once.



Anatomy Charts & Booklet FREE

Enroll now and we will include, at no extra cost, many needed supplies. Fit yourself to help meet growing demand for Scientific Swedish Massage. Send the coupon at once for complete details. Anatomy Charts and 32-Page Illustrated Booklet, FREE, postpaid.

THE COLLEGE OF SWEDISH MASSAGE
Dept. 664G, 100 East Ohio St., Chicago 11, Illinois

Please send me FREE and postpaid, Anatomy Charts, 32-page Booklet and complete details on Home Training.

Name.....
Address.....
City..... State.....

Floyd Clymers Popular MOTOR BOOKS

Send for FREE Motor Book Catalog

INDIANAPOLIS "500" RACE HISTORY BOOK

Just out! 2000 illustrations; 320 large pages; complete detailed data on every race held on Speedway since 1909. Foreign and U.S. cars and drivers shown. Enjoy for 10¢ a race year after year history. Complete book \$3.50; with De Luxe red Fabrikoid binding, \$5.00.

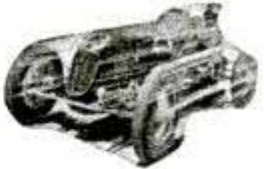

MOTOR RACING with MERCEDES-BENZ

Sensational book of Grand Prix Racing. 176 pages, includes 93 finest action photos. Famous speedways, cars described. See and read about Caracciola, Rosemeyer, Seaman, Ruesch, Mays, Nuvolari, Lang, others. Photos Mercedes-Benz, Auto-Union, Alfa-Romeo, Bugatti, Maserati, others. Graphic, thrilling race incidents. Postpaid, \$2.00; De Luxe clothbound \$3.00.

Ab Jenkins Race History Book, \$1.50 . . . Power & Speed, \$2.50 . . . Speed—How to Obtain It, \$1.50. All books postpaid. See our ad under Autos, Classified section. Pin check or M.O. to this ad—Mail Now to

CLYMER, Dept. A6, 2125 W. Pico, Los Angeles 6, Calif.

MUSIC LESSONS

LEARN . . . PROGRESS . . . EARN MORE . . . S . . . SUCCEED . . . S

Your own achievement, popularity, success through music. Learn in your home. Check course: Piano, Violin, Cornet, Saxophone, Clarinet, Guitar, Harmony, Arranging, History. If juvenile, parent's signature must accompany inquiry. Low cost. Easy Terms. FREE catalog. Suite U-392 765 Oakwood Bl. Chicago 15

UNIVERSITY EXTENSION CONSERVATORY

Fix Your Own ALARM CLOCKS

New, practical home course. Just out. Makes interesting hobby—profitable too. Save money by doing your own repairing at home. Easy if you know how. Price now only \$1.00. Details FREE. Send postcard.

THIES JEWELRY STORE, Genoa 3, Illinois

Get U.S. Gov't. Job

Splendid salaries, vacations, pension when retired. My low-priced, home-study practice tests help you make high grade in Gov't Exam. Write today, **OZMENT SCHOOL, 80, St. Louis, Mo.** (Veterans given preference)

Correspondence Courses in RADIO and ELECTRICAL ENGINEERING

LOW AS \$25

ELECTRICAL ENGINEERING. Get good grasp of wide electrical field. Modern. Very understandable. Theory made easy.

RADIO ENGINEERING. Extra fine course in radio, public address, photo-electric work. Trains you to be super-service man, real vacuum tube technician. Tuition ONLY \$25, either course. Deferred payment plan. Servicemen needed badly.

FREE Write for free copies of school catalogs, student magazines, etc.

LINCOLN ENGINEERING SCHOOL, Box 931-P90, Lincoln, Nebr.

SAY YOU SAW IT IN POPULAR MECHANICS

THERE'S MONEY IN CARTOONS!

RAYE BURNS will teach you HOW to CREATE ORIGINAL CARTOONS at home that you may SELL! Course contains 25 lessons and over 600 illustrations. All for Only..... **\$2.85**

Send name and address for free details.

RAYE BURNS SCHOOL, Dept. M, Box 3583, CLEVELAND, OHIO

WATCHES WANTED Broken or Usable

—all kinds, even Ingersolls. Highest prices paid for jewelry, rings, spectacles, gold teeth, etc. Cash mailed promptly. Write for Free Shipping Container.

LOWE'S, Holland Bldg., Dept. PM, St. Louis 1, Mo.

Make Your Own RUBBER MOLDS

with **RED LATEX MOLDING COMPOUND**

Earn money, have fun; make your own molds for plaster objects. Produce novelties and gifts for home and to sell to friends. **RED LATEX MOLDING COMPOUND** (60% density) now available in quart and gallon quantities. Gives perfect results, easy to apply. Send for complete information and prices.

OHIO SUPPLY CO., Dept. G2, 474 Lilly Ave., Columbus 5, Ohio



WHEN YOU BUY A HAMMER

...or a wrench, drill, paint brush, screwdriver or any other tool or hardware item, buy it from the man who has built his business on *quality*—your hardware dealer.

There is no substitute for the fine materials and precision workmanship that go into a top-quality tool. A man might find something that *looks* the same... at a tempting bargain price ... but it'll let him down when he needs it most.

Drop in at your hardware dealer's whenever you're nearby and see what's new in the world of fine tools and hardware. He'd rather serve you than ordinary customers because you're a *Popular Mechanics* reader and you're just as *quality-minded* as he is.

Your **HARDWARE DEALER** sells **QUALITY Tools and**
Hardware... BUY FROM HIM

**POPULAR
MECHANICS**

It's YOUR future — Make the most of it!



Start now to earn the bigger pay in electrical repair

WAS there ever such an opportunity to get started in electrical maintenance and repair—and at top-notch wages? Are you ready—with experience and ability—to cash in on it? Others are getting just the sort of background needed—quick! practical!—to handle the great variety of electrical maintenance and repair work TODAY—from this well-known electrical library. You can too!

THE LIBRARY OF ELECTRICAL MAINTENANCE AND REPAIR

5 vols., 1826 pages, 1724 illustrations

Gives you the "know-how" to tackle any wiring or motor job. Five books show you HOW—to install all types of motor and generator units—to inspect and repair motor starters and generators—to diagnose motor and generator troubles—to figure new windings for old cores—DC and AC windings—to test armature windings—test induction motors, etc., etc. One book is full of trouble-shooting charts that show quickly symptoms, causes, specific remedies, etc.

Take the first step toward improving YOUR future—Mail this coupon TODAY

No money down—special price—easy payments—FREE trial

McGraw-Hill Book Co., 330 W. 42 St., New York 18, N. Y.

Send me for ten days' free examination the Electrical Maintenance and Repair Library. If satisfactory I will send you \$1.50 in 10 days and \$3.00 monthly until the price of \$16.50 is paid. If not wanted I will return books postpaid. (To insure prompt shipment write plainly and fill in all lines.)

Name.....
 Home Address.....
 City and State.....
 Company.....
 Position..... PM-6-46

Do you want

- ➔ ..to go to College?
- ➔ ..or to enter a Profession?
(Such as Accounting, Architecture, Nursing, Dentistry; Teaching, Social Work, Osteopathy, Beauty Culture, Optometry, Embalming, Chiropractic, Law, Medicine, etc.)
- ➔ ..or get an Office Position?

To get anywhere, you practically MUST finish High School FIRST. You can complete our simplified High School Course in SPARE time at home, as FAST as your time and abilities permit. Equivalent to resident school work—prepares you for college, pre-professional examinations, business, industry. Standard texts furnished. Diploma. Credit for H. S. subjects already completed. Single subjects if desired. Low tuition, easy terms. American School, Chicago, est. 1897—endorsed by educators. Finish your high school education NOW. Write TODAY!

High School Course at Home Many Finish in 2 Years

American School, Dept. HA45, Drexel Ave. at 58th St., Chicago 37, Ill.
 Gentlemen: Send me FREE information covering special training in subjects checked below. No obligation on my part.

- | | |
|--|--|
| <input type="checkbox"/> High School Course | <input type="checkbox"/> Diesel Engineering |
| <input type="checkbox"/> Architecture and Building | <input type="checkbox"/> Drafting and Design for Men & Women |
| <input type="checkbox"/> Automotive Engineering | <input type="checkbox"/> Plastics |
| <input type="checkbox"/> Business Management | <input type="checkbox"/> Private Secretary |
| <input type="checkbox"/> Electrical Engineering | <input type="checkbox"/> Mechanical Engineering |
| <input type="checkbox"/> Elec. and Gas Refrigeration | <input type="checkbox"/> Aviation |
| <input type="checkbox"/> Air Conditioning | <input type="checkbox"/> Salesmanship |
| <input type="checkbox"/> Railway Training | <input type="checkbox"/> Radio |
| <input type="checkbox"/> Electronics, Industrial | |

Name.....
 Address.....



COMB-A-TRIM THE NEW QUICK TRIMMER

Something New! Trim your hair without any experience. It's easy! The excess hair comes off smoothly and easily by just pulling trimmer through hair like an ordinary comb. Also removes hair from legs—armpits. Save on hair-cut bills... Trim your own hair or the whole family's. Send 59c and your Comb-A-Trim will be sent at once.



59c

SPECIAL OFFER
 Send \$1.00 for 2 Comb-A-Trims and save 18c. **2 for \$1**

5 Extra Blades (Year's Supply) 25c
COMB-A-TRIM CO.
 1734 Carew Tower Dept. R-7 Cincinnati, O.



BUILDING HUMAN STATURE

"I grew 6 inches in a year through following instructions given in 'BUILDING HUMAN STATURE,'" says the younger man at left. "Now I am a head taller than my father."
 If you wish you were taller send for FREE outline of this remarkable book loaded with practical information.
CARILLON BOOKS, Dept. 20, Boerne, Texas

NEW WRITERS NEEDED

New writers needed to re-write ideas in newspapers, magazines and books. Splendid opportunity to "break-into" fascinating writing field. May bring you up to \$5.00 per hour spare time. Experience unnecessary. Write today for FREE details. NO OBLIGATION. Postcard will do.
COMFORT WRITER'S SERVICE
 200-T40 South Seventh (2) St. Louis, Mo.

TRI-STATE COLLEGE

B. S. Degree in 27 months in Engineering (all branches); Bus. Admin., Acc't and Sec. Science. 63rd year. School now filled to capacity. No applications can be accepted until further notice.
 646 College Ave., Angola, Ind.

\$\$\$ \$ if trained in arc welding
 Big income jobs await you. Learn quickly and thoroughly. Enroll under G. I. Bill. Write today.
Hubert Trade School, Box M-563, Troy, O.

ARTISTS MAKE MONEY

Do you like to draw? Send name, address, age and occupation for FREE ART TEST, to find out your ability.
ART INSTRUCTION, Inc.
 6136 ART INSTRUCTION BLDG., MINNEAPOLIS 15, MINN.

START HOME MAIL ORDER BUSINESS

Start small — grow big. Amazing new course shows you the way. Rush your name and address today for full particulars. No obligation.
BELFORT (Dept. A) Engineering Bldg. Chicago 6, Ill.

ENSHRINE THEIR MEMORIES WITH U.S. MONUMENTS \$14. UP
 There is none better. Our free catalog is ready for you. Write today. A-18 U.S. Marble & Granite Co., Oneco, Fla.

REFRIGERATION

Repair and improve all refrigerators. New manual tells how. Charts and pictures to help you. Price only \$1.00, postpaid. Money back guarantee. Supreme Publications, 9 S. Kedzie Ave., Chicago 12, Illinois.

SIGNS EASILY AND EXPERTLY PAINTED WITH LETTER PATTERNS
 AND SHOWCARDS MANY SIZES & STYLES WRITE FOR FOLDER!
JOHN F. RAHN
 1330-31 N. Central Ave. CHICAGO 51, ILL.

PLEXIGLAS

The Crystal-Clear Versatile Plastic

COLORED AND TRANSPARENT

Our complete warehouse facilities afford you great savings on guaranteed Grade 'A' Plexiglas.

ORDERS PROMPTLY FILLED

CLEAR PLEXIGLAS SHEETS, NEW PER SQ. FOOT:

1/16 \$1.24	3/16 \$1.97
1/8 \$1.61	1/4 \$2.31

COLORED PLEXIGLAS SHEETS: 10% ADDITIONAL
Add 10% for packaging on orders under \$10.

Write for free literature on Plastics and how to work them. Price lists on request for complete line of rods, sheets, tubes, odd shapes in all types of Plastics. Also dyes, cements, buffing compounds.

HOUSE OF PLASTICS

7604 Fenkell

Detroit 21, Mich.

SECRETS OF LOCKSMITHING



ONLY \$1.00. Now available to all, in handy, pocket sized book. Written by experienced lock experts. Contains practical, simple instructions on Key Duplicating, Fitting, Lock Repairing, Changing Combinations, Master Keying, Lock Opening, and many others. Hundreds of illustrations. Teaches locksmithing easily, quickly, at home. Costs only \$1.00. Send your \$1.00 today, on positive satisfaction or money back guarantee.

REPAIR SHOP SERVICE, Box 264-A, Skokie, Illinois

NOW.... ELECTROPLATING

Learn this profitable, interesting trade. Hobby or full time business. Chromium, Nickel, Gold, Silver, etc. Postcard brings full details, FREE.

PLATER HYDE, Dept. M, P.O. Box 176, National City, Calif.

BE A PERFUME DISTRIBUTOR

The most sensational profit possibilities in the whole field of selling: 100% year-round demand, liberal distributor discounts. Sell consumers or dealers, or both. Employ sub-salesmen. No experience needed; we'll tell you how. Finest perfumes made, exquisite, long lasting fragrances women just can't resist at your low prices. Men big buyers for gifts. Beautifully packaged. Write TODAY for free sample and details of tested sales plan.

DUDAN PARFUMS, 21-P West Illinois St., Chicago 10, Ill.

MAGIC LIQUID Prints Photos

On Wood, Leather, Cloth, Cards Letterheads or almost any surface. Use any snapshot or other negative. Make hundreds of prints without harming negative. Won't wash off. Easy to use. Complete kit for 100 or more photos now only \$1.00 postpaid, or \$1.29 C.O.D. (Canada \$1.50 money order only; no C.O.D.'s). Satisfaction positively guaranteed. Rush order today for the original, big, complete Magic Photo Printing outfit.

STYLE-ARTS, INC.

4649 Broadway, Dept. 26, Chicago 40, Ill.

ACCOUNTING

STUDY AT HOME for C.P.A. and BIG PAY Accounting opportunities with 42 year old school. No previous training needed. Texts furnished. EASY PAYMENTS. Send for FREE BOOK.



Mac CORMAC EXTENSION SCHOOL

Dept. 6-B, 1170 East 63rd St. Chicago 37, Ill.

LARGE GENUINE ANCIENT ROMAN COIN — \$1.00

20 different coins 15 countries.....	\$1.00
50 different coins allied nations.....	\$5.00
40 different coins defeated nations.....	\$5.00

Lists — Approvals

DEL MONTE • 40 West 18 • New York 11

FIX TYPEWRITERS

A Simplified Practical Homestudy Course. Many of our Students now have their own Business—Many Repair for others. Repair Shops Swamped. Health or Age no handicap.

WEBER TYPEWRITER MECHANICS SCHOOL
Box 269, Osborn, Ohio



FREE TRIAL IN YOUR HOME!

HERE'S THE HELP YOU NEED FOR BEST JOBS—RIGHT NOW!



DO ANY JOB.. EASIER.. QUICKER
MAKE MORE MONEY in the
BIG OPPORTUNITY FIELDS

SEND NO MONEY
Select the Books
YOU Need Now!
We Ship C.O.D.
Anywhere in U. S.
and Will Refund
Amount Paid if
Not Satisfactory.

Get into one of these big opportunity fields. Big money and many other advantages await you if you prepare now. Here is the help you need — EASY — QUICK — AT LOW COST. Thousands of men have already used these famous books. Beginners and experienced men alike have doubled and tripled their earnings with this help. You too, can now get the special knowledge you need for top pay, better jobs, or a business of your own. This is your GOLDEN OPPORTUNITY.



Air Conditioning

Big air conditioning boom interrupted by war is getting into full swing again. Bigger opportunities ahead than ever before. Get this complete and practical book by an international authority and be ready for your share of millions to be spent. Covers whole field in simple, non-technical language. Shows you what to do; how to do it; how to make money. 450 pages. Illustrated. \$4.00

Welding Practice

When you know welding you are in a profession that is tops in all industries. Start learning now with this newest book on all types of welding and heat treatment of metals. Written by recognized specialists in training men for production jobs. Use it for complete study or a reference guide. Prepare now for best jobs. Price \$4.00

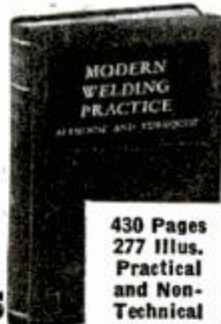

430 Pages
277 Illus.
Practical
and Non-
Technical



Auto Repairs

Car owners are spending big money to keep their good older cars looking like the new ones coming out. This practical, money-making guide shows you how to do it. Ideal for shop owners and every man who wants a share of the millions to be spent in keeping old cars looking new. Tells how to get a good job or start business of your own with small capital. 325 pages, 232 illustrations. \$3.50

SEND NO MONEY! Mail Coupon

GOODHEART-WILCOX CO.,
2009 S. Michigan Ave., Dept. 16, Chicago 16, Ill.

Send books checked, C.O.D. I will pay postman, plus few cents charges. If not satisfactory I will return books in 5 days and you will refund money paid. (Outside U.S. or possessions remit with order.)

<input type="checkbox"/> Auto Body and Fender Repairs	\$3.50	<input type="checkbox"/> Modern Welding Practice. \$4.00
<input type="checkbox"/>		<input type="checkbox"/> Air Conditioning

If remittance accompanies order we will pay all postage charges under same return privilege.

Name.....

Address.....

City..... State.....

WAR BARGAINS in LENSES and PRISMS

NOW! MAKE YOUR OWN BINOCULARS!



Complete Set of LENSES and PRISMS from Navy's 7X, 50 Model

Save Up to \$150.00

Here's an unusual opportunity to secure a fine set of Binoculars at a tremendous saving of money. Build them yourself with all of the very same optics contained in the Navy's 7 Power Glasses. Or you can construct a Monocular (1/2 a Binocular) in which case exactly one half quantities of the Binocular Components will be furnished. All Lenses and Prisms are in near perfect condition, Lenses are cemented and have the new low reflection coating. Complete assembly directions included for either project.

- Stock # 5102-H Near Perfect Binocular Set. \$25.00 Postpaid
- Stock # 5103-H Near Perfect Monocular Set. \$12.50 Postpaid
- Sorry! No more machined sets of 7X, 50 Binocular Metal Parts. We do have unmachined left and right body and cover plate castings . . . but no other parts.
- Stock # 820-H \$2.50 Postpaid
- 35 MM. KODACHROME PROJECTING LENS SET—Consists of 2 Achromatic Lenses for projecting, plus 2 Condensing Lenses and piece of Heat Absorbing Glass with directions.
- Stock # 4029-H \$3.10 Postpaid
- POLARIZING FILTER—Diam. 73 mm. Perfect condition.
- Stock # 637-H \$3.00 Postpaid
- TANK PRISMS—90-45-45 deg., 5 3/4" long, 2 1/4" wide, finely ground and polished.
- Stock # 3004-H Silvered Prism (perfect) \$2.00 Postpaid
- Stock # 3005-H Plain Prism (perfect) \$2.00 Postpaid

We have literally millions of war surplus lenses and prisms for sale at bargain prices. Write for Catalog "E"—Sent Free!

Satisfaction Guaranteed **Order by Stock No.**
EDMUND SALVAGE CO.
 P. O. AUDUBON, NEW JERSEY



FOR
DEAF PEOPLE
New!
Help!

PARAVOX

ONE CASE - ONE CORD

HEARING AID

Outstandingly free from cord and case noise.
NO SEPARATE BULKY BATTERY CARRIER

Comfortable in summer and winter—easy to carry—no extra wires—just one case and one cord. Clear amplification—wide range in tone. Replacement or repair of mechanical parts guaranteed for one year if found defective.

SERVICE PROBLEM SOLVED by the Paravox replaceable chassis. No sending of sets to factory—no bothersome loan sets.

Accepted by the Council on Physical Medicine, American Medical Association
PARAPHONE HEARING AID, INC.
 2045 East 4th St. • Cleveland 15, Ohio
Builders of one-case, one-cord vacuum tube hearing aids since 1942

Get This **FREE** BOOKLET



"NEW Satisfaction From Hearing Aids"

TRAIN NOW

AUTO MECHANICS and BODY & FENDER WORK

ENGINE OVERHAUL
REPAIR SERVICE
TROUBLE SHOOTING
IGNITION
CARBURETION
TRANSMISSION
 ETC., ETC.

MOST COMPLETE TRAINING PROGRAM OF ITS KIND

This old established shop training organization inaugurates a new all inclusive training program in advanced auto mechanics and modern Body and Fender work. Big, modern, fully equipped shop and expert instructors get you into practical do-it-yourself training immediately. Low tuition fee. Veterans, ask for "G.J." Bulletin. Write today for free Booklet No. 80.

Chicago **MOTIVE TRADES Institute**
 DIV. COMMERCIAL TRADES INSTITUTE
 1400 W. GREENLEAF AVE. • CHICAGO 40, ILL.

Get Ready for Big After War Opportunities!

I Will Train You at Home Until You Get a GOOD PAY JOB in

DRAFTING

Act now to get a better job with more pay and pleasant working conditions. Get into Drafting—the basic profession where all post war products will start. I will train you at home—give you experience—doing the same kind of jobs you will do with the best paying firms. I furnish instruments, drawing table and all equipment when you start. Write today for vital facts and FREE illustrated book. Give Age.

Engineer Dobe, Div. 16, Libertyville, Ill.

WORK WITH LEATHER!

Get this simplified "here's how" book; develop real skill in leather craft. Scores of stimulating illustrations show professional techniques, tricks, short-cuts. Order your copy of "WORKING IN LEATHER" today.

\$1.00 pp. Complete list FREE.

HOUSE OF LITTLE BOOKS, 80 E. 11th St., New York 3



SWISS MADE WATCHES

Wear 10 Days at Our Risk!

Swiss made watches are renowned for accurate time-keeping. This men's watch has a sturdy, finely-constructed chrome case, an open figure dial, genuine leather strap. **SEND NO MONEY!** Just pay postman for wristwatch \$8.50 plus few cents postage and 10% Federal excise tax. Wear for 10 days on our money-back if not satisfied guaranteed! Rush orders today—supply is limited. **UNITED PRODUCTS CO.,** 7941 S. Halsted, Dept. MM-304, Chicago 20, Ill.

ENGINEERING SERVICE

Complete with plans, investigations, research, reports, etc. Our technical aid—electrical, civil, mechanical—is available at a price you can afford. Write for FREE estimate.

WILLIAM H. JACQUES ASSOCIATES, Consulting Engineers
 Com'l Div., Zobel Bldg., Red Bank, N. J.

RADIO ENGINEERING. Broadcasting, Servicing, Electronics, Aviation, Marine & Police Radio taught thoroughly. 48 weeks' Engineering course equivalent to 3 years' college radio work. Approved Veteran Training. Co-educational. Catalog free.

VALPARAISO TECHNICAL INSTITUTE, Dept. D, Valparaiso, Ind.

STAMMER?

This new 128-page book, "Stammering, Its Cause and Correction," describes the Bogue Unit Method for scientific correction of stammering and stuttering—successful for 45 years. **Benj. N. Bogue,** Dept. 1837, Circle Tower, Indianapolis 4, Ind.



STOP CUSSIN'
 use **2-WAY**
SPECIAL INSECT REPELLENT

Nash & Kissella Labs., Inc. • St. Louis, Mo.



START YOUR OWN REFRIGERATOR REPAIR SHOP!

START SMALL GROW BIG

Learn to install and repair all types of REFRIGERATION and AIR-CONDITIONING equipment. You can start your own shop with as little as \$50 worth of tools. We show you how. Our practical, shop-tested home-training prepares you quickly and easily during your spare time, for a job or your own business in this fast-growing profitable industry. Send for FREE BOOKLET today. No obligation.

MECHANICS TRAINING SCHOOL
7217 S. Broadway, Dept. P-6 Los Angeles 3



GO WEST ~~SPORTS~~ MAN!

WESTERN SPORTSMAN is fresh as a breath of cold air from lofty crags of the Rockies. News, information, pictures and articles on hunting and fishing in the New West—greatest outdoors country on earth! Shake hands, Podnah, and get acquainted—7 issues for \$1.00. Head your buck our way. We'll do the rest.

WESTERN SPORTSMAN
3303 Bridle Path, Dept. H, Austin, Texas

Learn to MOUNT BIRDS



Tan SKINS, make up FURS

Be a Taxidermist. Double your hunting fun. We teach you at Home. Mount Birds, Animals, Fish, Heads, common specimens. Fun and profits. Decorate home and den **MAKE MONEY**. Mount game, tan for others. Big profits in spare time. **WRITE TODAY.** 100 game pictures in **FREE BOOK** Hunters, get your copy. It's Now Free. Send post card. State your AGE. **NORTHWESTERN SCHOOL OF TAXIDERMISTRY**
Dept. 337A Omaha, Nebraska

SIGN MEN EARN WELL

Tremendous demand always for glass and electrical sign men. Post war expansion assures growing need for more sign men. Only small investment required to start own business. Write today for full **FREE** particulars. **SIGN SERVICE**, 5944 Newark, Dept. S-201, Chicago 31, Ill.

LIQUID MARBLE COLORED POTTERY

Different! Marvelous! Color-glazed. Brush, spray, mold tiles, table-tops, ornaments! **SANITARY COMPOSITION FLOORING**—Dustless, noiseless; put on like plaster, plain or tile designs; yielding as cork, lasting as stone. **RUBBERLASTIC Mold Compound**—For plaster casting, novelties, statuary, toys, plaques, dolls. **TILEX Colored Roofing**. Build Modern **PLASTIC HOMES**. Illustrated literature free. **RAPID MARBLEIZING SERVICE**, Dept. 10-A, Edwardsville, Illinois

SHAW and Peppy-Pal "DU-ALL" GARDEN TRACTORS

1 to 9 H.P. Circulars on request. Building more now. We supply repairs for all SHAW Tractors sold in our 42 years in business.

BUILD YOUR OWN RIDING TRACTOR—"WAR HORSE"

using old auto parts, powered by 2 H.P. or larger air-cooled engine; or walking type Garden Tractor 1/2 to 3 H.P. or convert truck or auto into Farm Tractor. Each with steel or rubber tires; will plow, cultivate. Plans for building, in few hours, any one of above, postpaid for \$1.00 (state which wanted) or all 3 for \$2.00. Money Back Guarantee

SHAW MFG. CO., 4506 Front St.
Galesburg, Kansas
668G North 4th St., Columbus, Ohio

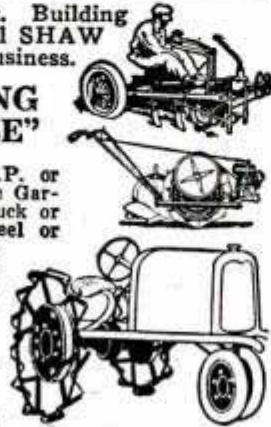

BOYS! MEN!

now you can

MOLD PLASTICS AT HOME!



Get in on the newest hobby craze! Make beautiful buttons, pins, ornaments, etc. of colorful plastics. Fascinating! Modern! And so **EASY** with



PLASTIC MOLDING SETS

Designed by expert Plastic Chemists and Engineers. Contain everything the home craftsman needs to start this absorbing pastime—assorted plastics in various colors, a practical, easy-to-use press, assortment of die-cast aluminum molds, fuel tabs, finishing materials, complete instructions—all packed in a sturdy metal box.

- The Number 1 Outfit costs only..... **\$2.60**
- Number 2 Outfit (illustrated)—more different kinds and colors of plastics in larger quantity, more and larger molds..... **\$4.85**

If your dealer cannot supply you, send money order or check direct. We pay postage.

(DEALERS: Write for particulars)

CANNON & COMPANY
216 Elliott Street, N. W., Atlanta, Ga.

IF  FALSE
TEETH
SLIP OR DROP

USE  **PLASTI-LINER**

MAKES **FIT PERFECTLY** OR
ALL **PERMANENTLY** MONEY
PLATES BACK

ONE APPLICATION LASTS FOR LIFE OF PLATE

PLASTI-LINER is a professionally developed reliner for home use that ends forever the mess and bother of temporary applications that last for only a few hours or a few months. It is NOT a paste, nor a powder; but a strip of genuine dental plastic!

SAFE AND EASY TO USE

PLASTI-LINER is non-toxic, pure, non-irritating, harmless, odorless, tasteless, smooth, molds to mouth. No heat necessary. Just 3 easy steps.

"Excellent Results" say users

"I bought your product over a year ago. Have had no trouble with my plates since. I have told my friends and now all of us with false teeth use PLASTI-LINER. It really works." Mrs. E. S. Brooklyn, N. Y.

FREE! Our competent staff dentist will answer all your plate problems.

SEND NO MONEY — ORDER TODAY

PLASTI-LINER CO., Dept. 55
Walbridge Bldg., 43 Court St., Buffalo 2, N. Y.

Rush PLASTI-LINER with complete directions. I will pay Postman \$_____ plus postage charges. I may return package for refund if I am not satisfied.

\$1 for UPPER or LOWER \$2 for Both

Name _____

Address _____

City _____ Zone _____ State _____

You Save Postage by Enclosing Money

SAY YOU SAW IT IN POPULAR MECHANICS

BOY IT'S KEEN! A REAL METAL
"G-BOY" REPEATING CAP PISTOL RAPID FIRING



ACTUALLY SMOKES ON FIRING
HAS LOUD EXPLOSIVE REPORT

Looks and feels like an Automatic "45." It's made of strong light-weight aluminum... with a plastic "Pearl" handle. It's easy to reload. Send check or money order for immediate shipment—express charges collect. (Smallest order \$1.00. No C.O.D. orders).

\$1.95

Gun Only

Box of 5 Rolls Caps only . 15c
7 Boxes . \$1.00

GENUINE COWHIDE HOLSTER FOR FAMOUS "G-BOY" GUN . \$2
UTILITY STORES, 117 S. Wabash Avenue
DEPT. FF-29, CHICAGO 3, ILLINOIS

RATS

K-R-O KILLS THEM OR
YOUR MONEY COMES BACK!

EASY TO USE! New, improved K-R-O Ready-Mixed comes in handy Bis-Kit form. Nothing to mix. No mess. No bother.

SAFE! K-R-O (Kills Rats Only) is made of red squill. Better to use around children, chickens, and farm animals.

CHEAP! Household size 35c; large economy package for farms, \$1. Also K-R-O Powder, enough to make 200 baits, only 75c. At most drug, seed, and feed stores. Stop losing money—get K-R-O, today!

FREE "Rat Proofing Buildings and Premises," by U. S. Dept. of Interior. Send for your copy, now. The K-R-O Company, Springfield, Ohio. Dept. 78.

K-R-O



LEARN REFRIGERATION at HOME

Simple, easy-to-understand directions for repairing household electric refrigerators. Complete details, diagrams, and photographs. Theory explained in simple terms. These books are authentic. Learn the CORRECT methods.

All yours in four volumes—neat flexible covers—handy size, 6 x 8 1/2 inches—544 pages—only \$4.00. Send cash with order or let us send you set C.O.D. Your money refunded if books are returned within ten days. Write to BUSINESS NEWS PUBLISHING CO., Dept. 31, 450 W. Fort St., Detroit 26, Mich.

Send for FREE folder describing other books on refrigeration and air conditioning.

BUILDING CONSTRUCTION



with composition cement and cheap wood builds 3 room house low as \$250, farm buildings low as \$50. Homemade forms make blocks, panels and tiles in color and wallboard of sawdust and other compositions. Wall-high blocks, insulated, with finished sides. Stream-lined roof and walls. Cement gutters, troweled roofs and floors. Ten formulas. Cabins, stores and sectional. 100 money and labor saving ideas. Mixer and saw easily made from an old auto. Make doors and windows. 50 proved way to earn \$10.00 to \$15.00 a day. Guaranteed, book, 100 illustrations, \$1.00.

MAKE FURNITURE OF COMPOSITION cement, sawdust, asbestos, paper. Some part scrap wood and metal. Illustrate. Instructions to make tables, cabinets, chests, racks, shelves, incised sinks, lawn novelties and toys, 500 per cent profit, 50c.

HOW TO MAKE ACCURATE SHOP MACHINES: Band, jig, and circular saws, electric drills, sanding wheels, forge, tools, electric weed cutters and many other things from old auto parts and washing machine motors. Illustrated, 50c.

HOME MFG. ENTERPRISES, 50 selected home shop projects, illus., 50c.

Special: All four booklets described above, \$2.00 postpaid. No C.O.D.

HOME INDUSTRIES, 1318 So. 30th Ave., Dept. PM, Omaha 5, Nebr.



CARTOON TO SUCCESS!

Learn to cartoon! Big pay! Easy, enjoyable work! Cartoon course, gag course, anatomy course and business course full of plans, markets, ideas. Drawing set and criticism. All one low price! Rush card for details!

HARTMAN SCHOOL, 2438 W ST., LINCOLN 3, NEBRASKA

OTTAWA TRACTOR SAW



350 CUTS PER MINUTE

Make money sawing wood. Use Ottawa—fastest cutting. Cuts large, small logs easiest way. Fells trees. One man operates. Thousands in use. Built to last with heavy, stiff saw blade. Positive safety clutch control: uses power take-off any tractor.

OTTAWA MFG. CO., D-627 Forest Ave., Ottawa, Kan.

Always write your name and full address clearly when answering advertisements.

BANG! with the Repeating G-BOY CAP PISTOL

ALL METAL — SILVER FINISH

- Shoots 50 caps automatically
- Rapid firing
- Looks like a real '45

De Luxe Model
7" Long



- Explodes with a "Bang"
- Actually smokes when fired
- Holds a 50 Cap Roll—easy to load
- Full sized plastic hand grip

Order Direct Now--Satisfaction Guaranteed

Enclose \$2.50 for G-BOY REPEATING CAP PISTOL and 20-50 Cap Rolls (1000 shots)—shipped express charges collect. Better include \$1.00 additional for 35 extra Cap Rolls (1750 shots). Satisfaction **GUARANTEED**. Sorry, no C.O.D.'s.

GAMCO, 215 W. Illinois St., Dept. PM-6, CHICAGO 10, ILL.

PISTOL ONLY \$1.95
PISTOL and 20-50 Cap Rolls \$2.50
EXTRA CAPS 35 Rolls (1750 Shots) \$1.00

BUILD YOUR OWN RADIO or RECORD PLAYER with these "Easy to Build Kits"

#1—Crystal Radio Kit—Complete, including Trimm De Luxe headphone, headband, cord, one special coil, one walnut finished base wired and drilled, 4 cellophane envelopes containing all necessary parts to make a complete working crystal radio.
Your Cost **\$2.97**

#2—One Tube Special—All the necessary parts to build a one tube AC-DC or battery operated radio—includes tube and cabinet.
Your Cost **\$9.95**

#3—Record Player Kit—Complete—Includes—
—110V 60 cy. AC motor and turntable
—Large P.M. Dynamic speaker and output transformer
—AC-DC—3 tube amplifier, complete with tubes
—Curved lightweight pickup with rest
—Beautifully styled—leatherette covered case
—Special low price—**\$32.50** only

Shipped Anywhere
10% Deposit With Order

NIAGARA RADIO SUPPLY CORP.
160 GREENWICH ST., NEW YORK 6, NEW YORK

HOW TO MAKE MONEY BY MAIL

Down-to-earth facts, directions (illustrated) for running business profitably, using expertly for **YOUR** good fortune the employees, trains, planes which Gov't places at your disposal **CHEAP**. Get orders by mail, ship by express or freight or mail, get out of the kindergarten . . . 14th edition, enlarged to 576 pages, now selling. It's **YOUR** winner. Make this year and the following years worth more. **THIS** knowledge really **PAYS OFF**.

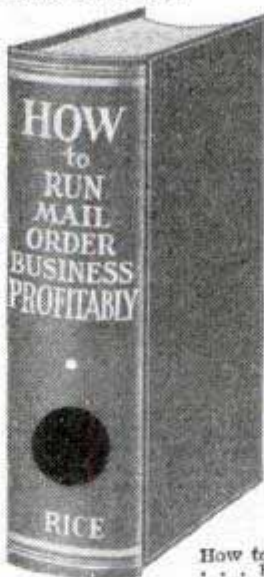

THE EASY WAY to start new or expand your present occupation. Do it **NOW**. Extraordinary plain, simple skill, know-how. No theory. Fact story of rich experience of author E. Rice day-by-day. How many times have we heard: "I wish I had some money, this patent would earn me a fortune," or "why can't my crop pay better?" or "I wish I knew how to sell this gadget myself," or "why should my boss alone do this when I too know how the money is made?" . . . Listen, you do not need money to start this Rice way. His method automatically pays all bills same day rendered, no bank loans, pay as you go, no borrowing from relatives or friends, no salesmen. Also no worry, quickly a home of your own all paid for. Rice paid off \$5000 in mortgages a year after using this skillful idea.

45 Years of PROOF

Sounds fishy? Sure, but this has been done steadily for 45 years, depression or no depression, by the author; that is why he wrote this book, to pass the good word along. Make it go with anything you have which is salable, or with what you are now doing. Rice made his pay plan go from the street when living in one room in a city lodging house. Turn your city or country home, your work, your hobby, into money. How to get orders coming steadily at cost of only \$4 for each \$100 taken in. The popular error to avoid in trying for sales. Business won free while others have to pay for it.

How to conceive the money-getting advertisement. . . . Profitable changes from ordinary ideas and methods. Not usual cut-and-dried pattern, 165 adventures, a dictated book in everyday talk by Rice

doing day by day what he discloses in his book can be done by his method. No dictionary writing. . . . Read how others are profiting big.

Take a chance on this book being worth a fortune to you and yours and send **\$2.95**. Book mailed same day order is received. Or ask two friends to chip in 98 cents each with your 99c to get this book. Hundreds of buyers whose letters we show you declare **emphatically** its superlative goodness. Follow its easy pattern for success. Cloth-bound, 576 pages, 8 1/2 by 5 1/2. Best seller, 14th edition now selling. Cut out the **\$2.95 HOW BOX** here, pin or stick it to sheet of paper bearing your name and address, mail in envelope with money order or check for **\$2.95** to

HOW \$2.95

HOWARD ST. HOUSE, Melrose 76d, Massachusetts

TAKE ORDERS GALORE 21 SUNSHINE NOTES FOR ALL OCCASIONS A NEW CREATION

Tricky, novel designs. Everybody buys. No greetings inside. Sells like hot cakes. Costs as low as 50c. Also new Beaded Everyday Boxes. Birthdays, Convalescent, Everyday Gift Wraps. Send for samples on approval today.

Sunshine Art Studios, 115 Fulton St., Dept. EEG, New York City

SAY YOU SAW IT IN POPULAR MECHANICS



now also contains

Guaranteed by Good Housekeeping

Kills the fleas QUICKLY!
Keeps others off for days!
Still 25¢ and 50¢

INVENTORS

Do Not Delay

Have you ever been startled by seeing a successful article on the market, and exclaimed—"Why, I invented THAT 5 years ago—I didn't think it valuable enough to Patent!"

The Patent Laws were intended for the Protection of the Inventor, and the Inventor who slumbers on his Rights may wake up to find someone else reaping the reward that could have been his.

Write NOW for Information and Record of Invention form FREE. RANDOLPH & BEAVERS, Registered Patent Attorneys, Columbian Bldg., Washington, D. C.

PERSONALIZED SERVICE — REGISTERED PATENT ATTORNEYS

RANDOLPH & BEAVERS

11-D Columbian Bldg., Washington, D. C.

Please send me full particulars on Patents, fees, etc., and "RECORD OF INVENTION" form—FREE.

Name

Street

City State

PLUMBERS & STEAM FITTERS

Audels Plumbers and Steamfitters Guides

4 Vols. \$6



A practical, illustrated, Reference Library and Study—Course for Master Plumbers, Journeymen and Apprentice Steamfitters, Gas Fitters and Helpers, Sheet Metal Workers, Draughtsmen, Master Builders, Engineers and all Building Trade Students. This valuable set of handy, pocket-size Guides explains in practical concise language and well-done illustrations all the principles, advances and short cuts of the Plumbing and Heating trade—based on modern practice. Contains careful, detailed instructions

on how to figure and estimate various jobs. Use FREE COUPON below to examine, without obligation, this valuable work.

INSIDE TRADE INFORMATION ON:

Soldering, tinning, Joint wiping, bending, beating. Pipe—iron—steel, threading. Mathematics, tables, physics. Materials—iron, steel, copper, brass, lead, tin, antimony, etc. Sheet metal—galvanized—plate. Sanitation, syphonage, tanks, Drainage, sewage, purification. Fixtures—bath—kitchen. Pipe fittings, soil pipe, tools. Laying out work. Roughing. Sewed fittings, flanges, joints. Pipe bending, examples, Elbows, Heating, ventilation, air conditioning, refrigeration. Water supply, mains, wells, tanks, Gas-fittings. Sheet metal work, problems, methods. Brazing, heating, lead burning. Welding, various welds, methods. Blacksmithing, forges, tools. Air Conditioning.

THEO. AUDEL & CO., 49 W. 23rd St., New York City

Mail Audels Plumbers Guides, 4 vols., on 7 days' free trial. If O. K. I will remit \$1 in 7 days, and \$1 monthly until \$6 is paid. Otherwise I will return them. No obligation unless I am satisfied.

Name

Address

Occupation

Reference PM



PATENTS AND TRADE MARKS

C. A. SNOW & CO.

Registered Patent Attorneys Since 1875
Write for Free Book and "Certification of Invention" form
427 SNOW BUILDING, WASHINGTON 1, D. C.

PATENT YOUR IDEAS

SEND FOR FREE BOOK HOW TO OBTAIN A PATENT

W. Ives, ex Former Member Examining Corps (1923-24) U. S. Pat. Office.
CARL MILLER, Registered Patent Attorney
Former Member Examining Corps U. S. Patent Office
Woolworth Bldg., Dept. 66-A New York — Bond Bldg., Dept. 66-A Washington, D. C.

PATENTS

Free preliminary advice
E. E. VROOMAN, Patent Lawyer
Registered Patent Attorney Since 1902
871 Woodward Building, Washington 5, D. C.

AMAZING NEW MONEY MAKER!

—SALES ARE TERRIFIC—

Gold Plated or Stainless Steel

Smart looking and distinctive to fit any wrist. Stainless Steel \$6 per doz. Gold Plated \$12 per doz. Sample Gold Plated \$1.50. Minimum order 1 doz. (except sample). Money Back Guarantee. ORDER TODAY.

NEW STREAMLINED EXPANSION WATCH BAND (Sample Post Paid \$1.00) Stainless Steel

SEMERAK & CO., Dept. P-6, 4439 Lincoln Ave., CHICAGO 25, ILL.

RADIO SET anyone can build

Only \$2.98

What a gift for a Real Boy!

A workable radio receiving set any boy can build. Kit complete with diagram, parts, instructions. No electrical outlets or batteries needed. When set is assembled attach serial-tune in. Better order two (one for Dad). Sent C.O.D. plus postage or send \$2.98 and we pay postage.

DISCO SALES, INC.
Dept. P.M. 3, 154 Nassau St., N. Y. 7.

Say You Saw It in POPULAR MECHANICS

HOW TO CUT RAFTERS

New vest pocket book gives lengths, Side cuts, Plumb cuts, Deductions. For all rafters for any building from one inch to forty feet wide. Gives numbers to cut on square. Also degrees for some cuts for Radial Saws. All standard pitches from 1/8 to 3/8. Just open book to pitch page and there are your lengths, side cuts, etc. Anyone who knows what a jack rafter is can frame a roof if he has this great book. Price one dollar prepaid.

BUILDERS' TOPICS, Dept. M, Med. Arts Bldg., Seattle 1, Wash. Original teachers of the square in five easy lessons by mail. Send for FREE list of plan books—Kamp Kabin to Mansions.

FREE! 40 PAGE HOBBY CATALOG

Over 1000 Items — Over 300 Photos

Our new 40-page catalog—just off the press—is the "bible" of wide-awake modelers. Practically every nationally advertised model is listed and many, many hard-to-get items. Planes, engines, boats, gliders, supplies, etc.

NEW "THOR" 1/6 H.P. GAS ENGINE.....\$10.20 p.p.

AMERICA'S HOBBY CENTER, INC.
Dept. B66, 156 W. 22 St. New York 11, N. Y.

BOWS & ARROWS

Write for 94 page Illustrated Instruction Hand Book 50c; 20 page catalog 5c; stamps or coin.

LE STEMLER-CO-QUEENS VILLAGE L.I.N.Y.

Arc Welded Design "Know-How"

Only \$3.50 each
3 different volumes
\$10.00 postpaid

Each volume contains over 100 welding designs. Write
Hobart Bros. Co. Box M-561, Troy, O.

PLASTICS

Turn Your Handiwork into Handsome Profits

CATALIN RING RODS, LADIES

Cut 12 beautiful rings from each 6" rod. Color, green, quartz. Price per rod \$.40

CATALIN RING RODS, MEN'S

Each 6" rod sufficient for 12 or more rings. Flat top suitable for inlaying. Color: black. Price per rod \$.20

CATALIN EXPERIMENTAL ASST.

Small pieces of rod, sheet, tube, castings suitable for jewelry, buttons, pins, etc. Polish brilliantly. Many colors in each lb. Price per lb. \$1.00
5 lbs. \$4.50

VINYL FILM, 36 inches wide. Tough durable plastic film ideal for raincoats, gun covers, tents, aprons and many other projects. Colors: clear, green, red, blue. Price per yard \$.75
5 yards \$3.50

VINYL, BLACK PATENT PLASTIC

Gleaming black plastic film for ladies handbags, luggage, camera cases, belts, etc.

15"x22" sheets \$1.70
30"x22" sheets \$3.25

ACRYLO COLD DIP DYES

Will permanently color Lucite, Plexiglas, Acetate. Easy to use. Instructions with each bottle. Colors: red, blue, yellow, gold, shell, emerald, amethyst, amber, brown, orange. Price per 8 oz. bottle \$.75

ACRYLO TRANSPARENT PLASTIC CEMENT

The fastest setting cement for Lucite or Plexiglas. 8 oz. bottle \$.75

POLYSTYRENE ROUND ROD

Thermoplastic material clear as glass and suitable for many things. $\frac{1}{8}$ " dia. x 48" \$.14 each
 $\frac{1}{4}$ " dia. x 36" \$.24 each
 $\frac{1}{2}$ " dia. x 72" \$.46 each

VINYL THIN TUBING

About the diameter of spaghetti. Six brilliant colors. Tough, durable and fine for braiding and weaving. Colors: red, yellow, blue, green, white and black. Price per running foot \$.03
Minimum quantity sold 25 feet.

VIMLITE PLASTIC GLAZING

Wire reinforced plastic glazing. Transmits ultra violet light and is ideal for partitions, green houses, sun porches, etc. 36" wide—any length. Price per square foot \$.14

HOW TO ORDER: List items selected. Total up cost prices. Add 10% for postage. Excess postage will be promptly refunded. Mail your order today. **GUARANTEE:** If after 5 days you are not completely satisfied, return order for full price refund.

BERTON PLASTICS

19-21 WEST 21st ST., NEW YORK

Newest Materials
Big Selections
Quick Delivery

LEAROK POLISHING COMPOSITION No. 884

Used by professional fabricators. The ideal polishing bar for Lucite and Plexiglas. 1 lb. bar \$.71

LIGHTWEIGHT HAND HEAT SEALER

For sealing vinyl film. Thermostatically controlled. Price—each \$8.50

LUCITE AND PLEXIGLAS EXPERIMENTAL ASSORTMENT

Each piece fully masked. This material suitable for jewelry, pins, small projects. No piece under 10 sq. inches. Price per lb. \$1.00
5 lbs. \$4.50

LUCITE AND PLEXIGLAS MASKED SHEET

1/16" thick x 12" x 12" Price—each \$1.60
1/8" thick x 12" x 12" Price—each \$2.25

3/16" thick x 12" x 12" Price—each \$2.75

COLORED ACETATE SHEET .030

Colors available—red, green, blue, black. 20" x 25"—each \$1.85
20" x 50"—each \$3.60

ABRASIVE PAPER TRI-M-ITE

Silicon Carbide Paper made by Minneapolis Mining. Fast-cutting, fine grits. Ideal for all plastics. Grit No. 600—9" x 11" sheet Price—each \$.10
Grit No. 360—9" x 11" sheet Price—each \$.10
Dozen sheets \$1.00

CELLULOSE ACETATE SHEET .025

Clear transparent. Fine for display boxes, photo albums, drafting instruments. Sheet size 20" x 25" \$1.35
Sheet size 20" x 50" \$2.50

CATALIN LAMP CASTING

Hollow square cylinder 2-15/16" x 2-5/16" x 10 1/4" long. Wall thickness—1/4". You can make a gorgeous lamp from this cylinder in one evening. Simply add base. Colors: Mottled orange and mottled wine. Price—each \$2.15

CATALIN SQUARE AND ROUND ROD ASST.

Many colors and no rod under 6" in length. Sold by the pound. Per lb. \$1.50

PHOSPHORESCENT PIGMENTS

Dry pigments to mix your own phosphorescent paints and inks. Thousands of uses. Colors: green and blue. 1 oz. jar \$.50
2 oz. jar \$.85

CATALIN ROUND CYLINDERS

Slice off bracelets, baby toys, shower rings, curtain rings, etc. 3" O.D.—2-3/5" I.D.—Length 3 1/4". Colors: red, light green. Price—each \$.50

GIANT CATALOG

SEND Offer includes Free Manual on Plastics Fabrication. Tells you how to saw, drill, rout, form, machine. A money-maker guide!



Learn to Repair ELECTRIC APPLIANCES

WRITE TODAY for FREE BOOK

Prepare now for a permanent future, independence and security with a business of your own. Our practical, easy-to-learn home course teaches you, during your spare time, how to repair washing machines, vacuum cleaners, electric ranges, lamps, motors, irons, etc., and do house wiring. Also how to get started on little capital. Write today for FREE BOOKLET. No obligation.

PACIFIC TRAINING SCHOOL
7217 S. Broadway, Dept. P-6 Los Angeles 3

The ALL-PURPOSE ARC WELDER



Weld, braze, solder, preheat any type metal. Full size (75 lb. shipping wt.) 110 volt A.C. arc welder for home work shop, garage or small repair shop. 125 AMP output. Fully equipped. \$45

FORNEY MFG. CO.
FORT COLLINS COLO.

Burn Your Name On Tools Electro Name Etcher Only

PROTECT valuable tools from thieves and tool borrowers! The Name-Etch BURNS your name, any design, permanently on tools, instruments, dog collars, any metal. Easy! Simple as writing with pen or pencil. Simply attach to any auto battery, dry cells, or toy transformer. (not supplied). **SEND NO MONEY!** Pay postman only \$1 plus few cents postage on delivery. Use 6 days, money back if not delighted. Name-Etch Co., Dept. H-600, Strader Av., Cincinnati 26, O.

SAY YOU SAW IT IN POPULAR MECHANICS

MAKE MORE MONEY

APPLYING OR SELLING

CORKSTONE PLASTIC FLOORING

EASY TO APPLY

Here's your opportunity to get into business for yourself applying or selling Corkstone, the economical, top-grade plastic flooring. Plenty of profit. Act without delay!



Dealers & Agents Wanted

WRITE FOR DETAILS OF OUR PROPOSITION
We believe in teamwork and cooperation. We'll help you get started. No cost; no obligation. Act today!

LASTING PRODUCTS COMPANY
MANUFACTURERS OF PAINTS, PUTTIES, PLASTICS
FRANKLINTOWN ROAD PLANT, BALTIMORE 23, MARYLAND

THE MECHANICAL FIELD HAS A

BRIGHT FUTURE

FOR YOU IN THE ARMY GROUND FORCES

A big break? Bet your life! A whirl at the world's most up-to-the-minute mechanical training—with good pay while you learn. More offers, too—so generous they take your breath away!

If you are 18 to 34 inclusive (17 with parents' consent) and enlist now for a period of three years, you may choose to join one of the arms or services of the U. S. Army, which offers you the best mechanical training available today.

FREE ON-THE-JOB TRAINING. You may qualify for one of the Army's top-flight mechanical schools, and master the technical details of all kinds of engines, including Diesel, radial and internal combustion. There is lots of practical experience in repairing and maintaining the Army's own equipment—and there's none more modern.

Add good pay, travel, clothing, food, quarters, medical and dental care and a 30-day furlough each year, a retirement plan second-to-none, and you'll see that it's an opportunity you can't afford to miss.

FREE EDUCATION. After your discharge from the Army, the GI Bill of Rights entitles you to attend any college, trade or business school which will admit you, provided you enlist before October 6, 1946.

After a 3-year enlistment, you may have up to 48 months of education, with the Government paying your tuition and incidental expenses up to \$500 per ordinary school year, and a living allowance of \$65 a month (\$90 a month if you have dependents). Get all the facts at your nearest Army Recruiting Station.

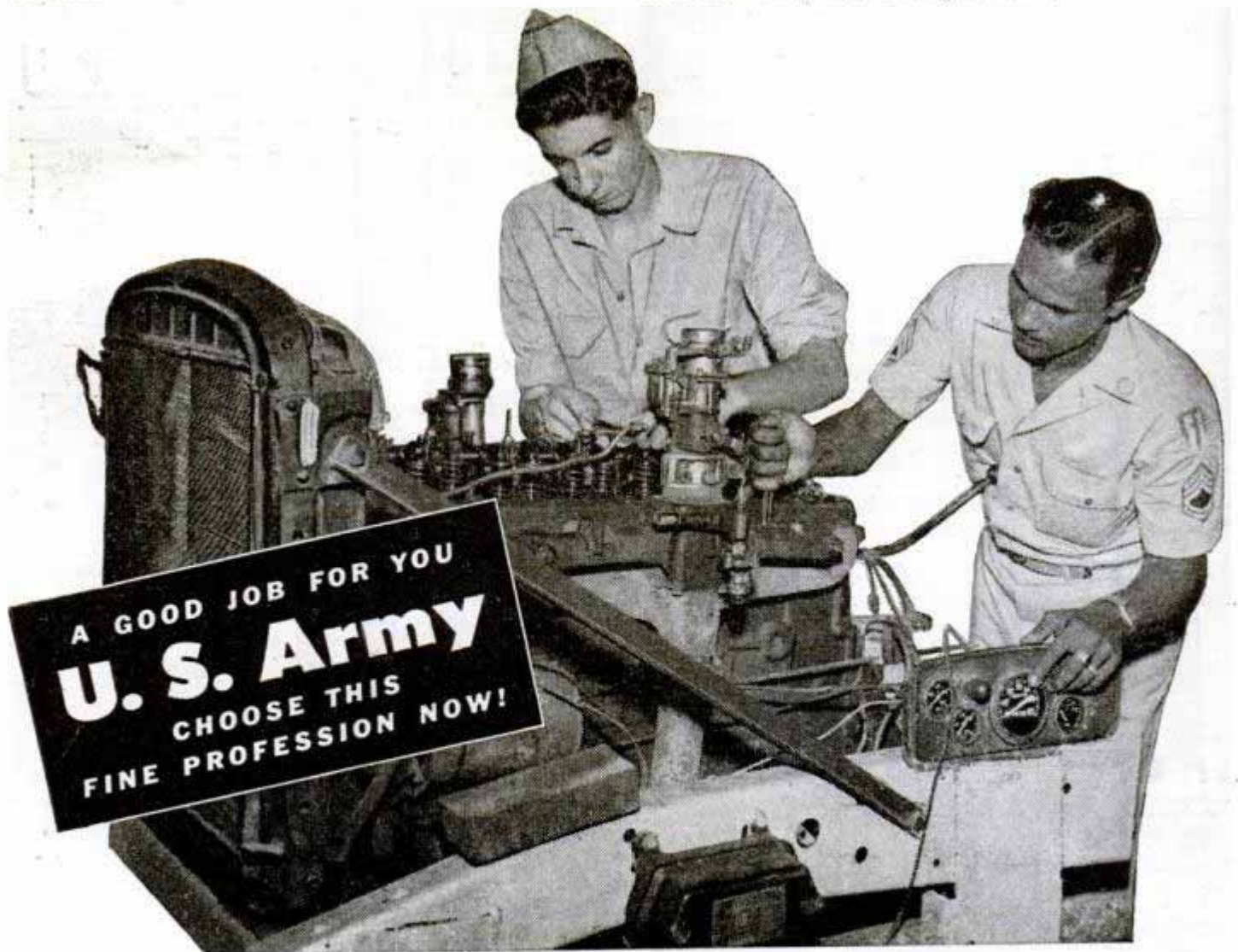

A GOOD JOB FOR YOU
U. S. Army
CHOOSE THIS
FINE PROFESSION NOW!

**WORLD'S
BEST
WANT AD
MEDIUM**

CLASSIFIED Advertisements



Advertisements in this section 50 cents per word, each insertion, minimum 10 words, payable in advance
To be inserted under proper classification in July issue, copy should be in our office June 4th
July issue on sale July 1st

F. W. Johnson, Manager, Classified Advertising
Popular Mechanics Magazine, 200 East Ontario Street, Chicago 11, Illinois

YOU'LL PROFIT

By reading and answering the classified ads in this section. Hundreds of opportunities to make and save money.

Popular Mechanics Magazine, 200 E. Ontario St., Chicago, Ill.

Gentlemen: During the past year we have advertised in more than fifty publications, using the same copy we gave you, and it may interest you to know that Popular Mechanics is far out in the lead of all other publications. In fact our actual cash returns have exceeded our advertising cost by better than \$3.00 for each \$1.00 in advertising cost. We no longer worry about the pulling power of Popular Mechanics but we do worry about getting our advertising in, and to be safe as you know, we are now paid three months in advance. Sincerely yours,
THE TAX-SAVER SYSTEM.
(Original letter on file in our office)

1420 CLASSIFIED ADVERTISEMENTS 1420 OPPORTUNITIES FOR YOU

AUTOMOBILES, MIDGET CARS

FLOYD Clymer's popular automobile books: Motor History of America, complete authentic book American automobile development \$3.00—Motor Racing With Mercedes-Benz, complete Europe Grand Prix Racing Book \$2.00—Ab Jenkins World's Record Book \$1.50—Sir Malcolm Campbell's World's Speed History Book \$2.00—Modern Steam Automobiles Background \$2.00—Power and Speed, wonderful book \$2.50—Sample copy English Autocar 50c. All books postpaid. See our advertisement under Motorcycles. Clymer, Dept. A61, 2125 W. Pico, Los Angeles 6, Calif.

OFFICIAL Pictures Indianapolis Motor Speedway 500 Mile Classic made by Official Speedway Photographers. Beautiful packet 26 pictures, each 4½x6½ inches, only \$1. Contains famous winning cars, daring drivers, spectacular crashes, track scenes. This year's winner included. Tower Studios; Official Speedway Photographers; Department C, 5454 East Washington St., Indianapolis 1, Indiana.

FREE 1946 List photos, racing cars, drivers. Photographer, Midland Park, N. J.

FOR Midget car bargains see our ad under Motorcycles. Midget Motors Directory, Athens, Ohio.

'39 **FIAT**, With steam motor, no boiler. \$350. Cost \$1000. Bill Schember, KFYO, Lubbock, Texas.

STREAMLINE Your automobile—beautiful, custombuilt, ten years newer by inexpensive, easy methods. Restyling manual \$1.00. Almqvist Engineering, 447-64 St., Brooklyn.

USE Scrap parts and easily build your own two-passenger midget "Jeep" or speedy Scooter-Car (three wheel, two-passenger runabout, powered with small gasoline engine). Working plans for both vehicles only \$1.00! Universal, 2671 Algonquin, Toledo 6, Ohio.

500 MILE Indianapolis Automobile Racing History Book, just printed. Complete history detailed year by year results every Indianapolis race since 1909. 320 large pages, over 2000 illustrations, drawings, photographs describe foreign, American racing automobiles. Photographs world's famous drivers. View in your arm chair every mile of every event at 10c a race average cost. Complete book postpaid \$3.50. De luxe edition bound attractive red Du Pont Fabrikoid \$5.00. Limited number available—hurry! Clymer, Dept. A62, 2125 W. Pico, Los Angeles 6, Calif.

PROFESSIONAL Midget racer, motor-scooter, midget roadster, and midget motorcycle. Plans, specifications for all four contained in illustrated handbook, 25c. Big list bargain priced used motors, motorscooters, servicycles, etc., included free! Midwest, 3839 Drummond, Toledo, Ohio.

AUTOCAR, English Automobile Magazine. Interesting advertisements, articles on foreign cars. Sample copy 50c postpaid. Clymer, Dept. A64, 2125 W. Pico, Los Angeles 6, Calif.

BUILD Speedy midget track racer from castoff parts! Plans, specifications, construction information, \$1.00. Motor Supply, Box 1682-CS, Toledo, Ohio.

R & R Mfg. Co., marine and auto division, Anderson, Indiana, Robert M. Roof. \$1.00 for our new 1946 speed and power equipment catalogue with price sheet—showing racing cars, midgets, speed boats with recommendations how to rebuild your motors for racing. Dual ignition racing cylinder heads for V-60-100 and Mercury Ford engines. Dual intake manifolds, racing pistons, camshafts, compound valve springs, Lynite flywheels, quick change gear boxes and numerous other supplies.

AUTOMOBILE Racing book, fifth edition, well illustrated. Instructions on building bodies, frames, engines. Ford A and B conversions. Plans. AAA rules, specifications. Roadster racing. Indianapolis cars. \$1.00 postpaid, \$1.30 C.O.D. Ray Kuns, Dept. 47, Madisonville, Cincinnati 27, Ohio.

CUSTOMIZE Your automobile. Illustrated, new restyling ideas, instructions, suggestions, specific model changes by simple methods. \$1. Speed Wheel, Box 723-E, Arcadia, California.

AUTO SUPPLIES AND EQUIPMENT

MONOGRAMMED Automobile seat covers (ready) made. Fit your car perfectly. Two-tone leatherette. Beautiful patterns. Pre-war quality. Money back guarantee. Sedans \$25.00—coupes \$15.00 prepaid. Send check or money order. State year, make, model, color of car and initials desired. Mono Seat Cover Co. of Hollywood, Box 1128, Los Angeles 53, California.

KNOW Your car. A modern motor chart which covers tune-up from A to Z. How to keep it in tip top shape. Tune your car for an evenings pleasure once a month. Send \$1.10 to Modern Motor Chart, P.O. Box 602, Trenton 4, N. J.

MECHANICS Sell and install our \$7.50 vacuum superchargers, watch the automatic graduated valve operate, send self addressed stamped envelope for pamphlet that will convince you. McDowell Company, 2000 NE Union, Portland 12, Ore.

QUICK Money! "Repairing Car Batteries." At home! Easy too! Write, Batteryman, Grand Junction, Colorado.

NO More worries about flat tires! Ernie Airline tire inflator \$1. Super Scissors auto jack \$6.50. Brake bleeder hose 25c. All three items delivered for \$6.50. Money back guarantee. Distributors wanted—Write for free details. Kramer Industries, PM3145 Euclid 17, Ohio.

1000 MOTORISTS Needed to make gas saving test. Up to 30% savings. For trial test offer write Vacu-matic Carburetor Co., 7617-1279 W. State Street, Wauwatosa, Wis.

AVIAWAX—"Cleans and polishes like magic!"—Automobiles, airplanes, boats, furniture, etc. Preserves finish. Defies water, dirt, grease, corrosion. Try a bottle; \$1.00. Aero-Trading System, Adams, Mass.

COST Record book for your car. Graphical analysis. Shows exactly when to trade, costs per mile. Price 50c. Information free. Garwood, 6034 Easton, Los Angeles 22, Calif.

MUFFLER Manual. Convert easily to Hollywood, Laguna, Westwood, duals, etc. Includes construction details, regulations, diagrams. Postpaid \$1. Mellotone, Box 723E, Arcadia, California.

BUG Screens: for car, truck or tractor. Prewar made. Highest quality. State make, year, model. \$1.25 value, 50c each. Postpaid. Allen Co., Clinton, Missouri.

MAGIC At your finger tips, with the new push button plastic key case, which automatically opens and selects your car key! Available in two colors, red or black. Send no money, \$1.00 C.O.D. Satisfaction guaranteed or money back. Filippo Mfg., P.O. Box 73, Oakland 8, Emeryville Branch, California.

GASOLINE Saving device. Chev-Jet, Ford 1932-1942. Dodge, Plymouth, 1933-1938. Walert Company, 3429 North 10th Street, Milwaukee 6, Wisconsin.

GRILLES For all cars, Meyers Auto Parts, 820 Dryades, New Orleans, La.

HAVING Car trouble? New, used, guaranteed auto, truck parts save money. Transmission specialists. Describe needs; immediate reply. Victory, 2930½ North-western, Chicago 18.

AUTO Parts for all autos and trucks. Trans., motors, differentials, fenders, carburetors. Also body parts. Security Auto and Truck Parts, 1941 BJ Eddy, Chicago 13.

OIL Pumping motors—Brought back to normal without ring job. Write for particulars. Joe Mullner, Box 3102, St. Paul 1, Minn.

PLATING Outfits for auto parts. Connect to a battery. No tanks used. Free particulars and proofs. Gunmetal Co., Ave. J, Decatur, Ill.

AUTO TRAILERS

STREAMLINED Trailers. Has everything. Large manual full of drawings, instructions, etc. \$1.00. Illustrated circulars, dime. Craftsmann Books, Box 1153-P3, Milwaukee 1, Wis.

BUILD Your own trailer! Save money! Have every feature you want! Plans for house, sport, camp and utility trailers. Catalog describing 9 models 10c. 15c in Canada and overseas. Jim Dandy, Box 125-A, Wausau, Wisconsin.

MOTORCYCLES, BICYCLES, MOTOR-SCOOTERS AND SUPPLIES

WHEELS! Complete with rubber tires for wagons, scooters, trailers, wheelbarrows, mowers. 6 1/2" to 16". Free list. Trulsen Mfg. Co., 311 E. 31, Kansas City, Mo.

PARTS. Accessories, pistons, chains. Motors, transmissions, generators rebuilt or exchanged. Allied Sales, Box 114, El Paso, Texas.

TIRES. Inner tubes, wheels, for small trucks, wheelbarrows, midget cars, power scooters, farm equipment, carts, etc. Sizes 8" to 18" o.d. in 2, 4, and 6 ply first-line quality tires, with removable inner tubes and heavy duty demountable wheels. Also caster forks, straight or swivel types. Free circular and prices. Experienced tire engineers to advise on your special equipment problems. Jahant Co., 826 East Exchange Street, Akron 6, Ohio.

CUSHMAN Motorscooter less motor \$18; midget racer less motor \$35; motorscooters \$40 up complete; motorbike \$30; 1 1/2 h.p. Smith motorwheel \$3; new 2 h.p. Lauson motor in factory crate \$22; Briggs-Stratton motors \$6 up. Over 1500 small tires in stock. \$1.50 up. Mail order only. Send 25c for catalogue Number 13 listing these and hundreds of other bargains. (35c by first class mail.) Midget Motors Directory, Athens, Ohio.

MOTORCYCLE Parts, new and used. List 10c. Ballak, 811 N. 9th, St. Louis 1, Mo.

2 1/2 HORSEPOWER Whizzer bicycle motors. Immediate delivery. Ace Cycle Shop, 819 E. 55th Street, Chicago 15, Illinois.

SEND 25c For complete motorbike plans and parts list. Motorbike Service, 1304 Indiana, New Albany, Ind.

WHEELS! Steel disc rubber tired for toys, wagons, scooters, etc. Sizes 5", 7", 8" available. United Wheels Mfg. Co., 11727 Lafayette Ave., Chicago 28, Illinois.

PLANS For attractive motor scooter \$2.00—Electric Bicycle Plans \$1.50. Clymer, Dept. A65, 2125 W. Pico, Los Angeles 6, Calif.

FLOYD Clymer's popular motorcycle books: Motorcycles, How to Manage Them \$1.50—Motorcycling Manual \$2.00—English Motorcycle Service Manual \$1.50—Speed, How to Obtain It \$1.50—Power and Speed \$2.50—Motorcycle Questions and Answers \$1.50—Sample English Motorcycling Magazine 50c—Complete plans build attractive motor scooter \$2.00—Plans Electric Bicycle \$1.50—all books postpaid. See our advertisement under Automobiles for automobile books. Clymer, Dept. A60, 2125 W. Pico, Los Angeles 6, Calif.

ENGLISH Motorcycle Magazine. Photographs, articles, advertisements interesting foreign motorcycles. Sample copy 50c postpaid. Clymer, Dept. A66, 2125 W. Pico, Los Angeles 6, Calif.

INDIANAPOLIS "500" Race History Book. 320 large pages, 2000 illustrations. Complete detailed information every event held Indianapolis Speedway since 1909. Year by year detailed results. \$3.50. De luxe edition red Du Pont Fabrikoid binding \$5.00 postpaid. See our ad under "Automobiles." Clymer, Dept. A67, 2125 W. Pico, Los Angeles 6, Calif.

NUMBER Three Clymer Motor Scrapbook now ready. Entirely different from Editions One and Two. 250 early automobiles, motorcycles illustrated, described. Pike's Peak Racing History included in Floyd Clymer's story. \$1.50. De luxe cloth-bound \$2.50. (Editions One and Two available same price.) Clymer's Steam Automobile Scrapbook \$2.00. All postpaid. Clymer, Dept. A63, 2125 W. Pico, Los Angeles 6, Calif.

BICYCLES Brand new. Men's, ladies', boys' girls. Also frames. Send dime for list. Century Cycle Company, 3447 Lawrence, Chicago 25, Illinois.

CHANGE Your bicycle to electric or gas motorcycle. T. M. McDonald, 837 Magnolia, Beaumont, Calif.

BUILD America's lowest priced motor-scooter speedster! Complete plans, specifications, \$1.00. Big list bargain priced used motors, etc., included free! Motor Supply, Box 1682-CS, Toledo, Ohio.

MOTORSCOOTER \$10, Motor \$3, tires \$2! Send 25c for big new catalog number 912, just printed, listing scores of other sensational bargains in motors, wheels, motorscooters, motorbikes, servicycles, tires, etc. Associated, Box CS-1764, Toledo, Ohio.

LARGE Stock Indian parts. Expert motor rebuilding. Indian Motorcycle Sales, Kansas City 1, Mo.

MODERN Motorcycle Mechanics manual, 560 pages, 300 illustrations, covers Harley, Indian and English makes. The most complete motorcycle book published, \$3.00 postpaid. Nicholson Brothers, Motorcycle Engineers, Saskatoon, Sask., Canada.

BOYS, Illustrated "Bicycle Repair Manual" teaches brake repairing, re-spoking wheels, etc. Dealers wanted, 65c. Robt. Klausner, Shelbyville, Ill.

GENUINE Moto-Scout parts. Complete wheels, tires, tubes, 4"x7, 3:50x6. AMSCO centrifugal clutch. Windshield, side cars. All other parts and accessories. Write for parts list. Also genuine engine parts for Briggs and Stratton, Lauson, American Moto-Scout Co., 1319 W. Carroll Ave., Chicago 7, Ill.

BICYCLE Book, how to buy, rebuild, sell used bicycles 50c. John Collett, Handley, Texas.

HARLEY-DAVIDSON Service, parts, accessories. Buddy seats \$17.75, tandems for 45" models \$12.50 (shipping paid). Can be fitted to other models. Send \$2.25 for Army Motorcycle Manual. 10c for bulletins. Knuth's (Harley-Davidson factory dealer), 2491 W. Fond du Lac, Milwaukee 6, Wis.

BUILD Scooters, trailers, midgets, conversions. Large manual \$1.00. Circulars dime. Craftsmann Books, Box 1153-P2, Milwaukee 1, Wis.

TIRES And industrial wheels, suitable for scooters, wheelbarrows, farm equipment, etc. All sizes. Bicycles and accessories. Largest assortment in America. Send dime for list. Cycle Transport Company, 1241 So. Michigan Ave., Chicago 5, Illinois.

AVIATION

PROPELLERS—All types, fit any motor—Airliner 3 blade for boats, sleds. Illustrated lightplane literature, aircool motor conversion 50c. Prompt delivery. Standard Aero Craft, Ft. Worth, Texas.

AIRPLANES—Used \$125 up. Engines, wings, parts. Send 25c for list. Aircraft, 2300 West Flagler, Miami 35, Florida.

FLYING Flea, plans \$1.00. Lightplane manual \$1.00. Illustrated circulars 20c. Craftsmann Books, Box 1153-P1, Milwaukee 1, Wis.

PILOT Log books \$1.00, clear dope \$2.40 gal., thinner \$1.70, combination oil, fuel pressure gage and distance thermometer \$9.75, suction gage \$2.50, electric relays \$3.50, automatic pilot follow-up controls \$2.95, liquid rubber, 3 cans \$1.00, pitch bank indicators \$3.95, aircraft altimeters 8000 meters \$2.95, aircraft spark plugs 18 m/m, \$1.00, everything new, guaranteed, 90% off cost. Air Transport, Mineola, New York.

AIRLINE Baggage stickers, 6 different 25c, 18—\$1.00, 28—\$2.00. Evans Smith, 45 East Banks, Chicago, Ill.

AIRPLANE Jettison gasoline tank, streamlined, 10' 6"x2' 4". 165 gallon, twenty gauge terne coated steel. Ideal for making boats, bob sleds, midget auto, etc. Price \$10.00 per tank, or \$7.50 per tank quantities of five or more. General Truck Sales, Inc., 205 Market South West, Grand Rapids, Michigan.

AVAILABLE! Valuable flying information \$1.00. 1030 Walter, Des Plaines, Ill.

JET Propulsion circular sent builders bikes, airplanes. Byrum, Buffalo, Okla.

CUBS, Wacos, Taylorcrafts, Aerocnas—\$125 and up! Big new catalog, 25c, lists these and thousands of other sensational airplane bargains. Some are "easy to repair" crackups. National, Box 1682-CS, Toledo, Ohio.

AIRPLANES, Gliders, crackups, located everywhere, some probably near you. Send 25c for directory, giving owner's price, name and address. (35c by first class mail.) Used Aircraft Directory, Athens, Ohio.

PROPELLERS For ice-snow sleds, air boats. Literature 5c. Banks Propellers, R.F.D. 7, Ft. Worth, Texas.

JET Propulsion experiments. New principle to drive boats, bicycles, model helicopters. Circular on plans. Rush name. Houston Maupin, Tipp City 53, Ohio.

ELECTRICAL SUPPLIES, EQUIPMENT

PORTABLE Electric steam heating plant. No larger than suitcase. Throws fan blown heat. Plug into any a.c. socket. Costs only few cents per day to operate. Price \$45.00. Write for folder. Gale Appliances, 149 Broadway, New York 6.

ELECTRIC Fans? Make your own. 16 in. correctly balanced aluminum fan blade. 1/2 in. bore. Ideal on any size motor 1/8-1/3 h.p., \$3.50. 18 in. all welded guard adjusted to fit 4 stops on motor, \$3.00. Adjustable floor standard, 4-8 ft. height, rigid, sturdy, \$9.00. Table standard, universal, fits any motor base, \$3.75. Ted Riseman, 1461 No. 3rd St., Springfield, Ill.

SURPLUS Bargain: 1001 uses, 15 ampere single pole, double throw, plunger or push-bottom type snap action switch. Bakelite housing 3/4"x3/4"x2" panel or surface mounting. Underwriters approved for motors up to 1/2 h.p. \$2.60 value for \$1.00, or 6 for \$5.00, postpaid. 20% deposit on C.O.D.'s. H. Zuba, Department B, 1 Grove Street, Mount Vernon, N. Y.

FAN Blades. 20" airplane type for ventilating or circulating, use on any small motor, 1/6 h.p. up, 1/2" shaft. \$3.00 postpaid. W & D Mfg. Co., Stuttgart, Ark.

BROKEN—Burned out electrical heating elements quickly repaired. Use new amazing Nichrome paste, simply overlap ends and turn on current. Family size \$1.00 bill. Satisfaction guaranteed. Armstrong Mfg., Box 861-X, Minneapolis, Minn.

LAMPS—Build your own. All parts. Send for prices: Gyro Lamps, 5416 Clark, Chicago 40.

INVENTION! Wartime discovery. Rotary solenoid electro magnet. Powerful. Hundred uses. Circulars. Rush name. Maupin, Tipp City 31, Ohio.

FOUR Powerful Alnico permanent magnets \$1.00. Kelly, 1515 Oriental Boulevard, Brooklyn 29, N. Y.

KITCHEN Exhaust fans, duct work, made to order—atmic fans, 6 ft. pedestal fans complete less motors. Bruce Industries, 418 Castleton Ave., S.I. #1, N. Y.

ELECTRICAL Pencil: Writes and engraves all metals, professional size, precision built \$1.00 postpaid. Reb. Industries, Box 265-X, Elmhurst, Illinois.

ELECTRIC Irons with 6 ft. snap-switch cord \$4.80. Automatic record changer \$35.95. Prepaid anywhere U. S. 25% deposit on C.O.D. shipments. F. Roberts, 511 East 83rd Street, New York 28, N. Y.

SINGLE Phase coil former. Fast and simple to operate. Write for information. Mc Caig Electric Company, Box 131 Vernon Branch, Los Angeles 11, California.

ELECTRIC Fans: Make your own 24" floor model adjustable pedestal fans. Complete kit, less motor, \$32.50 FOB N. Y. Consists of guard, 24" blade, heavy cast iron base, 5' to 8' telescopic adjustable column and all fittings. Use any 1/6 or 1/4 hp. motor and make a \$90.00 fan. Get in on the profits. Order now, 20% deposit, balance C.O.D. Jeannette Electric Co., Inc., 159 West 23rd Street, N. Y. 11, N. Y.

ELECTRIC Appliances, every description. Send for circular. United, 1554 York Ave., New York, N. Y.

ELECTRICAL Appliance repair. Open your own shop. Learn house wiring; electric motors, vacuum cleaners, washers, etc. Complete illustrated course shows how. Free booklet. Pacific Training School, Dept. AP-2, 7217 So. Broadway, Los Angeles 3, Calif.

NOW—Repair your own electrical appliances with Chanite Self-welding Electrical Heating Element Flux. Instructions delivered, price \$1.00. Stick form 25c ea., \$2.00 doz. Chanite Sales Company, 914 South Main, Fort Worth, Texas.

FLUORESCENT Tubes burned-out? You can relight and use indefinitely. Complete instructions \$1.00. Wallingford, 121 Burlington, York, Nebr.

ELECTRIC Pencil: Writes-engraves all metals \$1.00 postpaid. Beyer Mfg., 4515-H Cottage Grove, Chicago 15.

WELDING, SOLDERING, PLATING

NEW Model electric welder 110 volt a.c.-d.c.; will weld all metals; easy to use; full directions. Complete with power unit, flame and metallic arc attachments, carbons, fluxes, rods, mask; all for \$19.95. Used by the navy. Magic Welder Mfg. Co., 239-MP6 Canal St., New York City.

WELDERS, Farmers, shopmen—don't buy welder until you investigate new invention, 20-250 amps., using storage batteries, welds anything perfectly. Free information. Battweldco, Santa Barbara, Calif.

WELDING Shops build all steel rubber tired farm wagons, two wheel stock, dual wheel tractor trailers, plans \$1.00 each, all three \$2.50. "Doc" Fixit's, Mt. Vernon, Ohio.

ARC Welders wanted by the thousands. Learn with 516 page lessons manual. Over 500 how-to-do-it photos. \$2.00 copy. Money-back guarantee. Hobartweld, Box M-664, Troy, Ohio.

ACETYLENE Welding generators, latest type. \$45.00. Johnson Generator Co., Brookfield, Mo.

"**BUILD Your Own Arcwelder.**" Inquiries welcome. Welders Club, AB-3432, Chicago 54.

ACETYLENE Welding outfits like new; arcwelders, welders manual \$1.65. Eagle Welding, Dept. PM, 5085 Broadway, Chicago 40, Ill.

THUNDERBOLT—Transformer welder, dial-control, 3 heat stages, 60 amps, 110 volts-a.c., takes up to 3/32 rod, carrying case, all accessories, illustrated instructions. Professional heavy duty welding, brazing outfit, \$39.50. Also "Super-Welder" for light work, 110 volts, a.c.-d.c. \$19.95. Save 2%, send check. Or order C.O.D. west of Mississippi. \$5.00 deposit required on Super-Welder, \$10.00 on Thunderbolt. Super-Welder Mfg. Co., Dept. PMO, 23 E. 20th St., New York 3, New York.

AC WELDERS 95 To 205 ampere. Easiest working, quiet and best built. Write for information. Chester Brainard, Skaneateles, New York.

WELDING, Cutting, aircraft welding and soldering equipment. Electric arc welders. Superior Oxy-Acetylene Co., Hamilton, Ohio.

MACHINERY, TOOLS AND SUPPLIES

LIMITED Quantity machinist indicators, developed for war production, now available complete with wooden case. \$3.95 C.O.D. Kokomo Enterprises, Box 270, Kokomo, Indiana.

SAW Mandrels bronze bearings 5/8 inch shaft 1/2 inch arbor list 10c. Wilson Manufacturing and Sales, 2233 Summit Street, Columbus 1, Ohio.

ACETYLENE Welding generators, latest type. \$45.00. Johnson Generator Co., Brookfield, Mo.

BRASS Rods—round, square, hexagon, rectangular, 2 foot lengths. Bronze bushings—solid, cored. List free. American, 388 East 34th St., Brooklyn 3, N. Y.

HOBBYISTS! You can equip your workshop at a fraction usual cost by building your own mill, shaper, drillpress, bandsaw and other shop tools for metal and wood-working from Lewis castings, materials and blueprints. Easy to complete, and ideal for home use. Send 10c to cover cost of mailing latest catalog describing 23 items. Lewis Machine Tool Co., P. O. Box 116, Station A, Dept. M-65, Los Angeles 31, California.

MACHINISTS—Don't guess cutting speeds. Compute them instantly. Computer \$1. Elcraft, Dept. P6, Box 8184, Portland 7, Ore.

HARDWARE, Tools, pattern and model supplies, taps, dies, drills, saw mandrels, jewelers saws, steel, brass, drill rod. Catalog 10c. Terek, 6304 Patterson, Chicago 34.

DIAMOND Wheel dresser \$1.50. Slightly used roller bearings, manufacturing, models production. Specialty Machine, 2821 Mitchell, Racine, Wis.

ANGLE Plate C.I. 4"x3"x3". Ribbed, machine finished 4-sides, \$2.00, unfinished 75c. Punch centers in lathe work center drill unnecessary. Hardened punch 4" long \$1.00. Model Tool Service, 202 Wood Ave., Rock Falls, Ill.

DRILL Grinder for twist drills \$2.95, and other craftsman's tools. See ad on page 264.

GEARS For inventors, experimenters, model makers, schools, work shops, laboratories, etc. Government surplus made of brass, bronze, dural steel and stainless steel. 12 matched pairs; 24 gears, bevel, spur and ratchet. List price \$12.00, our price, \$2.50. 25 matched pairs; 50 gears, includes larger gears, also sets of worm gears. List price, \$30.00, our price, \$5.00. 50 matched pairs; 100 gears better assortment, including internal set and worm sets. List price, \$75.00, our price, \$10.00. Limited quantity. Order now. Write for our bulletins on ball bearings, rectifiers, relays, selsyns, horns and government surplus materials. Met Exchange, 323 Canal Street, New York.

TILTING Table bench saws, 8" blade, \$17.50. Band saw blades 80c. Broken blades welded 30c. Circular free. Sunshine, Berkshire Heights, Penna.

EXPERIMENTERS—400 Valuable new springs, 75 kinds, numerous sizes, 10,000 uses, \$2.00. Deluxe assortment, \$3.00. Jumbo, \$5.00. Guaranteed. Technico, Box 246-A, West Hartford, Conn.

ENGINES, MOTORS, DYNAMOS

ELECTRIC Motors—6000 or 7000 r.p.m.—24 volt series motors—\$3.95 each. State which. O. Kitz, P.O. Box 51, Morris Heights Station, New York.

WIZZ Electric motor. Assembles in a jiffy. Flashlight cell operates. Parts complete, plus illustrated instructions 30c postpaid. Eltro Company, 171E, Deer Park, New York.

BIG Pay jobs in welding. Complete welding lessons and reference books. 516 pages. 41 lessons. \$2.00 copy. Money-back guarantee. Hobartweld, Box 665-M, Troy, Ohio.

BARGAIN. Surplus motors. Pictures, particulars 10c. Bertelli, 2133 South 13th, Springfield, Illinois.

MOTORS, AC-DC, 110-Volt ball bearing 1500 rpm, precision built, adaptable for thousands of uses. Very compact power unit in a small housing. Send \$3.00; no extra charges. Duperoy Co., 1360 Fifth Avenue, New York 29, N. Y.

600 NEW Motor diagrams, tables, and controller connections for the practical electrician. Makes dual-voltage, multi-speed, star and Delta circuits clear and simple. Also includes all standard split-phase, repulsion induction, compensated series, two and three phase. Data for re-winding and reconnecting all types. Over 100 valuable tables. Money-back guarantee. Price \$2.75 prepaid. Educational Advancement Company, Dept. L, Lakewood, New York.

NEW Kohler electric plants a.c. and d.c. Other electric plants rebuilt. Write E. F. Schmalz, 314 Wyoming Ave., Kingston, Penna.

WINDING Data, listing 225 motors, single and three phase, \$1.00. Motor Data Co., Box 7631, Kansas City 3, Mo.

BOATS, OUTBOARD MOTORS, ETC.

"**BOAT-IN-A-BAG**" \$19.75. Imagine an inflatable, collapsible, portable rubber boat folding into package 13"x15"x3" weighing 10 lbs. Inflated size 40"x66". Complete with carrying case and hand paddles, only \$19.75. Ask for boat No. IP. Other sizes at \$24.50, \$29.50, \$39.50, \$49.50, \$54.50, \$59.50, \$69.50, \$79.50, \$89.50 depending upon type and condition. New pneumatic life preserver vests \$3.98. New dual Navy pneumatic life preserver belts 98c. Write for circular or order from this adv. Dealers wanted. Karl Ort, Dept. PM-11, York, Penna.

BOATS And all about them. How to select, build, repair and operate. For 40 years the leading practical boating magazine. Half price trial subscription. 12 issues for \$1.00. Motor Boat, 62 Gold Street, New York 7.

BOAT Trailer plan \$1.00. Palboats, 179 Ocean St., Lynn, Mass.

PONTOON Dock with built-in swimming basin. Safe, practical. Childrens delight. Easily built. Plans \$1.00. Lidemark, 226 Potomac, Buffalo, N. Y.

10' OR 15' Folding Kayak plans \$1.00. Foldcraft, 4015-F Oketo, Chicago 34.

NYLON Rope 1/4" 300 ft. coil \$12.00—1/2" 75 ft. coil \$12.00—3/4" 350 ft. coil \$51.00—all F.O.B. New Orleans. Freeland Products Company, 1019 Alta St., New Orleans 20, La.

ALL Copper water-jacketed exhaust manifolds for marine conversions of automobile and aviation engines and marine engine replacements; any make, model or age. Joseph Van Blerck & Son, 392 Woodcleft Avenue, Freeport, N. Y.

OUTBOARD Motor parts for 1930 Speeditwin, model 143. Bob Anderson, 109 Golden Gate Avenue, San Francisco, Calif.

MARINE Power—easily convert any Ford motor (domestic and foreign) with Osco parts and kits. Complete catalogue 25c (coin). Osco Motors Corp., 2020 East Orleans Street, Dept. M, Philadelphia 34, Penna.

PLASTIC Boats now! Make your own for pleasure or sale with streamlined 9'x4' one-piece reinforced molded hulls. Weight 50 lbs. Makes Adirondack car-top boat, sailing dinghy; ten other craft. Won't leak. Won't crack. Won't rot. Plastic Boats, Box 187, Lake Placid, N. Y.

KAYAK—Easily built. Instructions. \$1. Gee, 1211 Frisco, Far Rockaway, N. Y.

USED Outboard motor parts. Outboard Exchange, 1194 Remsen Ave., Brooklyn, 12, N. Y.

FORD-Mercury-Zephyr marine conversions. Catalog 10c. Lehman Manufacturing Company, Dept. D, Newark 2, N. J.

MARINE Muffler—Simple, low cost, cinch to install yourself. Guaranteed. Send for free folder. Savage Marine Co., P.O. Box 772, Boston, Mass.

OUTBOARD Motor brackets—New models for canoes, rowboats, sailboats. Send for free descriptive folder. Outboard Motor Brackets Co., P.O. Box 772, Boston 2, Mass.

ONE-MAN Boats—Ideal for hunters, fishermen. 7 1/2 foot long. Weighs only 30 pounds. Easily carried. Army surplus auxiliary fuel tank sections, of Terne plate steel, that convert easily to one-man boats. Approximately \$1.00 worth of welding will seal fuel outlets. Only \$4.75, prepaid anywhere in U. S. Address: Irving Goodman, P.O. Drawer 191, Galesburg, Illinois.

BOAT Designers are highly paid professionals. Complete course by mail. Catalog. Westlawn, Montville, N. J.

NINE Plywood boat plans 50c. Catalog boat building plans 10c. The Rudder, 15 Murray Street, New York.

FULL Size, cut to shape boat patterns, blueprints. 7 1/2 - 38 feet. Illustrated "Build a Boat" catalog, 10c (coin). "How to Build Boats" book, \$1.00. Cleveland Boat Blueprints Co., Dept. A-66, Cleveland, Ohio.

USED Marine motors, propellers, marine fittings, conversion manifolds. Stokes Marine Supply, Coldwater, Michigan.

ATHLETIC EQUIPMENT, BODY BUILDING COURSES

REVOLVING Sleeve barbell complete, \$23.00. Folder. Jackson Barbells, Springfield, N. J.

SUPER Strength hand balancing exercise. \$1.00 complete. Burgo, 1008 Grandview, Dallas, Texas.

DEADLY Judo—Fiercest fighting technique. Complete course (186 photographs). Particulars free. Variety House, Box 46-BF, Wall Station, New York City.

BECOME Professional acrobat! Free health booklet! MB. Knoff, Pewaukee, Wis.

EUREKA! Develop your arms, hands, fingers, with this newest sensational pocket size exerciser for old, young, athletes, non-athletes. Strengthens muscles, stimulates circulation. Recommended by doctors. Eureka gripper, made of Neoprene, now available; lasts years. Sold on 10-day money-back guarantee. Mail \$2.00 for pair. Eureka Gripper, 707 S. Broadway, Los Angeles, Calif.

BARBELLS, Exercise equipment. Courses. Special offers! Free booklet. Good Barbell Co., Reading, Penna.

SPORTING GOODS, GUNS, FISHING TACKLE, TRAPPING, ETC.

3000 BARGAINS, Firearms, binoculars, war relics, catalog 30c. Smith Firearms, Runnemed, New Jersey.

"**AMMUNITION**"—New and used "shot-guns," "rifles," "handarms." List 10c. Rudolph's, Atchison, Kansas.

FISHING Poles—Dealers only. Bob Pace, Combs, Ark.

\$50 PER Day and up often earned by expert trappers! Do bounty trapping in summer, catch fur animals in winter. Operate from your home town or travel. Full or part time. Free folder. Loye R. Hunt, Grygla, Minnesota.

FUN Under water! Rubber swim goggles \$1.00 postpaid. Sports Novelty, Box 582, Los Angeles 43, Calif.

NETS And seines to order. Don Cowart, Mountain Home, Ark.

SEND 10c For list 100 used guns. Frayseth's, Willmar, Minnesota.

CHUM (Unattached bait) attracts food and game fish—from 6 or 7 miles—to your hooks. Fresh or salt water. Cheap! Easy! Make 6 Rigs. Learn 8 secrets. Use 10 methods. Know 55 best chums. Send \$1.00 for a U. S. Chumming Guide. Fish Research, 5912D Thompson, Philadelphia 31, Penna.

FREE—"Amazing New Book"—"Profits From Classified Advertising." Tells how and what to advertise. Be sure to read this book before you invest one cent in advertising. Remember—it's free! Write for your copy now. F. W. Johnson, Classified Advertising Manager, 200 East Ontario Street, Chicago 11, Illinois.

FIELD GLASSES, MICROSCOPES, TELESCOPES AND MAGNIFIERS

POWERFUL, Efficient astronomical telescopes easily made. Perfect lenses and instructions. 100X \$2.00, 200X \$3.00, 400X \$4.00. Instructions alone 10c. Carl Jamer, Manorville, N. Y.

TELESCOPES 18 Inch 2-section 8-power precision ground polished lenses. Individually packed \$1.50. 36 inch 3-section 17 power precision ground polished lenses, including carrying case \$2.50 postpaid. Criterion Co., Dept. PM, 327 Trumbull St., Hartford, Conn.

REAL 17 Power telescopes \$3. Send \$1 deposit. United, 2309-P Lawrence, Toledo, Ohio.

COMPOUND Microscopes easily made. Perfect lenses and instructions. 50X \$1.00, 200X \$2.00, 400X \$3.00. Instructions alone 10c. Carl Jamer, Manorville, N. Y.

OPTICAL Grinding powders for the amateur. Micro-graded 30-40, 20-30, 10-20, 5-10 microns 1"x5" tubes, \$1.00, \$1.10, \$1.25, \$1.50 postpaid. W. A. Yarwood, 8573 Krull Parkway, Niagara Falls, N. Y.

REFLECTING Telescopes, complete, 3 1/2" diameter, equatorially mounted. View planets, stars, \$19.75. Write Skyscope Company, 475-P 5th Ave., New York.

BUILD Your own reflecting telescope. Copy of instructions 10 cents, Catalogue free. Mayflower, Katonah, N. Y.

PORRO Prisms 1 3/8" x 1 5/16" oval face. Manufactured by world-famous opticians for army and navy 8 x 50 binoculars. Rejected for slightly chipped edges. Outstanding bargain! 30c ea., 4 for \$1.00 postpaid. No c.o.d. Remit with order. Ross, 70 West Broadway, New York 7, N. Y.

TELESCOPES, Microscopes, binoculars, lens kits. Catalog free. Brownscope Co., 24 West 45th St., New York.

BINOCULARS, Telescopes, watches. Buy, sell, trade. Paul Schweer, Donnellson, Iowa.

TELESCOPES, Microscopes, cameras, binoculars: bought, sold, repaired. Lists 10c. Specify instrument wanted. Rasmussen and Reece, 41 Market, Amsterdam, N. Y.

DOGS, PETS, BIRDS AND RABBITS

ANGORA Rabbit raisers necessary equipment. New Patents. Write Modern Small Stock Equipment, Kurtz, Indiana.

MONEY In rabbits!—New car, home, etc., through spare-time efforts. Interesting information, literature sent for 25c coin. Odette Rabbitry, P. O. Box 5642, Dallas 2, Texas.

GUARANTEED Giant Chinchilla rabbits. Prolific. Profitable. Most valuable fur. Markets furnished. Details free. Willow Brook Farm, R 15, Sellersville, Pa.

ZOOLOGICAL And pet animals for sale. Illustrated catalogue, literature, 25c. Trails End Zoo-5, St. Stephen, S. C.

\$500.00 A Year raising canaries. Details free. George Gundrum, LeRoy, Michigan.

RAISE Guinea pigs. Profitable, low-cost feeding, small space required, small investment. Complete details 25c. Guinea Pig Farms, 3456 West 116th St., Chicago 43.

BEAUTIFUL Collie-shepherd pups, \$12. Paul Schultetus, New Liberty, Illinois.

SAMPLE Copy "Rabbit Profits" magazine, information regarding revolutionary new hutch plans and literature telling how to make most money from rabbits. 10c. Reliable Fur Industries, Dept. PM, Montebello, Calif.

ANGORA Rabbits bring steady income! Good wool producing stock supplied. House of Angora, Springfield, Illinois.

RAISE Moneymaking Angora rabbits. Wool \$14.50 pound. Plenty markets. Cash income. Future prospects bright. Particulars free. White's Rabbitry, Lawrence, Kansas.

ORIGINAL Chin-Chin giant Chinchilla rabbits. Gorgeous fur. Delicious meat. Most prolific. Easily raised anywhere. Free booklet shows amazing profits. Willow Farm, R15, Sellersville, Penna.

RAISE Diamond seal rabbits. We pay \$25 to \$50 each. We buy all you raise. Literature 10c with hutch plans \$1. Automatic cleaning, watering, feeding. 31 drawings, patterns. Hansen's Rabbitry, 1347 Miller Ave., Salt Lake, Utah.

ANGORA Rabbits, giant chinchillas—finest pedigree. Valuable wool \$15.00 pound; gorgeous two-tone furs. Raised anywhere. Literature free. Grinsteads, Edwardsville, Illinois.

MONEY Raising rabbits. Investigate. Folder 10c. Close Rabbitry, Tiffin, Ohio.

CHINCHILLA Giants, real. Most profitable. Prolific, easily raised anywhere. Breeders supplied reasonable. Satisfaction guaranteed. Free literature. Large illustrated catalogue, 25c. Fur samples, 25c. Chin-Chin Farms, Melvin Behrens, Gen-Mgr., Dept. 4, 44 Chester Pike, Darby, Pa.

PIGEONS, Rabbits, 30 varieties. Catalogue 10c. Jim Houck, Tiffin, Ohio.

ST. BERNARD Pups: Champion sired beauties. Franklin Young, R4, Riverhead, Long Island, New York.

RAISE Guinea pigs. Make money at home. Big demand. Free booklet. Tylors Guinea Pig Farm, Hapeville, Georgia.

STANDARD Rabbit Journal, Milton, Pa. 3 years \$1.00, sample dime.

A LIVING With rabbits and covies. Markets waiting. Magazine 10c. Book describing twenty breeds and magazine 25c. Book and magazine (monthly) one year 50c. Address Small Stock, Dept. 2, Pearl River, N. Y.

FARMS, FARM LANDS, REAL ESTATE

CHOOSE A good farm in Canada! Information about excellent opportunities in farms to fit your needs and capital will be sent to you promptly. State your preferences in size and kind of farm, and in what province you are interested. Address inquiry to H. S. Cresswell, Canadian Pacific, Montreal.

MISSOURI: 40 Acres \$100. Near town, railroad, highway, stream. Unimproved, unincumbered. Frederick Calvert, Rogers, Arkansas.

FOR Sale: Farms, homes, butcher shops, gas stations, restaurants, hotels, etc. State your requirements. George Boyer, Dept. P, 121 Canal St., Lebanon, Pa.

FERTILE South-American lands obtainable free. Homesteads. Plantations. 25,000 acre ranches. Interesting literature, 10c. Vallesp, New York 13.

A SIX Room house \$2800.00, complete, ready for you to move in. Built anywhere. Send card to Low Cost Housing Co., Box 642M, Salem, Mass., for free particulars.

OZARK Magazine, 111-A; Eureka Springs, Arkansas. For homeseekers. Year, \$1.00.

STROUT'S Green farm catalog—Over 1300 bargains—25 states—Maine to Florida, west to California, Oregon and Washington. Write today for this big book. Mailed free. Strout Realty, 255-P 4th Ave., New York 10, N. Y. 7 So. Dearborn St., Chicago 3, Ill. 453 So. Spring, Los Angeles 13, Calif.

FREE Catalog, farm bargains, 9 mid-west states. Many fully equipped for convenient quick start. Many pictures. Special service to help you locate quickly, if you state requirements, payment plan and general location desired in first letter. United Farm Agency, 1796-MP Arcade Bldg. 1. St. Louis, Mo.

OZARK Lands for all purposes. Actual River frontages. 5 acres \$90.00 and upwards. Free list and literature. Hubbard, 424PM, Minnesota Ave., Kansas City 4, Kansas.

CITRUS County, Florida, lands on easy terms. R. W. Stewart, Inverness, Florida.

WISCONSIN, Minnesota water frontages. \$5 down, \$5 month. 3505-K So. Hope, Los Angeles 7, Calif.

WEST'S 1946 Catalogue. Hundreds farm bargains, business opportunities, Pennsylvania, New York, New Jersey, Ohio, Delaware, Maryland. Free copy. West's Farm Agency, HE, Pittsburgh 16, Penna.

GOOD Farms—ranches, Washington, Minnesota, Montana, Idaho, Oregon, North Dakota. Dependable crops, favorable climate. Write for literature, lists describing typical postwar farm opportunities. Specify which state. J. W. Haw, 119 Northern Pacific Ry., St. Paul 1, Minn.

\$5.00 MONTHLY Buys 40 acres near town; price \$175.00. Free list. Box 425-P, Carthage, Mo.

OZARK Farm bargains. 5 to 5000 acres. Frank, Mountain View, Mo.

POULTRY AND FARM SUPPLIES

KNOW How to raise poultry for profit. Read Northeastern Poultryman. Every issue packed with helpful hints and practical suggestions. Latest articles on breeding, feeding, and management. Read nationally. Subscribe now. 1 year 65c; 2 years \$1.00. Northeastern Poultryman, Dept. M, 376 Boylston St., Boston 16, Mass.

RAISE Turkeys the new way. Write for free information explaining how to make up to \$3000.00 in your own backyard. Address National Turkey Institute, Dept. 3, Columbus, Kansas.

PROFITABLE OCCUPATIONS

PLAN Houses. Carpenters, owners, others, planning to build or remodel, make your own working plans. Anybody can learn quickly. Complicated blue prints not necessary. Drawing ability not required. We teach you our modern way of planning buildings. A revelation in planning methods. Aids framing. Lowers construction costs. Helps establish profitable, lifetime business. Complete illustrated course, \$2.00 postpaid. Modern Crafts, 302 Pine Street, Modesto, Calif.

ELECTRIC Clocks are every where you go, buildings, homes, parking lots, factories. Repairs increasing. Our easy to learn course with pictures and drawings teach you how to repair these clocks. Electronic Supply Co., P.O. Box 2350A, Houston 1, Texas.

SHELL Jewelry supplies. Wholesale only. McFarland Plastic Co., Sarasota, Fla.

INTERESTED In Latin American and foreign employment? \$1 brings 1946 copyrighted research report explaining how—where—when to apply with listing of 300 firms with foreign interests. L. J. Enterprises, Box 2549-PM, Hollywood 28, Calif.

WELDING Pays. Learn with 1942 trade school text manual. 516 pages. Over 500 photos. \$2.00 copy. Money-back guarantee. Hobartweld, Box M-663, Troy, Ohio.

NOVELTY Manufacturing is the best bet to start profitable, interesting business on little money. No expensive equipment or molds to buy—we furnish fast selling designs, reliable instruction at small cost. Orders waiting. Use garage or basement. Investigate opportunity, write to-day. Plastex Products, 127 Clement, San Francisco 18, Calif.

ECUADOR 10c Native's handworks are dollar sellers. Sample collection \$2.00. Moneyback guarantee. Estrella, Box 537, Quito, Ecuador.

RAISE Fishworms; improved method \$1. Details, stamp. Stoner's, Chattanooga 6, Tenn.

GOLD-STAMPING Is fascinating and profitable. Free booklet. Home City Specialties, Dept. PM1273, Springfield, Mass.

BE Independent, establish permanent, profitable business at home. Tested, practical. Small investment. Write Mediant Co., Box 123-G, Blythebourne Station, Brooklyn 19, New York.

MUSHROOMS Grown; boxes, barrels. Instructions 50c. Spawn \$1.00. Gordon, 553 William, Winnipeg, Manitoba.

MECHANICALLY Inclined men—Own and operate general appliance repair shop. Complete, illustrated course shows you how. Welding, refrigeration, motor repair, how to get business, etc., all phases covered. Free literature. Christy Supply, Dept. 465, 2835 N. Central Ave., Chicago.

"**PRACTICAL** Prospecting," illustrated book, tells how find minerals, treasures with electronic locators. Complete methods \$1.00 postpaid. Southwest Publishers, Tortilla Flat, Arizona.

BUY Unpainted plaques, statuary, etc. Decorate; sell locally. Good profits. Small cost. List free. Samples \$2.00. Artists' brushes, paints, instruction books available. Pioneer Plastex Art Products, Austin 6, Minnesota.

STORY Writing simplified! Don't dream—try! Fascinating, complete home study. Handsome earnings. Circular free. New Simple Segment System, Postoffice Box 834, Spokane, Wash.

TYPEWRITER Repairmen urgently needed. Earn \$40 to \$50 weekly spare time. Our easy to learn home study course teaches how to repair typewriters. Write for free information. Houston Typewriter Repair Service, P.O. Box 5357A, Houston 12, Texas.

"**12,000** ALASKAN Job and Business Opportunities," \$1 brings 1946 copyrighted booklet explaining how—when—where to apply with tips on excellent business opportunities and government homestead lands at 25c per acre to approved applicants. Transcontinental Research, Box 2147-PM, Hollywood 28, California.

GUARANTEED Investment. Immediate profits. Free details how, twenty dollars start. Agud Company, P.O. Box 861, Seattle 11, Washington.

SELL By mail! Fascinating, profitable. Sample booklet, circular, confidential prices 25c. Joe Jones, 1028 Broadway, Columbus, Georgia.

"REFRIGERATION Service Manual"—domestic, commercial. Construction, operation, installation, testing, trouble shooting, replacement, repair, etc. 300 pages; fully illustrated, \$2.25 postpaid. Money back guarantee. All books on technics, radio, television, homecrafts. Free catalogue. Modern Technical Book Co., Dept. MMC, 55 West 42nd St., New York 18.

GROW Plants; flowers—Interesting, profitable enterprise. Write: Bowers, Loy-altin, Penna.

ESTABLISHED Mail order business. 357% profit. Box 127, Station E, Columbus, Ohio.

QUICK Easy method of printing without printing press, using printer's type. Money making home business. Simple directions \$1.00. Details free. D. Crichton, 10 McNair Bldg., Moose Jaw, Sask., Canada.

LEARN "Cold-Process" roofing and water-proofing. Unlimited possibilities. Illustrated instructions \$1.00, or write for details. Associated Engineers, P.O. Box 1448, Dallas, Texas.

WHAT Could be more fun than opening letters containing money? Find out how by writing Quivira Mail Service, 207-a N. Pioneer, Lyons, Kansas.

YOU Too can make beautiful mirrors from inexpensive window glass. Formula with complete working details for dollar bill. Tesco, P.O. Box 189, Wilkes-Barre, Penna.

LEATHERCRAFT Supplies, Catalog 10c. Art Craft Supply Company, Box 148, Fort Worth, Texas.

ONE Dollar per hour working for yourself. Nothing to sell. Stamp for particulars. R. Henri, 173 Granita Street, Biddeford, Maine.

BECOME A locomotive engineer or railroad conductor, information 50c. The Student Railroader, Box A53, Elmhurst, Ill.

FOR An extremely profitable lifetime business, operate a Collection-Credit Bureau. Easily learned. Write Cole & Associates, Syracuse 2, N. Y.

"FROG Raising!" New book tells how. Marlboro House, 1035 Marlborough, Detroit 15, Michigan.

SOUTH America. 50,000 job opportunities in South America. Send \$1.00 now for list of over 200 American firms doing business in Central and South America. How and where to apply with sample application form included. Write Dept. 151, Box 3112, Winston-Salem, N. C.

MAKE Beautiful costume jewelry at home for large profits, hobby or therapy. Free illustrated wholesale catalogue of sea shell, metal and plastic parts contains detailed instructions. Florida Supply House, Bradenton, Florida.

WOULD You pay 3%—first \$350 made? Color-illustrated book "505 Odd, Successful Enterprises", free! Some offer occasional "day off". Start at home, office. Expect something odd! Pacific, 262-N Drake, New Rochelle, N. Y.

EXCELLENT Profits raising mink. Choice breeding stock available. Details furnished. Franklin Young, Riverhead, New York.

EARN While you learn the clock repair business! With our method of instruction, your income starts immediately. For details write Akron Clock Clinic, 964 Wye Drive, Akron 3, Ohio.

ANNOUNCING Home study course in commercial baking. Practical basic training. Good field for those with aptitude. Nearly depression proof. Send for free booklet, "Opportunities in the Baking Industry." National Baking School, 1315 Michigan Ave., Dept. 3432, Chicago 5, Ill.

LOCKSMITHING—Profitable business or hobby! New course teaches you how to pick locks, fit keys, de-code, masterkey, etc. Easy self-instruction lessons. Bargain price. Fascinating 100-page illustrated catalog free! Write—Nelson Company, Dept. 2-02, Chicago 5.

PAINTING Flagpoles often pays \$50.00 daily. Particulars free. The Skyline Co., P.O. Box 1601 B, Uniontown, Penna.

\$40.00 WEEKLY Made growing mushrooms, fresh, dried. Dominion patent 331583. Free spawn. North American, 169P Yonge, Toronto, Canada.

TYPEWRITER Repairing—Original course, simplified home study. Weber Typewriter Mechanics School, Box 269, Osborn, Ohio.

FREE—"Amazing New Book"—"Profits From Classified Advertising." Tells how and what to advertise. Be sure to read this book before you invest one cent in advertising. Remember—it's free! Write for your copy now. F. W. Johnson, Classified Advertising Manager, 200 East Ontario Street, Chicago 11, Illinois.

BOOKS, PERIODICALS, PICTURES, POSTCARDS

20 PACIFIC War veterans. Here's your chance to get 20 glossy photos, size 4x5 inches of the Philippine campaign and ruined Tokyo scenes. Each photo has typed descriptive caption. See Manila burning; looting; Linguyen sky battle; Kamikazee attack; Americans surrender at Corregidor (Jap photo); two good photos of "Tokyo Rose"; and many other scenes of familiar places. Fellows here's a good chance to get a swell collection of sharp photos for your war album. Better do it now while supply lasts. Price \$2.00. Money back guarantee. Al Rosen Studio, Chester, Penna.

BOOKS. List free. Gowdy, 11 Princeton St., East Boston 28, Mass.

BOOKFINDERS! Out-of-print, scarce, unusual books. Promptly supplied. Send wants. Clifton, Box 1377PM, Beverly Hills, Calif.

PACIFIC Veterans—Attention: Souvenir photo series with complete description of each photograph: New Guinea—thirty actual photos, glossy, postcard size \$2.50. Leyte, Philippines, twenty five actual photos, glossy, postcard size \$2.25. Special introductory offer, both of above, plus ten additional Philippine photos only \$5.25 postpaid. J. L. Hascall, 65 Ashland, Buffalo, New York.

READ Character at a glance. Book \$1. George Coralluzzo, Caruthers, Calif.

TRADE Magazines—business—vocational—diversion. Current single copies—all fields—over 700 different publications to choose from. Free price list; directory of 3342 periodicals, each with complete address. Classified as to field covered, year established, frequency of issue and domestic and foreign subscription rates, \$1.00. Commercial Engraving Publishing Co., 34C North Ritter, Indianapolis 1, Ind.

KWAJALEIN—Unpublished photographs snapped in action during Marshalls invasion \$1.00. Arthur Bazemore, 313 Tremont, Chattanooga 5, Tenn.

TERRIBLE! Atom bombed Nagasaki, 15 authentic photographs, \$1.00. Free particulars. Makins Pictures, 538 1/2 Washington, Bremerton, Washington.

NEW Plastic bookmark. Ideal, colorful, your initials 20c. Nameplates 15c. C. Greco, 2430 Morris Avenue, Bronx 58, N. Y.

JOIN New technical book club—free! Members receive current literature, guidance on all book problems, premiums. No obligation. All technical, scientific, home-craft, farming, sports, etc. Specify subject for free information. Modern Technical Book Co., Dept. M2MC, 55 West 42nd St., New York 18.

FIGUROLOGY—Vest pocket short-cut booklet 25c. Graphic mathematics 25c. Figurology, Box 222, Chicago 90.

SAMPLE Copy free. The Idea Exchange, Box 332, Fort Atkinson, Wisconsin.

TELESCREEN—Quarterly magazine for the arts of television. Articles of importance to enthusiasts, writers, actors and dancers. Subscription, \$1.00 yearly. Telescreen, 371 So. Orange Avenue, Newark, N. J.

WOULD You like to attain wealth and happiness, make others agree with you. Cash in on your ability. Read "Magic Story." Write for free literature. Hilton C. Cornwell, 1384 Dekalb Ave., Atlanta, Ga.

TRANSPARENCIES, Unmounted—beautiful pictures—\$1.00 per dozen—viewers, all accessories, something new. R & R Trading Company, 1930 E. 34th St., Bklyn, New York.

SEVEN Great books of information. Condensed library series. Descriptive literature and little blue book. Confessions of a gold digger for one dime. Joseph Russell, 79D Columbia, Cedarhurst, New York.

ATOMIC Age shorthand. Learn in 5 lessons, 10c each. Elliott School, 4426 Carrollton 19, New Orleans.

WHY Buy latest novels? Rent them by mail! Inexpensive. Free details. Mallibrary, 727 Silver Ave., Silver Spring, Md.

BOOKS You'll prize! Catalog free. Carlson, Box 643-E, Ann Arbor, Michigan.

CARDS: 10 Stars' homes, folder 25c. Boystown set 25c. 15 Calif. or Hollywood 25c. All states. 10 hotels 12c. 709 Queen Street, Bridgeport, Conn.

READ, "The Atomic Bomb And The End Of The World." 25c postpaid. Write New Age, 1708 So. Humboldt, Minneapolis, Minn.

READ "America's Most Expensive Magazine." Dixie Business 20-page quarterly \$5.00 year. Hubert Lee, Editor, Stone Mountain, Georgia.

WHAT Every Mason wants. We have Masonic books for Blue Lodge, Chapter, Commandery, Scottish Rite and Shrine. Our rituals are used the world over. Send for free catalog of books and rituals for Masons, Odd Fellows, Knights of Columbus, etc. Ezra A. Cook, Publisher, P.O. Box 796-PJE, Chicago 90, Ill.

SCOOP! 8 Sensational Russian photos \$1.00. Cathedrals, peasants, etc., glossy prints 3"x4". Bowman, 2117 No. Main Street, Santa Ana, California.

AIRMINDED? Authentic flying quiz \$1. Hangar Flying, Box 820A, Bloomington, Illinois.

MANILA Snapshots! Blasted buildings, street scenes, president's palace, natives, etc. Send \$3.00 for 25 photos and complete list. Lanning, Box 1015-C, South Bend, Indiana.

CARDS 3-50c. General Ike's home sent by Chrisman Cards, Abilene, Kansas.

100 FREE Books! . . . money-making, health, business, farming, copyright directions, patents, formulas, recipes, etc. Gold mine of free information. Source list 20c (coins). Refund if not delighted. Carsten, Rt. 1, Box 819, Orlando, Fla.

MAGAZINE Export Sales Company, 2084 First Avenue, New York 29, N. Y. U. S. A. Over-issue popular American magazines and pocket-size novels. Comics, fashions, pictorials, romances, screens, pulps, many others. Export only.

INTERESTING. Informative books. Various subjects; instruction, formulas, self-improvement. Write for free literature. Walter Gillen, 33 18th Ave., Paterson 3, New Jersey.

HERBALISM—Complete course in 2 volumes. 1000 recipes. Particulars free. Home Service, Forestville 2, Va.

TECHNICAL Books, largest list. Edwards, 324 North 18th, Quincy, Illinois.

GOOD "Used" self-instruction educational books on all subjects bought, sold, rented, exchanged. Satisfaction guaranteed. Complete information and 100-page illustrated bargain catalog free! Write—Nelson Company, Chicago 5.

SELF-EXPLAINING Bible: Illustrated circular free. Box 446-F, Minneapolis, Minn.

NATIONAL Geographic Magazines, 1888-1945, any issue. Periodical Service, Dept. PM. Swarthmore, Penna.

BOOKS. (Out-of-print, new, used) quickly supplied. Many 35c bargains. Catalogue. Mid-West Book Service, 18870 Marx Ave., Detroit 3, Mich.

BIG Profits taking subscriptions for all magazines. Agents' confidential catalog listing over 2500 periodicals and complete starting supplies free. Pines Subscription Agency, Flushing, New York.

MAGAZINES (Back dated)—foreign, domestic, arts. Books, booklets, subscriptions, etc. Catalog 10c (refunded). Cicero's, 863 First Ave., New York 17, N. Y.

"100,000 POST-WAR Jobs Abroad"—South America, China, India, Burma, Japan, Russia, Malaya. How, when and where to apply. Post-war U. S. participation in world reconstruction and trade demands thousands of American-trained mechanics, salesmen, technicians, engineers, foremen, laborers and business representatives—every trade needed. Our 15,000-word copyrighted forecast—compiled from business, professional and government sources—lists over 200 big U. S. firms with foreign interests, gives job information, salary brackets, contract tips, application letters, passport information, climatic conditions, etc.—everything needed for your immediate application. \$1.00. Return for refund in 7 days if not satisfied. Pacific Industrial Research Bureau, 202-E Studio Building, Portland 5, Oregon.

BEAUTIFUL Photos, South America, Panama Canal, Hawaii, including Wakiki, world's most beautiful beach. Ten \$1. Jerome Jones, 2830 North Eleventh Street, Philadelphia, Penna.

GAMES AND ENTERTAINMENT

FIREWORKS! Bombs, torpedoes, mines, sparklers, many others. Easily and cheaply made. Have fun. Sell some. Big profits. Complete illustrated instructions 25c. Presto Pyrotechnics, 407-409 Springdale Ave., East Orange, N. J.

98 DANCING Lessons, \$1.00! 84 cardtrix, 25c! Hirsch, Spring Valley 2, N. Y.

FASCINATING New card game. Free. P.O. Box 842, Denver 1, Colo.

WHAT Have you to offer? A collection? A "shoe box" accumulation? Anything in stamps. We urgently need them. Spot cash paid. Cosmopolitan Stamp Co., 1457 Broadway, Dept. 6-E, New York.

NEW Zealand, 50 scarce varieties including rare mints, \$1. W. L. Lovell, Tauripi, New Zealand.

500 QUALITY Mixture from China, Hongkong, Japan, Manchukuo, Philippines including airmails, pictorials and price list—\$1. J. Y. Chow & Co., Box 1075, Shanghai, China.

FIFTH Army commemoratives! Flashy stamps in three colors; with the shoulder patches of our own 5th Army and the Brazilian division—sold out on day of issue—20c and 40c. These colorful stamps given for only 5c to serious approval applicants. Star Stamp Co., Dept. 4, Lakewood, N. Y.

"GOYA Nude" set complete 25c with approvals. Royal Stamp Company, Tamaqua, Penna.

20 DIFFERENT Old U. S. 25c. Foreign approvals. P. O. Box 108, Meriden, Conn.

FREE Beautiful new issues, Greece, France, airmails. Triangle to approval applicants. Green & Company, Norwood 12, Ohio.

FREE! \$1.00 Worth of stamps. Your choice. List 10c. Lavalliere, 5 Craig, Sherbrooke, Que., Canada.

CUBA—60 Different, including airmails, 25c. Cash for your U. S. mint commemoratives. Green, Box 73, Coconut Grove, Miami 33, Florida.

GREECE, Roosevelt mourning 3 values, complete 25c. Bradford, Box 636, G.P.O., Brooklyn, New York.

BRAZIL Diamond shaped set 10c, with approvals. Vargo Stamps, 6044 South Fairfield, Chicago 29, Ill.

BIG Packet list 3c. Wright Company, Union Building, Syracuse, N. Y.

PENNY Approvals. Henry Jay Service, 15 Park Row, New York City.

U. S. COLLECTION—Thirty different fine unused commemoratives before 1939 including Columbians, bicentennials, parks price \$1.00 approval applicants only. Fort Orange Stamps, Albany 7, New York.

ADEN To Zanzibar! 40 different British empire, including Cyprus, Malta, Dominica; 5c with approvals. Lyman Company, 95 Nassau Street, N. Y. C. 7.

U. S. Mint sheets bought and sold. Ralph S. Appleman, 2300 Monterey, Detroit, Michigan.

SENSATIONAL Offer! Japanese-Philippine invasion currency; varied assortment 25 for \$1.00. Peter Winfield, 2516 Georgetown, Toledo, Ohio.

FREE Packet with approvals. Robert Smith, 801 Market, McKeesport, Penna.

BRITISH Colonial newsletter. Sample free. Seelye, 737 Norino, Whittier, Calif.

FREE Mint set and bargain bulletin. No approvals unless requested. Robert C. De Vere, Box 927, Santa Monica, Calif.

PHILIPPINES—Seven Jap occupation stamps 10c. Approvals. Ross Jewells, Tamaqua, Pa.

NUDE Duchess set (two varieties) 5c, approvals. Masters, Clifton and Kernan, Baltimore 7, Maryland.

DOLLAR Each—1500 foreign, 2000 British, 2000 Canada. Seiden, 1331 Intervale, New York 59.

50 DIFFERENT, Free. With approvals, any country. Purchase's, 231-F East 88th Street, Los Angeles 3.

200 DIFFERENT U. S. postage \$1.50. Less than a penny each. 80 different commemoratives \$1.00. Robert Gallup, Albany 3, New York.

25 DIFFERENT Egypt, Russia, China, Poland or Netherlands, 20c. No approvals. Elsea, Bowling Green, Ohio.

100 DIFFERENT U. S. comms and others, 30c. Jem Stamps, Port Jefferson, New York.

PACKET: Airm, comms., pictorials, etc., 3c. Approvals. Valentini, Box 1069, St. Petersburg, Fla.

\$1.00 WILSON—25 Airmails—approvals, 25c. O. Burgett, Lima, Ohio.

FREE Stationery, stamps, covers. Join hobby club. Write Box 758, Bridgeport, Conn.

FIVE Vatican City stamps free to approval applicants. Florida Stamp Company, Box 807, Miami 5, Florida.

200 HIGHER Value stamps—30c. Paul's Approvals, 1203 Albany St., Schenectady, New York.

FLASH! Amazing value! Djibouti, Bechuanaland, Camerouns, Dominica, others, all 6c, approval applicants only. Southwest Stamps, Box 117, Long Beach 1, Calif.

LOW Price U. S. approvals to serious applicants. Panther Stamp Co., Box 76, Dorchester 24, Mass.

DEPENDABLE Approvals. Special premium 10c. Standard, 3817 Sackett, Cleveland 9, Ohio.

UNITED States approvals. Fine quality. Klein, Box 22, Robinson, Illinois.

FREE! "Stamp Bargain Bulletin!" Send postcard. Hillard Hotteway, Elmhurst 2, New York.

25 DIFFERENT Swiss 10c—with 1/4, 1/2, 1c approvals. Carroll's, 4357A S. Hoover, Los Angeles 37, Calif.

HITLERS (19 Varieties complete) 50c. Approvals. Millhiser, 7724 Abbott, Pittsburgh 21, Penna.

ROOSEVELT 2c First covers—five items, \$1.00. 8x10 portrait included. Press, Warm-springs, Ga.

FREE! Tiny Chinese "midget" war set, approvals. Seminole, Glenburnie 1, Md.

FREE! 25 Different British Colonies with approvals. Stamphouse, 7235-A Sheridan, Chicago 26.

FREE! 18 Different Switzerland with approvals. Excel, Box 1315, Chicago 90.

25 DIFFERENT 10c With approvals. Tunis & Carpenter, Wakeman Ave., Newark 4, New Jersey.

50 DIFF. Denmark, 15c; 150 diff., \$1.50. Gold Crown Stamp Co., North Hollywood, Calif.

SCARCE 50 Yr. old commem, \$1 stamp, regular issues, coils, etc., included in packet, 33 different U. S. all free to approval applicants only. Mendelson, 5410-M Beverly Road, Brooklyn 3, N. Y.

STAMP Magazine—chock-full information, news and bargain ads! 15 issues 25c. "Stamp Post," Station A, Pasadena 3, Calif.

FREE! Big stamp outfit! Tong, perforation gauge, hinges. Packet airmail, commemorative, triangle stamps. 3c postage. Approvals. Auburn Stamps, Auburn, Mass.

PICTORIAL Sets on approval, mint or used. References. Crane Stamp Co., Box 67, Dyker Station, Brooklyn 28, N. Y.

SUPERB Approvals, net prices. Stamps 1/3 to 1/2 catalog. P. G. Beals, 170A Tremont St., Boston, Mass.

FOREIGN Pictorial approvals. Brandan, 1912 3rd Ave. So., Minneapolis 4, Minn.

FREE Mint Paraguay set sent with first approvals. 20th Century, P.O. Box 3413, Phila. 22, Pa.

LIMITED Offer—40 world wide 10c to approval applicants. Samson, 234 East Mayfield St., Phila. 34, Pa.

WASHINGTON Bi-centennial complete 15c. Fine illustrated catalog free. Kleinman, Jenkintown 4, Penna.

STAMPS: 50 U. S. Or 70 worldwide 10c. 700 mixed 25c. 120 different postmarks 25c. Approvals sent. Ryan, 709 Queen Street, Bridgeport, Conn.

EXCHANGE Stamps, postcards universe. "Exchangers" Bry 226, pres Paris, France. Particulars free.

"FINE" U. S., Foreign approvals. George Dronso, 3710 Plankinton, Cudahy, Wisconsin.

60 DIFFERENT U. S. Includes commemoratives, higher values, airmail, 10c. Ada Stone, 3547 28th St., Astoria 1, N. Y.

1000 U. S. MIXTURE Includes some F.A., other commemoratives \$1.00. Reim, 3931 Bayo, Oakland 2, California.

175 U. S. Commemoratives, airmails, etc., 25c. Lloyd Johnson, Hawarden, Iowa.

20 DIFFERENT Foreign coins, 10 different foreign notes. All \$1.00. Tapp, Greer, S. C.

5,713 DIFFERENT Stamps from 147 countries—many pictorials, commemoratives, and airmails—only one cent each on our collection building penny approvals. Pima Stamp Company, Sells, Arizona.

5,000 DIFFERENT Stamps \$5.00. Available only through our exchange system. Postcard brings full information. Comet, G.P.O. Box 517-P, Brooklyn, N. Y.

U. S.—200 DIFFERENT \$1.00, 75 different commemoratives, 60c. Clayton Doil, 85 Audubon Ave., New York 32, N. Y.

EX-JAP Naval base, scarce Nauru ship stamp. Bolshevik music stamp, victory stamp for 5c to approval applicants. Bob's Stamp Service, 430 Ralston, San Francisco 12, California.

OLD Scarce U. S. seconds on approval. Slightly defective, nice appearance, bargain prices. Hernfield, 551 Clinton, Newark 8, N. J.

100 DIFFERENT 10c With approvals. Jacobsen, 59 Nagle Ave., New York 34, New York.

EXCHANGE Duplicates. Swappers everywhere. List 10c. Particulars free. Box 2166-M, Denver 1, Colorado.

BRITISH Colony 25 different 10c with approvals. Pelican Stamp Co., 1609 S.W. 8th St., Miami 35, Fla.

FREE—Scarce coronation! Bargain approvals. Gramatan, Box 1002, Church Street Station, New York 8.

ONE, Two, four, five dollar U. S. stamps free to approval applicants. United Stamp Service, Box 1789-M, Miami 10, Florida.

55 DIFFERENT U. S.—5c. Approvals. Utechts, 1143C North Keeler, Chicago 51.

FREE St. Helena pictorial and big surprise packet to approval applicants. Pioneer, Box 414A, Pasadena 18, Calif.

U. S. Price list. Send postage. Stanley Gibbons, 38-P Park Row, New York.

EXCELLENT Pictorial approvals. Reasonably priced. Crown Stamp Company, Box 331, Toronto, Canada.

125 DIFFERENT U. S. Stamps, 30c. Frank Stroskey, Box 55, Perth Amboy, New Jersey.

ZANZIBAR, Palestine, Manchukuo, Azerbaijan, Haiti, Iraq, Siam, Victoria, Hitler stamp 5c. Approvals. Postzegel, Windham, New York.

FREE! Complete Balkan aviation set with approvals. Beaman, Glenburnie 1, Maryland.

APPROVAL Sheets, Frederick B. Driver, 909 Finance Building, Philadelphia 2, Pa.

PENNY Approvals, that satisfy. Neil Gronberg, Box 5441-P, Philadelphia 43, Penna.

MINT Pictorials free to approval applicants. Surf Stamp Co., Box 2296, Miami Beach 40, Florida.

UNITED Nations, scarce 5c U. S. commemorative and packet 30 different U. S., including airmail, commemoratives, revenues, etc. Catalogs 65c—to approval applicants for 5c. Curhan Stamp Company, Dept. H, Gloucester, Mass.

ZOWIE-E! A barrel of fun for only a dime. 500 United States stamps—absolutely unpicked and unsorted—just as received from church missions. Many varieties, including large commemoratives, airmails, high denominations up to \$5.00! Stampdom's biggest package of fun—and you might find something really valuable! Price only 10c to serious approval service applicants. Money back if not delighted. Illustrated bargain lists with each order. Mystic Stamp Company, Dept. 80, Camden, New York.

50 DIFFERENT United States, 10c. Price-list free. Seidenberg, Cassopolis, Mich.

GLOBAL Packet 40 stamps all different 10c. Eclipse, Box 635, St. Louis 1, Mo.

CANADA—75c Diff. 25c. Approvals. Lists. Victoria Stamp Co., London 4, Canada.

10 DIFFERENT U. S. Over 40 years old, 5c. Foreign, U. S. approvals. Scott, 30 Baker Ave., Lexington 73, Mass.

MINT Black Harding ten cents to approval applicants. Louis Merrill, 1623 5th, Portsmouth, Ohio.

STAMPS! 1000 Different \$2.50, 2000 different \$7.50. Ransom, 1333 Pontiac, Ann Arbor, Mich.

GORGEOUS Colors, scarce airmail surcharges, charities, sets, etc. All in our big premium packet only 3c to approval buyers. Dixie Stamp Company, Dept. M, Milwaukee 3, Wisconsin.

LATIN-AMERICA. 65 Diff., pictorials, airm, etc., 10 countries, 10c with approvals. Crescent Stamps, London, Canada.

FINE Approvals, freshly mounted. Fast, personal service. Tell me what countries you prefer and I'll send their stamps. Skinner, 438 Locust, Long Beach 2, Calif.

RICH Man's approvals, poor man's prices. Grand value packet containing five foreign sets, free with approvals. Stoll Stamp Service, 2630B West Burnett, Louisville 10, Kentucky.

FREE! Negro Triangle; Turks Islands "Cactus"; Dakar; Guinea; Palestine; "Fairy Tale." Pirate Chart. Map. Ship, Sea Lion and Snake stamps; French, British, Portugese Colonies, etc. Free for 3c postage. Approvals. Potomac Stamps, Washington 10, D. C.

WOW! \$10.00 Worth of fun only 10c. What a treasure hunt! Big package 500 foreign stamps—just as received from foreign missions other sources. Includes stamps from Africa, South America, Philippines, Free French, Cape Juby, Palestine, etc., including airmails, commemoratives, and stamps worth up to 50c and 75c. This amazing offer is given for 10c to serious approval applicants only. One to a customer, money back if not more than delighted. Jamestown Stamp Co., Dept. 22, Jamestown, New York. Stamps—valued up to 50c and 75c each.

UNITED States approvals complete coverage, fine quality, attractive prices. Seminole Stamps, Box 378, Coconut Grove, Florida.

FREE! Leeward Is., Cayman Is., Turks and Caicos plus 54 different mint World's Fair poster stamps, to approval service applicants sending 3c postage. Tatham Stamp Co., Springfield 30, Mass.

25 DIFFERENT India, 3c with approvals. Premiums with purchases. Brandwein Stamp Company, Box 92H, Bayonne, N. J.

MIXTURES. Worldwide accumulations 1,500 for \$1. Missions Outlet, Rev. Marshall, Paterson 1, N. J.

EXOTIC Pictorial collection, including Tahiti Spear Fishing, Melanesian Idol, Carib Archer, Malagasian Farmer and many other scarce stamps from strange countries. Everything only 5c. Imperial Stamp Co., Yonkers, N. Y.

50 DIFFERENT Including scarce diamond-shaped airmail 3c to approval service applicants. Avalon Stamp Co., Dept. M, Springfield 8, Mass.

19th CENTURY U. S. Commem., Civil War—Battleship revenues, \$5 and \$10 stamps free to U. S. approval applicants. Metropolitan Stamps, 198C Broadway, New York.

LIBERAL Offer, thick packet with Seychelles, Fiji, U. S. commemoratives, Tete, Djibouti, Inini, Congo, Porto Rico, Philippines and multitude others. Everything only 10c to approval applicants. Burmaster, Box 1910 A, Los Angeles 53, Calif.

DANDY United States approvals. Write immediately. Sullivan, Endicott Building, St. Paul 1, Minn.

1000 GRABAGS 15c Each. Super bags 25c. Zandy, 630 Bingham, Reading, Pa.

BOX Stamps containing hundreds all different, cataloging up to 25c each. Everything \$1.00. Longacre Shop, 108 West 42nd, New York City.

SCARCE "Pole to Pole" packet! Stamps from strange, mysterious countries only—Greenland (North Pole), Solomons, Spanish Morocco, Bhopal, Patiala, Siberia, Grahamland (South Pole), Djibouti, Zanzibar, etc., and including stamps cataloging up to 25c each! Our price only 5c to approval applicants. Big dime packet list free! Methuen Stamp Service, Inc., Dept. 136, Lawrence, Mass.

FREE U. S. price list. Postage 3c. Mark Hanna, 335 - 5th Avenue, Pittsburgh 22, Penna.

FREE—Pick 25c worth of stamps from our first U. S. approval selection. Approximately 100 stamps to choose from. Excellent value. No obligation to buy. Lists illustrating the most popular U. S. stamps—at prices you can afford—will be included. Don't miss this opportunity! Write today. S. C. Engel Co., 38 Park Row, New York City.

114 DIFFERENT Stamps from far away countries including airmail and Free Fighting French to approval applicants for 10c. Reich Stamp Co., 4647 Kenmore, Chicago 40, Dept. M9.

COMPLETE "United States" catalog with 1000 illustrations! Send 10c for mailing. Harris & Co., 137 Transit Building, Boston, Mass.

AMAZING Offer! Assortment each of giant stamps, midget stamps, flag stamps, airmail stamps, Free French Colonies, U. S. commemoratives and numerous others. Everything only 10c to approval applicants. Simon, Box 214, Iraan, Texas.

SCARCE 1880 U. S.—Hussey local carrier stamp listed at 15c. Also Costa Rica No. 65 listed at 40c. Both sent free to approval buyers sending 3c postage. Pladon Stamps, 1717-M Idaho, Toledo 5, Ohio.

WORLD'S Largest diamond and triangle stamps, free stamp magazine, stamps from fighting Free French, 20 stamps from 20 different countries, pictorials, airmails, big bargain 5c with approvals. Capital Stamps, Dept. 2, Little Rock, Ark.

FREE! Canadian sets, royal visit, George VI, George V, coronation, jubilee, others, to approval applicants. Ensign, Box 118-M, South Orange, N. J.

DEALERS—Wholesale list. Postage 3c. Frank, 5031 Queensberry, Baltimore 15, Md.

118 DIFFERENT Stamps including commemoratives, charities, airmail sets, etc., only 3c to approval buyers. We buy collections. Badger Stamp Co., Milwaukee 3, Wis.

VICTORY Packet free—Includes stamps from Tanganyika, British Cayman Islands, animal, scarce babyhead, coronation, early Victorian, airmail, map stamps, with big catalogue—all free. Send 5c for postage. Gray Stamp Company, Dept. PM, Toronto, Canada.

FREE! The Stamp Finder! Send today for the big new edition, fully illustrated, enabling you instantly to identify all difficult stamps! Also fine packet strange, fascinating stamps from Bosnia-Herzegovina, Monaco, Patiala, Cyprus, etc., including maps, ships, animals and strange scenes. All free to approval applicants inclosing 3c postage. Garcelon Stamp Company, Box 900, Calais, Maine.

HOBBIES AND COLLECTIONS

MILITARY Insignia: 22 different for \$1.00. (Value \$4.60). Introductory offer, never before equalled. Prices and Insignia Guide 10c. Sample 5c. Hobbyguild, P35 West 32nd St., New York.

RAISED Metal designs, figures, emblems made easier, faster on shell casings, bowls, plaques. Complete detailed, illustrated instructions and photos one dollar bill or M.O. to Perma-Craft, Box 608, Mt. Kisco, N. Y.

100 DIFFERENT Book match covers \$1.00. G. Curtis, 62 High, Oshkosh, Wis.

LOOK! Hobby collectors! Genuine over-sea helmets clearing sale, 50c. With liners, \$1.00, 20% extra for postage. Escondido Salvage Depot, P.O. Box 474, Escondido, Calif.

READ "Hobby Life Magazine" copy 25c. P. O. Box 1296P, Detroit.

GEM Cutters, 1/2 lb. gem agate and jade, \$1.00 postpaid. Gem House, Box 1003, Casper, Wyo.

MEMBERSHIP 50c. National Hobby Club, Box 1113, Rochester 3, N. Y.

FREE: 50 Military emblems when joining "Insignia Club." Price list, insignia guide 10c. Embroidered sample 5c. Hobbyguild, P35 West 32nd, New York.

INVENTING Can be an interesting and profitable hobby. Write for complete particulars. Institute of American Inventors, Dept. 40-E, 1926-Eye St. N. W., Washington 6, D. C.

NEW—15 Different match covers 10c. Box 202, Rochester 1, N. Y.

FOREIGN Decoration ribbons, list, sample, 20c. Foreign insignia packet, booklet, \$1.00. Insigniacrafts, 236-28th Ave. N.W., Calgary, Canada.

FOOL'S Gold—From famous gold camp, 10c per sample. Also mineral specimens from famous local mines. Martin's Snap Shop, 506 Harrison Ave., Leadville, Colo.

COLLECTING Hobbyists. Exchange duplicates. Swappers directory 10c. C. Bishop, Route 8, Kalamazoo 88, Michigan.

COLLECT Colorful Army patches. Pictures, prices and sample patch only 10c. Insignia Mart, 703 Broadway, N. Y.

UNUSED Match book covers. 100 all different \$1.00. 35 Royal Flash covers \$1.00. Free list. Charles Edelman, 13110 East 84, Cleveland 3, Ohio.

JEWELRY Stones removed from rings, etc., 100 assorted \$2.40; 50 large ones \$2.40. B. Lowe, Holland Bldg., St. Louis 1, Mo.

ANTIQUES, RELICS, INDIAN GOODS, CURIOS

COINS, Minerals, glass, Indian relics. Catalogue 5c. Cowboy Lemley, Las Cruces, New Mexico.

DECORATE And sell unpainted plaques, statuary, etc. Pioneer, Austin 6, Minn.

BIG Illustrated catalog. Japanese, Nazi relics; guns, swords, cartridges, 50c. Bellport Gun Shop, Dept. G, Bellport, N. Y.

SWORDS, Rapiers, daggers, pistols, armor. Illustrated catalog 50c. Robert Abels, 860-A Lexington Ave., New York.

4 FINE Ancient arrowheads, \$1.00. Stone Tomahawk, \$1.00. Flint knife, 50c. List free. Lear's, Box 569, Galveston, Texas.

MUSEUM Specimens. Indian relics, curios, den decorations. Illustrated catalogue, identification chart 25c. We also buy. Museum Supplies, 6601 Oshkosh, Chicago 31, Illinois.

50,000 INDIAN Arrows, tools, rainbow variations. Don McKillop, Regina Sask

MINERALS AND PRECIOUS STONES

12 ROUGH Red garnets 36 gram for only \$2.40. Brilliant cut genuine Australia green garnet \$3.00. Finest cut optical prism 1 3/4 inch \$3.00. Federal tax included. Ernest Meier, Church St. Annex, Post Office Box 302, New York 8, N. Y.

SMALL, Unpolished slabs, 1 each obsidian, Jasper, wood \$1.00. Smith, Box 422F, Albany, Oregon.

"GENUINE" Arizona rubies (garnets). Send quarter for packet. Mineral Specimens Company, Box 2651, Phoenix, Ariz.

CAMERAS AND PHOTO SUPPLIES

FOR Immediate delivery, cameras and equipment: movie cameras, projectors, still cameras, enlargers, lenses, screens, printers, trays, film, paper, chemicals, reflectors, dryers. Complete stock of dark-room equipment and hundreds of other photographic items. We pay highest prices for used cameras and equipment. Send for free new big catalog. Flash Photo Sales, 6612 N. Sheridan Rd., Dept. E-1, Chicago 26, Ill.

FILM! High speed. Five rolls, eight exposures, postpaid: No. 127, \$1.45; 120, \$1.75; 620, \$1.75; 116, \$2.00; G16, \$2.00. Artex, Union, New Jersey.

FREE—Set of filters for names and addresses of four camera owners. Photo-Craft, Canton 1, Ohio.

KENT Dark room kit; a complete printing and developing kit for beginner or advanced amateur. Contains the necessary equipment and materials for processing and printing photo negatives. \$10.00 set; special sale \$8.92. Conway Camera Company, 34 N. Clark, Chicago 2, Illinois.

SCOOP! Postpaid immediately taxes paid: Latest "Mercury II" coated f2.7 35mm. camera, EK film for 2350 shots, bulk film loader, exposure meter, total value \$93, special \$79.50; 200' EK packed XX 35mm. film \$5; enlarging lenses: "Ilex" 3 1/2" 16.3 \$14.63, 14.5 \$18.56; "Wirgin" 2" 14.5 \$14. All iris mounts. Lens specialists. Camera-Aids, 160 East 48th, New York.

ROLL Film, factory fresh popular brands, 6 rolls 127, \$1.65; 120-620, \$1.98; 116-616, \$2.30; 36 exposure 35mm. 85c each, postpaid. Imperial Foto, 122 Sharon, Glendale, Ohio.

STARTLING! Ansco color developing outfit for Ansco color film and Printon. Easy, beautiful, one-half gal. size, \$2.25; one gal. \$3.20. Printon set outfits, 1/4 size \$2.20. One gal. \$4.90. Pamphlets upon request. Conway Camera Co., 34 North Clark, Chicago 2, Illinois.

PAPER, Chemicals, roll film, repairs. Catalogue 3c. Photoking Supply Shop, 6803 N. Clark, Chicago 26, Ill.

PROJECTORS, New 16mm. "Excel," a.c. motor driven. Automatic rewinding. Ready to operate. \$15.50 postpaid. Photo-Craft, Box 470-Z, Jamaica 1, New York.

PHOTO Finishers. \$15 per thousand cash paid for empty spools 127, 120, 620, 116 and 616. Write stating quantities available. Howard West, 3 W. 42nd St., New York 18, N. Y.

FILMS, Fresh, dated 1948, outdoor type. 127—\$4.09 dozen. 120 or 620—\$4.81 dozen. 116 or 616—\$5.41 dozen, postpaid. "Cameraman," 542-5th Ave., New York 19.

PICTURES From everywhere. Build priceless collection of worthwhile prints. Exchange with camera enthusiasts everywhere. Beginners or advanced workers. All sizes—subjects. Bi-monthly bulletin. Year's registration \$1.00. Information free. Photographic Exchange Club, 1206-B New York Ave. N.W., Washington 5, D. C.

REPAIR Leaky camera bellows with Belloseal formula \$1.00. Henry A. Berg, 124 No. 19 W., Duluth, Minn.

ENLARGERS—Build your own. Kit of parts, \$6.00. Free particulars. Crescent Engineering, Box 586, North Hollywood, Calif.

BASS Says: Trade cameras? For 36 years Bass has satisfied thousands everywhere! Finest equipment available. Always satisfaction guaranteed or your money back! Bass buys 'em, sells 'em, trades 'em. Bass Camera Company, Dept. AG, 179 W. Madison St., Chicago 2.

CASH! Spot cash for cameras, lenses, binoculars, movie and still equipment. Send full description for prompt cash offer. Over 36 years of dependability. Bass Camera Company, Dept. AG, 179 W. Madison St. Chicago 2.

SURPLUS Cameras. Scarce items, new, used. Bargains. Camera Guide, 126-M Lexington Avenue, New York. Latest edition well worth 25c (coin, stamps).

PHOTOGRAPHY For pleasure or profit. Learn at home. Practical basic training. Long established school. Write for booklet. American School of Photography, 1315 Michigan, Dept. 3432, Chicago 5.

USED Camera Directory. Box 1031-M, Canton, Ohio—lists hundreds of war-bargain used cameras—35mm., Speed Graphics, Kodaks, Rolleiflex—many others. Send 25c for latest issue.

HAVE You a camera? Improve your hobby of photography and learn how to make better pictures. Write today for our latest book catalog and sample copy of American Photography, containing articles and pictures by the world's foremost writers and photographers. Camera House, 601, 353 Newbury St., Boston 15, Mass.

PHOTO FINISHING

DON'T Be in doubt! Try Smith's fine quality service! Any 8 exposure film developed, 8 prints and 2 enlargements, only 25c. 8 double-size, 25c. 35mm. fine grain developed, 36-3x4 enlargements, only 90c; 18, 55c. Cartridge reloaded, 36 exposures 35c; 18, 20c. Enlargements: 4x6, 10c; 5x7, 20c; 8x10, 35c. Write for mailers, sample print and price list. Smith Studios, 8 Saint John Street, Plains, Pennsylvania.

ROLLS Developed with 8 enlarged prints—3½x5 inches 25c. Enlargement coupon free. Skrudland, 6444 23 Diversey, Chicago 35.

GENUINE Moen-tone finishing approved by thousands since 1898. 8 exposure roll developed with 16 prints or 8 enlargements 25c. Moen Photo Service, 452, La Crosse, Wisconsin.

8 HOUR Service—Your 8 exposure roll developed and printed jumbo size 25c; deckled edge if requested. 12 exposure roll 35c. 16 exposure roll 50c. 36 exposures \$1.00. Reprints jumbo or regular size 3c each. All film developed fine grain. Workmanship, materials and 8 hour service guaranteed throughout. Quality Photo Service, Box 468, San Francisco 1, Calif.

ADVANCED Amateurs anticipating opening business, amazing details. Photographer, Midland Park, N. J.

ROLL Developed, 8 prints, 25c. Reprints 3c. Jumbo size 30c per roll. Jumbo reprints 4c. Prompt service, high quality Velox prints. Church Studio, Desk 2A, Enterprise, Ore.

2 BEAUTIFUL Hi-Gloss prints each good negative and enlarging coupon with each 6 or 8 exposure roll developed 28c. Owlphoto Co., Weatherford, Oklahoma.

ENLARGING, Printing, developing easily learned. Simplified instructions \$1.00. Fred Carpenter, Box 264, Hamlin, Texas.

ROLL Developed, eight sparkling 4x6 glossy enlargements, 35c. MacDonald's Photos, Box 28-A, Congress Park, Illinois.

MONEY Back guarantee—All this for 25c: Roll developed, 8 bigger deluxe prints, also 8 regular prints, plus two beautiful enlargements and tasteful Leathertone frame. Lifetone Photo Company, Dept. 639, Des Moines, Iowa.

FINE Grain 35mm.—36 exposures roll developed, with 36 beautiful 3x4 fade-proof prints, \$1.50. Immediate service. Veteran owned. Kershaw Photo Labs., Box 3687, Kensington Sta., Philadelphia 25 Penna.

QUALITY Enlargements on DW paper, 8x10, 50c; 5x7, 25c; 4x5, 15c. Roll developed, 2 prints each negative plus enlargement coupon 30c. Clover Photos, Box 28, Gravesend Station, Brooklyn 23, N. Y.

ENLARGEMENTS Expertly produced, 5x7, 25c each. 5 for \$1.00—8x10, 35c each, 3 for \$1.00. Rolls developed and printed, 6 or 8 exposure, 25c. 12 exposure 35c. Reprints 3c. 50 for \$1.00, minimum 25c. (See Miscellaneous ad.) Mystalabs, 31-D Bedford Street, Boston, Mass.

PROFESSIONAL Double weight 8x10" enlargement only \$1.00. (Been at it 40 years.) Jackson Home Studio, Metropolis, Ill.

GENUINE Velox fadeless supertone prints. 10 reprints 25c. 50 reprints \$1.00. 100 reprints \$1.50. Roll developed and two sets prints 25c. Four 5x7 enlargements. 50c. Star Studio, PM2, Sweetwater, Texas.

FREE Book "How To Take Better Snapshots" given with each roll of film developed. 8 exposures 25c. 12 exposures 40c. 127, 35mm. enlarged to 3"x4½" 5c per print. Studio, P. O. Box 217, Kansas City, Kansas.

FILM 6 Or 8 exposure roll developed & printed plus 5x7 enlargement free—complete 25c. Mail film to Joy-Photos, G.P.O. Box 606, New York 1, N. Y.

EXCLUSIVE Introductory offer! 4 beautiful enlargements for 10c. Send any 4 negatives of the same size (up to 2½"x4½") and we will return to you immediately 4 valuable enlargements—deckled and dated on Velox. Negatives returned with order. Send negatives, this ad and 10c coin today. This ad must accompany order. Mail-N-Save, Box 310-8 Quincy, Mass.

TRIAL Offer—Super size Hyglos prints with eight exposure rolls developed—29c. Free, \$1.00 framed enlargement coupon. Overnight service. Hollytints, P-1350, Hollywood, California.

FAST Delivery. Satisfaction guaranteed. Eight exposure rolls with two prints of each exposure, 30c; or eight jumbo size prints, 35c, completely finished. Write for special reprint prices. Pioneer Photo Print Service, Box 123, Wichita, Kansas.

AT Last we have films: 116 and 616, 38c ea.; 120 and 620, 33c ea.; 127, 27c ea. Roll developed, all your snapshots hand-colored as beautiful as most actual colored photography 35c. Hand colored reprints 4c each, 12 for 45c. Midwest Photo, Janesville 26, Wisconsin.

ROLLS Developed and eight 4x6 single weight enlargements from any size roll 30c. Reprints 4c each. Mohart Film Service, West Salem, Wisconsin.

FILM Developed, 8 album size enlargements or 16 sparkling prints, 25c; 8 snappy 4x6 enlargements, 30c. Reprints each: contact prints, 2c; album enlargements, 3c; 4x6 enlargements 4c. Crystal Studios, 159-F, Rushford, Minn.

ROLLS Developed and printed, 25c. Reprints, 2c; 5x7 enlargements, 15c; 8x10, 25c. Davis Studio, Guthrie, Oklahoma.

FREE Snapshots! Free album! Mail this ad and two negatives for free snapshots complete in album! When you see these free samples you'll want more. Artist. Dept. 131, Drawer 220, Regina, Sask.

BIGGEST \$1.00 Value in 35mm. finishing today. 36 exposure fine grain 3¼x4½ enlargements; deckled, embossed margin and date. Eighteen exposures 75c; 16 exposure splits 55c; 36 exposure reloads 50c. Special: return this ad with \$2.00 and we will send five 36 exposure reloads. Free mailers. 8 exposure rolls in beautiful, deckled contact finish with embossed wide margin, 25c. Mailbag Film Service, Box 5440A, Chicago 80, Ill.

8 VELOX Prints and two professional enlargements 25c. Send roll or negatives for trial offer. Young Photo Service, 405-C, Albany 2, N. Y.

50 REPRINTS \$1.00. No limit. Studio, 1408-M Bond, Rockford, Ill.

GLOSS Finish enlargements, 4 5x7 from negative 50c. 3 5x7 from photo 50c. Robert Renshaw, Jr., P.O. Box 478, Chester, Penna.

PHOTOGRAPHY For pleasure or profit. Learn at home. Practical basic training. Long established school. Write for booklet. American School of Photography, 1315 Michigan, Dept. 3451, Chicago 5.

8 EXPOSURE Rolls 25c, over 8 exposure 40c, for one Velox print each and free enlargement coupon. Reprints 3c, minimum 25c. Fred D. Eastman, Bode, Iowa.

6-8 EXPOSURE Rolls developed and enlarged mammoth size 30c. Reprints 3c. Thrifty Photos, Box 46, South Gate, Calif.

EVERY Picture an enlargement! 8 sparkling deckle-edge enlargements and roll developed 25c coin; 116 size or smaller; enlarge reprints 3c. Enlarge Photo, Box 791D, Boston, Mass.

BEAUTIFUL Double-size pictures 3¼c each, from 116 and 120 negatives. 3¼x4½ from all other sizes. All work guaranteed. Overnight service. Roll developed and 8 pictures 30c. Roll 12 pictures 45c. Roll 16 pictures 60c. Enlargements on double weight portrait paper 5x7—30c. 8x10—50c. Copies made from any picture 75c. Pacific Photo Service, Box 666, San Francisco, Calif.

SENSATIONAL Introductory offer! Send snapshot or negative, this ad, and 3c. We'll send you a beautiful 7"x5" enlargement! Or, Kodak roll developed with 16 guaranteed deckled-edge velox fade-proof prints or 8 double-size prints, 25c! Special! From your negatives, 16 regular-size or 8 double-size reprints, 25c! Candid rolls—36 exp. 35mm. developed, vaporated, enlarged to 3x4, \$1.00! 18 exp. 50c. Reprints, 3x4, 3c each. We have new, perfect 35mm. film. Low prices. Free mailers, details on request. American Studios, Dept. 279, LaCrosse, Wis.

CENTURY Delivers work and service that can't be beat. 8 exp. roll 25c with two professional enlargements free. Century Photo Service, LaCrosse, Wis.

8 PRINTS, All enlarged to nearly postcard size, from your roll or negative. 25c. Willard Studios, Box 3535A, Cleveland 18, Ohio.

MOTION PICTURES AND SOUND EQUIPMENT

FILM-Processing not included, 100 ft. lengths. Double 8, Weston 6 \$1.65; Weston 64, \$3.95; Single 8, Weston 6, \$1.15; Weston 64, \$2.40; 16mm. Weston 6, \$1.55; Weston 24, \$3.80; Weston 64, \$3.90. Promader Genera, Davenport 7, Iowa.

HOME Movies—Lists 3c. Sample Kodachrome scene "Allure" \$1.00. Kodachrome slides—sample 35c. Galloway Films, 3008 Fifth St., S.E., Washington 20, D. C.

PROJECT-O-COLOR, The new sensational accessory for movie projectors, available now! Information free. Write Project-O-Color, Palatine 2, Ill.

HOME Movies. Rent, buy, swap 8mm.-16mm. silent and sound at money-saving rates. Details for a dime. Midland, Box 429, Oak Park 4, Ill.

35MM. And 16mm. sound film and equipment. Will trade for 16mm. film and equipment. Send stamps. Mertz Films, Springfield, Illinois.

BRAND New 8mm. motor driven projectors \$36.25 postpaid. Sterling's, 679 Northampton, Easton, Pennsylvania.

MOVIE Projectors and binoculars bought and sold. List 10c. United, 2309-A Lawrence, Toledo, Ohio.

FAMOUS Films. Projection sample 35c. Excel projector \$14.50. Others, silent and sound. We change silent projectors to sound. Catalog 3c. Richardson Cinema, Wyoming, Penna.

FINEST Movie screens, inexpensive, make them yourself. Free literature. Snow White Screen Company, Danville, Illinois.

16MM. Motor driven projector \$16.00 postpaid. Selco Products, Danvers, Mass.

COLOR! 8mm. Movie film for Univex and double 8mm. cameras! Full color film processed free our laboratory! \$3.70 spool double 8mm. \$2.25 roll single 8mm. Limit, three rolls each type. C.O.D.'s accepted. ESO-S, 828 W. 39th, Kansas City 2, Missouri.

RENT 8MM.—16mm. and sound films by week. New catalogs. Lowest rates. Dayton Film, 2227 Hepburn, Dayton 6, Ohio.

16MM. SOUND Films \$2 up. Films shipped anywhere. Diversified, unusual bargains. Lists 3c. Imperial Film Service, R. D. 7, York, Penna.

HOME Movies. All kinds. Lists free. Box 337-A, Valley Stream, N. Y.

BASS Says: 36 years of leadership in the motion picture equipment field. Sound projectors, 8 and 16mm. equipment, finest accessories. Bass buys 'em, sells 'em, trades 'em. Always satisfaction guaranteed or money refunded! Bass Camera Company, Dept. A, 179 W. Madison St., Chicago 2.

BEAUTIFUL Kodachrome film subjects, 8mm., 16mm. Low prices. Big catalog, 25c. Projection length sample from "Waikiki Hula," \$1.00. World in Color, Box 392-F, Elmira, N. Y.

COMPLETE Stocks always of castle, official, pictorial films, 8mm., 16mm., sound. Musicals, soundies, free catalogs. We exchange your films and equipment, or buy them for cash. Frank Lane, 5 Little Bldg., Boston, Mass.

35MM. Sound westerns, features, shorts. C. Rogers, Box 26, East Atlanta, Ga.

UNUSUAL 8-16 mm. Film subjects. Big catalog with sample film, 10c. National Film Exchange, Broadway, Sta. E, Toledo 9, Ohio.

I BUY, Sell, swap, rent s.o.f., 8 and 16mm. films. List free. Harvey Iris, Box 539, Brockton, Mass.

MAKE \$8 To \$10 net profit daily with your 8mm. or 16mm. projector. Details free. Metcalf, 10806 Glenroy Ave., Chicago 43, Ill.

MOVIE Films, 100' outdoor 16mm. \$2.25; three rolls \$6.00; 100' indoor film \$4.25. Ambassador, 479-A, Quincy Street, Brooklyn, N. Y.

RENT 16 MM. sound films 50c reel. Large selection; free catalog. Film Service, 128 Chestnut Street, Roselle Park, N. J.

UNUSUAL Home movies—travel, adventure, sports, news, war films. Many film bargains. Big 1946 catalog and sample, dime. Audet, Box 6520-BQ, Philadelphia 38, Penna.

8MM, 16mm., 35mm. films. Samples 10c. Lists free. Paramount Films, Monmouth, Illinois.

35MM. Sound features, projectors. A Savarese, Woodcliff Lake, New Jersey.

"THE World's Greatest Passion Play," all sizes sound and silent. Write Hemenway Film, 33-F Melrose St., Boston 16, Mass.

LEARN Movie projection, management. Free catalog. Theatre Institute, Elmira, N. Y.

SPECIAL Movie film, 8mm., 25 feet double-Weston 8, \$2.00. Super double X, Pan indoor 60, outdoor 100, 16 mm.—\$6.50. Super X Pan indoor 24, outdoor 50, \$5.75. Pan Weston 12, \$5.00. 16 mm. 100 feet Weston 6, \$4.00. Free developing. Exhibitors Film Exchange, 630 9th Ave., New York 19, N. Y.

BEAUTIFUL Kodachrome slide and list, 25c. Art Slide Co., M-1, Canton, Ohio.

MOVIE Camera films, 100' 16mm. \$2.50. 25' double 8mm. \$1.25. Free developing. Better Films, 742 NewLots, Brooklyn 7, N. Y.

MUSIC AND MUSICAL INSTRUMENTS

PIANISTS—Quickly improve technique, sightreading, accuracy, memorizing, playing through mental-muscular coordination. Free booklet. Broadwell Studios, Dept. 46-F, Covina, Calif.

DRUM and banjo heads. Send for latest catalog. White Eagle, 1652 North Throop, Chicago 22, Illinois.

HARMONICA Magic. Easy new system eliminates notes. Self instruction method includes 75 songs. Send only \$1.00. Money back guarantee. Harmonica Magic, Dept. PM-1, Box 3445, Merchandise Mart, Chicago 54.

POPULAR Piano instruction by Boston's famed Phil Saltman. Nineteen lessons \$1.00. Kenmore Music, 581 Boylston, Boston.

IF Your song poem is for sale and if it's good, submit to Fulks News Syndicate, 119-G Victory Heights, Spokane, Wash.

SONGWRITERS: Collaborate with famous Hollywood composer. Send poems for free examination. Valuable monthly awards for best songs. Recording and manuscript service. Hollywood Harmony House, 126 S. La Brea, (M-11), Los Angeles 36, Calif.

SONGWRITERS: Collaborate with successful composer. Turner, Box 2201, Bridgeport 8, Conn.

FREE Literature on songwriting. Andy Toce, Box 37, Hartford 1, Conn.

WE want song poems and lyrics on all subjects. We offer the services of a noted Hollywood motion picture composer and arranger. Send your poem today for consideration and our liberal offer. Hollywood Melodies, P.O. Box 2168PM, Hollywood 28, Calif.

SONGWRITERS: Have your songs completed by an honest, experienced arranger. Submit songs for free analysis. Tommy Kilbourne, Box 1253, Bakersfield, Calif.

POEMS Wanted for musical setting. Composers' Guild of America, 545 Fifth Avenue, New York 17, N. Y.

SONGWRITERS: 6 Essential mailing lists, \$1.00. Publishers, 25c. M. Battiston, 31-69 41st St., Long Island City, N. Y.

HAWAIIAN Guitar chord chart \$1.00. Over 650 chords in A-E 7th-C#-B 11th—Notes and diagrams by Sol Hoopii and Dick McIntire. Best for arranging. Fator's, 3998 So. Vermont St., Los Angeles 37, Calif.

SONGWRITERS: We publish good songs without payment. Write for details. McGinty Music, 34 West Flagler, Miami, Fla.

SONGWRITERS Get our guaranteed proposition. Art Music, 1658 Broadway, New York 19, N. Y.

USED Jukebox records, off my machines. State your requirements. Olin Milner, 335 McDaniel St., Atlanta, Ga.

PLAY Piano the "Berry Way." Play melodies right away. Send \$1.00 for your copy of "A New Approach To Piano Playing." Earl Berry Music Studio, 11 State St., Meriden, Conn.

HARMONICAS \$1.50, \$2, \$2.90. Musician's Shop, 2 E. Centre Street, Baltimore 2, Md.

MUSIC Composed, arranged, taught, successfully. Lyricists taught melody writing. Conductors, leaders, bands, orchestras, choruses, get valuable free information about our "Ensemble Perfectionists." Singers, instrumentalists, having sight-reading troubles, send \$2.00 for our "Questionnaire." Explains, solves your problems. Details free. Morse, 440 W. 45th St., New York 19, N. Y.

SONGWRITERS—Send best poems today for our offer, or request free booklet "Getting Ahead In Songwriting." Song Service, 331-C, West 46th, New York.

GUITARISTS—Play professional, modernistic set, runs-breaks modulations, introductions, futuristic chords. Professional material. \$3.00. Nicosia, Box 596MP, Brooklyn 1, New York.

MUSIC Printed, music composed since 1910. Reginald Belcher, Florham Park, New Jersey.

THE 96 Page "The Complete Songwriter" tells how to write music, words, arrangements and publishing. Send \$2.00 M.O. Puritan Publishing Co., Inc., 343 So. Dearborn St., Chicago 4, Ill.

"GUITARS"—"Band and orchestra instruments"—"harmonicas." List free. Rudolph's, Atchison, Kansas.

SONGWRITERS—Excellent proposition. E. Madden, G.P.O. Box 1226, Syracuse, N. Y.

SONGWRITERS! Amazing, outstanding ethical offer. Hibbeler, C5, 2157 N. Avers, Chicago.

SONGWRITERS. A limited amount of musical compositions wanted for radio distribution. Tin Pan Alley, Inc., 1650 Broadway, New York 19, N. Y.

POPULAR Piano in 12 lessons, guaranteed. Beginners, advanced. Kelly School, 1734 30th Ave., San Francisco 23, Calif.

SONG Poems wanted, for musical settings. Send poem for free examination and outstanding offer. Write for free instructive booklet outlining opportunities. United Music, Salem 3, Indiana.

NEW Songs and lyrics wanted for popular radio program and professional promotion. Free examination. Transradio Music Inc., Dept. P., 1650 Broadway, New York.

MUSIC Composed to song-poems. Address: Frank Wildt, Lancaster, Penna.

SONG Writer's attention! The amazing demand for phonograph records, accelerated by more than 300,000 juke boxes and the hits popularized warrants your immediate consideration. We are offering song-poem writers the rare opportunity of having established composers collaborate on appealing material received this month. Recola Records, Box 987P, Hollywood 28, Calif.

POEMS Wanted for musical setting. Send poem for immediate consideration and free rhyming dictionary. Richard Brothers, 24 Woods Building, Chicago.

SONGWRITERS—Send poems for immediate examination and free book, "Your Future in Songwriting." Radio City Music Academy, 1674 Broadway, New York City 19.

WANTED! Lyrics, melodies for songs. We arrange, publish, sell. Superior Song Studios, Passaic, N. J.

ACCORDIONS. New and used at wholesale prices. Save up to \$100.00. Buy direct from factory. Del Principe, 307 So. Wabash, Chicago.

BEFORE Sending your poem to be set to music, know your composer. Free folder. Al. Moquin, 5333 La Cresta Court, Hollywood 38, Calif.

POEMS Wanted for musical setting. Send poem for immediate consideration. Five Star Music Masters, 630 Beacon Building, Boston.

SONG Poems wanted. Free examination. McNeil, Master of Music, 510-PM South Alexandria, Los Angeles, Calif.

WRITE Songs. Big money and reputation. Write for information. J. Gordon Pub Co., 201 N. Hoyne Ave., Chicago.

RADIOS AND SUPPLIES

RADIO Catalog free! Send name for new Concord Radio 112-page catalog, offering latest postwar radio sets, phono-radios, radio parts, amateur kits and supplies, electronic equipment, technical books. Thousands and thousands of items available now at low prices. This great catalog is free. Write for it now. Concord Radio Corporation, 901 W. Jackson, Dept. 10, Chicago 7, Illinois.

FAMOUS "Allen" Midget Semi-Fixed Crystal Detector, set building plans and 100 late crystal set distance reports all for 50c postpaid. Allen, 427-P, Clinton Mo.

MICROPHONES: Aircraft lip button with cable, surplus, \$1.75 postpaid. Ken Norberg, 21 Tamalpais, Mill Valley, Calif.

CRYSTAL Detector plays loud speaker. Handbook tells how; build your own. Send \$1; on delivery pay postman 99c and postage. R. G. Middleton, 47-25 44th St., Woodside, L. I., N. Y.

VEST Pocket radio! What fun! Listen while strolling or cycling. Local or distant reception. Plans sold all over U. S., Canada, Hawaii, West Indies. Standard parts. Cheap, easy. Free photograph with plans. Rush \$1.00 United Manufacturing Associates, 3316-2 Ave. G, Port Worth 5, Texas.

"**SUPERHET** Manual," \$2.50. Free electronics bookalog! Stone, Lunenburg 21, Mass.

LOUD Speaking crystal radio, improved design. Illustrated plans 25c. Radio Clinic, 10631-C, Cleveland 6, Ohio.

REVISED Plans 18 long distance crystal sets, including "Radiobuilder"—25c. Laboratories, Box I-C, San Carlos, Calif.

BUILD Newest, extra-loud crystal set. Instructions, 20c. "All About Crystal Sets," booklet, 45c. Amorose, R-4, Hungary Road, Richmond, Virginia.

ALL Radio tubes in stock. Send numbers you need. Raytron, 441 Summit, Toledo, Ohio.

RADIO Surplus. Bargain prices on hundreds of items. List 5 cents. Campbell, 3800 Kinzie, Racine, Wis.

FIXED Crystal detectors, \$1.00 postpaid. Berent's, 4300 Hampton Blvd., Norfolk, Virginia.

HAMS, Attention! Brush up your code with this inexpensive code oscillator costing less than \$2.00 to build! Illustrated plans \$1.00 postpaid, plus plans for two-way telegraph using only one wire free! If not completely satisfied, dollar refunded plus dime extra! Quivira Radio, 307-c N. Pioneer, Lyons, Kansas.

ALUMINUM Junction boxes 6" wide, 4" deep, 10" long with cover \$1.50. 7" wide, 4 1/2" deep, 10" long without cover \$1.00. Send for list other sizes low as 50c. Karl Ort, York, Penna.

WESTERN Electric fixed crystal. A war development. Excellent as a detector for crystal sets. Nothing like it. Highly sensitive. Gives extra loud steady reception. No adjusting. Fine for wave trap, meters. Many uses. Practically impossible to buy. Cost government \$8.00. Prepaid 99c. Free radio list P. Radio City Labs, 30 Church St., New York 7, N. Y.

WIRE—Solid #20 push-back. Tinned for easy soldering. 50-ft. coil 25c postpaid! Hayes, 4004-F Arcade Bldg., Seattle 1, Wash.

LEARN Code. Simplified method, 25c. Tesco, P.O. Box 189, Wilkes-Barre, Penna.

BUILD Radio. Complete kit with tubes \$10.95. Details, Radio, 9418e Avenue "A," Brooklyn, N. Y.

TEN, Simple, easy to build crystal radio diagrams and crystal 25c postpaid. Potter, 1314 McGee, Kansas City 6, Mo.

EARN Money repairing radios. Beginners instructions 35c. "Radio," Box 311, Benton Harbor, Michigan.

MICROPHONE With hookup diagrams. Money back guarantee. Postpaid 50c. Buckmann, Union Street, Hackensack, N. J.

RADIO Dealers and service men write for latest low price parts circular. Mc Gee Radio Co., 1330 Broadway, Denver, Colo.

CRYSTAL Radio diagrams, instructions. Nearly all possible circuits and applications. Exceptional results guaranteed. Different. \$1.00. Capitol Radio Laboratories, 2947 Mills Ave N. E., Washington, D. C.

FAMOUS Razor blade radio! Illustrated plans 35c. New Radio, Lohrville, Iowa.

HAVE Fun, building super crystal radios. Educational, illustrated instructions and crystal 25c (postpaid). Boyer, 634 Nebraska, Kansas City 2, Kansas.

HEADPHONES: New lightweight sensitive 2000 ohms, complete with headband and cord \$1.95. Naval aircraft control boxes \$2.00 per pair, worth \$10.00 for parts. Van Sickle Radio Supply Co., Indianapolis 6, Ind.

BUILD Your own radio. All kits complete, including speaker, 4 tubes and full instructions, \$10.95. Details and latest parts catalog. National Radio Distributors, 1029-M E. 163rd St., New York 59, N. Y.

MAKE Simple, tubeless, batteryless, distance-getting crystal radios. Crystal and illustrated instructions 25c postpaid. Allen, 427-P, Clinton, Missouri.

RADIO Tubes, parts, condensers. Free bargain lists. Potter, 1314 McGee, Kansas City, Mo.

FM Can now be heard on old radios! Very simple adaptor! Send postcard for free data! Topical Emprise Corporation, 1527 Highland, Box 42, Louisville 4, Ky.

RADIO Service flat rate schedules solve pricing problems. Compiled from 20 years experience. Write for information. Radio Equipment Co., 1415 W. Franklin Ave., Minneapolis 5, Minn.

RADIO Technician and radio service courses. Training for federal licenses. American Radio Institute, 101 W. 63 St., New York City. Approved under G. I. Bill of Rights.

BUSINESS OPPORTUNITIES

FORGE Ahead: Establish yourself in the most profitable division of mail order industry. Entirely new and unparalleled arrangement, not offered elsewhere, open to sincere persons. Moderate capital needed to start; sales, advertising and consultation service furnished. Request details of special setup with sales guarantee by letter. Mention, if veteran. Tait-Douglas Enterprises, 5345 Harper, Chicago 15, Ill.

OPERATE Profitable mail order business. Good opportunity. Details free. J. Ares, 4340-40th Street, Long Island City 4, N. York.

MORE Profit, less expense, manufacturing real gems synthetically! Proof, details free. Katchor, 186 Rutledge, Brooklyn 11, N. York.

A PROFITABLE Business of your own with Glow in the Dark products. Sample 10c (refunded). Progressive, 2160B Bleecker, Brooklyn 27, N. Y.

NEW Money-making opportunities selling by mail. Stamp for details. Rossell's, Box 34, Bellerose 6, N. Y.

FINANCIAL Security with your own business. Amazing book shows how. Free details. Bourque, 3712 Fifth, Marrero 3, Louisiana.

MAKE Flexible Molds, Statuary, Art Goods, Novelties, Artificial Marble Flooring, Liquid Marble. Literature free. Kemico, Park Ridge, 6M, Ill.

POCKET Up to 40% of nationally advertised price. Radios, household appliances, sporting goods, etc. Buyers' Ring, Landover, Maryland.

BRONZE Baby shoes! Big profits! New field! Details free. Write, Opportunity Center, Box 349, Long Beach 2, Calif.

START Your own business now. 101 post war money making opportunities. Free circular. Walter C. Haynes, 1919-A South Pearl Street, Anderson, Indiana.

DOLLARS Made by our tested plans. Free literature. Research Service, Magnolia St., Malden 48, Mass.

GUARANTEED Income! Grind lawn mowers. \$3.50 capital! Mowers, Janesville, Wis.

MAKE And mold genuine plastics. Forty worksheets with 70 illustrations explain simple, reliable home and shop methods. \$1. Circular free. Plastics Digest, 3937M Tracy, Kansas City 4, Mo.

GOT \$24,500: Used three "schemes" from "Schemer" magazine, Alliance, Ohio. Year, \$1.00. Four samples, 30c.

OWN A mail-order paper products business. Sell envelopes, tags, bags, boxes by mail, wholesale. Tremendous demand. Steady profits. No capital necessary. Write Omaha Envelope Service, Dept. 145, 4721 California, Omaha 3, Nebr.

"RECEIVE Mail." Money-making offers, opportunities, catalogs. Name listed 10c. Wholesale supply source directory included free. Ideal Service, Park Ridge 106, Ill.

MOTOR Rewinding pays. Simplified home-shop course \$1.00 prepaid. Lyle Publisher, Box 385-A, Lombard, Illinois.

HOW And where to obtain capital, small and large loans, free particulars. Star Service, Wapakoneta, Ohio.

ASTOUNDING Modern mailorder plan brings quick profits. Darrah, Orono, Me.

DOLLARS In your mail:—You keep 90c out of each dollar. Send 10c for literature, or \$1.00 for complete information. Shure Industries, 813 First National Bank Bldg., Memphis 3, Tennessee.

EXTRA Profits 50 to 75% home mail order business. Details free. Campbell Service, 1626 E. 75, Cleveland 3, Ohio.

SUCCEED In business with our illustrated business plans. Complete details free. Home-Art Supply, Box 732-A, Warren, Ohio.

BOOKKEEPER Double your income operate bookkeeping service part or full time your city. Write Tax-Saver System, Dept. C, Fort Worth, Texas.

SIX Mail order magazines, all different. 16 to 72 pages each. Full of money making information, 25c. Kraft, 3114-S1 Walnut, Chicago 12, Illinois.

INVENTION! Wartime discovery. Magic liquid waterproofs anything. Circulars. Rush name, Maupin, Tipp City 30, Ohio.

PERFUME—Brilliantine manufacturing business. Little capital. Large profits. Particulars free. Bob Celaya, 907 Adams, Brownsville, Texas.

BIG Money silvering mirrors. Easiest method, best results. Rumfeld, 5716 Junius, Dallas, Texas.

MAKE Money building bird houses. Illustrated instruction book. 25c. Popular Mechanics Press, (C-43), 200 E. Ontario, Chicago.

START Profitable business, package, sell amazing cleaner under your name. Details free, sample 25c. Linnell Co., Box 1720-A, Cleveland 5, Ohio.

HOME Mail order business opportunities for you. Big profits, small capital starts you. Particulars free. National, Route 4, Box 1508G, Tampa, Fla.

BIG Money-making opportunities book \$1.00. Service, Box 281, Salem, W. Va.

SELL Books by mail. Tremendous sales and profits. We furnish everything and help you succeed. Details free. Century, 101-M West 14th St., New York 11, N. Y.

BE Independent. Start a business of your own and enjoy financial freedom. Little or no cash required. 3c stamp brings full details. W. M. Drexler, 258 Broad, Newark 4, N. J.

MECHANICALLY Inclined men—Own and operate general appliance repair shop. Complete, illustrated course shows you how. Welding, refrigeration, motor repair, how to get business, etc., all phases covered. Free literature. Christy Supply, Dept. 165, 2835 N. Central Ave., Chicago.

FREE Literature—Tested money making business ideals. Kelly, 1080-C Casgrain, Detroit 9, Michigan.

PLASTICS Directory—Wholesale and retail sources for thousands of items, materials, molds, equipment, machines, supplies. \$1. Plastics Digest, 3937P Tracy, Kansas City 4, Mo.

BIG Money metalizing baby shoes at home! Lifetime opportunity! Free particulars! Kiktavi Company, 8620 South Ruthelen, Los Angeles 44, California.

DO-IT-YOURSELF! Thousands strangely richer! Permanent security! Easy, lifetime, tremendous mailorder work! A better living wants you! Honesty! Airmail dollar (seal envelope). Results or refund! Zigzag Corporation, Box 101-W, Guatemala, Central-America.

FINEST Quality liquid molding rubber—sample mold free. Better rubber makes better molds. \$3.00 quart, \$10.00 gallon. W. Wooley, 115-A Donald, Peoria, Ill.

MAKE Soap at home. No machinery. Profitable. Literature free. Kemico, Park Ridge, (SM6), Ill.

AT Home—Your own manufacturing business; making popular \$1.00 novelties. Cost you 3c to 15c. Everything supplied. Write So-Lo Works, Dept. F-600, Cincinnati, Ohio.

MANUFACTURE—Sell own products, DDT, foam cleaner, insecticides, moth proofing, etc. Twenty tested formulas, \$5. Halberstadt Company, Terre Haute, Ind.

BOOK, Seven cures for a lean purse if it's wealth you desire. \$1.00 postpaid. E. Kalb, 111-44 138 St., Jamaica 4, L. I., New York.

RUBBERCOAT Mold making liquid. Ready manufactured flexible molds. Make gifts, novelties. Free sample, catalogue. Rubbercoat, 3873A California, San Diego, California.

BABY Shoes preserved. Complete instructions. Exclusive rights. M. E. Watson, Bellefontaine, Ohio.

MAKE Flexible molds! Cast plaques, novelties, bookends! Free sample! H. Tooker, 630-A Chestnut, Hamilton, Ohio.

1946 GIGANTIC Directory of opportunities, advertisers supplies, sources, trade information, mail order ideas, products, wholesalers, valuable tips—just published! Descriptive literature free. Wilkin & Co., 118-AP East Main St., Hillsboro, Ohio.

FIREWORKS! Firecrackers! Torpedoes! Free catalog. Mackay Specialties, Box 441-D, Mackay, Idaho.

TYPISTS, Start full or part time business at home addressing envelopes, stickers, etc. Complete authentic information, 50c. Gaunt, 3521-P Broadway, Chicago, Ill.

GO Into the mail order business. My 32 years' experience tells how. Send 25 cents for instructions. Mail Order Institute, Box 1902, Cleveland 6, Ohio.

ART Of gem cutting, 128 page book giving full instructions, with free 32 page gem catalog, \$1.60 postpaid. Hill Gem Co., Route 7, Salem, Oregon.

FACTORY Repaired shoes, Army, others, wholesale, retail \$1.85 pr. Photo on request. "Gadgets," Box 28K, Jackson Heights, N. Y.

WOULD You like to make \$1500 "on the side" every year? Let me tell you how it can be done selling by mail. No obligation. Century, 101 W. 14th, New York.

BE Your own boss! Run your own business!—But first get the facts. Our accurate reports give you these facts: capital requirements, equipment, location, experience, etc. Send \$1.00 for a report on any one of the following businesses: restaurant, tea room, taxi business, overnight cabins, beauty salons, bookstore, gift shop, sporting goods store, summer camp, automobile laundry. Jackson Business Service, Box 62, Enfield, Conn.

ABOUT Your future—Free Bible course, all faiths. Voice of Prophecy, Box 55, Los Angeles, Calif.

HOW And where to obtain capital. Fully explained. Particulars free. Vidco, Box 2032, Philadelphia 3.

QUICK Money! "Repairing car batteries." At home! Easy too! Write, Batteryman, Grand Junction, Colorado.

BUILD And sell electric eye equipment! Large profits! Satisfaction guaranteed! Full details \$1.00. Omicron Electric Co., 521 5th Ave., New York City.

OPERATE Profitable commercial employment agency; \$5000, upwards annually possible. Copyrighted manual reveals all. Information free. Frank, Box 308, Burlingame 1, Calif.

YOUR Own business selling the original bubble liquid to candy, cigar stores, also beaches, parks and fairs. Regent Manufacturing Co., 276 Morris Ave., Elizabeth, N. J.

POSITIVELY Starts you in profitable mailorder business. Profitable business repeater. Free details. Skyland Specialties, 93 Cloyes Street, West Asheville, N. C.

EVERY User of the mails needs an envelope sealer. We manufacture a proven, practical sealer. Capacity forty per minute. Sells on demonstration \$2.50, immediate deliveries. Kendall Sealer Company, East Jaffery, New Hampshire.

FREE Literature giving details of several profitable home work plans. Webb, 1512 Buena Vista, Detroit 6, Michigan.

SIGNS Made easily. Instructions and ten sets modern alphabets, numerals, patterns. Sizes up to eight inches. All for \$1.00. Co-operative Business, Box 638, Chicago.

BEGINNERS—"How To Sell By Mail," 39 page treatise. Big value. Rush 25 cents. Forest Book Co., Box 297, North Hollywood, Calif.

OPERATE Profitable mail order business. Good opportunity. Details free. Florida Service, Box 328, Miami, Fla.

UNPAINTED Wall plaques, bookends, novelties, 100 assorted \$3.45. 30 diff. "samples" \$1.00. Illustrated list free. Oman, 642 Broadway, St. Paul 1, Minn.

EARN Up to \$2000 year, inventing simple items for special cash markets. Ideas only. No patents. Hendrickson, Argyle 7, Wisconsin.

4 COLOR Imprint folder! Particulars, 3c stamp. Ricketti, 2551 South Wanamaker, Philadelphia 43, Penna.

315 GOLDEN Money-making opportunities now ready for you, selling by mail! Details free! Mailway Agency, 10-620P, William, Winnipeg, Manitoba, Canada.

BEAUTIFUL Wall plaques, statuary, sample assortment \$3.50. Guaranteed as represented or money refunded. Pyramid Plastex, Dept. #1, 1620 Michigan, Kansas City, Mo.

20% COMMISSION—Attractive business. Building printing. Ace Printing, Brentwood, Maryland.

SELL Religious goods by mail! Easy to start. Big profits. Every home is your prospect. Cleveland, 243-B3 White, Clyde, Ohio.

SMALL Capital starts your own advertising agency, at home in spare time. Complete operation exposed. No stock or equipment. Opportunity for large earnings. Stamp brings folder and proof. P. Snyder, Box 4907-A, Philadelphia 19, Penna.

OPERATE Profitable home mail order business. Small investment. Details free. English Tower, 900 Tower Ave., Hartford, Conn.

MAKE Good money in spare-time. Free circular shows how. Robert Haney, Mather, Wis.

OPERATE Profitable mail order business. Good opportunity. Write, Walter Service, 4159 East 112th, Cleveland 5, O.

OBVIOUS Proof! War and developments boosted new twist of sound old business. Lucrative! Small capital. Part-time. Home. office, "road." No canvassing! Men, women. Simple! Central Illinois "mine, friends"! Furgeson, Decatur, Ill.

COULD You use \$200 a week? Then investigate the mail order business. Quivira Mail Service, 207-b N. Pioneer, Lyons, Kansas.

MONEYMAKING Offers, 1 year: 25c. Franklin, Box 342, Rock Hill, S. C.

CRITICAL Shortages: everybody clamoring; mail order local \$5.00 sales; merely distribute literature supplied. Remit: beginners 25c, experienced sellers \$1.00. South, 1026 Gunderson, Oak Park M-34, Illinois.

BE Your own boss. Work at home. Amazing profits. Literature free. Leonard, Box 42, Salem, Oregon.

FREE—Copy mailorder's leading journal. Stamp appreciated. Fouche, Bellflower 9, California.

BUSINESSES! Selling and listing is our business. List sent free. Albert Willson, Albia, Iowa.

10c **BRINGS** Moneymaking plans, ideas, schemes, mailorder magazines. Reamy, Box 174-K, Staten Island 1, N. Y.

FREE! Introductory offer! Collection of business plans, tested moneymakers, formulas. Send 10c cover postage, handling. Larson, Galetton 2, Penna.

LIFETIME Jobs, with unlimited earnings. Operate anywhere on small capital. Complete operating details \$1.00. Yates, Box 2152, Columbus 16, Ohio.

BE Wealthy. Get business self-starters. Own homes that pay for themselves. Midland Products, 67 S. Harris Ave., Columbus 4, Ohio.

LIQUID Marble—Make in any color. Soundproof plastic flooring. Flexible molds. Cast novelties, plaques, statuary. Big money—your own business. Free catalog. Write—Bing Products, 88-AP Broad Street, Boston 10, Massachusetts.

OPERATE Lucrative business. \$6 capital. Proven plan. For details, write Word Products, 110 Romaine, Jersey City, N. J.

ITALIAN Food recipes: Meat balls and spaghetti, pizza, roast beef, ravioli, sausages. Use for catering or sandwich business, carnivals, restaurant, delicatessen, parties, home, etc. 15c each recipe, or all 5 for 50c. A. Palumbo, P.O. Box 795, Chicago.

MAKE \$1500 Yearly "on the side" by mail. Thousands do. Copyrighted instructions \$1.00. Details free. Eljay, Box 277, Herrin, Ill.

MONEY, Money, money! Earn at home! Spare time, full time. Start small, grow big. Amazing literature free. Efficiency, Box 167, Los Angeles 53, Calif.

START Profitable home mail business. Spare, full time. Tremendous profits! Only few dollars needed. 25c brings multi-page folio of tested, proven money-maker plans, ideas. Coates, 46-A King, Dorchester, Mass.

REAL Opportunity! Start clean, legitimate mail order business with \$125.00 capital. May not make you rich, but should bring \$5.00 a day, or more—in spare time. Details free. Opportunity Press, 5015 Lake Park, Chicago 15, Illinois.

EX-GI Built \$1,000,000 mail order business in eight months. Details free. Logan, Box 131, Lakeland, Fla.

METALLIZE Baby shoes! Learn this moneymaking business from nationally recognized consultants. See Kushner ad, page 264.

BE Your own boss. 137 tested money making plans. Particulars free. Sem Tem Service, Marshal Bldg., Norwalk, Conn.

PANNING Gold. Free literature, pictures. Old Prospector, Box 21R40, Dutch Flat, Calif.

SYNTHETIC Latex with Neoprene base for making flexible molds! Quick drying! Quart \$2.00. Gallon \$5.95. Full instructions. Plastercraft, 1406 East 43rd Street, Cleveland 3, Ohio.

MAIL Order business can be your future! Same as hundreds advertising in this and other publications. "How to Build Your Own Mail Order Business"—noted specialist's 10,000-word treatise—shows how to make it pay, on small, capital start. 25c postpaid. Satisfaction guaranteed. Maupin & Maupin, LaFayette 3, Ind.

HARDWARE Business is one of the most interesting and profitable of them all. Be independent. You can start your own retail store with small investment and no previous experience. 15,000-word, copy-righted booklet tells you how. \$1.00 postpaid. C. R. Divan, P.O. Box 325, Santa Monica, Calif.

ESTABLISH Profitable home mail-order business. Ideal occupation. Excellent earnings. Free literature. Jay Peterson, Box 752, Minneapolis 1, Minnesota.

START A mailing list business in spare time. Big profit. Steady demand. Details free. MacAndrews, 8 Buick Street, Calais, Maine.

START A mailorder business in spare time. Details free. Monarch, 38-A Jefferson, Auburn, New York.

CASH By mail. Either sex. 10c brings offers. Bargain. Specialty Company, Box 635BO, Modesto, California.

GO Into rug and upholstery cleaning and mothproofing business. Extra double profits selling these two professionally used products to stores and homes. Russell-Johnson Company, Clarkfield, Minn.

IF You would like to make \$5,000 yearly in an easily learned office business of your own, send for free details immediately. G. H. Cole, Pres., Syracuse 2, N. Y.

START A business of your own. Can put you next to new profitable business opportunities. Particulars free. Beiers, 837-A N. Hoffert St., Bethlehem, Penna.

RAISE Your salary. Amazing new plan works wonders. Write immediately. Good Supply, Potsdam 7, New York.

RAISE Bean sprouts in dark room. Pays well. Free information. Mrs. Nickell, Route 1, Box 456, Bend, Ore.

COLORGLAZED Concrete pottery made without molds. New, low cost, patented method. Cemetery products, novelties, tiles, floors, etc. Basement leaksealing. Other moneymaking projects. Booklet, details free. Men only. National Potteries Company, Fergus Falls, Minnesota.

TREMENDOUS Profits mailing literature. Dealers information 3c. General-print, East Orange, N. J.

NEW Air curing liquid rubber to make molds for plaques and statues. Our repeat orders speak for themselves. Apex Plastic Products, 1740 Estes Ave., Chicago 26.

SPLENDID New Opportunity to get into legitimate mail order advertising and selling. Start small, expand rapidly. "How" booklet 10c. Kraft, 3114-85 Walnut, Chicago 12, Illinois.

CAST Bookends, novelties. We furnish rubber molds. Sell unfinished castings to us. Free information. Mold Craft Industries, Manheim, Penna.

WE Start you in business, at home, sparetime, earning \$10-\$30 weekly selling by mail. Stamp appreciated but not necessary. Driscoll Sales Service, Box 2771-A, Denver, Colo.

\$.47 PUTS You in business. Write Midwest Drug Co., Dept. 3, Columbus 15, Ohio.

SUREFIRE Profit maker. Write for details on what sells, who buys and how to reach them. Rennolet, 1022 9th St., Rock Island, Ill.

BUILD Lifetime income at home. Books of instruction for busy people. Full information free. News Specialty Company, 463 Daisy, Mansfield, Ohio.

ANGORA Rabbits bring steady income! Good wool producing stock supplied. House of Angora, Springfield, Illinois.

10c **BRINGS** You lots of mail. Catalogs, magazines, money making ideas, samples. Gardenville Publishers, Gardenville 1, N. Y.

LEARN Shell jewelry manufacturing. Complete, simplified home instruction course, beautifully illustrated, shows 45 styles pins, earrings, brooches, sprays, hair ornaments. Includes pearlizing, dyeing, golding, glow-in-dark methods. No tools needed! Learn-earn within a week. Only \$1 postpaid, including wholesale prices of all raw materials. House of Gifts, Box 4550-RF, Coral Gables, Fla.

MAIL Order opportunities. Read oldest trade journal. Copy 25c. Mail Order News, Somerville 35, N. J.

PROFITABLE Mail order plans, ideas, write today, free literature. Frank J. Artz, 1060C Harding Drive, Toledo 9, Ohio.

OPERATE Profitable mail order business. 75c profit each dollar. Powell Service, 5713 Euclid, Cleveland 3, Ohio.

CONCRETE Brick are a profitable product with a well established consumer demand. This is your opportunity to enter the concrete products field with the minimum equipment expenditure. R. S. Reed Company, Three Rivers, Mich.

ELITE Collection contains 137 practical money-making plans; local and mail order. New edition. Particulars free. Elite Co., 220-A Grand St., New York 13.

START Mailing service business at home in spare time 25c (refundable) brings success booklet. Riegel, 1111 Harrison, Philadelphia 24, Penna.

137 **WAYS** To make money, in home or office, business of your own. Full particulars free. Elite Co., 220-A Grand St., New York 13.

YOUR own profitable mail order business. Get set for life. Use sparetime to grow independent. We show you how. For full particulars write, Van Enterprise, 3308 S. Quincy Ave., Milwaukee 7, Wis.

MAKE More money. We show you how. Free catalogue. Interstate Publishers, 1429-D So. 51st Ct., Cicero 50, Ill.

EARN Dollars by mail. Valuable offering books, opportunities, 10c. National, 322T Union Avenue, Brooklyn 11, N. Y.

MANUFACTURE Costume jewelry at home for profit, hobby, therapy. Free wholesale supply catalogue. Instructions. Florida Supply House, Bradenton, Fla.

GET Big mails galore, latest money making offers, opportunities, catalogues, magazines, samples, etc., etc., by having your name listed in the National Opportunity Seekers Directory. One issue 10c, three issues 25c. Interstate Publishers, 1429-F So. 51st Ct., Cicero 50, Ill.

WOULD You pay 3%—first \$350 made? Color-illustrated book "505 Odd, Successful Enterprises" free! Some plans offer occasional "day off." Start at home, office. Expect something odd! Pacific, 262-L Drake, New Rochelle, N. Y.

PUBLISHER Of seventy page trade magazine offers cooperative distributorships to men desiring advancement in mail order field. Splendid opportunity. Good earnings. Send 10c for handbook; application form Progressive Publications, Sheboygan, Wisconsin.

WANTED Unused U. S. postage stamps, small discount. Advance Stamp Company, 24 East 23rd Street, New York.

FREE Literature upon request, describing many moneymaking plans. Island Mail Service, Box 162-G, Jamaica 4, New York.

NEW Flexible mold material, casts, catalin plastic, concrete, plaster, in same mold. Literature. Sanflex, Box M, Clyde, Ohio.

PLASTICS. Your own business at home. Make your own plastics, no expensive equipment needed, formula and molding instructions \$1.00. Box 224, Wickliffe 17, Ohio.

\$5,000 YEARLY Possible, selling books by mail. Distributors proposition. Nichols Publishers, Box 831, Pine Bluff 1, Ark.

INCORPORATE Your business. Delaware laws. Many advantages, free details. Tax Research Bureau, Inc., Delaware Trust Building, Wilmington, Delaware.

MAKE Big money. Exceptional opportunities. Real money makers. Free particulars. Turner, 5675-A Lannoo, Detroit, Michigan.

LIQUID Rubber, for making flexible molds, literature and sample free. H. Chaney, 1130 E. 16th St., Jacksonville 6, Fla.

GET Advertising tips on selling by mail. Contains valuable information on mail order business. Price \$1.00. A. H. Allen, 2335 Arapahoe St., Denver 5, Colo.

START Business—\$1.00 up. New 100-plan book. Also agents wanted. Sample 50c. Money back guarantee. Sole distributors, Golden Rule, 13997-C Northlawn, Detroit 4, Michigan.

PLASTIC Homes—Build yourself! Resurface old buildings! Wonderful building material. Particulars free. Marbleizing Service, Edwardsville, Illinois.

MAILING List! 5000 women mailorder buyers, \$25.00; 3000, \$15.00; 1000, \$6.00. Guaranteed accurate! Try them! Woods Remants, Bedford, Penna.

LIQUID Marble—Colorful, glazed! Molded, brushed, sprayed! Composition floors. Rubberlastic molds. Particulars free. Marblizing Service, Edwardsville, Ill.

SELL Exclusive books of instruction by mail. Assorted subjects. Popular prices. 70% profit. Rush name. Free sample imprint circulars and selling instructions. Financial Education, 404F Mack Building, Denver 2, Colorado.

FELLOW Workers—Down with bosses. Start own business. Be independent. Booklet describing 137 tested plans, free. P. Padney, 307 York St., Jersey City, N. J.

ELECTRICAL Appliance repair. Open your own shop. Learn house wiring; electric motors, vacuum cleaners, washers, etc. Complete illustrated course shows how. Free booklet. Pacific Training School, Dept. AP-1, 7217 So. Broadway, Los Angeles 3, Calif.

HANDY Men—Earn money home operating Community "Fix-It" Shop. Write Stafford, 708 Rawlings, Carbondale, Ill.

YOUR Own business. Big profits, very small capital. National organization teaches, helps, supplies everything. Interesting service business. Big demand everywhere. Americlean 211 North 7th Street, St. Louis 1, Mo.

BOOKKEEPERS—Operate your own "Dollar-A-Week" bookkeeping and tax service. Full or spare time. Details free. Ellis, Box 200, Cedar Grove, No. Carolina.

MAIL Order business course shows you how to make money, spare or fulltime. Teaches professional mail order technique—not penny-snatching schemes. Fascinating 100-page illustrated success-catalog free! Write—Nelson Company, Dept. 4-02, Chicago 5.

SELL Cosmetics by mail. Women spend millions on beauty. You can make your share of this cosmetic money. Let us show you how. Details free. Frank J. Artz, 1060 Harding Drive, Toledo 9, O., Dept. A.

BUILD Miracle homes. Yours. Others. Chamberlain, Fitzsimons Building, Pittsburgh 22, Penna.

LATEX For making flexible rubber molds. Thoroughly tested. No shrinkage. Complete instructions with each order. Stoneham Rubber Co., Box 244, Stoneham 80, Mass.

MEN — Women — "Everybody Likes Candy". Learn to manufacture professionally at home. (Our 35th year.) Ragsdale Candies, East Orange 2, N. J.

START Home business making statuary, plaques, novelties, garden furniture, artificial marble flooring, liquid marble. Make your own flexible molds. Amazing profits. Folder free. Creative Publishers, Box 236-L, Winnetka, Illinois.

SPARE Time mail business earned \$1400 monthly. Copyrighted instructions \$1.00. Wm. Boyd, 331 Fourth, Pittsburgh 22, Pa.

RUBBER Moulds for casting novelties. Latex for making moulds. Use thoroughly tested and approved products. Eastern Latex Laboratories, Box 153, Mattapan 26, Mass.

AMAZE Others. Add columns instantly. Add faster than adding machine. Free details. Math Institute, Box 633, Mobile 4, Ala.

"HOW To Make Simple Molds and Plaster Plaques". Profitable business or hobby! Instructive booklet 25c. Plastercraft, 1406 East 43rd Street, Cleveland 3, Ohio.

TYPEWRITER Repairing—Original course, simplified home study. Weber Typewriter Mechanics School, Box 269, Osborn, Ohio.

FLORIDA Opportunities—Pensacola offers exceptional opportunities for small industries, especially in the field of mahogany novelties and woodware, perfumes, soap, chemicals. Delightful year-round climate. Wonderful fishing, hunting, beach sports. For information write: Industrial Development Division, Municipal Advertising Board, Pensacola, Florida.

RECAST Old batteries into new. Latest achievements. Battery Laboratories, Minneapolis.

\$25 WEEKLY Working two hours daily. No canvassing. No manufacturing. Lycke, Box 2471, Cleveland 12, Ohio.

START Mailorder bookshop—Everything furnished; publisher cooperation. 25c brings booklet, exclusive setup, samples, exciting ideas. General Publications, Ossining, N. Y.

BECOME An "Attritionist Masseur". First improvement over Swedish massage in 100 years! Results unbelievable! Dr. Swearingen, 9128M, Station S, Los Angeles.

"10,000 ALASKA Fishing jobs." Alaska's largest industry regularly employs thousands of men and women in seafoods production. Possible earnings up to \$5,000 in few weeks. Authentic 7,000-word copyrighted report gives job information, union requirements, sample application letter, names and addresses over 40 Alaska fisheries. Newest edition includes similar information on California, Oregon and Washington fisheries. Vital facts for immediate application in a permanent industry. \$1.00. 7-day refund privilege. Pacific Industrial Research Bureau, Dept. PM-9, 202 Studio Building, Portland 5, Oregon.

BIG Money making Hollywood style pottery, bird baths, wishing-wells, benches, stucco-rock. New method. Clever designs. Color with chemicals, water-paints. Marbling, colored glaze effects. Dime brings samples, pictures, literature. Hollywood Cementcraft, 8527 Wonderland Ave., Hollywood 46, California.

LIQUID Marble; snow-white, multi-colored. Glazed. Unglazed. Composition flooring. Lifetime wear. Any color. No priorities. Flexible molds. Plaster casting. Get into the big money now. Full information given free. Write Compo-Tex, Box 786-R, St. Louis, Mo.

BRUSH Plating outfits connect to a battery. No tanks necessary. Good paying business at home plating autoparts, bathroom fixtures, bicycles, reflectors, silvering mirrors. No shop or experience required. Outfits furnished. Free booklet. Gunmetal Co., Ave. H, Decatur, Ill.

AGENTS—To mail our literature. Good profits. Home business. Maywood, 1133 Broadway, New York.

MONEYMAKING OPPORTUNITIES

WIN Contest money. General contest bulletin shows how. 16 big pages of helps. Many current contests listed. Sample 25c. General Contest Bulletin, 1609½ East 5th, Duluth 5, Minn.

OPERATE Profitable mail order business. "A Man, An Idea and \$5," tells how. Information free. Francis Bixby, 1503 Prospect Road, Ashtabula, Ohio.

BUY Articles wholesale. Make money by mail. Formulas, trade secrets. Free literature. Massey, 64 Sterling, Franklin, New Jersey.

MAKE Money at home. Paint and decorate wall plaques, brackets and book ends at home, no skill required, sell to stores, friends, bazaars, etc. Big demand, good profits. We furnish you with the plaques at very small cost. Write today. Marbleite Art Company, Ames Station, Box 53-P, Omaha, Nebraska.

GUARANTEED Giant Chinchilla rabbits. Prolific. Profitable. Most valuable fur. Markets furnished. Details free. Willow Brook Farm, R 15, Sellersville, Pa.

200 MONEY Making ideas, plans, rare formulas, schemes. Free folio. Formico-Eng., Box 572, Dayton, Ohio.

OPERATE Your own health service. Small investment to start. Many earn \$75 to \$125 per week. Work part or full time. Free booklet. Stanley Physical Therapy Supply & Equipment Co., 162 No. State St., Chicago 1, Ill.

THOUSANDS Of alarm clocks need repairing. Jewelry stores swamped. Our simplified course teaches you how to repair these clocks. Necessary tools and supplies furnished with course. Alarm Clock Repair Service, P.O. Box 2350A, Houston 1, Texas.

CREATE A small manufacturing business as I have done. Details 25c. Attention Manufacturing, 144 Dynevor Rd., Toronto, Canada.

LEARN To solder—make money in repair business. Solder brass, aluminum, iron, stainless steel, etc. For complete illustrated instruction by expert send \$1 to Craft-Skills, 612 Bartlett Bldg., Los Angeles 14.

AT Home—profitable business painting wall plaques. Experience unnecessary. Big demand. Free details. Alfred Novak, 2560-A Loop, Cleveland 13, Ohio.

SPARE, Full time home business opportunities. Bodin, 2007-B Hutchinson, Chicago 18.

EXCLUSIVE Circular letters guarantee profits for our mailers. See for yourself. Free samples. Argent & Ross, Landover, Maryland.

GET The newest and best offers. New service brings complete, ready-to-start offers at low cost. Saves time, effort. Particulars free. Kelly, 1080-K Casgrain, Detroit 9, Michigan.

1001 MONEY Making ideas for everybody. Write Neuway Institute, Box 5463, Chicago, Ill.

TATTOOING—Pleasure! Profit! Particulars free! Steele, 1138-S Market, San Francisco 2, California.

"HOW To Write Advertising", absolutely free! Dudley Bunn, 126-PM Lexington Avenue, New York 16.

PROFITABLE Ideas \$1.00. Free literature. Michael's Business Enterprises, 715 Lorimer St., Brooklyn, 11, N. Y.

100 MAIL Order tips, opportunities, formulas, information, 25c. Magazine free. William Scherrer, Coshocton, Ohio.

CASH Returns from spare time work. Write for literature. Redleg, One Wainwright Drive, Dayton 3, Ohio.

MONEY From scraps. Write Homecraft Projects, Lovers Lane, Gainesville, Texas.

SELL By mail to negroes! Big over-prosperous market. Details for stamp. Elmer Swanson, Niagara, No. Dak.

MAIL Buyers directory magazine tells how to make, save money! Contains supply sources, valuable information! Copy, 25c—Details free! DeWeese, Box 1023-B, York 1, Penna.

FREE Information! Locates thousands scarce bargain merchandise. Roberts, Box 1279-P, Joliet, Ill.

MECHANICALLY Inclined men—Own and operate general appliance repair shop. Complete, illustrated course shows you how. Welding, refrigeration, motor repair, how to get business, etc., all phases covered. Free literature. Christy Supply, Dept. 1165, 2835 N. Central Ave., Chicago.

CO-PUBLISH Magazine. Many profits. 16-page booklet free! Goldenberg, 5209-A Lindsay, Houston 3, Texas.

MAKE Money anywhere. Our book describes 300 ways. 25c. Moneyback guarantee. R-J Publications, Box 1651, Milwaukee.

MAKE Popular, fast-selling stainless steel bracelets at home, full or spare time. Easy 300% profit. Special introductory kit makes work quick, easy. Facts free. Ar-Clo Guild, 2055 W. Summerdale, Chicago 25, Ill.

DOLLARS Daily by mail. Profitable homework. Write Pioneer, B404, Yonkers 1, N. Y.

FREE Literature describing many money making plans. Address: Joe N. Bolden, 409 Washington St., Bristol, Penna.

YOUR Own business. Complete plans, supply sources, formulas, show you how easily. Only 50c. Louis Greenblatt, Box 2452-PM, Paterson 6, N. J.

ASSEMBLE Colorful handmade jewelry. Profitable sideline! Free details. Beginner's outfit, \$1 (refundable). Plastic Works, 712 Kimball, Danville 3, Ill.

START Your own business! Big money manufacturing novelties, plaques, statuary. Free catalog. Write—Bing Products, 38-AO Broad Street, Boston 10, Mass.

OILFIELDS Offer good paying jobs from boomtown to city offices. Names, addresses 100 companies list of jobs and pay rates. Oilco, Box 559, Victoria, Texas.

HIT The top in radio, plastics, electricity, aviation. Details free. Technibook, Box 261, Mt. Kisco, N. Y.

OPERATE Profitable mail order business. 75c profit each dollar. Powell, Samp-liner Bldg., Cleveland 3, Ohio.

EARN Money at home. Make shell brooch and earring sets. Kits include materials, actual photographs, complete instructions for one set—\$1.00—four sets \$3.00—six sets \$5.00. All different. Blacks Shells, 601 S. Newport Ave., Tampa 6, Florida.

START Your own business. Send 10c. Reese, 75 Walnut, Ridgewood, N. J.

MONEY - MAKING Opportunities, sources of supplies, personal interest guaranteed. For complete information, remit 10c. American Mail Trade Ass'n., 313 East 21st, New York.

EASY Extra money. No selling. Blue Star Stores, Excelsior, Minnesota.

THOUSANDS Buy "Businessman's Guide" (copyrighted). 25c brings copy, wholesale prices. Weyl, 1526-B Bryden, Columbus 5, Ohio.

"HOW To Build Your Own Mail Order Business". 25c postpaid. 50c refund guaranteed if you'll part with booklet! Other profit-for-you literature free. Upham and Son, 939-S Ravine Drive, Cleveland 12, Ohio.

CO-PUBLISH A magazine. Experience unnecessary. Samples and details, 25c (refundable). Newman Lott, Box 7172-B, Station "G," Los Angeles 37, California.

EARN \$2-\$6 An hour in spare time. Pleasant community work selling subscriptions. Nation's finest magazines. Work-as-you-please. Write: Coronet Magazine, Dept. P1, 919 N. Michigan Avenue, Chicago 11, Illinois.

PRACTICAL Money-making plans. Free literature. Goodrich, 14 Edgewood Ter., Longmeadow, Mass.

FREE. Money making opportunities. George Simon, 6843-A Jonathon, Dearborn, Michigan.

NEW Mail order opportunity having splendid profit possibilities. Small capital required. Operating instructions 10c. Kraft, 3114-S7 Walnut, Chicago 12, Ill.

EARN Morley evenings, copying and duplicating comic cartoons for advertisers. Adservice, Argyle 1, Wisconsin.

GIGANTIC Mails—Trade magazines—Name listed 10c. Jackson, Newfoundland 3, Kentucky.

RECEIVE Mails, samples, money-making opportunities, literature, steadily one year. 25c. Zbiegniewicz, 147-A North 8th St., Brooklyn 11, N. Y.

WIN Fame, success, security writing short stories, newspaper features. New, easy plan shows you how. Write today for exclusive details. Writer's Institute, 4-M So. 15th St., Philadelphia 2, Penna.

CREAM Of crop-mailorder money-making plans, offers, details free. G-Dez Mail Service, Box 148-A, Aurora, Indiana.

EARN Money at home! Thousands do! "Home Worker Magazine" tells how. Sample, 25c. Sizemore, Box 7, 4917 North Kostner, Chicago.

FORTIFY The future! Start own business; home, office. Booklet describing "Collection of 137 Tested Plans" free. Elite Co., 220-A Grand St., New York 13.

LEARN Battery repairing, rebuilding. Engineer offers money making methods. Battery Bureau, 2225 North 44th St., Milwaukee, Wis.

BIG Profits. Manufacture custom arch supports. Jul Corsen, 2638 Geyer, St. Louis 4, Missouri.

YOUR Big mail order opportunity—No time has ever been as good as right now. Get your start right. Let me show you how, what to sell and who will buy. Big profits, easy work at home. Write: H. S. Smith, 3139A So. Mabbett Avenue, Milwaukee 7, Wisconsin.

PUBLISH Your own magazine. Hand-some 52 page format, well edited, illustrated. Cost low as \$1.00 month. Brings you prestige, profits. 25c brings sample, details. National. Ord. Nebr.

I MAKE Big money in the mail-order business. You can do the same at home with my copyrighted system. Write me. I'll tell you how. F. Little, Box 8, Glen-shaw P.O., Pittsburgh, Penna.

LEARN Metascience. Remarkable drug-less healing. No manipulation. No apparatus. Unbelievable simplicity and results. Inexpensive correspondence course. Write Metascience, De Land, Florida.

WHAT Makes you think you couldn't sell by mail? We're doing it happily! New! Different! Exclusive! Alive with money-making opportunity. Full particulars free. Investigate! Compare! The What-To-Do-Shop, Box 1082, Tacoma, Wash.

EARN Money at home—realize independence. Write Successful Income Builders, 508A, Hollywood 28, Calif.

500,000 ARTICLES—Wholesale directory, dime. National, 322P Union Avenue, Brooklyn 11, N. Y.

MANUFACTURE Costume jewelry at home for profit, hobby, therapy. Free wholesale supply catalogue. Instructions. Florida Supply House, Bradenton, Fla.

WOULD You pay 3%—first \$350 made? Color-illustrated book "505 Odd, Successful Enterprises" free! Proven by "Little Fellows." Start at home, office. Expect something odd! Pacific, 262-M Drake, New Rochelle, N. Y.

I Made \$1000 from 1000 tomatoes using my unique methods. Detailed instructions, \$1.00. (refundable). Alfred Dinsmore, Marlborough, Mass.

FORMULAS, PLANS, ETC.

MANUFACTURE Fast-selling products yourself. Bubble blowing liquid, D.D.T. insecticide, \$1.00 each. Formula catalog free. Kemico, Park Ridge (16), Ill.

SELECTED Scientific formulas, processes, trade secrets, \$1.00. Fields, Empire, Colorado.

ENGINEERED Plans, Catalog 10c, processes; formulas, 50c. Experienced consultants. Westchester Engineering Service, Box 301, Inglewood, California.

OPPORTUNITIES Galore in manufacturing cosmetics, medicinal preparation, household specialties, vitamins, specialist 25 years experience offers valuable information. Belanger, 2623 West Third Street, Duluth 6, Minnesota.

"LUMINOUS Paint." Resilvering mirrors, 25c each. Soapmaking, (20 formulas) \$1.00. Ideal Service, 306, Park Ridge, Ill.

MAKE Plenty money. 546 formulas. Send \$1.00. Stroups, Ashtabula, Ohio.

ANY Formula, recipe, \$1.00. Manufacture at home. Suggestions free. Interstate Laboratories, 1515A Oriental Boulevard, Brooklyn 29, N. Y.

MODERN Specialties from formulation to packaged product. Gerard, Consultant, Fairmont, W. Va.

TIRE Carcasses everywhere, from these reclaim rubber to make molds, tire plastic, etc. Details for stamp. Betke, Box 699, Borger, Texas.

ICELESS Ice! Colder; cleaner; cheaper. Instructions, 25c. Duffy, C53, Covington, Ky.

FORMULAS: 15 Proven money-making formulas \$1.00. (Not stock-formula catalogue stuff), real unusual offers. List free. Marvel Laboratories, 6629 No. Maplewood, Chicago.

VALUABLE "Hair arranger" formula for Negroes 25c. S. C. Johnson, Box 484, Minneapolis 1, Minnesota.

DDT Insecticide, powder, liquid. Furox, great fur coat cleaner. 22 cleaners (\$86 value). 24 auto (\$72 value). Termite control. Saniflush. Water putty (can be sawed). Odorless dry cleaner. Aero-Wax. No-rub floor wax. Wet dry hosiery treatment. Around 100 others. All \$2.00. Great circular free. Satisfaction guaranteed. Teycer, Chemist, Box 1287, Chicago 90.

BUBBLE Liquid—Five different basic formulas—Sample "Miracle", wand—Source supplies, all for \$3.00. Johnson, 1028 E. 63rd Street, Chicago 37, Ill.

MAKE Bleach water formula \$1.00. Capotosto, 1707 Cranston Street, Cranston 9, R. I.

MAKE Magic bubble solution. Two formulas \$1.00. Satisfaction guaranteed. Robinson, 315 North West, York, Penna.

NEED Chemists? Formulas. Analyses. Ideas. Consulting Scientific Company, Swarthmore, Pennsylvania.

REAL Manufacturing formulas. Lists free. Cummings, Chemist, Gordon Ave., Syracuse, N. Y.

FORMULAS — Latest, best. Analysis. Literature free. Belfort, Engineering Building, Chicago.

PLASTICS

PLASTICS And supplies—new Plexiglas, Lucite, and Catalin—sheets, rods, tubes, etc. Plexiglas and Lucite sheets per sq. ft. 1/16" \$1.60; 1/8" \$2.00; 3/16" \$2.25; 1/4" \$2.75; 3/8" \$3.75; 1/2" \$4.75; 3/4" \$7.50; etc. 5% discount over 5 sq. ft., 10% over 10 sq. ft. Kits \$2.00; \$5.00; and \$8.00. Postpaid. List free. Send money order. Plas-met Sales and Engineering, 4648 Shirley Pl., St. Louis 15, Mo.

PLASTICS—10c Brings our complete plastics catalog containing many profitable, fascinating ideas! Special kits and bulk assortments. Full line of plastics. Also details about our free offer! Fast, reliable service! Write today to Belco Plastics, Inc., Dept. L2, 147 W. Sydney Ave., Mt. Vernon, New York.

COLD Molding resin plastic—Lucite—Plexiglas, prime sheets—12x12"—1/16" \$1.50, 1/8"—\$1.75, 1/4"—\$2.50. Add 10% postage. Dyes, rods, buffing compounds. Hande & Vibro tool, free listings. Craft Plastics, Box 129, Somerville, N. J.

PLEXIGLAS 14 3/4" x 16 3/4" x 3/16" \$1.75 postpaid. Alvin Telschow, 2322-7th St., St. Cloud, Minn.

PLEXIGLAS Any size, any amount, cheap. Free price list. Thomas Cavaliere, 2141 So. Beechwood St., Phila. 45, Pa.

LEARN At home "Working With Plastics." Full information on sheets, blocks, rods, tubes. Trade names, sizes, colors for fabrications, designing, tooling, bending, cementing, polishing. Also for home workshop. Only \$1.25 postpaid. Money back guarantee. Modern Technical Book Co., Dept. M4MC, 55 West 42nd Street, New York 18.

PLASTICS At right prices. Plexiglas, Catalin. Plastic cameos for rings, brooches etc. Send dime for lists. Craftsman Supply House, Scottsville 1, N. Y.

LUCITE—Price list free. Mid-West Plastic Supply, 1717 N. 66 St., Omaha, Neb.

LUCITE 5 Lb. \$2.50, 10lb. \$4.50 plus postage. Charles Gass, 307-14th, Arnold, Penna.

"LUCITE" Masked sheets, clear transparent 12"x12", 1/16" \$1.65, 1/8" \$2.40, 1/4" \$2.90; 12"x24", 1/16" \$2.70, 1/8" \$3.70, 1/4" \$4.70. Phosphorescent (after dark glow) 12"x12", 3/16" \$3.80. For larger sheets and special sizes write for prices. Rods, tubes. Beginner's kit #1, two jewel boxes \$2.20; kit #2, book-ends \$3.90; kit #3, you make it, \$4.95; kit #4, bric-a-brac shelf, 4"x14", amber, blue, green, red, white or crystal clear \$4.20. Add 10% for postage. Hamilton Plastics Corporation, 717 Cedar Lane, Teaneck, N. J.

COLORED Plastics—mottled colors; sheets and rods. Free price list. Hanson Plastics, Dept. D, 7625 South Park Ave., Chicago 19.

FABRICATE Plastic cameo brooch set. Material, instructions \$1.00 money order. Lewis, 1332 Laketon Road, Pittsburgh 21, Penna.

PLEXIGLAS, Clear, masked, 12"x12", 1/16"—\$1.50; 1/8"—\$2.00; 1/4"—\$2.75, postpaid. Dyes, 16 colors; dye concentrate; cements, colored, clear. List free. G. Baker Company, 685 Center Avenue, River Edge, New Jersey.

PLASTIC Craftsmen—Build this beautiful plastic coffee table. Substantial, sturdy, beautifully designed. Order kit No. 127, includes over 300 sq. inches of 1/4" Plexiglas, cut to size, formed and highly polished, with designs imprinted, ready to assemble. No cementing, assemble in 30 minutes with plated bolts included in kit. Requires glass top 27" diameter not included in kit. Price less glass top, \$9.75. Order today, or write for information. Utah Plastics Products Co., Box 308, Ogden, Utah.

INTERESTED In plastics, molding, as a business or hobby? Free information. Kanef's Plastics, Keokuk, Iowa.

PLASTIC Molding and fabricating, any item or quantity. Quick service. Plastic Products Co., Box 384, Dept. PM2, Massillon, Ohio.

PLASTIC Kit, fascinating and profitable, contains Plexiglas, Lucite, dyes, cement, polishing materials, drawings and instructions, \$2.50 and \$5.00 postpaid. Giles Plastic Supply Co., 3247 W. 92nd St., Cleveland 2, Ohio.

PLASTIC, Plexiglas sheets new; 144 square inches following thicknesses: 1/16" \$1.60; 1/8" \$1.85; 3/16" \$2.00; 1/4" \$2.50; 3/8" \$3.50; 1/2" \$4.50; 3/4" \$7.25; 1" \$9.25. 5% discount over 5 square feet, 10% discount over 10 square feet. Sent prepaid. Send money order. Plastic Supply Company, 2618 St. Louis Ave., St. Louis 6, Mo.

"FORMALIN" Liquid casting plastic, quicksetting. Pint \$2.25; quart \$3.95; gallon \$12.95. Formalin Works, 5 W. Larned St., Detroit 26, Mich.

LUCITE—Plexiglas scrap 60c pou.d. National Plastic Products Co., 5 W. Larned St., Detroit 26, Mich.

COLORED Plastic cements for Plexiglas, Lucite, or Acetate. Twelve transparent colors, red, yellow, orange, violet, bronze, walnut, mahogany, navy blue, sky blue, light and dark green, and clear. Choice of 5 in one-ounce bottles with instructions—\$2.25 postpaid in U.S.A. History and complete instruction booklet with photographs and step-by-step fabricating details—75 cents. Construction sheets only with price list—25 cents. No stamps. B & H Plastics, 1425A Lincoln Blvd., Santa Monica, California.

FREE! Instruction booklet—with large illustrated folder of attractive plastic gifts in kit form, only 10c. Plastic Products Co., Box 384-R, Massillon, Ohio.

LUCITE—Complete illustrated fabricating instructions, used in craft classes throughout the world, price list on lucite, dyes, complete supplies. Booklet 10c, with sample, 35c. "Gem-O-Lite," P.O. Box 686-B North Hollywood, California.

BIGGEST \$1.00 Plastic value transparent plexiglas and lucite sheets and strips in irregular shapes and thicknesses. Useful for many projects and experimental work—big package by return mail, no waiting. Double size package with dye and cement included \$2.00. Send money order to HomeCraftsman Plastics, 1945 W. Harrison Street, Chicago 12, Illinois.

CHEMISTRY

WINN'S New idea champion chemical-kits, apparatus-outfits and supplies for students home experimenting. (Established 1931.) Send 10c for catalog. John H. Winn, 124 W. 23rd St., Dept. 505, New York, N. Y.

FREE List of "Make-ur-Own" pamphlets. Pamphlet Publishers, Des Moines, Iowa.

EXPERIMENTERS—Laboratory apparatus, chemicals, catalog 5c. Kemic Supply, Box 14, Boulevard, New York 59.

CHEMICALS, apparatus, bargains—complete catalog 5c. Colonial Chemical, Brockton 28, Mass.

LABORATORY Supplies, chemicals, glassware and apparatus for home experiments. Lowest prices; pamphlet free. Meyer Scientific, 76 Willoughby Street, Brooklyn 1, N. Y.

HANDBOOK For chemical experimenters, illustrated, hundreds of experiments, 50c. Experiment booklet 15c. Chemistry catalog 5c. Reading Scientific Company, Reading, Penna.

STUDENTS' Laboratory supplies. Send 5c for catalog. Mel-Glo Chemical Co., 258 Fourth Ave., Brooklyn, N. Y.

APPARATUS, Chemicals, ounce quantities, catalog 5c. Fleischer's Laboratories, Everett 49, Mass.

FREE Catalog. Chemistry, mineralogy, biology, optics. Tracey Laboratories, Evanston, Illinois.

NEW 36 Page chemical apparatus order book. Complete line of chemical glassware, apparatus and chemicals. Send 10c for this book. Standard Science Supply Co., 1232 N. Paulina St., Chicago.

CHEMICALS And apparatus for industrial, analytical, and private laboratories. Complete supply service for correspondence school students. Send 3c for catalog. Dept. M-43, Biological Supply Co., 1176 Mt. Hope Ave., Rochester 7, New York.

LABORATORY Supplies at wholesale prices: Chemistry, biology, physics. Catalogue 10c. National Scientific Co., 2204 W. North Ave., Chicago. Established 1908.

HELP WANTED

DEALERS To sell patented auto tow-bars. Does away with traffic hazards, yanking motion and towropes. Large immediate consumer demand. Trial samples \$2.00, or \$21.00 dozen. Barnorarl Industry, 19338 Griggs, Detroit 21, Michign.

EXPERIMENTERS—Build model jet propulsion engines and Helicopter planes. Shea, Box 33, San Lorenzo 50, Calif.

MAN Over 30 with car to travel smaller cities calling on men's and women's patriotic and civic organizations; we book for them a dignified fund raising plan requiring no investment; no merchandise involved; permanent position; earnings \$90 to \$100 weekly plus quarterly bonus averaging \$400 to \$600. Write Sales Manager, 704 Waltham Bldg., Kansas City 6, Mo.

BIG Money conversion burners, furnaces, blowers. Peerless, 4322 Sheridan, Lincoln 6, Nebr.

OPPORTUNITY Of lifetime supplying DDT and other profitable products to farmers. No experience or capital required. Must have auto and good references. Permanent. Write or wire McNeess Company, Dept. 712, Freeport, Illinois.

AGENTS WANTED

IMMEDIATE Profits! Take orders for our new amazingly beautiful lifetime laminated plastic reproductions of any snapshot or negative. A genuine opportunity to build an interesting, profitable, business without investment. Write now for details. Gotham Products Co., Dept. G, 215 E. 149th St., New York 51, N. Y.

EXPANSION Watch band, sensational—sell on sight. Send for sample \$1.00 post-paid. Specialty Sales Co., 1507 So. Michigan Ave., Chicago 5, Ill., Dept. 0.

FASCINATING Year 'round income building plan. Take easy orders from friends, fellow workers, church organizations for 10 fast selling greeting card assortments. Sell \$1.00 each—cost you 50c up. Extra bonus. Experience unnecessary. Request foremost \$1.00 all occasion box on approval and free correspondence notes samples. Special offer. Bluebird Studios, Dept. 16-H, Pritchburg, Mass.

EVERYDAY Cards. Make \$5.00 with every ten \$1.00 assortments you sell. Also fancy note paper and everyday wrappings. Unusual demand. Send for samples today. Howard P. Ellis, Dept. PM-6, Pitman, N. J.

WE Pay you \$25 for selling fifty \$1.00 assortments birthday, all occasion cards. Tremendous demand. Sell for \$1.00—your profit 50c. It costs nothing to try. Write for samples. Cheerful Card Co., 173 White Plains, N. Y.

MAKE Unusual spare or full-time profits showing genuine leather jackets, rain-coats, 200 style and comfort shoes. Sample outfit free. Rush postcard. Mason Shoe Co., Dept. M-334, Chippewa Falls, Wis.

WONDER Silver plating liquid. Applied with cloth. Deposits permanent silver-plate on all silverware, brass, bronze, zinc, etc. Good carded item for stores. Wonderful demonstration. Big profits. Full details by mail. Wonder Products, 1265D Broadway, New York 1, N. Y.

AGENTS, Jobbers distributors, make big money selling manufacturers products to stores. Write for details. Evans, 6362 Hollywood Boulevard, Hollywood, California.

LUMINOUS Paint (shines in dark). Profitable seller to millions. Agents send 25c for profitable folio and luminous color sample. Address. Lite-Saver, 97C, Saybrook, Connecticut.

SELL Photo enlargements oil handcolored. Rich, 215 W. 98th, New York City.

BIG Bargains for big profits. Over 100 sensational values. Men's used suits \$2.00, pants 35c, topcoats \$1.25, overcoats \$2.00, shoes 20c. Experience unnecessary. Free wholesale catalog. Superior, 1250-FB Jefferson, Chicago 7.

TREMENDOUS Profits, history World War II, 1100 pages. Distributors, jobbers, agents wanted at once. Schiacke, A127 East Third, Cincinnati 2, Ohio.

EASY Money during leisure time. New item everyone wants on sight. Details, sample. International Industry, Culver City, Calif.

COSTUME Jewelry in great demand. Establish your own profitable business, direct to consumer. Small investment. Large profits. Velrus Jewelry, 799 Broadway, N. Y. 3.

NO Summer slump in magazine sales! Make money year 'round taking new, renewal orders from neighbors, friends. Helps furnished. Free catalog. Write McGregor Magazine Agency, Dept. PM6, Mount Morris, Ill.

AGENTS—Salesmen—solicitors—pitchmen—promoters desiring outstanding profits. Havaway's interesting proposition pyramids your chances. Write Havaway, 635 B Mills Building, San Francisco, Calif., else miss opportunities!

SILVER Plating liquid. Simply rub-on with a cloth. Cleans, silverplates, polishes, one rubbing. Puts on genuine 1000 fine silverplate. Renews silverplated ware like new. Silverplates onto brass, copper, bronze, etc. Lasting finish, won't come off. Sales representatives wanted. Details free. NuProcess Products, Dept. 227, Aurora, Ill.

MAKE Cleanup selling perfumes, toiletries. Distributors prices on request. Long profits. C. Behm Sales, 3635-G Roosevelt, Chicago 24, Ill.

PICTURES For framing. Samples and lists 10c. Curtis, Box 1916A, Denver 1, Colo.

SPECIALS—Greeting cards, Box 61-Times Square Station, New York 18.

MENS Arm bands, fancy elastic, carded \$10.80 gross pair. A. Fenton, 3744-78th St., Jackson Heights, New York.

AGENTS Wanted. Our service puts you in contact with hundreds of firms anxious to hire you. Agents National Service, 1311 Linden Avenue, Lima, Ohio.

DEMONSTRATE, Sell to taverns, amazing, original glass rinse "Clear Glass." No toweling, guaranteed no water spots. Riesen Chemical, 419 Vilet, Milwaukee, 12.

POWER Mower—less motor. Big saving. User agents. Farm Products, M-2006, Excelsior Springs, Mo.

HARMONICAS \$10.80, \$19.80 dz. Harmonica Wholesalers, 11 E. Centre Street, Baltimore 2, Md.

AGENTS, Here's a sure fire profit making combination, billfold and lighter sets. Retail \$5. Your cost \$27.50 doz. lots. Sample \$3. Musical powder boxes, retail \$7.50. Your cost \$47.50 doz. lots. Sample \$5. Cathers, 529 Springfield Ave., Newark, N. J.

SELL Full, part time, individualized belts, buckles, cap badges, tie holders. Thousand emblems. Every veteran prospect. Fast profits. Repeats. Write today special outfit offer. Hook-Fast, PM, Box 1425, Providence, R. I.

FLANGING Tool repairs beer pipes, fast seller. Sample \$1.00. Kelly Johnson, 172 Washington St., Newark 2, N. J.

\$10 STARTS You in business selling South sea shell jewelry so beautiful and exclusive it sells itself, big profits and opportunities. Skipper Naylor, P.O. Box 163, San Diego, Calif.

DISTRIBUTORS, Agents wanted! Sell new silverplating liquid, "Silveron." 100% profit assured! Rabiro, 228P East 2nd St., New York 9, N. Y.

AGENTS—Demonstrators, \$150.00 a day possible. Embossum transforms handwriting into beautiful gold-silver raised lettering for cards, stationery. Cost 20c, sells \$1.00. Sample writing, literature 13c. Embossum kit 60c. Western Chemical, Salem, Oregon.

"STERLO" Prevents runs in hosiery, gives many times the usual wear. 2 dozen in display carton \$3.00. Free sample. Sterling Products, 4225 Appleton St., Cincinnati 9, Ohio.

SELL Needed eyeglass cleaner, prevents steaming. \$1.00 for 8 25c tubes. Shurberg, Box 1514, Hartford 1, Conn.

AGENTS—Big money for men, women, boys, girls—selling gorgeous night-glowing orchids, gardenias; perfect imitation real flowers; last for years; all the rage for wear on hair or clothes. Write for wholesale prices. Marney's, Dept. M-3, P.O. Box 581, Ogden, Utah.

VELVETSKIN Cream, exceptional. \$2.40. Repeat business. Sample \$1.20. Graubard, P.O. Box 1043, Church St. Sta., New York 7, N. Y.

SELL Our effective suntan lotion during summer. Tans without burn. Ideal sideline, excellent profits. Bonny Fair, 53 State, Boston, Mass.

SELL, Full, part time. Individualized belt buckles, tie holders, cap badges. Thousand emblems. Service plaques. New lightning adding machines. Details. Hook-Fast, PM, Roanoke, Virginia.

EX-O-LENE! Most powerful gasoline stretcher! Easy sales! Big profits! Distributors wanted! Information free. Thermoxmiles, Peoria 4, Illinois.

\$1.00 BRINGS \$5.00 To \$25.00 clear profit. New kind concentrated merchandise and coupon deal. Write Kohen, 506 West 45th, Chicago 9.

AGENTS—300% Profit selling gold colored window letters; stores and offices. Free samples. Metallic Letter Co., 438-B North Clark, Chicago.

SELL The latest for dogs. Duet creme shampoo. Containing the remarkable insecticide D.D.T. Trylon Products, Chicago 14, Illinois.

200 MONEY Making deals. Plans, rare formulas. Schemes. Folio free. Formico Service, Box 572, Dayton, Ohio.

MEXICAN Feather pictures. Unusual novelty. 50c (stamps) bring \$2.00 worth samples, details. Refunded if unsatisfied. Aztec Art, Apartado 762, Mexico City.

SELL Housewives gadgets for ironing board—many other home uses. Wildfire seller. Sample 25c. Landau, P.O. Box 6553, Washington, D. C.

SELL Books by mail. Mammoth sales and huge profits. Everything furnished. Send 10c for complete details. Business Plans Foundation, Box 56-R, New York 10.

100% PROFIT On famous, popular Pines birthday, Christmas and all-occasion greeting cards. Wonderful 12 to 24 card, boxed assortments sell on sight for \$1.00. Write today for information and extra bonus distributors' plan. R. Pines, Box 32, Flushing, N. Y.

"COMIC-STRIPPER" Amazing new transfer liquid. Transfers newspaper pictures, comics on cloth, paper, wood. Works like magic. Everybody wild about it. Agents cleaning up. Profits tremendous. Write immediately for free sample pictures and moneymaking offer. H. B. Ketchum, Inc., Charlotte, N. C.

137 COMPLETE Plans for starting own business: local—mail order. Particulars free. Elite Co., 220-A Grand St., New York 13.

MAKE Quick clean-up selling perfume beads. Particulars free. Mission, 2328 W. Pico, Los Angeles 6, Calif.

ELECTRIC Ironing cords with indicator light. Iron-So-Ezee Company, Mt. Washington, Ohio.

MAGIC Cleaner and laundry soap deal. Hotter than a firecracker. Big profits. Sample free. Bestco, 5007 Irving Park, Chicago.

\$3 FIRE Extinguisher; quick sales, wholesale or direct; liberal profits. "Fire-Killer," 109 N. Franklin, Syracuse 1, N. Y.

90c PROFIT Each \$1 sale. Sell permanent mothproofing solution to housewives, stores, agents. Experience unnecessary. Postal brings details. Kinford, Wayne 3, Penna.

GOLD Lacquered window sign letters. New foils, styles, absolutely beautiful. Free samples. Atlas, 7941 Halsted, Chicago.

WAR Honor scroll: All branches of service represented. 12 by 16. Space provided for name and photograph. Truly beautiful. Agents make big money. Sample 25c. E. Condon, Dept. 6, Upper Darby, Penna.

SELL "Petite picture notes." Something really different in greeting cards. Sample free. Dunbar Cards, New Brunswick 20, N. J.

AGENTS: Stamping names on pocket-key protectors. Sample check with your name, address, 25c. Stamping outfits. Emblem checks, check-fobs, name plates. Hart Mfg. Co., 303 Degraw St., Brooklyn, N. Y.

AGENTS—Big line including food products. Fast selling premium and bargain deals. Low prices. Send card for big outfit offer with gift. Ho-Ro-Co, 2768 Dodier, St. Louis 7, Mo.

WHOLESALE Sources. 500,000 articles. Free directory. Maywoode, 1133 Broadway, New York.

PLATING Outfits for autopaarts, reflectors. Connect to a battery. No tanks necessary. Free booklet and particulars. Gunmetal Co., Ave. N. Decatur, Ill.

EXCELLENT Sideline for printing salesmen. Decalomania name plates in small quantities. Also, make money applying initials on automobiles. Free samples. "Ralco," X-164, Boston (18), Mass.

FREE Water and our concentrates, makes flavors, lotions, shampoos, 72 products, labels, bottles furnished. Qualico, E-20030 Russell, Detroit.

HIGH-GRADE SALESMEN

ADVERTISING Book matches. World's largest direct selling manufacturer of advertising book matches offers opportunity for profitable year 'round selling. Every business a prospect. Cash commissions. No experience needed to start. Full or part time. Factory service. Repeats. Sales kit furnished. Match Corp. of America, 3433 W. 48th Place, Dept. E-6, Chicago 32.

START Your own business on our capital. Always your own boss. Hundreds average \$5,000 to \$25,000 annual sales year after year. We supply stocks, equipment on credit. 200 home necessities. Selling experience unnecessary to start. Wonderful opportunity to own pleasant, profitable business backed by world wide industry. Write Rawleigh Co., Dept. F-U-PPM, Freeport, Illinois.

SALESMEN And dealers wanted for new fast selling household item. Nothing like it on the market. Send 25c for sample postpaid. F. R. Espling, Box 704, North Hollywood, Calif.

FAMOUS Picture—in four colors. 500,000 sold. Permanent opportunity. State experience. Sample print free. Our Flag Sales Corp., Dept. C-1074, Excelsior Springs, Mo.

BIG Commissions, selling to stores celluloid pricing tickets, metal shelf moulding. To restaurants, menu covers, signs. F. Pricing Press, 124 White St., New York 13, N. Y.

SELL Greeting cards, display signs, pictures, books, novelties. Big profits. Bulletin free. Elfco, 432 North Wells, Chicago 10.

SELL Annie Blain flavors. George S. Parker, New Brunswick, N. J.

MAKE Up to \$25 a day selling desk calendars. Ideal side line. Details free. Steel Advertising Service, P.O. Box 596, Richmond 5, Virginia.

FREE! Latest Issue Opportunity Magazine. Salesman's Guide. Inspiring, constructive. Shows how to earn money selling for others or in your own business. Hundreds postwar opportunities. Send name and describe what you have sold or are selling. Illustrated copy sent free. Opportunity Magazine, 620 N. Michigan, Dept. 17, Chicago 11, Ill.

AGENCIES WANTED

COMPETENT Well acquainted salesman solicits connections, as sales representative on commission, with American manufacturers, for the Territory of Puerto Rico. Fine references. Address Alvarez, Box 5052, San Juan 27, P. R.

EDUCATIONAL AND INSTRUCTION

LEARN Blueprint reading—quickly, easily visual method by Oscar Schuster, Lockheed manufacturing engineer who trained thousands; complete postpaid \$1.00; refund guaranteed if not satisfied; send check or postal order to Institute Modern Technics, 7904 Santa Monica Blvd., Los Angeles 46, Calif.

GOOD Jobs and a sound, substantial future await you in hotel and institutional field. Men and women—all ages—needed for well-paid positions that offer color, excitement, ever-new and fascinating duties. Record-breaking travel means even greater opportunities for trained men and women in hotels, clubs and institutions. Lewis School receiving calls for managers, assistant managers, stewards, hostesses, purchasing agents and 55 other types of important positions! From coast to coast there are important positions that offer splendid opportunities for advancement in a business where you are not dropped because you are over 40. Previous experience proved unnecessary! No need to leave your job to qualify. A good grade school education, plus Lewis Training qualifies you at home, in spare time. Our National Placement Bureau helps to place you—and our amazing Certified Job Plan—actually certifies you will "make good" when placed. Write today for free book! Veterans: This course approved for veterans' training. Lewis Hotel Training School, Room HO-368, Washington 7, D. C. (First and only school of its kind—in its 30th year.)

NEGATIVE Retouching. Learn at home in your spare time. Do studio work, free lance or produce better pictures for yourself. Details free. Santos School, Dept. M, 308 W. Washington, Chicago 6.

UNISCRIP Universal shorthand alphabet free. Textbook 25c. Guaranteed success \$5.00. Jesse L. Cook, Bartow, Fla.

WELDING—Electric arc. Learn profitable trade quickly through actual practice. Individual welder instructions at bare cost of materials. Full particulars free. Valuable welding lessons book 50c. Hobart Welding School, Box M-662, Troy, Ohio.

AMAZE With Super Memory! Facts, figures, names stick like burrs! Write A-18, Thor Books, Box 1210, Chicago.

TYPEWRITING Taught in ten lessons guaranteed (your home); also shorthand, bookkeeping-accounting, ninety hours each (unfailing "Psycho-Methods")—low rates. Osborne College of Short Methods, 212 West Third Street, Los Angeles 13, Calif.

LEARN Plane trigonometry better than others. Read Master Method instructions. 12 mimeographed sheets, wonderful ideas; \$1, guaranteed. J. Ziembra, 6123 Orchard, Dearborn, Mich.

U. S. GOVERNMENT Jobs! \$1506 to \$2650 year. Many examinations in next few months. Unusual opportunity! Prepare immediately at home. Full particulars free. Write today. Franklin Institute, Dept. R24, Rochester, N. Y.

LEARN Printing, typesetting complete, guaranteed course \$1.00. Elliott Service, West Chester, Penna.

GET Government job: Good salaries, permanent. Service men given preference. Low priced home study practice lessons help you make good grade. Write, Ozment's School, 75, St. Louis, Mo.

LEARN Radio announcing. Send 50c. Ryan Studio, 502 17th North, Seattle 2, Wash.

SOUTHERN Winter hotel positions. Beginners instruction. Write Lee's Hotel Institute, 7 Water Street, Boston 9.

FOOD Sanitation. Learn for profit, protection. Certificate awarded. Free details. Institute Sanitary Science, 2385-A Edgewater, Los Angeles 26, Calif.

FREE—Forging ahead in aviation selling—describes opportunities in America's fastest growing industry. Aviation Institute, 664 North Michigan, Chicago, Ill.

DRAFTSMEN Increase income. Guaranteed "how" sample \$1. Draftsmen's Foundation, Room 901-5, 45 Milk Street, Boston, Mass.

MATH-O-METER—Vest pocket slide rule 25c. Percentage mark-up chart 25c. Math-O-Meter, Box 222, Chicago 90.

LEARN Shoe rebuilding. State, gov't. Approved for GI training. Modern Shoe Rebuilding School, 2935 Belmont, Chicago.

MASTER-KEY To promotion, better job, larger pay. Unique, result producing technique, \$2.00. Ask for free sample lesson. Andree, Barnegat, N. J.

MIND Asleep? Thinking-alphabet helps thousands. Tibolt, 41P, Phila. 20, Pa.

DRAFTING Students—Improve tracing technique. Three genuine machine drawings, instructions, \$2.00. Technical Design, 6705 Freshpond Road, Brooklyn 27.

GET Your liberal education at home. Send \$5 for one year's study. Liberal Arts Institute, Box 444-B, 5757 University Ave., Chicago, Illinois.

COMPLETE Correspondence training course for roofers and siding applicators. Train in 90 days for unprecedented demand for skilled mechanics. Roy J. Peyton, Sr., 1611 So. Ky. Ave., Evansville 13, Indiana.

"PRACTICAL Air Conditioning"—new, complete course covering application of self-contained units. Load calculations, cooling towers, pumps, air duct and piping design. Non-technical. \$5.00 in advance. C. G. Shaw, Box 2201, Beaumont, Texas.

LEARN Professional photographic negative retouching. Short, illustrated home study course. Earn big money. Fascinating hobby. Free booklet. Duval School, Dept. G, 8519 Sunset, Hollywood 46, Calif.

GOOD Radio opportunities for right people! Write Topical Emprise Corporation, 1527 Highland, Box 42B, Louisville 4, Ky.

KNOW—"How to Drive Smoothly." Save yourself from accidents. Develop ability and confidence easily from illustrated, tested self-instructions. Excellent for learners. \$3.00 postpaid. The Brown Driving System, Box 105-M, Hill Station, Harrisburg, Penna.

NOW! New certified method for preparing your own home study course on any vocational or technical subject. Saves months of study, hundreds of dollars. Diploma granted. Free bulletin. DeVoto Schools, 35 Vicente, San Francisco 16, Calif.

MASSO-PHYSIO-THERAPY. Chiropody. Evans natural therapeutics home study courses, P.O. Box 1195, San Antonio 6, Texas.

HOME Studycourse, drugless therapy. Free literature. Institute of Drugless Therapy, Tama, Iowa.

TUNE Pianos scientifically. Lesson and diagram, \$1.00. Oscar Fylling, 841 Robinson, Oroville, Calif.

GOOD "Used" self-instruction educational books on all subjects bought, sold, rented, exchanged. Satisfaction guaranteed. Complete information and 100-page illustrated bargain catalog free! Write—Nelson Company, Chicago 5.

USED Educational and technical books on all subjects bought, sold, rented. Catalog free. Educational Exchange, Henagar, Ala.

29 LANGUAGES By Linguaphone. Russian, Spanish, Portuguese—Direct conversational method for mastering any language quickly, easily, correctly at home. Send for free book. Linguaphone Institute, 83 RCA Bldg., New York.

LEARN Photo-engraving at home or in oldest, largest school in America. Work for newspaper or establish own profitable business. New Tasope' Photo-Engraving equipment available soon. Write for information. Veterans ask about G.I. training. The Aurora School of Photo-Engraving, Tasope' Bldg., Aurora, Mo.

INVESTIGATOR Training. Phillips Secret Service, 1917B North Kenneth, Chicago 39, Illinois.

LOCKSMITH Course. Lock picking, key fitting, etc. \$1.00 prepaid. Locksmith, Canadian, Texas.

MEDICAL Laboratory technicians in great demand. We train you in your spare time, in your own home. You can practice while studying. Write for free catalog. Imperial Technical Institute, Box 973-E, Austin, Texas.

SECRET Investigation. Experience unnecessary. Investigators particulars free. George Wagner, M 125 West 86th, New York.

USED Educational books on all subjects sold, rented, also bought and exchanged. Moneyback guarantee. Write today for free catalog and details. Lee Mountain, Pisgah, Alabama.

PLAYS, STORIES, MANUSCRIPTS

WE Pay high fees for stories and articles. Submit manuscripts: Writer's Bureau, P.O. Box 2629, Cape Town, South Africa.

WRITERS. Create original plots from Folio shows how. Guaranteed. Price 50c. published stories without plagiarizing. Information free. Writcraft, Box 202-M, Chicago Heights, Ill. Thos. L. Powis, 3600 Sangamon St., Steger, Ill.

NEW Writers needed to rewrite ideas in newspapers, magazines and books. Splendid opportunity to "break into" fascinating writing field. May bring you up to \$5.00 per hour spare time. Experience unnecessary. Write today for free details. No obligation. Postcard will do. Comfort Press, Inc., 210-P South Seventh St., St. Louis 2, Missouri.

I WANT New writers to cash hundreds of checks for \$1 to \$100, offered each month. The easiest way to write for pay. No previous experience necessary. Send for free details. No obligation. Saunders M. Cummings, Box 609-M, Colorado Springs, Colo.

BUSINESS SERVICE

BUSINESS And personal representation, appraisal, and adjustments. 25 years experience. J. E. Rumfield, 2212 Summer, Dallas, Texas.

NEW Orleans, La., mail address. 25c each letter or \$2.00 month. Forwarded when wanted. Personal assignments. Cook, 6061 Tchovpitoulas St.

WASHINGTON, D. C. Mail address \$1.50 a month. Henninger, 25 You St., N. W.

INTERNATIONAL Purchasing—Investigating—selling—forwarding of mail. Personal or business representation in all cities of the United States, Mexico, Canada. Your address for prestige in any city \$2.00—1 month. Secretariat Services, 239 Bleecker Street, New York 14D, N. Y.

KEEP Your own records. Use amazingly simplified bookkeeping system adapted to your own business or personal needs. Free details of a system that only costs \$5.00. Write Bookkeeping Systems, 742-D Hampshire Road, Victoria, B. C., Canada.

TO Whom it may concern: We will represent you in the principal cities of the United States; Alaska; Brazil; Canada; Cuba; Greece; Hawaii; Mexico; Newfoundland; Panama; Philippines; Puerto Rico; South Africa and Sweden. Personal or business assignments \$1 per hour. James W. Farley, Citizens Bldg., Cleveland 14, Ohio. Note: Would appreciate hearing from someone who wishes to enter this business in your city. Will send you assignments immediately. References exchanged. State qualifications.

SPECIAL SERVICES

INTRODUCING New products? Let top-flight artists design your labels, packages, advertising layouts. Outstanding work at lowest prices. Write Modern Art Studios, 315 Baltimore Building, Memphis 3, Tenn.

DRAFTINGS For manufacturers and individuals. Chrisman Drafting Lab, Manhattan, Kansas.

RADIO-ELECTRONICS Consultation, engineering design, model development, technical writing. R. E. Lovejoy, 712 Yuma Street, S.E., Washington 20, D. C.

VISIT Atlantic City by mail. 3 postcard views 20c. Address, return, 1 remail. Letters mailed 15c. Muriel Koler, 1111 Atlantic Ave., Atlantic City, N. J.

HARD To get merchandise. Our shopping service knows where. What do you need? H. Kensey, 211 W. 145th, New York 30.

LET Us make your drawings. Reasonable, confidential. West Coast Drafting, 2602 E. Spring, Seattle, Washington.

ALASKA! Complete necessary information, business opportunities, travel, costs—everything \$1. Box 1906, Ketchikan, Alaska.

MAIL Forwarded 25c each letter. Rudawney, Box 2413, Salt Lake City, Utah.

MAKE Real butter at home. Method mailed 25c. Dietz, 3312 N. 15th, Phila. 40, Penna.

HAVE Drawings made of your ideas. Satisfaction guaranteed. Confident draftsman. Chrisman, Box 375, K. S. College, Manhattan, Kans.

GOOD "Used" self-instruction educational books on all subjects bought, sold, rented, exchanged. Satisfaction guaranteed. Complete information and 100-page illustrated bargain catalog free! Write—Nelson Company, Chicago 5.

CARTOONING, COMMERCIAL ART, SHOWCARD WRITING, SIGN PAINTING

"HOW To Draw Gals"—a book every beginning artist should have. It is an up-to-date, complete guide on all phases of female figure technique. Only 50c postpaid. Hargis Studio, 210—5th Avenue, Box 95, New York.

"CARTOONS And Drawing." (31 lessons), 50c! Free catalog. Stone, Lunenburg 2, Mass.

"HOW To Make Money With Simple Cartoons."—A book everyone who likes to draw should have. It is free; no obligation. Simply address Cartoonists' Exchange, Dept. 96-C, Pleasant Hill, Ohio.

CARTOONING, Draw comic characters instantly. Complete charts, instructions, \$1. Cartoonist Felix, Box 337, Duluth, Minnesota.

NEW Invention—magic anatomy-art double-jointed human figure. Thousands poses—art, cartoons. Busty, lusty, comic. Set up powerful action, graceful beauty. Draw, paint, photograph, make cartoon movies. Invent new characters, astonishing situations. Exciting results. Free circulars. Rush name. Maupin, Tipp City 32, Ohio.

STUDY Art, cartooning at low cost. Bargain lists for stamp. Box 592PM, Springfield, Illinois.

ALPHABETS. Ancient and modern. Contains over 120 types of English alphabets from 40 A.D. to 1940 A.D. Price \$2.00 postpaid. Kirk Book Mart, Box 84A, Wellington, Ohio.

CARTOONING Course:—30 illustrated lessons, over 500 sketches, complete \$1.00. Rex Cartoons, Box 892, Pasadena, Calif.

LEARN Chalk talk. Can make an interesting speaker of anyone. Command attention. Details free. Arthur E. Ryde, P.O. Box 1071, Springfield, Mass.

CHALK Talks. Laugh producing program, \$1.00. Catalog 10c. Balda The Cartoonist, Oshkosh, Wisconsin.

CARTOON Course—22 easy lessons, 200 figure sketches. 25c coin postpaid. Snack-Pack Co., 32 E. Georgia, Indianapolis 4.

MAKE Signs, letters, stencils, 9 complete alphabet pattern sets, 3 complete numeral pattern sets and catalog \$1.00. Sign Letter Distributors, P.O. Box 101, Mineola, N. Y.

ADVERTISING AGENCIES, LETTER WRITERS, FOR ADVERTISERS

COPYWRITING. Effective copy. Put your written message over better. Copy that works is like money in your pocket. Copy Service, Box 112, Skokie, Ill.

PROFITABLE Advertising in the South. Rate bulletin free! Alabama Advertising Agency, 216 Exchange Building, Birmingham 3, Alabama.

RESULTFUL Circular mailing, 1000—\$2.00. Harold C. Brown, Sullivan, Ind.

MILLIONS Of names and addresses of veterans typewritten individually on stickers. Ready for mailing, \$15.00 per thousand. All states as requested. All names guaranteed authentic. Min. 5000 names. Channel Sales Co., 391 Fulton Street, Brooklyn 1, N. Y.

MAILING Lists, certified, productive, inexpensive, \$5.00 1000. Homeworkers, agents, buyers, etc. Write Dixie Service, King, N. C.

ADVERTISING Placed everywhere lowest rates. Reliable guidance on publications, expert assistance on ads without charge. Newspaper, magazine, mailing-list ratebook free. Chicago Advertising Agency, 20-P West Jackson, Chicago 4.

ADVERTISERS! 6,000,000 Circulation 25 Sunday national key newspapers, 18 words, \$40.79. "Terrific pullers" 20 popular newspapers \$8. "Free booklet." Newmarks Advertising Agency, 217-7th Ave., New York.

ADVERTISING: Placed in any publication, anywhere. Write for mail-order rate sheet "M." LeGrand Advertising Agency (established 1923) Floral Park, N. Y.

MAILING Lists!—Fresh, reliable, names, addresses; \$10 thousand. Loyaltone Service, 868 Woodward Ave., Brooklyn 27, N. Y.

GUARANTEED Powerful mailorder letters, literature, campaigns planned and written. Famous for famous results. Investigate! Finkle Advertising, 1201½ South Ogden, Los Angeles 35.

FREE! 1946 Advertisers Rate & Data Directory. 52 pages! E. H. Brown Advertising Agency, 20 N. Wacker, Chicago 6.

WRITER Wants work! Effective sales letters, folders, catalogs, booklets, courses, speeches, etc., written or revised, \$2 per typewritten page. Twenty years experience. Dudley Bunn, 126 Lexington Avenue, New York 16.

ADVERTISE: 24 Words, 40 newspapers \$3.50. List free. Advertising Bureau, 4515-C Cottage Grove, Chicago 15.

ADVERTISERS Service—For men going in business. Put our experience in merchandising and advertising back of your products. Write Van De Mark, Times Star Bldg., Cincinnati 2.

24 WORDS In 64 weeklies \$4.96. H. J. Darnell, 730 Hays, Jackson, Tenn.

ADS Placed in out of town newspapers and magazines. Low rates. Catalogue free. Ideas that pay. Baker Advertising Agency, Successors Ankrum Agency, 189 W. Madison, Chicago 2.

TYPEWRITERS, DUPLICATORS, OFFICE DEVICES

RECONDITIONED Typewriters, mimeograph, multigraph printing devices, appliances, supplies. Catalog. Dixiegraph Service, King, N. Carolina.

PRINT Your own postal cards, paper, or anything on "Printomatic Self-feeding Rotary Postal Card Stencil Duplicator." Only \$9.50 with \$2.35 worth of supplies, stencils, ink, etc. Literature free. Pittsburgh Typewriter Supply, 336-RB Fourth Ave., Pittsburgh 22, Penna.

RUBBER STAMPS, OFFICE SUPPLIES

BETTER Rubber stamps. "Ezy-Order" literature free. Lee-Vall Press, Box 1242, Indianapolis 6, Indiana.

PICTORIAL Rubber stamps for school-room use, 10c each. Catalog free. Stamporium, 2660P Rochester, Detroit 6, Mich.

RUBBER Stamps, top quality, rubber cushioned, wooden backs and handles, gold indexed, 3 lines, \$1. Bernell Products Co. Inc., 170 Broadway, New York, N. Y.

KNOB Handle, cushioned, 2 lines 35c, 3—45c. Stamp Works, Centerport, N. Y.

THREE Lines, cushioned, indexed, knob handle, \$1.00. Additional lines 25c each. Ideal Rubber Stamp Co., Detroit 8, Mich.

PRINTING, MULTIGRAPHING, MIMEOGRAPHING, GUMMED LABELS

LITHOGRAPHED Letters, drawings, rule forms, music, folders of all types. Roger Reynolds Lithographic Co., 649 No. Hendricks St., Montebello, Calif.

NICER Printed stationery cheaper. Free samples. Whiteoak Valley, Couchhatta, La.

RETURN Address printed on 25 envelopes 25c. The Sunflower Printery, Hillsboro, Kansas.

MIMEOGRAPHING. Offset printing. Rush service. Duplicraft, 930 F Street, N.W., Washington 4, D. C.

1000 RAG Bond letterheads or envelopes \$4.00. Both \$7.75. Cash with order. Neatly printed. Smith & Wilson, Wabash, Ind.

QUICK, Expert mimeographing; illustrated letters, circulars. Virginia Carter, Latonia, Ky.

100 LETTERHEADS Or envelopes, \$1.00 postpaid. Hawkins Printery, 926 South Fifth Street, Louisville, Kentucky.

HAMMERMILL Letterheads, envelopes, 200 each \$2.00. Samples. Parker Press, 479 Main, Groveland, Mass.

500 BOND Letterheads 8½x11 postpaid \$1.95. Customprint, 211, Springfield 4, Missouri.

NOTEHEADS 500—\$2 Postpaid. Samples. Hurst Printing, 621 East 31st, Kansas City 3, Mo.

GOOD Printing quick, reasonable. Free samples. Established 1915. Southern Printing & Novelty Co., Box 215-A, Lithonia, Georgia.

COLORED Postcards! 150 word limit. 1000—\$4.50. Foster's, Box 2408, Oklahoma City 8.

150 EACH 8½x11—20 Lb. Hammermill letterheads, 6¾ envelopes, printed, postpaid, \$2.00. Race Printing, Hudson, N. Y.

100 CALLING Cards 75c, 100 postcards personalized (name, address) \$1.00. Castellano, 1974 West 6th, Brooklyn, N. Y.

1000 BUSINESS Cards, neatly printed, 2-color, \$2.00 postpaid. Globe Print Shop, Box 1062, High Point, N. C.

100 LETTERHEADS, 50 Envelopes, personal or monogrammed \$1.25. Ripple finish bond. Send money order. Specific Products Company, 119 North Water Street, Rochester 4, N. Y.

BUYERS Like our printing! Samples—Mail Printing, M93, Danvers, Mass.

1000 FINE Embossed business cards \$2 postpaid. Elmer Griffith, Sciotoville, Ohio.

PRINTING, Mimeographing, highest quality, low cost. Samples free. National Printers, 4012 Drexel Blvd., Chicago 15.

200 COLOR Letterheads, \$1.95. Samples, stamp. Mimeographing. Horace Mohler, R-10, Dayton 9, Ohio.

100 LETTERHEADS And envelopes, \$2; Monarch size or 8 1/2 x 11. 200 business cards \$1.00. Limit four lines. Postpaid. We solicit your printing business. Richmond Printers, Box 179, Buffalo 1, N. Y.

QUALITY Printing prepaid: Business, personal stationery, Letterheads, envelopes, statements. Prices reasonable. Samples. Mero Products, 100 Morrison, Punxsutawney, Penna.

500 ENVELOPES \$1.75. Samples free. Mango, 555-A South 20th, Newark 3, N. J.

500 BUSINESS Cards \$1.75 postpaid. Tucker, 2964 Northwestern, Indianapolis 8.

PRINTING, Multigraphing, mimeographing: Low prices, high quality workmanship. Write for samples. Bay Printing Co., 2440-A Oakland Road, Bay Village, Ohio.

LETTERHEADS, Envelopes, booklets, folders, imitation letters, statements, labels. Quality workmanship, low prices. Get our estimate on your needs. Lonelm Publishers, Paulding, Ohio.

350 BUSINESS Cards \$1.00 postpaid. Aircraft, 40-06 97th, Corona 1, N. Y.

GOOD Printing! Low prices! Small, large quantities. 250 letterheads, 250 envelopes, \$2.75. Joseph Johnson, 1382-A Fifth Avenue, New York City 29, N. Y.

QUALITY Printing at lowest cost. Free samples, pricelist. Adams, 30 West Washington, Chicago 2.

FINE Printing — Reasonably priced. Prompt service. Samples. Treaster Printing, Milroy, Penna.

SEND 10c Now, for our 36-page 1946 pricelist—refunded first order. McCall Press, 1326 S. 27th, Omaha, Nebraska.

BETTER Grade printing reasonable. Estimates on anything. Economic Press, Leonia, N. J.

MIMEOGRAPHING — Any copy. Reasonable. Mailers Service, Box 606-A, Chicago 90, Ill.

500 3/4 x 2 1/4 FOUR Line gummed stickers, 25c. Moritz Printery, Saginaw, Mich.

MIMEOGRAPHING—Letters, pricelists, formulas, instructions. Lowest prices. Lem's Letter Shop, 5710 Stanton, Detroit 8.

PRINTING OUTFITS AND SUPPLIES

PRACTICAL Home-made presses. Small model with instructions \$1.00. Details free. Riegele, 1111 Harrison, Phila. 24, Penna.

PRINTING Press plans \$1.00. Details, samples of work free. Homer DeSillier, 19 Stebbins St., Springfield, Mass.

PHOTO Engravings reasonable. Estimates. Spada Enterprises, 10 Lexington, Wethersfield 9, Conn.

MULTILITH, Model 200, Davidson feeder, \$650 complete. 7350 Exchange, Chicago 49.

BARGAINS — Presses, type, supplies. Send stamp. 8 Walden, Cambridge, Mass.

CUTS—Make real halftones, line cuts yourself! Samples 25c. Particulars free. Rapid Chemical Service, Edwardsville, Ill.

PRINTING Equipment, type and supplies. Send stamp for details or dime for complete illustrated supply book. Kelsey Inc., X-11, Meriden, Conn.

PRINT At home—Send 10c for catalogue—presses, type, supplies. Barnhard Co., 6 Columbia St., Newark 5, N. J.

INEXPENSIVE Home-made printing press. Details free. Novelty Shop, Downsville, Louisiana.

PATENT ATTORNEYS

INVENTORS—First things come first. Your first move toward securing a patent on your invention is acquiring full information on what to do. Our two books "Patent Protection" and "When and How to Sell Your Invention" contain this information and other helpful data. Get them immediately, together with our "Evidence of Invention" form. They cost you nothing, you assume no obligation. Write now to Victor J. Evans & Co., Patents, Trade Marks, Copyrights, 131-E Merlin Building, Washington 6, D. C.

PATENTS. Free preliminary advice. E. E. Vrooman, Patent Lawyer, Registered Patent Attorney, 871 Woodward Building, Washington 5, D. C.

INVENTORS—Take prompt steps to protect your invention. Delays are dangerous. Get new free book, "Protect, Finance and Sell Your Invention," and "Invention Record" form. Preliminary information free. Reasonable fees. Conscientious counsel. Easy payment plan. Learn how to protect and sell your invention. Write us today. McMorror, Berman & Davidson, Patent Attorneys, 134-S Atlantic Building, Washington 4, D. C.

INVENTORS: Learn now—without obligation—how to protect and sell your invention. Write for free "Record of Invention" form and complete information for making disclosure and establishing date of your invention. We also send our new free "Patent Guide for the Inventor," containing complete information about patent procedure and how to sell inventions; giving illustrations of many successful inventions; over 150 basic mechanical movements. We assure you prompt, confidential service. Delays may be dangerous. Write today for your free "Patent Guide" and "Record of Invention" form. Clarence A. O'Brien & Harvey Jacobson, Registered Patent Attorneys, 61B-E Adams Building, Washington, D. C.

PATENT Protection. Write for information and "Record of Invention" form, free. Registered Patent Attorneys. Randolph & Beavers, 21-C Columbian Bldg., Washington, D. C.

"INVENTOR'S Guide." 100 mechanical movements, free; advises on patenting, selling inventions. Frank W. Ledermann, 154 Nassau Street, New York 7.

PATENTS And trade marks. Wilfred E. Lawson, 1524 K Street N.W., Washington 5, D. C.

PATENTS—Trade marks. Irving L. McCathran, 315 McLachlen Bldg., Washington 1, D. C. Registered Patent Attorney.

INVENTORS—Before disclosing your invention to anyone send for form "Evidence of Conception"; Schedule of Government and Attorneys' Fees and instructions. Sent free. Lancaster, Allwine & Rommel, Registered Patent Attorneys, 411 Bowen Building, Washington 5, D. C.

PATENTS Obtained; selling service, information, recording forms free. Labiner, World Building, New York.

C. A. SNOW & Co., M-427 Snow Bldg., Washington 1, D. C. Registered patent attorneys. Established 1875. Literature mailed on request.

PATENTS, Copyrights. Robert Daley, Registered Patent Attorney, 19 South La Salle St., Chicago.

FOR INVENTORS

INVENTORS—Take prompt steps to protect your invention. Delays are dangerous. Get new free book, "Protect, Finance and Sell Your Invention," and "Invention Record" form. Preliminary information free. Reasonable fees. Conscientious counsel. Easy payment plan. Learn how to protect and sell your invention. Write us today. McMorror, Berman & Davidson, Patent Attorneys, 134-T Atlantic Building, Washington 4, D. C.

INVENTORS—Information on what to do first toward securing a patent on your invention is of vital importance. "Patent Protection" and "When and How to Sell Your Invention"—two valuable, richly illustrated books—explain fully what to do first, and a lot more. Get this information quickly, together with "Evidence of Invention" form. All three will be sent to you free. Write immediately to Victor J. Evans & Co., Patents, Trade Marks, Copyrights, 132-E Merlin Building, Washington 6, D. C.

DEPENDABLE Patent searches \$5.00—complete with patent copies. Protection form free. Write Raymond L. Smith, Patent Searcher, 410-M Bond Building, Washington 5, D. C. (Former U. S. Patent Office employee.)

INVENTORS: We design and market your idea or product. Gadget Designer, 725 Walnut St., Room 23D, Philadelphia 6, Penna.

PATENTED, Unpatented inventions promoted. M. Joyce Humphries, 1424 Landtitle, Philadelphia 10, Penna.

PATENT Promotion. Selling, designing, engineering, modeling. Tell us your problems. Write today. Associated Manufacturers, 223 Sterrett Avenue, Covington, Ky.

INVENTORS! Have you good patentable ideas? Write Mr. Metzler, 11 West 42nd, New York.

INVENTORS—Submit your invention to manufacturers of similar product. \$1 brings names and addresses. K. Emmons, R#5, Box 149, Royal Oak, Mich.

100—NATIONALLY Needed inventions, \$1.00. Fuller, Box 7056, Richmond, Va.

500,000 INVENTIONS Never made a nickel. Wise inventor "must" learn where others slipped. 10,000-word Inventors' business manual tells "How To Make Good Ideas Make Good." Straight-from-the-shoulder, non-technical instructions on legal, financial, commercial procedures, from unbiased source. Only \$1.00. Money-back guarantee. Research Division, Ric-Craft Industries, Box 1466-B, Tampa 1, Florida.

"INVENTOR'S Guide." 100 mechanical movements, free; advises on patenting, selling inventions. F. W. Ledermann, 154 Nassau Street, New York 7.

INVENTORS: Learn now—without obligation—how to protect and sell your invention. Write for free "Record of Invention" form and complete instructions for making disclosure and establishing date of your invention. We also send our new free "Patent Guide for the Inventor," containing complete information about patent procedure and how to sell inventions; giving illustrations of many successful inventions; over 150 basic mechanical movements. We assure you prompt, confidential service. Delays may be dangerous. Write today for your free "Patent Guide" and "Record of Invention" form. Clarence A. O'Brien & Harvey Jacobson, Registered Patent Attorneys, 61A-E Adams Building, Washington, D. C.

WANTED: Practical inventions. Inventors Exchange, Research Division, B6, Hartford 1, Connecticut.

I SELL Patents. Established in 1900. Charles A. Scott, 773PM Garson Ave., Rochester, N. Y.

INVENTIONS Having profit possibilities in demand by specific manufacturers, cash or royalty. Free descriptive booklet, protective disclosure form, references, and how to safely disclose an invention for sale, upon request. Invention Reporter, 5A-11106 So. Longwood Dr., Chicago 43.

INVENTORS: Avoid unnecessary expense. Write for free booklet explaining how our consulting and advisory service can assist you in deriving greatest profit from inventing. Institute of American Inventors, Dept. 40-A, 1926-Eye St. N.W., Washington 6, D. C.

CASH For practical ideas and inventions. Mr. Ball, AB-9441 Pleasant, Chicago.

RANDOLPH & Beavers: Registered Patent Attorneys, 11-E Columbian Building, Washington, D. C. In order to protect your invention and reap the reward that should be yours, patent your invention without delay. Write for complete information and "Record of Invention" form, free.

INVENTIONS WANTED

INVENTORS Attention! Have you an invention patented or patentable of a novel electrical or mechanical device? Are you the owner of dies you wish to dispose of? If you have either or both give full particulars. We are highly rated manufacturing concern with a nation-wide distributing organization. Your rights will be scrupulously respected. Lion Manufacturing Corp., Dept. BX, 2650 Belmont Ave., Chicago 18, Illinois.

WANTED By manufacturers—practical inventions of all kinds. Patented and unpatented. Write—John D. & Son, 140 Spruce St., Box 3213, Dept. 4, Bridgeport 5, Conn.

EARN Up to \$2000 year, inventing simple items for special cash markets. Ideas only. No patents. Hendrickson, Argyle (7-B), Wisconsin.

MANUFACTURER Wants to purchase small, patented device, submit description and price. General Purchasing Co., 613 Security Bank Bldg., Long Beach 2, Calif.

WE Market patented, unpatented inventions. Inventions Sales Company, Williamson Building, Cleveland 14, Ohio.

INVENTORS: Hundreds of manufacturers have requested our assistance in locating marketable new products. Complete information, free. Institute of American Inventors, Dept. 40-D, 1926-Eye St. N.W., Washington 6, D. C.

WANTED—Patented, unpatented inventions having profit possibilities, all kinds. If will sell, reply immediately. Descriptive booklet, references, free. Invention Reporter, 5B-11106 So. Longwood Drive, Chicago 43.

CASH For inventions, patented, unpatented. Mr. Ball, A-9441 Pleasant, Chicago.

MANUFACTURER Wants sensible mechanical device or idea with quick sales possibilities in low-priced field. Write Matt. 1412-D Great Northern Building, Chicago 4.

THREE First class items, outright or royalty basis. Sensational new type tweezers, household nail and screw starter, new non mechanical pencil, (no sharpening necessary), nothing like it. Items patent applied for, information to manufacturers only. Ellis B. Law, Box 588, Gulfport, Miss.

ELECTRIC Combination stove automatically supplies hot water with same power used for heating, cooking, baking, roasting and broiling. Patent 1912568 available for licensing. Nicholas DiLorenzo, Chatham, New York.

MUST Sell full patent rights on novel ashtray. Wm. Black, 1002 Milton, South Bend, Indiana.

PATENTED New type minnow bucket. Keeps minnows lively in hottest weather. Calvin Hubbell, Rankin, Ill.

AIR Rifle, breech-loading, powerful, easy to operate, has safety. Sell outright or royalty. C. G. Gillespie, R 1, Box 479, Birmingham 7, Ala.

ROYALTY—Recently patented plastic kitchen knife holder. Really new. Descriptive matter to large manufacturers on request. Paul E. Gilbert, 6004 Northside Drive, Los Angeles 22, Calif.

PATENTED Lock nuts. Wish to contact mfg. who will market and mfg. Royalty basis. R. Seitz, 1856 E. 101 St., Cleveland 6, Ohio.

INVENTORS: Test the commercial value of your patented or unpatented inventions, quickly and inexpensively. Write for free information. Institute of American Inventors, Dept. 40-B, 1926-Eye St. N.W., Washington 6, D. C.

MANUFACTURING

SEND Sketch for price on manufacturing your items. Machinists, 114-111 229th Street, St. Albans, N. Y.

INVENTORS—Market study; developing; manufacturing models. J. M., Burlington, Kentucky.

MODELS—Small lot manufacturing. Metals, plastics, etc. Milburn, Burlington, Kentucky.

NEW Inventions to manufacture in any quantity. Prefer small articles in variety store class, metal or wood. Gaston, 208 East Pershing, Springfield, Missouri.

MODELS AND MODEL SUPPLIES

SEND For free catalog of latest authentic design airplanes, ships, autos, railway trains (HO, O, OO gauge) and complete line circus wagons and figures, to Hau Models, 3927 N. Hamilton Ave., Chicago 18, Ill.

\$3.95 TOMMY Gun or cal. 30 carbine #3.50 actual size, authentic models by the makers of the real guns. Kits complete with regulation web sling. Add 30c to each for postage. International Models, Inc., Dept. PM-J, 879 8th Ave., New York 19, N. Y. Send 15c for complete catalogue 1001 items of models—tools.

WIZZ Electric motor. Assembles in a jiffy, flashlight cell operates. Parts complete, plus illustrated instructions 30c postpaid. Eltro Company, 171B, Deer Park, New York.

FLY-POWERED Plane—Real model plane uses housefly for engine. Simple instructions with complete plans \$1. Earl Enterprises, Box 9204M, Los Angeles 5, Calif.

MODELS: Scale trains, planes, boats, engines and accessories. Sargeants Hobbycraft, 4852 N. Springfield, Chicago 25, Ill.

LANDLOCKED Sailors! Here's a beautiful, richly illustrated, fully descriptive catalogue of famous model ships—whalers, slavers, corvettes, etc., authentic in every detail. Send for it today. Only 10c. Marine Model Company, Inc., Dept. C-17, Halesite, Huntington, N. Y.

MODEL Exchange service. For information write Model Exchange, 5721 Leland Ave., Chicago 30, Ill.

RAILWAY Models, complete line, 128 page catalog. HO and O gauge 25c. Walters, 247 Erie, Milwaukee 2, Wis.

BANTAM Gasoline engines. Rocket, Melcraft, Arden, Rogers, Thor, Cannon, Herkimer, others. Model airplanes, ships, accessories. Stamp for catalog. Hobby Shop, 639 Warren St., Boston 21.

MODEL Railroaders. Convert to 2-rail, freight wheels mounted, insulated, 2 wheels on axle 20c. Set of four to equip freight car or reefer 60c. Built to N.M.R.A. standards. Passenger wheels later. Dealers write Machine Products Co., 159 High St., Boston, Mass.

MANUFACTURING, inventions, machine brass work. Baum's Metal Specialties, Kansas City, Mo.

MOST Complete illustrated 68 page master model airplane and gas model catalog ever published. For your copy send 25c (includes refund coupon) to General Modelcraft Company, 91-17-M6 173rd Street, Jamaica 3, New York.

BRASS Gears and model supplies for the inventors. Send 10c for catalog. Pierce Model Works, Tinley Park, Ill.

ANTI-FRICTION Ball bearings. Ideal for model railroaders or hobbyists. 3/16 hole, 5/8 o.d., 19/64 long at hub. Can be fitted for thrust bearings for light machines. 30c each. H. Dowd, 97 Main St., South Acton, Mass.

MODEL Engine catalog, railroad supplies, 25c refunded. Simonsen, A-3054 Greenview, Chicago 13.

TINY Power model steam engines and boilers. Finished ready-to-run. Circulars for dime. Chas. V. Arnold, Philomath, Oregon.

COMPARE Our catalogue on engines, etc., 10c. Howard-A3, 2417 N. Ashland Ave., Chicago 14, Ill.

SHIP And yacht model fittings and blueprints. Hundreds of items to choose from. Send 25c for new illustrated catalog. A. J. Fisher, 1002 Etowah Ave., Dept. M, Royal Oak, Mich.

SHIP Models and yacht supplies complete. Large 64 page catalogue 25c. Bill Wild's, 510 East 11 St., New York City.

BIG Illustrated model engine catalog 10c. Active Products & Supply Co., 53 W. Jackson, Chicago 4.

BRASS, Copper, aluminum, stainless steel, monel. List 10c. Hobby Supply House, Box 2014, Pittsburgh 30, Penna.

MINIATURE Steam locomotives, 1/4", 1/2", 3/4" scales. Castings, parts, rail! Thorough drawings with instructions. Catalog 25c. Little Engines, Wilmington, Cal.

CATALOGS (Illustrated) for modellers! Airplanes, 60 page book on solids. Features construction data, specifications, camouflaging, 15c; railroads: 128 page "HO" guide. Equipment, accessories, fittings. 25c (includes refund coupon). Send coin or stamps for each profusely illustrated catalog desired. Polk's, "Nation's Leading Hobby House," 314-PM Fifth Ave., New York City 1.

SHIP Model kits and fittings. Complete line Fisher model yacht equipment. All Boucher, Fisher, Marine Model and Ideal kits, fittings and blueprints at standard prices. Most complete stock in New England. Send 10c for price list. James Bliss & Co., Inc., 220 State St., Boston, Mass.

HOME CRAFTSMEN

REDWOOD—Eureka! (I have found it.) Models will last forever. No deterioration, fire and rot resistant. Termite proof. Smart craftsmen demand the beautiful texture and light working ability that only genuine Redwood offers. Log cuts up to 8' diameter for table tops and lawn furniture. Dimensional Redwood up to 8 ft. shipped in package lots. Send for free price list. Redwood, Box 971, Eureka, California.

PATTERNS Of household projects. Send postal for list. Nelson Burbank, 5735 Wintrop, Cincinnati 24, Ohio.

FULL Size blueprint patterns of attractive folding chairs and tables for picnic or garden. Also full size patterns for large porch or lawn glider. Original, ingenious construction, easily and inexpensively made. Either set \$1.00. Mastercraft Plans, 7041 Olcott, Chicago 31, Illinois.

10c BRINGS Our booklet with illustrations, project suggestions, instructions on Lucite, Catalin, Plexiglas and Bakelite. Douglas Home Craftsman, Box 34C, Stamford, Conn.

CRAFTSMEN, inventors, hobbyists. Unusual service, supplies, projects. Free details. Wolf, Box 483, Frederick, Md.

VENETIAN Blind supplies, catalogue 10c. Manufacturing booklet \$1.25. "Roberta," Gloversville, New York.

SALES Galore, picturesque silhouette-house number ensemble, samples \$1.00. Glidercraft, 1921 Eastgate Pkwy., Rockford, Illinois.

HOBBYISTS! Learn to make things from magnesium alloys! Perfect for model work. Lightest metal for airplane construction. Instructions included. Deluxe kit contains six 12" rods 1/4 to 1 inch diameter. Price \$2.50 postpaid. Saginaw Bay Industries, 621 Harrison Street, Bay City, Michigan.

SHELLCRAFT Instruction book free, with catalog. Shell Company, Miami 36, Florida.

WHITTILLERS—We can supply read-cut blanks (pine, cedar, redwood) knives, etc. "Old" Whittler, 1402 Charles, La Crosse, Wis.

SUEDE-COAT! Luxurious art finish. Introductory kit—three colors, applicator, adhesive, directions, \$1.00. Craftsmen's catalog, 10c. Technicraft, 1156 Commonwealth, Boston 34.

80 LAWN Ornament, silhouette and novelty patterns, \$1.25. 6 new hanging shelf patterns, \$1.25. Doll stroller, colonial cradle, table chairs, and circus group, \$1.00. All patterns, \$3.00. Modern Woodcraft, Saginaw, Mich.

WHEELS—Rubber tired red enameled steel wheels; make your own wagon, shopping cart, scooter, wheelbarrow, golf cart, etc. Send money order. 4 inch wheel 1/4" bushing 75c. 6 inch wheel 3/8" bushing \$1.00. Circle Metal Mfg. Co., 4266 E. Pacific Way, Los Angeles 23, Calif.

JIGSAW Owners: square foot plywood yields \$46. Write, Woodarts, X-38, Bridgewater, Mass.

HEMOCRAFT Supplies: jewelry findings, shellcraft, sequins, plastic, leather, metal, misc. supplies. Illustrated catalog 5c refundable. Write us your needs. Marcrafft, 208 N. Wells, Chicago 6.

106 NEW Never marketed useful woodwork patterns \$3.00. 50 new different toy patterns \$1.50. All for \$4.00. Catherine Schilder, Cresbard, So. Dakota.

HERE Is something new. Gracefully curved birds and fish easily made out of cowhorn. Complete instructions with drawings \$1.00. H. Harrison, 14303 Strathmore, East Cleveland 12, Ohio.

PATTERNS. Full size rocking horse, bobby car, doll stroller, scooter, wheel barrow and 6 pull toys \$1.00 post paid. Lincoln's Craft Shop, Farmington, Conn.

LAWN Furniture: Single chair, settee, picnic table with benches, and garden bench. Four plans \$1.00. Woodcraft Plans, P.O. Box 136, Sedalia, Missouri.

HAG'S Leathercraft—tools, leather, designs, instructions. Samples, catalog, 10c. 7532-22 N. E., Seattle 5, Wash.

JEWELRY Accessories and findings. Plastic and metal pinbacks, screw eyes, clasps, chains, rings, etc. Prompt shipping service. Complete lists 10c. Doremby Company, Chisholm 1, Maine.

CERAMIC Jewelry supplies, bar pins, ear screws, for ceramic and woodworkers; also glass and seashell assemblers. Free catalog. Philadelphia Badge Co., 1007 Filbert St., Philadelphia, Penna.

FELT For home projects, bases, etc. 12 inch squares in assorted colors and grades. 9 pieces \$1.25 postpaid. Send 10c for full color chart. The Felt Crafters, Plaistow 10, N. H.

CRAFTSMEN—Fast selling, make childrens and adults lawn chairs. Plans and instructions \$1.00. Summercraft Studio, 42 Vernon St., Newton 58, Mass.

MANUFACTURE Costume jewelry at home for profit, hobby, therapy. Free wholesale supply catalogue. Instructions. Florida Supply House, Bradenton, Fla.

35 PATTERNS Of action pull toys, trucks, carts, toy furniture, etc., \$1.00. Continental Homecraft, 907 Birch, Eau Claire, Wisconsin.

CATALOG: Patterns plywood novelty furniture, letters, numerals, plaques, frames, weathervanes, silhouettes, lawn ornaments. 100 books and booklets on crafts and hobbies, picture frame mouldings, tools, large line decal transfers. Other lines. Hundreds articles finely illustrated. Write Wo-Met Shop, Ashburn, Ga.

KNOCKDOWN Cedar chest lumber veneers. Free price list. Giles-Kendall, Huntsville, Ala.

MAKE Shell jewelry—for gifts, as a hobby or start a business. Free catalogue and price list. Complete illustrated book of instructions 75c. Florida Shellcraft Company, Box 1840, Sarasota, Florida.

LEATHERCRAFT Kits, supplies. Leather samples and catalog 10c. Leroy Buckley, 2539 Devon, Chicago 45.

SHELL Jewelry supplies. Wholesale only. McFarland Plastic Co., Sarasota, Fla.

BUILD And sell lawn chairs. Plans \$1.00. We tell you how and where we sell. The Woodcraft Shop, Danby, Vermont.

JEWELRY Supplies. Shell metal and plastic parts for manufacturing. Free illustrated catalogue and detailed instructions on shell jewelry. Florida Supply House, 415 12th Street, Bradenton, Fla.

TOOLS And materials for your hobby. Metalcraft, woodwork, leathercraft, plastic-craft, modeling and pottery-craft. Send only 25c for prospectus on one of above (all five \$1.00) plus drawings for one or more projects, also treatise on hobbies, list of tool kits we supply. Send for yours now. Hobbycraft Company, Box 982, Pittsburgh 30, Pa.

MAKE IT YOURSELF

HOW To build a box kite. Complete plans, instructions. 25c stamps or coins. Zeis, 728 Lesley, Rockford, Illinois.

WHEELS For your own construction of wagon, scooter, racer, wheelbarrow and bicycle trailer. Drawings 25c each. 8x2" and 10x1.75" all-metal wheels with puncture-proof tires and ball bearings. \$2.25 per 8" wheel. \$3.25 per 10" wheel. F.O.B. Akron. Send orders to Jim Brown's Toy Co., 868 East Tallmadge Avenue, Akron, Ohio.

BUILD Farm type portable sawmill, blueprints \$3.00. Edger prints \$1.00. 12" planer prints \$1.00. Nichols Equipment Co., Purvis, Miss.

IF You have average mechanical ability, you can build a jet propulsion engine. Speed faster than sound possible. Simple and inexpensive. Material required: sheet metal and tubing. Not a toy. Complete drawings \$2.00. Jetlab, Box 471, San Diego 7, California.

AIRPLANE Lawn sprinkler easily made. Plans \$1 or write. Larry's Novelty Shop, P.O. Box 1771, Billings, Mont.

BUILD Your home yourself! Inexperienced? Years showing beginners! Sound construction only. Your labor saves up to 60%. Valuable circular 25c. Only the original bears this name: William Jackson, A.B., 1713 Howard, Port Huron, Michigan.

FURNACE Melts all metals. Ideal for small business or home workshop. Built cheaply from scrap material. Free details. Aladdin Laboratory, 9955-C Street, Oakland 3, California.

BUILD Concrete block machine, mixer, electric weed cutter, flame weeder, blueprints 50 cents each. Nichols Equipment Co., Purvis, Miss.

WIZZ Electric motor. Assembles in a jiffy, flashlight cell operates. Parts complete, plus illustrated instructions 30c postpaid. Eltro Company, 171K, Deer Park, New York.

BUILD Lathe from pipe fittings. 3 unique plans. Free circular or send \$1. Albert Losli, 501 So. Navajo, Denver, Colo.

OUTDOOR Fireplaces; build your own, we furnish grates, cooking plates, spits, etc. Write for folder. Smith-Matthews Foundry, 6640 Charlevoix, Detroit 7, Mich.

FREE List of "Make-ur-Own" pamphlets. Pamphlet Publishers, Des Moines, Iowa.

AUTO And farm plans, that can be made for \$1.00. List free. P. Lessard, 716 Tyler St., Oakland, California.

BUILD Motor vibrator, concrete block machine or hand tamp, in two days for \$10 (exclusive of motor). Makes 300 blocks per day. Complete, plans, photos, and instructions for building machine \$3.50 postpaid. Order from advertisement or write for details. Clyde Lee, Dept. A, Mt. View, Okla.

LOOSE False teeth can be made to fit tight, snug, with entirely new dental plate liner—made by a dentist. Do it yourself. One application lasts. New discovery—not a paste or powder. Guaranteed to make loose dental plates fit perfectly. Write for 15 day trial offer. Send no money. C. N. Reese, D.D.S., Box 268J, Winnetka, Ill.

METAL Wheels with rubber tire for construction of scooter, wagon, wheelbarrow, for youngsters. 7 1/2" diameter, 7/16" hole for axle \$1.00 each wheel, unpainted, 4 for \$3.75. You can find many uses for these wheels. 1/3 deposit, balance C.O.D. Orders with full payment shipped prepaid. H. Dowd, 97 Main St., South Acton, Mass.

CHILDREN'S Gym set. Make an all-steel complete playground set for youngsters for around \$20.00. Complete descriptions, no special tools, easy to make, materials available everywhere. \$1.00. Enjco Plans, Box 883, Whittier, California.

ARC Welders, power mowers, automatic hacksaw, supplies. Holgerson, B319, Canton, Kansas.

THERMOSTAT—Simple, accurate, build yourself. Sensitive bimetal, silver contacts and complete plans, all for \$1. Research & Engineering Co., 552A Hills Street, East Hartford, Conn.

BLUEPRINTS And instructions to make adjustable angle plate, tool makers vise, magnetic parallels, angle plate, each 40c, all \$1.35. Gaunt, 3521-P Broadway, Chicago 13, Ill.

COMPLETE Shop in one tool! Make your own drill, grinder, sander, carver, buffer, in one simple inexpensive tool. Detailed instructions, blueprints, \$1 cash, Box 3590, Washington 7, D. C.

BUILD Concrete block machine. Vibration and hand operated types. Easy, inexpensive. Sell blocks, build home, garage, barn at low cost. Free details. Horne, 206 West Wilder, Tampa 3, Florida.

BUILD Your home as a hobby. No rent. No mortgage. Save 50%. Use spare time. No special skill required. Amazing facts sent free. H. C. Lightfoot, Civil Engineer, Richboro 1, Penna.

INEXPENSIVE Jigsaw; circle saw; plans 25c each. Jeffery, 2214 Wolcott, Flint 4, Michigan.

BUILD Your own home. Save expensive labor, rent. We furnish complete construction materials estimate. Iron out any problems. 3c stamp brings details. L. F. Post, construction estimator, Box 1225, Clearwater, Florida.

CONCRETE Mixer, efficient hand power, inexpensive from oil drum. Plans \$2.00. A. Mitkos, 8802 Corwin, St. Louis 21, Mo.

FLUORESCENT Lights. How to make your own 20 watt lights for less than \$1.00 each. Materials available. Complete, guaranteed, detailed instructions \$1.00 cash or money order. Checks \$1.10. Specialty Sales, Box 1086, Muncie, Indiana.

WATCHES, OLD GOLD, JEWELRY, ETC.

WATCH Repairing easy learned by our home study course. Watch repairers are in demand and are among the highest paid craftsmen today. Write for free information. Houston Chronometer & Watch Co., P.O. Box 1140A, Houston 1, Texas.

SEND Only \$1.00 for men's guaranteed stainless steel adjustable expansion watch band postpaid. Robert Craig, Luzerne, Pa.

ALARM Clock repair instructions, complete 50c. Particulars, stamp. Clifford Jones, 1210P Dudley, Utica 3, N. Y.

WHY Not employ the convenient, easy-mail method of having your watch repaired. Work guaranteed for one year. Write to Geo. Banks, 55 years at 3 Malden Lane, New York 7, N. Y.

EXPANSION Type watch bands and bracelets repaired. Broken parts replaced like new. Mens, womens any make, \$1.98 complete job. Sherman's Bracelet Shop, 124 W. 6th St., Los Angeles 14, Calif.

"JEWELRY, Gem Cutting, Metalcraft." Fascinating designs for hobbies and money-making opportunities. New, complete illustrated book covers cutting, polishing, mounting gems, metal, jewelry work, etc. 287 pages, \$2.95 postpaid. Money back guarantee. We supply tools, materials at lowest cost. Modern Technical Book Co., Dept. M3MC, 55 West 42nd St., N. Y. 18.

WANTED—Old or broken jewelry. Cash paid immediately. Mail gold teeth, watches, rings, silverware, diamonds, spectacles. Satisfaction guaranteed or merchandise returned. Information free. Rose Smelting Co., 29 East Madison, Chicago, Dept. A.

WATCHES, Materials, tools, jewelry, diamonds—bought—sold. Catalogue. Gales, Box 1000, Chicago.

WATCH And clock repairing—complete practical course in modern horology. 66 illustrated self-instruction lessons. Just out! Low price. Fascinating 100-page illustrated catalog free! Write—Nelson Company, Dept. 8-02, Chicago 5.

TOBACCO, SMOKERS' SUPPLIES

CIGARS, Fifty, swell smoking, \$3.00, postpaid. Send check or money order. S. & E. Company, Dept. PM, Red Lion, Penna.

SMOKERS—Here's biggest pipe value in years. Full size, ruggedly styled pipe, waterproof tobacco pouch, and package of pipe cleaners—all for \$1.00 postpaid. Pipe is of fine quality, beautifully carved wood, has genuine para rubber bit and aluminum filter. Guaranteed perfect. Quantities strictly limited; send cash or money order (no C.O.D.'s). Bernell Products Co., Inc., 170 Broadway, New York 7.

CIGARETTE Case, tooled leather, pack size, Mexican handcraft, \$1.85 including tax and postage. Southwestern Import Company, P.O. Box 5052, Beacon Hill Station, San Antonio 1, Texas.

SPIRAL Pipe screens. 1551 Ocean Avenue, San Francisco, Calif. Lasting smoking enjoyment. Two screens, 25c, ten, \$1.

PARK Windproof vest-pocket lighters. Guaranteed for life, only \$2.00 postpaid. Free mechanical pencil with order. Mears, Hallwood, Va.

SURVEYING INSTRUMENTS

GUARANTEED Factory rebuilt transits and levels for sale (cash or terms) or rent (with purchase option). We will repair, trade, or buy old instruments. Ship prepaid for estimate and valuation. For complete information. Write for list M-26, Warren-Knight Co., (Manufacturers of Transits and Levels), 136 N. 12th St., Philadelphia 7, Penna.

FOR SALE MISCELLANEOUS

MECHANICAL Drawing instruments—Veeco, 4 piece, compact, precision set, brand new in lined case, value \$12.50, special, \$7.25—Deitzgen 11 piece set, \$10—Charvos 9 piece set, \$8.50. Army surplus slide rules, slightly used, 75c each. Hull auto compass, for accurate road direction, brand new, \$2.50. Brand new folding valise knapsacks made of heavy olive green duck, heavily bound and reinforced, repellent to fire or water. Inside 3 large snap fastened pockets, heavy webbed straps, hand and shoulder handles, size opened 22"x54", closed 22" rolled. Useful to hunters, Boy Scouts, hikers and for all traveling use. A \$7.50 value, special \$2.25 postpaid. Forward money with order. No C.O.D. shipments. Public Sports Shops, 13 S. 16th Street, Philadelphia, Penna.

ARMY Goods (used) canteens, mess sets, helmets, life preservers, raincoats, knapsacks \$1, cartridge belts, holsters, gas mask bags 50c. Life rafts \$7.50, bunks \$5, rubber suits \$5. N. Y. Salvage, 144 Chamber St., N. Y. C.

SURPLUS Aircraft oxygen masks, latest type, makes ideal respirator or shallow water diving mask. Government cost \$4; limited supply available, new—\$1.75, used, good condition—\$1.00, postpaid. Ken Norberg, 21 Tamalpais, Mill Valley, Calif.

FOR Sale carded pecans, cashews, almonds, pistachios, herring (smoked), dried shrimp, etc. 24—10c packages each card, retail \$2.40; your cost \$1.30 ea. Mercier Distributing Co., 2363-37th Ave., San Francisco 16, Calif.

CUTTERS, Dental burs assorted, reclaimed job-lot. \$1.90 per gross. Wolf, 1924 E. Hartlane, Philadelphia, Penna.

ALL For 10c. A 20 page catalog of HO-O, OO scale. Surprise list of Lionel. Used items list in all gauges for stamp. Name your gauge. Trilor Hobbyist, State Road, North Dartmouth, Mass.

MECHANICAL Drawing instruments, Charvos drawing set, \$7.50. K & E 3245-12 deluxe lettering set, \$55.00. 42x60 inch drawing boards with adjustable trestles, \$37.50. RCA 50 watt high-fidelity public address amplifier, \$235.00. Send for our Bi-monthly Electronic Swap Bulletin. Southeastern Merchandise Exchange, Opelika, Alabama.

WANTED MISCELLANEOUS

TRADE, Buy or sell guns, watches, cameras, movie projectors, binoculars, musical instruments, books, jewelry, antiques, printing equipment and thousands of other items with a low cost ad in The National Swappers Guide. Published monthly; contains hundreds of individual traders, buyers and sellers who list thousands of items they want. Send 25c for your copy today. See for yourself. National Swappers Guide, P.O. Box 415, Evansville, Indiana.

WHOLESALE Distributor wants—automotive—hardware. Marine Specialties, Box 423, Glen Cove, N. Y.

WILL Pay \$5000.00 each for certain old books! Histories \$125.00, poems \$2500.00; we also buy deeds, newspapers, autographs, and letters. Catalogue 10c. Ohio Historical Publishing Co., 209 W. 11th Ave., PM, Columbus, Ohio.

JOB Lots metal mailorder items from manufacturers, also buy used articles such as cameras, films, collections, etc. Charles Dutz, 109 Sixth, Lincoln, Ill.

JUSTICE Buys almost anything! List free. 9762 Santa Monica, Beverly Hills, Calif.

MERCURY—Highest prices. Free containers. Write. Wholesale Terminal, Norwood, Mass.

MERCURY (Quicksilver). Write for quotation stating quantity. Metallurgical Products Co., 35th and Moore Sts., Philadelphia, Penna.

FOR THE HOME

GUARANTEED—Grates, firepots, linings, Craxmend, Wringer rolls, Magoprodex, Royal Oak, Michigan.

PERSONAL

AMAZE Friends. Pretend visiting nation's capitol. Three souvenir cards 25c. Fifteen for \$1.00. Address, stamp, return, we remail. Orndoff, Box 1274, Washington 13, D. C.

JUST How smart are you? Professional I.Q. \$1.00. Certificate given with grade. Ray Moore, Box 1074, Columbus, Ohio.

AMPUTEES! Get facts on artificial limbs. Send for "John Silver, Twentieth Century" authoritative, unbiased, excellent gift 50c. Donald Balsh, R. 3, Irwin, Pa.

LEATHER Jackets scientifically cleaned, refinished like new, \$3.50. G.I. trousers dyed \$2.50. Lawrence Jacobson, 2825 N. Broad Street, Philadelphia 32, Penna.

SWAPPERS' Gazette—"Catalog of Swaps"—25c. 2836-PM Slevin, Louisville 12, Ky.

LAPEL Cross, gold plate, hand polished, screw button back, in gift box. 50c prepaid. Grace Products, Box 459-A, Hackensack, N. J.

LIVE Longer, feel better, enjoy life. Free information. Fairchild Company, Mt. Vernon, Ohio.

INTERESTING Poem, "A Glimpse of The West" 20c. Lewis Vikla, Lonsdale, Minnesota.

NERVOUS, Self-conscious, fears? Be courageous, self-confident, magnetic. Sensational psychology course. Only \$1.00. Dr. Malcolm Smith, 1104 Union Ave., Montreal 3, Canada.

FREE Handwriting analysis with handwriting charts 25c. Linde, 14147 School, Chicago 27.

MEXICAN Law practice, L. Gonzalez, Box 236, El Paso, Texas.

POOR Penmanship corrected—few hours. New-way. Ozment, 9, St. Louis, Mo.

HAIR Falling? Dandruff? Write Trichologist, 137 Lewis St., Phillipsburg, N. J.

MISCELLANEOUS

"STORY Of Prefabricated House," brief factual book prospective owners of new homes should have. Tells about materials, methods with factory made houses. Read it 5 days free, then remit \$1.25 or send only one dollar and receive it with our guarantee money back in 5 days. Research, Columbus 8A, Indiana.

\$50 RUTLAND Marble grave markers, 23½" x 11½", weight 70 lbs., parcel post prepaid, insured \$32. Guaranteed, full proof against moss or discoloration. Always white, tough, hard. Pass U. S. gov't test. Raised oval, gothic lettering—all you want. Beveled, glass-like, lasting, polished job. Send card. Cast Marble Co., 25 Kemp-ton Place, West Newton, Mass.

LOW Price electric projector. At last a practical all metal projector. Will project and enlarge photos, drawings, postcards, stamps, etc. In full color or black and white. 101 uses for schools, home or club. Send only \$3.98 or sent C.O.D. plus postage fees. Disco Sales, Inc., Dept. EP1, 154 Nassau Street, N. Y. 7, N. Y.

STAG Book matches, 10 for \$1.00. Logan Novelty Co., Bellefontaine, Ohio.

ILLUMINATED Magnifying inspection glass! Free trial! Virginia Carter, Latonia, Kentucky.

NAMEPLATES—Letters in raised, white glass beads. Reflects lights. Weatherproof. Board to match house trim. 25c letter—\$2.00 minimum. Plac-Art Co., Round Lake, Ill.

VICTORIAN Type furniture—for the home also metal furniture. Send list of needs for circular and prices. L. E. Peterson Agency, 3417 Adams Ave., San Diego, California.

NEW Powerful Goldak locators for minerals and metals and with wartime improvements now available. Screen grid and beam power tubes. Moneyback guaranteed detect buried gold and silver at greater depths than any competitive device. Write Goldak Co., 1544 W. Glenoaks Blvd., Glendale 1, Calif.

FLASH Light size rechargeable batteries, guaranteed—Write Kimley, 103 Highland, Williamsville 21, N. Y.

MEXICAN Jumping beans. Dozen 25c, hundred \$1.00, thousand \$5.00. Mexican Products Co., 126 N. Main, Tulsa 3, Okla.

"HOW To Make Money With Hobbies," Also nearly fifty human interest stories of hobbyists who made good. Book \$1.00 postpaid. Circulars, 5c. Bro Service, Box 843, Pawtucket, R. I.

WHITE Plaques to paint. Free price list. Graham Co., 4348 Bloomington, Minneapolis 7, Minn.

RECEIVE Mails, moneymaking opportunities, samples, literature. Your name in several mailing lists, 10c. Rogowski, 3415 Broadway, New York 31.

ALINICOV "Magic Magnets," most powerful steel, defy gravity, through wood, glass. Useful tool, stunts, gift. 2" long, 2 for \$1.00. Also "Toothpick Magnets," 8 for \$1.00; "Magnetic Wand," 2 for \$1.00. Eljay, Box 891, Newark 1, N. J.

4-LB. AIRCRAFT—Nuts, bolts, rivets, etc. \$1.00 plus postage. Johnny, Box 1516, Sharp Park, Calif.

BUILD Five room mountain cabin. Working drawings, materials, list. \$1.00. Al Stacey, Bks. 10, NATTC, Memphis, Tennessee.

"WHOLESALE Bargain List," watches, clocks, gifts, for stamp. Cathers, 529 Springfield Ave., Newark, N. J.

SEND No money: Try our magic polishing block for removing scratches from pianos, furniture, autos. Pay only 50c after satisfied. Bottle lovely perfume for promptness. Blue Star Stores, Excelsior, Minnesota.

HOW To search for missing heirs, relatives, names! Rewards! The Research Review \$1.00. Chaffee, 308 Washington, Chicago 6.

FREE Sample best double edge blade. Staff, 1430 Cuyler, Chicago (13).

CIGARS—Connecticut broadleaf wrappers, Havana filled. Special box of 25—\$2.75. Uhl Cigar Co., Wallingford, Conn.

INDIVIDUAL Bowling score books, 10c. Captain's 50c. Sim's, Saline 1, Mich.

VENETIAN Blind tape 25c yard. Color duck cord. 5c yard. Moore, Box 461, Kitting-tanning, Penna.

SOMETHING To swap? Advertise in Green Mountain Trader, National circulation. Sample, dime. Henshaw, Bondville 13, Vermont.

RUBBER—Everything in rubber. Patents developed. Dept. P.M. for catalog. Broadway Rubber Mfg. Co., Louisville 2, Ky.

"SILENT" Dog whistle. Used Hollywood sound stages. Dogs hear it—neighbors don't. Amazing! New! Price \$1.00. PM Totten, Young's Rd., Dedham, Mass.

ETCHED Aluminum decimal chart, attaches to drafting machines. Large, legible and convenient. Prepaid for \$1.00. No C.O.D. Enterprise Products, 15½ S. Van-buren, Freeport, Illinois.

TWO Deluxe permastatic copies of discharge paper for dollar (postpaid). Cameo Photostat Service, Drawer 923, Talladega, Alabama.

KILL All weeds with 2000 degree flame, famous fire gun sterilizes, thaws, incinerates, disinfects. Works like blow torch, burns kerosene, mostly air. Economical, safe, sure. Free literature tells how. Write Sine Equipment, P376, Quakertown, Pa.

TRIM-A-HAT—Cabbage roses \$2.00, value \$7.00. Flower hat on combs \$1.00. Flower bandeau \$1.00. All colors. Gorgeous Flower Studio, P.O. Box 5281, Chicago, Ill.

YOURS For better buying through the "Product of The Month." Free informative folders. Selected Products, Box 56-K Kensington, Brooklyn 18, N. Y.

LET'S Swap! What 'cha got? What'd'ye want? Dime trial. Swap Bulletin, Royal Oak, Mich.

INFORMATION. Any subject. The Rox-bys, 747 S. New Hampshire, Los Angeles 5.

NEW Homes. Factory-made. Send \$1.00 for names and addresses of 107 firms making prefabricated houses. Housing, 1829 Burwell, Louisville, Kentucky.

PHOTO Copy for safety. Blueprints, plans, tracings, documents copied photo exact. Trial offer: One or two sides to 8½x14, \$1.00—Particulars free. (See Photo-Finish ad.) Mystalabs, 31-D, Bedford Street, Boston, Mass.

EVERLASTING Calendar! Attractive, practical. Illustrated circular free. James Dollar, Grand Place, Vancouver, Wn.

SQUARE Dance instructions, calls, 25 sets, \$1.00. Rayburn, 111-K, Eureka Springs, Arkansas.

ALNICO—Four magnets \$1.00. Lift 30 times their weight! Literature free. Ronald Eyrich, Box 849, Milwaukee, Wis.

THE Lord's coming! Get dozens free proofs. Write quickly. International Evangelism, Box 263, Duluth, Minnesota.

MAKE Your own Plastoplate printing cuts. Simple, easy process. Plastoplate, Argyle 1, Wisconsin.

PHOTO Cards. Assortment 25c. Mail-ad-dress service. Details free. Haller, 436 N. Y. Ave., Brooklyn 25, N. Y.

TATTOOING Outfits, designs, colors. Write today. Zeis Studio, 728 Lesley, Rockford, Illinois.

HOUSE Construction, new type, 60% savings possible. Send \$1.00 for instructions. P.O. Box 713, Mobile 4, Alabama.

FIREWORKS—Send for free illustrated fireworks price list. Mail your request to Premium Fireworks Company, P.O. Box 703, Covington, Kentucky.

GOOD "Used" self-instruction educational books on all subjects bought, sold, rented, exchanged. Satisfaction guaranteed. Complete information and 100-page illustrated bargain catalog free! Write—Nelson Company, Chicago 5.

BIGGEST Money in tattooing now! No experience required. Complete instructions with outfits. Send for free literature. Tatuco, 651 South State, Chicago.

"BIBLE Studies," 70 lessons 25c. Bulletin, Box 87, Station H, New York 25.

MEDICAL Laboratory technicians in great demand. We train you in your spare time, in your own home. You can practice while studying. Write for free catalogue. Imperial Technical Institute, Box 973-J, Austin, Texas.

LUMINOUS Paint. Best quality. Glows bright blue in dark. 1 oz. each paint and sealer only \$1.39 postpaid. Black Light Products, 450 E. Ohio St., Chicago 11, Ill.

METAL, Mineral locators latest 1946 electronic type ready for immediate shipment. Fisher Research Laboratory manufactured 2 million dollars worth of electronic equipment for the U. S. Army, including some of the finest metal-locators. Experience gained is yours in the best metal, mineral locator. Free 16 page booklet upon request. Fisher Research Laboratory, Palo Alto, California.

BEAUTIFUL Oil colored 8x10 enlargement of your negative, \$2.00. Lakes Photo Studio, Round Lake, Ill.

SQUARE Dance calls and instructions for forty dances. "Handbook of American Square and Folk Dances." \$1.00 postpaid. Wesley Rader, 25-E. 16th Ave., Denver, Colo.

VETERANS! While they last. Your honorable discharge emblem in beautiful 4" decal transfer. Suitable for windshield, office window or toolbox. Adheres permanently. Quarter or five for dollar. "Veteran." Box 2845, Dallas, Tex.

New 1946 WHAT TO MAKE out now!

Our annual reprint of articles selected from our "CRAFTSMAN" Department is better than ever. It contains hundreds of ideas you can use around the home and in your workshop. 208 pages. 400 illustrations. Get the 50c paper edition from your News Dealer. We shall not sell this edition at all this year. In December we shall have it and the six previous volumes bound in good-looking, durable library cloth at \$1.25 each or \$8.00 for the complete set. A wonderful addition to any craftsman's library!

POPULAR MECHANICS PRESS

Dept. 617 200 E. Ontario St. Chicago 11



Money Making Pay Raising BOOKS Catalog FREE

SEND NAME AND ADDRESS TODAY—Selected books covering all trades, office helps, home workshop, spare time work, hobbies, etc. Learn how to earn more. 1946 edition. Popular Mechanics Press 200 E. Ontario St., Chicago 11

Little Library of Useful INFORMATION

5 for \$1.00
12 for \$2.00
25¢ Each

Here at amazingly low cost is the practical help and information you have always wanted. Articles in previous issues of Popular Mechanics have been classified according to subject and are now available in these handy reprint booklets. Check Titles wanted, clip ad and mail today.

BOOKLETS ON WORKSHOP EQUIPMENT

- Power-Driven Saws—74:** Complete details on scrollsaw, two circular saws, sliding cut-off saw, bandsaw.
- Drill Presses, Plane, Grinders—79.**
- Sanders—80:** Complete constructional details on 8 useful machines.
- Wood & Metal-Turning Lathes—81:** Two wood lathes, small metal-turning lathe.
- Filing Machine, Hacksaw, Cutoff Wheel, Shaper—82.**
- Metal Lathe Tools You Can Make—101.**
- Workbenches & Tool Cabinets—47.**
- Spray Painting—94:** Constructing spray guns, compressor, using spray gun.
- From Pattern to Casting—91:** How to make your own patterns and small castings.

BOOKLETS ON SHARPENING—USING TOOLS

- Correct Measurement—106:** How to use micrometers, gauges, calipers, etc.
- Tool and Saw Sharpening—92.**
- Using & Sharpening Drills & Wood Bits—90.**
- Successful Wood Turning—32:** All the information you need to master this art.
- How to Read Blueprints—71:** Tells you how to understand signs, symbols, and lines.
- Metal Turning Lathe Kinks—99:** Simple homemade tools, time and labor-saving shortcuts you can use.
- Operating a Metal Turning Lathe—100.**
- Heat Treating & Case Hardening—102.**
- Working with Glass—103:** Cutting, drilling, etching, blowing.

ELECTRICAL BOOKLETS

- Rewinding & Servicing Electric Motors—75:** Repairing and rewinding a.c. and d.c. motors. Locating trouble. Converting auto generators into 110 v. a. c. motors.
- House Wiring—89:** All the information you need to do a complete wiring job or install extra outlets.
- Electromagnets & Solenoids—44:** Designing and building.
- Transformer Construction—41:** Easy-to-understand instructions for all kinds of transformers.
- The Boy Electrician—43:** Easy-to-build motors, experiments.
- Soldering & Brazing—17.**
- Arc & Spot Welders—5:** Building and operating 110 v. a. c. arc and spot welders.
- Treasure Finders—13:** Build your own treasure finder and metal locator. Details for both large and small radio types.

ELECTROPLATING BOOKLETS

- Electroplating with Copper, Nickel, Chromium, Lead, Zinc, Cadmium—86.**
- Plating Leather & Other Non-Metallic Objects—Plating with Gold, Silver, Alloys—87.**

HOME IMPROVEMENT BOOKLETS

- Simple Home Improvements—104:** Modernizing; making storm sash, ironing boards, etc.
- Building Extra Rooms in Attic—23.**
- Attractive Basement Playrooms—24.**
- Lower Your Fuel Cost—31:** Practical hints that will save you hundreds of dollars.
- Hanging Wallpaper—38:** Tricks of hanging wallpaper, removing old paper, etc.
- Curing Leaky Basements—45.**
- Fitting Home Game Room—55:** Construct own game & tennis tables, shuffleboard court, action game, portable playrooms.

- Ridding the Home of Insect Pests—107:** Exterminating and protecting against moths, flies, termites, mosquitoes, etc.
- Built-in Fixtures—78:** Step and space-saving kitchen units, built-in beds, corner cabinets, vanities, linen chest.
- Constructing Indoor & Outdoor Fireplaces—88:** Stone fireplaces, portable mantels, garden fireplaces.

GARDENING BOOKLETS

- Backyard Gardening—39:** Selecting, planning and getting the best results.
- Lawn & Garden Novelties—72:** Jig-sawed ornaments, parkway numbers, sundials, flower boxes.
- Trellises, Pergolas, Fences—76.**
- Lawn & Garden Furniture—77:** Modern bent-tube furniture, arbor and seat combinations, swings, lawn chairs.
- Playground Equipment—73:** Two playhouses, ferris wheel, roller coaster, treadmill, play store, slide, two merry-go-rounds.
- Colored Concrete Garden Furniture—6:** Garden benches, pottery, flower boxes, bird baths and sundial pedestals in colored concrete. How to build small concrete mixer.
- Bird Houses—7:** Easy to build homes for all kinds of birds.
- Farm & Garden Tractors—8:** Two tractors you can build from old automobile parts.

CRAFT WORK—HOBBY BOOKLETS

Complete how-to-make-it instructions for hundreds of practical projects.

- Working with Plastics—61:** Using brilliantly-colored plastics in craftwork.
- Magazine Racks—49:** Ten attractive racks.
- Clock Cases—50:** Large Hall, Colonial wall and mantel, ship's wheel, miniature grandfather, desk, Spanish style banjo.
- Serving Trays for Every Occasion—53:** Fourteen different designs.
- Children's Room Furniture—51:** Twelve attractive pieces.
- Book Ends—52:** Ten designs offer good selection.
- Small Tables—54:** Modern and colonial styling.
- Smoking Stands—56:** Seven designs given.
- Jigsawed Novelties—57:** Sewing kits, string holders, place-card holders, plywood kitchenware, plant and flower holders, coin banks, door stops, drawer pulls.
- Desks—58:** Colonial writing desk, two modern-type desks, student's study desk of plywood, combined chest and writing desk.
- Book Cases—59:** Eight designs.
- Doll House & Doll Furniture—60.**
- 25 Shelves You Can Make—64.**
- Novelties Turned on Lathe—62.**
- Inlay Pictures—Veneering—63.**
- Whittling and Wood & Soap Carving—65.**
- Action Toys—66:** 21 easy-to-make toys.
- High Flying Kites—67.**
- Windmills & Weather-vanes—68.**
- Lamps in Wood, Metal, Plastic—69:** Selection of 14 designs.
- Metal Craft—28:** Brass tapping and making of novelties both decorative and useful.
- Small Looms—37:** Building hand looms for weaving rugs, etc.; leather novelties.
- Plain & Novelty Wood Finishing—40.**
- Gem Cutting—42:** How to cut and polish semi-precious stones.

BOAT BUILDING BOOKLETS

Build a boat at home—you can do it

- 14 Ft. Outboard Runabout—2:** Here is a fast 14 foot V-bottom boat. Suitable for motors of 4 to 24 hp., estimated cost, \$30 to \$40.
- 14 Ft. Sailing Dinghy—26:** This 14-foot boat combines strength and light weight. It carries 140 sq. ft. of canvas and weighs about 350 pounds. Actual photographs and diagrams illustrate every detail.
- 21 Ft. Sloop—46:** Every fact needed by the amateur boat builder to construct this craft which carries eight to ten persons.
- Rowboats, Bicycle Boat, Small Dinghy—83:** All the information you need to construct four low-cost boats.
- Small Sail Boats—84:** 12-ft. sailing dinghy, 6-ft. "training ship" for young sailors, how to sail a boat.
- Two Outboard Runabouts—85:** 14-Ft. family outboard weighs about 400 lbs. and 12-ft. plywood outboard weighs about 110 lbs. Both are V-bottom type.
- Build Your Own Canoe, Kayak, Surfboard—30:** Complete details on 16-ft. Canadian-type canoe, 17-ft. kayak, and 12-ft. hollow surfboard.
- Fast Class-E Ice Yacht—22:** Build your own Class-E ice yacht. Every detail of construction carefully explained.

AUTOMOBILE BOOKLETS

- Automobile Kinks and Shortcuts—10:** Money-saving hints on upkeep and operation.
- Building Trailers—27:** Small Streamlined house trailer; several utility trailers.
- Motor-Driven Midget Car & Scooter—34:** Both use gas engine of washing machine type.
- Curing Auto Electrical Troubles—95.**

PHOTOGRAPHY BOOKLETS

Save Money by constructing your own photo equipment.

- Photo Enlargers—1:** Condenser lens type; simple vertical; horizontal.
- Photo Printers & Dryer—25:** Describes three practical printers, timer and negative dryer.
- Photo Darkroom Equipment—96:** Cabinets, light-tight box, timer, agitator, Washer, trimmer.
- Picture Projector, Trick & Table Top Photography—97:** Projectors that enlarge magazine illustrations and shop drawings. Tips for table toppers, photomontages, tricks.
- Photo Kinks—98:** 63 time and money-saving ideas you can use.

FORMULA BOOKLETS

Transform simple ingredients into useful products

- Cleaning Preparations—11:** Easy-to-make cleaners for walls, glass, etc. Removing fabric stains.
- Cosmetic Formulas—12:** Hand lotions, creams, rouge, bath salts, beauty clay, lipsticks, etc.
- Re-Silvering Mirrors—70:** Formulas for silvering and coloring.

MISCELLANEOUS BOOKLETS

- Knots and Ropework—105.**
- Chemical Experiments—93:** Easy-to-perform experiments. Inexpensive lab.
- Taxidermy—9:** How to prepare skins and obtain life-like poses.
- Log Cabins & Tourists Cottages—14:** Year-round log cabins; inexpensive tourists' cabin.
- Magic for Everybody—29:** Simple tricks to puzzle your friends.
- Trapping Small Animals—33:** How to lure fur bearers, prepare bait and traps, dress skins.
- Tricks of Training Your Dog—35.**
- Small Furnaces—36:** Build own gas or electric.

POPULAR MECHANICS PRESS,
 200 E. Ontario St., Chicago 11, Ill.

I enclose (U. S. bills may be mailed if carefully wrapped)
 for "Little Library" booklets numbers:

.....
 Name
 Address Zone
 City State



MEN

This Horseshoe Ring, Handmade, Hand engraved, inlaid with simulated pearl, is a **KNOCKOUT!** Shoe and shank of everlasting Monel Metal is

GUARANTEED 20 YEARS

Supply is limited...rush your order! **SEND NO MONEY.** Pay Postman only \$3.85, plus excise tax and postage. Return for refund in five days if not delighted. State size. Address:

NATIONAL JEWELRY CO., Dept. 171-H, Wheeling, W. Va.

BEAT AN EGG IN THE SHELL



Without Breaking the Shell!

Yes, you'll believe it when you see it work. **IT CAN BE DONE WITH THE NEW . . .**

ATOMIC EGG BEATER

And we'll show you how to make real money by showing new uses to your friends.

This simple device will actually mix yolk and white together within the shell without breaking.

HOMES, HOTELS, RESTAURANTS use it!

Price only \$1.00 Postpaid

SEND DOLLAR BILL WITH YOUR NAME AND ADDRESS

Satisfaction Guaranteed or Your Money Back

MARTIN MFG. CO. 1166 So. Van Ness, San Francisco 10, California

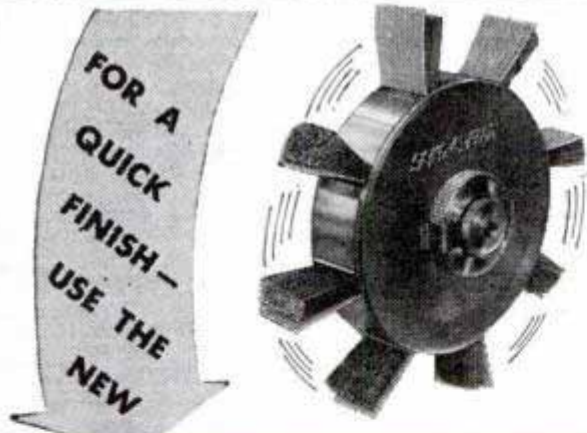

FOR A QUICK FINISH—USE THE NEW

SAND-O-FLEX ALL-PURPOSE SANDER

Here is a low-cost sander that really reaches into recesses, around edges, and handles all those tedious jobs that were formerly done only by hand. Eight bristle brushes "cushion" the abrasive cloth and force it "down in" or "evenly over" all wood and metal surfaces. The central magazine houses the strip abrasive which is fed out as needed. Refill abrasive cartridges are supplied in various grits for all types of work. Loads in less than a minute. Weight 2 3/4 pounds. Diameter 8", including brushes. Slips onto your motor shaft and produces miracle finishes on curves and contours. See your dealer or write for catalog today.

SAND-O-FLEX CORPORATION
4373 Melrose Avenue • Los Angeles 27, Calif.

BELCO PLASTICS, INC.

For HOME-CRAFTSMEN, FABRICATORS, SCHOOLS, RETAILERS, HOBBYISTS, ETC.

MAKE Sparkling, Useful PLASTICS WARE FOR YOUR HOME . . . or FOR PROFIT!

Kit #4 LUCITE CIGARETTE BOX
Only \$1.45

10c Brings Our COMPLETE PLASTICS CATALOG listing—

- FREE OFFER
- PRECISION CUT KITS
- PROFITABLE ASSORTMENTS
- SHEETS, PANELS, DYES, CEMENTS, etc.

Assemble this beautiful Lucite Cigarette Box—add a radiant, modern touch to Your Home! Crystal clear! Ideal for Candy-Nuts-Jewelry, etc. Holds 2 packs Standard or King size cigarettes. Complete with ALL MATERIALS, INSTRUCTIONS, PLASKWIKSET and PLASBUFER. Sold on our 5-day money back guarantee!

FAST, RELIABLE SERVICE!

BELCO PLASTICS, Inc.
147 W. Sidney Ave. Mt. Vernon, N. Y.

MAIL THIS COUPON TODAY!

BELCO PLASTICS, Inc. Dept. L1
147 W. Sidney Ave., Mt. Vernon, N. Y.

- I Enclose 10c for Complete Plastics Catalog
- I Enclose \$1.45 plus 15c for postage & handling. Please RUSH Kit #4 & Complete Plastics Catalog. If I am not completely satisfied, you will refund my money within 5 days!

Name.....
Address..... City..... State.....

SAY YOU SAW IT IN POPULAR MECHANICS

Now for EVERY WORK SHOP!

NEW INVENTION Electroplates by BRUSH



Easy to Plate CHROMIUM GOLD, SILVER, NICKEL, COPPER . . . For Pleasure and Profit!

If you have a workshop—at home or in business—you need this new Warner Electroplater. At the stroke of an electrified brush, you can electroplate models and projects—you can replate worn articles, faucets, tools, fixtures, silverware, etc. with a durable, sparkling coat of metal . . . Gold, Silver, Chromium, Nickel, Copper or Cadmium. Method is easy, simple, quick. Everything furnished—equipment complete, ready for use. *By doing a bit of work for others, your machine can pay for itself within a week.* So make your shop complete by getting a Warner Electroplater right away. Send today for FREE SAMPLE and illustrated literature. **ACT AT ONCE! Mail Coupon.**

WARNER ELECTRIC CO., DEPT. H-9
663 North Wells, Chicago 10, Illinois

FREE Details & Sample!

WARNER ELECTRIC CO., 663 North Wells, Chicago 10, Dept. H-9
Gentlemen: Send Free Sample and Details to:

Name.....
Address.....
City..... State.....

NOW AVAILABLE

PLASTICS

CATALOG and HANDBOOK

FUN AND PROFIT AHEAD

Plastics, colorful and glamorous materials of the future, offer you a fascinating hobby — or a profitable plastics fabricating business of your own.

CATALOG LISTS NEW MATERIALS

Ready now, the new 40-page Carmen-Bronson CATALOG gives you complete prices and data on all materials you need. Plexiglas, Lucite, Bakelite, Lumarith, Lignolite, Tenite etc. in sheets, rods, tubes and special forms—crystal-clear and in many rich, glowing colors. Catalog also lists numerous cements, dyes, compounds, accessories, supplies and semi-fabricated kits.

HANDBOOK GIVES INSTRUCTIONS

The new Carmen-Bronson PLASTICS HANDBOOK tells how to fabricate plastics easily and simply into beautiful objects for gift or sale. Contains construction plans for many simple and advanced projects. Profusely illustrated. Gives practical advice on how to start your business in this profitable field.

10¢ BRINGS BOTH BOOKS

Take the first step TODAY toward your brilliant future in plastics. Send only 10 cents NOW for your copies of the Carmen-Bronson CATALOG and Carmen-Bronson PLASTICS HANDBOOK.

CARMEN-BRONSON COMPANY

165 East 3rd Street, Dept. 6-B, Mount Vernon, N. Y.



10¢ BRINGS BOTH BOOKS



Quick, Easy, Lasting REPAIRS!



Cracks, holes, dents in wood, plaster, concrete, metal, etc. — loose handles, rungs, knobs, screws — mistakes in carpentry, etc. — fix them all with Savogran Crack Filler (hard as stone) or Savogran Wood Putty (easily tooled). Just mix with water, press into place. Stays put, hardens quickly, will not shrink! Can be painted, pre-colored. Ideal for models, inlays, etc. Patented! Big 1-lb. can only 30c at hardware and paint stores.

FREE CIRCULAR

Describes these and other Savogran Products: Heavy Duty Cleaner, Remover & Bleacher (renews floors), Paint Brush Cleaner, Strypeeze (removes all finishes), Coldfoam Soapless Soap Powder.

THE SAVOGRAN CO.
Dept. 32, Boston 10, Mass.



SAVOGRAN

Reg. U. S. Pat. Off.

CRACK FILLER · WOOD PUTTY

IN EVERY WELL-EQUIPPED HOME WORKSHOP

**V-8
DUALS
& SINGLES**



**A GENUINE PACKED
MUFFLER
WITH A BEAUTIFUL
DEEP TONE...**

Reduces back pressure and increases engine performance. Sandee time proven dependable mufflers are available in sturdy steel or durable aluminum. Savings in gasoline will usually pay for one of these new mufflers.

Ford V-8 and Mercury Duals **17⁵⁰** Aluminum \$20.00

Singles fit in place of regular mufflers.

Chevrolet, V-8, Plymouth to '42—Steel \$5.50, Aluminum \$6.50. Chrysler, Oldsmobile, Buick, etc.—Steel \$7.50, Aluminum \$8.50. Sandee steel mufflers will outlast two regular stock replacements. Sandee "Aluminum" are guaranteed for the life of the car.

SANDEE MUFFLER CO.
7523 S. WESTERN AVE., LOS ANGELES 44, CALIF.

BUILD YOUR OWN FAST FREEZER

PLANS \$1.00



It's easy to build this household appliance and profitable to use. Save up to 75%. Operates on 110 or 32 volts. Plans show 5 sizes and are easy to follow. ENJOY MAKING ONE OF these freezers from new or used parts. No expert knowledge needed. Mail \$1.00 bill or check for complete plans and catalog.

LE JAY MFG., 447 LeJay Bldg., Minneapolis 8, Minn.

LAW

STUDY AT HOME FOR PERSONAL SUCCESS and LARGER EARNINGS. 35 years expert instruction—over 108,000 students enrolled. I.L.B. Degree awarded. All texts furnished. Easy payments. Send for FREE BOOK—"Law and Executive Guidance."

AMERICAN EXTENSION SCHOOL OF LAW
Dept. 66-M, 646 N. Michigan Ave., Chicago 11, Ill.

SAVE MONEY ON GASOLINE

FITS ALL CARS



Now you can get up to 30% extra gasoline mileage with a Vacu-matic on your car. Quicker pick-up, smoother running, added power saves money every day. Guaranteed. **Automatic Supercharge Principle** Vacu-matic is entirely different! Operates on the Supercharge principle. Saves gas. Automatically provides a better gas mixture. Guaranteed to give up to 30% extra gas mileage, more power and better performance.

SALESMEN WANTED

Big profits. Every Car a Prospect. Send name and address for FREE PARTICULARS and how you get yours for introducing.

Vacu-matic Co., 7617-1277 W. State St., Wauwatosa 13, Wis.



Atom Bomb SPECIAL

RAPID FIRING, AUTOMATIC

HERE IT IS! Just what everybody has been looking for... Makes a LOUD REPORT... The very latest... Gun shoots... Rolls of 50 Rounds... Quick and Easy to reload... ALL METAL... easy grip trigger... Be the envy of the other boys... BE FIRST... Get the jump on the other fellow.

A Real Thriller
\$1.00
Post Paid

USE THIS COUPON . . . MAIL TODAY

AT-EM-BOM, INC., Dept. P-6
141 W. Jackson Blvd., CHICAGO 4, ILL. **RUSH**

Enclosed find \$.....send me.....All Metal AUTOMATIC CAP PISTOLS (\$1 each Postpaid).

NAME.....
ADDRESS.....
CITY..... STATE.....

MAKE MORE MONEY

Applying or Selling *Lasting* ROOF COATING

Extra profitable, easy to apply. Exclusive new formula makes this America's best roof coating for felt, composition, steel, slag, iron, gravel, concrete and metal roofs. Definitely superior in all climates, at all temperatures. Act at once!

DEALERS & AGENTS WANTED
Write for Details of Our Proposition



LASTING PRODUCTS COMPANY
MANUFACTURERS OF PAINTS, PUTTIES, PLASTICS
FRANKLINTOWN ROAD PLANT, BALTIMORE 23, MARYLAND

GET INTO REFRIGERATION AND AIR-CONDITIONING

Build your future in fast-growing industry. Prepare for high pay jobs or get into your own business. Resident classes only. Send ad with name and address for information. VETERANS Eligible for training under G. I. Bill. Check here

BOSTON TECHNICAL INSTITUTE
School of Refrigeration, 4707 Euclid Ave., Cleveland 3, Ohio

Say You Saw It in
POPULAR MECHANICS

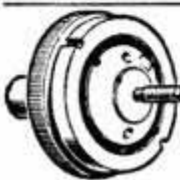

"WONDER" ELECTRIC BUTTON

Most interesting electrical apparatus ever discovered. Make your own Telephone Amplifier Detectaphone. Transmit your voice or music to distant rooms. Perform hundreds of fascinating experiments. So tiny it can be concealed in dozens of places. Send \$1 now for button and free 5,000 word instruction booklet with 50 illustrated experiments. SPECIAL OFFER 6 buttons and booklets sent post-paid for \$5.

BUCK MFG. COMPANY, Box A-28, No. Aurora, Ill.

THE INFERIORITY COMPLEX

has its roots in unreasonable fear and results in self-consciousness, nervousness, mental conflicts, lack of confidence in self, etc. Amazing psychology course points the way to **SELF-MASTERY** and a **MAGNETIC, SUCCESS-WINNING** personality! Sent postpaid for only \$1.25 (no C.O.D.'s or cheques). Money back if not satisfied. Free literature on request. **DR. G. MALCOLM SMITH, Dept. 105, 1104 Union Ave., Montreal 3, Canada.**

COLOR CONCRETE WITH CHEMICALS

A business of your own. Big money making Hollywood style pottery and birdbaths without moulds. Washing-wells, stucco-rock, benches. Marbling and cement water-paints. 10c brings sample, literature, pictures. **Hollywood CementCraft, 8529 Wonderland Ave., Hollywood 46, California**

HELPFUL BOOKS

Send post card asking for **FREE** catalog
Popular Mechanics Press, 200 E. Ontario, Dept. 601, Chicago 11

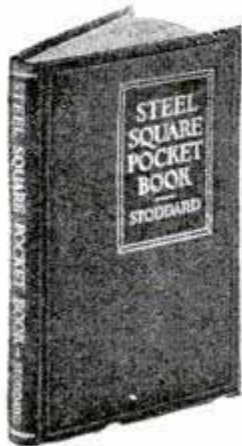

THIS BOOK SHOWS
HOW TO DO IT

STEEL SQUARE POCKET BOOK

Completely Revised

This concise and handy little book illustrates and describes the best methods of using the carpenter's steel square in laying out all kinds of carpentry work. It is easy to understand as a picture of the square laying directly on the work shows exactly how the various cuts are made. Its compact and handy size makes it convenient to carry in the pocket for quick reference.

Price \$1.00 Postpaid

POPULAR MECHANICS PRESS
DEPT. 627 200 E. ONTARIO, CHICAGO 11, ILL.

HOTEL FRONT OFFICE MANAGEMENT

A Complete Course on The Hotel Transcript

Written by the owner-manager of the Miramar Hotel (Miami) and based on teaching in the Miami Hotel School for many years, this book has been adopted by the Miami Hotel Greeters of America as their official text.

It is a complete course, explaining procedure for Room Clerks, Cashiers, Phone Operators, Night Auditor, Secretary and Manager. A special section is devoted to the Transcript of Accounts, is most important and has never been previously published in any book.

FOR HOTEL, TOURIST COURT

SUMMER RESORT— **\$5.00** POSTPAID

Whether you are now in the business or plan to enter it, this book will give you a complete course in management. It is based on actual teaching experience which has been proved successful. Send for your copy today!

FRANCIS F. HAMILTON
MIRAMAR HOTEL, MIAMI, FLA.

WE INVITE AMBITIOUS INDUSTRIAL SALESMEN

who want a permanent connection with a real future, with one of America's recognized leaders in the industrial stoker and combustion engineering field, to write us. We can offer a salary and expenses, or help an alert energetic individual get started as a dealer, in business for himself, by selling our engineering and equipment. A good salesman, or dealer, who applies himself, should net from \$6000 up annually.

Address: General Manager, Box 879, Chicago, Ill.



NOW! EASY-TO-MAKE HOMECRAFT NOVELTIES FOR PLEASURE AND PROFIT!

FREE! NEW 40-PAGE CATALOG

Our new free book is crammed with money-making facts about Leather Craft, Wood Carving, Clay Modeling, Lacing and Braiding, Wood Burning (Pyrography), Showcard Lettering, Finger Painting, Spatter Craft, Textile Coloring, and much more. New low prices on all kinds of tools, findings, crayons, art paper, modeling sets, and ready-to-finish woodcraft. Send for **FREE** copy TODAY!

- Make BEAUTIFUL Hand-Tooled BILDFOLDS CLAY MODELS WOOD CARVINGS POTTERY SPATTER CRAFT BOOK ENDS BRACELETS

DWINNELL CRAFT SHOP, Dept. P66, Elm Grove, Wheeling, W. Va.

LEARN WATCH & CLOCK REPAIRING At Home



STEADY WORK • SECURITY • HIGH PAY

Prepare yourself now for this fascinating high-grade occupation. You can earn while you learn. This UP-TO-DATE COURSE IN HOROLOGY shows you how to get the practical working experience you need for big-time success. THOROUGH SELF-INSTRUCTION TRAINING in American and Swiss watches, clocks, etc. Interesting **LEARN-BY-DOING** teaching method makes lessons easy. No previous experience necessary. Watchmaking is BASIC TRAINING for many scientific and mechanical precision jobs. Amazing low price. Satisfaction or money-back guarantee. Get into this fast-growing field NOW... big opportunities. Mail coupon for free information.

LOCKSMITHING & Key Making

Practical modern course for self-instruction. How to pick locks, de-code, make masterkeys, repair, install, service, etc., etc. For carpenter, fix-it shop, service station operator, hardware dealer, gunsmith, mechanic, home-owner, 53 easy illustrated lessons. Mail coupon for free details.

Practical ELECTRICITY

Quick course for men who demand how-to-do-it practical facts. Covers house-wiring, generators, storage batteries, telephones, lighting equipment, telegraphy, welding, etc. 55 lessons at surprisingly low price. Satisfaction guaranteed. Mail coupon below for complete interesting details.

SHORT-CUT Mathematics

How to be a "master mind!" This 2-in-1 self-study course teaches how to juggle figures, do baffling tricks with numbers. Also teaches practical mechanics... for every technically minded man who wants to get ahead. Used by stage magicians, expert accountants, etc. Only \$1. See coupon.

FREE! 100-PAGE BOOK! Mail this Now

NELSON CO., Dept. 2F02, 1139 S. Wabash Ave., Chicago 5, Ill.

Please send me—free and without obligation—big illustrated Success-Catalog containing complete information about subject (subjects) checked below. (No salesman will call).

- Watch & Clock Repairing Practical Electricity
 Locksmithing & Key making Short-Cut Mathematics

Name _____

Address _____

GLOWS in the DARK

MAKE BIG MONEY Selling Luminous Pictures

Your customers will gasp with wonder at these amazing new luminous pictures, statues, novelties. Be the first to sell them! Religious, nursery, glamour and other subjects. Sell on sight



Madison Mills, 303 Fourth Ave., New York 10 N. Y.

LEARN



PORTRAIT PAINTING AT HOME

• Previous art training or talent NOT necessary. The Stuart System teaches you, in 11 easy-to-follow lessons, to (1) locate features exactly to correspond to model's features, (2) outline head and face to correspond to model's outline, (3) make each feature a true portrait of that feature in the model, (4) produce shadows and shading that exactly correspond to that of model's face, (5) mix flesh paint tints that are like living flesh. You, too, can make exact charcoal and oil likenesses. Send for free booklet **today**.

STUART STUDIOS

121 Monument Circle, Room 666, Indianapolis 9, Ind.

Please send me free book and outline of lessons.

Name _____

Street _____

City _____

State _____

AMAZING MONEY SAVING OFFER **\$9.95** Plus Fed. Tax

BEAUTIFUL SWISS WATCH

AND MATCHED

STAINLESS EXPANSION BAND

No need now to pay high jewelry store prices—instead, you can save money and have a beautiful Swiss Watch and Stainless Expansion Band—Flexible From Tip to Tip—complete—ready for your wrist for only \$9.95, plus Fed. Tax. Think of it! Watch is a good time piece, has smart, white face, black numerals, and black hands. And the Band is a beauty. Highly durable for long wear service.



SEND NO MONEY—Just pay only \$9.95, plus 10% Fed. Tax and postage C.O.D. Or enclose \$10.95 (tax included) for postpaid delivery. Return in 5 days for refund if not delighted.

KENT JEWELERS, 105 N. Clark St., Dept. PM-6, Chicago 2, Ill.

SPONGE-AWAY



helps dog get over Summer Eczema from fleas

Is your dog scratching himself sore? Then treat him for Summer Eczema; sponge him with (or dip him in) Sponge-Away solution. Always itching, checks scratching. Kills fleas, lice, ticks. Promotes healing, hair regrowth. Speed your dog's recovery from disfiguring Summer Eczema. Get 25c bottle (makes 2 quarts) from pet, drug, or department store today.

A PULVEX QUALITY DOG PRODUCT

ONE-MAN SAWMILL LESS THAN \$200.00

Easy To Turn Trees Into Money

Makes lumber, ties, shingles, crates, lath, studding, siding.

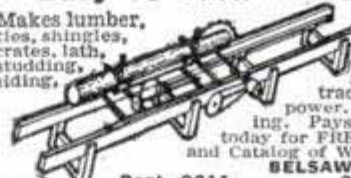

Belsaw Models

in 10, 14, 20, 24 ft. sawing lengths. Patented Mechanical Feed, accurate set works and positive dogs. Use tractor or old auto engine for low cost power. Thousands used for commercial sawing. Pays for itself quickly. Send post card today for FREE booklet, "How To Make Lumber" and Catalog of Woodworking Equipment.

BELSAW MACHINERY COMPANY

Dept. 2811

3542 Main Street, Kansas City, Mo.

NEW! Ideal Gift for Your Service Man!

Heavy 10K Solid Gold Souvenir Service Ring of World War II. A beautiful and authentic ring that your service man will be proud to wear and cherish forever. It plainly shows that he is a Veteran of our Armed Forces of World War II. Available in all sizes. We pay postage and Fed. Tax.

No. 1214 10K Solid Gold \$18.00
 Solid Sterling Silver - - - - \$6.00



Send for Circular of Service Jewelry

EDWIN W. LANE CO., Dept. PM, 32 W. Randolph St., Chicago 1.

CHAPMAN CHINCHILLAS

The originator of the first Chinchilla Farm in the United States. For information on purchasing the finest, selected breeding stock of these aristocratic animals that were virtually trapped to extinction write or visit—

Established 1919

Chapman Chinchilla Farm
 4957 West 104th Street
 Inglewood, California

SELL BIBLE SOUVENIR

METAL COINS, LORD'S PRAYER, ONE SIDE; JOHN 3:16 on THE OTHER—Quick Easy Sales—Very attractive pocket piece. Quantity Price \$6.00 per 100; \$27.50 per 500; \$50.00 per thousand. Don't Wait... Order Today. Sample Order 15 Coins with Display Card, \$1 Postpaid. **LOUIS LE VITE, 21 E. Van Buren St., Dept. P5, Chicago 5.**

SILVER DOLLAR SIZE

THE REVOLVING SENSATION A TRUE BALANCED GYROSCOPE

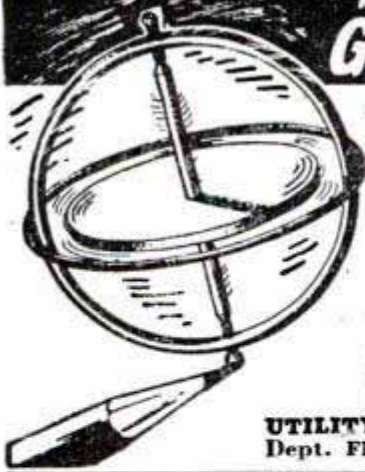

That Spins Like the Earth Itself!

- Balances on a pencil point!
- Spins across a string!
- A truly scientific toy!

Now Only
\$1
Postage extra

Both young and old will find great excitement and pleasure in this truly great toy. Order several now for Christmas. They make wonderful gifts.

UTILITY STORES, 117 S. Wabash
Dept. FF-31 Chicago 3, Illinois

PARVA-GRAPH



A COMBINATION SQUARE, DIVIDER, PROTRACTOR, TRIANGLE, RULER, COMPASS, FRENCH CURVE & MITRE

EASY TO USE

FOR CLASSROOM, WORK SHOP OR HOME

ONLY \$1.25

SEND CASH OR MONEY ORDER—TODAY!

MASTER SPECIALTIES CO., DEPT. P
Box 16, Boulevard Station, New York 59, N. Y.

AMAZING MYSTERY BUTTON



Startles Everybody. With this Electronic Button you can make your own Telephone—Amplifier—Detectophone. Attach this button to piece of cardboard—transmit conversation to another room. Music also transmitted to distant places. Most interesting, electrical apparatus ever discovered. Enables you to perform hundreds of experiments. So tiny it can be concealed in dozens of places. A Pre-War Product. Electronic Button including 5000 word instruction booklet with 50 illustrated experiments postpaid only \$1.00.

Electronic Products Company, Saint Charles, Ill.



WHY WEAR DIAMONDS

When diamond-dazzling Zircons from the mines of far-away mystic Siam are so effective and inexpensive! Thrilling beauty, stand acid, true backs, full of FIRE! Exquisite mountings. See before you buy. Write for FREE catalog.

National Zircon Co., Dept. 20
Wheeling, W. Va.

Catalog
FREE!

BUILD YOUR OWN ARC-WELDER

For Light or Heavy Work

No rewinding necessary—use coils taken from old auto generators. Works on 110 or 220 A.C. Has 20 different heats. Complete plans and BIG Catalog 35c.

LEJAY MFG. CO.

3347 LeJay Bldg.

Minneapolis, Minn.



We Make INVENTORS' MODELS

Models built to your specifications in absolute confidence. Fully equipped machine shop, competent skilled engineering organization. Send rough sketch for estimate.

WINTON ENGINEERING CO., 216 West Elder St., Cincinnati, Ohio



DRILL-INDEX A compact container for indexing and filing twist drills. Eliminates search. Made entirely of steel in nine sizes. See your dealer or write to HUOT MFG. CO.

Foot Schultz Bldg. St. Paul 1, Minn.

YOU CAN MASTER MATHEMATICS

Key to the Electronic, Atomic age. Mathematicians in great demand. \$200 to \$500 per month. Literature free.

O-UNIVERSAL SCHOOL OF MATHEMATICS
623 Walter Story Bldg., So. Broadway, Los Angeles, Calif.

CRESCENT TOOLS

Give Wings to Work

ASK YOUR
HARDWARE
DEALER

ANCO RAIN-MASTER

"Dead-Locker"

WINDSHIELD WIPER
ARMS and BLADES

BLADE SNAPS ON...
STAYS PUT

FINGER-
TIP
RELEASE

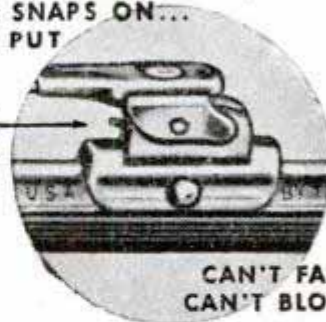

CAN'T FALL OFF
CAN'T BLOW OFF

(A war-born invention—by ANCO—first)
for military aircraft—now for your car.)

DON'T SHOOT YOUR GAS-PUMP MAN!

He's doing the best he can. Sure, he knows how dangerous it is for you to drive your car... in stormy weather... with your dull old windshield wipers that smear and smear. He'd gladly put on for you quickly a pair of keen new ANCO RAIN-MASTER Wiper Blades and Arms. He has them—Newest Models! But he forgets to remind you? Too busy? You can't shoot him for that!



PATENTS
MAKE JOBS

After all, it's *your* car to protect. So you remind him. Get RAIN-MASTERS... patented features... original equipment on many makes of high grade cars and trucks... used in war—on our fighting tanks and trucks and ships and bombers too... because ANCO RAIN-MASTERS clean quicker, clean cleaner... last longer. May save you a costly smashup.

Ask for RAIN-MASTER Windshield Wiper Arms and Blades next time you buy gas.

THE ANDERSON COMPANY

Established 1918

GARY, INDIANA

SAY YOU SAW IT IN POPULAR MECHANICS

Now! Get COPIES of Anything—in a Jiffy! . . . Right in your own office! New low-cost, error-proof method saves time, typing, hand-copying, drafting and checking.



AMAZING NEW UNIT—

The APECO PHOTOEXACT

Copies anything written, typed, printed, drawn or photographed—even if on both sides!

Photo-Copier
\$55
Copies up to 18" x 22"

Also continuous cabinet models for prints of any length, up to 42" wide.

Quickly, Easily copy LETTERS, BLUE PRINTS, PICTURES, CONTRACTS, VALUABLE PAPERS, FINANCIAL DATA, CHARTS, CLIPPINGS, MAPS (over 100 others)

NOW, make copies of anything written, typed, printed, drawn or photographed—even if on both sides! Photocopies made at 1-a-minute speed—for less than the price of a phone call! No darkroom or technical knowledge needed. Anyone can operate APECO—"America's Most Widely Used Photocopy Equipment." Get full information, TODAY!

MAIL COUPON NOW for this FREE BOOK

AMERICAN PHOTOCOPY EQUIPMENT CO.
2849 N. Clark St., Dept. GF66, Chicago 14, Ill.

Send without obligation, your 20-page illustrated book on Photocopying and its saving in time, money and labor.

NAME.....
COMPANY.....
TITLE.....
ADDRESS.....
CITY & STATE.....



STOP WORKING for the OTHER FELLOW

BE YOUR OWN BOSS — OPERATE YOUR OWN PROFITABLE BUSINESS IN . . .

HOME AND INDUSTRIAL APPLIANCES



MODERN SERVICE-REPAIR AND INSTALLATION WORK

NEW! DIFFERENT! . . . Gives you practical shop training on real appliances including washing machines, mangles, heat control systems, vacuum sweepers, electric motors, circuits and controls, plating processes, welding, etc. Start work immediately on actual machines under trained instructors.

ACTUAL SHOP TRAINING ON APPLIANCES

Thousands of appliances need expert repairs now. New ones coming off the assembly lines must be installed and serviced. It's fascinating, profitable work. Jobs are everywhere! Investigate this opportunity now. Let us show you the money-making possibilities—the need for trained men—how easy it is to open your own shop and be your own boss. Veterans, ask for special G.I. plan. Act now!

RUSH COUPON FOR FULL DETAILS

APPLIANCE TRAINING SCHOOL, Dept. M 21
Div. of Commercial Trades Institute
6312 N. Broadway, Chicago 40, Ill.
Gentlemen:
Please send Free Details.
Name.....
Address.....
City.....State.....
 Check here for G.I. plan.

OLD EST. SCHOOL MOST COMPLETE TRAINING COURSE OF ITS KIND

Make Anything GLOW



IN THE DARK

WITH THE NEW "GLOWING TAPE"

A new, improved innovation! Glowing Tape! Makes anything glow in the dark like magic! Adheres to any surface . . . no liquids, no mixing, no brushing. Easy to use. Just cut tape to desired size and paste to anything . . . and watch it "glow." Glows all night—lasts indefinitely. Will not mar most delicate surface. Can be used over and over again. Has many special uses. Ideal for light switches, clocks, house numbers, toys, ornaments, photo dark room equipment, camping equipment, staircases, safety signs, etc. Makes many novel party effects. Can be used in industry, at home or "just for fun." Magi-Glo tape is available with paper backing or the more durable cloth backing. Complete ready to use kit contains supply of 1", 2" and 4" wide tape strips.

MONEY BACK GUARANTEE!

Complete Magi-Glo Tape Kit with paper backing only \$1. With cloth backing \$1.50. Just send name and address plus check, cash or money order and kit will be forwarded promptly—postpaid. Satisfaction guaranteed or money refunded! Order today!

MAGI-GLO

Dept. 110, 356 W. 63rd St. Chicago 21, Ill.

FREE COLLECTOR'S RARITY
NEW MacArthur's GHO IDENTIFICATION PATCH



COLLECT RARE MILITARY SHOULDER PATCHES

Start a collection now of hard-to-get, famous U.S. and foreign military shoulder patches. Take your pick of Army, Navy, Marine, Air Force, German, Jap, RAF and other foreign insignia, in bright colors and fascinating designs. Send \$1.00 for Famous Group of 20 patches plus free catalog illustrating hundreds of patches, and get free the famous patch illustrated. You may if you choose send only 10c for big catalog and price list.

THE PATCH KING, Dept. 106

P.O. Box 101, Madison Square Station, New York 10, N. Y.



A PROFITABLE BUSINESS FOR YOU

You need no special skill to start a profitable business of your own. Earn \$5.00 per hour applying our quality gold and silver foil letters to window lettering, house numbers, automobile and truck signs. Our \$30.00 kit supplies you with carrying case, excellent selection of types and sizes of die-cut letters and numerals and all materials, plus thorough instructions for easy production of professional quality signs. A new and large field. Order your kit today or investigate our method of lettering by sending \$1 for your name in gold letters on glass name plate, plus free circular outlining this great opportunity.

SIMPLEX SIGN SYSTEM

1415 W. Howard Street

Chicago 26, Illinois

Be Your Own Boss — In Your Own Business

Start at home . . . small capital needed . . . prepare for exciting plastics jobs or Your Own Plastics Business. We teach you Fabrication and Casting right in your own home. All materials furnished. Send ad with name and address for information. VETERANS: Eligible for resident training under G. I. bill, Check here

LEARN

PLASTICS

PLASTICS TECH
School of America, Inc.
5200 Euclid Avenue
Dept. M-6, Cleveland 3, Ohio

NEW! D. D. T. AIR-GUN \$1

Loaded with half pound of 10% D.D.T. Powder. See article page 97, May Popular Mechanics. Safe and easy to use. Sent postpaid for only \$1. **AGENTS: SEND FOR DETAILS.**
ILLINOIS CHEMICAL, 12844 Carondelet Ave., Chicago 33, Ill.

SAY YOU SAW IT IN POPULAR MECHANICS



Building A New Home? Buying?

Read "Story of Prefabricated Houses." Every prospective owner needs this brief, factual book. Tells about materials, methods with factory-made houses. \$1.00 postpaid. Free Premium. **RESEARCH, Box 169-A, Columbus, Ind.**

RADIO PARTS GRAB BAG!!

\$25 original value assortment of Coils, Condensers, Transformers, Resistors, Controls, etc. An experimenter's dream. While they last, only
MARKO SUPPLY, Dept. P.M. 6
2924 Logan Blvd. Chicago 47, Ill. **\$3.98**

Start Today! LEARN SPANISH AT HOME *The Quick Easy Way!*



NOW! Learn to read, write, speak Spanish the new, quick easy way. Costs only a fraction as much as other courses. Only 3 records. Only 3 easy steps to each lesson. Written by an American for Americans. So easy to understand that anyone can learn quickly. Big asset in business and social life. Simple as A.B.C. No extras to buy. Money back if not completely satisfied. Supply of records limited. Rush handy coupon today.

Start now! Send for this Quick Record Course today! Written by Frank Henius, world famous linguist! Dramatically new! Amazingly simple! Almost miraculous!

\$6.04

Tax Included

ORDER DIRECT—TODAY—PROMPT SHIPMENT

UTILITY STORES

117 South Wabash Avenue, Dept. FF-33, Chicago 3, Illinois
 Enclosed find \$_____ for which ship at once QUICK SPANISH RECORD COURSE at \$6.04 for Complete Course.
 Name _____
 (Please Print)
 St. or R.F.D. _____
 City _____ Zone _____ State _____
 (Established 1906)

SHEET METAL PROJECTS OLD SNIPS' BEST SELLERS

- 34" x 44" Blueprints
 - #103 Colonial Post-Top Lamp . . . Hinged door for relamping. Makes beautiful copper project. . . . \$1.00
 - #427 Plate Girder & Box Truss Bridges . . . Inverted deck type. HO Scale with conversion table. . . . \$1.00
 - #865 Fishing Tackle Box . . . 3 trays, sinker bin, sand-spike, hook-holder, reel compartment. . . . \$1.00
 - #951 Executive's Desk Lamp . . . Modern fluorescent, built-in picture frame for 5 x 7 Portrait. . . . \$1.00
- DRAFTSMEN ASSOCIATES
 3300-2 Aldine St. Philadelphia 36, Pa.



NEW ART BOOK MAKES FIGURE DRAWING EASY

The new, revolutionary Block-In system of free hand sketching makes figure drawing so easy that even the beginner will be amazed at how easy he can learn to draw. Book contains a wide assortment of lovely artists models beautifully photographed. Published in 2 volumes. Only \$1.50 each. Mailed in plain, sealed wrapper. No C. O. D. or stamps.



ACME BOOK SERVICE, Dept. P-2, 5 Frankforts St., N. Y. 7, N. Y.

LEARN MASTER MACHINIST MECHANICAL DRAFTING

Expert training on Lathes, Milling Machines, Shapers, Grinders, etc. Allied shops are completely equipped and modern. Approved for G. I. Training. Days, Evenings.

ALLIED SCHOOL OF MECHANICAL TRADES
 1330 South Michigan Avenue Chicago 5, Illinois

WATCH REPAIRING at home

Construction, Repair adjustment. New, complete "PRACTICAL COURSE" for beginners and professional repairmen. All essential steps. Theory, operation. Many test cases. Full coverage of tools, materials. Fully illustrated. Only \$2.95 postpaid. Money back guarantee. Free catalogue.



We Supply Tools, Materials at Lowest Cost!
 Modern Technical Book Co., Dept. M5MC, 55 W. 42nd St., N. Y. 18

Now! A Better Soldering Tool... THE KWIKHEAT THERMOSTATIC SOLDERING IRON



Has Built-in Thermostat Control!

6 TIP STYLES

- #0—\$1.25
- #1—\$1.25
- #2—\$1.25
- #3—\$1.25
- #4—\$1.75
- #5—Melting Pot for tinning—\$1.25

HOT, READY FOR USE ONLY 90 SECONDS after plugging in! Kwikheat is the only soldering iron with a thermostat built into the tool itself*—maintaining the proper level of heat for most efficient, economical operation. SAFE! ... Cannot overheat—ECONOMICAL! ... Lasts longer—saves tips and requires less retinning. POWERFUL!—225 watts—yet exceptionally light weight (14 oz.). Well-balanced with cool protecting plastic handle. Modern streamlined design. Six interchangeable tip styles adapt one Kwikheat Iron to all your soldering jobs. You will be proud to own America's finest and most versatile soldering tool... from tip to plug Kwikheat is in a class by itself. Ask your dealer to demonstrate the quick-heating feature now!

*patented
 Kwikheat Iron with choice of any one tip . . . \$11.00
 Set of 5 Tips, consisting of #0, 2, 3, 4, and 5... \$5.50



Dept. PM-0, Kwikheat Division of
SOUND EQUIPMENT CORP., 3903 San Fernando Rd., Glendale, 4 Calif.

Play this New HARMONICA In 15 Minutes

OR MONEY BACK



For Only \$1.49 You Get This Brand New Golden-Tone Harmonica, Plus Hoppy's Sensational Simplified Course of Instruction That Quickly Teaches You to Play Song Hits of Every Kind . . .

TRY 7 DAYS AT OUR RISK

Not a toy, but a real musical instrument . . . that's what you get in this sensational Key of C HARMONICA offer! Every man and woman, every girl and boy, who can hum a tune now CAN own this simplified HARMONICA and HOPPY will teach you to play it. It's quick, it's easy, it's exciting! HOPPY shows you how to play ordinary tunes in 15 minutes. Then, let HOPPY'S Complete Book of Instruction teach you, and if you aren't playing waltzes, hymns, marches, dance music and even classics in one quick week, return purchase and your money will be refunded. Best of all, the wonderful HARMONICA plus HOPPY'S COMPLETE BOOK OF INSTRUCTION and 200 songs with words is yours for only \$1.49 on this special introductory offer.

SEND NO MONEY...WRITE TODAY

Just send your name and when your HARMONICA and BOOK OF INSTRUCTION arrives pay \$1.49 plus C. O. D. postage thru postman. You take no chances. Put your Golden-Tone HARMONICA and COURSE to every test. If a 7 day trial doesn't convince you in every way return purchase for full refund. Quantities are limited so act today. (Send \$1.49 with order and we pay postage.) Write today to

HOPKINSON COMPANY, Dept. 49-H
360 N. Michigan Ave. • Chicago 1, Illinois

PLASTIC HOBBY CRAFT KIT

Kit contains 2 lbs. PLEXIGLAS and LUCITE sheets and strips, dye, cement, sandpaper, buffing compound and fabricating instructions. Send \$3.00 money order to Dept. 8.

HOME CRAFTSMAN PLASTICS, 1945 W. Harrison St., Chicago 12, Ill.

BROADCAST Your Own PROGRAMS Thru Your Own RADIO!



Tell jokes, imitate stars, sing, give news reports, make funny remarks about your friends present. Loads of fun! Surprise friends by cutting in and out of regular radio programs to your own home broadcast. Test your radio voice, discover hidden talent, improve diction, amateur hour practice, etc. A real metal microphone NOT A TOY. Size 8" x 3 1/2". Easily attached to any radio. Comes complete with long flexible cord for hiding it in another room, and Push-Button Switch for cutting in and out of programs.

SEND NO MONEY—10 Day Trial Satisfaction Guaranteed or Money Back. Immediate delivery. Pay postman C. O. D. only \$1.49 plus postage, or send payment and we pay postage. You'll be thrilled!

GREAT AMERICAN SALES CO., 2226 Silverton Road, Dept. S 86, Chicago 16, Ill.



Only \$1.49

HAVE FUN WITH Hobby Craft

KITS 50¢ UP

Work with leather, clay, felt, metal, wood, plastics, etc. Complete kits with materials, tools and instructions. Sell what you make! Send 10c for 32 page catalog, "Have Fun with Hobbies."



FREE: To new Guild members, 20 booklets on hobbies. INQUIRE TODAY!

HOBBY GUILD

34B West 33rd St., N. Y. 1



SING-TALK thru your own Radio with Radio MICROPHONE

Put on your own broadcast at home with this Radio Mike. Sing, Talk from any room in the house. Make announcements. Lots of fun! It's wonderful voice practice. Easily attached to any radio. SEND NO MONEY. Pay postman \$1.98 plus postage. Send check or money order and save postage.

DISCO SALES, INC. (Dept. 22), 154 Nassau St., New York 7, N. Y.



"The Book They're Talking About"

ART ANATOMY OF THE HUMAN FIGURE

For the amateur and professional artist. Contains over 350 illustrations, charts and notes, giving detailed study of every part of the body. POSED and IN ACTION. Price Only \$1

Major Book Co. (Dept. 12-A), 241 E. Broadway, New York 2, N. Y.

LENSES 500,000 OF THEM

Buy them for a fraction of their original cost. U.S. ARMY & NAVY surplus lenses and prisms. RIGHT ANGLE PRISM 23 m/m sq. face. \$ 1.25 5 POWER TANK TELESCOPE (M71) Brand New. Coated Optics Completely Assembled. Value \$345.00 Perfect ea. 22.50 COMPLETE SET OF OPTICS FROM PERISCOPE RIFLE SIGHT, Value \$24.00. 2.25 METAL PARTS TO MAKE A COMPLETE 5 POWER TANK ARTILLERY SCOPE, Diagram included. 7.50

Send Money Order or Check—3 cent stamp for list
A. JAEGER, BOX 84 P, SO. OZONE PARK 20, N. Y.

New Designs in FRANZITE GRIPS



Modernize Your Gun! Improve Your Score! Most durable grips made. Positively unbreakable! For Colt, Smith & Wesson, Hi-Standard. Ortigas, Luger & Mausers in a wide choice of beautiful designs in ivory, pearl, walnut, onyx, etc. Low prices. FREE CATALOG. Dealers Wanted.

SPORTS, INC., (Mrs.) 5501 Broadway, Dept. P-6, Chicago 40, Ill.



Balance 4" x 9" Base. With either Metric or Avoirdupois Weights . . . \$6.00 Catalog with 3000 Illustrations of Laboratory Apparatus sent for 75 cents. Catalog listing 10,000 chemicals, drugs, minerals, etc. and 1500 scientific books sent for 25c. Catalog of 1000 books 10c. LABORATORY MATERIALS CO. 7321 Vincennes Ave. Chicago 21, Ill.

BUILD A POWERFUL BODY

The Progressive System Of Physical Culture used by professional strong men in acquiring their great strength is now available in its simplest and most economical form. It will pay you to investigate and compare with other methods. Write for information.

DR. FINN, 1725 E. 58th Place, Los Angeles 1, Calif.

WINDOW SIGN LETTERS

For Store Fronts and Office Windows. Anyone can put them on. Samples furnished. Genuine Gold and Silver. METALLIC LETTER CO., 430 N. Clark St., Chicago 10

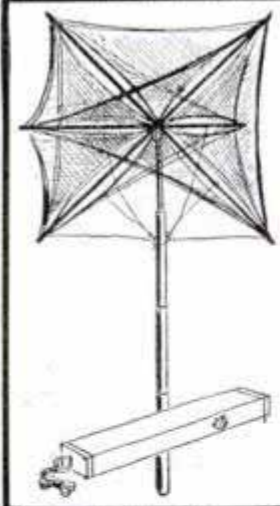

SENSATIONAL!
War Surplus!
TWO-WAY AERIAL

Collapses to Pocket Size
 Stainless monel metal mesh panels. Completely weatherproof. Cannot rust or corrode. Ideal for every radio use. For campers, Marine radios, portable sets. Complete directions included. **BRAND NEW.**
\$30.00 value. Your \$3 price, postpaid, only..
No C.O.D.'s.
SURPLUS SALES CO.
 1234 W. Kinzie St., Chicago, Ill.

GET THIS NEW HOME PLANNING KIT TODAY!



Not a Book of Plans but
A COMPLETE KIT OF WORKING MATERIALS TO HELP YOU PLAN YOUR HOME—As You Want It!

If you are planning a home you need this kit with its 17x22" Scale Layout Sheets for your Floor Plans, Scale Furniture Cutouts, Landscape Layout Sheets, Building Equipment and Material Selector, Dream House Check List, many other exclusive features.

FUN and HELP for HOME PLANNERS—

A portfolio of actual working materials you need to plan your home. Nothing else like it available anywhere. Comes in loose-leaf form, size 8½x11", with plastic binding posts so you can remove sheets and replace them; while you are working out your plans.

Special features include individual room layout sheets to scale, interior decorating charts, a Budget Planner for estimating your costs and monthly upkeep and a set of Model Specifications. Send for your copy today.



MONEY BACK \$200 GUARANTEE

Your money returned in full if you are not satisfied.

IMMEDIATE DELIVERY — Mail this Coupon Now

Red Lion Press, Golf 1, Ill.
RUSH me one of your new loose-leaf Home Planning Kits postpaid \$2.00 enclosed. I will pay postman \$2.00 plus C.O.D. charges.
 Name.....
 Street.....
 City.....Zone....State.....

GET INTO PLASTICS



FREE BOOK ON PLASTICS

Answers your "Plastic" Questions. Flexible Molds. Liquid Marble. Plastic Flooring. A guide to Money Making Opportunities. Tells you how to start. Questions and Answers. If you're interested in this new field write now!

FREE BOOKLET
Send for it Today!

Act now! Get started while the field is not crowded. Don't delay!

BING PRODUCTS Dept. A6, 88 Broad Street Boston 10, Mass.

LENSES

Surplus Lenses At a Small Fraction of Cost

Experimenter's Assortment—Twenty assorted lenses ranging from powerful short-focus microscope objectives to large magnifiers, some with edge chips or minor defects, but all usable—excellent for making all types of optical instruments. **\$1.50**
DeLuxe Assortment—includes forty large and small plain lenses, achromatic lenses, and prisms. Worth many times the price. **\$4.95**

PROMPT SHIPMENT GUARANTEED — WE PAY THE POSTAGE

BROWSCOPE CO., Dept. 6M, 24 W. 45th St., New York 19, N. Y.

MAKE BIG MONEY!
...SELL LOWEST-PRICED PRINTED STATIONERY in U.S.A.

Make really-BIG MONEY selling personal-printed stationery and printed stationery specialties at prices that are GUARANTEED lowest in U. S.! Highest quality. You sell big package of personal printed stationery containing customer's name and address beautifully printed on 40 sheets and 20 envelopes—for 39¢! Also 200 personally printed gummed labels for 35¢! Other amazing bargains that will open your and customers' eyes. Nationally advertised for years. Millions of packages sold yet tremendous market is practically untouched. We furnish complete selling outfit FREE! Write for full FREE details NOW! Please HURRY! Due to paper shortage we can accept limited number of representatives.

40 SHEETS & 20 ENVELOPES PRINTED WITH NAME and ADDRESS 39¢

WESTERN STATIONERY CO., Dept. 480-F, Topeka, Kansas

Say You Saw It in POPULAR MECHANICS

NEW CHEAP OIL BURNER



FOR COOKING & HEATING STOVES-FURNACES
 HEAT YOUR HOME, COOK YOUR MEALS WITH CHEAP FURNACE OIL

NO MORE SHOVELING COAL OR ASHES. New Fuelizer Starter Vaporizing System turns Cheap 130 Flash Furnace Oil into Oil Gas heat without clogging up. **LIFE-TIME GUARANTEE** against defects. **\$1.00-BONUS OFFER FOR TESTING.** We will let you try it in your own stove or furnace for one month. Get Yours for introducing. Big profits. Be first. Send in your name today.

NORTHWEST MFG. CO. 561-G 5th Ave. Mitchell, So. Dak.

ALL YOURS with an Evinrude

Check every quality and feature you want in a modern outboard motor . . . chances are, you'll find that Evinrude offers every one . . . *and more!* Each developed and perfected the sure and steady way . . . through 37 years of progressive engineering, experimenting, *proving*. That background is worth remembering—when you choose an outboard motor!

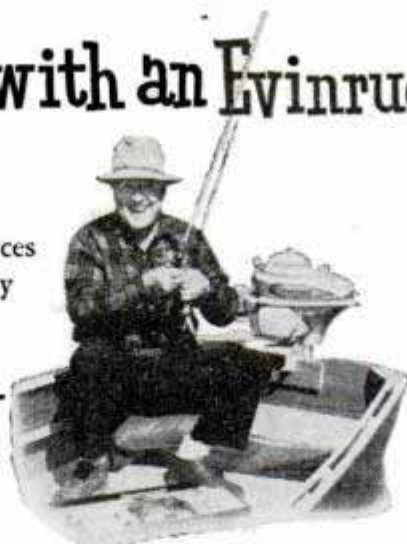

Want Sure Starting? Fine! That's an Evinrude "specialty" . . . always, on every model, it's mechanically *built right in!*



Co-Pilot Steering! On every model the "unseen hand" that grips when you let go . . . holds the motor on the course you set.



Operating Ease! — with controls so simple and troubleproof that even youngsters handle an Evinrude easily and capably.



Quiet! Smooth! Perfected underwater silencing buries exhaust fumes and noise. Float in vibration-absorbing bearings.



Slow Trolling Speed!—enables you to check right down to a slow trolling glide without choking, stuttering or stalling.



Full Reverse! On two great fishing models — provides instant reverse, utmost maneuverability, 360 degree steering.



Four-cylinder Performance! Nothing like it for smoothness, thrilling responsiveness — and Evinrude offers it in four models!



Widest Range of Models! The right motor, for every boat, every service. Eight models, all with O.B.C. horsepower certification.

It all adds up to finer *performance!* And back of every Evinrude is the priceless advantage of organized, responsible, nationwide *service* . . . available everywhere through a veteran organization of selected dealers. *See your Evinrude dealer* — look for his name in your classified phone directory under "Outboard Motors". *Catalog free!* Address, EVINRUDE MOTORS, 5297 N. 27th St., Milwaukee 9, Wisconsin

In Canada: Evinrude Motors, Peterboro, Ontario



EVINRUDE

OUTBOARD MOTORS

By Aubrey O. Cookman

FOR MANY weeks countless planes of all descriptions have been sweeping low over the Indianapolis Municipal Airport. A plane drops so close it almost touches down, only to roar away in a burst of power. In a short while another follows and repeats the performance.

Baffling to the casual onlooker, perhaps, but not to Civil Aeronautics Administration experts working hard to whip a major aviation problem—bad weather landings.

You didn't know it, of course, but the pilots in those planes were "blindfolded," to all intents and purposes, and the technique that brought them almost to touch-down was an important wartime radar development called GCA, or Ground Controlled Approach. It was born of a necessity to fly against the enemy in all kinds of weather and yet give our airmen every conceivable chance to operate safely. Now the CAA is testing to determine how many of its benefits are operationally practical enough to be passed along to civil aviation.

The Army has set down planes on dual runways at 30-second intervals, using the system, while the best that can be done

Search antenna atop radar landing control tower. Below, closeup of an indicator panel

POPULAR MECHANICS

JUNE
1946

WRITTEN SO YOU CAN UNDERSTAND IT
VOL. 85 NO. 6

Your air liner will one day land you in zero visibility, led by a radar man in a tower who can "talk down" one a minute

RADAR LANDS THEM BLIND

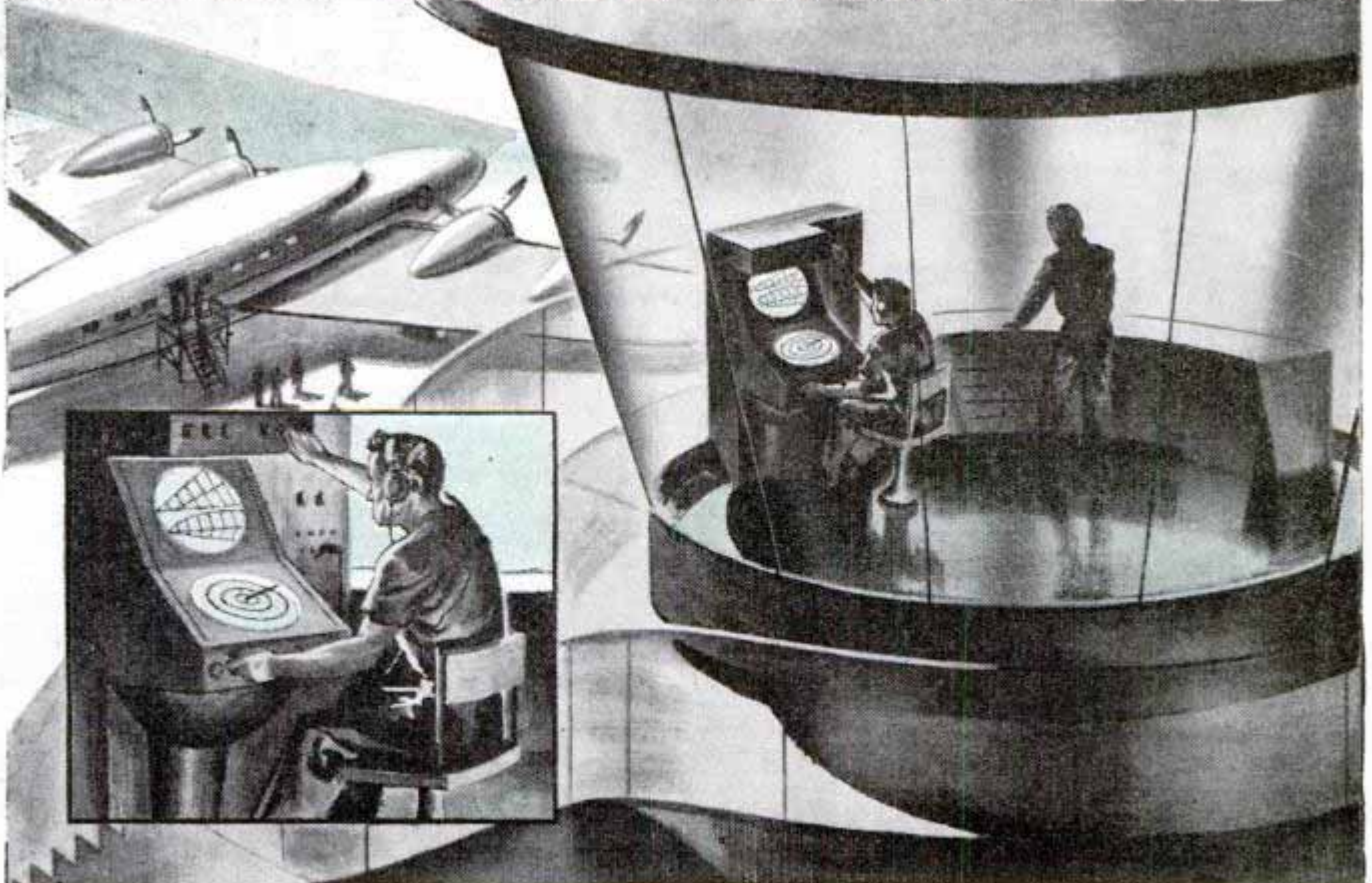

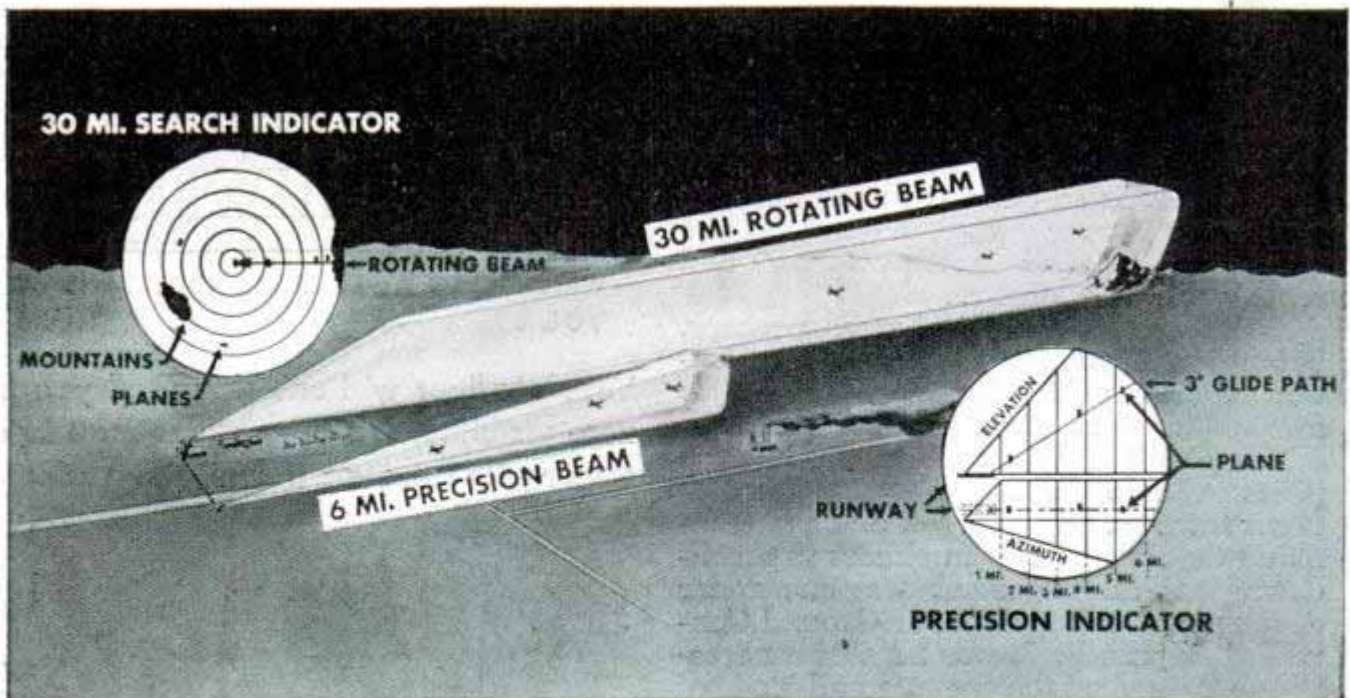

Plane first appears as a new and moving "blip" on search scope, with the precision system assuming control for the final stages of approach and the actual landing. Search beam swings completely around every two seconds

with a 500-foot ceiling and present instrument landing procedures, minus radar, is four or five an hour. Advocates say that within 18 months radar will handle landings as fast as an airport can accommodate them. And, further, that it will eliminate the time-consuming practice of "stacking" planes in layers overhead while they wait to land. One major air line recently stated that its actual revenue loss due to weather cancellations was \$2,000,000 a year. Noting that this represented a 45-plane fleet, mul-

tiple by an industry of 500 aircraft and you have an astronomical annual loss.

Another GCA advantage is that the only requirement for its use, whether by small personal plane or giant air liner, is standard aircraft radio equipment.

GCA uses five trained operators, in its present form, and consists of two microwave radar systems housed together in a specially designed trailer. One is a search system, with a radar beam rotating over a 30-mile radius once every two seconds.

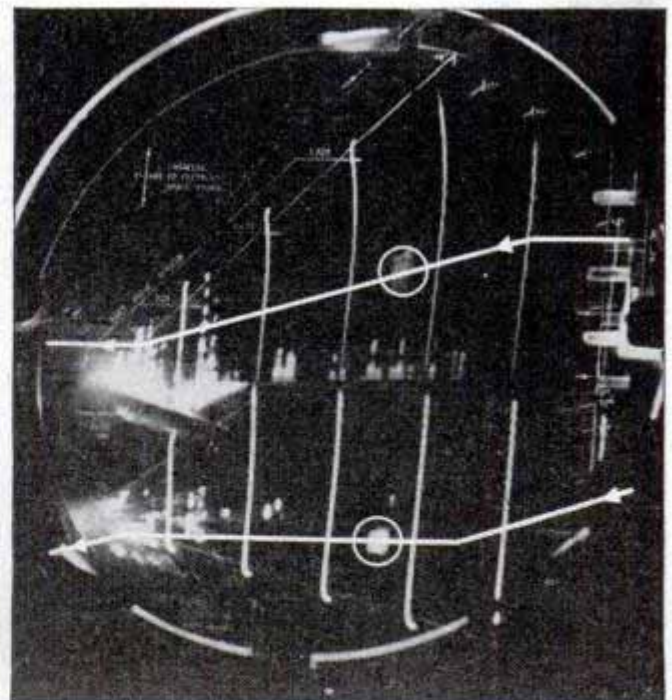
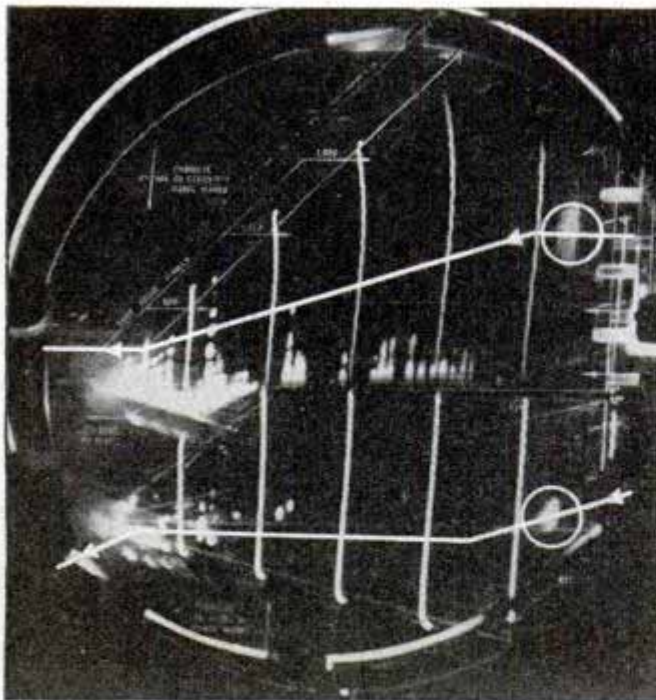

Photos by Gilfillan Bros., Inc.

First photos of an actual radar landing test. Elevation is shown in upper half and azimuth, or plane's horizontal path in relation to runway, in lower portion of this commercial version of the precision indicator, combining both factors on one scope. Reading from left to right, plane appears in first frame as circled blob of light in both upper and lower halves, nearing five-mile range mark electronically superimposed on the scope. Also shown in upper half are degrees of glide, with the $2\frac{1}{4}$ degrees required for this plane drawn on the scope by the operator. Also indicated, on the 45-degree-angle line at top left, are the elevations and around the perimeter



Interior of a GCA trailer, showing positions of five operators. Elevation indicator station is in foreground, final controller next, then the azimuth indicator post, with the two search scope watchers farthest from the camera

On its televisionlike 12-inch scopes the two operators can actually see every obstacle and aircraft in the entire 2800 square miles surrounding the airport. With them the bearing, distance and identity of planes can be determined with uncanny exactness.

Both search system operators are "talkers," with earphones and microphones; a push-button arrangement permits them to tune in on the radio channel the pilot is using. The No. 1 operator acts as general policeman for all air traffic within a 25 to

30-mile radius and has responsibility for initial pickup, identification and first directions to all aircraft landing on GCA.

Seated next to him is a second search system operator, watching a similar scope but concentrating his attention on the "blips" or blobs of light, as the planes appear on the scope, in the area immediately surrounding the field. He selects the plane to be landed and "talks" the pilot along to the final glide-path stage, where the precision system goes to work.

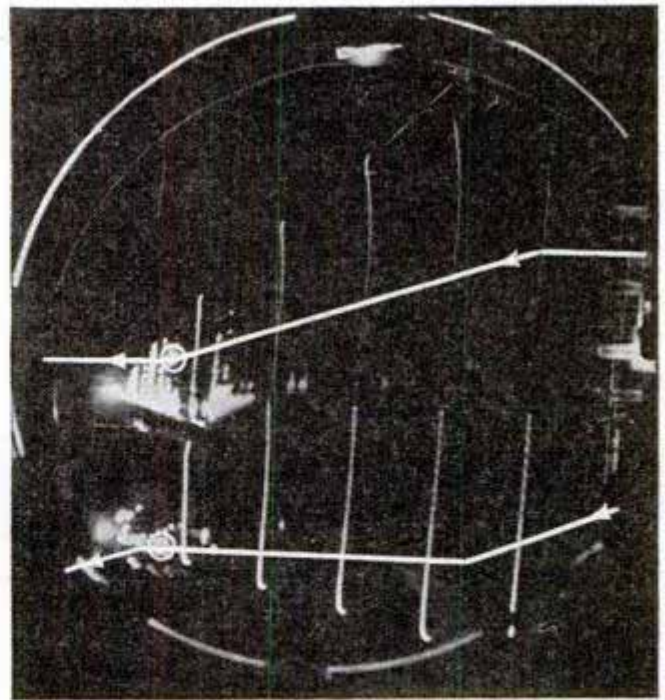
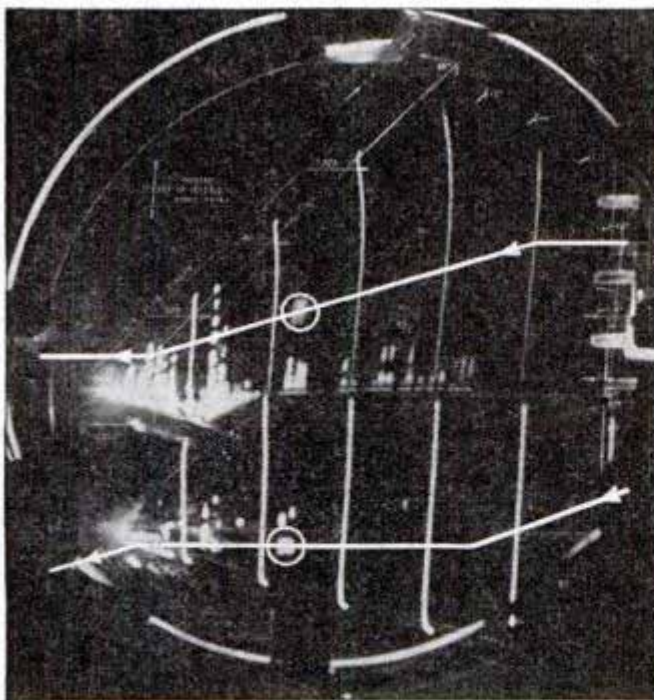

of the scope are the 360 degrees to facilitate heading instructions. Actual touchdown point is where the lines converge on each of the halves. In test the plane was purposely brought to within only 125 feet of touchdown and the approach path drawn in on the lower portion is actually to the left of true center and the elevation path is above that of actual touchdown. In frame two the plane is 3½ miles out and in frame three it has moved to slightly more than two miles from touchdown. In the final frame it comes to within a hundred yards of what would normally be the point of touchdown before pulling up and flying away, its test mission completed

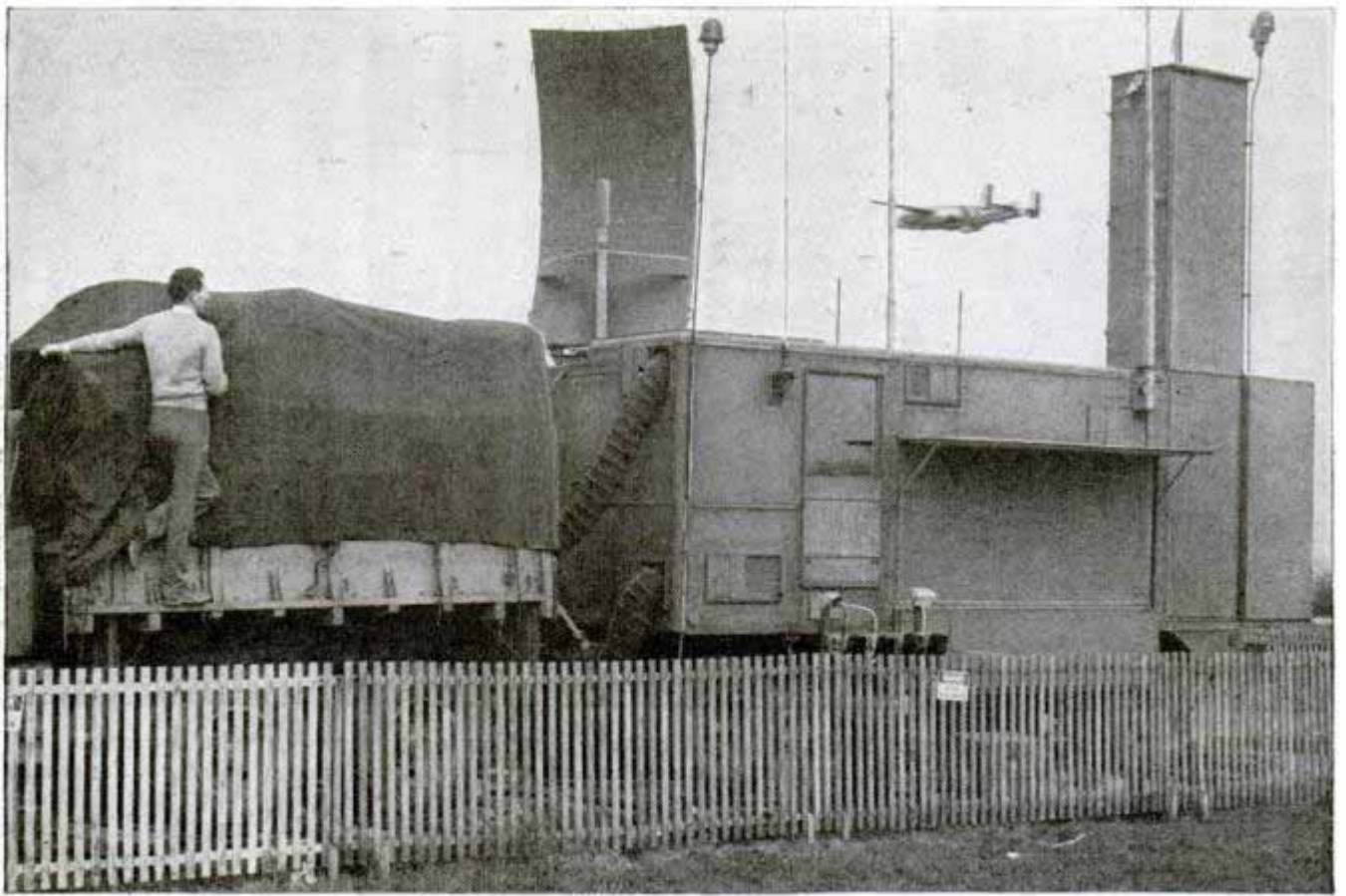

Truck and trailer, with search antenna assembly in upper center and elevation antenna housing at upper right

The precision system, heart of GCA, is run by three men. One follows the plane's rate of descent on an elevation indicator and the second checks direction on an azimuth indicator, showing the plane's heading in relation to the runway. Both manipulate metering devices that constantly relay to a panel before the third man, the final controller, information on the plane's course in relation to the prescribed landing path. Only the controller talks to the pilot.

Watching this data (from his aids) registering on the dials before him, the controller instructs the pilot to alter his course laterally or vertically, distances as small as feet, in order to place him safely on the approved path. Normally the pilot is able to take over control on a visual basis 100 or so feet off the runway, but in numerous instances controllers have brought aircraft down to actual and smooth contact with the runway. In the Indianapolis tests pilots are being guided only to the height at which they can normally see the runway, even in the worst weather, in order to speed up the number of experimental passes accomplished.

Primarily a mobile system when used by the Services, the GCA trailer is moved

about by a four-ton truck that also houses the auxiliary power equipment. The trailer is located 200 to 300 feet from the center line (to the pilot's left on an approach), and about 1000 yards from the downwind end of the runway being used. A large revolving search radar antenna mounted atop easily identifies the trailer.

One of the original manufacturers of GCA equipment, Gilfillan Brothers, Inc., of Los Angeles, has gone on to design a simplified system for possible commercial application. It weighs approximately 5 tons, in contrast to GCA's nearly 22 tons, and uses only two radar scopes, both of which are on the same panel and can be manned

by a single "talker." It is referred to as RLS, or Radar Landing System, rather than GCA. Wartime GCA radar equipment can be utilized merely by installing a coaxial cable to transfer control from the trailer to the operator in the control tower.

Though fully aware of the system's capabilities, the CAA is proceeding cautiously in the testing program, conscious of the many considerations to be met before adoption.

"We cannot immediately apply the newest things in radar to actual operations of



the air lines," Donald M. Stuart, chief of CAA's Technical Development Service, said. "With all radar's promise it must undergo further development before its use is acceptable to the air lines, to the air-line pilots and to the safety regulation officials of the CAA, all of whom are directly concerned with the safety of the flying public.

"Radar might be said to be in the third stage in our development of instrument approach and landing. Today, we are using low-frequency equipment which has definite drawbacks. We are now changing over to a Very High Frequency band where static and interference have less effect. This is stage two and we are also working to apply radar, which will be stage three."

Henry I. Metz, chief of CAA's experimental station at Indianapolis, additionally pointed out that "the cost of equipment, the skilled manpower required to operate it 24 hours each day and, above all, the responsibility held by the ground crew in landing an airplane are important factors against universal use of GCA as the basic system at this time."

But the most important fact is that GCA's war record has earned it the right to a thorough three-month testing program, and it may finally emerge as the answer to one of flying's few remaining hazards, landing planes safely in bad weather.

Position indicator at Winnipeg airport, top, on which all planes within 80 miles can be spotted. Equipment's broad rotating beam antenna is at center. The GCA controller's panel, bottom, with its dials calibrated in feet showing airplane's deviation from glide path. Elevation is at left and azimuth is at right

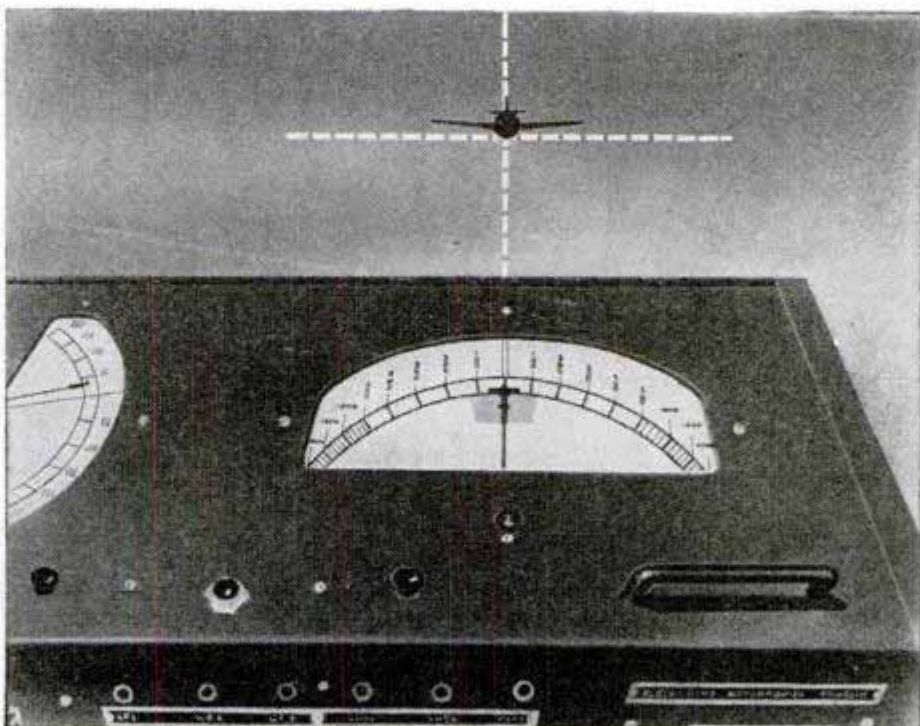
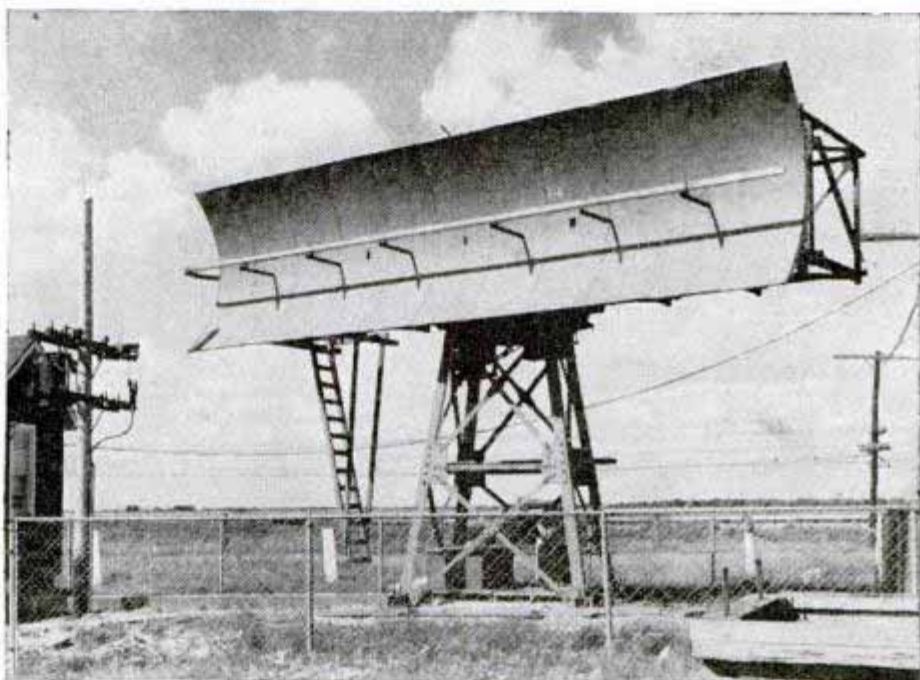
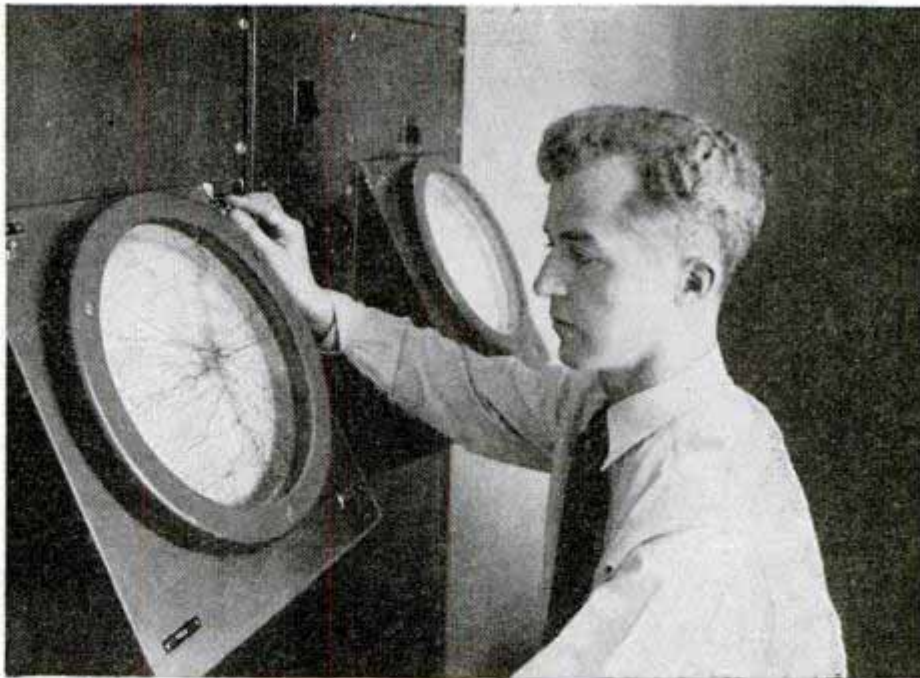

Midget French Automobile Accommodates Four People



(about 62 miles) on a gallon of gas. The model was built of wood and light metals. Production will begin as soon as coal, mineral ores and electric energy again are available in France. Factories already have the necessary tools and machinery. A twin-cylinder four-horsepower engine gives the automobile a speed of 53 miles an hour. The traditional chassis has been replaced by a framework made of light alloy castings. The car has doors on both sides and a convertible top. The engine is air-cooled, using an efficient ventilator that

French engineers have completed tests of a small but efficient touring car that weighs only 1100 pounds, accommodates four passengers and travels 100 kilometers

passes air over cooling flanges. Push-rod-operated valves and a floating motor unit are other advantages claimed for the midjet European model.

"Strato" Gun Shoots 12 Miles Up and Has Radar Director

Radar-directed "stratosphere" guns fire a 50-pound projectile more than 12 miles into the air. The 120-millimeter antiaircraft guns were used extensively toward the end of the war to shoot down enemy planes and buzz bombs. The gun is loaded with a "divided round"—the projectile is placed in the breech and followed by the cartridge case. Each weighs 50 pounds. The divided round is used because the combined weight of the projectile and cartridge case is too heavy to allow rapid loading by one man. The gun, transported on a four-wheel bogie, may be fired while in traveling position. The unit weighs about 20 tons.

Photos Printed in Daylight

Requiring no darkroom because it employs a green fluorescent light as a source of illumination, a new photographic reproducing unit can be used in daylight. The photographic paper is sensitive only to the green light and is unaffected by ordinary light. The unit can be used to reproduce anything written, drawn, typed or printed. No camera is required.

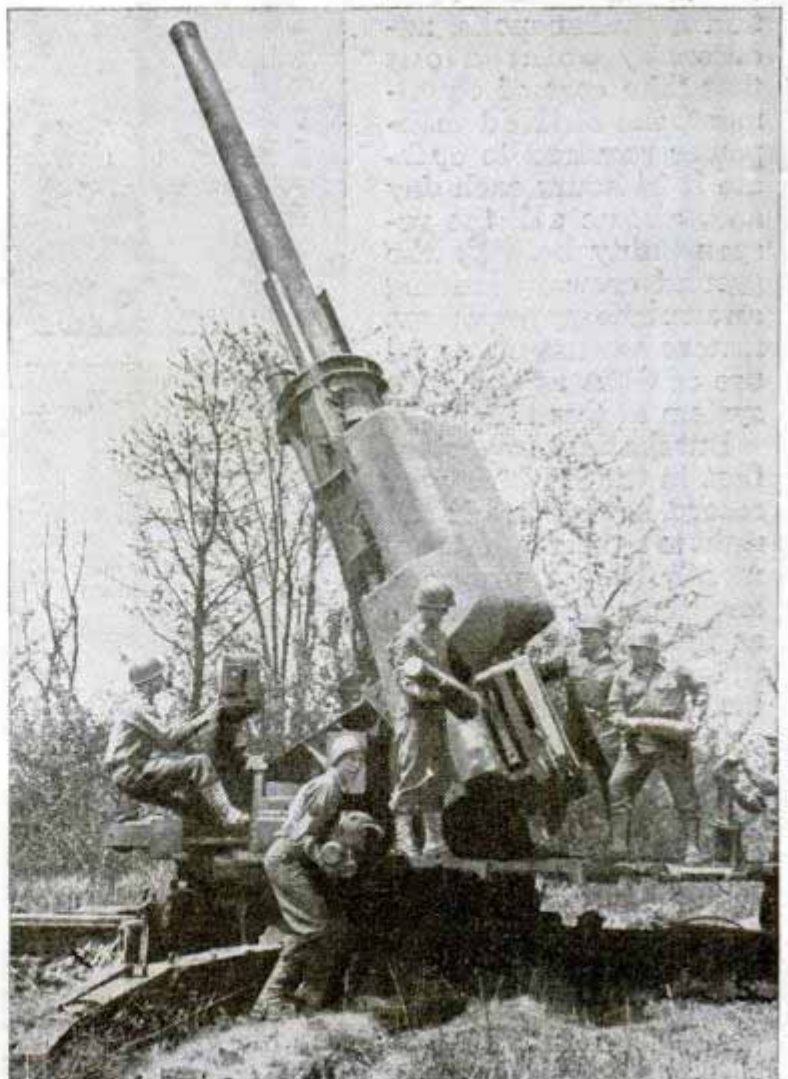

Signal Corps photo

Patients See Airborne Movies on ATC Hospital Planes

Soldier and sailor patients evacuated by air from overseas stations to hospitals in the United States are seeing movies as they fly. The Air Transport Command, which operates the hospital planes, introduced the motion pictures to relieve the monotony of long air evacuation flights. The flight nurse in attendance can dial desired programs on the self-contained 16-millimeter projection and reproduction unit which is placed forward in the plane cabin. The 38½ by 29-inch screen can be seen by patients from any location in the cabin. Sound is reproduced by a cabin loud-speaker or individual headsets.

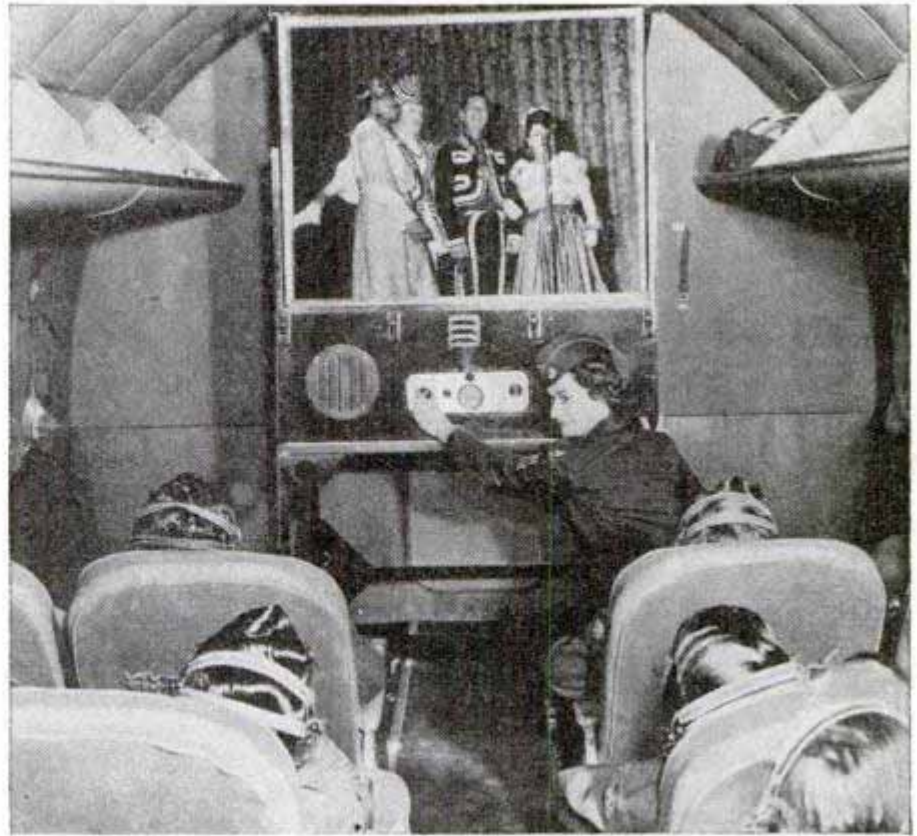

Official photo, U. S. Army Air Force

Canvas Cover on Framework Makes One-Room Cottage



Housing planners have come up with a "blanket" answer to the problem of providing temporary homes for veterans. A portable one-room cottage built by stretching a special canvas blanket over a wooden frame soon will be on sale to "homesick" veterans for \$1000. The blanket contains spun glass insulation for protection against heat and cold. It is stretched over a half-round framework that is similar in shape to the famed Quonset hut. The Army used structures similar to the "blanket home" to house soldiers in both the arctic and the tropics.



Information, including names and addresses of manufacturers, concerning products described in this issue may be obtained by writing to Bureau of Information, Popular Mechanics Magazine, 200 East Ontario Street, Chicago 11, Illinois.

Step on the Gas—



Nonglare black light illuminates jumbo-sized dials on dash of new Studebaker. Below, arrow points to plug on self-adjusting brake shoe described in text

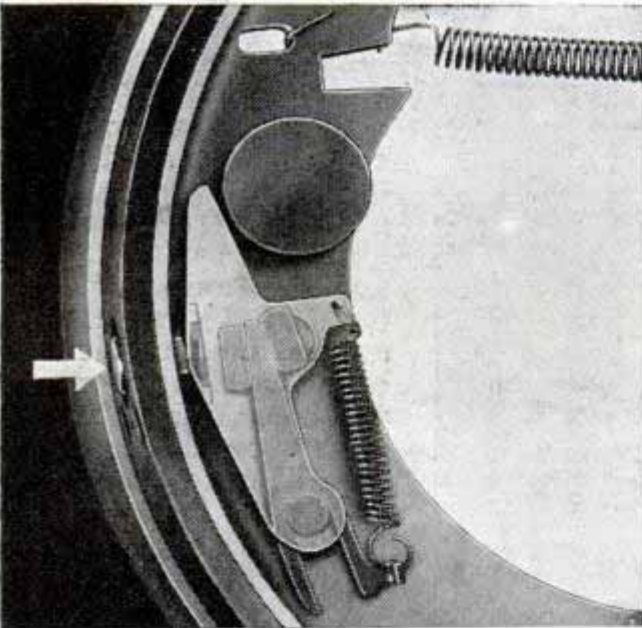

FROM one of the oldest automobile plants in America—Studebaker at South Bend, Ind.—are rolling new 1947 models that may hold a prophecy for the entire automobile industry.

If the '47 Studebakers are pacesetters, here are the features that car-hungry Americans can look forward to in the truly postwar cars: much lower bodies, wider and more comfortable seats, fenders absorbed into the bodies, a doubling of the glass area for windows, and such innovations as self-adjusting brakes and instrument panels illuminated with nonglare black light.

Most striking of the Studebaker models (as shown on the opposite page) is the five-passenger Commander coupe with a semi-circle of rear-view windows. Before its first showing in Chicago this car created such a sensation when being moved into a hotel that a police guard had to be called. The fenderless body design, while distinctly postwar, retains enough conventional styling for mass appeal. The windshield and rear windows offer double the vision of earlier models.

An ingenious braking system on the new Studebaker makes its own adjustments. The brake shoe is mounted on an eccentric in the center instead of being held rigidly by a fixed anchor pin at the bottom of the backing plate. A graphite bronze plug on the surface of the lining area of the front shoe maintains contact with the brake drum. As the brake lining wears, the plug moves inward and pulls up a spring-

Fenders streamline into body of '47 Champion sedan

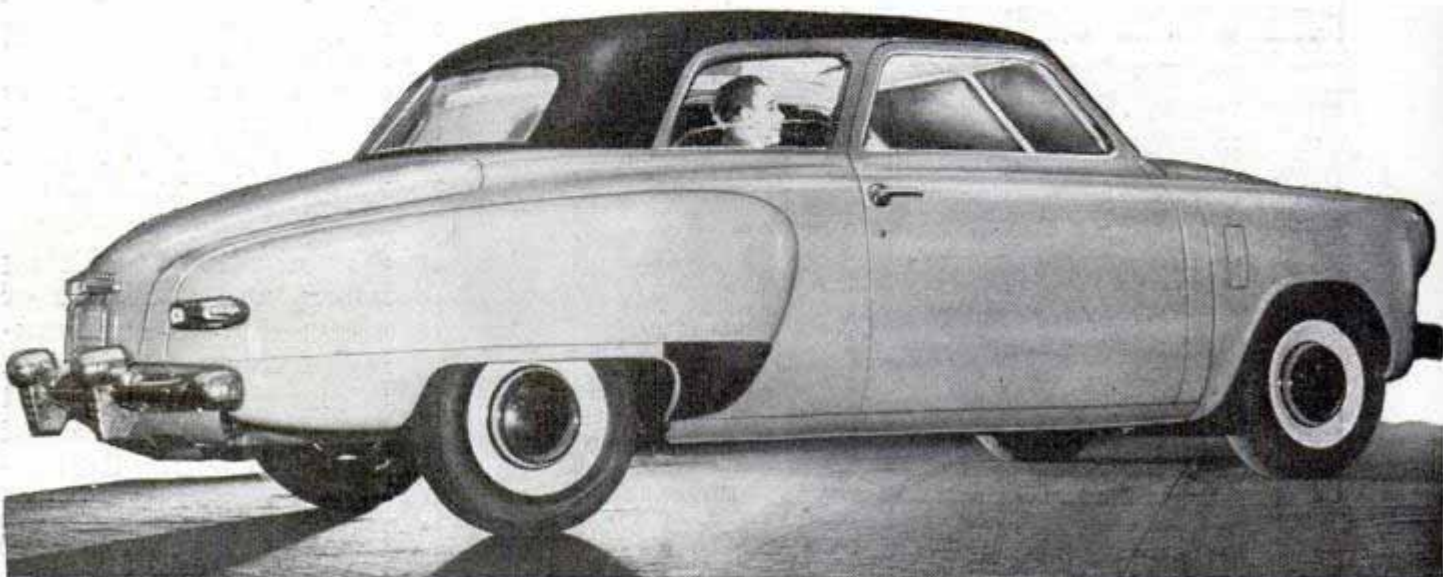

the '47s are Rolling!



Studebaker Commander coupe has that "postwar" look

mounted wedge-shaped arm that presses against the eccentric. This causes the shoe to move outward in steps of .004 of an inch.

Although height of the '47 Studebakers is only a fraction over five feet, head room has not been reduced. A lower center of gravity, vital factor in driving safety, has resulted from dropping the midsection of the frame. The passenger compartment has been moved 13 inches forward to a position $19\frac{1}{2}$ inches ahead of the rear axle, placing it close to the center of longitudinal balance. The engine also has been moved for-

Continued to page 256

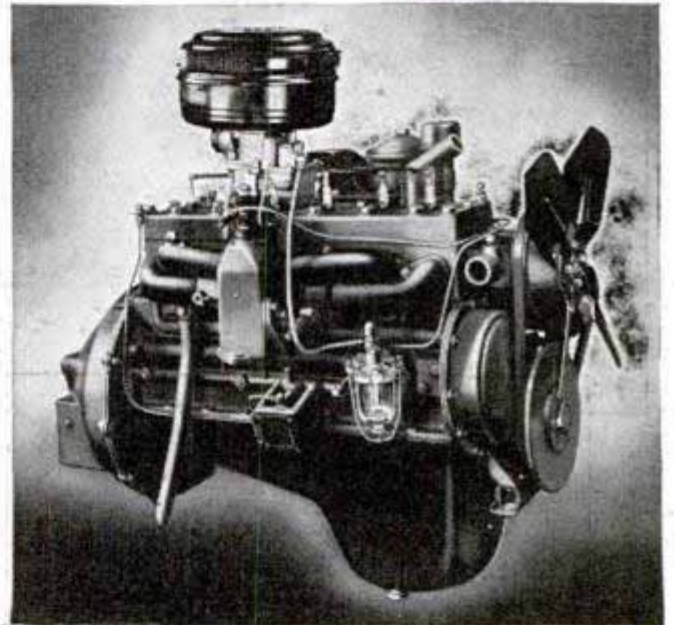

Studebaker power plant shows the "packaged" influence of Weasel; oil filler pipe is at front. Below, this view of Commander coupe shows semicircular rear windows





Nelson smacks an iron shot before an admiring crowd

The **Mechanics of GOLF**

Part 2

by
Byron Nelson

**Irons Are the "Payoff" Clubs
and Here the Game's Greatest
Master Tells How to Use Them**

LAST MONTH we studied the details of gripping a golf club and effective technique for playing the woods. In this second article we will delve into the mechanics of hitting shots with long and medium irons.

I think of the iron shots as somewhat of a refinement over the wood shots. While both accuracy and distance are desirable objectives in playing a wood shot, the importance of accuracy increases and emphasis on distance decreases as we progress into the shorter irons.

For example, most golfers try to hit the ball as far off the tee as they can, hoping it will stay in the fairway. Even some of the best stray off into the rough at times. But, each top-notch golfer actually is trying to sink every shot he hits to the green with a medium or short (Nos. 7, 8, 9) iron. Just "close" isn't good enough.

If you have been interested in golf for any length of time, no doubt you have heard the expression, "He hits his tee shots a mile and then scrambles the rest of the way around the course."

I must confess that at one time long ago this might have been a reference to my game—and that of hundreds of other as-

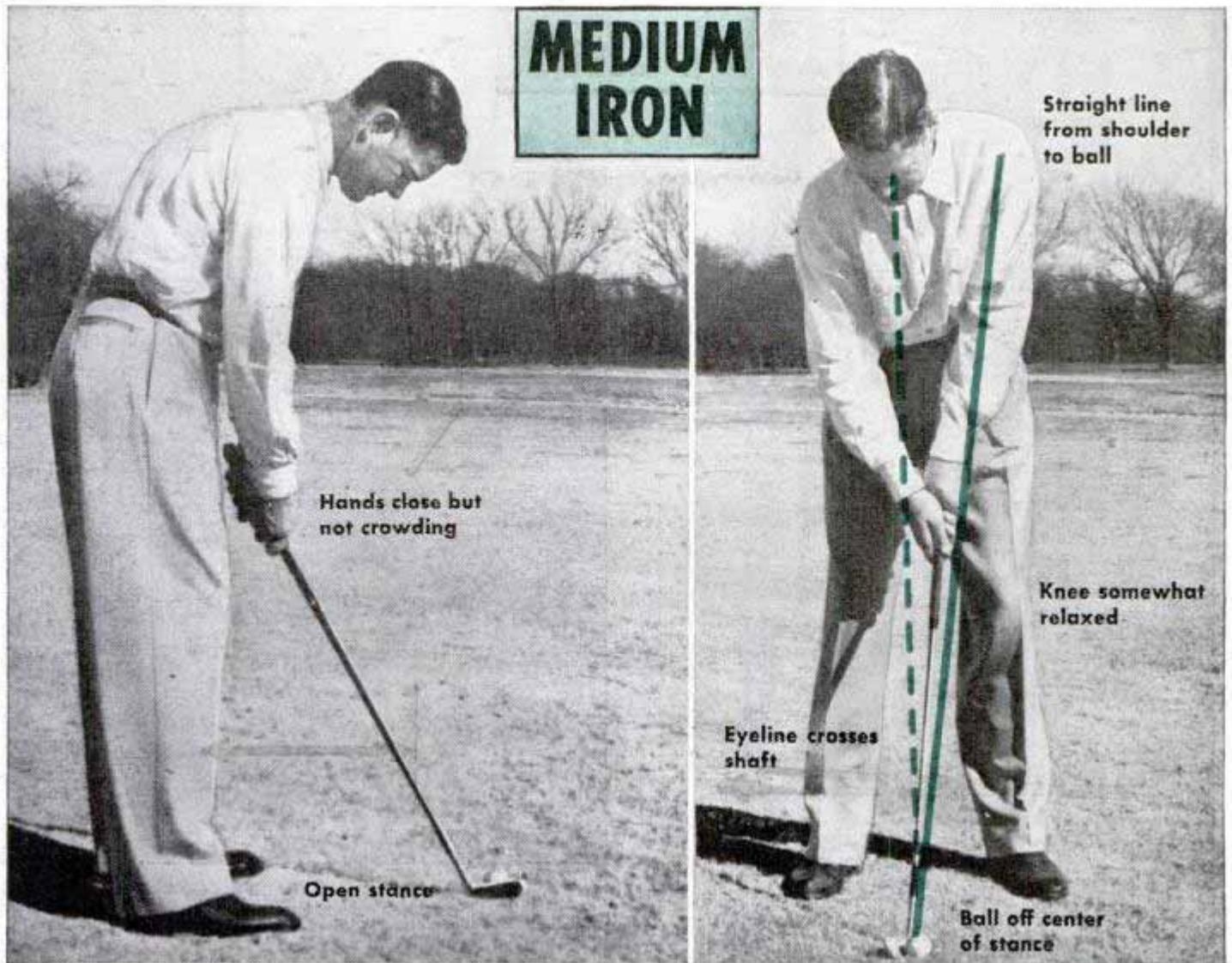

"Mr. Golf" illustrates with front and side views the stance he uses for playing the medium irons (Nos. 4, 5 and 6)

piring young pros. The earliest tendency in learning to play golf is to try to "crown" the ball with the woods and sort of let the irons take care of themselves.

The irons are the "payoff" clubs. It's rarely the one who is the longest off the tee who wins the tournaments. In fact, there are thousands of golfers who can hit out wood shots with the best of the amateurs and professionals. But when you come to checking the prize lists, it's the golfers who are most accurate with their irons who are consistently at the top.

Johnny Revolta, Harry Cooper, Ben Hogan, Henry Picard, Walter Hagen, Bobby Jones, Tommy Armour and Chick Evans rarely won driving contests, but their names are synonymous with winning golf. These men all developed deadly accuracy with their irons.

The greatest satisfaction and the most profitable results in my own golfing experiences have arisen from memorable iron shots.

After I had won the Red Cross Open at New Rochelle in 1944 with a 72-hole total of 275, which was 13 under par, most of the newspaper comment centered on my

"dead" iron shots. As a matter of fact, I was hitting my drives well, but no one placed any emphasis on this.

I also can thank my irons for pulling me through the most thrilling episode of my entire competitive career. It occurred in the 1945 Professional Golfers Association of America annual championship tournament at the Moraine Country Club, Dayton, Ohio.

Mike of the famed Turnesa golfing family had me two down with four holes to play in the second round of the tournament. He drove first on the par three 175-yard 15th hole and his ball rolled up to within nine feet of the pin. That meant a sure par three and a possible birdie two for Mike. My only hope for survival lay in hitting my iron shot from the tee for one putt and a birdie two. My iron came through for me. The ball stopped three feet from the cup. Turnesa missed, I stroked my short putt in and was only one down with three to go. This took off much of the pressure.

A short iron shot dead to the pin set me up for a birdie three on the next hole. Mike took four, and our match was even. On the 17th hole, the 35th of our match, my second

LONG IRON

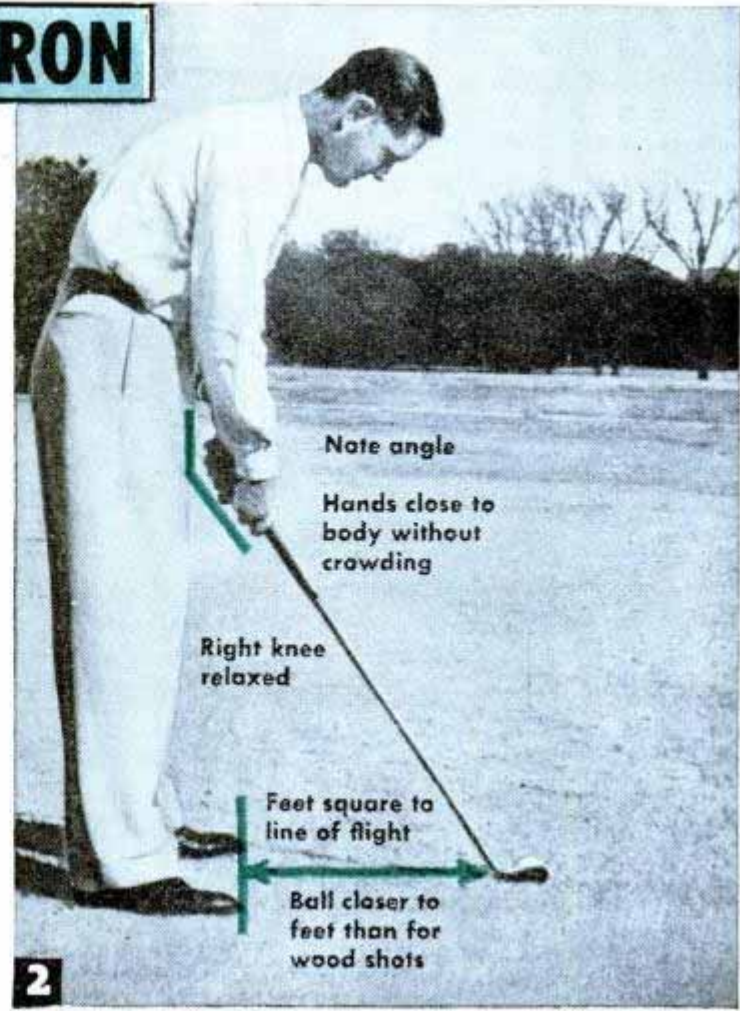

Follow the Nelson swing from

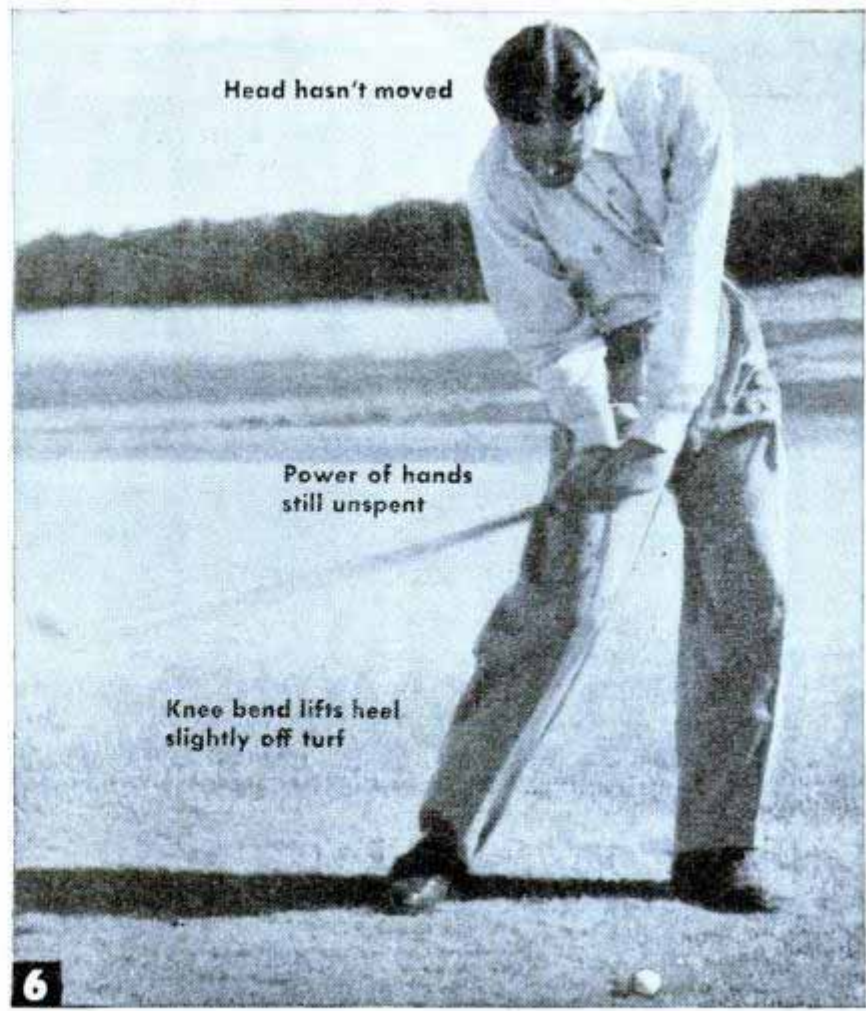

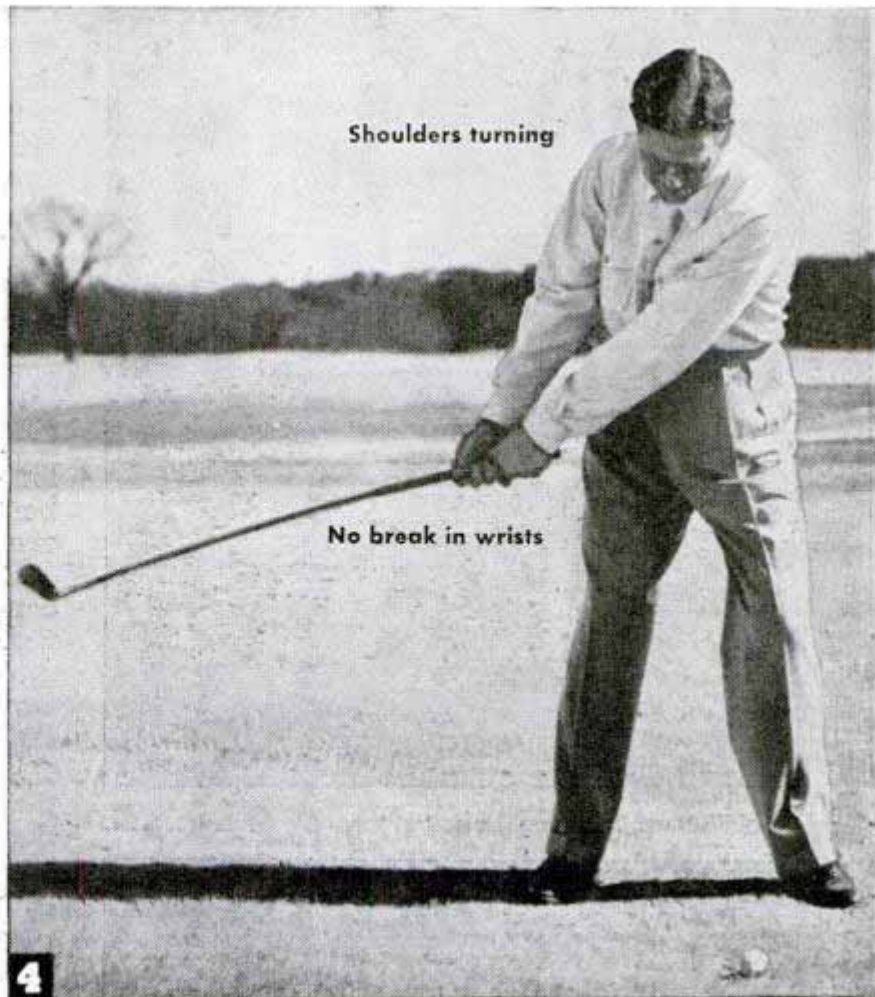
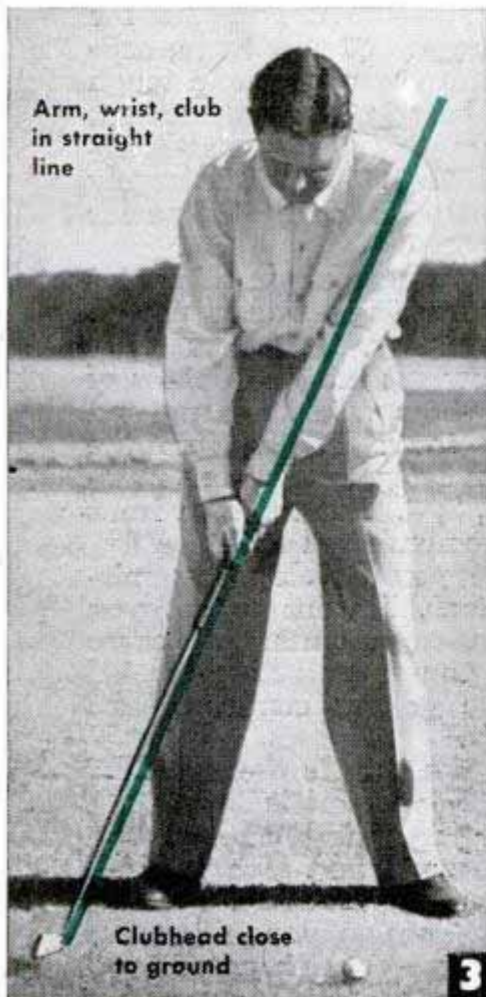

the address to the follow-through on these pages

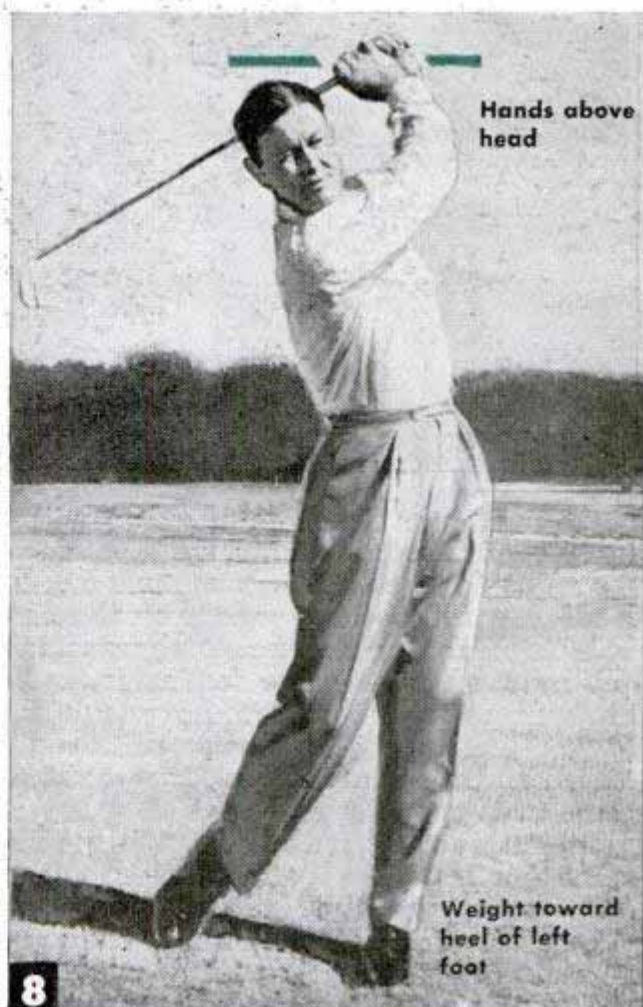
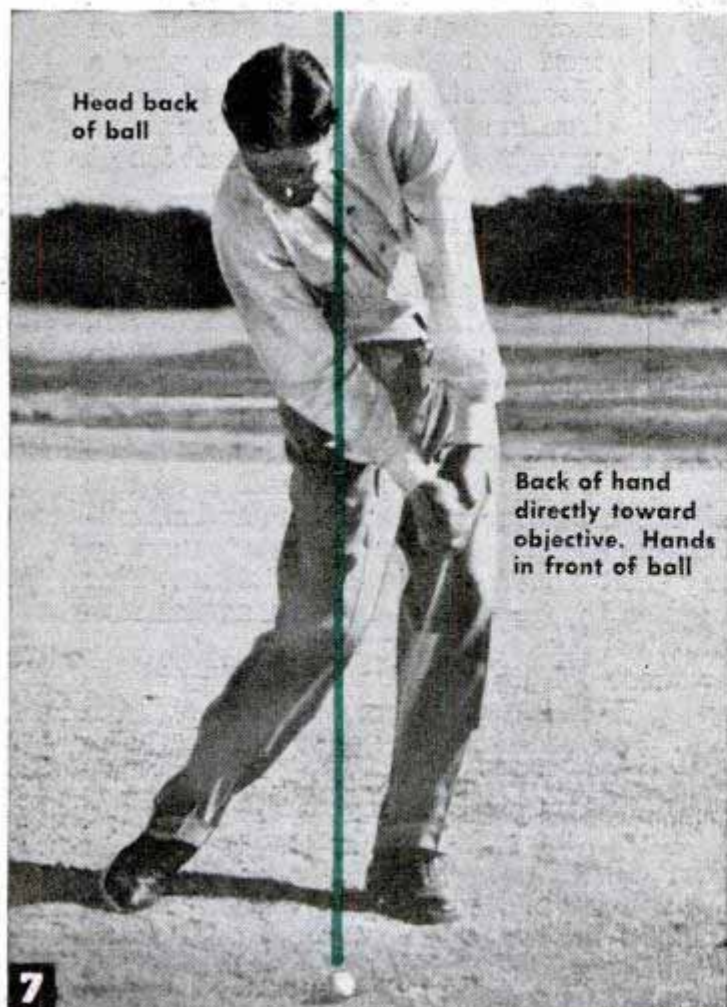



"Lord Byron" proves that even the best of them can get into trouble



shot on the par five hole edged to within five feet of the cup, enabling me to get down for an eagle three. This gave me a one-up lead. A conservative par four on the final hole tied Turnesa, and the match was mine.

I went on to win the tournament. I'll always remember that iron shot on the 15th at Moraine. It was the turning point of the match and the tournament for me. While the direct monetary returns are not so great in this event, it's one we professionals want to win above all others, with the possible exception of the National Open.

Bud Ward of Spokane, one of the great amateurs of recent years, isn't particularly straight with his drives, but right up to the

time he put aside his golf clubs for duty in the armed services his brilliant iron play made him a tough man to beat in any tournament. He won both the National Amateur and Western Amateur largely through the accuracy and power of his irons.

I hope to have made this point in the foregoing—it does pay to stress iron play.

We now get into the details of playing shots with the long and medium irons. Falling into the long iron category are irons numbered 1, 2, 3. The medium irons are those numbered 4, 5, 6.

Before you develop any misconceptions, I want to set you right on two points that cause most beginners and self-instructed would-be golfers confusion and difficulty.

First, the grip is the same for playing irons as it is for woods. Second, the swing employed in playing wood and iron shots is fundamentally the same. You will observe as we go along that there are some minor variations as you change clubs, but you should not make a deliberate attempt to swing differently.

As a general rule, you stand more closely to the ball to play an iron shot than you do to play a wood shot, for the clubhead on an iron is set on the shaft at a more upright angle and the shaft is not as long. The same holds true of the irons as the numbers increase. A No. 8 iron, for instance, has a shorter shaft and more upright clubhead angle than a No. 3 iron, so you stand closer to the ball to play the former. This means you also swing in a more upright arc and take a shorter swing.

I told you in Article I of this series that I found streamlining and simplification a real boon to my efforts to develop my golf swing to maximum efficiency. This applies to the mental as well as the mechanical (physical) processes.

Those golfers who go along trying to develop a different swing to go with each club and each varying shot are unnecessarily complicating the game.

There is a single general difference between a shot played with a wood and one played with an iron.

With a wood, you attempt to sweep the ball off the tee (with a driver) or the turf (with a brassie or spoon). In playing an iron

(Continued to page 244)

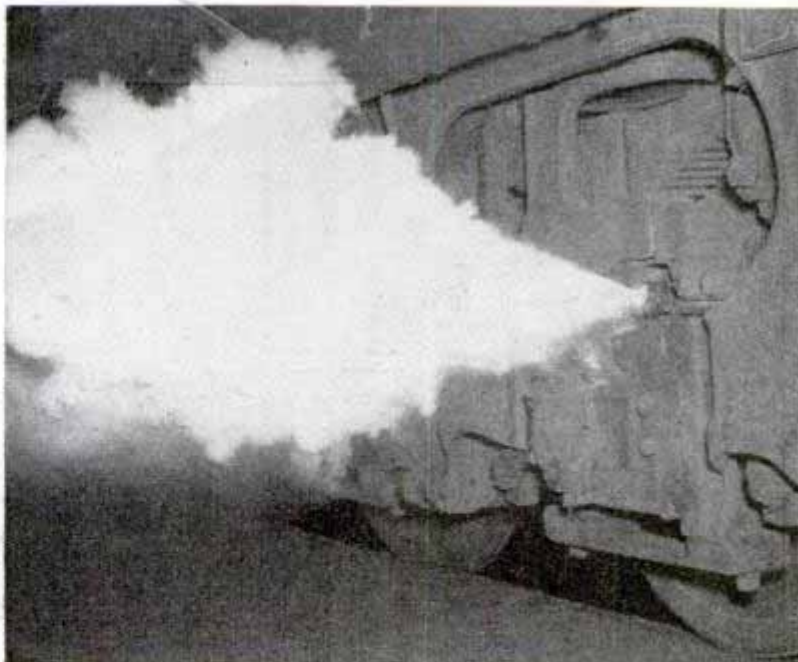
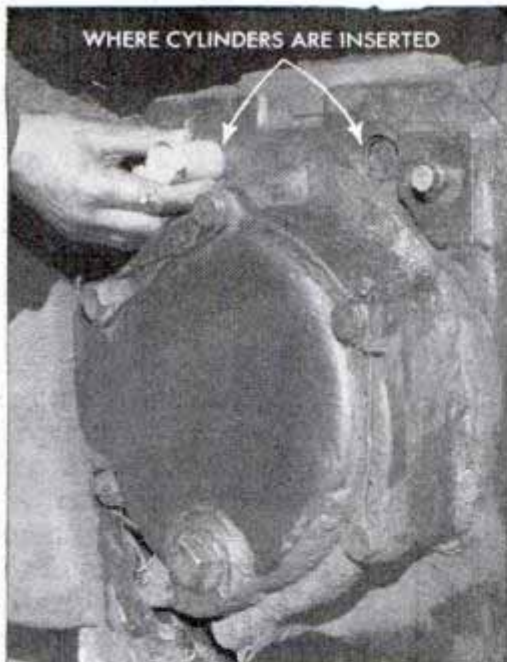

Smoke clouds and penetrating odor released by a hot-box alarm warn trainmen of overheated axle journals on New York Central trains. When heat in a journal reaches 220 degrees Fahrenheit, two cylinders go into action

Hot-Box Alarm for Train Emits Smoke and Odor

before real trouble develops. The smoke is produced by one cylinder and the odor by the other. The gases are released through small holes which are opened by extreme heat melting a fusible metal stopper.



"Mountain Dodger" Is Fast Climber

Requiring less than 800 feet for takeoff at a 6000 foot altitude, the new Callair A-2 is designed especially for operation in mountainous regions. Driven by a 125-horsepower Lycoming engine, the plane climbs 1000 feet a minute fully loaded and has a range of 500 miles.

"Stereo" Camera Range Finder Focuses Both Lenses

Both lenses of a new stereoscopic camera are coupled with the range finder to provide easier focusing and assure the same focus for both objectives. The view finder, located between the matched lenses, prevents parallax because the scene viewed is actually recorded on the film. The camera has built-in synchronization and its shutter has 10 speeds, from one second to $\frac{1}{200}$ second, with time and bulb exposures. It takes 15 double, or stereo, pictures on an 18-exposure 35-millimeter film in black-and-white or color. A folding cap covers both lenses and the view finder. A binocular type viewer to magnify the stereoscopic transparencies is available.



Nonsinkable Aluminum Boat Rides Over Rocky Beach



Rain or sun or a rocky beach has little effect on a weather-resistant one-piece nonsinkable aluminum boat designed for general use. The bow of the 12-foot, 150-

be used and oarlocks are provided. Oak runners and redwood seats muffle noise. Tests included runs over logs and beaching along rocky shores without damage.

Giant Self-Propelled Howitzer Fires 350-Pound Shell

"King Kong" of American field artillery weapons is a 63-ton self-propelled 240-millimeter howitzer which will fire a 350-pound shell 26,400 yards—nearly 16 miles. A crew of 18 men is assigned to the weapon which can travel on its tanklike chassis at 20 miles per hour. It can be put into firing service three minutes after it is pulled into position.



U. S. Army photo

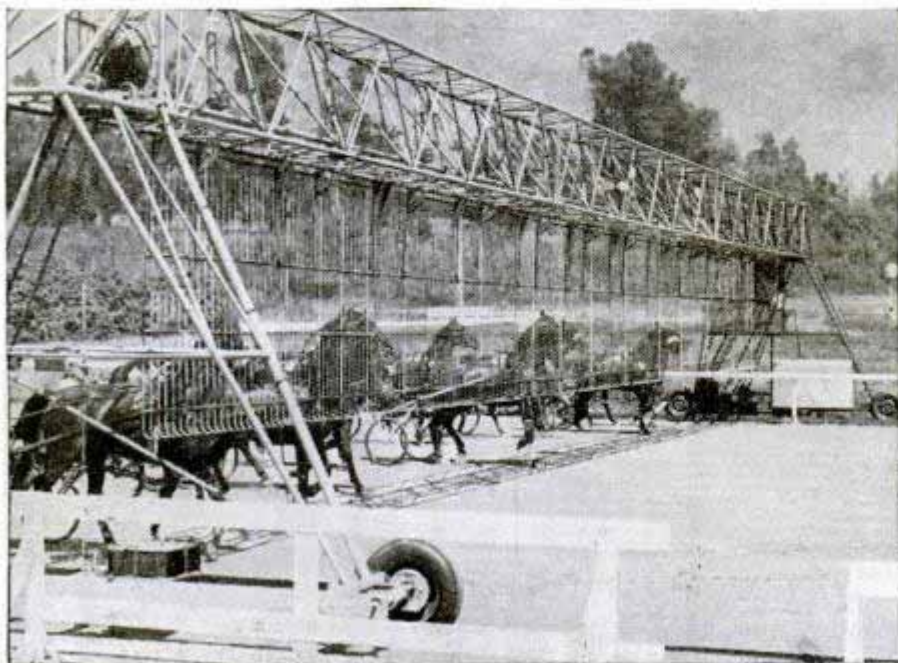

Harness Race Gate Moves With Horses

As horses and sulky drivers move toward the starting barricade on a harness racing track a mobile starting gate moves with the entries to assure an even start. The barrier is powered by automobile engines. As it reaches the starting point the gate is lifted and horses and sulky drivers get under way.

☐ Atom-smashing one pound of U-235 creates energy equal to 10,000,000 electrical kilowatt hours.

Mr. Watt *farm hand*

A billion dollars will be spent in five years to bring electricity to three million additional farms within the United States

FOR years, many Americans have had the erroneous impression that few European farmers enjoy the conveniences of electricity. But before we shed another tear for the "backward countries of Europe," think of this: In 1935 when less than 11 percent of American farms had electric high-line service, farm electrification had

reached 85 percent in Denmark, 90 percent in Germany, 95 percent in France and practically 100 percent in Holland. Even today, with slightly more than 40 percent of our farms electrified, we are still far behind these and other countries in that respect.

The war stopped much of the electric line construction which was planned to take up the backlog accumulated during the depression in the '30s. Now, with the war over and copper and other construction material again available, a giant five-year plan of rural electrification has been proposed. It is to be undertaken by private utilities, farm cooperatives and public agencies, and, based on prewar costs, will require the expenditure of about a billion dollars. The aim is to bring electricity to 3,655,000 additional rural consumers.

In addition to bringing the United States on a par with other countries, it is expected that this new construction will result in the sale of some three billion dollars worth of electric appliances. Since 25 percent of the modern farms use electricity for pumping water, an estimated 700 million dollars will go for additional plumbing installations. It will be a tremendous stimulus to continued

Lincoln Electric Co. photo

Arc welding outfit repairs loose braces on harrow

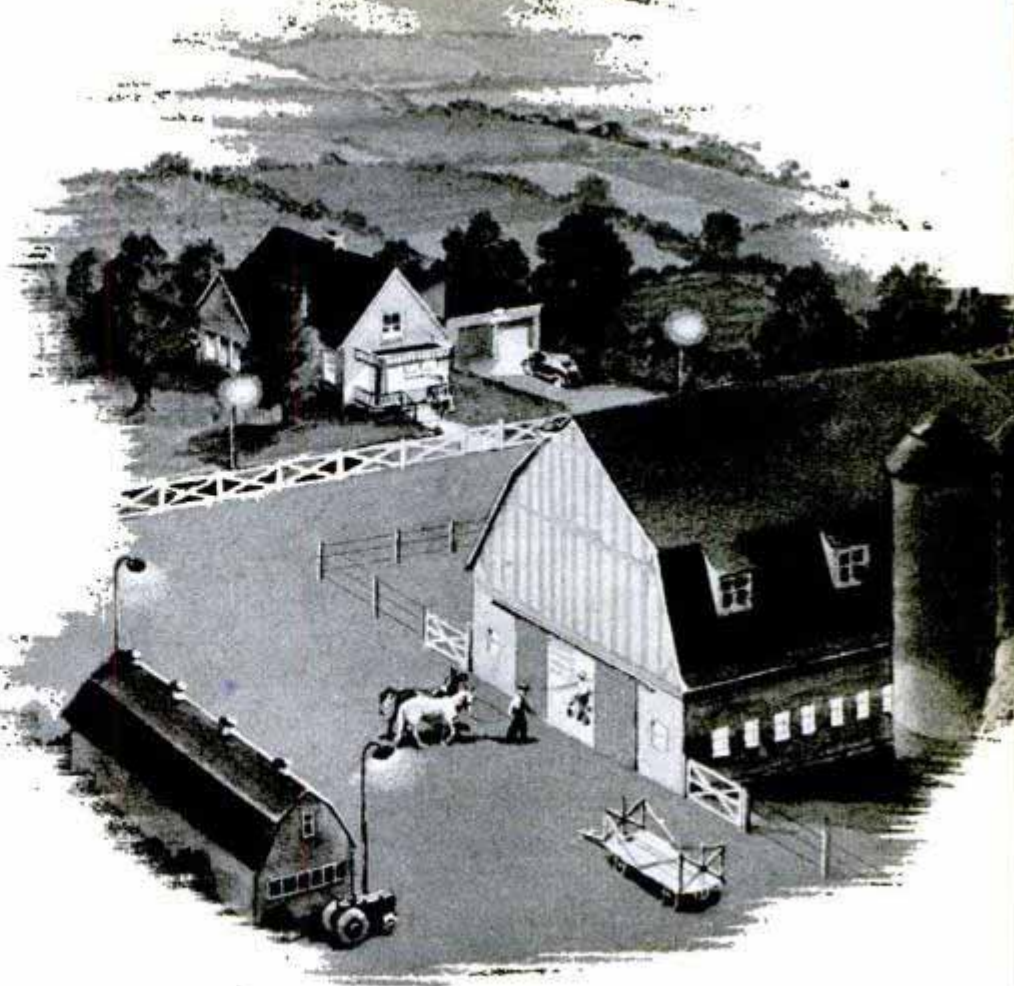

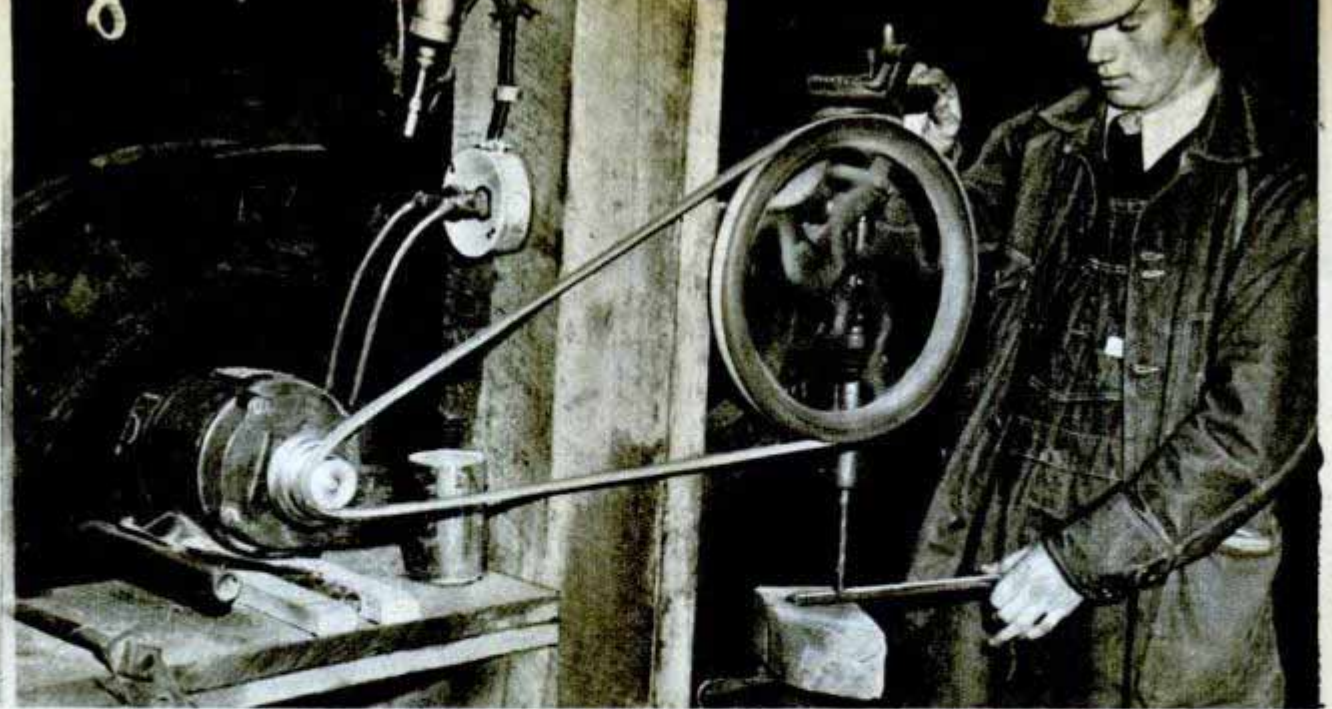

Workshops equipped with electricity aid farmers in doing their own repair work. Portable motor (below) comes in handy for many jobs, particularly hoisting



Light bulbs and a reflector installed behind a few boards create heat for brooder to protect little pigs

prosperity and provide employment for some of the millions of ex-servicemen. Best of all, it may help stop the exodus from the farms to the cities by making farm life pleasanter and more attractive, creating a better social, economic and cultural environment for our rural population.

The American farmer who, with less help, managed to feed the home population, our armed forces and a substantial part of the world, is a handy man. In places where electricity was brought to the farms, the farmers have found it a wonder-working tool. A homemade device—a few boards nailed in a corner of a hoghouse with a reflector and lamp dropped behind them—has saved an average of at least one pig per litter for many hog producers, both in protection from cold and crushing by the sows.

In poultry production, running water, pumped and heated electrically, controlled automatically and available at all times, not only saves thousands of steps for the poultryman but increases egg and poultry production. Other electrical aids to the poultry industry are safe, reliable electric brooders, night lighting of hen houses, egg



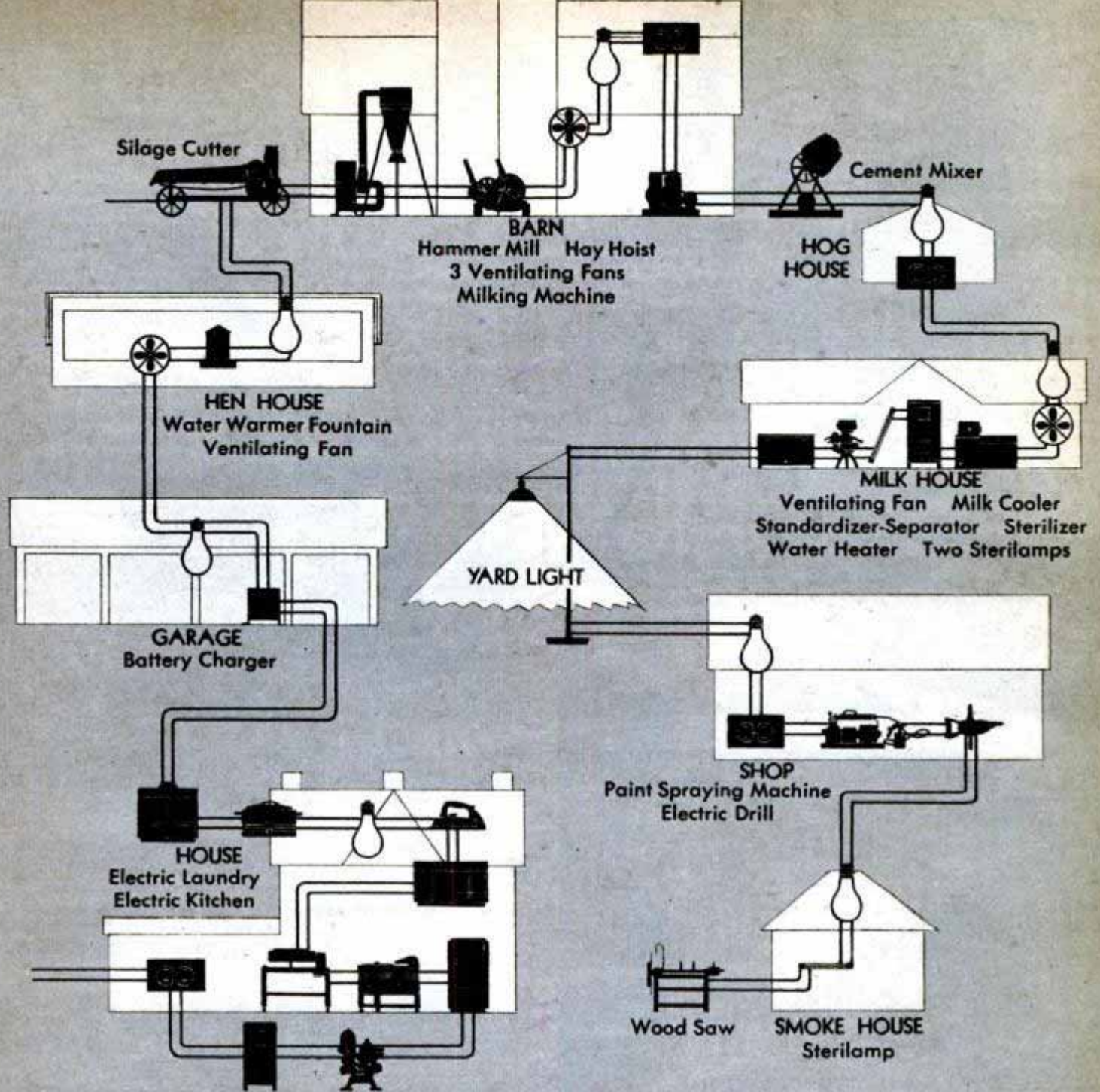

Westinghouse chart

Diagram of dairy farm that runs 25 machines by electricity. Below, pump draws liquid manure for fertilizer

candlers and graders, poultry house fans and egg coolers.

Having a tool ready to do a repair job at the right time often saves hours in the farmer's day. Electrically operated repair shops have become more numerous on farms. They prevent many trips to town. Where more specialized work is needed, many small communities have repair shops. Many of them also make electrically driven equipment for the farmers, such as elevators, hoists and other machinery for field work.

Irrigation during dry spells has frequently made the difference between poor yields and satisfactory ones for vegetable producers on both commercial and

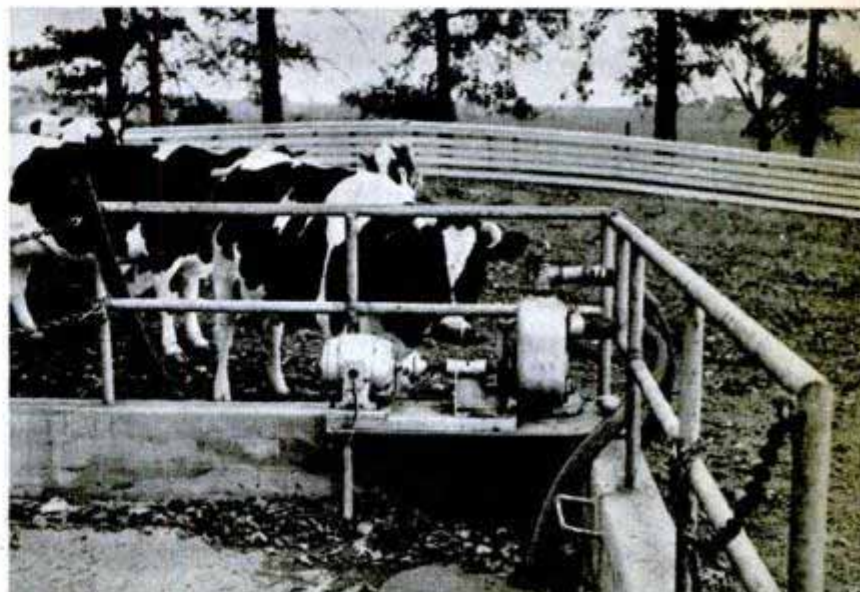



Public Service Co. of Northern Illinois photo
Unlike a windmill which works only when the wind is blowing, electric motor pumps water at any time

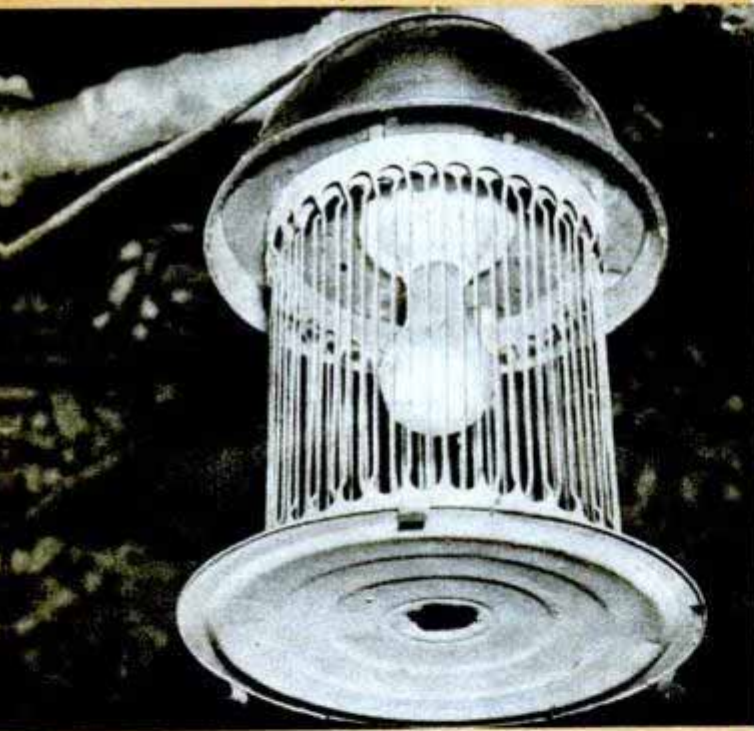

Light trap electrocutes insects with 4000-volt current wired to metal grille. Electric washer, ironer and dishwasher (below) cut hours from work on farm

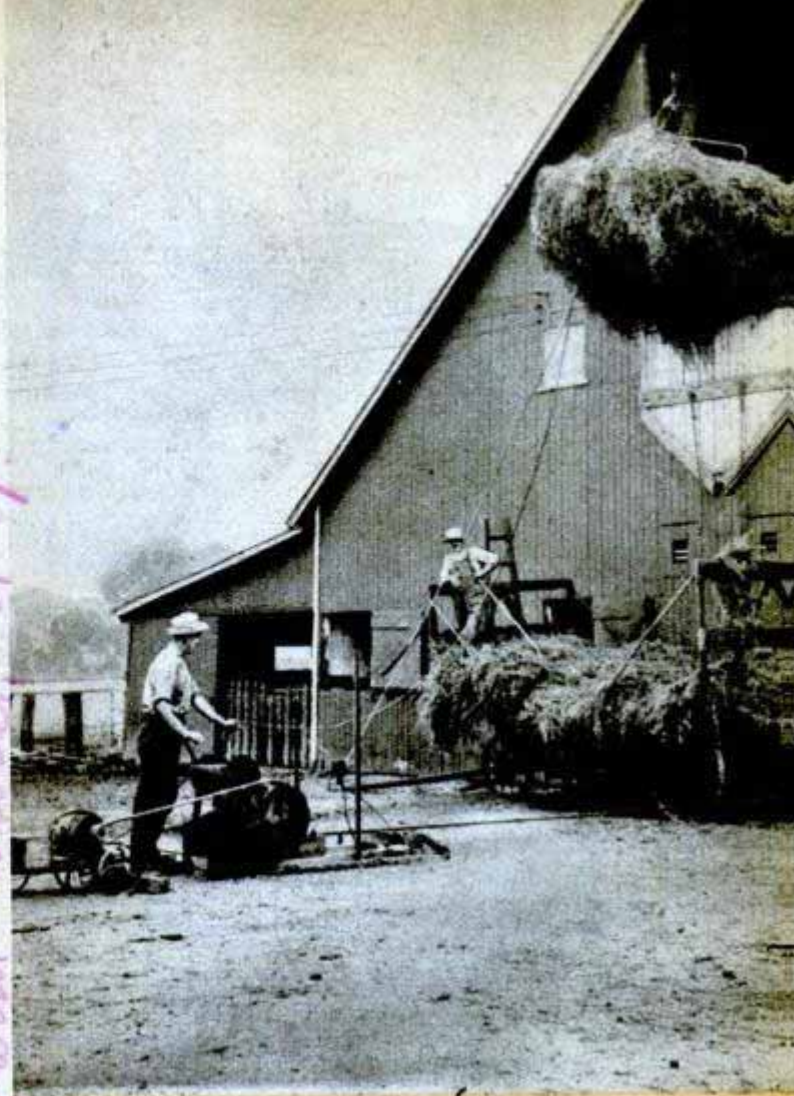

Storing hay becomes a one-man job with portable electric motor, releasing a tractor for field work. Below, homemade milk stirrers run by electric motor

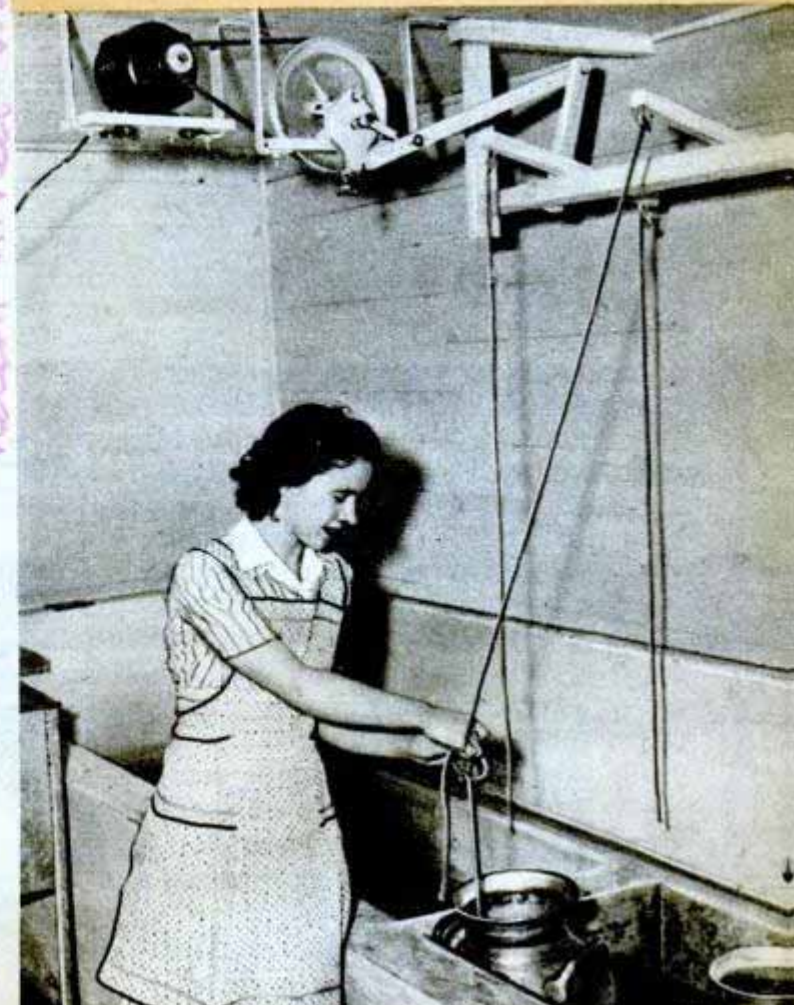

Helena R. Peet, Pruning Farm, Webster, Mo.



Eight cases of eggs per hour are graded by machine

self-supplying levels. Electrically pumped sprays, consisting of portable piping and easily moved from field to field, are being used by many farmers to stimulate growth and save crops.

Rural electrification has already brought one far-reaching benefit. It is making possible the development of rural industries and helping to decentralize industry. This is still an almost untouched field which holds promise of important public values. Industry, on a smaller scale than in most cities but adapted to the special needs of rural people, is reaching into rural areas which have electric service. Rural producers are seeing the economy of processing locally the raw materials produced locally—and the benefits in terms of greater community and individual income.

The combination farming-manufacturing life is now enjoyed by thousands in many industry-sponsored farm-factories. Probably the best examples are the village-in-

Quick-freeze unit preserves foods for future use



Electrically powered milk coolers are used widely by dairy farms to keep milk fresh which otherwise would spoil during the wait for shipment to market



Electric blower forces air through ducts to cure hay in mow. Below, electric clippers shear sheep



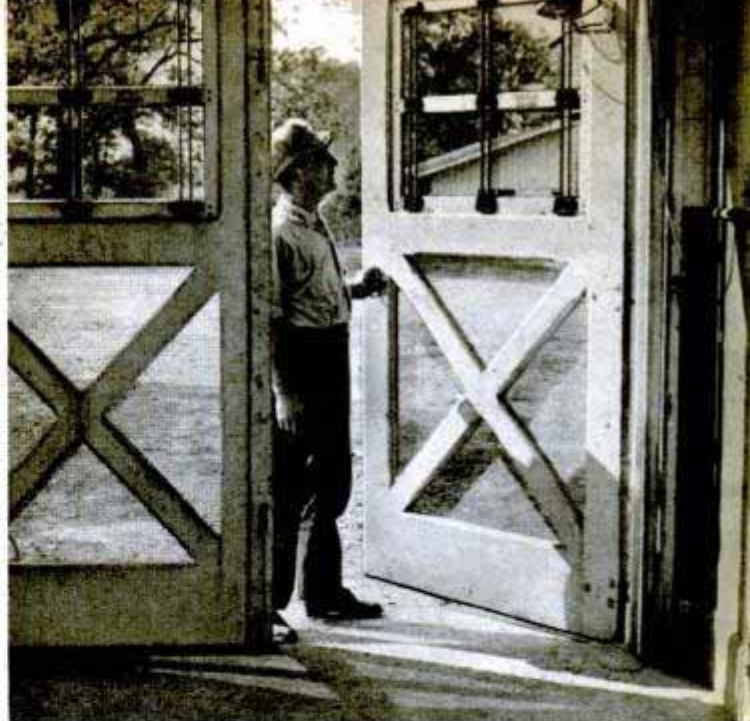

Fanning mill (at left) is driven by a small portable electric motor. Right, electric screens instantly kill flies

dustry projects of Henry Ford, where, during the slack farm season, farmers produce precision parts for automobiles. The worker, in addition to being provided year-round employment, has the dual advantage of healthy farm environment and high factory wages. This part-time farm-rural industrial employment holds promise of contributing to stability of income, maintenance of high standards of living and promotion of rural security.

Increased savings and income made possible by efficient application of electric power to farm tasks has encouraged many farmers to electrify their homes. Electric ranges not only save many hours of hard labor for the farm homemaker who stokes wood into a stove, but also permit her to do other tasks while her meal is cooking.

Electric refrigerators are often production tools, as farm families frequently store eggs and other small marketable items in the large-size family refrigerator.

Electric lights in the home mean almost unbelievable change in the lives of farm families who have struggled for years with inadequate, smoky oil lamps. Radios, washers, irons, vacuum cleaners—all the modern conveniences of the city home—soon will be available for more farm homemakers. These time-saving devices actually are more important to the farm housewife than to her city sister who seldom has "chores" outside the home.

Large-scale rural electrification is just beginning. Although the first central generation system went into service in 1882, until recent years farm electrification advanced very slowly. A few farms were connected to central-station power prior to World War I, and the early '20s saw a short-

lived spurt in which progress made in electrical engineering was reflected. But as late as 1939 only 20 percent of all farms in the United States had received central-station electric service.

In the period 1935-1945, due in part to the stimulating effect of the federal Rural Electrification Act of 1936, electric service was extended to an additional 30 percent of American farms. The act provides for loans to qualified organizations, preferably non-profit and cooperative enterprises, for the construction of power facilities for inhabitants of rural areas without central-station service.

To make the government-appropriated money go farther, Rural Electrification Administration engineers worked out a simple type of construction, using poles without cross-arms and stretching the wire in long spans. Previous rural electrification attempts had used heavy, expensive urban type construction which often made costs prohibitive.

As a further saving, almost all members and consumers of REA-financed cooperatives read their own electric meters and many figure their monthly bills, sending payments "on their own" to the cooperative office.

About half of rural America has been receiving central-station service since the first of January 1946. Congress appropriated \$200,000,000 for the fiscal year 1946 for the Rural Electrification Administration to be used as loans. An additional \$100,000,000 is available to finance REA systems. Scores of private and public utilities, too, have dusted off their blueprints and resumed bringing mankind's greatest servant to the American farmer.



PARIS *on a* TABLE TOP



Although George Alexander fled Europe before the war, he lives among the picturesque streets of Paris. The Los Angeles artist resided for 15 years in the French capital before the heavy curtain of war dropped over Europe. Anticipating the nostalgia that would depress him if he ever left the beautiful city, he spent many hours of his time re-creating characteristic sections of the capital in clay. He completed his ambitious project in 1936, but when he fled he had to leave it behind. At last he has it housed in his own studio. Alexander's Paris is complete with tawdry streets, curio shops, sidewalk cafes and wash hanging from apartment windows. On the shelves of corner newspaper kiosks are miniature periodicals. A typical mongrel dog sniffs hungrily in an alley. Alexander has even put miniature tomatoes, beans and other garden produce in the vegetable stores. An old street gate hangs awry on its hinges, and cracked plaster on the walls of the buildings adds a realistic touch



AN ARTIST

"Paints" With Wood

BEAUTIFUL PICTURES are created from thousands of tiny pieces of colored wood by 72-year-old John Wacha of Providence, R. I. Using more than 70 types of wood—some in natural color and others colored by impregnation—Mr. Wacha fashions lifelike flowers, trees, castles and anything that strikes his fancy. Buying his wood already sliced to minute thickness, he uses a fine-edged knife or saw to cut out the desired shapes which he fits together



Craftsman Wacha's grandson watches him polish a picture made from many tiny colored wood slivers

to form the picture. Some of the cutouts are so tiny that the artist employs jeweler's tweezers to handle them. For example, small flowers less than a half inch in diameter are made up of 20 pieces of colored wood. Each piece of wood is held in place by gummed paper. When the picture is completed, it is covered with binder paper, mounted on plywood and pressed for 36 hours. Then the binder is removed and the picture is sanded, shellacked and waxed.

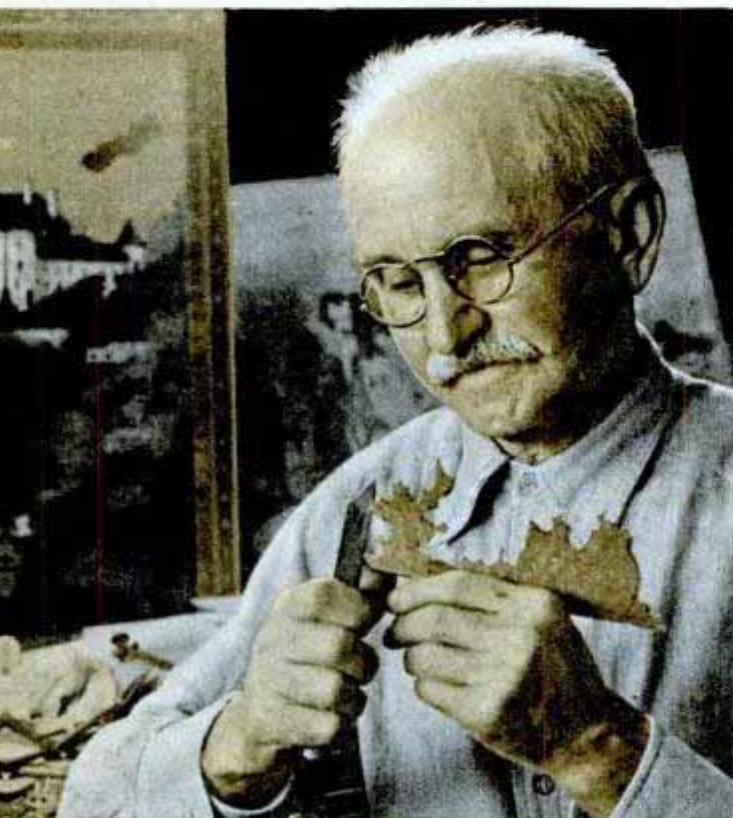

Intricate shapes are cut out with sharp knife. Wood from almost every corner of the globe is selected by the artist (below) to get the proper color for pictures

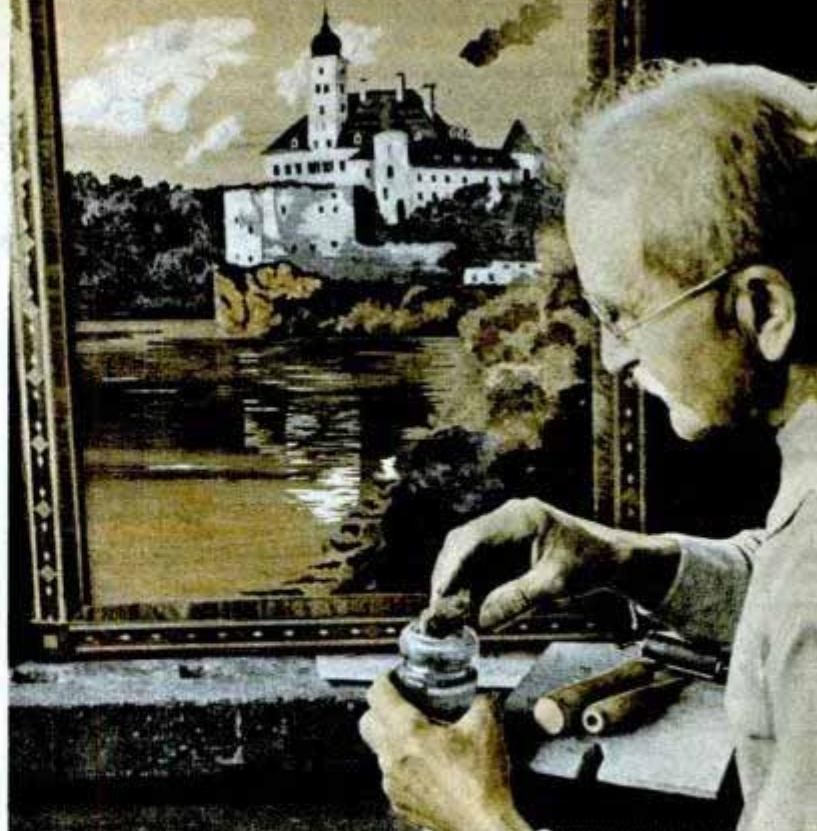
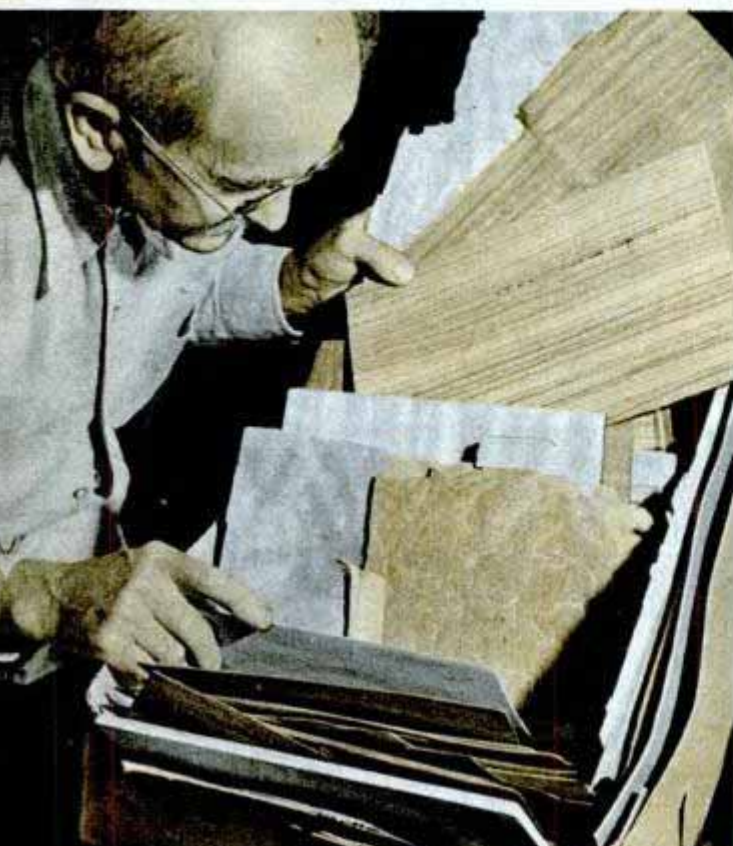

Preparing to apply an oil rub to an English castle scene. Light-colored wood created water reflections



A fine scroll saw is used to cut out the figure of Mother Eve. Below, a tiny sliver of wood is handled with tweezers for insertion in a palm leaf design



Gyro Keeps Its "Head" in Spins



Resistance to spins and dives is the feature of a lighter, smaller directional gyroscope developed by General Electric engineers. They have also built a climb-and-bank gyroscope approximately one third the weight of the present GE nine-pound instrument. The directional gyro has mechanical features designed to correct the tendency of conventional indicators to go awry when the plane goes into violent acrobatics, necessitating recaging and resetting when normal flight is resumed. It will take one third the instrument panel space of its predecessor and be more than a pound lighter. The climb-and-bank indicator likewise will occupy only one third the previous space on the instrument board.

Jap Copy of Jeep Lacks Power

America's versatile little jeep has a Japanese counterpart in a car of similar size built for military use. The Jap "jeep" has



power in its rear wheels only, while the American vehicle can be shifted to four-wheel drive whenever necessary. To compensate for this reduction in power, the car has larger wheels that give it slightly more clearance. Only the rear wheels are equipped with brakes. Most unusual feature of the little car is its front wheel suspension, consisting of coil springs and an elaborate hydraulic stabilizer. The vehicle holds three people, two in the front seats and one in the rear, with storage space on each side of the rear seat. A two-cylinder air-cooled, V-type engine provides the power. The vehicle can be shifted into three forward speeds and one reverse. It has one advantage over America's rugged jeeps—side curtains can be buttoned on during bad weather.

Phone Talks, Records Messages

Telephone calls are answered and recorded by an "electrical secretary" which goes into action when a physician or businessman leaves his office. Connected to



the telephone system, the reproducing apparatus has two turntables. One plays a record telling the caller that no one is in the office and giving instructions to leave the message. The message then is taken on another record. The entire operation of the unit is automatic, starting with the vibration of the ringing bell which actuates a detector to connect the telephone to the apparatus. The reproducing pickup is lowered to the record which informs the caller that his message is to be recorded during a 30-second period that begins at a gong signal. When the phone call is completed, the apparatus "hangs up" the receiver.

Cold Food Locker Has 60 Drawers

Latest development in frozen food lockers is a 60-drawer cabinet that can operate in a comfortably heated room, eliminating the need for customers to enter sub-zero chambers. Only the interior of the six-cubic-foot storage drawers is kept at zero temperature. To prevent meat or food spoiling, the drawers are so designed that they cannot be closed unless properly sealed. Each drawer lists the contents and the name of the user.

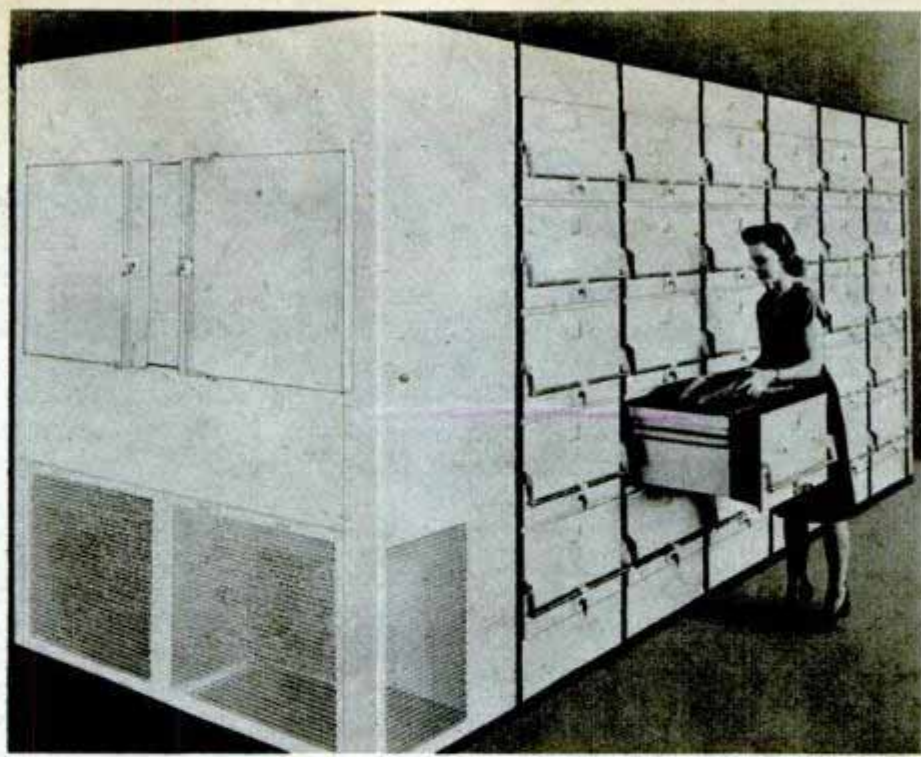

Wire Skeletons Brace Dolls Modeled After World Famous People



Using ordinary copper radio wire for the skeletons, Ruth Hope Leon of Jacksonville, Fla., fashions exquisite dolls modeled after famous people and fictional characters. After she inserts the wire skeleton in a cotton "skin" resembling a tiny diver's suit, Miss Leon adds cotton stuffing to fill out the legs, arms, torso and head. Eyebrows, eyes, eyelashes, nose, mouth and ears are applied by a few deft touches of water colors. Painstaking care produces authentic clothes for the dolls. Miss Leon's life-like figures, never taller than eight inches, have won many prizes.

Huck Finn, Marie Antoinette and Whistler's Mother dolls have framework made of wire

Names and addresses of manufacturers of new products featured in this issue will be supplied promptly by the Bureau of Information, Popular Mechanics Magazine, 200 East Ontario Street, Chicago 11, Illinois.

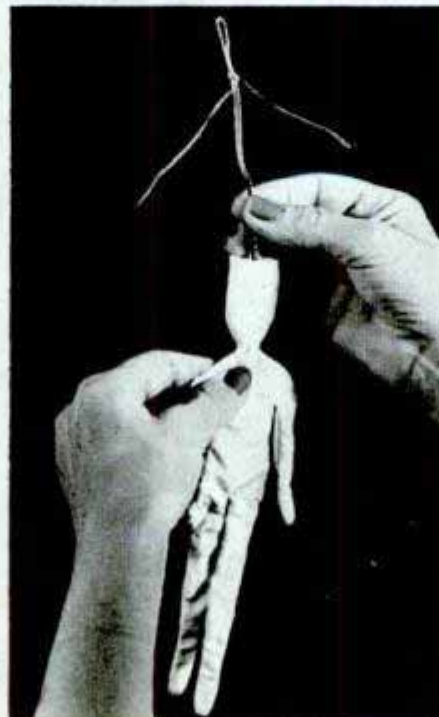

*100 National Women of Am. Penmanship
Jacksonville, Fla.*

1828
some features to my
car (any other, etc.)

Aladdin was

INSTEAD of simply waiting for the "bright new world" that everyone is talking about, Carl Mac Brainard, 23, is doing things to make that world come true.

Thanks to one of Brainard's inventions it soon may be practical to illuminate your home with cold light, using no more current than it takes to operate a console radio. The light sources will never wear out, the wiring eliminates fire hazards, and only a trickle of current is used. Instead of snap switches you may use circular controls, changing the intensity of the illumination to suit your needs.

That's just one of the Hollywood youngster's devices. For a peek at some of the others, let's imagine he is driving you home

from the theater. En route he reaches down to a toggle switch on the instrument board and clicks it four times.

"That," he explains carelessly, "turns on the furnace at home by short-wave. The house will be warm when we get there. And this—" clicking the switch five times—"turns on the lights in the garage. Two clicks open the garage doors."

Just then a bell rings in the glove compartment of the car. Brainard reaches in and nonchalantly hauls out a standard telephone set. "Yep," he says into the receiver, "this is Mac. I'm on my way home from the show."

By now you can't believe your eyes but Brainard still has a trick or two up his sleeve. Handing you the phone, he suggests that you call your home. You dial your number, listen to the ringing signal, and presently you are explaining patiently that you're tied up with business.

Brainard tells you that the car phone is hooked up by short-wave radio to his telephone at home. In effect it's a wireless extension of his regular telephone.

It works this way: a one-tube detector "listening circuit" at his house turns on a relay whenever a call comes in over the wires or whenever

By flicking the toggle switch in car Mac Brainard can start furnace, turn on lights and open garage doors by radio while he is miles from home

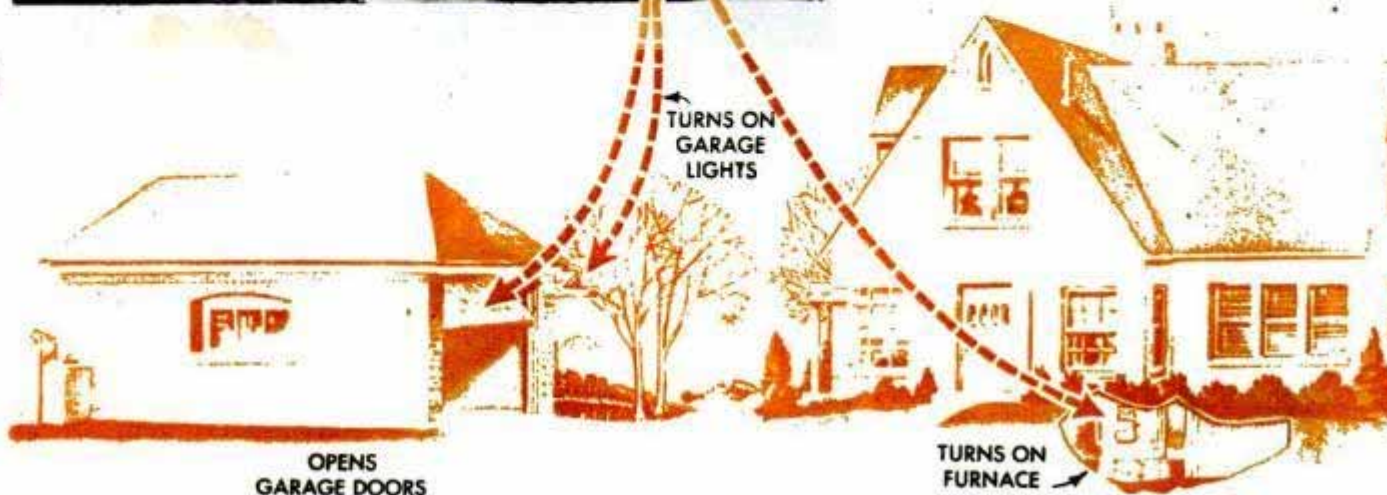

a fiker



Brainard picks up the phone in his car. The relay turns on a two-way short-wave radio set which is connected with the telephone wires. A converter system that permits you to dial numbers by radio is a special hookup, patent applied for.

With this outfit Brainard can dial any local number from his car or he can call the long distance operator to make out-of-town calls. Tolls are charged against his home phone number. The radio extension has a range up to 30 miles from his home set. There is no interference and very little static. Hills have little effect on transmission or reception, although tunnels or a channel of tall buildings will block off conversation.

Brainard's brain now is evolving a "remote remote" radio phone so that a golfer, for example, can call from a small phone in his caddy cart, leaving his car radio turned on at the clubhouse to act as an automatic two-way relay.

The young idea-man invented the fundamentals of his radio phone while in high school four years ago. Ultimately, he thinks, most cars will have built-in phone circuits with the handset cradled on the instrument board.

His radio circuits, which turn on the lights and perform other miracles at home while he is riding in his car, are somewhat simpler than the phone hookup.

A small transmitter in the car sends out an impulse every time he clicks the toggle switch. These signals are picked up at

Want to phone home from the golf course? Brainard's golf bag contains a telephone. He uses the radio in his car, parked nearby, as an automatic two-way relay

home by a three-tube impulse receiver in continuous operation. It consumes very little current. Amplified, the impulses operate a selector switch that completes the proper electrical circuit in the house. Instead of a toggle switch, a standard phone-type dial can be placed on the instrument board so that the number of impulses corresponding to the number you dial are transmitted automatically.

But still other surprises await you at Brainard's miracle home. As you step up on the porch an overhead light flashes on

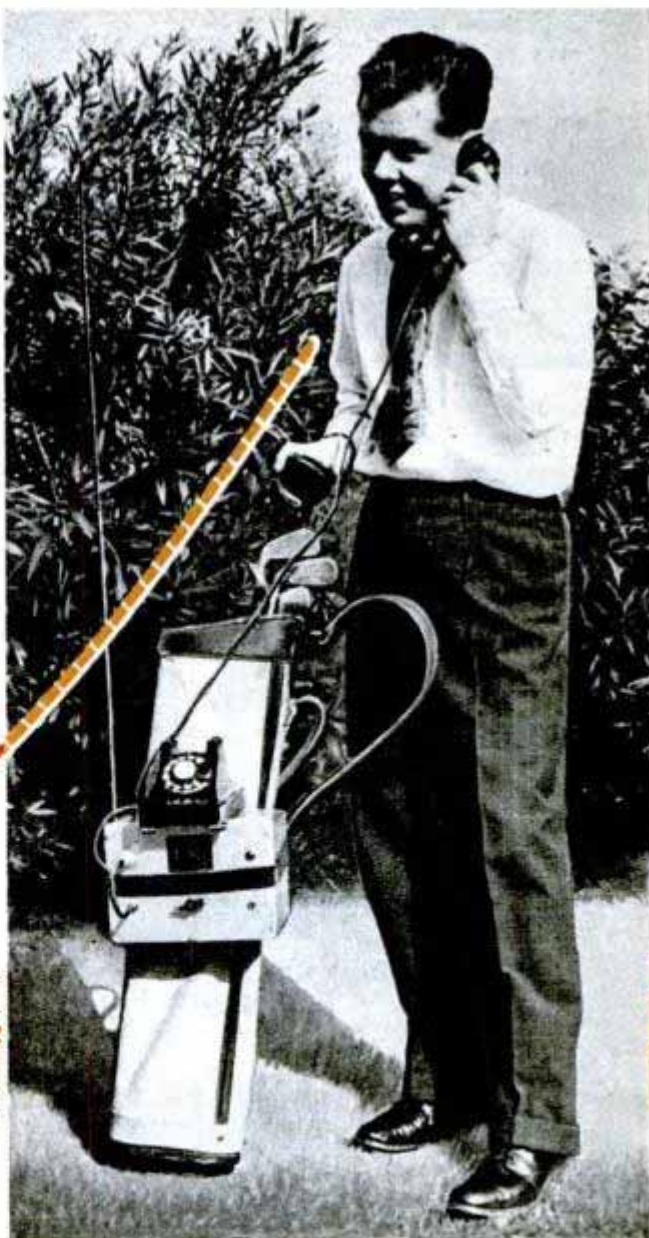

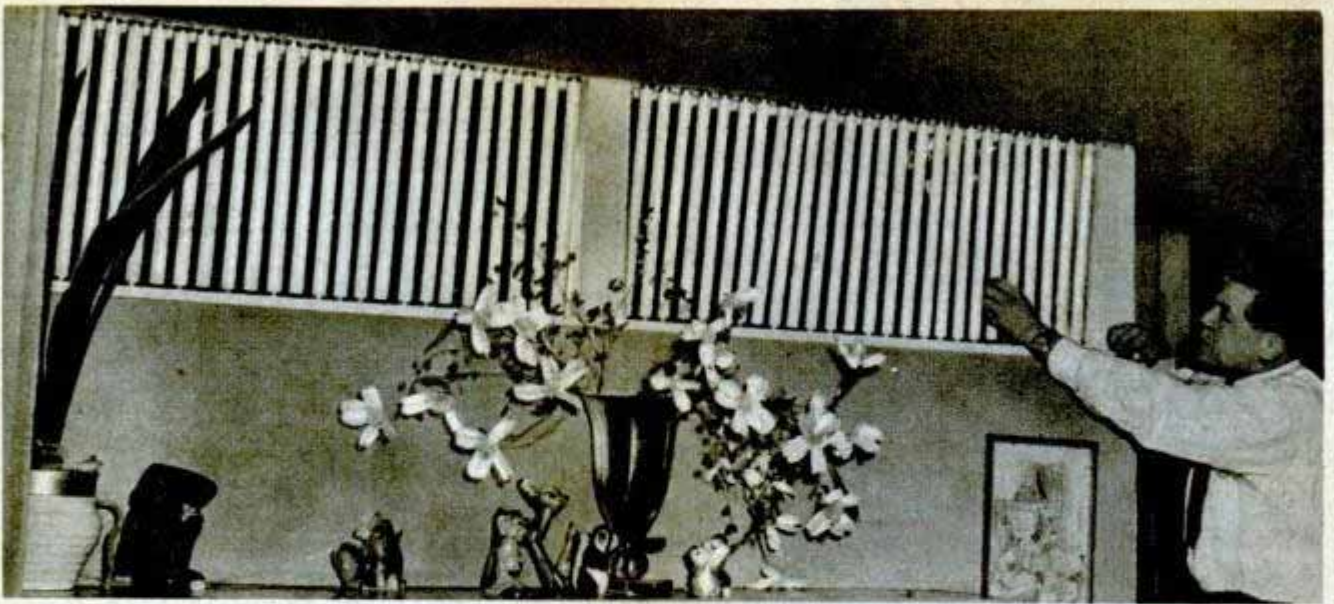

"Color organ" uses worn fluorescent tubes, flashes many hues in response to the radio's musical tones

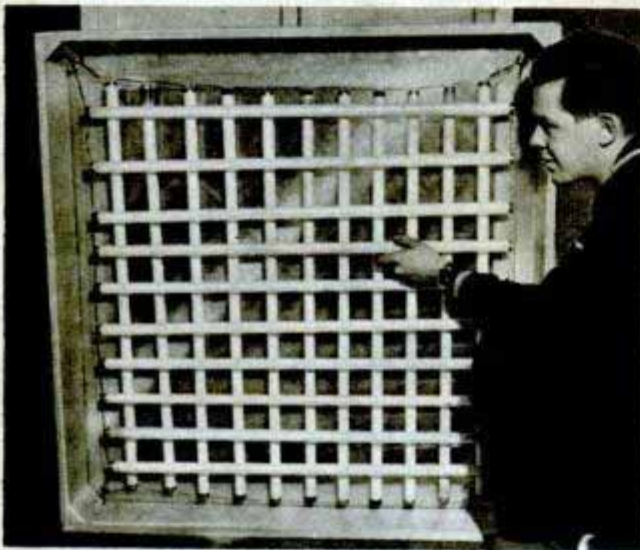

Rear view shows color organ's fluorescent grid. Below, movies glow brilliantly on screen of cathode-ray tube

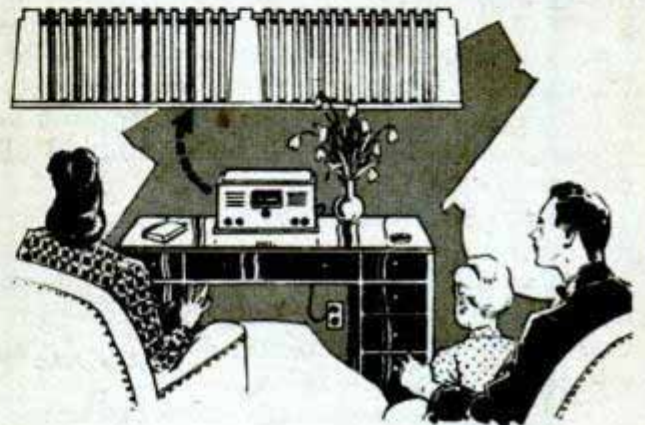

and, inside the house, chimes ring softly.

An electric-eye circuit could do this job, but Mac prefers a different system. On the wall just inside the entrance is an antenna that leads to a four-tube radio receiver perched on a convenient closet shelf. A metal mail box built into the wall is part of the antenna system.

When you stepped on the porch you changed the capacity of the system, unbalancing the receiver and causing it to close solenoid relays that turn on the porch light and ring the doorbell for you.

Mac finished high school, worked in a defense plant and then did a hitch in the Navy. He's studied radio since he was 12, building some new kind of circuit every time he got an idea. One novelty was a midget pocket broadcast receiver in a plastic cigarette case, complete with a hearing aid receiver that fits into your ear.

A couple of years ago Brainard was wondering how he could use burned-out fluorescent tubes. He hooked up a high-frequency power source to one of them and found that the tube glowed, as good as new. Then, partly by accident, he found a circuit that energizes the tubes by means of audio-frequency impulses, the same kind that operates your radio's loud-speaker. The



Brainard installs radio equipment in his car. Below, communication circuit uses standard telephone handset

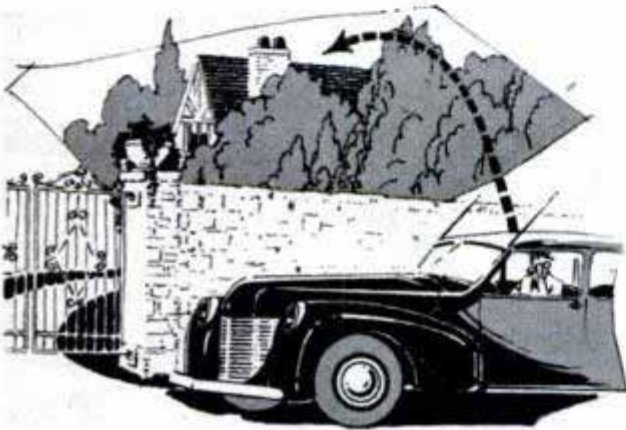

gas pressure inside the tube determined the necessary strength of the impulse. Brainard had a number of fluorescent tubes refilled with different gases, each producing a different color of light, and connected the tubes to the loud-speaker circuit of an ordinary broadcast receiver.

The result was a "color organ" with tubes lighting up in different hues at the same time that different notes of music are heard from the loud-speaker.

He built a magic-light color organ for himself, then a number of them for his friends. In the meantime he obtained a patent on the linking circuit that causes the tubes to respond to audio-frequency impulses. Now a huge organ is being built with a bank of 250 four-foot tubes that will stretch across the stage of a new auditorium at the North Island Naval Air Station, San Diego. The tubes will produce glowing colors to the music of an orchestra on the stage or to radio and phonograph music.

His "music with eye appeal" is to be marketed through Ideas, Unlimited, an organization that has given him a contract with a minimum guarantee of \$130,000 for the invention during the life of the patent. The lights will first be introduced as attachments to juke boxes.

Brainard now is expanding his original circuit so that such tubes can be used for illumination, the energy to be supplied by a one-tube radio tone generator. The current for operating that tube and a few others in a linking unit would be enough to illuminate an entire house.

By combining simple circuits with electrical equipment Brainard has installed trick hookups at the homes of some of his friends. Lou Costello, the movie star, has a bookcase in his home that swings open to reveal a secret room—if you know the secret. All you need to do is punch the nose of a certain character in a particular photograph on the wall. Mysteriously the bookcase swings open. The operation is the same as the circuit that turns on Brainard's porch light. The presence of your finger on the photograph disturbs the balance of a concealed radio-type circuit—that oper-

(Continued to page 240)

Print Your Own

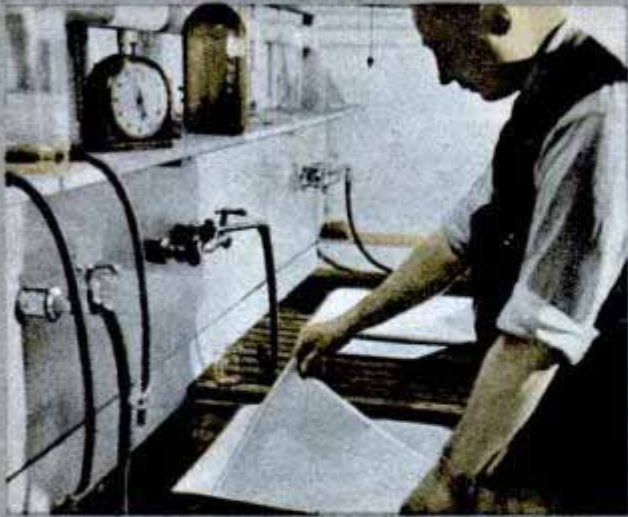

1—The three matrix films are developed after exposure



2—The matrices are registered in position, then trimmed



3—Inherent colors are added to the films in pans of dye

5—Dyes are transferred to the paper with a special roller



4—"Buttons" on the blanket re-register films for printing

6—Repetitive prints are made quickly, look exactly alike



Six of the major steps in printing color photographs are illustrated above. On the following pages the process is outlined in full detail

PPRINTING color photos is a magic trick that has baffled amateur photographers since the dawn of color film. After an eight or 10-hour bout with color materials in the darkroom most amateurs have been content to leave the tedious job of color printing to the professionals.

Color Photos



The news that you can successfully print your own Kodachromes at home is headline stuff to camera fans. It's as if some Houdini of photography had opened his choicest bag of tricks and announced: "Here, boys, is what you've been waiting for! Step right up and help yourselves."

Word is now being passed along the line of camera addicts from coast to coast that color prints are within the reach of any advanced amateur who can read and follow simple directions. All that is required is a couple of hours in the darkroom and the outlay of a surprisingly small pile of cash.



Top photos by Ray Chapin



The new Kodak Dye Transfer Process is basically similar to most other color printing processes. But there the likeness ends, according to both amateurs and professionals who have given it a tryout. They sing their praise of the new method in terms of superior prints, ease of control and a saving of time and labor.

Six hours were needed to make an original print with the most widely used of the former methods—the wash-off relief process. The dye transfer process requires only two hours in the



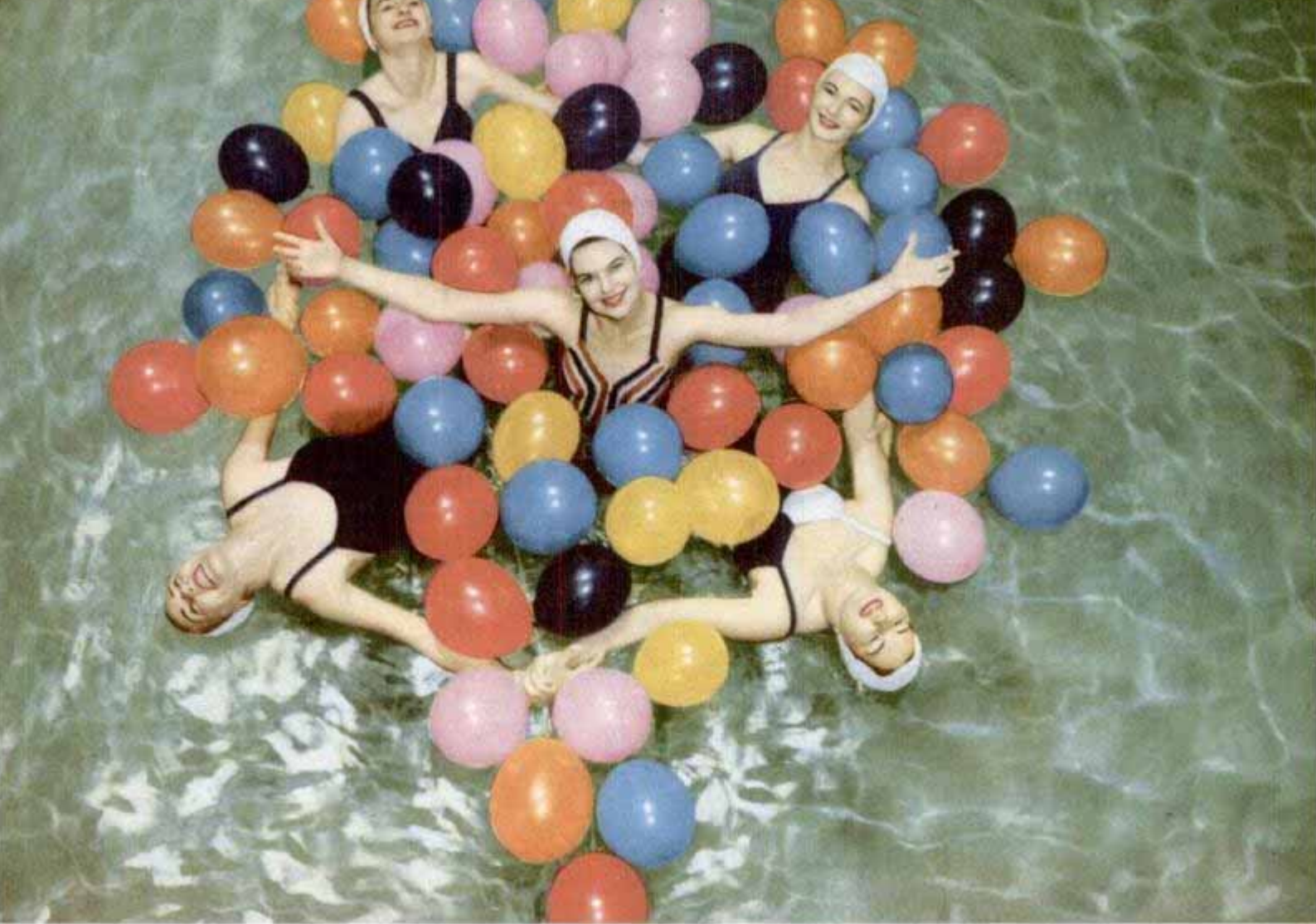

Photo by Ray Chapin

Now the amateur can translate his prized color transparencies into salon prints for framing. All the richness of natural color captured in these Kodachromes by amateur and professional photographers is brought to life in prints to adorn the walls of living room and game room

home darkroom. Repetitive prints can be made in one eighth the former time.

All necessary materials are included in a moderately priced kit. One of the most important items is a step-by-step "cook-book" instruction manual. Prints as fine as a professional's will result if directions are followed with care.

The process, developed by Louis Condax and Robert Speck of the Kodak Research Laboratory, passed its first practical test during the war. One apparently insignifi-

cant problem hampered production of sorely needed planes. Wire assemblies of the planes were so complicated that workers could not assemble them correctly without patterns.

Tracing each wire on a blueprint with a pencil of a particular color was too slow and subject to human error. One such pattern could be painstakingly drawn and colored. But how could this original be reproduced quickly in accurate colors?

This stumbling block was overcome with





the introduction of the new process. It was so simple and accurate that one drawing of the wire assembly was photographed, then reproduced hundreds of times—with the desired speed and accuracy. Upon distribution of the photographs among workers, production of the assemblies shot up 80 percent.

Most advanced amateurs have the minimum equipment needed for the dye transfer process. Any camera is suitable which will take ordinary color transparencies—films which show the object photographed in full color when held to the light. The required equipment also includes an enlarger with printing frame and a set of tricolor filters (F, N, and C4 plus 2A), an illuminator or contact printing box (easily improvised), at least eight standard developing trays, a thermometer, a squeegee, a trimming board or a sharp knife and straightedge and three graduates—10 c.c., 50 c.c. and quart size.

In addition to this minimum, the photographer must purchase a transfer board complete with a "dye transfer blanket" and a roller, machined especially for the new process.

Kits containing chemicals for the process are available at present in a "gallon" size. Each kit produces 12 sets of matrices and approximately 80 eight-by-ten prints, allowing for a few mistakes. Items contained in the kit also are available individually. A "quart" size kit may be marketed later.

Exclusive of the compact kit, the only materials required are Kodak matrix film and dye transfer paper.

In the new process the photographer makes three separate negatives in the usual manner. He filters the primary colors from the transparency one at a time. All colors of the spectrum are obtained from the three photographic pri-

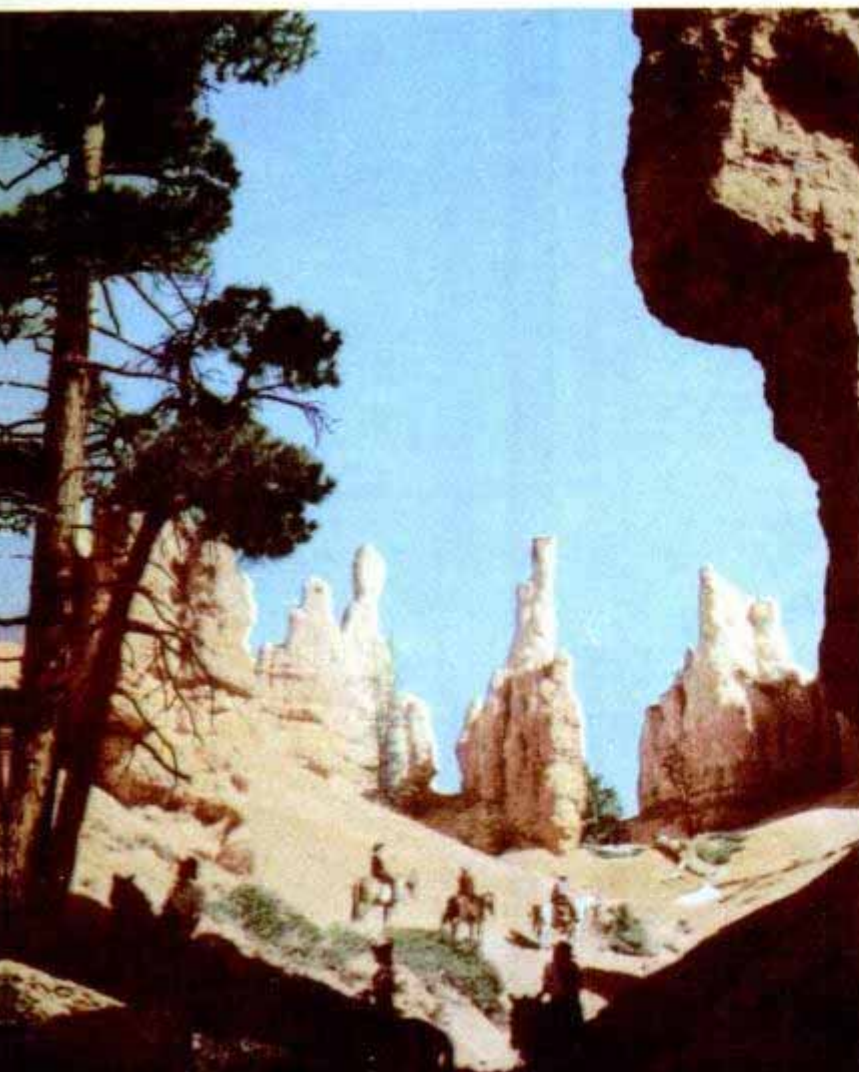

Vacation photographs, always the specialty of the amateur, can capture favorite playgrounds—in color



maries—red, green and blue. By placing a red filter in his enlarger beneath the transparency, he allows only red light to pass through. Unexposed portions of the negative material represent the two remaining colors—green and blue. This combination of green and blue is called “cyan.” Eventually he will dye the matrix of this negative cyan, then print the dye on paper to give part of the final combination of colors.

Similarly he filters green out of the picture for the second negative. This leaves blue-red, or “magenta,” on the negative material. With blue filtered out, he has red-green, or yellow, on the third negative.

His remaining problem is to transform these negatives into matrices—relief “maps” of the photograph—dye the matrices, and then transfer the dye to the final printing paper. The dye transfer process simplifies and speeds the methods formerly used in solving this problem.

After developing these separation negatives, the photographer has seven more steps to convert them into a color print.

First he must make the matrices. He places the red-filtered negative in his enlarger with a sheet of matrix film, emulsion side down, in the printing frame beneath it. When he passes light through the negative to the film, the image penetrates the base of the film and affects the emulsion. This image represents two colors, green and blue, in varying degrees. Matrices of the other negatives are made in the same way.

In the second step the photographer develops these films in a tray containing “matrix film developer,” a solution from the kit. The image becomes clearly visible on each film. The films, after developing, are rinsed in a stop bath to prevent further chemical action of the developing solution. Washing them in hot water melts away all unaffected parts of the emulsion. He then rinses them in cold water and suspends them for drying.

These films have become matrices. Each of them is a relief map of the image. Tiny hills occur on portions of the image where the particular colors of that matrix are shadowed, valleys where they are brighter.

Third, he must register these matrices, that is, place them together until they are in perfect position. To do this he places them one at a time on the illuminator (or contact printing box) and tapes them to the glass as each is properly positioned. The result is a complete picture.

Two edges of this “complete picture” then are trimmed. This is another advantage in the new process. For whenever the photographer again lines up these common edges of all three matrices, they automatically will be in perfect register.

(Continued to page 232)

Pouch for Baby Frees Mother's Arms



Junior becomes airborne when riding the “Cuddleseat,” a canvas pouch slung over his mother's shoulder. It frees her hands for carrying packages. The contraption, probably inspired by the kangaroo's most familiar feature, has a padded seat to make the baby comfortable. Promoters say that more than 100,000 of the seats have been sold in Australia.

“Demineralizer” Purifies Water

Salts and other minerals are removed from hydrant water by a purifier that functions without aid of heat or electricity. Suit-

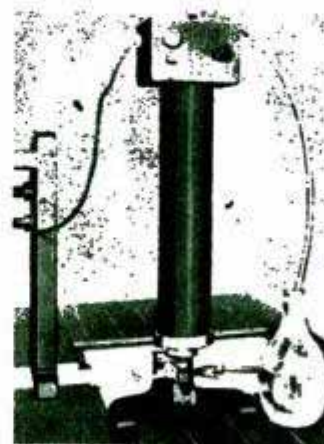

able for laboratories and industries which do mirror-silvering, radio and electronic work, the unit employs a cartridge filled with special resins to remove minerals from water. The resins convert dissolved salts into acids and then absorb these acids. One

cartridge filling provides as much as 300 gallons of purified water required for such operations as storage battery maintenance.

*Carnstead Still Sterilizer Co.
2 Hanesville Terrace*

T. G. 175 N. W. 11th
 PORTLAND, OREGON
 THE (BY) ...



At home in a "Round House"

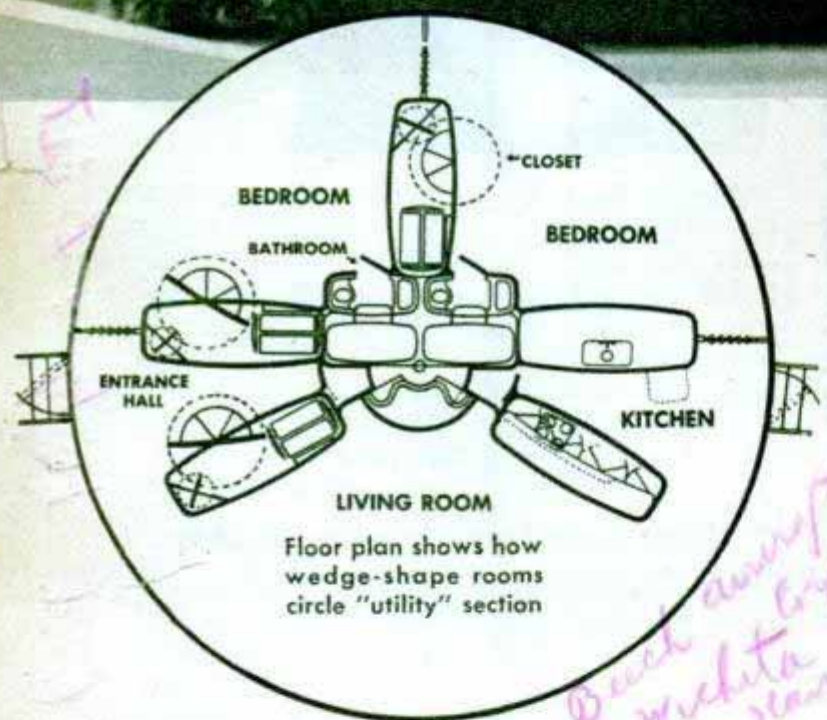

Side walls and partitions of this circular aluminum house are suspended by cables from a central steel mast. The house, designed by R. Buckminster Fuller, contains two bedrooms, kitchen, combination living-dining room and two complete bathrooms. Central axis holds the heating and air-conditioning equipment, refrigerator, washing machine and drier, dishwasher, range and sink. Beech Aircraft Corporation, Wichita, Kans., plans to build 50,000 Fuller houses in 1947. They will be shipped in parts, eight to a railroad boxcar, and can be erected by a 10-man crew in two days. The aluminum-stainless steel-plastic house will sell for \$6500. It has 1017 square feet of floor space

Closet door swings out to reveal revolving rack; immense living room window takes one third house perimeter



Single-Valve Mask Aids Firemen



Masks using compressed air at 1800 pounds' pressure are replacing the hitherto standard oxygen-type protector for firemen who must work in dangerous concentrations of smoke or gas. Complicated valves, by-passes and pipes, necessary in the use of oxygen, are replaced by a single reduction valve in the later device. A gauge with a luminous dial and worn on the wearer's chest tells him at a glance what his air supply is. The closely-fitted mask, of rubber, has contoured, laminated shatterproof lenses which permit full vision. Close-range conversation is permitted by a diaphragm-type inhalation valve and the entering air does not fog the lenses, a difficulty encountered with oxygen and other types of masks. Two sizes of air bottles are available; one worn on the back, with an hour's supply, and a smaller model for the chest, with 16 minutes' supply.

"Incendiary" Soap for the Army

Napalm, the incendiary ingredient that shot out of wartime flame throwers as a searing jet of flame, soon will be used by the Army as a harmless liquid soap. The War Department has announced that within a few months 50,000 gallons of a new quick-suds soap made of napalm will be issued to GIs for use in scrubbing everything from barracks floors to fingernails. The new soap can be made in the same plants that turned out the flame-thrower fuel. Napalm also is reported to have limited applications in hospital use.

"Spinning" Wrench Turns Bolts



Spinning a wrench with a single twist gives the tool enough motion to tighten or loosen bolts and nuts with little further aid. The wrench has a heavy crossbar that continues to rotate until the nut is tightened to almost the desired tension. Only an additional twist is needed for complete tightening. The manufacturer claims the tool speeds work 30 to 40 percent over ordinary wrenches. With attachments it can be used on bolts, nuts or stud screws.

Crossbar Holds Brush in Liquid

Made of heavy aluminum, a handy cup for holding paint or heating glue is equipped with a carrying handle and a removable crossbar inside the can. The crossbar can be used to wipe off surplus paint or to suspend the brush in the paint. A cone-shaped top fits over the handle and keeps the liquid from thickening. The container comes in one and two-quart sizes.





Have We

By John L. Kent

A SINGLE PLANE, dropping one bomb, could destroy it. What we'll do about protecting it I don't know—but we'll do something."

These were the recent words of Major General Leslie R. Groves, the Army's atom bomb chief, when speaking of the power of the atom bomb and what it could do to America's lifeline—the Panama Canal.

The vulnerability of the canal has long been recognized by our military leaders, and when Hitler's armies started their rampage of devastation, additional troops were rushed to the already large defense garrison in the Canal Zone. The war also brought up once more the necessity of a second canal in the event Panama was damaged by enemy action.

As far back as 1930 an Army engineer battalion, carrying out the orders of Congress, conducted a large-scale survey in Nicaragua over the route of a proposed second canal. This new canal would extend 173 miles across Nicaragua from Brito on the Pacific via the Rio Grande, Lake Nicaragua, the Rio San Juan and the Rio De-seado to Greytown on the Atlantic.

At the same time the Governor of the Panama Canal investigated the possibility of increasing the facilities at Panama. In 1939, based on the survey in Nicaragua and the findings of the Governor of the Panama Canal, Congress shelved the idea of a second canal and authorized instead a third set of locks at Panama. The cost of the project was not to exceed \$277,000,000. Actual work was begun on July 1, 1940, but the outbreak of the war caused the project to be greatly modified. Work was continued,

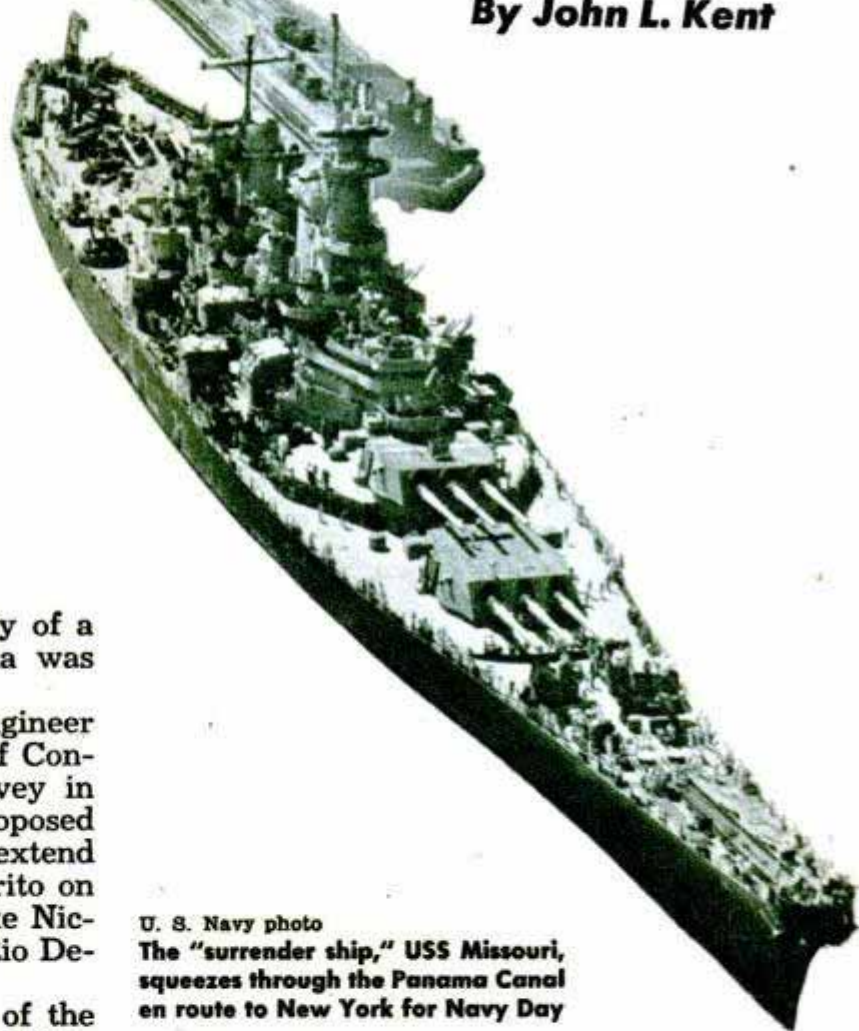

U. S. Navy photo
The "surrender ship," USS Missouri, squeezes through the Panama Canal en route to New York for Navy Day

however, throughout the war, and a large part of the dredging and excavating operations has been completed.

But the atom bomb may force the United States to build the second canal through Nicaragua. In building it our engineers would face an even greater task than the Panama project. The French tried—and failed—to build the Panama Canal.

The story of the French failure is well

USS Bunker Hill clears the last lock of the big ditch with inches to spare
U. S. Navy photo

known. In 1879 Ferdinand de Lesseps, builder of the Suez Canal, formed a company to dig a sea-level canal in 12 years at a cost of \$240,000,000. But disease, greed and graft prevented completion of the undertaking. After nine years' work, de Lesseps had spent over \$260,000,000—twice the cost of the

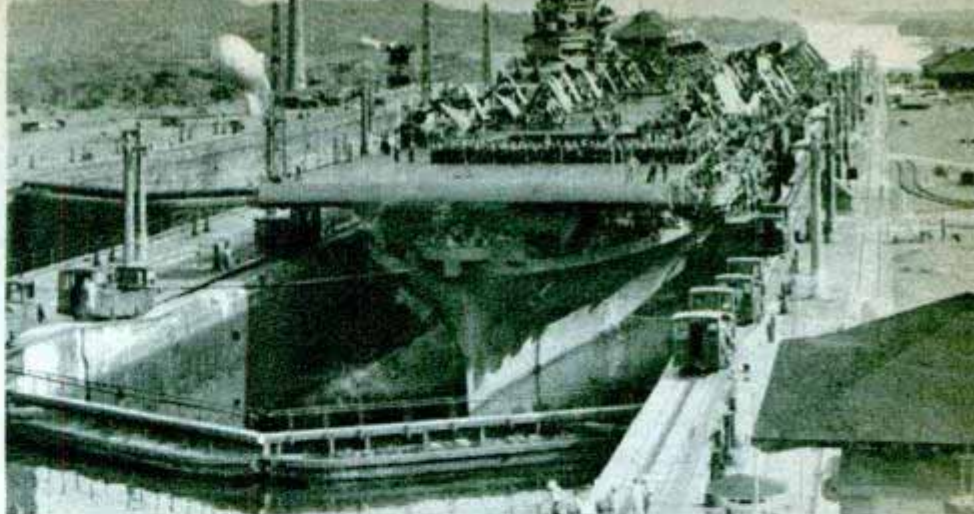

Outgrown the Panama Canal?

Suez Canal—yet less than a quarter of the canal was built. The French gave up.

In May 1904, having paid \$40,000,000 to the French company, the United States took possession of the unfinished canal. After some delay in getting started, Army engineers were ordered to continue the canal. An Isthmian Canal Commission, headed by Lieutenant Colonel George W. Goethals as chairman and chief engineer, set up headquarters in Panama. The commission performed what is recognized as one of the greatest feats of modern engineering.

Here, without construction equipment as we know it today, man struggled against Nature in many of her worst moods. Floods and giant earth slides slowed the progress of work. There were no bulldozers, dump trucks or self-loading earth scrapers. Thirty-six years ago steam still was king and excavation was by cumbersome steam shovel. Material was removed by railroad flatcars pulled behind puffing steam locomotives.

Then, too, it must be remembered that the high mountain divide of the Cordilleras runs through Panama much as the Rockies cross North America. Thus, a ship passing from ocean to ocean



U. S. Navy photos

It looks like a tight fit for Pacific-bound carrier facing the three sets of locks that will lift it 85 feet. Floating dry dock (below) was so wide it had to be tipped on its side and welded to pontoons to pass through canal

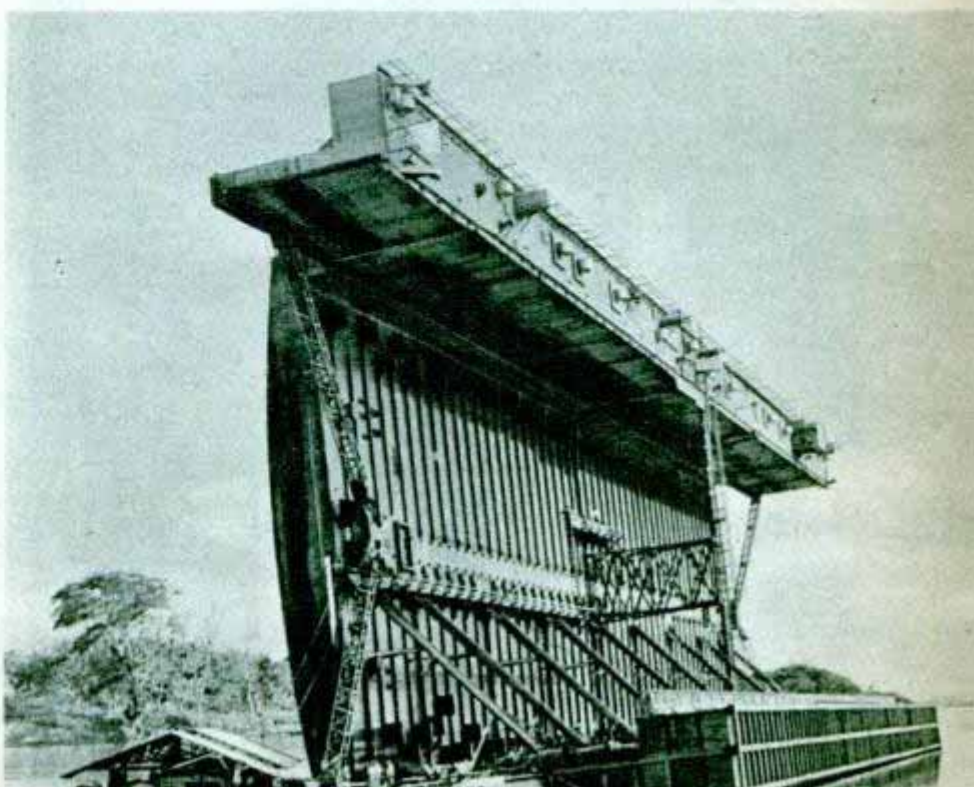



Map shows line of proposed Nicaraguan Canal. Below, U. S. Army engineers engaged in Nicaragua survey move diamond drill parts
Signal Corps photo



Below, building the \$20,000,000 Panama fuel pipe line with a daily capacity of 265,000 barrels of fuel oil—a wartime project
U. S. Navy photo



has to be lifted over the Continental Divide. On the Atlantic side is the Chagres River; on the Pacific side, Panama's Rio Grande. By building a huge dam across the Chagres, a lake 164 square miles in area and 85 feet above sea level was created.

To get a ship up the 85 feet to the lake, it was necessary to build a set of locks at Gatun. A tremendous amount of concrete was used to build these durable water gates. The side walls of the locks are more than 45 feet thick at the bottom and up to a point 24 feet above the floor. From there on they taper to 10 feet in width.

Having reached the lake, a ship then sails along the lake 24 miles to Culebra Cut. This giant slice through the Continental Divide was carved through six miles of solid rock. The cut, today called Gaillard Cut in honor of Lieutenant Colonel David du Bose Gaillard, an assistant of Goethals, is seven miles long. Its deepest part lies between two hills, one 660 and the other 400 feet high.

After passing through the divide, a ship has to descend 85 feet to the Pacific. To accomplish this, locks were built at both Pedro Miguel and Miraflores.

The canal was opened to navigation on August 15, 1914, 10 years after the actual digging of the "ditch" started. In the course of its construction, two hundred million cubic yards of earth were excavated. The total cost, exclusive of outlays for defense, was \$380,000,000. Additions and alterations and the clean-up of large earth slides in Gaillard Cut

(Continued to page 236)

Glass Fertilizer Feeds Soil Over Five-Year Period

Farmers eventually may fertilize their fields with a layer of glass beads or glass wool. Housewives' plants some day may eat the glass containers in which they're planted. Experiments during the past year indicate that a glass fertilizer which dissolves in the soil is practicable. Soils coated with the glass "digest" plant foods from it at a controlled rate. The process was developed by Dr. Roger H. Bray and Dr. Alfred E. Badger in experiments at the University of Illinois.

Impressed by the curious coincidence that glass contains all the needed plant foods except nitrogen, water and organic material, the two men developed a glass fertilizer that delivers plant foods to soils over a long period. Highly important potash and phosphates as well as minor foods are fused with silica to make glass which may be ground or blown into glass wool.

By controlling the ingredients of the glass the two men have been able to control the rate at which it dissolves in the soil. A reasonably accurate prediction can be made as to when the soil will need more fertilizer. One application may feed five years' crops.

Three advantages of the new fertilizer may encourage its development. It is less expensive because it need not be spread as often. Food is available at a "controlled rate," benefiting more than just one or two crops. And the farmer can estimate the time when his fields will need another application, a factor in farm management.

Experiments with the new glass have not yet been completed. Years may be needed to develop it. So don't plan to sow glass with your grass next spring.

"Ditched" Ocean Fliers Form Club



By "ditching" a plane in the ocean and crawling into a bobbing life raft, 1200 American men and women have unintentionally qualified for membership in the Sea Squatters Club. The lapel emblem worn by members is a tiny gold sea gull. Among the distinguished members are Eddie Rickenbacker and his crew, Gregory "Pappy" Boyington, and Harold Dixon and his two companions who sailed 1000 miles in 34 days to a tiny atoll in the South Pacific. Headquarters of the club is at 140 Cedar Street, New York City.



Anti-Foam Makes Oil Bubble-Free

Danger of air causing lubricating oil to bubble and foam out of high-speed motors is eliminated by an anti-foam agent developed by Gulf Oil Company. The glass cylinder at left, above, shows how air makes froth out of untreated oil.

Combination Sun Dial and Compass

Sun dial and direction finding compass are combined in a compact, waterproof instrument designed for campers, hunters and other sportsmen. The compass has an unbreakable crystal and luminous jeweled needle, housed in a solid brass case.



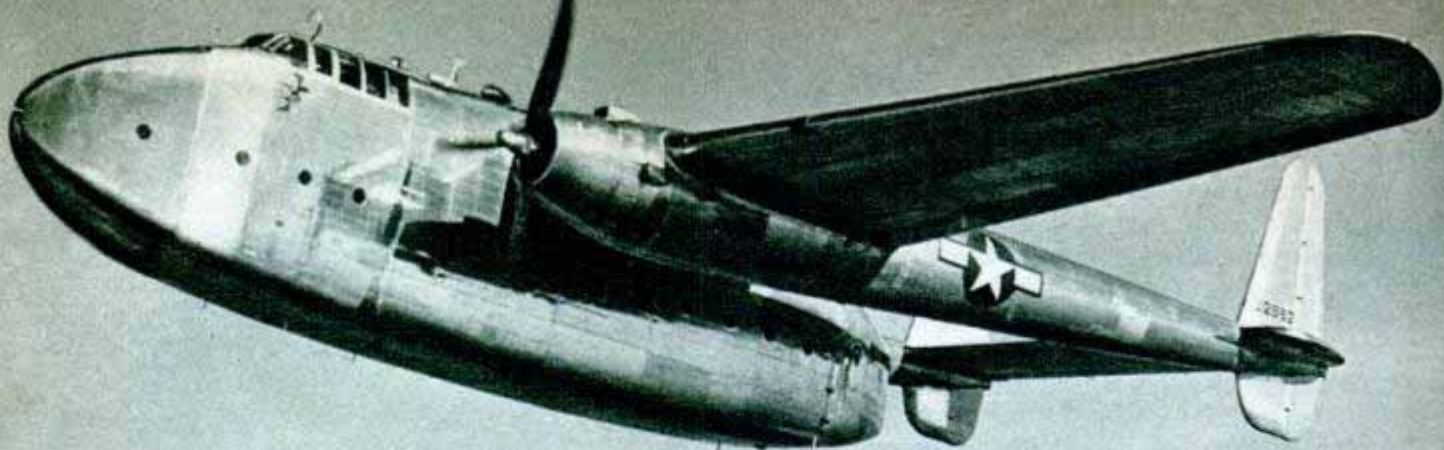

Flying Mailcar

AIRPLANE builders prophesy that special cargo planes carrying only air mail and parcel post soon will be in operation over the nation's transport routes. They point out that volume of air mail has increased so much that loads now must be divided among several passenger planes, often causing many hours' delay in delivery. One cargo plane, the Fairchild Packet, originally built for the Army, already has been redesigned for use as a flying mailcar in which up to seven tons of mail may be carried and sorted by airborne postal clerks who will work in flight. Capacity of the 38-foot-long hold is 93 percent that of a railroad car. Lightweight metal and plywood sorting tables, letter racks, chutes and bag racks are provided for the three clerks. Mail would be loaded at both ends of the hold simultaneously through a forward door and a huge clamshell-like rear door which opens at truck-bed height.

Two 2100-hp. engines power the Fairchild Packet, top. Cutaway drawings show: upper left, mail bags stored forward; left, lightweight mail sorting equipment; below, three "working" sections of the flying mailcar

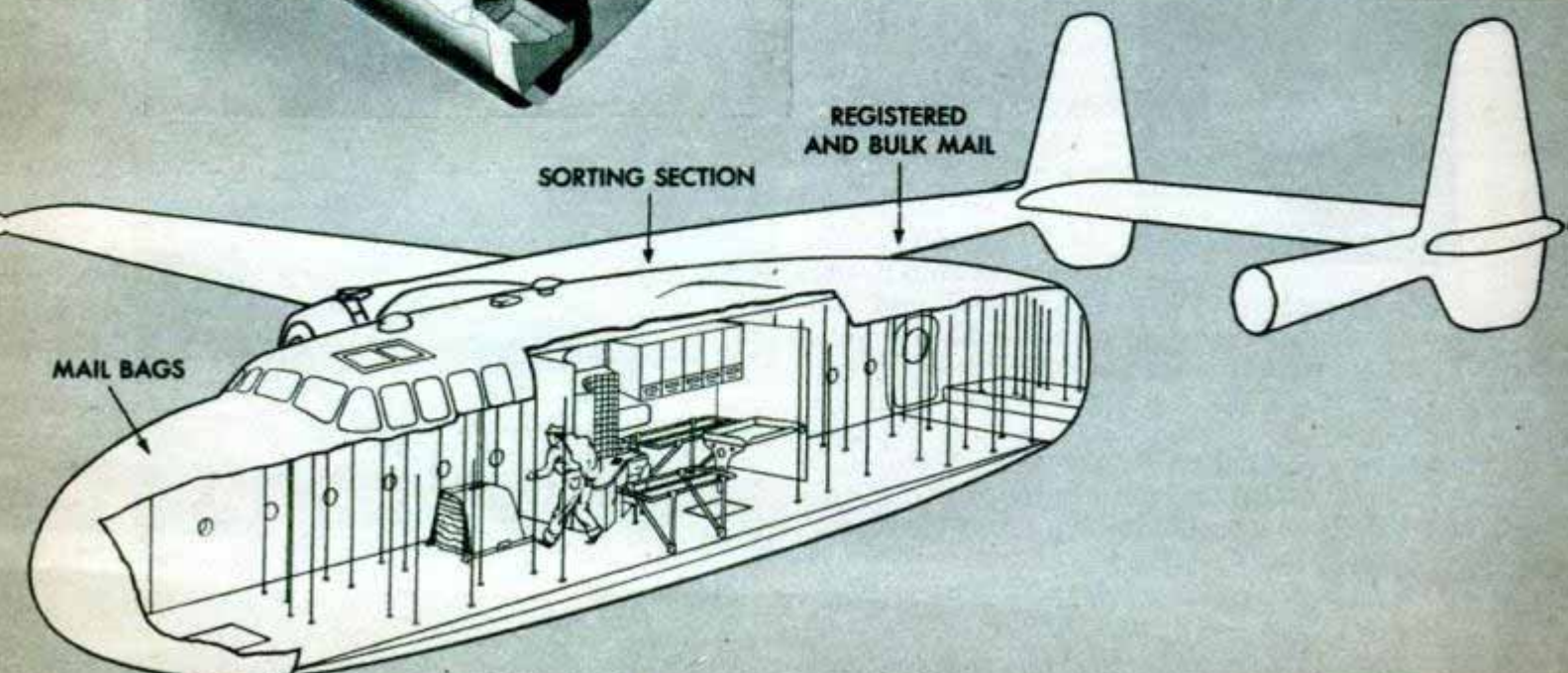
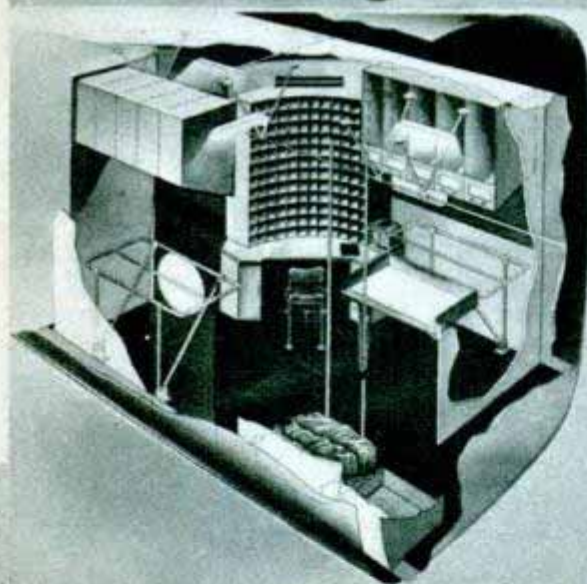
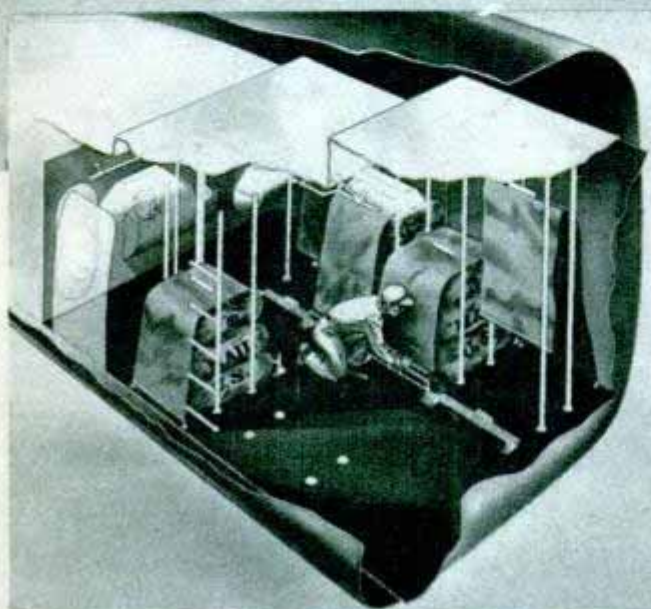



Fresh in the Air

Dual control of Sikorsky's S-51 is provided for at the center of the three-passenger-wide rear seat. It carries 1250 pounds and cruises at 80 miles an hour

Baby kits complete from diapers to canned foods are now provided on TWA trips and United has a special you can't ride unless accompanied by a small child



Seating five, Bell's Model 42 helicopter cruises 100 miles an hour and has a range estimated at 300 miles

Actual operating conditions are simulated in testing plane heaters and mufflers outdoors on a portable stand

Largest piece of Plexiglas ever formed, this "bubble" covers the crew of a Northrop F-15 photographic plane

British-built, the Miles Gemini is adaptable to use as a freighter, ambulance, personal plane, trainer or taxi



XP-81 Combines Turbine-Driven Prop With Jet Thrust at Rear

First plane ever to fly with a gas turbine providing the propeller drive, the AAF's new long range XP-81 has a jet engine in the rear developing a maximum thrust of 4200 pounds. When both engines are operating it is the fastest conventional fighter in the world. The design is based on the principle that a propeller loses its thrust efficiency at high speed while the pure jet becomes more efficient. The plane was built by Consolidated-Vultee with a General Electric Propjet engine in

the nose and a GE 1-40 in the rear. It can operate on either engine or both. Jet power in the forward unit is converted into rotational energy to drive a four-blade propeller, with added push coming from an exhaust jet almost directly below the cabin. The engine behind the pilot turns a centrifugal compressor and the remaining power of the blazing hot air and gases



passes out a large exhaust through the tail. Both engines burn the same fuel, usually kerosene, with the Propjet the more economical and the most used. Wing span of the 22,000-pound XP-81 is 50 feet six inches and the fuselage length is 44 feet eight inches. It has a tricycle landing gear. The Propjet pressurizes the cabin and heats it at high altitudes.

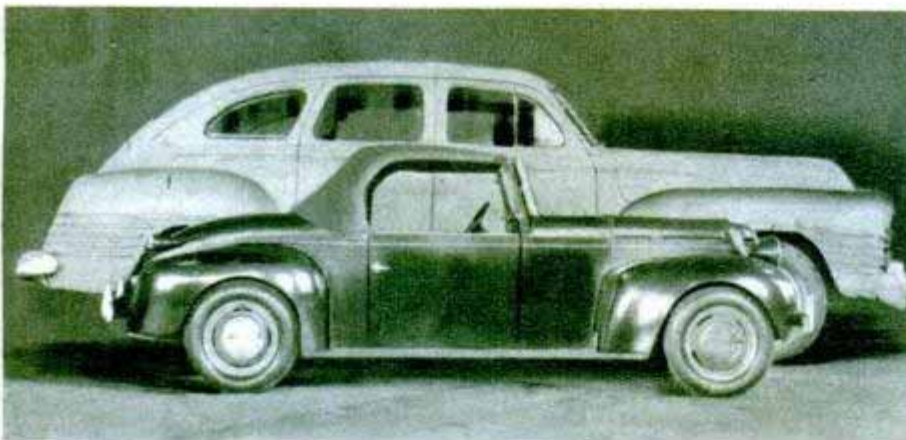

Midget Convertible Holds Gasoline for Trips of 500 Miles

Only 85 inches long and weighing but 1350 pounds; a "pocket size" convertible coupe designed and built by Talmadge Judd of Kingsport, Tenn., attains a speed of 70 miles an hour. Powered by a four-cylinder 20-horsepower engine, the "Humming Bird" carries 10 gallons of gasoline and averages 50 miles per gallon. Eight-gauge sheet metal instead of the standard 22-gauge was used in the construction. Tires are a special industrial make, 12 by 4.00. The car accommodates two passengers and is completely equipped with radio, heater and other accessories. Judd, an inventor and locksmith, reports he is negotiating with a manufacturer to mass-produce the little car.

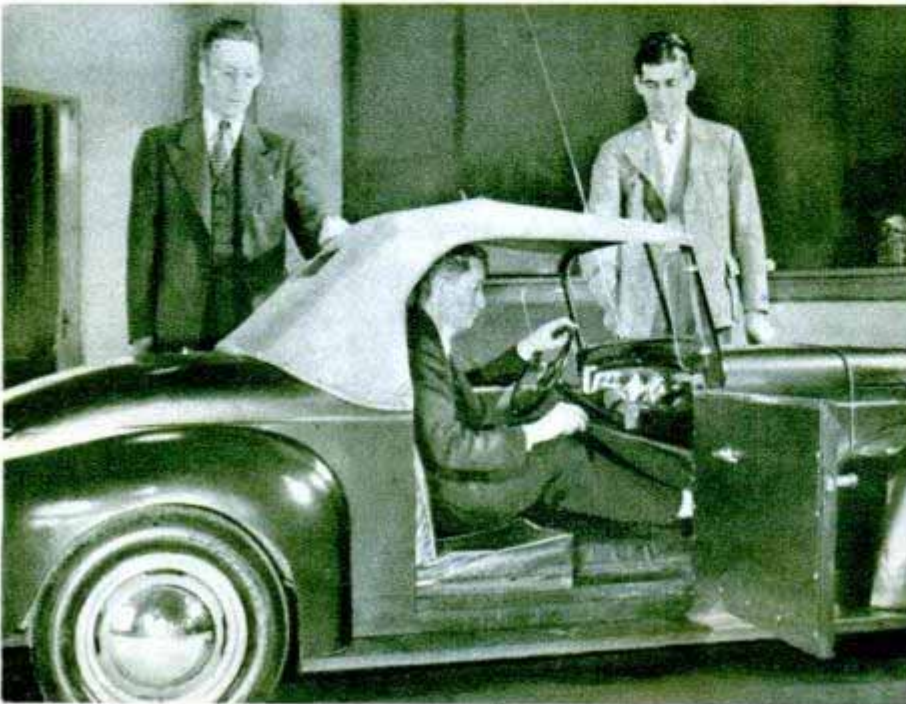

22-8-17

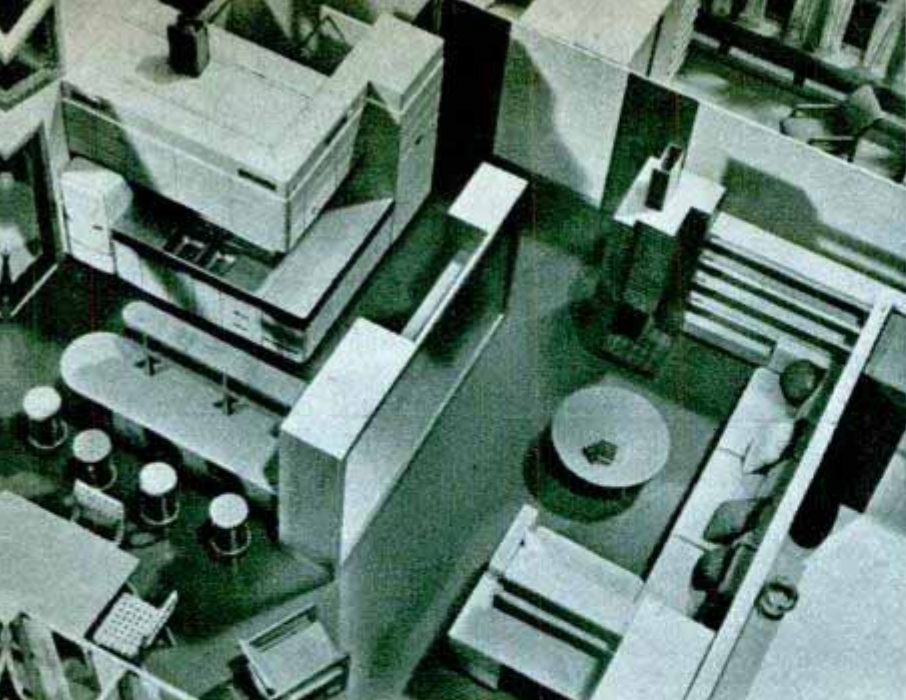

Unit occupies small space beneath chimney in model at left. Right, core is wheeled through standard doorway

Utility Unit Cuts Building Cost By Eliminating Basement

Heart of many a post-war home will be a central utility core, small enough to pass through any standard door aperture, which will comprise a furnace, electrical connections for the entire house and plumbing connections for bath, kitchen and laundry. The core, 30 inches wide, 90 inches long and 77 inches high, eliminates the necessity for a basement and thereby cuts construction costs substantially. It can be shipped from factory to home at any stage of construction and placed in a predetermined location at which the sewer stack and oil, gas and water risers have been stubbed in. After these

connections are made the electricity is connected to the core's multibreaker box from outside supply lines. The furnace chamber, locally supplied, is installed and connections are made to main heat distribution ducts; the chimney is joined to a base inside the core. Major bathroom and kitchen-laundry units are connected to prepared fittings, kitchen and laundry cabinets are hung on the core; addition of decorative finishing completes the installation. Seven noted architects have designed nine small houses, ranging from Cape Cod through ranch house to advanced modern designs, around these units.

Build-Your-Own-Home Kit Helps Prospective Builders Plan Houses

Planning a house becomes a game for prospective home builders with a kit containing materials for erecting model houses of their own design. The kit enables the planner to see his proposed home in three dimensions. It contains three paper layout sheets divided into one-half-inch squares, each representing a square foot of space. Slotted wooden blocks are placed on the sheets in accordance with the house plan. Into the blocks are fitted heavy cardboard cutouts that build up the walls, doors and windows. The size of the cutouts varies, so the builder can experiment with any combination he desires. Cutouts of 94 pieces of furniture scaled to fit the model are included.

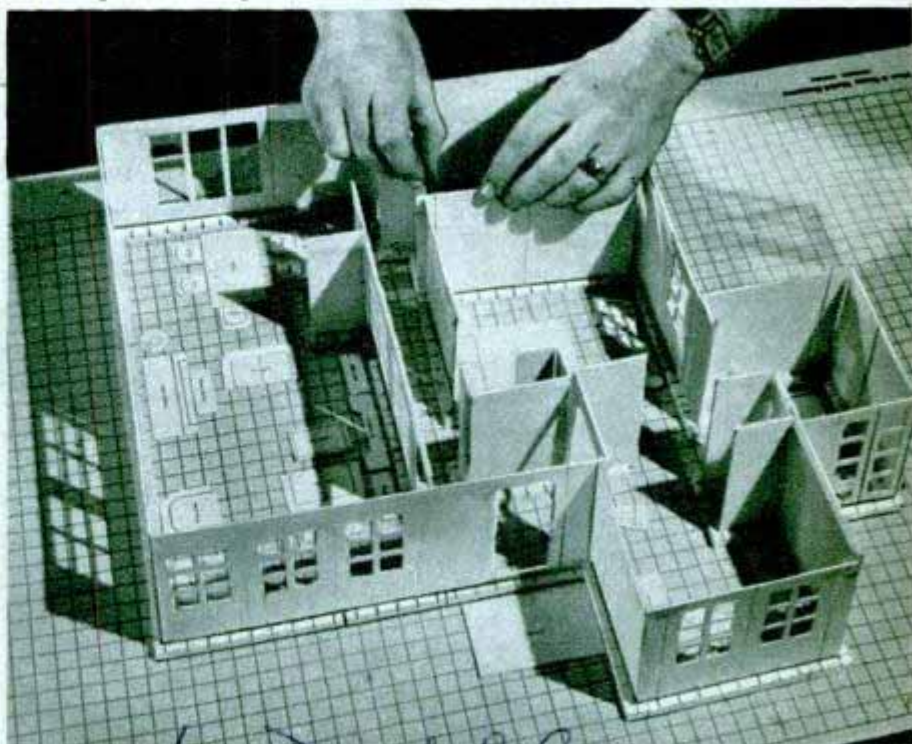

*Plan-a-Home Model Co.,
Elkhart, Indiana*

587 G
Wash.

Infrared Sighting Device on U. S. Army Carbine Spots Enemy in Dark



alties during the first seven days at Okinawa, according to the U. S. Army. Both the sniper-scope, mounted on a .30-caliber carbine, and the snooperscope, a hand model for observation and signaling, use the infrared ray principle, which additionally rendered camouflage almost ineffective. The sniper-scope has what appears to be a fog light with its face painted black attached below the carbine. A telescope is mounted above the rear sight, and the entire unit is connected through a cable to a small power pack on the soldier's back. On hearing a sound the soldier points the muzzle in its general direction, peers into the telescope and presses the power button. Moving the weapon back and forth like an invisible searchlight until he sights the enemy, he then adjusts the telescope sight and fires. All objects appear as various shades of green in the telescope regardless of their color in daylight. The snooperscope is a telescopic device on a hand grip with a similar

Two night-sighting devices, casting a beam of light invisible to the enemy, were responsible for 30 percent of the Jap casu-

fog light and power supply. The equipment was found highly effective in running locomotives and other vehicles at night.

Chemical Preservative for Fishing Line Permits Storage While Wet

Fishing lines will last longer and can be stored wet without damage when treated with a new preservative. The chemical solution stops rot without discoloring the line or making it sticky. Silk, cotton and cuttyhunk lines can be treated with the liquid, which is furnished in a two-ounce bottle—enough to treat 200 yards of 12-thread line. Inside the cap of the bottle is a rod with a loop at the end which extends down into the solution. The line is threaded through the loop, the rod is inserted in the bottle and the line pulled through the liquid.

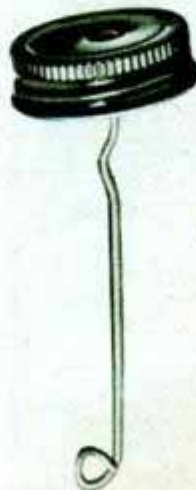

10,000-MILE FLYING WING



Side and rear views of 104½-ton XB-35. Diameter of the contrarotating propeller is 15 feet four inches

CAPABLE of carrying a tremendous bomb load one quarter of the way around the globe and returning nonstop, the XB-35 Flying Wing is the latest to join the Army Air Forces' impressive array of superbombers.

The huge wing is 172 feet from tip to tip and weighs 104½ tons fully loaded, compared with the 65-ton gross weight of the B-29. Designed and built by Northrop Aircraft, it has four Pratt & Whitney Wasp Major engines that develop a total of more than 12,000 horsepower. Each engine is shafted to a pusher-type eight-blade coaxial propeller built by Hamilton Standard. With reverse pitch the contrarotating pro-

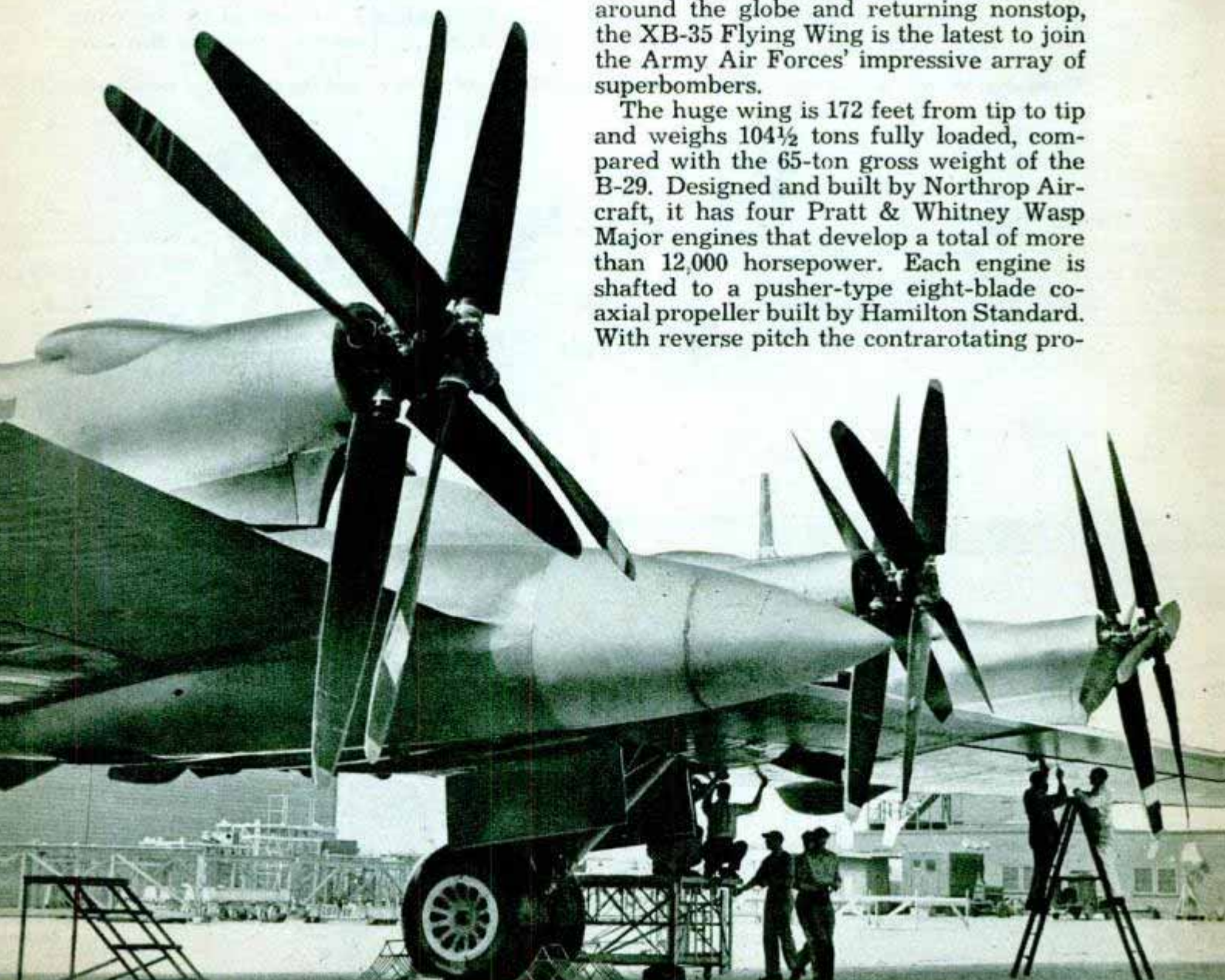

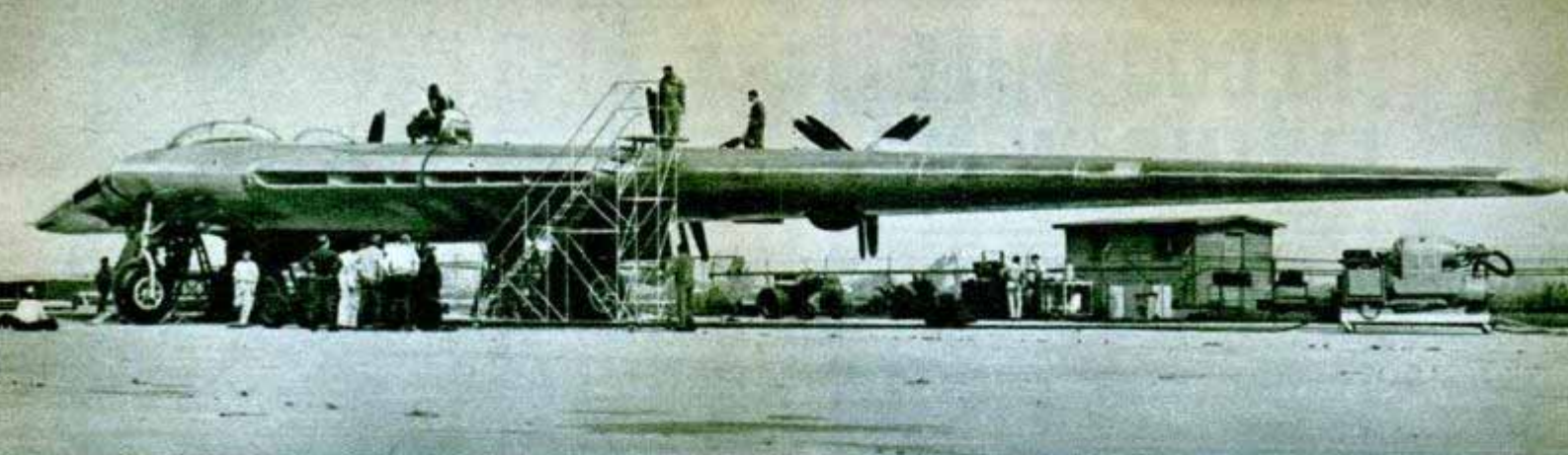

Pending delivery of the last eight-blade propeller the plane had one six-blader, seen in middle of photo

PELLERS can be used for braking to reduce the landing run.

Pressurized quarters inside the central section of the wing accommodate up to 15 men, although the normal operating crew consists of nine, including three gunners. Cabin space, with folding bunks, is provided for the six additional men to alternate with crew members on long flights. No official performance figures for the plane have been announced, other than the range indication.

Radical as the big wing looks, it is far from an untried innovation. Twenty-three years of research and millions of hours of wind tunnel tests, flights and engineering

studies are behind it. John K. Northrop first began experiments with flying wings in 1923. He built and tested a number before the war ("Flying Wings Are Coming," Popular Mechanics, March 1942), with the first, the N1M, now at the Wright Field Aviation Museum after 200 flights.

Northrop solved the problem of controlling the wing, with the normal tail surfaces absent, by inventing an "elevon" that combines the functions of both elevators and ailerons. These, each 34 feet six inches long, are located on the trailing edge of the wing, beyond the landing flaps. Trim tabs and split-flap rudders are placed at the wing tips. Additional control aids are the long

Close-up of the nose shows long blister used by pilot and the broad window area for copilot and bombardier

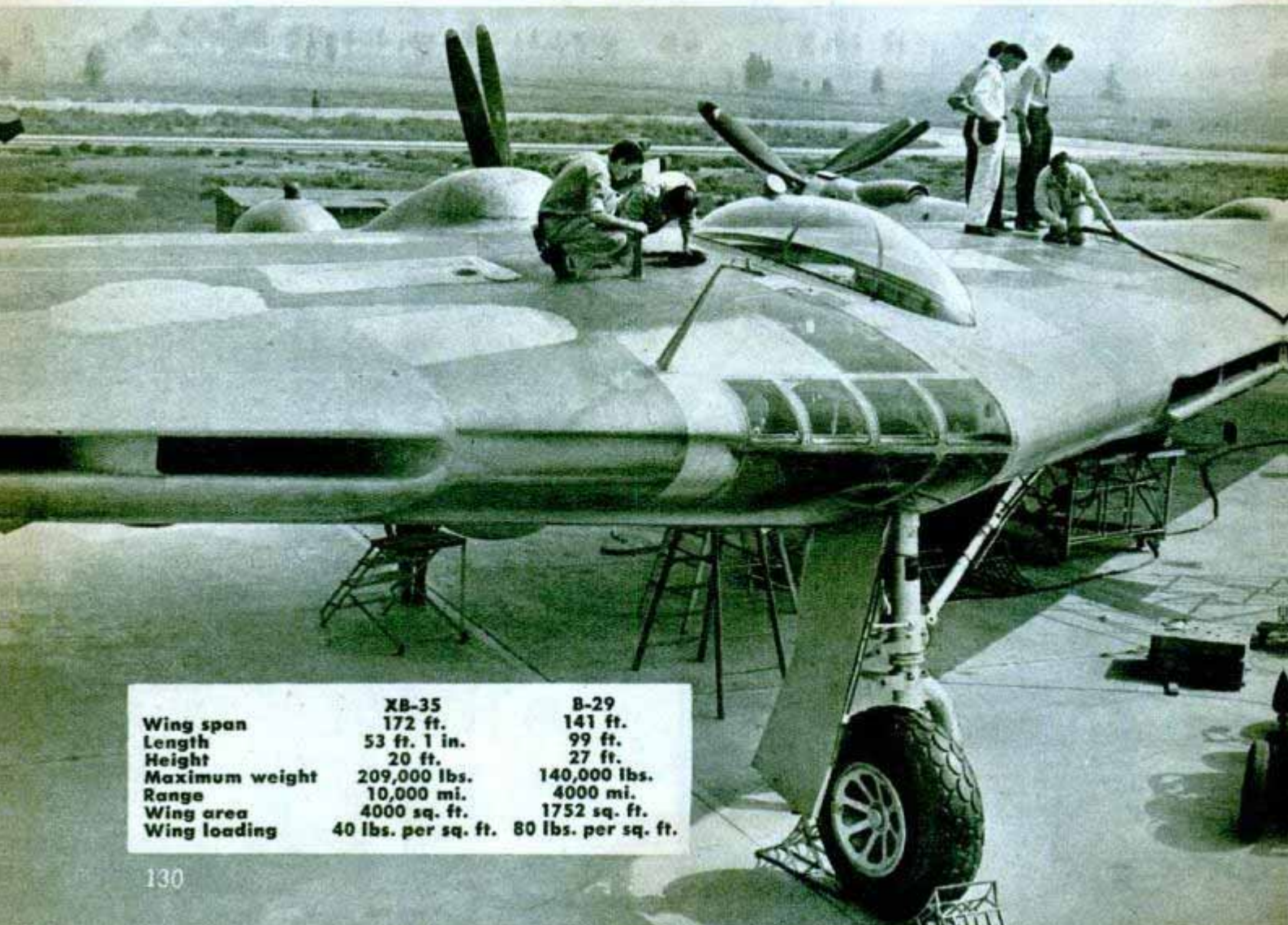

	XB-35	B-29
Wing span	172 ft.	141 ft.
Length	53 ft. 1 in.	99 ft.
Height	20 ft.	27 ft.
Maximum weight	209,000 lbs.	140,000 lbs.
Range	10,000 mi.	4000 mi.
Wing area	4000 sq. ft.	1752 sq. ft.
Wing loading	40 lbs. per sq. ft.	80 lbs. per sq. ft.

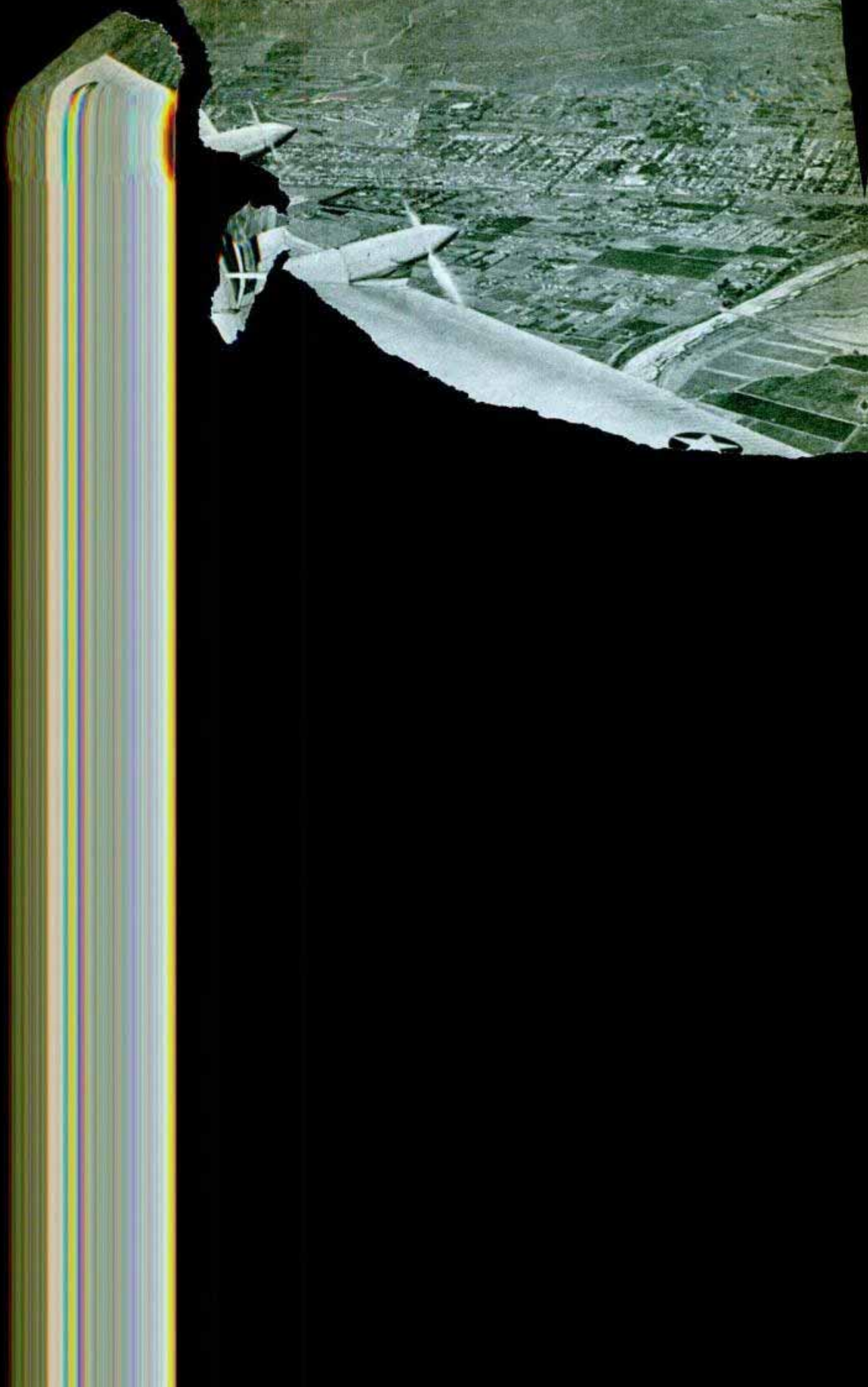

Sound-Film Movie Projector for Desk Is Set

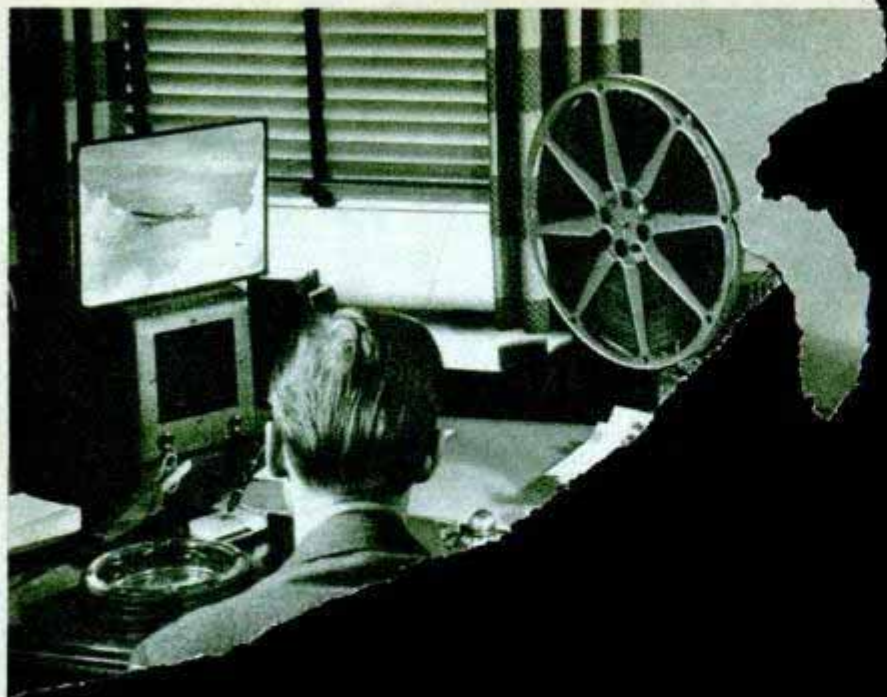

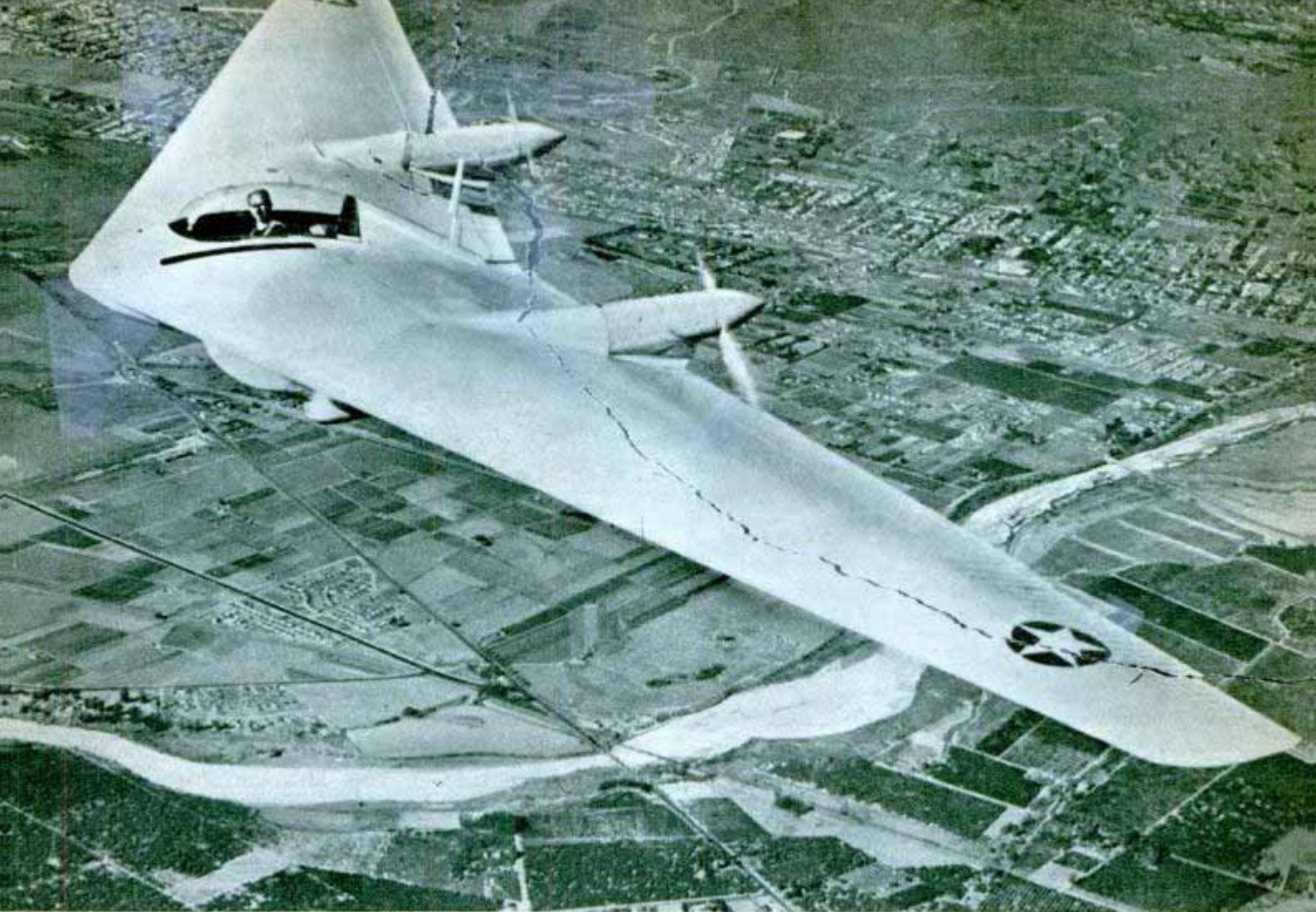

One of the 60-foot scale models of the XB-35, the N9M, flying as a guinea pig to test the wing's design

antistall slots just behind the leading edge, near the wing tips. At slow speeds they prevent interruption of the smooth flow of air, permitting positive control to be maintained. At high speeds the slots close automatically so that aerodynamic efficiency of the giant bomber is not impaired.

The XB-35 is 20 feet high when it rests on the five wheels of its retractable tricycle landing gear. The main gear has five-foot six-inch dual wheels and there is a four-foot eight-inch wheel at the nose. The center section of the wing is 37½ feet long, tapering to slightly more than nine feet at its tip. Sweep-back gives it the appearance of a giant boomerang.

The aircraft is completely clean except for the pilot's streamlined Plexiglas hump just to

the left of the nose, an adjacent astrodome for the navigator and three defensive armament blisters. A vestigial "stinger" tail projects between the second and third propellers to provide a defensive field of fire at the rear. The engines are in submerged housings in the wing.

Underside of left wing, showing elevon surface and landing

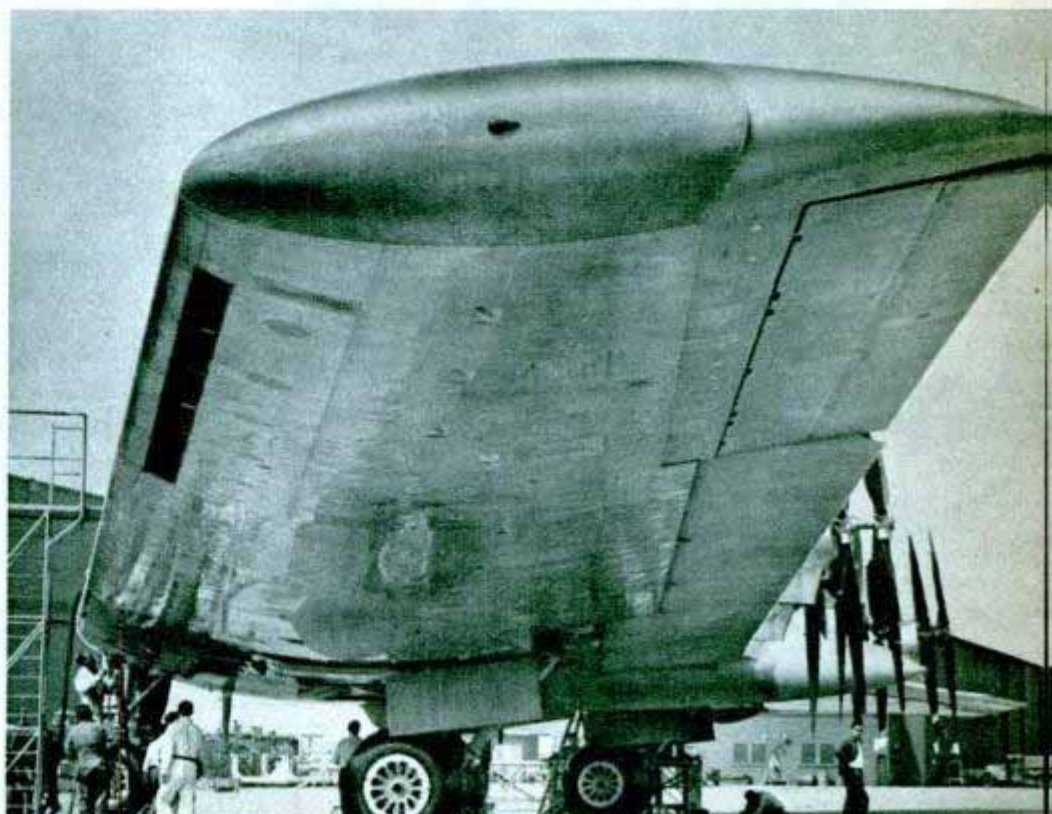

Sound-Film Movie Projector for Desk Is Set Up in Three Minutes

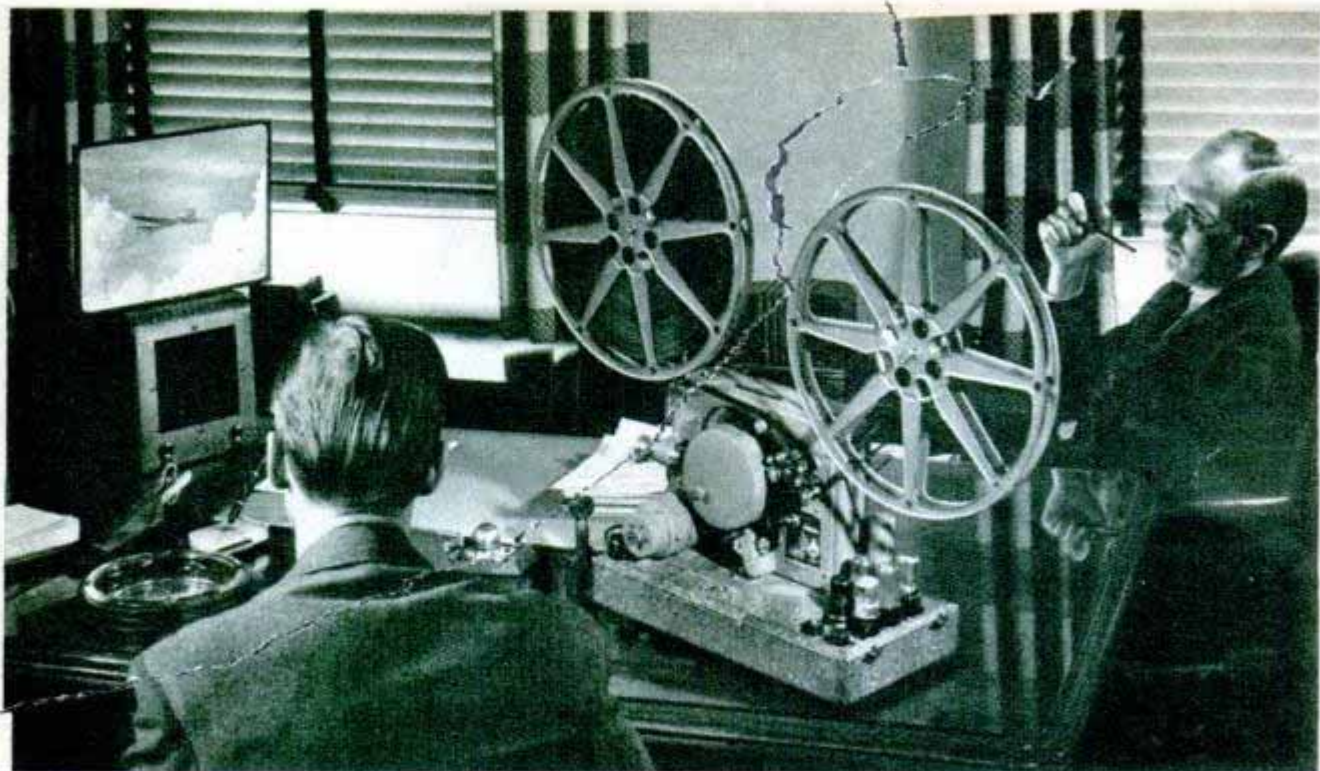

Weighing only 28 pounds and assembled in a case slightly larger than a portable typewriter, a 16-mm. sound-on-film movie projector is now available which can be set up and put into operation in less than three minutes. It is especially useful for salesmen or students. Designed to be used with both screen and projector on a single

desk or table, the Movie-Mite includes an 800-foot take-up reel and cords and reel arms for 2000-foot reels. The unit operates on a.c. or d.c. and a single lamp, cooled by a centrifugal blower, is used for both picture and sound. The projector is mounted on gum-rubber cushions to reduce noise of operation.

Rubber Straps and Pulleys Guide Swimmer on 'Ironing Board' Trainer



Water isn't needed for practice swims with the training machine invented by an Australian. Resembling an ironing board, the machine has a wide strap which circles the waist and holds the student's trunk rigid. While his ankles are laced in canvas jackets and held in place by strong rubber straps, the trainee alternately pulls downward on hand grips to "swim."

Alloy "Takes Its Own Temperature"

One chrome-cobalt metal alloy reveals its temperature by changing color under varying conditions. For example, at 500 degrees Centigrade it takes on a light straw color; at 550, bronze; 575, purple; 600, dark blue, and so on. A marked color change occurs with every 25-degree temperature change between 500 and 900 degrees Centigrade. After completing a scale of colors between 500 and 700 degrees, the metal repeats the colors from 700 to 900 degrees.

Information, including manufacturers' names and addresses, concerning products described in this issue may be obtained by writing to Bureau of Information, Popular Mechanics, 200 E. Ontario St., Chicago 11, Ill.

Needle and Thread Mend Bridge

Fake bridges made of canvas, burlap and cloth tape were used by Allied forces to fool German artillery spotters and attack bombers. The flimsy structures were near-perfect replicas of the rigid-truss Bailey bridge. At a distance of several hundred feet it was virtually impossible to distinguish between the dummy bridge and the genuine article. When the fake bridges were bombed or shelled, camouflage engineers "sewed" them up and put them back in use.

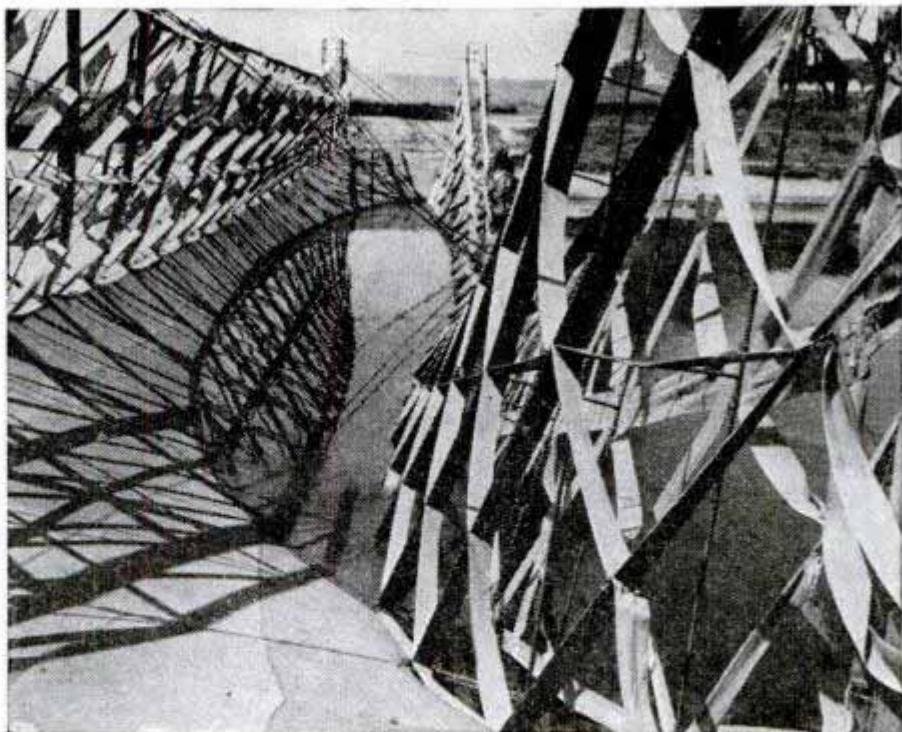

U. S. Army Signal Corps photo

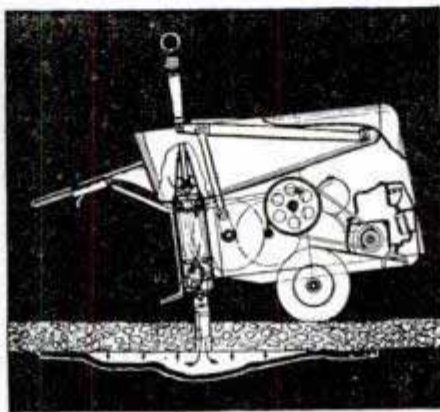

Mud Lifts Walk

Concrete slabs that have settled beneath the surface of sidewalks or pavements are raised to their original position with a mud jack. Small holes are drilled in the concrete through which mud mixed with cement is pumped to push the slab upward.

Belt Buckle Hides Gun

Nazis converted even the innocent gesture of looping one's thumbs over his belt into a potentially murderous motion with use of a deadly belt-buckle gun. Closed, the weapon resembles an ordinary belt buckle. Pressure on one end of the buckle causes the hinged front to open downward, exposing a stubby double-barrel gun. Individual triggers fire each two-inch barrel separately. The gun was brought into this country by an American soldier as a war souvenir.

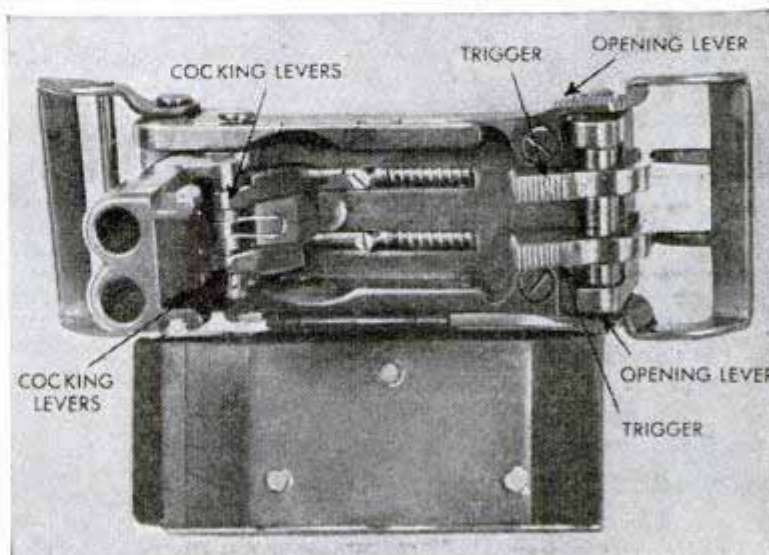

Transplant Teeth of Cat

Teeth of one kitten have been successfully transplanted to the jaw of another by Dr. Harry H. Shapiro of Columbia University and Dr. Bernice L. Maclean of Hunter College. Further experiments, if successful, may indicate that similar transfers could be made on human beings.

see also p 117 November 1970

Speedway in a Saucer

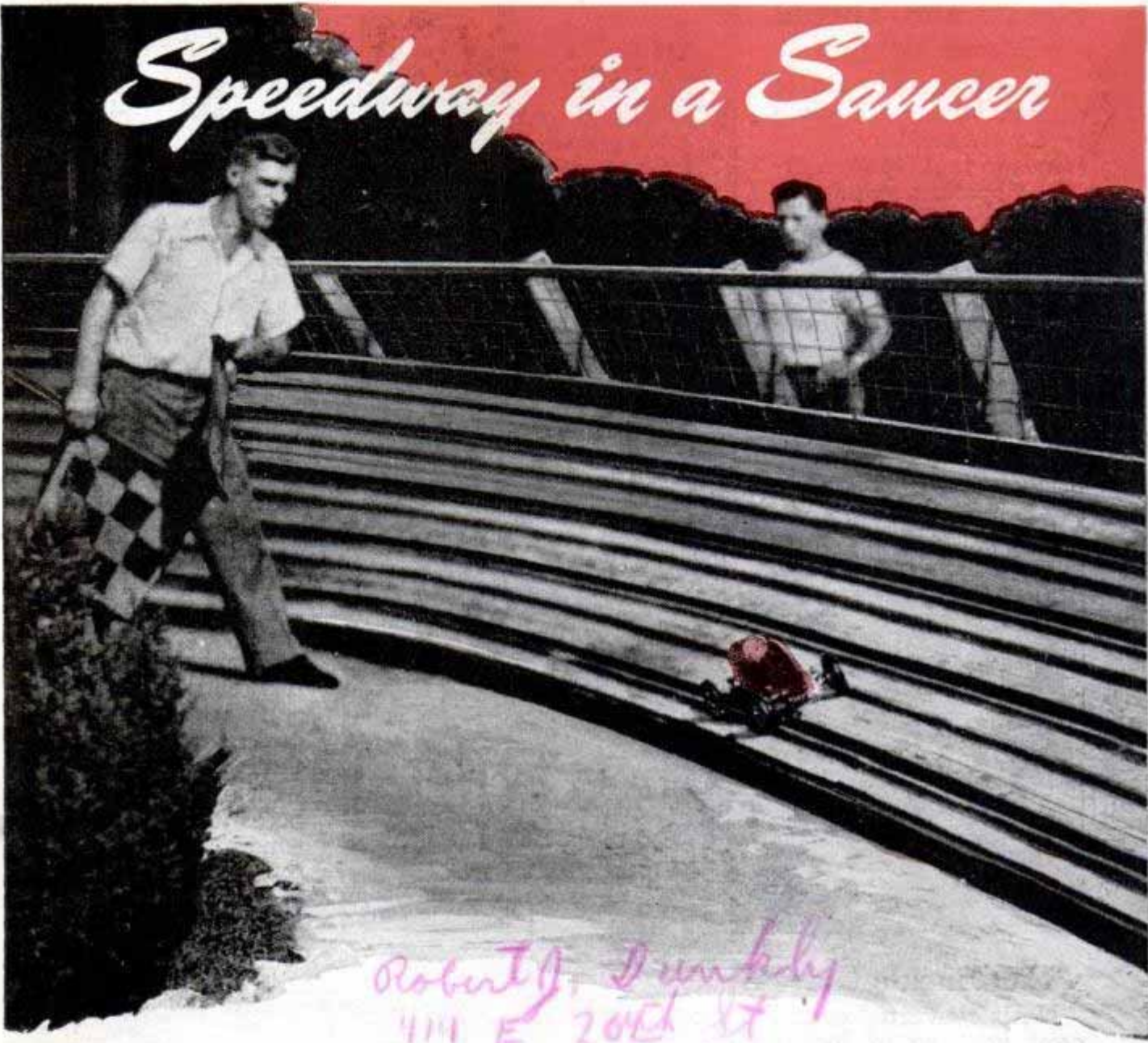

Robert J. Dunkley
4111 E 20th St
N Y 67, N Y.

By Clifford B. Hicks

WITH all the furor of major speedway events, races conducted at saucer-size tracks are attracting thousands of fans. Excited crowds whoop it up while six-pound model racing cars zip around a board track on a thimbleful of gasoline.

Motors roar and tires smoke on the turns, just as in the big-time races. Traveling at 75 to 80 miles an hour, the pilotless midgets circle a 264-foot course in slightly over two seconds.

Model racing car meets are held each summer on tracks spotted throughout the country. Thousands of enthusiasts, members of the American Miniature Racing Car Association, compete. Crack-ups, motor and tire troubles occur. Owners claim the sport gives all the thrills and chills of regular speedway meets without injury or death to drivers.

The A.M.R.C.A. is the group's national

organization. It was formed in 1939 and is subdivided geographically into six leagues of some 300 clubs. The members enter their 10,000 cars in local meets, interclub competitions, regional meets and the National Races.

This year's regional meets are being held at New York City, in Illinois and in San Francisco in late June and early July. The National Races will be run July 31 to August 3 on two 1/16-mile tracks built by the city of Detroit.

Two different kinds of competition are held, one for "cable" cars, the other for the "rail" type. A cable car is fastened to the end of a cable which is anchored to a socket in the middle of the track. Once the car is started, centrifugal force keeps the cable taut as the model circles the track. Much faster speeds are attained by cable cars than by rail racers because of less friction on the track. The champion cable model traveled 114.64 miles per hour in setting its

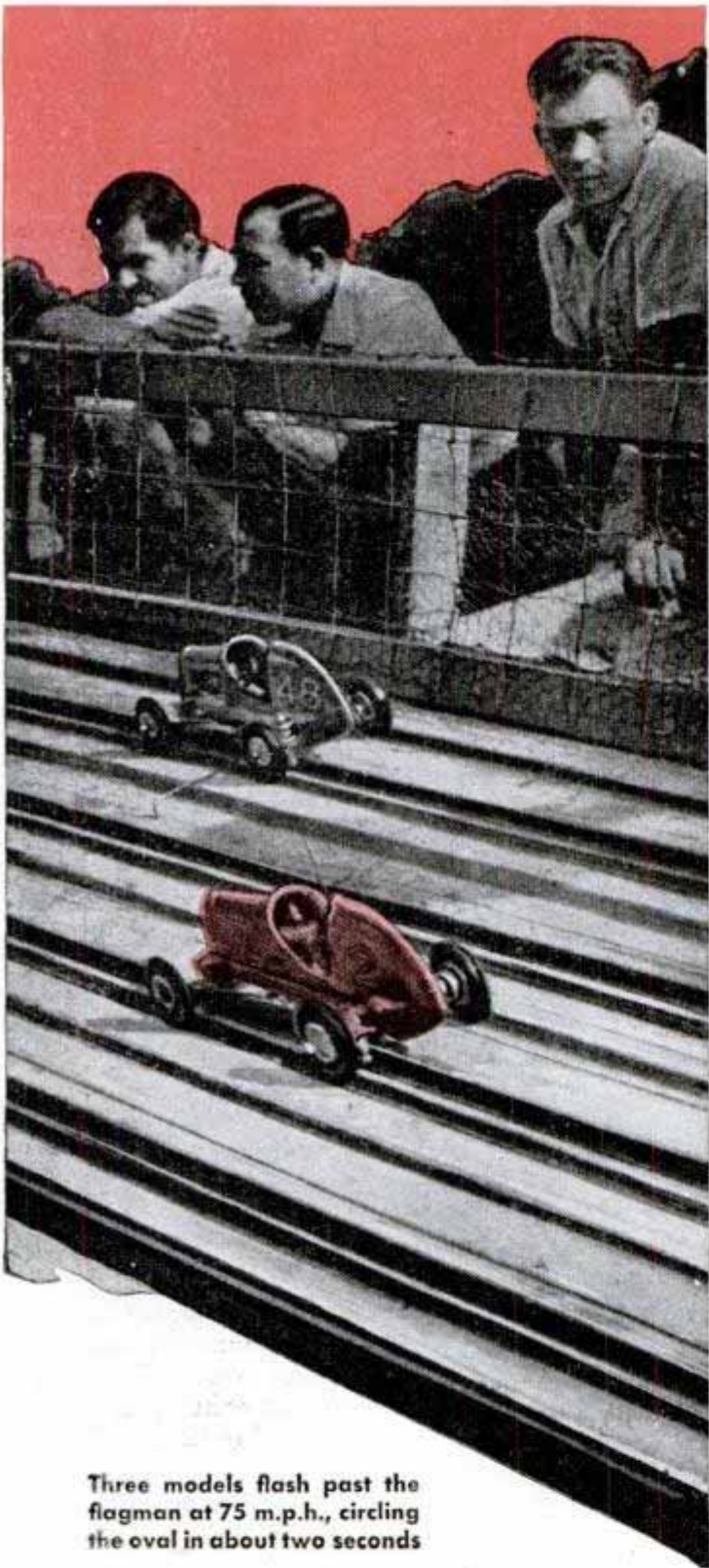

Three models flash past the flagman at 75 m.p.h., circling the oval in about two seconds

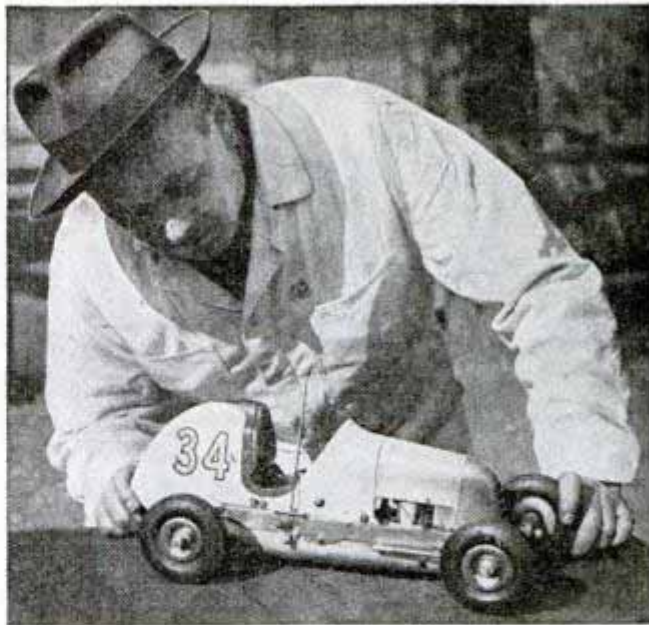

Owner gives his model final tune-up before the race



↑ An impatient car is fastened securely to the rail
↓ Note ball bearing locking studs on the front axle

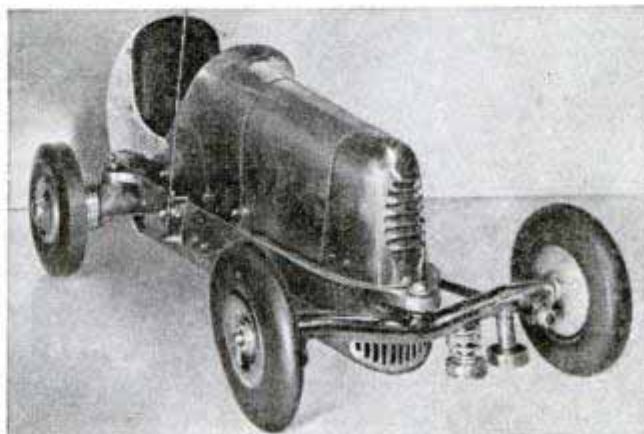

record. But the cable allows only one car to circle the track at a time. Instead of racing, it's car vs. stop watch.

For that reason enthusiasts are acclaiming rail racing as a better sport. "The future of the hobby definitely lies with the rail track," says Robert Mulhall, director-at-large of the national association.

Rail cars race on an elliptical track that is divided into four lanes. A flanged steel rail flanks each lane. Ball-bearing studs on front and rear axles lock the pygmies to these flanges. Friction against the rails reduces speeds to around 75 miles per hour.

Model Crafters
134 to 135
Bill Ryan

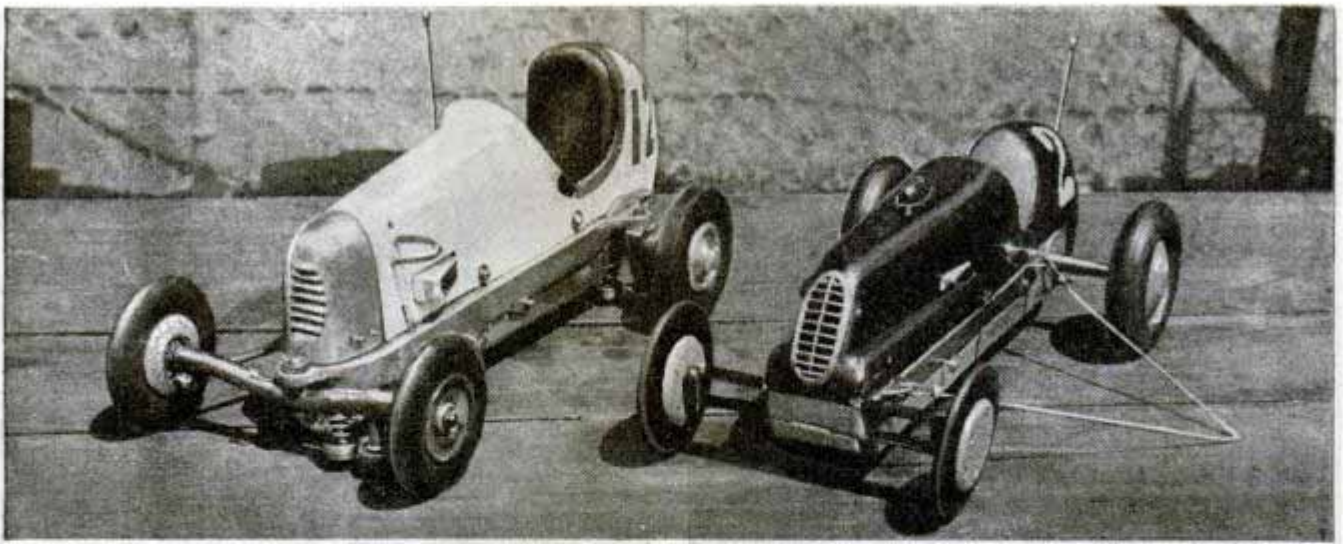

Racer at left rides a flanged steel rail around the miniature track. Steel wire on model at right fastens to a cable for faster cable-track racing. World's record cable car zoomed the course at more than 114 miles an hour

But in a recent race one car traveled so fast that its locking devices failed to hold. The six-pound model left the track at waist height to hurtle 40 feet through the air like a chunk of shrapnel before it struck the ground.

Engineers claim that turns in the track should be banked about 86 degrees—almost vertical—for cars traveling at present speeds. A good track costs \$1000 to \$2000 to build. But owners and spectators have the thrill of watching the Tom Thumb cars compete against each other.

Rules of the association limit the maximum weight of the models to 1½ pounds for every 1/10 cubic inch displacement, minimum one pound for each 1/10 cubic inch. Most of the cars weigh from 6 to 7½ pounds, with a 12½-inch wheelbase and 7½-inch tread. They cost about \$200 apiece, counting materials, motor and labor, and require two or three months of spare-time work to build from start to finish.

Frames made of magnesium are favored because they weigh about one third less than those of aluminum. A sheet aluminum skin covers this frame.

Two different styles are made, the "conventional," which is modeled after real racing cars, and the "streamliners," designed for speed rather than appearance. Streamliners average five miles per hour faster than conventional models, not because their lines are softer but because the design allows the power plant to be built lower to the track. Complete kits are manufactured for assembling the bodies.

Most of the engines are of a standard type called the "Hornet." The owner's ability to coax the most from his engine, coupled with the body style of his car, determines whether it is a winner. Engines cost about \$35, although prices on second-hand power plants skyrocketed to \$50 during the war. Like their big brothers, the en-

gines and frames are rebuilt for each race.

Parts are machined to 1/10,000-inch tolerances. A tiny spark plug is mounted on top of the engine. The piston has more clearance than those in family cars, because the engine's heat quickly expands it. The engine develops an estimated ¾ horsepower turning at 15,000 revolutions per minute. Anchored securely to the frame, it packs terrific energy into the models.

Fuel mixture is 70 percent alcohol and 30 percent castor oil, with a small amount of amyl acetate added, depending upon the temperature. The cars carry about 100 c.c. of fuel, enough to run a one-mile race plus a few additional laps.

Wheels of the little racers turn at 7000 to 8000 revolutions per minute. Tires would fly off or disintegrate at this speed if not held against a surface before the cars are released. Wheels are touched lightly to the track to cut down their speed until the race starts. One owner was knocked unconscious for 15 minutes by a small fragment of tire that broke loose and struck him behind the ear.

Tires are made of soft rubber. Like those on big racing cars, they last only a short time, usually not more than three or four races. During the war they were not manufactured. Prices of used tires soared, with a virtual black market developing.

Eight cells from pencil-type flashlights are soldered together to furnish a three-volt battery of high amperage. One basic problem is to stop the car after it is in motion. A wire switch extending like an antenna an inch or more above the top of the model is the solution. When the car is to be stopped, a handkerchief is held above the track. As the pygmy roars past, the handkerchief trips the extended switch, disconnecting the battery. One owner tried to trip the switch with his hand. The wire almost severed a finger.

Official races are sponsored by the national association. Qualification and elimination races are run before the feature event, which is a one-mile race for the four fastest cars of the preliminaries. The car with the best qualifying time is given the outside lane in the preliminaries, the inside in the feature.

Ben Meskowski of Chicago holds the official world's record at 79.92 miles per hour. Unofficial record, made at a meet without national sanction, belongs to William Weller at 80.09 miles per hour. T. J. Thompson, president of the Chicago association, built one of the most consistent winners. It placed first in 19 of 24 races during 1945.

At the starting line the "starting roller," a revolving cylinder flush with the surface of the track, starts the cars by rotating their wheels. Each growling model is then held forcibly in position until the others entered in that race are ready. Down comes the flag, owners release the cars, and away they roar, trailing a cloud of exhaust.

Photographs of the screaming models are difficult to obtain because of their high speeds. Films exposed for 1/1000 second are blurred. For the same reason no one can observe all the models in a race. A judge is appointed for each car. He follows that car until the race is over. Then judges and flagman compare observations to determine the winner.

If you see an excited crowd around a miniature track this summer, don't stop to watch the races. Keep moving unless you want to spend most of your spare time pursuing an exciting hobby. Owners say the sport is highly contagious.



Pit repairs hold all of the anxiety of big-time races. Below, streamliner sacrifices style for high speed



Tiny power plant requires frequent checking to develop highest speed

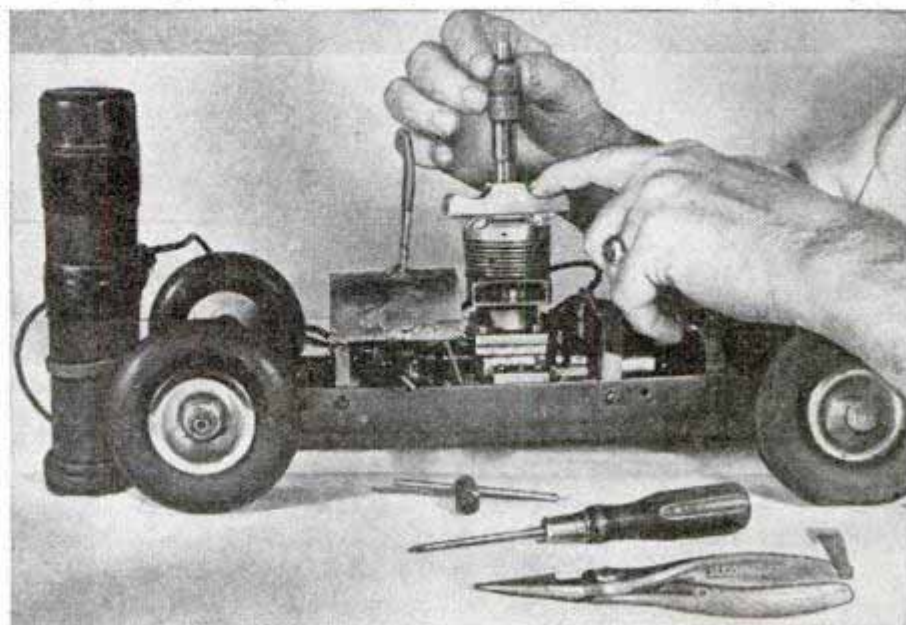



With the assistance of a walkie-talkie radio, a baseball team manager can instruct his players from the dugout and correct instantly any mistakes they may make dur-

Walkie-Talkie for Baseball

ing drill. Ben Chapman, manager of the Philadelphia Phillies of the National League, tried out a walkie-talkie to instruct his infield coaches during training.

Radar Tracks Course of Mortar Shell to Spot Gun Position of Enemy

Radar detection of artillery and mortar shells in flight has made it possible to locate hidden enemy gun positions within five miles of the radar screen. Army Signal Corps technicians developed the counter-mortar radar which tracks the upward and downward paths of an enemy projectile. The trajectory of the shells can be plotted from the radar bearings and this knowledge makes it possible to locate hidden gun positions five miles distant with less than 60 yards' error. Similar radar devices have detected moving vehicles 16 miles away.

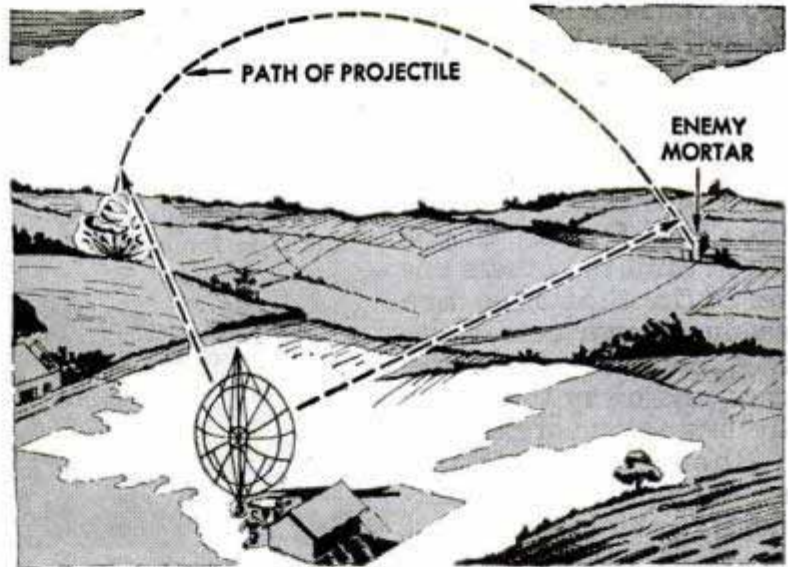

Twin-Tube Float for Swimmer Folds Into Small, Lightweight Package



Buoyant enough to support an adult are the twin tubes of a swimming float which, when deflated, folds into a package 10 inches square and weighing less than two pounds. The tubes are inflated from the mouth and are fitted inside a colorful fabric cover. Hand grips and a pull-up strap assist the swimmer in getting on the float. A front eyelet permits it to be towed.

❏ Iowa farmers bought 75 carloads of surplus bulletproof rubber fuel tanks for airplanes and used them as water troughs, sand boxes, brooder houses and pontoons for supporting pipe lines.

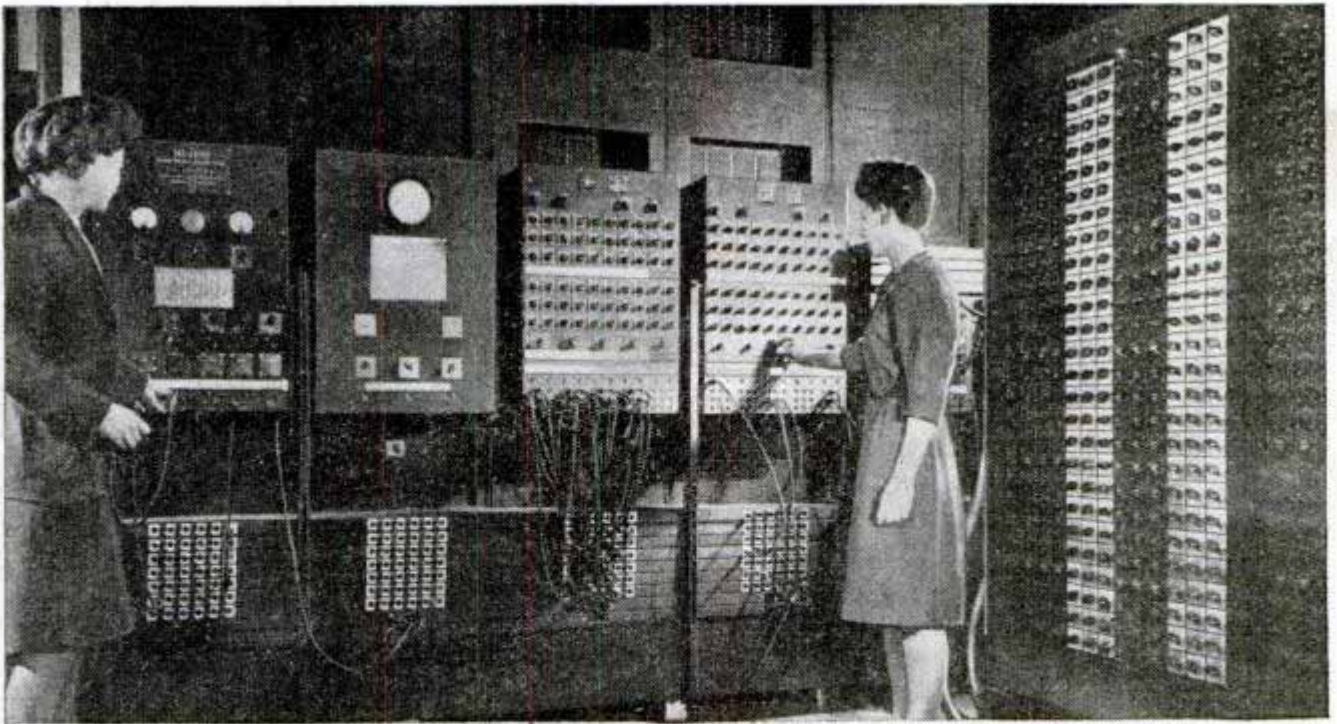

It Thinks With Electrons

Extremely complicated calculations in nuclear physics, aerodynamics and scientific weather prediction are among the peacetime jobs of the ENIAC. The machine, the first ever developed, gets its name from the first letters of the words describing its function as an Electronic Numerical Integrator and Computer. Built in 2½ years at the Moore School of Electrical Engineering at the University of Pennsylvania for the Army Ordnance Ballistic Research Laboratory, it was originally developed to solve ballistics problems. It is said to be the most intricate electronic device in the world, requiring for its operations 18,000 electronic tubes as compared with 400 tubes in the largest radar set. At maximum capacity, the ENIAC will carry out in five minutes more than 10,000,000 additions or subtractions of 10-figure numbers. In its first test the machine solved in two weeks calculations which would have required 100 man-years of trained computer's work. The ENIAC performs a single addition in 1/500 second, a single multiplication by a 10-digit multiplier in 1/360 second or a nine-digit result in division or square root extraction in 1/38 second

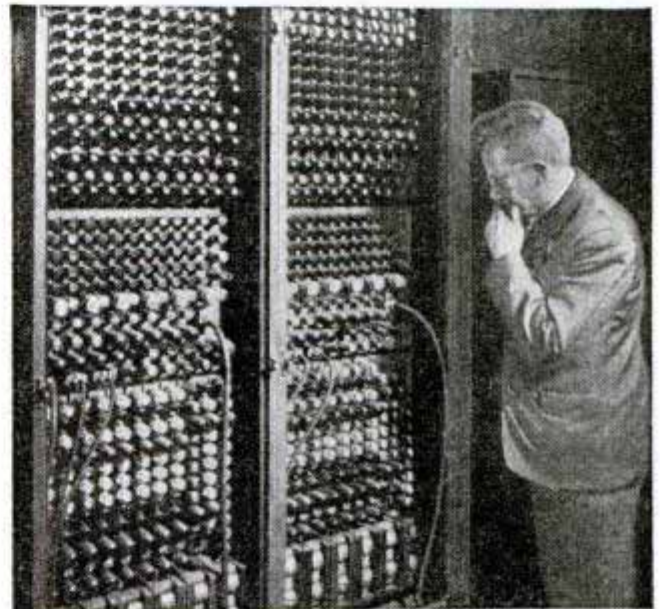

Getting ENIAC ready for operation, top. Above, rear view of section of machine showing tubes, plug-in chassis and transformers. Below, overall view of ENIAC being prepared to solve mathematical problem

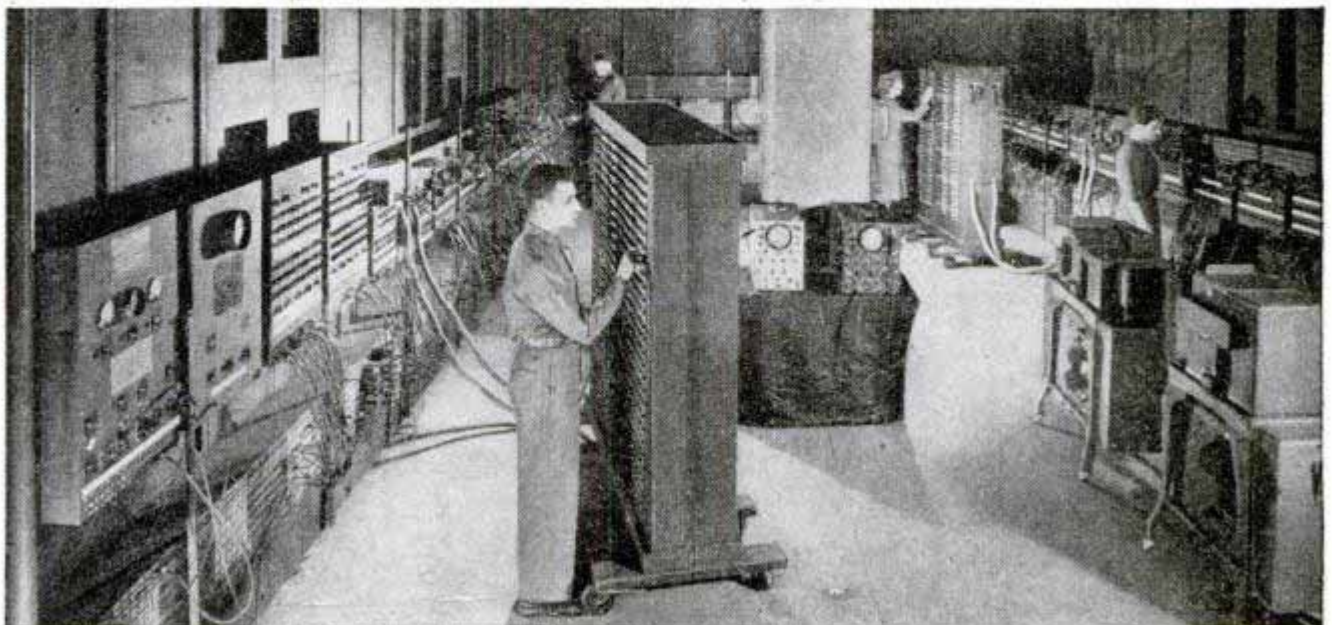

"Inside Stubb" for Your Home



- 1** Yarn is wound on a plastic "top" which permits it to unwind evenly
- 2** Portable washer cleans and dries three-pound load in 10 minutes
- 3** Inflated raft for baby prevents rolling off the rear seat of auto
- 4** Detachable twin-roller unit for wringing mops fits any size pail
- 5** Faucet insert fits most faucets, replaces worn washers, ends leaks
- 6** Lightweight electric polisher for floor shines wood, linoleum, tile
- 7** Plastic-covered wire-mesh window ventilator filters dust from air
- 8** Fireplace grill fits over andirons for home barbecue or corn popping
- 9** Nonslip holder keeps clothesline taut when tightened by quick tug
- 10** Soap rests on prongs in plastic dish to prevent "jelly" formation

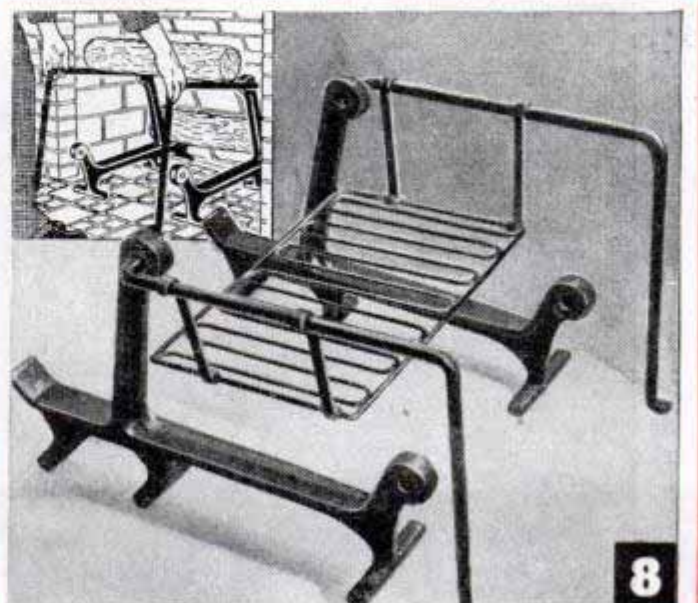
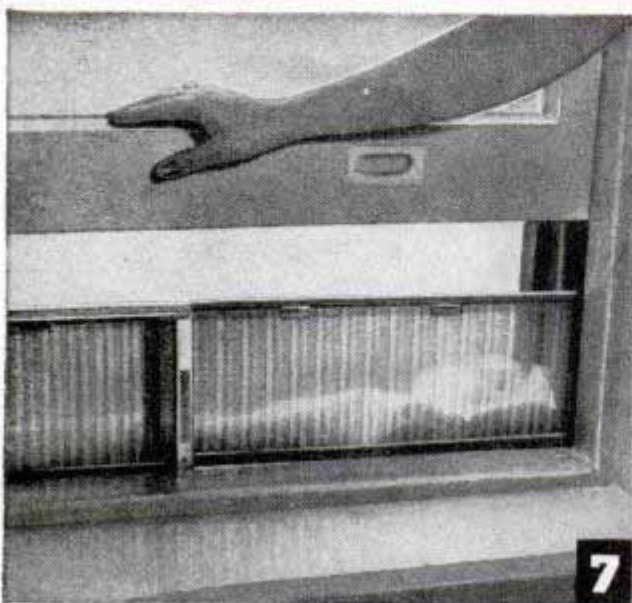

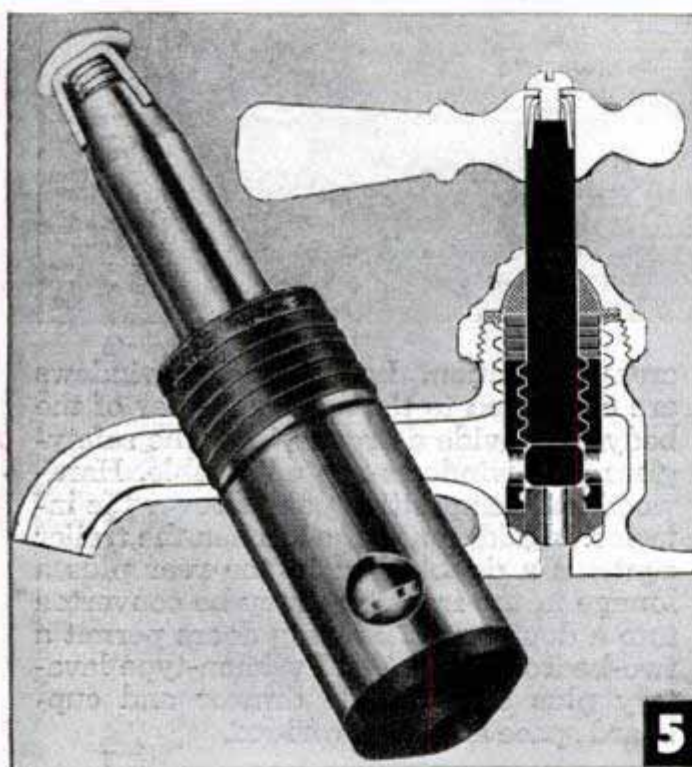

Light Metal House Trailer Contains a Complete Kitchen



Roomy kitchen in this shining new house trailer weighs only 150 pounds but it contains an aluminum range, oven, icebox, broiler and convenient drawer space



Light metals replace conventional materials in a new, lightweight trailer that is being built in accordance with techniques used in manufacturing aircraft. All parts except the axle and running gear are made of aluminum or magnesium. The total weight of the 20-foot trailer is 1860 pounds. It contains an all-aluminum 150-pound kitchen unit that includes a range, oven, broiler, icebox and several drawers. Ventilation louvers at the front of the trailer plus air vents in the roof permit controlled

cross-ventilation. Large Lucite windows are contoured to the front and rear of the body to provide a broad view. The safety-glass side windows are adjustable. Hardwood and composition panels cover the interior. In addition to the kitchen the trailer contains a double bed in the rear plus a lounge in the front that may be converted into a double bed. Folding doors permit a two-bedroom effect. A Pullman-type lavatory plus considerable drawer and cupboard space are also provided.

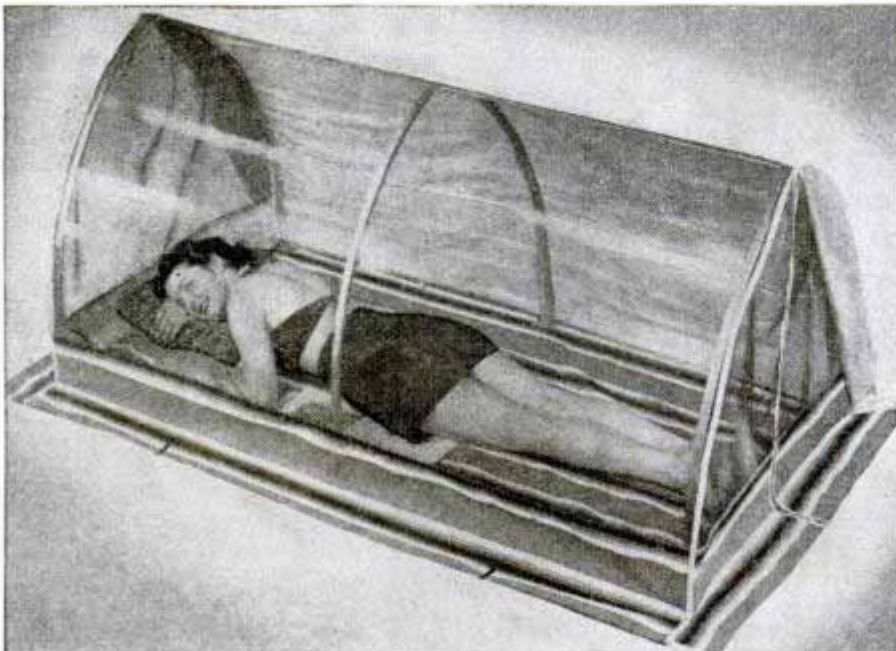

Sun Bathing Shelter Keeps Insects Out

When its outer cover is thrown back, a nylon screen prevents insects from entering a dual purpose shelter which serves as a beach accessory or play pen. When its brightly colored, weatherproof outer cover is in place the shelter can be used as a dressing room or overnight sleeper. The shelter can be put up or taken down easily in a few minutes and folds into a compact bundle weighing only 20 pounds.

Power Unit for Bicycle Replaces Rear Wheel

Any standard boy's or girl's bicycle can be converted into a power-driven bicycle with a 1½-horsepower engine-driven unit which replaces the rear wheel. No changes need be made in the bicycle frame and the bicycle can be converted back to "pedal power" simply by removing the power unit and reinstalling the rear wheel. The power unit is equipped with gas tank, kick starter and automatic clutch. A conventional bicycle coaster brake which is operated by the foot pedals gives added safety of operation. It attains speeds up to 32 miles per hour and gets 80 to 100 miles per gallon of gasoline.

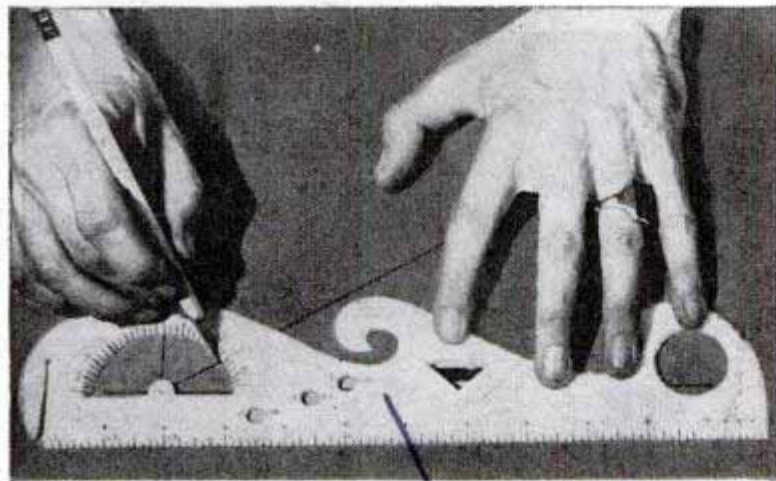

Eight-in-One Plastic Ruler

Combining eight instruments in one, a plastic ruler is an aid to artists, architects, draftsmen, engineers and craftsmen. It serves as a letter weigher, ruler, magnifier, French curve, compass, protractor, level and miter. To weigh a letter, it is inserted in a slot at one end. Then a pencil is placed in one of three holes marked ½, 1 or 2 ounces. If the letter tilts the ruler it is heavier than the weight marked at that hole.

Parva Products Co - West Haven 16, Conn.

Pusher-Prop Glider Skims Over Swamp

Driven by a pusher-type airplane propeller, a swamp glider built for the Coast Guard draws only four inches of water. The 18-foot boat will be used in the swamps of Florida and Mississippi for rescue and revenue missions.

Houseflies have been put to work to cross-pollinate celery plants raised by plant breeders at Cornell University. The breeders, seeking to develop a blight-resistant celery, use flies rather than bees because they are more easily handled.



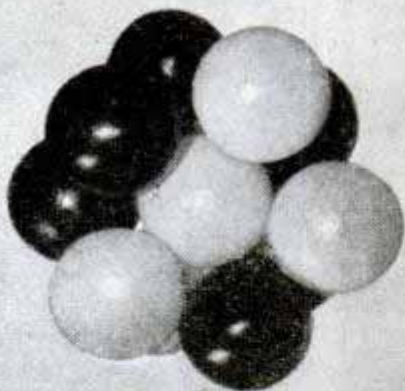

ORDINARY CARBON ATOM (C 12) NUCLEUS

Houdry Process Corp., Sun Oil Co. photo

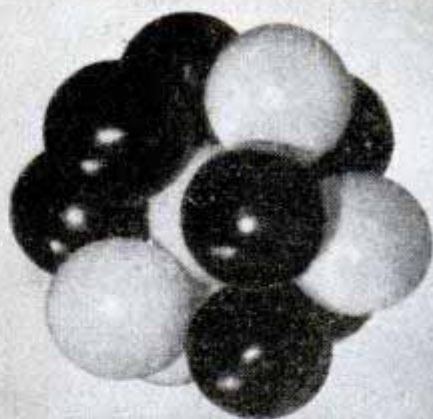

CARBON 13 ATOM NUCLEUS

White balls represent protons and black balls neutrons in atomic structure of ordinary carbon (C 12) at left and C 13, right. C 12 has six protons and six neutrons; C 13 has an extra neutron giving atom mass of 13

"TRACER BULLETS" on the

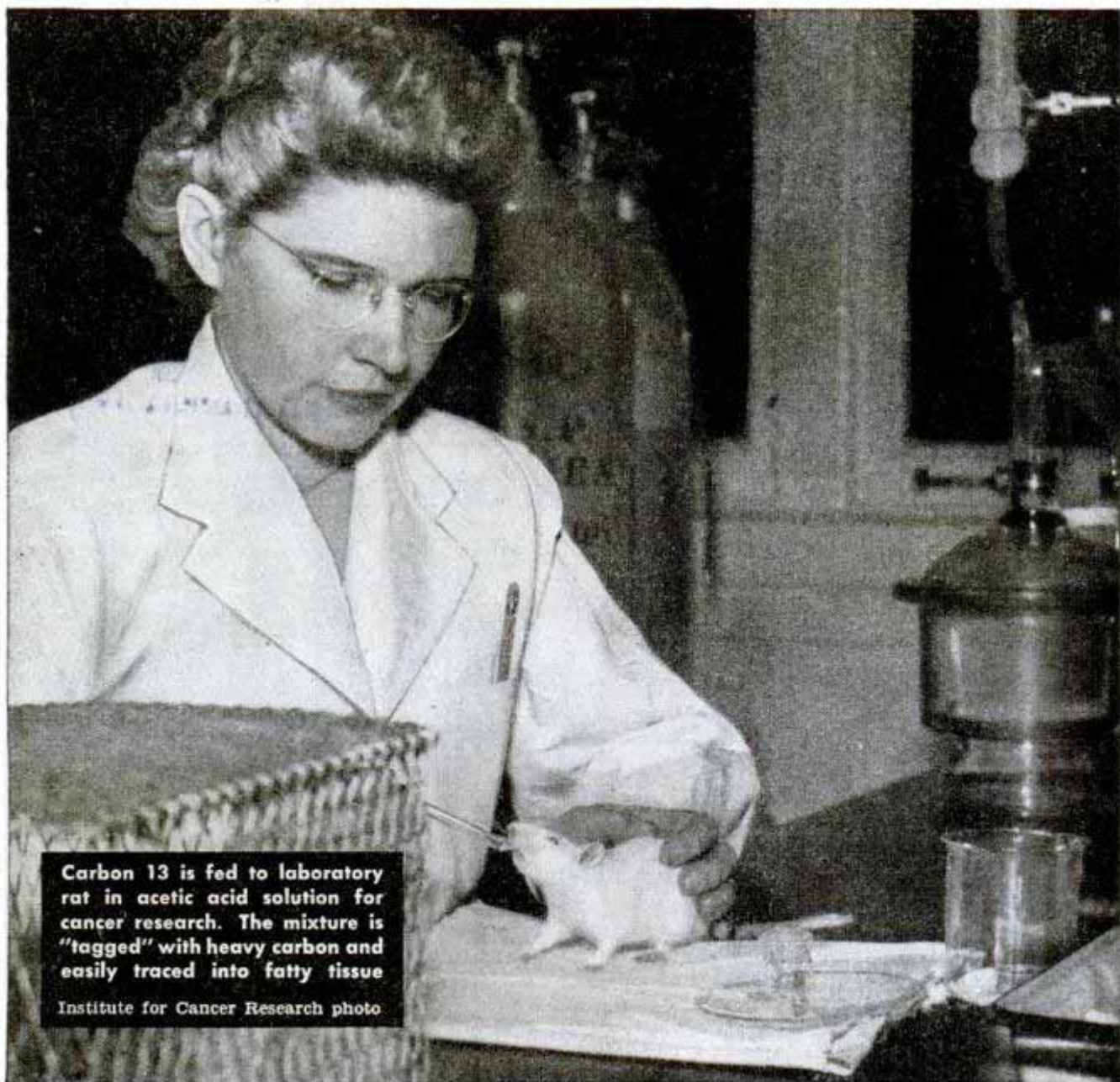

Carbon 13 is fed to laboratory rat in acetic acid solution for cancer research. The mixture is "tagged" with heavy carbon and easily traced into fatty tissue

Institute for Cancer Research photo

TELLTALE atoms may soon strip the mystery from some of man's deadliest enemies—cancer, hardening of the arteries, diabetes, heart disease.

A new key that researchers will use to gain knowledge of these ailments is a tiny particle of energy—Carbon 13, an isotope of ordinary carbon atoms. Some scientists believe it will prove to be as important a tool of medical research as the X-ray.

"Possibilities of research with Carbon 13 are almost beyond imagination," state two scientists, Dr. C. H. Werkman of Iowa State College and Dr. E. A. Evans of the University of Chicago, after experiments with the isotope.

Carbon 13 is invaluable in the study of metabolism, the chemical reaction by which

one unit more than ordinary carbon. Another isotope, Carbon 14, is two units heavier and when irradiated by a cyclotron retains a radioactive nature for a long time. Carbon 11, still another isotope, has a very short radioactive life.

Isotopes are merely chemical twins of various elements. Carbon 12 has six protons and six neutrons in its nucleus, giving a total atomic weight of 12 units. Suppose we add an extra neutron—an inactive particle—to the nucleus. This produces Carbon 13. Add another neutron and it becomes Carbon 14. Carbon 11, 13 and 14 cannot be distinguished either physically or

Trail of Cancer

By Nathaniel Nitkin

the body transforms foodstuffs into complex tissue. Metabolism, a basic process of life, has stubbornly resisted many experiments in the past because there was no laboratory method for following the process. Now Carbon 13 can be "tagged" or traced through the pathways it follows in the human body. Scientists say that experiments with the "tracer" may unlock many basic secrets of life.

This isotope can be traced because it differs in weight from the ordinary carbon atom, Carbon 12, so labeled because of its atomic weight. A Carbon 13 atom weighs

chemically from ordinary carbon. All react similarly when absorbed by living tissue. Fed to plants, Carbon 13 is processed exactly the same as ordinary carbon. If an animal eats this special food, the isotope becomes a part of the animal's living tissues.

But the factor that makes Carbon 13 of invaluable importance is that it can be traced through the daily functions of the body—biological metabolism—by a precision electrical instrument called the mass spectrometer, which is a refinement of the mass spectrograph.

Left, carbon dioxide from rat's breath is picked up in glass jar for analysis to discover Carbon 13 content. Right, plants containing Carbon 13 are particularly valuable in studying abnormal growths such as cancer

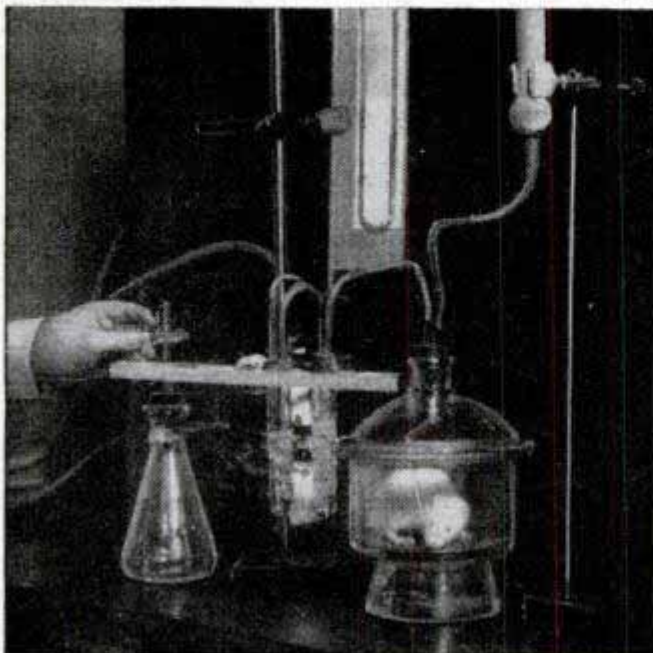



Houdry Process Corp., Sun Oil Co. photo and diagram

Scientists use the mass spectrometer as a "chemical microscope" in experiments to follow Carbon 13 "tracers" by measuring the masses of individual atoms

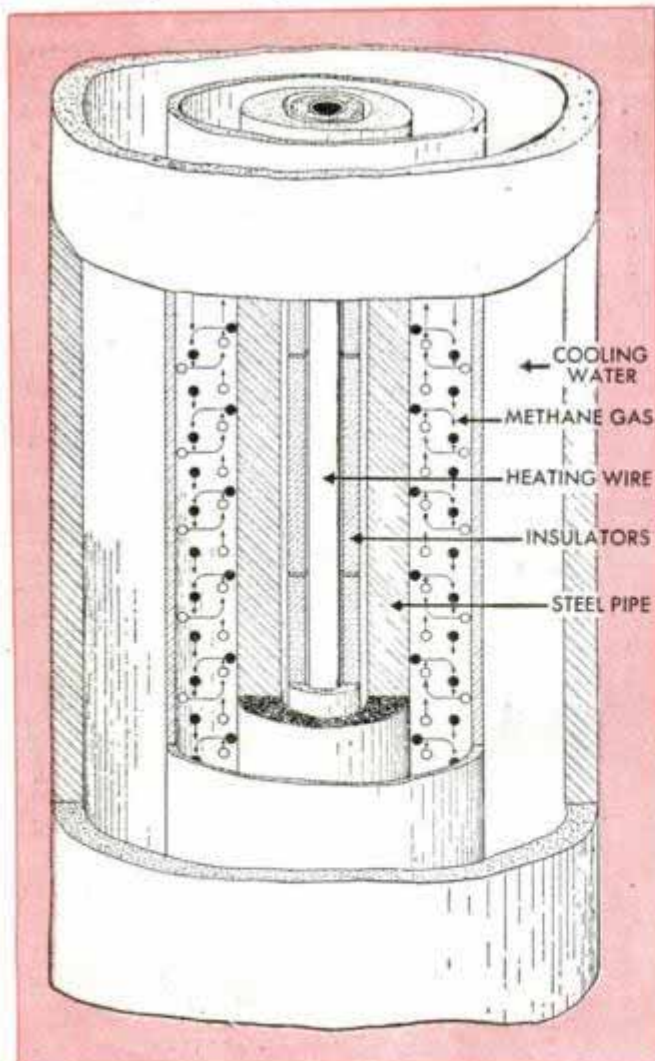

The mass spectrograph does to elements what a prism does to rays of white light. When light is passed through a prism, it is broken into colors of different wave lengths. Similarly the mass spectrograph separates the various isotopes of a single element.

It is a U-shaped device. In one arm are two slits separated by an electrical field. In the other arm is a powerful electromagnet. The curved body between is a vacuum chamber.

Before carbon is placed in a mass spectrograph it is changed to a gas and given an electrical charge. Then the atoms are passed through the first slit and are boosted in speed by the electrical field. They race through the second slit into the vacuum chamber. The electromagnet in the other arm immediately attracts them as they rush through the U-shaped body.

Now Carbon 13, being heavier than Carbon 12, travels more slowly. Thus its path has a longer curve than that of the ordinary element. Carbon 14, heaviest of the three, has the longest curved path. As the atoms collect through slits on the magnetic screen, Carbon 12 bunches on one side, Carbon 13 in the middle, and Carbon 14 on the other end.

This ability of the mass spectrograph to isolate Carbon 13 from its sisters in the carbon family, together with further refinements in the mass spectrograph, make it possible to trace the path of the isotope through an organic body and to analyze the processes of metabolism.

Using a single element such as Carbon 13 to study metabolism and cancer is not a new procedure. Scientists have already utilized radioactive Carbon 14 and Hydrogen 3 to study cancer. The purpose of these experiments was to "tag" the organic compounds—to trace radioactive carbon and hydrogen through the body and ultimately to identify the fragments when metabolism breaks down the compounds.

This, in effect, is also the goal of laboratory technicians using Carbon 13 as a "tracer bullet."

But radioactive elements are dangerous. Radium and thorium could not be used in the experiments. Temporary radioactive elements were used to some extent—common elements such as sodium, potassium and phosphorus, made radioactive artificially. Carbon 11 also has been used experimentally. The gamma rays given off by these elements are electro-magnetic and

Diagram of the thermal process for concentration of C13. Methane gas is introduced at top of 40-foot tubes and passes downward in space between heated inside tube and water-cooled wall. Gas molecules containing C13 flow downward along the cooled wall while C12 molecules travel upward along heated tube

can be traced through living organs. But such elements have a half-life—a radioactive period—of only a few minutes, allowing research technicians but a short time to study their trails through the body.

Carbon is the most common constituent of all living things. Its omnipresence proves its potential value in unlocking the mysteries of life. It is readily absorbed into tissues. But until Carbon 13 could be forged in large enough quantities for research, the element could not be used effectively for studies that were to cover a long period of time.

In 1943 Dr. Harold C. Urey of the University of Chicago isolated half a gram of the traceable carbon. The Houdry Process Laboratories built a small plant to manufacture it for research, but the factory could make only one fourth gram per month. This isotope was too expensive for large scale experiments.

Dr. Allen Reid discovered a catalyst that aided in building Carbon 13. A catalyst is simply a substance that speeds up chemical and atomic change. The catalyst remains the same throughout, merely boosting the process like a supercharger.

Using Dr. Reid's catalyst, Dr. Urey developed the principle that now makes possible large scale production of Carbon 13. Both physicists were among the foremost scientists in atom bomb research.

Now the Houdry Process Laboratories is building two large plants for the Sun Oil Company. They will produce 500 to 1000 times the amount of Carbon 13 that previously was produced each year, giving medical science an adequate supply for experiments that may uncover the cause and cure of man's baffling diseases.

Electric "Bath" for Metals Speeds Polishing Job

Electrolytic polishing for metals is rapidly replacing hand polishing in many industries because of savings in time and labor and improvement in the finish. Dr. A. E. Hostetter, associate professor of metallurgy at Kansas State College, reports that recent developments make it possible to electropolish metal in 30 seconds to four minutes, compared with 45 minutes to an hour by the hand process. With the electrolytic system the metal to be polished is attached to metal clips wired to a 40-volt d.c. generator or electrolytic rectifier. Then the piece is lowered into a container filled with acid which removes a thin surface layer of metal. This method is used to polish metal mirrors, light reflectors and costume jewelry, to remove burrs from fabricated parts and to smooth the internal cavities of molding equipment.

Rubber Strip Dangled From Car Saves Motorists From Shocks

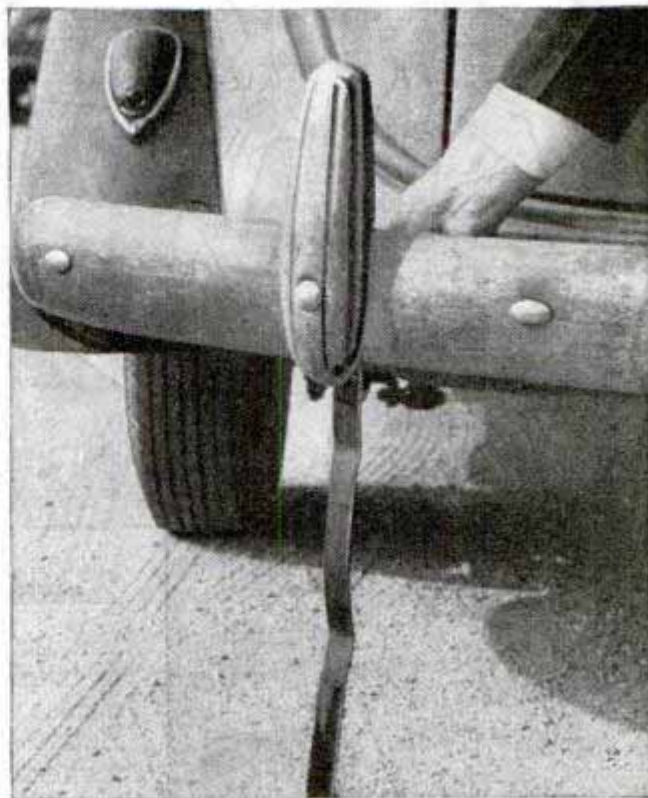

Unique in its ability to conduct electricity instead of insulating against it, a strip of rubber dangled from the undercarriage of a car eliminates shocks from door handles or other metal fittings. The strip is produced by the United States Rubber Company and despite its rubberlike qualities grounds electrical charges in the same way as drag chains on fuel trucks. Tail wheel tires on military airplanes were made of the same material to discharge static.

1230 6th AVE. N.Y. 10, N.Y.

Fins on Pipe Carry Off Heat To Give Cooler Smoke



Stainless steel bowl, dural body and rubber mouthpiece are combined in a new one-ounce pipe which requires no breaking in because of the construction of the bowl, according to the maker. Fins on the pipe serve to dissipate heat and provide a cooler smoke. The stainless steel bowl is cooled so that tobacco cake is not formed under normal smoking conditions.

By Benny McLoone and
40990 Melrose ave
Los Angeles 27, Calif.

M.A. R.R. LASHBROOK
NEWS PAPER

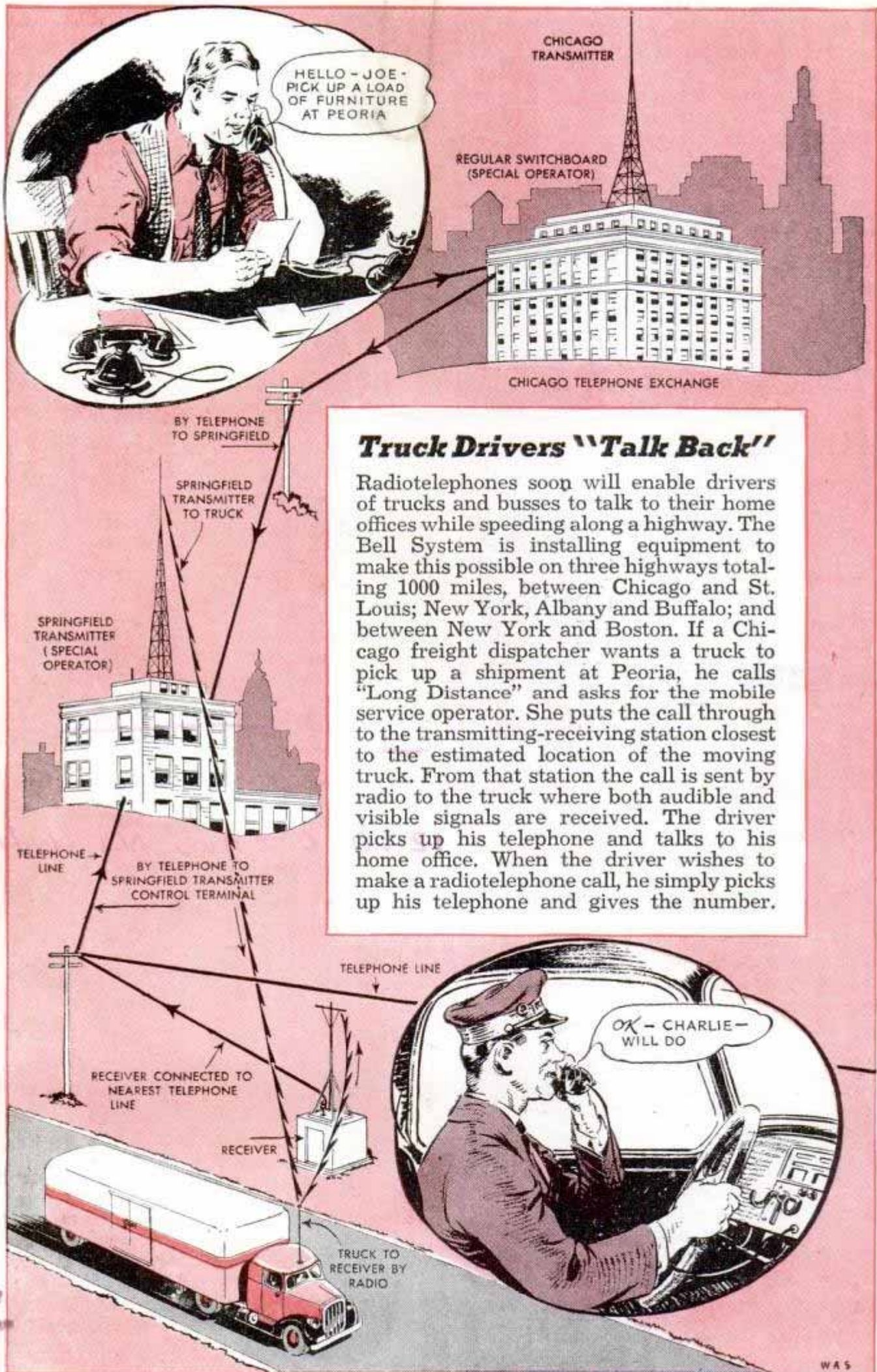

Truck Drivers "Talk Back"

Radiotelephones soon will enable drivers of trucks and busses to talk to their home offices while speeding along a highway. The Bell System is installing equipment to make this possible on three highways totaling 1000 miles, between Chicago and St. Louis; New York, Albany and Buffalo; and between New York and Boston. If a Chicago freight dispatcher wants a truck to pick up a shipment at Peoria, he calls "Long Distance" and asks for the mobile service operator. She puts the call through to the transmitting-receiving station closest to the estimated location of the moving truck. From that station the call is sent by radio to the truck where both audible and visible signals are received. The driver picks up his telephone and talks to his home office. When the driver wishes to make a radiotelephone call, he simply picks up his telephone and gives the number.

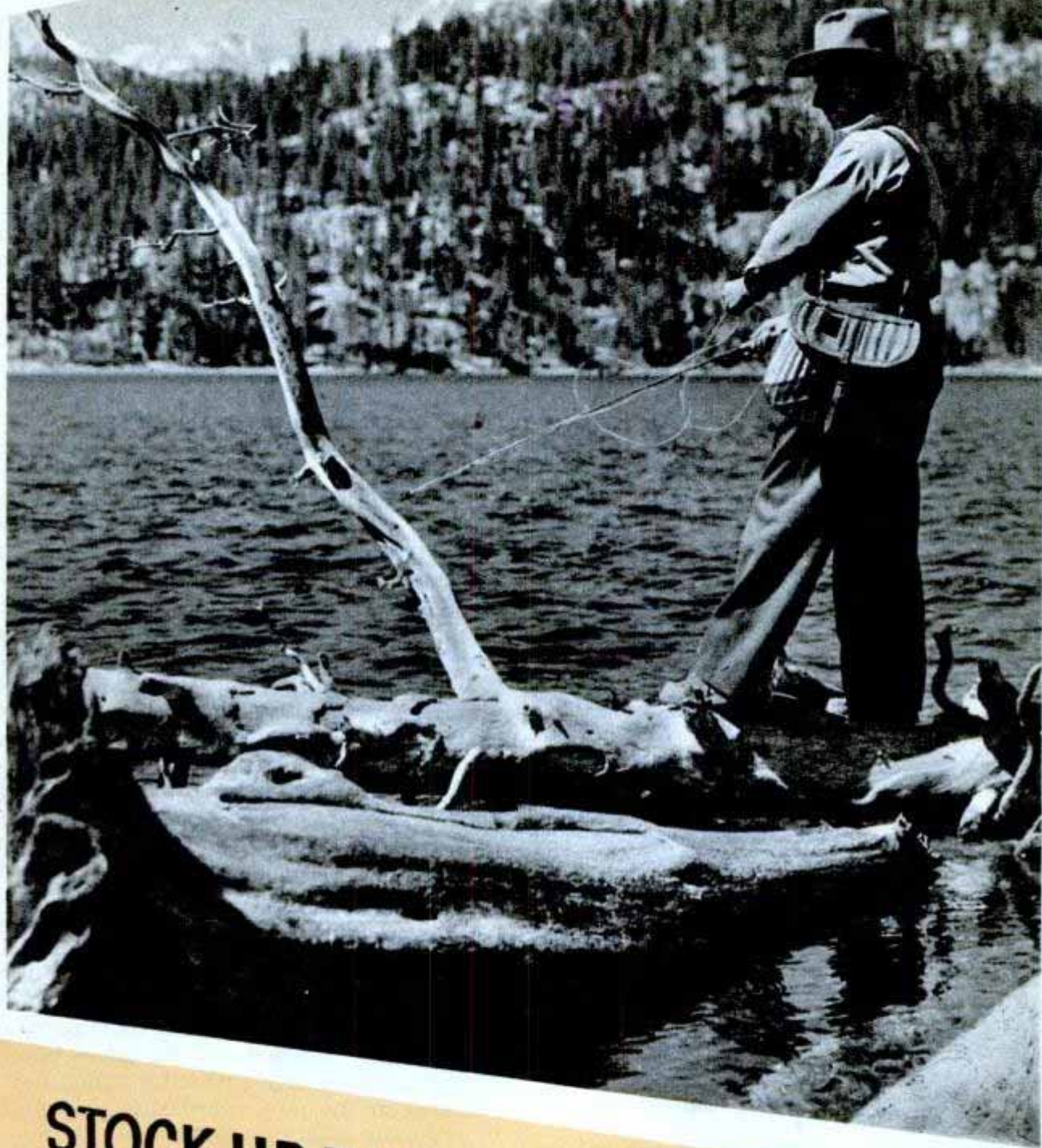

STOCK UP FOR THE *Outdoors*

There's a happy hunting ground
in bulging Army surplus stores

ELECTRIC gunsights, "pocket" cook-stoves, lightweight nylon tents and sleeping bags, and a hundred and one other new pieces of equipment will be available this year for your hunting, fishing and camping trips.

Lightness and compactness, based on military experience in the field, will be

featured in nearly all of the equipment.

Surplus Army material that is ideal for the out-of-doors also is coming on the market. Some sportsmen have outfitted themselves almost entirely from surplus material and use a four-wheel-drive jeep to carry them over rough trails to a distant lake where they inflate a two-man rubber

This powerful air gun hurls a frog spear, also metal pellets, arrows or handful of birdshot

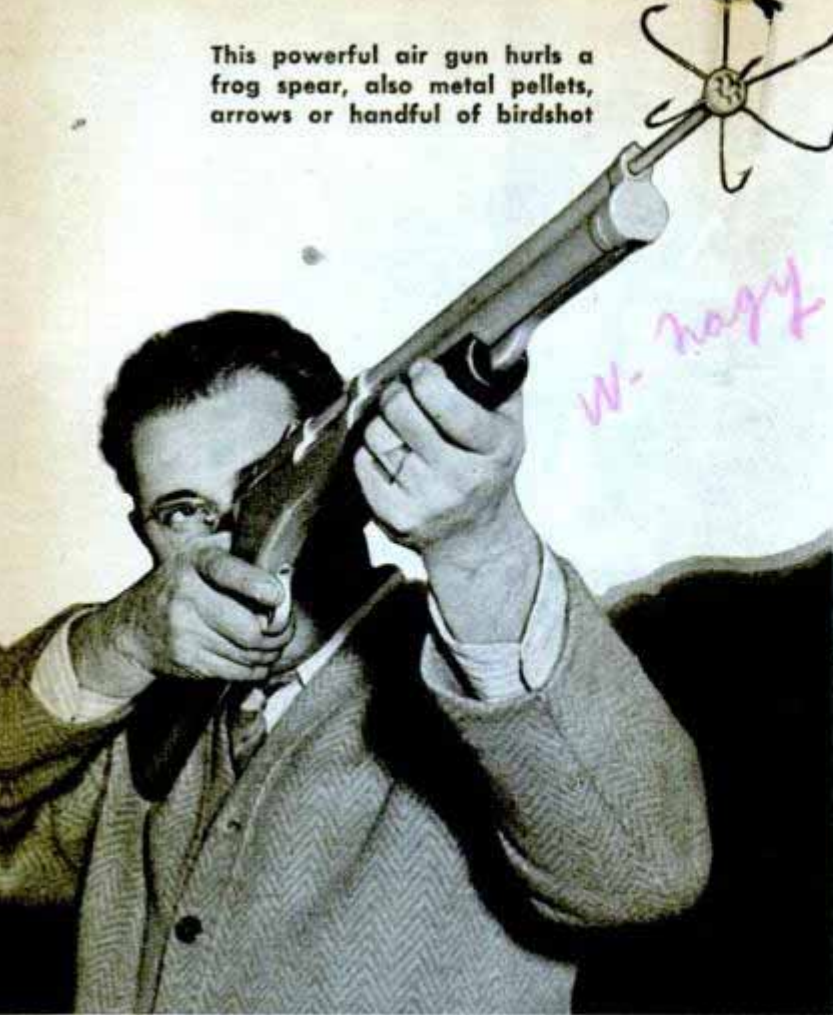

Resembling a specially built lathe, tiny apparatus below is for attaching gut leaders to trout hooks

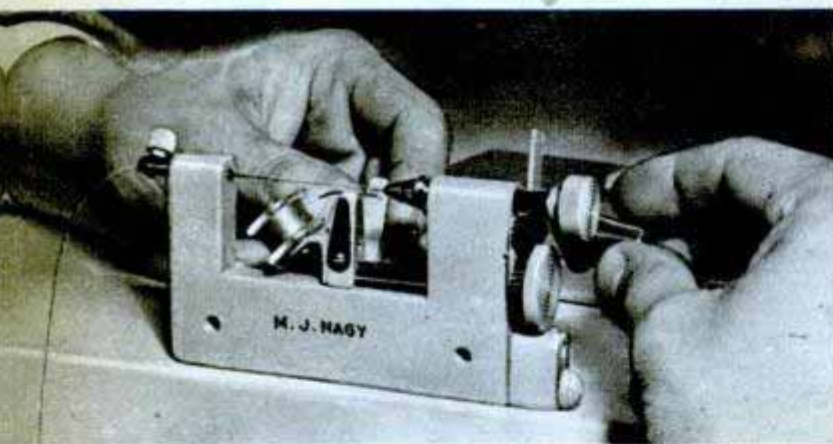

Flexible plug-casting rod was made of radio antenna from naval craft; other parts are also war surplus



life raft for fishing trips. Wearing paratrooper boots and other GI clothing, they cook and eat with ex-Army utensils that include an Army Coleman stove almost small enough to put in your pocket. It makes a hot flame from any kind of gasoline. Surplus insecticide bombs dispel mosquitoes and walkie-talkies provide communication facilities.

Two new gunsights that are based on the electric gunsights used by fighter pilots are taking much of the guesswork out of aiming a gun. With such a device there is no need to line up the front and rear sights; you simply point at the target and pull the trigger.

The Giese electric gunsight consists of a small optical case, with self-contained batteries, that mounts over the breach of the gun. When you aim through the sight you observe a small central illuminated dot, surrounded by an illuminated ring. The dot represents the exact spot at which the gun is pointed. Provided that you have made the proper range and windage corrections, your bullet will hit that part of the target covered by the dot. The alignment is such that the dot and ring are invisible unless your head is in proper position behind the gun.

A shotgun model operates similarly except that the central illuminated dot is replaced by an inner illuminated ring. The inner ring represents your shot pattern at 40 yards and the outer illuminated circle represents a five-yard lead against ducks at normal ranges. Both models have a built-in adjustable Polaroid filter that permits aiming into the sun without squinting.

Another sight, the Nydar shotgun sight, uses the reflection of sky light to illuminate its optical aiming dot and ring.

Based on research that was performed during the war, most kinds of sporting rifles now can be "hopped up" for more power and muzzle velocity without making major changes in the gun, increasing its weight or reducing safety factors.

The process is called "controlled combustion chambrage" and consists of reshaping the cartridges to provide sharper angles at the neck and reshaping the cartridge chamber of the gun to fit the changed shells. The purpose is to convert the neck of the shell into a true venturi orifice, allowing the hot powder gases to escape with less resistance and deliver a stronger and more sustained push to the bullet. Standard factory powder loads may be used or the cartridges may be overloaded with safety for even greater power. Increases in energy up to 92 percent at 300 yards are obtained. Average cost of converting a gun is \$25.

A new air gun, designed primarily for

public shooting gallery use, is "powered" by dry ice or carbon dioxide gas, the pressure being supplied by means of a rubber hose attached to the gun. The gun discharges a .24-caliber round lead pellet that has a range and penetration comparable to that of a .22 short.

Newly designed rowboats made of various plastic compounds are being readied for distribution. One aircraft manufacturer is producing an aluminum canoe that weighs only 38 pounds while another aircraft concern is building molded plastic canoes that come apart into six pieces for storing in a car.

Salt and freshwater fishermen will have their choice of a wide variety of new lures and baits. One novel fishing attachment that is said to be worth its weight in gold is a small polished brass or chrome streamline "attractor" that is bent to fit over the curved portion of a hook. Available in various sizes, the attractors are for hooks used with plugs or spoons or for any other hook to which bait is not attached. Simple and inexpensive, the bit of bright metal attracts the attention of a fish and causes it to strike directly at the hook itself instead of at the lure.

One manufacturer is turning out a plug-casting rod made from a small surplus Navy radio antenna, with a natural-grip handle cast from secondary



Waterproof nylon tent designed for Quartermaster Corps has air vents at top which keep out rain and snow. Ideal for sportsmen, the complete outfit including poles and stakes weighs only seven pounds. Below, collapsible barbecue grill folds to convenient size for trail



"Pocket" cookstove made for GIs is handy for camping; at right, pickaback creel has trap doors on top



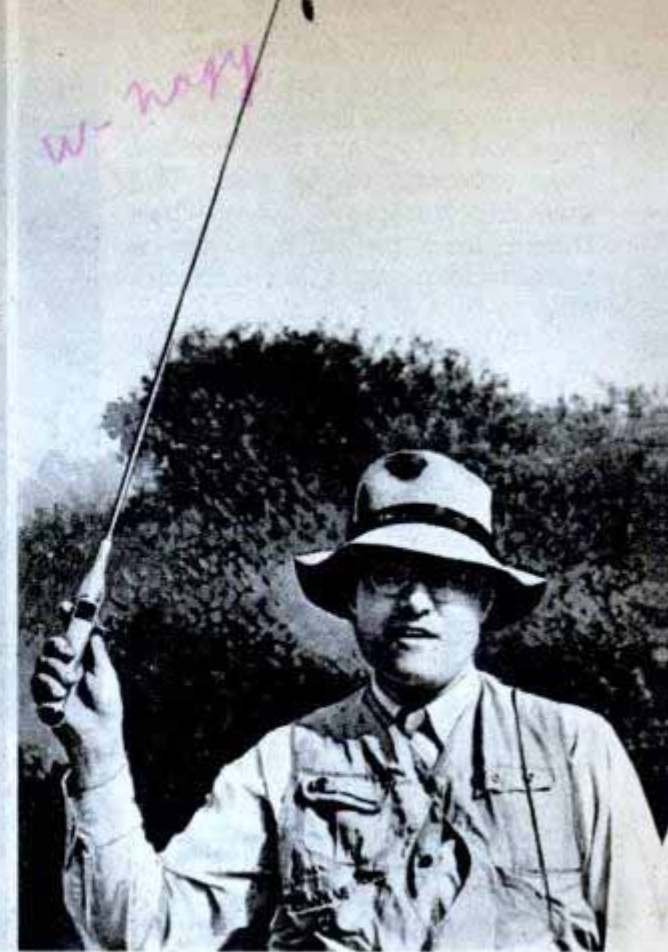
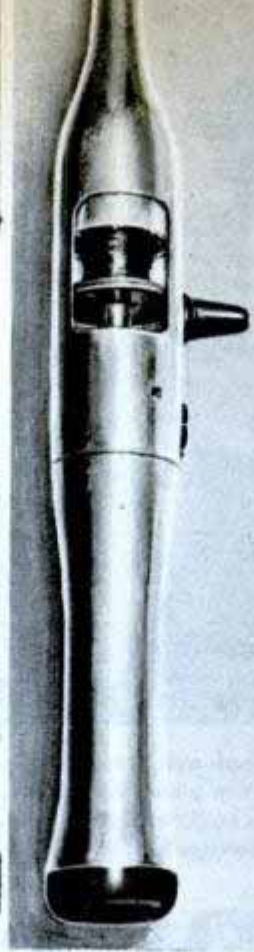

Grids on portable grill can be adjusted for broiling. Close-up (center) is of "spinning" reel inside handle of unique rod; reel does not turn and in casting (shown at right) the line pulls away from it with a minimum of drag

aircraft aluminum, and fitted with a reel stamped from leftover sheet metal. Some manufacturers, too, are experimenting with hollow plastic fishing rods that are light in weight and seem to have very good action.

Not yet in production but possibly available soon are a number of special pieces of equipment invented by Mike Nagy and Tom Willoughby, two Northrop Aircraft engineers. In their spare time during the

war the two men built numerous camping and fishing gadgets for their own use, then found that all their friends wanted samples for themselves. Now they have applied for patent protection on the devices and are getting ready to manufacture them.

Of their various fishing reels, one bantam is made of duralumin and weighs only two ounces although it carries enough line for ordinary fly casting. Another lightweight fly reel has an adjustable drag in addition to the usual click drag. A third, designed for a soldier friend who lost all but one finger of his right hand, employs an indented cup in place of the usual handle for reeling in line. The reel may be turned by the motion of one fingertip. Other fish-

Combination watch, alarm clock and flashlight fits pocket. Below, metal attractors cause strike at hook

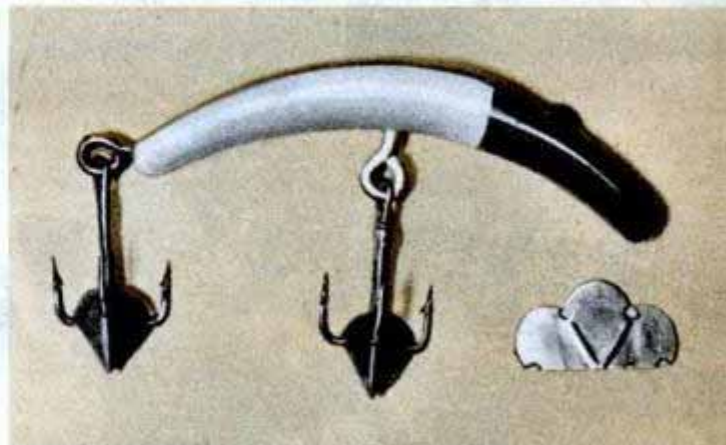
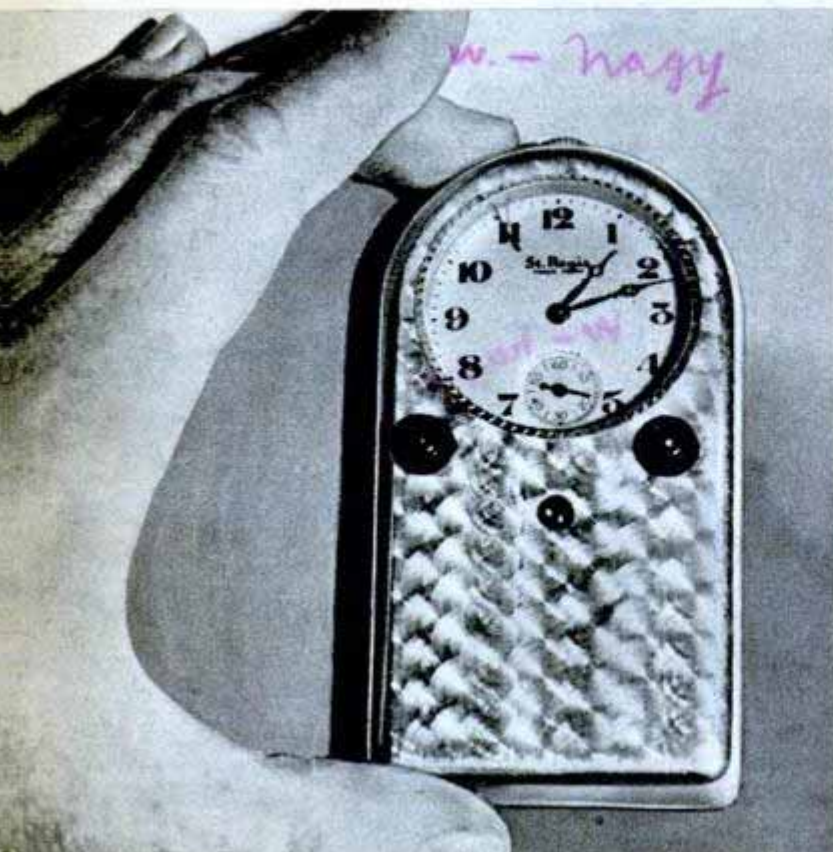

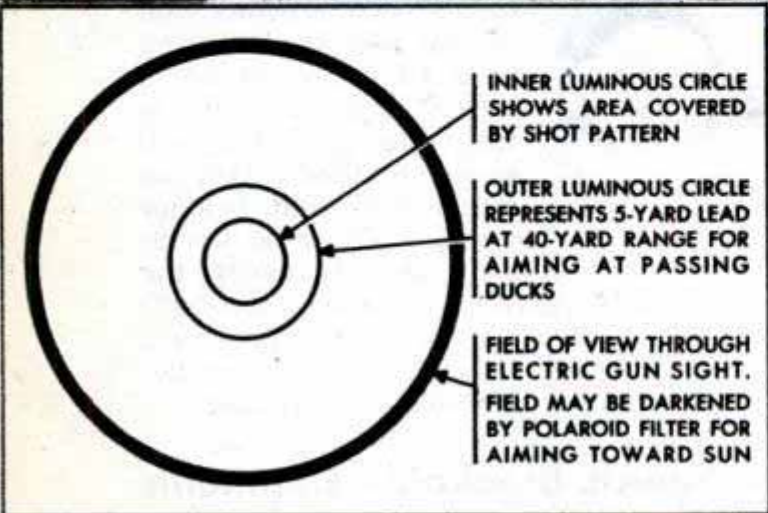
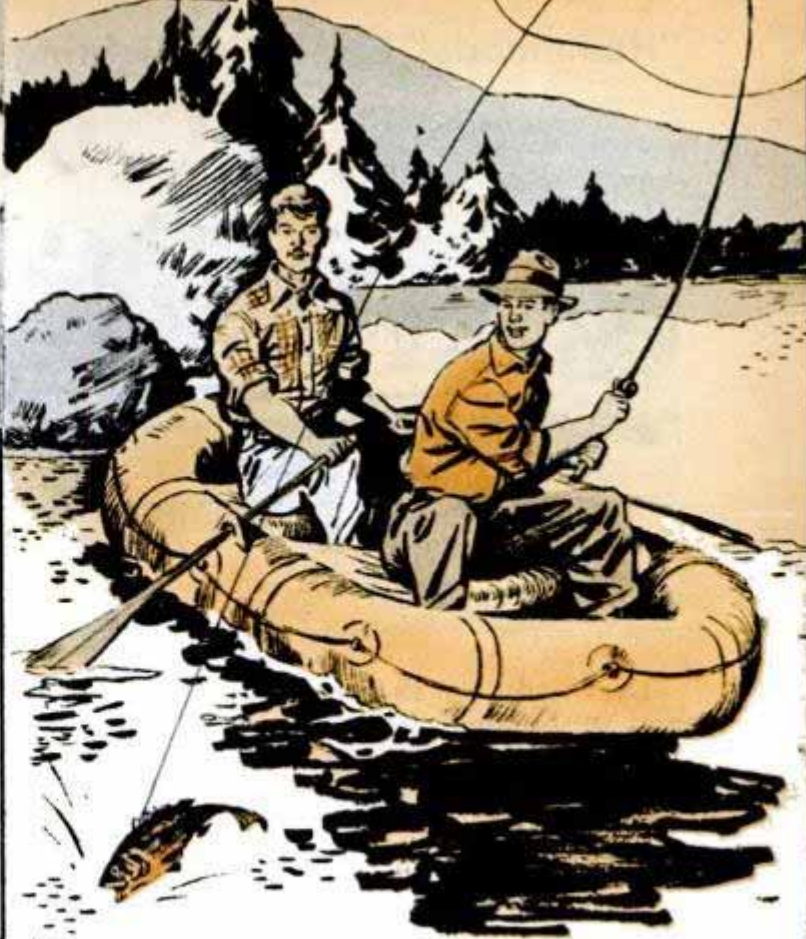

Electric gunsight mounted on hunting rifle is adaptable to shotguns. Right, fishing from inflatable life raft

ermen also like the reel because there is no projecting handle to catch in the clothes or rap the knuckles.

Still another reel is of the stationary spinning type which is entirely housed inside the handle of a lightweight plug-casting rod. The line is threaded through the hollow rod to the tip, eliminating the usual outside guides. Advantages of the spinning reel are that it does not rotate and that its axis is the same as that of the rod. Line slips off the reel with a minimum of drag and all chance of backlash is avoided. Line is recovered and replaced on the spool by means of a winding device operated by a small handle on the side of the rod. Basically an old English idea, the new design represents several improvements over past models.

Irritated by the conventional fishing creel that bangs against your side and snags in the brush, the two engineers devised a 15-ounce creel that you carry on your back between your shoulders. The creel has cloth sides and a ventilated duralumin top with a double spring-loaded trap door through which fish are dropped. The cloth that rests against your back is waterproofed and the whole creel collapses into a package four inches thick for storage. The top is quickly detachable for removing fish.

The creel is held in place by two thermo-setting plastic straps that hook over your shoulders. Soft and pliable when he re-

ceives them, the fisherman molds these straps to the contours of his shoulders and then places the straps in the sun for an hour or so. Heat of the sun hardens the straps, providing a permanent individual fit.

After experiencing the usual difficulties of cooking food in the thin air of high altitudes and not desiring to carry a large pressure cooker on his camping trips, Nagy built his own, a tube-shaped one-quart capacity cooker of stainless steel with a new type of positive safety valve. Small enough to be carried in a pocket, it may be used on a cabin stove or even placed upright in the coals of a campfire. It cuts the cooking time of food at high altitude to a fraction of the usual time. Packed in a thermal case, it can serve as a vacuum jug for carrying hot or cold liquids on trips.

Another device that the two engineers built for themselves is a combination watch, alarm clock and flashlight. They soon were swamped with orders for this item. The glass face of the watch contains an inside trigger and this face may be rotated so that the trigger will engage the hour hand at the time the alarm is desired. The alarm itself is a penetrating whine that is audible to a person who sleeps with the watch under his pillow and yet does not disturb people a few feet away. Two batteries inside the case illuminate the watch dial and also supply light for odd jobs in the

(Continued to page 260)

"Homemade" Forest-Fire Fighting Plow Does Work of 20-30 Men



Drawn by an 18-horsepower tractor, a new firefighting plow is doing the work of 20 to 30 men with hand tools in clearing fire lines in southeastern forests. The device, "homemade" by Forest Service me-

chanics and drawn by a light caterpillar-type tractor, includes a stout beam with a heavy rolling coulter and a plow of the middle-buster or two-way type that turns a clear furrow 28 inches wide. Disks and wings spread the loosened soil to cover forest litter on either side of the furrow, resulting in a fire line 48 to 54 inches wide. Plowing a wide furrow is a well known method of fighting forest fires and heavier units, of 35 or 50 horsepower, have been in use. However, the lighter unit, carried on a one-and-a-half-ton truck with a crew of three or four men, often can reach and subdue the blaze before heavier equipment can get rolling.

"Cushion-Meter" Test for Packages Protects Breakable Shipments

How much cushioning will a breakable article packed for shipment need? That's a question answered by a handy meter that eliminates the need of shipping test packages. A detector head, weighing half a pound, is packed into a package with cushioning. This head is connected with an indicator instrument. When the mockup package is dropped, neon lamps indicate the amount of shock sustained by the package. They continue to glow until a reset button is pressed, allowing the operator to concentrate on the package instead of the light panel. The unit fits into a case 16½ by 11 by 19 inches and weighs only 17 pounds.

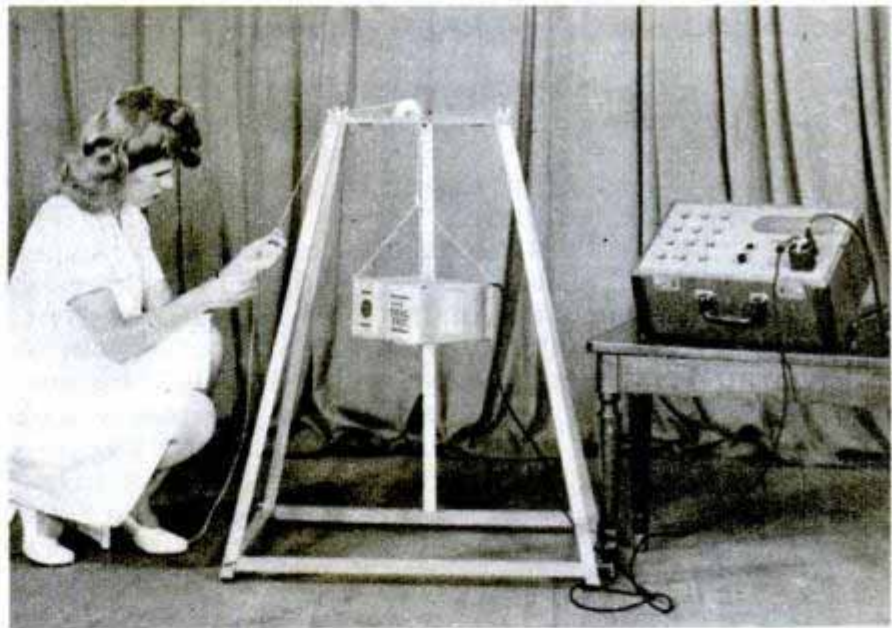

base and stem and a spiral steel needle which goes through small openings. Rubber cement applied to the stem and casing hole serves as a lubricant. A pull from a pair of pliers thins out the rubber stem to the desired diameter and enables it to slip through. The stem, released when the wire pulls off, shortens and spreads against the walls of the hole. Finally, the protruding rubber is snipped off an eighth of an inch from the casing tread or sidewall.

Blowout-Proof Rubber Rivet for Tires



Nail holes in tire casings can be plugged by rubber rivets, available in three sizes, which prevent water and slush from entering. The blowout-proof rivet consists of a rubber

Names and addresses of manufacturers of new products featured in this issue will be supplied promptly by the Bureau of Information, Popular Mechanics Magazine, 200 East Ontario Street, Chicago 11, Illinois

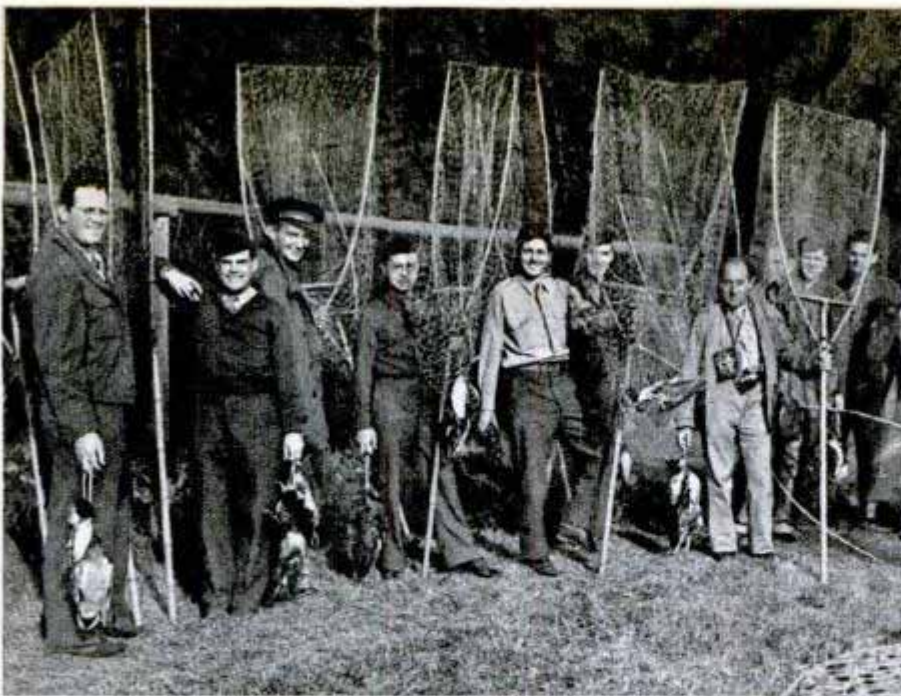

**"Butterfly" Nets Capture Ducks
At Japanese-Style Hunt**



Duck hunters in Japan must be dextrous because the Japanese way of taking the fowl is to capture them in long "butterfly" nets rather than shoot them. Assistance of

beaters is required also. The hunters hide behind screens on either side of narrow canals running from the central duck pond. As beaters flush the birds from the canal the hunters leap from behind the screens and attempt to snare the fast-flying ducks in their nets. Recently American newspaper and radio correspondents stationed in Japan tried Japanese-style duck hunting at the Imperial preserve near Tokyo and caught 50. The ducks were cooked for them by servants of the Imperial household.

Chemically Lined Tube Absorbs Oxygen From Air as Human Does

Imitating the human body's method, a new process obtains oxygen from the air for industrial use where regular supplies are not available. Air is blown through a tube lined with a specially compounded chemical which absorbs oxygen. When the absorption reaches its maximum, the air flow is halted. Oxygen is released when the tube is heated. The oxygen then is pumped into storage tanks and the pro-

cedure repeated. The chemical belongs to a group of compounds called chelates, organic substances having atoms of metal attached to them. In this case the metal is cobalt while in the blood it is iron. The metals greatly increase the oxygen-attracting power of blood and other organic compounds. The process was conceived while researchers were looking for something to indicate oxygen changes in submarines.

Mudslingers

By Richard W. Emery

Photos by Ray Chapin

IF it weren't for mud, you very likely wouldn't be driving an automobile. Gasoline would cost too much.

Mud makes rotary drilling possible. And rotary drilling reaches the deep oil pools, which produce petroleum in such abundance that gasoline costs you little.

When a rotary drilling rig thrusts a spinning steel tube down through thousands of feet of the earth's crust, mud serves as a circulating fluid. It is the life blood of the drilling well.

Only within the past few years, America's oil industry has worked out methods of chemically controlling

Left, mud from well flows through open sluiceways where it drops its sand. Below, derrickman funnels a sample of mud to test its viscosity

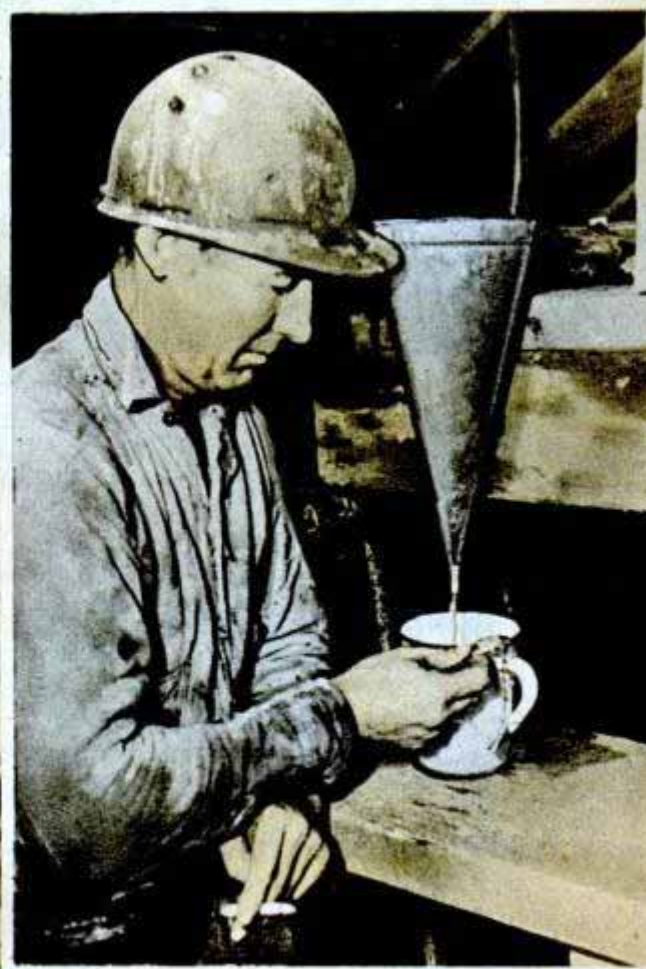

Bring Up Oil

certain physical properties of drilling mud.

In the early years of rotary drilling, any old gumbo would do. Cave-ins, blow-outs, gassers, fires and explosions were looked upon as part of the business. Rotary drills dug faster and reached deeper than the century-old cable-tool devices. Drillers found their problems multiplied with depth of hole. They found also that all mud was not alike; that mud was subject to mysterious sudden transformations. For no apparent reason, it would change from thick to thin, from thin to thick, or suddenly give up its water content, flooding the walls of the bore and causing cave-ins.

Here and there inquisitive men went to work to find out why mud behaved so strangely and what could be done about it.

Researchers, however, found that many a field man would have none of their puttering with his mud system.

Heckled and handicapped, the researchers at times "went underground" to try laboratory-proved theories on actual drilling operations. One chemical engineer

gave the field test to a laboratory process—now accepted as standard—by sneaking up to a drilling well near Ventura on California's coast line one night and pouring a bucketful of chemical into the mud pit.

Drilling an oil well through thousands of feet of the earth's crust is an engineering project where man's wits and labor are pitted against high-pressure gas pockets, underground rivers of hot water and thirsty layers of shale that swell when wet and "heave" like tidal waves.

After a geologist has "located" the drilling site, rig builders erect a tall derrick of timbers or steel. Machinery for pumping mud and for rotating and handling drill pipe is installed. The crew "spuds in" the new well. The rotating drill pipe, armed with a cutting tool or bit, sinks rapidly into the ground. When the drill has bored to a depth somewhat less than the height of the derrick, "roughnecks" attach another length or "stand" of pipe to the upper end of the drill pipe and drilling resumes.

In an oversized mayonnaise mixing basin

Diagram shows circulation of the mud around a rotary drill. Note the mud channel around the two pumps. Diagram from Pure Oil Co.

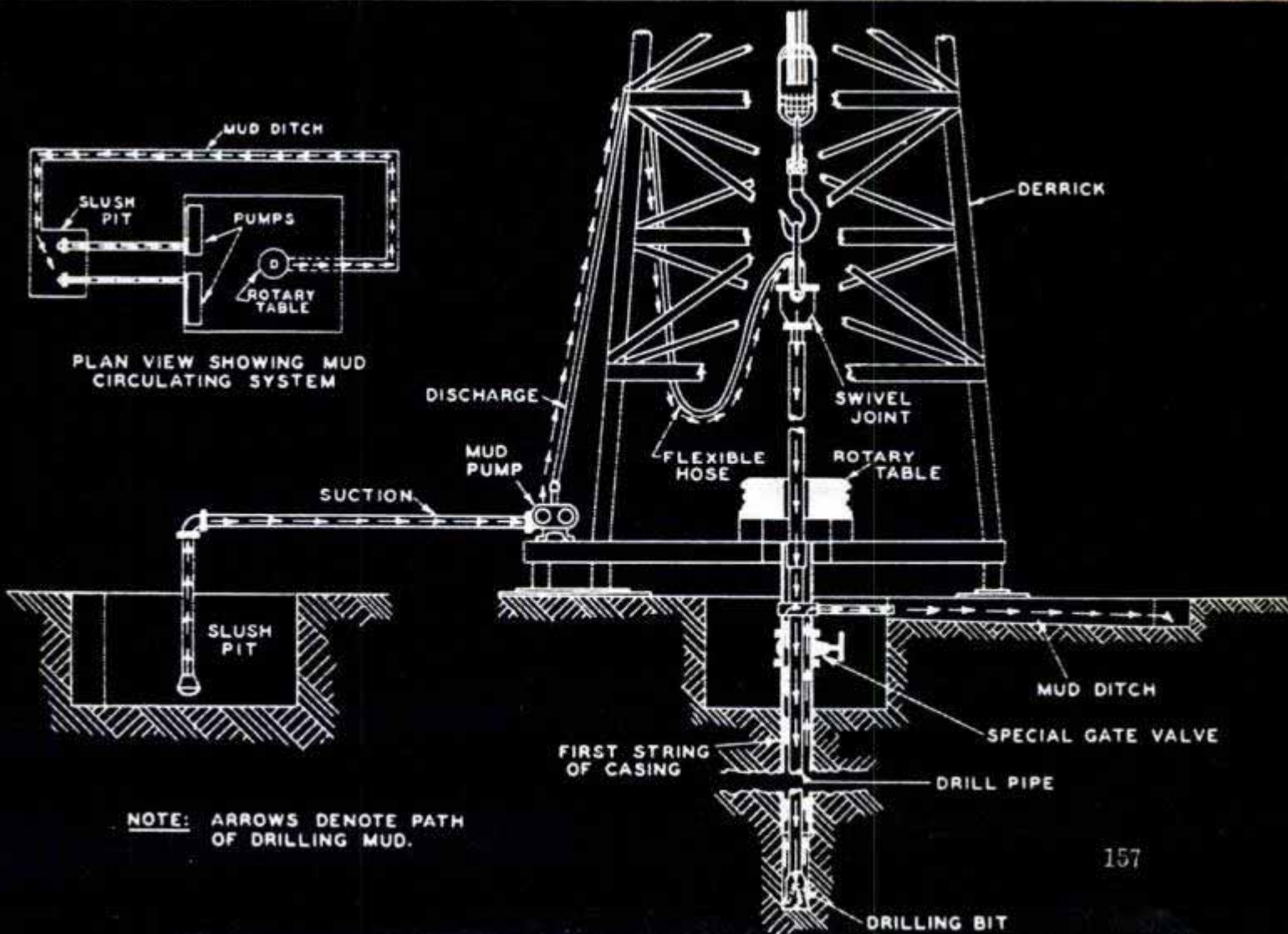

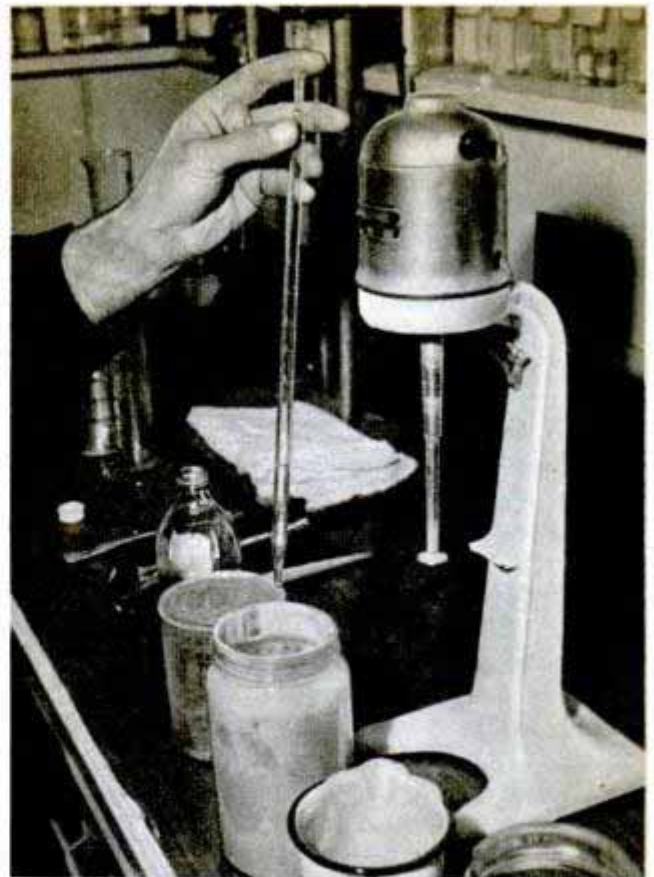

Colloidal material picked up in the underground bore has thickened this mud (left). The mud engineer can reduce its viscosity by adding a few drops of complex or poly phosphates to the sample as shown at right

called the mud pit, dry commercial rotary clays are jetted with water, a process called mud-gunning. When the resulting soupy mud is approved by the well's mud man, it is pumped into the drill pipe through a flexible high-pressure hose. If the well drills to great depth—say 14,000 feet—it will have 1500 barrels of mud in circulation. That's around 125 tons.

Under high pressure, the mud descends inside the drill pipe to the bit. There the liquid spurts out through holes close to the cutters, cooling and cleaning the blades or teeth. Scooping up cuttings as it goes, the mud then starts its climb between the outside of the pipe and the walls of the hole.

On reaching the surface the mud spills into a sluiceway, passes through a shaker screen which removes the cuttings, flows along a settling ditch where it drops its fine sand, and empties into a mud pit, soon to be picked up by the pumps for another round trip. The same mud is used over and over, and the supply is kept up by adding dry clay and water.

Primarily, the job of the drilling fluid is to cool the bit and wash cuttings from the hole. But it has many additional jobs.

Every few hours, the crew must remove the bit, which becomes worn from grinding against rock and sand. Stand by stand, the drill pipe is hoisted and racked in the derrick. A new bit is put on. Then, stand by stand, the drill pipe goes back into the hole.

The delay runs into several hours. A vital function of the mud is to support walls of the hole during this interval and keep in suspension the cuttings it has lifted.

To be able to suspend heavy particles, mud must have the colloidal characteristic of "setting" or gelatinizing when motionless. But it must not "gel" to the point where the pumps can't re-establish circulation. Laboratory tests determine a mud's "gel" rate. By chemical treatment, the rate can be regulated. Concentrated colloidal material such as bentonite, an aluminum silicate, increases the rate. Complex or poly phosphates thin the mud.

While drilling is going on, mud must lubricate the bore but must not plaster the walls of the bore too thickly with clay.

Mud must seal off porous sands but must not soak into the sand and cause a cave-in. It must wall off loose layers of rock or gravel but not plug formations which might produce oil. By its weight it must hold down gas or water or oil which may try to push into the hole and "blow out" the well, but the mud must not push out into loose strata of shale and start them "heaving."

Without chemistry, making rotary mud do all those things is a hit-or-miss effort.

Engineers who specialize in drilling fluids are called mud engineers. A typical member of that relatively new profession is Fred L. Walker, Monrovia, Calif., who demonstrated the laboratory tests shown.



Left, testing for acidity or alkalinity of the fluid. Right, tank drips chemicals into the mud circulation system

Each test reveals some characteristic of a sample of mud—its density, sand content, viscosity, rate of “setting” or gelatinizing, its degree of acidity or alkalinity, its salt content, its water-retaining properties and its degree of wall-building.

Hourly tests of viscosity and weight are made at the well. Once every shift or “tower,” there is a test for sand content and water-retaining property. Sudden changes in the mud are the first symptoms of trouble brewing deep in the earth.

For example, the toolpusher—drilling

superintendent—gets word from the mud man that mud returning from the hole is frothy and smells of natural gas. Somewhere in the deep bore, gas under tremendous pressure is forcing its way into the hole and cutting the mud, causing it to lose weight. Only the weight of the mud restrains the gas. So, as the mud gets lighter because of the bubbles, the gas gains headway and may blow out the whole column of mud. The blow-out may destroy the derrick, ruin the hole and set the gas on fire.

(Continued to page 248)

Left, mud's “gel” strength is checked by timing the sinking of an aluminum tube in a sample. Right, mud engineer tests under pressure the water-retaining property and cake-building rate of four samples of fluid

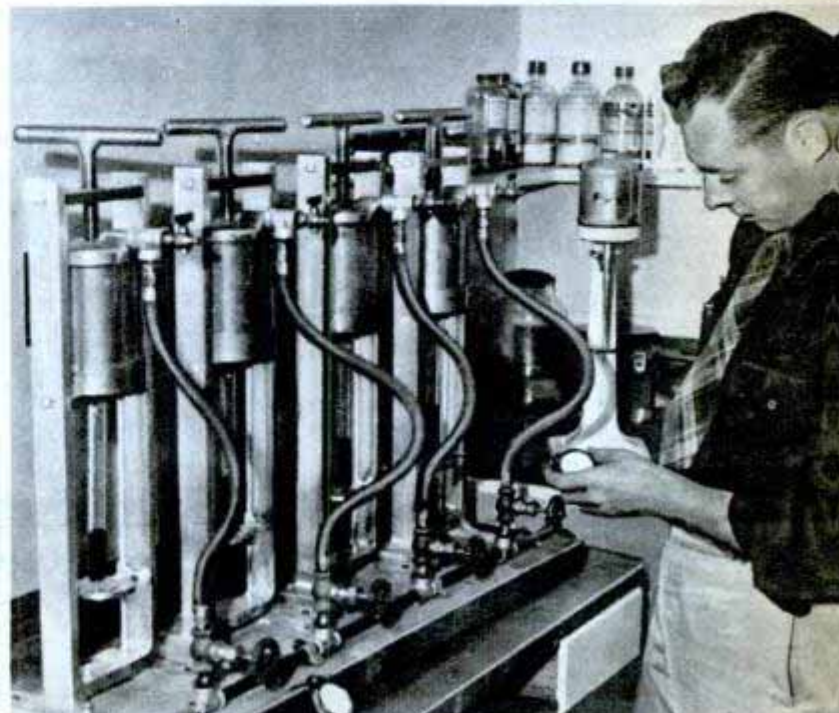



FISH-EATING

In marine garden above, delicate, flowerlike sea anemones look lovely. Their tentacles are death-trap for fish

In tanks of ocean water, sea anemones live on all-fish diet. Right, feeding time for "flowers" of marine garden

Tentacles fold inward and maneuver a small fish, below, into head-down position. Soon it disappears completely

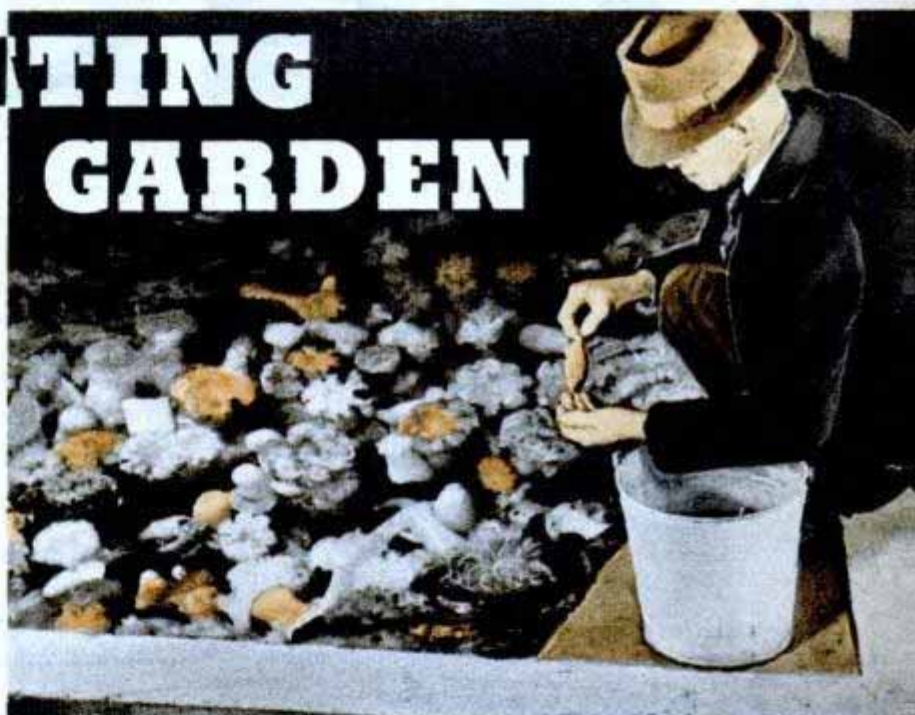

B RILLIANTLY colored in red, gold, blue and orange are the strange "flowers" in a fish-eating garden transplanted from the ocean depths to salt water tanks at Seaside, Oregon. There, George Smith grows sea anemones, ocean animals which look like flowers but which eat fish. The flowerlike appearance of the animal results from the gaily colored, feathery tentacles surrounding its mouth to belie its marine appearance. Fishermen bring Smith the sea anemones, which become ensnared in fishing nets many fathoms below the ocean surface. In "cultivating" his garden with a sea-food diet, Smith drops small fish into the center of the anemone, which quickly throws its tentacles around the food and folds it inward. Soon it disappears from view as it is drawn inside. Some time later the animal emits the fish bones. Occasionally, Smith will place 40 or 50 fish in the tank at one time. All of them are eaten in a few hours.



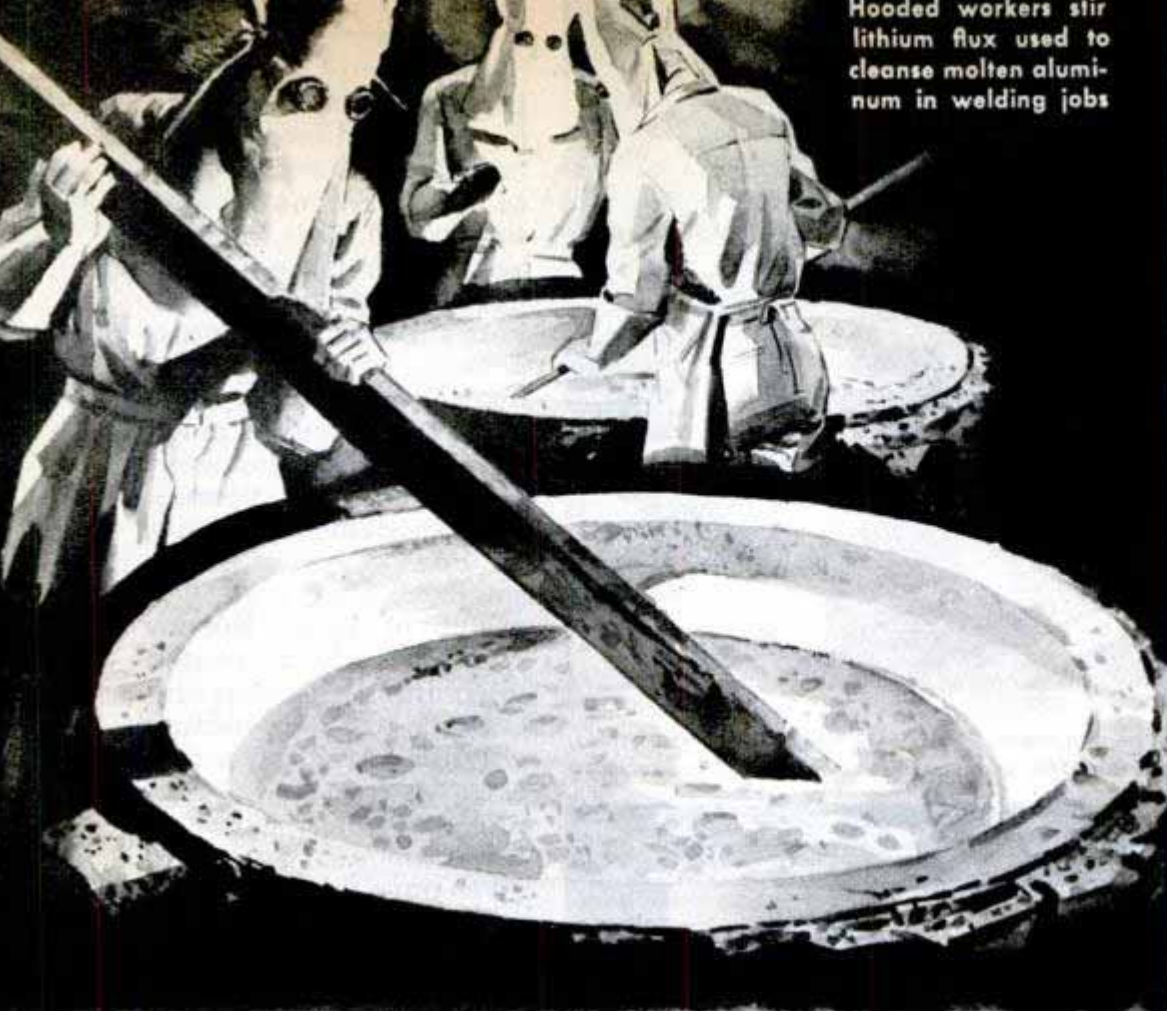

Hooded workers stir lithium flux used to cleanse molten aluminum in welding jobs

LITHIUM IS AT WORK



IN AERIAL BALLOONS

LITHIUM...the Hungry Metal

SOME metals, like gold, silver and platinum, have won fame as "noble" metals because they can't be touched by acids. Others, like iron, copper, aluminum and magnesium, are known as "use" metals since they are used in such huge quantities for building.

There is another classification of metals, just as important—the "servant" metals. They work just as hard as the "noble" and the "use" metals, only we seldom see them.

One of these metallic servants is lithium, the bantamweight. Pure lithium—you'll probably never see it outside of a laboratory—is the lightest of all metals. This soft metal, somewhat resembling silvery cheese, floats on gasoline, weighs 33 pounds a cubic foot. The same volume of magnesium weighs 108 pounds; aluminum, 176 pounds; iron, 490 pounds.

In spite of its lightness, you'll never split the breeze in a streamlined lithium plane. Lithium is weak and unstable. It can be cut with a knife; it tarnishes as soon as air strikes a freshly cut surface, and it decomposes in water almost instantly. Nevertheless, many uses have been found for compounds of lithium which depend on its chemical alacrity and the speed with which it grabs other elements such as oxygen and clings to them.

Lithium was discovered in 1817 by the Swedish chemist, August Arfvedson, but he was never able to isolate it in metallic form. This honor remained for Sir Humphrey Davy in 1818. Using an electric current, Davy decomposed lithium carbonate, obtaining small amounts of oxygen and lithium. Not until after the first World War were the difficulties involved in the separation processes overcome.

The United States has a world superiority in lithium supplies. One of our best sources is Searles Lake in California, a dry lake where evaporation has left huge deposits of chemical salts which are processed by the heavy chemical industries. One by-product of a

IN LUBRICANTS



IN POTTERY MAKING



IN WELDING FLUX



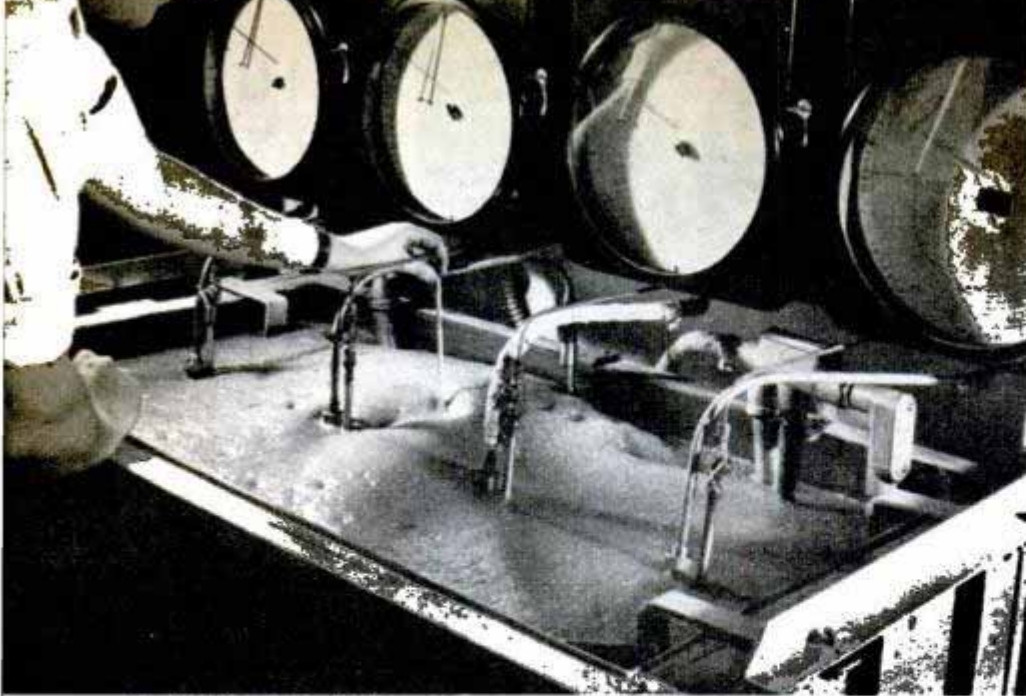

Foot Mineral Co. photo

Soapy mixture in vat is lithium grease under test; widely used in aircraft, lubricant withstands heat from 140 degrees Fahrenheit to 67 below zero

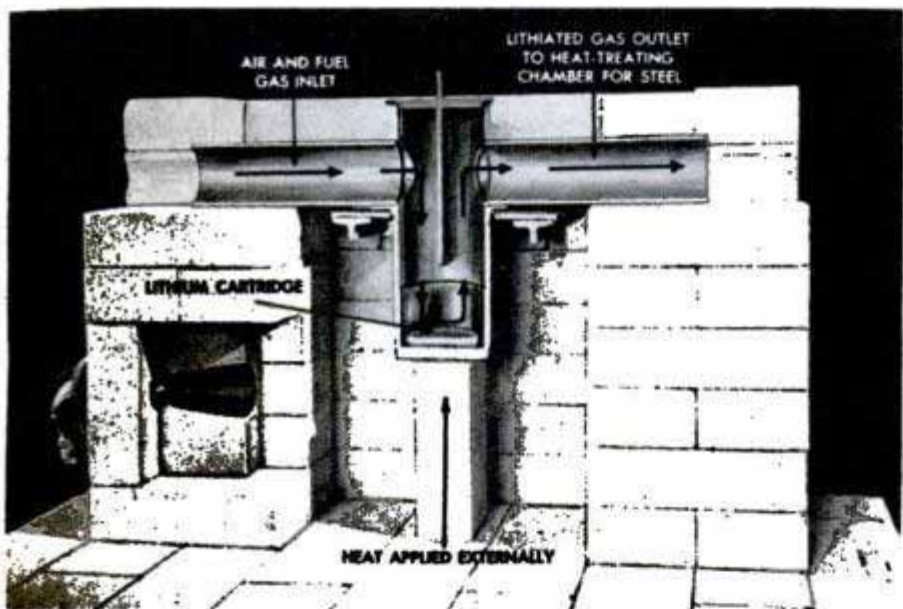

Protective blanket of gas from lithium generator shown in cross-section guards heated steel parts from ravages of oxygen and water vapor. Below, pound of lithium hydride makes 40 cubic feet of gas to lift the aerial
Photo below by Lithalloys Corp.



certain processing operation contains 10 percent lithium. Spodumene, the most abundant lithium ore, contains a maximum of 3.89 percent of this light metal. It is found in South Dakota and North Carolina. In South Dakota's Black Hills, prospectors have uncovered huge spodumene crystals 47 feet long and as much as four feet in diameter, weighing 50,000 pounds. Most spodumene crystals, of course, are much smaller. Many are like grains of sand. Spodumene usually is heated with lime and calcium chloride to obtain lithium chloride. An electric current, passing through lithium chloride, separates the component parts and gives pure lithium.

This sounds much more simple and inexpensive than it really is. The price of lithium metal fluctuates between \$12.50 and \$20.00 a pound, but manufacturers are confident the not-distant future will see lithium selling at only \$5.00 a pound. Increasing demand for lithium has caused its production to jump seven-fold since 1930. Last year some 14,000 tons of lithium minerals and concentrates were used.

Here's one example of how a little lithium does a vast amount of work. One compound—lithium hydride—gives off hydrogen gas when brought in contact with water; a pound of lithium hydride liberates 45 cubic feet of gas—and that's how lithium helped in rescue work during the war. When a plane was downed at sea, a message from the portable radio set—the famous "Gibson Girl"—gave the crew a chance of being rescued. But the radio's aerial had to be held high aloft so that the signals could be heard.

The downed flier, on his raft, opened a can containing a pound of lithium hydride. He immersed this in sea water. Hydrogen, liberated from the hydride, poured into the balloon. A balloon filled with some 40 cubic feet of hydrogen easily lifted the 300 feet of copper aerial.

In metallurgy, one major use of lithium is as a super-refining agent that makes nonferrous alloy castings tougher and stronger. About one half ounce of the pure metal is enough to clean all gases, oxides, sulphides and other nonmetallic impurities out of a 200-pound melt of copper or bronze. The chunk of the "master alloy"—made up of two to 10 percent pure lithium and the remainder of metal to match the melt—is added to the molten metal a few moments before it is poured.

During those few moments, plenty happens. Lithium is so chemically active that it combines with almost any gas, taking that unwanted gas away from the melted metal. Then, because lithium is so light, the lithium compounds formed in the crucible or ladle of molten metal rise quickly to the surface where they are skimmed off. Thus lithium sweeps all impurities out of melted metal, making the metal cleaner and the grain finer.

One maker of metal parts for the Navy was getting an average tensile strength of 42,000 pounds per square inch in his castings. In an effort to turn out better work, he tried lithium and raised the tensile strength to 52,000 pounds per square inch. Another foundry man was averaging 25 percent "weepers" (rejected castings) because his castings were porous

(Continued to page 252)

Hunk of pure lithium metal looks like silvery cheese and is cut easily; surface tarnishes due to "hunger" of the active metal

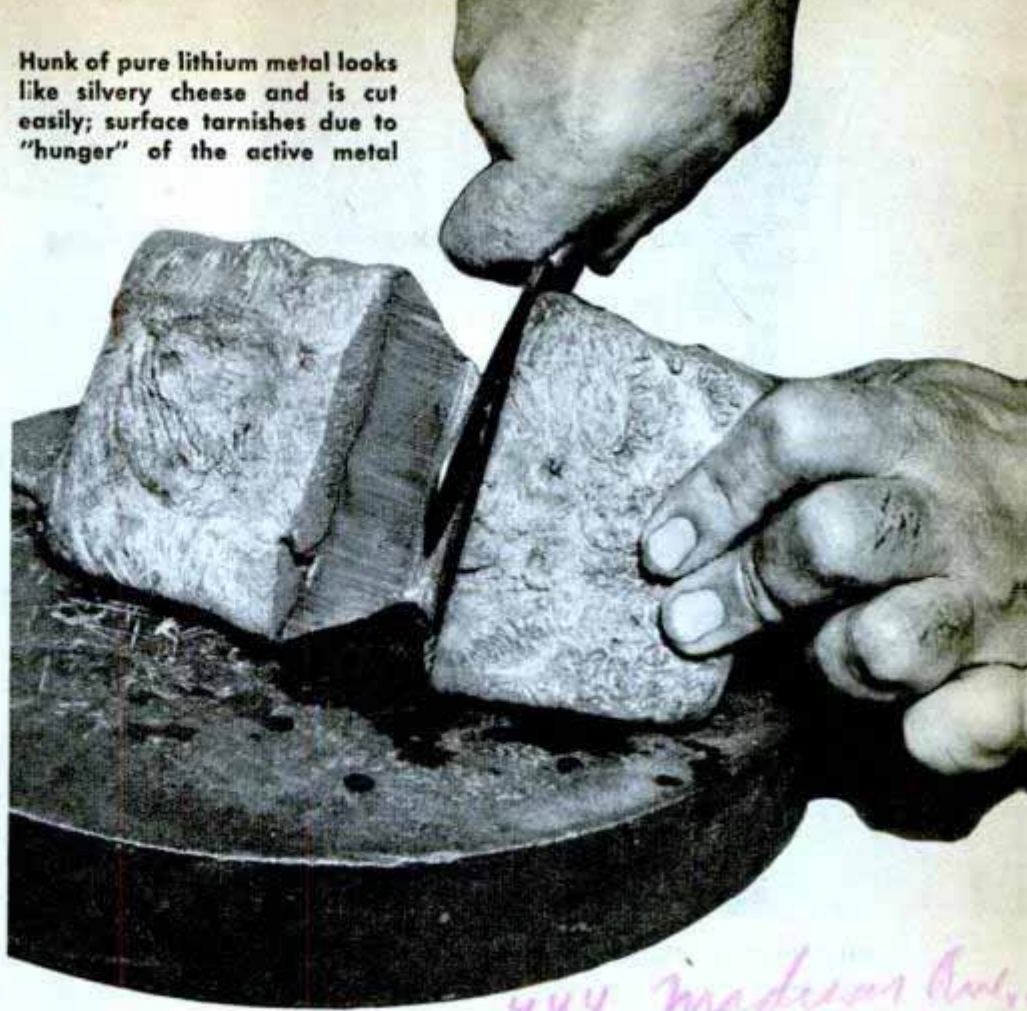

444 Madison Ave.
N.Y. 22, N.Y.

Super-lightweight lithium is 18 times lighter than brass; it floats on gasoline and is only one third as heavy as magnesium—the former light "champ"
Lithalloys Corp. photos

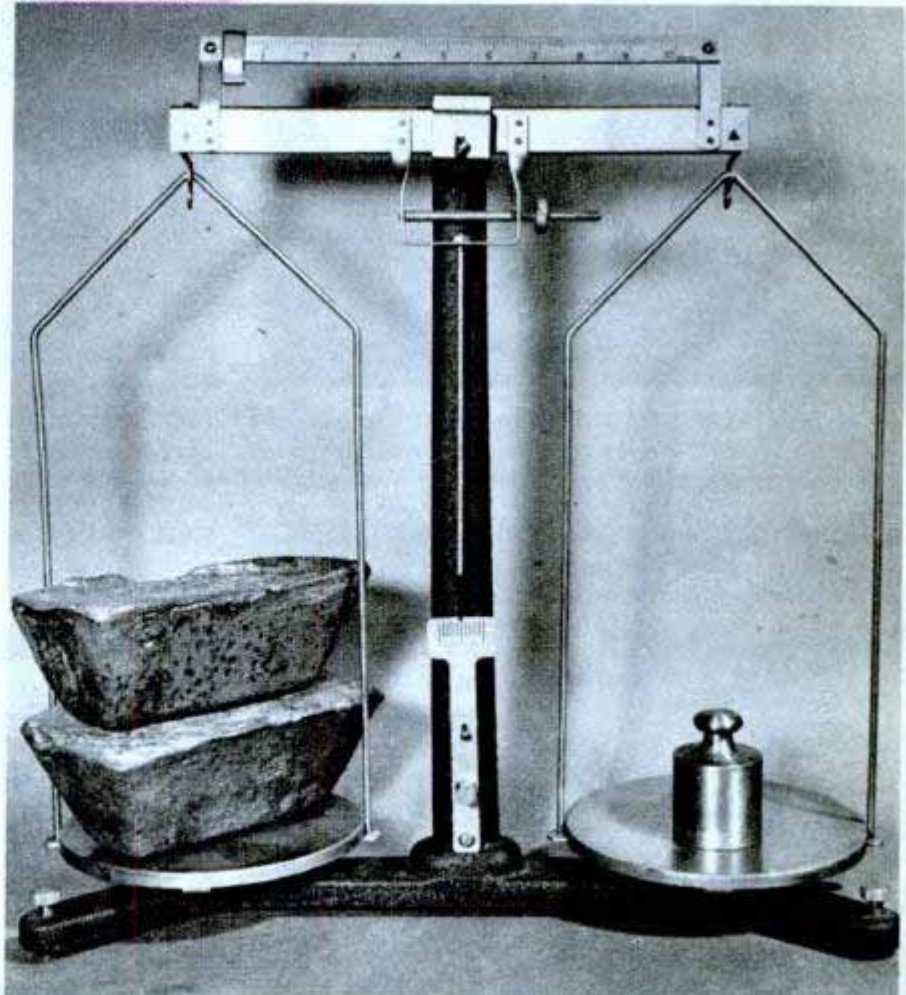

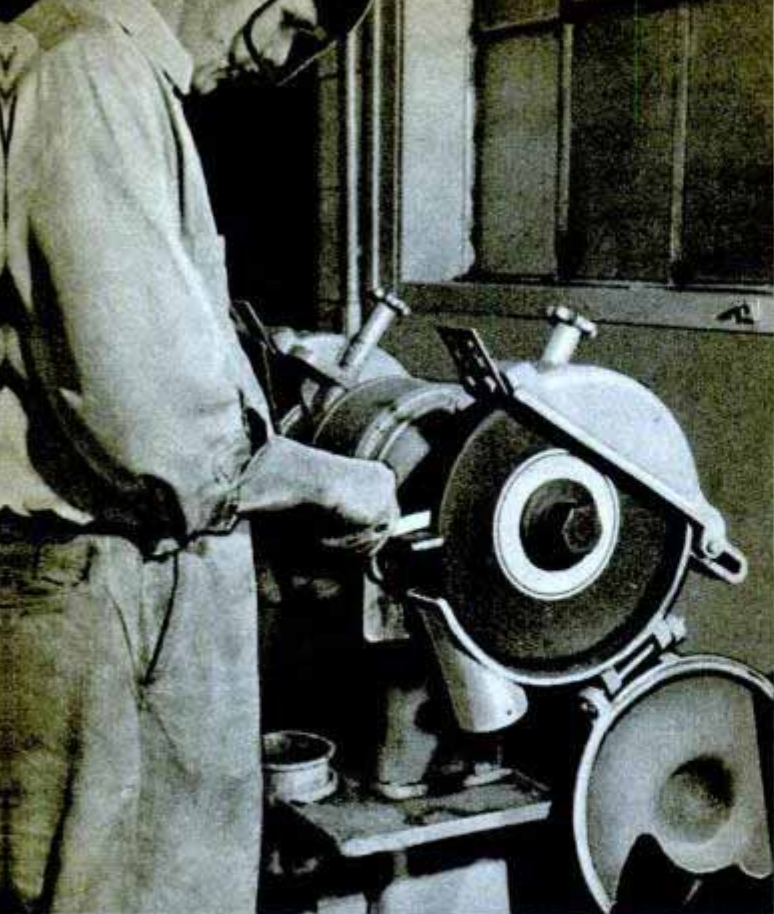

MULTIPURPOSE GRINDING WHEEL will cut cast iron, steel, brass, bronze and aluminum. The new wheel is made of grains of aluminum oxide and silicon carbide which are sealed together by a bond that is designed to produce a much cooler cutting surface



HERE'S A KNIFE with a hundred uses. The blades fan out to show saws, toothpicks, needles, tweezers, pliers, chisels, punches, pins, screwdrivers and surgical blades. Joe Gray, a Los Angeles veteran, purchased the knife at Heidelberg, Germany, for 50 cents



SPLIT BALL BEARINGS that permit easy installation in "impossible" locations are now available. The two races are held together by special taper-head screws

UNIQUE TOOL that operates like a pair of pliers flares tubing material. Single or double flares can be made in tubing measuring $3/16''$ to $5/8''$ in diameter

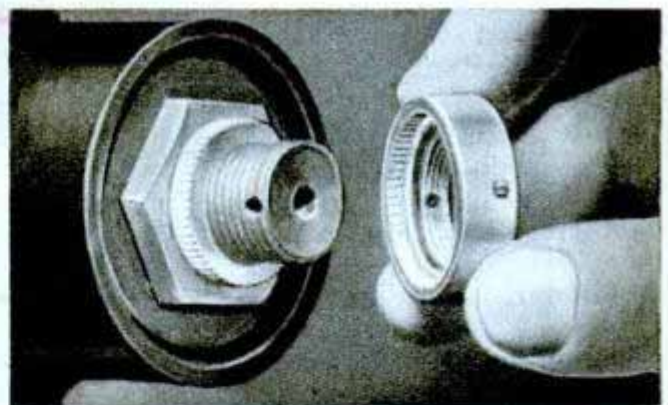
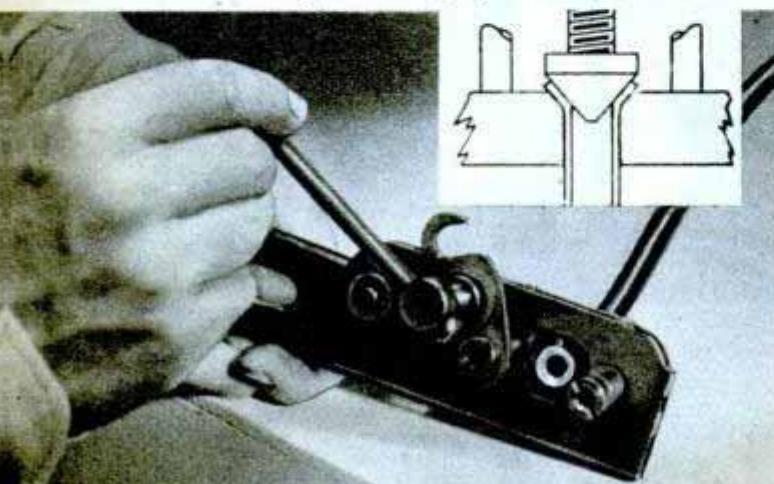

PRECISION ADJUSTMENT NUT with notches that mate permits pinpoint settings. When the nut has been set at the desired tension it is locked with a cotten-key

STEEL COIL INSERTS replace stripped or worn threads in either metals or plastics. The old thread is drilled out, then the hole is tapped and the coil inserted

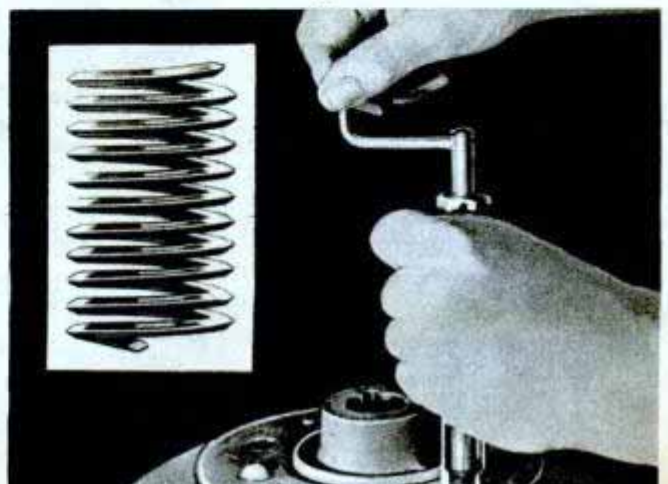

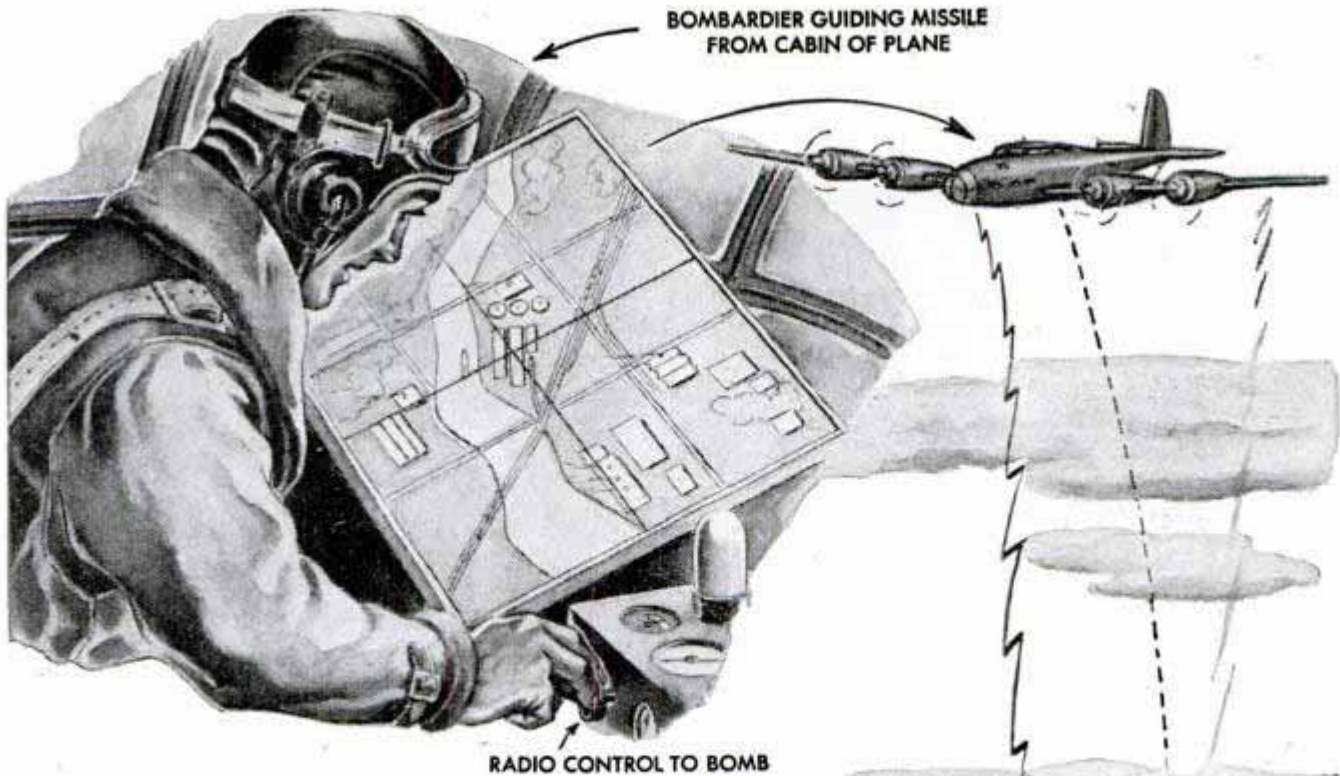

Radio Steers "Seeing Bomb"

With an automatic camera "eye" in the nose of a bomb, a bombardier can follow the missile's course on a television screen while directing its fall by radio. Crossed hairs on the screen itself help him steer the bomb's radio-controlled fins to the instant of impact. The camera, made by Remington Rand, weighs only 30 pounds and is 850 cubic inches in size. It consists of a standard lens with an automatic iris, a foot-long Vericon 212 vacuum tube and small parts similar to those in a radio receiver. A small companion pulse box is installed in the plane. The camera shutter is operated by a small motor that automatically compensates for changes in light conditions and a thermostatic device keeps the lens from fogging in the varied temperature zones through which it passes. As an indication of its ruggedness the camera can withstand the shock of acceleration up to 320 feet a second while en route to destruction when it hits the target.

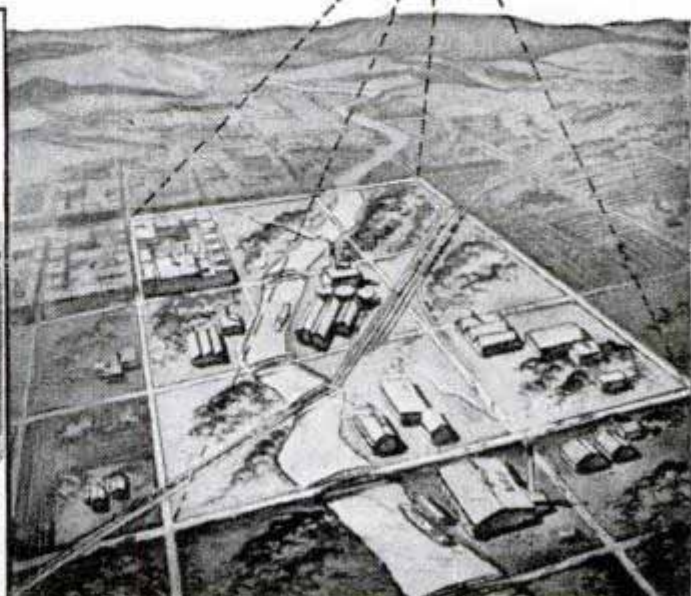
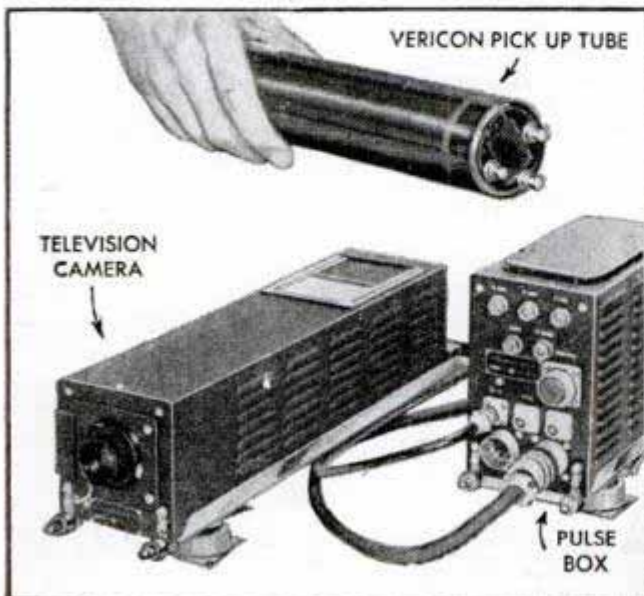
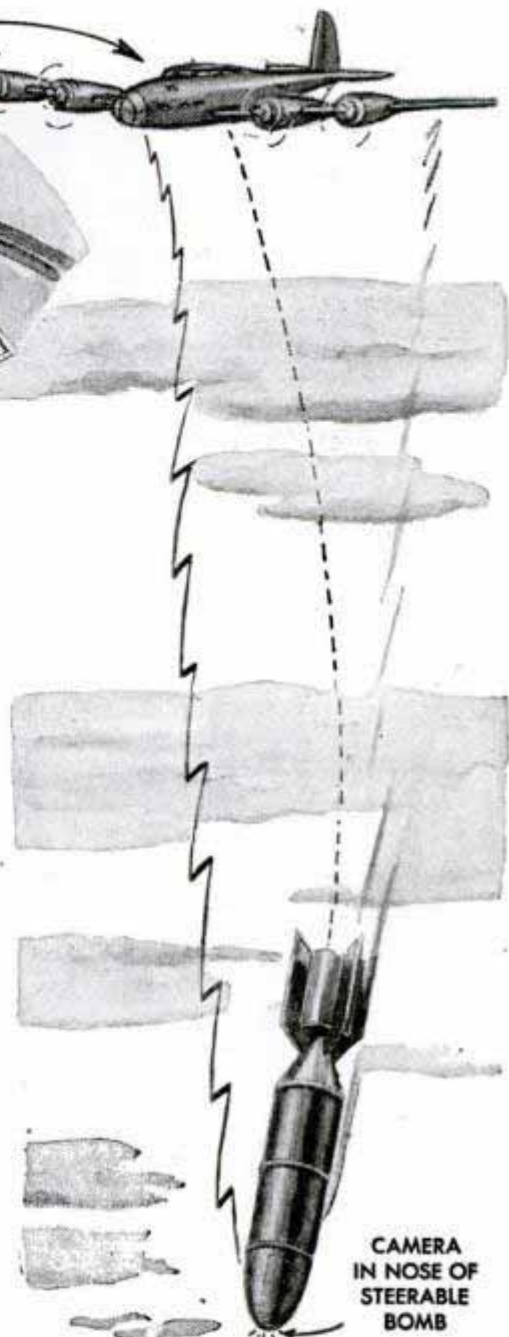

TOEHOLD ON A MOUNTAIN

By
Thomas E. Stimson, Jr.

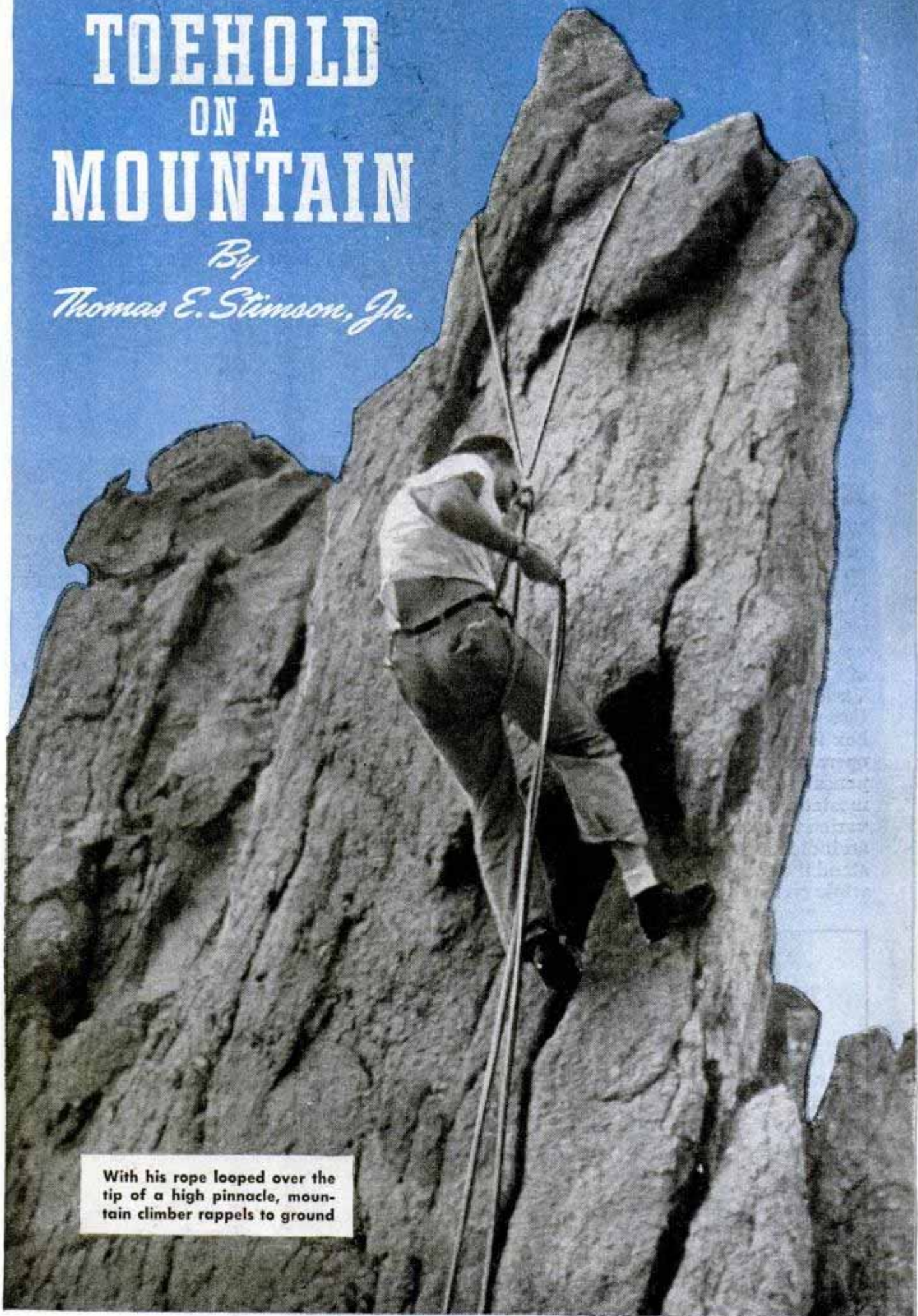

With his rope looped over the tip of a high pinnacle, mountain climber rappels to ground



YOUR left foot is resting on a projection of rock no larger than a baseball and your right foot is reaching cautiously for a crack into which you can dig your toe. You are clinging like a fly to the flat cliff.

It's 500 feet straight down to the tops of the pine trees you see between your knees.

Brave men have grown weak in situations not half as tough as this and yet, barring an unlikely accident, you are perfectly safe. You and your two companions are linked together by a stout rope and the rope will save you in case of a slip.

Rock climbing, once the exclusive sport of a few daredevil mountaineers, has become a standard outdoor sport in which

nearly anyone can participate. Girls make good climbers. Jim Gorin, president of the rock climbing section of the Sierra Club's southern chapter, has only one leg yet is an accomplished mountaineer. His crutch gives him firm footing in ascending or descending steep mountain trails. Roped up for a high angle climb over bare rock, he suspends his crutch from a sling around his neck and swings his leg and body from one hold to another by means of his arms.

Gorin's group holds week-end practice climbs to instruct novice climbers in the technique of making their way safely up the sheer faces of mountains. New members acquire skill and confidence by first

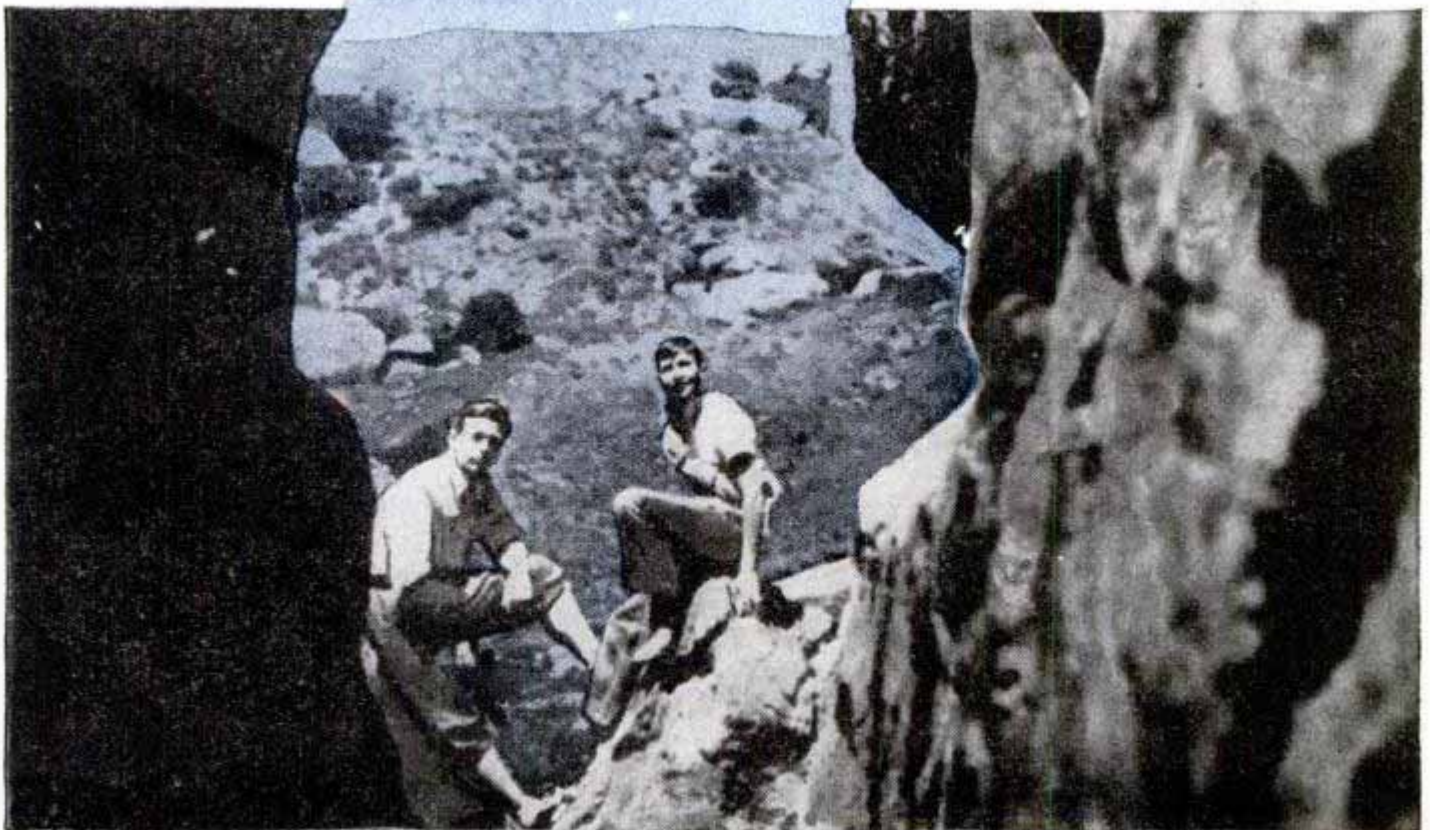

If you're tired of living, this sort of thing is recommended. Otherwise, don't try to jump across deep chasms

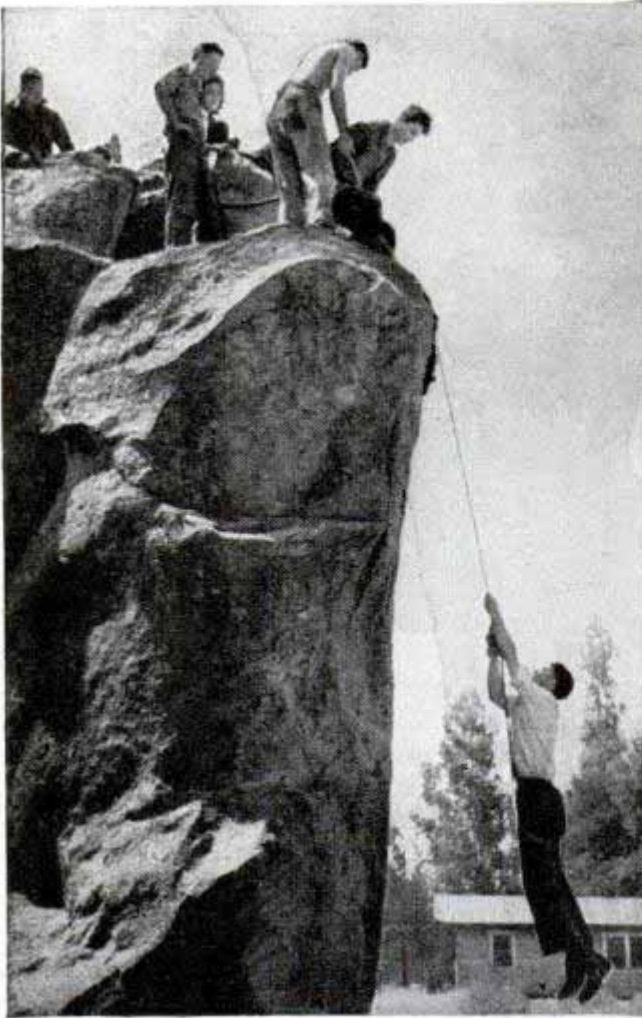

Practice-climbing on a "back-yard" rock. Below, a belayed rope safeguards leader against a long fall



climbing to the tops of rocks that are no taller than a one-story house. The rock wall may be just as steep as any mountain and the climbing problems may be just as difficult, but the novice has the psychological advantage of being only a few feet above soft ground. He can't possibly fall even those few feet because he is belayed from above by means of a rope tended by a fellow student.

Gradually the student members advance to more serious climbing. The club makes practice ascents on three mountains near Los Angeles, selected because of the different kinds of exposures and problems that each presents. The students are roped up with an experienced climber as leader for assaults on these peaks.

Student mountaineers learn that a flat tiny ledge hardly wide enough to receive the fingers of one hand can be trusted with your weight if you use your fingers to pull down on the ledge instead of out from it. The student learns to ascend a steep rock slope by inching himself along with his hands and feet, using the friction of his clothes to avoid sliding downhill. He learns how to wedge his hands in a crack and pull

For summer climbing the mountaineer wears rubber-soled shoes and carries pitons, a rope and a hammer



against them to partially support his weight while reaching for a new foothold. He learns never to trust any hold until he has tested it and even then to be chary of all holds on scaly rock.

The students are taught that spectacular climbing over bare rock can be safer than ascending by means of an adjacent gully that looks easier but in which a rock slide could easily start. They are taught that they must climb by means of their own individual strength and skill and that the safety rope is rarely used as a direct aid.

Acting as safety man, each student learns how to snub the safety rope around a protruding rock or how to sit and snub the rope around his own body so as to hold the others if one of them should slip and fall. A lightweight climber who correctly uses his weight can easily hold a much heavier companion by means of the rope.

The result of this training is that, although the Sierra Club members have scaled dozens of precipitous peaks in the West, no serious injury has ever occurred to a member on a scheduled club climb. Some climbers have been hurt and a few have been killed in the mountains on personal expeditions and all such accidents are traceable to violation of one of the basic safety rules.

Climbers wear ordinary outing clothes in good weather with long-sleeved shirts to prevent scratching their arms on the rock. Most of them prefer rubber-soled tennis shoes if the rock is dry. A leather patch on the seat of the pants and one on the right

Climber hammers a piton into crack in rock. Inset shows how rope is attached to ring hooked into piton

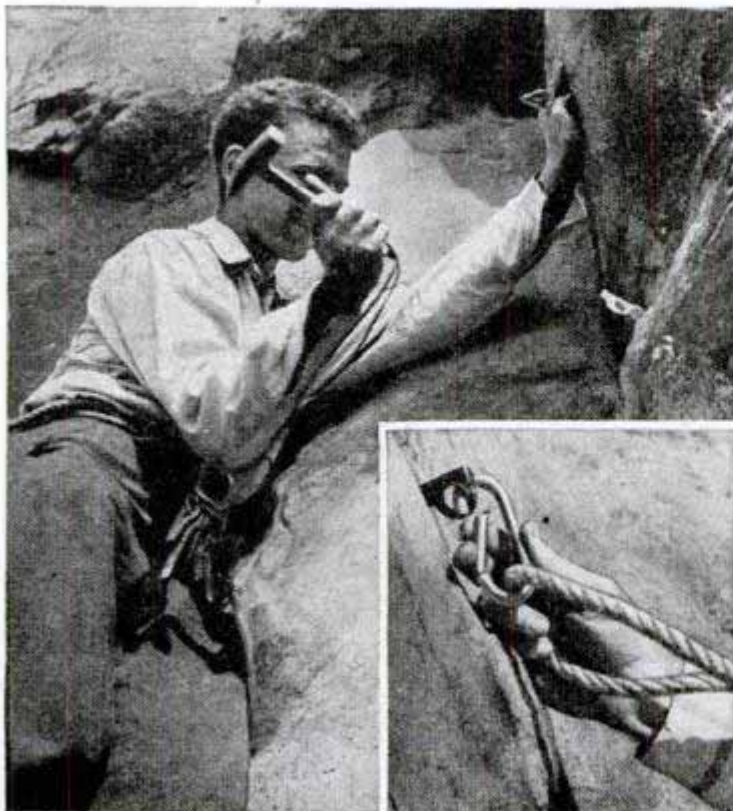

One-legged Jim Gorin scales a California mountain. Below, climber lowers himself with the aid of a rope

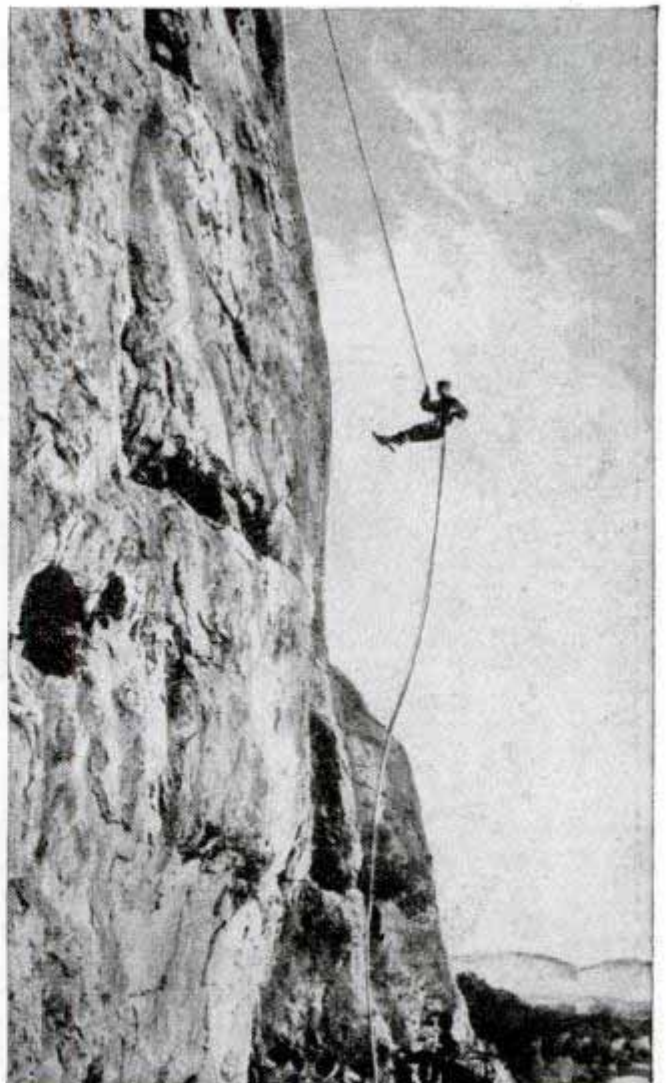



shoulder give protection against rope burns when sliding down a rope that is used for rappelling or descending a cliff rapidly.

The leader at the end of the rope carries a number of steel pitons, special rock spikes with an eye in the outer end, and a piton hammer for hammering them into cracks in the rock. Pitons are sometimes used as steps and handholds when no other means of ascent is possible but their ordinary purpose is to reduce the distance that a climber might fall in case of a slip.

After a leader has climbed 10 or 15 feet away from the man who is belaying him he hammers a piton into a convenient crack and then attaches the safety rope to the piton by means of a snap ring known as a carabiner. The rope slides through the carabiner without resistance, allowing him to continue to climb. At the same time it reduces the length of the rope that is free and this protects him against a long fall if he slips.

For climbing in ice and snow, mountaineers use lightweight winter clothing and heavy boots that are shod with sharp cleats and to which long-spiked crampons may be attached. Ice axes are carried for cutting steps and holds in ice walls, in addition to the rest of the equipment.

Actually, high angle rock work is a minor and not always necessary part of the sport of mountain climbing. Most of the tallest peaks in the United States can be ascended without roping up. Mount Whitney has a horse trail leading to its 14,501-foot summit. Many of the 300 mountains in Colorado above 13,000 feet may be climbed with no more effort than walking uphill.

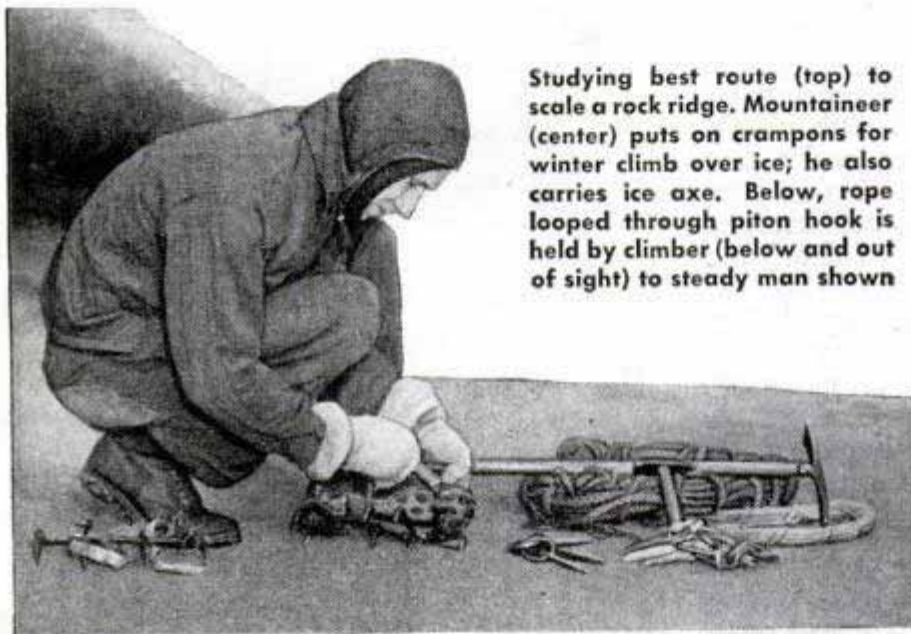

Studying best route (top) to scale a rock ridge. Mountaineer (center) puts on crampons for winter climb over ice; he also carries ice axe. Below, rope looped through piton hook is held by climber (below and out of sight) to steady man shown



The Appalachian Trail that extends from the summit of Mount Katahdin in Maine to the summit of Mount Oglethorpe in Georgia, the John Muir Trail in California that runs north to beyond Yosemite from the top of Mount Whitney, and the extensive trails of the Colorado Rockies are three mountain trail systems that are used by hikers and climbers during the summer. From these trails hundreds of adjacent peaks may be ascended. Many have never been climbed principally because they offer no challenge to an experienced climber.

The country's main trails are traversed by thousands of vacationists every summer, carrying sleeping bags and food in shoulder packs and camping equipment on pack animals. Supervised jaunts are conducted, such as "high trips" by the Sierra Mountain Club in California. Climbers range from knapsack groups who spend two weeks reaching an 11,000-foot level to parties of 275 persons on horseback accompanied by 80 mules carrying equipment.

The sheer rock faces of the Palisades along the Hudson River offer more difficult climbing problems than do most mountains. A few isolated rocks, such as Shiprock in the desert of New Mexico and the Devil's Tower on the Wyoming prairie, are far more difficult to ascend than some of the country's most tremendous mountains.

One of the most concentrated rock climbing regions in the United States is found in the Yosemite valley, where towerlike spires that stand out from the valley walls present climbing problems so difficult that until recent years most of them were regarded as unclimbable. Now all except one have been climbed and plans for surmounting that one have been made.

Cathedral Chimney in Yosemite withstood five attempts to ascend it before it was finally climbed. Mount Starr King is climbed by use of a two-inch crack that extends up its side, and Lower Cathedral Rock, climbed only once, was scaled after the lead man on the rope stood on the shoulders of a companion, part way up, to reach some difficult handholds. The companion, meanwhile, had his feet on a half-inch-wide ledge on the high angle cliff.

The famous Lost Arrow, a 2800-foot pinnacle that stands out from the north wall of the valley, so far has been just as unclimbable as 29,141-foot Mount Everest in the Himalayas. All attempts to reach the top of the Lost Arrow have failed hundreds of feet below the top, part way up the last 1400 feet of vertical rock. Mountaineers figure that the team of men who finally ascend to its top will need two days for the climb and that the men will have to tie themselves to the vertical cliff halfway up so they can sleep in safety overnight.

Dot-Dash Rule Helps Draftsmen

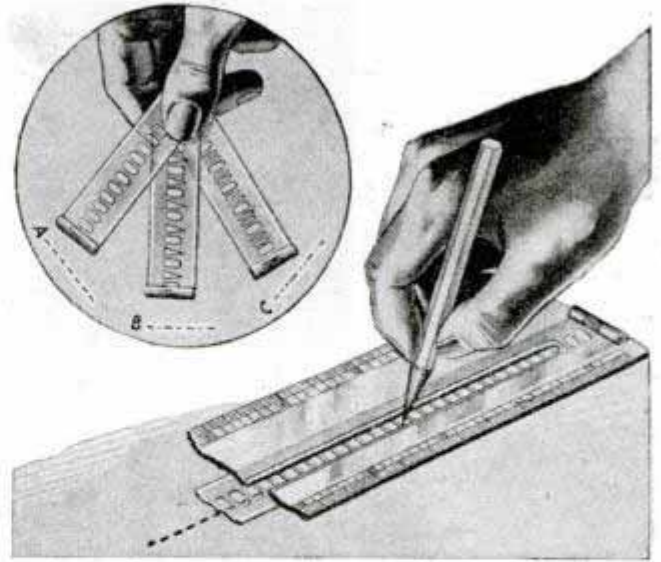

Dotted lines can be drawn as fast as straight lines with a transparent, slotted rule in which interchangeable inserts may be fitted to produce lines with even dots, a dot and dash or a dash and two dots. The pen or pencil is drawn over the insert and the dotted line automatically produced. Outside edges of the rule are graduated like an ordinary rule.

Hook and Clamp Hold Paint Can

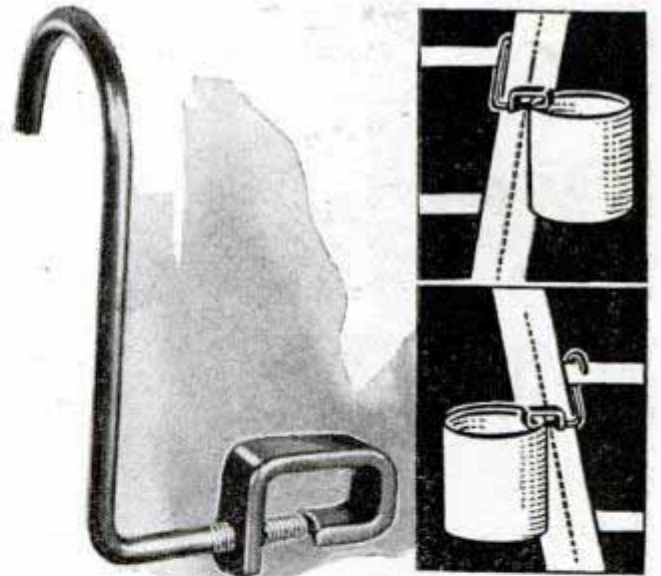

Additional safety and convenience for the painter working from a ladder are provided by a hook and clamp device which holds paint cans in an upright position. The firm hold on the can prevents overturning or spilling. The paint can may be hung on either the right or left side of the ladder at a height most convenient for the painter. The steel hook fits over the ladder rung and hangs vertically. At right angles to the hook and running parallel with the ladder rung is a clamp which holds the paint can on the outside of the ladder upright. The clamp is attached to the can so that the opening is left free for dipping and stirring.



Cork-shaped lump of pure uranium, left, was rejected by Westinghouse as possible lamp filament in 1922 but knowledge then gained helped American scientists develop atomic bomb. Right, quantity of liquid within container is visible in transparent plastic barrel of hand-operated oiler or sprayer made for home use



Double-deck streets, left, for pedestrians and bicycle traffic are city planners' answer to traffic problems in new housing development in Rotterdam. Giant "catcher's mask," right, covers sponge-boat propeller and assures divers who bring up sponges from Gulf of Mexico that their lifelines will not be fouled by propeller

The Craftsman

Here it is June again, and even the most confirmed craftsman comes out of hibernation in the basement shop to apply his talents to outdoor sports and gardening and picture-taking and backyard grills. So the Craftsman Section goes outdoors, too. On page 192 we offer you the best advice we have on the use of plant hormones. Try growing vegetables and flowers instead of weeds this year! Or you're planning a camping excursion: that tent on page 187 is light and easy to carry. There's a piece on page 214 about luminous paints. June brides and bridegrooms will get right down to the practical things of life and make costume jewelry from decorative buttons, as shown on page 182. Some hot June day the woodworker will go down in the cool basement shop and start that Dutch cupboard seen on page 174. And among the other 100-odd features and practical ideas are a story on page 207 telling how the blade guides of a bandsaw can be altered to permit crosscutting of long stock, and, on page 201, how to build a fluorescent-lamp unit for the advanced photographer's studio



BUTTON JEWELRY

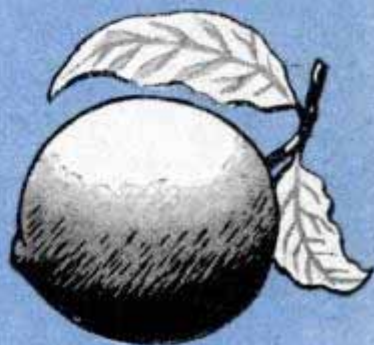

"HORMONIZED" GARDEN CROPS

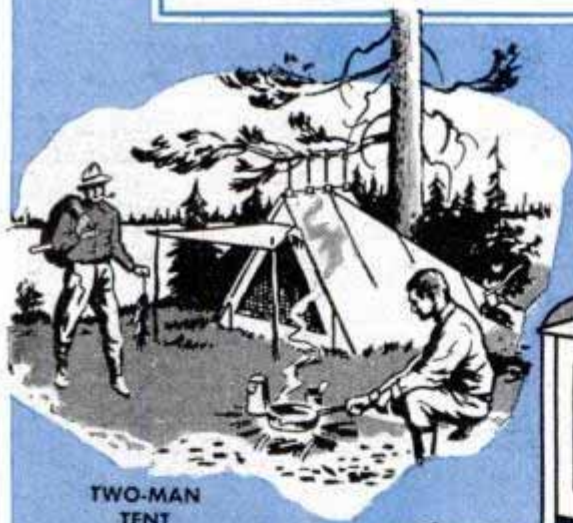

TWO-MAN TENT



DUTCH CUPBOARD



BLACK-LIGHT MAGIC



FLUORESCENT PHOTO LIGHT



ANGLE SAWING

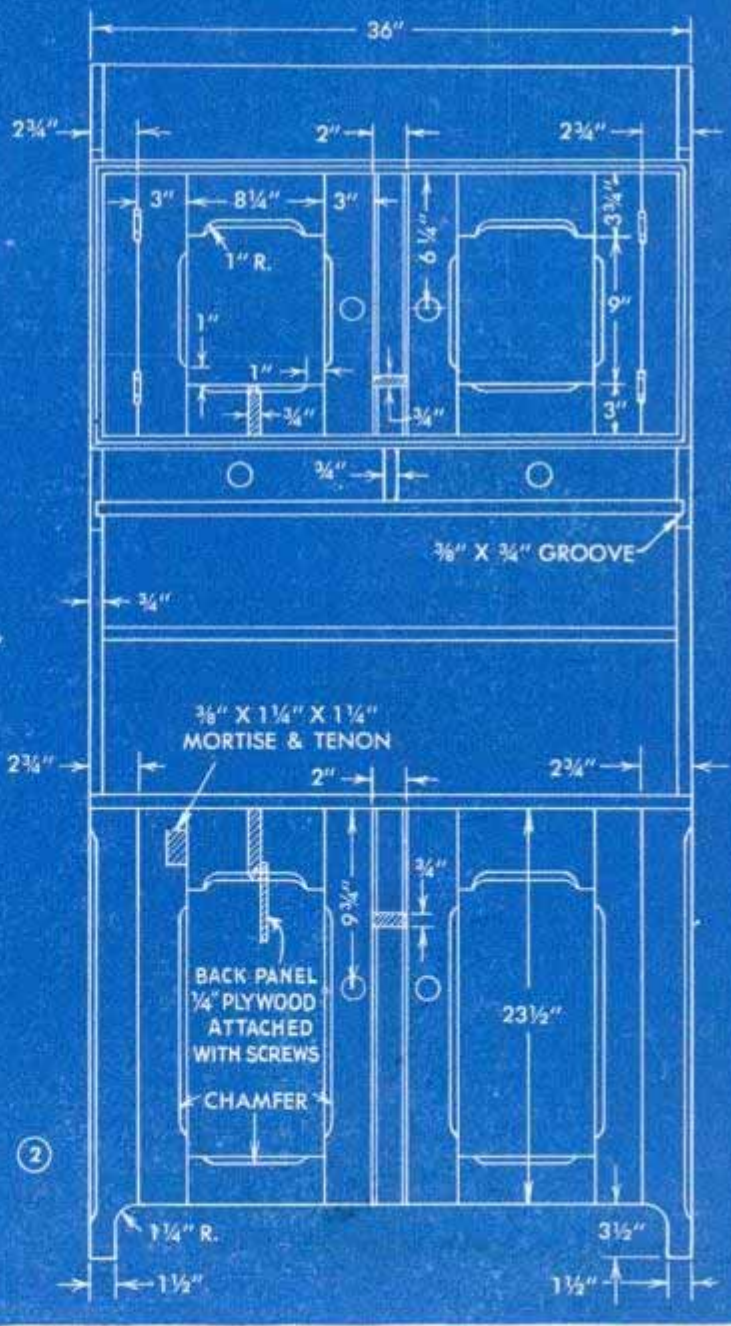
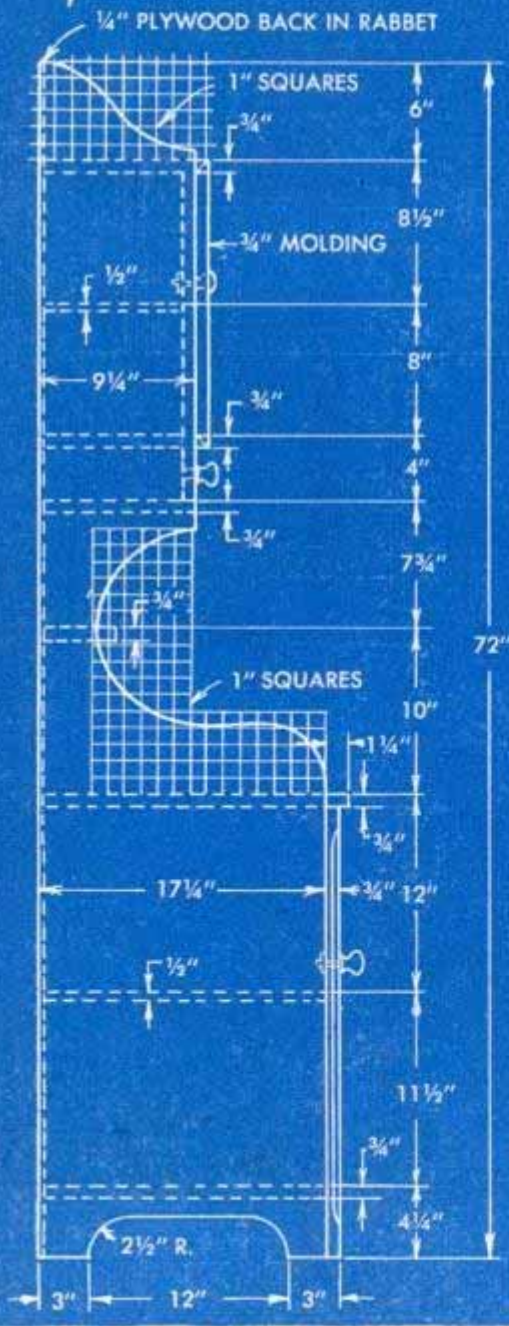
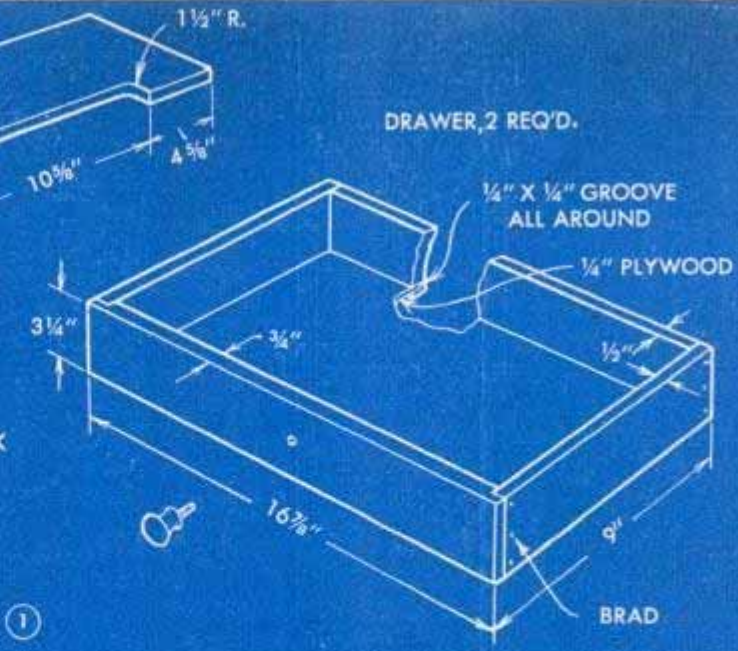
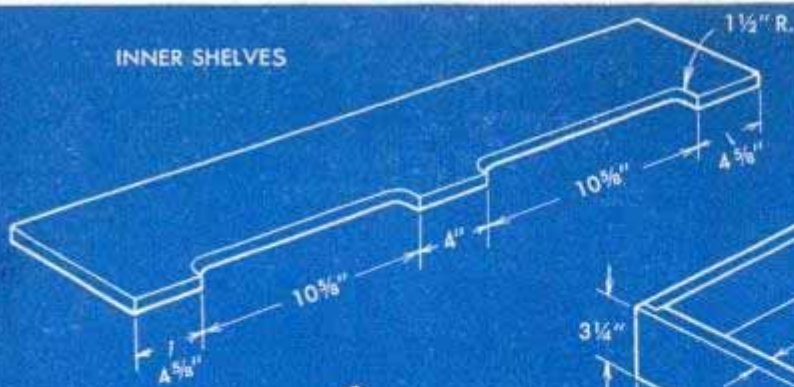

PENNSYLVANIA DUTCH CUPBOARD

By NORBERT ENGELS

If your taste in furniture leans toward the plain and simple lines of colonial days, here's a charming old cupboard that typifies the simplicity of early American craftsmanship. It's the type of furniture that challenges the skill of the craftsman who works with hand tools mainly and who takes special pride in producing an expert job of finishing.

Begin by building up two panels of solid stock for the sides of the cupboard. This is done by jointing four or five narrow boards, using either tongue-and-groove joints or plain butt joints doweled and glued. A saving in stock may be had by running only two of the boards the full length and using shorter lengths for the lower half. In arranging the pieces keep in mind that right and left-hand side members are required. You may find it more convenient to cut the rabbet for the plywood back if it is done before the boards are glued together. The scroll cuts likewise may be roughed out beforehand and later dressed down with a spokeshave or file, although they can be done afterward with a keyhole saw. Except for one shelf, which is set in a dado as shown in Fig. 2, the eight shelves simply are butted against the side members and glue-blocked. Note that the $\frac{1}{2}$ -in. shelves, Fig. 1, are cut out along the front edge, and that the desk shelf, Fig. 4, is notched at the front corners to project $1\frac{1}{4}$ in. and fit flush with the surface of the sides. The plywood back will add rigidity to the whole assembly, and it's a good idea when attaching it to do so while the framework is still clamped.

Next, the facing strips to which the lower doors are hinged are fitted to the front corners of the assembly. These are chamfered on the outer edge and are cut out at the bottom to form a part of the leg. Finally, the opening is divided equally with a beaded upright, which is fastened at the top to a nailing block and at the bottom by driving nails up through the lower shelf. The upper compartment is fitted the same way except that the pieces are set in flush with the sides and the shelves. A small molding like the one shown in the sectional detail A-A in Fig. 4 is mitered at the corners and glued and bradded to the facing edges of the opening. The two-drawer

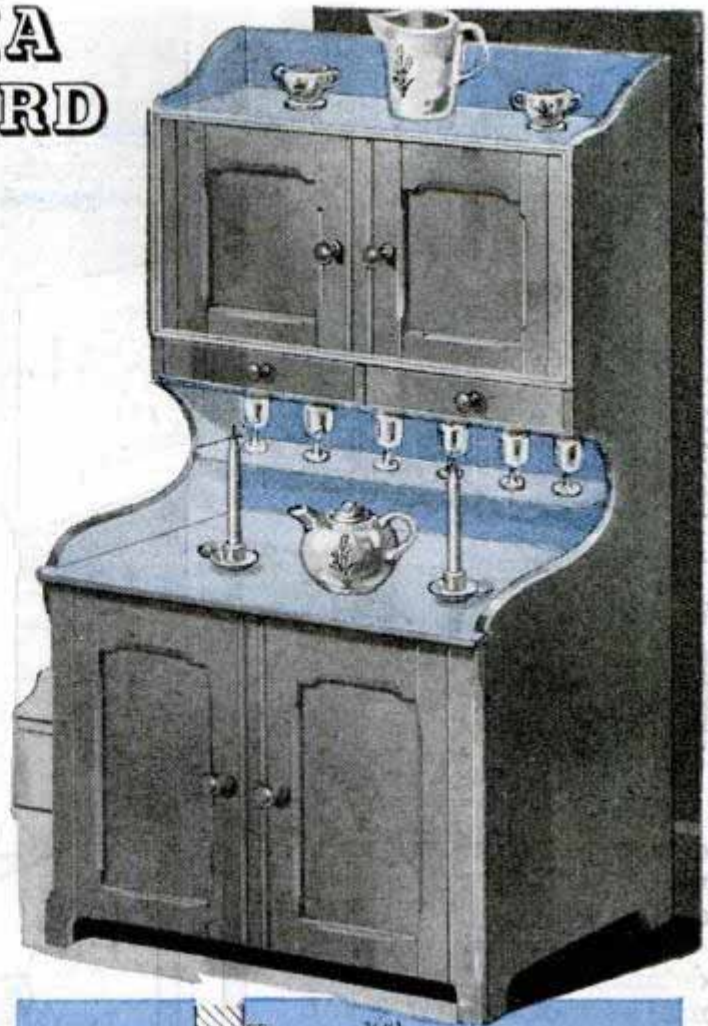

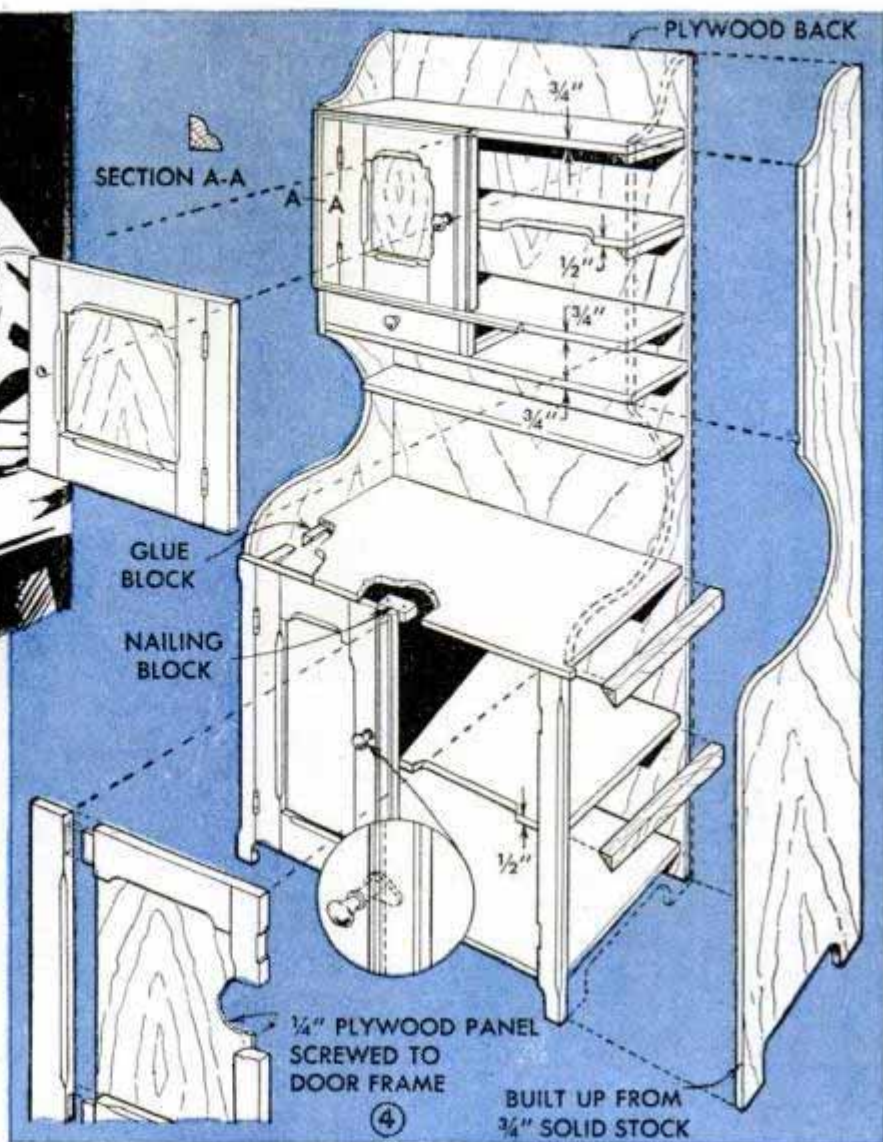

compartment below it is divided with a centerpiece and a runner.

Drawer construction is detailed in Fig. 1, while the method of making the doors is given in Fig. 4. Mortise-and-tenon joints are specified for the door frames but dowels may be used. Inner edges of the frames are chamfered to relieve plainness and plywood is screwed to the back of the frames. Fig. 3 shows how to make the wooden turnbuttons that are fitted to the doors. They should be installed to work

freely and latch against the back of the beaded uprights. A natural or a varnish finish is applied to the exterior of the cupboard, but the interior may be painted a pastel shade of bluish-green.

Rack for Tubes of Tooth Paste Attached to Cabinet Shelf

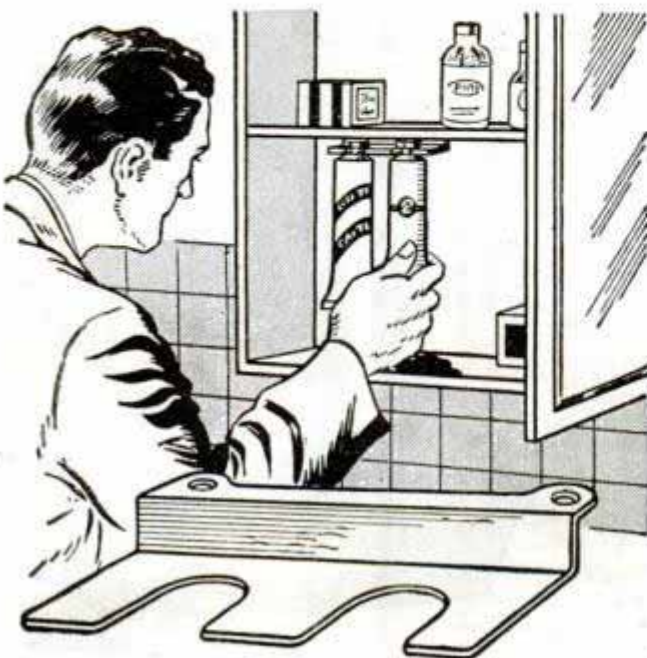

If you wish to keep tooth-paste tubes and other similar containers out of sight, a simple holder like the one shown may be screwed to the underside of one of the shelves in the bathroom cabinet. Any piece of nonrusting sheet metal will do for the holder and it can be made any size desired, depending on the number of tubes to be kept in the rack.

Repairs for Desk Drawers

If the joints of a drawer have become loose, it will be difficult to open and close it. In such a case, the remedy is to renail and glue the drawer so that it will slide easily. If swelling or warping is the cause of the trouble, the high spots should be sanded and waxed. It may be necessary to plane high spots.

Michael Ligocki, Gary, Ind.

Play Catapult Throws Projectiles High in Air

All small boys are attracted by any device that will throw a projectile high and far, and this catapult will do that very thing. If two or more boys use the catapult, different colored stones for each boy will help determine whose stone has traveled the farthest. As the upper left-hand detail indicates, fairly heavy lumber must be used in the construction of the device in order to provide sufficient strength to withstand hard use. Because of the size of the catapult, a tow rope is attached so that it can be moved about easily. Height or distance a stone is to fly is controlled by placing a log between the uprights, as indicated by the dotted line in the detail.

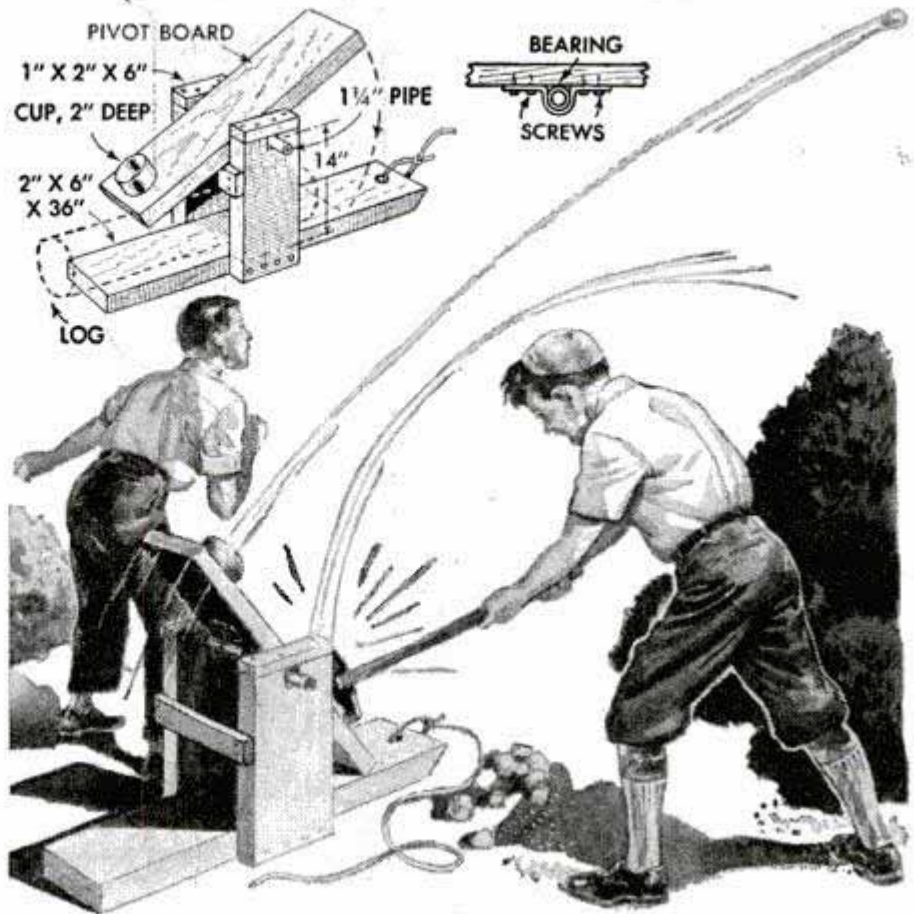

Fishing Rod Dropped in the Water Is Located by a "Buoy"

When a fishing rod is accidentally dropped in the water, chances are it will never be recovered unless a marker or buoy is floated over the place where it disappeared. A marker can be made from a

wooden tube such as a piece of bamboo or alder. One end of the tube is plugged and sealed and a cork is fitted in the other end. A length of fishing line, stapled to the tube, is weighted at one end with sinkers, which can be kept in the tube when not in use. When a rod is dropped, the weighted line is lowered to mark the place, and the tube will float on the water while preparations are made for retrieving the rod.

Addison Bain, Marion, Ohio.

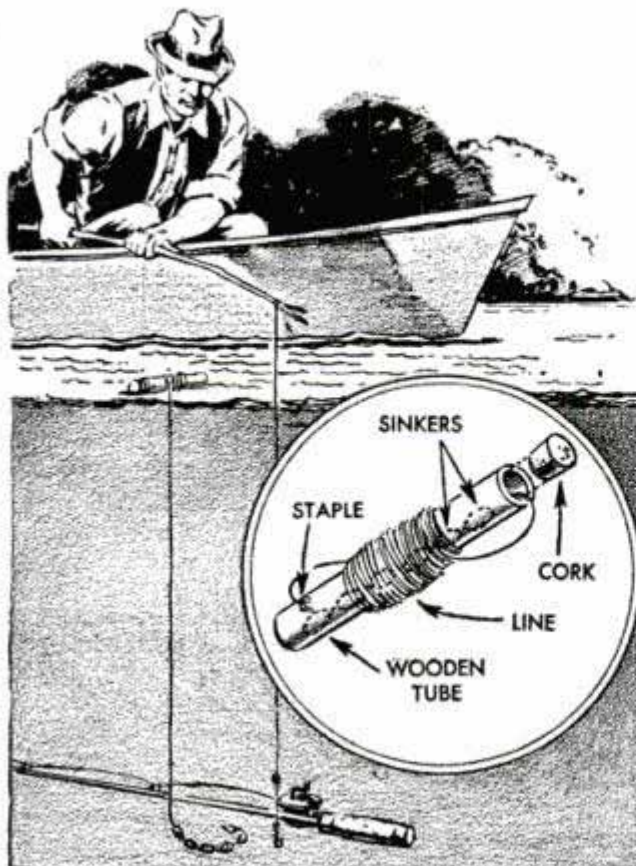

Cigarettes Will Stay in Pocket When Held by Rubber Bands

If you carry cigarettes in your shirt pocket, you can prevent the package from falling out when you bend over by wrapping rubber bands around the container. Those who have a metal case can cut a wide band from an inner tube, while those who carry a loose pack will find that a small rubber band at the top and bottom of the package will suffice.—C.D. Bassett, Ypsilanti, Mich.

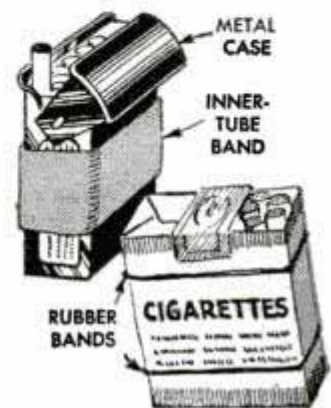



Solving Home Problems

1 Make it easier to clean your dust-pan brush by fitting an ordinary comb and a bracket to the pan, as indicated. Then, to clean the brush, merely draw the bristles through the teeth of the comb

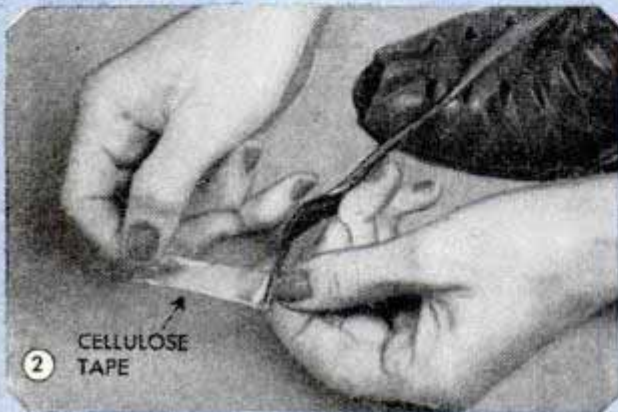

2 Should the tip of a shoelace be lost or damaged, a few turns of cellulose tape make a satisfactory repair. Wrap the end securely and you will have a tip that will last as long as the lace

3 The next time you bandage an injured finger, seal the end of the bandage with clear nail polish and also brush the polish over any ravelings. This produces a neat-looking wrapping that will stay on

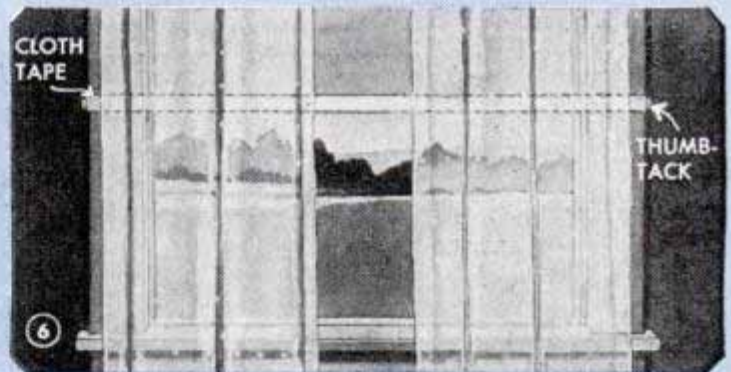

4 Sifter disks in larger compacts release so much powder that a considerable portion usually is wasted. This annoyance is eliminated by placing a stiff paper ring under the disk so that just the right amount of powder is released at a time



5 When sealing glasses of jelly, place the label on top of the seal before the paraffin hardens and when the wax is set the label will be firmly embedded. This eliminates pasting the label on the side of glass where it might be rubbed off

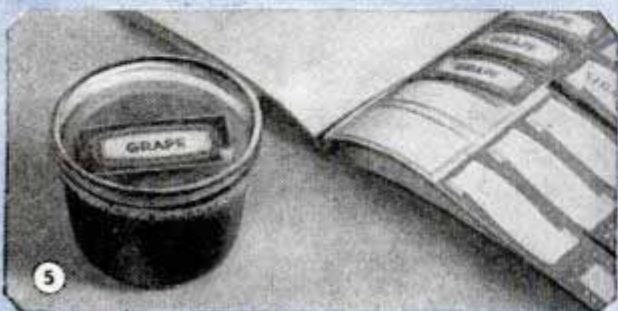

6 During the summer, when windows are open most of the time, curtains and drapes become soiled by brushing against the screens. One housewife prevents this by tacking a strip of tape halfway up the frame, using white tape and thumbtacks



7 Here is a neat and easily made tie holder that is particularly useful when traveling. Small windows are cut through heavy cardboard in the pattern shown and a similar slot is cut in the top of the holder for a hook

8 Don't throw away your old garden hose when you get a new one; you can make a yard sprinkler out of it. Plug one end of a 5-ft. length and couple the other to the hose. Two rows of holes provide good coverage

9 To keep the handle of a teakettle upright so it will remain cool when over the fire, make punch marks on both sides of the handle near the hinges. It is still possible to fold the handle down when necessary

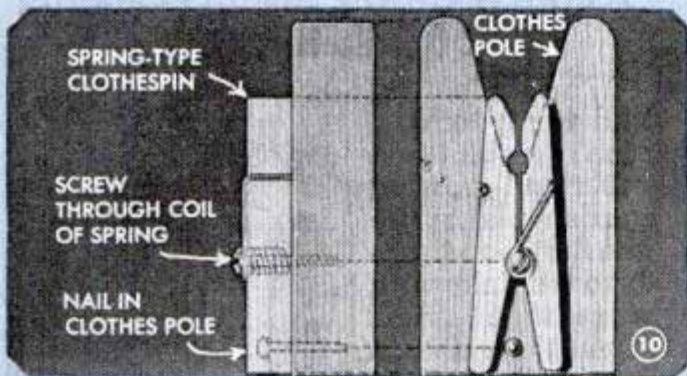

10 A spring-type clothespin on a clothes pole will prevent its sliding sideways when the wind whips the line. A screw through the coil spring on the pin fastens it to the pole, and the nail in the pole is to center the pin when opened to attach the line

11 This wooden grille will protect the upper portion of the screen on a door from being pushed out. A similar grille on the lower portion will protect the screen from the kicking to which it is often subjected. The grille should be painted to match the color of the door

12 Small garbage cans with tight-fitting lids are a nuisance because it takes two hands to remove the lid. One solution to this problem is to fasten a flat-iron strip, bent as shown, to the can so the extending leg of the angle is held down by the foot

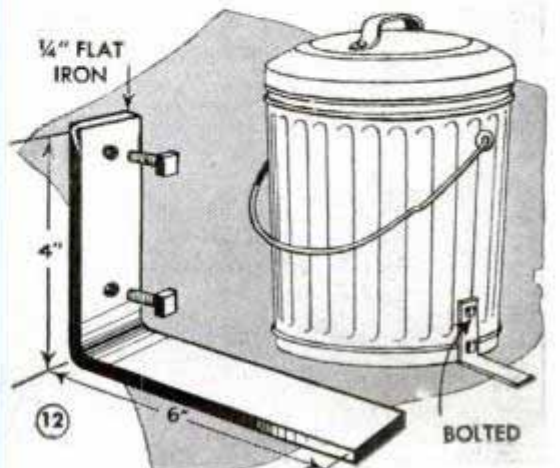
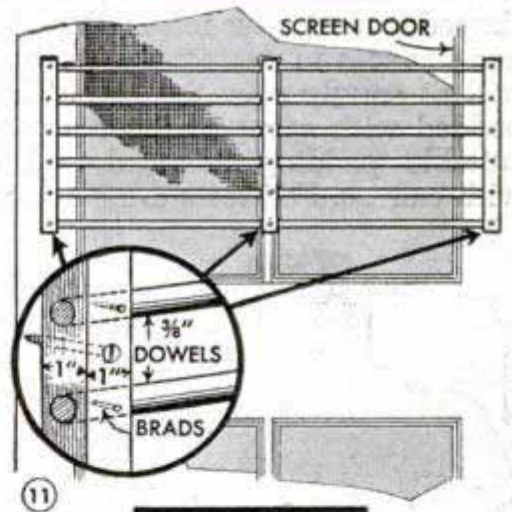
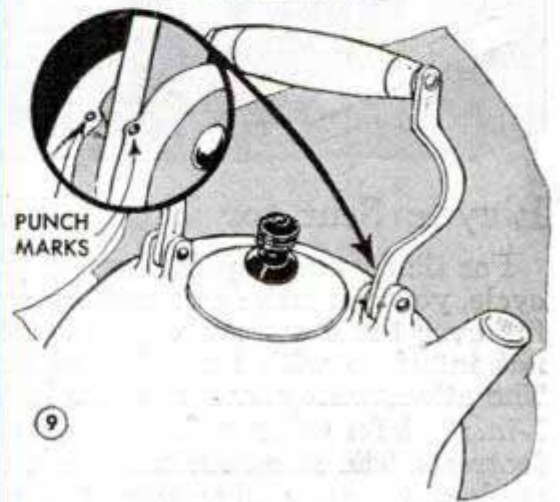
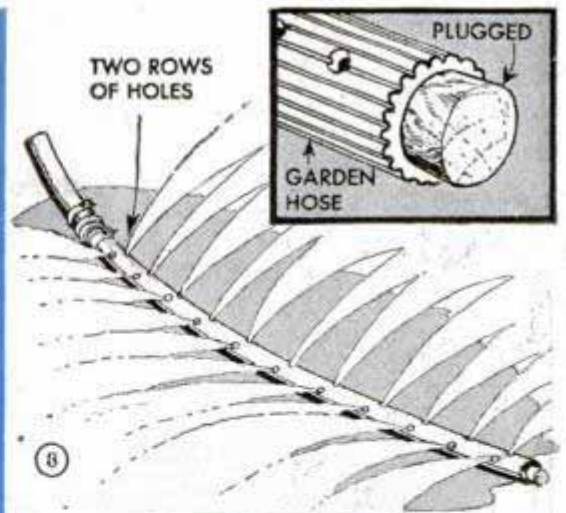

Back Rest Fits Rowboat Seat

A rowboat seat is more comfortable with a folding back rest like the one shown here which clamps to the regular seat on the boat. A standard-size life preserver cushion may be used for the back and for the seat. Or a cushion may be made for the seat and canvas may be stretched over the back, as was done in this case. The rest is removed easily yet it will remain firmly in place when clamped to the seat.—Ralph S. Wilkes, Elbridge, N. Y.

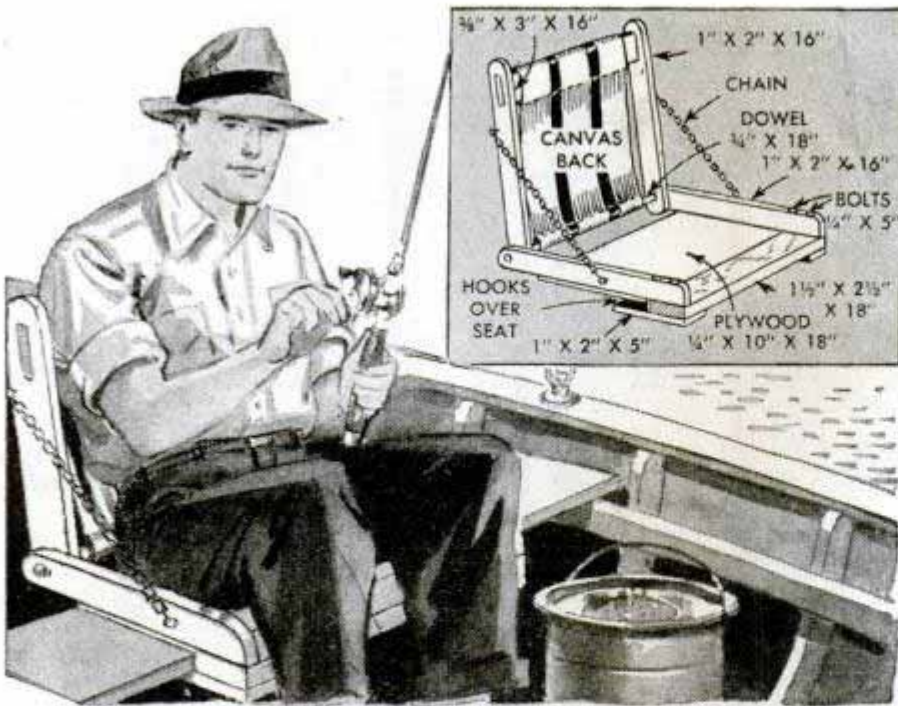

Bicycle Seat for Younger Passenger Slips Over Double Crossbars

For that younger passenger on your bicycle, you can make an auxiliary seat that fits over the crossbars where weight will not interfere with balancing or steering. The attachment consists of two lengths of 1-in. stock for side members, a seat and two footrests. The side members are cut at an angle at the top and screwed to a piece of wood which forms the seat. They should be shaped so that after felt is glued to the inner surfaces to protect the crossbars they will fit snugly over the bars. The seat is padded with sponge rubber or any other suitable padding material and covered with canvas. Footrests are screwed to the

lower edge of the side members and reinforced with angle brackets. Heel guides are attached as indicated.

Dr. Bernard Matzen, Napa, Calif.

Knotted Cord Prevents Chafing Of Staked Plants

When staking and tying tomato, zinnia, dahlia and other tall-growing garden plants, tie the first loop tightly to the stake with a square knot. Then tie a second loop loosely about the stem of the plant. In this way, the plant can swing freely without danger of chafing or breaking and the cord cannot slip down on the stake.

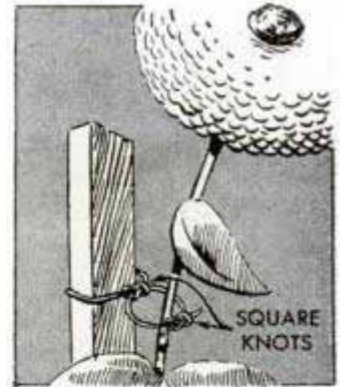

Handles Simplify Installing Screen

If installing window screens from inside your home, you can hold the screen firmly by using metal handles screwed on the inside of the screen frames at the sides. These handles are of the type which generally can be obtained from hardware and dime stores.—Roger M. Woodbury, Haverhill, Mass.

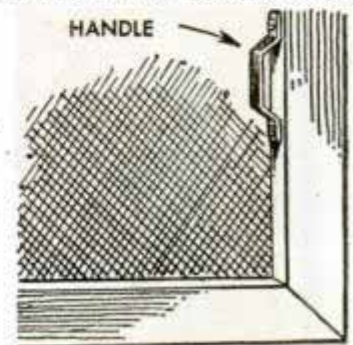

SIDEWALK SAILBOAT

for "Dryland Shippers"

Singly or in fleets, boys will find real sport in tacking and maneuvering these land-going sailboats. Since the rudder and sails are handled exactly like those on a real boat, youngsters can learn the art of sailing on dry land. And one of the fundamental rules of sailing is "don't get hit by the boom when tacking." To make the boat light so it will handle easily, $\frac{1}{4}$ -in. waterproof plywood is used for the sides and $\frac{3}{4}$ -in. wood for the transom and bottom. For ornamentation, a cutwater is screwed to the bow.

Three pairs of skate rollers mounted in heavy sheet-metal brackets support the hull. The original skate parts may be used, but this is not as neat a method of mounting. A nose wheel, Fig. 1, which clears the pavement by about an inch, is provided also to support the bow when sailing in "choppy waters." A king pin is welded on the rear roller unit for the tiller, Fig. 2, and a washer put on above and below the deck.

Unbleached muslin will make a good sail, with wide hems to slip over the mast and boom and a gusset for reinforcement where the two join. Shrouds and forestay are of galvanized wire and have turnbuckles for adjustment. There is no way to raise or lower the sail, but when not in use the boom is folded up; the sail is wrapped around it and held with light rope.

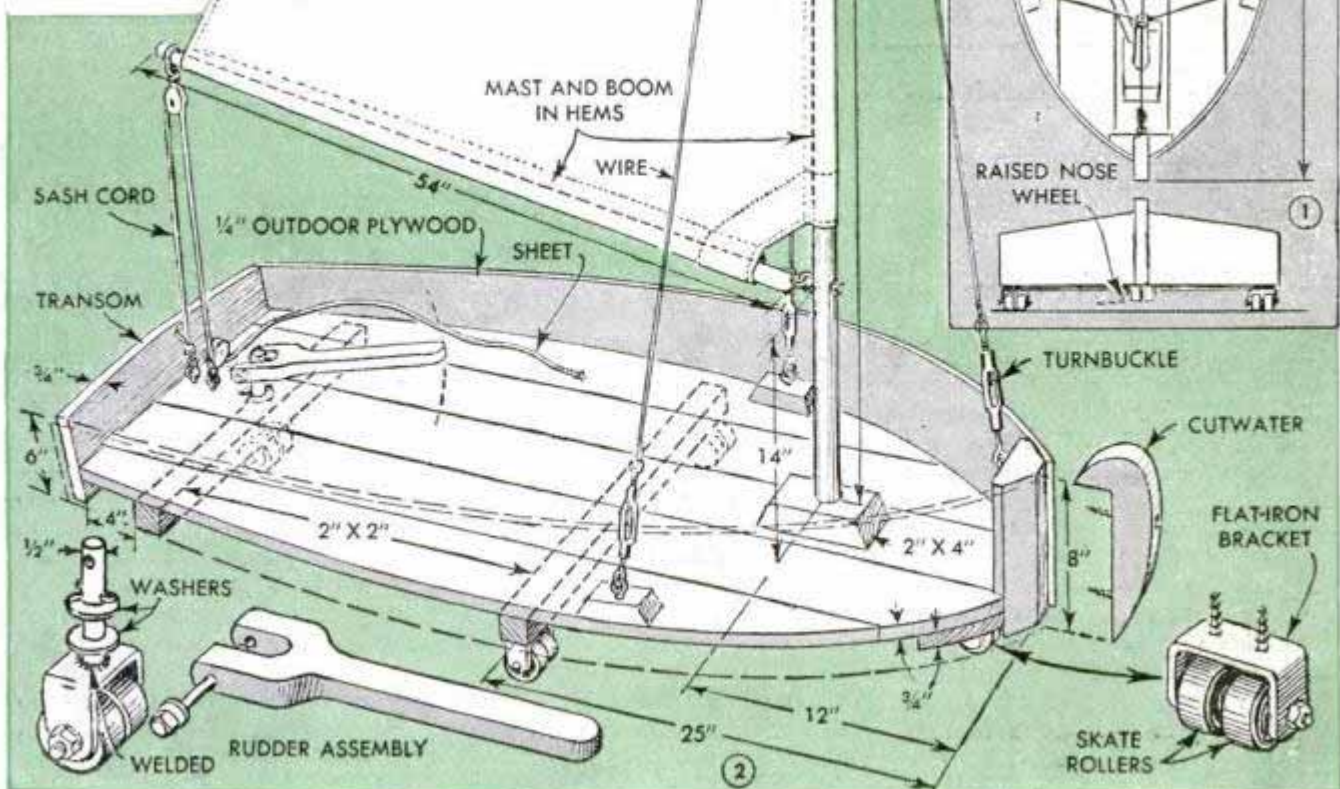

Costume Jewelry

By Simon S. Palestrant

Of course you could pick up fancy costume jewelry for a fancy price — plus tax—at a store. But you can make stunning ornaments of your own exclusive design from colorful buttons, old toothbrushes and plastic bottle caps

YOU'LL be setting the pace among your friends when you sport smart costume jewelry of your own design—and it's inexpensive, too, when made from practically nothing but buttons. The stunning effects to be had by combining buttons with dime-store lapel ornaments and similar charm trinkets are limitless. With these and some toothbrush handles, plastic bottle caps and a little ingenuity, you can produce unusual accessories. Much depends upon the choice of buttons as well

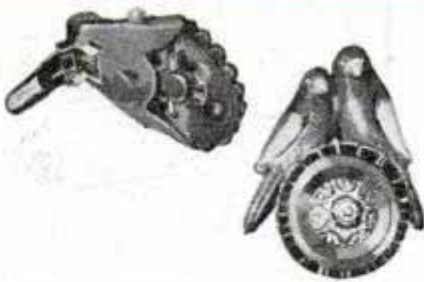

Dress Clip

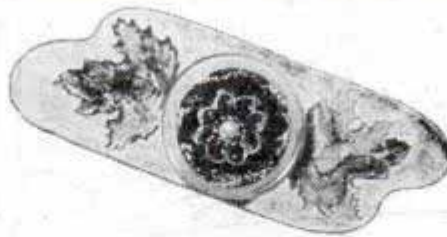

Barrette



Head Flower

Chic dress clips like the pair above can be made quickly by cementing novel buttons to metal clasps. Such clasps usually can be had from a jeweler's supply house or they can be removed from a discarded set. Clear nail polish will keep metal buttons looking bright, while buffing with rouge will give a high luster to plastic or bone buttons

There's no limit to the variety of barrettes that can be made. In this example, a piece of colored plastic or celluloid was shaped as shown and a large button was cemented to the center. Metal oak leaves from discarded earrings were cemented on either side. The fastening clamp was removed from another barrette and then cemented to the back

Clusters of small glass buttons encircling a large center one and bordered by bright ribbon "petals" make up this colorful head flower. The buttons are glued to a felt base having a scalloped edge, then pleated or gathered ribbon is sewed around the edge. Two rows of contrasting grosgrain ribbon were used on the attractive flower shown

From Decorative Buttons

as arrangement. The dime stores offer an excellent source for buttons—or you may find what you need right in the family button box. Don't overlook discarded dresses or uniforms for suitable and unusual buttons. Whether of plastic, glass, metal or wood, they'll all work up into attractive costume jewelry to reflect the personality and charm of the wearer. The tools required are practically nil—two small files, one round and one flat, a few tiny twist drills, also a coping saw and a tube of quick-

setting household or airplane cement will do for the most part. A few spring-type clothespins will be found handy for clamping the parts together while the cement is hardening. Solder can be used for fastening a clip or clasp to a metal button, although cement may be used for this purpose if a soldering iron is not available.

Plastic bottle caps are excellent for forming bands for button rings. A cap near finger size is selected and a hole is drilled through the top so a round file can be in-



Corsage



Necklace



Neck Decor

Artificial leaves are bound together to form a pleasing spray and the buttons are sewed onto the edges of the leaves in graceful groupings. Loops made of harmonizing ribbon are tacked securely underneath and to the spray. A plastic or metal pin back may be sewed to the ribbon as the means of fastening it to a dress or other garment

Careful selection of the right buttons is the making of this beautiful necklace or pendant. The foundation of the one shown is a disk of thin plastic or metal. The center consists of a medium-size glass button inset on one of metal. Slightly smaller buttons border the center and tiny square buttons then are glued around the perimeter of the disk

Simple yet smart looking is this decor or choker which is nothing more than a length of satin, velvet or other fine-grade ribbon studded with decorative buttons. The ribbon should be of a length to fit snugly around the neck, and is fashioned either by dress snaps sewed to the ends or by a tie cord. Space about 12 small buttons each way from the center



Hatpin



Ring



Earring

Heads of hatpins built up of several pretty buttons add a splash of color to a plain hat. A base to which the buttons can be cemented is shaped from thin plastic or metal and the pin is cemented to the back of the button-covered base. Or the hatpin can be soldered directly to a large metal button and then given a coat of clear nail polish

A common plastic bottle cap was used to form the band for this attractive button ring. A hole is made in the top of the cap and then it is enlarged with a round file, working it down until it slips over the finger. The button "setting" is cemented to a flat spot filed on the band after the latter has been sanded and buffed to a high polish

A single novelty button makes an attractive earring. Ear clips can be purchased or taken from an old set. If clip and button are metal, they may be soldered together. If clip is metal and button is plastic, fasten them with household or airplane cement. Hold the two parts together until the cement is well set, then lay them aside while it hardens



Worn shoes can be dressed up considerably with colorful button-studded bows whether complete new bows are added or just clusters of buttons are applied to original bows. Small buttons look the neatest for this, although just a large metal button sometimes looks chic when attached to the center of the bow

serted. After that it's merely a job of enlarging the hole to fit the finger. Finally a flat spot is made on the outside of the band for cementing a decorative button. Excess cement may be dissolved with nail polish remover, and you'll find various shades of nail polish ideal for touching up or accenting a desired effect.

A common item such as a toothbrush handle can be utilized to form a snap-on type bracelet by cutting off the bristle end and rounding it. The handle is made pliable for shaping by immersing it in boiling water for a few minutes. Decorative buttons



Bobby Comb



Bracelet



Slip-on Tiara

Bright buttons transform a plain bobby comb into a colorful hair ornament. Tiny holes are made through the top of the comb for attaching decorative buttons with thread or fine wire. Spacing of holes must match that of the buttons. In the case of large buttons where it is not desirable to sew them, you may fasten them with glue or cement

The handle of a discarded toothbrush studded with novelty buttons forms this attractive bracelet. The bristle end is cut off; then the handle is immersed in hot water to make it pliable for bending to fit the wrist. Buttons are attached by drilling holes and fastening with thread or fine wire, or they may be cemented to the outer surface

Another attractive hair ornament is this tiara. First a corset stay is shaped to clamp over the head by drawing it back and forth over a broomstick; then the stay is wrapped with ribbon. Buttons can be sewed or cemented to the ribbon, or they can be wired directly to the stay through holes made before the ribbon covering is wound around stay

are then cemented to the outer surface.

Metal buttons and ornaments can be kept looking bright with a coat of clear nail polish or lacquer. Parts of jewelry made of toothbrush handles and bottle caps can be buffed to a high luster by using rouge on a buffing wheel or simply by brisk rubbing with a rouge-coated cloth. Of course, any file marks should be removed beforehand by sanding with a fine sandpaper or crocus cloth of 6-0 grade, working with it either wet or dry. This will produce a dull finish which buffing will restore to a sparkling luster.



Here's another example of what can be done with buttons. Using a belt you already have, the buckle is discarded and the ends are fitted with snap fasteners. Then in place of the buckle a disk of felt or leather is covered or outlined with buttons and fitted to the belt in the front to conceal the snaps

Paddle Holder Stabilizes Canoe To Prevent Capsizing

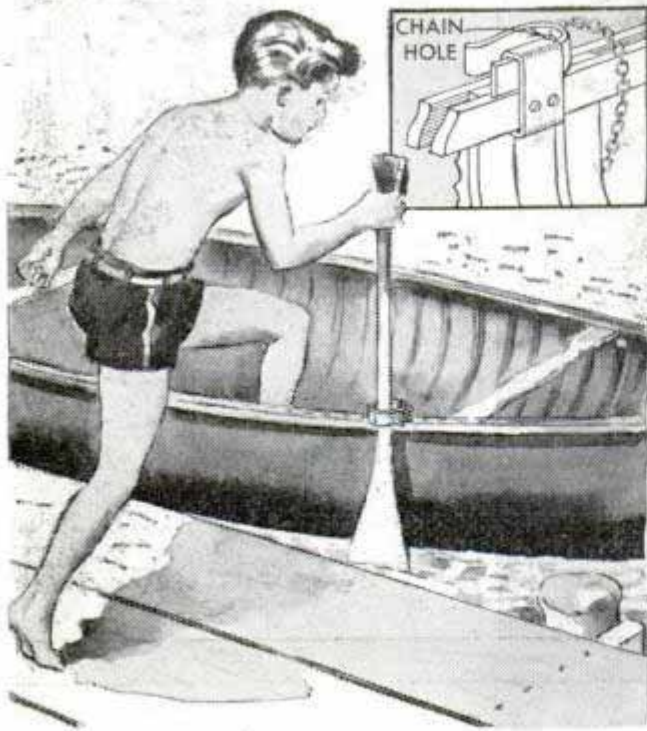

Many an unpleasant "dunking in the drink" can be avoided if you use a paddle and this holder to stabilize the rocking motion of your canoe when climbing in or out. The paddle is kept against the side of the canoe by the holder so that the tip of the blade rests firmly on the bottom, thereby preventing any rolling. A feature of the holder is that the clip can be removed so that it is out of the way, yet it is not easily lost because of the chain that fastens it to the canoe.

Small Silhouette Pictures Framed With Phonograph Records

Outdated and unused phonograph records provide attractive and novel backgrounds for small pictures. Silhouettes and flower prints are especially adaptable to



this type of treatment. Simply glue the picture over the printing in the center of the disk and, with adhesive or cellulose tape, attach a short loop of cord to the back of the record. The loop should be slightly below the edge of the disk.

Punch Marks Position Shaft Key

When reassembling the wheel on an automobile, it happens sometimes that the key slides up too far in the keyway so that the wheel does not seat properly on the axle. To prevent this from occurring, make a center-punch mark on both sides of the keyway to keep the key in its proper position.

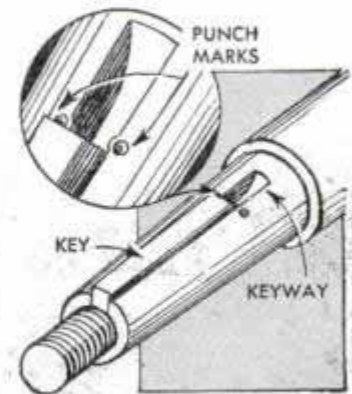

E. T. Gunderson, Jr., Humboldt, Iowa.

Wash Metal Boat Before Painting

The paint on many metal boats, soon after they have been finished, will start to peel and flake off because the surface was not properly cleaned before painting. To prevent this, remove all paint and go over the surface with a strong solution of cider vinegar. Then wash with soapsuds and rinse with clear water. When dry the boat is ready for painting. The same treatment may be applied to unpainted metal boats before the primer coat is applied.

Protective Holder for Fishhooks Prevents Damage to Tackle

Snelled fishhooks can be kept in this holder and they will not become tangled or damaged, as often occurs when they are kept loose in the tackle box. The panel is a piece of $\frac{1}{2}$ -in. or $\frac{3}{4}$ -in. hardwood 4 in. wide by 10 in. long. To hold the hooks, a $\frac{1}{2}$ -in. strip of cork is glued to the top of the panel. Two flutes are cut in the wood to hold screen-door springs. Hooks with shorter snells fit into the top spring and the longer ones fit into the bottom. The exact position of the springs is determined by the length of snells you use.—Harold Gluck, New York, N. Y.

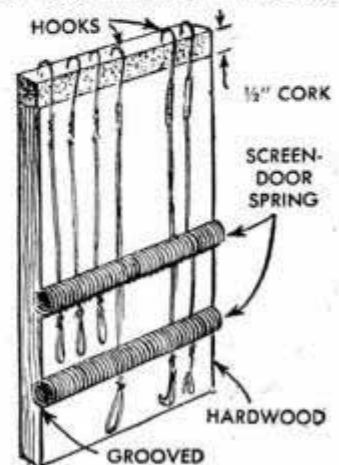

ALL-WEATHER TENT FOR TWO



COMPLETELY insect and vermin proof, this two-man tent is ideal for hikers, canoeists and others who require a lightweight outfit. It is made of waterproofed unbleached muslin and has a sewed-in floor. A bobbinet ventilator, protected by a hooded canopy as shown in Fig. 1, assures ample air circulation under all weather conditions. The door, also covered with bobbinet, closes tightly with a hookless slide fastener. An outside door flap that may be drawn down in case of rain can be tied in place from the inside with the tapes shown in Fig. 2, A. The tent can be set up with inside poles or suspended from a branch of a tree. If the latter method is used, screen-door springs or strips of inner

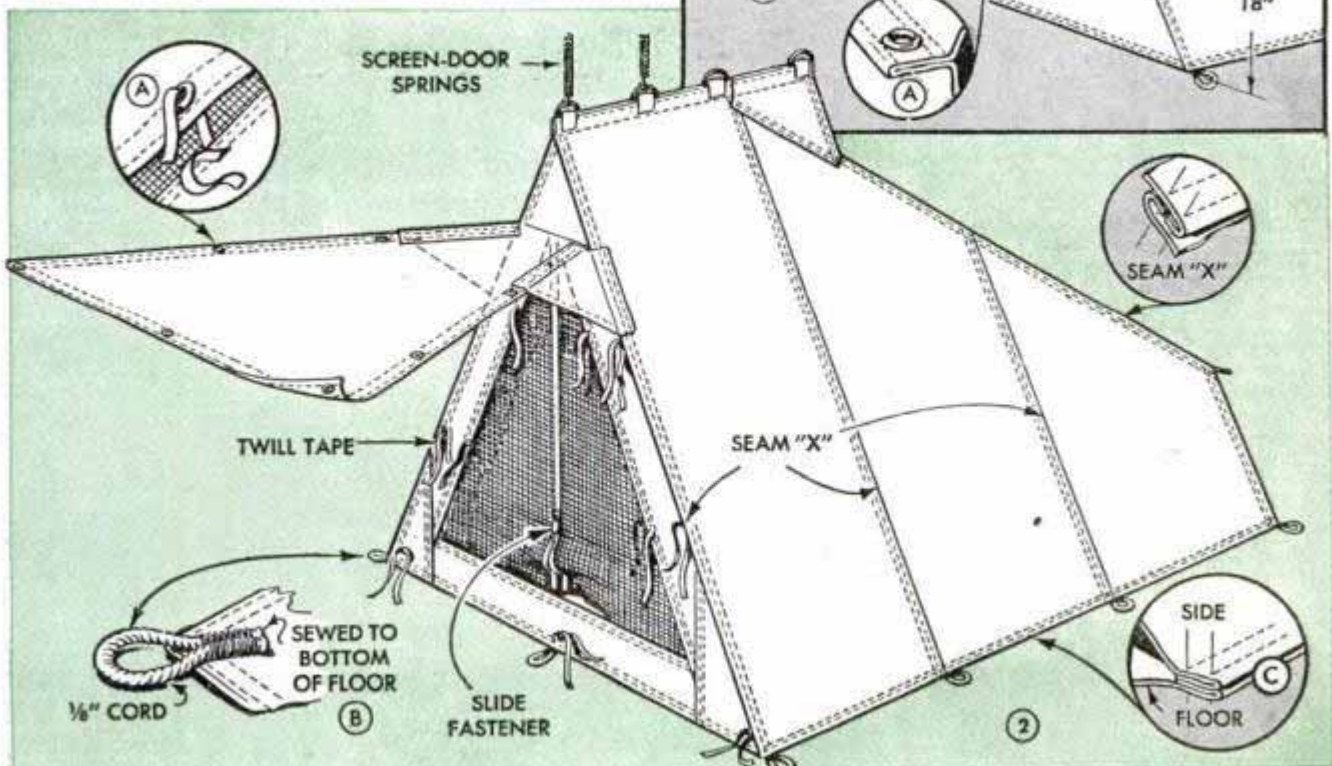
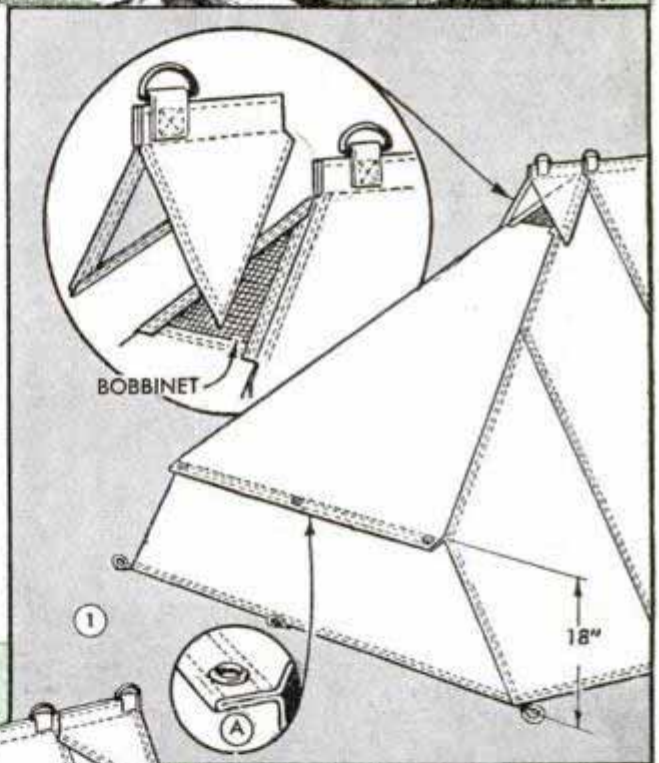

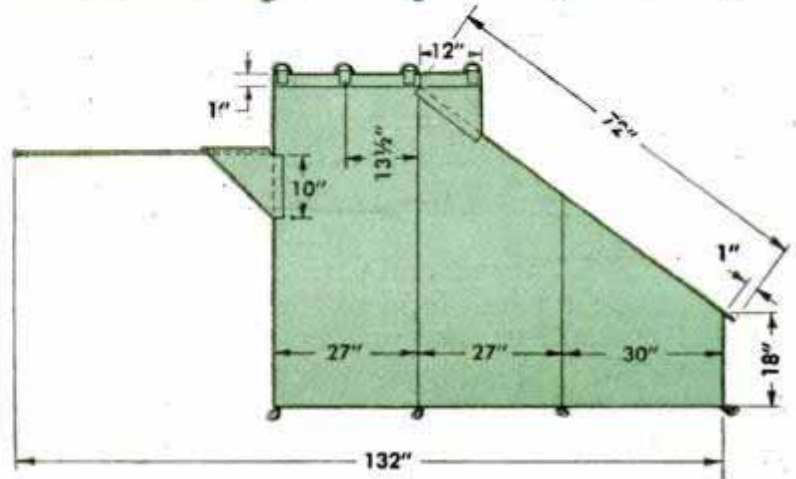
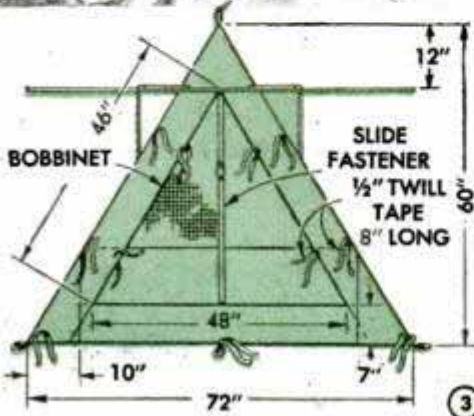
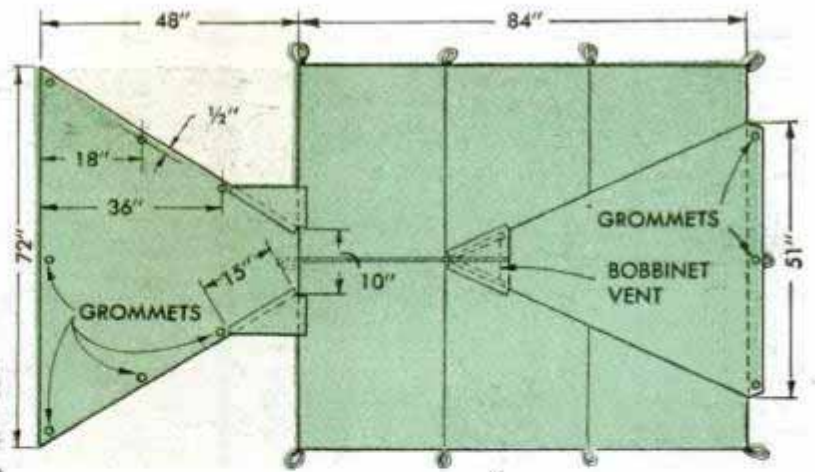

tube should be fastened between the tent and supporting ropes to allow for the swaying of the tree. Guy ropes are attached to the grommets, Fig. 1, A, to hold the rear wall vertical.

To make the tent, 20 yards of 80 by 80 unbleached muslin will be required. This is laid out and cut according to the dimensions given in Fig. 3. Care should be taken to allow enough material to make the various types of seams shown in the enlarged details of Fig. 1, A, Fig. 2 and Fig. 2, C. Loops of $\frac{1}{8}$ -in. cord then are sewed to the

bottom of the floor as indicated in Fig. 2, B, for the tent stakes. Other materials required are two spools of $\frac{1}{2}$ -in. twill tape, $1\frac{1}{4}$ yards of bobbinet or mosquito netting, one hookless slide fastener 40 in. long, 10 grommets, 20 ft. of $\frac{1}{8}$ -in. rope, four "D" rings, approximately 450 yards of thread and 2 gallons of tent waterproofing solution. A prepared waterproofing purchasable at most sporting goods stores can be used, or a good waterproofing compound can be made by mixing 1 pound of paraffin and 4 oz. of beeswax in a gallon of naphtha.

Small Clip Aids in Holding Sun Visor in Proper Position

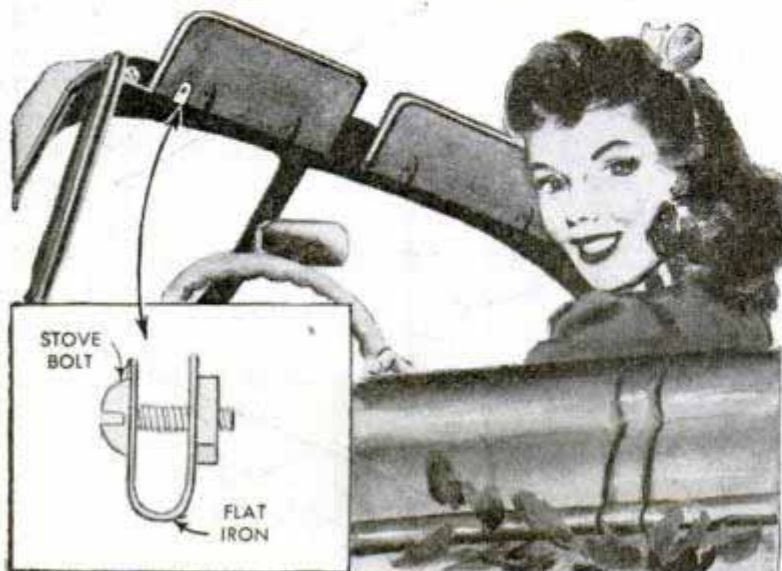

If the sun visor on your car will not stay in the position in which it is set, the clip shown here will be an aid. It is formed from light-weight flat iron and is fastened over the rod that holds the visor. Tightening the stove bolt holds the sun visor in place securely.—Lionel Louis, Johannesburg, South Africa.

When serving food on paper plates to children at a picnic, one housewife found that the youngsters were less apt to spill the food if the plates were thumbtacked to the table. The food is served after the plates are in place.

Turned Fruit Bowl Makes Beautiful Centerpiece

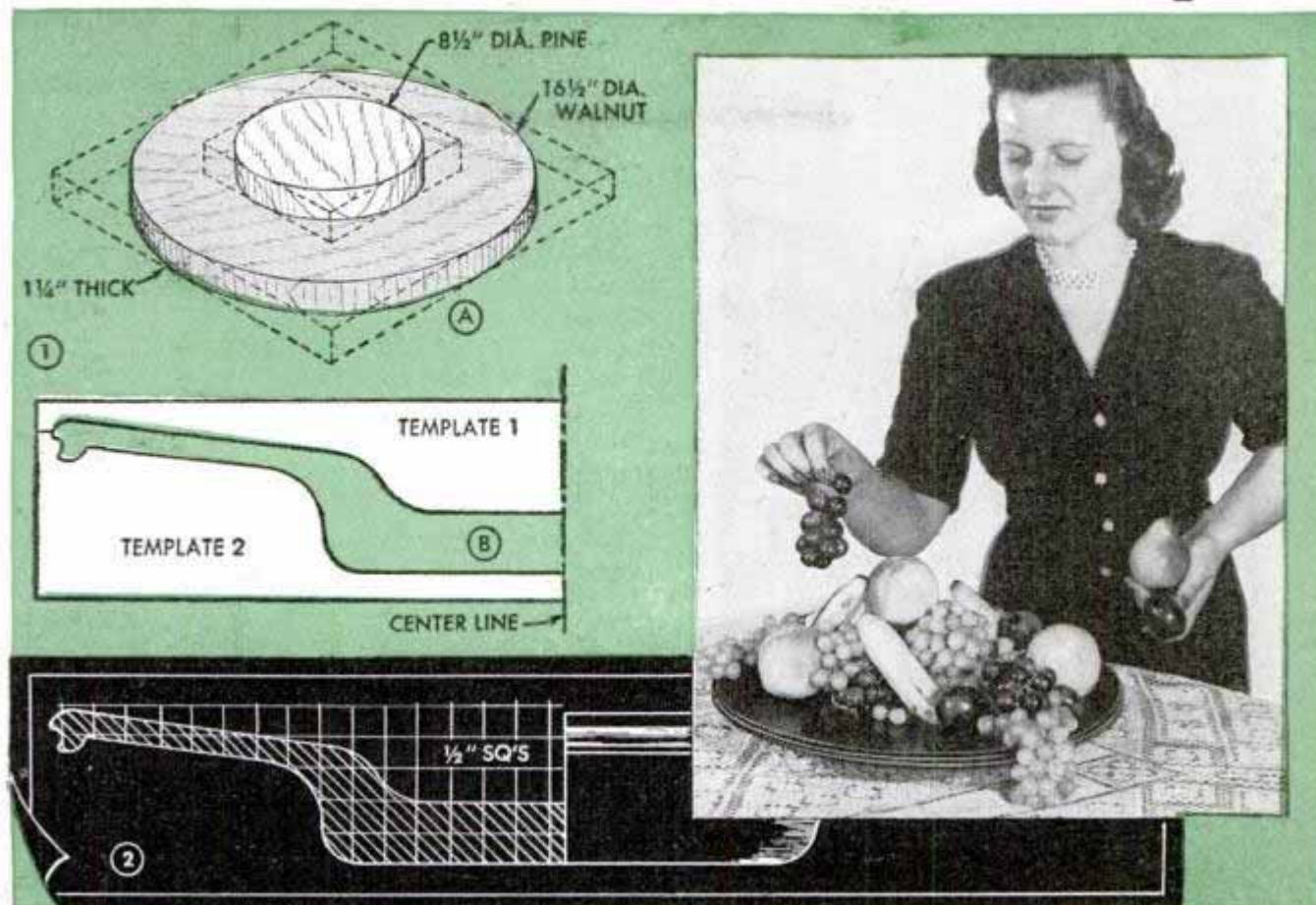

The beauty of this lovely fruit bowl reflects nicety of grain and a flawless finish. The drawing suggests a two-tone job, using a light wood for the bottom half and a darker wood for the top, although it can be made entirely of the same stock if you wish. Building up the turning of two separate disks as in A, Fig. 1, saves work and permits it to be made up of 1 1/4-in. stock. The top disk, detail A, Fig. 1, is made by gluing several pieces together edgewise, while the lower one can be of one piece. The small disk is centered on the larger, with the grain at right angles, and glued and clamped. Owing to its large diameter, the bowl in most cases must be turned on the outer end of the lathe headstock. Center the work on the faceplate and turn the bottom of the bowl first, using template No. 2, B, to check the contour as you go. Use heavy cardboard or light sheet metal in lay-

ing out the templates from the sectional drawing in Fig. 2. Next the work is reversed on the faceplate and the top is turned to match template No. 1. By carefully centering and gluing a scrap disk to the bottom of the work before turning the top, you can avoid screw holes in the finished job. Paper or thin cardboard should be placed between the glue joint so that the disk can be pried off later without marring the turned surface.

A beautiful shellac-spun finish can be applied to the bowl while it is on the faceplate. A mixture of equal parts of shellac and sweet oil is applied to the revolving work with a lintless cloth. Friction of the cloth against the work produces a rich-looking glazed surface which is built up with succeeding applications of shellac and oil. A final coat of wax may be applied if you wish.—Isadore M. Fenn, Chicago.

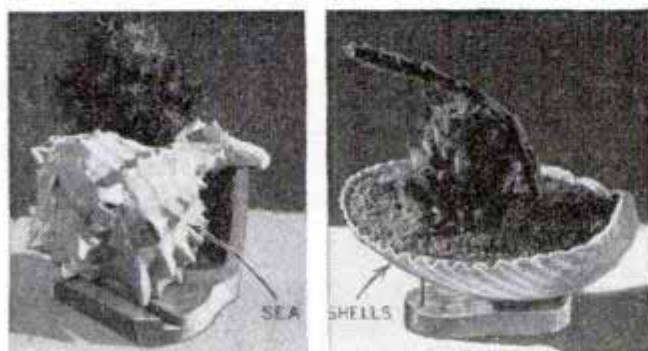

Novel Pots for Cactus Plants Made From Sea Shells

Sea shells can be made into artistic pots for small cacti and similar plants. The shells are mounted on bases of wood, as shown, and fastened securely in place. For a finish, the base can be painted with enamel, or for an unusual effect, it can be covered with a coat of plastic-type putty, roughly applied, and then painted.

Substitute Handle on Lawn Mower Made With Radius Rod

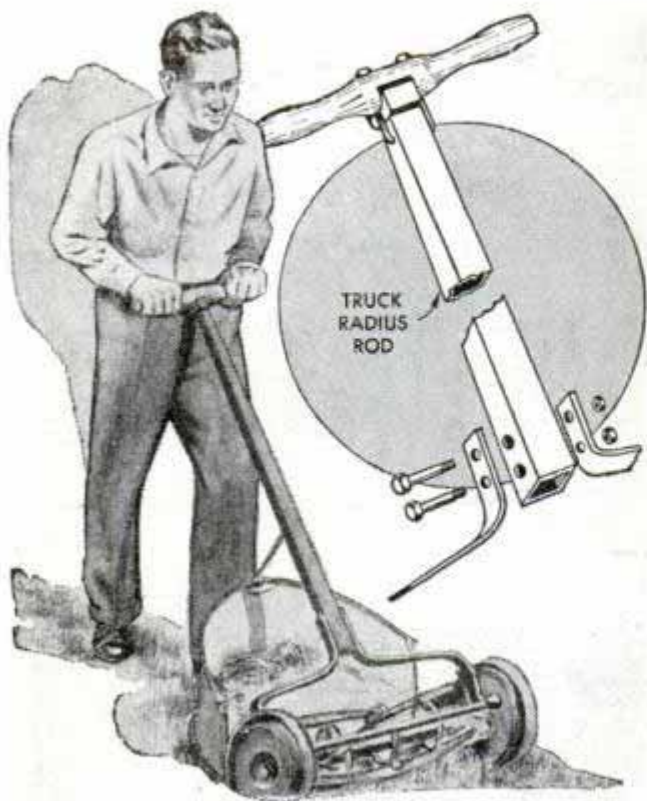

A piece of radius rod from a truck chassis will serve as a substitute lawn mower handle. Both ends of the rod may have to be cut to obtain a handle of the proper length. Holes are drilled in the ends to fit the hand grip and the mower. If the rod is the split-seam type, it is best to tack weld the seam at several spots to prevent possible spreading. Given a coat of paint, this sturdy handle will last a long time.

Benj. Nielsen, Aurora, Nebr.

Tags Used as Picture Hangers

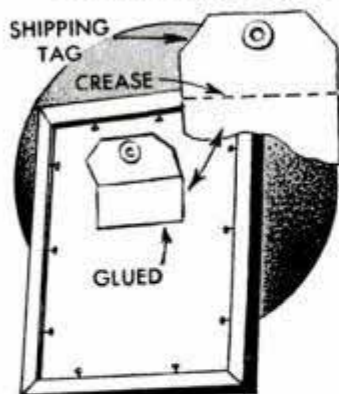

Shipping tags may be used to hang small pictures. The tag is cut and creased as shown and glued to the back of the frame. Care must be taken to fasten the tag so the picture will hang straight.

Emergency Repair for Canoes

When spruce gum is available, a leaking canoe can be repaired even though you do not have a repair kit with you. After the leak has been located, clean the area and allow it to dry thoroughly. Then fasten a piece of spruce gum the size of a hickory nut on the end of a stick. Heat the gum with

a match and allow the drippings to fall on the leak. Spread the gum around the area with a heated knife. When the patch has dried the canoe is ready for the water.

R. A. Jenkins, St. Louis, Mo.

Scrollsaw Switch Is Mounted On Front of Stand

If the motor switch on your scrollsaw is located at the back where it is hard to get at, you can mount an s.p.s.t. toggle switch on the front of the unit for convenience in operation. The switch should be connected in parallel with the one on the back of the saw. Be sure to solder and tape the joints well. The switch should be mounted to go "on" with an upward movement of the handle.

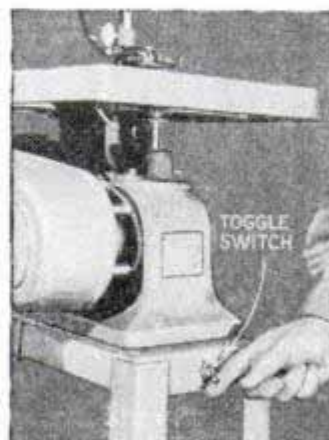

D. J. Bachner, Jackson Heights, N. Y.

Game Board Inlaid in Driveway If Yard Lacks Space

One city home owner solved the problem of providing play space for his small children by utilizing the concrete driveway that he was having laid for his garage. Tiles were cut to the proper shape and set in the concrete while it was wet. Then the numbers were painted on the tiles with white paint. Although in this case the tiles were set in cement, the entire game could be painted on a drive that had been laid previously.—Paul Hadley, Philadelphia, Pa.

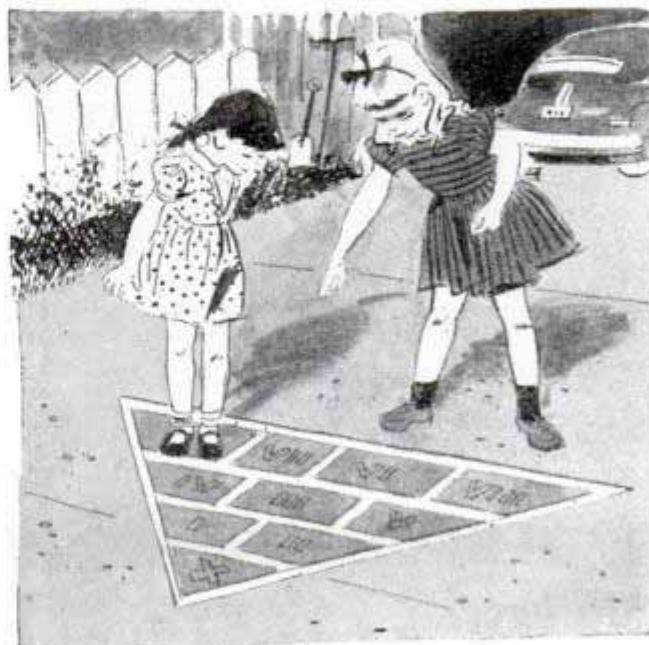



Turtle Traps That Catch 'Em

Turtles take a heavy seasonal toll of the spawn and fry of game fish and the young of waterfowl and small furbearing animals. The big soft-shelled "snappers" generally are the worst offenders and usually are the most numerous. Frequently it is necessary to control them or reduce their numbers as a measure in wild-life conservation. Fig. 1, A to D inclusive, details four traps that are easy to make and operate without constant attention. They are especially effective in ponds and the still backwaters of rivers and creeks. As turtles do not frequent swift water, anchoring the traps is a simple matter. The first, Fig. 1, A, is merely a half-gallon jug, tightly corked, and carrying about 30 to 36 in. of line, a heavy wire leader and a stout barbed hook baited with raw beef or flesh of the carp. Scaled fish are not attracted to either of these baits. Several such traps in a pond or still backwater will reduce the turtle population in a short time if regularly attended. Ordinarily this trap does not require anchoring in a small pond. Fig. 1, B, shows another type, the detail being self-explanatory. Bait is attached to the trap pan and the board is turned upside down. This trap can be anchored in a slow current. Detail C shows a more elaborate affair in which the design takes advantage of the turtle's habit of clambering onto partly submerged logs along the water's edge. Once adjusted and set afloat this trap is fully automatic. The hinged board tips so the turtle slides into the barrel, then the board returns to the original position, ready for the next customer. The trap shown in detail D is fully as effective in large ponds and there are no moving parts. And finally, by using two hooks tied together in the manner shown in Fig. 2, you can catch turtles with ordinary fishing tackle.

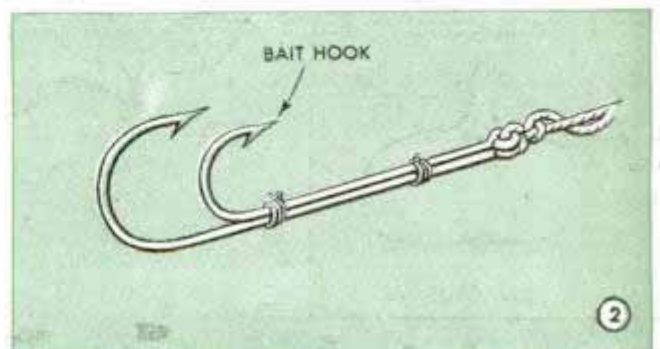
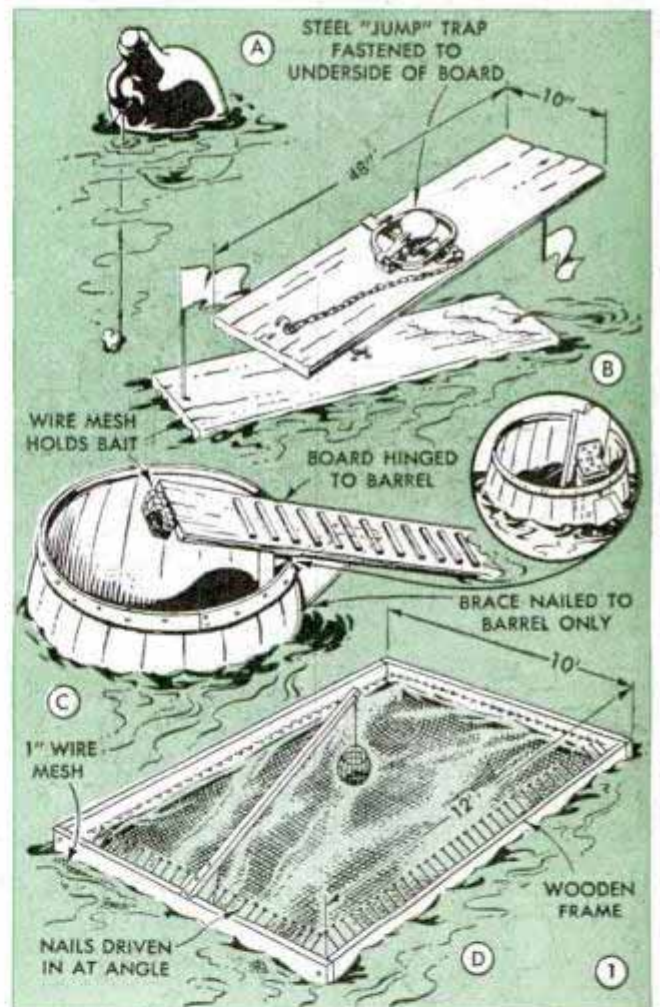

"Applied Chemistry"



POTATO

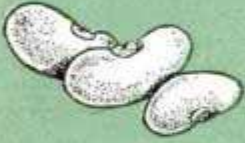

BEANS



LAWN GRASS



CORN



GARDEN PEAS



BEETS

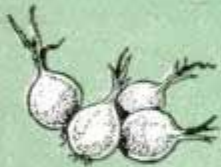

ONION SETS

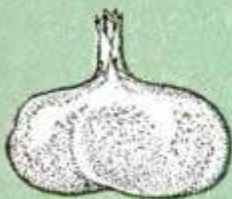

GLADIOLUS



TOMATO

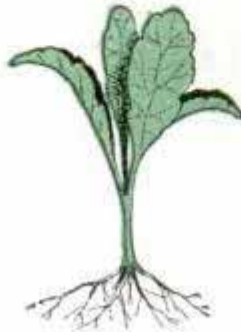

CABBAGE



CELERY



PEPPER



STRAWBERRY



CHINESE JUNIPER



POINSETTIA



GARDENIA

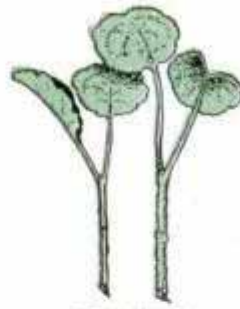

GERANIUM



YEW

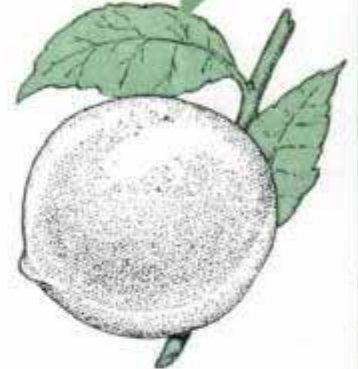

PEACH



PLUM

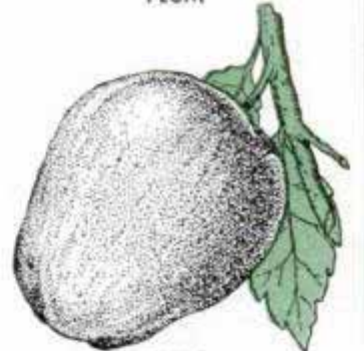

APPLE



TOMATO

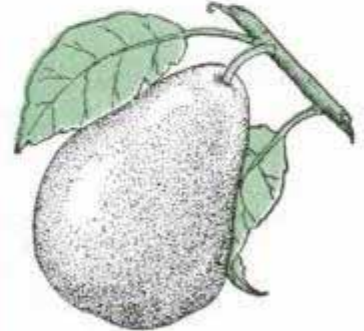

PEAR

① SEEDS AND BULBS

② TRANSPLANTS

③ CUTTINGS

④ FRUIT SET

Improves Garden Crops

A new day in home gardening is no longer just coming—it's already here. Plant hormones applied as sprays and dusts are proving a great aid in producing finer fruits and vegetables and a more vigorous growth of grasses and ornamentals

By W. Clyde Lammey

IN most cases you can handle the new chemical growth regulators—the so-called plant “hormones”—as easily as any of the old stand-by sprays and dusts which act as fungicides or insecticides or combinations of both. Most of these new chemical substances are applied in mixtures or solutions of very low concentration.

Application of newly developed chemicals to promote or alter plant growth and to protect plants from disease and insect attack is on the way to becoming a regular horticultural practice. Although many synthetic growth-promoting substances are still of only theoretical value to the average user, others have immediate practical applications of special interest to home gardeners, flower fanciers, farmers and orchardists. Usually the chemicals are applied to the roots, stems and buds of plants by dipping, dusting or spraying. In many instances you can use the ordinary hand or power sprayers and dusters. Although in certain cases the formula for a specific plant is quite critical, the recommended methods of application are very simple.

Since protection of the seed and seedling is closely related to the use of growth chemicals, one promising new method, Figs. 5 and 6, consists of coating individual seeds with a mixture combining a chemical growth regulator, a fertilizer and a fungicide, all of these preparations providing for the growth and protection of the seedling during and after emergence. Coated seeds of many of the common vegetables likely will be available to gardeners in the near future, but as yet the process is more or less in the experimental stage.

One important thing to keep in mind is that none of the new chemical growth substances, as now developed, is a plant food or fertilizer in the ordinary sense since the amounts of plant food that would normally produce an average healthy growth must always be present in the soil. Perhaps the best known of the synthetic plant-hormone treatments is the simple dusting of powdered, root-forming stimulants on

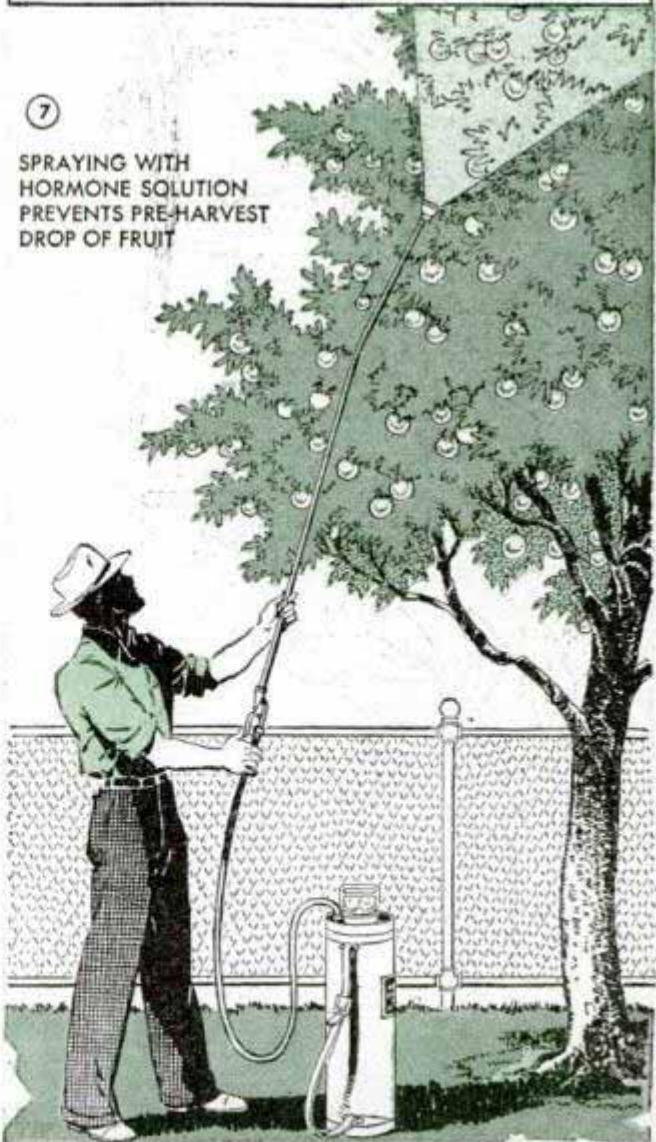
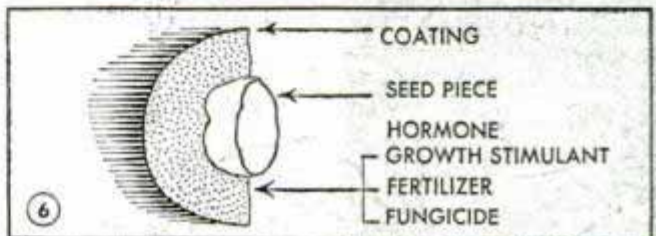



8

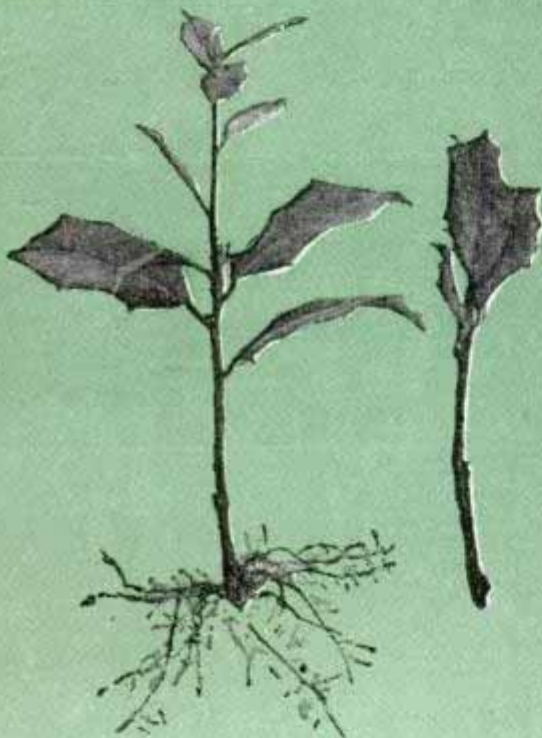

9 TREATED UNTREATED
AMERICAN HOLLY



10 UNTREATED TREATED
KENTUCKY BLUEGRASS

cuttings, seeds and bulbs, Figs. 1, 3 and 9. By this means the normal process of root formation is speeded up, resulting in stronger, healthier plants, faster growth and earlier flowering.

The various steps in rooting cuttings in this manner are quite simple and sure. The base or stem of the cutting first is moistened and then dipped into the hormone powder to a depth averaging about 1 in. It's important that the excess powder be shaken off so that only a thin coating remains on the stem. Then the treated cutting is placed in the propagation bed of wet sand in the usual way, Fig. 8, except that care must be taken that none of the powder is removed when planting. It's quite important that the sand be packed firmly around the stem. In taking cuttings, it's well to consult with your local experiment station for full information on the time and methods of propagating cuttings in your locality. Although in most cases cuttings should be treated and then planted in the propagating beds immediately, there are some exceptions to this practice. For example, it has been found that geraniums and the various cacti and succulents should be allowed to dry or "wilt" for 12 hours or more before treating and setting in the bed. Treated cuttings of some varieties "take hold" quickly, showing a vigorous, bunchy set of roots within two or three weeks. Others take from two to three months and perhaps longer, depending on local conditions. Manufacturers of hormone preparations suitable for use in rooting cuttings often recommend compounds of double strength for the slower-rooting varieties. A bottom heat in the cutting bed of 70 to 75 degrees also has been found a helpful supplement to the hormone treatment when rooting the species more difficult to start.

Ordinarily, when plants are moved, as in transplanting from beds to the row, Fig. 2, many of the delicate feeder roots are broken and growth stops until the damage has been repaired by natural processes. Loss of water due to the damaged root systems causes the familiar wilting. Many of the weaker plants, and those which have suffered the greatest root loss in handling, wither and die. As the secret of successful transplanting is the maintenance of root strength and the production of new root growth to replace that broken from the plant, another hormone treatment has been developed especially for use when transplanting. Comparisons of treated and untreated specimens of common transplants and cuttings invariably show the heavier root system of the treated specimen. Fig. 9 shows an example of two cuttings from American holly, a variety which ordinarily is difficult to root. Both treated and un-

treated cuttings were left in the propagating beds for the same length of time. Note the developing root system and the vigorous top growth of the treated specimen. There are several methods of applying this root-forming aid and all of them are very nearly as simple as merely watering the plants in the ordinary way. Fig. 16 gives a recommended formula for small trees and shrubs and Fig. 17 indicates the solution for soft-tissued plants and seedlings.

These solutions can be applied in several ways. One method especially effective on tender seedlings as a protection against wilting is "watering" with the solution a day or so before transplanting. Bare-rooted plants such as rose bushes, peonies and others should be soaked an hour or so before planting, all the roots being immersed in the solution. Still another method is transplanting as usual and then soaking the soil around the roots with the solution.

In addition to being an effective aid in re-rooting of transplants and cuttings, similar solutions of these same chemicals can be used in various ways in treating such widely diversified plant growth as seed potatoes, newly planted lawns, old established sods and balled specimens of evergreens and deciduous trees. Fig. 13 shows an easy method of treating seed potatoes. The seed pieces should remain in the solution for at least one hour, and after removing and drying they may be further treated with any of the mercurial or formaldehyde preparations without lessening the effectiveness of either treatment. Lawns may be watered with hormone solutions during the spring and fall months, using a siphon attachment on the garden hose as in Fig. 11. To assure uniform results by this method it is necessary to apply a given amount of the solution per 1000 square feet. Measure the lawn and locate the areas with markers. Then sprinkle uniformly, taking care not to soak or flood the areas. When working on a steep, sodded slope or terrace, keep the bulk of the water on the higher levels as it will seep down the slope. Use a light, spreading spray under low pressure and work on a still day. The two sample sods in Fig. 10, from treated and untreated experimental plots, show the superior root system of the treated specimen. The time interval was the same for both specimens.

Flower beds, rock gardens and the vegetable-growing plot can be given the same treatment. Hormone stimulant in the powder form also can be dusted on practically all common vegetable and flower seeds and bulbs, such as onion sets and gladioli, with beneficial results. Use a glass jar for dusting small seeds as in Fig. 14. The jar should be filled to one third of its depth. Bulbs can be dusted with a salt or pepper shaker

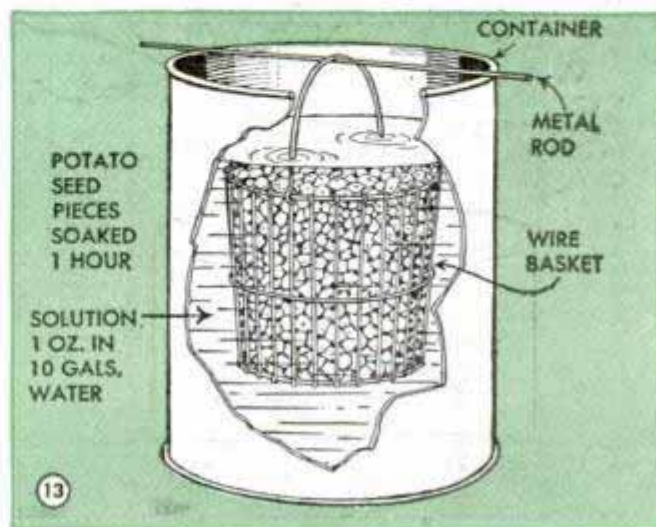

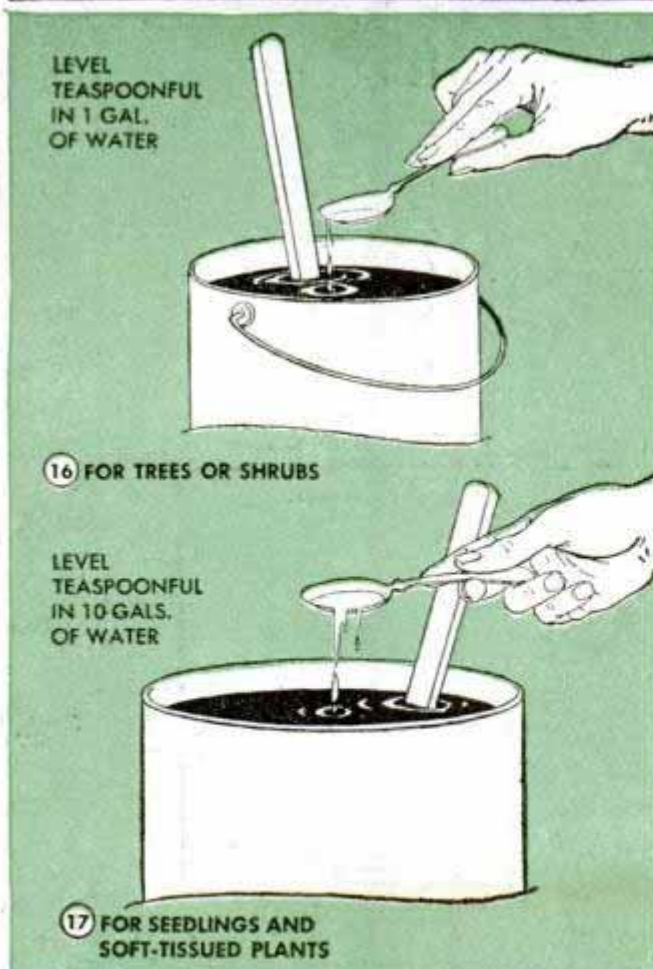
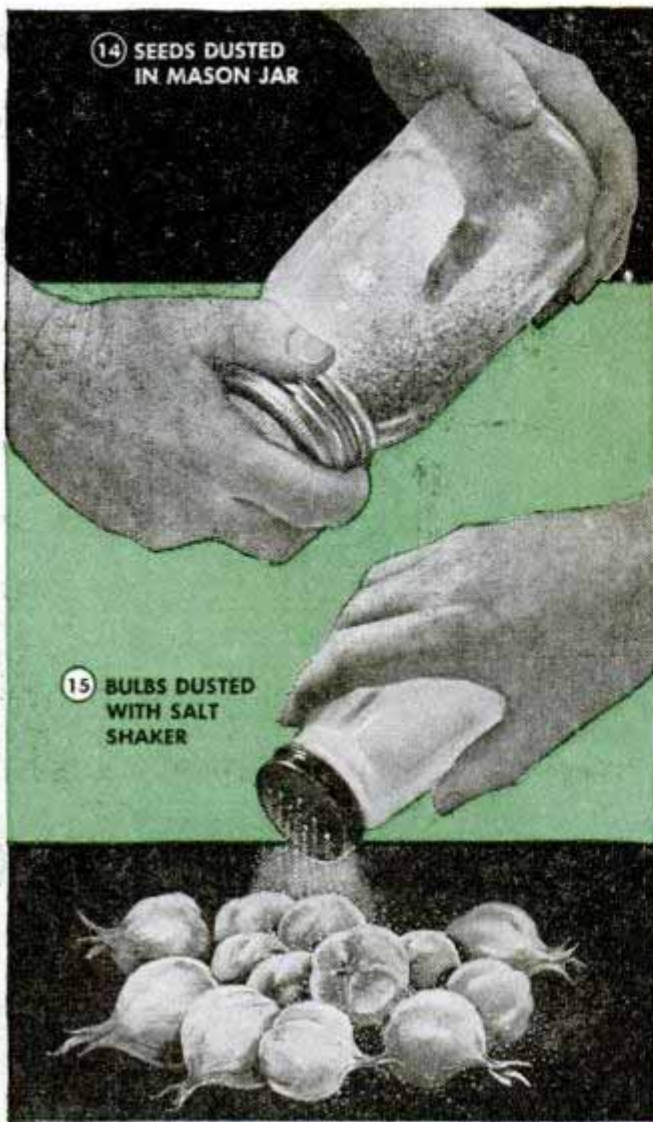

as in Fig. 15. Be sure that the dust covers all the bulbs. If necessary dampen them slightly so the dust will stick to the surfaces. Bulbs and seeds so treated should be planted immediately.

Still another hormone treatment can be applied as a spray to fruits, blossoms and foliage to delay drop of apples, Fig. 7, to pears, plums and peaches, Fig. 4, and to produce seedless tomatoes, Fig. 12; also to flowers to induce fruit set and hasten seed formation without pollenization, and to holly and evergreen holiday decorations to cause the foliage to remain on the twigs from two to three weeks longer than normally. The cell layer at the point where most fruits, foliage and flowers are attached to the plant is known as the abscission layer. As the individual cells wither and die, the fruit, leaf or flower drops from the stem or twig. A specially developed hormone spray solution applied with a knapsack sprayer, Fig. 7, slows this natural process, keeping the fruit or foliage-bearing stem in an active state of growth and checking premature drop. As examples of time and variety, most kinds of apples are sprayed with the solution about 10 days to two weeks before picking time. The McIntosh apple requires two sprays 10 days apart. On this particular variety the effect of the spray lasts a week or more while on others a single spray is effective for a period of three weeks to a month. Other fruits, such as pears and plums, can be sprayed with a hormone preparation two weeks or more before picking time to prevent premature drop. To be effective, the spray must hit the stem or adjacent tissue.

Among the diversified applications of this same hormone preparation is its use in the production of seedless tomatoes, Fig. 12. The process is simple. Spray the blossoms immediately after opening and then once a week for four weeks. Use a double-strength solution. If this procedure is followed most of the individual fruits will be seedless. Likewise, spraying the blooms of lima and string beans results in a heavier set of pods, increases in yields up to 30 percent having been recorded in tests. Most of the common varieties of sweet corn will respond to treatment. Spray the silks just as the pollen begins to fly and be sure that the spray hits all the silks of each individual ear. As a result the ears will be larger, better filled and more uniform in size. Of course, it should be remembered that there are other conditions which naturally affect yields. An adverse growing season, such as unusually wet or dry weather during the early or latter part of the growing period, will tend to reduce the yield of the crop.

Photos and certain information by courtesy of Dow Chemical Co. and American Chemical Paint Co.

SCREENED Baby Crib

When baby naps outdoors or on the porch, screen wire keeps insects out and the baby in. Crib is collapsible

By Milton L. Bobeng

YOU won't have to worry about flies and other insects bothering your baby if you keep it in a screened crib like this one, which is covered with fine-mesh screen wire. Since it can be folded as in Fig. 1, you can move the crib to the most pleasant spot in the yard or pack it in the car for picnics. An added advantage of the bed is that there are no sliding parts or bars to catch and pinch small fingers and toes.

Overall dimensions of the crib are given in Fig. 2, and the dimensions for the three hinged top pieces are shown in details A, B and C. Tongue-and-groove construction is used in assembling the various panels, and most of the panels are hinged to the other members. Fig. 3 shows in cross section how the screen is fitted in all frames, and details A and C of Fig. 4 illustrate the method of joining frame members. As each frame is cut, the pieces should be fitted for a trial assembly to check and determine that they are square.

Hinges which are countersunk should be fitted next. Those connecting the front stationary and drop frames, as well as those connecting the rear top folding frame to the back frame, are the loose-pin type. Solid-pin hinges, also countersunk, are used to connect the folding end frames to the legs.

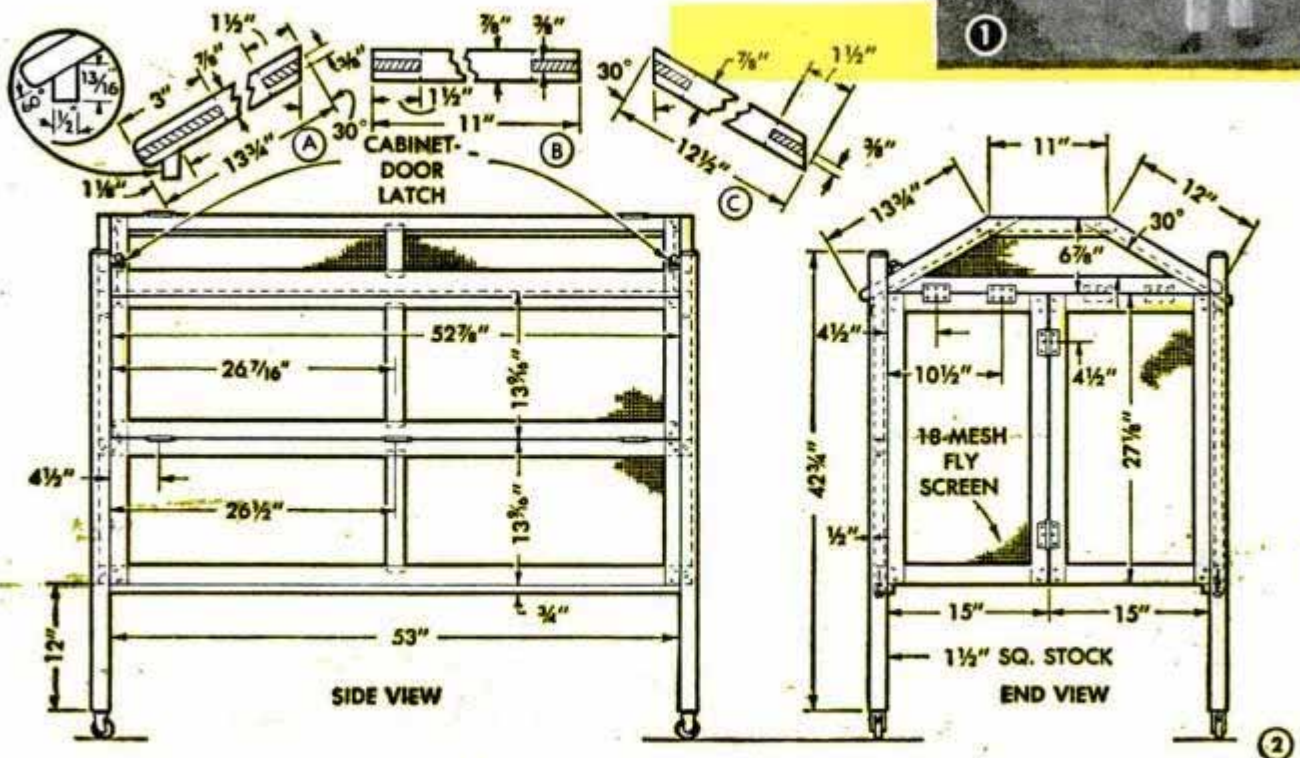
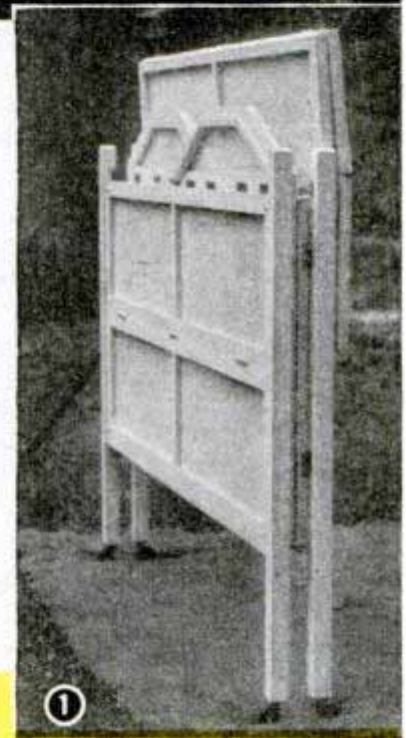
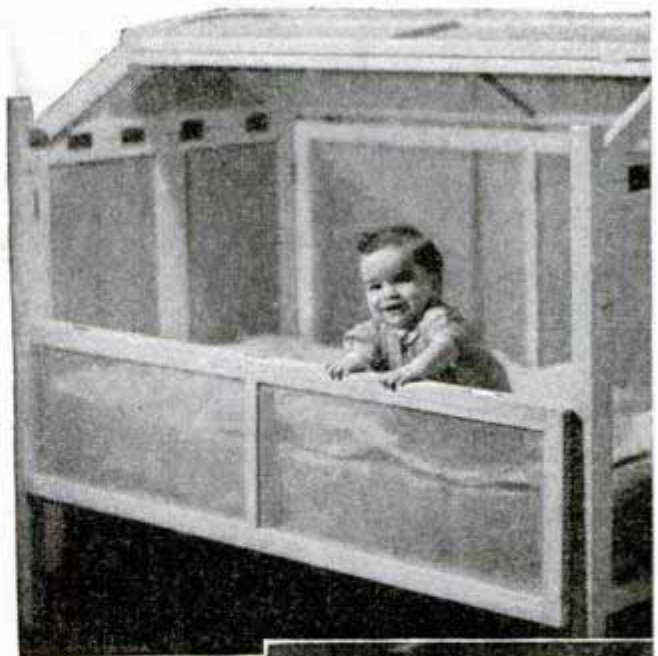

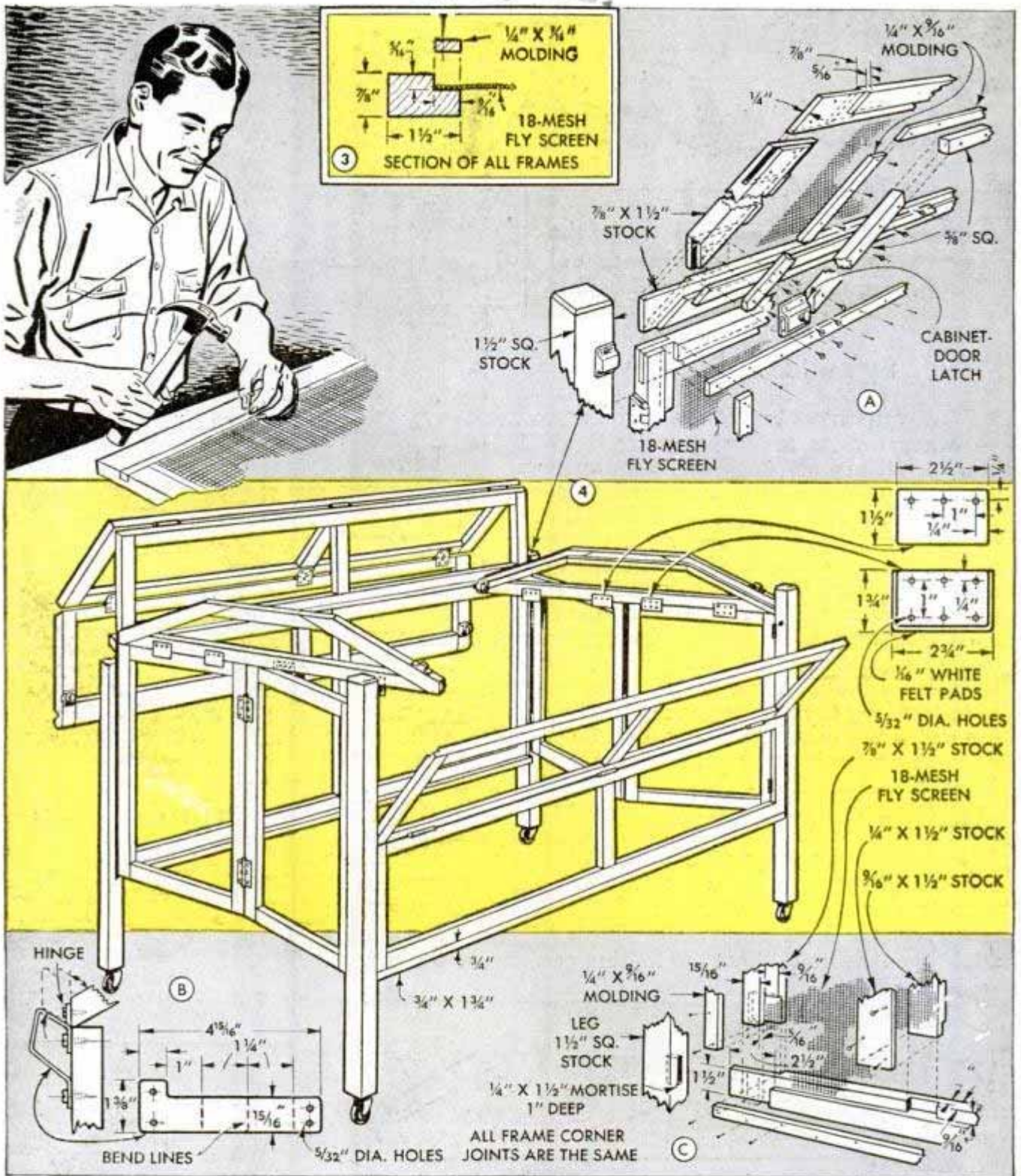

All other hinges are screwed on the surface of the frame pieces and are the loose-pin type. The manner in which the bed folds is indicated in Fig. 4, and the location of the hinges can be determined by reference to this illustration. Before final assembly, the frames should be painted, applying first an undercoat followed by two coats of enamel. Sand lightly after each coat has dried. Then a coat of wax should be applied to protect the surface during assembly.

The bumper and mending plates, Fig. 4, and the top rest bumper, detail B, should be made next. If desired, white felt pads are fitted beneath the plates where they

may strike and mar the wood. Note in Fig. 4 that some of the plates attach to the top and bottom members of the end frames, and some are fastened to the top members only. Small cupboard catches are installed as shown in Fig. 4 and detail A which serve to lock the crib in the open position and keep the child from pushing up the top.

To protect the parts of the crib where the members are not hinged, felt strips can be glued to the edges, and as a protection for the top when it is folded back, rubber bumpers can be installed. The casters, which should be installed last, are preferably a type that is relatively free wheeling so the crib can be moved easily.

Fly-Line Retriever Works Like a Tree Trimmer

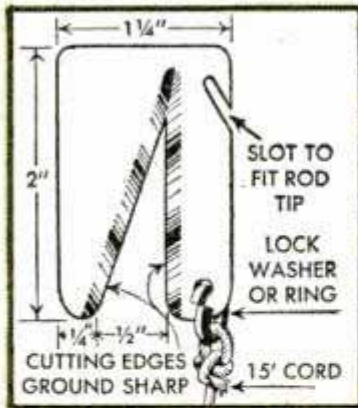

When you're whipping a trout stream and the speckled beauties are rising nicely to the fly—that's when it usually happens. A trifle too high on the back cast and fly and leader and maybe a yard or two of line are wound irretrievably around a small twig somewhere high out of reach. The problem of getting the line down is likely to be something of a poser unless you have the gadget detailed above. It's simply a piece of $\frac{1}{32}$ -in. tool steel with a V-shaped cutting edge ground razor sharp. One side of the cutter is slotted so that it can be hooked over the rod tip and raised to the offending twig as indicated. Then, after disengaging the rod, give the cord a strong pull and down come the twig and line.—M. J. McArthur, Beverly Hills, Calif.

Telltale Give Sailboat Skippers Exact Direction of Wind

A telltale atop the mast comes in handy when you're maneuvering a small sailboat in close quarters and the wind is tricky. And even when it's smooth sailing in perfect weather a check on the wind direction can be made at any time by a

quick glance aloft. In wind vanes of any type the essential thing is perfect balance so that there is no binding at the pivot point. The details below show several styles ranging from the heavy-duty type made of metal to the light, sensitive turkey feather for small racing craft. The

metal vanes are fitted with counterbalancing weights and specially designed pivots. When constructing any one of these it's usually a good idea to make a trial assembly and carefully check the balance, reducing the weight of either the vane or the counterbalance as necessary. Bearing sleeves should be a true fit on the spindles. Metal parts can be polished and finished bright with clear lacquer. In fitting a fabric vane over a metal frame be careful that the fabric is not stretched too tightly as the coating of airplane dope has the effect of shrinking the cloth.

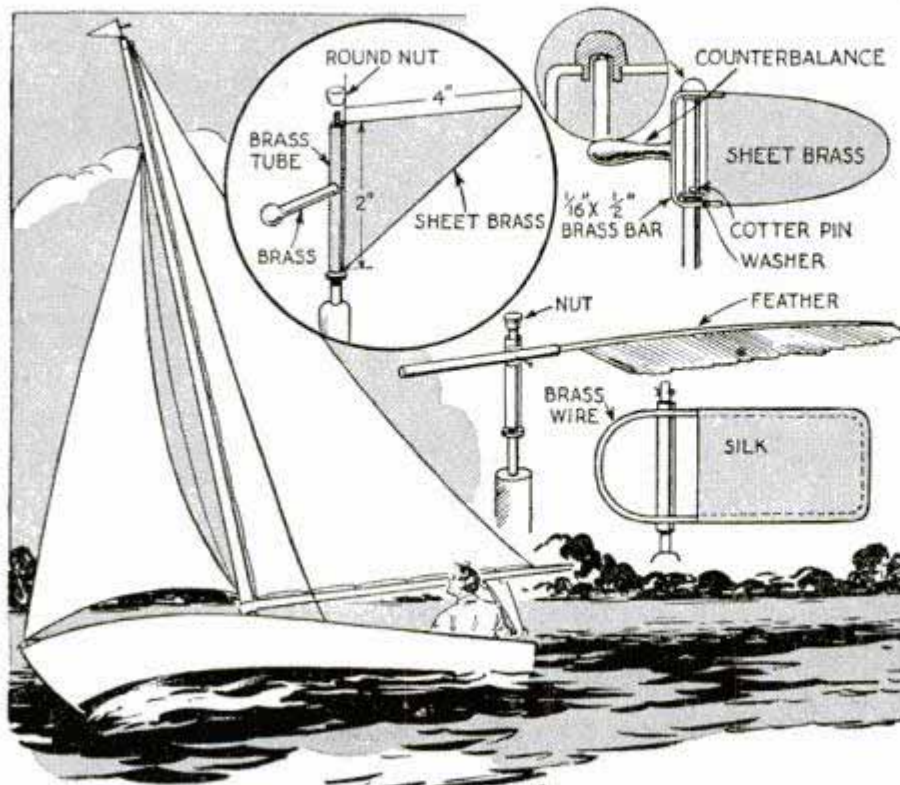

Data on Camera Carrying Case For Quick Reference

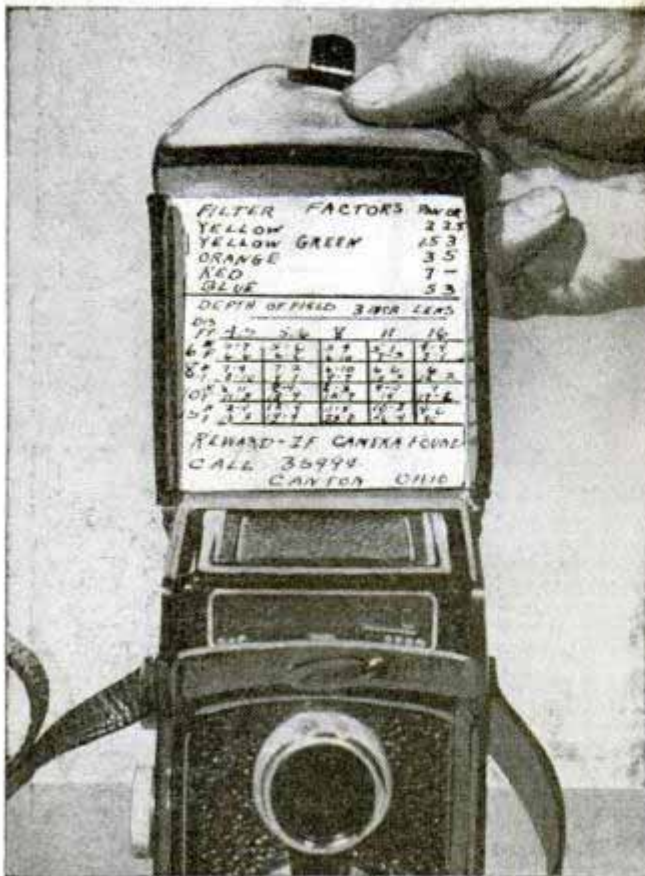

Camera information needed frequently may be printed on a card and pasted in the camera carrying case. Such information may consist of filter factors, depth-of-field tables and exposure charts. In addition, the owner's name and address should be on the card as a safeguard in case of loss.

H. Leeper, Canton, Ohio.

Flash Reflector Made From Pan

A compact and durable photoflash reflector may be made from a 1-qt. aluminum saucepan and a miniature flash bulb adapter. The pan is cut down so that it is about 1 1/2 in. deep and a 3/4-in. hole centered 1 in. from the bottom is drilled. Then a brass

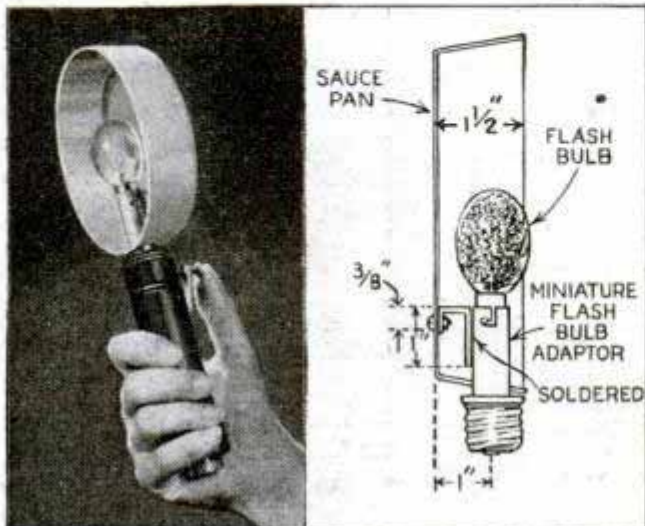

bracket is bent as shown and attached to the bottom of the pan and to the adapter. The adapter should be positioned so the bulb will be in the center of the reflector. The reflector can be used with any flash unit case that takes a standard bulb or it can be used in a light socket.

D. E. Horn, River Forest, Ill.

Finishing Inside of Lens Shade

Sometimes lens shades are painted inside instead of being flocked. In time the paint may wear or chip off and expose the shiny metal surface of the shade.

To correct this, paste strips of adhesive tape inside the shade and cover the tape with a flat black paint, such as show card color.



Clamp-On Photoflood Reflector

Using only a baking pan, a rat-trap and a few odds and ends, this reflector for No. 1 flood lights can be made in a short time. The light socket is screwed to a piece of wood which in turn is fastened to one end of the pan. One part of the pivoted support is bolted to the side of the pan and the other to the side of the trap. Adjustment is provided by a wing nut which fastens the two parts of the brace together. To protect the object to which it is clamped, the trap jaw should be wrapped with adhesive tape.

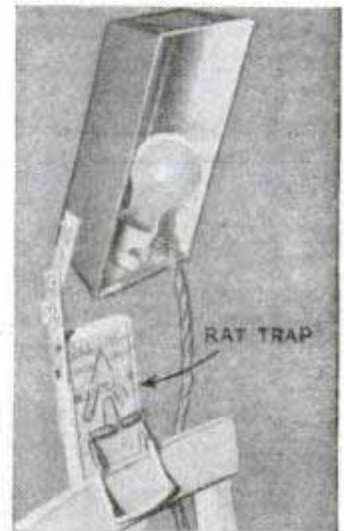

Herman Klein, Pittsburgh, Pa.

Line Level Helps "Set" Camera

When using a camera that has a view finder, often it is difficult to determine whether or not the camera is level. If a small line level such as the one shown is mounted on top of the camera it is a simple matter to frame the picture in the finder and then check the alignment with the level.—George T. Lundeen, Madison, Wis.

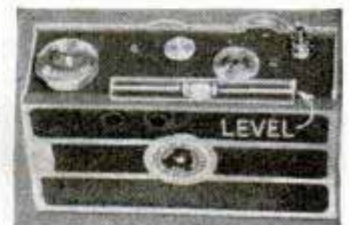



Fluorescent
PHOTO LAMP
gives soft light

By Tracy Diers

IF hot, bright photoflood lamps make your subjects uncomfortable while they are being photographed, this fluorescent portrait lighting unit will solve your problem. Its rays are intensely rich in actinic value and you should be able to click away at 1/10 second at f:16 on normal speed Panchromatic film. You will find that the negatives have a surprisingly long scale of tones and a welcome sparkle. The unit consists mainly of six 100-watt fluorescent tubes mounted on a piece of 1/4-in. plywood and wired as indicated in Fig. 7. The unit is suspended from the studio ceiling and can be tilted to almost any desired angle.

Start construction with the combination reflector and mounting board, which is reinforced at the edges on the back side with wood cleats as in Fig. 1. This reinforcement is necessary to stiffen the board when it is suspended. After the cleats have been screwed in place, attach the tube-socket

UNDERSIDE PAINTED
 FLAT WHITE

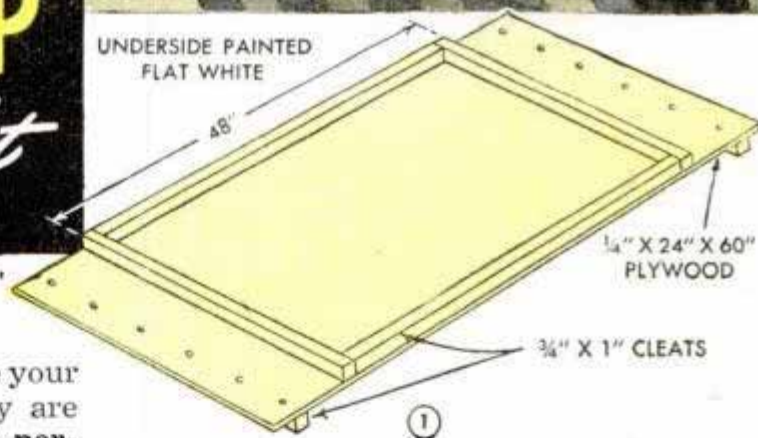

mounting cleats to the opposite side as indicated, and then paint this side with a washable, flat-white paint. You will need two sockets for each tube, or 12 in all. These usually are obtainable without mounting assemblies. Each socket should have a 3/16-in. hole drilled in it as in Fig. 2 so that it can be screwed to the mounting cleats. Fig. 3 shows how the sockets are attached to the mounting cleats with a long wood screw through each one. In order that the unit be self-starting when the current is turned on, automatic tube starters are used. You will need six of these, one for each tube, and their sockets. The starters should be of the two-prong type and are mounted on the back side of the reflector close to the tube sockets, Fig. 5.

The unit now is ready for wiring. This

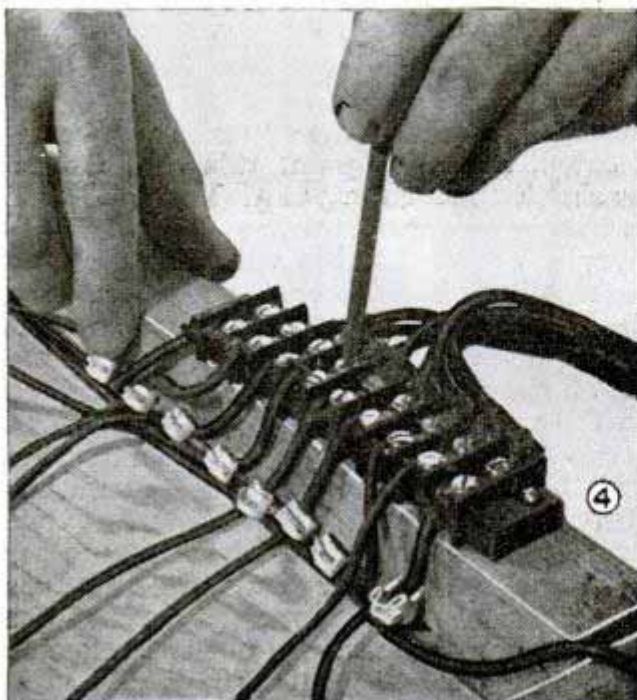
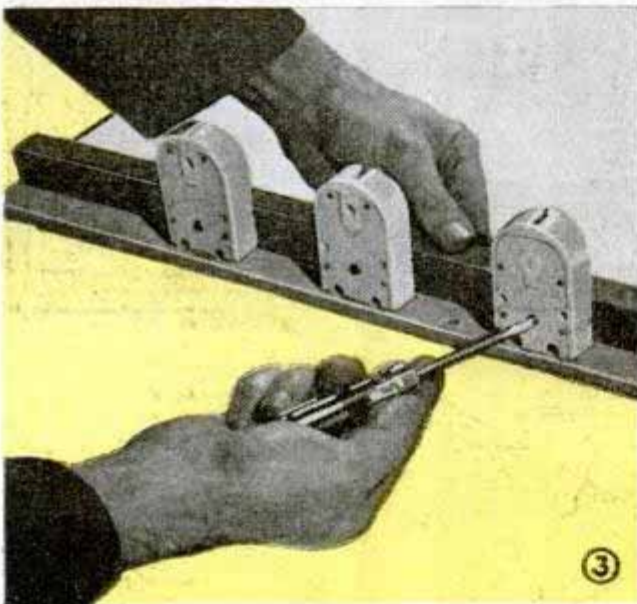
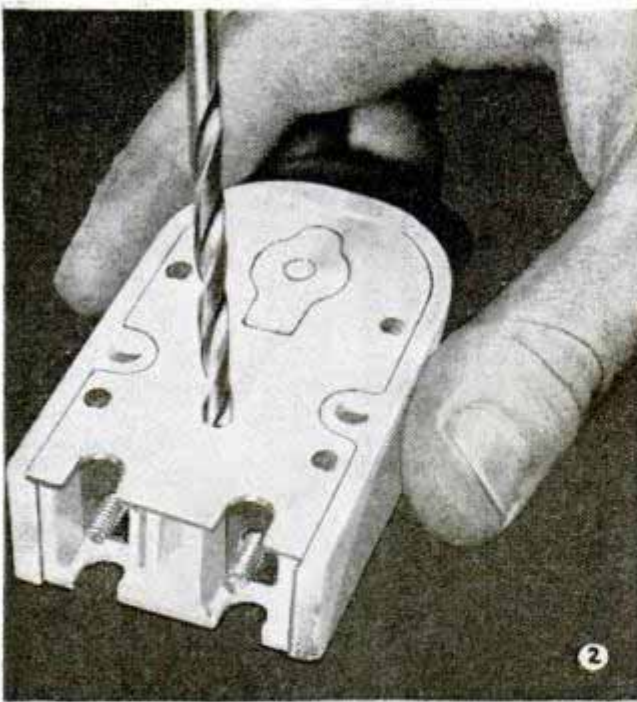

may seem rather complicated at first glance, but upon closer examination of Fig. 7 you will see that the entire circuit is merely a repetition of the hookup of the first two tubes. At one corner on the back side of the reflector, attach a nine-contact terminal strip as in Fig. 4. All the wiring is done on the back of the reflector, as indicated in Fig. 7, and the wires connect at the terminal strip.

After completing the wiring on the reflector board to the terminal strip, you are ready to install the tube ballasts. Three of these are required, one for each pair of tubes. If there is any possibility that you may wish to transport the unit, it is best to mount the ballasts separately so that the unit can be taken apart. If all parts were installed on the reflector, the unit would be heavy to move about. Mount each ballast on a board about 1 by 7 by 21 in. in size, as indicated in Fig. 6, and wire the outlet end of each ballast to one 3-pole polarized receptacle and input end to one 2-pole polarized plug. Then connect the 110-volt line to three 2-pole receptacles, wiring the latter in parallel. There should be a switch in the line for turning the unit on and off.

You will need a cable consisting of three 3-wire smaller cables. The cable can be made up from ordinary lamp cord or other flexible insulated wire, and can be of any length required to reach from the terminal strip on the reflector board to the ballasts, usually about 20 ft. Each of the small cables terminates in a 3-pole polarized plug and is connected to the terminal strip. In Fig. 7, each wire is numbered so that you can easily trace it through the terminal strip, cables, ballasts and on to the 110-volt line. By following these numbers you should experience no difficulty in wiring the unit. For example, wire No. 1 runs from a tube socket to the terminal strip, through one of the cables, then through the 3-pole plug and receptacle and into the outlet end of the ballast. Wire No. 2 is treated similarly. Wire No. 3 also is handled the same way except that it goes around the ballast directly to one side of the 2-pole plug, then to the 110-volt line. In Fig. No. 7 wire No. 3 is shown going into the cord leading from the current supply or input end of the ballast. Since there already are two wires coming out of this end of the ballast, wire No. 3 is merely connected to the one on the left-hand side as you face the ballast. Wires 6 and 9 are connected in a similar manner. In all cases, be sure that you connect the correct wires to the correct prongs in the plugs, and that the wires leading from the receptacle terminals correspond to those on the plug prongs.

This completes the unit except for installing the tubes, which should be of the

3500 Kelvin type as this color temperature is best suited to most portrait work. Before hanging the unit it is advisable to test it. To do this, first check the wiring, then put the tubes and starters in their sockets, plug in all ballast connections and close the switch in the 110-volt line. The tubes will flicker once or twice and then light up. Tubes or starters that fail to operate should be checked in other sockets.

A simple but strong ceiling support for the reflector can be made as indicated in Fig. 10. The support consists of three pieces of 1 $\frac{3}{4}$ -in. square stock, the two vertical pieces being attached to the picture molding at the ceiling with small corner irons. Heavy angles are used at the joints between the horizontal and vertical members to reinforce them. A strong hook should be screwed into the bottom surface of the horizontal member and a small pulley hung from it for easily suspending the reflector board. A short length of clothesline rope is tied to two heavy screw eyes driven into the upper edge of the reflector near the ends. Another length of rope is tied to the center of the first, then run over the pulley in the support and down to a screw hook in the lower edge of the reflector at the center. The length of this latter rope will determine the height of the unit from the floor. Several loop knots are tied in this rope so that the reflector can be tilted by hooking one of the various loops into the screw hook as indicated in Fig. 8.

It is best not to hang the unit too high when photographing people with deep-set eyes. A portrait must show high lights in the eyes and if you raise the unit too high, the eyes will be in subdued light. Always have the model at least 8 ft. from the unit. Fluorescent light is rich in violet rays and if the model is too close, the skin tones will appear chalky in the print. Although the unit does not cast sharp, harsh shadows, you should balance its light with a 100-watt lamp in a reflector on the side of the face opposite the fluorescent unit and close to the floor at a distance of 6 ft. from the model. Small spotlights or 150-watt mushroom lamps can be used to provide pickup lights in the hair. These lights

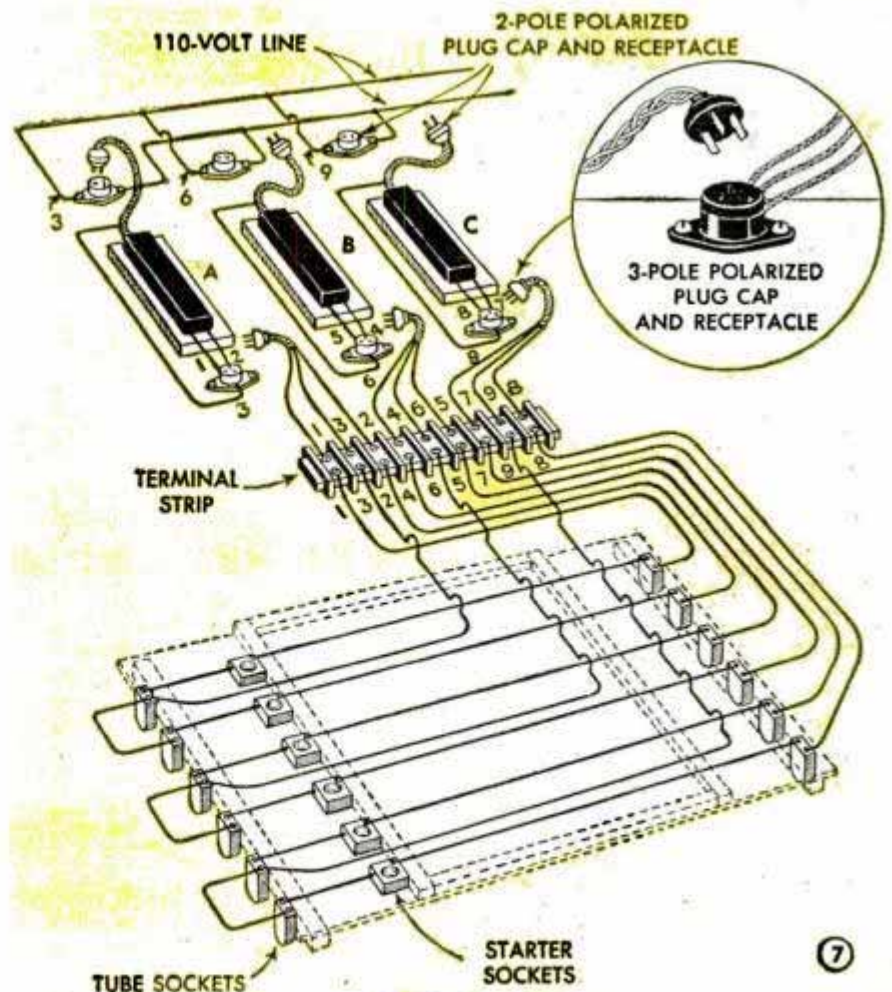
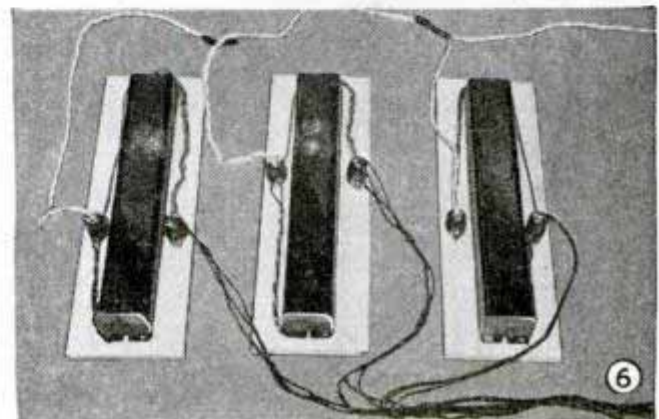
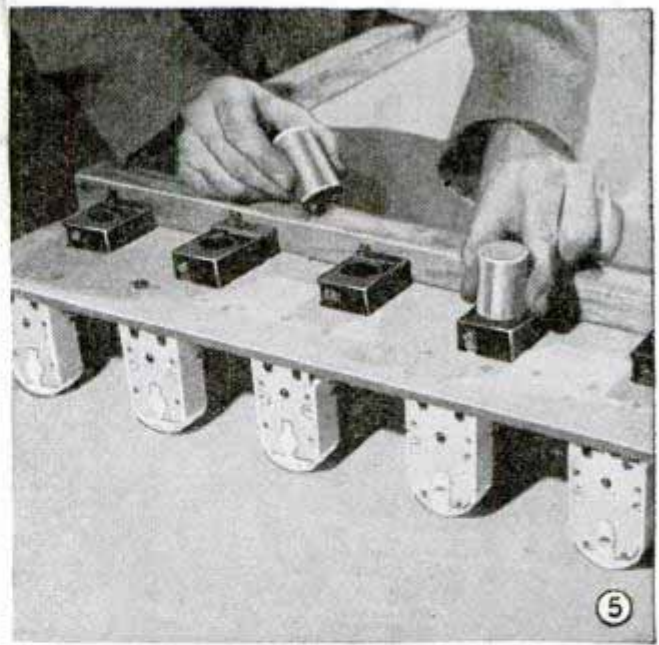

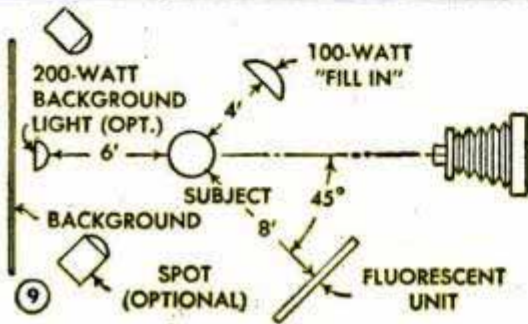
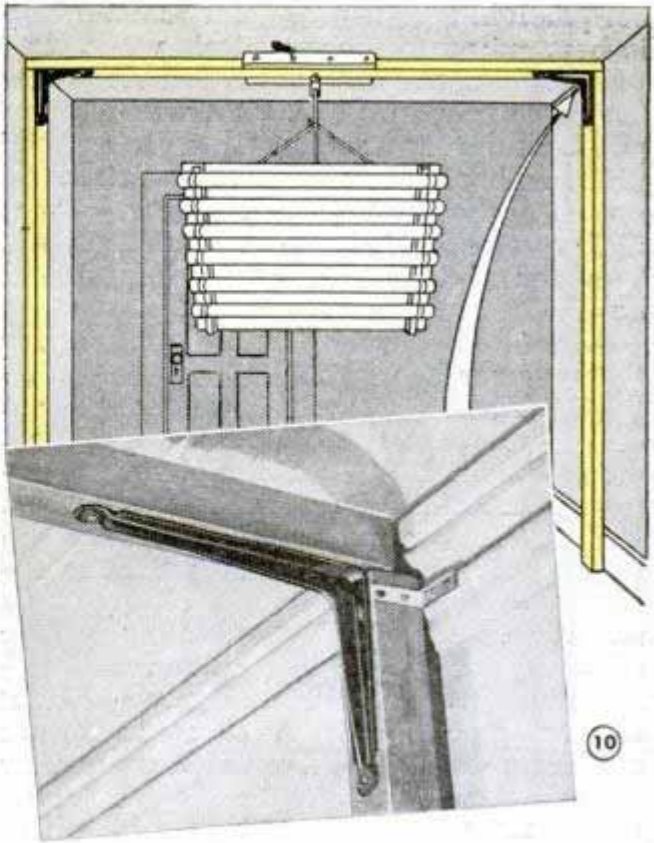
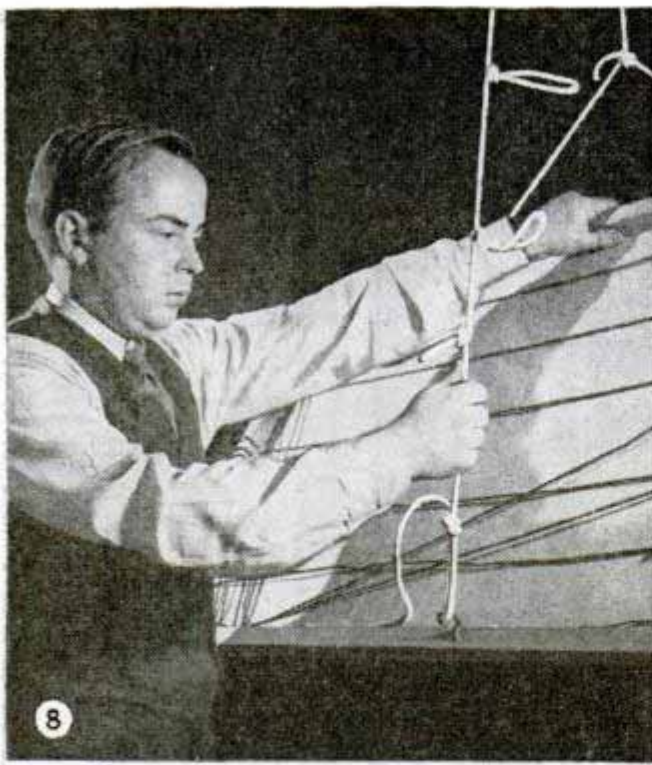

should be placed in back of the model. Fig. 9 shows the setup. Use a long focal length portrait lens so you can get in back of the unit and get a clearer image on the ground-glass screen.

Exposure is critical and you can over-

expose easily. When correctly exposed the negatives made with this unit have what is called luminosity and "roundness." Retouching will be minimized because of the large area of the light coming from the unit. If you use an inexpensive color correcting filter over the camera lens, the unit can be used with color film. Information on the correct filter to use should be obtained from the manufacturer of the film. Also, when using a light meter take the reflection reading from the face of the model at a distance of 2 ft. For enlargements, best results are obtained by using a slow paper.

Shaft Hangers From Pipe Fittings and Generator Bushings

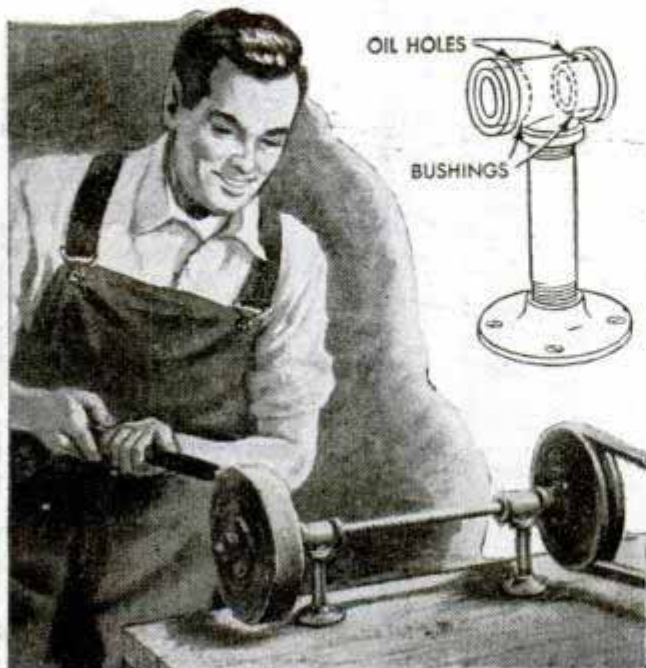

Shaft hangers for grinding wheels, buffers, etc., can be made with a few pipe fittings and some generator bushings. The outside diameter of the bushings should be such that they are a drive fit in the pipe tees after they have been reamed slightly. It may be necessary to ream the bushing also if the shaft is too tight a fit. The assembly is completed by fastening the tees to short lengths of pipe and floor flanges. Oil holes are drilled in the tees and oil cups can be screwed into these holes. A pulley is mounted on one end of the shaft and the grinding or buffing wheel on the other.

Raymond B. Stanfiel, Malvern, Ark.

ⓘ Mirrors never should be hung where the sun shines directly on them for any considerable length of time. A mirror exposed to direct sunlight may become cloudy.

Photo Timer and Enlarger Operated Together

If a switch is connected in series with the enlarger and in parallel with the timer, detail 1, the two will operate simultaneously. Any self-starting electric clock is used for this setup. The minute and hour hand are removed, leaving only the second hand. With a little work a reset device can be installed. The motor is removed and the shaft is threaded. Then the hand is replaced and the two washers, nuts and spring shown in detail 2 are added. The knob and catch which are shown in the lower left-hand detail are for the purpose of returning the hand to the 12 o'clock position. In operation, the knob is pushed in against the spring so the catch will engage the hand, and when the hand is set and pressure is removed, the catch will spring back.

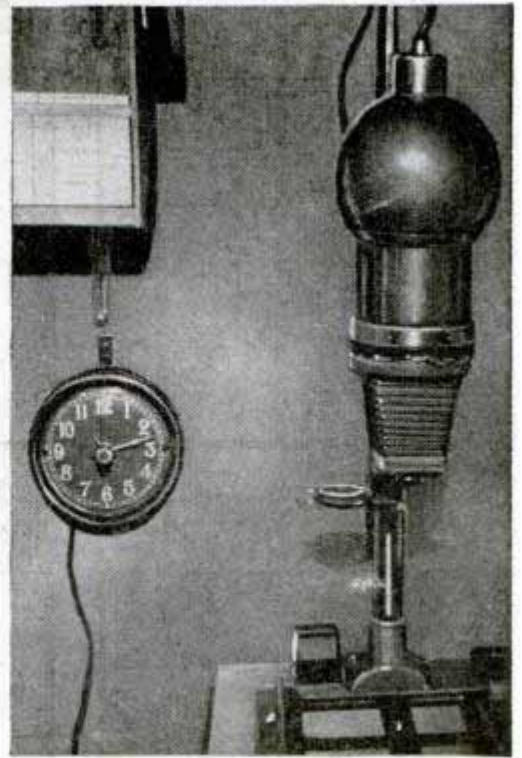
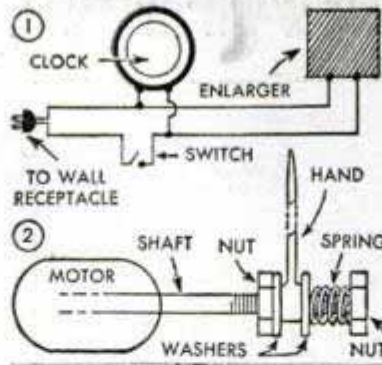

Acid Fixing Solution Is Tested With Outdated Film

Acid fixing solution can be tested by cutting a small piece of outdated film and placing it in the solution. Then the time required for the film to clear should be noted. If the hypo is exhausted, it will take more time for this to occur than is recommended by the maker of the fixing powder.

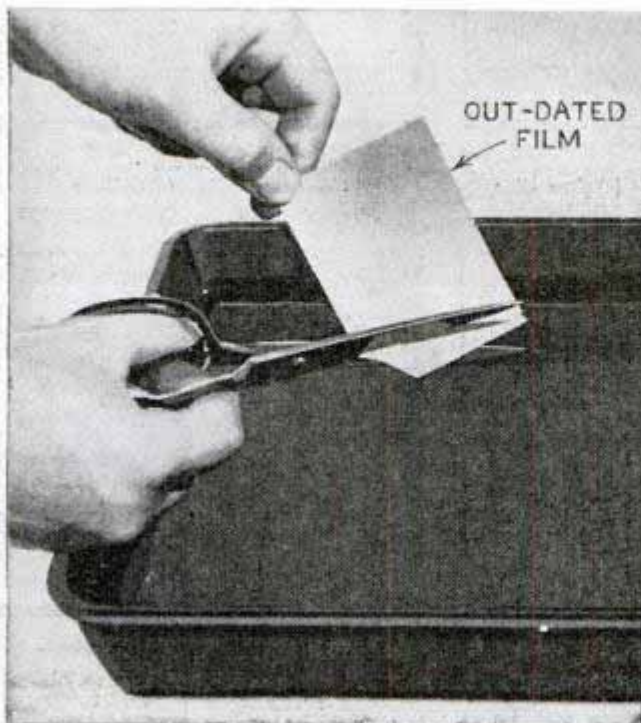

"Brushes" for Coloring Prints

In order to save time when tinting prints with water colors, try using medicine droppers as "fountain brushes." Procure a number of the droppers and wrap the tips with bits of cotton. Then insert a narrow clipping from the color book in each dropper and fill with water. The color will dissolve immediately and the "brush" is ready for use. This eliminates the use of separate dishes for each color, as well as continual cleansing of the brush.



Flash Data Given on Reflector

Printed tables are available giving data on shutter speeds and aperture openings for various types of flash bulbs now on the market. A convenient way to have such data at hand is to paste tables of the bulbs most often used on the back of the reflector.

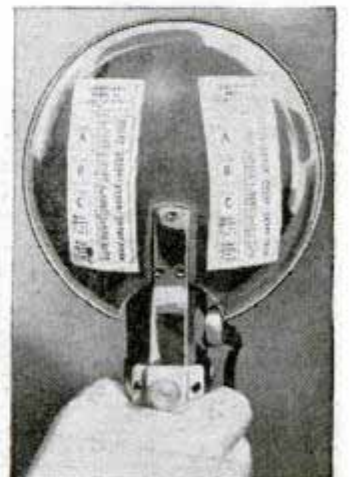

CRAFT QUIZ



1. He is using a—
 (a) Crosscut saw (c) Guard
 (b) Stop rod (d) Rip fence

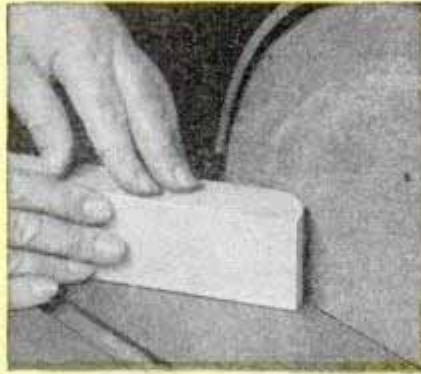

2. This red sanding disk is—
 (a) Flint (c) Open coated
 (b) Aluminum oxide (d) Garnet

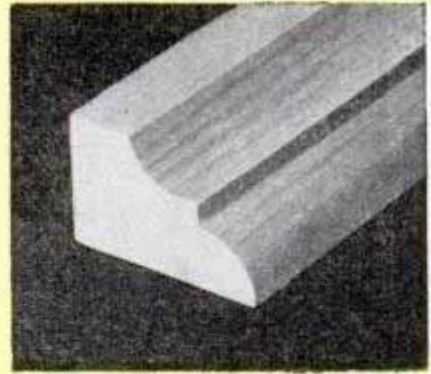

3. This molding is—
 (a) Double cove (c) Bead and cove
 (b) Cove and bead (d) Clover leaf

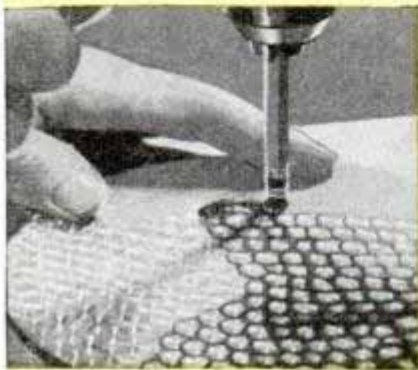

4. One name for this finish is—
 (a) Swiss (c) Engine
 (b) Round dot (d) Sparkle



5. This drill-press operator is—
 (a) Drilling wood (c) Drilling metal
 (b) Routing (d) Boring

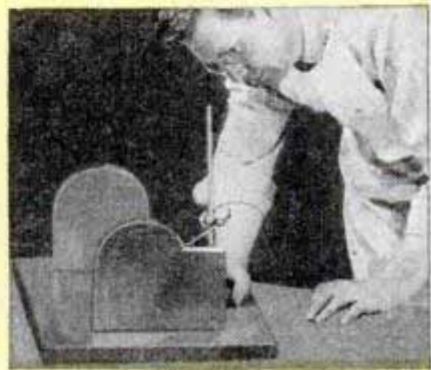

6. He is using a—
 (a) Combination square (c) Wiggler
 (b) Height indicator (d) Surface gauge



7. Spray painters don't like—
 (a) Lemon pie (c) Orange peel
 (b) Hash (d) Alligators

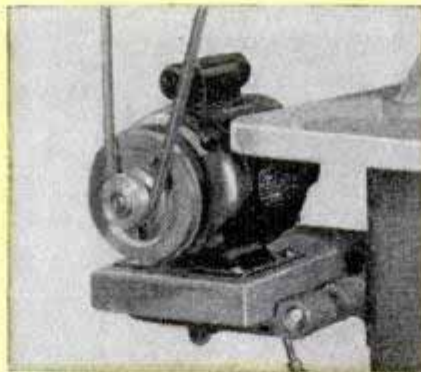

8. This motor is—
 (a) 1/2 hp. (c) Capacitor
 (b) Too big (d) Three phase

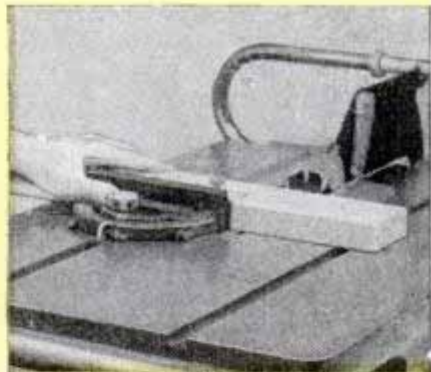

9. Wrong in this picture is—
 (a) Hand (c) Splitter
 (b) Saw blade (d) Miter gauge



10. He is using—
 (a) Slow speed (c) Overdrive
 (b) Cross feed (d) Slotting table

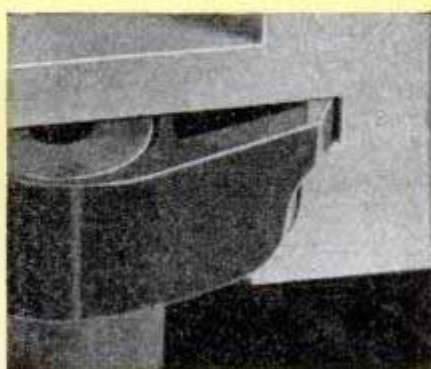

11. This wood shaper cut is called—
 (a) Undercutting (c) Edging
 (b) Thumb mold (d) Coping

ANSWERS: 1—b; 2—d; 3—b; 4—c
 (also called spot finish); 5—c (note
 pulleys — slow speed would not be
 used for wood operation); 6—d; 7—c
 (a faulty finish resembling orange
 peeling); 8—c; 9—a (should be at
 center of miter gauge); 10—b; 11—d

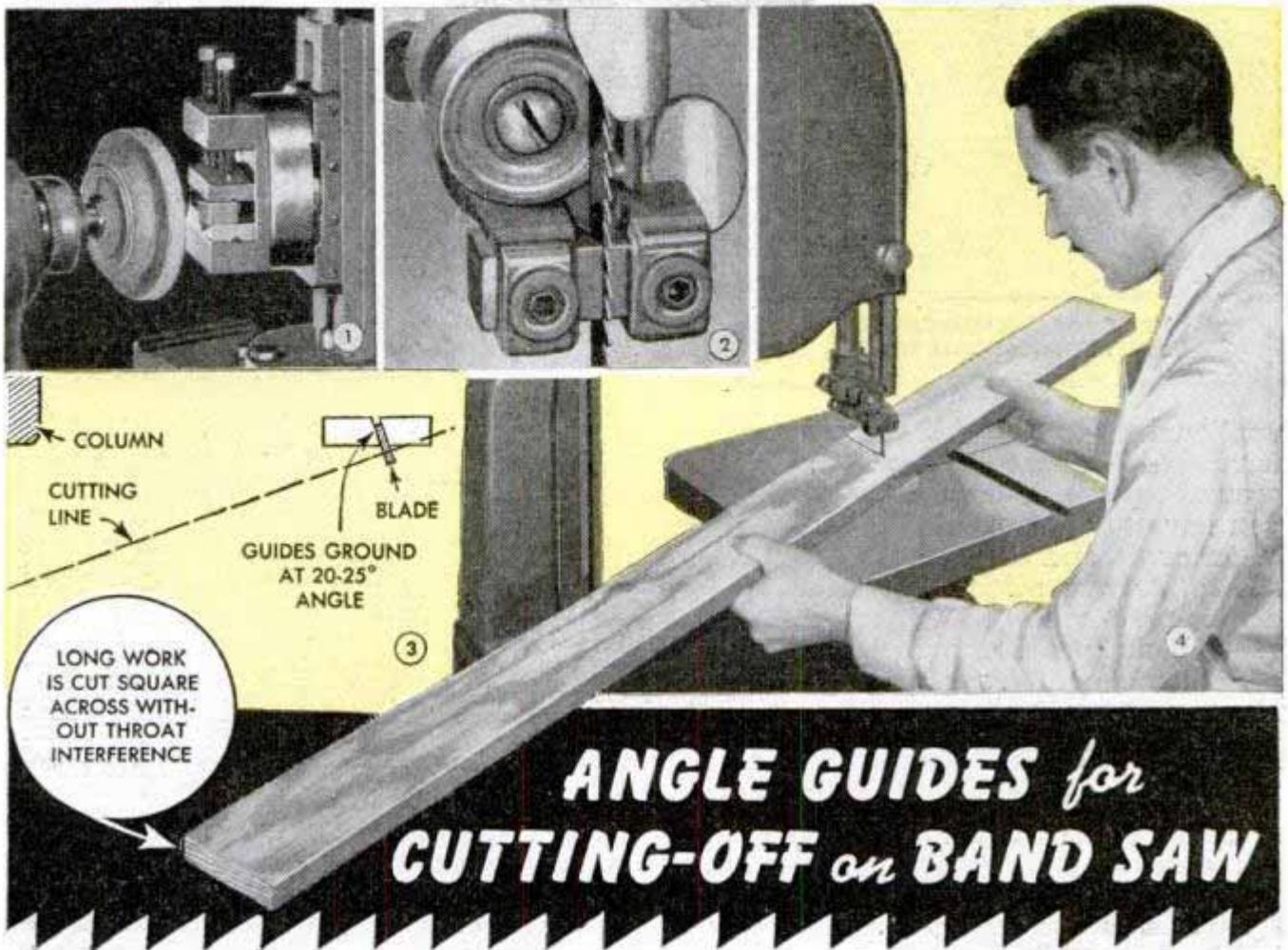

ANGLE GUIDES for CUTTING-OFF on BAND SAW

By Sam Brown

A simple twist of the blade and—presto!—your band saw can be used for square cutting-off on long work without throat interference. The best method of twisting the blade is to grind the guides at an angle of 20 to 25 deg. Fig. 3 shows the setup and Fig. 1 shows the grinding being done on a lathe with the use of a milling attachment. A close-up view showing the guides installed and ready for work is given in Fig. 2. With a 20-deg. twist to the blade, work of any length and up to 4 in. wide can be cut squarely across, as shown in Fig. 4. By backtracking and cutting from both sides an 8-in. board can be cut.

The angle guide blocks are needed only for the top guide, the bottom guide being backed off completely. Both blade supports or back-up guides are used in the same manner as for con-

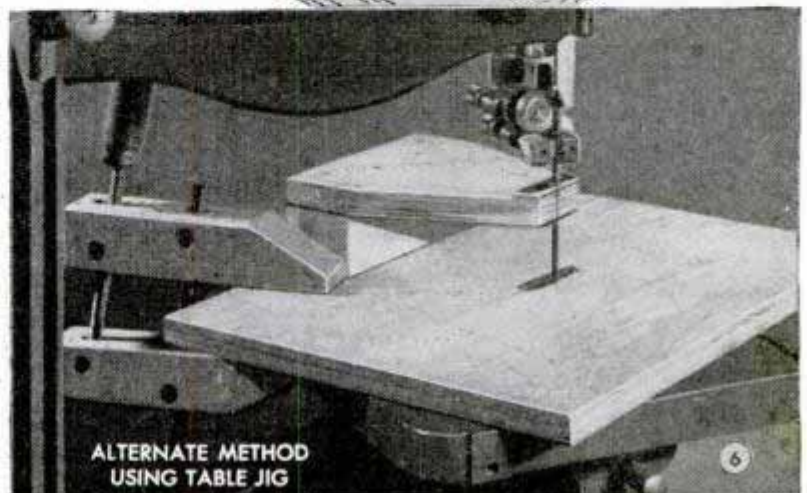
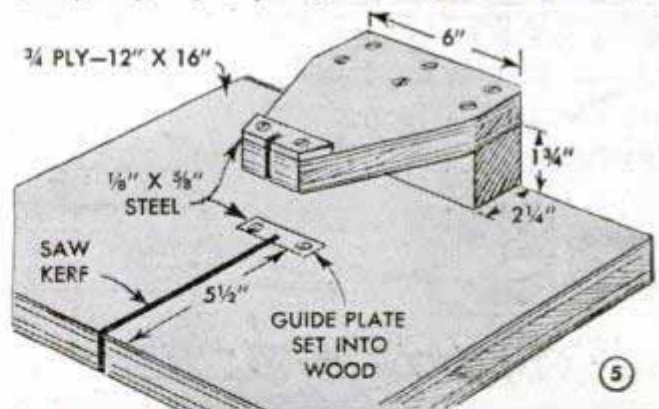

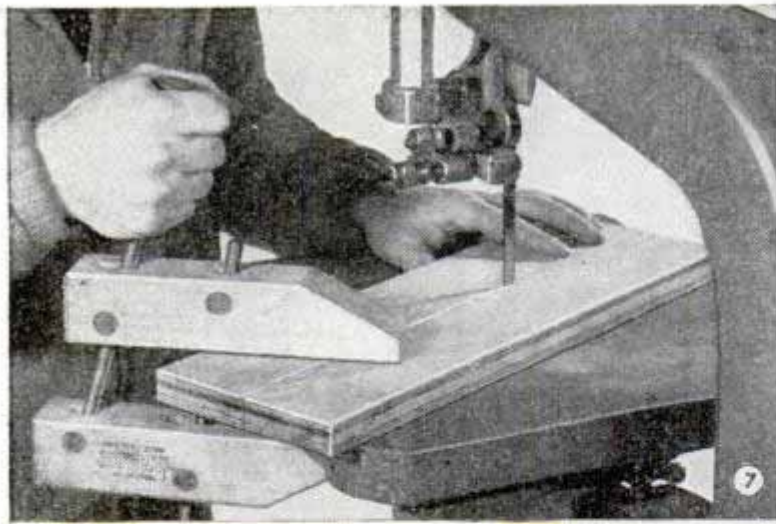

SIMPLE ANGLE BOARD CAN BE USED FOR OCCASIONAL WORK

ventional sawing. Most band saws have 1/2-in.-square guide blocks ground square at both ends—all you have to do is grind two ends at an angle and then reverse, as shown. A twist angle of up to 30 deg. is practical with the average 14-in. band saw, but best results are obtained with a smaller angle. Narrow blades work better than wide ones, the best size being the popular 1/4-in. width. No adjustment of the tracking is needed. This unusual band saw setup does not harm either the blade or the saw, although prolonged friction may eventually lead to blade breakage.

An alternate method of working is shown in Figs. 5 and 6. This employs an auxiliary wood table fitted with steel guide plates, Fig. 5. In use, the table is fitted over the

regular band saw table and then is turned to the required angle and clamped, Fig. 6. The regular blade guides are backed off completely, but both upper and lower blade supports are used.

Even simpler is the method shown in Figs. 7 and 8. All you do here is kerf a board halfway across, and then use this board to angle the blade, Fig. 7. As before, the regular guides are backed off, but both blade supports are used.

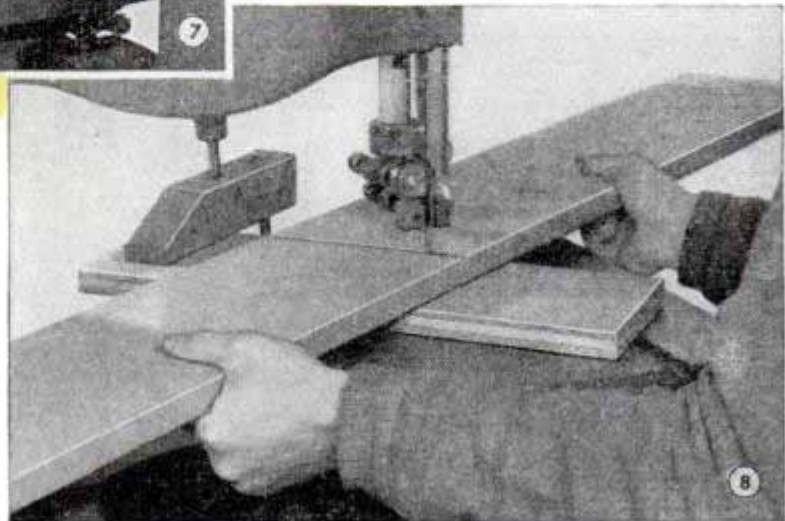
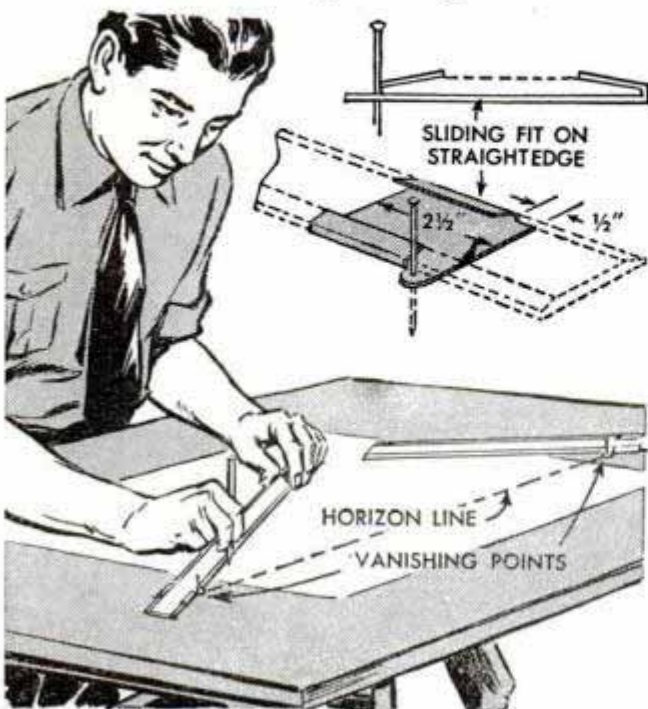

Fig. 8 shows this setup being used to cut a 6-in.-wide board in one pass.

For continuous working, such as cutting packing-box material, the blade should be 1/4 in. wide, with a good amount of set. The heavy set of the blade will permit lubrication of the guide pins with paraffin or wax, and the lubricant will not rub off quickly in the wide saw kerf.

Pivoted Straightedge Is Aid When Drawing in Perspective



To facilitate drawing when working in perspective, or when making exploded views, one draftsman uses this sliding guide in which the straightedge pivots. In the case of perspective drawings, the part of the guide that fastens to the board is pinned on at the vanishing point. By using two rules the drawing is made in a short time. The guide is cut from light metal to the dimensions given.

C. L. Meehan, Toronto, Ont., Can.

Welded Ends on Stranded Cable Will Not Unravel

The ends of stranded steel cable will not unravel if they are arc welded. First wrap light wire around each end and grind smooth. Then clamp the cable tightly in a grounded vise and run a light bead over the strands to weld them together.

Frederick Boch, Taylorville, Ill.

Barn Windows Are Controlled By Differential

Dairy and other barn windows may be opened and closed, or opened and held in any position, by using an auto differential, some pipe, a few hinges, some flat iron and an old steering wheel. No overall dimensions for the linkages can be given as the size and location of the windows will be determining factors in every case. The axle housing should be cut at a point about 6 in. from each end of the gear case and 1/2-in. pipe should be welded to the ends of the axles. The drive shaft should be shortened and the steering wheel attached to it. A linkage arrangement such

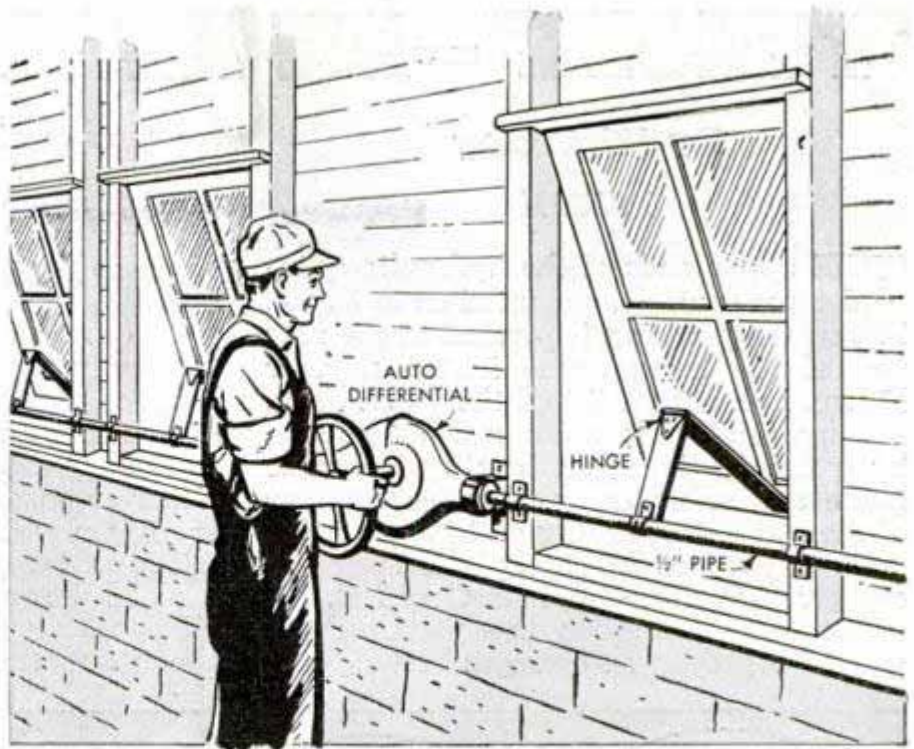

as is shown for attaching the window to the pipe will complete the assembly.

Wm. P. Houser, Organ, N. M.

Cardboard "Shelf" Fastened to Wall Will Keep Drillings Off Floor

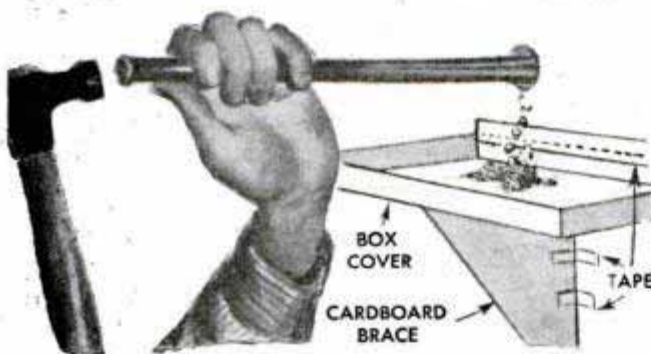

When drilling holes in a wall with a star drill, or when making a repair on a plastered surface, a cardboard "shelf" made from a shoe-box cover will keep plaster and other debris from falling on the floor. To support the shelf, cut a brace from stiff cardboard in the form of a bracket and tape it to the cover and to the wall. This will serve to support the shelf and its load safely.—Andrew Vena, Philadelphia, Pa.

Stand for Holding Transmission Case Can Be Made of Pipe Fittings

It's difficult to work effectively on an automobile transmission unless you have some means of holding it rigidly. One quick and easy way of assembling a stand is to turn a pipe nipple into the bottom drain hole in the transmission housing, then screw a matching floor flange to the bench top in a convenient position. Screw the nipple into the floor flange by turning the transmission slowly until the nipple tightens securely in the flange.

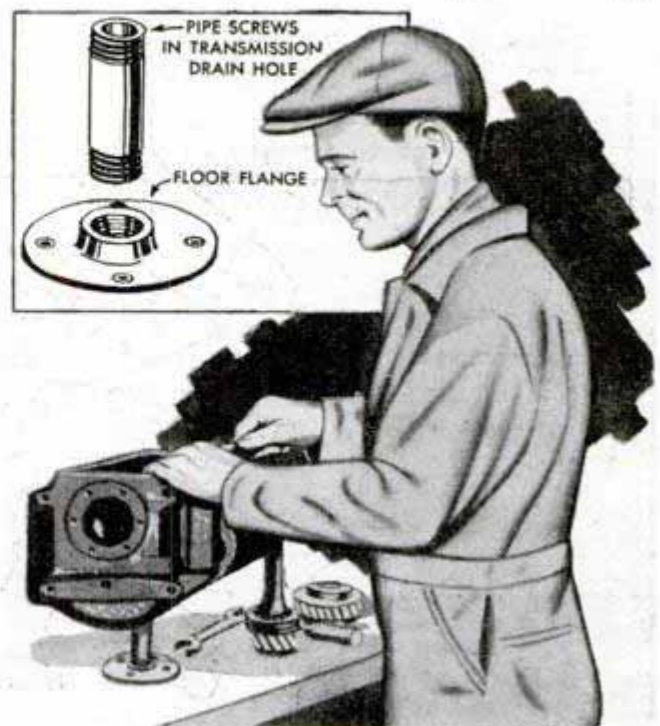

Water Lowers Tank Into Hole

If you have occasion to lower a large storage tank, oil drum or other bulky container into a hole, and have no helper to assist in lowering it, you can easily do the work yourself by filling the hole with water and sliding or rolling the tank in place. Then, when you pump out the water or let it drain away, the tank will settle gradually to the bottom.

"FEEJEE"—AN ALL-PURPOSE

By Hi Sibley

PART II

THE upper ends of the hydraulic-cylinder plungers are mounted as in Fig. 4, B, and the platform is pivoted at the rear end of the truck frame in the manner shown. For a high lift of the truck body, the hydraulic lift units are lengthened by removing the upper head and plunger guide and substituting a longer cylinder of seamless steel tubing and longer bolts.

Dimensions of the steel platform or bed are given in Fig. 4, details C and D. All parts which comprise the platform are welded together, as strength and rigidity

are necessary in this unit. The overall size as detailed was found to be the most practical for all ordinary purposes and, due to the low center of gravity, there is little danger of tipping even with comparatively high, bulky loads. When you have heavy parts or materials to load you'll appreciate the low platform. The full-box and half-box body were referred to in the first installment of this story, and dimensions were suggested for these parts. Of course, either or both of the boxes can be altered to suit any special requirements.

The next step is the mounting of the rear-wheel disks on the brake drums of the rear axle. Refer to Part I, Fig. 3, detail F, which shows how the wheel disks are welded to

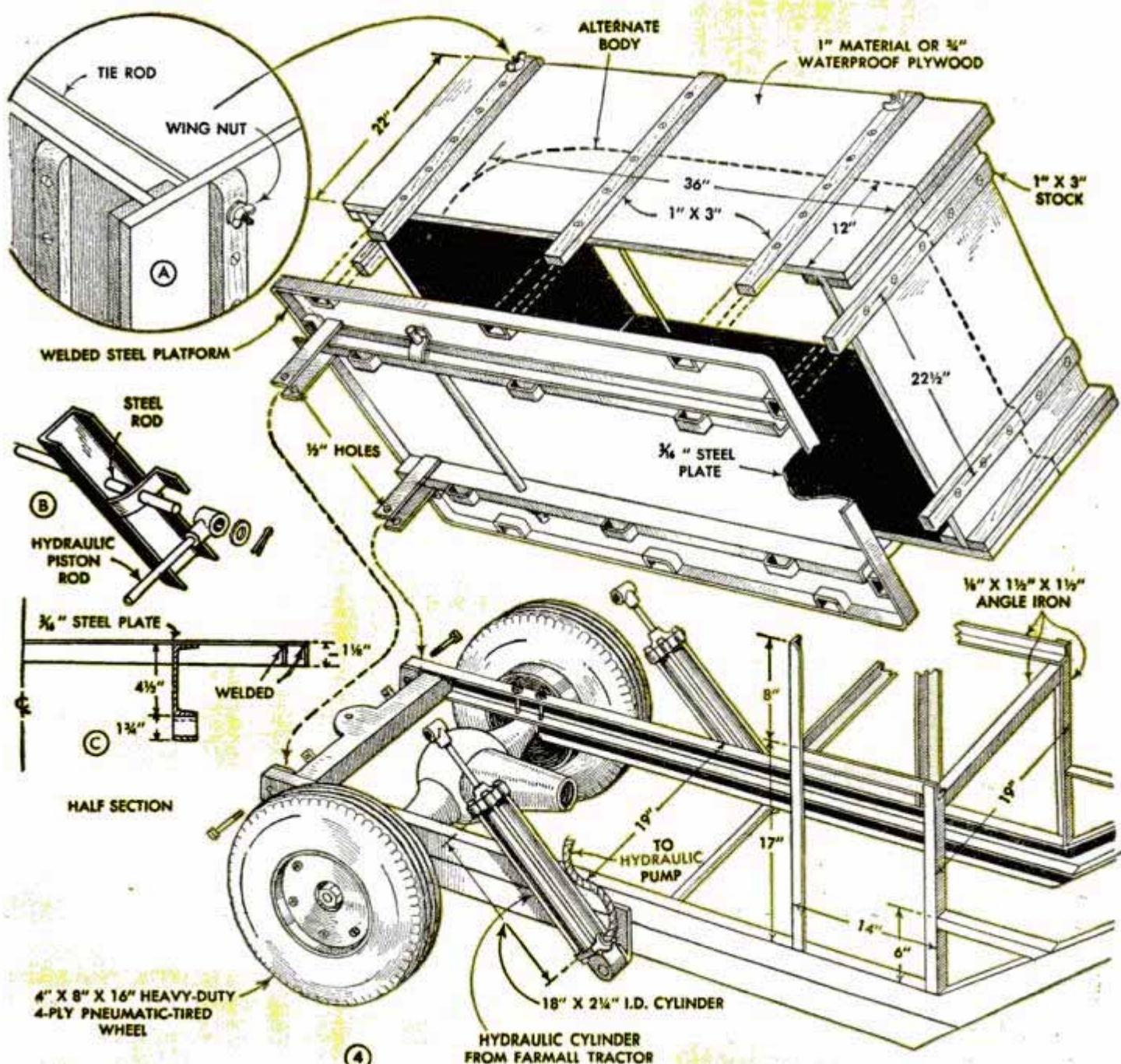

DUMP TRUCK

the brake drums. As you can see from Fig. 4, the wheels are 4 by 8 by 16 in. in size and are fitted with 4-ply pneumatic tires. Two-ply tires in the same size will not be satisfactory for the purpose except perhaps for very light loads. Although it is possible to bolt the 8-in. wheel disks to the original axle-wheel flanges by means of spacers, this method is not as satisfactory as welding the disks to the drums. As a rule, wheel disks of the type used consist of two halves held together with bolts and, as these will be inaccessible after the disks are welded to the drums, it's a good idea to weld the bolt heads beforehand to prevent them from loosening or turning. Care must be taken when welding the disks in place to

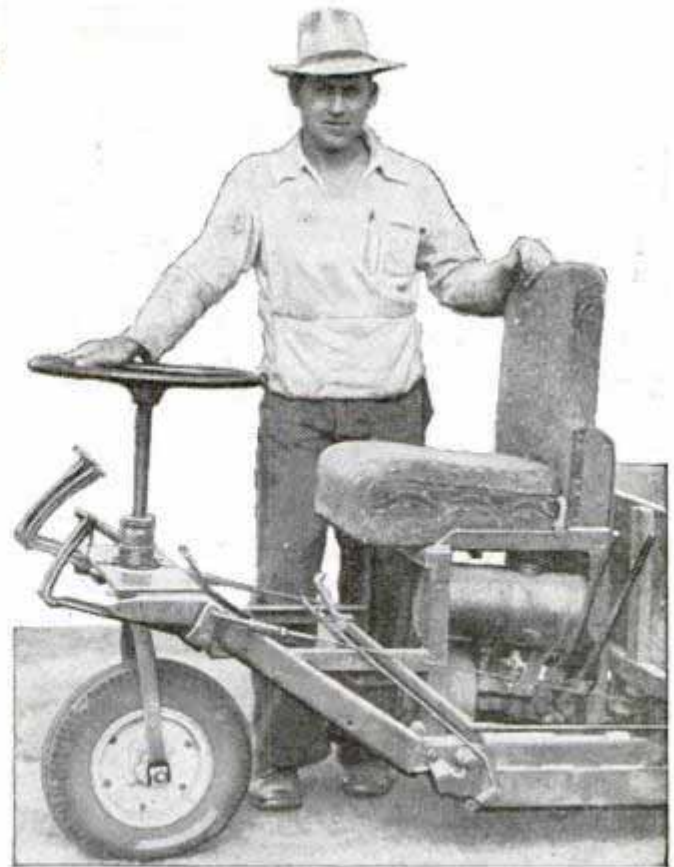

As you see here, the truck has a comfortable spring-cushioned seat mounted on an angle-iron frame

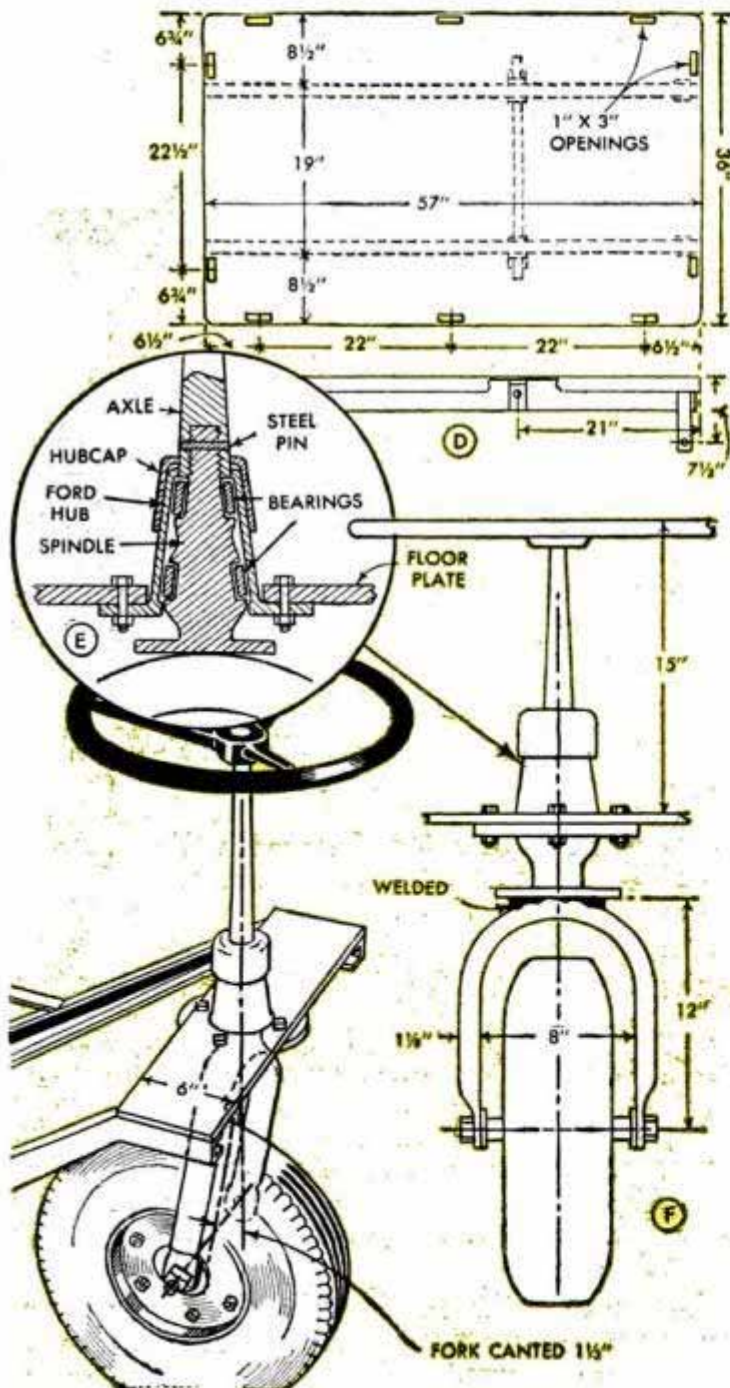

assure true-running wheels. Even a slight wobble will result in undue wear on the tires. The drums should be cleaned thoroughly before reassembling and, if necessary, the brake shoes should be relined.

Another welding job calling for the same care and precision is the assembly of the front-wheel fork, bearing and steering post. Details of this assembly are shown at E and F in Fig. 4. The front wheel is the same size as the rear wheels, but of course the hub and bearings are retained. The wheel fork is made from $1\frac{1}{8}$ -in. seamless steel tubing bent to the shape indicated. The ends are flattened before bending and are drilled to take a steel shaft having both ends shouldered and threaded for nuts and lock washers. This work can be done in a lathe. When mounting the wheel in the fork it may be necessary to use spacers at both ends of the hub. Short lengths cut from ordinary iron pipe will do, but the spacers must be a close fit on the shaft and the length must be such that the hub of the wheel has about $\frac{1}{16}$ in. end play when the assembly is complete. The hub should be provided with a pressure grease fitting. A steering-post bearing, Fig. 4, E, is adapted from a Ford front-wheel hub and the steering shaft is made up from a length of the live axle which was removed from the rear-axle assembly when cutting it down to a narrower tread. One end of this shaft is drilled and tapped to screw over the threaded end of the spindle, to which it is

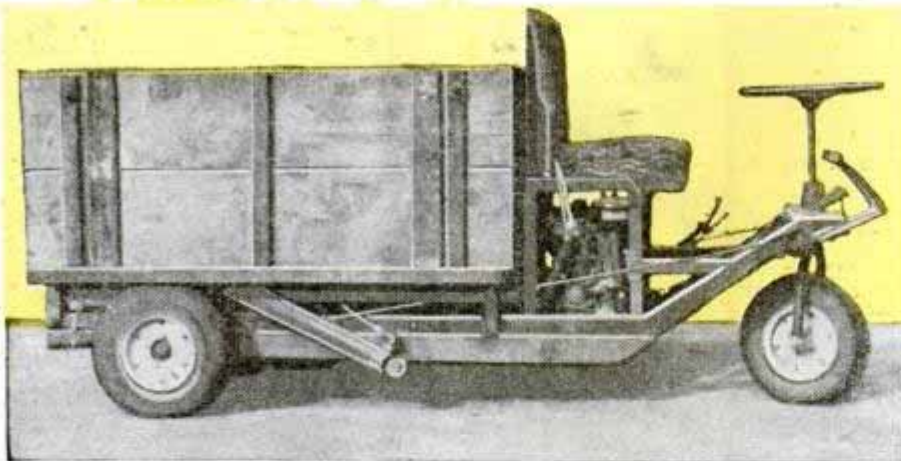

When fitted with the full-box body the truck will handle loose grain, ensilage, ground feeds or any small, loose parts of either metal or wood

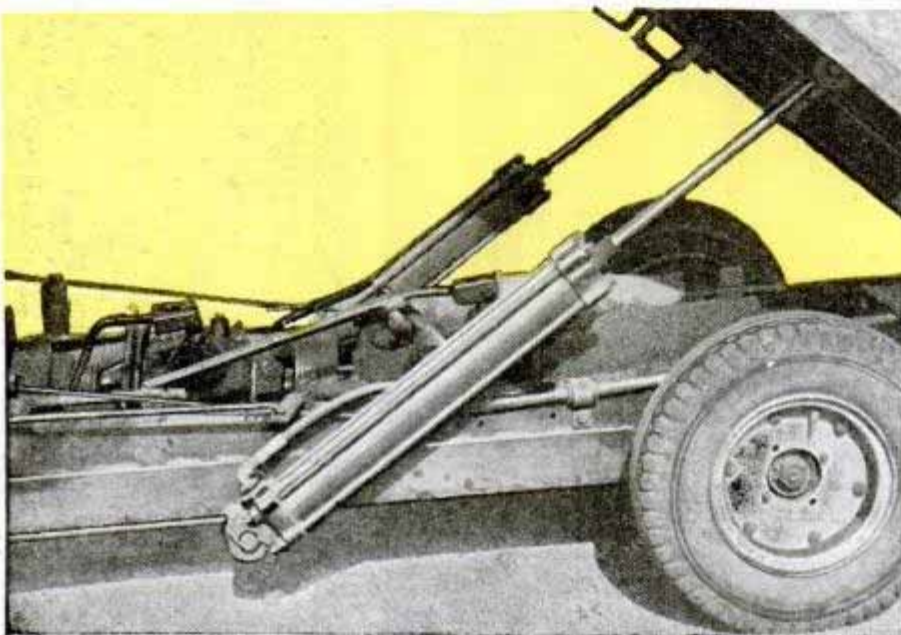

For a higher body lift the original hydraulic cylinders are easily lengthened with seamless steel tubing of the same diameter and longer stay bolts

making the assembly the wheel fork is welded to the end of the spindle and when making this weld care must be taken to cant the fork back $1\frac{1}{2}$ in. at the lower end. This arrangement gives the wheel the proper caster for stability and ease of steering. Before assembling the steering column completely, ream the outer end of the hub cap to a close fit over the steering shaft to keep out dirt and grit. Provide a pressure grease fitting for convenient lubrication of the bearing. When assembled in the truck frame it's important that the wheel, fork and steering column stand on a perpendicular center line as in detail F, Fig. 4. If the wheel is off-center or the column cants in relation to the frame the truck will not steer properly.

As the final step in the construction you have the seat frame, Fig. 4, and perhaps a few minor adjustments of pedals and control levers to assure that everything is in working order. The seat can be just about anything that suits you individually so long as it is safely constructed and serves the purpose. By fitting cushions from an ordinary auto seat in the angle-iron seat frame you finish up with something like that shown in several of the photos. And finally, although the truck will run just as well without painting, a coat of outdoor enamel will add to its appearance and keep off the rust.

(THE END)

pinned as indicated. The opposite end of the shaft is machined and threaded to take a 16 or 18-in.-dia. steering wheel. Usually a steering wheel of this type is keyed to the steering shaft with a semicircular or "half-moon" key. This work can be done in your local machine shop. The wheel-mounting flange is bolted to the floor plate of the truck frame when assembly is made. In

safely constructed and serves the purpose. By fitting cushions from an ordinary auto seat in the angle-iron seat frame you finish up with something like that shown in several of the photos. And finally, although the truck will run just as well without painting, a coat of outdoor enamel will add to its appearance and keep off the rust.

Sure-Grip Tongs for Light Work Improvised From Spring Paper Clip

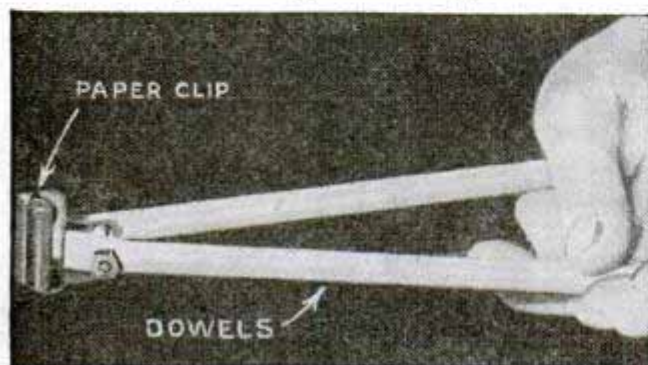

A pair of lightweight tongs to handle small pieces of hot metal or wire can be made from two lengths of dowel and a spring-type paper clip. Flats are cut on one end of each dowel to fit them to the handles of the clip and the dowels are fastened to the handles with small stove bolts.

☞ To preserve the finish properly, a car should never be washed in the sun or when its surface is warm.

How to Build an Irrigation Head-Gate Frame

An irrigation head-gate frame to regulate the flow of water in irrigation ditches can be made at a very low cost and will conserve the water supply. The width and height of the frame should be such that it will fit outside the bell of the tile. Two lengths of flat iron are used for the horizontal members and two lengths of angle iron are used for the vertical members. The frame is welded and four nuts are tacked to the inside leg of each angle to serve as slides for the gate. Then two bolts with nuts screwed on are welded to each corner of the frame to serve as anchor bolts to hold the frame in a concrete wall. The head gate, with a handle made of flat iron, is cut from heavy sheet metal to fit between the slides. Some provision must be made to hold the gate at the desired height. The frame is set in concrete when the form is poured.—Don L. Helt, Fort Collins, Colo.

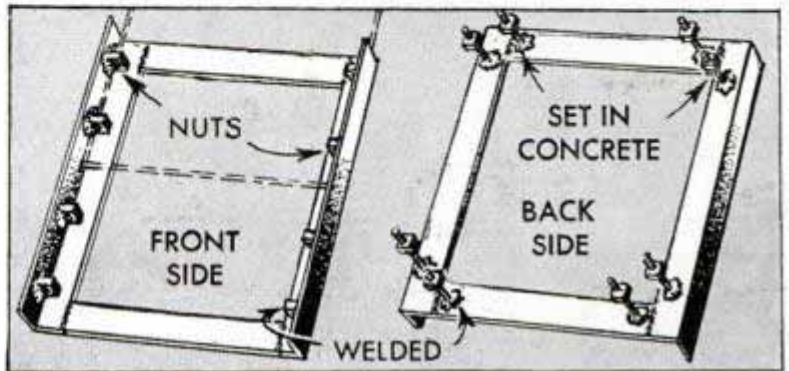
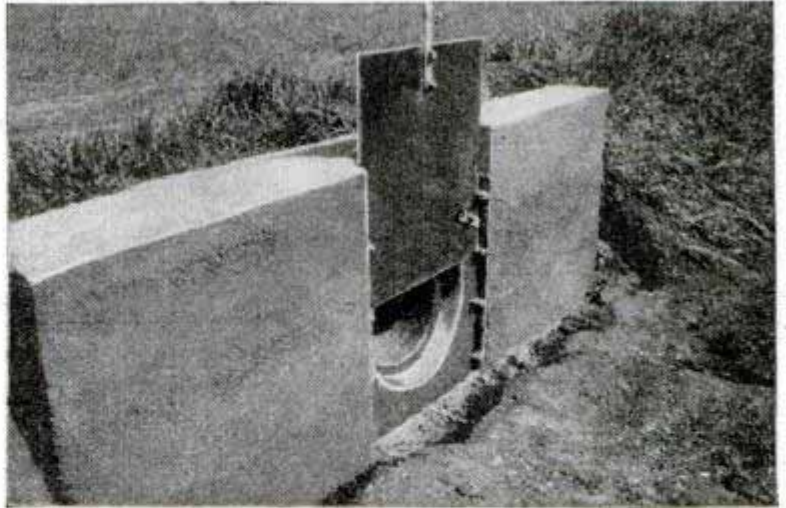

Split Garden Hose Fastens Flag On Projecting Truck Load

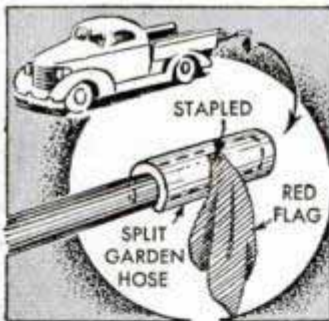

To attach a warning flag to pipe and similar loads projecting from the rear of a truck, staple one corner of a piece of red cloth to a short length of garden hose that has been split

lengthwise to slip over the pipe. When the load consists of lumber, use a short section of automobile tire casing in the same manner and slip it around the end of the longest board.—Kenneth Murray, Colon, Mich.

Hacksawing in Close Quarters

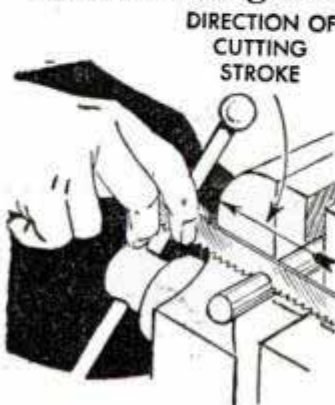

When it is necessary to use a hacksaw in close quarters where the frame cannot be inserted, remove the blade and use it with the teeth pointed toward you so the cutting is done when the blade is

pulled forward. When done in this way, there is no tendency for the blade to buckle.—Cpl. Jack L. Masters, Aberdeen Proving Ground, Md.

Handle Used on Drawing Board

A screen-door handle fastened to one side of a drawing board with wood screws is convenient for the draftsman when making field sketches. The handle should be attached to the top edge of the board so that it will be out of the way when sketching.

T. C. Evans, Fort Wayne, Ind.

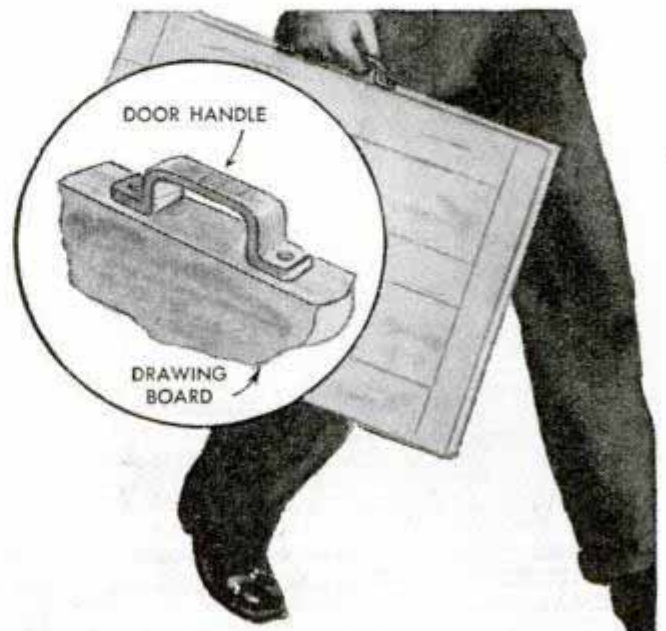

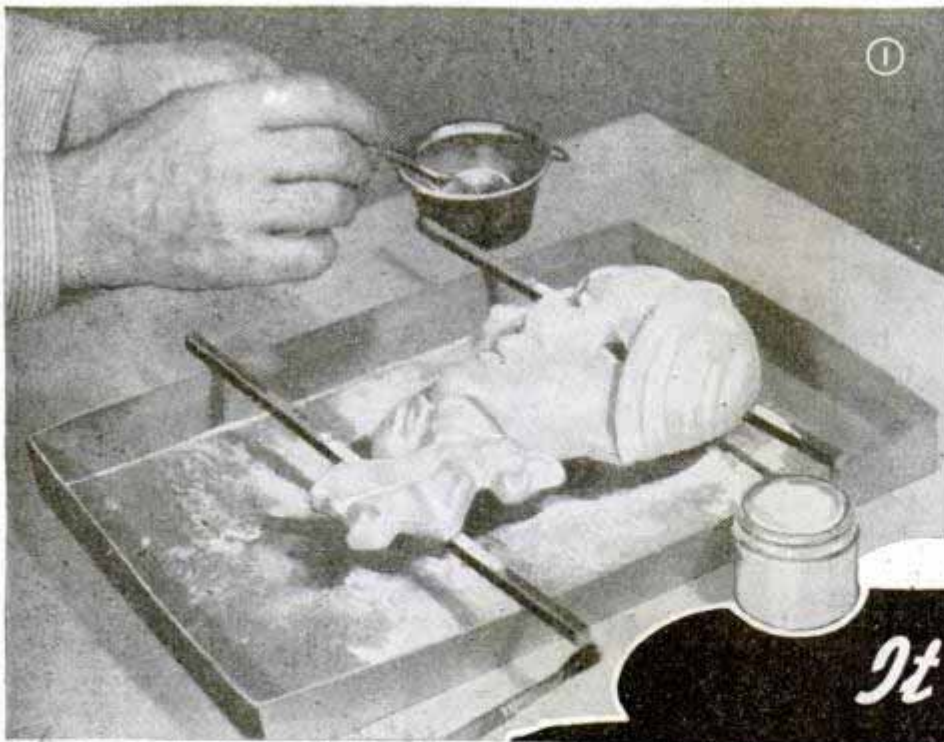

Photos courtesy Black Light Products

It GLOWS

By J. Cornell Richardson

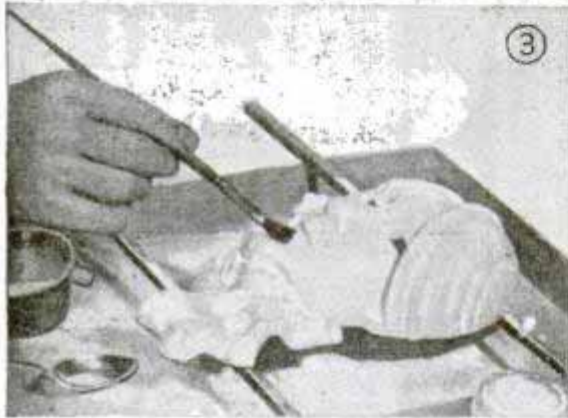

Application by dusting
is done by sifting luminous powder over wet varnish coat to which the powder adheres

POPULARIZED by varied uses, luminous paints and allied products find a steady and increasing use in industry, the home and "just for fun." Luminous paint is available in several in-the-dark colors, as is luminous pigment, and has a usable glow life of 15 minutes to 10 hours, depending on the kind used. A few of many products available are shown in Fig. 4.

Application by dusting: One of the most direct and best methods of applying luminous pigment is by dusting it on paper, novelty figures or other items. Applied to a mask, this process is shown in Fig. 1. The mask is coated first with a white-varnish enamel. After this has set for about 5 min. and while still tacky, the luminous powder is dusted on by sifting through a tea strainer or other sieve of about 40 mesh. After standing another 20 min., the excess powder is brushed off, as in Fig. 3, and the surface gently burnished. The object, when thoroughly dry, is finished with a clear top coat of shellac. This method gives a uniform coating which glows when the object is placed in the dark, Fig. 2.

Shadows are fun: In a darkened room, take a sheet of luminous paper and hold it behind your head, as shown in Fig. 6. Have someone turn on a light (a 100-watt lamp) so that your head casts a shadow. Hold the pose for about 5 sec. Turn out the light. In the dark the protected part of the sheet will show your shadow, Fig. 5, while the rest of the sheet, after exposure to light, will glow. This makes an interesting "guess what" party stunt by lumi-photographing hands or small objects. The luminous paper should be treated just like photoprinting paper—keep it in the dark or face down until you are ready, then expose and, finally, view it only in the dark. The best paper is one with a brilliant initial glow,



(4)

PIGMENT ... IN POWDER FORM VARIOUS COLORS

GUMMED TAPE ... WIDTHS TO 3"

COATED PAPER AND PLASTIC SHEETS

PREPARED PAINT

PLASTICS ... FLEXIBLE SHEETS AND PIGMENT-FILLED TUBES

Luminous products
... ARE VARIED AND INCLUDE A WIDE ASSORTMENT OF MATERIALS

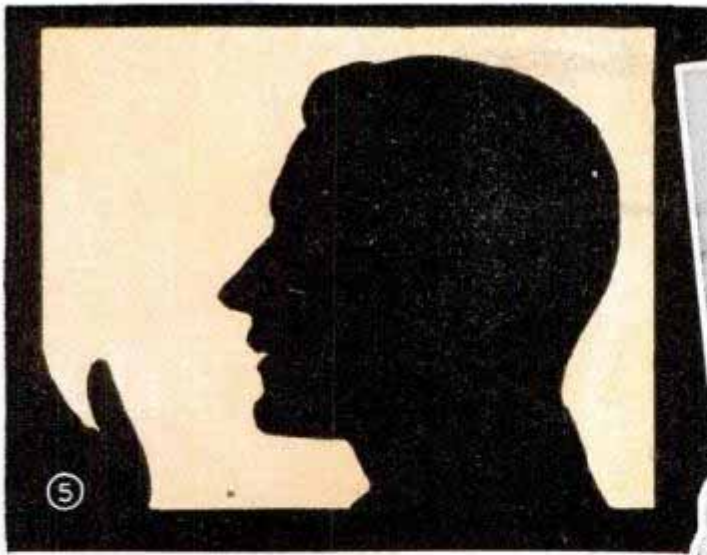

LUMINOUS PAPER



in the **DARK**

but having a short life of about 15 min. This will permit repetition of the stunt after a short interval so that three or four sheets will keep the performance going indefinitely.

Luminous crayons: Wax-base luminous crayons are available in the same colors as the paint and pigment. These can be used in any way an ordinary crayon would be, and they also have the added advantage of being visible in the dark.

Ways to make signs: By one method, the lettering is blocked in with black or other color paint, as shown in Fig. 10. This kills the glow so only the non-painted area shines in the dark. Fig. 11 shows this sign by day, the coloring of the letters being an off-white. Fig. 12 shows the sign by night—it will glow blue, green, violet or yellow depending on the color of paper you choose. A second method calls for spraying the letters directly with luminous paint. Fig. 13 shows a sign being sprayed, and Figs. 14 and 15 are day and night representations. The ground color of the panel is nonluminous dark red. Since luminous paint has practically no covering power, it is necessary first to spray the letters with white paint and then apply luminous paint over the white coating. This double operation is made easy by masking. Both of these methods can be reversed; that is, make the background glow and have the lettering nonluminous. Signs also can be cut out of luminous paper and pasted on a stiff cardboard panel, as indicated by Figs. 7, 8 and 9.

Shadows are fun
Here's one time you can walk away from your shadow if you cast it on luminous paper



⑦ SIGN LOOKS LIKE THIS BY DAY



⑧ THE LETTERS GLOW IN THE DARK

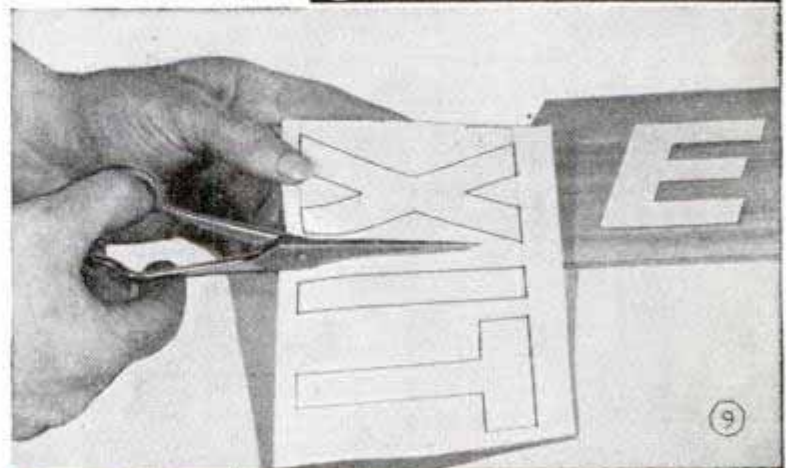

Cutout letters and figures of luminous paper provide a simple and inexpensive way of decorating rooms, making signs, etc. You can purchase plain or gummed-back paper for this purpose

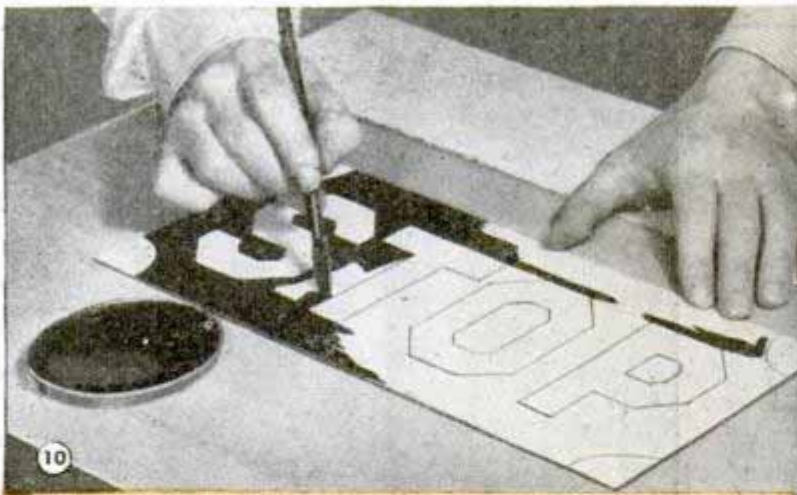

Two methods of making signs

First method, above, uses luminous paper with letters cut in with ordinary paint. Second method employs luminous paint sprayed directly over letters which should be painted white

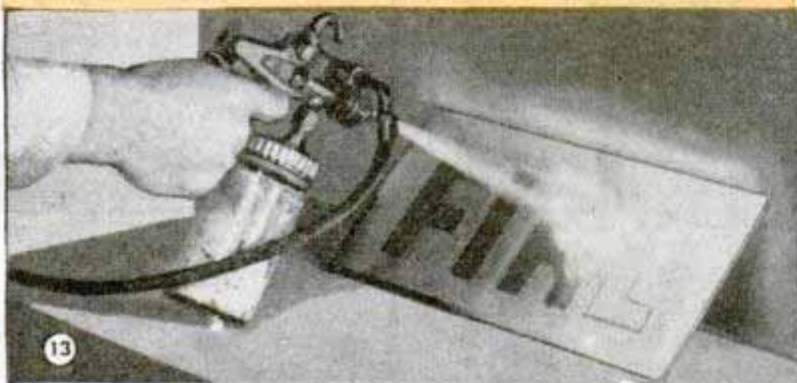

Making paint: Paint should be mixed 4½ lbs. of pigment for each gallon of vehicle. Use the chart, Fig. 30, for smaller quantities. Coverage is about 100 sq. ft. per gallon. The vehicle, Fig. 16, can be any clear neutral lacquer, any clear spirit varnish or most kinds of clear synthetic. Vehicles containing linseed oil, lead, manganese or cobalt, or having high moisture content or absorption, should not be used since these materials react chemically, causing reduction of glow. Homemade mixes may show a certain amount of jellying after standing several days and should be used immediately. Actual mixing is simply a job of stirring—no attempt should be made to grind the paint because breaking down the particles will kill the glow to some extent. Your homemade mix will settle quickly and should be stirred frequently. To retard settling and hardening, add either talc or titanium dioxide. Obtain twice the amount of vehicle required to make the paint. Keep one-half of this amount for an undercoat and overcoat. Whenever a white base is indicated, such as over metal, wood or glass, lithopone should be added to the undercoat until the required opacity is reached. The overcoat serves to protect the paint from moisture and cleaning operations.

Purchased paint: The vehicle commonly used is a synthetic—methyl methacrylate, vinyl acetate, alkyd resin and others. When you buy luminous paint, be sure to order thinner to match, Fig. 31. These paints are very heavy-bodied and usually require some reduction.

How to apply luminous paint: The surface must be white. Luminous paint has no great degree of opacity and will not cover dark or dirty marks on a white panel, Fig. 29. Further, the white panel must not be lead paint. The most satisfactory surface is the undercoat previously described. Smooth brushing is much more difficult with luminous than with ordinary paints, and the best practice is to apply three or four thin coats rather than one heavy one. For delicate work, such as the silk-screen process, a pigment especially formulated for fine texture should be used. Spraying is simple with light equipment if the paint is thinned to suit. All work must be coated heavily and uniformly in order to have an even glow. Be sure to apply the overcoat to all work.

Pigments: Pigment data is given in the table, "Characteristics of Phosphorescent Pigments." All pigments are sulphides, nontoxic and nonpoisonous, and should not

be confused with radium paints. Selection of pigment usually is made on the basis of intensity and life of glow. With the exception of zinc sulphide, all are sensitive to moisture so it is a good idea to treat all as moisture-sensitive. Any contact with water or moisture turns the pigment a dirty gray day color and practically kills all glow. The particle size of all pigments is relatively coarse, averaging 20 microns. While this is practically invisible to the eye, it is several times coarser than ordinary paint pigments. The glow color of the pigment is most pronounced immediately after activation but fades to white at about the halfway mark of full glow duration. Figs. 17, 18 and 19 show the relative life and intensity of strontium, zinc and calcium, respectively. As a general rule, pigments with the most intense initial glow will have the shortest life. All pigments can be reactivated indefinitely—they will last for years indoors and from 1 to 2 years outdoors.

Activation: The luminous coating must receive light before it will glow in the dark, Fig. 20. The period of activation need not be more than from several seconds to a



Making paint
is simply a job of stirring pigment into vehicle, such as lacquer or clear synthetic varnish.

minute and prolonged activation does not increase the glow. Any light source such as sunlight, electric light, flash light or even the light of a match will activate luminous material. It is well to remember, however, that the weaker the light, the longer is the required period of activation. Dip coating of light bulbs is practical and has little effect on regular lighting intensity, Fig. 21. An example of poor activation is shown in Fig. 22; basement stairs seldom get enough light of any kind to activate them strongly.

Intensity of glow: See Fig. 23. If you light an ordinary kitchen match and hold it about 2 ft. from a light-colored wall, you will get about the illumination possible with a

CHARACTERISTICS OF PHOSPHORESCENT PIGMENTS					
Pigment	Color 1 in Dark	Particle Size 2	Intensity of Glow	Period of Glow	Stability
Strontium	Blue	Coarse	High	8-10 Hrs.	4 Very Sensitive to Moisture
Zinc	Emerald	Medium	High	1 Hour	Stable
Calcium	Violet	Coarse	Medium	10-12 Hrs.	4 Very Stable Indoors
Zinc and Cadmium 3	Orange-Yellow	Coarse	High	15-30 Min.	Stable
Calcium and Strontium 3	Blue-Violet	Medium	Medium	10 Hrs.	4 Moisture Sensitive
Strontium and Zinc 3	Green	Coarse	High	8-10 Hrs.	4 Moisture Sensitive
Strontium 3 and Calcium	Green-Blue	Coarse	Medium-High	10 Hrs.	4 Very Sensitive to Moisture

1. Fades gradually to white in all cases. Day color of all pigments is off-white.
2. Runs from 10 to 40 microns. Very much coarser than ordinary paint pigments.
3. In all mixtures, pigment named first predominates.
4. Must always be protected with clear top coat . . . loses glow when exposed to moisture.

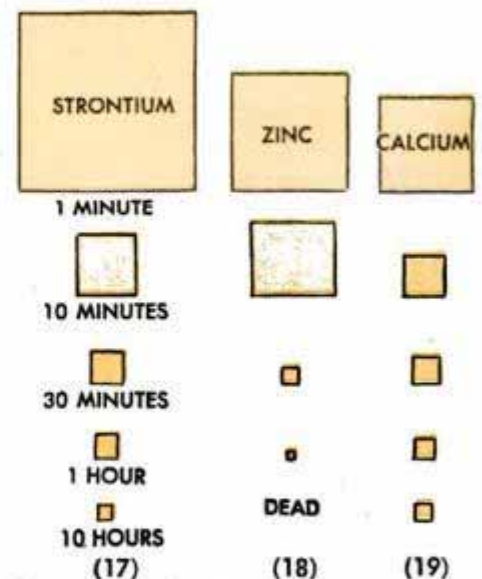

Brightness of various pigments represented by squares, shows intensity and life of luminous pigments

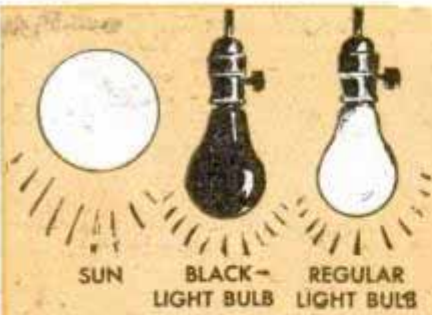

20 **ACTIVATION**
 All luminous pigments require activation before they will glow in dark. Source can be sun, black light or regular bulb

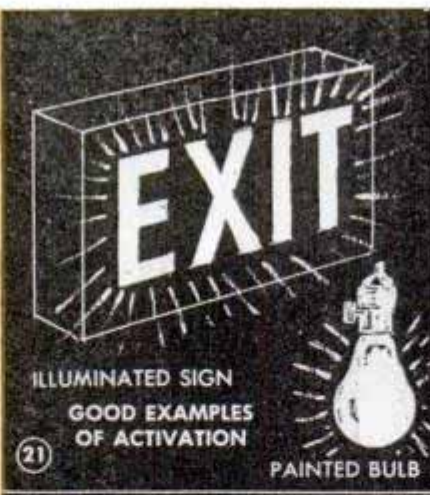

21 **ILLUMINATED SIGN**
GOOD EXAMPLES OF ACTIVATION
 PAINTED BULB

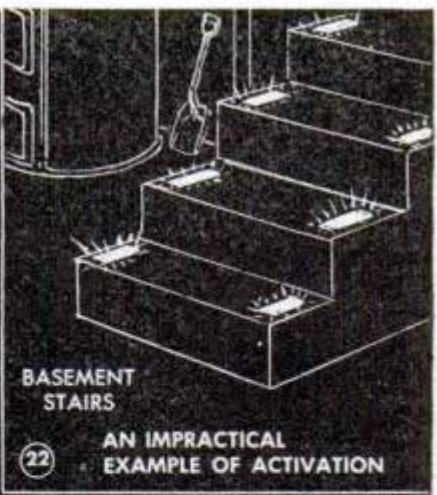

22 **BASEMENT STAIRS**
AN IMPRACTICAL EXAMPLE OF ACTIVATION

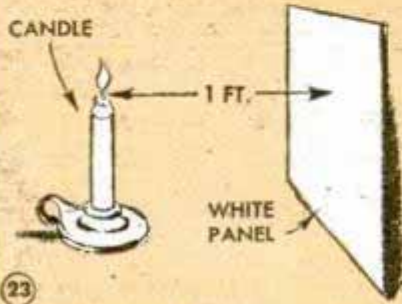

23 **INTENSITY OF GLOW**
 Brightest luminous pigments have illumination value of about 1/2 foot-candle. A foot-candle is illumination on white panel from candle 1 foot away



24 **BRIGHT GLOW SHORT LIFE PIGMENT NEEDED**



25 **LONG LIFE MORE IMPORTANT THAN BRIGHT GLOW**



26 **DARK-ADAPTED EYES**
 Walk outdoors on a dark night. Everything will at first look black, later become visible. Most luminous paints can be seen clearly only after eyes have become adapted to dark

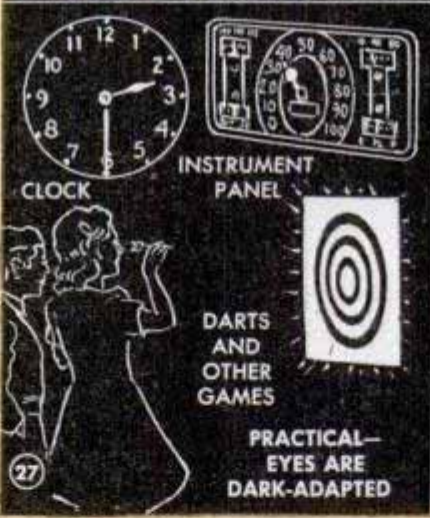

27 **PRACTICAL—EYES ARE DARK-ADAPTED**

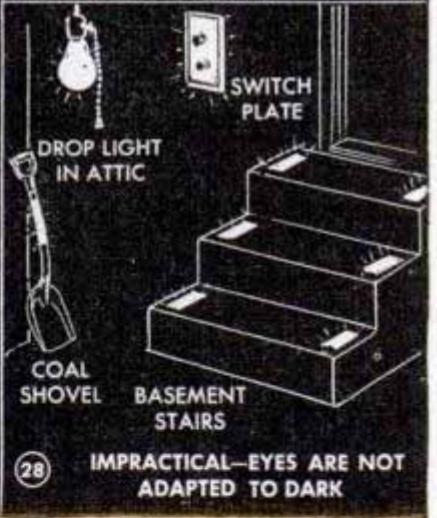

28 **IMPRACTICAL—EYES ARE NOT ADAPTED TO DARK**



29 **WORK SURFACE**
 Surfaces to be luminous painted should be white or receive a coat of white paint. Luminous paint will not cover dark colors or dirty marks on a white panel

VEHICLE (Liquid Measure)	PIGMENT (By Weight)
1 gallon	4 1/2 lbs.
1 quart	1 lb., 2 oz. (18 oz.)
1 pint	9 oz.
1/2 pint (8 oz.)	4 1/2 oz.
1/4 pint (4 oz.)	2 1/4 oz.
1 ounce	1/2 + oz.

30 **MIXING PROPORTIONS**
 All pigments take 4 1/2 lbs. pigment per gallon of vehicle

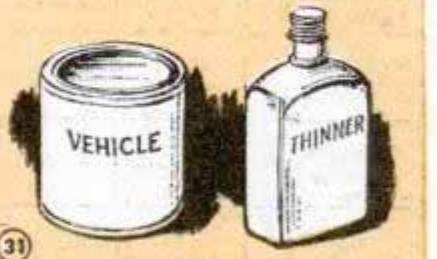

31 **VEHICLE and THINNER**
 Vehicle for homemade paints can be clear lacquer, spirit varnish or synthetic varnish. Factory mixtures use special vehicles—be sure that you use a compatible thinner



"IN-THE-DARK" VIEW OF BLACK SILHOUETTE BACKED WITH A SHEET OF LUMINOUS PAPER.



LUMINOUS PAPER

bright pigment immediately after exposure. Some applications require the brightest possible glow with duration of glow being secondary, Fig. 24. On the other hand, all outdoor and many indoor applications must glow all night, as indicated in Fig. 25, making duration more important than intensity.

Dark-adapted eyes: Dark-adaptation of the eyes is perhaps the most important factor to consider in luminous applications. The glow of the pigment is relatively weak when compared with white light, and in most instances is valueless unless the eyes are dark-adapted, Fig. 26. You are aware of how black the interior of a theater looks when you first enter, yet after your eyes become accustomed to the dark the illumination seems quite strong. Exactly the same thing applies to all luminous paints: a degree of glow which would be almost invisible to eyes not quite dark-adapted becomes quite strong when the eyesight is better adjusted to darkness. Perfect applications for dark-adapted eyes include instrument panels, clock hands, etc., as shown in Fig. 27. Impractical applications are shown in Fig. 28. In no instance can you walk from a well-

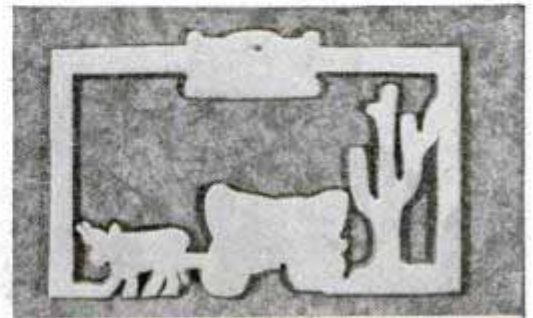

34 WOOD CUTOUT PAINTED LUMINOUS

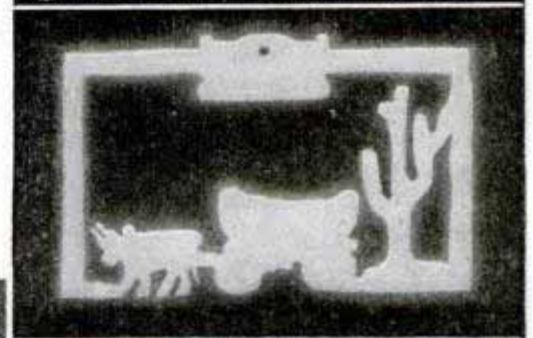

35 . . . GLOWS LIKE THIS IN DARK



36 TAPE APPLIED TO TABLE EDGES . .



37 . . . OFFERS PROTECTION IN DARK



TABLE LAMP SHADE SPRAYED WITH LUMINOUS PAINT GLOWS AFTER LIGHT IS TURNED OUT



38

lighted room into a dark room and expect to see the glow of a luminous object immediately—it just can't be seen.

Carrying power: Under normal conditions of brilliance, luminous objects are nearly invisible at 100 feet. Even when visible, the glow has no character.

Signs, house numbers, etc., all appear only as blur of light when viewed from a distance, and the object takes on character and outline only when viewed at a comparatively close range.

Application ideas: Figs. 32 through 38 show a few application ideas. With a little ingenuity and experimentation you can work out many effects that are amusing and practical.

Spark-Plug Tester Can Be Made From a Lead Pencil



Being unable to determine which spark plug was missing because he had no tools at hand, one motorist used an ordinary lead pencil as a tester. Both ends of the pencil were sharpened and a hole was cut in the center to allow a $\frac{1}{8}$ -in. air gap between the ends of the lead. To use the tester, place one end of the pencil on top of the plug and ground the other end on the engine block. If the plug is good, a spark will jump the air gap in the pencil.

Hulda Alexander, Lemmon, S. Dak.

Belt on a "Quarter-Turn" Drive Kept in Place by Guide Pulley

Since the rule that applies to all belt drives is that "as the belt leaves any pulley its center must lie in the plane of the pulley it approaches," difficulty often is experienced in keeping a belt in place on a short quarter-turn drive. This trouble can be avoided, however, by use of a guide pulley C mounted at an angle between the two pulleys A and B. Locate the guide pulley in such a way that the mid-point of the belt, as it leaves either pulley A or B, is in the same plane as the guide pulley. With

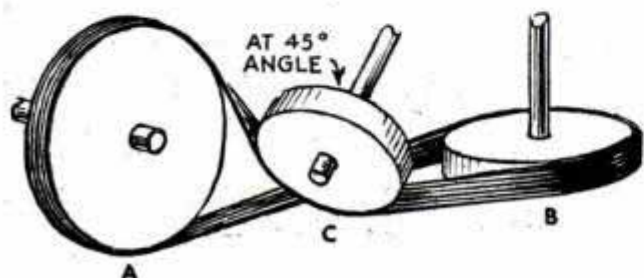

this arrangement, the center of the belt is in the plane of both pulleys and it can be run in either direction.

W. F. Schaphorst, Newark, N. J.

Brooder Lights Wired in Series Furnish Correct Intensity

When tinted bulbs of correct wattage for brooder heating cannot be obtained, ordinary bulbs may be used. An extra socket is wired in series with the one in the brooder. This will furnish the necessary heat and the light output will be subdued. Both bulbs should be of the same wattage. —C. W. Philpot, Laurens, S. C.

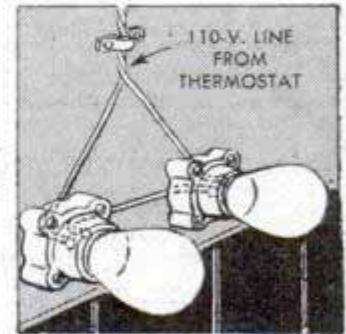

Drilling Jig Centers Round Stock

To center round stock in the drill press, try this jig. The dimensions given need not be followed as the design can be adapted to any size. However, the one shown is suitable for any diameter up to 1 in. Only one centering hole is drilled in the jig since the hole in the round can be spotted with the drill bit that fits the jig. The hole in the work then is finished with a drill of the desired size. The jig is made from flat steel, stamped with the drill size and then hardened. —J. Shest, New York, N. Y.

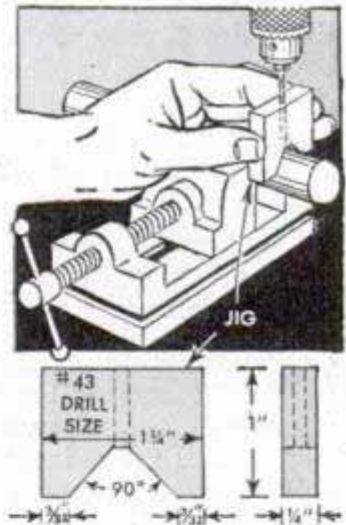

Improved Method of Soldering

If a small hole $\frac{1}{8}$ in. in dia. is drilled through a soldering iron about $\frac{1}{4}$ to $\frac{1}{2}$ in. from the tip, depending upon the size of the iron, more solder can be held. This will permit feeding the solder directly to the work when soldering seams and joints. The hole as well as the tip must be tinned, of course. —W. Riederich, Flint, Mich.

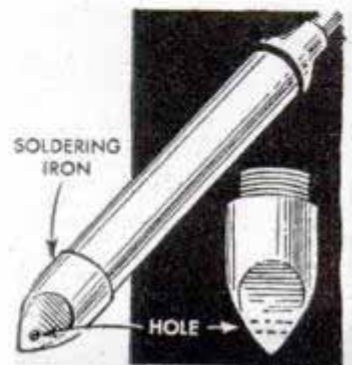

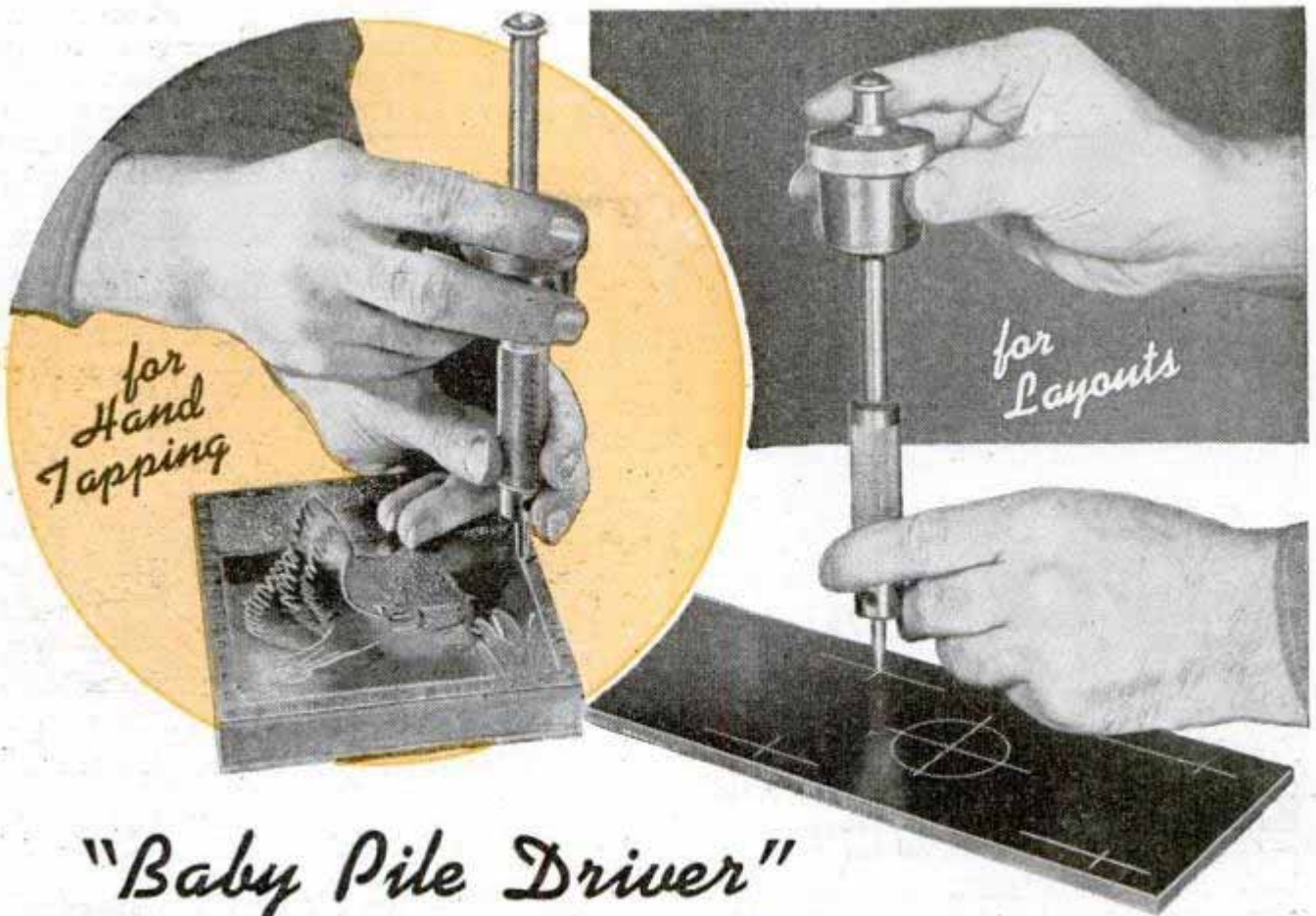

"Baby Pile Driver" CENTER PUNCH

YOU don't have to hunt for the hammer when you use this center punch because it's built right onto the punch. The tool does a good job, too, on precision layout work and is easy to handle for hand tapping or matting. Construction is simple and altogether a matter of lathe work. Mild steel is used for all parts except the punch, which should be made from hardened drill rod. The shank end of a broken drill also can be used for this purpose. Various styles of punches and tapping tools can be made up, all interchangeable and held in place by means of a setscrew, as shown in one of the photos. A slightly heavier head may be found useful for matting or hammering operations. How the tool is used will be apparent from the pictures. The sliding head simply is lifted and then dropped with a rapid movement. For roughing-in background areas in tapping, the tool can be used like an ice pick, letting the sliding head move up and down of its own accord.

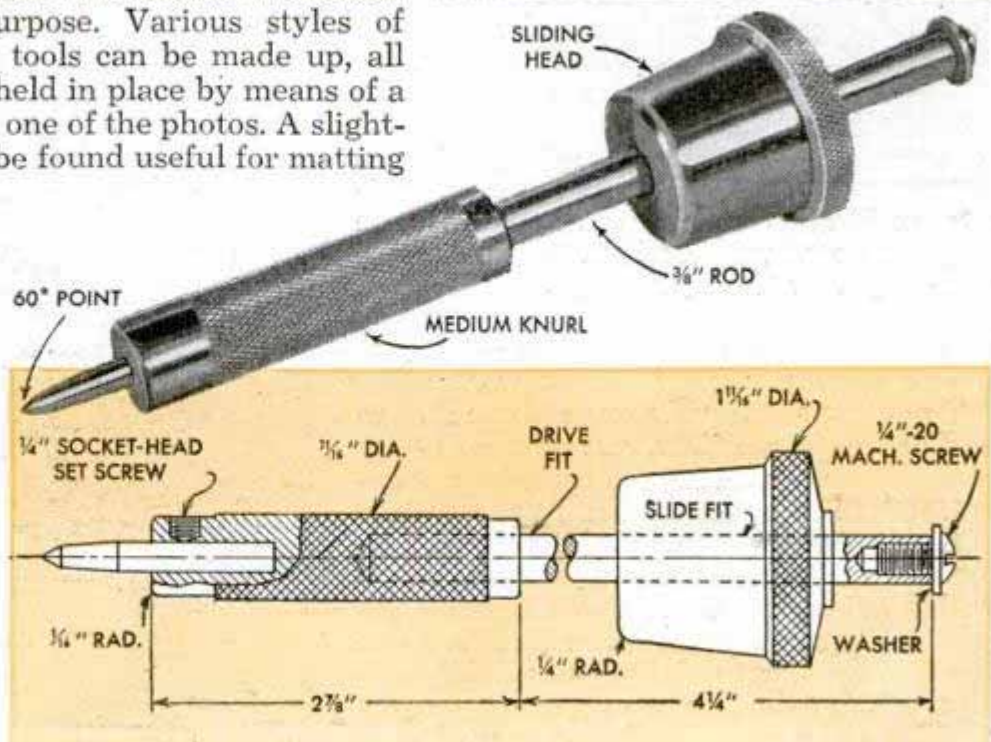
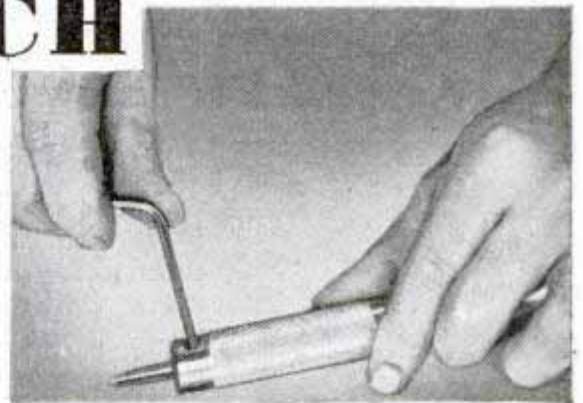

Spray Gun Applies Insect Killer In Liquid Form

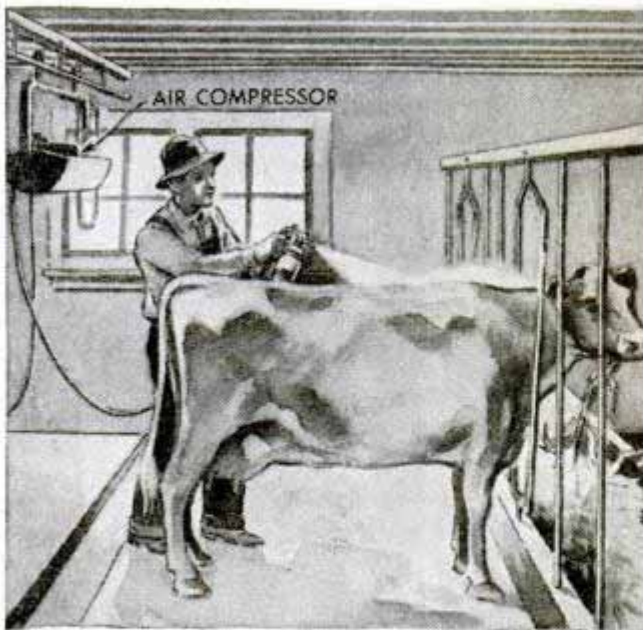

Where electric power is available on farms, an electric paint-spray gun can be used to apply liquid fly killer to cows. The air compressor is mounted on a platform built into the litter carrier and braced with cleats to prevent slipping. With this arrangement, access to all stalls is easier.

Files Are Used for "Follow Ups"

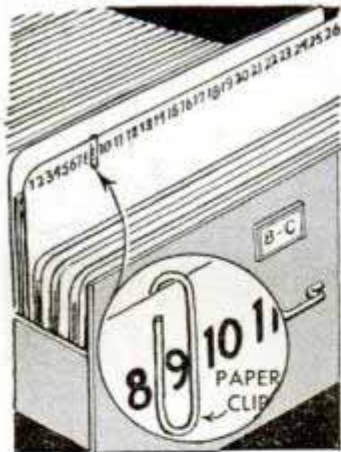

A simple "follow up" file system may be set up by marking an ordinary file folder along the top edge with the numerals 1 to 31. Then slip a paper clip over the number that represents the day of the month when the file is to be brought to the proper person's attention. Months could be marked on the file also and noted with a clip in the same manner.—Opie Read, Jr., Chicago.

Months could be marked on the file also and noted with a clip in the same manner.—Opie Read, Jr., Chicago.

Tumbler Cleans Small Parts

Tumbling small parts or machine screws and nuts to clean them can be done easily with this unit. A 1-qt. paint can with a snap-on lid is used as the barrel. In the bottom of the can drill a 1/4-in. hole slightly off center to take a 1/4-in. bolt. Secure the bolt with a nut and washers on the outside and inside. Next solder a 1/2-in. strip of tin down the interior length of the can at right angles to the side. Mix a cup of dry emery powder and a cup of boxwood or pine saw-

dust to serve as a cleansing agent, and place this and the parts to be cleaned in the can. Then chuck the projecting end of the bolt in a lathe and turn at about 200 r.p.m. for approximately three hours. After this time the parts can be removed by screening or sifting.—Ray Allen, Chicago.

Cursor on Slide Rule Is Cleaned With a Cigarette Paper

Cleaning the underside of the cursor on a slide rule is done easily without removing the glass if a cigarette paper is used. Simply fold the paper as shown and slip it under the cursor.

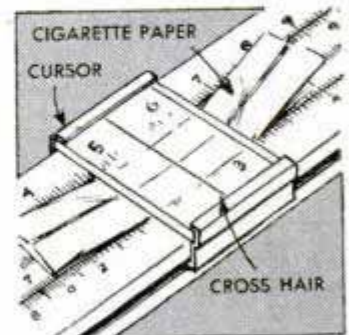

After grasping the projecting ends, the paper is worked back and forth until the undersurface is cleaned.

Edward S. Barnum, Detroit, Mich.

Hand-Driven Churn Converted To Electric-Motor Drive

This hand-driven churn was converted to power operation with the addition of an electric motor, reduction gears and reduction pulleys. In this particular case, the gears, which were taken from a hand grinder, had a ratio of 12 to 1. To further reduce the speed, a 2-in. pulley was used on the motor and a 5-in. drive on the gear-box. The same approximate ratios should be followed to secure satisfactory operation.—Wm. R. Jackson, Birmingham, Ala.

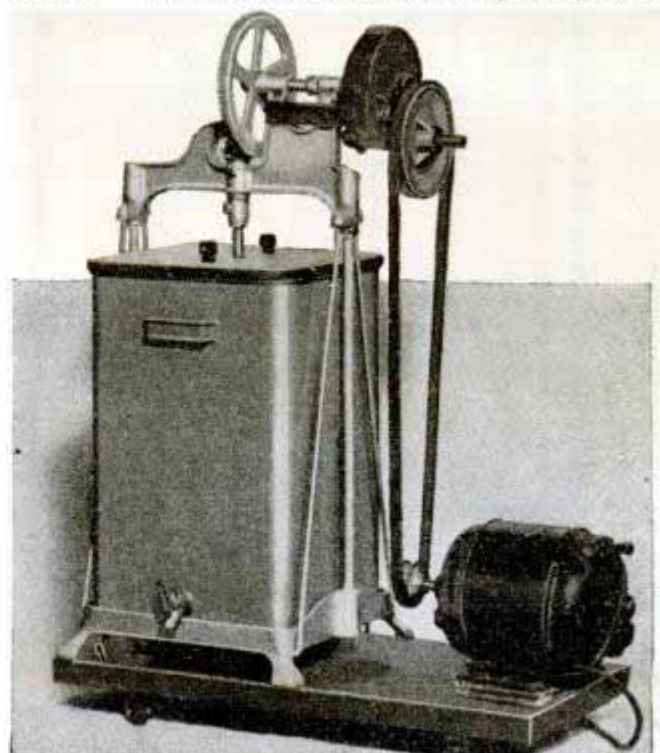

QUICK-CHANGE MOTOR MOUNT SERVES ALL MACHINES

CHANGING a motor from one machine to another in the home can be done in less than a minute with this all-position motor mount. Some of the many different positions in which it can be used are shown in Figs. 1 to 4 inclusive. Only motors built for vertical as well as horizontal mounting should be used as illustrated in Fig. 3.

Dimensions for the angle-iron frame (Fig. 5) are not given as these will vary according to the type and size of motor used. The corners are cut, bent and welded as detailed in Fig. 5, A, and two holes are drilled to take a $\frac{3}{8}$ -in. bolt on which the frame hinges. A third hole is drilled and filed to an oval shape for an adjustment screw, which is a $\frac{3}{8}$ -in. square-head bolt forged and drilled as shown in Fig. 5, D. Belt tensioning is accomplished by adjusting a square nut under the angle-iron frame and tightening a wing nut as in Fig. 5, C. Four angle-iron brackets are bolted permanently to each machine on which the motor mount is to be used. Mounting the motor between rubber washers as indicated in Fig. 5, B, will reduce vibration and eliminate motor hum.

A. E. Youngquist, Chicago.

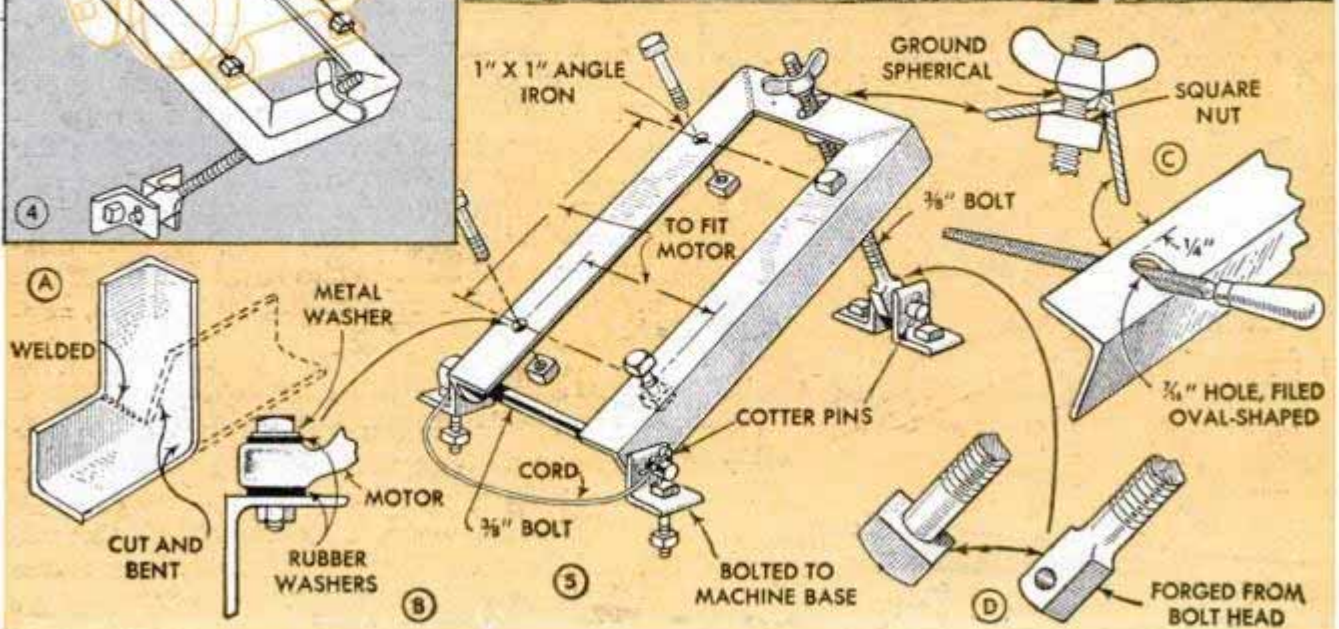
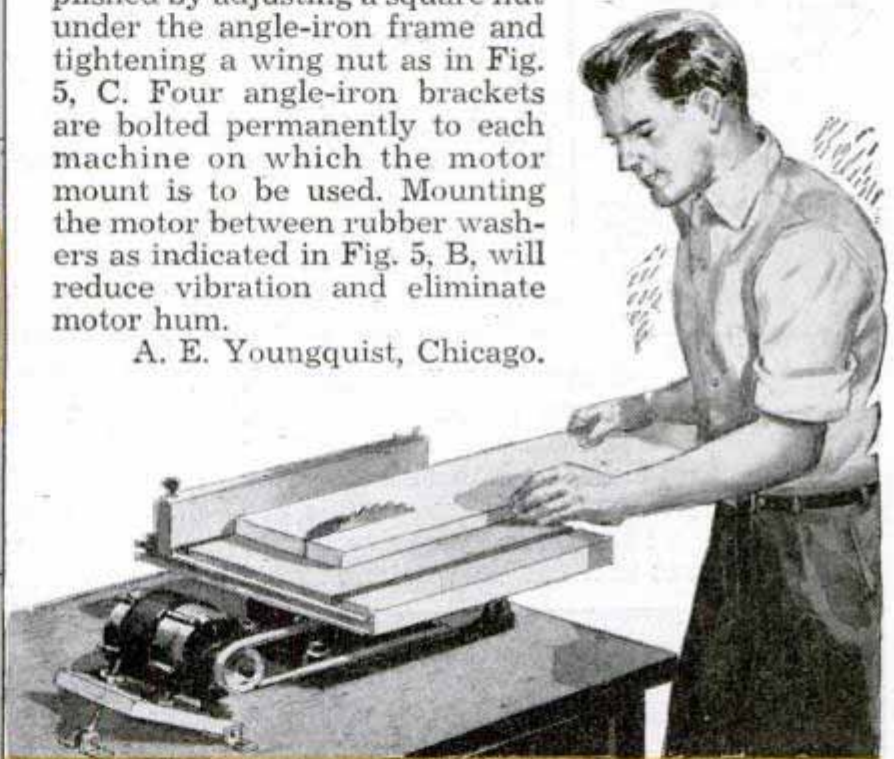
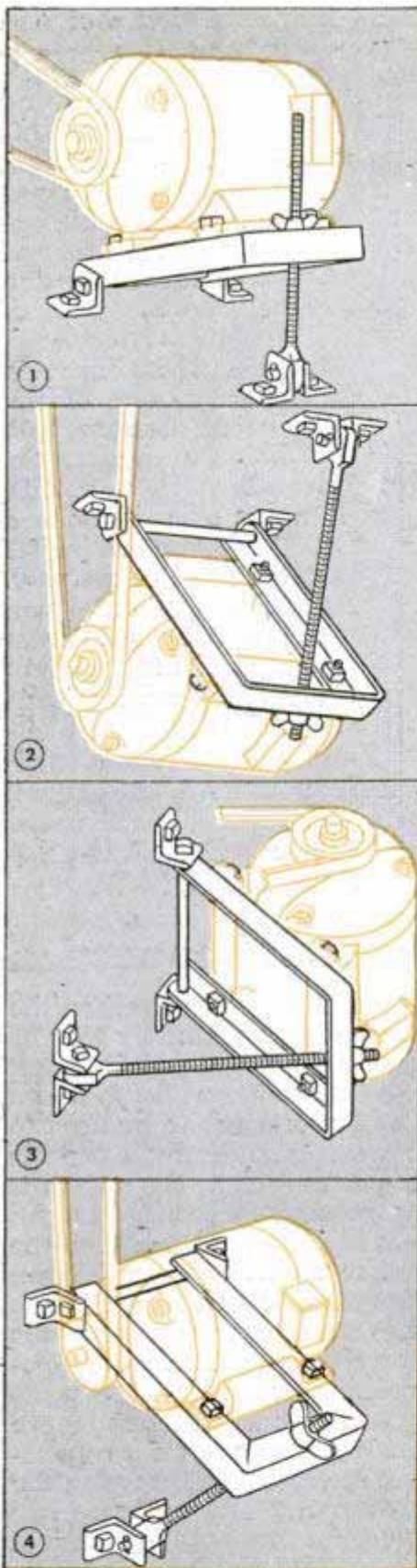

Extension on Bed of Truck Increases Capacity

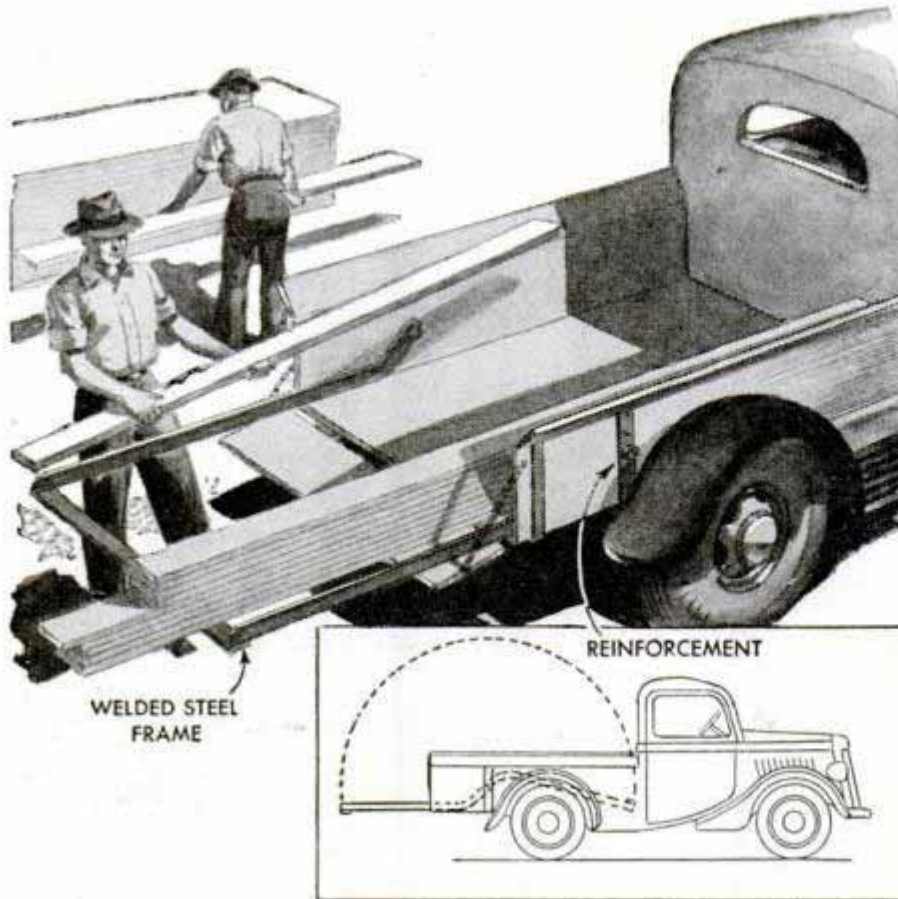

One contractor found that the capacity of his pickup truck for hauling bulky loads was increased greatly by adding the extension shown. It is of welded steel construction and bolts to the sides of the truck. A flat-iron reinforcement is fastened to the sides, one of the bolts being the same one that holds the extension. When not in use, the frame is folded back so that it rests on the bed of the truck out of the way. Although the extension will not bear any great weight, the arrangement is ideal for carrying loads such as lumber on a pickup truck. Since this, in effect, extends the truck body, warning flags may be necessary.—Paul Carlstedt, Edmonds, Wash.

Combination Circuit Tester and Soldering Iron Connection

With two porcelain sockets and an s.p.d.t. knife switch, you can combine a circuit tester with an electrical outlet suitable for plugging in a soldering iron or other tool used in electrical wiring. The sockets are mounted on a fiber-board panel with the switch wired to them as shown. The right-

hand socket receives full voltage when the switch is thrown to the right, and when the switch is thrown to the left the other socket is in series with that on the right so that a lamp bulb or other resistor can be used to reduce the voltage. In soldering, a bulb is used in the left-hand socket, the switch is thrown to the right and the iron is plugged into the right-hand outlet to heat; then the switch is thrown to the left to keep the iron hot with no danger of overheating. When the switch is thrown to connect the sockets in series, test prods can be used in connection with a small bulb, which will serve as a test lamp. A neon bulb will be found more sensitive to small leaks than an incandescent lamp. In order to avoid throwing the switch the wrong way and running full voltage through the prods, they should always be plugged into the left-hand outlet, with the bulb in the right-hand socket.

Walter R. Bufkin, Evansville, Ind.

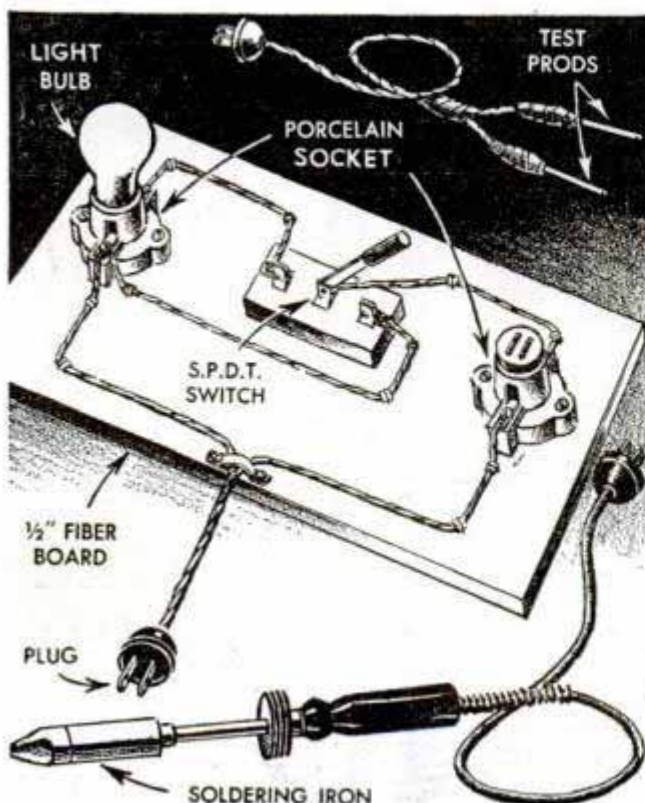

Building Paper Decorates Walls

If you wish to decorate the walls of your summer cottage or playroom with an unusual paper, try decorative building paper. It can be applied with tacks and paste and, being heavier than wallpaper, has more insulating value.

Sadie G. Lasley, Queen City, Mo.



RECORD PLAYERS TODAY

Now you can spin your favorite "platters" on improved turntables in cabinets housing amplifiers of advanced design. Photo No. 1 shows a most unusual 5-tube table radio-phonograph of Philco design that features an automatic record player. The operator merely places a record in the slot and closes the door. Then automatically the motor starts, a tone arm positions itself and the music plays. Furthermore, it will adjust itself to either 10 or 12-in. records.

A streamlined plastic cabinet model is offered by Garod; this radio-phonograph combination, shown in photo 2, is available in either ivory or walnut plastic with contrasting pickup arm and control knobs. It employs five multi-purpose tubes.

The convenient 6-tube combination phonograph-radio in photo 3 features the Farnsworth three-point suspension record changer that handles both 10 and 12-in. records. Its lightweight tone arm is provided with a crystal pickup.

A portable automatic record changer with audio amplifier is shown in photo 4. It is 15 in. wide, 15 in. deep and 10 in. high. This handy carry-about model by Audio Industries employs a speaker of the heavy-duty PM type.

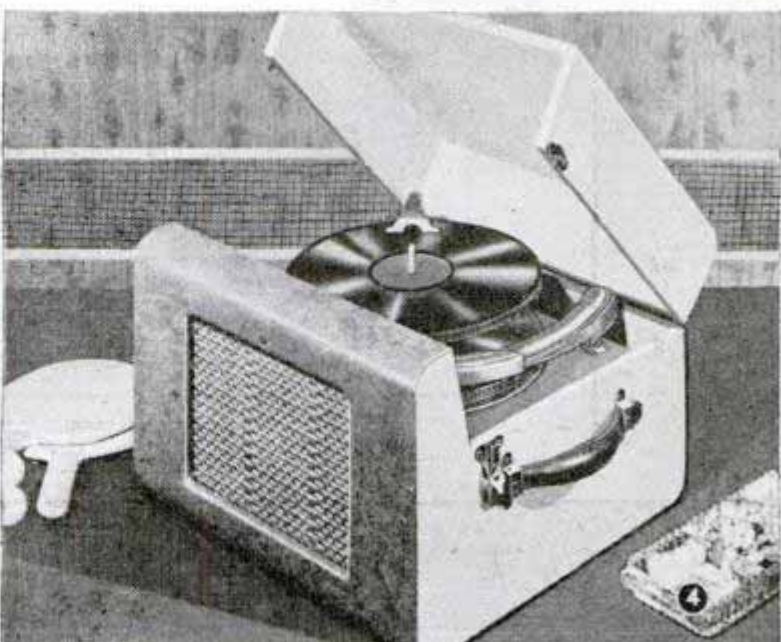

HI-EFFICIENCY TRANSCEIVER FOR THE

By L. M. Dezettel—W9SFW

DESIGNED around a high-frequency tube ideal for the new 2-meter "ham" band, this combination transmitter and receiver provides the newcomer as well as the pre-Pearl Harbor licensed amateur with an efficient means of getting on the air for local contacts while larger equipment is being built. It also may be used for mobile operation in a car with one of the new vibrator-type power supplies.

The 6N4 tube is a miniature triode self-controlled RF power oscillator and it is modulated with a type 7C5 loktal audio power tube in the "transmit" position. In the "receive" position the 6N4 is a super-regenerative detector and the 7C5 acts as an audio amplifier. All RF leads are extremely short; photos A and D show the compact construction.

A separate 300-volt a.c. power supply unit is detailed in Figs. 1 and 2. All circuit details and specifications for the transceiver appear in Fig. 3 and the photos. The 6N4 tube socket is a ceramic miniature type, mounted with terminals 1 and 7 at the bottom; terminals 4 and 6 are connected and grounded on the bracket. A National XP-6 "button" insulator is used to mount the bracket for tuning condenser C1. Small rubber grommets act as shock absorbers for the tube and choke assembly bracket

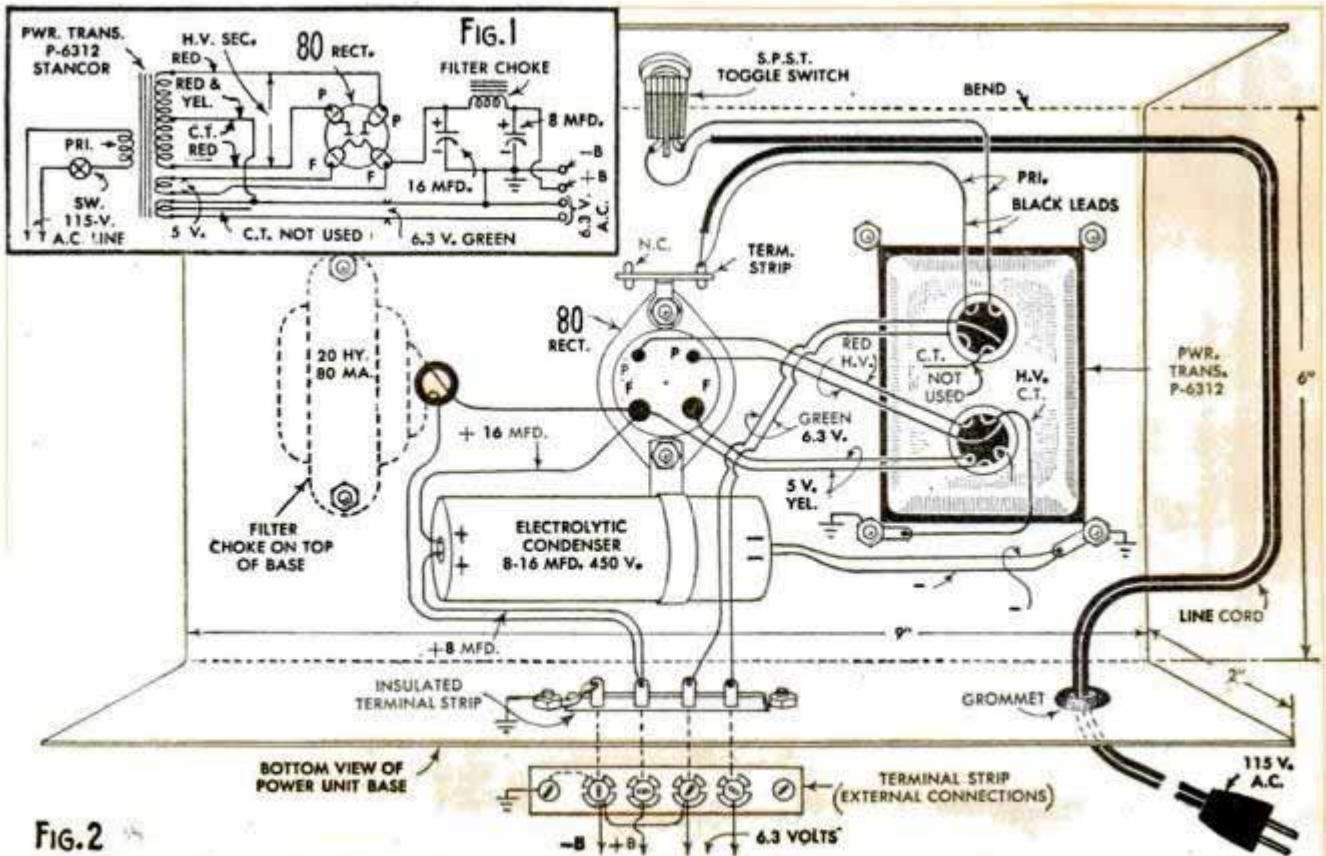
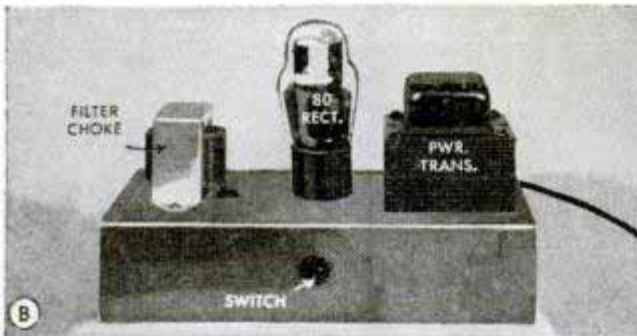
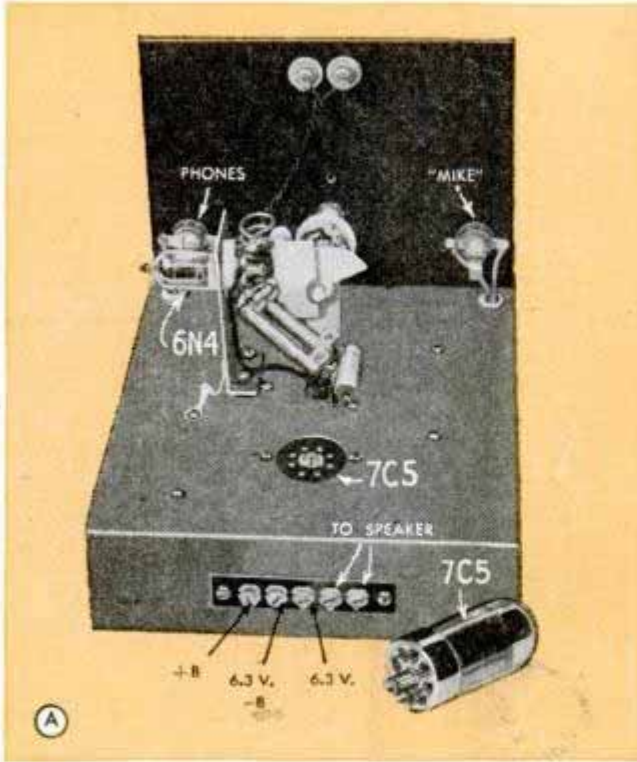

NEW 2-METER AMATEUR BAND

which is grounded with a short piece of heavy braided wire. Coil L1 is soldered to the variable condenser terminals as closely as possible. Fixed condenser C2 is a tiny 50-mmfd. "Muter X50" tubular mica type. The headphones used are of high impedance type.

The folded dipole antenna is shown in Fig. 4. If heavy wire is used, the dipole spacing may be 1 in. as shown; the feeders are made with "Amphenol" 300-ohm twin-lead transmission line, photo C. The entire antenna may be made with the twin-line material by cutting it to length and connecting the dipole ends. To operate, listen for another amateur station and adjust the sensitivity control for loudest signal. The rushing sound disappears when the station is tuned in. Adjust the two-turn pickup link coil L2 in coil L1, at the same time readjusting the sensitivity control for best reception; this coupling adjustment also is correct for transmitting. Any single-button carbon "mike" may be

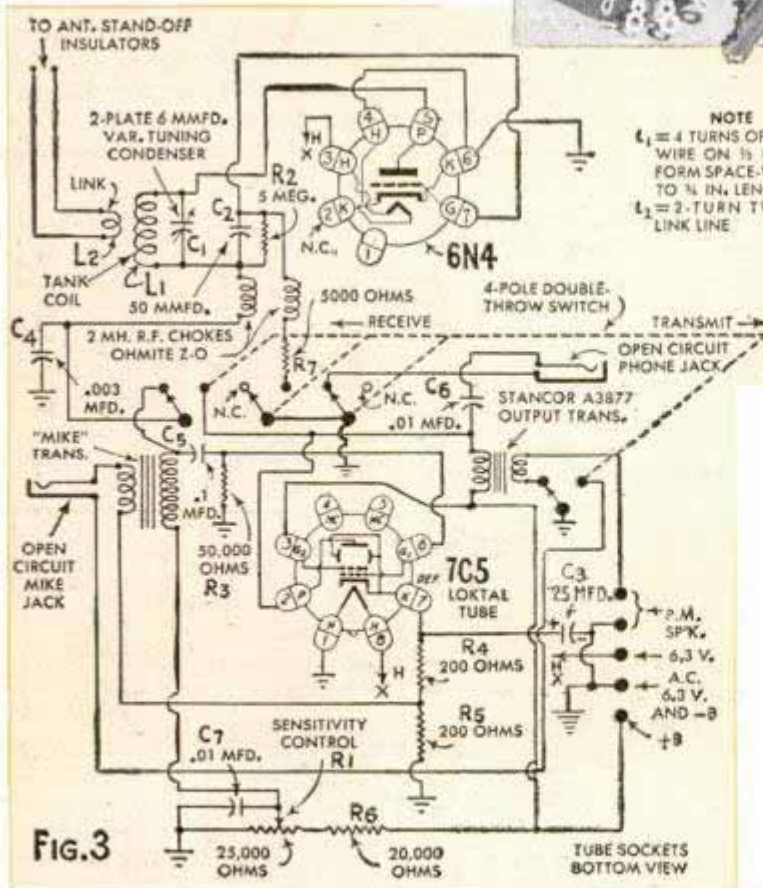
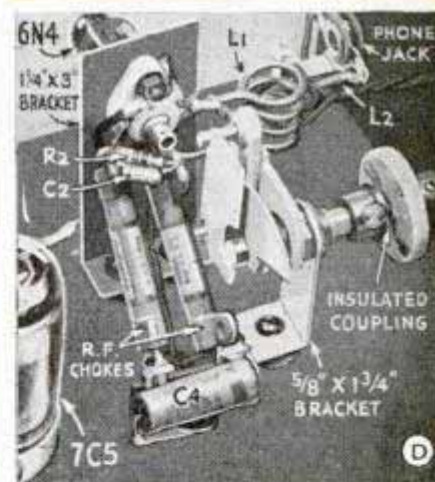
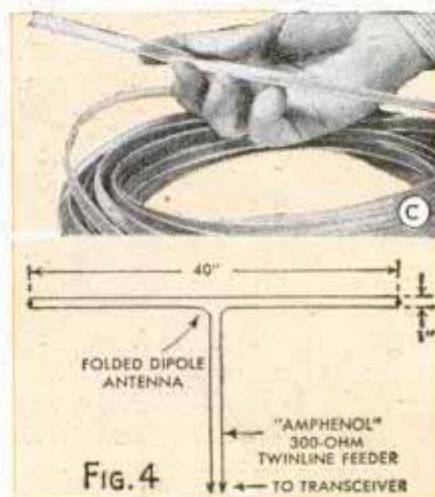
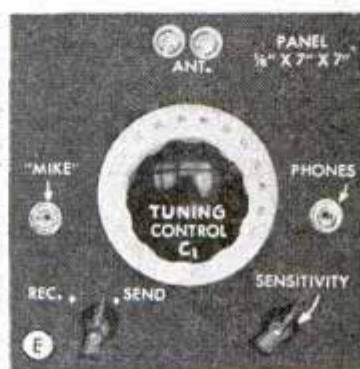
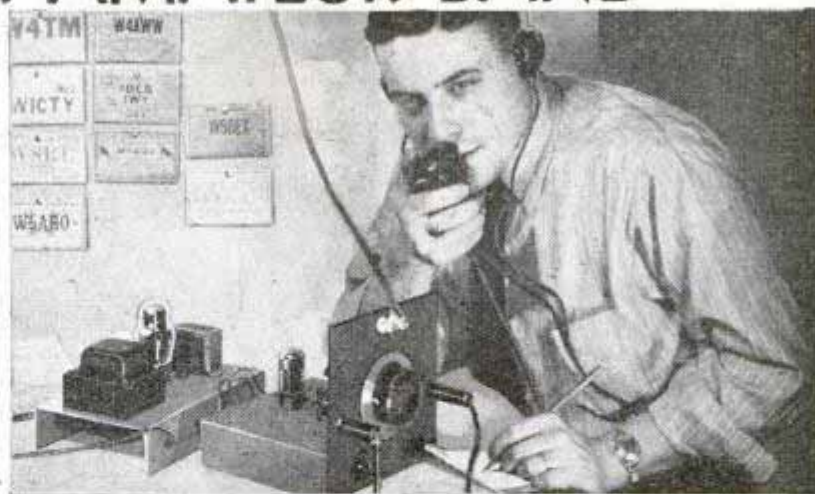

used; close talking is necessary for full modulation. The student reference number for this construction article is R-345.

Blueprints covering radio construction articles in this and past issues are available for 25 cents each; detailed student material lists and additional information can be obtained from our Radio and Electronics Department without charge on receipt of ordinary letter postage.

"Ham" Radio Suggestions



(A) Now you can regrind your own transmitting crystals or grind new blanks to any desired frequency in the recently reopened amateur bands. Everything that is required for grinding and finishing is contained in the kit shown in the photo. It includes coarse and fine abrasives; quartz etching fluid; four high quality quartz crystal blanks; one glass finishing plate; a carrier lapping plate with a pentagon well, and an instruction sheet. Two crystal holders with half-inch prong spacing that will fit into an ordinary octal tube socket also are included. The usual figure-8 crystal grinding stroke is clearly illustrated in sketch A-1

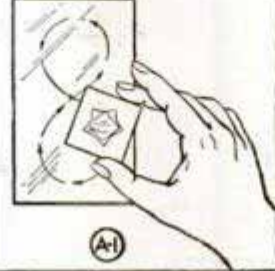
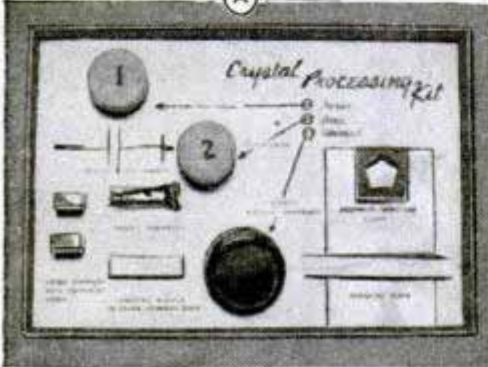

(B) Critical tuning adjustments are easily maintained with this fast acting dial-lock and tuning indicator. The lock is especially useful in mobile equipment where vibration and rough handling are encountered



(C) R.M.A. fixed resistor color-code guide for identifying resistor values. As fixed carbon resistors are now subject to the new R.M.A. standard values rating, radio parts houses will supply the nearest R.M.A. standard. This value may be slightly above or below the original specification but will not affect the efficiency of any circuit

Black -0	Black -0	Black -	Tolerance
Brown -1	Brown -1	Brown -0	Gold -- ± 5%
Red -2	Red -2	Red -00	Silver -- ± 10%
Orange-3	Orange-3	Orange-000	No Band-- ± 20%
Yellow -4	Yellow -4	Yellow -0000	
Green -5	Green -5	Green -00000	
Blue -6	Blue -6	Blue -000000	
Violet -7	Violet -7	Gold -Multiply by .1	
Gray -8	Gray -8	Silver -Multiply by .01	
White -9	White -9		

Tan -- Insulated

FIXED RESISTOR R.M.A. Color Code

(D) For practically silent operation mount your antenna change-over relay as shown in the photo. This heavy-duty "Gordon" R.F. relay also is suitable for transmitter tank switching and 60-cycle power switching. Adaptable for many applications, the small "Guardian" universal relay (E) can be operated on nine different a.c. or d.c. voltages simply by switching coil assemblies. A contact parts kit permits building many switch assembly combinations

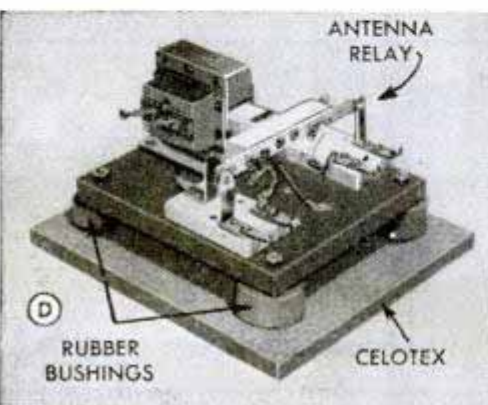

(F) One-tube code practice oscillator, complete with speaker, phone jack and built-in key, for classroom or individual use

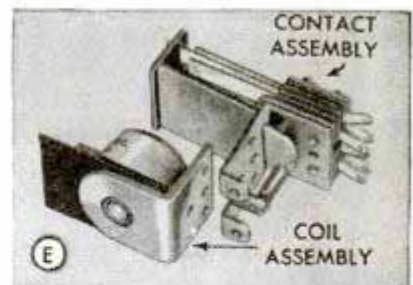

(G) Fuse clips eliminate complicated socket attachments for mounting rod antenna on portable receivers or transceivers

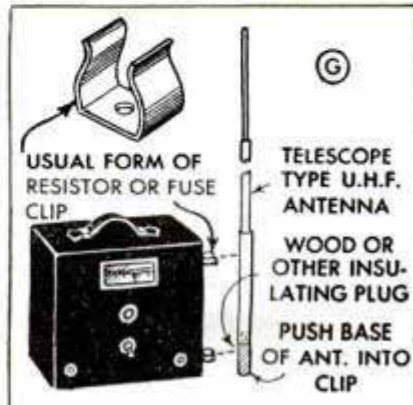
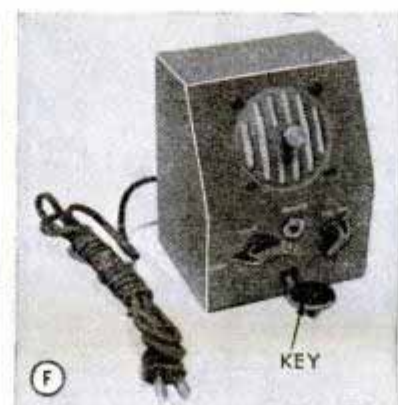



KODAK ORTHO-X (sheets)—top-speed ortho film. Gives ruddy skin effects, hence popular for pictures of men.



KODAK PANATOMIC-X (sheets, miniature rolls)—extremely fine grain, first choice for big enlargements.



KODAK PORTRAIT PANCHROMATIC (sheets)—a favorite multi-purpose film, especially valuable for portraits.

First step to a finer picture ... the right Kodak Film



And it won't be long before these seven favorites, and the rest of the Kodak Film family, will be back on Kodak dealers' shelves. The supply is steadily improving.



KODAK PLUS-X (rolls, packs)—all-around "pan" film; combines high speed, fine grain.



KODAK SUPER-XX (rolls, packs)—favorite high-speed film for both outdoors and indoors.

At your Kodak dealer's . . .
**Eastman Kodak Company,
Rochester 4, N. Y.**



KODAK SUPER PANCHRO-PRESS, TYPE B (sheets)—high speed, good highlight separation. Outstanding for portraits.



KODAK VERICHROME (rolls, packs)—fast, orthochromatic. America's favorite snapshot film by a wide margin.

Kodak

"I Always Have Luck with the JITTERBUG"

— writes girl angler



Jitterbug and Tina Lure Bass!

Tina with bass and a couple of pickerel caught on the Jitterbug. Seems from her letter that Tina, like many male anglers, is quite sold on the wobbly, noisy Jitterbug as a fish-getter.

Choice of Six Colors
\$1.21



Dear Fred:

"I caught these seven good-sized bass and two pickerel within a few hours on your 'Old Faithful' Jitterbug at Burden Lake.

"I always have luck with the Jitterbug. We use them on all our fishing trips and wouldn't be without them. Some day I intend to try your other lures and I hope they are as good."—(Miss) Tina C. Boel, Red Mill Road, Rensselaer, New York.

Write for New Catalog

Gives you complete information on where and how record catches are being made with Jitterbugs, my famous surface bait, and also my family of Hawaiian Wigglers. A copy is yours for the asking.

FRED ARBOGAST & CO., 1626 W. North St., Akron 3, Ohio

How to Avoid these "BOOBY TRAPS" in your home!

What you can't see CAN hurt you—says the National Safety Council

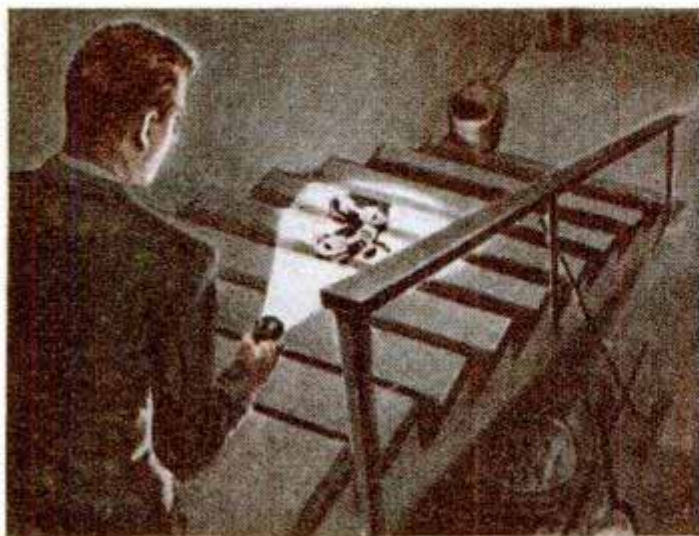

1 About 5,000,000 Americans are injured every year at home—33,500 fatally! Largest single cause: *falling*. A roller skate on a dark staircase; shin-catching obstructions; slippery objects: these can be lethal "booby traps." To avoid them, carry your "Eveready" flashlight in dark areas.



2 Be sure all obstacles are cleared away. Linoleum or carpeting should be tacked down firmly. In attic or basement, pack all loose objects in nonflammable boxes stored against the walls. Don't rely on *your* knowledge of where obstacles are located—the next person may not know.

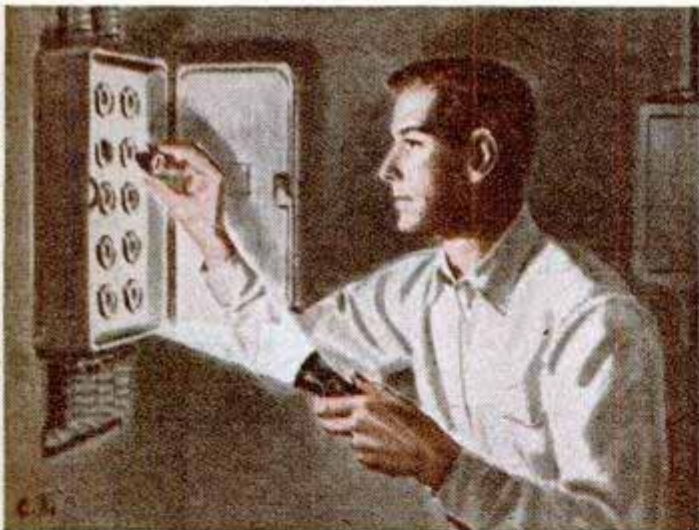

3 Know *in advance* where your fuse box, main water and gas valves, etc., are located; be sure you have a clear path to them. Armed with your "Eveready" flashlight, you can approach without fumbling in an emergency. Be sure loose wires are so placed that you won't trip over them.

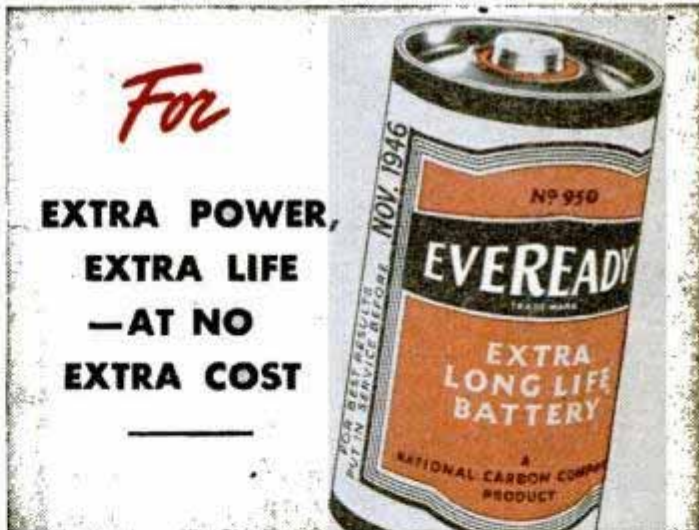

4 Keep your "Eveready" flashlight always in the same convenient place—so you won't be tempted to do without it because it can't be located. Keep it filled with "Eveready" batteries—they're again available at your dealer's. They are the *largest-selling* flashlight batteries in the world!

NATIONAL CARBON COMPANY, INC.
30 East 42nd Street, New York 17, N. Y.
Unit of Union Carbide and Carbon Corporation



EVEREADY
TRADE MARK

The registered trademark "Eveready" distinguishes products of National Carbon Company, Inc.

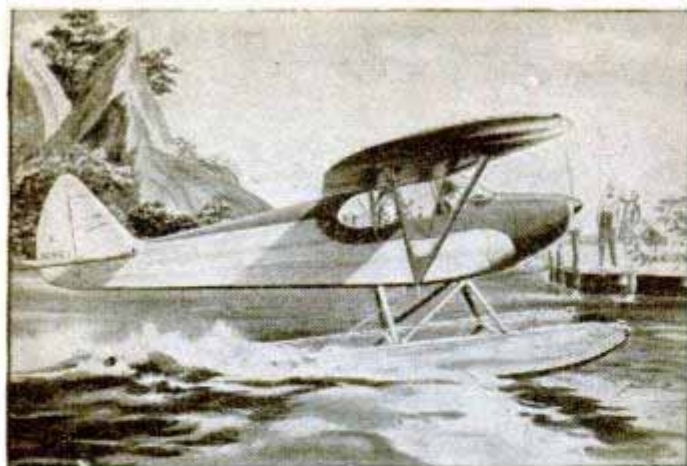

BUILDING MORE PLANES means building BETTER planes that cost LESS

THAT'S why Piper continues to lead in value, safety and economy. Ask your Piper Cub Dealer for a free flight demonstration in one of the new Piper Cubs. Get full information from him about the *free flying course* given with the purchase of every new Piper Cub.



Thousands of requests are pouring in for this latest Piper book on current models and for these new editions of two already famous books, off the press just a few weeks ago:

1. **Piper Cub Brochure.** Brand new! Beautiful full-color airplane illustrations, suitable for framing. Complete specifications of Piper Cubs.
2. **"How to Fly" Book.** Takes you on a typical flying lesson with 53 step-by-step photos and descriptions. Many other interesting facts.
3. **"What Your Town Needs" Book.** Will help you plan an inexpensive landing area now.

Get these books from your Piper Cub Dealer now. Or, if you prefer, send us 10c per book or 25c for all three. Use stamps or coins. Specify which books you desire. Write Dept. PM66.

PIPER AIRCRAFT CORPORATION
LOCK HAVEN, PENNA.

PIPER

Print Your Own Color Photos

(Continued from page 117)

Fourth, he dyes the matrices, first soaking them in hot water to prepare them for the dyes. Each matrix is placed in a pan of dye corresponding to its inherent color—cyan, magenta, or yellow. These dyes are prepared from concentrated solutions in the kit. Where the "hills" occur on the images, less dye will be absorbed, and eventually less dye of that color will be transferred to the finished print. "Valleys" absorb more dye and therefore relay a brighter color to the print.

Fifth, he prepares the dye transfer paper upon which the final print will be made. Former printing papers required a series of steps to prepare them for soaking up the dyes. The new paper is pre-mordanted—already treated—and needs to soak only 10 minutes in a single solution prepared from the kit. The photographer can soak it while he is dyeing the matrices. When it is ready, he places it on the transfer board, a flawless surface, and squeegees it taut.

Sixth, he places the matrices in acid baths that wash away all excess dye. In the first bath all changes in contrast and high lighting are made by adding more material from the kit. The second holds the dye rigid in preparation for transfer to the paper.

Seventh and last step is to print each matrix on the paper with the aid of the "dye transfer blanket." This blanket is a milk-white plastic sheet about the thickness and pliability of a magazine cover. It is fastened to one end of the transfer board so it can be folded back like the page of a book. On the under surface of the blanket are six "buttons" the size of a dime, two along the bottom and four along the side. These buttons are spaced at varying distances from the bottom and one edge, so that they are out of line with each other.

The photographer folds back the blanket to expose the buttons. He places the cyan-dyed matrix on the blanket so the two edges that were trimmed in registering fit snugly against any three of the buttons, two in length and one in width. When the other two matrices are placed against the same buttons, they will register perfectly.

He then folds the blanket and matrix down over the transfer board until the matrix is close to but not in contact with the paper. He transfers the dye by rolling the print roller over the back of the blanket to obtain perfect contact between the relief and the paper. After three minutes the cyan dye has been absorbed, and he folds back the blanket and removes the matrix.

(Continued to page 236)

Switch to -

AUTO-LITE

Money cannot
buy a better
spark plug



TUNE IN THE AUTO-LITE
RADIO SHOW STARRING
DICK HAYMES—SATURDAYS
8:00 P.M.—E.S.T. ON CBS



*The Spark Plug that's
Ignition Engineered*

Auto-Lite spark plugs are designed by the same engineers who design complete electrical systems for leading cars and trucks. This specialized engineering experience is one reason why money cannot buy a better spark plug. A complete set of ignition engineered Auto-Lite spark plugs in your car, helps give you quick starts, and full mileage from every gallon of gas. So switch to Auto-Lite when faulty spark plugs need replacing. See your Auto-Lite Spark Plug Dealer today.



THE ELECTRIC AUTO-LITE COMPANY
Toronto 1, Ontario Toledo 1, Ohio



Continuing tests and scientific research, plus 35 years' experience designing complete ignition systems, enable Auto-Lite Ignition engineers to maintain one high standard of quality.

AUTO-LITE SPARK PLUGS



Home Craft Sets are supplied either in the steel case illustrated or mounted on a panel which can be hung beside the lathe.

WILLIAMS Home Craft TOOL HOLDERS

● This set of 8 tool holders provides for all regular lathe operations and is ideal for home work shop use on lathes from 7 to 10" swing. Drop-forged from tough steel, accurately machined and specially heat-treated, these holders represent the same fine quality as the Williams industrial line. The high-speed steel cutters furnished, are ground, ready for use except those for turning. The "diamond-point" turning cutters require only a minimum of grinding to desired form. Sold by Industrial Distributors everywhere. Write Dept. M-66 for literature.

J. H. WILLIAMS & CO.
BUFFALO 7, NEW YORK

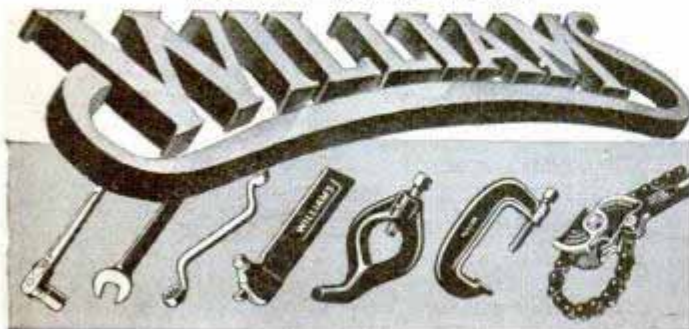

DROP FORGINGS AND DROP-FORGED TOOLS

**\$1 RIDES YOUR LAWN
OF UGLY WEEDS!**



WEED-NO-MORE

Magic Weed Killer

Destroys Ugly Weeds but Won't
Harm Common Lawn Grasses!

NO MORE back-breaking digging! Destroy ugly leafy weeds with WEED-NO-MORE!

The 8-ounce lawn-size package treats 1600 square feet! Now you can enjoy a beautiful weed-free lawn for only \$1!

WEED-NO-MORE kills dandelion, plantain and other ugly weeds—yet won't injure soil.

Get it today! Rid your lawn of ugly weeds for only \$1. Just spray on... WEED-NO-MORE!

On Sale at Paint, Hardware, Garden Supply, Department and Drug Stores

WEED-NO-MORE

THE AMAZING NEW WEED KILLER

Made by THE SHERWIN-WILLIAMS Co. Cleveland, Ohio



What marks a box,
a can, a jar
So all may know
what contents are?

Dennison

GUMMED LABELS

At Stationery Departments Everywhere



GERSTNER Tool Chests
The better construction of GERSTNER Chests assures better value at no greater cost. Free catalog for Tool, Die and pattern Makers.

GERSTNER TOOL CHESTS
446 Columbia St., Dayton 7, Ohio

Big Money for Workers In Home or Shop



LICENSED CONCRETE SPECIALISTS wanted. No experience needed. Make **Colorglazed** concrete lawn, cemetery pottery without molds. New, low cost, patented method. Hundreds of designs, sizes, shapes. Use only sand, cement, cheap materials. Statuary, novelties, giftware. Tiles, floors, walks. Imitation marble, granite, stone cemetery products, furniture, etc. Patching, repairing, resurfacing jobs. Basement leaksealing. Many other big pay projects. Booklet, cost data, details free. Men only.

NATIONAL POTTERIES COMPANY
542 Lincoln Avenue

Fergus Falls, Minnesota

Smooth HORSEPOWER



CASITE GUARANTEES BETTER AND SMOOTHER PERFORMANCE OR DOUBLE-YOUR-MONEY-BACK

● Protect that new motor—get a new thrill out of that old motor—with Casite.

Casite carries oil quickly to the tight spots . . . protects new motors during break-in period . . . reduces engine wear . . . retards formation of sludge and gum . . . keeps motors clean and full of zip.

And everyone knows that a clean motor runs better and lasts longer.

Put a pint in the crankcase every oil change and a pint through the air intake every three months—for better and smoother performance all-year-round. Sold by service stations, car dealers and garages, everywhere.

GUARANTEE Add Casite to crankcase and run through air intake according to instructions, then drive your car 100 miles or for 60 days, whichever is first. If not convinced that Casite gives you better and smoother performance, you get double-your-money-back by filling out guarantee certificate and mailing it to The Casite Corporation, Hastings, Mich. Maximum refund is \$1.30 per pint, twice the advertised price of Casite.



THE CASITE CORPORATION • HASTINGS, MICHIGAN

Never a Dull Moment

New Springtime Finish Beauty Needs SIMONIZ Protection, Too!

Ready your car for Spring. Remove winter dullness from the finish—easily, quickly, safely—with Simoniz Kleener. Then Simoniz to "point up" this new beauty. It's positive protection against gritty mud, airborne chemicals, ultra violet rays—in fact, all causes of finish dullness. Flint-hard Simoniz saves car washings, too. A dry cloth wipes off dust and dirt... brings back mirror brightness. There's nothing finer than Simoniz... nothing better than Simoniz Kleener. Get them today.



MOTORISTS WISE
SIMONIZ
HOUSEWIVES DO LIKEWISE



Sold by grocery, hardware, drug, paint, 5¢ to \$1, auto accessory and dept. stores.

THE SIMONIZ COMPANY, CHICAGO 16, ILL.

Recognized for over thirty years as authorities on preservation of fine finishes.

All parts of the image that are cyan (green-blue) now have been transferred to the paper. When he prints the magenta matrix he transfers all blue-red portions. In printing the yellow matrix, he completes all possible color combinations.

The result? A beautiful color print within two hours of the time the process started. He can make other prints quickly by redyeing the matrices and printing them in the same way.

Although beginners who use the dye transfer process may need practice before producing perfect prints, the advanced amateur will find it much easier and less expensive than the former wash-off relief process. And to the true darkroom fan there is a vast satisfaction in translating his own brilliant film transparencies into life on paper.

Have We Outgrown the Panama Canal?

(Continued from page 122)

brought the cost up to \$525,000,000 by 1921. The building of the canal, however, is one of the best bargains our country ever made. How many millions of man-hours and ship-hours were saved by the Panama Canal in World War II will never be calculated.

In money value, the canal is definitely a paying proposition. In the peak year of traffic in 1929, 6289 vessels paid more than \$27,000,000 in tolls.

Always well defended with giant coastal guns, the Canal Zone bristled during the war with anti-aircraft artillery. Barrage balloons were everywhere. A \$20,000,000 fuel pipe line from Cristobal on the Atlantic side of the Isthmus to Balboa on the Pacific side was completed just before the Japs threw in the towel. Conceived as a secret alternate supply artery from one ocean to the other in case the canal was knocked out by enemy action, the pipe line—originally a single 20-inch line 46 miles long—proved so valuable that a duplicate pipe line was begun even before the first was completed. The daily capacity of the dual artery is 265,000 barrels of fuel oil, 60,000 barrels of gasoline and 47,000 barrels of Diesel oil.

But while every precaution was taken to protect Panama, the possibility of the Nicaraguan Canal was not forgotten. Following the survey ordered by Congress in 1929, an Army officer and one noncommissioned officer remained behind to continue the collection of hydrological and meteorological data pertaining to the proposed canal. These men are in Nicaragua today, oper-

(Continued to page 240)

Presenting DELUXE



BURGESS

vibro-tool

Trade Mark Reg. U. S. Pat. Off.

In a convenient setting that appeals to every craft and shop worker . . . a gift to thrill anyone!

Note the convenient arrangement whereby all Vibro-Tool attachments are in plain view and may be withdrawn and replaced with a minimum of effort.

In designing the De Luxe Kit, Burgess has satisfied a long-felt need for a handsome package containing the Vibro-Tool, accessories, and a handy sharpening stone . . . all permanently boxed to give the best day-in and day-out service to the user.

The Vibro-Tool De Luxe combination is housed in a sturdily constructed, hinged wooden box with a natural polished finish . . . providing a case which is attractive in appearance and which offers a high degree of utilitarian value.

The De Luxe Kit contains not only the Vibro-Tool and newly-designed accessories conveniently placed in individual compartments, but a high quality sharpening stone as well, so that all of the attachments can be kept in finest condition.

The twenty-two attachments included are a new, longer-lived standard needle for most types of engraving; the sturdier Tantalum Carbide needle for hard metals and glass; new curved and straight-edged knives and foot gauge for regulating depth of cuts; six carving chisels for wood and linoleum; six leather working tools; an abrasive point for frosting glass and smoothing surfaces; and five ball points for leather working, peening, etc.

The Vibro-Tool Deluxe Kit V 150 Price \$16.50
SEE YOUR DEALER OR ORDER DIRECT

(HANDICRAFT DIVISION)

BURGESS BATTERY COMPANY
166 N. Wabash Avenue Chicago 1, Ill.

WORKSHOP WISDOM

REWINDING FISH RODS



When rewinding your rod, add more guides to distribute strain of strike more evenly.

A coat of CASCAMITE, the highly water-resistant glue, will protect areas under windings from damp rot.

How to rewind your rod:

Remove old windings, guides, ferrules.

Next, rotten stone or pumice all surfaces free of old varnish and glue.

Spread a thin film of CASCAMITE on areas to be wound, and wind guides on tight with silk thread. Coat section ends and tip with CASCAMITE and cap with ferrules.

When dry, varnish both rod and windings.

CASCAMITE also mends cracks between bamboo splits.

Gives rod added resilience and "whip."

Why folks prefer CASCAMITE:

Easy to mix. Just add CASCAMITE to cold water and stir.

Strong. CASCAMITE glue joints are stronger than the wood itself.

Economical. Mix CASCAMITE as you need it. No waste.

Get CASCAMITE—and CASCO—the standard casein household repair glue, at your hardware store—in 10¢, 25¢, and larger sizes. For outdoor and boat work, use CASCOPHEN, the new, completely waterproof resorcinol-resin glue.

WRITE FOR FREE GLUING GUIDE: Contains complete gluing directions plus helpful hints for household repairs. Address a post card to: Casein Company of America, Dept. PM-66, 350 Madison Ave., New York 17, N. Y.



CASCAMITE

Dry Powder Urea Resin Glue

Authenticast Exclusive!



FAMED USS MISSOURI
Full-hull official scale model with replica of surrender plaque



Kit plaque is slab of a quarter ready for mounting.

A DREAM OF A MODEL . . . you'll have hours of fun building it! And you'll enjoy owning this fine model for years to come.

Authenticast assembly kit includes easy directions, diagram, tools, over 100 cast-metal precision-perfect parts. Scale: 1 inch to 500 inches, finished model is 21 inches long. Priced \$12.95 complete at hobby shops.



Send 35c in coin for colorful 32-page *Authenticast* catalog.



132-01 91st Avenue, Richmond Hill 18, L. I., N. Y.



A HONEY OF A MIKE TURNER Challenger

High performance at low cost. Reproduces voice or music crisp and clear. Precision built with moisture-sealed crystal. Works indoors or out. Rich bronzed enamel finish. 7 ft. cable. Ideal for hams and home recording. Ask your dealer. Write for Free literature describing Turner Microphones

THE TURNER COMPANY

921 17th St N E., Cedar Rapids, Iowa

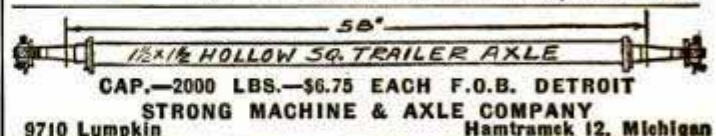

CAP.—2000 LBS.—\$6.75 EACH F.O.B. DETROIT
STRONG MACHINE & AXLE COMPANY
9710 Lumpkin Hamtramck 12, Michigan



It's easy to hone keen cutting edges on your chisels and plane blades. Precision adjustment for ANY ANGLE of bevel. Roller glide makes every stroke uniform across oil stone. Light, strong—ideal for home craftsmen, hobbyists, carpenters, cabinet makers.

check or money order \$2.95
POST PAID
McLAREN INDUSTRIES, INC., Box 606, TROY, N. Y.

The first pipe smoke!



The best pipe smoke!



The famous ZEUS Filter Cigarette Holder is back in Aluminum, with handy ejector.

Write for "Pipes—for a World of Pleasure." It's FREE L & H STERN, INC., 56 Pearl St., Brooklyn 1, N.Y.



Sir Walter Raleigh, father of pipe smoking, never knew the pleasures of a Sterncrest pipe. Poor chap, he was born too soon to puff an LHS of genuine Imported Briar, vita-fused for sweetness from the first puff.

IMPORTED BRIAR
Model #14 \$5

Dozens of others—antique or smooth.

LHS STERNCREST 14K, with gold band, imported briar \$7.50

Other LHS Pipes: \$10.00, \$3.50, \$1.50. at all good dealers

FREE RADIO CATALOG

Latest radio and electronic parts and devices, newest ham gear, gadgets, war surplus items. All in this new FREE catalog. Don't delay,

BURSTEIN-APPLEBEE CO.
1012M McGee, Kansas City 6, Mo.

STOP LEAKS!

Warner LIQUID SOLDER
NON-METALLIC—DEPOSITS TINY FIBERS TO REPAIR LEAKS

Cooling Systems Made Leak-Proof QUICKLY

WARNER LIQUID SOLDER—Non-Metallic—Deposits Tiny Fibers to Repair Leaks Anywhere in Cooling Systems. Simply pour in! Finds and REPAIRS every crack or hole. Do it yourself—or see your service man.

Warner-Patterson Co., 920 S. Michigan Ave., Chicago 5

ONE MOTION LIGHTS IT

\$1
at your dealer

THE only one-motion stainless steel lighter at \$1.00. New wheel and flint adjustment for velvet-smooth action.

PARKER SERVICE LIGHTER

PARKER OF LONDON LTD., NEW YORK

EARN BIG MONEY

MAKING DIES
in your own home workshop



HOME SHOP WORKERS
Here's what you've been waiting for!

The **FIRST** Really Low Cost
Drill Press
FILING ATTACHMENT

**FOR FILING, JIG SAWING, SLOTTING
NIBBLING, CUTTING KEYWAYS**

This amazingly simple invention can be readily adjusted to fit all standard makes of home shop drill presses. Made of the finest materials by a precision manufacturer, it costs you only \$18.50 prepaid, a small fraction of the price asked for other more complicated types. But production is limited. Order direct today for immediate delivery. Satisfaction guaranteed or your money refunded. Please state type of drill press used in your shop.

**DEALERS
AND
JOBBER
WANTED**

**ORDER
DIRECT
TODAY**

J B Products Co.
107 S. Beachwood Dr.
BURBANK
CALIFORNIA

ating rainfall stations, collecting evaporation data and recording lake levels, barometric pressure and wind velocity.

The information they have collected will prove of value, as once again an investigation into means of increasing the capacity and security of the Panama Canal is in progress. This time, the Nicaraguan Canal is bound to figure more prominently in the possibilities.

Since the locks are the most vulnerable part, it seems likely a proposal will be made to rebuild the Panama Canal as a sea-level waterway. There probably will be a recommendation that the canal be enlarged to allow aircraft carriers and larger ships of the future to pass. Even now the largest carriers can't make it and the battleship Missouri barely squeezes through.

In 1931 the Army's Interoceanic Canal Board said a new canal would lessen traffic demands on the Panama Canal and provide an alternate link between the oceans during emergency. By an ironic coincidence, one of the Army engineers who helped prepare the 1931 report on how to protect the canal, Major General Groves, also helped make the atom bomb—the weapon which can destroy it.

Aladdin Was a Piker

(Continued from page 111)

ates a relay—that furnishes current—that turns a motor—that swings the bookcase!

A similar circuit operates a burglar alarm that Brainard installed for Costello. The system is actuated when a prowler approaches the house—before he has had an opportunity to break in. Balanced circuits that are located at different places around the house all are connected with an indicator panel in Costello's bedroom. A buzzer sounds to attract attention when one of the circuits is disturbed, and a light indicates the location of the disturbance. The circuit may be hooked up to switch on lights when someone approaches the house.

For another friend, whose house is 300 feet from its gates, Brainard invented a mechanical gateman. He concealed a microphone in one of the gate pillars and placed a loud-speaker in an adjacent tree.

When a visitor sounds his car horn at the entrance gates the sound is picked up by the microphone, goes through an amplifier and relay and operates a buzzer in the house. The owner uses the concealed tree speaker and the microphone to talk with the visitor. He can push a button that unlocks and opens the gates if the visitor gives the correct password.

Built For Your Future . . .
*with hands skilled
 by the past*

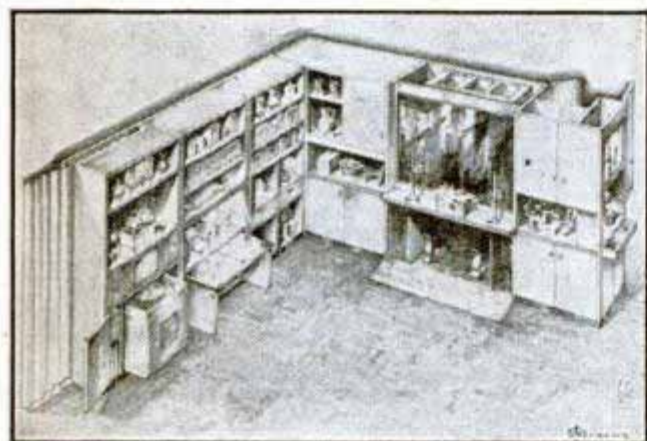
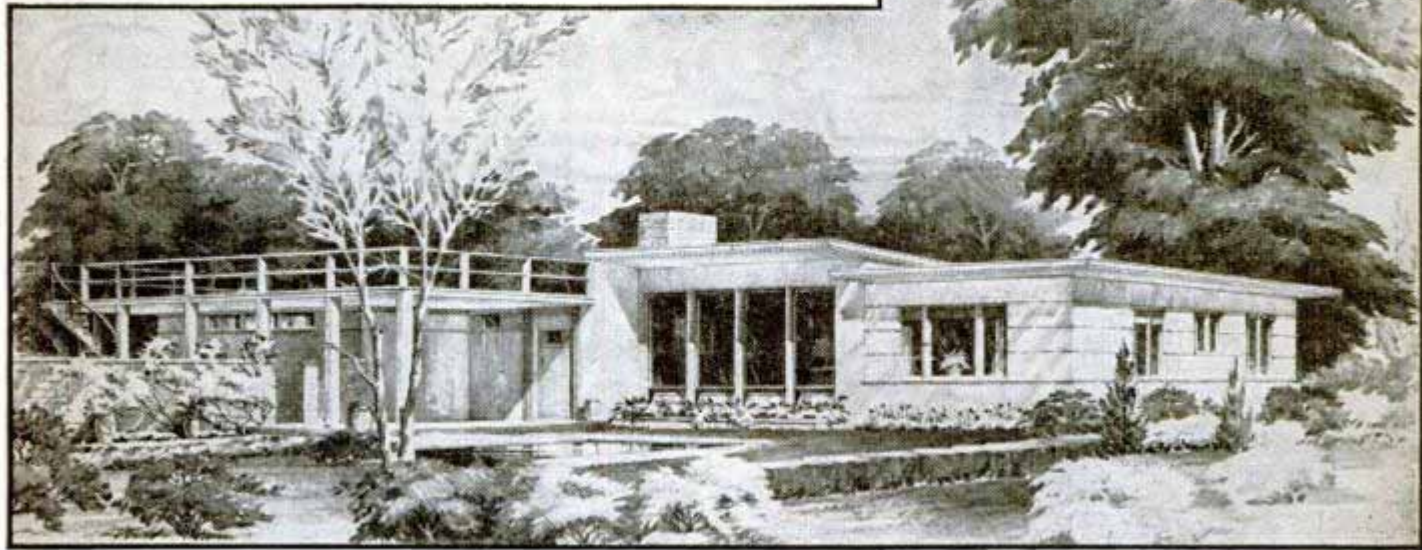

Defoe's "Working Walls" are distinctly a modern innovation. They put between-room wall space to work for the housewife and provide more storage while actually saving room space.*

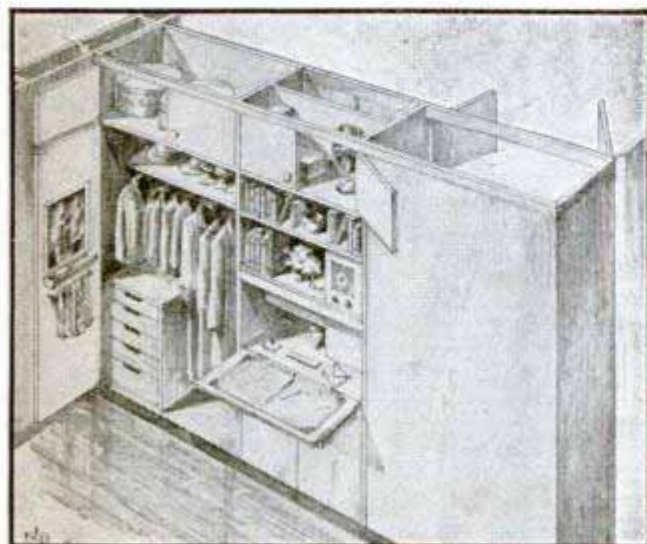

IT TAKES a lot of time and work to transform thought into reality. Things like the new Defoe Homes don't just happen. Back of them are the skill and experience born of more than forty years of painstaking workmanship under the exacting traditions of the shipbuilder's art.

• • For more than four decades everything Defoe has produced has been built to perform perfectly—and built to last! What the Defoe organization has learned in all those years has now been translated into the comfort, the convenience, and the economies of the new Defoe Homes. They will be a definite contribution to the better things for better living in the good times which lie just ahead.

*TRADE NAME REGISTERED



HOUSING DIVISION
 DEFOE SHIPBUILDING COMPANY Dept. PM-6
 BAY CITY, MICHIGAN

Please send me the descriptive brochure on the new Defoe Homes. Enclosed is 10c for handling and mailing costs.

Name _____

Street _____

City and State _____

**Cut your pipe faster
more easily
with this new
efficiency-balanced**

**RIGID
PIPE CUTTER**



*... with fast-action
thin-blade cutter wheel*

● Slap this new **RIGID** Cutter on a pipe, turn it tight and roll it right through your pipe in a few easy turns—thin wheel leaves practically no burr. You like the well-balanced feel of its new style malleable frame and the thin blade tool-steel wheel always cuts true—every cutter individually tested to assure it. Your choice of 5 sizes to 6" capacity. For easier pipe cutting buy **RIGID**, at your hardware or supply house.

RIGID

WORK-SAVER PIPE TOOLS

THE RIDGE TOOL COMPANY · ELYRIA, OHIO, U. S. A.

Electrically Welded Endless

Paramount

**BAND
SAW
BLADES**



Made in widths from 1/8" to 1-3/4"

Make your band saw do more work for you. The proper width of blade will extend the scope of this important machine. Burrill's Paramount Blades are made from tough Nickel Alloy Steel properly tempered. Teeth accurately set and filed, and all saws carefully straightened. Send order and check today. Delivery will be made as promptly as conditions permit, from a few days to a week or two. You can obtain these saws at the following prices:

1/4"-3/16"-3/8"-3/4" wide, 5'6" long.....\$.90 each
3/8"-3/16"-3/4"-3/4" wide, 6'6" long..... .95 each
1/2"-3/16"-3/4"-3/4" wide, 7'6" long..... 1.10 each

Other sizes at proportional prices

ALSO METAL CUTTING BAND SAWS

Made in widths from 1/8" to 3/4"

Your satisfaction is guaranteed

BURRILL SAW & TOOL WORKS

407 E. Main St., Iliou, N.Y.



Superior Quality
**ROTARY
FILES**

FOR HOME CRAFTSMEN

The nationally famous Ford Rotary Files, used for the past 25 years by leading precision manufacturers, are now available for the home craftsman in a handy dust proof case which contains six popular shaped tools.

The tools are made of the finest quality high-speed steel, hardened and tempered for maximum life. These ground cutters are efficient on steel, aluminum, brass, plastic or wood. The shapes will meet most home craftsman applications. These tools are made with standard 1/8-inch shank. Additional shapes and sizes are available.

Money with order prepaid
C.O.D. — postage extra

SIX TOOLS in
Dust Proof Case \$6.25

M. A. FORD MFG. CO.

400 WEST FIRST STREET
DAYTON, IOWA

SAY YOU SAW IT IN POPULAR MECHANICS

Thompson
**BEATS
the World
on BOATS**



**Better Built
Lower Prices**



Canoes



Rowboats



Outboards

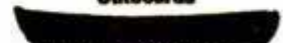

Light Boat for Auto

**Safe Boats With
Full Length Spray Rails**
Keep passengers perfectly dry—even at high speeds. Catalog also shows two new models of "Take-Along" Boats. Two big factories—save you freight.

CATALOG FREE

Write for your copy. State kind of boat in which you are interested.

THOMPSON BROS. BOAT MFG. CO. (181)
213 Ann St.,
PESHIGO, Wis.

(Write to
either place)

113 Elm St.
CORTLAND, N.Y.



Piston rings cost less than smoke rings...

EVEN youngsters today know hot smoke from a car means burning oil, wasted power, cumulative damage to cylinder walls. All these can be cured by reconditioning the engine and installing new Sealed Power Piston Rings. They lengthen engine life, restore original power, save oil, save gas.

Whatever the make, model, or degree of cylinder wear in your engine, there's a Sealed Power Ring Set specifically engineered to do the best possible job. Sealed Power people are proud of their product and its 35-year record of preference by leading car, truck and engine builders. See your Sealed Power franchise dealer and ask him for the new booklet, "What Causes Excessive Oil Consumption." Or write direct to Sealed Power Corporation, Muskegon, Michigan and Stratford, Ontario.

KEEP YOUR WAR BONDS! GET \$4 FOR \$3!

© 1946, Sealed Power Corp.

For better results 26 Basic Ring Designs

No one piston ring design can meet all replacement needs. Sealed Power Individually Engineered Ring Sets are made up from twenty-six (26) basic ring designs, which permit each set to be specifically engineered to do the best possible job in a particular make of engine.

These ring sets are engineered to save gas without sacrifice of oil economy, to save oil without inducing friction and cylinder wear. Each set gives balanced performance in a particular engine.

**Piston Rings
Pistons
Cylinder Sleeves
Valves
Water Pumps
Chassis Parts**



SEALED POWER PISTON RINGS

BEST IN NEW CARS! ★ BEST IN OLD CARS!

NOW! DUSTLESS SWEEPING



The Dustless brush is the only brush ever perfected for "Dustless" sweeping. This brush has a reservoir in its back for Arbitrin sweeping fluid. In the process of sweeping, Arbitrin filters through the brush and makes the best kind of sweeping compound out of every particle of dust it contacts. Besides reducing dust 97%, the Dustless brush also eliminates sweeping compound, saves labor and outlasts ordinary brushes 3 to 1. Get complete facts about this better method of sweeping. Write today.



- Dustless
- Speed Sweep
- Speed Wash brushes

MILWAUKEE DUSTLESS BRUSH COMPANY

528 N. 22nd Street • Milwaukee 3, Wisconsin

The Mechanics of Golf

(Continued from page 94)

shot, you strike the ball a descending blow.

Don't labor under the same delusion as one onlooker I once overheard. Observing that one of the contestants in a \$10,000 open tournament took a substantial piece of turf in playing his shorter iron shots, this non-conversant individual commented disgustedly, "I should pay good money to watch that guy butcher this beautiful turf! He should be diggin' dandelions, not playin' for dough."

As a matter of fact, if you hit the ball properly with an iron, you are bound to slice off a bit of the turf. What actually happens is that the ball is squeezed between the clubhead and the turf at the instant of impact, for the clubhead is traveling downward and has not reached the bottom of its arc. In fact it has not even started to cut into the turf. This happens after impact, and the bottom of the arc is reached at a point slightly in front of the spot at which the ball rests.

Generally speaking, the shorter the club (the higher the number), the larger the piece of turf taken in playing a full shot. You little more than scuff the turf when using Nos. 1 and 2 irons.

A common difficulty encountered by many golfers is that their clubhead strikes the turf before striking the ball. This always means a spoiled shot.

In my opinion, the most important single consideration in playing iron shots well is a firm grip on the club with both hands all the way through your swing. This means you will have control. Control is vital to both distance and accuracy. If the club is permitted to turn, twist or slip even slightly in your hands, the shot will not bring the desired results.

Photos 1 through 4 depict the stance, address and start of the backswing for the long iron shot. Together with the accompanying explanatory matter they cover all essential points in getting the clubhead started properly on the backswing.

Photo 5 is particularly important. It shows maximum distance a long iron or medium iron need travel on the backswing for full power and efficiency in the downswing.

The dangers in taking your clubhead back any more than this are (1) bending or "breaking" the firm left arm, (2) "breaking" the wrists, (3) loosening your grip on the club and (4) losing control of the club for the downswing.

Remember—the clubhead is started downward by the following simultaneous

(Continued to page 248)

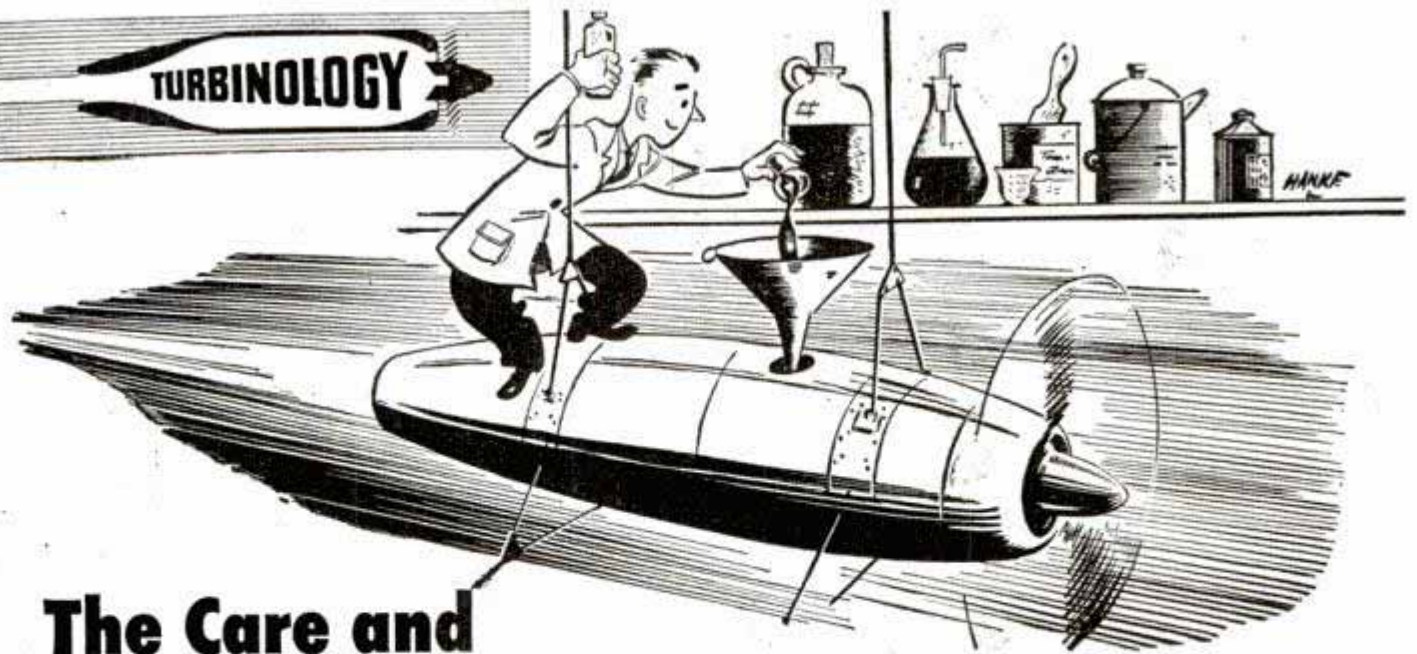

The Care and Feeding of a Turbine

The new propeller turbine of the Wright Aeronautical Corporation is no gourmet with a choosy appetite. It would be possible, though not very practical, to design it to run on either gasoline, kerosene, fuel oil, alcohol, cleaning fluid, or paint remover.

These liquids burn easily. And the main problem in "feeding" a turbine is to give it a free-burning fuel that produces intense heat to expand air and thus put enough pressure on the turbine blades to force them to turn.

If the turbine was for ground use, the cheapest fuel might be selected, fuel oil or crude oil. But in the air, every pound of fuel means one less pound of potential payload. So the fuel with the highest heat value for the lowest weight has to be selected.

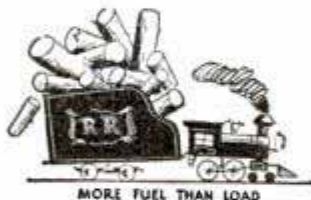

Otherwise, planes would be like trains a century ago, when they carried so much firewood there was scant room for passengers.

Years ago, scientists measured the heat necessary to raise the temperature of a pound of water one degree Fahrenheit. They

called this a British thermal unit. It is a very critical measure of fuel value. This is the way three common fuels rate in B.t.u.'s per pound: Dry wood 5,000, Coal 14,000, Gasoline 19,000.



Kerosene and fuel oil have about the same number of B.t.u.'s per pound as gasoline. Uranium has millions per pound but no one knows yet how to pour it into a fuel tank.

Kerosene is a promising turbine fuel. In cold weather, it flows easily, and doesn't "boil" or vaporize at high altitude as gasoline will. Since there is no "knock" problem in a turbine, it doesn't matter that kerosene has an octane rating far below gasoline.

However, gasoline is being used in the experimental models for several reasons. It is plentiful. From long experience with Cyclones, Wright engineers are

skilled in metering gasoline and designing air intakes and combustion chambers to get just the right combination of air and fuel for best heat results. Finally, there is less carbon, a serious problem on the delicately balanced turbine blades.

Yet if you should visit the Wright Aeronautical test cells in the coming months, you might see turbines being tested with gasoline, kerosene, fuel oil, or maybe mixtures of the three.

Eventually, Wright engineers will select one fuel to burn in the production models of the turbines. In line with their long practice of building more power with less weight and less fuel consumption, that fuel will be the one which will permit giant airliners to get the utmost in turbine power and still carry a maximum load in passengers, mail and cargo.



WRIGHT AIRCRAFT ENGINES

DIVISION OF
CURTISS WRIGHT
FIRST IN FLIGHT

Wright Aeronautical Corporation • Paterson, New Jersey, U.S.A.

The making of *Marlin* GUNS

Marlin brings to sportsmen, through this series of advertisements, interesting facts on gun-making... to enhance appreciation of fine sporting firearms and to encourage their thoughtful handling and care.



Tool-Making is Handwork of Infinite Precision

TOOL-MAKING • In the modern Marlin plant, jigs, dies and gauges make possible the manufacture of parts so precise and uniform as to be completely interchangeable. These basic tools control cutting operations of automatic machines, check uniformity of parts.

HAND PLUS MIND • Tool-design requires skilled engineering. Tools are made by hand... by talented, experienced craftsmen.

Tooling is starting-point and heart of modern line production... a system which produces fine rifles and shotguns in volume, at prices within the reach of all.

REPRINTS of advertisements on the Making of Marlin Guns will be sent FREE to sportsmen on request.



GUN REPAIR Also Requires Know-How and High Skill

THE *Marlin* FIREARMS COMPANY

NEW HAVEN, CONN., U. S. A. • FOUNDED IN 1870

BE SURE TO SEE MARLIN 1946 MODELS ON DISPLAY AT YOUR DEALER'S

SMALL EFFICIENT SPEED REDUCER

Sturdy, compact (see dimensions). Proved in thousands of industrial installations. Case of heat treated aluminum. Gears, SAE 65 (British Gear) Bronze. Worm of case hardened steel. Timken Bearings throughout. Available in 4 different assemblies (shown below) and in these standard ratios:

4-1	25-1	64-1	200-1
8-1	30-1	75-1	300-1
10-1	40-1	80-1	400-1
16-1	50-1	100-1	600-1
20-1	60-1	150-1	800-1

Torque capacity 100 inch pounds. Especially suited for bench work, home work shops, light production, animated displays, etc. When ordering be sure to specify assembly and ratio required. Shipping weight in carton, 8 lbs. Full money back guarantee. Prompt deliveries.



\$15.12

Net Price
F. O. B. Cleveland

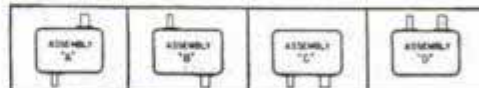

THE OHIO GEAR CO.

1400 EAST 179th ST. • CLEVELAND 10, OHIO

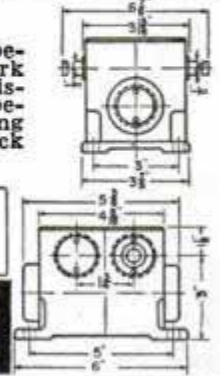

MODEL: Gasoline Engine Ready to Run



A precision built and engineered single cylinder FOUR-CYCLE model gasoline engine; adjustable valves; steel pinion and cam gears; a real ignition system; speed 300 to 3,000 rpm; develops approximately 1/2 hp. Bench tested and ready to run. Available with stationary or marine engine base. Full instructions. Lots of fun. Engine \$27.50. Coil and condenser \$2.75. Immediate delivery.

The THOMPSON ENGINEERING CO.

7 3/4" high—3" wide
Cyl. 1" dia.: stroke 1" 206 Winchester Place, Grand Rapids 2, Mich.

Made From IMPORTED BRIAR



- Sweet Smoking
- Superior Grains
- Modern Designs
- From \$3.50 to \$10

The Author

SEND FOR FREE ILLUSTRATED BOOKLET

C. B. WEBER & CO. 146 Cator Ave., Jersey City 5, N. J.

DUPLICATING MACHINE for \$4.00!

Earn Big Money making photographically exact copies of letters, certificates, photos, etc. Build clever machine in one evening with hand tools for less than \$4.00. Clearly illustrated instructions plus plan for operating your own copy business—\$1.00 postpaid.

J. P. KILMAN, 1301 SCOTT ROAD, BURBANK, CALIFORNIA

REPAIR YOUR OWN ELECTRIC APPLIANCES WITH NEW AMAZING NICHROCITE



Simply overlap ends, apply Nichrocite paste and turn on the current—a perfect weld results. Used by big utility companies and repair shops. Just the thing for that broken or burned out heating element in your electric iron, stove, toaster or heater. Does the job in a jiffy. Trial order, \$1; 4 ozs., \$2.50; 1 lb., \$8.00.



Handy for Home or Industrial Use

ARMSTRONG ELECTRIC CO., Box 861-MP, Minneapolis, Minn.

IT'S JOHNSON THAT GIVES YOU ...



....THE "BIG THREE" OF
OUTBOARD MOTORING



Full Range Performance! You've heard of the motor that packs real power... *silken* power... at high speed, yet gives you velvet smoothness at a crawl? That's Johnson, Dual Carburetion (which Johnson brought to outboard motoring 10 years ago) accounts for this beautiful performance.

Reverse! *Of course* you want reverse. Reverse, with 360° Steering, is one of the "big three" of outboard motoring. (It was a Johnson feature nearly 25 years ago.) Steer forward, sidewise, turn around or back up... The Sea-Horse at right develops 5.0 O.B.C. CERTIFIED brake horsepower at 4000 r.p.m.



Wonderful Smoothness! Twin-cylinder Alternate Firing, developed and perfected by Johnson, was introduced to America by Johnson 17 years ago. It gives you a wonderfully smooth flow of power. It is one of the "big three" of outboard motoring... The Sea-Horses above develop 16.0 O.B.C. CERTIFIED brake h.p. at 4000 r.p.m... For information on Johnson deliveries see your Johnson Dealer. Look for his name under "Outboard Motors" in your classified phone book.

FREE HANDY CHART! Write for your copy today. Describes all 5 models of the '46 Sea-Horse line. JOHNSON MOTORS, 400 Pershing Road, Waukegan, Ill.

There is No Substitute for Experience

JOHNSON SEA-HORSES for DEPENDability

**JOHNSON BUILDS
SEA-HORSE
MOTORS ONLY
-NO OTHERS**

**A HOME OF YOUR OWN..
WHERE YOU WANT IT!**

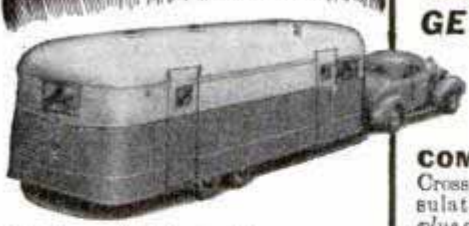

**BUY SCHULT
GET ALL
4**

● This mobile home has every facility of a modern house. Follow the job—or the fishing—in true comfort.
COMPLETELY FURNISHED
Built-in furniture; complete kitchen with oven range; daventryport in living room converts into an extra double bed. Sliding doors provide 3-room privacy!
For plus-value in mobile homes see your Schult dealer, or write for new catalog of 1946 models.
SCHULT CORPORATION, Dept., 3206 ELKHART, INDIANA, Member: TCMA

COMFORT
Cross ventilation; full insulation; built-in bed plus sofa bed; well-lighted vanity with lavatory.
CONVENIENCE
"A place for everything" in this mobile home designed for efficient living.
BEAUTY
Fabrics that harmonize with the beauty of rich interior woodwork.
QUALITY
Designed by the pioneers of the industry. Built by latest methods, painstakingly, of selected materials.

SCHULT TRAILER COACHES

BRIGHT EYES

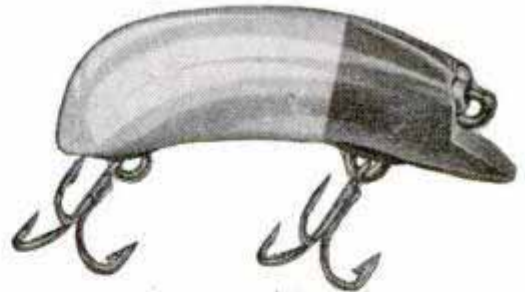

The sweetest casting lure you've ever used. Its ultra modern design—its exciting, whip-like action—its appeal to ALL game fish—its bright staring eyes that literally bore a path through the water—make it a must for the coming fishing season. Either a deep running, or surface lure, depending on speed of retrieve. Made of tenite, with two #1 P & K American made, nickel plated, treble hooks with extra sharp ground points. In 8 flashing color combinations. No. 44RW (Red & White), 44WL (Black body with white lateral line), 44YP (Yellow Perch), 44F (Frog), 44P (Pike), 44R (Rain-bow), 44GS (Green Scale), 44PR (Pearl). \$1.10 each.

We prefer that you buy P & K at your favorite dealer—BUT, if he hasn't it, you can order direct.

"ADVENTURES IN FISHING"

Just off the press. 32 pages—articles by Cal Johnson, famous outdoor writer and fishing authority—pictures in full color of P & K Lures and Accessories—hunting and fishing photos, etc. A regular 10c package of Raparound, the Invisible Ribbon Sinker, a MUST for Fly Fishermen, and this booklet, for only 10c, mailed postpaid. SEND YOUR DIME TODAY!



PACHNER & KOLLER, INC.
3428 Archer Ave. Chicago 8, Ill.

TESTED AND PROVED LURES AND FISHING ACCESSORIES

HOW TO GET THE MOST OUT OF BETTER FUEL

Don't expect to fill your tank with the new, higher-octane gas and get top-grade performance from spark plugs you may have switched to during the war. Now that you're getting far better fuel—and have returned to normal driving—you need to consult your service station about changing to AC plugs that run *cooler* than those you may have used with wartime fuels.

The correct type of plug is *necessary* to avoid hard starting—loss of power—waste of gas—cracked insulators—rapid electrode wear—excessive oxide coating—misfiring under heavy loads.

The AC Heat Range, and today's wider heat range per plug, enable you to fit spark plugs exactly to engine operating conditions. That's why AC's were standard equipment on 2 of every 4 new cars and trucks—why your Registered AC Dealer can help you to get the *utmost reliability* in spark plug performance. Have your plugs checked today. Be sure you have the type that will give you the best in performance.

AC SPARK PLUG DIVISION • GENERAL MOTORS CORPORATION



CLEAN PLUGS SAVE UP TO ONE GALLON OF GAS IN TEN



motions: (1) Start of lateral shifting of weight from right to left side, (2) turn of left shoulder which pulls the arms with it.

I always have the feeling in the downswing that my left hand is pulling the club, and my right hand is doing its best to keep up with the left.

Photo 7 will bear close observation. With the clubhead within four inches of the ball, and all the power at my command flowing into the club, my head remains fixed in its original position. It has not moved an inch, forward, backward, up or down. It serves somewhat the function of a hub in a wheel, with my arms and shoulders the "spokes."

Just as important is the position of my hands. One of the most helpful discoveries I made in trying to perfect my iron play was the value of keeping the back of my left hand facing directly toward my objective from the time the clubhead enters the "hitting area" (last 20 inches before clubhead impact with the ball) until it has reached a point in the follow-through at which the club shaft is nearly parallel with the ground and pointing at my objective. By keeping the hands as shown in photo 5 you will avoid many difficulties resulting from uncontrolled wrist action.

At the finish of the follow-through as illustrated in photo 8 you should note particularly the following points: (1) Club is still gripped very firmly, (2) pull of the shoulders has turned my head so that my eyes may follow the ball, but my head has not moved from its original position. My weight is over to the left side.

The photos on page 91 illustrate the stance and address for the medium irons. Together with the accompanying captions they are fully explanatory.

As we come to the end of Article II, I again remind you that, under normal conditions, the swing for all clubs is fundamentally the same.

In the final article of this series next month we will study the technique of playing short irons, chip shots, shots out of traps and putting. We will wind it up by playing two holes of golf together.

(Concluded next month)

Mudslingers Bring Up Oil

(Continued from page 159)

To shut off the flow of gas into the hole, a restraining pressure must be built up by weighted mud. The toolpusher orders 40 tons of weight material—powdered barite or hematite. Barite is barium sulphate or "heavy spar" with a specific gravity of 4.3

(Continued to page 252)



I NEVER DREAMED ANY HEARING AID COULD BE SO TINY! SO LIGHT!



AND HOW MUCH CLEARER-TRUER EVERYTHING SOUNDS NOW

Again! Beltone Cuts Size

of one-unit Hearing Aid.

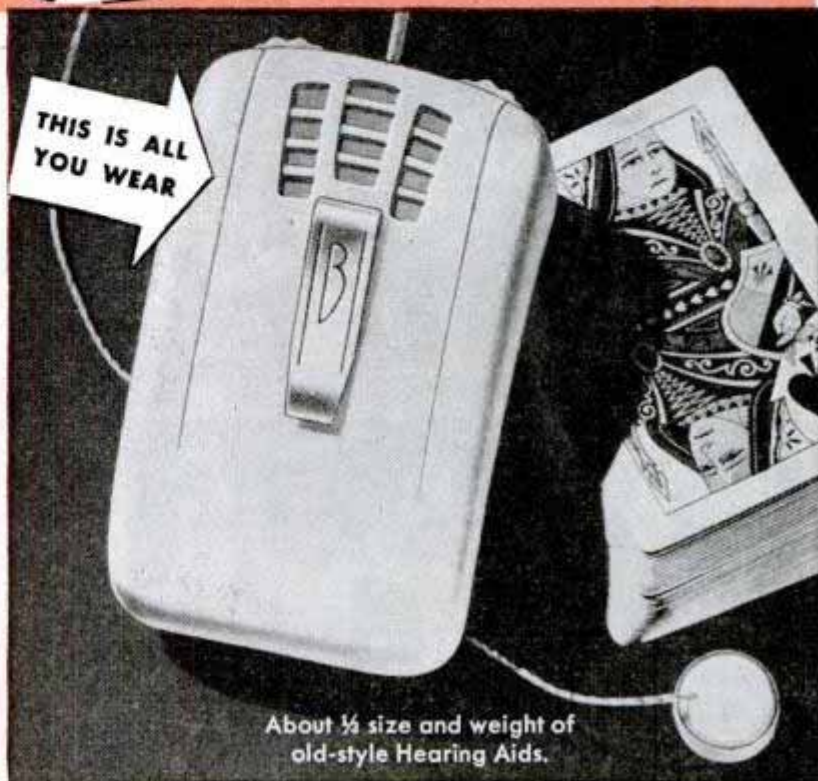

...and brings you Amazing Advances for

NEW HEARING EASE!

Amazing X-Cell out-performs units 5 times its size, providing ever-level, full tones. All one unit, hardly larger than a deck of cards. Controlled power gives you better hearing under all conditions.

Find out WHY there are more Beltone one-unit Hearing Aids in use than all others combined.

No Other Hearing Aid has all these Sensational Advantages

- Batteries and transmitter all in one small unit.
- Comfort-Curv Design. Wafer-thin case.
- Range Selector which eliminates background noises.
- "Plug-in" Electron Tubes that are easily changed if your hearing changes.

Mail This Coupon Now!
FREE BOOKLET



BELTONE HEARING AID CO., Dept. PM6
1450 W. 19th St., Chicago 8, Illinois

Without obligation, send me FREE information on how the new, smaller Beltone Mono-Pac makes better hearing so much easier now.

Name

Address

Town State

"1001" Re-Blade Knife*

with interchangeable surgical steel blades!



**KEEN!
EVER SHARP!
EVER READY!**

"1001" Knife as above, \$1.29
Knife with 3 extra, different blades and honing stone, \$1.59



The first really "balanced" craft knife

Whether you're an expert craftsman or just a passably fair workman or hobbyist, you'll do better work faster and easier with "1001"—the re-blade knife of 1001 uses! For "1001", thanks to its light, perfectly balanced, colorful plastic handle, is second to none for easy and exact whittling, chiseling, modeling and cutting of all sorts. Its patented, scientifically designed chromium finish blade holder simplifies the insertion and removal of "1001's" all-purpose blades, and keeps them firmly locked in place. Yourself—get a "1001"—feel the difference, see the difference in your work. It's as easy to handle as a pen or pencil.

• Buy "1001" wherever hobbycraft tools are sold. If your dealer cannot supply you, send check or money order for \$1.29 (or \$1.59) direct to

SOMAR SPECIALTY CORP.
Dept. M12—630 Fifth Ave., New York 20, N. Y.

*PAT. PENDING

SAY YOU SAW IT IN POPULAR MECHANICS

Famous Barron DRILL PRESS Accessories . . .

Multi-Purpose WOOD PLANER..\$7.50

Fits ANY drill press. Planes, panels, rabbets, routs, tenons, beads, grooves. Machined and balanced. Hi-Speed tool steel cutter knives. Thousands now in use. 10 Day Money Back Guarantee.

Rotary Surface SANDER . . . \$5.95

Fits chuck of drill press. Unexcelled for smooth, even surface sanding of woods and plastics. Original in design and a great labor saver. Complete with 20 sanding discs. 10 Day Money Back Guarantee.

Spiral Flute ROUTER BITS

Special radial shaped flutes for faster, smoother, easier routing, grooving, carving, round-end mortising. Extra long cutting flutes for deeper work. Available in individual sizes. Complete set of 6 sizes \$8.50

Auxiliary Drill Press TABLE \$8.85

Hard Alcoa aluminum 234 sq. inch table. Fits on standard drill press table to give greater working area. Precision ground. Heavily ribbed. With Barron steel fence. A "must" for every drill press.

Write for FREE Catalog

BARRON TOOL CO., INC.

369 Architects Bldg.

Detroit 1, Mich.

BARRON PRECISION WORK SHOP TOOLS



MINIATURE ENGINES

Gasoline—Steam
Air—Locomotive



THE WORLD'S MOST FASCINATING HOBBY

Build them yourself — In your own shop
With your own tools



Send 10 cents for my illustrated catalogue listing the world's largest selection of miniature engine castings and drawings.

WAYNE MILLER

Suite 201
Engineering Bldg., Chicago 6, U.S.A.



THE GEM MAKER

Amateurs or professionals . . . hobbyists or jewelers . . . Polish your own gems with a B&I Gem Maker. You will find this a profitable adventure. All necessary lapidary equipment is furnished, including a super-charged diamond blade for sawing, and all wheels for grinding, shaping and polishing, also complete instructions. The complete equipment as shown, less motor and belt, for only \$29.50, f.o.b., Burlington, Wis. Write today for information and literature on the Gem Maker and accessories. B&I MFG. CO., Dept. S, Burlington, Wis.



ALUMINUM RODS

FOR HOME CRAFTSMEN

Use these free-turning aluminum rods on model engines, planes, etc. Two typical kits below. Send postcard today for complete list.

KIT 1 \$1.00 plus postage, 7 pcs, 12" long, 3/8" to 1/2" diameter by 1/16ths.
KIT 2 \$4.00 plus postage, 5 pcs, 12" long, 1/2" to 1" diameter by 1/8ths.

THE PLEASANT CO., Aluminum Div., 13032 E. Jefferson, Detroit 15, Mich.

WOODWORKERS . . . Get this

CONSTANTINE MASTER MANUAL
Get the Most Fun From Your Hobby
Indispensable to woodworkers. Newest, biggest edition, more pages, more color, helpful how-to-do-it articles, pre-war and new items, more bargains. Send 25c today and we will include
FREE! FULL YRS. SUBSCRIPTION
to Chips and Chats, published bi-monthly. Keeps you up-to-date on everything in woodworking, offers big money-saving bargains. Send now.
ALBERT CONSTANTINE & SON, Inc.
791-K, 135th Street, New York 54, N. Y.



POWERlite

6-VOLT 2-LITE ELECTRIC LANTERN

Millions now in use. 2-Lites: spotlight *plus* floodlight. Runs 80 to 100 hours on one battery. Rugged. Lenses don't break. At Hdwe., sport, electric dealers.

\$3.65
LESS
BATTERY

Delta

DELTA ELECTRIC CO.
MARION, INDIANA



ALL OUTDOORS IS YOURS ON A HARLEY-DAVIDSON!



THE fun and beauty spots are calling you! Majestic mountains — lakes and rivers — forest and open country — broad highways and country lanes — are awaiting you and your NEW HARLEY-DAVIDSON. Pack your evenings, weekends and vacation days with pleasure! Join other Harley-Davidson riders on tours and endurance runs — or take in race meets, hillclimbs and other thrilling motorcycle events. See your Harley-Davidson dealer early, MAIL THE COUPON NOW!

HARLEY-DAVIDSON MOTORCYCLES

HARLEY-DAVIDSON MOTOR CO.
Department P, Milwaukee 1, Wisconsin

Please send free copy of 24-page "Enthusiast" Magazine, filled with motorcycle action pictures and stories.

Name

Address

City State

PAINTERS' STRIPING TOOL

A TOOL...
NOT A BRUSH

NEW, IMPROVED

Modern—streamlined—fits the hand like a fountain pen! Easy to use as a pencil. Draws parallel lines—straight, curve or circular. Does expert job on autos, furniture, toys, bikes, model planes, signs, bulletins, linoleum. (Makes wall board look like tile.)

Every painter and craftsman needs one! Type "M" MASTER Painters' Striping Tool complete with tip for 1/16" stripe, \$1.00. Extra tips 1/64", 1/32", 3/64", 1/16", 5/64", 3/32", 1/8"—75c each. Tool with complete set of 7 tips \$5.00. (C.O.D. orders 25c extra.) Paint dealers, write!

\$1.00
POST
PAID



WENDELL MFG. CO.

4234-B Lincoln Ave., Chicago 18, Illinois

DO YOU

WANT a permanent business profession of your own? Then BECOME A FOOT CORRECTIONIST. Earnings in this greatly needed profession run as high as \$50-\$100 weekly after a few weeks home training—not medical or chiropody—no further capital needed, no goods to buy. 50th year. Write for free booklet.

Stephenson System of Foot Correction

28 Back Bay.

Boston, Mass.

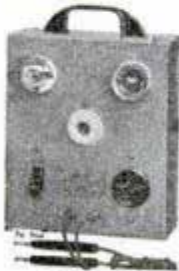

Pat. Pend.

LOCATES TROUBLE INSTANTLY IN ALL ELECTRICAL DEVICES

HANLAN APPLIANCE TESTER

In this single unit are combined all the necessary tests for examining every appliance. Checks thermostats under actual working conditions. Tells instant it opens or closes. Controls the heat on soldering irons. Prevents over-heating. Tests continuity, open circuits, etc. Checks automatic irons, vacuum cleaners, motors, shavers, bulbs, appliances with 3-way switches, etc. Great time, effort and money saver! ONLY \$9.50 COMPLETE.

FREE with each Tester. New, Complete Practical Course in electrical appliance repairing. WRITE FOR CIRCULAR. HANLAN CO., 1419-A, West Jefferson, Los Angeles 7, Calif.

From a smart Lad to a worthy Dad-



WATCH a man's eyes light up at the sight of a fine Biltmore Pipe. It's the right gift alright, always.

Biltmores are choicest imported briar, beautifully finished, rich-grained, mounted with sterling silver bands, and sweet-smoking from the first puff Packed in velvet bags and boxed. If not available at your dealer write Biltmore Pipe Co., 220 Fifth Ave., New York City.

Biltmore "DeLuxe," \$2.50 ★ Biltmore "Reserve," \$5.00
Biltmore "Blue Ribbon," \$3.50 ★ Biltmore "Executive," \$7.50
Biltmore "Goldencrest," with ultra grain, \$10.00

Biltmore

IMPORTED BRIAR PIPES

to 4.6. Hematite is an iron oxide with a specific gravity of 5.2. The "gel" property of the mud is built up with bentonite material so that the fluid will not permit particles of barite or hematite to settle.

Pumps drive the weighted mud into the drill pipe and the heavy fluid by hydrostatic pressure and pump pressure forces gas-cut mud to rise. If the increased weight of the mud column is enough to hold down the gas, the catastrophe has been averted.

In general a good drilling mud carries about one third solids and two thirds water. Its weight may run from 70 to 80 pounds per square foot for ordinary drilling, but can be changed to meet special problems. In comparison, water weighs 62.4 pounds per cubic foot. With an especially light oil-base mud (mixed with oil instead of water), drilling fluid at 60 pounds per cubic foot can create hydrostatic pressure of 2083 pounds per square inch at 5000 feet, 4166 pounds at 10,000 feet and 6249 pounds at 15,000 feet. Weighted mud at 115 pounds per cubic foot can create hydrostatic pressures of 3992 pounds per square inch at 5000 feet, 7985 pounds at 10,000 feet and 11,978 pounds at 15,000 feet.

Gas pressures of 5000 to 6000 pounds per square inch may strike back at the driller. If not kept under control, such enormous pressure can destroy a well and terrorize a whole section of an oil field.

"Gel" rate is measured by timing the sinking of a thin-walled aluminum tube in a sample of mud. To test for water-retaining properties, the engineer puts a sample of mud in a cylinder under 100 pounds per square inch pressure. The rate of dripping from a filter in the bottom of the cylinder provides an index. Thickness of clay deposit on the filter indicates the mud's wall-building properties.

Testing and treating mud for oil drilling is a new science, but it's come a long way since the days of frequent blow-outs, gas-sers and fires. Properly controlled by a mud engineer, rotary mud performs feats of engineering three miles underground.

Lithium . . . the Hungry Metal

(Continued from page 163)

and weak. Adding lithium brought his percentage of weepers down to one percent!

As an alloying agent lithium has startling properties. Adding as little as .01 percent of this metal to lead—a couple of pinches per 1000 pounds of lead—gives a lead alloy which remains hard even at high temperatures. Alloyed with magnesium,

(Continued to page 256)

GAL WON'T GO



'CAUSE CAR'S A MESS



**Just try
No. 7**



You'll say it's the easiest you ever used. This polish removes Traffic Film quickly—restores original color and lustre. If you want a brilliant job in half the time, use Du Pont No. 7 Polish.



Better Things for Better Living
... Through Chemistry

THIS QUICK SHINE-UP



MAKES "NO" A "YES"



NO. 7 POLISH

NEW TOOL READY!

War Industry's Handy, All'Round Machine
Now Available
To Home Shops!

The world-famous Mead Bandsander—invented for and used by hundreds of war plants—is at last available to you for home workshop use! This remarkable machine quickly shapes, sands, carves and polishes wood, metal, plastics! Works equally well on inside cut-out openings or irregular outside edges. Gets at places no other can! Tilting table for bevelling, chamfering. Rust-and-sweat proof top. Ball bearings. Saves time, labor, money on jobs in any home or industrial shop. Invaluable to home-craftsmen, makers of patterns, tools, dies, signs, costume jewelry, castings, forgings, ornaments, radio and electrical parts, stampings, etc. Nothing else like it. Sold on 5 Day Trial, money back guarantee. Circular Free!

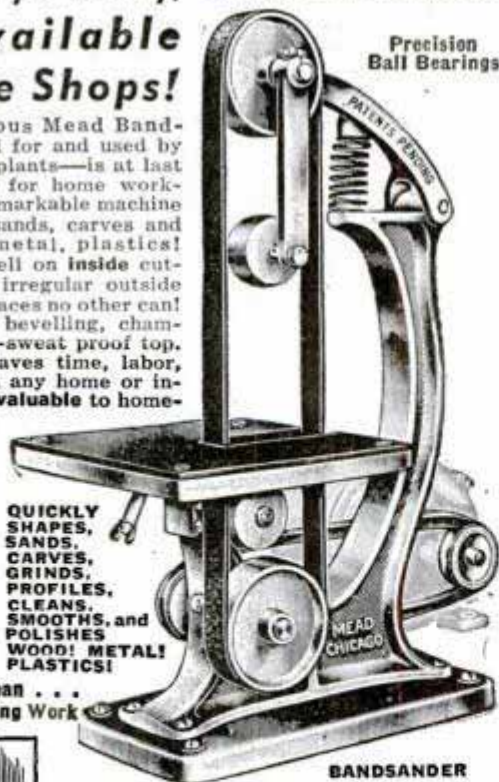

Precision Ball Bearings

BANDSANDER

QUICKLY SHAPES, SANDS, CARVES, GRINDS, PROFILES, CLEANS, SMOOTHS, and POLISHES WOOD! METAL! PLASTICS!

Cuts Fast and Clean . . .
Saves Filing, Sanding Work



Write for FREE Circular

Send for free details on "the machine that amazed the experts!" Rush a postcard today for Circular, surprisingly low price. Hurry!
MEAD SPECIALTIES CO.
4114 N. Knox Ave., Dept. 16, Chicago 41, Ill.

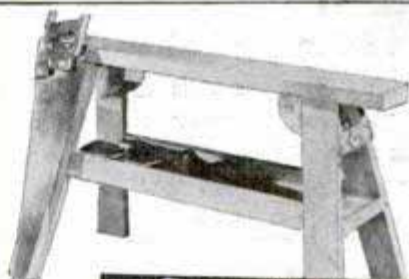

Here's a
Saw-horse
that folds
away



FOLD-HORSE

(Patented)

The only folding saw-horse that offers complete stability, yet occupies only 1/6 of normal storage space. It is ideal for job, shop or home craftsman. Takes up only 8" x 9" x 42" when folded—a definite advantage in transporting. Requires less than a minute to set up to standard saw-horse size. The rugged, 14-gauge, cadmium plated hardware is recessed to prevent nicking your saw. Top is clear, white pine with a 2" x 6" x 42" working surface and 9" x 36" tool tray. Place your order immediately to assure prompt delivery. Lists.....\$9.95 each.

Jobbers—write immediately, a few select territories still open!

UNIQUE TOOL PRODUCTS COMPANY

4634 N. Clark Street

Chicago 40, Illinois

take
Steam Heat
along



to your summer cottage!

Luggage light—carry it anywhere

Imagine! A portable steam heating "plant"—no larger than a suitcase—that pours out an abundance of clean, healthful steam heat in minutes . . . by just plugging into an electric outlet!

Fan-Circulated Steam Heat

Not a *spot* heater that "toasts" on one side. Efficient Wittie Steam Heater circulates 90 cubic feet of steam heat per minute . . . evenly and gently throughout the room. Real cozy warmth on those chilly days in the country . . . Winter-long comfort at home as well!

Safe and Economical

No glowing coils; heating element safe from prying fingers. Cabinet never gets hot. "Econo-miser" Control saves on current. Weighs only 32 lbs. 115 volts AC only. See new Wittie Heater at leading dealers now!

WITTIE MFG. & SALES CO., CHICAGO 5, ILLINOIS

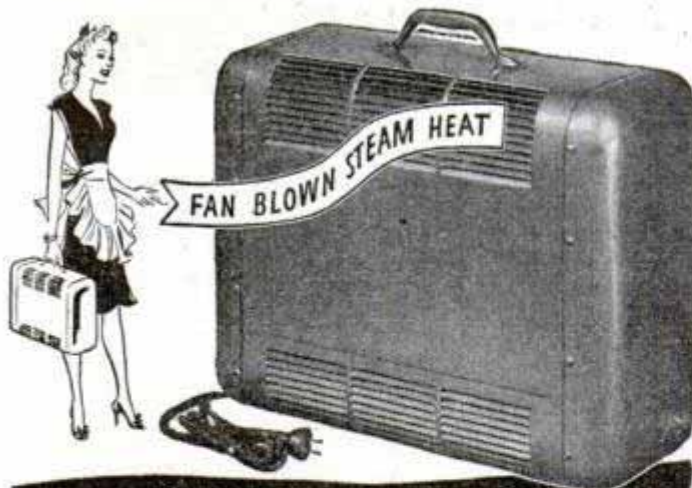

WITTIE
ELECTRIC *Steam* HEATER

KEEP a CAN of BOTH ON HAND!

Heavy 3-IN-ONE

Light 3-IN-ONE

Refrigerators, mixers, motors, power tools, lawn mowers, ironers.

Sweepers, sewing machines, hinges, guns, locks, metal drawers.



For over 50 years
America's accepted
household oil!

SOLD EVERYWHERE
IN 1 AND 3 OUNCE CANS



3 - IN - ONE *Oil*

FIND UNDERGROUND MINERALS and METALS with M-SCOPE

Employs same principle as Army Mine Detector. Unsurpassed in Efficiency. Write for Free 16 page booklet.

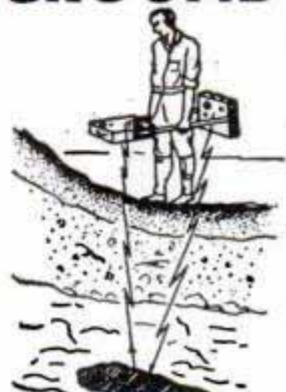

FISHER RESEARCH LABORATORY
PALO ALTO CALIFORNIA

Sand Casting—Forging—Heat Treating—Case Hardening

BRONZE FOUNDRY



is again available in limited quantity without priority. Orders filled in sequence as received. INVENTORS—SCHOOLS—CRAFTSMEN use FOUNDRYETTE for making castings quickly for new inventions, for instruction, and general purpose. Order now for early delivery. Three sizes are available capable of making bronze castings of 1½, 3, and 6 pounds weight, aluminum, copper, brass, etc., \$17.50, \$24.00, \$34.50, f.o.b. Kansas City. Domestic gas supply and 110 volt AC or DC energy required for operation. Write for circular.

KANSAS CITY SPECIALTIES CO.
Box 6022, Dept. P-67 Kansas City, Mo.

You CAN'T WORM WRONG

for tape, hook, whip, round (ascariid) worms when you worm your dog as directed with Pulvex Worm Capsules, a combination treatment which insures your worming right. Used by leading breeders. Packaged 2 ways: for puppies, for dogs. Either, 50¢; double-size, 75¢
At pet, drug, department stores.



PULVEX
★ COMBINATION TREATMENT
WORM CAPSULES

THE ONE AND ONLY PIPE OF ITS KIND

VanRoy
with the
Ajustomatic
STEM



FREE-TURNING—SELF-ALIGNING



VanRoy Ajustomatic Bard \$5

VanRoy Ajustomatic holds a man's affection; it is the only screw stem pipe that maintains perfect alignment of stem and bowl throughout its long, happy life! The exclusive VanRoy patent, "float-mounting"—allows free turning of the stem but grips it snugly in any position. The stem can't lock at an off angle, always lines up as straight as a die. A remarkable innovation, worthy of the VanRoy tradition of eminently fine quality. VANROY COMPANY, INC., Empire State Building, N. Y. 1, N. Y.



SIGNET OF QUALITY IN PIPES

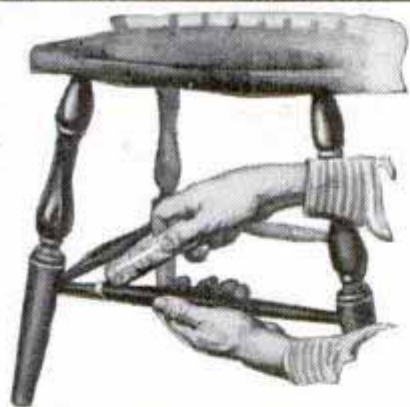

REPAIRS FURNITURE, TOYS

...also broken china, glassware, torn luggage and books. This handy adhesive is waterproof, transparent and flexible. Get a tube today!



DUCO CEMENT

REG. U. S. PAT. OFF.



Useful
TOOLS

SET
T-52
**Deluxe
Electrical
Ignition
and
Radio Set**

All For \$13.00
List Price

See your dealer or write us

SPINTITE SET
A Positive Need in Every RADIO,
HOME and ELECTRICAL SHOP.

Contains Chuck Type Handle, Reamawl, 3 Screw Drivers,
2 Pliers, 7 SPINTITES and Insulated, **WALDEN**
WORCESTER
Neutralizing Alignment Wrench.

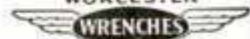

STEVENS WALDEN, INC.

WORCESTER 4, MASSACHUSETTS

NEXT TIME SAY BRIGHT STAR

and you will get a
FLASHLIGHT & BATTERIES
famous since 1909
for QUALITY,
STYLE and
SERVICE

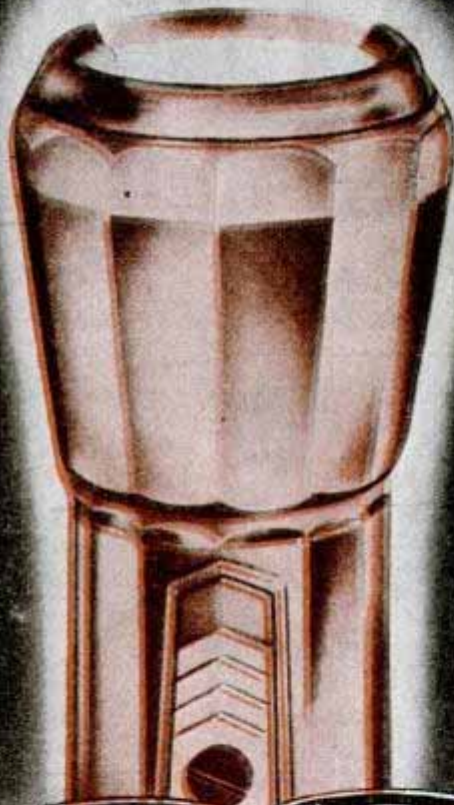

BRIGHT STAR BATTERY CO. CLIFTON N. J.

lithium confers both strength and hardness.

In the heat treatment of steels, oxygen and water vapor are deadly foes of the metal. Ordinarily, when steel is heated to 1600 degrees Fahrenheit, the metal grabs up oxygen rapidly. This forms a scale which must be removed by abrasive cleaning or pickling in sulphuric acid. Instead, a small, renewable "cartridge" containing compounds of lithium is inserted in a generator attached to the heat treating furnace. A "carrier" gas is allowed to flow over this lithium generator, picking up lithium vapor. The vapor fills the furnace and forms a protective blanket over the hot steel, protecting it from oxygen and water vapor. As a result, steel pieces come out of a lithium vapor furnace bright and shiny, ready for assembly. Their precision measurements are not altered.

One compound, lithium chloride, picks up moisture so rapidly that the material is being used extensively in air conditioning equipment. In a typical lithium air conditioning system, air is drawn into a tank containing lithium chloride in solution. By varying the strength of the lithium salt, moisture in the air can be decreased to a relative humidity of 11 percent.

Lithium compounds, added to certain lubricants and greases, have made it possible to use the resulting lubricants over temperature ranges from 140 degrees Fahrenheit to 67 below zero. These lubricants are finding wide application in planes.

Vases, plates, tiles and other ceramic products become stronger and possess glossier finishes when lithium compounds are added to the basic materials. Both the fluoride and the chloride of lithium are used in fluxes for aluminum welding to keep the surface of the molten metal clean during welding. Tomorrow, lithium will be working in even more fields, pushing back limitations which have been hampering industry.

Step on the Gas—the '47s Are Rolling!

(Continued from page 89)

ward until its center of weight is over the front spring suspension. This vertical and horizontal redistribution of weight is said to offer better stability and riding quality. An improved mounting which locks body and chassis resists shocks and strains.

As might be expected, few of the changes in these '47 cars are in the power plants. Studebaker officials are well satisfied with the 80-horsepower L-head six-cylinder

(Continued to page 260)

Goodbye Putty

TREMCO

MASTIC-GLAZE IN COLORS

Successor to putty!

- NEVER CRACKS • NEVER FALLS OUT
- EASIER TO USE • NEEDS NO PAINTING

At dealers everywhere

MC 1231



TREMCO QUALITY PRODUCTS
FOR HOMES AND FARMS

YOUR ELECTRIC DRILL

Has 100 Other Uses

when used with K-Jax attachments
METAL SAWING . . . SHEARING
RIVETING ATTACHMENTS

Write for illustrated circular

K-JAX, 2600 Canton St., Dallas, Texas

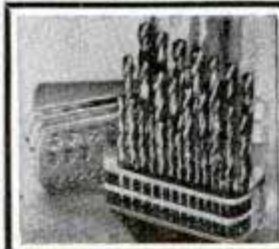

Why Hunt for Drills?

These Complete High Speed Drill Sets
Now Available at Low Prices
#1 to 60 Drills. . . . \$12.95 Per Set
1/16-1/2 by 64ths. . . \$16.95 Per Set
Drill Sets A-Z. . . . \$15.50 Per Set
(Drill Stands Free)

SID TOOL CO.
MACHINE SHOP SUPPLIES
183 Grand St., New York 13, N. Y.

FOLDING POCKET MAGNIFYING GLASS

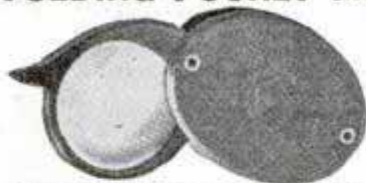

HIGH POWER

POST PAID **75c**

Double Lens \$1.35

CAPITOL SPECIALTIES, 100 Wall Street, Bridgeport 3, Conn.

SAY YOU SAW IT IN POPULAR MECHANICS



BUILD THESE PROJECTS

For garden or lawn. Easy to build. Easy to sell. Detailed Blueprints Model B-25 Dutch Windmill 50c; Model OM-60 Old Mill, 85c. Lawn Figure Patterns—Sunbonnet Girl, Dutch Boy, Tulip Girl, Holland Pair, 35c each, all 4—\$1. Catalog illustrating many models, send 10c, today.

CRAFTSMAN'S MODEL CO., Dept. P-92, 2030 N. 41st St., Milwaukee, Wis.

MARCOT KEY MACHINE

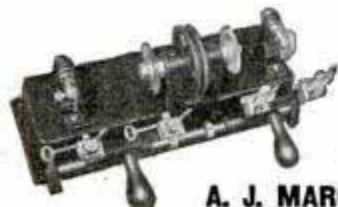

Marcot No. 8 Key Machine
Mounted on Cabinet. . . . \$ 75.00
Book on Modern Locksmithing 3.95
Auto Code Book and Depth Keys 12.50
2592 Assorted Key Blanks. 77.76
Set Key Files, Tools, Pins, Springs, Thimble 10.50

A. J. MARCOTTE CO., 1200 N. Kedzie Ave., CHICAGO 51, ILL.

It's Good to See Good Tackle Again!

That's exactly what we overheard anglers say when they saw the first South Bend Quality Tackle made since the war!

Here are rods, reels, lines and baits now being made. Not enough for all, it's true, so see your dealer early.



Two Great Fly Rods—No. 47 and No. 59



Most Popular Automatic Fly Reel

When you try an Oren-O-Matic, you'll know why it's so highly prized by fly rod anglers. Two sizes: No. 1130, capacity 26 yards D line; No. 1140, capacity 34 yards D line.

The No. 47 Fly Rod, shown here, is the favorite of anglers who want the extra snap and fast action of flame-finished split bamboo. Exclusive South Bend Comficient Grip and end-locking reel seat. The popular No. 59, lower in price, is also in production now.



Dependable Black-Oreno—Now Braided of NYLON

World-famed Black-Oreno is now being made—of NYLON! Smooth, pliable, easier casting, longer lasting, new moderate prices. Made in 12, 15, 20, 25, and 30-pound tests.



A Really Great Bait—The No. 1991 FISH-OBITE

We wish we could make enough of these wonder baits to meet the demand! Made of indestructible plastic, in the famous South Bend red arrowhead, white body pattern.

Fishing Photo Book—FREE

A 48-page book filled with action photos—every one a winner in the South Bend Fishing Photo Contest. Send a card today. Ask for "Fishing Photo Book."

SOUTH BEND BAIT COMPANY, 891 HIGH ST., SOUTH BEND 23, IND.

SOUTH BEND

A Name Famous in Fishing

SWIVEL-HEAD

FLASHLIGHT

nothing else like it!

**HEAD TURNS
LIGHT AT
ANY ANGLE**

Greatest advance in flashlight design in a generation. Turn powerful pre-focused beam where you want it . . . stand it up . . . clip it on . . . both hands are free. A handsome, durable, all-purpose flashlight for everyone. Ask your dealer.



**\$2 LESS
BATTERIES**



No. SW-22
Patented

No. 75 Heavy-Duty Dated Cell. Fresh Lasts longer. 10c

Flashlights & Batteries

If dealer cannot supply, send \$2.00 to Dept. P UNITED STATES ELECTRIC MFG. CORP., New York 11, N. Y.

*USA LITE Red-Head Safety Flashlight - a "MUST" for the motorist.

Test-O-Lite the MODERN TROUBLE SHOOTER



THE NEON GLOW

. . . LOCATES TROUBLE INSTANTLY in electric circuits, fuses, cut-outs, motors, radios, appliances. Tests everything electrical from 100 to 550 volts. Indicates hot or grounded wires. Tells AC from DC. Engineers prefer it because it has patented safety features.

↑ PUTS "FINGER" ON THE TROUBLE SPOT - QUICKLY

Far superior to ordinary clumsy test bulb. Saves precious time. Indispensable in shop or home. Vest pocket size. Lifetime guarantee. List \$1.50 (Pat. No. 1,778,883) Purchase through regular electrical dealers.

L. S. BRACH MFG. CORP.

200 Central Ave. Newark, N. J.



FUSES



MOTORS



OUTLETS



HUNTER'S COMPASS

Hunting Case, Watch Type, All Metal, Jeweled **\$3.50**

Engineers All Metal Army Type Hand-Sighting

LEVELS \$1.50



PUBLIC SPORT SHOPS

13 S. 16th St., Phila. 2, Pa.

No COD's

MAKE BIG MONEY!



Be a floor surfacing contractor and sand both new and old floors. Sanders are easy to operate and better still, you've your own boss. Write for latest "tell-all" booklet entitled "Opportunities in Floor Surfacing", enclosing 25 cents in coin or stamps to cover handling.

AMERICAN

FLOOR SURFACING MACHINE CO.
335 So. St. Clair Street • Toledo 3, Ohio

6 handy tools in ONE!

- 1 MITERING GUIDE
- 2 DIAMETER GAGE
- 3 ACCURATE SQUARE
- 4 MARKING GAGE
- 5 CENTER FINDER
- 6 CONVENIENT RULER

\$1.50
POSTPAID

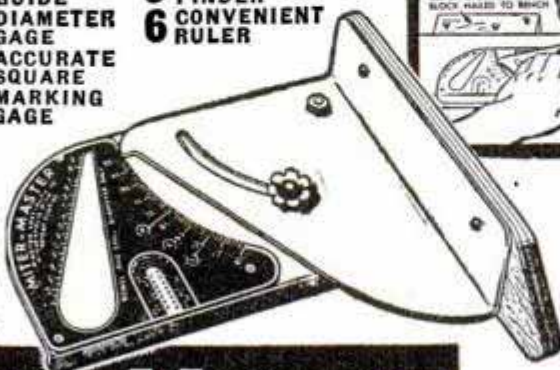

Miter Master takes the place of an expensive miter box accurately set to any angle. Scale marked for mitering 5, 6, and 8-sided frames. Steel construction. Built to last a lifetime. If your dealer can't supply you we will send it postpaid anywhere in the U. S. for \$1.50. (Foreign \$1.75.) Unconditional guarantee. If not satisfied within ten days for any reason whatsoever, your money will be refunded.

MITER-MASTER

MASTER SPECIALTY COMPANY

3018 EAST LAKE ST. • MINNEAPOLIS 6, MINN.

ELECTRICITY FOR ANY JOB ANYWHERE

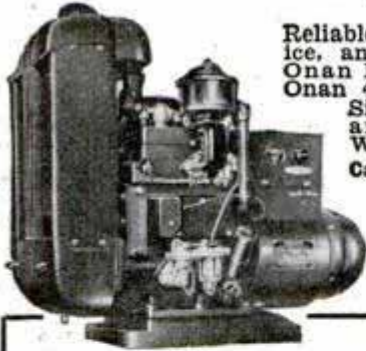

Reliable, economical electric service, anywhere, anytime, with an Onan Electric Plant. Driven by Onan 4-cycle, gasoline engines. Single-unit, compact design and sturdy construction. Water or air cooled.

Capacity range 350 to 35,000 watts
115 to 660 volts A.C.
50 to 800 cycles
6 to 800 volts D.C.
Combination A.C.-D.C. types
65 different models

WRITE FOR FOLDER

ONAN

D. W. Onan & Sons, 2518 Royalston Ave., Minneapolis 5, Minn.



Give Dad a HULL AUTOMOBILE COMPASS

A Father's Day gift for his comfort and welfare when driving. He'll use the HULL STREAMLINE AUTOMOBILE COMPASS the year around, to stay on the right road, avoid lost directions, backtracking, delays. Circular free. At your dealer's. Price \$3.95.



HULL MFG. CO.

P. O. BOX 246-D7

WARREN, OHIO

ENGINES IN STOCK: ONLY \$9.95

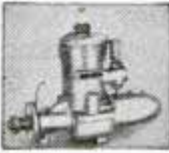

The "THOR" miniature gasoline engine that really operates is available. Over 10,000 sold to date. 1/8 H. P. Complete with coil and condenser and full illustrated instructions for only \$9.95. Fully bench tested and ready to run. Power for all models. Send only \$1.00—Shipped Collect C.O.D. same day. Send for FREE illustrated Catalog of hundreds of hobby items.

America's Hobby Center, Dept. B66T, 156 W. 22 St., N. Y. 11, N. Y.

BUILD YOUR OWN FAN with that old motor

One piece cast aluminum propellers used for cooling and ventilating. Also available to dealers at discount.

Size	Polished	Unpolished	Bore
In. 2 Bl. 3 Bl.	2 Bl. 3 Bl.	In.	
15 \$2.50 \$3.50	\$2.00 \$3.00	1/2, 5/8, 3/4,	
18 3.00 4.00	2.50 3.50	1/2, 5/8, 3/4,	
20 3.25 4.25	2.75 3.75	1/2, 5/8, 3/4,	
24 3.50 5.00	3.00 4.25	1/2, 5/8, 3/4,	
30 5.00	4.00	1/2, 5/8, 3/4, 1	

Let us give you our prices on your aluminum castings

KLOPPENBORG ALUMINUM FOUNDRY, Dept. SM2, Davenport, Iowa

LAWN ORNAMENT-NOVELTY PATTERNS

28 Lawn Ornament Patterns, 25c. Other patterns; 15-20" high; Dutch Girl, Dutch Boy, Pirate, Bull Terrier, Mexican Girl, Mexican Boy, Dwarf, Penguin, Flower Girl, 10c each. 25 Novelty Patterns, 30c. All 62 Full Size Patterns, \$1.00 Postpaid. Strother Pattern Service, Dept. G-8, Box 383, Belington, W. Va.

SAY YOU SAW IT IN POPULAR MECHANICS

GET THE BEST IN MUFFLERS V-8 DUALS & SINGLES



Finest Norman custom-built muffler sets - steel pack - torpedo type - heavy, perforated steel cores - chrome enamel finish - mellow, deep tone (improves with use) - designed to fit - all ways superior - double economy.

DUALS.....\$17.50 SINGLES.....\$7.00
V-8 Ford-Mercury Buick, Olds., Chrys.
SINGLES.....\$5.50 ORDER TODAY! Will outlast three ordinary mufflers.
Chev., Ford, Plym.

Distributors - Write for Full Details

NORMAN'S MUSICAL MUFFLERS

Dept. PM-5, 1216 W. Slouson Ave., Los Angeles 44, Calif.

AGENTS-SALESMEN Cash In On This Big Money Making Opportunity! Sell This Amazing Pen... Writes 2 Years Without Refilling

\$100 TO \$150 Per Week EASY

★

\$5.00 profit per pen. Sales waiting in every home, office, factory, school. Prospects everywhere. Wonderful Gift for Fathers' Day, Graduation and other occasions.



Outfit includes: pen, safety clip, polished aluminum desk stand, transparent cover, 2-year Reynolds's guarantee.

Nationally Advertised \$12.50



\$7.50 each in lots of 4 or more F.O.B. Chicago Sample \$12.50 Postpaid

Reynolds Pen INTERNATIONAL

The most amazing, versatile pen ever created. Writes 2 years without refilling. Writes with satin smoothness, fine, medium or heavy. Writes on cloth, through 6 carbons, under water. Will not drip, leak, smudge or smear. Dries instantly. The Pinnacle of Pen Perfection. . . Reynolds Pens come in red, blue or black barrels, silver tops, matching jewel caps. Order your supply. Remit with order. No C.O.D.'s. Use coupon.

STARR PRODUCTS

Dept. P. M., 502 S. Wells Street, Chicago 7, Illinois

STARR PRODUCTS, DEPT. P. M.

Distributors, Reynolds International Pen 502 S. Wells Street, Chicago 7, Illinois

\$7.50 Each in lots of 4 or more. Sample \$12.50

I enclose \$..... Ship following order:

..... Reynolds Pens, \$7.50 each (f.o.b. Chicago)

..... Sample Pens each \$12.50 postpaid

Name.....

Street and No.....

City.....State.....



Simplify Your Work
with an
AUTOMATIC DRILL

You'll find it a lot easier and quicker to make clean, accurate holes with a Millers Falls automatic drill. These quality tools assure sturdy, smooth operation. They offer such advantages as:

Eight fluted drill points ($1/16''$ to $11/64''$ in diameter) recessed in the handle for easy accessibility. Each one in a numbered compartment.

Sure-tightening chuck holds drill points securely.

Durable, attractive buffed-nickel finish.

Millers Falls automatic drills are becoming increasingly available. Let one of them save you time and effort. See them at your local dealer today.

One Thing In Common — QUALITY!



**MILLERS FALLS
COMPANY**
Greenfield, Mass.

Champion engine and the 94-horsepower Commander engine. Experience in building the famed war-going Weasel helped Studebaker engineers concentrate engine units in a minimum of space.

The connecting rod bearings are new and of an interchangeable type and the conventional elongated drive shaft has been replaced with a shaft in two sections. These sections meet at an angle in a rubber-mounted bearing in the center of the frame, eliminating the floor tunnel in the rear compartment.

The 1947 Commander models consist of sedans, coupes, station wagon and a convertible on a 119-inch wheelbase. The four-door Land Cruiser has a 123-inch wheelbase. The Champion is mounted on a 112-inch wheelbase, two inches longer than formerly, and has an overall length of 192 inches. It will be available in two sedans, two closed coupes, a station wagon and a smart convertible coupe with an automatic self-raising top. Broader wheel rims are featured on all the cars with 15x5.50 tires on Champions, 15x6.50 on Commanders.

Body details include outside door handles of a new pull-to type, interior hardware designed for minimum protrudence, a pistol-grip parking brake located in the center just below the dash, a new angle in the steering column which is said to reduce fatigue on long trips, and spring ends that "float" on rubber cushions.

Stock Up for the Outdoors

(Continued from page 153)

dark. The "sportsman's traveler" is four inches long and weighs six ounces.

One of the latest Nagy-Willoughby inventions is a powerful air gun made of aluminum alloy with a plastic stock and grip. The gun uses an air cylinder of new design that can be pumped up to a pressure of 8000 pounds per square inch and that holds its charge indefinitely. Interchangeable barrel liners in several diameters allow various loads, such as BB shot, steel balls up to $5/16$ -inch diameter, arrows or frog spears to be used. A frog spear is shot with accuracy up to 50-foot distances and the gun will put a heavy steel ball through a one-inch pine plank at moderate ranges. Loaded with a paper capsule that contains a small handful of birdshot, it throws a scattergun pattern comparable to that of a .410 shotgun at ranges up to 75 feet.

The fact that today's hunters and fishermen are getting the advantage of war-proved equipment means one thing: It's fine for the sportsmen but tough on their quarry.

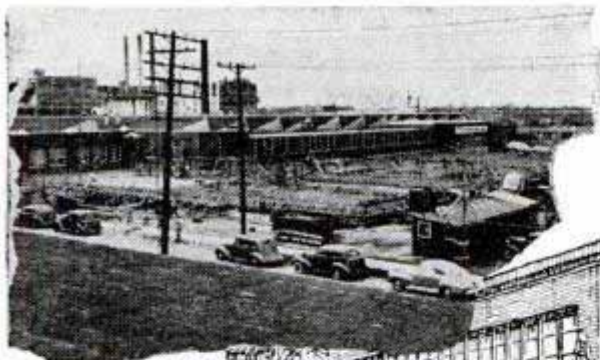

At left is a recent photograph showing construction under way on Delta's new plant addition. The artist's sketch below shows how the completed building will look.

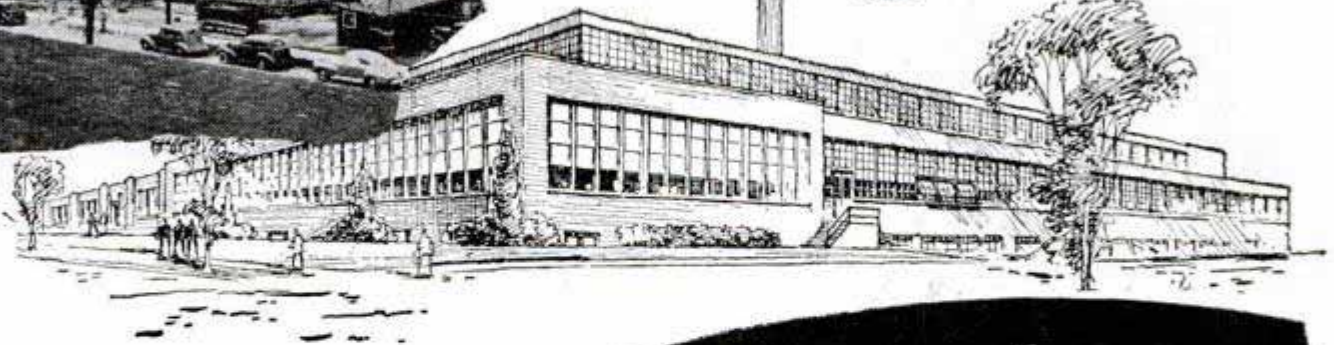

Building your Happiness

New plant addition now under construction speeds the day you can enjoy

DELTA HOMECRAFT* POWER TOOLS in your home shop . . .

We want you to enjoy the pleasure of using Delta Homecraft Power Tools. We want you to know the deep satisfaction that arises from working with *quality* tools like these.

Right now, though, the widespread demand for these famous power tools far exceeds the number we can produce. But we are cutting down the time you must wait until you *can* become the proud owner of Delta Homecraft Power Tools.

Shown here is our new plant addition scheduled for completion this summer—considerably increasing our capacity for building these tools. This is one way in which we will hasten Delta tools onto the floor of your nearby store.

We sincerely appreciate your patience thus far. Thanks!

Keep in touch with the store in your neighborhood that carries Delta Homecraft Power Tools.

*Trade Mark Reg. U. S. Pat. Off. HM-37

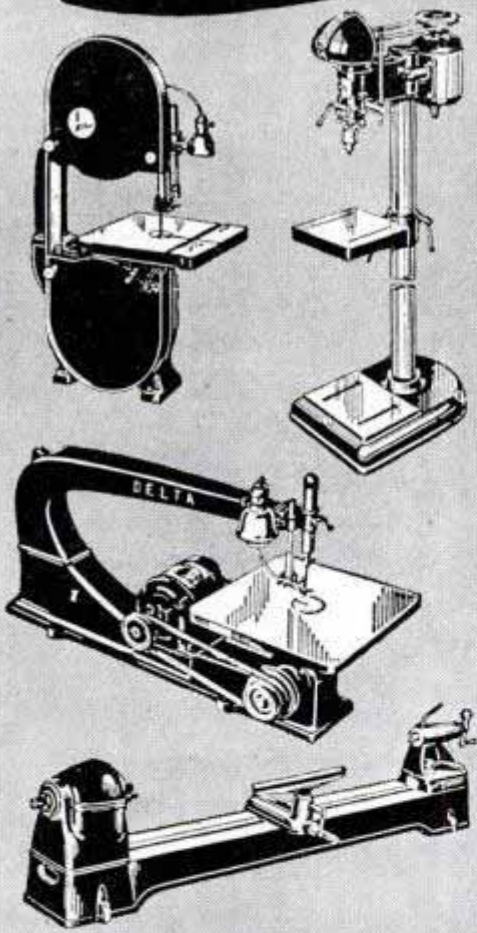

Tear out coupon and mail today!

FREE!

"Happiness Herald" — a tabloid newspaper that gives interesting facts, in words and pictures, about the fascinating, woodworking hobby. Pictures typical shops and projects. Enjoy its inspiration and ideas. Send coupon for your free copy.

THE DELTA MANUFACTURING CO.
681F E. Vienna Ave., Milwaukee 1, Wis.

Please send me my free copy of the "Happiness Herald."

Name.....
Address.....
City..... (.....) State.....

DELTA HOMECRAFT
MILWAUKEE POWER TOOLS

Subsidiary of Rockwell Manufacturing Co.

For Men who Really Know Pipes

Royalton CROWN

MOUTHPIECE TUBE
prevents backflow
of moisture

CONDENSING CHAMBER
traps and holds bitter
juices and sediment

BOWL GUARD
keeps shank
and bowl dry

REMOVABLE SECTION
eases thorough cleaning

CHAMBER GUARD
bars tobacco fragments
from bit

Patented

\$1.50

Selected
Briar



THIS REMARKABLE PIPE frees smokers from the annoyance of bitter juices and tobacco slugs. These nuisances are trapped by Royalton Crown's condensing well and other patented safeguards. For day-long, dry-cool smoking, no pipe can quite compare with a Royalton Crown.

HENRY LEONARD & THOMAS, INC. OZONE PARK 17, N. Y.

LORRAINE LIGHTER



Streamlined, smart, sure-fire. Precision-made of gleaming hi-polish dural-aluminum. Triple capacity gives three times longer use without re-filling. Lightweight: 1 1/4" x 2" x 7/16".

DISTRIBUTORS WANTED

Gross Lots or more
\$12 Doz.

Less than Gross Lots
\$15 Doz.

LORRAINE INC.

115th & Alameda Sts., Los Angeles 2, Calif.

**AGENTS EARNING UP TO \$300 A WEEK
SELLING AMAZING NEW FLOOR FINISH
REINFORCED WITH PLASTIC RESIN . . .
REQUIRES NO WAXING OR LABORIOUS
MAINTENANCE**

FREE SALES KIT!

Get in on the ground floor of one of the biggest money makers ever put out! Every home, office, store, restaurant, beauty parlor, church and factory a red hot prospect. Sells on sight. Anyone can apply. Just mop it on. Send for free sales kit today. Exclusive territory. Write our Mr. Thomas today.

FAIRCHILD CHEMICAL & COATINGS CO., INC.
280 Madison Ave., New York 16, N. Y.



SPECIAL!

Delco Permanent Magnet Motor
27V (D.C.). Runs off a 6V. battery.
For miniature or model \$3.00
trains, boats etc.....

Diamond Dressing Tool (used)
for grinding wheels or cutting glass.
4/5 of diamond still use-\$1.50
able

Eye Levels (Govt. Surplus). Well
constructed. Handy for \$1.00
many uses

All Prices Include Packing &
Postage! Send Check or M.O.

Holland Hardware Co., Inc.
24 VESEY ST., New York 7, N. Y.

DIE-LESS DUPLICATING

Many small parts can be formed without dies, to duplicated accuracy of .001" with DI-ACRO Precision Machines,—Benders, Brakes, Shears. Save die expense and time delay. Ideal for experimental and research work, making samples, models, etc., as well as regular production runs. Write for descriptive literature.

O'Neil-Irwin Mfg. Company
341 8th Ave. South
Minneapolis 15, Minn.



FORD'S OUT FRONT in style, too!

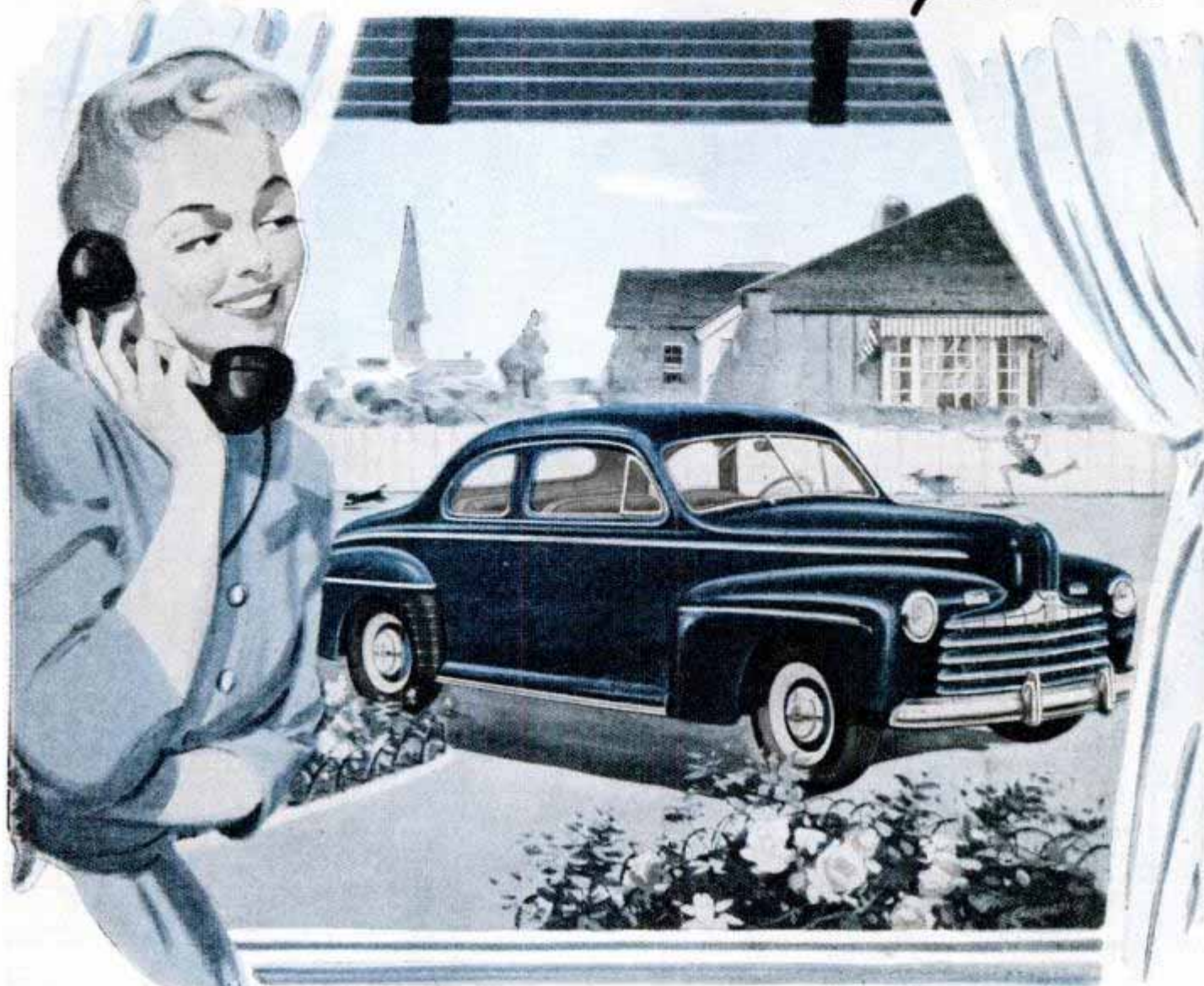

The Big New 1946 Ford Sedan Coupe

Whatever model you choose, the big new 1946 Ford car is a streamlined beauty from the newly styled grille to the rugged rear bumper! And there's refreshing new elegance inside, too. Rich fabrics! Restful seats! A new instrument panel, smartly decorated with plastic trim! For performance, Ford is the only car in the low-priced field with 100 horsepower,

the only car with 8 cylinders . . . the only car with a V-type engine (the kind used in America's costliest cars) . . . the only car that gives you the safety of such big oversized, self-centering hydraulic brakes! See it at your Ford dealer's.

TUNE IN . . . The FORD-Bob Crosby Show—CBS, Wednesdays, 9:30-10 P. M., E. S. T. . . . The FORD Sunday Evening Hour—ABC, Sundays, 8-9 P. M., E. S. T.

There's a *Ford* in your future



For FATHER'S DAY

...The Gift He Will USE Daily



Lady—give him a Twinplex sharpener for double edge safety razor blades—for Father's Day or any day—the gift he'll use and appreciate every day!

A Tip to Shavers:

Mister—clip this ad, leave where "she" can read it to solve her Father's Day gift problem. Twinplex Strop-Per—indispensable Shaver's Tool—is the practical gift for men to give or get. Used by millions to sharpen blades for quick, smooth shaves.



THE TRUTH ABOUT SHAVING

TRUTHFULLY, MEN... it's the blade edge that CUTS whiskers off... not the soap, cream or lather! The sharp-

er the edge, the better your shave. If that makes sense, get a Twinplex—insert any double edge blade—turn crank and let Twinplex strop-leather rollers polish edges to super-SHARPNESS in a jiffy! No skill required. Makes blades last longer! Only \$2. Ask your dealer for a demonstration.

TWINPLEX MFG. CO. CHICAGO



OWNERS BRAG ABOUT

Twinplex
BLADE STROPPER

USED BY MILLIONS SINCE 1915

UNCONDITIONALLY GUARANTEED ALDOR AUTOMATIC SPARK PLUGS



NON FOULING — AIR COOLED
THERMOSTATIC HEAT CONTROL
YOU GET
INCREASED POWER
SMOOTH PERFORMANCE
INSTANT STARTING
GREATER MILEAGE

For Cars, Trucks, Tractors, Marine Engines, Outboard Motors, Motorcycles, Buses, Farm Machinery and Lighting Plants

ALDOR AUTOMATIC SPARK PLUGS are the result of more than 40 years' experience in the manufacture of oil firing spark plugs

MILLIONS IN DAILY USE are giving the utmost in power and smooth performance to satisfied users
PRICE \$1.00 EACH—4 OR MORE .85 EACH

Mention Make and Year of Car — Order From

CENTRAL SALES

100 So. Ninth Louisville 2, Ky.
ORDERS SHIPPED PARCEL POST PREPAID
SEND CHECK, MONEY ORDER OR C. O. D.

NOW AVAILABLE!

Crosman Silent Rifles—America's favorite compressed air rifles for indoor and outdoor shooting are back again! Available in 22 cal. single shot and Magazine Loading Types. At your dealer—or order direct. Ask for Crosman SUPER-PELLS too—the better ammunition for all compressed air rifles. .177 Cal.—\$1.80 per M. .22 Cal.—\$2.00 per M.

CROSMAN ARMS CO., INC. • Rochester 7, N. Y.

WRITE For FREE Literature

BUILD YOUR OWN POWER LAWN MOWER

WHY BREAK YOUR BACK MOWING FIELD OR LAWN?



Now anyone can save time and effort mowing field or lawn, by building their own whirl type power mower.

We furnish complete information, and whirl type blade attachment. Write today.

THE RITE-WAY MOWER ATTACHMENT

T & H Mfg. Co.

811 E. 31, Dept. FP-4, Kans. City 3, Mo.

METALLIZE BABY SHOES

Learn this easy, money making business from nationally recognized consultant. Small investment; perpetual market. For free details write Joseph B. Kushner, B.S. Ch.E., Metal Finishing Consultant, Stroudsburg, Pennsylvania, R.D. 3G.

YOU NEED THESE CRAFTSMAN'S TOOLS

SUPER DRILL GRINDER

SUPER ARBOR

SUPER HACKSAW



Sharpens round shank drills from 3/32" to 1 1/16" diameter. Grinds Old Drills like new in 4 different drill point angles. Grinds Short, Medium and Long Twist Drills from 1 1/2" up to 11" long, for hand or power grinding wheels.

100,000 IN USE!

Grinds your drills like factory in 25 seconds. Gives perfect center and clearance. Saves drills, time and money. No shop should be without the Super Drill Grinder. Guaranteed to do the work or money back. The Grinder that gives a round point!

Only \$2.95

(PATENT PENDING)

A combination drilling or grinding wheel attachment. For 1/2" motor shafts. Will take grinding wheel with 1" hole on shaft and 1/2" hole on small end. Extension can be used for rag or wire wheel, or 3/4", 24-thread drill chuck which holds drills from No. 60 to 3/4" in diameter. Right hand thread only.

Price Only \$1.50

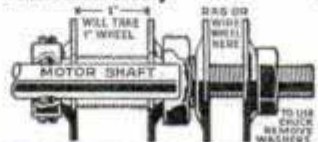

AND FLAT DIE FILE HOLDER



The tool with 100 uses! Holds broken hacksaw blades—used by mechanics, electricians, plumbers, auto mechanics, hobbyists and repairmen. Perfect for all-round household needs; ideal for difficult close-quarter work. Nothing like it for tool and die men. Price, without saw blade.

95c

At Your Dealer's or Postpaid

CRANDALL MFG. CO.

1512 West Slauson, Dept. FA-6
Los Angeles 44, Calif.



• Test ALL Home Outlets
 • Find Open Circuits
STAR TEST-PLIERS
 • Locate Blown Fuses
 • Remove Fuses SAFELY

A must tool for electricians, maintenance men, home owners. Made of a transparent, shock-proof Plastic. Replaceable lamp inside Plier tests 110 to 250 Volts. Plier pulls fuses from 10 to 100 Amperes. Requires the use of only one hand. Can be obtained from General Electric or Westinghouse stores, or

from local electrical dealers. Order one TODAY.
 Price \$2.75 without Leads, \$1.50 additional for Leads which provide greater reach and more flexibility.

STAR FUSE CO., 233 Canal St., New York 13, N. Y.

WRITE ON METAL-PERMANENT
 Etch With Ordinary Pen

"MAGI-CHEM" Without Electricity
 (Speedy Etch Process) Without Acid

• MARVELOUS INVENTION •
 NOW YOU CAN Permanently Mark Your Name or Other Identification on TOOLS or ANY METAL . . . By simply WRITING-IT-ON with "MAGI-CHEM"—It's there to stay . . . Yes PERMANENT . . . QUICK and EASY . . . Elegant for Jewelry, Key Rings, etc. . . . Marvelous for mechanics, garages, machine shops and the home. . . . You can make money writing on Key Rings, etc.
 AGENTS WANTED..ORDER TODAY
MAGI-CHEM, Dept. P, 1113 Lill Ave., CHICAGO 14, ILL.

ANYONE CAN DO IT
 Just Write It On
 It Stays Permanent
 INSTANTLY

Protect your valuable tools, jewelry, instruments, in fact anything metal.

ONLY \$1.00 Post Paid

GRAB BAG PIPE Sale!

- Why pay fancy prices? Genuine imported briar pipes ridiculously low priced. Slight imperfections make them unacceptable to famous makers. For shape and size selections trust our judgment. You can't get stuck because of **MONEY BACK GUARANTEE**. Save plenty and be delighted! No dealers.

2 PIPES \$3.00 4 FOR \$5.00

Mail Orders Only to Dept. A7
COLLECTORS' PIPES 101 Cedar Street
 New York 6, N. Y.

Here's a New **POWER CUTTER KIT**

with a cutting range of 5/8" to 2 1/2"



Two Bruno Adjustable Hole Cutters in one convenient kit for home users, mechanics, farmers, technicians! High speed steel blade cuts clean, fast holes in metal, wood, plastics. Quickly adjustable and easily sharpened. For drill press, portable drill or hand brace. Money back guarantee!

Only **\$785**
 Complete

POWER CUTTER KIT CONTAINS

MODEL	SHANK SIZE	EXPANSION	PRICE
100	1/4" st. shank	5/8"—1 1/2"	\$3.00
101	3/8" st. shank	1"—2 1/2"	\$5.00
790 KIT		5/8"—2 1/2"	\$8.00*

*Full Trade Minimum \$7.85

At all hardware stores or write direct, Dept. PM-6

BRUNO TOOLS 9330 Santa Monica Blvd.
 Beverly Hills, Calif.

Here's door-to-door transportation for YOU!



Ride one and you'll buy one!

New **WHIZZER** Motor makes your bike a motor bike

Why walk, when you can ride everywhere you go? New Whizzer fits any standard balloon-tired bike. This compact 2 1/2-horsepower motor will carry you swiftly, surely and comfortably along streets, highways and trails. At speeds from 5 to 35 miles per hour, the 5-quart tank carries gas enough for 150 miles or more!

Whizzer transportation is *all-purpose* transportation. Ride to the station, to business, to work, on errands, shopping trips, on vacation jaunts. Put a Whizzer on your bike now! **WHIZZER MOTOR COMPANY, Pontiac 15, Mich.**

FACTORY LIST PRICE
\$89.50
 PLUS TAX

Precision - designed, precision-built by automotive craftsmen in the heart of the auto industry. And auto-type assembly line production has brought its price within reach of all!

IF NO LOCAL DEALER, USE COUPON

WHIZZER MOTOR COMPANY
 Dept. 166, Pontiac 15, Mich.
 I enclose \$91.60, including \$2.10 Federal Excise Tax, () check or () money order. Send me one Whizzer motor, complete, tax paid, with full installation instructions. Written guarantee with every motor.
 If descriptive literature only is desired, check here ().

NAME _____
 ADDRESS _____
 CITY _____ STATE _____

A Fine, Precision EXPOSURE METER

\$13⁹⁵

COMPLETE WITH
LEATHER CASE
Including Tax
on Meter



The Sign of Precision

Make your camera take better, sharper photos. Eliminate guess-work, lost pictures and wasted film with a precision-built SKAN Exposure Meter. A *must* for color—still or movies. Be right in *any* light—day or night. Simple to use.

Sold at camera counters everywhere. For free literature write: G-M Laboratories Inc., 4290 N. Knox Ave., Chicago 41, Ill.



EXPOSURE METER

Say you saw it in Popular Mechanics!

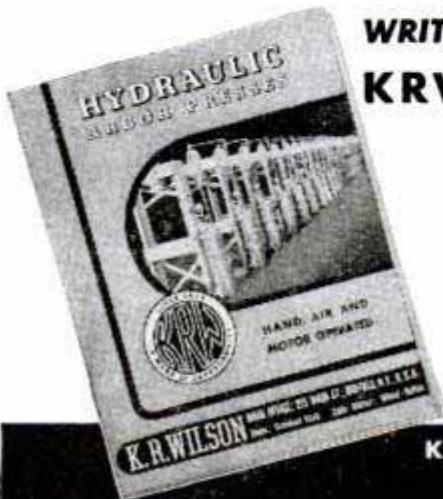

WRITE FOR YOUR **FREE** COPY OF THE NEW KRW HYDRAULIC PRESS BOOK

Describes all manner of Production and Shop Work on KRW Hydraulic and Bench Type Arbor Presses. 32 pages illustrating the new KRW Hand-operated, Electric-operated and Air-operated Hydraulic Presses.
Write for your copy today.



K. R. WILSON, DEPT. 17, 215 MAIN ST., BUFFALO 3, N. Y.
Builders of Shop Equipment for Ford Dealers Since 1916

STOP THAT DRIP

**NoDrip
TAPE**



EFFECTIVE IMMEDIATELY

New—for homes! A *sure cure* for condensation drip from cold water pipes. Pliable, cork-filled NoDrip Tape eliminates wet floors, makes idle space usable!

Quick, Clean, Easy to Wrap on—No tools needed. Covers joints as well as straight pipes. **\$1²⁵**

At hardware, dept. stores, lumberyards.
Roll, enough for 7 feet of 1/2" pipe.



Higher west of Rockies and Canada

Write for free NoDrip Tape Circular

J. W. MORTELL CO. 522 BURCH ST., KANKAKEE, ILL.

Army-Navy Type HEADPHONES

TYPE HS-23

Genuine U. S. Signal Corps headphones, better \$10.00 type. Leather-covered headband, detachable rubber cushions, 16. wt., impedance 8000 ohms. Ea. **\$2.95**



TELEGRAPH KEY

Genuine U. S. Signal Corps key with cutout switch, silver contacts **95c**

3 1/2" G. E. AUTOMATIC TIME METER

60 cycle 110 volts. This time meter consists of a cyclometer driven by a telechron synchronous motor. Connect to an electric circuit: it will measure and indicate the number of hours, tenths of hours or minutes that the circuit is in use. Ship- ping wt. 6 lbs.—list \$17.00. Your Cost. **\$4.95**

2500 mfd. 3 volt F. P. condensers, each. **49c**

Write for our illustrated literature of radio parts.
Plus shipping charges.

Arrow Radio Co., Dept. G, 2205 W. Division St., Chicago 22, Ill.



GLOWSO LUMINOUS PAINT

Generous 2 oz. jar of non-poisonous luminous paint—ready to use. Paint any object so that it glows in the dark—house numbers, bottom cellar step, pictures, ornaments, etc. Sent postpaid in U. S. for **\$1**

Send for prices in larger jars and quantity lots. (Agents wanted.)

UNO MFG. CO., 2738 Van Buren St., Chicago 12, Ill.

5X Long Range Telescope \$1.25



Here's a precision built, 3 section, long range telescope, at an amazingly low price. It's beautifully finished, constructed of genuine black plastic to withstand long and hard usage. Has scientifically ground 32mm. lens, easy to focus; clear, powerful vision. Telescope folds compactly, fits in any pocket or purse when closed. Excellent for indoor and outdoor events. Send \$1.25 and we'll pay postage. Try for 10 days. Return for refund if not satisfied. Handsome case with loops for attaching to belt included. Address

UTICA MAIL ORDER CO., 923 Eagle St., Utica 3, N. Y.



There's no substitute for capacity

Whether your shop is a hobby or a business, there are times when you need real industrial capacity in your lathes. The SHELDON S-56 Precision Lathe will give you tool room accuracy, small lathe convenience and big lathe capacity—11¼" swing, large 1¾" hole thru spindle (1" collet capacity), 56" bed (35" between centers) and a 4-speed (8 spindle speeds) underneath motor drive mounted on a 5-drawer steel bench as illustrated. Also supplied as a bench model (without bench) with 3-speed (6 spindle speeds) overhead motor drive (Model 1136-BMWQ).

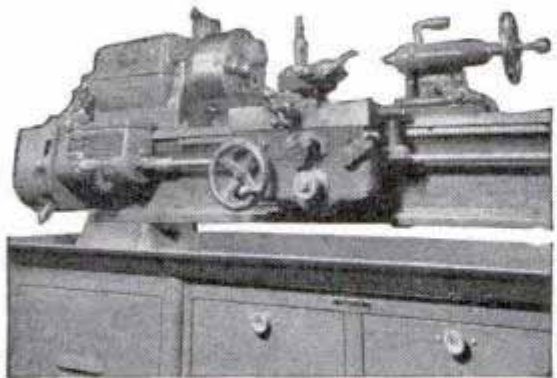

SHELDON MACHINE CO. Inc.

4266 N. KNOX AVE. CHICAGO 41.

**KITS OF
FREE-TURNING
BRASS RODS**



Meier Brass & Copper Co.

1320 EAST LARNED • DETROIT 7, MICHIGAN

All Kits F. O. B. Detroit

Keep a supply of these free-turning brass rods on hand in your home workshop for use on model boats, airplanes, etc. Round, hexagon, square and half-oval shapes. Kits available in 40 various combinations of sizes from 1/8" to 2", and kits with several pieces of one size only. All rods 12" long. Send for free catalog today.



**WHEELS
AT BARGAIN PRICES**

We have a quantity of the below size WHEELS WITH TIRES COMPLETE, on which we can offer SPECIAL PRICES,

- 8"x2" Semi Pneumatic tire,
- 7/16" Ball Bearing Hub..... \$2.75 each
- 10"x1.75 Semi Pneumatic Tire,
- 7/16" Ball Bearing Hub..... 3.75 each

Write number wheels wanted in space provided, tear out and mail this ad, with check or money order, and your name and address. TRULSON MFG. CO., 811 EAST 31 ST., KANSAS CITY 3, MO.

**WELD ANYTHING
ANYWHERE
ANYTIME**



ALL PURPOSE ARC WELDER

9 Models . . . 32 Volt D.C., 110 to 440 A.C.

A complete workshop in itself! Weld, cut, braze or solder any type metal; iron, castings, aluminum, steel, bronze . . . in any gauge or weight, with equal ease. Compact, complete, as sturdy as the Rockies. Formed steel and cast aluminum case, welded steel base, 4" cast wheels. Built with voltage control. Better on R.E.A. lines. Completely equipped. No instructions needed. Sold throughout the world. Several dealer territories open. Write:

FORNEY MFG. CO.
FORT COLLINS 2, COLORADO

Pals...

your good right hand and
that good Stanley Hammer

Almost the moment you wrap your hand around the handle and heft a Stanley Hammer you know you've found a pal.

Drop-forged from special analysis steel and given two "super-heat treatments" to make a tougher head . . . with "softer" claws to prevent breakage, end extra hardness in the poll and face. Claws have a uniform split and beveled grip that bites into a nail shank. The handle of young, live hickory is in the head to stay . . . the eye pre-shrunk to exclude moisture. Make friends with a Stanley Hammer and have a friend for life.



STANLEY

Trade Mark

**THE TOOL BOX
OF THE WORLD**

You'll want
these two books

The first book is free . . . "The Joy of Accomplishment", a brief introduction to tools and their uses. The second is the famous textbook, "How to Work with Tools and Wood", recently revised fully illustrated. The cost is just \$1.

Stanley Tools, 166 Elm St., New Britain, Conn.

Please send by return mail

- FREE booklet: "The Joy of Accomplishment."
- 188-page book: "How to Work with Tools and Wood." \$1.00 enclosed.

(In Canada: Send order to Stanley Tool Co. of Canada, Ltd., Roxton Pond, Quebec.)

Name

Address.....

City.....State.....

Holidays are Camera Days



MAKE SURE OF BETTER PICTURES

Come back with perfectly exposed pictures every time. It's easy with the new, improved G-E exposure meter to guide your camera. Gives you correct exposure in a jiffy. New, simplified dials make it easier, faster to use. Proved accuracy. Extreme sensitivity. And *now* lighter, sturdier. The ideal travel companion for your camera. A grand gift. See the G-E meter at photo dealers . . . it's 3 meters in one. *General Electric, Schenectady 5, New York.*



New, improved
G-E
EXPOSURE METER

GENERAL ELECTRIC

606-170C

SAY YOU SAW IT IN POPULAR MECHANICS

It's Easy...
EVEN THE MISSUS CAN RUN IT!

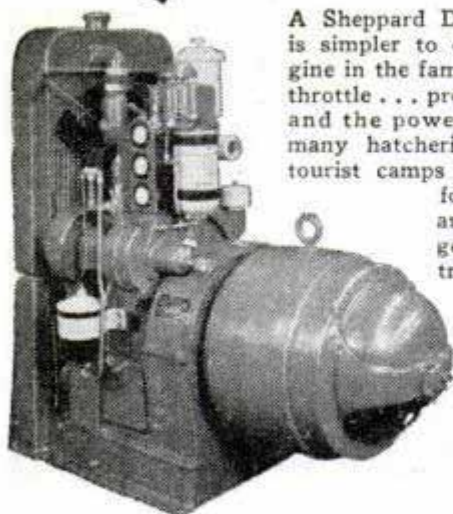

A Sheppard Diesel Generating Set is simpler to operate than the engine in the family car. Simply open throttle . . . press starter button . . . and the power's on. That's why many hatcheries, farms, factories, tourist camps and ice plants have found it so easy . . . and profitable . . . to generate their own electricity.

Generating Sets
2,000 to 36,000
watts
Power Units
3 3/4 to 56 H.P.
Marine Engines
3 3/4 to 62 H.P.

R. H. SHEPPARD COMPANY, INC., 48 Middle St., Hanover, Pa.

DIESEL'S THE POWER -

Sheppard's
THE DIESEL!

268

Your Rust Troubles are Over
CORODEX Rust Remover

is the war-time miracle liquid which cleaned millions of parts during war effort. CORODEX positively removes RUST and CORROSION regardless of depth, from iron, steel, brass, bronze, copper, chromium and nickel. Cleans tools, hardware, sports equipment, household utensils, etc., for a few cents a piece. No RUBBING or hard work.

CORODEX IS UNCONDITIONALLY GUARANTEED TO REMOVE RUST WHEN DIRECTIONS ARE FOLLOWED. Valuable Manual of Rust Control free with order.

At Sears Chicago, Suburban and Gary stores, 50c and \$1.00. Mail orders QUART SIZE ONLY \$1.00 Money Order or Check F.O.B. Chicago Express to:

SEARS, ROEBUCK AND CO.
403 SO. STATE STREET, DEPT. 8500-9, CHICAGO 5, ILLINOIS
(Corodex is made by Allied Products Co., 1133 Newport Ave., Chicago)

Cabin PLAN BOOK

BUILD YOUR OWN QUICKLY, EASILY

39—Exteriors with Floor Plans
48—Suggested Floor Plans
Low-cost cabins—Modern homes.
Floor plans and lumber lists for a build-your-own \$500 cabin and \$2500 2-bedroom cottage. Information on pre-fabricated houses. Fireplace construction. Built-in furniture. 3 Pages—Rowboat construction information; docks and floats.



WODBECK PUBLISHING CO.
206 Winchester Place
Grand Rapids, Mich.

BUILD-YOUR-OWN for next season's healthful fun. Send check or money order, today—\$2 postpaid. Copyright '45 W.P.Co.

Fun and HEALTH for You!

LONG PLAY PHONO-NEEDLES
Two for \$1.00

Revere genuine osmium-tipped needles now offered at the lowest price in history. They are kind to your records and bring out full brilliance of tone. We guarantee that there is no finer precious metal point needle at any price. New manufacturing methods enable us to pass along the saving to you. Send \$1.00 today and we will send you two Revere Needles postage prepaid.

INTERNATIONAL REVERE COMPANY
515 W. 65th Street, Chicago 21, Illinois

G E A R S

In Stock - Immediate Delivery

Gears, speed reducers, sprockets, thrust bearings, flexible couplings, pulleys, etc. A complete line is carried in our Chicago stock. Can also quote on special gears of any kind. Send us your blueprints and inquiries.

Send for Complete Catalog No.10
CHICAGO GEAR WORKS
440-50 N. Oakley Blvd., CHICAGO 12, ILL.



SUPER MYSTERY BUTTON

Many times as sensitive as our regular mystery button. Can be used for the same experiments and uses as the mystery button but with far better results. Needs no diaphragm of any kind. Ideal for musical instruments, intercommunication, recording, talking thru radio, and many other uses. When used with small head phone it makes an ideal inexpensive hearing aid. Shipped with 5000 word, 12 page booklet showing diagrams for dozens of uses, postpaid \$2.00.



Electronic Products Company
Saint Charles, Ill.

POPULAR MECHANICS

63½% Prefer Filter Pipes*

- 1 Cleaner, cooler smoke enters your mouth, because—
- 2 Sensational filter whirl-cools smoke, collects flakes and slugs, absorbs juices.
- 3 Replace filter when discolored.

Frank **MEDICO**

THE LARGEST-SELLING FILTER PIPE

\$1

with box of 10 filters



X-RAY VIEW

Genuine filters for MEDICO Pipes, Cigarette & Cigar Holders Packed Only in this Red and Black Box.

*American Legion Magazine Survey No. 2 "The Man Who Was GI Joe"



S. M. FRANK & CO., Inc., NEW YORK 22, N. Y.



DON'T USE CHISEL

Use KROIL, the new chemical lubricant that creeps into millionth inch spaces, dissolves rust and dried grease. **KROIL LOOSENS FROZEN PARTS** The fastest penetrating oil known, 5000 industrial plants used Kroil to keep war production going. Try it on money back basis. AT YOUR DEALER or send \$1 for two 8 oz. spout cans, postpaid, send dealers name.

KANO LABS., 3026 Lincoln Tower, CHICAGO 1, ILL.



BLOWERS HEATING COOLING

Blowers and Cooling Supplies. Gas and Oil Burning Furnaces, Conversion Burners. Good Profits. Wanted — men to sell and install.

PEERLESS SALES, 4318 Sheridan, Lincoln 6, Nebr.

AUTO ENGINE SPEED CONTROL GOVERNORS



\$19.50

For full details see our ads in Dec. to April issues of Popular Mechanics.

CANDEE, Dept. L, 2641 S. Hill, Los Angeles 7, Calif.

LAW

STUDY AT HOME for PERSONAL SUCCESS and LARGER EARNINGS. 35 years expert instruction—over 108,000 students enrolled. LL.B. Degree awarded. All texts furnished. Easy payments. Send for FREE BOOK—"Law and Executive Guidance."

AMERICAN EXTENSION SCHOOL OF LAW Dept. 66-M, 646 N. Michigan Ave., Chicago 11, Ill.



MOTO-TOOL ★ THE "POCKET-SIZE" MACHINE SHOP

PUT THIS "WAR VETERAN" TO WORK

Tough grinding and polishing jobs in tool rooms and machine shops fade away under the speed and versatility of Dremel Moto-Tools. Thousands of Moto-Tools helped establish production records in plants such as General Electric, Westinghouse, Remington Arms, Ford, Nash-Kelvinator, Consolidated Aircraft, Northrop, and Douglas. Others earned the respect of the armed forces in far flung repair depots.

Only Moto-Tools Have All These Features
A Model 2 Moto-Tool develops a speed of approximately 27,000 rpm. Weighs only 1.3 oz. Shaped to fit the hand. Sturdily built. Has shock-proof bakelite housing. Balanced for vibrationless operation. Uses 110-120 A.C. or D.C. current. Patented automatic chuck lock pin makes removal of accessories easy. Pin disengages automatically . . . prevents accidental burning out of motor.



MOTO-TOOL KIT

Kit No. 2 with 23 high grade accessories and Model 2 Moto-Tool, in hardwood case. \$23.50
Model 2 Moto-Tool, with 1 accessory . . . \$16.50

MONEY-BACK GUARANTEE

Ask your Dealer about Dremel Moto-Tools and accessories. If he does not handle them, send direct to factory. We send prepaid if cash in full accompanies order. \$2.00 brings Moto-Tool C.O.D. for balance, plus postage. Write for FREE CATALOG.

DREMEL MFG. CO., Dept. 116-F, RACINE, WISCONSIN

MOTO-SAW COMING!

Dremel Moto-Saw . . . the sensational electric scroll saw . . . will be back as soon as materials are available.

27,000 R.P.M.

- Sharpening
- Finishing
- Touching Up
- Sanding
- Drilling
- Mortising
- Engraving



A few of the jobs that can be done better and faster with a Moto-Tool.

- Burring
- Grinding
- Polishing
- Sanding
- Burnishing
- Inlaying
- Sawing
- Scoring
- Cleaning
- Routing
- Cutting
- Rasping
- Carving
- Brushing
- Dressing

PROVES WONDERFUL

to promptly relieve misery
and kill cause* of

ATHLETE'S FOOT

Helps
Guard
Against
Re-Infection!



Here's a product that *really* does what it claims. It's a Doctor's wonderfully soothing yet powerfully medicated liquid called Zemo. First applications relieve itching and burning between cracked, peeling toes and aid healing. Zemo actually kills on contact the vicious germs* that cause and spread this trouble. That's why Zemo has such an amazing record of *continuous* success. First trial convinces. All drugstores.

ZEMO

TRAILER AXLES, HITCHES, AND PARTS

• If you are interested in purchasing trailer axles, hitches, and other trailer parts, contact us promptly. **Write for free literature.**



HAMMER BLOW TOOL COMPANY, Dept. 106, WAUSAU, WIS.

BOOST YOUR INCOME

with the

"ARC BOOSTER"



... revolutionary feature of this NEW LINCOLN A.C. WELDER

Lincoln Electric... leader of the arc welding world... introduces the New "Fleet-Arc Jr." Welder, equipped with the exclusive "Arc Booster". Provides the easiest striking arc ever developed for repair shops. Simplifies repair, hard-facing, fabrication, construction welding. Increases your opportunities for profitable business.

Range 20 to 180 amps. with Continuous Current Control for easy, accurate adjustment of arc heat. Maximum input current of 35 amps. makes it ideal for rural power lines. Full details on request.

Write for free Bul. 365 today!



THE LINCOLN ELECTRIC COMPANY
Dept. 511 • Cleveland 1, Ohio
Largest Manufacturer of Arc Welding
Equipment in the World

\$2.95

TORNADO GAS TORCH

- NO COMPRESSED AIR REQUIRED
- NOTHING TO PUMP
- SELF ADJUSTING
- SAFE — ECONOMICAL

The ideal torch for the home mechanic. Simply use any convenient gas outlet or remove burner from gas stove. Connect one end of a hose to the torch, other end to outlet and operate. Tornado Torch No. 119 with 3 tips (3/8, 1/4, 3/16 blast) \$2.95. Send check or money order, post paid.

• **KENWALL SUPPLY** •
P. O. BOX 4, BOULEVARD STA., NEW YORK 59, N. Y.

RADIO PHONES

Made to U. S. Army Specifications, passed by Signal Corps Inspectors. Dynamic Microphone and dynamic receiver of finest quality — Water, shock, weather and altitude proof, used on tank and aircraft (B19) intercom systems. For recording, for battery-less telephone, talk through your radio set or use earphones for pocket-size set loud speaker.

Complete two receiver, cord set, hand band, and dynamic hand microphone including special connecting cord set. Less than regular cost of dynamic mic.

\$9.95

Postpaid

King of ELECTRIC SWITCHES

Versatile Switch of a Thousand Uses
Millions in Post War Applications

Floodlights your porch when the door is opened — sounds alarm when window is opened — signals arrival of mail — controls heating of furnace — filling of water tank, these and many other services are performed by this versatile switch. Shipped with instruction sheet showing numerous illustrated uses for this device at the low price of

\$1.00

Postpaid

BATAVIA 2, ILLINOIS

The Original Lifetime Miniature IDENTIFICATION TUBE

Solid Brass—Rustproof—Waterproof

Used to identify lost

- DOGS
- TACKLE BOXES
- GUN CASES
- GOLF BAGS
- BRIEF CASES

- HAND BAGS
- LUGGAGE
- TOOL BOXES
- UMBRELLAS
- CHILDREN

Agents Wanted

Price— **25c** each
SPECIAL 5 for \$1

Nickel Plated Tubes
35c each — 3 for \$1.00

Illustration 1/2 size.

CHARLES A. KRAUT, 2048 N. St. Louis Ave., Dept. F, Chicago 47, Ill.

THE NEW —

Blade cuts in any direction without turning frame.

Ideal for home use — for carpenters — mechanics.

**ALLWAYS SPIRAL
SAW BLADE!**

Cuts wood, light metal or plastics. For hand or motor-driven jig saws. Safe — outlasts ordinary blades.

**ORDER THROUGH YOUR
DEALER!**

TYLER MFG. CO.
938 Pico Blvd., Santa Monica, Calif.

SAY YOU SAW IT IN POPULAR MECHANICS

LIKE WINGS ON YOUR CAR

This powerful inexpensive impeller supercharger can be yours — will fit any automobile — adds up to eight horsepower — has gas saving qualities — complete plans for easy building — send for free literature. **AIRCHIEF SUPERCHARGER CO., P.O. Box 1102, Dept. 14, San Diego 12, Calif.**

WEATHERSTRIP YOUR WINDOWS NOW

SAVE MONEY — HAVE WINTER COMFORT

Set complete for one window \$1.95 at leading Hardware and Department Stores, or Filling Stations. Also Lighter Ash Tray \$2.25 and Sweater Blocker \$1.75. If you can't find at your Dealer's write direct to

'E-Z-ON' DEPT. 1, BOX 1061,
CHICAGO 90, ILL.
DEALER AND DISTRIBUTOR INQUIRIES INVITED

Only Forecaster Superb Pipes have this

NEW FILTER

Cleans, cools, filters smoke •
Traps nicotine • Prevents drip

Enjoy a clean, cool, dry
smoke always from a
Forecaster • The exclu-
sive aluminum winder
can be removed in a
jiffy—change cleaner
as often as you like. •
Choice, rich-grained
briar, in a variety of
popular shapes. •
Ask to see the
Forecaster Pipe
display at your
favorite dealer.

**FILTERS
SMOKE
FROM
BOWL
TO TIP!**

\$1.50

Sir Sheldon Pipes, \$2.50



*Pat.
App'd
For

**NATIONAL
Forecaster
SUPERB**

NATIONAL BRIAR PIPE CO • JERSEY CITY, N. J.

SAY YOU SAW IT IN POPULAR MECHANICS

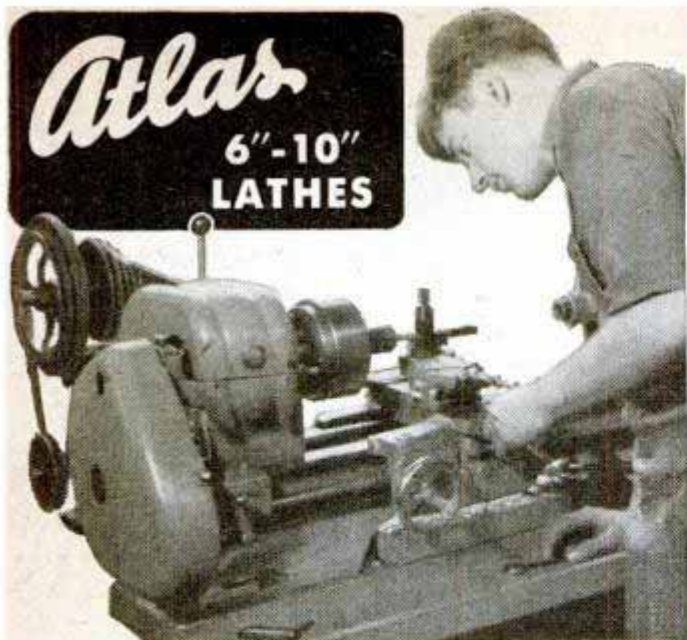

Atlas
6"-10"
LATHES

**The ALL-SEASON HOBBY FOR
THOUSANDS OF MEN...**

SEND FOR
FREE CATALOG



There's always something fascinating to do in a home workshop. And the handy man can make his time very profitable by keeping home equipment in repair and building many useful articles. The Atlas lathe has every precision and easy-operating feature you want. Ask your Atlas distributor for full details. Send for this free catalog.

ATLAS PRESS CO.
643 N. Pitcher St., Kalamazoo 13D, Mich.



**O'BRIEN
HYDRAULIC JACK**

ALL PURPOSE—BUMPER JACK

Powerful, safe, hydraulic jack makes your car a feather-weight. Instantly adjustable bumper hook. Car raises quickly with easy finger-tip strokes. Broad, solid steel base gives firm support to the multiple reinforced column. Lifts tremendous loads 17 1/4 inches. Built for cars, farm machinery and tractors—garages, industrial plants. Leak proof. Practically a lifetime accessory. Fully guaranteed.

If your dealer cannot supply, mail check or money order for \$13.50 and we will ship your O'Brien Jack immediately.

Address Dept. M

AUTO PRODUCTS CO.
6349 N. Clark Street, Chicago 26, Ill.

TELESCOPING MEASURING TOOLS
... Measure All Holes, Slots, Etc. — 5/16 Inch to 6 inches ...
Gives You Outside Micrometer Accuracy on Inside Measurements
FINISH YOUR OWN SET OF FOUR TOOLS

 **Only \$2.95 C.O.D.**

Plus Usual Small Postal Charge
PART OF THE MACHINE WORK ALREADY DONE—ONLY SIMPLE LATHE WORK NECESSARY TO COMPLETE. No special tools required—Threading, Knurling, etc., already done. Kit includes all material (part machined); simple drawings, and detailed instructions. Send \$2.95 cash with order and we pay postage.

ALCO SHOP, Dept. 6, Box 2214 Terminal Annex, Los Angeles 54, Calif.

WOOD WORKERS

LUMBER—PLYWOOD AVAILABLE
Harold Hunt wants to send new No. 15 catalog. Over 124 pages of woodworking ideas. **UNEQUALED BARGAINS** in imported and American woods, supplies, hard-to-find hardware. Send only 10c to cover postage and handling.

CRAFTSMAN WOOD SERVICE CO.
2729 S. Mary St., Dept. A-70, Chicago 8, Ill.

only 10¢



free! I'm also interested in...
 HOBART Arc Welders
 Arc Welding School
 "Build Your Own"
 A.C. Electric Welder
 Please check and mail today

This handy Vest Pocket Guide for Welders. Reference material, tables.

HOBART BROTHERS CO., BOX M-66, TROY, OHIO

Name _____

Address _____



Get big profits quickly with this HOBART welder



Thinking about starting a job welding shop? You'll make no mistake, for arc welding is one of the most profitable businesses today. It's easy to start, and most everyone brings the work to you. With Hobart, you'll find that welding is simplified, and perfect welds are produced faster. The Portable Electric, at left, is ideal for all-around shop work.

HOBART Portable Electric



If you would like to build your own Gasoline Drive Arc Welder, and save hundreds of dollars over a complete factory built unit, you'll find it easy with the Hobart Generator. By adding reconditioned auto motor and chassis, you'll have an arc welder that lets you go right out to the most profitable jobs.

HOBART "Build Your Own" Generator



The Hobart A. C. Transformer Type Arc Welder is perfect for all light duty welding. Operates on single phase from regular 220 volt power lines. Recommended especially for auto repair welding work. Exclusive Hobart features simplify operation—assure longer life. Remember—Hobart is "One of the World's Largest Builders of Arc Welders".

HOBART A.C.

HOBART BROS. CO., Box M-66 TROY, OHIO

Attend the HOBART SCHOOL of ARC WELDING and learn the trade in short, intensive course. Individual attention, low cost. Enroll, G. I. Bill.



you'll do faster, better work with this EFFICIENT SHOP TOOL



- ★ Polishing
- Grinding
- Carving
- Drilling
- Buffing
- Plastic
- Glass
- Metal
- Wood
- Bone

You'll enjoy doing many shop jobs with the Bantam Grinder. Correctly balanced for easy handling. Precision-built of quality materials for dependable, long-life service. Operates on 110-115 Volt AC-DC. Speed approx. 20,000 R.P.M. Internal ventilating fan. Fingertip switch. Weight—15 oz. With 8-ft. cord and plug, 23 accessories, substantial gift box... **\$25**



If your dealer doesn't have it, write us.

Small Motors, Inc.

Dept. 80, 2068 Elston Avenue • Chicago 14

Manufacturers of special small universal, fractional H. P. motors, shaded pole motors, heater motors for industrial and appliance uses.

Start Your Own PHOTO-PRINTING BUSINESS

Big Money in Photocopy

MAKE PHOTOCOPIES OF ANYTHING PRINTED, DRAWN OR WRITTEN . . . Ideal for Valuable Papers such as BIRTH and MARRIAGE CERTIFICATES, also DISCHARGED PAPERS, LEGAL DOCUMENTS, etc. Boys and girls are enthusiastic users . . . Easy to make prints QUICK . . . All you want!

- No Training
- SIMPLE—EASY
- NO DARK ROOM
- Make Your Own Prints All You Want
- COMPLETE OUTFIT COSTS YOU—**ONLY \$7.95** (Includes Fed. Tax)

PRINTS UP TO 8 1/2" x 11" MAKE PRINTS FROM NEGATIVES—MAKE NEGATIVES FROM PRINTS! Outfit comes complete with Printing Device, Trays, Chemicals, Drying-Squeegy Board, Roller, full box of Sensitized Printing Paper . . . Designed for Professional use and marvelous for amateurs. F.O.B. Chicago. REMIT WITH ORDER.

CRAFTEX LABORATORY
4615 ELSTON AVE., DEPT. P-6, CHICAGO 30, ILL.



New! 12" Sheet Metal Brake Only \$12

Fits in bench vise. Quickly, easily forms all kinds of angles in sheet metal, strap iron and aluminum, wire and plastic. Use it to make useful articles, experimental research work, patent models, etc. Simple gages made for quantity duplicating. All steel construction. Now available. Send for details.

WISE BRAKE MFG. CO.
1318 So. 30th Ave., Omaha 5, Nebr.

TUBULAR AXLES for TRAILERS, FARM WAGONS, TRUCKS and UTILITY

2,000 lb. capacity—58" track. Adaptable to Ford, Chev., Ply., and wheel hubs using Timken, Bower BT, New Departure or Tyson bearings No. 09074 and 15118. (Spring seats included.) SEND CHECK OR MONEY ORDER. Other Types Quoted On Request. **SPECIAL \$7.45** F.O.B. Detroit IMMEDIATE DELIVERY—FORGED STEEL COUPLER BALLS SPARTAN INDUSTRIES, 8213 McDougall, Detroit 11, Michigan

AMMCO 7" SHAPER

"A Precision Machine of a Thousand Uses"

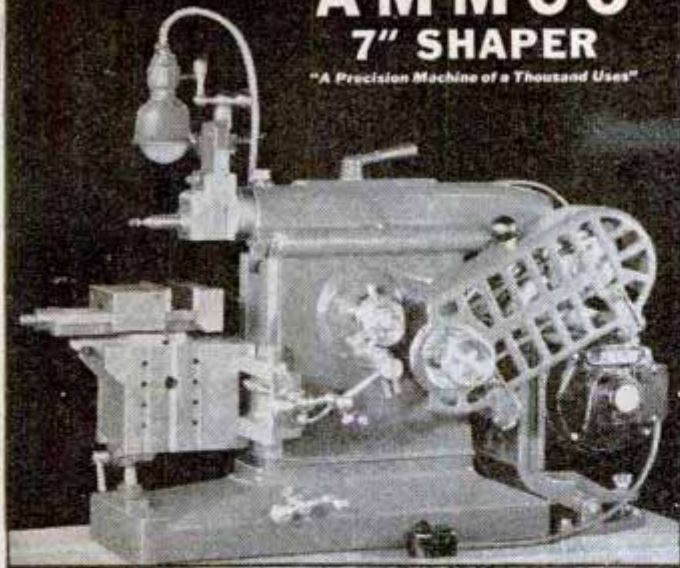

A wide variety of jobs can be done accurately, quickly, easily, and economically on the AMMCO Shaper (7" stroke).

Construction incorporates many features you would expect to find only in larger, more expensive machines... For example: WAYS of ram, tool head, and front face of the main frame are of the "VEE" type, hand scraped to insure accuracy and long life. Available for stationary installation or as portable unit.

Write today for specifications and prices

AMMCO

2140 Commonwealth Ave. North Chicago, Ill.

RAISED WOOD SIGN LETTERS

MADE OF THE BEST IDAHO WHITE PINE.
ALL SIZES, FACTORY PRICES.
Send 10c for Catalog

SIGN LETTER DISTRIBUTORS, P.O. Box 101, Mineola, N. Y.

DESK and TABLE LIGHTERS

Your

ANSWER
TO THAT
GIFT PROBLEM



Luxurious high-flame lighters, ideal gifts for family and friends... Keep one, too... Ornamental as well as useful. Finished in lustrous chrome, with soft felt bases, sure-fire action, large fuel capacity. Trojan Horse (4 3/4"), or Aladdin's Lamp (4")—

Only \$3.98 It not satisfied, return within 5 days, and money will be refunded.

S. KAYE SALES CO., 972 Broad Street, Newark 2, N. J., Dept. 607

Check lighter(s) desired.
 Trojan Horse Aladdin's Lamp
 I am enclosing \$..... send postpaid.
 Send lighter(s) C.O.D. I will pay postman \$3.98 each, plus postage.
 Name.....
 Address.....
 City..... State.....

FREE
Send for it
NOW



New 1946 Radio Parts
and Equipment

CATALOG

SERVICEMEN! Dealers! Soundmen! Amateurs! Builders! Here's your handiest, most complete 1946 Buying Guide for Everything in Radio! Features latest sets, parts, equipment of nationally known quality at lowest prices. Assures fastest service from world's largest and most complete stocks under one roof. Expert staff ready to help you.

NEW RADIO SETS
COMPLETE SOUND SYSTEMS
LATEST HAM GEAR
ALL SERVICE EQUIPMENT
BUILDER'S SUPPLIES
RADIO BOOKS



OVER 10,000 ITEMS

Everything for every radio use. New model radio sets, phonoradios, recorders, communication receivers, Ham kits, code apparatus, parts, tubes, tools, test instruments, public address equipment and accessories, low-cost easy-to-build kits, diagrams, matched parts lists, leading technical and non-technical books—at lowest prices.

ALLIED RADIO

ALLIED RADIO CORP.
833 W. Jackson Blvd., Dept. 5-F-6
Chicago 7, Illinois

Date.....

Rush new FREE 1946 CATALOG

Name.....

Address.....

City..... Zone..... State.....



Dozens of uses! **U-DIAL-IT** Simple to operate!
Sensational New Blade Cutter

This new 5 in 1 cutter is EASY to use... U-Dial-It for any cutting job around the home, office, workshop, school or camp. Simply loosen knob, turn top plate lightly to desired cutting position, tighten knob.



DIAL 1-IT SCRAPES

Wonderful for removing putty, paint, stickers, labels, etc.

SCRAPER



DIAL 2-IT SLICES

Just right for cardboard, heavy paper, mats, textiles, thin wood, etc.



SLICER

DIAL 3-IT CUTS

So handy for cutting cord, string, thread, fishing line, leaders, etc.



DIAL 4-IT RIPS

The best tool you've tried for ripping out stitches and basting quickly, neatly.



RIPPER

DIAL 5-IT CUTS

Amazing for shallow cuts... you can cut out clippings without spoiling other pages of magazine or newspaper.



30¢ ea.
POSTAGE PAID
SEND COIN OR
MONEY ORDER

DIAL CL-IT'S CLOSED

Blade is fully guarded, cutter safe to carry in pocket.



CLOSED

The U-Dial-It consists of only 3 parts... made of aluminum, light but sturdy... plus double edge razor blade. Each U-Dial-It comes complete with blade and instruction card. You'll want several to keep handy around your home and job. Order yours today.

DON'T DELAY • ORDER TODAY • YOU'LL WANT SEVERAL!

H. R. BASFORD COMPANY

425 SECOND STREET, SAN FRANCISCO 7, CALIF.

SAY YOU SAW IT IN POPULAR MECHANICS

NOW!

A Real War Surplus Bargain

"MAE WEST" LIFE VEST



Yes... the same famous "Mae West" that saved so many lives during the war. Now, for the first time, it's available to you at an extremely low "War Surplus" price. Ideal for boat owners, over-water flying, work over water, outboard racing, etc. Fun and protection for kiddies and grown-ups at the beach. Inflates immediately. Surprisingly little bulk. Government cost nearly \$10 each. Our price only \$1.85. Add 15c for postage and handling. Order now—satisfaction guaranteed.

M & E Marine Supply Company

P.O. Box 601, Camden, New Jersey

ATTENTION! 50 HP EVINRUDE OUTBOARDS—a few brand new heavy duty motors now available for immediate delivery. \$410 f.o.b. Write us about your motor needs.

BEFORE YOU PAINT

Fill Cracks and Holes
Caulk Windows and Doors
Quickly, Easily, with

PRESS-TITE CORDS



The soft, non-hardening plastic material of Press-Tite Caulking and Sealing Cords is the quickest, easiest and neatest method of filling unsightly cracks and holes in wood or plaster before painting.

Just press a rope-like section of Press-Tite Cords into the crack or crevice with fingers—no tools required—can be painted over immediately. Will not stain—always remains soft and pliable.

Get a better, smoother paint job by sealing all holes and cracks first, with easy-to-use Press-Tite Cords, at your dealer's hardware or paint counter.

Other Household Uses Include:

Sealing around bathtubs and sinks—Sealing around baseboards—Sealing against bugs and vermin—Glazing windows—and hundreds of others.

PRESTITE ENGINEERING COMPANY

3978 Chouteau Avenue

St. Louis 10, Missouri



IDENTIFICATION BRACELET only \$1.95. Heavy silver plated, name engraved without extra charge. Orders shipped same day. We also make these with a STERLING SILVER tag, heavy weight, with nickel silver chain, each boxed, \$2.95. We pay tax and postage.

MONT PETIT MFG. CO.
15 E. Pearson St., Dept. D Chicago, Ill.

FISH WORMS WITHOUT DIGGING

Get worms the easy way! Spend your time fishing, not digging worms. By using this new electric appliance worms shoot to the surface in seconds.

This sturdy rod, handy and convenient, pays for itself. \$1.50 postpaid, with instructions. ORDER NOW! Agents wanted.

WIGGLE-OUT BAIT CO.

6492 Sterling Detroit 2, Mich.

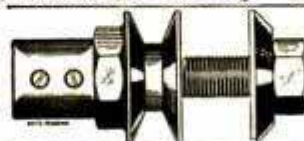

Build your own grinder with this combination pulley and arbor. Fits 1/2" shafts. **75c** Postpaid U.S.A.

AGENTS INVITED
F. ROESCH
502P - 1st St. Hoboken, N. J.

why not use a DIAMOND?

ALL PURPOSE GRINDING
WHEEL DRESSER
FOR ALL DRESSING
OPERATIONS

\$2.50

POST PAID

SEND CHECK OR
MONEY ORDER TO



KOEBEL DIAMOND TOOL CO.

9454 GRINNEL AVE., DETROIT 13, MICH.

POPULAR MECHANICS

BELL
GUARANTEED
WATCHES

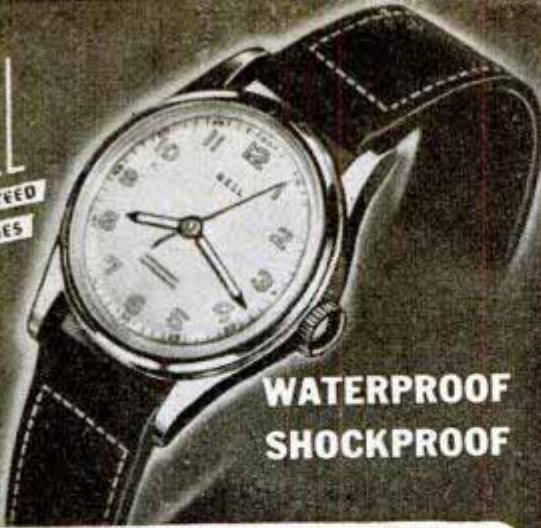

**WATERPROOF
SHOCKPROOF**

NOW AVAILABLE! Sturdy, handsome, reliable, a watch for every occasion—backed by the famous BELL guarantee.

Anti-magnetic, radium dial and hands, unbreakable crystal, sweep second hand, precision tested.

No. SM 197
17 jewels, stainless steel back..... **\$29.75**

No. SM 188
17 jewels, all stainless steel case..... **\$47.50**

No. SM 328 SELF-WINDING
17 jewels, all stainless steel case..... **\$59.75**

ORDER BY MAIL: Send check, money order, or pay postman C.O.D. Prices Incl. Fed. Tax & Postage. Gift Box. Wide choice of fine watches for men and women. Write for FREE Illustrated Booklet "SM"

BELL WATCH COMPANY
Time and Life Bldg., Rockefeller Center, New York 20, N. Y.

**BURN YOUR NAME ON TOOLS
WITH THE
ARKOGRAF**



PROTECT YOUR TOOLS FROM THEFT
Write with electricity any name or design on the hardest and finest tools and instruments or any metal, like writing on paper with pen or pencil. Thousands used by mechanics, garages, machine shops.
Complete Outfit \$3.50—Prepaid Anywhere
Interesting illustrated circular free. Write today.
ARKOGRAF PEN CO., 3927 S.E. Stark, Portland 15, Ore.



PHONO AMPLIFIER
3 TUBE — AC-DC
**COMPLETE KIT AND
5" SPEAKER, ONLY..... \$595**

WITH TUBES \$7.95 128Q7, 35Z5, 50L6
25% Required on C.O.D. orders. Free Catalogue.

Wholesale
Radio
Distributors

RISCO SALES COMPANY
224 E. 65th St., New York 21, N. Y.



**MASTER CHAMPION
LAWN MOWER SHARPENER**
Also Mfg., Saw Sharpening
& Key Machines

FRANK'S MFG. CO.
LUCAS 6929
Dept. PM, 3312 Tweedy Bl.
SOUTHGATE, CALIF., U.S.A.

NEW OTTAWA SAW

BIG FREE BOOK World's Fastest
6 H.P.
EASY TO MOVE
Fells trees.



Saws big logs, small logs, limbs. Pulley for belt work. Easy to handle, weighs less than lower powered units. FULLY GUARANTEED. Cash in on fuel shortage. Turn wood lots into cash.

OTTAWA MFG. CO., 627 PINE ST., OTTAWA, KANS.

RIVET
with
ONE HAND ONLY



**\$2.48
COMPLETE OUTFIT**

Rivet in glass, plastic, rubber, plywood, enameled surfaces—any kind of metal, wood or fabric. Real "BLIND" Riveting from one side of work.

Here is a GENUINE CHERRY RIVET OUTFIT, gun and rivets complete—ready to go to work for you—operating on the famous "pull rivet" principle. It is exactly the same principle used on the billions of rivets on aircraft and other construction during the war when Cherry equipment could be had only on high priority. Fill out and mail the FREE TRIAL coupon below with GUARANTEE of your complete satisfaction, backed by this big, well-established manufacturer.

Now you can rivet almost anything anywhere—make tight, neat joints with rivets that don't work loose like screws or bolts. Rivet in tubes or completely enclosed assemblies or the hundreds of other places around the shop, office or home where you can reach one side of the job only.



Rivet materials that previously could not be fastened this way—brittle materials—soft materials. Action is gentle but firm. No hammering, pounding or bucking. It's all done with a steady, controlled PULL.



Send no money!

This kit, gun, or replacement rivets can be secured from your dealer. Or, just fill out and mail the coupon below. You can paste it on a penny postcard if you wish. Pay postman only \$2.48 plus slight C.O.D. charge and postage. Your Cherry Rivet Kit will be delivered complete with a generous supply of Cherry Rivets. Try it out on almost anything that needs fastening. Do difficult jobs with it. Satisfy yourself. Then, if you are not completely pleased with results, send the outfit back within ten days and every penny you spent for it will be returned.

YOU GET THIS COMPLETE OUTFIT

This Cherry Jr. Riveter is a real Cherry Rivet kit—not a toy. It's something you will be proud to have among your tools. EASY TO USE. Anyone can follow the simple directions with COMPLETE SUCCESS the first time. Use standard pull-through Cherry Rivets 3/32" dia.



PASTE THIS COUPON ON A POSTCARD

Cherry Rivet Company

231 Winston St., Los Angeles 13, Calif. Dept. PM-66

Send me one complete Cherry Jr. Riveter outfit, including a generous supply of rivets at \$2.48 plus postage and C.O.D. charges. I agree to pay postman on delivery. I understand I am to be completely satisfied or my money will be refunded on application within ten days.

Name _____ Please Print
Address _____
City _____ Zone _____ State _____

SAY YOU SAW IT IN POPULAR MECHANICS

Amazing TYPHOON SUPER-CHARGER

with oil bath air cleaner
AVAILABLE AGAIN!

NEW Power! Pickup! Pep!

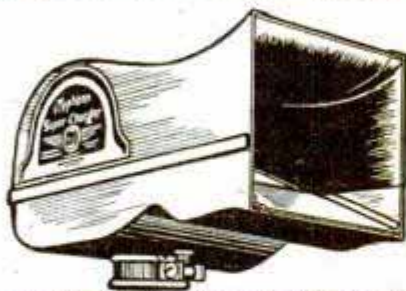

Thrilling news for all motor car drivers—the amazing TYPHOON SUPERCHARGER, off the market during the war years, is back again—ready to put new life into old motors, add to power, pickup, pep, performance . . . add to resale value.

11,000 satisfied users find gasoline economy . . . you will, too. Takes 5 minutes to install, replacing old-type air cleaner—and what a difference supercharging makes! Motor "knock" vanishes . . . oil bath air cleaning keeps harmful dust out.

Order yours today; mention make and year of car. West of the Rockies, add 10% to sales price; Ohio orders add 3% State Sales Tax.

ACT NOW—quantities are still limited, and orders will be filled promptly upon receipt.

\$5.95

TYPHOON PRODUCTS CO.
507 Engineers Bldg. • Cleveland 14, Ohio

SAY YOU SAW IT IN POPULAR MECHANICS

NEW-ALL QUICK CHANGE GEAR BOX
Increases Production up to 1000%

NEW IMPROVED MODEL!

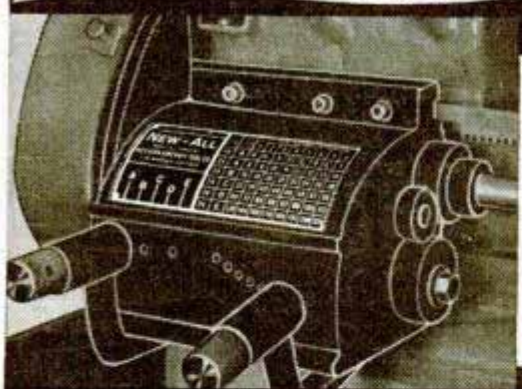

PAYS FOR ITSELF in 30 DAYS!

30-DAY Money-Back Guarantee!

Drastically Cuts LABOR COSTS!

NO TIME LOST FINDING GEARS! Inexperienced workmen easily produce top output. Easy to install. You simply drill and tap four holes. **Guaranteed Accuracy!**

IS GUARANTEED TO CUT ACCURATE THREADS from 4 to 224 per inch with approximately 3/1000 feed for fine turning. It safeguards entire production in process throughout the complete operation. **Precision Constructed**

PRECISION CONSTRUCTED THROUGHOUT with gears of quality hobbed steel. Gear Box housing is made of high grade aluminum alloy casting—with replaceable bronze bearings.

NEW LOW PRICE . . . \$75.00 F.O.B. Los Angeles
For ATLAS, CRAFTSMAN, LOGAN, POWERKRAFT and SOUTH BEND 8-in., B & C.—Use Your Own Lead Screw.

Write Div. PMG

WESTERN AIRCRAFT TOOL CO.
650 No. Hoover St. Los Angeles 4, Calif. NOrmandy 2-4711

SOLDERING? Need another hand?

PAT. APPLD FOR
SODERGUN
Attachment for
Electric Soldering Irons



A Compact Sturdy unit easily attached to your favorite iron. Feeds the Solder right where you need it and leaves one hand free to hold work in place. Model A Delux Chromilite Finish. Sent Post Paid, only..

\$2.50

C. W. BROOKS MFG. CO., 12021 Washington Pl., Culver City, Cal.

NEW EASY WAY TO TIGHTEN CLOTHES LINE



Now—tighten clothes line automatically, without pulling and tugging. Simply turn the lever on Draw-Tite. Keeps line tight despite heaviest wash. Easily attached in yard or basement. Fully guaranteed. Also tightens electric fence wire, tennis nets, anchors boats to pier.

AGENTS! Women buy on 10 second demonstration. Nothing like it in stores. Low price. Get agents' deal. **CHICAGO HOUSEWARES CO.**, 1003 E. 75th, Dept. PM-646, Chicago, Ill.

LET US FIND THAT NEEDLE

Hard-to-Get Items for Home, Boats, Photography, IN Models, Hobbies of All Types

A buying service at no additional cost to you. Write us item wanted—Give name and specifications. We send reply giving price—if article is desired—send 1/3 of amount with order—balance paid with postage C.O.D.

BALTO PRODUCTS CO., 475 5th Ave., New York 17, N. Y.



1 New - Improved OIL FOR ALL ---
HOUSEHOLD-SPORTSMAN-MECHANIC
Lubricates - Prevents Rust - Cleans Metal

3 oz. 40c **FIENDOIL**

JET PROPULSION



GAS TURBINE Model Engine

★ ★ Be one of the first to build a real Turbo-Jet Model Engine. Single-stage centrifugal compressor and turbine. This is a real engine, easily made with ordinary home workshop equipment. Complete plans for construction . . . design formulas and curves for checking performance and testing.

\$2.00
Post paid

THE ROTOJET CO. Department 11
BOX 757 • LOS ANGELES 25 • CALIFORNIA

Here They Are: BUILD YOUR OWN RACER

EACH WHEEL COMPLETE WITH GENUINE GOODYEAR 10 x 1.75 RIB TREAD SEMI-PNEUMATIC TIRE . . . WILL CARRY 300-lb. LOAD

OR—WHEEL BARROW—FOUR WHEEL TRUCK

—GOLF BAG CARRIERS—MARKET CARRIERS—PUSHMOBILES—GARDEN TRUCKS—SCOOTERS—WAGONS and MANY HOME and FACTORY VEHICLES



EQUIPPED WITH
**ARGUTO
OILLESS BEARINGS**



20 years
without
a drink—

THE BEARING WITH THE BUILT IN OIL FILM. UNAFFECTED BY DUST OR DIRT

MADE OF HEAVY GAUGE PRESSED STEEL . . . RIVETED DISCS, BRIGHT ZINC PLATED . . . 20" LONG AXLE AND HANGERS . . .

NOTE THESE LOW PRICES . . . BETTER HURRY!

1 COMPLETE WHEEL (as illustrated)	\$2.90
2 COMPLETE WHEELS (as illustrated)	\$5.50
4 COMPLETE WHEELS (as illustrated)	\$10.00
Kit "A" 2 Complete Wheels, 1-20" long x 1/2" dia. Axle, 2 Heavy Hangers, Washers & Cotter Pins. READY FOR USE all plated	ONLY \$7.50
Kit "B" 4 Complete Wheels, 2-20" long x 1/2" dia. Axles, 4 Heavy Hangers, Washers & Cotter Pins. READY FOR USE all plated	ONLY \$13.50

OSBORN WHEEL COMPANY
115 So. Main St. Dept. P-6

ORDER TODAY
DOYLESTOWN, PA.

REAL FUN . . . SPEED GALORE

Give the boy a REAL THRILL . . . Make him happy . . . Help him BUILD A RACER or one of the practical carriers that every boy likes . . . He'll be the talk of the neighborhood . . . Kit "B" contains 4 complete wheels, 2 axles, 4 hangers, etc. . . . Ready to use . . . In a few minutes he has a racer . . . The best kind of a gift for the boy or the girl . . . Built by Precision Aircraft Parts Manufacturer.

BUY DIRECT FROM MANUFACTURER

Be First . . . Start a Soap Box Derby

OSBORN WHEEL CO.
115 So. Main St., Dept. P-6
Doylestown, Pa.

RUSH
F.O.B. Doylestown

Enclosed find \$.....ship the items checked.

—1——2——4—Complete Wheels as illustrated

Kit "A" Complete as described

Kit "B" Complete as described

NAME.....

ADDRESS.....

CITY.....STATE.....

New!
Exclusive!
Ready Now

WRL GLOBE TROTTER

TRANSMITTER KIT



25 WATT
OUTPUT
KITS

\$59.95

Complete including all parts, chassis panel, streamlined cabinet, less tubes, coils, and meter.

Cat. No. 70-300 Kit same as above, wired by our engineers \$75.00
Complete kit of 8 tubes Cat. No. 70-314.....\$5.95
3 in. meter Cat. No. 70-318..... 4.95
Coils, per set, any band Cat. No. 70-316..... 2.95
Crystals, 40-80 meters, mounted Cat. No. 70-322 ea..... 2.65
Quality crystal mike and stand Cat. No. 70-320..... 9.45
Here is the latest, most outstanding transmitter value on the market today. The WRL Globe Trotter is capable of 25 Watts output on all bands from 3500 KC through 28 Megacycles. Incorporates the Tritet Oscillator using a 40 metal X-tal and providing sufficient drive at 10 meters for the 807 final; Heising choke modulation; three bands, all pretuned; 10, 20, and 80 meters; metering provided for both oscillator and final stages; two power suppliers, one for 807 final and modulator tubes, and one for the speech amplifier and oscillator stage.

FREE!

**Our Latest FLYER
of radio parts.**
Giant Radio Reference
Map 3 1/2 x 4 1/2 ft. . . . 15c
Tube Base Calculator 25c



Formerly Wholesale Radio Laboratories
Address Dept. PM-6, Council Bluffs, Iowa

**Start a
SAW REPAIR
BUSINESS!**

MAKE A GOOD LIVING IN YOUR OWN BUSINESS—sharpening saws with the Foley Automatic Saw Filer. It makes old saws cut like new again. All hand saws, also band saws and cross-cut circular saws can be filed on this ONE machine.

THERE ARE HUNDREDS OF SAWS TO BE FILED in your own neighborhood, used by farmers, carpenters, homes, schools, factories, etc. W. L. Tarrant writes: "I left my old job last September and in 10 months have filed 2,159 saws. We have a lovely business worked up and cannot keep up with the work."

SEND FOR FREE PLAN

Shows how to start this steady cash business. No experience needed, no eyestrain, no canvassing. Send coupon today.



FOLEY Automatic SAW FILER

FOLEY MANUFACTURING CO.

616-E Foley Bldg., Minneapolis 13, Minnesota

Send Free Plan on Saw Filing business, no obligation

Name.....

Address.....

NOW - 8-PLACE FOLDING PORTABLE POKER GAMES TABLE

NEW LOW PRICE \$29⁹⁵ PREPAID

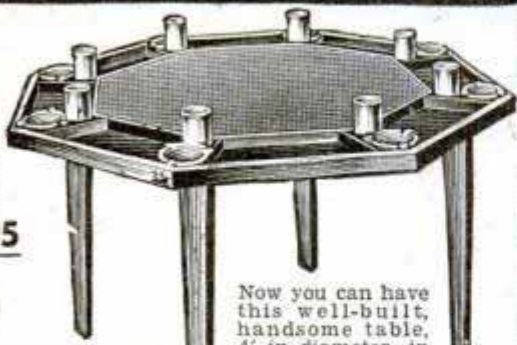

Now you can have this well-built, handsome table, 4' in diameter, in mahogany or oak finish at less than you would expect to pay. It has sturdy legs. Nothing to work loose or wear out. Built for years of hard service in home, apartment, recreation room or club. The ideal gift.

ORDER TODAY

On Our Money Back Guarantee Shipped direct to you on receipt of only \$29.95! Transportation PREPAID. Your money refunded promptly if you are not pleased.

THE CLARK CO.
800 N. Clark St., Chicago 10, Ill.

FEATURES

- Folds to only 4" thick! Convenient! Portable.
- Fine, perfected card felt playing surface.
- 8 non-slip holders for glasses, 8 for ash trays.
- 8 compartments for chips, cards, etc., below playing surface.
- Alcohol proof finish.
- Seats 8 comfortably.

POPULAR CLARK PRODUCTS

Folding table top, for use in serving on 4' 8 place table, \$7.50. Chrome and aluminum bar stools, \$10.95 up. Tennis tables, 9 place, solid oak, 54" games tables, Grills, settees, bars, swings. Hundreds of other products for home games and entertainment.

WRITE FOR LITERATURE and NEW LOW PRICES

SAY YOU SAW IT IN POPULAR MECHANICS

THE ALL PURPOSE TILTING ARBOR SAW For Immediate Delivery

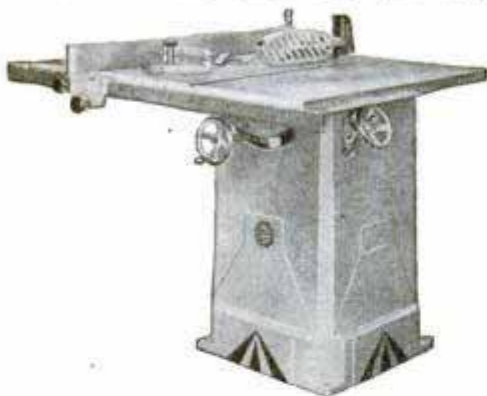

Will Take Anything From Thin Box Lumber to a 4 1/8" Log Easily - Quickly - Accurately

For complete details write,

DARRA-JAMES CORP.
93 North Main Street, Waterbury 14, Conn.

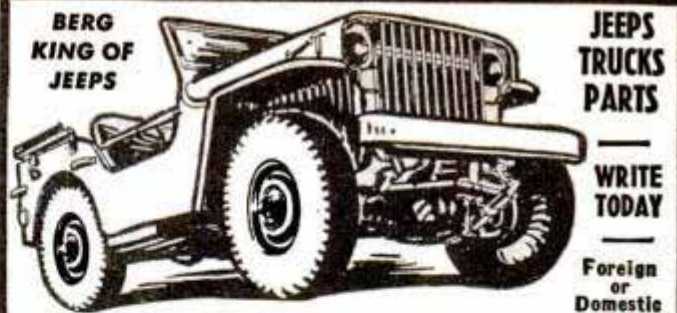

BERG KING OF JEEPS

JEEPS TRUCKS PARTS

WRITE TODAY

Foreign or Domestic

WRITE BERG FOR JEEPS, TRUCKS, PARTS, EQUIPMENT

Build your own race cars from BERG'S new or used parts—Convert our motors to marine use—Buy amphibious Trucks and amphibious Jeeps.

Be first to own a Jeep! For sport, farming, hauling, towing, or business there's nothing better. ARMY Jeeps, completely overhauled, or good used jeeps. They're strong! rugged! speedy! tough! powerful! 600 x 16 tires; hydrau. brakes; 16:25 HP motor; 2 spd. aux. trans.; many other features. Can also supply amphibious jeeps, amphibious trucks, contractors shovels, cranes, army trucks. Tell us your needs; we have it or can get it for you! Special atten. to EXPORT buyers.

PARTS! - SEND FOR FREE CATALOG - MOTORS!

FREE CATALOG! We can supply new or used parts for JEEPS, TRUCKS, etc. Transmissions, gears, bodies, axles, rims, MOTORS, chassis—everything you need to build or rebuild JEEPS, AUTOS, TRUCKS. Now you can build your own racing cars, marine motors, etc. SEND TODAY FOR FREE CATALOG and PRICES. DO IT NOW!

BERG TRUCK & PARTS COMPANY
"America's First Jeep Distributor"
1608 S. WABASH AVE. CHICAGO 16, ILL.

RACER

HIGHLY POLISHED CAST ALUMINUM

8 1/2 inches long. Heavy single unbreakable casting. Free running rubber wheels. Can't rust.

Trim, sleek lines. Looks like models selling up to \$12.00.

Form a racers' club today! Every youngster wants one.



Send \$2⁹⁸

Postpaid in U.S.A.

Dealer Inquiries Invited
POST OFFICE BOX 43
CHICAGO 17, ILLINOIS

BARTON INDUSTRIAL PRODUCTS CORP., Dept. 6

Supercharge YOUR CAR



Protected by U.S. Foreign Pat.

HIGH-FREQUENCY TRANSFORMER

Makes Motor Start Quicker - Run Smoother
ELECTRIC SUPERCHARGER is a patented high-frequency transformer designed for POWER, ECONOMY and SUPER PERFORMANCE in motors. Car owners, mechanics and fleet owners report amazing results, even on new cars. NOTHING LIKE IT ON THE MARKET. Gives engine New Life - Increased Power - a 60% Longer and Hotter Spark—more Complete Combustion—less Spark Plug Fouling and Longer Life. Fits all cars except Ford V8 and Mercury. Order Model V Supercharger for 1942-46 Ford or Mercury. **ELECTRIC SUPERCHARGER** is sold on a 15 DAY TRIAL—MONEY BACK GUARANTEE FOR ONLY \$3.95 in U. S.

HOLTHOUSE LABORATORY
3918 W. Grand Ave., Dept. A-2, Chicago 51, Ill.

WAR SURPLUS

Lathes, Milling Machines, Drill Presses, Sawing equipment, Motors and thousands of miscellaneous items. Also information on Helicopters, Sleeper Trailers, Garden Tractors, Power Lawn Mowers, Welders, Jet Impulsion for Cars and Tractors etc. RUSH name for free literature.
THE WAYNE ENGINEERING CO., Dept. 1000, Greenville, Ohio



NOW! HOT WATER QUICKLY with Electric Water Heater

You can have hot water almost instantly anywhere that you have an electric outlet by just immersing FLASHEAT in water. SEND NO MONEY. Send name and address and we will send it C.O.D. plus postage. Save postage, send \$1.95, we will ship Flasheat postpaid.

DISCO SALES, Inc., 154 Nassau St., Dept. PH. 1, N.Y. 7



Today

write for your FREE copy of the
"ASCO BUSINESS PLAN FOR YOU"

Here are full directions for establishing yourself in the rapidly expanding Coin Operated Vending Machine field. Key executives tell you how to organize a highly profitable route featuring the ASCO 5¢ HOT NUT VENDOR.

This is your opportunity to go into business for yourself . . . full or part-time. The new ASCO 5¢ HOT NUT VENDOR is sturdily constructed of highly polished aluminum. Beautiful, modern design make it easy to locate. Organize your route now for big, continued profits — operators are now earning as much as \$100.00 and more a week on their investment.

Every business man should read "Asco Business Plan for You". Send for your FREE, illustrated copy today.



ASCO VENDING MACHINE EXCHANGE

55-57-59 BRANFORD ST., Dep't No. PM, NEWARK 5, N. J., Bigelow 3-7744-5

REPAIR KIT AVAILABLE



Entire kit sent postpaid for only \$4.00 plus 18c postage.

Contains a complete assortment of terminals, pins, porcelain insulators, mica, etc. that will fit most flat irons and appliances. Practically every part necessary in the ordinary repairing of flat irons in one handy kit. Additional supplies obtainable so that your kit can be replenished.

Christy Supply Co. 2835 N. Central Ave. Dept. K-250, Chicago 34, Ill.

Low Price The OTTAWA "Buzz" Master



FREE Details

CLEAR LAND FAST! Powerful 6-HP motor with friction clutch for safe operation. Cuts down timber, brush and hedge; turn blade vertical; saw logs to length. Can be equipped to fell largest trees. Has clutch pulley for belt work; guaranteed.

OTTAWA MFG. COMPANY, 627 Brush Ave., Ottawa, Kans.

MACHINE SHOP EQUIPMENT

Every man who owns a workshop should have a copy of this new, authentic catalog of Machine Shop Equipment . . . the latest tools made by the biggest manufacturers in the United States. Replete with illustrations, descriptions, prices. Prompt delivery on most tools listed in this catalog. Available at the cost of printing—50c a copy—Get yours today! Price of Catalog Refunded on First Order over \$5.00. Send check or Money Order to

CENTER TOOL CO.
154 Centre St., New York 13, N. Y.



IT'S FLAMELESS!

Just puff and your cigarette is lit!

LEKTROLITE LIGHTER

LIGHTS UP INSTANTLY

A Light Every Time!
For Men and Women
Smart, Lightweight
Order Yours Today

\$1.50

EVEN IN THE STRONGEST WIND—no matter how the wind blows! Just insert cigarette into head of lighter, press the bottom, and draw.—Presto, the easiest light you ever had! No fitful flicker—no wick or wheel to stall your service. Lektrolite Fluid included at no extra cost!

UTILITY STORES 117 S. WABASH AVE. CHICAGO 3, ILLINOIS

HERE'S A REAL TELEPHONE SYSTEM FOR ONLY **\$9.95** LESS BATTERIES



SEND ONLY \$1
and pay Postman Balance on delivery Plus Postage or send \$9.95 and SAVE POSTAGE!

Easily Installed!
Instructions Included!

YES! YOU CAN CALL AND RECEIVE CALLS UP TO HUNDREDS OF FEET

- Ideal for**
- Farms
 - Stores
 - Homes
 - Children
 - Office
 - Factories
 - Garages

And other uses too numerous to mention!

- Built-in 2-Way Buzzer System
- Each Set Fully Guaranteed
- 70 ft. Single Conductor Wire Included

Never before has a Telephone System at so low a cost proven as great a success as this! All that is required is two wires running between the phones. Starting with two dry-cell batteries at each phone. The set will operate for hundreds of feet depending upon the number of batteries used. (Price does not include batteries.)

Made of Durable Pressed Metal—Black Baked Enamel Finish!
ORDER DIRECT—TODAY . . . PROMPT SHIPMENT

UTILITY STORES

117 S. Wabash Ave., Chicago 3, Ill., Dept. FF-22

I enclose \$1.00. Ship at once Two-way Telephone System at \$9.95 per set.

I will pay Postman \$8.95 Plus Postage when package arrives.

Enclosed is \$9.95—You pay postage.

NAME
Please Print Name and Address

STREET OR R.F.D.

CITY STATE

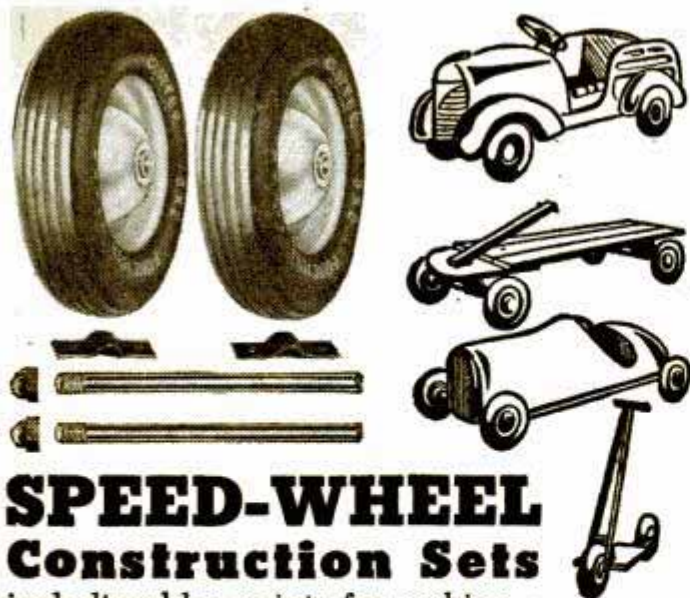

SPEED-WHEEL Construction Sets

including blue prints for making—

- Express Wagons**\$13.20
(Includes 4 8" x 2" Tires, Wheels, Axles, etc.)
- Midget Racers**\$17.70
Includes 4 10" x 1.75" Tires, Wheels, Axles, etc.)
- Bicycle Trailers, Scooters**.....\$7.80
(Includes 2 8" x 2" Tires, Wheels, Axle, etc.)
- Wheelbarrow Set**\$4.85
(Includes 1 10" x 1.75" Tire, Wheel, Axle, etc.)

Immediate Delivery • Order Now

JIM BROWN TOY COMPANY

869 E. Tallmadge Ave.

Akron 10, Ohio

EXPERIMENT WITH BLACK LIGHT!

FUN! THRILLS! PROFITS!



BL-5 6W tubular
BLACK LIGHT,
AC only, \$15.50

We furnish all supplies with full instructions. Trial kit of 8 fluorescent lacquers for only \$6.25. 6W tubular BLACK LIGHT, special, while they last \$15.50. Also black bulb for beginners \$2.00. We furnish lacquers, crayons, fabrics, etc. promptly. Write for free descriptive list and full details today.

EXPERIMENT WITH LUMINOUS PAINT



"IT GLOWS IN THE DARK"

Make things glow in the dark—in colors! Get our beginners complete kit, contains one ounce each of 3 lasting colors—Bright Blue—Gardenia and Chartreuse, and one ounce of Sealer for only \$3.95. Paint artificial flowers, lapel ornaments, house numbers, signs, light switches etc.

\$3.95

BLACK LIGHT PRODUCTS

67 EAST LAKE STREET

CHICAGO 1, ILL.

LUMINOUS PAINT KIT FOR PROFESSIONALS



Send for this complete professionals' kit of Luminous paint, tools and accessories. Contains 2 oz. jar each of Base White, Phosphorescent-Luminous Paint, Mixer Lacquer, Finishing Lacquer, and Brush Cleaner. Two mixing jars with air-tight screw caps to avoid waste, two brushes, two mixing rods, and complete instructions. Paint light switches, house numbers, stage settings, costume jewelry artificial flowers, cat or dog collars. Will glow for 1000 minutes. Sent anywhere in U. S. for

ORDER NOW

All materials in professional kit are non-toxic.

\$5.00

POSTPAID

NITEGLO PAINT CO.

4513 COTTAGE GROVE AVE., DEPT. P. M., CHICAGO, ILL.



250 POWER TELESCOPE COMPLETE LENS SET only \$2.50

See the mountains and craters on the moon, the ringed planet Saturn, the moons of Jupiter, distant ships, people, and hundreds of other interesting sights. Make your own high powered telescope in one evening of easy work. All optical parts for 6 ft. long refracting telescope completely finished. Set consists of 3 inch diameter 75 inch focal length ground and polished objective lens and all eyepiece lenses needed to give magnifications of 50X, 100X, 150X, 200X, and 250X as an astronomical telescope, and 50X, 100X, and 150X as a terrestrial telescope. Complete lens set with full directions for mounting, only \$2.50 postpaid.

BROWSCOPE CO., Dept. 66M, 24 W. 45th St., New York 19, N. Y.

PLASTAKIT

Make your own ornaments, decorations and jewelry designs out of plastic. Box of 60 pieces including pieces necessary to make your own pins, earrings, brooches and decorations. Unlimited uses. Send \$2... box sent postpaid. No C.O.D.'s.

WASHINGTON PLASTICS CO.

Dept. P

Box 41

Pawtucket, R. I.

PRESTO! ANYONE CAN MASTER GLAZE



Car Owners! Meet Master Glaze—the sensationally different luster for new and used cars! Not a wax—not an oil polish—not a paint!—nothing that "smears" over the surface.

MASTER GLAZE is a unique discovery—a creamy liquid—quick and easy to apply! Gives a hard, glass-like surface. Even gasoline cannot dull it! Lasts six months to a year! Amazing luster—beautiful, sparkling clean and brilliant! Doesn't finger-mark—doesn't smear! A match box full glazes an entire car. Seals the pores—protects! NOTHING LIKE IT!

AGENTS
An unusual opportunity! Quick, flashy demonstrator. Big profits. Good territory. Write today!

FREE SAMPLE

Just send your name and address today to MASTER GLAZE CO., 7720-552 W. Harwood Ave., Milwaukee, Wis.

LATHE OWNERS CONVERT YOUR LATHE

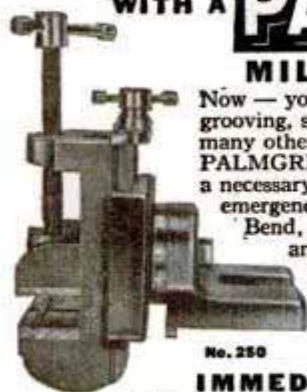

WITH A **PALMGREN** MILLING ATTACHMENT

Now — you can do milling, slotting, grinding, grooving, squaring shafts, sawing at angles, and many other important operations on your lathe. PALMGREN MILLING ATTACHMENT is a necessary fixture for small shops, schools and emergency work in large plants. Fits South Bend, Atlas, Craftsman, Logan, Sheldon and all other makes. It has 360° graduation for rotary angle adjustments, also graduated feed and adjustment screw. Easily mounted by straddling lathe's regular tool post. Try one—it will quickly pay for itself.

No. 250
IMMEDIATE DELIVERY

No.	Width Jaws	Depth Jaws	Jaws Open	Weight Pounds	Base Opening	Price F. O. B. Factory
150	1½"	1"	1½"	6½	1"	\$18.75
250	2½"	1¾"	2½"	11	1½"	24.75
400	4"	1½"	4"	25	2"	39.75

Order from your dealer or jobber. Write for circular No. 349

CHICAGO TOOL AND ENGINEERING CO.

Mfrs. of PALMGREN PRODUCTS for Over 28 Years

8365 South Chicago Avenue • Chicago 17, Illinois

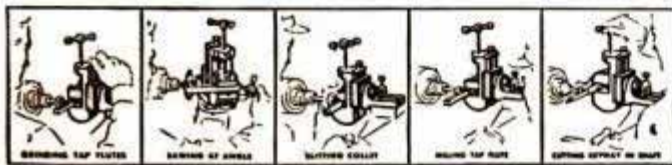

Send for our Catalog of
TOOLS & EQUIPMENT for DEVELOPMENT
WORK WATCHMAKERS TOOLS...

CATALOGUE

of Precision Tools, Equipment for Development Work, for the making of New Worlds.

"Mail Orders Only"

HENRY PAULSON & CO. CHICAGO 3, U.S.A.



New! Complete! RADIO CATALOG

READY NOW! Send For Your FREE Copy!

Radio sets...radio kits (including 19 Popular Mechanics Kits)...radio parts...electronic equipment...amplifiers...complete, standard lines of post-war designed equipment and supplies; pages and pages of what you've been waiting for...in the new Concord Catalog, ready now! Rush coupon for your copy...sent FREE!

CONCORD RADIO CORP.

LAFAYETTE RADIO CORPORATION

CHICAGO 7, ILL. 901 W. Jackson Blvd. • 265 Peachtree St. ATLANTA 3, GA.

CONCORD RADIO CORPORATION, Dept. P-66
901 W. Jackson Blvd., Chicago 7, Ill.

Rush FREE copy of new, complete Concord Catalog.

Name
Address
City State

A TOOLSHOP IN YOUR HAND!

- GRIND • DRILL • ROUT
- POLISH • ENGRAVE
- CUT • SAND • SAW, etc.

Make Things From
Wood—Plastics—Metals—Glass—Linoleum—Leather—Alloys—Horn—Stone—Bone, etc.

HANDEE TOOL OF 1001 USES

Smooth, steady power at your fingertips! You can turn out professional looking projects for pleasure or profit—ship, plane or train models, costume jewelry, wood carvings, puppets, initialed tumblers, etc. Handee, first small portable tool and today's finest, uses 300 different accessories. AC or DC. 25,000 r.p.m. Weight, 12 oz. With 7 accessories, postpaid..... \$18.50

GET A GOOD START

Get the
**HANDEE
KIT**

HANDEE Tool and 45 of the most popular accessories, all packed in handsome, compact steel carrying case. You'll be amazed at what you'll accomplish!
Complete, postpaid, \$25.00

FOR YOURSELF OR A FRIEND...
THE GIFT OF A LIFETIME!

NEW PRECISION ATTACHMENTS

Fit DeLuxe Handee only. Enable novice or craftsman to perform precision operations not possible with other portable tools. Magically, easily, your offhand carving, routing, shaping, etc. is perfect as to depth of cut, accuracy of line. Set of 6 attachments with instructions, postpaid \$7.95



ORDER NOW—
USE COUPON

FREE
64-PAGE
Catalog

CHICAGO WHEEL & MFG. CO.
1101 W. Monroe St., Dept. PM
Chicago 7, Ill.

Send me HANDEE TOOL HANDEE KIT
 PRECISION ATTACHMENTS
 Remittance enclosed. Send C.O.D.
 Send 64-page Catalog.

Name

Address

SAY YOU SAW IT IN POPULAR MECHANICS

AMAZING NEW "THERMO-SAW"

CHILDREN ARE ENTHUSIASTIC USERS AND OPERATE IT WITH SAFETY (Cuts With Heat)

WOW! How the Boys and Mechanics go for this NEW "THERMO-SAW" **AN IDEAL GIFT**
 Operates simple, easy and quick... Cuts plywood 1/2" to 3/4" ... Excellent for cutting difficult patterns... Cuts 14" x 36" board... **NOISELESS — NO VIBRATION — NO SAWDUST and SPEEDY**... Also, **NO TURNING OF THE WORK**... Cuts in **EVERY DIRECTION!**
 A special transformer produces high frequency current in a tough steel wire "blade" from ordinary Alternating (AC) Current... Will cut 1/2" Plexiglas very well... Extra Blades **ONLY 20c per dozen.**
Machine Measures 11" x 4" x 3 1/2" High. Throat 7" Deep. PATTERN INCLUDED FREE. Order Today.

CUTS RAPIDLY AND CLEANLY THROUGH WOOD AND OTHER MATERIALS
NOTE: Operates on 110 volt Alternating Current only; 50 to 60 cycle.

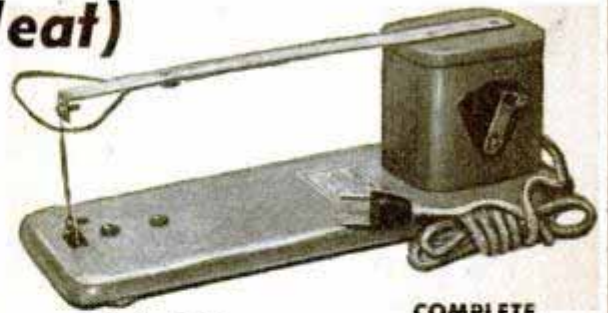

Boisselier Mfg. Co., Dept. P-6, Glen Ellyn, Ill.

\$4.75 in Canada & Mexico. \$5.00 elsewhere. No C.O.D. Orders Please!

ONLY \$4.50 Postpaid

COMPLETE outfit as illustrated with transformer and 12 spare blades.

NEW! AUTOMATIC 4 INCH C CLAMP

Sensational war-development. The Gordon Automatic "C" clamp now available for you! **CLOSING ADJUSTMENTS:**

Push screw handle forward, give it a quarter turn insuring a bull-dog grip on the work that cannot open.

FOR AUTOMATIC INSTANTANEOUS RELEASE: Release tension by quarter turn of screw handle, press "magic release button," presto! clamp is open.

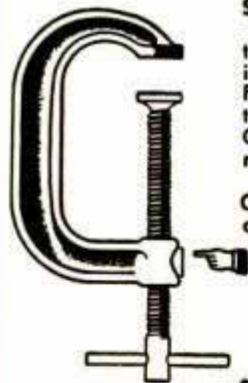

SPECIFICATIONS: Special steel alloy construction. Drop forged! Indestructible tool hardened thread! Four inch opening with wide throat capacity! Patented Gordon automatic close and release feature!

If your dealer doesn't carry Gordon Automatic Clamps, order today by mail. Send Cash, Money Order or C.O.D. \$4.50 each, post paid. If you live west of the Mississippi add thirty-five cents additional for postage.

SATISFACTION GUARANTEED OR MONEY CHEERFULLY REFUNDED.

GORDON AUTOMATIC TOOL CORP.
 50 Hamilton Avenue, Paterson 1, N. J.
DEALERS AND DISTRIBUTORS WANTED

WORLD'S LOWEST PRICED ADDING MACHINE

BEST POCKET SIZE IDEAL FOR BUSINESS OR PERSONAL USE

FREE TRIAL
ONLY \$2.50
TOTAL COST
SEND NO MONEY

Each Baby Calculator in Beautiful, rich-looking Leatherette case — at no extra cost. **FREE!!**



Fits vest pocket or purse. Guaranteed accurate. Operated as easily, and as reliable, as machines costing many times as much. Not a toy. Substantially made of 28-gauge steel—guaranteed for life against defects in construction. You positively can't buy a calculator of equal quality for as little money. **ACCEPTED AS THE FINEST LOW PRICED CALCULATOR FOR OVER 30 YEARS!** Operates with a flick of your finger. Adds, subtracts, multiplies, divides—counts up to ten million. Pays for itself over and over in mistakes avoided, and time saved. **MAKES IDEAL GIFT.**

Sold on a positive money back guarantee. Send only \$2.50. Calculator sent postpaid, or send name and address and pay postman \$2.50 plus postage. **MONEY BACK IN 10 DAYS IF NOT DELIGHTED!** (If outside U. S. send \$3.00.) **AGENTS WANTED.**

CALCULATOR MACHINE CO. (Mfrs.)
 Dept. 179, P. O. Box 248, Glenview, Illinois

SAY YOU SAW IT IN POPULAR MECHANICS

MOTORIZE YOUR LAWN MOWER WITH A GASOLINE OR ELECTRIC WASHING MACHINE MOTOR

ENJOY CUTTING GRASS AND MAKE MONEY RENTING YOUR MOWER. SEND FOR OUR GUARANTEED COMPLETE INSTRUCTIONS ILLUSTRATING EVERY DETAIL OF BUILDING THIS MACHINE.



ZETCO PRODUCTS CO., BELLEFONTAINE, OHIO

PRICE \$1.00

Now A DYNAMIC HEAVY DUTY INDUSTRIAL WELDER

IDEAL FOR AUTO - HOME APPLIANCE AND FARM REPAIRS

DESIGNED TO DO HIGH GRADE WELDING INEXPENSIVELY—Maintenance Men; Farmer's Mechanics; Machine Shops; Foundries; Auto, General Repair and Job Welding Shops; all using the DYNAMIC find it so indispensable and useful that they cannot afford to be without it. If inexperienced, you can easily learn to do a variety of high grade welding jobs by following the practical, simplified operating and welding instructions furnished. Once you see a DYNAMIC in operation, you won't want to be without it. Its simplicity will amaze you. In a year the DYNAMIC only costs you about 6c a day. Helmet, rods, cables, holder and operating instructions, etc., furnished.

SAVES YOU VALUABLE TIME AND MONEY!

This portable DYNAMIC WELDER—easily carried to the job—can be operated from any convenient, properly wired 110 volt, 60 cycle line. Can also be supplied for 220 volt, 60 cycle operation and for other voltages and cycles at slight additional cost. Works on IRON, STEEL, BRASS, BRONZE, AND OTHER METALS—has 8 metallic and carbon arc welding heat stages—does work you would think only possible with larger more expensive machine. **DYNAMIC WELDER CO. • 13 East 23rd St., FF, Chicago 16, Ill.**

FOR ONLY \$23.50 COMPLETE...

AVAILABLE NOW WITHOUT PRIORITIES!

WRITE TODAY FOR PARTICULARS
 Get details on our 10 day trial offer.

Member Chicago Association of Commerce





TANK PRISMS

Build your own periscope with a pair of these tank prisms—look over the heads of crowds, etc. Slightly soiled and scuffed but optically perfect. Measures 6 5/16 x 2 1/8 x 1 11/16 inches. Shipping weight 2 lbs. **98c**
R-234—Price each, . . .

CAVALRY SPURS



Genuine wish-bone type cavalry spurs. Nickered brass. **A102, Pair, .98c**
A103 Spur straps per set of four . . . **50c**

WAR

SURPLUS

AND HUNDREDS OF OTHER BARGAINS

MOSQUITO TENTS

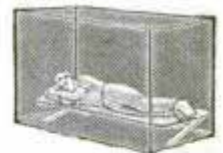

Of marquisette with taped seams. Metal rods and bars included. Covers cot or hammock. Brand new. **A104—EACH \$2.95**

U. S. ARMY COTS

Brand new Army cots. Hardwood frame with extra heavy canvas. Folds compactly—opens to 27x78 inches. Will support 1000 pounds. Fits in mosquito tent listed above. Wgt. 25 lbs. **\$5.95**
232—Each

ARMY BANDOLEERS

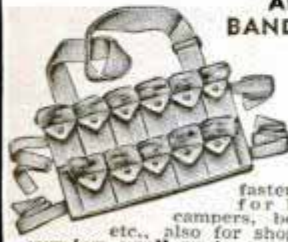

Of fine heavy khaki. Big roomy pockets with button fasteners. Fine for hunters, campers, boy scouts, etc., also for shop work in carrying small parts, etc. Material alone is worth this price.

11 Pocket Type No. 129 **49c** Each
5 Pocket Type No. 110 **29c** Each

MESS KITS



Regulation Army Mess Kits. Ideal for campers, boy scouts, etc. Slightly used but guaranteed perfect. Two pieces. Folding handle. **A116—EACH 69c**

CANTEENS, CANTEEN COVERS and CUPS



Regular U. S. Government Issue Canteens. Plastic screw top chained to body. Slightly used.
A117—Metal Body 69c
A118—Plastic Body 69c
A109—Canteen Covers, New, Ea. . . 69c
A119—Canteen Covers, Used, Ea. . . 35c
A120—Canteen Covers, Used, Each 25c



GI POCKET BELTS
Of heavy canvas. Adjustable waist size. Each with 5 pockets, and metal recoil fitting. Brand new. Fine for hunters, boy scouts, etc. **A107 98c**

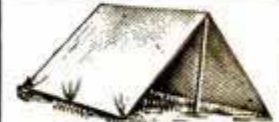

PUP TENTS

Regulation Army Pup Tents of durable, brown canvas. Used, but in good condition. Fine for campers, outdoorsmen, boy scouts, etc. Grand Xmas gift for children. Wgt. 5 lbs. **A100—Tent Only \$3.95**
A110—Tent, new . . \$7.95
A101—Ropes, wooden poles and stakes for above. Per set \$1.00

AMMUNITION BOX

Fine for storing valuables, carrying lunches, etc. Of heavy gauge 7 1/2 x 11 x 4 inches. Fireproof. Hinged lid with folding handle. Olive drab finish. Used, but perfect. Shipping wt. 4 lbs. **A525—EACH 25c**



7-LB. EXPERIMENTER PARTS ASSORT.

A "gold mine" for the radio serviceman. Hundreds of valuable radio parts, new radar and electronic parts and sub-assemblies, coils, resistors, trimming condensers, —worth many times this low price. **A130R—7 LBS. \$1.79**



HEAD NETS



Real protection from insects, etc. Fits over hat. Draw string in net. Celluloid window. For campers, fishermen, etc. **A509, ONLY 89c**



McCLELLAN ARMY SADDLES

Brand new! McClellan model saddles. Top grade cowhide with hair girth, fonder and 12 inch seat. Has straps for blanket roll and knapsack. Buckles, gunboot and sabre loops. A splendid value. **A-145—Each \$13.95**

SADDLE BAGS



Made of finest top grain leather. Rivet reinforced seams. Bottom and side gussets. Each canvas lined bag measures 12x13 inches. Fine for motorcyclists. May be separated to make two duffel bags. Used, but perfect. **A151—Each \$6.95**

MICROPHONE BUTTON



Brand new! For experiments in radio, electronics and other electrical apparatus. Used in telephone, amplifier and detectaphone work. Diameter 2 1/2 inches. New. **A512—EACH 98c**

SATCHEL POUCH

Heavy canvas pouch. Ideal for toting lunches, shopping, books, etc. Has three 11 x 12 inch pockets. Brand new, guaranteed perfect. Has oversize flap with single strap fasteners. **A113—EACH \$1.69**



RADIO HEAD PHONES



Extremely sensitive with 4000 ohms resistance. Brand new and fully guaranteed. With moisture-proof cord and phone plug. A splendid value for the radio serviceman and experimenters.

A106—PAIR \$2.95
New supersensitive phones. **A108—Pair . . \$5.95**

27 LENSES, ALL NEW, PERFECT. For experimental work in optics. Consists of 27 precision ground and polished prisms and lens elements in assorted diameters and focal lengths. Big variety, positive, negatives, etc. Actual value over \$100.00. **A519—27 PIECES \$7.95**



SHIPS LANTERN



Purchased from the Navy. Stands 22 1/2 inches high, 9 3/4 inches wide. Of heavy sheet metal. Windproof ventilation. Mounts on any wall. Burns oil—may be wired for electricity. All new. **R-516 Each \$12.50**

ANTENNA UNITS



Antenna Coupling unit. Eliminates radio static, and improves reception on all types of radio sets. Worth much more. Wgt. 4 lbs. **637— \$2.95**
Each only

50 LENSES SEMI-FINISHED
Lenses similar to above but not polished. All are blanked and formed ready for polishing. Negatives, positives, and prisms in Crown and Flint glass. Worth many times this low price. **A520—\$1.95**
50 assorted lenses, only

LIFE PRESERVER BELTS



Right from the invasion beaches. Consists of two air chambers. May be inflated automatically with "sparklet" cartridges or manually by attached hose. Adjustable in waist size. One air chamber guaranteed air tight—other may need a tire patch. All belts are used and slightly soiled but a bargain at this low price. **No. 1261 Each \$1.00**

ORDER DIRECT FROM THIS AD

Values galore! Hundreds of hard-to-find items for home, shop and outdoors. Make remittances by money-order, bank draft or personal check. Send 25% deposit on C.O.D. orders. No C.O.D.'s on orders for less than \$5.00. Include sufficient postage on parcel-post orders—any overage will be promptly refunded. All quotations F.O.B. Chicago. Used items and materials are guaranteed serviceable and as described. Your money back if not more than satisfied.

BIG ILLUSTRATED CATALOG FREE

STARK'S Dept. PM646
509 So. State St.
CHICAGO 5, ILL.

RUBBER BOAT



Purchased from U.S. Gov't. Has 5 man or 1000 pound capacity. Used but guaranteed perfect. Furnished complete with pump for inflating and oars. Shipping wgt. 70 lbs. **\$49.50**
No. 811—Each

THE ALL-PURPOSE MACHINE TOOL FOR ALL TYPES OF SHOPS

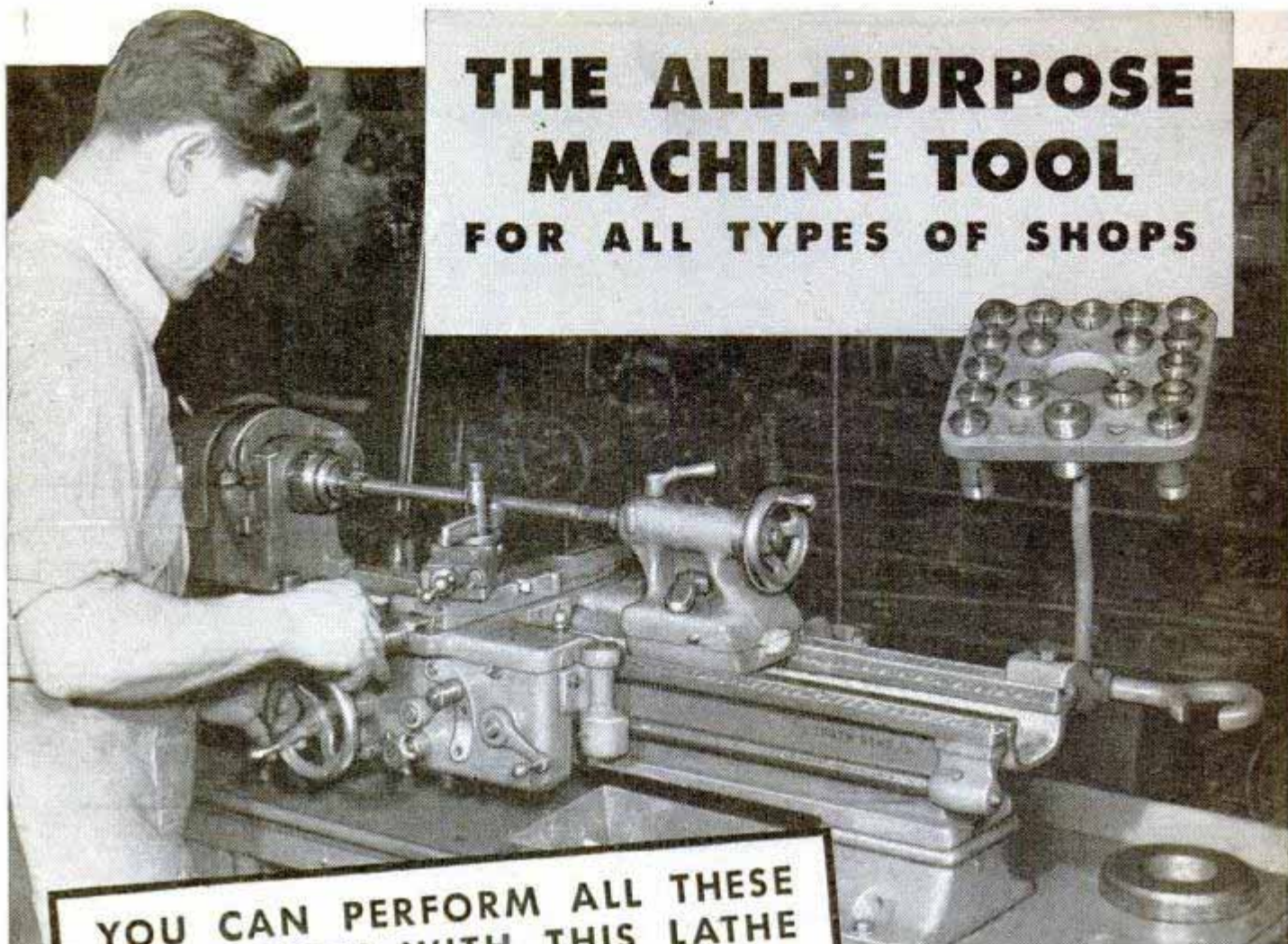

**YOU CAN PERFORM ALL THESE
OPERATIONS WITH THIS LATHE**

On Metals, Alloys, Fibers, Plastics, Compositions, Wood, Other Materials

TURNING • FACING • BORING • DRILLING • REAMING
TAPPING • THREAD CUTTING • MILLING • GRINDING
FILING • POLISHING • HONING • LAPPING • BUFFING

Because they are accurate, versatile and dependable, South Bend Precision Lathes are widely used in every type of large and small metal working industry. The same qualities which make these lathes so valuable to industry, make them the favorites for auto, radio, and appliance repair work, tool and instrument shops, model making, and hundreds of other uses. South Bend Precision Lathes are made with 9", 10", 13", 14½", and 16" swings to meet the great majority of lathe needs. Mention size in which interested when writing for free catalog.



MILLING ATTACHMENT

Mounts on compound rest base. Permits using hand or power feeds for milling and boring. Made for all sizes of South Bend Lathes. Write for Catalog 77.

10-INCH LATHE FEATURES

- Fine workmanship by highly skilled machine tool craftsmen
- Superfinished spindle with large, adjustable sleeve bearings
- Belt drive for smooth, silent operation at high speeds
- Back-gear drive for power and low speeds
- Spindle Speeds from 50 r.p.m. to 1357 r.p.m.
- Thread cutting range - 4 to 224 per inch, 48 pitches R.H. or L.H.
- Precision lead screw for thread cutting
- Worm drive and friction clutch for power longitudinal and cross feeds
- Three hand-scraped V-ways and a flat way on bed insure perfect alignment of headstock, saddle and tailstock

HOW TO RUN A LATHE

This valuable book shows you how easy it is to operate a South Bend Lathe, and the wide variety of work that can be done on it. Contains 128 pages, 365 illustrations. Price only 25c postpaid, U.S. coin or stamps.



LATHE BUILDERS SINCE 1906

SOUTH BEND LATHE WORKS

455 E. MADISON STREET • SOUTH BEND 22, INDIANA



Printed by Popular Mechanics Company, Chicago, Ill., U. S. A.

look **SHARP**

feel **SHARP**



be **SHARP**

use

Gillette

Blue Blades

with the **SHARPEST** edges
ever honed!



**5 for
25¢**

You look **SHARP** because you get the best-looking shaves any man ever had!

You feel **SHARP** because Gillette Blue Blades give you the quickest, most refreshing shaves of your life!

You are **SHARP** when you buy Gillette Blue Blades with the **SHARPEST** edges ever honed, because you get more shaves per blade and save money!

Copyright, 1946, by Gillette Safety Razor Company.

GILLETTE'S CAVALCADE OF SPORTS presents the major boxing event of the week every Friday night over American Broadcasting Company stations coast to coast

Gillette Safety Razor Company, Boston 6, Mass.



By all means, try the "TRIUMPH"
before you
Choose a Pen!

Anyone can see at a glance—how Sheaffer's "TRIUMPH" is different . . . different in the bigger, smoother-writing, cylindrical 14-K *Lifetime** POINT—different in the fluid supply visibility of the transparent barrel—different in "tailoring"—even different in the new clip! These are some of the differences which make "TRIUMPH" outstanding to own or to give.

VALIANT "TRIUMPH" pen, \$12.50; pencil, \$5; complete set, \$17.50. Federal excise tax additional. Other sets, \$3.95 up.

Complete range of Colors.



The
Lifetime
 POINT



New
Fineline
 SLEEVE TIP

Unconditionally Guaranteed
 For First User's Lifetime With-
 out Repair Charges If Sent To
 Sheaffer Factory!

Reduces
 Lead
 Breakage

SHEAFFER'S

Copyright 1946, W. A. Sheaffer Pen Co. *Trademark Reg. U. S. Pat. Off.
 †Licensed U. S. Patent No. 2170734

"TRIUMPH" Pens and Fineline Pencils
 Unmatched Tailoring and Quality

LISTEN EVERY SUNDAY to SHEAFFER'S PARADE with Carmen Cavallaro — NBC Network, 2 P. M. E. S. T., 3 P. M. E. D. T.