

POPULAR MECHANICS

MAGAZINE

WRITTEN SO YOU CAN UNDERSTAND IT



REG. TRADE MARK GREAT BRITAIN NO. 410420

REG. U.S. PAT. OFF.

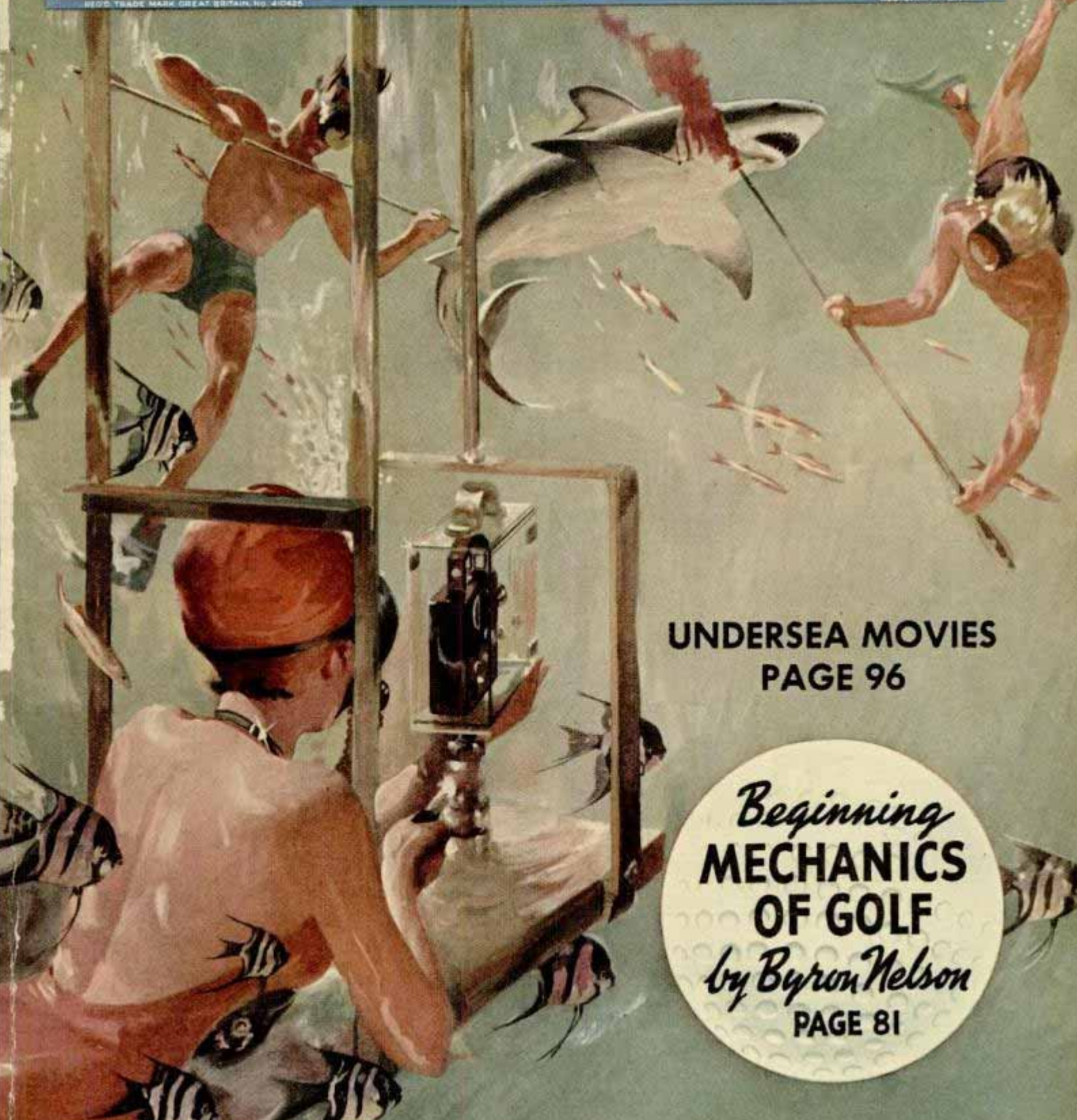

UNDERSEA MOVIES
PAGE 96

Beginning
**MECHANICS
OF GOLF**
by Byron Nelson
PAGE 81



look **SHARP**

You look **SHARP** because you get the best-looking shaves any man ever had!



feel **SHARP**

You feel **SHARP** because Gillette Blue Blades give you the quickest, most refreshing shaves of your life!



be **SHARP**

You are **SHARP** when you buy Gillette Blue Blades with the **SHARPEST** edges ever honed, because you get more shaves per blade and save money!

use Gillette Blue Blades

with the **SHARPEST** edges ever honed!



5 for
25¢

GILLETTE'S CAVALCADE OF SPORTS presents the major boxing event of the week every Friday night over American Broadcasting Company stations at 10 o'clock E.D.T. Gillette Safety Razor Company, Boston 6, Mass.

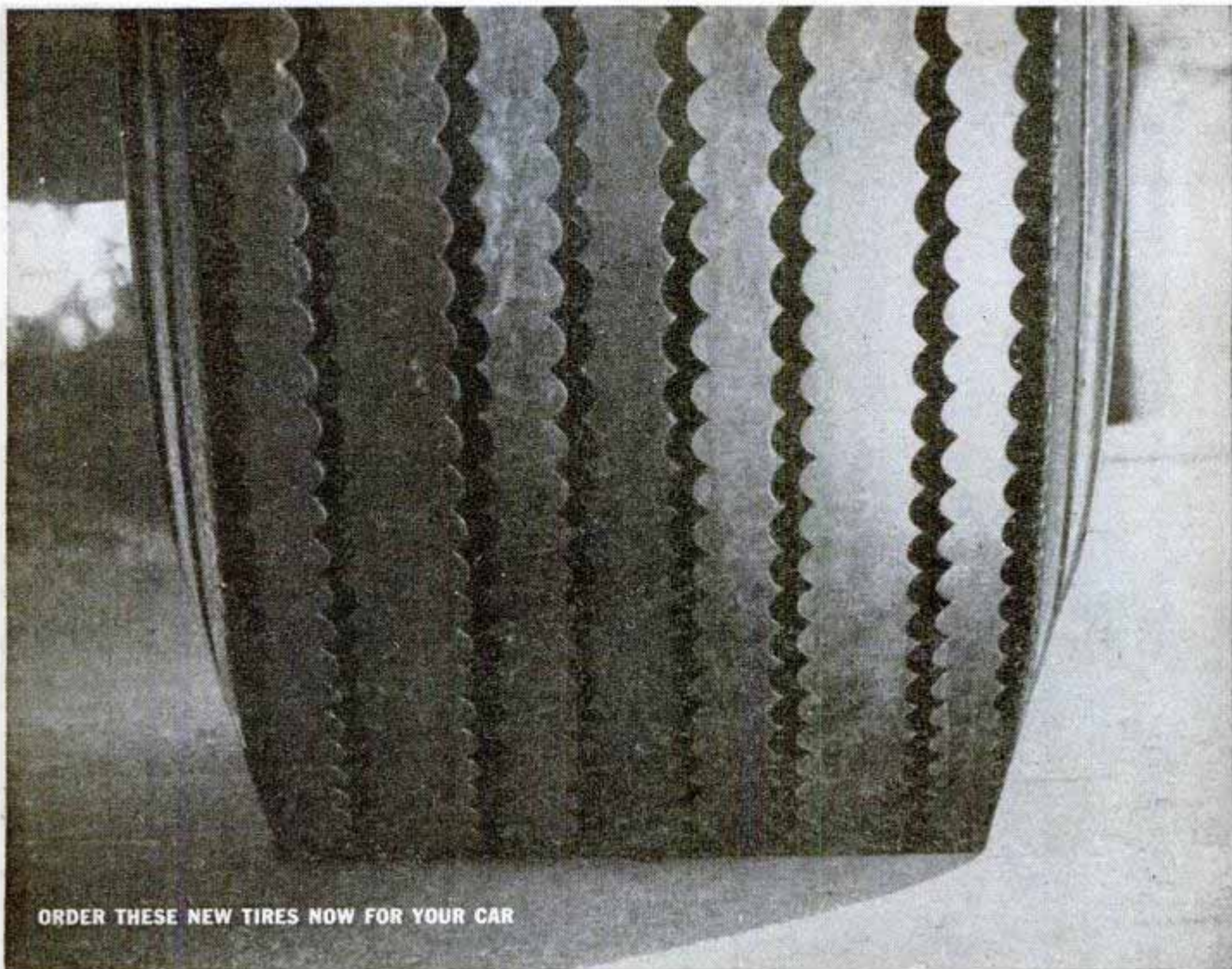

ORDER THESE NEW TIRES NOW FOR YOUR CAR

HERE'S THE NEW B. F. GOODRICH TIRE THAT OUTWEARS PREWAR TIRES

POLICE CARS have tested them! Taxi fleets have tested them! The B. F. Goodrich fleet has tested them! These new tires have passed more than 17 million miles of tests with flying colors.

Why?

Because the new wider, flatter tread (see picture above) puts more rubber on the road—more rubber to share the wear. No part of the tread has to take too much of the burden.

Because the body of the tire has been made 35 per cent stronger by using tougher cords—and more of them.

Because an extra shock-absorbing

breaker strip is included in the new tire.

The result is a tire that offers better than prewar mileage. But that's not all. In laboratory tests it resists bruising better than prewar tires, and it will stand more rough wear than you are ever likely to give it. Even at high speeds this new tire will outwear prewar tires.

The demand for these new, bet-

ter tires is still running ahead of our ability to make them. But we are making tires and shipping them every day.

If your B. F. Goodrich dealer does not have these new tires in stock, let him take your order. He'll notify you as soon as they arrive. Meanwhile he'll help you get the most out of the tires you now have. *The B. F. Goodrich Co., Akron, Ohio.*

B.F. Goodrich

FIRST IN RUBBER

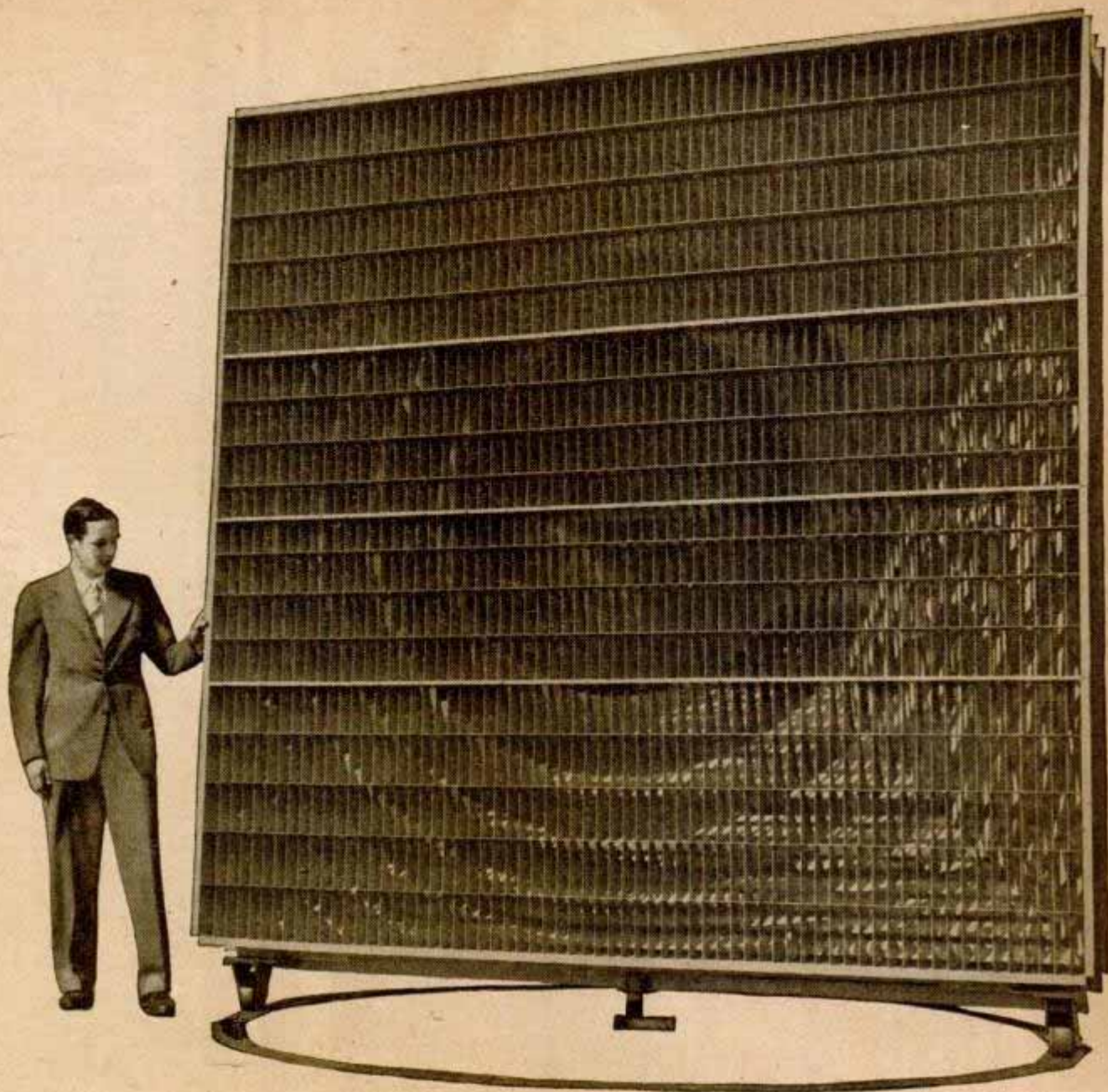

● A "SEARCHLIGHT" TO FOCUS RADIO WAVES

In the new microwave radio relay system between New York and Boston, which Bell Laboratories are developing for the Bell System, giant lenses will shape and aim the wave energy as a searchlight aims a light beam.

This unique lens—an array of metal plates—receives divergent waves through a waveguide in the rear. As they pass between the metal plates their direction of motion is bent inward so that the energy travels out as a nearly paral-

lel beam. At the next relay point a similar combination of lens and waveguide, working in reverse, funnels the energy back into a repeater for amplification and retransmission.

A product of fundamental research on waveguides, metallic lenses were first developed by the Laboratories during the war to produce precise radio beams.

But how to focus waves is only one of many problems that Bell Telephone Laboratories are working on to speed microwave transmission. The goal of this and all Bell Laboratories research is the same—to keep on making American telephone service better and better.



BELL TELEPHONE LABORATORIES

Exploring and inventing, devising and perfecting for continued improvements and economies in telephone service

Popular Mechanics Magazine

Registered in U. S. Patent Office and Canada

H. H. WINDSOR, Founder

H. H. WINDSOR, Jr., Editor and Publisher

Next Month

PHOTOGRAPHS in full color in the June issue will bring the good news to the amateur camera fan—now he can print his own color photos! Ready for introduction to the home darkroom enthusiasts is a new dye transfer process by which any amateur can make the original color print from his own film in two hours and additional prints in a fraction of the time formerly required. The seven basic steps are outlined in next month's article, illustrated by full color photographs and pictures of the step-by-step process.

HOME gardeners can now grow seedless tomatoes, start transplants without wilting, prevent pre-harvest drop of fruit, and root new lawns and shrubs in a fraction of the time formerly required. A June article tells how you do it with synthetic plant hormones.

NYLON sleeping bags and electric gunsights are only two of many new items available for camping, fishing or hunting trips. How to "Stock Up for the Outdoors" is featured in June.

BYRON NELSON will be with us again in June with tips on how to handle long and medium irons—the second of his three articles on "The Mechanics of Golf."

RADIO amateurs will want to get on the new 2-meter band with the Hi-Efficiency Transceiver described next month.

BILLION-DOLLAR farm hand—that's "Mr. Watt," the farmer's electrical helper. A June feature tells what's ahead in rural electrification.

IT GLOWS in the Dark," a feature in the June Craftsman section, lets you in on the mysteries of "black light," tells you how to mix the paint, how to make signs that glow in the dark, how to cast your shadow on luminous paper.

Volume 85

MAY 1946

Number 5

Managing Editor.....	Roderick M. Grant
Assistant Managing Editor.....	Wayne Whittaker
Shop Notes and Crafts Editor.....	James R. Ward
Radio and Electronics Editor.....	Frank L. Brittin
Aviation Editor.....	Aubrey O. Cookman
Associate Editor.....	John R. Kinsey
Eastern Editor.....	Bill Reiche
Western Editor.....	Thomas E. Stimson, Jr.
Art Director.....	Frank Beatty

Assistant Editors

Clifford B. Hicks

Maston M. Jacks

Virgil T. Swanson

Assistant Editors, Shop Notes and Crafts

W. Clyde Lammey Wayne C. Leckey John F. Shrock A. E. Youngquist

In This Issue

The Mechanics of Golf By Byron Nelson	81
Prize Secret of the Flattops	90
Do's and Don'ts of DDT	97
How the Iron Pin Boy Works	107
Fisherman, Lead With Right Hook!	114
How Deep Is the Ocean?	124
The Army's Torture Chamber	130
Le Tourneau Lays a House	138
The Gold Bug Bites Again	145
Half a Billion in the Slot	155
Atomic Power Plants in the Sky	162

For the Craftsman

Optics of the Projector	178
Deep Freeze Food Storage	188
Weaving Rags Into Rugs	193
How to Build a Midget Farm Truck	205
Radio and Electronics	221

Other items, and manufacturers of available products described, are listed on pages 8 and 10

Published monthly by POPULAR MECHANICS COMPANY, 200 East Ontario Street, Chicago 11, Ill. H. H. Windsor, Jr., president; Paul H. Dunakin, vice president and general manager; D. F. Windsor, vice president and secretary-treasurer; William Harrison Fetridge, assistant to the publisher; Clover L. Perkins, advertising manager; Alan M. Deyoe, circulation manager. Single copy in the United States, 25 cents; subscription rates in United States and possessions, and countries of the Pan-American Postal Union, 1 year, \$2.50; 2 years, \$4.50; 3 years, \$6.00. Single copy in Canada, 30 cents; subscription rates, 1 year, \$3.00; 2 years, \$5.50; 3 years, \$7.50. To all other countries add \$1.00 a year over United States prices for overseas postage. If you plan to move, notify us at least 60 days in advance so you will not miss an issue. Give both old and new addresses. Entered as Second Class Matter, September 15, 1903, at the Post Office at Chicago, Illinois, under Act of March 3, 1879. Entered as Second Class Matter at Post Office Dept., Canada. Copyright 1946, by Popular Mechanics Company. Copyright under International Copyright Union. All rights reserved under Pan-American Copyright Union. Printed in the United States of America.

Ingenious New Technical Methods

To Help You with Your
Reconversion Problems

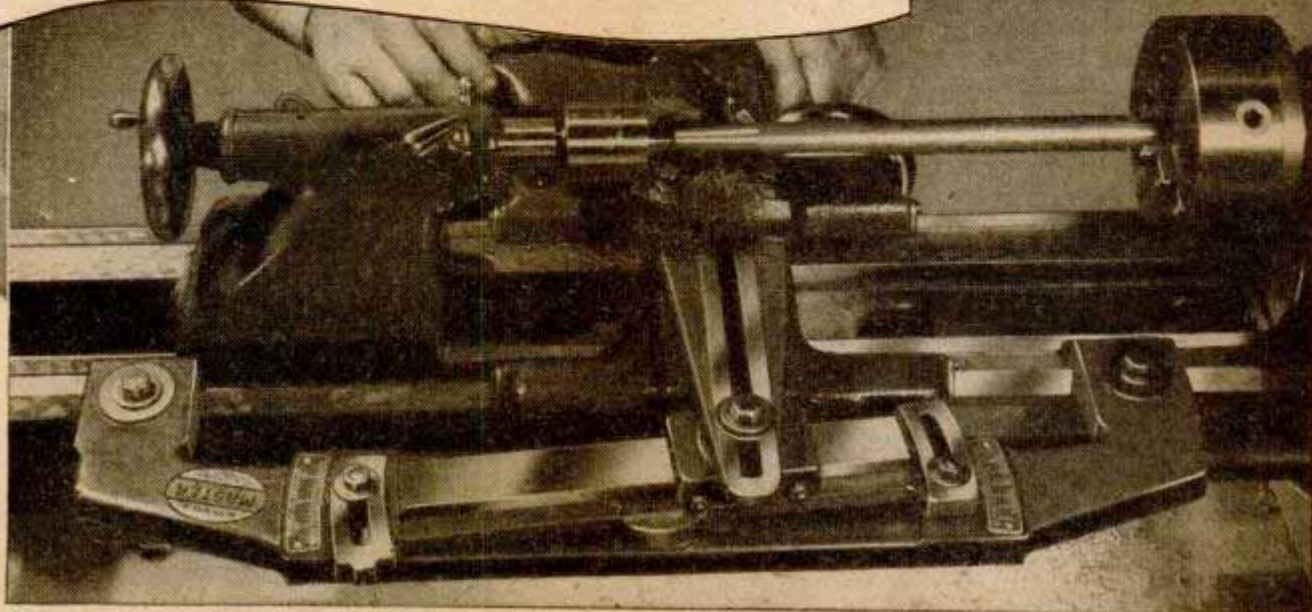

Simplified Master Taper Attachment Fits All Types of Lathes Instantly!

Now! A "universal" taper attachment that fits all lathes, old or new, big or small—that can be attached or removed in *minutes!* This taper attachment is not bulky or cumbersome. It bolts easily to the bed, in the back of any lathe.

The Master performs accurate taper turning, boring and threading with the ease of any straight line tool operation. It precisely duplicates any tapered part. Is usable in any position. Does not interfere with straight turning. The bar is precisely machined and fitted. There is no vibration. Taper graduations are in inches at one end; degrees at the other. The Master is available now, in two sizes; two feet and four feet in length.

Available today also, is delicious Wrigley's Spearmint Gum. This is one treat you can enjoy even when your hands are busy. And the pleasant chewing helps to keep you alert and wide-awake, even through a monotonous job.

Chewing Wrigley's Spearmint satisfies a fellow. In addition, it helps keep your mouth moist and fresh—so you feel better. And feeling better, you naturally work better. By making chewing gum available to all, scores of plants and factories report increased morale and efficiency that really pays off.

*You can get complete information from the Keene Electrical Machinery Co.
549 W. Washington Blvd., Chicago 6, Ill.*

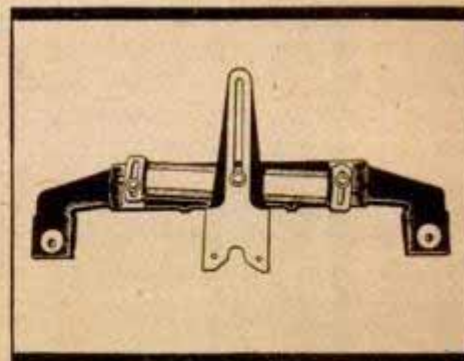

Model 710 Master Taper Attachment



AA-67

DEFOE HOMES CAN ANSWER YOUR HOUSING PROBLEM

THE Housing Division of the Defoe Shipbuilding Company was developed with a two-fold purpose—to maintain, as closely as possible, the wartime employment level upon which the people of the industrial area in which the plant is located had come to depend and to offer the public a new solution to America's housing problem.

- • With this in mind, Defoe designers and engineers were called upon to create a new line of homes which would bring to their owners the comforts of functional design, the ease of maintenance made possible by modern compact construction—plus the economies of mass production methods. In addition, they must be built to outlast houses of standard construction!

- • The Defoe organization has delivered. The skill and experience acquired by more than forty years of fine workmanship and adherence to the age-old traditions of the shipbuilder's art have brought into being an entirely new concept of gracious living. The Defoe Homes reach new highs in comfort and convenience. While there is nothing fantastic or extreme about them, they are certainly a radical departure from any prewar "prefabricated" houses or temporary wartime structures.

- • With the war won and with great hope for a permanent peace just ahead, "Better Things for Better Living" is the slogan for the coming era. The Defoe Homes will be a worthwhile contribution to the good times ahead.

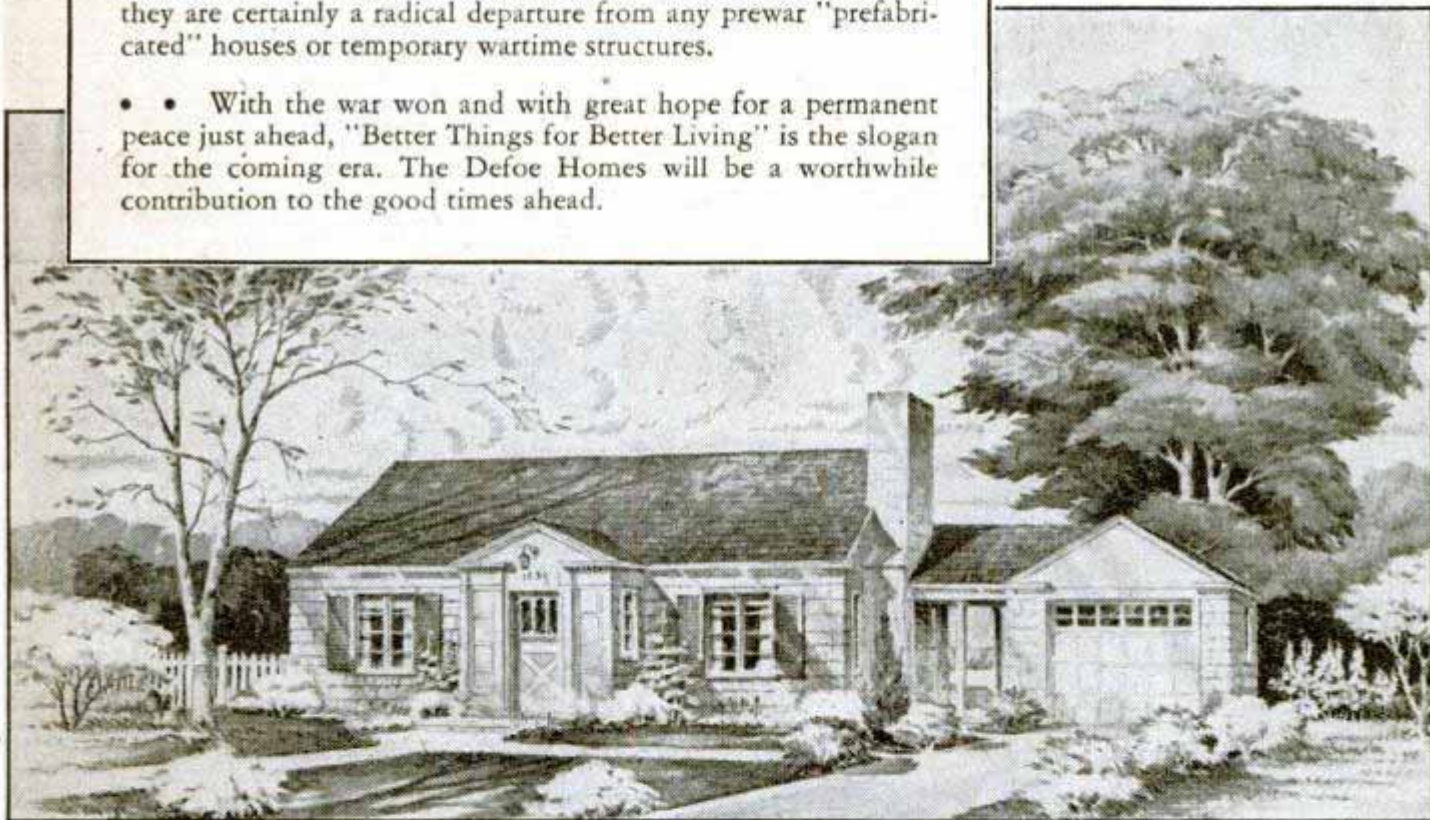

This attractive Cape Cod home can be erected by the Defoe system. Variations in floor plan and exterior treatment can be made to satisfy individual requirements. This, like all Defoe Homes, can be purchased with or without the breezeway and garage.



HOUSING DIVISION
DEFOE SHIPBUILDING COMPANY, Dept. PM-5
BAY CITY, MICHIGAN

Please send me the descriptive brochure on the new Defoe Homes. Enclosed is 10c for handling and mailing costs.

This One



5B62-5F8-Q2SW

In your Mind's Eye

The Secret of MENTAL CREATING

IF you just like to dream, read no further. There comes a time when your fancies *must be* brought into light—and stand the test of every-day, hard realities. Are you one of the thousands—perhaps millions—whose thoughts never get beyond the stage of *wistful wishing*? Do you often come to from a daydream with the sigh, "If only I could bring it about—*make it real*?"

All things begin with thought—it is what follows that may take your life out of the class of those who hope and dream. Thought energy, like anything else, can be dissipated—or it can be made to produce actual effects. *If you know how to place your thoughts* you can stimulate the creative processes within your mind—through them you can assemble things and conditions of your world into a happy life of accomplishment. *Mental creating* does not depend upon a magical process. It consists of *knowing how* to marshal your thoughts into a power that draws, compels and organizes your experiences into a worth-while design of living.

ACCEPT THIS *Free* BOOK

Let the Rosicrucians tell you how you may accomplish these things. The Rosicrucians (not a religious organization), a world-wide philosophical fraternity, have preserved for centuries the ancients' masterful knowledge of the functioning of the inner mind of man. They have taught men and women how to use this knowledge to *recreate their lives*. They offer you a free copy of the fascinating book, "The Mastery of Life." It tells how you may receive this information for study and use. Use coupon opposite.

The **ROSICRUCIANS**
(AMORC)

SAN JOSE

CALIFORNIA

SCRIBE: B. V. T.
The Rosicrucians (AMORC),
San Jose, California.

Please send free copy of "The Mastery of Life,"
and I shall read it as directed.

Name.....

Address.....

City.....

Why be a BOOKKEEPER?

...When Accountancy
offers more Money
and Success...

If you are a bookkeeper, you are right on the threshold of a profession that pays far above average—where there's real opportunity to get ahead and move up fast.

Why not step *UP* from bookkeeping—be an accountant—make *real* money!

You can learn Accountancy by the interesting LaSalle Problem Method—in your convenient spare time, at home, without losing a day from your work. You learn by *doing*... you study Accounting principles and solve Accounting problems under the clear guidance of experienced C.P.A.'s. You cover Accountancy from the basic principles right up through Accounting Systems and Income Tax Procedure—to advanced training for the C.P.A. degree if you so desire. And as you go along step-by-step, you master the principles of auditing, business law, statistical control, cost accounting, organization, management, finance, etc.

You go as fast or as slowly as you choose. And you may start "cashing in" on your new ability long before you complete the training—as thousands of others have proved. Many advance quickly to better positions, even before they are half way through. And that is only the *beginning* of a growing and continuing success for the rest of your business life.

Why remain "just a bookkeeper" when Accountancy holds so much for you? Our free 48-page booklet, "ACCOUNTANCY, THE PROFESSION THAT PAYS," tells you what you must know to be an Accountant, and how you can prepare in your leisure time, at moderate cost and on easy terms.

Send the coupon today. Get all the facts and judge for yourself. There is no obligation. You are already started in this field...find out how you can rapidly go to the top! Mail coupon NOW!

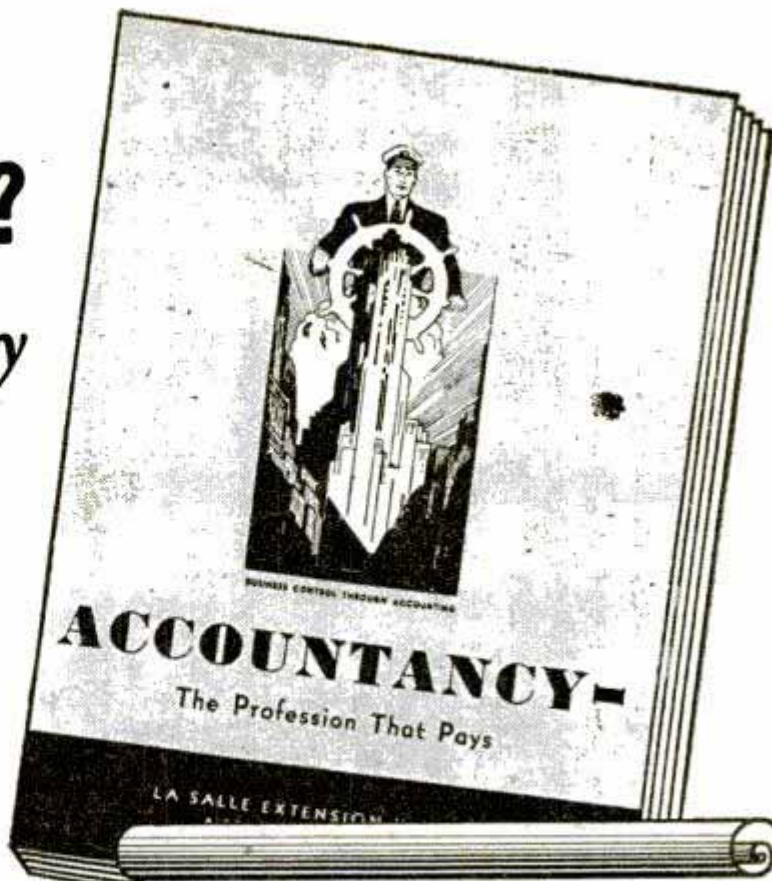

FREE
BOOKLET

LA SALLE Extension University *A Correspondence Institution*

Dept. 564-H • 417 S. Dearborn • Chicago 5, Ill.

I'd like to know more about your home study program to help me prepare for an accounting career. Please send me your free 48-page booklet, "Accountancy, the Profession That Pays."

Name

Position Age

Address

City, Zone and State

"I'm **GOING**
to be an
ACCOUNTANT!"



LASALLE
EXTENSION UNIVERSITY
A Correspondence Institution

when you say...
"ADD PYROIL"

... these good
 things happen
 to your car



... You provide a constant protective film of lubrication to cylinders and pistons. No metal to metal contact.

... Pyroil reduces wear due to friction. Permits easy starting ... reduces battery drain.

... Pyroil protects cylinder walls from rust and corrosion.

... Pyroil frees away sludges and gums and reduces carbon formation.

PYROIL FOR AIRCRAFT ENGINES

Use Aircraft Pyroil B for lubricating oil, Aircraft Pyroil A for gasoline.

Manufactured and Guaranteed by Pyroil Company, W. V. Kidder, Founder, 55 Pyroil Bldg., La Crosse, Wis.



PYROIL COMPANY

55 Pyroil Bldg., La Crosse, Wisconsin

I want my car to last and run properly. Please tell me more about Pyroil and how it can accomplish this for me.

Name.....
 Address.....
 City or Town..... State.....



Jerry, the talking dog, is entertaining hospitalized veterans, by courtesy of the PYROIL COMPANY. Picture of Jerry sent on request.

WHERE-TO-BUY-IT INDEX

Manufacturer's name and address appear in parentheses directly after items believed by us to be commercially available

AUTOMOTIVE

- Six-wheel tractor can climb wall.....129
- Bottled gas inflates tires (Beacon Devices, North Tonawanda, N. Y.).....135
- Electric flare for motorists (Turnsignal Corp., 400 E. Rittenhouse St., Philadelphia, Pa.).....144
- Spotlight fastens with suction cup (S. H. Thompson Mfg. Co., Dayton, Ohio).....150
- Rockets assist racing car.....161
- Jeep steers with all four wheels (Berg Truck & Parts Co., 1608 S. Wabash Ave., Chicago 16).....167

AVIATION

- Proposed carrier was to have been made of huge ice cubes...104
- Testing proposed 29-passenger helicopter (Roto-Craft Corp., Los Angeles, Calif.).....113
- Martin Mauler is newest torpedo bomber.....113
- One-man airplane jack for light planes (Consolidair, Inc., Alliance, Ohio).....128
- Propeller blades shot-blasted to increase strength.....128
- Cold weather fuel for planes permits two-minute starting...142
- Hangar has removable walls (Atlas Aircraft Products Corp., 405 E. 42nd St., New York).....144

FARM AND GARDEN

- Sugar beet harvester digs 200 tons per day (Blackwelder Mfg. Co., Rio Vista, Calif.).....106
- Cart for milk cans (Dairy Equipment Co., 1313 University Ave., Madison, Wis.).....123
- Homemade Diesel-powered tree shaker.....123
- "Walk through" milking barn saves time.....123
- Four-row corn picker made of two double-rows (Caterpillar Tractor Co., Peoria, Ill.).....123
- Chicken brooder heated with conductive rubber (U. S. Rubber Co., Rockefeller Center, New York).....150
- Water jet kills codling moth larvae.....154

HOUSE AND HOME

- Rake has adjustable tines (J. H. Wiley, 14-101 Merchandise Mart, Chicago).....152
- Doorstop holds heavy doors (Swallow Airplane Co., Inc., Wichita 1, Kans.).....152
- Steak tenderizer (Roy F. Trauger, 1488 Merchandise Mart, Chicago).....152
- Electric stove unit (Proctor Information Center, 220 E. 42nd St., New York 17).....152
- Electrical heater remains cool (Mandel Bros., State and Madison, Chicago).....153
- Clothesline reel (Auto Arc-weld Mfg. Co., 8-07 Grand Ave., Cleveland 4, Ohio).....153
- Razor has styptic pencil in handle (D. C. Dillon & Co., Irvington, N. J.).....153

INDUSTRY

- Eavesdropping through 24 feet of steel..... 88
- Asbestos felt fused to steel for stronger sheeting (Robertson Co., Farmers Bank Bldg., Pittsburgh, Pa.).....106
- Direct-reading spectrometer for alloys.....121
- One man moves five tons with lifting bar (Arnolt Motor Co., Warsaw, Ind.).....123
- Self-propelled pavement breaker does work of eight men (Rapid Pavement Breaker Co., 1517 Sante Fe Ave., Los Angeles, Calif.).....134
- Elastic plastic (Glenn L. Martin Co., Baltimore 3, Md.).....134
- Plywood panels 50 feet long (Washington Veneer Co., Olympia, Wash.).....143
- Built-in jacks lift bulldozer onto wheels (Gunderson Bros. Eng. Corp., 4700 N. W. Front Ave., Portland, Ore.).....150
- Fabric lining aids drying of concrete (U. S. Rubber Co., Rockefeller Center, New York).....161
- Magnetic sweeper collects chips (Sjostrom Machine Co., Lawrence, Mass.).....168
- Optical gauge measures thickness of plastic (Aireon Mfg. Corp., 166 W. Olive Ave., Burbank, Calif.).....168

OUTDOOR RECREATION

- "Invisible" fish lures of transparent plastic (Martin Fish Lure Co., 431 Eastlake, Seattle, Wash.).....128
- Plastic fishing rod container (Horrocks-Ibbotson Co., Utica, New York).....137
- Skiff doubles as roof for trailer.....160

PHOTOGRAPHY

- Waterproof camera shoots movies under water (Sea-Net Mfg. Co., Inc., 1428 Maple Ave., Los Angeles 15, Calif.)..... 96
- Pocket-size color meter for photographers (Harrison & Harrison, 6363 Santa Monica Blvd., Hollywood, Calif.).....150

RADIO AND ELECTRICAL

- Electric heater heats water in pail (National Ideal Co., 914 Summit St., Toledo 4, Ohio).....123
- Radio is removable in radio-phonograph combination (Westinghouse Electric Corp., Sunbury, Pa.).....150
- Flat-face television receiving tube (Philco Corp., Philadelphia, Pa.).....221

TOOLS

- Tool cuts and drives nails at high speed (Auto-Nailer Co., 267 Marietta St., N. W. Atlanta 3, Ga.).....111
- Handle utilizes old hacksaw blades (Crandall Mfg. Co., 1512 W. Slauson Ave., Los Angeles 44, Calif.).....111
- Screwdriver has power arm for extra leverage (Swallow Airplane Co., Inc., Wichita, Kans.).....128
- Tool saws, grinds or polishes (Parlec Power Tools, 919 E. Redondo Blvd., Inglewood, Calif.).....143

MISCELLANEOUS

- Ball bearing pen writes under water (Reynolds International Pen Co., 732 S. Federal St., Chicago 5).....111
- Three-wheeled powered vehicle for crippled (Howell Industrial Truck Co., Cleveland, Ohio).....122
- Wheeled cane guides blind.....122

(Continued to page 10)

FINISH YOUR HIGH SCHOOL COURSE

THAT'S the most important step you can take. Think back over your high school days, review the list below and supply the information in the coupon at the bottom of the page. Then fill in your own name and address and mail the coupon to us.

- | | | | |
|-------------------------|-----------------------|-----------------------------|---------------------------|
| 1. English—1st year | 11. Botany | 23. Language—1st year | 27b. Drawing—Designing |
| 1a. English—2nd year | 12. Biology | 23a. Language—2nd year | 27c. Drawing—Mechanical |
| 1b. English—3rd year | 13. Physiology | 23b. Language—3rd year | 27d. Drawing—Industrial |
| 1c. English—4th year | 14. Chemistry | 23c. Language—4th year | 28. History of Art |
| 2. Public Speaking | 15. Physics | 23d. Language—1st year | 29. Manual Training |
| 3. Oral English | 16. General Science | 23e. Language—2nd year | 30. Typing |
| 4. Journalism | 17. History—Ancient | 23f. Language—3rd year | 31. Shorthand |
| 5. Dramatics | 17a. History—Medieval | 23g. Language—4th year | 32. Bookkeeping |
| 6. Business English | 17b. History—Modern | 24. Home Economics | 33. Commercial Arithmetic |
| 7. Algebra—1st year | 17c. History—U. S. | 24a. Home Economics—1st yr. | 34. Commercial Law |
| 7a. Algebra—Advanced | 18. Civics | 24b. Home Economics—2nd yr. | 35. Commercial Geography |
| 8. Geometry—Plane | 19. Sociology | 25. Home Nursing | 36. Glee Club |
| 8a. Geometry—Solid | 20. Economics | 26. Foods | 37. Band |
| 9. Trigonometry | 21. Pacific Rim | 27. Drawing—Free Hand | 38. Orchestra |
| 10. General Mathematics | 22. Current Events | 27a. Drawing—Commercial | 39. Physical Education |

The arrangement of numbers in the list above corresponds with the arrangement in coupon below.

INTERNATIONAL CORRESPONDENCE SCHOOLS

BOX 5578-K, SCRANTON 9, PENNA.

This is to certify that I _____ attended the _____
High School of _____ from _____ to _____ 19____

Below is a statement of my record.

	Yrs. Taken 1, 2, 3, 4	No. Weeks	Periods Per Week	Grade	Credits		Yrs. Taken 1, 2, 3, 4	No. Weeks	Periods Per Week	Grade	Credits		Yrs. Taken 1, 2, 3, 4	No. Weeks	Periods Per Week	Grade	Credits	
1						11						23						27b
1a						12						23a						27c
1b						13						23b						27d
1c						14						23c						28
2						15						23d						29
3						16						23e						30
4						17						23f						31
5						17a						23g						32
6						17b						24						33
7						17c						24a						34
7a						18						24b						35
8						19						25						36
8a						20						26						37
9						21						27						38
10						22						27a						39

I.C.S. On the record above, please tell me, without obligation, how I can make up the needed credits to merit my High School Diploma.

Name _____ Age _____ Home Address _____
City _____ State _____ Present Position _____ Working Hrs. _____ A. M. to _____ P. M.

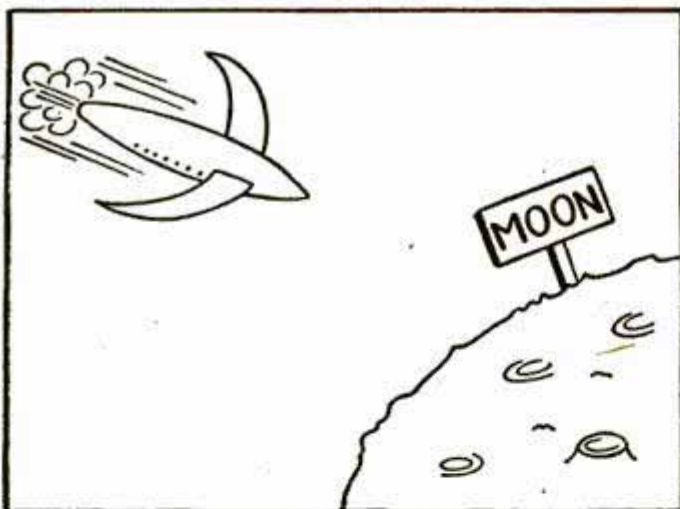
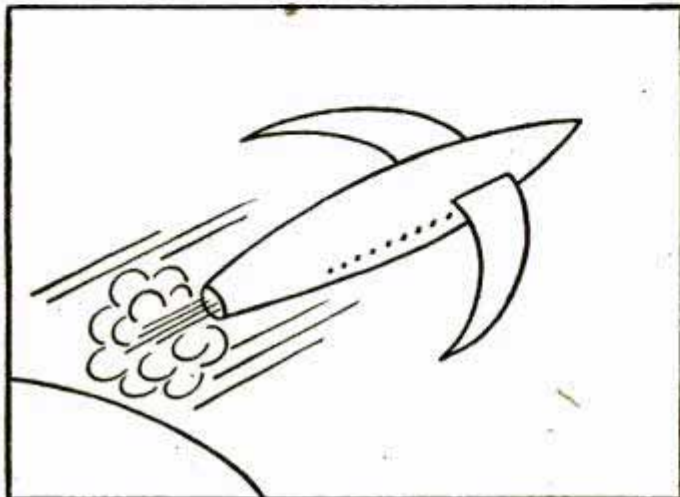
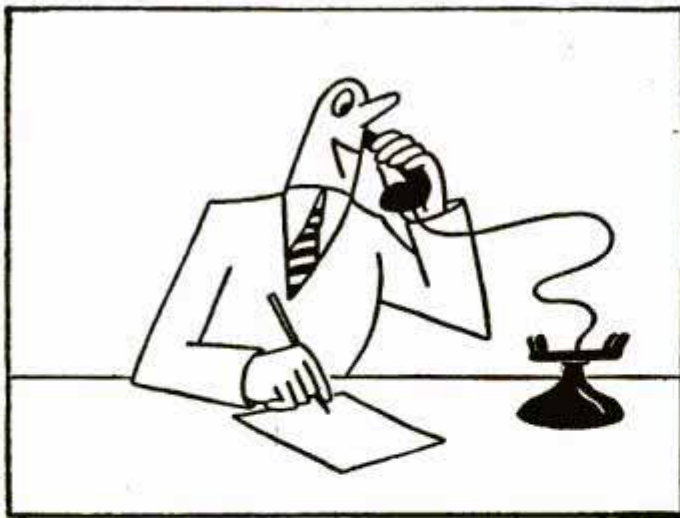

(Continued from page 8)

Tanks with lifebelts swim ashore.....	129
Line-throwing gun and rifle designed by gunner's mate ..	134
Water bags fit over tracks on Jap amphibian tank.....	135
Hands for the handicapped.....	136
Page holder pins book open (Baukus Research Laboratory, Saginaw, Mich.)	137
"Catch" device on rope breaks lineman's fall (Jesse O. Cox, Robbinsdale, Minn.)	142
Hollanders make rafts out of biscuit cans.....	150
Boy sculptures wild life in mahogany.....	151
British make model of Coventry for rebuilding.....	154
Vibration tests prove Golden Gate bridge flutterproof.....	160
Computing device easily read (George H. Morse, 927 28th St. S., Arlington, Va.).....	161

Craftsman and Shop Notes Index

AUTOMOTIVE

Front axle wedged to prevent swaying.....	176
Reflector aids when parking car in small garage at night.....	178
Fitting prevents loss of grease from high-pressure hose... ..	220

CAMPING

Durable fish scaler from power-hacksaw blades.....	172
Reel aids in handling and storing small craft.....	177
Bamboo case for casting rods.....	184
Pin untangles backlash line.....	192

FARM

Dry ice clears well-spear screen.....	186
Portable three-section hoghouse.....	209
Automatic trap releases hens from chicken house.....	217

HOUSEHOLD

Solving home problems.....	174
Rack carries supplies for home-repair jobs.....	186
"Filing" system keeps kitchen utensils in order.....	187
Tape rug pad before rug is laid.....	187
Clothes pole made from pipe is removable.....	192
Two-tone chime improvised from doorbell.....	197
Helpful hints for moving day.....	219

LAWN AND GARDEN

Pipe "planted" with tree conducts water to roots.....	177
Bird house supported on storm-sash hangers.....	192

PHOTOGRAPHY

"Paste up" photographs give novel effects.....	198
Door brace steadies enlarger for better prints.....	200
Improving appearance of tripod.....	200
Saucer used as flash reflector.....	200
Dark slide substitute made from notebook cover.....	200
Focusing spotlight for indoor photography.....	201
Renewing color on darkroom thermometer.....	202
Roll film suspended horizontally will dry faster.....	202
Preserving camera cover and case.....	202
Direct-vision viewfinder for box camera.....	203
Ammunition box converted into camera case.....	203

RADIO AND ELECTRONICS

Flat screen picture tube improves television reception.....	221
Utility P.A. amplifier system is self-contained.....	222
Eight helpful auto radio service hints.....	224

STORE, SHOP AND OFFICE

Easily made lettering pen rack.....	210
Metal bag filler speeds work of filling sacks.....	210
Typing paper removed easily from hinged box.....	210
Rack to hold drawings made from broken rule.....	216
Roll paper cutter improvised from piano wire.....	217
Number of lines to be typed shown by indicator.....	218
Cheesecloth protects fixtures from chewing gum.....	220

TOOLS

Cardboard container on drill shank catches debris.....	172
Vise positions work for drill press.....	176
Washer aids in adjusting drill.....	196
Grooved jaws hold small work in vise.....	198
Craft quiz.....	204
Babbitt in handle protects chisel from hammer blows.....	209
Wire-stripping fixture utilizes razor blades.....	210
Pin in bar of speed clamp prevents jaw from slipping.....	210
Seven new uses for flexible couplings.....	215
Tightening large hose clamps.....	218
Small drills and taps kept in cigarette box.....	218

TOYS AND NOVELTIES

Novel smoking set makes "strike" with bowlers.....	173
Pine cone indicates humidity to forecast weather.....	173
Lever attached to block in bowl makes novel nutcracker.....	184
Child's swan rocker.....	185

MISCELLANEOUS

Decorative wall plaques from modeling-clay patterns.....	170
Mesh and metal strip form rack for small tools.....	172
Method of hanging double cabinet doors.....	172
Music staves drawn quickly with multiple chalk holder.....	176
Nail in pocket protects pencil.....	184
Steel book end supports book while reading.....	184
Heated ice pick enlarges hole in rubber stopper.....	186
Nut locked permanently by saw slot in bolt.....	186
Adhesive tape cleans lighter wheel.....	192
Devised eggs carried to picnic in carton.....	192
Sawhorse fits under bench to save space.....	196
Short nipples threaded in vise with pipe jaw.....	196
Rubber band protects drain tile joints so cement will set.....	218
Number of barrels in tank calculated with chart.....	220

IMPORTANT NOTICE

It is the intention of this magazine to provide its readers with information regarding the latest developments in the mechanical arts. We take no responsibility as to whether the disclosures contained in our articles are covered by patents and advise readers to investigate this subject before making, using, or selling any of the products, machines, or processes described in order to avoid possible liability for patent infringement.

AUDELS REFRIGERATION & AIR CONDITIONING GUIDE.....\$4

New from Cover to Cover—1280 Pages, Fully Illus. Covering basic principles, servicing, operation & repair of household, commercial & industrial refrigeration & air conditioning. A gold mine of essential important facts for engineers, servicemen, users.

AUDELS CARPENTERS & BUILDERS GUIDES—4 Vols.\$6

A practical illustrated trade assistant on modern construction for carpenters, joiners, builders, mechanics and all woodworkers. 4 vols., 1600 pages, 3700 illustrations, flexible covers. Pocket size. Each volume sold separately \$1.50 a vol.

AUDELS AUTOMOBILE GUIDE.....\$4

A practical quick ready reference book for auto mechanics, service men, operators & owners. Explains theory, construction & servicing of modern motor cars, trucks, buses & auto type Diesel engines. 1540 pages, fully illustrated, 55 chapters. Indexed. A standard book for mechanics. New fluid drive covered.

AUDELS DIESEL ENGINE MANUAL.\$2

A practical, concise treatise with questions and answers on the theory, operation and maintenance of modern diesel engines including General Motors 2 cycle Diesel. 384 pages, fully illus., flexible binding, pocket size. All details plainly brought out, this book is of extreme value to engineers, operators & students.

AUDELS WIRING DIAGRAMS.....\$1

210 Pages. Illustrated. Gives practical facts on wiring of electrical apparatus. It shows clearly how to wire apparatus for practically all fields of electricity. Each diagram is complete & self-explanatory. Highly Endorsed Pocket Companion.

AUDELS PLUMBERS & STEAMFITTERS GUIDES—4 Vols.\$6

A Practical Trade Assistant & Ready Reference. Explains in plain language & by clear illustrations, diagrams, charts, graphs, pictures principles of modern plumbing practice including Marine Pipe Fitting and Air Conditioning. 4 Vols.—1670 Pages—3642 Diagrams. Pocket size. Each Vol. Sold Separately \$1.50 a Vol.

AUDELS SHEETMETAL WORKERS HANDY BOOK.....\$1

Practical inside information, Fundamentals of Sheet Metal Work. 388 pages. Illustrated. 11 sections. Clearly written. Essential & important facts, figures, pointers in everyday language. Ref. Index.

AUDELS SHEETMETAL PATTERN LAYOUTS.....\$4

Developed by Experts for Sheet Metal Workers, Layout Men & Mechanics. A Practical Encyclopedia in 10 Sections, size 7 x 10 x 2—1125 Pages—350 Layouts—1600 Illustrations. 1001 Key Facts. Fully indexed for ready reference in answering your layout problems. Covers all phases of sheet metal work including Pattern Cutting, Pattern Development & Shop Procedure.

AUDELS ANSWERS ON BLUE PRINT READING.....\$2

For Mechanics & Builders. Covers all types of blue print reading including ship & airplane. 376 pages, fully illustrated.

AUDELS NEW MACHINIST & TOOLMAKERS HANDY BOOK...\$4

Covers modern machine shop practices in all its branches. 5 practical books in 1. New from cover to cover. Tells how to set up & operate lathes, screw and milling machines, shapers, drill presses and all other machine tools. 1600 pages, fully illustrated, 5 x 6 1/2 x 2. Indexed. 5 sections. 1—Modern Machine Shop Practice. 2—Blue Print Reading & How to Draw. 3—Calculations & Mathematics for Machinists. 4—Shop Physics. 5—How to Use the Slide Rule. 60 chapters. Easy to read and understand. A shop companion that answers your questions.

AUDELS MATHEMATICS & CALCULATIONS FOR MECHANICS \$2

Mathematics for home study or reference. 700 pages, 550 illus. Practical mathematics from beginning. How to figure correctly. Easy, correct methods covering a complete review. Ill. & Indexed.

AUDELS HANDY BOOK OF PRACTICAL ELECTRICITY.....\$4

For maintenance engineers, electricians & all electrical workers. 1440 Pages, 2600 illus. Covers important electrical information in handy form—including Marine Wiring, Radio Principles, Welding. Indexed. A Key to a practical understanding of electricity.

AUDELS RADIOMANS GUIDE.....\$4

A key to the practical understanding of radio including Frequency Modulation, Television, etc., Aircraft & Marine Radio. For radio engineers, servicemen, amateurs. 773 pages. 400 illustrations & Diagrams. Photos. Review Questions & Answers, Reference Index. Authentic, clear, concise.

AUDELS ELECTRONIC DEVICES...\$2

Tells What You Want to Know About Electric Eye. Easily Understood. Covers photo-electric cells & their applications. Amplifiers, illumination, frequencies, voltage, photocell, tubes, Ohm's Law, wiring diagrams, etc.

AUDELS WELDERS GUIDE.....\$1

A concise, practical text on operation & maintenance of all welding machines for all mechanics. Over 400 pages, illustrated. Covers all methods of electric and acetylene welding including airplane work.

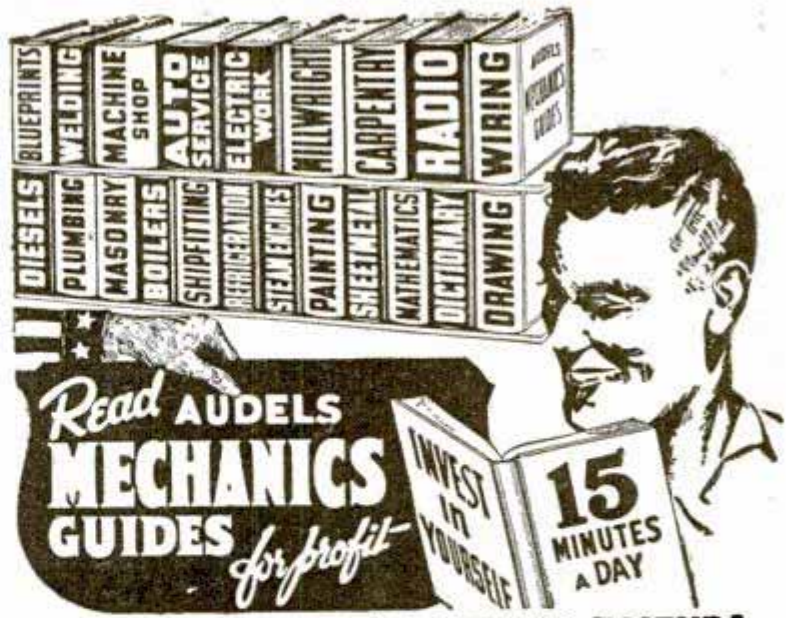

Read AUDELS MECHANICS GUIDES for profit

AN AUDEL GUIDE IS A GOOD FRIEND!

Use the brains and experience of others in these Guides of the Trades. Save time and money with right methods, short cuts, labor saving ideas. CHECK NOW! You can look over any Audel Guide in your home. Start the Easy Payments if satisfied.

CUT HERE MAIL ORDER

THEO. AUDEL & CO., 49 W. 23 St., New York 10, N.Y.

Please mail me for 7 days' free examination the books marked (X) below. I agree to mail \$1 in 7 days on each book or set ordered, and to further mail \$1 a month on each book or set ordered until I have paid purchase price.

If I am not satisfied with Guides I will return them.

- Audels REFRIGERATION & Air Conditioning Guide . \$4.
- Audels POWER PLANT ENGINEERS GUIDE . 4.
- Audels PUMPS, HYDRAULICS & AIR COMPRESSORS . 4.
- Audels WELDERS GUIDE . 1.
- Audels BLUE PRINT READING . 2.
- Audels SHEET METAL WORKERS Handy Book . 1.
- Audels SHEET METAL PATTERN LAYOUTS . 4.
- Audels AIRCRAFT WORKER . 1.
- Audels MATHEMATICS and CALCULATIONS . 2.
- Audels MACHINISTS & TOOLMAKERS Handy Book . 4.
- Audels MECHANICAL Dictionary . 4.
- Audels AUTOMOBILE GUIDE . 4.
- Audels DIESEL ENGINE MANUAL . 2.
- Audels MARINE ENGINEERS Handy Book . 4.
- Audels SHIPFITTERS Handy Book . 1.
- Gueths MECHANICAL DRAWING COURSE . 1.
- Rogers DRAWING and DESIGN . 2.
- Audels MILLWRIGHTS and Mechanics Guide . 4.
- Audels CARPENTERS and Builders Guides (4 vols.) . 6.
- Audels PLUMBERS and Steamfitters Guides (4 vols.) . 6.
- Audels MASONS and Builders Guides (4 vols.) . 6.
- Master PAINTER and DECORATOR . 2.
- Audels GARDENERS & GROWERS GUIDES (4 vols.) . 6.
- Audels ENGINEERS and Mechanics Guides Nos. 1, 2, 3, 4, 5, 6, 7 and 8 complete . 12.
- Audels Answers on Practical ENGINEERING . 1.
- Hawkins Aids to ENGINEERS EXAMINATION . 2.
- Audels ELECTRICIANS EXAMINATIONS . 1.
- Audels WIRING DIAGRAMS . 1.
- Audels Handy Book of PRACTICAL ELECTRICITY . 4.
- Audels ELECTRICAL POWER CALCULATIONS . 2.
- Hawkins ELECTRICAL Guides at \$1. each . 10.
- Audels ELECTRONIC DEVICES . 2.
- Audels ELECTRIC Dictionary . 2.
- Audels RADIOMANS GUIDE . 4.
- Audels NEW ELECTRIC LIBRARY at \$1.50 a Volume Vols. I, II, III, IV, V, VI, VII, VIII, IX, X, XI, XII.

Name.....
 Address.....
 Occupation.....
 Employed by..... PM

AUDEL, Publishers, 49 W. 23 St., N. Y. 10

Now Hear Better



THE AMAZING NEW

Beltone
WAY

COMPLETE IN
ONE POCKET-SIZE UNIT
(with cord and plug)



Beltone Mono-Pac brings you a new world of sound—amazingly clear, natural—perfected by advanced electronic research. One lightweight unit—about the size of a spectacle case—does it all. Weighs about one-half as much as old style hearing aids with no clumsy, separate battery pack, no battery wire. Such a sensational advance that already tens of thousands of hard-of-hearing people have been delighted with how splendidly they hear now with this tiny but powerful device.

Send Post Card Today for
FREE BOOKLET

with valuable information for hearing problems.

BELTONE HEARING AID CO., Dept. PM-5

1450 W. 19th Street, Chicago 8, Illinois

SAY YOU SAW IT IN POPULAR MECHANICS



Save 1/2
**MAKE YOUR
SPARE TIME PAY!**

**Assemble These
Beautiful Home Furnishings Yourself
NO TOOLS... NO WORKSHOP NEEDED!**

Your spare time is worth money! Make these smart, modern furnishings for your home... or as luxurious gifts for your friends! Styled by Paul Hudson Stanley, nationally known designer, these ultra-new accessories combine the natural beauty of clear-grained Harvest Oak and the trim lines of sparkling Lucite!

IT'S EASY AND IT'S FUN!

A tabletop Hobby! Each beautiful accessory comes in *complete Kit form*. All parts and materials of selected woods and gleaming Lucite are accurately pre-cut and ready for assembly. Nothing to cut, carve or shape... **NOTHING ELSE TO BUY!** Step-by-step instructions guarantee easy assembly, beautiful results!

HERE'S HOW YOU SAVE ONE-HALF!

Leading stores now feature *identical* items at assembled retail prices exactly **DOUBLE** your cost for complete Hobby Kits! You **SAVE ONE-HALF**... make your spare time **PAY** by building these articles with your own hands! For Pleasure and Profit... write today for free details of this enjoyable new Hobby!

HEMOCRAFTERS GUILD Dept. F-2
360 N. MICHIGAN AVENUE • CHICAGO 1

**CRYSTAL CLEAR
LUCITE
AND
GOLDEN GRAIN
HARVEST OAK**

**FREE 32-PAGE BOOKLET ABOUT
MODEL RAILROADING**
THE WORLD'S MOST FASCINATING HOBBY



FREE 32-PAGE BOOKLET tells all about this absorbing hobby for skilled tradesmen, business and professional men. Give yourself hours of satisfaction and relaxation building your own scale model railroad which performs and looks like the real thing. It's easy and relatively inexpensive. Get started now. Send at once for our free booklet "Your Model Railroad."

MODEL RAILROADER MAGAZINE
DEPT. MR MILWAUKEE 3, WISCONSIN

LEARN



PORTRAIT PAINTING AT HOME

• Previous art training or talent **NOT** necessary. The Stuart System teaches you, in 11 easy-to-follow lessons, to (1) locate features *exactly* to correspond to model's features, (2) outline head and face to correspond to model's outline, (3) make each feature a true portrait of that feature in the model, (4) produce shadows and shading that *exactly* correspond to that of model's face, (5) mix flesh paint tints that are like living flesh. You, too, can make *exact* charcoal and oil likenesses. Send for free booklet **today**.

STUART STUDIOS

121 Monument Circle, Room 656, Indianapolis 9, Ind.

Please send me free book and outline of lessons.

Name _____

Street _____

City _____ State _____



RADIO SERVICING pays good money for full time work. Many others make \$5, \$10 a week EXTRA fixing Radios in spare time.

★ ★ ★ Building this
A. M. SIGNAL GENERATOR

gives you valuable experience. Provides amplitude-modulated signals for test and experiment purposes.

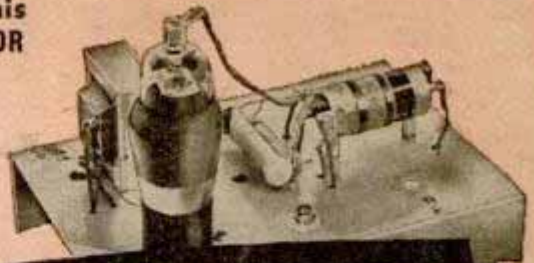

Learn RADIO by PRACTICING in Spare Time

with 6 Big Kits of Radio Parts I Send You

Let me send you facts about rich opportunities in Radio. See how knowing Radio can give you security, a prosperous future. Send the coupon for FREE 64-page book, "Win Rich Rewards in Radio." Read how N.R.I. trains you at home. Read how you practice building, testing, repairing Radios with **SIX BIG KITS** of Radio parts I send you.



You build this **SUPERHETERODYNE CIRCUIT** that brings in local and distant stations. You get practical experience putting this set through fascinating tests.

You build this **MEASURING INSTRUMENT** yourself early in the course—use it for practical Radio work on neighborhood Radios to pick up EXTRA spare time money!

Future for Trained Men Is Bright in Radio, Television, Electronics

The Radio Repair business is booming NOW. There is good money fixing Radios in your spare time or own full time business. Trained Radio Technicians also find wide-open opportunities in Police, Aviation, Marine Radio, in Broadcasting, Radio Manufacturing, Public Address work, etc. Think of the boom coming now that new Radios can be made! Think of even greater opportunities when Television and Electronics are available to the public!

Many Beginners Soon Make \$5, \$10 A Week EXTRA in Spare Time

The day you enroll I start sending EXTRA MONEY JOB SHEETS to help you make EXTRA money fixing Radios in spare time while learning. You LEARN Radio principles from my easy-to-grasp Lessons — PRACTICE what you learn by building real Radio Circuits with Radio parts I send — USE your knowledge to make extra money in spare time.

Mail Coupon for Free Copy of Lesson and 64-Page Illustrated Book

I will send you FREE a sample lesson, "Getting Acquainted with Receiver Servicing," to show you how practical it is to train for Radio in spare time. With it I'll send my 64-page, illustrated book, "Win Rich Rewards in Radio." Just mail coupon in an envelope or paste it on a penny postal. — J. E. SMITH, President, Dept. 6EP, National Radio Institute, Pioneer Home Study Radio School, Washington 9, D. C.

**BE A SUCCESS in RADIO
I Will Train You at Home**

Sample Lesson FREE

Gives hints on Receiver Servicing, Locating Defects, Repair of Loudspeaker, I.F. Transformer, Gang Tuner, Condenser, etc., 31 illustrations. Study it—keep it—use it—without obligation! Mail coupon NOW for your copy!



**GET BOTH 64 PAGE BOOK
SAMPLE LESSON FREE**

MR. J. E. SMITH, President, Dept. 6EP
National Radio Institute, Washington 9, D. C.
Mail me FREE, without obligation, Sample Lesson and 64-page book about how to win success in Radio and Television—Electronics. (No salesman will call. Please write plainly.)

Name.....
Address.....
City..... Zone..... State..... 4PR

If you are a war veteran, check here.



My Course Includes Training in
TELEVISION ★ ELECTRONICS

INVENT

NOW IS THE TIME TO PATENT AND SELL YOUR INVENTION

Now, more than ever before, is the right time to patent and sell your invention. Why? Because manufacturers everywhere, in striving to keep ahead of competition, are looking for new inventions and buying up the patent rights thereon so that they will have better and more attractive items to make and sell. Hence, the wise thing for you to do is also to act at once. Protect your invention—and yourself—by applying for a patent now.

FREE "PATENT GUIDE" EXPLAINS WHAT TO DO

Our Free 48 page "Patent Guide for the Inventor", containing complete information about patent procedure and selling inventions, answers many important questions concerning Patents that inventors constantly ask. It tells what facts, details, drawings, sketches, etc., are necessary to apply for a Patent; how to protect your invention through dated and witnessed disclosure; how to do this at once to safeguard your rights; how Patent Office Records can be checked to determine whether the invention is probably patentable before filing fees need be paid; discusses costs involved and a practical way these can be paid as the application progresses. It tells how some inventors secured financial backing; how many simple inventions have proved large commercial successes; how Patents covering improvements also can be profitably utilized and marketed; and countless other facts that every inventor will want to know. And in addition, our "Patent Guide" contains illustrations of over 150 basic mechanical movements.

WHY YOU NEED EXPERT ASSISTANCE

The Patent Laws were enacted for your benefit—to give you protection for the features of your invention which are Patentable. But these features must be legally and concisely set forth in the form of "claims". This phase of the procedure is so complex that the U.S. Patent Office advises the Inventor to engage a competent Registered Patent Attorney. We maintain a large staff—carefully trained registered patent attorneys—expert draftsmen—experienced searchers—to serve you. We have been serving inventors for more than twenty years. Write for a free copy of our "Patent Guide for the Inventor" today. Clarence A. O'Brien & Harvey B. Jacobson, Registered Patent Attorneys, 61-E Adams Building 4, Washington, D. C.

**CLARENCE A. O'BRIEN
& HARVEY B. JACOBSON**
REGISTERED PATENT ATTORNEYS

Free Book
for

TORS

48
PAGES
*Over 150
Mechanical
Movements*

FREE

"RECORD OF INVENTION"

With our free "Patent Guide for the Inventor" you will receive also free a "Record of Invention" form. This "Record of Invention" enables you to conveniently make a proper, dated disclosure of your invention before you file your patent application, which will prove of great value to you, should the occasion for evidence arise.

TAKE FIRST STEP NOW

Remember, in Patent matters action is important. Delay can be costly. Therefore, take your first step now—toward protecting your invention. Send for your free copy of our "Patent Guide for the Inventor" containing complete information about patent procedure and selling inventions. At the same time, receive a free "Record of Invention" form with complete instructions for making a disclosure of your invention and establishing its date. This step costs you nothing—yet may be vital to your success. Mail the coupon in an envelope, or paste it on a penny postcard—now.



CLARENCE A. O'BRIEN & HARVEY B. JACOBSON

CLARENCE A. O'BRIEN & HARVEY B. JACOBSON
Registered Patent Attorneys before the United States Patent Office
61-E Adams Building, Washington 4, D. C.

Please send me your 48-Page "Patent Guide for the Inventor" and your specially prepared "Record of Invention" form FREE. This request does not obligate me.

Name.....

Address.....

City..... State.....

(Please write or print plainly.)

*Worthy of
Your Trust*

LET ME TRAIN YOU

for RADIO ELECTRONICS & TELEVISION

I'll Supply a FULL RADIO SET

for SIMPLIFIED INSTRUCTION — PRACTICE & TESTING

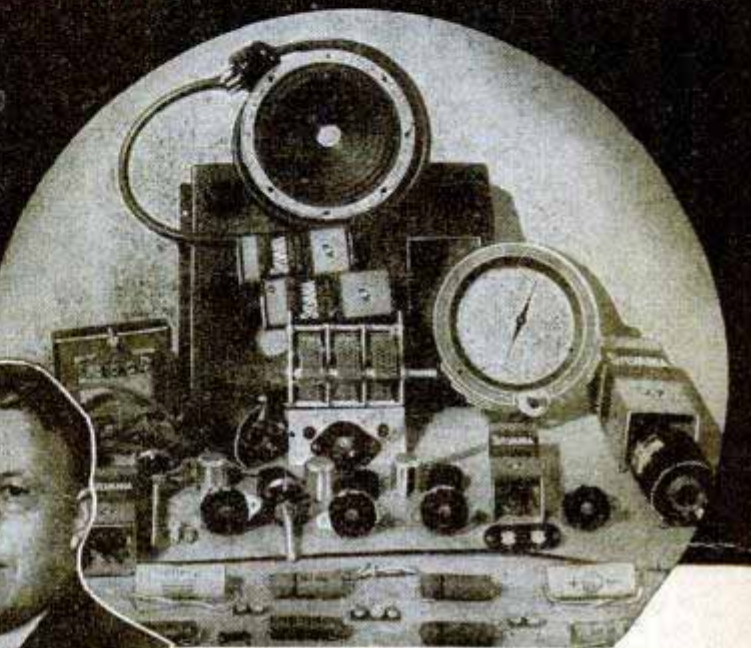

Beginners Learn FAST
START NOW! Big Developments
 Ahead in F. M., Radar, Television



MAKE GOOD MONEY IN
a Business of Your Own
...or a Good Radio Job.

The offer I make you here is the opportunity of a lifetime. It's your big chance to get ready for a wonderful future in the swiftly expanding field of Radio-Electronics INCLUDING Radio, Television, Frequency Modulation and Industrial Electronics. Be wise! NOW'S the time to start. Opportunities ahead are tremendous! No previous experience is necessary. The Sprayberry Course starts right at the beginning of Radio. You can't get lost. It gets the various subjects across in such a clear, simple way that you understand and remember. And, you can master my entire course in your spare time.

You Do Practical Experiments

There's only one right way to learn Radio Electronics. You must get it through simplified lesson study combined with actual "shop" practice under the personal guidance of a qualified Radio Teacher. It's exactly this way that Sprayberry trains you... supplying real Radio parts for learn-by-doing experience right at home. Thus, you learn faster, your understanding is clear-cut.

I'll Show You a New, Fast Way to Test Radio Sets Without Mfg. Equipment

The very same Radio Parts I supply with your Course for gaining pre-experience in Radio Repair work may be adapted through an

exclusive Sprayberry wiring procedure to serve for complete, fast, accurate Radio Receiver trouble-shooting. Thus, under Sprayberry methods, you do not have one cent of outlay for manufactured Test Equipment.

Succeed As a Radio-Electronician

My training will give you the broad, fundamental principles so necessary as a background, no matter which branch of Radio you wish to specialize in. I make it easy for you to learn Radio Set Repair and Installation Work. I teach you how to install and repair Electronic Equipment. In fact, you'll be a fully qualified RADIO-ELECTRONICIAN, equipped with the skill and knowledge to perform efficiently and to make a wonderful success of yourself.

Read What Graduate Says "One Job Nets About \$26.00"

"Since last week I fixed 7 radios, all good-paying jobs and right now I am working on an amplifier system. This job alone will net me about \$26.00. As long as my work keeps coming in this way, I have only one word to say and that is 'Thanks' to my Sprayberry training and I am not afraid to boast about it."—ADRIEN BENJAMIN, North Grosvendordale, Conn.

DON'T PUT IT OFF!

Get the facts about my training—now! Take the first important step toward the money-making future of your dreams. All features are fully explained in my big, illustrated FREE Catalog which comes to you along with another valuable FREE book you'll be glad to own.

FREE BOOKS

"How To Read Radio Diagrams and Symbols"

... a valuable new book which explains in simple English how to read and understand any Radio Set Diagram or circuit. Includes translations of all Radio symbols. Send for this FREE book now, and along with it I will send you another big FREE book describing my Radio-Electronic training.

RUSH COUPON for BOTH



SPRAYBERRY ACADEMY OF RADIO

F. L. Sprayberry, President
 Room 1056, Pueblo, Colorado

Please rush my FREE copies of "How to MAKE MONEY in RADIO, ELECTRONICS and TELEVISION," and "HOW to READ RADIO DIAGRAMS and SYMBOLS."

Name.....Age.....

Address.....

City.....State.....

(Mail in envelope or paste on penny postcard)

MAIL COUPON AT ONCE!

Stop DAY-DREAMING about getting a New Body!



Start Now! Let Me Prove I Can Make You a NEW MAN



*Charles
Atlas*

—actual untouched
photo of the man
who holds the title,
"The World's Most
Perfectly Developed
Man."

IN ONLY 15 MINUTES A DAY I can put a handsome, rippling coat of muscle all over your body! *Wishing* for super-human strength and red-blooded vigor won't GIVE them to you. You may be sick and tired of letting other, huskier fellows "lord it over you" — but until you're willing to DO something about it, you'll never get anywhere!

But if you'll give me just FIFTEEN MINUTES A DAY — I'LL PROVE I CAN BUILD YOU A POWERFUL NEW BODY! I can make you feel so strong and alive you'll laugh at fatigue! Let me give you a battering-ram punch, develop your shoulders and back into a tough wall of solid muscle, build you a tough, supple belt of punch-proof stomach muscles, re-make your legs into young "tree trunks" of strength and flexibility. Let me pump real HE-MAN power into every part of your body — INSIDE AND OUTSIDE! Only 15 minutes a day — right in your own home! — is all I ask. And there's no cost if I fail.

What's My Secret?

"Dynamic Tension!" That's the ticket! The identical natural method that I myself developed to change my body from a scrawny, skinny-chested weakling to my present prize-winning physique! Thousands of other fellows are becoming marvelous physical specimens — my way — "Dynamic Tension." You simply utilize the DORMANT muscle-power in your own God-given body — watch it increase

and multiply double-quick into real, solid LIVE MUSCLE.

Just think what that will mean! You'll no longer have to stand back and let other fellows walk off with the prettiest girls, step into the best jobs, grab the spotlight at every party. YOU can now have the kind of handsome, healthy body and red-blooded HE-MAN VITALITY that spells SUCCESS in every way! You just won't be able to HELP attracting admiring looks wherever you go — winning instant attention — steadily forging ahead in life!

My method — "Dynamic Tension" — will turn the trick for you. No theory — every exercise is practical. And, man, so easy! Spend only 15 minutes a day in your own home. From the very start you'll be using my method of "Dynamic Tension" almost unconsciously every minute of the day — walking, bending over, etc. — TO BUILD MUSCLE and VITALITY.

FREE BOOK

"EVERLASTING HEALTH AND STRENGTH"

In it I talk to you in straight-from-the-shoulder language. Packed with inspirational pictures of myself and pupils — fellows who became NEW MEN in strength, my way. Let me show you what I helped THEM do. See what I can do for YOU! For a real thrill, send for this book today, AT ONCE. CHARLES ATLAS, Dept. 8E, 115 E. 23rd St., New York 10, N. Y.



CHARLES ATLAS, Dept. 8E

115 E. 23rd Street, New York 10, N. Y.

I want the proof that your system of "Dynamic Tension" can help make me a New Man — give me a healthy, husky body and big muscle development. Send me your FREE book, "Everlasting Health and Strength." No obligation.

Name.....
(Please print or write plainly)

Address.....

City.....
 Check here if under 16 for Booklet A

INVENTORS

LEARN HOW TO
PROTECT and SELL
YOUR INVENTION

GET NEW **FREE** BOOK



FREE

Invention Record
Know How Successful
Inventors Protect and
Sell Their Inventions

Our new FREE Book is a book every inventor should have. Mail the coupon today for "How to Protect, Finance and Sell Your Invention" and learn . . .

- How to know if there is a prior U. S. patent on your invention.
- How to save steps in getting patent action.
- How to prepare your application for presentation to the Patent Office.
- How you may patent an improvement on something in use now.
- How to obtain funds to patent and promote your invention.
- How to find a buyer or backer for your invention.
- How to protect yourself in making royalty agreements.

MODERN BUSINESS WANTS INVENTIONS

Practical and novel inventions are in big demand today. The opportunity for quick money is enticing. Sales sources are many if your invention has merit. But, be sure—before you place your device in strange hands—that it is fully protected. A United States Patent gives you this protection. *The first step toward inventive success always is—and always has been—the application for a U. S. Patent. There is no other way to protect your invention in accordance with the laws of this country.*

MAKE THIS RECORD NOW

If you have an invention, and wish to secure it for the future, act at once. Have it dated now and recorded in our office. We will send you this FREE Invention Record Form for the purpose. Fill out the Invention Record Form fully describing the nature of your invention. Make a sketch of its main features. Mail it to us and we will record the date it was received in our office. The earlier the date the better your chance of combating rival inventors who may lay claim to your idea later. *Don't delay a single minute in taking this important step. Your whole future may depend upon it. Mail the coupon for our FREE Invention Record Blank and New FREE Book today!*

HOW WE SERVE YOU AS REGISTERED PATENT ATTORNEYS

The U. S. Patent Office strongly recommends—unless the inventor is familiar with such matters—that he employ the services of a Registered Patent Attorney in the preparation of his Patent Application. We are Registered Patent Attorneys fully qualified to represent you at the Patent Office. We have had long experience in studying hundreds of types of inventions. This gives us the ability to judge your invention and to describe it accurately and convincingly in technical language. It gives us the perception to center arguments upon those details of your invention which, in our judgment, will be looked upon most favorably by the Patent Office Examiner.

Mail the coupon today for our new FREE Book, "How to Protect, Finance and Sell Your Invention," and our FREE Invention Record Form—maybe this step will pave the way to future security for you and your family. Act Today!

McMORROW, BERMAN & DAVIDSON

REGISTERED PATENT ATTORNEYS

135-R ATLANTIC BUILDING, WASHINGTON 4, D. C.

Send me your new FREE book, "How to Protect, Finance and Sell Your Invention"—and "Invention Record" form at once. I understand that this request does not obligate me.

NAME

ADDRESS

CITY STATE

(Write or print name clearly)

McMORROW, BERMAN & DAVIDSON

Registered Patent Attorneys

135-R Atlantic Building, Washington 4, D. C.

Training is essential to advancement in any field—and it's important to have it on record.

International Correspondence Schools' sound and practical training goes on record—and counts in the record. I. C. S. regularly reports the progress of its students to their employers, regularly receives letters expressing appreciation for this service.

A typical employer communication notes: "I have every I. C. S. report on my men filed with their personal records, the records which help to determine any action taken in regard to those men."*

YOU want your record to show you have *trained* for promotion. **YOU** want your employer to know that you have *prepared* yourself for larger responsibilities. Then *act* now to obtain that training. I. C. S. Courses cover more than 400 business and technical subjects. The coupon brings full information.

*Name furnished on request



INTERNATIONAL CORRESPONDENCE SCHOOLS



BOX 5579-K, SCRANTON 9, PENNA.

Without cost or obligation, please send me full particulars about the course *before* which I have marked X:

- | | | | |
|---|---|--|--|
| <p>Air Conditioning and Plumbing Courses</p> <input type="checkbox"/> Air Conditioning
<input type="checkbox"/> Heating <input type="checkbox"/> Plumbing
<input type="checkbox"/> Refrigeration <input type="checkbox"/> Steam Fitting <p>Chemistry Courses</p> <input type="checkbox"/> Chemical Engineering
<input type="checkbox"/> Chemistry, Analytical
<input type="checkbox"/> Chemistry, Industrial
<input type="checkbox"/> Chemistry, Mfg. Iron & Steel
<input type="checkbox"/> Petroleum Refining <input type="checkbox"/> Plastics
<input type="checkbox"/> Pulp and Paper Making <p>Civil Engineering, Architectural and Mining Courses</p> <input type="checkbox"/> Architectural Drafting
<input type="checkbox"/> Architecture
<input type="checkbox"/> Bridge and Building Foreman
<input type="checkbox"/> Building Estimating
<input type="checkbox"/> Civil Engineering
<input type="checkbox"/> Coal Mining
<input type="checkbox"/> Contracting and Building
<input type="checkbox"/> Highway Engineering
<input type="checkbox"/> Lumber Dealer
<input type="checkbox"/> Reading Structural Blueprints
<input type="checkbox"/> Sanitary Engineering
<input type="checkbox"/> Structural Drafting | <p><input type="checkbox"/> Structural Engineering
 <input type="checkbox"/> Surveying and Mapping</p> <p>Communications Courses</p> <input type="checkbox"/> Electronics
<input type="checkbox"/> Practical Telephony
<input type="checkbox"/> Radio, General
<input type="checkbox"/> Radio Operating
<input type="checkbox"/> Radio Servicing
<input type="checkbox"/> Telegraph Engineering <p>Electrical Courses</p> <input type="checkbox"/> Electrical Drafting
<input type="checkbox"/> Electrical Engineering
<input type="checkbox"/> Electric Light and Power
<input type="checkbox"/> Lighting Technician
<input type="checkbox"/> Practical Electrician <p>Internal Combustion Engines Courses</p> <input type="checkbox"/> Auto Technician <input type="checkbox"/> Aviation
<input type="checkbox"/> Diesel-Electric
<input type="checkbox"/> Diesel Engines <input type="checkbox"/> Gas Engines <p>Mechanical Courses</p> <input type="checkbox"/> Aeronautical Engineering
<input type="checkbox"/> Aircraft Drafting
<input type="checkbox"/> Flight Engineer
<input type="checkbox"/> Foundry Work
<input type="checkbox"/> Heat Treatment of Metals | <p><input type="checkbox"/> Industrial Engineering
 <input type="checkbox"/> Industrial Metallurgy
 <input type="checkbox"/> Machine Shop
 <input type="checkbox"/> Mechanical Drafting
 <input type="checkbox"/> Mechanical Engineering
 <input type="checkbox"/> Mold-Loft Work
 <input type="checkbox"/> Patternmaking—Wood, Metal
 <input type="checkbox"/> Reading Shop Blueprints
 <input type="checkbox"/> Sheet-Metal Drafting
 <input type="checkbox"/> Sheet-Metal Worker
 <input type="checkbox"/> Ship Drafting <input type="checkbox"/> Ship Fitting
 <input type="checkbox"/> Tool Designing
 <input type="checkbox"/> Toolmaking
 <input type="checkbox"/> Welding—Gas and Electric</p> <p>Railroad Courses</p> <input type="checkbox"/> Air Brake <input type="checkbox"/> Car Inspector
<input type="checkbox"/> Diesel Locomotive
<input type="checkbox"/> Locomotive Engineer
<input type="checkbox"/> Locomotive Fireman
<input type="checkbox"/> Railroad Section Foreman <p>Steam Engineering Courses</p> <input type="checkbox"/> Boilermaking
<input type="checkbox"/> Combustion Engineering
<input type="checkbox"/> Engine Running
<input type="checkbox"/> Marine Engineering
<input type="checkbox"/> Steam Electric <input type="checkbox"/> Steam Engines | <p>Textile Courses</p> <input type="checkbox"/> Cotton Manufacturing
<input type="checkbox"/> Rayon Weaving
<input type="checkbox"/> Textile Designing
<input type="checkbox"/> Woolen Manufacturing <p>Business and Academic Courses</p> <input type="checkbox"/> Accounting <input type="checkbox"/> Advertising
<input type="checkbox"/> Arithmetic <input type="checkbox"/> Bookkeeping
<input type="checkbox"/> Business Correspondence
<input type="checkbox"/> Business Management
<input type="checkbox"/> Certified Public Accounting
<input type="checkbox"/> Commercial
<input type="checkbox"/> Cost Accounting
<input type="checkbox"/> Federal Tax
<input type="checkbox"/> First Year College
<input type="checkbox"/> Foremanship <input type="checkbox"/> French
<input type="checkbox"/> Good English <input type="checkbox"/> High School
<input type="checkbox"/> Higher Mathematics
<input type="checkbox"/> Illustrating <input type="checkbox"/> Motor Traffic
<input type="checkbox"/> Postal Service
<input type="checkbox"/> Salesmanship <input type="checkbox"/> Secretarial
<input type="checkbox"/> Sign Lettering
<input type="checkbox"/> Spanish <input type="checkbox"/> Stenography
<input type="checkbox"/> Traffic Management |
|---|---|--|--|

Name _____ Age _____ Home Address _____
 City _____ State _____ Present Position _____
 Working Hours _____ A.M. to _____ P.M. Length of Service in World War II _____

Canadian residents send coupon to International Correspondence Schools Canadian, Ltd., Montreal, Canada.
 British residents send coupon to I. C. S., 71 Kingsway, London, W. O. 2, England.

THESE *Free Books* GIVE PRACTICAL POINTERS ON HOW TO PROTECT, PATENT AND SELL YOUR **INVENTION**



These two valuable books, "Patent Protection" and "When and How to Sell Your Invention" have guided many an inventor like you straight to a strong patent and SUCCESS. They tell you step by step, the proper procedure to find out if your invention can be patented . . . the steps necessary to secure a patent, and reliable, helpful suggestions on how to sell your invention. IN ADDITION . . . you'll find illustrated for your guidance . . . 115 MECHANICAL MOVEMENTS . . . just the information you may need to complete your invention.

**GET THESE FREE BOOKS AT ONCE . . .
DON'T WAIT UNTIL TOMORROW
INDUSTRY WANTS YOUR INVENTION NOW**

Now . . . while industry and business are looking ahead to future markets . . . now, when they are eagerly seeking new and improved products, new and improved machines, tools and methods . . . is the RIGHT TIME TO SECURE YOUR PATENT. If you have an invention . . . BE A DO-ER! Don't take the chance of someone's beating you to it.

THE RIGHT START will save you time, money and trouble. That's why we advise you to get . . . RIGHT AWAY . . . the FREE books and the FREE important "Evidence of Invention" form that may help you establish your claim.

**THIS COUPON MAY BE YOUR TICKET TO SUCCESS
...Mail It Today**

VICTOR J. EVANS & Co.

**PATENTS — TRADE MARKS — COPYRIGHTS
130-E Merlin Building, Washington 6, D. C.**

Please send me your books — "Patent Protection" and "When and How to Sell Your Invention" — also important "Evidence of Invention" form, without cost or obligation.

Name.....

Address.....

City and State.....

SAY YOU SAW IT IN POPULAR MECHANICS

"YOU ARE UNDER ARREST!"



There's a Thrill in Bringing a Crook to Justice Through Scientific

CRIME DETECTION!

I have taught thousands this exciting, profitable, pleasant profession. Let me teach you, too, in your own home. Learn Finger Printing, Fire Arms Identification, Police Photography and Criminal Investigation thoroughly, quickly and at small cost.

53% of All American Bureaus of Identification employ students or graduates of I. A. S. You, too, can fit yourself to fill a responsible crime detection job with good pay and steady employment. But don't delay—get the details now. Let me show you how easily and completely I can prepare you for this fascinating work, during spare time, in your own home. You may pay as you learn. Write today . . . Now . . . Be sure to state age.

**Be A
FINGER
PRINT
Expert**

FREE!!!
Send for Thrilling
"BLUE BOOK
OF CRIME"

INSTITUTE OF APPLIED SCIENCE
1920 Sunnyside Ave., Dept. 1355, Chicago 40, Ill.



TRI-STATE COLLEGE

B. S. Degree in 27 Months

Distinguished for technical 2 1/4-year courses in Civil, Electrical, Mechanical, Chemical, Radio, Aeronautical Engineering; Business Administration, Accounting, and Secretarial Science.

VETERANS can complete work here in shortest possible time. Special Prep. Dep't. Also REFRESHER COURSES. 36-Week Courses in Surveying, Drafting. Low tuition. Low living costs. Cosmopolitan student body. 63rd year. Enter Sept., March, June, Jan. Catalog. 546 College Ave. **ANGOLA, INDIANA**



LEARN MEAT CUTTING At Home — In Spare Time

Get into the vital meat industry. Concise, practical Home Training based on 25 years proven instruction methods used at National's famous resident school. Prepares you for bigger pay as Meat Cutter, Supervisor, market manager or more money in your own store. Go as rapidly as your spare time permits. Diploma. Start NOW to turn your spare hours into money. Send for FREE bulletin today. No obligation.

National School of Meat Cutting, Inc., Dept. U-69, Toledo 4, Ohio

LEARN MONEY- MAKING CARTOONING

IN SPARE TIME — by Easy Picture Chart Method
Same Simplified Method that has helped train creators of "Terry & Pirates," "Freckles," "Out Our Way," "Winnie Winkle," "Reg'lar Fellers," "Strange As It Seems," "The Neighbors," and many others. Earn while learning. Send 10c for Picture Chart (to test your ability), and full details. (State age.)



Landon School of Cartooning, Dpt.4605 Philadelphia 1(Pa.)

Learn LANDSCAPE GARDENING!

A thorough, constructive, interesting home-training, covering your regional conditions, for those who wish to become LANDSCAPERS, DESIGNERS, GARDENERS, etc., for profit or pleasure. Write today for FREE INFORMATION, without obligation, to

NATIONAL LANDSCAPE INSTITUTE
Dept. P-5 756 So. Broadway Los Angeles 14, California

EASY TO LEARN CODE

Learn or increase speed with an Instructograph — the Code Teacher that takes the place of an operator-instructor and enables anyone to master code without further assistance. Available tapes from beginners alphabet to typical messages on all subjects. Speed range 5 to 40 WPM. Always ready—no QRM. Thousands have "acquired the code" with the Instructograph System. Write today for convenient rental and purchase plans.



INSTRUCTOGRAPH COMPANY
4713 Sheridan Road, Chicago 40, Illinois

LEARN WATCH REPAIRING



AT HOME. By our modern and original system of instruction you can learn every part of the WATCH REPAIRING TRADE AT HOME. Prepare yourself for a well-paying position or start in business after completing our course of instruction. Good watch repairers are in demand and generally earn very good salaries. For particulars apply to the Wisconsin School of Watch Repairing 759 North Milwaukee St., Milwaukee 2, Wis.

YOURS FREE!

SENSATIONAL NEW BOOK TELLS EXACTLY HOW TO MAKE MONEY IN YOUR OWN RADIO-ELECTRIC SHOP



Now you can be your own boss, running your own Radio-Electric Shop! Let me send you **ABSOLUTELY FREE** my latest book, "Starting and Operating a Profitable Electrical or Radio Business." Tells of the opportunities—how to start on small capital, how to choose a location, how to advertise, how to get orders, etc. **Yours to keep.** No strings to this amazing offer. Act today!



JUST MAIL COUPON

FOR YOUR COPY... and 7 DAY FREE TRIAL ON MY GIANT

COYNE *Trouble Shooting* Manual



Whether you start your own shop or do any kind of Radio or Electrical work, you need this sensational 612-page TROUBLE SHOOTING MANUAL. Easy to use. Practical. Helps you locate troubles quickly, on Motors, Armatures, Radios, Auto Ignition, Electronic Devices, Refrigerators, Home Appliances, etc. 500 full size Shop Prints and how to read them. Many other valuable features—all in one giant 8½x11" handsomely bound book. Price \$8.00 cash or \$8.95 on time, after 7 days' free trial.

SEND NO MONEY!

But don't take my word for it. See—examine—try out this amazing Trouble-Shooting Manual yourself. 7 DAYS FREE. For doing this, you get my free gift book, "Starting and Operating a Profitable Electrical or Radio Business." If not delighted, return the Manual only, and **KEEP MY SPECIAL GIFT BOOK.** Offer limited. Rush coupon now.

H. C. LEWIS, President Dept. 56-R6
COYNE ELECTRICAL SCHOOL
 500 S. Paulina St. Chicago 12, Ill.

FREE BOOK COUPON

H. C. LEWIS, Pres., COYNE ELECTRICAL SCHOOL, 500 S. Paulina St., Dept. 56-R6, Chicago 12, Ill.

Send my FREE copy of "Starting and Operating a Profitable Electrical Radio Business" and also send on 7 DAY FREE TRIAL, the Coyne Trouble Shooting Manual, all postpaid. Within 7 days I'll either return the Manual and OWE YOU NOTHING or send \$3.00, and then \$3.00 a month until total of \$8.95 is paid. In either case I'm to keep the FREE BOOK.

Name.....
 Address.....
 City.....Zone.....State.....
 Occupation.....

SAVE 10% —Send cash price, \$8.00, and save over 10% Same 7-DAY FREE TRIAL and MONEY BACK GUARANTEE OF SATISFACTION.

"I'll show YOU how to make yourself COMMANDO-TOUGH

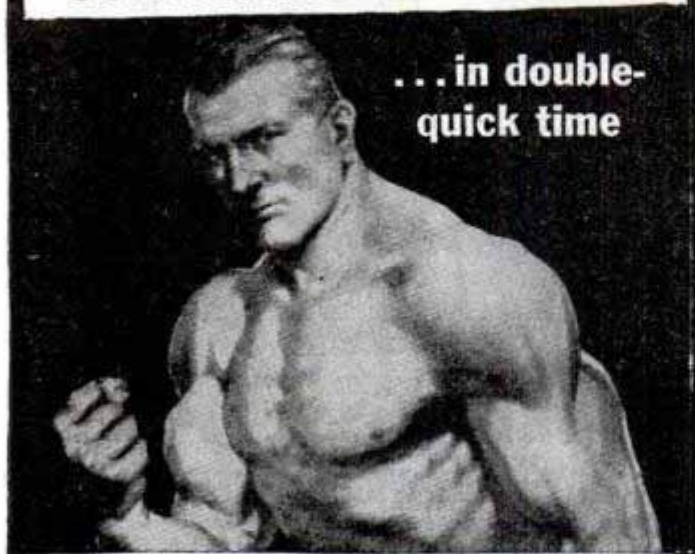

...in double-quick time

...OR IT WON'T COST YOU A CENT!"

says *George F. Jowett*

WORLD'S GREATEST BODY BUILDER

Let me prove to YOU that you can put inches of dynamic muscles on your arms! Add inches to your chest! Broaden your shoulders and power-pack the rest of your body. I can do for you what I've done for thousands the world over, including many officers and men now in the U. S. and British Armed Forces.

GIVE ME 10 MINUTES A DAY!

I'll Show You My Secrets Of Body Building

I'll help you learn the "Progressive Power Method" through which I rebuilt myself from a physical wreck to the holder of more strength records than any other living athlete or teacher! No matter how skinny or flabby you are, you can learn my methods right in your own home. Through my proved secrets I show you how to develop your power, inside and out, until YOU are fully satisfied that you are the man you want to be. "The Jowett System," says R. F. Kelly, Physical Director of the YMCA, Atlantic City, "is the greatest in the world!"

If you want a physique that will inspire respect from men, and admiration from women... ACT LIKE A HE-MAN! Decide at once! The famous book, "Nerves of Steel—Muscles Like Iron!" will be included FREE! Priceless for the strength fan! Full of photos of marvelous power-bodied men who will show you what Jowett has done for them and how he can do the same for you. Reach out... Grasp this Special Offer today!

Jowett Institute of Physical Culture
230 Fifth Avenue
Dept. PM-65
New York 1, N.Y.

PROVE TO YOURSELF IN ONE NIGHT!

Send only 25c for test Course, "Molding a Mighty Arm." Read it the evening it arrives—learn from experience the thrill you can give your muscles!

SEND FOR THESE FIVE FAMOUS COURSES IN BOOK FORM

ONLY 25c EACH
or ALL 5 for \$1.00

This Book Free!



BOOK WITH PHOTOS OF FAMOUS STRONG MEN
MAIL COUPON NOW **FREE**



Jowett Institute of Physical Culture
230 Fifth Avenue, Dept. PM-65, New York 1, N. Y.

George F. Jowett: Your proposition looks good to me. Send by return mail, prepaid, the courses checked below, for which I enclose (), include FREE book of PHOTOS.

George F. Jowett
Champion of Champions

- | | |
|--|---|
| <input type="checkbox"/> All 5 courses for . . . \$1 | <input type="checkbox"/> Molding Mighty Legs 25c |
| <input type="checkbox"/> Molding a Mighty Arm 25c | <input type="checkbox"/> Molding a Mighty Grip 25c |
| <input type="checkbox"/> Molding a Mighty Back 25c | <input type="checkbox"/> Molding a Mighty Chest 25c |
| <input type="checkbox"/> Send all 5 C.O.D. (\$1 plus postage.) No orders less than \$1 sent C.O.D. | |

NAME Age
(Print name)

ADDRESS

TRAIN for SUCCESS in the Poultry Business

Study at home in spare time. Earn extra while learning.



YOU CAN MAKE MONEY FROM POULTRY

Get ready now—the easy, scientific, inexpensive way! For 25 years, we've been helping thousands to greater success—showing how to cut losses, avoid mistakes, get biggest profits! How to start their own poultry projects and succeed at it! Proper management and "know how" means profits ANY season, for life. Indorsed by leading colleges, poultrymen. Free catalog describes courses, methods, service, opportunities. Write today to the President.

NATIONAL POULTRY INSTITUTE
DEPT. 50 ADAMS CENTER, NEW YORK

PHOTOGRAPHY

For Today's & Tomorrow's

**BIGGEST
OPPORTUNITIES**

NEW YORK
Dept. 49

Nationwide opportunities, sound future career waiting for trained photographers. N.Y.I. graduates winning success from coast to coast. Success-proved home study courses. Also resident. Write today. INSTITUTE OF PHOTOGRAPHY
10 West 33 St. New York 1, N. Y.

ENGINEERING DEGREE IN 27 MONTHS

INDIANA
TECHNICAL
COLLEGE

Aeronautical, Chemical, Civil, Electrical, Mechanical, and Radio Courses. B.S. degree. 1-yr. diploma in Electrical, Mechanical, and Radio Service; Drafting. Prep. courses, Gov't. approved for GI's. Low rate. Earn board. Large industrial center. Demand for graduates. Enter June, Sept., Dec., March. Catalogue. 556 E. Washington Blvd., Ft. Wayne 2, Ind.

What Every Mason Wants



We have important Masonic books for Blue Lodge, Chapter, Commandery, Scottish Rite, and Shrine.

Our Rituals Are Used the World Over. Send for free catalog of books and rituals for Masons, Odd Fellows, Knights of Pythias, Knights of Columbus, etc. EZRA A. COOK, Publisher, P. O. Box 796, PMY, Chicago 90, Ill.

Learn Public Speaking

Learn theory and fundamentals at home—in spare time. Then acquire actual experience and practice. Send for FREE booklet "Power of Effective Speech."

North American School, Dept. 1355
1315 S. Michigan Ave., Chicago 5, Illinois

LAW

STUDY AT HOME for PERSONAL SUCCESS and LARGER EARNINGS. 35 years expert instruction—over 108,000 students enrolled. LL.B. Degree awarded. All texts furnished. Easy payments. Send for FREE BOOK—"Law and Executive Guidance."

AMERICAN EXTENSION SCHOOL OF LAW
Dept. 65-M, 646 N. Michigan Ave., Chicago 11, Ill.

MAKE MONEY AT HOME

RUBBER MOLDS

Low as
6¢ EA.



Amazing rubber mold-making outfit makes perfect flexible molds of plaques, ash trays, bookends, etc. Molds cost 6c to 25c each. Each mold makes hundreds of novelties and gifts to sell for \$1.00 apiece and more! No experience necessary. Everything furnished. Quick and easy. Start profitable business in your home—sell to stores, gift shops, friends, resorts, road stands, by mail. Full or spare time. Write for complete FREE details and easy instructions.

SO-LO WORKS, Inc., Dept. F-800, Loveland, Ohio

WHICH OF THESE *Opportunities* INTERESTS *You* MOST?

Accounting & C. P. A.
Air Conditioning
Architecture & Building
Automotive Engineering
Aviation—Practical
Aviation Drafting & Design
Better Foremanship
Bookkeeping
Business Management
Contracting

Diesel Engineering
Drafting & Design
Electrical Engineering
Electricity—Practical
Electronics, Industrial
High School Courses
Machine Shop Operations
Mechanical Engineering
Plastics Engineering
Plumbing—Practical

Private Secretary
Radio Operating & Servicing
Railway Training
Refrigeration
Sheet Metal Pattern Drafting
Shop Management
Surveying & Topographical
Drafting
Tool Making

THINK! LOOK FORWARD!

Business is making big, new plans

Men and Women are preparing for the future

WHAT ARE YOU DOING ABOUT YOUR TOMORROWS?

● *Today*, choose the job you want—and prepare for it. Or if you are already engaged in the work you like best, start training *now* for quicker promotion. Acquire the knowledge that will help you to get ahead faster, make more money and have greater security.

Invest part of your spare time in more rapid progress. Start training now, in spare time in your own home. Be ready to grasp your opportunity and step out ahead of those who lack the ability you have attained.

American School, founded in 1897 as an educational institution *not for profit*, can help you to reach your goal just as it has helped others during the past forty-nine years. Give serious thought to the list above. Pick one or more subjects that interest you. Then check the coupon at right, add your name and address and mail it at once. The school will send you details on its training plan and outline of study prepared by specialists. There is no charge, no obligation, so send the coupon immediately.

PRACTICAL, EFFECTIVE HOME - STUDY TRAINING SINCE 1897

Take This First Easy Step

CHECK, CLIP AND MAIL COUPON NOW

AMERICAN SCHOOL, Dept. G545, Drexel at 58th, Chicago 37, Ill.
Without obligation, Please send FREE and postpaid, bulletin and details of the Subject checked.

- | | | |
|--|---|--|
| <input type="checkbox"/> PLASTICS ENGR | <input type="checkbox"/> Accounting & C.P.A. | <input type="checkbox"/> Drafting and Design for Men and Women |
| <input type="checkbox"/> Refrigeration | <input type="checkbox"/> Electrical Engr. | <input type="checkbox"/> Radio |
| <input type="checkbox"/> Architecture and Building | <input type="checkbox"/> Electricity-Pract. | <input type="checkbox"/> High School |
| <input type="checkbox"/> Contracting | <input type="checkbox"/> Electronics, Industr. | <input type="checkbox"/> Air Conditioning |
| <input type="checkbox"/> Practical Plumbing | <input type="checkbox"/> Bookkeeping | <input type="checkbox"/> Mechanical Eng. |
| <input type="checkbox"/> Automotive Engineering | <input type="checkbox"/> Private Secretary | <input type="checkbox"/> Shop Management |
| <input type="checkbox"/> Aviation Drafting | <input type="checkbox"/> Diesel Engineering | <input type="checkbox"/> Tool Making |
| <input type="checkbox"/> Aviation | <input type="checkbox"/> Surveying & Topographical Drafting | <input type="checkbox"/> Better Foremanship |
| <input type="checkbox"/> Business Mgmt | <input type="checkbox"/> Sheet Metal Pattern Drafting | <input type="checkbox"/> Machine Shop Operations |
| <input type="checkbox"/> Railway Training | | |

Name..... Occupation.....
Address..... Age.....
City..... State.....

AMERICAN SCHOOL

Dept. G545, Drexel at 58th Street, Chicago 37



REFRIGERATION AIR CONDITIONING

Air Conditioning and Refrigeration are among the great industries of today and tomorrow. Installations everywhere—in restaurants, shops, homes, etc., need service. Thousands of businesses are waiting for new installations. Today, more and more homes are being air conditioned. The Refrigeration and Air Conditioning industries are headed for greater prosperity and men who have the "know how" and experience should ride along.

Train Now Before the Expected EXPANSION Begins

Experts predict large demand for men to install and service Air Conditioning and Refrigeration equipment. . . Rise to the kind of job which requires a competent, trained man who can carry the responsibilities of installing costly equipment and maintaining it. If he knows the answer when he is called in for consultation, his reputation grows and his pay should grow also.

Follow This Way to Knowledge

If over 17, and under 60, here's all it takes to get you ready for experience in this modern industry. Just invest a limited amount of your spare time—while you are still on your present job. Through our balanced training, you learn first through home study, how to handle Installation, Maintenance & Service Work on Refrigeration and Air Conditioning equipment. Then you can get practical training in our big shops under capable instructors—experienced men who'll take a personal interest in helping you learn. When you're through you should have knowledge that enables you to get started in this vast industry.

WANT YOUR OWN REPAIR SHOP?

UEI training is easily understood by mechanically inclined men. You gain experience when you complete your course. Equipment, tools and personal following can accumulate as you progress. Soon you may find it wise to set up your own shop.

GET FREE FACTS RIGHT NOW!

It costs you nothing to get all the facts about this great field. Simply mail the coupon below and we'll tell you, without obligation the whole, sensational story of what's ahead in Refrigeration and Air Conditioning. Mail the FREE coupon now.



UTILITIES ENGINEERING INSTITUTE

1314 W. Belden Avenue, Dept. 156, Chicago 14, Ill.

Please send me the FREE FACTS about opportunities in Air Conditioning and Mechanical Refrigeration. I have marked the one that interests me most.

Air Conditioning Mechanical Refrigeration

NAME _____ AGE _____

ADDRESS _____

CITY _____ ZONE _____ STATE _____

EASY to
PLAY

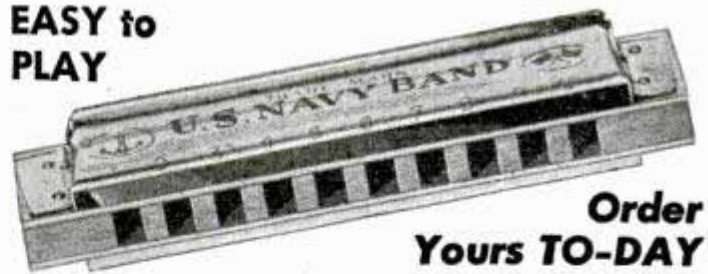

Order
Yours TO-DAY

The New Luellen HARMONICA

Most wonderful pocket instrument ever made is the harmonica. Easy to master, fun for Everyone. The Luellen has 19 holes, 20 notes. Key of C. Beautiful tone. Now ready. Postpaid Only..... **\$2.10**

INSTRUCTION BOOK. Simple for youngest child. No notes, scales nor exercises. Ten lesson charts show everything. Includes 75 popular songs. Price \$1.00. Here's our special introductory offer: The Instructor and the Harmonica, both postpaid, both for \$2.69. Send Check or Money Order Today.

JOHN LUELLEN & CO., 17034 Page Avenue, Dept. 503, Hazelcrest, Ill.

HOME-STUDY BRINGS BIGGER PAY

Don't be caught napping when Opportunity knocks. Prepare for advancement and more money by training now for the job ahead. *Free 48-Page Books Tell How.* Write for the book on the business field you like—or mail us this ad with your name and address in the margin. *Now, please.*

- | | |
|--|--|
| <input type="checkbox"/> Higher Accountancy | <input type="checkbox"/> Business Management |
| <input type="checkbox"/> Traffic Management | <input type="checkbox"/> Business Corres. |
| <input type="checkbox"/> Law—Degree of LL.B. | <input type="checkbox"/> Salesmanship |
| <input type="checkbox"/> Commercial Law | <input type="checkbox"/> Modern Foremanship |
| <input type="checkbox"/> Industrial Management | <input type="checkbox"/> Expert Bookkeeping |
| <input type="checkbox"/> Stenotypy | <input type="checkbox"/> C. P. A. Coaching |

LASALLE EXTENSION UNIVERSITY

A Correspondence Institution

Dept. 564-R 417 So. Dearborn St. Chicago 5



You can learn plain, rapid writing or fancy ornamental writing for social and business advancement, right in your own home during spare time by my Simplified Method. Write for my free book, "How to Become an Expert Penman," which shows what others have accomplished by taking my Courses. Send 10c for one of my favorite Pen Points and your name with a beautiful flourished bird written on a card. Write today. T. M. Tevis, Box 25K, Chillicothe, Mo.

Learn BAKING At Home

Baking is one of America's high industries in wages. Nearly depression-proof. Thorough basic home course lays sound foundation. If you have aptitude, write for FREE BOOKLET, "Opportunities in Commercial Baking." National Baking School, 1315 Mich. Ave., Dept. 1355, Chicago 5



LEARN MASTER MACHINIST MECHANICAL DRAFTING

Expert training on Lathes, Milling Machines, Shapers, Grinders, etc. Allied shops are completely equipped and modern. Approved for G. I. Training. Days, Evenings.

ALLIED SCHOOL OF MECHANICAL TRADES
1330 South Michigan Avenue • Chicago 5, Illinois

PLAY GUITAR

LIKE THE

COWBOYS
DO... **8** ^{only} _{A LESSON}



Just out—very latest guaranteed, simple, easy method. Play cowboy songs the Western way in a few minutes by ear. Surprise and amaze your friends. Be in big demand at parties, camps, public entertainments, on the radio, etc. 12 Complete Lessons.

SEND NO MONEY. Pay postman only \$1.00 plus postage and C.O.D. charges, or send \$1.00 and get EXTRA SONGS all postpaid. (Canada, \$1.25 money order only.) Nothing else to buy. Positive money back guarantee. *Rush order today.*

WESTERN RANGER STUDIOS, Dept. 155, Hutchinson, Kans.

See

how readily YOU can train at home for BIGGER EARNINGS

in

RADIO ELECTRONICS



FREE KIT PACKET SHOWS HOW YOU CAN GET LOTS OF "LEARN-BY-DOING" RADIO EXPERIENCE AT HOME FROM DeFOREST'S THRILLING RADIO

"Home Laboratory"

133 EXPERIMENTS

DeForest's Kit Packets show how you can get real Radio experience from the many standard Radio parts furnished you with DeForest's Training. See how you may quickly build Radio Circuits that work... how you may experiment with Photo Electric Cell "Magic"... a 5-Tube Superheterodyne Receiver... a Radio Telephone and scores of other fascinating projects. See how you get actual "shop training" at home to give you the practical Radio experience you need.

Now—you can see for yourself why DeForest's Training does such a grand job of preparing men for a bright future in one of America's most promising opportunity fields—Radio and Electronics. Send the coupon below for your free "Kit Packet" plus the big free book, "Victory For You!" that has helped so many to good pay jobs. You'll be surprised at the opportunities ahead of FM Radio, Aviation Radio, Broadcast Radio, a profitable Business of Your Own, Motion Picture Sound Equipment, and Electronics—plus the exciting future possibilities ahead of Television, Radar, etc. You can train in your spare time at home—or you may get all of your training in our Chicago laboratories.

VETERANS!

Big things are happening at De Forest's for veterans! See how we may prepare you without cost for a GOOD JOB or BUSINESS OF YOUR OWN in the vast Radio-Electronic opportunity field.

DeFOREST'S PROVIDES ALL 3 HOME TRAINING AIDS

- A** DeVry Movie Projector and Learn-By-Seeing Movie Film
- B** Actual Radio Parts for working out 133 experiments
- C** 90 lessons prepared under the supervision of Dr. Lee DeForest—the "Father of Radio."

You Also Get EFFECTIVE EMPLOYMENT SERVICE

Upon completing your training, you get the full benefit of DeForest's Employment Service that has helped so many men to get started in the Radio-Electronic field.



DeFOREST'S TRAINING INCLUDES INSTRUCTION IN MOTION PICTURE SOUND EQUIPMENT, FM RADIO AND TELEVISION... RESIDENTIAL TRAINING IN OUR MODERN CHICAGO LABORATORIES ALSO AVAILABLE—ASK US FOR INFORMATION!

E. B. DeVry, President
DeFOREST'S TRAINING, INC.
2535-41 North Ashland Ave., Dept. PM-C5
Chicago 14, Illinois, U.S.A.

Send FREE RADIO KIT PACKET and "VICTORY FOR YOU!" BOOK.



Name _____ Age _____

Address _____ Apt. _____

City _____ Zone _____ State _____

If under 16, check here for special information. If a discharged Veteran of World War II, check here.



DeFOREST'S TRAINING, INC.
CHICAGO 14, ILLINOIS



SO IT NEEDS FIXING

By S. T. CHRISTENSEN
the "Fix-it Man"

"WELL, I guess I'm the fellow to see, for I've repaired thousands of refrigerators (home and commercial both), vacuum cleaners, radios, washing machines, irons, fans, lamps, mangles, motors, etc. In fact, many of my customers call me their "electrical appliance doctor." And, "doctoring," I might add, has paid me a good substantial income for quite a few years. Funny, in a way, how I got started. Always liked to tinker and by experimenting around I found that most electrical appliances had many things in common. That, regardless of what the appliance was used for, or who the manufacturer was, the basic principles were much the same. From fixing my own appliances to fixing friends' and then for strangers at a fee, seems now to have been but a small step.

What to Charge?

At first, I let the owner decide the charge and, frankly, I was amazed at what I earned per hour. But then, when one figures what initial costs are involved in buying most electrical appliances, one can readily see that spending extra dollars for repairs is well worth while. Before long I was making more in my spare time repairing than from my regular job. The result . . . I went into business for myself. When war came, business boomed, for new appliances were not available.

For a while, repair parts (needed on some

jobs) were a little difficult to get. But that situation quickly adjusted itself and many repair parts were given the high priority rating of AA2. After all, we had to provide for the health and well-being of our civilian population.

The Future Offers

Friends ask me about my future. And, I think I've got a grand one. Age is no handicap in repairing. I have in my files enthusiastic letters from repairmen ranging in age from 18 to 79 years. Now the war is over we are certain to see hundreds of new products on the market . . . products that the average person never dreamt of. These new products and our old appliances are all going to need at some time or other "fixing." Well, I'll still be the fellow to do it. The field open for appliance repairmen is unlimited. I don't worry at all about too much competition.

If You Are Ambitious

To the contrary, I've prepared a complete course, chuck full of simple, easy to understand photos and drawings and written in the same non-technical language as this article. I know the course is good, because I have hundreds of men all over the country writing to me telling me how the course has helped swell their pockets with cash. If you too want to prepare now for your future, I suggest you read the next page and send me the handy coupon."



**BIG MONEY
INDEPENDENCE**
*A PROFITABLE
LIFETIME
BUSINESS
OF
YOUR OWN!*

LEARN ELECTRICAL APPLIANCE REPAIRING

PREPARE NOW FOR THE FUTURE

If now employed, start your home appliance repair business NOW in your spare time and be set with a business of your own no matter what happens. You don't need elaborate fixtures or expensive equipment to be a successful repairman. Operate from your garage, basement, vacant store, etc. Work as many hours as you wish—the home appliance repairman is his own boss. It is a profitable occupation for on many types of repairs it is not unusual for a repairman to charge on the basis of \$5.00 to \$6.00 per hour. Don't gamble with your future—learn a trade that will always support you. Remember, as long as electrical appliances are used, there will be a need for electrical appliance repairmen.

If you are at all mechanically inclined—can hold and use tools—then you have all of the qualifications required for becoming a big money earning home appliance repairman. It does not matter if you have not had a great deal of schooling or had previous experience along these lines—**WE WILL TEACH YOU.** Age should be no barrier—nor should any minor physical handicap.

New Course Tells All

Profusely illustrated, our new course shows you in simple, easy to understand language and drawings how to make each repair on refrigerators, vacuum cleaners, washing machines, motors, etc. Explains and gives you a working knowledge of electricity, welding, nickel plating, etc. Shows you how to build the power tools you need and how to solicit and keep business coming to you. Not a theory course but an honest to goodness course written by and used by repairmen the country over. Price of course is so low that the savings on your own household appliance repairs will quickly pay for it. Act now! Mail the handy coupon below today.

----- Read What Our Students Say About Course -----

I really believe your course the best investment a mechanically minded man can make.—Claude E. Allen, Indianapolis, Ind.

I have received your Course in Appliance Repairing and I must say I am well pleased with same. I am only sorry I did not have said Course some years ago. I have learned so much more through this course I would not part with it.—Charles Schwarz, Hamilton, Ohio.

The Course in Appliance Servicing arrived a few days ago. Want to take out a few minutes of my valuable time to let you know that this is just what I have been looking for ever since I opened up my Fix-It shop. I must admit that you told the truth when you said that it contains quite a bit more information than I bargained for.—P. J. Bretl, Sebring, Ohio.

I am a mechanic for the Western Union Telegraph Co. Three days after receiving the lessons in refrigeration I earned the exact cost of the course.—Henry S. Lee, Washington, D. C.

I work day times at the shipyard and after 4:00 P.M. I operate from my cellar and garage. I average \$10.00 to \$15.00 clear every day.—Walter Hanby, Brockton, Mass.

GET STARTED TODAY — MAIL THIS COUPON

CHRISTY SUPPLY CO.
2835 N. Central Ave., Dept. D-3303
Chicago 34, Illinois

Please send me free illustrated literature about America's Fastest Growing Industry — **ELECTRICAL APPLIANCE REPAIRING.**

Name.....

Address.....

City..... State.....

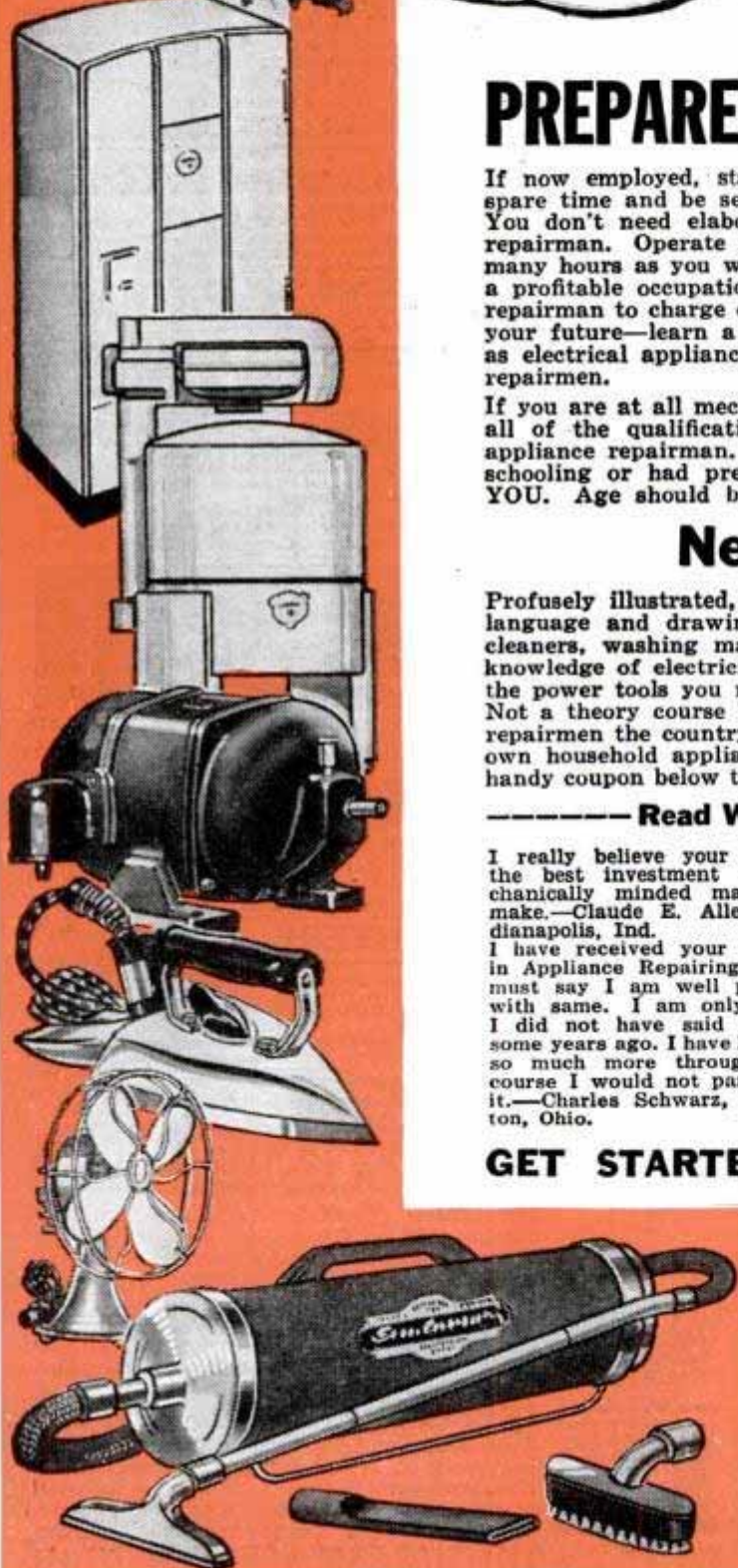



AUTO

BOOKS ON APPROVAL

SEND NO MONEY. Just mail the coupon for a complete set of Six Big Auto Books, 20th Edition. Whether you are a mechanic or helper, expert or apprentice, auto owner or driver, take immediate advantage of this FREE EXAMINATION OFFER.

**MAKE GOOD MONEY NOW
HOLD A PERMANENT JOB**

America wants its automobiles kept in good repair. Men with "know how" are in demand, at big pay. These books will help you get and hold an important job, or give you a chance to go into business for yourself now or later. Any man who half tries to improve himself can learn auto servicing and repairing by this quick reference method. Use the JIFFY INDEX to find easily understood answer to any auto problem. These wonder books prepared by eleven of America's great automobile engineers. Many hundreds of valuable illustrations. Send the coupon TODAY.

[A year's consulting privileges with our engineers now given with these books without extra charge.]

Vocational Publishers Since 1898

CAN YOU FIX IT?

These wonder books tell step by step HOW to make difficult repairs and adjustments. How to keep a car at maximum efficiency, including latest improvements in car design and operation. Engine troubles and how to correct them well covered.

6 BIG VOLUMES
2800 pages, 2000 illustrations, wiring diagrams, etc., including Diesel engines. Beautiful modernistic, washable cloth binding.

AMERICAN TECHNICAL SOCIETY, Dept. A519
Drexel Ave. at 58th St., Chicago 37, Ill.

I would like to examine your Six-Volume Set of Auto Books. I will pay the delivery charges only, but if I choose I may return them express collect. If after 10 days' use I prefer to keep them, I will send you \$2 and pay the balance at the rate of only \$3 a month until \$24.80 has been paid. Please include consulting service as offered above.

Name

Address

City

Please attach a letter stating your age, occupation, employer's name and address, and name and address of at least one business man as a reference. Men in service, also please give home address.

Your OWN Business!



As little as \$100
Starts You NOW!

No Training Needed

Make good money by making photo-exact copies of important papers, letters, drawings, photos, veterans' discharges, etc.—for local firms, lawyers, real estate men, accountants, advertising men, engineers, architects, others. Every business is your prospect for error-proof, low-cost photocopies. New, amazingly simple

method requires no lens, darkroom, or training! A table-top with only \$100 worth of APÉCO equipment puts you in business for yourself! Easy to start . . . many prospects . . . quick results . . . pleasant work—here's a combination that's a real money-making opportunity—good for a lifetime!

Get Full Information! MAIL COUPON NOW!

AMERICAN PHOTOCOPY EQUIPMENT CO.
2849 N. Clark St., Dept. GF56
Chicago 14, Ill.

Please send me your illustrated book and details about the APÉCO business opportunity.

NAME

STREET

CITY

STATE

BIG MONEY NOW IN LIQUID MARBLE

THREE wonderful new opportunities for your own big money-making business—regardless of your age, sex, or previous experience!

- 1. LIQUID MARBLE.** Make beautiful artificial Marble Slabs. Pour from liquid state. Glazed or unglazed. This marble may be mottled, veined, multi-colored or left in original snow-white state. The color is actually a part of the marble! Does not fade or wear away. Liquid Marble is unsurpassed on kitchen or bathroom walls. Easy to make and install.
- 2. PLASTIC FLOORING.** May be made in any color or combination of colors. Gives a lifetime of wear. Dustproof, Soundproof, Verminproof. Resilient to the tread. Lay out solid from wall to wall or in pattern design of various shaped blocks.
- 3. FLEXIBLE MOLDS.** For plaster casting. Make your own moulds for few cents each. \$1.00 in raw materials will make up to \$25.00 worth of finished goods. We furnish names of buyers. Write now for FREE information about our BIG THREE money-making opportunities! Get in on busy season just starting. Send penny postcard or letter. No obligation.

COMPO-TEX, Box 786-5G, ST. LOUIS 1, MO.



Get Started in Radio
TEN "HOW-TO-DO-IT" BOOKS

Get a solid foundation in radio by means of these 10c timely text books. Each clearly written, profusely illustrated, contains over 15,000 words. You'll be amazed at the wealth of information packed into these handy books. Excellent for reference—ideal for technical library. Your money back if not satisfied.

5 Books for 50c- 10 Books for \$1!
SENT TO YOU POSTPAID

- | | |
|--|-------------------------------------|
| No. 1—How To Make Four Doerle Short Wave Sets | No. 4—All About Aerials |
| No. 2—How To Make The Most Popular All-Wave 1 and 2 Tube Receivers | No. 5—Beginners' Radio Dictionary |
| No. 3—Alternating Current for Beginners | No. 6—How To Have Fun With Radio |
| | No. 7—How To Read Radio Diagrams |
| | No. 8—Radio for Beginners |
| | No. 9—Simple Electrical Experiments |
| | No. 10—Television |
- Remit by check or money order—register letter if you send cash or stamps.
RADIO PUBLICATIONS, 23B West Broadway, New York (7)



WONDERFUL INVENTION — Corrects poor penmanship in few hours. Guaranteed. No failures. Increases prestige. Helps one get better job. Write Ozment, 34, St. Louis, Mo.

Thrilling Work COLORING PHOTOS

Fascinating vocation learned at home by those with aptitude. Thrilling pastime. National method brings out life-like colors. Free booklet.
EASY TO LEARN
NATIONAL PHOTO COLORING SCHOOL
1315 S. Michigan, Dept. 1355, Chicago 5

FIX TYPEWRITERS

A Simplified Practical Homestudy Course. Many of our Students now have their own Business—Many Repair for others. Repair Shops Swamped. Health or Age no handicap.
WEBER TYPEWRITER MECHANICS SCHOOL
Box 269, Osborn, Ohio

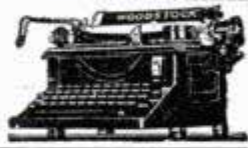

Get into Good Paying AUTO BODY and FENDER WORK



Men 18 to 60. If you are mechanically inclined, start now to learn to become an auto body mechanic and fender repair man. U. E. I. spare time, home-study training combined with actual shop practice gives you sound, basic knowledge of practical methods so you may get the experience which may bring you big pay. Course includes acetylene welding, spray painting, use of hand and power tools.

WRITE FOR FACTS

THOROUGH, RELIABLE TRAINING
Auto body and fender repairing is one of the best profit-makers in any garage or service station. Employment placement service included, or we'll show you how to go about to get started in your own shop. Get the facts FREE today!

AUTO-CRAFTS DIVISION • UTILITIES ENGINEERING INSTITUTE
1314 BELDEN AVENUE, Dept. 156X, CHICAGO 14, ILLINOIS

NOTICE: Over 125,000 ambitious men have been helped to higher paying jobs with the aid of books listed on this page.



Which of these books can help you GET A BETTER JOB AND MAKE MORE MONEY



Beat job competition and insure yourself of a prosperous future. Gateway Books help you tackle those tough jobs you've always had your eye on. They show you how to do the HARDEST jobs the EASIEST way in LESS time. Gateway Books are written by men who are experts in their particular field . . . men who have worked themselves up the hard way. Take advantage of their

knowledge the easy GATEWAY way. Our Money Back Guarantee appears where on this page. Study this list of popular books now.

Order From This List

PAINTING

1. **SPRAY PAINTING.** Spraying technique and operating instructions on paints, materials, finishes. 125 fully illust. pages. \$2.00
2. **INTERIOR WALL DECORATION.** Practical working methods for plain and decorative wall finishes. 185 illus., 491 pages. \$3.50
3. **THE MIXING OF COLORS AND PAINTS.** How to mix colors for interior decorating, arts, crafts, general mixing methods. \$2.50
4. **CYCLOPEDIA OF PAINTING AND DECORATING.** Covers methods, tools and materials for the home and workshop, including every branch of painting and decorating. Any particular job is fully explained with large illustrations to clarify text. 350 pages. \$3.50
5. **PAPER HANGING.** A practical book that shows you how to do your own papering and save many times the cost of this book. Plenty of illustrations. Over 200 pages. \$2.50
6. **FURNITURE, FURNITURE FINISHING, DECORATION AND PATCHING.** Practical new book that covers Period Furniture, Furniture Decoration, Patching, Finishing and many special finishes. 580 pages. \$5.00

WOODWORKING

7. **CARPENTRY CRAFT PROBLEMS.** 320 pages explain and illustrate hundreds of practical solutions to all types of carpentry problems met by the amateur and professional woodworker. Complete in every detail. \$2.50
8. **BUILDING—FORMS, STAIRS, ROOFS.** Latest information on how to build forms, staircases, roofs, etc., correctly. For carpenters and their helpers. 250 pages, illus. \$2.50
9. **WOODEN BOAT AND SHIP BUILDING.** Solves every type of problem in building wooden boats and ships. 244 pp., illus. \$2.25
10. **HOW TO MAKE RUSTIC FURNITURE.** Hundreds of ideas and plans on making all types of rustic furniture for the home. Completely illust., thoroughly described. \$2.00
11. **WOOD TURNING.** An excellent book for every home craftsman. Tells and shows how to do the most artistic work. Numerous photos and many detailed drawings. \$2.50
12. **MODERN HOMECRAFT.** 240 pages of ideas for modern home furniture and how to make it. Scale drawings, fully illust. \$3.50
13. **BLUE PRINT READING.** A practical book that shows how to read and interpret blue prints. 111 pages, 69 illust. \$1.50
14. **CONCRETE DESIGN AND CONSTRUCTION.** 508 pages, 251 illust. A new and enlarged edition covering all phases of concrete work and how to do it. \$5.00
15. **HOME REMODELING.** An excellent book for those planning remodeling. Gives hundreds of ideas that save money and add beauty to the finished job. 528 pages, illust. \$5.00
16. **HOW TO PLAN A HOUSE.** Here's a book for every person who ever intends to build their own home. This book shows how to design every single part of a modern house to save you the most money. 525 pages. \$5.00

Guarantee

Gateway Books are guaranteed to be absolutely satisfactory in every respect, or your money will be cheerfully refunded. The GATEWAY BOOK CO., Dept. PM-17 32 N. State — Chicago 2, Illinois

REFRIGERATION - PLUMBING AIR CONDITIONING

17. **REFRIGERATION SERVICE MANUAL.** Domestic and Commercial refrigeration used in markets, milk depots, soda fountains, home refrigerators are all covered so you can service any of these and many other units easily. Fully illustrated. \$2.50
18. **PLUMBING INSTALLATION and REPAIR.** Practical 236 page book tells how to repair leaky faucets, clogged toilets, drains, pipes, traps, vents, etc. 153 illust. \$2.50
19. **HEATING COOLING and AIR CONDITIONING.** 706 pages on heating of all types, cooling, Air Conditioning, equipment, furnaces, controls, etc. 64 charts, 351 illus. \$4.50

HOBBIES

20. **TIN CAN PROJECTS.** Tells how to turn tin cans into objects of beauty that command high prices and praise. This handy book has all the working patterns and designs. \$1.50
21. **LEATHER WORKING.** Tells of tools, materials and equipment needed. Gives working drawings of key holders, billfolds, book marks, coin purses, belts, frames, etc. \$2.00
22. **HOW TO WHITTLE and CARVE.** Complete directions for all types of whittling and carving of toys, jewelry, and novelties, etc. Illustrations simplify the work. \$2.75
23. **CREATIVE CRATE CRAFT.** Tells how to make clever and useful pieces of furniture from discarded crates and boxes. \$2.00
24. **IDEAS FOR THE YARD.** Novel book that gives hundreds of suggestions and plans for things you can make for your yard. \$1.50

DEALERS: Write today for our attractive discounts on these titles.

SPORTS

25. **TAXIDERMERY MADE EASY.** A handy book that brings this fascinating hobby within the reach of every sportsman. Explains tools, materials and methods. Profusely illus. \$2.50
26. **THE AMERICAN RIFLE.** A basic book on the rifle and its use for hunting and target shooting. Includes practical information on guns and equipment. Illust. \$3.00
27. **PISTOL AND REVOLVER.** Detailed information on the care of, types, accessories and uses of handguns. Regional shoots described. \$3.50
28. **SAILING CRAFT.** One of the most complete works ever printed on sailing and racing. All types of boats are discussed and illustrated. Over 400 illustrations, nearly 800 pages, size 7 1/2 x 10. Original cost was \$12.00. Now it's yours for. \$5.00
29. **SMALL BOAT BUILDING.** An excellent handbook giving specific information on small boat building. Many boats fully described with large line drawings and working blueprints. Now . . . build your own boat. \$3.00

METAL WORKING

30. **WELDING.** Arc, spot, butt and electric welding, etc. 280 pages, illust. \$2.00
31. **SHEET METAL WORKERS MANUAL.** Complete instructions and information on every phase of sheet metal working. Includes many tables. 552 pages, 375 illust. \$3.00
32. **METAL SPINNING.** A new art of proven popularity. Step-by-step descriptions of the various phases of the craft show you how to make the most out of your metal work. \$1.75
33. **METAL SPINNING PROJECTS.** Tells how to make bowls, lamps, serving dishes, book ends, candle sticks, etc. Complete working patterns and instructions. \$2.75

ELECTRICITY

34. **PRACTICAL ELECTRICITY and HOUSE WIRING.** An ideal book for around the home because it debunk all the mysteries of electricity and shows you how you can save plenty by doing all of your own wiring. \$2.00
35. **ARMATURE and MAGNET WINDING.** The construction of armatures and their repairs are fully covered with illust. \$2.00

AUTOMOTIVE SERVICE MANUALS

- The newest and most authoritative books published. Originally made for the U. S. Armed Forces Institute. Covers every make of automobile. Hundreds of illust. to explain text.
36. **THE ENGINE** . . . \$1.50
 37. **COOLING, LUBE AND FUEL SYSTEMS** . . . \$1.50
 38. **AUTOMOTIVE ELECTRICITY** . . . \$1.50
 39. **THE POWER FLOW** . . . \$1.50
 40. **CHASSIS UNITS** . . . \$1.50
 41. **COMBINATION PRICE:** Above five volumes bound in paper, app. 300 pages each. Special money-saving price of only \$6.75

CHECK, CLIP AND MAIL THIS COUPON NOW

THE GATEWAY BOOK CO., 32 N. State St., Dept. PM-17, Chicago 2, Illinois
O.K. Send the books I've circled. If C.O.D., I'll pay postman cost of books plus a few cents postage and handling charge. If prepaid, Gateway pays all shipping charges. If any book is not entirely satisfactory, I will return it in 10 days and you will refund my money. No C.O.D.'s outside the U. S.

1 2 3 4 5 6 7 8 9 10 11 12 13 14 15 16 17 18 19 20 21
22 23 24 25 26 27 28 29 30 31 32 33 34 35 36 37 38 39 40 41
(Please print name clearly)

Name.....
Address.....
City.....Zone.....State.....

JUST OUT! NEW FROM COVER TO COVER

AUDELS REFRIGERATION and AIR CONDITIONING GUIDE

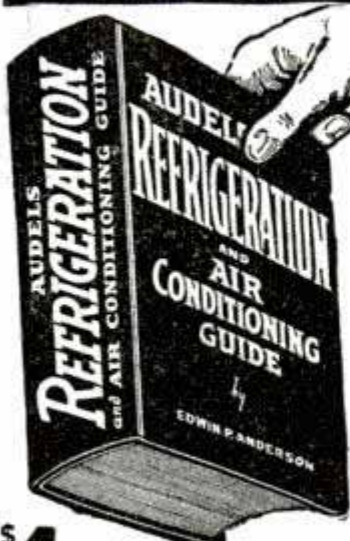

4 Books in One! Covering:
 Basic principles, Servicing, Operation, Repair of
 1—Household Refrigeration
 2—Special Refrigeration Units
 3—Commercial & Industrial Refrigeration
 4—Air Conditioning Systems
 A gold mine of essential important facts for ENGINEERS, SERVICEMEN & USERS.
 A Good Book is a Good Friend! Here you have at your fingers' ends a Complete Library in ONE VOLUME, the necessary data you have been looking for on: MODERN UNITS, SYSTEMS & MACHINES, REFRIGERANTS, including Freon, Lockers, Water Coolers, Quick Freezing & Air Conditioning Systems.
 1250 Pages, 46 chapters all Fully Illustrated & indexed for Ready Reference.

ANSWERS YOUR QUESTIONS
 Get This Information for Yourself. Mail Coupon Today. No Obligation Unless Satisfied. ASK TO SEE IT.

\$4 COMPLETE • PAY ONLY \$1. A MONTH

AUDEL, Publishers, 49 W. 23rd St., New York 10, N.Y.
 MAIL AUDELS NEW REFRIGERATION GUIDE for free examination. If O. K. I will send you \$1 in 7 days; then remit \$1 monthly until price of \$4 is paid. Otherwise I will return it.

Name _____
 Address _____
 Occupation _____
 Employed by _____ PM

AVIATION Career

MAXIMUM TRAINING IN MINIMUM TIME

CAL-AERO TECH TRAINING will add dollars to your pay check all the rest of your life. Specializing in AERONAUTICAL ENGINEERING and MASTER AVIATION MECHANICS since 1929, Cal-Aero Tech training is carefully designed for just one thing—TO MAKE MORE MONEY FOR YOU. An alumni of over 6000 successful graduates proves our career training is unsurpassed.

VETERANS —Write us about Aviation Training, as provided under "G.I. Bill of Rights."



MAIL THIS COUPON TODAY!

Cal-Aero Technical Institute, Grand Central Airport, Glendale 1, California
 Please send full information on Aviation Training FREE—without obligation. Dept. PM-5

Name _____ Birth Date _____
 Street _____
 City _____ State _____

Silk Screen Process
A PROFITABLE BUSINESS OF YOUR OWN

We Send You Complete Kit of Supplies

Practice in Your Spare Time
 A HIGH PROFIT BUSINESS, OR A THRILLING HOBBY
 Silk Screen Processed signs and displays needed everywhere. A lucrative future for you in the great advertising boom. Easy to do—quick to learn—you may make more than course costs before it's completed... **BOOKLET** with 3-color Silk Screen Processed Cover and samples sent **FREE**... Write now, California School Screen Process, Dept. PMD5462710 So. Spaulding, Los Angeles 16, Calif.

ELECTRICAL TRAINING

Intensive 8 months residence course in fundamentals of industrial electrical engineering, including radio, electronics. Prepares for technician, engineering aides. Approved for veteran training. 53rd year. Catalog.

BLISS ELECTRICAL SCHOOL
 7632 Takoma Ave., Wash. 12, D. C.

ANALYZE HANDWRITING

Qualify for Certified Grapho-Analyst Degree. New uncrowded, fascinating field of service. Gratifying earnings reported by graduates in Employment, Credit, Social Service, Police and Judicial, and Entertainment fields. Others have developed profitable private practice, full or spare time, as Personal Problem and Vocational Counselors. Send for 3000 word test lesson and Grapho-Analyst

FREE

ADDRESS A. I. G. A. Inc. 120 NOEL, MO.

SAY YOU SAW IT IN POPULAR MECHANICS

Learn PHOTOGRAPHY at Home

Splendid opportunities. Prepare in spare time. Practical basic training. Long-established school. Send for free book, "Opportunities in Photography." No obligation.
 American School of Photography, 1315 S. Michigan Ave., Dept. 1355, Chicago 5, Ill.

Train Your Own HORSES!

Colts — Stock Horses — Circus Horses
 Gait Show Horses — Write for FREE BOOK
ANIMAL LOVERS' ASSOCIATION
 Box KA-111, Tarzana, Calif.

\$5, \$10, \$15 FOR ONE DRAWING

Be an ARTIST!

—Train at Home in Your Spare Time
 The fascinating field of Art offers commercial opportunities to men and women. **COMMERCIAL ART, CARTOONING, DESIGNING** all in one complete course. TWO ART OUTFITS furnished. Learn to draw step-by-step. Trained Artists are capable of earning \$40, \$60, \$75 a week. Write today for full information in FREE BOOK. "Art for Pleasure and Profit." Mail coupon now.

FREE BOOK gives details

Washington School of Art, Studio 125C
 1115—15th St., N. W., Washington 5, D. C.

Name _____ AGE _____
 Address _____
 City _____ Zone () State _____

**LEARN
AT HOME**

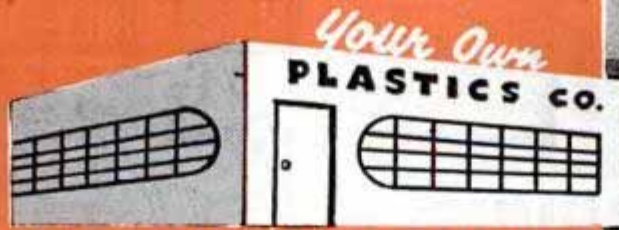

START YOUR OWN BUSINESS

PLASTICS

FABRICATION

New - Profitable Industry!



**MAKE PRODUCTS
LIKE THESE**

YOU'LL really enjoy learning plastics this new, interesting way! For you'll actually make beautiful, useful plastics articles during your home study training with Plastics Industries Technical Institute.

NOW'S YOUR OPPORTUNITY—Yes, the exciting age of plastics is here! Demands of war have caused phenomenal growth in the plastics industry—creating exceptional opportunities for those who know plastics. If you are a person with an eye to the future, you won't remain on the outside looking in—you'll want a choice position in the growing, expanding plastics field—or a plastics business of your own.

WE SUPPLY MATERIALS—For your interesting and practical work with plastics, we supply handsome, colorful, transparent rods, sheets and tubes of plastics from which you make useful, attractive creations. You saw, cement, machine, buff, form, dye, decorate, cast and laminate various types of plastics.

You also design your own plastics articles—develop your own ideas—express your originality. Earn money while learning.

A COMPLETE COURSE—This practical training in plastics fabrication is only one part of the Plastics Institute home study course. In addition, you learn about the many types of plastics, their manufacture, characteristics, properties and uses—intensive coverage of molding and mold design—testing and cost analysis—everything to help prepare you for your place in plastics.

START YOUR FUTURE TODAY—Mail the coupon below now! We will send you an interesting, illustrated free booklet with valuable information about plastics. We'll tell you how, at small cost, you can prepare for a future in this important industry while carrying on your present work. Don't put it off. Clip the coupon and mail it today!

VETERANS: ASK ABOUT G.I. TRAINING

NEW YORK

Dept. PM6-5, 122 E. 42nd St.

CHICAGO

Dept. PM6-5, 221 N. La Salle St.

LOS ANGELES

Dept. PM6-5, 1601 S. Western

SPECIAL RATES FOR SERVICE MEN

Plastics

INDUSTRIES TECHNICAL INSTITUTE

Plastics Industries Technical Institute
221 N. La Salle St., Dept. PM6-5, Chicago 1

Mail in Envelope or
paste on penny postcard

Gentlemen: Please send me the booklet "World of Plastics" and information on your training program. I understand there is absolutely no obligation.

Name.....Occupation.....

Street.....Age.....

City.....Zone.....State.....

Veterans: Check for special information. If under 18: Check for special booklet.



FREE BOOKLET
Send for It Today!

The set of
books
that makes



MASTER MACHINISTS and leads to bigger pay!

This big home-study and reference course gives you the practical facts on machines and methods you need to advance in machine shop work. Take advantage of the other man's experience as found in books, to solve your problems, increase your efficiency, with

The AMERICAN MACHINISTS' LIBRARY

6 volumes—2368 pages—2516 illustrations
(A combined home-study course and reference library)

This library of machine shop practice was written for practical men. It gives you the best methods for every kind of machine shop work. It fully explains lathes, drills, and other machine tools and their operation, automatic screw machines, speeds and feeds, gear design and production, jigs and fixtures, punch and die work, metal surfacing, etc., etc. Plainly written—completely illustrated—the best kind of help to the machine shop man who wants to advance himself.

No money down—special price—easy payments.

EXAMINATION COUPON

McGraw-Hill Book Co., 330 W. 42nd St., N. Y. 18

Send me for ten days' examination the American Machinists' Library. If satisfactory I will send you \$1.50 in 10 days and \$3.00 monthly until the price of \$19.50 is paid. If not wanted, I will return the books postpaid. (To insure prompt shipment write plainly and fill in all lines.)

Name
Home Address
City and State
Company
Position PM 5-46

8 BIG BUILDING BOOKS

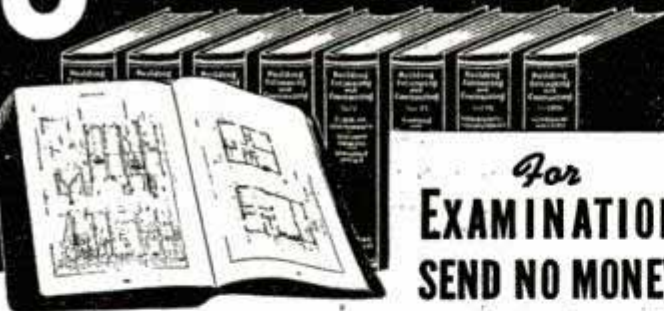

For
**EXAMINATION
SEND NO MONEY**

Learn to draw plans, estimate, be a live-wire builder, do remodeling, take contracting jobs. These 8 practical, profusely illustrated books cover subjects that will help you to get more work and make more money. Architectural design and drawing, estimating, steel square, roof framing, construction, painting and decorating, heating, air-conditioning, concrete forms and many other subjects are included.

BETTER JOBS — BETTER PAY

Keep busy now at good pay, and be prepared for after-war building boom. Big opportunities are always for MEN WHO KNOW HOW. These books supply quick, easily understood training and handy, permanent reference information that helps solve building problems.

UP-TO-DATE EDITION

These books are the most up-to-date and complete we have ever published on these many subjects.

Coupon Brings Eight Big Books For Examination

AMERICAN TECHNICAL SOCIETY Vocational Publishers since 1898
Dept. G519 Drexel at 58th Street Chicago 37, Ill.

You may ship me the Up-to-Date edition of your eight big books, "Building, Estimating and Contracting," without any obligation to buy. I will pay the delivery charges only, and if fully satisfied in ten days, I will send you \$2.00, and after that only \$3.00 a month, until the total price of only \$34.80 is paid. I am not obligated in any way unless I keep the books.

Name
Address
City State

Please attach a letter stating your age, occupation, employer's name and address, and name and address of at least one business man as a reference. Men in service, also please give home address.

MAKE MONEY—DO ELECTRICAL WORK



Only \$7.50 will make anyone handy with tools a practical electrician. Nothing to study. With this job ticket handbook in your pocket you can do 240 different electrical jobs on the spot. Flip the pages to the job you are doing. Follow the step by step directions and simple diagrams and you can't go wrong. Nothing like it. Reg. U.S. Pat. office. Users say easily worth up to \$100. Gives you chance to do good pay work in field of Electricity. Quantity limited. Send check or P. O. money order. Satisfaction guaranteed or money refunded.

C. H. SMITH, Pres., 2130 Lawrence Ave., Dept. P, Chicago 25, Ill.

HOME BIBLE COURSE

Simple, helpful, instructive. Study entire Bible under personal guidance of experienced instructors.

TOTAL COST \$3

includes textbooks, all supplies, regular examinations, certificate upon completing course.

\$1.00 starts you, or simply request Prospectus

The Bible Study School 382 VAN HOUTEN STREET
PATERSON 1, NEW JERSEY

NEW WRITERS NEEDED

New writers needed to re-write ideas in newspapers, magazines and books. Splendid opportunity to "break-into" fascinating writing field. May bring you up to \$5.00 per hour spare time. Experience unnecessary. Write today for FREE details. NO OBLIGATION. Postcard will do.

**FREE
DETAILS**

COMFORT WRITER'S SERVICE

200-T40 South Seventh (2)

St. Louis, Mo.

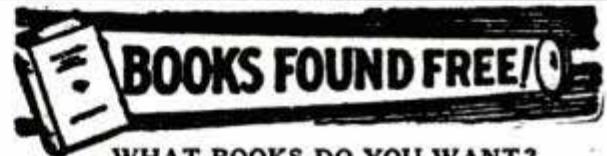

WHAT BOOKS DO YOU WANT?

We quote the lowest market prices. No charge for locating Hard-to-Find and Out-of-Print Books. All books, OLD or NEW, mailed POST-FREE.

SEARCHLIGHT BOOK CLUB, 22 East 17th St., New York City

MONEY for MEN ALL FREE

THE PLASTEX Industry needs manufacturers on small scale and for big production of Lamp and Clock Stands, Art Goods and Novelties in Plastex and Marble imitation. Experience unnecessary. 1/2c material makes regular 10c store sellers. Rubber moulds furnished for speed production. Small investment brings good returns. Big chain store orders now being placed. Ambitious men have chance for real prosperity. Our Free booklet will interest and benefit you.

PLASTEX INDUSTRIES, Dept. P, 1085 Washington Ave., New York, N.Y.

WANT TO BE AN ARTIST?



5 BOOKS • 7 SUBJECTS
OVER 100 ILLUSTRATIONS

- 1 CARTOONS - PEN AND INK
- 2 FIGURE DRAWING
- 3 DRAWING & PERSPECTIVE
- 4 WATER COLORS
- 5 OIL PAINTING

**\$1.00
FOR
5
POCKET
EDITIONS**

SEND TODAY for COMPLETE SET
POSTPAID

★ HOLLYWOOD ARTISTS

P. O. BOX 2344,
LOS ANGELES 54, CALIF.

NAME _____ PM 5-2

ADDRESS _____

CITY _____ STATE _____

SIMPLY ENCLOSE \$1 BILL

Prepare for YOUR FUTURE *Now*

You'll Need "ALL-AROUND" Training to Meet New Conditions!

Get Ready QUICK—in 1 of these 2 Opportunity Fields!

ELECTRICITY OR **RADIO ELECTRONICS TELEVISION**



ELECTRICITY in its Many Branches...

Electricity is a permanent necessity in war or peace. Be ready for the opportunities in such branches as Power Plant Work, Motors, Armature Winding, Industrial and House Wiring, Maintenance, etc., with COYNE shop training.

This big fire-proof building is occupied entirely by the Coyne Electrical School.

RADIO-ELECTRONICS... A great field now, even greater growth ahead. Prepare for a real Radio career. Learn construction, operation, trouble-shooting on Radio Receivers, Public Address Systems, Sound Picture Units, FM, Photo-Cells, Television—the practical COYNE way.

"LEARN-BY-DOING"—12 WEEKS TRAINING

Student Finance Plan

Now that peace has returned, many "one-operation" jobs that paid well in war times, no longer exist. Do you have a good job with a real future? Plan for steady pay and advancement by training NOW, while there's still time! Come to the big shops of COYNE in Chicago, for "all-around" training in **Electricity or Radio-Electronics**—the 2 great opportunity fields of today and tomorrow. I'll finance most of your training.

TRAIN ON ACTUAL EQUIPMENT!

My famous "Learn-by-Doing" method gives you practical experience on full-size equipment. Not by correspondence, but actual shop work. You are trained right here in the Coyne shops, that has been training men and young men for over 46 years.

START NOW—PAY LATER! LIFETIME JOB SERVICE TO COYNE GRADUATES

Don't let lack of money hold you back. My "Pay-Tuition-after-Graduation" plan has helped thousands. Coupon brings details. Many earn while learning, to help take care of living expenses while here. Men from 16 up to 40, with or without experience, Coyne training is for you!

First I train you for a good job and future, then assist you in getting located. As a Coyne graduate, use this service whenever you need it—no charge. Also FREE review privileges at any time. Get the facts!

INDUSTRIAL ELECTRONICS and Electric Refrigeration

Included With Either Course—No Extra Charge
Extra training in these great fields of INDUSTRIAL ELECTRONICS and ELECTRIC-REFRIGERATION makes you more valuable to employer, leads to opportunities for bigger pay. This valuable EXTRA TRAINING included with either my Electrical or Radio Course, without extra cost. We also have facilities for men with physical disabilities whether due to war or other causes. Check coupon for details if you have a physical disability of any kind.

VETERANS—

Coyne is also equipped to train those who qualify for training under G. I. Bill of Rights. Check coupon for our Special G. I. Bulletin.



H. C. Lewis

PICK FIELD YOU LIKE—SEND FOR BIG BOOK

FREE



Some men prefer Electricity, others Radio-Electronics. Whichever interests you most, we will train you in 12 short weeks at Coyne—on full-size equipment, by my famous "Learn-by-Doing" method. I have a big, fully illustrated book on each course, and will send you the one you want, without the slightest cost or obligation. Simply check below, then mail coupon in envelope or paste on post-card. No salesman will call. You are the sole judge. Don't delay. Your future is at stake. Rush coupon to me—TODAY.

H. C. LEWIS, Pres.,
COYNE ELECTRICAL SCHOOL,
500 S. Paulina St., Dept. 56-72H, Chicago 12, Ill.

Send me your BIG FREE BOOK—for the course checked below. Also full details of your "Pay-After-Graduation" plan.

- ELECTRICITY RADIO-ELECTRONICS
 Physical disability Send special G. I. Bulletin

NAME.....

ADDRESS.....

CITY.....STATE.....

COYNE ELECTRICAL SCHOOL

500 So. Paulina Street, Dept. 56-72H, CHICAGO 12, ILL.

H. C. LEWIS, Pres.

Founded 1899



MACHINISTS! MECHANICS!

Get New **VEST POCKET REFERENCE BOOK**

\$1.25
Only

214 PAGES OF TIME-SAVING FORMULAS, DATA, SHORT CUTS, NEW IDEAS

Here is just a partial listing of vital, useful everyday information included in this handy vest pocket size book.

Twist Drill Sizes
Multiple Thread Indexing
Screw Threads; Pipe Threads
Allen Hexagon Wrench Sizes
Nut Sizes (Hexagon and Square)
Pipe Plug and Ring Gauge Sizes
Tapered Pins; Wire Gauges
Standard Keyway Dimensions
Hardness Conversion Table

Ball Racer Diameters
Grinding Wheel Hardness Table
Spur Gears
Fellows Stub Tooth Gear
Diametral and Circular Pitches
Bevel Gears; Spiral Gears
Milling Cutters; Radial Tools
Grinding V Tools
Draft Angle Chart

Covers a total of 100 essential subjects—including important mathematical data, formulas and tables. (Sturdy leather binding. Pocket size, only 5/16" thick.) Amazing fund of information you use in your daily work. Compiled by recognized authorities. Order your copy today on 10-day Money-Back Guarantee. Use the handy coupon below.

ORDER NOW—MAIL THIS COUPON

ZIFF-DAVIS PUBLISHING CO., Dept. M-8
185 North Wabash Avenue, Chicago 1, Illinois

Rush my copy of "Vest Pocket Reference Book." I may return it within 10 days for full refund.

- Send C.O.D. for \$1.25, plus postage
 I enclose \$1.25, you pay postage

NAME.....

ADDRESS.....

CITY.....ZONE.....STATE.....



NORTHROP Aeronautical Institute

(Division of Northrop Aircraft, Inc.)

1 and 2 Year Courses

AERONAUTICAL ENGINEERING

The two-year Aeronautical Engineering course at Northrop gives you a thorough working knowledge of aeronautics, including all fundamentals as well as advanced theory. A one-year course in Aeronautical Engineering is also available. After completing your training at Northrop Field, in the midst of one of the world's great aircraft engineering and research organizations, you can enter upon your career in commercial aviation with the confidence of a trained practical aeronautical engineer.

Other Courses Offered—The Aircraft and Engine (A&E) Mechanics courses are thorough and modern. Special methods of presentation, developed for the exclusive use of Northrop students, are utilized.

Veterans—The institute is approved for the training of veterans under the G. I. Bill of Rights.

NORTHROP AERONAUTICAL INSTITUTE

1527 E. Broadway, Hawthorne, California

SEND COUPON FOR COMPLETE INFORMATION

NORTHROP AERONAUTICAL INSTITUTE
1527 E. Broadway, Hawthorne, California

Please send me your free, illustrated booklet and information, including starting dates and tuition rates, on the training courses checked below.

- Aeronautical Engineering Master Aircraft & Engine Mechanic (A&E)

Name.....

Address.....

Age.....

City.....

Zone.....

State.....

Check one: Veteran In Service Civilian

Learn to Service and Repair ELECTRICAL APPLIANCES

Learn to be a service mechanic on all types of electrical appliances . . . and prepare now for a permanent future, independence and security, operating a business of your own. You won't have to worry about losing your job when the next depression comes if you have your own electrical appliance repair business. There is always a demand for repair work . . . and it can't be done by a machine. Our practical, easy to learn home-training teaches you how to repair washing machines, vacuum cleaners, stoves, lamps, motors, irons, etc., and how to do house wiring. Also how to start your own business on little capital. Write today for FREE illustrated booklet which will explain in detail. No obligation. No salesmen will call.

PACIFIC TRAINING SCHOOL

7217 So. Broadway, Dept. P-5, Los Angeles 3, Calif.

It's easy to be a FINGER PRINT EXPERT

LIFT FINGERPRINTS ANYWHERE WITH THIS PROFESSIONAL CRIME DETECTION KIT

With this Crime Detection and Fingerprint kit you can quickly learn how to take fingerprints just like G-Men. Kit contains fingerprint powder, lifting tape, dusting brush, magnifying glass, ink and roller, and book of instructions on "How To Read Finger Prints." Send \$1.00 for complete kit, prepaid.

CHAMPION MANUFACTURING COMPANY
2903 Apco Tower Okla. City 2, Okla.



5 SECRETS... OF WINNING GOLF



Easy to Learn "Dynamic Swing" Every Pro Uses

PLAY IN THE 70's. Enjoy your game. Amaze your friends. Get out of the "dub" class by using golf's most powerful and accurate swing. **Five basic secrets** give you rhythm and power, eliminate hook and slice . . . make you **MASTER OF EVERY CLUB**. Easy to make long drives and beautiful approach shots. Learn in a few days—10 minutes' practice a day. **COMPLETE COURSE NOW ONLY \$1.00** postpaid, or \$1.00 plus 24c for postage and C. O. D. fee. Your money back if you're not amazed with results, so order NOW!

THE SYLVAN COMPANY 125 Seventh Ave., Dept. V, LaGrange, Ill.

Get Ready for Big After War Opportunities!

I Will Train You at Home Until You Get a GOOD PAY JOB in

DRAFTING

Act now to get a better job with more pay and pleasant working conditions. Get into Drafting—the basic profession where all post war products will start. I will train you at home—give you experience—doing the same kind of jobs you will do with the best paying firms. I furnish instruments, drawing table and all equipment when you start. Write today for vital facts and FREE illustrated book. Give Age.

Engineer Dobe, Div. 15, Libertyville, Ill.

THERE'S MONEY IN CARTOONS!

RAYE BURNS will teach you HOW to CREATE ORIGINAL CARTOONS at home that you may SELL! Course contains 26 lessons and over 600 illustrations. All for Only.....

\$2.85

Send name and address for free details.

RAYE BURNS SCHOOL, Dept. M, Box 3583, CLEVELAND, OHIO

WANTED

Home workshops, local shops, mechanics, mechanically inclined men and boys. Use engineering company plans to make and install household and auto utilities. Business of your own, or add to present business. Full or part time. ALSO: JET IMPULSION FOR AUTOS, JET ENGINE EXPERIMENTS, HELICOPTER INFORMATION AND INSTRUCTION KIT. Circular on plans. Rush name.

HOUSTON MAUPIN, Tipp City 2, Ohio

GET INTO RADIO

TELEVISION ELECTRONICS NOW!



You build this complete, modern super-heterodyne receiver with the equipment that comes with your National Training at no extra cost.

This amazing new shop instruction system gives you actual experience with a Home Radio Laboratory—part of the

SHOP METHOD HOME TRAINING

FOR YOU—A REAL HOME LABORATORY IN MODERN RADIO

from one of the world's best established Oldest and Largest Technical Trade Schools

Send the coupon below, immediately. Learn how this **sensationally improved**, practical speed-up training can fit you, in a short time, for the **GREAT BUSINESS OF RADIO**—for the **NEW AND RAPIDLY EXPANDING FIELD OF FREQUENCY MODULATION (F.M.), TELEVISION AND ELECTRONICS.**

This is the thoroughly proved, quick and easy speed-up method used so extensively in wartime training—endorsed by the success of **National men everywhere**—a system by which you study in spare time—off hours, even minutes right in your home and yet have the **ADVANTAGE OF REAL SHOP EXPERIENCE** to back you up.

Trained Radio Men Wanted

The man who really **knows modern Radio** is in greater demand today than ever before—not only in Radio proper but in Television and Electronics—in Aviation, Transportation, Communications. **Good jobs**

are wide open, WAITING FOR YOU, in the production, operation and maintenance of modern electronic equipment—in radio stations, in hundreds of industries—in homes, theatres and studios. Good, sound training in this important field is absolutely necessary. And now, National Schools brings such training to you **no matter where you live or what you may be doing**—not only the fundamental theory but the **actual experience that comes with knowing shop practice and working with real equipment**—demonstrating each step with first-hand knowledge. This is true **"learning by doing"**—direct from the great shops and laboratories of National Schools where new developments in methods, equipment and applications are constantly going forward.

Only National can offer you such practical training because only National has the plant to back it up. **Sample this training yourself. MAIL THE COUPON FOR A FREE LESSON.**

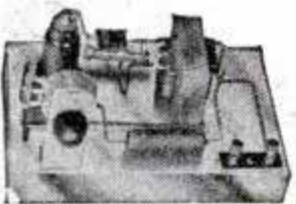

Your National Training Kits include equipment for hundreds of practical electronic experiments in your own home. You have the genuine parts for this audio oscillator which you get to understand by building it yourself.

You learn modulation, beat frequencies, signal generation by actually building this small radio transmitter with your National shop parts.

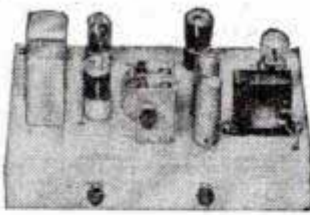

Your training outfits from National are made up of the most modern radiomic equipment—much of it just out of the experimental laboratory. You learn new ways of handling equipment by modern methods. Get the details by mailing the coupon.

POSTWAR SUCCESS and SECURITY FOR YOU

Radio is a Big Sound Well-Established Business. **Television is just on the threshold of limitless expansion.** When you hang up your uniform—when your war job folds up, will you step out proudly into an essential established industry? Perhaps into a business of your own? Answer these questions by reading the catalog sent you **FREE** from National Schools. **Face realities now!** Fill out and mail the coupon today.

Check the Job You Now Have With These Opportunities in RADIO

1. Financial Security Radio has grown from \$100 million to \$5 billion in past few years.
2. Limitless Future predicted by over 1,800 manufacturers of equipment.
3. Television promises over half a million jobs alone—experts estimate.
4. Electronics opens wide new fields in home and industrial use.
5. Your Own Business with little or no capital.

Get the details. Use the coupon!

FREE GET THESE 2 BIG BOOKS



NATIONAL TRAINING WINS BIG JOBS

You, too, can share the success of National graduates. Joseph Grumich, Lake Hiawatha, N. J., writes: "My latest offer was for \$5,800.00 as Radio Photo Engineer, but I am doing well where I am. I am deeply indebted to National."



While still a student of National training, I. Wilson of Vallejo, California, writes: "My pay has jumped from \$52.18 a week to \$72.65, and the end is not in sight. I am proud of my National Course."

Joseph Michel, Jr., Granite City, Illinois, writes: "I am enthused with National training. I am now earning \$225 a month as a radio operator and technician and \$20 a week more in my shop at home."

NATIONAL SCHOOLS

LOS ANGELES 37, CALIFORNIA EST 1905

MAIL OPPORTUNITY COUPON FOR QUICK ACTION

National Schools, Dept. PM-5
4000 South Figueroa Street
Los Angeles 37, California

(Mail in envelope or paste on penny post card)

Mail me **FREE** the books mentioned in your ad including a sample lesson of your course. I understand no salesman will call on me.

NAME..... AGE.....

ADDRESS.....

CITY..... STATE.....

Include your zone number

BIG REWARD

FOR
MEN AND WOMEN

WITH
KNOW HOW
IN COMING

REAL ESTATE
BOOM



Early birds get the worms. Prepare yourself now for big pay, permanent, dignified position, or your own real estate business. \$2,500 to \$10,000 a year in property management, appraisal, brokerage, loans, insurance jobs. Fortunes will be made in real estate. There is an urgent need for trained men and women by real estate firms, insurance companies, banks, Federal Agencies, etc. Learn in few months what took others years to get. Get the facts. This authentic Home Study Program (Est. 1936) can be your spring board to independence and security. Be a doer. Act to prove your right of way.

RUSH COUPON FOR FULL DETAILS

**WEAVER SCHOOL OF REAL ESTATE, Dept. B-1
1200 Oak St., Kansas City, Missouri**

Gentlemen: Send me FREE and without obligation your catalog explaining the Weaver Real Estate Home Study Program.

Name

Street or RFD.

City State

— PASTE ON POST CARD AND MAIL —

AUDELS Carpenters and Builders Guides 4 vols. \$6

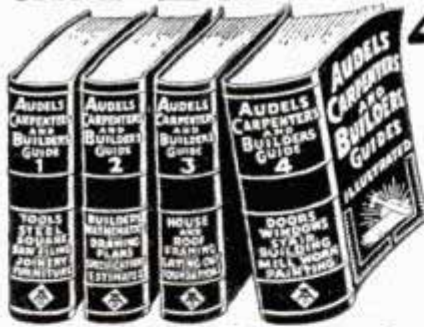

Inside Trade Information for Carpenters, Builders, Joiners, Building Mechanics and all Woodworkers. These Guides give you the short-cut instructions that you want—including new methods, ideas, solutions, plans, systems and money saving suggestions. An easy progressive course for the apprentice and student. A practical daily helper and Quick Reference for the master worker. Carpenters everywhere are using these Guides as a Helping Hand to Easier Work, Better Work and Better Pay. To get this assistance for yourself, simply fill in and mail the FREE COUPON below.

Inside Trade Information On:

How to use the steel square—How to file and set saws—How to build furniture—How to use a mitre box—How to use the chalk line—How to use rules and scales—How to make joints—Carpenters arithmetic—Solving mensuration problems—Estimating strength of timbers—How to set girders and sills—How to frame houses and roofs—How to estimate costs—How to build houses, barns, garages, bungalows, etc.—How to read and draw plans—Drawing up specifications—How to excavate—How to use settings 12, 13 and 17 on the steel square—How to build hoists and scaffolds—skylights—How to build stairs—How to put on interior trim—How to hang doors—How to lath—lay floors—How to paint



THEO. AUDEL & CO., 49 W. 23rd St., New York City

Mail Audels Carpenters and Builders Guides, 4 vols., on 7 days' free trial. If O.K. I will remit \$1 in 7 days, and \$1 monthly until \$6 is paid. Otherwise I will return them. No obligation unless I am satisfied.

Name

Address

Occupation

ReferencePM

Learn WATCH REPAIRING

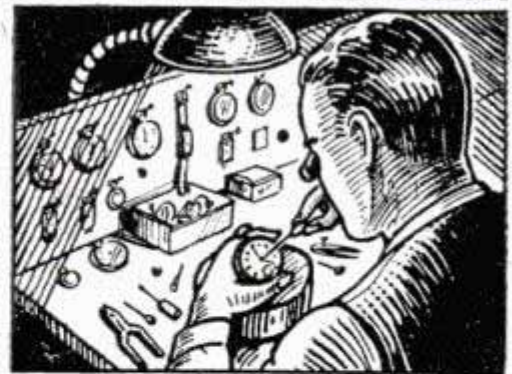

In Your Spare Time At Home
EARN WHILE LEARNING

Now—with the manufacture of watches scheduled for enormous production to meet big demand—the need for watch repairmen will be greater than ever before. Our practical Home Training Course prepares men and women for a big-pay profession. Be the ace Watch Repairman in your territory. Write TODAY for details.

FREE WATCH working tools and watch included as part of our Watch Repairing Course.

ILLINOIS SCHOOL OF WATCH REPAIRING
6312 Huntington Street, Dept. PM-5, Chicago 30, Illinois

WHY DON'T YOU WRITE?

Writing short stories, articles on business, homemaking, gardening, shop crafts, local and club activities, etc., will enable you to earn extra money. In your own home, on your own time, the New York Copy Desk Method teaches you how to write—the way newspaper men learn, by writing. Our unique "Writing Aptitude Test" tells whether you possess the fundamental qualities essential to successful writing. You'll enjoy this test. Write for it, without cost or obligation.

Veterans: This course approved for Veterans' Training.

NEWSPAPER INSTITUTE OF AMERICA
SUITE 559-E, ONE PARK AVENUE, NEW YORK 16, N. Y.

★ ★ **500 PERSONAL GUMMED LABELS**
Only **50¢**

COMPLETE NAME AND ADDRESS
PRINTED ON EACH!

500 Personal Labels, only 50¢ Postpaid! Two-colors—handsome blue printing of your complete name and address on attractive white gummed label paper! Use on letters, envelopes, postcards, checks, books, tools, egg cases, etc. HUNDREDS OF USES! Wonderful for those in Service! Order today! FAST SERVICE. Limited supply. Money-back Guarantee.

WESTERN STATIONERY CO., Dept. 473-E, Topeka, Kan.

LAW STUDY AT HOME for PERSONAL SUCCESS and LARGER EARNINGS. 35 years expert instruction—over 108,000 students enrolled. LL.B. Degree awarded. All texts furnished. Easy payments. Send for FREE BOOK—"Law and Executive Guidance."
AMERICAN EXTENSION SCHOOL OF LAW
Dept. 65-M, 646 N. Michigan Ave., Chicago 11, Ill.

Real Relief for Rupture Sufferers!



The Web Truss has brought comfort to thousands of satisfied users. Enthusiastic letters tell us it gives the wearer **real relief**. Scientifically shaped to do the job, made of strong washable materials, the

Web Truss gives the RIGHT support WHERE NEEDED. Satisfaction GUARANTEED.

Write for FREE descriptive literature, or ask your druggist about the Web Truss.

The WEB Truss Co., Dept. M18, Hagerstown, Md.

He'd rather serve you



★ Your hardware dealer is proud of his store. He's put a lot of time and a lot of work into making it a place where you can always find the newest and the best in quality tools and hardware.

Quality is the key to his business success. He learned a long time ago that there's no substitute for the real thing... that you can't do a good job without good tools.

So naturally he prefers to serve people like you... men who *know* superior design and workmanship and won't accept anything less... men with imaginations that create and skilled hands that get things done... men who read *Popular Mechanics* and have the alert, enthusiastic "P.M. MIND" that's always wide open to good new ideas.

Take advantage of your hardware dealer's preference for customers like you. Whatever you need in tools or hardware, he'll give *you* better service every time.

your HARDWARE DEALER sells QUALITY Tools and Hardware
...BUY FROM HIM

**POPULAR
MECHANICS**

10,000 HELPS TO BE YOUR OWN BOSS IN THIS BIG BOOK!



IF IT'S RESULTS YOU WANT—GET ACTION QUICKLY WITH THESE PRACTICAL IDEAS

Never before has a more helpful book been printed for those planning a business of their own. Gathered in this large illustrated volume are the formulas, recipes, facts and secrets that have contributed so largely to America's great industrial progress. Capitalize on this information for making most any conceivable product without experience, special equipment or previous knowledge of chemistry. Start at home, expand with profits—built for a profitable independence. The experts who compiled this book are authorities, and present this information in simple, understandable language. They also give you wholesale supply sources for needed materials, short cuts and economy methods for the most profitable results. Hundreds of good paying businesses have been built on a product made from a simple

recipe. Opportunities in this field exist everywhere. Choose from any of the 102,000 facts and 10,000 formulas of which the following are only a very few: Adhesives, Alloys, Anti-Freeze Solutions, Cosmetics, Beverages and Liquors, Candy, Gum, Casein, Celluloid, Oils and Ointments, Paints, Paper, Perfumes, Photography, Polishers, Powders, Remedies for Man, Beast or Fowl, Rubber Products, Refrigerants, Soaps, Solder and Soldering, Tooth Cements, Transformers, Transparencies, Varnishes and Thousands of others for making all sorts of profitable and practical things.

INCLUDED
Formulas for "D.D.T." insecticide. Also our New Book of Money Making Facts: "The More You Know the More You Can Earn—Easier and Quicker."

FORTUNES MADE FROM A SINGLE IDEA!
This comprehensive book is an accepted authority by chemists, schools, industry, etc. and is the largest and most comprehensive book of its kind ever issued. Nothing else like it in existence. A single formula has been worth a thousand times this book's small cost to countless owners. Crammed with money-making ideas. Invaluable for reference. Ideal for Factory, Home, Farm, Office or Workshop. As necessary as the dictionary and more useful for manufacturers, chemists and salesmen who put up products for profit.

POSTPAID!
\$3.50
U.S.A.
\$3.85
FOREIGN

ADAMS BROWN COMPANY, Dept. 165
Chestnut Hill 67, Massachusetts, U.S.A.

PLUMBERS & STEAM FITTERS

Audels Plumbers and Steamfitters Guides



4 Vols. \$6
A practical, illustrated, Reference Library and Study-Course for Master Plumbers, Journeymen and Apprentices Steamfitters, Gas Fitters and Helpers, Sheet Metal Workers, Draughtsmen, Master Builders, Engineers and all Building Trade Students. This valuable set of handy, pocket-size Guides explains in practical concise language and well-done illustrations all the principles, advances and short cuts of the Plumbing and Heating trade—based on modern practice. Contains careful, detailed instructions

on how to figure and estimate various jobs. Use **FREE COUPON** below to examine, without obligation, this valuable work.

INSIDE TRADE INFORMATION ON:

Soldering, tinning. Joint wiping, bending, beating. Pipe—iron—steel, threading. Mathematics, tables, physics. Materials—iron, steel, copper, brass, lead, tin, antimony, etc. Sheet metal—galvanized—plate. Sanitation, syphonage, tanks. Drainage, sewage, purification. Fixtures—bath—kitchen. Pipe fittings, soil pipe, tools. Laying out work. Roughing. Screwed fittings, flanges, joints. Pipe bending, examples. Elbows. Heating, ventilation, air conditioning, refrigeration. Water supply, mains, wells, tanks. Gas-fittings. Sheet metal work, problems, methods. Braising, heating, lead burning. Welding, various welds, methods. Blacksmithing, forges, tools. **Air Conditioning.**

THEO. AUDEL & CO., 49 W. 23rd St., New York City

Mail Audels Plumbers Guides, 4 vols., on 7 days' free trial. If O. K. I will remit \$1 in 7 days, and \$1 monthly until \$6 is paid. Otherwise I will return them. No obligation unless I am satisfied.

Name.....
Address.....
Occupation.....
Reference..... PM

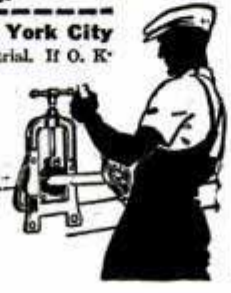

SALESMEN FOR CITY AND COUNTY

Nationally Known Manufacturer

Build up a business of your own with Nationally Advertised Products bearing Underwriters' label. Sell to schools, factories, service stations, warehouses, hotels, restaurants, public institutions, truck and bus companies, grain elevators, house trailers, autos, farms, homes, etc. **Capable man can earn real money.** Established in 1916. Write letter with details, age, experience, etc.

THE FYR-FYTER CO.,

Dept. 90-17 Dayton 1, Ohio

Correspondence Courses in RADIO and ELECTRICAL ENGINEERING

LOW AS \$25

ELECTRICAL ENGINEERING Get good grasp of wide electrical field. Modern. Very understandable. Theory made easy.
RADIO ENGINEERING Extra fine course in radio, public ad-be super-service man, real vacuum tube technician. Tuition **ONLY \$25**, either course. Deferred payment plan. Servicemen badly needed.

FREE SPECIAL! Write for copies school catalogs, student magazines, etc. Send **TODAY** and receive Free Copy of new booklet containing perhaps the most understandable explanation of the Atomic Bomb ever written! Many illustrations including probable bomb construction. **FREE** if you write at once!

LINCOLN ENGINEERING SCHOOL, Box 932-PA Lincoln, Nebr.

SECRETS OF LOCKSMITHING



At last in handy pocket size. Written by experts, after years of experience. Practical, simple instructions on Key Duplicating, Key Fitting, Lock Repairing, Changing Combinations, Master Keying, Lock Opening, etc. Hundreds of illustrations. Learn easily at home. Total Cost \$1.00. Send \$1.00 today—Satisfaction or money back guaranteed.

REPAIR SHOP SERVICE, Box 264-A, Skokie, Illinois

Fit-Rite makes False Teeth TIGHT

Makes loose dental plates fit snugly and comfortably. **LASTS for MONTHS!**

Simply squeeze on dental plate and put it in your mouth. Hardens and becomes part of plate. Money-back guarantee.
FREE Generous package of Dental Plate Cleanser with each order. Send \$1.00 or mailed parcel post collect.
Fit-Rite Co., 1573 Milwaukee Ave. Dept 5-P.M., Chicago, Ill.



HOME STUDY OR SHOP TRAINING

Learn Plastics, Refrigeration or Diesel. Study at home. Also shop courses in Body and Fender, Machine Shop, Tool and Die. 41,000 graduates. Established 1902. Free booklet. Specify trade.
GREER SHOP TRAINING, Dept. 156, 460 S. State St., Chicago

INVENTING —FOR PROFIT!

If you have an inventive turn of mind, write for free 28-page booklet explaining how the Institute of American Inventors is helping inventors pre-test the profit possibilities of proposed devices to fill today's unprecedented demand for new inventions.

INSTITUTE OF AMERICAN INVENTORS
Dept. 4, 1926 Eye St. N.W. Washington 6, D. C.

STUDY AT HOME

With An Educational Institution

Men with specialized training win higher positions, insure larger earnings, and are bigger successes in business and public life. Opportunities NOW greater than ever before. Send for our Catalog.

ARTS and SCIENCES

Courses in Philosophy; Education; Letters; Public Health; Medical Jurisprudence; Psychology; Sociology; Physics; Chemistry; Plastics; Geology; Political Science; Theology; Business and Commerce; Accounting; Mathematics; Statistics; Agriculture.

ENGINEERING

Courses in Electrical, Civil, Mechanical, Drafting, Architectural, Steam, Aeronautical, Radio, Structural, Mining, Industrial, Petroleum, Marine, Chemical, Diesel, Automobile, Refrigeration, and Air Conditioning Engineering.

LAW

Complete Professional Law Course includes 20 Hornbook Series college grade textbooks. Courses also in Commercial Law, Patent Law and Medical Jurisprudence. McKinley-Roosevelt Incorporated, 4619 K, Sheridan Rd., Chicago 40, Ill.

FREE GIFT for a Boy!

PARENTS COMPLAIN about cheap comic books. We will send the current issue of **FELLOWS** FREE and special gift card . . . plus 6 more big issues with 6-month's subscription for only \$1. **FELLOWS** is for boys 10-18. Stories, articles and game features of thrilling interest in wholesome all-American manner.



FELLOWS, 200-PM S. 7th, St. Louis 2



"MAGIC IS FUN"

A New Magazine for Amateur Magicians!

Now on sale at newsstands and magic dealers. CONTENTS: 24 large pages of easy to do tricks with coins, cards, mind reading effects, stories of famous magicians, instructions in Showmanship, etc. If your dealer does not have **MAGIC IS FUN**, remit 25c for first issue or \$1.50 for 6 issues. Outside U.S.A. price 30c per copy, \$1.75 for 6 issues.

D. ROBBINS & CO., Dept. M.I.F.
152 W. 42nd Street, New York 18, N. Y.

SAY YOU SAW IT IN POPULAR MECHANICS

BUILDING



Millions of homes needed. Nation wide call for builders. Big opportunities. Learn now in spare time. — at home. Practical training with blue prints. No books. Send for **FREE** Trial Lesson and blue print plans.

CHICAGO TECHNICAL COLLEGE
E-150 Tech. Bldg., 2000 S. Mich. Ave.
Chicago 16, Ill.

Collect U. S. Army Shoulder Patches

An interesting, fascinating hobby. From 20c to 50c each. Master set of 400 patches—\$97.50. Special Christmas Assortments \$1, \$5, \$10, \$25, \$50. Official patches available for every major Army and Air Corps Unit. Send \$1 for sample selection of patches and **PATCH CATALOGUE**. Orders from Canada—add 20%.



SPRINGER'S

286 San Francisco Street
EL PASO, TEXAS



NEW and Ready for you

ALLIED'S 1946 CATALOG

of Radio and Electronic Supplies

FREE
Send for it
NOW



BRINGS YOU LATEST, finest values in Radio! New receivers, phono-radios, Ham gear, parts, tubes, kits, code apparatus, tools, books, test instruments, public address—all types of equipment. Over 10,000 items. Leading makes. Guaranteed quality. Fastest service from the world's largest and most complete stocks under one roof. Send for your free copy of Allied's new 1946 Buying Guide now. *Save time and money.*

HELPFUL RADIO BOOKS

Radio Formulas & Data No. 37-752. 10c
Dictionary of Radio Terms No. 37-751. 10c
Radio Circuit Handbook No. 37-753. 10c
Radio Builders' Handbook No. 37-750. 10c
Simplified Radio Servicing No. 37-755. 10c
Radio Data Handbook No. 37-754. 25c
ALL SIX BOOKS No. 37-799. 75c
Parallel Resistance and Series Capacitance Calculator. No. X37-960. 25c
R-F Resonance and Coil Winding Calculator. No. 37-955. 25c

ALLIED RADIO

ALLIED RADIO CORP.
833 W. Jackson Blvd., Dept. 5-EE-6
Chicago 7, Illinois

Date.....

Send FREE 1946 CATALOG
 Send..... Books/Calculator No..... } \$..... enclosed
Calculator No.....

Name.....

Address.....

City..... Zone..... State.....

Do you want

- ➔ ..to go to College?
- ➔ ..or to enter a Profession?
- ➔ ..or get an Office Position?

(Such as Accounting, Architecture, Nursing, Dentistry; Teaching, Social Work, Osteopathy, Beauty Culture, Optometry, Embalming, Chiropractic, Law, Medicine, etc.)

To get anywhere, you practically MUST finish High School FIRST. You can complete our simplified High School Course in SPARE time at home, as FAST as your time and abilities permit. Equivalent to resident school work—prepares you for college, pre-professional examinations, business, industry. Standard texts furnished. Diploma. Credit for H. S. subjects already completed. Single subjects if desired. Low tuition, easy terms. American School, Chicago, est. 1897—endorsed by educators. Finish your high school education NOW. Write TODAY!

High School Course at Home

Many Finish in 2 Years

American School, Dept. H545, Drexel Ave. at 58th St., Chicago 37, Ill.

Gentlemen: Send me FREE information covering special training in subjects checked below. No obligation on my part.

- | | |
|--|--|
| <input type="checkbox"/> High School Course | <input type="checkbox"/> Diesel Engineering |
| <input type="checkbox"/> Architecture and Building | <input type="checkbox"/> Drafting and Design for Men & Women |
| <input type="checkbox"/> Automotive Engineering | <input type="checkbox"/> Plastics |
| <input type="checkbox"/> Business Management | <input type="checkbox"/> Private Secretary |
| <input type="checkbox"/> Electrical Engineering | <input type="checkbox"/> Mechanical Engineering |
| <input type="checkbox"/> Elec. and Gas Refrigeration | <input type="checkbox"/> Aviation |
| <input type="checkbox"/> Air Conditioning | <input type="checkbox"/> Salesmanship |
| <input type="checkbox"/> Railway Training | <input type="checkbox"/> Radio |
| <input type="checkbox"/> Electronics, Industrial | |

Name.....

Address.....

Keep that Car "TICKING"



Every operator and mechanic needs AUDELS AUTO GUIDE.

This book saves time, money and worry. Highly endorsed. It presents the whole subject of auto mechanics:

- 1—Basic principles
 - 2—Construction
 - 3—Operation
 - 4—Service
 - 5—Repair
- Handy Size. Easily understood.

NEW FLUID DRIVE, HYDRAULIC SHIFT AND DIESEL ENGINES FULLY COVERED

Over 1500 pages—1540 illustrations showing inside views of modern cars, trucks and buses with instructions for all service jobs.

4 COMPLETE • PAY ONLY \$1. A MONTH

ASK TO SEE IT!—To Get This Assistance for Yourself Simply Fill in and Mail Coupon Today.

AUDEL Publishers, 49 West 23rd St., New York
 MAIL AUDELS NEW AUTO GUIDE for free examination. If O.K. I will send you 51 in 7 days; then remit \$1 monthly until price of \$4 is paid. Otherwise I will return it.

Name.....
 Address.....
 Occupation.....
 Employed by..... PM

LET US TEACH YOU TO Mount Birds



Animals, Fish, Heads; to TAN. Hunters, Trappers, be a Taxidermist. Let this old reliable school teach you—at home, in spare time. Our school has over 300,000 students. Save your fine trophies. Mount and keep ducks, deer, ALL wild-game. Tan skins, make robes and rugs, double your interest in HUNTING AND FISHING. Have a home museum.

Free Book

Yes, FREE, this great strange book, with 100 fine wild-game pictures. Tells how YOU can become a real TAXIDERMIST, easily and quickly. It is amazing, thrilling, and may bring you a lifetime of PLEASURE and PROFIT. SPORTSMEN, grasp this opportunity. SEND NOW. A postal will do. But WRITE TODAY—don't fail. State your age.

N. W. SCHOOL OF TAXIDERMISTRY
 DEPT. 3375 OMAHA 2, NEBR., U. S. A.

CHAPMAN CHINCHILLAS

The originator of the first Chinchilla Farm in the United States. For information on purchasing the finest, selected breeding stock of these aristocratic animals that were virtually trapped to extinction write or visit—

Established 1919 **Chapman Chinchilla Farm**
 4957 West 104th Street
 Inglewood, California

FENCING

EXCITING FUN HARMLESS

NEW—Clean—Healthful Develops Strong Body—Alert Mind. Become best swordsman in your neighborhood. FREE BOOKLET (with foils) teaches Quickly—Easily. HARMLESS because the 3 ft. Spring Steel Foils (swords) have safety rubber buttons. Complete outfit 2 Steel Foils (swords) and FREE Instructions. Now Only \$1.98 postpaid. MAIL CHECK or M.O. today. Add 28c for Foreign Postage.

LEE PRODUCTS CO., 1613U-First Ave., New York 28, N.Y.

Learn TOOL DESIGN

Now, as never before, draftsmen and tool designers are needed to redesign for peacetime reconversion. Qualify quickly. Many making \$100 to \$150 per week. More qualified men needed than available. Good pay jobs waiting. Rush name and kind of job wanted today for full free facts. State age.

OHIO INSTITUTE OF TECHNOLOGY, Box 307, Greenville 1, Ohio

FALSE TEETH FIT TIGHT

WITH LINO-DENT

Permanently

Simply place strip of Lino-Dent on your plastic plate—insert in mouth and bite to make a perfect fit. Almost instantly looseness and slipping vanish. Gum soreness heals and disappears. Lino-Dent is made of the same, safe, non-irritating material many dentists use—the same material most modern dentures are made of—that's why we can guarantee perfect plate comfort with Lino-Dent—not for just months but permanently with one application. Not messy or sticky. Easily removable if desired. Full size package—send only \$1, specify upper or lower, we pay postage. Your money back at any time if not completely satisfied.

LINO-DENT, Inc., Dept. C 4 Clarke Place, New York 52, N. Y.



Three months after taking your course I STARTED TO PLAY FOR DANCES

"Before I took it I didn't know a note of music"
writes Miss Rosie Montemurro of Vancouver, B. C., Canada
 "Words cannot express my feelings to the U. S. School of Music. Before I took your course I didn't know one note of music. Three months later I started to play for dances. It has a clear explanation in every lesson." *Miss Rosie Montemurro.*
You, too, can learn your favorite instrument quickly, easily, for ONLY 7c A DAY



This letter is typical of many we have from pupils. Thousands who didn't know a note are now playing their favorite instruments—thanks to this simple home study way to learn music for only 7c a day. Learning music this famous "Print and Picture" way is easy as A-B-C! No long-winded explanations. No tiresome exercises. You play real tunes by note right from the start. If interested, send for Free Booklet and "Print and Picture" Sample. Mail coupon today, to U. S. School of Music, 75 Brunswick Bldg., New York 10, N. Y.

FREE! Print and Picture Sample

U. S. School of Music
 75 Brunswick Bldg., New York 10, N. Y.

Please send me Free Booklet and Print and Picture Sample. I would like to play instrument checked below.

<input type="checkbox"/> Piano	<input type="checkbox"/> Saxophone	<input type="checkbox"/> Clarinet
<input type="checkbox"/> Guitar	<input type="checkbox"/> Trumpet, Cornet	<input type="checkbox"/> Tenor Banjo
<input type="checkbox"/> Hawaiian Guitar	<input type="checkbox"/> Modern	<input type="checkbox"/> Mandolin
<input type="checkbox"/> Violin	<input type="checkbox"/> Elementary	<input type="checkbox"/> Practical
<input type="checkbox"/> Piano Accordion	<input type="checkbox"/> Harmony	<input type="checkbox"/> Finger Control

Name..... Have You Instrument?.....
 Address.....
 City..... State.....

Save 2c—Stick Coupon on Penn/ Postcard

See how easy it is!

"My country 'tis of thee, sweet land of liberty"

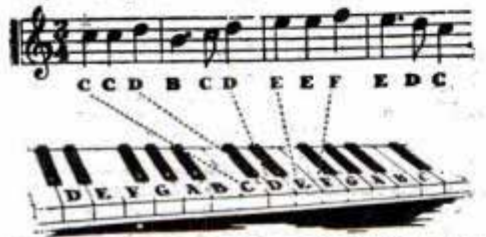

★
 Look at the music. The first note is "C." Follow the dotted line to the keyboard and locate "C" on the piano. Find other notes the same way. Strike the notes as indicated and you'll play the melody of America.

START YOUR OWN BUSINESS!

Amazing Postwar Development Now Gives You the Opportunity to Make Money Fast!

Startling scientific discovery, just now becoming available for general use, will enable you to start your own business and reap great profits! Plastics, one of the most revolutionizing and rapidly expanding industries, offers a great opportunity to all enterprising men and women. This is one of the few industries in which home manufacturers thrive and prosper. You can start even on a spare time basis in your own home, and expand rapidly into a full time business, paying good profits.

LIQUID MARBLE
 Make LIQUID MARBLE the amazing Plastic, with a thousand uses. LIQUID MARBLE can be poured into FLEXIBLE MOLDS for casting all kinds of artistic and serviceable articles such as: ornaments, novelties, desk sets, paper weights, book-ends, souvenirs, statuary, toys, etc.

FLEXIBLE MOLDS
 Make your own FLEXIBLE MOLDS. The cost is low—in fact, a large sized mold costs but a few cents. Hundreds of casts can be taken from a single mold.

NO EXPERIENCE NEEDED!
 No skill or previous knowledge is necessary. All you do is follow our easy-to-understand instructions.

UNLIMITED MARKET
 The market is literally unlimited. You will find steady year-round demand in your own community. Your problem will not be in selling but in supplying the huge pent-up demand. Moreover, we supply you with names of big buyers for your finished products.

WRITE TODAY
 Bing Products will show you how to start with a small investment and build a permanent, independent, profitable business! Don't fail to grasp this opportunity! Write today for FREE CATALOG.

BING PRODUCTS Dept. A4, 88 Broad Street
 BOSTON 10, MASS.

START YOUR OWN REFRIGERATION REPAIR SHOP!

Exceptional opportunity for men of all ages up to 60 who like to work with tools. Learn to be a service mechanic in REFRIGERATION. Our practical, thorough home training is easy to grasp in your spare hours with a common school education. Learn how to start your own business with \$50.00 worth of tools in garage, basement or small shop. Or take a well paid job in this active field.

FREE Booklet

• Write for FREE BOOKLET today.

MECHANICS TRAINING SCHOOL
 7217 So. Broadway Dept. P-5 Los Angeles 3, Calif.



DEAF PEOPLE
 WINTER AND SUMMER WEAR COMFORTABLY

PARAVOX
 ONE CASE - ONE CORD
HEARING AID

The last word in hearing-aid comfort and efficiency. All elements in one small, stylish case with one cord and ear-receiver. Handy as a compact or cigarette case — superb hearing efficiency.
NO SEPARATE BULKY BATTERY CARRIER

Comfortable in summer or winter. No extra wires — no extra battery case. Parts designed with watchmaker precision. Clear amplification, wide range in tone. Guaranteed for one year against material defect — Priced right.

Try a Paravox — you be the judge.

SERVICE PROBLEM SOLVED

No sending set to factory for service — no bothersome loan sets.

Accepted by the Council on Physical Medicine, American Medical Association



Get this booklet "New Satisfaction from Hearing Aids"

PARAPHONE HEARING AID, INC.
 2045 East 4th St. Cleveland 15, Ohio



You'll Agree It Was
Worth the Wait!

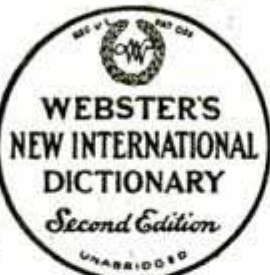

The
**Merriam-
WEBSTER**

YOU may have had to wait for your copy of WEBSTER'S NEW INTERNATIONAL DICTIONARY, Second Edition. Now, however, more and more copies are reaching your dealer. See him today—he may have one for you or will get it soon.

The MERRIAM-Webster contains 3,350 pages, illustrations for 12,000 terms, and a total of 600,000 entries—122,000 more than any other dictionary. It is the only unabridged dictionary completely revised and rewritten in 25 years—the dictionary for today's needs. G. & C. MERRIAM COMPANY, Publishers, Springfield 2, Mass.

"The Supreme Authority"

**Learn this
Profitable
Profession**



**IN 90 DAYS
AT HOME**

**Money-Making Career Open
to Men and Women, 18 to 50**

Hundreds of men and women between 18 and 50 make \$10 to \$20 in a single day giving scientific Swedish Massage and Hydro-Therapy treatments. There is big demand from doctors, hospitals, sanatoriums and clubs. Graduates earn large full time incomes from these or in private practice in their own offices. Others make good money from home treatments given in spare time. Learn this interesting, money-making profession in your own home, through our home study course. Same instructors as in our nationally known resident school. You can win independence and prepare for future security by qualifying for your Diploma. Course can be completed in 3 to 4 months. Many earn while they learn. Begin your training at once.

Anatomy Charts & Booklet FREE

Enroll now and we will include, at no extra cost, many needed supplies. Fit yourself to help meet growing demand for Scientific Swedish Massage. Send the coupon at once for complete details. Anatomy Charts and 32-Page Illustrated Booklet, FREE, postpaid.



THE COLLEGE OF SWEDISH MASSAGE
Dept. 664E, 100 East Ohio St., Chicago 11, Illinois

Please send me FREE and postpaid, Anatomy Charts, 32-page Booklet and complete details on Home Training.

Name.....

Address.....

City..... State.....

**BECOME A
SERVICE
EXPERT**

**REFRIGERATION
and
AIR CONDITIONING**

Millions of Older Units Need Expert Service. Big After-the-War Expansion Will Create Even More Opportunities

Approved for Veterans "G.I." Training

Now, not "next week," is the time to start training for a top-pay job in this vital field. A drastic shortage of trained service experts exists. Many thousands more will be needed for big post-war expansion caused by new industrial uses. Train NOW to get your pick of best jobs. We will give you the practical training you need. For 2 years we trained men and women for the Army and Navy only, in fine-precision aircraft instrument work. So our methods must be right. Common schooling is all you need. Our unique system makes everything easy to grasp. You can train at home and in our big Chicago shops. Write for full facts TODAY, without obligation.

INDUSTRIAL TRAINING INSTITUTE

2150 Lawrence Avenue, Dept. PIR, Chicago 25, Illinois



**BUILDING
HUMAN STATURE**

"I grew 6 inches in a year through following instructions given in 'BUILDING HUMAN STATURE,'" says the younger man at left. "Now I am a head taller than my father."

If you wish you were taller send for FREE outline of this remarkable book loaded with practical information.

CARILLON BOOKS, Dept. 18, Boerne, Texas

**The Feuchtinger Method
develops to the
the natural
charm of your Voice**

Train yourself at home. Write for voice book—free. Sent only to those over 17 years of age.

PERFECT VOICE STUDIOS
Kimball Hall Bldg., 75 E. Jackson, Chicago 4, Studio 1355

BE A SHOW CARD WRITER



Be independent. Big money. Learn showcard writing. Fascinating. No special skill needed. Lifetime business of your own. Write for information.

SHERWOOD PUBLISHING CO.
P.O. BOX 8-D IRVINGTON, N. J.

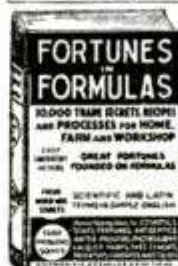

**ONE GOOD IDEA
MEANS SUCCESS**

Here's 10,000 formulas, recipes, plans, trade secrets, many of which have built fortunes. This massive 890-page volume in its 14th edition is an accepted scientific and industrial authority. Very simply written and may hold the key to your success. Only \$2.50 postpaid. C.O.D. PAID slightly higher.

C. H. BREWER CO., Dept. B
138 VINE ST., HARRISBURG, PA.

do you WORRY?

Why worry and suffer any longer if we can help you? Try a Brooks Patented Air Cushion. This marvelous appliance for most forms of reducible rupture is GUARANTEED to bring YOU heavenly comfort and security—day and night—at work and play—or it costs you NOTHING. Thousands happy. Light, neat-fitting. No hard pads or springs. For men, women, and children. Durable, cheap. Sent on trial to prove it. Not sold in stores. Beware of imitations. Write for Free Book on Rupture, no-risk trial order plan, and proof of results. All Correspondence Confidential.



Brooks Company, 359 State St., Marshall, Mich.

BE YOUR OWN BOSS - IN YOUR OWN BUSINESS



PLASTICS TECH.
The First School of
Plastics Fabrication
Home Training.

NOW--
YOU CAN CHOOSE
the way that
Suits You Best to
GET INTO PLASTICS!

Learn PLASTICS

FABRICATION AND CASTING,
OR ENGINEERING.

PREPARE NOW FOR
Key Positions in Plastics or
a Business of Your Own.

HOME TRAINING

BUILD YOUR OWN FUTURE
BE YOUR OWN BOSS

Get the full free story on the amazing new opportunity Plastics holds for you today. Learn how to do fascinating experiments in your own home with interesting materials. It's easy, lots of fun! Be your own boss, come and go as you please.

LEARN AT HOME THIS NEW
EASY WAY

Learn how you can start at home, with little money, to build your own big-paying business. We give you at home the fundamentals of Plastics you need for success. Practical experience, too. You learn to fabricate, shape, form, finish, cement, cast, compound, and make molds.

YOU MAKE FINISHED
PRODUCTS EARLY IN
THE COURSE

VETERANS!
COME TO CLEVELAND!
Approved for G. I.
Training.
TRAIN IN RESIDENT
CLASSES:

RESIDENT TRAINING

CLEVELAND CLASSES
ADVANCED TRAINING

Highly specialized Plastics engineering training is offered in our Cleveland resident classes and labs. Prepares you for key positions. We give you all the practical Plastics knowledge you need for success. Also the "know-how" experience from basic materials and design to finished products.

PLASTICS TECH PROGRAM PREPARES YOU FOR IMPORTANT KEY JOBS

Send coupon today. Learn how you can become a Plastics engineer, designer, draftsman, foreman, supervisor, consultant, purchasing agent, product-development engineer. These are but a few of the important jobs you can fill. The lack of trained men is holding back progress in the Plastics industry. Never before in the history of American industrial progress has so great an opportunity been presented to ambitious men. Plastics is your future, make the most of it now!

VETERANS: Check Coupon
for G. I. Training



Mail coupon at once and we will immediately send you our new book showing you opportunity for success in Plastics. And with it, a sample of our lesson material to show you how easily you can learn by actually doing the work at home.

GET SAMPLE LESSON MATERIAL FREE
1946 SUCCESS BOOK

PLASTICS TECH SCHOOL OF AMERICA, Inc.
5200 Euclid Avenue, Cleveland 3, Ohio

Mail me FREE Full Information without obligation.

Please check Veteran Civilian

Name.....Age.....

Street.....Zone.....

City.....State.....

I am interested in:

Home Training Resident School Training

FIRST RECOGNIZED PLASTICS SCHOOL IN

MS THE EAST

Learn to MOUNT BIRDS



Tan SKINS, make up FURS

Be a Taxidermist. Double your hunting fun. We teach you at Home. Mount Birds, Animals, Fish, Heads, common specimens. Fun and profits. Decorate home and den **MAKE MONEY**. Mount game, tan for others. Big profits in spare time. **WRITE TODAY.**

100 game pictures in FREE BOOK

Hunters, get your copy. It's

Now Free. Send post card. State your AGE.

NORTHWESTERN SCHOOL OF TAXIDERMY
Dept. 3375 Omaha, Nebraska

"How to Make Money With Simple Cartoons"

A book everyone who likes to draw should have. It is free; no obligations. Simply address

CARTOONISTS' EXCHANGE

Dept. 95

Pleasant Hill, Ohio

SUPER-MEMORY

Earn more. Learn more. Names, facts, figures stick like burrs. Perform amazing mental feats. For facts write **V3-THOR BOOKS**
-Box 1210, Chicago, Ill.

INVENTORS

WITH GOOD INVENTIONS

Should write us without delay for **FREE BOOKLET**. Protective Disclosure Form and facts about **The Inventor's Most Logical Markets**. Patented, Unpatented Inventions, all kinds, Cash, Royalty, needed by specific manufacturers. If your invention is for sale, write today for full particulars. A Post-Card will do! Address:

THE INVENTION REPORTER

5C-11106 South Longwood Drive

Chicago 43, Illinois

NAVIGATE Your Boat with Skill!

- **EXTREMELY SIMPLE METHOD OF CELESTIAL NAVIGATION WITH TABLES, PLOTTING SHEETS AND ACTUAL PROBLEMS.**
- **COASTAL PILOTING COMPLETE WITH POSITION-FINDING BEARINGS AND ALL THE RULES OF THE ROAD.**
- **CRUISING YOUR YACHT WITH GREATER SAFETY AND MORE FUN.**

This big 300-page book, **THE COMPLETE CRUISER**, packed with boating facts, 23 helpful photos, and more than 70 charts, diagrams and tables, has just been written by an expert skipper, Brandt Aymar, who spent two years navigating small craft as an officer in the U. S. Coast Guard (R). Covers everything from how to take sextant sights and instantly find your position—to stocking up for your cruise. Morse code, code flags, gasoline and diesel engines, equipment, maneuvering ship, compass variation and deviation, safety precautions, laying out a cruise, logs, plus hundreds more. **Only \$3.50**



FREE TRIAL

GREENBERG: PUBLISHER

406-Y Madison Ave., New York 17, N. Y.

Send me **THE COMPLETE CRUISER**. I will deposit \$3.50 plus postage with the postman. If not satisfied I may return it within five days for refund.

I enclose payment of \$3.50. Send postpaid. Same return privilege

NAME.....

ADDRESS.....

CITY AND STATE.....

How to Write

Short Stories, Mysteries, Novels, Articles,
Radio Scripts — Learn at Home in Your Spare Time.



"Since studying the Palmer course, I've been able to sell to The Post, American, Coronet, Esquire, Liberty, and other top pay magazines. It's the finest course anywhere."
Keith Monroe

The demand for writers creates great new opportunities for people with an urge to write and for experienced writers who want to make their work still better.

It's not as hard to be a successful writer as you may imagine. Most famous authors were once just ordinary people—with an urge to write. Some of them learned the slow, hard way, by trial and error. But now there's a direct road—Palmer Institute's home study training.

Endorsed by Famous Authors

Endorsed by Rupert Hughes, Gertrude Atherton, Ruth Comford Mitchell and others. There have been hundreds of successful graduates—new as well as established writers—in our 29 years' experience teaching fiction—the basis of big pay writing in all fields (short stories, novels, mysteries, newspaper and magazine articles, radio scripts).

Special Added Feature: two special courses, writing articles and radio scripts, now offered with Palmer Fiction Training without extra cost.

Learn At Home

You get thorough, individual instruction, right in your home. You get actual writing experience to develop your own style. Go fast or slow. Learn more. Save time and money.

To find out how you too may enjoy an ideal part time or full time career, send for FREE illustrated book—Palmer Institute of Authorship, Est. 1917, Hollywood 28, Calif. Desk T52. Send TODAY!

PALMER INSTITUTE OF AUTHORSHIP, Est. 1917
6362 Hollywood Blvd., Desk T52, Hollywood 28, Calif.

Please send me free illustrated book, "The Art of Writing Salable Stories," explaining how your training helps new writers get started and experienced writers increase their income. I understand this request is confidential and no salesman will call.

Name.....

Address.....

City.....Zone.....State.....

WHEN BOOMS GO BUST
WILL YOU BE BROKE OR BUSY
in a well-paying GOVERNMENT JOB?
(Thru CIVIL SERVICE)

CAREER TRAINING INSTITUTE will...



...prepare you NOW (Men and Women) at home thru broad, intensive, simple training to take tests for good jobs offered in Civil Service. Hundreds of classifications, many jobs for 1946, every chance to advance. Vacations with pay, pensions, sick leaves. No layoffs, no strikes, no discrimination. Our course is so inexpensive, no sensible person should delay mailing coupon TODAY.

CAREER TRAINING INSTITUTE, Dept. 202-A
1060 Broad Street, Newark 2, N. J.

Please send me FACTS regarding Government Employment (Civil Service), and how your course will help prepare me for tests.

Name.....

Address.....

City.....Zone.....State.....

Veteran? yes.....no.....



SAY YOU SAW IT IN POPULAR MECHANICS

**BE YOUR OWN BOSS — OPERATE
YOUR OWN PROFITABLE BUSINESS**

HOME and INDUSTRIAL APPLIANCES

SERVICE — REPAIR — INSTALLATION

ONLY shop training course of its kind. Gives you actual shop training on washing machines, mangles, heat control systems, water heaters, toasters, vacuum sweepers, etc., etc. Work on actual machines under trained instructors. Low tuition. Old established school. Most complete training course of its kind. Investigate this opportunity — its money-making possibilities and the need for trained men. Write today for details. No obligation. Veterans ask for GI plan. Act now!

APPLIANCE TRAINING SCHOOL—Dept. 52

Division of Commercial Trades Institute

6312 N. Broadway — Chicago 40, Ill.



**MUSIC
LESSONS**

LEARN . . . PROGRESS . . . EARN MORE . . . SUCCEED . . .
Your own achievement, popularity, success thru music. Learn in your home. Check course: Piano, Violin, Cornet, Saxophone, Clarinet, Guitar, Harmony, Arranging, History. If juvenile, parent's signature must accompany inquiry. Low cost. Easy Terms. FREE catalog. Suite U391 765 Oakwood Bl. Chicago 15

UNIVERSITY EXTENSION CONSERVATORY

CODE SPEED SHORT CUT

Radio Operator. Be an expert. Learn to be a Telegraph or work—good pay. Thousands of men needed. Intensely interesting work—good pay. Learn at home or wherever you are, quickly, easily with the famous Candler Speed System. Book of particulars Free. CANDLER SYSTEM CO., Dept. 5-E, Box 928, Denver 1, Colo., U.S.A.

CARTOONING



BECOME CARTOONISTS QUICKLY with our NEW, EASY, 45 LESSON COURSE. Only \$2.85 postpaid. Sample LESSON PLATE, details on our FREE EMPLOYMENT SERVICE and BIG TRIPLE VALUE OFFER sent FREE. Rush name and address TODAY.

NATIONAL ARTISTS BUREAU

Dept. A-7, Box 4248

Dallas 8, Texas

STAMMER?

This new 128-page book, "Stammering, Its Cause and Correction," describes the Bogue Unit Method for scientific correction of stammering and stuttering—successful for 45 years. Benj. N. Bogue, Dept. 1836, Circle Tower, Indianapolis 4, Ind.



Begin today. Write now for our Free Book, "How to Become a Good Penman." It contains specimens and tells how others learned to write in spare time. Enclose 10c for your name beautifully written and a pen point suitable for shaded writing. Write today.

THE TAMBLYN SCHOOL OF PENMANSHIP
N-441 Ridge Building, Kansas City, Mo.

CHANITE SELF-WELDING FLUX

REPAIRS ALL ELECTRIC HEATING ELEMENTS

So simple anyone can make repairs in your broken or burnt-out electrical appliances—irons, toasters, stoves, etc. Guaranteed nothing like it. From our mines to your appliances. \$1.00 per package. \$7.50 per doz. Stick form 25c. \$2.00 per doz. CHANITE SALES COMPANY, 914 So. Main, Fort Worth 4, Texas



FIBRE ARMS AND LEGS!

Light, correctly fitted, strong and comfortable. Natural appearance. Braces for all deformities. Scientific design. Fair Terms.

BUCHSTEIN-MEDCALF

610-3rd Av. S., Minneapolis, Minn.



The GLENWOOD MEMORIAL

Freight Paid Anywhere in U.S.A.

In all its beauty and durability is pictured in our free catalog of genuine Marble and Granite. Write for yours today.

U. S. MARBLE & GRANITE CO., A-18, Oneco, Fla.

SIGNS EASILY AND EXPERTLY PAINTED WITH LETTER PATTERNS

AND SHOWCARDS MANY SIZES & STYLES WRITE FOR FOLDER! JOHN F. RAHN 1330-31 N. Central Ave. CHICAGO 51, ILL.



Why be an ABECEDARIAN*

25c

*Webster says it's a tyro, a beginner, a novice, i.e., one who hasn't read Hodgman's 1946 Handy Book of Sportsmen's Secrets—the latest, biggest issue, sparkling with 168 pages of authentic, little known outdoor tricks—bulging with facts, crowded with dope on how to cram your creel and garnish your game bag. Order your copy now—it will be off the press soon. Only 25c—or a special DeLuxe edition for \$1.00.

HODGMAN RUBBER CO.
Paul St. Framingham, Mass.



Now You Can Lick ANY AUTO REPAIR JOB!

Look up make, model, job in MoToR's AUTO REPAIR MANUAL—and go to work! Complete guide for every model built since 1935. 764 pages; 1000 illustrations; 450 charts; 200,000 repair facts. Index. After 7 days' Free Examination, send \$1; then \$1 monthly for 4 months, 35c postage. If not satisfied, return book, pay nothing. MoToR Book Dept., Desk 1E, 572 Madison Ave., New York 22, N. Y.

HOW TO CUT RAFTERS New vest pocket book gives lengths, Side cuts, Plumb cuts, Deductions. For all rafters for any building from one inch to forty feet wide. Gives numbers to cut on square. Also degrees for same cuts for Radial Saws. All standard pitches from 1/8 to 5/8. Just open book to pitch page and there are your lengths, side cuts, etc. Anyone who knows what a jack rafter is can frame a roof if he has this great book. Price one dollar prepaid.

BUILDERS' TOPICS, Dept. M, Med. Arts Bldg., Seattle 1, Wash. Original teachers of the square in five easy lessons by mail. Send for FREE list of plan books—Kamp Kitchens to Mansions.

GET
INTO

REFRIGERATION AND AIR-CONDITIONING

Build your future in fast-growing industry. Prepare for high pay jobs or get into your own business. Dept. M5 Resident classes only.

Send ad with name and address for information. VETERANS Eligible for training under G. I. Bill, Check here

BOSTON TECHNICAL INSTITUTE
School of Refrigeration, 4707 Euclid Ave., Cleveland 3, Ohio



Fix Your Own ALARM CLOCKS

New, practical home course. Just out. Makes interesting hobby—profitable too. Save money by doing your own repairing at home. Easy if you know how. Price now only \$1.00. Details FREE. Send postcard.

THIS JEWELRY STORE, Genoa 3, Illinois

TAKE ORDERS GALORE 21 SUNSHINE NOTES 1 FOR ALL OCCASIONS A NEW CREATION

Tricky, novel designs. Everybody buys. No greetings inside. Sells like hot cakes. Costs as low as 50c. Also new Beaded Everyday Boxes, Birthdays, Convalescent, Everyday Gift Wraps. Send for samples on approval today.

Sunshine Art Studios, 115 Fulton St., Dept. EE5, New York City

RUPTURED?

Get Relief This Proven Way

Why try to worry along with trusses that gouge your flesh—press heavily on hips and spine—enlarge opening—fail to hold rupture? You need the Cluthe. No leg-straps or cutting belts. Automatic adjustable pad holds at real opening—follows every body movement with instant increased support in case of strain. Cannot slip whether at work or play. Light. Waterproof. Can be worn in bath. Send for amazing FREE book, "Advice To Ruptured," and details of liberal truthful 60-day trial offer. Also endorsements from grateful users in your neighborhood. Write: **CLUTHE SONS, Dept. 31, Bloomfield, New Jersey**

WAR BARGAINS in LENSES and PRISMS

NOW! MAKE YOUR OWN BINOCULARS!

Complete Set of LENSES
and PRISMS from
Navy's 7 x 50 Model

Save Up to \$150.00!



Here's an unusual opportunity to secure a fine set of Binoculars at a tremendous saving of money. Build them yourself with all of the very same optics contained in the Navy's 7 Power Glasses. Or you can construct a Monocular (1/2 a Binocular) in which case exactly one half quantities of the Binocular Components will be furnished. All Lenses and Prisms are in near perfect condition. Lenses are cemented. Complete assembly directions included for either project.

Stock #5102-H Near Perfect Binocular Set. \$25.00 Postpaid
Stock #5103-H Near Perfect Monocular Set. \$12.50 Postpaid
We now have some of the Metal Parts and Bodies for Navy's 7 x 50 Binoculars. Complete details sent with all orders for above sets or upon request.

35 MM KODACHROME PROJECTING LENS SET—Consists of Achromatic Lens for projecting, plus a Condensing Lens and piece of Heat Absorbing Glass with directions.

Stock #4025-H \$1.95 Postpaid

ALL THE LENSES YOU NEED TO MAKE YOUR OWN TELESCOPE! ALL ARE ACHROMATIC LENSES

GALILEAN TYPE—Simplest to make but has narrow field of view.

Stock #5018-H 4 Power Telescope. \$1.25 Postpaid
Stock #5004-H Small 2 Power Pocket Scope. \$1.00 Postpaid

PRISM TELESCOPES—Uses Prism instead of Lenses to erect image. Have wide field of view.

Stock #5012-H 20 Power Telescope. \$7.25 Postpaid

"OUR ADVERTISING SPECIAL"—15 lenses, plus 10-page Idea Booklet. Make your own telescope, microscope, magnifier, drawing projector, Kodachrome viewer; use for experimental optics, copying, ultra close-up shots, etc. Many uses.

Stock #1-H \$1.60 Postpaid
NEW 50-PAGE IDEA BOOK "FUN WITH CHIPPED EDGE LENSES." Contains wide variety of projects and fully covers the fascinating uses of all Lenses in sets listed above—only \$1.00 Postpaid.

TANK PRISMS—PLAIN OR SILVERED

90-45-45 deg. 5 3/4" long, 2 1/8" wide, finely ground and polished.

Stock #3004-H Silvered Prism (Perfect).... \$2.00 Postpaid

Stock #3005-H Plain Prism (Perfect).... \$2.00 Postpaid

Stock #3100-H Silvered Prism (Second).... \$1.00 Postpaid

Stock #3101-H Plain Prism (Second).... \$1.00 Postpaid

(Illustrated Book on Prisms included FREE)

MAGNIFIER SET... 5 Magnifying Lenses... Powers from 1 to 10. Various diam. for many uses. Free Booklet on Home-made magnifiers included.

Stock #1026-H..... \$2.00 Postpaid

OPTICS FROM 4-POWER PANORAMIC TELESCOPE—Excellent condition. Consists of Objective Prism, Dove Prism, Achromatic Objective Lens, Amici Roof Prism, Eye Lens Set (.... a \$60.00 value).

Stock #5016-H \$6.00 Postpaid

MICROSCOPE SETS

Consisting of two Achromatic Lenses and two Convex Eye Piece Lenses which you can use to make a 40 Power Pocket Microscope, or 140 Power Regular Size Microscope. These color corrected Lenses will give you excellent definition.

Stock #1052-H..... \$3.00 Postpaid

Consisting of Prism, Mirror and Condensing Lens. These used together with Stock #1052-H will make an excellent Microprojector enabling you to get screen magnification of 400 to 1000 Power according to screen distance.

Stock #1038-H..... \$2.00 Postpaid

SPECTROSCOPE SETS... These sets contain all Lenses and Prisms you need to make a Spectroscope plus FREE 15-page Instruction Booklet.

Stock #1500-H Hand Type Spectroscope... \$3.45 Postpaid

Stock #1501-H Laboratory Type Spectro-

scope..... \$6.50 Postpaid

We have literally millions of war surplus lenses and prisms for sale at bargain prices. Write for Catalog "H"—sent free!

Satisfaction
Guaranteed

Order by
Stock No.

Immediate
Delivery

EDMUND SALVAGE CO.

P. O. AUDUBON, NEW JERSEY

INVENTORS

Do Not Delay

Have you ever been startled by seeing a successful article on the market, and exclaimed—"Why, I invented THAT 5 years ago—I didn't think it valuable enough to Patent!"

The Patent Laws were intended for the Protection of the Inventor, and the Inventor who slumbers on his Rights may wake up to find someone else reaping the reward that could have been his.

Write NOW for Information and Record of Invention form FREE. RANDOLPH & BEAVERS, Registered Patent Attorneys, Columbian Bldg., Washington, D. C.

PERSONALIZED SERVICE — REGISTERED PATENT ATTORNEYS

RANDOLPH & BEAVERS

11-D Columbian Bldg., Washington, D. C.

Please send me full particulars on Patents, fees, etc., and "RECORD of INVENTION" form—FREE.

Name

Street

City State



PATENTS

AND TRADE MARKS

C. A. SNOW & CO.

Registered Patent Attorneys Since 1875
Write for Free Book and "Certification of Invention" form
427 SNOW BUILDING, WASHINGTON 1, D. C.



PATENT YOUR IDEAS

SEND FOR FREE BOOK

HOW TO OBTAIN A PATENT

Written by Former Member Examining Corps (1922-24) U. S. Pat. Office.
CARL MILLER, Registered Patent Attorney
Former Member Examining Corps U. S. Patent Office
Woolworth Bldg., Dept. 56-A New York — Bond Bldg., Dept. 56-A Washington, D. C.

PATENTS

Free preliminary advice

E. E. VROOMAN, Patent Lawyer

Registered Patent Attorney Since 1902
871 Woodward Building, Washington 5, D. C.

MAKE MORE MONEY

Applying or Selling **ROOF COATING**

Lasting

Extra profitable, easy to apply. Exclusive new formula makes this America's best roof coating for felt, composition, steel, slag, iron, gravel, concrete and metal roofs. Definitely superior in all climates, at all temperatures. Act at once!

DEALERS & AGENTS WANTED
Write for Details of Our Proposition

LASTING PRODUCTS COMPANY
MANUFACTURERS OF PAINTS, PUTTIES, PLASTICS
FRANKLINTOWN ROAD PLANT, BALTIMORE 23, MARYLAND



LEARN MOVIE PROJECTION

THEATRE MANAGEMENT

The Motion Picture Theatre Business offers big opportunities for trained men. Get into a fascinating field with a post-war future. Train at home in spare time. Free Catalog. Established 18 years.

370 Washington St., Elmira, New York

THEATRE INSTITUTE, AT HOME

MAKE MONEY CASTING

FREE FACTS SENT

Make hundreds of Plaster Casts, quick, easy. Sell output to stores, novelty shops, etc. Enormous profits. No experience. Very little capital needed. Start in basement, garage or workshop. Complete, simple instructions anyone can follow. Start now while merchants are begging for merchandise to sell. Rush.

PLASTIC ARTS STUDIOS, R.R. 5, Dept. 29, Muncie, Ind.

NOW ELECTROPLATING

Learn this profitable, interesting trade. Hobby or full time business. Chromium, Nickel, Gold, Silver, etc. Postcard brings full details, FREE.

PLATER HYDE, Dept. M, P.O. Box 176, National City, Calif.

FALSE TEETH

KLUTCH holds them tighter

KLUTCH forms a comfort cushion; holds dental plates so much firmer and snugger that one can eat and talk with greater comfort and security; in many cases almost as well as with natural teeth. Klutch lessens the constant fear of a dropping, rocking, chafing plate. 25c and 50c at druggists . . . If your druggist hasn't it, don't waste money on substitutes, but send us 10c and we will mail you a generous trial box. © I. P. INC.

KLUTCH CO. Box 4693-E ELMIRA, N. Y.

REFRIGERATION AIR CONDITIONING

MODERN SHOP TRAINING

approved **GI** training

TRAIN WHERE THE ARMY TRAINED IN THE SHOP OR AT HOME

This new, fast growing industry needs trained men now! It's fascinating work—easy to learn in our big shops—or train at home on special assignments and finish with practical intensive shop training. G.I. approved for home study, too. Same course and instructors from Army Training program attests the thoroughness and professional level of this long established institute in modern refrigeration and air conditioning.



LEARN BY DOING — WORK ON REAL MACHINES

Proven training methods and expert instructors get you into the heart of this work immediately. Work with tools on actual machines right from the start. It's practical, interesting and it gives you the "know-how" and the "know-why" that distinguishes CTI graduates in the field today. Investigate this opportunity now! Certificate issued.

FREE BIG 16 PAGE BOOK OF VITAL INFORMATION
Tells you the true facts . . . gives you vital information on CTI approved training.

RUSH COUPON TODAY FOR FULL DETAILS

ACT NOW!

LEARN IN YOUR SPARE TIME AT HOME

Commercial Trades Institute, Dept. M25
209 W. Jackson Blvd., Chicago 6, Ill.

Gentlemen:—Without obligation, please send me the facts. Let me judge for myself the opportunities and post-war security this training offers.

Check here if interested in GI training.

Name

Address

City State

SAY YOU SAW IT IN POPULAR MECHANICS

HOME INDUSTRY OPPORTUNITIES



Make Good Door Mats from Old Tires with simple homemade cutting and hole punching equipment powered with a 1/4 HP motor. Illustrated instructions, 50c.
 Profitable Toy Making. From scrap wood, paper, metal, rubber, linoleum, cloth, plaster, etc., 25c.
 Liquid Rubber from Old Tires. Make molds, door mats and rubber articles. Ten formulas and processes, 50c.
 How to Make 30 Useful Articles of Wire and Sheet Metal with homemade jigs. Illustrated, 50c.
 Rubber Mold Making. Marbleizing, glazing, flock, etc., 25c.
 Security in a Small Farm. Twenty ways described, 25c.
 10 Local Business Plans net up to \$200 a month, 25c.
 Collection of 100 Selected Formulas, 25c.

All 8 of the Above List of Booklets and Formulas, \$2.00. No C.O.D.

BUILDING CONSTRUCTION



with composition cement and cheap wood builds 3 room house low as \$250, farm buildings low as \$50. Homemade forms make blocks, panels and tiles in color, and wallboard of sawdust and other compositions. Wall-high blocks, insulated, with finished sides. Stream-lined roof and walls. Cement gutters, troweled roofs and floors. Ten formulas. Cabins, stores and sectional. 100 money and labor saving ideas. Mixer and saw easily made from an old auto. Make doors and windows. 50 proved way to earn \$10.00 to \$15.00 a day. Guaranteed, illustrated book, \$1.00.

MAKE FURNITURE OF COMPOSITION cement, sawdust, asbestos, paper. Some part scrap wood and metal. Illustrated instructions to make tables, cabinets, chests, racks, shelves, inclosed sinks, lawn novelties and toys, 500 per cent profit, 50c.

HOW TO MAKE ACCURATE SHOP MACHINES: Band, jig, and circular saws, electric drills, sanding wheels, forge, tools, electric weed cutters and many other things from old auto parts and washing machine motors. Illustrated, 50c.

HOME MFG. ENTERPRISES, 50 selected home shop projects, illus., 50c. Special: All four booklets described above, \$2.00 postpaid, No C.O.D.

HOME INDUSTRIES, 1318 So. 30th Ave. Dept. PM, Omaha 5, Nebr.

OTTAWA TRACTOR SAW



350 CUTS PER MINUTE

Make money sawing wood. Use Ottawa—fastest cutting. Cuts large, small logs easiest way. Fells trees. One man operates. Thousands in use. Built to last with heavy, stiff saw blade. Positive safety clutch control: uses power take-off any tractor.

OTTAWA MFG. CO., D-527 Forest Ave., Ottawa, Kan.

FREE BOOK and Price List

The ALL-PURPOSE ARC WELDER



Weld, braze, solder, preheat any type metal. Full size (75 lb. shipping wt.) 110 volt A.C. arc welder for home work shop, garage or small repair shop. 125 AMP output. Fully equipped.

\$45

FORNEY MFG. CO.
FORT COLLINS COLO.

So You Think You're Living?

Yes, you're going through the motion, all right—eating, sleeping, working and all that. But are you really LIVING? And how do you KNOW you are living? To find out read "Life Unlimited," a message for immortals. Your copy mailed free on request.

LIFE UNLIMITED, Dept. PM-5

3227 Indiana Ave. St. Louis 18, Mo.

You can learn touch typing while you play

SWEET MUSIC

on the

typatune*



\$14.95

including Typatune Music Book No. 1

Everybody's talking about this amazing musical instrument and educational toy! Teaches touch typing while you play your favorite songs. No musical knowledge necessary. Typatune has 32 musical notes indicated by letters of the alphabet arranged like a standard typewriter keyboard. All you do is follow the simple letter arrangement in the Typatune Music book. You play songs right from the start, and automatically learn touch typing. It's a sensational fun-maker at parties . . . a fascinating gift for children. See Typatune at your dealer. If he cannot supply you, use coupon below.

TYPATUNE, Inc., Dept. PM-5, 45 W. 18 St., N. Y. C.

Send me C.O.D. one Typatune with Music Book No. 1, at \$14.95 plus delivery charges.

Name

Address

City State

AIR RIFLES BENJAMIN AIR PISTOLS ARE IN PRODUCTION

ORDER BENJAMIN AIR RIFLES & BENJAMIN AIR PISTOLS from your DEALER. Send for our FREE FOLDER and Complete Specifications TODAY. Both Calibre Benjamin H-C Pellets are available now. BENJAMIN AIR RIFLE CO., 812 MARION ST., ST. LOUIS 4, MO.

TRAVEL FOR "UNCLE SAM"!

\$1,506 to \$2,650 FIRST YEAR

RAILWAY POSTAL CLERKS

Veterans Get Special Preference



Many other Government Jobs. City and Rural Carriers — Postoffice Clerks — Patrol Inspectors — Accountants — Customs Guards — etc. Prepare Now for 1946 Examinations.

FRANKLIN INSTITUTE, Dept. R79, Rochester 4, N. Y.

Sirs: Rush to me, without charge, copy of 32-page book, "How to get a U. S. Government Job," list of positions, and full particulars telling how to prepare for them.

Name

Address Vet?



BOY IT'S KEEN! A REAL METAL RAPID FIRING "G-BOY" REPEATING CAP PISTOL

- RAPID FIRING! • LOOKS LIKE A REAL "45"
- ACTUALLY SMOKES ON FIRING
- HAS LOUD EXPLOSIVE REPORT.

It's a thriller. Yes! Looks and feels like the Automatic "45's" carried by our Army Officers... with a plastic "Pearl" handle. Easy to reload. Any boy would gladly give his entire allowance for one of these.

\$1.95

ORDER DIRECT... TODAY... PROMPT SHIPMENT
Satisfaction is guaranteed. Send check or money order for immediate shipment—express charges collect. (Smallest order \$1.00. No C.O.D. orders.)

UTILITIES STORES, 117 S. Wabash Ave., Dept EA, Chicago 3, Ill.
I enclose \$..... Ship at once via express, charges collect,.....
G-Boy Repeating Cap pistols,rolls of caps, andholsters.
Name.....
Please Print Name and Address
Street or R.F.D.....
City..... State.....
Established 1906

PROMPT SHIPMENT

ORDER DIRECT TO DAY!



Box of 5 rolls caps only 15c
7 Boxes for \$1.00

Genuine Cowhide Holster for Famous "G-Boy" Gun \$2

Now Available! For Immediate Shipment! EXCEL 16 MM. Movie Projector



A Laugh a Minute Cartoon Films
• Our Gang Comedies
• Krazy Kat
• The 3 Stooges
• Scrappy
in 100 ft. Rolls at only \$2.75 a roll.

Enjoy the Fun of Movies at Home!

This is the Finest Low-Priced Motor-Driven Projector Available. Comes furnished with a 200 ft. Take-up Reel, 2-inch lens in focusing mount, tilting device, 120-watt lamp, accessible Spring Belt Drive, Motor Driven Rewind, Switch control Motor, Baked on Enamel Finish and Power-House Type Constant speed motor. A.C. only. Shipping wt. 7 lbs.

FOR ONLY

\$15.50 (Movie Projector Plus Postage)

MAIL COUPON NOW!

UTILITY STORES, 117 S. Wabash, Dept. EG, Chicago 3, Ill.
Please ship as indicated below:
____ Excel 16MM Movie Projectors at \$15.50 \$____
____ 100 ft. Rolls of "Laugh a Minute" Cartoons at \$2.75 \$____
for which I enclose \$____ Postage \$____
Check Films Wanted: Krazy Kat Scrappy
 Our Gang Comedies The 3 Stooges
Name _____
Street or R.F.D. _____
City _____ State _____
Established 1906

Look! STURDY ALL-METAL SKOOTER SKATE

Just What the Boys and Girls Have Been Waiting For

\$2.59 Plus 20c Mailing Charge

- Yes! It's all metal.
- It has steel ball bearing wheels
- Will take hard wear.

An ideal toy to make children happy and strong. Order several for the nicest children you know.



ORDER DIRECT - TODAY... PROMPT SHIPMENT

UTILITY STORES, 117 S. Wabash, Dept. EB, Chicago 3, Ill.
Enclosed is \$____ Send at once
ALL STEEL Skooter Skates at \$2.59 each, plus 20c mailing charge.
Name _____ PLEASE PRINT
Street or R.F.D. _____ State _____
City _____ *Established 1906*

**WORLD'S
BEST
WANT AD
MEDIUM**

CLASSIFIED Advertisements



Advertisements in this section 50 cents per word, each insertion, minimum 10 words, payable in advance
To be inserted under proper classification in June issue, copy should be in our office May 4th

June issue on sale June 1st

F. W. Johnson, Manager, Classified Advertising

Popular Mechanics Magazine, 200 East Ontario Street, Chicago 11, Illinois

YOU'LL PROFIT

By reading and answering the classified ads in this section. Hundreds of opportunities to make and save money.

Popular Mechanics Magazine,
Chicago, Illinois

Dear Mr. Johnson: Attached please find pay for the next month's insertion of our ad in the classified section, under same heading and same as featured in the last issue now on newsstands. The ad is still pulling like a ten mule team and checking reveals that it brings almost as many inquiries and orders as the next three mechanical magazines combined.

(Original letter on file in our office)

Cordially yours,

A. CHERVENCE

1457 CLASSIFIED ADVERTISEMENTS 1457 OPPORTUNITIES FOR YOU

AUTOMOBILES, MIDGET CARS

DUALTONE Custom built twin muffler sets, for Fords and Mercurys. Eliminates back pressure giving increased gas mileage and horsepower. Designed for deep mellow tones. Instructions included, \$20.00. Dual-tone Mufflers, 2636C India Street, San Diego 1, California.

USE Scrap parts and easily build your own two-passenger midget "Jeep" or speedy Scooter-Car (three wheel, two-passenger runabout, powered with small gasoline engine). Working plans for both vehicles only \$1.00! Universal, 2671 Algonquin, Toledo 6, Ohio.

AUTOCAR, English Automobile Magazine. Interesting advertisements, articles on foreign cars. Sample copy 50c postpaid. Clymer, Dept. A54, 2125 W. Pico, Los Angeles 6, Calif.

AUTOMOBILE Racing book, fifth edition, well illustrated. Instructions on building bodies, frames, engines. Ford A and B conversions. Plans. AAA rules, specifications. Roadster racing. Indianapolis cars. \$1.00 postpaid, \$1.30 C.O.D. Ray Kuns, Dept. 47, Madisonville, Cincinnati 27, Ohio.

FLOYD Clymer's popular automobile books: Motor History of America, complete authentic book American automobile development \$3.00—Motor Racing With Mercedes-Benz, complete Europe Grand Prix Racing Book \$2.00—Ab Jenkins World's Record Book \$1.50—Sir Malcolm Campbell's World's Speed History Book \$2.00—Modern Steam Automobiles Background \$2.00—Power and Speed, wonderful book \$2.50—Sample copy English Autocar 50c. All books postpaid. See our advertisement under Motorcycles. Clymer, Dept. A51, 2125 W. Pico, Los Angeles 6, Calif.

500 MILE Indianapolis Automobile Racing History Book, just printed. Complete history detailed year by year results every Indianapolis race since 1909. 320 large pages, over 2000 illustrations, drawings, photographs describe foreign, American racing automobiles. Photographs world's famous drivers. View in your arm chair every mile of every event at 10c a race average cost. Complete book postpaid \$3.50. De luxe edition bound attractive red Du Pont Fabrikoid \$5.00. Limited number available—hurry! Clymer, Dept. A52, 2125 W. Pico, Los Angeles 6, Calif.

REPAIR Your car. Motor parts for all engines, chassis parts, ignition and carburetor parts, etc. New replacement parts. Genuine and highest quality at manufacturers' retail prices. P.O.B. Chicago. No body parts. B & N Engineering Co., Box 3454 Merchandise Mart P.O., Chicago 54, Illinois.

CUSTOMIZE Your automobile. Illustrated, new restyling ideas, instructions, suggestions, specific model changes by simple methods. \$1. Speed Wheel, Box

PROFESSIONAL Midget racer, motor-scooter, midget roadster, and midget motorcycle. Plans, specifications for all four contained in illustrated handbook. 25c. Big list bargain priced used motors, motor-scooters, servicycles, etc., included free! Midwest, 3839 Drummond, Toledo, Ohio.

JET Impulsion now for automobiles. Rush name. Free literature. Wayne Engineering, Greenville 1, Ohio.

R & R Mfg. Co., marine and auto division. Anderson, Indiana, Robert M. Roof, \$1.00 for our new 1946 speed and power equipment catalogue with price sheet—showing racing cars, midgets, speed boats with recommendations how to rebuild your motors for racing. Dual ignition racing cylinder heads for V-60-100 and Mercury Ford engines. Dual intake manifolds, racing pistons, camshafts, compound valve springs, Lynite flywheels, quick change gear boxes and numerous other supplies.

FREE List Photos race cars with drivers. Frank Smith, Midland Park, N. J.

TRUCK Operators, auto owners and maintenance men. Systematic automotive maintenance will keep equipment rolling, prolong its life, prevent accidents and save money. Copyrighted 1946. Price \$1.00. Bureau of Systematic Maintenance, Box 356, Eau Claire, Wis.

BUILD Speedy midget track racer from castoff parts! Plans, specifications, construction information, \$1.00. Motor Supply, Box 1682-CS, Toledo, Ohio.

KNOW Your car, a modern motor chart which covers tune up from A to Z. How to keep your car in tip top shape. Tune your car once a month for efficiency and top performance. Send \$1.10 to Modern Motor Chart, P.O. Box 602, Trenton 4, New Jersey.

AUTO SUPPLIES AND EQUIPMENT

NO More worries about flat tires! Ernie Airline tire inflator \$1. Super Scissors auto jack \$6.50. Brake bleeder hose 25c. All three items delivered for \$6.50. Money back guarantee. Distributors wanted—Write for free details. Kramer Industries, PM3145 Euclid 17, Ohio.

LOREMAN Spark plugs. Quick starting, fast getaway, smooth driving, more mileage. State make, year, model, number of cylinders. Sets of 4 or more only 59c each. Check or money order. Loreman Automotive Products, Salisbury, Maryland.

MUFFLER Manual. Convert easily to Hollywood, Laguna, Westwood, duals, etc. Includes construction details, regulations, diagrams. Postpaid \$1. Mellotone, Box 723E, Arcadia, California.

AIR Compressor outfits, complete with quart size spray guns, less motors. Use your own 1/4-horsepower motor. Limited quantity. Write for details. Box 172, North

LICENSE Plate discharge insignia \$1.00 postpaid. Serwell Products, Cleveland 3, Ohio.

BUG Screens: for car, truck or tractor. Prewar made. Highest quality. State make, year, model. \$1.25 value. 50c each. Postpaid. Allen Co., Clinton, Missouri.

TIRE Reliners \$1.50 each. Self vulcanizing. Allied Rubber Co., East St. Louis, Ill.

OPERATE Cars, trucks, tractors, motors, with wood or coal gas, 1/2 cost of gasoline. Extensively used in Europe. Complete detailed instructions \$1.00. W. M. Cross, Lone Rock, Wis.

1000 MOTORISTS Needed to make gas saving test. Up to 30% savings. For trial test offer write Vacu-matic Carburetor Co., 7616-1275 W. State Street, Wauwatosa, Wis.

SURPLUS—Automobile washing coats, rubberized, rear-fastener, new, \$2.80, four for \$10.00. Belmont, One LaSalle, Chicago.

MAGIC At your finger tips, with the new push button plastic key case, which automatically opens and selects your car key! Available in two colors, red or black. Send no money. \$1.00 C.O.D. Satisfaction guaranteed or money back. Flippo Mfg., P.O. Box 73, Oakland 8, Emeryville Branch, California.

RINGS For all old or new cars, trucks, tractors, engines, compressors, pumps. Exact diameter and width must accompany order. Standard Piston Company, 1306 Commonwealth, Boston.

MECHANICS Make money selling and installing Vacuum Superchargers, more speed, power, and a real gasoline saver, uses gasoline your motor is now wasting. Only \$7.50, self-addressed envelope for pamphlet. McDowell Co., 2000 NE. Union, Portland 12, Oregon.

GASOLINE Saving device. Chevrolet, Ford 1932-1942, Dodge, Plymouth, 1933-1938. Walert Company, 3420 North 10th Street, Milwaukee 6, Wisconsin.

GRILLES For all cars, Meyers Auto Parts, 820 Dryades, New Orleans, La.

HAVING Car trouble? New, used, guaranteed auto, truck parts save money. Transmission specialists. Describe needs; immediate reply. Victory, 2930 1/2 North-western, Chicago 18.

AUTO Parts for all autos and trucks. Trans., motors, differentials, fenders, carburetors. Also body parts. Security Auto and Truck Parts, 1941 BJ Eddy, Chicago 13.

OIL Pumping motors—Brought back to normal without ring job. Write for particulars. Joe Mullner, Box 3102, St. Paul 1, Minn.

PLATING Outfits for auto parts. Connect to a battery. No tanks used. Free particulars and proofs. Gunmetal Co., Ave. J. Decatur, Ill.

AUTO TRAILERS

BUILD Streamlined trailer coach. Has everything. Fine, large 18"x24" blueprint and instructions, \$3.00. Manual of working drawings, \$1.00. Craftsmann Books, Box 1153-P4, Milwaukee 1, Wis.

BUILD Your own trailer! Save money! Have every feature you want! Plans for house, sport, camp and utility trailers. Catalog describing 9 models 10c. 15c in Canada and overseas. Jim Dandy, Box 125-A, Wausau, Wisconsin.

AUTOMOBILE—Trailer Travel, monthly magazine, \$1.00 year. Kimbel, Plant City, Florida.

MOTORCYCLES, BICYCLES, MOTOR-SCOOTERS AND SUPPLIES

INDIANA Distributor for English B.S.A. and Sunbeam motorcycles, eleven distinct models. Parts accys, all makes. Parts inquiries answered free. Catalogue at request. Let us major your motor and block test. Largest stock motorcycle parts in Indiana. Preston Motors Inc., 133 Columbia St., West, Ft. Wayne, Ind. 611 So. Harrison.

BUILD Electric bike. Relay controlled. No gears or welding required. Klaus, 1369 Missouri St., Pittsburgh 6, Pa. Plans \$1.00.

CHANGE Your bicycle to electric or gas motorcycle. T. M. McDonald, 837 Magnolia, Beaumont, Calif.

BUILD A Velocar (pedal car). 10c will bring you illustrated literature. Velocar Reg'd, 1643 Bourbonniere, Montreal, Can.

PARTS, Accessories, pistons, chain motors, transmissions, generators rebuilt or exchanged. Allied Sales, Box 114, El Paso, Texas.

HOW To build motorbikes and scooters. Complete plans, with motor repair and other information, \$1.00. Dept. M, Post Office Box 124, Evansville 5, Ind.

MOTORSCOOTER Plans for boys. Speedy, simple to build. Uses washing machine gas motor. \$1.00. Strachan Scooter Shop, Howard 2, Kansas.

MOTORSCOOTER \$10, Motor \$3, tires \$2! Send 25c for big new catalog number 912, just printed, listing scores of other sensational bargains in motors, wheels, motorscooters, motorbikes, servicycles, tires, etc. Associated, Box CS-1764, Toledo, Ohio.

BUILD America's lowest priced motor-scooter speedster! Complete plans, specifications, \$1.00. Big list bargain priced used motors, etc., included free! Motor Supply, Box 1682-CS, Toledo, Ohio.

MOTORCYCLE Cylinders rebored to any size and polished \$3.00. Indian Motorcycle Sales, 1420 S. Calhoun St., Fort Wayne 2, Indiana.

CUSHMAN Motorscooter less motor \$18; midget racer less motor \$35; motorscooters \$40 up complete; motorbike \$30; 1½ h.p. Smith motorwheel \$3; new 2 h.p. Lauson motor in factory crate \$22; Briggs-Stratton motors \$6 up. Over 1500 small tires in stock. \$1.50 up. Mailorder only. Send 25c for catalogue Number 13 just out listing these and hundreds of other bargains. (35c by first class mail.) Midget Motors Directory, Athens, Ohio.

METAL Disc rubber tired wheels for toys, wheel barrows, wagons, scooters, etc. Sizes 8-7-6-5 axles available. United Wheels Mfg. Co., 11727 LaFayette Ave., Chicago 28, Ill.

INDIANAPOLIS "500" Race History Book. 320 large pages, 2000 illustrations. Complete detailed information every event held Indianapolis Speedway since 1909. Year by year detailed results, \$3.50. De luxe edition red Du Pont Fabrikoed binding \$5.00 postpaid. See our ad under "Automobiles." Clymer, Dept. A57, 2125 W. Pico, Los Angeles 6, Calif.

FLOYD Clymer's popular motorcycle books: Motorcycles, How to Manage Them \$1.50—Motorcycling Manual \$2.00—English Motorcycle Service Manual \$1.50—Speed, How to Obtain It \$1.50—Power and Speed \$2.50—Motorcycle Questions and Answers \$1.50—Sample English Motorcycling Magazine 50c—Complete plans build attractive motor scooter \$2.00—Plans Electric Bicycle \$1.50—all books postpaid. See our advertisement under Automobiles for automobile books. Clymer, Dept. A50, 2125 W. Pico, Los Angeles 6, Calif.

ENGLISH Motorcycle Magazine. Photographs, articles, advertisements interesting foreign motorcycles. Sample copy 50c postpaid. Clymer, Dept. A56, 2125 W. Pico, Los Angeles 6, Calif.

NUMBER Three Clymer Motor Scrapbook now ready. Entirely different from Editions One and Two. 250 early automobiles, motorcycles illustrated, described. Pike's Peak Racing History included in Floyd Clymer's story, \$1.50. De luxe cloth-bound \$2.50. (Editions One and Two available same price.) Clymer's Steam Automobile Scrapbook \$2.00. All postpaid. Clymer, Dept. A53, 2125 W. Pico, Los Angeles 6, Calif.

PLANS For attractive motor scooter \$2.00—Electric Bicycle Plans \$1.50. Clymer, Dept. A55, 2125 W. Pico, Los Angeles 6, Calif.

MODERN Motorcycle Mechanics manual, 560 pages, 300 illustrations, covers Harley, Indian and English makes. The most complete motorcycle book published, \$3.00 postpaid. Nicholson Brothers, Motorcycle Engineers, Saskatoon, Sask., Canada.

BOYS, Illustrated "Bicycle Repair Manual" teaches brake repairing, re-spoking wheels, etc. Dealers wanted, 65c. Robt. Klausner, Shelbyville, Ill.

GENUINE Moto-Scoot parts. Complete wheels, tires, tubes, 4:00x7, 3:50x6. AMSCO centrifugal clutch. Windshield, side cars. All other parts and accessories. Write for parts list. Also genuine engine parts for Briggs and Stratton, Lauson, American Moto-Scoot Co., 1319 W. Carroll Ave., Chicago 7, Ill.

NEW Ranger Scootericycles, the latest word in power scooters. Light, weighs only 83 lbs.; fast, up to 30 miles per hour; economical, up to 90 miles per gallon. See your Ranger dealer or write Mead Cycle Company, 4520 W. Madison Street, Chicago 24, Illinois.

BICYCLE Book, how to buy, rebuild, sell used bicycles 50c. John Collett, Handley, Texas.

HARLEY-DAVIDSON Service, parts, accessories. Buddy seats \$17.75, tandems only 45" models \$12.50 (shipping paid). Can be fitted to other models. Send \$2.25 for Army Motorcycle Manual, 10c for bulletins. Knuth's (Harley-Davidson factory dealer), 2491 W. Fond du Lac, Milwaukee 6, Wis.

BUILD Scooters, trailers, midgets, conversions. Large manual \$1.00. Circulars dime. Craftsmann Books, Box 1153-P2, Milwaukee 1, Wis.

COMPLETE Motorcycle parts list, 10c. All models Indian and Harley. Pistons, chains, sprockets, generator repairs, carburetor rebuilding, motor rebuilding, repair manuals. Bootz, 622 E. Grand, Des Moines 9, Iowa.

MOTORCYCLE Cams ground for speed and power. For information write Harold Schaller, 247 West Main, Turlock, Calif.

LARGE Stock Indian parts. Expert motor rebuilding. Indian Motorcycle Sales, Kansas City 1, Mo.

TIRES, Tubes, wheels, for industrial trucks, carts, wheelbarrows, scooters, midget cars, coaster wagons. Nationally known makes, first-line quality. Sizes 8" to 18" o.d. in 2, 4, and 6 ply tires, separate inner tubes, heavy duty demountable wheels. Also caster forks, straight and swivel types. Free illustrated circular and prices. Jahant Co., 626 East Exchange Street, Akron 6, Ohio.

TIRES And industrial wheels, suitable for scooters, wheelbarrows, farm equipment, etc. All sizes. Bicycles and accessories. Largest assortment in America. Send dime for list. Cycle Transport Company, 1241 So. Michigan Ave., Chicago 5, Illinois.

AVIATION

PROPELLERS—All types, fit any motor. 3 blade Airliner for sleds, boats. Illustrated lightplane literature. Aircool motor conversion 50c. Quick delivery. Standard Aero-craft, Ft. Worth, Texas.

NOW! Learn flying at home. Build trainer for little or nothing. Detailed drawings—extensive flying instructions. \$2.45. Train-O-Plane Company, 805 S.W. 124th, Seattle 66, Wash.

AIRLINE Baggage stickers, 7 different 25c, 20—\$1.00, 32—\$2.00. Evans Smith, 45 East Banks, Chicago, Ill.

HELICOPTER Instructions. Rush name. Free literature. Wayne Engineering, Greenville 1, Ohio.

JET Propulsion circular sent builders bikes, airplanes. Byrum, Buffalo, Okla.

CUBS, Wacos, Taylorcrafts, Aerocars—\$125 and up! Big new catalog, 25c. lists these and thousands of other sensational airplane bargains. Some are "easy to repair" crackups. National, Box 1682-CS, Toledo, Ohio.

AIRPLANES, Gliders, crackups, located everywhere, some probably near you. Send 25c for directory, giving owner's price, name and address. (35c by first class mail.) Used Aircraft Directory, Athens, Ohio.

JET Propulsion. Know jet propulsion. Build your own units for model airplanes. Get complete data, drawings, design charts. Only 50c. Technical Press, Box 951 Y., Salem, Mass.

PROPELLERS For ice-snow sleds, air boats. Literature 5c. Banks Propellers, R.F.D. 7, Ft. Worth, Texas.

LIGHTPLANE! How to build them. Illustrated circular 20c. Craftsmann Book, Box 1153-P1, Milwaukee 1, Wis.

JET Propulsion experiments. New principle to drive boats, bicycles, model helicopters. Circular on plans. Rush name. Houston Maupin, Tipp City 53, Ohio.

BATTERIES, GENERATORS, ETC.

EDISON Batteries. Light. Power. Fifteen year life. Unconditionally guaranteed. Complete lighting plants. Free literature. See-Jay Company, 321 Yonkers Avenue, Yonkers, New York.

ELECTRICAL SUPPLIES, EQUIPMENT

FOR Sale: ceiling box holder for old house wiring. Alex Yeschick, Brainerd, Minn.

MAKE Your own automatic electric water heater. Save 75%. Sell to others, big profits. Easy guaranteed plans \$1. Information free. Write Crane Electric, Eugene 4, Oregon.

ELECTRIC Test panel, tests bells, fuses, bulbs, toasters, irons, motors, appliances; shop necessity; hobbyists delight. Send \$15.00 for practical and attractive board complete or \$1 for blue print. Hawco Products Co., 444 Hart Street, Brooklyn 21, N. Y.

SINGLE Phase coil former. Fast and simple to operate. Write for information. Mc Caig Electric Company, Box 131 Vernon Branch, Los Angeles 11, California.

ELECTRIC Fans: Make your own 24" floor model adjustable pedestal fans. Complete kit, less motor, \$32.50 FOB N. Y. Consists of guard, 24" blade, heavy cast iron base, 5' to 8' telescopic adjustable column and all fittings. Use any 1/8 or 1/4 hp. motor and make a \$90.00 fan. Get in on the profits. Order now. 20% deposit, balance C.O.D. Jeannette Electric Co. Inc., 159 West 23rd Street, N. Y. 11, N. Y.

ALNICO Magnets, immediate delivery. Terry Sales Company, 3726 South Detroit Avenue, Toledo 9, Ohio.

LAMP Parts—Harps, finials, couplings, pipes, etc. All parts. Send for prices. Gyro Lamps, 5416 N. Clark, Chicago 40.

ELECTRIC Fans? Make your own. 16 inch correctly balanced aluminum fan blade 1/2 inch bore, ideal on any size motor 1/8-1/3 h.p.—\$3.50. 18 inch all welded guard, adjusted to fit four stops on motor \$3.00. Adjustable floor standard 4-8 feet height, rigid, sturdy, \$9.00. Table standard, universal, fits any motor base \$3.75. Prepaid anywhere U.S. 25% deposit on C.O.D. shipments. Dealers write. Ted Riseman, 1461 North 3rd Street, Springfield, Illinois.

ELECTRIC Appliances, every description. Send for circular. United, 1554 York Ave., New York, N. Y.

ELECTRICAL Appliance repair. Open your own shop. Learn house wiring; electric motors, vacuum cleaners, washers, etc. Complete illustrated course shows how. Free booklet. Pacific Training School, Dept. AP-2, 7217 So. Broadway, Los Angeles 3, Calif.

NOW—Repair your own electrical appliances with Chanite Self-welding Electrical Heating Element Flux. Instructions delivered, price \$1.00. Stick form 25c ea., \$2.00 doz. Chanite Sales Company, 914 South Main, Fort Worth, Texas.

FLUORESCENT Tubes burned-out? You can relight and use indefinitely. Complete instructions \$1.00. Wallingford, 121 Burlington, York, Nebr.

ELECTRIC Pencil: Writes-engraves all metals \$1.00 postpaid. Beyer Mfg., 4515-H Cottage Grove, Chicago 15.

BROKEN—Burned out electrical heating elements quickly repaired. Use new amazing Nichroite Paste, simply overlap ends and turn on current. Family size \$1.00 bill. Satisfaction guaranteed. Armstrong Mfg., 861-X, Minneapolis, Minn.

HOBBY Books. Latest titles. Catalog free. Popular Mechanics Press, (C-43).

WELDING, SOLDERING, PLATING

ACETYLENE Welding outfits like new; arcwelders, welders manual \$1.65. Eagle Welding, Dept. PM, 5085 Broadway, Chicago 40, Ill.

THUNDERBOLT—Transformer welder, dial-control, 3 heat stages, 60 amps, 110 volts-a.c., takes up to 3/32 rod, carrying case, all accessories, illustrated instructions. Professional heavy duty welding, brazing outfit. \$39.50. Also "Super-Welder," for light work, 110 volts, a.c.-d.c. \$19.95. Save 2%, send check. Or order C.O.D. west of Mississippi. \$5.00 deposit required on Super-Welder, \$10.00 on Thunderbolt. Super-Welder Mfg. Co., Dept. PMC, 23 E. 20th St., New York 3, New York.

AC WELDERS 95 To 205 ampere. Easiest working, quiet and best built. Write for information. Chester Brainard, Skaneateles, New York.

GUARANTEED 110/220 Volt a.c. welders. All sizes, \$68.00 to \$245.00 FOB, Chicago. Specifications free. Williams Sales Co., Box 4100, Portland 8, Oregon.

ARC Welders wanted by the thousands. Learn with 516 page lessons manual. Over 500 how-to-do-it photos. \$2.00 copy. Money-back guarantee. Hobartweld, Box M-564, Troy, Ohio.

NEW Model electric welder 110 volt a.c.-d.c.; will weld all metals; easy to use; full directions. Complete with power unit, flame and metallic arc attachments, carbons, fluxes, rods, mask; all for \$19.95. Used by the navy. Magic Welder Mfg. Co., 239-MP5 Canal St., New York City.

OKINAWA "Flame thrower" slip-on soldering tip for fender men. Fits all torches. Postpaid anywhere in U. S. \$2.35. L. E. Kelly, 1947—19th Avenue, San Francisco 16, Calif.

WELDING, Cutting, aircraft welding and soldering equipment. Electric arc welders. Superior Oxy-Acetylene Co., Hamilton, Ohio.

BUILD D.C. arcwelder without rewinding armature. Pans \$1.00 each, 25 to 600 amperes from automotive d.c. motors, light plant generators, automobile starter-generators. Welders Club, AB-3432, Chicago 54.

MACHINERY, TOOLS AND SUPPLIES

BUILD Your own grinder with combination pulley and arbor. Fits 1/2" shafts. Right and left hand. 75c postpaid. Fred Roesch, 502-P First Street, Hoboken, N. J.

BRASS, Round and square rod, 2-foot lengths; list free. American, 388 East 34th St., Bklyn 3, N. Y.

EQUIP Your home workshop quickly, efficiently, economically by building your own mill, shaper, drillpress, vise, bandsaw, jointer or other metal and woodworking tools. Lewis castings and materials are ready to finish, detailed blueprints show how. Send 10c to cover cost of mailing new catalog describing 23 items. Lewis Machine Tool Co., P.O. Box 116, Station A, Dept. M-64, Los Angeles 31, California.

SNAP-IN Punch set. Contains handle with 5 pin and center punches. Satisfaction guaranteed. \$1.50. Zetco Products Co., Bellefontaine, Ohio.

TILTING Table bench saws, 8" blade, \$17.50. Band saw blades 80c. Broken blades welded 30c. Circular free. Sunshine, Berkshire Heights, Penna.

SAW Mandrels 5/8" shaft, 1/2" arbor, heavy duty bronze bearings, total length, 12", precision made, expressly for craftsmen and hobbyists, \$1.98, including pulley, 30-day guarantee, 10c brings item list. Wilson Manufacturing & Sales, 2233 Summit Street, Columbus 1, Ohio.

WAR Surplus, machines, tools etc. Rush name. Free literature. Wayne Engineering, Greenville 1, Ohio.

DRILL Grinder—Grinds drills to factory accuracy. Calipers with direct reading scales. Circle cutters. New tool grinder. Lowest prices. Free literature. Factory; 811-B East 31st, Kansas City 3, Mo.

HARDWARE, Machinist tools, pattern and model maker supplies, taps, dies, drills, saw mandrels, grinders, jeweler saws, steel, brass, drill rod. Catalog 10c. Terek, 6304 Patterson, Chicago 34.

BUILD Your circlesaw, lathe, drillpress, and bandsaw from castoff parts! Plans, specifications, for all four 25c. Allied, 2671 Algonquin, Toledo, Ohio.

MISC. Bolts, nuts, screws, washers, 350 items, \$1.00. Alvin, 3704 Gordon, Ft. Worth, Texas.

DRILL Grinder for twist drills \$2.95, and other craftsman's tools. See ad on

SELSYN Motor manufactured by Bendix, weigh 5 lbs. ea., 2 transmitters, 2 differentials, set of 4, \$25.00. Also transmitters manufactured by Bendix, Diehl Electrolux, \$7.50 ea. All operate on 110 volt, 60 cycle, a.c. current. Suitable for remote control, beam antenna, bingo signalling, wind indicators, and many other uses. Special Bendix type c.s. 1, weigh 1 lb. ea. 28 volt d.c. motor. Will run on 15 volt, a.c. about 2000 r.p.m.. \$2.25 ea. Charges prepaid on all items within the United States. Columbo Trading Company, Inc., 304 Canal Street, New York City, 13.

GEARS For inventors, experimenters, model makers, schools, work shops, laboratories, etc. Government surplus made of brass, bronze, dural steel and stainless steel. 12 matched pairs; 24 gears, bevel, spur and ratchet. List price \$12.00, our price, \$2.50. 25 matched pairs; 50 gears, includes larger gears, also sets of worm gears. List price, \$30.00, our price, \$5.00. 50 matched pairs; 100 gears better assortment, including internal set and worm sets. List price, \$75.00, our price, \$10.00. Limited quantity. Order now. Write for our bulletins on ball bearings, rectifiers, relays, selsyns, horns and government surplus materials. Met Exchange, 323 Canal Street, New York.

ANGLE Plate C.I. 4"x3"x3. Ribbed, machine finished 4-sides, \$2.00, unfinished 75c. Model Tool Service, 202 Wood Ave., Rock Falls, Ill.

PATENT Equipment sharpens pipe wrench jaws in your own shop or mount in car trunk and travel. Very profitable. J. C. Moore Industries, Box 234, Fredonia, Penna.

BUILD It! Circular saw and drill press. No castings, pipe fittings. Two simple plans. Complete, \$1.00 cash. Western Colorado Sales Co., Box 584, Grand Junction, Colorado.

EXPERIMENTERS—400 Valuable new springs, 75 kinds, numerous sizes, 10,000 uses, \$2.00. Deluxe assortment, \$3.00. Jumbo, \$5.00. Guaranteed. Technico, Box 246-A, West Hartford, Conn.

INDEX Heads for sale. Very inexpensive. Sixty-two different divisions. Used on small lathes, drill press, milling machines, etc. Make gears, hobbs, cutters, etc. Very accurate, and durable. Not a toy. Used by defense schools and hobbyists. Write for free folder. Long's Index Heads, 2117 East B St., Torrington, Wyo.

ENGINES, MOTORS, DYNAMOS

MOTOR Winding tester, indicates burned out or partly shorted coils in single or three-phase motors, indispensable for repairmen. Send for bulletin. Motor Industries, Quincy, Illinois.

600 NEW Motor diagrams, tables, and controller connections for the practical electrician. Makes dual-voltage, multi-speed, star and Delta circuits clear and simple. Also includes all standard split-phase, repulsion induction, compensated series, two and three phase. Data for rewinding and reconnecting all types. Over 100 valuable tables. Money-back guarantee. Price \$2.75 prepaid. Educational Advancement Company, Dept. L, Lakewood, New York.

ELECTRIC Motors rebuilt, guaranteed, limited quantity, one a customer, 1/4 to 20 hp., a.c.-d.c. Temps Bros. Motor Company, 70-24 Myrtle Avenue, Brooklyn 27, New York.

RECONDITIONED 32v Delco plants \$30, motors \$6.00, radios \$10.00, cleaners \$10. Write Ray Chapin, New Berlin, N. Y.

BIG Pay jobs in welding. Complete welding lessons and reference books. 516 pages, 41 lessons, \$2.00 copy. Money-back guarantee. Hobartweld, Box 565-M, Troy, Ohio.

MOTORS, Water, air, steam driven. 3" novelty \$3.50, 4" novelty \$5.50, prepaid. Specials 1/8 h.p. \$5.50, 1/4 h.p. \$7.50, 1/2 h.p. \$9.50, 1 h.p. \$16.50, prepaid. Duplex Motors, Burlington, Iowa.

NEW Kohler electric plants a.c. and d.c. Other electric plants rebuilt. Write E. F. Schmalz, 314 Wyoming Ave., Kingston, Penna.

WINDING Data, listing 225 motors, single and three phase, \$1.00. Motor Data Co., Box 7631, Kansas City 3, Mo.

PRACTICAL Winding of a.c. motors. A course of instruction on winding, connecting, and testing single, two, and three phase motors. Clearly written in everyday non-technical language. Illustrated throughout. This book is recommended for beginners interested in learning motor rewinding and repair. Satisfaction guaranteed or remittance refunded. \$2.00 prepaid. Educational Advancement Co., Dept. Y,

150 AMPERE Generator for welding \$47.50. Extra flexible cable, 8 ft. lengths \$2.75. Other bargains. Butler Electric Company, 1885 Milwaukee, Chicago 47.

BOATS, OUTBOARD MOTORS, ETC.

"BOAT-IN-A-BAG" \$19.75. Imagine an inflatable, collapsible, portable rubber boat folding into package 13"x15"x3" weighing 10 lbs. Inflated size 40"x66". Complete with carrying case and hand paddles, only \$19.75. Ask for boat No. IP. Other sizes at \$24.50, \$29.50, \$39.50, \$49.50, \$54.50, \$59.50, \$69.50, \$79.50, \$89.50 depending upon type and condition. New pneumatic life preserver vests \$3.98. New dual Navy pneumatic life preserver belts 98c. Write for circular or order from this adv. Dealers wanted. Karl Ort, Dept. PM-9, York, Penna.

MARINE Power—easily convert any Ford motor (domestic and foreign) with Osco parts and kits. Complete catalogue 25c (coin). Osco Motors Corp., 2020 East Orleans Street, Dept. M, Philadelphia 34, Penna.

PLASTIC Boats now! Make your own for pleasure or sale with streamlined 9'x4' one-piece reinforced molded hulls. Weight 50 lbs. Makes Adirondack car-top boat, sailing dinghy; ten other craft. Won't leak. Won't crack. Won't rot. Plastic Boats, Box 187, Lake Placid, N. Y.

HOW To build seaworthy low cost canvas canoe, kayak or open type, 35c. Dudley, Dept. P, Box 1554 Mobile 9, Alabama.

BOATS & Models, marine steam engines. Catalog plus detailed plans, instructions 18' racing sloop, 25c. Marine Laboratory, Groton, Conn.

FISHING Rowboat plans, 12' or 15'. Plain lumber. \$1.00. Strachan Boats, Howard 2, Kansas.

2 PLACE, 12 Foot kayak kit, complete for assembly in one evening. All parts, canvas, paint, instructions, \$29.95 f.o.b. factory. Immediate delivery. Your dealer or send check or money order to Westin New Haven Co. Inc., Mt. Carmel, Conn.

SILENT Oar locks and holders. No more clanking. A boon to hunters and fishermen. Set four pieces \$3.50 postpaid. Send check or money order. R. Knauss, 715 Delaware St., Peoria 4, Illinois.

SAILKITS 100 Square feet \$13.90, boat supplies. Boy Scout tents, wall tents, carbide lamps, canoe canvas, airplane dope, Swedish kerosene stoves, kapok life preservers, etc. Alan-Clarke, 96 Chambers, New York City.

BUILD A boat: Brooks knock-down parts saves time and money. Simple as A B C. Outboards, inboards, sail and racing boats. Send 10c for complete literature. Brooks Boat Company, Dept. PM, Carrollton, Michigan.

ATTENTION Sportsmen! Make kayak from complete easy construction kit. Literature. Pla-yaks, Dedham, Mass.

SAIL Your canoe—build the rig. Instructions, \$1.00. Gee, 1211 Frisco, Far Rockaway, N. Y.

KAYAK—Easily built. Instructions, \$1. Gee, 1211 Frisco, Far Rockaway, N. Y.

USED Outboard motor parts. Outboard Exchange, 1194 Remsen Ave., Brooklyn, 12, N. Y.

FORD-Mercury-Zephyr marine conversions. Catalog 10c. Lehman Manufacturing Company, Dept. D, Newark 2, N. J.

MARINE Muffler—Simple, low cost, cinch to install yourself. Guaranteed. Send for free folder. Savage Marine Co., P.O. Box 772, Boston, Mass.

OUTBOARD Motor brackets—New models for canoes, rowboats, sailboats. Send for free descriptive folder. Outboard Motor Brackets Co., P.O. Box 772, Boston 2, Mass.

ONE-MAN Boats—Ideal for hunters, fishermen. 7 1/2 foot long. Weighs only 30 pounds. Easily carried. Army surplus auxiliary fuel tank sections, of Terne plate steel, that convert easily to one-man boats. Approximately \$1.00 worth of welding will seal fuel outlets. Only \$4.75, prepaid anywhere in U. S. Address: Irving Goodman, P.O. Drawer 191, Galesburg, Illinois.

BOATS And all about them. How to select, build, repair and operate. For 40 years the leading practical boating magazine. Trial subscription, 12 issues for \$1.00. Motor Boat, 62 Gold Street, New York 7.

BOAT Designers are highly paid professionals. Complete course by mail. Catalog. Westlawn, Montville, N. J.

NINE Plywood boat plans 50c. Catalog boat building plans 10c. The Rudder, 15 Murray Street, New York.

FULL Size, cut to shape boat patterns, blueprints. 7½ - 38 feet. Illustrated "Build a Boat" catalog, 10c (coin). "How to Build Boats" book, \$1.00. Cleveland Boat Blueprints Co., Dept. A-66, Cleveland, Ohio.

USED Marine motors, propellers, marine fittings, conversion manifolds. Stokes Marine Supply, Coldwater, Michigan.

ATHLETIC EQUIPMENT, BODY BUILDING COURSES

HALF Alive? I'll quickly put your body in shape. Professional acrobats, enjoy! Free health information. Write! Knoff, 2154MA North 52nd Street, Milwaukee, Wisconsin.

DEADLY Judo—Fiercest fighting technique. Jitsu, wrestling, foot-fighting, police tactics. Complete course (186 photographs). Special \$1.00. Variety House, Box 46-BD, Wall Station, New York City.

BARBELLS, Exercise equipment. Courses. Special offers! Free booklet. Good Barbell Co., Reading, Penna.

SPORTING GOODS, GUNS, FISHING TACKLE, TRAPPING, ETC.

FISHERMEN! Latest tackle sensation! "Para-Lure" nationally advertised. Lure-teaser-drag for trolling, casting, chumming. Parachute principle maintains drag on leader. Prevents hook throwing. Permits using lighter tackle. \$1.50 postpaid. Satisfaction guaranteed. Details free. Para-Lure Co., Box 7051, Newark 7, N. J.

TENTS! These lightweight Paulins make a splendid waterproof tent or lean-to. Made of rubberized fabric, they are yellow one side, blue on other. Size 7 ft. by 10½ ft. Weigh only 3½ lbs. Equipped with 20 grommets. Tent size 7' wide, 7' long, 4' high. Poles, stakes, ropes and flaps not included. Ask for stock No. 77. \$12.95 postpaid. Army mosquito headnets 95c. Plastic wrist compasses \$3.50. Floating flashlights with two bulbs and battery \$1.50. Karl Ort, Dept. PM-10, York, Penna.

CHUM (Attract) water, prior to fishing. Congregate soft shelled crayfish, minnows, catfish, other fresh and salt water bait, food and game fish. Catch by the hundreds with hooks, nets or traps. Cheap! Easy! Quick! Guaranteed! Send \$1.00 for Chum Guide Number 2. Fish Research, 5912D Thompson, Phila. 31, Penna.

NETS And seines to order. Don Cowart, Mountain Home, Ark.

INDIAN War bonnet kits and materials. Archery. Write—Chas. T. Schneider, Whitehall, Michigan.

MAKE Fish traps. Blueprint, 30c. Wee-sho-Uco, Box 51, Detroit, Mich.

COMPASS, Sensational luminous, waterproof, plastic, wrist-type guaranteed only \$1.98; telescope 17 power \$1.98. Karl Gruenewald, 3837P Coolidge, Oakland 2, Calif.

FISHING Poles: Dealers only. Samples: 20' bamboo \$2.50; 12' Talta \$2.50; jointed native cane \$2.50. Bob Pace, Combs, Ark.

THROWING Knives, perfectly balanced, handcrafted, \$1.25. Frank Stark, 1718 Walnut, Allentown, Penna.

FISHERMEN'S Secrets. 10 "gits-em" bait recipes \$1.00. Strachan Shop, Howard 2, Kansas.

\$50 A DAY Often earned by expert trappers! Learn how you may qualify for year round employment at this high paying interesting work. Only a few hundred dollars capital required. Loye R. Hunt, Grygla, Minnesota.

CRASHPROOF 22 Inch 3 bladed "flying propeller" flies 250 feet. Always returns to you. No motor. No wings. Ready to fly \$1.00. Carl Jamer, Box 594, Manorville, N. Y.

FISHERMEN: This is it, they can't resist it. Draws fish like a magnet. Like bears paw. Put it on any bait or flour dough. Formula \$1. Burger's Formula Service, 1734 Meldrum, Detroit 7, Mich.

CHUM (Unattached bait) attracts food and game fish—from 6 or 7 miles—to your hooks. Fresh or salt water. Cheap! Easy! Make 6 Rigs. Learn 8 secrets. Use 10 methods. Know 55 best chums. Send \$1.00 for a U. S. Chumming Guide. Fish Research, 5912D Thompson, Philadelphia 31, Penna.

2000 BARGAINS, Firearms, binoculars, war relics, catalog 30c. Smith Firearms, Runnemed, New Jersey.

SEND 10c For list 100 used guns. Frayseth's, Willmar, Minnesota.

USED Guns, bought, sold, exchanged. List stamp. Howe Fur Company, Coopers Mills, Maine.

FIELD GLASSES, MICROSCOPES, TELESCOPES, MAGNIFIERS

REFLECTING Telescopes, complete. 3½" diameter, equatorially mounted. View planets, stars. \$19.75. Write Sky-scope Company, 475-P 5th Ave., New York.

BUILD Your own reflecting telescope. Copy of instructions 10 cents. Catalogue free. Mayfloor, Katonah, N. Y.

REAL 17 Power telescopes \$3. United, 2309-P Lawrence, Toledo, Ohio.

POWERFUL Astronomical telescopes easily made. Trifling cost. Lenses and instructions 100X (100 diameters magnification) \$2.00, 100X and 200X \$3.00, 100X, 200X and 400X \$4.00. Instructions alone 10c. Carl Jamer, Box 594, Manorville, N. Y.

PORRO Prisms 1½" x 15/16" oval face. Manufactured by world-famous opticians for army and navy 8 x 50 binoculars. Rejected for slightly chipped edges. Outstanding bargain! 30c ea., 4 for \$1.00 postpaid. No c.o.d. Remit with order. Ross, 70 West Broadway, New York 7, N. Y.

COMPOUND Microscopes easily made; trifling cost. Lenses and instructions 50X (50 diameters magnification) \$1.00, 50X and 200X \$2.00, 50X, 200X and 400X \$3.00. Instructions alone 10c. Carl Jamer, Box 594, Manorville, N. Y.

TELESCOPES, Powerful 17-power chip-board, \$1.98; 6-power, 75c; 7-power plastic case, \$1.49. Karl Gruenewald, 3837P Coolidge, Oakland 2, Calif.

TELESCOPES, Microscopes, binoculars, lens kits. Catalog free. Brownscope Co., 24 West 45th St., New York.

TELESCOPES 17 Power, \$3.00. Candid cameras, \$3.98. Cardone, 1324 Sheffield, Pittsburgh 12, Penna.

BINOCULARS, Telescopes, watches. Buy, sell, trade. Paul Schweer, Donnellson, Iowa.

TELESCOPES, Microscopes, cameras, binoculars: bought, sold, repaired. Lists 10c. Specify instrument wanted. Rasmussen and Reece, 41 Market, Amsterdam, N. Y.

DOGS, PETS, BIRDS, RABBITS

SAMPLE Copy "Rabbit Profits" magazine, information regarding revolutionary new hutch plans and literature telling how to make most money from rabbits. 10c. Reliable Fur Industries, Dept. PM, Montebello, Calif.

ENGLISH Shepherds—border collie puppies, all ages, both sexes, choice colors. Faithful workers. Satisfaction guaranteed. Fairmont Farms, Cedar Falls, Iowa.

MAKE Some more money—The frog industry booklet tells how—Send 25 cents, stamps or coin. Chariton Corp., Century Building, Chicago 4.

ENGLISH Angora rabbits, pair \$15.00. Snowwhite Angora Colonies, Malta, Mont.

BEAUTIFUL, Useful collie-shepherd pups \$11. Paul Schultetus, New Liberty, Illinois.

BEAUTIFUL Puppies, Collies, Fox Terriers, hunting, Airedales, Doberman Pinschers, etc. Ulrey, Paw Paw, Ill., Box 45.

ANGORA Rabbits bring steady income! Good wool producing stock supplied. House of Angora, Springfield, Illinois.

HALF Police, half English Shepherd. E. Anson, Mose, N. Dak.

ENGLISH And Boston Bull puppies. Catalogue 10c. Challenger Kennels, Jackson Center, Ohio.

RAISE Moneymaking Angora rabbits. Wool \$14.50 pound. Plenty markets. Cash income. Future prospects bright. Particulars free. White's Rabbitry, Lawrence, Kansas.

ORIGINAL Chin-Chin giant Chinchilla rabbits. Gorgeous fur. Delicious meat. Most prolific. Easily raised anywhere. Free booklet shows amazing profits. Willow Farm, R15, Sellersville, Penna.

ZOOLOGICAL And pet animals for sale. Illustrated catalogue, literature, 25c. Trails End, Zoo-5, St. Stephen, S. C.

RAISE Diamond seal rabbits. We pay \$25 to \$50 each. We buy all you raise. Literature 10c with hutch plans \$1. Automatic cleaning, watering, feeding. 31 drawings, patterns. Hansen's Rabbitry, 1347 Miller Ave., Salt Lake, Utah.

ANGORA Rabbits, giant chinchillas—finest pedigree. Valuable wool \$15.00 pound; gorgeous two-tone furs. Raised anywhere. Literature free. Grinsteads,

MONEY Raising rabbits. Investigate. Folder 10c. Close Rabbitry, Tiffin, Ohio.

CHINCHILLA Giants, real. Most profitable. Prolific, easily raised anywhere. Breeders supplied reasonable. Satisfaction guaranteed. Free literature. Large illustrated catalogue, 25c. Fur samples, 25c. Chin-Chin Farms, Melvin Behrens, Gen-Mgr., Dept. 4, 44 Chester Pike, Darby, Pa.

PIGEONS, Rabbits, 30 varieties. Catalogue 10c. Jim Houck, Tiffin, Ohio.

ST. BERNARD Pups: Champion sired beauties. Franklin Young, R4, Riverhead, Long Island, New York.

RAISE Guinea pigs. Make money at home. Big demand. Free booklet. Taylors Guinea Pig Farm, Hapeville, Georgia.

STANDARD Rabbit Journal, Milton, Pa. 3 years \$1.00, sample dime.

A LIVING With rabbits and cavia. Markets waiting. Magazine 10c. Book describing twenty breeds and magazine 25c. Book and magazine (monthly) one year 50c. Address Small Stock, Dept. 2, Pearl River, N. Y.

SEEDS, PLANTS, NURSERY STOCK

AMAZING Silverton soiltester brings garden success! 35c. With three 25c plant hormones, outfit, \$1.00. Silverton Laboratories "M", Toms River, N. J.

FARMS, FARM LANDS, REAL ESTATE

WANT To be your own boss? A good farm in Canada is your answer. Low prices. Favorable terms. Drop a postal to-day, giving your preferences as to size and kind of farm, and province in which you are interested. Address H. S. Cresswell, Canadian Pacific, Montreal.

STROUT'S Green farm catalog—Over 1300 bargains—25 states—Maine to Florida, west to California, Oregon and Washington. Write today for this big book. Mailed free. Strout Realty, 255-P 4th Ave., New York 10, N. Y. 7 So. Dearborn St., Chicago 3, Ill. 453 So. Spring, Los Angeles 13, Calif.

FREE Catalog, farm bargains, 9 mid-west states. Many fully equipped for convenient quick start. Many pictures. Special service to help you locate quickly, if you state requirements, payment plan and general location desired in first letter. United Farm Agency, 1796-MP Arcade Bldg. 1, St. Louis, Mo.

OZARK Lands for all purposes. Actual River frontages. 5 acres \$90.00 and upwards. Free list and literature. Hubbard, 424PM, Minnesota Ave., Kansas City 4, Kansas.

FERTILE South-American lands obtainable free. Homesteads, plantations, 25,000 acre ranches. Interesting information, 10c. Vallesp, New York 13.

OZARK Homesites; \$55 up. Beautifully timbered. Write Mr. Armstrong, Shook, Missouri.

OZARK Farms, resorts. Free list. Farmfinders, 111-K, Eureka Springs, Arkansas.

40 ACRES Virgin Missouri land \$145. Terms and complete Ozark information. Write Armstrong, Shook, Missouri.

CITRUS County, Florida, lands on easy terms. R. W. Stewart, Inverness, Florida.

WISCONSIN, Minnesota water frontages. \$5 down, \$5 month. 3505-K So. Hope, Los Angeles 7, Calif.

"HOW To Buy a Farm or Ranch" \$1. Wm. M. Wells, licensed broker, 105-P No. Ave., No. 56, Los Angeles 42, Calif.

WEST'S 1946 Catalogue. Hundreds farm bargains, business opportunities. Pennsylvania, New York, New Jersey, Ohio, Delaware, Maryland. Free copy. West's Farm Agency, HE, Pittsburgh 16, Penna.

GOOD Farms—ranches. Washington, Minnesota, Montana, Idaho, Oregon, North Dakota. Dependable crops, favorable climate. Write for literature, lists describing typical postwar farm opportunities. Specify which state. J. W. Haw, 119 Northern Pacific Ry., St. Paul 1, Minn.

HOMESITES \$450—Low terms. California's finest garden spot. On Morro Bay's wooded shores. Wonderful fishing, hunting, boating, etc. Fertile soil, soft water, temperate climate, congenial community. Free literature. Richard M. Otto, 6560 Hollywood Blvd., Hollywood 28, Calif.

\$5.00 MONTHLY Buys 40 acres near town; price \$175.00. Free list, Box 425-F, Carthage, Mo.

OZARK Farm bargains. 5 to 5000 acres. Frank, Mountain View, Mo.

40 POWER Tools You Can Make. Book giving full details \$1.25. Popular Mechan-

POULTRY AND FARM SUPPLIES

BABY Chicks, champion mated. 52 varieties, 7 hybrids, licensed, inspected, blood tested. Rush postal, large colored book, low prices. Berry's Farm, Route 12, Clarinda, Iowa.

KNOW How to raise poultry for profit. Read Northeastern Poultryman. Every issue packed with helpful hints and practical suggestions. Latest articles on breeding, feeding, and management. Read nationally. Subscribe now. 1 year 65c; 2 years \$1.00. Northeastern Poultryman, Dept. M, 376 Boylston St., Boston 16, Mass.

RAISE Turkeys the new way. Write for free information explaining how to make up to \$3000.00 in your own backyard. Address National Turkey Institute, Dept. 3, Columbus, Kansas.

PROFITABLE OCCUPATIONS

SOILLESS Gardening instructions 50c. Chemicals \$1.00. Alvin, 553 William, Winnipeg, Manitoba.

MECHANICALLY Inclined men—Own and operate general appliance repair shop. Complete, illustrated course shows you how. Welding, refrigeration, motor repair, how to get business, etc., all phases covered. Free literature. Christy Supply, Dept. 464, 2835 N. Central Ave., Chicago.

BECOME A locomotive engineer or railroad conductor, information 50c. The Student Railroader, Box A53, Elmhurst, Ill.

BUY Unpainted plaques, statuary, etc. Decorate; sell locally. Good profits. Small cost. List free. Samples \$2.00. Artists' brushes, paints, instruction books available. Pioneer Plastex Art Products, Austin 5, Minnesota.

BE Independent; establish permanent, profitable business at home. Tested, practical; small investment. Write Mediant, Box 123-F, Blythebourne Station, Brooklyn 19, N. Y.

FOR An extremely profitable lifetime business, operate a Collection-Credit Bureau. Easily learned. Write Cole & Associates, Syracuse 2, N. Y.

MUSHROOMS Grown; boxes, barrels. Instructions 50c. Spawn \$1.00. Gordons, 553 William, Winnipeg, Manitoba.

BE A novelty manufacturer, fascinating, interesting work. Exceptional profits. No expensive equipment needed, quickly learned, use garage or basement, inexpensive materials. Successful manufacturer shows how, orders waiting. Literature free. State age. Plastex Products, 127 Clement, San Francisco 18, Calif.

RAISE Fishworms, improved method \$1. Details, stamp. Stoner, Chattanooga 6, Tenn.

NEW, Home or business, make rock flower pots, fountains, birdhouses, baths, lampbases, etc. Easy instructions \$1.00. D'Arcy, 625 West 169th St., New York, N. Y.

LEARN Chemical gardening—Fascinating, profitable hobby. Grow bigger, better flowers, plants, vegetables the modern scientific soilless way. Special trial offer: chemicals and instructions, \$1.00. Details and bulletin free. Ward Distributing Co., 1007 Broxton, Los Angeles 24, Calif.

TADPOLES Make frogs, both make money, booklet explains, send 25 cents, stamps or coin. Chariton Corp., Century Building, Chicago 4.

TATTOOING—Fun, profit. Literature free! Steele, 1138-0 Market, San Francisco 2, California.

HURRY Success—Learn money-making facts, inside information, amazing course in mail selling, only \$5.00. Treasured gift free with order. Information, booklet, 25c. Parcell Market, 2701P S. Main, Elkhart, Ind.

"FOREIGN Job opportunities" including South America. \$1 brings 1946 copyrighted booklet explaining potential opportunities in foreign employment and how-where-when to apply with listing of 300 firms with foreign interests. L. J. Enterprises, Box 2549-PM, Hollywood 28, Calif.

LEARN Sewing machine repairing. Pays well. Work at home. Simplified serviceman-ual fixes any make like new. Work city, town or country. Start immediately. Copyrighted, guaranteed \$1.59. Serviceman, 231 Main, Hamilton 2, Ohio.

GOOD Jobs obtainable in Latin-America. High salaries. Interesting booklet, 3c. Vallesp, New York 13.

SELL By mail! Fascinating, profitable. Sample booklet, circular, confidential prices 25c. Joe Jones, 1028 Columbus Ga.

AIRLINE Jobs! Huge demand for men, women. Foreign countries and U. S. airlines personnel manual explains opportunities, qualifications, salaries. Where to apply. Price only \$2. Aeronautical Publishing Co., Box 1051, Kansas City, Missouri.

WELDING Pays. Learn with 1942 trade school text manual. 516 pages. Over 500 photos. \$2.00 copy. Money-back guarantee. Hobartweld, Box M-363, Troy, Ohio.

"12,000 ALASKAN Job and business opportunities." \$1 brings 1946 copyrighted booklet explaining how-where-when to apply with tips on excellent business opportunities and government homestead lands at 25c per acre to approved applicants. Transcontinental Research, Box 2147-PM, Hollywood 28, Calif.

PROFITABLE Occupation with books, religious, reference, health, biography, dictionaries, many distinguished books. Beautiful illustrated catalog, prices, plans, \$1.00. Information, directory-magazine 25c. Parcell Market, 2701P S. Main, Elkhart, Ind.

"FROG Raising!" New book tells how. Marlboro House, 1035 Marlborough, Detroit 15, Michigan.

MIRROR Making is profitable! Illustrated instructions, formulas, 50c. Specialties, Box 599, Grand Rapids, Michigan.

LEARN Oil burner servicing \$1. Installations \$2. Big demand, very profitable. Simplified home study. Jackson, 30-74—48 Street, Long Island City, N. Y.

STORY Writing simplified! Don't dream—try! Fascinating, complete home study. Handsome earnings. Circular free. New Simple Segment System, Postoffice Box 834, Spokane, Wash.

SOUTH America. 50,000 job opportunities in South America. Send \$1.00 now for list of over 200 American firms doing business in Central and South America. How and where to apply with sample application form included. Write Dept. 151, Box 3112, Winston-Salem, N. C.

MAKE Beautiful costume jewelry at home for large profits, hobby or therapy. Free illustrated wholesale catalogue of sea shell, metal and plastic parts contains detailed instructions. Florida Supply House, Bradenton, Florida.

KITS To make 12 shell birds \$1.00. Completed samples included. Hall & Neilson, Shells, 860 West 33, Sarasota, Florida.

LEATHERCRAFT Supplies. Catalog 10c. Art Craft Supply Company, Box 148, Fort Worth, Texas.

WOULD You pay 3¢—first \$350 made? Color-illustrated book "505 Odd, Successful Enterprises" free! Some offer occasional "day off". Start at home, office. Expect something odd! Pacific, 262-N Drake, New Rochelle, N. Y.

SHARPEN Dull pipe wrenches with special new patent grinder. No competition, very profitable. J. C. Moore Industries, Box 234, Fredonia, Penna.

EXCELLENT Profits raising mink. Choice breeding stock available. Details furnished. Franklin Young, Riverhead, New York.

SEWING Machine troubles? Electric or treadles. Fix it at home, save money. Fix others, make money. Profitable business. Service manual guaranteed, \$1.00. Serviceman, 231 Main, Hamilton 2, Ohio.

EARN While you learn the clock repair business! With our method of instruction, your income starts immediately. For details write Akron Clock Clinic, 964 Wye Drive, Akron 3, Ohio.

ANNOUNCING Home study course in commercial baking. Practical basic training. Good field for those with aptitude. Nearly depression proof. Send for free booklet, "Opportunities in the Baking Industry." National Baking School, 1315 Michigan Ave., Dept. 3432, Chicago 5, Ill.

LOCKSMITHING—Profitable business or hobby! New course teaches you how to pick locks, fit keys, de-code, masterkey, etc. Easy self-instruction lessons. Bargain price. Fascinating 100-page illustrated catalog free! Write—Nelson Company, Dept. 2-02, Chicago 5.

PAINTING Flagpoles often pays \$50.00 daily. Particulars free. The Skyline Co., P.O. Box 1601 B, Uniontown, Penna.

\$40.00 WEEKLY Made growing mushrooms, fresh, dried. Dominion patent 331583. Free spawn. North American, 169P Yonge, Toronto, Canada.

TYPEWRITER Repairing—Original course, simplified home study. Weber Typewriter Mechanics School, Box 269, Osborn, Ohio.

GOLD-STAMPING. Exceptional post-war opportunity. Free booklet. Home City Specialties, Dept. 1273, Springfield, Massachusetts.

RAISE Earthworms. Nature's Gardners. Circular free. Instructions \$2.00. Moudy, Spruce Creek, Penna.

BOOKS, PERIODICALS, PICTURES, POSTCARDS

PRIZE Fighters. Actual photographs. List free. Reid, Box A74, Sunnyside 4, L. L. New York.

MAGAZINE Export Sales Company, 2084 First Avenue, New York 29, N. Y. U. S. A. Over-issue popular American magazines and pocket-size novels. Comics, fashions, pictorials, romances, screens, pulps, many others. Export only.

INTERESTING, Informative books, various subjects; instruction, formulas, self-improvement. Write for free literature. Walter Gillen, 33 18th Ave., Paterson 3, New Jersey.

BOOK Bargains—Send 35c for one cloth-bound volume—list of famous editions included. Buckley, 800 N. President, Jackson 6, Miss.

DON'T Spend now. Keep money. Book tells how—\$1.00. Jim Byers, 2530 No. Kedzie Blvd., Chicago 47.

SUBSCRIPTIONS To any magazine through CMA, 1631 Glynn, Detroit 6, Michigan. Catalogue free.

HERBALISM—Complete course in 2 volumes. 1000 recipes. Particulars free. Home Service, Forestville 2, Va.

STAMPS. Books, autographs—lists 3c. Wright Company, Union Building, Syracuse, N. Y.

ATOM Bombed Nagasaki, 15 photographs, \$1.00 postpaid. Makins Pictures, 538 1/2 Washington, Bremerton, Wash.

"SECURITY Acres"—Money, happiness, independence. \$1.00 prepaid (refundable). Publishers, 5345-B Harper, Chicago 15.

RAMBLER—Hobby, mailorder magazine. Sample 10c. Box 174, Staten Island 1, N. Y.

DIFFERENT Self-Mastery book. Description free. Eugene Macklean, Eureka, California.

REFRIGERATION Service Manual. Domestic, commercial. Construction, operation, installation, testing, trouble shooting, replacement, repair etc. 300 pages; fully illustrated, \$2.25 postpaid. Money back guarantee. Modern Technical Book Co., Dept. MMC, 55 West 42nd St., New York 18.

PICTURE Post cards produced from your photograph; for hotels, resorts and advertising purposes. 4154 Fifth Street, Philadelphia 40.

WHAT Every Mason wants. We have Masonic books for Blue Lodge, Chapter, Commandery, Scottish Rite and Shrine. Our rituals are used the world over. Send for free catalog of books and rituals for Masons, Odd Fellows, Knights of Columbus, etc. Ezra A. Cook, Publisher, P.O. Box 796-PMY, Chicago 90, Ill.

OPERATE Magazine subscription agency, wholesale, catalog, 5000 magazines, complete supplies 25c. Cassell Publishers Service, Westfield, New Jersey.

BOOKS, Unusual, rare bargain catalog free. Sweeper, 141 West St., Newark, N. J.

JOIN New Technical Book Club—free! Members receive current literature, guidance on all book problems, premiums. No obligation. All technical, homecraft, farming, sports, etc. Specify subject for free information. Modern Technical Book Co., Dept. M2MC, 55 West 42nd St., New York 18.

UNFRAMED Color pictures. Samples 10c. Curtis, Box 1916A, Denver 1, Colo.

HIMALAYAN Mountain photos. Eight for dollar. Other CBI. Larry, Box 1142, Des Moines, Iowa.

PROFESSIONAL Slide rule and instruction book. \$1. North American Trading Co., Box 131, Grand Central Annex, New York, N. Y.

OZARK Magazine, 111-A, Eureka Springs, Arkansas. For homeseekers. Year, \$1.00.

POWER Through knowledge. Extraordinary bargain catalogues. 10c. Continental Publications, Elmhurst, New York.

BIBLE Says, "Swords into Plowshares." When? Free booklet explains. Ketchum, 1848 S. 18th, Springfield, Illinois.

BOOKS. New, used, rare. 6c brings "Bookfinder." 319 So. Marengo, Pasadena, Calif.

FLOYD Clymer's popular motor books. See classified advertisements under Automobiles, Motorcycles.

BOOKFINDERS! (Scarce, out-of-print, unusual books) quickly supplied. Send wants. Clifton, Box 1377pm, Beverly Hills, Calif.

TRADE Magazines—Business, vocational, diversion. Current single copies. All fields to choose from. Free price-lists. Commercial Engraving Publishing Co., 34C North Ritter, Indianapolis 1, Indiana.

TECHNICAL Books, largest list. Edwards, 324 North 18th, Quincy, Illinois.

MAGAZINE Subscription service. Agents wanted. Sutherland Agency, Ringgold, Va.

USED Correspondence courses, technical, writers, how-to books bought and sold. Literature free. Benchat, 36 Maple, Hastings-on-Hudson 6, N. Y.

GOOD "Used" self-instruction educational books on all subjects bought, sold, rented, exchanged. Satisfaction guaranteed. Complete information and 100-page illustrated bargain catalog free! Write—Nelson Company, Chicago 5.

SELF-EXPLAINING Bible: Illustrated circular free. Box 446-F, Minneapolis, Minn.

NATIONAL Geographic Magazines, 1888-1945, any issue. Periodical Service, Dept. PM, Swarthmore, Penna.

BOOKS. (Out-of-print, new, used) quickly supplied. Many 35c bargains. Catalogue. Mid-West Book Service, 18870 Marx Ave., Detroit 3, Mich.

BIG Profits taking subscriptions for all magazines. Agents' confidential catalog listing over 2500 periodicals and complete starting supplies free. Pines Subscription Agency, Flushing, New York.

MAGAZINES (Back dated)—foreign, domestic, arts. Books, booklets, subscriptions, etc. Catalog 10c (refunded). Cicerone's, 863 First Ave., New York 17, N. Y.

"100,000 POST-WAR Jobs Abroad"—South America, China, India, Burma, Japan, Russia, Malaya. How, when and where to apply. Post-war U. S. participation in world reconstruction and trade demands thousands of American-trained mechanics, salesmen, technicians, engineers, foremen, laborers and business representatives—every trade needed. Our 15,000-word copyrighted forecast—compiled from business, professional and government sources—lists over 200 big U. S. firms with foreign interests, gives job information, salary brackets, contract tips, application letters, passport information, climatic conditions, etc.—everything needed for your immediate application. \$1.00. Return for refund in 7 days if not satisfied. Pacific Industrial Research Bureau, 202-E Studio Building, Portland 5, Oregon.

REBINDING: We bind magazines, old books, Bibles, hymnals. Heckman Bindery, Dept. D, North Manchester, Indiana.

GAMES AND ENTERTAINMENT

FIREWORKS Manufacturers who ship direct to you. List 25c. Specialties, Box 599, Grand Rapids 1, Michigan.

AT Last: A sensationally new universal game. It's exciting, it's educational. Can be played in any language. Develops the vocabulary, increases knowledge of mathematical and chemical formulas. \$1.98 postpaid. Lexigraph Co., Suite 915-A, Dept. 3, San Francisco 8, California.

"84 CARD Tricks," 25c! "Simplified Dancing," \$1.00! Hirsch, Spring Valley 2, New York.

GIANT Kites 6 foot. Complete with twine and reel, \$2 postpaid. Albert Bach and Company, North Adams, Mass.

THE Number Teacher. A child's educational game. Addition, subtraction made easy. 10c. Wellhouse, 1212 Bernal, Burlingame, Calif.

FASCINATING New card game. Free. P.O. Box 842, Denver 1, Colo.

MAGIC TRICKS, PUZZLES, JOKER NOVELTIES

CARD Tricks exposed. Howard Thurston's book shows you how. Special 50c. Reid, Box A74, Sunnyside 4, L. I., N. Y.

VENTRILOQUISM Complete instruction only \$1. LeSueur, 77 Wellesley, Toronto, Canada.

FREE! Twelve clever card tricks. Monarch, 38 Jefferson, Auburn, New York.

ENTERTAINER'S Script catalog, free. Kleinman, 25-31-B 30th Road, Long Island City 2, New York.

FIRECRACKERS! Free catalog. No Utah orders accepted. Vern's Specialties, Box 29B, Sugarhouse, Utah.

SLICK Tricks, funny joke items. Novelty, puzzles. Latest catalog 10c. Sample Magic Magazine included. Magic Fun, Box 35-E, Irvington 11, N. J.

NEW Enlarged folio of card tricks, all self-working miracles, \$1.00 copy now only 50c. Jack Armstrong, R-5, Box 219 South Bend, Ind.

FLOATING Cigarette. Trick—cigarette floats in air. With instructions—dime. J. Eastwood, Box 623 Parkersburg, W. Va.

VANISHING Quarter trick 10c, catalog free. Tom DeLime, 30 Pershing Ave., Ridgewood, N. J.

FREE! Large catalog of magical apparatus if you remit 25c for "Magic Is Fun" magazine. Robbins Co., 152-F West 42nd Street, New York.

PROFESSIONAL Catalog 10c. Free when remitting 25c for Magic Book. Williams, 900 Plymouth, Ellwood City, Penna.

MILLIONAIRE'S Trick 25c. Magic game free. American Magic, Box 2485, Kansas City, Missouri.

80 TRICKS By Gibson, illustrated price only 25c. Alfred Ellis, 76 Sagamore Ave., Winthrop 52, Mass.

GOOD Magic! Beautiful flower magically appears on performer's coat lapel. Easy to do. Good comedy. 50c. House of Magic, 1117 Brown St., Dayton 9, Ohio.

INTRODUCTORY Offer. Jumbo joke book, 128 pages of riot, plus new, copy-righted edition of "mystifying" card tricks. (Formerly \$1.00). Self working. Any deck. Both \$1.00. Oudeman, Box 1840-M, Cleveland 6, Ohio.

"DRUGSTORE Magic" explains magic with common chemicals. Write for circular. Specialties, Box 599, Grand Rapids 1, Michigan.

PUN, Entertainment, pastime. Assortment of pocket size puzzles, tricks, games 10c. Money refunded if dissatisfied. Bob McCauley, Alexandria Bay 1, N. Y.

MAKE Money with magic. Details free. Alfred Ellis, 76 Sagamore Ave., Winthrop 52, Mass.

FREE! Twelve catchy tricks; magic catalog. Send stamp for postage. Lee's 2231-M McKinley, Berkeley 3, Calif.

FORTY Amusing, confusing mathematical puzzles. 25c. Howar, Box 128ME, Westport, Conn.

THREE Card Monte 25c. Cigarette vanisher 50c. 10 trick magic kit \$1.00. Kogel's Magic Novelty Co., 6751-A Colbert St., New Orleans 19, La.

SELL Funny business cards, tricks, jokes. Samples 10c. National, Box 301-M, Cincinnati 1, Ohio.

ENTERTAIN! Earn money! Ten lesson magic course discloses secret, presentation, patter. Tricks without special apparatus. Only \$1.00. Don Rogers, Box 183M, West-erly, Rhode Island.

MAGIC, Novelty catalog, and one trick, 10c. Wencel, 2615 Evaline, Hamtramck 12, Mich.

AMAZE And mystify your friends with highest quality magic. New catalogue 25c coin. Mazda Magic Co., Mt. Sterling, Ky.

ENTERTAIN! Mystify! New, bigger magic catalog and 4 secret tricks 25c. Herbert, P-192 N. Clark, Chicago 1.

WORLD'S Largest professional magic shop keeps you in touch with latest tricks. To receive mailings send 25c for new catalog. Holden, 220M W. 42nd St., New York.

TRICKY Match box, it turns around! It stands up! and it opens, most weird uncanny magic novelty trick. Complete ready to do. 25c. The Magician, 2463-M, Kensington Ave., Philadelphia, Penna.

MAGIC: Big 160 page Illustrated Catalog Latest Magic Goods, 25c. For over 1/3 century we have supplied Professional as well as Beginner. Chicago Magic Co., 2300 N. Mason, Chicago 39.

EARN Money in any crowd. Call names of strangers, tell unspoken questions. Professional course mind reading, faked spiritualism, etc., \$1. Henderson, Box 341, San Bernardino, Calif.

SURPRISE, Astonish, thrill, with empty hands, make clouds of smoke appear from fingertips or huge snow flakes float in air also make a five foot ribbon with empty hands, etc. Easy to do with Magic Paste, special 2 tubes enough for 70 tricks \$1.00 postpaid with big magic catalog. The Magician, 2463-M, Kensington Ave., Philadelphia 25, Penna.

"MAGIC Vanishing card." Throw it into air, it completely disappears, reproduce it later from spectator's pocket. Easy to do. Complete 25c with magic catalog. The Magician, 2463-C Kensington Ave., Phila-

LEARN Ventriloquism, 3c stamp brings particulars. Smith, 801 Bigelow, Peoria, Ill.

500 TRICKS You can do! Douglas' famous catalog of 500 tricks, now only 10c. America's fastest service on magic for pocket, parlor, stage, professional, amateur. Douglas Magic Shop, Box 274, Dallas, Texas.

BE A magician. Large professional magic catalogue of latest tricks 25c. Ireland, C-109 North Dearborn, Chicago 2.

NEW Vanishing key and catalog 25c. Sterling Magic, 345 John R, Detroit, Mich.

MAGIC Tricks, puzzles, books, cards, punch boards. Catalog 10c. Specialty, Box 671, St. Louis 1, Mo.

COINS, TOKENS, CURRENCY

5 DIFFERENT (New) Jap-Philippine bills—\$1.50. Castellano, 1974 West 6th, Brooklyn, N. Y.

FOREIGN Coin and lists, 10c. Oddehon, Box 482, St. Louis, Mo.

TWENTY-FIVE Different better grade foreign coins each from a different country, \$2 postpaid. Richard A. Webb, 268 Market, San Francisco 11, Calif.

FOREIGN Coin collection—fourteen different countries—one coin from each country—all for only \$1.75. Japanese Philippines invasion one and five centavos bills, 25c pair. Orleans Coins, 814 Royal, New Orleans 16, La.

ARE You a private collector of pennies? Let me give you information how to have an outstanding collection. Write John B. Lodgett, Rural Route 4, Box 181, Des Moines 13, Iowa.

JAPANESE Invasion bills, 5 different, 35c. Sallade, 4410 Branch Ave., Tampa, Florida.

25 DIFFERENT Coins \$1.00. Harry Elsholz, Box 9014A, Pittsburgh 24, Penna.

WILL Pay \$10 each for certain Lincoln pennies! Indianheads \$50.00; dimes \$1000. Catalogue 10c. Federal Coin Exchange, 5-PM, Columbus, Ohio.

FREE! Free! Free! Colorful, picturesque Japanese 5-sen and 10-sen notes! Current issue. Uncirculated. Genuine. Absolutely free with order for large surprise packet of Japanese Philippine-Invasion currency. Note: Hard-to-get 1000 peso (\$500.00) note included! You'll be amazed!—and pleased! Only \$1. Supply limited. This offer cannot be repeated. Order now! Stewart Byers, Box 187, Rayville, La.

WANTED: U. S. and foreign gold coins, class rings for my collection, will pay good price. Andrew Kranack, 806 Montiero, Pittsburgh, Penna.

OLD Money wanted. Do you know that coin collectors pay up to \$100.00 for certain U. S. cents? And high premiums for all rare coins? We buy all kinds. Send 4c for large coin folder. May mean much profit to you. Numismatic Co., Dept. 20, Fort Worth, Texas.

50,000 COINS, Medals, Colonial, Confederate, invasion currency. Illustrated lists free. Nagy, 8½ South 18th, Philadelphia 3, Penna.

PRESIDENTIAL Medallions, \$1.00 each. Fine condition. John Dietrich III, R.R. 1, Cedarburg, Wis.

WE Pay from \$2.00 to \$50.00 each for hundreds old, odd coins. Indian and Lincoln cents wanted. Keep all until posted. Send 10 cents for illustrated coin value book 4x6. Buying and selling prices. 40 years in business. Coin Exchange, 5, LeRoy, N. Y.

GENUINE Confederate bills, 5 different, only \$1.00. DuBose, Box 993, Atlanta 1, Ga.

MILITARY Medals, decorations, enameled orders bought, sold. Collections purchased. Kenneth Lee, Security Bldg., Glendale 3, Calif.

COMMEMORATIVE ½. Oregon, Texas; Kentucky, Cleveland, Long Island, \$2.00 ea. Illustrated catalogue 25c. Norman Shultz, Salt Lake 9, Utah.

QUICK Service; reasonable prices. United States catalog 10c. Foreign catalog 10c. Ben's Coin Company, 72 West Washington, Chicago 2, Illinois.

FREE! Foreign coin, banknote and coin collectors illustrated catalog to approval service applicants. Send 3c postage. Tatham Coinco, Springfield-125, Mass.

GET Profit and pleasure in collecting old coins. Send 10c for 56-page illustrated coin catalog. You'll be delighted with it. Send for it now. B. Max Mehl, 370 Mehl Building, Fort Worth, Texas. Largest rare coin establishment in U. S.

STAMP COLLECTING

GRAHAM Land, South Georgia, South Orkneys, South Shetlands, Falkland Island dependencies. Stamp from each dependency with approvals, 10c. Collins', 71 Coleridge, San Francisco 10, Calif.

POSITIVELY Greatest free offer—Latest Scott's International \$5.00 stamp album—covering entire world, contains 36,000 illustrated descriptive spaces; Scott's 1946 standard \$5.00 catalogues "Philately's Encyclopedia"—absolutely free to applicants for foreign approvals becoming customers. Bargain Stamp Service, Palm Springs, California.

SEMI-POSTALS Eight different Greece—latest issue 5c with approvals. Aldee, Box 38, Tremont Station, Bronx, N. Y.

5,713 DIFFERENT Stamps from 147 countries—many pictorials, commemoratives, and airmails—only one cent each on our collection building penny approvals. Pima Stamp Company, Sells, Arizona.

ALSACE-LORRAINE German occupation scarce! 4 different 10c, 22 different \$2.50. Illustrated list free. Bradford, Box 636, G.P.O. Brooklyn 1, New York.

5,000 DIFFERENT Stamps \$5.00. Available only through our exchange system. Postcard brings full information. Comet, G.P.O. Box 517-P, Brooklyn, N. Y.

5 FASCINATINGLY Beautiful pictorial sets only a dime to applicants for economical personalized approval selections. Hintz, R-1, West DePere, Wis.

SCARCE Russian colorful pictorial set cataloguing \$1.40. Special 10c to approval applicants. "PG," 195 Park, Lewiston, Me.

FREE—Liberia Triangle, Hitler stamps, half-stamp triangle, Devil's Island, others. Approvals. Postage 3c. Pilgrim Co., 6406 Old Hartford, Baltimore 14, Md.

STAMPS From forty countries, 10c. 50 different Poland, 50c. 25 different Russia, 20c. 25 different Netherlands, 20c. No approvals. Eisea, Bowling Green, Ohio.

HITLERS! 10 Different 10c. Free price-list upon request! Lory's Stamp Corner, Villa Park, Illinois.

WORLD Wide collection. Excellent assortment. 1000 stamps only \$1.00! Stamp Shop, Box 308-G, Harriman, Tenn.

50 DIFFERENT With approvals 5c. Lake Stamp Co., Ballston Lake, N. Y.

\$1.00 WILSON—35 Foreign, approvals, 10c. O. Burgett, Lima, Ohio.

25 DIFFERENT Switzerland—10c—with 1/2-1c approvals. Carroll's, 4357A S. Hoover, Los Angeles 37, Calif.

FLAG Stamp free with U. S. approvals. Wenigman, 929 Oakdale, Chicago.

FOREIGN Grabbags 50c. \$1.00, \$1.50. Slotin, 328 Bannerman, Winnipeg, Manitoba.

28 DIFFERENT Unused Russia, or 25 Rumanian, 3c. Approvals. Rosen, 1619 Bathgate, N. Y. C.

100 DIFFERENT Stamps 5c with approvals. Thurman Bailey, Pierson, Fla.

FREE! 200 Mixed stamps, approvals. Barwis, 4748A Umbria, Phila. 27, Penna.

LOW Priced United States approvals. Steger, 1165 Downing, Denver 3, Colorado.

BEAUTIFULLY Cancelled U. S. flag sets, \$1.25. Lloyd Johnson, Hawarden, Iowa.

BRITISH Colonies and South America on approval. Theo. Stevens, Box 3705, Kercheval Station, Detroit 15, Mich.

U. S.—200 DIFFERENT \$1.00, 75 different commemoratives, 60c. Clayton Doll, 85 Audubon Ave., New York 32, N. Y.

GUATEMALA Bi-sect, only 5c to applicants for our better grade approvals. Sco-Ban Stamp Co., Box 166, Austin, Tex.

HITLER Heads: 14 different—35c coins. Moore's Stamp Shop, La Crosse, Wis. Wants filled.

100 DIFFERENT U. S. \$1.00, 200 different, \$2.00. Lists 5c. Hobbycraft, Bowler, Wisconsin.

ATTRACTIVE Packet free to approval applicants. Rare Stamp Service, 1171 N. W. 66th Street, Miami 38, Fla.

OLD Scarce U. S. seconds on approval. Slightly defective, nice appearance, bargain prices. Hernfield, 551 Clinton, Newark 8, N. J.

ITALY—Bandiera Fascists, three stamps, complete 10c to approval applicants. Astoria Stamp Exchange, Box 25, Woolsey Station, L. I. C. 5, N. Y.

FREE! Valuable premium, price lists, etc., to approval applicants. Conklin Stamp Company, Department 12, Osage, Iowa.

UNITED States. #219, #220, #280, #376, #378, #413, #414, #C27, C28, C29, U349. Send 50c. Approvals accompany. Whiton Stamps, Norwalk 4, Conn.

GREECE "Roosevelt" set complete 35c. Approvals. Ross Jewells, Tamaqua, Penna.

5c SETS List free. With or without approvals. Purchase's, 231-B East 88th Street, Los Angeles 3.

1000 U. S. Mission mixture 25c. Monjar, 1750 Fairmount, Cincinnati, Ohio.

ATTENTION Collectors, Venezuela No. 177 cat. \$1.00. Only 25 cents with approvals. C. A. Turner, 97 Pearson Rd., Somerville, Mass.

75 U. S. Airmails, commemoratives 25c. Corryville Exchange, 119 St. Clair, Cincinnati, Ohio.

EX-JAP Naval base, scarce Nauru ship stamp. Bolshevik music stamp, victory stamp for 5c to approval applicants. Bob's Stamp Service, 430 Ralston, San Francisco 12, California.

50 CANADIAN, Newfoundland, including earlies, commemoratives, 10c. Approvals. Reede, 696 Gerrard, Toronto.

U. S. Commemorative packet only 10c. Imperforate nineteenth century and other obsolete. 75 different U. S. including Civil and Spanish War revenues, commemoratives, airmails 25c. 200 different \$1.00. To approval applicants. AAA Stamp Company, Arcade Building, St. Louis, Mo.

100 DIFFERENT 10c With approvals. Jacobsen, 59 Nagle Ave., New York 34, New York.

FREE! Airmail packet with approvals. Deane Stamp Co., Box 1002, Miami Beach 39, Florida.

"GOYA Nude" set complete 25c with approvals. Royal Stamp Company, Tamaqua, Penna.

"VATICAN City," "Fourteen" bi-colored stamps issued at the time of the appointment of the new Cardinals in Rome. A complete mint set only 50c to approval applicants! "Stanley the Stamp Man," 3120 South Adams Ave., Milwaukee 2, Wis.

HITLER Heads! 9 different, 10c, to approval applicants. Riverside Stamp Co., Box 1565, Miami 35, Florida.

BEST Way to build collection yet. Write for information. 2346 Zanja Way, Mentone, Calif.

EXCHANGE Duplicates. Swappers everywhere. List 10c. Particulars free. Box 2166-M, Denver 1, Colorado.

QUALITY Approvals that really satisfy. Schultheis, Box 41, Irwin, Penna.

LIBERIAN Triangular set, 10c with approvals. Vargo Stamps, 6044 South Fairfield, Chicago 29, Ill.

SCARCE Collection of unused Hitler Portrait stamps issued by the Nazis while Berlin was under siege. This collection of 13 different for only 20c to approval applicants. Reference please. Beeken, 13814 Gallagher, Detroit 12, Mich.

COMPLETE Set of Bicentennials 15c, Parks 35c, 25 different coils 30c. Free United States price list. A. Bartke, Palisade, New Jersey.

FREE Illustrated wholesale list. Imperial, First National Building, Yonkers, N. Y.

WHAT Have you to offer? A collection? A "shoe box" accumulation? Anything in stamps. We urgently need them. Spot cash paid. Cosmopolitan Stamp Co., 1457 Broadway, Dept. 5-E, New York.

SCANDINAVIAN Stamps. 100 different. Sweden \$2.00, Norway \$2.00, Denmark \$2.00, Finland \$2.00. Airmailed. Erik H. Sundell, Halsingborg, Sweden.

BRITISH Colony 25 different 10c with approvals. Pelican Stamp Co., 1609 S.W. 8th St., Miami 35, Fla.

33 DIFFERENT U. S. including 19th and 20th century commems.—regular issues, \$1.00 stamp included. All free to U. S. approval applicants only. Mendelson, 5410 Beverley Road, Brooklyn 3, N. Y.

DRESS Up your collection! Unusual assortment modern sets. \$2. Three times as many. \$5. Philately Exchange, 823 1/2 Maple, Santa Monica, California.

SPAIN—Five airmails, 10c. Approvals. Buchanan, 307 East 23rd, New York 10.

100 DIFF. Stamps, hinges, perforation gauge, illustrated lists, etc., 15c. North Texas Stamps, B-2817, Dallas.

SPECIAL Free offer to serious approval purchasers. Stamps, 6341 Dennis, Detroit 10, Michigan.

FREE! Big stamp outfit. Perforation gauge, hinges, giant packet airmail, commemorative, triangular stamps, 3c postage. Approvals. Auburn Stamps, Auburn, Mass.

VATICAN City set 10c. Souvenir, approvals. Foley, Box 2, Sheepshead Bay, Brooklyn, N. Y.

FREE "Hitler head" set. Request approvals. Blatt's, 1015 Pine, Philadelphia 7, Penna.

FREE: Iran, Iraq, Syria mint stamps. Request approvals. Premiums. Discounts. Virgil Stamp Mart, 305 Vallette, New Orleans 14, La.

VATICAN Cardinal set, 14 different, 90c. Approvals. Paul Kelly, 2078 East 24th Street, Brooklyn 29, New York.

FAN Mail! 75 foreign covers sent to movie stars. \$1.00. Gold Crown Stamp Co., North Hollywood, Calif.

CASH For stamps. List 10c. Reimer, 1119-P Chestnut, Saginaw, Michigan.

LIBERIA—Roosevelt commemoratives. Two postage values only 15c with approvals. Brown, Box 2024, Evansville, Ind.

FREE—Mint Philippine Island sent with foreign approvals. 20th Century, P.O.B. 3413, Philadelphia 22, Penna.

DEPENDABLE Approval service. Special packet 10c to applicants. Standard, 3817 Sackett, Cleveland 9, Ohio.

FREE—Scarce coronation! Bargain approvals. Gramatan, Box 1002, Church Street Station, New York 8.

HAITI Roosevelt memorial airmails, 2 values 30c; Hungary Horthy mourning stamp, beautiful semi-postal 20c. Herken's Stamp Shop, Benson, Illinois.

1000 MIXED United States 18c. Two pounds \$1.25. Mixture list free. Halay, 452 West 58th, New York 19.

ONE, Two, four, five dollar U. S. stamps free to approval applicants. United Stamp Service, Box 1789-M, Miami 10, Florida.

UNITED States approvals. Fine quality. Priced right. George Klein, Vincennes 2, Indiana.

55 DIFFERENT U. S.—5c. Approvals. Utechts, 1143C North Keeler, Chicago 51.

FREE St. Helena pictorial and big surprise packet to approval applicants. Pioneer, Box 414A, Pasadena 18, Calif.

FOREIGN Stamps packet 3c. Approvals. Smith, Box 71-A, Roselle, New Jersey.

U. S. Price list. Send postage. Stanley Gibbons, 38-P Park Row, New York.

BECHUANALAND, Tonga, Pitcairn, others—3c with approvals! Saxons, Walden, New York.

EXCELLENT Pictorial approvals. Reasonably priced. Crown Stamp Company, Box 331, Toronto, Canada.

1000 WELL Mixed Canadian stamps, \$1.00. No approvals. T. Johnstone, 421 Mt. Pleasant Rd., Toronto 12, Ont. Canada.

25 DIFFERENT British colonials, 5c with approvals. Stamphouse, 7235-A Sheridan, Chicago 26.

PENNY Approvals. Beautiful foreign stamps. Till, Box 202, Millbrae, Calif.

NUDE Duchess set (two varieties) 5c, approvals. Masters, Clifton and Kernan, Baltimore 7, Maryland.

125 DIFFERENT U. S. Stamps, 30c. Frank Stroskey, Box 55, Perth Amboy, New Jersey.

EARN Extra money. Become a part-time dealer, send 5c for our illustrated catalog. City Stamp Co., 2850 Clafin, Bronx 63, New York.

ZANZIBAR, Palestine, Manchukuo, Azerbaijan, Haiti, Iraq, Siam, Victoria, Hitler stamp 5c. Approvals. Postzegel, Windham, New York.

FREE! Complete Balkan aviation set with approvals. Beaman, Glenburnie 1, Maryland.

APPROVAL Sheets, Frederick B. Driver, 909 Finance Building, Philadelphia 2, Pa.

PENNY Approvals, that satisfy. Neil Gronberg, Box 5441-P, Philadelphia 43, Penna.

MAGAZINE—Chock-full stamp information, news and bargain ads! 15 issues 25c! "Stamp Post," Station A, Pasadena 3, Calif.

MINT Pictorials free to approval applicants. Surf Stamp Co., Box 2296, Miami Beach 40, Florida.

200 DIFFERENT Foreign, many countries 30c. Jem Stamps, Port Jefferson, N. Y.

UNITED Nations, scarce 5c U. S. commemorative and packet 30 different U. S., including airmail, commemoratives, revenues, etc. Catalogs 65c—to approval applicants for 5c. Curhan Stamp Company, Dept. H, Gloucester, Mass.

ZOWIE-E! A barrel of fun for only a dime. 500 United States stamps—absolutely unpicked and unsorted—just as received from church missions. Many varieties, including large commemoratives, airmails, high denominations up to \$5.00! Stampdom's biggest package of fun—and you might find something really valuable! Price only 10c to serious approval service applicants. Money back if not delighted. Illustrated bargain lists with each order. Mystic Stamp Company, Dept. 80, Camden, New York.

50 DIFFERENT United States, 10c. Price-list free. Seidenberg, Cassopolis, Mich.

FREE—Abyssinia, Cayman Islands, Tuna triangle, Indochine, Syria, Ivoire, Philippines (Jap "shame" issue), Turkish harem, Damascus, Cambodia, African "beauty," Pirate Islands, Colonials, others—All free for 3c postage with approvals. Belmont Stamps, Washington 10, D. C.

GLOBAL Packet 40 stamps all different 10c. Eclipse, Box 635, St. Louis 1, Mo.

CANADA—75c Diff. 25c. Approvals, Lists. Victoria Stamp Co., London 4, Canada.

10 DIFFERENT U. S. Over 40 years old, 5c. Foreign, U. S. approvals. Scott, 30 Baker Ave., Lexington 73, Mass.

MINT Black Harding ten cents to approval applicants. Louis Merrill, 1623 5th, Portsmouth, Ohio.

STAMPS! 1000 Different \$2.50. 2000 different \$7.50. Ransom, 1333 Pontiac, Ann Arbor, Mich.

WOW! \$10.00 Worth of fun only 10c. What a treasure hunt! Big package 500 foreign stamps—just as received from foreign missions other sources. Includes stamps from Africa, South America, Philippines, Free French, Cape Juby, Palestine, etc., including airmails, commemoratives, and stamps worth up to 50c and 75c. This amazing offer is given for 10c to serious approval applicants only. One to a customer, money back if not more than delighted. Jamestown Stamp Co., Dept. 22, Jamestown, New York. Stamps—valued up to 50c and 75c each.

GORGEOUS Colors, scarce airmail surcharges, charities, sets, etc. All in our big premium packet only 3c to approval buyers. Dixie Stamp Company, Dept. M, Milwaukee 3, Wisconsin.

LATIN-AMERICA, 65 Diff., pictorials, airs, etc., 10 countries, 10c with approvals. Crescent Stamps, London, Canada.

FINE Approvals, freshly mounted. Fast, personal service. Tell me what countries you prefer and I'll send their stamps. Skinner, 438 Locust, Long Beach 2, Calif.

RICH Man's approvals, poor man's prices. Grand value packet containing five foreign sets, free with approvals. Stoll Stamp Service, 2630B West Burnett, Louisville 10, Kentucky.

UNITED States approvals complete coverage, fine quality, attractive prices. Seminole Stamps, Box 378, Coconut Grove, Florida.

FREE! Negro Triangle; Turks Islands "Cactus"; Dakar; Guinea; Palestine; "Fairy Tale," Pirate Chart, Map, Ship, Sea Lion and Snake stamps; French, British, Portuguese Colonies, etc. Free for 3c postage. Approvals. Potomac Stamps, Washington 10, D. C.

FREE! Leeward Is., Cayman Is., Turks and Caicos plus 54 different mint World's Fair poster stamps, to approval service applicants sending 3c postage. Tatham Stamp Co., Springfield 30, Mass.

25 DIFFERENT India, 3c with approvals. Premiums with purchases. Brandwein Stamp Company, Box 92H, Bayonne, N. J.

MIXTURES. Worldwide accumulations 1,500 for \$1. Missions Outlet, Rev. Marshall, Paterson 1, N. J.

EXOTIC Pictorial collection, including Tahiti Spear Fishing, Melanesian Idol, Carib Archer, Malagasian Farmer and many other scarce stamps from strange countries. Everything only 5c. Imperial Stamp Co., Yonkers, N. Y.

50 DIFFERENT Including scarce diamond-shaped airmail 3c to approval service applicants. Avalon Stamp Co., Dept. M, Springfield 8, Mass.

19th CENTURY U. S. Commem., Civil War—Battle ship revenues, \$5 and \$10 stamps free to U. S. approval applicants. Metropolitan Stamps, 198C Broadway, New York.

LIBERAL Offer, thick packet with Seychelles, Fiji, U. S. commemoratives, Tete, Djibouti, Inini, Congo, Porto Rico, Philippines and multitude others. Everything only 10c to approval applicants. Burmaster, Box 1910 A, Los Angeles 53, Calif.

DANDY United States approvals. Write immediately. Sullivan, Endicott Building, St. Paul 1, Minn.

1000 GRABAGS 15c Each. Super bags 25c. Zandy, 630 Bingham, Reading, Pa.

BOX Stamps containing hundreds all different, cataloging up to 25c each. Everything \$1.00. Longacre Shop, 108 West 42nd, New York City.

SCARCE "Pole to Pole" packet! Stamps from strange, mysterious countries only—Greenland (North Pole), Solomons, Spanish Morocco, Bhopal, Patiala, Siberia, Grahamland (South Pole), Djibouti, Zanzibar, etc., and including stamps cataloging up to 25c each! Our price only 5c to approval applicants. Big dime packet list free! Methuen Stamp Service, Inc., Dept. 136, Lawrence, Mass.

FREE U. S. price list. Postage 3c. Mark Hanna, 335 - 5th Avenue, Pittsburgh 22, Penna.

FREE—Pick 25c worth of stamps from our first U. S. approval selection. Approximately 100 stamps to choose from. Excellent value. No obligation to buy. Lists illustrating the most popular U. S. stamps—at prices you can afford—will be included. Don't miss this opportunity! Write today. S. C. Engel Co., 38 Park Row, New York City.

TURKS, Caicos, Grenada, Brunei, Dominica, Caymans; everything 3c with approvals. Viking, 130(Z) Clinton St., Brooklyn, N. Y.

114 DIFFERENT Stamps from far away countries including airmail and Free Fighting French to approval applicants for 10c. Reich Stamp Co., 4647 Kenmore, Chicago 40, Dept. M9.

COMPLETE "United States" catalog with 1000 illustrations! Send 10c for mailing. Harris & Co., 137 Transit Building, Boston, Mass.

AMAZING Offer! Assortment each of giant stamps, midget stamps, flag stamps, airmail stamps, Free French Colonies, U. S. commemoratives and numerous others. Everything only 10c to approval applicants. Simon, Box 214, Iraan, Texas.

DEALERS—Wholesale list. Postage 3c. Frank, 5031 Queensberry, Baltimore 15, Md.

SCARCE 1880 U. S.—Hussey local carrier stamp listed at 15c. Also Costa Rica No. 65 listed at 40c. Both sent free to approval buyers sending 3c postage. Pladon Stamps, 1717-M Idaho, Toledo 5, Ohio.

WORLD'S Largest diamond and triangle stamps, free stamp magazine, stamps from fighting Free French, 20 stamps from 20 different countries, pictorials, airmails, big bargain 5c with approvals. Capital Stamps, Dept. 2, Little Rock, Ark.

118 DIFFERENT Stamps including commemoratives, charities, airmail sets, etc., only 3c to approval buyers. We buy collections. Badger Stamp Co., Milwaukee 3, Wis.

VICTORY Packet free—Includes stamps from Tanganyika, British Cayman Islands, animal, scarce babyhead, coronation, early Victorian, airmail, map stamps, with big catalogue—all free. Send 5c for postage. Gray Stamp Company, Dept. PM, Toronto, Canada.

FREE! Canadian sets, royal visit, George VI, George V, coronation, jubilee, others, to approval applicants. Ensign, Box 118-M, South Orange, N. J.

FREE! The Stamp Finder! Send today for the big new edition, fully illustrated, enabling you instantly to identify all difficult stamps! Also fine packet strange, fascinating stamps from Bosnia-Herzegovina, Monaco, Patiala, Cyprus, etc., including maps, ships, animals and strange scenes. All free to approval applicants inclosing 3c postage. Garcelon Stamp Company, Box 900, Calais, Maine.

HOBBIES AND COLLECTIONS

WORLDWIDE Hobby Club, 25c year. Unique, 4125 Lafayette, St. Louis, Mo.

"**GEM** Cutting" profitable, interesting hobby. Instructive illustrated booklet, one dollar. Mineral Specimens Company, Box 1191, Santa Monica, Calif.

OUTSTANDING Gifts. Representing the west and redwood empire. Retail—wholesale. Useful gifts and literature 10c. Miniature Burl vases 75c. Johnson, 812 S. Virginia, Reno, Nevada.

WANTED: Old cigarette cards. Write Charles Bray, East Bangor, Penna.

MEMBERSHIP 50c. National Hobby Club, Box 1113, Rochester 3, N. Y.

GEM Cutters, 1-lb. gem agate and jade \$1.00 postpaid. Gem House, Casper, Wyo.

SOMETHING To swap? Advertise it free. Hurry! Swaplist, Bondville, Vt.

TEN Small fire opal specimens \$1.00. Thirty mixed rough Mexican opals \$1.25. Minerals, gem stones and Indian relics on approval. Dr. Ralph E. Mueller, Professional Bldg., Kansas City 6, Mo.

FREE: 50 Military emblems when joining "Insignia Club." Price list, insignia guide 10c. Embroidered sample 5c. Hobbyguide, P35 West 32nd, New York.

BEAUTIFUL Selection of twenty hard to get, unused Canadian matchbook covers. Hotels, grills, one dollar postpaid. Joly, 8230 Drolet, Montreal, Canada.

INVENTING Can be an interesting and profitable hobby. Write for complete particulars. Institute of American Inventors, Dept. 40-E, 1926-Eye St. N. W., Washington 6, D. C.

NEW—15 Different match covers 10c. Box 202, Rochester 1, N. Y.

FOREIGN Decoration ribbons, list, sample, 20c. Foreign insignia packet, booklet, \$1.00. Insigniacrafts, 236-28th Ave. N.W., Calgary, Canada.

FOOL'S Gold—From famous gold camp, 10c per sample. Also mineral specimens from famous local mines. Martin's Snap Shop, 506 Harrison Ave., Leadville, Colo.

COLLECTING Hobbyists. Exchange duplicates. Swappers directory 10c. C. Bishop, Route 8, Kalamazoo 88, Michigan.

COLLECT Colorful Army patches. Pictures, prices and sample patch only 10c. Insignia Mart, 703 Broadway, N. Y.

WHITTLES—20 Patterns, instructions, X-acto knife, wood, \$1.00. "Old Whittler," 1402 Charles, LaCrosse, Wis.

UNUSED Match book covers, 100 all different \$1.00. 35 Royal Flash covers \$1.00. Free list. Charles Edelman, 1311C East 84, Cleveland 3, Ohio.

JEWELRY Stones removed from rings, etc., 100 assorted \$2.40; 50 large ones \$2.40. B. Lowe, Holland Bldg., St. Louis 1, Mo.

ANTIQUES, RELICS, INDIAN GOODS, CURIOS

DECORATE—And sell unpainted plaques, statuary, etc. Pioneer, Austin 5, Minn.

SWORDS, Rapiers, daggers, pistols, armor. Illustrated catalog 50c. Robert Abels, 860-A Lexington Ave., New York.

4 FINE Ancient arrowheads, \$1.00. Stone Tomahawk, \$1.00. Flint knife, 50c. List free. Lear's, Box 569, Galveston, Texas.

MUSEUM Specimens. Indian relics, curios, den decorations. Illustrated catalogue, identification chart 25c. We also buy. Museum Supplies, 6601 Oshkosh, Chicago 31, Illinois.

50,000 INDIAN Arrows, tools, rainbow variations. Don McKillop, Regina, Sask.

MINERALS AND PRECIOUS STONES

FOUR Rough gemmy agates \$1.00. Smith, Box 422F, Albany, Oregon.

12 ROUGH Red garnets 36 gram for only \$2.40. Brilliant cut genuine Australia green garnet \$3.00. Finest cut optical prism, 1 3/4 inch \$3.00. Federal tax included. Ernest Meier, Church St. Annex, Post Office Box 302, New York 8, N. Y.

CAMERAS AND PHOTO SUPPLIES

ENLARGER Build your own. Simple, inexpensive, no machine work necessary. Many satisfied users getting beautiful enlargements! Complete blueprints, specifications, instructions. Send \$1.00. Enlargo-craft, 120 East 233 Street, Euclid, Ohio.

PHOTOGRAPHERS—Beautifully printed press card 50c. Castellano, 1974 West 6th, Brooklyn, N. Y.

BASS Says: Trade cameras? For 36 years Bass has satisfied thousands everywhere! Finest equipment available. Always satisfaction guaranteed or your money back! Bass buys 'em, sells 'em, trades 'em. Bass Camera Company, Dept. AG, 179 W. Madison St., Chicago 2.

FOR Immediate delivery, cameras and equipment: movie cameras, projectors, still cameras, enlargers, lenses, screens, printers, trays, film, paper, chemicals, reflectors, dryers. Complete stock of dark-room equipment and hundreds of other photographic items. We pay highest prices for used cameras and equipment. Send for free new big catalog. Flash Photo Sales, 30 W. Washington St., Dept. E, Chicago 2, Illinois.

PIERCE Exposure meter, no calculating, plastic case, Weston reading, extinction type. Price at \$1.79 prepaid. Gary Camera Co., 619 Washington, Gary, Indiana.

SURPLUS Cameras. Scarce items, new, used. Bargains. Camera Guide, 126-M Lexington Avenue, New York. Latest edition well worth 25c (coin, stamps).

EXPOSURE Meters at bargain prices. Our price DeJur model 5B with case only \$13.44 plus \$1.06 tax. Brand new and guaranteed. Immediate delivery. Townsend Products, 755 Boylston St., Boston 16, Mass.

"PHOTOGRAPHY For Fun," 50c. Free catalog. Stone, Lunenburg 58, Mass.

PHOTO Printer kit \$1.00. L. Spada, 10 Lexington, Wethersfield 9, Conn.

CASH! Spot cash for cameras, lenses, binoculars, movie and still equipment. Send full description for prompt cash offer. Over 36 years of dependability. Bass Camera Company, Dept. AG, 179 W. Madison St., Chicago 2.

FILMS, Fresh, dated 1948, outdoor type. 127—\$3.49 dozen. 120 or 620 \$4.21 dozen. 116 or 616 \$4.81 dozen, postpaid. "Camera-man," 542-5th Ave., New York 19.

THE New 1946 model "Champion" camera is precision built, durable. Has genuine Simpson lens. Takes full natural color pictures. Now only \$4.45, postpaid. Instructions included. Order yours today. Herman Neely, Somerset, Kentucky.

CAMERA, New candid model. Good lens. Uses 127 film, exceptional value—\$3.25. Films, standard brand, fresh stock, 120, 620, each 30c. 116, 616, each 35c. (127, with camera order, tested surplus film, 27c.) Limit dozen. Add 10c postage on order. Photo-Craft, Box 470-C, Jamaica 1, N. Y.

PICTURES From everywhere. Build priceless collection of worthwhile prints. Exchange camera enthusiasts everywhere. Beginners or advanced workers. All sizes—subjects. Bi-monthly bulletin. Year's registration \$1.00. Information free. Photographic Exchange Club, 1206-B New York Ave. N. W., Washington 5, D. C.

REPAIR Leaky camera bellows with Bellose formula \$1.00. H. A. Berg, 124 No. 19 W. Duluth, Minn.

TELEPHOTO Camera, over four feet long, easily made. Trifling cost. Telephoto lens and instructions \$2.00. Instructions alone 10c. Carl Jamer, Box 594, Manorville, N. Y.

FILM! Fast Army. Five rolls, eight exposures, postage included: No. 127, \$1.45; 120, \$1.75; 620, \$1.75; 116, \$2.00; 616, \$2.00. Artex, Union, New Jersey.

INTERESTED In photography as career? Send stamp. Frank Smith, Midland Park, New Jersey.

ENLARGERS—Build your own. Kit of parts, \$6.00. Free particulars. Krescent Engineering, Box 586, North Hollywood, Calif.

CAMERAS, Enlargers, lowest prices. Free catalog. Cavalier Camera, 1822 Center, Pittsburgh 19, Penna.

OIL Coloring photographs can be a fascinating hobby or profitable sideline for those with artistic talent. Learn at home. Easy simplified method. Send for free booklet. National Photo Coloring School, 1315 Michigan, Dept. 3432, Chicago 5, Ill.

PHOTOGRAPHY For pleasure or profit. Learn at home. Practical basic training. Long established school. Write for booklet. American School of Photography, 1315 Michigan, Dept. 3432, Chicago 5.

USED Camera Directory, Box 1031-M, Canton, Ohio—lists hundreds of war-bargain used cameras—35mm., Speed Graphics, Kodaks, Rollei-flex—many others. Send 25c for latest issue.

HAVE You a camera? Improve your hobby of photography and learn how to make better pictures. Write today for our latest book catalog and sample copy of American Photography, containing articles and pictures by the world's foremost writers and photographers. Camera House, 601, 353 Newbury St., Boston 15, Mass.

PHOTO FINISHING

REPRINTS 1c Each with this ad. Photographer, Box 5, River Grove, Ill.

8 HOUR Service. Your 8 exposure roll developed and printed jumbo or regular size 25c, deckled edge if requested. 12 exposure rolls 35c, 16 exposures 50c, 36 exposures \$1.00. Reprints jumbo or regular size 3c each. All film developed fine grain. Workmanship, materials and 8 hour service guaranteed throughout. Quality Photo Service, Box 468, San Francisco 1, Calif.

DOUBLE-SIZE Prints from your negatives or rolls. 8 exposure rolls, 30c—reprints, 4c each. London Photo Service, Dept. P.M., Box 551, London, Ontario, Canada.

VETERANS Attention—Get extra prints of your negatives, pictures or discharge papers. Fresh film and finer photo finishing. Write for free price list and mailers. Universal Photo Service, La Crosse, Wis.

TECHNIFINISH Printon color prints. Big 3 1/4 x 4 1/2 enlargements with exclusive white borders only 65c, 5x7 \$2.00, 8x10 \$3.00. Additional charge for mounting. Black-and-white enlargements from your miniature color transparencies when mounted in 2x2 cardboard mounts, 10 negatives and 10 3 1/4 x 4 1/2 prints only \$1.00, 3 for 50c. Write for new folder. Technifinish, Dept. 84, Rochester 3, N. Y.

GENUINE Moen-tone finishing approved by thousands since 1898. 8 exposure roll developed with 16 prints or eight enlargements, 25c. Moen Photo Service, 452, La Crosse, Wisconsin.

35MM Special! 36 exposure roll fine grain developed, hardened, enlarged to 3 1/4 x 4 1/2 glossy, 90c. 18 exposures 55c. Reloads, 36 exposures 35c, 18 exposures 20c. 8 exposure roll developed, 8 sparkling double-size enlargements 25c. MacDonald's Photos, Box 28-A, Congress Park, Illinois.

TECHNIFINISH 35MM Films fine grain developed and 36 glossy prints enlarged to 3 1/4 x 4 1/2 only 90c, 18 exposures 55c. Reloads for 35mm cartridges, 36 exposures 35c, 18 exposures 20c. Black-and-white positives from your 35mm. films, 36 exposures 75c, 18 exposures 50c. Write for new folder, sample print and mailing bag. All free. Technifinish, Dept. 85, Rochester 3, New York.

FILM 6 Or 8 exposure roll developed & printed plus 5x7 enlargement free—complete 25c. Mail film to Joy-Photos, G.P.O. Box 606, New York 1, N. Y.

EXCLUSIVE Introductory offer! 4 beautiful enlargements for 10c. Send any 4 negatives of the same size (up to 2 1/2" x 4 1/2") and we will return to you immediately 4 valuable enlargements—deckled and dated on Velox. Negatives returned with order. Send negatives, this ad and 10c coin today. This ad must accompany order. Mail-N-Save, Box 310-8 Quincy, Mass.

TECHNIFINISH. Any 8 exposure roll developed and all pictures enlarged to 3 1/4 inches wide—only 25c. Write for new folder, sample print and mailing bag. All free. Technifinish, Dept. 83, Rochester 3, N. Y.

TRIAL Offer—Super size Hyglos prints with eight exposure rolls developed—29c. Free, \$1.00 framed enlargement coupon. Overnight service. Hollytints, P-1350, Hollywood, California.

FAST Delivery. Satisfaction guaranteed. Eight exposure rolls with two prints of each exposure, 30c; or eight jumbo size prints, 35c, completely finished. Write for special reprint prices. Pioneer Photo Print Service, Box 123, Wichita, Kansas.

DELUXE Enlargements! Expertly reproduced from your negative. 5x7, 25c each; 8x10, 45c each. Satisfaction guaranteed. Mysto Labs., 31-A Bedford St., Boston, Mass.

ROLL, Developed, printed 25c. Enlargement free. Reprints, 50c—\$1.00. Howard's, 3760 Fremont, Chicago 13.

FREE Enlargement coupon with each roll developed and printed. 8 exposure 25c, over 8 exposure, 40c. Reprints 3c. B&W Photorium, Box 157P, Pleasant Hill Missouri.

MONEY Back guarantee—All this for 25c: Roll developed, 8 bigger deluxe prints, also 8 regular prints, plus two beautiful enlargements and tasteful Leathertone frame. Lifetone Photo Company, Dept. 539, Des Moines, Iowa.

PHOTOSTATING—Plastic sealing, discharges, pictures, etc. Send stamp for special folder. Plasti-Kov, 7904 Santa Monica Blvd., Hollywood 46, Calif.

TRIAL 1 Roll developed, printed, 10c. Dick's Photo, Louisville, Ky.

8x10 ENLARGEMENT 40c, 3 for \$1.00; 5x7 20c, 3 for 50c. Send negative and money today. Clover Photos, P.O. Box 28, Gravesend Station, Brooklyn, N. Y.

COLOR—Beautiful enlargements! Hand colored in oil paints 8x10 \$3.00. Send negative, color specifications, and remittance to Cook Studios, Box 151, Caldwell, New Jersey.

BEAUTIFULLY Colored enlargements. 11x14 \$3.00. Haynescraft, 706 Eighth, Washington 1, D. C.

AT Last we have films: 116 and 616, 38c ea.; 120 and 620, 33c ea.; 127, 27c ea. Roll developed, all your snapshots hand-colored as beautiful as most actual colored photography 35c. Hand colored reprints 4c each, 12 for 45c. Midwest Photo, Janesville 26, Wisconsin.

ROLLS Developed and eight 4x6 single weight enlargements from any size roll 30c. Reprints 4c each. Mohart Film Service, West Salem, Wisconsin.

FILM Developed, 8 album size enlargements or 16 sparkling prints, 25c; 8 snappy 4x6 enlargements, 30c. Reprints each: contact prints, 2c; album enlargements, 3c; 4x6 enlargements 4c. Crystal Studios, 159-F, Rushford, Minn.

ROLLS Developed and printed, 25c. Reprints, 2c; 5x7 enlargements, 15c; 8x10, 25c. Davis Studio, Guthrie, Oklahoma.

FREE Snapshots! Free album! Mail this ad and two negatives for free snapshots complete in album! When you see these free samples you'll want more. Artisto, Dept. 131, Drawer-220, Regina, Sask.

BIGGEST \$1.00 Value in 35mm. finishing today. 36 exposure fine grain 3 1/4 x 4 1/2 enlargements; deckled, embossed margin and date. Eighteen exposures 75c; 16 exposure splits 55c; 36 exposure reloads 50c. Special: return this ad with \$2.00 and we will send five 36 exposure reloads. Free mailers. 8 exposure rolls in beautiful, deckled contact finish with embossed wide margin, 25c. Mailbag Film Service, Box 5440A, Chicago 80, Ill.

8 VELOX Prints and two professional enlargements 25c. Send roll or negatives for trial offer. Young Photo Service, 405-C, Albany 2, N. Y.

2 BEAUTIFUL Hi-Gloss prints each good negative and enlarging coupon with each 6 or 8 exposure roll developed, 28c. Owl Photo Co., Weatherford, Okla.

50 REPRINTS \$1.00. No limit. Studio, 1408-M Bond, Rockford, Ill.

GLOSS Finish enlargements. 4 5x7 from negative 50c. 3 5x7 from photo 50c. Robert Renshaw, Jr., P.O. Box 478, Chester, Penna.

PHOTOGRAPHY For pleasure or profit. Learn at home. Practical basic training. Long established school. Write for booklet. American School of Photography, 1315 Michigan, Dept. 3451, Chicago 5.

8 EXPOSURE Rolls 25c, over 8 exposure 40c, for one Velox print each and free enlargement coupon. Reprints 3c, minimum 25c. Fred D. Eastman, Bode, Iowa.

6-8 EXPOSURE Rolls developed and enlarged mammoth size 30c. Reprints 3c. Thrifty Photos, Box 46, South Gate, Calif.

CENTURY Delivers work and service that can't be beat. 8 exp. roll 25c with two professional enlargements free. Century Photo Service, LaCrosse, Wis.

8 PRINTS, All enlarged to nearly postcard size, from your roll or negative, 25c. Willard Studios, Box 3535A, Cleveland 18, Ohio.

SENSATIONAL Introductory offer! Send snapshot or negative, this ad, and 3c. We'll send you a beautiful 7"x5" enlargement! Or, Kodak roll developed with 16 guaranteed deckled-edge velox fade-proof prints or 8 double-size prints, 25c! Special! From your negatives, 16 regular-size or 8 double-size reprints, 25c! Candid rolls—36 exp. 35mm. developed, vaporated, enlarged to 3x4, \$1.00! 18 exp. 50c. Reprints, 3x4, 3c each. We have new, perfect 35mm. film. Low prices. Free mailers, details on request. American Studios, Dept. 279, LaCrosse, Wis.

EVERY Picture an enlargement! 8 sparkling deckle-edge enlargements and roll developed 25c coin; 116 size or smaller: enlarge reprints 3c. Enlarge Photo, Box 791D, Boston, Mass.

BEAUTIFUL Double-size pictures 3 1/2c each, from 116 and 120 negatives. 3 1/4 x 4 1/2 from all other sizes. All work guaranteed. Overnight service. Roll developed and 8 pictures 30c. Roll 12 pictures 45c. Roll 16 pictures 60c. Enlargements on double weight portrait paper 5x7—30c. 8x10—50c. Copies made from any picture 75c. Pacific Photo Service, Box 666, San Francisco, Calif.

MOTION PICTURES AND SOUND EQUIPMENT

FOR Owners of home movie projectors. See the outstanding home movie production. Project it yourself free. Send postal card today to Preferred Film Producers, Hamilton 25, Ohio.

GUARANTEED Fresh movie film! Three spools double 8mm. \$3.45! Six spools single 8mm. for Univex cameras \$3.50! Processing free! Postpaid. (\$1.00 deposit C.O.D.'s.) State camera make. New catalog. ESO-S, 4038 Broadway, Kansas City 2, Missouri.

HOME Movies. All kinds. Lists free. Box 337-A, Valley Stream, N. Y.

MOVIE Projectors 16mm. silent \$24.50 up, 16mm. sound new and used. Several makes and models from home movie to professional sizes. 8mm. and 16mm. cameras. DeVry portable 35mm. 1000' sound projector. Griswold 8mm. and 16mm. splicers \$16.50. GE exposure meters \$23.75. Mercury 11 35mm. candid camera f2.7 lens \$73.49 8mm. and 16mm. films. Gallagher Film Service, Green Bay, Wis.

\$1 BRINGS "Surprise" assortment, 8mm. titles! Guaranteed. LeMoine Films, Nevada, Mo.

BASS Says: 36 years of leadership in the motion picture equipment field. Sound projectors, 8 and 16mm. equipment, finest accessories. Bass buys 'em, sells 'em, trades 'em. Always satisfaction guaranteed or money refunded! Bass Camera Company, Dept. A, 179 W. Madison St., Chicago 2.

FILM, Free processing 100 ft. 16mm. Weston 6, \$2.50; Weston 24, \$4.90; Weston 64, \$4.95; 25 ft. double 8, Weston 6, \$1.35; Weston 24, \$1.89; Weston 64, \$1.99. Free circulars. Fromader Genera, Davenport 7, Iowa.

16MM. Sound projectors, film, catalog. Holmes, 2940 N. Camac St., Philadelphia 33, Penna.

BEAUTIFUL Kodachrome film subjects, 8mm., 16mm. Low prices. Big catalog, 25c. Projection length sample from "Waikiki Hula." \$1.00. World in Color, Box 392-F, Elmira, N. Y.

COMPLETE 16MM. sound cartoons, good condition, \$9.95. 100' used sound film, \$1. We buy, sell, trade sound films. Big list available. Blackhawk Films, Dept. PM25, Davenport, Iowa.

MOVIES Over 150 names, addresses where to obtain free. Silent, sound. Color Films, 1308 Conn. Ave., Washington, D. C.

COMPLETE Stocks always of castle, official, pictorial films, 8mm., 16mm., sound. Musicals, soundies, free catalogs. We exchange your films and equipment, or buy them for cash. Frank Lane, 5 Little Bldg., Boston, Mass.

35MM. Sound westerns, features, shorts. C. Rogers, Box 26, East Atlanta, Ga.

UNUSUAL 8-16 mm. Film subjects. Big catalog with sample film, 10c. National Film Exchange, Broadway, Sta. E, Toledo 9, Ohio.

USED 16MM. Sound film \$5.00 reel up. Silents \$4.00. Sloat, 640 Greenville, Johnston 9, R. I.

PROJECTOR 16MM. A.c. motor driven. Focusing lens. With lamp, 200 ft. reel. \$15.50 postpaid. Photo-Craft, Box 470-U, Jamaica 1, New York.

FREE 16MM. Films. 140 addresses \$2.00. 16mm. projector \$15.50. Catalog 10c. Richardson Camera Service, Wyoming, Penna.

8MM.-16MM. Films bought, sold, exchanged. Complete sound subjects \$2.00 up. Catalogues, end title 10c. International-M, 2120 Strauss, Brooklyn.

SAVE Money. Buy, rent, exchange 8-16 mm. and sound home movies. Details for dime. Midland Film Exchange, Box 429, Oak Park 4, Illinois.

NEW 16MM. motor driven projectors \$16.00 postpaid. Sterling's, 679 Northampton, Easton, Pennsylvania.

I BUY, Sell, swap, rent s.o.f., 8 and 16mm. films. List free. Harvey Iris, Box 539, Brockton, Mass.

SWAP Your 16mm. sound films. Send \$2 bill or money order with any Castle sound film and we will send you any Castle film of your own choice in exchange. Films must be in good condition. Eanrob Exchange, Box 583, New Bedford, Mass.

LEARN Professional motion picture technique at home. Free catalog. Motion Picture Institute, Birmingham 4, Mich.

MAKE \$8 To \$10 net profit daily with your 8mm. or 16mm. projector. Details free. Metcalf, 10806 Glenroy Ave., Chicago 43, Ill.

MOVIE Films, 100' outdoor 16mm. \$2.25; three rolls \$6.00; 100' indoor film \$4.25. Ambassador, 479-A, Quincy Street, Brooklyn, N. Y.

RENT 16 MM. sound films 50c reel. Large selection; free catalog. Film Service, 128 Chestnut Street, Roselle Park, N. J.

UNUSUAL Home movies—travel, adventure, sports, news, war films. Many film bargains. Big 1946 catalog and sample, dime. Audet, Box 6520-BG, Philadelphia 38, Penna.

8MM., 16mm., 35mm. films. Samples 10c. Lists free. Paramount Films, Monmouth, Illinois.

35MM. Sound features, projectors. A Savarese, Woodcliff Lake, New Jersey.

"THE World's Greatest Passion Play," all sizes sound and silent. Write Hemenway Film, 33-F Melrose St., Boston 16, Mass.

LEARN Movie projection, management. Free catalog. Theatre Institute, Elmira, N. Y.

SPECIAL Movie film, 8mm., 25 feet double-Weston 8, \$2.00. Super double X, Pan indoor 60, outdoor 100, 16 mm.—\$6.50. Super X Pan indoor 24, outdoor 50, \$5.75. Pan Weston 12, \$5.00. 16 mm. 100 feet Weston 6, \$4.00. Free developing. Exhibitors Film Exchange, 630 9th Ave., New York 19, N. Y.

BEAUTIFUL Kodachrome slide and list, 25c. Art Slide Co., M-1, Canton, Ohio.

MOVIE Camera films, 100' 16mm. \$2.50. 25' double 8mm. \$1.25. Free developing. Better Films, 742 NewLots, Brooklyn 7, N. Y.

MOVIE Projectors bought and sold. List 10c. United, 2309-A Lawrence, Toledo, O.

MUSIC AND MUSICAL INSTRUMENTS

THE 96 Page "The Complete Songwriter" tells how to write music, words, arrangements and publishing. Send \$2.00 M.O. Puritan Publishing Co., Inc., 343 So. Dearborn St., Chicago 4, Ill.

USED Phonograph records—10 or 10,000, state your requirements. Olin Milner, Wholesaler, 335 McDaniel St., Atlanta, Ga.

"GUITARS"—"Band and orchestra instruments"—"harmonicas." List free. Rudolph's, Atchison, Kansas.

STRADIVARIZE Your violin, plan \$2.00. Guaranteed, refund. Patmor, Zion, Ill.

ACCORDIONS: All sizes and makes. Wholesale prices. Free catalogue. American Accordion Center, 39 S. Kedzie, Chicago 12, Ill.

SONGS Wanted. Lyrics, melodies for publication. Send for details. Wyner, Mayo & King, 1658 B'way, N. Y. (19) Room 426.

SONGWRITERS! Rare opportunity. Contact Billy Hannon, 6703 N. Oshkosh, Chicago, Ill.

SONGWRITERS—Excellent proposition. E. Madden, G.P.O. Box 1226, Syracuse, N. Y.

ORGAN Recording of your song. Sample 35c. Hanert, 11030 Hermosa, Chicago.

PUBLICATION Guaranteed for accepted poems or complete songs. Stevens Music Co., Suite 817, 141 Broadway, New York 6.

GUITARISTS—Modernistic set, runs, breaks, introductions, modulations, futuristic chords. Strictly professional material \$3.00. Nicosia, Box 596PME, Brooklyn 1, New York.

LYRICS, Melodies—\$3.00. Revisions. Sholl, 2217 Penn St., Harrisburg, Penna.

VALUABLE Monthly awards for best songs. Songwriters: collaborate with nationally famous composer of "Boots and Saddles." Send poems for free examination. Get free instructive booklet. Hollywood Harmony House, 126 South La Brea, M-10, Los Angeles 36, California.

SONGWRITERS: Essential, mailing lists, publishers, 25c. M. Battiston, 31-69, 41st St., Long Island City, New York.

POETRY Recorded for home reproduction. Narration, original organ interpolations by established radio artists. The Radioart Company, Box 2918 Terminal Annex, Los Angeles 54, Calif.

GUARANTEE To teach you to play Spanish guitar or Hawaiian guitar in ten lessons or piano—one dollar. Frank's Musicians Supply, 732 Jersey Court, San Diego 8, California.

WE Offer the services of a noted Hollywood motion picture composer and arranger. Recordings made by NBC singer. Send your poem on any subject today for consideration and our liberal offer. Hollywood Melodies, P.O. Box 2168PM, Hollywood 28, Calif.

VOCALIST Pay well. Amazing home method. Details free. Vocalto, Madison Hotel, Box 132-D, Atlantic City, N. J.

WE Buy accordions any size, any make; top prices paid in cash. 754 N. Damen Ave., Chicago 22, Illinois.

SONGWRITER'S Publishing agreement free. Stuckmann Music Press, 5426 Broadway, Chicago 40.

MAGAZINE For songwriters! 10c. Songs published free. "Songwriter's Review" 111-M West 48th, New York City.

SONGWRITERS. Have your songs or lyrics completed by an honest, experienced arranger. Free analysis report. Tommy Kilbourne, Box 1253, Bakersfield, Calif.

HAWAIIAN Guitar chord chart \$1.00. Over 650 chords in A-E 7th-C#-B 11th-Notes and diagrams by Sol Hoopil and Dick McIntire. Best for arranging. Fator's, 935 W. Santa Barbara, Los Angeles 37, Calif.

SONGWRITERS! Amazing, outstanding ethical offer. Hibbeler, C5, 2157 N. Avers, Chicago.

SONGWRITERS. A limited amount of musical compositions wanted for radio distribution. Tin Pan Alley, Inc., 1650 Broadway, New York 19, N. Y.

POPULAR Piano in 12 lessons, guaranteed. Beginners, advanced. Kelly School, 1734 30th Ave., San Francisco 22, Calif.

POEMS Wanted! I'll compose special music. Send poem for free examination. Eliot Wright, Master Composer, 107 Rivoli Theater Building, Portland, Oregon.

SONG Poems wanted, for musical settings. Send poem for free examination and outstanding offer. Write for free instructive booklet outlining opportunities. United Music, Salem 3, Indiana.

NEW Songs and lyrics wanted for popular radio program and professional promotion. Free examination. Transradio Music Inc., Dept. P., 1650 Broadway, New York.

SONG Poems wanted—All subjects. Send your best poems today for free examination, or write for free booklet "Getting Ahead in Songwriting." Song Service, 331-C West 46th, New York.

MUSIC Composed to song-poems. Address: Frank Wildt, Lancaster, Penna.

SONG Writer's attention! The amazing demand for phonograph records, accelerated by more than 300,000 juke boxes and the hits popularized warrants your immediate consideration. We are offering song-poem writers the rare opportunity of having established composers collaborate on appealing material received this month. Recola Records, Box 987P, Hollywood 28, Calif.

POEMS Wanted for musical setting. Send poem for immediate consideration and free rhyming dictionary. Richard Brothers, 24 Woods Building, Chicago.

SONGWRITERS—Send poems for immediate examination and free book, "Your Future in Songwriting." Radio City Music Academy, 1674 Broadway, New York City 19.

WANTED! Lyrics, melodies for songs. We arrange, publish, sell. Superior Song Studios, Passaic, N. J.

ACCORDIONS. New and used at wholesale prices. Save up to \$100.00. Buy direct from factory. Del Principe, 307 So. Wabash, Chicago.

BEFORE Sending your poem to be set to music, know your composer. Free folder. Al. Moquin, 5333 La Cresta Court, Hollywood 38, Calif.

POEMS Wanted for musical setting. Send poem for immediate consideration. Five Star Music Masters, 630 Beacon Building, Boston.

SONG Poems wanted. Free examination. McNeil, Master of Music, 510-PM South Alexandria, Los Angeles, Calif.

WRITE Songs. Big money and reputation. Write for information. J. Gordon Pub Co., 201 N. Hoyne Ave., Chicago.

RADIOS AND SUPPLIES

MAKE Simple, tubeless, batteryless, distance-getting crystal radios. Crystal and illustrated instructions 25c postpaid. Allen, 427-P, Clinton, Missouri.

CRYSTAL Radio diagrams, instructions. Nearly all possible circuits and applications. Exceptional results guaranteed. Different, \$1.00. Capitol Radio Laboratories, 2947 Mills Ave. N. E., Washington, D. C.

BUILD "Proximity Alarm." Works like famous "proximity fuse." Instructions and photo \$1.50. Robert, Box 2044, Columbus 16, Ohio.

HEADSETS, Used Army headsets of finest quality complete with headband, cord and plug. Adaptable for use with crystal or other type radios, \$2.50 per pair. Shipping charges 25c extra. Arnold Electric, Middletown, Penna.

AIRFORCE Surplus! R14 headphones, \$1.00. Mikes, throat, \$1.00. hand type, \$2.50. mask type, 50c. 3-6 meg. airplane receivers, \$7.50. Four damaged meters, \$1.00. All used. Aero Instrument Company, Municipal Airport, Houston, Texas.

LOUD Speaking crystal radio, improved design. Illustrated plans 30c. Radio Clinic, 10631 C, Cleveland 6, Ohio.

NEW Radio tubes, most kinds, OPA ceiling, free list. Give tube number. Radio, 1800 Classen, Oklahoma City 6, Oklahoma.

NEW Radio tubes, retail. Spada Enterprises, 10 Lexington, Wethersfield 9, Conn.

REVISED Plans 18 long distance crystal sets, including "Radiobuilder"—25c. Laboratories, Box I-C, San Carlos, Calif.

FAMOUS Razor blade radio! Illustrated plans 35c. New Radio, Lohrville, Iowa.

THREE Tube ac-dc phonograph amplifier, complete with tubes—\$8.50. A. Alena, 636 Water Street, New York 2.

HEADPHONES: New lightweight sensitive 2000 ohms, complete with headband and cord \$1.95. Naval aircraft control boxes \$2.00 per pair, worth \$10.00 for parts. Van Sickle Radio Supply Co., Indianapolis 6, Ind.

HOW To build a crystal radio that works. No tubes, no batteries. Fully illustrated booklet 25 cents coin. Money-back guarantee. Jesse Francis, 4645 Mayfield Road, Cleveland, Ohio.

RADAR Crystals now available for your crystal set. Free details. Hayes, 4004-C Arcade Bldg., Seattle, Wash.

HAVE Fun, building super crystal radios. Educational, illustrated instructions and crystal 25c (postpaid). Boyer, 634 Nebraska, Kansas City 2, Kansas.

CRYSTAL Set kits complete with phone, hookup wire and solder. All you need is screwdriver and iron. \$3.95 postpaid. Diagrams for anything 50c. Western Radio, Brady, Texas.

FREE List surplus of standard radio parts, etc. Send your requirements. John Barron, 662 85th St., Brooklyn 9, N. Y.

VEST Pocket radio! Local or distant reception. Plans sold over U. S., Canada, Hawaii, Porto Rico. What fun! Listen while strolling or cycling. Standard parts. Cheap. Easy. Free photograph with plans. Rush \$1.00. United Manufacturing Associates, 3316-1 Ave. G, Fort Worth 5, Tex.

LIGHT Beam transmitter-receiver, vacuum tube Oudin coil, ultra portable transmitter, reflex amplifier-detector, miniature tube AC-DC superhet. Blueprints 45c each, 4 for \$1.10. Diaprints, #204, 117 Park Rd., Burlingame, Calif.

WESTERN Electric fixed crystal. A war development. Excellent as a detector for crystal sets. Nothing like it. Highly sensitive. Gives extra loud steady reception. No adjusting. Fine for wave trap, meters. Many uses. Practically impossible to buy. Cost government \$6.00. Prepaid 99c. Free radio list M. Radio City Labs, 30 Church St., New York 7, N. Y.

PASS Radio license examination; self instruction manual 25c. Publishers, Box 712, Pittsburgh, Pa.

BUILD Newest, extra-loud crystal set. Instructions, 20c. "All About Crystal Sets," booklet, 45c. Amorose Radio, R-4 Hungary Road, Richmond, Virginia.

BUILD Your own radio. All kits complete, including speaker, 4 tubes and full instructions, \$10.95. Details and latest parts catalog. National Radio Distributors, 1029-M E. 163rd St., New York 59, N. Y.

BUILD Full-scale radio. Pictorial diagram, instruction book; tools; tubes. Complete kit only \$11.50 postpaid. Fidelis Appliances, 61 So. Washington Ave., Bergenfield, N. J.

TEN, Simple, easy to build crystal radio diagrams and crystal 25c postpaid. Potter, 1314 McGee, Kansas City 6, Mo.

RADIO Tubes, parts, condensers. Free bargain lists. Potter, 1314 McGee, Kansas City, Mo.

MAKE Simple, tubeless, batteryless, distance-getting crystal radios. Crystal and illustrated instructions 25c postpaid. Allen, 427-F, Clinton, Missouri.

FM Can now be heard on old radios! Very simple adaptor! Send postcard for free data! Topical Emprise Corporation, 1527 Highland, Box 42, Louisville 4, Ky.

RADIO Service men and experimenters send stamp for our giant radio catalogue. Save dollars. United Radio Co., (1000-V) Newark 1, N. J.

RADIO Service flat rate schedules solve pricing problems. Compiled from 20 years experience. Write for information. Radio Equipment Co., 1415 W. Franklin Ave., Minneapolis 5, Minn.

RADIO Technician and radio service courses. Training for federal licenses. American Radio Institute, 101 W. 63 St., New York City. Approved under G. I. Bill of Rights.

HELPFUL Radio books. Up-to-date list free. Popular Mechanics Press, (C-43).

BUSINESS OPPORTUNITIES

PROFITABLE Business at home in your spare time. Hustlers write Eagle Ink Company, Forest Hills, N. Y.

TIRE Carcasses everywhere, from these reclaim rubber to make molds, tire plastic, etc. Details for stamp. Betke, Box 699, Borger, Texas.

RECOVER Silver from X-ray and photographic film and solutions. Simple, profitable process for only \$1.00. Shorewood Laboratories, 333 No. Michigan, Chicago.

WHY Money worry? Own—operate typewriter repair business. Low capital required. Large earnings! Qualify quickly. Easy directions. Write Athey's Typewriter Supply, P-5, Tarentum, Penna.

GUARANTEED Income! Grind lawn mowers. \$3.50 investment! Mowers, Janesville, Wis.

MAIL Buyers directory magazine, tells how to make, save money! Contains supply sources, valuable information! Copy, 25c. DeWeese, Box 1023, York 1, Penna.

RUBBER. Moulding liquid cast plaques. Sample. Kents Studio, Worthington, Ohio.

SYNTHETIC Latex with Neoprene base for making flexible molds! Quick drying! Quart \$2.00. Gallon \$5.95. Full instructions. Plastercraft, 1406 East 43rd Street, Cleveland 3, Ohio.

MAIL Order business can be your future! Same as hundreds advertising in this and other publications. "How to Build Your Own Mail Order Business"—noted specialist's 10,000-word treatise—shows how to make it pay, on small, capital start. 25c postpaid. Satisfaction guaranteed. Maupin & Maupin, LaFayette 3, Ind.

100 AND More ideas make money home. Big profits. Large folder free. 20th Century Service Co., 505 Fifth Avenue, N. Y.

BEST Mail order seller in years. Be independent. Own your own business. Details free. A. B. Hadeland Publications, 36 Walnut St., Ridgewood, New Jersey.

HARDWARE Business is one of the most interesting and profitable of them all. Be independent. You can start your own retail store with small investment and no previous experience. 15,000-word, copy-righted booklet tells you how. \$1.00 postpaid. C. R. Divan, P.O. Box 325, Santa Monica, Calif.

RAISE Rabbits commercially, big profits, small starting capital. Read the International Commercial Rabbit Journal, copy 10c, \$1 yr. Box 667, Salem, Oregon.

ESTABLISH Profitable home mail-order business. Ideal occupation. Excellent earnings. Free literature. Jay Peterson, Box 752, Minneapolis 1, Minnesota.

START A mailing list business in spare time. Big profit. Steady demand. Details free. MacAndrews, 8 Buick Street, Calais, Maine.

HANDLE Advertising novelties! Large income from fast-selling, year-round items needed by new, expanding business. Advertiser's name printed on handsomely designed, inexpensive calendars, desk blotter holder, luminous altar shrine, tie rack, etc. Send \$2.00 for sample line and arrangements. Seven day money refund. Coronet Paper Products, 1375 Boston Road, New York, N. Y.

WHOLESALE Distributors: Amazing patented screw-holding screw drivers; removes, holds, inserts screws instantly hard-to-get-at places; also used as regular screw driver; 7 models; tremendous market to stores, factories; big profits; returnable trial order. Write now, Millen Mfg., 93A Federal, Boston, Mass.

MAKE Big money in window cleaning business. Be independent in a business of your own. Details free. Write P.O. Box 6, Springfield, Mass.

START A mailorder business in spare time. Details free. Monarch, 38-A Jefferson, Auburn, New York.

HERE Is five brand new profit making mail selling plans. Free literature. Frank Davis, 68 N.E. Stanton, Portland, Oregon.

CASH By mail. Either sex. 10c brings offers. Bargain. Specialty Company, Box 635BO, Modesto, California.

GO Into rug and upholstery cleaning and mothproofing business. Extra double profits selling these two professionally used products to stores and homes. Russell-Johnson Company, Clarkfield, Minn.

A PROFITABLE Business of your own with Glow in the Dark products. Sample 10c (refund). Progressive, 2160B Bleck-

MAKE Flexible Molds, Statuary, Art Goods, Novelties, Artificial Marble Flooring, Liquid Marble. Literature free. Kemico, Park Ridge, 5M, Ill.

BOOKKEEPERS—Earn additional income posting at home. Barnhart & Kennedy, Public Accountants, Memorial Square, Chambersburg, Penna.

SHIP Pictures of World War II. Big profits for agents, salesmen and veterans. Liberty Picture Co., P.O. Box 3797, Portland 8, Ore.

FREE Literature describing successful business plans. Michael's Business Enterprises, 715 Lorimer St., Brooklyn 11, N. Y.

OPERATE Your own profitable business anywhere. Free details. Yates, Box 2152, Columbus 16, Ohio.

START Profitable business, package, sell amazing cleaner under your name. Details free, sample 25c. Linnell Co., Box 1720, Cleveland 5, Ohio.

CASH In. 64 page book, over 40,000 words, 25c. Money making business secrets, mail order plans galore. No ad-meant only. M. W. Cohen, Dept. 24, 1141 S. Independence Blvd., Chicago 24, Illinois.

FREE Particulars! "Plasticize" agency, locally. Smiths, Box 116, Unionville, Conn.

YOUR Best investment is daily Bible study. Start today!

SIX Mail order trade publications 25c. Containing articles, plans, schemes, wholesale offers. Kraft, 3114-S1 Walnut, Chicago 12, Illinois.

TATTOOING Equipment — Supplies. Wholesale, retail. Steele, 1138-G Market, San Francisco.

NEED Representatives—Big opportunity. Joseph Sliwa, 889 Seneca St., Buffalo N. Y.

COMPREHENSIVE New business report, "Success With a Small Shop," gives dependable detailed instructions for starting your own store successfully on very small capital. \$2.15 postpaid. Market Research Associates, 7905 Evans, Chicago 19, Ill.

MAKE Soap at home. No machinery. Profitable. Literature free. Kemico, Park Ridge, (SM5), Ill.

A BUSINESS Of your own selling the "Original" Bubble Liquid to cigar, candy, dept. stores, also beaches, parks and fairs. Buy direct from manufacturer and save. Regent Manufacturing Co., 276 Morris Ave., Elizabeth, N. J.

DO-IT-YOURSELF! Virgin opportunities! Quick permanent security! Thrilling, lifetime mailorder business "pulls" money without schemes or capital! Unlimited! Honest! Complete! Airmail dollar. Results or refund. Zigzag Corporation, Box 101-W, Guatemala, Central-America.

DOLLARS Made by our tested plans. Free literature. Research Service, Magnolia St., Malden, Mass.

IF You would like to make \$5,000 yearly in an easily learned office business of your own, send for free details immediately. G. H. Cole, Pres., Syracuse 2, N. Y.

315 GOLDEN Business opportunities, \$1.00, more details free. Kommer, 2354 31st Avenue, San Francisco 16, California.

PROFITABLE Plans, ideas 10c. Spada Enterprises, 10 Lexington, Wethersfield 9, Conn.

LIQUID Marble—make in any color. Soundproof plastic flooring. Flexible molds. Cast novelties, plaques, statuary. Big money—your own business. Free catalog. Write Bing Products, 88-AM Broad Street, Boston 10, Massachusetts.

WHY Job worry? Learn electro-plating, interesting, highly paid business. Postcard brings full details, free. Plater Hyde, Dept. MC, P.O. Box 176, National City, Calif.

START A business of your own. Can put you next to new profitable business opportunities. Particulars free. Beiers, 837-A N. Hoffert St., Bethlehem, Penna.

EARNINGS, \$2,000 Year easy; inventing simple items for special cash markets. Ideas only. No patents. Write Hendrickson, Argyle 7, Wisconsin.

JOKES And tricks at wholesale. Make your store the hottest spot in town. Storekeepers, jobbers send for free list. P. Schwamm, 237 East Ninth St., New York 3, N. Y.

RAISE Your salary. Amazing new plan works wonders. Write immediately. Good Supply, Potsdam 7, New York.

RAISE Bean sprouts in dark room. Pays well. Free information. Mrs. Nickell, Route 1, Box 456, Bend, Ore.

MECHANICALLY Inclined men—Own and operate general appliance repair shop. Complete, illustrated course shows you how. Welding, refrigeration, motor repair, how to get business, etc., all phases covered. Free literature. Christy Supply, Dept. 164, 2835 N. Central Ave., Chicago.

COLORGLAZED Concrete pottery made without molds. New, low cost, patented method. Cemetery products, novelties, tiles, floors, etc. Basement leaksealing. Other moneymaking projects. Booklet, details free. Men only. National Potteries Company, Fergus Falls, Minnesota.

MAKE And mold genuine plastics. 40 illustrated worksheets (70 illustrations) explain simple, reliable methods—processes. \$1. Free circular. Plastics Digest, 3937M Tracy, Kansas City 4, Mo.

SPECIALTY Manufacturing, the big money business that can be operated anywhere, start on a very small capital; we supply dependable formulas and complete instructions; get interesting free booklet, "Moneymaking Opportunities in Specialty Manufacturing." Howard Robinson, Ph.G., 1300-A South Ohio Street, Sedalia, Mo.

PROFITABLE Mailorder moneymaking information free! Opportunity, Box 48, Decatur 60, Illinois.

TREMENDOUS Profits mailing literature. Dealers information 3c. General-print, East Orange, N. J.

NEW Air curing liquid rubber to make molds for plaques and statues. Our repeat orders speak for themselves. Apex Plastic Products, 1740 Estes Ave., Chicago 26.

FORTUNES In formulas, 9909 trade secrets, recipes, processes, 867 pages, \$3 postpaid. Money back guarantee. Ray Co., 3605A South 15th Ave., Minneapolis 7, Minn.

PLASTICS Directory—Wholesale and retail sources for thousands of items, materials, molds, equipment, machines, supplies \$1. Plastics Digest, 3937P Tracy, Kansas City 4, Mo.

SPLENDID New Opportunity to get into legitimate mail order advertising and selling. Start small, expand rapidly. "How" booklet 10c. Kraft, 3114-S5 Walnut, Chicago 12, Illinois.

POSTWAR Security! The greatest legitimate scheme ever devised to secure a big mailing list and a stream of dimes. Free particulars. Jack Killion, Box 3096 Terminal Annex, Los Angeles 54, Calif.

DOLLARS For you. Be your own boss. Make and sell Antimist windshield soap. Complete formula, \$1. Sterling Products, 4225 Appleton St., Cincinnati 9, Ohio.

FINANCIAL Independence is yours. Utilize your spare time. Hundreds of tested plans and formulas. Free particulars. Delta Distributors, Box 65, West Farms Station, New York 60, N. Y.

FREE Literature—Tested money making business ideals. Kelly, 1080-B Casgrain, Detroit 9, Michigan.

10c **BRINGS** Mailorders' fastest dollar puller. Honest dollar orders pour in. Harrison, R2, Berrien Springs, Mich.

START Your own business now. Little or no investment. Full or part time. Free literature describing over 200 moneymaking plans. Anes-Hausen, Box 1643 New Orleans 11, Louisiana.

JIGSAW Owners: Square foot plywood yields \$46. Write: Woodarts, X-37, Bridgewater, Mass.

RESILVER Mirrors—Big profits. Opportunity of a lifetime, experience unnecessary, small capital investment, free literature. Nu-Lustre Products, 84-A Main St., Little Falls, N. J.

EARN \$15 Daily operating curtain laundry service from own home. Either sex. Part or full time. Copyright instructions \$2 explains all. M. E. Curtain Service, 10024 Detroit, Cleveland 2, Ohio.

MAKE Strange new plastic—1c pound. Makes durable, attractive floors, walls, roofs. Build for half. Bays Laboratory, Oklahoma City 9.

PANNING Gold. Free literature, pictures. Old Prospector, Box 21R25, Dutch Flat, Calif.

FREE Details! Start profitable mail order business at home on \$5 capital. D. Ax-tell, 3705 Zender, Detroit, Mich.

PROFITABLE Addressing business for typists. Little investment. Man or woman can operate full or part time. Treatise \$1. Gaunt, 3521-P Broadway, Chicago, Ill.

CAST Bookends, novelties. We furnish rubber molds. Sell unfinished castings to us. Free information. Mold Craft Industries, Manheim, Penna.

REALLY Something new in mail selling. Start small. Build big enough to be independent. Free information. Troutwine, 8654 S. W. Ninth, Portland 1, Ore.

EARN \$10-\$25 Per week spare time. No canvassing. Experience unnecessary. Unique Service, Box 851-M, Minneapolis, Minn.

SELL Religious goods by mail! Easy to start. Big profits. Every home is your prospect. Cleveland, 243-B2 White, Clyde, Ohio.

MEN—Women start own business, home or office; no peddling; little or no investment. Particulars free. Paisley, Box 5307, Los Angeles 55, Calif.

OPERATE Profitable typewriter repair business from garage or basement. Money-making course. Service School, University Station, Box 134, Seattle 5, Wash.

OPERATE Your own employment agency, fast growing profession. Many make \$500 upwards monthly. Copyrighted manual reveals all. Small investment. Write for particulars. Frank, Box 308, Burlingame, Calif.

BECOME Suite cleaning specialist. Small investment. Tremendous profits daily. Write Gansler Specialties, Bridgeport 1, Ohio.

HOME Business monthly copy 50c. Alvins, 553 William, Winnipeg, Manitoba.

BECOME A wholesale distributor for quality products under your own brand. As little as \$10.00 capital will start you. Several of our distributors now financially independent, earning three to six thousand dollars yearly. Experience unnecessary. We tell you how—free! Send 10c for new 31 page catalogue with complete information. Over 100 proven repeat items, needed in every home. Excellent money-making opportunities for ambitious men and women. Don't delay. Dept. M, General Products Laboratories, Inc., Established 1934, 137 E. Spring St., Columbus 15, Ohio.

BECOME A finance man. Particulars free. George Lenhoff, Lincoln 8, Nebr.

PROFITS Plus volume with NeoCraft clothesline tightening device. Carton 30, postpaid \$2.45—15c seller. NeoCraft, Harvey, Ill.

SEND Details of your business for free inclusion in business directory here: MVL, Box 3642, Johannesburg, South Africa.

BOOKKEEPER Double your income operate bookkeeping service part or full time your city. Write Tax-Saver System, Dept. B, Fort Worth, Texas.

AT Home—Your own manufacturing business; making popular \$1.00 novelties. Cost you 3c to 15c. Everything supplied. Write So-Lo Works, Dept. E-600, Cincinnati, Ohio.

WE Start you in business, at home, sparetime, earning \$10-\$30 weekly selling by mail. Stamp appreciated but not necessary. Driscoll Sales Service, Box 2771-A, Denver, Colo.

PREPARE Now to start own business making Venetian blinds. Splendid prospects. Illustrated instruction book \$1.00. Elwert, 6900 North Ashland, Chicago 26.

WELDING Is growing day by day. Good business to enter now. Get this 400-page nationally known book on welding. Simple instructions, many illustrations and photographs. Complete "know how" information given by recognized experts. Send \$1 for this wonderful book and complete details how to earn home and shop welding outfit. You learn and earn. Magic Welder Mfg. Co., 193MH5 Center St., New York City.

BOOKKEEPERS. Be your own boss. Operate profitable bookkeeping service. Start small, grow big. Details free. Bourque, 3712 Fifth, Marrero 1, Louisiana.

OWN A mail-order paper products business. Sell envelopes, tags, bags, boxes by mail, wholesale. Tremendous demand. Steady profits. No capital necessary. Write Omaha Envelope Service, Dept. 142, 4721 California, Omaha 3, Nebr.

\$4.97 PUTS You in business. Write Midwest Drug Co., Dept. 3, Columbus 15, Ohio.

NEW Mail selling idea! Proved, tested. Seven billion dollar market. No trashy, catch-penny schemes but articles of genuine merit. Legitimate, clean, profitable, "small-capital" methods. Write letter (no postal) for details. Elmer Swanson, Niagara, No. Dak.

MAILING Lists—all types—accurate—inexpensive. Write Charles, Box 232, Station A, Manchester, Conn.

START Big profit vendor business. Cost small. Free details. Factory Silver King 623 Duquesne Blvd., Chicago 14, Ill.

GO Into business for yourself. Make \$50-\$100 weekly. Others doing it. Be independent! Small capital starts you. We furnish everything. Send \$1.00 for samples, and full information. Universal Service, 209 W. 125th Street, New York 27, N. Y.

SUREFIRE Profit maker. Write for details on what sells, who buys and how to reach them. Rennolet, 1022 9th St., Rock Island, Ill.

LET My \$3.00 duplicator help you make profits. Quickly prints your cards, letters, advertisements. Money back guarantee. C. B. Sales Co., 9111 So. Hoyne, Chicago, Ill.

YOUR Own business. Complete plans, supply sources, formulas. Show you how easily. Only 50c. Louis Greenblatt, Box 2452-PM, Paterson 5, N. J.

STOP! Don't throw it away! There could be a fortune in your attic or cellar. New—fascinating. Full particulars 25c. Research Enterprises, P. O. Box 5296, Highlandtown, Baltimore, Md.

COOPERATIVE Ads bring 90c profit on \$1. Orders filled direct. Plan \$1. Bayle Company, Box 5996, Dallas, Texas.

START Your own business! Steady weekly income assured with a route of 5c Asco Hot Nut Dispensers. For full information send 25c in stamps for completely illustrated booklet. Asco Vending Machine Exchange, 55 Branford Street, Dept. PM, Newark 5, New Jersey.

PROFITABLE Workable home or office business plans. Send for exciting free literature. Efficiency Distributors, 5618 Denker, Los Angeles 37, Calif.

AMBITIOUS? Reverting manufacturing offers financial independence to productive salesmen. Twelve quart case; moth-proofing foam cleaner \$6.00, window cleaner \$3.00, foam cleaner \$3.00, amazing "all suds" washing powder 10 lb. \$1.50. Halberstadt Company, Terre Haute, Ind.

BELTS! Make 'em and make money. No tools! Sample 50c. Artinc Leather, 411 Joseph Ave., Rochester 5, N. Y.

BE Your own boss. Start small—grow big. Send postal card for free information on how you can do it. Preferred Buyers Service, Hamilton 1, Ohio.

VENDING Machines. Be independent; earn a steady income. Operate a route of our new 1946 models of postage stamp, stationery, peanut or ball gum vending machines. Earnings are as high as \$8.00 weekly profit per machine. Machines cost as low as \$10.75 each. Car and experience unnecessary. Routes can be operated as a spare or full time investment. Act quickly—write for free illustrated catalogue. Parkway Machine Co., 3046H Tioga, Baltimore 15, Maryland.

FIFTEEN Practical plans for starting your own business with small capital. Plans, 10c each; 15, \$1.00. Dept. R, 819 Seventh, New Orleans.

OBVIOUS—Proof! War-boosted new twist of sound old business. Lucrative! Small capital. Part-time. Home, office. Either sex. Simple! Central Illinois unavailable! Ferguson, Decatur, Ill.

GIANT Mails, moneymaking offers, galore. Details, stamp. Warren's, Free-land, Mich.

YOUR Own business—As little as \$100 starts you now! No training needed! See our ad on page 28. American Photocopy Equipment Co., 2849 N. Clark St., Dept. GF56, Chicago, Ill.

BUILD Lifetime income at home. Books of instruction for busy people. Full information free. News Specialty Company, 463 Daisy, Mansfield, Ohio.

START A build-it-yourself workshop. A money-maker. Described by Reader's Digest 9/40. Husted, 1260—20th Ave., San Francisco.

WANT To sell by mail? Start now, write Elco Service, 3338 Monterey, Detroit 6, Mich.

MAKE Plastic jewelry. Free information. Attler Company, 23-60 29th, Long Island City 5, New York.

PHOTOCOPY Business pays big. Build your own machine for few dollars. Complete plans, drawings, instructions, photographs. \$3.50. Lockrey Photo Research, 40-16 150th St., Flushing, N. Y.

ESTABLISH Your own sales and service business with Bug Blitz genuine DDT insecticides and other products. Veterans here is a square deal. Write today for details. Elwood & Son, Co., 3605 Lafayette Bldg., Detroit 26, Mich.

315 GOLDEN Money-making opportunities for you, selling by mail! Details free! Mail-Way Agency, 10-620P, William Ave. Winnipeg, Manitoba, Canada.

SMALL Capital starts you as distributor for fast selling 83 fire extinguisher; exclusive territory. Write "Fire-Killer," Zone 1, Syracuse, N. Y.

ANGORA Rabbits bring steady income! Good wool producing stock supplied. House of Angora, Springfield, Illinois.

PROFITABLE Business, \$5-\$10 capital. Free literature, no obligations. Falb, Box 375A, R. 10, Akron, Ohio.

YOUR own profitable mail order business. Get set for life. Use sparetime to grow independent. We show you how. For full particulars write, Van Enterprise, 3308 S. Quincy Ave., Milwaukee 7, Wis.

PERFUME—Brilliantine manufacturing business. Little capital. Large profits. Particulars free. Bob Celaya, 907 Adams, Brownsville, Texas.

MAKE More money. We show you how. Free catalogue. Interstate Publishers, 1429-D So. 51st Ct., Cicero 50, Ill.

RADIO—Practical training at minimum expense. Write—Hayes, 4004-D Arcade Bldg., Seattle, Wash.

EARN Dollars by mail. Valuable offering books, opportunities, 10c. National, 3221 Union Avenue, Brooklyn 11, N. Y.

SUCCESSFUL \$10.00 Capital mail order plan, dime. Bowers, Loyaltown, Penna.

OPERATE A children's positive foot print identification system from office, business establishment or home. Beneficial, profitable business for men or women. The Smith System, 217 W. Keefe Ave., Milwaukee 12, Wis.

MANUFACTURE Costume jewelry at home for profit, hobby, therapy. Free wholesale supply catalogue. Instructions. Florida Supply House, Bradenton, Fla.

GET Big mails galore, latest money making offers, opportunities, catalogues, magazines, samples, etc., etc., by having your name listed in the National Opportunity Seekers Directory. One issue 10c, three issues 25c. Interstate Publishers, 1429-F So. 51st Ct., Cicero 50, Ill.

YOUR Own business, selling Ramsay Simplified Bookkeeping Systems. No book-keeping knowledge necessary to sell or operate. Acknowledged leader. Furnishes complete information government requires. Helps stop losses, show added profits. Excellent opportunity for accountants to service more clients easier. Large commissions paid daily. Full details. Ramsay Systems, Inc., 192 Lexington Ave., New York 16, N. Y.

WOULD You pay 3¢—first \$350 made? Color-illustrated book "505 Odd, Successful Enterprises" free! Some plans offer occasional "day off." Start at home, office. Expect something odd! Pacific, 262-L Drake, New Rochelle, N. Y.

MAKE \$2.50 Hour refinishing furniture like professional. Minit-Finish makes you expert. Enormous demand, permanent business. Send \$2.00 complete instructions. Master Finisher, Box 247, Albany, Oregon.

PUBLISHER Of seventy page trade magazine offers cooperative distributorships to men desiring advancement in mail order field. Splendid opportunity. Good earnings. Send 10c for handbook; application form Progressive Publications, Sheboygan, Wisconsin.

WANTED Unused U. S. postage stamps, small discount. Advance Stamp Company, 24 East 23rd Street, New York.

BUSINESS Plans illustrated. Proven money-makers for operators from coast to coast. Write for proof. Wilkin & Company, 118½-PM E. Main, Hillsboro, Ohio.

BABY Shoes preserved. Complete instructions. Exclusive rights. M. E. Watson, Bellefontaine, Ohio.

DEALERS To market low priced auto towbar. Barnorarl Industry, 19338 Griggs, Detroit 21, Michigan.

FREE Literature upon request, describing many money-making plans. Island Mail Service, Box 162-G, Jamaica 4, New York.

EARN Money with textile painting course. Free details. George Gundrum, LeRoy, Michigan.

NEW 1946 Information directory \$1.00. Tells you where to buy. Box 6900, Pittsburgh 12, Penna.

NEW Flexible mold material, casts, catalin plastic, concrete, plaster, in same mold. Literature. Sanflex, Box M, Clyde, Ohio.

PLASTICS. Your own business at home. Make your own plastics, no expensive equipment needed, formula and molding instructions \$1.00. Box 224, Wickliffe 17, Ohio.

\$5,000 YEARLY Possible, selling books by mail. Distributors proposition. Nichol Publishers, Box 821, Pipe Bluff, Ark.

EXPORT, Import, represent manufacturers. Deal with South America, Africa, China, Europe. War-peace time big business. Uncrowded fields. Unlimited opportunities. Deposit one dollar for two bulletins. Money back if unsatisfied. P. Benko, 246 Fifth Avenue, New York 1.

INCORPORATE Your business. Delaware laws. Many advantages, free details. Tax Research Bureau, Inc., Delaware Trust Building, Wilmington, Delaware.

OPERATE Your own advertising agency profitable. New, different manual reveals all. Learn how. Start in spare time, at home, with little capital. No stock or equipment necessary. Earnings unlimited. Sincerely interested send stamp for special folder. P. Snyder, Box 4907-A, Philadelphia 19, Penna.

MAKE Big money. Exceptional opportunities. Real money makers. Free particulars. Turner, 5675-A Lannoo, Detroit, Michigan.

RUBBERCOAT Mold making liquid. Plasticwood intermix finishing materials, models. Ready manufactured molds, make gifts, novelties. Free samples. Information catalogue. Rubbercoat, 3873A California, San Diego, Calif.

A JOB Slave? Learn today how you can live a happy, prosperous "tomorrow" as your own boss. Details free. G. Kindig, 1629 Vine St., Philadelphia 3, Penna.

FORGE Ahead in the mail-order field with your own business; regardless of location. Small capital, plus initiative, starts you toward success. Particulars free, write: Tait-Douglas, Dept. 312-B, 5345 Harper, Chicago 15, Illinois.

LIQUID Rubber, for making flexible molds, literature and sample free. H. Chaney, 1130 E. 16th St., Jacksonville 6, Fla.

GO Into the mail order business. My 32 years experience tells how. Send 25 cents for instructions. Mail Order Institute, Gen. Del. Main Postoffice, Cleveland, O.

GET Advertising tips on selling by mail. Contains valuable information on mail order business. Price \$1.00. A. H. Allen, 2335 Arapahoe St., Denver 5, Colo.

START Business—\$1.00 up. New 100-plan book. Also agents wanted. Sample 50c. Money back guarantee. Sole distributors. Golden Rule, 13997-C Northlawn, Detroit 4, Michigan.

FREE Literature on profitable books. Ritt & Ritt, 112A 9th Avenue South, Nashville 3, Tennessee.

SEE Terminate Control ad in "Formulas, Plans." Make extra money.

10c BRINGS You lots of mail. Catalogs, magazines, money making ideas, samples. Gardenville Publishers, Gardenville 1, N. Y.

LEARN Shell jewelry manufacturing. Complete, simplified home instruction course, beautifully illustrated, shows 45 styles pins, earrings, brooches, sprays, hair ornaments. Includes pearlizing, dyeing, gilding, glow-in-dark methods. No tools needed! Learn-earn within a week. Only \$1 postpaid, including wholesale prices of all raw materials. House of Gifts, Box 4550-RF, Coral Gables, Fla.

MAIL Order opportunities. Read oldest trade journal. Copy 25c. Mail Order News, Somerville 35, N. J.

PROFITABLE Mail order plans, ideas, write today, free literature. Frank J. Artz, 1060C Harding Drive, Toledo 9, Ohio.

OPERATE Profitable mail order business. 75c profit each dollar. Powell Service, 5713 Euclid, Cleveland 3, Ohio.

CONCRETE Brick are a profitable product with a well established consumer demand. This is your opportunity to enter the concrete products field with the minimum equipment expenditure. R. S. Reed Company, Three Rivers, Mich.

ELITE Collection contains 137 practical money-making plans; local and mail order. New edition. Particulars free. Elite Co., 220-A Grand St., New York 13.

START Mailing service business at home in spare time 25c (refundable) brings success booklet. Riegel, 1111 Harrison, Philadelphia 24, Penna.

137 WAYS To make money, in home or office, business of your own. Full particulars free. Elite Co., 220-A Grand St., New York 13.

FINEST Quality liquid molding rubber. Sample mold free. Cost more, worth more. \$3.00 quart, \$10.00 gallon. W. Wooley, 115-A Donald, Peoria, Ill.

BOOKKEEPERS: General ledger and tax report experience. Operate permanent, profitable accounting service for the smaller business. Part or full time. Simplified method. Write now! L. A. Bell, 1404 West 25th Street, Cleveland, 13, Ohio.

TESTED Success plans. Details free. Dunn, Box 955, Hartford, Conn.

EARN More money. Hundreds of live business, formulas, secrets, manufacturing plans. "Inside" supply sources of buying home, or business needs, at lowest possible prices. Booklet and literature, 25 cents. Charles Service, 117 East Second Street, Girard, Ohio.

PLASTIC Homes—Build yourself! Resurface old buildings! Wonderful building material. Particulars free. Marbleizing Service, Edwardsville, Illinois.

MAILING List! 5000 women mailorder buyers, \$25.00; 3000, \$15.00; 1000, \$6.00. Guaranteed accurate! Try them! Woods Remants, Bedford, Penna.

DOLLAR Orders filled free. Fastest selling mailorder line. Darrah, Orono, Maine.

LIQUID Marble—Colorful, glazed! Molded, brushed, sprayed! Composition floors. Rubberlastic molds. Particulars free. Marbleizing Service, Edwardsville, Ill.

SELL Exclusive books of instruction by mail. Assorted subjects. Popular prices. 70% profit. Rush name. Free sample imprint circulars and selling instructions. Financial Education, 404F Mack Building, Denver 2, Colorado.

FELLOW Workers—Down with bosses. Start own business. Be independent. Booklet describing 137 tested plans, free. P. Padney, 307 York St., Jersey City, N. J.

ELECTRICAL Appliance repair. Open your own shop. Learn home wiring; electric motors, vacuum cleaners, washers, etc. Complete illustrated course shows how. Free booklet. Pacific Training School, Dept. AP-1, 7217 So. Broadway, Los Angeles 3, Calif.

HANDY Men—Earn money home operating Community "Fix-It" Shop. Write Stafford, 708 Rawlings, Carbondale, Ill.

YOUR Own business. Big profits, very small capital. National organization teaches, helps, supplies everything. Interesting service business. Big demand everywhere. Americlean, 211 North 7th Street, St. Louis 1, Mo.

GOT \$24,500 Using "schemes" from "Schemer" Magazine. Alliance, Ohio. 48th year, \$1.00; 4 samples, 30c.

BOOKKEEPERS—Operate your own "Dollar-A-Week" bookkeeping and tax service. Full or spare time. Details free. Ellis, Box 200, Cedar Grove, No. Carolina.

MAIL Order business course shows you how to make money, spare or fulltime. Teaches professional mail order technique—not penny-snatching schemes. Fascinating 100-page illustrated success-catalog free! Write—Nelson Company, Dept. 4-02, Chicago 5.

SELL Cosmetics by mail. Women spend millions on beauty. You can make your share of this cosmetic money. Let us show you how. Details free. Frank J. Artz, 1060 Harding Drive, Toledo 9, O., Dept. A.

START A home business in spare time. Make extra money. Experience not essential. Literature free. Rolf S. Iverson, Box 916A, Grand Central Annex, New York 17, N. Y.

BUILD Miracle homes. Yours. Others. Chamberlain, Fitzsimons Building, Pittsburgh 22, Penna.

LATEX For making flexible rubber moulds. Thoroughly tested. No shrinkage. Complete instructions with each order. Stoneham Rubber Co., Box 244, Stoneham 80, Mass.

MEN — Women — "Everybody Likes Candy." Learn to manufacture professionally at home. (Our 35th year.) Ragsdale Candies, East Orange 2, N. J.

START Home business making statuary, plaques, novelties, garden furniture, artificial marble flooring, liquid marble. Make your own flexible molds. Amazing profits. Folder free. Creative Publishers, Box 236-L, Winnetka, Illinois.

SPARE Time mail business earned \$1400 monthly. Copyrighted instructions \$1.00. Wm. Boyd, 331 Fourth, Pittsburgh 22, Pa.

RUBBER Moulds for casting novelties. Latex for making moulds. Use thoroughly tested and approved products. Eastern Latex Laboratories, Box 153, Mattapan 26, Mass.

AMAZE Others. Add columns instantly. Add faster than adding machine. Free details. Math Institute, Box 633, Mobile 4, Ala.

BUILD Own business mailing penny post cards; six profitable plans with information for starting. Gordin Publishers, Box 23, Pawtucket, R. I.

"HOW To Make Simple Molds and Plaster Plaques." Profitable business or hobby! Instructive booklet 25c. Plastercraft, 1406 East 43rd Street, Cleveland 3, Ohio.

WORK For yourself. Your own business. Operate entirely by mail—direct from your home in spare time. Few dollars starts you. Literature free. Albert Wilcox, PM21, Nicholls, Georgia.

"10,000 ALASKA Fishing jobs." Alaska's largest industry regularly employs thousands of men and women in seafoods production. Possible earnings up to \$5,000 in few weeks. Authentic 7,000-word copy-righted report gives job information, union requirements, sample application letter, names and addresses over 40 Alaska fisheries. Newest edition includes similar information on California, Oregon and Washington fisheries. Vital facts for immediate application in a permanent industry. \$1.00. 7-day refund privilege. Pacific Industrial Research Bureau, Dept. PM-9, 202 Studio Building, Portland 5, Oregon.

FLORIDA Opportunities—Pensacola offers exceptional opportunities for small industries, especially in the field of mahogany novelties and woodware, perfumes, soap, chemicals. Delightful year-round climate. Wonderful fishing, hunting, beach sports. For information write: Industrial Development Division, Municipal Advertising Board, Pensacola, Florida.

RECAST Old batteries into new. Latest achievements. Battery Laboratories, Minneapolis.

\$25 WEEKLY Working two hours daily. No canvassing. No manufacturing. Lycke, Box 2471, Cleveland 12, Ohio.

TYPEWRITER Repairing—Original course, simplified home study. Weber Typewriter Mechanics School, Box 269, Osborn, Ohio.

QUICK Money! "Repairing Car Batteries." At home. Easy too. Write Batteryman, 901 South Avenue, Grand Junction, Colo.

START Mailorder bookshop—Everything furnished; publisher cooperation. 25c brings booklet, exclusive setup, samples, exciting ideas. General Publications, Ossining, N. Y.

BECOME An "Attritionist Masseur." First improvement over Swedish massage in 100 years! Results unbelievable! Dr. Swearingen, 9128M, Station S, Los Angeles.

HOW And where to obtain capital. Fully explained. Particulars free. Star Service, Wapakoneta, Ohio.

BIG Money making Hollywood style pottery, bird baths, wishing-wells, benches, stucco-rock. New method. Clever designs. Color with chemicals, water-paints. Marbling, colored glaze effects. Dime brings samples, pictures, literature. Hollywood Cementcraft, 8527 Wonderland Ave., Hollywood 46, California.

LIQUID Marble: snow-white, multi-colored. Glazed. Unglazed. Composition flooring. Lifetime wear. Any color. No priorities. Flexible molds. Plaster casting. Get into the big money now. Full information given free. Write Compo-Tex, Box 786-R, St. Louis, Mo.

BRUSH Plating outfits connect to a battery. No tanks necessary. Good paying business at home plating autoparts, bathroom fixtures, bicycles, reflectors, silvering mirrors. No shop or experience required. Outfits furnished. Free booklet. Gunmetal Co., Ave. H, Decatur, Ill.

AGENTS—To mail our literature. Good profits. Home business. Maywood, 1133 Broadway, New York.

METALLIZE Baby shoes! Learn this moneymaking business from nationally recognized consultant. See Kushner ad, page 274.

MONEYMAKING OPPORTUNITIES

SPARE Time home business opportunities, plans. Bodin, 2007-B Hutchinson, Chicago 18.

EVERYBODY. See the greatest opportunity, order pulling, success circular. Educational, healthful, profitable. Free. Drop postal. Teycer, Box 1287, Chicago 90, Ill.

HOW To make and sell novelty barometer ornaments. \$1.00 postpaid. Gerald McNeely, 3044 Jackson Blvd., Chicago 12, Illinois.

PRACTICAL Moneymaking plans. Free literature. Goodrich, 14 Edgewood Ter., Longmeadow, Mass.

FREE. Money making opportunities. George Simon, 6843-A Jonathon, Dearborn, Michigan.

VENETIAN Blind cleaning offers tremendous profits. Build your own machine at small cost. Exceptional results makes business self-advertising. Competition negligible. Field unlimited. Investigate. Plans and instructions \$2.00. Write R. R. Cooper, Box 6218, Hillyard Station, Spokane, Washington.

MECHANICALLY Inclined men—Own and operate general appliance repair shop. Complete, illustrated course shows you how. Welding, refrigeration, motor repair, how to get business, etc., all phases covered. Free literature. Christy Supply, Dept. 1164, 2835 N. Central Ave., Chicago.

NEW Mail order opportunity having splendid profit possibilities. Small capital required. Operating instructions 10c. Kraft, 3114-S7 Walnut, Chicago 12, Ill.

300 MAIL Business starting offers monthly for 5 months, 10c. Thomason, 857-m, East Jessamine, Fort Worth 3, Tex. Dept. 1163, 2835 N. Central Ave., Chicago.

START Your own business! Big money manufacturing novelties, plaques, statuary. Free catalog. Write Bing Products, 88-AN Broad Street, Boston 10, Mass.

"**THERE'S** Big money in junk!" Easy! Fascinating! Free circular. Batteryman, Grand Junction 11, Colorado.

EARN Money evenings, copying and duplicating comic cartoons for advertisers. Adservice, Argyle 1, Wisconsin.

THOUSANDS Articles wholesale. "Supply Source Directory" 10c. Ideal Service, D-5, Park Ridge, Ill.

\$200 MONTHLY With camera! Forty money-makers with camera, 50c. Frank Dickson, 808 Elizabeth Street, Anderson, South Carolina.

GIGANTIC Mails—Trade magazines—Name listed 10c. Jackson, Newfoundland 3, Kentucky.

PROFITABLE Homework. Write Homecraft Projects, 313 Lovers Lane, Gainesville, Texas.

WHOLESALE Catalog and directory 10c (refundable). Thousands of articles. Stafford, Sunnyside-A, Indianapolis 44, Ind.

GIANT Mails. Moneymaking magazines, home work opportunities, plans, imprints, 10c; year 25c. Wolf's, 3240 Glenview St., Dept. 20, Philadelphia, Penna.

BUY Articles wholesale. Make money by mail. Formulas, trade secrets. Literature free. Massey, 64 Sterling, Franklin, New Jersey.

RECEIVE Mails, samples, money-making opportunities, literature, steadily one year, 25c. Zbiegniewicz, 147-A North 8th St., Brooklyn 11, N. Y.

START Your own business! Experience or capital not necessary. Book containing 77 formulas of fast-selling necessities, made at home from cheap chemicals, \$1. Money back if not satisfied. Nu-Way Formula, 1209 S. W. Washington, Portland 5, Oregon.

OILFIELDS Offer glamorous opportunities, good pay! For names, addresses, 100 companies, including pay rates, qualifications, duties, etc. Send \$1.00 cash, check, money order. No C.O.D.'s. Oilco, Box 559, Victoria, Texas.

\$565.00 PROFIT From every \$15.00 invested. Write Ralph Vail, LaGrange 1, Ind.

MAKE Enormous profits quickly! Amazing mailorder plan 25c. Surety Main, P.O. Box 65, Dearborn, Mich.

IF You can walk, talk, read and write and want to make \$15.00 to \$20.00 daily, send 25c (refundable) for sample new item. Protected U. S. Pat. office. Elco M, 305 Parker St., Tampa 6, Fla.

HUNDREDS—Home moneymaking offers and saving opportunities from all over America. Write National, 18900-P Cardoni, Detroit 3, Michigan.

MAIL Order business pays big dividends. Mail \$1.00. Postal brings plan. Personal Service, Box 2252-N. S., Bridgeport 8, Conn.

WIN Fame, success, security writing short stories, newspaper features. New, easy plan shows you how. Write today for exclusive details. Writer's Institute, 4-M So. 15th St., Philadelphia 2, Penna.

SECURITY Acres and independence. Amazing book shows how:—Enterprises, 5345-B Harper, Chicago 15.

200 MONEY Making deals. Plans, rare formulas, schemes. Folio free. Formico-Eng, Box 572, Dayton, Ohio.

OPERATE Your own mail order business. Details, dime. Thomas, Box 1806, Providence, R. I.

CREAM Of crop—mailorder moneymaking plans, offers, details free. G-Dez Mail Service, Box 148-A, Aurora, Indiana.

WOULD You pay somebody a few cents if he made you your own boss? The next ten years will offer hundreds of attractive opportunities to the alert-minded who wish to make money and become independent. Rush stamp for circular MJ-12. "The Guild"—2726 Holland Avenue, New York 67, New York.

MAKE Mail order pay on small capital! "How to Build Your Own Mail Order Business" tells how—10,000 words! Know! Don't guess! Invest a quarter, make money! Satisfaction absolutely guaranteed. Other profit-for-you literature free. Everything postpaid. Upham and Son, 939-D Ravine Drive, Cleveland 12, Ohio.

AGENTS, opportunity seekers, book buyers. Send postal for interesting offers. Lido Pacini, 187 Mateo Ave., Daly City, Calif.

300 TESTED Moneymakers, business secrets, formulas, wholesale supply sources, mail order plans. 68 pages, 40,000 words—no ads, meat only, 25c postpaid. Russell Publications, 3866 Dwight, Riverside (2), California.

WHAT Makes you think you couldn't sell by mail? We're doing it happily! New! Different! Exclusive! Alive with money-making opportunity. Full particulars free. Investigate! Compare! The What-To-Do-Shop, Box 1082, Tacoma, Wash.

START A home business in spare time. Interesting, profitable. Literature free. Alfred Novak, 2560-A Loop, Cleveland 13, Ohio.

MORE Money! Spare time. Details free. Mona Schlotzhauer, Shenandoah, Virginia.

BIG 6x9 Surprise mail, moneymaking opportunities, magazines, etc. 25c. V. Ruckoldt & Son, 3639 Page Ave., Chicago 34.

OPERATE Profitable home mail-order business. Dime brings details. Billings, 210 Fifth Avenue, New York.

MAKE Popular, fast-selling stainless steel bracelets at home, full or spare time. Easy 300% profit. No experience needed. We supply complete kits, full instructions. Money-making facts free. Write today. Ar-Clo Products, 2055 W. Summerdale, Chicago 25, Ill.

HELP Yourself to success in plastics, radio. Details free. Technibook Service, Box 261, Mt. Kisco, N. Y.

BE Your own boss, 137 tested money making plans. Particulars free. Sem Tem Service, Marshal Bldg., Norwalk, Conn.

BUY French oils, make fine perfumes, wonderful profit, easy instructions \$1.00. Western Research Laboratory, 1725 West Mallon Ave., Spokane 11, Washington.

HAVE Unusual plan for beginners raising mink. Pioneer Fur Farms, Box 280, Indianapolis, Ind.

EARN Money at home—realize independence. Write Successful Income Builders, 508A, Hollywood 28, Calif.

PUBLISH Your own magazine and instruction folios. Real profits! Everything furnished! Only few dollars needed! Sample, complete plan, 25c. Free folder, "Profits in Plastic Mfg." included. E. L. Hill, Box 681, Fall River, Mass.

MAIL Dealers: 100 top wholesalers of fast-selling mail order items \$1.00 postpaid. Satisfaction guaranteed. National Distributors, Box 1920, Memphis 1, Tenn.

BEST Money makers out. Fine assortment, plans, schemes, hobbies. Free descriptive book, literature. Savage Service Bureau, Whaleyville 4, Va.

NEED Money? Guaranteed spare-time mail plan 25c. Nemso, 1301 Commonwealth Avenue, Allston 34, Massachusetts.

GIGANTIC Mails, magazines, samples, listing 10c, three times 25c. Waddell's Directory, 341 East 76th Street, New York 21.

HOME Mail business will pay big profits. Booklet and literature on quick starting offers, 25 cents. Charles Service, 117 East Second Street, Girard, Ohio.

500,000 ARTICLES—Wholesale directory, dime. National, 322P Union Avenue, Brooklyn 11, N. Y.

MANUFACTURE Costume jewelry at home for profit, hobby, therapy. Free wholesale supply catalogue. Instructions. Florida Supply House, Bradenton, Fla.

WOULD You pay 3¢—first \$350 made? Color-illustrated book "505 Odd, Successful Enterprises" free! Proven by "Little Fellows." Start at home, office. Expect something odd! Pacific, 262-M Drake, New Rochelle, N. Y.

I Made \$1000 from 1000 tomatoes using my unique methods. Detailed instructions, \$1.00. (refundable). Alfred Dinsmore, Marlborough, Mass.

MAIL Business booming! Moneymaking magazine, 10c. Hawkins (Lasanimas), Colorado Springs, Colo.

PAPERHANGING! Make \$16.00, \$20.00 daily. We teach you. Opportunity School, Box 1813, Memphis, Tennessee.

RAISE Moneymaking giant Chinchilla rabbits. Valuable fur. Delicious meat. We buy your youngsters. Willow Farm, R15A, Sellersville, Penna.

ASSEMBLE Colorful plastic jewelry without tools or equipment! Profitable sideline. Free details. Trial 200 links and instructions, \$1 (refundable). Plastic Works, 712 Kimball, Danville 3, Illinois.

EARN Money at home! Thousands do! "Home Worker Magazine" tells how. Sample, 25c. Sizemore, Box 7, 4917 North Kostner, Chicago.

FORTIFY The future! Start own business; home, office. Booklet describing "Collection of 137 Tested Plans" free. Elite Co., 220-A Grand St., New York 13.

INSURE Your future against poverty—failure, become successful, independent, no money needed. Remarkable results. Free information. Gilbert Service, Box 1464, Mobile 8, Alabama.

WIN Contest money. General contest bulletin shows how. Sample 25c. 1609 1/2 East 5th, Duluth 5, Minn.

10c INCLUDES Your name in numerous mailing lists for opportunities, moneymaking offers, magazines. New Age Enterprises, 578-A Prospect, New York City 55.

LEARN Battery repairing, rebuilding. Engineer offers money making methods. Battery Bureau, 2225 North 44th St., Milwaukee, Wis.

BIG Profits. Manufacture custom arch supports. Jul Corssen, 2638 Geyer, St. Louis 4, Missouri.

YOUR Big mail order opportunity—No time has ever been as good as right now. Get your start right. Let me show you how, what to sell and who will buy. Big profits, easy work at home. Write: H. S. Smith, 3139A So. Mabbett Avenue, Milwaukee 7, Wisconsin.

PUBLISH—Your own magazine. Hand-some 52 page format, well edited, illustrated. Cost low as \$1.00 month. Brings you prestige, profits. 25c brings sample. details. National. Ord. Nebr.

I MAKE Big money in the mail-order business. You can do the same at home with my copyrighted system. Write me. I'll tell you how. P. Little, Box 8, Glen-shaw P.O., Pittsburgh, Penna.

LEARN Metascience. Remarkable drug-less healing. No manipulation. No apparatus. Unbelievable simplicity and results. Inexpensive correspondence course. Write Metascience, De Land, Florida.

FORMULAS, PLANS, ETC.

FURNACE Melts all metals. Ideal for small business or home workshop. Built cheaply from scrap material. Free details. Aladdin Laboratory, 9955-C Street, Oakland 3, California.

LUMINOUS Paint formulas. Six colors \$5. Melmar, 11130 Parnell, Chicago 28.

MANUFACTURE Fast-selling products yourself. Bubble blowing liquid, D.D.T. insecticide. \$1.00 each. Formula catalog free. Kemico, Park Ridge (16), Ill.

ICELESS Ice! Colder; cleaner; cheaper. Instructions, 25c. Duffy, A53, Covington, Ky.

BUBBLE Liquid—Five different basic formulas—Sample "Miracle", wand—Source supplies, all for \$3.00. Johnson, 1028 E. 63rd Street, Chicago 37, Ill.

"LUMINOUS Paint." Resilvering mirrors, 100 other formulas—50c. Soap making, (20 formulas) \$1.00. Ideal Service, 305, Park Ridge, Ill.

500 TESTED Moneymaking formulas—13c. Chemists, Box 113-A, Buffalo, Sta. G, New York.

ANY Formula or recipe supplied, \$1.00. Interstate Laboratories, Dept. C, 1515 Oriental Boulevard, Brooklyn 29, N. Y.

MAKE Bleach water formula \$1.00. Capotosto, 1707 Cranston Street, Cranston 9, R. I.

TERMITE Control fluid, permanent, arsenic toxic, completely stable water base. Used and tested ten years. Better fluid, tenth the cost of others. Instructions, formula, five dollars. Enzecco, 1255 W. Seaside, Apt. C, Long Beach 2, Calif.

MAKE Magic bubble solution. Two formulas \$1.00. Satisfaction guaranteed. Robinson, 315 North West, York, Penna.

BOTTLE Bubble formula 50c. Originally sold for \$5. Post Office Box 5083, San An-

500 FORMULAS, Recipes 10c (book). Formulas, Box 113-G, Buffalo 13, N. Y.

FORMULAS, Ideas, processes, experi-enced chemist. Consult Pelmar Laboratory, 509—5th Ave., New York City.

VALUABLE "Hair Straightener" formula for Negroes 25c. S. C. Johnson, Box 484, Minneapolis, Minn.

FORTUNE In formulas, 10,000 trade secrets, 900 pages, \$1.50 postpaid. Rare, scarce technical books supplied. Classic Bookshop, 218 John R, Detroit 26, Mich.

NEED Chemists? Formulas, Analyses. Ideas. Consulting Scientific Company, Swarthmore, Pennsylvania.

REAL Manufacturing formulas. Lists free. Cummings, Chemist, Gordon Ave., Syracuse, N. Y.

FORMULAS—Latest, best. Analysis. Literature free. Belfort, Engineering Building, Chicago.

PLASTICS

PLEXIGLAS, Bakelite, sheets, rods, tubes, cut-offs, discs 1/2x5, 3/8x3, flats. Tools, screws, bearings, pulleys, etc. Catalogue 10c. Metiplas Supply Co., 1420 So. 16th, Maywood, Ill.

PLASTICS—10c Brings our complete plastics catalog containing many profitable, fascinating ideas! Special kits and bulk assortments. Full line of plastics. Also details about our free offer! Fast, reliable service! Write today to Belco Plastics, Inc., Dept. Ll, 147 W. Sydney Ave., Mt. Vernon, New York.

MOLD Model aeroplanes, propellers, golf tees, fishing lures, toys, costume jewelry, and novelties on a hand operated two ounce capacity injection molding machine you can build yourself. Only nine inch lathe and bench drill press required. Plans \$2.00. Post Office Box 503, Toledo 1, Ohio.

PLASTIC, Plexiglas sheets new; 144 square inches following thicknesses: 1/16" \$1.60; 1/8" \$1.85; 3/16" \$2.00; 1/4" \$2.50; 3/8" \$3.50; 1/2" \$4.50; 3/4" \$7.25; 1" \$9.25. 5% discount over 5 square feet, 10% discount over 10 square feet. Sent prepaid. Send moneyorder. Plastic Supply Company, 2618 St. Louis Ave., St. Louis 6, Mo.

"FORMALIN" Liquid casting plastic, quicksetting. Pint \$2.25; quart \$3.95; gallon \$12.95. Formalin Works, 5 W. Larned St., Detroit 26, Mich.

PROFITS In plastics! Sample kit \$1.00. Craft Co-Op, 3928 Dumaine, New Orleans, La.

LUCITE—Plexiglas scrap 60c pound. National Plastic Products Co., 5 W. Larned St., Detroit 26, Mich.

COLORED Plastic cements for Plexiglas, Lucite, or Acetate. Twelve transparent colors, red, yellow, orange, violet, bronze, walnut, mahogany, navy blue, sky blue, light and dark green, and clear. Choice of 5 in one-ounce bottles with instructions—\$2.25 postpaid in U.S.A. History and complete instruction booklet with photographs and step-by-step fabricating details—75 cents. Construction sheets only with price list—25 cents. No stamps. B & H Plastics, 1425A Lincoln Blvd., Santa Monica, California.

LEARN At home "Working with Plastics." Full information on sheets, blocks, rods, tubes. Trade names, sizes, colors for fabrications. Designing, tooling, bending, cementing, polishing. Also for homeworkshop. Only \$1.25 postpaid. Money back guarantee. Modern Technical Book Co., Dept. M4MC, 55 West 42nd St., New York 18.

PLEXIGLAS, Lucite 12"x12" sheets, 1/16" \$1.60, 1/8" \$2.00, 3/16" \$2.25, 1/4" \$2.75. Rods 23" length by diameters, 3/8" 40c, 1/2" 60c, 3/4" \$1.25. Cements 2 ounces 50c. Dyes: aqua, red, amber and other colors 2 ounces 50c each. Novelty rods each: heart 75c, cross 75c, donkey 60c, anchor 60c, ring 35c. Plexiglas assortment 1 lb., includes cement, drawings and instructions \$1.25. Add 10% for postage. Complete catalog 10c. Douglas Home Craftsman, Box 34L, Stamford, Conn.

MONEY In plastics! Lucite plastic hobby kit. Two pounds Lucite material, coloring dye, cement. Instructions. Send \$2.50 to Plastic Specialty Co. (Dept. M), 192 Lexington Ave., New York 16.

"LUCITE" Clear transparent sheets, rods, tubes. Color transparent, translucent, opaques, phosphorescent sheets. Any amount. Also kits. Manufacturers, craftsmen: send for free price list. Hamilton Plastics Corp., 717 Cedar Lane, Teaneck, New Jersey.

PLASTICS—Make your own at home. Formula and molding instructions \$1.00.

FREE! Instruction booklet—with large illustrated folder of attractive plastic gifts in kit form, only 10c. Plastic Products Co., Box 384-R, Massillon, Ohio.

LUCITE, Plexiglas, prime quality 12"x 12" masked sheets 1/16" \$1.50, 1/8" \$1.75, 1/4" \$2.50. Add 10% postage. Dyes, rods, buffing compounds, Handee tool. Free listings. Craft Plastics, Box 129, Somerville, New Jersey.

PLEXIGLAS, New, clear, masked, 12"x12", 1/16" \$1.50, 1/8" \$2.00, 1/4" \$2.75. Dyes—red, blue, yellow, 4 oz. 60c; other colors. Cements. Postpaid. List free. G. Baker Company, 685 Center Ave., River Edge, New Jersey.

LUCITE—Complete illustrated fabricating instructions, used in craft classes throughout the world, price list on lucite, dyes, complete supplies. Booklet 10c, with sample, 35c. "Gem-O-Lite," P.O. Box 686-B North Hollywood, California.

ONE Hundred twenty eight page completely illustrated instruction book chock full of ideas and projects in all plastics now given with Kosto Plasti-Kit Number Three postpaid \$5.00 in U. S. Kit contains lucite, plexiglas, catalin, dyes, solvents, cements, polishing materials. Now ready. No waiting. Kosto Plasti-Kits, 3263 M Street, N.W., Washington 7, D. C. Dept. M14.

MOLD Model aeroplanes, propellers, golf tees, fishing lures, toys, costume jewelry, and novelties on a hand operated two ounce capacity injection molding machine you can build yourself. Only nine inch lathe and bench drill press required. Plans \$2.00. Post Office Box 503, Toledo 1, Ohio.

BIGGEST \$1.00 Plastic value transparent plexiglas and lucite sheets and strips in irregular shapes and thicknesses. Useful for many projects and experimental work—big package by return mail, no waiting. Double size package with dye and cement included \$2.00. Send money order to HomeCraftsman Plastics, 1945 W. Harrison Street, Chicago 12, Illinois.

CHEMISTRY

LABORATORY Supplies, chemicals, glassware and apparatus for home experiments. Lowest prices; pamphlet free. Meyer Scientific, 76 Willoughby Street, Brooklyn 1, N. Y.

HANDBOOK For chemical experimenters, illustrated, hundreds of experiments, 50c. Experiment booklet 15c. Chemistry catalog 5c. Reading Scientific Company, Reading, Penna.

WINN'S New idea champion chemical-kits, apparatus-outfits and supplies for students home experimenting. (Established 1931.) Send 10c for catalog. John H. Winn, 124 W. 23rd St., Dept. 504, New York, N. Y.

STUDENTS' Laboratory supplies. Send 5c for catalog. Mel-Glo Chemical Co., 258 Fourth Ave., Brooklyn, N. Y.

CHEMICAL Experimenter's supply catalog 5c. Colonial Chemical Company, Brockton 28, Mass.

APPARATUS, Chemicals, ounce quantities, catalog 5c. Fleischer's Laboratories, Everett 49, Mass.

FREE Catalog. Chemistry, mineralogy, biology, optics. Tracey Laboratories, Evanston, Illinois.

NEW 36 Page chemical apparatus order book. Complete line of chemical glassware, apparatus and chemicals. Send 10c for this book. Standard Science Supply Co., 1232 N. Paulina St., Chicago.

CHEMICALS And apparatus for industrial, analytical, and private laboratories. Complete supply service for correspondence school students. Send 3c for catalog. Dept. M-43, Biological Supply Co., 1176 Mt. Hope Ave., Rochester 7, New York.

LABORATORY Supplies at wholesale prices: Chemistry, biology, physics. Catalogue 10c. National Scientific Co., 2204 W. North Ave., Chicago. Established 1908.

HELP WANTED

BIG Money conversion burners, furnaces, blowers. Peerless, 4322 Sheridan, Lincoln 6, Nebr.

DISTRIBUTORS, Carded pecans, shrimp (dried), herring, (24 pkgs. per card). Cards cost you \$1.40 each, retail at \$2.40 each. You sell at \$1.85 each. Freight prepaid. Mercier Distributing Co., 67 Shipley St., San Francisco, Calif.

JET Propulsion, helicopter experimenters demonstrate to the public. Rush name for circulars. Shea, P.O. Box 33, San Lorenzo 40, Calif.

AGENTS To sell auto towbars. Trial samples \$2.00. Dozen \$21.00. Barnorarl Industry, 19338 Griggs, Detroit 21, Mich.

OPPORTUNITY Of lifetime supplying DDT and other profitable products to farmers. No experience or capital required. Must have auto and good references. Permanent. Write or wire McNess Company, Dept. 712, Freeport, Illinois.

AGENTS WANTED

SELL The latest for dogs. Duet creme shampoo. Containing the remarkable insecticide D.D.T. Trylon Products, Chicago 14, Illinois.

SPECIAL Offer: 12 piece set of gold plated engraved costume jewelry consisting of 6 pair earrings, 3 beautiful bracelets, 3 pins set in cluster of pearls. The entire 12 piece set for \$6.00. You sell them from \$1.00 to \$1.95 each. Order from 1 to 3 sets. Send payment with order. Marlin Jewelry Co., 2391 Bedford Ave., Brooklyn 26, N. Y.

BILLFOLDS. Genuine selected calf leather with special card cases, and coin pocket. Sample \$2.00. Satisfaction guaranteed. Special distributors prices. Imperial Billfold Co., Box 271, Waterloo, Iowa.

ABRAHAM Lincoln operated a saloon, we have license issued him 1833. Rare, historic, tremendous seller. Sample terms 25c. Select, Little Falls, N. J.

200 MONEY Making deals. Plans, rare formulas. Schemes. Folio free. Formico Service, Box 572, Dayton, Ohio.

PLASTONE; Amazing new polish for floors, furniture, autos. Beautifully packaged. Low priced. Whirlwind seller to stores, gas stations, homes. Fast repeater. Unconditional moneyback guarantee. Write for "free sample kit offer." Plastone Co., 2207-P5 West Chicago Ave., Chicago 22, Ill.

SELL Individualized belts, buckles, cap badges, emblems, tie holders. Over thousand emblems to choose. Every veteran prospective customer. Fast profits. Repeat business. Write today special outfit offer. Hook-Fast Specialties, Box 1425, Providence, Rhode Island.

EVERYDAY Cards. Make \$5.00 with every ten \$1.00 assortments you sell. Also fancy note paper and everyday wrappings. Unusual demand. Send for samples today. Howard P. Ellis, Dept. PM-5, Pitman, N. J.

SELL Greeting cards. Easy money showing gorgeous all occasion, birthday, religious, humorous box assortments. Wrappings, stationery, correspondence notes. Special offers. Experience unnecessary. Quick service. Request \$1.00 everyday assortment on approval. Hedenkamp, 343 Broadway, Dept. PM5, New York 13, N. Y.

SELL Beautiful deluxe aluminum cigarette lighters! All highly polished! \$2.00 brings two samples! Money-making sales plan! Rosel, 2015 - 74th Street, Brooklyn 4, N. Y.

GUARANTEED To sell! New household cleaner, refrigerator deodorizer, and other saleable products. Excellent profit opportunities for distributors and enterprising individuals. G.B.G. Chemical Products, 318 Lorimer St., Brooklyn, N. Y.

COLORED Folks buy on sight. Agents wanted to earn quick money taking orders for Sweet Georgia Brown hair dressing, 8 shades brown face powders, pink and brown creams, fine perfumes, sachet powders, incense, hair dye. 300 fast sellers. Big profits to agents. Be your own boss. Write today for free samples and free sample offer. Write Valmor, Dept. OOA, 2451 S. Michigan, Chicago 16.

PLEASANT, Profitable year 'round sideline. No capital needed. Helps furnished. Opportunities unlimited. Liberal commissions. Mail penny card for free wholesale price list today! McGregor Magazine Agency, Dept. PM6, Mount Morris, Ill.

FASCINATING Year 'round income building plan. Take easy orders from friends, fellow workers, church organizations for 10 fast selling greeting card assortments. Sell for \$1.00 each—cost you 50c up. Extra bonus. Experience unnecessary. Request foremost \$1.00 all occasion box on approval, free correspondence notes samples. Special offer. Bluebird Studios, Dept. 16-G, Fitchburg, Mass.

WAR Surplus without bidding. Monthly catalog sheets. Agents wanted. Maupin, Tipp City, Ohio.

COSTS 4c. Sells 25c. Immediate demand, big repeater, hose preservative. Sample 25c. Details free. Lyle Products, 5 E. Spaulding, Willoughby, Ohio.

SELL Novelty stationery. Box 61, Times Square Station, New York.

WE Pay you \$25 for selling fifty \$1.00 assortments birthday, all occasion cards. Tremendous demand. Sell for \$1.00—your profit 50c. It costs nothing to try. Write for samples. Cheerful Card Co., 144, White Plains, N. Y.

SELLS Themselves novelties. 101% different. Repeat—repeatedly. You and merchant sitting pretty shortly. New wholesale catalog 25c. Specialties, Bristol, Va.

DEMONSTRATING Embossem transforms handwriting into gold, silver raised lettering for cards, stationery. \$150.00 a day possible. Cost 5c, sells \$1.00. Sample writing 10c. Embossem 50c. Western Chemical, Salem, Oregon.

ABRAHAM Lincoln operated a saloon in 1833. We have reproduction of license issued him. Historic document. Every tavern will want some. Samples, agent's price 25c. Pioneer Publications, P. O. Box 1402, Philadelphia 5, Penna.

NEW Sensation! Beautiful perfume dispenser! Sample, 60c. Rosele, 2015-74th Street, Brooklyn 4, N. Y.

NEW American Christian honor scroll 85% profit, particulars free. Extra-special 5 scrolls \$1. Evangel, Box 3825K, Cleveland 10, Ohio.

BALLOONS, Toys! Sell like nylons. Everywhere! The kiddies go wild! \$9.50 gr., sample 15c. Novelty Enterprises, 790 Broad, Newark 2, N. J.

DON'T Be a shirt tucker in. Agents make money taking orders for Staput shirt retainers. Keeps shirt from creeping. No metal or fasteners to injure the finest fabrics. Sample and details 25c. Carolina Industries, P.O. Box 1355, Wilmington, N. C.

ENORMOUS Profits, big sellers, history World War II, Bibles. J. Henry Schlake, A127 East Third, Cincinnati 2, Ohio.

MEXICAN Feather pictures. Unusual novelty. 50c (stamps) bring \$2.00 worth samples, details. Refunded if unsatisfied. Aztec Art, Apartado 762, Mexico City.

AGENTS—Salesmen—solicitors—pitchmen—promoters desiring outstanding profits, Havaway's interesting proposition pyramids your chances. Write Havaway, 635 A Mills Building, San Francisco, Calif., else miss opportunities!

SELL Housewives gadgets for ironing board—many other home uses. Wildfire seller. Sample 25c. Landau, P.O. Box 6553, Washington, D. C.

GREETING Cards, gift wrappings, stationery, novelties. 4154g Fifth Street, Philadelphia 40.

FREE Wholesale catalog, hard to get merchandise. American Merchandising, PM-5 12 Adams Ave., Montgomery 4, Ala.

NEW Year 'round extra money plan. Show friends exclusive greeting card assortments. Up to 100% profit. Request all occasion \$1.00 assortment on approval. Also show birthdays, social notes, gift wrappings. Free sample personalized stationery. Thomas Terry Studios, 156 Union Ave., Westfield, Mass.

MAKE Unusual spare or full-time profits showing genuine leather jackets, raincoats, 200 style and comfort shoes. Sample outfit free. Rush postcard. Mason Shoe Co., Dept. M-333, Chippewa Falls, Wis.

\$1 STARTS you in business. Sell deluxe five fold ties. 100% wool interlining. Cost you only \$7 per dozen, you make \$5 dozen. Send \$1.00 for special introductory offer two five fold ties. Catalog complete line free. Philip's Neckwear, 20 West 22nd St., Dept. K-2, New York 10.

AGENTS—Distributors—build profitable lifetime business with fast-selling household necessity. Good repeater. Beaver Products, 4620-F St. Clair, Cleveland 3, O.

SELL Books by mail, Mammoth sales and huge profits. Everything furnished. Send 10c for complete details. Business Plans Foundation, Box 56-R, New York 10.

SILVER Plating liquid. Simply rub on with a cloth. Cleans, silverplates, polishes, one rubbing. Puts on genuine 1000 fine silverplate. Renews silverplated ware like new. Silverplates onto brass, copper, bronze, etc. Lasting finish, won't come off. Sales representatives wanted. Details free. NuProcess Products, Dept. 221, Aurora, Ill.

GI Self building members. House book 25c. Bello, Gardner, Mass.

BIG Money in selling price tags to grocery stores, can make \$20.00 a day. Each sale nets you \$2.50. Hand & Heffner Co.,

NO Money or experience required. Spare or full time writing orders for guaranteed men's hosiery. We deliver and collect. Advance profit and 33% cash bonus. Huge demand everywhere. Steady repeat business. Write for free sales outfit including everything needed to make money. Kentcraft, 44 Court St., Dept. 101, Brooklyn 2, N. Y.

AGENTS. Reconverting manufacturer still has territories available. Distributors and salesmen needed for quality business and household products. Write Halberstadt Company, Terre Haute, Indiana.

ALL Purpose household rack. \$1.50 or write. Bello, Gardner, Mass.

STAINLESS Steel expansion watch bands. Nationally advertised. Regular \$4.50 retailer (OPA). Sample \$1.50. Money-back guarantee. Check with order. No C.O.D. will be accepted. Wm. Semerak & Company, Chicago 25, Illinois.

SELL Amazing wax polish everywhere. Free sample. Cary Company, Indianapolis 1, Ind.

CUT Labor and time fifty percent when waxing cars. Use Wax-Aid. Large size 89c. Auto Aid Products, 42 Lyall Road, Clifton, New Jersey. Agents wanted.

BIGGEST Selling stock signs. Newest designs. Beautiful, snappy. Retail 25c. 500% profit. Needed now! Send 25c for 3 samples and lists. Randles Manufacturers, Hutchinson, Kansas.

SELL Mexican bird pictures with real feathers. Stupendous profits. Samples 25c. Particulars free. Foley's, 217 Grafton St., Brockton 6, Mass.

"BREEZE Kar Kooler." New clever device keeps car cool in hottest weather. Low priced. Amazing profits. Agents-dealers, write immediately. Economy Specialties Co., 407 So. 4th St., Sturgis, Mich. See page 246.

SENSATIONAL New product, used by men, women, children. Opportunity to build steady income for years. Men or women agents. Free literature. Wilmot McAvoy, 137a Brookside Dr., Toronto 13, Canada.

100% PROFIT On famous, popular Pines birthday, Christmas and all-occasion greeting cards. Wonderful 12 to 24 card, boxed assortments sell on sight for \$1.00. Write today for information and extra bonus distributors' plan. R. Pines, Box 32, Flushing, N. Y.

SELL These profit items to stores and direct: Tanay Creme Shampoo and Sure-Go Drain Pipe Kleener. Write today for details. Consolidated Chemical Mfg. Co., Dept. P.M., Chicago 6, Illinois.

GOLD Honor scroll. Retail \$1.00, costs 15c. Sample free! Levine's, Box 15-X, Boulevard Station, New York 59, N. Y.

MEXICAN Novelty curiosities. Fastest selling items. Biggest profits. Free samples. "Productos," Apartado 9318, Mexico City, Mex.

SELL Personalized stationery, jokes, novelties. Big profits, easy to sell. Basil Churchill, 172 Pond, Randolph, Mass.

MAKE Money selling perfume. Sample odor and details. Runyan, 157C Conwell, Aurora, Indiana.

"COMIC-STRIPPER." Amazing new transfer liquid. Transfers newspaper pictures, comics on cloth, paper, wood. Works like magic. Everybody wild about it. Agents cleaning up. Profits tremendous. Write immediately for free sample pictures and money-making offer. H. B. Ketchum, Inc., Charlotte, N. C.

LUMINOUS Pictures that glow in the dark. Large manufacturer wants factory representatives; wonderful new item; fast seller, free sample. Madison Mills, 303 Fourth Ave., New York City.

137 COMPLETE Plans for starting own business: local—mail order. Particulars free. Elite Co., 220-A Grand St., New York 13.

MAKE Quick clean-up selling perfume beads. Particulars free. Mission, 2328 W. Pico, Los Angeles 6, Calif.

ELECTRIC Ironing cords with indicator light. Iron-So-Ezee Company, Mt. Washington, Ohio.

90c PROFIT Each \$1 sale. Sell permanent mothproofing solution to housewives, stores, agents. Experience unnecessary. Postal brings details. Kinford, Wayne 3, Penna.

MAGIC Cleaner and laundry soap deal. Hotter than a firecracker. Big profits. Sample free. Bestco, 5007 Irving Park, Chicago.

\$3 FIRE Extinguisher; quick sales, wholesale or direct; liberal profits. "Fire-

GOLD Lacquered window sign letters. New foils, styles, absolutely beautiful. Free samples. Atlas, 7941 Halsted, Chicago.

WAR Honor scroll: All branches of service represented. 12 by 16. Space provided for name and photograph. Truly beautiful. Agents make big money. Sample 25c. E. Condon, Dept. 6, Upper Darby, Penna.

SELL "Petite picture notes." Something really different in greeting cards. Sample free. Dunbar Cards, New Brunswick 20, N. J.

AGENTS: Stamping names on pocket-key protectors. Sample check with your name, address, 25c. Stamping outfits. Emblem checks, check-fobs, name plates. Hart Mfg. Co., 303 Degraw St., Brooklyn, N. Y.

AGENTS—Big line including food products. Fast selling premium and bargain deals. Low prices. Send card for big outfit offer with gift. Ho-Ro-Co, 2768 Dodier, St. Louis 7, Mo.

WHOLESALE Sources. 500,000 articles. Free directory. Maywoode, 1133 Broadway, New York.

PLATING Outfits for autoparts, reflectors. Connect to a battery. No tanks necessary. Free booklet and particulars. Gunmetal Co., Ave. N. Decatur, Ill.

EXCELLENT Sideline for printing salesmen. Decalcomania name plates in small quantities. Also, make money applying initials on automobiles. Free samples. "Ralco," X-164, Boston (18), Mass.

FREE Water and our concentrates, makes flavors, lotions, shampoos, 72 products, labels, bottles furnished. Qualco, E-20030 Russell, Detroit.

AGENCIES WANTED

COMPETENT Well acquainted salesman solicits connections, as sales representative on commission, with American manufacturers, for the Territory of Puerto Rico. Fine references. Address Alvarez, Box 5052, San Juan 27, P. R.

HIGH GRADE SALESMEN

THIS Is it making sales history. Brand new genuine rayon silk covered flower plaques, statuettes, novelties \$1.80 per doz. up. Large 9x12 sample \$1.25, worth double your money, agents wanted. Paris Novelty, 611 W. 7th St., St. Paul, Minn.

101% DIFFERENT, New profitable novelties. Catalog 25c. Specialties, Bristol, Va.

FAMOUS Picture—in four colors. 500,000 sold. Permanent opportunity. State experience. Sample print free. Our Flag Sales Corp., Dept. C-1074, Excelsior Springs, Mo.

LOOK Here! Wanted—Men and women to start in business on our capital. Sell some 200 farm-home products. Thousands our dealers now make quick sales, big profits. For particulars write Rawleigh Co., Dept. E-192-PPM, Freeport, Ill.

BIG Commissions, selling to stores celluloid pricing tickets, metal shelf moulding. To restaurants, menu covers, signs. P. Pricing Press, 124 White St., New York 13, N. Y.

SELL Greeting cards, display signs, pictures, books, novelties. Big profits. Bulletin free. Elfco, 432 North Wells, Chicago 10.

SELL Annie Blain flavors. George S. Parker, New Brunswick, N. J.

MAKE Up to \$25 a day selling desk calendars. Ideal side line. Details free. Steel Advertising Service, P.O. Box 596, Richmond 5, Virginia.

FREE! Latest issue Opportunity Magazine. Salesman's Guide. Inspiring, constructive. Shows how to earn money selling for others or in your own business. Hundreds postwar opportunities. Send name and describe what you have sold or are selling. Illustrated copy sent free. Opportunity Magazine, 620 N. Michigan, Dept. 17, Chicago 11, Ill.

EDUCATIONAL AND INSTRUCTION

LEARN Professional photographic negative retouching. Short, illustrated home study course. Earn big money. Fascinating hobby. Free booklet. Duval School, Dept. G, 8519 Sunset, Hollywood 46, Calif.

TYPEWRITING Taught in ten lessons, guaranteed; (your home) also, bookkeeping and accounting, ninety hours; shorthand, ninety hours—low rates. Osborne College of Short Methods, 212 West Third Street, Los Angeles, California.

FOOD Sanitation. Learn for profit, protection. Certificate awarded. Free details. Institute Sanitary Science, 2385-A Edge-

GOOD Jobs and a sound, substantial future await you in hotel and institutional field. Men and women—all ages—needed for well-paid positions that offer color, excitement, ever-new and fascinating duties. Record-breaking travel means even greater opportunities for trained men and women in hotels, clubs and institutions. Lewis School receiving calls for managers, assistant managers, stewards, hostesses, purchasing agents and 55 other types of important positions! From coast to coast there are important positions that offer splendid opportunities for advancement in a business where you are not dropped because you are over 40. Previous experience proved unnecessary! No need to leave your job to qualify. A good grade school education, plus Lewis Training qualifies you at home, in spare time. Our national placement Bureau helps to place you—and our amazing Certified Job Plan—actually guarantees you will "make good" when placed. Write today for free book! Veterans: This course approved for veterans' training. Lewis Hotel Training School, Room HL-368, Washington 7, D. C. (First and only school of its kind—now in its 30th year.)

GOOD Radio opportunities for right people! Write Topical Emprise Corporation, 1527 Highland, Box 42B, Louisville 4, Ky.

WANT A government job? Commence \$125-\$220 month. Men-women. Prepare now at home, for 1946 examinations. Full particulars and list positions, free. Write today. Franklin Institute, Dept. P24, Rochester 4, N. Y.

ATOMIC Age shorthand. Learn in 5 lessons, 10c each. Elliott School, 4426 Carrollton 19, New Orleans.

AMAZE With Super Memory! Facts, figures, names stick like burrs! Write A-17, Thor Books, Box 1210, Chicago.

BECOME A Doctor of Psychology or Metaphysics. Teach secret of contentment, happiness. Win degree of Ps.D. or Ms.D. Solve mental worries. Free book. College of Universal Truth, 5153-B North Clark, Chicago.

KNOW—"How to Drive Smoothly." Save yourself from accidents. Develop ability and confidence easily from illustrated, tested self-instructions. Excellent for learners. \$3.00 postpaid. The Brown Driving System, Box 106-M, Hill Station, Harrisburg, Penna.

NOW! New certified method for preparing your own home study course on any vocational or technical subject. Saves months of study, hundreds of dollars. Diploma granted. Free bulletin. DeVoto Schools, 35 Vicente, San Francisco 16, Calif.

RESORT Hotel positions. Winter and summer, South and North. Beginners instructed. Lee's Hotel Institute, 7 Water Street, Boston.

WELDING—Electric arc. Learn profitable trade quickly through actual practice. Individual welder instructions at bare cost of materials. Full particulars free. Valuable welding lessons book 50c. Hobart Welding School, Box M-562, Troy, Ohio.

LEARN Plain trigonometry better than others. Read Master Method instructions. 12 mimeographed sheets, wonderful ideas; \$1, guaranteed. J. Ziemba, 6123 Orchard, Dearborn, Mich.

LEARN To write for money. Read character at a glance. Seven cures for lean purse. Books for parents, brides. Many others. Particulars free. Sem Tem Service, Marshal Bldg., Norwalk, Conn.

MASSO-PHYSIO-THERAPY, Chiropody. Evans natural therapeutics home study courses. P.O. Box 1195, San Antonio 6, Texas.

LEARN Shoe rebuilding. Practical. Low tuition. Investigate. Gusias School, 3803 Lake St., Chicago.

RADIO—Practical training at minimum expense. Write—Hayes, 4004-E Arcade Bldg., Seattle, Wash.

DRAFTING Students—Draw and trace genuine engineering plans of machine parts. Send \$2.50 for first two plans and instructions. Tekage, 42 Vernon St., Newton 58, Mass.

SENSATIONAL, New, magic shorthand and typing home study course. Price 25c. Rlegel, 1111 Harrison, Philadelphia 24, Pa.

HOME Studycourse, drugless therapy. Free literature. Institute of Drugless Therapy, Tama, Iowa.

RENTAL Library offers real value in mail order reading courses. Pays book dividends. Write for details and lists.

TUNE Pianos scientifically. Lesson and diagram, \$1.00. Oscar Fylling, 841 Robinson, Oroville, Calif.

LEARN To type! Use the touch system. Free details. Emile Jeunesse, 5706 Dauphine St., New Orleans 17, La.

GOOD "Used" self-instruction educational books on all subjects bought, sold, rented, exchanged. Satisfaction guaranteed. Complete information and 100-page illustrated bargain catalog free! Write—Nelson Company, Chicago 5.

USED Educational and technical books on all subjects bought, sold, rented. Catalog free. Educational Exchange, Henagar, Ala.

29 LANGUAGES By Linguaphone. Russian, Spanish, Portuguese—Direct conversational method for mastering any language quickly, easily, correctly at home. Send for free book. Linguaphone Institute, 83 RCA Bldg., New York.

LEARN Photo-engraving at home or in oldest, largest school in America. Work for newspaper or establish own profitable business. New Tasope' Photo-Engraving equipment available soon. Write for information. Veterans ask about G.I. training. The Aurora School of Photo-Engraving, Tasope' Bldg., Aurora, Mo.

INVESTIGATOR Training. Phillips Secret Service, 1917B North Kenneth, Chicago 39, Illinois.

LOCKSMITH Course. Lock picking, key fitting, etc. \$1.00 prepaid. Locksmith, Canadian, Texas.

MEDICAL Laboratory technicians in great demand. We train you in your spare time, in your own home. You can practice while studying. Write for free catalogue. Imperial Technical Institute, Box 973-E, Austin, Texas.

SECRET Investigation. Experience unnecessary. Investigators particulars free. George Wagner, M 125 West 86th, New York.

USED Educational books on all subjects sold, rented, also bought and exchanged. Moneyback guarantee. Write today for free catalog and details. Lee Mountain, Pisgah, Alabama.

PLAYS, STORIES, MANUSCRIPTS

COMPLETE Assistance for writers. Inquire National Writers Club, 1837 Champa, Denver 2, Colorado.

NEW Writers needed to rewrite ideas in newspapers, magazines and books. Splendid opportunity to "break into" fascinating writing field. May bring you up to \$5.00 per hour spare time. Experience unnecessary. Write today for free details. No obligation. Postcard will do. Comfort Press, Inc., 210-P South Seventh St., St. Louis 2, Missouri.

I WANT New writers to cash hundreds of checks for \$1 to \$100, offered each month. The easiest way to write for pay. No previous experience necessary. Send for free details. No obligation. Saunders M. Cummings, Box 609-M, Colorado Springs, Colo.

CARTOONING, COMMERCIAL ART, SHOWCARD WRITING, SIGN PAINTING

ADJUSTABLE Drawing board stand folds flat, simplified plans 25c. Box 82, Bergenfield, New Jersey.

STUDY Art, cartooning at low cost. Bargain lists for stamp. Box 592PM, Springfield, Illinois.

BARGAINS, Books, courses. Quick landscape painting, poster art-lettering, cartooning, etc., supplies. Illustrated catalogue 10c. Art Book Shop, Arnold, Mo.

ALPHABETS, Ancient and modern. Contains over 120 types of English alphabets from 40 A.D. to 1940 A.D. Price \$2.00 postpaid. Kirk Book Mart, Box 84A, Wellington, Ohio.

CARTOONING Course:—30 illustrated lessons, over 500 sketches, complete \$1.00. Rex Cartoons, Box 892, Pasadena, Calif.

COMPLETE Cartooning course! 50c. Westway Educational Service, Box 58, Los Angeles 35.

LEARN Chalk talk. Can make an interesting speaker of anyone. Command attention. Details free. Arthur E. Ryde, P.O. Box 1071, Springfield, Mass.

CHALK Talks. Laugh producing program, \$1.00. Catalog 10c. Balda The Cartoonist, Oshkosh, Wisconsin.

CARTOON Course—22 easy lessons. 200 figure sketches. 25c coin postpaid. Snack-Pack Co., 32 E. Georgia, Indianapolis 4.

MAKE Signs, letters, stencils. 9 complete alphabet pattern sets. 3 complete numeral pattern sets and catalog \$1.00. Sign Letter Distributors, P.O. Box 101, Mineola, N. Y.

ADVERTISING AGENCIES, LETTER WRITERS, FOR ADVERTISERS

DIRECT Advertising pays. Names of 1500 new mothers \$2.00, 200 brides \$1.00, 6,000 veterans \$3.50. Burdick, Box H, San Diego 7, Calif.

MAILORDER Buyers lists—fresh, certified. Free prospectus. Dixie, King, N. Car.

40 **WORDS** Display 14,000 readers. 50 magazines, your name as publisher \$2.00. Renick, Holland, N. Y.

FREE—New rate bulletin, southern daily newspapers. Advertise in the South, "Dominating Market of America." Alabama Advertising Agency, 216 Exchange Building, Birmingham 3, Alabama.

GUARANTEED Powerful mailorder letters, literature, campaigns planned and written. Famous for famous results. Investigate! Finkle Advertising, 1201½ South Ogden, Los Angeles 35.

ADVERTISE Profitably: \$20.00 reaches 5,000,000 Sunday newspaper readers with 24-word ad. Newspaper, magazine, mailing-list ratebook free. Chicago Advertising Agency, 20-PA W. Jackson, Chicago 4.

FREE! 1946 Advertisers Rate & Data Directory. 52 pages! E. H. Brown Advertising Agency, 20 N. Wacker, Chicago 6.

WRITER Wants work! Effective sales letters, folders, catalogs, booklets, courses, speeches, etc., written or revised, \$2 per typewritten page. Twenty years experience. Dudley Bunn, 126 Lexington Avenue, New York 16.

ADVERTISE: 24 Words, 40 newspapers \$3.50. List free. Advertising Bureau, 4515-C Cottage Grove, Chicago 15.

ADVERTISERS Service—For men going in business. Put our experience in merchandising and advertising back of your products. Write Van De Mark, Times Star Bldg., Cincinnati 2.

24 **WORDS** in 64 weeklies \$4.96. H. J. Darnell, 730 Hays, Jackson, Tenn.

INCH Display adv. 50 magazines yr. \$24. Wood's Popular Services, Atlantic City, (N. J.)

ADS Placed in out of town newspapers and magazines. Low rates. Catalogue free. Ideas that pay. Baker Advertising Agency, Successors Ankrum Agency, 189 W. Madison, Chicago 2.

BUSINESS SERVICE

TO Whom it may concern: We will represent you in the principal cities of the United States; Alaska; Brazil; Canada; Cuba; Greece; Hawaii; Mexico; Newfoundland; Panama; Philippines; Puerto Rico; South Africa and Sweden. Personal or business assignments \$1 per hour. James W. Farley, Citizens Bldg., Cleveland 14, Ohio. Note: Would appreciate hearing from someone who wishes to enter this business in your city. Will send you assignments immediately. References exchanged. State qualifications.

WILL Represent you on personal or business assignments \$1 per hour in Houghton County, Mich. H. Sauvola, Chassell, Mich.

SEATTLE Mail or branch office address. \$2.00 month—mail forwarded when wanted—also personal or business assignments, \$1.00 per hour. Business Messenger Service, 517 Third Ave., Seattle 4, Wash. (Opposite County-City Bldg.)—Established 1940.

YOUR Office conducted Los Angeles, Hollywood \$1.50 month. Hollywood Personal Services, Suite 218, 1154 No. Western Ave., Hollywood 28.

SPECIAL SERVICES

MAIL Forwarded 25c each letter. Rudawney, Box 2413, Salt Lake City, Utah.

HOW Thousands of missing persons were located. Facts \$1.00. Chaffee, Research, 308 Washington, Chicago 6.

INDUSTRIAL Equipment designed. Industrial Engineering Service, Box 234, Defiance, Ohio.

MAKE Real butter at home. Method mailed 25c. Dietz, 3312 N. 15th, Phila. 40, Penna.

REFRIGERATION Engineering consultations \$1. Mail problems. Bachrach, Engineer, 4815 15th Ave., Brooklyn 19, N. Y.

HAVE Drawings made of your ideas. Satisfaction guaranteed. Confident draftsman. Chrisman, Box 375, K. S. College, Manhattan, Kans.

GOOD "Used" self-instruction educational books on all subjects bought, sold, rented, exchanged. Satisfaction guaranteed. Complete information and 100-page illustrated bargain catalog free! Write—Nelson Company, Chicago 5.

CONSULTING ENGINEERS

RADIO-ELECTRONICS Consultation, engineering design, model development, technical writing. R. E. Lovejoy, 712 Yuma Street, S.E., Washington 20, D. C.

TYPEWRITERS, DUPLICATORS, OFFICE DEVICES

USED Typewriters, mimeograph, multi-graph, presses, supplies, appliances. Dixie-Graph, King, N. Car.

PRINT Your own postal cards, paper, or anything on "Printomatic Self-feeding Rotary Postal Card Stencil Duplicator." Only \$9.50 with \$2.35 worth of supplies, stencils, ink, etc. Literature free. Pittsburgh Typewriter Supply, 336-RB Fourth Ave., Pittsburgh 22, Penna.

RUBBER STAMPS, OFFICE SUPPLIES

FINEST Rubber stamps. Indexed, knob handles. Three lines 75c. Signature \$3.00. Pad 25c. Catalogue 5c, refundable. Black's, Pigeon, Mich.

BETTER Rubber stamps. Ezy-order. Literature free. Lee-Vall Press, Box 1242, Indianapolis 6, Indiana.

3 **LINE** 35c; signatures \$1.75; pads 25c. Stamprite, Wauwatosa, Wis.

THREE Lines, cushioned, indexed, knob handle, \$1.00. Additional lines 25c each. Ideal Rubber Stamp Co., Detroit 8, Mich.

RUBBER Stamps, 25c line, any size. Parcel Press, 53 Astor Sta., Boston, Mass.

PROMPT Service. Cushioned, indexed, 1 line 25c, 2—35c, 3—50c. Stampcraft, 1707 Virginia, Gary, Indiana.

RUBBER Stamps, all kinds. Send for catalog. Excello, Box 500, Shreveport, La.

PRINTING, MULTIGRAPHING, MIMEOGRAPHING, GUMMED LABELS

FIRST Class printing. Samples. Walker Printing Service, Box 1298, Amarillo, Tex.

ADCARDS, Envelopes, letterheads, other printing. Samples. Parker Press, 479 Main, Groveland, Mass.

QUALITY Printing prepaid: Business, personal stationery. Letterheads, envelopes, statements. Prices reasonable. Samples. Mero Products, 100 Morrison, Punxsutawney, Penna.

8½x11 **LETTERHEADS**; Billheads; cards; envelopes; each 200 \$1.00. Benneville, 907 West Roosevelt, Philadelphia 40, Penna.

COMPLETE Mimeographing and mailing services. Job or contract. Write for complete details and rates. Niagara Secretarial Services, 1655 South Avenue, Niagara Falls, New York.

GUMMED Labels; 500 business illustrated \$1.00. Samples. Presto, Dayton, Kentucky.

500 **ENVELOPES** \$1.75. Samples free. Mango, 555-A South 20th, Newark 3, N. J.

500 **BUSINESS** Cards \$1.75 postpaid. Tucker, 2964 Northwestern, Indianapolis 8.

100 **MIMEOGRAPHED** Letters (like typewriting) \$1.50; additional 100's, 50c. Accurate, speedy. Multico, Nine Cornhill, Boston 8.

SCOUT Stationery, dues cards, patrol, camp forms. Samples 6c. Leyden, 904 Madison, Brooklyn 21, N. Y.

500 **ENVELOPES** Or 8½x11 letterheads \$2.35. 1000, \$3.75. Samples. Burns, Box 291, Sacandaga Road, Schenectady, N. Y.

PRINTING, Multigraphing, mimeographing: Low prices, high quality workmanship. Write for samples. Bay Printing Co., 24404-A Oakland Road, Bay Village, Ohio.

1000 **BUSINESS** Cards \$1.95 postpaid. Hamilton, 4341 N. Meade, Chicago 34.

ATTRACTIVE Business-building printing. See our samples first! Ace Printing, Brentwood, Maryland.

WE "Ain't" making any money, but we're making satisfied customers. 100 letterheads, envelopes, billheads, statements, cards or noteheads \$1.00. All six \$5.00 postpaid. Ace Press, 403 East Ostend,

150 **LETTERHEADS** And envelopes \$2.00 postpaid. Gilliam Print Shop, 140 Sunset Ave. N. W., Atlanta, Ga.

NEW Photo business card, samples. Details 10c. Cowling, 533 Somerset, San Francisco.

LETTERHEADS, Envelopes, booklets, folders, imitation letters, statements, labels. Quality workmanship, low prices. Get our estimate on your needs. Lonelm Publishers, Paulding, Ohio.

350 **BUSINESS** Cards \$1.00 postpaid. Arcraft, 40-06 97th, Corona 1, N. Y.

GOOD Printing! Low prices! Small, large quantities. 250 letterheads, 250 envelopes, \$2.75. Joseph Johnson, 1382-A Fifth Avenue, New York City 29, N. Y.

MIMEOGRAPHED Letters, 100—\$1.00. Printing. Haynescraft, 706 8th, Washington 1, D. C.

QUALITY Printing at lowest cost. Free samples, pricelist. Adams, 30 West Washington, Chicago 2.

200 8½x11 **HAMMERMILL** letterheads, \$1.00 postpaid. Envelopes, billheads, business cards same. Race Printing, Hudson, New York.

QUALITY Printing, reasonable. Send copy for estimate. Globe Print Shop, High Point, N. C.

500 8½x11 **HAMMERMILL** Letterheads, 500 large envelopes, printed, prepaid \$5.00, 1000 each, \$9.00. Stump, South Whitley, Indiana.

FINE Printing—Reasonably priced. Prompt service. Samples. Treaster Printing, Milroy, Penna.

1,000 **ENVELOPES**, 6¾, \$3.75 Postpaid. Booklets, pamphlets and publications at lowest prices. Courier & Digest, 201 Eighth Street, Charleroi, Penna.

SEND 10c Now, for our 36-page 1946 pricelist—refunded first order. McCall Press, 1326 S. 27th, Omaha, Nebraska.

QUALITY Printing; prompt, efficient service. Samples. Lakeside Press, Bolton Landing, N. Y.

"**PRINTING** That Satisfies." Samples free. Mail Printing, 93, Danvers, Mass.

BETTER Grade printing reasonable. Estimates on anything. Economic Press, Leonia, N. J.

MIMEOGRAPHING—Any copy. Reasonable. Mailers Service, Box 606-A, Chicago 90, Ill.

500 3¼x2¼ **FOUR** Line gummed stickers, 25c. Moritz Printery, Saginaw, Mich.

MIMEOGRAPHING—Letters, pricelists, formulas, instructions. Lowest prices. Lem's Letter Shop, 5710 Stanton, Detroit 8.

PRINTING OUTFITS AND SUPPLIES

WANTED: Cash for your used printing equipment, hand and power presses, complete plants. Reconditioned equipment for sale. Printers Exchange, Troy, Ohio.

PRACTICAL Home-made printing presses. Details free. Riegel, 1111 Harrison, Philadelphia 24, Penna.

PREFIXT—New combination carbon and second sheets system. Saves time, money. Free samples. Logan, Box 131, Lakeland, Fla.

PRINTING Press plans \$1.00. Details, samples of work, free. Homer De Sellier, 19 Stebbins St., Springfield, Mass.

CUTS—Make real halftones, line cuts yourself! Samples 25c. Particulars free. Rapid Chemical Service, Edwardsville, Ill.

PRINTERS, Make cuts the Quick Etch method. Details free. Charles P. Medlock, Box 256C, Goodland, Indiana.

PRINTING Equipment, type and supplies. Send stamp for details or dime for complete illustrated supply book. Kelsey Inc., X-11, Meriden, Conn.

PRINT At home—Send 10c for catalogue—presses, type, supplies. Barnhard Co., 6 Columbia St., Newark 5, N. J.

INEXPENSIVE Home-made printing press. Details free. Novelty Shop, Downsville, Louisiana.

PATENT ATTORNEYS

INVENTORS—First things come first. Your first move toward securing a patent on your invention is acquiring full information on what to do. Our two books "Patent Protection" and "When and How to Sell Your Invention" contain this information and other helpful data. Get them immediately, together with our "Evidence of Invention" form. They cost you nothing, you assume no obligation. Write now to Victor J. Evans & Co., Patents, Trade Marks, Copyrights, 131-E Mer-

INVENTORS: Learn now—without obligation—how to protect and sell your invention. Write for free "Record of Invention" form and complete information for making disclosure and establishing date of your invention. We also send our new free "Patent Guide for the Inventor," containing complete information about patent procedure and how to sell inventions; giving illustrations of many successful inventions; over 150 basic mechanical movements. We assure you prompt, confidential service. Delays may be dangerous. Write today for your free "Patent Guide" and "Record of Invention" form. Clarence A. O'Brien & Harvey Jacobson, Registered Patent Attorneys, 61B-E Adams Building, Washington, D. C.

INVENTORS—Take prompt steps to protect your invention. Delays are dangerous. Get new free book, "Protect, Finance and Sell Your Invention," and "Invention Record" form. Preliminary information free. Reasonable fees. Conscientious counsel. Easy payment plan. Learn how to protect and sell your invention. Write us today. McMorrow, Berman & Davidson, Patent Attorneys, 134-R Atlantic Building, Washington 4, D. C.

PATENTS, Copyrights. Robert Daley, Registered Patent Attorney, 19 South LaSalle St., Chicago.

DAVIES & Son, patents-trade marks, 7240 Wisconsin Ave., Washington 14, D. C.

PATENTS. Free preliminary advice. E. E. Vrooman, Patent Lawyer, Registered Patent Attorney, 871 Woodward Building, Washington 5, D. C.

PATENT Protection. Write for information and "Record of Invention" form, free. Registered Patent Attorneys, Randolph & Beavers, 21-C Columbian Bldg., Washington, D. C.

"**INVENTOR'S Guide.**" 100 mechanical movements, free; advises on patenting, selling inventions. Frank W. Ledermann, 154 Nassau Street, New York 7.

PATENTS And trade marks. Wilfred E. Lawson, 1524 K Street N.W., Washington 5, D. C.

PATENTS—Trade marks. Irving L. McCathran, 315 McLachlan Bldg., Washington 1, D. C. Registered Patent Attorney.

INVENTORS—Before disclosing your invention to anyone send for form "Evidence of Conception"; Schedule of Government and Attorneys' Fees and instructions. Sent free. Lancaster, Allwine & Rommel, Registered Patent Attorneys, 411 Bowen Building, Washington 5, D. C.

PATENTS Obtained; selling service, information, recording forms free. Labiner, World Building, New York.

C. A. SNOW & Co., M-427 Snow Bldg., Washington 1, D. C. Registered patent attorneys. Established 1875. Literature mailed on request.

FOR INVENTORS

INVENTORS—Information on what to do first toward securing a patent on your invention is of vital importance. "Patent Protection" and "When and How to Sell Your Invention"—two valuable, richly illustrated books—explain fully what to do first, and a lot more. Get this information quickly, together with "Evidence of Invention" form. All three will be sent to you free. Write immediately to Victor J. Evans & Co., Patents, Trade Marks, Copyrights, 132-E Merlin Building, Washington 6, D. C.

INVENTORS: Learn now—without obligation—how to protect and sell your invention. Write for free "Record of Invention" form and complete instructions for making disclosure and establishing date of your invention. We also send our new free "Patent Guide for the Inventor," containing complete information about patent procedure and how to sell inventions; giving illustrations of many successful inventions; over 150 basic mechanical movements. We assure you prompt, confidential service. Delays may be dangerous. Write today for your free "Patent Guide" and "Record of Invention" form. Clarence A. O'Brien & Harvey Jacobson, Registered Patent Attorneys, 61A-E Adams Building, Washington, D. C.

PATENT Office searching exclusively. Prompt, confidential service assured. Invention protection form free. Write Raymond L. Smith, Patent Searcher, 410-M Bond Building, Washington 5, D. C. (Former U. S. Patent Office employee.)

WANTED: Practical inventions. Inventors Exchange, Research Division, B6, Hartford 1, Connecticut.

I SELL Patents. Established in 1900.

INVENTORS—Take prompt steps to protect your invention. Delays are dangerous. Get new free book, "Protect, Finance and Sell Your Invention," and "Invention Record" form. Preliminary information free. Reasonable fees. Conscientious counsel. Easy payment plan. Learn how to protect and sell your invention. Write us today. McMorrow, Berman & Davidson, Patent Attorneys, 134-P Atlantic Building, Washington 4, D. C.

500,000 INVENTIONS Never made a nickel. Wise inventor "must" know in advance where others slipped. 10,000-word prospectus tells "How to Make Good Ideas Make Good." Straight-from-the-shoulder, non-technical instructions on legal, financial, commercial procedures, from unbiased source. Send \$1.00. Research Division, Ric-Craft Industries, Box 1466-A, Tampa, Florida.

INVENTIONS Having profit possibilities in demand by specific manufacturers, cash or royalty. Free descriptive booklet, protective disclosure form, references, and how to safely disclose an invention for sale, upon request. Invention Reporter, 5A-11106 So. Longwood Dr., Chicago 43.

INVENTORS: Avoid unnecessary expense. Write for free booklet explaining how our consulting and advisory service can assist you in deriving greatest profit from inventing. Institute of American Inventors, Dept. 40-A, 1926-Eye St. N.W., Washington 6, D. C.

CASH For practical ideas and inventions. Mr. Ball, AB-9441 Pleasant, Chicago.

RANDOLPH & Beavers: Registered Patent Attorneys, 11-E Columbian Building, Washington, D. C. In order to protect your invention and reap the reward that should be yours, patent your invention without delay. Write for complete information and "Record of Invention" form, free.

INVENTORS: We design and market your idea or product. Gadget Designer, 725 Walnut St., Room 23, Philadelphia 6, Penna.

INVENTIONS WANTED

INVENTORS Attention! Have you an invention patented or patentable of a novel electrical or mechanical device? Are you the owner of dies you wish to dispose of? If you have either or both give full particulars. We are highly rated manufacturing concern with a nation-wide distributing organization. Your rights will be scrupulously respected. Lion Manufacturing Corp., Dept. BU, 2650 Belmont Ave., Chicago 18, Illinois.

EARNINGS, \$2000 Year easy; inventing simple items for special cash markets. Ideas only. No patents. Write Hendrickson, Argyle (7-B) Wisconsin.

WANTED Practical inventions of all kinds by manufacturers. Patented or unpatented. Cash or royalty. Write—John D. & Son, 140-V Spruce St., Box 3213, Bridgeport 5, Conn.

INVENTORS: Hundreds of manufacturers have requested our assistance in locating marketable new products. Complete information, free. Institute of American Inventors, Dept. 40-D, 1926-Eye St. N.W., Washington 6, D. C.

WANTED—Patented, unpatented inventions having profit possibilities, all kinds. If will sell, reply immediately. Descriptive booklet, references, free. Invention Reporter, 5B-11106 So. Longwood Drive, Chicago 43.

INVENTORS! Have you good patentable idea? Write Mr. Metzler, 11 West 42nd, New York.

CASH For inventions, patented, unpatented. Mr. Ball, A-9441 Pleasant, Chicago.

MANUFACTURER Wants sensible mechanical device or idea with quick sales possibilities in low-priced field. Write Matt, 1412-D Great Northern Building, Chicago 4.

PATENTS FOR SALE

ELECTRIC Home broiler. Patent pending, for sale outright. Compact, cheap to make. Two sizes, for homes and restaurants. Joseph Piantan, 2128 Van Ness Ave., San Francisco, California.

ROYALTY: Snap-off sealer ring. Screws on tight; snaps off easily. Readily manufactured, big possibilities. Bob Morrison, Kindersley, Sask., Canada.

UNITED States and Canadian patents on revolutionary new tobacco pipe. Robert Sadtler, 22 Moreland, Boston, Mass.

HOUSEHOLD Patent. Cheaply made;

PATENTED Lock nuts. Wish to contact mfg. who will market and mfg. Royalty basis. R. Seitz, 1856 E. 101 St., Cleveland 6, Ohio.

PATENT Pending. Fused electric plug. Outright, royalties. Harold Auerbach, 2345 Ocean Avenue, Brooklyn 29, N. Y.

INVENTORS: Test the commercial value of your patented or unpatented inventions, quickly and inexpensively. Write for free information. Institute of American Inventors, Dept. 40-B, 1926-Eye St. N.W., Washington 6, D. C.

MANUFACTURING

2-3 TUBE Amplifiers built to your specifications. Victoria Electronics & Supply Co., 1039 Memorial Avenue, West Springfield, Mass.

INVENTORS—Market study; developing; manufacturing models. J. M., Burlington, Kentucky.

PLASTIC Fabricating—Any item or quantity. Products developed. Complete engineering service. Plastic Products Co., Dept. PM-1, Box 384, Massillon, Ohio.

MODELS—Small lot manufacturing. Metals, plastics, etc. Milburn, Burlington, Kentucky.

MODELS AND MODEL SUPPLIES

RAILWAY Models, complete line, new, larger catalog. HO and O gauge 25c. Walters, 247 Erie, Milwaukee 2, Wisconsin.

NEW! Cleveland 82½ inch Winston Reliant plane kit. Radio control. \$15.00 dry (less operating unit or motor) postpaid. Write for details. Get your name on our Monthly News list. Nobil Hobbycraft, P.O. Box 3527, Phila. 22, Penna.

MODEL Airplane and gas model mail order catalogue. Profusely illustrated, 68 pages, 8½x11. Catalogue includes model airplanes, gas models, solid models, gliders, gas engines, supplies, tools. For your copy send 25c (includes refund coupon) to General Modelcraft Co., Dept. M-4, 91-17 173rd Street, Jamaica 3, N. Y.

GAS Motors. Forster Arden, Ohlsson, Hurricane, Cannon, Herkimer, Rocket, Merlin, Vivell, Thor, Delong, etc. List free. Wilco, 4608½ North Kedzie, Chicago 25.

GAS Engines, aircraft, ship, army vehicle models. List 10c, refunded first order. Hobby Center, 3324 E. Tenth, Indianapolis 1, Ind.

½ **LB.** Assorted nuts, bolts, lock washers. 75c. Box 471, Corona Del Mar, Calif.

BRASS Gears and model supplies for the inventors. Send 10c for catalog. Pierce Model Works, Tinley Park, Ill.

ANTI-FRICTION Ball bearings. Ideal for model railroaders or hobbyists. 3/16 hole, ½ o.d., 19/64 long at hub. Can be fitted for thrust bearings for light machines. 30c each. H. Dowd, 97 Main St., South Acton, Mass.

MODEL Engine catalog, railroad supplies, 25c refunded. Simonsen, A-3054 Greenview, Chicago 13.

LANDLOCKED Sailors! Here's a beautiful, richly illustrated, fully descriptive catalogue of famous model ships—whalers, slavers, corvettes, etc., authentic in every detail. Send for it today. Only 10c. Marine Model Company, Inc., Dept. C-15, Halesite, Huntington, N. Y.

WIZZ Electric motor; assembles in jiffy. Flashlight cell operates. All parts complete. Illustrated instructions. Send 25c, plus 5c postage. Eitro Company, 171B Deer Park, N. Y.

ARDEN Gasoline engines, Rocket, Melcraft, Marvin, Rogers, Thor, others. Airplane models, ships, accessories. Stamp for catalog. Hobby Shop, 639 Warren St., Boston 21.

LOOK! Midget speed boat. It runs. Generates own power. Realistic! Only \$1.50 postpaid. Fletcher, Box 183 University Station, Fayetteville, Arkansas.

MANUFACTURING New inventions, models dies. Candle moulds. Baum's Metal Specialties, Kansas City, Mo.

TINY Power model steam engines and boilers. Finished ready-to-run. Circulars for dime. Chas. V. Arnold, Philomath, Oregon.

COMPARE Our catalogue on engines, etc., 10c. Howard-A3, 2417 N. Ashland Ave., Chicago 14, Ill.

SHIP And yacht model fittings and blueprints. Hundreds of items to choose from. Send 25c for new illustrated catalog. A. J. Fisher, 1002 Etowah Ave., Dept. M, Royal Oak, Mich.

SHIP Models and yacht supplies complete. Large 64 page catalogue 25c. Bill Wild's, 510 East 11 St., New York City.

BIG Illustrated model engine catalog 10c. Active Products & Supply Co., 53 W. Jackson, Chicago 4.

BRASS, Copper, aluminum, stainless steel, monel. List 10c. Hobby Supply House, Box 2014, Pittsburgh 30, Penna.

MINIATURE Steam locomotives, 1/4", 1/2", 3/4" scales. Castings, parts, rail! Thorough drawings with instructions. Catalog 25c. Little Engines, Wilmington, Cal.

CATALOGS (Illustrated) for modellers! Airplanes, 60 page book on solids. Features construction data, specifications, camouflaging, 15c; railroads: 128 page "HO" guide. Equipment, accessories, fittings. 25c (includes refund coupon). Send coin or stamps for each profusely illustrated catalog desired. Polk's, "Nation's Leading Hobby House," 314-PM Fifth Ave., New York City 1.

SHIP Model kits and fittings. Complete line Fisher model yacht equipment. All Boucher, Fisher, Marine Model and Ideal kits, fittings and blueprints at standard prices. Most complete stock in New England. Send 10c for price list. James Bliss & Co., Inc., 220 State St., Boston, Mass.

BOAT Models. P.T., cabin cruiser, speedboat. Free circular. All Star, 2003 Lincoln Ave., Chicago 14.

Homecraftsmen

12 JIGSAW Silhouette designs for wall pictures with instructions \$1.00. A. G. Devine, Silhouette Workshop, 144 School Street, Watertown 72, Mass.

MACHINISTS—Don't guess cutting speeds. Compute them instantly. Computer \$1. Elcraft, Box 8184, Portland 7, Ore.

HERE Is something new. Gracefully curved birds and fish easily made out of cowhorn. Complete instructions with drawings \$1.00. H. Harrison, 14303 Strathmore, East Cleveland 12, Ohio.

FELLOWS Build your own radio, complete kit, easily assembled. Can be used on bicycle. Associated Model Manufacturers, 5 North Sixth St., Philadelphia 6, Pa.

MACHINISTS, Can you make molds dies; lathe, milling, grinding. Will forward blueprints upon receipt of facilities. Beacon Engineering, 60 East 42nd St., N. Y. C.

PATTERNS. Full size rocking horse, bobby car, doll stroller, scooter, wheel barrow and 6 pull toys \$1.00 post paid. Lincoln's Craft Shop, Farmington, Conn.

LAWN Furniture: Single chair, settee, picnic table with benches, and garden bench. Four plans \$1.00. Woodcraft Plans, P.O. Box 136, Sedalia, Missouri.

WHAT-NOT Shelf (2 drawers) full size pattern plans \$2.25. 25c drawings illustrations, particulars. Johnston, 1207 South Thomas, Arlington, Virginia.

INTRODUCING, "Sadie, The Surprising Seal." Amazing new action toy. Full size pattern, plus a pleasant surprise for profit minded craftsmen for only 25c. Scully-Hall, 92-46 220th Street, AEG Queens Village 8, N. Y.

HAG'S Leathercraft—tools, leather, designs, instructions. Samples, catalog, 10c. 7532-22 N. E., Seattle 5, Wash.

BUILD Sparkling crystal boudoir lamps. All parts (except wire, sockets and shades). Send \$2.00 for pair. Gyro Lamps, 5416 N. Clark, Chicago 40.

JEWELRY Accessories and findings. Plastic and metal pinbacks, screw eyes, clasps, chains, rings, etc. Prompt shipping service. Complete lists 10c. Doremby Company, Chisholm 1, Maine.

100 UNPAINTED Plaster paris novelties and rubber ash tray mold, \$6.50. Louie Irons, 204 Maple, Terre Haute, Ind.

DON'T Use squares. Enlarge drawings with Enlarge. Faster, more accurate than "graph-squares." Generous supply 50c. Particulars free. Enlarge, 80 Putnam Circle, Springfield, Mass.

LUCITE Poker rack; build it yourself; sells for \$12.50; send only \$4.79 for completely machined parts; jigs, cement, polishing equipment, complete instructions free. Murriness, 1113 North Genessee, Los Angeles 46, Calif.

PLEXIGLAS Picture frame kit, masked, machined, 5x6 60c postpaid. New plastics polishing outfit, results guaranteed, 65c postpaid. Lucite kit—stock; red, blue, yellow dye; cement, instructions, \$2.00 postpaid. Combination, \$3.00 postpaid. Technicraft, 1156 Commonwealth, Boston 34, Mass.

CERAMIC Jewelry supplies, bar pins, ear screws, for ceramic and woodworkers; also glass and seashell assemblers. Free catalog. Philadelphia Badge Co., 1007 Filbert St., Philadelphia, Penna.

INLAY Strips 1/8" x 3/4" assorted cherry, maple, oak, curly maple, etc. 100 linear inches in 6" to 12" strips, \$1.00 plus 15c postage and packaging. Eastern Industries, Canisteo, New York.

FOLDING Tables and chairs for picnics or porch. Attractive original designs, ingenious construction, light weight, easily and inexpensively made. Full size blueprint plans and complete details, \$1.00. Mastercraft Plans, 7041 Olcott, Chicago 31, Illinois.

VELT For home projects, bases, etc. 12 inch squares in assorted colors and grades. 9 pieces \$1.25 postpaid. Send 10c for full color chart. The Felt Crafters, Plaistow 10, N. H.

PANTOGRAPHS. Indispensable workshop instrument. \$2.50 postpaid. Automatically enlarges drawings. Eliminates graph squares. Large capacity. Precision construction. Moneyback guarantee. Immediate shipment. Information dime. Pantographs, Munising 1, Michigan.

ENGINEERED Plans. Catalog 10c, processes; formulas, 50c. Experienced consultants. Westchester Engineering Service, Box 301, Inglewood, California.

JIG Saw, patterns 10 beautiful full size patterns postpaid U.S.A. \$2.00. Join Pattern of Month Club \$2.00 year. No C.O.D. Kraft design. Kretors, D.B., 2331 Edwards St., Alton, Ill.

STAINLESS Steel assortment and plans for making rings, bracelets, pins and clasps. 1 lb. lot postpaid \$2.00. Harper's Machine Shop, 218-22nd Street, Dunbar, W. Va.

CRAFTSMEN—Fast selling, make children and adults lawn chairs. Plans and instructions \$1.00. Summercraft Studio, 42 Vernon St., Newton 58, Mass.

MANUFACTURE Costume jewelry at home for profit, hobby, therapy. Free wholesale supply catalogue. Instructions. Florida Supply House, Bradenton, Fla.

35 PATTERNS Of action pull toys, trucks, carts, toy furniture, etc. \$1.00. Continental Homecrafter, 907 Birch, Eau Claire, Wisconsin.

CATALOG: Patterns plywood novelty furniture, letters, numerals, plaques, frames, weathervanes, silhouettes, lawn ornaments. 100 books and booklets on crafts and hobbies, picture frame mouldings, tools, large line decal transfers. Other lines. Hundreds articles finely illustrated. Write Wo-Met Shop, Ashburn, Ga.

KNOCKDOWN Cedar chest lumber veneers. Free price list. Giles-Kendall, Huntsville, Ala.

MAKE Shell jewelry—for gifts, as a hobby or start a business. Free catalogue and price list. Complete illustrated book of instructions 75c. Florida Shellcraft Company, Box 1840, Sarasota, Florida.

80 PATTERNS, 40 Lawn ornaments, 20 novelties, 20 silhouettes. \$1.00. 6 new hanging shelf patterns \$1.00. List 100 other patterns. Modern Woodcraft, Saginaw, Mich.

LEATHERCRAFT Kits, supplies. Leather samples and catalog 10c. Leroy Buckley, 2539 Devon, Chicago 45.

SHELL Jewelry supplies. Wholesale only. McFarland Plastic Co., Sarasota, Fla.

BUILD And sell lawn chairs. Plans \$1.00. We tell you how and where we sell. The Woodcraft Shop, Danby, Vermont.

JEWELRY Supplies. Shell metal and plastic parts for manufacturing. Free illustrated catalogue and detailed instructions on shell jewelry. Florida Supply House, 415 12th Street, Bradenton, Fla.

WHITTLES—20 Patterns, instructions, X-acto knife, wood. \$1.00. "Old Whittler," 1403 Charles, LaCrosse, Wis.

MAKE IT YOURSELF

OUTDOOR Barbecue parts; build your own outdoor fireplace, cast iron grates, cleanout doors, spits, etc., now available. Smith-Matthews Fdy. Co., 6640 Charlevoix, Detroit 7, Mich.

KEEP Food cool without ice, electricity. Build Fogwood Cooler, chimney draft operates. Plans 25c. Fogwood Company, King, Ontario, Canada.

BUILD A fine home quick freezer. Complete plans, detailed instructions, \$2. Davis Engineering Company, 911 East Elmwood, Burbank, Calif.

FREE Hot water. Solar water system works any locality. Free literature. Miami

BUILD Concrete block machine. Vibration and hand operated types. Easy, inexpensive. Sell blocks, build home, garage, barn at low cost. Free details. Horne, 206 West Wilder, Tampa 3, Florida.

BUILD Your home yourself! Inexperienced? My third year showing beginners. Your labor saves up to 60%. Valuable circular 25c. Only the original bears this name: William Jackson, A. B., 1713 Howard, Port Huron, Michigan.

METAL Wheels with rubber tire for your own construction of wagon or wheelbarrow for youngsters. 7 1/2" diameter, 7/16" hole for axle. Price only \$1.00 each wheel or 4 for \$3.75. There are many uses for these wheels. Send order with 1/3 payment, balance C.O.D. to H. Dowd, 97 Main Street, South Acton, Mass.

ELECTRIC Portable phonograph. Save up to 80%. Make one with our modern 3-tube "Delux Amplifier." Write for free information. Anderson's Lab., 430 Kearny Ave., Kearny, N. J.

30" EXHAUST Fan—full scale plans, complete detailed instructions \$1. Flohr's Workshop Plans, 1200 Arthur Street, Vicksburg, Mississippi.

ALARM For windows and doors. Safeguard children and valuables. Easily made and installed. No wires visible. Materials cost approximately \$4.00. Complete plans \$1. Schengco, Box 1213, Milwaukee 1, Wis.

BUILD Your home as a hobby. No rent. No mortgage. Save 50%. Use spare time. No special skill required. Amazing facts sent free. H. C. Lightfoot, Civil Engineer, Richboro 1, Penna.

INEXPENSIVE Jigsaw; circle saw; plans 25c each. Jeffery, 2214 Wolcott, Flint 4, Michigan.

AIRPLANE Lawn sprinkler, very interesting, plans \$1 C.O.D. Larrys Novelty Shop, Box 1771, Billings, Mont.

HOME Made concrete mixer plans \$2.00. Dan Brown, Sunset, Texas.

BUILD Your own power lawn mower and save \$50. Complete kit of precision factory-made parts and instructions for new-type, three-wheel whirling blade mower. Write B-M Mower Co., Box 66, Blue Mound, Kansas.

POWER Lawnmower—convert any hand lawnmower. Complete, instructions, photographs showing easy, cheap way, simple clutch. Have made and sold over 250 powermowers from ordinary hand mowers and any make washing machine motors. No theories, but a practical copyrighted system that gets the job done. \$1.00 money order. Woodridge Lawnmower Co., 744 McConnell, Memphis, Tenn.

BUILD Your own home. Save expensive labor, rent. We furnish complete construction materials estimate. Iron out any problems. 3c stamp brings details. L. F. Post, construction estimator, Box 1225, Clearwater, Florida.

CONCRETE Mixer, efficient hand power, inexpensive from oil drum. Plans \$2.00. A. Mitkos, 8802 Corwin, St. Louis 21, Mo.

FLUORESCENT Lights. How to make your own 20 watt lights for less than \$1.00 each. Materials available. Complete, guaranteed, detailed instructions \$1.00 cash or money order. Checks \$1.10. Specialty Sales, Box 1086, Muncie, Indiana.

BEAT The heat! Build efficient, inexpensive air-conditioners to suit any space. Large profits selling to homes, stores, offices. Plans, instructions, \$1.00. Imperial, 10237 McQuade, Detroit 6, Michigan.

WATCHES, OLD GOLD, JEWELRY, ETC.

FOUND Money in your dresser drawer. Cash sent immediately for gold teeth, watch chains, silver. Satisfaction guaranteed or merchandise returned. Bonded-licensed dealer. J. Tropp, 15 Park Row, New York 7, N. Y.

GENUINE Diamonds, out-of-pawn low prices, wonderful values. Unredeemed loans and big buying power enable us to offer beautiful gems at prices far less than original cost. Shipped free for inspection, appraisal. Send for big free list showing fine diamonds at startling low prices. Lloyd J. Butler, President, Prudential Loan Association, 133-VE North Clark St., Chicago 2.

REPAIRING Watches, clocks. Correct-Time, P.O. Box 102, Brooklyn (Sta. P), New York.

ALARM Clocks easily repaired, adjusted. Instructions 50c. Jones, 1210P Dudley, Utica 3, N. Y.

THE Key to your gift problems! Attractive costume jewelry made to order. Quarter (refundable) rushes illustrated cata-

JEWELRY. Gem cutting, metalcraft. Fascinating designs for hobbies and money-making opportunities. New, complete illustrated book covers cutting, polishing, mounting gems, metal, jewelry work, etc. 287 pages, \$2.95 postpaid. Money back guarantee. We supply tools, materials at lowest cost. Modern Technical Book Co., Dept. M5MC, 55 West 42nd St., N. Y. 18.

IDEAL Beginners jeweled pocket watch movements as is \$2.00 each. Bezkor, 1491 Metropolitan Ave., New York 62, N. Y.

\$1.50 BUYS Stainless steel expansion watch band. Postpaid. Regular price much higher. Craig's, 61 Main St., Luzerne, Penna.

OUTSTANDING Watch value \$8.95. Men's attractive wrist watches built by Swiss craftsmen. Sweep second hand, unbreakable crystal. Chrome case. Satisfaction guaranteed. Send C.O.D. Atlantic Watch Co., Box 213, Baldwin, N. Y.

WANTED—Old or broken jewelry. Cash paid immediately. Mail gold teeth, watches, rings, silverware, diamonds, spectacles. Satisfaction guaranteed or merchandise returned. Information free. Rose Smelting Co., 29 East Madison, Chicago, Dept. A.

SEND \$2.20 For high grade gents stainless steel expansion watch band. Lowe's, Holland Bldg., St. Louis 1, Mo.

GEMS, Precious and semi-precious, all genuine, from world wide sources. Deal direct, no overhead, save money. Catalog 10c. Hill Co., Route 7, Salem, Oregon.

WATCHES, Materials, tools, jewelry, diamonds—bought—sold. Catalogue, Gales, Box 1000, Chicago.

WATCH And clock repairing—complete practical course in modern horology, 66 illustrated self-instruction lessons. Just out! Low price. Fascinating 100-page illustrated catalog free! Write—Nelson Company, Dept. 8-02, Chicago 5.

TOBACCO, SMOKERS' SUPPLIES

NEW "Atomic" highly polished cigarette lighter. Sure, easy action. Lightweight and attractive. Guaranteed! Retail value \$5.00, sample \$3.00. Special distributor prices. Quality Lighters, Box 271, Waterloo, Iowa.

CIGARS, \$2.95 up, box 50. Wholesale and retail. Free price list. Zibar, Roselle 1, N. J.

SPIRAL Pipe screens, 1551 Ocean Avenue, San Francisco, Calif. Lasting smoking enjoyment. Two screens, 25c, ten, \$1.

CIGARS; Extra fine. Direct from manufacturer. 15c value, 50 prepaid \$4.00. Lawrence, 1021 Ainslie, Chicago.

CIGARS—50, Smokers say swell, \$3.00 postpaid. S. & E. Co., Red Lion, Penna.

TOOLED Leather cigarette case, pack size, made in Old Mexico, \$2.25 including postage and 20% federal tax. Sorry no c.o.d. Southwestern Import Co., P.O. Box 5052, Beacon Hill Station, San Antonio 1, Texas.

FOR SALE OR EXCHANGE

BE Scotch—swap with your neighbor no matter where. Low cost. Write for list today. Traders Exchange, Chittenango, N. Y.

FOR THE HOME

ELIMINATE Down-draft, keep the chimney dry. Save fuel. See page 302 March issue. Chimney Umbrella, 1014 Washington St., Hoboken, N. J.

FOR SALE MISCELLANEOUS

POWER Mower—Sensation. User agents wanted. Farm Products, M-2005, Excelsior Springs, Mo.

SELFWINDING Extension reels equipped with 16 feet No. 18 electric cord. Suitable for factory or garage. These reels manufactured by Vacuum Cleaner Corporation of America on special order. Closing out at \$2.25 each postpaid. Radio Reel Co., 1116 Rust Building, Tacoma 2, Wash.

BAGS, Smooth, rubberized canvas, 4x8" size, flap closure with snap button, 70,000 available. Send 10c in coin or stamps for sample. Low price in quantities. North American Sales, 8 South Dearborn, Chicago 3, Illinois.

11 3/4 MILES Of wire for \$4.95. Has many uses. .0095 diameter. Breaking strain, 8 pounds. Rustproof Bethanized steel. Formerly government assault wire. Your order filled immediately. Albert Bachand, North Adams, Mass.

CUTTERS, Dental burs assorted, reclaimed job-lot, \$1.90 per gross. Wolf,

MECHANICAL Drawing instruments—Veeco, 4 piece, compact, precision set, brand new in lined case, value \$12.50, special, \$7.25—Deitzgen 11-piece set, \$10.00—Charvos 9-piece set, \$8.50. Army surplus slide rules, slightly used, 75c each. Hull auto compass, for accurate road direction, brand new, \$2.50. Brand new folding valise knapsacks made of heavy olive green duck, heavily bound and reinforced, repellent to fire or water. Inside 3 large snap fastened pockets, heavy webbed straps, hand and shoulder handles, size opened 22"x54", closed 22" rolled. Useful to hunters, Boy Scouts, hikers and for all traveling use. A \$7.50 value, special \$2.25 postpaid. Forward money with order. No C.O.D. shipments. Public Sport Shops, 13 S. 16th Street, Philadelphia, Penna.

CATALOG Covering model railroad supplies and kits in OO- O- HO gauges, still 10c. Lionel and American Flyer, new and used list in your gauge for stamp. Trilior Hobbyist, State Road, North Dartmouth, Mass.

ARMY Goods (used). Canteens, cups, covers and Mess kits \$1, set, jeep hats, overseas caps 10c, mask bags 25c, steel helmets \$1, gun slings, holsters 75c, cartridge belts 50c, waist belts 25c, rubber wading boots \$2.50, life suits \$5, portable buzzer phone \$2, spark coils \$3, raincoats \$1, leggings 25c, knapsacks \$1, tool boxes \$1, bolo knives \$3.75, canvas 7c foot. Minimum shipment \$1. No C.O.D. N. Y. Salvage, 144 Chambers St., New York City.

WANTED MISCELLANEOUS

JUSTICE Buys almost anything! List free. 9762 Santa Monica, Beverly Hills, Calif.

DIRECT Manufacturers connection for mail order items. "Melrose," 142-C East Bernice Drive, Melrose Pk. 3, Ill.

MERCURY—Highest prices. Free containers. Write. Wholesale Terminal, Norwood, Mass.

MERCURY (Quicksilver). Write for quotation stating quantity. Metallurgical Products Co., 35th and Moore Sts., Philadelphia, Penna.

PERSONAL

MYSTIFY Your friends. Mail forwarded from New York. Ask for details. Rockmann, 69 East 55th St., Brooklyn 3, N. Y.

FEAR The future? Loss of job? No confidence? Afraid to ask for pay raise? Throw these silly fears away. Write Mighty Midget Publications, Box P-352, South Omaha, Nebraska.

READ Any face. Amazing new dial helps you analyse every face. \$1.00 postpaid. Voncrowe, 360 Wrexham Ave., Columbus 4, Ohio.

SWAPPERS! Traders! Information. Write: "Swappers' Gazette," 2836-P Slevin, Louisville 12, Ky.

NAME Tapes to sew on clothing. Washable. Trial 25 (your name) 35c. Gottwald, P. O. Box 84, Sta. W., Brooklyn 11, N. Y.

NERVOUS, Self-conscious, fears? Be courageous, self-confident, magnetic. Sensational psychology course. Only \$1.00. Dr. Malcolm Smith, 1104 Union Ave., Montreal 3, Canada.

FREE Handwriting analysis with handwriting charts 25c. Linde, 14147 School, Chicago 27.

100 PHOTOSTAMPS \$1.00 Delivered. (Any photo.) Cowling, 533 Somerset, San Francisco.

FALSE Teeth fit like new. Apply my improved dental plate liner at home easily. Perfect fit guaranteed. Descriptive literature free. No obligation. Dr. C. N. Reese, Dentist, Box 268H, Winnetka, Illinois.

NERVOUS? Bashful? "Fears?" Free, encouraging information. Jno. Englund, Ironwood, Michigan.

VISIT Hollywood by proxy. We send 3 post cards for 20 cents. You address, stamp, return for mailing from Loring Novelty Company, Box 9688, Station 27, Hollywood, California.

MEXICAN Law practice, L. Gonzalez, Box 236, El Paso, Texas.

I Dye suits, coats, dresses, drapes, etc., and G.I. coats, jackets, pants, etc. Lawrence Jacobson, 2825 N. Broad, Philadelphia 32, Pa.

POOR Penmanship corrected—few hours. New-way. Ozment, 9, St. Louis, Mo.

HAIR Falling? Dandruff? Write Trichologist, 137 Lewis St., Phillipsburg, N. J.

COSMETIC Formulas. Make own hand lotions, cold creams, rouge, etc. Instruction booklet 25c. Popular Mechanics Press,

NAMEPLATES—Light reflecting, white glass head letters on 6" brick or blue board. Plac-Art Co., Round Lake, Ill.

CEMENT Block easily and cleanly laid without messy mortar with cheap material bought anywhere. Plans and clear directions, one dollar. F. C. Watson, Washington Crossing, Penna.

RESEARCH Air filters \$1.00 each—Remove 90% of dust that filters on walls, etc.—Fits furnace blower 16"x20"x2", other sizes too. Satisfaction guaranteed by 25 year old concern. Accurate Mfg. Works, 2336 Milwaukee, Chicago 47.

WANTED Manufacturer: Antigliare headlights with eyelids without dimmers. International clock for commercial aviation. Koib, DeKalb, Texas.

THE Lord's coming! Get dozens free proofs. Write quickly. International Evangelism, Box 263, Duluth, Minnesota.

TAILORED Homes. 69 sketches one-story houses styled Colonial, English, Spanish and moderne. Price \$1.00. H. P. Jones, 486K Brandeis Th. Bldg., Omaha 2, Nebraska.

VENETIAN Blind tape 25c yard. Colors mulberry, blue, chocolate, duck. Cord 5c yard. Color, duck. Moore, Box 461, Kittanning, Penna.

MAKE Your own Plastoplate printing cuts. Simple, easy process. Plastoplate, Argyle 1, Wisconsin.

"RECEIVE Mail." Moneymaking offers, opportunities, catalogs. Name listed 10c. Ideal Service, 105 Park Ridge, Ill.

WOOLLY Lapel pandas. Handmade, 25c. Cado Products, Mdse. Mart, P. O. Box 3495C, Chicago.

I DARE You! Demand the best in life and get it! Conquer nerves, fears, worries. Gain confidence. Wake your mind powers. Write today for free Personal Development Home Study plan. School of Personal Psychology, 1008-1009 Washington Bldg., Louisville 2, Ky.

STAG Book matches, 10 for \$1.00. Logan Novelty Co., Bellefontaine, Ohio.

RECEIVE Mails, samples, moneymaking opportunities, literature. Your name in several mailing lists, 10c. Rogowski, 3415 Broadway, New York 31.

KILL Weeds with 2000 degree flame, kill poison ivy, stalks, seeds, roots. Can be used for irrigating, thawing, sterilizing, rock splitting. Endorsed by agricultural experts. 600,000 users. Sold in every nation and civilized country of the globe. Valuable literature free. Write today. Sine Equipment, P376, Quakertown, Penna.

PHOTO Cards. Assortment 25c. Mail-address service. Details free. Haller, 436 N. Y. Ave., Brooklyn 25, N. Y.

ONLY \$1 Brings you list of 928 U. S. gov. royalty free patents suitable for home, shop, factory. Citizens only. Tech-List Research Publications, Box 485, Beverly Hills, California.

BEAUTIFUL 9"x12" Mirror plaque free. Write Lariel Inc., Lake Ariel, Penna.

VISIT Beautiful Bermuda by proxy. Send dollar for ten views. You address, return, we remit. 75 cents brings ten souvenir cards, unaddressed. Vospreed, Box 423, Hamilton, Bermuda.

TATTOOING Outfits, designs, colors. Write today. Zeis Studio, 728 Lesley, Rockford, Illinois.

HELP Your church raise money. Harold C. Brown, Sullivan, Indiana.

"MAILERS" 6 1/2"x9 1/2" Catalog envelopes. Unprinted. 125—\$1.00 pp., 500—\$3.50. V. Ruckoldt & Son, 3639 Page Ave., Chicago 34.

HOUSE Construction, new type, 60% savings possible. Send \$1.00 for instructions. P.O. Box 713, Mobile 4, Alabama.

BRAZILIAN Orchids. Ask catalog. Orquideario Catarinense—Exporters—Corppa, Santa Catarina, Brazil.

BRICKLAYERS, Builders—No more sagging lines. Make own tighteners, costs little. No nails, knots, simple, any tension. Guaranteed. Instructions dollar. 38 Garfield, South Hamilton, Ontario, Can.

RATS? Formula 83 contains ANTU (Alphanaphthylthiourea) sensational new killing agent so powerful one lick kills rats. Harmless to chickens. Ready to use. No mixing. 35c; 3 for \$1.00. Potentially enough to kill 1000 rats. Guaranteed! Linck Company, Dept. E, Montclair, N. J.

FIREWORKS—Send for free illustrated fireworks price list. Mail your request to Premium Fireworks Company, P.O. Box 703, Covington, Kentucky.

"ANT Hara-Kiri" amazing ant suicide device. War-veteran's story explains fully. Use it yourself. Folio sent postage-paid. Satisfaction guaranteed. Send \$1.00 now. Anthony, Box 57, Allston 34, Mass.

RECEIVE Mail. Home moneymaking opportunities, plans, publications. Year's listing 10c. Carter, Box 8-FCB, Station A, New York 12.

CEMADOBE Brick will not melt, are durable, attractive, fireproof, soundproof and dirt cheap. Make them yourself of earth and cement at a very low cost. Latest discovery in soil stabilization. A veritable Godsend to those needing homes. No priorities needed. Easy to build with Cemadobe. Now being done. All the know-how necessary is contained in booklet Cemadobe. Just off the press. 40 chapters and over 50 illustrations. Mailed for \$1.00. Bob and Ed Williams, Dept. PM1, P.O. Box 775, Vallejo, Calif.

WANT To make a good trade? Got anything to buy, sell, or swap? Send \$1.00 for 8 months' subscription to Yankee Magazine, Box PM1, Dublin, New Hampshire. "A Good Trade on Every Page."

BLUE Plan booklet. Illustrating 10 small houses. Now 10c. Model Service, 4302 Oak, Kansas City 2, Mo.

TRADE Magazines—Business, vocational diversion. Classified directory 3343 publications with complete addresses and subscription rates. \$1.00. Commercial Engraving Publishing Co., 34C North Ritter, Indianapolis 1, Ind.

INCORPORATED Association of cost accountants (Inc. in Vic.) (Founded 1933). Designation of members: Fellows F.A.C.A., Associates A.A.C.A., Licentiate L.A.C.A. Write for air for full particulars. H. C. Brierley F.A.C.A., 10 O'Connell St., Sydney, N. S. W. Australia.

TATTOOING Outfits—Electric machines, stencils. Steele, 540 Leavenworth, San Francisco.

SQUARE Dance instructions, calls. \$1.00. Guide, 111-R, Eureka Springs, Arkansas.

A PRINT of a Texan's idea of the map of the United States. 16"x20". Suitable for framing, \$1.00. Downing, 512 Lamar, Ft. Worth, Texas.

A SIX Room house \$2800.00, complete, ready for you to move in. Built anywhere. Send card to Low Cost Housing Co., Box 642M, Salem, Mass., for free particulars.

TREASURE Finders and mineral locators by Goldak, the world's largest manufacturer of supreme instruments, are again available. Goldaks have always been the world's champion locators and always will be. Wartime improvements have made Goldaks even better than before. Remember, every Goldak, even our lowest priced model, is moneyback guaranteed to detect buried gold, silver, metals and minerals at greater depth than any other make whatever, regardless of vague claims, price or design. When you get a Goldak you are certain of the finest. Write, The Goldak Co., 1544 W. Glenoaks, Glendale 1, Calif.

ANYTHING But your wife and kids bought, sold or traded. Satisfaction guaranteed. Farmers & Traders Exchange, Chittenango, N. Y.

EVERLASTING Bronze grave markers, signs, reasonable. Berg, Box 3162-A, Bridgeport, Conn.

CARPENTERS—Fast! Accurate! Calculator. Simplifies everything. Postcard brings particulars. Box 1414, Great Falls, Montana.

GOOD "Used" self-instruction educational books on all subjects bought, sold, rented, exchanged. Satisfaction guaranteed. Complete information and 100-page illustrated bargain catalog free! Write—Nelson Company, Chicago 5.

BIGGEST Money in tattooing now! No experience required. Complete instructions with outfits. Send for free literature. Tatuco, 651 South State, Chicago.

"**BIBLE** Studies." 70 lessons 25c. Bulletin, Box 87, Station H, New York 25.

MEDICAL Laboratory technicians in great demand. We train you in your spare time, in your own home. You can practice while studying. Write for free catalogue. Imperial Technical Institute, Box 973-J, Austin, Texas.

LUMINOUS Paint. Best quality. Glows bright blue in dark. 1 oz. each paint and sealer only \$1.39 postpaid. Black Light Products, 450 E. Ohio St., Chicago 11, Ill.

METAL, Mineral locators latest 1946 electronic type ready for immediate shipment. Fisher Research Laboratory manufactured 2 million dollars worth of electronic equipment for the U. S. Army, including some of the finest metal-locators. Experience gained is yours in the best metal, mineral locator. Free 16 page booklet upon request. Fisher Research Laboratory, Palo Alto, California.

BOWS & ARROWS

Write for 94 page Illustrated Instruction Hand Book 50c; 20 page catalog 5c; stamps or coin.

LE STEMLER CO. QUEENS VILLAGE, N.Y.

Say you saw it in Popular Mechanics!

HOW TO MAKE MONEY BY MAIL

Down-to-earth facts, directions (illustrated) for running business profitably, using expertly for YOUR good fortune the employees, trains, planes which Gov't places at your disposal **CHEAP**. Get orders by mail, ship by express or freight or mail, get out of the kindergarten... 14th edition, enlarged to 376 pages, now selling. It's YOUR winner. Make this year and the following years worth more. THIS knowledge really **PAYS OFF**.

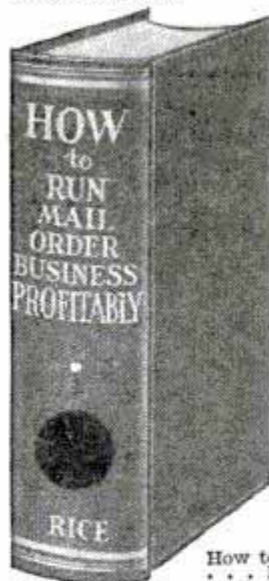

THE EASY WAY to start new or expand your present occupation. Do it NOW. Extraordinary plain, simple skill, know-how. No theory. Fact story of rich experience of author E. Rice day-by-day. How many times have we heard: "I wish I had some money, this patent would earn me a fortune," or "why can't my crop pay better?" or "I wish I knew how to sell this gadget myself," or "why should my boss alone do this when I too know how the money is made?" . . . Listen, you do not need money to start this Rice way. His method automatically pays all bills same day rendered, no bank loans, pay as you go, no borrowing from relatives or friends, no salesmen. Also no worry, quickly a home of your own all paid for. Rice paid off \$5000 in mortgages a year after using this skillful idea.

45 Years of PROOF

Sounds fishy? Sure, but this has been done steadily for 45 years, depression or no depression, by the author; that is why he wrote this book, to pass the good word along. Make it go with anything you have which is salable, or with what you are now doing. Rice made his pay plan go from the start when living in one room in a city lodging house. Turn your city or country home, your work, your hobby, into money. How to get orders coming steadily at cost of only \$4 for each \$100 taken in. The popular error to avoid in trying for sales. Business won free while others have to pay for it.

How to conceive the money-getting advertisement. . . . Profitable changes from ordinary ideas and methods. Not usual cut-and-dried pattern, 165 adventures, a dictated book in everyday talk by Rice method. No dictionary writing. . . . Read how others are profiting big.

Take a chance on this book being worth a fortune to you and yours and send \$2.95. Book mailed same day order is received. Or ask two friends to chip in 98 cents each with your 99c to get this book. Hundreds of buyers whose letters you show you declare emphatically its superlative goodness. Follow its easy pattern for success. Cloth-bound, 376 pages, 8 1/2" by 5 1/2". Best selling 14th edition now selling. Cut out the \$2.95 **HOW** BOX here, pin or stick it to sheet of paper bearing your name and address, mail in envelope with money order or check for \$2.95 to

HOWARD ST. HOUSE, Melrose 76d, Massachusetts

HOW \$2.95

SPONGE-AWAY



Checks Scratching

You give your scratching dog quick comfort when you sponge him with (or dip him in) Sponge-Away solution. It allays itching; kills any fleas, lice, ticks. Also promotes healing, regrowth of hair. Don't let your pet scratch himself into a worse condition or continue suffering. Get 25c bottle (makes 2 quarts) from pet, drug or department store today.

A PULVEX QUALITY DOG PRODUCT

POCKET WATCHES

SWISS MOVEMENTS



Now available "EXPERT" watches. Swiss made watches are known the world over for their accurate time-keeping and quality construction because they are made by master watch craftsmen. This handsome men's pocket watch has a sturdily-constructed chrome case and open figure dial. A timepiece you will be proud to own. **SEND NO MONEY**. Simply pay postman \$8.50 plus 10% tax and postage. Wear 10 days on our money back if not satisfied guarantee. **United Products Co., 7941 S. Halsted, Dept. P-227, Chicago 20, Ill.**

YOU CAN MASTER MATHEMATICS

Key to the Electronic, Atomic age. Mathematicians in great demand. \$200 to \$500 per month. Literature free. **O-UNIVERSAL SCHOOL OF MATHEMATICS** 623 Walter Story Bldg., So. Broadway, Los Angeles, Calif.

NEW CHEAP OIL BURNER

FOR COOKING & HEATING STOVES-FURNACES
HEAT YOUR HOME, COOK YOUR MEALS
WITH CHEAP FURNACE OIL



NO MORE SHOVELING COAL OR ASHES. New Fuelizer Starter Vaporizing System turns Cheap 130 Flash Furnace Oil into Oil Gas heat without clogging up. **LIFE-TIME GUARANTEE** against defects. \$1.00-BONUS OFFER FOR TESTING. We will let you try it in your own stove or furnace for one month. Get Yours for introducing. Big profits. Be first. Send in your name today.

NORTHWEST MFG. CO. 561-E 5th Ave. Mitchell, So. Dak.

MOLDING TRIMS

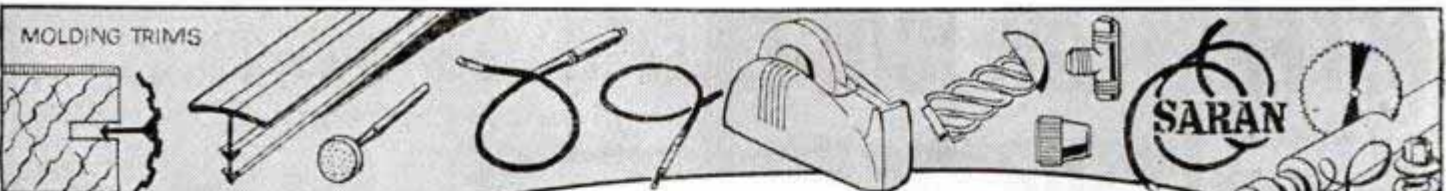

SARAN

PLASTIC price list
and CATALOG

FREE
CATALOG

PLASTICS
Fabrication
Manual

BERTON PLASTICS, INC.

SMALL DIME brings you valuable new manual on PLASTICS FABRICATION!

Edited by experienced plastics technicians. Easy-to-follow procedures. Latest techniques. All Plastic materials. Comprehensive. Special offer includes Free copy of brand new Plastics Catalogue. Covers all types of rigid, semi-rigid, flexible and laminating materials. Gives sizes, specifications, prices. Lists polishing and buffing compounds, cements, dyes, hardware, tools, accessories. All for your one dime. Mail today. Satisfaction guaranteed.

BERTON PLASTICS, INC.
19 W. 21st St., New York 10, N. Y.

TEAR OUT COUPON · MAIL TODAY

BERTON PLASTICS, INC.,
19 W. 21st St., Dept. P.M., New York 10, N. Y.
I enclose 10c. Send me your Fabrication Manual and Free Catalog.

NAME _____
ADDRESS _____
CITY & STATE _____

Floyd Clymer's Popular MOTOR BOOKS

Send for FREE
Motor Book
Catalog

INDIANAPOLIS "500" RACE HISTORY BOOK

Just out! 2000 illustrations; 320 large pages; complete detailed data on every race held on Speedway since 1909. Foreign and U.S. cars and drivers shown. Enjoy for 10c a race year after year history. Complete book \$3.50; with De Luxe red Fabrikoid binding, \$5.00.



MOTOR RACING with MERCEDES-BENZ

Sensational book of Grand Prix Racing. 176 pages, includes 93 finest action photos. Famous speedways, cars described. See and read about Caracciola, Rosemeyer, Seaman, Ruesch, Mays, Nuvolari, Lang, others. Photos Mercedes-Benz, Auto-Union, Alfa-Romeo, Bugatti, Maserati, others. Graphic, thrilling race incidents. Postpaid, \$2.00; De Luxe clothbound \$3.00.

Ab Jenkins Race History Book, \$1.50 . . . Power & Speed, \$2.50 . . . Speed—How to Obtain It, \$1.50. All books postpaid. See our ad under Autos, Classified section. Pin check or M.O. to this ad—Mail Now to

CLYMER, Dept. A5, 2125 W. Pico, Los Angeles 6, Calif.

Electric Heating Element

FLUX

Repair burned out electric elements of coffee urns, electric stoves, flat irons, toasters, and other electrical appliances. Simply apply Christy Electric Heating Element Flux to the break, turn on the current and PRESTO the job is done and your appliance is ready again for years of satisfactory service. Generous size package (enough to repair 50 elements) sent postpaid for only \$1.00.

ELECTRICAL APPLIANCE REPAIR PARTS

- RENUALL Iron element. Guar. 1 year. Package of 6.....\$3.12
- Toaster element forms, Clear Mica. Fits most toasters. 10 for.. 1.80
- Heating element wire 10 ft. coiled 1/4" O.D. #20..... 2.55
- Heating element wire 10 ft. coiled 3/16" O.D. #22..... 1.77
- Appliance cord. Rubber covered. Stranded copper wire. 100 ft.... 4.50
- Ribbon element heating wire. Std. size. 100 ft..... .75
- Percolator elements. Universal. Flat type. 1 yr. guar. 2 for... 1.20
- Element cement. Withstand 3000° F. 1 lb. pkg. \$1.00, 5 lb. pkg. 3.50
- Lead wire. Asbestos covered heater hook-up wire. 10 ft..... 1.00
- Iron Cord Sets with complete plug attachments. 10 for..... 5.00
- Carbon brush set. Assorted. 104 brushes, 15 springs. Complete set 3.00
- Screw removers. Complete set 6 removers, 6 drills, 1/8" to 1".... 4.20

APPLIANCE REPAIR TOOLS & SUPPLIES

- Bearing tools. Enable you to install all sizes motor bearings from 1/2" to 1 1/2" O.D. Complete with 7 adapters and instructions...\$6.69
- Adjustable Reamers. High-speed steel blades. Complete set of 11 reamers ranging from 8/32" to 27/32".....38.00

HOW TO FIX IT BOOKS

- Modern Electric & Gas Refrigeration.....\$5.00
- Practical Electricity & House Wiring.....1.50
- Refrigeration Service Manual..... 2.00

Here is your opportunity to save on repairing your own appliances and to earn extra money repairing appliances for friends and neighbors.

CHRISTY SUPPLY COMPANY

2835 N. Central Ave. Dept. T-250 Chicago 34, Ill.

GENUINE PRE-WAR QUALITY

FIREWORKS!

OH-BOY

Banner has always been right there with the newest and best in fireworks. Now we give you JET PROPULSION...an amazing rocket plane that can be used over and over again. Write quick for details of this newest sensation in fireworks. It's astounding. It's colossal.

BIG SPECIAL OFFER \$4.95

Giant assortment of over 150 pieces, including 2-3-5 inch salutes, star shells, aerial bombs, flower pots, skyscreamers, battle-in-the-clouds, Roman candles, tubular salutes, and many others...regular \$8.15, retail value for only \$4.95. Rush your order. Supply limited. Catalog FREE.

BANNER FIREWORKS MFG. CO., INC.
DEPT. 108 TOLEDO 12, OHIO

OFFERS LOW COST LIFE INSURANCE

Postal Life offers \$2000. in Protection for \$1.78 monthly (age 21). Other Ages in Proportion

THIS PREMIUM HALF PERMANENT RATE

NEW YORK, Saturday. Postal Life of New York, unique among the important Old Line, Legal Reserve Life Insurance Companies, is again offering this special modified policy, already owned by thousands of American families. You pay half the permanent rate until the 5th year; as little as 89c per \$1000.00 of Solid Protection at age 21. You pay only \$1.13 per \$1000. at 30; \$1.56 monthly at 40; proportionate amounts at other ages. At these low rates, \$1500. is the minimum amount that can be offered.

For your convenience we print below a coupon form that can be clipped out and sent to Postal Life in New York. Full information, rates, etc., will be sent to you promptly. There is no obligation to buy but we advise immediate action. Life Insurance is vital to your future and your family's welfare. Postal Life Insurance Company, 511 Fifth Avenue, New York 17, New York.

Postal Life Insurance Company
511 Fifth Ave., Dept. M-576, New York 17, N. Y.

Mail me complete information about your low-cost Modified "4" Policy at my age.

Name

Occupation Date of Birth

Address

Include Postal Zone, if any

LAY OUT ELECTRICAL DESIGNS and CIRCUITS FASTER



Only \$200 Postpaid

Saves Time

For Professional, Student and Amateur IN RADIO - ELECTRICITY

RAPIDESIGN, INC., P. O. Box 592, Glendale, Calif.

The RAPIDESIGN ELECTRO SYMBOL

With this instrument you can more quickly, neatly, and accurately fill in the most commonly used Standard Electric Symbols. Made from heavy gauge transparent drafting instrument quality plastic sheets, with inner contours cleancut and precise. Also makes many other symbols by combining the various contours. Order today.

MAIL THIS COUPON TODAY

RAPIDESIGN, INC., Dept. C-5
 P. O. Box 592, Glendale, Calif.

Gentlemen: Please send me postpaid.....ELECTRO SYMBOLS for which I enclose.....

Name.....

Address.....

City.....State.....

Start Your Own PHOTO-PRINTING BUSINESS

Big Money in Photocopy

Ideal for Valuable Papers such as BIRTH and MARRIAGE CERTIFICATES, also DISCHARGED PAPERS, LEGAL DOCUMENTS, etc. Boys and girls are enthusiastic users... Easy to make prints QUICK... All you want!

PRINTS UP TO 8 x 10"

MAKE PHOTOCOPIES OF ANYTHING PRINTED, DRAWN OR WRITTEN . . .

MAKE PRINTS FROM NEGATIVES—MAKE NEGATIVES FROM PRINTS!

Outfit comes complete with Printing Device, Trays, Chemicals, Drying-Squeegee Board, Roller, Elegant Album and box of Sensitized Printing Paper . . . Designed for Professional use and marvelous for amateurs. F.O.B. Chicago. REMIT WITH ORDER.

CRAFTEX LABORATORY
 4615 ELSTON AVE., DEPT. P-5, CHICAGO 30, ILL.

- No Training
- SIMPLE—EASY
- NO DARK ROOM
- Make Your Own Prints on Album
- COMPLETE OUTFIT COSTS YOU—
 —ONLY \$7.95 (Includes Fed. Tax)

GLOW PAINT

Luminous "Glow Paint" in water colors. New discovery! Add water for water colors. Add Glow Paint Lacquer for washable paint. Brush or spray. Hundreds of uses! Paint steps for safety — objects for resale — go into business for yourself — open a gift shoppe.

Complete two color kit—\$1.25. Money back guarantee. Pay postman or send cash, we pay postage.

GLOW PAINT, 1416 Lewis Dr., Lakewood 7, Ohio

SWISS MADE WATCHES

Wear 10 Days at Our Risk!

Swiss made watches are renowned for accurate time-keeping. This men's watch has a sturdy, finely-constructed chrome case, an open figure dial, genuine leather strap. SEND NO MONEY! Just pay postman for wristwatch \$8.50 plus few cents postage and 10% Federal excise tax. Wear for 10 days on our money-back if not satisfied guarantee! Rush orders today — supply is limited. UNITED PRODUCTS CO., 7941 S. Halsted, Dept. MM-204, Chicago 20, Ill.

PLASTIC HOMES New Building Material! Resurface old homes; build new ones. Colorful, Beautiful! **LIQUID MARBLE**—Color-glazed! Molded, brushed, sprayed. **SANITARY COMPOSITION FLOORING**—Dustless, noiseless; put on like plaster; resilient—yielding as cork; lasts like stone; plain or marked in tile design. **RUBBERLASTIC Mold Compound**—Mold novelties, statuary, toys, gifts, plaques, plaster animals. **COLOR POTTERY**—Birdbaths, garden furniture, vases. **TILEX** colored roofing. Illustrated literature FREE. **RAPID MARBLEIZING SERVICE, Dept. 10-B, Edwardsville, Illinois**

WINDOW SIGN LETTERS

For Store Fronts and Office Windows. Anyone can put them on. Samples furnished. Genuine Gold and Silver. **METALLIC LETTER CO., 430 N. Clark St., Chicago 10**

SHAW and Peppy-Pal GARDEN TRACTORS

1 to 9 H.P. Circulars on request. Building more now. We supply repairs for all SHAW Tractors sold in our 42 years in business.

BUILD YOUR OWN RIDING TRACTOR—"WAR HORSE"

using old auto parts, powered by 2 H.P. or larger air-cooled engine; or walking type Garden Tractor ½ to 3 H.P. or convert truck or auto into Farm Tractor. Each with steel or rubber tires; will plow, cultivate. Plans for building, in few hours, any one of above, postpaid for \$1.00 (state which wanted) or all 3 for \$2.00. Money Back Guarantee

SHAW MFG. CO., 4505 Front St. Galesburg, Kansas
 668 North 4th St., Columbus, Ohio



PORK POULTRY BEEF
FROZEN FOOD
BUILD YOUR OWN
WE SHOW YOU HOW!
 SAVE BY BUILDING YOUR OWN FROZEN FOOD LOCKER AND WALK-IN COOLER COMBINED!
 WE ASSIST YOU IN OBTAINING MATERIAL BIG DISCOUNT OR USE DISCARDED MATERIAL LAYING AROUND MOST HOMES WITH OR WITHOUT ELECTRICITY
 SEND \$1 FOR INSTRUCTIONS WITH DIAGRAMS AND REFRIGERATION REQUIREMENTS TO
REFRIGERATION CLINIC
 Dept. C, P. O. Box 572 Houston 1, Texas

FREE CATALOG TELLS HOW
Gem Cutting!
 A fascinating, profitable business or hobby ...
 Cut and polish valuable gem stones from inexpensive rough Jade, Opal, Agate, Tiger Eye, etc. Make rings, brooches, pendants, clips! It's easy with our Compact Lapidary Unit. WRITE NOW!
Lapidary EQUIP. CO.
 Dept. S, 2020 Westlake, Seattle 1, Wash.
FREE CATALOG illustrates the 4 simple steps of cutting and polishing a cabochon, gem, and gives other useful information. SEND NOW!

GENUINE U.S. BARGAINS
 Army O. D. Wool Blankets, 5 lbs. \$5.95
 Army Pocket Knife, Scout Style \$2.50
 Pup Tents, Poles and Pegs, Used \$4.85
 Mess Kit—Knife, Fork and Spoon, Used \$.50
 Thousands of Other Bargains in Military, Outdoor & Sport Goods for Hunter, Farmer, Scout. Send 10c for 32-page catalog returned with first order.
A and N SUPPLY CO.
 4720 LESTER ST. RICHMOND, VA.
 EST. 1868

BRUSH PLATING OUTFITS
 for re-plating articles in the home and shop. No tanks necessary. Free particulars.
GUNMETAL CO., AVE. M, DECATUR, ILLINOIS

CRESCENT TOOLS
Give Wings to Work
 ASK YOUR HARDWARE DEALER

WET BASEMENTS Start your own waterproofing business with Seal Seep. New—patented. Seals from inside. Easy to apply. Guaranteed. Big Profits—exclusive territory. Free offer.
SEAL SEEP CO., 510 Dawson Road, Cincinnati 27, Ohio

\$\$\$\$ if trained in arc welding
 Big income jobs await you. Learn quickly and thoroughly. Enroll under G. I. Bill. Write today.
Hobart Trade School, Box M-563, Troy, O.

RADIO PARTS GRAB BAG!
 \$25 original value assortment of Coils, Condensers, Transformers, Resistors, Controls, etc. An experimenter's dream. While they last, only.....
MARKO SUPPLY, Dept. P.M. 5
 2924 Logan Blvd. Chicago 47, Ill. **\$3.98**

Balance 4" x 9" Base. With either Metric or Avoirdupois Weights ... \$6.00
 Catalog with 2000 Illustrations of Laboratory Apparatus sent for 75 cents. Catalog listing 10,000 chemicals, drugs, minerals, etc. and 1700 scientific books sent for 25 cents. 100 scientific books, 10 cents.
LABORATORY MATERIALS CO.
 7321 Vincennes Ave. Chicago 21, Ill.

Say you saw it in
POPULAR MECHANICS

FREE TRIAL IN YOUR HOME!

HERE'S THE HELP YOU NEED FOR BEST JOBS—RIGHT NOW!



DO ANY JOB.. EASIER.. QUICKER
MAKE MORE MONEY in the
BIG OPPORTUNITY FIELDS

SEND NO MONEY
 Select the Books YOU Need Now! We Ship C.O.D. Anywhere in U. S. and Will Refund Amount Paid if Not Satisfactory.

Get into one of these big opportunity fields. Big money and many other advantages await you if you prepare now. Here is the help you need—EASY—QUICK—AT LOW COST. Thousands of men have already used these famous books. Beginners and experienced men alike have doubled and tripled their earnings with this help. You too, can now get the special knowledge you need for top pay, better jobs, or a business of your own. This is your GOLDEN OPPORTUNITY.



Air Conditioning

Big air conditioning boom interrupted by war is getting into full swing again. Bigger opportunities ahead than ever before. Get this complete and practical book by an international authority and be ready for your share of millions to be spent. Covers whole field in simple, non-technical language. Shows you what to do; how to do it; how to make money. 450 pages. Illustrated. \$4.00

Welding Practice

When you know welding you are in a profession that is tops in all industries. Start learning now with this newest book on all types of welding and heat treatment of metals. Written by recognized specialists in training men for production jobs. Use it for complete study or a reference guide. Prepare now for best jobs. Price \$4.00

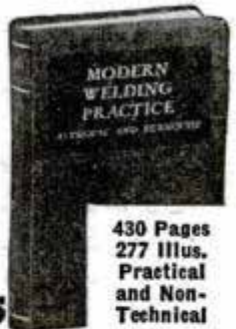

430 Pages
 277 Illus.
 Practical and Non-Technical

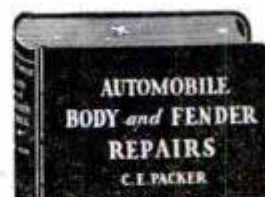

Auto Repairs

Car owners are spending big money to keep their good older cars looking like the new ones coming out. This practical, money-making guide shows you how to do it. Ideal for shop owners and every man who wants a share of the millions to be spent in keeping old cars looking new. Tells how to get a good job or start business of your own with small capital. 325 pages, 232 illustrations. \$3.50

SEND NO MONEY! Mail Coupon

GOODHEART-WILLCOX CO.,
 2009 S. Michigan Ave., Dept. 15, Chicago 16, Ill.

Send books checked, C.O.D. I will pay postman, plus few cents charges. If not satisfactory I will return books in 5 days and you will refund money paid. (Outside U.S. or possessions remit with order.)

Auto Body and Fender Repairs \$3.50 Modern Welding Practice. \$4.00
 Air Conditioning \$4.00

If remittance accompanies order we will pay all postage charges under same return privilege.

Name

Address

City.....State.....

IF FALSE TEETH SLIP OR DROP



USE **REFIT MAGIC** **PLASTI-LINER**

MAKES ALL PLATES FIT PERFECTLY OR MONEY BACK PERMANENTLY

ONE APPLICATION LASTS FOR LIFE OF PLATE

PLASTI-LINER is a professionally developed re-liner for home use that ends forever the mess and bother of temporary applications that last for only a few hours or a few months. It is NOT a paste, nor a powder; but a strip of genuine dental plastic!

SAFE AND EASY TO USE

PLASTI-LINER is non-toxic, pure, non-irritating, harmless, odorless, tasteless, smooth, molds to mouth. No heat necessary. Just 3 easy steps.

"Excellent Results" say users

"I bought your product over a year ago. Have had no trouble with my plates since. I have told my friends and now all of us with false teeth use PLASTI-LINER. It really works." Mrs. E. S., Brooklyn, N. Y.

FREE! Our competent staff dentist will answer all your plate problems.

SEND NO MONEY — ORDER TODAY

PLASTI-LINER CO., Dept. 54
Walbridge Bldg., 43 Court St., Buffalo 2, N. Y.

Rush PLASTI-LINER with complete directions. I will pay Postman \$_____ plus postage charges. I may return package for refund if I am not satisfied.

\$1 for UPPER or LOWER \$2 for Both

Name _____

Address _____

City _____ Zone _____ State _____

You Save Postage by Enclosing Money

ARTISTS MAKE MONEY

Do you like to draw? Send name, address, age and occupation for FREE ART TEST, to find out your ability.

ART INSTRUCTION, Inc.

5136 ART INSTRUCTION BLDG., MINNEAPOLIS 15, MINN.

HUNTING and FISHING

is a monthly magazine crammed full of hunting, fishing, camping, dog and boating stories and pictures, invaluable information about guns, fishing tackle, game law changes, best places to fish and hunt—countless ideas that will add more fun to your days afield.

Special Trial Offer

Send 25c in stamps or coin and we will send you Hunting & Fishing for six months.

HUNTING & FISHING
MAGAZINE

251 Sportsmen's Bldg., Boston, Massachusetts

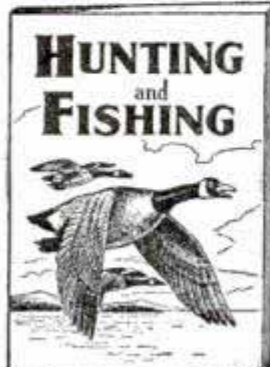

RAISE JUMBO BULL FROGS

VERY PROFITABLE

Female lays 10,000 to 20,000 eggs yearly. Price of breeders free, or send one dollar for a ten-page letter on how to raise Frogs, based upon my 20 years' experience.



VOL BRASHEARS, BERRYVILLE, ARK.

PRINT-O-TYPELESS PRINTERS PRESS

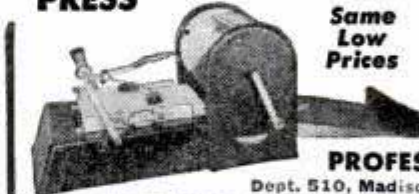

Same Low Prices

These stencil duplicators available again at lowest pre-war prices. Letter, legal or post-card sizes. Hand or automatic feed. Also lowest prices on supplies. Send for samples of work.

PROFESSIONAL PRODUCTS

Dept. 510, Madisonville, Cincinnati 27, Ohio

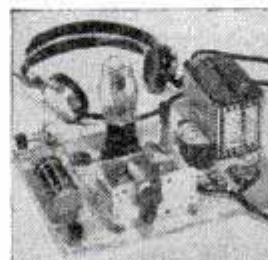

RADIO TRAINER

Learn the theory and practical side of radio by building this simplified battery tube set. Experimental model teaches you to design larger radios, not just assemble them. Efficient, sensitive circuit brings in local as well as distant stations. Compact and portable. Can be used on camping trips and on farms without electricity. All parts furnished including tube, batteries, double earphones, aerial and ground wire and easy-to-follow illustrated instructions. Soldered or solderless connections. Complete, postpaid, only \$9.95. Or send \$1.00—shipped C.O.D. for balance plus postage. Money-back guarantee. Order today! B. G. FLEMING MFG. CO.

Dept. 5-A, 906 Main St., Cincinnati 2, O.

New Designs in FRANZITE GRIPS

Modernize Your Gun! Improve Your Score!

Most durable grips made. Positively unbreakable! For Colt, Smith & Wesson, Hi-Standard, Ortgies, Luger & Mausers in a wide choice of beautiful designs in ivory, pearl, walnut, onyx, etc. Low prices. FREE CATALOG. Dealers Wanted.

SPORTS, INC., (Mfrs.) 5501 Broadway, Dept. P-5, Chicago 40, Ill.



Send 10c for Stanley Plan Set No. 14

Bird houses, nesting shelter and feed box, trellis and garden seat. Send 10c for 5 project designs. Stanley Tools, 156 Elm Street, New Britain, Conn.

COLOR CONCRETE WITH CHEMICALS

A business of your own. Big money making Hollywood style pottery and birdbaths without moulds. Washing-wells, stucco-rock, benches, Marbling and cement water-paints. 10c brings sample, literature, pictures. Hollywood CementCraft, 8529 Wonderland Ave., Hollywood 46, California

SELL BIBLE SOUVENIR

METAL COINS, LORD'S PRAYER, ONE SIDE; JOHN 3:16 on THE OTHER—Quick Easy Sales—Very attractive pocket piece. Quantity Price \$6.00 per 100; \$27.50 per 500; \$50.00 per thousand. Don't Wait... Order Today. Sample Order 15 Coins with Display Card, \$1 Postpaid. LOUIS LE VITE, 21 E. Van Buren St., Dept. P5, Chicago 5, IL.

SILVER DOLLAR SIZE



DRILL-INDEX

A compact container for indexing and filing twist drills. Eliminates search. Made entirely of steel in nine sizes. See your dealer or write to

HUOT MFG. CO. Foot Schultz Bldg. St. Paul 1, Minn.

SAY YOU SAW IT IN POPULAR MECHANICS

JET PROPULSION

Experimenters! New principle to drive boats, bicycles, model helicopters. Circular on plans. Rush name. H. Maupin, Tipp City 12, Ohio.

ANGORA RABBITS Giant CHINCHILLAS

World's most profitable rabbits! Valuable ANGORA WOOL (high priced)—shear regularly; no messy killing! Plenty markets. Luxurious 2-tone CHINCHILLA Furs! Finest pedigreed stock. Guaranteed. Easily raised anywhere. Illustrated literature free. GRINSTEAD RABBIT COLONIES, Dept. 15-E, Edwardsville, Illinois

PLEXIGLAS

**The Crystal-Clear Versatile Plastic
COLORED AND TRANSPARENT**

Our complete warehouse facilities afford you great savings on guaranteed Grade 'A' Plexiglas.

ORDERS PROMPTLY FILLED

CLEAR PLEXIGLAS SHEETS, NEW PER SQ. FOOT:

1/16 \$1.24 3/16 \$1.97
1/8 \$1.61 1/4 \$2.31

COLORED PLEXIGLAS SHEETS: 10% ADDITIONAL

Orders over 5 sq. feet (assorted sizes) 10% discount.
Add 10% for packaging on orders under \$10.

Write for free literature on Plastics and how to work them. Price lists on request for complete line of rods, sheets, tubes, odd shapes in all types of Plastics. Also dyes, cements, buffing compounds.

HOUSE OF PLASTICS

7604 Fenkell

Detroit 21, Mich.



Advice to budding
ARTISTS

Have your work judged by an art studio capable of advising the training you need, school to attend; correct art materials to use! Send sample of your drawings for analysis—criticism. (Don't send framed pictures.) One art sample sufficient but more intelligent analysis possible when 2 or more samples submitted! Complete analysis \$1.00 per drawing (6 for \$5.00).
Jerry Bryant Studios, 919 N. Michigan, Chicago 11, Ill.

BE A PERFUME DISTRIBUTOR

The most sensational-profit possibilities in the whole field of selling; 100% year-round demand, liberal distributor discounts. Sell consumers or dealers, or both. Employ sub-salesmen. No experience needed; we'll tell you how. Finest perfumes made, exquisite, long lasting fragrances women just can't resist at your low prices. Men big buyers for gifts. Beautifully packaged. Write TODAY for free sample and details of tested sales plan.

DUDAN PARFUMS, 21-P West Illinois St., Chicago 10, Ill.

ELECTRICAL Whatever your technical problem, turn to Professional Engineers for advice. We will solve your problem for a fee which you can afford. Write today for FREE estimate.

CIVIL

MECHANICAL **JACQUES & FINDLAY, Consulting Engineers**
Com'l Div., Zobel Bldg., Red Bank, N. J.

SAY YOU SAW IT IN POPULAR MECHANICS

Burn Your
Name On Tools

Electro Name Etcher

Only



PROTECT valuable tools from thieves and tool borrowers! Electro Etcher BURNS your name, any design, permanently on tools, instruments, dog collars, any metal. Easy! Simple as writing with pen or pencil. Rush order today—supply limited—no more when these are gone! **SEND NO MONEY!** Pay postman \$1.00 plus few cents postage on delivery. Use 5 days—money back if not delighted. Electro Etcher, Dept. G-600, Strader Ave., Cincinnati, O.

**ENDS TROUBLES WITH
LOOSE FALSE TEETH**

only one
application

DENTSEAL

\$1.00

Eliminate your troubles with loose false teeth once and for all. No more powders or pastes. No more day to day treatments for relief. Give your plate a tight-fitting, comfortable, new hard surface that will last.

DENTSEAL Plastic Resurfacer is a clean, plastic material which permanently fills the hollow spaces that often cause loose plates. The simple process is completed by anyone OVERNIGHT.

YOU BE THE JUDGE. Try DENTSEAL on your plate for 30 days. If it does not completely satisfy YOU in every way, return the tube and your money will be refunded.

DENTSEAL LABORATORIES
Dept. P.M., P.O. Box 676, Toledo 1, Ohio

**YOU'RE NATURALLY
MORE**

Confident



WHEN YOU LOOK YOUR BEST

You know how people talk about the fellow with the "porcupine" hair. Be careful this never happens to you! Now it's so easy to keep your hair smartly and neatly well-groomed *all day long* with Glover's Imperial Hair Dress. Try the one-minute massage tomorrow morning with Glover's Hair Dress and see the difference in more *natural-looking* softness that makes you feel sure of yourself. **NON-ALCOHOLIC** to avoid scalp dryness... **ANTISEPTIC** for clean, *protected* scalp! Ask for Glover's at any Drug Store or Drug Counter—or mail the Coupon today!

GLOVER'S Imperial HAIR DRESS

FREE TRIAL SIZE



Send Coupon for Free Trial Size
—with easy instructions for the famous Glover's 3-Way Medicinal Treatment and FREE booklet, "The Scientific Care of the Hair."

MAIL COUPON

Glover's, 101 W. 31st St.,
Dept. 1A5, New York 1, N. Y.

Send Free Trial Application package in plain wrapper by return mail, containing Glover's Imperial Hair Dress, GLO-VER Shampoo, and Glover's Mange Medicine in hermetically-sealed bottles, with informative FREE booklet. I enclose 10¢ to cover cost of packaging and postage.

Name _____

Address _____

City _____ Zone _____ State _____

THE IDEAL TOY FOR BOYS!

"ARMY OFFICERS"

.45 REPEATING AUTOMATIC

CAP PISTOL

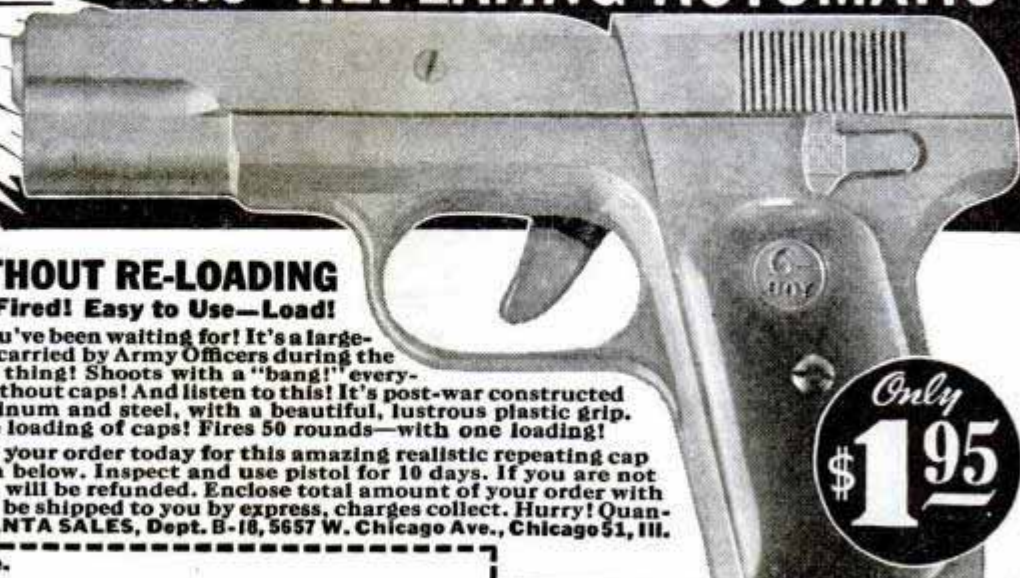

FIRES 50 ROUNDS WITHOUT RE-LOADING

Barrel Actually Smokes When Fired! Easy to Use—Load!

Boy-oh-Boy! This is the cap pistol you've been waiting for! It's a large-size model of the Colt .45 Automatic carried by Army Officers during the war. Feels and handles like the real thing! Shoots with a "bang!" every-time you pull the trigger...with or without caps! And listen to this! It's post-war constructed inside and out of long-lasting aluminum and steel, with a beautiful, lustrous plastic grip. Pistol "breaks" open for easy inside loading of caps! Fires 50 rounds—with one loading!

MONEY-BACK GUARANTEE! Rush your order today for this amazing realistic repeating cap pistol and ammunition. Use coupon below. Inspect and use pistol for 10 days. If you are not delighted, return it and your money will be refunded. Enclose total amount of your order with coupon. Pistol and ammunition will be shipped to you by express, charges collect. Hurry! Quantity limited! Rush your order now! **SANTA SALES, Dept. B-18, 5657 W. Chicago Ave., Chicago 51, Ill.**

SANTA SALES, 5657 W. Chicago Ave. Dept. B-18, Chicago 51, Ill.

Please rush _____ "Army Officers" .45 Automatic Repeating Cap Pistols at \$1.95 each. _____ Boxes of 250 ROUNDS of CAPS at 15c each, or _____ Boxes of 1750 ROUNDS of CAPS at \$1.00 each. I enclose \$_____ full amount of order. Please ship express, charges collect. If I am not delighted with pistol, I can return it in 10 days and get my money back.

Name

Address

City State

ORDER AMMUNITION

Box of 250 Rounds of Caps . 15c
Box of 1750 Rounds of Caps . \$1.00

Have more fun with your repeating cap pistol! Keep a good supply of roll caps on hand.

CAPS NOT SOLD WITHOUT GUN
Order blank for additional supplies of caps included with your shipment.

LEARN WATCH & CLOCK REPAIRING At Home



STEADY WORK • SECURITY • HIGH PAY

Prepare yourself now for this fascinating high-grade occupation. You can earn while you learn. This UP-TO-DATE COURSE IN HOROLOGY shows you how to get the practical working experience you need for big-time success. THOROUGH SELF-INSTRUCTION TRAINING in American and Swiss watches, clocks, etc. Interesting LEARN-BY-DOING teaching method makes lessons easy. No previous experience necessary. Watchmaking is BASIC TRAINING for many scientific and mechanical precision jobs. Amazing low price. Satisfaction or money-back guarantee. Get into this fast-growing field NOW... big opportunities. Mail coupon for free information.

LOCKSMITHING & Key Making

Practical modern course for self-instruction. How to picklocks, de-code, make masterkeys, repair, install, service, etc., etc. For carpenter, fix-it shop, service station operator, hardware dealer, gunsmith, mechanic, home-owner, 53 easy illustrated lessons. Mail coupon for free details.

Practical ELECTRICITY

Quick course for men who demand how-to-do-it practical facts. Covers house-wiring, generators, storage batteries, telephones, lighting equipment, telegraphy, welding, etc. 55 lessons at surprisingly low price. Satisfaction guaranteed. Mail coupon below for complete interesting details.

SHORT-CUT Mathematics

How to be a "master mind!" This 2-in-1 self-study course teaches how to juggle figures, do baffling tricks with numbers. Also teaches practical mechanics... for every technically minded man who wants to get ahead. Used by stage magicians, expert accountants, etc. Only \$1. See coupon.

FREE! 100-PAGE BOOK! Mail this Now

NELSON CO., Dept. 2E02, 1139 S. Wabash Ave., Chicago 5, Ill.

Please send me — free and without obligation — big illustrated Success-Catalog containing complete information about subject (subjects) checked below. (No salesman will call).

- Watch & Clock Repairing Practical Electricity
 Locksmithing & Key making Short-Cut Mathematics

Name

Address

AMAZING ELECTRIC SWITCH

ELECTRIC SWITCH OF A THOUSAND USES
MILLIONS NOW IN USE

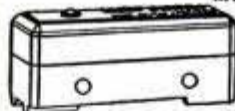

Turn on your porch light when you open the door—sound an alarm when the mail is put in the box—shut off the water when the tank gets full, these and many other services are performed with this amazing switch. Shipped with an instruction sheet showing more than 40 illustrated uses for this device, at the bargain price of \$1.00 postpaid.

ELECTRONIC PRODUCTS CO.

St. Charles 10, Illinois



SING, TALK THROUGH YOUR OWN RADIO RADIO MICROPHONE

Put on your own Broadcast at Home with this Radio Mike. Sing, Talk, from any room in the house. Make announcements. Lots of Fun 2! It's wonderful voice practice. Easily attached to any Radio. **SEND NO MONEY.** Pay Postman \$1.98 plus postage. Send check or money order and save postage.

DISCO SALES, INC., 154 Nassau St., Dept. PM 2, N. Y. 7



MAKE YOUR OWN COSTUME JEWELRY BIG EARNINGS AT HOME

YOU can make costume earring and pin sets, brooches, necklaces, dress clips, cameos, etc.

WE supply the jewelry findings; bar pins, ear screws, jump rings, chains, screws, stone sets, sequins, shells, boxes, cement, cards, etc.

WRITE FOR FREE CATALOGUE

PHILADELPHIA BADGE, 1007 FILBERT ST., PHILA. 7, PA.

HELPFUL BOOKS

Send post card asking for **FREE** catalog

Popular Mechanics Press, 200 E. Ontario, Dept. 601, Chicago 11

Cabin PLAN BOOK - \$2.00



**HEALTH AND FUN
FOR YOU, WHETHER IN
SUNNY CALIFORNIA
OR RUGGED MAINE**



• A multitude of ideas for practical, low-cost cabins and cottages. Pictures and floor plans. Suggestions for fireplaces, barbecue pits, built-in furniture. Plans for row-boats, docks and floats.
• Complete drawings and lumber lists for a build-your-own \$500 cabin or \$2500 2-bedroom cottage.

Woodbeck Publishing Co.
232 Winchester N.E.
Grand Rapids 2, Michigan

BUILD-YOUR-OWN for next season's healthful fun, now! Send check or money-order today.
Copyrighted '45 W.P.Co.

Fun and HEALTH for You!

SALESMAN WANTED

SELL DIRECT TO STORES • BIG COMMISSIONS
Every dealer in your territory is a prospect for this fast selling specialty. Gov't surplus Gas Masks sell like wildfire for use as toys. Thousands already sold—reorders every day. Big commissions assure big earnings. Two sample Masks and selling Kit \$1.00. Kit alone FREE. Write today.
STARK'S, 509 S. State St., Dept. X4, Chicago 5, Ill.

WORK WITH LEATHER!

Get this simplified "here's how" book; develop real skill in leather craft. Scores of stimulating illustrations show professional techniques, tricks, short-cuts. Order your copy of "WORKING IN LEATHER" today. \$1.00 postpaid
House of Little Books, 80 E. 11th St., New York 3



PRINTING PAYS BIG

Make your future secure. Prepare for a highly paid position or a print shop of your own. Students throughout the world are enthusiastic in their praise of our training program and the personal attention given each student. Rush name today for free literature and sample lesson. No salesman will call. Dept. M56.
COMPLETE COURSE ONLY \$14.50 CASH
TERMS AVAILABLE

International School of Printing, Box 334, Dayton, Ohio

arc welding manual and text book...\$2.00 • Teaches you how to become an arc welding operator - one of highest paid trades today. Write today!
Hobart Bros. Co., Box M-562, Troy, Ohio

CARTOON TO SUCCESS!
Learn to cartoon! Big pay! Easy, enjoyable work! Cartoon course, gag course, anatomy course and business course full of plans, markets, ideas. Drawing set and criticisms. All one low price! Rush card for details!
HARTMAN SCHOOL, 2438 W ST., LINCOLN 3, NEBRASKA

PLASTIC HOBBYCRAFT KIT
Kit contains 2 lbs. PLEXIGLAS and LUCITE sheets and strips, dye, cement, sandpaper, buffing compound and fabricating instructions. Send \$3.00 money order to
HOME CRAFTSMAN PLASTICS, 1945 W. Harrison St., Chicago 12, Ill.

THIS IS DIFFERENT!
A collection of the greatest, modern money making projects you ever imagined it possible to obtain. Copyrighted 1948, and created to meet to-days conditions TO-DAY. FOLDER OF AMAZING facts FREE.
R. P. MOREY, 087 Somerset, Springfield 8, Mass.

THE INFERIORITY COMPLEX
has its roots in unreasonable fear and results in self-consciousness, nervousness, mental conflicts, lack of confidence in self, etc. Amazing psychology course points the way to **SELF-MASTERY** and a **MAGNETIC, SUCCESS-WINNING** personality! Sent postpaid for only \$1.25 (no C.O.D.'s or cheques). Money back if not satisfied. Free literature on request. **DR. G. MALCOLM SMITH, Dept. 105, 1104 Union Ave., Montreal 3, Canada.**

IT'S FLAMELESS!

Just puff and your cigarette is lit!

LEKTROLITE LIGHTER



LIGHTS UP INSTANTLY
EVEN IN THE STRONGEST WIND - no matter how the wind blows! Just insert cigarette into head of lighter, press the bottom, and draw. - Presto, the easiest light you ever had! No fitful flicker - no wick or wheel to stall your service. Lektrolite Fluid included at no extra cost!

\$1.50

**MAIL ORDERS DIRECT TO
UTILITY STORES, 117 S. Wabash
CHICAGO 3, ILLINOIS**

While They Last!

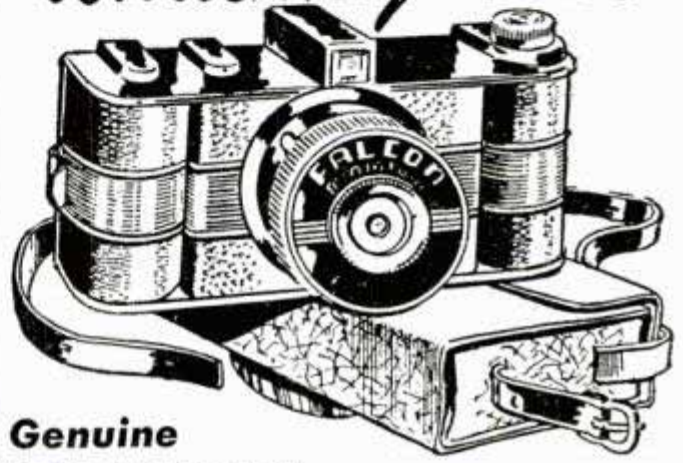

Genuine
"FALCON" CANDID TYPE CAMERA

Included at no extra cost!
Carrying Case and Shoulder Strap.

Comes complete with Case, Shoulder Strap, and Your Name Personalized in Gold on case.
\$3.98
ALL FOR ONLY

- NOTE THE SPECIAL FEATURES!**
- Takes brilliant full pictures. Also regular black and white photos.
 - The film track is scientifically curved in the camera to bring every part into sharp focus.
 - Takes snapshots and time exposures.
 - Takes 16 pictures for the price of 8 in black and white—12 pictures for the price of 6 in color.
 - Uses No. 127 or A8 film for black and white—No. 127 Kodacolor for color.
 - Has a Genuine Graf lens.
 - Has eye-level centering viewfinder.
 - Fully guaranteed.

Included at no extra cost!
Your Name Personalized in Gold—on case.

MAIL COUPON NOW!

UTILITY STORES, 117 S. Wabash Ave., Chicago 3, Ill., Dept. E.E-9

I enclose \$..... Ship at once Falcon Candid Type Cameras at \$3.98 each.

NAME.....
Please Print Name and Address

STREET OR R.F.D.....

CITY..... STATE.....



"A little land - a lot of living"
 Our "Have-More" Plan tells how to make a small cash income into the best and happiest kind of a living any family could want . . .

"This is the way I want to live - the rest of my life!"



Mrs. Robinson and our son Jack and I haven't any land to sell; we aren't promoting anybody's products. We just want to tell you some things we've learned about how to have more fun, more living and more security than 99% of the people in this world ever had before.

We call it our "Have-More" Plan because that's how it has worked for us . . . we are having more of just about everything that makes life worth living!

Our "Have-More" Plan is the true story of how we Robinsons moved from the city to our small place in the nearby country to find "a little land and a lot more living"—how I kept a regular full-time job in town.

It tells how we grow most of our family's food in spare time—have fun doing it—have better living—more sunshine and fresh air—more peace and quiet—more security and independence—in fact, as I said before, more of just about everything!

Our Plan is \$1.00

My "Have-More" Plan contains over 50,000 words, 73 illustrations, many actual photographs of our own place. And I've kept the price as low as I possibly could, only \$1.00 postpaid.

It tells just how we do everything—all our short-cuts, ideas, labor-saving methods—how it takes us only an hour or so of spare time a day to have tender chicken to eat, plenty of really fresh eggs, a wonderful garden with a lot less work, delicious rabbit meat, rich milk, butter, cream from our miniature dairy, tasty ham, pork, bacon, sausage, geese, turkeys, squab, spring lamb, honey bees, fruit trees instead of shade trees, luscious grapes, raspberries, strawberries, etc.—how we use the latest, easiest preserving methods, including quick freezing.

No "Magic" About It

Now please don't get me wrong. This is no "crack-pot theory" on how to make an easy living. I suppose that if you absolutely had to, you could live a long time entirely off a small place like ours. But that would be just existing, not really living.

You've got to have some cash income—from a job or a pension or something. What I'm saying is that with my "Have-More" Plan you can make a small cash income into the best and happiest kind of a living any man could want. That's why we call it our "Have-More" Plan.

Will You Join Us?

A friend said, the other day, "Ed, why do you bother with other people? Why don't you settle down and just enjoy your own job and your "Have-More" Homestead? Why try to spread it all over the country?" I may sound silly trying to tell you why. But I feel, somehow, that in the years to come, the U. S. is going to need all the help it can get toward happiness and peace and security. We aren't always going to have a boom going on. I've got a boy I want to see grow up in a good country, and if ten or twenty million American families can get set as well as we Robinsons are I don't think anything can hurt this nation. Do you see what I mean? That's why I've worked so hard putting this Plan together. That's why I was so careful to be truthful and sensible in everything we put in it. And that's why I've kept the price as low as I possibly could—only \$1.00 postpaid.

Now It's Up To You

So if you are one of our kind of people, if you want to have a look at our "Have-More" Plan, just fill in the coupon here and send it to me. When you get the Plan—by return mail—look it over. If you are disappointed in it in any way, if it looks hard to do, or doesn't suit you, put it right back in the envelope and return it to me. I'll give your dollar back and send you a dime for your postage.

On the other hand, if you like it, help me by showing it to your friends and getting them to start a "Have-More" Homestead also.

Yours for a "little land and a lot of living."

Ed Robinson
NOROTON 2705, CONN.

Send to **ED ROBINSON,**
 P.O. Box 2705, Noroton, Conn.
 Dear Ed:—
 Here's your dollar. I want to see your "Have-More" Plan. If it's what I want I'll keep it. If not I'll send it back and you're to return my money—and we'll still be friends.

Name.....
 Address.....
 City..... State.....

(Please make checks \$1.05 to cover bank charge)



BE YOUR OWN BOSS! MAKE MORE MONEY

\$1.00 VALUE
25¢
68 PAGES
40,000 WORDS

In "CASH IN" you now get THE real money-makers—dozens of profitable tested mail order plans, confidential business secrets, dozens of practical tested formulas, successful tested schemes—actual experiences of men who have started on a shoestring—with less than \$10 capital.

25c a copy postpaid. Send U. S. stamps, money order, or coin.

MONEY BACK GUARANTEE
NATIONAL PLANS COMPANY
 P. O. Box 26Y, Station N, New York 23, N. Y.

ART INSTRUCTION COURSE and DRAWING KIT



Complete \$1.00

Complete 31 Lesson Art Course, which explains step-by-step and shows with over 600 How-to-do-it sketches and illustrations, how to draw:—Cartoons, Portraits, Figures, Animals, Posters, Advertising, and Commercial Art, Illustrations, Lettering, Anatomy, Details, Caricatures, Comic Strips, etc. Together with Drawing Pad, 3 Art Pencils, Art Eraser—also a MANIKIN for posing and drawing and a Triangle and French Curve which you can trace, mount and use.

Amazing Bargain: If you can write, you can learn to draw. Here's everything you need to start! Send only \$1.00 (or C.O.D. plus postage) for Book of Art Instructions and the complete outfit of Drawing Supplies. Money back Guarantee. Write NOW! Knickerbocker Pub., 120 Greenwich St., Dept. A, New York

EXPERIMENT WITH LUMINOUS PAINT



Complete kit of luminous paints in colors. Paint artificial flowers, lamp ornaments, novelties, house numbers, light switches, etc. Kit of one oz. each of 3 lasting colors, bright blue, gardenia and chartruse, one ounce sealer. Guaranteed best quality.

COMPLETE KIT WITH 3 COLORS AND SEALER \$3.95 PRE-PAID

New Address
BLACK LIGHT PRODUCTS • 67 E. Lake St. • Chicago 1, Illinois

WATCHMAKING



Construction, repair adjustment. Your big opportunity. Learn this profitable trade at home through the most reliable book. New complete "PRACTICAL COURSE" for beginners and professionals. All essential steps. Theory, operation. Many test cases. Full coverage of tools, materials. Fully illustrated. Only \$2.95 postpaid. Money back guarantee.

We supply tools, materials at lowest cost.
MODERN TECHNICAL BOOK CO.
 Dept. M3MC, 55 West 42nd St., New York 18

ACCOUNTING

STUDY AT HOME for C.P.A. and BIG PAY Accounting opportunities with 42 year old school. No previous training needed. Texts furnished. EASY PAYMENTS. Send for FREE BOOK.

Mac CORMAC EXTENSION SCHOOL
 Dept. 5-B, 1170 East 63rd St. Chicago 37, Ill.

Arc Welded Design "Know-How"

Only \$3.50 each
 3 different volumes
 \$10.00 postpaid

Each volume contains over 100 welding designs. Write
 Hobart Bros. Co. Box M-561, Troy, O.

WATCHES WANTED Broken or Usable

—all kinds, even Ingersolls. Highest prices paid for jewelry, rings, spectacles, gold teeth, etc. Cash mailed promptly. Write for Free Shipping Container.

LARGE GENUINE ANCIENT ROMAN COIN - \$1.00

20 different coins 15 countries..... \$1.00
 50 different coins allied nations..... \$5.00
 40 different coins defeated nations..... \$5.00

Lists - Approvals
DEL MONTE • 40 West 18 • New York 11

RADIO

ENGINEERING, Broadcasting, Servicing, Electronics, Aviation, Marine & Police Radio taught thoroughly. 48 weeks' Engineering course equivalent to 3 years' college radio work. Approved Veteran Training. Co-educational. Catalog free.

REFRIGERATION

Repair and improve all refrigerators. New manual tells how. Charts and pictures to help you. Price only \$1.00, postpaid. Money back guarantee. Supreme Publications, 9 S. Kedzie Ave., Chicago 12, Illinois.

YOU CAN HAVE **THE WORLD'S FINEST**

MECHANICAL TRAINING AND EARN WHILE YOU LEARN

If you are interested in machinery and want the knowledge and experience for a lifetime career in the field of mechanics, the U. S. Army has a twofold opportunity for you.

First, if you are 18 to 34 inclusive (17 with parents' consent) and will enlist now for a period of three years, you may choose to join one of the arms or services of the Army Ground Forces, Army Air Forces, or Army Service Forces, which will give you some of the best mechanical training in existence today.

You may attend one of the Army's top-flight mechanical schools, and master the technical details of all kinds of engines, including diesel, radial and internal combustion. You will be given practical experience in repairing and maintaining the Army's own fine equipment.

Second, under the GI Bill of Rights, after your discharge from the Army, you will be entitled to attend any college or trade or business school of your choice which will admit you, provided you enlist before October 6, 1946.

After a 3-year enlistment, you may have up to 48 months of education, with the Government paying your tuition and incidental expenses up to \$500 per ordinary school year, and a living allowance of \$65 a month (\$90 a month if you have dependents).

Add to this good pay, travel, clothing, food, quarters, medical and dental care and a 30-day furlough each year, and you'll see that it's an opportunity you can't afford to miss. Get all the facts at your nearest U. S. Army Recruiting Station.

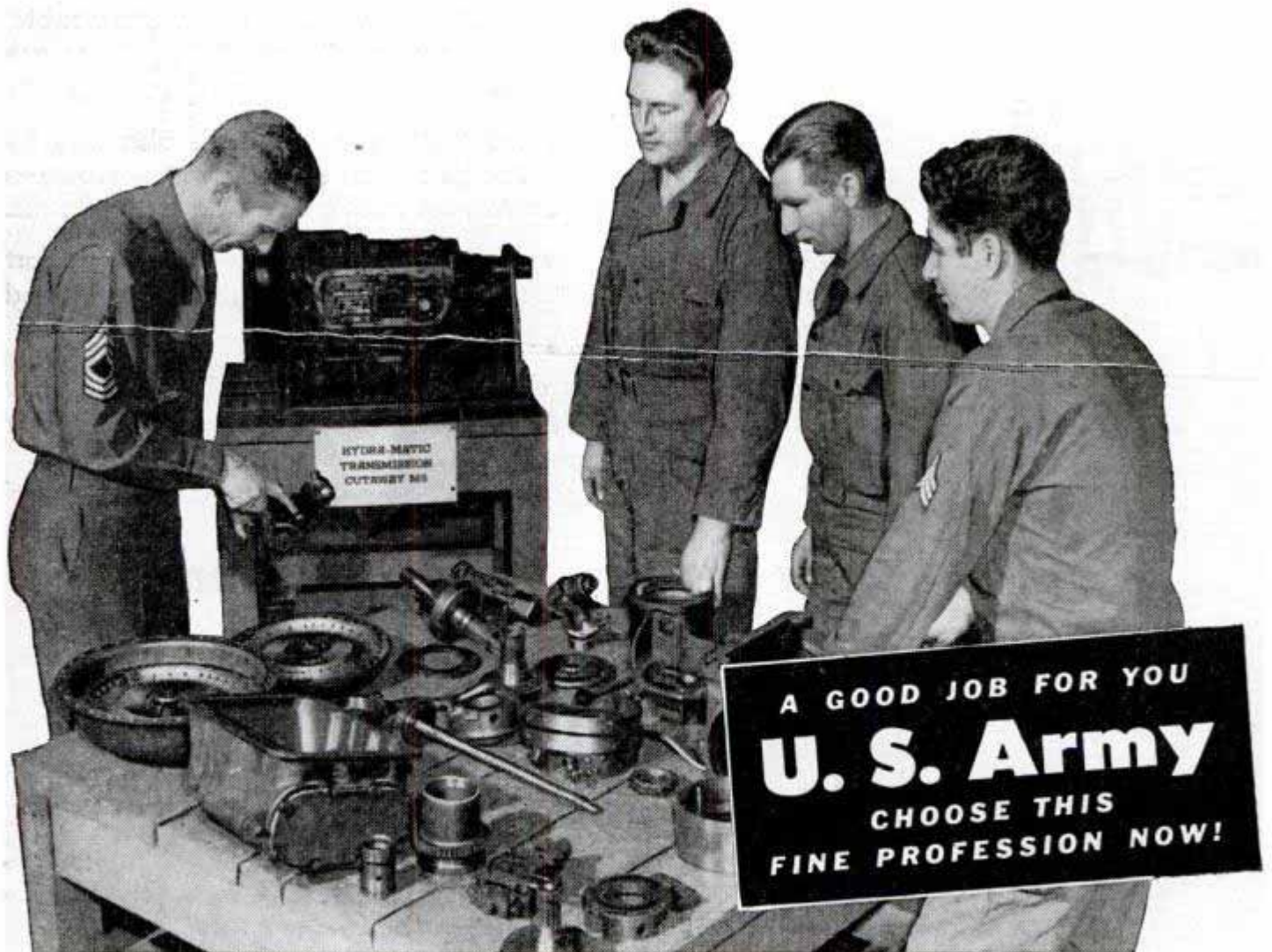

Where Nature

Lets off steam...

YELLOWSTONE NATIONAL PARK

Pillars of steaming water spout skyward. Roaring falls, mysterious lakes, and pools like bubbling paint-pots also are part of Nature's magic show in Yellowstone.

The famous Yellowstone bears, with their entertaining antics, perform for visitors and there is other wild-life in abundance.



Beautiful Grand Teton National Park is but a few miles south of Yellowstone. Together they offer a double attraction for vacationists. Comfortable, inexpensive guest accommodations are available.

These western wonderlands also may be visited as a short side-trip when enroute to or from the Pacific Coast via Union Pacific.

Travel by train and begin your vacation with relaxation. Ride in comfort and arrive rested. Union Pacific offers a variety of fast Streamliners and steam-powered transportation.

More western scenic regions are served by Union Pacific than by any other railroad. It's the world's greatest vacation travel bargain. For unexcelled passenger service—



be Specific -
say "Union Pacific"



The Progressive

UNION PACIFIC RAILROAD

ROAD OF THE Streamliners AND THE Challengers

The Mechanics of GOLF

by
Byron Nelson

Tee off with the greatest golfer of all time for a series of three lessons. In this he takes up wood shots

PART I

I was approached recently by a golf fan who queried, "Can you, in one word, describe the most important factor in developing your golf swing to its present efficiency?"

"Streamlining," was my answer.

In the case of my golf game, this streamlining process has been an extended one, going back about 20 years.

The original model left plenty of room for improvement. In my first competitive venture—a caddy tournament at the Glen Garden course in Fort Worth, Texas—I shot 118. The following year I tied my caddy pal, Ben Hogan, in the regular medal play, and then came through with a 39 to Ben's 40 to win the playoff. This taste of victory got me excited about golf. For several years thereafter I competed in amateur tournaments in the Southwest.

I turned professional at Texarkana on November 28, 1932, to shoot at some of the \$500 prize money in an open tournament there. I managed to win \$75—the most money I had ever had in my possession at one time. I've played for cash ever since.

Through the following 12 years my game was good enough to win the National Open, the P.G.A. national match play championship and a few major money events. However, my duties as club professional took too much time to permit me to concentrate on refining my game to the desired degree.

In September 1944, I resigned my position as professional at the Inverness Club



HOW NELSON GRIPS HIS CLUBS



Place handle of club at angle shown across forefinger of left hand. Note the exact position in which handle rests across first two fingers and palm. It has an important bearing on the grip's effectiveness

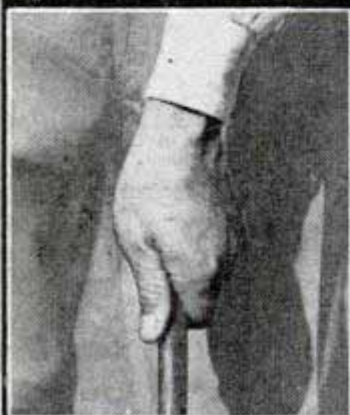

Next, you close the left hand, with thumb on the shaft, one fourth of the way around from a point opposite the body. The "V" formed by the closing of the hand over the handle points in the direction of your right shoulder. About half the back of your left hand should be visible



As you close your right hand on the club handle, be sure it is placed so that control of the club will be equally divided between the palm and the fingers. This is a very important feature



The thumb of the right hand now rests about one fourth of the way around the shaft after you have closed your hand. Notice that the "V" formed between the thumb and the forefinger is aimed at the right shoulder. The forefinger grips particularly firmly, giving feel and control as you swing

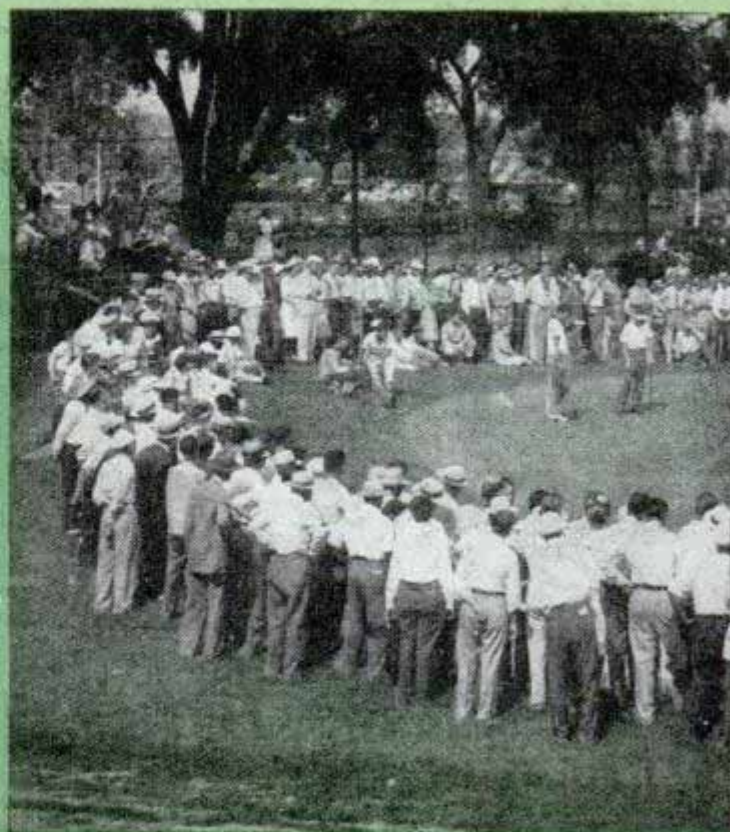

Nelson putting at Chicago's Tam O'Shanter

in Toledo and started working intensively from mental blueprints on my concept of the ideal golf swing.

This was the beginning of the most successful phase of my golf career. My goal was to take the waste motion out of my swing, and thus reduce the possible margin of error. I felt that if I could arrive at a compact, simplified swing, I could improve my efficiency and also my consistency.

The results of this improvement program showed during the 1945 season when I averaged 68.33 strokes for 120 rounds of competition in P.G.A.-sponsored tournaments.

The first part of my game to undergo detailed study (once my resignation from Inverness had made available the needed time) was my method of gripping the club.



This closeup shows the details of my overlapping grip. Note closely that the small finger of my right hand overlaps left hand's forefinger



Country Club, where he captured the rich All-American Open four consecutive years

To me a sound grip is the most important factor in playing good golf.

The most prevalent weakness in the grip is looseness. If your grip is lax enough to permit the club to turn or slip in your hand, even just slightly, you can't possibly hit a good shot. This flaw spoils both distance and accuracy.

With all this in mind, I experimented—trying to incorporate maximum firmness into my grip. In playing golf today, I grip the club very firmly in both hands, with emphasis on the left hand. By firmness I don't mean squeezing the handle so tightly that arms and hands are tense. Grip just firmly enough so that you have complete control of the club throughout your swing.

I favor the overlapping grip illustrated in the photos on page 82. The name is derived from the fact that the little finger of the right hand overlaps the forefinger of the left hand. The overlapping grip permits both hands to

work as one. It is this coordination that helps provide a smooth application of power to the club as you swing.

In my blueprint of the most effective golf swing, the left hand guides the club at all stages of the swing. You may have to make

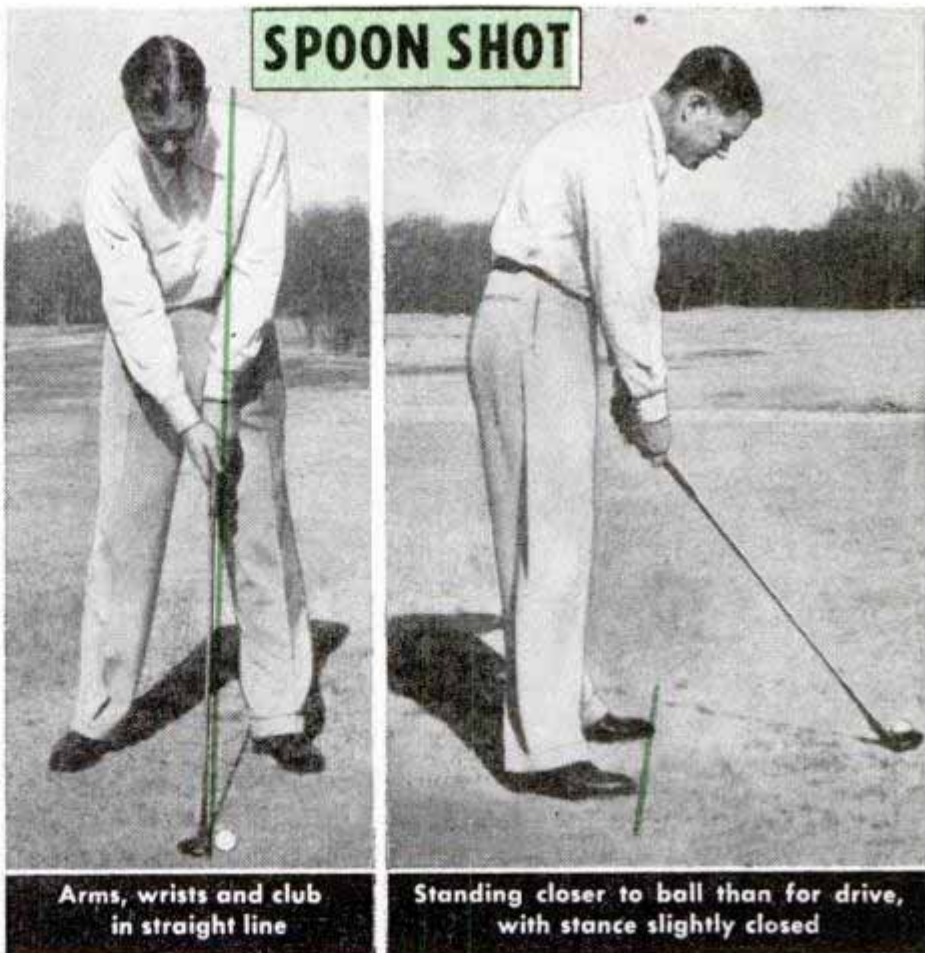

Arms, wrists and club in straight line

Standing closer to ball than for drive, with stance slightly closed

THE DRIVE

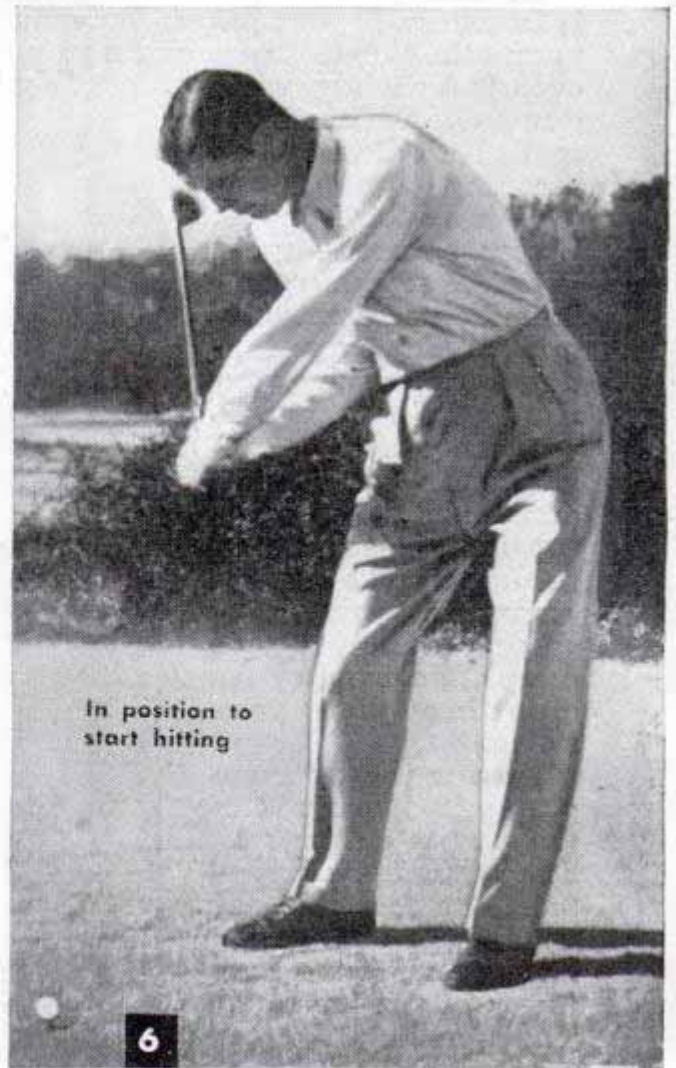
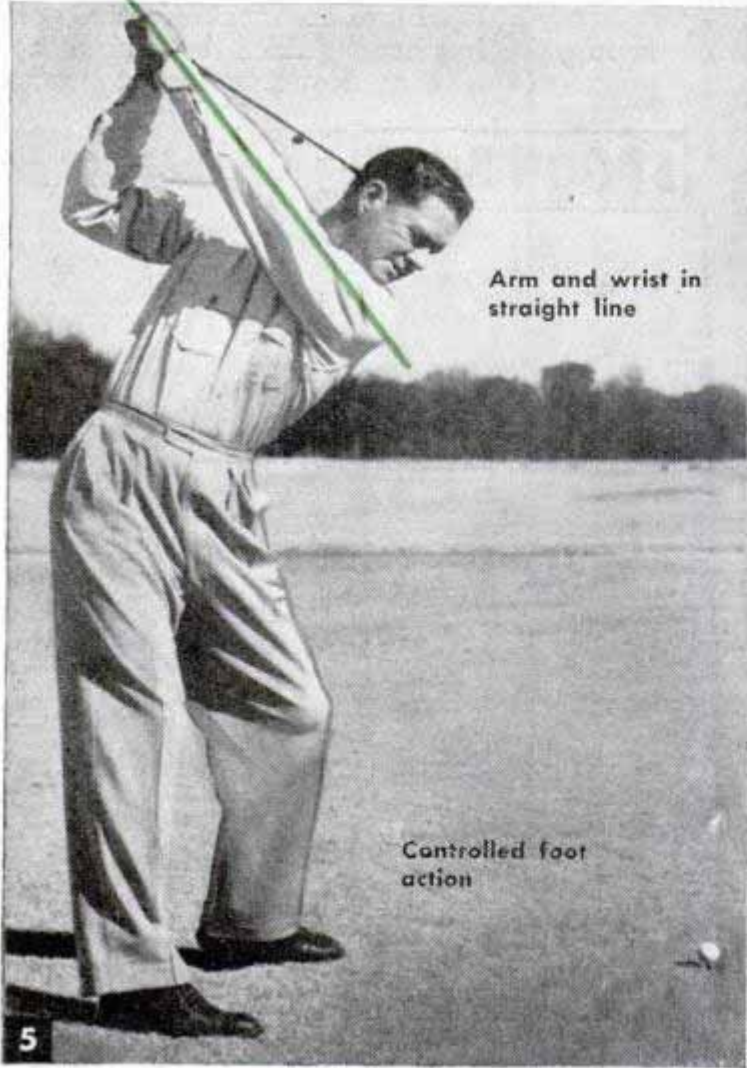
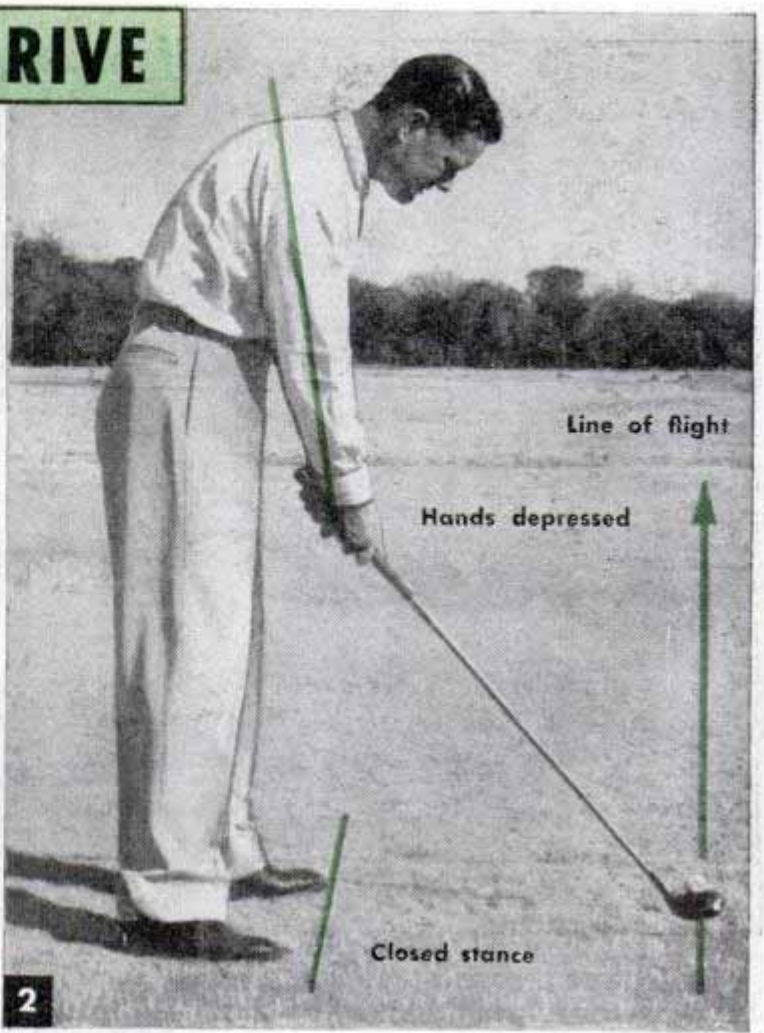
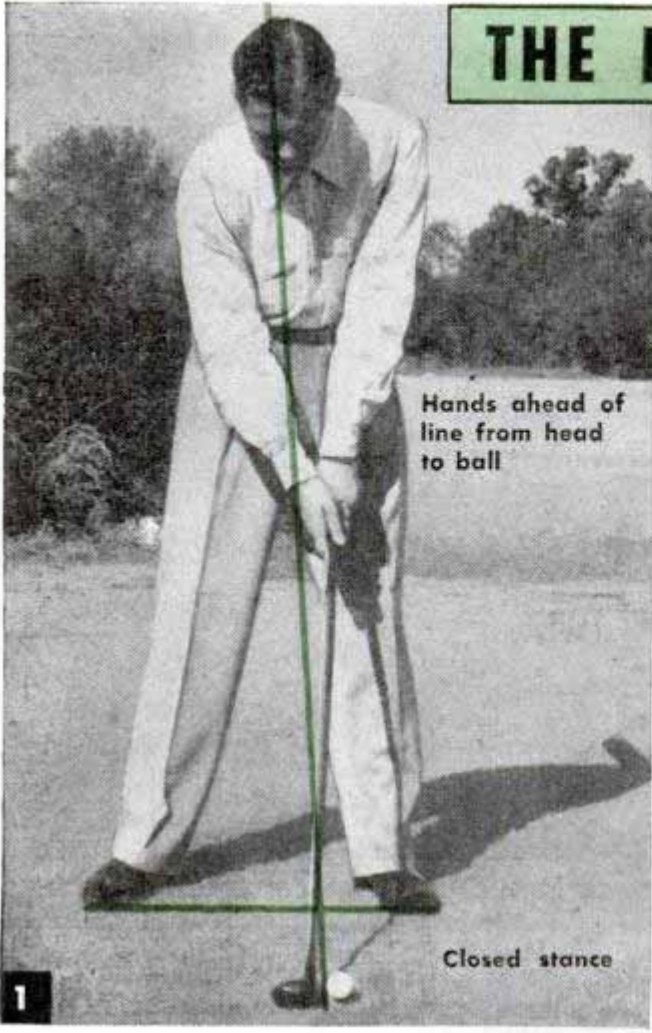

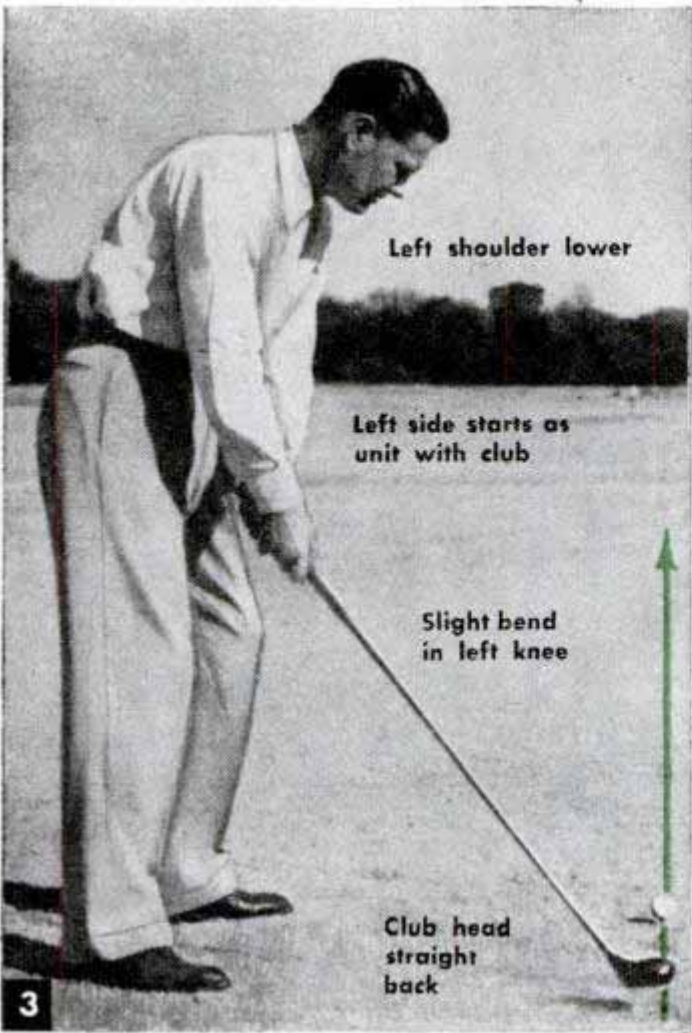

Left shoulder lower

Left side starts as unit with club

Slight bend in left knee

Club head straight back

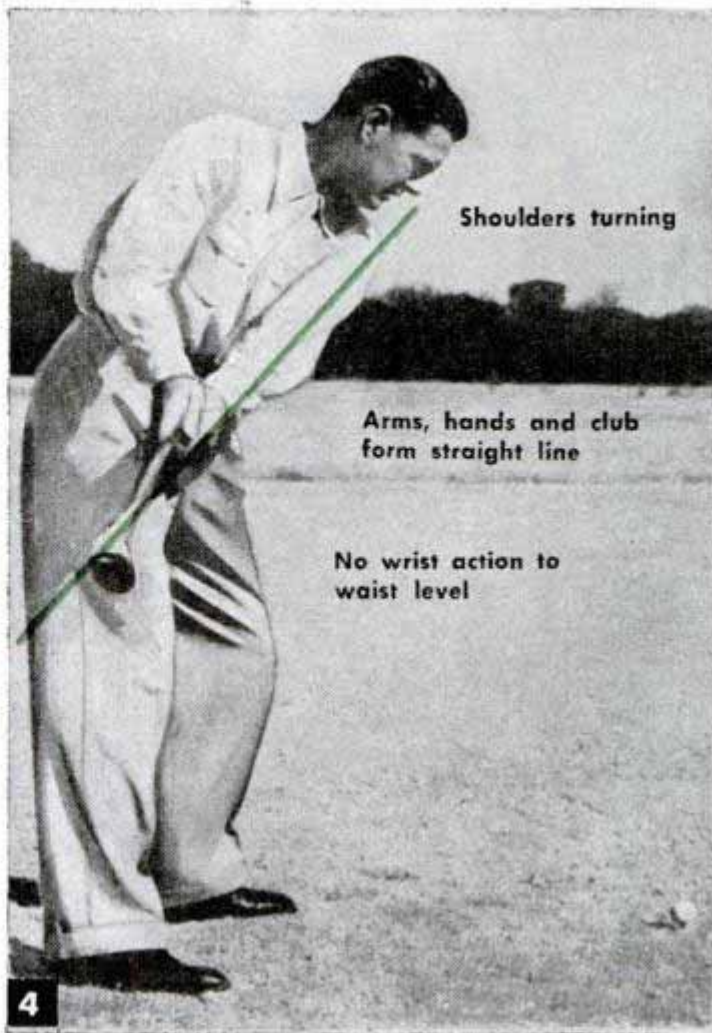

Shoulders turning

Arms, hands and club form straight line

No wrist action to waist level



Weight on left side

a conscious effort to get this feeling at first, but it will become second nature after practice. Remember this: at no point in the swing should your left hand lessen its grip on the club. This is essential to proper control. The last three fingers of the left hand are particularly firm in their hold on the club.

Don't be the least bit discouraged if, at first, this overlapping grip feels awkward. After a few hours of practice it will seem perfectly normal to hold the club in that fashion.

As I improved my grip, I eliminated much of the grief I had encountered in straying into woods, heavy roughs and traps. Firmness gives me much better control. Control of the club means greater accuracy and consistency.

Satisfied that I had worked out a grip incorporating maximum efficiency, I looked next to my method of standing up to the ball for a wood shot.

I got my best results when assuming a stance (position) like that shown in photo 1, page 84. The distance between my feet corresponds closely to the width of my shoulders. The toes are pointing outward.

Your feet are the foundation from which you swing. Without benefit of surveyor's instruments you must learn to "line yourself up" accurately. Otherwise you cannot possibly make the ball go where you want it to.

The favorite device in getting properly situated to swing is the "line of flight"—an imag-

(Continued to page 244)

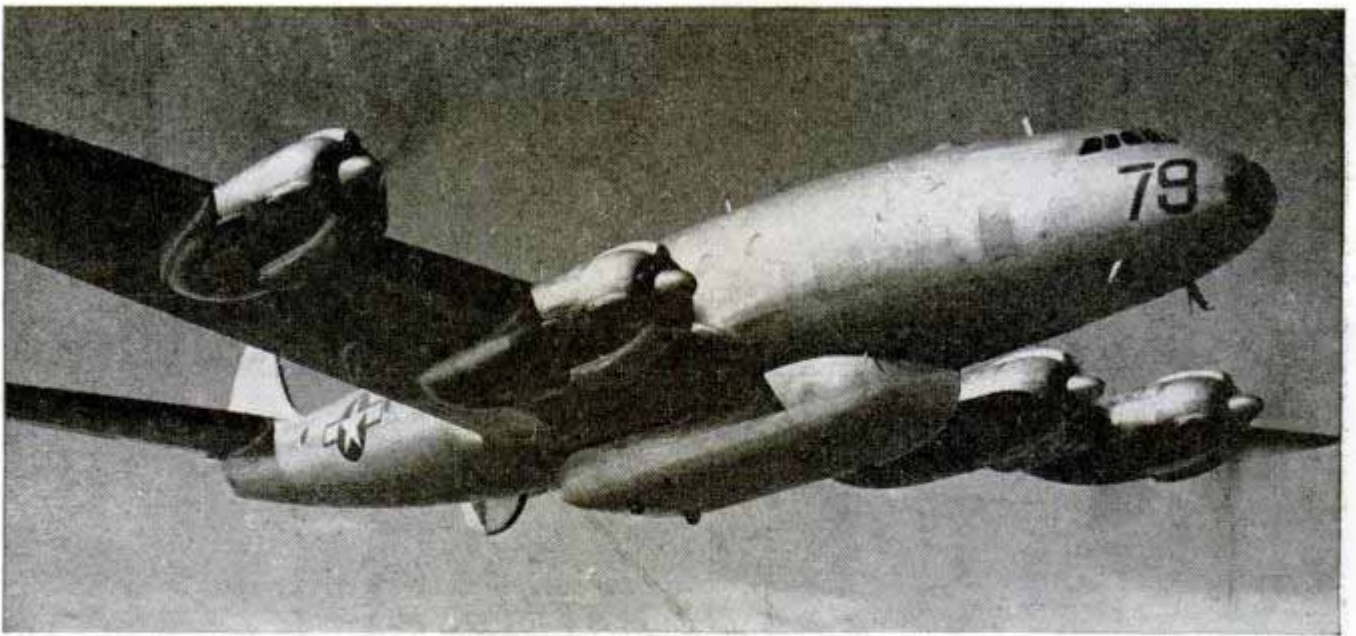

Cargo "Pouch" Holds 4 Tons

Payload of Constellation air liners is increased four tons with a detachable cargo container fitted snugly under the fuselage. The container, or Speedpak, can be removed or attached in two minutes. It is lowered for loading by a built-in electric hoist. The unit reduces cruising speed by only 10 miles an hour.

Two-Minute Blast From Jet Lifts Weather Forecast Rocket 43½ Miles

Scientists have pushed back weather frontiers by hurling a 1000-pound rocket 43½ miles into outer space. At the peak of the rocket's climb, a parachute opens and allows it to return gently to earth. Automatic weather instruments, similar to those which have been carried about 25 miles up by radio-sonde balloons, send out signals

giving temperatures, wind velocities and other important data. The needle-nosed rocket is 16 feet long, 12 inches in diameter and is made of steel, aluminum and magnesium. Its liquid fuel is said to be exhausted in two minutes. The rocket was developed by the California Institute of Technology and built by Douglas Aircraft.

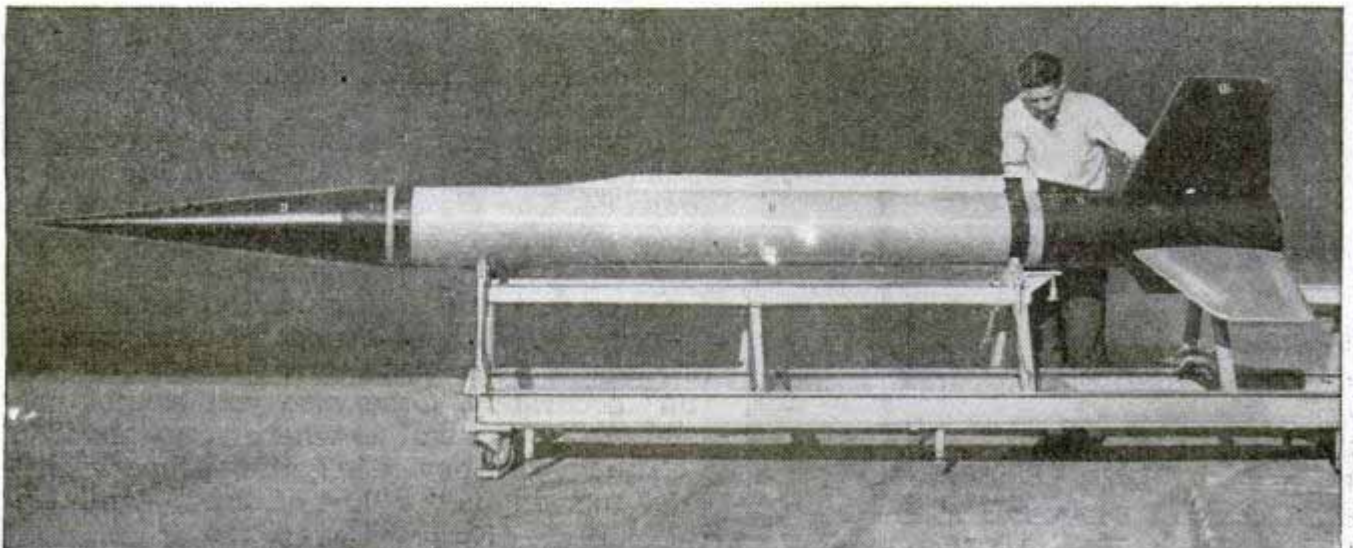

Flying Automobile Sheds Wings in Five Minutes

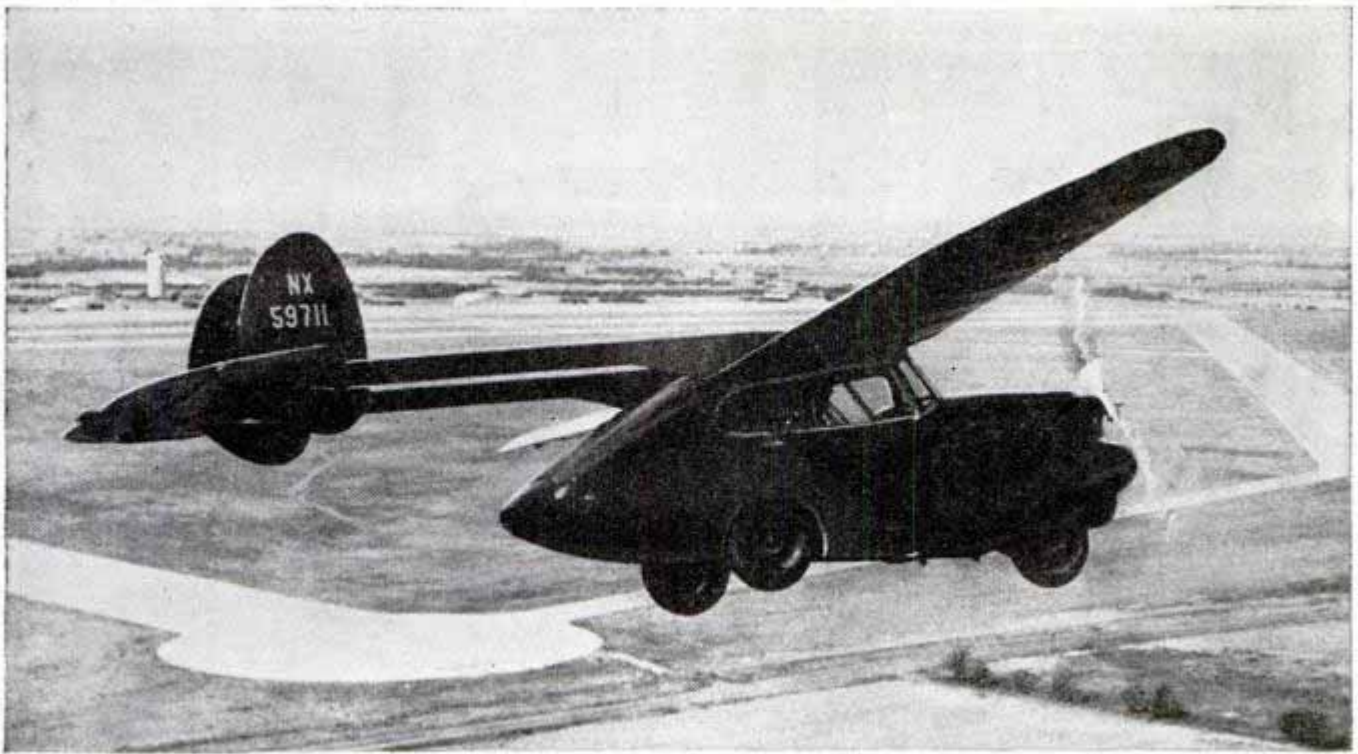

Small enough to park in the family garage, a combination two-place automobile and airplane is known as the Roadable. It is an experimental craft using the auto's rear-wheel drive along with the propeller's power for speedier takeoff as an airplane. Once airborne, the gears driving the rear wheels are disengaged. The car-plane has all the conventional automobile controls and the steering wheel operates the ailerons and elevator when in the air. The 30-foot wing, tail and tail boom are in one section and, with the propeller, can be removed in about five minutes. Driven both in the air and on the ground by a 130-horsepower air-cooled six-cylinder engine, the plane cruises at 110 miles an hour and has a range of more than



600 miles. It has three wheels and weighs 1800 pounds. Southern Aircraft, the developer, announced it has no intention of marketing the plane in its present form.

Millionth-of-an-Inch Measurements Made With Varicolored Lights

Particles of matter as small as two millionths of an inch can be measured by a new method that is both rapid and accurate. The tiny particles, too minute to be seen with an optical microscope, are suspended in a liquid. Light of various colors is passed through the liquid. The amount of light of each color that emerges is meas-

ured, as particles of different sizes transmit colors in different degrees. The average size of the particles is computed from this data. Proportionate amounts of various sized particles also can be found. The operation requires about two hours and can be accomplished by a nontechnical worker with relatively simple equipment.

Eavesdropping Through 24



Reflectoscope operator on assembly line at left keeps sharp eye on screen where echo waves rise to a peak if defect is discovered in steel parts. Portable unit at right is used in railroad yard to test locomotive as protection against hidden flaws; the smallest crack is accurately detected and located by high-frequency sound waves

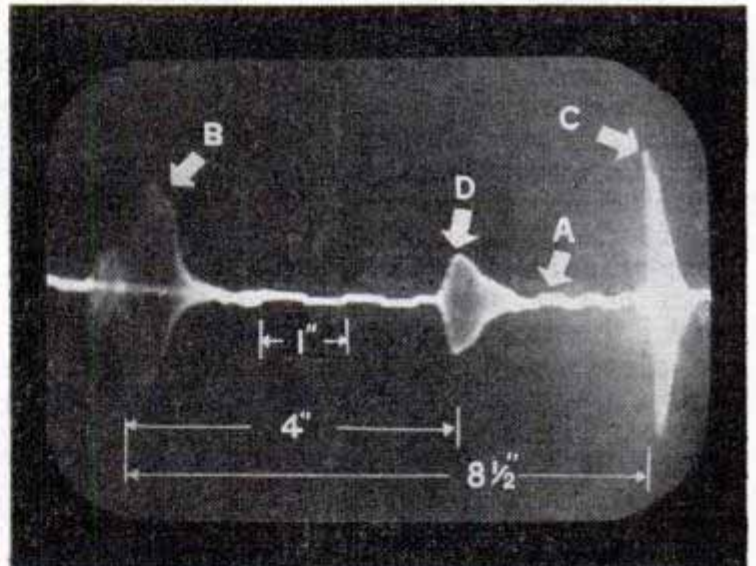
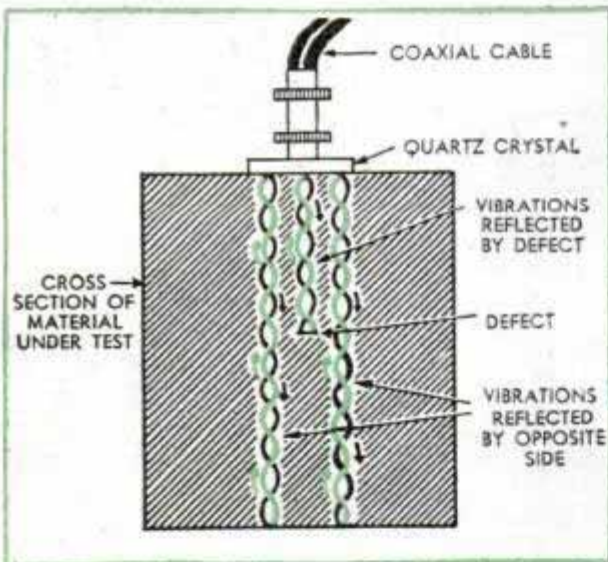

Drawing shows how high-frequency sound waves bounce back when they strike a defect recorded on screen at right as peak D. B is initial impulse, C is reflected vibration, and A is sweep line with inch mark waves. Below, defect indicated by arrow at right was found by reflectoscope 12 inches from shoulder of 14-foot steel part

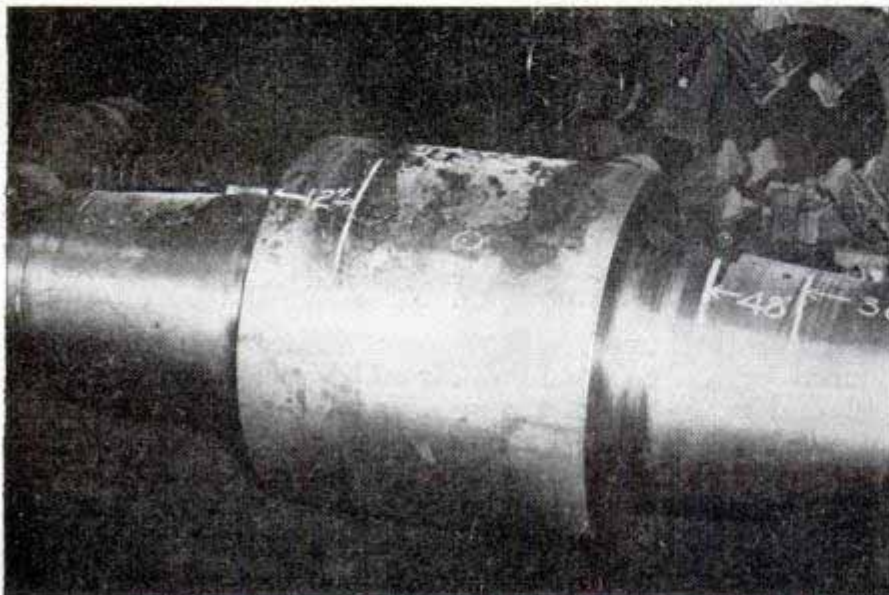

Feet of STEEL!

By Bill Reiche

A GIANT steel billet, half again as long as an automobile, lies on blocks in the great mill that produced it. From the outside it looks perfect—its shape and surface texture are right—but nobody can swear that it is flawless, and this is what the industrial customer has to know.

Until recently there have been only two commonly accepted methods for testing metals, plastics, ceramics, glass and other commonly used materials: examination by taking a sample or bisecting the material, or X-ray examination. Both techniques have limitations and disadvantages.

Now science has provided a means of detecting most types of flaws—not by “looking” for them, but by “listening” for them. An ingenious instrument, no larger than a console radio, has been developed which sends high-frequency sound waves speeding through material under test and reports its findings instantaneously on a screen—as plain as the nose on Mickey Mouse.

This electronic eavesdropper, called a supersonic reflectoscope, operates on the principle that sound waves transmitted through an object will take a predictable time to penetrate to the opposite side and bounce back to the starting point—the time depending on frequency of the sound waves and character of the material.

The reflectoscope comprises a pulse generator and a coaxial cable with a quartz crystal searching unit at the end of it. The generator creates supersonic vibrations at frequencies of from one half million to five million per second (one half to five megacycles) which are transmitted through the cable to the crystal.

The crystal is placed against a relatively flat surface of the object under test, which has been covered with a light film of oil to improve sound transmission. Acting as a transmitter, the crystal sends out a burst of supersonic vibrations for a few millionths of a second. It then automatically becomes a receiver and transmits the reflected vibrations to a cathode-ray oscilloscope.

On the oscilloscope screen is a scale which has been adjusted to represent the distance from the near surface to the far surface of the test object. If the material is flawless, the scale will be marked by peaks at either end to indicate the transmitted sound waves and the bounce from the opposite side. But a flaw will reflect the vibrations back to the device sooner than the

(Continued to page 256)

Twin-Lens Reflex Camera Has Built-In Flash



Those who've been curious about new camera prospects in the medium price field will welcome a twin-lens reflex introduced by Eastman Kodak. It has seven shutter speeds from $\frac{1}{2}$ to $\frac{1}{200}$ second, built-in flash synchronization, and is equipped with “coated” taking lens which increases negative brilliance and color purity. Both taking and focusing lenses are fully color corrected and are f:3.5s of 80-mm. focal length. This easy-to-use camera makes $2\frac{1}{4}$ by $2\frac{1}{4}$ negatives. The camera is made of die-cast aluminum, finished in semigloss black lacquer and chrome. It makes 12 negatives on eight-exposure No. 620 Kodak film or nine negatives on six-exposure Kodacolor film.

TNT “Kick” Made From Air

Nitric oxide, an essential chemical in the production of fertilizers and explosives, can be made by a new method so simple and inexpensive it promises to replace all methods formerly used. Nitric oxide is made by chemically combining nitrogen and oxygen contained in air. To do this, air must be heated to a high temperature to combine the elements, then cooled almost instantaneously to keep them from dividing again. In the new process, air is preheated in a pebble bed, passed through an extremely hot gas-fired furnace, then quickly chilled in a second pebble bed. This second bed stores the heat that is released, in cooling, for preheating air when the process is reversed. The advantage of the process is that little of the heat used to combine the elements is lost in the cooling. It was developed by Prof. Farrington Daniels and William G. Hendrickson of the University of Wisconsin.

By Lieut. Comdr. J. Stewart Hunter, USNR
and Lieut. Max Hodge, USNR

ON a blustery November afternoon in 1910, Eugene Ely made the first flight from a ship, taking off from a specially constructed platform on the forecastle of the USS Birmingham at Hampton Roads, Va.

"Wonderful!" exclaimed a high Navy official, but added cautiously: "What good is it to fling flying machines off a ship in the middle of the ocean if the planes can't land on the ship?"

As a reply to that question, the same Eugene Ely announced that he would attempt to land a plane aboard ship. Another platform, longer than the one on the Birmingham, was erected on top of the after turret of the battleship USS Pennsylvania in San Francisco Bay. The sides of the platform had fitted guard rails, a huge canvas screen was erected at the forward end and canvas nets were stretched along the sides; still, after a conference was held, it was generally agreed that the provisions for stopping the airplane were insufficient. The plane would certainly take more than the 120-foot platform to come to a complete stop.

"If we could reach out and grab it," someone suggested—and an idea was born. A grab hook! That was the solution. But the plane couldn't be stopped too abruptly or it would break in two pieces. How about using a series of sandbags which would progressively add resistance to the plane's forward movement? This idea had been used successfully to stop racing automobiles.

Twenty-two carefully weighed 50-pound sandbags were lined up along each side of the platform at three-foot intervals. Manila lines were stretched taut across the platform, and to each end of every line was attached a sandbag. The lines were suspended a foot above the deck for the three steel hooks that were fitted to the tail of the plane to grab.

At a speed of 39 miles an hour, Ely landed on the platform, missing the first 10 lines but catching the 11th. Each yard of forward movement brought 100 pounds more drag until finally the thousand-pound plane puffed to a com-

The 45,000-ton aircraft carrier, Franklin D. Roosevelt, heads for Upper New York Bay. Below, cables held by stanchions at sides of deck catch plane if it misses arresting gear; stanchions are hinged to fold into deck

Prize Secret

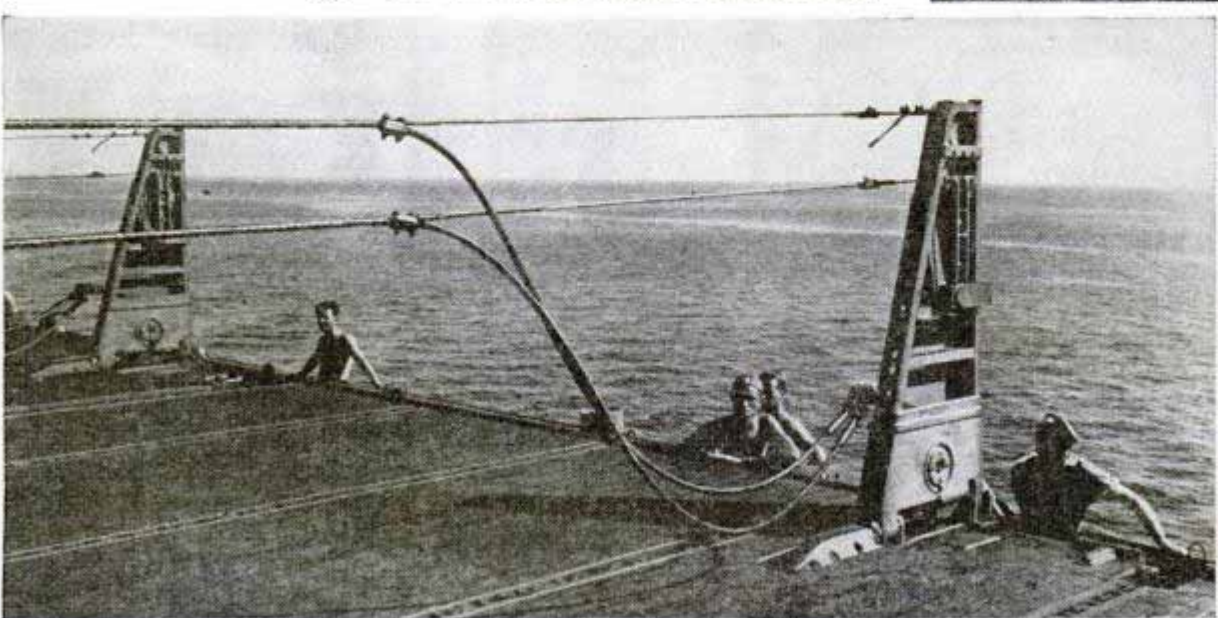
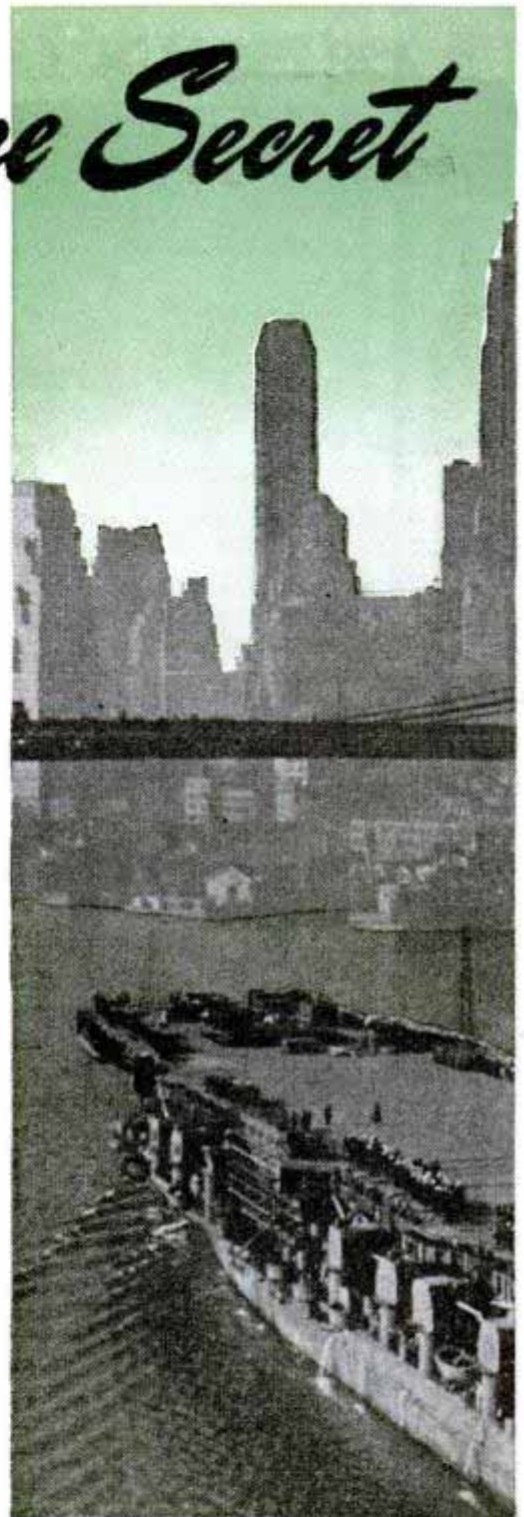

of the Flattops

At last it can be told—the full story of the U. S. Navy's amazingly efficient arresting gear that stops planes cold when they hit the carrier deck



plete stop just as it picked up the 22nd—and last—line.

On that morning of January 18, 1911, was born the modern airplane carrier and the principle of the arresting gear. The principle has never changed—only refinements have been made. It started with sandbags and passed through weight lifting and friction drums to the present hydraulic type, the mechanics of which were one of the most guarded secrets of the war.

So many weapons—radar, the atom bomb, jet-propelled planes—have been tagged “secret weapons” that the term has been worn threadbare. But the present hydraulic type arresting gear in aircraft carrier warfare had a unique niche reserved for it in the top drawer of that confidential file.

Unlike the atom bomb, for example, everyone—including the enemy, the 10-year-old neighbor boy and even yourself—was conscious of the fact that such a contraption as the arresting gear did exist. Planes landed on carrier tops and were stopped short. Everyone knew that the plane simply let out a hook that caught on a cable; yet all carrier photographs during the war had those cables blacked out and a big white-lettered “censored” stamp overprinted. Were we overcautious? Enemy secret files recently examined are proof that it was one of the smartest censorship rules of the war. Japanese carriers simply could not be operated with maximum efficiency because of their inadequate arresting gears.

They would have given their emperor with his palace tossed in for our Navy arresting gear plans!

Without the arresting gear it would be impossible to operate modern aircraft carriers. Planes weighing upwards of 16,000 pounds that normally require a landing run of a quarter of a mile could not be taken aboard ships with their limited deck space unless those planes were stopped short by cables. At the present time the Navy has two types of arresting gear in use whose fundamental differences are in capacity only. Both are capable of stopping any carrier-type airplane for some years in the future.

Let's go aboard one of today's Essex-class carriers. You are standing on the flight deck watching a fighter plane several hundred yards away flying in the opposite direction of your own ship's course. Suddenly it turns toward the ship, approaching slightly from the rear or “fantail.” Once it is directly behind the ship it makes another 90-degree turn

LANDING SEQUENCE

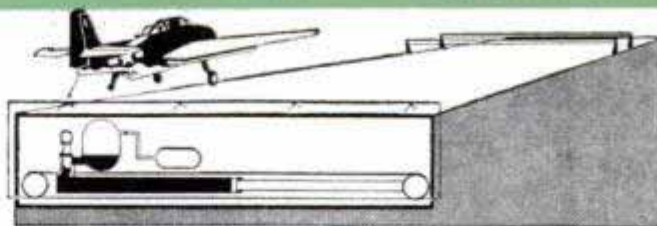

With deck pendants and barrier cables raised and landing area clear, the carrier is ready to receive the plane, coming in with the arresting hook down

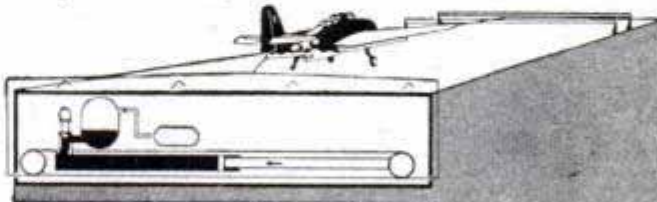

The plane's arresting hook engages the cross-deck pendant, pulling it forward, while purchase cable is being pulled out from the deck edge pulley wheels

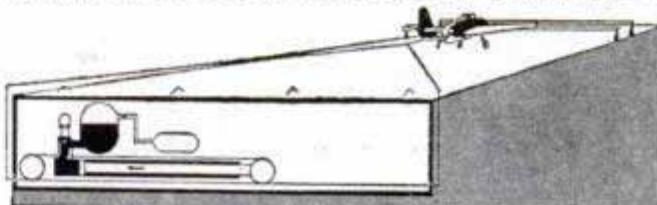

As plane travels, purchase cable is pulled out and engine ram forced into engine cylinder, displacing hydraulic fluid through control valve into the tank. This fluid metering process through control valve slows down the pulling out of the purchase cable

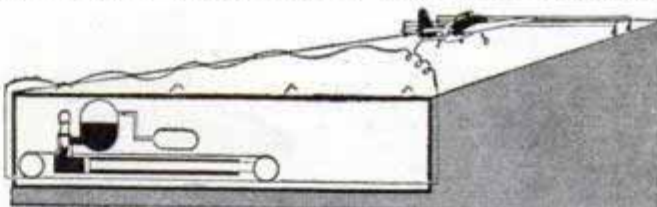

The restraining action halts the plane and on full stoppage the control valve closes, preventing the plane being pulled aft along the deck by pendant

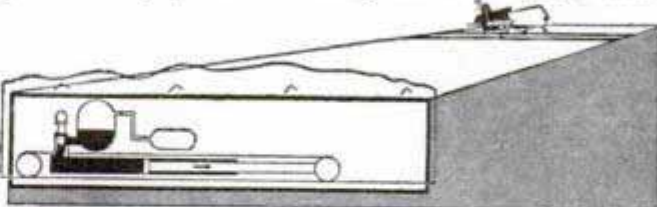

The plane moves ahead over the downed barriers or is lowered to hangar deck. Fluid from tank flows to cylinder, returning pendant to its ready position

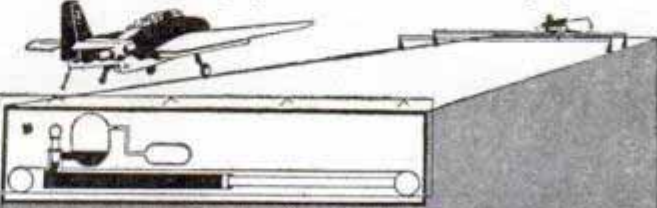

With plane No. 1 out of the way, barriers reraised, landing area clear and all arresting engines once more at battery, carrier is ready for plane No. 2

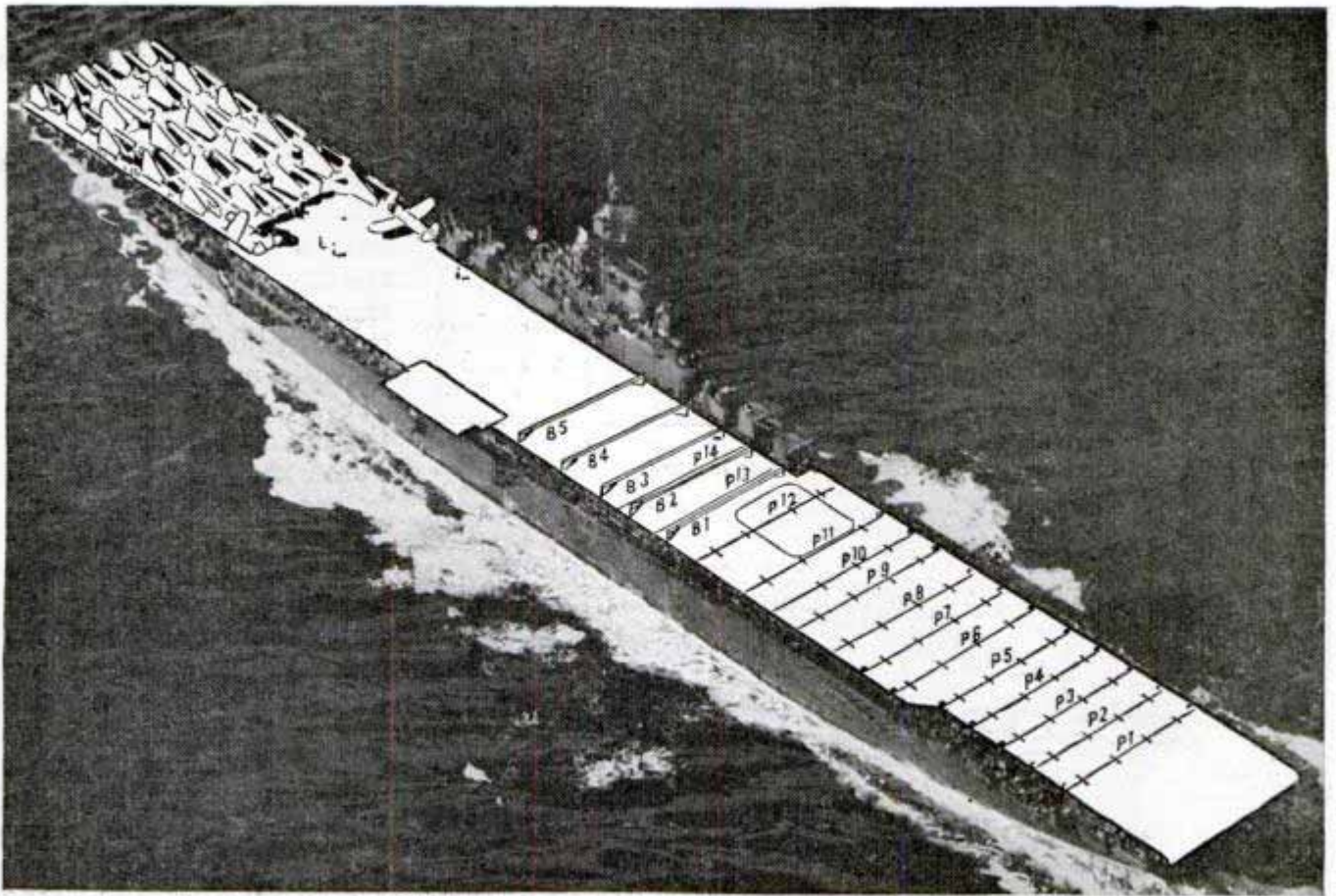

Arresting deck pendants and barriers on an Essex-class carrier are numbered for station assignments

and you see that it is now flying the same course you are making and is settling down to make a landing. The approach to the flight deck is almost identical to an approach made for a normal landing at your local airport.

Look at the stern of the flight deck. Stretched across the deck at 20-foot intervals are 12 single cables held about five inches above the deck itself by small inverted V-shape supports. These supports

Machinery below deck controls stanchion cables and pendants

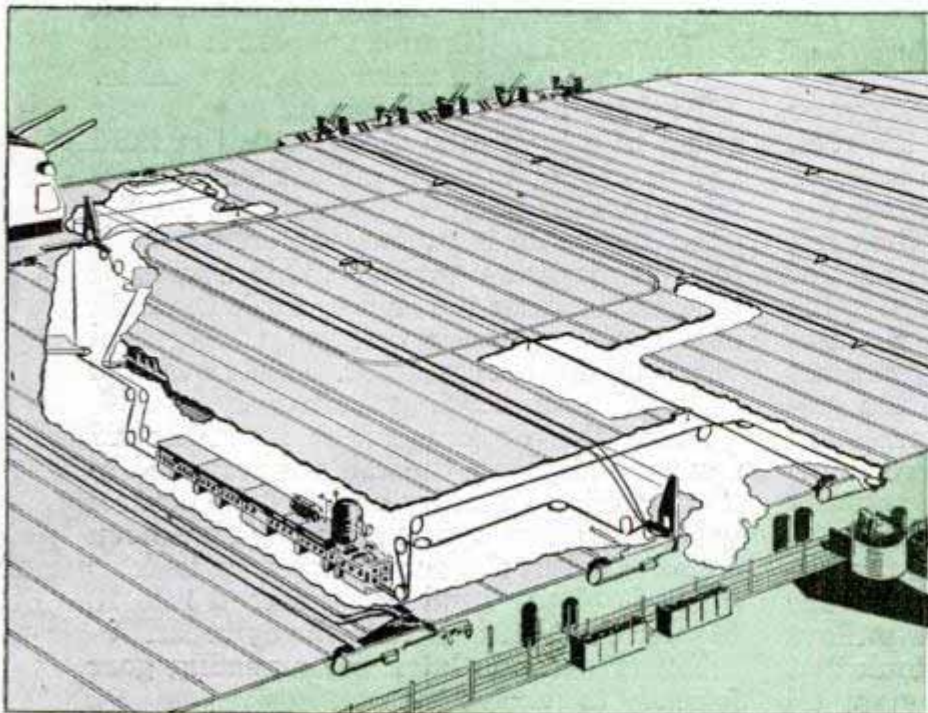

are known as yielding elements or deck pendant supports while the cables themselves are the deck pendants. In such a position, these cables can easily be caught by the arresting hook—a simple, solid steel hook—which trails from the tail of the airplane during the landing approach.

But just in case that landing hook doesn't catch—if through pilot error, mechanical failure or battle damage the plane threatens to come plowing into other planes that may be parked in the forward area of the deck—five "fences" five feet high, supported by stanchions on either side of the deck, are provided as protection. These barriers, each consisting of two cables, stop the plane in much the same way as the deck pendants except that they engage the plane itself.

The landing plane slowly settles to within a few feet of the deck. Suddenly the hook catches and the cable or deck pendant seems to be stretching much like a rubber band. Actually what is happening can best be described by comparing the operation to a fishing rod. When the hook catches a fish, the weight of the fish pulls more line from the reel. The way you keep the line from completely unrolling from the

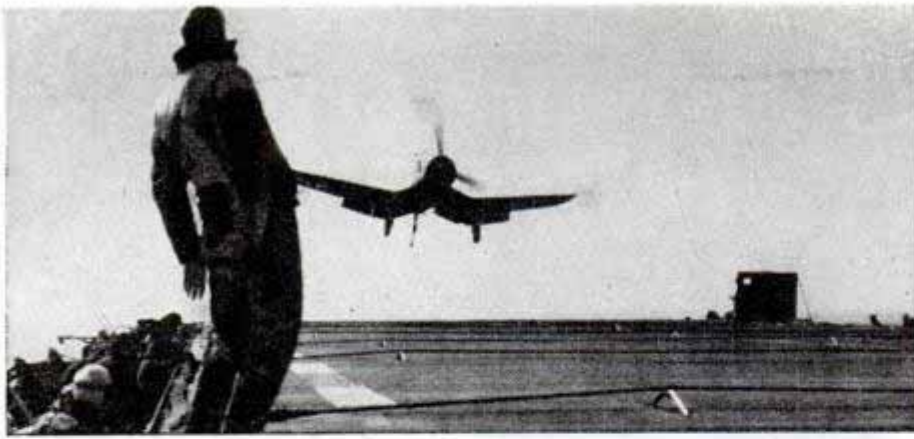

With flaps down and hook extended, plane drops toward deck; note cables



An F6F-3 is about to hook arresting gear cable five inches above deck

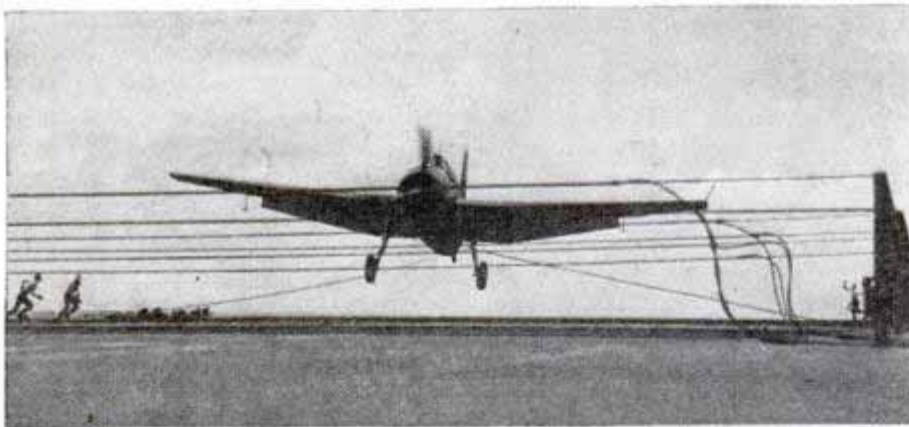

Double cable barriers will hold back fighter should deck pendants fail

reel is to exert gradual pressure with your fingers, thus slowing the speed of the reel. An arresting gear works the same way.

However, the giant finger that exerts the pressure is not on the flight deck. The deck apparatus is actually a very small part of the machinery that goes to make up this complex hydraulic system. To see the majority of the arresting machinery you must go down under the flight deck to the gallery deck where you will find the arresting engine, the control valve and the accumulator. This is the equipment that actually does the work of stopping the airplane.

Here are the heart and brains of the hydraulic-type arresting gear. What you see are long steel girders, with steel pulleys and cables, an engine and a steel tank that appears to be a miniature of a giant oil

storage tank. One of these arrangements is never connected to more than two deck pendants or one barrier cable and one deck pendant, which, in effect, results in a number of self-contained arresting systems rather than one system for all cables and barriers. This permits continuation of air operations even though some of the equipment may be damaged and out of commission. Thus on the modern carrier there are eight to 10 of these arresting engine units spaced at irregular intervals, usually near the port side along the gallery deck.

Here is what happens when a plane lands on the flight deck of a big Navy carrier:

The hook of the plane engages the deck pendant or cable, drawing the cable forward on the deck. The purchase cable, a continuation of the deck pendant, is pulled along with the deck pendant from the sheaves or pulley wheels at both edges of the deck. This purchase cable may be visualized as a continuous cable looped around a set of fixed and a set of movable pulleys in the arresting engine and with its ends coupled to a deck pendant or barrier cable.

To these fixed spools or pulley wheels is attached a hydraulic cylinder full of fluid and to a set of movable pulleys a ram is attached which fits into the cylinder. As the purchase cable is pulled out on the deck by the airplane through this series of wheels, it causes the ram to force the fluid out of the cylinder through the control valve to the accumulator. This slows the plane without stopping it abruptly.

After the deck pendant is unhooked from the airplane, the cable is returned to its normal position by opening the control valve and allowing the air, which has been compressed in the accumulator or tank as a result of the fluid being forced into it, to push the fluid back into the cylinder.

Thirty seconds later the arresting gear is ready to receive the next plane.



Rocket-Assist Lifts P-80

Takeoff distances for the jet-propelled Lockheed P-80 have been halved by use of external rocket-assist units delivering a total of 2000 pounds of thrust for 12 to 15 seconds. In one test the plane was airborne at 1185 feet, about 40 percent of its normal requirement. The units make it possible for a fighter to use short emergency landing strips during combat operations. The two units, called JATO, are heavy steel tubes about eight inches in diameter and three feet long. They burn a solid rocket

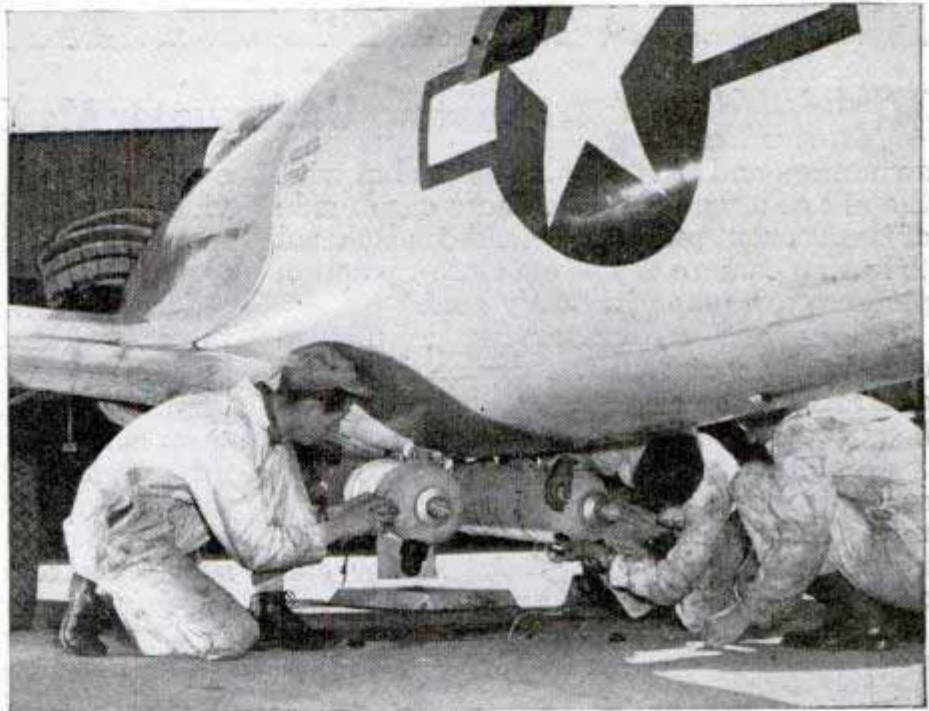

engine on the underside of the fuselage, the JATO units are electrically discharged by a gun trigger on the pilot's control stick.

Mine Ambulance Runs on Rails to Speed First Aid to Injured Men



Injured coal miners are insured a quick, safe and comfortable ride to the hospital in an electrically heated mine ambulance which has been put into operation at Piney Fork Mine in Ohio. The underground ambulance is mounted on rail wheels. It is equipped with first-aid supplies, medicine and a portable cot which can be rolled quickly into a regular ambulance at the mine entrance.

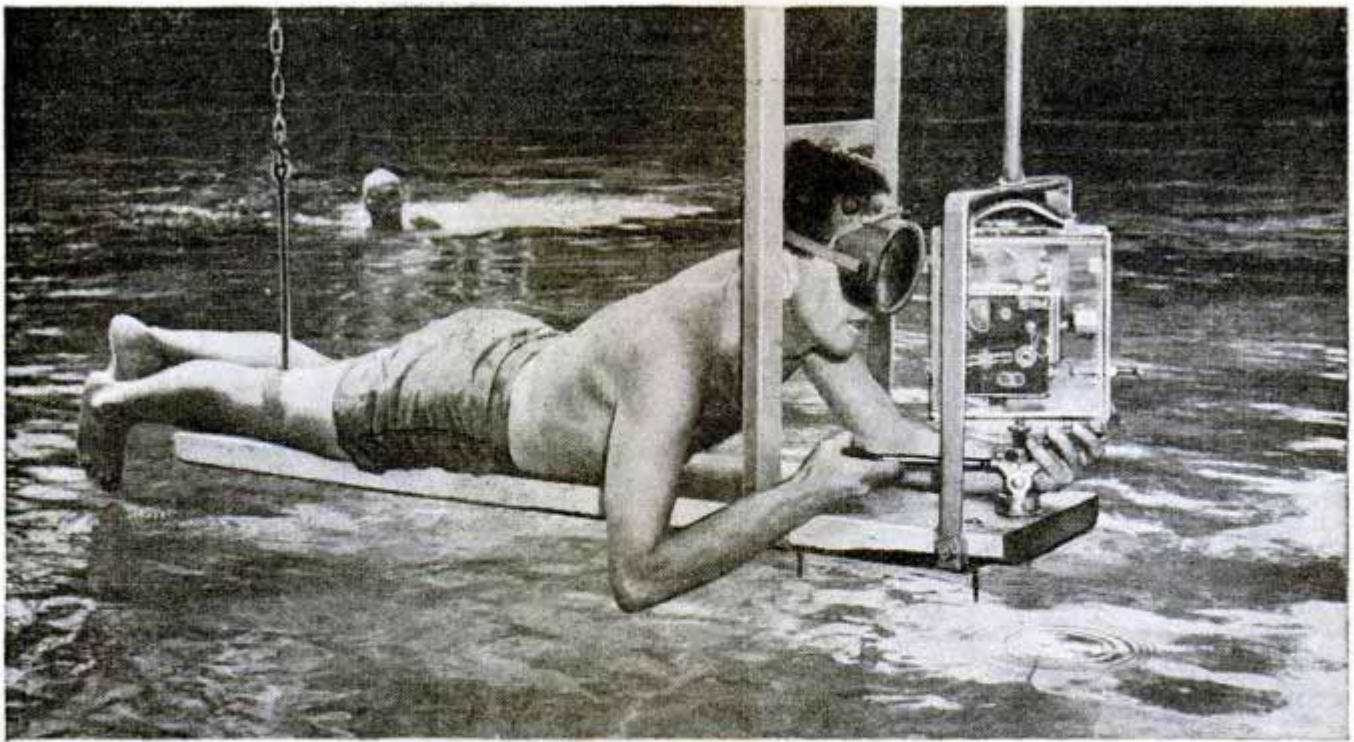

FISH-VIEW movies of underwater

Shooting Underwater Movies

swimmers and sea growth can be shot with the aid of a waterproof camera case made of transparent plastic. The case is also used to keep a camera dry when close-up action pictures are taken in heavy surf.

Ordinary 16-millimeter motion picture cameras will fit into the device. External controls on the case permit the camera to be started and stopped with ease.

Amateur underwater photographers use sea-dive masks to keep their eyes dry and thus give them normal vision while shooting their movies. The photographer can take short footage of film by diving beneath

the surface and holding his breath. How-

ever, lightweight diving helmets that provide oxygen are available, enabling swimmers and photographers to remain underwater for half an hour or more.

Placed on a movable underwater stage, the camera and case aid swimming coaches by taking close-ups of a swimmer's action in the water. Natural color movies have been made of swimmers exploring the kelp forests along the coast of California. Photographers also have shot action sequences of swimmers using harpoons to catch small sharks and other fish, and have filmed "flying fish" views of paddle board races.



Do's and Don'ts of DDT

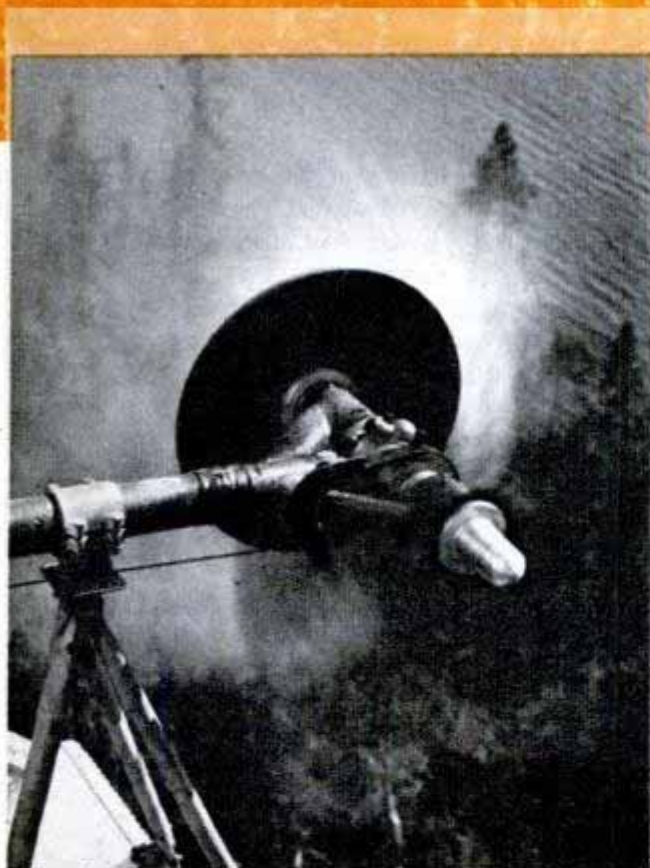

DDT is sprayed from a plane (top) to kill insects threatening Canada's forests. Above, close-up of sprayer

By John L. Kent

PUBLICITY given to DDT as an insecticide has created wide interest in its possible uses, and now that it is available for agricultural and civilian purposes, many inquiries regarding it are being received by the U. S. Department of Agriculture.

The Bureau of Entomology and Plant Quarantine, in cooperation with various State Agricultural Experiment Stations and other agencies, has conducted many tests with DDT during the past three years. The results of many of the preliminary small-scale experiments are already available, but the outcome of more extensive tests being conducted are still to be determined. Information at hand indicates that for certain purposes and under certain conditions DDT is effective and safe to use at the present time.

DDT is suitable for use as an insecticide only when properly prepared. It is not easy to formulate an insecticidal dust from technical grade DDT. However, many manufacturers are equipped to grind it with talcs, clays, sulphur or other materials into fine powders that contain DDT in various strengths. Pure DDT is a white, crystalline, synthetic substance resulting from the reaction between monochlorobenzene and chloral hydrate or chloral. The name DDT was officially adopted by the United States

- ★ ★ ★ ★ ★ ★ ★ ★ ★ ★ ★
- ★ **DDT is wonderful. It will kill lots of insects.** ★
- ★ **But be careful how you use the poison—** ★
- ★ **it can't tell a cockroach from a honeybee** ★
- ★ ★ ★ ★ ★ ★ ★ ★ ★ ★ ★

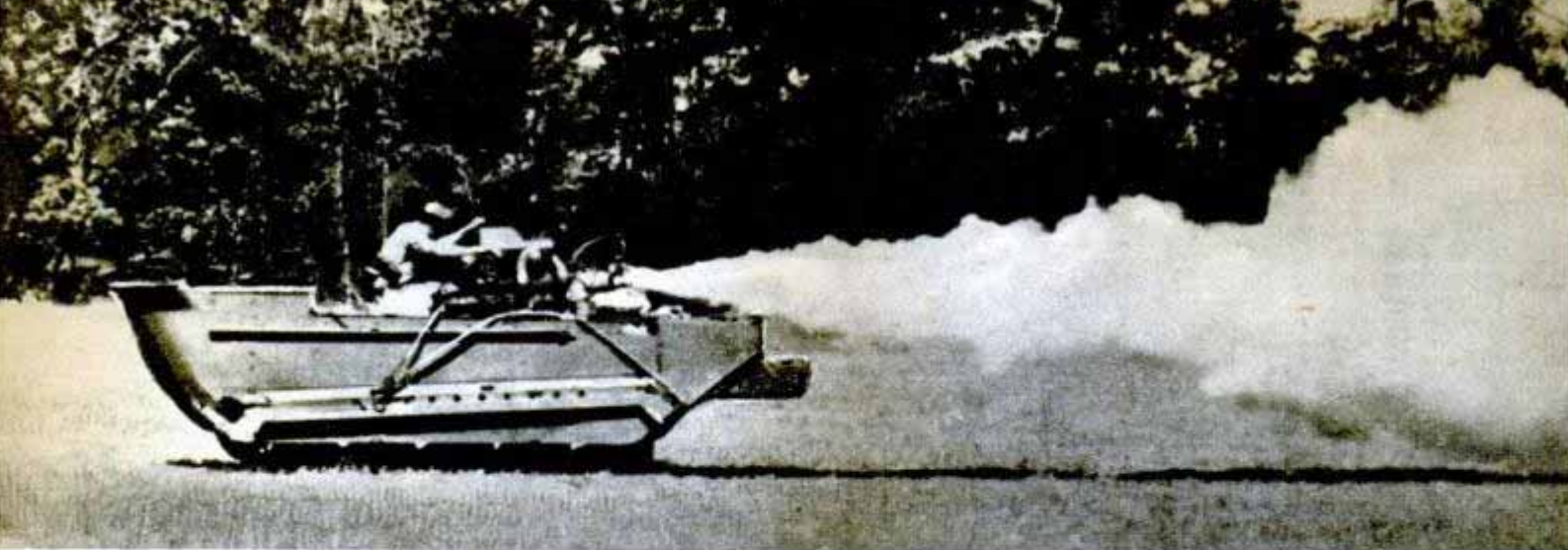

New York State Science Service photo

Mounted on an Army Weasel, a Todd insecticidal applicator shoots out DDT fog over Long Island marshes

and British armed forces to stand for the initial letters of its chemical name—dichloro-diphenyl-trichloroethane.

DDT is not a new discovery. It is more than 70 years old, and its recent "discovery" should be more appropriately called a rediscovery. The story of DDT goes back to 1874 when a chemistry student, Othmar Zeidler, attending the University of Strassburg, included in his thesis an account of a chemical compound he had discovered in routine experiments. The thesis was duly read and filed, and Zeidler, having received his diploma, went through life in comparative obscurity.

In 1939, 65 years after Zeidler first made the tiny white crystals in the university laboratory, a Swiss scientist, Dr. Paul Muller, began experimenting with dichloro-diphenyl-trichloroethane. He is generally credited with discovering its insecticidal use. He was issued patents on the compound by Great Britain, and these were assigned to his employer, the J. R. Geigy Chemical Company. In October 1942 this company introduced the insecticide in the United States under a trade name. Tests carried out at the Orlando, Fla., laboratory of the Bureau of Entomology and Plant Quarantine proved it to be sure death to body lice—just the sort of insecticide the armed forces needed. It was also found to be deadly to bedbugs, flies and fleas.

In the meantime, experiments showed that DDT was effective against malaria-carrying mosquitoes. Malaria was taking a heavy toll of our men in the Pacific and louse-borne typhus was threatening them in the European theater. All production of DDT therefore was immediately channeled to the armed forces.

DDT insecticides proved effective not only for killing the adult mosquito, but also for killing the larvae or "wrigglers" that hatch in swamps and other stagnant waters. By employing a large airplane and newly invented devices for distribution, it was possible to treat more than 500 acres

with 800 gallons of DDT spray in 30 minutes.

The successes scored by DDT against disease-carrying insects have been described graphically by newspapers and magazines. By the middle of 1944, the Department of Agriculture had received so many requests for supplies of DDT that officials were forced repeatedly to inform the public that DDT was not available for civilian use, and while it appeared promising for future control of many insects, many of the experiments to test its effects on insects, plants and higher animals were still in preliminary stages. Even today, entomologists agree that although it is the most effective mosquito control agent yet known, it must be properly prepared and applied to give satisfactory results.

But under proper handling DDT is bound to be a great aid to mankind. For example, DDT saved a giant fir tree in Clatsop County, Oregon, from destruction by loopers, swarming caterpillars which constitute a serious threat to timber. Believed to be the biggest tree in the Pacific Northwest, this tree has a diameter of 15 feet and is thought to be at least 1000 years old. DDT killed hundreds of loopers clinging to it.

The Department of Agriculture is conducting widespread experiments on increased use of DDT to destroy insect pests that plague the nation's forests. One 75-acre tract in Grand Mesa National Forest



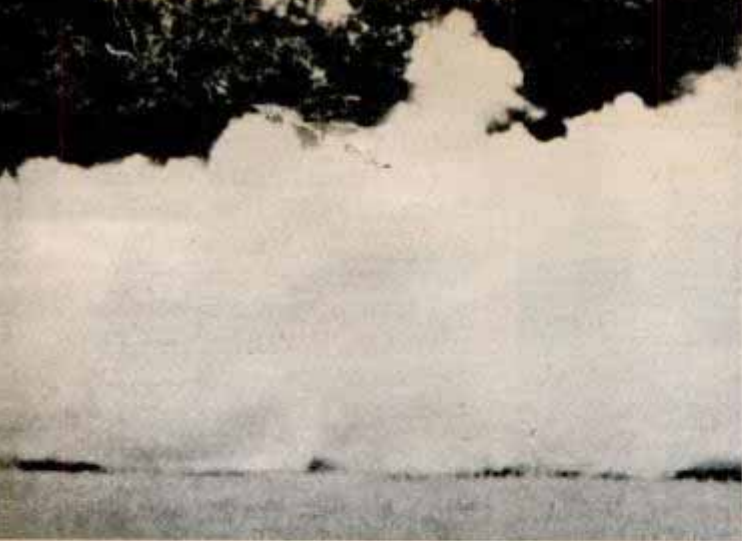

in Colorado is the target for "attack" by aerial spraying. One pest in particular that the government men are "gunning for" is the spruce budworm. This pest is extremely prevalent in Colorado's 15 national forests which cover more than 15,000,000 acres, according to John W. Spencer, Rocky Mountain regional forester.

Canada, likewise, is experimenting with the use of DDT to fight budworms which attack forests. Both Canadian and American scientists are engaged in spraying 85,000 acres, aided by Royal Canadian Air Force planes and pilots.

DDT is used in aircraft for spraying over large areas to kill mosquitoes only when such use is found to be necessary and is directed by competent authorities. Improper application may upset the balance of nature by killing beneficial insects which aid the growth of trees and plant life. Also, there is the danger of destroying fish.

DDT acts both as a contact poison and a stomach poison. The toxic effect from either contact or ingestion is apparently exerted principally on the nervous system of the insect. Insects first display hyperactivity and tremors, followed by progressive paralysis of their locomotor appendages and death.

DDT has a great residual effect, and for

THE DON'TS OF DDT

DON'T use larger doses than specified in directions



DON'T use on cats and don't apply penetrating oil solution to any animal



DON'T use near fire; solution often contains kerosene



DON'T inhale DDT spray or powder; leave closed room immediately after spraying



DON'T use near food



DON'T leave oil solution on skin; wash off with soap



DON'T keep DDT within reach of children or pets



DON'T expect DDT to discriminate between a mosquito and a honey bee



several weeks or even a month after the original application in the form of a spray or powder, the deposit will kill insects which rest on or crawl over the treated areas. This prolonged action, while desirable from the point of view of insect control, introduces a possible hazard from residues left on plants.

DDT is also very workable—it may be used in water suspensions, solutions, emulsions, dusts and aerosols.

When used experimentally, DDT has been found promising for the control of several types of insects attacking cereal and forage crops. Corn borers, vetch bru-

DDT fog dispensers attached to trucks "de-bug" a weed-covered field next to Woodbine, N. J., hospital





Canadian Army chemist sprays liquid DDT insecticide into a spruce forest

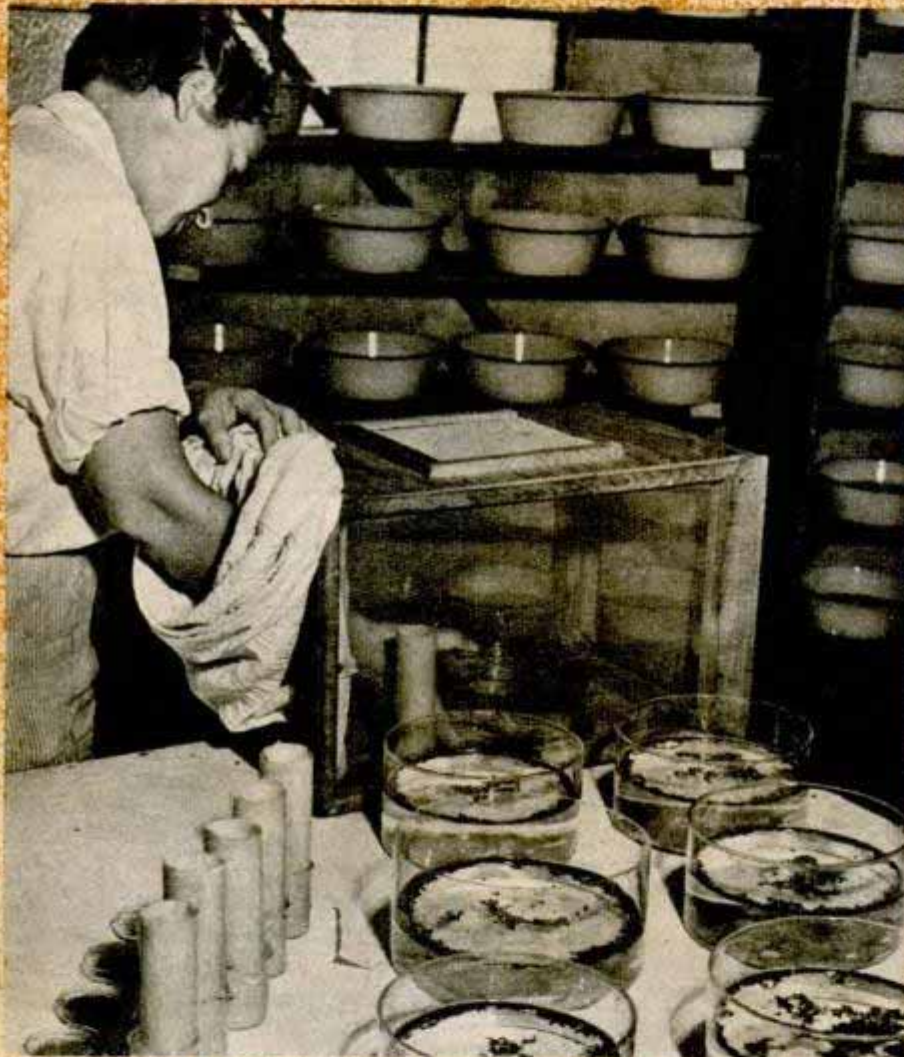

Department of Agriculture entomologists raise mosquitoes with which to test DDT sprays. Cows are sprayed with DDT (below) to rid them of flies



chids, white fringed beetles and velvetbean caterpillars become victims.

DDT has been found extremely effective against most of the common pests of stored seed, and its use for that purpose is recommended. It is best used in combination with a carrier dust to give it greater volume and insure a better distribution over the seed. A very effective combination is obtained by using magnesium oxide as the carrier dust. DDT alone does not repel insects, but magnesium oxide does. One half ounce of a three percent DDT dust per bushel of seed will give complete protection. Neither product has any adverse effects on germination, regardless of the moisture content of the seed.

Because of the poison hazard, the use of DDT is not recommended on stored grains or cereal products that are to be used for food by humans or animals.

Sprays, containing five percent or less of DDT dissolved in refined deodorized kerosene or in water suspension or emul-

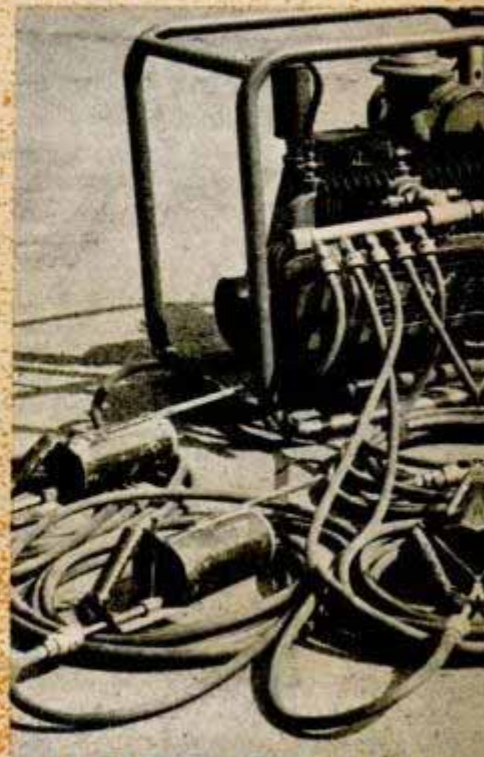

sion, have been found very effective and are recommended for use on walls and woodwork of warehouses, flour mills and empty grain bins.

In one test at Corvallis, Ore., a ship bottom repelled barnacles for more than six months after being painted with a DDT mixture developed by Prof. R. E. Dimick of Oregon State College.

DDT has shown great promise in controlling insects affecting man's habitation and his person. Although conflicting reports have been received on its effectiveness against certain species of ants, cockroaches and spiders, it is potent against house flies, mosquitoes and bedbugs.

A five percent solution of DDT in odorless kerosene or a 2½ percent suspension made of DDT powder, a wetting agent and water may be applied as a spray to any surface where flies rest, such as walls, doors, screens and ceilings. These sprays are applied at the rate of two to four quarts per 1000 square feet. Flies die one to three hours after alighting on surfaces which received this treatment. The same method will kill mosquitoes. The material sprayed remains effective for two to six months.

The annoyance from sand flies in homes can be reduced by treating screens with a five percent DDT oil spray. The screens and wall or ceiling surfaces near lights may be sprayed or treated with a cloth. This treatment remains effective for several weeks.

For cockroaches a 10 percent DDT powder is about as good as sodium fluoride for treating their hiding places. It lasts longer than sodium fluoride, but, as in the case of

that material, about one week elapses before there is a marked reduction in the number of roaches present. A five percent spray containing DDT may be used on the underside of table tops, drawers, refrigerators and shelving as additional treatment.

To get rid of ants in buildings, it is recommended that five percent DDT kerosene be sprayed behind and beneath baseboards, behind window sills and frames, to all table legs and chair legs, about sinks in the kitchen and bathroom and to any cracks and crevices leading to the outside of the building. Not all types of ants will be destroyed but a single application of the spray will kill most of them.

DDT is the answer to the bedbug problem. When properly applied as a five percent spray or as a 10 percent powder, beds and mattresses will remain free of bedbugs for six months or more.

House pets, too, benefit from this new insecticide, as a few applications of DDT will rid a home of such pests as brown dog ticks and fleas. For fleas in houses, 10 percent powder may be applied to the sleeping places of dogs and cats. It may be used beneath rugs and on floors visited by flea-infested animals. One half pound will treat 1000 square feet. A five percent DDT kerosene spray may be used on similar places as well as on the top surface of rugs. Use one quart to 250 square feet and apply as a thick spray; fine sprays will drift away.

DDT is a marvelous discovery. It does all that scientists say it will do. But DDT will not work its magic in all the preparations now being sold. Some preparations

Delousing machine (left) developed by the Quartermaster Corps dusts 600 persons per hour with DDT powder. Right, an American soldier delouses former slave laborers and political prisoners freed from a German camp

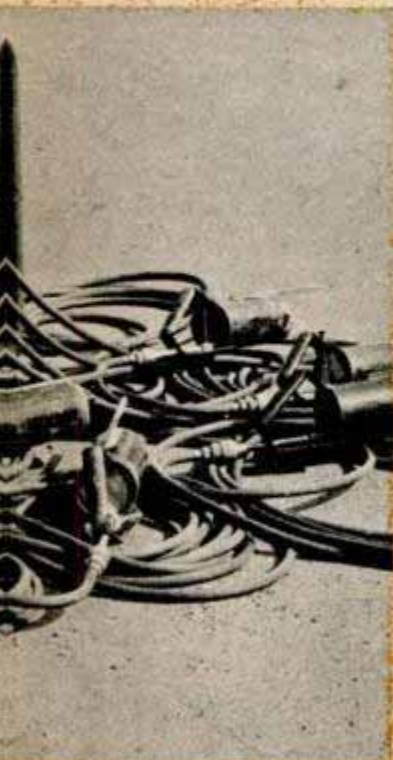



H. D. Hudson Mfg. Co. photo 587 E. TULLINIS ST
 DDT is applied to chair with electrical sprayer. Below, nurse at Arlington, Va., sprays a hospital bed



Westinghouse photo

DDT bug bombs developed for the war are now avail-

presumably containing this highly effective insecticide are actually far too dilute. Public demand, fanned by exaggerated claims, misleading advertising and incomplete labels, has skyrocketed sales.

The Insecticide Division of the Department of Agriculture is preparing to crack down on those who violate the Insecticide Act of 1910 by making false statements on labels. To avoid making statements which may later have to be changed, or which may result in legal action, manufacturers have been urged to submit copies of their proposed labels, together with formulas of the preparation, to the Department of Agriculture for approval.

On the other hand, users are cautioned by the Bureau of Entomology and Plant Quarantine that insecticides containing this new material will be suited to some of their needs, but not to all of them. Scientists at the bureau and at other private and government agencies are still occupied in mastering it. Used indiscriminately, DDT is a poison. Here are some precautions:

1. Do not use larger dosage than called for by the directions.
2. Do not use on cats and do not apply oil solutions to any animals. Also, DDT is definitely poisonous to warm-blooded ani-

ST CHARLES HILL



able for civilian use to combat flies, lice and roaches

imals when a considerable quantity is eaten.

3. Do not use near open flame or fire, as kerosene or "coal oil" is often used to carry DDT in solution. For the same reason, do not smoke while spraying.

4. Do not inhale considerable amounts of either solution or powder containing DDT. Therefore, do not remain in a closed room immediately after spraying.

5. Do not spray or use powders on or near foods.

6. Do not leave oil solutions on skin. In oil solutions or emulsions DDT is readily absorbed through the skin. In case of accidental spillage, wash hands or other parts of body immediately with soap and water.

When used in the home, keep DDT out of reach of children and away from household pets.

When used on the farm remember that there is the danger of destroying desirable insects, such as honeybees and insect-feeding birds. It is highly toxic to fish.

In many ways DDT preparations are superior to the older insecticides, but do not expect miracles. In fairness to yourself and to the product used, familiarize yourself with the particular spray or powder and find out how to use it and what results can be reasonably expected.



U. S. Dept. of Agriculture photos

Painting screens with DDT solution to kill flies and mosquitoes. Below, spraying DDT behind baseboards





THIRTEEN MOTORS TO PORT AND STARBOARD, EACH RECEIVING POWER FROM A CENTRAL TURBO-GENERATING PLANT

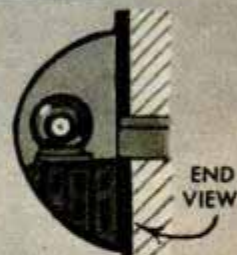
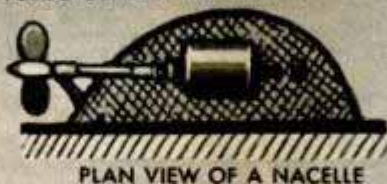
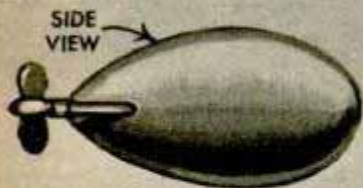

ICE CUBE FLATTOP

Designed by British to Fight Subs

Habakkuk Project was the British designation for a 2,000,000-ton torpedoproof aircraft carrier to be built of blocks of reinforced ice. The iceberg carrier, more than a third of a mile in length, was designed to fight subs and to provide air cover for the invasion of Europe. Plans called for walls 40 feet thick, laced with refrigerating pipes and covered with insulating material. The ice blocks, dubbed Pykrete, were reinforced with 14 percent wood pulp because ice alone was too brittle. Thirteen nacelles on each side were to provide propulsion units with each propeller driven by an electric motor. A 1000-ton model was built on a Canadian lake. The project, sanctioned by Winston Churchill, was abandoned only after the war against the U-boats turned in the Allies' favor in 1943.

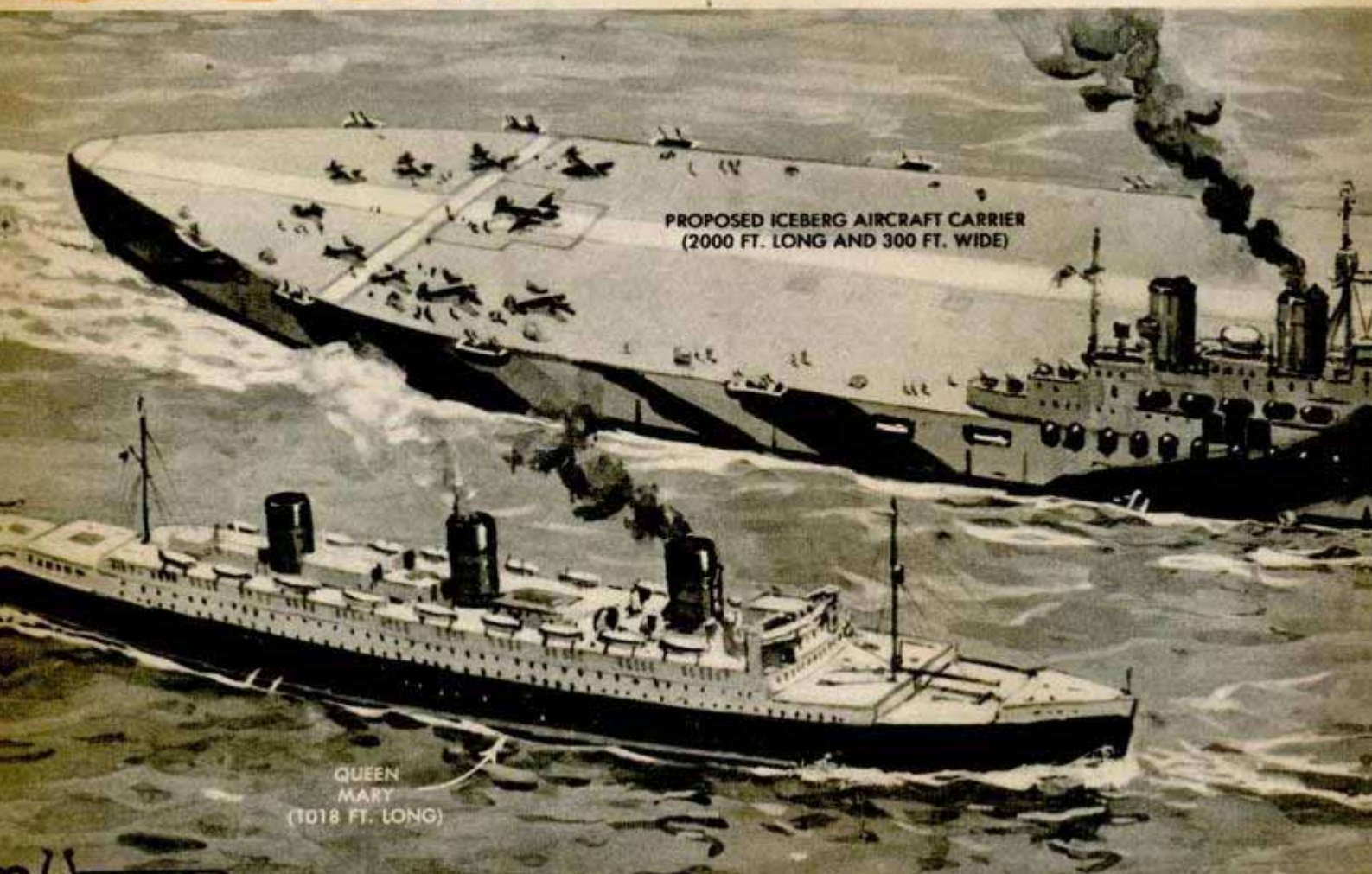

PROPOSED ICEBERG AIRCRAFT CARRIER
(2000 FT. LONG AND 300 FT. WIDE)

QUEEN
MARY
(1018 FT. LONG)

ICE WALLS
OUTER AND INNER INSULATING COVERING

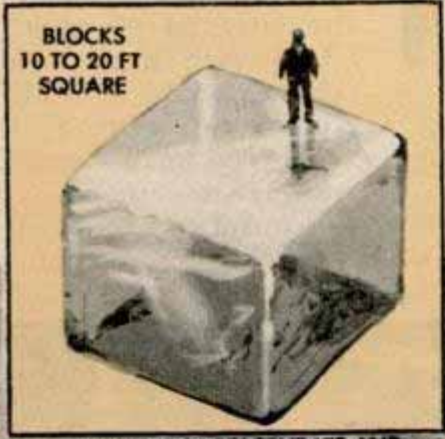
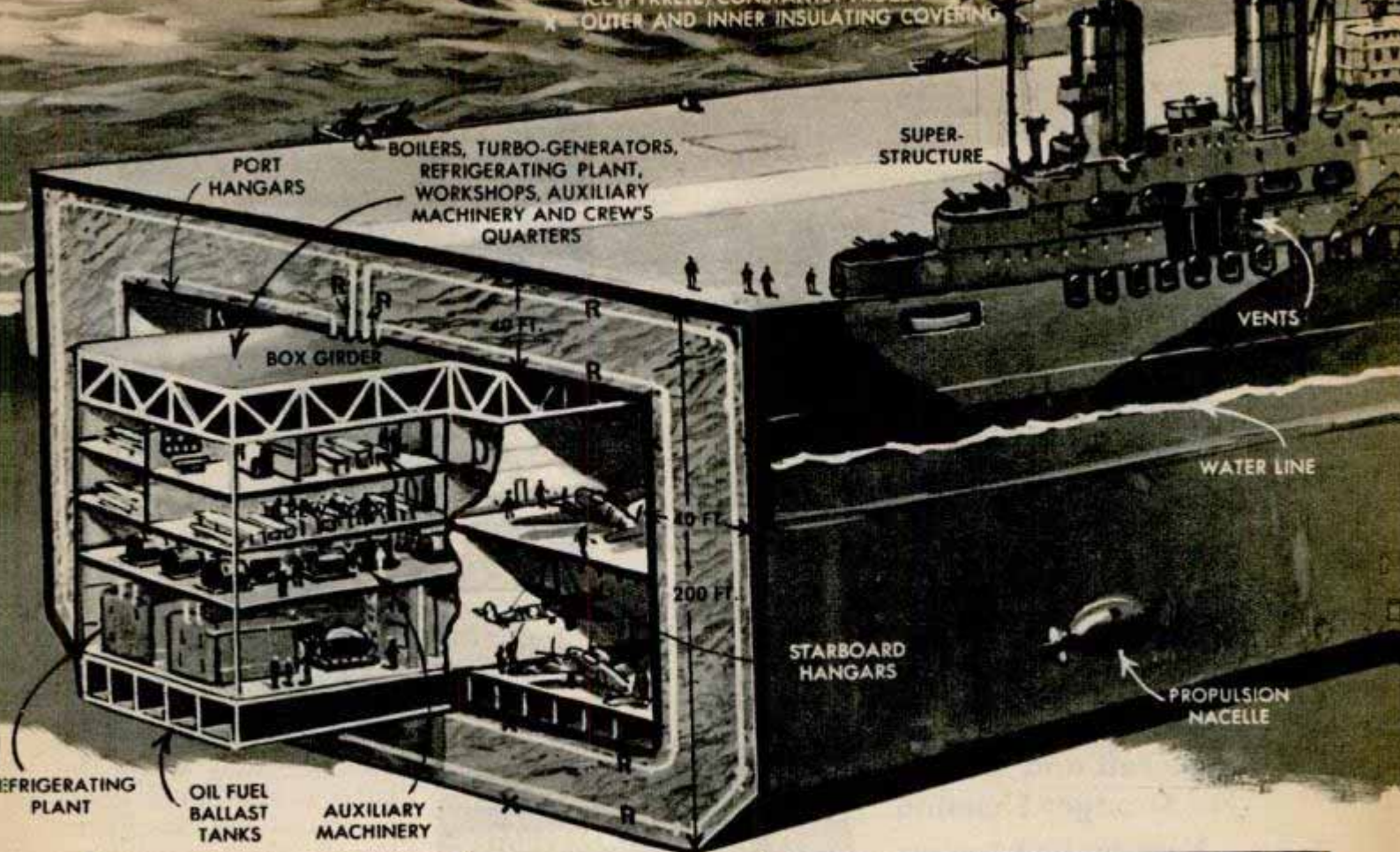

PYKRETE IS 86 PERCENT ICE AND 14 PERCENT WOOD PULP

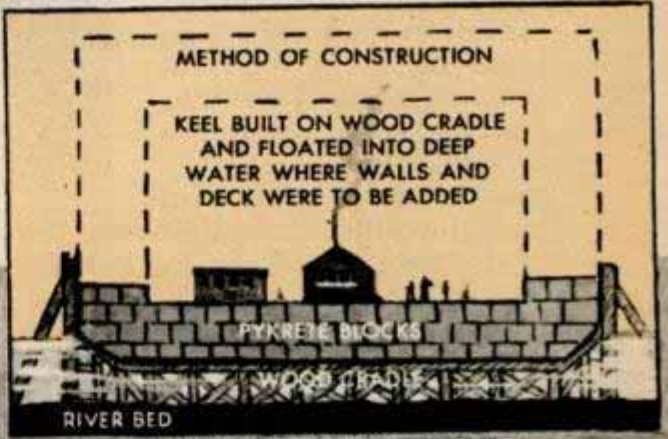

IT WAS TO BE BUILT OF PYKRETE BLOCKS FROZEN TOGETHER

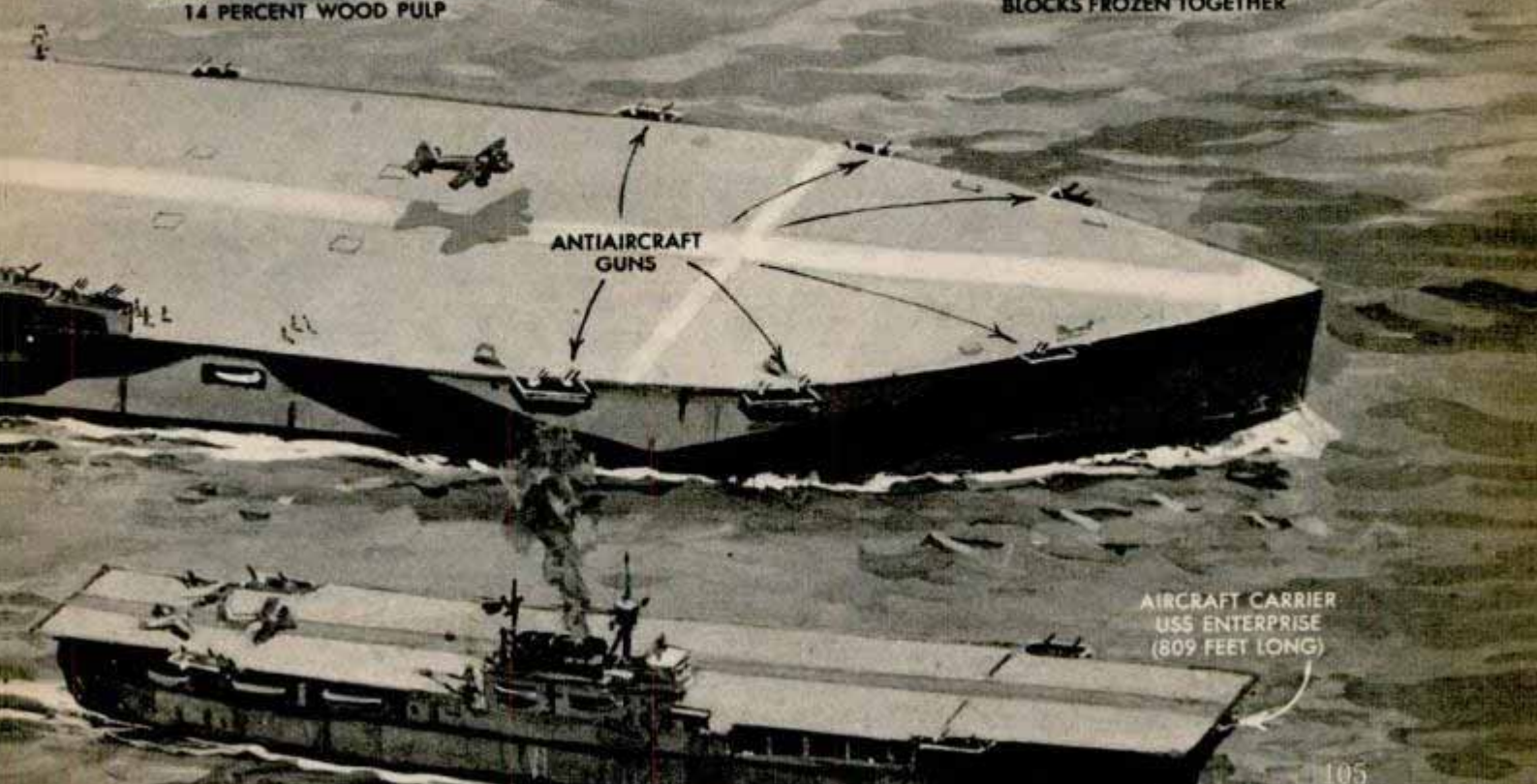

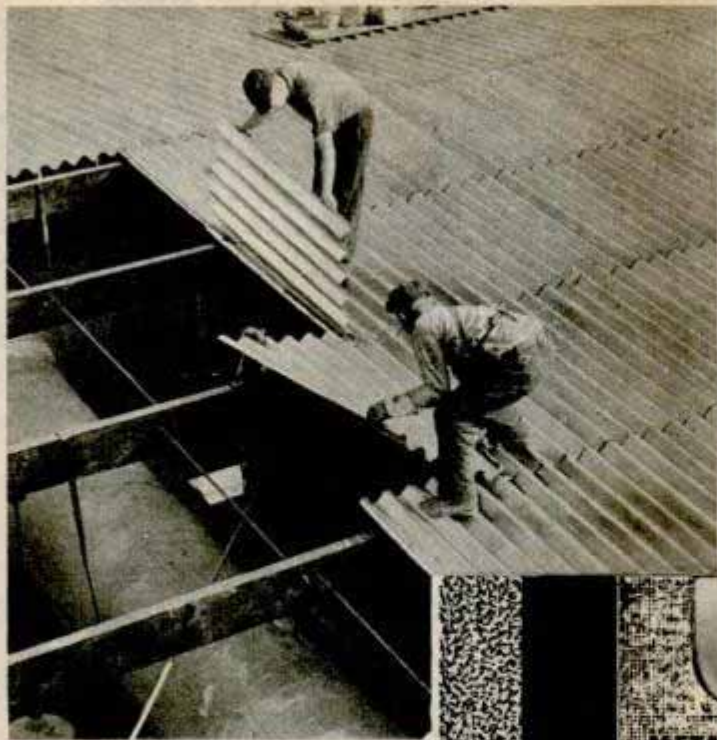

Fuse Felt and Steel For Stronger Sheeting

Made by fusing asbestos felt to steel, a sheeting material has a high resistance to wind, weather and the corrosive fumes of industrial areas. First step in the process is to add a metallic alloy adhesive to the surface of the steel core. Then the felt is squeezed

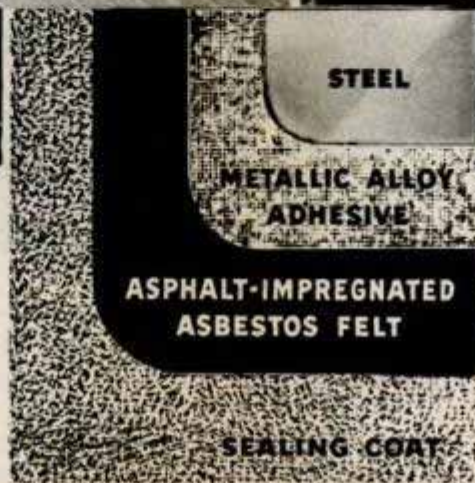

into the alloy while the latter is still liquid, deeply embedding the fibers. For further protection, the surface is impregnated with asphalt and coated with a sealing compound, giving it a black, leatherlike appearance. The sheeting, in either flat or corrugated form, can be worked on regular sheet metal shop equipment.

into the alloy while the latter is still liquid, deeply embedding the fibers. For further protection, the surface is impregnated with asphalt and coated with a sealing compound, giving it a black, leatherlike appearance. The sheeting, in either flat or corrugated form, can be worked on regular sheet metal shop equipment.

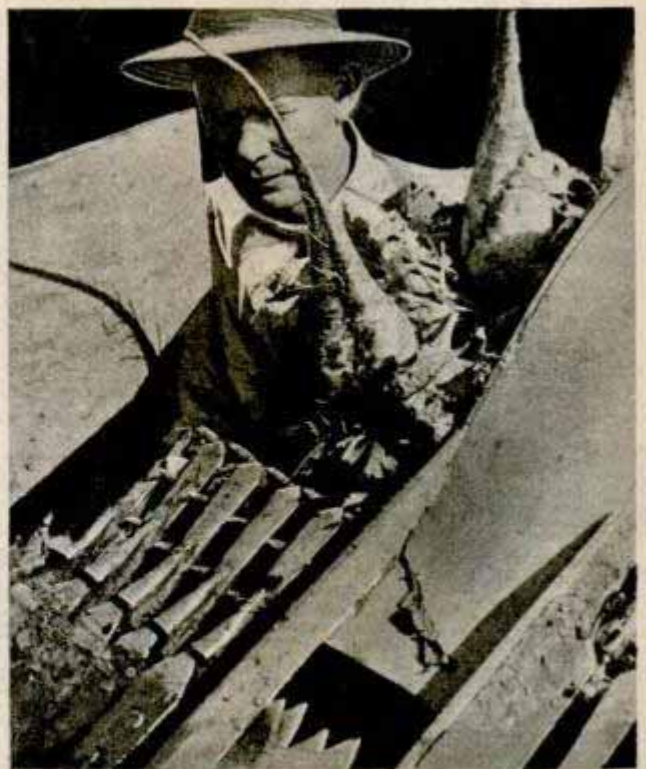

Beet harvester digs and slices the tops from 200 tons of beets per day. Sharp spikes jutting from the wheels unearth the beets and deposit them on stainless steel knives

which shear off the tops. A conveyor belt loads the produce into a truck or trailer moving alongside the machine. It formerly required 40 men a day to do the work.

How the Iron Pin Boy Works

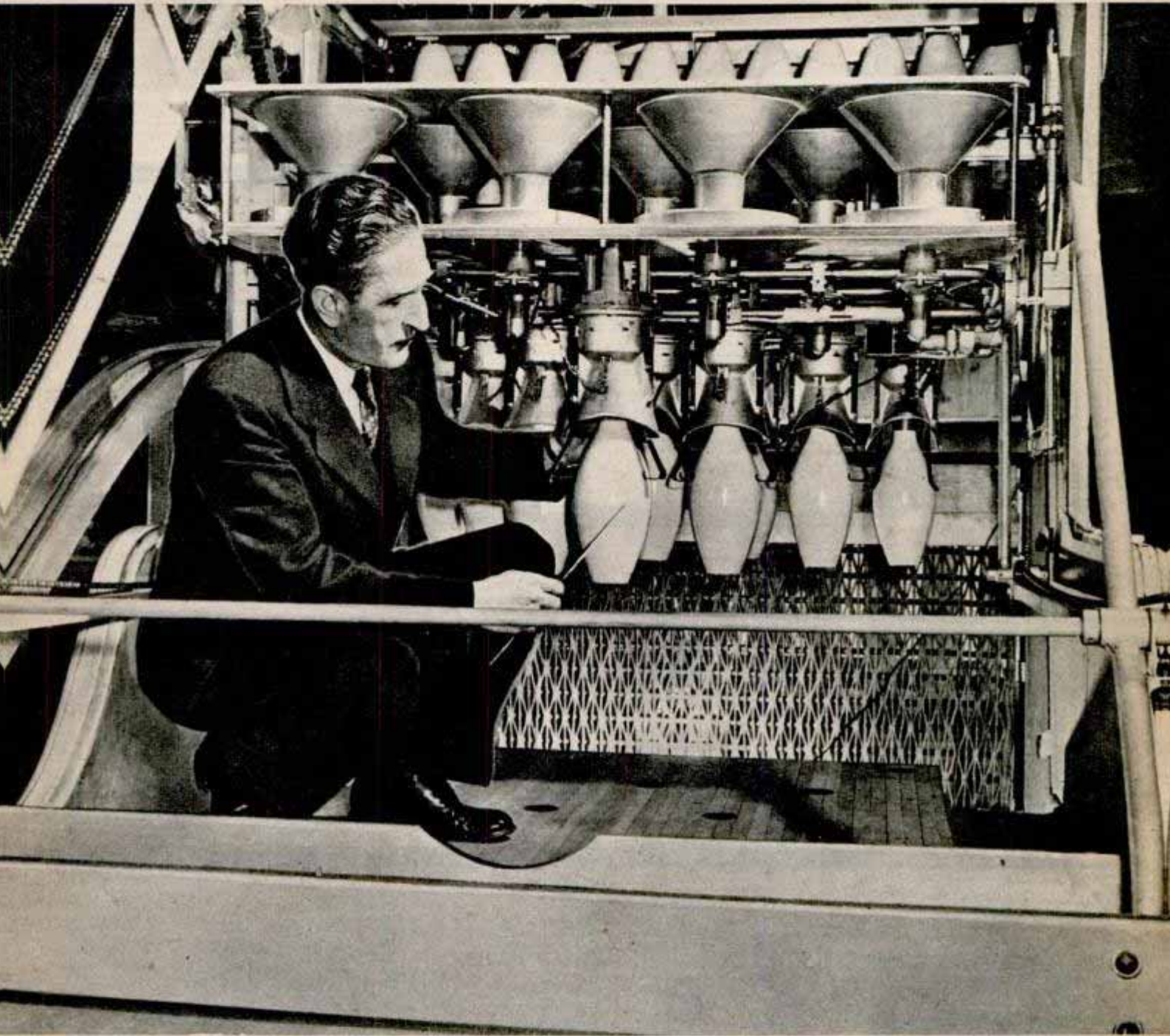

Robot pin spotter is examined by its inventor, Fred Schmidt, who spent 12 years developing the mechanism

SOME DAY it may be unnecessary for 100,000 Americans to bend over about 30,000,000 times a day. An automatic pin spotter may replace the pin boys now toiling in 74,000 alleys serving some 15,000,000 bowlers.

The spotter, produced by the American Machine & Foundry Company, long-time producers of cigarette and cigar-making machinery, almost wholly mechanizes the most popular participant sport in the nation today. The bowler provides the only remaining human touch as this almost super-human gadget sets the pins with perfect accuracy; lifts standing pins after the first ball; sweeps away the deadwood and

returns the ball; resets the standing pins in their original positions; clears the alley after the second ball, and sets up another ten pins for the next bowler. All this in 17 seconds, if the man at the other end of the alley keeps pace, and it even keeps score!

To begin the machine's cycle, we shall assume that the pins are spotted and the bowler is rolling his first ball. Six pins are felled and as the ball drops into the pit it sets the spotter's operation in motion. The ball is lifted by a cradle over the back of the pit and dropped into a track on which gravity returns it to the player. A triangular spotting table directly above the pin formation is lowered. On its underside are

5577 2nd floor

Steps in the Operation



- 1** The machine has been started and the guard, which is kept down across an idle alley has been raised. The indicator shows ready for first ball. The first ball is bowled. Note the second set of pins stored in the loading station near the top of the machine

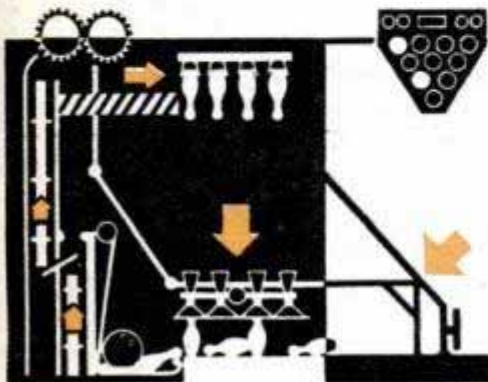

- 2** When the ball drops into the pit, the cycle of operation begins. The guard and sweep are lowered to the alley. The second set of pins is moved to the pin transfer. The spotting table descends and the respotting cups automatically locate themselves over the standing pins. Indicator registers pins standing

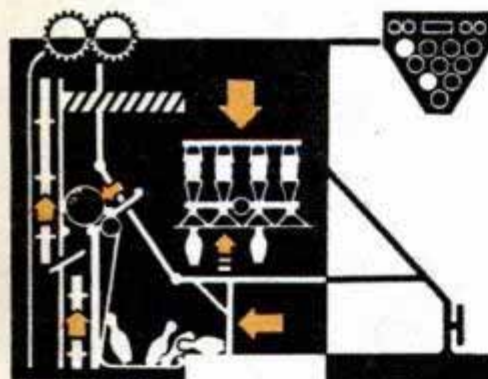

- 3** The standing pins are lifted off the alley and held out of the way while the sweep clears the alley and gutters of all dead wood. The pin transfer places the second set of pins in the spotting cups. The cradle has lifted the ball and placed it on the ball return

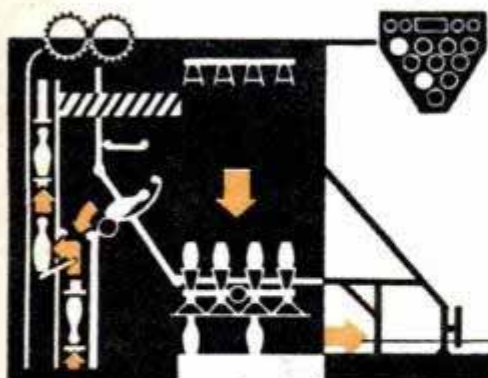

- 4** The respotting cups reset all standing pins in the exact position they were in after the first ball. The sweep returns to the front. The apron has been raised, delivering pins to the pin elevator through the track. The ball is returning to the bowler



- 5** The pin elevator puts the pins on a belt conveyor which delivers them, upside down, to the loading station. Meanwhile, the spotting table has been raised and the apron restored to its original position





6 When the spotting table is out of the way, the guard and sweep are raised. The indicator shows ready for the player's second ball

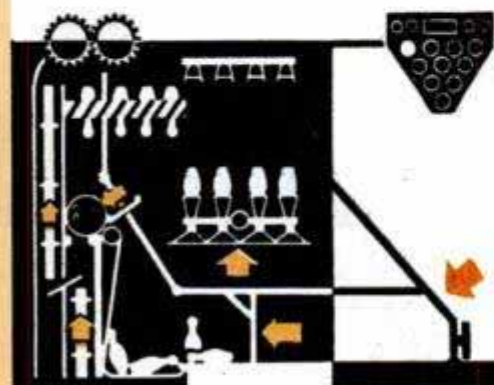

7 After player bowls second ball guard is lowered and the alley is swept, this time removing fallen and standing pins alike. Indicator shows one pin left



8 The entire spotting table, with the second set of pins now in the spotting cups, is rotated 180°, bringing the pins right-side-up over the alley. The sweep returns to the front. The cradle has returned the ball and the apron has delivered the pins as before

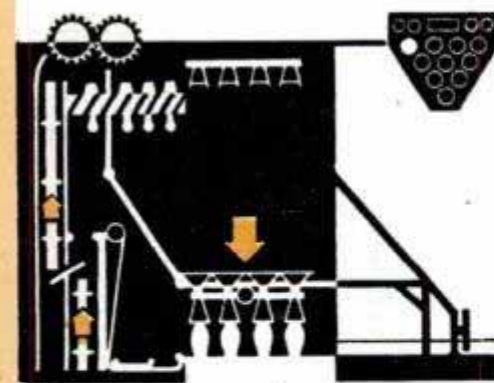

9 The spotting table deposits the second set of pins accurately upon the spots. The pins just used are now returning to the loading station

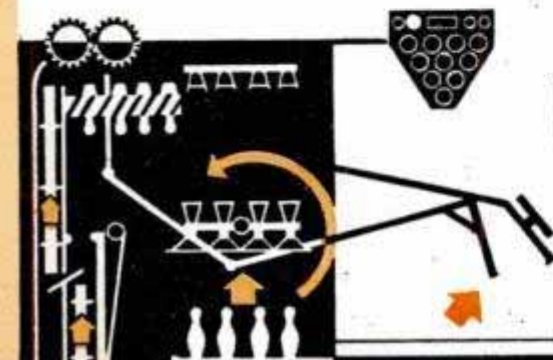

10 The table is raised and reversed. The guard is then lifted and the alley is ready for the next frame. The indicator shows ready for the first ball

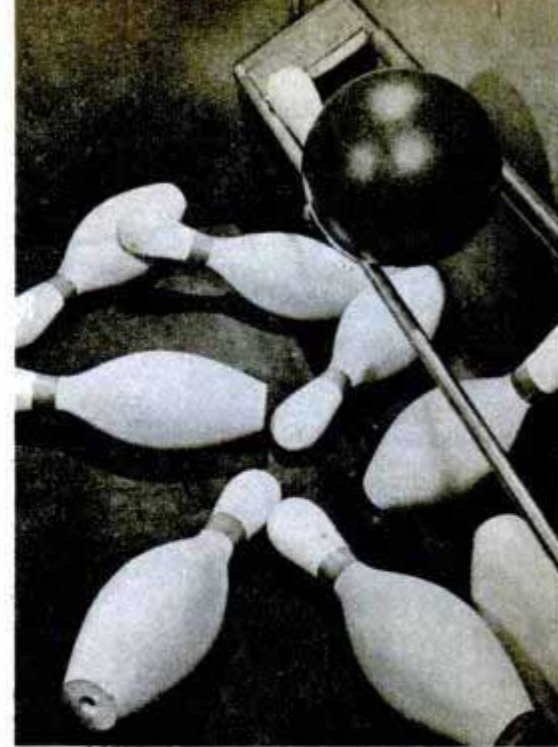
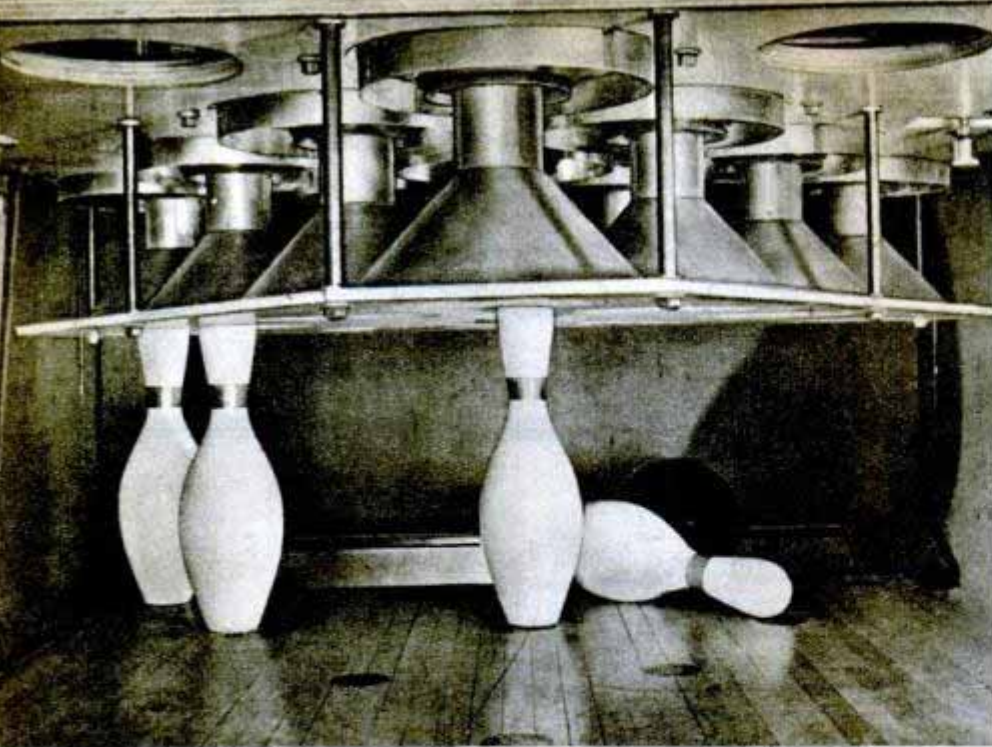

Pins pushed to an off-spot position by the bowler's first ball are picked up by suction cups and returned to their off-spot position. Right, the mechanical pin spotter picks up ball and pins knocked into the pit

metal cups, shaped like the receiving ends of funnels, which settle over the standing pins and lift them from the alley. If a pin has "walked," or moved off its spot without falling, the descending cup "feels" the top of the pin in its new location and shifts so that the head can be grasped by suction, raised and later replaced in the position to which it "walked."

A wooden sweep, shaped to scrape both alley and gutters, which is suspended over the alley in front of the pin area, is lowered and sweeps back to remove all deadwood. The spotting table replaces standing pins and the floor covering of the pit raises to spill the fallen pins onto an inclined moving board, which shakes them into position to be carried up to the top level by an endless escalator. There they are conveyed in an inverted position between turning, ridged round rods into an in-line position at right angles to the alley.

Immediately following the rolling of the first ball, the alternate set of pins has been lifted by mechanical clamps from the line-up and placed—still inverted—in spotting position in the top of the spotting table.

The second ball is bowled and returned to the player; the remaining pins are sent "upstairs"; the spotting table rotates 180 degrees and deposits the ten pins exactly on ten spots and the whole procedure begins again.

The secret of the success of the AMF spotter is that it can locate and replace with unerring accuracy a standing pin which has been joggled off its spot—a quality necessary in any spotter which is to be accepted by bowling authorities.

Inventor of the robot pin setter is Fred Schmidt, a former patternmaker and fac-

tory engineer who is now a member of the AMF engineering staff. His talented brain child, seven feet nine inches high, can be installed in any regulation alley without alteration.

Schmidt became interested in the idea of developing a mechanical pin spotter about 12 years ago when he lived in Pearl River, N. Y. A friend asked him why, since he was always "monkeying around with new ideas," he didn't invent an automatic pin setter that would really work.

Accepting the challenge, Schmidt went to work in an old shed and welded together various pieces of scrap metal to fashion a rough model of a device he figured could do the job. Then, armed with enthusiasm, blueprints and a working model, he contacted the American Machine & Foundry Company, whose officials decided to back him.

Actually, development work and manufacturing plans progressed to a point where the company was prepared shortly before the war to begin full-scale production. But those plans were halted by the war. Meanwhile, during spare moments, Schmidt added refinements to the device.

The latest model is lighter and more compact than the one originally planned for production. Also, an attachment has been added which detects fouls. If a bowler's foot slides across the foul line, the tireless pin spotter immediately sets up the pins for the bowler to try again.

An additional improvement is the use of new production techniques to create a more silent-operating machine. In the past 40 years many inventors have tried to develop automatic pin setting machines but noise had been one of the chief bugaboos.

Ball Bearing Pen Writes Under Water

Instead of an ordinary pen point, a new fountain pen uses a tiny steel ball that revolves in a socket and spreads a thin line of ink on paper as you write. Because of its thriftiness with ink and its large capacity, one filling of the pen will write a line 21 miles long and serve the average user for two years. The pen will make up to eight carbon copies and will even write under water or on cloth and the ink dries immediately. Another feature is that the pen never leaks, even at high altitudes.

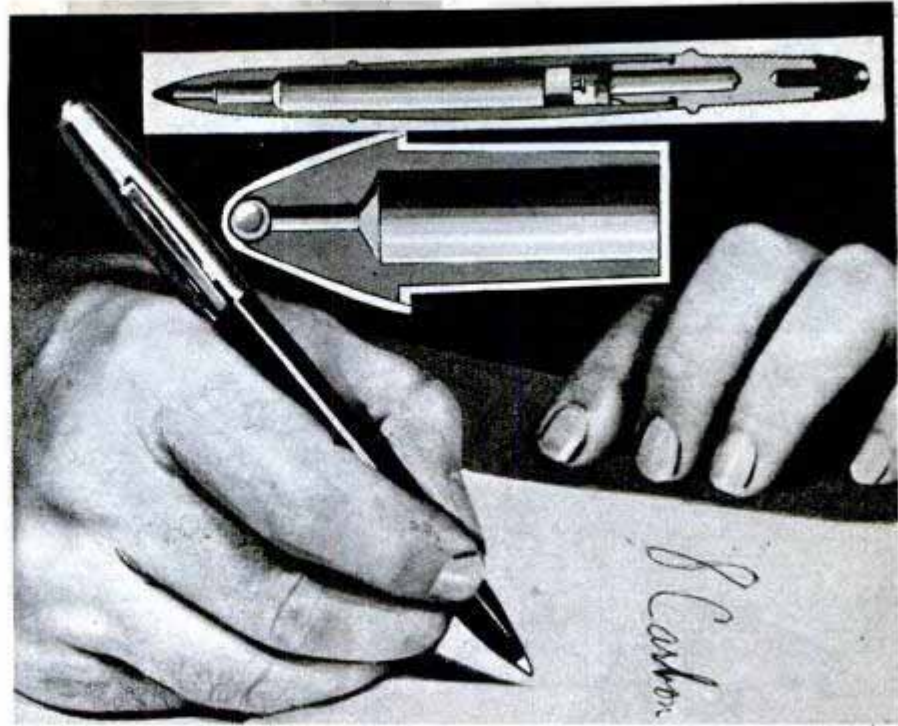

Tool Cuts and Drives Nails At Sewing-Machine Speed

Making and using its own product at the same time, an automatic tool cuts and drives three nails a second from a spool of wire. From three to nine times faster than hand nailing, the unit operates like a sewing machine when nailing in a straight

line. Pressure up to 500 pounds holds work to be nailed, assuring a tight joint. Adjustments can be made to drive nails flush or to countersink them. The machine cuts needle-point or blunt nails from $\frac{1}{4}$ to $\frac{3}{4}$ inch long, driving them equally well into wood, masonite or plastic.

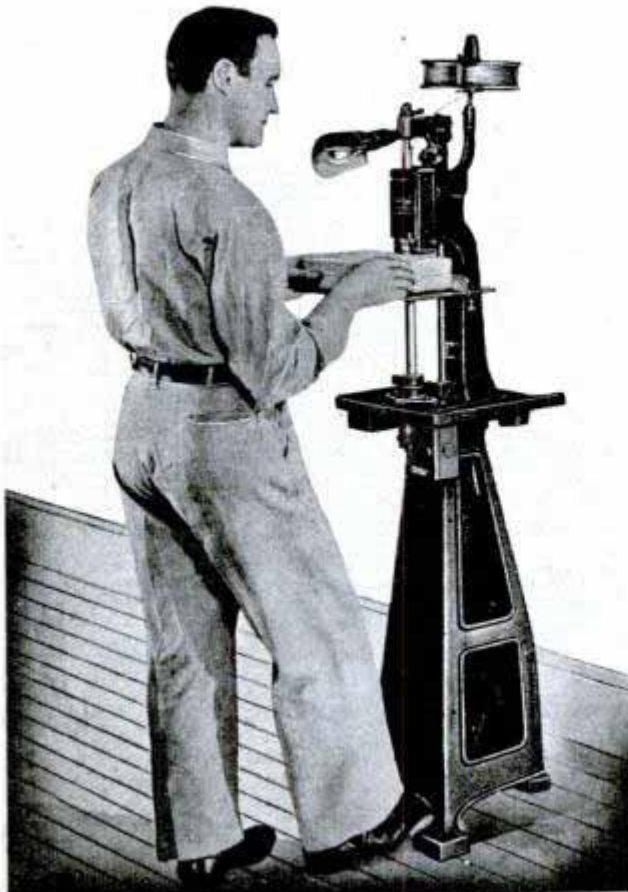

Handle Utilizes Old Saw Blades

Broken hacksaw blades no longer need be discarded. A tool now on the market holds almost any length blade, making a new saw out of a broken one. The device is a tubular handle with an extended grip for securing the working end of the broken blade. The handle is slotted to hold the broken blade rigidly in place. A saw formed in this way can be used in cramped quarters where bulkier saw frames prove impractical. The tool also can be used as a handle for knives or scrapers made from broken blades or pieces of thin file.



☞ Portable dance floors are built in sections by a Hollywood, Calif., manufacturer to accommodate from eight to 3000 persons.

PIN-POINT LIGHT

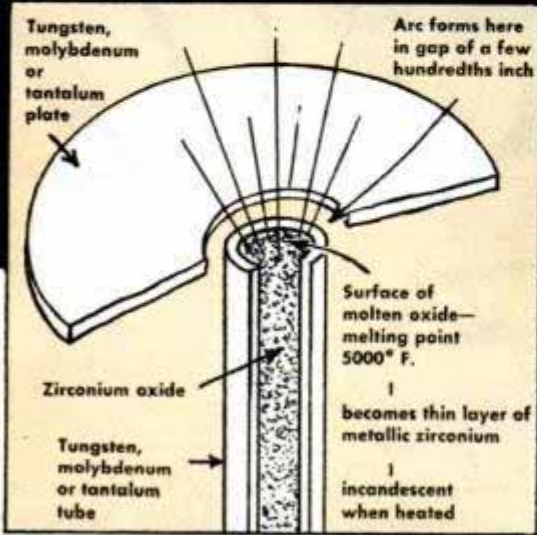
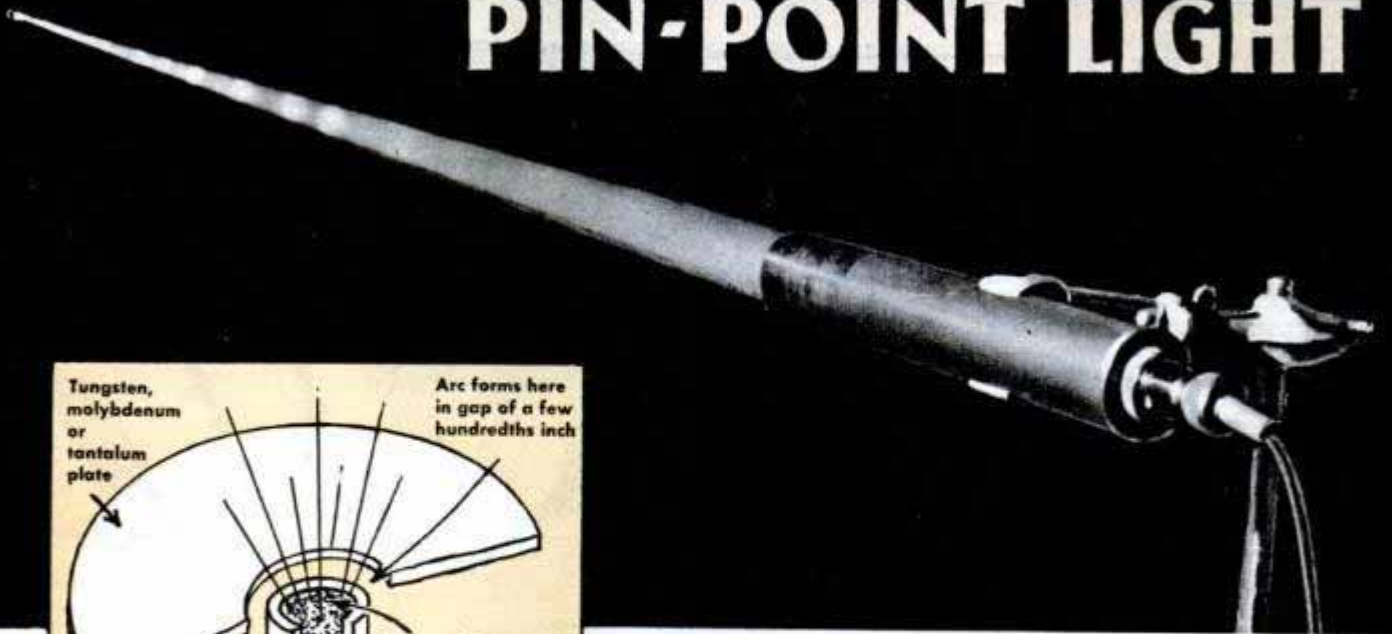

One sixteenth the surface brightness of the sun is produced by a concentrated-arc lamp which may revolutionize optical testing, motion picture projection and photographic enlarging. Developed by the Western Union Telegraph Company, this tiny spotlight creates 100 candlepower per square millimeter, compared with 1600 by the sun and 10 by a tungsten filament incandescent lamp. The new light achieves its results by projecting its rays in almost perfect parallel. Main parts of the lamp are two electrodes and a cathode, a wire or tube from 3/1000 inch in diameter for the two-watt size to 3/8 inch for the 1500-watt unit. The cathode is filled with zirconium oxide. When the arc leaps from the anode the oxide in the end of the tube melts, giving off a brilliant white light augmented by zirconium vapor combined with inert gas in the lamp. As the zirconium evaporates and flies from the cathode the particles are ionized by the arc and return to the cathode, giving the lamp a self-perpetuating action. A generator or well-filtered rectifier is used with the lamp, plus sufficient ballast resistance to limit the current to its normal value. In photographic enlarging, the pin-point light produces large prints of great detail, clarity and definition. The light also may make it possible to project 16-millimeter film in theaters with results equal to the showing of 35-millimeter film. And it may be substituted for klieg lights.

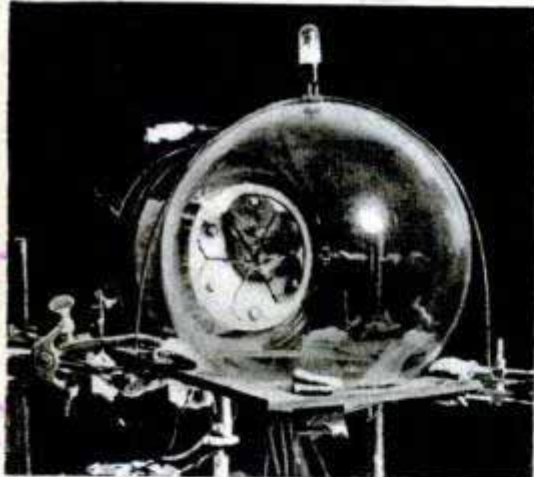

Knopf-PIX photos

Light beam from two-watt concentrated-arc lamp (top) is focused to a pin-point. Light source is shown in drawing of fan-shaped anode and tubular cathode. Tiny two-watt lamp perches atop 1500-watt unit (above). Testing optical lens (right) with light beam. Ten-watt lamp (below, left) resembles a radio tube. Casting an image of the light source (right)

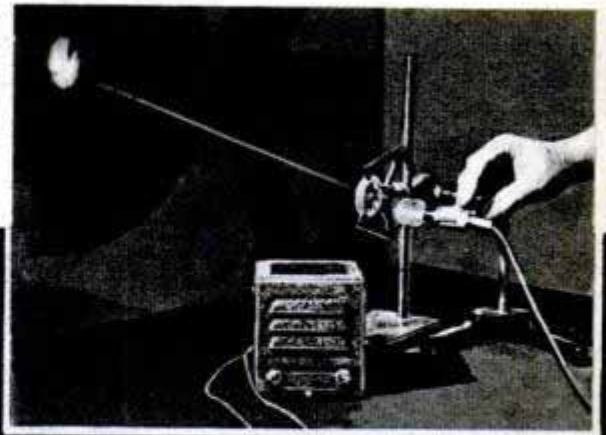

60 Hudson St
N.Y. N.Y.



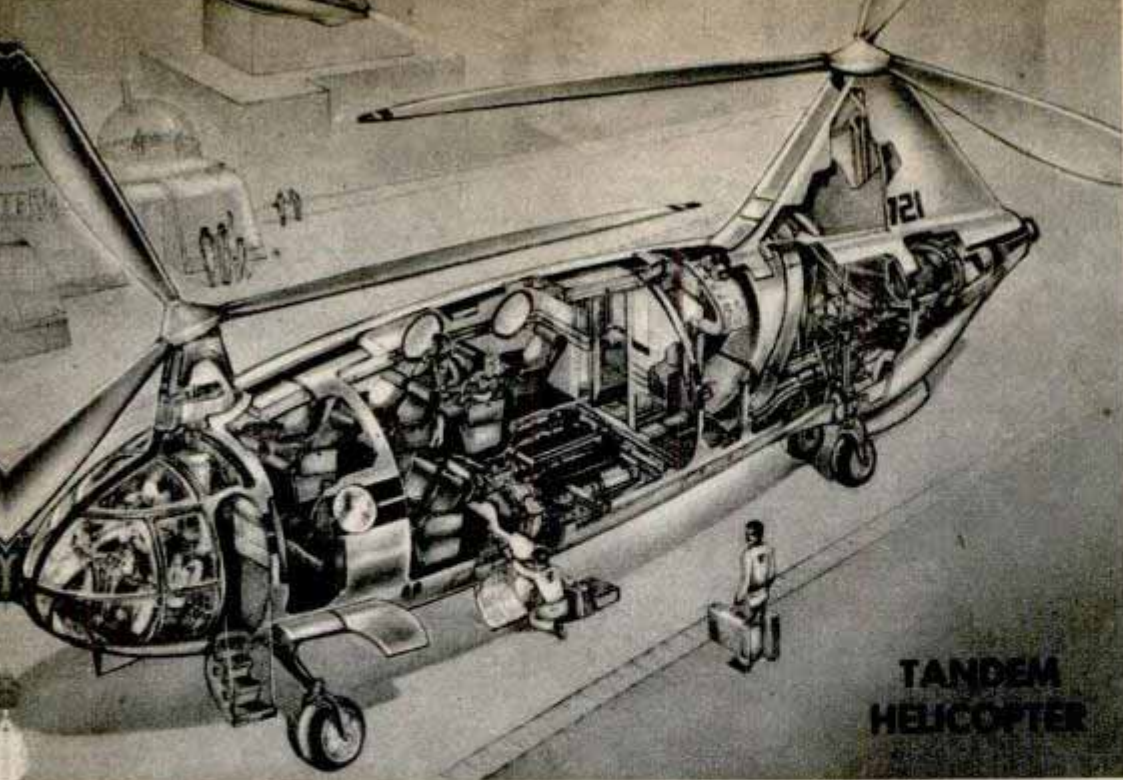

**TANDEM
HELICOPTER**

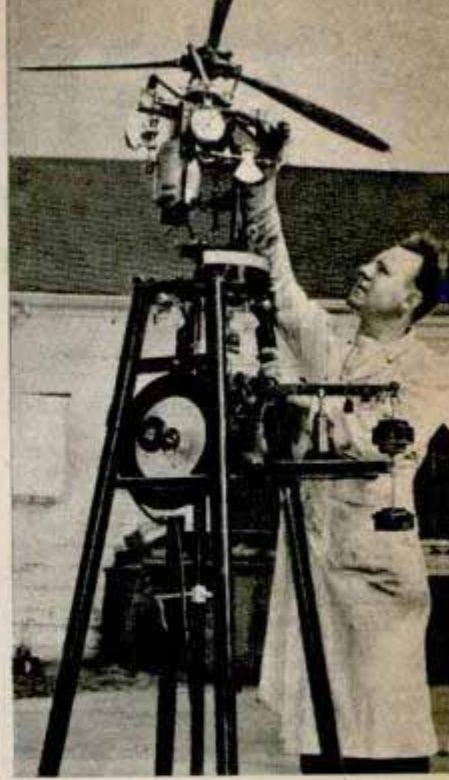

Cutaway of intercity tandem helicopter. Adjusting mechanisms, upper right, for a test run of quarter-size rotor blades. Right, flying rubber-band-powered model

Research on the rotor blades and driving mechanisms of a proposed 29-passenger intercity tandem helicopter is being conducted on an ingenious rotor test stand. Comparable to an outdoor wind tunnel, the stand is placed on a flat-bed truck for runs simulating a helicopter in flight. Rotor blades one fourth actual size are attached to the test mechanism and rotated by a motor. Measurements of lift, horizontal thrust, torque and pitching and rolling forces developed by the blades are computed from scales and balances on the stand.



"Finger" dive brakes on Mauler improve bombing accuracy—Intermeshing, finger-type dive brakes that slow the vertical descent of the Martin Mauler to 350 miles per hour are a significant feature of the Navy's newest dive-torpedo bomber. This permits a lower altitude pull-out and greater bombing accuracy. The Navy-designated BTM-1 is in the over-350-mile-an-hour class, with a Pratt & Whitney Wasp Major engine and maximum range of 1700 miles. It is built for dives of more than 500 miles an hour.

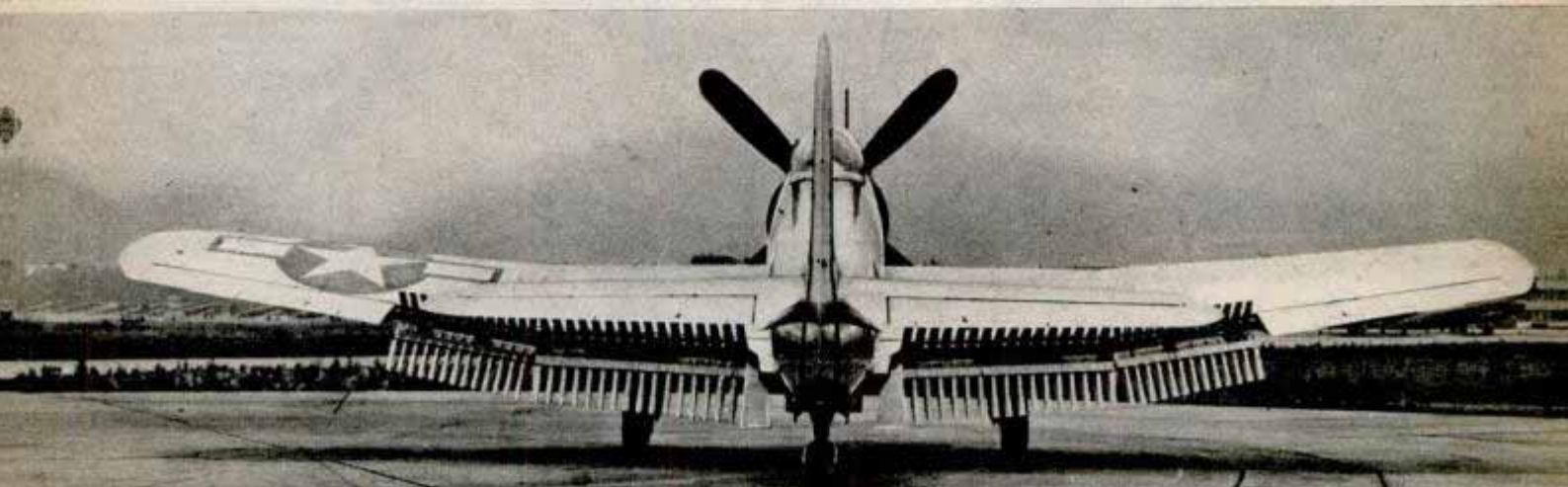

FISHERMAN,

Lead with the Right Hook



Playing a big bass, angler uses right hook, small enough for light tackle, large enough to catch in bass' mouth

BY RICHARD W. EMERY
PHOTOS BY RAY CHAPIN

Consider for a moment the lowly fishhook! Of all the trinkets and doodads in your fishing tackle kit, it's probably the smallest. It cost you little. It doesn't look like much. But what's the first part of your tackle to meet the fish eye-to-eye and challenge him to a tussle?

You're right—the hook!

So give the lowly fishhook a second thought and you'll agree that it's important, after all. Whether you're strictly a holiday and vacation fisherman, or a postgraduate angler who really goes at it scientifically, a speaking acquaintance with hook lore will help you land more fish.

The modern fishhook didn't get its sleek lines and metallurgically foolproof interior through somebody's idle whim! Cavemen invented the hook because they were hungry. The first "hook" actually was a gorge made of flint which the fish could swallow with the bait but which it could not eject. The cavemen later invented the barb for the same reason. Primitive fishermen tried making hooks of stone, bone, seashells, horn, thorns and wood. When they learned to use metal, they made better hooks and caught more fish. Most of the features of modern hooks were tried out hundreds or even thousands of years ago.

To know how a fishhook works, you need to know about its various parts. Each part of the hook has a job to do. Each part can be designed to do a good job in very special circumstances.

That leaves up to you, the fisherman, the problem of choosing a fishhook with features which will give you advantages in your effort to catch a certain kind and size of fish.

Here are the parts of a hook: the point, which reaches from tip to barb; the bend, which gives the hook its curve; the shank, which serves as a backbone; and the eye, which guides the leader and line down to the hook.

Scope of a hook—that is, its width between point and shank—is called its throat. And the depth

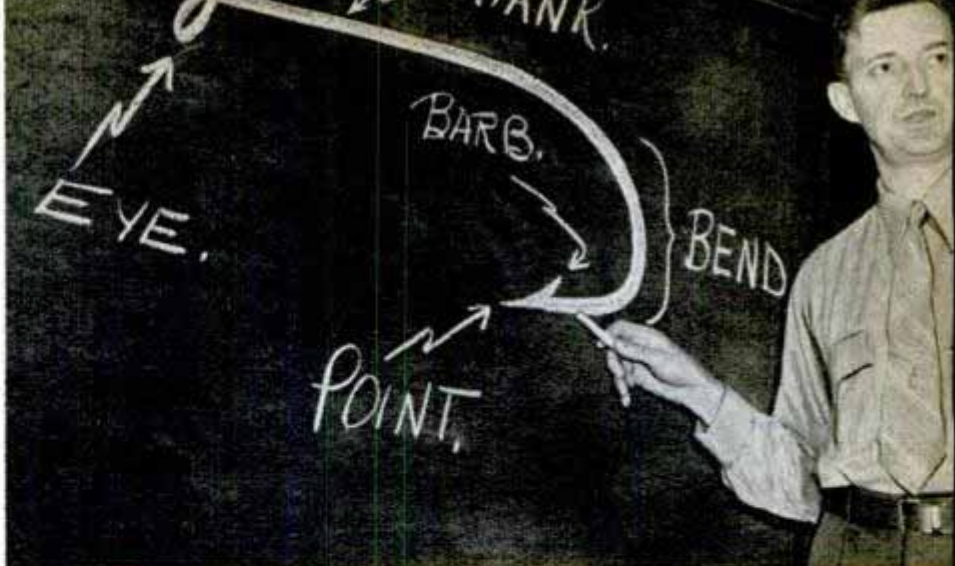

Blackboard diagram shows the principal parts of a fishhook. Below, to grab and stick with one of these marlins the hook must bite quick and deep. Once hooked, the marlin goes into a frenzy of action, leaping and plunging across the surface

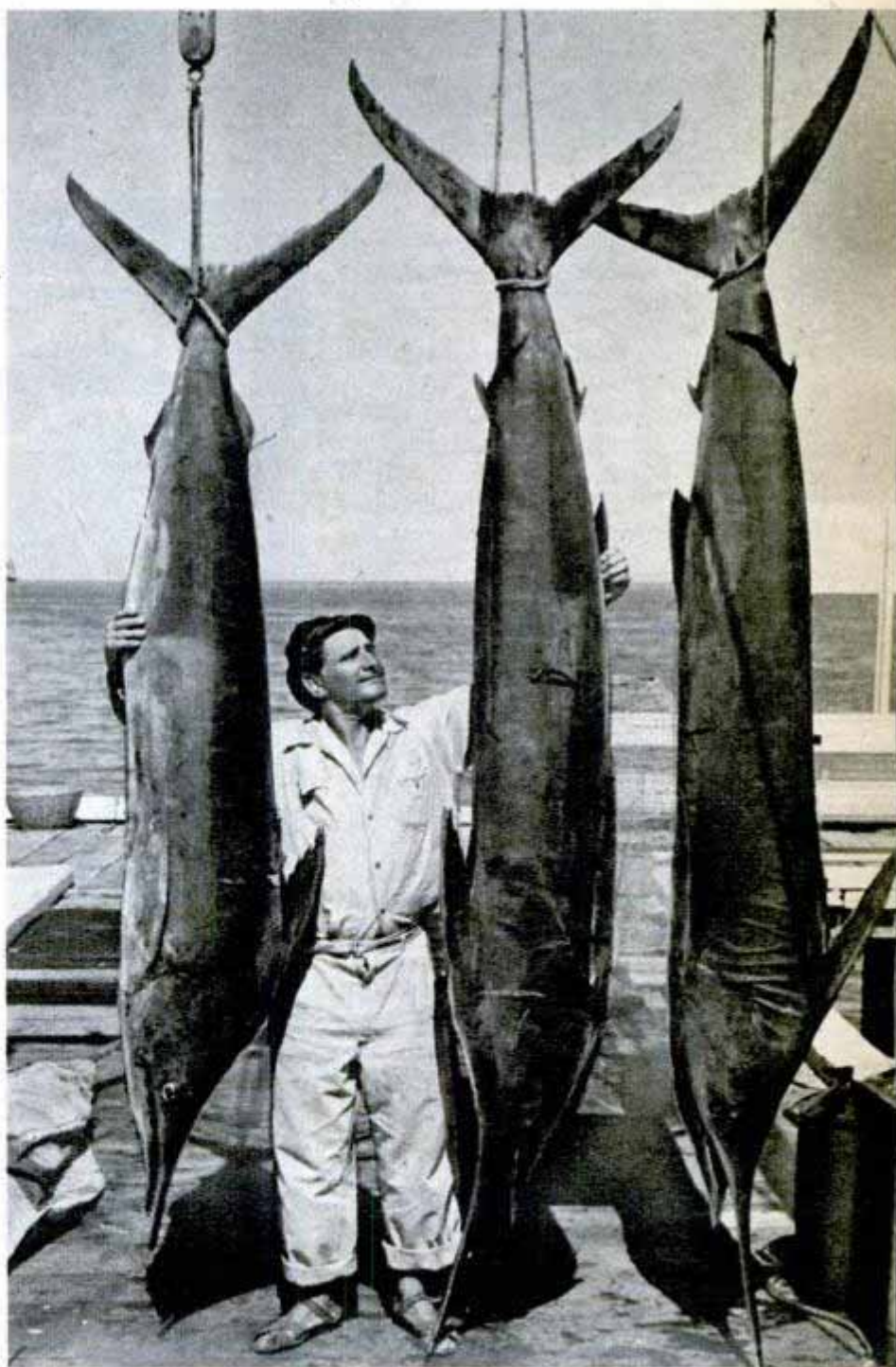



Proper hooks put more "panfish" in the pan! Below right, these hooks, for catching trout to swordfish, are actual size. Note the differences in the points, barbs, bends and shanks

of the hook from throat to bend is called its bite.

Now, there are three qualities which are essential in any hook that lands a fish. The hook must be usable with the bait or lure that the fish will strike. The hook must be able to take hold. And it must be able to keep its hold despite the fish's struggles.

For thousands of years, anglers have been trying to devise a hook which will excel in all three qualities.

But, alas, no such hook exists! Modern tackle manufacturers are still trying to gaff an answer to the problem. Until some inspired fisherman comes up with the solution, you will have to decide which qualities to accent, in your hook, and which to sacrifice.

To illustrate: Suppose you want to catch a big, husky trout. If you use a big, husky hook, the trout will laugh at you. He's eating mosquitoes today! You must choose a tiny hook to suit the tiny fly, sacrificing holding power.

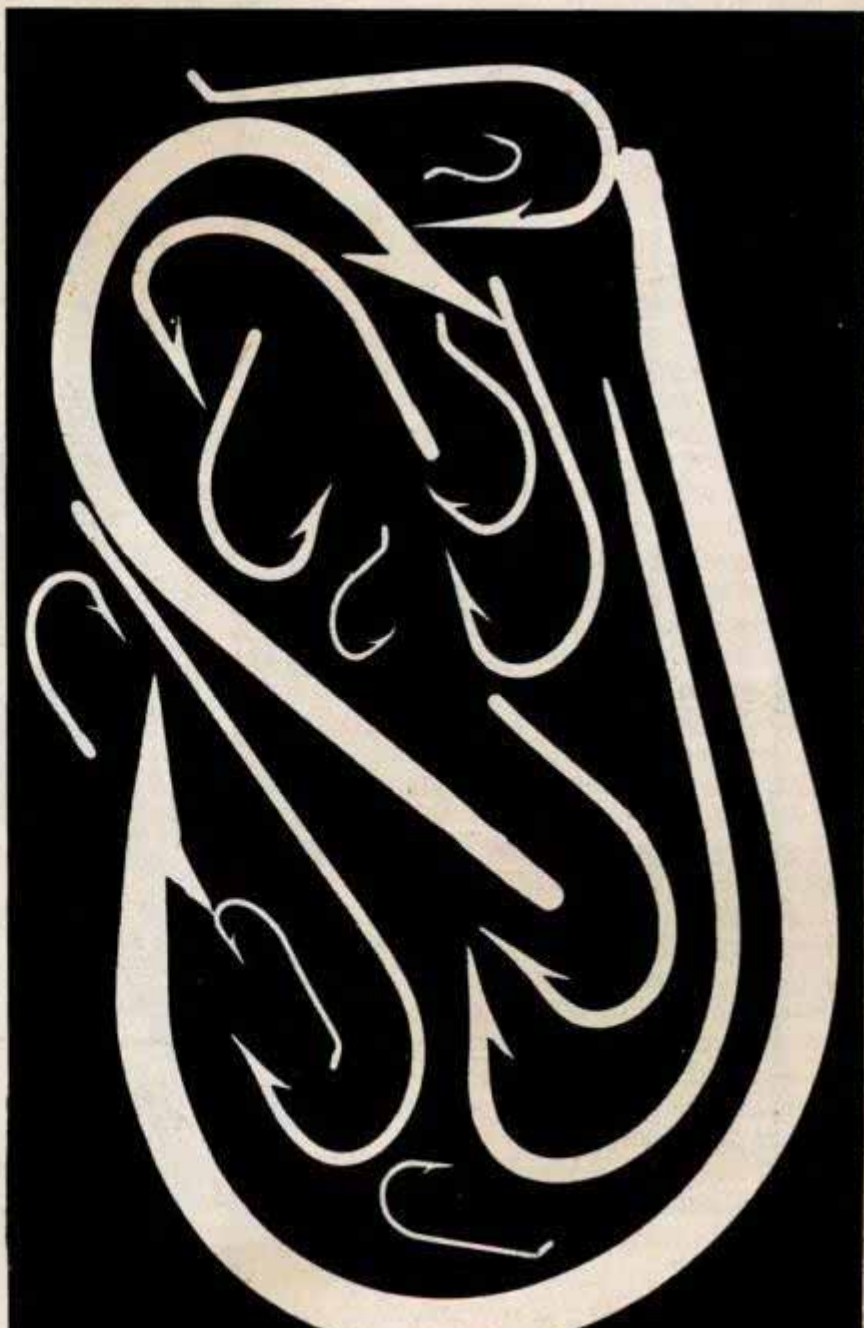



Above, angler holds up the record Oregon trout, almost 14 pounds, and the hook that landed it. Left, wise fishermen will have a well-chosen assortment of hooks in the tackle box



Or suppose you want to catch a big, savage marlin swordfish, which you know will jitterbug across the waves when he feels the hook. You know he'll shake and yank and turn somersaults. The biggest problem is to find a hook that will hold, even at a sacrifice of quick hooking. So you choose a heavy-gauge hook with a curve even closer than a half-circle, with loss of hooking power but gain of holding power.

Or suppose you're after a big black bass. He has a mouth like a coal scuttle and he'll hit a big bait or lure. You're willing to take a chance on holding him, if you can just get him hooked! So for maximum chance of getting him hooked, you use a large, wide hook of light



These giant sea bass call for a big hook that won't pull loose

wire, with a point that reaches deep for the bass' gullet.

Your problem of choosing the proper hook is tougher if you're after more than one kind of fish. The table manners of fish vary as much as their mouths, appetites and personalities. In size, game fish range from the fingerling trout which nips at gnats to the mighty broadbill which spends its leisure killing whales.

Fish mouths are small like the perch's, or big like the bass'; soft like the young brook trout's, or bony like the tarpon's; smooth like the corbina's or toothy like the pike's. In choosing your hooks, look for features that will overcome the main problem posed by your particular fish—don't just choose hooks that look rakish.

Hooks vary in hardness and temper. Your best buy in hooks is standard merchandise backed by a reputable maker.

Hooks are made in various sizes of wire, either standard, light or heavy. A light hook weighs less and penetrates easier, but is more likely to rip or spring. A heavy hook penetrates bone and holds better under heavy strain, but has disadvantages if used on floating lures or with live bait.

Points of hooks vary in two ways. The points differ in shape and the angle of penetration may range from shallow to deep. Needle point,

spear point and hollow point are most popular. The needle point is smooth, thin and round. When properly made, it is very strong and has excellent penetrating quality. The spear point, usually found on inexpensive hooks, turns slightly outward. The hollow point is a quick-hooker for fish with soft mouths.

By its angle of penetration, the point enters flesh or bone and enables the hook to take hold. A point that aims slightly away from the hook will penetrate quickly and at a deeper angle. A point that aims parallel with the shank will put maximum pressure on the point of penetration and is best for hard-mouthed fish. A point that aims slightly inward toward the shank loses some of its hooking power but gains in holding power. If turned more than very slightly inward, it loses depth of bite.

For general fishing, a long barb offers more advantages than a short barb, and if properly made it should not break. The short barb may bury itself quicker, but it is more easily dislodged.



Planning to fish for trout this summer? Your tackle box should contain some of these hooks. In upper left column are dry-fly hooks. Reading from top down, they are sizes 18, 16, 14, 12, 10 and 8. At upper right are dry-fly barbless hooks, sizes 8, 10, 12, 14 and 16. Other dry-fly hooks are in upper center. Below are four hollow-point hooks and at bottom is an assortment of wet-fly and bait hooks



In the open mouth of a 125-pound sailfish, a tricky hook-fighter, is lodged the barb that landed him



This crappie wrapped his mouth around a big bass hook

The bend of a hook not only aims the point, but gives the hook a bite or hold upon which the fishing line can pull. A hook may have a straight bend or an offset bend. A straight-bend hook is on a plane with point parallel with shank. An offset-bend hook is twisted at the bend so that the point's aim is askew.

Straight-bend hooks penetrate more nearly in the direction of pull from the fishing line than do offset-bend hooks. They drive harder into bone. The argument for

offset hooks is that they are less likely to be withdrawn from a fish's mouth without penetrating. Offset hooks give their best performance in still-bait fishing. Straight-bend hooks are your best bet for moving baits or lures.

The shank of a hook usually is made of rolled steel wire. Sometimes oval wire is used for extra strength. Occasionally the shank is flattened along the sides of both shank and bend to give greater strength. A shank may have several slices, or barbs, to help hold soft bait in place. Shanks of hooks intended for use with lures are frequently humped, to anchor the body of the lure. The longer the shank in proportion to the size of the hook, the shallower will be the bite of the hook. Rather than use an extremely long-shank hook for a streamer lure, use single hooks in tandem. You'll be apt to take more fish.

The eye of a hook may be straight or turned up or down. Hooks for dry-fly fishing have tapered eyes, for balance and lightness, at sacrifice of strength. Some eyes are looped or brazed to protect leaders from sharp edges of metal. Where great strength and hard-hooking qualities are needed, as in big game fishing, the straight eye—also called ringed eye—has been proved best.

There you have a quick once-over on the subject of the lowly fishhook. If you know the table manners of any given fish, you can figure out the best hook for catching him. But the all-around perfect hook still awaits its inventor. In fishhooks, as in other things, you can't have everything!

Two primitive barbless hooks (with lines attached) are compared with a variety of efficient modern hooks. Right, catching the west coast yellowtail, a fish with a narrow bony mouth, requires a small, strong hook



ALLOY *Detective*

Concentrations of various metals in alloys are measured and recorded in 40 seconds by a direct reading spectrometer developed by Dow Chemical Company. Girl operators can be trained in a day to read the analyses charted automatically on paper

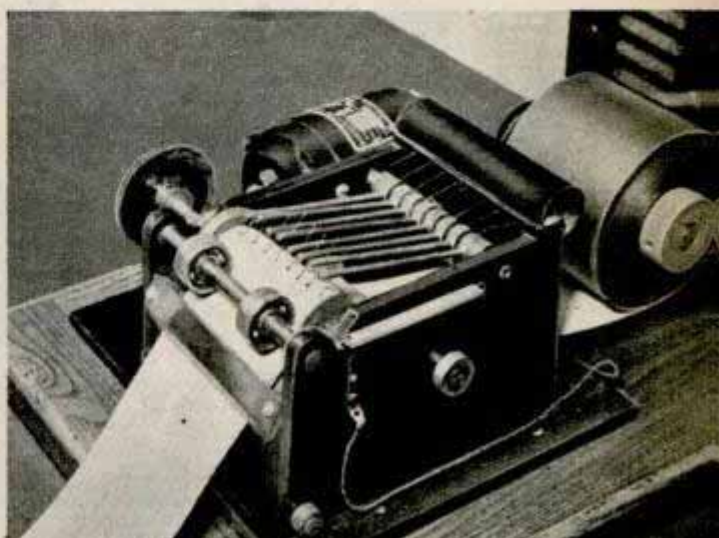
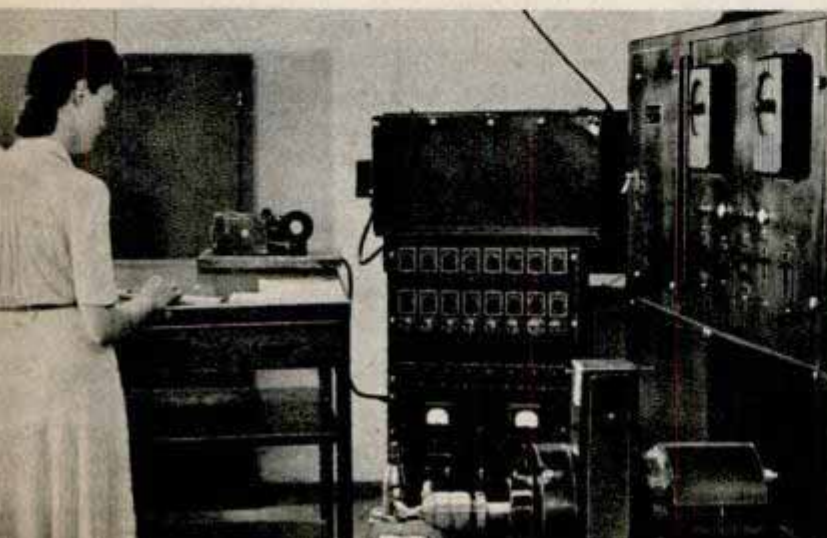
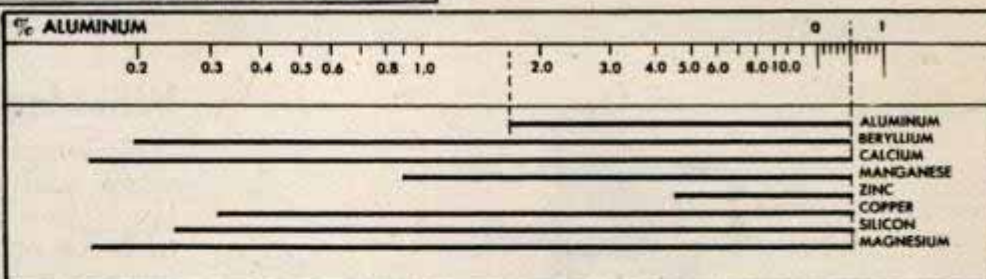
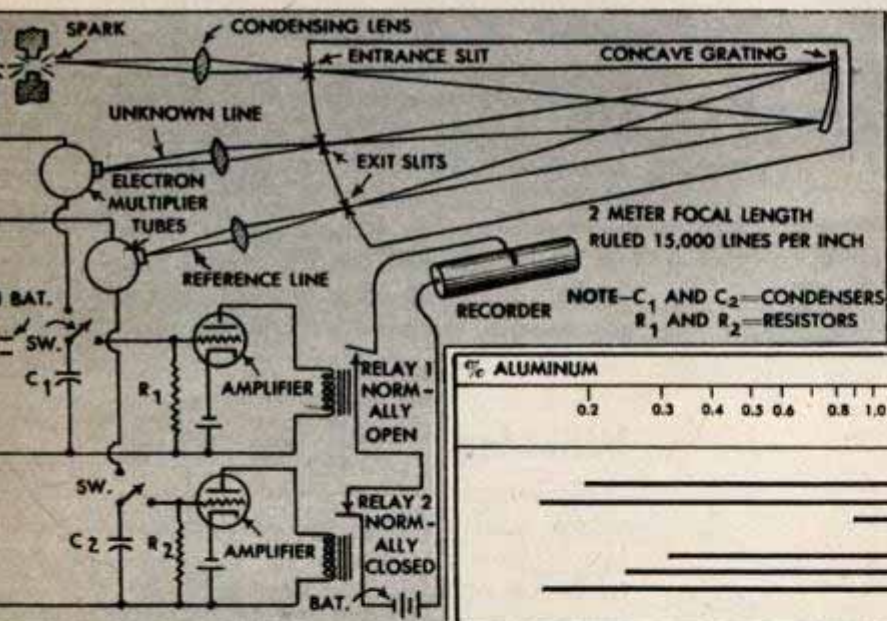
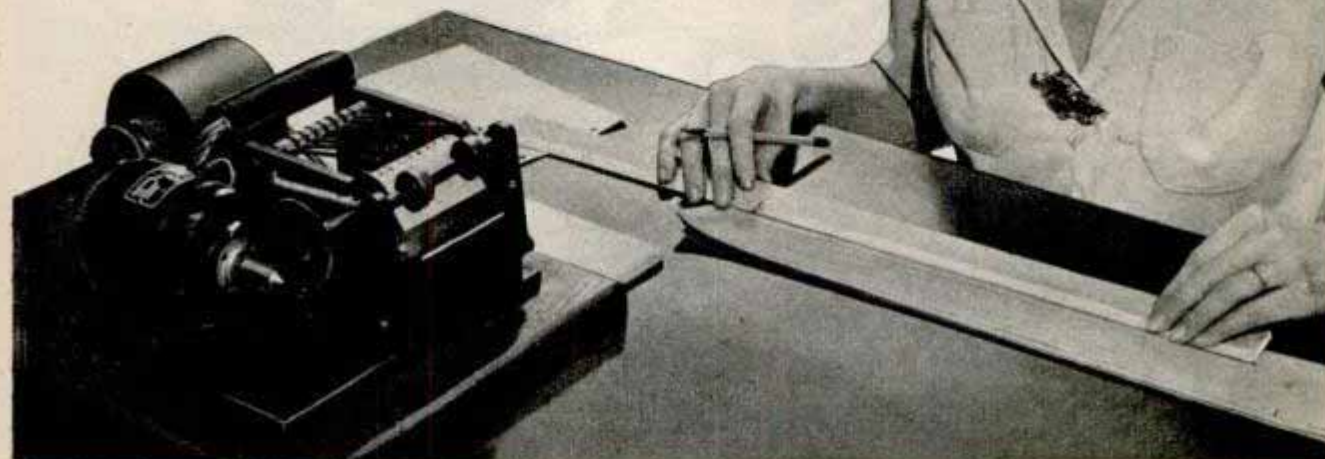



'Magic Carpet' for Cripple

Especially designed for maimed servicemen and poliomyelitis victims is the "Magic Carpet," a three-wheeled vehicle driven by a 3½-horsepower single-cylinder engine. Speed is from a "crawl" to 25 miles an hour. Clutch, brake and throttle controls are all on one lever, permitting the machine to be operated by any two members, such as a hand and a foot. By means of extra attachments it can be fitted for household tasks, like mowing the lawn. The engine is equipped with an impulse type magneto for easy starting.



Wheeled Cane for Blind

So sensitive that it actually can warn a blind person when there is a paper match on the sidewalk in front of him is a combination cane and wheel now being made for the sightless. The four-inch cast aluminum guide is attached to the end of a 36-inch softwood cane which has a metal pistol-grip handle. Completed, the cane weighs 15 ounces and has an overall length of 42 inches. The cane and wheel are banded a bright red and white to further safeguard the user. Made by a member of the Monterey Park, Calif., Lions Club, the wheeled canes are being distributed free of charge by that organization to blind persons in Southern California.

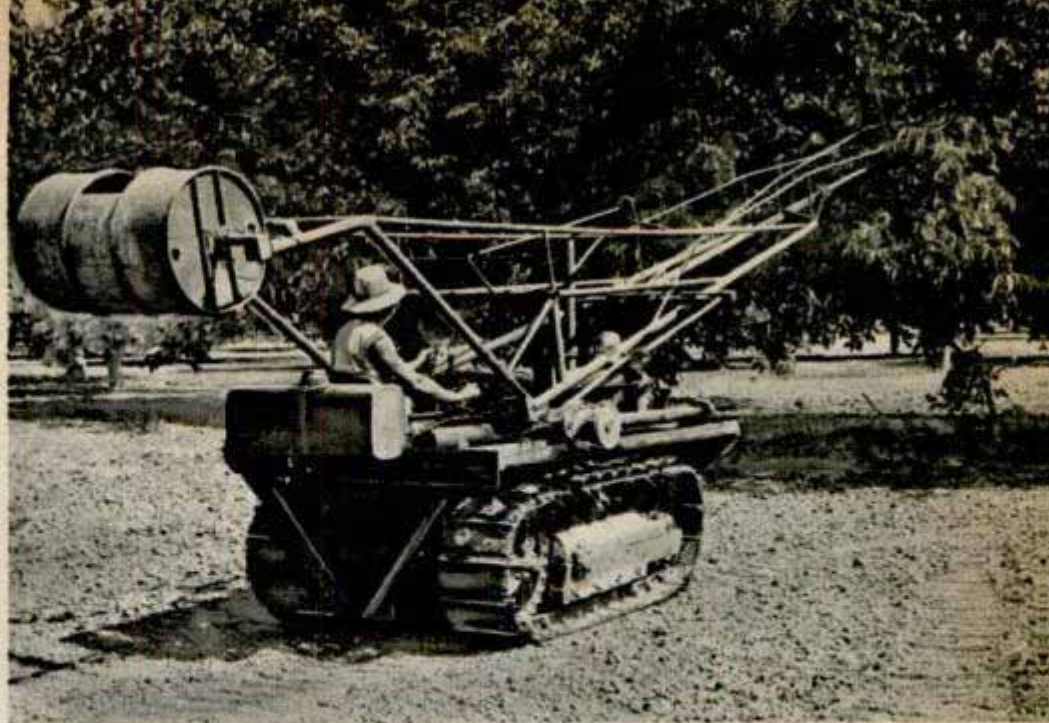

Rubber tired cart, above left, is equipped with hooks which fit under the collar of a milk can for easy handling of the heavy containers. Adjustable collar hooks fit any can, holding it in an upright position. At right, a home-built, labor and time-saving walnut tree shaker built by a California rancher is powered by a Diesel tractor

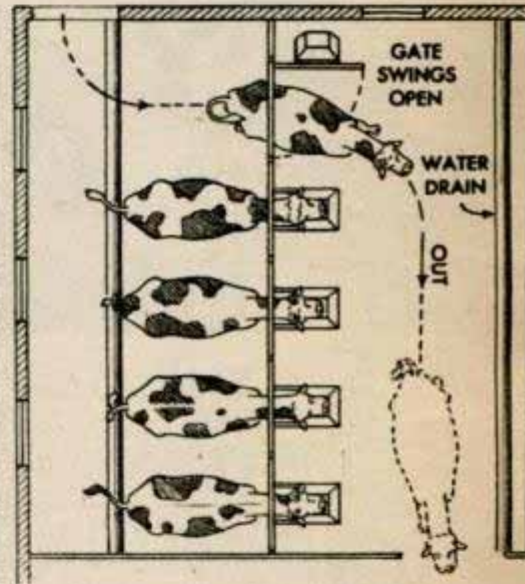
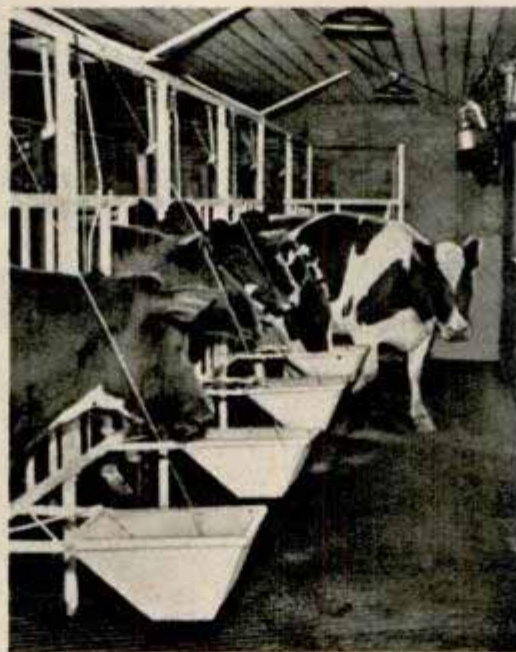

Automatic water heater, left, provides boiling water a few minutes after pail is hung on hook of portable electric unit. Photo and diagram at right show how "walk through" milking barn saves time at Fresno, Calif., dairy farm. After milking, front stanchion gate is opened, allowing the cow to walk out of the stanchion through second corridor and exit instead of turning around and going out the same way it came in. Below left, one man can lift and move loads up to five tons with a lifting bar which has a steel roller in the toe plate. Right, an Illinois farmer combined two two-row corn pickers into one four-row picker to save time and labor

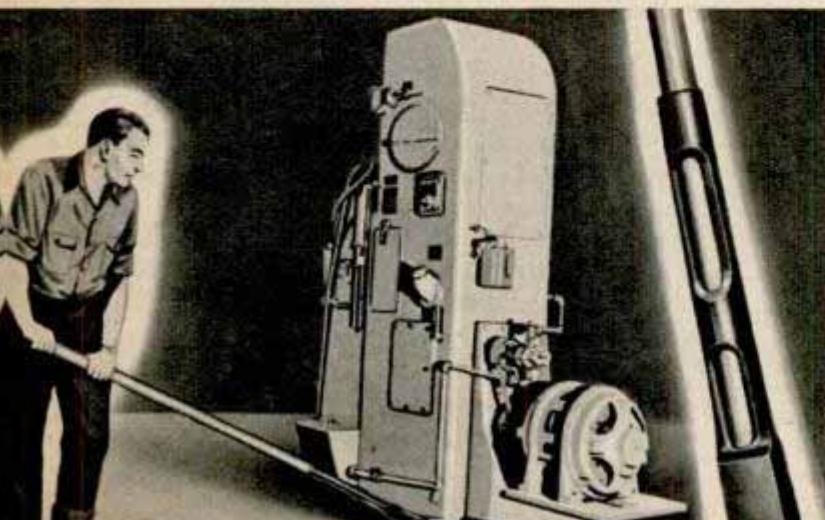

HOW DEEP is the OCEAN?



Landing Ships, Tank, unload supplies into Amtracs on the edge of the Okinawa reef. Knowledge of the reef was essential in planning the campaign

By Lieut. Comdr. Cecil C. Snyder, USNR, and Lieut. Comdr. Richard R. Frame, USNR

LIEUTENANT Bill Davidson, USNR, taxied his Hellcat into position on the aircraft carrier Hornet's flight deck. The launching officer lowered the checkered flag and Davidson was on his way. He circled the carrier and joined up with the other planes assigned to the mission.

As they winged their way to the target, Davidson studied his instructions. In the fuselage of his plane was some unusual photographic equipment never before used in combat. It was his job, with the new camera, to record photographic information needed for a new landing against Japan.

This was tricky photography. He had been instructed to fly over the beach of the target island at an altitude of 200 feet at a speed of 300 knots, maintaining this altitude within the critical distance of 10 feet.

Ugly puffs of black smoke over the island showed ineffective anti-aircraft fire coming up from below. His altimeter registered 200 feet. This was the important test. The lights on the instrument panel indicated that the camera was functioning properly. He completed his run without incident, joined his fighter escort and returned to the ship.

Back at headquarters on Oahu and Guam the tension was as heavy as the rain-laden clouds hanging over the islands. Ahead lay the campaign for Okinawa, exposed southern flank of the Japanese home islands.

On March 5, just 26 days before the landings were scheduled to take place, the photographic interpretation officers at Guam received the rolls of film of the Hagushi beaches, taken by Davidson. This new type of photography had never been invasion-tested. What were the results?

Questions flooded the interpretation officers as they huddled over viewers and made computations.

"I want to land heavy artillery from an LST on Green 2 Beach on Love Day at H plus one hour. How far do you figure I can get her in before she goes aground?" asked a Marine colonel.

"You'll run aground 810 feet offshore," said Lieutenant Robert N. Colwell, USNR.

In the hectic days of planning for the Okinawa invasion only a few antiquated and inaccurate charts of the area were in the files. It was photographic reconnaissance that provided information that was vital



Pilots equipped with polaroid spectacles study a Sonne stereo strip that gives a three-dimensional effect. Right, a photo interpretation officer looks through a stereo comparator to measure height and depth

for the landing. This would not be another Tarawa!

For months, back in the states, the Navy's Photographic Science Laboratory and Photographic Intelligence Center in Washington had been experimenting with the "Sonne" continuous strip stereo camera for water depth determination. The story of this new photographic development goes back over 10 years to a man in Chicago named Fred Sonne. He was engaged in making aerial surveys and manufacturing equipment for use in this work.

Sonne was endeavoring to find some means of making large-scale photographs from low altitudes. To him the circuit camera, that venerable monstrosity responsible for many an old-time panoramic view, offered a principle of operation that could be utilized in aerial photography. The principle is a simple one—the film, traveling opposite to the direction of flight, is made to pass before a slit opening, which acts as a shutter, and the image is literally painted on the film.

Sonne's original camera was a single-lens model with an adjustable slit and a variable rate of film travel. It produced a continuous photograph nine inches wide by any length up to 200 feet, but it still did not meet military requirements.

With standard aerial cameras, overlapping photographs are obtained which, when viewed through a

stereoscope, give third dimension and make it possible to compute differences in height above the ground.

Even though interest lagged, Sonne continued the experimental work. Two lenses, in place of one, were mounted on the camera and made to rotate either slightly forward or slightly aft of the neutral position. With this modification, Sonne obtained stereo pairs on a continuous strip where large-scale detail was possible.

Meanwhile, Army Air Forces experts at Wright Field had also been working on the Sonne camera, helping to bring it to a high state of development by 1940.

The Navy awakened to the possibilities of such a camera when Commander Thorne Donnelley reported to Washington to head the Navy's Photographic Science Laboratory. He knew Sonne and was already a staunch advocate of his system. As work progressed, he obtained orders for Lieutenants F. K. Mansfield and Philip Kistler to go to Chicago and become familiar with the camera.

"With the Sonne camera



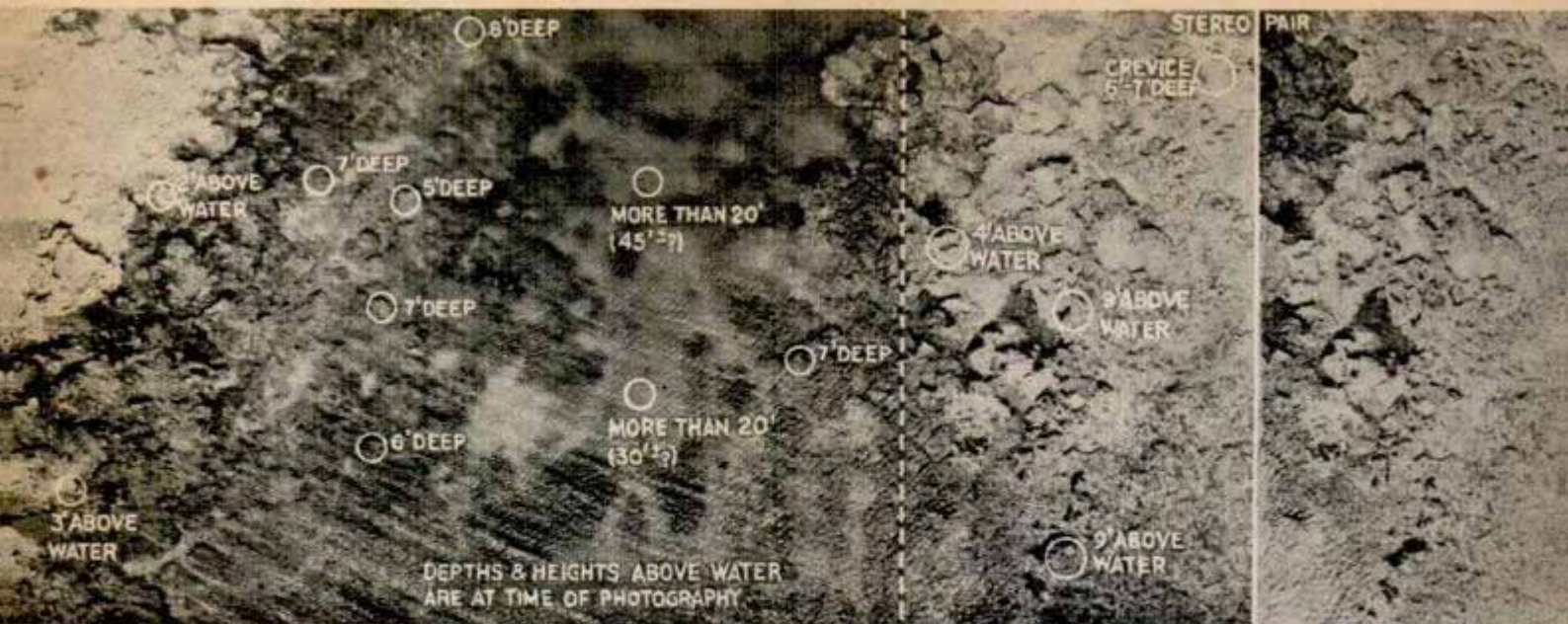

Notations on this Sonne photograph give height and depth measurements for planning amphibious operations

mounted in fast fighter aircraft we could reasonably expect coverage at a scale of 1 to 500, or 10 times larger than with other methods, still maintaining pilot safety," said Mansfield.

"The operation of the camera had to be made completely automatic," he went on. "It meant designing equipment that would synchronize the optical system and the film speed of the camera with the ground motion of the beach as the plane passed over it. The entire problem was eventually solved by employing electronic gadgets to do the work. The pilot turns on his camera and flies his course. Science does the rest." Many of the tests of the equipment were

made at Cat Cay, Bahama Islands, where reef conditions are similar to those found in the Pacific. Line soundings of depths from two to 14 feet were made, and buoys anchored at these points. Runs were made over the area and the film was interpreted and checked for accuracy against the original soundings. While these installation problems were being worked out, Sonne modified an existing stereo comparator, eventually producing an instrument which gave a high degree of exactness to underwater calculations.

For purposes of measurement, the water must be free from silt or other material which would obscure the reef. Detail on the bottom is necessary to provide reference for measurement. There must be ripples or slight waves on the water to catch the light in order to record the surface area on the film. This is the secret of water depth determination with low-level Sonne photography. The stereo comparator measures the distance between the surface of the water and the bottom.

The viewer was constructed so either the negative or a black and white print may be used for interpretation. The tests run at Cat Cay showed an average error of six inches with a maximum error of slightly over one foot in depth measurements.

Marine Corps personnel place a Sonne camera and equipment in a fast Navy fighter for a reconnaissance mission over a Jap-held beach





The height of this island sea wall was accurately determined by Sonne photography before the first man stepped ashore. Below, the photographs aided in spotting caves and mine fields

Such was the state of development of this new system of photography when the request for Sonne equipment and trained personnel arrived in Washington from Advanced Fleet Headquarters late in November. Mansfield had several men working with him who knew the operation of the camera and its installation. Kistler and a few other officers at the Photographic Intelligence Center were familiar with the interpretation technique.

Mansfield reached Pearl Harbor on December 1. Kistler followed two weeks later.

"Our first job was the designing of change kits to adapt the Sonne equipment to the camera mount in the F6F photographic plane," said Mansfield. "Then we were ordered to Ulithi to board the Hornet for its scheduled Okinawa strike."

Everything was in readiness

(Continued to page 228)





One-man airplane jack requires only light pressure on the extra long handle to raise the wheel of a light plane. It is slipproof and can be locked at any height. Made of lightweight tubular steel with a metal base, the jack can be fitted with a wooden platform for use on soft ground.

"Invisible" fish lures molded of transparent plastic tease salmon, muskies and other big game fish for the postwar angler. Fresh bait is thrust headfirst into the plastic and skewered by means of two projecting wires and two fishhooks. With tail free and head visible through the plastic, the bait wriggles through the water in a lifelike manner, and the tough plastic successfully resists the snapping jaws of even "the big one that got away."

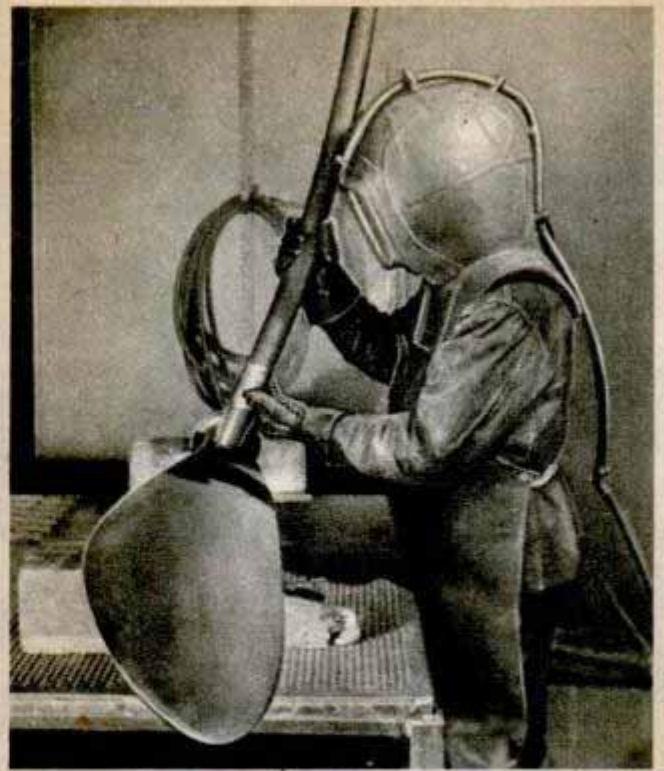

Thousands of pellets hurled against propeller blades under pressures up to 85 pounds increase stress resistance of propeller metals at the Hamilton Standard Propeller plant. A rubber apron, heavy work clothes and a rubber diver-type helmet protect shot-blast operators from the pellets, which ricochet from the blades and walls like an intense hailstorm. Water-cooled air is pumped into the helmet through a hose.

Screwdriver with power arm gives extra leverage for making screws tighter or loosening rusted screws. The power arm unfolds from the handle and allows pressure to be brought both against the screw and for turning it. The tool is available in 5, 6 and 8-inch lengths.

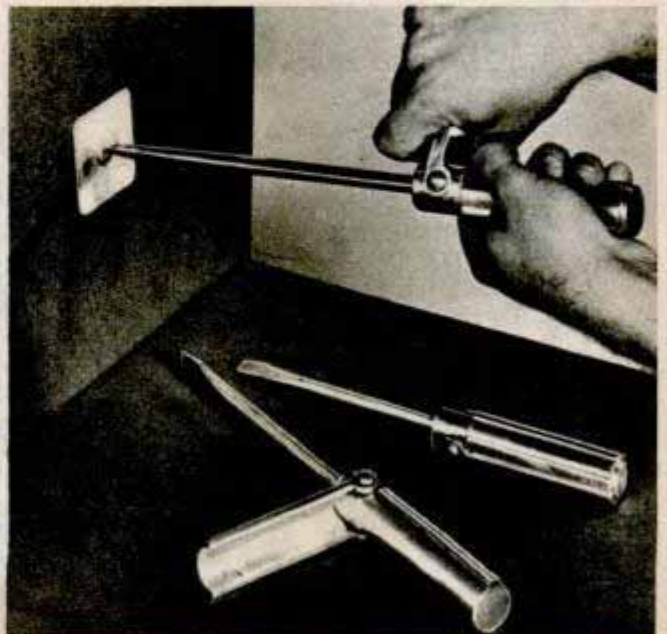

6-Wheel Tractor Can 'Climb Wall'

Rough terrain doesn't discourage a six-wheel tractor built by Charles Ferraro of Minneapolis. With the traction supplied by its unique rear-end construction the tractor will almost "back up a wall." Although both sets of the rear wheels are suspended independently, all four wheels provide power. Each hub of the rear axle is fitted with a cast iron cam that is wedged between the two wheels on that side. The wheels are suspended from an arm that projects across the axle. When power is supplied by the engine, the rear axle revolves the cams which in turn spin each of the four wheels by friction. Independent springing of the wheels provides a crawling action which reduces jars over rough terrain. The tractor was built on the chassis of a stripped-down automobile and uses standard automobile tires.

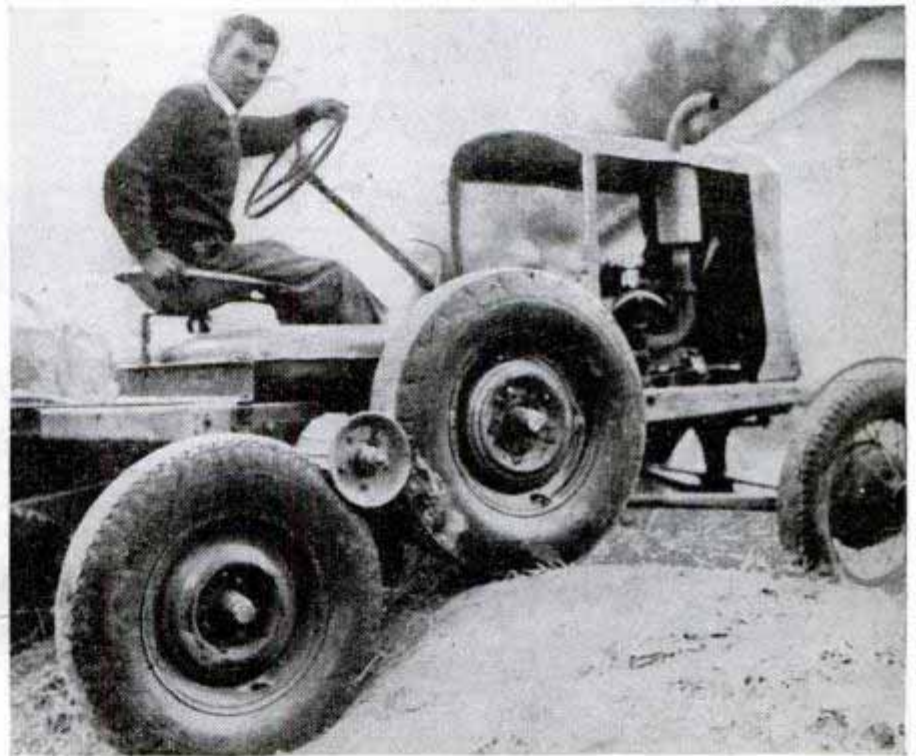
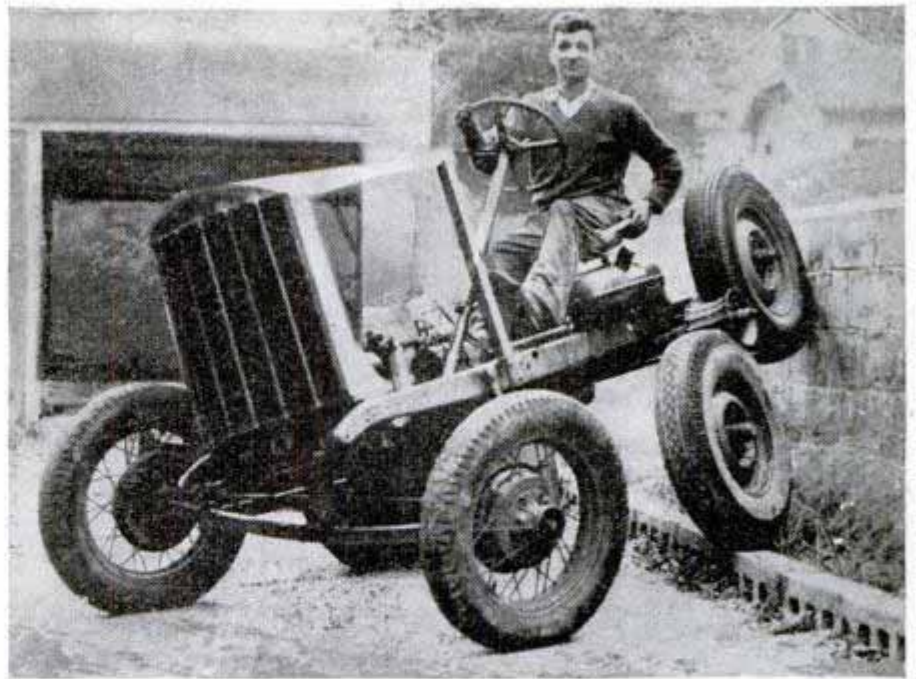

Tanks Swim Ashore Aided by Lifebelts

Thirty-ton Army tanks were converted into tiny warships which swam ashore from landing craft to furnish fire support to assault troops at Okinawa. Lifebelts of steel pontoons filled with rubber sponge to stop rifle and machine gun fire were attached to both sides

of the tanks to make them seaworthy even in rough water. Once on the beach, rivets holding the pontoons were exploded and the tank was freed of its amphibian girdle.



3838 N.E. POLK ST.
MINNEAPOLIS, MINN.

The Army's **TORTURE CHAMBER**

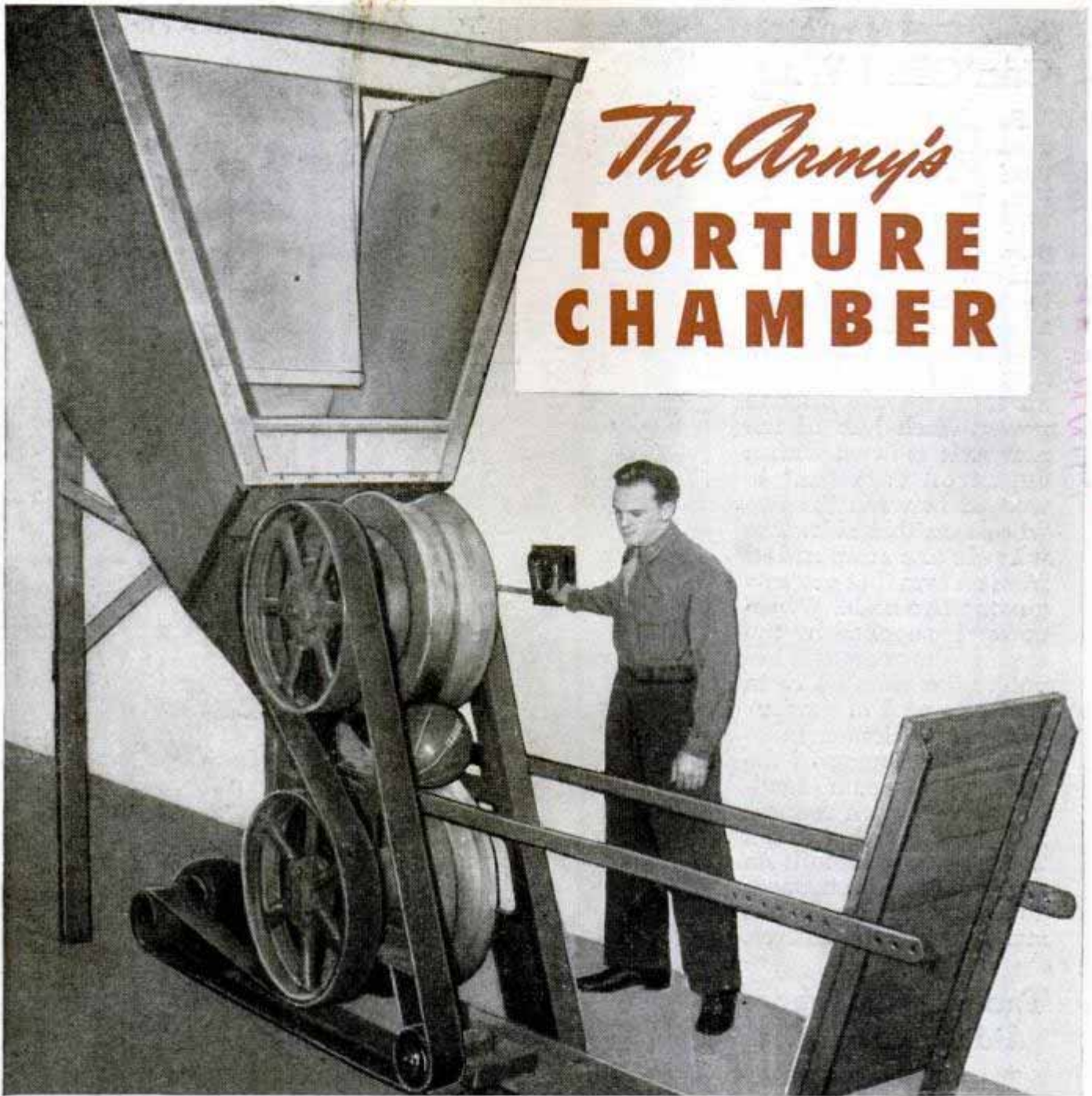

Years of wear are simulated in a few minutes by a compression roller which squeezes and bounces basketballs

Our enemies contrived tortures for their prisoners that were worse than medieval. Our Army has its own torture chamber—but the victims are footballs, tennis racquets and other sports equipment

BROTHER, if you sell a sports article to the Army, it had better be good!

Take a baseball, for example. Here's what value-minded Army buyers do to test a baseball to be used by soldier players: they smack it with a 15-pound mechanical bat that makes Hank Greenberg's blows seem puny. They squash the stuffings out of it with a 390-pound press. They scuff it against a sandpaper sideboard for a day or two. Then, like mad puppies, the Army experts tear it apart to check such factors as the strength of the cover stitching or grease content of the wool yarn.

It's the Army's way of making sure that

our soldiers get the finest sports equipment in the world. And if the Army testers decide an item could be made better, they contact the manufacturer about it.

Baseballs, basketballs, footballs, golf balls, bats, boxing gloves—in fact, 150 types of athletic equipment—go through a “torture chamber” at the Army's Jeffersonville, Indiana, Quartermaster Depot.

Every article has to demonstrate that it can take a beating. In setting up its stiff examinations for sports' equipment the Quartermaster Corps first went direct to the manufacturers to learn as much as possible about the products, what they were

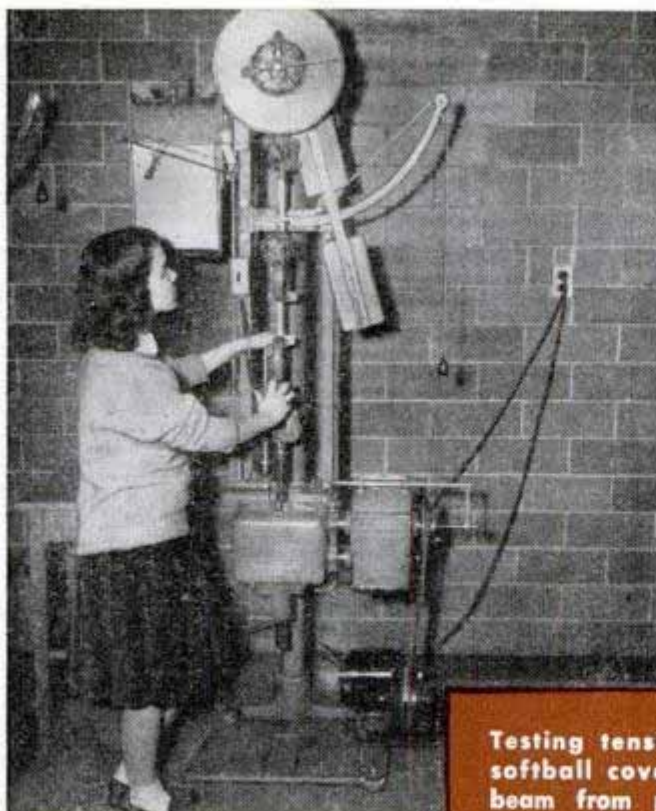

Testing tensile strength of softball cover (left). Light beam from projector (right) measures bounce of volleyball. Squeezer (below) checks ruggedness of baseballs under pressures up to 390 pounds

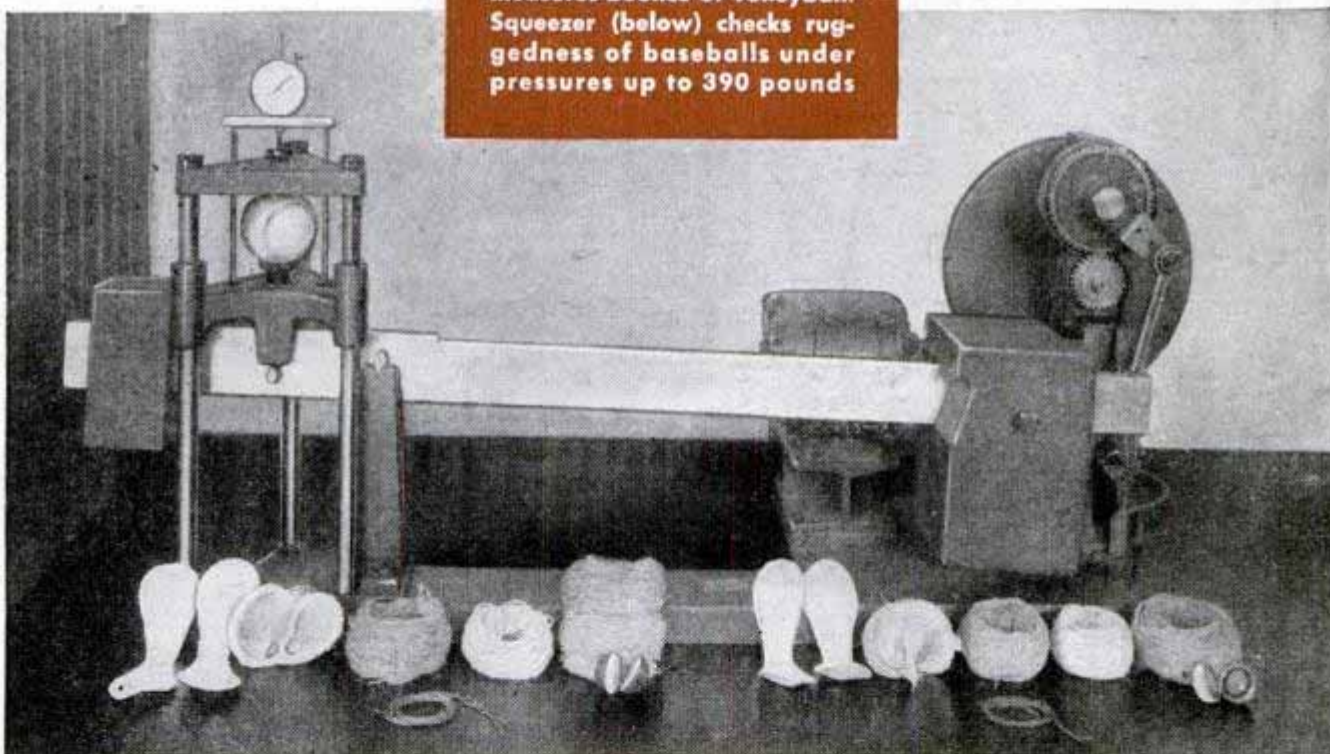

made of, how they were made and packed.

Then the research laboratories were established at Jeffersonville because of its proximity to the geographic center of the athletic goods industry and because of the Quartermaster Depot's long experience in procuring wood, leather, rubber, canvas, cork, twine, textiles, metals and plastics—chief materials for sports articles.

The Army had two main goals: (1) to draw up procurement specifications that would insure uniform products conforming with the regulations of various sports, and (2) to provide the Army with "the best that money can buy."

To put 150 types of athletic equipment through their paces, Army engineers devised various machines which, like untiring nerveless players, tested different items and obtained in a few hours the results that duplicated months and years of actual use.

For example, a whacking machine tests the fatigue of tennis rackets and the resistance of tennis balls; a guillotine finds out whether golf balls can "take it," a drop hammer simulates quickly the amount of abuse a baseball or softball receives in several games of real play; another robot determines whether golf balls go "true" when hit in the air or putted on a green; a roller-

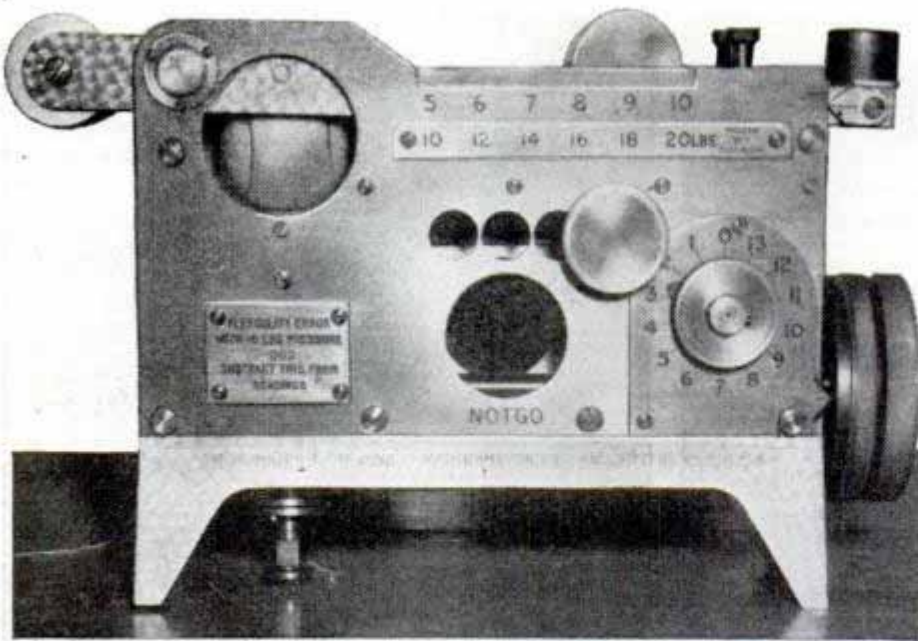

Compressibility of tennis balls is tested by the instrument shown above. Baseballs get a "whacking" test (below) to check durability, roundness

type machine dribbles basketballs and bounces them against a backboard to provide performance data in seven hours that corresponds to months of use.

In addition to these ruggedness tests, a salt spray apparatus duplicates atmospheric conditions aboard ships and at sea bases. Ovens, air-conditioned and humidity-controlled rooms copy the climate of far-away lands.

The artificial climates serve for such purposes as determining a tennis ball's ability to maintain its bounce in a lonely

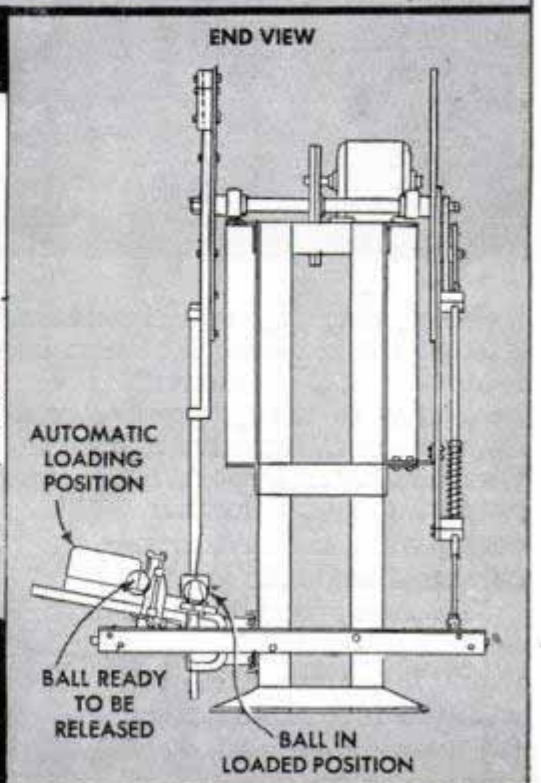
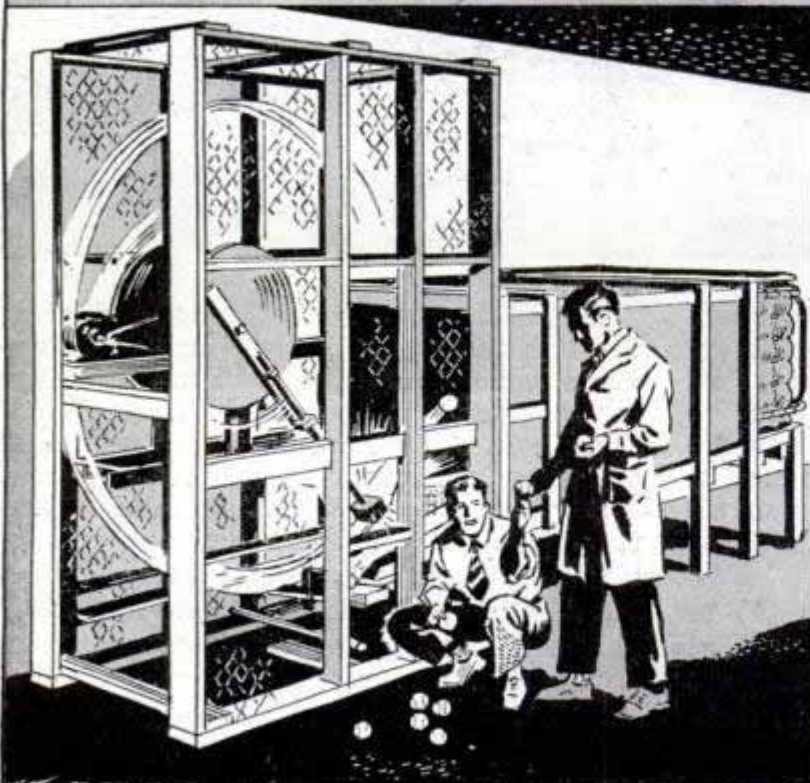
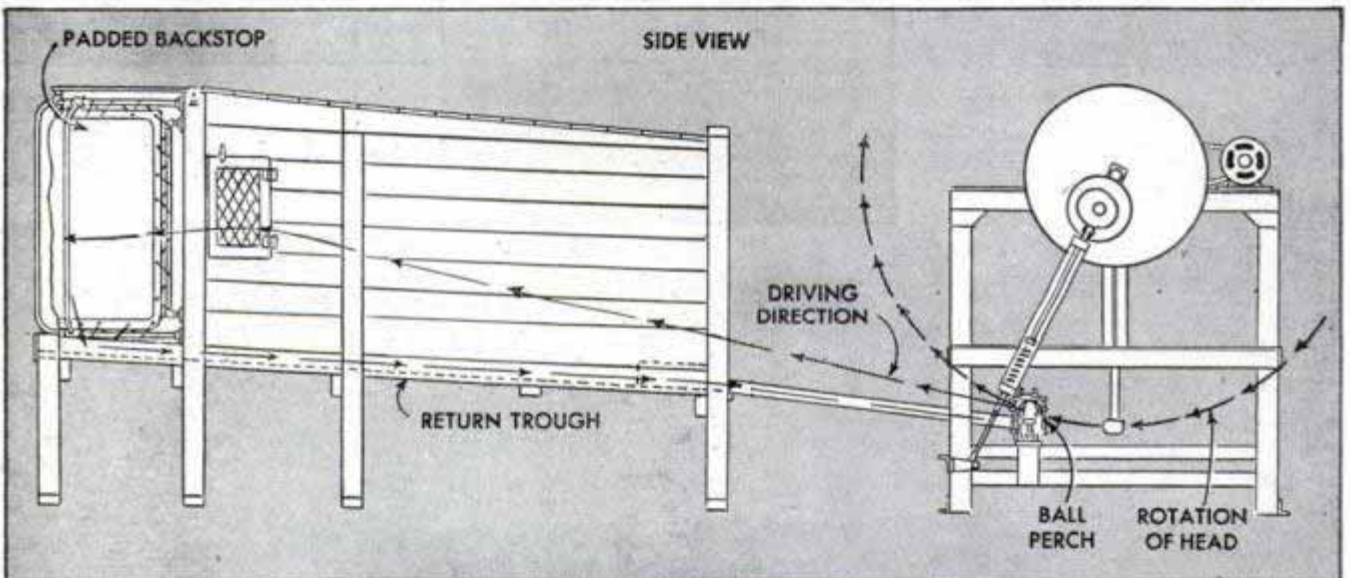

Army post somewhere in the tropics. For this test, tennis balls are placed in an oven in which the temperature is kept at 100 degrees or more for months. Periodically, the balls are examined, bounced and given various other tests.

What has the Army learned as the result of all these tests? Well, for one thing, several items of athletic equipment were not being manufactured in compliance with the rules of sports. Footballs, the Army announced, were approximately one inch smaller around the minor axis than the rules called for. There was a wide deviation in the weight and size of table tennis balls. Softballs ranged from 5½ to 7½ ounces, whereas the official weight is 6 to 6¼ ounces.

But the Army found that most sporting goods manufacturers worked hard, cooperated in following specifications and gave our armed forces the best athletic equipment in the world.

As the result of the Army's research work, several new materials and manufacturing processes are now being considered by the makers of sports equipment. One new material is typha, a product of cattail fluff that can be substituted for hard-to-get kapok as a softball core.

In a hot and humid section of Florida the Army is trying out the idea of using nylon for baseball stitching as an added resistance against mildew and fungus growth. Special studies also are under way to improve methods of moistureproof packaging.

As a possible substitute for leather coverings for basketballs and footballs, the Depot, with the aid of athletic equipment manufacturers and coated fabrics manufacturers, recently developed a heavy plastic-coated textile with a playing life equal to or better than genuine cowhide.

The "torture chambers" have assured flawless athletic equipment for our men in uniform. The tests undoubtedly will mean improved sports goods for you.

Automatic "toe" (top) measures rebound of a football in foot-pounds. A press (center) bears down on basketballs until they burst to test durability. Machine at bottom "kicks" football 100 yards

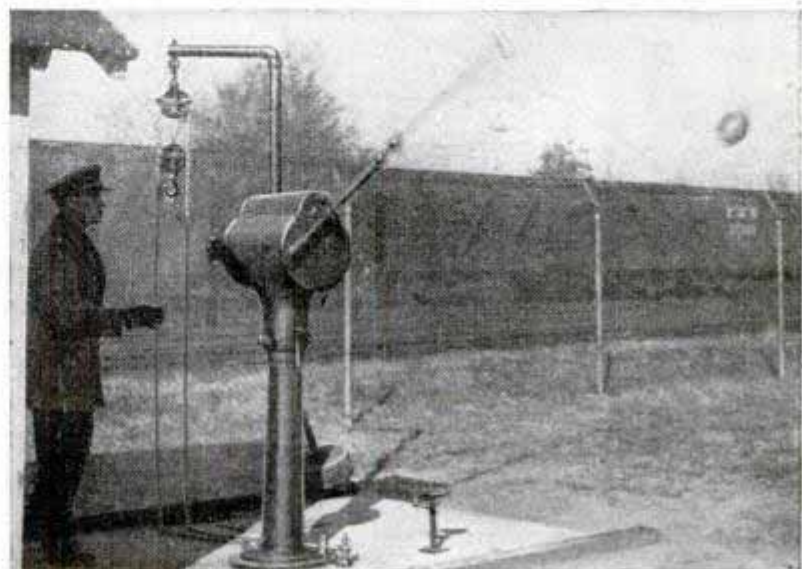
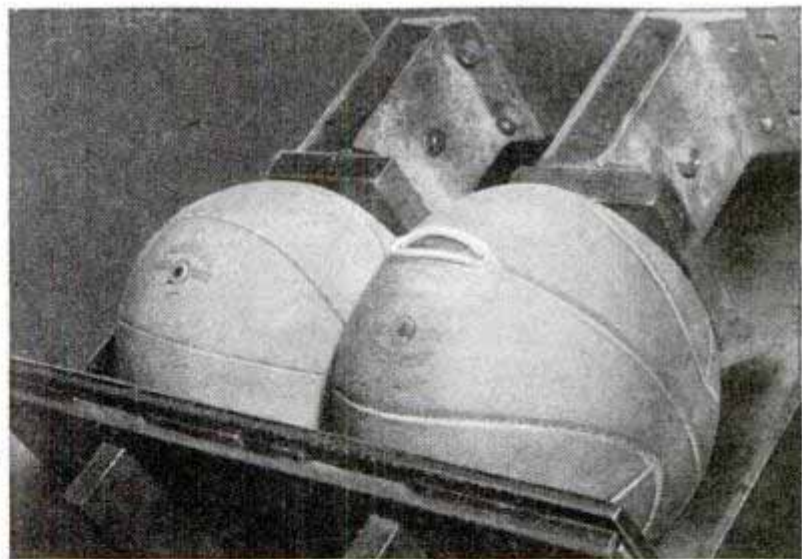
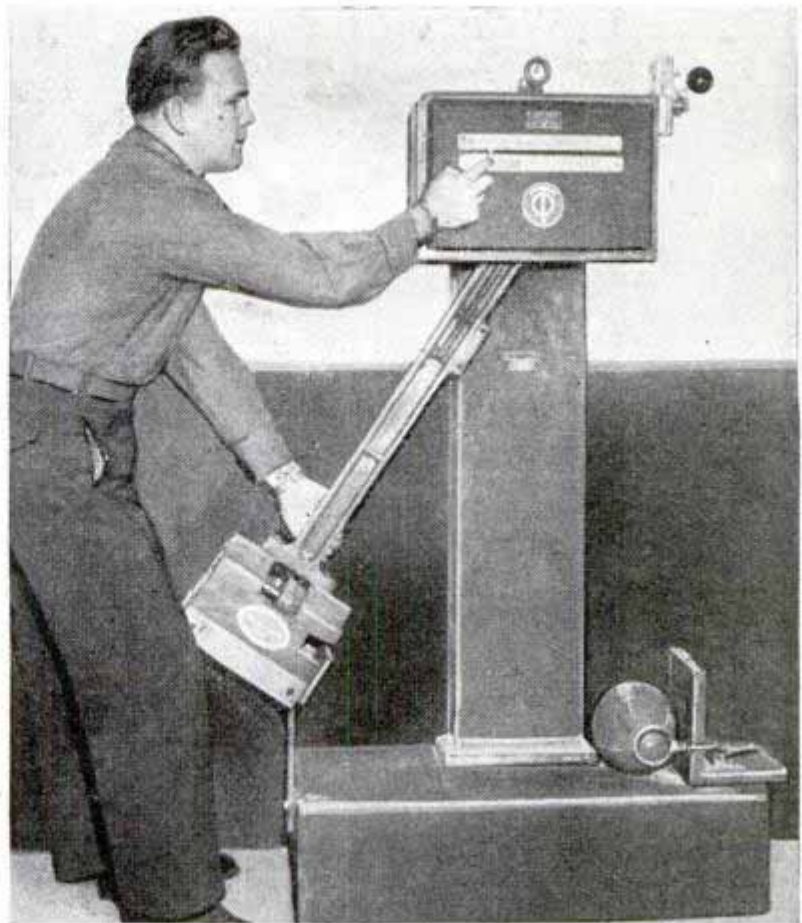

U. S. Coast Guard Washington 25, D. C.

Line-Throwing Gun and Rifle Designed by Gunner's Mate



U. S. Coast Guard photos

Two new types of firearms, recently announced by the Coast Guard, carry the name of Chief Gunner's Mate James E. Sieg of Baltimore, Md., who designed them in conjunction with the Coast Guard's Research and Development Division.

One is an automatic rifle of 30.06 caliber, 36 inches long, weighing 10 $\frac{5}{8}$ pounds. The rifle has a rate of fire of 650 to 700 rounds per minute with a magazine that holds 20 rounds. The double trigger is pivoted for either full or semiautomatic fire. A unique compensator is said to reduce recoil so effectively that the weapon may be fired with

one hand. The compensator does not interfere with the use of a bayonet, flash-hider or grenade-launcher.

Developed primarily for use by the U. S. Merchant Marine, the second firearm is a line-throwing gun. It promises to surpass all previous models in both range and accuracy. It is .50 caliber and weighs 25 pounds. The gun throws a four-pound projectile that carries a 150-pound-test nylon line to a range of 400 yards. A second type of projectile contains a mechanism for firing a CO2 cartridge which inflates a "donut" float upon impact with the water.

Self-Propelled Paving Breaker Does Work of Eight Men



Cuts are adjustable between six inches and five feet with a self-propelled pavement breaker which does the work of six to eight men. One man operates the machine. All controls are accessible from the driver's seat. The machine weighs 4200 pounds, has a 93-inch boom, six-inch bore

and 40-inch stroke. It is mounted on a 1 $\frac{1}{2}$ -ton running gear. A 210-cubic-foot air compressor is required for operating at full capacity. A 3 $\frac{1}{4}$ -horsepower air motor drives the swing gear and also propels the breaker forward or backward.

Rubberlike Plastic

"Marvinol" resin, new elastic plastic, will be used in swimming suits, infants' pants, purses, gloves, shoes, raincoats,

umbrellas and transparent garden hose, according to the manufacturer. In raw form the polyvinyl plastic is a granular white powder. When combined with other substances it varies from a rigid to a soft rubbery state. The manufacturer claims it resists chemicals and is durable.

Bottled Carbon Dioxide Fills Tires or Puts Out Flames

Carbon dioxide gas, used in wartime to inflate collapsible rubber rafts, now is being used to inflate flat tires. Ten ounces of gas, enough to fill three tires, are compressed into the three-pound nine-ounce steel cylinder. Because it quickly smothers fires, the lightweight non-toxic carbon dioxide cylinder can be used also as a fast-operating fire extinguisher. The cylinders can be refilled.

Film Records Talks Over Railway Radio

Automatic film type recorders jot down two-way conversations carried on over a high-frequency radio communication system now being tested by the Reading Railroad at Philadelphia. Designed by Maguire Industries, Inc., the recorder employs a voice-actuated relay to start the mechanism. The radio equipment makes it possible to conduct two-way conversations between the main railroad station and three Diesel-electric locomotives moving about the yards. Messages also can be exchanged between locomotives and to and from remote points in large offices.



Water Bags Silence Tank Movements

Bags which fit over the treads of this Japanese amphibious personnel carrier are filled with water for "silent" operation when the tank is operated on land.

☐ Airplanes scatter mustard seed over mountainous areas devastated by fire so the quick-growing plants will help prevent serious erosion.

HANDS FOR THE

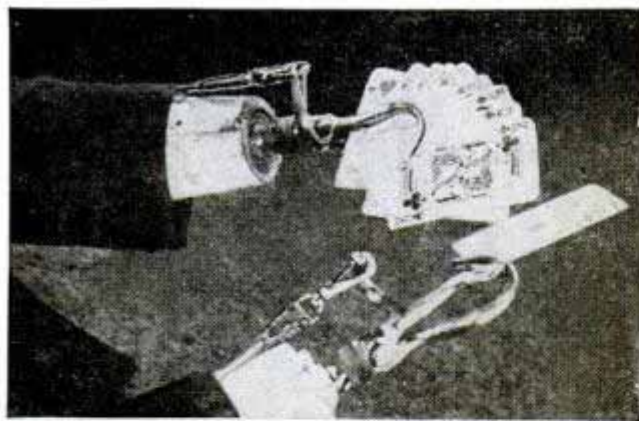

A veteran can handle cards with metal fingers which are operated by cables from the shoulder

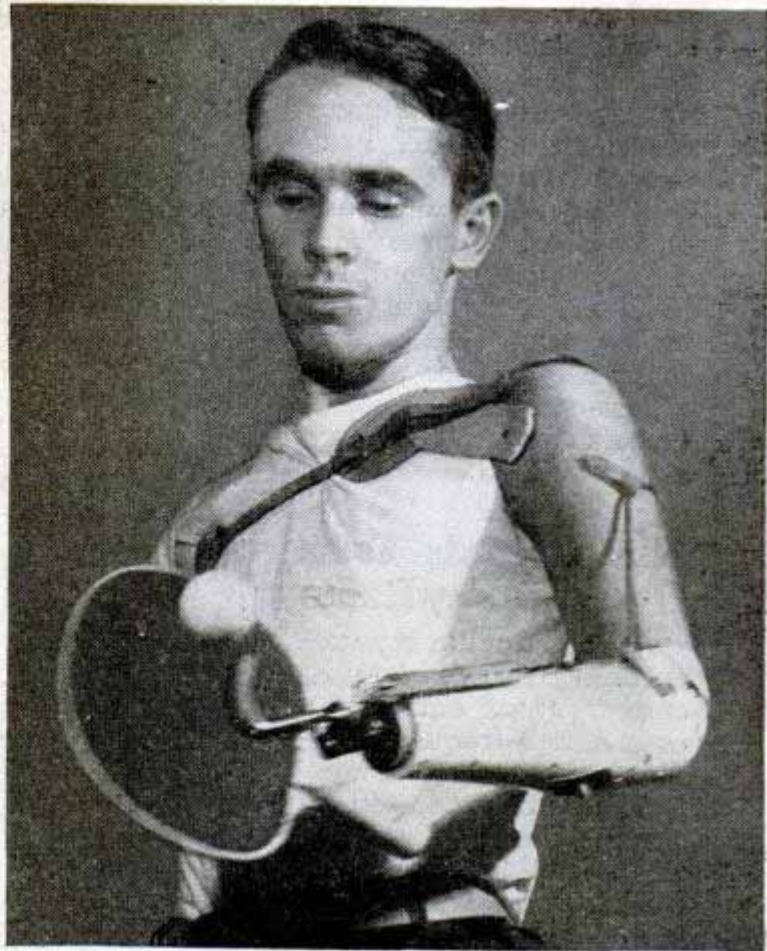

Signal Corps photos

Although this veteran has had his new arm only one week, he can already play ping-pong, a game that develops coordination through sweeping arm movements. Below, two man-made hands demonstrate degree of dexterity needed to tie shoelace

Even the necessary everyday tasks seem insurmountable to the man who has lost both hands. But with practice he can learn to manipulate table utensils (above), dress himself, drive an automobile and do practically anything he could do before his injury. When he gains more confidence he can even teach his new hands how to typewrite

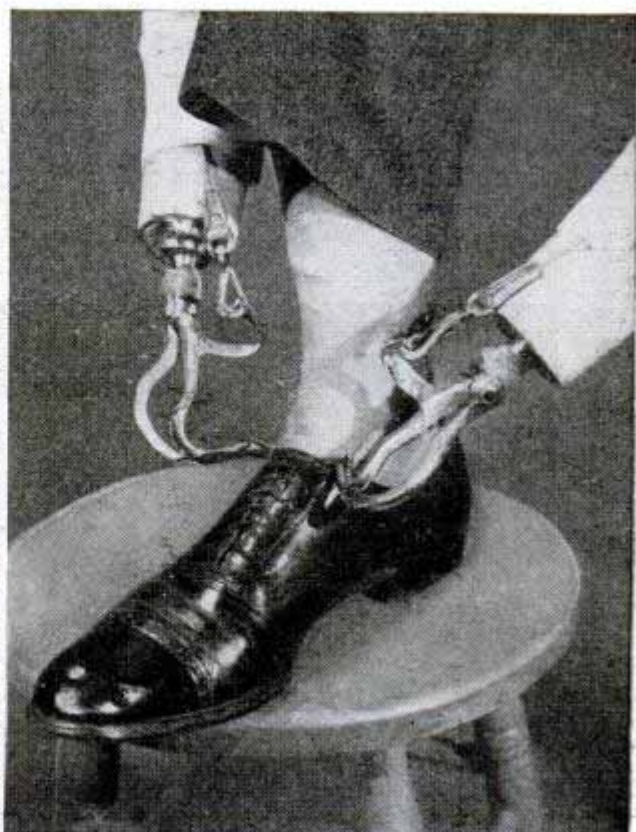

HANDICAPPED

FOURTEEN thousand men—the equivalent of one full Army division—are sweating out their discharges in Army hospitals. Each member of this “phantom division” wears the Purple Heart and at least one overseas theater ribbon. Many wear their country’s highest combat decorations, including the Medal of Honor.

But each member also bears a cross that is a lifelong reminder of service to his country—the loss of at least one limb.

More than 90 percent lost at least part of one limb, five percent parts of two limbs, nine men are triple amputees and two lost parts of all their limbs. Members of this “phantom division” can become self-supporting once more only if they are fitted with man-made hands, arms and legs.

Experimentation in the development of artificial limbs was given terrific impetus by the war. Private manufacturers are striving to market satisfactory limbs. Last January the Veterans Administration shouldered the research work for this important project.

Progress is slow and claims are cautious. All sincere experimenters warn the amputee not to lift his hopes too high. Yet limbs that “work” are being produced.

In 1943 the Army adopted the “Trautman” leg, which is far from perfect but is still the best of those available. Made of wood fiber, it is light, durable and can be adjusted easily to amputations of all types.

Development of adequate artificial hands has lagged far behind the production of legs. Movements of the fingers, thumb, wrist and elbow are too difficult to duplicate at the present time. The so-called “cosmetic” hand resembling a human hand can simulate only a few movements and is mainly a show piece. The “working” hand is a metal “claw” or “hook” hand. Compound joints have given it a greater range of motion and flexibility.

After an artificial limb is fitted, the amputee receives training in its use. Leg amputees are taught to march to music, walk over rough obstacles and up and down stairs. Claw hands, with practice, can be made to duplicate several simple motions of the human hand. The amputee can learn to eat and dress without help, play games and even typewrite.

But the aim of the experimenters has not changed. It is to provide the best possible appliances so that amputees can resume their places in society with confidence and pride. The nation can do no less for men of the “phantom division.”

Plastic Container for Fishing Rod Prevents Tackle Damage

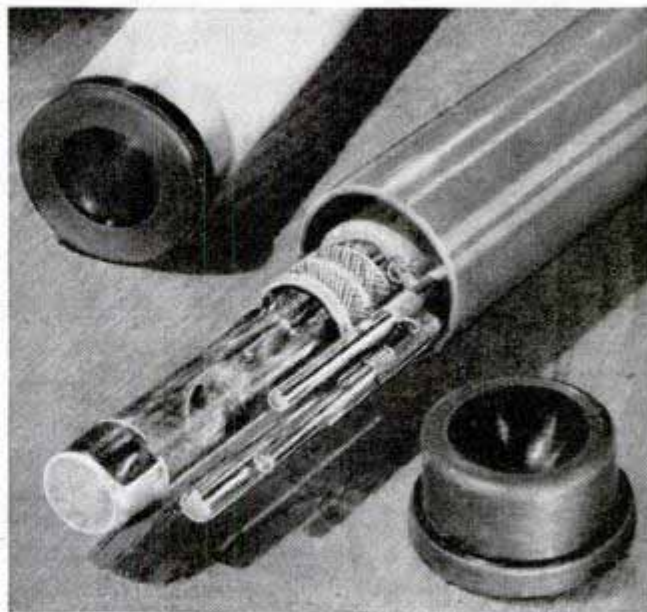

Shatterproof cylindrical containers of plastic afford full protection for fishing rods whether thrown in the back of the car with other fishing gear or in storage on crowded shelves. The lightweight containers are 1½ inches in diameter and a little over three feet long. One end is permanently sealed and the other has a rubber plug. The containers are made in several colors.

Page Holder Pins Book Open

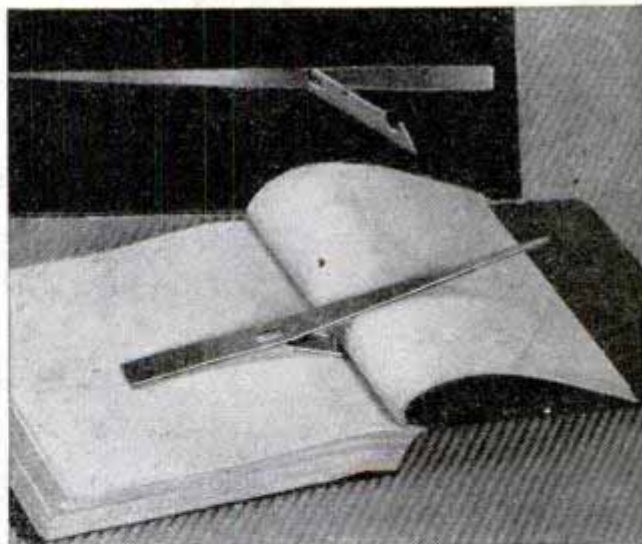

Typists, bookkeepers and other office workers will find many uses for a knifelike instrument designed specifically for holding a book or notebook open at a certain page for copying. The bottom blade is inserted in the book’s binding while the upper part holds down the pages. The page holder comes in various models, some ruler-marked and others equipped with a small magnifying glass. It also can be used as a letter opener or as a knife for cutting cord from packages.

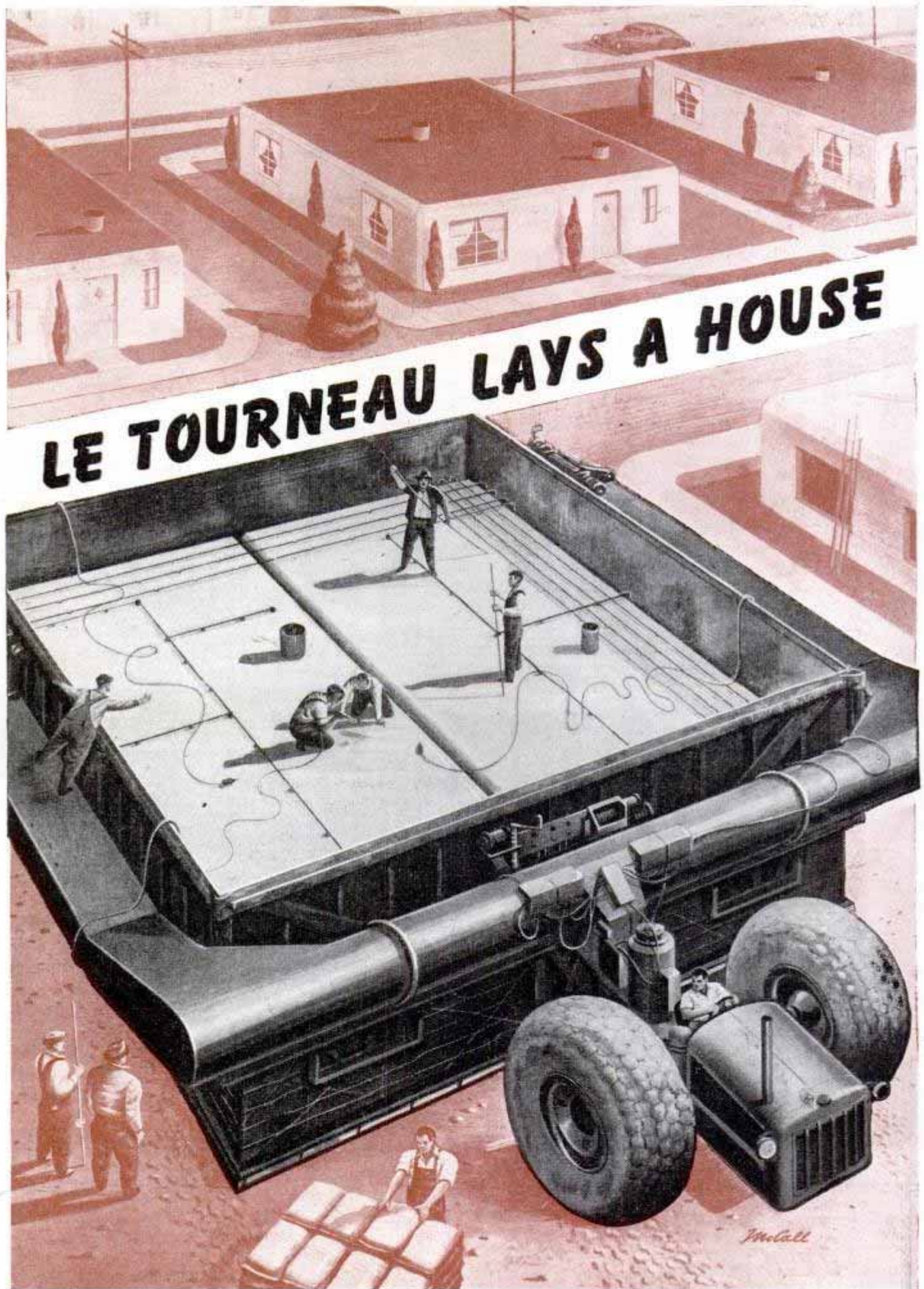

LE TOURNEAU LAYS A HOUSE

Like a giant chicken laying eggs, this huge machine forms and gently sets in place complete concrete homes. Roof and walls, with allowances for doors and windows, are poured after inner and outer forms are built and steel reinforcing is installed. After setting 24 hours, the house is carried to its site by the robot contractor

By William F. McDermott

HUGE bombers that have laid "eggs" all over Germany and Japan now have a rival in a mammoth bulldozer-type machine that may some day "lay" houses all over America. It is the latest of many developments by R. G. LeTourneau, Inc., in the house-building field. It really isn't house building, but "house pouring," because this behemoth takes the flowing stream of cement and sets it into a complete house form.

The revolutionary Tournalaid house is far beyond the blueprint stage. Several already have been constructed and are in use near Vicksburg, Miss. The need for housing the families of LeTourneau employees and for factory offices gave birth to the mammoth Tournalayer. Dimensions of the bowl of the vehicle are 24 by 30 by 9.5 feet—the earthmoving capacity of such a box would be 317 cubic yards, or 21 big scraper loads.

That is only for comparison, because it is not designed for earthmoving and is too wide for maneuvering on most highway projects, since the overall width is $34\frac{1}{4}$ feet. It does, however, freely navigate housing project areas and can be unbolted for transportation to new locations. When travel-

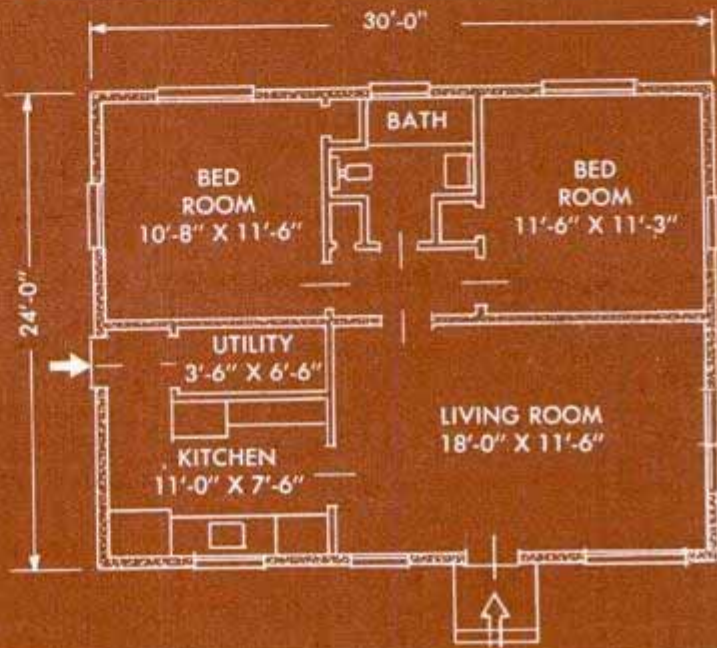

Laid in a day, the concrete home and its floor plan (above). Inner form (below) provides "nest" over which Tournalayer drops its load

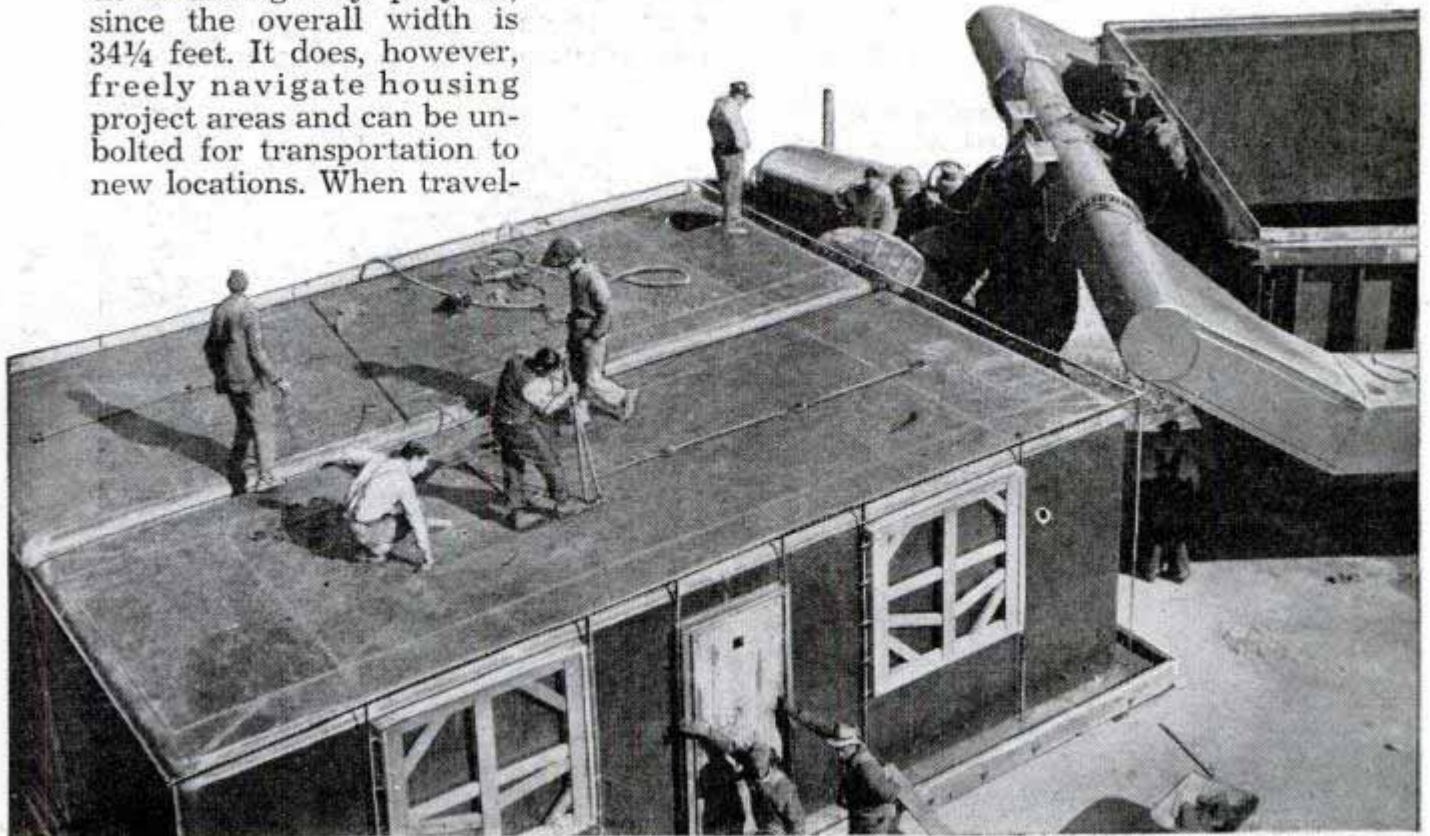

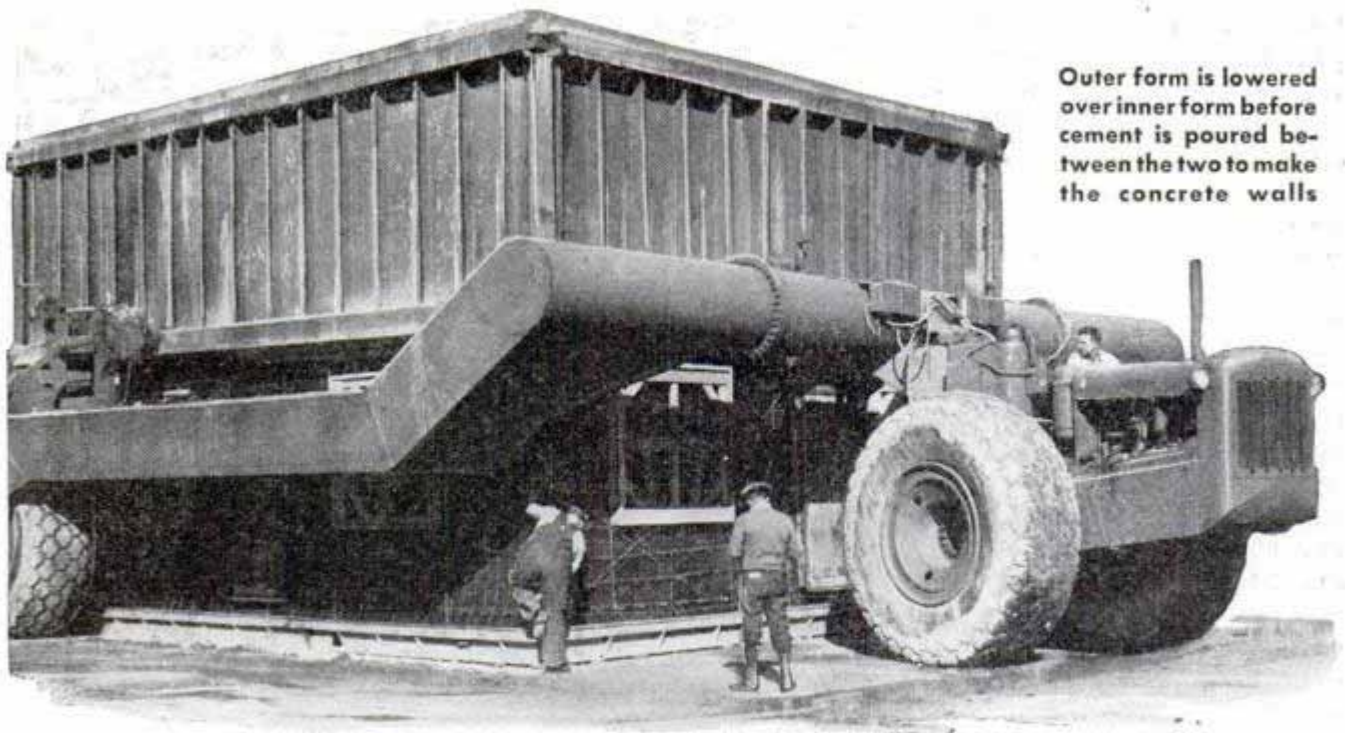

Outer form is lowered over inner form before cement is poured between the two to make the concrete walls

ing, this strange contraption has no bottom. After the concrete from a huge mixer has been poured within its form and has set, the Tournalayer transports it to the new site. After the exact spot for the new home has been determined, the operator presses a button and the bowl slowly lifts to disclose a rectangular concrete house, with doors, windows and partitions.

The Tournalaid house form is in three sections—one outside. The inside form is composed of two independent sections so spaced that a partition wall can be poured between them.

After the two inside forms have been covered with reinforcing mesh, the Tournalayer straddles them and lowers over them the outside form, which is the body

or bowl of the Tournalayer. The concrete is poured. After it has had time to set, the operator collapses the inside form walls away from the house by pressing an electric button. He presses another button and the outside form with the house is lifted up. Lowering its load to traveling level, the Tournalayer walks off to the house site. There it brings the form down to the ground, lays its egg, lifts the form off and struts back. The house is left standing on a broad foundation which is part of its walls. In the meantime the inside forms have been expanded by reversing the action on their walls and are ready for covering with reinforcing mesh. The operator or foreman takes a look at his print for the next structure, then spots doors and win-

In one operation the concrete is poured to form both the walls and roof. Note the steel reinforcement

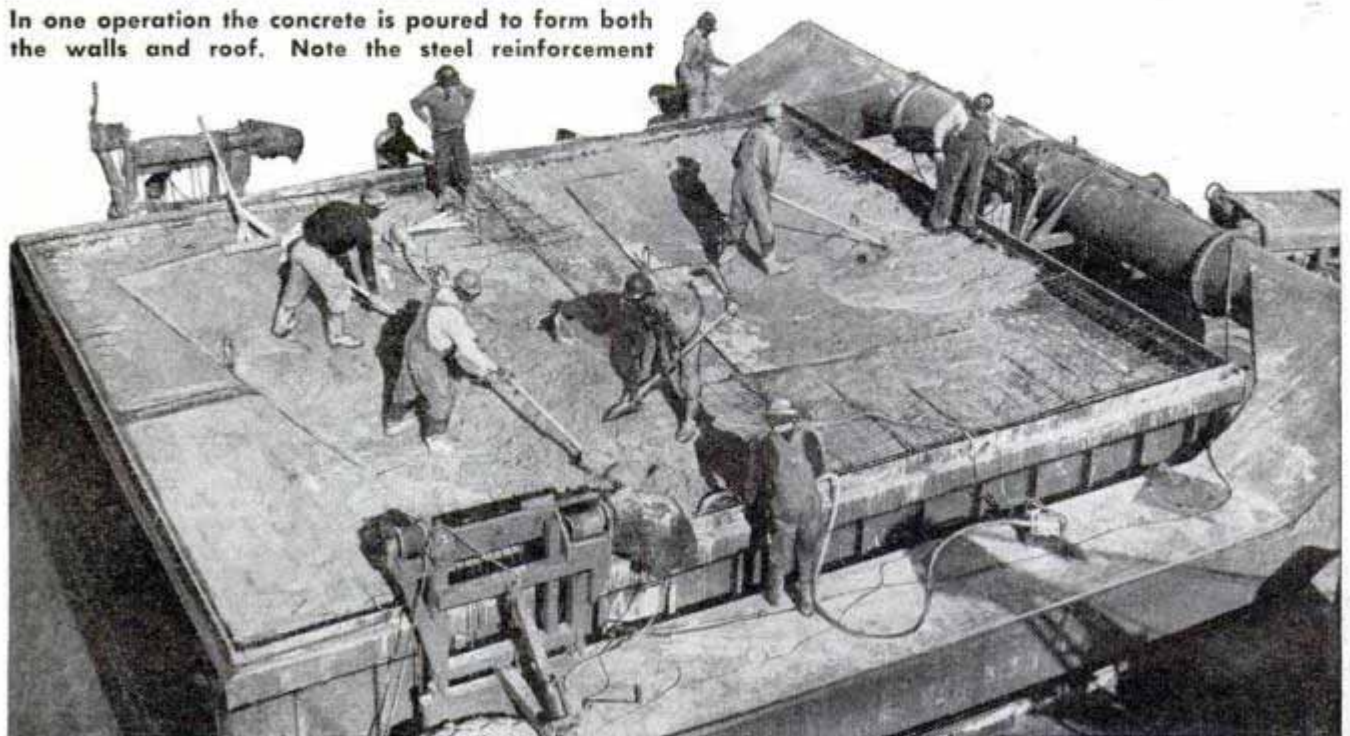

dows wherever they are required by pegging metal frames into the holes which are conveniently located all over the walls of the form.

All this work of the automatic house builder, however, takes place after a certain amount of hand work. The first step is to lay a concrete floor with quick-drying cement. Contractors may lay long rows of floors, opening the way for quick setting of entire blocks of homes. Floor-laying is done in the usual manner and does not require any help from the Tournalayer. All utility lead-ins are laid with the floor, as well as a system of hot water pipes which run through the floor to provide radiant heating.

Tourna-transit-mixers—which are in R. G. LeTourneau's mind, although not yet on the drawing boards—equipped with extra high dumping facilities, can bring concrete from the batch plant and pour 30 cubic yards of concrete—about five loads—at a cost of about \$10 a yard in place. When the house is poured and the concrete is sufficiently set for lifting it off the inside form and traveling, the Tournalayer will waddle off with it to the homesite.

The first LeTourneau pre-fabricated concrete houses were of a sort of intersecting tunnel design, which the designer referred to as clover-leaf, but most of the factory force called igloo. Curved walls presented problems. Appearance, to speak moderately, was a bit unusual. The Tournalaid house, however, is conventional in shape and with the form or forms now used can be poured in a wide variety of styles and for a multitude of floor plans.

While there are no immediate plans for marketing Tournalaid houses—undoubtedly there will be considerable further development before any such plans will be made—the Vicksburg, Miss., plant and its employees are going to get more Tournalaid homes, offices and factory buildings.

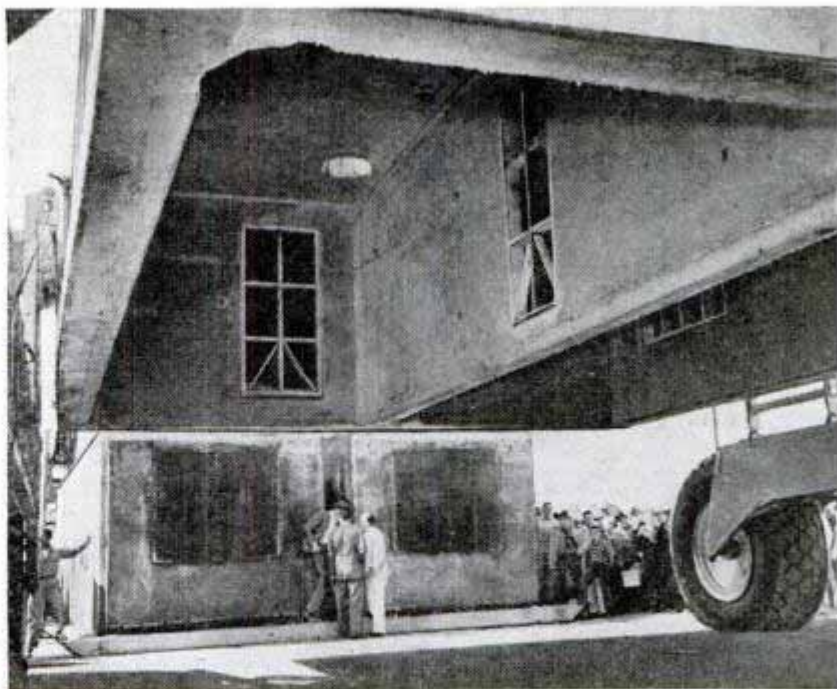

Hardened concrete house is removed from the inner core by hydraulic lifts of the home builder. The home then is deposited on its site



At the site (above) the home is set down and the house layer prepares to move away for more concrete to build another structure. Below, Tournalayer containing another new house is on way to site

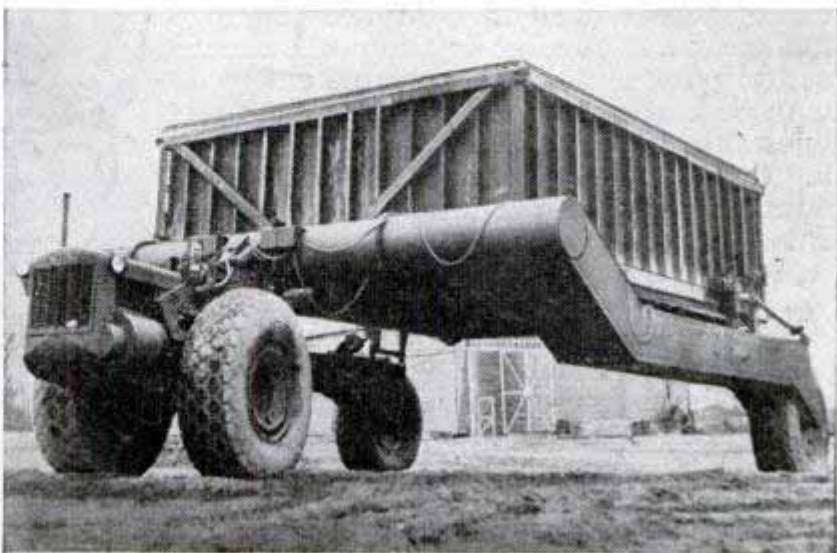

Speed Below-Zero Plane Starting



Cold weather starting of plane engines in two minutes instead of as much as six hours is possible with a new fuel developed by the Texas Company and now being tested by the Army Air Forces. It is expected to eliminate the cumbersome pre-heating equipment for subzero takeoffs when aviation gasoline will not start the engines. These gasolines cannot contain the low boiling fractions needed for starting in such weather because of the dangers of vapor locking in flight. The cold starting fuel is used in regular aviation carburetor and priming systems. A portable external tank or bottle is attached to regular fuel lines, shutting off main fuel lines and allowing the special fuel to flow for about two minutes. After the engine is warm the portable tank is disconnected.

Find First New Gem Since 1909

Brazilianite, a mineral recently discovered in the country for which it was named, is suitable for cutting into gem stones. The mineral is yellowish-green with glasslike properties and has sufficient quality in color and perfection to warrant cutting it into

gems. The discoverers, Edward P. Henderson of the Smithsonian Institution and Frederick H. Pough of the American Museum of Natural History, believe, however, that it is not likely to become a popular gem because of its scarcity and because it is not hard enough to withstand long wear. Brazilianite is the first new mineral with gem-stone possibilities to be discovered since 1909.

"Catch" Device on Rope Breaks Lineman's Fall

Telephone and electric linemen are assured safety from falling with a recently patented device that grips the pole immediately if the climber accidentally falls or his spikes fail to grip. A loop of rope is substituted for the lineman's arms in encircling the pole. A wire woven through the center of the rope keeps it stiff enough to be moved easily. At one end of the rope are two loops, one used as a hand grip. At the other end is a similar hand grip, with an extension of the rope which fastens to the climber's belt with a hook. The rope is placed round the pole and the free end is passed through one of the loops at the other end and fastened to the lineman's belt. The lineman lifts the rope with him as he climbs. Should his spikes fail, his weight immediately falls on the rope, which tightens around the pole.

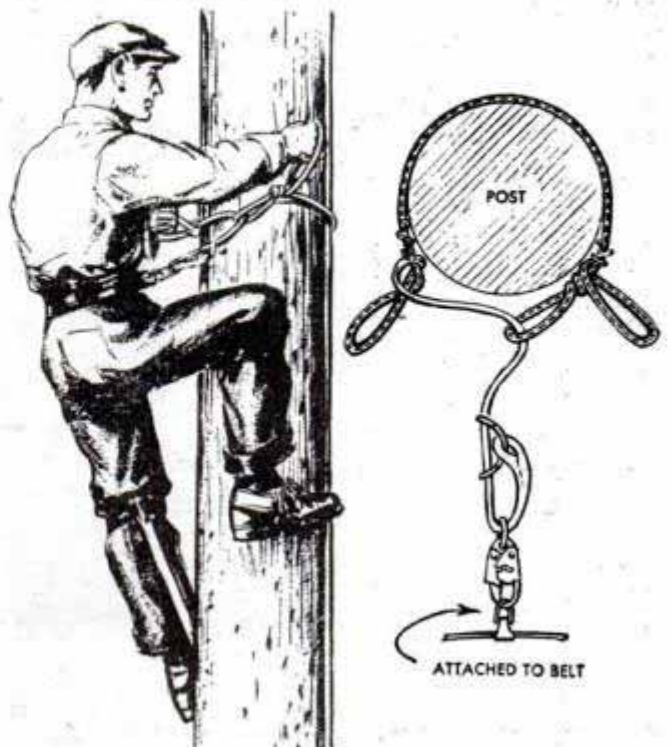

Tool-of-All-Work for Workshop Saws, Grinds or Polishes

Grinder, sander, buffer and saw are combined into one power tool for home workshops, model makers and light manufacturing. The basic tool is an abrasive grinder on one end and a sanding disk with adjustable work rest at the other end. Either the grinding wheel or sanding disk may be replaced with buffing or polishing wheels for a second combination. A third adaptation makes up into an eight-inch power saw with tilting table. A fourth combination is provided in the design of the saw table so that dado heads may be used for routing. The base of the power tool is cast iron, machined to aircraft tolerances, with self-lubricating ball bearings used at the two bearing points. The saw table is cast aluminum, ground to accurate flatness. It is recommended that a $\frac{1}{2}$ or $\frac{1}{3}$ -horsepower motor be used with the tool.

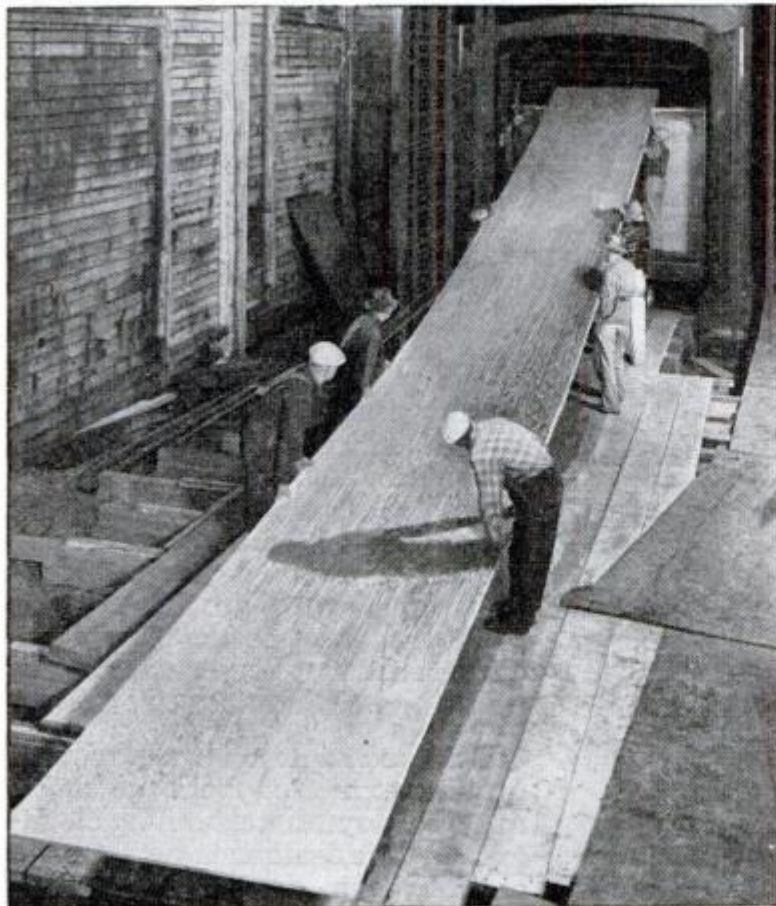
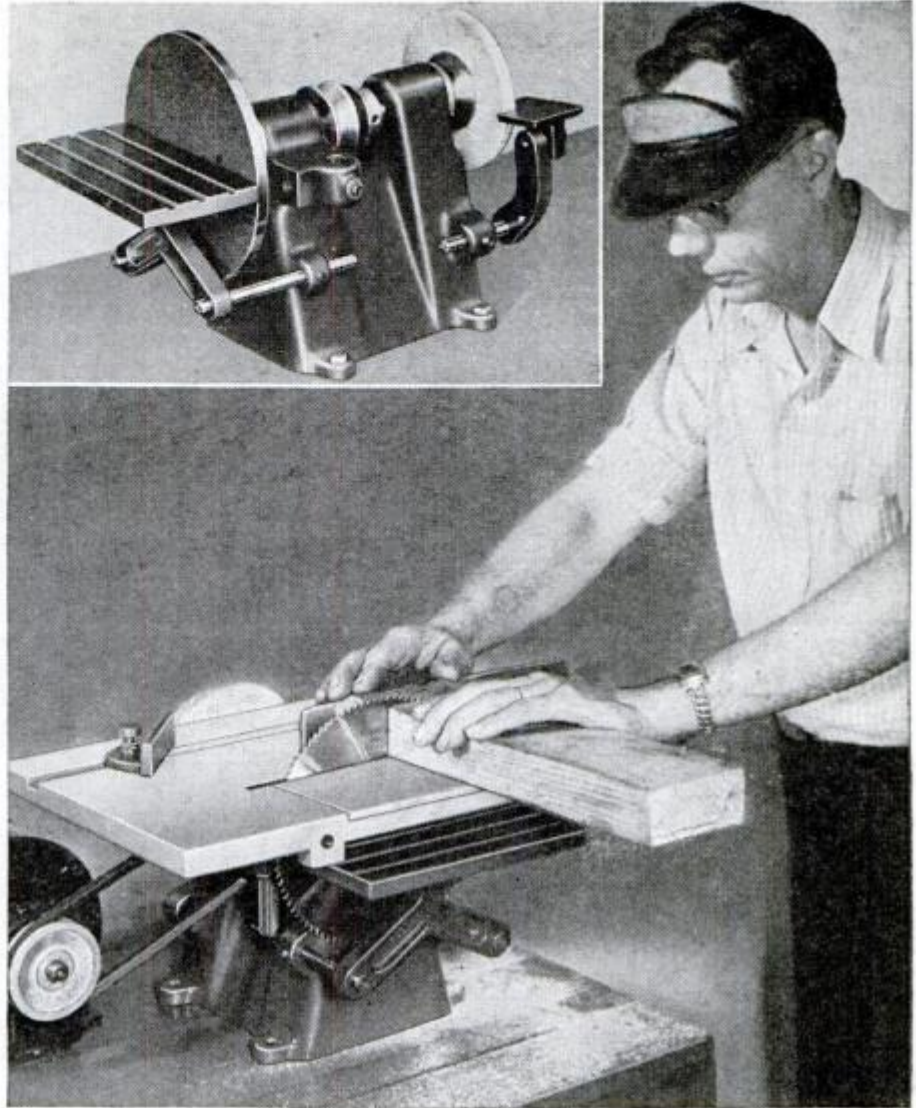

50-Foot Plywood Panels Made of Small Sheets

Plywood panels almost as long as a freight car are being made with production techniques developed during the war. The panels are 50 feet long, five feet wide, $\frac{3}{4}$ inch thick, and weigh 550 pounds each. They will be used in building boats, outdoor signs, structural beams and store fronts. To make the extra-large panels, the ends of standard-size sheets are tapered in a scarfing machine and then bonded together with waterproof adhesives. A new press, the largest of its kind, applies both pressure and heat to seal the bond. The joints then are sanded smooth. Waterproof adhesives enable the panels to be used in boat building.

Write to the firms listed in the Where-to-Buy-It Index, page 8, to learn more about products described in this magazine. Say you saw it in Popular Mechanics.

Hangar With Removable Walls Eases Storage Problems

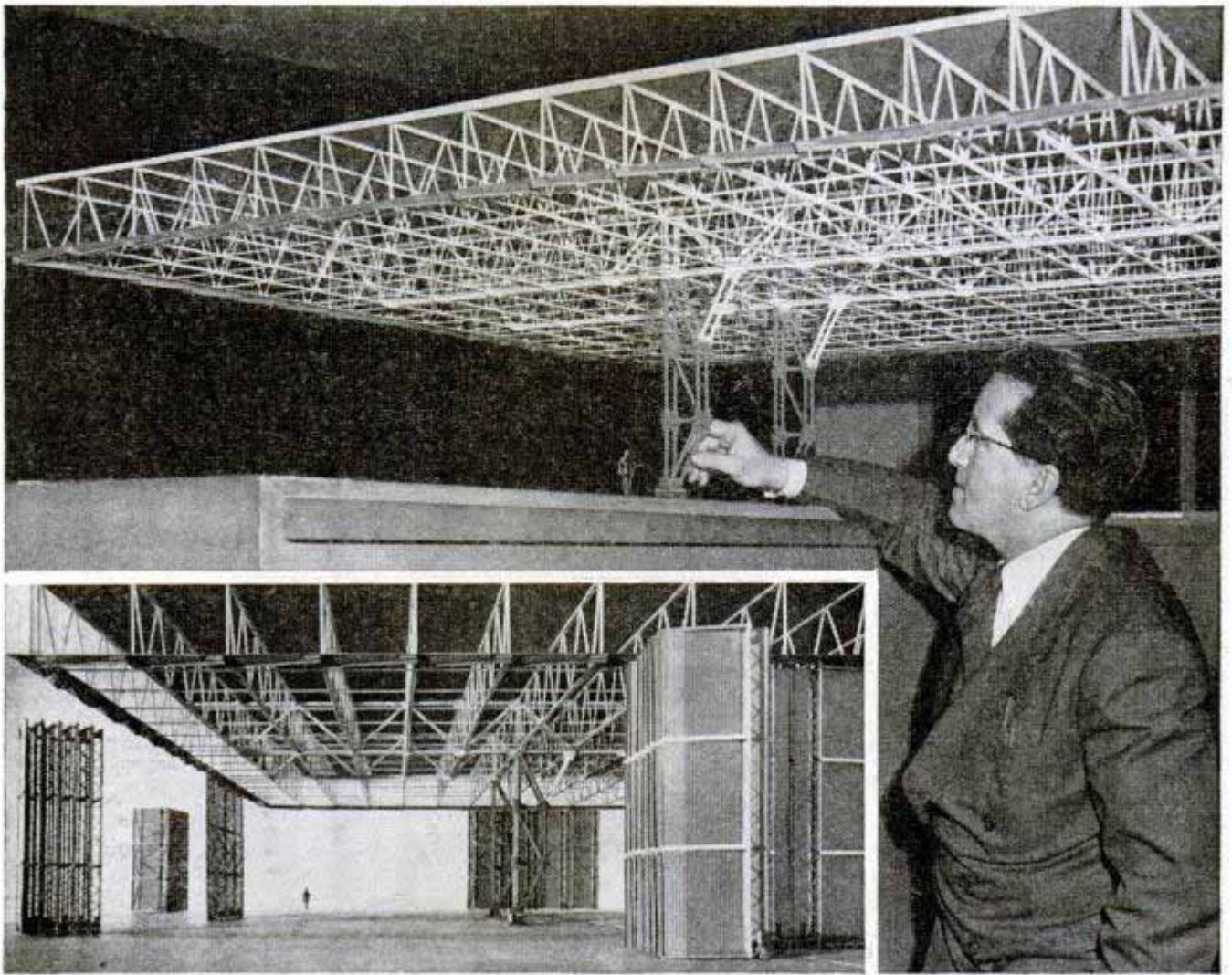

Hangars with all walls completely and instantly removable for exit or entry of planes anywhere along the building line are possible with a new method of prefabricated construction. The wall units double as doors and are completely independent of the hangar, without hinges, tracks or other permanent connections. They stand by themselves or can be rolled entirely away, since they carry none of the building's structural load. The new method also

utilizes a metal tube joint entailing no riveting, hand welding or other skilled operations. It will permit the owner to extend, modify or demount the hangar with 100 percent salvage after erection. According to the designer, the wall units are planned so they can be rigged horizontally to a dolly and a tractor and used as semitrailers to transfer the building materials from one site to another. This type of construction is adaptable to warehouses or factories.

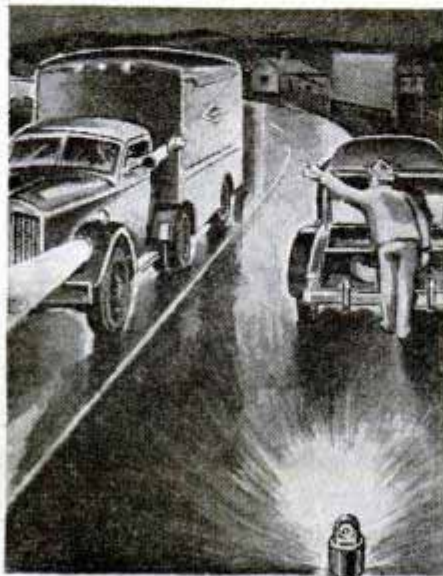

Motorists' Electric Flare

Pint-sized electric red flares, which light by denting a metal blister on the bottom, can be used by motorists when stalled along the roadside at night. Depressing the blister sets up a chemical reaction which will light the bulb for 24 hours. The device is not rechargeable, but may be turned off by being placed on its side.

Believed superior to the natural product extracted from the chestnut tree, a synthetic tanning chemical for sole leather is being made entirely from domestic materials.



The Gold Bug Strikes Again

By **ANDREW HAMILTON**

HERMAN CONROW, JR., 36-year-old discharged Army veteran, recently decided to return to the peaks and forests of his native Colorado to try his hand at gold mining.

He liked the looks of some property up near Cripple Creek—scene of a mad gold rush in 1892 and shortly thereafter one of the richest gold fields ever discovered in the United States, producing more than

Is history to repeat itself with a '46 gold rush? One GI got rich on foxhole technique

Small-scale miners, above, collect bedrock pay dirt in a rocker where the gold is removed. Below, washing cycle in a typical hydraulic gold mine in California

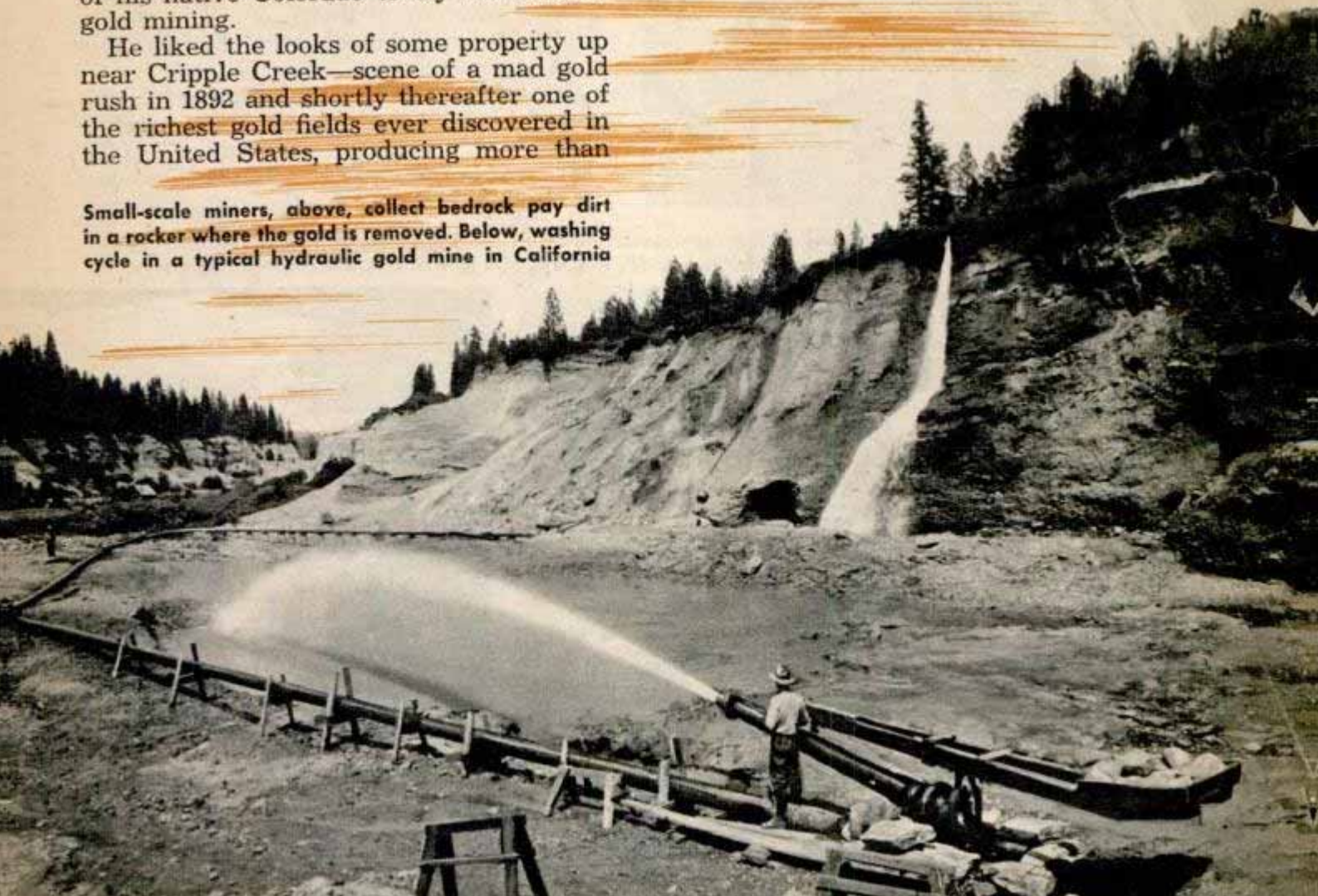

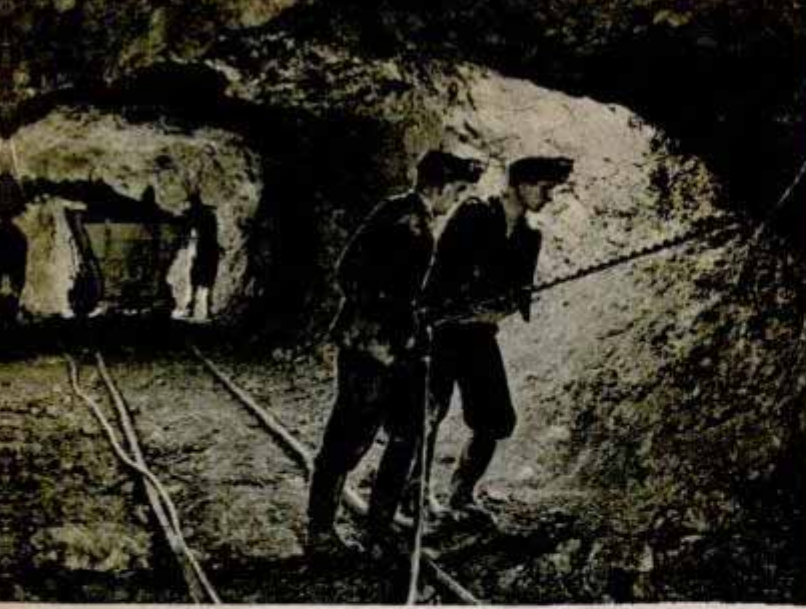

A far cry from the tools of '49ers is the mechanized equipment, above and below, which points to an upsurge in gold mining activity in the U. S. this year



Gold mine and mill. Lode operations of this type comprised 60 percent of the 3500 prewar mines, with the remainder placers

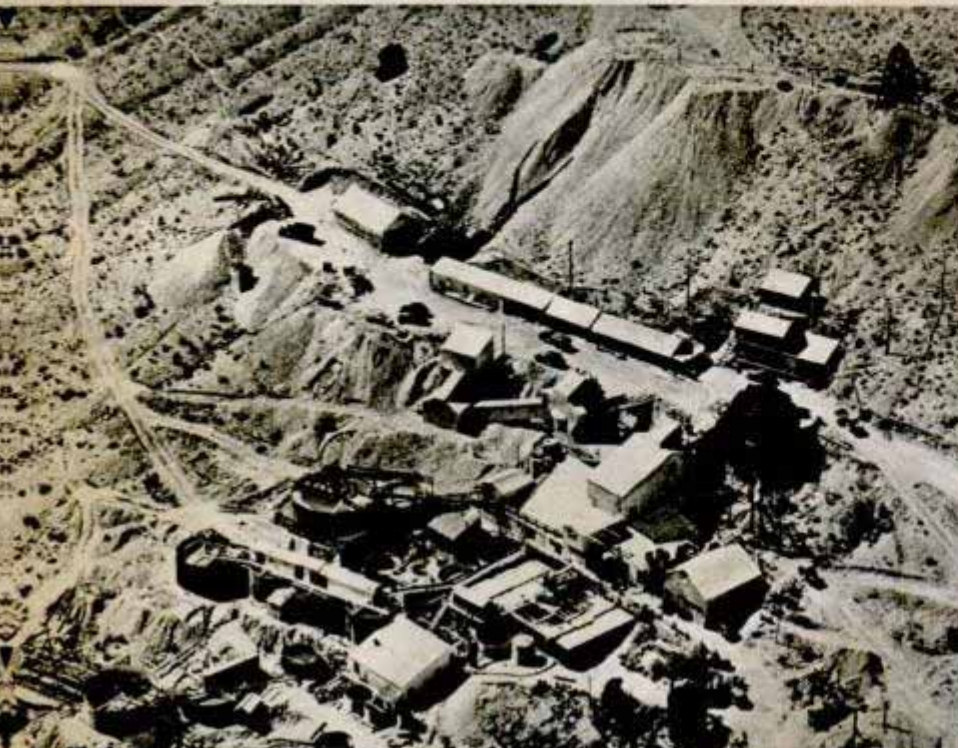

a million ounces of yellow stuff annually.

Using his foxhole technique, the ex GI struck a rich vein that ran 80 ounces to the ton. It was \$2800 ore compared to \$13 rock in the largest United States mines and \$20 to \$30 stuff in some of the richest Canadian mines. By the time Conrow had taken out \$25,000 his story was in the headlines.

For several months now, Conrow's lucky strike has been a hot topic of conversation among large mining companies, small-time operators, or "snipers," and veterans who have been bitten by the gold bug. And as the yellow metal comes up for Congressional debate, gold mining—1946 style—becomes of interest to the general public as well.

Another gold strike in the Cripple Creek district was reported this spring by the Golden Cycle Corporation. A rich lode that may be worth \$2,000,000 was discovered in the company's Ajax mine. It is said to be the biggest strike in the district in the last decade.

Gold mining was suspended in October 1942 when the government's famous L-208 order, designed to switch manpower, explosives and machinery into the mining of more essential metals, was issued.

America's gold mining industry, which had employed nearly 40,000 men in prewar days, quickly dropped off to approximately 6000. And many of these served merely as pump tenders, machinery maintenance men and watchmen.

In 1940 the gold mining industry produced 6,003,150 troy ounces of the precious metal with a value of more than \$210,000,000. In 1944 the yield was 1,022,238 ounces, worth only \$35,000,000—the lowest produc-

Pure 24 karat, this is the finest specimen of crystallized gold ever discovered



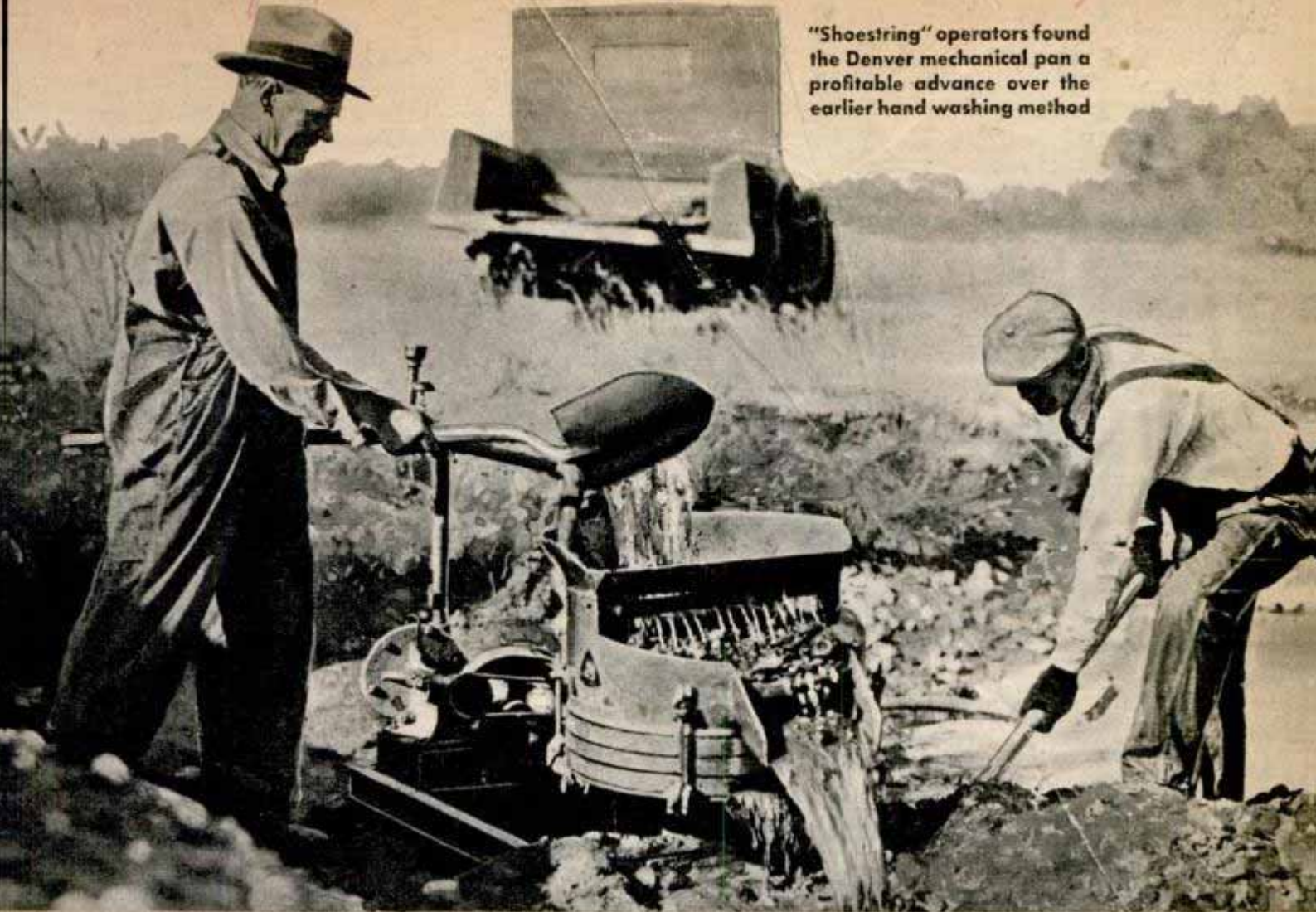

"Shoestring" operators found the Denver mechanical pan a profitable advance over the earlier hand washing method

tion since 1847, two years before the California gold rush days of '49. Now the L-208 order has been lifted and gold mining is getting under way once more.

Some are pessimistic about the future of gold mining in the United States. They argue that increased costs of labor and supplies, with narrower margins of profit, will

Bars of precious metal at a pier awaiting shipment



make it impossible to return production to the 1940 level. But others predict that gold mining is heading for a moderate boom. New equipment, plus possibility of a gold price boost, gives them reason for hope.

Gold on hand in the United States Treasury dropped from more than \$22,000,000,000 in 1940 to about \$20,000,000,000 last summer. Before the war the United States was importing gold at a rate of \$75,000,000 a month; today we are exporting it at the rate of \$100,000,000 per month. To make certain that our monetary system is founded on a solid financial basis and to cover federal issue of notes and currency, economists say the United States soon will have to replenish its supply of gold.

One suggested remedy to bolster our dwindling gold supply and to stimulate gold mining is an increase in the price of gold. Gold first became a medium of exchange in London in the 12th century and was priced at \$3.65 an ounce, valued in shillings. It rose steadily until the 17th century, when it leveled off at \$20.67 per ounce. Then in 1933 it was revalued at its present price of \$35 per ounce.

Representative Claire Engle of California, who calls himself a "one man gold bloc," has introduced legislation (1) to raise the price of gold from \$35 to \$56 per



ounce, (2) to increase the amount of federal loan money available to gold miners, and (3) to reimburse them for losses suffered during the war when the government put them out of business. He would also have the Treasury Department mint a new \$50 gold coin to popularize the use of gold in our monetary system.

Most of the gold mined in the United States comes from the western states. For nearly a century the traditional leaders have been California, South Dakota, Colorado, Nevada, Utah, Arizona, Montana, Idaho, Oregon and Washington. During the war Utah rose temporarily to the top because of gold production incidental to copper mining.

Alaska and the Philippines, in peacetime, were big producers and usually were included in United States statistics. With these two areas, the United States is said to produce about one seventh or one eighth of the total supply of the world's gold.

Before the war the United States had in operation about 3500 mines. Approximately 60 percent of these were lode mines and 40 percent placer mines. Lode mining refers to digging the ore out of veins in rock, usually underground. Placer mining refers to various techniques for scooping gold-bearing gravel off the top of the earth and washing the gold out of it.

Lode mining is expensive, requiring an extensive outlay of machinery and involving high labor costs. South Dakota's great Homestake mine, largest single gold mine in the world, is an example of a lode mine. Before the war some 2000 were employed

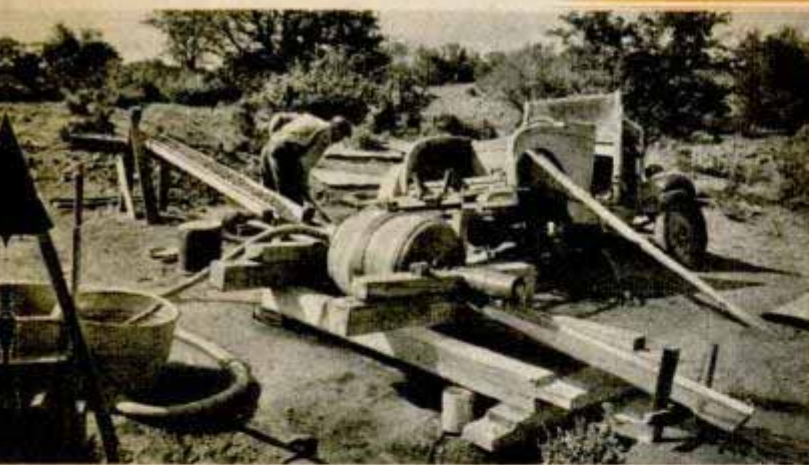

Upper left, small-scale dry placer mining in the desert. Left, the auto's rear wheel serves as power plant for this homemade ball mill. Below, horse-operated mill for treating gold

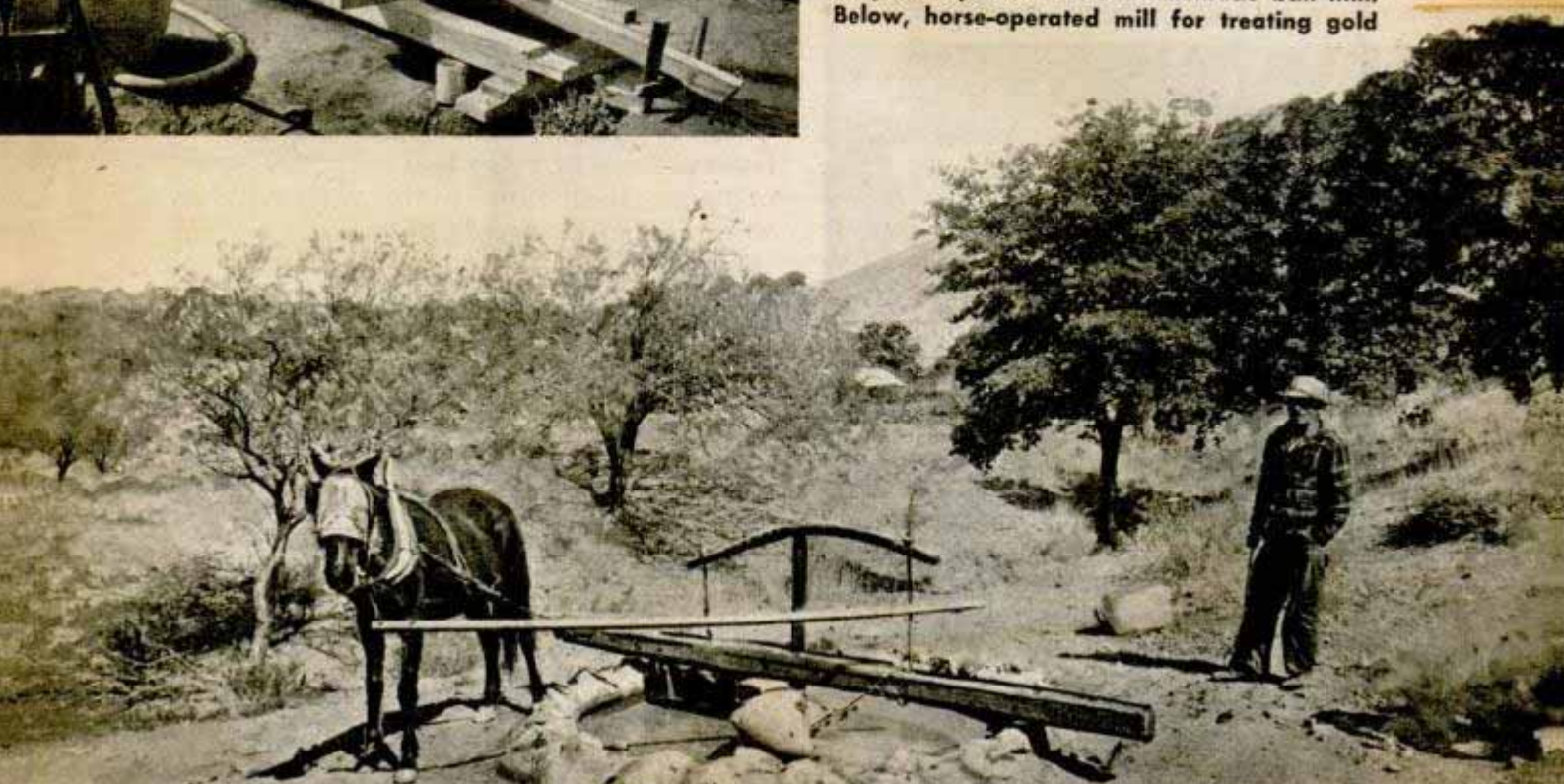

at Homestake. Its developed ore reserves are estimated at 19,183,783 tons—about 15 years' supply based upon 1942 production figures. Average recovery is about \$13.39 per ton of ore.

As a general rule the gold mining industry, and especially lode mining, is slow to adopt and develop new equipment because gold veins are narrow and hard to work with mechanized tools. Mining bureaus in several western states, however, have indicated that the greatest strides in lode mining will come with wider use of such electrically powered equipment as drills, hoists and pumps.

Placer mining, including various types of bucket-connected dredges and small-scale panning operations, should show a quicker postwar recovery. The effects of the shutdown will be less because labor costs are smaller. In addition, most placer equipment has remained virtually intact while some lode mining equipment has been dismantled and removed.

(Continued to page 232)

Monorail cars shuttle gold ore from a Death Valley mine to loading centers. Bottom, a 15-cubic-foot dredge used in placer mining



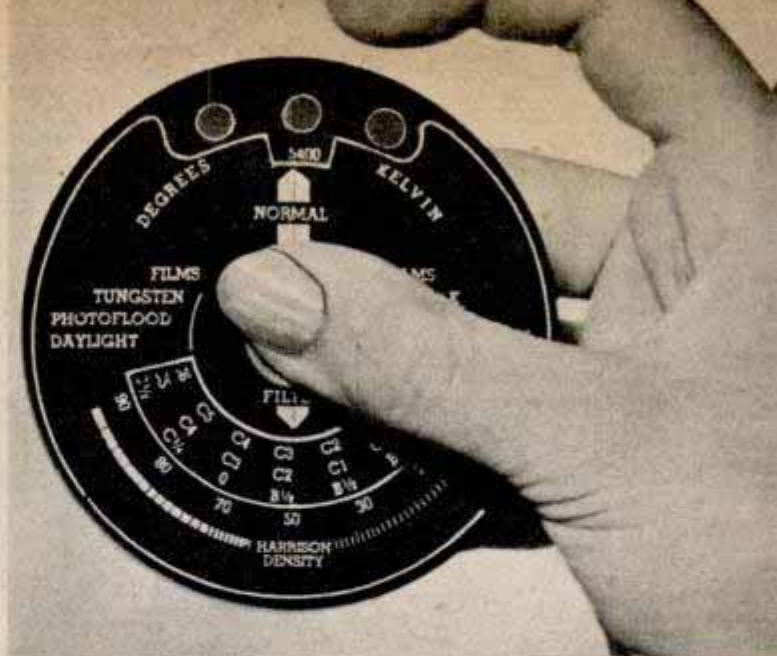

Left, baby chicks are kept warm in a brooder heated by conductive rubber, a product developed to keep ice from forming on warplanes. Inset shows chemically treated rubber pad which warms the brooder by radiant heat. Right, a pocket-size meter that measures color is now available for photographers. The user finds the degree of color in illumination by looking through the device to measure the light reflected from a white card

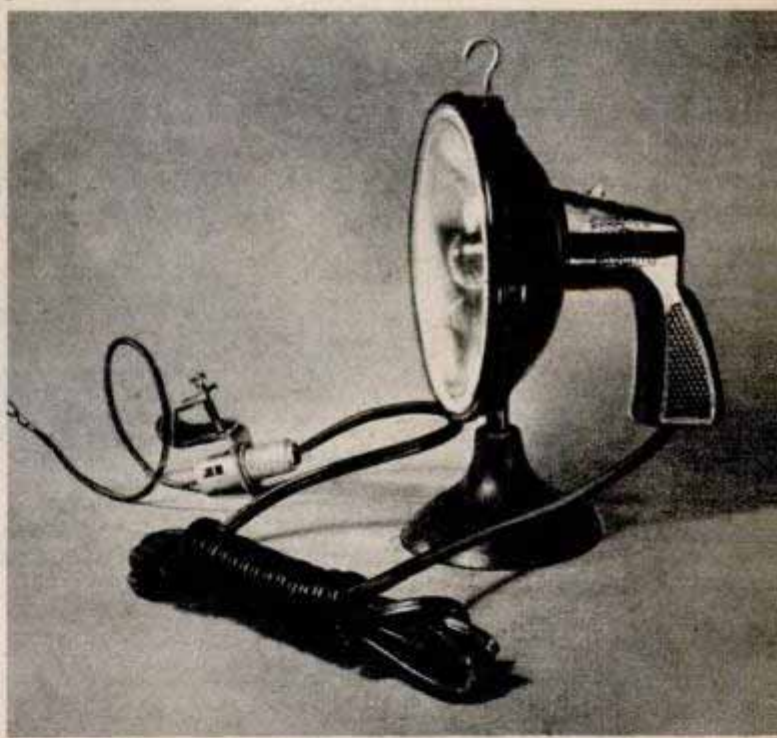

Left, a radio which forms the front section in a new radio-phonograph combination can be removed from the unit for use elsewhere. Right, an automobile spotlight for emergency repair work is equipped with a suction cup and hook to fasten it to any part of the car. A socket on the long wire plugs into any six-volt battery

Below left, built-in hydraulic jacks lift this combination tractor and bulldozer on to its own rubber tired wheels for high-speed transportation. Right, Hollanders make rafts of biscuit cans that were dropped from planes by the Allies to relieve the food shortage. The rafts are used to navigate the canals of Rotterdam



Golden Gate Span Proven 'Flutterproof' in Delicate Vibration Tests

Ten vertical vibration recorders, spaced 525 feet apart, are proving San Francisco's Golden Gate Bridge, world's longest single suspension span, to be "flutterproof." Engineering precautions were believed to have provided the 4200-foot structure with adequate protection against this hazard, but when a Tacoma, Wash., bridge fluttered itself to pieces in 1941, steps were taken immediately to double-check against such risk at Golden Gate. The delicately balanced instruments, some paired on opposite sides of the bridge, have indicated no movement in wind velocities under 40 miles an hour, while the Tacoma span had "waved" perceptibly in only an eight-mile wind. Greatest vertical movement recorded thus far at Golden Gate has been 14 inches dur-



ing a 48-mile gale, a safe margin under the span's allowable movement of 20 feet. The bridge is built to withstand a sideways movement of 27 feet in the center.

ing a 48-mile gale, a safe margin under the span's allowable movement of 20 feet. The bridge is built to withstand a sideways movement of 27 feet in the center.

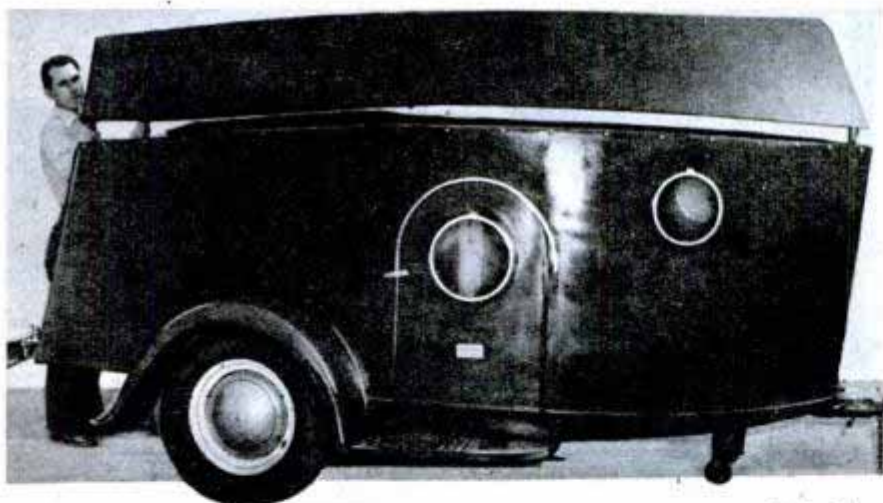

Skiff Doubles As Trailer Roof

By using a boat as the roof for his trailer, Guy W. Patterson of Los Angeles has both land and water transportation within the same unit. The sportsman built the trailer so an 11½-foot skiff can be inverted over the top. The boat weighs 125 pounds and can be removed easily by one person

with the aid of a small jack under the stem that raises the bow about three inches. Two handles then make it possible to lower the skiff to the ground, one end at a time. When the boat is removed for fishing or duck hunting it is replaced by a heavy canvas canopy that buttons snugly along the sides and is supported by three steel bows. The 12-foot trailer is equipped with an innerspring mattress, a locker for guns and fishing gear, gasoline stove, icebox, water tank and food storage space.



IF YOU WANT TO BUY IT—

Write to the manufacturer or distributor listed in the Where-to-Buy-It Index, page 8, to learn more about commercially available products described in this magazine. Say you saw it in Popular Mechanics.



1 Adjustable rake tines enable user to close rake for cleaning restricted areas or open it to rake leaves or grass

2 Heavy doors can't slip when held by spring-loaded aluminum door-holder. Catch holds door-stop up when not in use

3 Tough steaks are tenderized by device which breaks down fibers with five spiked wheels without disfiguring meat

4 Electric stove unit attains full heat in 40 seconds, providing automatic temperature control for top-of-stove cooking

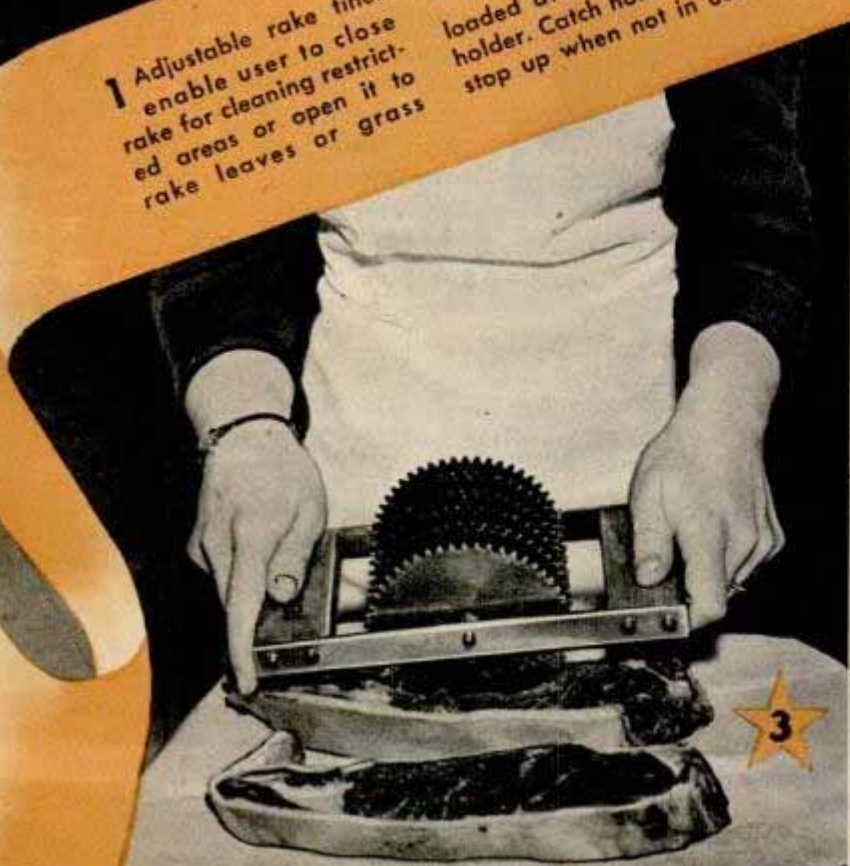
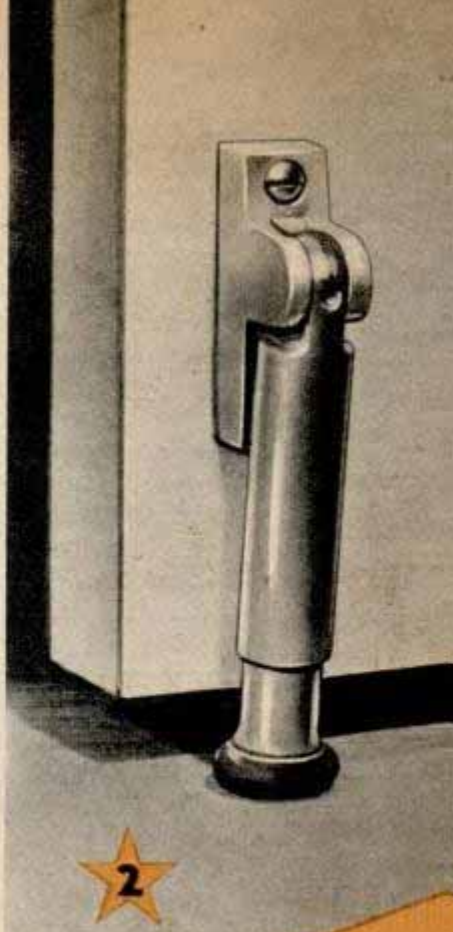

"Inside Stubb" for Your Home



5

5 Air taken in at top is warmed, then blown from bottom of electric heater which never becomes too hot to touch

6 With one end of line looped over hook, handy reel mounted on bracket can be used to adjust tautness of line

7 Razor holds styptic pencil in handle, ready for instant use merely by drawing the cap out. Razor is made of plastic

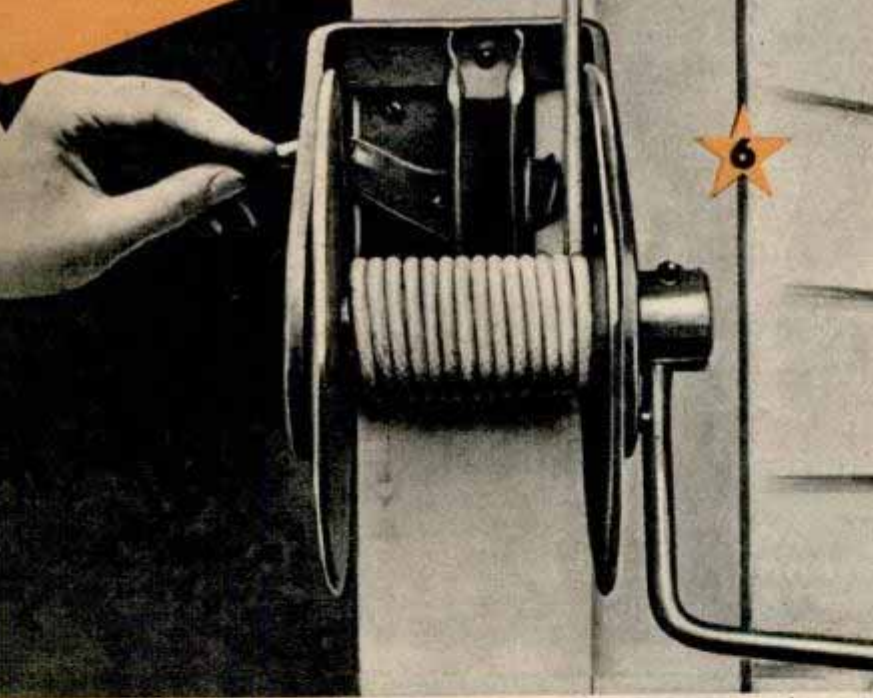

6

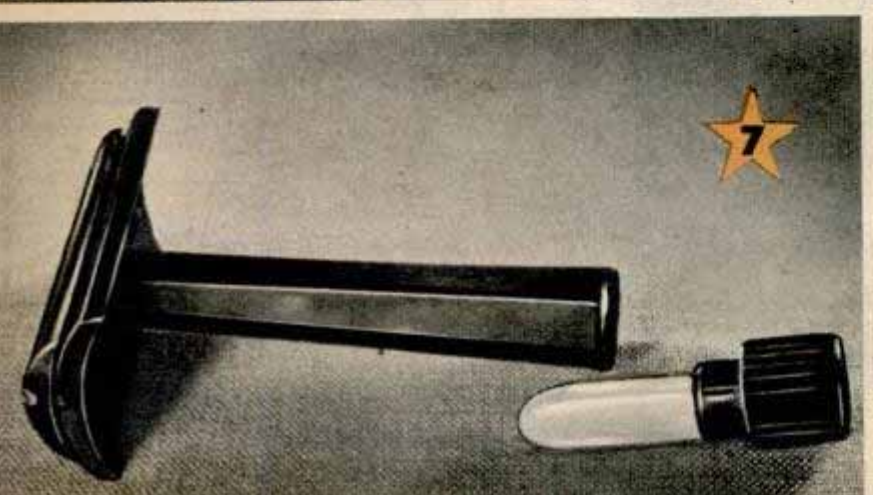

7

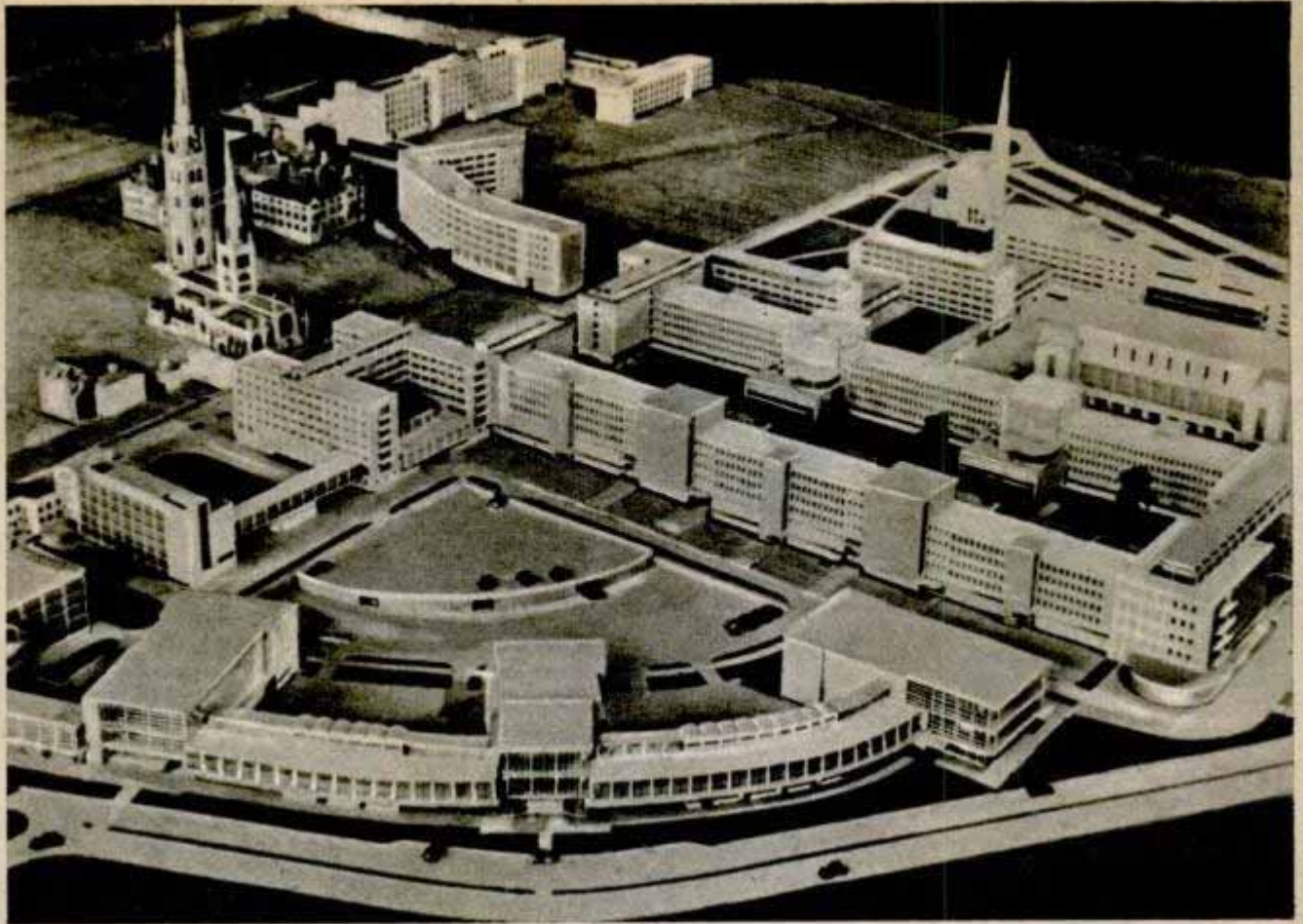

Coventry Rebuilt in Model Form

British engineers are making extensive plans for rebuilding war-damaged English cities. Scale models of proposed buildings

are often used by planners to aid their projects. Coventry, totally destroyed during the war, has already been completely rebuilt in model form including modern buildings as well as the cathedral.

Water Jet Kills Apple Worm Moths by Cutting Bark From Trees

Water under 500 to 600 pounds pressure is sprayed on apple trees in a new method of killing codling moth larvae, the ordinary "apple worms" which damage the trees. The spray is of such force that it removes

the rough bark, where the larvae establish winter quarters. The conventional method of hand-scraping the trees and burning the bark requires several hours' work on each tree. Regular spraying equipment is used

in the new process, which was developed by Dr. Dwight Powell, a horticulturist of the University of Illinois.



Radios May Signal to Subs

Submarines of the future may be able to communicate directly with control stations on land without surfacing in order to use their radios, according to D. W. R. McKinley, a Canadian physicist. Investigations show that powerful transmitting stations capable of radiating at least 500,000 watts should be able to send signals to submerged craft several hundred miles away. The physicist says that undersea craft may be able to reply with signals from below the surface.

Half a Billion in the Slot

What'll it be? A sizzling hot dog, a quick movie or a package of frozen strawberries? The new coin machines will dispense almost everything

COIN-OPERATED machines have come a long way since a fellow named Hero invented an automatic gadget in Alexandria about 200 B.C. that dispensed holy water for five drachmas.

Today, "robot-salesmen" plink out candy bars, soft drinks, cigarettes, peanuts. They snap your picture and give you a finished print. They dole out music, hot or classical. They send telegrams, check parcels, take subway fares, hand out stamps and even chunks of ice.

In one year: 250,000 cigarette machines sell about 750,000,000 packs for more than \$100,000,000, five percent of all sold. Candy machines unload \$23,000,000 worth of candy, seven percent of all candy sales. A million penny machines dispense peanuts in nearly every village and city in the country. Some 120,000 soft drink units satisfy people's thirsts the year 'round. And juke boxes to the tune of 400,000 pound out recorded music both day and night.

By **JOHN R. KINSEY**

Adding it all up, coin machines sell the American public somewhere around \$500,000,000 worth of merchandise and service every year.

But that's just a warm-up compared to what's coming, according to the vending machine industry. Here are some of the new developments that shortly may become as commonplace as gas stations:

1. Hot sandwich maker which in 15 seconds electronically cooks a hot dog, hamburger or cheese in a bun for 10 cents.
2. Frozen food and canned goods dispensers installed in front of grocery stores to serve customers after closing hours.
3. Hot drink-o-mat to pour out steaming coffee (black, with sugar, with cream, or with both), hot chocolate and soup.

Magic electrons cook hot dogs and hamburgers in coin machine at right. Diagram shows the heating element that warms food without touching it

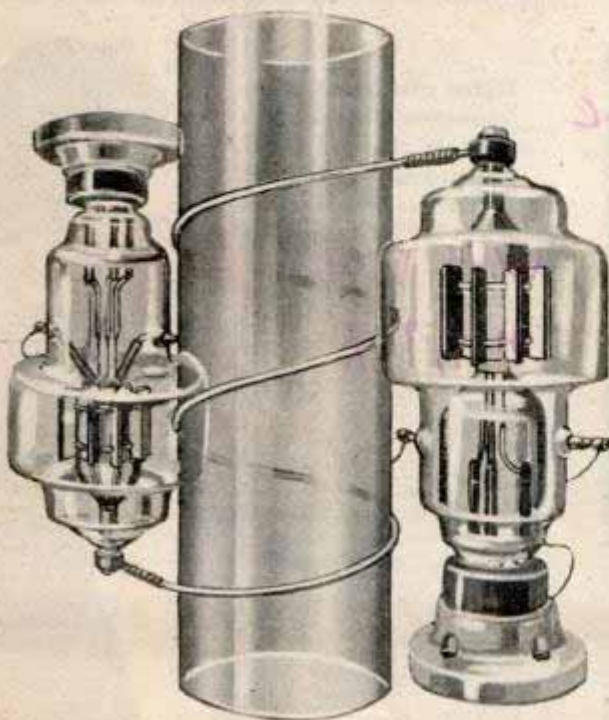

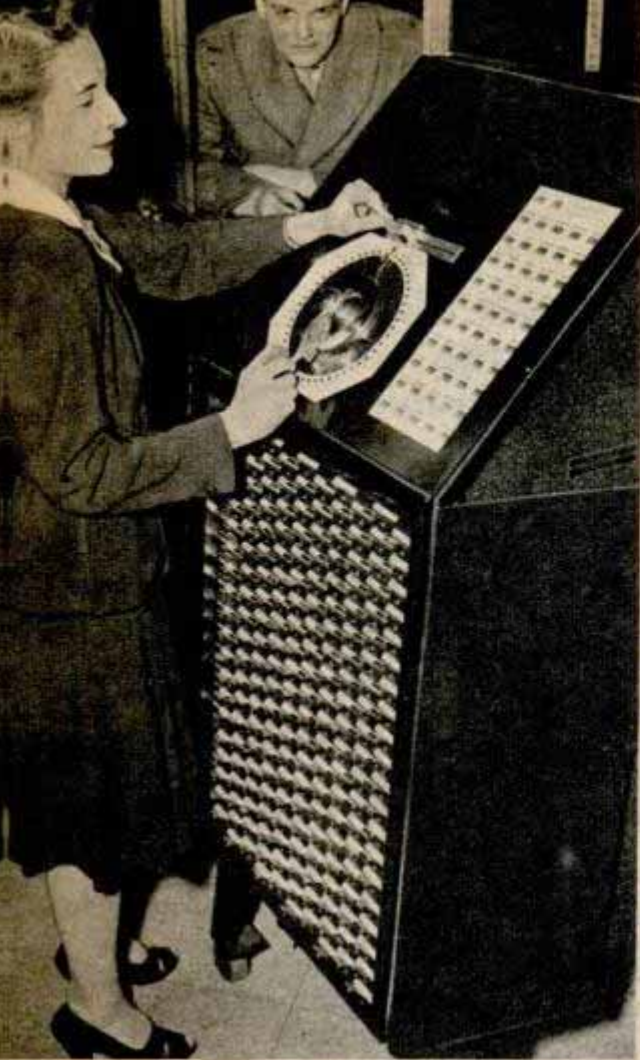

MR. J. KOSFIN 422 METROPOSTAL BLDG CHICAGO



Chicago, Ill.

Railroad tickets are retailed by trip ticket printer (left). Newspapers are dispensed by coin machine (right)

4. Combination ice cream maker and vendor that will make an ice cream "stick," spiral-wrap it and hand it to you in a jiffy.

5. Mechanical departments in grocery stores in which the housewife will select metal tokens representing standard packaged goods, then hand the tokens to an operator to insert in a device that mechanically conveys the packages to a central wrapping department.

6. Coin-operated gasoline dispensers to

serve motorists who run out of gas at night.

7. Vending machine stations containing nothing but coin-actuated dispensers supplying the usual things plus drugstore articles, special foods, etc.

For a closer examination of some of the new help-yourself gadgets, let's start with the hot dog machine developed by engineers of the Automatic Canteen Company of America and General Electric Company. Equipped with a glass window that enables



*Vendo Co.
1207 Grand Blvd
Hannover City &
Mo. 7400 E.
12 St.
K.O.
1/20*



Dimes and quarters are converted into nickels by coin changer (left). Telegrams dropped into a slot are sent automatically by unit below

*W.V. Telegraph Co.
N.Y. N.Y.
277*

*W. Post Office
Chicago, Ill.*

HOW A Juke Box WORKS

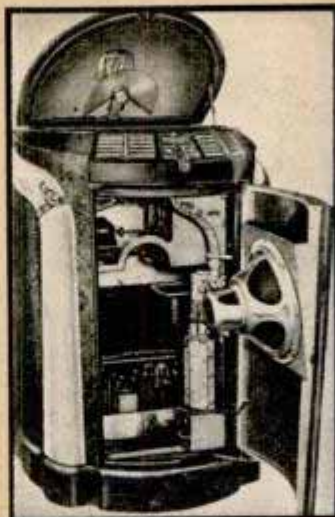
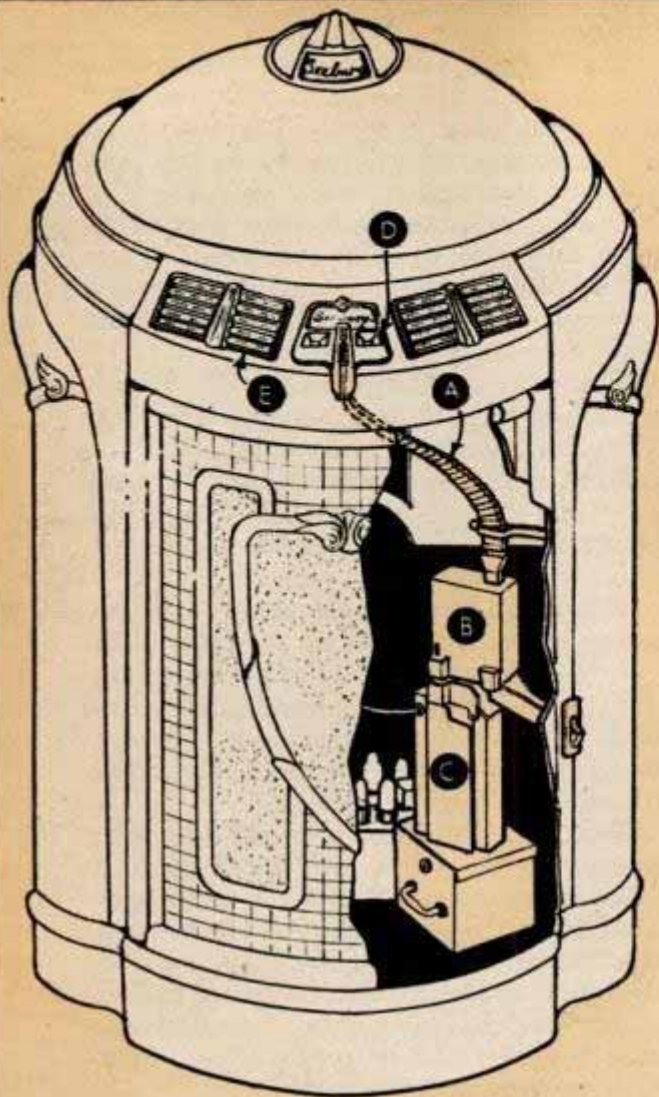

When a coin—nickel, dime or quarter—is dropped into the coin slot, it rolls down flexible tube A and drops into slug rejector B. Here the coin is sized, weighed and its metal electrically analyzed. A legitimate coin will fall into selector unit C. This box relays the number of records to be played to the illuminated register D. Whenever a record is finished, it is subtracted from the register. The juke customer always knows how much of his investment is left. Meanwhile, the coin closes a relay, switching on the mechanical part of the juke box.

When a button is pushed on the selector panel E, the impulse is transmitted to a solenoid drum F (below) which has a selector for every record on the panel. For example, if button No. 1 is pushed, the No. 1 solenoid pin G will rise and stop a projecting pin on disk H. The helix I, coupled to this disk, has projections that index the tray of records. The slide J reaches over and picks up record tray No. 1 which has been indexed. It carries the tray to the lifting position K, where turntable L moves up, lifting the record out of the tray into playing position. The tone arm M moves over and plays the record. Eccentric grooves at the end of the record oscillate the tone arm tripping mechanism N, which reverses the action, fling record in its proper place.

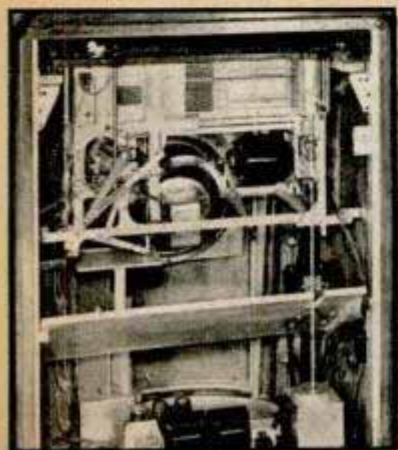
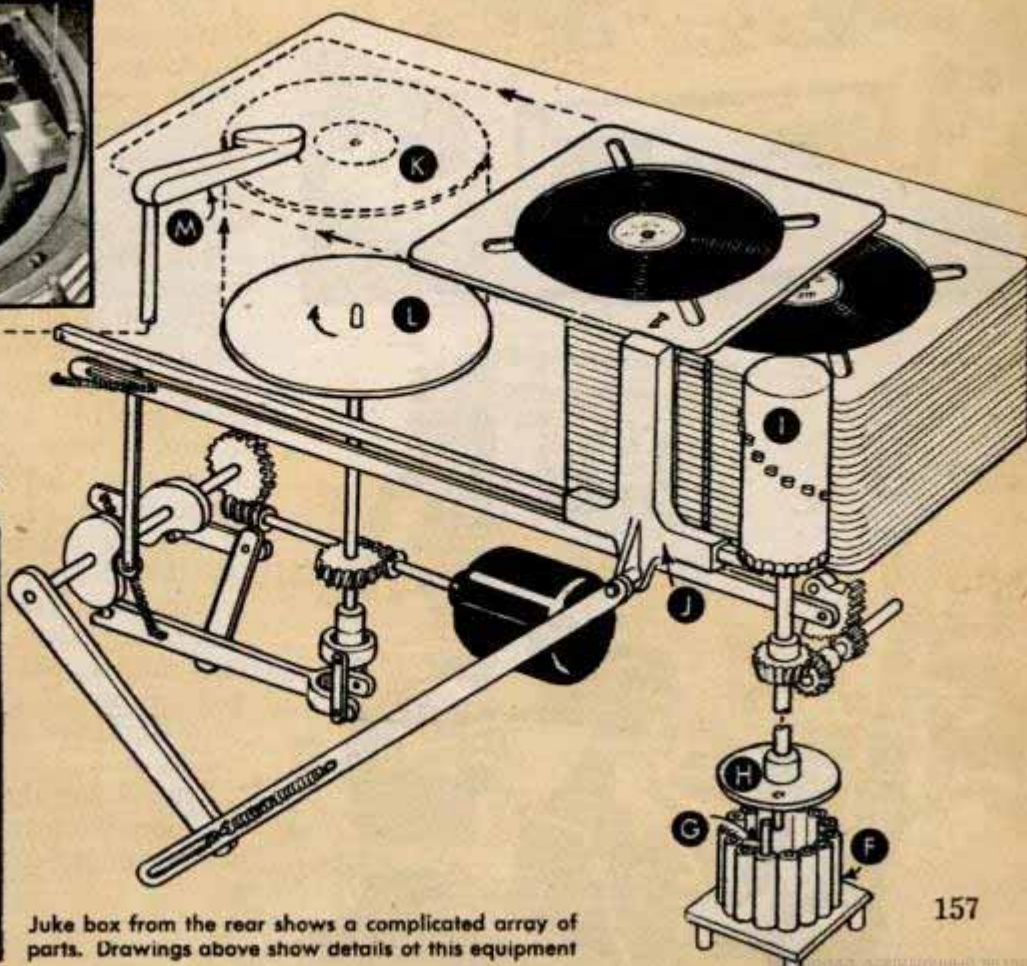
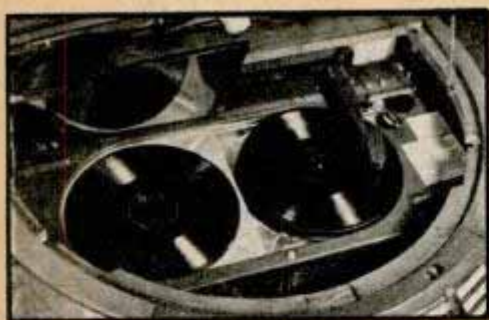

Juke box from the rear shows a complicated array of parts. Drawings above show details of this equipment



Dancers in cabaret (above) deposit coin and telephone request for musical number to operators (below) who send recorded tune by wire. Bottom, coin box provides movies



the customer to see his food cooked by radio waves, the electrical chef dishes up a Cellophane-wrapped sandwich before you can say "yum, yum."

Here's how it works. You drop a dime in a slot and push a button. That moves a tray containing precooked frankfurters or hamburgers, or cheese, in hot dog buns and wrapped in Cellophane. The sandwich selected falls into a cooking tube powered by two electronic tubes which create radio waves, generate the necessary heat (150 to 160 degrees) and cook the sandwich.

What about the mustard? That's troubling the hot dog machine men, too. They don't want any messy mustard jars around their sandwich makers. So they may put a little mustard in a separate container and insert it inside each sandwich wrapper.

If you can build machines to serve hot sandwiches, it should be no more difficult to design automatic vendors to handle frozen foods and canned goods. And look at the potential business, particularly among people who find it impossible to shop during the day.

That's the thinking of one Middle West manufacturer of frozen food cabinets who is experimenting with coin-operated frozen food machines. He believes that grocery stores of the future will be designed so that frozen food and canned goods dispensers can be installed outside the stores but under cover, probably in the entrance way.

Past the development stage is the hot drink dispenser which supplies coffee, hot chocolate and soup. One machine which a western railroad plans to install on its trains employs a unique method to provide coffee with or without sugar and cream. In other words, you can have coffee in any of four ways: black, with sugar only, with cream only, or with cream and sugar.

It's all done by "pills" developed by one of the country's largest dairy concerns. The coffee is prepared in pellets; some are just coffee, others have sugar or dehydrated cream added, or both. When a coin is placed in the slot, the machine drops a pill into a grinder which grinds up the pellet at the same time that 140-degree water is added. To protect customers from grabbing the cup and being burned while the hot water is still pouring down, an electric eye device shuts off the machine if you put your hand too near the mouth. Another coffee maker will use powdered coffee.

This is simply a preview of a few of the more exciting vending machines that are either here or coming soon. Actual-

ly, the fields of merchandising to be invaded by mechanical self-service devices appear to be almost unlimited.

Harvey Carr, editor and publisher of Coin Machine Journal and one of the world's outstanding authorities on coin machines, sees the day fast approaching when virtually all types of stores, particularly drugstores, will install many mechanical vendors.

"Take a drugstore," Carr explains. "Many's the time a man walks in to buy some razor blades. That's all he wants and he knows just what brand he wants. But the clerk is waiting on some woman who spends maybe five minutes or more picking out a lipstick.

"Now if they had a coin operated machine to sell razor blades, the man would get his little package and be on his way in a matter of seconds."

Mills Industries, Inc., big producer of vending machines, is so optimistic about the future of this business that they set up a Special Merchandising Division to work closely with manufacturers of anything suited to help-yourself selling.

"Anything that can be packaged can be merchandised by vending machines," asserts Ralph J. Mills, chairman of the board. He points out that refinements in refrigeration, dehumidifying equipment and germ-killing rays make it possible for coin machines to vend almost any food product. Fruit, fruit juices and milk (whole or powdered) are kept in good shape by proper refrigeration, he explains, and buns for sandwiches are prevented from becoming soggy by dehumidifiers.

Such firms as Mills will

(Continued to page 236)



Coin-operated dispenser "rescues" out-of-gas motorists late at night



Drop a coin and get hot coffee, with or without cream and sugar.



Frozen foods may be dispensed by coin machines after stores close
Automatic grocery (below) with coin-actuated facilities is planned



419 W. 11th St. Chicago, Ill.

J.C. Lippincott & Co.

FROZEN

**WITH A
CHISEL**

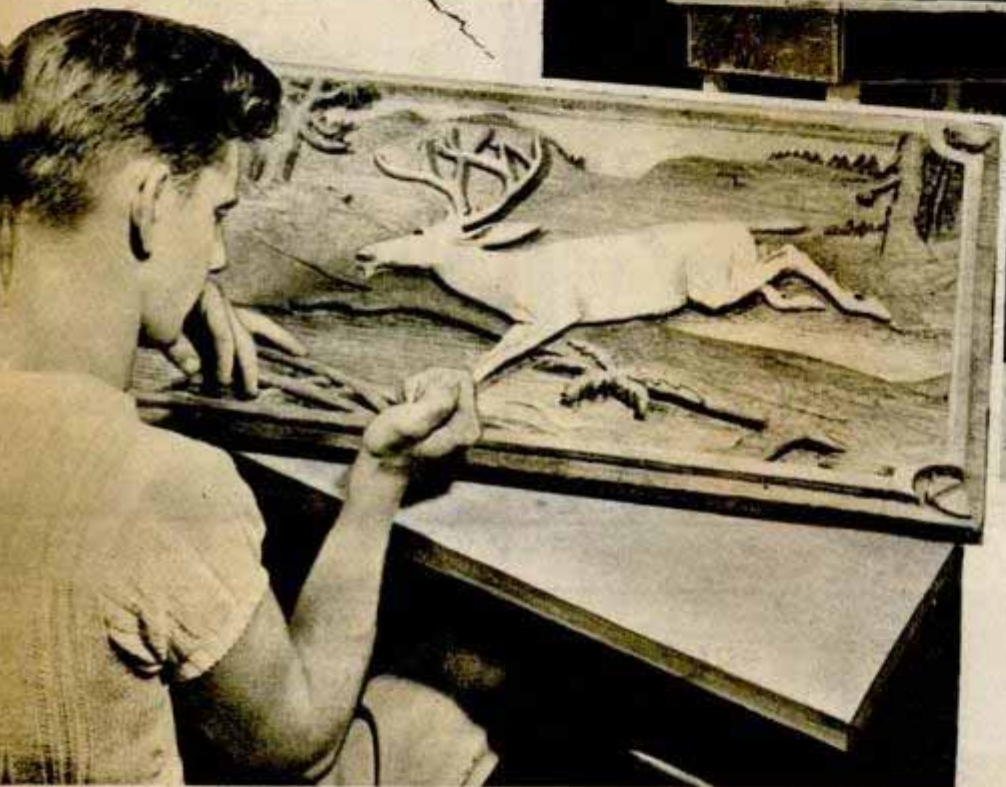

Although only one inch deep, carving gives illusion of greater depth. Bill finishes by sandpapering knife marks

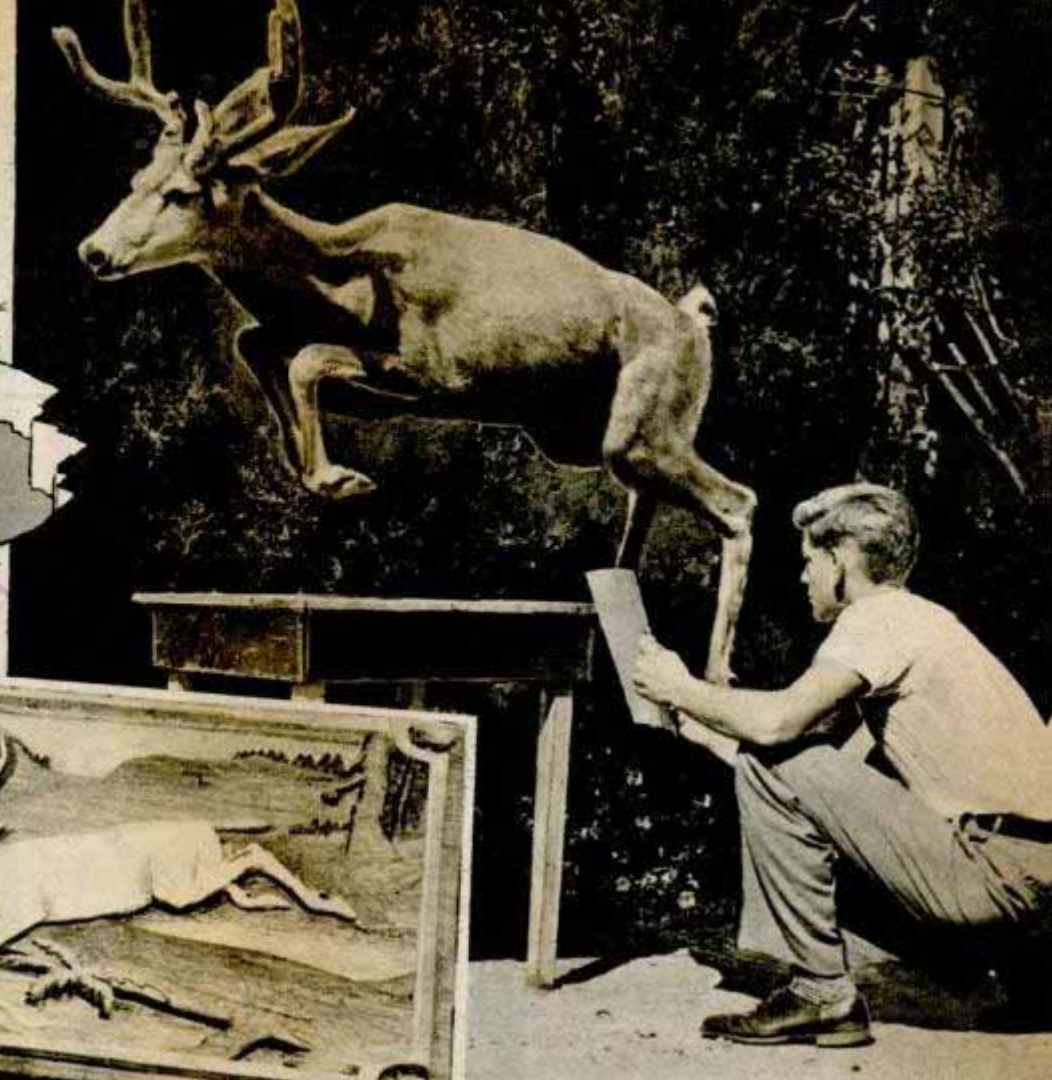

Seventeen-year-old Bill Burnham has three pet deer to model for wildlife studies he carves with chisel and knife in Philippine mahogany. Above, one of the pets "poses" for the artist

For accuracy in a carving showing a startled deer hurdling a log, above left, Bill made a sketch of one of his pets making a similar leap. His three pets follow him through the streets at Encino, Calif., without a leash. Below, one inquires into the progress of Bill's chiseling



Rockets Assist Racing Car

Rocket power serves as an auxiliary to give extra speed to a racing car used by Bill Reynolds, Sidney, Australia, driver. The car runs normally on its gasoline motor, the rockets acting only as a booster for a quick start. A recent attempt to break the world's quarter-mile speed record did not succeed because some of the rockets failed to function properly. Reynolds says he will try again.

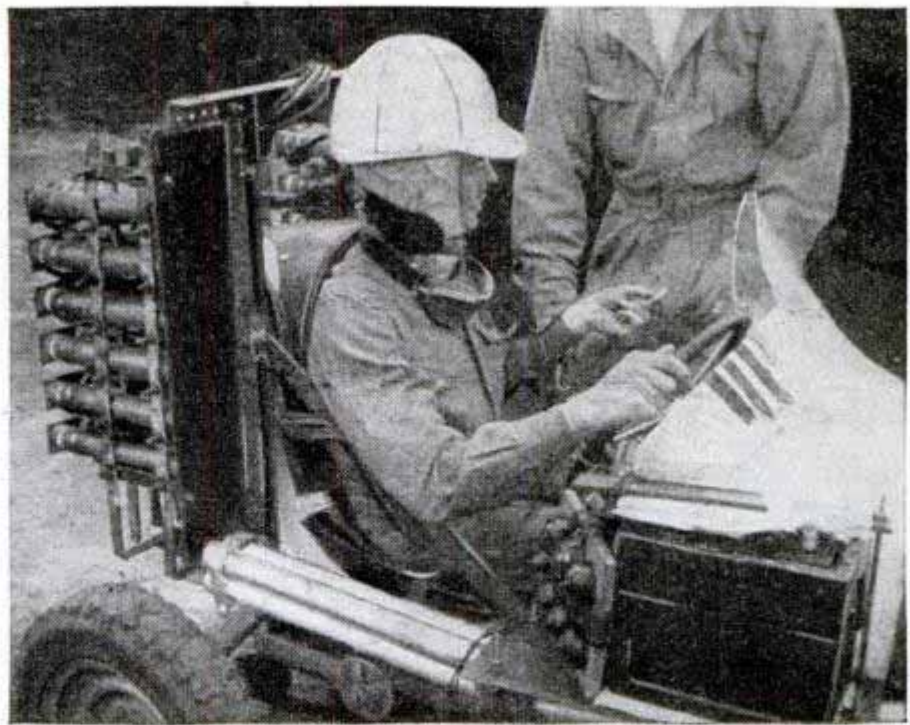

Fabric Lining Aids Drying of Concrete

Concrete dries with a satin finish that absorbs 40 percent less moisture when a new lining for concrete forms is used. Called Hydron, the lining resembles tough cardboard faced with a cotton fabric. It is manufactured in sheets 6 feet by 4 feet, is lightweight and flexible, and can be shaped easily to curved forms. The sheets are stapled to ordinary plywood facings in the forms. When the concrete has set, the form may be removed without removing the lining, which may be left on the concrete surface as long as two weeks to control drying. The lining promises surfaces of greater durability at less expense for some types of work. Tests with

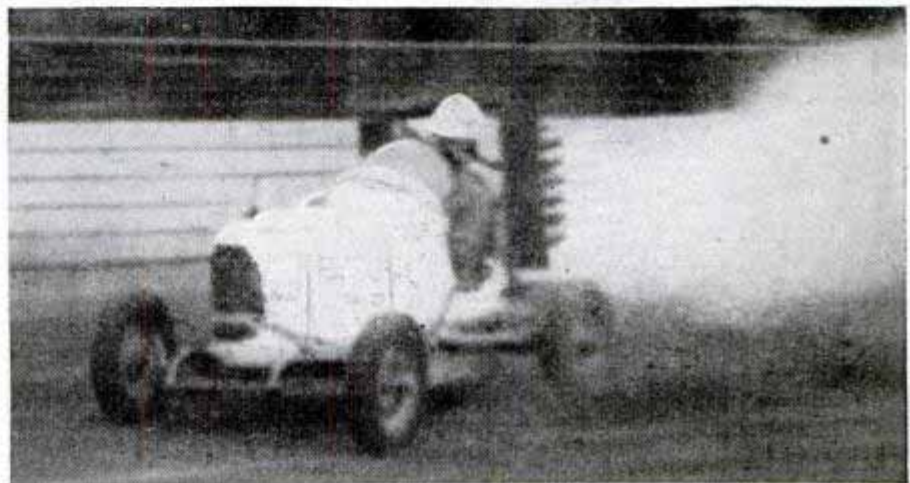

Battery of rockets behind driver, top, start him off in a cloud of smoke

steel shot indicate that concrete formed with ordinary plywood will chip much easier than that formed with Hydron. Surfaces that must be scraped periodically are less expensive when the lining is used, as sanding and polishing are unnecessary.

Computing Device Fitted With Magnifying Glass Permits Easy Reading

Small enough to fit into a brief case, a computing device is said to solve problems which would require a slide rule 36½ feet

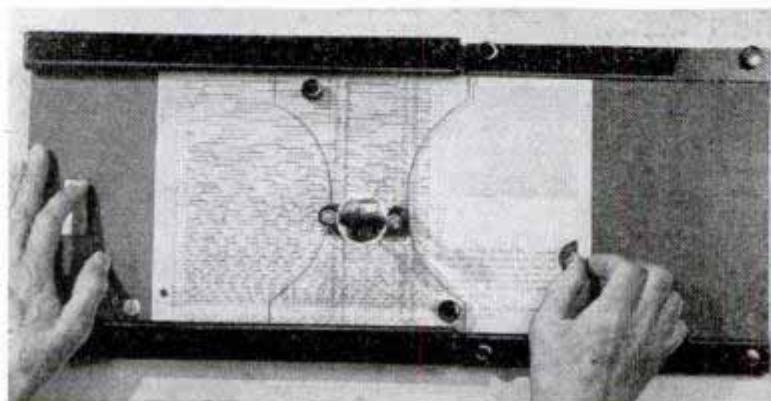

long. Although it handles ordinary multipliers and divisors as well as square-root quantities, it employs only half the number of scales used by a slide rule. Settings are simple and do not require reading scale against scale. A magnifying glass is attached for reading the square-root scale which is in small type. The principal scale is easily read and its major divisions are printed alternately on red and white backgrounds. All numbers on both scales stand in normal reading position in relation to the operator. The scales are printed on a nonwarping plastic.

ATOMIC POWER PLANTS *in the Sky*



Chemical action comparable to the creation of atomic power takes place in stars like these in the constellation of Orion. Below, an astronomer at Mt. Wilson Observatory collects data with a 10-inch photographic telescope



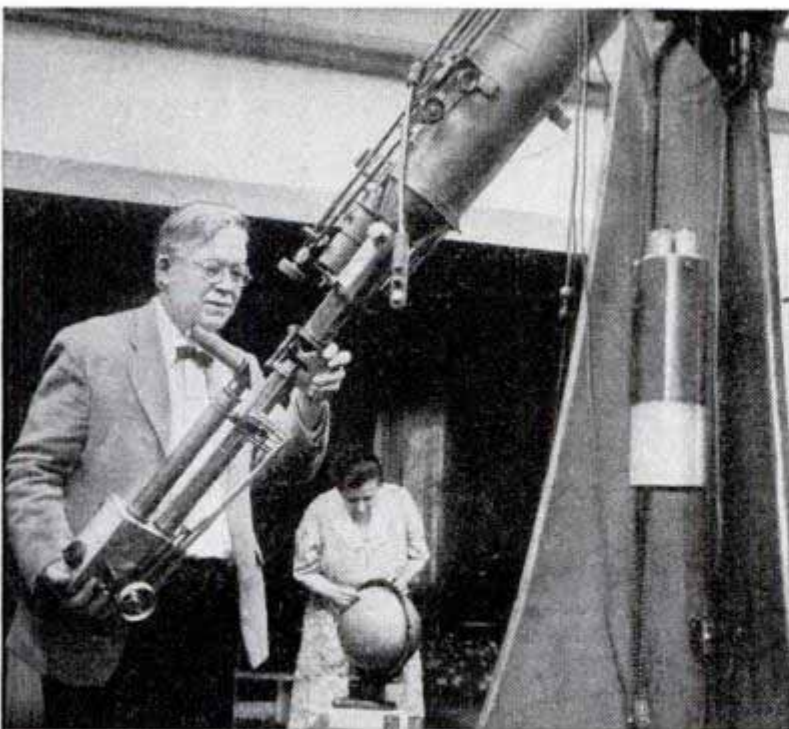

Using a telescope in his own home, Dr. Edison Pettit accidentally discovered the bright new star Nova Puppis

By Robert S. Richardson and Anthony Wausnock

YOU have heard of the atomic power plants built by the U. S. Government at Oak Ridge, Tenn., Pasco, Wash., and Los Alamos, N. M.

But have you ever heard of the atomic power plants in the sky? Of Y Cygni, Betelgeuse, Sirius B and Nova Puppis?

Long before the atomic bomb, astronomers believed the stars derive their apparently limitless supply of radiation from energy locked within the atom. For at least a quarter of a century astronomers have regarded the stars, not as mere twinkling points of light, but rather as mighty laboratories in which unique atomic reactions take place.

In the past the world has not always taken the astronomers' work too seriously. People often ask, with considerable reason, "Why build a 200-inch telescope to look at stars so distant that their light takes thou-

sands of years to reach us?" Yet prior to 1939 the same type of question could have been asked of nuclear physicists. "Why spend a million dollars building a cyclotron to convert microscopic quantities of hydrogen and lithium into helium?"

Today no one doubts the vital importance of planning great laboratories for atomic research. Unfortunately, however, the elusive atom refuses to perform many of its most remarkable antics except at temperatures of millions of degrees and pressures of millions of atmospheres. We cannot hope to create such extremes of temperature and pressure artificially. Where then shall we find them?

In the stars. They can serve us as celestial laboratories and as the atomic power plants of the future.

Let us consider the sun, an ordinary sort of star of moderate brightness. If we paid

Stages in the one-month growth of new star from slightly brighter than the sun to 300,000 times its luminosity



FORCE OF GRAVITY VARIES ON RED STAR BETELGEUSE...

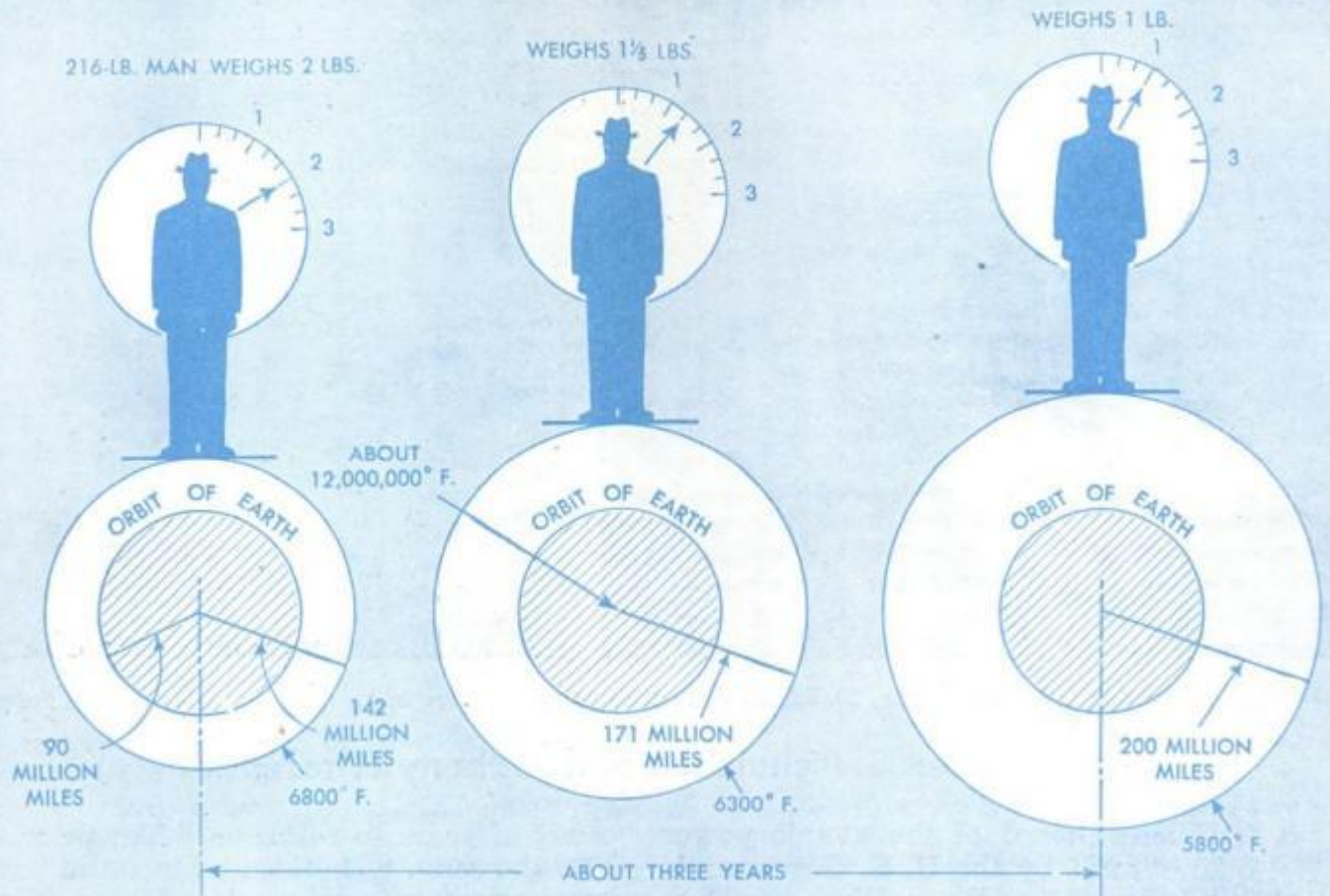

Surface gravity on Betelgeuse is so little that a 216-pound man would weigh two pounds there when the star is smallest and shrink to a mere pound when star is fully expanded. Actually Betelgeuse has no surface; it is so tenuous that it has been called a "red-hot vacuum"

Rush job! Astronomer develops plate from 10-inch photographic telescope to see if picture will require another shot before morning



for the radiation the sun sends us at the rate of 2½ cents per kilowatt-hour the bill for a single day would come to \$100,000,000,000,000. How can the sun keep producing, year after year, such a stupendous amount of energy without diminution in amount? In 1900 astronomers could give but one honest answer to this question: "We don't know!"

Then in 1905 a physicist by the name of Albert Einstein, 26 years old at the time, published a paper about half the length of this article. In this brief paper he demonstrated the equivalence between mass and energy and gave a simple formula which told how much energy could be obtained by annihilating, for example, a pound of matter. The quantity so obtained surpassed the wildest dreams of scientists. They saw at once that if matter itself could

SIRIUS-B IS A HEAVYWEIGHT

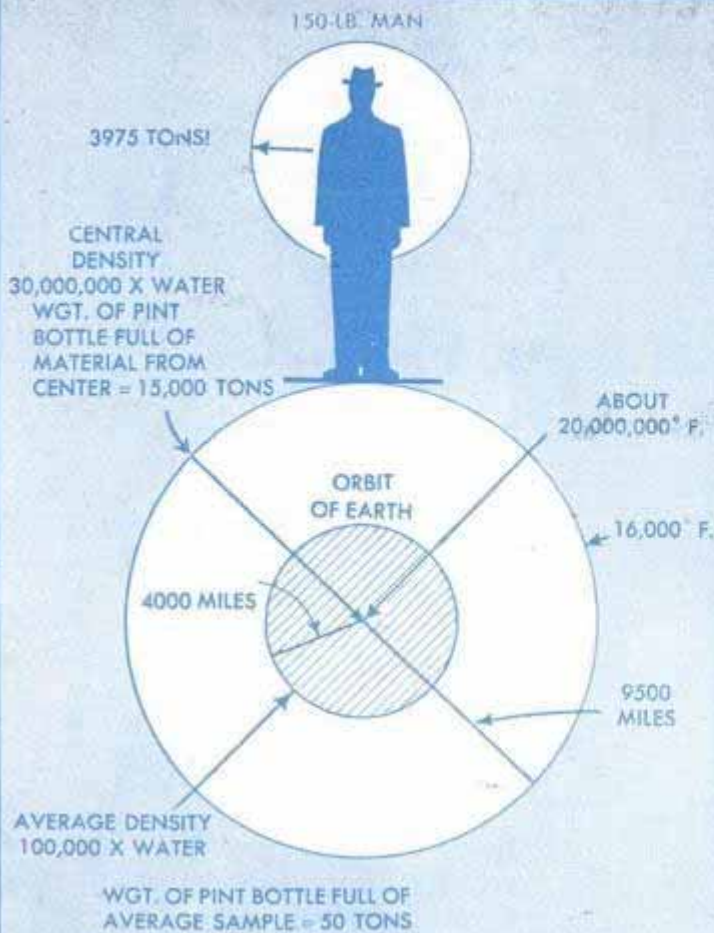

Although hotter than the sun, Sirius B is much fainter because it is only 19,000 miles in diameter, or a little more than twice size of earth

somehow be converted into radiation, the source of the sun's energy was found.

For a long time the precise means by which the sun managed to accomplish the trick eluded us. Not until 1939 did we know enough about how matter behaves at temperatures of millions of degrees to decide which particular atomic reaction must work in the sun. By a process of elimination it became obvious that there was only one that satisfied all the conditions. It con-

sisted of a series of reactions in which hydrogen, combining with carbon and nitrogen, is transformed into helium with the liberation of energy. That is, hydrogen may be thought of as "fuel" which, with the help of carbon and nitrogen, "burns" with the evolution of light and heat, finally ending as helium, the "ash."

The sun looks dazzling bright in the sky, but, as we have said, actually it is a star of only moderate luminosity. In the northern constellation of Cygnus a star called Y Cygni makes the sun look like a shadow by comparison. Too far away to be seen without a telescope, it outshines the sun 32,000 times. If the earth revolved around Y Cygni, it would have to move in an orbit extending out to nearly five times the distance of Pluto, the farthest planet, in order to receive the same light and heat that we do from the sun.

Y Cygni pours out energy at such a prodigious rate that it must be converting hydrogen into helium a thousand times faster than the sun. The age of the universe, determined from the uranium content of meteorites and from other sources, is about 2000 million years. It is hard to see how Y Cygni could have been stocked with sufficient hydrogen originally to have shone at its present rate for more than 100 million years. Thus, excessively luminous stars must be comparatively young. They seem to spend their precious store of hydrogen recklessly, heedless of the fact that if they keep it up they are headed for extinction in 70 million years or less.

An atomic power plant different from Y Cygni is the brilliant red star Betelgeuse. Betelgeuse looks red because its surface temperature is 6000 degrees Fahrenheit as compared with 11,000 degrees for a yellow star like the sun. Yet if the sun were at the same distance as Betelgeuse we could not even see it without a telescope. What is it that makes Betelgeuse look so bright in the sky?

COMPARATIVE BRIGHTNESS OF STARS AND SUN

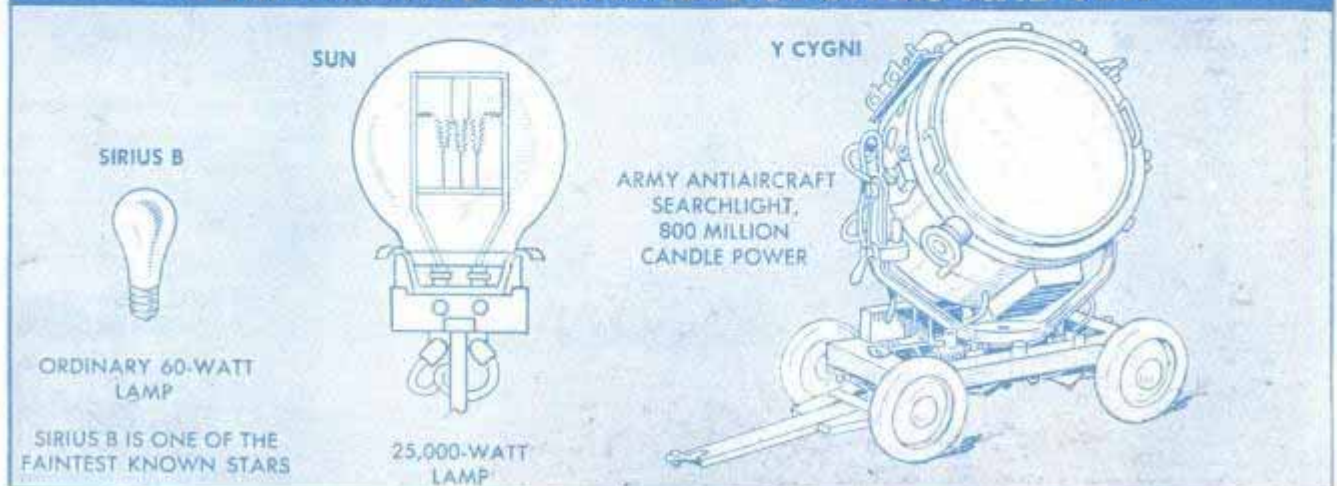



Photograph of a painting of the November meteors as they appeared in 1868. Below, the sun is apparently an inexhaustible atomic energy plant, although actually a star of rather moderate luminosity

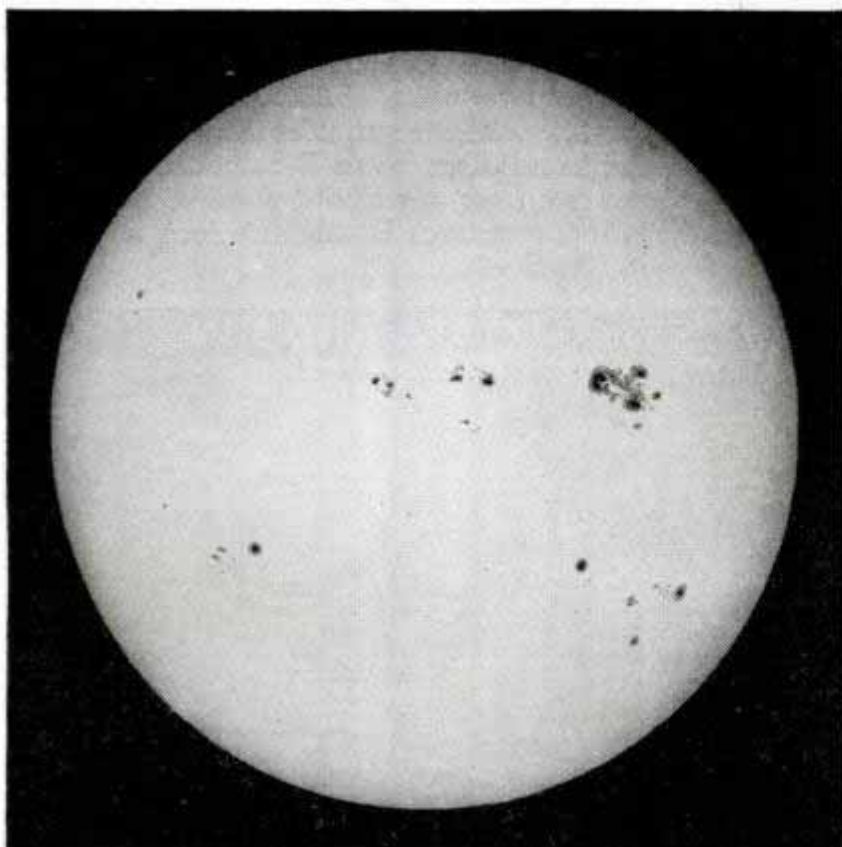

The answer came in December 1920 when the diameter of Betelgeuse was first measured with an instrument called the interferometer. Later measurements showed that on the average the diameter of Betelgeuse is 400 times that of the sun. We say "on the average" because the measures showed that Betelgeuse expands and contracts like a giant balloon. Betelgeuse is so enormous that the sun could be placed at its center with room left over for the earth to revolve in its present orbit.

By a "mathematical boring process" the central temperature of stars like Betelgeuse has been found to be quite low, only about 12,000,000 degrees Fahrenheit as compared with 45,000,000 degrees for a star like the sun. Under such conditions hydrogen would be converted into helium so slowly that Betelgeuse must derive its energy from some other atomic reaction that operates at a low temperature, as for example those involving deuterium (heavy hydrogen) and the light elements lithium, beryllium and boron.

Sirius A is the brightest star of all in the sky, sparkling on a clear frosty night like a blue-white diamond. But Sirius A is interesting to astronomers chiefly because of its tiny companion, Sirius B, so faint that only under the most favorable conditions can it be detected with a powerful telescope. Most of the time Sirius B is hidden by the dazzling light of Sirius A.

Sirius A is a star not essentially different from many others. But Sirius B is about as massive as the sun although much fainter. Many faint stars are known, practically all of which are deep red. Sirius B, however, is white. In order for a star to appear white its surface temperature must be high. And stars of high temperature give out a lot of light per square inch of surface. Yet the observations show that Sirius B is only $\frac{1}{400}$ as bright as the sun.

We saw that Betelgeuse, al-

4-Wheel-Steering Jeep Turns in 12 Feet

though cooler than the sun, appears very bright because it is so immense. Sirius B, hotter than the sun, is faint because it is so small, being 19,000 miles in diameter or a little more than twice the size of the earth.

Into this pygmy star is packed as much matter as our whole sun contains. As a result its density is incredibly high—on the average 100,000 times as dense as water. A pint bottle holds about a pound of water. Therefore, a pint bottle filled with a representative sample of material from Sirius B would weigh 100,000 pounds. And this is merely the average density. At the center of the star the density probably soars to 30 million times and a pint bottle full of material from there would weigh about 15,000 tons.

Gravity on the surface of such a body would be terrific. A 150-pound man would weigh 3975 tons on Sirius B. His muscles could never support such a weight. He would be instantly squashed by the weight of his own body. To attain such a high density, the atoms must be crushed into their separate components so they fill only a fraction of the space they ordinarily would occupy. Imagine a box loosely packed with 100 Christmas ornaments. By packing them carefully possibly 200 might be squeezed in. Now let us crush the ornaments to a fine powder until we can get thousands of them into the box, which then would be much heavier than when it contained only 100.

Another type of celestial power plant is the nova—a new star that suddenly flares up to thousands of times its former brightness. Nova Puppis, which appeared in November 1942, was a fine example of such a star. For three days Nova Puppis ranked among the 10 brightest stars in the sky. Then it faded rapidly and in a few weeks was barely visible to the naked eye. Now it can be seen only with a telescope.

Even more awe inspiring are the supernovae which have been photographed in

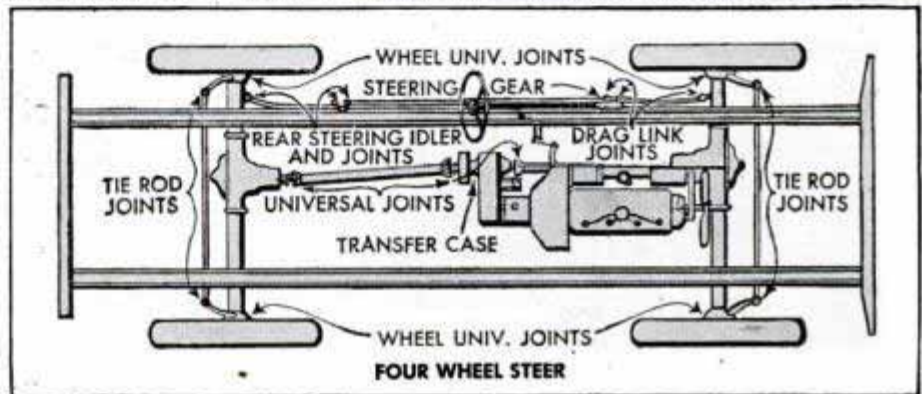

Redesigned jeeps have been made even more maneuverable than the Army models. One was converted to four-wheel steering by installing, at front and rear, axles equipped with steering knuckles. The rear wheels can turn sideways, with the result that the jeep can turn around in 12 feet.

galaxies millions of light years away. One such star blazed with the light of 600 million suns—a hundred times as bright as the whole island universe of stars that contained it!

The brightest supernovae ever recorded shows on our plates as a faint speck of light. Yet they are the most spectacular example of the atomic power plants of the sky.

Vitamin A Produced Chemically

Vitamin A, previously produced from fish liver oils, can be made synthetically as the result of experiments conducted at Massachusetts Institute of Technology. Seven or eight steps are required to produce the vitamin. Potency of the artificially produced product—still not out of the laboratory stage—is $\frac{1}{10}$ to $\frac{1}{30}$ that of pure vitamin A crystals obtained from natural sources, but 50 to 100 times greater than that of cod liver oil itself.

Magnetic Sweeper Collects Chips

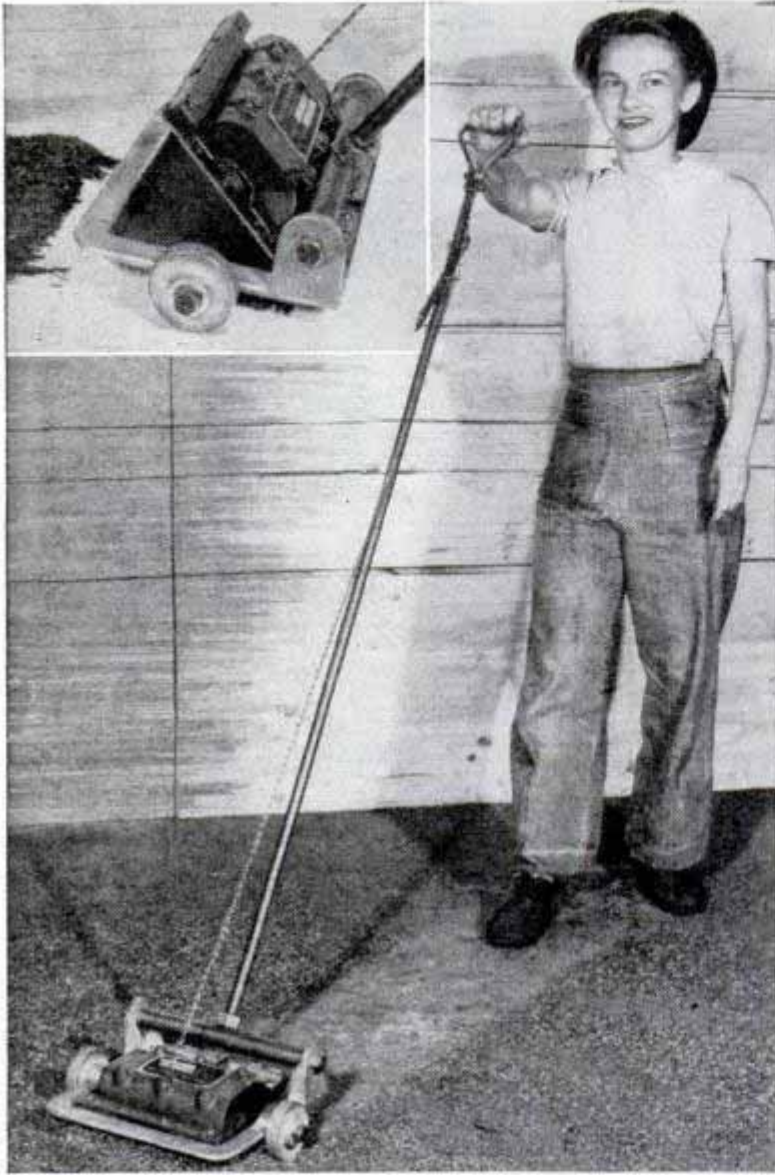

Metal particles under and around machines can be swept up quickly with a magnetic sweeper. Chips, filings, dropped screws and bolts all are picked up by a plastic plate over which is suspended a magnet. By pulling a chain attached to the handle the magnet is lifted and the clinging particles automatically are detached from the plastic plate. The magnet requires no electrical connection.

Water Yield Tripled In Compression Still

Scientists are studying a variety of peacetime uses for one war-developed method of extracting fresh water from sea water. Called compression distillation, this method produces approximately 175 pounds

of distilled water for each pound of fuel consumed, which is three to four times as much distilled water as obtained with previous distillation systems. The main difference between the old and the new way is that in the latest method steam is raised to a higher temperature and the resulting heat is used to evaporate more water in a still. Fuel is used to drive the compressor instead of to boil water in the still. This procedure may find many applications in industry.

Optical Gauge Measures Plastic Thickness

Measurement of the thickness of large or curved pieces of plastic sheet or glass is simplified with an optical micrometer which can be used in positions inaccessible to the ordinary micrometer. The instrument, which operates on the principle of apparent depth, "sees" through the plastic sheet to gauge its thickness by measuring the distance to a crayon mark on the underside of the sheet being checked. Measurement consists of sharply focusing the mark in the eyepiece of the instrument. Readings on the barrel and thimble, as in an ordinary micrometer, give the thickness of the material. A plastic nosepiece, held against the sheet to be measured, prevents the metal parts of the instrument from scratching the surface of material being measured.





The Craftsman

- Decorative Wall Plaques . . . 170
- Optics of the Projector . . . 178
- Child's Swan Rocker 185
- Deep-Freeze Food Storage . 188
- Weave Your Own Rugs . . . 193
- Novel Paste-Up Photos . . . 198
- Focusing Photo Spotlight . . 201
- Three-Wheel Farm Truck . . . 205
- Build Your Own Relays . . . 211
- Utility P.A. Amplifier 222

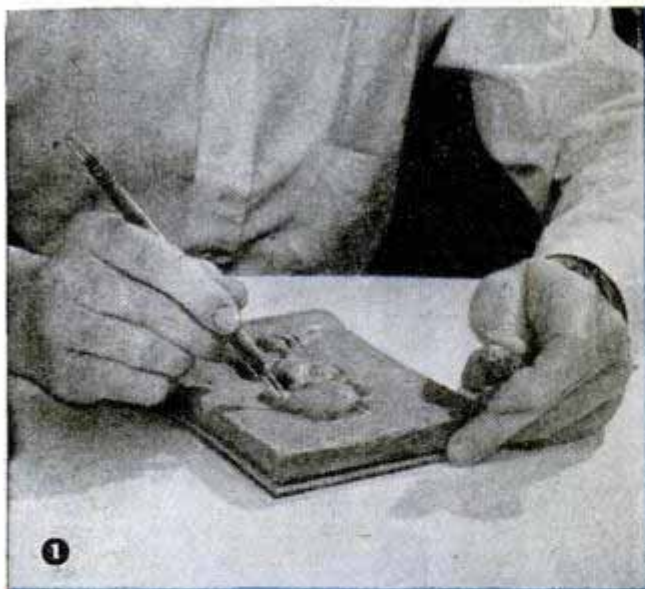

1 Outline the figure on a piece of clay and carefully pull away the material until the subject is in relief

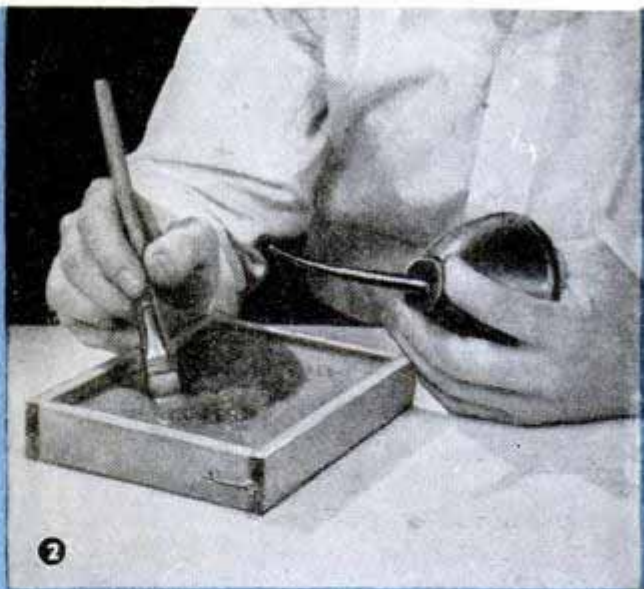

2 Place the clay in a wooden frame and paint the frame and surface of the clay with ordinary motor oil

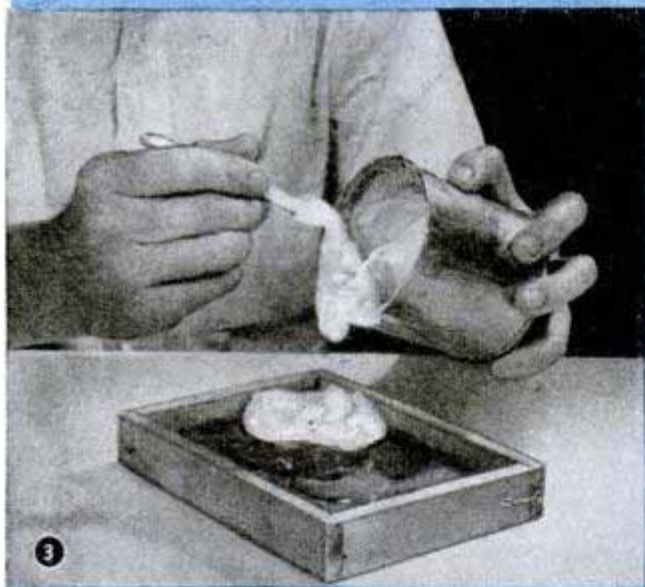

3 Mix a small quantity of plaster of paris to the consistency of pancake batter and pour the mold full

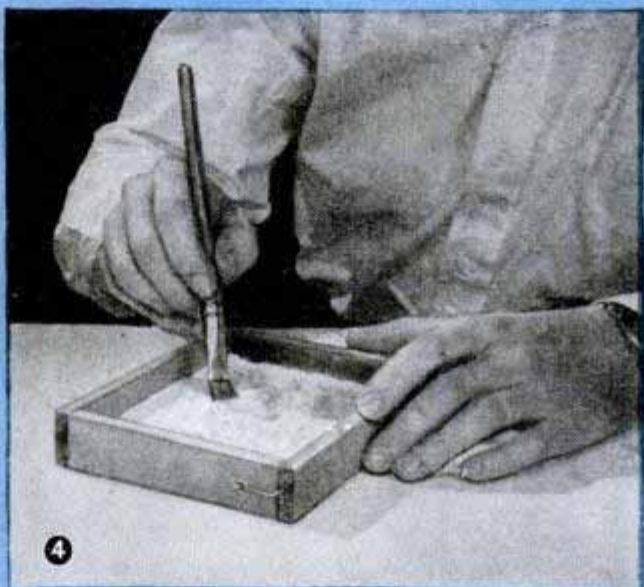

4 When thoroughly dry remove the clay model and give the surface of the plaster two coats of white shellac



5 Place the mold back in the frame, oil the surface and once again pour the mold full of plaster of paris



6 When the plaster cast has dried thoroughly, remove and shellac as before. Then paint with oil color

DECORATIVE WALL PLAQUES

From Modeling-Clay Patterns

By Dick Hutchinson

IF you begin with clay patterns it's easy to satisfy a desire to work in modeling clay without getting discouraged right at the start. Shaping a figure or object, such as a ship, in simple relief on a flat surface requires far less skill and effort than carving the same thing in wood. Figs. 1 to 6 inclusive show how a pattern is made from modeling clay and how it is used in casting a wall plaque from plaster of paris. First, you select a clipping or photo of the subject desired and from this determine the size of the plaque. Then cut a modeling board from $\frac{1}{4}$ -in. plywood to this size. Place a piece of the clay on the board, smooth it out to the edges and square up to a thickness of about $\frac{5}{8}$ in. Outline the figure in the clay, then begin modeling the relief by pulling away excess material as in Fig. 1. Professionals use the set of tools shown in Fig. 7, A to D inclusive, but for simple detail a hairpin, E, Fig. 7, does very well. You will see that the advantage of modeling clay is that if too much is removed or scraped away from any point on the surface, more clay may be added and the area gone over again to correct the error. Once the figure or shape is finished as desired, make a small bottomless box that will fit over the pattern and modeling board as in Fig. 2. Diagonally opposite

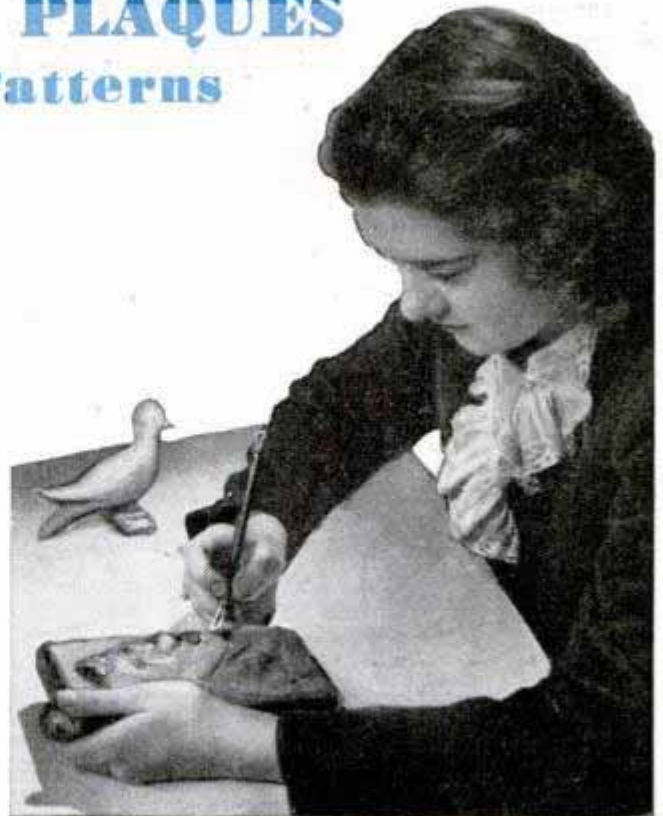

corners are held with small hooks so that the box can be removed without damaging the pattern. After the plaster of paris mold has hardened it is placed in the box and shellacked. When pouring the plaster plaque as in Fig. 5, a small hanger bent from wire is placed at the top end as indicated. Fig. 6 shows a plaque being painted, while the two views in Fig. 8 show a pattern and the finished plaque made from it.

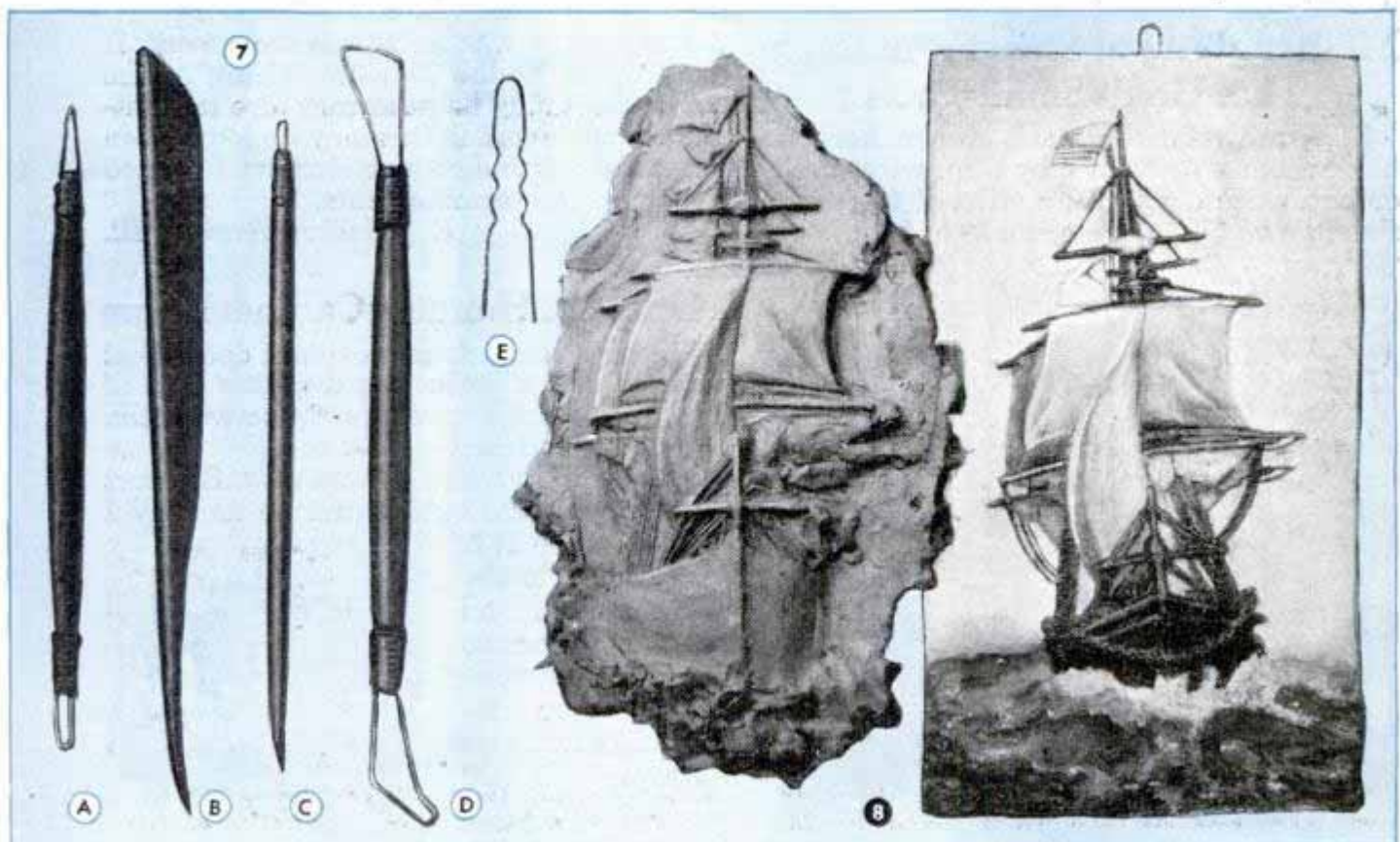

Durable Fish Scaler Easily Made From Power-Hacksaw Blades

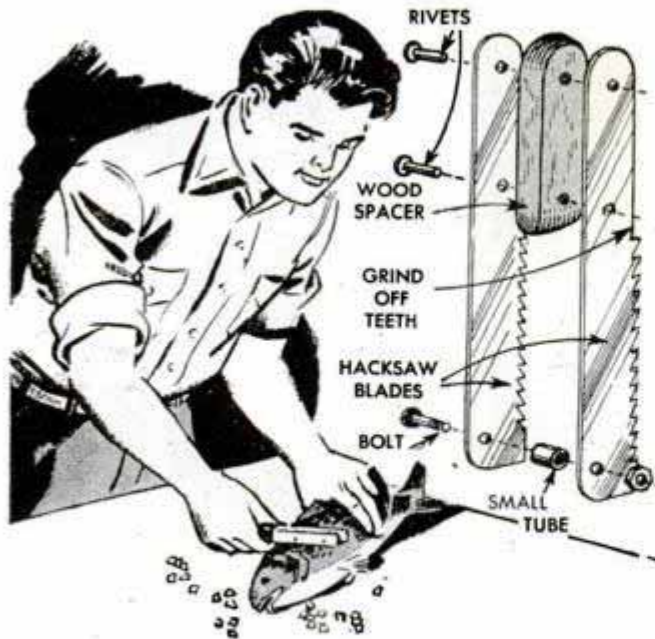

Discarded power-hacksaw blades are used by one fisherman to make a fish scaler. Two pieces of blade $7\frac{1}{2}$ in. long are required and the teeth are ground off for a distance of 4 in. to form a handle. Note, however, that the teeth point in the opposite directions so that the maximum scraping effect is obtained. A wood spacer, which is sawed and sanded to fit the contour of a handle, is riveted between the blades. To complete the scaler, a tube of a length equal to the width of the wooden spacer is inserted where indicated.

W. B. Townsley, South Bend, Ind.

Mesh and Metal Strip Form Rack That Holds Small Tools

The universal tool rack shown here is made from a piece of 6 by 8-in. wire mesh or hardware cloth and a strip of 18-gauge sheet metal $1\frac{1}{2}$ in. wide and 18 in. long. The

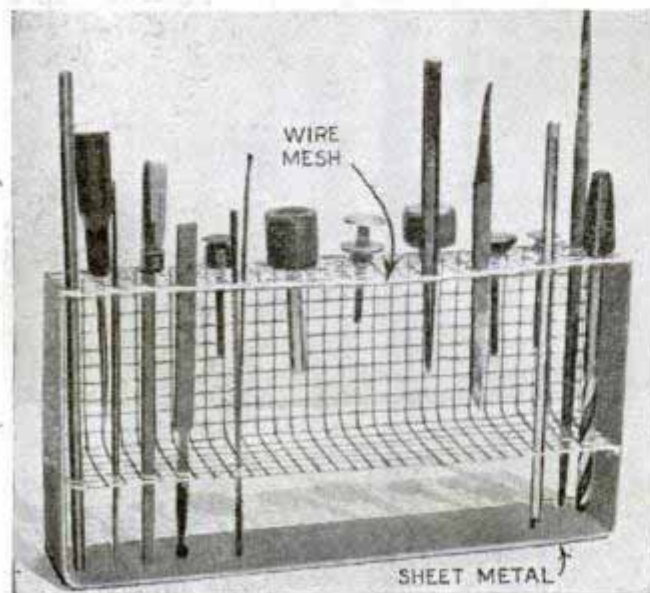

metal strip and the hardware cloth both are bent to a U-shape and soldered together to make a sturdy, all-purpose holder.

Container on Drill Catches Debris From Overhead Borings

You need not be bothered with shavings or bits of plaster going down your sleeves and shirt collar when boring overhead holes if you use a container as shown to catch the drillings. Punch a hole large enough to slip over the shank of the drill and fasten it with cellulose tape. Then put the bit in the brace and proceed to drill. The debris will fall into the container and save clean-up time.—Benj. Nielsen, Aurora, Nebr.



Remedy for Flickering Car Lights

Two frequent causes of flickering lights in an automobile are poor ground cable connections and loose wiring at the ammeter. On cars where the motor has a floating mount, the cables should be tightened every two or three thousand miles as they are subject to extreme vibration. One solution is to fasten the cable to a transmission bolt where there is less movement. If the trouble is due to loose wiring at the ammeter, it may be necessary also to tighten the inside nut as this may be loose even when the outside connections are fastened tightly to the terminal nuts.

Hal Geihm, Aurora, Ill.

Method of Hanging Cabinet Doors

When hanging double cabinet doors that have an offset projecting over the face of the cabinet, put a spacing strip between the two doors and nail a cleat to the backs so they can be handled as one unit. Support the doors in the cabinet frame and level the top. Then it is easy to locate the hinge screws and hang the doors so the space between them will be uniform from top to bottom.—Harold W. Stanton, Lake Arrowhead, Calif.

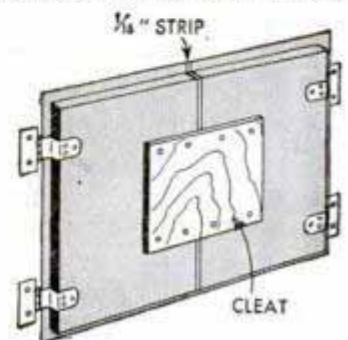

Novel Smoking Set Makes "Strike" With Bowlers

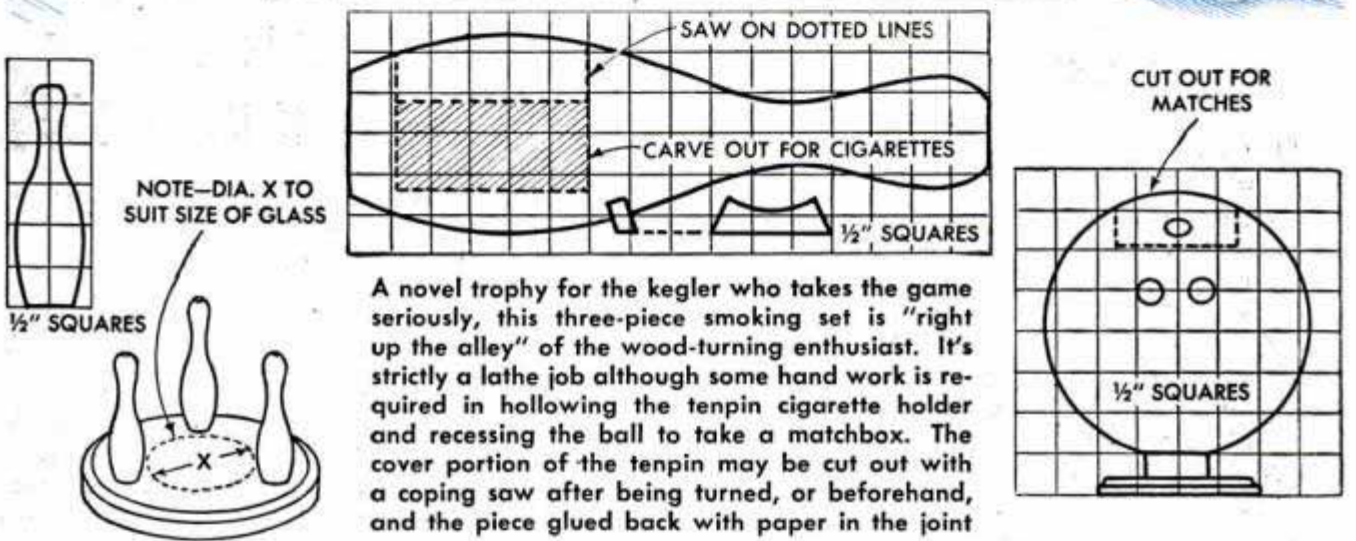
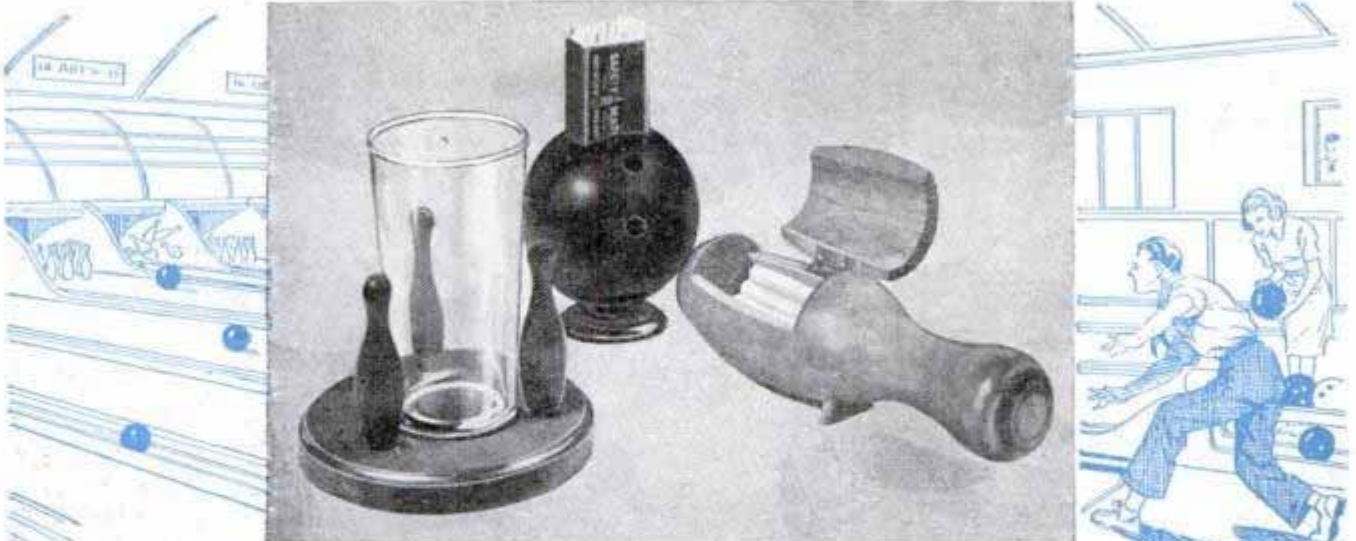

A novel trophy for the kegler who takes the game seriously, this three-piece smoking set is "right up the alley" of the wood-turning enthusiast. It's strictly a lathe job although some hand work is required in hollowing the tenpin cigarette holder and recessing the ball to take a matchbox. The cover portion of the tenpin may be cut out with a coping saw after being turned, or beforehand, and the piece glued back with paper in the joint

Pine Cone Will Indicate Humidity to Forecast Weather

Because the cones from pine trees tend to open when the air is dry and close when the air is damp, knowledge of this fact can be utilized in making this weather forecaster. The body of the animal is a pine cone; the head is cardboard and the legs are short lengths of wire resting on a cardboard base. During periods of high humidity when rain is more likely, the cones will be closed, but when the humidity is low and the weather probably will be fair, the cones will be open.—S. Leonard Bastin, Christchurch, Hants, England.

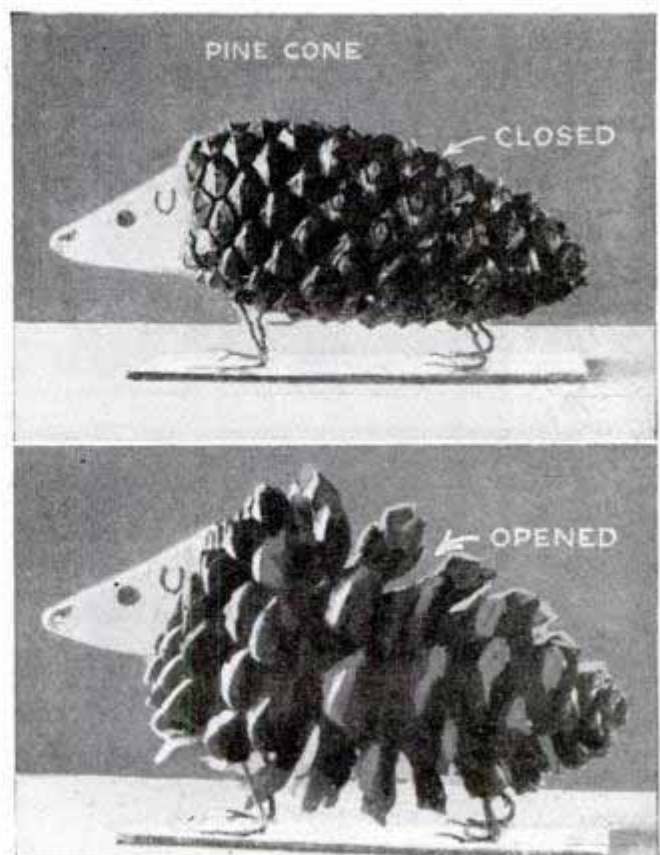

Cigarettes Used to Measure Fish

Not many fishermen carry a rule to measure their catch, but fish of doubtful length can be measured by using a cigarette. All standard brand cigarettes are 2 3/4 in. long and the "king" size are 3 1/4 in. For example, a fish having a legal length of 8 in. would scale three standard cigarette lengths with 1/4 in. over to be on the safe side.—R. A. Jenkins, Los Angeles, Calif.

Solving Home Problems



1 Extension cords for household appliances will not pull out of drop-cord receptacles when the end of the extension is looped and secured to the drop cord with a rubber band or piece of string while being used



2 Drawers will glide noiselessly and easily if thumbtacks are pressed into the runners on which the drawers slide. A thumbtack that has a rounded head and an enameled finish is better than a flat-head tack

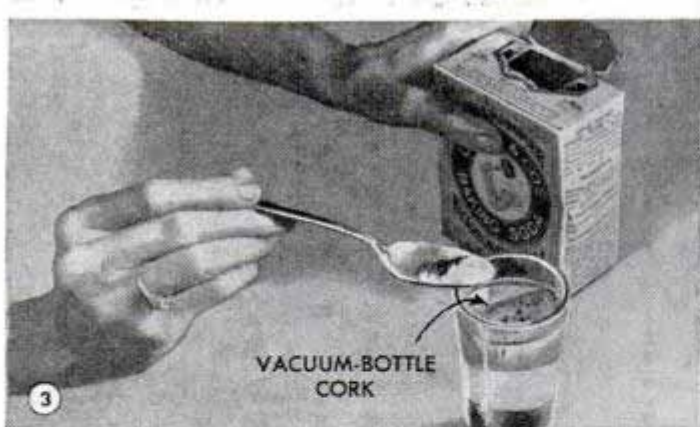

3 Keeping a vacuum-bottle cork submerged when soaking it in a baking soda solution to sweeten it is not difficult if the cork is wedged into a small glass. When this is done, the cork can be covered completely

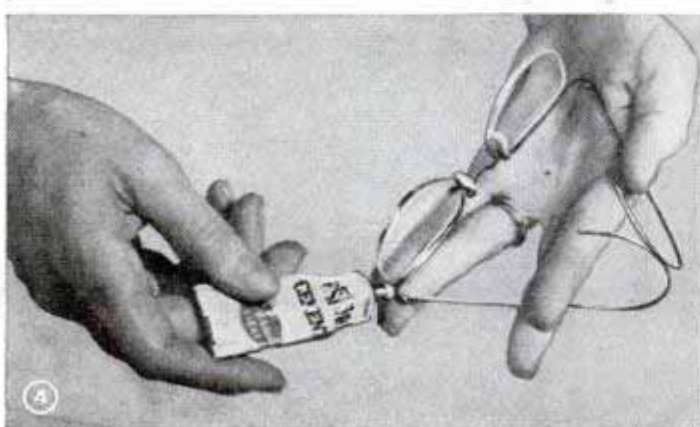

4 The small screws in eyeglasses that hold the temple to the frame are a frequent source of annoyance because they refuse to stay tight. The next time this happens apply liquid cement to the loose screws

5 A brick and a piece of soft cloth make an improvised floor polisher when the regular polisher is not available. Wrap the brick in the cloth, fold the ends as shown and fasten in the clamp of a floor-mop handle

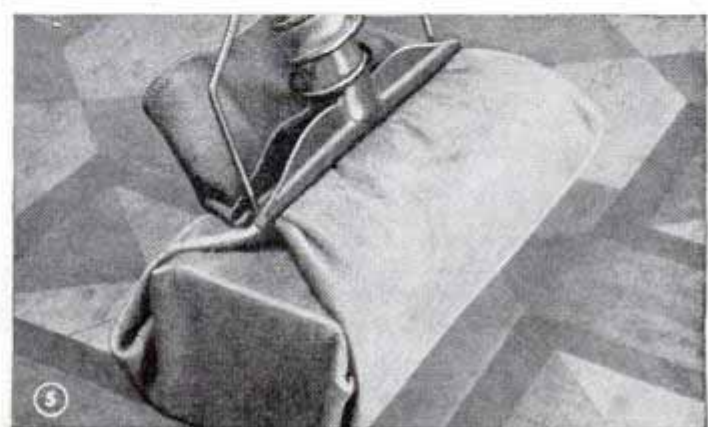

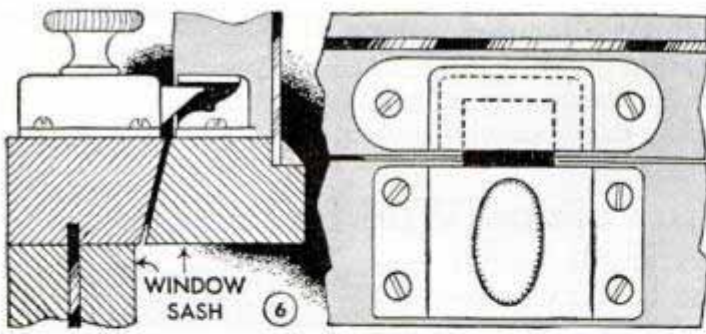

6 Because most window locks must be fastened by hand, they frequently are left unlocked. To insure having your windows locked when closed, install a latch that snaps shut

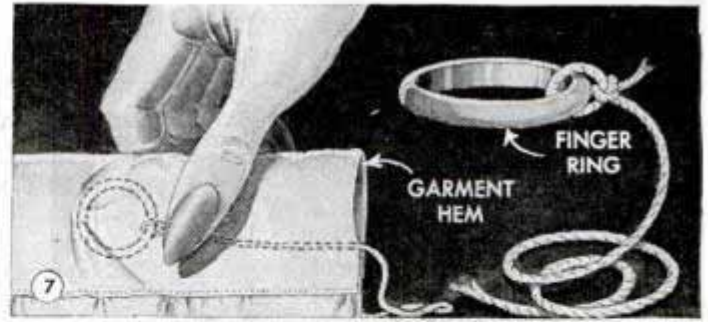

7 In an emergency, a finger ring is used to pull a draw string through the hem of a garment. After the string has been fastened to the ring, it is worked through the hem

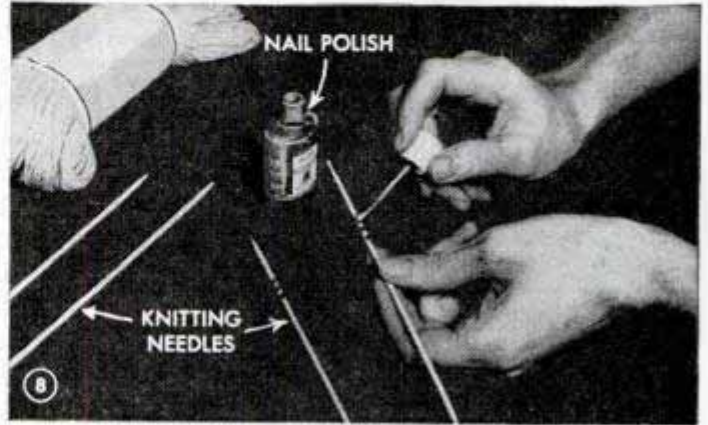

8 To identify sock knitting needles, mark the size on the needle with colored fingernail polish. Those in the photograph are size 3 and are identified with three dots



9 When space is at a premium, it is a good idea to store baking dishes with the lids inverted. This permits stacking dishes so the knobs on the lids are not broken easily

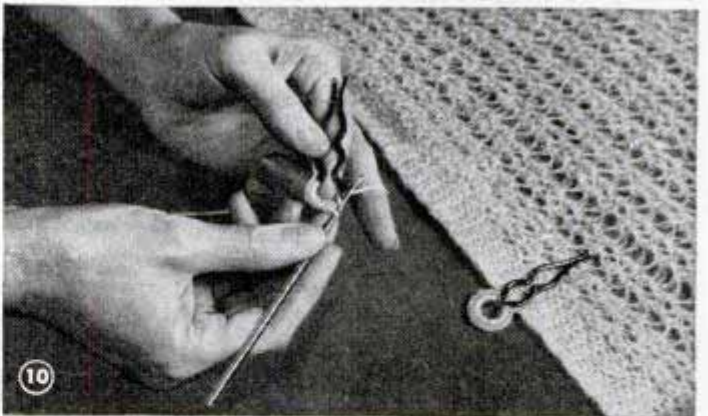

10 After crocheting your fascinator, use the same yarn to crochet around the tops of two bone hairpins. These make "invisible" holders to keep this head covering in place

11 Embedded in the paraffin while it is soft, a milk bottle cap provides a handy tab for easy removal of the paraffin, which can be reused as it will not break when removed

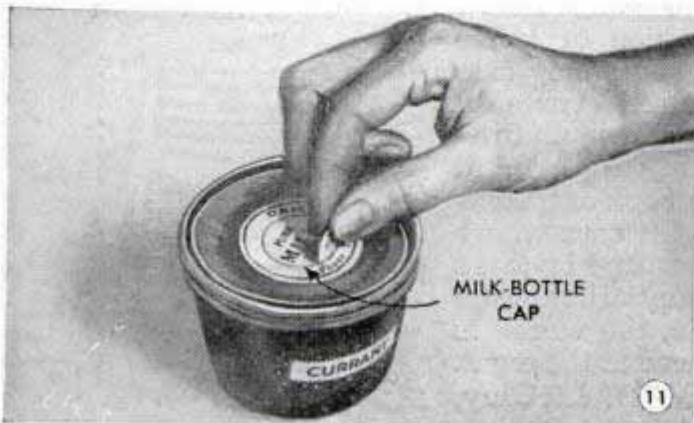

12 Here's one way to install half-screens. Small blocks serve as stops at the base; the screen rests against the sash at the top and turnbuttons on the sides hold it in place

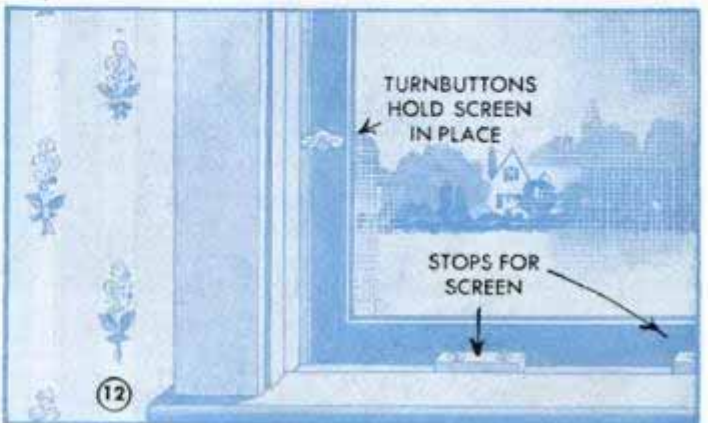

Music Stuffs Are Drawn Quickly Using Multiple Chalk Holder



Teachers will find this multiple chalk holder convenient for drawing music staves on the blackboard. Five equidistant holes are drilled in a piece of hardwood and tapered lengths of chalk are pressed into the holes. The ends must be even so that all sticks are in contact with the board when drawing staves.—V. Palmer, Alleppo, Syria.

Reflector Aids When Parking Car In Small Garage at Night

In a garage where space is at a premium, a large red-glass reflector attached to the rear wall in line with the center of the driveway will enable you to park your car



without difficulty. All that is necessary is to sight down the center of the hood, lining up the radiator ornament with the reflector, as the car is driven inside.

Vise Positions Work on Drill Press

A small bench vise of the clamp-on type is handy for holding light work on a drill press. Clamp the vise to the table of the machine and swing the table so that the work comes under the drill bit. This arrangement will be especially useful for such jobs as

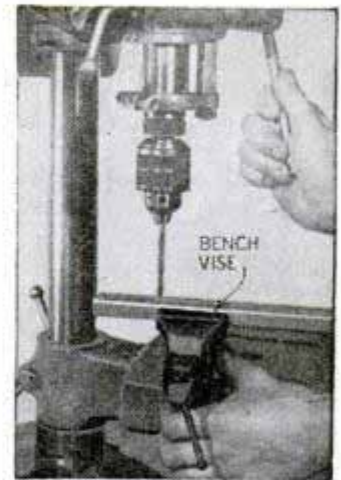

drilling a large number of holes in aluminum strips used to protect the edges of stair treads and table tops, as shown here.

D. J. Bachner, Jackson Heights, N. Y.

Washing Rugs Without a Machine

When you do not have a washing machine in which to clean such heavy articles as rag rugs or chenille and crocheted bedspreads, soak them overnight in the bathtub in thick soap suds. The next morning dip them up and down several times and, without wringing, hang them on the clothesline. Turn the hose on them until all the soap is rinsed out.

Ruth C. Buck, Jackson, Miss.

Wedge Tilts Front Axle of Car To Prevent Swaying

A car may have a tendency to "weave" over the road because the front axle is not tilted backward sufficiently. Often this trouble can be corrected by inserting a wedge between the axle and spring as indicated. Thickness of the wedge will be determined by the amount of tilt required. A good wedge for this purpose is made from a piece of knife file. On many cars the axle rests on the spring and the wedge is placed at the back of the axle. On cars where the spring is mounted below the axle, the wedge is placed at the front.

—W. H. McClay, Pasadena, Calif.

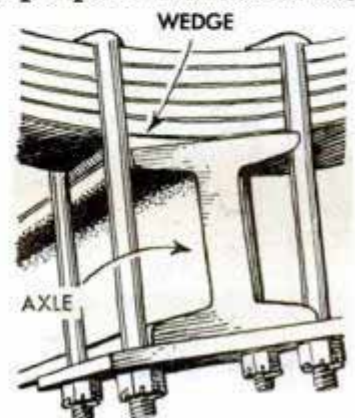

Reel Aids in Handling and Storing Small Boat

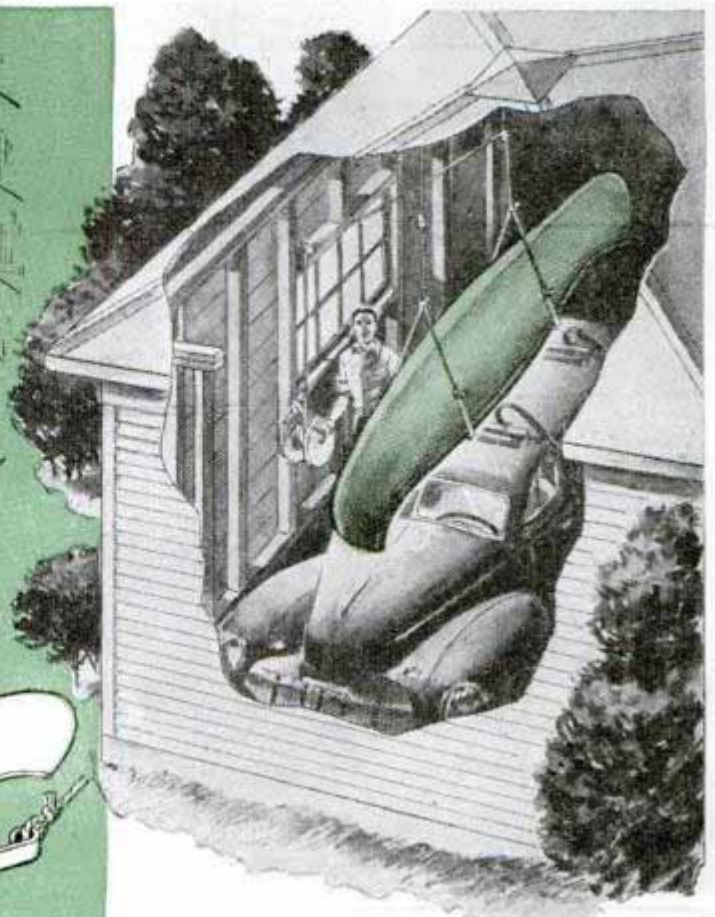
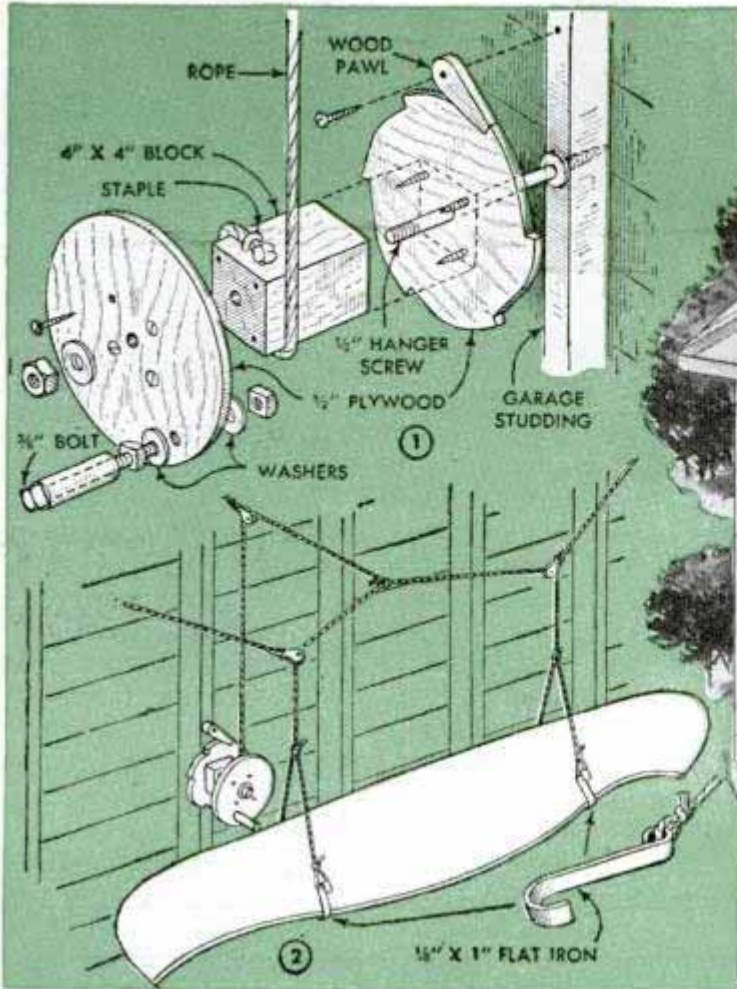

Canoes, small boats and kayaks can be lowered to or removed from the top of a car with little effort if the reel and pulley arrangement shown here is used. When the craft is raised above the car it is stored out of the way until ready for the water again. Two of the pulleys are attached to the roof by short lengths of rope, and the third pul-

ley, through which passes the rope attached to the hooks, is fastened to the side of the building. Size of the pulleys is determined by the size of the rope, and this depends upon the weight of the boat. The reel is made as indicated in Fig. 1 and is screwed to the studding at waist height. The hooks, Fig. 2, from which the boat is slung are bent to fit over the sides of the craft.—D. E. Horn, River Forest, Ill.

Pipe "Planted" With Young Tree Conducts Water to Roots



When a young tree is planted, its roots can be assured of a plentiful supply of water if a length of 6-in. pipe is placed in the hole near the roots. The pipe is filled with water, which will be fed directly to the roots instead of seeping through the ground to be absorbed by the soil.

B. G. Reams, Winter Garden, Fla.

Fan Belt Made from Inner Tube

If the fan belt on your car breaks and you're not near a garage, here's an emergency repair that will keep you going until you can get a belt. Cut bands from an inner tube into strips about 1/4-in. wide. Stretch several of these over the pulleys and bind them with cord, using a half-hitch knot. Care must be taken to avoid "bunching."

Arthur Drummond, Jr., Rye, N. Y.

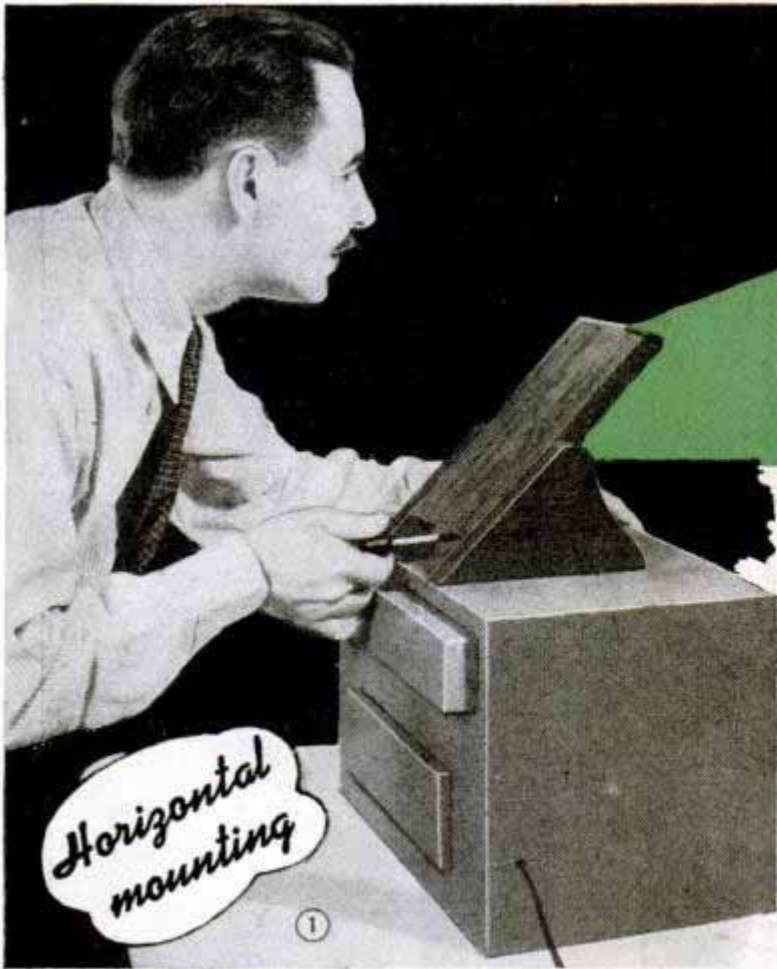

By Sam Brown

A PROJECTOR is an optical device for enlarging opaque copy and projecting it on a wall, screen or sheet of white paper. Artists, sign writers and many craftsmen find a projector very useful. To use it, fasten the drawing, picture or clipping to a copy board, place the board in the projector box, snap the switch and there's your picture—any size you want it with only slight adjust-

	SINGLE LENS	COMPOUND LENS	PROJECTOR LENS	CAMERA LENS
TYPE OF LENS	<p>PLANO CONVEX DOUBLE CONVEX ACHROMAT</p>	$E.F. = \frac{F \times F}{F + F - S}$		
FIELD	<p>TO COPY 20° PLANO-CONVEX LENS</p>	<p>20°</p>	<p>25°</p>	<p>50°</p>
DISTORTION	<p>HEAVY PINCUSHION DISTORTION—ABOUT 1/4" TO 3/8" IN 12" AT IMAGE</p>	<p>VERY SLIGHT DISTORTION—NOT OVER 1/32" IN 12" AT IMAGE</p>	<p>SLIGHT DISTORTION ABOUT 1/16" IN 12" AT IMAGE</p>	<p>NO DISTORTION</p>
ILLUM.	<p>FAIR ILLUMINATION. WORKS BEST AT F:11 TO F:16</p>	<p>GOOD ILLUMINATION. WORKS AT F:8</p>	<p>EXCELLENT ILLUMINATION. WORKS AT F:4</p>	<p>GOOD TO EXCELLENT. WORKS AT F:4 TO F:8</p>
REMARKS	<p>POOREST TYPE OF LENS AND SHOULD BE USED ONLY FOR JUVENILE PLAY PROJECTORS. SINGLE ACHROMATIC LENSES ARE NO BETTER THAN PLANO OR DOUBLE CONVEX</p>	<p>BEST INEXPENSIVE TYPE. ONLY FAULT IS NARROW FIELD. SHOULD BE ABOUT 8" EQUIVALENT FOCAL LENGTH (E.F.). COST OF LENSES 1 1/2" DIAMETER ABOUT 20c EACH</p>	<p>BEST TYPE FOR LONG THROWS OR WHERE STRONG ILLUMINATION IS NEEDED. COST IN RACK-AND-PINION MOUNT ABOUT \$15. FOCAL LENGTH SHOULD NOT BE SHORTER THAN 6 1/2"</p>	<p>BEST ALL-PURPOSE LENS. RAPID RECTILINEAR TYPE RECOMMENDED IN VIEW OF LOW COST (ABOUT \$3). OTHER TYPES (ANASTIGMATS) ARE TOO EXPENSIVE FOR GENERAL USE</p>

The OPTICS of the PROJECTOR

ments of the copy board and lens. With minor changes in design a projector works equally well when used in the horizontal position, Figs. 1 and 3, for projecting pictures on the wall or a screen, or in the vertical position, Fig. 4, where it is used for projecting images onto an easel or drawing board so they can be traced in outline or in full detail.

General lens terms: The lens is the heart of the projector. Before discussing lenses, a few general terms should be understood; first of all, the focal length. If you hold any lens in sunlight and over a piece of paper, you will find that at a certain distance from the paper, the lens projects a sharp image of the sun. The distance from lens to paper is the focal length of the lens. If you are checking a thick lens like the compound type shown in Fig. 2, the focal length should be measured from paper to about halfway between the two lenses. This is not exactly accurate, but is close enough for practical use. Lenses recommended for projectors run about 4½ to 10-in. focal length. The *f*: value of any lens indicates the ratio between the focal length and lens diameter, and is found by dividing the focal length by the diameter. For example, a lens of 12-in. focal length and 1-in. diameter is rated *f*:12. If you take a piece of cardboard with a ½-in. hole in it and place it over the same lens, the *f*: value then is 12 divided by ½ or *f*:24. It can be seen that the higher the *f*: number the less light the lens will pass. Such lenses are called "slow." Lenses recommended for projectors should have an *f*: value of 11 or faster because good illumination is important.

Lenses: Lenses are described graphically in Fig. 2. From a study of this table, you

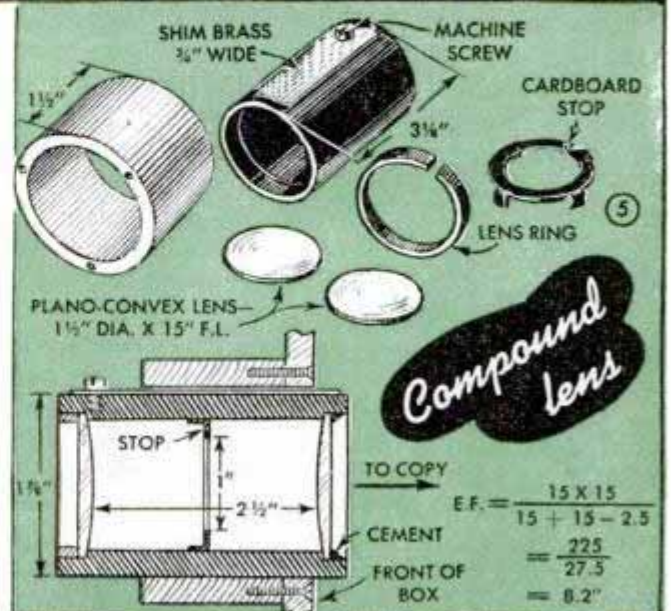
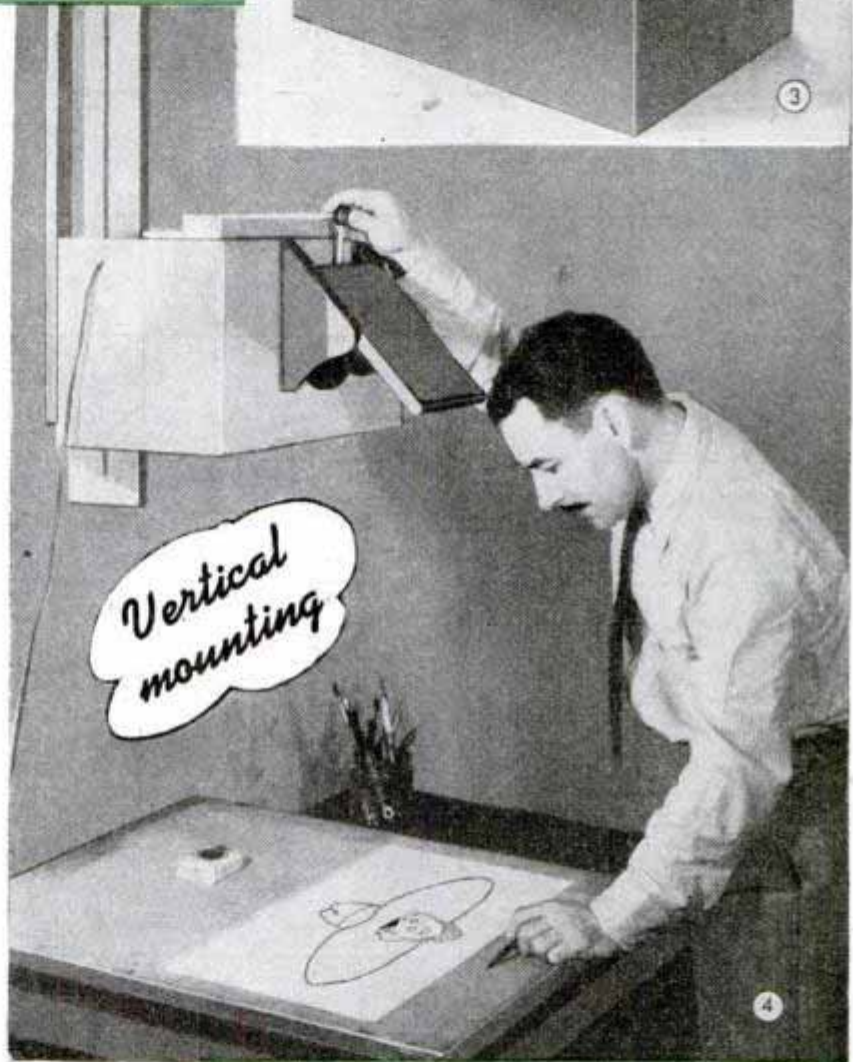

Use this table to find

1. GENERAL DIMENSIONS OF BOX—as determined by distance from lens to copy and size of copy covered.
2. WORKING SPACE NEEDED—as determined by distance from lens to image.
3. THE SIZE OF COPY any lens will cover at any specified degree of enlargement.

LENS	CHARACTERISTICS	DEGREE OF ENLARGEMENT								
		1X	2X	3X	4X	5X	6X	7X	8X	10X
3" FOCAL LENGTH	TO IMAGE	6	9	12	15	18	21	24	27	33
	TO COPY	6	4½	4	3¾	3½	3½	3⅞	3¾	3⅞
	20° FIELD	2¼	1¾	1½	1¼	1¼	1¼	1¼	1¼	1¼
	25° FIELD	2¼	2	1¾	1½	1½	1½	1½	1½	1½
	50° FIELD	5¼	4	3½	3¼	3¼	3¼	3	3	3
3½" FOCAL LENGTH	TO IMAGE	7	10½	14	17½	21	24½	28	31½	38½
	TO COPY	7	5¼	4⅞	4¼	4¼	4½	4	3⅞	3¾
	20° FIELD	2½	1¾	1½	1¼	1¼	1¼	1¼	1¼	1¼
	25° FIELD	3¼	2¾	2½	2¼	2¼	2¼	2¼	2¼	2¼
	50° FIELD	6¼	4¾	4¼	3¾	3¾	3¾	3½	3½	3½
4" FOCAL LENGTH	TO IMAGE	8	12	16	20	24	28	32	36	44
	TO COPY	8	6	5½	5	4⅞	4⅞	4⅞	4½	4¾
	20° FIELD	2⅞	2¼	2¼	2¼	2¼	2¼	2¼	2¼	2¼
	25° FIELD	3½	2⅞	2¾	2½	2½	2½	2	2	1⅞
	50° FIELD	7	5¾	4¾	4½	4¼	4¼	4	4	3¾
4½" FOCAL LENGTH	TO IMAGE	9	13½	18	22½	27	31½	36	40½	49½
	TO COPY	9	6½	6	5½	5¼	5¼	5¼	5¼	4⅞
	20° FIELD	3⅞	2¾	2¼	2	1⅞	1¾	1⅞	1⅞	1¾
	25° FIELD	4	3	2⅞	2½	2½	2½	2¼	2¼	2¾
	50° FIELD	8	6	5¾	5	4¾	4¾	4½	4½	4¾
5" FOCAL LENGTH	TO IMAGE	10	15	20	25	30	35	40	45	55
	TO COPY	10	7½	6⅞	6¼	6	5⅞	5¾	5¾	5½
	20° FIELD	3½	2¾	2¾	2¾	2¾	2¾	2½	2	1⅞
	25° FIELD	4⅞	3¾	2⅞	2½	2½	2½	2½	2½	2¾
	50° FIELD	8¾	6¾	5¾	5½	5¼	5¼	5	5	4¾
5½" FOCAL LENGTH	TO IMAGE	11	16½	22	27½	33	38½	44	49½	60½
	TO COPY	11	8¼	7⅞	7¼	6¾	6⅞	6¼	6¾	6¾
	20° FIELD	3¾	2¾	2¾	2¾	2¾	2¼	2¾	2¾	2¾
	25° FIELD	4¾	3¾	3¼	3	2⅞	2¾	2¾	2¾	2¾
	50° FIELD	9¾	7¼	6½	6	5¾	5¾	5½	5½	5¾
6" FOCAL LENGTH	TO IMAGE	12	18	24	30	36	42	48	54	66
	TO COPY	12	9	8	7½	7¾	7	6¾	6¼	6¾
	20° FIELD	4¼	3¾	2¾	2¾	2¾	2½	2½	2¾	2¾
	25° FIELD	5¾	4	3½	3¾	3¾	3¼	3	3	2¾
	50° FIELD	10¾	8	7	6¾	6¾	6¼	6	6	5¾
7" FOCAL LENGTH	TO IMAGE	14	21	28	35	42	49	56	63	77
	TO COPY	14	10½	9¾	8¾	8¾	8¾	8	7¾	7¾
	20° FIELD	4¾	3¾	3¾	3¼	3	2¾	2¾	2¾	2¾
	25° FIELD	6¾	4¾	4¼	3¾	3¾	3¾	3¼	3¼	3¾
	50° FIELD	12¾	9¼	8¼	7¾	7¾	7¼	7	7	6¾
8" FOCAL LENGTH	TO IMAGE	16	24	32	40	48	56	64	72	88
	TO COPY	16	12	10¾	10	9¾	9½	9¼	9	8¾
	20° FIELD	5¾	4¼	3¾	3¾	3¾	3¾	3¼	3¾	3¾
	25° FIELD	7½	5¾	4¾	4¾	4¾	4¼	4	4	3¾
	50° FIELD	14¼	10¾	9½	8¾	8½	8¼	8	8	7¾

will note that the compound lens is the best lens for an inexpensive projector. Camera lenses are best if you want a large field, but the cost of a modern camera lens of suitable focal length is too high to make it practical for projector use. An earlier type of camera lens, the rapid rectilinear, or R. R., makes an excellent projector lens and usually can be located in second-hand photo stores. The projector lens is really an old-type portrait lens; in fact, one of the very first camera lenses. It is used extensively on movie projectors and gives excellent illumination because it can be worked at f:4. However, the field covered is small, and it is little better than the homemade compound lens, while costing much more. The compound lens is homemade from two plano-convex lenses which you can purchase for a few cents from any dealer handling chipped-edge lenses. It gives good

definition over a 20-degree field when stopped down to about f:8.

Making the compound lens: The compound lens in a slide-type mount is detailed in Fig. 5. Cylinders can be plastic or wood. The lenses should be about 1½-in. diameter by 15-in. focal length. The calculation for figuring the equivalent focal length of the combined lenses is given in Figs. 2 and 5. In this specific example, it works out at about 8 in. In order to favor the narrow field, the focal length should not be shorter than 7 in. Any lens of this type will give the best definition, or sharpness of image, if it is stopped down to about f:8 or f:11. To find the size of stop for any focal-length lens, divide the focal length by the desired f: number. In the example shown, Fig. 5, the focal length is 8 in., so the stop diameter would be 1 in. for a value of f:8.

Lens table: The lens table, Fig. 6, gives

all the data you need in designing a projector for any particular lens or for any particular purpose. You will note that a long focal-length lens coupled with high magnification means a long throw from projector to screen, while a short focal-length lens means a short system. Also note that, for any specific lens, the longer the focal length the wider the field or size of copy you can cover. You will find that lens selection is a matter of compromise. You probably will want a fairly short system, possible with a short-focus lens, but at the same time you will want the large field obtained with a long-focus lens. If you use a single, compound or projector lens, you will have to go to at least 7 or 8-in. focal length

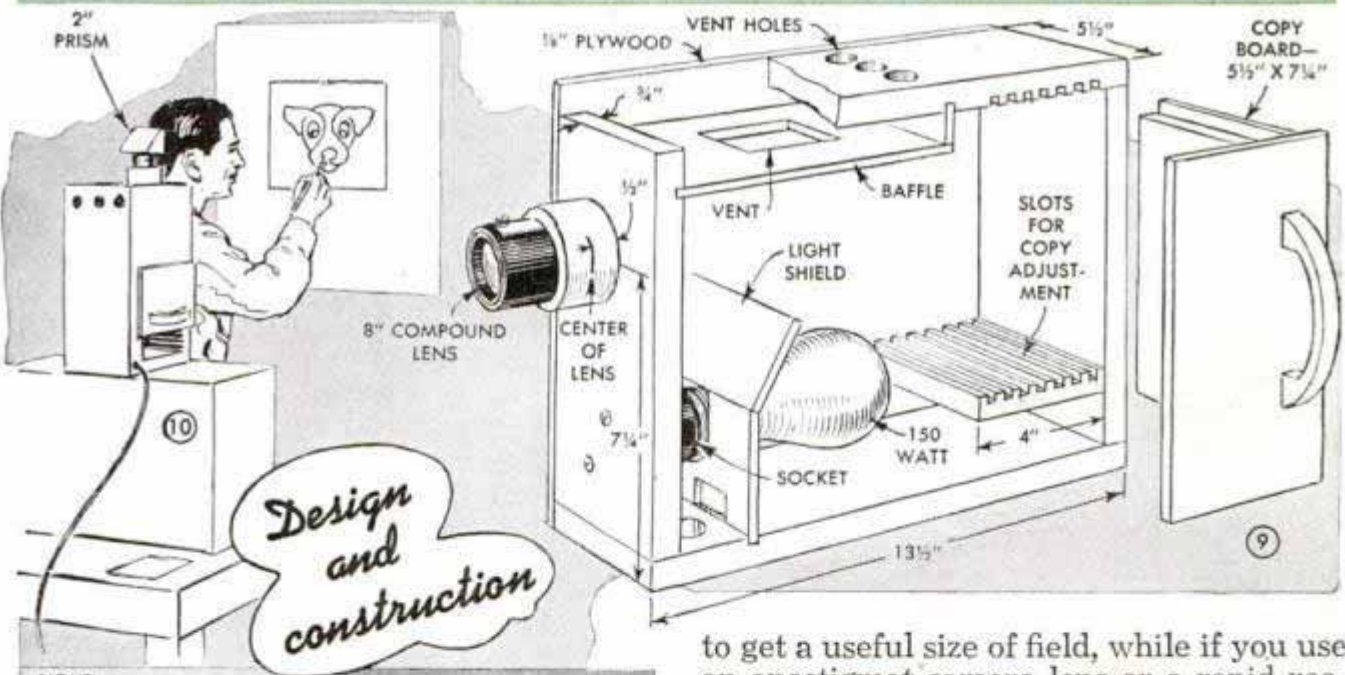
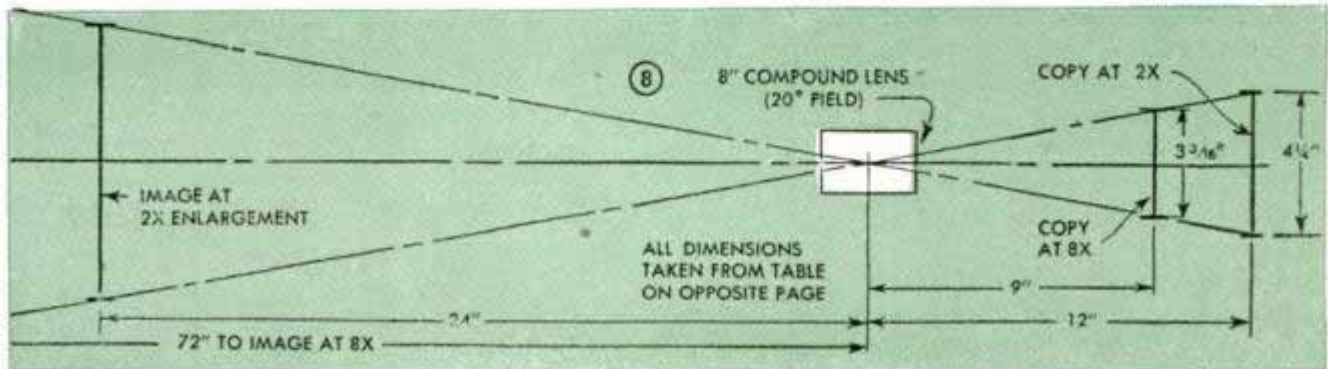
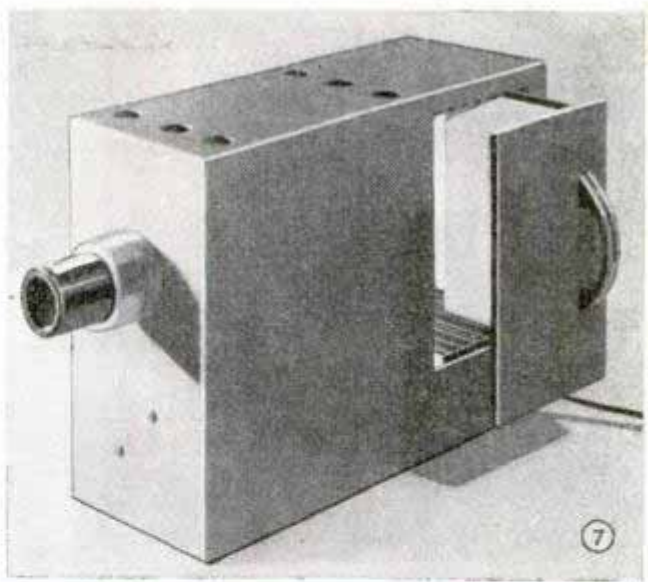

to get a useful size of field, while if you use an anastigmat camera lens or a rapid rectilinear, you can get a good-size field with a 4 to 6-in. focus lens. If you want data on focal lengths not shown in Fig. 6, simply double up; that is, figures for a 10-in. focal-length lens are double the figures for a 5-in. lens, and so on.

Designing a simple projector: Fig. 8 shows how the 8-in. compound lens previously described works out for a projector enlarging from 2 to 8 diameters. At 8X the copy will be 9 in. from the lens, while at 2X the copy will be 12 in. from the lens. These figures are taken from the table, Fig. 6. Also from Fig. 6, note that at 8X the

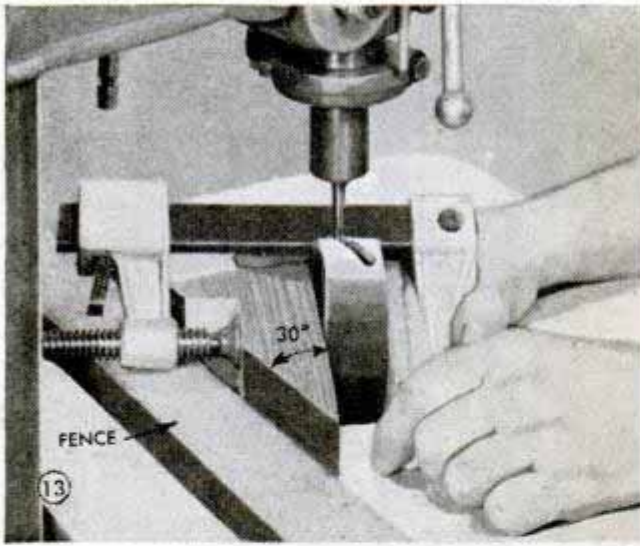

Erecting the image: A projector made as in Fig. 9 reverses the copy. This is not important for cutout work, but if you are working with lettering an erect image is needed. Erecting the image can be accomplished with a right-angle mirror, Fig. 11, or a 2-in. prism, Fig. 12. Both of these items can be purchased for about one dollar each from dealers handling surplus optical goods. When used with a mirror or prism, the box is mounted with the lens pointing toward the ceiling, as shown in Fig. 10.

distance from lens to image will be 72 in. The total length of the system would be 84 in. when working at 8X. Obviously, a system this long could not be worked vertically because the average room height would not accommodate it. However, it would make a satisfactory horizontal projector. Made up as such, the construction might be something like Figs. 7 and 9, although the box can be any of a dozen shapes as long as it incorporates the optical distances needed.

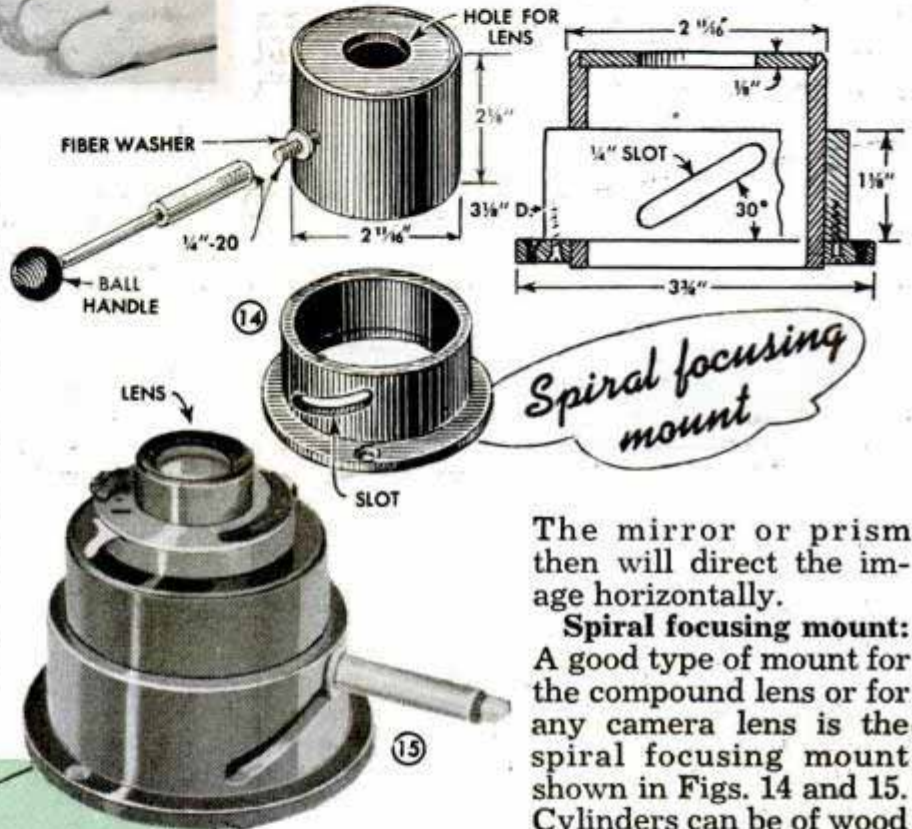

The mirror or prism then will direct the image horizontally.

Spiral focusing mount: A good type of mount for the compound lens or for any camera lens is the spiral focusing mount shown in Figs. 14 and 15. Cylinders can be of wood

or plastic. Fig. 13 shows how the slot is routed in a drill press.

The erecting projector: The mirror for erecting the image can be mounted permanently as part of the projector. In designing a system of this kind, optical dimensions are taken from Fig. 6 as previously described. A typical layout showing a 5 1/2-in. rapid rectilinear lens in a spiral focusing mount is shown in Fig. 16. The R. R. lens covers a field of about 50 degrees. At 5X the lens shown will cover copy 5 7/8 in. square. Figs. 17, 18 and 19 show how the construction is worked out to accommodate the optical dimensions. Built as shown, the box is designed primarily for horizontal mounting, as indicated in Fig. 1, but it also can be mounted vertically, as shown in Fig. 4. However, if specifically for vertical projection, it would be better to have the copy slide in from the end of the box.

Building your own: Specific projector designs serve only to show the general construction. When you design your own, you must make the box to suit your lens and

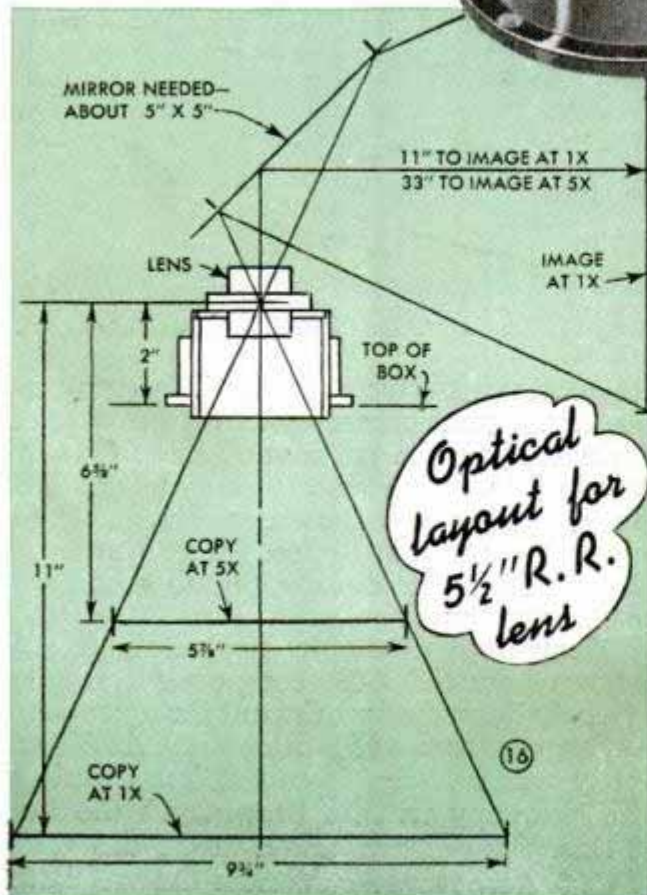

the range of magnification you want. Repeating the process as already described, you first make an optical layout, taking dimensions from the table, Fig. 6. Over this layout you then draw the shape of the box which will accommodate the optical dimensions. If you use a permanent mirror, the field angle should be drawn in, as shown in Fig. 16, in order to determine the size of mirror needed. Almost any kind of wood will do for the box. If the projector is to be a more or less permanent affair, or if it is to be subjected to considerable hard use, a good quality of material should be used. A small box can be made almost wholly from $\frac{1}{8}$ -in. plywood, this thickness in 3-ply birch being about right for side panels, top, etc. Join the parts with

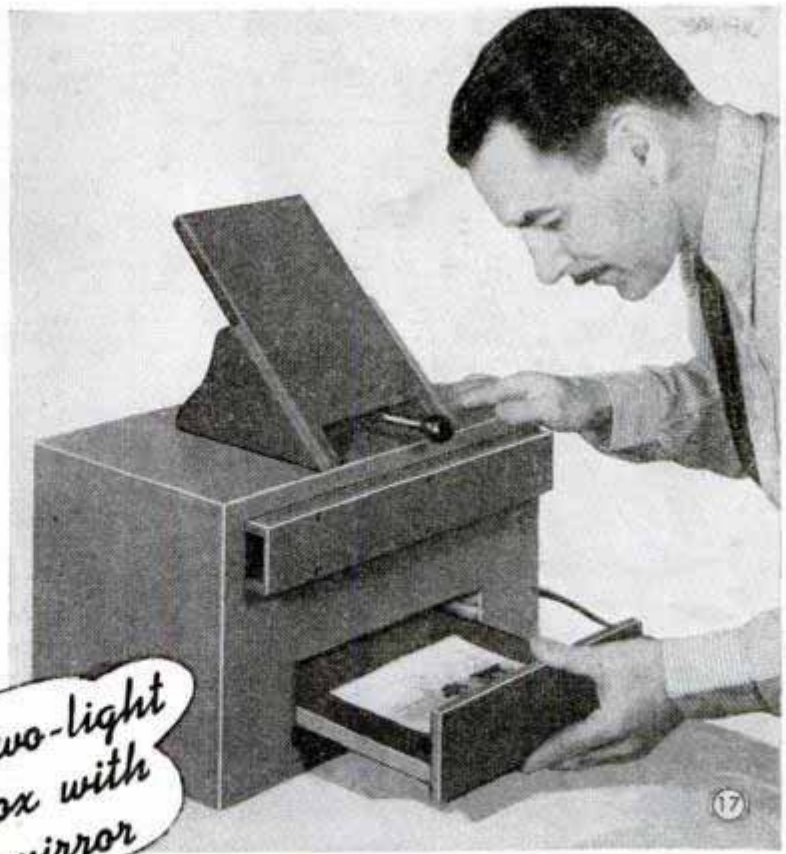

A two-light box with mirror

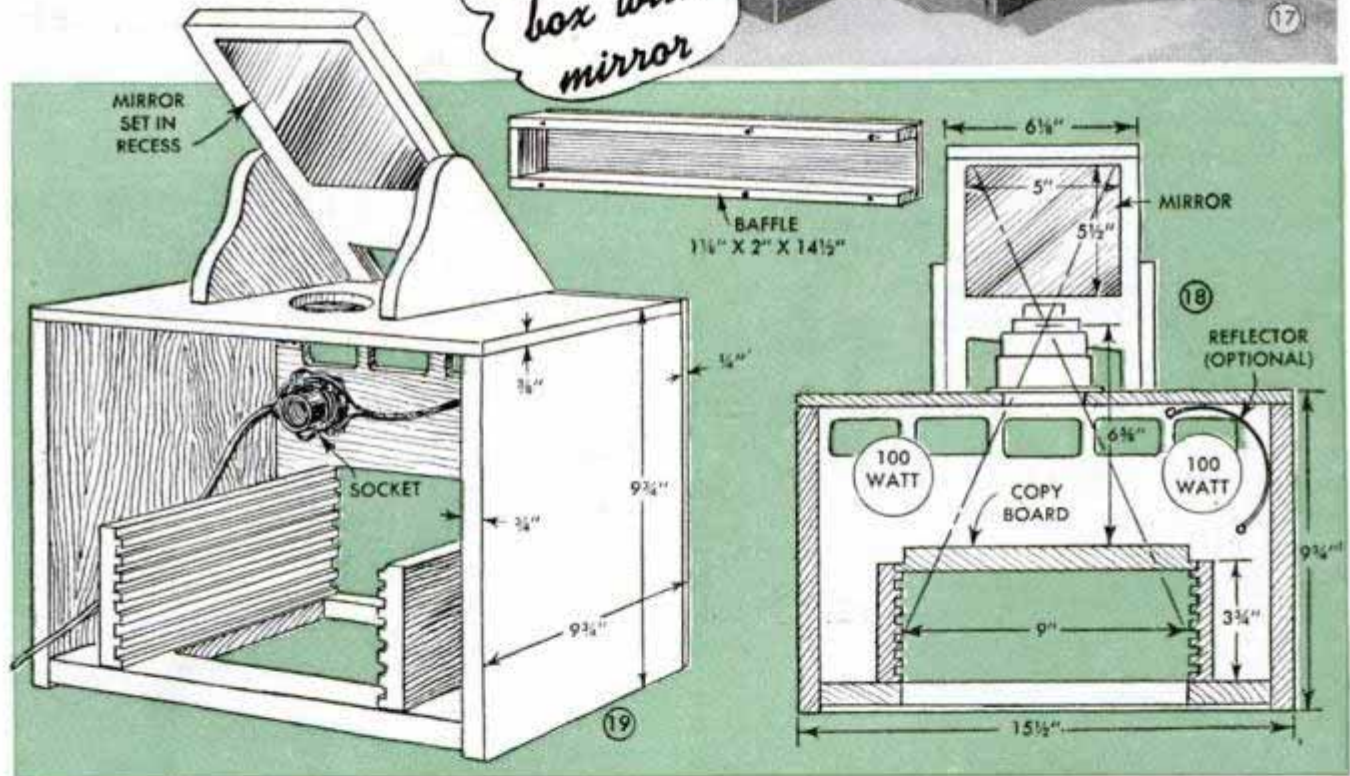

small screws. There's no need to use glue in the joints. Where the copy board is tongued to slide in grooves, the grooves should be somewhat wider than the thickness of the tongue so that the board will slide in and out without sticking. The manner of making the light traps and baffles shown in Figs. 9 and 19 should be followed quite closely.

Limitations: Some limitations are worth noting: Lenses of less than 4-in. focal length should not be used because they require placing copy too close to the lens. Also, if anything but a camera lens, the field covered by a lens of less than 4-in. focal length will be too small. Lenses over 10-in. focal

length should not be used because this places the image too far from the lens. The magnification limit of the simple compound lens is about 8X—over that, the image lacks sharp definition. With a camera lens or projector lens you can go as high as you like, but you will need strong lights to carry the image over the greater distance.

Finish: Paint the inside of the lens tube flat black. The rest of the box, inside and out, can be any color. There is no particular advantage in painting the inside of the box anything but a camera lens, the field cov- black. An ordinary oil paint should not be used in any case as heat from the lamps will cause cracking and peeling of the paint film.

Lever Attached to Block in Bowl For Novel Nutcracker



Attached to any conventional nut bowl, this lever cracks nutshells in the bowl so small pieces of shell are not scattered over the table. The cracker arm is sawed from $\frac{1}{4}$ -in. aluminum stock and has a wooden handle. The hinge is a $\frac{1}{2}$ -in. square rod screwed to a wooden base, as shown, and riveted to the arm of the nutcracker. For a base, oak or similar hardwood should be used.—R. L. O'Steen, Boca Chica, Fla.

Grit Number Identifies Sandpaper

When tearing sandpaper into small pieces for special work, it is best to identify it by marking the grit number on the back of each piece. As the number usually is stamped in only one place on the paper, it will be difficult to tell the grade of small pieces if they are not marked.

M. A. Carty, Mt. Vernon, Wash.

Bamboo Case for Casting Rods

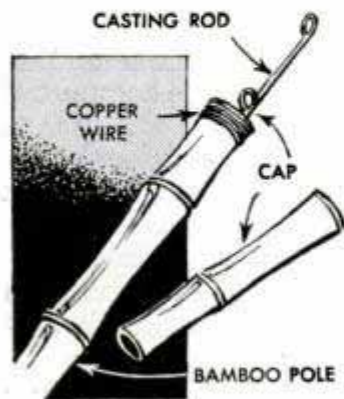

There won't be any danger of your favorite casting rod being damaged when transporting it in a car with other luggage if you keep it in a carrying case made from a piece of large-diameter bamboo. Two pieces are required, one of a diameter large enough to take the butt end of the rod, and another of a size to take the small end of the rod and slip into the end of the large piece. The connecting webs in-

side the bamboo can be punched or burned out with a red-hot rod. The open ends of the case can be fitted with ferrules cut from thin-walled tubing, or you can wrap them with fine copper wire and flow solder over it. The solder should be smoothed down to make a snug fitting joint when the case is assembled.

Nail in Pocket Protects Pencil

Workmen who carry a pencil in their pocket can prevent it from being broken when carrying a heavy object in their arms or when leaning against something by carrying a large headless nail in the pocket with the pencil. The nail acts as a reinforcement to take any unusual pressure or strain that might break the pencil.—Howard Johnson, Carter's Creek, Tenn.



Metal Book End Supports Text While Reading

A book support that is useful when reading or studying is made by punching a hole through the bottom of a pressed-steel book end and inserting a brass paper clip. The ends of the clip are spread to form a brace for the book. If the book stands too straight, the vertical part of the book end may be bent backward slightly.

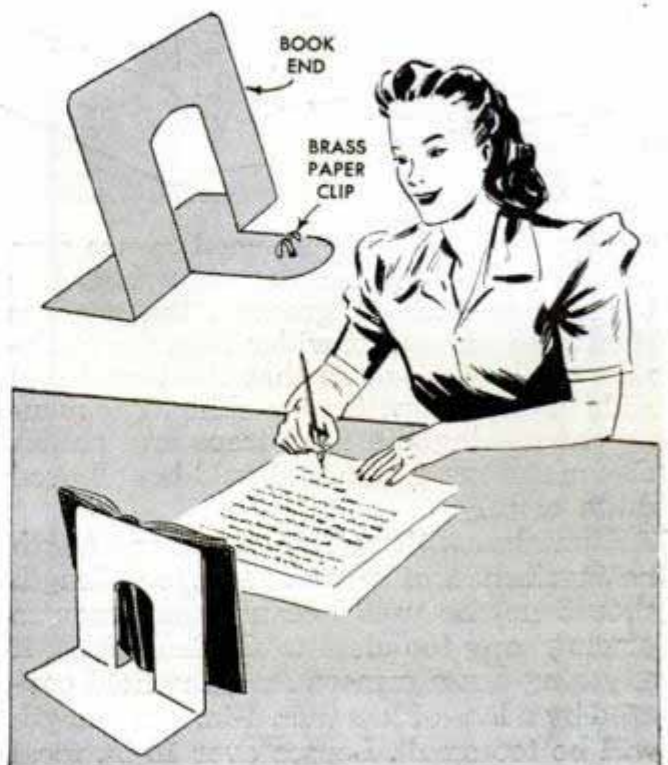

Child's Swan Rocker

HOURS of amusement for small children are provided if this swan rocking chair is in the play-room. It is silent in operation and easy for young tots to use. As indicated in the drawing, Fig. 3, the sides, ends and other flat surfaces are $\frac{1}{2}$ -in. plywood, although any wood will be satisfactory if it is sufficiently rigid. These parts should be rough-sawed and then sanded to a smooth finish. The rocking mechanism, Fig. 3, is fastened to the base frame and to the chair proper with T-hinges so that the rocker pivots at these points. Although only one set of springs is shown attached to the three rocking arms and the base, larger children may require two or more sets if one is too weak to impart the proper motion.

The head of the swan, Fig. 2, is rough-cut from 4-in. stock and finished by hand. An old broomstick, sawed to the proper length, serves as a handle and the two eyes can be shoe buttons or any similar small, round buttons. To finish the rocker, the bill of the swan should be painted a dark orange. Other parts that are subject to wear, such as the step, Fig. 1, should be finished in a dark color also. Although the plumage of a swan is white, it would be better to paint the balance of the rocker a light tint that does not show dirt too easily.

Peter B. Horsley, Pembroke, Ont., Can.

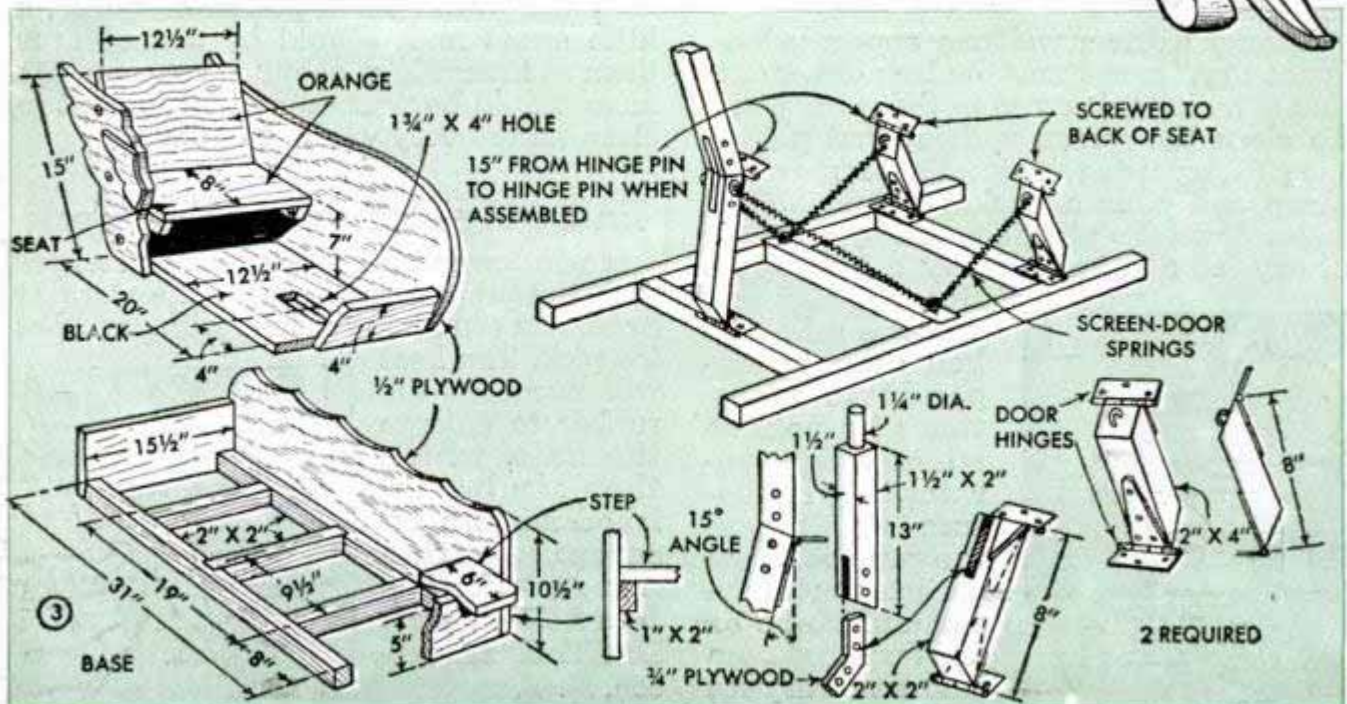
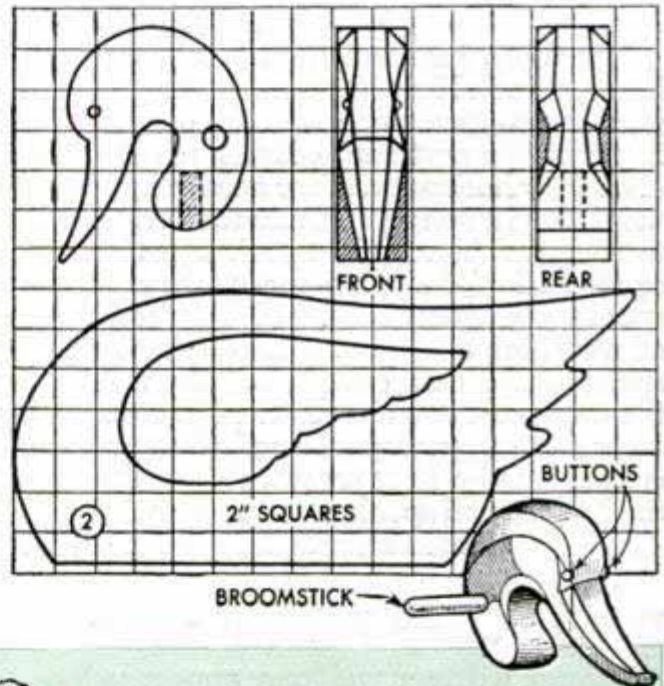

Supplies for Home-Repair Jobs Carried in Wire-Mesh Rack

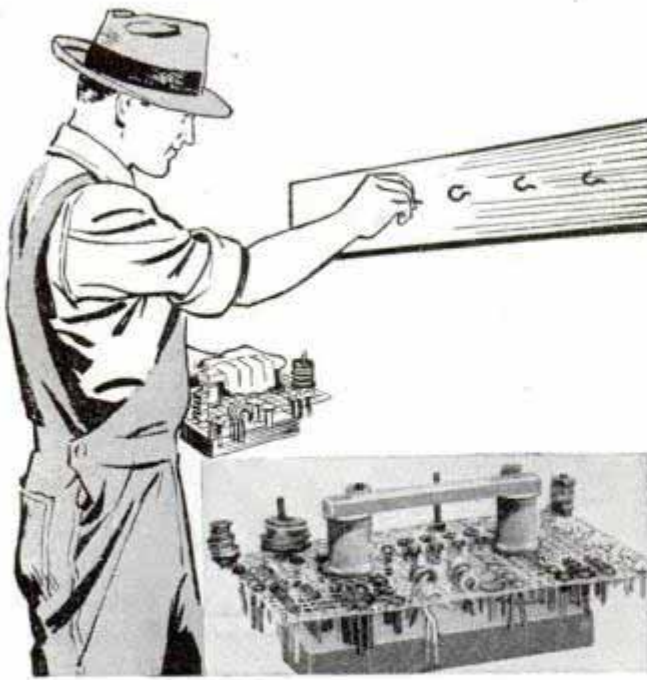

For those incessant odd jobs about the home, a rack like the one shown will be of great assistance since it is capable of storing a wide assortment of nuts, bolts, washers, screw hooks and other necessary equipment, thus saving you numerous trips back to the workbench. The rack consists of a square of $\frac{1}{4}$ -in. wire mesh, four thread spools, a wooden base and a narrow strip of wood for a handle. The spools serve as spacers, two being set under the mesh on the base, and two above. The handle is laid across the upper spools and the assembly is held by two long screws driven through the handle and spools into the base.

Ronald Eyrich, Milwaukee, Wis.

Dry Ice Clears Well-Spear Screen

Though a driven well may appear to have "gone dry," sometimes the lack of water is due to a clogged screen in the spear point. To clean the screen without first pulling the pipe, try using dry ice. First remove the pump and pour a bucket full of boiling water down the pipe followed by a bucket of dry ice and immediately cap the pipe.



Because dry ice, which is solid carbon dioxide, expands to many times its volume when it evaporates, high pressure is built up in the pipe to force particles out of the screen. More or less than the stated amount of dry ice

may be required, but care should be taken not to use amounts that would develop pressure beyond the strength of the pipe. Gloves should be worn when handling dry ice.—Andrew Vena, Philadelphia, Pa.

Slotted Bolt Locks Nut Tightly

You won't need lock washers or cotter pins to keep a nut from coming off a bolt if you use this method of securing it. Just saw a slot $\frac{3}{32}$ in. deep in the threaded end of the bolt and screw the nut on tightly. Then, with a cold chisel, spread the slotted end and the nut cannot be unscrewed because of the enlarged diameter of the bolt.

—G. S. Hudson, Jr., Baltimore, Md.

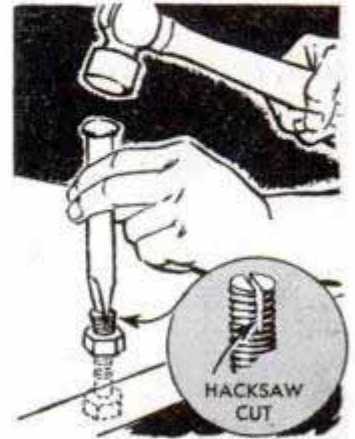

Livelier Worms When Bait Fishing

Although earthworms may be used when freshly dug from the ground, they will live longer on the hook and will attract more fish if well "scoured" before use. To do this, a quantity of sphagnum moss, such as is used by nurserymen in packing plants for shipment, is put into a stoneware crock or tight wooden box. The moss should be well moistened, but excess water should be wrung out before the moss is placed in the container. The worms should be kept in the moss in a cool place for at least two days, preferably three or four. At the end of that period they should be lively and almost transparent. Should it become necessary to keep the worms for a period of weeks, a little sweet milk should be poured over them at intervals of about a week and the moss should be washed and wrung out in clean water every week or 10 days.

Enlarging Hole in Rubber Cork

If you haven't a rubber cork or stopper with the proper size hole for the work at hand, you can ream the hole with a red hot ice pick. The heat will burn out the rubber to enlarge the hole, which then can be finished smooth by scraping with a narrow knife blade.

—Irwin Margiloff, Laurelton, N. Y.

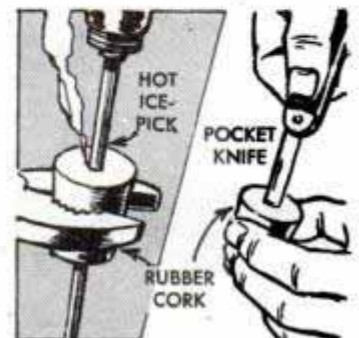

"Filing" System Keeps Kitchen Utensils in Order

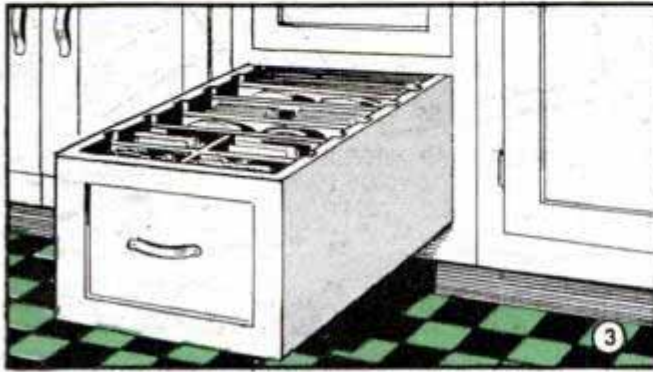
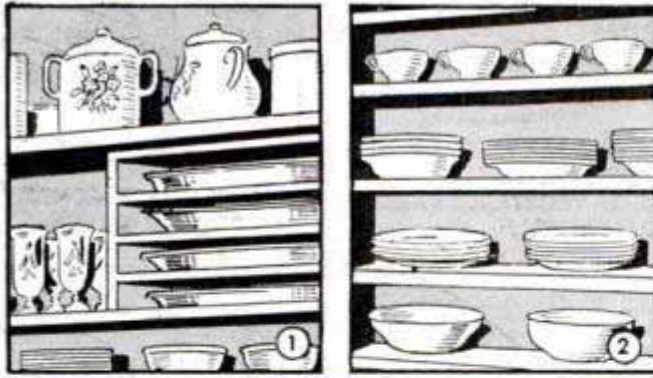

A utility shelf, a partitioned orange crate, a platter "file," and a deep drawer are handy storage units

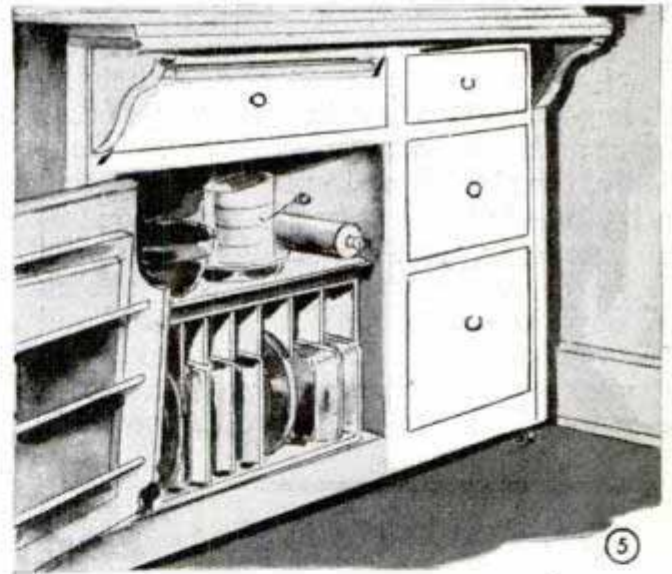

The old rule of "a place for everything and everything in its place" can't have any more practical application than in the modern kitchen. To save time and steps you must know where things are placed. Stacked platters and odd-sized cups and saucers generally are a nuisance in a cupboard for there is the ever-present danger of breakage, and besides, the item you want always seems to be at the bottom of the stack. A platter "file," Fig. 1, and narrow shelves built into a corner of the cupboard as in Fig. 2, take care of this problem effectively. A deep drawer, partitioned as in Fig. 3, will hold a lot of necessary items that just won't fit anywhere else. The same thing is true of a partitioned orange crate, Fig. 5. And then, of course, utility shelves mounted on the wall near the stove or kitchen table, as in Fig. 4, are a "must" in most up-to-date kitchens. They are easily made from odds and ends of material and

can be painted or enameled to match the general color scheme of the room.

Mrs. Vivien B. Dailey, Lowman, N. Y.

Rug Pad Will Not Slide If Taped Before Rug Is Laid

Laying a rug on a pad frequently is difficult because of the tendency of the rug and pad to slide on the floor. If the pad is taped to the floor first, the rug can be rolled over it and both will be in the correct position. Fairly long strips should be applied at the four corners. By using this method it is possible for one person to lay a rug. Usually two people are required if the job is to be done quickly and with minimum effort.

E. J. Wiczorek, Chicago.

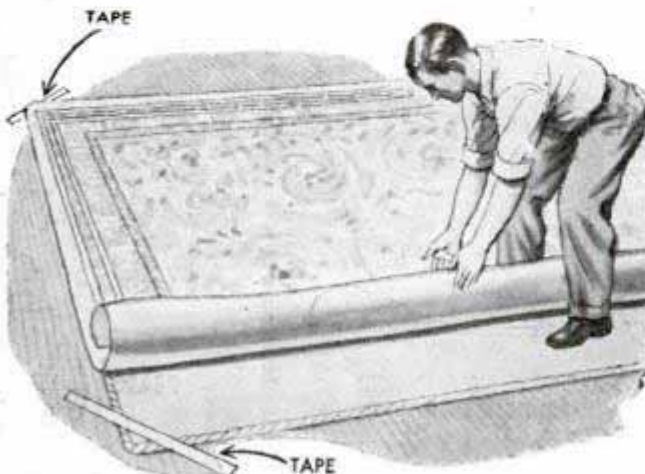

Meats

MEAT SHOULD BE KEPT AT 0° F. OR LOWER



FEBRUARY						
S	M	T	W	T	F	S
3	4	5	6	7	8	9
10	11	12	13	14	15	16
17	18	19	20	21	22	23
24	25	26	27	28		

BEEF SHOULD HANG 4 OR 5 DAYS BEFORE FREEZING



CARTONS FOR MEAT SHOULD BE LINED WITH MOISTURE-PROOF VEGETABLE PARCHMENT PAPERS



HEAVILY WAXED CONTAINERS ARE IDEAL FOR GROUND MEATS

Poultry



WHOLE FOWL IS DIFFICULT TO WRAP SNUGLY ...



... IT'S BETTER TO DISJOINT IT AND WASH PIECES IN COLD WATER ...



... THEN WRAP INDIVIDUALLY IN MOISTUREPROOF PAPER AND PACK IN CARTON



WRAP GIBLETS SEPARATELY

PREPARING FOOD for DEEP-

WHILE prompt handling has much to do with success in storing foods in home freezers, it's equally important that you know how to process and, especially, package them to retain as much of the flavor and nutritive value as possible. Generally, the right time to prepare fruits and vegetables is when they are ready for immediate table use. They should be gathered in the early morning before they absorb the day's sun and should be processed and frozen with as little delay as possible. Loss of vitamin value occurs rapidly at room temperature, and holding products over to

the following day should be avoided, especially after shelling, scalding or cutting. It should be remembered that freezing does not necessarily sterilize the product. Consequently, it is important that all utensils as well as the hands be thoroughly clean before preparing the food.

In most cases, a storage temperature of 0 deg. F. will give satisfactory results when just a few packages of food are to be frozen at one time. Large amounts will require a lower temperature of -10 deg. F., although it's best not to try to freeze too many packages at once. As it is not as cold near the

Milk

FROZEN MILK WILL KEEP ONE OR TWO MONTHS



CREAM IS NOT GOOD AFTER FOUR MONTHS

Eggs

THE YOLKS OF WHOLE EGGS WILL JELL AT 22° F.

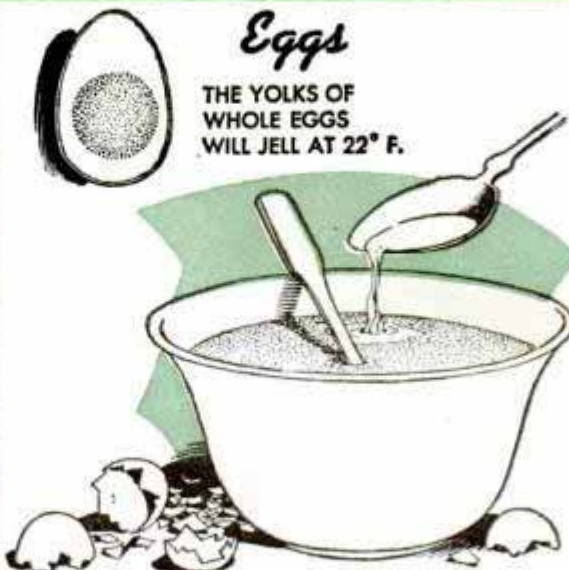

IT'S BETTER TO BREAK THEM AND STIR YOLKS AND WHITES TOGETHER ADDING 5% CORN SYRUP, SALT OR SUGAR

THESE ITEMS REQUIRE

SNAP BEANS



BANANAS



PEARS



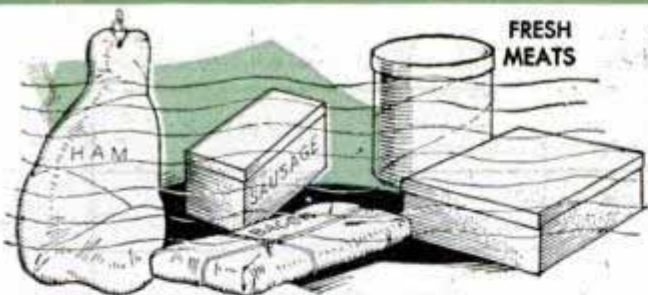

FRESH MEATS

SMOKED MEAT WILL IMPART FLAVOR TO FRESH MEAT IF STORED CLOSE TO IT



IF STORED WHOLE, STOCKINETTES WILL KEEP THE MOISTURE-PROOF PAPER CLOSE TO THE FLESH



FREEZE STORAGE

Label and date each package for future identification. A waxed school crayon or grease pencil is just the thing for marking packages

top of the freezer, always check the temperature at this point. A periodic check should be made to detect possible power failure or mechanical breakdown. Should such an event occur, little thawing will take place during the first 15-20 hours. After this time it is best, if possible, to move the food to a locker plant or use dry ice to prevent excessive thawing until freezing is resumed. As a precaution against lowering the temperature too greatly, use dry ice sparingly. The length of time that products may be stored depends upon the temperature maintained. At 0 deg. F. fruits and vegetables may be stored 10-12 months,

while at 5 deg. F. the period is shortened to 8-10 months. In the case of meat, much is dependent upon the length of time it is held prior to freezing. Beef requires at least 4 or 5 days in a cool place for aging before it is cut up and packaged. Lamb, pork and veal should be frozen as soon as it is thoroughly chilled. Pork, especially, should be kept at a low temperature as it oxidizes easily and becomes rancid at higher temperatures. Dipping pork cuts quickly in hot lard will seal them and help prevent drying out during storage. Frozen meats should always be thawed thoroughly before cooking, especially large roasts, oth-

SPECIAL CARE

ASPARAGUS

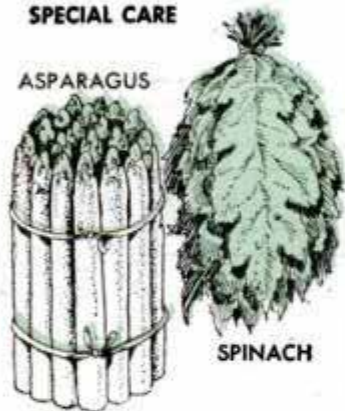

SPINACH

Vegetables

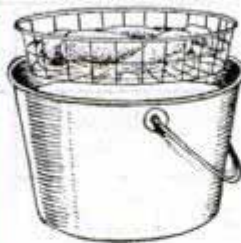

BLANCH IN BOILING WATER AND CHILL TO 50° F.

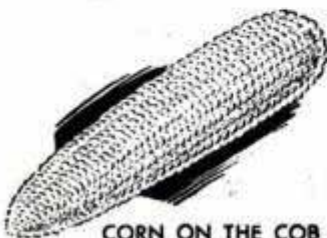

CORN ON THE COB



... THEN FREEZE AND STORE AT 0° F.

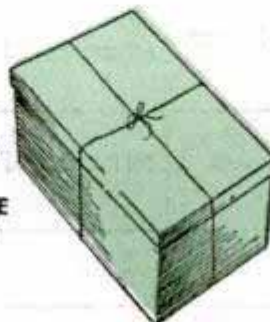

Fruits

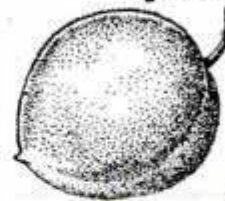

FRUITS TO BE FROZEN SHOULD BE PICKED AT THE SOFT-RIPE STAGE



CHERRIES AND BERRIES SHOULD BE WASHED IN ICE WATER

A Guide for Freezing Fruits and Vegetables

Product	Maturity Desired	Preparation	Scalding		Type of Pack
			Boiling Water	Steam	
Asparagus	Tender tips best	Trim, wash, and discard all but upper 6 inches	Small stalks: 3 min. Large stalks: 4 min.	3½ min.* 4½ min.*	Without brine
Lima beans—bush or pole	Green beans best	Shell	Medium beans: 1½ min.* Large beans: 2 min.* Small beans: 1 min.*	2½ min. 3 min. 2 min.	Without brine
Soy beans	Green beans best	Scald pods, shell	2 min.*	3 min.	Without brine
Snap beans	Small beans best	Snip; cut into ¾-inch lengths	2 min.*	3 min.	Without brine
Beets	Young and tender	Cut off tops; mature beets should be cooked, then rub off peels; slice	1½ inches in diameter: 2½ min. Over 1½ inches: cook until tender	3½ min.* Cook until tender	Without brine
Peas	Sweet and not starchy	Shell, discard starchy peas	Small peas: 45 sec.* Large peas: 1 min.*	1½ min. 2 min.	Without brine
Spinach	Young	Cut and discard thick stems	2½ min.*	3½ min.	Without brine
Sweet corn, on cob	Before starchiness develops	Husk; don't use immature and overmature ears	Small ears: 6 min. Medium ears: 8½ min. Large ears: 10½ min.	6½ min.* 8½ min.* 10½ min.*	Without brine
Sweet corn, cut	Before starchiness develops	Scald on cob as directed above, cool, then cut off whole kernels; or cut whole kernels from cob, then scald	Not recommended	2½ min.*	Without brine
Swiss chard	Small leaves best	Cut off and discard main stem	2 min.*	3 min.	Without brine
Apples	Fully mature	Peel, slice in 12ths	Not recommended	1½ min.; cool	Dry (no sugar or sirup)
Blueberries	Fully ripe	Stem, wash, crush slightly	Not recommended	Not recommended	4 or 5 pounds fruit to 1 pound sugar
Cherries, sour	Fully ripe	Wash, chill, pit	Not recommended	Not recommended	3 pounds fruit to 1 pound sugar
Gooseberries	Fully ripe	Stem, wash, crush slightly	Not recommended	Not recommended	3 pounds berries to 1 pound sugar
Peaches	Fully ripe	Peel, pit, slice	Not recommended	Not recommended	Cover with 60 or 70 percent sirup**
Pears	Fully ripe	Peel, core, quarter	Not recommended	Not recommended	Cover immediately with 60 or 70 percent sugar sirup**
Plums	Fully ripe	Wash, pit, quarter	Not recommended	Not recommended	Cover immediately with 60 or 70 percent sugar sirup**
Prunes	Fully ripe	Wash, pit, quarter	Not recommended	Not recommended	Cover immediately with 60 or 70 percent sugar sirup**
Raspberries	Fully ripe	Sort, wash in ice water, hull; crush or leave whole	Not recommended	Not recommended	4 or 5 pounds crushed berries to 1 pound sugar; cover whole ones with 50 or 65 percent sugar sirup**
Strawberries	Fully ripe	Sort, wash in ice water, hull and slice one quarter inch thick or leave whole	Not recommended	Not recommended	4 or 5 pounds sliced berries to 1 pound sugar; cover whole berries with 50 or 65 percent sugar sirup**
Rhubarb	Early spring best	Eliminate leaves; cut into 1-inch lengths	1½ min.*	2 min.	Without sugar or sirup if desired

*Indicates preferred method.

**For preparing sirup see table page 191.

New York State Agricultural Experiment Station.

Preparation of Sirup For Freezing Fruits

Dissolve the sugar in boiling water or mix the sirup with boiling water; cool to room temperature.

50-percent sirup: 2½ cups sugar per pint of water; 3 cups water to 4 cups crystal white corn sirup; 3½ cups water to 4 cups high-grade confectioners' corn sirup.

60-percent sirup: 3½ cups sugar per pint of water; 1½ cups water to 4 cups crystal white corn sirup; 2 cups water to 4 cups high-grade confectioners' corn sirup.

65-percent sirup: 4½ cups sugar per pint of water; ½ cup water to 4 cups crystal white corn sirup; 1½ cups water to 4 cups high-grade confectioners' corn sirup.

70-percent sirup: 5½ cups sugar per pint of water; ¼ cup water to 4 cups crystal white corn sirup; 1 cup water to 4 cups high-grade confectioners' corn sirup.



A moderately hot household iron, applied for a few seconds, will seal "bag-in-carton" containers. Cellophane bags may be sealed with a curling iron, taking care not to burn them

erwise the meat will not cook uniformly.

The importance of doing a thorough and careful job of packaging cannot be over-emphasized. The wrapping material used not only must protect the food from loss of moisture, but also must prevent transfer of odors. Ordinary waxed paper is not sufficiently moistureproof to package meat satisfactorily. In addition to special moistureproof paper for wrapping frozen foods, there are Cellophane, Pliofilm and rubber-latex bags which provide excellent protection. Present recommendations are that the size of the packages should not exceed 2 lbs. per package for fruits and vegetables and a package weight of 5 lbs. for chilled meats is about right. Roasts and other cuts of meat should be wrapped tightly to make them as airtight as possible and securely sealed with cellulose tape or tied with twine. Two separate wrappings, of course, are better than one. An outer covering of mesh cloth known as a stockinette will serve to protect the wrapping. Small cuts of meat are stored best in containers lined with moistureproof paper. To exclude as much air as possible, containers should be packed to the very top. Vegetable and fruit juices must have room for expansion. Containers most commonly recommended for storing fruits and vegetables are heavily waxed cylindrical and square cartons, "bag-in-box" types and special moisture and vapor-resistant bags of Cellophane. In filling Cellophane bags the tops must be kept clean for later heat-sealing. This can be done with a household iron, or a curling iron if not too hot. There is less moisture loss with a double bag than a single one.

In blanching, or scalding, the vegetables are placed in a wire basket and lowered into boiling water for the required time as given in the table on the opposite page. They are chilled immediately afterward in running water 50 deg. F. and packed for storing. Fruits require a covering of sirup prepared according to the table above. The sirup should cover the fruit completely.

It's best to prepare poultry during the colder months as it is difficult otherwise to cool it properly before freezing. Unlike meat, poultry is more tricky to prepare because chickens, ducks and turkeys have a soft layer of fat directly beneath the skin that oxidizes quickly. It also is difficult to package the whole fowl because of the awkward shape which hampers wrapping it snugly. A stockinette, if available, helps to solve this problem, but it is recommended that the bird be cut up into smaller sections and each of these wrapped individually. As is true with meat, poultry never should be thawed for cooking by placing in water. Allow it to thaw gradually while in the package at room temperature.

Ammonia Cleans Greasy Oven

Usually difficult to remove, grease which has spilled in stove ovens and baked on the enameled surface is removed with household ammonia. Saturate several cloths with the solution and spread them over the oven racks. Allow them to remain overnight and on the following day scrub the spots with soap and water. In stubborn cases, several applications may be necessary.

R. F. Rothrock, Jr., Quonset Point, R. I.

Birdhouse Is Supported on Wall By Storm-Sash Hangers

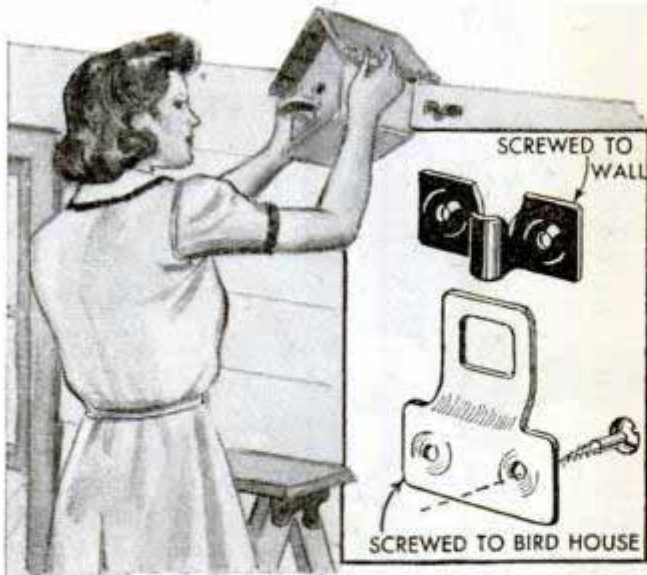

If a birdhouse is supported on storm-sash hangers, it can be taken down and stored indoors at the approach of winter, then replaced when the birds return. The hook part of the hanger is screwed to the wall or post against which the house is to be set, and the eye part is fastened to the back of the birdhouse close to the top edge. The weight of the house will keep it securely in place even in fairly strong winds.

Dick Sutz, Chicago.

Clothesline Pole Made of Pipe Is Easily Removed

From two lengths of standard pipe you can make a permanently installed clothesline pole that can be taken out of the ground

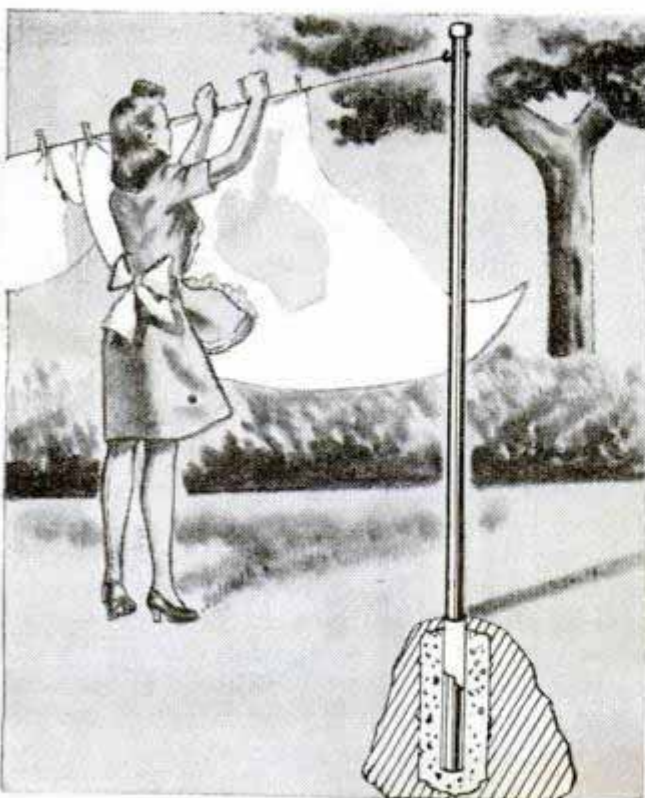

whenever necessary. A 3-ft. length of 2-in. pipe is cemented in the ground flush with the surface. A 10-ft. length of 1½-in. pipe then is used for the clothesline pole, being held firmly by the larger pipe. When the clothesline pole is removed, the pipe in the ground should be plugged to keep out dirt.

Deviled Eggs Carried to Picnic In Paper Carton

Deviled eggs will arrive at the picnic ground in good condition if they are carried in an egg carton as illustrated. After preparing the eggs, fit together and then wrap in waxed paper and place in the carton. The eggs are easy to pack, they will not



mash nor will they dry out for some time.

Lighter Wheel Cleaned With Tape

To clean the teeth of the wheel on your cigarette lighter quickly, run the serrated edge over the tacky side of a strip of adhesive tape several times. The adhesive will lift out dirt and bits of flint much more quickly than could be done by more tedious methods, such as digging out the dirt with a pin or other fine point.—Kenneth Murray, Colon, Mich.



Pin Untangles Backlashed Line

A safety pin having a small barb or hook formed on the pointed end is ideal for untangling fishing lines that have become backlashed. It is possible to get at small knots and tangled parts that are inaccessible otherwise. When the pin is closed the guard will cover the hook and prevent it from becoming misshaped.—H. L. Thompson, Sarnia, Ont., Can.

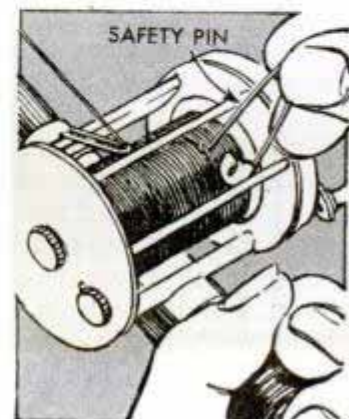



WEAVING RAGS INTO RUGS

BESIDES providing an excellent way of using up accumulated scraps of cloth, there's a lot of fun and profit in weaving colorful and serviceable rugs from rags.

Hooked rugs: Here you need a wooden frame—an old window screen will do—and a suitable weaving hook. Details A, B and C in Fig. 1 show three ways of assembling a frame. The peg arrangement permits adjustment to take rugs of different sizes, while the clamping method makes it easy

Three types — hooked, fluff, woven — all made from cloth scraps on simple wood "looms"

to take up slack as the work progresses. Detail E shows how to proportion the frame to the pattern

and D shows a method for laying out an oval. The frame is covered with burlap or coarse linen and either is fastened with thumbtacks or stitched to cloth sleeves as in B. Keep the threads of the burlap running parallel with the frame and allow sufficient material to turn under and hem later. A rug hook is made by shortening the shank of an ice pick and filing a hook like

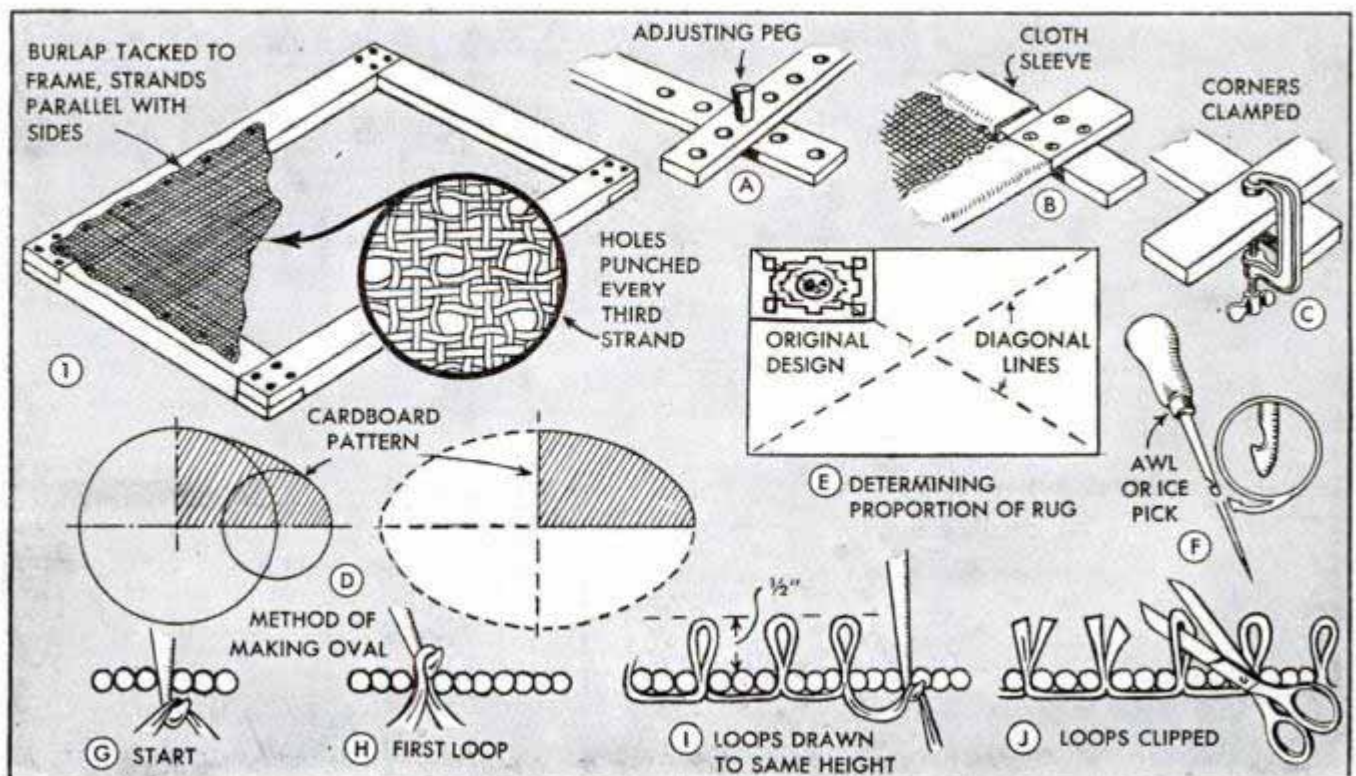

LIGHT SHADES OF
GRAY, GREEN, PINK

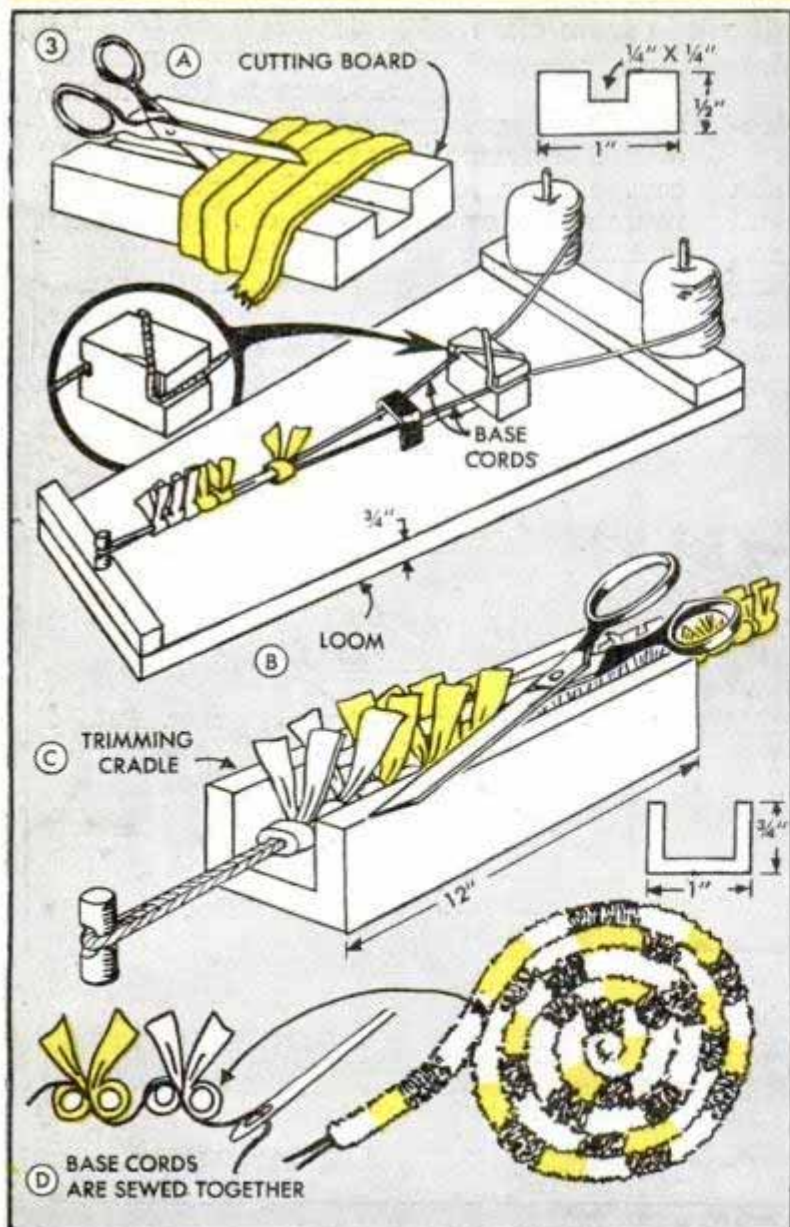
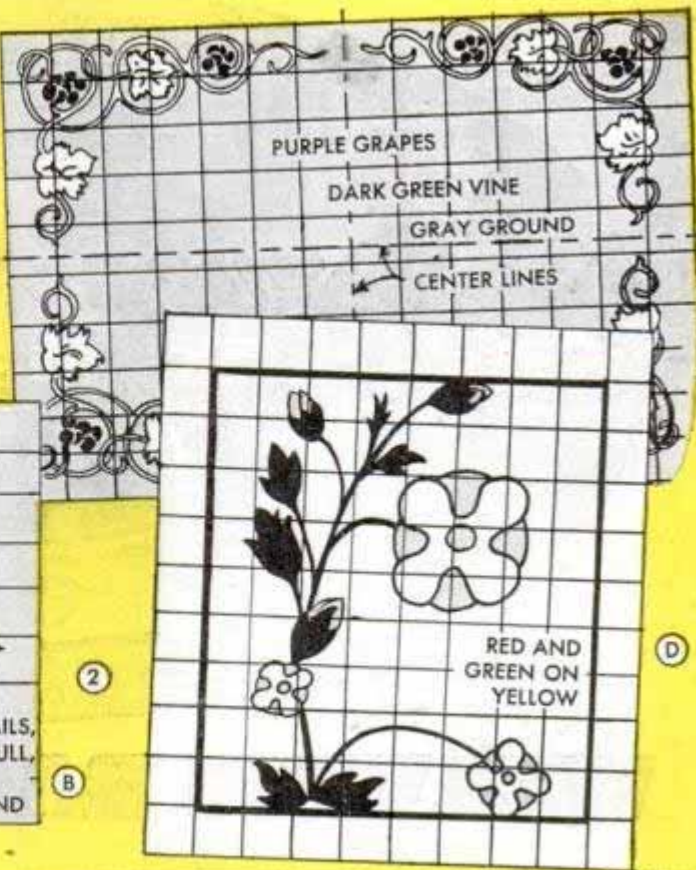
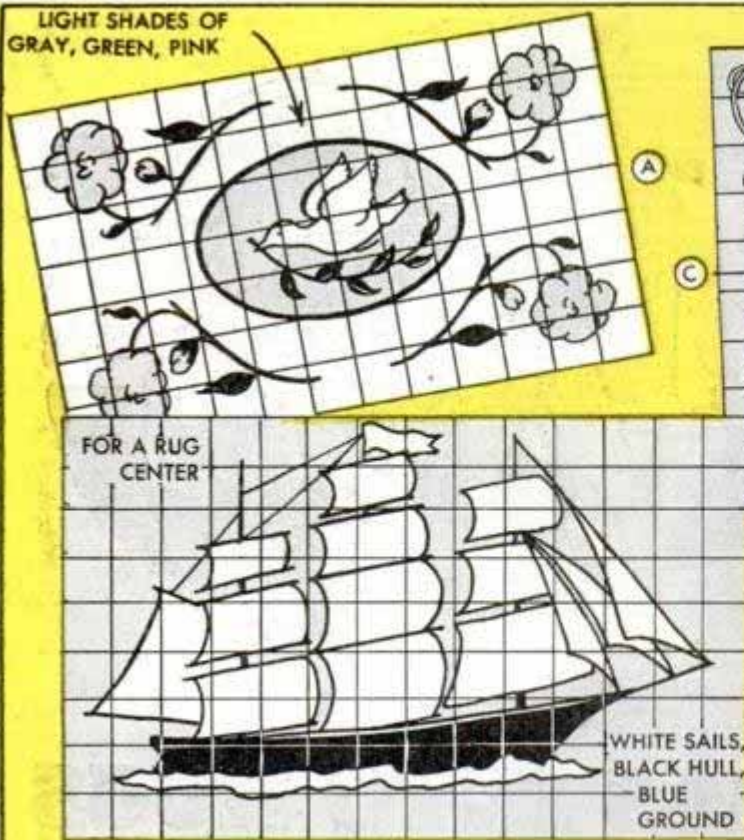

that shown in Fig. 1, detail F.

Suggestions for appropriate patterns can be found by thumbing through magazines. Enlarge the pattern to full size and draw it on the burlap with a crayon. Then, working outward from the center, push the hook through the burlap, G, and pull a strip of $\frac{1}{2}$ -in. cloth up through to form a loop $\frac{1}{2}$ in. long, H. Push the hook through again, three strands from the first insertion, and draw up another loop, I. When a row has been completed, the loops can be clipped, J, or they may be left uncut. From here on it is simply a matter of repeating as before. Certain portions of the design can be made to stand out in relief by allowing the loops to extend higher than the others.

Fluff rugs: Although similar to a hooked rug, the fluff rug is a continuous strip of material wound in a spiral and sewed together as in D, Fig. 3, to form a thick, soft rug. First, wind a $\frac{3}{4}$ -in. strip of cloth around a grooved board and cut as in A. Then with a loom made and rigged with carpet warp as in B, begin attaching the cloth strips to the warp. These are not tied but simply brought up between the cords as at D and pushed together as you

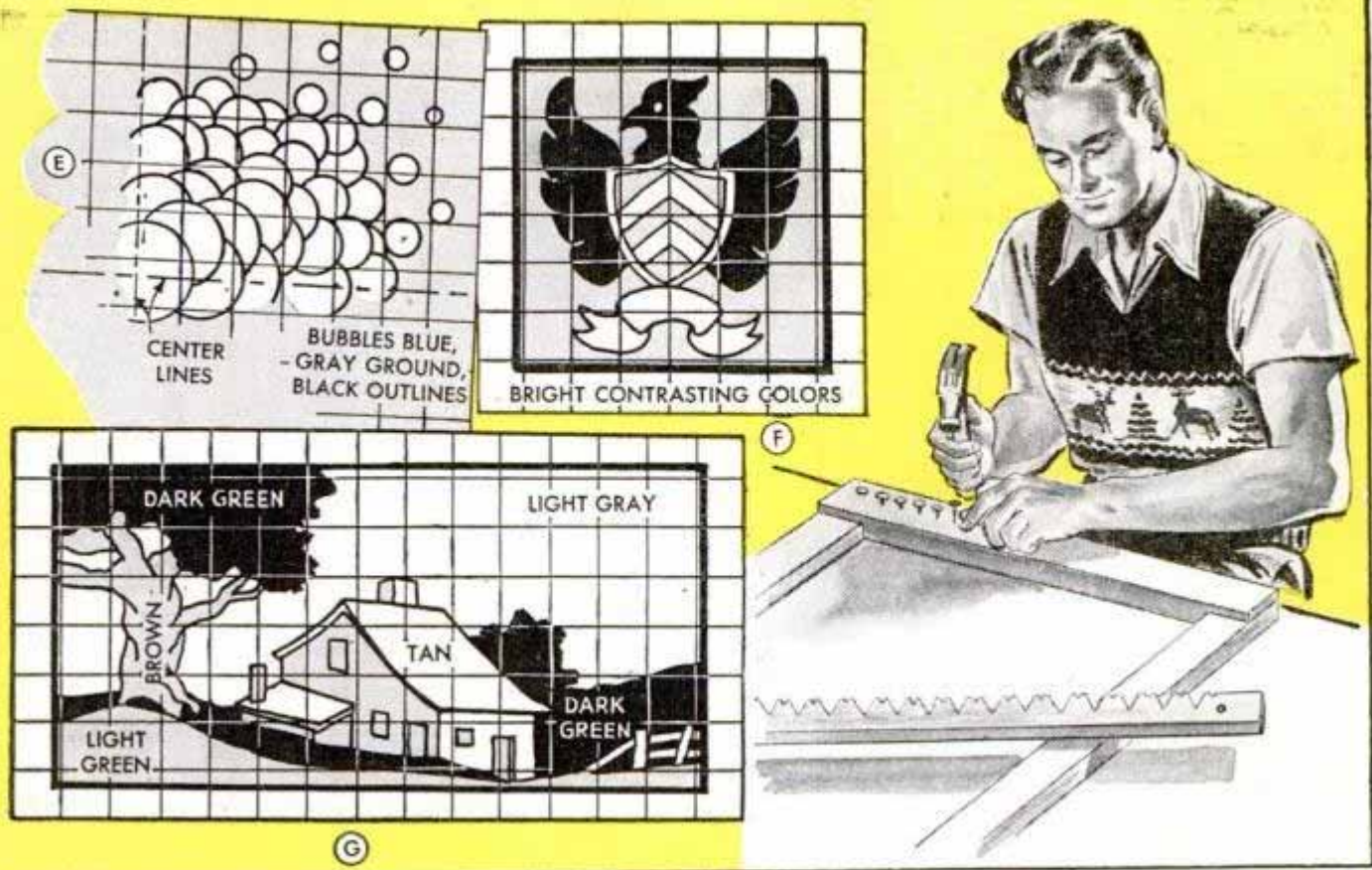

go. When the length has been built out to a foot or so, place a trimming board under the cord and snip the tops off evenly. Proceed as before until you have a length of "fluff" sufficient to complete the size rug desired. Strips of white, yellow and black will give a pleasing mottled effect.

Woven rugs: For these you'll need a loom such as the one at A, Fig. 4, on which you can turn out small throw rugs up to 16 by 24 in. The loom is rigged with regular carpet warp by running it back and forth and around the nail heads at the ends. Two heddles, one being notched, are used alternately to raise the warp strands. This is illustrated in details D and E. First, the plain heddle is set edgewise to raise one set of warps, then the shuttle is passed through, after which the heddle is placed flat. The same is done with the notched heddle which produces a pattern as at C. After each passing of the shuttle, the woof is crowded against the previous strand. Sample designs A to G inclusive, Fig. 2, can be enlarged to full size easily by ruling an equal number of larger squares on paper and transferring the design to each respective square.

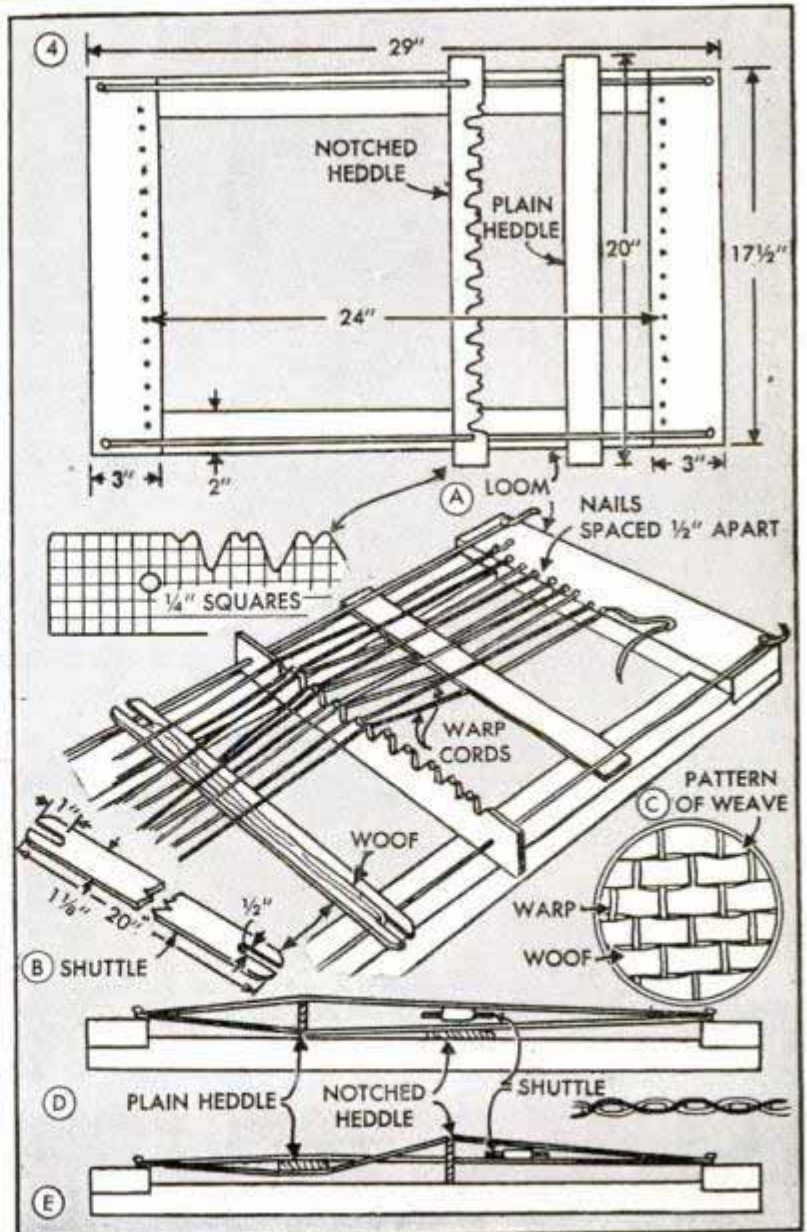

Sawhorse Fits Under Workbench To Conserve Shop Space

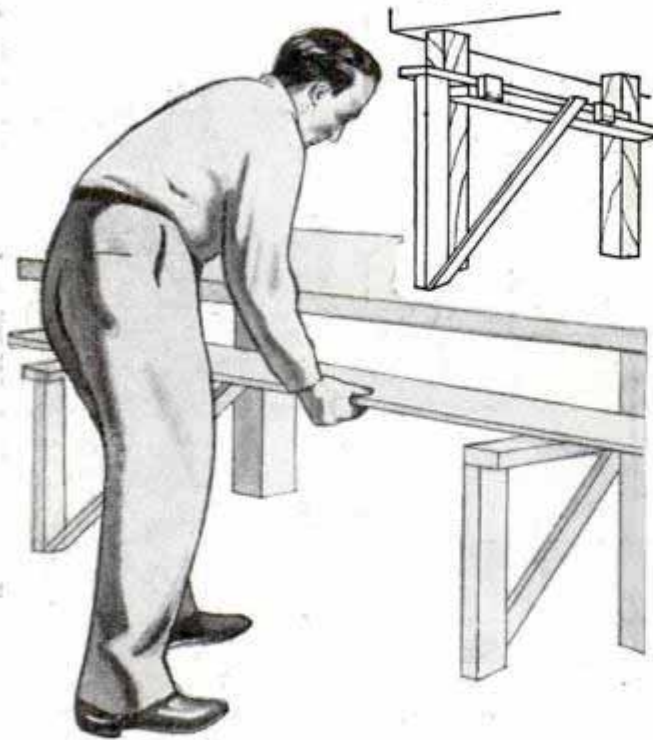

For small workshops, the sliding sawhorse illustrated is a space saver. When not in use it fits under the workbench where it is out of the way. Slides for the top member of the horse are fastened to the inside of the legs of the bench. The distance between the two sawhorses is determined by the length of the workbench, and any convenient height may be used.

W. G. Peugh, Aberdeen, Miss.

Tape "Clamp" Mends Chinaware

Instead of cementing one piece at a time when repairing broken china, the whole mending job can be done at once if cellulose tape is used to hold each piece in place while the cement dries. It is best to fit all the pieces together first, using the tape only. In this way the job can be done more quickly and, since all the cementing is done at one time, the risk of having a last piece that does not fit is avoided.

G. A. Macaulay, Quarries, Ont., Can.

Washer an Aid in Adjusting Drill

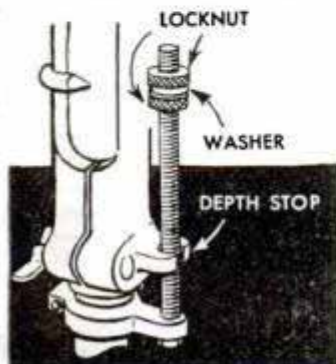

The depth stops on some drill presses are made adjustable by means of a lock-nut arrangement similar to the one which is shown here. If a flat washer is placed between the two

nuts, it will facilitate changing the adjustment as the "lock" will break more easily. Keep the washer covered with a light film of grease to aid in loosening the adjustment.

Grooved Jaws Hold Small Work

Bolts, small rods and other round work sometimes is hard to hold in a vise if the jaws are smooth. Or, if the vise is tightened enough to hold such work, the screws or rods may be flattened. To avoid this, one craftsman filed vertical and horizontal grooves in the jaws and found that he could hold small work easily.

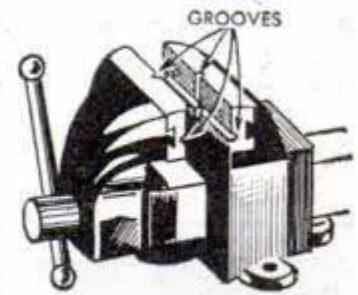

Short Nipples Can Be Threaded In Vise With Pipe Clamp

When making some plumbing repairs in my basement, I found it difficult to clamp short pieces of pipe, an inch or so long, in a vise for threading. But by using a longer piece of pipe I was able to make and thread short nipples. Detail A shows how the pipe is threaded at both ends and cut off at one end for a nipple of the correct length. Then a coupling is screwed on the threaded end of the longer piece and the short length is fastened to it, as indicated in detail B. The unthreaded end of the nipple can be finished now by using a die of the right size and the collar that is to be used is one size larger so it will slip over the coupling. For example, a 1/2-in. die will require a 3/4-in. collar.

William A. Walker, Indianapolis, Ind.

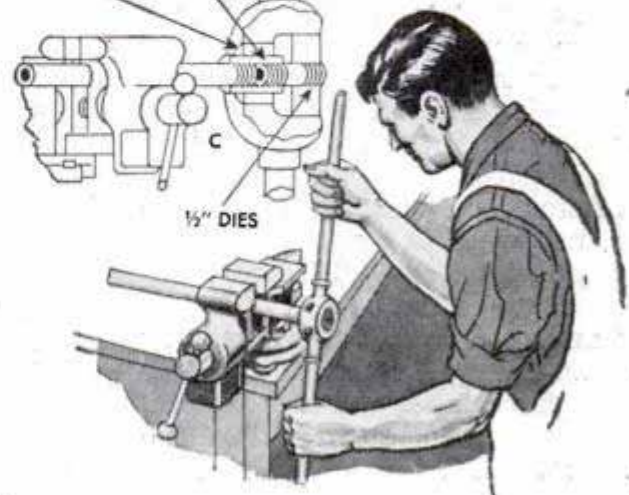
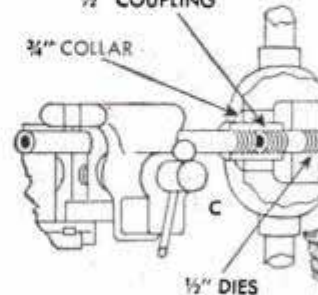
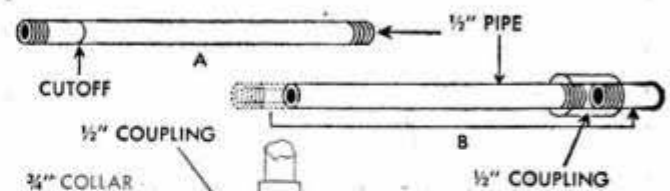

Two-Tone Chime Improvised From Doorbell

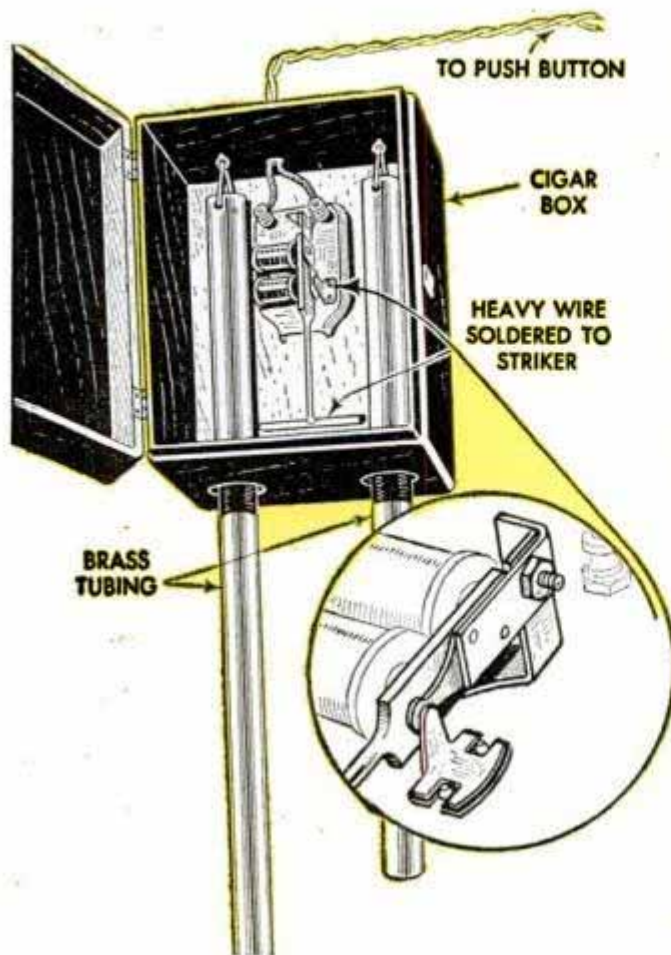

By a simple alteration of a doorbell-coil unit and the addition of two lengths of brass tubing you can make a two-tone door chime at very little cost. The bell is removed from the unit and the vibrating contacts are soldered together to transform the armature to single-stroke vibration. Then a length of heavy wire is soldered to the contact spring so that it projects at a right angle under the coils as indicated. The unit is enclosed in a case such as a cigar box, oversize holes being bored through one end of the box to allow the 1-in.-dia. brass

tubes to project without touching the wood. Variation in tone is obtained by cutting one tube 30 in. long, the other 38 in., but to get just the right pitch it may be necessary to file away the lower end of one or the other, or both, by a cut-and-try procedure until the tone is satisfactory. The tubes are hung at the sides of the coils by cords. Some care in assembly will be necessary to assure that the tubes hang free in their respective holes and do not touch the box when the case is mounted on the wall.

Fred J. Kammerer, New York.

Nail Polish Between Sheets of Plastic Will Color Novelty Jewelry

With nothing more than a few pieces of clear plastic and some colored nail polish you can make novelties, such as bric-a-brac, necklaces and other bits of jewelry that are striking in appearance. As an example, take a Scottie necklace ornament. To make it, cement two sheets of plastic together with black nail polish. Do this by coating a side of one piece and then pressing the two sheets together, being careful that no air bubbles are trapped between the pieces. Then scribe the outline of the dog and jigsaw around the outline. Finish by filing, sanding and buffing. An eye can be put in the Scottie by drilling a small hole and inserting a white bead held in place

with cement. The pattern for the Scottie can be cut from a picture in a magazine or newspaper, as can many other patterns.

Screws Held in Plastic With Cotton

If you find it difficult to assemble plastic parts with screws because they cause the material to chip or break around the holes, try this method of doing it. Drill holes in the plastic for the screws, then soak cotton in solvent and fill each hole with the cotton. When the screws are driven into this, they will form threads in the cotton which will harden and hold the screws securely.

G. James, Louisville, Ky.

" PASTE UP "

By Paul Hadley

YOU can make "new" pictures from old ones and get photo effects that look impossible simply by combining parts of two or more prints in a paste-up composite from which a new negative is made. A look at Figs. 2 and 5 will give you an idea of what can be done in attaining realism with the more tricky compositions.

The process is easy. After the prints have been selected, desired parts of each are cut out carefully and the edges shaved thin so that when pasted together and photographed the edges will not show as a line. This is quite important, for by concealing the edges you avoid the appearance of a fake. After pasting up the composite, making sure that the edges adhere tightly to the base, any necessary retouching or spotting should be done with a retouching pencil or paint. From there on you make the new negative and develop and print it in the usual way.

The composite picture in Fig. 1 was made from three prints, one each of the sky, the figure, and the



A composite of three prints: sunset sky, silhouette of the Washington Monument, and an indoor shot of the figure

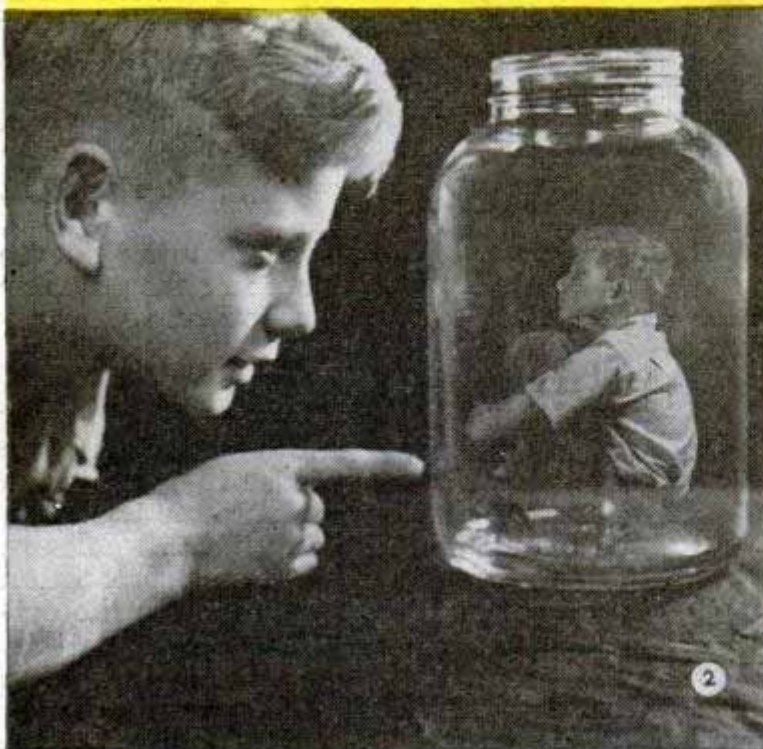

PHOTOGRAPHS GIVE NOVEL EFFECTS

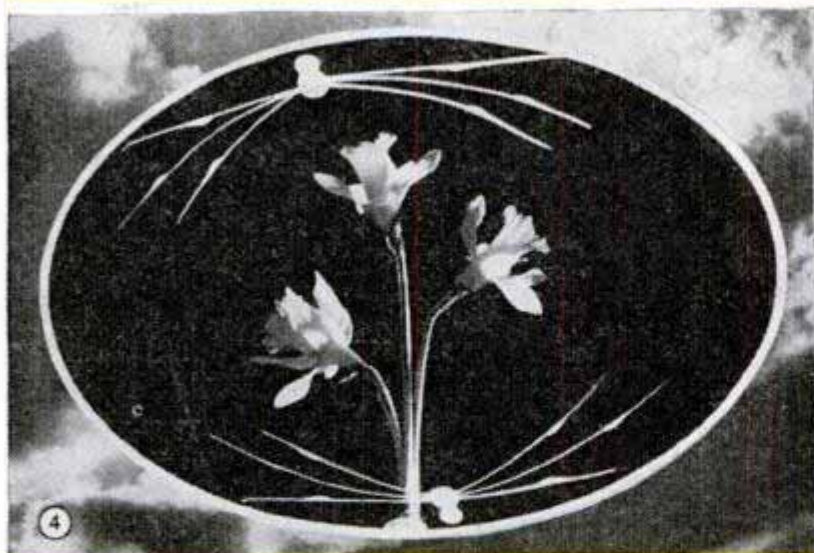

The first print is a "reflection" shot of flowers in a mirror. Then this is pasted to a print from a suitable cloud negative

Washington Monument. The novel "portrait" in Fig. 3 was made by cutting out the portion of the print showing the mirror glass and then using the opening in the print to frame a portrait of the girl in the paste-up. Photos in Figs. 4 and 6 were made in a similar manner, separate photos being taken both indoors and out to get the various prints necessary. By using the enlarger to make the prints, parts of any negatives may be used, making them the correct size by carefully measuring the image on the enlarging easel when printing.

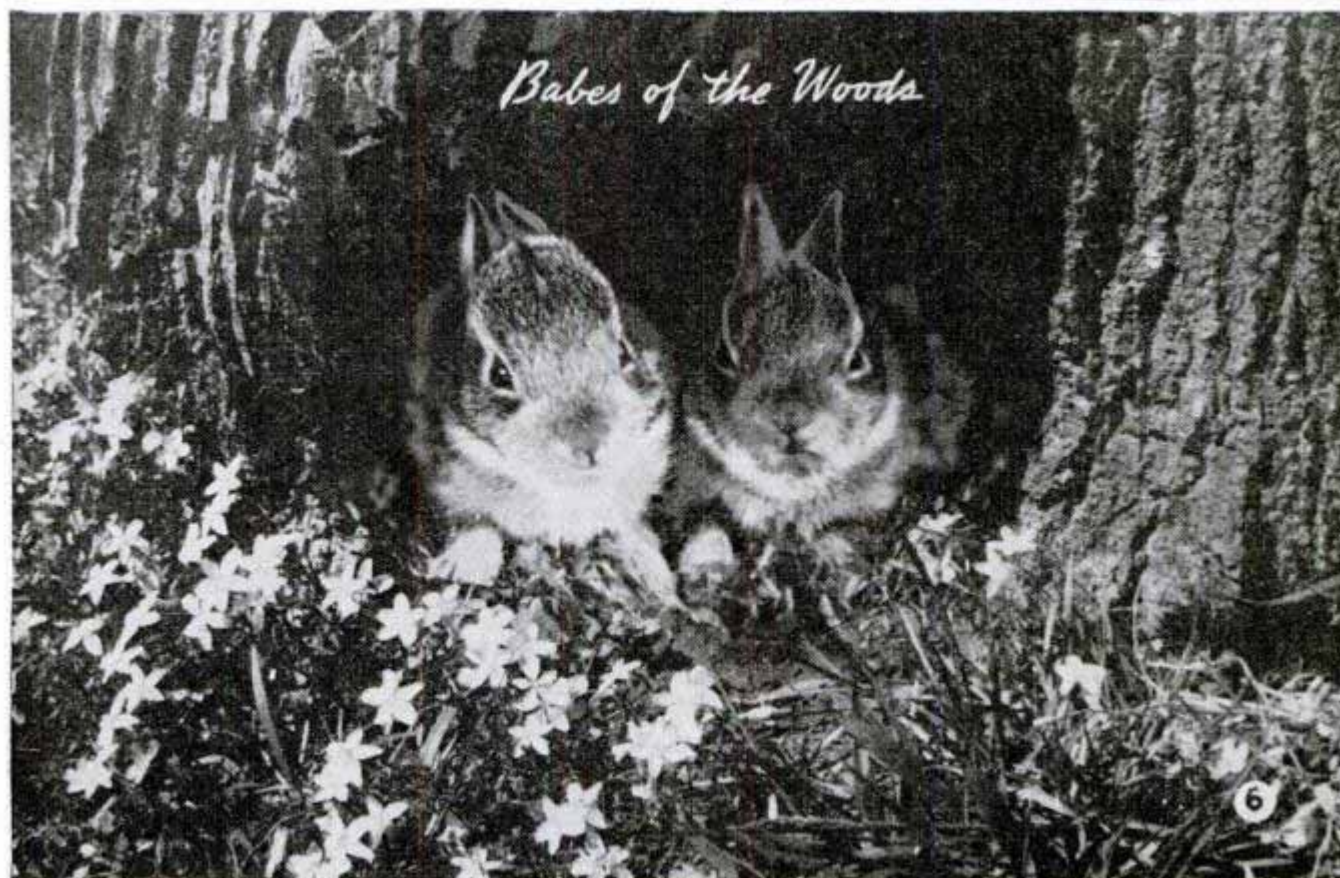

Door Brace Holds Enlarger Rigid For Better Prints

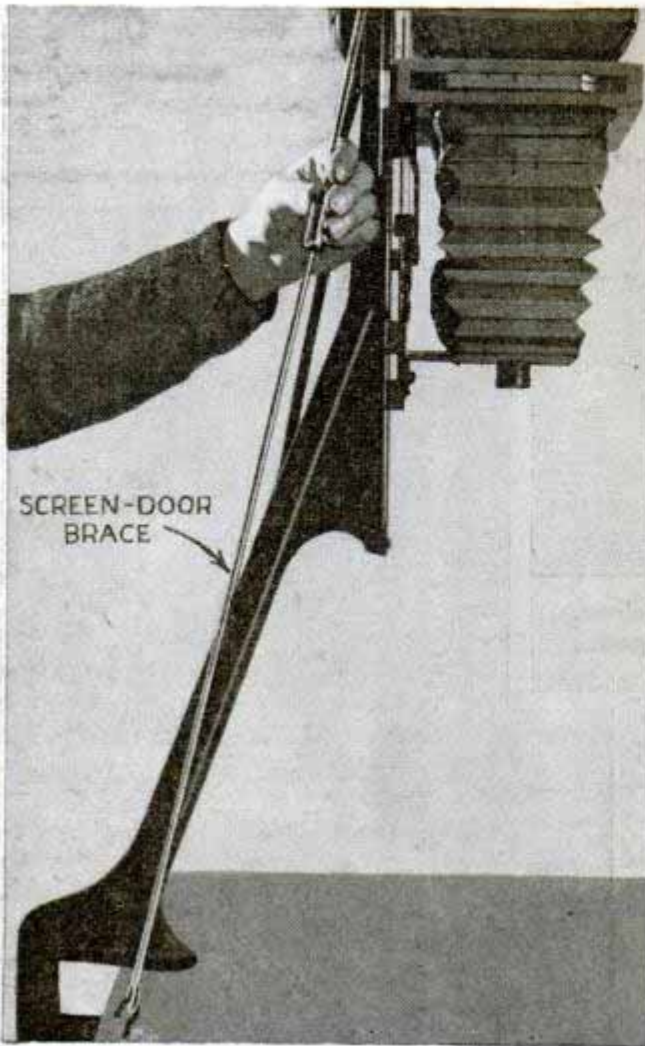

If your enlarger is not steady, prints made with it will lack clearness. To correct this, fasten screen-door braces to the top of the enlarger column and to the table on which the prints are made, using one brace on each side. The turnbuckles on the braces should be drawn up tightly.

Improving Appearance of Tripod



An inexpensive wood tripod can be improved in appearance by attaching a strip of zinc linoleum binding tape around the head. The tape is held in place with small brads or it can be glued.

Quick Prints From Roll or Cut Film

A simple and quick way to make contact prints from roll or cut film without a contact printer is to secure a piece of heavy plate glass large enough to cover the nega-

tives. Using an enlarger table, or any table with an overhead light, place the paper emulsion side up and the negative emulsion side down over the paper. Then lay the glass over them. No clamping is needed as the weight of the glass is sufficient. Turn on the light for the needed printing time and, after exposure, develop in the usual way. If you use an enlarger, take the lens mount out for direct light. If you have a large piece of glass, you can print full sheets of paper rather than just strips cut from the paper.—C. C. Caswell, Clarinda, Iowa.

Saucer Used as Flash Reflector

When you wish to make flash-bulb photographs and a regular reflector is not at hand, a white china saucer will serve as a substitute. The saucer is held against the bulb and socket as shown. This leaves one hand free to operate the camera. Care should be taken to hold the saucer and socket so the hand will be protected if the bulb breaks when it is flashed.



Dark Slide Substitute Is Made From Notebook Cover

If you have lost the dark slide from a film holder, you can make an emergency slide that is light tight from the shiny, flexible covers that come on some notebooks. After the cardboard has been cut to fit, a pull, which is the rounded end of the spring device found in film packs, is added to complete the slide.—R. M. Roland, Chicago.

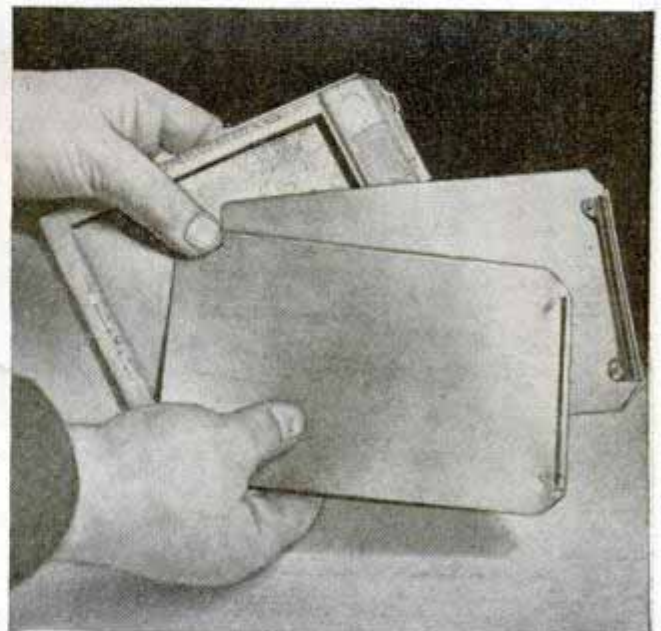

Focusing Spotlight for Indoor Photography

A focusing spotlight, Fig. 2, ideal for table-top photography or similar projects, where large areas need not be lighted, can be made using a standard 6 by 6 by 6-in. metal radio cabinet and a chipped condensing lens. Begin by removing the covers of the cabinet and draw diagonal lines on the top to locate the center. Cut a 3-in.-dia. vent in the top, Fig. 1, and fit a baffle to form a light trap. Then cut the slot in the bottom so the bulb can be moved for focusing. This slot also admits air for ventilation. A flange-type socket is fitted in the slot and slides back and forth in the light trap. A spice can, or a can of similar size, will serve the purpose, detail C of Fig. 1. Two $\frac{1}{4}$ -in. holes are drilled in the sides of the cabinet and 10-32 screws are inserted to hold the box in the cradle.

The opening in the front panel for the lens, detail B, Fig. 1, should be small enough so that it will cover any imperfec-

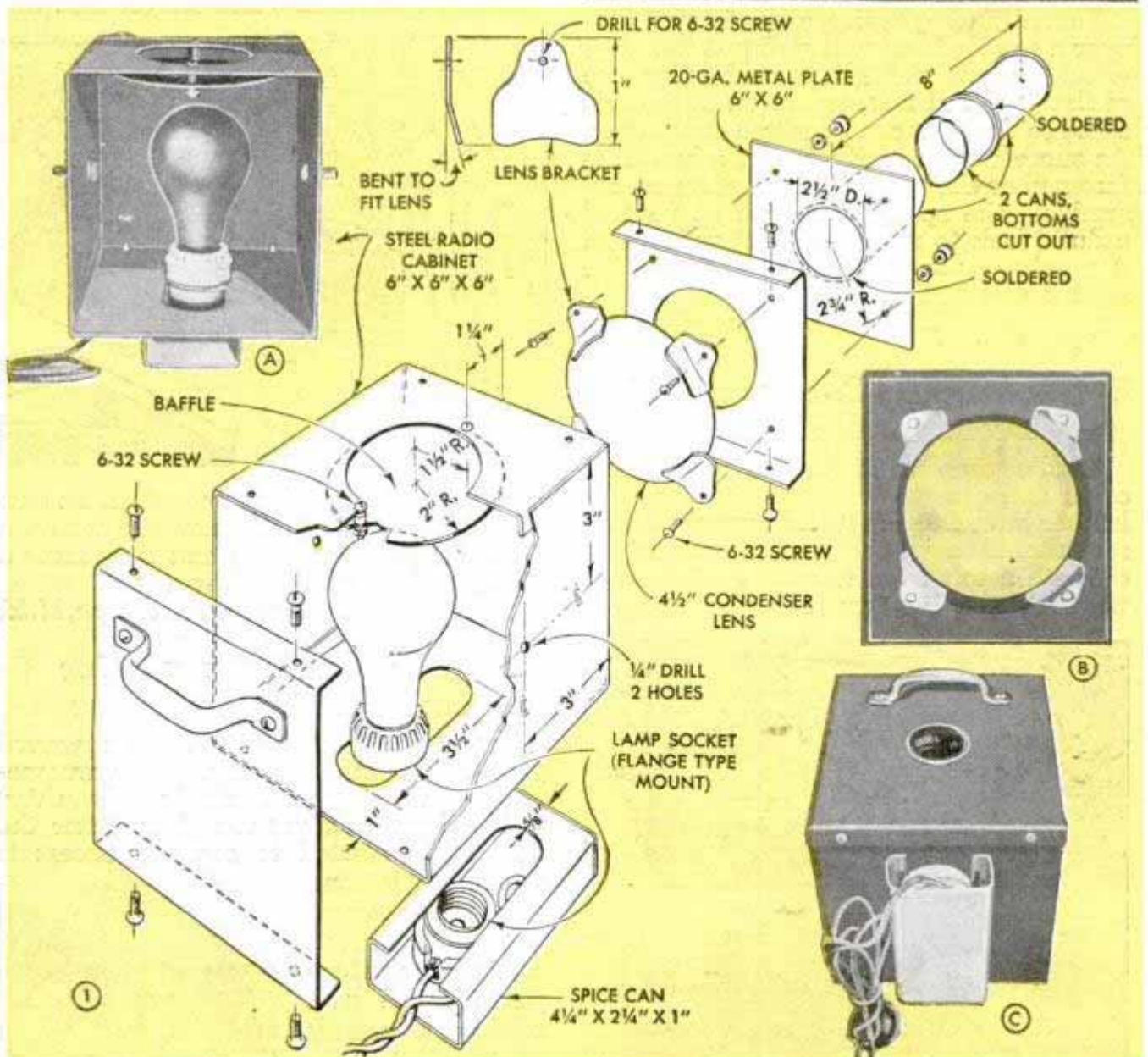

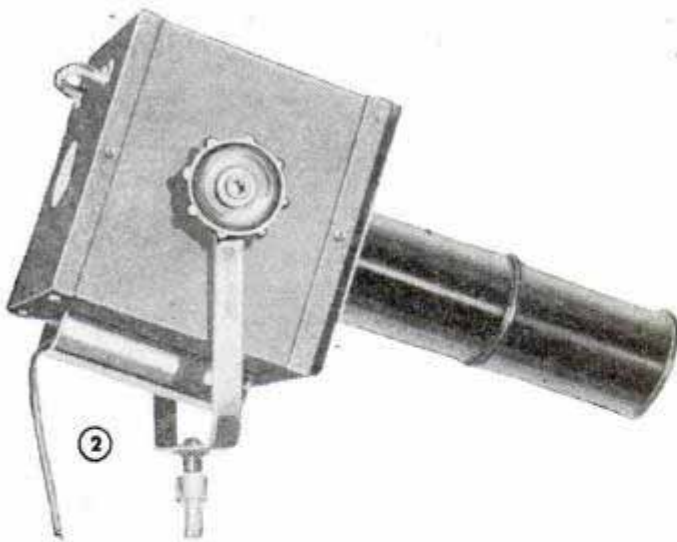

tions on the edges of the lens. The flat side of the lens is held against the panel with clips, as shown in Fig. 1. To make the light-control tube, cut the tops and bottoms out of two cans of the same diameter and solder them end to end. Then solder the tube to the plate which bolts on the front panel. Different sized tubes can be made to vary the size and intensity of the light beam.

For a diffusing device, organdy stretched over a sewing hoop will give just the right effect. The cradle, Fig. 3, is cut from a piece of flat iron and fastened to an adjustable stand so the light can be raised or lowered. As another aid to adjustment, a handle is fastened on the back. After all parts are assembled, the spotlight should be painted a dull black to minimize light reflections. A number one photoflood is shown in the light, detail A, Fig. 1.

Dan W. Damrow, Chicago.

Saddle Soap on Camera and Case Preserves the Leather

Saddle soap applied to your camera cover and case will not only preserve the leather but will keep it looking bright. The soap should be applied sparingly and wiped off with a soft cloth to remove dirt, after which another light coat is applied and pol-

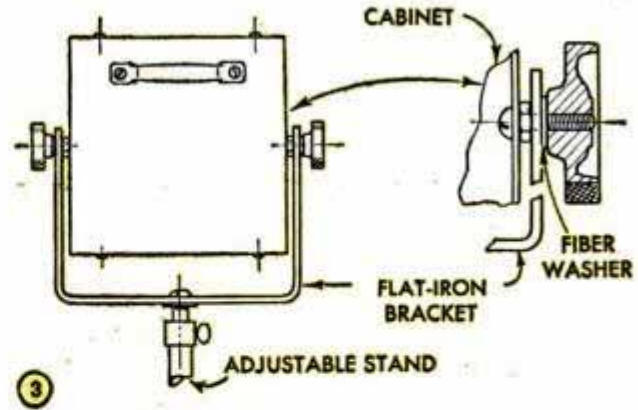

ished with a lamb's-wool shoe buffer to make the leather shine.

Herman Klein, Pittsburgh, Pa.

Roll Film Suspended Horizontally Will Dry Faster

Roll film can be dried much faster if it is hung horizontally instead of vertically, as is the usual method. When held in this position, there is also less danger that wa-

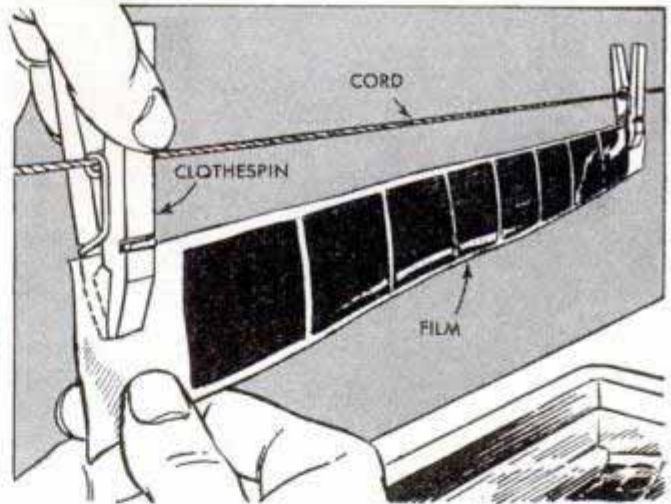

ter marks will streak the negative. To suspend the strip in this manner, clip each end with a spring clothespin and hang from a string which has been drawn taut.

William Swallow, Brooklyn, N. Y.

Nail Polish Renews Color On Worn Thermometer

If the color is worn off the engraved graduations on your darkroom thermometer, it can be renewed quickly by brushing red nail polish along the glass. After the polish has started to set, the excess is wiped off, leaving only the graduations colored. Nail polish is waterproof and not readily affected by photo solutions.

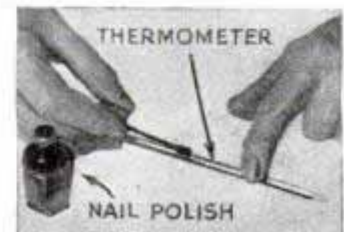

Direct-Vision Viewfinder Is Used on Box Camera

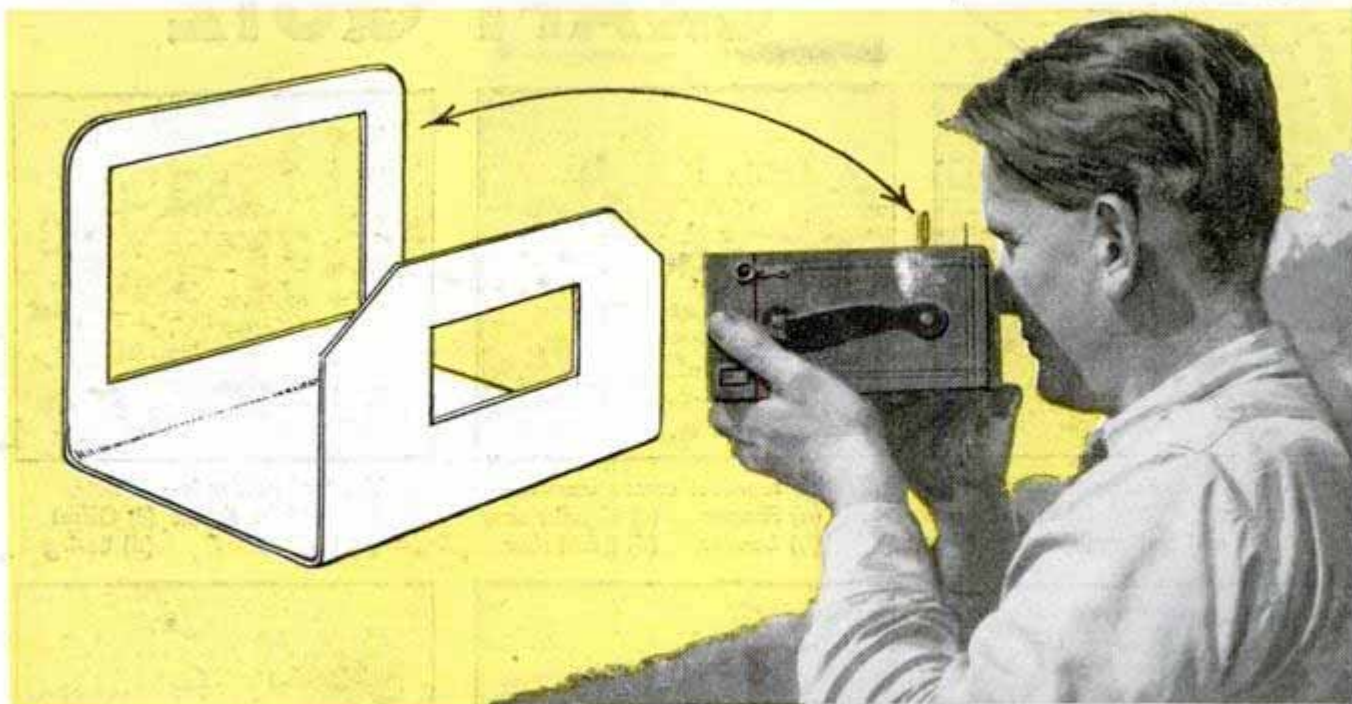

Since most box cameras are fitted with a reflecting viewfinder, addition of a direct-vision viewer will add to the effectiveness of the instrument. Pictures taken at eye level differ from those taken at waist level; with the two finders, you will be able to get different angles and different effects. Construction of the viewfinder is simple, but you will have to proportion the front and

rear sights so they cover the same field as that covered by the reflecting finder. This is done by trial and error. A temporary finder can be cut from cardboard and experimented with until openings of the desired size are obtained. Then use the cardboard as a pattern and cut the finder from sheet metal. It can be fastened to the camera with screws after it has been painted.

Ammunition Box Can Be Converted to Case for Camera

A .30-caliber ammunition box makes an ideal carrying case for small cameras and accessories. This all-metal box is watertight and measures 10 in. long, 3½ in. wide and 7 in. deep. It is equipped with a cantilever spring catch and a collapsible metal handle on top. In addition, there are two swing loops, one on the front and one on the side of the box, to which shoulder straps may be attached. The inside should be well padded so that camera equipment will not be damaged. Sheets of sponge rubber which have been cut to size and fastened with rubber cement are ideal for this purpose.—Simon S. Palestrant, New York.

Removing Stain From Photo Tray

Developing trays can be cleared of stains with a 10-percent solution of laundry bleach, which should be left in the tray for several hours. Also, the acetic-acid solution used as a shortstop in developing prints can be used. However, the tray then must be rinsed to remove all traces of the bleach or acid, even a small amount of which will spoil developer used in the tray.

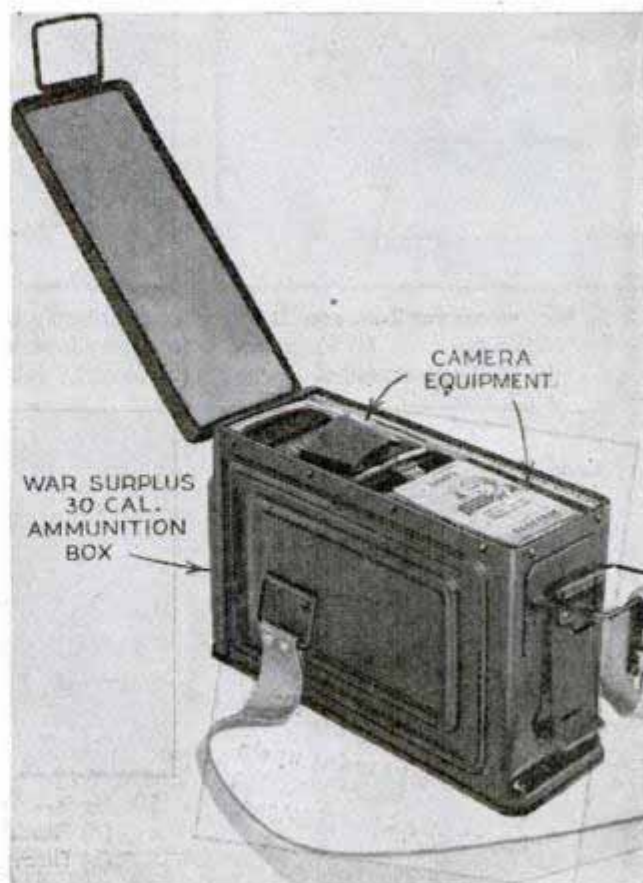

CRAFT QUIZ



1. Method of building this model is—
 (a) Roll top (c) Frame
 (b) Bread and butter (d) Batten seam



2. This "sawdust" comes from a—
 (a) Shaper (c) Circular saw
 (b) Sander (d) Band saw

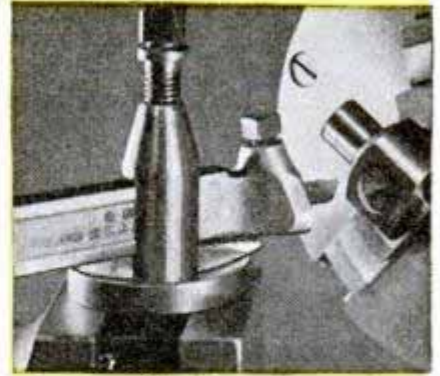

3. The tool holder is—
 (a) Straight shank (c) Offset
 (b) Duplex (d) Boring

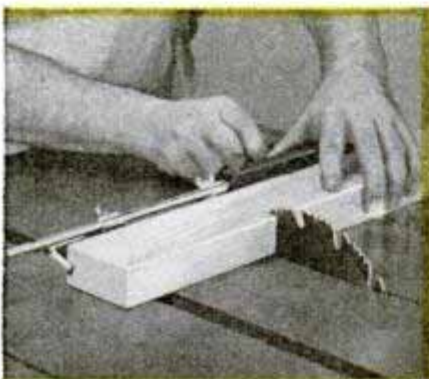

4. Wrong in this picture is—
 (a) Hands (c) Saw height
 (b) Kind of saw (d) Stop rod

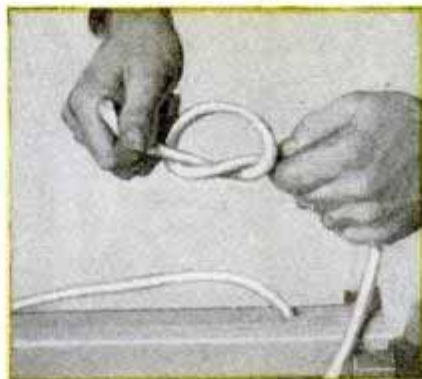

5. Knot he is tying is—
 (a) Overhand (c) Wall
 (b) Bowline (d) Square

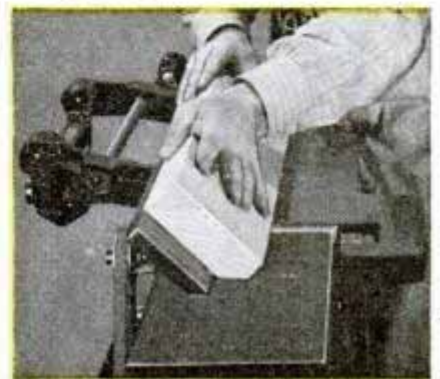

6. This cut is a—
 (a) Bevel (c) Miter
 (b) Chamfer (d) Tongue

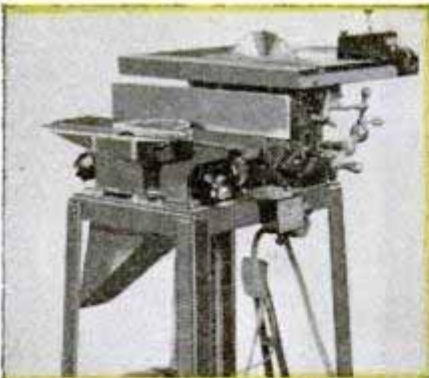

7. Best motor for 8-in. saw is—
 (a) 1/3 hp. (c) 1/2 hp.
 (b) Split phase (d) 3/4 hp.

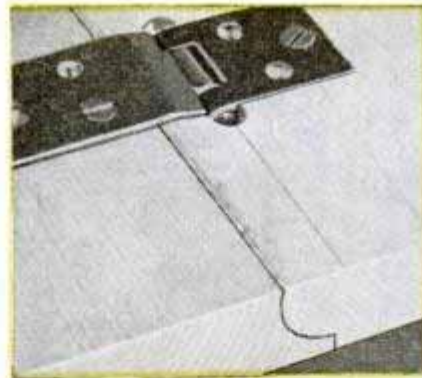

8. Eventually this will be a—
 (a) Draw leaf table (c) Folding screen
 (b) Butterfly table (d) Folding ladder



9. This spray gun is—
 (a) Pressure feed (c) External mix
 (b) Internal mix (d) Angle head

ANSWERS: 1-b (it is built up in layers like a sand-rod is never used on free end of work); 2-a; 3-c; 4-d (stop which); 2-a; 3-c; 4-d (stop up in layers like a sand-rod is never used on free end of work); 5-a; 6-b; 7-c (note horns on cop); 10-c; 11-a (end grain 45 to 90° with surface)

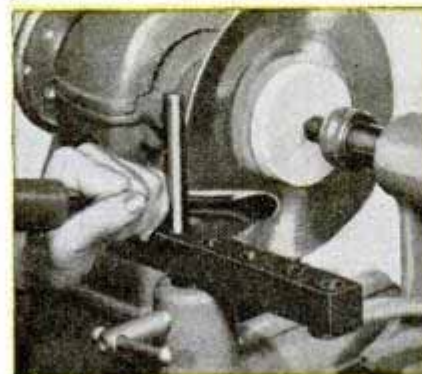

10. He is—
 (a) Planishing (c) Spinning
 (b) Throwing (d) Following

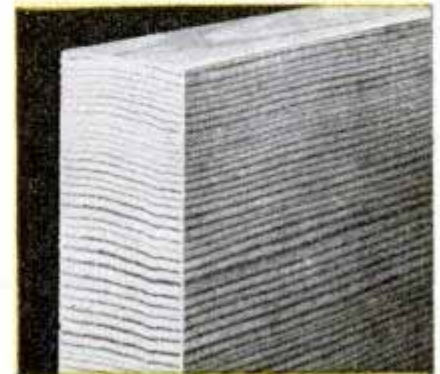

11. End grain shows this wood is—
 (a) Quarter-sawed (c) Sapwood
 (b) Flat-cut (d) Heartwood

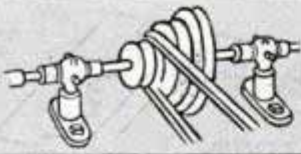

"FEEJEE"

An All-Purpose Dump Truck

Feejee—Built by Don W. Street, a California poultry rancher, takes its name from a contraction of the words Feed and Jeep.

By Hi Sibley

PART I

HANDY around the poultry farm, the dairy barn, in the feedlot and in industrial plants, this capable midget dump truck has the capacity for half-ton loads, weighs 600 lbs. empty and has a tread width of only 31 in. A 3-hp. air-cooled engine drives through two standard automobile transmissions hooked up in tandem, thus giving a wide variation in gear ratios for the heavy pulls. A power-driven hydraulic lift, separate foot brakes on the rear wheels and a foot accelerator combine to give a degree of control equal to that of any standard dump truck. The narrow width lets the midget through small gates and feed-bunk alleys and its ability to turn in its own length gets it around square corners and into and out of narrow driveways with a full load.

Some departures from the design as detailed are possible. A 3 or 5-hp. engine equipped with integral clutch will save building the spring-loaded clutch arrangement shown. Where the going is fairly level and there are no steep grades to negotiate regularly, a 3-hp. engine driving through a single transmission will give satisfactory performance. Two types of side panels are fitted to the platform to provide three body types: a half box, a flat bed and a deep double

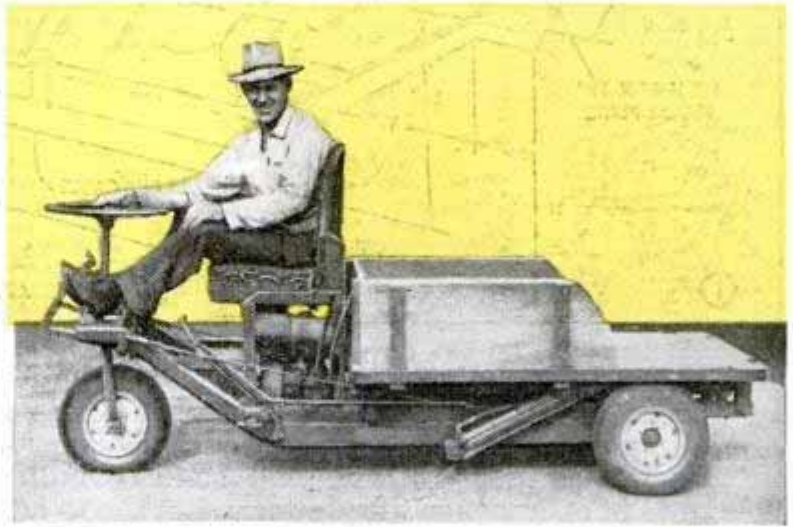

Comparative size of truck is shown by man in seat. Half-body is used for hauling sacked grain and items not in bulk

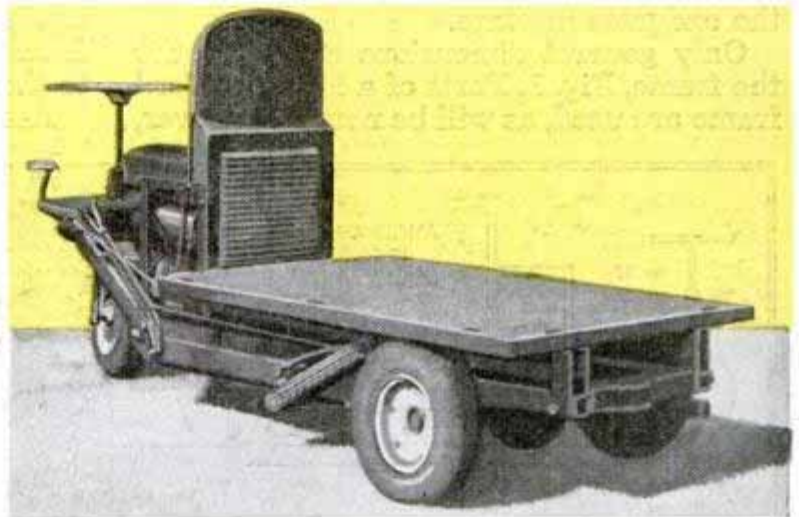

With the sides removed the flat bed can be used to haul bulky articles such as baled hay, lumber or large crates

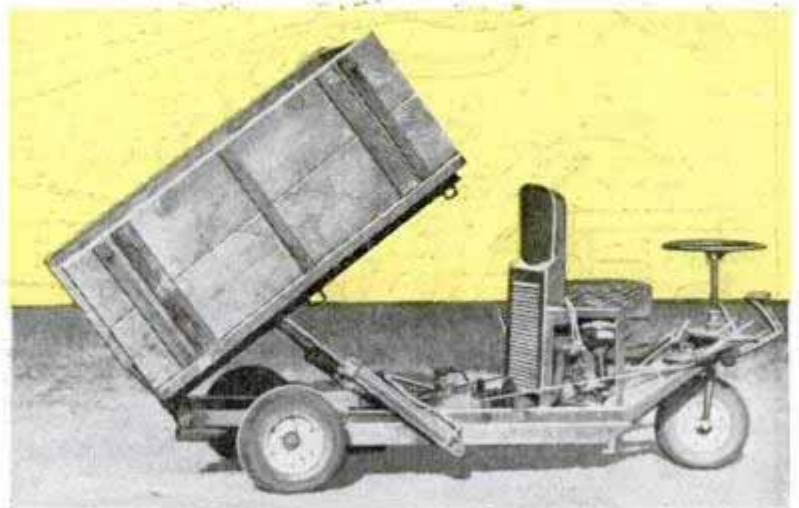

With box-body half a ton of feed or fertilizer can be hauled. Hydraulic cylinders hoist the body to the dumping position

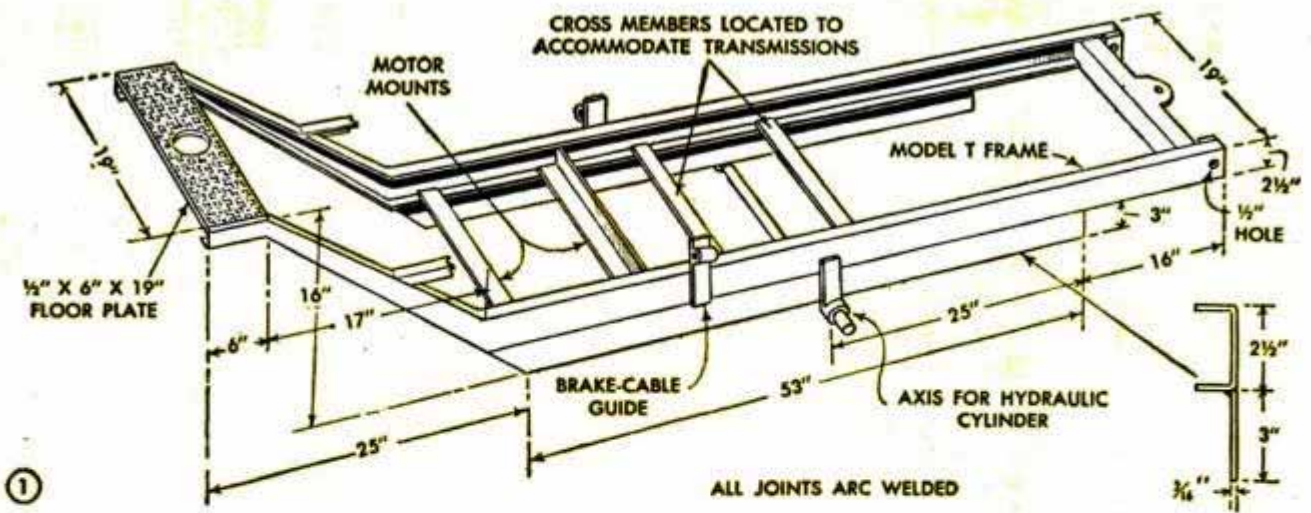

box, with endgates, for small grains, ensilage or ground feeds. Side panels are made of white pine or waterproof plywood and fitted with hardwood cleats and stakes spaced to fit openings in the platform. Both cleats and stakes are riveted to the panels for extra strength. Endgates are of the same construction and wagon-box rods cut down to the proper length are provided to hold the endgates in place.

Only general dimensions are given for the frame, Fig. 1. Parts of a Model T Ford frame are used, as will be noted. However,

you can use steel channels for the frame side members and save welding on stiffeners, which are called for in Fig. 1. In building the chassis frame it is necessary to adapt it to the parts and equipment you have available or at hand. The frame should be long enough to accommodate engine, clutch, two transmissions, hydraulic pump and the rear axle. If you use the same equipment as on the original vehicle, the frame dimensions will correspond closely to those given in Fig. 1.

Assembly of the driving parts is illus-

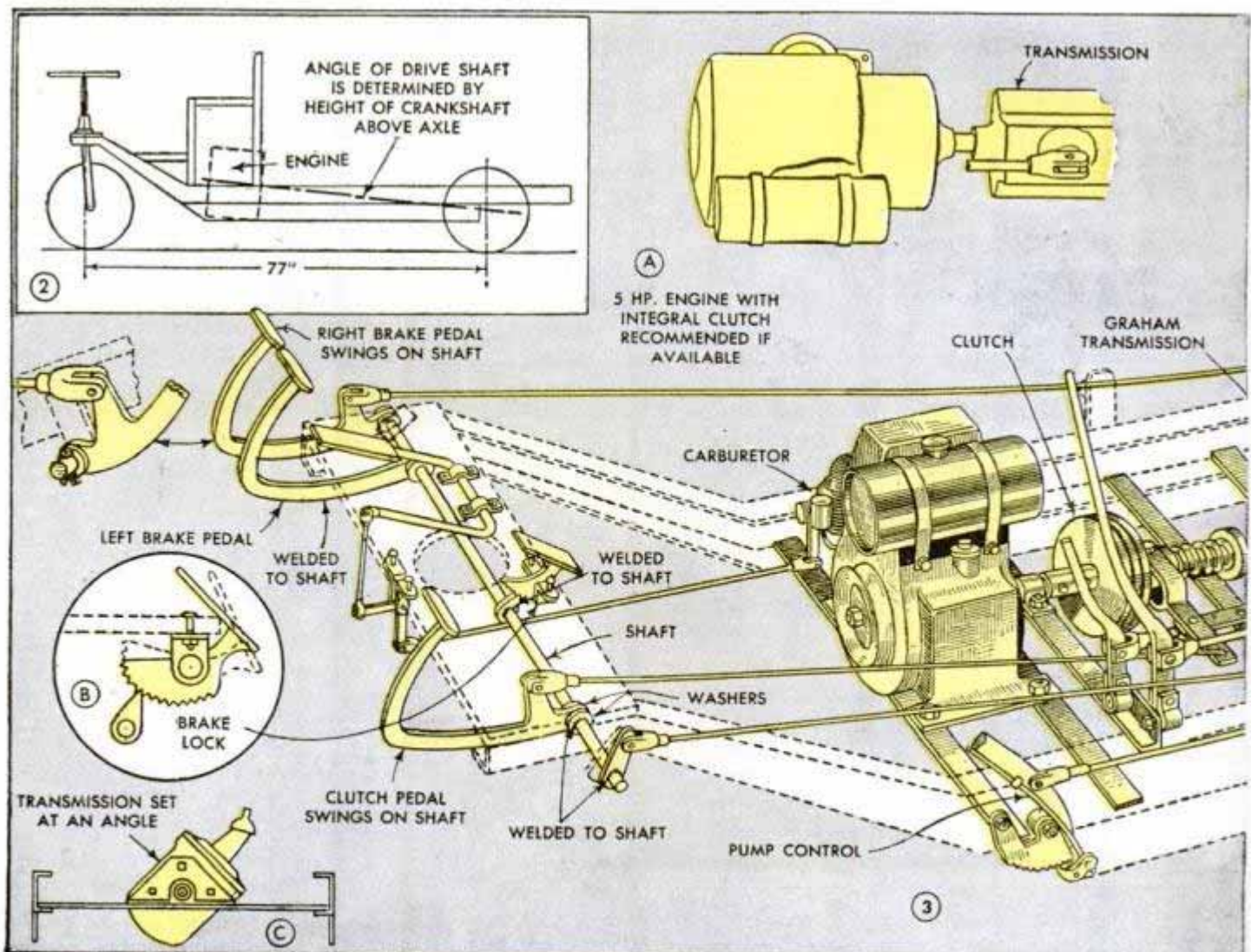

trated in the perspective view in Fig. 3. Main-frame channels are cut and welded to form the "kick-up" forward portion. Stiffeners of flat steel are welded along the bottom of the straight section to give additional rigidity. A steel floor plate is welded to the front end, with a round opening to receive the steering-post bearing. Seat frame is built up of $\frac{1}{8}$ by $1\frac{1}{2}$ by $1\frac{1}{2}$ -in. angle iron with all joints welded. This should be dimensioned to accommodate the cushions you will use.

Supports for engine, transmissions, etc., are located where required, and a shaft carrying the lower eye bearings of the hydraulic cylinders is supported by bearings welded to the side frames as shown. Place the transmissions, engine and other parts in position and from this trial set-up determine the location of supporting members on the frame. Don't weld frame cross-members in place until you make this trial assembly. Using an engine with an inte-



gral clutch, Fig. 3, A, will change the relative positions of these parts. Provide for a tow hook at the rear end of the frame and install guides for brake cables on each side. The cables should be located after brake pedals are installed. Holes are drilled in the extreme rear ends of the channel members to receive the bolts on which the dump body hinges.

Relative locations of the parts, when using a spring-loaded clutch, Fig. 3, D, can be worked out on the partially completed frame. Generally, it's best to begin by bolt-

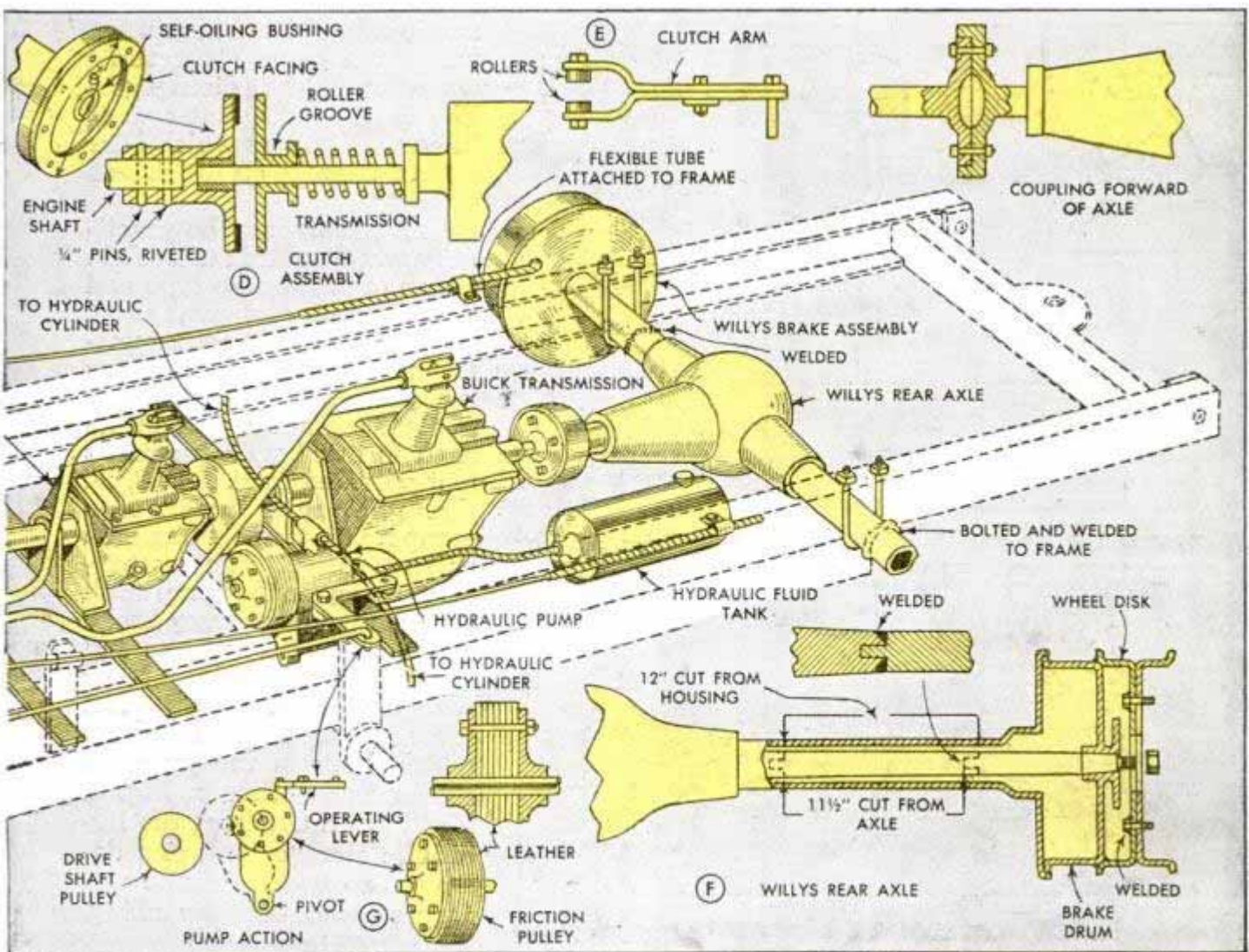



Narrow tread and single-wheel steering permits use in close quarters



All operating levers are within easy reach of the driver's seat

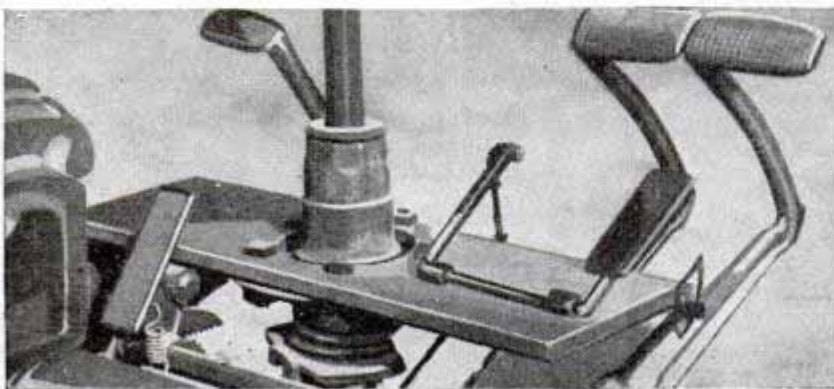

Independent brakes on rear wheels are operated by separate pedals which can be locked to hold truck on a grade

ing the rear axle in position and then work back to the engine. The angle of the drive shaft is determined by the height of the crankshaft above the center of the rear axle, Fig. 2. With the frame blocked up, the axle is bolted directly to the frame, under the channels and at the ends of the stiffeners as shown. U-bolts made from $\frac{3}{8}$ -in. round rods will serve to hold the axle in place. In the original job a Willys rear-axle assembly is used and the tread is narrowed to 31 in. by cutting out a 12-in. section of the housing and $11\frac{1}{2}$ in. of the live axles on each side as in Fig. 3, detail F. The ends of the axles then are turned in a lathe as shown in the detail and welded, as is the housing. A coupling to connect with the rear transmission—in this case a Buick transmission—is made as shown. Any similar coupling will be satisfactory if a different make of transmission is used. In order that the tops of the transmissions will clear the bottom of the body, it is necessary to mount them at an angle as in Fig. 3, C.

The second transmission, taken from a Graham car, was originally fitted with an emergency brake, the drum of which is utilized to drive the hydraulic pump through a friction pulley, Fig. 3, detail G. Next comes the clutch assembly, shown in Fig. 3, details D and E. On the original job this was made especially for the purpose. The driving disk is faced with

clutch facing and is fitted with an oil-impregnated bearing in which the drive shaft turns when the clutch is disengaged. The clutch throw-out arm is fitted with rollers which bear against a flange on the driven disk.

Foot pedals may be practically any standard automobile clutch or foot-brake type and are linked up as shown in Fig. 3. Gearshift levers are mounted on a frame crossmember as indicated. Link bars are bent to clear the body. The brake shaft is fitted with a ratchet foot-operated lock, Fig. 3, B.

A gear-type hydraulic pump is mounted on the frame as indicated. The leather-faced pulley on the pump shaft contacts the emergency brake drum, and is thrown into and out of contact by a hand lever with a ratchet. The ratchet lever and bell-crank linkage which controls the pump is shown in position in Fig. 3. Fluid is drawn from the hydraulic storage tank and delivered to two hydraulic cylinders through flexible tubing.

(To be continued)

Portable Hoghouse Is Made In Three Sections

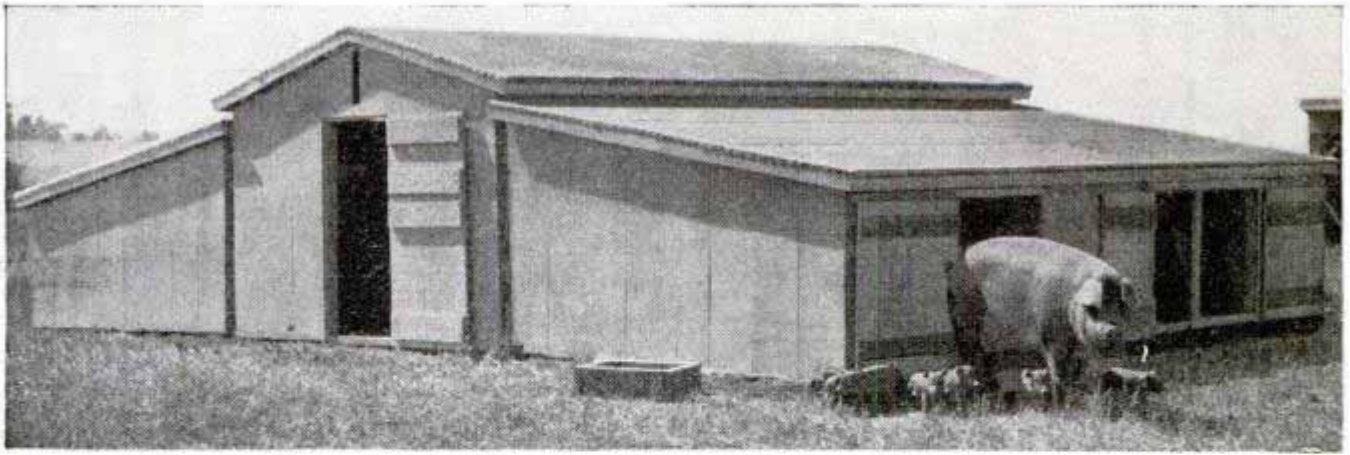

All three sections of this hoghouse are on skids for easy portability, each section providing 8 by 18 ft. of floor space. The gable-roofed center section can be used as a pig creep, as a storage space for sacked feed, a sunshade, a general runway, or for additional pens. The lean-tos are divided into three pens each and doors to the pens are spaced along the low sides. Hinged half-doors in the ends of the center section make it possible to regulate ventilation, admit sunshine without letting the hogs escape, or leave the lower ends of the house open and the top half closed. The buildings also are handy for sheltering lambs, for feed storage units or as tool sheds for small farm equipment. The outer sheds may be slid together to make a six-pen single house or used separately. The lower photo shows



construction of the lean-tos. Runners or skids are 4 by 6-in. creosoted stock, 18 ft. long, with 4 by 4-in. cross sills and 4 by 4-in. corner posts and studding spaced as shown. End rafters are of 2 by 4-in. stock but the center rafters are cut from 2 by 6-in. material. The same material sizes are used in the center section.

A. M. Wettach, Mt. Pleasant, Iowa.

Babbitt in Handle Protects Chisel From Hammer Blows

Here's one way to keep wooden chisel handles from splintering or "brooming." Secure a heavy ferrule that will just fit over the handle and slip it halfway on so the top half forms a cup. Then extend this by wrapping several layers of heavy wrapping paper around the ferrule and pour babbitt into the mold until the metal is about $\frac{1}{2}$ in. above the ferrule. Then remove the mold. When the chisel is used the hammer will strike only the babbitt. In time the babbitt will wear down and it will be necessary to replace it. A rubber crutch tip will slip over the handle of some chisels, but this tends to cushion the hammer blows and does not wear as well as babbitt.

W. F. Schaphorst, Newark, N. J.



Metal Bag Filler Speeds Work When Filling Many Sacks



This bag filler will enable a clerk to fill a large number of paper bags without help in a short time. The cylindrical part should be large enough to be a close fit inside the sack, and the mouth should flare out so that vegetables and fruits will not spill. Note that both ends of the filler are beaded for reinforcement.

Carl J. Taber, Elmira, N. Y.

Typing Paper Is Removed Easily From Box With Hinged Lid

If the lid of a box containing typing paper is altered as shown, it will not be necessary to remove the lid to withdraw a few sheets. This is handy especially if the box is stored in a drawer. Frequently fingernails are broken when it is necessary to dig down in

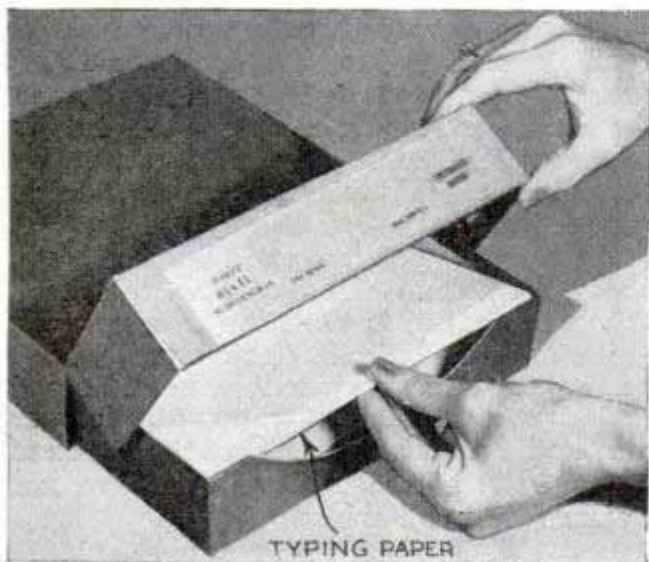

the box to get the last few sheets of paper. The cutout in the lower half eliminates this difficulty. Wide adhesive tape makes a durable hinge for the lid sections.

Substitute Wire-Stripping Fixture Utilizes Razor Blades

Two razor blades can be held, V-shaped, in a vise and used to remove insulation from wire if no regular stripping tool is available. Some makes of blade are extremely thin, and if this type is used it will be necessary to brace the blades with small pieces of metal as shown. To use the stripper, place the wire at the junction of the blades and rotate it once to cut the insulation through completely. Then press down and pull the wire through.—Wray Bell, Pattonsburg, Mo.



Pin in the Bar of a Speed Clamp Prevents Slipping of Jaw

To prevent the movable jaw of a speed clamp from slipping when the teeth become worn, drill a row of holes about an inch apart along the bar and insert a pin or heavy nail to hold the jaw. The pin is held by a length of light chain attached to the bar.

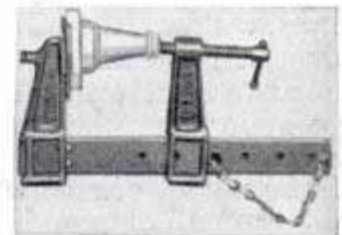

C. F. Bareis, Philadelphia, Pa.

Quickly Made Lettering Pen Rack

There is no need to search for lettering pens if they are kept in a convenient rack with the India ink bottle. A narrow strip of corrugated cardboard can be wrapped around the bottle and secured with a rubber band or a strip of adhesive or cellulose tape to provide a score of compartments which are just the right size and shape to accommodate a large number of lettering pens.



Build Your Own RELAYS

PART 3—THERMAL RELAYS

By C. A. Crowley

THERE are two principal types of thermal relays; the hot-wire type, Figs. 35 and 36, and the thermostatic or bimetal type, Fig. 44. The hot-wire relay consists of a resistance wire held under tension by a contact spring. When current from a battery or low-voltage transformer is passed through the wire it is heated and expands or stretches, permitting the contact to close or to open, depending on which type of relay is in use. Thermal relays can be used to control motors, lights, heaters or any other electrical apparatus. It is frequently desirable to insulate the low-voltage controlling circuit, which operates the relay, from the circuit that is to be controlled. A method of insulating the relay circuit from the controlled or operating circuit is shown in Fig. 37, A.

Both the hot-wire and bimetal types are actually delayed-action relays, since the contacts will not close until the wire has had time to heat and expand. The time interval between closing of the relay circuit and operation of the relay can be controlled by adjustment of the gap between the contacts, using a machine screw as in Fig. 37, B. Another method of speeding up the operation of a thermal relay is to slip a length of glass tubing over the resistance wire as in Fig. 40. This will retard heat loss from the wire and cause it to expand more rapidly. However, relays which are speeded in closing by this method will be correspondingly slower to open when the current is shut off. To slow down a hot-wire relay, one can increase the gap be-

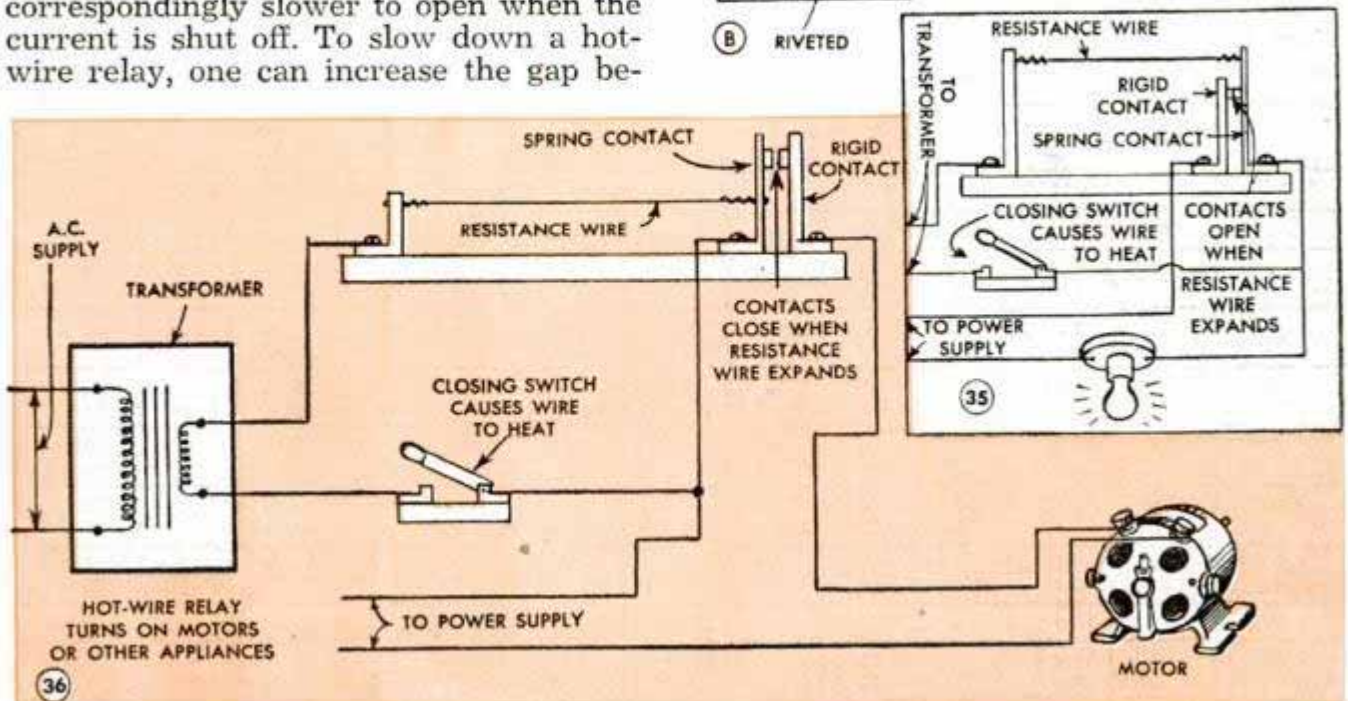
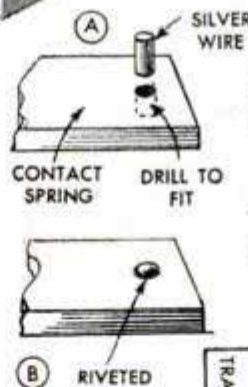

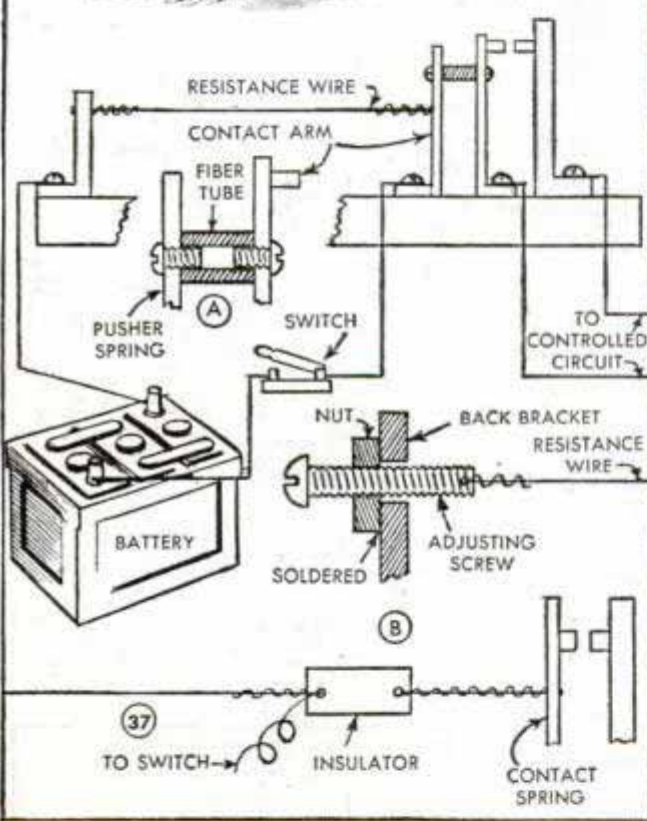

tween the contacts, but if the gap is too great the contacts won't close. Another method is to connect a rheostat in series with a hot wire as in Fig. 43. By increasing the resistance it is possible to increase the time interval to almost any desired extent. Fig. 43 shows how two identical relays can be made to operate consecutively by adjusting the control rheostats to different positions. Details A and B in Fig. 41 show, by comparison, how a short length of wire can be used to give a larger contact movement as indicated by positions L1 and L2. For example, by connecting the wire in the position shown in Fig. 41, B, the wire must expand only $\frac{1}{32}$ in. to move the contacts $\frac{1}{16}$ in.

The design of hot-wire relays is simple. Where alternating current is available, a low-voltage transformer with an output of 6 to 20 volts is the most convenient source of the relay current. By using low voltage, all relay wiring can be laid with bell wire. If a.c. current is not available, a 6-volt storage battery, Fig. 37, is a good power supply. After selecting the length of wire and the

38

DESIGN OF HOT-WIRE RELAYS

Voltage	12" Wire				6" Wire				8" Wire			
	B & S	Ohms	Amps.	Watts	B & S	Ohms	Amps.	Watts	B & S	Ohms	Amps.	Watts
6	20	.635	10	75	28	2.05	4	25	24	1.29	5	30
	22	1.017	7	50								
8	24	1.61	6	60	32	5.09	2	25	26	2.06	5	40
	26	2.57	4	50								
10	26	2.57	5	50	34	8.2	2	25	28	3.28	4	40
	28	4.10	3	40								
12	28	4.10	3	40	34	8.2	2	25	30	5.20	3	40
	30	6.50	2	30								
14	30	6.50	3	40					32	8.13	2	30
	32	10.17	2	30								
16	32	10.17	2	30					34	13.10	2	25
	34	16.4	2	25								
18	34	16.4	2	30					34	13.10	2	30
20	34	16.4	2	30								

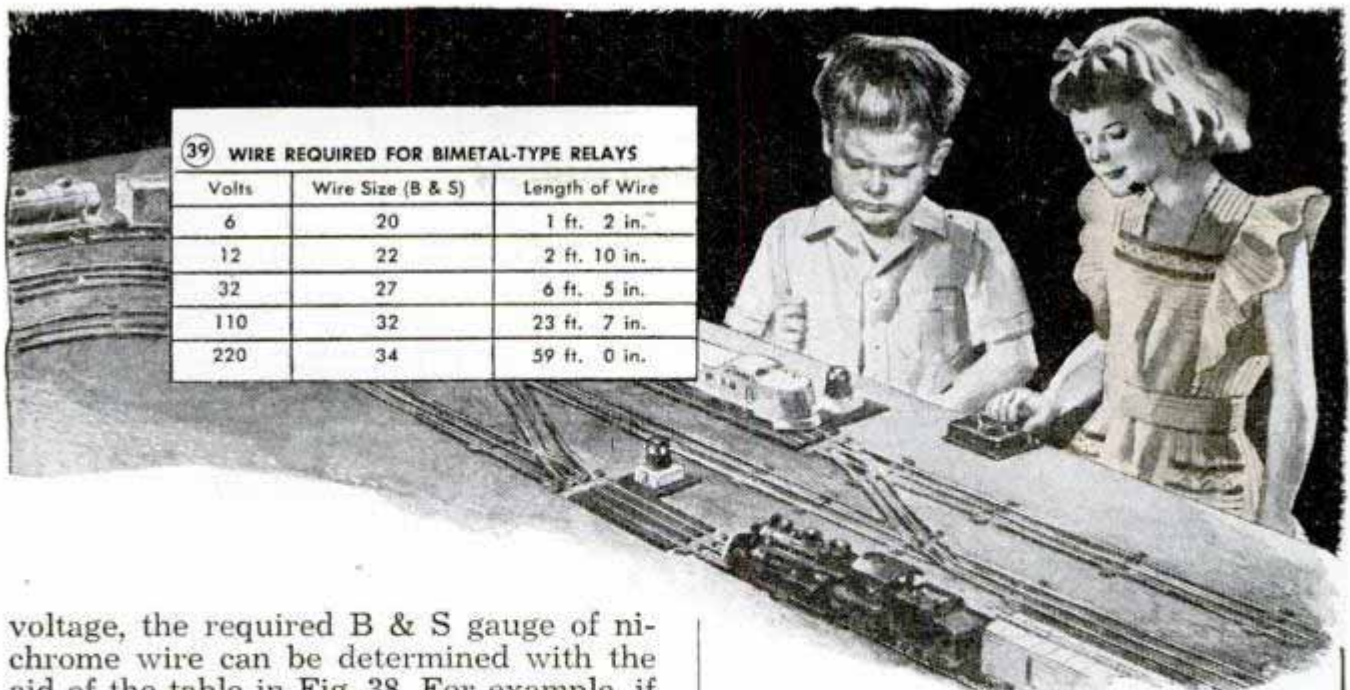

39 WIRE REQUIRED FOR BIMETAL-TYPE RELAYS

Volts	Wire Size (B & S)	Length of Wire
6	20	1 ft. 2 in.
12	22	2 ft. 10 in.
32	27	6 ft. 5 in.
110	32	23 ft. 7 in.
220	34	59 ft. 0 in.

voltage, the required B & S gauge of nichrome wire can be determined with the aid of the table in Fig. 38. For example, if the wire is to be 8 in. long and operated at 14 volts, No. 32 or 34 wire can be used. The smaller wire will operate at higher temperature and give faster operation. Increasing the voltage with a given size of wire will increase the speed of action. The contacts should be capable of carrying the currents required. Silver contacts can be made as shown in Fig. 34, A and B.

Hot-wire relays can be used in place of

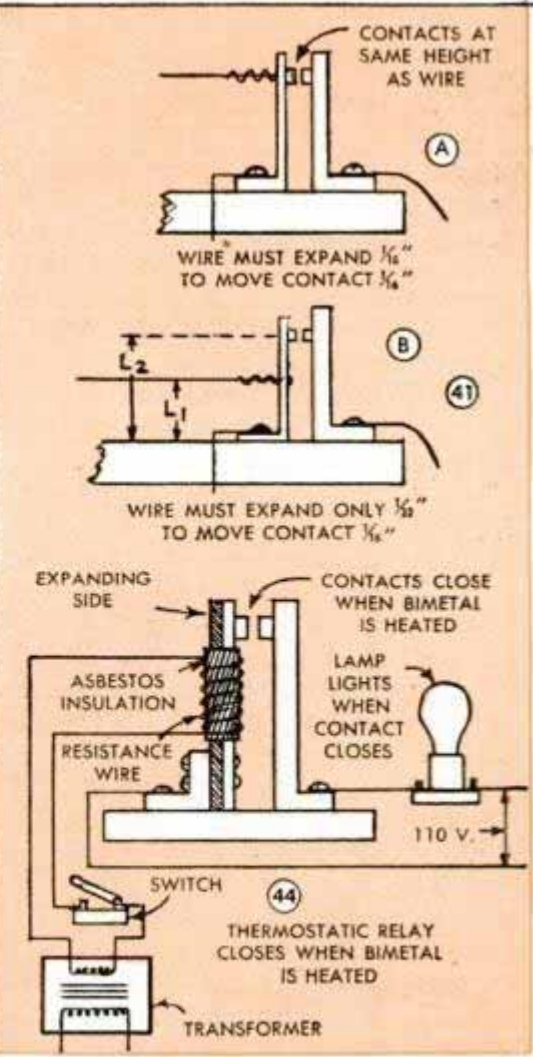
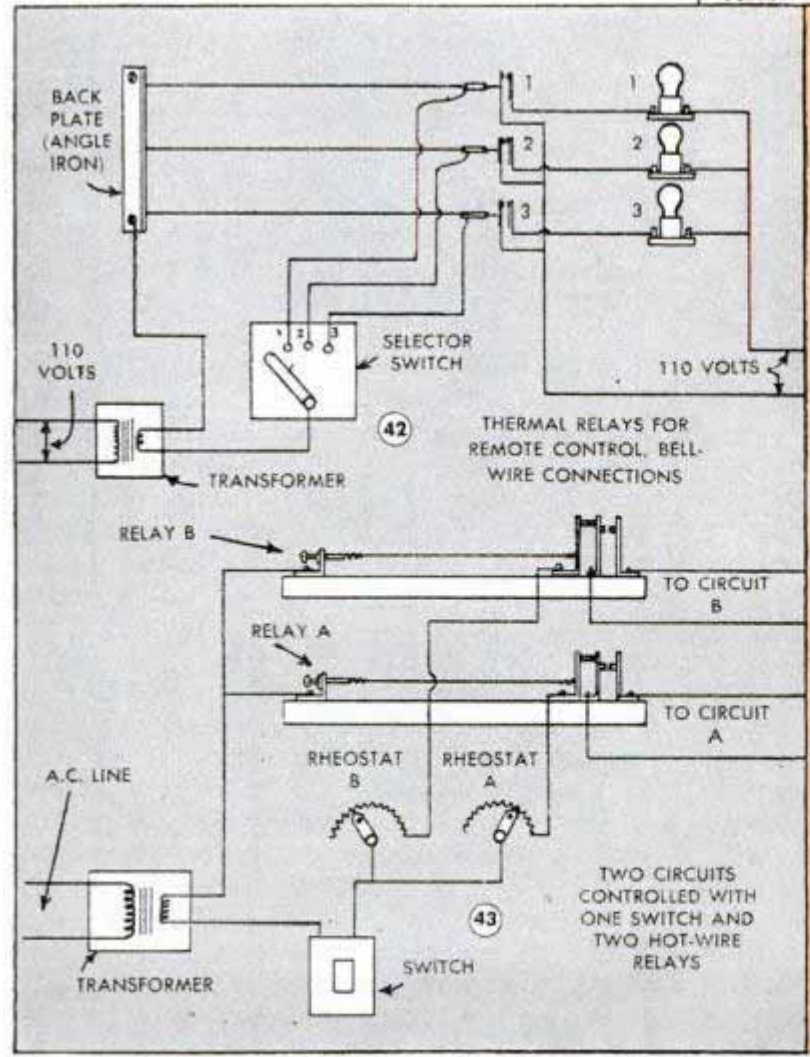
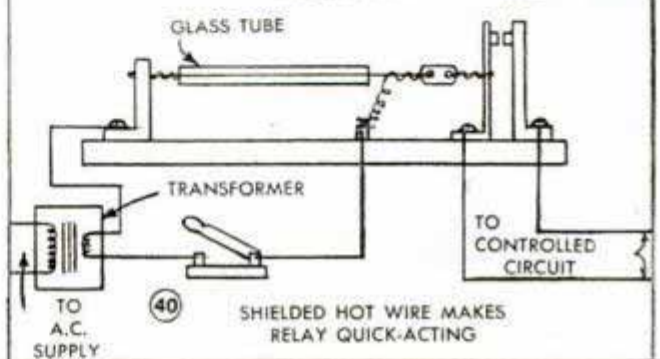

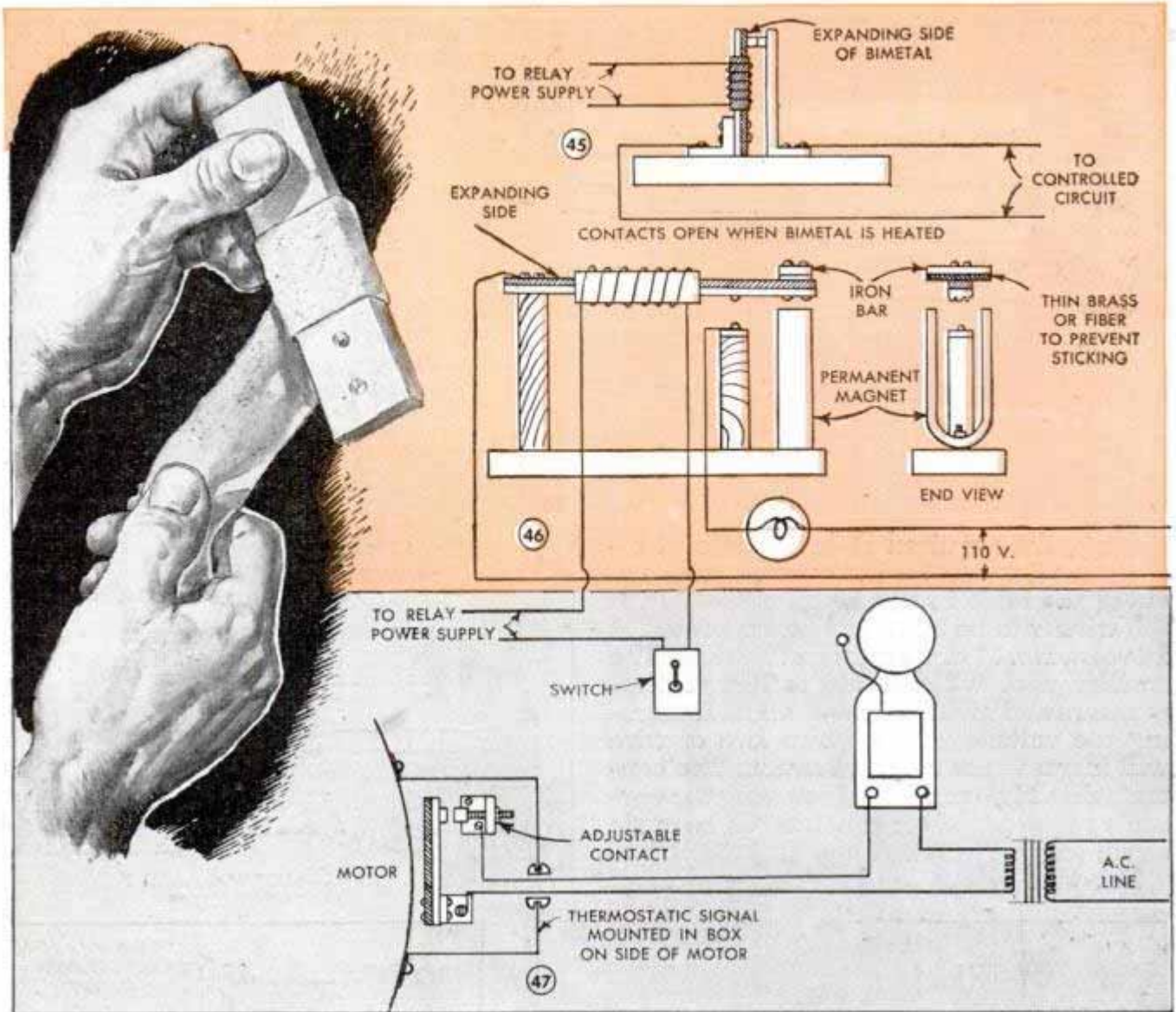

magnetic relays in most cases except on emergency controls where rapid action is essential or where heavy sparking will occur when contact is broken. In Fig. 42 a group of thermal relays is used for remote control of a group of lamps. By setting the selector switch any one of the remote circuits can be controlled and time delay can be made short or long. In Fig. 43 two motors are controlled by one switch, but can be made to go on at any desired time interval after throwing the switch by adjusting the rheostat controls. The delayed action hot-wire relay also can be used to ring a bell if a door is left open for an appreciable period of time, Fig. 33. Normal use of the door will not cause annoying ringing, but warning will be given if the door is left ajar.

Bimetal-type relays, Figs. 44 and 45, consist of a strip of thermostatic bimetals about which a heating element of nichrome wire is wound. A thin layer of asbestos paper is wound around this, as shown in Fig. 44. When the resistance coil is heated, it causes the bimetals to bend and open or close the contacts. To lengthen the time delay, a heavier layer of asbestos is wound around

the bimetals strip. To shorten the time lag, the nichrome wire is wound over a thin layer of asbestos paper, and a layer of asbestos is wound over the coil. In either case, the relay will be slower to open. The time lag of bimetals relays also can be controlled by adjusting the contact gap and by connecting a rheostat in series with the heater coil, as already explained for hot-wire relays.

The design of bimetals relays often requires a little experimentation. Ordinarily, a strip of bimetals 0.030 in. thick, 1/2 in. wide and 4 to 6 in. long will be suitable for the element. The size of nichrome wire required then can be found by referring to the chart, Fig. 39, which also gives the approximate length of wire required. The ends of the nichrome wire must be fastened to the copper-wire leads with machine screws or by brazing. Figs. 44 to 47 inclusive show a number of applications of bimetals relays. In Fig. 47 the bimetals thermostat without winding is secured to the metal frame of an electric motor so that a bell will ring if the motor overheats. Fig. 46 details a snap-action type of bimetals relay.

THE END

7 NEW USES FOR FLEXIBLE COUPLINGS

One of the handiest and most versatile items the home craftsman can have around his shop is a flexible coupling of the type used to drive machinery directly from a motor shaft. When taken apart and finished as shown in Figs. 1 to 4 inclusive, one of these couplings provides two flanges that can be used to mount numerous tools on shafts. The seven methods indicated are but a few of the uses that will suggest themselves to the worker after he becomes accustomed to them



Couplings having a wide flange with room for bolt holes should be used. Remove the leather connector and . . .

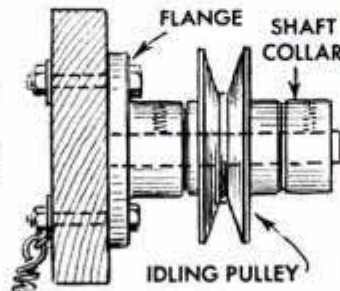
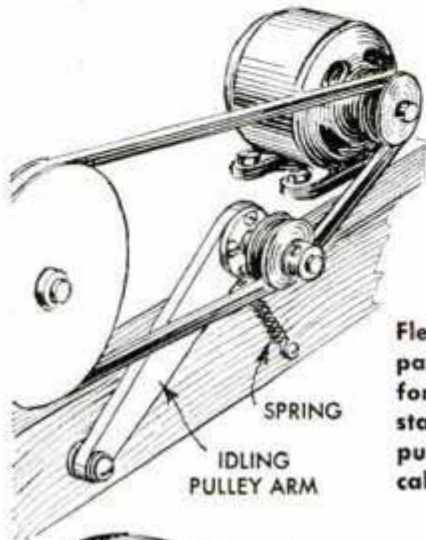

Flexible-coupling flanges are particularly useful as brackets for holding short lengths of stationary shafting. The idling pulley shown above is a typical application of this kind

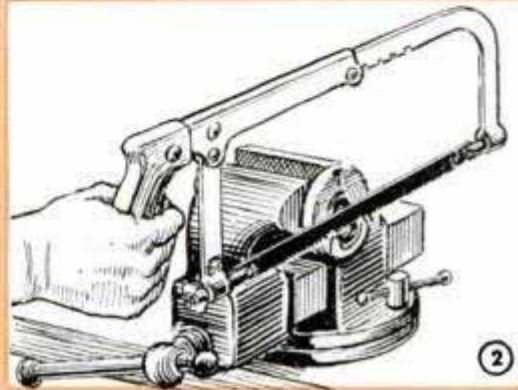

. . . saw off the projecting knobs on each flange. Then file flush with the flange surface to provide a perfectly flat base

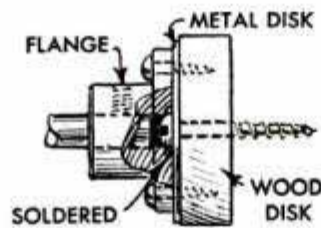
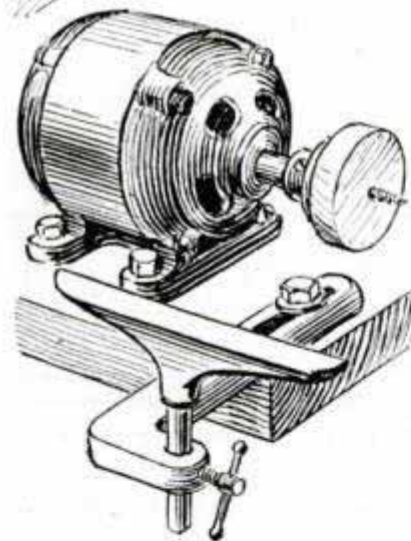

An improvised wood lathe for turning knobs and small parts can be made by soldering a wood screw on a metal disk and mounting it between the flange and a disk of wood as shown above. The assembly is then fastened to a motor shaft

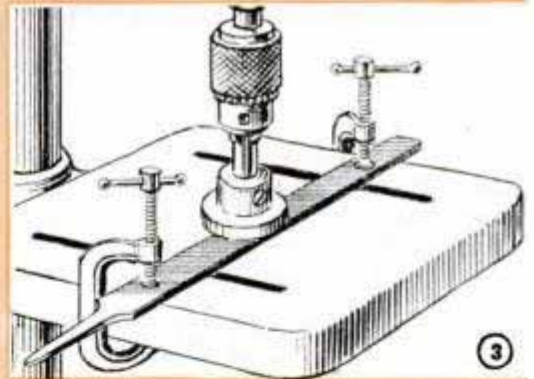

Flanges used to mount rotating tools can be trued up by spinning against a file clamped on the drill-press table

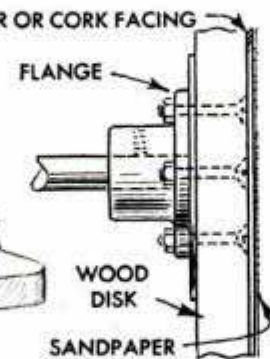
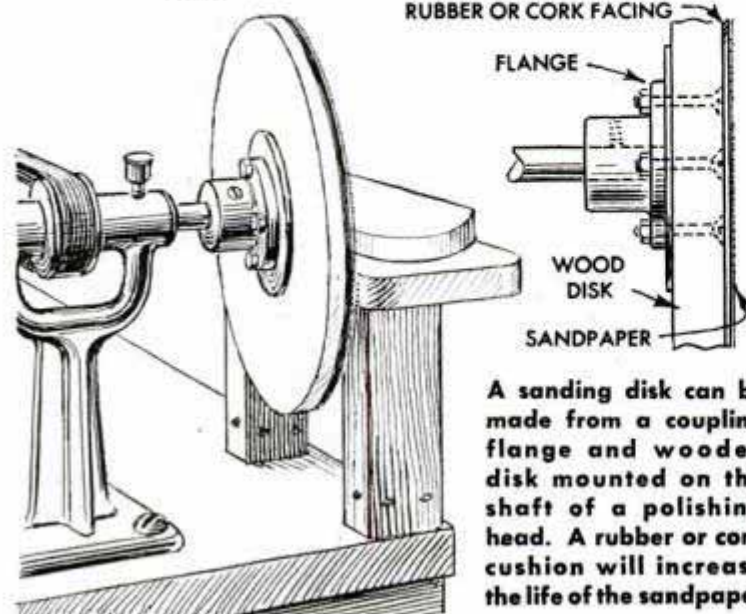

A sanding disk can be made from a coupling flange and wooden disk mounted on the shaft of a polishing head. A rubber or cork cushion will increase the life of the sandpaper

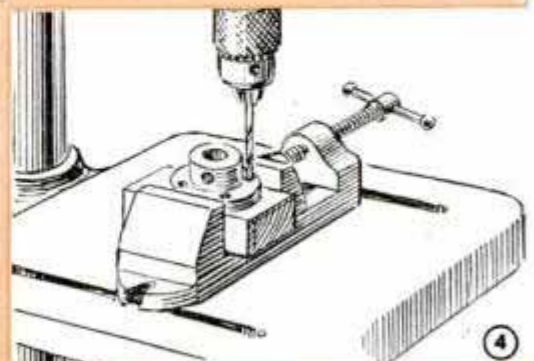

Four bolt holes, spaced to clear the set-screws, are then drilled 90 degrees apart and the flange is ready for use

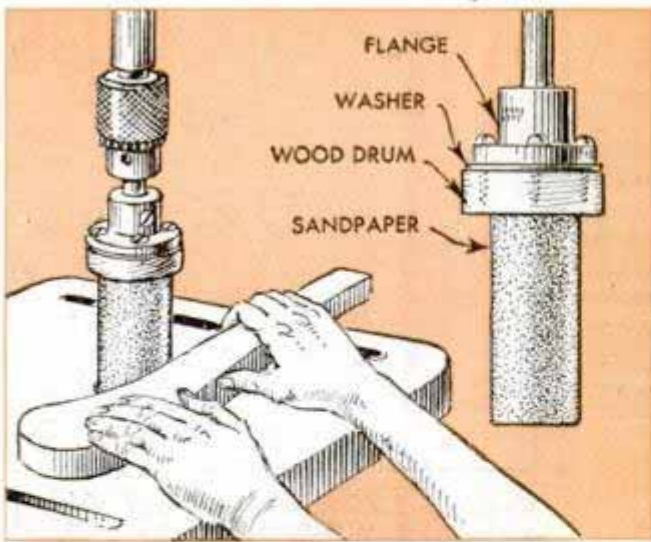

The sanding drum, pictured above, will speed up sanding of curved surfaces. A thick rim should be left at the top of the drum for fastening to the flange

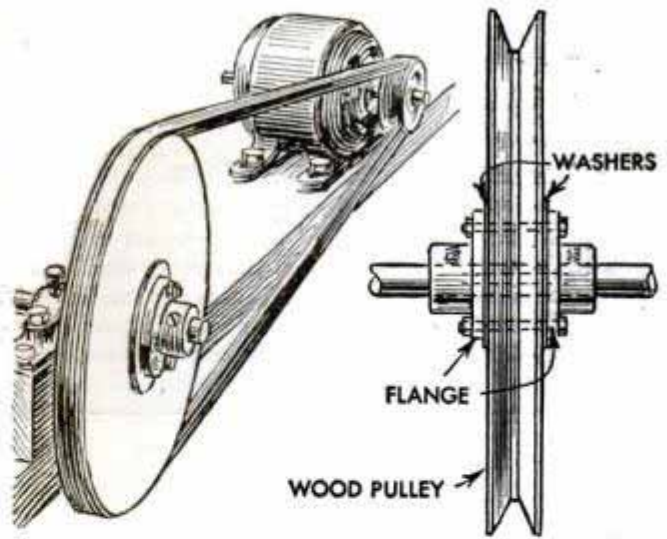

Large slow-speed pulleys turned from wood and bolted between two coupling flanges are especially useful where a reduction of motor speed is desirable

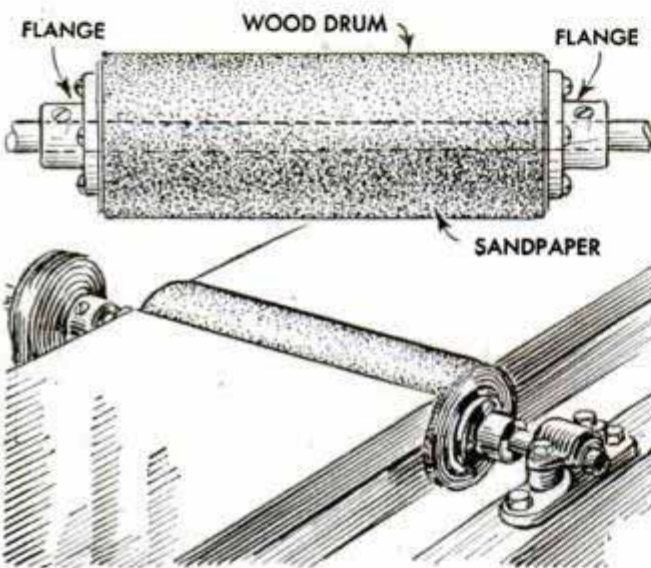

A table sander can be made by mounting a wooden drum, such as a rolling pin, on a shaft between two flanges. The drum can be trued up after assembling. A rear table surface should be flush with the top of the drum and the front table about 1/32 inch lower

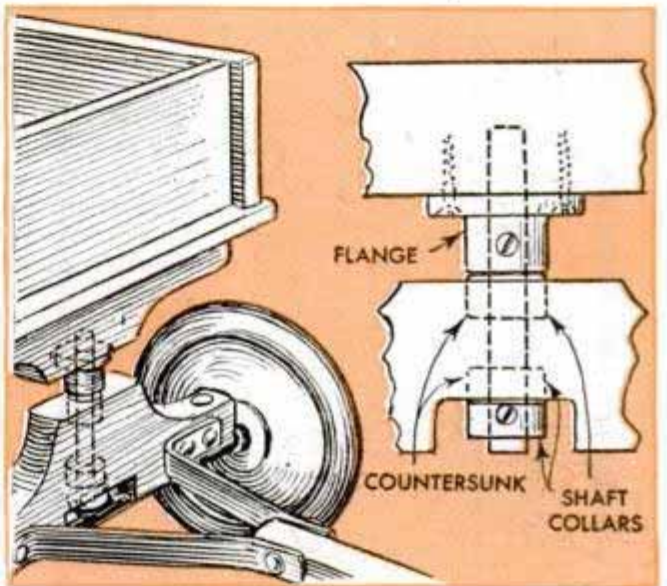

The steering assembly of a child's wagon is another example of using the flange as a bracket. Two collars, with setscrews removed, are countersunk into the crossarm to serve as bearings. A third collar that has the setscrew tightened keeps the assembly together

Rack to Hold Shop Drawings Is Made From Broken Rule

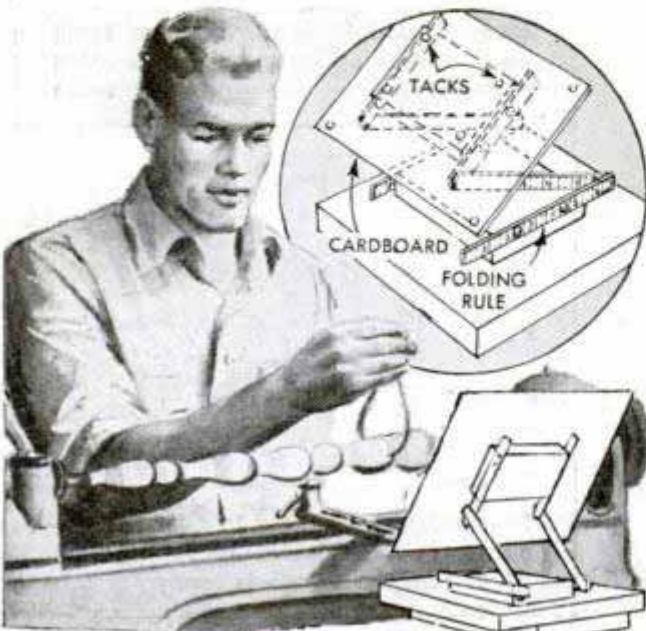

When you have a folding rule that is broken, you can make a holder for shop plans, using two three-section lengths. Dimensions can be varied to suit. The rack is adjustable to any angle and it is especially convenient for holding plans back of the machine but near the work.

Ralph S. Wilkes, Elbridge, N. Y.

Solution Will Remove Brick Stain

If powdered colors such as burnt sienna or Indian red are mixed with muriatic acid, the solution is ideal for washing brick surfaces that have paint stains. The acid dissolves the stain and deposits the color on the brick. The color used should match the original brick as closely as possible.—Richard Verbrugge, Grosse Pointe Park, Mich.

Tunnel Trap Releases Hens From Laying House

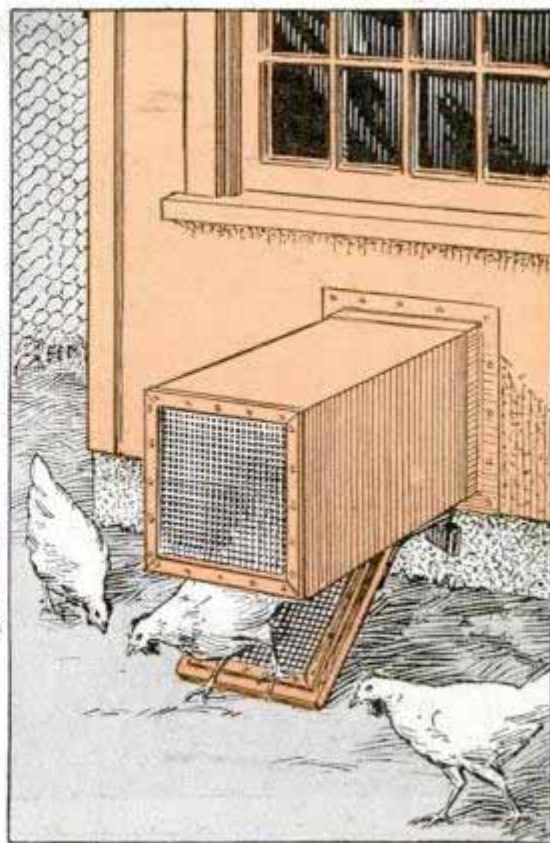
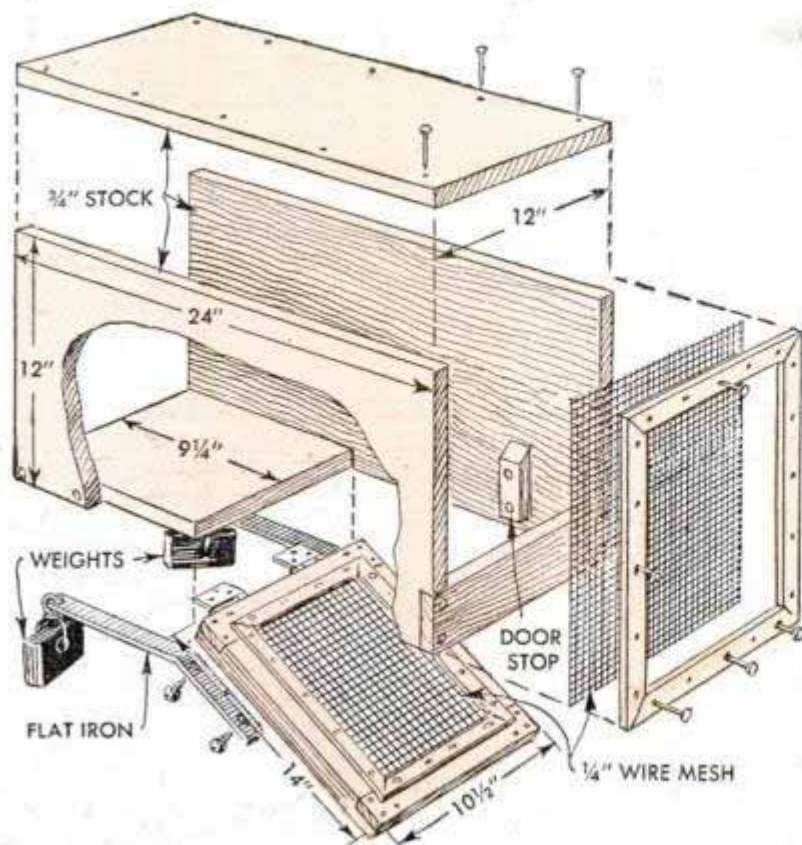

Every poultryman knows the advantages of releasing his flock from the laying house to the yard or range in the early morning at certain seasons of the year. To avoid the expense of a time clock and other devices for opening a door automatically at a given time, one poultryman built a simple trap that operates by gravity, keeps out marauding "varmints" during the night, and allows the chickens to release themselves at will as they come from the roosts. The parts are

cut to the dimensions given from 3/4-in. white pine boards and after assembly the trap is attached to the side of the building slightly above the floor level. The opening in the side of the building should be the same size as the inside dimensions of the trap. The trap is attached to the building with light steel angles and screws and any cracks or openings around the angles are filled with putty or caulking compound to prevent water from leaking in.

Roll Paper Cutter Is Improvised From Light Piano Wire

Needing an additional paper cutter in a hurry, one shipping clerk improvised a cutter in the manner shown. The top of the table was slotted as indicated and two L-shaped metal brackets were screwed to the under side of the table top as in the detail. The length of piano wire is attached to the brackets with a coil spring at each end to provide the necessary tension. To cut the paper you simply grasp the wire at the center, lift it about 6 in. and let go. The down "snap" of the wire severs the paper neatly.

L. Meehan, Toronto, Ont., Can.

Ⓒ A peculiar noise sometimes heard in belt-driven equipment often is attributed to loose or dry bearings. In some cases the noise may be due to a loose setscrew in the driving or driven pulley. Should this noise occur, tighten all setscrews as well as oiling and checking the bearings.

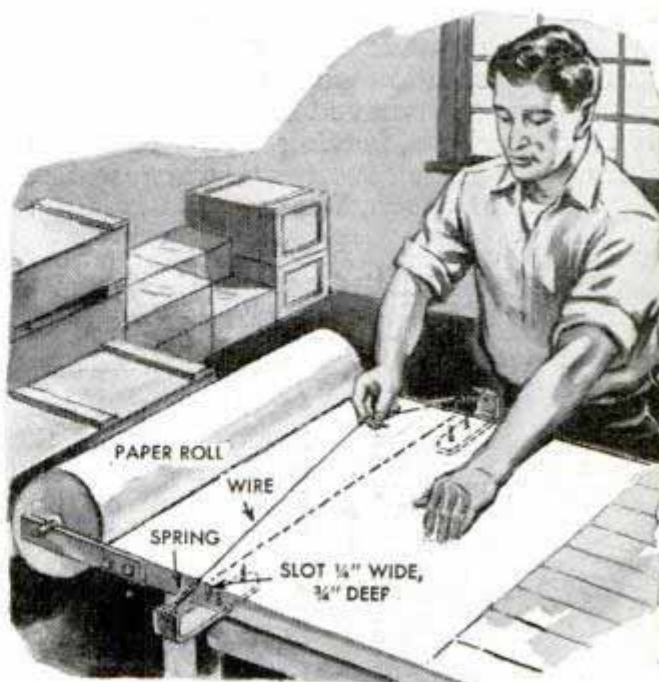

Cement Is Held in Drain-Tile Joint By Wide Rubber Band



When laying drain tile, sometimes the seepage of water is so great that cement at the bell joints is washed away before it hardens. To overcome this, one contractor cuts wide bands from an old inner tube and slips one of them onto each piece of tile. Then after the tile is laid and the joints are filled with cement, the bands are pulled over the bell. The tile may be covered immediately and no damage will result if the rubber is left on the joint.

A. H. Waychoff, Phoenix, Ariz.

Ways of Removing Grease and Oil

Before painting, grease and oil can be removed from machinery by brushing the surface with slaked lime and water and letting the solution stand overnight. Oil and grease are removed from wood by applying whitewash, leaving it on for several hours and washing it off with warm water.

Nathan Bogoch, Winnipeg, Man., Can.

Number of Lines to Be Typed Shown by Indicator



Here is a way of telling at a glance how many lines remain between the bottom of the page and the line being typed. Attach a strip of adhesive tape around the center of the

roller and type a number for each line. Then remove the tape and fasten it near the end of the roller. Start with number one when inserting a sheet of paper and roll the sheet through the machine to determine the number of rotations before the end of the sheet is reached. As an example, it may be determined that the roller rotates twice plus eight lines. Thus, if the roller has already made two complete turns and the indicator is at figure two, this means that six lines remain.

Frank Shore, New York, N. Y.

Tightening Large Hose Clamps

Finding it hard to tighten clamps on hose 2 in. and larger in diameter, one pipe fitter used a compressing tool made from a heavy strap hinge. The rounded ends of the hinge were cut square and the two leaves were bent in an arc to form a circle. This was fitted over the clamp and hose and tightened in a vise. Using this method, there is no danger of bending the clamp out of shape and it is compressed enough so that it can be bolted easily.

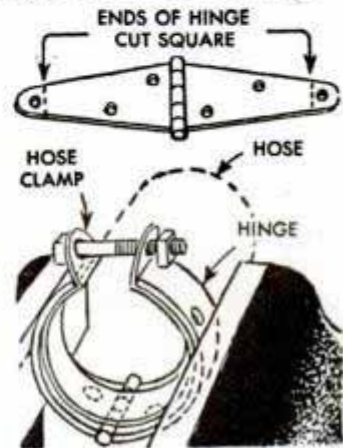

Small Drills and Taps Are Kept In Flat Cigarette Box

A handy box to hold small drills and taps can be made from a flat cigarette box and corrugated cardboard. A square of cardboard is cut to fit the box and a smaller strip is attached to the lid. The corrugations should match so that when the box is closed each drill or tap will be in a channel formed by the facing corrugations. Drill and tap sizes can be lettered on the inside of the lid at the proper grooves.

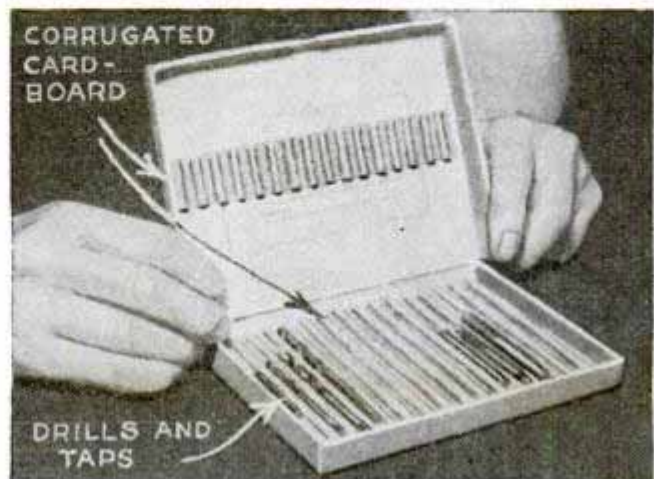

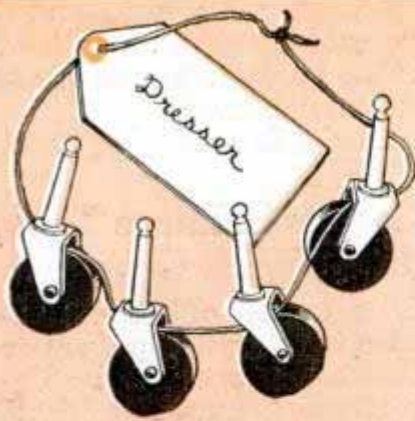

Loose casters may drop out and be lost in transit. Remove each set, tie the casters together and label with a tag



Covers on baking-powder tins, bottle caps, etc., can be secured with strips of adhesive tape to prevent spilling

HELPFUL HINTS for MOVING DAY

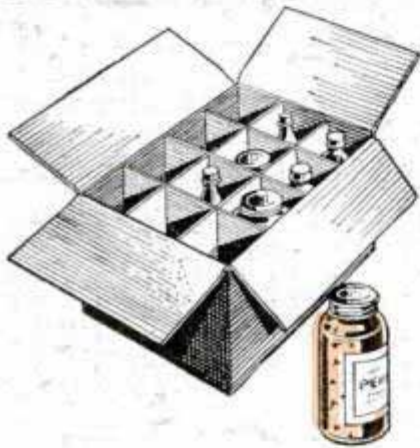

Bottled inks, preserves and medicines may be protected against breakage by packing in a partitioned paper carton



You can avoid a lot of stair climbing by lowering or hoisting boxes, small furniture and similar items with a rope

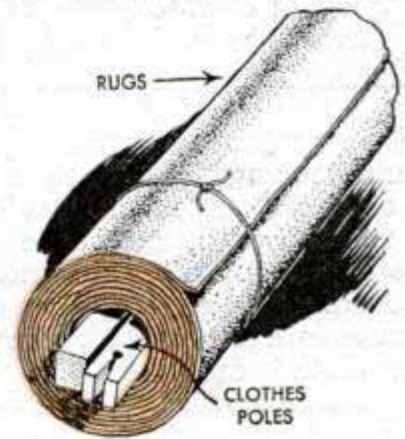

A clothes pole or section of a quilting frame in each rug aids in keeping the roll straight when you pick it up

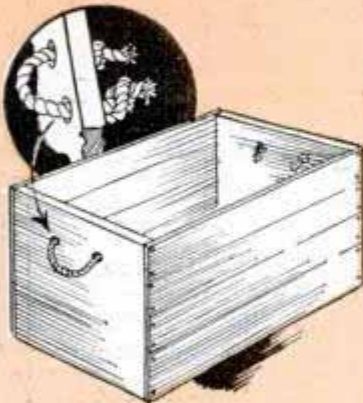

Wooden boxes packed with tools or books need a handle at each end. Drill holes at the ends and tie in rope handles



Pack records and magazines together. Insert the records between the magazine pages and tie the bundle securely

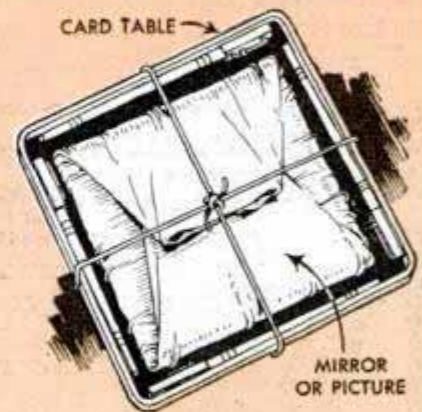

Wrap a mirror or picture with padding and tie it to the underside of a card-table top so that it cannot fall out

Cheesecloth Will Protect Fixtures From Chewing Gum

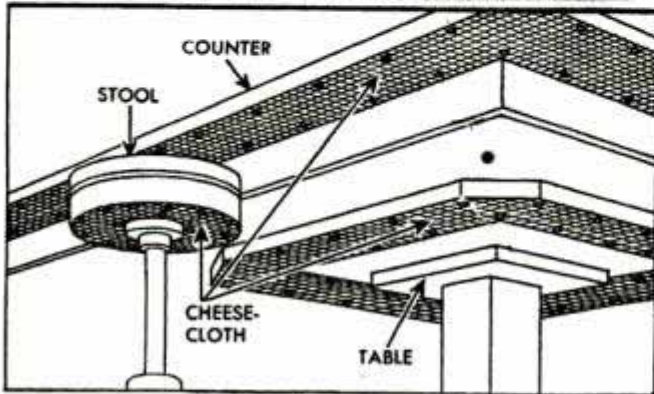

One restaurant owner found that by thumbtacking cheesecloth to the underside of counters, tables and stools, he was able to remove easily gum stuck there by the customers. A double thickness of the cloth is used. When cleanup time comes the old cheesecloth is removed, thrown away, and new cloth is tacked on.

Peter B. Horsley, Brandon, Man., Can.

Roofing Paper for Storage Bins

If grain storage bins are needed in a hurry, temporary ones can be made of No. 12 wire fencing and asphalt roofing. The fencing is wired in the shape of a circle and is lined with asbestos-surface asphalt roofing. For the top the same paper is used, but the flooring is ordinary asphalt roofing.

Harold Melville Peer, Des Moines, Iowa.

Fitting Prevents Loss of Grease Out of High Pressure Hose

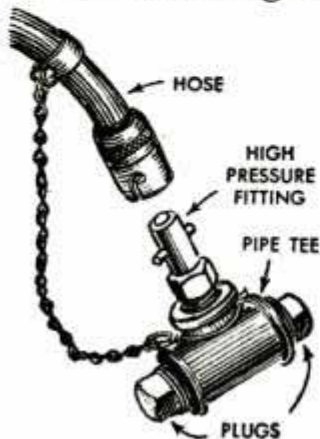

When the hose is removed from a high pressure fitting, grease sometimes leaks out of the hose and makes a puddle where the work is being done. This can be prevented by using an assembly similar to the one shown. It con-

sists of a $\frac{1}{8}$ -in. tee, two $\frac{1}{8}$ -in. plugs and a straight high pressure fitting. A length of chain fastened to the hose will prevent mislaying the plug when not in use.

Charles H. Hardy, Los Angeles, Calif.

Number of Barrels in Large Tank Is Calculated With Chart

Calculation of the number of barrels contained in a circular tank, standpipe, vat or other large cylindrical shape can be determined easily if the height and inside diameter are known. In the preparation of this chart a 50-gal. barrel was taken as the standard. To use the chart, locate the height of the tank on column A and the diameter on column C. Connect the two points. Where the connecting line crosses column B a third point is found which shows the number of barrels in the tank. As the example shows, a tank 40 ft. high and 50 ft. in diameter would contain approximately 12,000 barrels. To determine the number of barrels when a 50-gal. barrel is not the standard, find the number of gallons in the tank by multiplying the estimated number of 50-gal. barrels by 50 and divide this by the number of gallons in a barrel of different capacity.

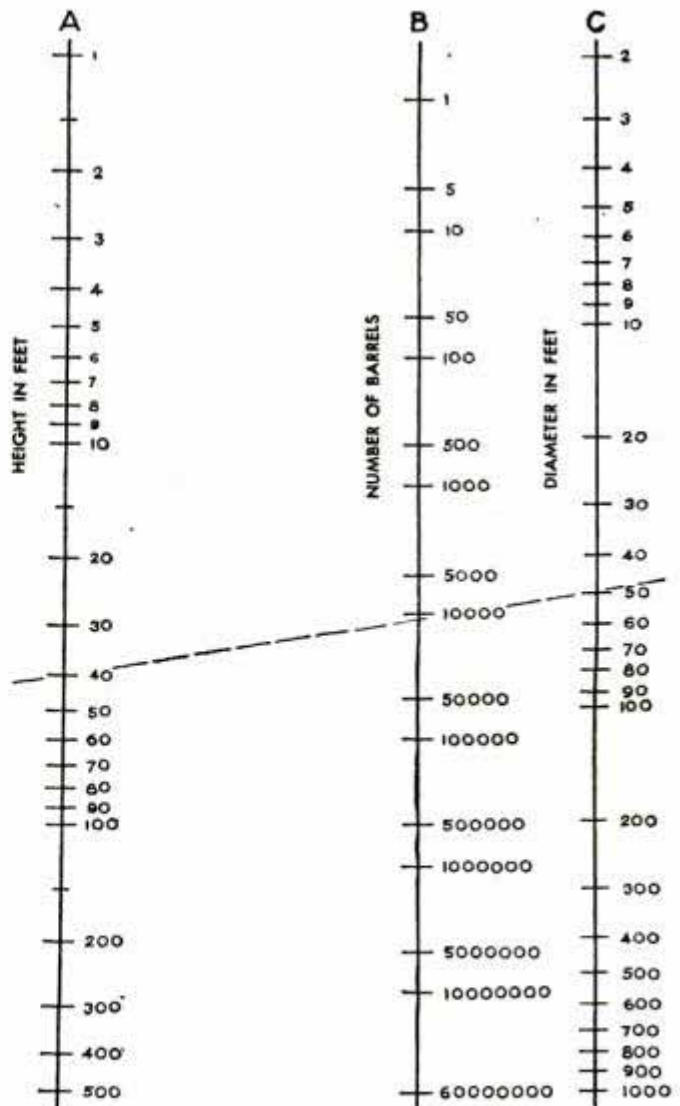



Flat Screen Picture Tube

THERE are no rounded corners on the end of this cathode-ray television receiving tube to reduce the useful area of the screen. The face of the tube presents a perfectly flat surface upon which the fluorescent screen is deposited, therefore an undistorted picture is presented to the viewer when looking at it from any angle, as illustrated in photo A.

Conventional tubes, unless viewed from a position directly in front of the tube, show edge distortion because the image details are curved away from the viewer. The engineers of the Philco Corporation have solved this problem with the tube shown in photo B. Additional improvements eliminate a troublesome yellowish brown stain that often occurs in the center of the picture screen after a few hours' operation. This stain is caused by heavy negative ion impact upon the screen which cannot be focused and deflected by the usual magnetic deflection coils. Passing down the center of the tube, they concentrate on one central spot and destroy the fluorescent properties of the screen in that area. Diagram Fig. 1 shows how a "bent" electron gun permits a special bending coil to be adjusted so that the useful electron beam issuing from the cathode is bent to follow the axis of the gun. The unwanted ions thus are trapped and removed from the electron beam.

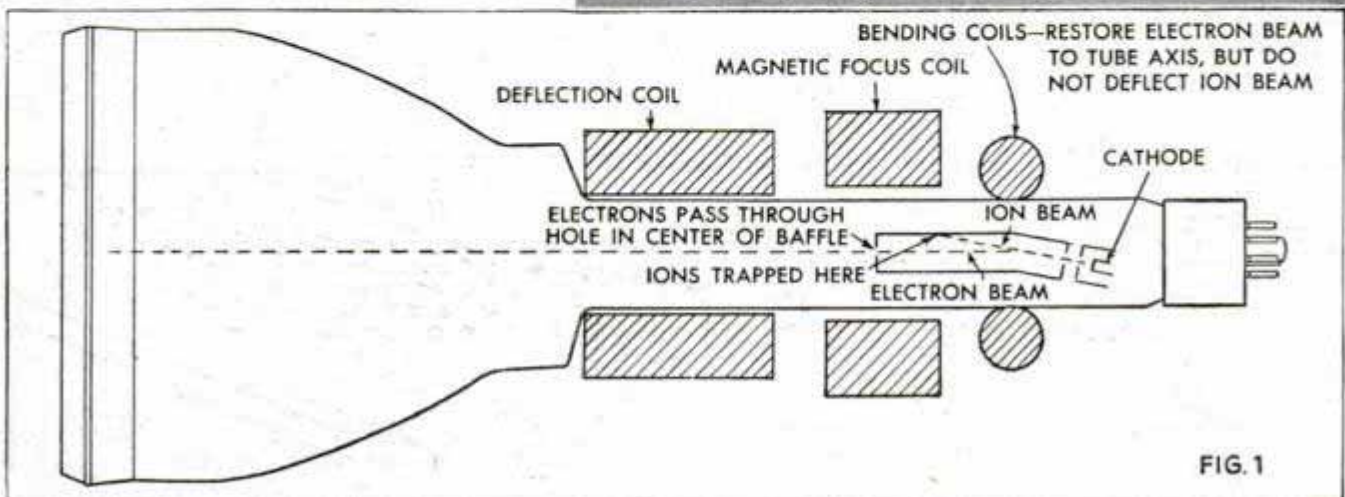
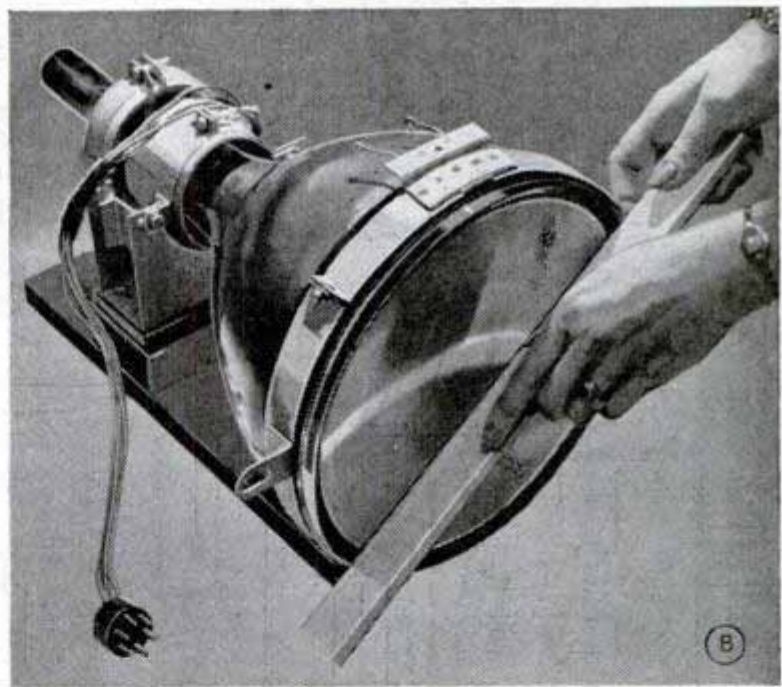
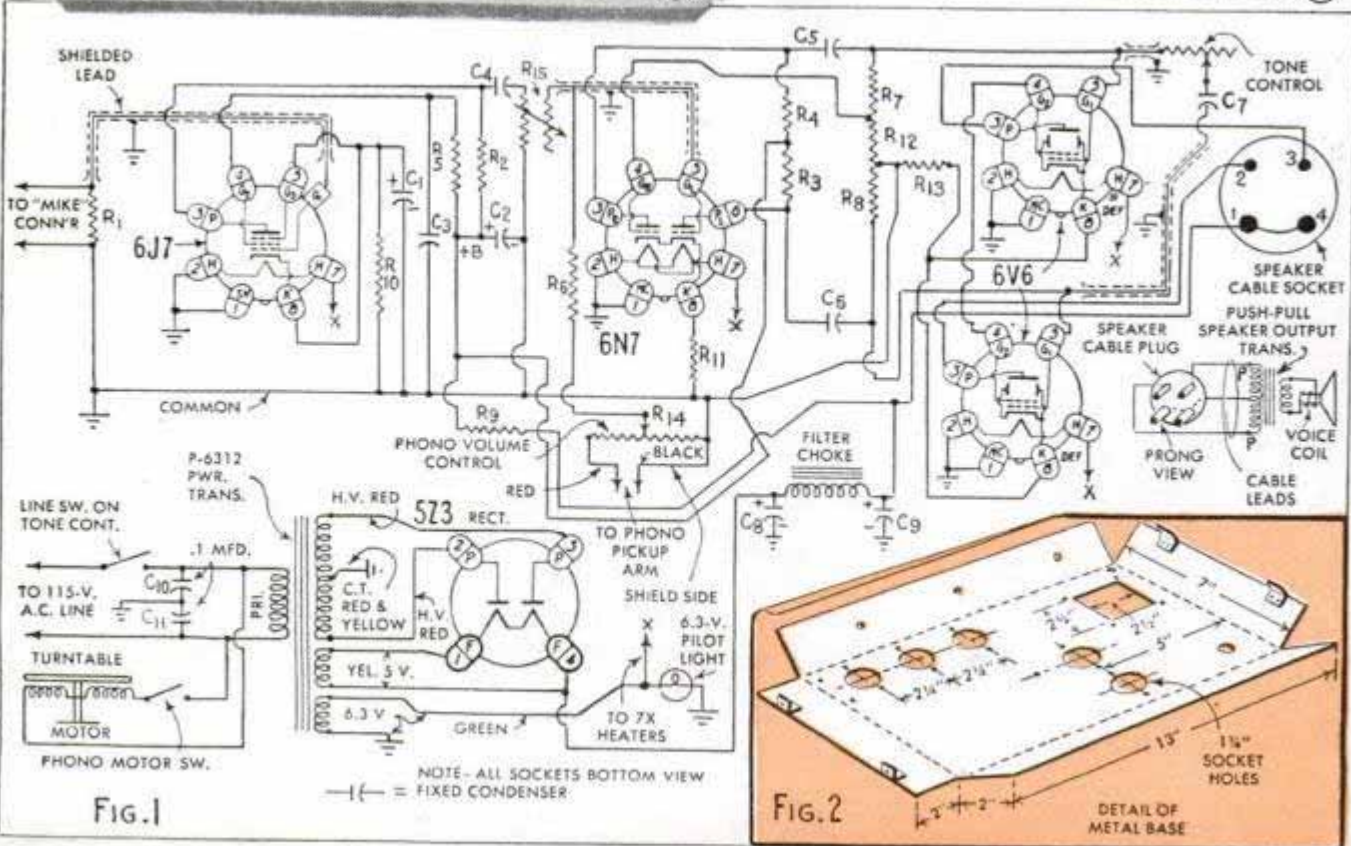
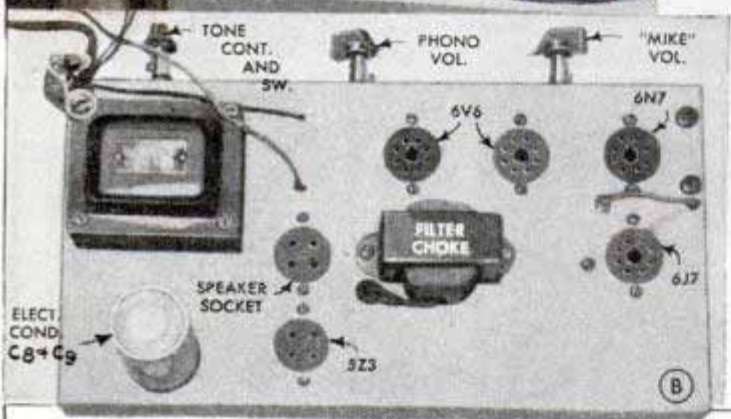

FIG. 1

UTILITY P.A. AMPLIFIER SYSTEM

By A. I. Rattray

THIS compact unit is a self-contained amplifier with speaker and record player combined within a standard metal case which also acts as the speaker baffle. The utility of such a piece of electronic equipment is immediately apparent as it is unnecessary to run speaker cables or connect a separate record player. All you have to do is plug into a 115-volt outlet and you are ready to operate. A microphone channel is provided and separate controls adjust the volume of "mike" and phono channels individually; a tone control is also included.



IS SELF-CONTAINED

Push-pull 6V6 beam power output tubes provide excellent quality and sufficient volume for dancing parties or audiences up to 500 without distortion. The amplifier chassis, phono motor and pickup are "float" mounted on soft rubber bushings.

Photos A and C show front and back views of the completed unit and it will be noted that a heavy duty 10-in. PM speaker is employed. A top view of the amplifier chassis appears in photo B and the schematic circuit diagram is given in Fig. 1. Fig. 3 shows the "mike" connector assembly which is mounted on the front panel. The metal cabinet is 16 by 16 in. and 8 in. deep; any a.c. phono motor and 9-in. turntable may be used. Wiring details and specifications are shown in the pictorial diagram, Fig. 4.

This highly efficient unit also may be used with a pickup microphone for amplifying stringed instruments. Detailed student material list R-344 is available from Popular Mechanics radio and electronics department upon receipt of ordinary letter postage.

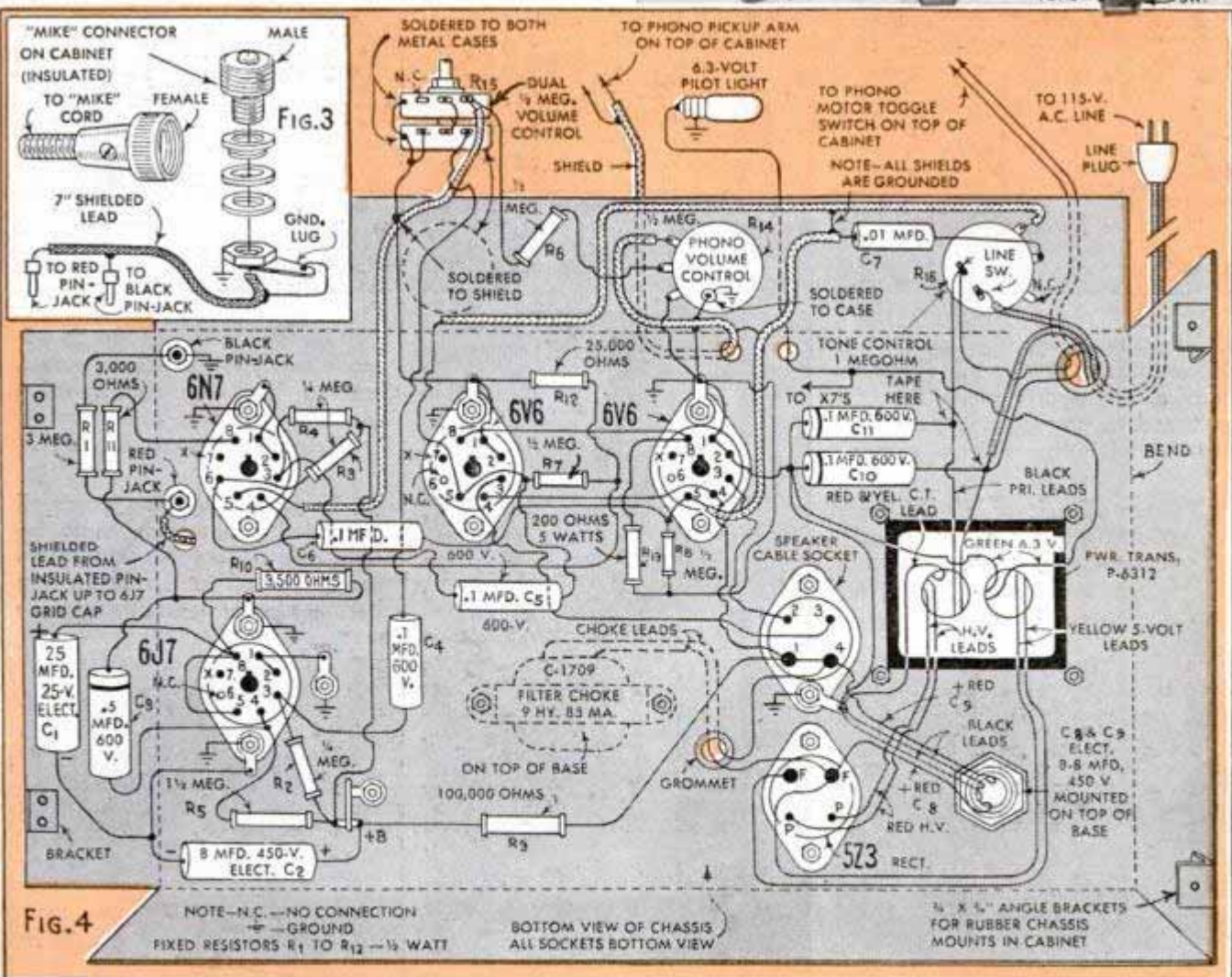

Helpful AUTO RADIO SERVICE HINTS



(A) Loose or corroded rod antenna connections in mounting insulators may cause weak reception. A simple test for this condition is to substitute a temporary antenna; a short length of No. 12 rubber-covered wire is taped along the side of the car and clipped directly to the set antenna terminal

(B) When opening the set for repairs, mark the case covers before removing, as usually only one correct position will prevent shorting of terminals

(C) After making repairs, such as soldering loose connections or replacing defective parts, shake out all loose particles of solder by jarring the set gently on the workbench as illustrated

(D) Intermittent reception often is caused by the shorting of tube grids to cover plate or speaker housing if attached to lid. Adhesive tape over tube-shield tops will solve this problem

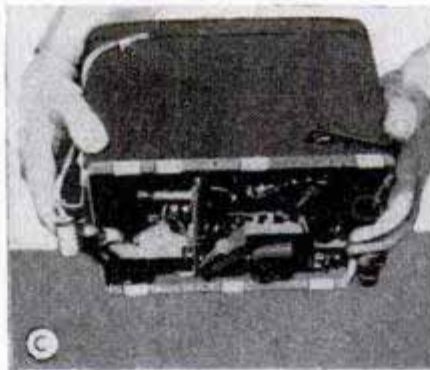
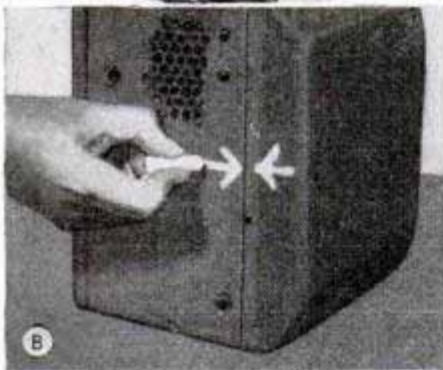

(E) When replacing fixed condensers or other parts having flexible leads, all exposed terminals should be taped to prevent any possible contact with the bottom cover

(F) Tighten all screws in shielding compartments after working on any auto radio as vibration loosens such screws and is a cause of troublesome humming noises

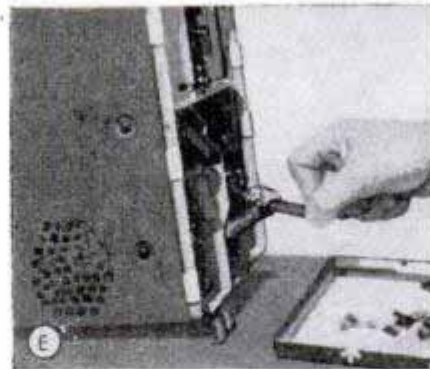

(G) Emery cloth is used to remove rust spots on cover plates, as the inside edges of these plates must make good contact with the case to avoid noise

(H) To prevent ignition noises all grounded connections must be good. Shielded cable with metal braid bonded to the case often becomes loose; clean and resolder

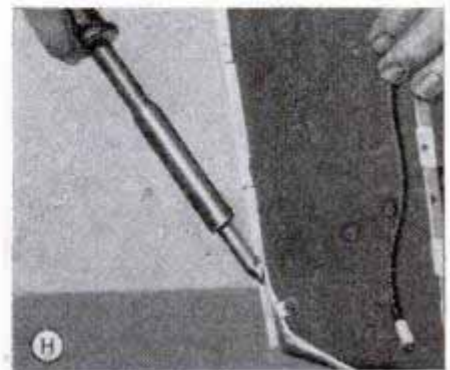
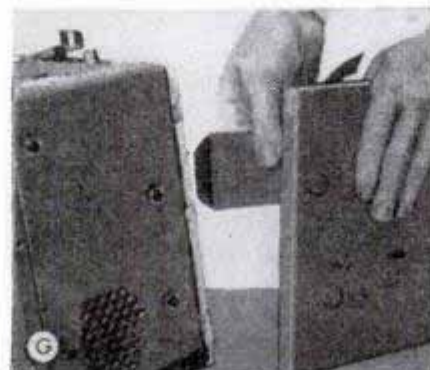
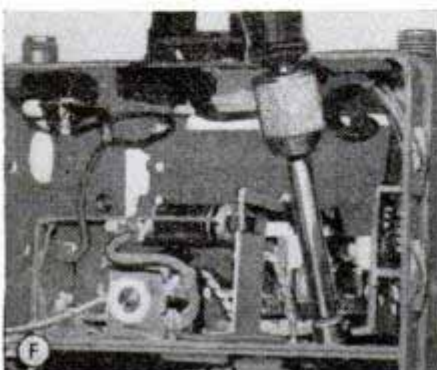

First step to a finer picture . . . the right Kodak Film

This summer you'll again have a wide choice — for example . . .



KODAK VERICHROME (rolls, packs)—America's favorite snapshot film by a wide margin.



KODAK PLUS-X (rolls, packs)—all-round "pan" film; combines high speed, fine grain.



KODAK PANATOMIC-X (sheets, miniature rolls)—extremely fine grain, for big enlargements.



KODAK SUPER-XX (rolls, packs)—favorite high-speed film for both outdoors and indoors.



KODAK TRI-X PANCHROMATIC (sheets)—very fast; excellent when exposures must be short.



KODAK SUPER PANCHRO-PRESS, SPORTS TYPE (sheets)—Kodak's fastest—for tough sports shots.

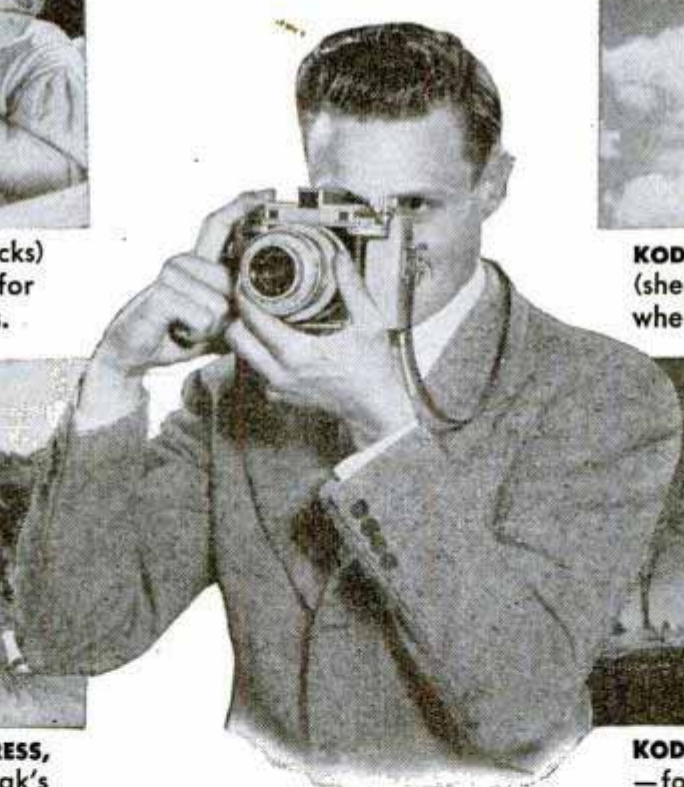

KODAK INFRARED (rolls, sheets)—for dramatic effects; cuts through haze.

At your Kodak dealer's . . . Eastman
Kodak Company, Rochester 4, N.Y.

Kodak

Got Two Man Limit in 3 Hours

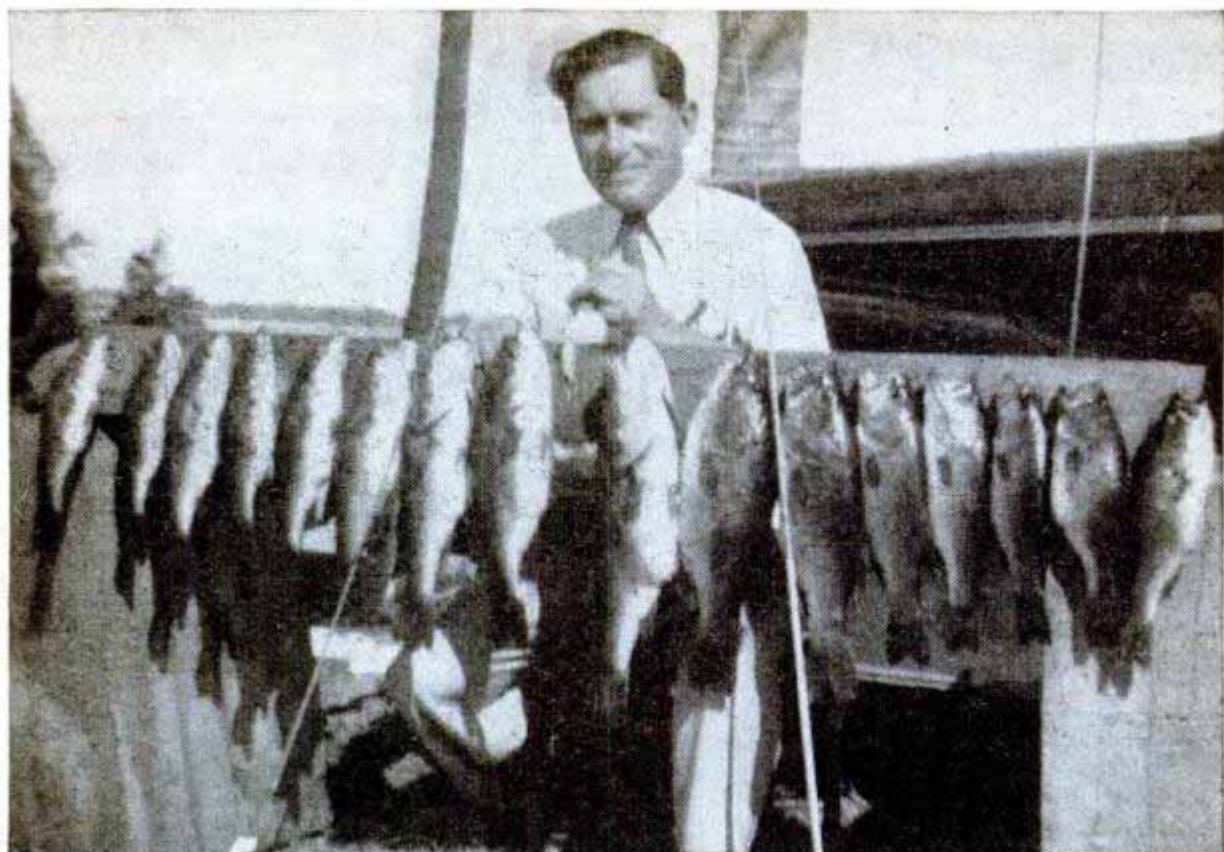

Lake Okeechobee catch made by Dr. Field and friend on Hawaiian Wigglers

With No. 2 HAWAIIAN WIGGLER

Dr. J. J. Field, dentist of Washington, D. C., writes that he and Leroy Howard, Ft. Lauderdale, Florida, caught these bass with No.

2 Hawaiian Wigglers at South Shores, Lake Okeechobee. They got their limit of eight per person in three hours.

Shallow Running

No. 2 Hawaiian Wiggler \$1.10

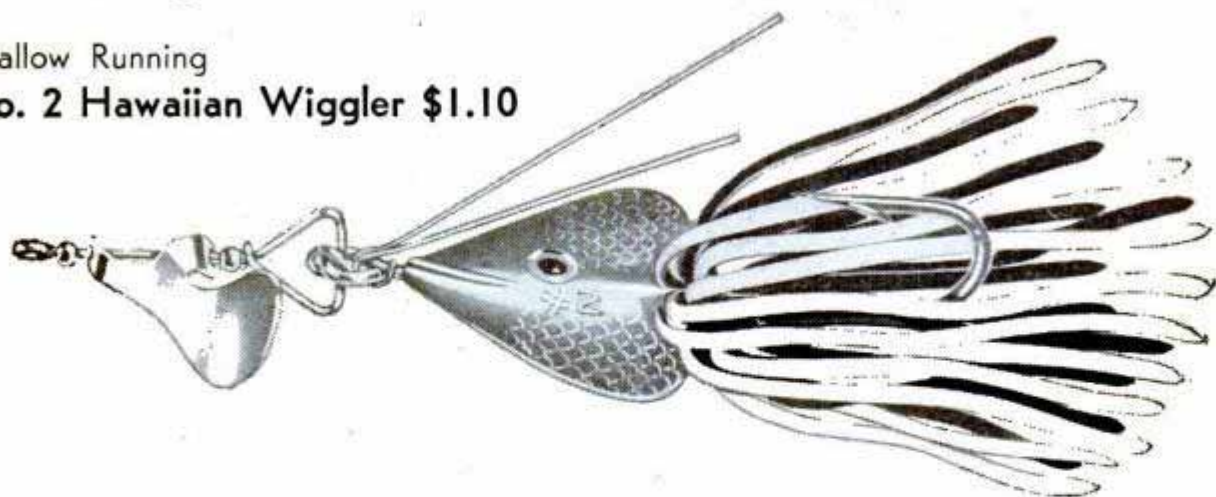

Write for Free Catalog

It has all the latest information on where and how to use Hawaiian Wigglers, Jitterbug,

my famous surface bait, and also my new Hula Dancer just announced.

FRED ARBOGAST & CO., 1605 North St., Akron 3, Ohio

How to CHANGE A TIRE AT NIGHT...

More Quickly—More Safely!



1 Most any motorist can change a tire. But few can change it at night with top speed, efficiency—and *safety!* Night-time tire-changing can be hazardous—but a little care and an "Eveready" flashlight can reduce the danger. First principle, says the American Automobile Association, is...



2 Park *off* the highway, if at all possible. Next best place is on a *straight* stretch of road where you can be seen for at least 500 feet. If you *must* park on a curve, a light should be set on the road some distance back. Be sure neither you nor a by-stander blocks off the view of your tail-light!

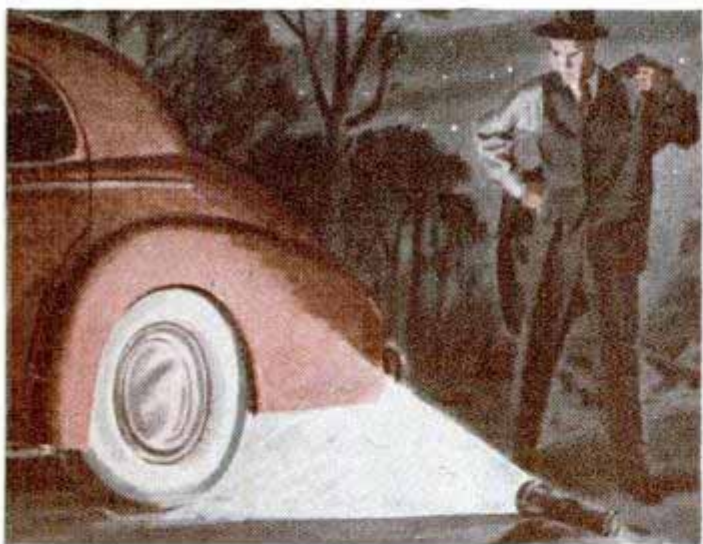

3 Keep all your tire-changing tools tied or boxed *together*, where you can pick them up without searching or fumbling. Remove your spare before jacking up car—tugging at it later might push car off jack. If alone, set flashlight on a stone in convenient position.

For

**EXTRA POWER,
EXTRA LIFE
—AT NO
EXTRA COST**

FOR BEST RESULTS PUT IN SERVICE BEFORE OCT. 1946

NO 950

EVEREADY

EXTRA LONG LIFE BATTERY

NATIONAL CARBON COMPANY PRODUCT

4 In your car or at home—wherever you need a flashlight—rely only on "Eveready" batteries. For "Eveready" batteries have no equals... that's why you'll find them in *more* flashlights than any other battery in the world! Now that they're available again, there's no need to accept a substitute!

NATIONAL CARBON COMPANY, INC.
30 East 42nd Street, New York 17, N. Y.
Unit of Union Carbide and Carbon Corporation



EVEREADY
TRADE-MARK

The registered trademark "Eveready" distinguishes products of National Carbon Company, Inc.

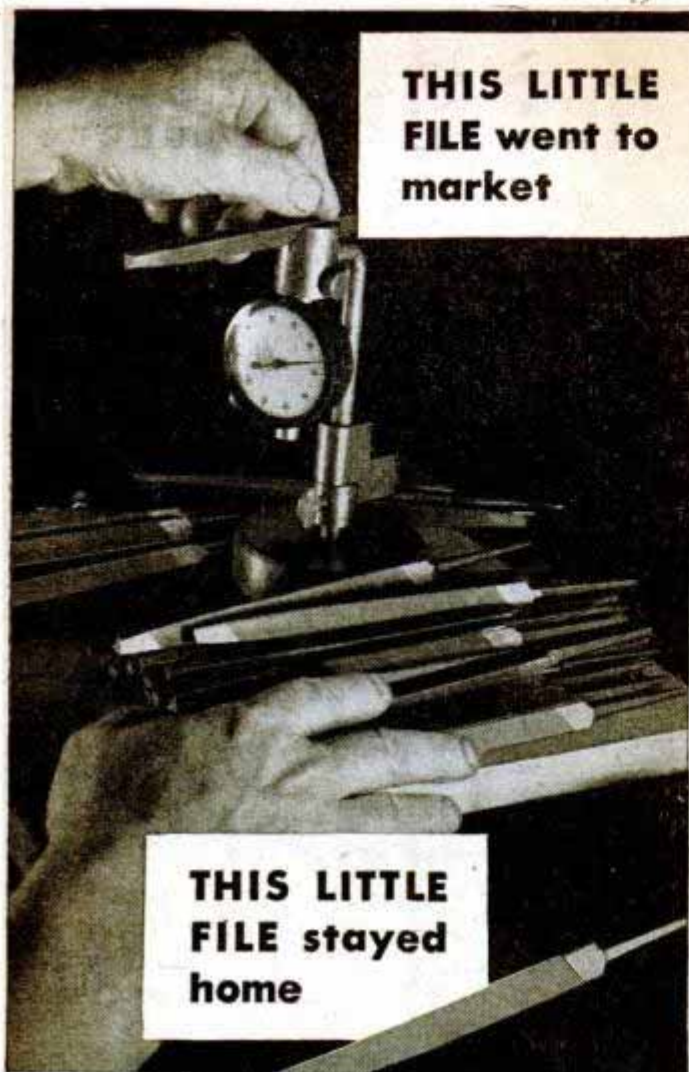

**THIS LITTLE
FILE went to
market**

**THIS LITTLE
FILE stayed
home**

THE little files that "go to market" under the world-famous Nicholson and Black Diamond trade-marks are only those which can uphold the long-standing Nicholson guarantee of *Twelve perfect files in every dozen.*

Those which "stay home"—the rejects—are the few which fail to pass the score or more of meticulous tests and inspections that guard the various manufacturing stages.

The testing operation illustrated above is one of many. Here, triangular files are being checked, one by one, with a dial gauge to see that edges are uniformly correct in width.

The mechanic who asks the boss for Nicholson or Black Diamond brands shows that he knows files—and, most likely, that he is a worker of high talents.

FOR REPAIR SHOP, HOBBY SHOP, HOME OR FARM, get Nicholson or Black Diamond files from your hardware dealer. For information on kinds, use and care of files send for free book, "FILE FILOSOPHY"—48 interesting illustrated pages.

NICHOLSON
U.S.A. **NICHOLSON FILE CO.**
22 Acorn St., Providence 1, R. I.
(In Canada, Port Hope, Ont.)

**NICHOLSON
FILES** FOR EVERY PURPOSE

How Deep Is the Ocean?

(Continued from page 127)

when, at the last moment, the Hornet's orders were changed and instead of striking Okinawa the task force sortied for an attack on Formosa. Later the Hornet did hit Okinawa but by that time the pilots trained for the Sonne work had been switched to other assignments for tactical reasons. Still undaunted, Kistler took two green pilots, gave them hurried instructions and sent them off, hoping for the best.

Under these circumstances it is not surprising that the mission was unsuccessful. The first pilot flew a perfect course but was just above his altitude limit. The second pilot failed to open the camera doors in front of the lenses.

Last chance to get the coverage came on March 1 when the Hornet again hit Okinawa. Kistler had stuck with it. He now had his original pilots back with him and his hopes brightened.

The day of the strike broke bright and clear. The Hornet turned into the wind and launched a flight of Hellcats, among them Davidson and his Sonne equipment. Then followed the period of waiting for the planes to return to the ship, with nerves on edge and minutes dragging into hours.

Some of the group had landed when Kistler spotted the photo plane coming up the groove. The landing signal officer was giving Davidson the "come on," trying to get him into position. At the last moment, the plane was waved off.

Just as Davidson made his turn for the second approach, the engine coughed and sputtered. He inadvertently switched to a reserve gas tank which was already empty. The engine cut out and the plane headed for the drink with its equipment and film and undoubtedly the whole future of Sonne photography.

Davidson switched to another tank, this

(Continued to page 232)

**Model Builders
Attention!**

	V	V-2	V-3
Hex	1/2"	3/8"	5/16"
Thread	3/8"-24	1/4"-32	1/4"-32
Thread Length	7/32	7/32	5/32
Weight, Grams	8	3 1/2	2 1/2

Actual Size V-Plug

Champion spark plugs for model gas engines give the same dependable performance as regular Champions. Silliment sealed. Sillimanite insulator. Alloy needlepoint electrodes for easy starting. One piece construction.

CHAMPION

SPARK PLUG COMPANY • TOLEDO 1, OHIO

Why Bus Lines specify Champion Spark Plugs

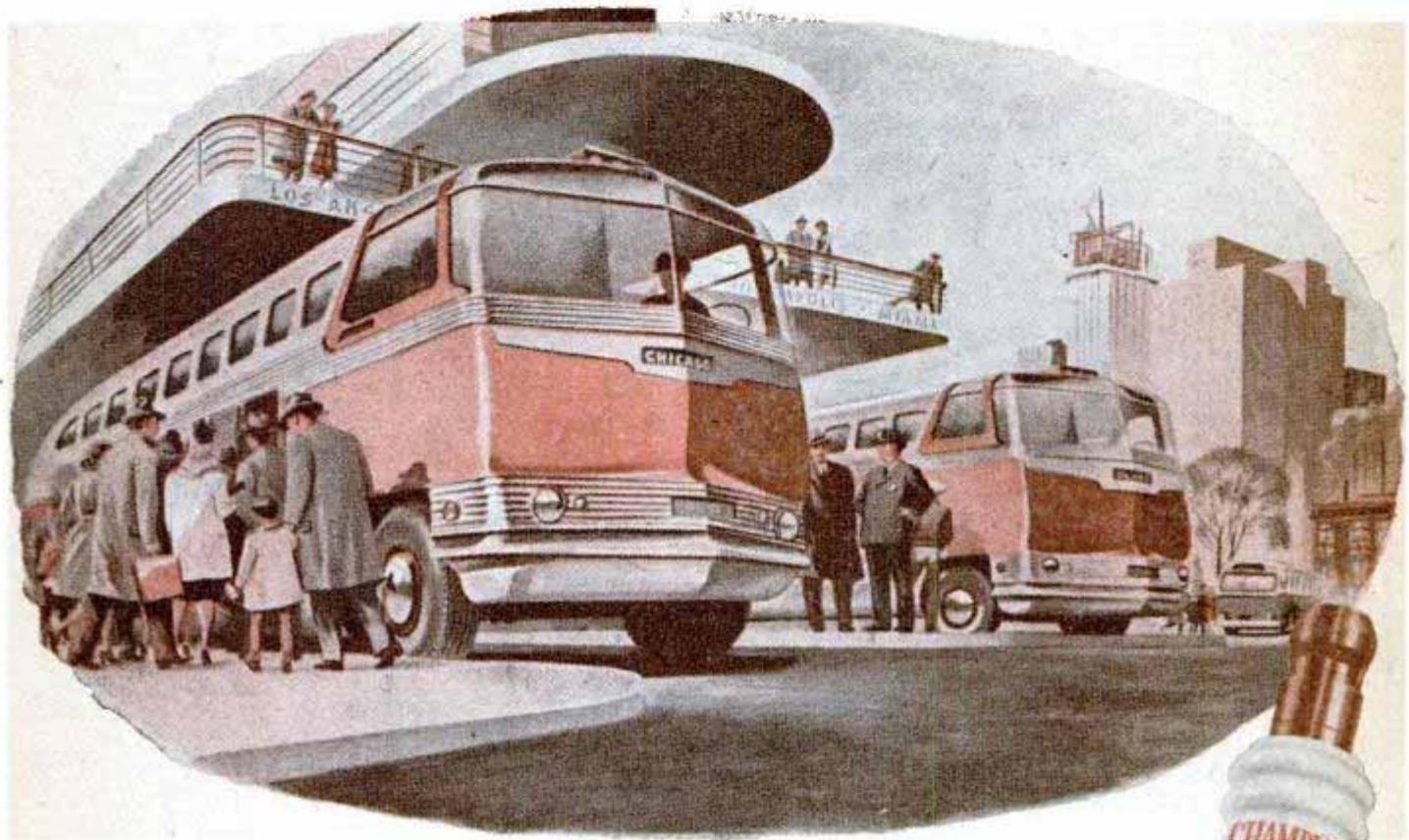

THEY'RE DEPENDABLE!

The bus lines of America are indispensable to our transportation system. They are experts on maintenance of equipment because efficiency and economy are absolute essentials to success in their business—no factor is too small to escape detailed study. That is why most bus lines with the best maintenance records specify dependable Champion Spark Plugs. This is another example of preference for Champions by experts—substantial evidence that they're better for your car. Champion Spark Plug Company, Toledo 1, Ohio.



FOLLOW THE EXPERTS . . . DEMAND DEPENDABLE CHAMPIONS

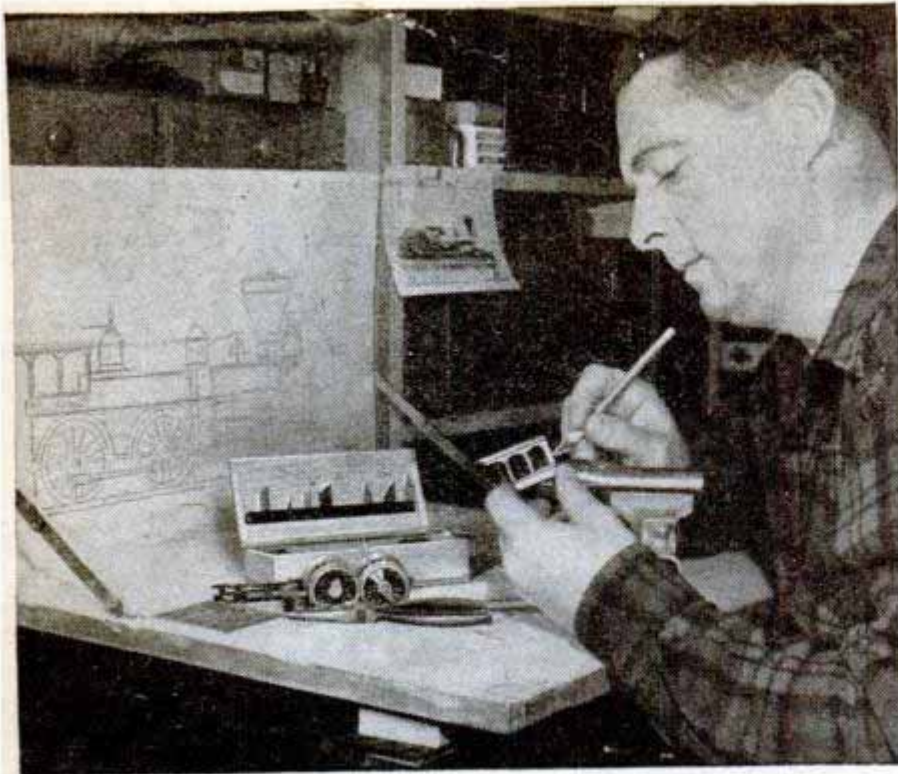

BURBANK DOES IT!...SO CAN YOU!

How Expert Model Builder Gets Topnotch Results

James W. Burbank, of Narrowsburg, N. Y., builds scale models of famous old locomotives. He's a perfectionist. When he finishes a model, it looks real enough to chug off under its own steam.

Here you see him finishing the in-laid walnut cab for his model of the Erie's old George C. Bernard, speed demon of the 1870's. You see, too, three good reasons why he turns out such beautiful work, i.e., the picture of the original engine; his own accurate scale design; and his *indispensable* X-acto Knife Set.

"X-acto Knives are tops," says hobby crafter Burbank. "They're so versatile. I can find a blade-handle combination for the toughest or most delicate jobs . . . And those little pin vises . . . their heads fit my hands

perfectly. I recommend X-acto to every model builder!"

Be Expert At Your Hobby!

X-acto adds skill to your wrist. Smooth-cutting, easy to use as a pencil, X-acto is the indispensable tool for whittlers, wood carvers, artists, photographers.



No. 85 X-acto Tool Chest - 3 all-metal knives; full assortment of blades; saw; sander; stripper; planer; 2 drill holders; 10 drills; 6" steel ruler; Complete in wooden chest, \$12.50. Also #84 Set, \$7.50.



x-acto

KNIVES & TOOLS

X-acto Knives & Knife Chests From 50c to \$5.00

Buy where you see this sign. At better hardware, hobby and gift shops - or if not available write direct to X-acto Crescent Products Co., Inc., 440 Fourth Avenue, New York 16, N. Y.

*Reg. U. S. Pat. Off.

V is for Versatile

... as in

X-ACTO!



X-acto's 3 handle styles and 13 blade shapes fit every type of cutting job. But if you're a one-knife man, we recommend for all-round work . . .



X-ACTO No. 2 KNIFE, with solid duraluminum handle, made with new improved chuck collet. Knife alone, 50c. With 5 assorted blades, in #52 Set, \$1.

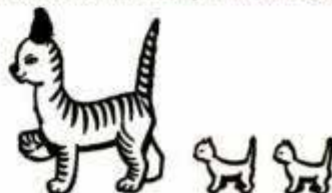

WHITTLE A LITTLE? Send 10c for a copy of "Whittling Is Easy with X-acto!" You'll be an expert in no time.



YOU'LL BE VERSATILE, TOO. Send for these helpful booklets, 10c each.

(1) Building Your First Flying Model. (2) The Knife As a Drawing Instrument. (3) Commercial Artists Handbook. (4) How To Build Scale Model Planes.



SAVES CUT FINGERS - X-acto is designed for firm grip and sure control. Blades lock in, can't fold under. So much handier and safer than razor blades.



OK, JUNIOR! Here's your X-acto Junior Knife, shaped like a Spitfire fuselage, with a two-edged blade. All-metal. Only 25c.

SPLIT SECOND SPEED



Savage Model 6— .22 cal. automatic rifle. "15 shots as fast as you can pull the trigger." Also, instantly adjustable as a bolt action repeater or single shot.

Fast? You bet! With a Savage .22 caliber automatic rifle you'll get off 15 shots as fast as you can pull the trigger. Here's the auto-loader you've been waiting for. It's light in weight, fine handling and brings you all the built-in features of accuracy, dependability and correct design for which Savage sporting arms are world famous. For the thrilling sport of speed shooting at small running game, rapid fire target work, or just plain and fancy "plinkin'," you'll double your shooting thrills with this great Savage rifle. Your dealer has—or will have soon—this Savage .22 automatic and a selection of other Savage sporting arms, including the sensational new Lightweight Automatic Shotgun.

SAVAGE ARMS CORPORATION, UTICA, N.Y.
Operating plants in Utica, N.Y. and Chicopee Falls, Mass.



Savage Model 29— .22 cal. hammerless, slide action repeating rifle. Extra long, "man's size" checkered fore-end gives perfect balance and permits easy, relaxed shooting position.



Savage Model 4— .22 cal. bolt action, clip magazine, repeating rifle. Easy to handle, accurate, priced moderately. Just the rifle for informal target shooting and small game hunting.



SAVAGE
**WORLD FAMOUS FOR
DEPENDABILITY AND
ACCURACY**

**Manufacturer of
SPORTING ARMS, LAWN MOWERS AND ICE CREAM CABINETS**

RUB ON

Let dry a minute

WIPE OFF

*Clean em up
Shine em up*

The
**Quick
ZECOL
Way**



ZECOL's popularity with car owners is due to its Quality, its Quickness and Ease of Application.

ZECOL adds a brilliant lustre to all types and colors of leathers and enamels.

Keep your car looking shiny and new. It's so easy with ZECOL.

If your car has an accumulated road film, use ZECOL Scum Remover before applying ZECOL Wax.

Ask for ZECOL—at service stations and garages. Pints 75c, quarts \$1.25, in U.S.A.



**ZECOL
COOLING SYSTEM
CONDITIONER**

Recommended to remove and prevent rust. Easy to use. No draining or flushing. Add to radiator—clean up rusty water while you drive. Lubricates water pump, bearings and seals. At service stations and garages.

**ZECOL INC., Dept. 3
Milwaukee 1, Wis.**



CAR OWNERS . . .

For smooth engine performance—pep and power—for stepped up lubrication—to free sticky valves—keep rings and valves free—ask for LUBAID. At service stations and garages.

**LUBAID CO., Dept. 3
Milwaukee 1, Wis.**

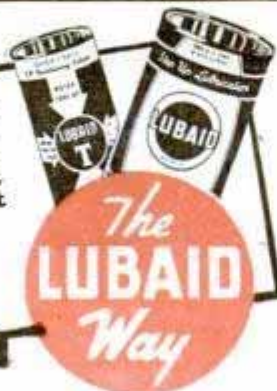

ly five feet off the water, the engine caught. As it turned out, the photography was excellent. Kistler flew the films to Guam on March 5. The results were so reassuring that the Army requested two Hellcats be assigned to Yontan Field to do tactical Sonne photography as the Okinawa campaign progressed.

Nine low-level Sonne combat missions were flown over Okinawa during the fighting. Large scale photos, taken at altitudes from 100 to 300 feet, provided ground support information that was not available by any other photographic means. As Colwell pointed out later, "the scale of the photographs was so large that you could see Japs, telephone wires and everything but the fleas on the sugar cane."

Although Japan surrendered before this new system of photography could be tested further in combat, it did arrive in time to prove its value. Reports from the fleet indicate that the Sonne camera is here to stay.

"With the camera able to procure photographs at air speeds even greater than 1000 miles per hour, it would appear that this is the only naval aerial camera adapted to ultramodern, high-speed warfare," said Commander Hutchison of Fleet Photographic Group Two.

Kistler and Colwell, who went ashore with the invasion forces at Okinawa, had the satisfaction of verifying many of their height and depth computations with actual measurements. Their average error on water depth and roughness of the reef was considerably less than one foot.

"Incidentally," reported Colwell, "the LST loaded with artillery went aground on the reef 800 feet from shore."

The Gold Bug Strikes Again

(Continued from page 149)

Highly mechanized, placer mining includes the use of such Rube Goldberg equipment as bucketline and dragline dredges and power shovels which scoop up gold-bearing gravel in huge bites. The gravel then is relayed to a processing unit and the gold washed or shaken out.

Dragline operation holds the most promise for the future. In the 11 years before operations closed down, dragline mining grew from a \$6000 to a \$6,000,000 industry and today there are from 300 to 400 such dredges in operation all over the world.

Draglines require a low initial investment, can be operated by three men per shift and are sectionalized so that they may be moved quickly by truck, train, ship or

(Continued to page 236)

RIDE A NEW

HARLEY-DAVIDSON

DOWN THE ROAD TO HAPPINESS

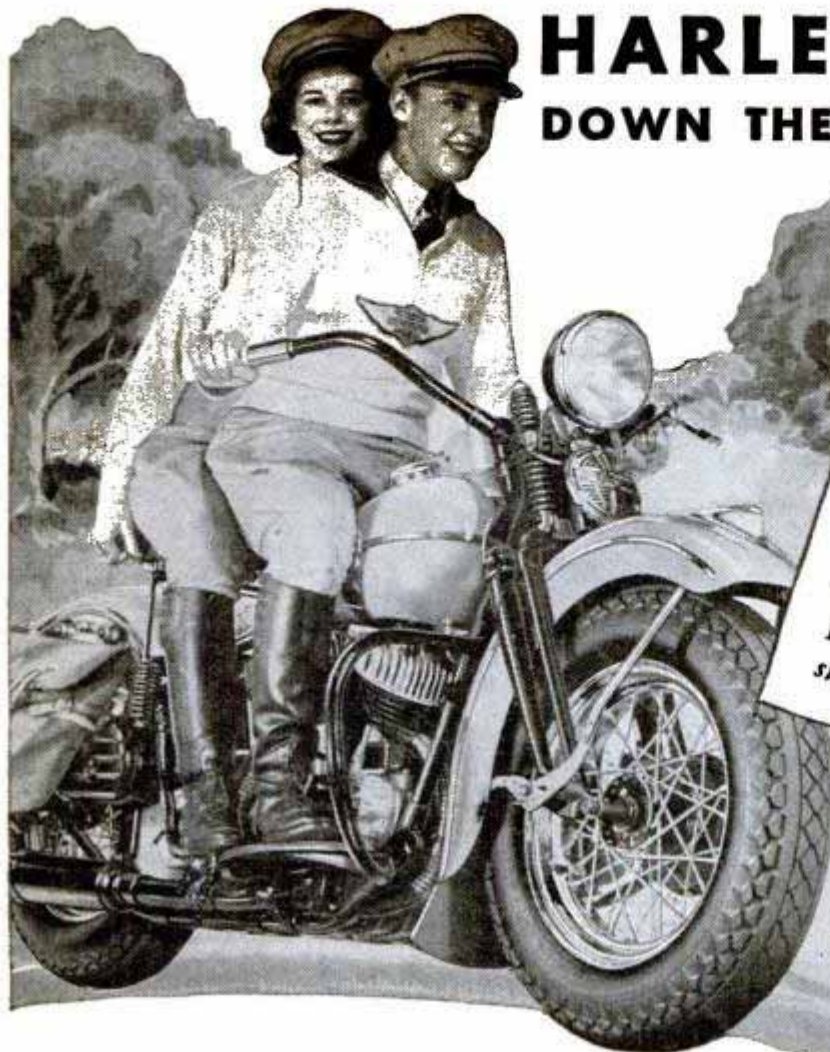

Here's a letter that's typical of many received:

"Have an order for a 610HV with my home dealer — for delivery about the time I hope to be discharged. Many pleasant memories were left behind when I entered the service. I know how anxious all riders are to get astride a dependable Harley-Davidson and start down the road to happiness."



THAT letter tells the whole story! Thousands of enthusiasts are eagerly looking forward to good times in the world's greatest sport — motorcycling! Be ready to ride *your own* NEW HARLEY-DAVIDSON on fun-filled vacation trips — or take in race meets, hillclimbs, endurance runs and other thrill-packed motorcycling events! See your Harley-Davidson dealer EARLY — and send the coupon NOW!

HARLEY-DAVIDSON

Motorcycles

HARLEY-DAVIDSON MOTOR COMPANY, Dept. P, Milwaukee 1, Wis.

Please send at once free copy of 24-page "Enthusiast" Magazine, filled with motorcycle action pictures and thrilling stories.

Name.....

Address.....

City..... State.....



★ **WHEN IT'S AN EXIDE... YOU START**



Expect good service from the dealer who features product brands of **KNOWN** high quality...and you'll seldom be disappointed.

THE ELECTRIC STORAGE BATTERY COMPANY

Philadelphia 32

Exide Batteries of Canada, Limited, Toronto

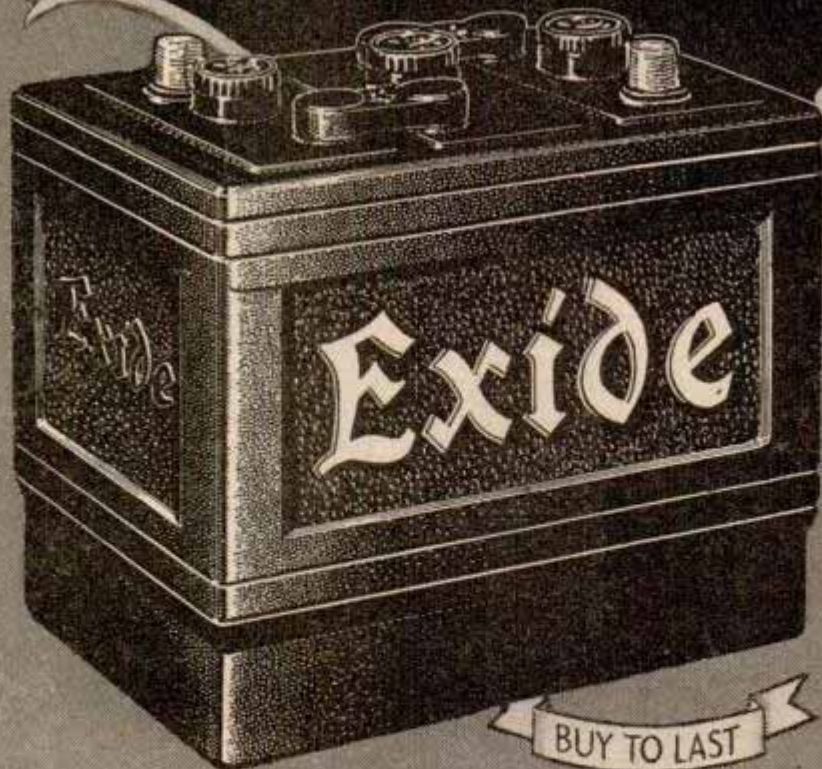

BUY TO LAST

Depend on the Exide dealer for good products, good service.

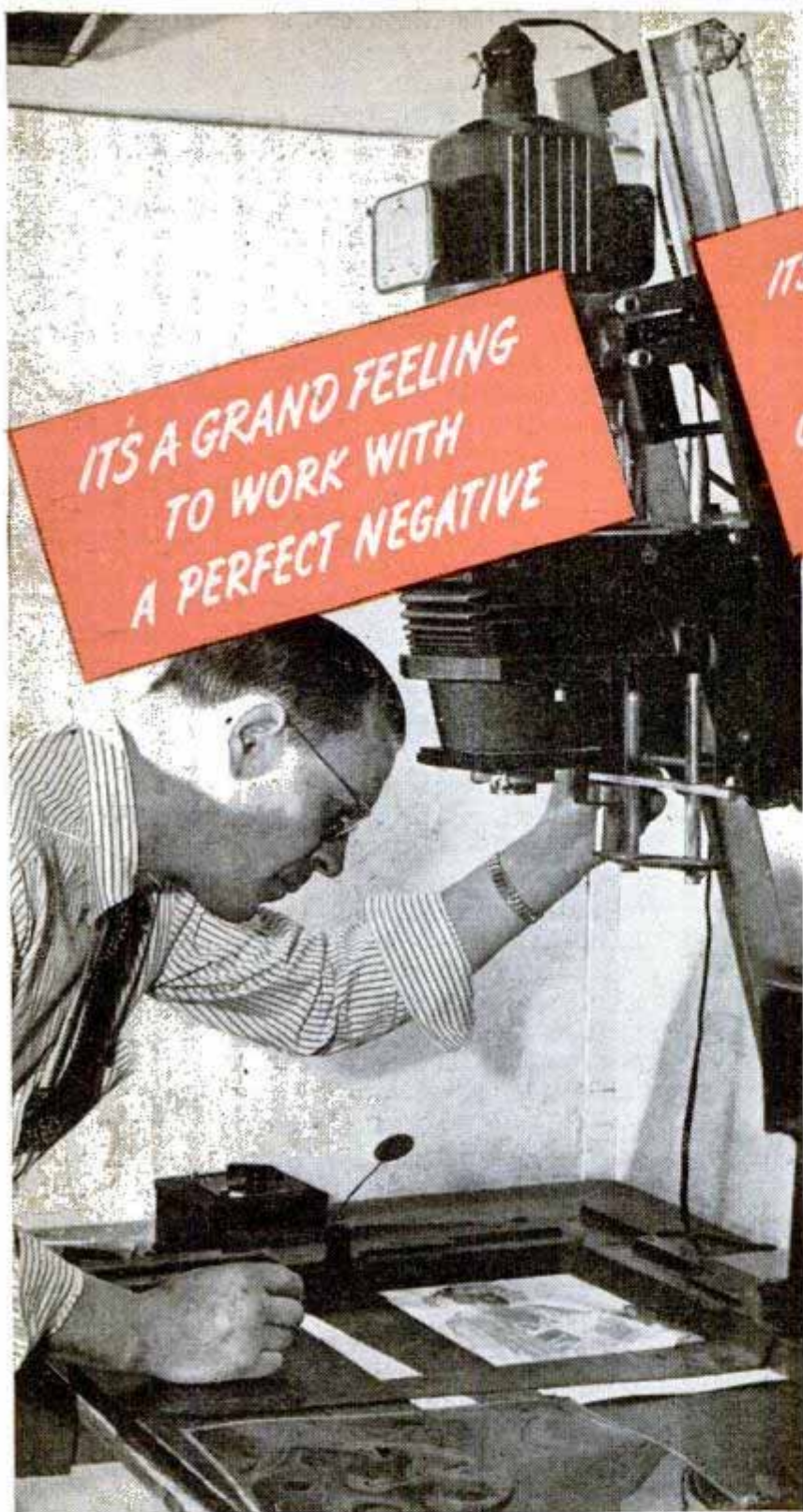

IT'S A GRAND FEELING
TO WORK WITH
A PERFECT NEGATIVE

IT'S A GRAND FEELING, TOO,
WHEN YOUR CAR IS
CUSHIONED WITH MARFAK
CHASSIS LUBRICATION

MARFAK makes smooth riding last longer . . . a thousand miles and more . . . tangible evidence that your car bearings are lubricated against wear.

You see, *Marfak* is scientifically designed to do the job . . . its special adhesive and cohesive qualities resist wash-out, jar-out and squeeze-out. *Marfak* clings to bearing surfaces . . . sealing out dirt and grime.

Yes, it's a grand feeling when your car is "cushioned" with *Marfak* chassis lubricant. See your Texaco Man today, and say: "*Marfak*, please."



With ordinary grease . . . you're taking the road shocks again after a few hundred miles.

Marfak stays on the job hundreds of miles longer—means more velvet smooth riding.

You're welcome at

TEXACO DEALERS



FIRE-CHIEF
GASOLINE



SKY CHIEF
GASOLINE



HAVOLINE AND TEXACO
MOTOR OILS



MARFAK
LUBRICATION



THE
TEXAS
COMPANY

Tune in the TEXACO STAR THEATRE every Sunday night starring JAMES MELTON with his guest, ED WYNN. See newspapers for time and station.

NEXT TIME SAY BRIGHT STAR

and you will get a
FLASHLIGHT & BATTERIES
famous since 1909
for QUALITY,
STYLE and
SERVICE



BRIGHT STAR BATTERY CO. CLIFTON N. J.

plane. With widespread air transportation dragline mining should expand even more.

The outlook for small-scale operations, in which many veterans have expressed an interest, is difficult to determine. Certainly there is no lack of interest. Officials of the Colorado State Mining Association have had dozens of letters from veterans with a preference for the quiet of mining camps to the noise and confusion of a big city. Most mining areas are localities of picturesque beauty where battle-weary veterans can enjoy the values of recuperation.

But veterans are being warned that small-scale operations involve hard, back-breaking work and low return. Every man dreams, however, that he will strike it rich and Conrow is an example of how Dame Fortune bestows her favors. Such has been the lure of gold down through the ages.

Some veterans, like Conrow, are taking advantage of the split-check system. Under this arrangement, the small-scale prospector operates a lease with all equipment, air and hoisting expense, and even shipping costs, paid for him. All he does is furnish the labor and divide the profits with the landowner.

Some equipment has been developed especially for the small operator. One of these is the inexpensive Denver mechanical pan which can easily be rigged to a small motor or the rear wheel of an automobile. Essentially it is a gold pan with improvements that make it vastly superior to the old hand washing technique.

Gold will continue to play an important part in our way of life for many years to come. And gold fever—even in safe and sane 1946 style—will continue to excite a nation of pioneers.

Half a Billion in the Slot

(Continued from page 159)

move cautiously, however, before designing special dispensers for new products. For example, a manufacturer who suggested that a coin machine be made to sell combs only was turned down on the theory there would not be enough demand.

Mills is devoting considerable productive capacity to a machine that is an offshoot of the coin-operated sound movie "box" which presents three-minute musical comedies.

The offshoot is an improved motion picture machine, minus the coin slot, which is being used extensively for entertainment and rehabilitation work in Army and Navy hospitals. Pictures are even shown on the ceiling for bedfast patients.

Weighing only 185 pounds, the machines

(Continued to page 240)

POWER

BY CONTINENTAL

From the half-horse Tiny Tim to heavy duty Diesels, the Continental Red Seal identifies engines world famous for their stamina, economy, and all-round reliability.

The Continental line is complete. It includes a wide range of engines, each expressly designed to meet a specialized need in aviation, transportation, industry or on the farm. There are Red Seal engines for use with gasoline, natural gas, and distillate. And production has now started on Continental Diesels with "Cushioned Power" Combustion Chamber for greatest fuel economy, still further broadening the applications of Continental Power. Continental Red Seal Engines are on the job wherever there's work to do.



POWER BY



Engines
CONTINENTAL

CONTINENTAL MOTORS

CORPORATION — MUSKEGON, MICHIGAN

44 YEARS' EXPERIENCE BUILDING ENGINES FOR INDUSTRY, TRANSPORTATION, AVIATION, AND THE FARM

TWO FAMOUS LINES

- NOW BEING
MADE IN

Nylon



The Top in Casting Lines

World-famed Black-Oreno is back—in Nylon! Hard braided, water-proofed, exceptionally

smooth, it's easy to cast and has the great long-lasting quality for which this dependable line is famous. 6 tensile tests: 12, 15, 20, 25 and 30 pound.



The Top in Fly Lines

Excel-Oreno has always been known for long wear and dependable service. Now braided of

Nylon, finished with exacting, painstaking care, Excel-Oreno is now your best investment in fly lines. Level lines, H to C, in 25-yard coils. Double tapers—HEH, HDH and HCH—30-yard coils.

LINE-ORENO NYLON IS BACK, TOO!

This original South Bend Nylon casting line is an unusually serviceable line of exceptionally long life. 12, 15, 20, 25 and 30 pound test.



FISHING PHOTO BOOK — FREE!



Send for this 48-page book packed with fishing action photos—all prize winners in the South Bend Bait Company Fishing Photo Contest.

SOUTH BEND BAIT COMPANY
891 S. High St., South Bend 23, Indiana

SOUTH BEND

A Name Famous in Fishing

**\$1 RIDES YOUR LAWN
OF UGLY WEEDS!**



WEED-NO-MORE

Magic Weed Killer

Destroys Ugly Weeds but Won't
Harm Common Lawn Grasses!

NO MORE back-breaking digging! Destroy ugly leafy weeds with WEED-NO-MORE!

The 8-ounce lawn-size package treats 1600 square feet! Now you can enjoy a beautiful weed-free lawn for only \$1!

WEED-NO-MORE kills dandelion, plantain and other ugly weeds—yet won't injure soil.

Get it today! Rid your lawn of ugly weeds for only \$1. Just spray on... WEED-NO-MORE!

On Sale at Paint, Hardware, Garden Supply, Department and Drug Stores

WEED-NO-MORE

THE AMAZING NEW WEED KILLER

Made by **THE SHERWIN-WILLIAMS Co.** Cleveland, Ohio

MORE
WORK
IN LESS
TIME
with ..

HOLD-E-ZEE

AUTOMATIC GRIP
SCREWDRIVERS

Hold-E-Zees do the job better, faster. They excel wherever screwdrivers are used. Gripper instantly released by spring action, sliding up out of way when not in use. Highest quality materials throughout.

At Leading
Dealers Everywhere!



PATENTED



UPSON BROS., INC., 86 Exchange St., Rochester 4, N. Y.



Quilted

ASBESTOS MITTS

... they last twice as long

These asbestos mitts for handling hot metal molds and shapes are reversible to fit either hand. Both sides quilted, won't shred or fray on rough, jagged material. Double wear, double life. Wool lined. All seams double stitched. The answer to troublesome problems. \$2.20 a pair. Discounts for quantities. One of 4300 production-speeding,

time-saving safety gloves, aprons, sleeves, spats, etc. Write for Free catalog.

INDUSTRIAL GLOVES CO.

6487 Garfield Blvd., Danville, Ill.
(In Canada: Safety Supply Co., Toronto)



YOU WERE WRONG THE TIME YOU LET THE KIDS "PLAY" IN THE BASEMENT

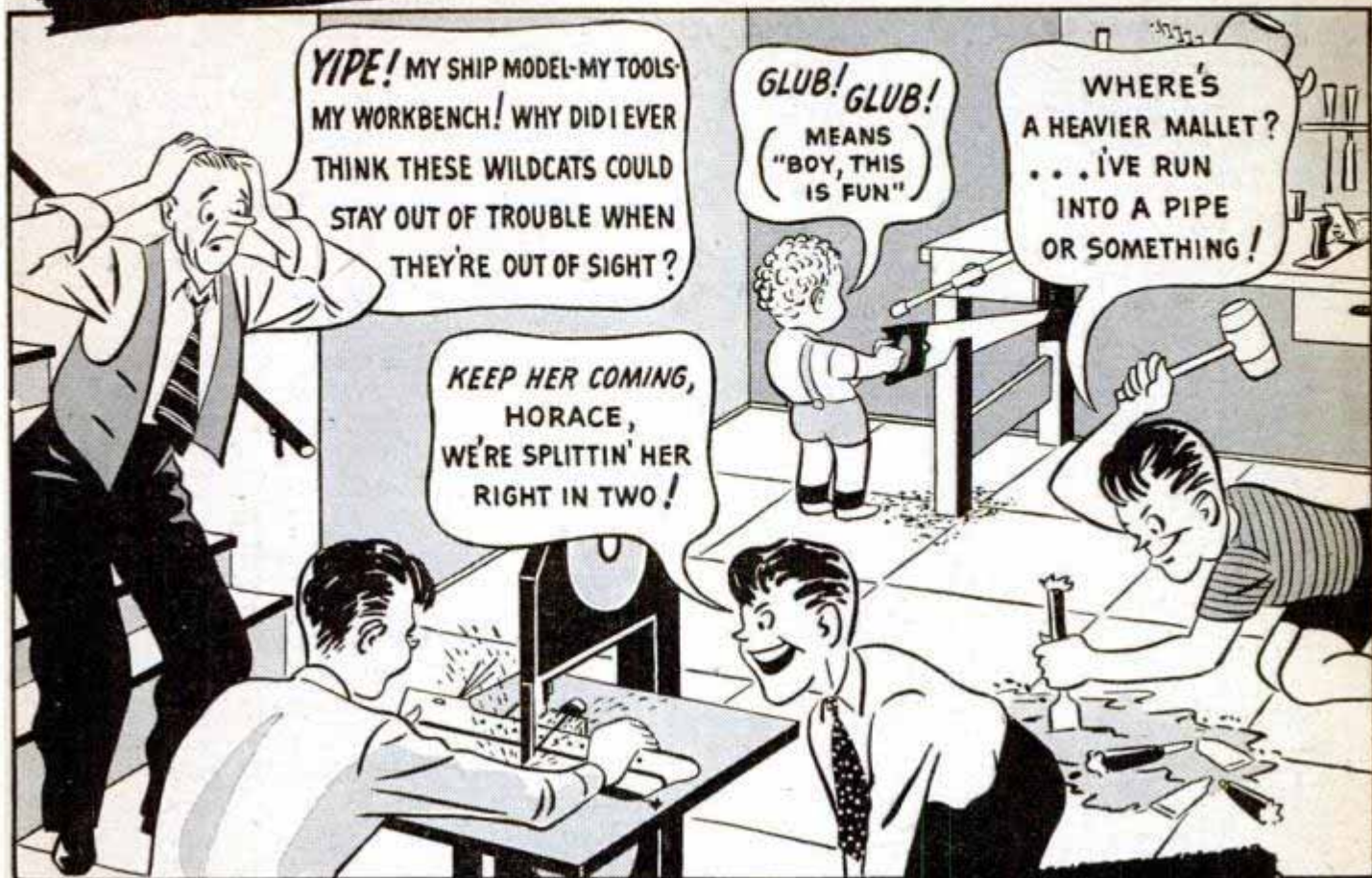

Everybody makes a mistake once in a while, but here's a chance to even up the score: Replace those worn-out spark plug wires in your car with

Packard Four-Forty ignition cable ... and you can be sure you're *right!*

You'll get a kick out of the new power, pep and performance your car delivers with Packard Four-Forty on the job. This longer-lasting cable is built with a tough protective sheath that withstands heat, cold, oil, moisture, corona and abrasion ... that safeguards the insulation against cracks and deterioration for tens of thousands of top-performance miles. You don't have to worry about wiring shorts or electrical losses when

But... YOU'RE RIGHT with PACKARD CABLE!

Packard Four-Forty ignition cable "carries the current" to your spark plugs.

As the original-equipment choice of leading car manufacturers ... the replacement choice of better service stations and garages ... Packard cable is *right* for your car. Always insist on Packard spark plug wires, lighting wires, battery cables and ground straps.

PACKARD CERTIFIED RE-WIRING SERVICE

This sign means cable service at its best—the right Packard cable and the right methods. Thousands of dealers provide better electrical service as a result of the Packard Certified Re-Wiring Program.



Packard
REG. U.S. PAT. OFF.
TRADE MARK

PACKARD ELECTRIC DIVISION
GENERAL MOTORS CORPORATION
WARREN, OHIO



FOREMOST BUILDER OF AUTOMOTIVE AND AVIATION WIRING

Not just a single tool...
IT'S AN ENTIRE Kit!

- ADJUSTABLE END WRENCH
- LOCK-ON WRENCH
- PIPE WRENCH
- GRIPPING TOOL
- PLIERS
- HAND VISE
- CLAMP



Fits
AS IT GRIPS
and it HOLDS
With One-Ton
Pressure

PRESSURE LOCK WRENCH

• You'll find a thousand uses for this handy, high quality wrench that was created by tool engineers in answer to the need for a one-hand tool that would accomplish more, in less time, and with less effort.

• Takes hold of nuts, studs, pipe, short, broken or irregular pieces—and holds them with a one-ton grip, even when the hand is removed. Released with the flick of a finger, it is ready to grab another piece of slightly different size or shape—without fussy adjustment.

JAWS ALWAYS PARALLEL

By an exclusive, patented device that moves the jaw end of the toggle to accommodate for varying sizes of grip, the jaws are always parallel when they close. That means you can use it on both round or flat pieces without rounding the edges or damaging the piece. No. 7 wrench has calibrated jaw openings to $\frac{1}{4}$ " ; No. 9 to 1".

TWO SIZES

No. 7—maximum jaw opening— $\frac{3}{4}$ in.....\$2.75

No. 9—maximum jaw opening—1 in.....\$3.50

At leading hardware, auto equipment, and mill supply stores

PAT. APP. FOR

BMC MANUFACTURING CORP.
Binghamton, N. Y.

can handle 1600 feet of film which is automatically rewound as it is run off. Mills predicts that future applications will include: travel pictures to be shown in railroad and bus stations and at airports to whet the public appetite for future trips; in schools for educational purposes; in factories to instruct new employees; in department stores to demonstrate appliances.

And speaking of appliances, automatic washing machines and clothes driers now are being equipped for coin-in-the-slot operation in some apartments and at a few self-service laundries.

Developed by the Westinghouse Electric Corporation and Automatic Laundry Distributors, Inc., the washers and driers have coin slots that enable the housewife to employ electrical "servants" for a nominal charge. At one self-service laundry in Mansfield, Ohio, a woman tosses a bundle of clothes into the automatic washer, adds soap, puts a quarter in the slot and 30 minutes later the clothes are thoroughly washed, rinsed and damp dried.

In general, the workability of all types of vending machines has reached such a high degree of efficiency that customers seldom have occasion to cuss or bang them to get money back.

Many new drink dispensers are equipped with devices that flash a warning when the last drink is consumed. Increased use of electrically operated mechanisms—electronic controls in particular—have made the automatic vendors practically fool-proof. One electronic regulator adjusts the volume of juke boxes to cope with surrounding noise.

Also, the "slugger" has little chance of gyping the latest models. This always has been quite a problem, with losses from slugs running as high as \$300,000 in one year. Even ice slugs have been used in some food plants to "beat" candy and drink dispensers. Sensitive controls that operate only by genuine coins of the prescribed size, weight and metallic content have just about removed the larceny element.

Yes, coin machines have come a long way. Back in 1846 about the only mechanical vendor in America was a complicated, hit-or-miss gadget that sliced off a hunk of chewing tobacco for a nickel.

Today, you can get your shoes shined by a contraption whose buffer goes into action when you put in a dime in the slot. Or you can use a coin-actuated electric razor sterilized by germ-killing rays.

About the only thing needed, according to one cynic, is a special slot for juke boxes that would give you three minutes of silence for five cents.

Rigid boring bar cuts bearing seat accurately. The cut is light, maintaining closer tolerances than are possible with ordinary drilling or reaming.



Precision-bored Bearing Seats help you enjoy greater accuracy ...smoother operation—with your

DELTA
MILWAUKEE
REG. U. S. PAT. OFF.

POWER TOOLS

Other advanced engineering features include:

Lubricated-for-life Ball Bearings. You don't have to worry about oiling these bearings. They're *lubricated for life* when they leave the factory. And they are *double-sealed* against harmful dust.

Pre-loaded Bearings. This is the result of an extra manufacturing operation that reduces the "play" in the bearings to help you enjoy long-time operating efficiency and accuracy.

Precision-ground Shafts. These are shafts built to run without any "wobbling" which may throw off measurements.

Dynamically-balanced Pulleys. The pulleys which transmit the power from your motor to your power tool are balanced to help eliminate annoying, damaging vibration.

The accuracy and precision *built into* Delta tools largely replace the manual skill of the old-time hand craftsman. Once you set a tool for the job, it takes care of keeping the work true and straight . . . helps you produce attractive, professional-looking work.

There's a store near you—perhaps right in your own neighborhood — that carries Delta tools. The people there are looking forward to giving you the complete Delta *quality* story. Drop in to see them.

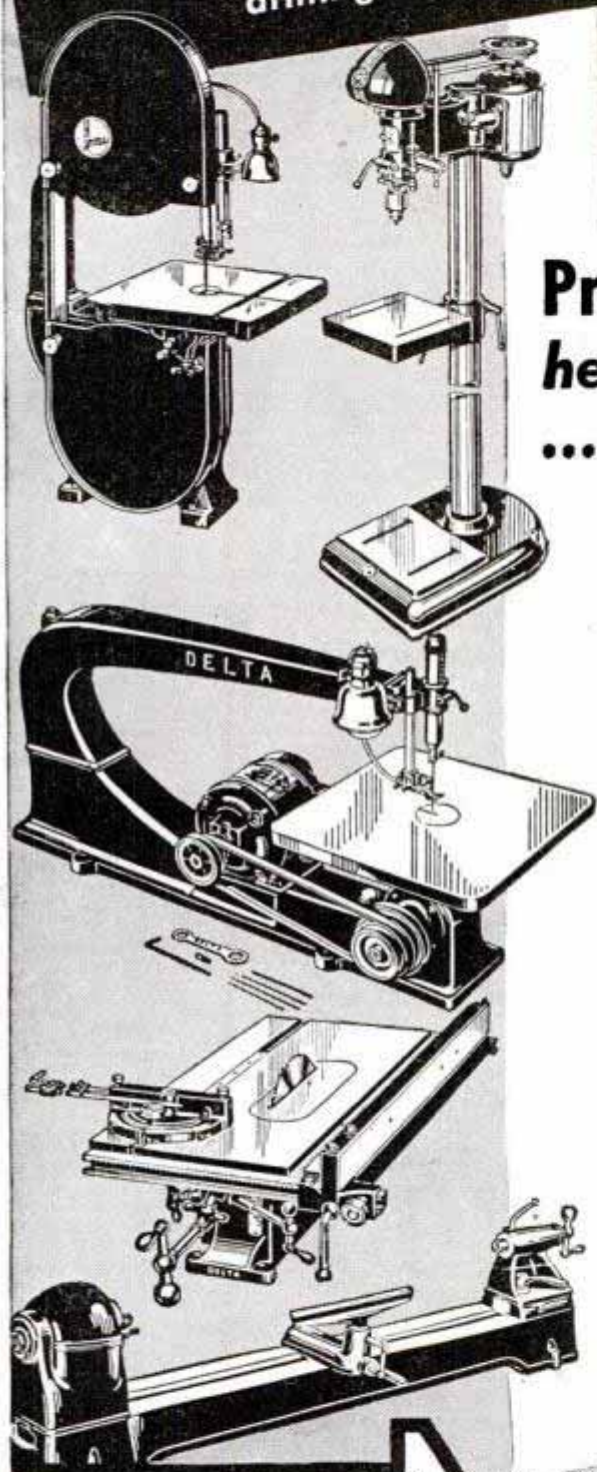

FREE!

"Happiness Herald" — an illustrated tabloid newspaper with facts about woodworking as a hobby. Tells how this popular hobby aids mental health and happiness . . . how it can pay its way. Pictures typical shops and projects. Enjoy its inspiration and ideas. Use coupon.



Tear out coupon and mail today!

THE DELTA MANUFACTURING CO.
681E E. Vienna Ave., Milwaukee 1, Wis.

Please send me my free copy of the "Happiness Herald."

Name.....

Address.....

City..... () State.....

ANY WAY YOU LOOK AT IT...
MERCURY II
 IS A BETTER BUY!



**WORLD'S FIRST SUPER-SPEED, SUPER-PRECISION
 CANDID CAMERA**

ESPECIALLY DESIGNED FOR COLOR!

CHOSEN BY HARVARD OBSERVATORY for supreme accuracy, the 1/1000 second rotary focal plane shutter is typical of the many advanced Mercury II features that assure you:

1. Sharper candid and action shots...
2. Richer portraits and still lifes...
3. Color shots clear and true right out to the edges, sharp in background as well as foreground.

NEW FILM ECONOMY—32 negatives on standard 35mm. 18-exposure color or black-and-white film cartridge, 65 exposures on 36-exposure cartridge.

UNIVERSAL CAMERA CORPORATION
 New York • Chicago • Hollywood

MERCURY II
 ...It's a UNIVERSAL

Mows and Trims Lawns



In One Simple
 Easy Operation
 8¼ Lbs.



Save Time
 and Labor with a
MONTAMOWER

New model. New type metal handle has special device to adjust cutting height. Drive shaft now mounted on free rolling, factory lubricated, and sealed ball bearings. No tired backs or aching arms. 8¼ lbs. of live precision made mechanism that first gathers, then cuts smoothly a clean 16" swath through grass, dandelions, spike grass and weeds. No noise or clatter. As modern and efficient as your electric razor. Cuts right up to walls, fences, trees or posts; leaves no fringes to be trimmed by hand. Cutters are self-sharpening. Built to last many years. Many thousands in use. Sold direct from factory. Costs little. Write at once for guarantee information and literature.

MONTAMOWER DISTRIBUTING CO.
 823 Keeler Bldg. GRAND RAPIDS 2, MICHIGAN

TURNER VT-73 DESK MICROPHONE

Here's the mike you want for your rig. It's got looks, it's tough, and man, oh man how it performs. It's a TURNER! Ask your dealer or write for Free Literature on other low cost Turner Microphones.



THE TURNER COMPANY
 921 17th St., N.E., Cedar Rapids, Iowa

NOW AVAILABLE!

Crosman Silent Rifles—America's favorite compressed air rifles for indoor and outdoor shooting are back again! Available in 22 cal. single shot and Magazine Loading Types. At your dealer—or order direct. Ask for Crosman SUPER-PELLS too—the better ammunition for all compressed air rifles. .177 Cal.—\$1.80 per M. .22 Cal.—\$2.00 per M.

CROSMAN ARMS CO., INC. • Rochester 7, N. Y.

DO YOU WANT a permanent business profession of your own? Then **BECOME A FOOT CORRECTIONIST.** Earnings in this greatly needed profession run as high as \$50-\$100 weekly after a few weeks home training—not medical or chiropody—no further capital needed, no goods to buy. 50th year. Write for free booklet.

Stephenson System of Foot Correction
 28 Back Bay, Boston, Mass.

ARMSTRONG TOOL HOLDERS

enabled American industry to change to war production "over night." For they are the permanent, multi-purpose tools used by 96 per cent of the machine shops and tool rooms, on lathes, planers and shapers—the tools used to make dies and jigs, to build production machines. They are the tools you will want for your own shop—**ARMSTRONG TOOL HOLDERS** for industry, ACE Tool Holders for home work shops.



ARMSTRONG BROS. TOOL CO.

"The Tool Holder People"
 368 N. Francisco Ave., Chicago 12, U.S.A.



"Switch to Auto-Lite
... money cannot buy
a better spark plug"
Dick Haymes

"They put a song
in the heart
of your engine".

*Helen Forrest and
Gordon Jenkins*

*The Spark Plug
that's Ignition Engineered*

TREAT your engine to a new set of Auto-Lite Spark Plugs, ignition engineered for today's gasoline. If your spark plugs are faulty, you will restore gasoline mileage, get faster starts, smoother operation. And when so many of the nation's leading car manufacturers specify Auto-Lite Spark Plugs as original factory equipment, you can bet Dick Haymes is right . . . "Money cannot buy a better spark plug." So see your friendly Auto-Lite Spark Plug Dealer today.

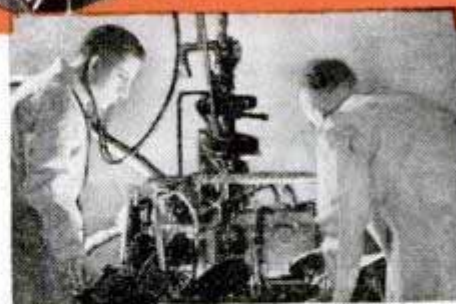

Auto-Lite Spark Plugs are ignition engineered. They're designed by men who have designed complete automotive electrical systems for 35 years!

Toronto 1, Ontario • THE ELECTRIC AUTO-LITE COMPANY • Toledo 1, Ohio

TUNE IN THE AUTO-LITE RADIO SHOW STARRING
DICK HAYMES, SATURDAYS, 8:00 P.M.—E.S.T. ON CBS

Switch to -

AUTO-LITE SPARK PLUGS
"Ignition Engineered"

The Mechanics of Golf

(Continued from page 85)

inary line running from your objective back through the ball. (See photo 2.) Picture this in your mind. It will be referred to frequently.

As you can see in photo 2, my right foot is drawn back slightly from the line parallel with the line of flight. This means I am playing my drive from what is known as a "closed" stance. I prefer this stance for all shots played with woods.

In setting the clubhead behind the ball, which is teed up about one inch from the ground, the ball is a little toward me from the center of the club face.

Make sure that you do not reach out awkwardly for the ball. Your weight as you address (stand up to) the ball should rest evenly on the ball and heel of each foot.

Nearly everyone has a tendency to get tense and stiff just before starting to swing at the ball. During my search for improved technique and methods I found that the best way to counteract this tension is to make a few short, loose, wigwag motions with the clubhead along the same general path to be used in the swing.

One day, as I prepared to tee off before a large gallery assembled at the first tee of the Tam O'Shanter course in Chicago to watch the All-American tournament, I was going through my brief warmup "waggle" when an uninitiated feminine bystander exclaimed, "Look at him shake. My, he must be nervous."

Well, I wouldn't say that my nerves are perpetually quiet, but this particular little gesture was not a manifestation of the "shakes." Most of us who make the tournament circuits learn to keep our nervousness pent up inside.

So far we have considered the preliminaries to swinging a wooden club, in this case a driver. Next comes the swing, in which my streamlining program shows its effect most clearly.

Through the early stages of my playing career I followed the popular pattern—starting the backswing with a turn of the body. This movement caused the clubhead to pull up and curve back sharply away from the ball. Remember, the backswing describes the pattern for the downswing. The clubhead, coming through in the aforementioned arc, is quite apt to hit the ball a downward blow and start it offline. Only when using irons are you supposed to strike the ball a descending blow. I sought the cure for this difficulty.

I found the solution to lie in shifting the hips in a lateral motion (backward and for-

(Continued to page 248)



STOP DUST

It is no longer necessary to put up with a dirty room every time you sweep the floor. By sweeping with a Dustless brush, which makes its own sweeping compound as it sweeps, you can eliminate up to 97% of germ laden dust in the air between sweepings. You can also do away with costly sweeping compound and cut labor costs. Thousands of factories, shops, offices, schools, and stores now use Dustless sweeping. Get complete facts about this better method of dust control. Write today.



- Dustless
- Speed Sweep
- Speed Wash brushes

Dustless
DOES MORE FOR LESS

MILWAUKEE DUSTLESS BRUSH COMPANY

528 N. 22nd Street • Milwaukee 3, Wisconsin

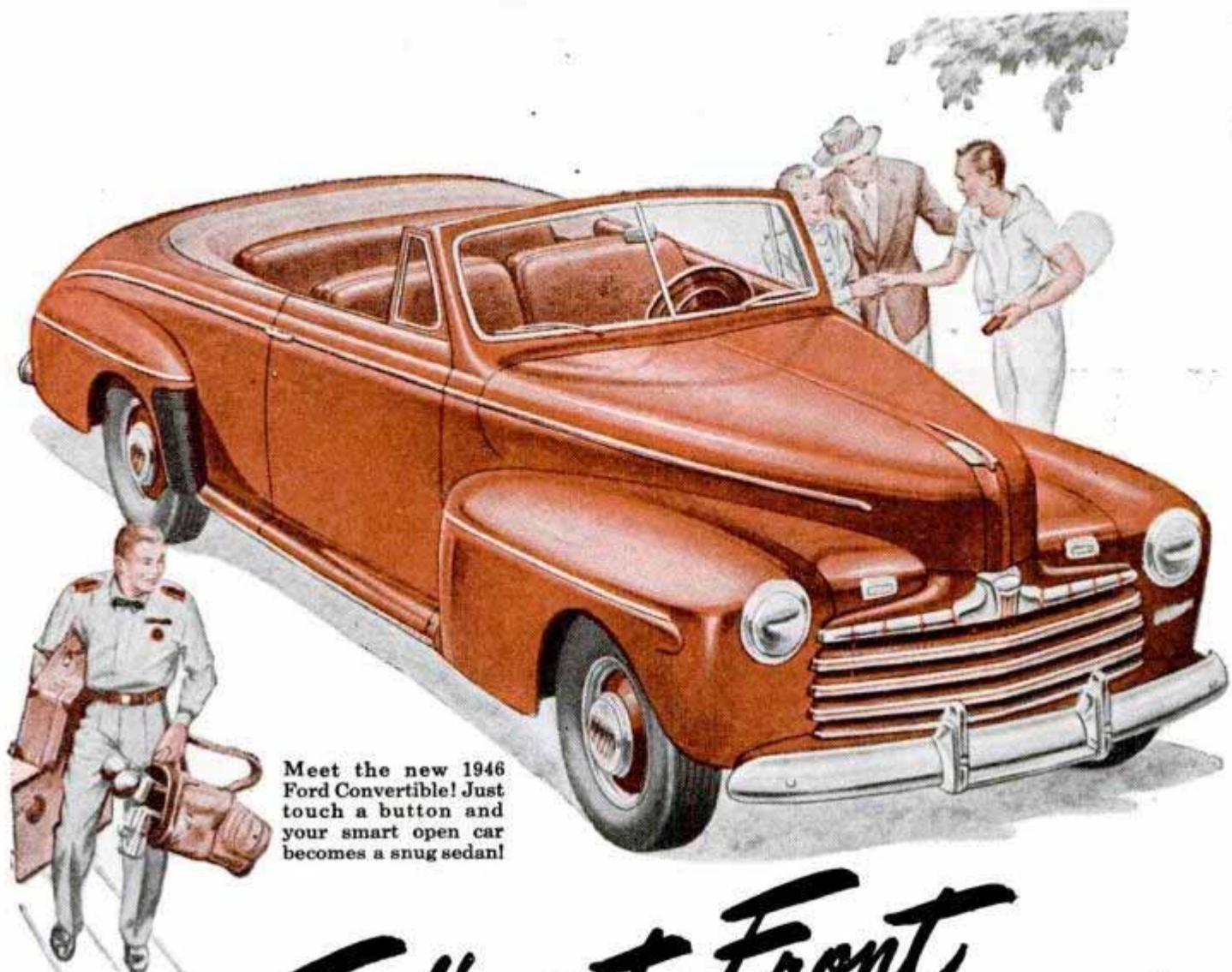

Meet the new 1946 Ford Convertible! Just touch a button and your smart open car becomes a snug sedan!

Ford's out Front

WITH THE BIG 100 h.p. V-8 ENGINE!

• No other car in its price class performs like the 1946 Ford because no other has the V-8 engine . . . no other has 100 horsepower! The V-8 type of engine, you know, is used in America's most expensive automobiles!

The new Ford V-8 is thrifty on gas and oil because of new 4-ring aluminum pistons and new balanced carburetion.

With this engine . . . with new oversized hydraulic brakes . . . with wider, lower, handsomer appearance . . . and with dozens of other improvements, no wonder so many people say: "Ford's out front in the low-priced field!"



There's a **Ford** in your future

TUNE IN . . .

The FORD-Bob Crosby Show—CBS, Wednesdays, 9:30-10 P.M., E.S.T.
The FORD Sunday Evening Hour—ABC, Sundays, 8-9 P.M., E.S.T.

THE MAKING OF *Marlin* GUNS

Marlin brings to sportsmen, through this series of advertisements, interesting facts on gun-making... to enhance appreciation of fine sporting firearms and to encourage their thoughtful handling and care.

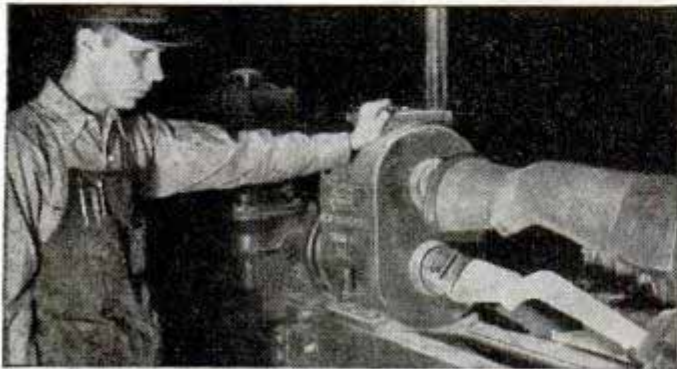

New automatic electric machines shape Marlin stocks

GUNSTOCKS • Functioning, balance and beauty of firearms are all affected by design and quality of gunstock. Only selected hardwoods go into Marlin stocks. Blanks are turned in new automatic machines which handle sharper, more intricate forms than any hitherto developed. The heavy, cast iron "master" accurately controls triple cutters as the lathe turns. After turning, the stock is "shaped" by skilled craftsmen; sanded, polished, stained and finished.



Final assembly demands fine craftsmanship

TARGETING • In the four modern ranges at Marlin, expert marksmen target every rifle before shipment. Sights are carefully adjusted until shots group in the center of the bull's-eye.

ASSEMBLING • Interchangeable parts make for efficient, economical production. Deft hands and experienced eyes, however, are needed for the accurate work of final assembly.



Expert marksmen target Marlin rifles

THE
Marlin
FIREARMS CO.
NEW HAVEN, CONN. EST. 1870

(The next advertisement in this Marlin series will reveal more interesting facts on fine gun-making.)

Be sure to see Marlin 1946 models on display at your dealer's

MOTORISTS!

BREEZO KAR KOOLERS



**DIRECT COOLING
BREEZE WHERE YOU
WANT IT IN YOUR CAR**

INSTANTLY attached to any General Motors or Chrysler-made car, 1939-46. Snaps on or off. Extension for other makes or older models. Triple adjustment feature permits accurate control of cool air flow to feet, lap or chest area, as you desire. Don't suffer — get this hot weather driving aid now. Set of two BREEZO Kar Coolers only \$1.25 postpaid anywhere in U.S.A. \$1.50 in Canada. Money back if not pleased. Give name and model of car when ordering.

**\$1.25
PAIR
POSTPAID**

Send cash or Postal Money Order. \$1.50 in Canada

DEALERS: Car-owners buy Breezo on 10-second demonstration. Write for BREEZO "Extra Profits" OFFER!

ECONOMY SPECIALTIES CO. 407 SOUTH 4TH STREET, BOX 67, STURGIS, MICH.

**THE HEAVYWEIGHT OF BENCH MILLS
BEEFED UP FOR PRODUCTION — PRICED LOW FOR HOME SHOPS**

Diamond MODEL B-12

DIAMOND MODEL B-12, sturdiest, heaviest bench mill on the market. All engineering refinements for high precision and long life. Taper roller spindle bearings, 6 spindle speeds (100 to 400 r.p.m.), large hand-scraped vee ways. Table travel 12" longitudinal. Table surface 5 1/4" x 20". Price only \$372.00, f.o.b. Los Angeles, less motor. Full line of accessories. Free Folder!



DIAMOND MACHINE TOOL CO.

Dept. I, 3429 E. Olympic Blvd., Los Angeles 23, Cal.

Manufacturers of the DIAMOND Line of Precision Milling Machines and Accessories



**CAPE COD CHAIRS
TRELLISES**

Arbors Fence Pickets

Chairs styles B-C-A Plans 50c ea. All 3 only \$1.00. 12 different trellis designs. Plan of all 12 only 50c. Beautiful 31-family Mt.

Vernon martin house. Large, fully detailed plan \$1.00. Four fine lawn figure patterns: Dutch Boy, Tulip Girl, Holland Pair and Sunbonnet Girl—all four patterns only \$1.00.

Send 10c for beautiful catalog illustrating many fine home and garden projects, plans, knockdown kits and completed projects.

CRAFTSMAN'S MODEL CO., Dept. P91, 2030 No. 4 1st St., Milwaukee 8, Wis.

Fix Scratches, Dents, Nicks the Professional Way!

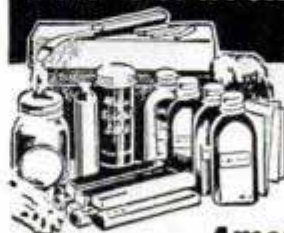

Get This Handy Kit!

Repair damaged furniture surfaces with new practical kit. Enables anyone to do fast, easy touch-up jobs like a professional cabinet finisher. Makes furniture and cabinets look new. Every home and shop needs this remarkable kit. Pays for itself over and over!

Amazing Results—Easy to Use

Kit includes 23 different items—scratch removers for slight scratches, assorted shades of shellac sticks for deep nicks, bottles of light and dark stains, shading lacquer, alcohol lamp with fuel, stainless steel spatula, touch-up brushes, scratch sticks, steel wool, sandpaper, rubbing liquid. Packed in handy leatherette finish case. Send for it today. Best investment of lifetime. Fully guaranteed. Detailed instructions supplied.

**\$3.95
Postpaid**

AMERICAN HOUSEHOLD BUREAU
Dept. F, 520 N. Michigan Ave., Chicago, Ill.

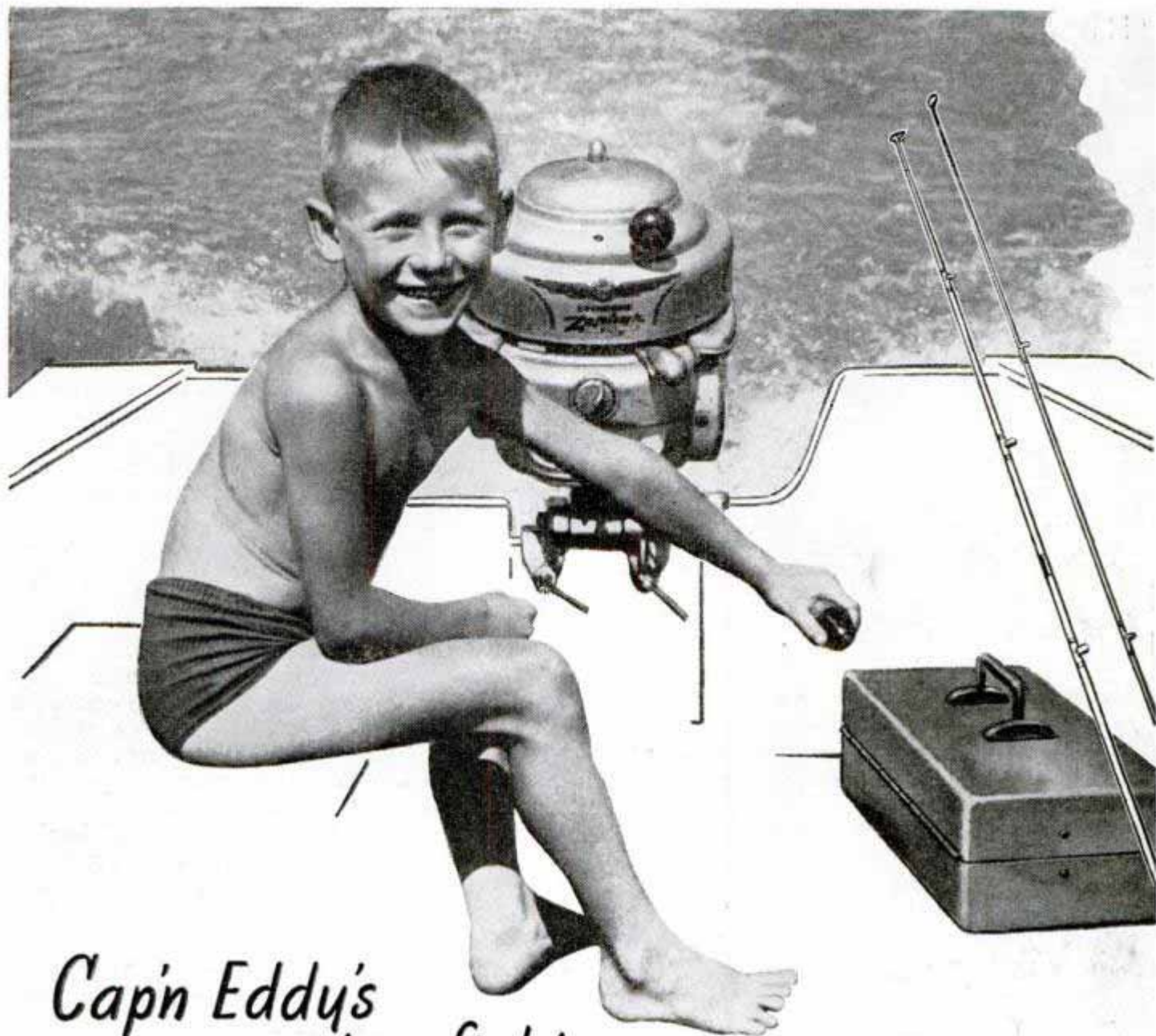

Cap'n Eddy's going fishing

Cap'n Eddy may seem a bit youthful to be skippering all that horsepower! But Eddy agrees with his dad . . . it's a sound idea to start 'em young!

So Eddy is "an old hand" with Evinrudes, and revels in all the pleasures that go with them. A lot of happy miles have foamed in his wake, he has baited many a hook and "boats" his fish like an old-timer.

In thousands of family albums there are snap shots such as this one of Eddy*. Photographs of children running Evinrudes capably, easily, joyfully.

Each picture is a forthright testimonial to an Evinrude quality that users prize above all others.

The assurance of carefree performance, even in a youngster's hands. Performance that has been perfected step by step during 36 years of building fine outboards . . . trustworthy performance that is mechanically built right in, ready to go and keep on going!

It's waiting for you — see your Evinrude dealer! Look for his name under "Outboard Motors" in the classified section of your phone directory. Write for catalog of the complete Evinrude line. Address, EVINRUDE MOTORS, 5264 North 27th Street, Milwaukee 9, Wisconsin.

In Canada, Evinrude Motors, Peterboro, Ontario.

*Eddy Ogrodowski of Toledo, Ohio.

EVINRUDE
OUTBOARD MOTORS

Royalton CROWN

For Men who Really Know Pipes

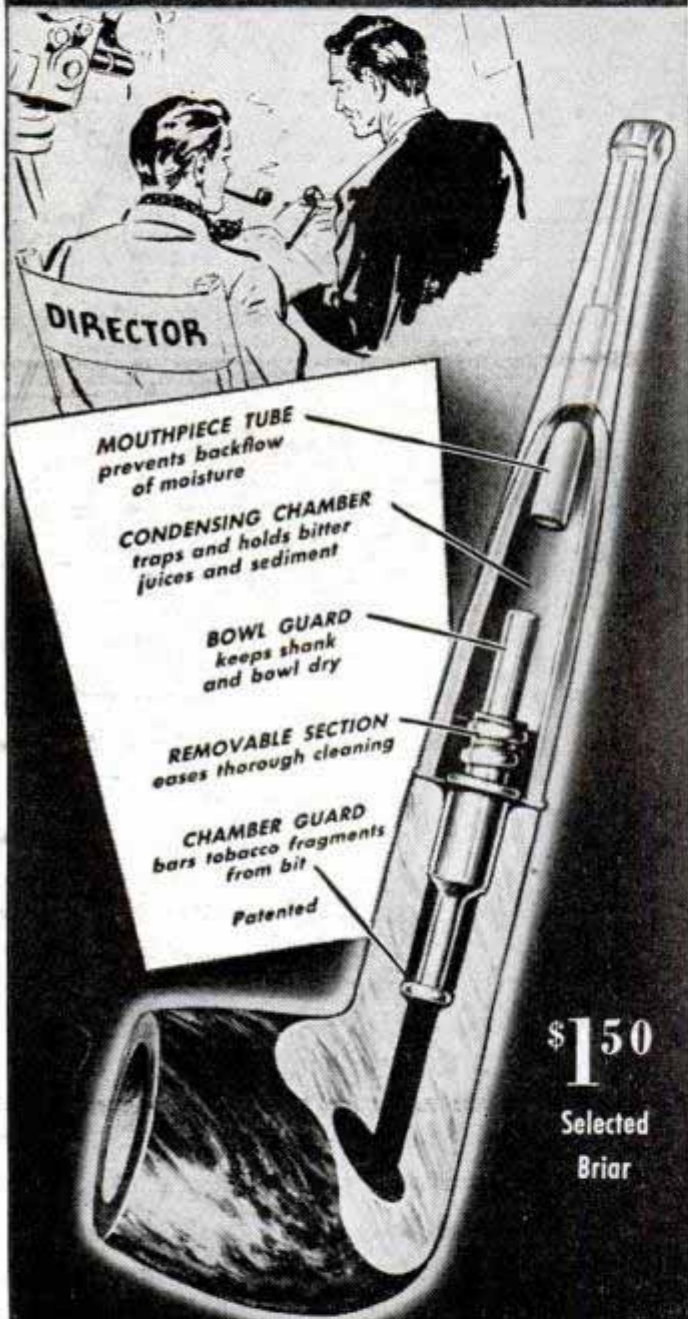

ROYALTON CROWN PROVIDES EXTRA SMOKING SATISFACTION because its condensing well and other safety features protect you from irritating juices and bitter slugs. Every bowlful smokes so clean, so cool, so ever-dry. Enjoy the full measure of pipe pleasure with a Royalton Crown.

HENRY LEONARD & THOMAS, INC., OZONE PARK 17, N.Y.

ward on the line of flight). This enabled me to start the clubhead straight back from the ball and close to the ground (photo 3). It also shifted my weight back into position to add its force to the power behind the ball in the downswing.

This lateral motion was a tremendously important factor in taking "bugs" out of my game. Now I'm often called the "Mechanical Man of Golf" because I'm so consistently straight. To the best of my memory, I didn't get off the fairways once in four rounds during the 1945 Seattle Open as I set a new world's record of 259 strokes for 72 holes over the Broadmoor course there.

Photo 4 covers the next stage of the backswing showing the shoulders turning.

The top of my backswing (photo 5) also was subjected to revision as I continued my efforts to perfect my swing.

I observed that many golfers had a tendency to overswing at this point, believing that by doing so they could get a longer and more powerful stroke at the ball. This thinking is completely erroneous.

If you overswing, you loosen your grip on the club, and also force an exaggerated "break" or bend in the wrists. This means that the firmness is completely lost and the club gets out of control. Once you permit this to happen, you can't recover.

I discovered that if I took the club back to a point at which it was about parallel with the ground (refer to photo 5) I could (1) keep a very firm grip with both hands, (2) keep my wrists in firm position, (3) maintain a straight left arm and (4) retain the original position of my head.

In other words, I eliminated all surplus motion at the top of the backswing. Thus I streamlined my swing. I gained in accuracy and consistency and lost nothing in the distance the ball traveled.

A straight left arm, like a draftsman's compass, enables me to describe repeatedly the same arc with my hands. This means I have "grooved" my swing. The clubhead will, as a result, consistently follow the same path to and through the ball.

I made no effort to wind up or "cock" my wrists at the top of the backswing. A conscious attempt to do so leads to looseness. Looseness in a golf swing is a barrier to good golf.

Photo 6 portrays what I believe to be the most satisfactory way of starting the downswing. For the sake of emphasis, I repeat that you should make no conscious attempt to add the power of the hands to the force of the downswing until the clubhead is within 20 inches of the ball. Maximum clubhead speed provided by the combined effort of hands, wrists, arms, shoulders and

(Continued to page 252)

Snap-on Tools

TOP CHOICE
FOR AIRLINE
MAINTENANCE



NORTHWEST



PAN AMERICAN

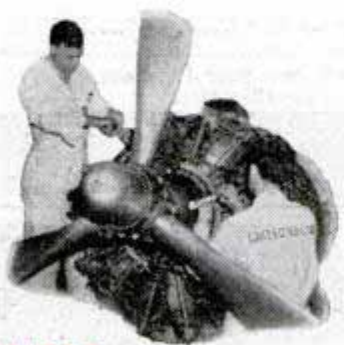

UNITED



TRANS-CANADA



PENNSYLVANIA CENTRAL



CONTINENTAL

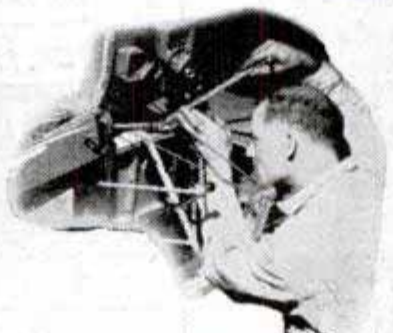

CHICAGO & SOUTHERN



BRANIFF



AMERICAN

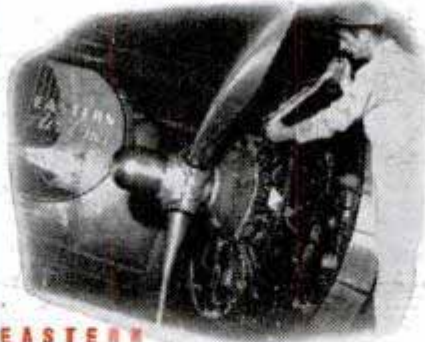

EASTERN



WESTERN

Matching the most rigid standards for speed, accuracy, safety . . . widely preferred by the maintenance executives and skilled mechanics who keep America's air fleets at peak efficiency . . . Snap-ons are everywhere recognized as the tools of aviation. Throughout industry Snap-on tools are *the choice of better mechanics* — almost unanimously selected by men who know that fine tools mean added earning power.

SNAP-ON TOOLS CORPORATION • 8062-E 28th Avenue
KENOSHA, WISCONSIN



SWIVEL-HEAD

FLASHLIGHT

nothing else like it!

HEAD TURNS LIGHT AT ANY ANGLE



Greatest advance in flashlight design in a generation. Turn powerful pre-focused beam where you want it . . . stand it up . . . clip it on . . . both hands are free. A handsome, durable, all-purpose flashlight for everyone. Ask your dealer.

\$2 LESS BATTERIES



No. SW-22 Patented

No. 75 Heavy-Duty Dated Cell. Fresh Lasts longer. 10c

Flashlights & Batteries

If dealer cannot supply, send \$2.00 to Dept. P UNITED STATES ELECTRIC MFG. CORP., New York 11, N. Y.

*USALITE Red-Head Safety Flashlight - a "MUST" for the motorist.

Do a Better Job WITH ONE OF THESE EMPIRE LEVELS

Smallest, most handy and accurate Level made. "Cigar-shaped"—no sharp corners to tear pocket. Aluminum stock. Only 3 oz. wgt. 9" long. Has Level, Plumb, 45° Vials. No. 26.....\$1.75



ALUMINUM LEVEL — No. 151

Cast and Machined, a Beautiful Tool, with Patented, Removable Level and Vial. With 2 Plumb, 2 Levels, 2 — 45° Vials. 18".....\$5.00 24".....\$5.50 28".....\$6.25

Order EMPIRE LEVELS from your local dealer. Write direct for literature.

EMPIRE LEVEL MFG. CO.
717 S. 6th St. Dept. P-240 Milwaukee 4, Wis.



The Modern PLASTIC for lasting Home Repairs

PERMANENTLY mends cracks or holes in wood, tile, stone or plaster. Sticks and stays put—Does not chip, shrink or fall out. Easy to use. Economical. Mold it, chisel it, polish or paint it. If unobtainable from your lumber, paint or hardware dealer, the big 4-lb. can will be sent you post-paid (in U.S.) for only \$1. Full money-back guarantee, order now.

DONALD DURHAM CO.
Box 804-H, Des Moines, Iowa

PULVEX FLEA POWDER

now also contains DDT



Kills the fleas QUICKLY!
Keeps others off for days!
Still 25c and 50c



YOU NEED THESE CRAFTSMAN'S TOOLS

SUPER DRILL GRINDER SUPER ARBOR SUPER HACKSAW

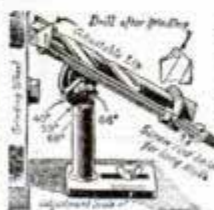

Sharpens round shank drills from 3/32" to 1 1/16" diameter. Grinds Old Drills like new in 4 different drill point angles. Grinds Short, Medium and Long Twist Drills from 1 1/2" up to 11" long, for hand or power grinding wheels.

100,000 IN USE!

Grinds your drills like factory in 25 seconds. Gives perfect center and clearance. Saves drills, time and money. No shop should be without the Super Drill Grinder. Guaranteed to do the work or money back. The Grinder that gives a round point!

Only **\$295**

(PATENT PENDING)

A combination drilling or grinding wheel attachment. For 1/2" motor shafts. Will take grinding wheel with 1" hole on shaft and 3/4" hole on small end. Extension can be used for rag or wire wheel, or 3/4", 24-thread drill chuck which holds drills from No. 60 to 3/8" in diameter. Right hand thread only.

Price Only **\$150**

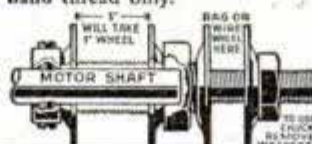

AND FLAT DIE FILE HOLDER



The tool with 100 uses! Holds broken hacksaw blades—used by mechanics, electricians, plumbers, auto mechanics, hobbyists and repairmen. Perfect for all round household needs; ideal for difficult close-quarter work. Nothing like it for tool and die men. Price, without saw blade.

Only **95c**

At Your Dealer's or Postpaid
CRANDALL MFG. CO.
1512 West Slauson, Dept. FA-5
Los Angeles 44, Calif.

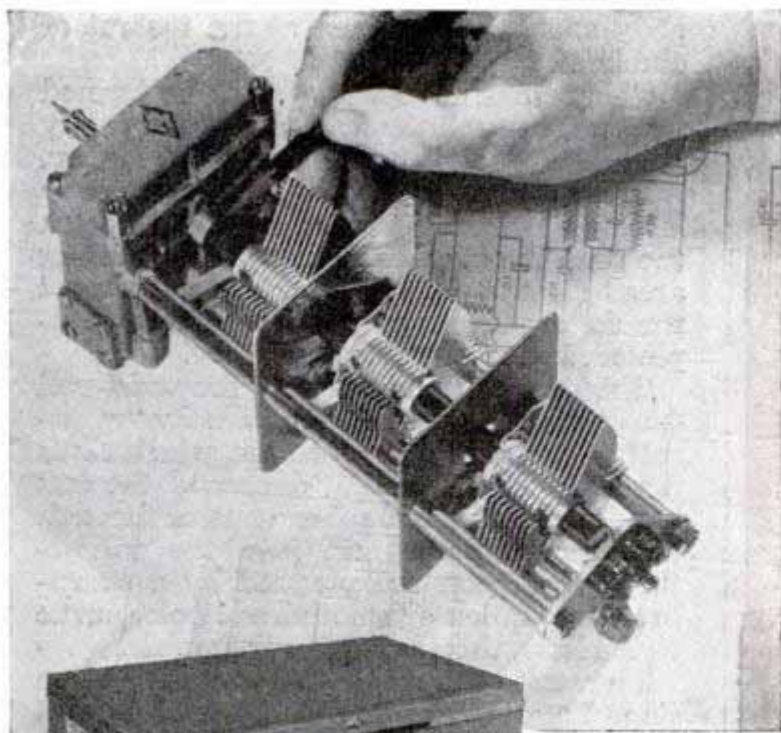

Men who really know radio look for certain high-performance characteristics in a receiving set. Extreme sensitivity and selectivity, particularly, are tell-tale marks of true craftsmanship and superlative engineering.

The NC-2-40C, designed and built by National Company, offers these characteristics to a degree not found in many receivers. With this model, you can bring the whole world into your home. It is recommended either with matching table speaker or with a Jensen console speaker.



NC-2-40C



NATIONAL COMPANY

EST.  1914
MALDEN, MASS

THE MOST DISTINCTIVE NAME IN RADIO COMMUNICATIONS



*The BIG THREE
of Outboard Motoring*

JOHNSON SEA-HORSES for DEPENDability

For utmost fun in outboard boating there are three "musts" to be considered in your motor. First, smoothness; second, reverse; third, full power at high speed with steady performance at trolling speed. You'll find all three in Johnson Sea-Horses.

Sea-Horses are strictly quality motors — built with dozens of refinements. And Johnson quality is backed by expert nation wide service — another Johnson "plus." See your Johnson dealer. Look for his name under Outboard Motors in your classified phone directory.

JOHNSON MOTORS, 400 Pershing Road, Waukegan, Ill.

JOHNSON BUILDS SEA-HORSE MOTORS ONLY—NO OTHERS

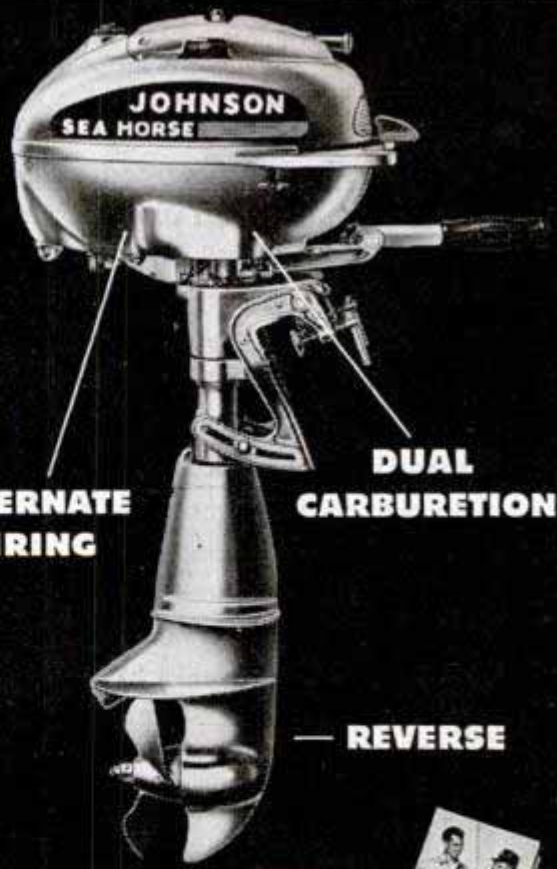

FREE HANDY CHART. Write for a copy of the new Sea-Horse Handy Chart which gives complete specifications on the 5 great Sea-Horses of the 1946 line.



T H E R E I S N O S U B S T I T U T E F O R E X P E R I E N C E

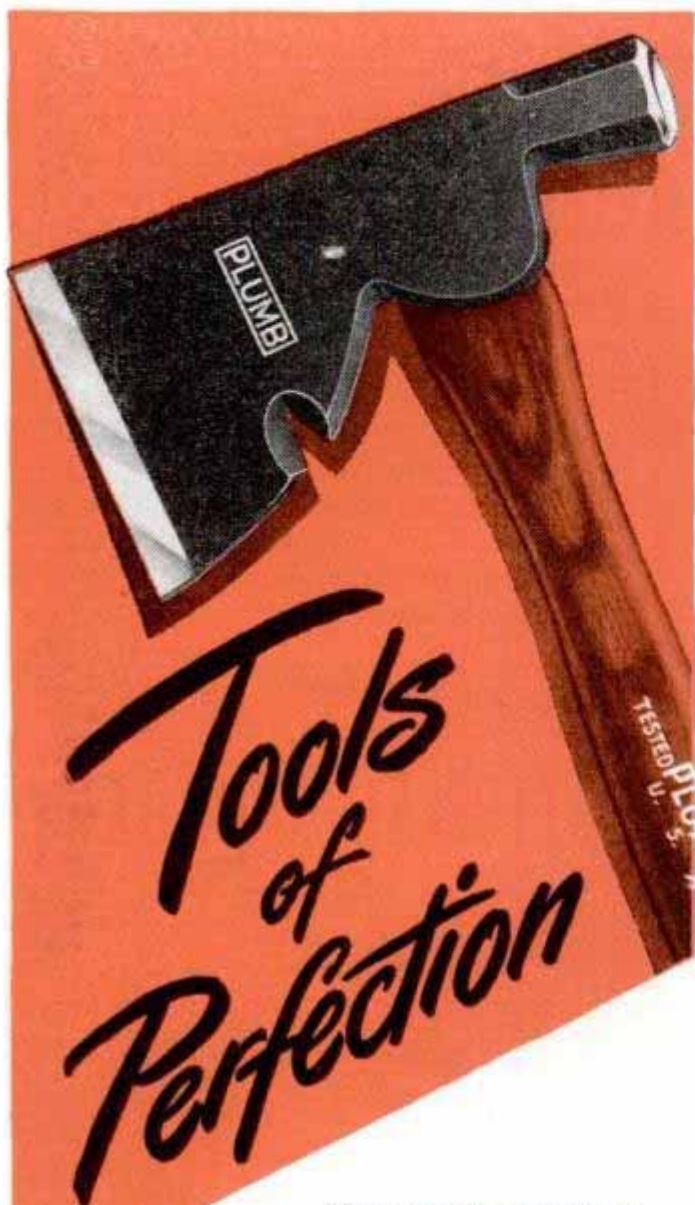

Tools of Perfection

How good should a hand tool be? Plumb's answer is "perfect". That's why no effort, time or research has been spared to make the Plumb name mean "tools of perfection".

Plumb hand tools last longer . . . do the work better, faster . . . are correctly balanced for comfort and ease. Head of one-piece special analysis steel . . . handles of tested second growth hickory. Each tool is easily identified by the red handle and the black head. Fayette R. Plumb, Inc., Philadelphia 37, Pa.

PLUMB

body should be reached at the instant of clubhead impact with the ball.

This brings us to what might be termed the "most revolutionary" discovery of my intensified search for maximum efficiency.

I found that by keeping the back of my left hand directly toward my target from the time the clubhead entered the "hitting area" (last 20 inches before impact) until the follow-through was one fourth completed, I gained greater accuracy.

This technique eliminated the wrist-roll—a prevalent source of trouble. By "wrist-roll" I mean the wrist action which finds the right hand turning over and the left hand under as the clubhead passes through the impact point and into the follow-through. If you are plagued by a sharp-breaking, quick or smothered hook (curve to the left), this may be your trouble.

I haven't been off the fairway very often since I started keeping the back of my left hand toward my objective throughout the bottom-most 50 inches of my swing.

Photo 7 gives you the essentials of properly finishing your follow-through. After all my power has been expended, my hands are still firmly in control of the club.

Notice particularly that my eyes are following the flight of the ball. Don't construe this to mean that I haven't kept my head down. My eyes were fixed on the spot where the ball was teed until the clubhead was almost parallel with the ground on the upswing and pointing at my objective.

From this point the turning of my shoulders has pulled my head around to the position in which you see it. This is a natural sequence. My head has turned, not moved.

THE SPOON

The difference in stances assumed for hitting a tee shot with a driver and a fairway or rough shot with a spoon is covered in the photos on page 83.

Because the ball is not teed up for a brassie or spoon shot, you must stand a little more closely to the ball. A brassie shot would not be played quite as far back toward the center of the stance as a spoon shot.

Don't try to use a brassie (No. 2 wood) unless the ball is sitting up enough so that you can get a good clean sweep at it with the clubhead.

The swing is identically the same for all wood shots.

* * *

(Next month, in the second article of this series, Byron Nelson will tell you how he plays his medium and long irons. In the opinion of most experts, Nelson is the greatest iron player of all time. In the third article you will learn how he plays his short irons and chip shots; also how he explodes the ball out of a sand trap and how he putts. "Lord Byron" will conclude the third article by playing two typical holes for you.)

THE ONE AND ONLY PIPE OF ITS KIND

VanRoy

with the NEW

Ajustomatic STEM

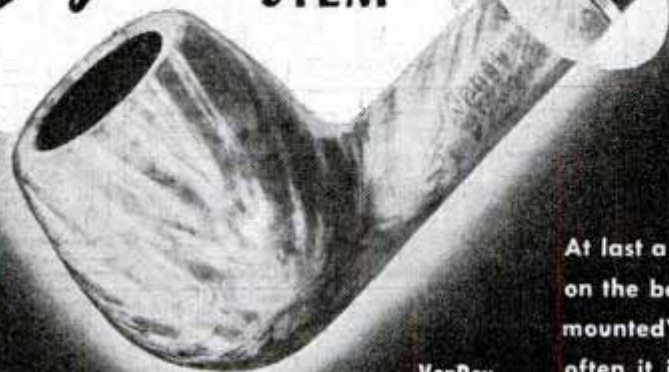

VanRoy
Ajustomatic
Bard \$5



At last a new kind of screw-stem pipe with a stem that stays on the beam. With VanRoy Ajustomatic the patented, "float-mounted" stem will not lock at an off-angle. No matter how often it is turned the stem holds its precision alignment for the life of the pipe. For the utmost in smoking satisfaction—get Ajustomatic, a pipe in the tradition of VanRoy quality.

VANROY COMPANY, Inc., Empire State Bldg., N. Y. 1, N. Y.



Signet of Quality in Pipes

6 handy
tools in
ONE!

- 1 MITERING GUIDE
- 2 DIAMETER GAGE
- 3 ACCURATE SQUARE
- 4 MARKING GAGE
- 5 CENTER FINDER
- 6 CONVENIENT RULER

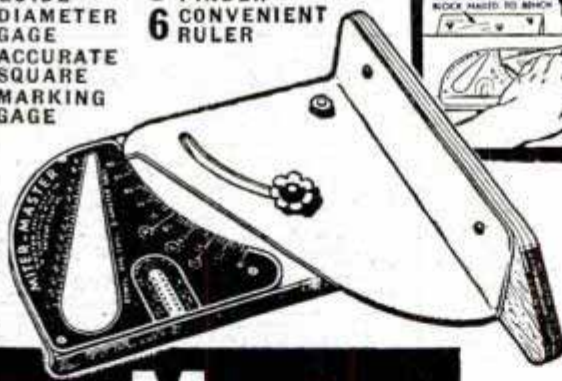

\$1.50
POSTPAID

MITER-MASTER

Miter Master takes the place of an expensive miter box accurately set to any angle. Scale marked for mitering 5, 6, and 8-sided frames. Steel construction. Built to last a lifetime. If your dealer can't supply you we will send it postpaid anywhere in the U. S. for \$1.50. (Foreign \$1.75.) Unconditional guarantee. If not satisfied within ten days for any reason whatsoever, your money will be refunded.

MASTER SPECIALTY COMPANY
3018 EAST LAKE ST. • MINNEAPOLIS 6, MINN.

Authenticast SCALE MODELS OF TANKS AND SOLDIERS!



GI's with bazookas, tommy guns, rifles — machine gunners, anti-tank crews behind the famous M12 — 155mm "Long Tom"

PERFECTLY CAST—ALL METAL

AUTHENTICAST scale models are scoring a direct hit with hobbyists everywhere! Ask your hobby dealer to show you the complete AUTHENTICAST collection of tanks, jeeps, scout cars, half tracks and soldiers. Tanks \$1.10 to \$2; Men \$1.85 box of 12 asst'd. Scaled to match, 1 in. to 9 ft. Send 35c in coin for 32-page color catalog.



Authenticast
COMET METAL PRODUCTS CO. INC.

132-01 91st Ave., Richmond Hill 18, N. Y.

NEW KIND OF POWER SAW



**Easy to Handle!
Triples Production!
Low Cost Upkeep!**



FELLING TREES

30" Oak felled in two minutes and fifty-two seconds with the Lowther C-Saw—11" Pine in fifteen seconds.



CUTTING LOGS

Cutting 10 to 20 cords of wood a day—on only 3 gallons of gasoline.



CLEARING LAND

Transforms brush covered wasteland into valuable pasture—Quickly and Easily.



HARRY A. LOWTHER COMPANY

141 West Jackson Boulevard Chicago 4, Illinois
Send Me Circular No. 407

Name

Address

This Lowther C-Saw has been proved in 478 Lumber Camps, in the production of millions of cords of wood!

Now available to you without Priority rating!

That standing timber on your farm and on your neighbor's is urgently needed at good prices today. Turn it into cash—the same way successful Lumber Companies do—with the Lowther C-Saw. Producing Cordwood has never been so easy as it is now—you use your head and let the Lowther C-Saw do the work.

J. A. Best of Mountain Grove Missouri says of the Lowther C-Saw: "We have cut everything from Blue Grass to 30" Oak Trees and still say this saw will do more than you claim for it!" Write us now! Get full information and learn of the many farm uses of this amazing new saw.

SMALL EFFICIENT SPEED REDUCER



\$15 12

Ceiling Price
F. O. B. Cleveland

Sturdy, compact (see dimensions). Proved in thousands of industrial installations. Case of heat treated aluminum. Gears, SAE 65 (British Gear) Bronze. Worm of case hardened steel. Timken Bearings throughout. Available in 4 different assemblies (shown below) and in these standard ratios:

4-1	25-1	64-1	200-1
8-1	30-1	75-1	300-1
10-1	40-1	80-1	400-1
16-1	50-1	100-1	600-1
20-1	60-1	150-1	800-1

Torque capacity 100 inch pounds. Especially suited for bench work, home work shops, light production, animated displays, etc. When ordering be sure to specify assembly and ratio required. Shipping weight in carton, 8 lbs. Full money back guarantee. Prompt deliveries.

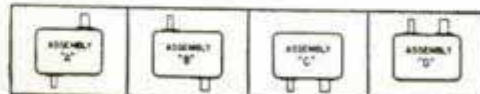

THE OHIO GEAR CO.
1400 EAST 179th ST. · CLEVELAND 10, OHIO

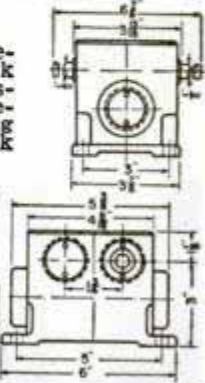

MARCOT KEY MACHINE

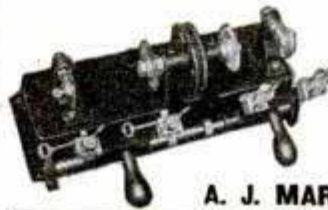

Marcot No. 8 Key Machine
Mounted on Cabinet..... \$ 75.00
Book on Modern Locksmithing 3.95
Auto Code Book and Depth Keys 12.50
2592 Assorted-Key Blanks. 77.76
Set Key Files, Tools, Pins, Springs, Thimble 10.50
\$179.71

A. J. MARCOTTE CO., 1200 N. Kedzie Ave., CHICAGO 51, ILL.

SAY YOU SAW IT IN POPULAR MECHANICS

WOOD WORKERS

LUMBER — PLYWOOD AVAILABLE

Harold Hunt wants to send new No. 15 catalog. Over 124 pages of woodworking ideas. UNEQUALLED BARGAINS in imported and American woods, supplies, hard-to-find hardware. Send only 10c to cover postage and handling.

CRAFTSMAN WOOD SERVICE CO.
2729 S. Mary St., Dept. A-69, Chicago 8, Ill.

only 10¢



BUILD ARC WELDER PLANS 35c

We Show You How to build this new powerful welder without rewinding. For light or heavy work. Uses coils taken from old auto generators. Works on 110 or 220 volts A. C. Has 20 different heats. Send 35c for complete PLANS and valuable Catalog. Write today.

LEJAY MFG. CO., 1347 LeJay Bldg., Minneapolis 8, Minn.



Thompson BEATS the World on BOATS



Better Built Lower Prices

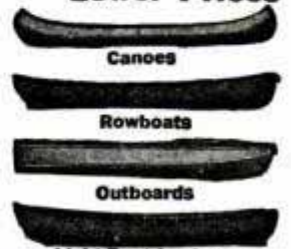

Safe Boats With Full Length Spray Rails
Keep passengers perfectly dry—even at high speeds. Catalog also shows two new models of "Take-Along" Boats. Two big factories—save you freight.

CATALOG FREE
Write for your copy. State kind of boat in which you are interested.

THOMPSON BROS. BOAT MFG. CO. (151)
213 Ann St. PESHIGO, WIS. (Write to either place)
113 Elm St. CORTLAND, N.Y.



STOP LEAKS!

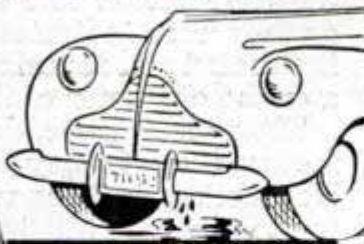

**Cooling Systems
Made Leak-Proof QUICKLY**

WARNER LIQUID SOLDER—Non-Metallic—Deposits Tiny Fibers to Repair Leaks Anywhere in Cooling Systems. Simply pour in! Finds and REPAIRS every crack or hole. Do it yourself—or see your service man.

Warner-Patterson Co., 920 S. Michigan Ave., Chicago 5

NO SLIPS ON MOTOR TRIPS

It's easy to miss directions on strange highways or city streets—unless you drive with a **HULL STREAMLINE AUTOMOBILE COMPASS**. Accepted guide of motorists. Saves miles of travel and valuable time. Circular free. At your dealer's. Price \$3.95.

HULL MFG. CO.

P. O. BOX 246-D6

WARREN, OHIO



Available Now! New ALL-PURPOSE MOTO-SCOOT

We are now making deliveries on **MOTO-SCOOT**s. Amazing new improved **MOTO-SCOOT** world's most economical form of motorized travel—up to 80 miles per gallon! Completely enclosed package compartment. Both "Solo" and "Delivery" Models ideal for utility and sport. To assure prompt delivery place your order at once. To obtain colorful illustrated booklet, giving full details, write us today. Be sure to state your complete address including county.



AMERICAN MOTO-SCOOT CO., Dept. 5PM
1305-23 W. Carroll Ave. Chicago 7, Ill.

CUT ANY SIZE HOLE

IN METAL • WOOD • PLASTICS

Bruno Adjustable Hole Cutter for home users, mechanics, farmers, technicians! High speed steel blade cuts clean holes quickly. Fits drill press, portable drill or hand brace. Money back guarantee! At all hardware stores or write direct, Dept. PM-5.

Model No.	Shank Size.	Cutter Expansion Capacity	User's Price
100	1/2" straight shank	1/2"-1 1/2"	\$2.95
100-B	Square Bit Stock	1/2"-1 1/2"	\$2.95
101	1/2" straight shank	1"-2 1/2"	\$4.95
101-B	Square Bit Stock	1"-2 1/2"	\$4.95

Model No. 100

BRUNO TOOLS
BEVERLY HILLS, CALIFORNIA

\$2.95

RIVET

with
ONE HAND ONLY



Rivet in glass, plastic, rubber, plywood, enameled surfaces—any kind of metal, wood or fabric. Real "BLIND" Riveting from one side of work.

Here is a **GENUINE CHERRY RIVET OUTFIT**, gun and rivets complete—ready to go to work for you—operating on the famous "pull rivet" principle. It is exactly the same principle used on the *billions of rivets on aircraft* and other construction during the war when Cherry equipment could be had only on high priority. Fill out and mail the **FREE TRIAL** coupon below with **GUARANTEE** of your complete satisfaction, backed by this big, well-established manufacturer.

Now you can rivet almost anything anywhere—make tight, neat joints with rivets that don't work loose like screws or bolts. Rivet in tubes or completely enclosed assemblies or the *hundreds of other places* around the shop, office or home where you can reach *one side of the job only*.



Rivet materials that previously could not be fastened this way—brittle materials—soft materials. Action is gentle but firm. No hammering, pounding or bucking. It's all done with a steady, controlled **PULL**.



Send no money!

This kit, gun, or replacement rivets can be secured from your dealer. Or, just fill out and mail the coupon below. You can paste it on a penny postcard if you wish. Pay postman only \$2.48 plus slight C.O.D. charge and postage. Your Cherry Rivet Kit will be delivered complete with a generous supply of Cherry Rivets. Try it out on almost anything that needs fastening. Do *difficult jobs* with it. Satisfy yourself. Then, if you are not completely pleased with results, send the outfit back within ten days and every penny you spent for it will be returned.

YOU GET THIS COMPLETE OUTFIT

This Cherry Jr. Riveter is a real Cherry Rivet kit—not a toy. It's something you will be proud to have among your tools. **EASY TO USE**. Anyone can follow the simple directions with **COMPLETE SUCCESS** the first time. Use standard pull-through Cherry Rivets 3/32" dia.

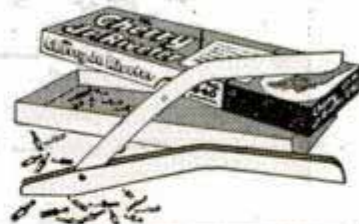

PASTE THIS COUPON ON A POSTCARD

Cherry Rivet Company

231 Winston St., Los Angeles 13, Calif. Dept. 56

Send me one complete Cherry Jr. Riveter outfit, including a generous supply of rivets at \$2.48 plus postage and C.O.D. charges. I agree to pay postman on delivery. I understand I am to be completely satisfied or my money will be refunded on application within ten days.

Name _____ Please Print

Address _____

City _____ Zone _____ State _____

SAY YOU SAW IT IN POPULAR MECHANICS

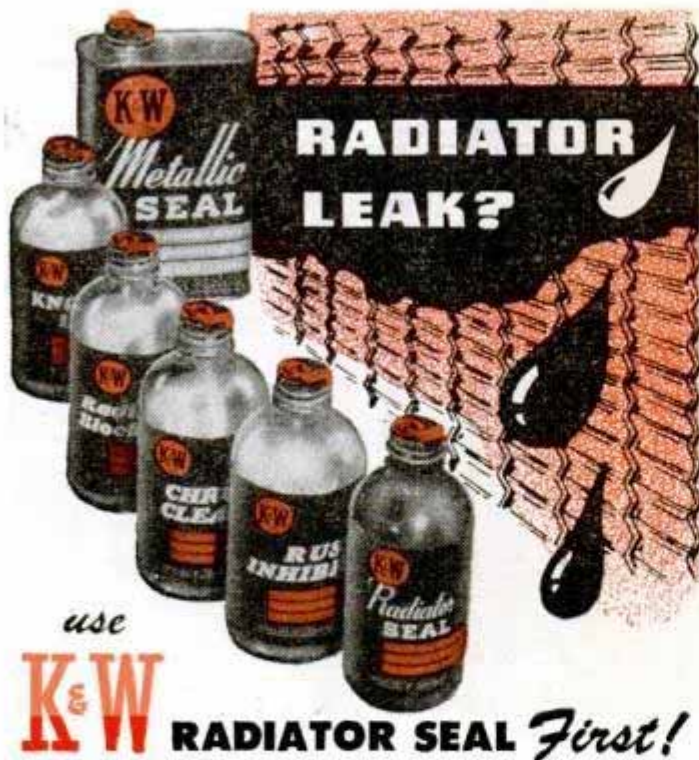

use

K & W RADIATOR SEAL *First!*

Want fast, positive repair for that leaky radiator? It's easy with K & W Radiator Seal — guaranteed to restore leaking radiators to unimpaired service in just 30 minutes!

Don't waste time and money trying one seal after another. Use K & W first—because, if one bottle of K & W does not seal every leak in a 24-quart radiator in 30 minutes, no seal, but only a competent radiator repair shop can make that repair!

K & W Radiator Seal is efficient, economical, easy to use. Merely pour in radiator—hoses or thermostat need not be detached. K & W will not clog or flush out, leaves nothing in suspension, needs no "extra charge" service labor.

K & W Radiator Seal is part of the famous K & W family of "Guaranteed Products For Better Car Service." Ask for these outstanding products at your service shop today!

AND . . . FOR IMMEDIATE, INVISIBLE, REPAIRS TO CRACKED BLOCKS AND HEADS

● K & W Metallic Seal and Mechanical Method—two war-proved, absolutely guaranteed methods for restoring cracked engines to unimpaired service. Used chiefly by leading engine rebuilders, fleet operators, railroads and military repair centers, these amazing time and money saving K & W services are now available to car owners at better service shops everywhere.

K & W METALLIC SEAL AND MECHANICAL METHOD REPAIRS ARE GUARANTEED FOR THE LIFE OF THE ENGINE

If you cannot locate a K & W Service Shop in your community wire or write Kerkling & Company, Bloomington, Indiana for names of those nearest you.

Eavesdropping Through 24 Feet of Steel!

(Continued from page 89)

opposite wall, since it is of necessity nearer the transmitter. The location of the peak on the screen indicates how deeply the flaw is situated and reveals to a practiced operator the character of the defect.

The reflectoscope, developed and manufactured by Sperry Products, Hoboken, New Jersey, is being widely used in industry to examine billets, forged axles, tools, armor plate, heavy machinery, turbine blades, aluminum extrusions for aircraft, locomotive components and other materials in which quality control is vital.

Its advantage over fracturing a notched sample or cross-sectioning the material is obvious—it doesn't destroy what it only wishes to test. The comparison with X-ray inspection is not quite so clean-cut, but the reflectoscope has much in its favor.

The largest readily obtainable X-ray machine, of 5,000,000-volt capacity, will penetrate approximately 18 inches of steel. The largest X-ray unit, the 100,000,000-betatron type, will see through several feet of steel, its developers claim. Both types are extremely costly and hardly portable, in contrast to the "eavesdropper," which can be wheeled about on balloon tires almost as freely as a baby carriage and is operated on standard 110-volt alternating current.

X-ray is admittedly superior for giving great detail of surface defects but lacks the range of the reflectoscope, which will "listen" through 24 feet of steel, 28 feet of aluminum or magnesium, three to four feet of iron and widely varying distances in plastics depending on the resin content.

The distance which can be penetrated by the telltale echo depends on the inherent solidity of the material under examination. It passes through six times as much steel as iron, since the former is much less porous and porosity acts like an infinite series of defects, hindering the transmitted signal and clouding the return signal.

The device can detect flaws in objects so large that the signal cannot completely penetrate and echo. Forty-foot aluminum wing members for U. S. superbombers were examined and defects located without the bounce characteristic when a signal was reflected from a point 23 feet from one end and 17 feet from the other.

□ About the size of a grain of wheat and barely $\frac{1}{16}$ inch in diameter, the world's smallest incandescent light bulb signaled air bombardiers when missiles were released, and now—attached to surgical instruments—is aiding doctors.

No further data - try A.M.A. Journal

NEW EASY WAY TO TIGHTEN CLOTHES LINE



Now — tighten clothes line automatically, without pulling and tugging. Simply turn the lever on Draw-Tite. Keeps line tight despite heaviest wash. Easily attached in yard or basement. Fully guaranteed. Also tightens electric fence wire, tennis nets, anchors boats to pier.

AGENTS! Women buy on 10 second demonstration. Nothing like it in stores. Low price. Get agents' deal. **CHICAGO HOUSEWARES CO.**, 1003 E. 75th, Dept. PM-546, Chicago, Ill.

GET THE BEST IN MUFFLERS V-8 DUALS & SINGLES



Finest Norman custom-built muffler sets — steel pack — torpedo type — heavy, perforated steel cores — chrome enamel finish — mellow, deep tone (improves with use) — designed to fit — all ways superior — double economy.

DUALS.....\$17.50 **SINGLES**.....\$7.00
 V-8 Ford-Mercury Buick, Olds., Chrys.
SINGLES.....\$5.50 **ORDER TODAY!** Will outlast three ordinary mufflers.
 Chev., Ford, Plym. **Distributors — Write for Full Details**

NORMAN'S MUSICAL MUFFLERS

Dept. PM-5, 1216 W. Slauson Ave., Los Angeles 44, Calif.

Sand Casting—Forging—Heat Treating—Case Hardening BRONZE FOUNDRY



is again available in limited quantity without priority. Orders filled in sequence as received. **INVENTORS—SCHOOLS—CRAFTSMEN** use **FOUNDRYETTE** for making castings quickly for new inventions, for instruction, and general purpose. Order now for early delivery. Three sizes are available capable of making bronze castings of 1½, 3, and 6 pounds weight, aluminum, copper, brass, etc., \$17.50, \$24.00, \$34.50, f.o.b. Kansas City. Domestic gas supply and 110 volt AC or DC energy required for operation. Write for circular.

KANSAS CITY SPECIALTIES CO.

Box 6022, Dept. P-66 Kansas City, Mo.

KEEP A CAN OF BOTH ON HAND!

Heavy 3-IN-ONE

Refrigerators, mixers, motors, power tools, lawn mowers, ironers.

Light 3-IN-ONE

Sweepers, sewing machines, hinges, guns, locks, metal drawers.



For over 50 years America's accepted household oil!

SOLD EVERYWHERE IN 1 AND 3 OUNCE CANS



3 - IN - ONE Oil



"OSWALD! DRIVE STRAIGHT TO A GARAGE! THIS CAR WASTES TOO MUCH GAS AND OIL... IT NEEDS NEW BURD 'GRAF-FLOX' PISTON RINGS!"

STOP FUEL AND OIL LOSSES WITH BURD "GRAF-FLOX" PISTON RINGS

When your car starts smoking and your fuel and oil mileage drops alarmingly, it's high time to go to your favorite repair shop and ask for a re-ringing job with Burd "Graf-Flox" Piston Rings. You'll be amazed at the improvement in engine performance . . . at savings in gas and oil. The secret of Burd's superiority lies in (1) using electric furnace iron for castings, for strength and uniform tension; (2) precision grinding and finishing; (3) by an exclusive Burd process, applying deeply penetrating colloidal graphite to the finished piston rings for quicker seating and longer wear. The result: Burd "Graf-Flox" Piston Rings stop fuel and oil losses and restore "new car" pep. Mail the coupon today for two FREE booklets described below.

BURD PISTON RING CO. DEPT. PM ROCKFORD, ILL.



THIS COUPON BRINGS FREE BOOKS

BURD PISTON RING CO., DEPT. PM
 Rockford, Illinois
 Gentlemen:

I'd like a FREE copy of your "Handy Handbook" which tells how to keep my car in good working order. Also send a "Car Economy Record Book."

Name.....
 Address.....
 City..... State.....



Quick Change Gear Box for Atlas, Logan, Craftsman and Power-Kraft Lathes

Cut threads from
4 to 224 per inch

Approximately .003 feed
for fine turning

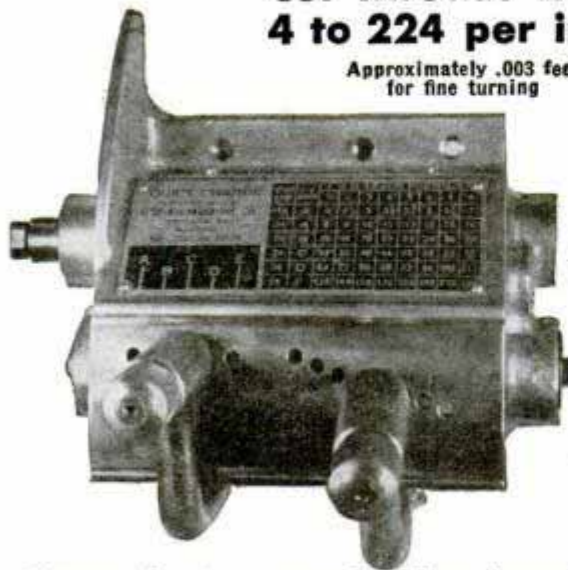

Only
\$75⁰⁰

F.O.B.
Chicago

Sold on
money-back
guarantee
if not
satisfied.

This gear box is constructed of all-steel gears in aluminum casting with bronze bearings throughout. Easy to install. Full instructions with shipment. Speedy production; maintained accuracy. Easy to set. Prompt delivery. Write Today!

THE O'BRIEN MACHINE CO.
Dept. PM-5 1620 Highland Ave. Chicago 26, Ill.

SAY YOU SAW IT IN POPULAR MECHANICS

MILL IT
ON YOUR LATHE



WITH A **PALMGREN**

MILLING ATTACHMENT

Now — you can do milling, slotting, grinding, grooving, squaring shafts, sawing at angles, and many other important operations on your lathe. **PALMGREN MILLING ATTACHMENT** is a necessary fixture for small shops, schools and emergency work in large plants. Fits South Bend, Atlas, Craftsman, Logan, Sheldon and all other makes. It has 360° graduation for rotary angle adjustments, also graduated feed and adjustment screw. Easily mounted by straddling lathe's regular tool post. Try one — it will quickly pay for itself.

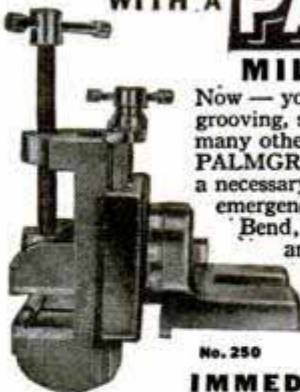

No. 250

IMMEDIATE DELIVERY

No.	Width Jaws	Depth Jaws	Jaws Open	Weight Pounds	Base Opening	Price F. O. B. Factory
150	1 1/4"	1"	1 3/4"	6 1/2	1"	\$18.75
250	2 1/4"	1 1/4"	2 1/4"	11	1 1/4"	24.75
400	4"	1 1/2"	4"	25	2"	39.75

Order from your dealer or jobber. Write for circular No. 349

CHICAGO TOOL AND ENGINEERING CO.

Mfrs. of **PALMGREN PRODUCTS** for Over 25 Years

8365 South Chicago Avenue • Chicago 17, Illinois



POWERlite

6-VOLT 2-LITE
ELECTRIC LANTERN

Millions now in use. 2-Lites: spotlight plus floodlight. Runs 80 to 100 hours on one battery. Rugged. Lenses don't break. At Hdwe., sport, electric dealers.

\$3⁶⁵

LESS
BATTERY

Delta

DELTA ELECTRIC CO.
MARION, INDIANA



**REPAIR
FURNITURE**

WITH THE GLUE THAT
MANUFACTURERS USE

FRANKLIN GLUE

GENUINE LIQUID HIDE GLUE

READY-TO-USE

Makes joints stronger than the wood itself. No mixing — No heating — No unpleasant odor — No chilled joints.

THE FRANKLIN GLUE CO., COLUMBUS 15, OHIO

AT YOUR HARDWARE DEALER



IT'S FUN TO MAKE THINGS OF WOOD



CONSTANTINE'S MANUAL TELLS HOW TO DO IT

Beginner or expert will find many helpful hints and tips on veneering, woodfinishing, cabinet making, carpentry, etc. Describes and illustrates over 100 different kinds of wood and 980 different items for you. ALL AT MONEY SAVING PRICES. Includes Identification Panel & Chart of Over 60 Rare Woods in NATURAL COLOR. A source of supply for anything in wood regardless of quantity. Send only 25c in stamps or coin, 25c refunded or credited on first order so Manual costs you nothing.

ALBERT CONSTANTINE & SON, INC.
791-J East 135th St. New York 54, N. Y.

You CAN'T WORM WRONG

for tape, hook, whip, round (ascaris) worms when you worm your dog as directed with Pulvex Worm Capsules, a combination treatment which insures your worming right. Used by leading breeders. Packaged 2 ways: for puppies, for dogs. Either, 50¢; double-size, 75¢
At pet, drug, department stores.



PULVEX
★ COMBINATION TREATMENT
WORM CAPSULES

Multi-Kwik

THE ORIGINAL ALL-STEEL 16 DISC WHEEL BEGINNERS' ROLLER Skates



HEY KIDS! COUNT EM!
16 DISC WHEELS
FOR EASY ROLLING

AGES 3 TO 7 LEARN QUICKLY, SAFELY FUN WITHOUT FEAR

ONLY \$2.40

(Plus Freight Some Localities)

Designed for small boys and girls ages 3 to 7, this wonderful, real all-steel roller skate provides healthful, muscle-building fun from the start. Beginners at once gain confidence because of lower center of gravity, foot balance, 16 Disc Wheels and soft straps. ADJUSTABLE.

AT LEADING STORES EVERYWHERE

MULTI-KWIK CO. A Division of Radiobar Company of America
WEST LOS ANGELES 25, CALIFORNIA



MODEL: Gasoline Engine Ready to Run

A precision built and engineered single cylinder FOUR-CYCLE model gasoline engine. Bench tested and ready to run. Available with stationary or marine engine base. Full instructions. Lots of fun. Engine \$27.50. Coil and condenser \$2.75. Immediate delivery.

The THOMPSON ENGINEERING CO.
206 Winchester Place, Grand Rapids, Mich.

7 3/4" high—3" wide

SHEATH WAR-BORN WONDER OIL Eliminates Cause of Rust

[A CHEMICAL DEVELOPMENT OF SCIENTIFIC WARFARE]



NOW

—Here's a jungle proven rust preventive that actually eliminates the cause of rust. Keep tools and equipment — everything you own—free from the ravages of rust and corrosion with an application of Sheath—It's the "impossible" our troops demanded and got, and now it's available to you.

Cleaves to wet or dry metal surfaces giving an amazing film of protection that displaces water, finger prints, all the causes of rust—Not messy or greasy—a light, free-flowing oil that acts like magic. You've never seen anything like it!

SPECIAL INTRODUCTORY OFFER—Sheath is so new to civilian markets that your dealer may not yet have it, so to those who act at once we will send our regular full 8-oz. \$1.00 bottle direct with all postage paid. Simply enclose one dollar bill or money order and forget your rust worries.



IT'S TRUE!
YOUR RUST WORRY'S OVER

BROWNELL INDUSTRIES, Dept. 10, Montezuma, Ia.

LAW

STUDY AT HOME for PERSONAL SUCCESS and LARGER EARNINGS. 35 years expert instruction—over 108,000 students enrolled. L.L.B. Degree awarded. All texts furnished. Easy payments. Send for FREE BOOK—"Law and Executive Guidance."

AMERICAN EXTENSION SCHOOL OF LAW
Dept. 65-M, 646 N. Michigan Ave., Chicago 11, Ill.

MACHINE SHOP EQUIPMENT

Every man who owns a workshop should have a copy of this new, authentic catalog of Machine Shop Equipment . . . the latest tools made by the biggest manufacturers in the United States. Replete with illustrations, descriptions, prices. Prompt delivery on most tools listed in this catalog. Available at the cost of printing—50¢ a copy—Get yours today! Price of Catalog Refunded on First Order over \$5.00. Send check or Money Order to

CENTER TOOL CO.

154 Centre St., New York 13, N. Y.



Largest pipe ever made, Vienna, 1789.
From an old print — Bettmann Archives

36-man pipe

1-man pipe



It's hard enough to get 1 man to agree on a pipe style, much less 36! That's why LHS has always designed a wide range of handsome models to suit individual tastes, and pocketbooks.

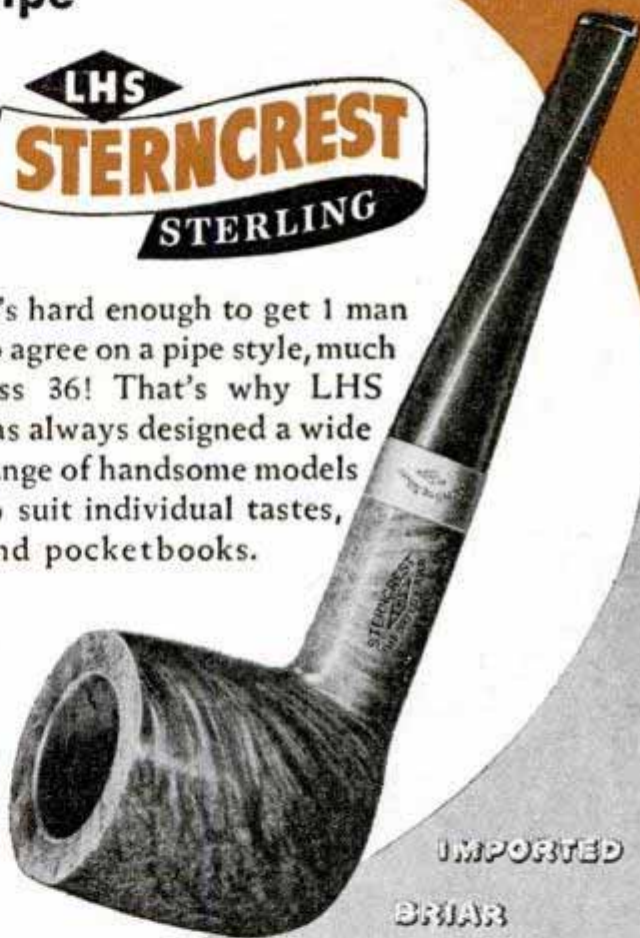

IMPORTED

BRIAR

LHS Pipes Include

Imported Briar

- LHS Sterncrest Ultrafine \$10.00
- LHS Sterncrest 14K . . . 7.50
- LHS Certified Purex . . . 3.50
- LHS Purex Superfine (Domestic Briar) 1.50

at good dealers everywhere.

\$5

Model #21.
Plain Finish.
Other handsome models. Plain or Antique.



FREE. Write for "Pipes—for a World of Pleasure"
L & H STERN, INC., 56 Pearl St., Bklyn 1, N.Y.

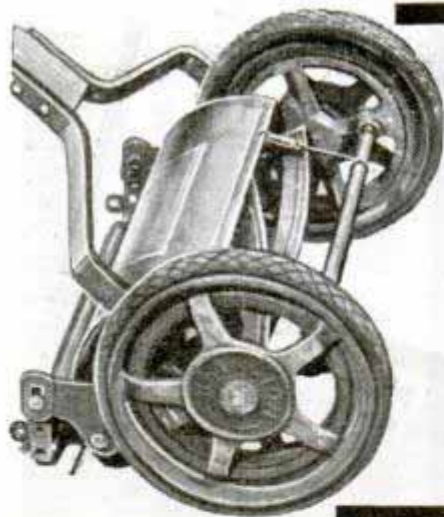

It's Simple — Safe — Quick — Efficient

New **KUT-RITE** LAWN MOWER SHARPENER

Grinding wheel principles applied. Actually self sharpening. Takes only 3 minutes — costs less than one professional sharpening, and equally as good. Described in April issue Popular Mechanics — Page 151.

14 inch only \$1.25

16 inch only \$1.35

18 inch only \$1.50

Send Check — Money Order or C.O.D.

ACCURATE SHARPENER MFG. CO.
2230-A N. Hubbard Street
Milwaukee 12, Wis.

BOYS

Earn big money sharpening your neighbors' mowers with the New **KUT-RITE** Sharpener. Order yours today.

Paul Bunyan's



VARI-PITCH

Adjustable Speed Propeller for **Outboard Motors**

Now you can troll without plates or special devices. A quick adjustment of the "pitch" on the Paul Bunyan Vari-pitch propeller gives you any trolling speed you want.

To speed up, merely readjust the pitch and speed will be limited only by the load, size of the boat and power of your motor. Pitch adjustment is simple, the self-locking nut is fool-proof, it can't come loose.

Quickly and easily installed. Available now for motors up to 6 hp. For larger motors later. \$6.95 for motors 3.5 hp. and lower. \$9.95 for motors up to 6 hp. If your dealer can't supply you, write direct, giving make, model and horsepower of your outboard motor.

PAUL BUNYAN BAIT COMPANY
Minneapolis 5, Minnesota

UTICA TOOLS



ALL TYPES FOR MORE TOOL MILEAGE

Ask Your Dealer



UTICA DROP FORGE AND TOOL CORPORATION
UTICA 4, NEW YORK



GEARS

In Stock - Immediate Delivery

Gears, speed reducers, sprockets, thrust bearings, flexible couplings, pulleys, etc. A complete line is carried in our Chicago stock. Can also quote on special gears of any kind. Send us your blueprints and inquiries.

Send for Complete Catalog No. 10

CHICAGO GEAR WORKS
440-50 N. Oakley Blvd., CHICAGO 12, ILL.

Low Price The **OTTAWA "Buzz" Master**



FREE Details

CLEAR LAND FAST! Powerful 6-HP motor with friction clutch for safe operation. Cuts down timber, brush and hedge; turn blade vertical; saw logs to length. Can be equipped to fell largest trees. Has clutch pulley for belt work; guaranteed.

OTTAWA MFG. COMPANY, 527 Brush Ave., Ottawa, Kans.

BLACK on WHITE for BETTER SIGHT

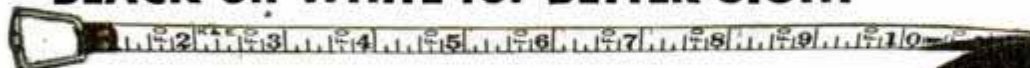

WYTEFACE Steel Tapes have black graduations on a crack-proof white surface. Easy to read in any light, from any angle. Faster measurements with fewer errors. Designed for hard service. Resists abrasion from rails, pipe, rocks, concrete. Protected against rust.

KEUFFEL & ESSER CO.
EST. 1867



WYTEFACE
TRADEMARK
STEEL MEASURING TAPES

NEW YORK • HOBOKEN, N. J.
CHICAGO • DETROIT • ST. LOUIS
SAN FRANCISCO • LOS ANGELES
MONTREAL



Drafting
Reproduction
Surveying Equipment
and Materials
Slide Rules
Measuring Tapes

PLASTICS

There's fun and profit in making plastic jewelry, novelties, and furnishings, in your home workshop! We have every material you need — Plexiglas, Lucite, Bakelite, Lignolite, Tenite II, Lumarith, in a large variety of sheets, rods, tubes, and special shapes. Also dyes, cements and other plastics supplies and accessories. Send 10 cents today for complete catalog.

CARMEN-BRONSON CO.

165 East 3rd St., Dept. 5-B Mt. Vernon, N. Y.

IT'S EASY!

IT'S FUN!

Build Your Own

• Transmitter Kits • Phono Amplifier Kits • Antenna Kits • Crystal Sets and many others.

FREE! 52 PAGE CATALOG

Tube and Circuit Book.....10c
Giant Radio Reference Map.....15c
Handy Tube-Base Calculator.....25c

Address PM-5,
Council Bluffs,
Iowa.

Formerly Wholesale
Radio Laboratories

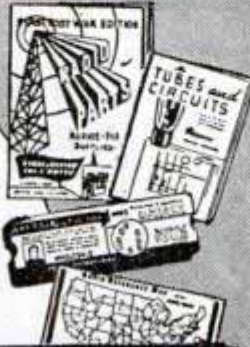

I HEARD YOU THE FIRST TIME!

*So Inconspicuous

I'M WEARING my new Zenith Hearing Aid and I can hear again!

Yes—I admit it took me a long time to come to my senses. For years I thought it was strictly *my* affair if I didn't wear an aid.

But when I realized I was penalizing my friends, too—forcing them to shout to make me hear—I decided my not wearing an aid was actually selfish.

So I tried a Zenith. And I've worn it as casually as eyeglasses ever since, because its Neutral-Color Earphone and Cord are so inconspicuous!

My friends enjoy my company more now that they don't have to shout. And I feel perfectly at ease when I'm with them. Smartest thing I ever did for myself *and* my friends was putting on a Zenith!

* * *

Hard of hearing? You owe it to yourself to have a free, personal demonstration of The New Zenith Radionic Hearing Aid that has helped thousands! No one presses you to buy. Let your own ears decide! See your dispenser—soon.

FREE! New, helpful booklet—tells how bad hearing may be helped without needless embarrassment. Write: The Zenith Radio Corporation, Dept. PM-5B, Chicago 39, Illinois.

Super-powered Model A-3-A \$50

- New 4 Position Tone Control—adjusts to your personal hearing needs with the flick of a finger.
- Choice of amplifier colors at no extra cost.
- Also available—Model B-3-A Zenith (Bone Conduction) \$50.



THE NEW
ZENITH
RADIONIC
HEARING AID

BY THE MAKERS OF ZENITH RADIOS

COPYRIGHT 1946, ZENITH RADIO CORP.

THE GEM MAKER

Amateurs or professionals . . . hobbyists or jewelers . . . Polish your own gems with a B&I Gem Maker. You will find this a profitable adventure. All necessary lapidary equipment is furnished, including a super-charged diamond blade for sawing, and all wheels for grinding, shaping and polishing, also complete instructions. The complete equipment as shown, less motor and belt, for only \$29.50, f.o.b., Burlington, Wis. Write today for information and literature on the Gem Maker and accessories.
B & I MFG. CO., Dept. S, Burlington, Wis.

"WONDER" ELECTRIC BUTTON

Most interesting electrical apparatus ever discovered. Make your own Telephone Amplifier, Detectaphone. Transmit your voice or music to distant rooms. Perform hundreds of fascinating experiments. So tiny it can be concealed in dozens of places. Send \$1 now for button and free 5,000 word instruction booklet with 50 illustrated experiments. **SPECIAL OFFER** 6 buttons and booklets sent post-paid for \$5.
BUCK MFG. COMPANY. Box A-28, No. Aurora, Ill.

50"
1 1/2" x 1/2" HOLLOW SQ. TRAILER AXLE

CAP.—2000 LBS.—\$6.75 EACH F.O.B. DETROIT
STRONG MACHINE & AXLE COMPANY
9710 Lumpkin Hamtramck 12, Michigan

REPAIR YOUR OWN ELECTRIC APPLIANCES WITH NEW AMAZING NICHROCITE

Simply overlap ends, apply Nichrocite paste and turn on the current—a perfect weld results. Used by big utility companies and repair shops. Just the thing for that broken or burned out heating element in your electric iron, stove, toaster or heater. Does the job in a jiffy. Trial order, \$1; 4 ozs., \$2.50; 1 lb., \$8.00.

Handy for Home or Industrial Use

ARMSTRONG ELECTRIC CO., Box 861-MP, Minneapolis, Minn.



MOTO-TOOL ★ THE "POCKET-SIZE" MACHINE SHOP

PUT THIS "WAR VETERAN" TO WORK

Long before Pearl Harbor, Dremel Moto-Tools had won their spurs by tackling tough jobs in tool rooms and machine shops. Now they have the respect of every branch of the armed forces. And thousands of them helped establish production records in plants such as General Electric, Westinghouse, Remington Arms, Ford, Nash-Kelvinator, Consolidated Aircraft, Northrop, Douglas and others.

Only Moto-Tools Have All These Features

A Model 2 Moto-Tool develops a speed of approximately 27,000 rpm. Weighs only 13 oz. Shaped to fit the hand. Sturdily built. Has shock-proof bakelite housing. Balanced for vibrationless operation. Uses 110-120 A.C. or D.C. current.



A few of the jobs that can be done better and faster with a Moto-Tool.



MOTO-TOOL KIT
Kit No. 2 with 23 high grade accessories and Model 2 Moto-Tool, in hardwood case. \$23.50
Model 2 Moto-Tool, with 1 accessory. \$16.50

MONEY-BACK GUARANTEE
Ask your Dealer about Dremel Moto-Tools and accessories. If he does not handle them, send direct to factory. We send prepaid if cash in full accompanies order. \$2.00 brings Moto-Tool C.O.D. for balance, plus postage. Write for FREE CATALOG.

MOTO-SAW COMING!
Dremel Moto-Saw . . . the sensational electric scroll saw . . . will be back as soon as materials are available.

27,000 R.P.M.

- Sharpening
- Finishing
- Touching Up
- Sanding
- Drilling
- Mortising
- Engraving
- Burring
- Grinding
- Polishing
- Burnishing
- Inlaying
- Sawing
- Scoring
- Cleaning
- Routing
- Cutting
- Rasping
- Carving
- Brushing
- Dressing

DREMEL MFG. CO., Dept. 116-E, RACINE, WISCONSIN

Your Favorites are Returning - Watch for Them

BASS OUTDOOR FOOTWEAR

WEEJUNS
FOR
LEISURE-WEAR

QUAIL HUNTERS
FOR
FIELD & STREAM

SPORTCASINS
FIRST
ON THE FAIRWAY

SKI BOOTS
SMOOTH
ON THE SLOPES

G. H. BASS & CO., 65 MAIN STREET, WILTON, MAINE

WRITE For FREE Literature

BUILD YOUR OWN POWER LAWN MOWER

WHY BREAK YOUR BACK MOWING FIELD OR LAWN?

Now anyone can save time and effort mowing field or lawn, by building their own whirl type power mower. We furnish complete information, and whirl type blade attachment. Write today.

BUILD YOUR OWN FAN with that old motor

One piece cast aluminum propellers used for cooling and ventilating. Also available to dealers at discount.

Size	Polished	Unpolished	Bore		
In. 2 Bl. 3 Bl. 2 Bl. 3 Bl.			In.		
15	\$2.50	\$3.50	\$2.00	\$3.00	1/2, 5/8, 3/4
18	3.00	4.00	2.50	3.50	1/2, 5/8, 3/4
20	3.25	4.25	2.75	3.75	1/2, 5/8, 3/4
24	3.50	5.00	3.00	4.25	1/2, 5/8, 3/4
30	5.00		4.00		1/2, 5/8, 3/4, 1

Plus 10% Excise Tax
KLOPPENBORG ALUMINUM FOUNDRY, Dept. SM, Davenport, Iowa

THE RITE-WAY MOWER ATTACHMENT

ASSEMBLE YOUR OWN POWER TOOL STAND

Four aluminum angle legs complete with aluminum foot and top castings and adjustable shelf bracket. Only twelve bolts or screws to attach any size top and motor shelf. Height 28". Weight, 4 legs complete, 5 1/4 lbs. Postpaid in U. S. on receipt of \$5.75

J. N. MACKENZIE
DEALERS Write for Information 194 CHRISTIANA ST., N. TONAWANDA, N. Y.

COLORED PLASTICS

The very latest and most practical for craftsmen's projects, Gem-like beauty—as easy to work with as wood. In five rich colors—mottled opaques and translucent. All new stock with masked polished surfaces. In 3/16" and 3/8" sheets, 6x6" to 12x24" and 1" and 1 1/2" diam. rods 10" and 20" long. Write for low price list.

SPECIAL INTRODUCTORY OFFER
Kit for matched set of cigarette box, ashtray and matches holder complete with plans and adhesive, shipping wt. 2 lbs., only \$3.80. Set is easily worth \$20.00 retail. Specify choice of marble-tone green or translucent tortoise shell. Send \$3.80 on money back satisfaction guarantee and we'll pay postage. Or send no money and pay postman C.O.D. plus postage.

HANSON PLASTICS, Dept. A, Chicago 19, Illinois

WRITE FOR YOUR FREE COPY OF THE NEW KRW HYDRAULIC PRESS BOOK

Describes all manner of Production and Shop Work on KRW Hydraulic and Bench Type Arbor Presses. 32 pages illustrating the new KRW Hand-operated, Electric-operated and Air-operated Hydraulic Presses. Write for your copy today.

K. R. WILSON, DEPT. 17, 215 MAIN ST., BUFFALO 3, N. Y.
Builders of Shop Equipment for Ford Dealers Since 1916

A TOOL... NOT A BRUSH



\$1.00 POST PAID

PAINERS' STRIPING TOOL

NOW! PAINT STRIPING MADE EASY!

Easy to use as a pencil! Draws parallel lines, straights, curves, circles with paint, enamel, lacquer, etc. Do your own striping on autos, furniture, toys, bikes, model planes, signs, linoleum... make wall board look like tile. Painters—craftsmen, order today! Type "M" Master Painters' Striping Tool complete with tip for 1/16" stripe, \$1.00. Extra tips 1/64", 1/32", 3/64", 1/16", 5/64", 3/32", 1/8" - 75c each. Tool with complete set of 7 tips \$5.00. (C.O.D. orders 25c extra.) Dealers write!

WENDELL MFG. CO.
4234-B Lincoln Ave., Chicago 18, Illinois

Army-Navy Type HEADPHONES

TYPE HS-23

Genuine U. S. Signal Corps headphones, better \$10.00 type. Leather-covered headband, detachable rubber cushions, 16. wt., imped-
ance 8000 ohms. Ea. **\$2.95**

TELEGRAPH KEY

Genuine U. S. Signal Corps key with cutout switch, silver con-
tacts **95c**

3 1/2" G. E. AUTOMATIC TIME METER

60 cycle 110 volts. This time meter consists of a cyclometer driven by a telechron synchronous motor. Connect to an electric circuit; it will measure and indicate the number of hours, tenths of hours or minutes that the circuit is in use. Ship-
ping wt. 6 lbs.—list \$17.00. Your Cost. **\$6.95**

2500 mfd. 3 volt F.P. condensers, each 69c

Write for our illustrated literature of radio parts.
Plus shipping charges.

Arrow Radio Co., Dept. G, 2205 W. Division St., Chicago 22, Ill.

"For the SPARK that NEVER Fails"

INSIST ON



RUMIN FLINTS
Gold Coated
and LIGHTER FLUID

At drug and cigar stores, PX and Ship's Service.

ROCK FLINT CO., 123 Doughty Blvd., Far Rockaway, N.Y.

ENGINES IN STOCK: ONLY \$9.95



The G. H. Q. miniature gasoline engine that really operates is available. Over 100,000 sold to date. 1/5 H. P. Complete with coil and condenser and full illustrated instructions for only \$9.95. Fully bench tested and ready to run. Power for all models. Send only \$1.00—Shipped Collect C.O.D. same day. Send for free illustrated Catalog of hundreds of hobby items.

GHQ MOTORS, Dept. BX56, Box 193, Sta. O, N. Y. 11, N. Y.

REPAIR CRACKED BLOCKS AND HEADS-



External and internal leaks in blocks, cylinders and valve ports quickly and easily with LUSCO PLASTIC SEAL.

90 day Service Guaranteed or your money back. Send money order or check for full pint—more than **\$3.00** Postpaid sufficient for average repair...

C. F. LUSK CO., 4626 EUCLID AVE., CLEVELAND 3, OHIO

Only Forecaster Superb Pipes have this

New FILTER*

Cleans, cools, filters smoke • Traps nicotine • Prevents drip

Enjoy a clean, cool, dry smoke always from a Forecaster • The exclusive aluminum winder can be removed in a jiffy—change cleaner as often as you like. • Choice, rich-grained briar, in a variety of popular shapes. • Ask to see the Forecaster Pipe display at your favorite dealer.

\$1.50

Sir Sheldon Pipes, \$2.50

FILTERS SMOKE FROM BOWL TO TIP!



*Pat. App'd For

NATIONAL Forecaster SUPERB

NATIONAL BRIAR PIPE CO • JERSEY CITY, N. J.



Be the authority on accuracy in your shop!

A man's work is only as good as his measurement. You can be the "accuracy man" in your shop. Learn to work with genuine Ford "Jo-Blocks," guaranteed accurate to within 2, 4 or 8 millionths of an inch, plus or minus. For a small investment, you can own a fine working set of Jo-Blocks—keep your mikes and gages at millionth-inch precision. There is only ONE true American-made Jo-Block, made only by—

WRITE FOR THESE FREE BOOKLETS!

An absorbing story of the search for precision. A new De Luxe Catalog of Ford Jo-Blocks and Accessories.

FORD MOTOR COMPANY
Johansson Division
 Dept. 510, Dearborn, Michigan



Johansson
 GAGE BLOCKS



This is the way to Make Money!

MACHINE SAW FILING with the Foley Automatic Saw Filer is the modern way to recondition saws. Anyone can do the work—no experience needed—no eye-strain. Start in spare time—Foley-filed saws cut so smooth and fast, they will advertise for you, bring you new customers and a steady repeat cash business.

The Foley is the ONLY machine that files all hand saws, also band and cross-cut circular saws—enables you to handle work from schools, shops and factories as well as farmers, carpenters, etc.

Send for FREE PLAN

Shows how to start—no canvassing. Send coupon today.



"I bought a Foley Saw Filer, one year later had all debts paid and also \$400 on a new home. Many days I earn as much as \$16," says J. H. Kellogg.

W. L. Tarrant writes: "I left my old job last September and in 10 months have filed 2,159 saws. We have a lovely business worked up the work."

Thor Nedribe, Iowa, says: "I have filed 550 saws, made \$350. As I'm a carpenter, I just file saws in spare time—have more than I can take care of."

FOLEY Automatic SAW FILER

FOLEY MANUFACTURING CO.
 516-6 Foley Bldg., Minneapolis 13, Minnesota
 Send Free Plan on Saw Filing business, no obligation

Name _____

Address _____

SAY YOU SAW IT IN POPULAR MECHANICS

Your Rust Troubles are Over CORODEX Rust Remover

is the war-time miracle liquid which cleaned millions of parts during war effort. CORODEX positively removes RUST and CORROSION regardless of depth, from iron, steel, brass, bronze, copper, chromium and nickel. Cleans tools, hardware, sports equipment, household utensils, etc., for a few cents a piece. No RUBBING or hard work.

CORODEX IS UNCONDITIONALLY GUARANTEED TO REMOVE RUST WHEN DIRECTIONS ARE FOLLOWED. Valuable Manual of Rust Control free with order.

At Sears Chicago, Suburban and Gary stores, 50c and \$1.00. Mail orders QUART SIZE ONLY \$1.00 Money Order or Check F.O.B. Chicago Express to:

SEARS, ROEBUCK AND CO.
 403 SO. STATE STREET, DEPT. 8500-9, CHICAGO 5, ILLINOIS
 (Corodex is made by Allied Products Co., 1133 Newport Ave., Chicago)

NO HUFFING... NO PUFFING with this Jim Dandy... GUARANTEED SELF-BLOWING Alcohol BLOW TORCH



This is the handiest little dandy you ever used. No workshop is complete without one. Gives a pointed flame of concentrated heat of over 1400° F. Made entirely of brass and nickel plated throughout. Leakproof construction insures long life flame and maximum pressure. Priming is automatic. Operates about 3/4 of an hour on each alcohol filling. Operation starts within 15 seconds and it remains working for about 3/4 of an hour. Immediate deliveries.

\$1.75 ea.
 plus 10c for postage.
 Check or M.O.

BRAFTEX PRODUCTS CO. 1123 BROADWAY, NEW YORK 10, N. Y.

FREE BOOK ON PLASTICS

Answers your "Plastic" Questions. Flexible Molds. Liquid Marble. Plastic Flooring. A guide to Money Making Opportunities. Tells you how to start. Questions and Answers. If you're interested in this new field write now!

BING PRODUCTS Dept. A5, 88 Broad Street BOSTON 10, MASS.

Big Money for Workers In Home or Shop



Licensed Concrete Specialists wanted. No experience needed. Make *Colorglazed* concrete pottery without molds. New, low cost, patented method. Cemetery products, novelties, tiles, etc. Basement leaksealing. Other big pay projects. Booklet, details free. Men only.

NATIONAL POTTERIES COMPANY
 542 Lincoln Avenue Fergus Falls, Minnesota

Van's BOOT SAVER



Here's the smart way to dry your boots and other outdoor footwear quickly—also to store them to save folding and prolong life. Indispensable to hunters, fishermen, farmers and all outdoor workers and sportsmen. On trips carry in coat pocket.

\$1.25 prepaid in U. S. A. if your dealer can't supply you.

NOEL VAN TILBURG CO.

1029 Washington Ave. S. E., Minneapolis 14, Minn.

POPULAR MECHANICS

UNCONDITIONALLY GUARANTEED ALDOR AUTOMATIC SPARK PLUGS

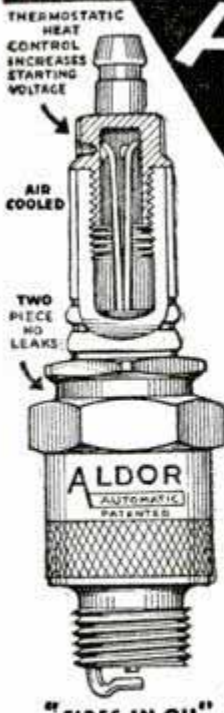

NON FOULING — AIR COOLED
THERMOSTATIC HEAT CONTROL
YOU GET
INCREASED POWER
SMOOTH PERFORMANCE
INSTANT STARTING
GREATER MILEAGE

For Cars, Trucks, Tractors, Marine Engines,
Outboard Motors, Motorcycles, Buses, Farm
Machinery and Lighting Plants
ALDOR AUTOMATIC SPARK PLUGS
are the result of more than 40 years' experience
in the manufacture of oil firing spark plugs
MILLIONS IN DAILY USE
are giving the utmost in power and
smooth performance to satisfied users
PRICE \$1.00 EACH—4 OR MORE .85 EACH
Mention Make and Year of Car — Order From

CENTRAL SALES
100 So. Ninth Louisville 2, Ky.
ORDERS SHIPPED PARCEL POST PREPAID
SEND CHECK, MONEY ORDER OR C. O. D.

"FIRES IN OIL"

Build These Two New Sensational CLEVELAND MODELS

First of a Brand New Line of Authentic Scale of
C-D Models Engineered for Flight



**Lockheed P-80
"SHOOTING STAR"**
Big 30" model of amazing
new Turbo Jet. \$100
C-D Kit IT-90.... \$100



Ryan "FIREBALL"
Big 30" model of first plane designed
to fly with conventional front propeller
for take-offs. And rear turbo jet unit
for high speeds. \$100
C-D Kit IT-92..... \$100

CATALOG 5¢
(See dealer for free circular)

See your dealer now. If he can't supply you,
accept no substitute. Order direct, including
20c extra for packing-postage.
CLEVELAND MODEL & SUPPLY CO.
4508F45 Lorain Ave., Cleveland 2, Ohio
"World's Largest Manufacturers of Model Aircraft Since 1919"

War Surplus GAS MASKS

GREATEST TOY SENSATION IN YEARS
Loads of fun! Cost U. S. Gov't. \$2.50. Fine war
relic—great toy—also useful for spraying paint,
insecticides, etc. Big plastic shatterproof goggles
makes you look like man from Mars. All brand
new! Adjustable head size. Canvas shoulder
strap bag included. Satisfaction
guaranteed. Order now. \$1
STARK'S — Dept. PM5
509 S. State Chicago 5, Illinois POST PAID



TELESCOPING MEASURING TOOLS

Measure All Holes, Slots, Etc. — 5/16 inch to 6 inches...
Gives You Outside Micrometer Accuracy on Inside Measurements
FINISH YOUR OWN SET OF FOUR TOOLS
Only \$2.95 C.O.D.
Plus Usual Small Postal Charge
PART OF THE MACHINE WORK ALREADY DONE—ONLY
SIMPLE LATHE WORK NECESSARY TO COMPLETE. No special tools
required—Threading, Knurling, etc., already done. Kit includes all
material (part machined); simple drawings, and detailed instructions.
Send \$2.95 cash with order and we pay postage.
ALCO SHOP, Dept. 6, Box 2214 Terminal Annex, Los Angeles 54, Calif.



FREE RADIO CATALOG

Latest radio and electronic parts and
devices, newest ham gear, gadgets,
war surplus items. All in this new
FREE catalog. Don't delay,



BURSTEIN-APPLEBEE CO.
1012M McGee, Kansas City 6, Mo.

A TOOLSHOP IN YOUR HAND!

- GRIND • DRILL • ROUT
- POLISH • ENGRAVE
- CUT • SAND • SAW, etc.

Make Things From
Wood—Plastics—Metals—Glass—Linoleum
—Leather—Alloys—Horn—Stone—Bone,
etc.

HANDEE TOOL OF 1001 USES

Smooth, steady power at your fingertips! You can turn out professional looking projects for pleasure or profit—ship, plane or train models, costume jewelry, wood carvings, puppets, initialed tumblers, etc. Handee, first small portable tool and today's finest, uses 300 different accessories. AC or DC. 25,000 r.p.m. Weight, 12 oz. With 7 accessories, **postpaid..... \$18.50**

GET A GOOD START

Get the
HANDEE KIT

HANDEE Tool and 45 of the most popular accessories, all packed in handsome, compact steel carrying case. You'll be amazed at what you'll accomplish!
Complete, postpaid, \$25.00

FOR YOURSELF OR A FRIEND...
THE GIFT OF A LIFETIME!

NEW PRECISION ATTACHMENTS

Fit DeLuxe Handee only. Enable novice or craftsman to perform precision operations not possible with other portable tools. Magically, easily, your offhand carving, routing, shaping, etc. is perfect as to depth of cut, accuracy of line. Set of 6 attachments with instructions, **\$7.95 postpaid**



ORDER NOW—USE COUPON

FREE 64-PAGE Catalog

CHICAGO WHEEL & MFG. CO.
1101 W. Monroe St., Dept. PM
Chicago 7, Ill.

Send me HANDEE TOOL HANDEE KIT
 PRECISION ATTACHMENTS
 Remittance enclosed. Send C.O.D.
 Send 64-page Catalog.

Name

Address

Lights in Wind in One Motion



\$1
at your dealer

THE only one-motion stainless steel lighter at \$1.00. New wheel and flint adjustment for velvet-smooth action.

PARKER SERVICE LIGHTER

PARKER OF LONDON LTD., NEW YORK

AMMCO 7" SHAPER

"A Precision Machine of a Thousand Uses"

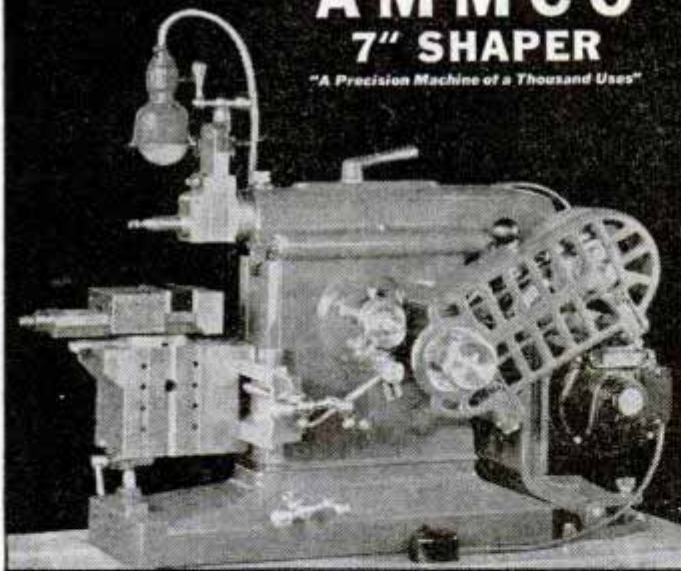

A wide variety of jobs can be done accurately, quickly, easily, and economically on the AMMCO Shaper (7" stroke).

Construction incorporates many features you would expect to find only in larger, more expensive machines... For example: WAYS of ram, tool head, and front face of the main frame are of the "VEE" type, hand scraped to insure accuracy and long life. Available for stationary installation or as portable unit.

Write today for specifications and prices

AMMCO

2140 Commonwealth Ave. North Chicago, Ill.



HUNTER'S COMPASS

Hunting Case, Watch Type, All Metal, Jeweled **\$3.50**

Engineers All Metal Army Type Hand-Sighting

LEVELS
\$1.50



PUBLIC SPORT SHOPS

13 S. 16th St., Phila. 2, Pa.

No COD's

WELD ANYTHING ANYWHERE ANYTIME



ALL PURPOSE ARC WELDER

9 Models . . . 32 Volt D.C., 110 to 440 A.C.

A complete workshop in itself! Weld, cut, braze or solder any type metal; iron, castings, aluminum, steel, bronze . . . in any gauge or weight, with equal ease. Compact, complete, as sturdy as the Rockies. Formed steel and cast aluminum case, welded steel base, 4" cast wheels. Built with voltage control.

Better on R.E.A. lines. Completely equipped. No instructions needed. Sold throughout the world. Several dealer territories open. Write;

FORNEY MFG. CO.
FORT COLLINS 2, COLORADO

WISE-GRIP WRENCH

Wise-Grip does more things, easier and quicker, than any other tool! Remains locked to the work with hands removed. Holds anything, any shape. Light, trim, handsome. Made of fine alloy steel. Electroplated.

Sold by Tool Jobbers and Dealers
PETERSEN MFG. CO., Dept. P-56, DeWitt, Nebr.

Gives 1 Hand
TON-GRIP



Double
Lever
Action



STOP CUSSIN'

use **2-WAY**
SPECIAL INSECT
REPELLENT

Nash & Kinsella Labs., Inc. • St. Louis, Mo.

KEEL-GUIDED BOAT ROLLER



FOR BOATS and CANOES. Easily mounted to dock, pier, trailer. Boat rolls on even keel, simplifies handling. Cuts damage and repair cost. Rollers of hard durable rubber. Assembled ready to use, \$7.95, F.O.B. FREE FOLDER. See your dealer or order from **BERG'S** Madison 4, Wis.

Here We Go!



OVER 75 MILES PER GAL

The CUSHMAN, during recent years, has proved itself to be so amazingly useful and economical that the demand, today, is terrific. If you want a CUSHMAN this season, we urge you to see your dealer or write us—IMMEDIATELY!

POWERFUL: 4 H.P. engine—new low and high gear supplies power for steepest hill. Floating Drive applies power smoothly. **ECONOMICAL:** 400 miles per \$1 worth of gas! **SPEEDY:** Up to 35 miles an hour! **COMFORTABLE:** Special springing, long wheel base, balloon tires. **SAFE:** Low center of gravity, heavy brakes. Durably constructed of finest materials. Thousands in use.

Made in several models for carrying extra passenger or heavy loads. Standard, shown above (windshield and tandem seat are extras)—or 3-wheel Side-Kar or 3-wheel Package-Kar.

WRITE See your CUSHMAN dealer. Or, send for full details on all models. Send Today!

CUSHMAN MOTOR WORKS, Dept. P-74, Lincoln, Nebr.

1 New - Improved OIL FOR ALL ---
HOUSEHOLD-SPORTSMAN-MECHANIC
Lubricates - Prevents Rust - Cleans Metal

3 oz. 40c

FIENDOIL

MOTORIZE YOUR LAWN MOWER
 WITH A GASOLINE OR ELECTRIC WASHING MACHINE MOTOR

ENJOY CUTTING GRASS AND MAKE MONEY RENTING YOUR MOWER. SEND FOR OUR GUARANTEED COMPLETE INSTRUCTIONS ILLUSTRATING EVERY DETAIL OF BUILDING THIS MACHINE.

PRICE \$1.00

ZETCO PRODUCTS CO., BELLEFONTAINE, OHIO

CIGARETTES

ALL POPULAR BRANDS

\$1.35 PER CARTON

NO OTHER COSTS

Minimum order 3 cartons

Perfect delivery guaranteed
 Send check or money order to
ACE MAIL ORDER CO.
 East Orange 20 N. J.

LOCATES TROUBLE INSTANTLY IN ALL ELECTRICAL DEVICES

HANLAN APPLIANCE TESTER

In this single unit are combined all the necessary tests for examining every appliance. Checks thermostats under actual working conditions. Tells instant it opens or closes. Controls the heat on soldering irons. Prevents over-heating. Tests continuity, open circuits, etc. Checks automatic irons, vacuum cleaners, motors, shavers, bulbs, appliances with 3-way switches, etc. Great time, effort and money saver! **ONLY \$9.50 COMPLETE.**

Pat. Pend.

FREE with each Tester. New, Complete Practical Course in electrical appliance repairing. **WRITE FOR CIRCULAR.**

HANLAN CO., 1419-A, West Jefferson, Los Angeles 7, Calif.

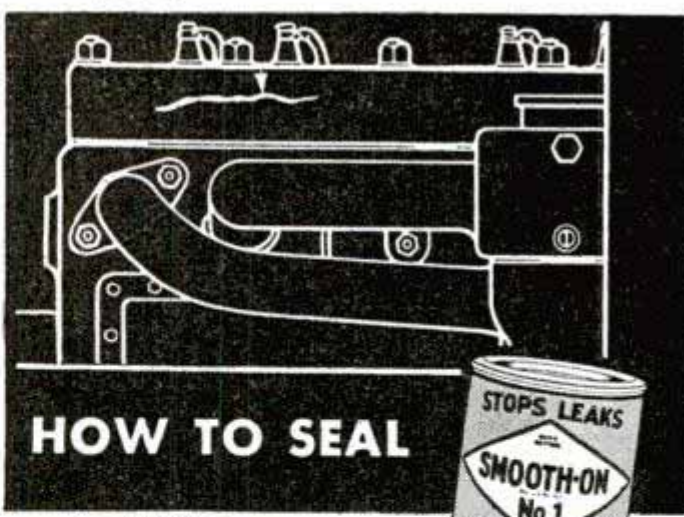

HOW TO SEAL CRACKED CASTINGS TIGHT

STOPS LEAKS
SMOOTH-ON No. 1
 CEMENTS IRON

Cracks in cast iron boilers, firepots, auto crank cases, gear cases, water jackets, etc., are lastingly sealed with Smooth-On No. 1 at very low cost. Even cracks that are long, or on parts subject to pressure, can be effectively sealed with this time-tested iron repair cement.

You use Smooth-On like putty, no heat needed. It hardens like metal and holds tight because it expands a little as it sets. You'll be surprised at the effectiveness of the repairs you can make with Smooth-On No. 1. Sold in 1 3/4-oz., 7-oz. and larger sizes at hardware dealers. If your dealer hasn't it write us.

FREE 40-PAGE REPAIR HANDBOOK

Clear, simple instructions for innumerable practical metal repairs. 170 diagrams. Pocket size. Just send coupon.

Sign and Mail NOW

Smooth-On Mfg. Co., Dept. 37
 570 Communipaw Ave., Jersey City 4, N. J.
 Please send me a Smooth-On Handbook.

Name.....
 Address.....
 5-46

Do it with SMOOTH-ON
 The Iron Repair Cement of 1000 Uses

Revolutionizing

MAN'S VIEWPOINT ON PIPE APPEAL



A rare combination of Craftsmanship and Style



Briar House Policy:

To provide maximum smoking pleasure... to assure mellowness by using only carefully seasoned and patiently matured briar... to merit Good Will and Confidence by furnishing the best pipes for the money.

Buy EDWARDS... greater values than similarly priced pipes.

Exclusive Patented Aluminum Filter



Briar House

1052 GREENE AVE. • BROOKLYN 21, N. Y.

SAY YOU SAW IT IN POPULAR MECHANICS

PRECISION DRIVES for your POWER EQUIPMENT

CONGRESS

PULLEYS & COUPLINGS

Available in a large range of sizes, CONGRESS DRIVES increase the performance of your workshop. They are the same precision drives that are being used as standard equipment by many of the worlds largest manufacturers of high priced precision machinery.

Better hardware, hobby shop and farm equipment dealers are selling CONGRESS DRIVES. They are available in all popular sizes with diameters ranging from 1 1/2" to 14". You pay no more for CONGRESS than for ordinary drives.

CONGRESS DIE CASTING DIVISION
Detroit 12, Michigan



LOOK FOR THIS DISPLAY

It identifies the dealer selling superior CONGRESS pulleys and couplings.



LORRAINE LIGHTER

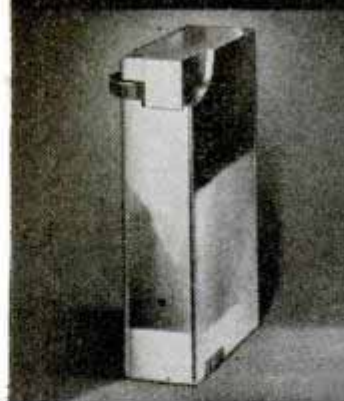

Streamlined, smart, sure-fire. Precision-made of gleaming hi-polish dural-aluminum. Triple capacity gives three times longer use without re-filling. Lightweight: 1 1/4" x 2" x 7/16".

DISTRIBUTORS WANTED

Gross Lots or more
\$12 Doz.

Less than Gross Lots
\$15 Doz.

LORRAINE INC.

115th & Alameda Sts., Los Angeles 2, Calif.



Send for our Catalog of TOOLS & EQUIPMENT for DEVELOPMENT WORK WATCHMAKERS TOOLS...
A House of Finger Tips

CATALOGUE

of Precision Tools, Equipment for Development Work, for the making of New Worlds.

"Mail Orders Only"

HENRY PAULSON & CO. CHICAGO 3, U.S.A.

NEW OTTAWA SAW

BIG FREE BOOK

World's Fastest
6 H.P.
EASY TO MOVE



Fells trees. Saws big logs, small logs, limbs. Pulley for belt work. Easy to handle, weighs less than lower powered units. FULLY GUARANTEED. Cash in on fuel shortage. Turn wood lots into cash. OTTAWA MFG. CO., 527 PINE ST., OTTAWA, KANS.



WREN HOUSE and 5 COLORFUL GARDEN BIRDS Assemble House Yourself

Birds, true types. Weatherproof colors. No assembly. Flexible legs, just twist on bush or shrub. A fine improvement for any garden. Authentic model house. Complete instructions for assembly. All material, hooks, hardware included. Nothing to cut, saw, or paint. PREPAID. Attaches to wall, post, tree. Will attract wrens. Immediate shipment.

STAR MFG. CO. LINCOLN, NEBRASKA

1.00

STOP THAT DRIP



Effective Immediately

New—for homes! A sure cure for condensation drip from cold water pipes. Pliable, cork-filled NoDrip Tape eliminates wet floors, makes idle space usable! Quick, Clean, Easy to Wrap on—No tools needed. Covers joints as well as straight pipes. \$1.25 At hardware, dept. stores, lumberyards. Roll, enough for 7 feet of 1/2" pipe.



Higher west of Rockies and Canada Write for free NoDrip Tape Circular J. W. MORTELL CO. 522 BURCH ST., KANKAKEE, ILL.



Superior Quality ROTARY FILES

FOR HOME CRAFTSMEN

The nationally famous Ford Rotary Files, used for the past 25 years by leading precision manufacturers, are now available for the home craftsman in a handy dust proof case which contains six popular shaped tools.

The tools are made of the finest quality high-speed steel, hardened and tempered for maximum life. These ground cutters are efficient on steel, aluminum, brass, plastic or wood. The shapes will meet most home craftsman applications. These tools are made with standard 1/8-inch shank. Additional shapes and sizes are available.

Money with order prepaid
C.O.D. — postage extra

SIX TOOLS in
Dust Proof Case \$6-25

M. A. FORD MFG. CO. 800 WEST FIRST STREET
DAVENPORT, IOWA

JET PROPULSION



GAS TURBINE Model Engine

★ ★ Be one of the first to build a real Turbo-Jet Model Engine. Single-stage centrifugal compressor and turbine. This is a real engine, easily made with ordinary home workshop equipment. Complete plans for construction . . . design formulas and curves for checking performance and testing.

\$2.00
Post paid

THE ROTOJET CO. Department 11
BOX 757 • LOS ANGELES 25 • CALIFORNIA

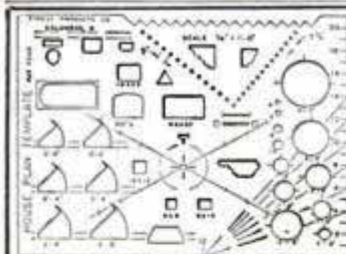

HOUSE PLAN TEMPLATE

Made of clear sheet plastic, with accurate cut-outs for drawing door-swings, plumbing and electric fixtures, fireplace, stairs, moldings, roof-pitch, etc. Standard 3/4" equals 1'-0" scale.

AT YOUR DEALER \$1.50
or mailed postpaid

TIMELY PRODUCTS CO.
Box 206C, Columbus 9, Ohio

DUPLICATING MACHINE for \$4.00!

Earn Big Money making photographically exact copies of letters, certificates, photos, etc. Build clever machine in one evening with hand tools for less than \$4.00. Clearly illustrated instructions plus plan for operating your own copy business—\$1.00 postpaid.

J. P. KILMAN, 1301 SCOTT ROAD, BURBANK, CALIFORNIA

If They'll Bite You Can CATCH 'EM With The



FISHIN' GADGET Sets Hook Automatically

The greatest fishing invention since the fishhook! Automatically sets the hook on fish, that bite. First day's results insure lifetime use. Will last for years. Made of non-corrosive metal. Use on any line . . . for any kind of fishing. See your dealer or send coupon and \$1 bill for your Fishin' Gadget . . . now!

Money Back Guarantee



Send
Coupon
and \$1 Bill

Sent Postpaid
Get Yours Now!

Graham - Campbell Co.
1405-7 Walnut St.
Kansas City 6, Mo.

Here is a \$1 BILL. Send me a
FISHIN' GADGET quick!

NAME.....

TOWN.....

STREET..... STATE.....

4-WAY ACCURACY

with a
Streamline
rule...

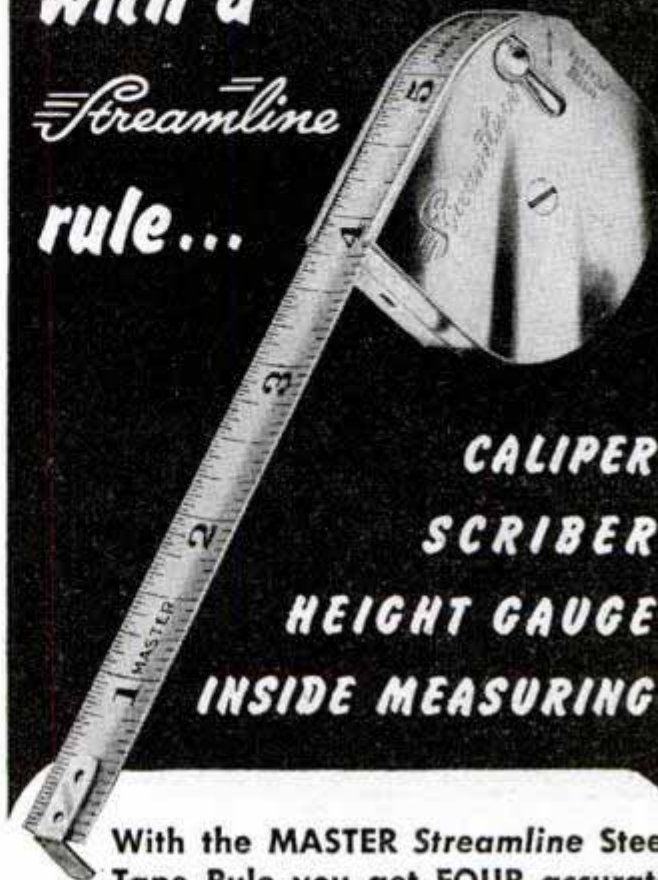

CALIPER
SCRIBER
HEIGHT GAUGE
INSIDE MEASURING

With the MASTER *Streamline* Steel Tape Rule you get FOUR accurate measuring instruments in one. The flat bottom case with the positive lock, and the six or eight-foot steel rule with markings on both sides, makes this precision tool the ideal for all-round shop or drafting room work. The extra long "claw" on the tip anchors the rule when making out-of-reach measurements.

All first-class hardware dealers carry the
STREAMLINE. Or you can order direct
from MASTER by using the coupon.

MASTER

WOOD AND TAPE RULES

TRADE MARK

MASTER RULE MFG. CO., INC.
815 E. 136th St., New York 54, N. Y., Dept. F5
Branch: P.O. Box 1587, Oakland, Cal.

Enclosed find \$2.65 for the new 6 ft. "Streamline" complete with spare blade.

NAME.....

ADDRESS.....

CITY..... STATE.....

A Fine, Precision EXPOSURE METER



\$11.50
WITH
LEATHER CASE
TAX EXTRA



The Sign of Precision

Make your camera take better, sharper photos. Eliminate guess-work, lost pictures and wasted film with a precision-built SKAN Exposure Meter. A *must* for color—still or movies. Be right in *any* light—day or night. Simple to use.

FREE—Write for descriptive literature. Please give nearest dealer's name. G-M Laboratories Inc., 4290 N. Knox Ave., Chicago 41, Ill.



EXPOSURE METER

SAY YOU SAW IT IN POPULAR MECHANICS

BURN YOUR NAME ON TOOLS

WITH THE ARKOGRAF

PROTECT YOUR TOOLS FROM THEFT
Write with electricity any name or design on the hardest and finest tools and instruments or any metal, like writing on paper with pen or pencil. Thousands used by mechanics, garages, machine shops.
Complete Outfit \$3.50—Prepaid Anywhere
Interesting illustrated circular free. Write today.
ARKOGRAF PEN CO., 3927 S.E. Stark, Portland 15, Ore.



FIND UNDERGROUND MINERALS and METALS with M-SCOPE

Employs same principle as Army Mine Detector. Unsurpassed in Efficiency. Write for Free 16 page booklet.

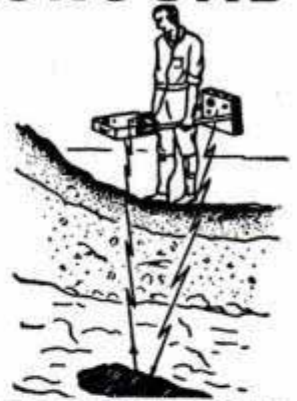

FISHER RESEARCH LABORATORY
PALO ALTO CALIFORNIA



MEN

This Horseshoe Ring, Handmade, Hand engraved, inlaid with simulated pearl, is a **KNOCKOUT!** Shoe and shank of everlasting Monel Metal is

GUARANTEED 20 YEARS

Supply is limited... rush your order! **SEND NO MONEY.** Pay Postman **only \$3.85**, plus excise tax and postage. Return for refund in five days if not delighted. State size. Address:

NATIONAL JEWELRY CO., Dept. 504-H
Wheeling, W. Va.

STOP KEY HOLE FUMBLING!

Flick switch and **LITE-A-LOCK** floods keyhole and keys. Anyone can install to 6 volt door bell circuit in a jiffy.

INSTALL
LITE-A-LOCK

SEND CHECK OR MONEY

ORDER TO-
DAY.



\$2.00
POST-PAID

LITE-A-LOCK

POST OFFICE BOX 243, ROYAL OAK, MICHIGAN

FREE!! 40 PAGE HOBBY CATALOG

Over 1000 Items — Over 300 Photos

Our new 40 page catalog is the "bible" of wide-awake modelers. Hundreds of models to choose from! Planes, engines, boats, jeeps, tanks, gliders, supplies, etc. Send for yours today! 20c up.

NEW THOR 1/6 H.P. GAS ENGINE.....\$10.20 Postpaid
AMERICA'S HOBBY CENTER, INC. Dept. 856, 156 W. 22 St.
N. Y. 11, N. Y.



TENNIS SAVE ON OUR LOW PRICES

● Gut Tennis and Badminton Strings direct from factory to you.
● Vises & Frames ● Tennis Equipment
H.E. WILLS CO. Catalog **FREE**

1047 W. 47 St.

Dept. PM-56
Chicago



CARBIDE SCRIBER NON-MAGNETIC

FOR HARDEST STEEL, GLASS, ETC.

Tungsten Carbide — the hardest metal made by man — carefully ground on diamond laps, brazed into stainless steel 6" handle for marking steel and other metals — for etching, marking, cutting glass. Cuts all directions. Easy to follow any contour. In plastic case with pocket clip.

LUCAS-MILHAUPT ENGINEERING COMPANY 5049 S. LAKE DRIVE
CUDAHY, WISCONSIN

PRICE
POST PAID

\$2.00

Dealers Wanted

IT'S FUN to BUILD THE NEW LEJAY FAST-FREEZER

ENJOY BUILDING THIS
HANDY FREEZER

When you consider how necessary such equipment is to the modern household, you will realize what these complete plans mean to men, like yourself, who enjoy making such things and get a big kick out of saving money in doing so. Its sturdy simplicity and ease of construction appeal to all handy men and amateurs.



**NO KNOWLEDGE
OF REFRIGERATION
REQUIRED**

Plans are easy to follow and you may have much of the material at hand. FAST FREEZERS made from these plans have been in use since 1938.

**MILK COOLER
PLANS, TOO**

are included at no extra cost. Send only \$1.00 for the complete plans. Canada, \$1.10.

LEJAY MFG. CO.

447 LeJay Building
Minneapolis 8, Minn.

**FROZEN
STORAGE**
from 5° above
to 10° below
zero

For Fish,
Meat, Game,
Fruit etc.
5 Sizes
8-40 Cu.Ft.
capacity

LENSES 500,000 OF THEM

Buy them for a fraction of their original cost.
U.S. ARMY & NAVY surplus lenses and prisms.
RIGHT ANGLE PRISM 23 m/m sq. face.ea. \$ 1.00
5 POWER TANK TELESCOPE (M71) Brand New.
Coated Optics Completely Assembled. Value \$345.00 Perfect. ea. 22.50
COMPLETE SET OF OPTICS FROM PERISCOPE RIFLE
SIGHT. Value \$24.00.ea. 2.25
METAL PARTS TO MAKE A COMPLETE 5X TANK
ARTILLERY SCOPE. Diagram included. 7.50

Send Money Order or Check—3 cent stamp for list

A. JAEGER, BOX 84 P, SO. OZONE PARK 20, N. Y.

NEW OTTAWA Wood Saw



FOR TRACTORS Makes wood sawing fast; easy. Cuts enough wood to pay for itself quickly. Easily moved while attached. Big blade; send for FREE details.
OTTAWA MFG. CO., W527 Oak Ave., Ottawa, Kans.

LAWN ORNAMENT-NOVELTY PATTERNS

28 Lawn Ornament Patterns, 25c. Other patterns; 15-20" high; Dutch Girl, Dutch Boy, Pirate, Bull Terrier, Mexican Girl, Mexican Boy, Dwarf, Penguin, Flower Girl, 19c each. 25 Novelty Patterns, 30c. All 62 Full Size Patterns, \$1.00 Postpaid. Strother Pattern Service, Dept. F-8, Box 383, Bellington, W. Va.

Kill Dandelions Easily



New Spray Treatment Kills Dandelions and Does Not Kill Grass. Simple, inexpensive, and easy to use. Quick, permanent results. NON-POISONOUS. Rid your lawn of dandelions. Have beautiful green grass. Write Today for Illustrated Booklet. It is FREE — no obligation.

AMERICAN HOMEGROUNDS INSTITUTE
Dept. 16 Columbus, Kans.

NOW! RIDE wherever you go
with NEW
WHIZZER
BIKE MOTOR

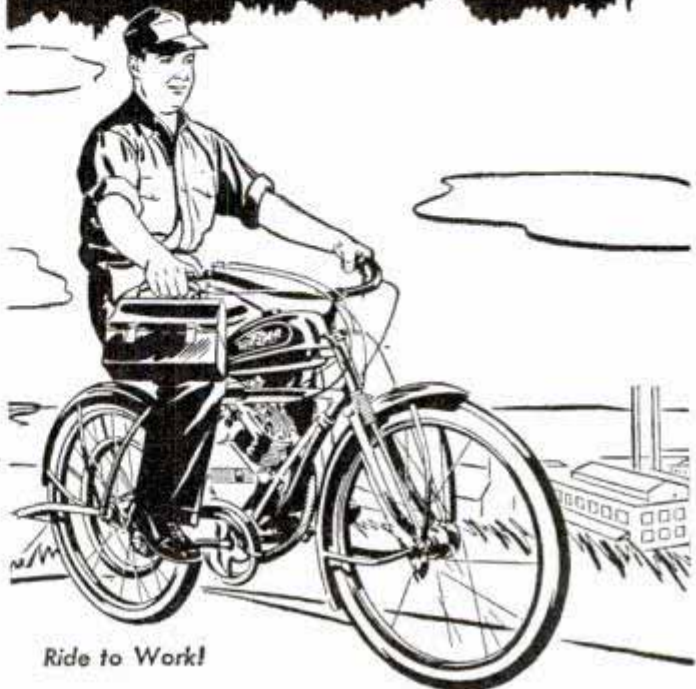

Ride to Work!

Whizzer is compact, sturdy, powerful; you can install it easily within the frame of any balloon-tired bike to give you personal, dependable, low-cost transportation. Whizzer's 2½ horsepower, driving the rear wheel through a V-belt unaffected by weather and road conditions, will take you swiftly and comfortably along streets, roads and trails. 125 or more miles on a gallon of gas; 5 to 35 miles per hour. Open up new avenues of adventure with Whizzer! Put a Whizzer on your bike now! WHIZZER MOTOR COMPANY, Pontiac 15, Michigan.

FACTORY
LIST PRICE
\$89.50
PLUS
TAX

Whizzer on your bike will take you anywhere! One owner rode from Los Angeles to Pontiac, Michigan, in 9 days! Reports 3500 miles at a total cost of \$5.47. "A swell trip," he says.

IF NO LOCAL DEALER, USE COUPON

WHIZZER MOTOR COMPANY
Dept. 165, Pontiac 15, Mich.

I enclose \$91.60, including \$2.10 Federal Excise Tax, () check or () money order. Send me one Whizzer motor, complete, with full installation instructions, tax paid. Written guarantee with every motor.

If descriptive literature only is desired, check here ().

NAME _____

ADDRESS _____

CITY _____ STATE _____

THE LIGHTWEIGHT Balanced Golf Bag

... makes golf more enjoyable • The patented features of **BALANCED GOLF BAG** make it *lightweight*, perfectly balanced, non-sagging and easy to carry. Clubs won't spill out—no need to continually "yank" it up. It's spacious, sturdy, good-looking—it's just what you've always wanted.

- Wide, adjustable, padded shoulder strap
- Rustproof hardware, drag plate
- Large pocket with zipper
- Unbreakable hickory rod
- Finest quality duck



\$5 at your store or club

(Use coupon if dealer can't supply you)

BALANCED GOLF BAG, INC.
NORTH & NOBLE • CHICAGO 22, ILL.

BALANCED GOLF BAG, INC.
North & Noble, Chicago 22, Illinois

Please send me one **BALANCED GOLF BAG**
Sun-tan or White (please check color desired).
Check or money order for \$5 is enclosed.

Name _____
Street _____
City and State _____

NEW TOOL READY!

War Industry's Handy, All'Round Machine
Now Available
To Home Shops!

The world-famous Mead Bandsander—invented for and used by hundreds of war plants—is at last available to you for home workshop use! This remarkable machine quickly shapes, sands, carves and polishes wood, metal, plastic! Works equally well on inside cut-out openings or irregular outside edges. Gets at places no other can! Tilting table for bevelling, chamfering. Rust-and-sweat proof top. Ball bearings. Saves time, labor, money on jobs in any home or industrial shop. Invaluable to home-craftsmen, makers of patterns, tools, dies, signs, costume jewelry, castings, forgings, ornaments, radio and electrical parts, stampings, etc. Nothing else like it. Sold on 5 Day Trial, money back guarantee.

Circular Free!
Cuts Fast and Clean . . .
Saves Filing, Sanding Work

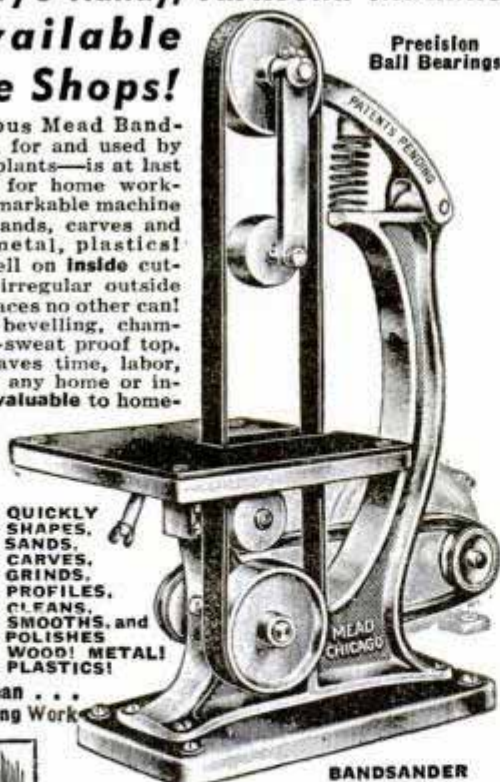

Precision
Ball Bearings

BANDSANDER

Write for **FREE Circular**

Send for free details on "the machine that amazed the experts!" Rush a postcard today for Circular, surprisingly low price. Hurry!
MEAD SPECIALTIES CO.
4114 N. Knox Ave., Dept. 15, Chicago 41, Ill.



**AGENTS MAKING \$300 A WEEK
SELLING AMAZING NEW PLASTIC
FLOOR FINISH . . . ELIMINATES
OLD FASHIONED WAXING PROBLEM!**

FREE SALES KIT!

Get in on the ground floor of one of the biggest money makers ever put out! Every home, office, store, restaurant, beauty parlor, church and factory a red hot prospect. Sells on sight. Anyone can apply. Just mop it on. Send for free sales kit today. Exclusive territory. Write our Mr. Thomas today.

FAIRCHILD CHEMICAL & COATINGS CO., INC.
280 Madison Ave., New York 16, N. Y.



IDENTIFICATION BRACELET only \$1.95. Heavy silver plated, name engraved without extra charge. Orders shipped same day. We also make these with a **STERLING SILVER** tag, heavy weight, with nickel silver chain, each boxed, \$2.95. We pay tax and postage.

MONT PETIT MFG. CO.
15 E. Pearson St., Dept. C Chicago, Ill.

TUBULAR AXLES for TRAILERS, FARM WAGONS, TRUCKS and UTILITY

2,000 lb. capacity—Spindles ground and threaded—fit standard front auto hubs and bearings—58 inch track. **SEND CHECK OR MONEY ORDER TODAY.** **\$6.75** F.O.B. DETROIT
Other types quoted on request. (Prices subject to change without notice)

SPARTAN INDUSTRIES
8211 McDougall • Detroit 11, Michigan

TRAILER AXLES, HITCHES, AND PARTS

• If you are interested in purchasing trailer axles, hitches, and other trailer parts, contact us promptly. **Write for free literature.**
HAMMER BLOW TOOL COMPANY, Dept. 105, WAUSAU, WIS.

PRESTO! MASTER GLAZE



Car Owners! Meet Master Glaze—the sensationally different luster for new and used cars! Not a wax—not an oil polish—not a paint!—nothing that "smears" over the surface.

MASTER GLAZE is a unique discovery—a creamy liquid—quick and easy to apply! Gives a hard, glass-like surface. Even gasoline cannot dull it! Lasts six months to a year! Amazing luster—beautiful, sparkling clean and brilliant! Doesn't finger-mark—doesn't smear! A match box full glazes an entire car. Seals the pores—protects! **NOTHING LIKE IT!**

AGENTS
An unusual opportunity!
Quick, flashy demonstrator.
Big profits.
Good territory.
Write today!

FREE SAMPLE

Just send your name and address today to
MASTER GLAZE CO., 7720-547 W. Harwood Ave., Milwaukee, Wis.

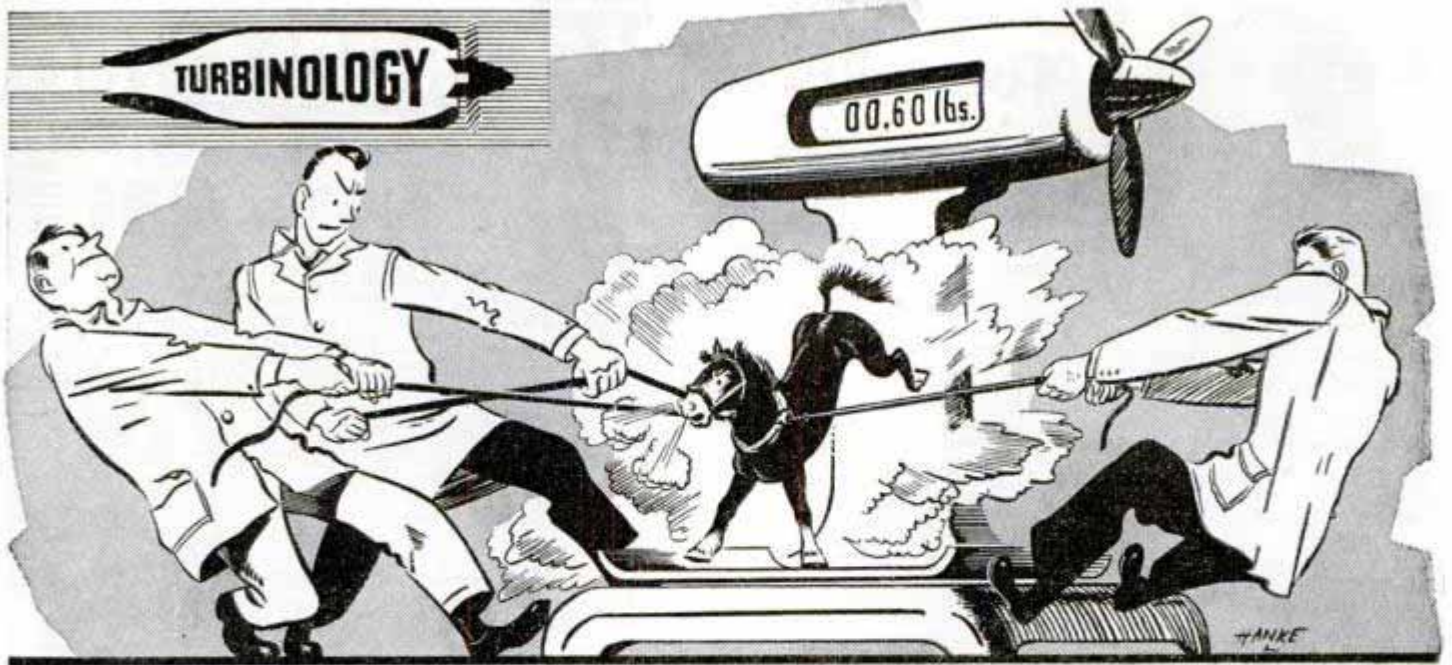

Pony-Weight Horsepower

When a plane is described as being 200,000 pounds in gross weight, this figure includes not

only the weight of the plane but all of its load of gasoline, oil, crew, passengers, mail, and cargo.

If the plane structure is "heavy", the useful load is light. If its engines are gas hogs, more fuel and fewer passengers go aboard. And if the engines are heavy for the power they deliver, still more potential load remains on the ground.

The champion of all reciprocating engines for weight-per-power is the Cyclone 9, first engine to weigh less than a pound per horsepower. It delivers 1,425 horsepower but weighs only 1,352 pounds, or 0.95 of a pound per horsepower. Most engines run over a pound per HP, especially in the high output types.

Now there is another champion, in a new power field. The Wright propeller turbine has made the sharpest of all cuts in weight, while at the same time doubling the power of the Cyclone types. Within a short time, Wright turbines will deliver many times the power of the Cyclone 9 at a weight of only 0.60 of a pound per horsepower. It will make a difference of hun-



dreds of thousands of dollars in airline revenue and will mean lower passenger fares and cargo rates.

On a two-place training plane, the difference between 0.95 and 0.60 of a pound per HP is not a major one. Maybe about a dozen pounds. But on the new air giants taking off with as much as 30,000 HP, the difference is tremendous. A plane with this much power from ordinary type engines would have to carry over 30,000 pounds in engine weight. But



Wright turbines of equal power, would only weigh 18,000 lbs. Much of the weight saving in the Wright turbine comes from its sheer simplicity. There are just two main moving parts: the air compressor and the turbine

wheel, plus gears to slow down the turbine speed to efficient propeller speed. Eliminated are the individual cylinders, pistons, valves, connecting rods, crankshafts and counterweights, cams and intricate gear trains. In the four Cyclones of a B-29, there are 144 spark plugs while the turbine has but three per engine.

The turbine is well balanced and needs no counterweights. Turning continuously, with no pistons moving up and down, it does not set up strong vibrations and thus uses a lighter housing than engines of equal power.



These figures on weight savings, and what they mean in terms of payload, are only one of the reasons why the giant planes to come are being designed for Wright propeller turbines. And these figures are just one more indication of the way Wright Aeronautical engineering produces better aviation power for all types of aircraft.

WRIGHT
AIRCRAFT ENGINES

DIVISION OF
CURTISS WRIGHT
FIRST IN FLIGHT

Wright Aeronautical Corporation • Paterson, New Jersey, U.S.A.



here's a paying business!

Hobart
simplified arc
welding

Stationary Electric Drive

BIG PROFITS FROM YOUR SHOP

It's easy to establish your own arc welding job shop and make it pay big dividends! All kinds of automotive, farm and factory arc welding repair work will come to you. Arc welding is one of today's most highly paid businesses—and now's the time to get into it.

EASIER WELDING WITH HOBART

Construction and operation features found only in Hobart Arc Welders let you do a better job of arc welding in less time with a minimum of work. 1000 combinations of welding heat, remote control at the work are good reasons why experienced welders prefer Hobart.

CHOOSE THE RIGHT WELDER

In Hobart's complete line you'll find Electric Drive Portable and Stationary; Gasoline Drive; A. C. Arc Welder; Generator Only — in a size and range that fits your requirements. Use the coupon for details.

HOBART BROS. CO., Box M-56
Troy, Ohio. "One of the World's
Largest Builders of Arc Welders."



Electric Drive
Portable



A.C. Arc Welder

Save \$150 to \$300, "Build Your Own" HOBART ARC WELDER.

With this Hobart Generator and used auto parts, it's easy to build-your-own gas drive welder.



Reach for Your Scissors

HOBART BROS. CO., Box M-56, TROY, OHIO

I'm interested in Hobart Arc Welders. Tell me what they can do for me — send details on items checked:

- Electric Drive
- Gasoline Drive
- A.C. Arc Welder
- Generator Only

NAME _____

STREET _____

CITY _____

STATE _____

ELECTROPLATING OUTFIT

BRUSH ON
SILVER, COPPER

Only \$4.95 COMPLETE



Comes Ready to Use—Nothing Else to Buy!

Here's the Handy ELECTRO-PLATER outfit for your home-workshop or business! Only \$4.95 complete! Puts a smooth, shining, silver or copper plating on silverware, toys, models, doorknobs, auto accessories, home fixtures . . . everything with a conductive surface! Simple, easy to use! Complete instructions furnished. Just brush on silver or copper plating! Comes complete—ready to use—with liberal jars of silver and copper plating materials, cleaner, two brushes, battery power unit . . . everything you need to start plating at once! Nothing else to buy.

SEND NO MONEY! GUARANTEED!

Just mail name and address today! Pay postman only \$4.95 plus few cents postage on delivery. Use electroplater for 10 days. If you are not completely satisfied, return outfit and your money will be refunded. Rush your order today!

HANDY ELECTRO-PLATER - Dept. A-400
259 Strader Avenue Cincinnati 26, Ohio

METALLIZE BABY SHOES

Learn this easy, money making business from nationally recognized consultant. Small investment; perpetual market. For free details write Joseph B. Kushner, B.S. Ch.E., Metal Finishing Consultant, Stroudsburg, Pennsylvania, R.D. 3E.



DON'T USE CHISEL

Use KROIL, the new chemical lubricant that creeps into millionth inch spaces, dissolves rust and dried grease. **KROIL LOOSENS FROZEN PARTS** The fastest penetrating oil known, 5000 industrial plants used Kroil to keep war production going. Try it on money back basis. AT YOUR DEALER or send \$1 for two 8 oz. spout cans, postpaid, send dealers name.

KANO LABS., 3025 LINCOLN TOWER, CHICAGO 1, ILL.



SUPER MYSTERY BUTTON

Many times as sensitive as our regular mystery button. Can be used for the same experiments and uses as the mystery button but with far better results. Needs no diaphragm of any kind. Ideal for musical instruments, intercommunication, recording, talking thru radio, and many other uses. When used with small head phone it makes an ideal inexpensive hearing aid. Shipped with 5000 word, 12 page booklet showing diagrams for dozens of uses, postpaid \$2.00.

Electronic Products Company
Saint Charles, Ill.

ONE-MAN SAWMILL LESS THAN \$200.00
Easy To Turn Trees Into Money

Makes lumber, ties, shingles, crates, bath, studding, siding. **Belsaw Models** in 10, 14, 20, 24 ft. sawing lengths. Patented Mechanical Feed, accurate set works and positive dogs. Use tractor or old auto engine for low cost power. Thousands used for commercial sawing. Pays for itself quickly. Send post card today for FREE booklet, "How To Make Lumber" and Catalog of Woodworking Equipment. **BELSAW MACHINERY COMPANY** Dept. 1811-Z 3542 Main Street, Kansas City, Mo.

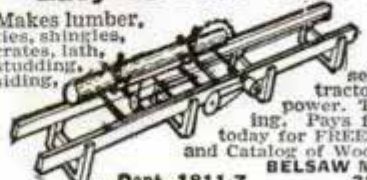

The Complete Home Workshop

Only
\$34⁹⁵

Less Motor and
 Saw Blade



5

Now you can do the kind of woodworking you've always wanted—with speedy, accurate power equipment!

- Lathe
- Drill Press
- Bench Saw
- Grinding Wheel
- Disc Sander

This smooth running Emrick Home Woodworker combines FIVE Power Tools in one compact unit. It's designed to handle all kinds of home woodworking jobs. And it's durable, powerful, heavily built of welded steel construction with high quality bronze bearings.

Lathe is 30" between centers, with 9" swing. Saw has 10"x15" table. Uses 6" blade. Drill Press drives 1/2" drill in steel. 8" sanding disc and 5" grinding wheel furnished. 1/4 hp. motor supplies ample power.

This machine is now in mass production, and is being shipped direct to user on MONEY-BACK Guarantee. Get the facts about it NOW before prices advance. Mail coupon today!

EMRICK MACHINE CO., KALAMAZOO, MICH.

PLEASE PRINT PLAINLY

EMRICK MACHINE COMPANY
 Kalamazoo, Michigan

Send free literature at once on the 5-in-1 Emrick Home Woodworking Machine.

NAME.....

STREET NO.....

CITY.....STATE.....

Mail
Coupon Today
For FREE
Literature

Announcing . . . New Style Hi-Speed Router & Round End Mortising Bits

BARRON SPIRAL FLUTE ROUTER BITS

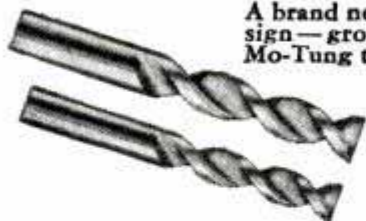

A brand new double spiral fluted design—ground from finest hi-speed Mo-Tung tool steel—with special radial shaped flutes for faster, smoother, easier routing, grooving, carving, and round-end mortising. Insures true, straight walls and smooth bottom surfaces. Extra long cutting flutes for

deeper operations. The router bit that's different—AND BETTER. $\frac{3}{8}$ "—\$1.10, $\frac{5}{8}$ "—\$1.40. Set of 6 sizes up to $\frac{1}{2}$ "—\$8.50 shipped prepaid.

THE BARRON ROTARY SURFACE SANDER

\$5.95
COMPLETE



Note these Special

Features—Made of Alcoa aluminum. Machined and balanced for smooth operation in drill press chuck. For surface sanding woods, plastics or polishing metal surfaces. Complete with 20 instantly removable sanding cup discs. No messy glueing needed. Leaves an agate smooth, absolutely true surface finish. Does not leave waves, ripples, steps or striations in work piece. The only tool of its kind. Shipped prepaid on 10 DAY MONEY BACK GUARANTEE for \$5.95.



The IMPROVED Barron Multi-Purpose Drill Press Planer .. \$7.50

Not only surface planes toughest woods and plastics to precision limits—but rabbets, routs, tenons, panels, grooves, beads. Will cut rabbets, tenons, panels, etc. to a depth of 1" with special Barron extra long hi-speed cutter blades. Thousands now in use. Made of Alcoa aluminum, machine finished thru-out. Vibrationless. Fits any drill press. Shipped prepaid on 10 DAY MONEY BACK GUARANTEE on receipt of cash, money order or C.O.D. for \$7.50.

BARRON ALL-METAL Auxiliary DRILL PRESS Table .. \$8.85



Hard Alcoa aluminum die casting heavily ribbed—machined both sides. Has 234 sq. inch extra large working surface. Equipped with Barron Steel Planer Fence. Can also be used for shaper operations, innumerable other drill press uses. A real buy at \$8.85, express collect.

See Your DEALER . . . Or Write For CATALOG

BARRON TOOL CO., INCORPORATED
369 Architects Bldg.: Detroit 1, Mich.

BARRON PRECISION WORK SHOP TOOLS



Make Your Own RUBBER MOLDS

with **RED LATEX MOLDING COMPOUND**

Earn money, have fun; make your own molds for plater objects. Produce novelties and gifts for home and to sell to friends. RED LATEX MOLDING COMPOUND (60% density) now available in quart and gallon quantities. Gives perfect results, easy to apply. Send for complete information and prices. OHIO SUPPLY CO., Dept. E2, 474 Lilly Ave., Columbus 5, Ohio

SAY YOU SAW IT IN POPULAR MECHANICS

AUTO ENGINE SPEED CONTROL GOVERNORS

(REGULADORES)

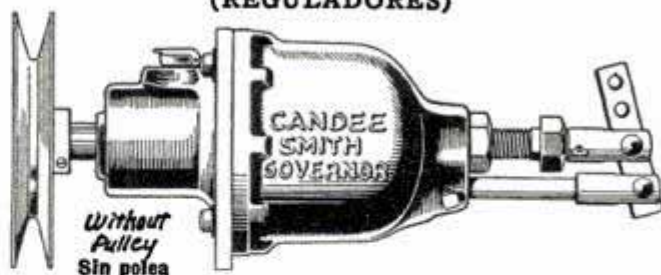

Without Pulley Sin polea

Give constant or changeable speed to any auto or truck engine, when used for power. Guaranteed. Instructions. Oil ring bearing, \$12.50. Full ball bearing, \$19.00. Postage west of Miss., 50c; east of Miss., 85c. Sent COD or—Postage to any country in the world \$1.00 each. Pulleys to 3", \$1.00, wt. 1 lb.; to 6", \$1.50, wt. 1 1/2 lb. Governor speed 1400 to 2400 rpm. Figure your pulley size.

Agents Wanted: Parts and Implement Dealers, Garages, Welders, Wreckers, Catalog and Mailing List Houses, etc.



These valves used where carburetors have outside attachments. State size of opening and distance between bolt holes.

1", \$3.75; 1 1/4", \$5.25; 1 1/2", \$6.50; 1 3/4", \$7.50; V8, \$7.00. Mailing weight, 3 lbs. If remitting, enclose for postage. You may order from this ad, or we will send circulars. Stocks carried: In Montreal 15, Canada: 7546 Wiseman St. In Skaneateles, N. Y.: Horie Welding Supply.

CANDEE, Dept. K, 2641 S. Hill, Los Angeles 7, Calif.

BUILD YOUR OWN RADIO or RECORD PLAYER with these "Easy to Build Kits"

#1—Crystal Radio Kit—Complete, including Trimm De Luxe headphone, headband, cord, one special coil, one walnut finished base, wired and drilled, 4 cellophane envelopes containing all necessary parts to make a complete working crystal radio.
Your Cost \$2.97

#2—One Tube Special—All the necessary parts to build a one tube AC-DC or battery operated radio—includes tube and cabinet.
Your Cost \$9.95

#3—Record Player Kit—Complete—Includes—
—110V 60 cy. AC motor and turntable
—Large P.M. Dynamic speaker and output transformer
—AC-DC—3 tube amplifier, complete with tubes
—Curved lightweight pickup with rest
—Beautifully styled—leatherette covered case
—Special low price—\$32.50 only
Shipped Anywhere
10% Deposit With Order

NIAGARA RADIO SUPPLY CORP.
160 GREENWICH ST., NEW YORK 6, NEW YORK

30 PIECE GRINDING WHEEL ASSORTMENT

FOR INDUSTRY & HOME SHOP



WAR SURPLUS ALL NEW!

Known names—NORTON—CARBURUNDUM—MACKLIN—MANHATTAN includes assortment of sizes invaluable for industry and home-workshop. If wheels were bought singly, value would be over \$30.00. Amazingly low price for complete assortment of 30 new grinding wheels only \$4.95 postpaid. Send check or money order today.

ONLY \$4.95 POST PAID

MOUNTED GRINDING POINTS— all new! Special "Hurry-up" offer gets you SEVEN mounted grinding points. ONLY \$1.00 post-paid

GROBAN SUPPLY CO.
1522 SO. MICHIGAN AVENUE, CHICAGO 5, ILL.

TYPICAL KITS

KIT NO. 1
7 pcs. \$1⁰⁰
ROUNDS
 1/8" - 1/2" by 1/16's

KIT NO. 25
5 pcs. \$3⁵⁰
 3/8"
SQUARE

KIT NO. 29
9 pcs. \$1⁰⁰
 3/8" x 3/32"
HALF OVALS

Immediate Delivery!
KITS OF FREE-TURNING BRASS RODS

Keep a supply of these free-turning brass rods on hand in your home work shop for use on model boats, airplanes, etc. Round, hexagon, square and half-oval shapes. Kits available in various combinations of sizes from 1/8" to 2"; also kits with several pieces of one size only. All rods in 12" lengths. Order yours today! All prices subject to change without notice.

All Kits F. O. B. Detroit
Meier Brass & Copper Co.
 1320 EAST LARNED
 DETROIT 7, MICHIGAN

KIT NO. 15
7 pcs. \$1⁰⁰
 1/4"
HEXAGONS

KIT NO. 2
5 pcs. \$4⁰⁰
ROUNDS
 1/2" - 1" by 1/8's

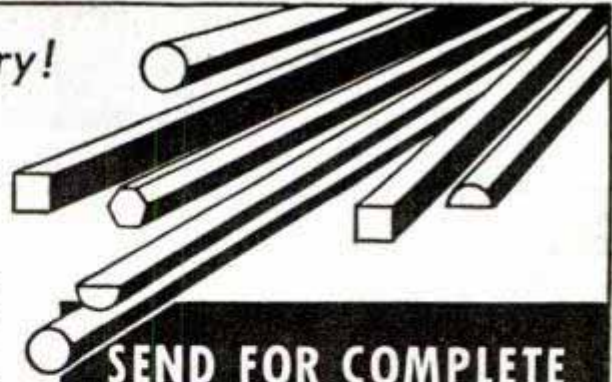

SEND FOR COMPLETE LIST OF KITS, PRICES TODAY!

Meier Brass & Copper Co.
 1320 E. Larned, DETROIT 7, MICH.

Please send me your complete list of free-turning brass rod kits and prices.

Name _____

Address _____

City _____

Zone _____ State _____

CAN'T GET A NEW CAR?



DON'T WORRY OR FUSS

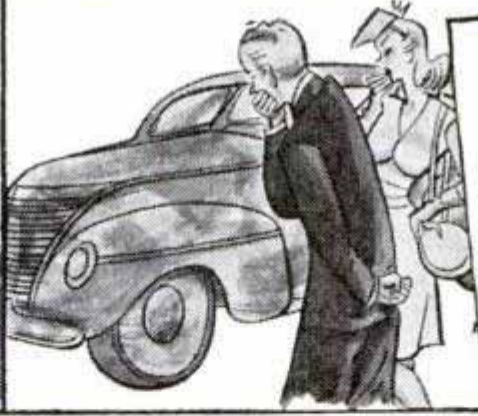

GET THIS EASY POLISH



SHINE UP THE OLD BUS

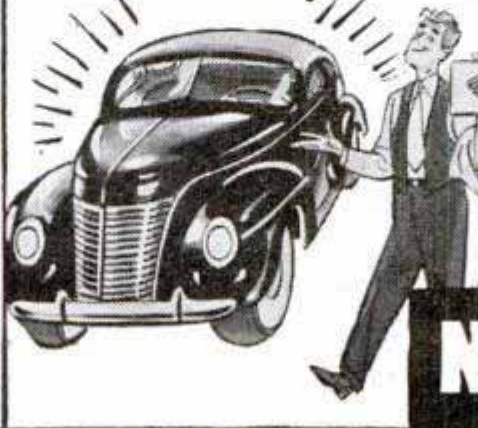

Here's the easiest-working, speediest polish ever

Just once over cleans away traffic film and grime, makes your car sparkling bright. For the shine of your life, try a can of Du Pont No. 7 Polish.



Better Things for Better Living
 ... Through Chemistry

NO. 7 POLISH

YOUR OWN BUSINESS IN YOUR OWN HOME!

Start a big-profit business in your basement or spare room—repairing all makes of Vacuum Cleaners and other electrical appliances! Prospects are tremendous because new appliances are hard to get and everybody's old ones need repair! It's easy to fix 'em with the parts and tools we supply. We have huge stocks of parts on hand for all vacuum cleaners and appliances. You order as you need them—or send us the appliance and we repair for you at wholesale prices!



New 68-page catalog with wholesale prices on vacuum cleaner parts, service and electrical supplies. It's yours FREE—just mail coupon.

Send coupon for FREE Catalog with Wholesale Prices!

Re-New has helped thousands start in business, for thirty years! Don't let this chance to make easy money slip through your fingers! Mail coupon NOW! Get catalog by return mail! When available, we will have new and guaranteed rebuilt Vacuum Cleaners for you at wholesale prices! You'll be first in your town! Re-New Sweeper Co., 9591 Grand River Ave., Detroit, Michigan.

Re-New Sweeper Co., 9591 Grand River Ave., Detroit, Mich.

Please send me, without obligation, your free catalog. I am anxious to start my own appliance-repair business.

Name.....
Address.....
City..... State.....

Now for EVERY WORK SHOP!

NEW Invention Electroplates by BRUSH



Easy to Plate CHROMIUM GOLD, SILVER, NICKEL, COPPER . . . For Pleasure and Profit!

If you have a workshop—at home or in business—you need this new Warner Electroplater. At the stroke of an electrified brush, you can electroplate models and projects—you can replat worn articles, faucets, tools, fixtures, silverware, etc. with a durable, sparkling coat of metal . . . Gold, Silver, Chromium, Nickel, Copper or Cadmium. Method is easy, simple, quick. Everything furnished—equipment complete, ready for use. *By doing a bit of work for others, your machine can pay for itself within a week.* So make your shop complete by getting a Warner Electroplater right away. Send today for FREE SAMPLE and illustrated literature. ACT AT ONCE! Mail Coupon.

WARNER ELECTRIC CO., DEPT. H-8
663 North Wells, Chicago 10, Illinois

FREE Details & Sample!

WARNER ELECTRIC CO., 663 North Wells, Chicago 10, Dept. H-8
Gentlemen: Send Free Sample and Details to:

Name.....
Address.....
City..... State.....



A must tool for electricians, maintenance men, home owners. Made of a transparent, shock-proof plastic. Replaceable lamp inside Plier tests 110 to 250 Volts. Plier pulls fuses from 10 to 100 Amperes. Requires the use of only one hand. Can be obtained from General Electric or Westinghouse stores, or

from local electrical dealers. Order one TODAY. Price \$2.75 without Leads, \$1.50 additional for Leads which provide greater reach and more flexibility.

STAR FUSE CO., 237 Canal St., New York 13, N. Y.

RACER

HIGHLY POLISHED CAST ALUMINUM

8½ inches long. Heavy single unbreakable casting. Free running rubber wheels. Can't rust. Trim, sleek lines. Looks like models selling up to \$12.00. Form a racers' club to-day! Every youngster wants one.



Send \$2.98

BARTON INDUSTRIAL PRODUCTS CORP., Dept. 5

Postpaid in U.S.A.
Dealer Inquiries Invited
POST OFFICE BOX 43
CHICAGO 17, ILLINOIS



A Product of Distinction

It will neither rot, tarnish nor deteriorate in service regardless of weather conditions. It's CRYSTAL-CLEAR Plastic. Always Clean and Sanitary. On or Off your wrist in a Jiffy. Price \$2.00 each.

GENERAL UTILITIES (Plastic Div'n)
Box 314-7 Grand Central Annex
New York City

Say you saw it in
POPULAR MECHANICS



SENSATIONAL! War Surplus! TWO-WAY AERIAL

Collapses to Pocket Size

Stainless monel metal mesh panels. Completely weatherproof. Cannot rust or corrode. Ideal for every radio use. For campers, Marine radios, portable sets. Complete directions included. BRAND NEW.

\$30.00 value. Your price, postpaid, only... **\$3**
No C.O.D.'s.

SURPLUS SALES CO.
1234 W. Kinzie St., Chicago, Ill.

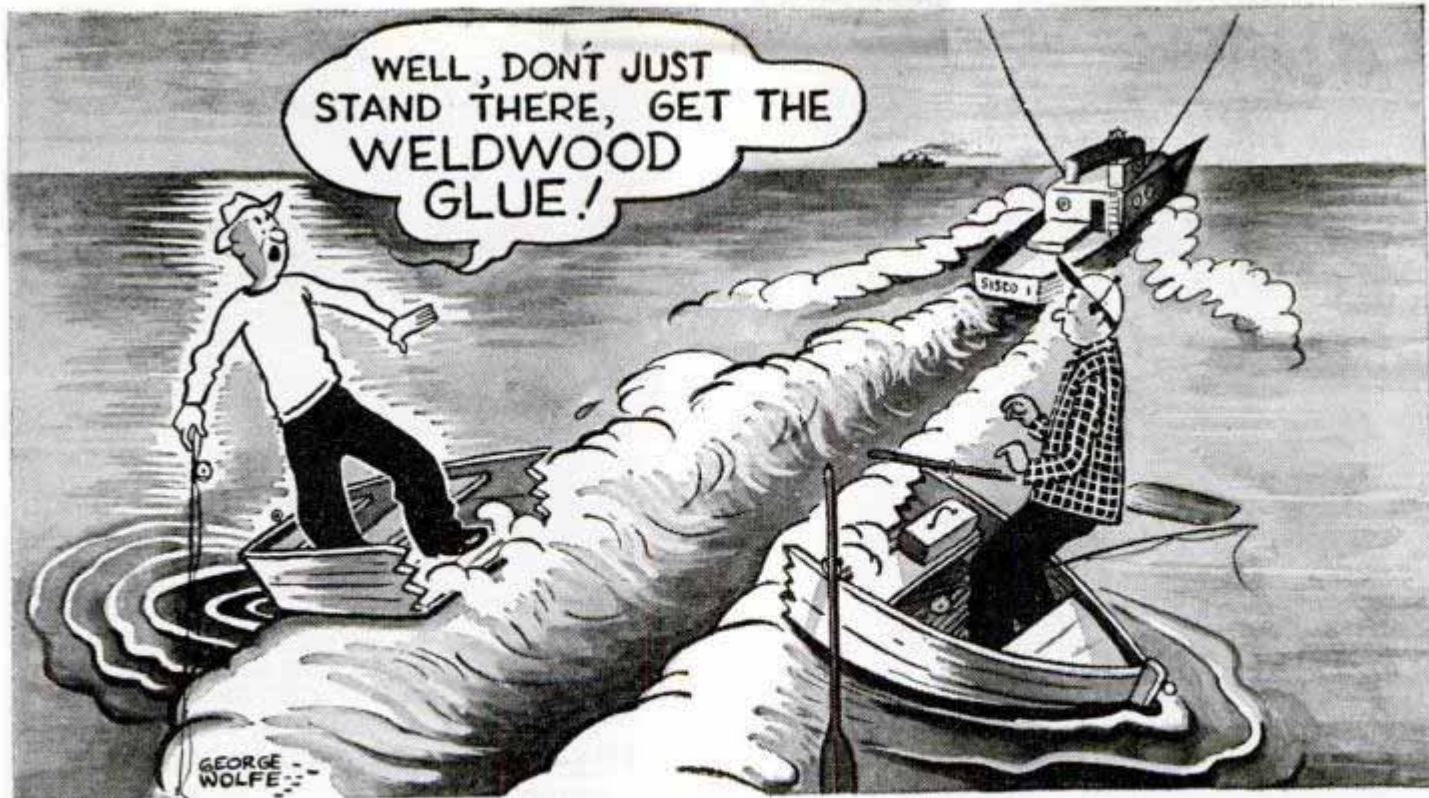

When you want to fix things fast . . . remember Weldwood Glue. It's quick to mix . . . easy to use . . . tremendously strong . . . stain-free . . . rot-proof . . . and permanent. At hardware stores, lumber yards, chain stores.



WELDWOOD PLASTIC RESIN WATERPROOF GLUE

UNITED STATES PLYWOOD CORPORATION, New York 18, N. Y.



Tonight, settle back and relax with this friendly smoke

Forget the problems of the day as you enjoy the honest fragrance—the just-right mildness—of Christian Peper Pouch Mixture. There's down to earth satisfaction in this blend.



POCKET-SIZE PACKAGE **25¢**
28

Christian Peper SAINT LOUIS
FINE TOBACCO SINCE 1852

Jet Propelled! SPEED BOAT



Actually sounds like a real speedboat!

No Springs!

No Gears!

\$1

Complete,
Postpaid

Runs half an hour on a small piece of fuel. (Fuel included). Sounds like a real 2-cylinder speed boat. Easy to operate. Will delight both young and old. Order several. They make a wonderful gift.

Extra Fuel
Supply In-
cluded at no
Extra Cost

All Metal!
No
Moving
Parts

MAIL ORDERS DIRECT TO
UTILITY STORES, 117 S. Wabash,

Dept. EE-18

CHICAGO 3, ILLINOIS

AT LAST! Scientific "No Glare"



AIR CORPS TYPE SUN GLASSES



\$4.95

SELLS EVERYWHERE AS HIGH AS \$10 to \$15!

★ Released for civilian use. Genuine 12 Karat Gold-filled Sun-Goggles with ray-absorbent, "No-Glare" sage green lenses, ground and polished before curving. Protect your eyes from glare, sun, wind, dust and exposure. Wonderful for auto drivers, out-door workers and sportsmen. 10-Day No Risk Money-Back Guarantee. **SUPPLY LIMITED — ORDER TODAY!**

Send No Money—Just Mail Coupon

MIDWEST SCIENTIFIC CO., Dept. 35
1148-1160 W. Chicago Ave., Chicago 22, Ill.

Please rush Air Corps type Sun-Glasses complete with genuine leather case. I enclose \$.....; send postage prepaid. Send C.O.D. I will pay postman. Money gladly refunded if not satisfied.

NAME.....
ADDRESS.....
CITY..... Zone..... STATE.....
(PLEASE PRINT PLAINLY)

FLUORESCENT KITCHEN LIGHTS

ORDER DIRECT FROM MANUFACTURER



PLUGS INTO YOUR PRESENT FIXTURE

GENNA ELECTRIC MFG. CO.
13 N. 7th St., Phila. 6, Pa.

LIMITED OFFER

Enclosed find check or money order for
 2 light 24" fixtures @ \$ 8.75 } Prices include tubes
 3 light 24" fixtures @ \$11.75 }
 All metal frame baked enamel finish
Extra tubes @ 75c;Extra starters @ 35c

Name.....
Address.....
City..... State.....

WE PAY POSTAGE IN THE U. S. A.



DIG 2 POST HOLES A MINUTE WITH A ROPER!

Installed and operated by one man. No hazardous belt. No stripping down tractor. Efficient up to 30" deep in any type soil. Ideal for tree planting. (Available for Ford tractors with Ferguson System only until further notice.)

ORDER DIRECT OR WRITE FOR DETAILS

\$12500

ROPER MFG. CO.

F.O.B. FACTORY

Walnut Dr.

ZANESVILLE, OHIO

SHARPER CUTTING EDGES
Easy • Accurate • Quick



It's easy to hone keen cutting edges on your chisels and plane blades. Precision adjustment for ANY ANGLE of bevel. Roller glide makes every stroke uniform across oil stone. Light, strong—ideal for home craftsmen, hobbyists, carpenters, cabinet makers.

check or money order
\$2.95

POST PAID

McLAREN INDUSTRIES, INC., Box 606, TROY, N. Y.

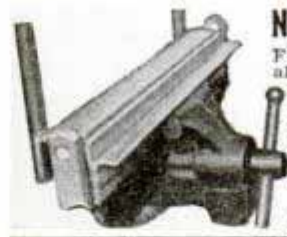

New! 12" Sheet Metal Brake Only \$12

Fits in bench vise. Quickly, easily forms all kinds of angles in sheet metal, strap iron and aluminum, wire and plastic. Use it to make useful articles, experimental research work, patent models, etc. Simple gears made for quantity duplicating. All steel construction. Now available. Send for details.

WISE BRAKE MFG. CO.
1318 So. 30th Ave., Omaha 5, Nebr.

AMAZING MONEY SAVING OFFER **\$995** Plus Fed. Tax

BEAUTIFUL SWISS WATCH
AND MATCHED



STAINLESS EXPANSION BAND

No need now to pay high jewelry store prices—instead, you can save money and have a beautiful Swiss Watch and Stainless Expansion Band—Flexible From Tip to Tip—complete—ready for your wrist for only \$9.95, plus Fed. Tax. Think of it! Watch is a good time piece, has smart, white face, black numerals, and black hands. And the Band is a beauty. Highly durable for long wear service.

SEND NO MONEY—Just pay only \$9.95, plus 10% Fed. Tax and postage C.O.D. Or enclose \$10.95 (tax included) for postpaid delivery. Return in 5 days for refund if not delighted.

BAND EXPANDS TO FIT ANY WRIST

KENT JEWELERS, 105 N. Clark St., Dept. PM-5, Chicago 2, Ill.

U. S. SURPLUS—A MIRACLE OF VALUES!

CAMPER'S SLEEPING BAG

Water proof construction fully padded for comfort and warmth. No other cover required. Has mosquito net. Size 34x86". A real buy!



\$12.95

SHOULDER BAG



For Fishing, Hunting, Messengers, etc. Brand New, made of heavy duck material, water-repellent.

79c each

POCKET FLASHLIGHT



Constructed of satin finish aluminum tubing. Has Micro-lite bulb, and Bake-lite turn knob. An innovation in pocket lites! ... **98c**

VACUUM SERVER



The same front line server used by our Armed Forces to keep food hot or cold for 24 hours. Has three 8 qt. covered pans. Ideal for campers, etc. Complete.. **\$17.95**

CHICKEN FRYER

All steel, glistening finish. 8 qt. size, 12" dia., complete with cover. Ideal for campers, home, etc. First time offered. Each



\$1.95

100% WOOL ARMY O.D. BLANKET



Just released from Army surplus stocks! Completely reclaimed, renovated, dry-cleaned, and sterilized for added freshness. Size 66x82", wt. 3 1/2 lbs. A life-time of warmth for... **\$4.95**

ARMY FOLDING COT



Heavy duty canvas folding cot made to rigid army specifications. Folds compactly for easy storage. While they last! Each

\$5.95

CAMPER'S RATIONS

Gov't Inspected and approved!



Beef & Gravy, 98c
30 oz. can...
Pork & Gravy, 98c
34 oz. can...



U. S. NAVY RAINCOAT

The same heavy duty raincoat that protected our servicemen from all kinds of weather. Dressy dark blue. Sizes 32-40. **\$6.95**

FLIGHT JACKET



A Must for outdoor men! Deep mouton lamb collar. Full wool pile lining. Knit wrist and waist. Water repellent material. Zipper fastener. Sizes 36-42... **\$16.75**

U. S. STEEL STOCK POTS

Bright steel finish, wt. 17 lbs. Slightly tapered bottom for heating convenience. Comp. with cover. 10 gal. size... **\$9.75**
15 gal. size... **\$10.75**

ORDER NOW FROM THIS AD

NO C.O.D.S — INCLUDE POSTAGE WITH ORDER

SURPLUS SALES COMPANY

1234 W. KINZIE ST.
CHICAGO, ILLINOIS

MANY-USE Electric VOLT-TESTER



Automatically indicates if 110, 220 or 440 volts. CHECKS if AC or DC, if 25 or 60 cycles, if broken circuit. LOCATES TROUBLE—from 60 to 550 volts, fuses, radios, etc.

\$1.75 complete With 110-220 volt reading **\$1.25**. Dealer rates.

American Standard Labs., 1924 E. Hart La., Philadelphia, Pa.



Build your own grinder with this combination pulley and arbor. Fits 1/2" shafts. **75c**

AGENTS INVITED Postpaid U.S.A.

F. ROESCH

502P - 1st St. Hoboken, N. J.

A REAL THRILLER for the ENTIRE FAMILY!

Blow Yourself to a Grand Evening of FUN! Invite your friends and neighbors... This is the WORLD'S FASTEST NEW GAME! Not essentially a war game... Nothing technical to break or explode... Every player participates in every play... It's fun to be BOMBARDIER... At the same time it's fun to escape the AT-EM-BOM!... Packed with fun and action... Unique invitations to an "AT-EM-BOM Party" come with each game... Be the first in your community to hold a party... The very latest... Built to last... Nothing to get out of order... Play it the year 'round... Makes friends... Every member of the family will enjoy it... Our Guarantee—you'll stay awake playing this game. If not yet at your neighborhood store... Order direct... USE THIS COUPON.



ONLY **\$3.50** Post Paid

IT'S TIMELY
IT'S EXCITING
IT'S A THRILLER
NEW GAME

ATOM BOMB

EXPLODES IN TOY WORLD

the GAME of CHANCE - SUSPENSE - SPEED
A Revolutionary Idea in Entertainment
Easy To Learn... 2 to 9 Can Play — Exciting
INVITE YOUR FRIENDS TO AN AT-EM-BOM PARTY

Atom Bomb SPECIAL



RAPID FIRING, AUTOMATIC
HERE IT IS! Just what every boy has been looking for... Makes a LOUD REPORT... The very latest... Gun shoots Rolls of 50 Rounds... Quick and Easy to reload... ALL METAL... easy grip trigger... Be the envy of the other boys... BE FIRST... Get the jump on the other fellow. **GUN ONLY**

A Real Thriller **\$1.00** Post Paid

AT-EM-BOM, INC., Dept. P-5
141 West Jackson Blvd. CHICAGO 4, ILL.

AT-EM-BOM, INC., Dept. P-5
141 W. Jackson Blvd., CHICAGO 4, ILL. ■ RUSH ■

Enclosed find my remittance for \$..... Please RUSH the item I have checked by Parcel Post PREPAID.

AT-EM-BOM New Game. Each, \$3.50 Postpaid.
 All-Metal, AUTOMATIC CAP PISTOL. Each, \$1.00 Postpaid.

NAME.....

ADDRESS.....

CITY.....STATE.....

**AMAZING 12 FOOT PORTABLE
RADIO ANTENNA**

**Real \$15 value now only \$3.95 POST PAID
FOR HOMES, BOATS or AUTOS**

Just released Government surplus same as used on Army tanks. These telescopic rustproof antenna have a tremendous pickup and eliminate dangerous wiring. Made of Solid Brass throughout which practically insures **NOISE FREE RECEPTION.**

**12 exceptionally rugged sections
compress into 1 ft. 4 in.**

**Handy for Camping Trips, also Useful
for Transmitting and FM sets**

*Each antenna comes with clamps, nut, lug,
and wire. Easy to install anywhere.*

QUANTITY LIMITED

**ORDER TODAY. A real \$15 value for only \$3.95
Postpaid. Send check or money order now. Money
back in 10 days if not satisfied.**

RADIO HOSPITAL

1113 LEXINGTON AVE., DEPT A
NEW YORK 21, N. Y.



Be Your Own Boss



There's a great feeling to being in something for yourself, where all the profits go into your own pocket. American floor sanders make it possible for you to realize this ambition without special schooling or a big investment. Begin small and work up to as large an enterprise as you desire... It all depends on your ambition to get ahead.

Ask for "tell-all" booklet entitled "Opportunities in Floor Surfacing". Use coupon and enclose 25 cents in coin or stamps to cover handling.

**AMERICAN
FLOOR SURFACING MACHINE CO.**

535 So. St. Clair St. • Toledo 3, Ohio

Gentlemen:
Enclosed find 25c in stamps or coin for booklet "Opportunities in Floor Surfacing," telling me how I can start my own floor sanding business.

Name _____
Street _____
City _____ State _____



**NOW! A Dependable
ELECTRIC DOOR OPENER**



for the Home

Let the youngsters in or out of doors without leaving your work. **ELECTRELEAS** opens garage, cellar or other doors without going out or downstairs.

Great, too, for den or workshop when you don't want to leave your work. Operates on house current through transformer or batteries. Easy to install. Guaranteed. Opener supplied with buzzer.

Send check or money order to
ARROW METAL PRODUCTS
2 Depot Plaza, White Plains, N. Y.
Territories are open for distributors

\$2.95

Electrelease THE ELECTRIC HOME
DOOR OPENER

FLEXIBLE SHAFT



**53 1/2" MULTI-PURPOSE
RUGGEDLY CONSTRUCTED
PERMANENTLY LUBRICATED
Sealed Against Dust & Dirt
LIMITED QUANTITY
— AS PICTURED —**

**\$5.75
Only Post Paid**

Can be used with any size shaft on motor up to 1/4 HP., or in a Chuck up to 3/4" capacity. Speed range—1725 RPM to 3600 RPM. Shaft size—3/8" diameter, 24 threads per inch. Can be bent or looped to radius of 6" for working in hard-to-get-at places. Outer covering of Oil-resistant Neoprene. Useful for Buffing, Grinding, Drilling, Polishing, Rotary Filing and Transmission of Power. **ORDER NOW... DEALERS INVITED.**

**ELECTRIC TRADING CO. 313 CANAL ST.
NEW YORK 13, N. Y.**
Fans & Blowers for Every Industrial, Commercial & Domestic use. Fan & Blower Kits & Parts. Electric Tools, Compressors & Spray Equipment, in stock.



GERSTNER Tool Chests

Skilled mechanics have made Gerstner Chests for 40 years. Preferred by Tool, Die and Pattern makers. Free Catalog.

GERSTNER TOOL CHESTS
446 Columbia St., Dayton 7, Ohio

why not use a DIAMOND?

**ALL PURPOSE GRINDING
WHEEL DRESSER
FOR ALL DRESSING
OPERATIONS**

\$2.50

POST PAID

SEND CHECK OR
MONEY ORDER TO

KOEBEL DIAMOND TOOL CO.
9454 GRINNEL AVE., DETROIT 13, MICH.

Say You Saw It in
POPULAR MECHANICS

CASTINGS

SMALL MACHINE TOOLS AND ATTACHMENTS

Many of these castings have been described in previous issues of Popular Mechanics and may be ordered either rough or semi-finished. High Speed Drill Press, Tool Post Grinder, Step Collet, Expanding Step Collet for holding internally, Boring Bar Holder, 4" Indexing Head, 3" and 4" Tool Post Turrets, Midget Circular Saw, V-Blocks, Angle Blocks, Step Blocks, Face Plates 6" and 9", Chuck Back Plates 4", 5", or 6". Detailed plans and instructions on any 2 items \$1.00. Castings variously priced. We make castings for special projects. Send blue prints or write us for your needs.

T-P Manufacturing Company, P. O. Box 7024, Dallas, Texas

AIRFLOW ADJUSTABLE CUBOID FOOT LEVELERS

SIZES TO FIT ANY SHOE

EXTRA AIR-CUSHION METATARSAL ARCH-LIFT

USE THIS CUBOID LIFT WHEN NEEDED

MORE ARCH RAISE HERE IF WANTED

\$3.50 PAIR
OUR FINEST LEATHER
\$5.00 PAIR

Changeable To any Shoe
MEN'S OR WOMEN'S

MOST MODERN INVENTION FOR FOOT COMFORT IN YEARS. Their primary purpose is to level and alter the posture of the foot, give better body balance and protect the feet from over-riding the outside of the shoes, and whetting off heels, by raising the outer border, with soft, spongy air-cushions. AIR-FLOW ADJUSTABLE CUBOID FOOT LEVELERS are light and airy, made to fit any size shoe—interchangeable, they combine the latest modern features for adjusting the arches to the needs of the individual foot. Wear same size as shoes. Write Factory direct. **Do it now.** We pay postage if money accompanies order.

C. H. STEMMONS MFG. CO.
Dept. 15 Kansas City 2, Mo.

UNIQUE VALUE Men's Wrist Watch
Swiss movement, very handsome looking, durable chrome plated case. **SEND NO MONEY.** Pay postman \$8.50 plus postage and 10% Federal Excise Tax. Wear 10 days, money back if not satisfied.
Jerome Products Co., 1744 W. Roosevelt Rd., Dept. M5, Chicago 8, Ill.

FREE! REAM DREAM

A catalog of cutting tools and supplies made available for the first time—is yours for the asking. Hard-to-get cutting tools and supplies—hundreds of them—are in our available stock. A postal card will bring this catalog to you without charge.

Write or Phone **EASTERN TOOL & SUPPLY COMPANY**
176 Grand Street, New York 12, N. Y.
Canal 6-3749

Always write your name and full address clearly when answering advertisements.

REVOLUTIONARY Fish-Gettin' METHOD

AMAZING SURE-CATCH METHOD
Gets 'em 100 Feet from Shore

Now you can catch big fish in deep water up to 100 FEET FROM SHORE—without boat, rod or reel. Fish boatless virgin lakes. Fish any time, anywhere from bank or pier. Sensational POWERLINE is first basic fishing invention since barbed hook. Pocket outfit always ready for action! Made of specially developed modern material. Tested 3 years by real fisherman who only now reveals his secrets to you.

Powerline

GIVES THAT TEASING ACTION
Beats casting or trolling. Fish weed beds without a boat. Fish deep-snagged trout holes from any angle without disturbing water. Moves bait with NATURAL ACTION through spots where fish feed and find cover. Keeps minnows and frogs alive until killed by strike. Gives enticing life to plugs, spoons, streamers, spinners, bugs, and worms. Be first in your crowd to discover POWERLINE! Catch 'em bigger, catch 'em faster!

ACCEPT THIS 5-DAY TRIAL OFFER
SEND NO MONEY! Demonstrate POWERLINE on your lawn. If not convinced, return in 5 days for prompt refund. Complete outfit, 3 Powerline units, \$1.00 book of fishing secrets only \$2.00 plus C.O.D. postage. Or remit \$2.00 with order and we prepay. Given with prompt orders, 84 ft. quality fishline and bobber stick for POWERLINE. ACT NOW! Show your cronies how a real fisherman gets 'em. Order today for yourself and friends.

POWERLINE TACKLE SALES CO.
126 Powerline Bldg.
GRAND RAPIDS 3, MICH.

84 FOOT QUALITY FISHLINE GIVEN!

REWARD FOR PROMPT ORDERS

TRY ONE . . . FREE!



Smokes like magic. New 6 in 1 Cig-Smoker, scientific invention for safe-clean-filtered cigarette smoking. The Cig burns inside this miracle, durable Silverglas creation. It combines a Holder, Filter, Fire Shield, Ash Guard, Smoke Cooler and Automatic Snuffer. Prevents fires, burns, ash mess, accidents, irritating harmful smoking. It's wind and rain proof . . . Nothing else like it.

Agents, Dealers, Exporters, Ask for Sales Data **Pat. & Mfr., SAFE-GARD MFG. CO.**
21 Perry-Payne Bldg. Cleveland 13, Ohio

LOOK! Make 5 in 1 Chairside Desk
1-in writing desk, 2-end table, 3-typewriter desk, 4-book, magazine shelf desk, 5-all-purpose table. Period design, with patented "fold-a-way" desk leaf, has drawers, typewriter storage optional. Send \$100 for easy-to-make plans, or 10¢ for description to **FOLDADESK, 1904 N. 85th ST., MILWAUKEE 13, WIS.**

Marvelous New 3 WHEEL ROLLER SKATE

• **Faster, Smoother, Easier Skating** •



SALES . . . SALES . . . EVERYWHERE . . . No matter where these outstanding 3 Wheel Roller Skates are shown they win instant approval . . . Lighter in weight makes for Easier Skating . . . The Streamlined principle gives more SPEED and Smoother Skating . . . For Rink, Figure and Sidewalk Skating . . . Fully Chrome Plated. **EXCLUSIVE FEATURE:** Has a Brake for quick stopping.

Sales Are Tremendous!

\$4.25 pair
Plus 35¢ for Postage & Handling. Give Size. Higher in Canada.

This is an unusual opportunity for **QUICK, BIG VOLUME SALES** and we want wide-a-wake Distributors and Local Agents to take care of this business in their territory . . . The interesting part of this BEB Skate is . . . it is interchangeable to Ice Skating in a few minutes . . . Ice Skate Attachment \$1.90 extra.

DISTRIBUTORS . . . AGENTS WANTED EVERYWHERE
We want every territory covered . . . Dealers are enthusiastic and order in large quantities . . . We want Go-Getters to supply this demand and offer a **BIG MONEY-MAKING** Proposition.

BEB SKATE CO., Dept. P-5, 4529 Ravenswood Ave., CHICAGO 40, ILLINOIS

THREE BALL BEARING WHEELS in line gives **MORE SPEED** with **LESS EFFORT** . . . Simply raise the toe to **STOP QUICK.**



CHANGEABLE FROM ROLLER TO ICE SKATES

Here's a Rare Bargain!

12 CUTTERS

ASSORTED
GROUND FROM THE SOLID—
FROM HARDENED HI-SPEED STEEL

ONLY
\$4.95

These are the Famous
YEOMANS

burring tools—hi-speed
milling cutters and rotary
files—new and recuts

Great for die makers,
mechanics, repair men
—for routing, deburring,
grinding. Used in drill
presses, electric hand
drills, flexible shafts and
grinders. They are
worth from \$1.60 to
\$4.50 each at original
list price. Money back
guarantee. Immediate
shipment subject to
prior sale and quantity
now on hand. Going fast
—order today and
insure delivery. Send
check or money order to

105
ASSORTED
ONLY
\$4.40

Long—useful life
—each cutter can
be resharpened
30 to 40 times.

A-Y MANUFACTURING CO.

2710 BAY STREET • SAGINAW, MICHIGAN

ELECTRICITY FOR ANY JOB ANYWHERE



Reliable, economical electric service, anywhere, anytime, with an Onan Electric Plant. Driven by Onan 4-cycle, gasoline engines. Single-unit, compact design and sturdy construction. Water or air cooled.

Capacity range 350 to 35,000 watts
115 to 660 volts A.C.

50 to 300 cycles

6 to 800 volts D.C.

Combination A.C.-D.C. types
65 different models

WRITE FOR FOLDER

ONAN

D. W. Onan & Sons, 2517 Royalston Ave., Minneapolis 5, Minn.

AUTOMOBILE "TOP LOAD" CARRIERS for every purpose

All steel frame type—800-lb.
distributed weight capacity

TL-20 Sedan and Coupe... \$11.50
TL-26 Truck and Sedan... 13.50
TL-22 Box—56" x 40" x 7 1/2"... 27.50
TL-24 Platform 60" x 40"... 24.50

Combination Steel-Wood-Boat Carriers, 350-lb. Capacity

TL-30 with 48" cross
bars and tie straps... \$10.00
TL-30 with 56" cross
bars and tie straps... 11.00
ALSO: TL-1 5" Fishing pole
carriers—complete set, 2.00

WRITE FOR DESCRIPTIVE LITERATURE.
ORDER TODAY. ALL SHIPMENTS
F.O.B. PITTSBURGH.

LIEBMAN MFG. CO.

464 McClellan Drive
Pittsburgh 27, Pa.

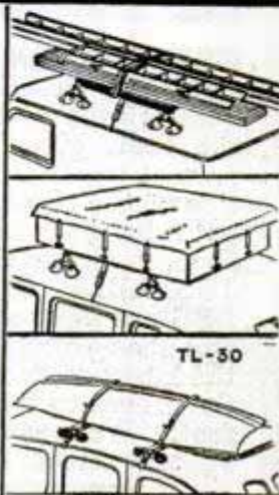

FIXES

BROKEN CHINA

... also glassware, luggage, toys
and furniture. It's transparent and
waterproof. Makes models, too.



DUPONT

DUOCO CEMENT

REG. U. S. PAT. OFF.



LONGINE

WATCH COMPASS

Genuine U.S. Army Compass. Made according to Gov't Specifications by the Longine Wittnauer Watch Co. Packed individually in sealed boxes. **\$2.95**

NEW LONGINE WATCH COMPASS...each only

LONGINE, WALTHAM, TAYLOR WATCH COMPASSES
SLIGHTLY USED...each only **\$2.45**

AMERICAN MILITARY OUTFITTERS

14 N. FRANKLIN ST., CHICAGO 6, ILL.

EXPERIMENT WITH **BLACK LIGHT!**

FUN! THRILLS! PROFITS! See seven page article on this fascinating science in June 1945 issue of Popular Mechanics. We furnish all supplies. Trial Kit of 8 lacquers only \$0.25. Black bulb for testing, \$2.00. Lamps, lacquers, crayons, fabrics, etc. Write for descriptive list and full details today!

New Address
BLACK LIGHT PRODUCTS, 67 East Lake Street
Chicago 1, Illinois

"Use Adair Pow'r Mast'r"

Airplane Type Water Injection For Your Car

Injection of water into the air entering your cylinders through the carburetor, slows down the burning rate of fuel-air mixture, producing the same effect as adding tetraethyl lead to fuel. You use low grade gas, eliminate carbon formation, spark plug fouling, hot motor, piston ring and valve troubles. You get the anti-knock effect with water. Take advantage of this car and money saving system. Get yours now by sending M.O. Prepaid \$17.00, West of Rockies \$18.00.

Adair Company, Inc., 2044 Rugby Road, Dayton 6, Ohio

Slug your way to the TOP
with a... **LOUISVILLE
SLUGGER**



By following the example of the champs before them, Baseball's "greats" in batting got that way with a Louisville Slugger. To make the most of YOUR baseball chances, follow the lead of the champs. It's safe to stake your batting success on a Louisville Slugger!

Ask your dealer or send 5¢ to Dept. P-31, Hillerich & Bradsby Co., Inc., Louisville 2, Ky., for your copy of The 1946 Famous Slugger Yearbook.



**Louisville
SLUGGER BATS**
FOR BASEBALL & SOFTBALL



ALUMINUM



**8-INCH TILTING
TABLE SAWS**

Cutting depth 2 1/16";
table size 15" x 18";
weight 33 lbs. \$47.50
less blade. Full details
upon request.

Arrowheart Industries, Box 126, Detroit 19, Mich.



**WHEELS
AT BARGAIN PRICES**

FOR EVERY PURPOSE

WAGONS—SCOOTERS—WHEELBARROWS—
TRAILERS—COASTERS—MOWERS—ETC.
Due to shortage of storage space we are
offering wheels with tires at bargain prices.
Satisfaction Guaranteed.

Write No. Wanted. Tear out this ad and mail with your name and
address, and check or money order.

-10x1.75 puncture proof tire 1/2 or 3/8" hub.....\$3.20 Each
-10x1 1/2 solid rubber tire 1/2" hub.....3.20 Each
-8x2 Semi Pneumatic Tire with wheel.....2.75 Each
-6 1/2" Scooter Wheels and Tires......75 Each
-10x2.75 Tire and wheel, 2 1/2x3/8" Ball bearing
Semi Pneumatic tire.....5.75 Each
-Wheelbarrow and trailer wheels, cast aluminum,
Ball Bearing, 5/8" shaft, 8x4.00 2 ply tires
and inner tubes, Complete.....11.80 Each

TRULSON MFG. CO., 811 E. 31 St., Kansas City 3, Mo.

FREE

Send for it
NOW



New 1946 Radio Parts
and Equipment

CATALOG

**SERVICEMEN! Dealers! Soundmen! Amateurs!
Builders! Here's your handiest, most complete
1946 Buying Guide for Everything in Radio!**
Features latest sets, parts, equipment of nation-
ally known quality at lowest prices. Assures
fastest service from world's largest and most
complete stocks under one roof. Expert staff
ready to help you.



**NEW RADIO SETS
COMPLETE SOUND SYSTEMS
LATEST HAM GEAR
ALL SERVICE EQUIPMENT
BUILDER'S SUPPLIES
RADIO BOOKS**



OVER 10,000 ITEMS

Everything for every radio use.
New model radio sets, phono-
radios, recorders, communication
receivers, Ham kits, code apparat-
us, parts, tubes, tools, test instru-
ments, public address equipment
and accessories, low-cost easy-to-
build kits, diagrams, matched parts
lists, leading technical and non-
technical books—at lowest prices.



ALLIED RADIO

ALLIED RADIO CORP.
833 W. Jackson Blvd., Dept. 5-E-6
Chicago 7, Illinois

Date.....

Rush new FREE 1946 CATALOG

Name.....

Address.....

City.....Zone.....State.....

A PLANER AND SANDER FOR YOUR DRILL PRESS

'FlexTop Sander
6 1/8" Dia.

Few jobs too small or large for these precision tools. Accurate to thousandths of an inch while working at amazing speed. They minimize tedious hand finishing. High spots and knots are dressed and finished satin smooth. The patented "Angle Set", shear cut, blades prevent chipping or breaking of fine edges.

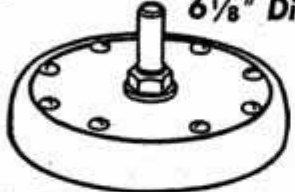

PRECISION PLUS SPEED FOR YOU

Here are the tools, endorsed by woodworkers, that convert a drill press into a multipurpose machine. No need for space-consuming tools, no big investment. Convert your drill press with these tools and do faster, smoother planing and sanding. Get these proven tools, constructed of heavy metal alloy.

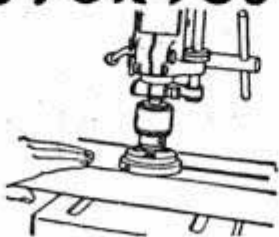

BERRY PLANER 7⁵⁰ **FLEXTOP SANDER 9⁹⁵**

10 day, money back guarantee. See your hardware dealer or send order to
J. H. BERRY MANUFACTURING CO.
2293 SCOTT ST. DETROIT 7, MICH.

IT PAYS TO BE EXTRAVAGANT WITH 1¢ electricity

This summer thousands of tourists will jam the highways . . . many of them on their first vacation in five years. People, holiday bent, are drawn to bright lights like moths to a candle. Give your tourist camp, wayside park, eating place, or service station the sparkling gaiety of unstinted lighting, the low-cost way. Install a Sheppard Diesel Generating Set and generate your own power for about 1¢ per K.W. hour! Models from 2,000 to 36,000 watts. Write today for complete information and name of your nearest Sheppard Distributor.

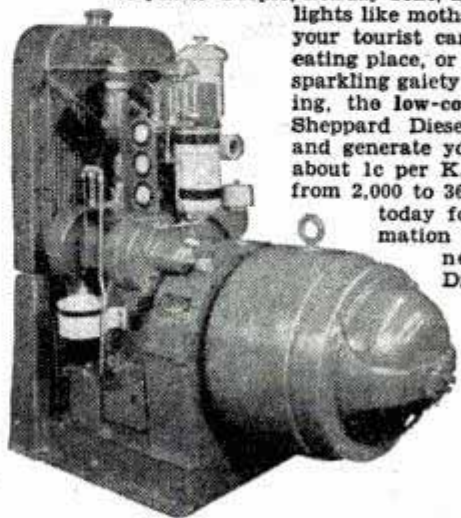

- Generating Sets
2,000 to 36,000 watts
- Power Units
3 1/4 to 56 H.P.
- Marine Engines
3 1/4 to 62 H.P.

R. H. SHEPPARD COMPANY, INC., 48 Middle St., Hanover, Pa.

DIESEL'S THE POWER - Sheppard's THE DIESEL!

King of ELECTRIC SWITCHES

Versatile Switch of a Thousand Uses
Millions in Post War Applications



Floodlights your porch when the door is opened—sounds alarm when window is opened—signals arrival of mail—controls heating of furnace—filling of water tank, these and many other services are performed by this versatile switch. Shipped with instruction sheet showing numerous illustrated uses for this device at the low price of \$1.00 postpaid.

KING PRODUCTS COMPANY BATAVIA 2, ILLINOIS

SICKNESS or ACCIDENT can't rob me of my savings

I'VE A FAMILY MUTUAL HOSPITALIZATION POLICY

Costs only **3¢** A DAY • EACH ADULT
1 1/2¢ A DAY • EACH CHILD

Benefits begin the day you enter a hospital

FOR SICKNESS OR ACCIDENT	
Hospital Expenses paid, up to (beginning with the first day)	\$540.00
FOR ACCIDENT	
Doctor Expense paid, up to	\$135.00
Loss of Wages reimbursed up to	\$300.00
Loss of Life by Accident	\$1000.00
WAR COVERAGE AND EXTRA BENEFITS	
Childbirth Expense paid, up to	\$75.00

Sickness or accident can easily wipe out, in a few weeks, savings it may have taken years to accumulate. Don't let this happen to you. With a Family Mutual Hospitalization policy you'll be able to pay your hospital bills. In case of accident, you will be reimbursed for your doctor expenses and for loss of time from work. You may choose any hospital in the United States and your own family doctor may attend you. Benefits applying to children are 50% of those paid adults.

MAIL COUPON TODAY—No Agent Will Bother You

FAMILY MUTUAL LIFE INSURANCE CO., WILMINGTON 99, DEL.

Family Mutual Life Insurance Co. PM-13
601 Shipley St., Wilmington 99, Del.

Please send me, without obligation, complete information on your Economical Hospitalization Plan.

NAME _____
ADDRESS _____
CITY _____ STATE _____

New! Complete! RADIO CATALOG

READY NOW! Send For Your FREE Copy!

Radio sets...radio kits (including 19 Popular Mechanics Kits)...radio parts...electronic equipment...amplifiers...complete, standard lines of post-war designed equipment and supplies; pages and pages of what you've been waiting for...in the new Concord Catalog, ready now! Rush coupon for your copy...sent FREE!

CONCORD RADIO CORP.

LAFAYETTE RADIO CORPORATION
CHICAGO 7, ILL. 901 W. Jackson Blvd. • 255 Peachtree St. ATLANTA 3, GA.

CONCORD RADIO CORPORATION, Dept. P-56
901 W. Jackson Blvd., Chicago 7, Ill.
Rush FREE copy of new, complete Concord Catalog.

Name _____
Address _____
City _____ State _____

AMBITIOUS VETERANS PLAN FOR SUCCESS with *Atlas* TOOLS



"While in the Navy I had many occasions to use Atlas equipment and tools . . . laying plans for my own business . . . it is with pleasure that I write to a company that manufactures machines which I know are built to do the job and also take a lot of rough work."
— J.J.K., Upper Darby, Pa.

"I have been in ordnance work in the Air Corps for 21 months and have had many occasions to use an Atlas lathe. I was very impressed by its precision as well as its ease of operation. Since I want to start a shop of my own, I want to purchase some Atlas tools."
— Cpl. M.A.G., Bolling Field, D.C.



"I owned an Atlas lathe which I sold upon entry into the Army . . . While in the Army I used the Atlas shapers with which our mobile machine shops were equipped and am well pleased with the performance of both machines. We handled some jobs on the bench shaper which seemed almost impossible on such a small machine. I had built up a fair business of general machine work in my small shop at home, which included some gunsmithing. I now wish to continue that enterprise."
— W.W.M., Wheaton, Ill.

Resourceful, ambitious, enterprising—these veteran's letters reflect the spirit with which so many Atlas-equipped small businesses have gone ahead to great success. If you are interested in outfitting a commercial or home shop of your own, send for this free catalog.

ATLAS PRESS CO.

543 N. PITCHER ST.
KALAMAZOO 13D, MICH.



6"-10" Lathes



Milling Machines



Shapers



Drill Presses

SEND FOR
FREE CATALOG



BELL
GUARANTEED
WATCHES

**WATERPROOF
SHOCKPROOF**

NOW AVAILABLE! Sturdy, handsome, reliable, a watch for every occasion—backed by the famous BELL guarantee.

Anti-magnetic, radium dial and hands, unbreakable crystal, sweep second hand, precision tested.

No. NM 197
17 jewels, stainless steel back..... **\$29.75**

No. NM 188
17 jewels, all stainless steel case..... **\$47.50**

No. NM 328 SELF-WINDING
17 jewels, all stainless steel case..... **\$59.75**

ORDER BY MAIL: Send check, money order, or pay postman C.O.D. Prices Incl. Fed. Tax & Postage. Gift Box

Wide choice of fine watches for men and women.
Write for FREE Illustrated Booklet "NM"

BELL WATCH COMPANY
Time and Life Bldg., Rockefeller Center, New York 20, N. Y.

**for both
PLEASURE
and PROFIT!**

The Mead
Ranger

SCOOTER-CYCLE

\$148.00

UP TO 100
MILES PER
GALLON

**Can't Be Beat for
Fast, Economical Transportation**

Scoot to and from work, school, golf, shopping, etc. . . . on estates, farms, industrial plants, etc. Feel the exhilarating purr of its rubber mounted 1 1/2 H.P. Lauson motor—revel in its brilliant, vibration-free performance—its speed and ease in handling. Its advanced engineering features include automatic centrifugal clutch—throttle and brake controls at your fingertips.

ONLY A FEW DOLLARS MORE THAN A BIKE

In this modern Scooter-cycle Mead engineering brings you utmost utility—brilliant reliable performance—new safety features and astounding economy. Modern aero type tubular construction gets weight down to 83 pounds. Big 6 inch balloon tires give you a cushioned ride. Comes to you complete—ready to go for \$148.00 F.O.B. Chicago. Available now.

**SEE YOUR NEAREST DEALER OR
WRITE DIRECT FOR FREE LITERATURE**

**FAMOUS
FOR
BICYCLES
SINCE
1887**

MEAD CYCLE COMPANY
4522 WEST MADISON STREET
CHICAGO 24 ILLINOIS

MASTER ARBOR SETS \$5.95



Money back if you are not satisfied value is \$15.00 or more

Combination of 3/32" and 1/8" shafts. Very large assortment of wanted pieces includes: Brushes, stones, felts, mandrels, grinding wheels, rubber polishers, sanders, 7 burrs, cutoff discs, polishing rouge etc.

60 PIECE ARBOR SET (3/32") \$1.95



Includes assortment of engraving and carving burrs, grind stones, cutoff wheels, polishing buffs, bristle polishing brush, 2 mandrel arbors, garnet and emery sanding discs. If items bought singly value is over \$4.00.

DE LUXE SET \$3.95

140 Pieces

All the above in larger quantities plus many other hard to get items, many with demountable shafts — Really a \$7.95 value. Will ship to any part of the world prepaid. Send Check, Money Order or Cash.



DISTRIBUTORS WANTED — WRITE

GENERAL AIRE CO. Dept. PM-5
447 W. Norris Street
Philadelphia 22, Pa.

SAY YOU SAW IT IN POPULAR MECHANICS

Supercharge YOUR CAR

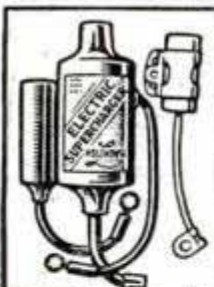

Protected by U.S. Foreign Pat.

HIGH-FREQUENCY TRANSFORMER

Makes Motor Start Quicker — Run Smoother
ELECTRIC SUPERCHARGER is a patented high-frequency transformer designed for POWER, ECONOMY and SUPER PERFORMANCE in motors. Car owners, mechanics and fleet owners report amazing results, even on new cars. NOTHING LIKE IT ON THE MARKET. Gives engine New Life — Increased Power — a 60% Longer and Hotter Spark — more Complete Combustion — less Spark Plug Fouling and Longer Life. Fits all cars except Ford V8 and Mercury, Order Model V Supercharger for 1942-46 Ford or Mercury. ELECTRIC SUPERCHARGER is sold on a 15 DAY TRIAL — MONEY BACK GUARANTEE FOR ONLY \$3.95 in U. S.

HOLTHOUSE LABORATORY

3918 W. Grand Ave., Dept. A-1, Chicago 51, Ill.

A new device takes the place of goggles — PROTECTS EYES

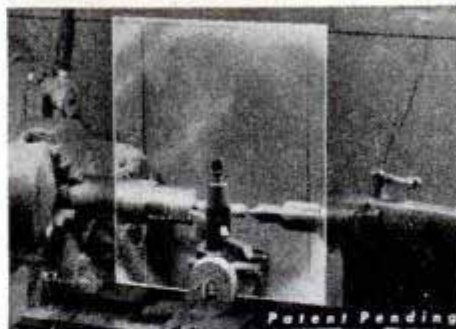

MAGNETIC Grip Shields
for
SHOP and HOME
6" x 8" size
\$3.40 each

Thousands of machine operators like the MAGNETIC Grip-Shield because it protects eyes and person without using uncomfortable goggles. It is transparent plastic with a powerful magnet attached. The magnet anchors the shield to any ferrous surface. There are different types for lathes, drill presses, etc. They are now used by many of the country's largest manufacturers. Most employers, IF YOU REQUEST, will supply YOU MAGNETIC Grip-Shields in place of goggles. Will sell on a 10 day trial money back guarantee. Send a dollar and pay postman balance plus postage — or send full amount and we pay postage. ASK YOUR EMPLOYER.

Write for Literature

THE DILLEY MANUFACTURING CO.

10113 Euclid Ave. • Cleveland 6, Ohio

Machine Tools & Machine Shop Equipment

DRILLS
TAPS
DIES
REAMERS
CUTTERS
SLEEVES
ARBORS

We can supply all your machine shop needs with fine tools made by leading U. S. manufacturers. Mail orders will be promptly dispatched. We invite you to send for our complete and illustrated catalogue—40c—which sum will be refunded on first order of \$10. Write to the

Veteran Tool & Supply Co., Dept. A
88 Baxter Street, New York, N. Y.

ELECTRIC TOOLS
GRINDERS
COLLETS
VISES
CHUCKS
MICROMETERS
SURFACE PLATES

The HELICOPTER

Looms big in tomorrow's transportation problems. The American Helicopter Association, founded to further Helicopter mechanical advancements and promote Helicopter industrial and individual interests, offers many unusual benefits to its members. Write today, without obligation, for complete details. A post card will bring them.

AMERICAN HELICOPTER ASSOCIATION

Dept. 1355, Suite 923, 600 S. Michigan Ave., Chicago 5, Ill.

Money Making
Pay Raising
BOOKS
Catalog
FREE

SEND NAME AND ADDRESS TODAY—Selected books covering all trades, office helps, home workshop, spare time work, hobbies, etc. Learn how to earn more. 1946 edition. Popular Mechanics Press
200 E. Ontario St., Chicago 11



1 Set (2 DISC HALVES) . . . 60c
2 Sets (4 DISC HALVES) . \$1.10
4 Sets (8 DISC HALVES) . \$2.00
TIRES, each \$1.35

NOW YOU CAN BUILD YOUR OWN RACER

2 DISC HALVES
make each wheel
"GENUINE GOODYEAR
RIB TREAD
SEMI-PNEUMATIC
TIRE TO FIT"

Hole in disc flange push fit for 1 1/8" O.D. Make your own bearing to fit any size axle.

Note: Not assembled

Easily Riveted or Bolted Together

OR — IDEAL FOR WHEEL BARROW — FOUR WHEEL TRUCK — GOLF BAG CARRIERS — MARKET CARRIERS — PUSHMOBILES — COACHES — GARDEN TRUCKS — SCOOTERS — COASTERS — WAGONS — AND MANY HOME, FARM AND FACTORY USES.

Newest and BEST All-Purpose Wheel for Home, Farm and Industrial Use . . . All holes in place for quick and easy assembly . . . Each wheel will carry 300 lb. load . . . Each Disc Formed of Heavy Gauge Steel; BRIGHT ZINC PLATED . . . Built by Precision Aircraft Parts Manufacturer . . . Make useful things for your children or help them build . . . They will enjoy these wheels.

SOLD DIRECT BY MANUFACTURER . . . ORDER TODAY
PRICES F.O.B. DOYLESTOWN. REMIT WITH ORDER

EDISON MACHINE SHOP, DEPT. P-5, DOYLESTOWN, PA.

WORLD'S LOWEST PRICED ADDING MACHINE

VEST POCKET SIZE
IDEAL FOR BUSINESS OR PERSONAL USE

FREE TRIAL
ONLY \$2.50
TOTAL COST
SEND NO MONEY

Each Baby Calculator in Beautiful, rich-looking, leatherette case—at no extra cost. **FREE!!**



Fits vest pocket or purse. Guaranteed accurate. Operated as easily, and as reliable, as machines costing many times as much. Not a toy. Substantially made of 28-gauge steel—guaranteed for life against defects in construction. You positively can't buy a calculator of equal quality for as little money. **ACCEPTED AS THE FINEST LOW PRICED CALCULATOR FOR OVER 30 YEARS!** Operates with a flick of your finger. Adds, subtracts, multiplies, divides—counts up to ten million. Pays for itself over and over in mistakes avoided, and time saved. **MAKES IDEAL GIFT.**

Sold on a positive money back guarantee. Send only \$2.50. Calculator sent postpaid, or send name and address and pay postman \$2.50 plus postage. **MONEY BACK IN 10 DAYS IF NOT DELIGHTED!** (If outside U. S. send \$3.00.) **AGENTS WANTED.**

CALCULATOR MACHINE CO. (Mfrs.)
Dept. 178. P. O. Box 248, Glenview, Illinois

WEATHERSTRIP YOUR WINDOWS NOW

Have comfort next Winter—Save money. All metal interlocking. Install yourself. Lasts forever. Set complete for one window \$1.95 at leading Hardware and Department Stores. Also Desk Cigarette Lighter \$2.00 and Sweater Blocker \$1.50. If you can't find at your Dealer's write direct to

E-Z-ON PRODUCTS Box 1061,
CHICAGO 90, ILL.
DISTRIBUTOR AND DEALER INQUIRIES INVITED

BLOWERS HEATING COOLING

Blowers and Cooling Supplies. Gas and Oil Burning Furnaces. Conversion Burners. Good Profits. Wanted—men to sell and install.

PEERLESS SALES, 4318 Sheridan, Lincoln 6, Nebr.

START HOME MAIL ORDER BUSINESS

Start small—grow big. Amazing new course shows you the way. Rush your name and address today for full particulars. No obligation.

BELFORT (Dept. A) Engineering Bldg. Chicago 6, Ill.

Say You Saw It in
POPULAR MECHANICS

12 ASSORTED { NEW HIGH SPEED ROTARY FILES } ONLY \$6.00 POSTAGE PREPAID
1/4 Inch Shank
SEND FOR CIRCULAR

VICTOR MACHINERY EXCH., Inc., 251 Centre St., N. Y. 13, N. Y.

**V-8
DUALS
AND SINGLES**



A genuine steel pack muffler WITH A BEAUTIFUL MOTORBOAT TONE. Sandee Mufflers feature improvements far in the lead, years ahead of competition. Increases mileage and power, reduces back pressure and gives better performance. Savings in gasoline will pay for a Sandee Muffler.

V-8 FORD AND MERCURY DUALS **\$17.50**

SINGLES—FIT IN PLACE OF REGULAR MUFFLER

Chev., V-8 Ford, Plym., \$5.00 Chrys., Olds., Buick, etc., \$7.00
These mufflers will outlast two regular stock replacements.

Dealers Wanted

SANDEE MUFFLER CO.
7523 S. WESTERN AVE., LOS ANGELES 44, CALIF.

HE'S A PICTURE... FRESH FROM HIS BATH



Make sure you get it!

NEW IMPROVED
G-E
Exposure Meter

Whenever Baby invites a picture—movie or still—make sure you get it... with the new, improved G-E Exposure Meter to guide your camera.

New, simplified dials make it easier to use. Lighter. Sturdier. Proved accuracy. Extremely sensitive. See the G-E meter at your photo dealer's. *General Electric, Schenectady 5, N. Y.*



GENERAL ELECTRIC
606-165 E

- Convalescents
- Invalids
- Shut-Ins

Now—you can have a
Walk-A-Chair!

**FOR THERAPY • MOBILITY
UTILITY • CONVENIENCE**

Used in leading hospitals, including Walter Reed General Hospital, Washington, D. C.

SEE for yourself how a Walk-A-Chair can help you!

Get this FREE illustrated booklet. MAIL COUPON TODAY!

A few areas still available for distributorship

The WALK-A-CHAIR Company
1217 Field Bldg., Dept. 5
135 LaSalle St., Chicago, Ill.

Without obligation on my part I would like a FREE illustrated booklet explaining benefits of a Walk-A-Chair.

Name

Address

No statement herein can be construed as an endorsement by the military. Endorsement of any article is prohibited by regulations.

Walk-A-Chair!



Walk-A-Chair Corporation

"1001" Re-Blade Knife*
with interchangeable surgical
steel blades!



**KEEN!
EVER SHARP!
EVER READY!**

"1001" Knife
as above, \$1.29
Knife with 3
extra, differ-
ent blades
and honing
stone, \$1.59

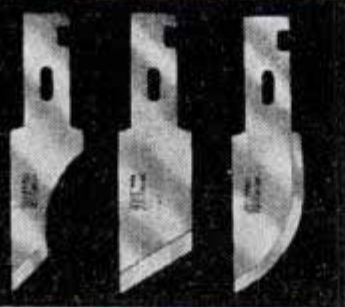

The first really "balanced" craft knife

Whether you're an expert craftsman or just a passably fair workman or hobbyist, you'll do better work faster and easier with "1001"—the re-blade knife of 1001 uses! For "1001", thanks to its light, perfectly balanced, colorful plastic handle, is second to none for easy and exact whittling, chiseling, modeling and cutting of all sorts. Its patented, scientifically designed chromium finish blade holder simplifies the insertion and removal of "1001's" all-purpose blades, and keeps them firmly locked in place. Yourself—get a "1001"—feel the difference, see the difference in your work. It's as easy to handle as a pen or pencil.

• Buy "1001" wherever hobbycraft tools are sold. If your dealer cannot supply you, send check or money order for \$1.29 (or \$1.59) direct to

SOMAR SPECIALTY CORP.
Dept. M12—630 Fifth Ave., New York 20, N. Y.

*PAT. PENDING

SAY YOU SAW IT IN POPULAR MECHANICS

MAKE MONEY

Selling
FLUORESCENT SAVES 1/2

on Electric Light Bills

INTO SOCKET JUST LIKE BULB!

SALESMEN! Once expensive—once costly to install—out of the reach of most people, Fluorescent Lights still sold in millions. Experts now predict war starved market of 3 1/2 BILLION, and with invention of fixture that screws in like an ordinary light bulb, a fixture that can be installed in an instant, a fixture that sells complete with tubes at a new low price—the most spectacular sales opportunity of the decade has been opened up for salesmen and distributors. Enormous advance commissions. Exceptional factory co-operation includes financing big orders by shipping open account to your customers.

FREE If earnings of \$5,000, \$10,000 and \$15,000 a year don't scare you, rush your name by fastest way for sensational facts—sales plans—complete line with pictures and prices. This is the hottest item in direct selling today. Even if you don't answer another ad in this magazine, rush your name on this proposition—right now.

North American Mfg. Co., 5042 Cottage Grove, Dept. 35, Chicago 15, Ill.

AMAZING NEW MONEY MAKER!

— SALES ARE TERRIFIC —



Gold Plated or
Stainless Steel

Smart looking and distinctive to fit any wrist. Stainless Steel \$12 per doz. Gold Plated \$24 per doz. Sample Gold Plated \$2. Minimum order 1 doz. (except sample). Money Back Guarantee. **ORDER TODAY.**

NEW STREAMLINED EXPANSION WATCH BAND
(Sample Paid \$1.50)
Stainless Steel

SEMERAK & CO., Dept. P-5, 4439 Lincoln Ave., CHICAGO 25, ILL.

NEW PLASTIC GOGGLES

For Factories, Auto Mechanics, Work Shops. Amazing Full Vision **EYE SAVERS**, scientifically designed for eye protection and comfort—wear over glasses. Non-splinter 134-FAX lenses provide crystal clear vision. No fogging, no perspiration or skin irritation—feather weight. Approved by largest industries. Agent Distributors—Unlimited profit opportunity supplying Eye Savers to Factories, Garages, Shops, all industries. Mail \$2.25 for sample and Money Making offer. **H. MEINHARDT & CO., INC., Dept. P**
4138 N. Sheridan Rd. Chicago 13, Ill.



THIS BOOK SHOWS
HOW TO DO IT

STEEL SQUARE POCKET BOOK

Completely Revised

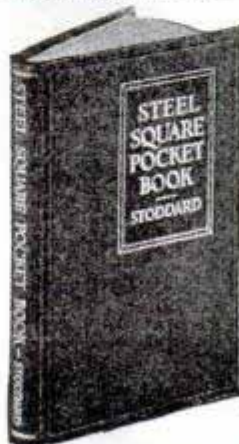

This concise and handy little book illustrates and describes the best methods of using the carpenter's steel square in laying out all kinds of carpentry work. It is easy to understand as a picture of the square laying directly on the work shows exactly how the various cuts are made. Its compact and handy size makes it convenient to carry in the pocket for quick reference.

Price \$1.00 Postpaid

POPULAR MECHANICS PRESS
DEPT. 627 200 E. ONTARIO, CHICAGO 11, ILL.

POPULAR MECHANICS

Do Your Own Welding and SAVE MONEY

With the MAGIC WAND electric flame and metallic arc Welder, beginners quickly become expert at welding, brazing and soldering. This complete, portable outfit, built into a handy, shockproof carrying case, is ready for instant use anywhere, by plugging in on the nearest 110-V, 60-cycle AC outlet. Handles any metal—steel, iron, bronze, brass, aluminum, etc. Includes heavy-duty transformer with 6 stages of welding heat; dual-purpose electrode holders (flame and arc); polarized outlet plug; welding, brazing and soldering rods and fluxes, welding helmet; Instruction Manual. Weighs less than 30 lbs. packed. Quickly pays for itself. Sold by hardware dealers and automotive jobbers.



For Descriptive Folder, address:
JOHN H. GRAHAM & CO., INC.
General Sales Agent
Dept. D, 105 Duane St., New York 8, N. Y.

COMPLETE
\$34⁵⁰
F. O. S. FACTORY

Magic Wand **WELDER**
MADE BY PATENT SPECIALTIES, INC., NEW YORK, N. Y.

MAKE MORE MONEY

APPLYING OR SELLING

CORKSTONE PLASTIC FLOORING

**EASY
TO
APPLY**

Here's your opportunity to get into business for yourself applying or selling Corkstone, the economical, top-grade plastic flooring. Plenty of profit. Act without delay!



Dealers & Agents Wanted

WRITE FOR DETAILS OF OUR PROPOSITION
We believe in teamwork and cooperation. We'll help you get started. No cost; no obligation. Act today!

LASTING PRODUCTS COMPANY
MANUFACTURERS OF PAINTS, PUTTIES, PLASTICS
FRANKLINTOWN ROAD PLANT, BALTIMORE 23, MARYLAND

ANCO RAIN-MASTER "Dead-Locker" WINDSHIELD WIPER ARMS and BLADES

BLADE SNAPS ON...
STAYS PUT

FINGER-
TIP
RELEASE

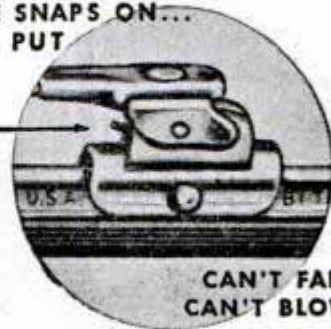

(A war-born invention—by ANCO—first)
for military aircraft—now for your car.)

DON'T SHOOT YOUR GAS-PUMP MAN!

He's doing the best he can. Sure, he knows how dangerous it is for you to drive your car... in stormy weather... with your dull old windshield wipers that smear and smear. He'd gladly put on for you quickly a pair of keen new ANCO RAIN-MASTER Wiper Blades and Arms. He has them—Newest Models! But he forgets to remind you? Too busy? You can't shoot him for that!



After all, it's *your* car to protect. So *you* remind *him*. Get RAIN-MASTERS... patented features... original equipment on many makes of high grade cars and trucks... used in war—on our fighting tanks and trucks and ships and bombers too... because ANCO RAIN-MASTERS clean quicker, clean cleaner... last longer. May save you a costly smashup.

Ask for RAIN-MASTER Windshield Wiper Arms and Blades next time you buy gas.

THE ANDERSON COMPANY
Established 1918
GARY, INDIANA

Relief Models Help Blind Student



Models of campus buildings at Princeton University enable blind John K. Dupress, freshman from Fitchburg, Mass., to find his way without help. He lost his sight while serving with the Army in Europe. The models were made by G. Vinton Duffield, chief of circulation in the Princeton library.

Spark Plugs "Grow" With Use

Two recent developments designed to improve high altitude flying are a spark plug with electrodes that grow with use and an ignition system using high-frequency currents to fire the plug. The special electrodes lengthen as they are used. This "growth" is about equal to the wear on ordinary electrodes and is expected to keep the spark gaps more nearly constant and double the life of the plugs. Principal feature of the ignition system is the use of radio frequency currents to fire the new plugs.

Help! Help!

This fellow, known as "Nat," is waving for help because the editors slighted him in the January issue. Nat is a miniature "iron man," ingeniously fashioned of bolts and nuts, and is the trademark of the National Screw and Manufacturing Company, to whom belated apology is made here. His picture appeared without credit in a January article, "Modeling With Nuts and Bolts."

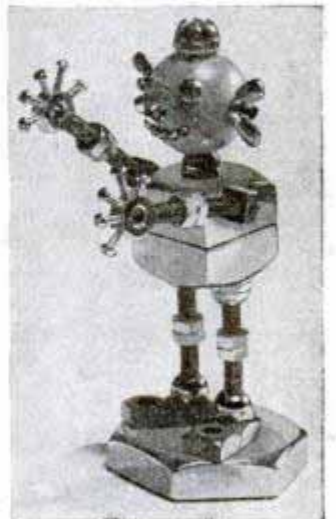

"MORE
VERSATILE
THAN EVER"

BURGESS vibro-tool

Trade Mark Reg U-S Pat Off

For tooling on leather, for a host of craft and shop jobs, the Vibro-Tool is unequalled.

Operates by vibration, 120 strokes per sec.; 60 cycles, 110V AC. See Your Dealer Today, or Order Direct.



The Vibro-Tool with engraving needle \$7.50; with set of attachments \$16.15.

HANDICRAFT DIVISION

BURGESS BATTERY COMPANY

166 N. Wabash Ave., Chicago 1, Ill.

NOW REDUCED

The ORIGINAL ~~\$3.00~~ VALUE

**STAINLESS STEEL
E-X-P-A-N-S-I-O-N
WATCH BAND**

SAVE 1/3

\$2 TAX EXEMPT POSTAGE FREE

- Order Now for Quick Delivery
- Looks Like \$10 or \$15 Band
- Slips on-and-off easily
- No Buckle Fussing
- Fits Any Watch and Wrist
- Lighter, Flexible, Adjustable
- Money Back Guarantee
- Ideal Gift for Any Man

GOLD PLATED

450 Value

\$3

MAIL THIS COUPON NOW

APPEL INDUSTRIES, 5 N. Wabash Ave., Chicago 2, Ill., Dept. M 100

Enclosed find \$..... please send me..... Stainless Steel Bands at \$2.00 each,..... Gold Plated Bands at \$3.00 each Postage Free! (cash-check-money order)

Please send me C.O.D. plus postage

Stainless Steel Bands, Gold Plated Bands

Name.....

Address.....

City..... Zone..... State.....



TANK PRISMS

Build your own periscope with a pair of these tank prisms—look over the heads of crowds, etc. Slightly soiled and scuffed but optically perfect. Measures 6 5/16 x 2 3/8 x 1 1/18 inches. Shipping weight 2 lbs. **98c**
R-234—Price each....



OFFICERS WATCH COMPASS

Brand new gov't surplus, Army-Navy model. Single jewel mounted needle. Silver colored dial. A splendid value. **\$3.35**
A174—EACH....

WAR SURPLUS AND HUNDREDS OF OTHER BARGAINS

MOSQUITO TENTS



Of marquisette with taped seams. Metal rods and bars included. Covers cot or hammock. Brand new. **A104—EACH \$2.95**

U. S. ARMY COTS

Brand new Army cots. Hardwood frame with extra heavy canvas. Folds compactly—opens to 27x78 inches. Will support 1000 pounds. Fits in mosquito tent listed above. Wgt. 25 lbs. **\$5.95**
232—Each

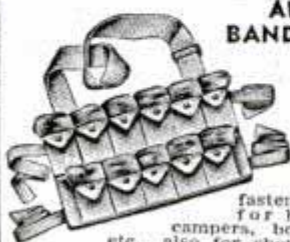

ARMY BANDOLEERS

Of fine heavy khaki. Big roomy pockets with button fasteners. Fine for hunters, campers, boy scouts, etc., also for shop work in carrying small parts, etc. Material alone is worth this price.

11 Pocket Type No. 129 **49c** Each....
5 Pocket Type No. 110 **29c** Each....

MESS KITS



Regulation Army Mess Kits. Ideal for campers, boy scouts, etc. Slightly used but guaranteed perfect. Two pieces. Folding handle. **A116—69c**
Each

CANTEENS, CANTEEN COVERS and CUPS



Regular U. S. Government issue Canteens. Plastic screw top chained to body. Slightly used. **A117—Metal Body 69c**
A118—Plastic Body 69c
A109—Canteen Covers, New, Ea... 69c
A119—Canteen Covers, Used, Ea... 35c
A120—Canteen Covers, Used, Each..... 25c

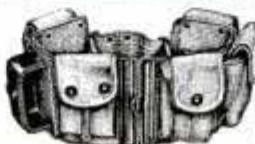

GI POCKET BELTS
Of heavy canvas. Adjustable waist size. Each with 5 pockets, and metal recoil fitting. Brand new. Fine for hunters, boy scouts, etc. **A107 98c**



PUP TENTS

Regulation Army Pup Tents of durable, brown canvas. Used, but in good condition. Fine for campers, outdoorsmen, boy scouts, etc. Grand Xmas gift for children. Wgt. 5 lbs. **A100—Tent Only \$3.95**
A110—Tent, new .. \$7.95
A101—Ropes, wooden poles and stakes for above. Per set \$1.00

AMMUNITION BOX

Fine for storing valuables, carrying lunches, etc. Of heavy gauge 7 1/2 x 11 x 4 inches. Fireproof. Hinged lid with folding handle. Olive drab finish. Used, but perfect. Shipping wt. 4 lbs. **A525—EACH..... 25c**



7-LB. EXPERIMENTER PARTS ASSORT.

A "gold mine" for the radio serviceman. Hundreds of valuable radio parts, new radar and electronic parts and sub-assemblies, coils, resistors, trimming condensers,—worth many times this low price. **A130R—7 LBS. \$1.79**



LATEX AIR PILLOWS



Air pillows for camping, etc. Made of fine white latex fabric. Folds compactly for storage. Quickly inflated. A splendid value at this low price. Shp. wt. 1 lb. **212—Each \$1.75**



MCCLELLAN ARMY SADDLES

Brand new! McClellan model saddles. Top grade cowhide with hair girth, fender and 12 inch seat. Has straps for blanket roll and knapsack. Buckles, gunboot and sabre loops. A splendid value. **A-145—Each \$13.95**



MICROPHONE BUTTON

Brand new! For experiments in radio, electronics and other electrical apparatus. Used in telephone, amplifier and detection work. Diameter 2 1/2 inches. New. **A512—EACH..... 98c**



SADDLE BAGS

Made of finest top grain leather. Rivet reinforced seams. Bottom and side gussets. Each canvas lined bag measures 12x13 inches. Fine for motorcyclists. May be separated to make two duffle bags. Used, but perfect. **A151—Each... \$6.95**



RADIO HEAD PHONES

Extremely sensitive with 4000 ohms resistance. Brand new and fully guaranteed. With moisture-proof cord and phone plug. A splendid value for the radio serviceman and experimenters.

A106—PAIR \$2.95
New supersensitive phones. **A108—Pair... \$5.95**



SHIPS LANTERN

Purchased from the Navy. Stands 22 1/2 inches high, 9 3/4 inches wide. Of heavy sheet metal. Windproof ventilation. Mounts on any wall. Burns oil—may be wired for electricity. All new. **R-516 \$12.50**
Each



ANTENNA UNITS

Antenna Coupling unit. Eliminates radio static, and improves reception on all types of radio sets. Worth much more. Wgt. 4 lbs. **637— \$2.95**
Each only....

SACHEL POUCH

Heavy canvas pouch. Ideal for toting lunches, shopping, books, etc. Has three 11 x 12 inch pockets. Brand new, guaranteed perfect. Has oversize flap with single strap fasteners. **A113—EACH \$1.69**



27 LENSES, ALL NEW, PERFECT. For experimental work in optics. Consists of 27 precision ground and polished prisms and lens elements in assorted diameters and focal lengths. Big variety, positive, negatives, etc. Actual value over \$100.00. **A519—27 PIECES..... \$7.95**



50 LENSES SEMI-FINISHED

Lenses similar to above but not polished. All are blanked and formed ready for polishing. Negatives, positives, and prisms in Crown and Flint glass. Worth many times this low price. **A520—\$1.95**
50 assorted lenses, only..

PROF. TELEGRAPH KEY

Purchased from the gov't. Finest design and construction. Base measures 3 x 4 3/4 inches. Original value \$2.50. All parts of instrument brass. Adjustable. **A147—Each 98c**



LIFE PRESERVER BELTS



Right from the invasion beaches. Consists of two air chambers. May be inflated automatically with "sparklet" cartridges or manually by attached hose. Adjustable in waist size. One air chamber guaranteed air tight—other may need a tire patch. All belts are used and slightly soiled but a bargain at this low price. **No. 1261 \$1.00**
Each.....

ORDER DIRECT FROM THIS AD

Values galore! Hundreds of hard-to-find items for home, shop and outdoors. Make remittances by money-order, bank draft or personal check. Send 25% deposit on C.O.D. orders. No C.O.D.'s on orders for less than \$5.00. Include sufficient postage on parcel-post orders—any overage will be promptly refunded. All quotations F.O.B. Chicago. Used items and materials are guaranteed serviceable and as described. Your money back if not more than satisfied.

BIG ILLUSTRATED CATALOG FREE

STARK'S Dept. PM546
509 So. State St.
CHICAGO 5, ILL.

98 Booklets filed with Money and Time-Saving Helps

Little Library of Useful INFORMATION

5 for \$1.00
12 for \$2.00
25¢ Each

Here at amazingly low cost is the practical help and information you have always wanted. Articles in previous issues of Popular Mechanics have been classified according to subject and are now available in these handy reprint booklets. Check Titles wanted, clip ad and mail today.

BOOKLETS ON WORKSHOP EQUIPMENT

Power-Driven Saws—74: Complete details on scroll saw, two circular saws, sliding cut-off saw, bandsaw.
Drill Presses, Plane, Grinders—79.
Sanders—80: Complete constructional details on 8 useful machines.
Wood & Metal-Turning Lathes—81: Two wood lathes, small metal-turning lathe.
Filing Machine, Hacksaw, Cutoff Wheel, Shaper—82.
Metal Lathe Tools You Can Make—101.
Workbenches & Tool Cabinets—47.
Spray Painting—94: Constructing spray guns, compressor, using spray gun.
From Pattern to Casting—91: How to make your own patterns and small castings.

BOOKLETS ON SHARPENING—USING TOOLS

Correct Measurement—106: How to use micrometers, gauges, calipers, etc.
Tool and Saw Sharpening—92.
Using & Sharpening Drills & Wood Bits—90.
Successful Wood Turning—32: All the information you need to master this art.
How to Read Blueprints—71: Tells you how to understand signs, symbols, and lines.
Metal Turning Lathe Kinks—99: Simple homemade tools, time and labor-saving shortcuts you can use.
Operating a Metal Turning Lathe—100.
Heat Treating & Case Hardening—102.
Working with Glass—103: Cutting, drilling, etching, blowing.

ELECTRICAL BOOKLETS

Rewinding & Servicing Electric Motors—75: Repairing and rewinding a.c. and d.c. motors. Locating trouble. Converting auto generators into 110 v. a. c. motors.
House Wiring—89: All the information you need to do a complete wiring job or install extra outlets.
Electromagnets & Solenoids—44: Designing and building.
Transformer Construction—41: Easy-to-understand instructions for all kinds of transformers.
The Boy Electrician—43: Easy-to-build motors, experiments.
Soldering & Brazing—17.
Arc & Spot Welders—5: Building and operating 110 v. a. c. arc and spot welders.
Treasure Finders—13: Build your own treasure finder and metal locator. Details for both large and small radio types.

ELECTROPLATING BOOKLETS

Electroplating with Copper, Nickel, Chromium, Lead, Zinc, Cadmium—86.
Plating Leather & Other Non-Metallic Objects—Plating with Gold, Silver, Alloys—87.

HOME IMPROVEMENT BOOKLETS

Simple Home Improvements—104: Modernizing; making storm sash, ironing boards, etc.
Building Extra Rooms in Attic—23.
Attractive Basement Playrooms—24.
Lower Your Fuel Cost—31: Practical kinks that will save you hundreds of dollars.
Hanging Wallpaper—38: Tricks of hanging wallpaper, removing old paper, etc.
Curing Leaky Basements—45:
Fitting Home Game Room—55: Construct own game & tennis tables, shuffleboard court, action game, portable playrooms.

Ridding the Home of Insect Pests—107: Exterminating and protecting against moths, flies, termites, mosquitoes, etc.
Built-in Pictures—78: Step and space-saving kitchen units, built-in beds, corner cabinets, vanities, linen chest.
Constructing Indoor & Outdoor Fireplaces—83: Stone fireplaces, portable mantels, garden fireplaces.

GARDENING BOOKLETS

Backyard Gardening—39: Selecting, planting and getting the best results.
Lawn & Garden Novelties—72: Jig-sawed ornaments, parkway numbers, sundials, flower boxes.
Trellises, Pergolas, Fences—76.
Lawn & Garden Furniture—77: Modern bent-tube furniture, arbor and seat combinations, swings, lawn chairs.
Playground Equipment—73: Two playhouses, ferris wheel, roller coaster, treadmill, play store, slide, two merry-go-rounds.
Colored Concrete Garden Furniture—6: Garden benches, pottery, flower boxes, bird baths and sundial pedestals in colored concrete. How to build small concrete mixer.
Bird Houses—7: Easy to build homes for all kinds of birds.
Farm & Garden Tractors—8: Two tractors you can build from old automobile parts.

CRAFT WORK—HOBBY BOOKLETS

Complete how-to-make-it instructions for hundreds of practical projects.

Working with Plastics—61: Using brilliantly-colored plastics in craftwork.
Magazine Racks—49: Ten attractive racks.
Clock Cases—50: Large Hall, Colonial wall and mantel, ship's wheel, miniature grandfather, desk, Spanish style banjo.
Serving Trays for Every Occasion—53: Fourteen different designs.
Children's Room Furniture—51: Twelve attractive pieces.
Book Ends—52: Ten designs offer good selection.
Small Tables—54: Modern and colonial styling.
Smoking Stands—56: Seven designs given.
Jigsawed Novelties—57: Sewing kits, string holders, place-card holders, plywood kitchenware, plant and flower holders, coin banks, door stops, drawer pulls.
Desks—58: Colonial writing desk, two modern-type desks, student's study desk of plywood, combined chest and writing desk.
Book Cases—59: Eight designs.
Doll House & Doll Furniture—60.
25 Shelves You Can Make—64.
Novelties Turned on Lathe—62.
Inlay Pictures—Veneering—63.
Whittling and Wood & Soap Carving—65.
Action Toys—66: 21 easy-to-make toys.
High Flying Kites—67.
Windmills & Weathervanes—68.
Lamps in Wood, Metal, Plastic—69: Selection of 14 designs.
Metal Craft—28: Brass tapping and making of novelties both decorative and useful.
Small Looms—37: Building hand looms for weaving rugs, etc.; leather novelties.
Plain & Novelty Wood Finishing—40.
Gem Cutting—42: How to cut and polish semi-precious stones.

BOAT BUILDING BOOKLETS

Build a boat at home—you can do it

14 Ft. Outboard Runabout—2: Here is a fast 14 foot V-bottom boat. Suitable for motors of 4 to 24 hp., estimated cost, \$30 to \$40.
14 Ft. Sailing Dinghy—26: This 14-foot boat combines strength and light weight. It carries 140 sq. ft. of canvas and weighs about 350 pounds. Actual photographs and diagrams illustrate every detail.
21 Ft. Sloop—46: Every fact needed by the amateur boat builder to construct this craft which carries eight to ten persons.
Rowboats, Bicycle Boat, Small Dinghy—83: All the information you need to construct four low-cost boats.
Small Sail Boats—84: 12-ft. sailing dinghy, 6-ft. "training ship" for young sailors, how to sail a boat.
Two Outboard Runabouts—85: 14-Ft. family outboard weighs about 400 lbs. and 12-ft. plywood outboard weighs about 110 lbs. Both are V-bottom type.
Build Your Own Canoe, Kayak, Surfboard—30: Complete details on 16-ft. Canadian-type canoe, 17-ft. kayak, and 12-ft. hollow surfboard.
Fast Class-E Ice Yacht—22: Build your own Class-E ice yacht. Every detail of construction carefully explained.

AUTOMOBILE BOOKLETS

Automobile Kinks and Shortcuts—10: Money-saving hints on upkeep and operation.
Building Trailers—27: Small Streamlined house trailer; several utility trailers.
Motor-Driven Midget Car & Scooter—34: Both use gas engine of washing machine type.
Curing Auto Electrical Troubles—95.

PHOTOGRAPHY BOOKLETS

Save Money by constructing your own photo equipment.

Photo Enlargers—1: Condenser lens type; simple vertical; horizontal.
Photo Printers & Dryer—25: Describes three practical printers, timer and negative dryer.
Photo Darkroom Equipment—96: Cabinets, light-tight box, timer, agitator, washer, trimmer.
Picture Projector, Trick & Table Top Photography—97: Projectors that enlarge magazine illustrations and shop drawings. Tips for table toppers, photomontages, tricks.
Photo Kinks—98: 63 time and money-saving ideas you can use.

FORMULA BOOKLETS

Transform simple ingredients into useful products

Cleaning Preparations—11: Easy-to-make cleaners for walls, glass, etc. Removing fabric stains.
Cosmetic Formulas—12: Hand lotions, creams, rouge, bath salts, beauty clay, lipsticks, etc.
Re-Silvering Mirrors—70: Formulas for silvering and coloring.

MISCELLANEOUS BOOKLETS

Knots and Ropework—105.
Chemical Experiments—93: Easy-to-perform experiments. Inexpensive lab.
Taxidermy—9: How to prepare skins and obtain life-like poses.
Log Cabins & Tourists Cottages—14: Year-round log cabins; inexpensive tourists' cabin.
Magic for Everybody—29: Simple tricks to puzzle your friends.
Trapping Small Animals—33: How to lure fur bearers, prepare bait and traps, dress skins.
Tricks of Training Your Dog—35.
Small Furnaces—36: Build own gas or electric.

POPULAR MECHANICS PRESS,
200 E. Ontario St., Chicago 11, Ill.

I enclose (U. S. bills may be mailed if carefully wrapped)
for "Little Library" booklets numbers:

Name
Address Zone
City State

IDEAL FOR Auto-Home Appliance and Farm REPAIRS

Now A DYNAMIC HEAVY DUTY INDUSTRIAL WELDER

Available Now Without Priorities!

Designed to Do High-Grade Welding *Inexpensively*

Maintenance men, farmers, mechanics, machine shops, foundries, auto, general repair and job welding shops using the DYNAMIC WELDER find it so indispensable and useful that they cannot afford to be without it. If inexperienced you can easily learn to do a variety of high-grade welding jobs by following the practical, simplified operating and welding instructions furnished.

WORKS ON IRON, STEEL, BRASS, BRONZE and OTHER METALS

Has eight metallic and carbon arc welding heat stages. Does work you would think only possible with a larger, more expensive machine.

READ WHAT USERS SAY...

Repair Shop Owner says, "It will do more than you say"

"I want to say I operate a repair garage and am more than satisfied with the welder. It will do more than you say." C. P., Butler, Ohio

It's the Greatest Portable Outfit

"Now I am equipped for all kinds of welding and I must say it's the greatest portable outfit for welding any man could ever wish to own. I wouldn't sell mine for the cost of plenty welders I have seen which were very high in cost but not in convenience. You may put me on file as a booster of your wonderful welding product." W. J. B., St. John, N. B., Canada

Better Than I Expected

"I have done quite a little welding with my welder and will say it is better than I expected. The price, convenience, and variety of work that can be done with the Dynamic are the attractive points." W. R. P., Portland, Ore.

EASY TO OPERATE!

DYNAMIC SUPERCHARGED WELDER

GET DETAILS ON OUR 10-DAY TRIAL OFFER!

Once you see a DYNAMIC in operation you won't want to be without it. Its simplicity will amaze you. In a year the DYNAMIC only costs you about 6c a day. Comes complete, ready to operate, with helmet, rods, cables, electrode holder and operating instructions, etc. Nothing else to buy. Write today for Free particulars. Act now and get details on our amazingly low priced Dynamic Welder and 10 day trial offer.

DYNAMIC WELDER CO.

13 East 23rd Street—FE

CHICAGO 16, ILLINOIS

FOR ONLY
\$23⁵⁰
COMPLETE

AMAZINGLY SIMPLE TO OPERATE!

This portable Dynamic Welder, easily carried right to the job, can be operated from any convenient, properly wired 110 Volt 60 cycle line. Can also be supplied for 220 Volt 60 cycle operation and for other voltages and cycles at slight additional cost.



SOUTH BEND LATHES

ESSENTIAL SHOP EQUIPMENT

South Bend Precision Lathes are accurate, versatile, dependable. Their ability to perform a wide variety of operations on all metals and other machinable materials make them essential tools in all types of maintenance, repair, and experimental shops as well as in toolrooms and production plants.

9-INCH LATHE FEATURES

Fine workmanship by highly experienced machine tool craftsmen.

Superfinished spindle with large bearings.

Belt drive for smooth, quiet operation at high speeds.

Back-gear drive for power and low speeds.

6, 8, 12 or 16 spindle speeds.

Thread cutting range (Model A)—4 to 224 per inch, 48 pitches.

Precision lead screw for thread cutting.

Worm drive and friction clutch for power longitudinal and cross feeds (Models A and B).

Three hand-scraped V-ways and a flat way on bed to insure perfect alignment of headstock, saddle and tailstock.

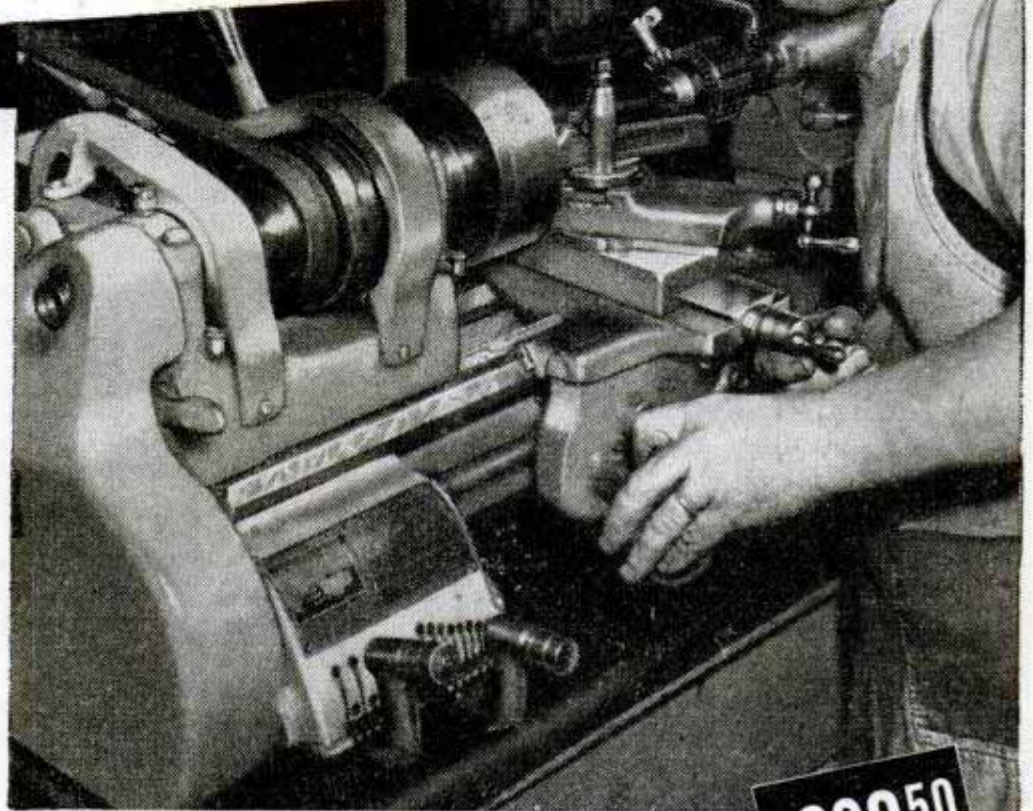

9" x 3' South Bend Model A Precision Bench Lathe with 12-Speed Drive, less electrical equipment and bench,

\$239.50
F.O.B. FACTORY

South Bend 9-inch Precision Bench Lathes are widely used, both in small shops and in large factories. They perform difficult precision jobs easily and with unfailing accuracy on all types of materials from tool steels to new light metals and plastics. They are fast, easy and economical to operate. Dependable service and long life are designed and built into them. South Bend Lathe prices are moderate and operating costs definitely are low. If you plan to equip a shop soon, or to increase or replace your present equipment, write today for a catalog and the name of your nearest South Bend Lathe distributor.



Write for Catalog

South Bend Precision Lathes are made with 9", 10", 13", 14-1/2", and 16" swings. State size lathe in which interested when writing for catalog.

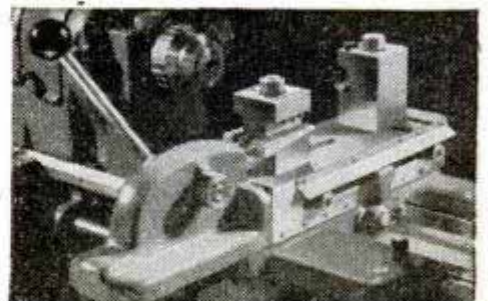

Handlever Double Tool Cross Slide

This attachment permits a three tool set-up which speeds successive operations in production work. The complete line of South Bend Attachments and Accessories are shown in Catalog 77. Write for it.

LATHE BUILDERS SINCE 1906

SOUTH BEND LATHE WORKS

455 E. MADISON STREET • SOUTH BEND 22, INDIANA



Printed by Popular Mechanics Company, Chicago, Ill., U. S. A.



**Piston rings
wear out, too**

Billions of miles of good engine life go up in smoke every year—the smoke that pours out of automobile exhausts. Plain as day this smoke says: "Your piston rings are worn out. Replace them immediately!"

Smoke is only one symptom of worn-out rings. Others are: oil-pumping . . . slow get-away . . . loss of power. At the first sign of any of these symptoms, take your car to a motor specialist for a complete check-up.

If new rings are needed, it will pay to get Hastings piston rings. They *stop* oil-pumping, *check* cylinder wear, *restore* performance.

HASTINGS MANUFACTURING COMPANY • HASTINGS, MICHIGAN
Hastings Ltd., Toronto



HASTINGS STEEL-VENT PISTON RINGS

TOUGH ON OIL-PUMPING

GENTLE ON CYLINDER WALLS



The Light that Never Fails!

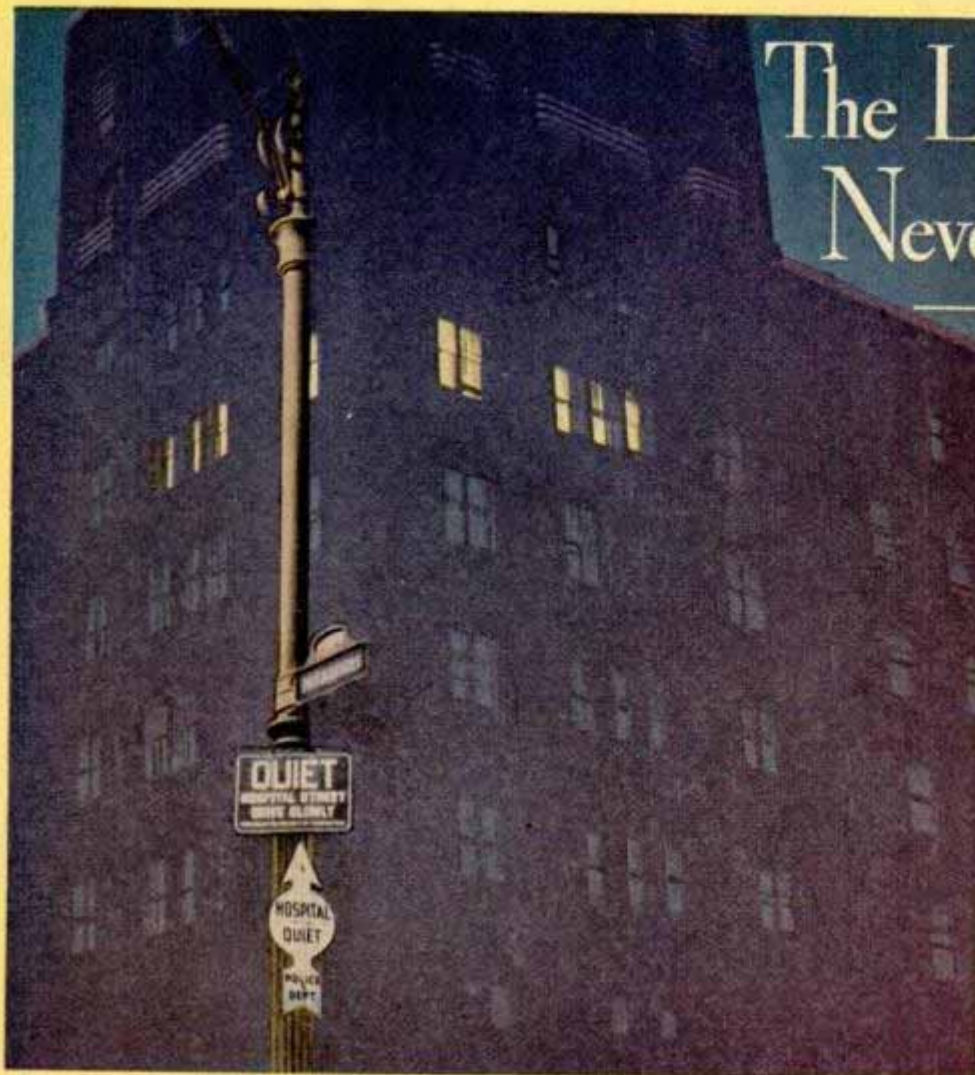

"Emergency Case!"

While the city sleeps, lights blaze in a hospital ward — they mean "Doctors at Work!"

HE ISN'T interested in making speeches and taking bows on the magnificent job he does. He's just interested in doing that job with all the skill and devotion he possesses.

His work is never done. His battle knows no lulls. But he asks no quarter. All this he knew when those proud letters "M.D." were first affixed to his name.

R. J. Reynolds Tobacco Co., Winston-Salem, N. C.

According to a recent Nationwide survey:

MORE DOCTORS SMOKE CAMELS THAN ANY OTHER CIGARETTE!

● "WHAT CIGARETTE DO YOU SMOKE, DOCTOR?"

Three independent research organizations recently put that question to 113,597 doctors. Family physicians, nose and throat specialists... doctors in every branch of medicine were asked. More doctors named Camel as their smoke than any other cigarette.

Like the rest of us, doctors smoke for pleasure too. Camel's full, rich flavor appeals to their taste... Camel's cool mildness registers with their throats... just as with millions of other Camel smokers' the world over.



THE "T-ZONE" TEST WILL TELL YOU

The "T-Zone"—T for taste and T for throat—is the proving ground for any cigarette. For only your taste and throat can decide which cigarette tastes best to you... how it affects your throat.



CAMELS

Costlier
Tobaccos