

POPULAR MECHANICS MAGAZINE



WRITTEN SO YOU CAN UNDERSTAND IT

REG'D. TRADE MARK, GREAT BRITAIN, No. 410138

REG. U.S. PAT. OFF.

APRIL
1946
25 CENTS
30c IN CANADA



FLYING WATER BUGS
PAGE 96

*An Amazing
Improvement!*



RAY-O-VAC

LEAKPROOF FLASHLIGHT BATTERIES

Stay Fresh
FOR YEARS

NO DATING NECESSARY

RAY-O-VAC COMPANY, MADISON 4, WIS.



See how this new B. F. Goodrich tire **OUTWEARS PREWAR TIRES**

*Order these new tires
now for your car*

THE two tires you see here have spent their entire lives together—running on the same car. They have covered exactly the same number of miles, under the same driving conditions, over the same roads. They were shifted from wheel to wheel so that there could be no possible advantage for either.

The one on the right is a prewar tire. The one on the left is the new B. F. Goodrich Silvertown. Just look at the difference. And this is no isolated case. These new tires have passed nearly 17 million miles of

tests—on taxi fleets, police cars, and on B. F. Goodrich test cars.

The new tire has a wider, flatter tread that puts more rubber on the ground, spreads the wear over the whole tread surface. And *even* wear means longer wear! The tire body, or carcass, is stronger, too . . . made that way by using tougher cords and more of them.

You can forget all your worries about "wartime tires" if you get one

of these new B. F. Goodrich Silvertowns—they've proved that they will outwear prewar tires. They've passed the toughest tests anyone can give them in the laboratory or on the road. Supplies are still limited, of course, but we're making and shipping these new tires every day and hope to have much larger quantities in the hands of most dealers within the next few months. *The B. F. Goodrich Co., Akron, Ohio.*

B.F. Goodrich

FIRST IN RUBBER

Here's why most Farmers prefer Champion Spark Plugs



THEY'RE DEPENDABLE!

The American farmer is by far the most proficient user of cars, trucks, tractors and stationary engines. As such he is a qualified expert on engine performance.

Survey after survey has proved that farmers prefer Champion Spark Plugs in overwhelming majority—powerful evidence that you can depend on Champions for better performance in every engine. Champion Spark Plug Company, Toledo 1, O.



FOLLOW THE EXPERTS . . . DEMAND DEPENDABLE CHAMPIONS FOR YOUR CAR

Ingenious New Technical Methods

To Help You with Your
Reconversion Problems

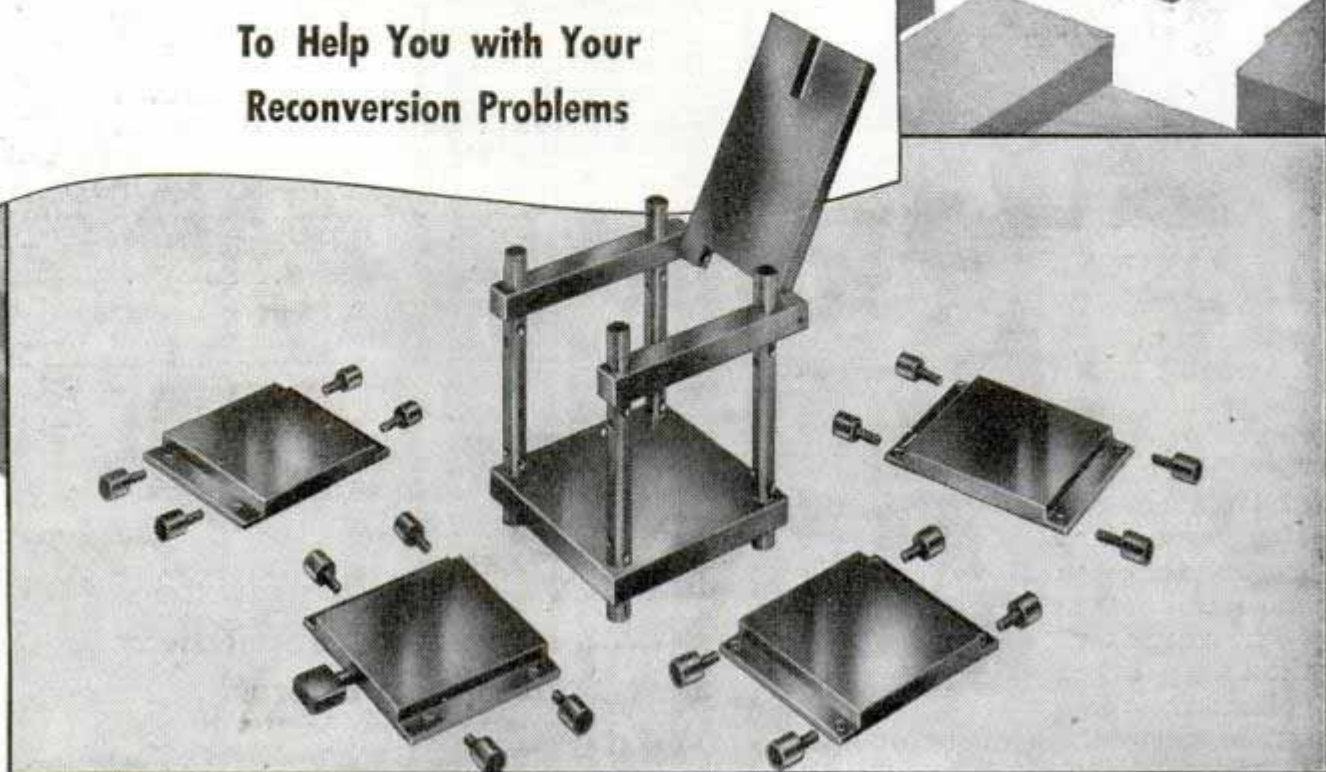

Drillet Box Jig Saves Up to 75% of Jig Body Expense and Labor!

The six-sided Drillet Box Jig above and at right has a range of 125 different sizes, making it possible to accommodate all sizes up to 6" capacity—for drilling, reaming, counter boring, counter sinking, spot facing, tapping, etc.

The Drillet Box Jig makes special tool design for drill jig unnecessary. Saves up to 75% of the time and cost of building a jig body. By merely turning thumbscrews and raising leaf, parts may be quickly loaded or unloaded. The jig may be used on all six sides, taking advantage of its full capacity.

Another useful product is chewing gum. You can enjoy chewing Wrigley's Spearmint Gum even while your hands are busy. The pleasant chewing helps to steady you—helps keep you alert and on your toes when you're doing a monotonous job.

Besides the satisfaction chewing gives you, it helps keep your mouth moist and fresh so you naturally feel better—and feeling better you work better.

Scores of industrial plants report that they have stepped up their workers' morale and efficiency by making chewing gum available to them.

You can get complete information from The Chicago Drillet Corporation, 920 S. Michigan Ave., Chicago 5, Ill.

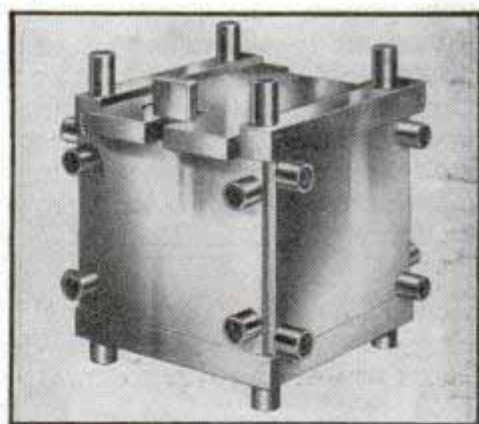

Drillet Box Jig in Locked Position



AA-62



Coming!
FM in
RADIO

Here!

FM in
HEATING

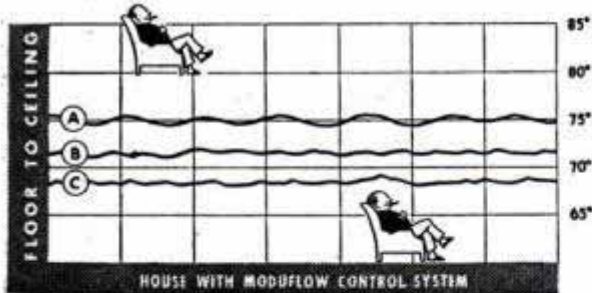
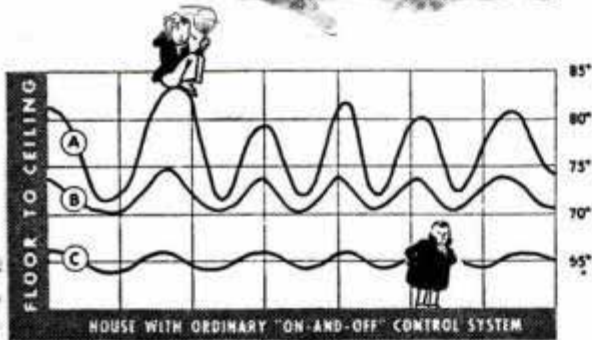

A — Temperature at ceiling
 B — at five foot level. C — temperature at floor.

See how Moduflow smooths out the up-and-down temperatures caused by ordinary control systems. Without Moduflow, temperature varies as much as 20 degrees from floor to ceiling. With Moduflow there is comfort temperature from ceiling to floor.

MODUFLOW

The New HONEYWELL Heating Control System

We are all expecting great things of F-M in radio (Frequency Modulation). In heating, F-M—"Full Modulation"—is already here, and is being installed in thousands of homes throughout the country. The Moduflow system, an exclusive Honeywell development, provides continuous flow of heat for every room in your house at the comfort temperature you and your family desire. Moduflow "Full Modulation" banishes temperature gaps, practically equalizing ceiling and floor temperatures. Much of the heat formerly wasted at the ceiling is used to heat the living part of the room; result, all-over comfort with improved efficiency in operation.

And unlike F-M in radio, Moduflow can be installed on your *present* automatic heating system. You don't have to wait until you build a new home. Send for the interesting booklet, "Heating and Air Conditioning the Postwar Home." It tells how Moduflow has created a new high standard of home heating comfort. Simply mail the coupon for your free copy.

MINNEAPOLIS-HONEYWELL REGULATOR CO.
 2751 Fourth Avenue S., Minneapolis 8, Minn.

Please send my free copy of "Heating and Air Conditioning the Postwar Home."



FREE!

Name _____

This One

Address _____

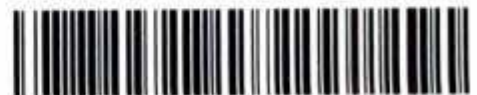

City _____

PUJS-PKH-TZ9J

Tomorrow's Apartment will have Personalized Heat Control... with Moduflow



**KNOWLEDGE
THAT HAS
ENDURED WITH THE
PYRAMIDS**

A SECRET METHOD FOR THE MASTERY OF LIFE

WHENCE came the knowledge that built the Pyramids and the mighty Temples of the Pharaohs? Civilization began in the Nile Valley centuries ago. Where did its first builders acquire their astounding wisdom that started man on his upward climb? Beginning with naught they overcame nature's forces and gave the world its first sciences and arts. Did their knowledge come from a race now submerged beneath the sea, or were they touched with Infinite inspiration? From what concealed source came the wisdom that produced such characters as Amenhotep IV, Leonardo da Vinci, Isaac Newton, and a host of others? Today it is known that they discovered and learned to interpret certain *Secret Methods* for the development of their inner power of mind. They learned to command the inner forces within their own beings, and to master life. This secret art of living has been preserved and handed down throughout the ages. Today it is extended to those who dare to use its profound principles to meet and solve the problems of life in these complex times.

This Sealed Book—FREE

Has life brought you that personal satisfaction, the sense of achievement and happiness that you desire? If not, it is your duty to yourself to learn about this rational method of applying natural laws for the mastery of life. To the thoughtful person it is obvious that everyone cannot be entrusted with an intimate knowledge of the mysteries of life, for everyone is not capable of properly using it. But if you are one of those possessed of a true desire to forge ahead and wish to make use of the subtle influences of life, the Rosicrucians (not a religious organization) will send you *A Sealed Book* of explanation without obligation. This *Sealed Book* tells how you, in the privacy of your own home, without interference with your personal affairs or manner of living, may receive these secret teachings. Not weird or strange practices, but a rational application of the basic laws of life. Use the coupon, and obtain your complimentary copy.

The ROSICRUCIANS

SAN JOSE

(AMORC)

CALIFORNIA



MENHOTEP IV
Founder of Egypt's
Mystery Schools

*Use this
coupon for
FREE
copy of book*

SCRIBE A. V. C.
The Rosicrucians (AMORC)
San Jose, California

Please send free copy of Sealed Book,
which I shall read as directed.

NAME.....

ADDRESS.....

CITY.....

**"What's he got
that I haven't got?"**

LOOK at the successful men you know. "What have they got" that you haven't?

Very little, probably. In most ways these men are no brighter or naturally more capable than average. Many of them probably have no more formal education or better natural aptitudes than you.

But that little extra they have is important. They have the special knowledge and ability for which business is glad to pay well—they know the what, why and how of business. They have also the confidence and aggressiveness which come from knowing that they know and can apply their knowledge.

You may add that extra—may get that same profitable knowledge and ability—that same confidence and aggressiveness—if you are willing to pay the price in earnest, necessary study. For LaSalle has spent 37 years developing, testing and proving, with over a million student members, spare-time success training in certain specialized business fields. What scores of thousands of men and women—many just like you—have done, you should be able to do.

You need not leave your home or interrupt your job; you need pay comparatively little money. But you must be ambitious and willing to study seriously. And soon after you start training, the results will begin to show up in your own confidence and in your work. For what you learn at home tonight is so practical that often you can apply it on the job tomorrow.

How much do you want success—more money, a promotion or a new job, prestige and responsibility? If you really want it, you will use the coupon below to find out what LaSalle training can do for you. It costs only a postage stamp, but a coupon like it has been the starting point to real success for scores of thousands—and can be for you.



LA SALLE Extension University
A Correspondence Institution

Dept. 464-R • 417 S. Dearborn • Chicago 5, Ill.

I want to know how LaSalle can help me win success in the field I have checked below. Please send me your free 48-page booklet about that field and your success training in it.

- | | |
|--|--|
| <input type="checkbox"/> Accountancy | <input type="checkbox"/> Salesmanship |
| <input type="checkbox"/> Bookkeeping | <input type="checkbox"/> Effective Speaking |
| <input type="checkbox"/> C.P.A. Coaching | <input type="checkbox"/> Executive Management |
| <input type="checkbox"/> Business English | <input type="checkbox"/> Industrial Management |
| <input type="checkbox"/> Law: LL.B. degree | <input type="checkbox"/> Traffic Management |
| <input type="checkbox"/> Foremanship | <input type="checkbox"/> Stenotypy |

Name.....Age.....

Position.....

Address.....

City, Zone and State.....

LA SALLE EXTENSION UNIVERSITY
A Correspondence Institution

With Gasoline... With Oil... Add Pyroil...



Ask your gas station attendant to add Pyroil . . . and give your car the benefit of full lubrication. Avoid dry starts...metal to metal wear. Prevent carbon and sludge formations. Reduce battery drain on cold starts. Pyroil adds life to your car.

Pyroil for Aircraft Engines

Use Aircraft Pyroil B in lubricating oil, Aircraft Pyroil A in gasoline.

Manufactured and Guaranteed by Pyroil Company, W. V. Kidder, Founder, 54 Pyroil Bldg., La Crosse, Wis.

PYROIL COMPANY

54 Pyroil Bldg., La Crosse, Wisconsin

I want my car to last and run properly. Please tell me more about Pyroil and how it can accomplish this for me.

Name.....

Address.....

City or Town.....State.....



Jerry, the talking dog, is entertaining hospitalized veterans, by courtesy of the PYROIL Company. Picture of Jerry, the talking dog, sent on request.

WHERE-TO-BUY-IT INDEX

Manufacturer's name and address appear in parentheses directly after items believed by us to be commercially available

AUTOMOTIVE

- Truck trailer wheels turn in sets (Union Metal Mfg. Co., Canton, Ohio) 95
- British car has three-cylinder engine mounted at rear.....107
- New Crosley goes 50 miles on gallon of gas (Crosley Motors, Inc., Cincinnati, Ohio)123
- Air-operated tool spreads tires (Char-Lynn Co., 1920 Washington Ave., S., Minneapolis 4, Minn.).....132
- Inflatable cushion for auto seat (General Tire & Rubber Co., Akron, Ohio)132
- Motorcycle truck hauls 1000 pounds (Toolcraft Mfg. Co., Huntington Park, Calif.).....150
- Removable plastic auto top.....150
- "Bubble" top automobile.....151
- New Chrysler has safety-rim wheel.....162

AVIATION

- Ramps facilitate work on Constellation.....116
- Toy-sized planes teach student pilots.....143
- More power from new type 16-cylinder engine.....152

FARM AND GARDEN

- Eight-in-one gardening tool sharpens own blade (Hardman Enterprises, 310 Parkway, Chula Vista, Calif.)..... 94
- Tractor carries own jack (Harry Ferguson, Inc., Ford Motor Co., Dearborn, Mich.).....133
- Mechanical cotton picker; tractor attachment for planting vegetables; subsoiler increases moisture penetration (International Harvester Co., Chicago).....133
- Self-sharpener for lawn mower (Accurate Sharpener Mfg. Co., 2230A N. Hubbard St., Milwaukee 12, Wis.).....151
- Pull-type hand plow for small gardens (Tug-O-Wheel Hand Plow Co., Ballston Spa, N. Y.).....169

INDUSTRY

- Gripper lifts loaded steel barrels (Boyer-Campbell Co., 6540 St. Antoine St., Detroit 2, Mich.).....101
- Emergency power-light unit adapted from PT boat.....103
- Synthetic nonpetroleum lubricant (National Carbon Co., Inc., 230 N. Michigan Ave., Chicago).....107
- Steel clip holds box top tightly (Tinnerman Products, Inc., 2023 Fulton Rd., Cleveland 13, Ohio).....107
- 28½-inch Diesel engine develops 3¾ horsepower (R. H. Shepard Co., Hanover, Pa.).....116
- Plumber's "stethoscope" (Globe Phone Mfg. Corp., Reading, Mass.).....116
- Precision gauge kit (DoAll Co., Minneapolis, Minn.).....116
- New preparation prevents fogging of glass surfaces (American Optical Co., Southbridge, Mass.).....143
- "Wobble" roller packs earth on airfield (Wm. Bros Boiler & Mfg. Co., Minneapolis, Minn.).....175
- Waste sawdust makes inexpensive wallboard.....176

OUTDOOR RECREATION

- One finger operates fishing reel (Magna Products, P. O. Box 268, La Tijera Station, Los Angeles, Calif.).....104
- Mechanical golf pro (Cotto Products, Ltd., Scunthorpe, Lincolnshire, Eng.)106
- Silicone oil bath for dry flies.....137
- Fishing reel equipped with centrifugal governor (Cycloid Corp., 208 N. Wells St., Chicago 6).....143
- Barbecue outfit folds into suitcase (A. C. Mfg. Co., 8000 Woodley Ave., Van Nuys, Calif.).....158
- Fishing from a jeep.....159
- Solar still to beach ball (Du Page Plastics, Lombard, Ill.).....169

PHOTOGRAPHY

- Two-eyed camera records electrical gun director tests.....116
- "Double boiler" developer (Morse Instrument Co., Hudson, O.).....131
- Automatic timer (Gray Mfg. Co., 43 W. Apple St., Dayton 2, O.).....132
- Photos printed on various materials with sensitized coating...158

RADIO AND ELECTRICAL

- Two-way lamp gives heat or sun tan..... 94
- Multipurpose lamp tilts on swivel (Mandel Bros. Dept. Store, Chicago) 95
- "Bent" light illuminates sign (Baldwin & Shackleton, Inc., Sweetland Bldg., Cleveland, Ohio).....102
- "Lighthouse in a tube" triples glow of lamp.....102
- Midget "leakage" tester (Weston Electrical Instrument Corp., Newark, N. J.).....107
- Outdoor lamp repels insects (Solar Electric Corp., Warren, Pa.).....137
- Photoelectric cells are "eyes" for blind.....144
- Built-in radios (Paneltone-Ansley Corp., 1941 Broadway, New York 23)239
- Image orthicon television pickup tube (RCA, 30 Rockefeller Plaza, New York 20).....232

TOOLS

- "Screw-on" aluminum legs for benches (J. N. Mackenzie, 194 Christiana St., North Tonawanda, N. Y.).....101
- "Push-pull" vise (National Machine Tool Co., Racine, Wis.).....132
- "Jackknife" screwdriver (Isley Engineering Corp., Harrison Bldg., Fourth St. & Pacific Ave., Bremerton, Wash.).....137
- Sawing and filing tool gets into corners (Mid-States Equipment Corp., 2533 E. 73rd St., Chicago 49).....159
- Snap gauge (Carl Zeiss, Inc., 485 Fifth Ave., New York).....159
- Electronic "blowtorch" gives uniform heat.....159
- Rubber-web drill chuck (Jacobs Mfg. Co., Hartford 2, Conn.).....175

MISCELLANEOUS

- Steel post has built-in jack (Tel-O-Post Co., 140 Ash St., Akron 8, Ohio).....102
- Bottle opener and recapper in one unit (Swallow Airplane Co., Inc., Wichita 1, Kans.).....103
- Pocket tester for booby traps.....103
- Lopsided locomotive has off-center boiler (Lima Locomotive Works, Inc., 60 E. 42nd St., New York 17).....104
- Salt water butterflies.....105
- Direct-writing electrocardiograph (Electro-Physical Labs., Inc., 45 W. 18th St., New York 11).....116
- Young railroaders build model railway.....122

(Continued to page 10)

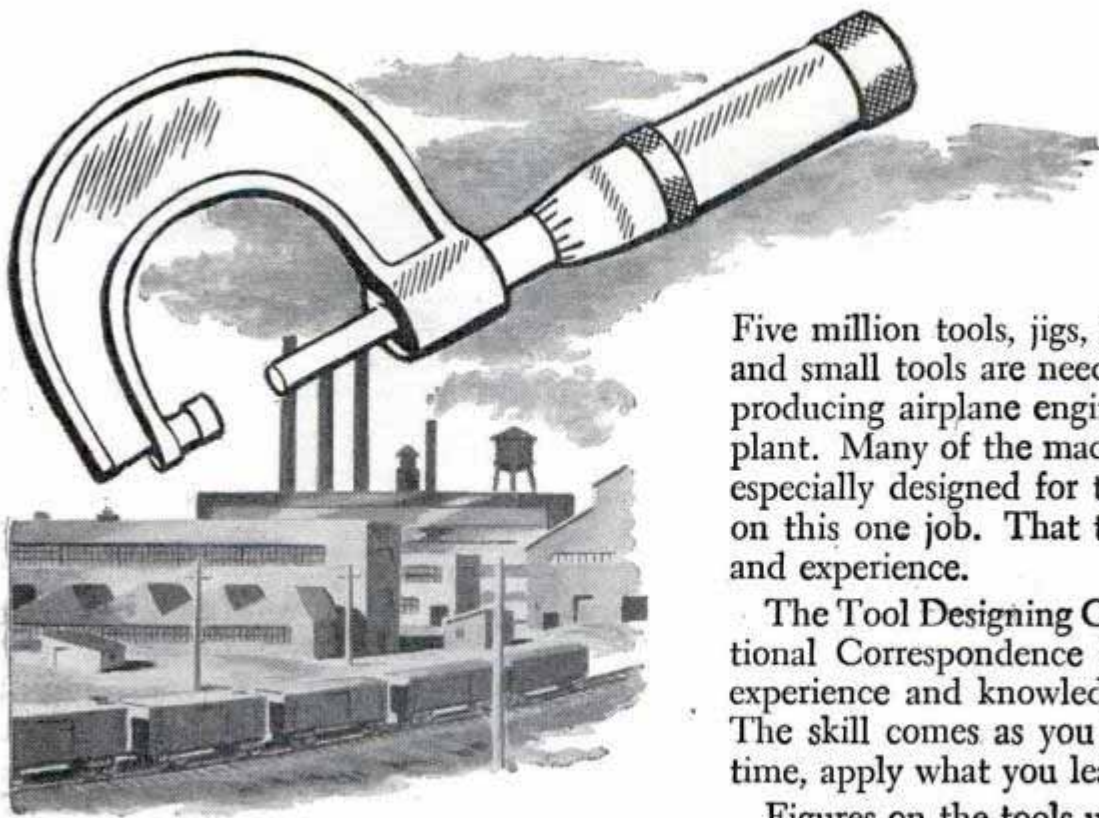

5 million tools IN 1 PLANT!

Five million tools, jigs, dies, fixtures, gauges and small tools are needed by the machines producing airplane engines in just one U.S. plant. Many of the machine tools had to be especially designed for the work to be done on this one job. That takes real knowledge and experience.

The Tool Designing Course of the International Correspondence Schools makes such experience and knowledge available to you. The skill comes as you study in your spare time, apply what you learn right on the job.

Figures on the tools used in a single plant give some idea of the vast dimensions of the tool designing field. You know, too, that change and improvement is constantly going on. *All that means demand for tool engineers.* Now is the time to prepare for it — and assure yourself of a solid, well-paid future.

You can't learn Tool Designing overnight. You can, by mailing the coupon, set yourself on the road to mastering this great profession.

INTERNATIONAL CORRESPONDENCE SCHOOLS



BOX 5575-K, SCRANTON 9, PENNA.

Without cost or obligation, please send me full particulars about the course *before* which I have marked X:

Air Conditioning and Plumbing Courses

- Air Conditioning
- Heating Plumbing
- Refrigeration Steam Fitting

Chemistry Courses

- Chemical Engineering
- Chemistry, Analytical
- Chemistry, Industrial
- Chemistry, Mfg. Iron & Steel
- Petroleum Refining Plastics
- Pulp and Paper Making

Civil Engineering, Architectural and Mining Courses

- Architectural Drafting
- Architecture
- Bridge and Building Foreman
- Building Estimating
- Civil Engineering
- Coal Mining
- Contracting and Building
- Highway Engineering
- Lumber Dealer
- Reading Structural Blueprints
- Sanitary Engineering
- Structural Drafting

- Structural Engineering
- Surveying and Mapping

Communications Courses

- Electronics
- Practical Telephony
- Radio, General
- Radio Operating
- Radio Servicing
- Telegraph Engineering

Electrical Courses

- Electrical Drafting
- Electrical Engineering
- Electric Light and Power
- Lighting Technician
- Practical Electrician

Internal Combustion Engines Courses

- Auto Technician Aviation
- Diesel-Electric
- Diesel Engines Gas Engines

Mechanical Courses

- Aeronautical Engineering
- Aircraft Drafting
- Flight Engineer
- Foundry Work
- Heat Treatment of Metals

- Industrial Engineering
- Industrial Metallurgy
- Machine Shop
- Mechanical Drafting
- Mechanical Engineering
- Mold-Loft Work
- Patternmaking—Wood, Metal
- Reading Shop Blueprints
- Sheet-Metal Drafting
- Sheet-Metal Worker
- Ship Drafting Ship Fitting
- Tool Designing
- Toolmaking
- Welding—Gas and Electric

Railroad Courses

- Air Brake Car Inspector
- Diesel Locomotive
- Locomotive Engineer
- Locomotive Fireman
- Railroad Section Foreman

Steam Engineering Courses

- Boilermaking
- Combustion Engineering
- Engine Running
- Marine Engineering
- Steam Electric Steam Engines

marked X:

Textile Courses

- Cotton Manufacturing
- Rayon Weaving
- Textile Designing
- Woolen Manufacturing

Business and Academic Courses

- Accounting Advertising
- Arithmetic Bookkeeping
- Business Correspondence
- Business Management
- Certified Public Accounting
- Commercial
- Cost Accounting
- Federal Tax
- First Year College
- Foremanship French
- Good English High School
- Higher Mathematics
- Illustrating Motor Traffic
- Postal Service
- Salesmanship Secretarial
- Sign Lettering
- Spanish Stenography
- Traffic Management

Name _____ Age _____ Home Address _____

City _____ State _____ Present Position _____

Working Hours _____ A.M. to _____ P.M. Check here if Veteran of World War II _____

Canadian residents send coupon to International Correspondence Schools Canadian, Ltd., Montreal, Canada.
British residents send coupon to I. C. S., 71 Kingsway, London, W. C. 2, England.

OVER
2,000,000,000
MILES OF FLYING



behind YOUR NEW
PIPER CUB

The Piper Cub Special has fifteen years of light-plane experience built into it. Safe, easy-to-fly, economical to operate, it costs less than any other plane today... only \$665 down. A free flying course goes with every new Piper Cub! See your Piper Cub Dealer for a free flight demonstration.



HERE ARE 3 FINE AVIATION
BOOKS FOR
Your Library!

Thousands of requests are pouring in for this latest Piper book on current models and for these new editions of two already famous books, off the press just a few weeks ago:

1. **Piper Cub Brochure.** Brand new! Beautiful full-color airplane illustrations, suitable for framing. Complete specifications of Piper Cubs.
2. **"How to Fly" Book.** Takes you on a typical flying lesson with 53 step-by-step photos and descriptions. Many other interesting facts.
3. **"What Your Town Needs" Book.** Will help you plan an inexpensive landing area now.

Get these books from your Piper Cub Dealer now. Or, if you prefer, send us 10c per book or 25c for all three. Use stamps or coins. Specify which books you desire. Write Dept. PM46.

PIPER AIRCRAFT CORPORATION
LOCK HAVEN, PENNA.

PIPER

(Continued from page 8)

"Canned" Army equipment passes dunking test.....	123
Sealing fleet vessels recreated in models.....	130
Holder for baby's bottle.....	132
Germs on groceries killed by ray "bath" (Electronics Eng. Co., South 175 Wall St., Spokane, Wash.).....	137
Adjustable typewriter stand for bedridden patients.....	144
"Plastic lung" frees arms and legs (Douglas Sales Co., 750 S. La Brea, Los Angeles 36, Calif.).....	144
Bed telephone for paralyzed veterans.....	144
Novel lighting effects produced with Army searchlights.....	153
Smoking pipe protected by holster (Process Co. of America, 208 Fifth Ave., New York 10).....	152
Computing machine for discharge points.....	159
"Umbrella" for Chicago amphitheater.....	159
Mopping up starfish that prey on oysters.....	160
Flagpole washing machine operated from ground.....	162
What's new in locomotives.....	163

Craftsman and Shop Notes Index

ART AND ARTIST	
Substitute pantograph devised with few materials.....	186
Drawing board has false edge to handle long tracings.....	215
Plywood pocket stores drawings at side of work table.....	224
Scale fastened to drawing board aids in ruling lines.....	228
ELECTRICAL	
Electric-clock wall outlet hidden from view.....	187
Welding machine line load reducer.....	215
Clothespin connects electric lines temporarily.....	228
FARM	
Tractor scraper made in farm shop.....	213
Lip on grain scoop protects granary floor.....	216
Old tires used to insulate electric fence.....	224
HOUSEHOLD	
Canvas and clothesline make durable bathinette cover.....	187
Bell attached to shoe or lace indicates child's presence.....	200
Solving home problems.....	202
Ladder is anchored with grapples to hold it secure.....	218
LAWN AND GARDEN	
Motorize your lawn mower.....	183
Windmill rids garden of gophers.....	194
Removable fence posts held in hollow tile.....	194
Weeding tool from discarded hoe.....	195
Hose nozzle protected by rubber ball.....	199
Concrete toadstools "grow" in garden the year around.....	201
OFFICE, STORE AND SHOP	
Postal card holder aids typist.....	216
Baking-pan drawers hold small parts.....	216
Reverse position of spout on can to pour liquid.....	218
Portable roadside stand.....	225
Holes prevent children bursting paper bags.....	226
Attention-getting displays.....	227
Folded sheet protects stack of paper from wind.....	228
Empty grease can holds oily rags.....	228
Temporary support for sign cards.....	228
OUTDOOR RECREATION	
Rest on bow eliminates danger of feather cuts.....	182
Metal tip increases penetration of plastic-head arrows.....	182
Fitting sails to a rowboat.....	185
Improvised shear pin for outboard motor.....	186
Cushion fashioned from inner tube.....	186
Hole in golf score card holds pencil.....	186
Tennis balls carried on racquet.....	194
Floating fish tank keeps fish alive.....	204
PHOTOGRAPHY	
Small camera carried in tobacco pouch.....	208
Applicator holds warm developer ready for use.....	208
Waxed paper used as ground glass to check focus.....	208
Do your own developing.....	209
Keeping print developer at proper temperature.....	211
Fan cools spotlight lamp.....	211
RADIO AND ELECTRONICS	
Built-in radios for every home.....	229
Electronic volt-ohm reader for students and experimenters.....	230
Ultra-sensitive television "camera" pickup tube.....	232
TOOLS	
Combination marking gauge and circle scribe.....	204
Craft quiz.....	212
Eye-glass case holds micrometer.....	218
Plumb bob has reel for line.....	218
Metal belt clip to carry hammer.....	224
TOYS AND NOVELTIES	
A play kitchen ensemble for the young miss.....	195
Tires for model work made on dowel or rod.....	199
"Feet" on legs of lawn swing avoid sinking into ground.....	200
Swing safety chain prevents drop if hanger breaks.....	200
MISCELLANEOUS	
Smoking stand of contrasting wood.....	177
Quick way of painting newly puttied window sash.....	201
Pipe is laid in concrete to provide door threshold.....	204
Road flares are improvised from tin cans and tubing.....	214
Brush is soaked in tilted jar.....	216
Walk is built of concrete blocks without preliminary fill.....	216
Bookbinder's paper trimmer used like a hand plane.....	217
Posts and chains form stand for barrels and drums.....	224
Mold is fitted around curve by making saw cuts.....	226
Tray held on engine block studs keeps tools handy.....	226
Paraffin coating protects pencil during damp weather.....	226
Bearing surface tested with blue vitriol before babbitting.....	226

IMPORTANT NOTICE

It is the intention of this magazine to provide its readers with information regarding the latest developments in the mechanical arts. We take no responsibility as to whether the disclosures contained in our articles are covered by patents and advise readers to investigate this subject before making, using, or selling any of the products, machines, or processes described in order to avoid possible liability for patent infringement.

AUDELS REFRIGERATION & AIR CONDITIONING GUIDE....\$4

New from Cover to Cover—1280 Pages, Fully illus. Covering basic principles, servicing, operation & repair of household, commercial & industrial refrigeration & air conditioning. A gold mine of essential important facts for engineers, servicemen, users.

AUDELS CARPENTERS & BUILDERS GUIDES—4 Vols.\$6

A practical illustrated trade assistant on modern construction for carpenters, joiners, builders, mechanics and all woodworkers. 4 vols., 1600 pages, 3700 illustrations, flexible covers. Pocket size. Each volume sold separately \$1.50 a vol.

AUDELS AUTOMOBILE GUIDE....\$4

A practical quick ready reference book for auto mechanics, service men, operators & owners. Explains theory, construction & servicing of modern motor cars, trucks, buses & auto type Diesel engines. 1540 pages, fully illustrated, 55 chapters. Indexed. A standard book for mechanics. New fluid drive covered.

AUDELS DIESEL ENGINE MANUAL.\$2

A practical, concise treatise with questions and answers on the theory, operation and maintenance of modern diesel engines including General Motors 2 cycle Diesel. 384 pages, fully illus., flexible binding, pocket size. All details plainly brought out, this book is of extreme value to engineers, operators & students.

AUDELS WIRING DIAGRAMS.....\$1

210 Pages, Illustrated. Gives practical facts on wiring of electrical apparatus. It shows clearly how to wire apparatus for practically all fields of electricity. Each diagram is complete & self-explanatory. Highly Endorsed Pocket Companion.

AUDELS PLUMBERS & STEAMFITTERS GUIDES—4 Vols.\$6

A Practical Trade Assistant & Ready Reference. Explains in plain language & by clear illustrations, diagrams, charts, graphs, pictures principles of modern plumbing practice including Marine Pipe Fitting and Air Conditioning. 4 Vols.—1670 Pages—3642 Diagrams. Pocket size. Each Vol. Sold Separately \$1.50 a Vol.

AUDELS SHEETMETAL WORKERS HANDY BOOK.....\$1

Practical inside information. Fundamentals of Sheet Metal Work. 388 pages, Illustrated. 11 sections. Clearly written. Essential & important facts, figures, pointers in everyday language. Ref. Index.

AUDELS SHEETMETAL PATTERN LAYOUTS.....\$4

Developed by Experts for Sheet Metal Workers, Layout Men & Mechanics. A Practical Encyclopedia in 10 Sections, size 7 x 10 x 2—1125 Pages—350 Layouts—1600 Illustrations. 1001 Key Facts. Fully indexed for ready reference in answering your layout problems. Covers all phases of sheet metal work including Pattern Cutting, Pattern Development & Shop Procedure.

AUDELS ANSWERS ON BLUE PRINT READING.....\$2

For Mechanics & Builders. Covers all types of blue print reading including ship & airplane. 376 pages, fully illustrated.

AUDELS NEW MACHINIST & TOOLMAKERS HANDY BOOK....\$4

Covers modern machine shop practice in all its branches. 5 practical books in 1. New from cover to cover. Tells how to set up & operate lathes, screw and milling machines, shapers, drill presses and all other machine tools. 1600 pages, fully illustrated, 5 x 6 1/2 x 2. Indexed. 5 sections. 1—Modern Machine Shop Practice. 2—Blue Print Reading & How to Draw. 3—Calculations & Mathematics for Machinists. 4—Shop Physics. 5—How to Use the Slide Rule, 60 chapters. Easy to read and understand. A shop companion that answers your questions.

AUDELS MATHEMATICS & CALCULATIONS FOR MECHANICS \$2

Mathematics for home study or reference. 700 pages, 550 illus. Practical mathematics from beginning. How to figure correctly. Easy, correct methods covering a complete review. Ill. & Indexed.

AUDELS HANDY BOOK OF PRACTICAL ELECTRICITY.....\$4

For maintenance engineers, electricians & all electrical workers. 1440 Pages, 2600 illus. Covers important electrical information in handy form—including Marine Wiring, Radio Principles, Welding. Indexed. A Key to a practical understanding of electricity.

AUDELS RADIOMANS GUIDE.....\$4

A key to the practical understanding of radio including Frequency Modulation, Television, etc., Aircraft & Marine Radio. For radio engineers, servicemen, amateurs. 772 pages. 400 Illustrations & Diagrams. Photos. Review Questions & Answers, Reference Index. Authentic, clear, concise.

AUDELS ELECTRONIC DEVICES....\$2

Tells What You Want to Know About Electric Eye. Easily Understood. Covers photo-electric cells & their applications. Amplifiers, illumination, frequencies, voltage, photocell, tubes, Ohm's Law, wiring diagrams, etc.

AUDELS WELDERS GUIDE.....\$1

A concise, practical text on operation & maintenance of all welding machines for all mechanics. Over 400 pages, illustrated. Covers all methods of electric and acetylene welding including airplane work.

AUDEL, Publishers, 49 W. 23 St., N. Y. 10

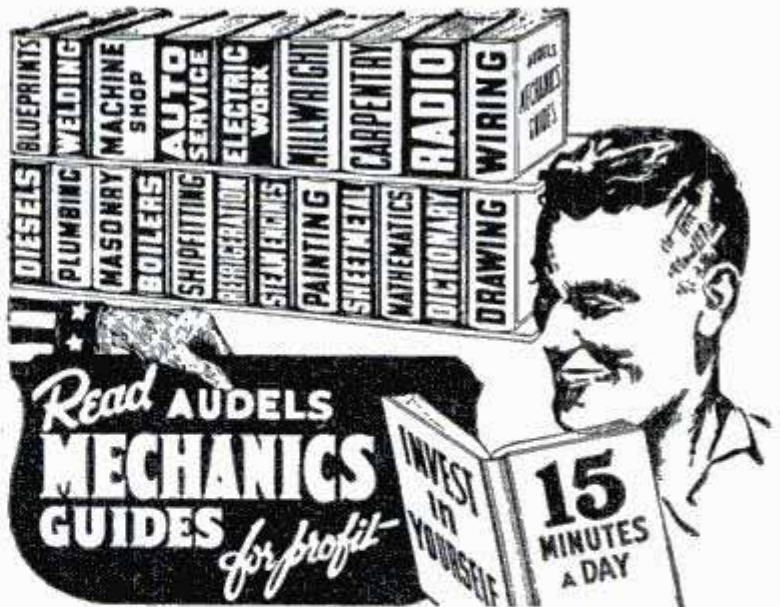

AN AUDEL GUIDE IS A GOOD FRIEND!

Use the brains and experience of others in these Guides of the Trades. Save time and money with right methods, short cuts, labor saving ideas. CHECK NOW! You can look over any Audel Guide in your home. Start the Easy Payments if satisfied.

CUT HERE MAIL ORDER

THEO. AUDEL & CO., 49 W. 23 St., New York 10, N. Y.

Please mail me for 7 days' free examination the books marked (X) below. I agree to mail \$1 in 7 days on each book or set ordered, and to further mail \$1 a month on each book or set ordered until I have paid purchase price.

If I am not satisfied with Guides I will return them.

- Audels REFRIGERATION & Air Conditioning Guide . \$4.
- Audels POWER PLANT ENGINEERS GUIDE . 4.
- Audels PUMPS, HYDRAULICS & AIR COMPRESSORS 4.
- Audels WELDERS GUIDE . 1.
- Audels BLUE PRINT READING . 2.
- Audels SHEET METAL WORKERS Handy Book . 1.
- Audels SHEET METAL PATTERN LAYOUTS . 4.
- Audels AIRCRAFT WORKER . 1.
- Audels MATHEMATICS and CALCULATIONS . 2.
- Audels MACHINISTS & TOOLMAKERS Handy Book . 4.
- Audels MECHANICAL Dictionary . 4.
- Audels AUTOMOBILE GUIDE . 4.
- Audels DIESEL ENGINE MANUAL . 4.
- Audels MARINE ENGINEERS Handy Book . 4.
- Audels SHIPFITTERS Handy Book . 1.
- Gueths MECHANICAL DRAWING COURSE . 1.
- Rogers DRAWING and DESIGN . 2.
- Audels MILLWRIGHTS and Mechanics Guide . 4.
- Audels CARPENTERS and Builders Guides (4 vols.) . 6.
- Audels PLUMBERS and Steamfitters Guides (4 vols.) . 6.
- Audels MASONS and Builders Guides (4 vols.) . 6.
- Master PAINTER and DECORATOR . 2.
- Audels GARDENERS & GROWERS GUIDES (4 vols.) . 6.
- Audels ENGINEERS and Mechanics Guides Nos. 1, 2, 3, 4, 5, 6, 7 and 8 complete . 12.
- Audels Answers on Practical ENGINEERING . 1.
- Hawkins Aids to ENGINEERS EXAMINATION . 2.
- Audels ELECTRICIANS EXAMINATIONS . 1.
- Audels WIRING DIAGRAMS . 1.
- Audels Handy Book of PRACTICAL ELECTRICITY . 4.
- Audels ELECTRICAL POWER CALCULATIONS . 2.
- Hawkins ELECTRICAL Guides at \$1. each . 10.
- Audels ELECTRONIC DEVICES . 2.
- Audels ELECTRIC Dictionary . 2.
- Audels RADIOMANS GUIDE . 4.
- Audels NEW ELECTRIC LIBRARY at \$1.50 a Volume Vols. I, II, III, IV, V, VI, VII, VIII, IX, X, XI, XII.

Name.....

Address.....

Occupation.....

Employed by..... PM

Now

Hear Better

THE AMAZING NEW

Beltone WAY

COMPLETE IN
ONE POCKET-SIZE UNIT
(with cord and plug)

Beltone Mono-Pac brings you a new world of sound—amazingly clear, natural—perfected by advanced electronic research. One lightweight unit—about the size of a spectacle case—does it all. Weighs about one-half as much as old style hearing aids with no clumsy, separate battery pack, no battery wire. Such a sensational advance that already tens of thousands of hard-of-hearing people have been delighted with how splendidly they hear now with this tiny but powerful device.



Send Post Card Today for
FREE BOOKLET

with valuable information for hearing problems.

BELTONE HEARING AID CO., Dept. PM-4

1450 W. 19th Street, Chicago 8, Illinois

ENROLL NOW!

for
**AERONAUTICAL
ENGINEERING**
or
**AIRCRAFT and
ENGINE MECHANICS**
(A & E)

at **Northrop Aeronautical Institute**

(Division of Northrop Aircraft, Inc.)

VETERANS and CIVILIANS This is your opportunity to prepare for your career in commercial aviation! Enrollments are still being accepted for Aeronautical Engineering and Aircraft and Engine Mechanics students. Send today for complete information on the modern training courses you can now obtain at Northrop.

VETERANS The Institute is approved for the training of veterans under the G. I. Bill of Rights.

NORTHROP AERONAUTICAL INSTITUTE

1527 E. Broadway, Hawthorne, California

SEND COUPON FOR FULL INFORMATION

NORTHROP AERONAUTICAL INSTITUTE
1527 E. Broadway, Hawthorne, California

Please send me your free, illustrated booklet and information, including starting dates and tuition rates, on the training course checked below:

Aeronautical Engineer Aircraft & Engine Mech. (A&E)

Name _____

Address _____ Age _____

City _____ Zone _____ State _____

Check one: Veteran In Service Civilian

TRAIN FOR KEY JOB OR BUSINESS OF YOUR OWN

REFRIGERATION and AIR CONDITIONING

Millions of Older Units Need Expert Service. Big After-the-War Expansion Will Create Even More Opportunities. Approved for Veterans "G. I." Training

A key job—a successful business of your own—you can have either in this vital, war-hit industry. A serious shortage of service-experts exists in every branch. Big post-war boom will open thousands of new opportunities. Get ready for your big chance. We'll give you the practical training you need—at home—and in our big Chicago shops, largest and most completely equipped in the country. No advanced schooling needed. Our unique methods make everything easy to grasp. We've trained thousands. Pay as you go. Quit when you want to. Get the full facts without obligation. Write TODAY.

INDUSTRIAL TRAINING INSTITUTE

2150 Lawrence Avenue, Dept. P1Q, Chicago 25, Ill.

DRAFTING

**SPRINGBOARD
TO SUCCESS!**

Increased salary, larger responsibilities, a real career instead of just a job—these are to be had by the trained draftsman. I.C.S. makes the way to thorough, practical training open to you. Check up and you'll find that nearly every "big name" American in engineering and production acquired experience at the drafting board. Many of them started by writing for the I.C.S. free booklet. Send for it today! It can be the most important act of your life.

INTERNATIONAL CORRESPONDENCE SCHOOLS
BOX 5577-K, SCRANTON 9, PENNA.

Send me full information on the following subject:

Name.....Age.....

Home Address.....

City.....State.....

Present Position.....Working Hours.....A.M. to.....P.M.



I Will Show You How to Learn RADIO by Practicing in Spare Time

I Send You 6 Big Kits of Radio Parts

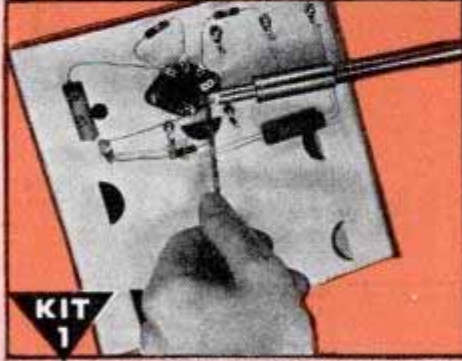

KIT 1

I send you Soldering Equipment and Radio Parts; show you how to do Radio soldering; how to mount and connect Radio parts; give you practical experience.



KIT 2

Early in my course I show you how to build this N.R.I. Tester with parts I send. It soon helps you fix neighborhood Radios and earn EXTRA money in spare time.

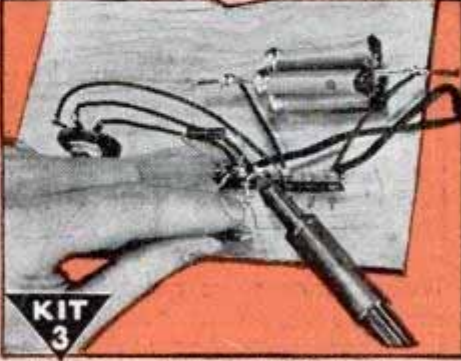

KIT 3

You get parts to build Radio Circuits; then test them; see how they work; learn how to design special circuits; how to locate and repair circuit defects.

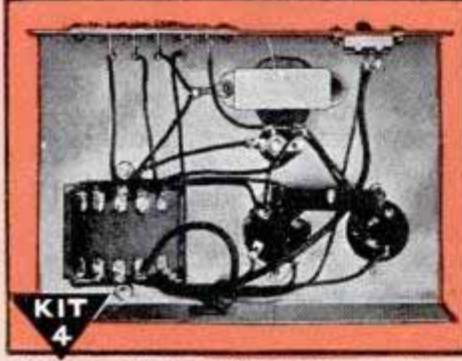

KIT 4

You get parts to build this Vacuum Tube Power Pack; make changes which give you experience with packs of many kinds; learn to correct power pack troubles.

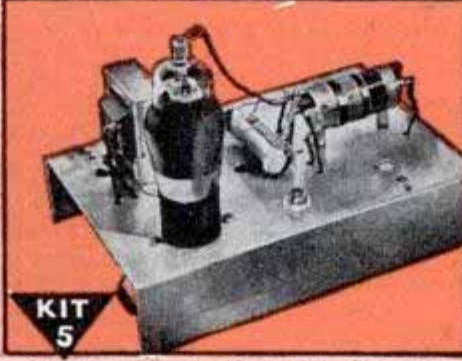

KIT 5

Building this A. M. Signal Generator gives you more valuable experience. It provides amplitude-modulated signals for many tests and experiments.



KIT 6

You build this Superheterodyne Receiver which brings in local and distant stations—and gives you more experience to help you win success in Radio.

KNOW RADIO - Win Success I Will Train You at Home - SAMPLE LESSON FREE

Send coupon for FREE Sample Lesson, "Getting Acquainted with Receiver Servicing," and FREE 64-page book, "Win Rich Rewards in Radio." See how N.R.I. trains you at home. Read how you practice building, testing, repairing RADIOS with SIX BIG KITS of Radio parts I send you.

made! Think of even greater opportunities when Television and Electronics are available to the public!

Many Beginners Soon Make \$5, \$10 a Week EXTRA in Spare Time

The day you enroll I start sending EXTRA MONEY JOB SHEETS to help you make EXTRA money fixing Radios in spare time

while learning. MAIL COUPON for sample lesson and 64-page book FREE. It's packed with facts about opportunities for you. Read about my Course. Read letters from men I trained, telling what they are doing, earning. MAIL COUPON in envelope or paste on penny postal. J. E. SMITH, President, Dept. 6DP, National Radio Institute, Pioneer Home Study Radio School, Washington 9, D. C.

Future for Trained Men is Bright in Radio, Television, Electronics

The Radio Repair business is booming NOW. Fixing Radios pays good money as a spare time or full time business. Trained Radio Technicians also find wide-open opportunities in Police, Aviation, Marine Radio, in Broadcasting, Radio Manufacturing, Public Address work, etc. Think of the boom coming now that new Radios can be

Our 32nd Year of Training Men for Success in Radio

Good for Both - FREE

MR. J. E. SMITH, President, Dept. 6DP, National Radio Institute, Washington 9, D.C. Mail me FREE, your sample lesson and 64-page book. (No salesman will call. Please write plainly.)

Name Age

Address

City State 4PR
(Please include Post Office Zone Number)



My Course Includes Training in TELEVISION - ELECTRONICS

INVENTOR

NOW IS THE TIME TO PATENT AND SELL YOUR INVENTION

Now, more than ever before, is the right time to patent and sell your invention. Why? Because manufacturers everywhere, in striving to keep ahead of competition, are looking for new inventions and buying up the patent rights thereon so that they will have better and more attractive items to make and sell. Hence, the wise thing for you to do is also to act at once. Protect your invention—and yourself—by applying for a patent now.

FREE "PATENT GUIDE" EXPLAINS WHAT TO DO

Our Free 48 page "Patent Guide for the Inventor", containing complete information about patent procedure and selling inventions, answers many important questions concerning Patents that inventors constantly ask. It tells what facts, details, drawings, sketches, etc., are necessary to apply for a Patent; how to protect your invention through dated and witnessed disclosure; how to do this at once to safeguard your rights; how Patent Office Records can be checked to determine whether the invention is probably patentable before filing fees need be paid; discusses costs involved and a practical way these can be paid as the application progresses. It tells how some inventors secured financial backing; how many simple inventions have proved large commercial successes; how Patents covering improvements also can be profitably utilized and marketed; and countless other facts that every inventor will want to know. And in addition, our "Patent Guide" contains illustrations of over 150 basic mechanical movements.

WHY YOU NEED EXPERT ASSISTANCE

The Patent Laws were enacted for your benefit—to give you protection for the features of your invention which are Patentable. But these features must be legally and concisely set forth in the form of "claims". This phase of the procedure is so complex that the U.S. Patent Office advises the Inventor to engage a competent Registered Patent Attorney. We maintain a large staff—carefully trained registered patent attorneys—expert draftsmen—experienced searchers—to serve you. We have been serving inventors for more than twenty years. Write for a free copy of our "Patent Guide for the Inventor" today. Clarence A. O'Brien & Harvey B. Jacobson, Registered Patent Attorneys, 61-D Adams Building 4, Washington, D. C.

**CLARENCE A. O'BRIEN
& HARVEY B. JACOBSON**

REGISTERED PATENT ATTORNEYS

Free Book
for

TORS

48
PAGES
Over 150
Mechanical
Movements

FREE "RECORD OF INVENTION"

With our free "Patent Guide for the Inventor" you will receive also free a "Record of Invention" form. This "Record of Invention" enables you to conveniently make a proper, dated disclosure of your invention before you file your patent application, which will prove of great value to you, should the occasion for evidence arise.

TAKE FIRST STEP NOW

Remember, in Patent matters action is important. Delay can be costly. Therefore, take your first step now—toward protecting your invention. Send for your free copy of our "Patent Guide for the Inventor" containing complete information about patent procedure and selling inventions. At the same time, receive a free "Record of Invention" form with complete instructions for making a disclosure of your invention and establishing its date. This step costs you nothing—yet may be vital to your success. Mail the coupon in an envelope, or paste it on a penny postcard—now.



CLARENCE A. O'BRIEN & HARVEY B. JACOBSON

CLARENCE A. O'BRIEN & HARVEY B. JACOBSON
Registered Patent Attorneys before the United States Patent Office
61-D Adams Building, Washington 4, D. C.

Please send me your 48-Page "Patent Guide for the Inventor" and your specially prepared "Record of Invention" form FREE. This request does not obligate me.

Name.....

Address.....

City..... State.....

(Please write or print plainly.)

*Worthy of
Your Trust*

I'LL SHOW YOU HOW TO SUCCEED IN RADIO

Here's the right training for Big Post-War Pay!



F. L. Sprayberry, one of the country's foremost Radio Teachers.



A RADIO SERVICE BUSINESS OF YOUR OWN



A GOOD JOB IN RADIO & TELEVISION BROADCASTING



RADIO-ELECTRONIC SERVICE ENGINEER

BE A RADIO ELECTRONICIAN

NOW! YOU CAN PREPARE AT HOME IN SPARE TIME FOR AMAZING OPPORTUNITIES AHEAD IN **RADIO • ELECTRONICS • TELEVISION**



I SUPPLY A FULL RADIO SET for practical Easy LEARNING



The offer I make you here is the opportunity of a lifetime. It's your big chance to get ready for a wonderful future in the swiftly expanding field of Radio-Electronics INCLUDING Radio, Television, Frequency Modulation and Industrial Electronics. Be wise! NOW'S the time to start. Opportunities ahead are tremendous! No previous experience is necessary. The Sprayberry Course starts right at the beginning of Radio. You can't get lost. It gets the various subjects across in such a clear, simple way that you understand and remember. And, you can master my

entire course in your spare time. It will not interfere in any way with your present duties. Along with your Training, you will receive my famous **BUSINESS BUILDERS** which will show you how to make some nice profits while learning.

Prepares You for a Business of Your Own or Good Radio Job
My training will give you the broad, fundamental principles so necessary as a background, no matter which branch of Radio you wish to specialize in. I make it easy for you to learn Radio Set Repair and Installation Work. I teach you how to install and repair Electronic Equipment. In fact, you'll be a fully qualified RADIO-ELECTRONICIAN, equipped with the skill and knowledge to perform efficiently and to make a wonderful success of yourself.

JUST OUT! FREE!

"How to Read Radio Diagrams and Symbols"

... a valuable new book explaining in simple English how to read and understand any Radio Set Diagram or circuit. Includes translations of all Radio symbols. Send for this FREE book now, and along with it I will send you another big FREE book describing my Radio-Electronic training.



GET FREE BOOKS

SPRAYBERRY TRAINING GIVES YOU BOTH TECHNICAL KNOWLEDGE—SKILLED HANDS

There's only one right way to learn Radio Electronics. You must get it through simplified lesson study combined with actual "shop" practice under the personal guidance of a qualified Radio Teacher. It's exactly this way that Sprayberry trains you... supplying real Radio parts for learn-by-doing experience right at home. Thus, you learn faster, your understanding is clear-cut, you acquire the practical "know how" essential to a good-paying Radio job or a Radio business of your own.

I'll Show You a New, Fast Way to Test Radio Sets Without Mfg. Equipment

The very same Radio Parts I supply with your Course for gaining pre-experience in Radio Repair work may be adapted through an exclusive Sprayberry wiring procedure to serve for complete, fast, accurate Radio Receiver trouble-shooting. Thus, under Sprayberry methods, you do not have one cent to outlay for manufactured

Test Equipment which is not only expensive but scarce.

Read What Graduate Says "One Job Nets About \$26.00"

"Since last week I fixed 7 radios, all good-paying jobs and right now I am working on an amplifier system. This job alone will net me about \$26.00. As long as my work keeps coming in this way, I have only one word to say and that is, 'Thanks to my Sprayberry training' and I am not afraid to boast about it."—ADRIEN BENJAMIN, North Grosvenordale, Conn.

DON'T PUT IT OFF!

Get the facts about my training—now! Take the first important step toward the money-making future of your dreams. All features are fully explained in my big, illustrated FREE Catalog which comes to you along with another valuable FREE book you'll be glad to own. Mail Coupon AT ONCE!

SPRAYBERRY ACADEMY OF RADIO

F. L. Sprayberry, President
Room 1046, Pueblo, Colorado.

Please rush my FREE copies of "HOW TO MAKE MONEY IN RADIO, ELECTRONICS and TELEVISION," and "HOW TO READ RADIO DIAGRAMS and SYMBOLS."

Name..... Age.....

Address.....

City..... State.....

(Mail in plain envelope or paste on penny postcard)

15 Minutes a Day!

Give me just this
and I'll prove I can make you
A NEW MAN!

I'M "trading-in" old bodies for new! I'm taking men who know that the condition of their arms, shoulders, chests and legs—their strength, "wind," and endurance—is not 100%. And I'm making NEW MEN of them. I'm giving them the kind of powerful, healthy HE-MAN build that spells SUCCESS in life and business.

Only 15 Minutes a Day!

Are you ALL MAN — tough-muscled, on your toes every minute, with all the up-and-at-'em that can lick your weight in wildcats? Or do you need the help I can give you—the help that has already worked such wonders for other fellows, everywhere?

All the world knows I was ONCE a skinny, scrawny 97-lb. weakling. And NOW it knows that I am the holder of the title, "The World's Most Perfectly Developed Man." How did I do it? How do I work miracles with the bodies of other men in only 15 minutes a day? The answer is "Dynamic Tension," the amazing method I discovered and which changed me from a 97-pound weakling into the champion you see here!

In just 15 minutes a day, right in the privacy of your own home, I'm ready to prove that "Dynamic Tension" can lay a new outfit of solid muscle over every inch of your body. Let me put new, smashing power into your arms and shoulders—give you an armor-shield of stomach muscle—strengthen your legs into real columns of surging stamina. If lack of exercise or wrong living has weakened you *inside*, I'll get after that condition, too, and show you how it feels to LIVE!

FREE This Famous Book that Tells You How to Get a Body that Men Respect and Women Admire

My book, "Everlasting Health and Strength," tells you exactly what "Dynamic Tension" can do. And it's packed with pictures that SHOW you what it does. RESULTS it has produced for other men. RESULTS I want to prove it can get for YOU! If you want to learn how you can actually become a NEW MAN, right in the privacy of your own home and in only 15 minutes a day, then man!—get this coupon into the mail to me as fast as your legs can get to the letterbox! CHARLES ATLAS, Dept. 8D, 115 East 23rd St., New York 10, N. Y.



Charles Atlas

—actual photo of the man who holds the title, "The World's Most Perfectly Developed Man."

Charles Atlas—America's Greatest "Builder of Men"

Among all the physical instructors and "conditioners of men" ONLY ONE NAME STANDS OUT. That name is Charles Atlas!

In every part of the country Charles Atlas is recognized as "America's Greatest Builder of Men." Thousands upon thousands have put their physical development into his capable hands!

Now more than ever, employers are "on the lookout" for vigorous, red-blooded HE-MEN who can be depended on to do a better job. That is why so many men of every age and condition are today asking Charles Atlas to prepare them physically for success.

MAIL THIS
COUPON NOW!



CHARLES ATLAS, Dept. 8D

115 East 23rd St., New York 10, N. Y.

I want the proof that your system of "Dynamic Tension" will help make a New Man of me—give me a healthy, husky body and big muscular development. Send me your free book, "Everlasting Health and Strength."

Name.....
(Please print or write plainly)

Address.....

City..... Zone No. (If any)..... State.....

Check here if under 16 for Booklet A.

INVENTORS

LEARN HOW TO
**PROTECT and SELL
YOUR INVENTION**

GET NEW FREE BOOK



FREE
Invention Record
Know How Successful
Inventors Protect and
Sell Their Inventions

Our new FREE Book is a book every inventor should have. Mail the coupon today for "How to Protect, Finance and Sell Your Invention" and learn . . .

- How to know if there is a prior U. S. patent on your invention.
- How to save steps in getting patent action.
- How to prepare your application for presentation to the Patent Office.
- How you may patent an improvement on something in use now.
- How to obtain funds to patent and promote your invention.
- How to find a buyer or backer for your invention.
- How to protect yourself in making royalty agreements.

MODERN BUSINESS WANTS INVENTIONS

Practical and novel inventions are in big demand today. The opportunity for quick money is enticing. Sales sources are many if your invention has merit. But, be *sure*—before you place your device in strange hands—that it is fully protected. A United States Patent gives you this protection. *The first step toward inventive success always is—and always has been—the application for a U. S. Patent. There is no other way to protect your invention in accordance with the laws of this country.*

MAKE THIS RECORD NOW

If you have an invention, and wish to secure it for the future, act at once. Have it dated now and recorded in our office. We will send you this FREE Invention Record Form for the purpose. Fill out the Invention Record Form fully describing the nature of your invention. Make a sketch of its main features. Mail it to us and we will record the date it was received in our office. The earlier the date the better your chance of combating rival inventors who may lay claim to your idea later. *Don't delay a single minute in taking this important step. Your whole future may depend upon it. Mail the coupon for our FREE Invention Record Blank and New FREE Book today!*

HOW WE SERVE YOU AS

REGISTERED PATENT ATTORNEYS

The U. S. Patent Office strongly recommends—unless the inventor is familiar with such matters—that he employ the services of a Registered Patent Attorney in the preparation of his Patent Application. We are Registered Patent Attorneys fully qualified to represent you at the Patent Office. We have had long experience in studying hundreds of types of inventions. This gives us the ability to judge your invention and to describe it accurately and convincingly in technical language. It gives us the perception to center arguments upon those details of your invention which, in our judgment, will be looked upon most favorably by the Patent Office Examiner.

Mail the coupon today for our new FREE Book, "How to Protect, Finance and Sell Your Invention," and our FREE Invention Record Form—maybe this step will pave the way to future security for you and your family. Act Today!

McMORROW, BERMAN & DAVIDSON

Registered Patent Attorneys

135-P Atlantic Building, Washington 4, D. C.

McMORROW, BERMAN & DAVIDSON

REGISTERED PATENT ATTORNEYS

135-P ATLANTIC BUILDING, WASHINGTON 4, D. C.

Send me your new FREE book, "How to Protect, Finance and Sell Your Invention"—and "Invention Record" form at once. I understand that this request does not obligate me.

NAME

ADDRESS

CITY..... STATE.....

(Write or print name clearly)

Is your future in the air?



Photograph courtesy TWA

"UP IN THE AIR" about your future? Or do you see your future in the air?

There's all the difference in the world between those few words.

The man who is "up-in the air" about his future doesn't know where he's going. And he doesn't get anywhere.

The man who sees his future in the air is busily *training* himself for a responsible post in Aviation. He has selected a great industry that is becoming a greater one. He knows the position he wants and is making progress towards it.

Many are obtaining their training from the famous International Correspondence Schools. Spare-time study with I. C. S.—at low cost—has many advantages for the man with a definite objective in the aircraft industry. Mail the coupon for full information on practical, authoritative I. C. S. training.

INTERNATIONAL CORRESPONDENCE SCHOOLS



BOX 5576-K, SCRANTON 9, PENNA.

Without cost or obligation, please send me full particulars about the course *before* which I have marked X:

- | | | | |
|--|--|--|---|
| <input type="checkbox"/> AIRCRAFT ENGINE MECHANICS
<input type="checkbox"/> PRIVATE PILOT
<input type="checkbox"/> COMMERCIAL PILOT
<input type="checkbox"/> FLIGHT ENGINEER
<input type="checkbox"/> AERONAUTICAL ENGINEERING
<input type="checkbox"/> AIRCRAFT DRAFTING
<input type="checkbox"/> WEATHER OBSERVING
<input type="checkbox"/> ELECTRONICS
<input type="checkbox"/> RADIO
<input type="checkbox"/> TRAFFIC MANAGEMENT

<input type="checkbox"/> Air Conditioning and Plumbing Courses
<input type="checkbox"/> Air Conditioning
<input type="checkbox"/> Heating <input type="checkbox"/> Plumbing
<input type="checkbox"/> Refrigeration <input type="checkbox"/> Steam Fitting

<input type="checkbox"/> Chemistry Courses
<input type="checkbox"/> Chemical Engineering
<input type="checkbox"/> Chemistry, Analytical
<input type="checkbox"/> Chemistry, Industrial
<input type="checkbox"/> Chemistry, Mfg. Iron & Steel
<input type="checkbox"/> Petroleum Refining <input type="checkbox"/> Plastics
<input type="checkbox"/> Pulp and Paper Making | <input type="checkbox"/> Civil Engineering, Architectural and Mining Courses
<input type="checkbox"/> Architectural Drafting
<input type="checkbox"/> Architecture
<input type="checkbox"/> Bridge and Building Foreman
<input type="checkbox"/> Building Estimating
<input type="checkbox"/> Civil Engineering
<input type="checkbox"/> Coal Mining
<input type="checkbox"/> Contracting and Building
<input type="checkbox"/> Highway Engineering
<input type="checkbox"/> Lumber Dealer
<input type="checkbox"/> Reading Structural Blueprints
<input type="checkbox"/> Sanitary Engineering
<input type="checkbox"/> Structural Drafting
<input type="checkbox"/> Structural Engineering
<input type="checkbox"/> Surveying and Mapping

<input type="checkbox"/> Electrical Courses
<input type="checkbox"/> Electrical Drafting
<input type="checkbox"/> Electrical Engineering
<input type="checkbox"/> Electric Light and Power
<input type="checkbox"/> Lighting Technician
<input type="checkbox"/> Practical Electrician

<input type="checkbox"/> Internal Combustion Engines Courses
<input type="checkbox"/> Auto Technician <input type="checkbox"/> Aviation
<input type="checkbox"/> Diesel-Electric
<input type="checkbox"/> Diesel Engines <input type="checkbox"/> Gas Engines | <input type="checkbox"/> Mechanical Courses
<input type="checkbox"/> Foundry Work
<input type="checkbox"/> Heat Treatment of Metals
<input type="checkbox"/> Industrial Engineering
<input type="checkbox"/> Industrial Metallurgy
<input type="checkbox"/> Machine Shop
<input type="checkbox"/> Mechanical Drafting
<input type="checkbox"/> Mechanical Engineering
<input type="checkbox"/> Mold-Loft Work
<input type="checkbox"/> Pattermaking—Wood, Metal
<input type="checkbox"/> Reading Shop Blueprints
<input type="checkbox"/> Sheet-Metal Drafting
<input type="checkbox"/> Sheet-Metal Worker
<input type="checkbox"/> Ship Drafting <input type="checkbox"/> Ship Fitting
<input type="checkbox"/> Tool Designing
<input type="checkbox"/> Toolmaking
<input type="checkbox"/> Welding—Gas and Electric

<input type="checkbox"/> Railroad Courses
<input type="checkbox"/> Air Brake <input type="checkbox"/> Car Inspector
<input type="checkbox"/> Diesel Locomotive
<input type="checkbox"/> Locomotive Engineer
<input type="checkbox"/> Locomotive Fireman
<input type="checkbox"/> Railroad Section Foreman

<input type="checkbox"/> Steam Engineering Courses
<input type="checkbox"/> Boilermaking
<input type="checkbox"/> Combustion Engineering
<input type="checkbox"/> Engine Running | <input type="checkbox"/> Marine Engineering
<input type="checkbox"/> Steam Electric <input type="checkbox"/> Steam Engines

<input type="checkbox"/> Textile Courses
<input type="checkbox"/> Cotton Manufacturing
<input type="checkbox"/> Rayon Weaving
<input type="checkbox"/> Textile Designing
<input type="checkbox"/> Woolen Manufacturing

<input type="checkbox"/> Business and Academic Courses
<input type="checkbox"/> Accounting <input type="checkbox"/> Advertising
<input type="checkbox"/> Arithmetic <input type="checkbox"/> Bookkeeping
<input type="checkbox"/> Business Correspondence
<input type="checkbox"/> Business Management
<input type="checkbox"/> Certified Public Accounting
<input type="checkbox"/> Commercial
<input type="checkbox"/> Cost Accounting
<input type="checkbox"/> Federal Tax
<input type="checkbox"/> First Year College
<input type="checkbox"/> Foremanship <input type="checkbox"/> French
<input type="checkbox"/> Good English <input type="checkbox"/> High School
<input type="checkbox"/> Higher Mathematics
<input type="checkbox"/> Illustrating <input type="checkbox"/> Motor Traffic
<input type="checkbox"/> Postal Service
<input type="checkbox"/> Salesmanship <input type="checkbox"/> Secretarial
<input type="checkbox"/> Sign Lettering
<input type="checkbox"/> Spanish <input type="checkbox"/> Stenography |
|--|--|--|---|

Name _____ Age _____ Address _____

City _____ State _____ Present Position _____

Working Hours _____ A.M. to _____ P.M. Check here if Veteran of World War II _____

Canadian residents send coupon to International Correspondence Schools Canadian, Ltd., Montreal, Canada.
 British residents send coupon to I. C. S., 71 Kingsway, London, W. C. 2, England.



I'll PROVE I can make
YOU, too,
TOUGH as a
MARINE

..... and add
 Powerful **POUNDS**
 and Vital **INCHES** of
DYNAMIC MUSCLE
 to your **ARMS, LEGS,**
BACK, CHEST,
and SHOULDERS

says
George F. Jowett
WORLD'S GREATEST
BODY BUILDER

..OR IT WON'T COST YOU A CENT!

Let me prove to YOU that you can put inches of dynamic muscles on your arms! Add inches to your chest! Broaden your shoulders and power-pack the rest of your body. I can do for you what I've done for thousands the world over, including many officers and men now in the U. S. and British Armed Forces!

GIVE ME 10 MINUTES A DAY!

I'll Show You My Secrets Of Body Building

I'll help you learn the "Progressive Power Method" through which I rebuilt myself from a physical wreck to the holder of more strength records than any other living athlete or teacher! No matter how skinny or baby you are, you can learn my methods right in your own home. Through my proved secrets I show you how to develop your power, inside and out, until YOU are fully satisfied that you are the man you want to be. "The Jowett System," says R. F. Kelly, Physical Director of the YMCA, Atlantic City, "is the greatest in the world!"

If you want a physique that will inspire respect from men, and admiration from women... **ACT LIKE Muscles Like Iron!** will be included **FREE!** Priceless for the strength fan! Full of photos of marvelous power-bodied men who will show you what Jowett has done for them and how he can do the same for you. Reach out... Grasp this Special Offer today!

PROVE TO YOURSELF IN ONE NIGHT!

Send only 25c for test Course, "Molding a Mighty Arm." Read it the evening it arrives—learn from experience the thrill you can give your muscles!

SEND FOR THESE FIVE FAMOUS COURSES IN BOOK FORM ONLY 25c EACH or ALL 5 for \$1.00

Jowett Institute of Physical Culture
 230 Fifth Avenue
 Dept. PM-64
 New York 1, N. Y.

This Book Free!



BOOK WITH PHOTOS OF FAMOUS STRONG MEN MAIL COUPON NOW FREE



Jowett Institute of Physical Culture
 230 Fifth Avenue, Dept. PM-64, New York 1, N. Y.
 George F. Jowett! Your proposition looks good to me. Send by return mail, prepaid, the courses checked below, for which I enclose (). Include **FREE** book of PHOTOS.

- George F. Jowett Champion of Champions
- All 5 courses for . . . \$1
 - Molding Mighty Legs 25c
 - Molding a Mighty Arm 25c
 - Molding a Mighty Grip 25c
 - Molding a Mighty Back 25c
 - Molding a Mighty Chest 25c
 - Send all 5 C.O.D. (\$1 plus postage.) No orders less than \$1 sent C.O.D.

NAME **Age**

(Please print plainly. Include Zone Number.)

ADDRESS

Do You Make These Mistakes in English?

MANY persons say "between you and I" instead of "between you and me"—or use "who" for "whom"—or don't know whether to spell certain words with one or two "c's" or "m's" or "r's," or with "ie" or "ei," etc. Every time you speak or write you show what you are. Mistakes in English reveal lack of education, refinement. Lack of language power prevents you from presenting your thoughts in the strongest way. Real command of English will help you reach ANY goal. Stop making mistakes in spelling, punctuation, pronunciation, grammar. Increase your vocabulary.



Sherwin Cody

WONDERFUL INVENTION

Only 15 minutes a day with Sherwin Cody's new invention—and you can actually SEE your English improve. It teaches by **HABIT**—makes it easier to do the **RIGHT** way. Wonderful self-correcting lessons.

FREE BOOK ON ENGLISH Lack of language power may be costing you friendships, income, every year. See what Mr. Cody can do for you; it costs nothing to find out. Write this very minute for free book, "How You Can Master Good English in 15 Minutes a Day." It will prove a revelation. **WRITE NOW. SHERWIN CODY SCHOOL OF ENGLISH, 54 B & O Bldg., Rochester 4, N. Y.**

Learn LANDSCAPE GARDENING!

A thorough, constructive, interesting home-training, covering your regional conditions, for those who wish to become **LANDSCAPERS, DESIGNERS, GARDENERS,** etc., for profit or pleasure. Write today for **FREE INFORMATION**, without obligation, to

NATIONAL LANDSCAPE INSTITUTE
 Dept. P-4 756 So. Broadway Los Angeles 14, California

LEARN MONEY-MAKING CARTOONING

IN SPARE TIME — by Easy Picture Chart Method

Same Simplified Method that has helped train creators of "Terry & Pirates," "Freckles," "Out Our Way," "Winnie Winkle," "Rep'lar Fellers," "Strange As It Seems," "The Neighbors," and many others. Earn while learning! Send 10c for Picture Chart (to test your ability), and full details. (State age.)



Landon School of Cartooning, Dept. 4604 Philadelphia 1, Pa.

What Every Mason Wants



We have important Masonic books for **Blue Lodge, Chapter, Commandery, Scottish Rite, and Shrine.**

Our Rituals Are Used the World Over. Send for free catalog of books and rituals for Masons, Odd Fellows, Knights of Pythias, Knights of Columbus, etc. **EZRA A. COOK, Publisher, P. O. Box 796, PA, Chicago 90, Ill.**

Learn PHOTOGRAPHY at Home

Splendid opportunities. Prepare in spare time. Practical basic training. Long-established school. Send for free book, "Opportunities in Photography." No obligation.

American School of Photography, 1315 S. Michigan Ave., Dept. 1354, Chicago 5, Ill.

Train Your Own HORSES!

Colts — Stock Horses — Circus Horses
 Gait Show Horses — Write for **FREE BOOK**
ANIMAL LOVERS' ASSOCIATION
 Box KA-111, Tarzana, Calif.



WATCHES WANTED Broken or Usable

—all kinds, even Ingersolls. Highest prices paid for jewelry, rings, spectacles, gold teeth, etc. Cash mailed promptly. Write for Free Shipping Container.

LOWE'S, Holland Bldg., Dept. PM, St. Louis 1, Mo.

MONEY MEN ALL DATA FREE!

THE PLASTEX Industry needs manufacturers on small scale and for big production of Lamp and Clock Stands, Art Goods and Novelties in Plastex and Marble imitation. Experience unnecessary. 4c material makes regular 10c store sellers. Rubber moulds furnished for speed production. Small investment brings good returns. Big chain store orders now being placed. Ambitious men have chance for real prosperity. Our Free booklet will interest and benefit you.

PLASTEX INDUSTRIES, Dept. P, 1085 Washington Ave., New York, N. Y.

SAY YOU SAW IT IN POPULAR MECHANICS

Prepare for YOUR FUTURE Now

You'll Need "ALL-AROUND" Training to Meet New Conditions!

Get Ready QUICK—in 1 of these 2 Opportunity Fields!

ELECTRICITY **RADIO ELECTRONICS**
TELEVISION

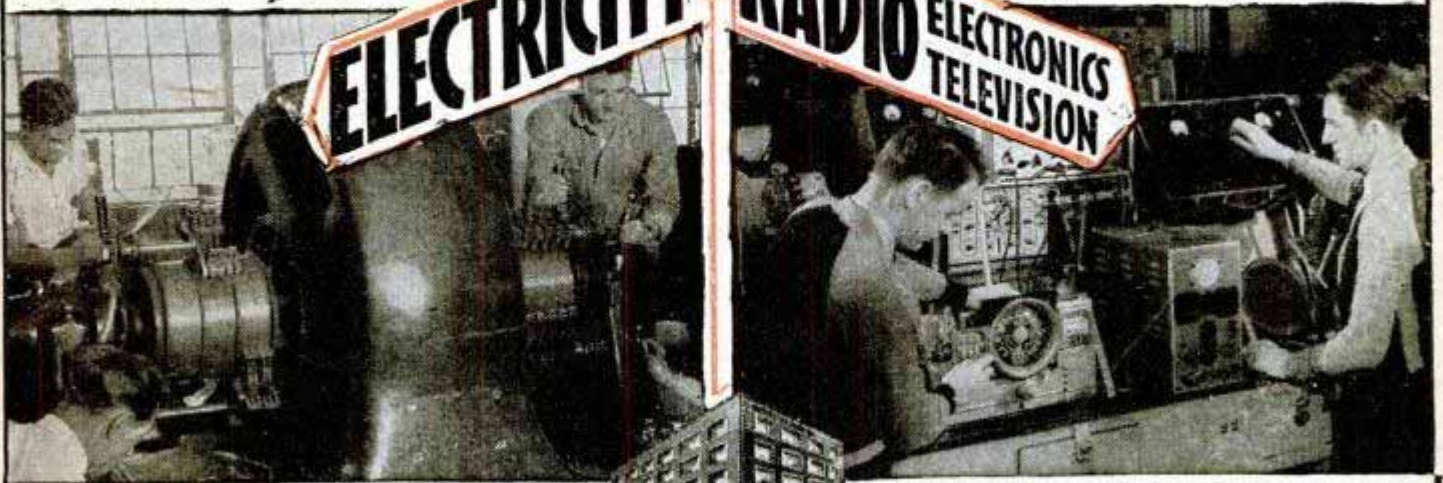

ELECTRICITY in its Many Branches...

Electricity is a permanent necessity in war or peace. Be ready for the opportunities in such branches as Power Plant Work, Motors, Armature Winding, Industrial and House Wiring, Maintenance, etc., with COYNE shop training.



This big fire-proof building is occupied entirely by the Coyne Electrical School.

RADIO-ELECTRONICS...A great field

now, even greater growth ahead. Prepare for a real Radio career. Learn construction, operation, trouble-shooting on Radio Receivers, Public Address Systems, Sound Picture Units, FM, Photo-Cells, Television—the practical COYNE way.

"LEARN-BY-DOING"-12 WEEKS TRAINING

Student Finance Plan

Now that peace has returned, many "one-operation" jobs that paid well in war times, no longer exist. Do you have a good job with a real future? Plan for steady pay and advancement by training NOW, while there's still time! Come to the big shops of COYNE in Chicago, for "all-around" training in Electricity or Radio-Electronics—the 2 great opportunity fields of today and tomorrow. I'll finance most of your training.

TRAIN ON ACTUAL EQUIPMENT!

My famous "Learn-by-Doing" method gives you practical experience on full-size equipment. Not by correspondence, but actual shop work. You are trained right here in the Coyne shops, that has been training men and young men for over 46 years.

START NOW—PAY LATER!

Don't let lack of money hold you back. My "Student Finance Plan" has helped thousands to get ahead. Coupon brings details. Many earn while learning, to help take care of living expenses while here. Men from 16 up to 40, with or without experience, Coyne training is for you!

LIFETIME JOB SERVICE TO COYNE GRADUATES

First I train you for a good job and future, then assist you in getting located. As a Coyne graduate, use this service whenever you need it—no charge. Also FREE review privileges at any time. Get the facts!

PICK FIELD YOU LIKE—SEND FOR BIG BOOK



FREE

H. C. Lewis



Some men prefer Electricity, others Radio-Electronics. Whichever interests you most, we will train you in 12 short weeks at Coyne—on full-size equipment, by my famous "Learn-by-Doing" method. I have a big, fully illustrated book on each course, and will send you the one you want, without the slightest cost or obligation. Simply check below, then mail coupon in envelope or paste on postcard. No salesman will call. You are the sole judge. Don't delay. Your future is at stake. Rush coupon to me—TODAY.

INDUSTRIAL ELECTRONICS

and Electric Refrigeration

Included With Either Course—No Extra Charge

Extra training in these great fields of INDUSTRIAL ELECTRONICS and ELECTRIC-REFRIGERATION makes you more valuable to employer, leads to opportunities for bigger pay. This valuable EXTRA TRAINING included with either my Electrical or Radio Course, without extra cost. We also have facilities for men with physical disabilities whether due to war or other causes. Check coupon for details if you have a physical disability of any kind.

VETERANS—

Coyne is also equipped to train those who qualify for training under G. I. Bill of Rights. Check coupon for our special G. I. Bulletin.



H. C. LEWIS, Pres.

Founded 1899

COYNE ELECTRICAL SCHOOL

500 So. Paulina Street, Dept. 46-72H, CHICAGO 12, ILL.

H. C. LEWIS, Pres.,
COYNE ELECTRICAL SCHOOL

500 S. Paulina St., Dept. 46-72H, Chicago 12, Ill.

Send me your BIG FREE BOOK — for the course checked below. Also full details of your "Student Finance Plan."

ELECTRICITY RADIO-ELECTRONICS
 Send special G. I. Bulletin Physical disability

NAME.....

ADDRESS.....

CITY..... STATE.....

Increasing your hold on your job and giving yourself a chance for advancement

Few men deliberately plan to work persistently on self-improvement. If progress comes naturally, they're happy; if it doesn't, they worry or ignore the situation. Yet it is possible to pay attention to self-improvement with considerable hope of success. A noticeable degree of advancement is practically assured any one who will make an intelligent and persistent effort. Thousands of men have proved this for themselves, with:



The Croft Library of Practical Electricity

The Croft Library is a complete electrical educator. It is founded on practice—on 20 years of shirt-sleeve experience—on work as it is actually done. It is jammed from cover to cover with the kind of hard-headed facts you want. Written so that the beginner can easily understand it, yet so sound, so thorough, that it is the daily guide of 50,000 highly paid electrical workers and engineers. Croft tells you the things you need to know about motors, generators, armatures, commutators, transformers, circuits, switchboards, distribution systems—electrical machinery of every type—wiring for light and power—wiring of finished buildings—underwriters and municipal requirements—illumination in its every phase—the most improved methods of lighting lamps—and lamp effects, etc.—how to do a complete job, from planning it, to completion.

No money down—easy payments

Fill in and mail the coupon attached and we will send you the entire set of seven volumes for ten days' examination on approval. We take all the risk—you assume no obligation. If you decide to keep the books, send \$3.00 in ten days and the balance at the rate of \$3.00 a month. Send the coupon NOW and see the books for yourself.

McGraw-Hill Book Co., 330 W. 42nd St., New York 18, N. Y.
Send me for ten days' examination on approval the Croft Library of Practical Electricity, 7 vols. If satisfactory I will send you \$3.00 in 10 days and \$3.00 monthly until the price of \$18.00 is paid. If not wanted, I will return the books postpaid. (To insure prompt shipment write plainly and fill in all lines.)

Name.....
Home Address.....
City and State.....
Company.....
Position..... PM-4-46

PLUMBERS & STEAM FITTERS

Audels Plumbers and Steamfitters Guides



4 Vols. \$6

A practical, illustrated, Reference Library and Study-Course for Master Plumbers, Journeymen and Apprentice Steamfitters, Gas Fitters and Helpers, Sheet Metal Workers, Draughtsmen, Master Builders, Engineers and all Building Trade Students. This valuable set of handy, pocket-size Guides explains in practical concise language and well-done illustrations all the principles, advances and short cuts of the Plumbing and Heating trade—based on modern practice. Contains careful, detailed instructions

on how to figure and estimate various jobs. Use FREE COUPON below to examine, without obligation, this valuable work.

INSIDE TRADE INFORMATION ON:

Soldering, tinning. Joint wiping, bending, beasting. Pipe—iron—steel, threading. Mathematics, tables, physics. Materials—iron, steel, copper, brass, lead, tin, antimony, etc. Sheet metal—galvanized—plate. Sanitation, syphonage, tanks. Drainage, sewage, purification. Fixtures—bath—kitchen. Pipe fittings, soil pipe, tools. Laying out work. Roughing. Screwed fittings, flanges, joints. Pipe bending, examples. Elbows. Heating, ventilation, air conditioning, refrigeration. Water supply, mains, wells, tanks. Gas-fittings. Sheet metal work, problems, methods. Brazing, heating, lead burning. Welding, various welds, methods. Blacksmithing, forges, tools. Air Conditioning.

THEO. AUDEL & CO., 49 W. 23rd St., New York City

Mail Audels Plumbers Guides, 4 vols., on 7 days' free trial. If O. K. I will remit \$1 in 7 days, and \$1 monthly until \$6 is paid. Otherwise I will return them. No obligation unless I am satisfied.

Name.....
Address.....
Occupation.....
Reference..... PM



DRAW CARTOONS BIG MONEY!

EASY . . . PLEASANT WORK!
Let CHAS. H. KUHN, with 25 years actual experience in drawing a daily newspaper cartoon, teach you how to create, draw and sell your work. 52 complete lessons—one sent each week. Professional criticism on every lesson. Write today.

Complete Course
Only \$15.00

KUHN SCHOOL OF CARTOONING
420 MURPHY BUILDING Dept. M INDIANAPOLIS 4, INDIANA

LEARN WATCH REPAIRING



AT HOME. By our modern and original system of instruction you can learn every part of the WATCH REPAIRING TRADE AT HOME. Prepare yourself for a well-paying position or start in business after completing our course of instruction. Good watch repairers are in demand and generally earn very good salaries. For particulars apply to the Wisconsin School of Watch Repairing 759 North Milwaukee St., Milwaukee 2, Wis.

NEW WRITERS NEEDED

New writers needed to re-write ideas in newspapers, magazines and books. Splendid opportunity to "break-into" fascinating writing field. May bring you up to \$5.00 per hour spare time. Experience unnecessary. Write today for FREE details. NO OBLIGATION. Postcard will do.

FREE
DETAILS

COMFORT WRITER'S SERVICE

200-T40 South Seventh (2)

St. Louis, Mo.



BOOKS FOUND FREE/10

WHAT BOOKS DO YOU WANT?

We quote the lowest market prices. No charge for locating Hard-to-Find and Out-of-Print Books. All books, OLD or NEW, mailed POST-FREE. SEARCHLIGHT BOOK CLUB, 22 East 17th St., New York City



CODE-SENDING-RECEIVING SPEED

Learn to send and receive Radio Code with greater speed. Stop nervous tension. Have confidence. Be proficient. Same system used by radiotelegraph specialists. Thousands of operators needed. Rush name for FREE book.

CANDLER SYSTEM CO.

Dept. 5-D, Box 928, Denver 1, Colo., U. S. A.



Begin today. Write now for our Free Book, "How to Become a Good Penman." It contains specimens and tells how others learned to write in spare time. Enclose 10c for your name beautifully written and a pen point suitable for abraded writing. Write today.

THE TAMBLYN SCHOOL OF PENMANSHIP
N-441 Ridge Building, Kansas City, Mo.

Become a Doctor of PSYCHOLOGY

Win the degree of Ps.D. Teach the secret of contentment, happiness. Solve mental worries. Experience the revelation of truth. Chartered college. Individual help. Write for FREE book. COLLEGE OF UNIVERSAL TRUTH, 5153-B North Clark St., Chicago.

FIBRE ARMS AND LEGS!



Light, correctly fitted, strong and comfortable. Natural appearance. Braces for all deformities. Scientific design. Fair Terms.

BUCHSTEIN-MEDCALF

610-3rd Av. S., Minneapolis, Minn.

Store Route Plan PAYS BIG MONEY

SELL COUNTER CARD PRODUCTS

Build a good-paying business of your own! Call on dealers of all kinds; show nationally-advertised Aspirin, Vitamins, Cosmetics and 200 other necessities. Big 5c and 10c retail packages, high quality. Attractive counter displays sell goods fast. Free book gives amazing facts. Write!

World's Products Co., Dept. 10-Y, Spencer, Ind.



WHICH OF THESE *Opportunities* INTERESTS *You* MOST?

Accounting & C. P. A.
Air Conditioning
Architecture & Building
Automotive Engineering
Aviation—Practical
Aviation Drafting & Design
Better Foremanship
Bookkeeping
Business Management
Contracting

Diesel Engineering
Drafting & Design
Electrical Engineering
Electricity—Practical
Electronics, Industrial
High School Courses
Machine Shop Operations
Mechanical Engineering
Plastics Engineering
Plumbing—Practical

Private Secretary
Radio Operating & Servicing
Railway Training
Refrigeration
Sheet Metal Pattern Drafting
Shop Management
Surveying & Topographical
Drafting
Tool Making

THINK! LOOK FORWARD!

Business is making big, new plans

Men and Women are preparing for the future

WHAT ARE YOU DOING ABOUT YOUR TOMORROWS?

● *Today*, choose the job you want—and prepare for it. Or if you are already engaged in the work you like best, start training *now* for quicker promotion. Acquire the knowledge that will help you to get ahead faster, make more money and have greater security.

Invest part of your spare time in more rapid progress. Start training now, in spare time in your own home. Be ready to grasp your opportunity and step out ahead of those who lack the ability you have attained.

American School, founded in 1897 as an educational institution *not for profit*, can help you to reach your goal just as it has helped others during the past forty-nine years. Give serious thought to the list above. Pick one or more subjects that interest you. Then check the coupon at right, add your name and address and mail it at once. The school will send you details on its training plan and outline of study prepared by specialists. There is no charge, no obligation, so send the coupon immediately.

PRACTICAL, EFFECTIVE HOME - STUDY TRAINING SINCE 1897

Take This First Easy Step

CHECK, CLIP AND MAIL COUPON NOW

AMERICAN SCHOOL, Dept. G445, Drexel at 58th, Chicago 37, Ill.
Without obligation, Please send FREE and postpaid, bulletin and details of the Subject checked.

- | | | |
|--|---|--|
| <input type="checkbox"/> PLASTICS ENG'R | <input type="checkbox"/> Accounting & C.P.A. | <input type="checkbox"/> Drafting and Design for Men and Women |
| <input type="checkbox"/> Refrigeration | <input type="checkbox"/> Electrical Engr. | <input type="checkbox"/> Radio |
| <input type="checkbox"/> Architecture and Building | <input type="checkbox"/> Electricity-Pract. | <input type="checkbox"/> High School |
| <input type="checkbox"/> Contracting | <input type="checkbox"/> Electronics, Industr. | <input type="checkbox"/> Air Conditioning |
| <input type="checkbox"/> Practical Plumbing | <input type="checkbox"/> Bookkeeping | <input type="checkbox"/> Mechanical Eng. |
| <input type="checkbox"/> Automotive Engineering | <input type="checkbox"/> Private Secretary | <input type="checkbox"/> Shop Management |
| <input type="checkbox"/> Aviation Drafting | <input type="checkbox"/> Diesel Engineering | <input type="checkbox"/> Tool Making |
| <input type="checkbox"/> Aviation | <input type="checkbox"/> Surveying & Topographical Drafting | <input type="checkbox"/> Better Foremanship |
| <input type="checkbox"/> Business Mgmt | <input type="checkbox"/> Sheet Metal Pattern Drafting | <input type="checkbox"/> Machine Shop Operations |
| <input type="checkbox"/> Railway Training | | |

Name..... Occupation.....
Address..... Age.....
City..... State.....

AMERICAN SCHOOL

Dept. G445, Drexel at 58th Street, Chicago 37

Do you want

- ..to go to College?
- ..or to enter a Profession?
- ..or get an Office Position?

(Such as Accounting, Architecture, Nursing, Dentistry, Teaching, Social Work, Osteopathy, Beauty Culture, Optometry, Embalming, Chiroprody, Law, Medicine, etc.)

To get anywhere, you practically **MUST** finish High School **FIRST**. You can complete our simplified High School Course in **SPARE** time at home, as **FAST** as your time and abilities permit. Equivalent to resident school work—prepares you for college, pre-professional examinations, business, industry. Standard texts furnished. Diploma. Credit for H. S. subjects already completed. Single subjects if desired. Low tuition, easy terms. American School, Chicago, est. 1897—endorsed by educators. Finish your high school education **NOW**, Write **TODAY!**

High School Course at Home

Many Finish in 2 Years

American School, Dept. H445, Drexel Ave. at 58th St., Chicago 37, Ill.

Gentlemen: Send me **FREE** information covering special training in subjects checked below. No obligation on my part.

- | | |
|--|--|
| <input type="checkbox"/> High School Course | <input type="checkbox"/> Diesel Engineering |
| <input type="checkbox"/> Architecture and Building | <input type="checkbox"/> Drafting and Design for Men & Women |
| <input type="checkbox"/> Automotive Engineering | <input type="checkbox"/> Plastics |
| <input type="checkbox"/> Business Management | <input type="checkbox"/> Private Secretary |
| <input type="checkbox"/> Electrical Engineering | <input type="checkbox"/> Mechanical Engineering |
| <input type="checkbox"/> Elec. and Gas Refrigeration | <input type="checkbox"/> Aviation |
| <input type="checkbox"/> Air Conditioning | <input type="checkbox"/> Salesmanship |
| <input type="checkbox"/> Railway Training | <input type="checkbox"/> Radio |
| <input type="checkbox"/> Electronics, Industrial | |

Name.....

Address.....

AUDELS Carpenters and Builders Guides

4 vols. \$6



Inside Trade Information for Carpenters, Builders, Joiners, Building Mechanics and all Woodworkers. These Guides give you the short-cut instructions that you want—including new methods, ideas, solutions, plans, systems and money saving suggestions. An easy progressive course for the apprentice and student. A practical daily helper and Quick Reference for the master worker. Carpenters everywhere are using these Guides as a Helping Hand to Easier Work, Better Work and Better Pay. To get this assistance for yourself, simply fill in and mail the **FREE COUPON** below.

How to use the steel square—How to file and set saws—How to build furniture—How to use a mitre box—How to use the chalk line—How to use rules and scales—How to make joints—Carpenters arithmetic—Solving mensuration problems—Estimating strength of timbers—How to set girders and sills—How to frame houses and roofs—How to estimate costs—How to build houses, barns, garages, bungalows, etc.—How to read and draw plans—Drawing up specifications—How to excavate—How to use settings 12, 13 and 17 on the steel square—How to build hoists and scaffolds—skylights—How to build stairs—How to put on interior trim—How to hang doors—How to lath—lay floors—How to paint



THEO. AUDEL & CO., 49 W. 23rd St., New York City

Mail Audels Carpenters and Builders Guides, 4 vols., on 7 days' free trial. If O.K. I will remit \$1 in 7 days, and \$1 monthly until \$6 is paid. Otherwise I will return them. No obligation unless I am satisfied.

Name.....

Address.....

Occupation.....

Reference.....PM

TRAIN for SUCCESS in the Poultry Business



Study at home in spare time. Earn extra while learning.....

YOU CAN MAKE MONEY FROM POULTRY

Get ready now—the easy, scientific, inexpensive way! For 25 years, we've been helping thousands to greater success—showing how to cut losses, avoid mistakes, get biggest profits! How to start their own poultry projects and succeed at it! Proper management and "know how" means profits ANY season, for life. Indorsed by leading colleges, poultrymen. Free catalog describes courses, methods, service, opportunities. Write today to the President.

NATIONAL POULTRY INSTITUTE
DEPT. 50-I ADAMS CENTER, NEW YORK

"YOU ARE UNDER ARREST!"



Help Bring Crooks to Justice Through Scientific CRIME DETECTION!

I have taught thousands this exciting, profitable, pleasant profession. Let me teach you in your own home. Learn Finger Printing, Firearms Identification, Police Photography, Criminal Investigation thoroughly, quickly, at small cost. 53% of all American Bureaus of Identification employ I. A. S. students or graduates. I can prepare you for this fascinating work, during spare time. Write today, stating age, for "Blue Book of Crime."

INSTITUTE OF APPLIED SCIENCE, 1920 Sunnyside Ave., Dept. 1354, Chicago, Ill.



You can learn plain, rapid writing or fancy ornamental writing for social and business advancement, right in your own home during spare time by my Simplified Method. Write for my free book, "How to Become an Expert Penman," which shows what others have accomplished by taking my Courses. Send 10c for one of my favorite Pen Points and your name with a beautiful flourished bird written on a card. Write today. T. M. Tevis, Box 25K, Chillicothe, Mo.

"How to Make Money With Simple Cartoons"

A book everyone who likes to draw should have. It is free; no obligations. Simply address

CARTOONISTS' EXCHANGE
Dept. 94-D Pleasant Hill, Ohio

NOW . . . ELECTROPLATING

Learn this profitable, interesting trade. Hobby or full time business. Chromium, Nickel, Gold, Silver, etc. Postcard brings full details, **FREE**.

PLATER HYDE, Dept. M, P.O. Box 176, National City, Calif.

FIX TYPEWRITERS

A Simplified Practical Homestudy Course. Many of our Students now have their own Business—Many Repair for others. Repair Shops Swamped. Health or Age no handicap.
WEBER TYPEWRITER MECHANICS SCHOOL
Box 269, Osborn, Ohio

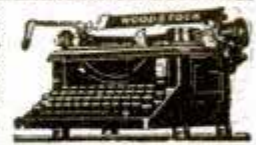

STAMMER ?

This new 128-page book, "Stammering, Its Cause and Correction," describes the Bogue Unit Method for scientific correction of stammering and stuttering—successful for 45 years. Benj. N. Bogue, Dept. 1835, Circle Tower, Indianapolis 4, Ind.



Inventions Wanted

Patented or Unpatented

Inventions can now be safely sold without patenting expense. If you have a practical, useful idea for sale, either unpatented or patented, write

INSTITUTE OF AMERICAN INVENTORS
Dept. 4, 1926 Eye St., N.W. Washington 6, D. C.

SOON WE'LL PHONE HOME FROM AUTO
 RADIO INDUSTRY POISED FOR BIG BOOM
 Big Boom in FM Broadcasting
 Seen
 MARKET FOR 100 MILLION RADIOS REVEALED BY SYLVANIA SURVEY
 OVER FIVE- OR SIX-YEAR PERIOD, RESU
 COAST TO COAST NETWORK BEING PLANNED FOR FM

Let TODAY'S HEADLINES Guide You to TOMORROW'S OPPORTUNITIES

Learn **RADIO** ELECTRONICS DeFOREST'S MODERN "A-B-C" WAY .. at Home

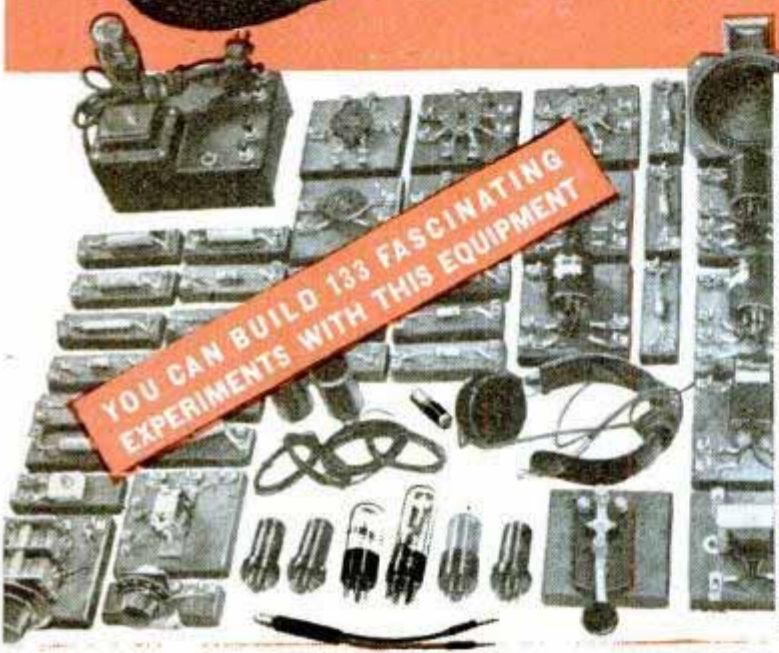

YOU CAN BUILD 133 FASCINATING EXPERIMENTS WITH THIS EQUIPMENT

Plan your future the way business men do: Watch the headlines! Pick a field that's "in the news"—one with many opportunities for interesting, PROFITABLE EMPLOYMENT or a good chance for establishing a BUSINESS OF YOUR OWN with little capital. Pick a field that offers a variety of interesting opportunities—a field with one of America's most promising futures . . . and see how you may MAKE YOUR START TOWARD A PLACE IN THIS FIELD BEFORE JOB COMPETITION BECOMES ACUTE. Write for DeForest's Big, Free, Illustrated Book—"VICTORY FOR YOU." Learn how DeForest's prepares you at home, in your leisure time—without interfering with the work you are now doing—then helps you make your start in the vast BILLION DOLLAR Radio-Electronics field.

You Get **EMPLOYMENT SERVICE**

DeForest's Employment Service offers you the advantage of long and favorable contacts with some of America's foremost Radio-Electronics concerns. "VICTORY FOR YOU" tells you how this Service has helped many to their start in Radio-Electronics. You'll see how DeForest students and graduates are prepared to win and to hold good paying jobs—how DeForest students start businesses of their own with little, if any, capital.

A You "LEARN-BY-DOING" at Home with Practical Equipment

Enjoy a "Home Laboratory." DeForest's provides 8 BIG KITS OF RADIO ASSEMBLIES AND PARTS to give you valuable practical experience at home. Build modern Radio Receivers and Circuits that operate. Build Electric Eye Devices, an Aviation Band Receiver, a Public Address System, a Wireless Microphone and numerous other fascinating experiments—in fact, 133 in all, in your spare time at home. NEW colorful Kit Supplement tells you about DeForest's "Home Laboratory," and how you use valuable Radio parts and sub-assemblies to get real practical experience as you learn.

DEFOREST'S TRAINING INCLUDES INSTRUCTION IN MOTION PICTURE SOUND EQUIPMENT, FM RADIO AND TELEVISION . . .

C ILLUSTRATED LOOSE-LEAF LESSONS

DeForest's provides 90 loose-leaf lessons prepared under the supervision of the man often referred to as the "Father of Radio"—Dr. Lee DeForest, inventor of the Audion Tube, and holder of over 300 important patents. . . . ACT PROMPTLY! See how you can learn Radio the modern A-B-C DeForest's way by Reading . . . by Doing . . . by Seeing—at Home. Mail coupon Now!

B Home MOVIES Help You Learn FASTER...EASIER

With DeForest's, you use a genuine DeVRY 16 mm. Motion Picture Projector and exciting training films to help you learn some of Radio's fundamentals FASTER . . . EASIER. SEE what happens inside of many circuits you are working on. SEE how electrons function. SEE how RADIO waves are changed into sound. Get DeForest's big, free book! Use it as a key to show you the way to Radio-Electronics job opportunities of today and tomorrow—the opportunities the headlines tell about.



Send for **FREE BOOK & SUPPLEMENT TODAY!**

DEFOREST'S TRAINING INC., Chicago, Ill.

DeFOREST'S TRAINING, INC., 2533-41 N. Ashland Ave., Dept. PM-C4, Chicago 14, Illinois, U.S.A. Send me both your big book "VICTORY FOR YOU" and Kit Supplement, showing how I may make my start in Radio-Electronics with your modern A-B-C home training plan. No obligation.



Name _____ Age _____
 Address _____
 City _____ Zone _____ State _____
 If under 18, check here for special information. If a discharged veteran of World War II, check here.



SO IT NEEDS FIXING

By S. T. CHRISTENSEN
the "Fix-it Man"

WELL, I guess I'm the fellow to see, for I've repaired thousands of refrigerators (home and commercial both), vacuum cleaners, radios, washing machines, irons, fans, lamps, mangles, motors, etc. In fact, many of my customers call me their "electrical appliance doctor." And, "doctoring," I might add, has paid me a good substantial income for quite a few years. Funny, in a way, how I got started. Always liked to tinker and by experimenting around I found that most electrical appliances had many things in common. That, regardless of what the appliance was used for, or who the manufacturer was, the basic principles were much the same. From fixing my own appliances to fixing friends' and then for strangers at a fee, seems now to have been but a small step.

What to Charge?

At first, I let the owner decide the charge and, frankly, I was amazed at what I earned per hour. But then, when one figures what initial costs are involved in buying most electrical appliances, one can readily see that spending extra dollars for repairs is well worth while. Before long I was making more in my spare time repairing than from my regular job. The result . . . I went into business for myself. When war came, business boomed, for new appliances were not available.

For a while, repair parts (needed on some

jobs) were a little difficult to get. But that situation quickly adjusted itself and many repair parts were given the high priority rating of AA2. After all, we had to provide for the health and well-being of our civilian population.

The Future Offers

Friends ask me about my future. And, I think I've got a grand one. Age is no handicap in repairing. I have in my files enthusiastic letters from repairmen ranging in age from 18 to 79 years. Now the war is over we are certain to see hundreds of new products on the market . . . products that the average person never dreamt of. These new products and our old appliances are all going to need at some time or other "fixing." Well, I'll still be the fellow to do it. The field open for appliance repairmen is unlimited. I don't worry at all about too much competition.

If You Are Ambitious

To the contrary, I've prepared a complete course, chuck full of simple, easy to understand photos and drawings and written in the same non-technical language as this article. I know the course is good, because I have hundreds of men all over the country writing to me telling me how the course has helped swell their pockets with cash. If you too want to prepare now for your future, I suggest you read the next page and send me the handy coupon."



**BIG MONEY
INDEPENDENCE**

*A PROFITABLE
LIFETIME
BUSINESS
OF
YOUR OWN!*

LEARN ELECTRICAL APPLIANCE REPAIRING

PREPARE NOW FOR THE FUTURE

If now employed, start your home appliance repair business NOW in your spare time and be set with a business of your own no matter what happens. You don't need elaborate fixtures or expensive equipment to be a successful repairman. Operate from your garage, basement, vacant store, etc. Work as many hours as you wish—the home appliance repairman is his own boss. It is a profitable occupation for on many types of repairs it is not unusual for a repairman to charge on the basis of \$5.00 to \$6.00 per hour. Don't gamble with your future—learn a trade that will always support you. Remember, as long as electrical appliances are used, there will be a need for electrical appliance repairmen.

If you are at all mechanically inclined—can hold and use tools—then you have all of the qualifications required for becoming a big money earning home appliance repairman. It does not matter if you have not had a great deal of schooling or had previous experience along these lines—**WE WILL TEACH YOU.** Age should be no barrier—nor should any minor physical handicap.

New Course Tells All

Profusely illustrated, our new course shows you in simple, easy to understand language and drawings how to make each repair on refrigerators, vacuum cleaners, washing machines, motors, etc. Explains and gives you a working knowledge of electricity, welding, nickel plating, etc. Shows you how to build the power tools you need and how to solicit and keep business coming to you. Not a theory course but an honest to goodness course written by and used by repairmen the country over. Price of course is so low that the savings on your own household appliance repairs will quickly pay for it. Act now! Mail the handy coupon below today.

----- Read What Our Students Say About Course -----

I really believe your course the best investment a mechanically minded man can make.—Claude E. Allen, Indianapolis, Ind.

I have received your Course in Appliance Repairing and I must say I am well pleased with same. I am only sorry I did not have said Course some years ago. I have learned so much more through this course I would not part with it.—Charles Schwarz, Hamilton, Ohio.

The Course in Appliance Servicing arrived a few days ago. Want to take out a few minutes of my valuable time to let you know that this is just what I have been looking for ever since I opened up my Fix-It shop. I must admit that you told the truth when you said that it contains quite a bit more information than I bargained for.—P. J. Bretl, Sebring, Ohio.

I am a mechanic for the Western Union Telegraph Co. Three days after receiving the lessons in refrigeration I earned the exact cost of the course.—Henry S. Lee, Washington, D. C.
I work day times at the shipyard and after 4:00 P.M. I operate from my cellar and garage. I average \$10.00 to \$15.00 clear every day.—Walter Hanhy, Brockton, Mass.

GET STARTED TODAY — MAIL THIS COUPON

CHRISTY SUPPLY CO.
2835 N. Central Ave., Dept. D-3203
Chicago 34, Illinois

Please send me free illustrated literature about America's Fastest Growing Industry — **ELECTRICAL APPLIANCE REPAIRING.**

Name.....

Address.....

City..... State.....

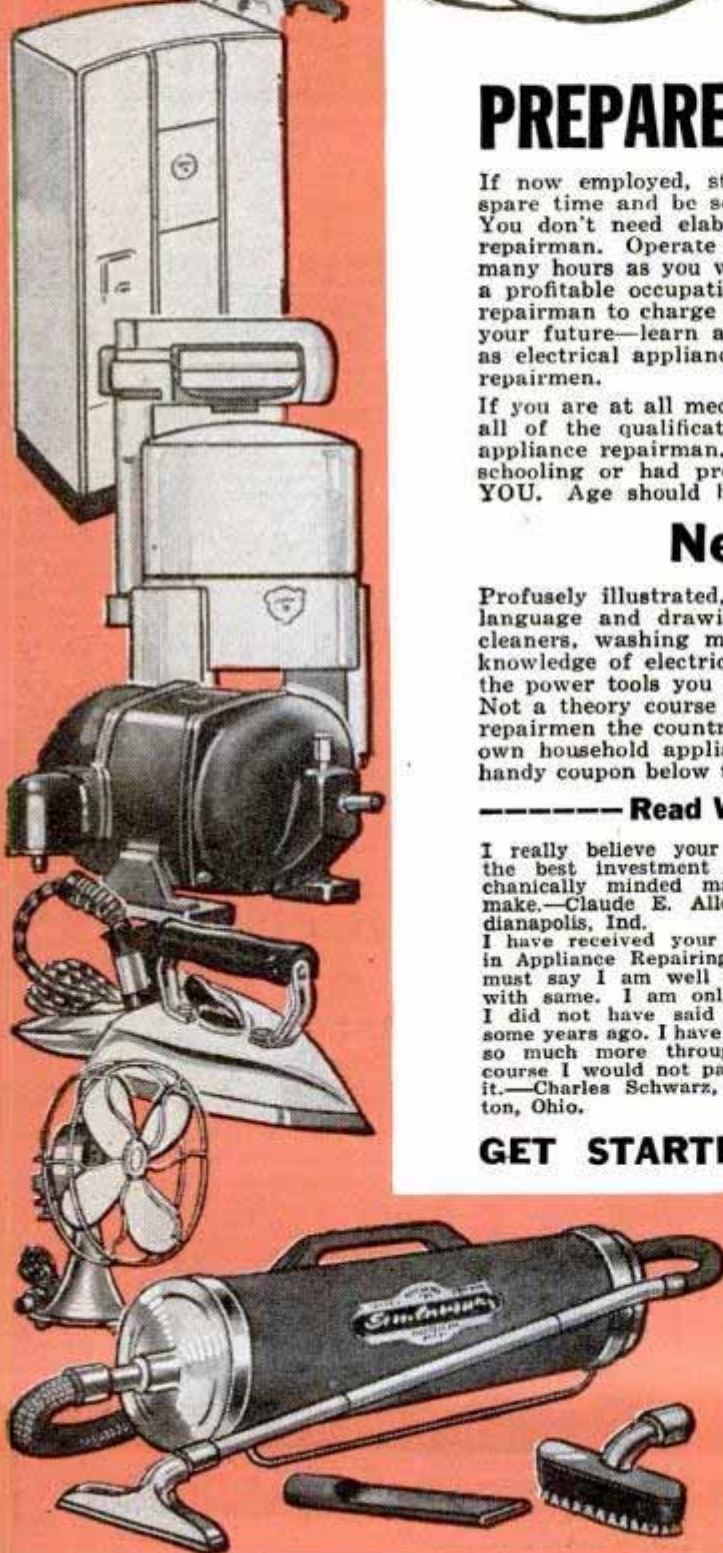

8 BIG BUILDING BOOKS

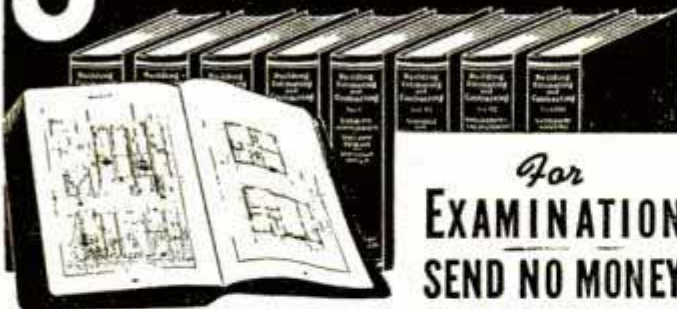

For
EXAMINATION
SEND NO MONEY

Learn to draw plans, estimate, be a live-wire builder, do remodeling, take contracting jobs. These 8 practical, profusely illustrated books cover subjects that will help you to get more work and make more money. Architectural design and drawing, estimating, steel square, roof framing, construction, painting and decorating, heating, air-conditioning, concrete forms and many other subjects are included.

BETTER JOBS — BETTER PAY UP-TO-DATE EDITION

Keep busy now at good pay, and be prepared for after-war building boom. Big opportunities are always for MEN WHO KNOW HOW. These books supply quick, easily understood training and handy, permanent reference information that helps solve building problems.

These books are the most up-to-date and complete we have ever published on these many subjects.

Coupon Brings Eight Big Books For Examination

AMERICAN TECHNICAL SOCIETY Vocational Publishers since 1898
Dept. G419 Drexel at 58th Street Chicago 37, Ill.

You may ship me the Up-to-Date edition of your eight big books, "Building, Estimating and Contracting," without any obligation to buy. I will pay the delivery charges only, and if fully satisfied in ten days, I will send you \$2.00, and after that only \$3.00 a month, until the total price of only \$34.80 is paid. I am not obligated in any way unless I keep the books.

Name.....
Address.....
City.....State.....

Please attach a letter stating your age, occupation, employer's name and address, and name and address of at least one business man as a reference. Men in service, also please give home address.

Your Own PHOTOCOPY Business!

No Training Needed

AS LITTLE AS \$100 starts you in business for yourself

Start Right Out Making Money

Make photoexact copies of important papers, letters, drawings, photos, veterans' discharges, etc.—for local firms, lawyers, real estate men, accountants, advertising men, engineers, others. Every business is your prospect for error-proof, low-cost photocopies. New, amazingly simple method requires no lens, darkroom or training. For only \$100 you own your own business—with APÉCO, "America's Most Widely Used Photocopy Equipment." Easy to start... many prospects... quick results... pleasant work. A real money-making opportunity, good for a lifetime!

Get Full Information! MAIL COUPON NOW

AMERICAN PHOTOCOPY EQUIPMENT CO.
2849 N. Clark St., Dept. GF46, Chicago 14, Ill.

Please send me your illustrated book and details about the APÉCO business opportunity.

NAME.....
STREET.....
CITY & STATE.....

SAY YOU SAW IT IN POPULAR MECHANICS

MEN WANTED!

GOOD MONEY NOW and a Bright POST-WAR FUTURE

Returning Veterans... office and factory workers... others! If you want to enjoy a FINE INCOME NOW, with even greater opportunities in the future, write us today! We are a nationally known manufacturer of Fire Fighting equipment... including "AUTOFYRSTOP," the amazing combination fire extinguisher and alarm that holds unequalled records. Our product sell FAST and in QUANTITIES to factories, schools, stores, homes. NO EXPERIENCE NEEDED. Write for FREE FACTS!

AUTOFYRSTOP CO., Dept. M-46, 2035 Washington Ave., Philadelphia 46, Pa.

ANALYZE HANDWRITING

Qualify for Certified Grapho-Analyst Degree. New uncrowded, fascinating field of service. Gratifying earnings reported by graduates in Employment, Credit, Social Service, Police and Judicial, and Entertainment fields. Others have developed profitable private practice, full or spare time, as Personal Problem and Vocational Counselors. Send for 3000 word test lesson and Grapho-Analyst

FREE

ADDRESS A. I. G. A. Inc. 120 NOEL, MO.

HOW TO GET A BIG PAY JOB IN Real Estate

Tremendous real estate boom predicted. Big-pay, permanent jobs or your own 6-profit business. Salaries up to \$2,500 to \$10,000 a year in property management, brokerage, appraisal, loans, insurance, building. Many make fortunes selling real estate. Thousands of trained men, women, required yearly by real estate firms, insurance companies, banks, Federal agencies. Rush post-card for 32-page QUIZ BOOK—mailed FREE with full details on new and only 5-volume library, MODERN REAL ESTATE PRACTICE! Lane Books, Dept. B-4, 100 East Ohio St., Chicago 11, Illinois.

Write for FREE BOOK!

RADIO ENGINEERING, Broadcasting, Servicing, Electronics, Aviation, Marine & Police Radio taught thoroughly. 48 weeks' Engineering course equivalent to 3 years' college radio work. Approved Veteran Training. Co-educational. Catalog free.

VALPARAISO TECHNICAL INSTITUTE, Dept. D, Valparaiso, Ind.

Learn Public Speaking

Learn theory and fundamentals at home—in spare time. Then acquire actual experience and practice. Send for FREE booklet "Power of Effective Speech."

North American School, Dept. 1354
1315 S. Michigan Ave., Chicago 5, Illinois

DRAW for MONEY

Be An ARTIST!

Trained Artists Are Capable of Earning \$30 - \$50 - \$75 A WEEK

Use Your Spare Time to Prepare for a Profitable Art Career!

It's pleasant and interesting to study Art the W.S.A. way. COMMERCIAL ART, DESIGNING and CARTOONING—all in ONE complete home study course. No previous Art experience necessary—we teach you step by step—hundreds have profited by our practical method. TWO ART OUTFITS FURNISHED. Full information in colorful, FREE BOOK. "Art for Pleasure & Profit"—tells all about our course, service, what our graduates say—and commercial opportunities for you in Art.

FREE BOOK gives details!

WASHINGTON SCHOOL OF ART
Studio 124C, 1115 15th St., N. W., Wash. 5, D. C.

Send your booklet and full particulars about your course.

Name.....AGE.....
Address.....
City.....Zone (.) State.....

POPULAR MECHANICS

INVENTORS

THESE **FREE BOOKS** HAVE HELPED THOUSANDS TO SUCCESS...

They May Help You!

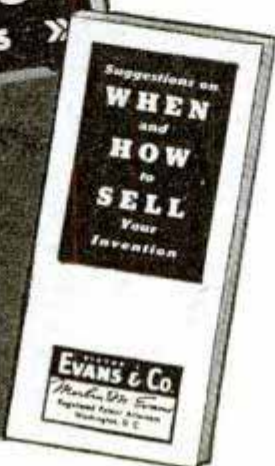
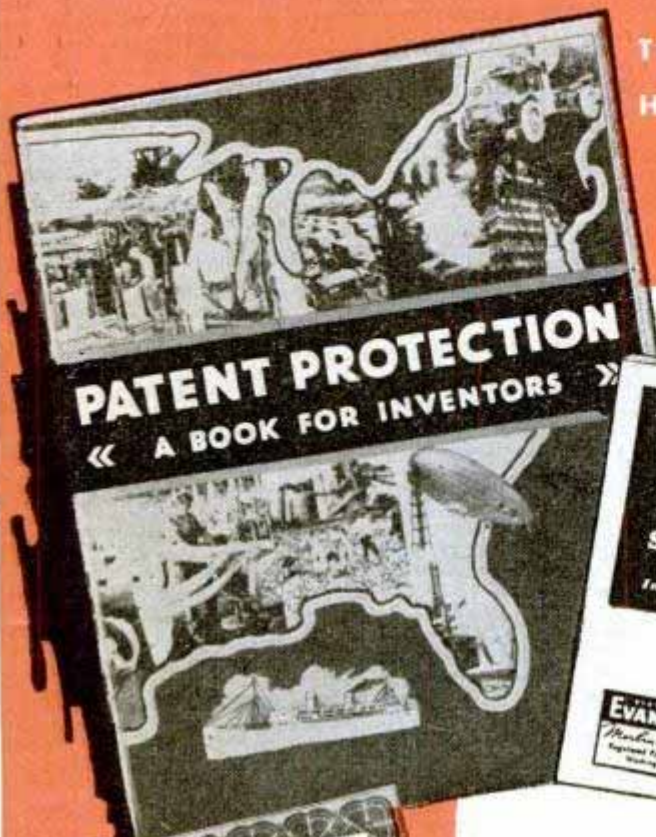

SEND FOR THEM TODAY!

They will help start you in the right direction . . . and the right direction is so important to you and your invention. They tell you what **STEPS YOU MUST TAKE TO SECURE A PATENT** . . . Illustrate 115 fundamental mechanical movements that may help you develop or complete your invention . . . give information on U. S. Patent Laws, royalties, infringements, sale of patents. You'll say that you've never seen 64 pages packed with more facts and information of interest to inventors. They should be authoritative . . . they should be packed . . . they are the results of nearly 50 years' experience in Patent Practice and in helping inventors.

TIME IS PRECIOUS

Sent to you with the two books is an Evidence of Invention form which may help you establish your claim because, attached to your drawing or sketch, it shows the date of your disclosure to us.

ucts, new processes for huge world markets. Inventors are busy . . . some one may be thinking of the same thing you are.

HOW EVANS HELPS INVENTORS

Our experienced staff of Registered Patent Attorneys, searchers, draftsmen and specification writers handle all details for you once you send in a sketch or description with the Evidence of Invention form. Through their knowledge and skill thousands of inventors have secured strong patents . . . that same knowledge and skill will be put to work for you.

WE RECOMMEND THESE TWO STEPS

- 1—GET OUR TWO FREE BOOKS
- 2—RUSH A SKETCH OF YOUR IDEA OR INVENTION to us so that we can make a search and report to you whether or not, in our opinion, your invention is patentable.

ONLY ONE WARNING — Do it today! Manufacturers want new prod-

HERE IT IS...THE COUPON THAT MAY BE YOUR STEPPING STONE TO SUCCESS AS AN INVENTOR, MAIL IT TODAY!

VICTOR J. EVANS & Co.

Merlin M. Evans

REGISTERED PATENT ATTORNEY

Main Office: 130-D Merlin Building
Washington 6, D.C.
Pittsburgh Office: 521-N Empire Building
Los Angeles Office: 738-N Security Building

Rush by return mail. Free copies of your books, "Patent Protection" and "When and How to Sell an Invention"—also important—"Evidence of Invention" form.

Name.....

Address.....

City and State.....



AUTO

BOOKS ON APPROVAL

SEND NO MONEY. Just mail the coupon for a complete set of Six Big Auto Books, 20th Edition. Whether you are a mechanic or helper, expert or apprentice, auto owner or driver, take immediate advantage of this FREE EXAMINATION OFFER.

MAKE GOOD MONEY NOW HOLD A PERMANENT JOB
America wants its automobiles kept in good repair. Men with "know how" are in demand, at big pay. These books will help you get and hold an important job, or give you a chance to go into business for yourself now or later. Any man who half tries to improve himself can learn auto servicing and repairing by this quick reference method. Use the JIPPY INDEX to find easily understood answer to any auto problem. These wonder books prepared by eleven of America's great automobile engineers. Many hundreds of valuable illustrations. Send the coupon TODAY.

[A year's consulting privileges with our engineers now given with these books without extra charge.]
Vocational Publishers Since 1898

CAN YOU FIX IT?
These wonder books tell step by step HOW to make difficult repairs and adjustments, how to keep a car at maximum efficiency, including latest improvements in car design and operation. Engine troubles and how to correct them well covered.

6 BIG VOLUMES
2800 pages, 2000 illustrations, wiring diagrams, etc., including Diesel engines. Beautiful modernistic, washable cloth binding.

AMERICAN TECHNICAL SOCIETY, Dept. A-419
Drexel Ave. at 58th St., Chicago 37, Ill.

I would like to examine your Six-Volume Set of Auto Books. I will pay the delivery charges only, but if I choose I may return them express collect. If after 10 days' use I prefer to keep them, I will send you \$2 and pay the balance at the rate of only \$3 a month until \$24.80 has been paid. Please include consulting service as offered above.

Name

Address

City..... State.....

Please attach a letter stating your age, occupation, employer's name and address, and name and address of at least one business man as a reference. Men in service, also please give home address.

Learn this Profitable Profession



IN 90 DAYS AT HOME
Money-Making Career Open to Men and Women, 18 to 50

Hundreds of men and women between 18 and 50 make \$10 to \$20 in a single day giving scientific Swedish Massage and Hydro-Therapy treatments. There is big demand from doctors, hospitals, sanatoriums and clubs. Graduates earn large full time incomes from these or in private practice in their own offices. Others make good money from home treatments given in spare time. Learn this interesting, money-making profession in your own home, through our home study course. Same instructors as in our nationally known resident school. You can win independence and prepare for future security by qualifying for your Diploma. Course can be completed in 3 to 4 months. Many earn while they learn. Begin your training at once.



Anatomy Charts & Booklet FREE
Enroll now and we will include, at no extra cost, many needed supplies. Fit yourself to help meet growing demand for Scientific Swedish Massage. Send the coupon at once for complete details. Anatomy Charts and 32-Page Illustrated Booklet, FREE, postpaid.

THE COLLEGE OF SWEDISH MASSAGE
Dept. 664-D, 100 East Ohio St., Chicago 11, Illinois
Please send me FREE and postpaid, Anatomy Charts, 32-page Booklet and complete details on Home Training.

Name.....

Address.....

City..... State.....

SAY YOU SAW IT IN POPULAR MECHANICS

MUSIC LESSONS

LEARN . . . PROGRESS . . . EARN MORE . . . \$. . . SUCCEED . . . \$
Your own achievement, popularity, success through music. Learn in your home. Check course: Piano, Violin, Cornet, Saxophone, Clarinet, Guitar, Harmony, Arranging, History. If juvenile, parent's signature must accompany inquiry. Low cost. Easy Terms. FREE catalog. Suite U-354 765 Oakwood Bl. Chicago 15

UNIVERSITY EXTENSION CONSERVATORY

EASY TO LEARN CODE

Learn or increase speed with an Instructograph—the Code Teacher that takes the place of an operator-instructor and enables anyone to master code without further assistance. Available tapes from beginners alphabet to typical messages on all subjects. Speed range 5 to 40 WPM. Always ready—no QRM. Thousands have "acquired the code" with the Instructograph System. Write today for convenient rental and purchase plans.

INSTRUCTOGRAPH COMPANY
4713 Sheridan Road, Chicago 40, Illinois

LEARN MEAT CUTTING

At Home—In Spare Time

Get into the vital meat industry. Concise, practical Home Training based on 25 years proven instruction methods used at National's famous resident school. Prepares you for bigger pay as Meat Cutter, Supervisor, market manager or more money in your own store. Go as rapidly as your spare time permits. Diploma. Start NOW to turn your spare hours into money. Send for FREE bulletin today. No obligation.

National School of Meat Cutting, Inc., Dept. U-68, Toledo 4, Ohio

MAGIC LIQUID

Prints Photos

On Wood, Leather, Cloth, Cards Letterheads or almost any surface. Use any snapshot or other negative. Make hundreds of prints without burning negative. Won't wash off. Easy to use. Complete kit for 100 or more photos now only \$1.00 postpaid, or \$1.29 C.O.D. (Canada \$1.50 money order only; no C.O.D.'s). Satisfaction positively guaranteed. Rush order today for the original, big, complete Magic Photo Printing Outfit.
L. & M. MFG. CO.
Dept. 390-I, 229 W. Breckinridge, Louisville 8, Ky.

FLIGHT JACKET INSIGNIA

With your own first name **50¢** each
Come and get 'em, only... Postpaid

Dress up your sweater, blouse, or lumber jacket and look just like the men that fly our big bombers. Indicate selection by number and print carefully your first name, or your nick name. Mail with 50¢ today. Agents Make Money—Take orders. Sell for \$1.00. Illustrated book of all Army Insignia Emblems only 25¢.

INSIGNIA MART
703 Broadway, Dept. P, New York 3, N.Y.

WONDERFUL INVENTION—Corrects poor penmanship in few hours. Guaranteed. No failures. Increases prestige. Helps one get better job. Write Ozmment, 34, St. Louis, Mo.

ARTISTS MAKE MONEY

Do you like to draw? Send name, address, age and occupation for **FREE ART TEST**, to find out your ability.

ART INSTRUCTION, Inc.
4136 ART INSTRUCTION BLDG., MINNEAPOLIS 15, MINN.

Learn BAKING At Home

Baking is one of America's high industries in wages. Nearly depression-proof. Thorough basic home course lays sound foundation. If you have aptitude, write for **FREE BOOKLET**, "Opportunities in Commercial Baking."

National Baking School, 1315 Mich. Ave., Dept. 1354, Chicago 5

INVENTORS

WITH GOOD INVENTIONS

Should write us without delay for **FREE BOOKLET**, Protective Disclosure Form and facts about The Inventor's Most Logical Markets. Patented, Unpatented inventions, all kinds, Cash, Royalty, needed by specific manufacturers. If your invention is for sale, write today for full particulars. A Post-Card will do! Address:

THE INVENTION REPORTER
5C-11106 South Longwood Drive Chicago 43, Illinois

AVIATION *Career*

MAXIMUM TRAINING IN MINIMUM TIME

**CAL-AERO TECH. TRAINING will ADD DOLLARS
to YOUR pay check all the rest of YOUR life!**

Your future EARNINGS depend upon your *training*. A wise investor always determines in advance what the return on his investment will be before he puts cash "on the line." You who plan to invest in a course of training, for a future career, **MUST** do the same. It is even more important to you, because your choice of training will determine **HOW MUCH MONEY YOU WILL MAKE THE REST OF YOUR LIFE**. Specializing in *Aeronautical Engineering* and *Master Aviation Mechanics* since 1929, Cal-Aero Technical Institute training is carefully designed to do just **ONE THING—MAKE MORE MONEY FOR YOU**. An alumni of over 6000 proves that **CAL-AERO TECHNICAL TRAINING** can get results and increase your pay check. **CAL-AERO** has provided its graduates with a profitable occupation, and secure future since it trained them in advance for the highest position they could ever expect to occupy. **IT CAN DO THE SAME FOR YOU.**

We invite your consideration, investigation and comparison. Send coupon TODAY.

VETERANS

Train in Sunny Southern California. Cal-Aero Technical Institute is on the list of approved schools on file with the Veterans' Administration, making discharged servicemen attending Cal-Aero eligible for the educational benefits, as provided under the "G. I. Bill of Rights."

Write us—we will be happy to help you with your future plans. Many ex-servicemen are now enrolling and taking advantage of these benefits here at Cal-Aero.

CAL - TECHNICAL  **AERO INSTITUTE**
MAJOR C. C. MOSELEY PRES. SINCE 1929
FORMERLY CURTISS-WRIGHT TECHNICAL INSTITUTE

**GRAND CENTRAL AIR TERMINAL
GLENDALE 1, CALIFORNIA
LOS ANGELES COUNTY**

"DON'T MISS THE BOAT" — MAIL THIS COUPON TODAY!

Cal-Aero Technical Institute, Grand Central Airport, Glendale 1, California
Please send full information and illustrated catalog on Aviation Training
FREE—without obligation. Dept. PM-4.

NAME _____ BIRTH DATE _____

STREET _____

CITY _____ STATE _____

I PLAN TO ENROLL—Month _____ Year _____

AVIATION'S MOST DISTINGUISHED SCHOOL OF AERONAUTICS

No Waiting to LEARN

Start at Once to EARN!

This BIG BOOK SHOWS HOW

If it's Results you want, you can get action quickly with this practical book.

Never before has a more helpful book been printed for those planning a business of their own. Gathered in this large illustrated volume are the formulas, recipes, facts and secrets that have contributed so largely to America's great industrial progress. Capitalize on this information for making most any conceivable product without experience, special equipment or previous knowledge of chemistry. Start at home, expand with profits—build for a profitable independence. The experts who compiled this book are authorities, and present this information in simple, understandable language. They also give you wholesale supply sources for needed material, short cuts and economy methods for the most profitable results. Hundreds of good paying businesses have been built on a product made from a simple recipe. Opportunities in this field exist everywhere. Choose from any of the 162,000 facts and 10,000 formulas of which the following are only a very few: Adhesives, Alloys, Anti-Freeze Solutions, Cosmetics, Beverages and Liquors, Candy, Gum, Casein, Celluloid, Ceramics, Cheese, Cleaning Preparations, Concrete, Copper, Cotton, Dentifrices, Depilatories, Dyes, Embalming Fluids, Enameling, Glass, Glazes, Household Formulas, Inks, Insecticides, Iron, Jewelers' Formulas, Lacquers, Laundry Preparations, Leather, Linoleum, Lubricants, Manicure Preparations, Marble (artificial), Metals, Mirrors, Oils, Ointments, Paints, Paper, Perfumes, Photography, Polishes, Powders, Remedies for Man, Beast or Fowl, Rubber Products, Refrigerants, Soaps, Solder and Soldering, Tooth Cements, Transfers, Transparent Varnishes and Thousands of others for making all sorts of profitable and practical things.

10,000 FORMULAS, RECIPES SECRET PROFIT IDEAS

924 Illustrated Big Pages



Cloth Bound Size 5 1/2" x 8 1/2" x 2 1/4"

Prepare for "After-War-Business"

Especially recommended for ex-Servicemen and ex-War Workers planning a profitable business of their own. This comprehensive book is an accepted authority by chemists, schools, industry, etc. and is the largest and most comprehensive book of its kind ever issued. Nothing else like it in existence. A single formula has been worth a thousand times this book's small cost to countless owners. Crammed with money-making ideas, invaluable for reference. Ideal for Factory, Home, Farm, Office or Workshop. As necessary as the dictionary and more useful for manufacturers, chemists and salesmen who put up products for profit.

This Complete Book Only \$2.98 POST PAID

Worth More

ALSO INCLUDED! Formulas for "D.D.T." insecticide. Also our New Book of Money Making Facts: "The More You Know the More You Can Earn—Easier and Quicker." Ambitious Folks! Profit by this valuable information.

Immediate Shipment—Safe Delivery Guaranteed. \$2.98 postpaid, Canada or Foreign, \$3.25 U. S. Funds. (C.O.D. shipments U. S. A. only.) **ADAMS BROWN COMPANY Books of Applied Science Dept. 304, Chestnut Hill 67, Massachusetts, U. S. A.**

JUST OUT! NEW FROM COVER TO COVER

AUDELS REFRIGERATION and AIR CONDITIONING GUIDE

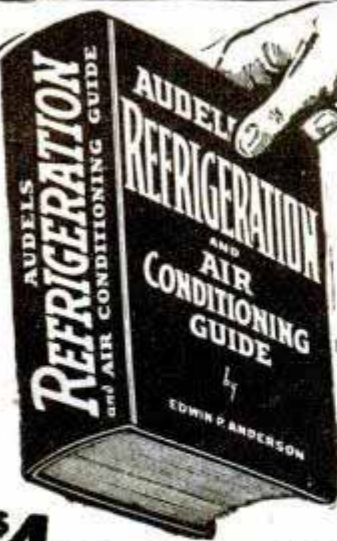

4 Books in One! Covering:

- Basic principles, Servicing, Operation, Repair of
- 1—Household Refrigeration
- 2—Special Refrigeration Units
- 3—Commercial & Industrial Refrigeration
- 4—Air Conditioning Systems

A gold mine of essential important facts for ENGINEERS, SERVICEMEN & USERS. A Good Book is a Good Friend! Here you have at your fingers' ends a Complete Library in ONE VOLUME, the necessary data you have been looking for on: MODERN UNITS, SYSTEMS & MACHINES, REFRIGERANTS, including Freon, Lockers, Water Coolers, Quick Freezing & Air Conditioning Systems. 1280 Pages, 46 chapters all Fully Illustrated & Indexed for Ready Reference.

ANSWERS YOUR QUESTIONS Get This Information for Yourself. Mail Coupon Today. No Obligation Unless Satisfied. ASK TO SEE IT.

\$4 COMPLETE • PAY ONLY \$1. A MONTH

AUDEL, Publishers, 49 W. 23rd St., New York 10, N.Y. MAIL AUDELS NEW REFRIGERATION GUIDE for free examination. If O. K. I will send you \$1 in 7 days; then remit \$1 monthly until price of \$4 is paid. Otherwise I will return it.

Name _____
 Address _____
 Occupation _____
 Employed by _____ PM

BIG MONEY NOW IN LIQUID MARBLE

THREE wonderful new opportunities for your own big money-making business—regardless of your age, sex, or previous experience!

- 1. LIQUID MARBLE.** Make beautiful artificial Marble Slabs. Pour from liquid state. Glazed or unglazed. This marble may be mottled, veined, multi-colored or left in original snow-white state. The color is actually a part of the marble! Does not fade or wear away. Liquid Marble is unsurpassed on kitchen or bathroom walls. Easy to make and install.
- 2. PLASTIC FLOORING.** May be made in any color or combination of colors. Gives a lifetime of wear. Dustproof, Soundproof, Verminproof. Resilient to the tread. Lay out solid from wall to wall or in pattern design of various shaped blocks.
- 3. FLEXIBLE MOLDS.** For plaster casting. Make your own moulds for few cents each. \$1.00 in raw materials will make up to \$25.00 worth of finished goods. We furnish names of buyers. Write now for FREE information about our BIG THREE money-making opportunities! Get in on busy season just starting. Send penny postcard or letter. No obligation.

COMPO-TEX, Box 786-5G, ST. LOUIS 1, MO.

3 NEW CRAFT BOOKS

Make every stroke with authority; every tooling with adroitness; every carving with competence. These instructive books by experts tell how. All the tricks, all the short cuts, graphically illustrated. \$1.00 each postpaid

HOUSE OF LITTLE BOOKS
 80 E. 11th St., New York 3, N. Y.

Get Started in Radio TEN "HOW-TO-DO-IT" BOOKS

Get a solid foundation in radio by means of these 10 timely text books. Each clearly written, profusely illustrated, contains over 15,000 words. You'll be amazed at the wealth of information packed into these handy books. Excellent for reference—ideal for technical library. Your money back if not satisfied.

5 Books for 50c - 10 Books for \$1 SENT TO YOU POSTPAID

- | | |
|---|-------------------------------------|
| No. 1—How To Make Four Doerle Short Wave Sets | No. 4—All About Aerials |
| No. 2—How To Make The Most Popular All-Wave 1 and 2 Tube Receivers | No. 5—Beginners' Radio Dictionary |
| No. 3—Alternating Current for Beginners | No. 6—How To Have Fun With Radio |
| Remit by check or money order—register letter if you send cash or stamps. | No. 7—How To Read Radio Diagrams |
| RADIO PUBLICATIONS, 23A West Broadway, New York (7) | No. 8—Radio for Beginners |
| | No. 9—Simple Electrical Experiments |
| | No. 10—Television |

Good Handwriting HELPS YOU WIN SUCCESS!

It's so important to write a good hand for business and social advancement. Poor illegible penmanship often causes costly errors and marks you for failure. Why write a poor hand? It's so easy to learn at home in spare time. Write for our new free booklet today. If you wish, send 10c for a penpoint suitable for shaded writing and your name beautifully written.

THE TAMBLYN SCHOOL OF PENMANSHIP
 In Business Since 1895 H-441 Ridge Bldg., Kansas City, Mo., U. S. A.

Thrilling Work COLORING PHOTOS

Fascinating vocation learned at home by those with aptitude. Thrilling pastime. National method brings out life-like colors. Free booklet.

EASY TO LEARN NATIONAL PHOTO COLORING SCHOOL
 1315 S. Michigan, Dept. 1354, Chicago 5

TRAIN Your VOICE!

Results GUARANTEED

We build, strengthen the vocal organs—not with singing lessons—but by sound, scientifically correct silent and vocal exercises and absolutely guarantee complete satisfaction with results. Write for Voice Book, FREE. Sent to no one under 17 years old unless signed by parent.

Perfect Voice Studios, Studio 1354, Kimball Hall Bldg., Chicago 4, Ill.

NOTICE: Over 125,000 ambitious men have been helped to higher paying jobs with the aid of books listed on this page.



Which of these books can help you GET A BETTER JOB AND MAKE MORE MONEY

Here's how to beat job competition and insure yourself of a prosperous future. Gateway Books help you tackle those tough jobs you've always had your eye on... because they show you how to do the HARDEST jobs the EASIEST way in LESS time. Gateway Books are written by men who are experts in their particular field... men who have worked themselves up the hard way. Now you can take advantage of their knowledge the easy GATEWAY way.

Our Money Back Guarantee and Special offer appear elsewhere on this page. Study this list of popular books now.

Order From This List

PAINTING

1. **HANDBOOK OF ORNAMENT.** For artists, designers, jewelers, architects, etc. Topics covered include: Elements of Decoration, Decorated Objects, and Ornaments as applied to Features. 3,000 illus., 548 pages.....\$5.00
2. **INTERIOR WALL DECORATION.** Practical working methods for plain and decorative wall finishes. 185 illus., 491 pages.....\$3.00
3. **THE MIXING OF COLORS and PAINTS.** How to mix colors for interior decorating, arts, crafts, general mixing methods. 302 pages, fully illust.\$2.50
4. **CYCLOPEDIA of PAINTING and DECORATING.** Covers methods, tools and materials for the home and workshop, including every branch of painting and decorating. Any particular job is fully explained with large illustrations to clarify text. 350 pages.....\$3.50
5. **PAPER HANGING.** A practical book that shows you how to do your own papering and save many times the cost of this book. Plenty of illustrations. Over 200 pages.....\$2.50
6. **FURNITURE, FURNITURE FINISHING, DECORATION and PATCHING.** Practical new book that covers Period Furniture, Furniture Decoration, Patching, Finishing and many special finishes. 580 pages, 360 illust.\$5.00

WOODWORKING

7. **CARPENTRY CRAFT PROBLEMS.** 320 pages explain and illustrate hundreds of practical solutions to all types of carpentry problems met by the amateur and professional woodworker. Complete in every detail....\$2.50
8. **BUILDING—FORMS, STAIRS, ROOFS.** Latest information on how to build forms, staircases, roofs, etc., correctly. For carpenters and their helpers. 250 pages, illus.....\$2.50
9. **WOODEN BOAT and SHIP BUILDING.** Solves every type of problem in building wooden boats and ships. 244 pp., illust.....\$2.25
10. **HOW TO MAKE RUSTIC FURNITURE.** Hundreds of ideas and plans on making all types of rustic furniture for the home. Completely illust., thoroughly described.....\$2.00
11. **WOOD TURNING.** An excellent book for every home craftsman. Tells and shows how to do the most artistic work. Numerous photos and many detailed drawings.....\$2.50
12. **MODERN HOMECRAFT.** 240 pages of ideas for modern home furniture and how to make it. Scale drawings, fully illust....\$3.50
13. **BLUE PRINT READING.** A practical book that shows how to read and interpret blue prints. 111 pages, 69 illust.....\$1.50

Guarantee

Gateway Books are guaranteed to be absolutely satisfactory in every respect, or your money will be cheerfully refunded. **The GATEWAY BOOK CO., Dept. PM-16 32 N. State — Chicago 2, Illinois**

14. **CONCRETE DESIGN and CONSTRUCTION.** 508 pages, 251 illust. A new and enlarged edition covering all phases of concrete work and how to do it.....\$4.75
15. **HOME REMODELING.** An excellent book for those planning remodeling. Gives hundreds of ideas that save money and add beauty to the finished job. 528 pages, 319 illust. and 12 tables.\$5.00
16. **HOW TO PLAN A HOUSE.** Here's a book for every person who ever intends to build their own home. This book shows how to design every single part of a modern house to save you the most money. 525 pages, 8 full size blueprints.\$5.00

REFRIGERATION - PLUMBING AIR CONDITIONING

17. **REFRIGERATION SERVICE MANUAL.** Domestic and Commercial refrigeration used in markets, milk depots, soda fountains, home refrigerators are all covered so you can service any of these and many other units easily.\$2.50
18. **PLUMBING INSTALLATION and REPAIR.** Practical 236 page book tells how to repair leaky faucets, clogged toilets, drains, pipes, traps, vents etc. 153 illust.....\$2.50
19. **HEATING COOLING and AIR CONDITIONING.** 706 pages on heating of all types, cooling, Air Conditioning, equipment, furnaces, controls, etc. 64 charts, 351 illus.\$4.50

HOBBIES

20. **TIN CAN PROJECTS.** Tells how to turn tin cans into objects of beauty that command high prices and praise. This handy book has all the working patterns and designs....\$1.50
21. **LEATHER WORKING.** Tells of tools, materials and equipment needed. Gives working drawings of key holders, billfolds, book marks, coin purses, belts, frames, etc....\$2.00
22. **HOW TO WHITTLE and CARVE.** Complete directions for all types of whittling and carving of toys, jewelry, and novelties, etc. Illustrations simplify the work.....\$2.75
23. **CREATIVE CRATE CRAFT.** Tells how to make clever and useful pieces of furniture from discarded crates and boxes.....\$2.00
24. **IDEAS FOR THE YARD.** Novel book that gives hundreds of suggestions and plans for things you can make for your yard....\$1.50

SPORTS

25. **TAXIDERM Y MADE EASY.** A handy book that brings this fascinating hobby within the reach of every sportsman. Explains tools, materials and methods. Profusely illus. \$2.50
26. **THE AMERICAN RIFLE.** A basic book on the rifle and its use for hunting and target shooting. Includes practical information on guns and equipment. Illust.....\$3.00
27. **PISTOL and REVOLVER.** Detailed information on the care of, types, accessories and uses of handguns. Regional shoots described\$3.50
28. **SAILING CRAFT.** One of the most complete works ever printed on sailing and racing. All types of boats are discussed and illustrated. Over 400 illustrations, nearly 800 pages, size 7 1/2 x 10. Original cost was \$12.00. Now it's yours for.....\$5.00
29. **SMALL BOAT BUILDING.** An excellent handbook giving specific information on small boat building. Many boats fully described with large line drawings and working blueprints. Now... build your own boat. \$3.00

METAL WORKING

30. **WELDING.** Arc, spot, butt and electric welding, etc. 280 pages, illust.....\$2.00
31. **SHEET METAL WORKERS MANUAL.** Complete instructions and information on every phase of sheet metal working. Includes many tables. 552 pages, 375 illust.....\$3.00
32. **METAL SPINNING.** A new art of proven popularity. Step-by-step descriptions of the various phases of the craft show you how to make the most out of your metal work...\$1.75
33. **METAL SPINNING PROJECTS.** Tells how to make bowls, lamps, serving dishes, book ends, candle sticks, etc. Complete working patterns and instructions.....\$2.75

ELECTRICITY

34. **PRACTICAL ELECTRICITY and HOUSE WIRING.** An ideal book for around the home because it debunks all the mysteries of electricity and shows you how you can save plenty by doing all of your own wiring...\$2.00
35. **ARMATURE and MAGNET WINDING.** The construction of armatures and their repairs are fully covered with illust....\$2.00

CHECK, CLIP AND MAIL THIS COUPON NOW

THE GATEWAY BOOK CO., 32 N. State St., Dept. PM-16, Chicago 2, Illinois
O.K. Send the books I've circled. If C.O.D., I'll pay postman cost of books plus a few cents postage and handling charge. If prepaid, Gateway pays all shipping charges. If any book is not entirely satisfactory, I will return it in 10 days and you will refund my money. No C.O.D.'s outside the U. S.

1 2 3 4 5 6 7 8 9 10 11 12 13 14 15 16 17 18
19 20 21 22 23 24 25 26 27 28 29 30 31 32 33 34 35
(Please print name clearly)

Name.....

Address.....

City.....Zone.....State.....



For Men Who are Trained in AUTO BODY & FENDER WORK

Men 18 to 60. Want a future with good pay, perhaps a business of your own later? If you are mechanically inclined, start now to learn to become an auto body mechanic and fender repair man. This fast growing field has great possibilities for trained men with experience. U. E. I. spare time, home-study training combined with actual shop practice gives you sound, basic knowledge of latest, best methods so you may get the experience which may bring you big pay. Capable instructors supervise your studies and actual practice on automobiles. Course includes acetylene welding, spray painting, use of hand and power tools.

THOROUGH, RELIABLE TRAINING

U. E. I. has trained men for new opportunity fields since 1927 and many students are now making good. Auto body and fender repairing is one of the best profit-makers in any garage or service station. Little capital required for mechanically inclined men to get into this business. Free employment placement service, or we will show you how to start your own shop. Get the facts FREE, without obligation. Write today

UTILITIES ENGINEERING INSTITUTE

AUTO-CRAFTS DIVISION
1314 Belden Avenue, Dept. 146X Chicago 14, Ill.

Gentlemen:—YES! I want to get into profitable Auto Body and Fender Repair Work. Please send me FREE FACTS at once. This inquiry does not obligate me in any way.

Name _____ Age _____
Address _____
City _____ Zone _____ State _____

Learn How to Repair ELECTRICAL APPLIANCES

Nearly 3,000,000 additional American homes have been wired for electricity since 1940 . . . making the opportunity and demand for service mechanics in this field the greatest in history. Our practical, easy-to-learn home course teaches you, during your spare time, how to repair washing machines, vacuum cleaners, stoves, lamps, motors, irons, etc., and to do house wiring. Learn how to—

OPEN YOUR OWN REPAIR SHOP

Have a Secure, Permanent Future

WITH A BUSINESS OF YOUR OWN

You won't lose your job if another big depression comes along when you have your own shop. You can start a business of your own in your garage or basement with \$20.00 worth of tools. One good repair job can pay for the cost of the entire course. Write today for further information, without obligation.

USE
COUPON
BELOW

SEND FOR FREE BOOKLET TODAY!

Pacific Training School

7217 So. Broadway, Dept. P-4, Los Angeles 3, Calif.

Dear Sirs: Please send me, without obligation, your free catalog and full details.

Name.....
Address.....
City..... State.....

LET US TEACH YOU TO Mount Birds



Animals, Fish, Heads; to TAN. Hunters, Trappers, be a Taxidermist. Let this old reliable school teach you—at home, in spare time. Our school has over 300,000 students. Save your fine trophies. Mount and keep ducks, deer, ALL wild-game. Tan skins, make robes and rugs, double your interest in HUNTING

AND FISHING. Have a home museum.

Free Book

Yes, FREE, this great strange book, with 100 fine wild-game pictures. Tells how YOU can become a real TAXIDERMIST, easily and quickly. It is amazing, thrilling, and may bring you a lifetime of PLEASURE and PROFIT. SPORTSMEN, grasp this opportunity. SEND NOW. A postal will do. But WRITE TODAY—don't fail. State your age.

N. W. SCHOOL OF TAXIDERMISTRY
DEPT. 3374 OMAHA 2, NEBR., U. S. A.



TRI-STATE COLLEGE

B. S. Degree in 27 Months



Distinguished for technical 2 1/2-year courses in Civil, Electrical, Mechanical, Chemical, Radio, Aeronautical Engineering; Business Administration, Accounting, and Secretarial Science.

VETERANS can complete work here in shortest possible time. Special Prep. Dep't. Also REFRESHER COURSES. 36-Week Courses in Surveying, Drafting. Low tuition. Low living costs. Cosmopolitan student body. 63rd year. Enter Sept., March, June, Jan. Catalog. 446 College Ave. ANGOLA, INDIANA

IMPROVE YOUR PLAYING



PIANISTS—Send for FREE Booklet showing how you may greatly improve your technique, accuracy, memorizing, sightreading and playing thru Mental-Muscular Coordination. Quick results. Practice effort minimized. Used by famous pianists, organists, teachers and students. No obligation.

BROADWELL STUDIOS, Dept. 156D, Covina, Calif.

LAW

STUDY AT HOME for PERSONAL SUCCESS and LARGER EARNINGS. 35 years expert instruction—over 108,000 students enrolled. LL.B Degree awarded. All texts furnished. Easy payments. Send for FREE BOOK—"Law and Executive Guidance."

AMERICAN EXTENSION SCHOOL OF LAW
Dept. 64-M, 646 N. Michigan Ave., Chicago 11, Ill.



NEW OTTAWA Wood Saw

FOR TRACTORS Makes wood sawing fast; easy. Cuts enough wood to pay for itself quickly. Easily moved while attached. Big blade; send for FREE details. LOW PRICE OTTAWA MFG. CO., W427 Oak Ave., Ottawa, Kans.

YOU CAN ADVANCE IN PLASTICS!

Plastics can be the next great industry . . . expanding as swiftly and largely as the automotive, radio and aviation businesses. Already, it is an important industry and a growing one. With I. C. S. training, you can take advantage of the many opportunities in Plastics today. At the same time, you prepare for the vast possibilities of tomorrow. Write for the free booklet containing full information! Do it right now!

INTERNATIONAL CORRESPONDENCE SCHOOLS BOX 5577-K, SCRANTON 9, PENNA.

Send me full information on the following subject:

Name..... Age.....
Home Address.....
City..... State.....
Present Working Position..... Hours..... A.M. to..... P.M.

GET INTO RADIO ELECTRONICS & TELEVISION NOW!

Hundreds of Industries Need Radio and Television Men Now and for Great Future Demands

The man trained in electronics is wanted not only in Radio and Television, but in Aviation, Transportation, Communications, ... in the designing, engineering and operation of hundreds of industries today and for years to come. Learn how great the field is for YOU... How you may GET INTO BUSINESS FOR YOURSELF. Mail the coupon now.



Send for **FREE Lesson** and Prove to Yourself How Quick and Easy You Get Ahead in Radio by the **NEW**

SHOP METHOD HOME TRAINING OF THIS GREAT, ESTABLISHED RESIDENT SCHOOL



Learn by Doing!
Use real Radio Equipment Furnished with your Course

Experience is the best teacher and you learn by experience with the National Shop Method of Home Training. You build a long distance, high fidelity, superheterodyne receiver—build many other circuits and conduct experiments with the big kits of standard radio parts included with your training at no extra cost.

Here is the kind of training that gives you a first hand knowledge advanced and approved means and methods. Not only do you understand the basic principles of the industry but you become expert with practical experience.

Send the coupon for detailed information on all the different departments of this course of training.

CHOOSE YOUR FUTURE

1. Radio is a \$6-billion business. Radar, just starting, already does \$2-billion a year.
2. Thousands of men needed for stations and communication companies—for operation and maintenance.
3. Half million jobs in Television right at start is the opinion of industrial leaders.
4. Limitless future in Electronics—in the home and industry.

Get ready for Television and FM. Get your share of the Radio Service Business. Take your place in industry as an Electronics expert. Here is a sensationally improved way for you to get the right training. Study in spare time—odd hours, even minutes—and have the advantage of actual shop experience behind you.

This exclusive shop method of home training comes to you right from one of the world's greatest vocational educational centers—the resident training shops and experimental laboratories of the great NATIONAL SCHOOLS. It is sound, based on the actual experience of qualified instructors, engineers and technicians—men who are right in the industry.

National Schools has been training men for higher pay and greater opportunity for more than a third of a century. Fill out and mail the coupon below for details.

Shop Method Training Wins Good Jobs



"My latest offer was \$5,800.00 as Radio Photo Engineer... but I'm doing well where I am now engaged. I am deeply indebted to National."—Joseph Grumich, Lake Hiawatha, New Jersey.

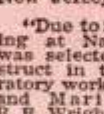

"Due to my training at National I was selected to instruct in the laboratory work of Navy and Marines."—R. R. Wright, Blackfoot, Idaho.



"I believe National offers the best course to be had... Keep up the good work."—O. K. Ivey, Washington, D. C.

Read what hundreds of other enthusiastic students have written about National Training. Send in your coupon today.

Grasp This Opportunity

Experts agree that Radio, Electronics and Television is right at the start of the greatest boom in history. Right now is the time to prepare yourself for **BIG SUCCESS** and **LIFETIME SECURITY**. Take part in the great expansion. The field is wide open.

You need no previous experience—no electrical or mechanical knowledge. National Shop Method Home Training is complete in itself—up-to-date.

Make use of your free time NOW to build yourself a great future. See how quickly you progress—how easy it is to get a firm, practical understanding of Electronics in all branches.

See for Yourself

Take the first step now. Fill out, and mail the coupon below. Be among the first to get into the big money—to win a position of importance—to have a **BUSINESS OF YOUR OWN**.

The industry is crying for trained men everywhere. It holds out rich rewards—a prosperous future. Well trained men **ONLY** are wanted.

Examine the National Shop Method of Home Training carefully in the quiet of your own

home. Make up your own mind. No salesman from National will call on you. Fill out and mail the coupon today.

GET THESE 2 BIG BOOKS FREE!

Learn for yourself just how easy this SHOP METHOD HOME TRAINING gives you the practical, down-to-earth experience you can never get from theory alone.

NATIONAL SCHOOLS

LOS ANGELES 37, CALIFORNIA EST. 1905

MAIL OPPORTUNITY COUPON FOR QUICK ACTION

National Schools, dept. PM-4
4000 South Figueroa Street,
Los Angeles 37, California

(Mail this in an envelope or paste on a postcard.)

Send me **FREE** the two books mentioned in your ad including a sample lesson of your course. I understand no salesman will call on me.

NAME AGE

ADDRESS

CITY STATE

Include your zone number

FREE

Send for it
NOW



New 1946 Radio Parts
and Equipment

CATALOG

SERVICEMEN! Dealers! Soundmen! Amateurs! Builders! Here's your handiest, most complete 1946 Buying Guide for Everything in Radio! Features latest sets, parts, equipment of nationally known quality at lowest prices. Assures fastest service from world's largest and most complete stocks under one roof. Expert staff ready to help you.



**NEW RADIO SETS
COMPLETE SOUND SYSTEMS
LATEST HAM GEAR
ALL SERVICE EQUIPMENT
BUILDER'S SUPPLIES
RADIO BOOKS**



OVER 10,000 ITEMS

Everything for every radio use. New model radio sets, phonoradios, recorders, communication receivers, Ham kits, code apparatus, parts, tubes, tools, test instruments, public address equipment and accessories, low-cost easy-to-build kits, diagrams, matched parts lists, leading technical and non-technical books—at lowest prices.



ALLIED RADIO

ALLIED RADIO CORP.
833 W. Jackson Blvd., Dept. 5-D-6
Chicago 7, Illinois

Date.....

Rush new FREE 1946 CATALOG

Name.....

Address.....

City.....Zone.....State.....

Say you saw it in Popular Mechanics!

STUDY AT HOME

With An Educational Institution

Men with specialized training win higher positions, insure larger earnings, and are bigger successes in business and public life. Opportunities NOW greater than ever before. Send for our Catalog.

ARTS and SCIENCES

Courses in Philosophy; Education; Letters; Public Health; Medical Jurisprudence; Psychology; Sociology; Physics; Chemistry; Plastics; Geology; Political Science; Theology; Business and Commerce; Accounting; Mathematics; Statistics; Agriculture.

ENGINEERING

Courses in Electrical, Civil, Mechanical, Drafting, Architectural, Steam, Aeronautical, Radio, Structural, Mining, Industrial, Petroleum, Marine, Chemical, Diesel, Automobile, Refrigeration, and Air Conditioning Engineering.

LAW

Complete Professional Law Course includes 20 Hornbook Series college grade textbooks. Courses also in Commercial Law, Patent Law and Medical Jurisprudence.
McKinley-Roosevelt Incorporated, 4610-K, Sheridan Rd., Chicago 40, Ill.

ENGINEERING DEGREE IN 27 MONTHS

**INDIANA
TECHNICAL
COLLEGE**

Aeronautical, Chemical, Civil, Electrical, Mechanical, and Radio Courses. B.S. degree. 1-yr. diploma in Electrical, Mechanical, and Radio Service; Drafting. Prep. courses. Gov't. approved for G.I.'s. Low rate. Earn board. Large industrial center. Demand for graduates. Enter June, Sept., Dec., March. Catalogue. 546 E. Washington Blvd., Ft. Wayne 3, Ind.

Your Future
in
PHOTOGRAPHY



Nationwide opportunities, sound future waiting. Photographers needed by studios, newspapers, advertisers, in business, industry, science. Qualify through success-proved home study courses. Also resident instruction. FREE catalog gives details. **N. Y. INSTITUTE OF PHOTOGRAPHY**, Dept. 49, 10 W. 33 St., New York 1, N. Y.

Get into the Right Occupation!

Success and happiness depend upon doing that work at which you can apply, to best advantage, your particular talents, abilities, and interests. The Crux Analysis helps you determine the field of vocation for which you are best fitted, and also presents constructive suggestions for increasing your personal effectiveness. Write for free particulars.

THE CRUX ANALYSIS

Box 145, Capital Hill Sta.

Denver 6, Colo.

PEPSI-COLA HITS THE SPOT

LEARN MASTER MACHINIST - MECHANICAL DRAFTING

Expert training on Lathes, Milling Machines, Shapers, Grinders, etc. Allied shops are completely equipped and modern. Approved for G. I. Training. Days, Evenings.

ALLIED SCHOOL OF MECHANICAL TRADES
1330 South Michigan Avenue • Chicago 5, Illinois

MAKE MONEY AT HOME

RUBBER MOLDS Low as 6¢ EA.



Amazing rubber mold-making outfit makes perfect flexible molds of plaques, ash trays, bookends, etc. Molds cost 6c to 25c each. Each mold makes hundreds of novelties and gifts to sell for \$1.00 apiece and more! No experience necessary. Everything furnished. Quick and easy. Start profitable business in your home—sell to stores, gift shops, friends, resorts, road stands, by mail. Full or spare time. Write for complete FREE details and easy instructions.

SO-LO WORKS, Inc., Dept. E-800, Loveland, Ohio

POPULAR MECHANICS

GET THIS NEW BOOK FREE

Just for
Examining this
New 1946 Electrical
**TROUBLE
SHOOTING
MANUAL**

COYNE
ELECTRICAL and RADIO
**TROUBLE SHOOTING
MANUAL**

500 SHOP PRINTS and MOTOR DIAGRAMS
with Detailed Instructions on
HOW TO READ AND USE THEM
COVERS ALL WIRE & MOTOR - UNWINDERS - CHANGE
WINDING - REPAIRING - ALL ELECTRICAL - ALL
WIRING - TESTS - TROUBLE - TROUBLE
HOW TO USE BY YOUR OWNERS
ELECTRICAL and RADIO SHOPPING
STARTING AND RADIO PLANS
Published by COYNE ELECTRICAL SCHOOL, CHICAGO

Sensational new 612-page "Coyne Electrical and Radio Trouble Shooting Manual". 500 shop prints and "how to use them"—plus many other practical features—all in one giant 8½" x 11" handsomely bound volume. New time saving, easy-to-follow methods of shooting trouble. Includes D. C. and A. C. Motors, Armatures, Switchboards, Electronic Controls, Radio Receivers; Auto Ignition, Refrigeration and Air Conditioning, etc. Most amazing book of its kind ever published. You get it FREE for 10 day trial *plus* the new book "Starting and Operating a Profitable Electrical or Radio Shop" as our outright gift to you. Rush coupon today for this amazing offer.

... FREE with TROUBLE SHOOTING MANUAL

Act now and I'll include 1 full year of personal counsel from the Coyne Staff—technical advice by mail on any Electrical or Radio problem. A real help in your daily work.

ALSO FREE: 1 year subscription to Coyne Technical News—latest facts on Electrical and Radio Progress, illustrated and explained.

COYNE H. C. LEWIS, President
ELECTRICAL SCHOOL
500 S. Paulina Street, Dept. 46-R6, Chicago 12, Ill.

**JUST OFF
THE PRESS**

Starting and
Operating a
Profitable
**ELECTRICAL
or RADIO
BUSINESS**

SEND NO MONEY

Yes, that's right! You get Coyne's sensational new book "Starting and Operating an Electrical or Radio Shop" FREE—HERE'S MY OFFER—Mail the coupon below—and I'll rush you a copy of 1946 edition of Coyne "Electrical and Radio Trouble Shooting Manual" for 10 days free trial—*plus* FREE copy of my "Starting a Shop" book. Examine the "Trouble Shooting Manual" 10 days, *then* DECIDE. IF NOT 100% pleased return the manual and owe nothing—if you keep it, pay according to terms in coupon below. But

REMEMBER, whether you keep the "Coyne Electrical and Radio Trouble Shooting Manual"—or return it—the "Starting and Operating an Electrical or Radio Shop" book is yours to keep FREE.

10 DAYS' FREE TRIAL

"Starting and Operating a Profitable Electrical or Radio Shop" tells you how to start full or part time Electrical or Radio Shop on small capital. Explains how to finance, choose a location, how and what to buy, advertising, salesmanship, business and legal angles, record keeping. For a *Limited Time* this amazing new book is given absolutely FREE... just for examining the sensational new 1946 edition of Coyne's "Electrical and Radio Trouble Shooting Manual" 10 days at our expense. **ACT NOW**—mail the 10 days' FREE TRIAL coupon today!

MAIL COUPON FOR FREE BOOK

H. C. LEWIS, President, COYNE ELECTRICAL SCHOOL, Dept. 46-R6,
500 South Paulina Street, Chicago 12, Illinois

O K.—send me your new Coyne Electrical and Radio Trouble Shooting Manual, post-paid along with my FREE COPY of "Starting and Operating a Profitable Electrical or Radio Shop." Within 10 days after the books come I'll either return the "Trouble Shooting Manual" to you AND OWE NOTHING or send \$3.00 and \$3.00 a month until a total of \$8.95 is paid. **Either way I keep the "Starting and Operating an Electrical or Radio Shop" book as my free gift.**

Name _____

Address _____

Town _____ Zone _____ State _____

Occupation _____

SAVE 10% Send cash price, \$8.95— you save over 10 percent. Same 10-day free trial and MONEY BACK SATISFACTION GUARANTEE.

LANGUAGE IS POWER



... Forge ahead, win special assignments, promotion, better job in global peace time opportunities through ability to speak a foreign language.

Speak

**FRENCH
RUSSIAN
GERMAN
ITALIAN
SPANISH
PORTUGUESE**

or any of 23 other languages by the

LINGUAPHONE METHOD

The World's Most Approved Language Courses

It's all talk; natural every-day conversation. In your own home you can learn to speak any of 29 languages by the world-famous Linguaphone Ear-Eye Conversational Method. It is amazingly simple and practical. You HEAR voices of native teachers... they speak to you as often as you want them, never tiring... you REPEAT what they say, answer their questions... before you are actually aware, you are conversing in a foreign language.

Learn alone, or have the family or friends join you in a delightful pastime that pays dividends.

Save time, work and money, learn the Linguaphone Way which has helped thousands in the Army, Navy, Flying, Signal Corps and other services, as well as more than 1 million home-study students.

FREE—Get the facts about this time and money saving way to learn languages—send for the **FREE** illustrated Linguaphone Book.

LINGUAPHONE INSTITUTE

98 RCA Building, New York 20, New York

LINGUAPHONE INSTITUTE
98 RCA Bldg., New York 20, N. Y.
Send me the **FREE** Linguaphone Book.

Name

Address..... City.....

Language Interested.....

RADIO, ELECTRONICS and YOU!

THERE are big rewards in the communications line for the Radio man who has the answers! Too, the equipment that has made Radio communication possible is functioning now in other rewarding fields. Electron tubes in industry promise a whole new World of Electronics. I. C. S. has a variety of Radio Courses and a great new standard Electronics Course. Write for booklet, pick your Course.

INTERNATIONAL CORRESPONDENCE SCHOOLS BOX 5577-K, SCRANTON 9, PENNA.

Send me full information on the following subject:

Name.....Age.....

Home Address.....

City.....State.....

Present Working Position.....Hours.....A.M. to.....P.M.

**EASY to
PLAY**



**Order
Yours TO-DAY**

The New Luellen HARMONICA

Most wonderful pocket instrument ever made is the harmonica. Easy to master, fun for Everyone. The Luellen has 10 holes, 20 notes. Key of C. Beautiful tone. Now ready. Postpaid Only..... **\$2.10**

INSTRUCTION BOOK. Simple for youngest child. No notes, scales nor exercises. Ten lesson charts show everything. Includes 75 popular songs. Price \$1.00. Here's our special introductory offer: The Instructor and the Harmonica, both postpaid, both for \$2.69. Send Check or Money Order Today.

JOHN LUELLEN & CO., 17034 Page Avenue, Dept. 403, Hazelcrest, Ill.

REFRIGERATION

and AIR CONDITIONING

APPROVED GI TRAINING

Train where the Army trained. Learn at home or in our big shops. Expert instructors—real machines. Easy to learn. Write for big **FREE** catalog today. No obligation. **COMMERCIAL TRADES INSTITUTE**, 209 W. Jackson Blvd., (Dept. M-24), Chicago, Ill.

VETERANS ASK FOR GI PLAN

WHY DON'T YOU WRITE?

Writing short stories, articles on business, homemaking, gardening, shop crafts, local and club activities, etc., will enable you to earn extra money. In your own home, on your own time, the New York Copy Desk Method teaches you how to write—the way newspaper men learn, by writing. Our unique "Writing Aptitude Test" tells whether you possess the fundamental qualities essential to successful writing. You'll enjoy this test. Write for it, without cost or obligation.

Veterans: This course approved for Veterans' Training.
NEWSPAPER INSTITUTE OF AMERICA
SUITE 559-D, ONE PARK AVENUE, NEW YORK 16, N. Y.

HAIR CAN BE SAVED

"GIVE YOUR HAIR A CHANCE"

In the amazing book by J. W. KING, Sc. B. on dandruff, baldness, thinning and graying hair. Much valuable information.—*Ohio State Medical Journal*. Best investment.—*Science Education*. Debunks hair facts.—*Scientific American*. Scientific fact.—*Sunset Magazine*. Without commercial bias.—*Teaching Biologist*. Book of a scientist.—*Home Acres*. Enormous assistance.—*Pictorial Review*. Fractional.—*Science News Letter*. Send only \$2.00 today for postpaid copy of this authentic instruction, on how to save your hair. 6th printing. Prompt refund if not helped.

BRADNER PUBLISHING CO. (EST. 1933) Dept. 75, Cambridge 42, Mass.

Give Your Hair A Chance
JOHN W. KING, Sc. B.

WINDOW SIGN LETTERS

For Store Fronts and Office Windows. Anyone can put them on. Samples furnished. Genuine Gold and Silver.
METALLIC LETTER CO., 430 N. Clark St., Chicago 10

RUPTURED?

Get Relief This Proven Way

Why try to worry along with trusses that gouge your flesh—press heavily on hips and spine—enlarge opening—fail to hold rupture? You need the Cluthe. No leg-straps or cutting belts. Automatic adjustable pad holds at real opening—follows every body movement with instant increased support in case of strain. Cannot slip whether at work or play. Light. Waterproof. Can be worn in bath. Send for amazing **FREE** book, "Advice To Ruptured," and details of liberal truthful 60-day trial offer. Also endorsements from grateful users in your neighborhood. Write:
CLUTHE SONS, Dept. 31, Bloomfield, New Jersey

Now YOU Can Lick Any AUTO REPAIR JOB!

IN LESS TIME—WITH LESS WORK



**FREE
7-DAY OFFER**

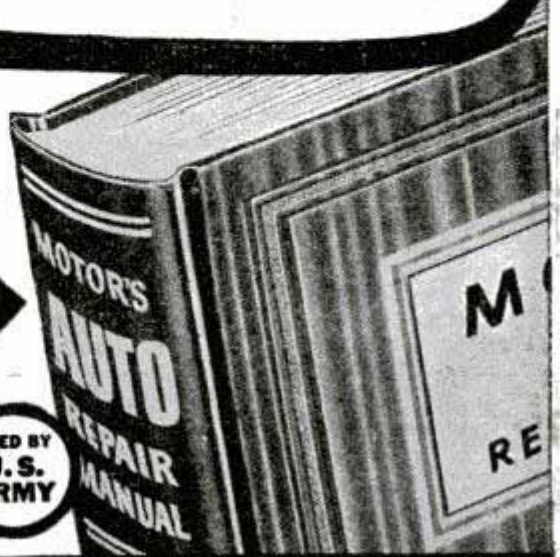

MoToR's New Auto REPAIR MANUAL shows you how to service and repair ANY part of ANY car!

No auto repair job is too tough when you've got MoToR's AUTO REPAIR MANUAL! YOU can repair anything from carburetor to rear end—quickly, easily, right! Just look up make, model, and the job in the quick index—and go to work! Clear, illustrated instructions lead you step by step.

To make such an amazing book possible, the engineer-editors of MoToR Magazine collected and "broke down" 150 official factory shop manuals for you, spotted all the vital repair information you need, dove-tailed it all together into ONE handy, easy-to-understand book.

No Other Manual Like It!

This BIG book—764 pages, 8½x11 inches, bound in sturdy fabric—brings you nearly 200,000 service, repair, adjustment, replacement, tune-up facts on every car built from 1935 through 1946! More than 1000 cut-away photos, diagrams,

drawings show you exactly WHAT to do and HOW to do it! Used by the U. S. Army, trade and technical schools everywhere, thousands of auto servicemen.

Now YOU—without cost—can see for yourself what a wonderbook MoToR's Auto Repair Manual really is. TRY it—FREE for 7 days! Learn first-hand how it can pay for itself the first few times you use it.

**SEND NO MONEY
7-Day Free Examination**

Just mail coupon below—without money! When the postman brings your book, pay him nothing. First make it show you what it's got! Unless you agree this is the greatest time-saver and work-saver you've ever seen—return book in 7 days and pay nothing. Mail coupon today! Address: MoToR Book Department, Desk 1D, 572 Madison Ave., New York 22, New York.

**Clear, Pictured Facts on Every Job
on Every Car Built Since 1935!**

Nearly 200,000 service and repair facts on all these makes:

- | | | |
|-----------|-----------|------------|
| American | Ford | Oldsmobile |
| Bantam | Graham | Overland |
| Auburn | Hudson | Packard |
| Austin | Hupmobile | Pierce |
| Buick | Lafayette | Arrow |
| Cadillac | La Salle | Plymouth |
| Chevrolet | Lincoln | Pontiac |
| Chrysler | Lincoln | Reo |
| Cord | Zephyr | Studebaker |
| Crosley | Mercury | Terraplane |
| De Soto | Nash | Willys |
| Dodge | | |

764 big pages; including 50 pages of carburetor text, charts, illustrations, covering all models. Over 500 charts, tables: Tune-up Chart; Valve Measurements; Compression Pressure; Torque Wrench Reading; Starting Motor; Engine Clearances; Generator; Clutch & Brake Specifications; Front End Measurements, etc.; Engines; Electric, Fuel, Cooling, Lubricating Systems; Transmissions; Universals; Front Ends; Wheels; Rear Ends, etc.

Same FREE 7-Day Offer Applies on

MoToR's TRUCK REPAIR MANUAL

For mechanics, truck specialists, service stations, fleet owners. Covers EVERY job on EVERY truck made since 1936! 1400 pictures, 914 pages, 300,000 facts. Used by Armed Forces. Warranted to contain every essential fact you need to know. Sturdy binding, size 8½x11. Covers all types Gasoline En-

gines; Diesels and Hesselmanns, Fuel Systems, Governors, Lubrication Systems, Ignition Systems, Starters, Generators, Clutches, Transmissions, Axles, Torque Dividers, Transfer Cases, Brakes, Steering, etc., etc.

ALSO SERVICES buses, farm and industrial tractors, contractor and road building equipment, stationary power machinery, etc. (on all parts described in Manual). Offered on same FREE 7-Day examination as Auto Repair Manual. Check box in coupon at right.



MoToR Published by MoToR, The Leading Automotive Business Magazine. MoToR's manuals assure high standards of repair work.

MAIL COUPON NOW FOR 7-DAY FREE TRIAL

MoToR Book Dept., Desk 1D, 572 Madison Ave., New York 22, N.Y.

Rush to me at once: (check box opposite book you want)

MoToR's AUTO REPAIR MANUAL. If O.K. I will remit \$1 in 7 days, and \$1 monthly for 4 months, plus 35c delivery charge with final payment (\$5.35 in all). Otherwise I will return book postpaid in 7 days. (Foreign price, remit \$7 cash with order.)

MoToR's TRUCK REPAIR MANUAL. (Described at left.) If O.K. I will remit \$2 in 7 days, and \$2 monthly for 3 months, plus 35c delivery charge with final payment (\$8.35 in all). Otherwise I will return book postpaid in 7 days. (Foreign price, remit \$11 cash with order.)

Print Name.....Age.....

Print Address.....

Zone No.

City.....(if any).....

State.....Occupation.....

SAVE 35c! Check here if enclosing full payment (Check, M.O. or Postal Note) WITH coupon. We pay 35c shipping costs. Same 7-day return-refund privilege.

OFFERS LOW COST LIFE INSURANCE

Postal Life offers \$1724. in Protection for \$2.00 monthly (age 21). Other Ages in Proportion

THIS PREMIUM HALF PERMANENT RATE

Policy Fully Paid-up in 30 years

NEW YORK, Saturday. Postal Life of New York, unique among important Old Line, Legal Reserve Life Insurance Companies, is again offering this special modified policy, already owned by thousands of American families. You pay half the permanent rate until the 6th year; \$2.00 monthly for substantial amounts of Protection, depending on age! \$2.00 monthly pays for \$1754. of life long protection at 20; \$1142. at 40; \$5.00 monthly buys \$3650. at 30, etc. Proportionate amounts at other ages. You pay no premiums after 30 years; policy fully paid-up and in force your entire life.

For your convenience we print below a coupon that can be clipped and sent to Postal Life. Full information, rates, etc., will be sent to you promptly. There is no obligation to buy but we advise immediate action. Life Insurance is vital to your future and your family's welfare. Postal Life Insurance Company, 511 Fifth Avenue, New York 17, N. Y.

Postal Life Insurance Company
511 Fifth Ave., Dept D-566, New York 17, N. Y.

Mail rates and full details about your "\$2.00-per-month", 30-Payment Life Policy at my age.

Name _____

Occupation _____ Date of Birth _____

Address _____

Include P. O. District Number, if any

AIR RIFLES BENJAMIN AIR PISTOLS

ORDERS NOW ACCEPTED

ORDER BENJAMIN AIR RIFLES AND AIR PISTOLS from your DEALER or DIRECT AT ONCE. Send for our FREE FOLDER and Complete Specifications TODAY. Both Calibre Benjamin H-C Pellets are available now. BENJAMIN AIR RIFLE CO., 812 MARION ST., ST. LOUIS 4, MO.

TAKE ORDERS GALORE 21 SUNSHINE NOTES 1 FOR ALL OCCASIONS
A NEW CREATION

Tricky, novel designs. Everybody buys. No greetings inside. Sells like hot cakes. Costs as low as 50c. Also new Beaded Everyday Boxes, Birthdays, Convalescent, Everyday Gift Wraps. Send for samples on approval today.
Sunshine Art Studios, 115 Fulton St., Dept. EE3, New York City

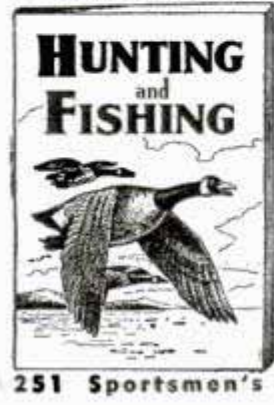

HUNTING and FISHING

251 Sportsmen's Bldg., Boston, Massachusetts

HUNTING and FISHING is a monthly magazine crammed full of hunting, fishing, camping, dog and boating stories and pictures, invaluable information about guns, fishing tackle, game law changes, best places to fish and hunt—countless ideas that will add more fun to your days afield.

Special Trial Offer
Send 25c in stamps or coin and we will send you Hunting & Fishing for six months.

HUNTING & FISHING MAGAZINE

SEND FOR THIS TIME SAVING **OHMITE** Ohm's Law Calculator



Figures Ohms, Watts, Amperes Volts... Quickly! Any Ohm's Law Problem solved with one setting of slide. All values direct reading. (4 1/8" x 9")
Send only 10c in coin to cover cost of handling.
OHMITE MFG. CO., 4930 Flournoy St., Chicago 44, Ill.

ANYONE CAN DO THIS IF THEY HAVE OUR CHART



SPECIAL OFFER FOR AGENTS

Blue Print 27" x 36" shows how to find length of any rafter; find any angle in degrees, frame of any polygon 3 to 16 sides, read board foot and brace tables, octagon scale, rafter tables and many other uses. Can be scaled down for model work as well as full scale framing. Also Chart changing pitches to degrees for use with Radial Saws. Send 50c in coin or M. O. No Checks or Stamps. **MASON & PARRISH ENGINEERS, 2031-B N. Burdick St., Kalamazoo 81, Mich.**

FREE! 40 Page Hobby Catalog

Over 1000 Items — Over 300 Photos

Our new 40-page catalog—just off the press—is the "bible" of wide-awake modelers. Practically every nationally advertised model is listed and many, many hard-to-get items. Planes, engines, boats, gliders, supplies, etc.
America's Hobby Center, Inc., Dept. B46, 156 W. 22 St., N. Y. 11, N. Y.

ENSHRINE THEIR MEMORIES WITH **U.S. MONUMENTS** \$14. UP



Freight Paid
There is none better. Our free catalog is ready for you. Write today. A-18 U. S. Marble & Granite Co., Oneco, Fla.

NEW CHEAP OIL BURNER

FOR COOKING & HEATING STOVES-FURNACES
HEAT YOUR HOME, COOK YOUR MEALS WITH CHEAP FURNACE OIL



NO MORE SHOVELING COAL OR ASHES. New Fuelizer Starter Vaporizing System turns Cheap 130 Flash Furnace Oil into Oil Gas heat without clogging up. **LIFE-TIME GUARANTEE** against defects. \$1.00-BONUS OFFER FOR TESTING. We will let you try it in your own stove or furnace for one month. Get Yours for introducing. Big profits. Be first. Send in your name today.
NORTHWEST MFG. CO. 561-D 5th Ave. Mitchell, So. Dak.

do you WORRY?

Why worry and suffer any longer if we can help you? Try a Brooks Patented Air Cushion. This marvelous appliance for most forms of reducible rupture is **GUARANTEED** to bring YOU heavenly comfort and security—day and night—at work and play—or it costs you **NOTHING**. Thousands happy. Light, neat-fitting. No hard pads or springs. For men, women, and children. Durable, cheap. **Sent on trial** to prove it. Not sold in stores. Beware of imitations. Write for Free Book on Rupture, no-risk trial order plan, and proof of results. All Correspondence Confidential.

ABOUT RUPTURE



Brooks Company, 359 State St., Marshall, Mich.

TIE UP YOUR FUTURE *with these* Growing Industries

AIR CONDITIONING and REFRIGERATION



Air Conditioning and Refrigeration are among the great industries of today and tomorrow. Installations everywhere—in restaurants, shops, homes, etc., need service. Thousands of businesses are waiting for new installations. Today, more and more homes are being air conditioned. The Refrigeration and Air Conditioning industries are headed for greater prosperity and men who have the "know how" and experience should ride along.

TRAIN NOW Before the Expected Expansion Begins

Experts predict large demand for men to install and service Air Conditioning and Refrigeration equipment : : : Rise to the kind of job which requires a competent, trained man who can carry the responsibilities of installing costly equipment and maintaining it. If he knows the answer when he is called in for consultation, his reputation grows and his pay should grow also.

FOLLOW THIS WAY TO KNOWLEDGE

If over 17, and under 60, here's all it takes to get you ready for experience in this modern industry. Just invest a limited amount of your spare time—while you are still on your present job. Through our balanced training, you learn first through home study, how to handle Installation, Maintenance & Service Work on Refrigeration and Air Conditioning equipment; Then you can get practical training in our big shops under capable instructors—experienced men who'll take a personal interest in helping you learn. When you're through you should have knowledge that enables you to get started in this vast industry.

WANT YOUR OWN REPAIR SHOP?

UEI training is easily understood by mechanically inclined men. You gain experience when you complete your course. Equipment, tools and personal following can accumulate as you progress. Soon you may find it wise to set up your own shop.

Get Free Facts Right Now!

It costs you nothing to get all the facts about this great field. Simply mail the coupon below and we'll tell you, without obligation, the whole, sensational story of what's ahead in Refrigeration and Air Conditioning. Mail the FREE coupon now.



UTILITIES ENGINEERING INSTITUTE

1314 W. Belden Ave., Dept. 146, Chicago 14, Ill.

REFRIGERATION
TRAINING
Since 1927

UTILITIES ENGINEERING INSTITUTE
1314 W. Belden Avenue, Dept. 146, Chicago 14, Ill.

Please send me the FREE FACTS about opportunities in Air Conditioning and Mechanical Refrigeration. I have marked the one that interests me most.

Air Conditioning Mechanical Refrigeration

NAME.....AGE.....

ADDRESS.....

CITY.....ZONE.....STATE.....

Keep that "TICKING"
Car

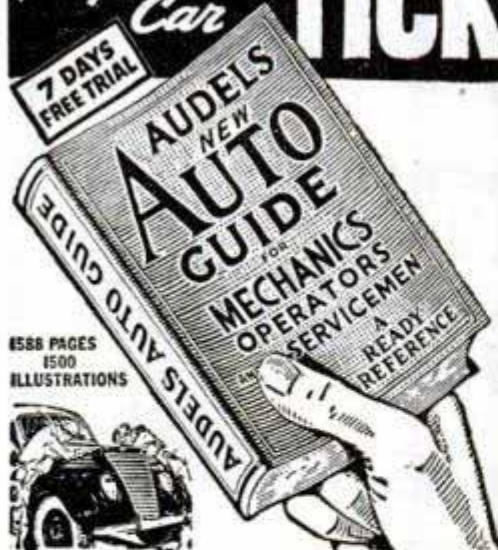

Every operator and mechanic needs AUDELS AUTO GUIDE.

This book saves time, money and worry. Highly endorsed. It presents the whole subject of auto mechanics:

- 1—Basic principles
 - 2—Construction
 - 3—Operation
 - 4—Service
 - 5—Repair
- Handy Size. Easily understood.

NEW FLUID DRIVE, HYDRAULIC SHIFT AND DIESEL ENGINES FULLY COVERED

Over 1500 pages—1540 illustrations showing inside views of modern cars, trucks and buses with instructions for all service jobs.

4 COMPLETE • PAY ONLY \$1. A MONTH ←
ASK TO SEE IT!—To Get This Assistance for Yourself Simply Fill in and Mail Coupon Today.

AUDEL Publishers, 49 West 23rd St., New York
MAIL AUDELS NEW AUTO GUIDE for free examination. If O. K. I will send you \$1 in 7 days; then remit \$1 monthly until price of \$4 is paid. Otherwise I will return it.

Name _____
Address _____
Occupation _____
Employed by _____ PM

GET BIG PROFITS from
SMALL INVESTMENT
OTTAWA
6 H-P LOG SAW



Log Saw of the Future TODAY!

FELLS TREES...
SAWS LOGS Fast, Easy

Buzzes Up Small Limbs

Demand for wood increases! Prices are higher than ever before. You can make real money sawing wood, if you have an Ottawa. Equipped with an easy to start, air-cooled 6 H-P engine. Designed for easy handling. Complete one-man machine with safety Saw Guide and other exclusive Ottawa features for fast sawing.

USE FOR OTHER JOBS—when not sawing wood, use engine for any belt job. Thousands in use. FREE BOOK and price list. Write today.
OTTAWA MFG. CO., 427 Pine Street, Ottawa, Kans.



SALESMEN FOR CITY AND COUNTY
Nationally Known Manufacturer

Build up a business of your own with Nationally Advertised Products bearing Underwriters' label. Sell to schools, factories, service stations, warehouses, hotels, restaurants, public institutions, truck and bus companies, grain elevators, house trailers, autos, farms, homes, etc. **Capable man can earn real money.** Established in 1916. Write letter with details, age, experience, etc.

THE FYR-FYTER CO.,

Dept. 90-16 Dayton 1, Ohio

ELECTRICAL TRAINING

Intensive 8 months residence course in fundamentals of industrial electrical engineering, including radio, electronics. Prepares for technician, engineering aides. Approved for veteran training. 53rd year. Catalog.

BLISS ELECTRICAL SCHOOL
7630 Takoma Ave., Wash. 12, D. C.

POCKET WATCHES

SWISS MOVEMENTS



Now available "EXPERT" watches. Swiss made watches are known the world over for their accurate time-keeping and quality construction because they are made by master watch craftsmen. This handsome men's pocket watch has a sturdily-constructed chrome case and open figure dial. A timepiece you will be proud to own. **SEND NO MONEY.** Simply pay postman \$8.50 plus 10% tax and postage. Wear 10 days on our money back if not satisfied guarantee. United Products Co., 7911 S. Haisted, Dept. P-127, Chicago 20, Ill.

GENUINE U.S. BARGAINS



- Army O. D. Wool Blankets, 5 lbs.\$5.95
 - Army Pocket Knife, Scout Style.....\$2.50
 - Pup Tents, Poles and Pegs, Used.....\$4.85
 - Mess Kit—Knife, Fork and Spoon, Used\$.50
- Thousands of Other Bargains in Military, Outdoor & Sport Goods for Hunter, Farmer, Scout. Send 10c for 32-page catalog returned with first order.

A and N SUPPLY CO.
4720 LESTER ST. RICHMOND, VA.

LEARN



PORTRAIT PAINTING AT HOME

• Previous art training or talent NOT necessary. The Stuart System teaches you, in 11 easy-to-follow lessons, to (1) locate features exactly to correspond to model's features, (2) outline head and face to correspond to model's outline, (3) make each feature a true portrait of that feature in the model, (4) produce shadows and shading that exactly correspond to that of model's face, (5) mix flesh paint tints that are like living flesh. You, too, can make exact charcoal and oil likenesses. Send for free booklet **today.**

STUART STUDIOS
121 Monument Circle, Room 646, Indianapolis 9, Ind.

Please send me free book and outline of lessons.
Name _____
Street _____
City _____ State _____

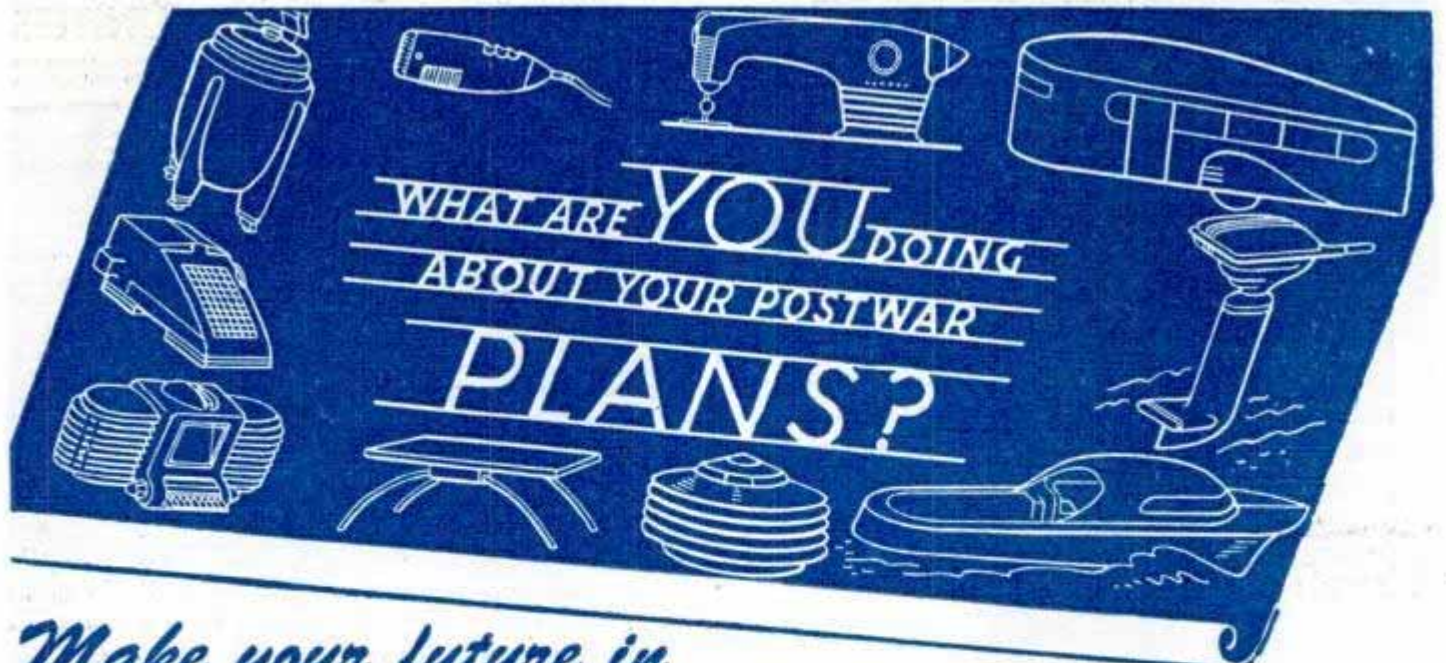

Make your future in **PLASTICS**

Every day you read of new and wonderful uses for plastics in this, our postwar world. The wide range of objects that can be made of plastics—from buildings to surgical appliances, from cars to textiles—challenges the imagination.

THE PLASTICS ERA IS HERE—Are you ready? Opportunities are opening in every branch of the plastics industry. Plastics know-how is necessary in practically every type of manufacturing. Are you capable of grasping these opportunities? If you want a choice position in this expanding plastics field, or a business of your own, act *now*—get in on the ground floor!

A COMPLETE COURSE—You learn the various phases of plastics from this course . . . materials, designing, molding, fabricating, laminating and testing. You acquire a basic knowledge of plastics that can be invaluable to you in acquiring the type of position you want in this great new industry.

YOU LEARN AT HOME—Your present work need not be interrupted, and this thorough, easy-to-understand course requires no previous technical experience.

EXCLUSIVELY PLASTICS—Plastics Institute is America's oldest and largest educational organization which devotes all of its facilities exclusively to plastics.

YOU MAKE THINGS—We supply materials. To give you practical experience in working with plastics, we supply handsome, colorful, rods, sheets and tubes of plastics from which you make useful, attractive creations. You saw, cement, buff, form, dye, decorate, cast and laminate various types of plastics. You also design your own plastics articles—develop your own ideas. You may earn money while learning.

START YOUR FUTURE TODAY—Mail the coupon below, now! You will get an interesting, illustrated, free booklet with valuable information about plastics. You will see how, at small cost you can prepare for a future in this important industry while carrying on your present work. Clip this coupon and mail it **TODAY!**

VETERANS ASK ABOUT G. I. TRAINING.

NEW YORK

Dept. PM6-4, 122 E. 42nd St.

CHICAGO

Dept. PM6-4, 221 N. LaSalle St.

LOS ANGELES

Dept. PM6-4, 1601 S. Western

SPECIAL RATES FOR SERVICE MEN



Plastics

INDUSTRIES TECHNICAL INSTITUTE

Plastics Industries Technical Institute,
221 N. La Salle St., Dept. PM6-4, Chicago 1

Mail in Envelope or
paste on penny postcard

Gentlemen: Please send me the booklet "World of Plastics" and information on your training program. I understand there is absolutely no obligation.

Name..... Occupation.....

Street..... Age.....

City..... Zone..... State.....

Veterans: Check for special information. If under 18: Check for special booklet.

Your Own Business in PLASTICS

Get in on today's **BIG Opportunities** in this vast new field. Tremendous waiting markets for "1001" different profitable plastic products. Profit by our experience in successful plastic manufacturing business. Save money with our plans and full instructions for building your own equipment. Avoid costly mistakes with our "Guide to Success in Plastics." Read our offer below and **ACT**

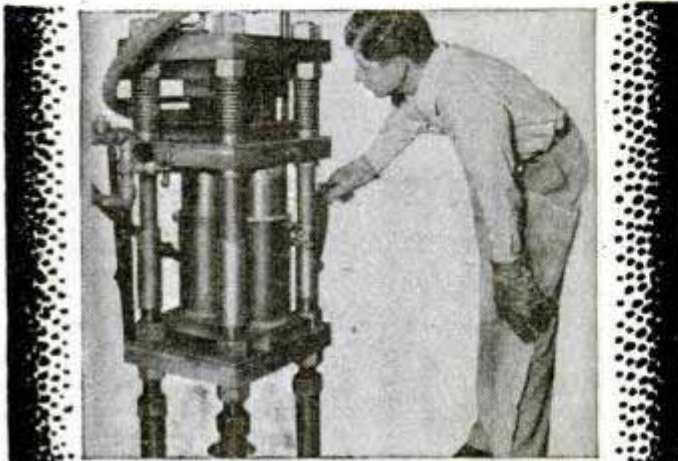

PLANS FOR 75-TON MOLDING PRESS
Easily built at home from readily available parts and materials . . . at a **SAVING OF HUNDREDS OF DOLLARS!** Adaptable for home or factory production, for compression molding or for laminating products out of plastic; hand mold or semi-automatic. The latest type press used for big volume plastic production. Complete plans and instructions for assembling and operating—**FOR ONLY \$300**

SPECIAL—"Guide to Success in Plastics" **GIVEN** with each order for above plans. Tells how to get started, what to make, where to get materials and dies, how to get orders, and other helpful and valuable information not available elsewhere. Fill out and mail coupon **TODAY**.

MONEY BACK if you're **NOT SATISFIED**

PLASTICS ENGINEERING COMPANY

P. O. BOX 425 • MINNEAPOLIS 1, MINNESOTA

- I enclose \$3.00 for Molding Press Plans and Instructions and "Guide to Success in Plastics," with the understanding that if not satisfactory I can return them within 5 days of delivery and my money will be refunded.
- Send Plans C. O. D.—on same guarantee.

NAME.....

Address.....

CITY.....ZONE.....State.....

HOME INDUSTRY OPPORTUNITIES



Make Good Door Mats from Old Tires with simple homemade cutting and hole punching equipment powered with a 1/4 HP motor. Illustrated instructions, 50c.
Profitable Toy Making. From scrap wood, paper, metal, rubber, linoleum, cloth, plaster, etc., 25c.
Liquid Rubber from Old Tires. Make molds, door mats and rubber articles. Ten formulas and processes, 50c.
How to Make 30 Useful Articles of Wire and Sheet Metal with homemade jigs. Illustrated, 50c.
Rubber Mold Making. Marbleizing, glazing, etc., 25c.
Security in a Small Farm. Twenty ways describes, 25c.
10 Local Business Plans net up to \$200 a month, 25c.
Collection of 100 Selected Formulas, 25c.

All 8 of the Above List of Booklets and Formulas, \$2.00. No C.O.D.

NEW WAYS CUT BUILDING



cost of houses, garages, poultry and farm buildings, cabins and stores. Make wall-high, insulated blocks with inside and outside finish with simple, homemade equipment. Composition roofs and floors. Ten formulas. Cement panels, blocks and tiles in color. Stream-lined roof, walls and gutters. Several ways to use cheap wood with cement makes strong buildings. Wallboard of sawdust. Save hundreds of dollars. 100 money and labor saving ideas. Mixer and buzz saw easily made from an old auto. 40 proved ways to earn \$10 to \$15 a day. Guaranteed illustrated booklets, \$1.00.

MAKE FURNITURE OF COMPOSITION cement, sawdust, asbestos, paper. Some part scrap wood and metal. Illustrated instructions to make tables, cabinets, chests, racks, shelves, inclosed sinks, lawn novelties and toys, 500 per cent profit, 50c.

HOW TO MAKE ACCURATE SHOP MACHINES: Band, jig, and circular saws, electric drills, sanding wheels, forge, tools, electric weed cutters and many other things from old auto parts and washing machine motors. Illustrated, 50c.

HOME MFG. ENTERPRISES, 50 selected home shop projects, illus., 50c. Special: All five booklets described above, \$2.00 postpaid. No C.O.D.

HOME INDUSTRIES, 1318 So. 30th Ave., Dept. PM, Omaha 5, Nebr.

SCREWS NUTS, BOLTS, RIVETS, SPRINGS, WASHERS, Etc.



5 POUND ASSORTMENT
More than 1000 pieces. Great for mechanics, repairmen, hobbyists, experimenters. Worth double. Satisfaction guaranteed. Order now. Write for bargain list of fiber, bakelite, rubber, felt washers, pads; radio lugs, clips, connectors, etc.
\$1.98
Two for \$3.69

HUDSON TRADING CORPORATION
A 1521 N. Wells Street Chicago 10, Illinois

Correspondence Courses in RADIO and ELECTRICAL ENGINEERING LOW AS \$25

ELECTRICAL ENGINEERING Get good grasp of wide electrical field. Modern. Very understandable. Theory made easy.
RADIO ENGINEERING Extra fine course in radio, public address, photo-electric work. Trains you to be super-service man, real vacuum tube technician. Tuition **ONLY \$25**, either course. Deferred payment plan. Servicemen badly needed.

FREE SPECIAL! Write for copies school catalogs, student magazines, etc. Send **TODAY** and receive Free Copy of new booklet containing perhaps the most understandable explanation of the Atomic Bomb ever written! Many illustrations including probable bomb construction. **FREE** if you write at once!

LINCOLN ENGINEERING SCHOOL, Box 931-PA Lincoln, Nebr.

WANT TO BE AN ARTIST?

5 BOOKS - 7 SUBJECTS OVER 100 ILLUSTRATIONS

- 1 CARTOONS - PEN AND INK
- 2 FIGURE DRAWING
- 3 DRAWING & PERSPECTIVE
- 4 WATER COLORS
- 5 OIL PAINTING

\$1.00 FOR 5 POCKET EDITIONS

SEND TODAY for COMPLETE SET POSTPAID

HOLLYWOOD ARTISTS
P. O. BOX 2344, LOS ANGELES 54, CALIF.

NAME..... PM 4-2

ADDRESS.....

CITY.....STATE.....

SIMPLY ENCLOSE \$1 BILL

DO ANY JOB.. EASIER.. QUICKER
MAKE MORE MONEY *in the*
BIG OPPORTUNITY
FIELDS

Here's the Help You Need
For Best Paying Jobs
Right NOW!

FREE TRIAL
IN YOUR OWN HOME

Used by Army, Navy, Other Government
Depts., 200 Schools and Industrial Firms.

SEND NO MONEY
 Select the Books
YOU Need Now!
 We Ship **C.O.D.**
 Anywhere in U. S.
 and Will Refund
Amount Paid if
Not Satisfactory.

Don't submit to tough, heartbreaking job competition, now that wartime jobs are over. Get into one of these big opportunity fields. Big money and many other advantages await you if you prepare now. Here is the help you need—**EASY—QUICK—AT LOW COST.** Thousands of men have already used these famous books. Beginners and experienced men alike have doubled and tripled their earnings with this help. You too, can now get the special knowledge you need for top pay, better jobs, or a business of your own. This is your **GOLDEN OPPORTUNITY.**

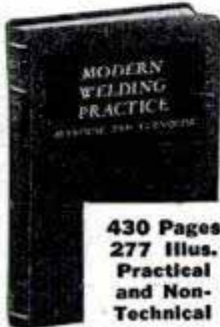

MODERN WELDING PRACTICE

Newest book on all types of welding and heat treatment of metals. Written by recognized specialists in training men for production jobs. Prepare for best jobs. Price \$4.00.

430 Pages
277 Illus.
Practical and Non-Technical

AIR CONDITIONING

Big air conditioning boom interrupted by war will be bigger than ever in post-war days. Get this non-technical book by international authority and be ready for your share of millions to be spent. Covers whole field. 450 pages. Illustrated. \$4.00.



NEW 20th
 EDITION
Leading Auto Book for Over 32 Years

World's GREATEST AUTO BOOK

New Material on Transmissions, Trucks, Tractors, Diesels, Aircraft and Auto Engines

Now with millions of cars needing repairs and thousands of men needed to do the work, you need the famous DYKE Auto Book more than ever before. Brand new 20th Edition covers all principles, construction, repair, adjustments, testing, troubles and remedies of all cars. Over a half million copies of 20 editions of Dyke's have been sold. Gives specifications of old and newer cars. World's biggest book value. \$7.00.

This big book, a complete auto library in one volume, has 1483 pages—4500 illustrations and diagrams—weighs 6 lbs.—equal to 4 ordinary books.

ELECTRICAL BOOKS
That Pay Big Dividends

HOUSE WIRING

New Printing

Gives complete practical instruction on every phase of house wiring. Goes further than most books. Gives National Electric Code. 400 pages, 669 illus. \$2.50.

A.C. POWER WIRING

New Printing

Covers every type of A.C. Power wiring, motors and generators, switchboard, measuring instruments, etc. 100% practical and helpful. 460 pages. 400 illus. Price \$4.00. Also — D.C. Power Wiring, 497 pages, \$4.00.

BODY & FENDER REPAIR

Owners will spend big money to keep their good older cars looking like the new ones coming out. This is a practical money-making guide, ideal for shop owners and every man who wants a share of the millions to be spent in keeping

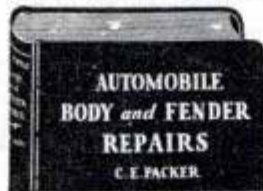

old cars looking new. Tells how to get a good job or start business of your own with small capital. 325 pages, 232 illustrations. \$3.50.

ENGINEERS HANDBOOK

World famous Bailey's Handbook for Stationary, Marine and DIESEL engineers and firemen. Prepares for any license examination. Pocket size, \$2.00.

AIRPLANE WELDING

New 2nd edition by J. B. Johnson, Materials Division, Wright Field. The authoritative and practical book on airplane welding and materials. 420 pages, 193 illus. \$3.50.

15 Million Refrigerators
Need Service and Repairs



REFRIGERATION—Book of the Hour!
Biggest Opportunity in Many Years!

NEW PRINTING—ALMOST 1000 PAGES

408 Pictures—17 Diagrams in Colors Makes All Refrigerator Service Maintenance, Repairs Simple as A. B. C.

Thousands of Refrigerators need repairs! Owners will pay big for competent service which will be needed more and more. Get **MODERN GAS AND ELECTRIC REFRIGERATION**, the non-technical guide to all types of refrigerators and get your share of this new profit. Get a job or start your own service business. This book will help you make money anywhere. Price \$5.00.

DYKE'S CARBURETOR BOOK

The standard guide in the best paying auto work for a generation. It has helped thousands of men make money. New edition covers engine tune-up, compression, ignition, carburetion, fuel pump, valves, etc. Use this book to specialize in this big field. 244 pages, 549 illus. \$3.50.

Mail Coupon to

Goodheart-Willcox Co., Inc.
 209 S. Michigan Ave., Dept. 14, Chicago 16, Ill.

SEND NO MONEY! Mail Coupon

GOODHEART-WILCOX CO.,

209 S. Michigan Ave., Dept. 14, Chicago 16, Ill.

Send books checked. C.O.D. I will pay postman, plus few cents charges. If not satisfactory I will return books in 5 days and you will refund money paid. (Outside U.S. or possessions remit with order.)

- | | |
|--|--|
| <input type="checkbox"/> Gas & Electric Refrigeration \$5.00 | <input type="checkbox"/> Air Conditioning \$4.00 |
| <input type="checkbox"/> Dyke's Auto Book \$7.00 | <input type="checkbox"/> Engineers Handbook \$2.00 |
| <input type="checkbox"/> Dyke's Carburetor Book . \$3.50 | <input type="checkbox"/> Body and Fender Repair . \$3.50 |
| <input type="checkbox"/> Modern Welding \$4.00 | <input type="checkbox"/> House Wiring \$2.50 |
| <input type="checkbox"/> Airplane Welding \$3.50 | <input type="checkbox"/> A.C. Power Wiring \$4.00 |
| | <input type="checkbox"/> D.C. Power Wiring \$4.00 |

If remittance accompanies order we will pay all postage charges under same return privilege.

Name
 Address
 City State

MEN WANTED

In Building Industry



Here's a chance to get into one of the future's most profitable and promising businesses... Be a floor surfacing contractor and sand both new and old floors during the coming building boom! Sanders are easy to operate—no big overhead—no large investment—no special schooling... Just the ambition to get ahead and be your own boss. Ask for latest "tell-all" booklet entitled "Opportunities in Floor Surfacing"—use coupon and enclose 25c in coin or stamps to cover handling.

AMERICAN FLOOR SURFACING MACHINE CO.

535 So. St. Clair St. • Toledo 3, Ohio
Gentlemen:
Enclosed find 25c in stamps or coin for booklet "Opportunities in Floor Surfacing," telling me how I can start my own floor sanding business.

Name _____
Street _____
City _____ State _____



MAKE MORE MONEY

APPLYING OR SELLING

CORKSTONE PLASTIC FLOORING

EASY TO APPLY

Here's your opportunity to get into business for

yourself applying or selling Corkstone, the economical, top-grade plastic flooring. Plenty of profit. Act without delay!



Dealers & Agents Wanted

WRITE FOR DETAILS OF OUR PROPOSITION

We believe in teamwork and cooperation. We'll help you get started. No cost; no obligation. Act today!

LASTING PRODUCTS COMPANY
MANUFACTURERS OF PAINTS, PUTTIES, PLASTICS
FRANKLINTOWN ROAD PLANT, BALTIMORE 23, MARYLAND



59c

COMB-A-TRIM

THE NEW QUICK TRIMMER

Something New! Trim your hair without any experience. It's easy! The excess hair comes off smoothly and easily by just pulling trimmer through hair like an ordinary comb. Also removes hair from legs—armpits. Save on hair-cut bills... Trim your own hair or the whole family's. Send 59c and your Comb-A-Trim will be sent at once.

SPECIAL OFFER
Send \$1.00 for 2
Comb-A-Trims
and save 18c. **2 for \$1**

5 Extra Blades
(Year's Supply) 25c

COMB-A-TRIM CO.

1734 Carew Tower

Dept. R-5

Cincinnati, O.

What gives each file a guiding mark
Like lighted street signs, after dark?

Dennison

INDEX TABS

At Stationery Departments Everywhere

REFRIGERATION

Repair and improve all refrigerators. New manual tells how. Charts and pictures to help you. Price only \$1.00, postpaid. Money back guarantee. Supreme Publications, 9 S. Kedzie Ave., Chicago 12, Illinois.

JET PROPULSION

Experimenters! New principle to drive boats, bicycles, model helicopters. Circular on plans. Rush name. H. Maupin, Tipp City 12, Ohio.

MECHANICS WANTED!

Men wanted for Body and Fender, Machine Shop, Auto Mechanics, Tool-Die, Diesel, Welding. Earn up to \$12 a day or start your own business. Established 1902. 41,000 graduates. **GREER SHOP TRAINING**, Dept. 246, 460 S. State St., Chicago.



Fix Your Own ALARM CLOCKS

New, practical home course. Just out. Makes interesting hobby—profitable too. Save money by doing your own repairing at home. Easy if you know how. Price now only \$1.00. Details FREE. Send postcard. **THIS JEWELRY STORE**, Genoa 3, Illinois

120 MILES PER GALLON

Complete motor ready to mount on ordinary balloon-tired bicycle. No mechanical skill required to install. No alteration of bike necessary. Easy to operate.



Can be pedalled by merely releasing clutch. Speed 5 to 40 M.P.H. Shipped prepaid complete with 4 cycle, 2 1/2 H.P. motor, all attachments and heavy duty stand. Get complete facts about this low-cost, convenient transportation...

Write today for descriptive illustrated literature.

WHIZZER MOTOR SALES CO.
Dept. A, 3132 E. Washington, Los Angeles 23, California

TO THOSE WHO THINK LEARNING MUSIC IS HARD

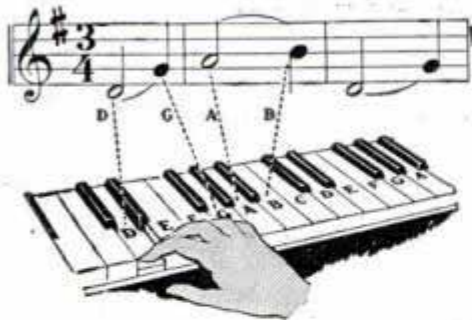

Look at the diagram. The first note of the music is "D." Following the dotted line to the keyboard you'll find "D" is the white key between the two black keys near the middle of the keyboard. Now read below how you can learn to play any instrument quickly and easily.

Easy as A-B-C--COST LESS than 7c a day!

● Perhaps you think learning music is a tedious grind. It isn't any longer! Long hours of practicing scales and monotonous exercise are over. You have no excuse for not getting started toward musical good times now! For through an easy method you can now learn to play right at home—without a teacher—for less than 7c a day.

Learn to Play by Playing

The lessons come to you by mail from the famous U. S. School of Music . . . complete instructions, clear diagrams, and all the music you need. You learn to play by playing real tunes by note. First you are told how to do a thing. Then a picture shows you how. Then you do it yourself and hear it. Remember, don't confuse our method with any system claiming to teach music "by ear" or by trick methods. We teach you to play only from real notes!

SUCCESS!

Here's what one of our thousands of pupils writes: "I learned more from your course than many of my friends who studied under private teachers have for years. The fact that I've already taken 2 courses and am now enrolling for a third should speak for itself." F. A. S., Indiana.

You learn to play by playing real tunes by note. First you are told how to do a thing. Then a picture shows you how. Then you do it yourself and hear it. Remember, don't confuse our method with any system claiming to teach music "by ear" or by trick methods. We teach you to play only from real notes!



Don't delay, send now for our illustrated Free Booklet and "Print and Picture" Sample which fully explain this remarkable method. So decide which instrument you want to play and mail the coupon today. U. S. School of Music, 74 Brunswick Bldg., New York 10, N. Y. (Successful 48th Year)

FREE! Print and Picture Sample

U. S. School of Music
74 Brunswick Bldg., New York 10, N. Y.

Please send me Free Booklet and Print and Picture Sample. I would like to play instrument checked below.

- | | | |
|-----------------|----------------|-------------------|
| Piano | Saxophone | Modern Elementary |
| Guitar | Trumpet Cornet | Harmony |
| Hawaiian Guitar | Reed Organ | Mandolin |
| Violin | Tenor Banjo | Practical Finger |
| Piano Accordion | Clarinet | Control |

Name..... Have You Instrument?.....

Address.....

City..... State.....

Save 2c—Stick Coupon on Penny Postcard

MAKE MONEY—DO ELECTRICAL WORK



Only \$7.50 will make anyone handy with tools a practical electrician. Nothing to study. With this job ticket handbook in your pocket you can do 240 different electrical jobs on the spot. Flip the pages to the job you are doing. Follow the step by step directions and simple diagrams and you can't go wrong. Nothing like it. Reg. U.S. Pat. office. Users say easily worth up to \$100. Gives you chance to do good pay work in field of Electricity. Quantity limited. Send check or P. O. money order. Satisfaction guaranteed or money refunded.

C. H. SMITH, Pres., 2130 Lawrence Ave., Dept. P, Chicago 25, Ill.

NEW! Ideal Gift for Your Service Man!

Heavy 10K Solid Gold Souvenir Service Ring of World War II. A beautiful and authentic ring that your service man will be proud to wear and cherish forever. It plainly shows that he is a Veteran of our Armed Forces of World War II. Available in all sizes. We pay postage and Fed. Tax. No. 1214 10K Solid Gold \$18.00 Solid Sterling Silver \$6.00

Send for Circular of Service Jewelry EDWIN W. LANE CO., Dept. PM, 32 W. Randolph St., Chicago 1.



LEARN AT HOME TO MOUNT BIRDS



Animals, Heads, Fishes, Pets; to TAN. Be a Taxidermist. Profit and FUN. Hunters, save your valuable TROPHIES. Mount ducks, squirrels, everything. Learn to TAN for leather and furs. Wonderful HOBBY Have a HOME MUSEUM.—BIG PROFITS mounting for others. INVESTIGATE NOW.

FREE BOOK With 100 fine game pictures. NOW absolutely FREE. Write TODAY.

Send Postal TODAY for FREE BOOK. State AGE. N. W. SCHOOL OF TAXIDERMISTRY, Dept. 3374, Omaha, Neb.



Say you saw it in Popular Mechanics

"Glad I Waited for the BEST Handy-Sized Dictionary"



WEBSTER'S COLLEGIATE has been hard to get, but copies will soon be on the way to your bookseller. See him now and place your order with him.

Based on and abridged from Webster's New International Dictionary, Second Edition—"The Supreme Authority"—and edited with the same careful scholarship. Defines all the words most commonly used. 1,300 pages; 110,000 entries. \$4 to \$8.75, depending on choice of binding. G. & C. Merriam Co., Springfield 2, Massachusetts.

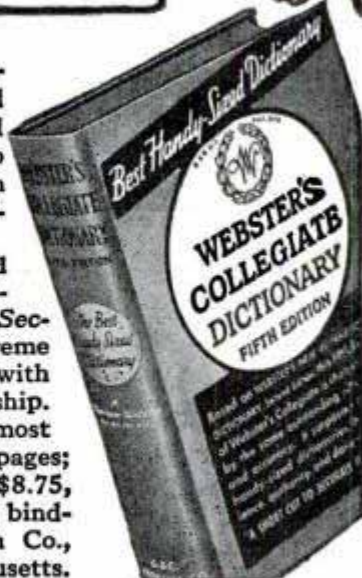

WEBSTER'S COLLEGIATE
A Merriam-Webster
REG. U.S. PAT. OFF.

TRAIN AT HOME FOR RADIO-ELECTRONICS

FOR BEGINNERS... 36 COURSES IN ONE!

Send coupon today! See how Ghirardi's famous RADIO PHYSICS COURSE book at only \$5 can give you complete basic training that can pave your way to a good-pay job in the fascinating and growing Television, F-M, Facsimile, Broadcasting, Communications, Radio Servicing, Industrial Electronics fields. This one giant, 972-page profusely illustrated book gives you a thorough training... just the training you need—easier, better, faster, and AT FAR LESS COST. Easily worth \$50 if sold in lesson form. No previous training necessary. Makes every step crystal clear. Over 500 illustrations. Many who never even saw a circuit diagram have completed it in a few weeks.

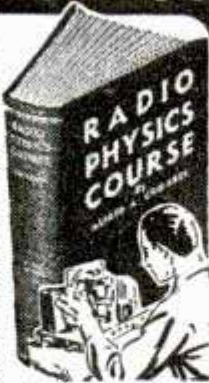

ONLY \$5
More widely used for Home Study, and by more Signal Corps, Navy and Civilian schools and colleges than any other book of its kind!

LEARN FAST—LEARN RIGHT

FIX RADIOS FOR FUN AND PROFIT!

This 4 Lb. Handbook Shows Exactly How to Diagnose & Repair Common Troubles in Practically Every Radio in Use

You don't have to be an expert! You don't require a lot of costly test equipment in order to repair radios—NOT when you have A. A. Ghirardi's 744-page RADIO TROUBLE-SHOOTER'S HANDBOOK. Just look up the receiver you want to repair in the big, 494-page Trouble Case History section. Nine times out of ten Ghirardi's HANDBOOK will automatically tell you EXACTLY what is wrong—EXACTLY how to fix it. No lost time! No needless, tedious testing! The HANDBOOK teaches you—automatically! Over 300 additional pages contain hundreds of charts, graphs, color codes, diagrams, hints, and compilations that will help you repair any radio ever made EASIER, BETTER, TWICE AS FAST! Only \$5 complete.



BE A PROFESSIONAL RADIO SERVICE EXPERT

It's easy with this book! Never before has there been such a demand for professionally trained technicians with exactly the training Ghirardi gives you in this big 1300-page MODERN RADIO SERVICING. Ideal for home study. Explains all test instruments; how to make preliminary trouble checks; how to analyze circuits scientifically; how to troubleshoot; how to make all kinds of repairs and installations—and hundreds of other subjects including How to Start and Operate a Successful Service Business of Your Own. Over 700 illus. Only \$5—on a 5-DAY MONEY-BACK GUARANTEE.



5-DAY MONEY-BACK GUARANTEE

MURRAY HILL BOOKS, Inc., Dept. PM-46
232 Madison Ave., New York 16, N. Y.

- Enclosed find \$..... for books checked; or send C.O.D. (U.S.A. only) for this amount plus postage. If not fully satisfied, I'll return the books within 5 days for complete refund.
- | | |
|--|---|
| <input type="checkbox"/> RADIO PHYSICS COURSE \$5 (\$5.50 foreign) | <input type="checkbox"/> MODERN RADIO SERVICING \$5 (\$5.50 foreign) |
| <input type="checkbox"/> RADIO TROUBLE-SHOOTER'S HANDBOOK \$5 (\$5.50 foreign) | <input type="checkbox"/> MONEY-SAVING COMBINATION Offer—BOTH Modern Radio Servicing AND Troubleshooter's Handbook ONLY \$9.50 (\$10.50 foreign) |

Name.....
Address.....
City & Dist. No..... State.....



Collect U. S. Army Shoulder Patches



An interesting, fascinating hobby. From 20c to 50c each. Master set of 400 patches—\$97.50. Special Christmas Assortments \$1, \$5, \$10, \$25, \$50. Official patches available for every major Army and Air Corps Unit. Send \$1 for sample selection of patches and PATCH CATALOGUE. Orders from Canada—add 20%.



SPRINGER'S
286 San Francisco Street
EL PASO, TEXAS



GENUINE PRE-WAR QUALITY FIREWORKS!
OH-BOY!

Banner has always been right there with the newest and best in fireworks. Now we give you JET PROPULSION... an amazing rocket plane that can be used over and over again. Write quick for details of this newest sensation in fireworks. It's astounding. It's colossal.

BIG SPECIAL OFFER \$4.95

Giant assortment of over 150 pieces, including 2-3-5 inch salutes, star shells, aerial bombs, flower pots, skyscreamers, battle-in-the-clouds, Roman candles, tubular salutes, and many others... regular \$8.15, retail value for only \$4.95. Rush your order. Supply limited. Catalog FREE.

BANNER FIREWORKS MFG. CO., INC.
DEPT. 107 TOLEDO 12, OHIO

DRAFTING

More good jobs now in Drafting. Learn AT HOME in spare time (or at our Chicago School). Send postcard for FREE TRIAL LESSON and see how easy to learn and get a good job.

CHICAGO TECHNICAL COLLEGE
D-207 Tech Bldg., 2000 S. Mich. Ave.
Chicago 16, Ill.

1,471 WAYS TO EARN MONEY!

Year 1944. 500,000 persons made \$10,000. to \$25,000. each. New Copyrighted book No. 359,607 has 1,293 DRAWINGS, 1,471 PATENT NUMBERS. Shows how you can make what 1,471 Successful men and women made, as toys, gadgets, devices, compounds, etc. How you can obtain Patents, Designs, Trade-Marks and Copyrights. Book 8 by 11 has 110 pages. \$1. Postpaid. Satisfaction or money back. Free Particular.

S. L. Centofanti, PM-PUB. 25 S. Pearl St., Youngstown 6, Ohio.

MAKE MONEY BY MAIL!

Start your own business at home, spare time. I get CASH in every mail... YOU can too! I'll tell you HOW! Send for FREE folder, "Your Own Mail Order Business."

B. W. COATES, 46-P King Street, Dorchester, Mass.

SHAW and Peppy-Pal GARDEN TRACTORS

1 to 9 H.P. Circulars on request. Building more now. We supply repairs for all SHAW Tractors sold in our 42 years in business.

BUILD YOUR OWN RIDING TRACTOR—"WAR HORSE"

using old auto parts, powered by 2 H.P. or larger air-cooled engine; or walking type Garden Tractor 1/2 to 3 H.P. or convert truck or auto into Farm Tractor. Each with steel or rubber tires; will plow, cultivate. Plans for building, in few hours, any one of above, postpaid for \$1.00 (state which wanted) or all 3 for \$2.00. Money Back Guarantee

SHAW MFG. CO., 4504 Front St.
Galesburg, Kansas
668G North 4th St., Columbus, Ohio

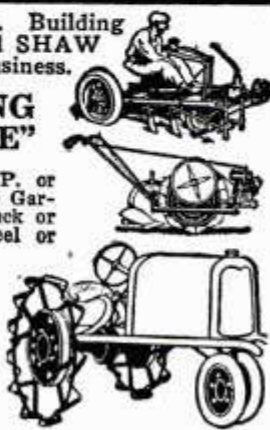

Learn TO BE A Service Mechanic IN REFRIGERATION and AIR-CONDITIONING

AT HOME
In Your Spare Time

**YOU CAN PAY FOR
YOUR TRAINING
WITH JUST ONE
GOOD REPAIR JOB**



**OPEN YOUR OWN
REPAIR SHOP
and
Be Independent**

Your job is always safe when you own your own business . . . and the opportunity to earn is unlimited, depending on how much you care to expand. Even if you prefer to work for someone else, remember—no one can ever invent a machine to take your place. It takes **HANDS** to service and install. There's always work for you to do in good times and bad.

**NEW BOOK
"HOW TO START YOUR
OWN BUSINESS"
Sent at No Extra Cost
If You Act Promptly**

This valuable book covers locating your shop, contains drawings of how to build and wire work-benches, where and how to advertise, what to charge, how to hire solicitors, etc. Let's hear from you, **TODAY**.

Here's a great, uncrowded expanding field with an almost unlimited horizon. There's not only a big shortage of trained service and installation mechanics **RIGHT NOW** . . . but the electrification of new areas, the big home-building boom ahead, and new uses for refrigeration and air-conditioning units should almost double the **MONEY-MAKING POSSIBILITIES**. Modern housewives now want **DEEP FREEZE** units *besides* regular refrigerators . . . and even automobiles are installing air-conditioning. So homes, farms, stores, cafes, theatres, buildings and even motorists are all prospects . . . for repairs, sales of units, parts or installation. **OPPORTUNITY IS WIDE OPEN.**



**H. T. ARMSTRONG
General Manager**

Interesting Work! Easy to Learn!

Our practical, thorough course teaches you this interesting, good paying business **AT HOME DURING YOUR SPARE TIME**. It is easy to grasp. No previous experience required. A grade school education is all you need. Learn how to start your own business with \$50.00 worth of tools in your garage, basement or small shop. Or, take a well paid job in this active field. Send for our **FREE BOOKLET TODAY**. No obligation.

**FREE BOOKLET
MAIL THIS COUPON
TODAY**

H. T. ARMSTRONG, General Manager,
**MECHANICS TRAINING SCHOOL, Dept. P-4,
7217 So. Broadway, Los Angeles 3, Cal.**

Dear Sirs: Please send me, without obligation, your **FREE BOOKLET**, and full details.

Name

Address

City State

COMPLETE 5-PIECE CANDID CAMERA OUTFIT

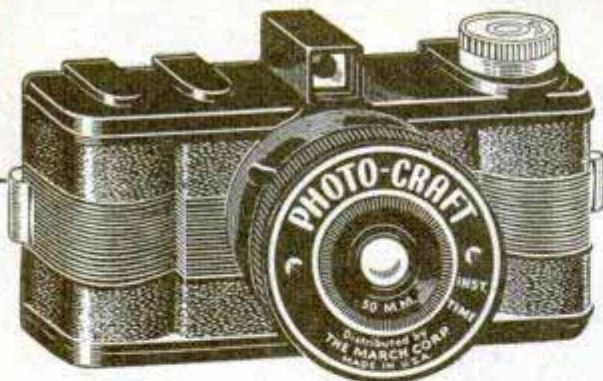

Includes all This!

- ★ GENUINE PHOTOCRAFT CANDID Type CAMERA
- ★ CARRYING CASE with Your Name in 23-Kt. GOLD
- ★ 3 ROLLS of No. 127 FILM

ALL YOURS FOR ONLY \$ **3.98** POST PAID

CARRYING CASE With Handy Shoulder Strap INCLUDED

LOOK AT THESE FEATURES

- ★ Genuine Simpson Ground and Pitch Polished Lens
- ★ Takes 16 Pictures on Any Standard No. 127 Film
- ★ Will Take Pictures in Full Color
- ★ Has "Bullseye" Level View Finder
- ★ Easy, Simple, Foolproof Operation

THREE ROLLS OF FILM INCLUDED



Personalized WITH YOUR NAME IN 23-Kt. Gold

PICTURES YOU TAKE TODAY WITH THIS BIG 3-IN-1 OUTFIT WILL BE THE TREASURES OF TOMORROW

... For while time stands still for no one, the memories of happy times can be preserved by Photocraft. Your Photocraft candid camera outfit comes to you ready to go to work — with a handy shoulder strap carrying case Personalized with the name of your choice in 23-Kt. GOLD, and enough film for 48 exposures — for only \$3.98 postpaid! Your Photocraft will also take full color pictures when loaded with Colorchrome film. So whether for a gift or for yourself, order your Complete 5-piece Photocraft Outfit now! Our guarantee is your assurance of satisfaction.



RUSH THIS COUPON NOW

Sold On A "Examine At Our Risk" GUARANTEE OF SATISFACTION

Yes, if you don't feel that Photocraft is everything you expected, you may return it in 10 days for a complete refund.

IMPERIAL INDUSTRIES—Dept. PC 276
618 South Dearborn St., Chicago 5, Ill.

Rush my Photocraft Candid Camera Outfit at \$3.98 with Personalized Carrying Case and 3 rolls of No. 127 Film. My money will be refunded if returned in 10 days.

- Name Wanted in Gold _____
- Please Print
- CHECK ONE
- I'm enclosing \$3.98 in full payment. Please send my Photocraft Outfit Postpaid.
 - Send my Photocraft C.O.D. I am enclosing \$1.00 deposit because I want my Carrying Case Personalized in GOLD. I'll pay postman balance of \$2.98 plus postage.
 - Send my Photocraft C.O.D. without name on Carrying Case. I will pay postman \$3.98 plus postage.

Name _____
Please Print Clearly
Address _____
City _____ Zone _____ State _____

"It's The Best Band in The Land"

The New and Better BANDMASTER

Adjustable, Expansion Stainless Steel

WATCH BAND \$ **2** TAX FREE POST PAID



Check These Features

- ★ Guaranteed Stainless Steel
- ★ Will not Tarnish or Rust
- ★ Super-Flexible — Adjustable
- ★ Fits Any Watch — Any Wrist

De Luxe 18-Kt. Gold Plated BANDMASTER WATCH BAND

WITH STAINLESS STEEL BACK, WARRANTED TARNISH-PROOF \$ **3** POST PAID TAX FREE

Bandmaster Makes Any Watch Look Good . . . and Good Watches Look Better!

Yes, Bandmaster, at its truly low affordable price is the expensive looking, expensive performing, *tarnish-proof* watch band the world has been waiting for! So *flexible*, so *lightweight*, so *everlastingly smart!* End bothersome buckle-fussing with shabby, quick-aging leather bands. Order your *easy-on, easy-off* Bandmaster today.

GENERAL SALES SUPPLY—Dept. B102
608 So. Dearborn St.—Chicago 5, Ill.

Please rush Bandmaster Expansion Watch Bands checked off below. If not delighted I may return within 5 days for refund.

CHECK ONE

- Stainless Steel 1 for \$2 2 for \$3.50 3 for \$5
- Gold Plated 1 for \$3 2 for \$5.50 3 for \$8
- I am enclosing \$_____ payment in full
- Ship C.O.D. I will pay postman \$_____ plus postage

Name _____
Please Print Clearly
Address _____
City _____ Zone _____ State _____

RUSH COUPON

**WORLD'S
BEST
WANT AD
MEDIUM**

CLASSIFIED Advertisements



Advertisements in this section 50 cents per word, each insertion, minimum 10 words, payable in advance
To be inserted under proper classification in May issue, copy should be in our office April 4th

May issue on sale May 1st

F. W. Johnson, Manager, Classified Advertising

Popular Mechanics Magazine, 200 East Ontario Street, Chicago 11, Illinois

1455 CLASSIFIED ADVERTISEMENTS 1455 OPPORTUNITIES FOR YOU

AUTOMOBILES, MIDGET CARS

R & R Mfg. Co., marine and auto division, Anderson, Indiana, Robert M. Roof. \$1.00 for our new 1946 speed and power equipment catalogue with price sheet—showing racing cars, midgets, speed boats with recommendations how to rebuild your motor for racing. Dual ignition racing cylinder heads for V-60-100 and Mercury Ford engines. Dual intake manifolds, racing pistons, camshafts, compound valve springs, Lynite flywheels, quick change gear boxes and numerous other supplies.

RACING Car performance for all cars. Increase power, speed, pick-up. Special "Custom-built" equipment. Write Lee Motorcraft, 1412-A, Great Northern Bldg., Chicago 4, Ill.

FREE List Photos race cars with drivers. Frank Smith, Midland Park, N. J.

JET Impulsion now for automobiles. Complete installation instructions, \$1.98. Wayne Engineering, Greenville 1, Ohio.

1946 **SUPER-IGNITIONER** \$5.50. Quicker starting, pep, mileage. EG Mfg. Co., 355A East 149th St. New York.

KNOW Your car, a modern motor chart which covers tune up from A to Z. How to keep your car in tip top shape. Tune your car once a month for efficiency and top performance. Send \$1.10 to Modern Motor Chart, P.O. Box 602, Trenton 4, New Jersey.

HENRY Ford—His Life, His Work, His Genius. Wonderful new 384 page Ford History book. Unusual photographs, illustrations, early and late Ford cars. \$3.00 postpaid. Cloth bound edition \$4.00. Clymer, 2125 W. Pico, Los Angeles 6, Calif.

DYNAMIC Power thru water injection. The same principle that gives our fighter planes their terrific, smashing power can now be applied to your automobile. The Hydro-Meter reduces carbon, eliminates ping, adds speed, power and increases gas mileage. Installed quickly by anyone. Hydro-Meter complete with instructions \$9.95 postpaid. Enterprise Laboratories, Box 390, New Haven 11, Connecticut.

REPAIR Your car. Motor parts for all engines, chassis parts, ignition and carburetor parts, etc. New replacement parts. Genuine and highest quality at manufacturers' retail prices. F.O.B. Chicago. No body parts. B & N Engineering Co., Box 3454 Merchandise Mart P.O., Chicago 54, Illinois.

NOW Ready! Floyd Clymer's Historical Motor Scrapbook Number Three, entirely different from Editions One and Two. Ads, photos, descriptions, specifications over 200 early autos, including Rolls-Royce, Owen Magnetic, Fordmobile, Revere, Ruxton, Cord, Roamer, Diana, Adler, Mercedes-Benz, Stutz Bearcat, Marmon, Stout, Flint, Lozier; steam and electric cars, many others. Motorcycle section includes early Cleveland, Henderson "6," Peerless, Wagner, Crocker, AMC, BMW, Excelsior, Ariel, Flanders, others. Pike's Peak races, many interesting incidents early automotive days described. Profusely illustrated. Continues Floyd Clymer's interesting autobiography. \$1.50 postpaid; Deluxe cloth-bound, \$2.50. (Editions One and Two also available at these prices.) Clymers, 2125 W. Pico, Los Angeles, Calif.

PROFESSIONAL Midget racer, motor-scooter, midget roadster, and midget motorcycle. Plans, specifications for all four contained in illustrated handbook. 25c. Big list used motors, motorscooters, Servicycles, etc., included free! Midwest, 3839 Drummond, Toledo, Ohio.

PHOTOGRAPHS. World's finest automobiles. List 10c. Box 1028, Minneapolis, Minnesota.

BUILD Midget racer from castoff parts! Plans, specifications, construction information, \$1.00. Motor Supply, Box 1682-CS, Toledo, Ohio.

SENSATIONALLY Easy to build inexpensive midget two-passenger "Jeep" from readily available materials! Large working plans, construction information, \$1.00. Universal, 2671 Algonquin, Toledo 6, Ohio.

CUSTOMIZE Your automobile. Illustrated, new restyling ideas, instructions, suggestions, specific model changes by simple methods. \$1. Speed Wheel, Box 723-E, Arcadia, California.

INTERESTING, Educational, illustrated English "Motor" magazine on foreign automobiles. 50c postpaid. Clymers, 2125 W. Pico, Los Angeles 6, Calif.

STEAM Car Scrapbook. Compiled by Floyd Clymer. Historical, authentic, amusing. Ads, photos, descriptions 250 early steam cars, with fascinating story by one-time world's youngest auto dealer. Postpaid \$2.00. Deluxe cloth-bound \$3.00. Clymers, 2125 W. Pico, Los Angeles 6, Calif.

AUTOMOBILE Racing book, fifth edition, well illustrated. Instructions on building bodies, frames, engines, Ford A and B conversions. Plans, AAA rules, specifications. Roadster racing, Indianapolis cars. \$1.00 postpaid, \$1.30 C.O.D. Ray Kuns, Dept. 47, Madisonville, Cincinnati 27, Ohio.

AUTO SUPPLIES AND EQUIPMENT

MECHANICS Make money selling and installing Vacuum Superchargers, more speed, power, and a real gasoline saver, uses gasoline your motor is now wasting. Only \$7.50, self-addressed envelope for pamphlet. McDowell Co., 2000 NE, Union, Portland 12, Oregon.

VACU-MATIC Carburetor controls operate on the supercharge principle. Functions automatically from vacuum created in manifold. You get more power and increased mileage on every gallon of gas. Up to 26 miles per gallon. Easy to install, fits all cars, trucks and tractors. You risk nothing, our 30-day trial offer protects you. So try Vacu-matic. State name and model of your car. Vacu-matics come fully guaranteed, price \$4.00. W. Behrend, 1658 W. Congress St., Chicago 12, Ill.

BEAUTIFUL Chrome foglights, sent postpaid anywhere in U.S.A., \$7.95 pair. Rich cloth seat covers \$9.95 postpaid, state make, model, year of car. Send check or money order. Gem Distributors, Box 261, Stratford, Conn.

QUICK Money "repairing car batteries" at home! Easy too! Write Batteryman, Grand Junction, Colorado.

SOAP Paste, grit, big profit. Larkin Soap Co., Teaneck, N. J.

HOSE: All kinds—oxyacetylene hose. 25 ft. sets coupled \$6.40—service station air 25 ft. \$3.00. Carter, Box 33 Grand River Station, Detroit 8, Mich.

1000 MOTORISTS Needed to make gas savings test. Up to 30% savings. For trial test offer write Vacu-matic Carburetor Co., 7617-1273 W. State Street, Wauwatosa, Wis.

GASOLINE Saving device. Chevrolet, Ford 1932-1942, Dodge, Plymouth, 1933-1938. Walert Company, 3429 North 10th Street, Milwaukee 6, Wisconsin.

GRILLES For all cars. Meyers Auto Parts, 820 Dryades, New Orleans, La.

HAVING Car trouble? New, used, guaranteed auto, truck parts save money. Transmission specialists. Describe needs; immediate reply. Victory, 2930½ Northwestern, Chicago 18.

AUTO Parts for all autos and trucks. Trans., motors, differentials, fenders, carburetors. Also body parts. Security Auto and Truck Parts, 1941 BJ Eddy, Chicago 13.

OIL Pumping motors—brought back to normal without ring job. Write for particulars. Joe Mullner, Box 3102, St. Paul 1, Minn.

PLATING Outfits for auto parts. Connect to a battery. No tanks used. Free particulars and proofs. Gunmetal Co., Ave. J, Decatur, Ill.

AUTO TRAILERS

BUILD Streamlined trailer coach. Has everything. Fine, large 18"x24" blueprint and instructions, \$3.00. Manual of working drawings, \$1.00. Craftsmann Books, Box 1153-P4, Milwaukee 1, Wis.

BUILD Your own trailer! Save money! Have every feature you want! Plans for house, sport, camp and utility trailers. Catalog describing 9 models 10c. 15c in Canada and overseas. Jim Dandy, Box 125-A, Wausau, Wisconsin.

MOTORCYCLES, BICYCLES, MOTOR-SCOOTERS AND SUPPLIES

MOTORSCOOTER Plans for boys. Speedy. Simple to build. Uses washing machine gas motor, \$1.00. Strachan Scooter Shop, Howard 2, Kansas.

DISC WHEELS, Metal 8" with 3/4" axle hole. Universal, 4713 Virginia, St. Louis, Mo.

SEND 25c For complete motorbike plans and parts list. Motorbike Service, 1304 Indiana, New Albany, Ind.

BICYCLES, Kroll, Stork baby carriages, thirty-five dollars. Strollers and doll buggies. Send dime for list. Century Cycle Co., 3447 Lawrence, Chicago 25, Ill.

BOYS, Illustrated "Bicycle Repair Manual" teaches brake repairing, re-spoking wheels, etc. Dealers wanted, 65c. Robt. Klauser, Shelbyville, Ill.

MOTORCYCLE Parts. New and used. List 10c. Ballak, 811 N. 9th, St. Louis 1, Mo.

FOR Real fun! Two-passenger, three wheeled motorized run-about. More than a motorscooter! Simple construction. Complete plans, \$1.00. Universal, 2671 Algonquin, Toledo, Ohio.

GENUINE Moto-Scoot parts. Complete wheels, tires, tubes, 4:00x7, 3:50x6. AMSCO centrifugal clutch. Windshield, side cars. All other parts and accessories. Write for parts list. Also genuine engine parts for Briggs and Stratton, Lauson. American Moto-Scoot Co., 1319 W. Carroll Ave., Chicago 7, Ill.

MOTORBIKE And scooter manual contains motorbike and scooter plans and small motor data. \$1.00. Variety Enterprise Co., P.O. Box 124, Evansville, Ind.

NEW Ranger Scooter-cycles, the latest word in power scooters. Light, weighs only 83 lbs.; fast, up to 30 miles per hour; economical, up to 90 miles per gallon. See your Ranger dealer or write Mead Cycle Company, 4520 W. Madison Street, Chicago 24, Illinois.

BICYCLE Book, how to buy, rebuild, sell used bicycles 50c. John Collett, Handley, Texas.

"MODERN Motorcycle Mechanics" enlarged, revised, second edition, 560 pages, 300 illustrations. The most up-to-date and complete motorcycle book published. Extensively covers design, operating, and servicing Harley-Davidson, Indian and English makes. Price \$3.00 postpaid. Nicholson Brothers, Motorcycle Engineers, Saskatoon, Canada.

HARLEY-DAVIDSON Service, parts, accessories. Buddy seats \$17.75, tandems for 45" models \$12.50 (shipping paid). Can be fitted to other models. Send \$2.25 for Army Motorcycle Manual. 10c for bulletins. Knuth's (Harley-Davidson factory dealer), 2491 W. Fond du Lac, Milwaukee 6, Wis.

MOTORCYCLES—How to Manage Them. 288 pages, 175 illustrations, drawings, 29th edition now available. Read and become better motorcyclist. Expertly written. \$1.50 postpaid. Clymer, 2125 W. Pico, Los Angeles 6, Calif.

EOLENS Factory-built midget racer \$40 complete; boys midget car less motor \$8; twin-cylinder motorbike \$35; Indian twin motorcycle \$60; Harley \$70; motorscooters \$35 up; Briggs-Stratton motors as low as \$5. Over 1500 balloon tires for midget cars and motorscooters in stock \$1.50 up. Parts plans. Mailorder only. Send 25c for big war-bargain catalogue Number 12 just out listing the above and almost 400 other motorized bargains. (35c by first class mail.) Midget Motors Directory, Athens, Ohio.

BUILD Scooters, trailers, midgets, conversions. Large manual \$1.00. Circulars dime. Craftsmann Books, Box 1153-P2, Milwaukee 1, Wis.

MOTORSCOOTER \$10, Motor \$3, tires \$2. New catalog, 25c, lists these and many other sensational bargains in motors, wheels, motorscooters, and motorbikes! Associated, Box CS-1764, Toledo, Ohio.

COMPLETE Motorcycle parts list, 10c. All models Indian and Harley. Pistons, chains, sprockets, generator repairs, carburetor rebuilding, motor rebuilding, repair manuals. Bootz, 622 E. Grand, Des Moines 9, Iowa.

MOTORCYCLE Cams ground for speed and power. For information write Harold Schaller, 247 West Main, Turlock, Calif.

FLOYD Clymer's Motorcycling Manual. 120 illustrations. Information, specifications, descriptions dozens motorcycles. Engines, transmissions, carburetors, square four, two piston singles, overhead camshafts, spring frames, hydraulic forks, sidecars, riding instructions. Two cycle engines and power bicycles described, illustrated. \$2.00 postpaid. Clymers, 2125 W. Pico, Los Angeles 6, Calif.

PARTS, Accessories, pistons, chain Harley Davidson motorcycles. George's, P.O. Box 114, El Paso, Texas.

LARGE Stock Indian parts. Expert motor rebuilding. Indian Motorcycle Sales, Kansas City 1, Mo.

BUILD America's lowest priced motor-scooter speedster! Complete plans, specifications, \$1.00. Big list used motors, etc., included free! Motor Supply, Box 1682-CS, Toledo, Ohio.

FLOYD Clymer's popular motorcycle, automobile books. See advertisement under Automobiles! Clymers, 2125 W. Pico, Los Angeles 6, Calif.

TIRES, Tubes, wheels, for industrial trucks, carts, wheelbarrows, scooters, midget cars, coaster wagons. Nationally known makes, first-line quality. Sizes 8" to 18" o.d. in 2, 4, and 6 ply tires, separate inner tubes, heavy duty demountable wheels. Also caster forks, straight and swivel types. Free illustrated circular and prices. Jahant Co., 626 East Exchange Street, Akron 6, Ohio.

ENGLISH "Motorcycling" Magazine. Interesting, educational, foreign motorcycles. Racing, new-old models, advertisements. 50c sample copy. Clymers, 2125 W. Pico, Los Angeles 6, Calif.

PLANS, Scale drawings, specifications, illustrations for building attractive motor scooter complete \$2.00; plans electrically driven bicycle \$1.50. Postpaid. Clymers, 2125 W. Pico, Los Angeles 6, Calif.

TIRES And industrial wheels, suitable for scooters, wheelbarrows, farm equipment, etc. All sizes. Bicycles and accessories. Largest assortment in America. Send dime for list. Cycle Transport Company, 1241 So. Michigan Ave., Chicago 5, Illinois.

GET Your copy of the new Ranger bicycle lubrication chart. A genuine check-chart which shows you how to service your bicycle. Only 10c. Mead Cycle Co., 4520 W. Madison Street, Chicago 24, Illinois.

AVIATION

PROPELLERS—All types, fit any motor. Special 3-blade for sleds, boats. Illustrated lightplane literature. Aircoo motor plans, 50c. Fast delivery. Standard Aero Craft, Ft. Worth, Texas.

HELICOPTER Instructions. Rush name for free literature. Wayne Engineering, Greenville 1, Ohio.

JET Propulsion. Know jet propulsion. Build your own units for model airplanes. Get complete data, drawings, design charts. Only 50c. Technical Press, Box 951 Y., Salem, Mass.

P-47 AIRPLANE jettison gasoline tanks—streamlined 10½ feet long, 28" diameter, 165 gal. capacity, constructed of 20 gauge terne coated steel. Ideal for making boats, bob sleds, midget autos, etc. Price \$17.50 per tank or \$12.50 per tank in quantities of 3 or more. Special quantity discount to dealers. Ramona Manufacturing Company, Ramona Park, East Grand Rapids, Michigan.

PROPELLERS For ice-snow sleds, air boats. Literature 5c. Banks Propellers, R.F.D. 7, Ft. Worth, Texas.

AERO-SLED Blueprints, open job, \$3.00. Adastik Bros., Grand Rapids, Mich.

SEND 25c For big war-bargain catalogue of used airplanes located everywhere, some probably near you. (35c by first class mail.) New issue just out. Used Aircraft Directory, Athens, Ohio.

PORTERFIELD \$275, Waco \$125. New catalog, 25c. Lists thousands of sensational bargains in airplanes, motors, parts, parachutes, supplies. Aviation "Business Opportunity" section included free! National, Box 1682-CS, Toledo, Ohio.

LIGHTPLANE! How to build them. Illustrated circular 20c. Craftsmann Book, Box 1153-P1, Milwaukee 1, Wis.

JET Propulsion experiments. New principle to drive boats, bicycles, model helicopters. Circular on plans. Rush name. Houston Maupin, Tipp City 53, Ohio.

BATTERIES, GENERATORS, ETC.

EDISON Batteries. Light Power. Fifteen year life. Unconditionally guaranteed. Complete lighting plants. Free literature. See-Jay Company, 321 Yonkers Avenue, Yonkers, New York.

ELECTRICAL SUPPLIES, EQUIPMENT

SPEED Indicating Tachometer, watch type construction, registers to 25,000 r.p.m. \$3.95. Surg. Specialty Co., 4868½ Sheridan Rd., Chicago, 40, Ill.

PHOTO - ELECTRIC Cells—Generate electricity by light. Operate meters, relays. While they last, \$5.95 postpaid, C.O.D., \$6.25. Star Co., 235 Canal St., N.Y.

FLUORESCENT Lights—Home, industrial, commercial. Ray, Box 329, Posen, Ill.

MANUAL "Know your multispeed motors," explains in detail this electric motor. \$2.00. Literature free. Electric Generator Manufacturing Co., 1333 N. Dale St., St. Paul 3, Minn.

ELECTRIC Fans? Make your own. 16 inch correctly balanced aluminum fan blade ½ inch bore, ideal on any size motor 1/6-1/3 h.p.—\$3.50. 18 inch all welded guard, adjusted to fit four stops on motor \$3.00. Adjustable floor standard 4-8 feet height, rigid, sturdy, \$9.00. Table standard, universal, fits any motor base \$3.75. Prepaid anywhere U.S. 25% deposit on C.O.D. shipments. Dealers write. Ted Riseman, 1461 North 3rd Street, Springfield, Illinois.

IRON Element and cord set. Plus element for toasters or heaters, hotplates. Three \$1.50. United, 1554 York Ave., New York 28, N. Y.

MOTOR Winding supplies, wire, insulations, in small quantities. Electrical Service, 19165 Gallagher, Detroit 12, Mich.

ELECTRIC Irons \$5.50. "Electro" six-tube ac dc superheterodyne 1946 radios, \$26.25. Two burner stoves, \$6.95. Electric broilers, \$13.95. Heaters, \$4.95. 8" electric fans, \$8.95. 20% deposit. Jeannette Electric Co. Inc., 159 West 23rd Street, New York 11, N. Y.

FOR Sale: Mpls.-Honeywell elect. janitor sets No. Y100A. One set \$16.00. 5 sets \$78.50, delivered east of Mississippi River. Detroit ordinance forces sale. L. Wallner, 9663 Cheyenne St., Detroit 27, Michigan.

ELECTRIC Appliances, every description. Send for circular. United, 1554 York Ave., New York, N. Y.

NOW Available! Electric quick freezers for home and farm. Immediate delivery! Write for free catalogue. Modernlite Company, Box 1167-B, Baltimore 3, Md.

TOASTER, Heater and iron elements. Complete ready to install. Electronic Service Co., Box 95, Wyandotte, Mich.

FAN Blades. 20" airplane type for ventilating or circulating, use on any small motor, 1/6 h.p. up. ½" shaft. \$3.00 postpaid. W & D Mfg. Co., Stuttgart, Ark.

ELECTRICAL Appliance repair. Open your own shop. Learn house wiring; electric motors, vacuum cleaners, washers, etc. Complete illustrated course shows how. Free booklet. Pacific Training School, Dept. AP-2, 7217 So. Broadway, Los Angeles 3, Calif.

NOW—Repair your own electrical appliances with Chanite Self-welding Electrical Heating Element Flux. Instructions delivered, price \$1.00. Stick form 25c ea., \$2.00 doz. Chanite Sales Company, 914 South Main, Fort Worth, Texas.

FLUORESCENT Tubes burned-out? You can relight and use indefinitely. Complete instructions \$1.00. Wallingford, 121 Burlington, York, Neb.

ELECTRIC Pencil: Writes-engraves all metals \$1.00 postpaid. Beyer Mfg., 4515-H Cottage Grove, Chicago 15.

BROKEN—Burned out electrical heating elements quickly repaired. Use new amazing Nichrome Paste, simply overlap ends and turn on current. Family size \$1.00 bill. Satisfaction guaranteed. Armstrong Mfg., 861-X, Minneapolis, Minn.

WELDING, SOLDERING, PLATING

NEW Model electric welder 110 volt a.c.-d.c.; will weld all metals; easy to use; full directions. Complete with power unit, flame and metallic arc attachments, carbons, fluxes, rods, mask; all for \$19.95. Used by the navy. Magic Welder Mfg. Co., 239-MP4 Canal St., New York City.

ARC Welders wanted by the thousands. Learn with 516 page lessons manual. Over 500 how-to-do-it photos. \$2.00 copy. Money-back guarantee. Hobartweld, Box M-464, Troy, Ohio.

ACETYLENE Welding outfits like new; arcwelders, welders manual, \$1.65. Eagle Welding, Dept. PM, 5085 Broadway, Chicago 40, Ill.

BUILD 110 Volt a.c. welder. Plugs in socket. Plans \$1.00. Easily built. Franks' Projects, Box 555, Louisville, Ky.

USED Welding cable, like new. Size 2/0. 20c foot. N. Carter, 71 Hobson St., Sausalito, Mass.

OKINAWA "Flame thrower" slip-on soldering tip for fender men. Fits all torches. Postpaid anywhere in U. S. \$2.35. L. E. Kelly, 1947—19th Avenue, San Francisco 16, Calif.

WELDING, Cutting, aircraft welding and soldering equipment. Electric arc welders. Superior Oxy-Acetylene Co., Hamilton, Ohio.

"THUNDERBOLT"—Transformer welder, dial-control, 3 heat stages, 60 amps., 110 volts-a.c., takes up to 3/32 rod, carrying case, all accessories, illustrated instructions. Professional heavy duty welding, brazing outfit. \$39.50. Also light-work welder, 110-volts, a.c.-d.c. \$19.95. Save 2%, send check. Or order C.O.D. Super-Welder Mfg. Co., Dept. PMC, 23 E. 20th St., New York 3, N. Y.

BUILD D.C. arcwelder without rewinding armature. Plans \$1.00 each. 25 to 600 amperes from automotive d.c. motors, light plant generators, automobile starter-generators. Welders Club, AB-3432, Chicago 54.

MACHINERY, TOOLS AND SUPPLIES

SELSYN Motor manufactured by Bendix, weigh 5 lbs. ea., 2 transmitters, 2 differentials, set of 4, \$25.00. Also transmitters manufactured by Bendix, Diehl Electrolux, \$7.50 ea. All operate on 110 volt, 60 cycle, a.c. current. Suitable for remote control, beam antenna, bingo signalling, wind indicators, and many other uses. Special Bendix type c.s. 1, weigh 1 lb. ea. 28 volt d.c. motor. Will run on 15 volt, a.c. about 2000 r.p.m., \$2.25 ea. Charges prepaid on all items within the United States. Columbo Trading Company, Inc., 304 Canal Street, New York City, 13.

BUILD Quickchange gear box for Craftsman 12" Atlas 10" lathes. Adaptable to others. No castings. Complete drawings, \$3.00. Stevens Engineering, 2604 Military, Los Angeles 34, Calif.

BRASS, Round and square rods, 2 foot lengths. List free. American, 388 East 34th St., Brooklyn 3, N. Y.

GOVERNMENT Surplus speed reduction units. Brass gears in Oilite bearings. 133:1 and 66.5:1 ratios. Each \$1.00. Box 112, Russiaville, Ind.

GEARS For inventors, experimenters, model makers, schools, work shops, laboratories, etc. Government surplus made of brass, bronze, dural steel and stainless steel. 12 matched pairs; 24 gears, bevel, spur and ratchet. List price \$12.00, our price, \$2.50. 25 matched pairs; 50 gears, includes larger gears, also sets of worm gears. List price, \$30.00, our price, \$5.00. 50 matched pairs; 100 gears better assortment, including internal set and worm sets. List price, \$75.00, our price, \$10.00. Limited quantity. Order now. Write for our bulletins on ball bearings, rectifiers, re-ays, selsyns, horns and government surplus materials. Met Exchange, 323 Canal Street, New York.

IT'S Easy to build your own metal and woodworking tools from Lewis castings, materials and blueprints—and at savings up to 80%! Lewis mills, shapers, drill-presses and other shop tools have ample capacity and performance for home workshop jobs. New catalog—sent on receipt of 10c to cover mailing—describes 23 Lewis tools. Address Lewis Machine Tool Co., P.O. Box 116, Station A, Dept. M-63, Los Angeles 31, California.

SINE Bars. Simplified, accurate. Instructions included. \$8.75. Capanna, 552 Morgan, Akron 11, Ohio.

ANGLE Plate C.I. 4"x3"x3. Ribbed, machine finished 4-sides. \$2.00, unfinished 75c. Model Tool Service, 202 Wood Ave., Rock Falls, Ill.

WAR Surplus, machines, tools, etc. Rush name for free literature. Wayne Engineering, Greenville 1, Ohio.

PATENT Equipment sharpens pipe wrench jaws in your own shop or mount in car trunk and travel. Very profitable. J. C. Moore Industries, Box 234, Fredonia, Penna.

HARDWARE. Tools, saw mandrels, model and pattern supplies, drills, taps, jeweler saws, screws, steel, brass. Catalog. 10c. Terek, 6304 Patterson, Chicago 34.

BUILD It! Circular saw and drill press. No castings, pipe fittings. Two simple plans. Complete, \$1.00 cash. Western Colorado Sales Co., Box 584, Grand Junction, Colorado.

BUILD Your circlesaw, lathe, drillpress, and bandsaw from castoff parts! Plans, specifications, for all four, 25c. Allied, 2671 Algonquin, Toledo, Ohio.

CHANGE Any 1/2 inch shaft motor to power grinder or polisher with Greenleaf arbor. Arbor slips on motor shaft, takes any wheel with 1/2 inch hole. Only 70c postpaid. Money back guarantee. Send check or money order to Greenleaf Mfg. Co., Paoli, Penna.

LATHE Owners—Genuine "Accur-Craft" die and tap holders. Designs, 25c each. Accur-Craft, Box 3351, Los Angeles, Calif.

MORE Machine shop tools released for private industry. 13"x5" Loose change-gear lathes, \$140. 16"x6", \$180. Medium size Brown and Sharpe and other turret lathes, \$110. Bench miller, \$110. Motorized universal grinder, \$325. 28" Colburn boring mill, \$325. Small Blunt tool grinders, \$55. Drill grinder, \$140. Conversion Parts Co., 278 Adams St., Boston 22, Mass.

MAKE Circular saw yourself. Prints, information, 25c. L. Bazuin, Grand Rapids 3, Mich.

HANDEE Tool. 1001 uses. Grinds, drills, polishes, etc. 25,000 rpm. ac. dc. 7 accessories. Circular free. Appliance Mart, 21-P Castine, Bangor, Maine.

DRILL Grinder for twist drills \$2.95, and other craftsman's tools. See ad on page 266.

EXPERIMENTERS—400 Valuable new springs, 75 kinds, numerous sizes, 10,000 uses, \$2.00. Deluxe assortment, \$3.00. Jumbo, \$5.00. Guaranteed. Technico, Box 246-A, West Hartford, Conn.

INDEX Heads for sale. Very inexpensive. Sixty-two different divisions. Used on small lathes, drill press, milling machines, etc. Make gears, hobs, cutters, etc. Very accurate, and durable. Not a toy. Used by defense schools and hobbyists. Write for free folder. Long's Index Heads, 2117 East B St., Torrington, Wyo.

ENGINES, MOTORS, DYNAMOS

BIG Pay jobs in welding. Complete welding lessons and reference books. 516 pages. 41 lessons. \$2.00 copy. Money-back guarantee. Hobartweld, Box 465-M, Troy, Ohio.

150 AMPERE Generator for welding \$47.50. Extra flexible cable, 8 ft. lengths \$2.75. Other bargains. Butler Electric Company, 1885 Milwaukee, Chicago 47.

COMPARE Our catalogue on engines, etc., 10c. Howard-A3, 2417 N. Ashland Ave., Chicago 14, Ill.

WIZZ Electric motor: Assembles in a jiffy. Operates on flashlight cell. All parts complete. Instructions. Send 25c. plus 5c postage. Eltro, Box 171B, Deer Park, N. Y.

ELECTRIC Motor Course giving instruction on rewinding, connecting and testing single, two and three phase motors. Clearly written in everyday, non-technical language. Illustrated throughout. Especially recommended for the electrician interested in learning the electric motor trade. Prepaid \$2.00. Satisfaction guaranteed or remittance refunded. Educational Advancement Co., Dept. L, Lakewood, N. Y.

NEW Kohler electric plants a.c. and d.c. Other electric plants rebuilt. Write E. F. Schmaltz, 314 Wyoming Ave., Kingston, Penna.

WINDING Data, listing 225 motors, single and three phase, \$1.00. Motor Data Co., Box 7631, Kansas City 3, Mo.

MOTOR Controls and protective devices. A book filled with data and connections for drum controls and starting devices such as used for electric locomotives, cranes, elevators, machine tools, multi-speed two and three phase motors. Also included are relays of various types, DC motor and meter connections. Prepaid \$2.50. Satisfaction guaranteed or remittance refunded. Educational Advancement Co., Dept. L, Lakewood, New York.

BOATS, OUTBOARD MOTORS, ETC.

BUILD A boat: Brooks knock-down parts saves time and money. Simple as A B C. Outboards, inboards, sail and racing boats. Send 10c for complete literature. Brooks Boat Company, Dept. PM, Carrollton, Michigan.

BUILD 16" Cabin cruiser. Outboard. Simple to build. Blueprints \$3.00. 12" fishing rowboat. Blueprint \$1.00. 15" outboard-rowboat. Blueprint \$1.00. 16" Canadian canoe. Blueprints \$1.00. Strachan Boat Shop, Howard 2, Kansas.

BUILD \$200 Boat for \$25 of surplus material. Looks like wingless seaplane. Quickly constructed, no welding, caulking, nails. Blueprints \$1.00. Blueprints, 3167 Madison, San Diego 4, Calif.

ATTENTION Sportsmen! Make kayak from complete easy construction kit. Literature. Pla-yaks, Dedham, Mass.

SAIL Your canoe—build the rig. Instructions, \$1.00. Gee, 1211 Frisco, Far Rockaway, N. Y.

10' OR 15' Folding Kayak plans \$1.00. Oldcraft, 4015-F Oketo, Chicago 34.

KAYAK—Easily built. Instructions, \$1. Gee, 1211 Frisco, Far Rockaway, N. Y.

HOW To build an inexpensive canvas canoe, open or kayak type, 35c. Dudley, Dept. P., 1953 Eagle Drive, Mobile, Ala.

USED Outboard motor parts. Outboard Exchange, 1194 Remsen Ave., Brooklyn, 12, N. Y.

FORD-Mercury-Zephyr marine conversions. Catalog 10c. Lehman Manufacturing Company, Dept. D, Newark 2, N. J.

MARINE Muffler—Simple, low cost, cinch to install yourself. Guaranteed. Send for free folder. Savage Marine Co., P.O. Box 772, Boston, Mass.

OUTBOARD Motor brackets—New models for canoes, rowboats, sailboats. Send for free descriptive folder. Outboard Motor Brackets Co., P.O. Box 772, Boston 2, Mass.

ONE-MAN Boats—Ideal for hunters, fishermen, 7 1/2 foot long. Weighs only 30 pounds. Easily carried. Army surplus auxiliary fuel tank sections, of Terne plate steel, that convert easily to one-man boats. Approximately \$1.00 worth of welding will seal fuel outlets. Only \$4.75, prepaid anywhere in U. S. Address: Irving Goodman, P.O. Drawer 191, Galesburg, Illinois.

MARINE Power—Easily convert any Jeep or Ford Motor (domestic and foreign) with Convo parts and kits. Complete catalogue 25c (coin). Osco Motors Corp., Dept. M, 2020 E. Orleans St., Philadelphia 34, Penna.

BOATS And all about them. How to select, build, repair and operate. For 40 years the leading practical boating magazine. Trial subscription, 12 issues for \$1.00. Motor Boat, 62 Gold Street, New York 7.

BOAT Designers are highly paid professionals. Complete course by mail. Catalog. Westlawn, Montville, N. J.

FULL Size, cut to shape boat patterns, blueprints, 7 1/2 - 38 feet. Illustrated "Build a Boat" catalog, 10c (coin). "How to Build Boats" book, \$1.00. Cleveland Boat Blueprints Co., Dept. A-66, Cleveland, Ohio.

NINE Plywood boat plans 50c. Catalog boat building plans 10c. The Rudder, 15 Murray Street, New York.

USED Marine motors, propellers, marine fittings, conversion manifolds. Stokes Marine Supply, Coldwater, Michigan.

ATHLETIC EQUIPMENT, BODY BUILDING COURSES

REVOLVING Sleeve Barbell complete, \$20.50. Folders. Jackson Barbells, Springfield, N. J.

DEFEAT A boxer. Secret Ju-Jitsu defense. Complete instructions 25c. Dr. Malcolm Smith, 1104 Union Ave., Montreal 3, Canada.

PHYSICAL Perfection courses \$1.00 (guaranteed). Barbell Equipment, Sid's System, Southgate, California.

DEADLY Judo—Piercest fighting technique. Jitsu, wrestling, foot-fighting, police tactics. Complete course (186 photographs). Special \$1.00. Variety House, Box 46-BD, Wall Station, New York City.

BARBELLS. Exercise equipment. Courses. Special offers! Free booklet. Good Barbell Co., Reading, Penna.

SPORTING GOODS, GUNS, FISHING TACKLE, TRAPPING, ETC.

A Reel value! Aluminum and stainless steel fishing reel. Smooth running, convertible to click action. Lifetime built. Send \$4.95, check or money order; or pay postman plus postage. Money back guarantee. Midland Corp., 596 Springfield Ave., Newark 3, N. J.

RUBBER Suits. Used but perfect condition. Govt. surplus. Large size. Includes shoes, gloves, cap. Ideal for trappers, hunters. \$4.00 each. \$1.00 deposit, balance C.O.D. Money refunded if not satisfied. Meyers, 820 Dryades, New Orleans 13, La.

FISHING Poles: Dealers only. Sample jointed cane prepaid, \$2.50. Bob Pace, Combs, Ark.

INDIAN War bonnets and kits, archery kits. Write Chas. T. Schneider, Whitehall, Michigan.

FISHERMEN'S Secrets, 10 "gits-em" bait recipes \$1.00. Strachan Shop, Howard 2, Kansas.

TRAPPERS. Want a partner? Want to learn about conditions in other states, Canada and Alaska? "Lone Wolf" Hunt can help you. State age and experience in first letter. Loye R. Hunt, Grygla, Minn.

GUNSMITHS—Dealers—Fix all shop operators. Let us do your gun refinishing work. Write for details of our new break-down plan giving greater discounts. Also pricelist. Erie Metal Finishing Company, 318 West Osborne Street, Sandusky, Ohio.

SAILKITS 100 Square feet \$13.90, boat supplies. Boy Scout tents, wall tents, carbide lamps, canoe canvas, airplane dope, Swedish kerosene stoves, kapok life preservers, etc. Alan-Clarke, 96 Chambers, New York City.

PUP Tents U. S. Gov't surplus, sleeps two, slightly used \$2.95, new \$6.95. Ideal for campers. When ordering add 35c for postage. Satisfaction guaranteed or money back. United Trading Co., 50 Myrtle Ave., Brooklyn 1, N. Y.

"AMMUNITION"—New and used "shot-guns," "rifles," "handarms." List 10c. Rudolph's, Atchison, Kansas.

GUNS! Antique and modern, 52 page catalog. 25c. Retting, West Hurley, N. Y.

CHUM (Unattached bait) attracts food and game fish—from 6 or 7 miles—to your hooks. Fresh or salt water. Cheap! Easy! Make 6 Rigs. Learn 8 secrets. Use 10 methods. Know 55 best chums. Send \$1.00 for a U. S. Chumming Guide. Fish Research, 5912D Thompson, Philadelphia 31, Penna.

2000 BARGAINS, Firearms, binoculars, war relics, catalog 30c. Smith Firearms, Runnemede, New Jersey.

SEND 10c For list 100 used guns. Frayseth's, Willmar, Minnesota.

USED Guns, bought, sold, exchanged. List stamp. Howe Fur Company, Coopers Mills, Maine.

FIELD GLASSES, MICROSCOPES, TELESCOPES, MAGNIFIERS

TELESCOPES 18 inch, 2-section 8 power, precision ground and polished lenses. Individually packed \$1.50. 36 inch, 3-section 17 power, precision ground and polished lenses including carrying case \$2.50 postpaid. Criterion Co., Box 1285, Hartford, Conn.

LENSES And instructions for making 100x astronomical telescope, \$2.00. 400x, \$4. Carl Jamer, Box 595, Manorville, N. Y.

TELESCOPES, Powerful 17-power chip-board, \$1.98; 6-power, 75c; 7-power plastic case, \$1.49. Karl Gruenewald, 3837P Coolidge, Oakland 2, Calif.

ILLUSTRATED Instructions 10c. Make telescopes, microscopes, telephoto cameras. Carl Jamer, Box 595, Manorville, N. Y.

TELESCOPES, Microscopes, binoculars, lens kits. Catalog free. Brownscope Co., 24 West 45th St., New York.

TELESCOPES—Real 17-power telescopes \$3. United, 2309-P Lawrence, Toledo, Ohio.

LENSES And instructions for making 50x compound microscope, \$1.00. 200x, \$2.00. 400x, \$3.00. Carl Jamer, Box 595, Manorville, N. Y.

TELESCOPES 17 Power, \$3.00. Candid cameras, \$3.98. Cardone, 1324 Sheffield, Pittsburgh 12, Penna.

REFLECTING Telescopes, complete, 3½" diameter, equatorially mounted. View planets, stars, \$19.75. Write Skyscope Company, 475-P 5th Ave., New York.

BINOCULARS, Telescopes, watches. Buy, sell, trade. Paul Schmeer, Donnellson, Iowa.

BUILD Your own reflecting telescope. Complete plan with each kit. Send for free catalog. Mayflor Products, Katonah 1, N. Y.

TELESCOPES, Microscopes, cameras, binoculars; bought, sold, repaired. Lists 10c. Specify instrument wanted. Rasmussen and Reece, 41 Market, Amsterdam, N. Y.

DOGS, PETS, BIRDS, RABBITS

PUPPIES—Fox or rat terriers, collies. Others. Cheap. Beauties. Ulrey, Paw Paw, Ill.

SELL The latest for dogs. Duet Creme Shampoo, containing the remarkable insecticide D.D.T. Trylon Products, Chicago 14, Illinois.

CAVIES, Rabbits, quality breeders, all colors, good type. L. M. Landis, Doylestown, Pa., R. D. 1.

JUMBO Frogs, fishing canes, cedar lumber. Vol Brashears, Berryville, Ark.

RAISE Money-making Angora rabbits. Wool \$14.50 pound. Plenty markets. Cash income. Future prospects bright. Particulars free. White's Rabbitry, Lawrence, Kansas.

ORIGINAL Chin-Chin giant Chinchilla rabbits. Gorgeous fur. Delicious meat. Most prolific. Easily raised anywhere. Free booklet shows amazing profits. Willow Farm, R15, Sellersville, Penna.

ENGLISH Shepherds—border collie puppies, all ages, both sexes, choice colors. Faithful workers. Satisfaction guaranteed. Fairmont Farms, Cedar Falls, Iowa.

DOG Tags—Name, address. Return to owner, 25c. Collar tag—reward 35c. Miller, 1745 Congress, Beloit, Wis.

ZOOLOGICAL And pet animals for sale. Illustrated catalogue, literature, 25c. Trails End, Zoo-5, St. Stephen, S. C.

ANGORA Rabbits supply living from wool, meat. House of Angora, Springfield, Ill.

RAISE Birds for us. Canaries, love birds, finches, and others. Interesting, profitable spare time work. Breeders supplied. Catalog and instructions free. Universal Aviaries, 1216 So. Michigan St., South Bend 18, Indiana. "Successors to Tom and Ann."

MONEY Raising rabbits. Investigate. Folder 10c. Close Rabbitry, Tiffin, Ohio.

RAISE Diamond seal rabbits. We pay \$25 to \$50 each. We buy all you raise. Literature 10c with hutch plans \$1. Automatic cleaning, watering, feeding. 31 drawings, patterns. Hansen's Rabbitry, 1347 Miller Ave., Salt Lake, Utah.

ANGORA Rabbits, giant chinchillas—finest pedigree. Valuable wool \$15.00 pound; gorgeous two-tone furs. Raised anywhere. Literature free. Grinsteads, Edwardsville, Illinois.

CHINCHILLA Giants, real. Most profitable. Prolific, easily raised anywhere. Breeders supplied reasonable. Satisfaction guaranteed. Free literature. Large illustrated catalogue, 25c. Fur samples, 25c. Chin-Chin Farms, Melvin Behrens, Gen. Mgr., Dept. 4, 44 Chester Pike, Darby, Pa.

PIGEONS, Rabbits, 30 varieties. Catalogue 10c. Jim Houck, Tiffin, Ohio.

ST. BERNARD Pups: Champion sired beauties. Franklin Young, R4, Riverhead, Long Island, New York.

RAISE Guinea pigs. Make money at home. Big demand. Free booklet. Taylors Guinea Pig Farm, Hapeville, Georgia.

STANDARD Rabbit Journal, Milton, Pa. 3 years \$1.00, sample dime.

A LIVING With rabbits and cavies. Markets waiting. Magazine 10c. Book describing twenty breeds and magazine 25c. Book and magazine (monthly) one year 50c. Address Small Stock, Dept. 2, Pearl River, N. Y.

SEEDS, PLANTS, NURSERY STOCK

THERE'S Money in tomatoes. See adv. under moneymaking opportunities. Dinamore.

AMAZING Silverton soiltester brings garden success! 35c. With three 25c plant hormones, outfit, \$1.00. Silverton Laboratories "M", Toms River, N. J.

15 BABY Evergreens 4/8 inches \$2.00. Postpaid, Arbor Vitae, Junipers, Yews, Retinosporas, Hemlocks, and Colorado Blue Spruce T. Ask for price list. Fischer Nursery Service, Box 36, Bakerstown, Penna.

FARMS, FARM LANDS, REAL ESTATE

STROUT'S Spring farm catalog just out! Big 132-page book—over 1300 bargains—25 states—Maine to Florida and west to California, Oregon and Washington. Write today for this big dollar-saving time-saving book. Mailed free. Strout Realty, 255-P 4th Ave., New York 10, N. Y. 7 So. Dearborn St., Chicago 3, Ill. 453 So. Spring, Los Angeles 13, Calif.

OZARK Farms, resorts. Free list. Farmfinders, 111-K, Eureka Springs, Arkansas.

40 ACRES Virgin Missouri land \$145. Terms and complete Ozark information. Write Armstrong, Shook, Missouri.

CITRUS County, Florida, lands on easy terms. R. W. Stewart, Inverness, Florida.

160 ACRES: 200,000 Feet good timber and locusts, log shack, terms. Bob Pace, owner, Combs, Ark.

CANADIAN Tax sale lands for a dollar an acre and up. Small monthly payments. Farms, timber, hunting and fishing camps, minerals. Limited number of properties. Write at once for free catalogue. Tax Sale Service, Room 613, 72 Queen St. W., Toronto 1, Canada.

FERTILE South-American lands obtainable free. Homesteads. Plantations. 25,000 acre ranches. Interesting information, 10c. Vallesp, New York 13.

WISCONSIN—Minnesota water frontages. \$5 down, \$5 month. 3505-K So. Hope, Los Angeles 7, Calif.

"HOW To Buy a Farm or Ranch" \$1. Wm. M. Wells, licensed broker, 105-P No. Ave., No. 56, Los Angeles 42, Calif.

WEST'S 1946 Catalogue. Hundreds farm bargains, business opportunities. Pennsylvania, New York, New Jersey, Ohio, Delaware, Maryland. Free copy. West's Farm Agency, HE, Pittsburgh 16, Penna.

FREE Catalog, farm bargains, 8 midwest states. Many fully equipped for convenient quick start. Many pictures. Special service to help you locate quickly, if you state requirements, payment plan and general location desired in first letter. United Farm Agency, 1796-MP Arcade Bldg. 1, St. Louis, Mo.

GOOD Farms—ranches. Washington, Minnesota, Montana, Idaho, Oregon, North Dakota. Dependable crops, favorable climate. Write for literature, lists describing typical postwar farm, opportunities. Specify which state. J. W. Haw, 119 Northern Pacific Ry., St. Paul 1, Minn.

OZARK Lands for all purposes. Actual River frontages. 5 acres \$75.00 and upwards. Free list and literature. Hubbard, 424PM, Minnesota Ave., Kansas City 4, Kansas.

HOMESITES \$450—Low terms. California's finest garden spot. On Morro Bay's wooded shores. Wonderful fishing, hunting, boating, etc. Fertile soil, soft water, temperate climate, congenial community. Free literature. Richard M. Otto, 6560 Hollywood Blvd., Hollywood 28, Calif.

\$5.00 MONTHLY Buys 40 acres near town; price \$175.00. Free list. Box 425-P, Carthage, Mo.

OZARK Farm bargains. 5 to 5000 acres. Frank, Mountain View, Mo.

POULTRY AND FARM SUPPLIES

YOUR Greatest poultry problem will look simple when you read American Poultry Journal regularly. 500,000 poultrymen do, why not you? 2 years 50c, 5 years \$1.00. American Poultry Journal, 572 South Clark, Chicago.

CHICKS, 21 Breeds. Get our prices. Empire Hatchery, Seward, N. Y.

BABY Chicks, champion mated. 52 varieties, 7 hybrids, licensed, inspected, blood tested. Rush postal, large colored book, low prices. Berry's Farm, Route 12, Clarinda, Iowa.

KNOW How to raise poultry for profit. Read Northeastern Poultryman. Every issue packed with helpful hints and practical suggestions. Latest articles on breeding, feeding, and management. Read nationally. Subscribe now. 1 year 65c; 2 years \$1.00. Northeastern Poultryman, Dept. M, 376 Boylston St., Boston 16, Mass.

RAISE Turkeys the new way. Write for free information explaining how to make up to \$3000.00 in your own backyard. Address National Turkey Institute, Dept. 3, Columbus, Kansas.

PROFITABLE OCCUPATIONS

PROFITABLE Hobby. Rare cholla wood novelties. Ready, easy to assemble. Good seller. Lamp kit \$2.00. Book ends \$1.00. Picture frames 50c. Electrical equipment not included. Old Pueblo Manufacturing Company, 2024 South Seventh Avenue, Tucson, Arizona.

BE Independent. Establish permanent profitable business at home. Tested, practical. Small investment. Mediant Sales Co., Box 123-A, Blytheburne Station, Brooklyn 19, N. Y.

WELDING Pays. Learn with 1942 trade school text manual. 516 pages. Over 500 photos. \$2.00 copy. Money-back guarantee. Hobartweld, Box M-463, Troy, Ohio.

EXTRA Money with your hobby or start hobby. Easy, exciting, profitable. Cornell, Sandston, Virginia.

BECOME A locomotive engineer, or railroad conductor. Information 50c. The Student Railroader, Box A53, Elmhurst, Ill.

SOILLESS Farming. Instructions 50c, chemicals \$1.00. Gordon, 553 William, Winnipeg, Manitoba.

TEXAS Cactus. Beautiful blooming kind. Special introductory offer, dozen, \$1.29, postpaid. Satisfaction guaranteed. Odell Hudman, wholesale dealer, Bryson, Texas.

MECHANICALLY Inclined men—Own and operate general appliance repair shop. Complete, illustrated course shows you how. Welding, refrigeration, motor repair, how to get business, etc., all phases covered. Free literature. Christy Supply, Dept. 463, 2835 N. Central Ave., Chicago.

LEARN Chemical gardening—Fascinating, profitable hobby. Grow bigger, better flowers, plants, vegetables the modern scientific soilless way. Special trial offer: chemicals and instructions, \$1.00. Details and bulletin free. Ward Distributing Co., 3770 Clarington, Los Angeles 34, Calif.

ELECTRIC Clocks are every where you go. Buildings, homes, parking lots, factories. Repairs increasing. Our easy to learn course with pictures and drawings teach you how to repair these clocks. Electronic Supply Co., Dept. A, P.O. Box 2350, Houston 1, Texas.

TYPEWRITER Repairmen urgently needed. Earn \$40 to \$50 weekly spare time. Our easy to learn home study course teaches how to repair typewriters. Write for free information. Houston Typewriter Repair Service, P.O. Box 5357C, Houston, 12, Texas.

SHARPEN Dull pipe wrenches with special new patent grinder. No competition, very profitable. J. C. Moore Industries, Box 234, Fredonia, Penna.

EXCELLENT Profits raising mink. Choice breeding stock available. Details furnished. Franklin Young, Riverhead, New York.

GET Aboard the gravy train. The business with a future. \$100 and more weekly possible. Full or part time, very little competition. No town too small, work neighboring towns. Book tells where to get business, supplies, and how to shampoo rugs, carpets and upholstery right in homes, hotels, stores, churches, etc., or in your plant. Every rug owner can use book. Tells how to remove stains, spots and how to select good rugs. Don't delay, send \$2 for book and free advice. Modern Rug Cleaners and Suppliers, Box 306, Newark 1, New Jersey.

NOVELTY Cutouts for shutters, kitchens, rumpus rooms, etc. You paint any color desired and make nice profit. Attractive selling display with samples in full color and instructions, \$3.00. Nolte Enterprises, Toms River, New Jersey.

LEATHERCRAFT Supplies. Catalog 10c. Art Craft Supply Co., Box 148, Fort Worth, Texas.

SEWING Machine troubles? Electric or treadles. Fix it at home, save money. Fix others, make money. Profitable business. Service manual guaranteed, \$1.00. Serviceman, 231 Main, Hamilton 2, Ohio.

LEARN Money-making facts, other inside information. Now complete, mail order course, only \$5.00. Hurry your success order today. Information and offers 10c. Parcell Market, 2701 So. Main, Elkhart, Indiana.

WOULD You pay 3%-first profits? Color-illustrated book "505 Odd and Successful Enterprises" free! Some plans offer occasional "day-off"—others: busy days; at home, office! Pacific, 262 Drake, New Rochelle, N. Y.

RAISE Fishworms; 500 breeders, spawn, instructions \$4. Stoners, Chattanooga 6, Tenn.

TURN Hobbies into cash. \$1.00 is route map to success. Dougherty, 366 Madison, New York 17.

PIANO Tuners needed! Profitable, lifetime occupation. Particulars free. I. Brucker, 3863 West Pine (711) Saint Louis 8, Mo.

EARN While you learn the clock repair business! With our method of instruction, your income starts immediately. For details write Akron Clock Clinic, 964 Wye Drive, Akron 3, Ohio.

MAKE Beautiful lifetime bracelets from stainless steel rod, sell \$10.00 up. Easy instructions, drawings \$1.00. G. W. Osborne, Opportunity, Wash.

"12,000 **ALASKAN** Job opportunities." Mechanics, carpenters, fishermen. Earn years pay in four months. \$1 brings copyrighted folio explaining where to apply with listing of firms. Information on business opportunities and government home-steading lands included. Transcontinental Research Box 2147-PM, Hollywood, Calif.

"77,000 **EXCELLENT** Foreign Job Opportunities" including South and Central Americas. \$1.00 brings copyrighted folio explaining how, when, where to apply with listing of 300 firms with foreign interests. L. J. Enterprises, Box 2549-PM, Hollywood, Calif.

SHELL Jewelry, novelties. Easy to make at home as hobby or to sell. Beginners kit \$1.00. Catalog 5c. Burton, Dept. M-2, Box 27, Station A, St. Petersburg, Fla.

OPERATE A children's positive foot print identification system from your home. Parents welcome this service. Free information. The Smith System, 217 W. Keefe Ave., Milwaukee 12, Wisconsin.

RAISE Bean sprouts in dark room. Pays well. Free information. Mrs. Nickell, Route 1, Box 456, Bend, Ore.

ANNOUNCING Home study course in commercial baking. Practical basic training. Good field for those with aptitude. Nearly depression proof. Send for free booklet, "Opportunities in the Baking Industry." National Baking School, 1315 Michigan Ave., Dept. 3432, Chicago 5, Ill.

LOCKSMITHING—Profitable business or hobby! New course teaches you how to pick locks, fit keys, de-code, masterkey, etc. Easy self-instruction lessons. Bargain price. Fascinating 100-page illustrated catalog free! Write—Nelson Company, Dept. 2-02, Chicago 5.

TWELVE Service trades paying big money now and can be combined in small communities. Course includes rug cleaning, sanding, janitorial, gardening. Instructions \$1.00. If not pleased, return for refund in three days. United Business Service, 137 Cordova, San Francisco, Calif.

EARN At home, learn at home. Short, easy course trains you in professional negative retouching. Free booklet. Duval School, Dept. A, 8519 Sunset, Hollywood 46, California.

PAINTING Flagpoles often pays \$50.00 daily. Particulars free. The Skyline Co., P.O. Box 1601 B, Uniontown, Penna.

\$40.00 **WEEKLY** Made growing mushrooms, fresh, dried. Dominion patent 331583. Free spawn. North American, 169P Yonge, Toronto, Canada.

TYPEWRITER Repairing — Original course, simplified home study. Weber Typewriter Mechanics School, Box 269, Osborn, Ohio.

MUSHROOMS Grown: boxes, barrels. Instructions 50c. Spawn \$1.00. Gordon, 553 William, Winnipeg, Manitoba.

GOLD-STAMPING. Exceptional post-war opportunity. Free booklet. Home City Specialties, Dept. 1273, Springfield, Massachusetts.

BOOKS, PERIODICALS, PICTURES, POSTCARDS

PACIFIC War veterans. Don't miss this! 100 photos, clear, sharp, size 4x5 inches, glossy, of Philippine campaign. See Manila burning; looting; Jap prisoners taken at Manila; Lingayen Gulf sky battle; Kamikaze attack; Americans surrendering at Corregidor (Jap print); Japs pulling down American flag at Corregidor; 2 perfect photos of "Tokyo Rose"; American troops entering Japan; Jap ruined cities; photos have descriptive captions included. A perfect collection to complete your war album. Price 100 photos \$10.00 c.o.d. Pay postman. Al Rosen Studio, Chester, Pa.

SPECIALS For service men and veterans of World War 2. You can get Reader's Digest for two years for \$3.00. Life for one year \$3.50, two years \$6.00. Send your serial number with order. Free catalog. Miss Frances C. Winn, Box 87, Clinton, S. C.

BOOKFINDERS! (Scarce, out-of-print, unusual books) quickly supplied. — Send wants. Clifton, Box 1377pm, Beverly Hills, Calif.

TRADE Magazines—Business, vocational, diversion. Current single copies. All fields to choose from. Free price-lists. Commercial Engraving Publishing Co., 34C North Ritter, Indianapolis 1, Indiana.

GOLDEN Gate and San Francisco Bay bridges—construction detail from official information, foundations to air beacons, caissons, cable spinning, etc., with dimensions sufficient for models. Pictorial, dimensional comparisons other great bridges. Nontechnical language. 128 pages elaborately illustrated, 200 drawings. \$1 postpaid. Roy Patton, 375 Bush Street, San Francisco, Calif.

WHAT Every Mason wants. We have Masonic books for Blue Lodge, Chapter, Commandery, Scottish Rite and Shrine. Our rituals are used the world over. Send for free catalog of books and rituals for Masons, Odd Fellows, Knights of Columbus, etc. Ezra A. Cook, Publisher, P.O. Box 796-PA, Chicago 90, Ill.

BIBLE And science; harmonious. 25c. Bulletin, Box 87, Station H, New York 25.

RAMBLER—Hobby, mail order magazine sample 10c. Box 174, Staten Island 1, N. Y.

UNFRAMED Color pictures. Samples 10c. Curtis, Box 1916, A, Denver 1, Colo.

FOR Sale: Complete file Detective Book Club books, cheap. Walter Lee, 108 Stratford, Houston, Texas.

"**GUIDE** To Free Publications" on science, mechanics, nature, business, world affairs, etc. \$1.00 per year. Free sample. Research Publishing Company, 622-A Penfield Building, Philadelphia 7, Penna.

"**BARGAIN** Buyer's Guide," 64 pages. Merchandise at rock bottom prices. \$1.00. Stafford, Sunnyside, Indianapolis 44, Ind.

"98 **DANCING** Lessons." \$1.00! Hirsch's Bargain-Novels Bookshop, Spring Valley 2, N. Y.

MAILORDER Magazine 15c, year \$1.00. Alvin, 553 William, Winnipeg, Manitoba.

TECHNICAL Books, largest list. Edwards, 324 North 18th, Quincy, Illinois.

MAGAZINE Subscription service. Agents wanted. Sutherland Agency, Ringgold, Va.

BACK-DATED Magazines supplied quickly. Send wants. List free. Arkell's, 1071-pm N. Western, Los Angeles 27, Calif.

OZARK Magazine, 111-A, Eureka Springs, Arkansas. For homeseekers. Year, \$1.00.

READY Reckoner. Calculation tables for mechanics, businessmen, farmers. Revised. 286 pages. 65c postpaid. Reader's Service, Box 110-R1, Hilton Village Branch, Newport News, Virginia.

AGENTS—Ship pictures of World War II. Liberty Picture Co., Box 3797, Portland 8, Ore.

BACK Number magazines reasonable. Reedmore, 841 Intervale Ave., New York, New York.

RULES Of fortune building \$1.00 postpaid. Bedard, 3420 Montclair, Detroit 14, Michigan.

"**BOOK-MEND**" Repairs damaged book-bindings perfectly. Liberal tube 50c postpaid. May Chemical, 925 Larrabee, Chicago 10, Illinois.

ELECTRICAL Windings for alternators, dynamos, transformers, (book) \$1—corresponding course \$10—Vitzins, American Institute Electrical Engineers, 39 West 39th Street, New York 18, N. Y.

USED Correspondence courses, technical, writers, how-to books bought and sold. Literature free. Benchat, 36 Maple, Hastings-on-Hudson 6, N. Y.

WEALTH From small beginnings generally awaits intelligence—perseverance—integrity. Outstanding testimonials mailed free. John Buckley, 909 West Fifth, Los Angeles 13, Calif.

POWER Through knowledge. Extraordinary bargain catalogues. Stamp. Continental Publications, Elmhurst, N. Y.

EASTER, Birthday, everyday, and get-well greeting cards. Thos. J. Troxell, 1307½ Franklin St., Tampa 3, Florida.

SCIENCE Quest magazine is chemistry, physics, biology: 25c. Included free: 50-page booklet: "Chemistry of Familiar Things"; "Einstein's Relativity Explained". Send 25c for copy latest issue and both booklets to: Peterson, 6204 North Hermitage, Chicago 26.

SECRETS That make millionaires become financially independent. Successful, workable plan. \$1.00. Free literature. Success Publications, Box 513, Berkeley, Calif.

GET Rich now! Let the amazing book, "Seven Cures for Lean Purses" guide you. It actually works! Only \$1.00. Order now. Cunningham, 81 Bailey, Lawrence, Mass.

BEAUTIFUL 12x16 Religious art pictures, 3 for \$1.00. Crucifixion, Lord's Supper, Gethsemane, etc. Rev. Clifford, 456 So. 16th St., Newark 3, N. J.

BOOKS . . . New, used, rare. 6c brings "Bookfinder." 319 So. Marengo, Pasadena, Calif.

WHY Pay \$3.00 for a book when you can rent it for 25c. Free information. Emile Jeunesse, 5706 Dauphine St., New Orleans 17, La.

FREE Catalog—Semi-technical books for home study, reference, schools. Livingston, 4034 Keystone, Chicago.

JOIN New technical book club—free! Members receive current literature, guidance on all book problems, premiums. No obligation. All technical, scientific, home-craft books, etc. Specify subject for free information. Modern Technical Book Co., Dept. MMC, 55 West 42nd St., New York 18.

TAILORED Homes—the modern plan book. Ad under Heading Miscellaneous.

GOOD "Used" self-instruction educational books on all subjects bought, sold, rented, exchanged. Satisfaction guaranteed. Complete information and 100-page illustrated bargain catalog free! Write—Nelson Company, Chicago 5.

SELF-EXPLAINING Bible: Illustrated circular free. Box 446-P, Minneapolis, Minn.

NATIONAL Geographic Magazines, 1888-1945, any issue. Periodical Service, Dept. PM, Swarthmore, Penna.

BOOKS. (Out-of-print, new, used) quickly-supplied. Many 35c bargains. Catalogue. Mid-West Book Service, 18870 Marx Ave., Detroit 3, Mich.

BIG Profits taking subscriptions for all magazines. Agents' confidential catalog listing over 2500 periodicals and complete starting supplies free. Pines Subscription Agency, Flushing, New York.

MAGAZINES (Back dated)—foreign, domestic, arts. Books, booklets, subscriptions, etc. Catalog 10c (refunded). Cicerone's, 863 First Ave., New York 17, N. Y.

"100,000 **POST-WAR** Jobs Abroad"—South America, China, India, Burma, Japan, Russia, Malaya. How, when and where to apply. Post-war U. S. participation in world reconstruction and trade demands thousands of American-trained mechanics, salesmen, technicians, engineers, foremen, laborers and business representatives—every trade needed. Our 15,000-word copyrighted forecast—compiled from business, professional and government sources—lists over 200 big U. S. firms with foreign interests, gives job information, salary brackets, contract tips, application letters, passport information, climatic conditions, etc.—everything needed for your immediate application. \$1.00. Return for refund in 7 days if not satisfied. Pacific Industrial Research Bureau, 202-E Studio Building, Portland 5, Oregon.

REBINDING: We bind magazines, old books, Bibles, hymnals. Heckman Bindery, Dept. D, North Manchester, Indiana.

MONEY-MAKING Ideas. Latest books. Catalog free. Popular Mechanics Press, (C-43), 200 E. Ontario, Chicago.

GAMES AND ENTERTAINMENT

NEW Checkerboard trick copyrighted. Take two checkers, keep opponent out of kingrow \$1.00. Taulton, 1911 Clarence, Dayton 10, Ohio.

FASCINATING New card game. Free. P.O. Box 842, Denver 1, Colo.

MAGIC TRICKS, PUZZLES, JOKER NOVELTIES

MAGIC Cellar, 230 Bankers' Investment Bldg., San Francisco 2, California, will rush sensational "lightning four column" mathematical trick, place you on select list of "Magic For Fun or Profit," latest catalog pocket, close up tricks. All for 10c.

MYSTERY Box — Operator receives marked token which then appears inside two boxes and sack, all rubber banded. Postpaid 35c. Medaris, 5641 Hohman, Hammond 1, Ind.

USED Professional magical apparatus, free bargain catalogue. Magicland, Franklin, Mass.

THREE Card Monte 25c. Cigarette vanisher 50c. 10 trick magic kit \$1.00. Kogel's Magic Novelty Co., 6751-A Colbert St., New Orleans 19, La.

FOUR Baffling mind reading acts and two card tricks. Anyone can do them. Absolutely no props or equipment needed! Convince people of occult powers. Only 50c. Inner Circle, 616 Blue Island Avenue, Chicago, Illinois.

FORTY Amusing, confusing mathematical puzzles. 25c. Howar, Box 128MD, Westport, Conn.

SELL Funny business cards, tricks, jokes. Samples 10c. National, Box 301-M, Cincinnati 1, Ohio.

"FLYING Propeller", 22 inch, 3-bladed, durable. No wings. No motor. Hand launched. Flies 250 feet and always returns to you. \$1.00 postpaid. Carl Jamer, Box 595, Manorville, N. Y.

COMEDIANS Needed! Free instructions! Kleinman, 25-31-B 30th Road, Long Island City 2, New York.

ENTERTAIN! Earn money! Ten lesson magic course discloses secret, presentation, patter. Tricks without special apparatus. Only \$1.00. Don Rogers, Box 183M, West-erly, Rhode Island.

TRICK That fooled the Nazis, \$1.00. American Magic, Box 2485, Kansas City, Missouri.

3 "MAGIC Horse Races" 25c. "Famous Card and Coin Tricks" \$1.00. Lewis Davis, Box 1015, Lynchburg, Va.

MAGICAL Sensation! Any safety match visibly changes to beautiful red carnation. Guaranteed easy to do. Price \$1.00. House of Magic, 1117 Brown St., Dayton 9, Ohio.

TRICKY Magnetic dogs! Fun for young and old. Quick seller! Sample pair 50c. 3 pairs \$1.00. Leeart Company, 7438 So. Chappel, Chicago 49.

SLICK Tricks, funny joker's items, exciting new novelties, books. Latest catalog 10c. Magic Fun, Box 35E, Irvington 11, N. J.

LATEST Novelties, tricks, puzzles. Catalog free. Hughes Services, Shillington, Penna.

MAGIC Book, 101 tricks, 25c. Ace, 4304 Maryland, St. Louis 8, Mo.

PROFESSIONAL Magic catalog, dime. Williams, 900 Plymouth, Ellwood City, Penna.

MAGIC, Novelty catalog, and one trick, 10c. Wencel, 2615 Evaline, Hamtramck 12, Mich.

MAKE Money fast with simple, easy, unbelievable trick. Costs 5c. Sells for \$1.00. Six for only 25c. Sample 10c. Magic, 839-West 17th St., Los Angeles 15, Calif.

JOIN Magician's Fraternity! Magic magazine, sample and details, 20c. International Magicians, Mt. Morris, Illinois.

DOUBLETALK, A riot of fun. Learn quickly. Simplified instructions 25c. Illustrated novelty lists included. Cable's Novelty Shop, 3166 B3, W. 25th, Cleveland 9, Ohio.

"101 TRICKS" Book, quarter. Free trick included. Donnelly, 90 Barkley, Clifton, N. J.

BE A magician! Book of 80 professional tricks. These are baffling, mystifying, professional tricks—Not junk. Well illustrated. Get your copy now! Only \$1.00 postpaid. William Hill, Box 413-A, Akron 9, Ohio.

AMAZE And mystify your friends with highest quality magic. New catalogue 25c coin. Mazda Magic Co., Mt. Sterling, Ky.

NEW! Simplified card tricks! Amazing self-working bafflers \$1.00 postpaid. James W. Roundtree, 529 Elliott St., River Rouge, Michigan.

ENTERTAIN! Mystify! New, bigger magic catalog and 4 secret tricks 25c. Herbert, P-192 N. Clark, Chicago 1.

WORLD'S Largest professional magic shop keeps you in touch with latest tricks. To receive mailings send 25c for new catalog. Holden, 220M W. 42nd St., New York.

TRICKY Match box, it turns around! It stands up! and it opens, most weird uncanny magic novelty trick. Complete ready to do. 25c. The Magician, 2463-M, Kensington Ave., Philadelphia, Penna.

MAGIC: Big 160 page Illustrated Catalog Latest Magic Goods, 25c. For over 1/3 century we have supplied Professional as well as Beginner. Chicago Magic Co., 2300 N. Mason, Chicago 39.

EARN Money in any crowd. Call names of strangers, tell unspoken questions. Professional course mind reading, faked spiritualism, etc., \$1. Henderson, Box 341, San Bernardino, Calif.

SURPRISE, Astonish, thrill, with empty hands, make clouds of smoke appear from fingertips or huge snow flakes float in air also make a five foot ribbon with empty hands, etc. Easy to do with Magic Paste, special 2 tubes enough for 70 tricks \$1.00 postpaid with big magic catalog. The Magician, 2463-M, Kensington Ave., Philadelphia 25, Penna.

"MAGIC Vanishing card." Throw it into air, it completely disappears, reproduce it later from spectator's pocket. Easy to do. Complete 25c with magic catalog. The Magician, 2463-C Kensington Ave., Philadelphia 25, Penna.

LEARN Ventriloquism, 3c stamp brings particulars. Smith, 801 Bigelow, Peoria, Ill.

FREE! Large catalog of magical apparatus if you remit 25c for book "102 Easy Tricks." Robbins Co., 152-P West 42nd Street, New York.

500 TRICKS You can do! Douglas' famous catalog of 500 tricks, now only 10c. America's fastest service on magic for pocket, parlor, stage, professional, amateur. Douglas Magic Shop, Box 274, Dallas, Texas.

VENTRILQUISM, Complete course only \$1. LeSueur, 77 Wellesley, Toronto, Canada.

BE A magician. Large professional magic catalogue of latest tricks 25c. Ireland, C-109 North Dearborn, Chicago 2.

NEW Vanishing key and catalog 25c. Sterling Magic, 345 John R, Detroit, Mich.

MAGIC Tricks, puzzles, books, cards, punch boards. Catalog 10c. Specialty, Box 671, St. Louis 1, Mo.

COINS, TOKENS, CURRENCY

CHOICE Japanese invasion currency; seven denominations, \$1.00. "Marche Unique," 1221 Sherman, Coeur d'Alene, Idaho.

RYUKYU Invasion bills (three), and one Japanese bill, \$1. "G.I. in Japan," amazing 11,300 word commentary, \$1. Lee Beal, 402 Grand Avenue, Oakland 10, Calif.

OLD Money wanted. Will pay fifty dollars for nickel of 1913 with Liberty head (no buffalo). We pay cash premiums for all rare coins. Send 4c for large coin folder. May mean much profit to you. Numismatic Co., Dept. 20, Fort Worth, Texas.

WILL Pay \$10.00 each for certain Lincoln pennies! Indianheads \$50.00; dimes \$1,000.00. Catalogue 10c. Federal Coin Exchange, 4-PM, Columbus, Ohio.

JAPANESE Bill, foreign bill, two foreign coins and price list, all twenty cents. Nassau Hobby Center, Freeport, N. Y.

UNITED States coin handbook. Illustrated. 128 pages, 5x7 1/2", cloth bound. Postpaid 60c. Details and coin folder list free. Wm. Walter, Box 412, Lima, Ohio.

JAPANESE Invasion money mint condition, 12 all different \$1.00 returnable. J. S. Doucet, 45 Fort Ave., Roxbury 19, Mass.

50,000 COINS, Colonial, Confederate, Philippine invasion currency. Illustrated lists free. Nagy, 8-A South 18th, Philadelphia 3, Penna.

MILITARY Medals, decorations, enameled orders bought, sold. Collections purchased. Kenneth Lee, Security Bldg., Glendale 3, Calif.

WORLD Coins, large itemized descriptive list 10c. Harry Elsholz, Box 9014A, Pittsburgh 24, Pennsylvania.

COMMEMORATIVE 1/2, Oregon, Texas, Kentucky, Cleveland, Long Island, \$2.00 ea. Illustrated catalogue 25c. Norman Shultz, Salt Lake 9, Utah.

QUICK Service; reasonable prices. United States catalog 10c. Foreign catalog 10c. Ben's Coin Company, 72 West Washington, Chicago 2, Illinois.

FREE! Foreign coin, banknote and coin collectors illustrated catalog to approval service applicants. Send 3c postage. Tatham Coinco, Springfield-125, Mass.

20 DIFFERENT Coins \$1.00. 20 different bills \$1.00. Oddehon, Box 462, St. Louis, Mo.

GET Profit and pleasure in collecting old coins. Send 10c for 56-page illustrated coin catalog. You'll be delighted with it. Send for it now. B. Max Mehl, 370 Mehl Building, Fort Worth, Texas. Largest rare coin establishment in U. S. Established 46 years.

OLD STAMPS WANTED

I WILL Pay \$100.00 each for 1924 1c green Franklin stamps, rotary perforated eleven (up to 1,000.00 each unused). Send 6c today for large illustrated folder showing amazing prices paid. Vernon Baker, (PM-64), Elyria, Ohio.

STAMP COLLECTING

SUPER Nichel value! Scarce Borneo, Pahang, Sultan, gigantic six-color foreign airmail showing American flag—in packet 25 different countries, plus Manchukuo census set and perforation gauge. Everything 5c to approval applicants. Odd Stamps Co., Dept. A, 5391 Metropolitan Station, Los Angeles 55, Calif.

GERMAN Hitler stamps brought over by American soldiers in small quantities as souvenirs. These stamps are bound to be very scarce because all remainders have been burned by Allied governments. The most unique items in any collection. We will send two values, mint, one regular size and one large size, both for only 10c to sincere approval applicants. Please state whether approvals should consist of United States or foreign or both. Approval Headquarters, Globus Stamp Company, 268 4th Avenue, New York City 10, Dept. 201.

NEW Service, new issues, mint, used, world wide, put up in packets for \$1, \$2, \$5, \$10. Guaranteed to please or money refunded. Once you try a packet you will want many more. Always something new. Armour Stamp Co., St. Albans 12, N. Y.

GRAHAM Land, South Georgia, South Orkneys, South Shetlands, Falkland Island dependencies. Stamp from each dependency with approvals 10c. Collins', 71 Coleridge, San Francisco 10, Calif.

FREE 25 Different Italy approval applicants send 3c postage. Helen Hayek, 1580 E. 19 Street, Brooklyn 30, N. Y.

WHAT Have you to offer? A collection? A "shoe box" accumulation? Anything in stamps. We urgently need them. Spot cash paid. Cosmopolitan Stamp Co., 1457 Broadway, Dept. 4-E, New York.

EXTRAORDINARY Value 250 assorted U. S. includes 19th century. Hivalues, famous Americans, commemoratives, flags, airmails. All \$1.00. Don't delay. Limited. Esquire Stamp, 154 Nassau St., New York 7.

HITLERS (19 Varieties complete) 50c. Approvals. Millhiser, 7724 Abbott, Pittsburgh, Penna.

12 LIBERIA Triangles, 2 complete sets 60c. D. O'Keefe, 7517 Merrill, Chicago 49, Ill.

50 DIFFERENT U. S. commemoratives \$1.00. Approvals. W. H. Robinson, Box 815, Battle Creek, Michigan.

YEAR'S Cleverest trick. 10c with applications for unsurpassed approvals. Box 333, South Pasadena, Calif.

FREE! Airmail packet to approval applicants. Deane Stamp Co., Box 1002, Miami Beach 39, Florida.

10 IRISH Comms., Roman State (facsimile) 5c. Approvals. Valentini, Box 1069, St. Petersburg, Fla.

FREE 200 Mixed stamps, approvals included. Barwis, 4748 Umbria, Philadelphia 27, Penna.

SPAIN'S Nude Goya set complete 25c. Approvals. Royal Stamp Company, Tam-aqua, Penna.

U. S. Mixture, pound 60c, 1/4 lb. sample 20c. Nichols, 746 River, Mattapan 26, Mass.

FREE! 15 Central America. Approvals. Super Stamp Shop, 2 S. Madison, Greencastle, Indiana.

UNITED States approvals. Fine quality. Priced right. George Klein, Vincennes 2, Indiana.

1000 MIXED U. S. old and new 25c. Weatherby, Medina, Ohio.

SETS, Wonderful assortment, \$2.00. Philately Exchange, 823 1/2 Maple, Santa Monica, Calif.

ATTRACTIVE Foreign sets sent on approval. Maurice Rouillard, 181 Chestnut St., Holyoke, Mass.

55 DIFFERENT U. S.—5c. Approvals. Utechts, 1143C North Keeler, Chicago 51.

WORLDWIDE, Airmails, pictorials, commemoratives, Colonials, packets 50c-\$1.00. Slotin, 328 Bannerman, Winnipeg, Manitoba.

SEND For our better U. S. approvals now. Box 488, Minneapolis.

FREE St. Helena pictorial and big surprise packet to approval applicants. Pioneer, Box 414A, Pasadena 18, Calif.

CONFEDERATE State mint block free with approvals. Paul Kelly, 2078 East 24th Street, Brooklyn 29, New York.

1c EACH. Arranged by countries. Each stamp catalog numbered. Adults only. Lange, Box 21, Station R, New York 55.

10 MAP Stamps 10 cents. Approvals included. Larson, 209 South 14th, Fargo, N. Dak.

FOREIGN Stamps packet 3c. Approvals. Smith, Box 71-A, Roselle, New Jersey.

STAMPS From 20 countries free. Quality penny approvals included. Harding Stamp Co., 5031 No. Harding, Chicago 25, Ill.

OLD Scarce U. S. Seconds. Approvals. Slightly defective. Bargain prices. Hernefield, 551 Clinton, Newark 8, New Jersey.

EACH 25c, 8 Berlin Occupation, 8 Austria American Occupation, 10 Austria New Republic. Bargain lists free! Bradford, Box 636, GPO, Brooklyn, New York.

FREE Set with approvals. Lennig, 9338 Amesbury Ave., Cleveland, Ohio.

50 DIFFERENT "Quality" \$1.00 to approval applicants. J. Beedle, Box 467, Ajo, Arizona.

U. S. Price list. Send postage. Stanley Gibbons, 38-P Park Row, New York.

URUGUAY—100 Different 50c with approvals. Ross Jewels, Tamaqua, Penna.

RUSSIA 10 Different and victory stamps 10c with requested approval. Southland, 1805 Roosevelt, Los Angeles 6, Calif.

FOREIGN Pictorial approvals. Brandan, 1912-3rd Ave., South, Minneapolis 4, Minn.

EXCELLENT Pictorial approvals. Reasonably priced. Crown Stamp Company, Box 331, Toronto, Canada.

FREE—Tannou Touva "teddybear" triangle, Reunion, Uganda, Tanganyika, old American colony, including stork stamp, war refugees, others—all free with approvals for 3c postage. Dominion Stamps, Arlington, Virginia.

31 DIFFERENT With George Washington stamps from Brazil and Ecuador; Pirate Island; victory issue; medical set; others—all 4c with approvals. Grayson Company, Sherman, Texas.

175 U. S. commemoratives, etc. 10c. 500—25c. P.O. Box 457, Newark, N. J.

COLOSSAL Value packet only 10c. Approval applicants. Standard, 3617 Sackett, Cleveland, Ohio.

125 DIFFERENT, Czechoslovakia set. Perfect gauge. Hitler head. Japanese occupation, everything 10c. Requesting approvals. Ferguson, 1619A West 50th St., Los Angeles 37, Calif.

FREE! 3 Different Hitler heads to approval applicants. Riverside Stamp Co., Box 1565, Miami 35, Florida.

BECHUANALAND, Tonga, Pitcairn, others—3c with approvals! Saxons, Walden, New York.

PICTORIAL Set free. Approvals. Davis, 1320 South 12th, Waco, Texas.

U. S. Collection—Thirty different fine unused commemoratives 1893-1939 including Columbians, Bicentennials, Parks, only \$1.00 to approval applicants. Orange Stamp Co., Albany, New York.

1000 WELL Mixed Canadian stamps, \$1.00. No approvals. T. Johnstone, 421 Mt. Pleasant Rd., Toronto 12, Ont. Canada.

25 DIFFERENT Romania, or Switzerland, 3c! Approvals. Rosen, 1619 Bathgate, New York.

25 DIFFERENT British colonials, 5c with approvals. Stamphouse, 7235-A Sheridan, Chicago 26.

50 DIFFERENT Cuba 50c. Approvals. Stoneham Stamp Co., Stoneham 80, Mass.

SPECIAL—Stamp tongs, perforation card, 7 mint Free French, to approval customers for 5c. Co-operative Stamp, Box 69B, Brooklyn 29, N. Y.

\$1.00, \$5.00 U. S. Postage dues—3c with approvals. Riffle, 211 Jefferson, York, Penna.

PENNY Approvals. Beautiful foreign stamps. Till, Box 202, Millbrae, Calif.

VATICAN "Christ" set—25c with approvals. Suburban Stamp Sales, St. Louis 14, Mo.

UNITED States \$4, \$5 and \$10 stamps only 3c to approval applicants. P. Wineholt, Woodbine, Penna.

NOW! Get British colonial, airmails, pictorials. Premiums! Send for bargain bulletin. Reuter, 611-C West 40th, Los Angeles 37.

30 STAMPS From 30 countries. Venezuela mint set. 3 cents to approval applicants. Robert C. De Vere, Box 927, Santa Monica, Calif.

NUDE Duchess set (two varieties) 5c, approvals. Masters, Clifton and Kernan, Baltimore 7, Maryland.

FREE Packet with approvals. Robert Smith, 801 Market, McKeesport, Penna.

PERU, 50 Different, 50c; 100—\$1.00; 200—\$7.75. Bedard, 3420 Montclair, Detroit 14, Michigan.

ARMY Navy set 10c, foreign, U. S. approvals. Yokums, Box 1327, San Antonio 6, Texas.

POSITIVELY Greatest free offer—Latest Scott's International \$5.00 stamp album—covering entire world, contains 36,000 illustrated, descriptive spaces; Scott's 1946 Standard \$5.00 catalogues "Philately's Encyclopedia" — absolutely free to applicants for foreign approvals becoming customers. Plymouth, Bell, Calif.

LOOK! Sensational offer! Thrilling Russian war set showing action scene of brave defense of Leningrad (big guns!) and five famous heroes plus magnificent mint tri-colored British Colony pictorial stamps from far-away South Georgia, Graham Land, South Orkneys, and South Shetlands. We offer this unusually attractive assortment of valuable stamps missing from most collections for only 10c to serious applicants for our quick-service approvals! Write now! Littleton Stamp Co., Box 50, Littleton, New Hampshire.

125 DIFFERENT U. S. Stamps, 30c. Frank Stroskey, Box 55, Perth Amboy, New Jersey.

U. S. APPROVALS—Reasonably priced. W. D. Treaster, Milroy, Penna.

300 DIFFERENT Given free with approvals. Postage 3c. Windsor Stamps, 1435 East 67th Place, Chicago 37.

FREE! Tiny Chinese "midget" war set, approvals. Seminole, Glenburnie 1, Md.

EXPLORER'S Packet! 120 different north, south poles, jungles (cannibals, headhunters, mysterious Sudan), Mongolia, Azerbaijan, etc., 3c. Approvals. Auburn Stamps, Auburn, Mass.

APPROVALS That satisfy, reasonable, freshly mounted, sent promptly. Edwin Wagner, Box 664, Manasquan, N. J.

EARN Extra money. Become a part-time dealer, send 5c for our illustrated catalog. City Stamp Co., 2850 Clafin, Bronx 63, New York.

ZANZIBAR, Palestine, Manchukuo, Azerbaijan, Haiti, Iraq, Siam, Victoria, Hitler stamp 5c. Approvals. Postzegel, Windham, New York.

NIUE (Savage island) mint set (3) only 5c to serious collectors requesting low-priced mint British Colonies on approval. Glen B. Wilson, 711 North A St., Tampa 6, Florida.

PACKETS! \$1.00 each! U. S. 125 different; Canada 100 different, 54 other packets, list free! Henry Faville, Box 2005, Madison 5, Wis.

COMMEMORATIVES—Denmark—9 different 5c. Free lists. Lucky, 745 Josephine, Glendale 22, Missouri.

50 FOREIGN, Catalog over \$10.00 for \$1.00. No two packets alike. Desplaines Exchange, Des Plaines, Illinois.

IMPORT Your own! Directory \$1.00. Joseph Soult, Pinecrest Powers, Mich.

FREE! Complete Balkan aviation set with approvals. Beaman, Glenburnie 1, Maryland.

100 DIFFERENT Stamps 5c. Approvals. W. J. Lange, Marion, Iowa.

APPROVAL Sheets, Frederick B. Driver, 909 Finance Building, Philadelphia 2, Pa.

PENNY Approvals, that satisfy. Neil Gronberg, Box 5441-P, Philadelphia 43, Penna.

MAGAZINE—Chock-full stamp information, news and bargain ads! 15 issues 25c! "Stamp Post," Station A, Pasadena 3, Calif.

PHILIPPINES—Hard to get occupation stamps included in my approvals. Also fill want lists. 10c brings approvals and price lists. James W. Burnette, Manila, Luzon, Philippine Islands.

NEW Issue price list free. Bengston, Box 13, Minneapolis, Minnesota.

U. S. Approvals write W. H. Robinson, Box 815, Battle Creek, Michigan.

PHILIPPINES—44 Different—\$1.00. Request approvals. Alex Abad, 229 Zurbaran, Manila.

"SPECIAL Notice," discounts, worth-while premiums, free with approvals. Box 2068, Miami Beach 40, Fla.

BRITISH Empire mixture over 300 stamps 50c with approvals. Astoria Stamp Exchange, Woolsey Station, Box 25, Long Island City 5, N. Y.

MINT Pictorials free to approval applicants. Surf Stamp Co., Box 2296, Miami Beach 40, Florida.

NEWFOUNDLAND! Collectors most popular country; 14 different 5c with pictorial and commemorative approvals. Lyman, 99 Nassau St., New York 7.

200 DIFFERENT Foreign, many countries 30c. Jem Stamps, Port Jefferson, N. Y.

UNITED Nations, scarce 5c U. S. commemorative and packet 30 different U. S., including airmail, commemoratives, revenues, etc. Catalogs 65c—to approval applicants for 5c. Curhan Stamp Company, Dept. H, Gloucester, Mass.

BEGINNERS Only! Our progressive U. S. approvals, postage or precancel, are guaranteed to please. Write today! Richard Cole, 43 Rinewalt, Williamsville, N. Y.

45 DIFFERENT Unused U. S. commemoratives \$2.00, 100 interesting foreign \$1.00. Other stamps on approval. Charles Mekeel, 2101 East Market, York, Penna.

ZOWIE-E! A barrel of fun for only a dime. 500 United States stamps—absolutely unpicked and unsorted—just as received from church missions. Many varieties, including large commemoratives, airmails, high denominations up to \$5.00! Stampdom's biggest package of fun—and you might find something really valuable! Price only 10c to serious approval service applicants. Money back if not delighted. Illustrated bargain lists with each order. Mystic Stamp Company, Dept. 80, Camden, New York.

TRADERS—Exchange your duplicates. Any stamps accepted. Postcard brings full information. Comet, GPO Box 517P, Brooklyn, N. Y.

50 DIFFERENT United States, 10c. Price-list free. Seidenberg, Cassopolis, Mich.

FREE—Abyssinia, Cayman Islands, Tuna triangle, Indochine, Syria, Ivoire, Philippines (Jap "shame" issue), Turkish harem, Damascus, Cambodia, African "beauty," Pirate Islands, Colonials, others—all free for 3c postage with approvals. Belmont Stamps, Washington 10, D. C.

DOLLAR Each—1500 foreign, 2000 British, 2000 Canada. Seiden, 1331 Intervale, New York 59.

GLOBAL Packet 40 stamps all different 10c. Eclipse, Box 635, St. Louis 1, Mo.

U. S. And foreign bargains galore! Write for list. Crane, Rutland, Massachusetts.

CANADA—75c Diff, 25c. Approvals, Lists. Victoria Stamp Co., London 4, Canada.

10 DIFFERENT U. S. Over 40 years old, 5c. Foreign, U. S. approvals. Scott, 30 Baker Ave., Lexington 73, Mass.

EXCHANGE Your duplicates for others you need. Particulars and one ancient U. S. revenue for dime. McPherson, Branch, Mich.

MINT Black Harding ten cents to approval applicants. Louis Merrill, 1623 5th, Portsmouth, Ohio.

SURPRISE Packet, 10c. U. S., foreign approvals. Hanover Stamps, Brown's Mills, N. J.

CHOICE Approvals 1/2c up. Stamps, 1267 Tutwiler, Memphis 7, Tenn.

STAMPS! 1000 Different \$2.50, 2000 different \$7.50. Ransom, 1333 Pontiac, Ann Arbor, Mich.

ATTRACTIVE Approvals for beginners, advanced collectors. Jacobsen, 59-M Nagle Ave., New York 34, N. Y.

WOW! \$10.00 Worth of fun only 10c. What a treasure hunt! Big package 500 foreign stamps—just as received from foreign missions other sources. Includes stamps from Africa, South America, Philippines, Free French, Cape Juby, Palestine, etc., including airmails, commemoratives, and stamps worth up to 50c and 75c. This amazing offer is given for 10c to serious approval applicants only. One to a customer, money back if not more than delighted. Jamestown Stamp Co., Dept. 22, Jamestown, New York. Stamps—valued up to 50c and 75c each.

GORGEOUS Colors, scarce airmail surcharges, charities, sets, etc. All in our big premium packet only 3c to approval buyers. Dixie Stamp Company, Dept. M, Milwaukee 3, Wisconsin.

LATIN-AMERICA. 65 Diff., pictorials, airs, etc., 10 countries. 10c with approvals. Crescent Stamps, London, Canada.

\$1.00 WILSON—25 Others, approvals, 6c. O. Burgett, Lima, Ohio.

FINE Approvals, freshly mounted. Fast, personal service. Tell me what countries you prefer and I'll send their stamps. Skinner, 438 Locust, Long Beach 2, Calif.

ILLUSTRATED Price list, American and foreign complete sets, many Italian specials, free. Kuley, 2 Crary Avenue, Mount Vernon, New York.

RICH Man's approvals, poor man's prices. Grand value packet containing five foreign sets, free with approvals. Stoll Stamp Service, 2630B West Burnett, Louisville 10, Kentucky.

UNITED States approvals complete coverage, fine quality, attractive prices. Seminoles Stamps, Box 378, Coconut Grove, Florida.

NEW Zealand 48 good, including rare mints \$1. W. Lovell, Taupiri, New Zealand.

FREE! Negro Triangle; Turks Islands "Cactus"; Dakar; Guinea; Palestine; "Fairy Tale," Pirate Chart, Map, Ship, Sea Lion and Snake stamps; French, British, Portuguese Colonies, etc. Free for 3c postage. Approvals, Potomac Stamps, Washington 10, D. C.

FREE! Leeward Is., Cayman Is., Turks and Caicos plus 54 different mint World's Fair poster stamps, to approval service applicants sending 3c postage. Tatham Stamp Co., Springfield 30, Mass.

PERSONALIZED Approvals. "Tailored" to fit your needs. Schlotzhauer's, Shenandoah, Virginia.

25 DIFFERENT India, 3c with approvals. Premiums with purchases. Brandwein Stamp Company, Box 92H, Bayonne, N. J.

CANADA War set 10 var. 10c with interesting approvals. Rheasume, 8949 Routhier, Montreal 12, Canada.

MIXTURES. Worldwide accumulations 1,500 for \$1. Missions Outlet, Rev. Marshall, Paterson 1, N. J.

EXCHANGE Duplicates. Swappers everywhere. List free. Box 2166, Denver 1, Colorado.

EXOTIC Pictorial collection, including Tahiti Spear Fishing, Melanesian Idol, Carib Archer, Malagasian Farmer and many other scarce stamps from strange countries. Everything only 5c. Imperial Stamp Co., Yonkers, N. Y.

50 DIFFERENT Including scarce diamond-shaped airmail 3c to approval service applicants. Avalon Stamp Co., Dept. M, Springfield 8, Mass.

19th CENTURY U. S. Commem., Civil War—Battleship revenues, \$5 and \$10 stamps free to U. S. approval applicants. Metropolitan Stamps, 198C Broadway, New York.

MOZAMBIQUE Triangles, unused. Set 10c with approvals. Vargo Stamps, 6044 South Fairfield, Chicago 29, Ill.

LIBERAL Offer, thick packet with Seychelles, Fiji, U. S. commemoratives, Tete, Djibouti, Inini, Congo, Porto Rico, Philippines, and multitude others. Everything only 10c to approval applicants. Burmaster, Box 1910 A, Los Angeles 53, Calif.

DANDY United States approvals. Write immediately. Sullivan, Endicott Building, St. Paul 1, Minn.

1000 GRABAGS 15c Each. Super bags 25c. Zandy, 630 Bingham, Reading, Pa.

BOX Stamps containing hundreds all different, cataloging up to 25c each. Everything \$1.00. Longacre Shop, 108 West 42nd, New York City.

SCARCE "Pole to Pole" packet! Stamps from strange, mysterious countries only—Greenland (North Pole), Solomons, Spanish Morocco, Bhopal, Patiala, Siberia, Grahamsland (South Pole), Djibouti, Zanzibar, etc., and including stamps cataloging up to 25c each! Our price only 5c to approval applicants. Big dime packet list free! Methuen Stamp Service, Inc., Dept. 136, Lawrence, Mass.

FREE U. S. price list. Postage 3c. Mark Hanna, 335 - 5th Avenue, Pittsburgh 22, Penna.

FREE—Pick 25c worth of stamps from our first U. S. approval selection. Approximately 100 stamps to choose from. Excellent value. No obligation to buy. Lists illustrating the most popular U. S. stamps—at prices you can afford—will be included. Don't miss this opportunity! Write today. S. C. Engel Co., 38 Park Row, New York City.

25 DIFFERENT Guatemala 10c with 1/4, 1/2, 1c approvals. Carroll's, 4357A S. Hoover, Los Angeles 37, Calif.

TURKS, Caicos, Grenada, Brunei, Dominica, Caymans; everything 3c with approvals. Viking, 130(Z) Clinton St., Brooklyn, N. Y.

114 DIFFERENT Stamps from far away countries including airmail and Free Fighting French to approval applicants for 10c. Reich Stamp Co., 4647 Kenmore, Chicago 40, Dept. M9.

COMPLETE "United States" catalog with 1000 illustrations! Send 10c for mailing. Harris & Co., 137 Transit Building, Boston, Mass.

AMAZING Offer! Assortment each of giant stamps, midget stamps, flag stamps, airmail stamps, Free French Colonies, U. S. commemoratives and numerous others. Everything only 10c to approval applicants. Simon, Box 214, Iraan, Texas.

DEALERS—Wholesale list. Postage 3c. Frank, 5031 Queensberry, Baltimore 15, Md.

SCARCE 1880 U. S.—Hussey local carrier stamp listed at 15c. Also Costa Rica No. 65 listed at 40c. Both sent free to approval buyers sending 3c postage. Pladon Stamps, 1717-M Idaho, Toledo 5, Ohio.

WORLD'S Largest diamond and triangle stamps, free stamp magazine, stamps from fighting Free French, 20 stamps from 20 different countries, pictorials, airmails, big bargain 5c with approvals. Capital Stamps, Dept. 2, Little Rock, Ark.

118 DIFFERENT Stamps including commemoratives, charities, airmail sets, etc., only 3c to approval buyers. We buy collections. Badger Stamp Co., Milwaukee 3, Wis.

FRESHLY Mounted approvals for collectors using Scott's International Junior album. Wlaschim, 55 Nagle Ave., New York 34.

VICTORY Packet free—Includes stamps from Tanganyika, British Cayman Islands, animal, scarce babyhead, coronation, early Victorian, airmail, map stamps, with big catalogue—all free. Send 5c for postage. Gray Stamp Company, Dept. PM, Toronto, Canada.

FREE! Canadian sets, royal visit, George VI, George V, coronation, jubilee, others, to approval applicants. Ensign, Box 118-M, South Orange, N. J.

FREE! The Stamp Finder! Send today for the big new edition, fully illustrated, enabling you instantly to identify all difficult stamps! Also fine packet strange, fascinating stamps from Bosnia-Herzegovina, Monaco, Patiala, Cyprus, etc., including maps, ships, animals and strange scenes. All free to approval applicants inclosing 3c postage. Garcelon Stamp Company, Box 900, Calais, Maine.

NEW Denmark King Christian set 5c with my penny approvals. Edward Moore, 1129 Wesley, Oak Park, Ill.

MINT Will Rogers set from Nicaragua 3c with approvals. Brown, Box 2024, Evansville, Ind.

ILLUSTRATED U. S. buying list; shows the price we pay under each picture! It's free! Postage appreciated. George Wentz, San Marcos 5, Texas.

HOBBIES AND COLLECTIONS

TEN Small fire opal specimens \$1.00. Thirty mixed rough Mexican opals \$1.25. Minerals, gem stones and Indian relics on approval. Dr. Ralph E. Mueller, Professional Bldg., Kansas City 6, Mo.

FREE: 50 Military emblems when joining "Insignia Club." Price list, insignia guide 10c. Embroidered sample 5c. Hobbyguild, P35 West 32nd, New York.

BEAUTIFUL Selection of twenty hard to get, unused Canadian matchbook covers. Hotels, grills, one dollar postpaid. July, 8230 Drolet, Montreal, Canada.

LEATHER Scraps for hobby and craft workers, six pounds for \$2.00. Book on leather craft, ideal for hobbyist. "Applied Leathercraft" \$2.75. Northern Supply Co., Sheboygan, Wis.

COLLECTORS. Cutters mixed pound Agates, Jasper, Wood \$1.00. Smith, Box 422F, Albany, Oregon.

JET Propulsion speedier boats, airplanes, autos, experimental people interested. Circular free. Shea, Box 33, San Lorenzo 21, Calif.

INVENTING Can be an interesting and profitable hobby. Write for complete particulars. Institute of American Inventors, Dept. 40-E, 1926-Eye St. N. W., Washington 6, D. C.

NEW—15 Different match covers 10c. Box 202, Rochester 1, N. Y.

RAILROAD Photographs, books, etc. Satisfaction guaranteed. Pictorial catalogue free. Grahame Hardy, 538 15th St., Oakland 12, Calif.

FASCINATING Hobby. Poinsettias for Christmas. Lilies, hyacinths for Easter. Flowers in bloom the year 'round in your own window garden. Build small, inexpensive conservatory. Enjoy many hours of rare pleasure. Instructions, photographs \$1.00. Ostertag, Glenburnie, Md.

GENUINE Rubber cement. Full pint \$1.00 postpaid. May Chemical, 925 Larrabee, Chicago 10, Ill.

FOREIGN Decoration ribbons, list, sample 20c. Foreign insignia packet, booklet, \$1.00. Insigniacrafts, 236-28th Ave. N.W., Calgary, Canada.

EARN Cash collecting plants for me. Elbert, Box 414V, Vandyke, Mich.

PHILIPPINES—Souvenirs. Wooden shoes with beautiful carvings and paintings, bamboo hats, silver rings, bracelets, beautiful grass-skirts and hundreds of other souvenirs. Price lists of souvenirs, 10c. James W. Burnette, Manila, Luzon, Philippine Islands.

FOOL'S Gold—From famous gold camp, 10c per sample. Also mineral specimens from famous local mines. Martin's Snap Shop, 506 Harrison Ave., Leadville, Colo.

COLLECTING Hobbyists. Exchange duplicates. Swappers directory 10c. C. Bishop, Route 8, Kalamazoo 88, Michigan.

RAISED Metal designs, figures, emblems, on brass or copper shell casings, vases, bowls, plaques. Interesting, profitable hobby. Easy to follow, fully illustrated, detailed instructions and projects one dollar bill or m.o. Perma-Craft, Box 608, Mt. Kisco, N. Y.

INSIGNIA Collectors, Army, Navy and Marine, send for list of 444 different shoulder patches. No charge. Box 228, New York 10, N. Y.

COLLECT Colorful Army patches. Pictures, prices and sample patch only 10c. Insignia Mart, 703 Broadway, N. Y.

WHITTLES—20 Patterns, instructions, X-acto knife, wood. \$1.00. "Old Whittler," 1402 Charles, LaCrosse, Wis.

UNUSED Match book covers, 100 all different \$1.00. 35 Royal Flash covers \$1.00. Free list. Charles Edelman, 1311C East 84, Cleveland 3, Ohio.

JEWELRY Stones removed from rings, etc., 100 assorted \$2.40; 50 large ones \$2.40. B. Lowe, Holland Bldg., St. Louis 1, Mo.

ANTIQUES, RELICS, INDIAN GOODS, CURIOS

INDIAN Relics, beadwork, coins, minerals. Catalog 5c. Sistershop, Northbranch, Kansas.

COINS, Minerals, glass, Indian relics. Catalogue 5c. Cowboy Lemley, Las Cruces, New Mexico.

4 FINE Ancient arrowheads, \$1.00. Stone Tomahawk, \$1.00. Flint knife, 50c. List free. Lear's, Box 569, Galveston, Texas.

MUSEUM Specimens. Indian relics, curios, den decorations. Illustrated catalogue, identification chart 25c. We also buy. Museum Supplies, 6601 Oshkosh, Chicago 31, Illinois.

50,000 INDIAN Arrows, tools, rainbow variations. Don McKillop, Regina, Sask.

MINERALS AND PRECIOUS STONES

"GENUINE" Arizona "Rubies" (Garnets). Send quarter for packet. Mineral Specimens Company, Box 2651, Phoenix, Arizona.

CAMERAS AND PHOTO SUPPLIES

KENT Dark room kit; a complete printing and developing kit for beginner or advanced amateur. Contains the necessary equipment and materials for processing and printing photo negatives. \$10.00 set; special sale \$8.92. Conway Camera Company, 34 N. Clark, Chicago 2, Illinois.

FILM! Fast Army. Five rolls, eight exposures, postage included: No. 127, \$1.50; 120, \$1.75; 620, \$1.75; 116, \$2.00; 616, \$2.00. Artex, Union, New Jersey.

PHOTO Printer kit, \$1.00. L. Spada, 10 Lexington, Wethersfield 9, Conn.

INTERESTED In photography as career? Send stamp. Frank Smith, Midland Park, New Jersey.

ENLARGERS—Build your own. Kit of parts, \$6.00. Free particulars. Krescent Engineering, Box 586, North Hollywood, Calif.

COPY Anything at low cost! Fotofiek System, Box 181, Cincinnati 1, Ohio.

NEW Camera takes sixteen pictures, \$3.95. Postage free. Kravat, 1581 E. 24 St., Brooklyn 29, N. Y.

DELUXE Contact printers 4x5. \$12.50 plus tax. Write for details. 28 N. W. 37th Ave. Miami, Florida.

GARY Camera Co. may help you in your photographic needs. Visit or write us. Gary Camera Co., 619 Washington, Gary, Indiana.

CASH! Spot cash for cameras, lenses, binoculars, movie or still, sound projectors. Send full description by mail, or wire for prompt cash offer. Over 30 years of dependability insures honorable dealings. 35c postpaid for 100 page book "Military & News Photography" by Jack Price. Up to the minute information. Bass Camera Company, 179 West Madison Street, Chicago, Illinois.

FILMS. Surplus Kodak Panchromatic. 3 rolls, 127, 85c. 120-620 \$1.05. 116-616 \$1.20. Postpaid, no limit. Cameraman, 542x Fifth Ave., New York 19.

CAMERAS. Enlargers, lowest prices. Free catalog. Cavalier Camera, 1822 Center, Pittsburgh 19, Penna.

OIL Coloring photographs can be a fascinating hobby or profitable sideline for those with artistic talent. Learn at home. Easy simplified method. Send for free booklet. National Photo Coloring School, 1315 Michigan, Dept. 3432, Chicago 5, Ill.

ARROW Films. Can be used for indoor and outdoor snapshots. Packages of 5 rolls. No. 127, \$1.45; No. 120 also No. 620, \$1.75; No. 116 also No. 616, \$2.00, postpaid. Empire Photos, Newark 8, New Jersey.

PHOTOGRAPHY For pleasure or profit. Learn at home. Practical basic training. Long established school. Write for booklet. American School of Photography, 1315 Michigan, Dept. 3432, Chicago 5.

USED Camera Directory. Box 1031-M, Canton, Ohio—lists hundreds of war-bargain used cameras—35mm., Speed Graphics, Kodaks, Rolleiflex—many others. Send 25c for latest issue.

BASS Says: War time proves Bass leadership. Amazing selection of finest still cameras—Leica, Contax, new and used still available. Write for quotations. Satisfaction guaranteed or your money refunded. Bass buys 'em, sells 'em, trades 'em. 35c postpaid for 100 page book "Military & News Photography" by Jack Price. Up to the minute information. Bass Camera Company, Dept. AG, 179 W. Madison St., Chicago, Illinois.

HAVE You a camera? Improve your hobby of photography and learn how to make better pictures. Write today for our latest book catalog and sample copy of American Photography, containing articles and pictures by the world's foremost writers and photographers. Camera House, 601, 353 Newbury St., Boston 15, Mass.

PHOTO FINISHING

ENLARGED Reprints 3c each, forty \$1.00. DeLuxe doubleweight enlargements 4x6 10c; twelve \$1.00; 5x7 15c, eight \$1.00; 8x10 25c, five \$1.00. MacDonald's Photo, Box 28-A, Congress Park, Illinois.

AT Last we have films: 116 and 616, 38c ea.; 120 and 620, 33c ea.; 127, 27c ea. Roll developed, all your snapshots hand-colored as beautiful as most actual colored photography 35c. Hand colored reprints 4c each, 12 for 45c. Midwest Photo, Janesville 26, Wisconsin.

FILM Developed. 8 album size enlargements or 16 sparkling prints, 25c; 8 snappy 4x6 enlargements, 30c. Reprints each: contact prints, 2c; album enlargements, 3c; 4x6 enlargements 4c. Crystal Studios, 159-F, Rushford, Minn.

8 EXPOSURE Roll developed and printed 25c. Free enlargement coupon. Reprints 3c. B & W Fotatorium, Box 157P, Pleasant Hill, Mo.

BEAUTIFUL Prints, 25—50c. No limit. Studio, Box 944, Longview, Texas.

VETERANS—Discharges—photostated—wallet size—plastic copy. Selco Products, Danvers, Mass.

ROLLS Developed and printed, 25c. Reprints, 2c; 5x7 enlargements, 15c; 8x10, 25c. Davis Studio, Guthrie, Oklahoma.

ROLL Developed, eight prints, 35c. The very best in workmanship and materials. 7x11 enlargement, matte, double weight paper, sepia toned, oil colored—\$2.00. Alston Photo Service, Littleton, N. C.

8x10 ENLARGEMENTS. Photo or negative \$1.00. Box 339, Lake Orion, Mich.

FREE Snapshots! Free album! Mail this ad and two negatives for free snapshots complete in album! When you see these free samples you'll want more. Artisto, Dept. 131, Drawer 220, Regina, Sask.

ENLARGING. Printing, developing easily learned. Simplified instructions \$1.00. Fred Carpenter, Box 264, Hamlin, Texas.

BIGGEST \$1.00 Value in 35mm. finishing today. 36 exposure fine grain 3 1/4 x 4 1/2 enlargements; deckled, embossed margin and date. Eighteen exposures 75c; 16 exposure splits 55c; 36 exposure reloads 50c. Special: return this ad with \$2.00 and we will send five 36 exposure reloads. Free mailers. 8 exposure rolls in beautiful, deckled contact finish with embossed wide margin, 25c. Mailbag Film Service, Box 5440A, Chicago 80, Ill.

ANY Size picture reproduced postage-free. 100 photostamps \$1.50. Artcraft, 1602 Coney-Island, Brooklyn 30, N. Y.

MONEY Back guarantee—All this for 25c; roll developed 8 bigger deluxe prints also 8 regular prints, plus two beautiful enlargements and tasteful leathertone frame. Reprints low as 1c. Lifetone Photo Company, Dept. 339, Des Moines, Iowa.

FAST Delivery, satisfaction guaranteed. 16 prints 30c, 8 jumbo size 35c including developing 8 exposure roll. Pioneer Service, Box 123, Wichita, Kansas.

8 VELOX Prints and two professional enlargements 25c. Send roll or negatives for trial offer. Young Photo Service, 405-C, Albany 2, N. Y.

2 BEAUTIFUL Hi-Gloss prints each good negative and enlarging coupon with each 6 or 8 exposure roll developed, 28c. Owl Photo Co., Weatherford, Okla.

50 REPRINTS \$1.00. No limit. Studio, 1408-M Bond, Rockford, Ill.

GLOSS Finish enlargements, 4 5x7 from negative 50c. 3 5x7 from photo 50c. Robert Renshaw, Jr., P.O. Box 478, Chester, Penna.

PHOTOGRAPHY For pleasure or profit. Learn at home. Practical basic training. Long established school. Write for booklet. American School of Photography, 1315 Michigan, Dept. 3451, Chicago 5.

FINER Photo finishing specials 25c. Eight exposure rolls developed with two prints each good negative or one enlarged print of each. Try today's quicker, finer Moen-Tone Enamel finish. Satisfaction since 1898. Moen Photo Service, 452 Moen Bldg., LaCrosse, Wis.

8 EXPOSURE Rolls 25c, over 8 exposure 40c, for one Velox print each and free enlargement coupon. Reprints 3c, minimum 25c. Fred D. Eastman, Bode, Iowa.

6-8 EXPOSURE Rolls developed and enlarged mammoth size 30c. Reprints 3c. Thrifty Photos, Box 46, South Gate, Calif.

CENTURY Delivers work and service that can't be beat. 8 exp. roll 25c with two professional enlargements free. Century Photo Service, LaCrosse, Wis.

8 PRINTS. All enlarged to nearly postcard size, from your roll or negative, 25c. Willard Studios, Box 3535A, Cleveland 18, Ohio.

SENSATIONAL Introductory offer! Send snapshot or negative, this ad, and 3c. We'll send you a beautiful 7"x5" enlargement! Or, Kodak roll developed with 16 guaranteed deckled-edge velox fade-proof prints or 8 double-size prints, 25c! Special! From your negatives, 16 regular-size or 8 double-size reprints, 25c! Can-did rolls—36 exp. 35mm. developed, vaporated, enlarged to 3x4, \$1.00! 18 exp. 50c. Reprints, 3x4, 3c each. We have new, perfect 35mm. film. Low prices. Free mailers, details on request. American Studios, Dept. 279, LaCrosse, Wis.

EVERY Picture an enlargement! 8 sparkling deckle-edge enlargements and roll developed 25c coin; 116 size or smaller; enlarge reprints 3c. Enlarge Photo, Box 791D, Boston, Mass.

BEAUTIFUL Double-size pictures 3 1/2 x 4 1/2 each, from 116 and 120 negatives. 3 1/4 x 4 1/2 from all other sizes. All work guaranteed. Overnight service. Roll developed and 8 pictures 30c. Roll 12 pictures 45c. Roll 16 pictures 60c. Enlargements on double weight portrait paper 5x7—30c, 8x10—50c. Copies made from any picture 75c. Pacific Photo Service, Box 666, San Francisco, Calif.

MOTION PICTURES AND SOUND EQUIPMENT

FILM—Processing not included, 100 ft. lengths. Double 8, Weston 6 \$1.65; Weston 64, \$3.95; Single 8, Weston 6, \$1.15; Weston 64, \$2.40; 16mm. Weston 6, \$1.55; Weston 24, \$3.80; Weston 64, \$3.90. Fromader Genera, Davenport 7, Iowa.

PROJECT-O-COLOR The new sensational accessory for movie projectors available now! Information free. Write Project-O-Color, Palatine 1, Illinois.

100' 16MM. Used sound film. \$1.00. One reel sound cartoons, used, \$9.95. We buy, sell, trade. Ask for list. Blackhawk Films, Dept. PM24, Davenport, Iowa.

SAVE Money. Buy, rent, exchange 8-16 mm. and sound home movies. Details for dime. Midland Film Exchange, Box 429, Oak Park 4, Illinois.

16MM. Film rentals. Free list. Robert Salmon, 3558 11th, East Salt Lake City, Utah.

NEW 16MM. motor driven projectors \$16.00 postpaid. Sterling's, 679 Northampton, Easton, Pennsylvania.

FILMS. Lower prices, 8mm., 16mm., S.O.F. 1946 16mm. sound projectors. Free particulars, Charlie Poorman, Dept. P.M., Schuylkill Haven, Penna.

ANSCO—Color film! Fresh supply, 16-16MM, 100 foot rolls, \$8.75 postpaid. LeMoine Films, Nevada, Missouri.

PROJECTORS 35MM, 16MM sound. Nusslock, 4614 Green Tree, Milwaukee 9, Wisconsin.

HOME Movies in color! 8mm., 16mm, Catalog, 25c. Projection length Kodachrome sample from "Waikiki Hula." \$1. Specify width. Iriscope kits, \$5.00. Movie camera film. Accessories, Jenkins, 392-F, Elmira, New York.

I BUY, Sell, swap, rent s.o.f., 8 and 16mm. films. List free. Harvey Iris, Box 539, Brockton, Mass.

16MM. TITLES Custom made, 2 for \$1. Wolf, 6858 Stony Island, Chicago.

LOW Cost, 8 16mm. rentals and sales. Lists, Kodachrome sample dime. Warrington, 1418 Knecht Ave., Halethorpe 27, Md.

1946 FILM Catalog free; film samples 10c. Cameras, projectors; photographic items. Goodwill Company, Jackson, Tenn.

8MM., 16MM., 35MM. silent sound films. Bedner, 5300 So. Talman, Chicago.

WORLD'S Best Passion Play—Sound and silent. 16 and 35 mm. Prints only. All Sacred Film Co., 38 Melrose Street, Boston, Massachusetts.

BUY, Sell and exchange 16mm. sound films. Maurice Mann, 34 Sprague St., Fitchburg, Mass.

SWAP Your 16mm. sound films. Send \$2 bill or money order with any Castle sound film and we will send you any Castle film of your own choice in exchange. Films must be in good condition. Eanrob Exchange, Box 583, New Bedford, Mass.

LEARN Professional motion picture technique at home. Free catalog. Motion Picture Institute, Birmingham 4, Mich.

UNUSUAL 8-16 mm. Film subjects. Big catalog with sample film, 10c. National Film Exchange, Broadway Sta. E, Toledo, Ohio.

MAKE \$8 To \$10 net profit daily with your 8mm. or 16mm. projector. Details free. Metcalf, 10806 Glenroy Ave., Chicago 43, Ill.

MOVIE Films. 100' outdoor 16mm. \$2.25; three rolls \$6.00; 100' indoor film \$4.25. Ambassador, 479-A, Quincy Street, Brooklyn, N. Y.

RENT 16 MM. sound films 50c reel. Large selection; free catalog. Film Service, 128 Chestnut Street, Roselle Park, N. J.

UNUSUAL Home movies—travel, adventure, sports, news, war films. Many film bargains. Big 1946 catalog and sample, dime. Audet, Box 6520-BG, Philadelphia 38, Penna.

8MM., 16mm., 35mm. films. Samples 10c. Lists free. Paramount Films, Monmouth, Illinois.

NEW Catalogue 35mm. motion picture productions. Roadshow attractions. Westerns. Gangster. Medicals. Any type picture you want. Low prices. Catalogue 25c. Bussa Film Exchange, Friendship, Ohio.

35MM. Sound features, projectors. A Savarese, Woodcliff Lake, New Jersey.

"THE World's Greatest Passion Play," all sizes sound and silent. Write Hemenway Film, 33-F Melrose St., Boston 16, Mass.

BASS Says: Leadership in the cine field is apparent in war times. Here ready—your choice of 8 mm. and 16 mm. apparatus. Write for quotations. Your old equipment is worth real money in trade—describe please. Or we buy for cash and pay immediately on receipt. Write to headquarters. Bass buys 'em, sells 'em, trades 'em. Satisfaction guaranteed or your money refunded. 35c postpaid for 100 page book "Military & News Photography" by Jack Price. Up to the minute information. Bass Camera Company, Dept. A, 179 W. Madison St., Chicago, Illinois.

LEARN Movie projection, management. Free catalog. Theatre Institute, Elmira, N. Y.

SPECIAL Movie film, 8mm., 25 feet double-Weston 8, \$2.00. Super double X, Pan indoor 60, outdoor 100, 16 mm.—\$6.50. Super X Pan indoor 24, outdoor 50, \$5.75. Pan Weston 12, \$5.00. 16 mm. 100 feet Weston 6, \$4.00. Free developing. Exhibitors Film Exchange, 630 9th Ave., New York 19, N. Y.

BEAUTIFUL Kodachrome slide and list, 25c. Art Slide Co., M-1, Canton, Ohio.

MOVIE Camera films, 100' 16mm. \$2.50. 25' double 8mm. \$1.25. Free developing. Better Films, 742 New Lots, Brooklyn 7, N. Y.

MOVIE Projectors bought and sold. List 10c. United, 2309-A Lawrence, Toledo, O.

MUSIC AND MUSICAL INSTRUMENTS

WE Want song poems and lyrics on all subjects. We offer the services of a noted Hollywood motion picture composer and arranger. Send your poem today for consideration and our liberal offer. Hollywood Melodies, P.O. Box 2168PM, Hollywood 28, Calif.

SONGWRITER'S Publishing agreement free. Stuckmann Music Press, 5426 Broadway, Chicago 40.

POEMS Wanted for musical setting. Composers' Guild of America, 545 Fifth Avenue, New York 17, N. Y.

SONGWRITERS! For best proposition, write Art Music, 1658 Broadway, New York 19.

MAGAZINE For songwriters! 10c. Songs published free. "Songwriter's Review" 111-M West 48th, New York City.

GUITARISTS—Play professional—modernistic set, runs-breaks, modulations, introductions, futuristic chords. Strictly professional material, become outstanding. Notes, fingering, diagrams, \$3.00. Beginners inquire, personalized lessons, Nicosia, Box 596PMD, Brooklyn 1, New York.

MELODIES, Lyrics, \$3.00. Arrangements, recordings, revisions. Sholl, 2217 Penn St., Harrisburg, Penna.

VOCALIST Pay well. Amazing home method. Details free. Vocalito, Madison Hotel, Box 132-C, Atlantic City, N. J.

SONGWRITERS! Excellent proposition. E. Madden, G.P.O., Box 1226, Syracuse, New York.

WANTED—Saxophone, accordion, clarinet, trumpet. Pay cash. Sims, Warwick, New York.

HAWAIIAN Guitar chord chart \$1.00. Over 650 chords in A-E 7th-C#-B 11th-Notes and diagrams by Sol Hoopii and Dick McIntire. Best for arranging. Fator's, 935 W. Santa Barbara, Los Angeles 37, Calif.

SONGS Remodeled. Write for information. Kuhlmanns, 403 East Main, Woodville, Ohio.

WANTED Songs, also music salesmen. Sample book and two songs \$1.00. Mrs. J. L. Benziger, Knoxville, Tennessee.

SONGWRITERS! Collaborate with nationally famous composer of "Boots and Saddles." Send poems for free examination. Valuable monthly awards for best songs. Get free instructive booklet. Hollywood Harmony House, 126 South La Brea, M-9, Los Angeles 36, California.

ACCORDIONS—Dealers' prices. New or used. All sizes and makes. Free catalog. Metro Accordion Co., 31 South Cicero, Chicago 44, Ill.

SUBSCRIBE To "The Guitarist and Mandolinist," monthly publication devoted to players of all string instruments. \$2.50 year. Sample 25c. Ricardo, Geneva, N. Y.

LEARN Piano in 5 lessons. Complete course \$1. Neale, 1616 Carl St., Cincinnati 25, Ohio.

GUITAR—Learn to play through Applied Psychology of Mental and Muscular Coordination. Spanish guitar, Hawaiian guitar or piano in twenty lessons \$2.00. Frank's Musicians Supply, 732 Jersey Ct., San Diego 8, Calif.

SONGWRITERS. Have your songs or lyrics completed by an honest, experienced arranger. Free analysis report. Tommy Kilbourne, Box 1253, Bakersfield, Calif.

SONGWRITERS! Amazing, outstanding ethical offer. Hibbeler, C5, 2157 N. Avers, Chicago.

SONGWRITERS. A limited amount of musical compositions wanted for radio distribution. Tin Pan Alley, Inc., 1650 Broadway, New York 19, N. Y.

POPULAR Piano in 12 lessons, guaranteed. Beginners, advanced. Kelly School, 1734 30th Ave., San Francisco 22, Calif.

SONGWRITERS! Oshms set to music. Billy Hannon, 6703 N. Peshkosh, Chicago 31.

POEMS Wanted! I'll compose special music. Send poem for free examination. Eliot Wright, Master Composer, 107 Rivoli Theater Building, Portland, Oregon.

SONG Poems wanted, for musical settings. Send poem for free examination and outstanding offer. Write for free instructive booklet outlining opportunities. United Music, Salem 3, Indiana.

NEW Songs and lyrics wanted for popular radio program and professional promotion. Free examination. Transradio Music Inc., Dept. P, 1650 Broadway, New York.

SONG Poems wanted—All subjects. Send your best poems today for free examination, or write for free booklet "Getting Ahead in Songwriting." Song Service, 331-C West 46th, New York.

MUSIC Composed to song-poems. Address: Frank Wildt, Lancaster, Penna.

SONG Writer's attention! The amazing demand for phonograph records, accelerated by more than 300,000 juke boxes and the hits popularized warrants your immediate consideration. We are offering song-poem writers the rare opportunity of having established composers collaborate on appealing material received this month. Recola Records, Box 987P, Hollywood 28, Calif.

LEARN To write music, words, arrangements and publishing. The Complete Songwriter tells how. Send \$2.00 M.O. postpaid to Puritan Publishing Co., Inc., 343 So. Dearborn St., Chicago 4, Ill.

POEMS Wanted for musical setting. Send poem for immediate consideration and free rhyming dictionary. Richard Brothers, 24 Woods Building, Chicago.

SONGWRITERS—Send poems for immediate examination and free book, "Your Future in Songwriting." Radio City Music Academy, 1674 Broadway, New York City 19.

WANTED! Lyrics, melodies for songs. We arrange, publish, sell. Superior Song Studios, Passaic, N. J.

ACCORDIONS. New and used at wholesale prices. Save up to \$100.00. Buy direct from factory. Del Principe, 307 So. Wabash, Chicago.

BEFORE Sending your poem to be set to music, know your composer. Free folder. Al. Moquin, 5333 La Cresta Court, Hollywood 38, Calif.

POEMS Wanted for musical setting. Send poem for immediate consideration. Five Star Music Masters, 630 Beacon Building, Boston.

SONG Poems wanted. Free examination. McNeil, Master of Music, 510-PM South Alexandria, Los Angeles, Calif.

WRITE Songs. Big money and reputation. Write for information. J. Gordon Pub Co., 201 N. Hoyne Ave., Chicago.

RADIOS AND SUPPLIES

POCKET Radio! Build vest pocket radio for local and long distance reception. Listen while walking or working. Attractive, unique. Plans and photo \$1.00. United Manuf. Associates, R2 B239-A1, Ft. Worth, Tex.

YOUR New free catalog is ready! Radionic's catalog lists hard-to-get radio parts and books. All available for immediate shipment. Send today to: Radionic Equipment Co., Dept. S4; 170 Nassau St., New York 7, N. Y.

BUILD Newest, extra-loud crystal set. Instructions, 20c. "All About Crystal Sets," booklet, 45c. Amorse Radio, R-4 Hungary Road, Richmond, Virginia.

TUBE Radio kit. Includes tube phone, two batteries. Nothing else to buy. Easy to build. Place parts on picture diagram and connect. Any boy can do it. Gets local, distant stations, \$10.95 prepaid. Crystal set kit, headphone, all parts, \$2.95. Army-Navy headphones, rubber ear cups, \$2.65. Free list C. John Barron, 662 85th St., Brooklyn, N. Y. 9.

BUILD Cigarette case radio, one tube, uses Penlite cells. Complete plans 50c. \$4.50 for kit less batteries. For best results, use our special miniature battery pack, \$1.50, extra tube, \$1.60. Factory Method Radio, 2061 Central, Augusta, Ga.

RADIOS. New 1946 Electro, six-tube superheterodyne ac, dc, built-in antenna, \$26.25. 20% deposit. Jeannette Electric Co. Inc., 159 West 23rd St., N. Y. 11, N. Y.

PORTABLE Electric amplified record player. Detailed plans, instructions 50c. Addis Radio, Kimmell, Indiana.

EXPERIMENTERS! Large assortment coils, condensers, transformers, resistors, etc. Great value, \$3.98. Marko Supply Co., 2924 Logan Blvd., Chicago 47, Ill.

PARATROOP All metal folding antenna, used by landing troops. New, comes in original government container. Real sensation. Expands 17'-12 ft. with the snap of the wrist to a riding mast. Good for boats, auto radio. Worth \$10.00 prepaid \$1.49. Limited stock. Act quickly. Western Electric fixed crystal detector. No adjusting, gives loud steady signal. Nothing-like it. A war development. Excellent for crystal set, meters, other uses. Cost government \$6.00, prepaid 99c. Free surplus list A. Radio City Lab., 30 Church St., New York 7, New York.

PASS Radio license examinations; self instruction manual 25c. Publishers, Box 712, Pittsburgh, Pennsylvania.

BUILD Your own radio. All kits complete, including speaker, 4 tubes and full instructions, \$10.95. Details and latest parts catalog. National Radio Distributors, 1029-M E. 163rd St., New York 59, N. Y.

MAKE Simple tubeless distance-getting "electric" crystal radios. Complete instructions 25c. Jacobsen Sales, 848 East 37th South, Salt Lake City 5, Utah.

HAMS. One brand new Emerson transmitter-receiver. Cost \$650, now \$150. Bass, 2180 Sheridan, Detroit, Michigan.

BUILD Full-scale radio. Pictorial diagram, instruction book; tools; tubes. Complete kit only \$11.50 postpaid. Fidelis Appliances, 61 So. Washington Ave., Bergenfield, N. J.

BUILD "Hi-Fi" radio tuner utilizing radar development. Basic kit \$2.00. Robert, Box 2044, Columbus 16, Ohio.

TEN. Simple, easy to build crystal radio diagrams and crystal 25c postpaid. Potter, 1314 McGee, Kansas City 6, Mo.

BEGINNER'S Radio repair booklet 25c. Radio, Box 311-T, Benton Harbor, Mich.

REVISED Plans 18 long distance crystal sets, including "Radiobuilder"—25c. Laboratories, Box I-c, San Carlos, California.

RADIO Tubes, parts, condensers. Free bargain lists. Potter, 1314 McGee, Kansas City, Mo.

HEADPHONES: New lightweight sensitive 2000 ohms, complete with headband and cord \$1.95. Naval aircraft control boxes \$2.00 per pair, worth \$10.00 for parts. Ask for bargain sheet with your order. Van Sickle Radio Supply Co., Indianapolis 6, Ind.

MAKE Simple, tubeless, batteryless, distance-getting crystal radios. Crystal and illustrated instructions 25c postpaid. Allen, 427-P, Clinton, Missouri.

FM Can now be heard on old radios! Very simple adaptor! Send postcard for free data! Topical Emprise Corporation, 1527 Highland, Box 42, Louisville 4, Ky.

BUILD Radio. Complete kit with tubes \$10.95. Details, Radio, 9418e Avenue "A," Brooklyn, N. Y.

RADIO Service men and experimenters send stamp for our giant radio catalogue. Save dollars. United Radio Co., (1000-V) Newark 1, N. J.

RADIO Service flat rate schedules solve pricing problems. Compiled from 20 years experience. Write for information. Radio Equipment Co., 1415 W. Franklin Ave., Minneapolis 5, Minn.

RADIO Technician and radio service courses. Training for federal licenses. American Radio Institute, 101 W. 63 St., New York City. Approved under G. I. Bill of Rights.

BUSINESS OPPORTUNITIES

MAKE \$2.50 Hour refinishing furniture like professional. Minit-Finish makes you expert. Enormous demand, permanent business. Send \$2.00 complete instructions. Master Finisher, Box 247, Albany, Oregon.

DO-IT-YOURSELF! Fame! Independence! Lifetime plan "pulls" money without schemes or capital. Honest. Complete. Airmail dollar. Results or refund. Zigzag Corporation, Box 101-W, Guatemala, Central America.

HARDWARE Business is one of the most interesting and profitable of them all. Be independent. You can start your own retail store with small investment and no previous experience. 15,000-word, copyrighted booklet tells you how. \$1.00 postpaid. C. R. Divan, P. O. Box 325, Santa Monica, Calif.

PUBLISHER Of seventy page trade magazine offers cooperative distributorships to men desiring advancement in mail order field. Splendid opportunity. Good earnings. Send 10c for handbook; application form Progressive Publications, Sheboygan, Wisconsin.

BEGINNERS—“How to Sell by Mail” our 39 page “treatise”—only 25c. Rush, Forest Book Co., Box 297, North Hollywood, Calif.

LOW Capital ideas write to Dranichak & King, P. O. Box 310, Binghamton, N. Y.

PERFUME—Brilliantine manufacturing business. Little capital. Large profits. Particulars free. Bob Celaya, 907 Adams, Brownsville, Texas.

MAKE Flexible Molds, Statuary, Art Goods, Novelties, Artificial Marble Flooring, Liquid Marble. Literature free. Kemico, Park Ridge (4-M), Ill.

THE Big little business. Money-maker for practical people. It's hot now! Parker, Box 223, Bedford, Ohio.

BE Your own boss. Own your business cleaning rugs and furniture right in homes and offices. Investment less than \$900.00. For brochure write Burklin Process Co., 7240 Wisconsin Ave., Bethesda 14, Md.

WANTED Unused U. S. postage stamps, small discount. Advance Stamp Company, 24 East 23rd Street, New York.

BUSINESS Plans illustrated. Proven moneymakers for operators from coast to coast. Write for proof. Wilkin & Company, 118½-PM E. Main, Hillsboro, Ohio.

CASH in, 68 page book, over 40,000 words, 25c money making business secrets, mail order plans galore. No ads, meat only. M. W. Cohen, Dept. 21, 1141 S. Independence Blvd., Chicago 24.

LIFETIME Profits from fascinating, easily built, still picture projectors. Write Gladwal Engineering, 61 Ashdale, Toronto, Canada.

BE Independent, make more money, new business ideas, show you how, particulars free. Pioneer, Box 243 C, St. Louis 3, Mo.

BABY Shoes preserved. Complete instructions. Exclusive rights. M. E. Watson, Bellefontaine, Ohio.

ORANGEADE. Best made. Good mixer. Bonafide recipe. Dollar bill. Young, 1339 S. Careso, Compton, California.

START Mimeograph shop. Send \$1.00 for 70-page book, Illustrated Mimeographing Technique and Equipment. Schubert, 2614 Sunset, Los Angeles 26.

DEALERS To market low priced auto towbar. Barnorai Industry, 19338 Griggs, Detroit 21, Michigan.

START A mailing list business in spare time. Big profit. Steady demand. Details free. MacAndrews, 8 Buick St., Calais, Maine.

SIX Mail order trade publications 25c. Containing articles, plans, schemes, wholesale offers. Kraft, 3114-S1 Walnut, Chicago 12, Illinois.

PLASTICS—Wholesale and retail sources for thousands of items, materials, molds, equipment, machines, supplies, accessories. Directory \$1. Plastics Digest, 3937P Tracy, Kansas City 4, Mo.

SPECIALTY Manufacturing, the big money business that can be operated anywhere, start on a very small capital; we supply dependable formulas and complete instructions; get interesting free booklet, “Money-Making Opportunities in Specialty Manufacturing.” Howard Robinson, Ph.G., 1300-A South Ohio Street, Sedalia, Missouri.

GUARANTEED Income! Grind lawn mowers. Instructions \$1.50. De Lambert's, Janesville, Wis.

FREE Literature upon request, describing many moneymaking plans. Island Mail Service, Box 162-G, Jamaica 4, New York.

BE Wealthy. Get business self-starters. Own homes that pay for themselves. Midland Products, 67 S. Harris Ave., Columbus 4, Ohio.

AT Home—Your own manufacturing business; making popular \$1.00 novelties. Cost you 3c to 15c. Everything supplied. Write So-Lo Works, Dept. D-600, Cincinnati, Ohio.

PANNING Gold. Free literature, pictures. Old Prospector, Box 21R7, Dutch Flat, Calif.

LIQUID Marble—make in any color. Soundproof plastic flooring. Flexible molds. Cast novelties, plaques, statuary. Big money—your own business. Free catalog. Write Bing Products, 88-AH Broad Street, Boston 10, Massachusetts.

START Your own business. New book, 137 successful plans (\$2.98). Literature free. Interstate Distributors, Box 732, Evanston, Ill.

START Profitable business, package, distribute amazing cleaner under your name. Details free. Sample 25c. Linnell Co., Box 1720A, Cleveland 5, Ohio.

EARN Money with textile painting course. Free details. George Gundrum, LeRoy, Michigan.

GO Into rug and upholstery cleaning and mothproofing business. Extra double profits selling these two professionally used products to stores and homes. Russell-Johnson Company, Clarkfield, Minn.

MAKE And mold genuine plastics merchandise (Lucite, etc.) Forty work-sheets with 70 illustrations explain simple methods-processes. \$1. Free circular. Plastics Digest, 3937M Tracy, Kansas City 4, Mo.

SPLENDID New opportunity to get into legitimate mail order advertising and selling. Start small, expand rapidly. “How” booklet 10c. Kraft, 3114-S5 Walnut, Chicago 12, Illinois.

MAKE Soap at home. No machinery. Profitable. Literature free. Kemico, Park Ridge (SM-4), Ill.

NEW 1946 Information directory \$1.00. Tells you where to buy. Box 6900, Pittsburgh 12, Penna.

NEW Flexible mold material, casts, catalin plastic, concrete, plaster, in same mold. Literature. Sanflex, Box M, Clyde, Ohio.

PLASTICS. Your own business at home. Make your own plastics, no expensive equipment needed, formula and molding instructions \$1.00. Box 224, Wickliffe 17, Ohio.

\$5,000 YEARLY Possible, selling books by mail. Distributors proposition. Nichols Publishers, Box 831, Pine Bluff 1, Ark.

FOLDERS, Circulars mailed, 500, \$1.00. Bourque, 3712 Fifth, Marrero 2, Louisiana.

HAVE More! Do more! Be more! Get out of the rut you're in! Riches and happiness don't “just happen.” They are caused. Read “The Magic Story.” Attain very things you want. Your future is what you make it. Build belief in yourself. This is not a sermon nor weary preaching. The Magic Story could be expanded into a course of 20 lessons and sold for many times its present low price. It has actually changed the course of many men's lives. Develop that “gift of getability.” \$1 brings amazing “Magic Story” literature free. Donald Kelly, 1080 Casgrain, Detroit 9, Michigan.

EXPORT, Import, represent manufacturers. Deal with South America, Africa, China, Europe. War-peace time big business. Uncrowded fields. Unlimited opportunities. Deposit one dollar for two bulletins. Money back if unsatisfied. P. Benko, 246 Fifth Avenue, New York 1.

MECHANICALLY Inclined men—Own and operate general appliance repair shop. Complete, illustrated course shows you how. Welding, refrigeration, motor repair, how to get business, etc., all phases covered. Free literature. Christy Supply, Dept. 163, 2835 N. Central Ave., Chicago.

LIFETIME Business, steady income repairing sewing machines. Book instructions \$1.00. Connan, 114 S. E. 74, Portland 16, Oregon.

INCORPORATE Your business. Delaware laws. Many advantages, free details. Tax Research Bureau, Inc., Delaware Trust Building, Wilmington, Delaware.

SELL Religious goods by mail! Easy to start. Big profits. Every home is your prospect. Cleveland, 243-B White, Clyde, Ohio.

SOMETHING Different in mailorderdom; immediate and future profits; particulars dime; refundable. Skyland Specialties, 93 Cloyes St., West Asheville, N. C.

WE Give you the new 576 page “How to Make Money by Mail” with our complete advertising program, designed for new mail order dealers. 10 services; layouts for circulars, sales letters, ads to start you right. Program, ads and book sent postpaid, satisfaction guaranteed. Send postal to Capitol Industries, 335-A Rock Creek, Church Road, N. W. Washington 11, D. C.

OPERATE Your own advertising agency profitable. New, different manual reveals all. Learn how. Start in spare time, at home, with little capital. No stock or equipment necessary. Earnings unlimited. Sincerely interested send stamp for special folder. P. Snyder, Box 4907-A, Philadelphia 19, Penna.

INVENTORS—We will help you if you have a good idea. We supply the finances to patent your idea in your own name. You own the patent. We also arrange profitable manufacturing connections for inventions. Write without obligation. Patent Financing Corporation, 717A Old Industrial Trust Building, Providence, 3, R. I.

OWN A mail-order paper products business. Sell envelopes, tags, bags, boxes by mail, wholesale. Tremendous demand. Steady profits. No capital necessary. Write Omaha Envelope Service, Dept. 138, 4721 California, Omaha 3, Nebr.

SUREFIRE Profit maker. Write for details on what sells, who buys and how to reach them. Rennolet, 1022 9th St., Rock Island, Ill.

MAKE Big money. Exceptional opportunities. Real money makers. Free particulars. Turner, 5675-A Lannoo, Detroit, Michigan.

WORK For yourself. Average \$1.00 hourly. Absolutely no selling. Pleasant spare-time work. Convincing particulars, stamp. American Business Service, Nescopeck, Penna.

WE Need a representative in your community to accept subscriptions for leading magazines. Liberal commissions. Complete supplies free. American Readers Service, 14 Dekalb St., Gwynedd, Penna.

UNPAINTED Wall plaques, 2½c up. Illustrated list free. Oman, 642 Broadway, St. Paul 1, Minn.

MAKE And sell your own products and be your own boss. Send dollar bill today for five selected A-1 moneymaking formulas and manufacturing data. Industrial Aids, P.O. Box 3247, San Francisco, Calif.

CHAMPION Belts \$9.00 dozen. Leathercraft Mfg. Institute, 524 W. Mulberry St., Baltimore 1, Md.

YOUR Own business—As little as \$100 starts you now! No training needed! See our ad on page 28. American Photocopy Equipment Co., 2849 N. Clark St., Dept. GF46, Chicago, Ill.

RUBBERCOAT Mold making liquid. Plasticwood intermix finishing materials, models. Ready manufactured molds, make gifts, novelties. Free samples. Information catalogue. Rubbercoat, 3873A California, San Diego, Calif.

A JOB Slave? Learn today how you can live a happy, prosperous “tomorrow” as your own boss. Details free. G. Kindig, 1629 Vine St., Philadelphia 3, Penna.

IDEAS. Use and teach work simplification method improvements. How to get and develop ideas. Write Ideas, Inc., Tujunga, California.

FREE Details. Operate mail order business. Katz Service, 1754 Twyckenham, South Bend 14, Indiana.

JIGSAW Owners: Square foot plywood yields \$46. Write: Woodart's, X-36, Bridgewater, Mass.

FREE Details. Operate home mail order business. Profitable \$5 required. Edwards Bureau, 2915 North Cascade, Colorado Springs, Colorado.

BE Your own boss. Own a Lewis Canteen. Complete or plans. Successfully operated everywhere. Write Lewis, E1223 Pacific, Spokane 15, Wash.

10c BRINGS You lots of mail. Catalogs, magazines, business opportunities, samples. Norwood Name Agency, 206 Cleveland Ave., Norwood, Penna.

FORGE Ahead in the mail-order field with your own business; regardless of location. Small capital, plus initiative, starts you toward success. Particulars free, write: Tait-Douglas, Dept. 312-B, 5345 Harper, Chicago 15, Illinois.

LIQUID Rubber, for making flexible molds, literature and sample free. H. Chaney, 1130 E. 16th St., Jacksonville 6, Fla.

GO Into the mail order business. My 32 years experience tells how. Send 25 cents for instructions. Mail Order Institute, Gen. Del. Main Postoffice, Cleveland, O.

GET Advertising tips on selling by mail. Contains valuable information on mail order business. Price \$1.00. A. H. Allen, 2335 Arapahoe St., Denver 5, Colo.

“COLLECT Butterflies for fun and profit.” Butterflies direct from South America. Assorted beautiful butterflies 10c each, \$1.00 per dozen, \$8.00 per hundred. Brilliant blue Morphos, 5 inch wing-spread 60c each. Make your own butterfly serving trays, pictures, plaques, sell them to friends, gift stores, etc. Write for free booklet of instructions. American Butterfly Company, 3457 Park Heights Avenue, Baltimore 15, Maryland.

NEW Air curing liquid rubber to make molds for plaques and statues. Makes casting a pleasure. Apex Plastic Products, 1740 Estes Ave., Chicago 26.

START Business—\$1.00 up. New 100-page book. Also agents wanted. Sample 50c. Money back guarantee. Sole distributors, Golden Rule, 13997-C Northlawn, Detroit 4, Michigan.

RUBBER Molds—Start profitable business casting plaster faces, plaques, animals, bookends. Arbee, 55 E. 21 St., Brooklyn 26, New York.

FREE Literature on profitable books. Ritt & Ritt, 112A 9th Avenue South, Nashville 3, Tennessee.

METAL Identification tags, fifty cents. Agents proposition five cents. James Parker, Stockton, Kansas.

OPERATE Profitable home mail order business. Details free. Bieber, 1611 High St., Ft. Wayne 7, Ind.

METALLIZE Baby shoes! Learn this moneymaking business from nationally recognized consultant. See Kushner ad, page 257.

SUCCESSFUL Selling by mail, own business. Particulars free. Buckeye Mail Order Service, Box No. 66 Station A, Toledo, 5, Ohio.

MONEYMAKING Mailorder opportunities—successfully operating 45 years. Nominal capital needed. Sure-fire profits. Consultation. Trial. Astonishing testimonials, particulars. Raymond Dow, 2922A 164th Street, Flushing, N. Y.

NEW Highly profitable business with established demand in every locality. Repeats. Developed by ex-army engineer. Wonderful future. No capital or experience required. Complete plans \$1.00. Free details; stamp. Northcliffe and McBain, 30 W. Washington St., Chicago 2, Ill.

SEE Termite Control ad in "Formulas, Plans." Make extra money.

MOST "Amazing facts" ever published concerning secret service tricks to find missing persons, and astounding "gags" of collection agents. Only 25c. Amazing all profit plan included free. Profit Builders, 305-West 8th, Dept. A-3, Los Angeles 14, Calif.

RUBBER-LATEX Molding liquid. "The real thing." Sample quart, directions \$2.95. Gallon \$9.50. Plastic Material Supply, 1416-N2 Fletcher, Chicago.

HOMEWORKERS—Attention veterans! Castwood plastic gifts, novelties; material and instructions furnished. Sample quart with mold model, \$2.00. 20th Century Products, 3151-3 Southport, Chicago.

PROFITS Through mail selling. Details free. Staab, 14101 Clark, Chicago 27, Ill.

WELDING Is growing day by day. Good business to enter now. Get this 400 page nationally known book on welding. Simple instructions, many illustrations and photographs. Complete "know how" information given by recognized experts. Send \$1.00 for this wonderful book and complete details how to earn home and shop welding outfit. You learn and earn. Magic Welder Mfg. Co., 193 MH Center St., New York City.

FREE Hot water the year 'round. First cost is last cost. Build your own solar water system. Average cost less than seventy dollars. Good business opportunity sell solar in your community—it's easy. Complete instructions and drawings send two dollars. Will produce hot water any locality. Miami Solar Water Co., P.O. Box 175, Coral Gables, Florida.

WOULD You pay 3¢—first \$350 made? Color-illustrated book "505 Odd and Successful Enterprises" free! Proven by "Little Fellows." Some plans offer occasional "day off"—others: busy, full days! Start business; home, office. Pacific, 262 Drake, New Rochelle, N. Y.

OPERATE Profitable home mail order business, \$5 required. Details free. Norris J. Haynie, Box 24, Reedville, Va.

SOMEBODY Owes you money. Collect it easily. Sell instructions rapidly by mail 25c. Cost you one cent. Sample copy 10c. Profit Builders, 305-West 8th, Los Angeles 14, Calif.

LEARN Gauge installation and calibration free. State experience. Liquid Scale-Gauge Co., 5243 S. California Ave., Chicago 32, Illinois.

HIGH School seniors: Make good money selling our graduation name cards. Biggest commissions! Season starting **Hurry!** Craftcards, Box 235-AL, Pittsburgh, Penna.

10c BRINGS You lots of mail. Catalogs, magazines, money making ideas, samples. Gardenville Publishers, Gardenville 1, N. Y.

LEARN Shell jewelry manufacturing. Complete, simplified home instruction course, beautifully illustrated, shows 45 styles pins, earrings, brooches, sprays, hair ornaments. Includes pearlizing, dyeing, gilding, glow-in-dark methods. No tools needed! Learn-earn within a week. Only \$1 postpaid, including wholesale prices of all raw materials. House of Gifts, Box 4550-RF, Coral Gables, Fla.

MAIL Order opportunities. Read oldest-trade journal. Copy 25c. Mail Order News, Somerville 35, N. J.

PROFITABLE Mail order plans, ideas, write today, free literature. Frank J. Artz, 1060C Harding Drive, Toledo 9, Ohio.

OPERATE Profitable mail order business. 75c profit each dollar. Powell Service, 5713 Euclid, Cleveland 3, Ohio.

PAINTED And unpainted plaques, bookends, shelves and whatnots—Free list. "Homemaker" Art Craft Co., Dept. 4, 338 Sibley St., St. Paul 1, Minn.

CONCRETE Brick are a profitable product with a well established consumer demand. This is your opportunity to enter the concrete products field with the minimum equipment expenditure. R. S. Reed Company, Three Rivers, Mich.

ELITE Collection contains 137 practical money-making plans; local and mail order. New edition. Particulars free. Elite Co., 220-A Grand St., New York 13.

WHOLESALE Catalog and directory 10c (refundable). Thousands of articles. Stafford, Sunnyside-A, Indianapolis 44, Ind.

ANGORA Rabbits supply living from wool, meat. House of Angoras, Springfield, Illinois.

MAKE Liquid Marble, Plaster Plaques, Statuary. Instructions, formulas, \$1.00. Ideal Service, 179-M, Park Ridge, Ill.

TREMENDOUS Profits mailing literature. Dealers information 3c. General-print, East Orange, N. J.

MAKE Mirrors, mirrored signs, table-tops, etc., for pleasure, profit. Illustrated instructions, formulae, 50c. Details free. Specialties, Box 599, Grand Rapids 1, Michigan.

START Mailing service business at home in spare time 25c (refundable) brings success booklet. Riegel, 1111 Harrison, Philadelphia 24, Penna.

137 WAYS To make money, in home or office, business of your own. Full particulars free. Elite Co., 220-A Grand St., New York 13.

FINEST Quality liquid molding rubber. Sample mold free. Cost more, worth more. \$3.00 quart, \$10.00 gallon. W. Wooley, 115-A Donald, Peoria, Ill.

BOOKKEEPERS: General ledger and tax report experience. Operate permanent, profitable accounting service for the smaller business. Part or full time. Simplified method. Write now! L. A. Bell, 1404 West 25th Street, Cleveland 13, Ohio.

SELL Books by mail. Nice commissions! New titles! Big demand! Details for stamp. Elmer Swanson, Box 201, Niagara, North Dakota.

OPERATE Profitable credit-collection agency business; many earn \$5,000-\$10,000 upwards annually; fulltime-lifetime vocation; sparetime possibilities; postcard brings interesting literature free. Write, Educational Extension Service, Department 101, Los Angeles 36.

PERSONAL Publicity will help you in your business or profession. Write for details. John B. Martin, 1101 West State, Jacksonville, Illinois.

WHY Money worry? Own—operate typewriter repair business. Low capital required. Large earnings! Qualify quickly. Easy direction. Write Athey's Typewriter Supply, Desk P, Tarentum, Pa.

TESTED Success plans. Details free. Dunn, Box 955, Hartford, Conn.

WHY Spend many dollars to find sources of supplies. Save money and time. Details free. Business Plans Foundation, P.O. Box 56-B, New York 10, N. Y.

AT Last! Real \$25 weekly opportunity! Work from home! Rush stamp! MacCormac, F-300, Madeira, Ohio.

OPERATE Mail order business profitable on \$5 capital. Details free. Valence, 119 Dedham, Needham, Mass.

JOKES, Tricks at wholesale. Make your store the hottest spot in town. 10 different samples \$1.00. 50 different \$5.00 with wholesale price list. Schwamm, 237 East Ninth St., New York 3.

HOME Mail business will pay big profits. Small capital. Spare or full time. Full particulars and starting offer free. Charles Service, 117 East Second Street, Girard, O.

PLASTIC Homes—Build yourself! Re-surface old buildings! Wonderful building material. Particulars free. Marbleizing Service, Edwardsville, Illinois.

EARN More money. Hundreds of live business, formulas, secrets, manufacturing, plans. "Inside" supply sources of buying home, or business needs, at lowest possible prices. Booklet and literature, 25 cents. Charles Service, 117 East Second Street, Girard, Ohio.

MAILING List! 5000 women mailorder buyers, \$25.00; 3000, \$15.00; 1000, \$8.00. Guaranteed accurate! Try them! Woods Remants, Bedford, Penna.

DOLLAR Orders filled free. Fastest selling mailorder line. Darrah, Orono, Maine.

LIQUID Marble—Colorful, glazed! Molded, brushed, sprayed! Composition floors. Rubberlastic molds. Particulars free. Marbleizing Service, Edwardsville, Ill.

FINKLE Knows mailorder advertising! Nationally known creator guarantees powerful letters, literature, selling campaigns. Big, positive results! Postcards ignored. Finkle Advertising, 1201½ South Ogden, Los Angeles 35, California.

SELL Exclusive books of instruction by mail. Assorted subjects. Popular prices. 70% profit. Rush name. Free sample imprint circulars and selling instructions. Financial Education, 404F Mack Building, Denver 2, Colorado.

CAST Bookends, novelties. We furnish rubber molds. Sell unfinished castings to us. Free information. Mold Craft Industries, Morris Plains, N. J.

LET Us form a national association of business promoters. Applicable to many businesses, especially mail order. Send card or letter for my proposed charter and other details. Earl Whitaker, Box 53, Sand, Texas.

MEN, Women, start own business, home, office; no peddling; little or no investment. Folder describing collection of 137 plans free. Saunders, Box 246, Ambridge, Penna.

PELLOW Workers—Down with bosses. Start own business. Be independent. Booklet describing 137 tested plans, free. P. Padney, 307 York St., Jersey City, N. J.

PLASTICOAT—Covers, protects, glazes plaster castings, etc. Any color. Sample pint \$1.00. Plastic Art Products, 1321 Belmont, Chicago.

ELECTRICAL Appliance repair. Open your own shop. Learn home wiring; electric motors, vacuum cleaners, washers, etc. Complete illustrated course shows how. Free booklet. Pacific Training School, Dept. AP-1, 7217 So. Broadway, Los Angeles 3, Calif.

HANDY Men—Earn money home operating Community "Fix-It" Shop. Write Stafford, 708 Rawlins, Carbondale, Ill.

YOUR Own business. Big profits, very small capital. National organization teaches, helps, supplies everything. Interesting service business. Big demand everywhere. Americlean, 211 North 7th Street, St. Louis 1, Mo.

OPERATE Postage stamp vending machines. Legal! Steady profits! Free details! Adair Company, 6924 Roosevelt, Oak Park, Illinois.

MAIL Order beginners! "How to Build Your Own Mail Order Business." Noted specialist's 10,000-word treatise, shows—step by step—how to make it pay, on small-capital start. 25c, satisfaction guaranteed. Maupin & Maupin, LaFayette 3, Indiana.

GOT \$24,500 Using "schemes" from "Schemer" Magazine, Alliance, Ohio, 48th year, \$1.00; 4 samples, 30c.

RUBBER—Airlastex liquid, pre-war quality. "Makes molds overnight." Sample pint, instructions \$1.50. Gallon \$9.00. 20th Century Products, 3151-3 Southport, Chicago.

BUSINESS Machine repairing. Self teaching course. First lessons teach how to make money in garage or basement. Office Machines Service School, University Station, Box 134, Seattle 5, Washington.

PLASTIC—Intermix, makes ordinary casting plaster shatterproof. Pint develops 100 pounds, \$1.25 postpaid. Plastic Material Supply, 1416-N2 Fletcher, Chicago.

BE Independent. Start a business of your own and enjoy financial freedom. Little or no cash required. 3c stamp brings full details. W. M. Drexler, 258 Broad, Newark 4, N. J.

BOOKKEEPERS—Operate your own "Dollar-A-Week" bookkeeping and tax service. Full or spare time. Details free. Ellis, Box 200, Cedar Grove, N. Carolina.

MAIL Order business course shows you how to make money, spare or fulltime. Teaches professional mail order technique—not penny-snatching schemes. Fascinating 100-page illustrated success-catalog free! Write—Nelson Company, Dept. 4-02, Chicago 5.

SELL Cosmetics by mail. Women spend millions on beauty. You can make your share of this cosmetic money. Let us show you how. Details free. Frank J. Artz, 1060 Harding Drive, Toledo 9, O., Dept. A.

TAILORED Homes—the modern plan book. Ad under heading Miscellaneous.

MANUFACTURE Nameplates, house numbers, electric signs. Box 221, Newport News 6, Virginia.

START A home business in spare time. Make extra money. Experience not essential. Literature free. Rolf S. Iverson, Box 916A, Grand Central Annex, New York 17, N. Y.

BUILD Miracle homes. Yours. Others. Chamberlain, Fitzsimons Building, Pittsburgh 22, Penna.

LATEX For making flexible rubber moulds. Thoroughly tested. No shrinkage. Complete instructions with each order. Stoneham Rubber Co., Box 244, Stoneham 80, Mass.

MEN — Women — "Everybody Likes Candy." Learn to manufacture professionally at home. (Our 35th year.) Ragsdale Candies, East Orange 2, N. J.

START Home business making statuary, plaques, novelties, garden furniture, artificial marble flooring, liquid marble. Make your own flexible molds. Amazing profits. Folder free. Creative Publishers, Box 236-L, Winnetka, Illinois.

SPARE Time mail business earned \$1400 monthly. Copyrighted instructions \$1.00. Wm. Boyd, 331 Fourth, Pittsburgh 22, Pa.

RUBBER Moulds for casting novelties. Latex for making moulds. Use thoroughly tested and approved products. Eastern Latex Laboratories, Box 153, Mattapan 26, Mass.

SELL By mail with Elfco Ready Made Circular Service! Large profits! Catalog free! Elfco, 434 North Wells, Chicago 10.

AMAZE Others. Add columns instantly. Add faster than adding machine. Free details. Math Institute, Box 633, Mobile 4, Ala.

BUILD Own business mailing penny post cards; six profitable plans with information for starting. Gordin Publishers, Box 23, Pawtucket, R. I.

"HOW To Make Simple Molds and Plaster Plaques." Profitable business or hobby! Instructive booklet 25c. Plastercraft, 1406 East 43rd Street, Cleveland 3, Ohio.

WORK For yourself. Your own business. Operate entirely by mail—direct from your home in spare time. Few dollars starts you. Literature free. Albert Wilcox, PM21, Nicholls, Georgia.

"10,000 ALASKA Fishing Jobs." Alaska's largest industry regularly employs thousands of men and women in seafood production. Possible earnings up to \$5,000 in few weeks. Authentic 7,000-word copyrighted report gives job information, union requirements, sample application letter, names and addresses over 40 Alaska fisheries. Newest edition includes similar information on California, Oregon and Washington fisheries. Vital facts for immediate application in a permanent industry. \$1.00. 7-day refund privilege. Pacific Industrial Research Bureau, Dept. PM-9, 202 Studio Building, Portland 5, Oregon.

FLORIDA Opportunities—Pensacola offers exceptional opportunities for small industries, especially in the field of mahogany novelties and woodware, perfumes, soap, chemicals. Delightful year-round climate. Wonderful fishing, hunting, beach sports. For information write: Industrial Development Division, Municipal Advertising Board, Pensacola, Florida.

RECAST Old batteries into new. Latest achievements. Battery Laboratories, Minneapolis.

\$25 WEEKLY Working two hours daily. No canvassing. No manufacturing. Lycke, Box 2471, Cleveland 12, Ohio.

TYPEWRITER Repairing — Original course, simplified home study. Weber Typewriter Mechanics School, Box 269, Osborn, Ohio.

QUICK Money! "Repairing Car Batteries." At home. Easy too. Write Batteryman, 901 South Avenue, Grand Junction, Colo.

START Mailorder bookshop—Everything furnished; publisher cooperation. 25c brings booklet, exclusive setup, samples, exciting ideas. General Publications, Ossining, N. Y.

BECOME An "Attritionist Masseur." First improvement over Swedish massage in 100 years! Results unbelievable! Dr. Swearingen, 9128M, Station 8, Los Angeles.

COLORGLAZED Concrete pottery made without molds. New, low cost, patented method. Cemetery products, novelties, tiles, floors, etc. Basement leaksealing. Other moneymaking projects. Booklet, details free. Men only. National Pottery Company, Fergus Falls, Minnesota.

HOW And where to obtain capital. Fully explained. Particulars free. Star Service, Wapakoneta, Ohio.

BIG Money making Hollywood style pottery, bird baths, wishing-wells, benches, stucco-rock. New method. Clever designs. Color with chemicals, water-paints. Marbling, colored glaze effects. Dime brings samples, pictures, literature. Hollywood Cementcraft, 8527 Wonderland Ave., Hollywood 46, California.

LIQUID Marble; snow-white, multi-colored. Glazed. Unglazed. Composition flooring. Lifetime wear. Any color. No priorities. Flexible molds. Plaster casting. Get into the big money now. Full information given free. Write Compo-Tex, Box 786-R, St. Louis, Mo.

BRUSH Plating outfits connect to a battery. No tanks necessary. Good paying business at home plating autoparts, bathroom fixtures, bicycles, reflectors, silvering mirrors. No shop or experience required. Outfits furnished. Free booklet. Gunmetal Co., Ave. H, Decatur, Ill.

AGENTS—To mail our literature. Good profits. Home business. Maywood, 1133 Broadway, New York.

OPERATE Profitable mail order business on \$5 capital. Details free. Luzerne Service Bureau, 61 Main St., Luzerne, Penna.

SELL Books by mail. Tremendous sales and profits. We furnish everything and help you succeed. Details free. Century, 101-M West 14th St., New York 11, N. Y.

BIG Money metalizing baby shoes at home! Lifetime opportunity! Free particulars! Kiktavi Company, 8620 South Ruthelen, Los Angeles 44, California.

20,000 ENEMY Patents now available royalty free. Amazing opportunity. Complete information, list \$1.00. F. Heri, Logan, Utah.

MONEYMAKING OPPORTUNITIES

NEW Mail order opportunity having splendid profit possibilities. Small capital required. Operating instructions 10c. Kraft, 3114-S7 Walnut, Chicago 12, Ill.

NOVELTY Manufacturing offers splendid opportunity to start highly profitable business. No expensive equipment, orders waiting, large profits, easily learned. Write today. Plastex Products, 127 Clement, San Francisco 18, Calif.

MONEY Making ideas, opportunities galore, 10c. Thomason, 857-a, East Jessamine, Fort Worth 3, Texas.

MAKE Money at home by mail. Your own business. Pleasant, easy, spare time work. Write Albert Wilcox, PM31, Nicholls, Georgia.

HOW To get dollars in the mail. Details 10c. Hughes Services, Shillington, Penna.

START Your own business! Big money manufacturing novelties, plaques, statuary. Free catalog. Write Bing Products, 88-AK Broad Street, Boston 10, Mass.

THOUSANDS Articles wholesale. "Supply Source Directory" 10c. Ideal Service, D-4, Park Ridge, Ill.

FASCINATING Manufacturing, modern, profitable, low cost methods. Information 25c. Wollner, 1321A Arch Street, Room 1004, Philadelphia, Penna.

WANT Financial independence? I've helped thousands. Dr. Tibolt, 74M, Philadelphia 20.

300 TESTED Moneymakers, business secrets, formulas, wholesale supply sources, mail order plans. 68 pages, 40,000 words—no ads, meat only, 25c postpaid. Russell Publications, 3866 Dwight, Riverside (1), California.

I Made \$1000 from 1000 tomatoes using my unique methods. Detailed instructions, \$1.00. (refundable). Alfred Dinsmore, Marlborough, Mass.

PROFITABLE Homework, write—Homecraft Service, 313 Lovers Lane, Gainesville, Texas.

MAIL Business booming! Moneymaking magazine, 10c. Hawkins (Lasanimas), Colorado Springs, Colo.

MECHANICALLY Inclined men—Own and operate general appliance repair shop. Complete, illustrated course shows you how. Welding, refrigeration, motor repair, how to get business, etc., all phases covered. Free literature. Christy Supply, Dept. 1163, 2835 N. Central Ave., Chicago.

ONE Dollar brings rubber mold and model of beautiful 3½"x5" plaque of Capitol. If you have a good model let me make your mold. Write today. Robert Fitzpatrick, 15825 Wormer Ave., Detroit 23, Michigan.

"THERE'S Big money in junk". Easy, fascinating. Free circular. Batteryman, Grand Junction, Colorado.

PAPERHANGING! Make \$16.00, \$20.00 daily. We teach you. Opportunity School, Box 1813, Memphis, Tennessee.

\$18,000 YEARLY Gross profit reported! Business most anyone can start! Small capital! Details free. Upham and Son, 939-B Ravine Drive, Cleveland 12, Ohio.

RAISE Moneymaking giant Chinchilla rabbits. Valuable fur. Delicious meat. We buy your youngsters. Willow Farm, R15A, Sellersville, Penna.

THOUSANDS Of alarm clocks need repairing. Jewelry stores swamped. Our simplified course teaches you how to repair these clocks. Necessary tools and supplies furnished with course. Alarm Clock Repair Service, Dept. B, P.O. Box 1983, Houston, Texas.

(300 TESTED Moneymakers.) Booklet 25c. P. O. Schlott, 131-D Prospect St., Rockville, Conn.

"MAILS Galore," literature, samples, moneymaking opportunities, listing 10c, three times 25c. V. Ruckoldt & Son, 3639 N. Page Ave., Chicago 34.

COLOR-ILLUSTRATED Book "505 Odd and Successful Enterprises" free! Several hundred dollars monthly reported (exceptional)! Some plans offer occasional "day off"—others: full days; at home, office. Pacific, 262 Drake, New Rochelle, N. Y.

FREE Literature. 200 moneymaking ideas. No investment. Lynch, 402-PM Hazlett, Baltimore.

OPERATE Profitable home mail-order business. Dime brings details. Billings, 210 Fifth Avenue, New York.

HUGE Collection—Over 500 home moneymaking and saving opportunities, secrets, etc. Write National, 18900-P Cardoni, Detroit 3, Mich.

ASSEMBLE Colorful plastic jewelry without tools or equipment! Profitable sideline. Free details. Trial 200 links and instructions, \$1 (refundable). Plastic Works, 712 Kimball, Danville 3, Illinois.

MORE Money! Spare time. Details free. Mona Schlotzauer, Shenandoah, Virginia.

MANUFACTURE And sell, garden tool under patent license. 3c royalty, stamp. A. Thompson, Marysville, Calif.

RECEIVE Mails, magazines, moneymaking offers galore. Warren, Freeland 12, Mich.

"101 WAYS To make money at home" 50c. 500 red hot names \$1.00. Lewis Davis, Box 1015, Lynchburg, Va.

MONEYMAKING Tips, offers and sources for homeworkers, mailorder minded in "Mail Merchandise Mart Magazine." Dime brings copy. AP-Chervence, Lock Box 79f, Chicago 90.

EARN Money at home! Thousands do! "Home Worker Magazine" tells how. Sample, 25c. Sizemore, Box 7, 4917 North Kostner, Chicago.

FORTIFY The future! Start own business; home, office. Booklet describing "Collection of 137 Tested Plans" free. Elite Co., 220-A Grand St., New York 13.

PROFITABLE Home business—manufacture fast-selling candies. Professional instructions. Big earnings! Spare, full time. No experience! Literature free. Coates Service, 46-M King, Dorchester, Mass.

START Profitable credit-collection agency business; home, office, spartime, full-time vocation; investigate Educational Extension Service advertisement under Business Opportunities.

EARN Money evenings, copying and duplicating comic cartoons for advertisers. Adservice, Argyle 1, Wisconsin.

500,000 ARTICLES—Wholesale directory, dime. National, 322P Union Avenue, Brooklyn 11.

WHAT Makes you think you couldn't sell by mail? We're doing it happily! New! Different! Exclusive! Alive with moneymaking opportunity. Full particulars free. Investigate! Compare! The What-To-Do Shop, Box 1082, Tacoma, Wash.

SWAP; Trade. Information. Write "Swappers' Gazette," 2836-PM Slevin, Louisville 12, Ky.

\$200 MONTHLY With camera! Guide, 50c. Foto-Diary, comprehensive record for photographs, 50c. Frank Dickson, 808 Elizabeth Street, Anderson, South Carolina.

INSURE Your future against poverty—failure, become successful, independent, no money needed. Remarkable results. Free information. Gilbert Service, Box 1464, Mobile 8, Alabama.

\$1 BRINGS You hundreds of dollars worth of information. Revealing book just out describes the how of many moneymaking opportunities. For your copy rush one dollar to Andrew J. Massey, 64 Sterling St., Franklin, New Jersey.

MAKE Real money selling spectacular bubble liquid. \$1.00 brings formula. Northwest Specialty "A," 7926 46th Ave. So., Seattle 8, Wash.

WIN Contest money. General contest bulletin shows how. Sample 25c. 1609 1/2 East 5th, Duluth 5, Minn.

10c INCLUDES Your name in numerous mailing lists for opportunities, money-making offers, magazines. New Age Enterprises, 578-A Prospect, New York City 55.

READ "How to Go into Business for Yourself." 64 pages of eye-opening information. Rush one dime. George A. Simon, 6843 Jonathon, Dearborn, Mich.

"HOW To Make Money with Big Mails" booklet 25c. Frank J. Artz, 1060p Harding Drive, Toledo 9, Ohio.

MONEY Made office, home or room. 10c brings envelope opportunities. Bargain Specialty Company, Box 635C, Modesto, California.

LEARN Battery repairing, rebuilding. Engineer offers money making methods. Battery Bureau, 2225 North 44th St., Milwaukee, Wis.

EARNINGS \$2,000 Year easy; inventing simple items for special cash markets. Ideas only. No patents. Write, Hendrickson, Argyle 7, Wisconsin.

BIG Profits. Manufacture custom arch supports. Jul Corssen, 2638 Geyer, St. Louis 4, Missouri.

YOUR Big mail order opportunity—No time has ever been as good as right now. Get your start right. Let me show you how, what to sell and who will buy. Big profits, easy work at home. Write: H. S. Smith, 3139A So. Mabbett Avenue, Milwaukee 7, Wisconsin.

PUBLISH Your own magazine. Handsome 52 page format, well edited, illustrated. Cost low as \$1.00 month. Brings you prestige, profits. 25c brings sample. details. National, Ord. Nebr.

I MAKE Big money in the mail-order business. You can do the same at home with my copyrighted system. Write me. I'll tell you how. F. Little, Box 8, Glenshaw P.O., Pittsburgh, Penna.

LEARN Metascience. Remarkable drugless healing. No manipulation. No apparatus. Unbelievable simplicity and results. Inexpensive correspondence course. Write Metascience, De Land, Florida.

FORMULAS, PLANS, ETC.

AUTHENTIC Formulary. 924 page illustrated book. 10,000 scientific formulas, recipes, secrets, instructions for most any product. Countless profitable business opportunities, including D.D.T. new insecticide. And our new book: "The More You Know the More You Can Earn." \$2.98 postpaid (c.o.d. U. S. only). Foreign \$3.25 delivered. Adams Brown Company, Dept. 366, Chestnut Hill 67, Mass.

MANUFACTURE Fast-selling products yourself. Bubble blowing liquid \$1.00. Formula catalog free. Kemico, Park Ridge (16), Ill.

EXCLUSIVE Formulas. Combination dry cleaner, insect killer, silver polish \$2.00. List free. Ruch Research, 136 S. Crescent, Rome, N. Y.

"LUMINOUS Paint." resilvering mirrors, 100 other formulas—50c. D.D.T. insecticide \$1.00. Soap making, (20 formulas) \$1.00. Ideal Service, 304 Park Ridge, Ill.

LOOK! The largest and most comprehensive book of its kind ever issued. Endorsed by universities. Over 10,000 clearly described formulas, receipts, money-making ideas and trade secrets. Thousands have found this book a starting point for their own business. Get the best. \$2.98 postpaid, or C.O.D. Satisfaction or money back. Literature free. Jordan's, 3116-A N. W. 27th, Oklahoma City 7, Oklahoma.

FORMULAS! Money makers—savers. literature free. Duffy, T55, Covington, Ky.

TIRE Carcasses everywhere, from these reclaim rubber to make molds, tire plastic, etc. Details for stamp. Betke, Box 699, Borger, Texas.

EXCLUSIVE Formulas, all-purpose, modern, opportunity—building. Details free. MFR's Advisory Service, Dept. PM, 349 Sackett St., Brooklyn, N. Y.

FIVE Selected A-1 money-making formulas and manufacturing data. All for dollar bill. Send today to Industrial Aids, P.O. Box 3247, San Francisco, Calif.

BUBBLES—Sample "Miracle," wand, formulas and source supplies \$2.00. Johnson, 1028 E. 63rd Street, Chicago 37, Ill.

FORTUNE In formulas, 10,000 trade secrets, 900 pages, \$1.50 postpaid. Rare, scarce technical books supplied. Classic Bookshop, 218 John R, Detroit 26, Mich.

"SALUTE Fourth" model cannon. Super noise-maker! Plans, fuse, gunpowder formulas \$1.00. Anderson Laboratories, Monee, Illinois.

TERMITE Control fluid, permanent, arsenic toxic, completely stable water base. Used and tested ten years. Better fluid, tenth the cost of others. Instructions, formula, five dollars. Enzeeco, Garden Grove, Calif.

FORMULAS: 15 Proven moneymaking formulas \$1.00. (Not stock-formula catalogue stuff), real unusual offers. List free. Marvel Laboratories, 6629 No. Maplewood, Chicago.

LIGHTENING Cleaner. Released warty-time discovery. Huge profits. 2 1/2 gallon to make. Sells 49c up. Dirt, grime, grit dissolve magically from porcelain, enamel, paint, woodwork, machines, etc. Water mixed ingredient available everywhere. Safe, harmless. Formula \$1. C. Mowrey, Demarest Pkwy., Elmira, N. Y.

AMAZING Furnace melts all metals. Built cheaply. Detailed plans \$1.00. Aladdin Laboratory, 9955 C Street, Oakland 3, California.

10,000 AUTHENTIC, Scientific formulas, secrets. 924 page illustrated book. Earn immediately. Build profitable independence. Produce any conceivable product. Latest discoveries! Genuine bargain \$2.49 postpaid. (C.O.D.—U.S.A.) Literature free. Continental Publications, 79-02m Woodside, Elmhurst, New York.

ANY Formula or trade process supplied, \$1.00. Jackson, Newfoundland 3, Ky.

FORMULAS 25c Each. What do you want to make? Nunn, 659 E. Oxnard, Calif.

MANUFACTURE New products inexpensively. Free literature. Commercial Projects, St. John 2, N. B.

NEED Chemists? Formulas, Analyses. Ideas. Consulting Scientific Company, Swarthmore, Pennsylvania.

REAL Manufacturing formulas. Lists free. Cummings, Chemist, Gordon Ave., Syracuse, N. Y.

FORMULAS—Latest, best, Analysis. Literature free. Belfort, Engineering Building, Chicago.

PLASTICS

PLEXIGLAS, Lucite 12"x12" sheets, 1/16" \$1.60, 3/8" \$2.00, 3/16" \$2.25, 1/4" \$2.75. Rods 23" length by diameters, 3/8" 40c, 1/2" 60c, 3/4" \$1.25. Cements 2 ounces 50c. Dyes: aqua, red, amber and other colors 2 ounces 50c each. Novelty rods each: heart 75c, cross 75c, donkey 60c, anchor 60c, ring 35c. Plexiglas assortment 1 lb., includes cement, drawings and instructions \$1.25. Add 10% for postage. Complete catalog 10c. Douglas Home Craftsman, Box 34A, Stamford, Conn.

PLEXIGLAS Cut to size—1/8" masked 11 1/2 sq. in. Red, blue, yellow, amber, green, black, concentrated dye, rapid cement, 75c each four ounces. Discounts on supplies, tools. \$5.00 orders postpaid. Technicraft, 1156 Commonwealth, Boston 34, Mass.

KOLD-DYP Plastic dyes—for Lucite, etc. Simply dip, rinse, dry. 3 large bottles, colors intermixable, only \$1.25. Plastic supply catalog 10c. Plastic Products Co., Box 384-N, Massillon, Ohio.

PLASTIC Manufacturer solicits new items or ideas. Will buy outright or on royalty basis. Bradford Company, 59 Elm Street, Boston, Mass.

LUCITE, Selling out. 5 lbs. \$2.50, 10 lbs. \$4.50, 100 lbs. \$37.50 plus postage. Charles Gass, 307 14th St., Arnold, Penna.

LUCITE, Plexiglas, prime quality 12"x12" masked sheets 1/16" \$1.50, 1/8" \$1.75, 1/4" \$2.50. Add 10% postage. Dyes, rods, buffing compounds, Handee tool. Free listings. Craft Plastics, Box 129, Somerville, New Jersey.

PLEXIGLAS, Assorted workable pieces. 75c lb. Imperial Plastics, R4, Box 344, Toledo 9, Ohio.

MAKE, Mold new plastic at home! Instructions \$1.00. Tirekop (E4), Madeira, Ohio.

RUBBER Molds made to order. Stock molds for sale. Moderne Creations, 3356 Cullom, Chicago 18.

LEARN At home "Working with Plastics". Full information on sheets, blocks, rods, tubes. Trade names, sizes, colors for fabrications. Designing, tooling, bending, cementing, polishing. Also for home workshop. Only \$1.15 postpaid. Money back guarantee. Modern Technical Book Co., Dept. M3MC 55 West 42nd St., N. Y. 18.

PROFITS In plastics! Use factory-like methods. Details and sample \$1.00. Craft Co-op, 3928 Dumaine, New Orleans, La.

PLASTIC Kit, with project drawings, complete instructions, contains Lucite, Plexiglas, dyes, cement, polishing materials, \$2.50 and \$5.00—real value. Dodd-Giles Plastic Supply Company, 3247 West 92nd Street, Cleveland, Ohio.

PLASTICS—10c Brings our free offer and complete Flyer containing many profitable, fascinating ideas! Special kits and bulk assortments. Full line of plastics. Fast, reliable service. Write today to Bell Plastics Co., Dept. L1, 98 Gramatan Ave., Mt. Vernon, New York.

PLASTICS—Make your own at home. Formula and molding instructions \$1.00. Forester, Box 84, Station K, Toronto, Can.

FLEXIBLE Molds, plaques, bookends, novelties. Illustrated list free. Farinella, 228 Grove, St. Paul 1, Minn.

3x3/8 PLEXIGLAS Disks 20c. 5x1 1/2 disks 45c. Cutoff disk and flat assortments, 1 lb. \$1.00, 5 lbs. \$4.00, 10 lbs. \$7.00. Please include postage. Excess refunded. Catalogue on plastics, tools, etc. 10c. Metiplas Supply Co., 1420 S. 16th, Maywood, Ill.

PLEXIGLAS, New, clear, masked, 12"x12", 1/16" \$1.50, 1/8" \$2.00, 1/4" \$2.75. Dyes—red, blue, yellow, 4 oz. 60c; other colors. Cements. Postpaid. List free. G. Baker Company, 685 Center Ave., River Edge, New Jersey.

FABRICATION Instructions, dye sample, cement, catalog. All free with either picture frame, desk set, or 1/2 pound lucite for only \$1.00. Glassite, 625-P Atlantic, Monterey Park, Calif.

MONEY In plastics. Plastic kit contains 2 lbs. lucite sheets coloring dye and cement with instructions. Send \$2.50 to Plastic Specialty Co., 192 Lexington Ave., New York City, N. Y. express collect.

TWO New projects. Plexiglas candy box and 5x7 picture frame. 128 page instruction and idea book fully illustrated. This is Kosto Plasti-Kit No. 4 sent postpaid in the United States for only \$6.50 during April only. Contains all materials and instructions for two professionally designed projects. Ready now. No waiting. Kosto Plasti-Kits, Dept. S-4, 3263 M Street, N.W., Washington 7, D. C.

LUCITE—Complete illustrated fabricating instructions, used in craft classes throughout the world, price list on lucite, dyes, complete supplies. Booklet 10c, with sample, 35c. "Gem-O-Lite," P.O. Box 686-B North Hollywood, California.

ONE Hundred twenty eight page completely illustrated instruction book chock full of ideas and projects in all plastics now given with Kosto Plasti-Kit Number Three postpaid \$5.00 in U. S. Kit contains lucite, plexiglas, catalin, dyes, solvents, cements, polishing materials. Now ready. No waiting. Kosto Plasti-Kits, 3263 M Street, N.W., Washington 7, D. C. Dept. M14.

PLEXIGLAS And Lucite kit assortments, including cement, working drawings, instructions—One pound \$1.25; 6 pounds \$5.00; masked sheets 12"x12"—1/16" thickness \$1.75; 1/8" \$2.50; 3/16" \$2.75; 1/4" \$3.00. Masked sheets 12"x24"—1/16" thickness \$2.75; 1/8" \$3.75; 3/16" \$4.25; 1/4" \$4.75. Cement \$1.00. Red, blue, yellow, green plastic dyes \$1.00 each. Polishing compound 65c. Add 10% for postage. Carmen-Bronson, 1658 East Third, Mount Vernon, N. Y.

PLASTIC Stock and kits. Plexiglas sheets: New, per square foot, following thicknesses: 1/16" \$1.60; 1/8" \$2.00; 3/16" \$2.25; 1/4" \$2.75; 3/8" \$3.75; 1/2" \$4.75; 3/4" \$7.50; 1" \$9.50. 5% discount on orders over 5 square feet and 10% over 10 square feet. Other plastic supplies. Plastic kits: \$2, \$5 and \$10 each. We pay shipping charges. Send money order to—Plastic Supply Co., 2618 St. Louis Ave., St. Louis 6, Mo.

MAKE Rubber molds. New easy way. Circulars. Shuman Tackle, 3 Green Terrace, Kent, Ohio.

MOLD Model aeroplanes, propellers, golf tees, fishing lures, toys, costume jewelry, and novelties on a hand operated two ounce capacity injection molding machine you can build yourself. Only nine inch lathe and bench drill press required. Plans \$2.00. Post Office Box 503, Toledo 1, Ohio.

CHEMISTRY

CHEMICAL Experimenter's supply catalog 5c. Colonial Chemical Co., Brockton 28, Mass.

CHEMICALS, Reagents, apparatus, educational experimental kits. Catalog 5c. U. S. Scientific, 237 Christopher Ave., Brooklyn 12, N. Y.

WINN'S New idea champion chemical-kits, apparatus-outfits and supplies for students home experimenting. (Established 1931.) Send 10c for catalog, John H. Winn, 124 W. 23rd St., Dept. 504, New York, N. Y.

HANDBOOK For chemical experimenters, illustrated, hundreds of experiments, 50c. Experiment booklet 15c. 1946 chemistry catalog 5c. Reading Scientific Company, Reading, Penna.

CHEMISTS! All chemicals 10c. New type supplier. Send for list 10c. Neutron, Box 1, Station C, New York.

SCIENCE Quest Magazine is chemistry, physics, biology; 25c. Particulars free. Paterson, 6204 North Hermitage, Chicago 26.

APPARATUS, Chemicals, ounce quantities, catalog 5c. Fleischer's Laboratories, Everett 49, Mass.

SEMI-TECHNICAL Chemistry brochures. Literature free. Lankton, 310 Westmoreland, Lansing 15, Mich.

FREE Catalog. Chemistry, mineralogy, biology, optics. Tracey Laboratories, Evanston, Illinois.

NEW 36 Page chemical apparatus order book. Complete line of chemical glassware, apparatus and chemicals. Send 10c for this book. Standard Science Supply Co., 1232 N. Paulina St., Chicago.

CHEMICALS And apparatus for industrial, analytical, and private laboratories. Complete supply service for correspondence school students. Send 3c for catalog. Dept. M-43, Biological Supply Co., 1176 Mt. Hope Ave., Rochester 7, New York.

LABORATORY Supplies at wholesale prices: Chemistry, biology, physics. Catalogue 10c. National Scientific Co., 2204 W. North Ave., Chicago. Established 1908.

HELP WANTED

AGENTS To sell auto towbars. Trial samples \$2.00. Dozen \$21.00. Barnorall Industry, 19338 Griggs, Detroit 21, Mich.

CARPENTER Wanted in every town to build Composter Cabinets for our customers. Should have small shop and tilting power saw. Compo Industries, Dept. 1, 3614 S.E. Ninth, Portland, Ore.

DEALERS And installation men to sell and install gas conversion burners. Large profits. Peerless, 4322 Sheridan, Lincoln 6, Nebr.

OPPORTUNITY Of lifetime supplying DDT and other profitable products to farmers. No experience or capital required. Must have auto and good references. Permanent. Write or wire McNeess Company, Dept. 712, Freeport, Illinois.

AGENTS WANTED

SELL Greeting cards. Easy money showing gorgeous all occasion, birthday, religious, humorous, Easter box assortments. Wrappings, stationery, correspondence notes. Special offers. Experience unnecessary. Quick service. Request \$1.00 everyday assortment on approval. Hedenkamp, 343 Broadway, Dept. PMA, New York 13, N. Y.

SALES Agents, sell novelty jewelry. Write for information and ask for catalog of manufactured merchandise. Immediate delivery. Unique Novelty Jewelry Corporation, 98 Park Place, New York 7, N. Y.

WE Pay you \$25 for selling fifty \$1.00 assortments—birthday, all occasion cards. Tremendous demand. Sell for \$1.00—your profit 50c. It costs nothing to try. Write for samples. Cheerful Card Co., 117 White Plains, N. Y.

STOP Door slamming. New, clever gadget. Whirlwind seller. Excellent profit. Unlimited demand. Write quickly. Trommen, 1962 Renova Road, Philadelphia 38, Penna.

FASCINATING Year 'round income building plan. Take easy orders from friends, fellow workers, church organizations for 10 fast selling greeting card assortments. Sell for \$1.00 each—cost you 50c up. Extra bonus. Experience unnecessary. Request foremost \$1.00 all occasion box on approval, free correspondence notes samples. Special offer. Bluebird Studios, Dept. 16-P, Fitchburg, Mass.

NO More worries about flat tires! Ernie Airline Tire Inflator! Send \$1. Money back guarantee. Distributors wanted. Kramer Industries, PM3145, Euclid 17, O.

\$1 STARTS you in business. Sell deluxe five fold ties. 100% wool interlining. Cost you only \$7 per dozen, you make \$5 dozen. Send \$1.00 for special introductory offer two five fold ties. Catalog complete line free. Philip's Neckwear, 20 West 22nd St., Dept. K-1; New York 10.

SILVER Plating Liquid. (NuSilver and Replateo trade marks.) Apply with a cloth. Simply rub-on with a saturated cloth, dry-off and buff-up bright with a dry soft polishing cloth. All done in 1 minute. It cleans, silverplates and polishes from the one application. Easily done at home or in the office by anyone. NuSilver Plating Liquid is a more than 50% (1/2 plus) genuine U. S. Government Treasury Department Domestic Silver solution, 1000 Fine (pure Silver), Sterling. It renews all Sterling and plated silverware. It also silverplates onto brass, copper, bronze, zinc, nickel-silver, german-silver, and some other composition metals. Over 100 uses listed to date. NuSilver is a permanent lasting finish. Won't wash off. Won't brush off. Won't boil off. Once applied as directed it is there to stay. NuSilver Plating Liquid is a widespread and intensive seller. Working sales distributors are wanted for areas not now being worked. Easily sold to merchants in dozen lots and up by a sales set-up which furnishes free printed guarantees, printed advertising leaflets and one store counter display card for each one dozen bottles. Any kind of a store or business place can sell NuSilver. Any kind of an average distributor-Salesman can sell NuSilver. You sell, deliver and collect your big profits in cash each day as you work. Details by letter-mail. For U.S.A. Territory only. Can sell both wholesale and retail, and to jobbers or any way you like. We also have a companion product, the Lectrik Silver Cleaner Atomic Metal Plate (catalytic principle). Cleans silverware fast. Simply dip, rinse and rub-up dry. Has de-tarnished and cleaned as many as 100 pieces per minute. A really sensational demonstrating product. Strictly a "must" product for Eating Places of all kinds with lots of tableware to be de-tarnished and cleaned daily. These two products together are making a lot of profits for hustling distributors now. This is not a dream but a reality now. Do you want to get hold of two money making products like these as a distributor for your territory? If so write us for complete details and let's see if we can get together. Simply address: Nu-Process Products Laboratories, Dept. 216, Aurora, Illinois.

GOLD Honor scroll. Retail \$1.00, costs 15c. Sample free! Levine's, Box 15-X, Boulevard-Station, New York 59, N. Y.

UP To 100% profit selling friends sensational \$1.00 all occasion greeting card assortment. Costs you 50c up. Birthday, baby, gift wrapping, humorous, scripture boxes 35c up. Extra bonus. Request \$1.00 box on approval, free personal stationery portfolio. Special offer. Elmira Greeting Card Co., M-88, Elmira, N. Y.

NEW — Discharge emblems auto, wall and desk type, embossed in colors, appeals to millions. Free literature. L. Brown, 344 E. 25th St., Baltimore 18, Md.

NEW Year 'round extra money plan. Show friends exclusive greeting card assortments. Up to 100% profit. Request all occasion \$1.00 assortment on approval. Also show birthdays, social notes, gift wrappings. Free sample personalized stationery. Thomas Terry Studios, 148 Union Ave., Westfield, Mass.

FAST Selling new item. Beautiful maple leaf wall shelf. Sample 10c. Clark System, Ellwood City, Penna.

EVERYDAY Cards. Make \$5.00 with every ten \$1.00 assortments you sell. Also fancy note paper and everyday wrappings. Unusual demand. Send for samples today. Howard P. Ellis, Dept. PM-4, Pitman, N. J.

MAKE Unusual spare or full-time profits showing genuine leather jackets, raincoats, 200 style and comfort shoes. Sample outfit free. Rush postcard. Mason Shoe Co., Dept. M-332, Chippewa Falls, Wis.

SELLING Lifetime costume jewelry on sight. Tremendous profits. Particulars free. No risk sample outfit proposition. Fairview, 475A Fifth Ave., New York 17, N. Y.

MEXICAN Novelty curiosities. Fastest selling items. Biggest profits. Free samples. "Productos," Apartado 9318, Mexico City, Mex.

SELL Strip-O-Grams. Clever device for stores and offices. Sample 10c. John E. Markham, Saginaw, Michigan.

COSTS 4c. Sells 25c. Immediate demand, big repeater, hose preservative. Sample 25c. Details free. Lyle Products, 5 E. Spaulding, Willoughby, Ohio.

AT Last! Something new and sensational in everyday greeting cards. Gorgeous "glass bead" designs never before offered. Get orders fast. Up to 100% profit. Other fast-selling box assortments. Samples sent on approval. Write today. Puro Company, Inc., 3041 Locust, Dept. 640-D, St. Louis 3, Mo.

SPRING Months offer money making opportunities. Easy sales. Unlimited market in your community. Our helps build business. Write for free wholesale catalog today! McGregor Magazine Agency, Dept. PM6, Mount Morris, Ill.

GOG-L-WIPERS Are new. Postcard brings sample. Shaws', 160 Homer Ave., Palo Alto, California.

FREE Wholesale catalog, hard to get merchandise. American Merchandising, PM-4, Vandiver Building, Montgomery, Alabama.

ROYAL Glow products "They Glow in the Dark." Men, women write today for special sample offer. Quick sales, big profits. Royal Glow Products (Dept. 26), 1472 Broadway, New York.

SUPER Scissors Auto Jack lifts 2 tons easily. Send \$6.50. Money back guarantee. Distributors wanted. Kramer Industries, PM3145, Euclid 17, Ohio.

200 MONEY Making ideas. Plans. Rare formulas. Schemes. Folio free. Formico Service, Box 572, Dayton, Ohio.

ABRAHAM Lincoln operated a saloon in 1833. We have reproduction of license issued to him. Historic document. Every tavern will want some. Samples, agent's price 25c. Pioneer Publications, Box 1402, Philadelphia-5, Penna.

25 WAYS To make money with luminous paint (shines in dark). Rush only 25c for this very profitable information and luminous color sample. Address, Lite-Saver, 97C, Saybrook, Conn.

SELL Mexican bird pictures, with real feathers, stupendous profits. Samples 25c. Particulars free. J. Foley, 217 Grafton St., Brockton 6, Mass.

AGENTS—Big money for men, women, boys, girls—selling gorgeous night-glowing orchids, gardenias; perfect imitation real flowers; last for years; all the rage for wear on hair or clothes. Write for wholesale prices. Marney's, Dept. M-2, P.O. Box 581, Ogden, Utah.

WHOLESALE: Knives, flashlights, leather billfolds, trick novelties, cigarette lighters, etc. Write for illustrated price list. National Sales Co., Dept. 113, 221 Page St., Flint 5, Mich.

AGENTS Wanted, sell stamps, no investment. William Waugh, 2140 N. N. W., Washington 7, D. C.

HANDY Hair trimmer. Sells like wild. Trims as you comb. Saves barber bills. Samples sent on trial. Kristee, 124, Akron, Ohio.

MAKE Your money "on the spot." The front-money is yours on every order you take for a beautiful Plastiq-Craft Plaq, a reproduction in plastic of any snapshot or photograph. It sells itself. Unlimited field. Send for complete details. Plastiq-Craft, Dept. 446, P.O. Box 1221, Philadelphia 5, Penna.

QUICK Money! Distributors sell "go faster—longer—cheaper mileage." Fast, profitable seller. Thermomiles, Peoria 4, Illinois.

SELL Aluminum cigarette lighters, price \$12.00 dozen, sample \$1.00, ceiling \$4.50. Frant Bros., 200 W. 85th St., New York 24, New York.

DISTRIBUTORS, Agents, wanted! Sell new, silver plating liquid, "silver-on"—100% profit assured! Rabiro, 228-S, East 2nd St., New York 9, N. Y.

MOVIE-STAR Statuettes and real photographs, big profits. Free details. Danel's, Box 1816, Los Angeles 36.

"BREEZE Kar Kooler." New clever device keeps car cool in hottest weather. Low priced. Amazing profits. Agents-dealers, write immediately. Economy Specialties Co., 407 So. 4th St., Sturgis, Mich.

AGENTS, Try our name list. 100 newly-wed names for 25c. Norwood Name Agency, 206 Cleveland Ave., Norwood, Pa.

SELF-ADJUSTING Men's expansion wrist watch bracelets. Stretches double. Stainless steel. Sample \$1.00 C.O.D. United Watch Company, Saint Cloud, Minnesota.

SELL Personalized stationery, jokes, novelties. Big profits, easy to sell. Basil Churchill, 172 Pond, Randolph, Mass.

\$20.00 DAILY Selling our household products. Box 106, Scottdale, Pa.

PLASTONE; Amazing new polish for floors, furniture, autos. Beautifully packaged. Low priced. Whirlwind seller to stores, gas stations, homes. Fast repeater. Unconditional moneyback guarantee. Write for "free sample kit offer." Plastone Co., 2207-P4 West Chicago Ave., Chicago 22, Ill.

"SOLVEX" Cleans dirty hands without water. Write Solvex, Monticello, Iowa.

MAKE Money selling perfume. Sample odor and details. Runyan, 157C Conwell, Aurora, Indiana.

"COMIC-STRIPPER." Amazing new transfer liquid. Transfers newspaper pictures, comics on cloth, paper, wood. Works like magic. Everybody wild about it. Agents cleaning up. Profits tremendous. Write immediately for free sample pictures and moneymaking offer. H. B. Ketchum, Inc., Charlotte, N. C.

BUBBLE Solution. \$1.00 per gallon. Free sample. Rainbow Bubbles, P.O. Box 1883 G.P.O., Boston 5, Mass.

SILVER-ON, Silver plating liquid. Plates, cleans and polishes in one application. Permanent, won't wash off, renews all plated and sterling ware, plates onto metals. Distributors wanted. Details. Rabiro, 228P E. 2nd St., New York 9, N. Y.

LUMINOUS Pictures that glow in the dark. Large manufacturer wants factory representatives; wonderful new item; fast seller, free sample. Madison Mills, 303 Fourth Ave., New York City.

FREE—New 42-page book entitled "How to Become a Successful Direct Salesman." Written by salesmen for those who want to become salesmen and earn up to \$100 and more weekly. Send penny postcard. Specialty Salesman Magazine, Dept. PM, 307 N. Michigan, Chicago 1, Ill.

WONDER Rat boards. A new type trap made of special glue. No poisons, no disagreeable odors. "Like catching flies on flypaper." Cost \$4.00 dozen, \$45.00 gross. Resell at \$9.00 dozen, \$100.00 gross. Star Exterminating Co., 2958 Nostrand Ave., Brooklyn 29, New York City.

SCHOOL Seniors! Your postal will bring our wonder, Kwick-Sell Cardalog of popular graduation name cards. Biggest profits! Only firm giving free souvenir chest and card case. Don't miss out! Hurry that postal! Craftcards, Box 235-L, Pittsburgh 30, Pennsylvania.

FREE—Mexican novelty curiosities. Fast seller. Big profits. "Cedimex," Orozco y Berra 1-301, Mexico, D. F.

MAKE Money at home by mail. Sell books. Send 3c stamp for complete set-up. Business Plans Foundation, P.O. Box 56R, New York 10, N. Y.

137 COMPLETE Plans for starting own business: local—mail order. Particulars free. Elite Co., 220-A Grand St., New York 13.

NEW Offers—Write Thriftmaster, Box 61, Times Square Station, New York.

EASY Money during leisure time. New item everyone wants on sight. Details, sample. International Industry, Culver City, Calif.

SELL Individualized belts, buckles. Over thousand emblems to choose. Fast money maker. Repeat business. Write today special outfit offer. Hook-Fast Specialties, Box 1425, Providence, Rhode Island.

SELL The cosmetic line backed by advertising right in your own territory. Fast-selling cosmetics, toiletries, shampoos, etc. Write for free particulars. Huthnance Products Co., 201 E. Holbrook Ave., Flint, Michigan.

JOKERS Novelties. Wholesale. Hundred pieces dollar. Pauly, 2295 Concourse, New York City 53.

MAKE Quick clean-up selling perfume beads. Particulars free. Mission, 2328 W. Pico, Los Angeles 6, Calif.

NOT For sale—Central Illinois! \$1100.00—30 days! Thousands yearly. Tiny business just 2 years ago! Simple—either sex. Part-time. Home. Ferguson, Decatur, Ill.

ELECTRIC Ironing cords with indicator light. Iron-So-Ezee Company, Mt. Washington, Ohio.

90c PROFIT Each \$1 sale. Sell permanent mothproofing solution to housewives, stores, agents. Experience unnecessary. Postal brings details. Kinford, Wayne 3, Penna.

SCHOOL Seniors: Sell classmates superb Craftcards for super profits. Write Craftcards, Box 235-AK, Pittsburgh, Penna.

AGENTS! Register your name, address with us and receive latest mail order propositions. Free listing. Mail-Way Agency, 10P-620 William Ave., Winnipeg, Manitoba, Canada.

SIMPLE, Dramatic demonstrations insure easy sales. Sensational \$3.00 fire extinguisher. Liberal discounts. Other products. Molonite Company, 5713 Euclid, Cleveland 3, Ohio.

MEXICAN Feather pictures. Unusual novelty. 50c (stamps) bring \$2.00 worth samples, details. Refunded if unsatisfied. Aztec Art, Apartado 762, Mexico City.

MAGIC Cleaner and laundry soap deal. Hotter than a firecracker. Big profits. Sample free. Bestco, 5007 Irving Park, Chicago.

\$3 FIRE Extinguisher; quick sales, wholesale or direct; liberal profits. "Fire-Killer," 109 N. Franklin, Syracuse 1, N. Y.

GOLD Lacquered window sign letters. New foils, styles, absolutely beautiful. Free samples. Atlas, 7941 Halsted, Chicago.

WAR Honor scroll: All branches of service represented. 12 by 16. Space provided for name and photograph. Truly beautiful. Agents make big money. Sample 25c. E. Condon, Dept. 6, Upper Darby, Penna.

SELL "Petite picture notes." Something really different in greeting cards. Sample free. Dunbar Cards, New Brunswick 20, N. J.

AGENTS: Stamping names on pocket-key protectors. Sample check with your name, address, 25c. Stamping outfits. Emblem checks, check-fobs, name plates. Hart Mfg. Co., 303 Degraw St., Brooklyn, N. Y.

AGENTS—Big line including food products. Fast selling premium and bargain deals. Low prices. Send card for big outfit offer with gift. Ho-Ro-Co, 2768 Dodier, St. Louis 7, Mo.

WHOLESALE Sources. 500,000 articles. Free directory. Maywoode, 1133 Broadway, New York.

PLATING Outfits for autoparts, reflectors. Connect to a battery. No tanks necessary. Free booklet and particulars. Gunmetal Co., Ave. N. Decatur, Ill.

BIG Profits taking subscriptions for all magazines. Agents' confidential catalog listing over 2500 periodicals and complete starting supplies free. Pines Subscription Agency, Flushing, New York.

EXCELLENT Sideline for printing salesmen. Decalomania name plates in small quantities. Also, make money applying initials on automobiles. Free samples. "Ralco," X-164, Boston (18), Mass.

FREE Water and our concentrates, makes flavors, lotions, shampoos, 72 products, labels, bottles furnished. Quailco, E-20030 Russell, Detroit.

HIGH GRADE SALESMEN

START Your own business on our capital. Always your own boss. Hundreds average \$6,000 to \$25,000 annual sales year after year. We supply stocks, equipment on credit. 200 home necessities. Selling experience unnecessary to start. Wonderful opportunity to own pleasant, profitable business backed by world wide industry. Write Rawleigh Co., Dept. D-U-PPM, Freeport, Illinois.

BIG Commissions, selling to stores celluloid pricing tickets, metal shelf moulding. To restaurants, menu covers, signs. P. Pricing Press, 124 White St., New York 13, N. Y.

OPERATE Magazine subscription agency, wholesale catalog 5000 magazines, complete supplies 25c. Cassell Dealers Service, Westfield, New Jersey.

SELL To dealers. America's finest line counter-carded novelties and necessities. We show you how to make profits very first day. Highlander, Dept. 4C, 4613 North Clark, Chicago 40, Ill.

SELL Greeting cards, display signs, pictures, books, novelties. Big profits. Bulletin free. Elfco, 432 North Wells, Chicago 10.

SELL Annie Blain flavors. George S. Parker, New Brunswick, N. J.

NO Money or experience required. Spare or full time writing orders for guaranteed men's hosiery. We deliver and collect. Advance profit and 33% cash bonus. Huge demand everywhere. Steady repeat business. Write for free sales outfit including everything needed to make money. Kentcraft, 44 Court St., Dept. 100, Brooklyn 2, N. Y.

EARN \$3 On \$5 sale! Experience unnecessary. Call on stores, business and professional men. Leave self-selling booklet. Return later and write orders. We deliver and collect. Complete selling equipment free. Kendex Co., Temple Bar Bldg., Dept. 200, Brooklyn 2, N. Y.

GOOD Profit. Quality lucite merchandise sells itself. Write for proposition, catalog. Glassite, 625-P Atlantic, Monterey Park, Calif.

SALESMEN—Would you like to make up to \$75 cash commission weekly? Address Schutt Co., 244 East Ohio Street, Indianapolis 4, Indiana.

THIS Is it—"Making Sales History." Brand new; genuine rayon silk covered, flower plaques, statuettes, novelties. \$1.80 per doz. up. Large 9x12. Paris Novelty, 611 W. 7th St., St. Paul 2, Minn.

MAKE Up to \$25 a day selling desk calendars. Ideal side line. Details free. Steel Advertising Service, P.O. Box 596, Richmond 5, Virginia.

FREE! Latest issue Opportunity Magazine. Salesman's Guide. Inspiring, constructive. Shows how to earn money selling for others or in your own business. Hundreds postwar opportunities. Send name and describe what you have sold or are selling. Illustrated copy sent free. Opportunity Magazine, 620 N. Michigan, Dept. 17, Chicago 11, Ill.

EDUCATIONAL AND INSTRUCTION

"HOW To Break and Train Horses"—A book every farmer and horseman should have. It is free; no obligation. Simply address Beery School of Horsemanship, Dept. 1104, Pleasant Hill, Ohio.

MAKE Up to \$25-\$35 week as a trained practical nurse! Learn quickly at home. Booklet free. Chicago School of Nursing, Dept. M-4, Chicago.

WELDING—Electric arc. Learn profitable trade quickly through actual practice. Individual welder instructions at bare cost of materials. Full particulars free. Valuable welding lessons book 50c. Hobart Welding School, Box M-462, Troy, Ohio.

DRAFTING Students—Draw and trace genuine engineering plans of machine parts. Send \$2.50 for first two plans and instructions. Tekage, 42 Vernon St., Newton 58, Mass.

FREE Trade magazines. Learn more about your field. Send for list. No obligations. Harris Publications, Harris Bldg., Mahopac 48, N. Y.

BOOKKEEPERS: Double your pay checks. No foolin'. Write, Employment Opportunities, Bogard 2, Mo.

SENSATIONAL, New, magic shorthand and typing home study course. Price 25c. Riegel, 1111 Harrison, Philadelphia 24, Pa.

USED Home study, self-instruction material and correspondence courses. Refrigeration, plastics, mechanical, business, technical, etc. All subjects sold, rented. Large catalog free. Harris Publications, Harris Bldg., Mahopac 3, N. Y.

AMAZE With Super Memory! Facts, figures, names stick like burrs! Write A-16, Thor Books, Box 1210, Chicago.

HOME Studycourse, drugless therapy. Free literature. Institute of Drugless Therapy, Tama, Iowa.

TUNE Pianos scientifically. Lesson and diagram, \$1.00. Oscar Fylling, 841 Robinson, Oroville, Calif.

HERE'S Health! Professional acrobats enjoy. Free health information. Write! Knoff, 2154M North 52nd St., Milwaukee, Wisconsin.

PICK A new career! Wonderful new radio opportunities! Write Topical Empire Corporation, 1527 Highland, Box 42-W, Louisville 4, Ky.

WRITE Short stories at home for pleasure and profit. Fame, riches and happiness of achievement are rewards to be realized by students who acquire tested technique. Get free booklet from home study school with 50 years experience. Write today! Blackstone-Sprague, Dept. 14, 307 North Michigan, Chicago 1.

LET Us train you for that accounting career. Complete bookkeeping, basic accounting course. Western Home Study Institute, Box 2506, San Francisco 26, Calif.

AMAZE Others! Calculate mentally! New shortcut methods! Only 25c postpaid. Reiss, 3017 Ocean Parkway, Brooklyn 24, New York.

SEEKING New job or promotion. Learn accepted method of preparing and presenting qualifications, naming salary. Complete course \$1.00. Apton Company, Box 716A, Augusta, Ga.

LEARN Touch typing at home in thirty days. After the sixth lesson you will know your keyboard by touch. Professional Typing postpaid, \$1.00. Hobson Book Press, Cynthia, Kentucky.

\$5000-\$15,000 EARNED By many, every year. Learn credit-collection agency business, by correspondence. Fulltime, spare-time, home, office. Fascinating and uncrowded. Write for free bulletin. Franklin Credit School, Roanoke 7, Virginia, Dept. P. M.

WANT A better job? Do you want the job you dream about? Write George Sauer, Myoma Village, Box 139, Mars, Penna.

FIND Yourself and a real opportunity. Tibolt, Ph.D., 13M, Philadelphia 20.

NEW Personalities for old by correspondence. Results guaranteed. Personal development plan free. Write today. Personal Psychology, Incorporated, 1008 Washington Bldg., Louisville 2, Ky.

WE Guarantee you can learn touch type-writing at home in ten hours by the "Analytical-Psycho Method"; also: shorthand and bookkeeping, ninety hours each. Osborne College of Short Methods, Los Angeles 13, California.

NEW, Used, practical books, courses, catalogs, dime-refunded. Westway Educational Service, Box 58C, Los Angeles 35, Calif.

RENTAL Library offers real value in mail order reading courses. Pays book dividends. Write for details and lists. Black Hawk, Box 249P, Rock Island, Ill.

LEARN Fascinating credit-collection agency business; fulltime-lifetime vocation; investigate Educational Extension Service advertisement under Business Opportunities.

LEARN To type! Use the touch system. Free details. Emile Jeunesse, 5706 Dauphine St., New Orleans 17, La.

LEARN Shoe repairing. Practical. Investigate. Modern Shoe Rebuilding School, 2935 Belmont, Chicago.

WHO Can become a good pianist? 10c. Wm. Otto, 4215 Park Ave., Union City, N. J.

REAL Estate. Study through experienced brokers. Free bulletin. DeVoto Realty Schools, 35 Vicente, San Francisco 16, Calif.

USED Educational and technical books on all subjects bought, sold, rented. Catalog free. Educational Exchange, Henagar, Ala.

GOOD "Used" self-instruction educational books on all subjects bought, sold, rented, exchanged. Satisfaction guaranteed. Complete information and 100-page illustrated bargain catalog free! Write-Nelson Company, Chicago 5.

GET Government job: Good salaries, permanent. Service men given preference. Low priced home study practice lessons help you make good grade. Write, Ozment's School, 75, St. Louis, Mo.

29 LANGUAGES By Linguaphone. Russian, Spanish, Portuguese—Direct conversational method for mastering any language quickly, easily, correctly at home. Send for free book. Linguaphone Institute, 83 RCA Bldg., New York.

LEARN Photo-engraving at home or in oldest, largest school in America. Work for newspaper or establish own profitable business. New Tasope' Photo-Engraving equipment available soon. Write for information. Veterans ask about G.I. training. The Aurora School of Photo-Engraving, Tasope' Bldg., Aurora, Mo.

INVESTIGATOR Training. Phillips Secret Service, 1917B North Kenneth, Chicago 39, Illinois.

LOCKSMITH Course. Lock picking, key fitting, etc. \$1.00 prepaid. Locksmith, Canadian, Texas.

MEDICAL Laboratory technicians in great demand. We train you in your spare time, in your own home. You can practice while studying. Write for free catalogue. Imperial Technical Institute, Box 973-E, Austin, Texas.

SECRET Investigation. Experience unnecessary. Investigators particulars free. George Wagner, M 125 West 86th, New York.

USED Educational books on all subjects sold, rented, also bought and exchanged. Moneyback guarantee. Write today for free catalog and details. Lee Mountain, Pisgah, Alabama.

PLAYS, STORIES, MANUSCRIPTS

1946 MARKET Folios! 100 paying markets for humor and cartoons—25c. 100 paying markets for poems and greetings—25c. 100 paying markets for fillers and short items—25c. Instructions, tips included. Typing, revision, criticism services. Bierman, 185 Lexington Ave., New York 16, N. Y.

NEW Writers needed to rewrite ideas in newspapers, magazines and books. Splendid opportunity to "break into" fascinating writing field. May bring you up to \$5.00 per hour spare time. Experience unnecessary. Write today for free details. No obligation. Postcard will do. Comfort Press, Inc., 210-P South Seventh St., St. Louis 2, Missouri.

COMPLETE Assistance for writers. Inquire National Writers Club, 1837 Champa, Denver 2, Colorado.

I WANT New writers to cash hundreds of checks for \$1 to \$100, offered each month. The easiest way to write for pay. No previous experience necessary. Send for free details. No obligation. Saunders M. Cummings, Box 609-M, Colorado Springs, Colo.

WIN Fame, success, security writing short stories, newspaper features. Easy-to-learn course shows you how. Exclusive details yours for a penny postal. Writer's Institute, 4-M South 15th Street, Philadelphia 2, Penna.

CARTOONING, COMMERCIAL ART SHOWCARD WRITING, SIGN PAINTING

NOW Make signs in six months, daily practice, simplified fundamentals, \$1.00. Jantzen, 252 West New York, New Jersey.

"HOW To Make Money With Simple Cartoons"—A book everyone who likes to draw should have. It is free; no obligation. Simply address Cartoonists' Exchange, Dept. 94-C, Pleasant Hill, Ohio.

WE Can teach you to paint signs. Our 52 lesson course is guaranteed to give you results. Write for details. Stewart Sign Co., Box 626, Pomona, Calif.

"HOW To Draw Gals"—a book every beginning artist should have. It is an up-to-date, complete guide on all phases of female figure technique. Only 50c postpaid. Hargis Studio, 210—5th Avenue, Box 95, New York.

WE Print student's cartoons. Free literature. School of Cartoons, P.O. Box 3291, San Francisco 19, Calif.

CHALK Talks. Laugh producing program, \$1.00. Catalog 10c. Balda The Cartoonist, Oshkosh, Wisconsin.

MAKE Signs, letters, stencils. 9 complete alphabet pattern sets, 3 complete numeral pattern sets and catalog \$1.00. Sign Letter Distributors, P.O. Box 101, Mineola, N. Y.

CARTOON Course—22 easy lessons. 200 figure sketches. 25c coin postpaid. Snack-Pack Co., 32 E. Georgia, Indianapolis 4.

ADVERTISING AGENCIES, LETTER WRITERS, FOR ADVERTISERS

ADVERTISERS! We buy your 1945-46 order letters. Spot cash. Rogoff 1692P Park Place, Brooklyn, New York.

35 WORDS, 12,000 readers, 3 months \$2.00. Renick, Holland, New York.

TOP-NOTCH Advertising—free particulars. Productive Advertising Service, 852 East 34th Street, Brooklyn 10, New York.

ADVERTISING Placed everywhere lowest rates. Reliable guidance on publications, expert assistance on ads without charge. Newspaper, magazine, mailing-list ratebook free. Chicago Advertising Agency, 20-P West Jackson, Chicago 4.

ADVERTISING That sells! You want that kind? Dynamic sales letters, ads, prospectus, etc. Written by mail sales specialist, 29 years experience. You'll get the business! Printing—from cards to catalogues. Any mailing list you want. Advice, suggestions, free. Faultless Advertisers, 3439-P Michigan, Chicago 16.

FREE! 1946 Advertisers Rate & Data Directory. 52 pages! E. H. Brown Advertising Agency, 20 N. Wacker, Chicago 6.

WRITER Wants work! Effective sales letters, folders, catalogs, booklets, courses, speeches, etc., written or revised, \$2 per typewritten page. Twenty years experience. Dudley Bunn, 126 Lexington Avenue, New York 16.

ADVERTISE: 24 Words, 40 newspapers \$3.50. List free. Advertising Bureau, 4515-C Cottage Grove, Chicago 15.

ADVERTISERS Service—For men going in business. Put our experience in merchandising and advertising back of your products. Write Van De Mark, Times Star Bldg., Cincinnati 2.

24 WORDS In 64 weeklies \$4.96. H. J. Darnell, 730 Hays, Jackson, Tenn.

INCH Display adv. 50 magazines yr. \$24. Wood's Popular Services, Atlantic City, (N. J.)

ADS Placed in out of town newspapers and magazines. Low rates. Catalogue free. Ideas that pay. Baker Advertising Agency, Successors Ankrum Agency, 189 W. Madison, Chicago 2.

BUSINESS SERVICE

SALES Correspondence service. Manufacturers, jobbers, wholesalers, retailers. Inquiries invited. Box 5991, Cleveland, O.

SEATTLE Mail or branch office address, \$2.00 month—mail forwarded when wanted—also personal or business assignments, \$1.00 per hour. Business Messenger Service, 517 Third Ave., Seattle 4, Wash. (Opposite County-City Bldg.)—Established 1940.

CHICAGO Mail or branch office address. Lowest rates. Service, 3439 Michigan Ave.

TO Whom it may concern: We will represent you in the principal cities of Arizona; California; Colorado; Florida; Illinois; Indiana; Louisiana; Maine; Maryland; Massachusetts; Michigan; Minnesota; Mississippi; Missouri; New Jersey; New York; Ohio; Oregon; Pennsylvania; South Carolina; Tennessee; Texas; Washington; Wisconsin; also Alaska; Canada; Panama and Mexico. Personal or business assignments \$1 per hour. James W. Farley, Citizens Bldg., Cleveland 14, Ohio. Note: Would appreciate hearing from someone who wishes to enter this business in your city.

YOUR Office conducted Los Angeles, Hollywood \$1.50 month. Hollywood Personal Services, Suite 218, 1154 No. Western Ave., Hollywood 28.

NEW Jersey mail system. Send and receive your mail through me. 25c cash each letter. Kent, 65 Devon St., North Arlington, New Jersey.

PERSONAL And business representation in 48 states. \$1 per hour. Mail forwarded \$1 monthly. Those interested in being our representative write Secretariat Services, 239 Bleecker Street, New York City 14, N. Y.

PHILIPPINES—Let me represent you here. Letters mailed for 25c. Business transacted reasonably. Details 25c. James W. Burnette, Manila, Luzon, Philippine Islands.

BOOKS, Speeches, etc. ghost-written. 10 years' professional experience. K. Benton, 310 E. 74th, Los Angeles, California.

BUSINESS Representation. Mail forwarded, \$15.00 yearly. United Business Service, 137 Cordova, San Francisco, Calif.

SPECIAL SERVICES

500 New products, manufacturers. Bulletin 50c. Chaffee, 308 Washington, Chicago 6.

WHERE To buy. Over 1 million items listed, commercial, scientific and domestic—unusual items—50c per item. 3 for \$1. Send cash or money order; money refunded if no reference. Products of the World, 470 Landfair Ave., Los Angeles 24, Calif.

VISIT Atlantic City by mail. 3 postcard views 20c. Address, return, I remail. Letters mailed 15c. Muriel Koler, 1111 Atlantic Ave., Atlantic City, N. J.

I Will forward your mail from Santa Barbara, California 25c. Confidential Service, 1327 Punta Gorda.

MANUFACTURING Consultant; engineering tools, methods and equipment problems solved. Details, R. & H., Spenceville, Ohio.

REFRIGERATION Engineering consultations \$1. Mail problems. Irving Bachrach, 4815—15th Ave., Brooklyn 19, N. Y.

INTELLIGENCE Test correction, analysis, complete \$1. Rutherford Preparatory School, Box 347, Long Beach 1, Calif.

LET Us know your wants. Box 61, Times Square Station, New York.

HAVE Fun! Pretend visiting California. 3 postcard views 20c. Address, return, I remail. Letters mailed 15c. Free information. Ira Smith, 153 Liberty, San Francisco 10, California.

INTERSTATE Personal Services your New York City representative, save business trip, shopping, collecting, mailing address, nominal charge. Box 98, New Hyde Park, New York.

GOOD "Used" self-instruction educational books on all subjects bought, sold, rented, exchanged. Satisfaction guaranteed. Complete information and 100-page illustrated bargain catalog free! Write-Nelson Company, Chicago 5.

LETTERS Written for every purpose. Sales, business, personal, collection, etc. 17% direct orders from one letter mailed to ten thousand prospects. Hastings Letter Service, P.O. Box 467, San Francisco, Calif.

RADIO-ELECTRONICS Consultation, engineering design, model development, technical writing. R. E. Lovejoy, 712 Yuma Street S.E., Washington 20, D. C.

TYPEWRITERS, DUPLICATORS, OFFICE DEVICES

USED Typewriters, mimeograph, multi-graph, presses, supplies, appliances. Dixie-Graph, King, N. Car.

PRINT Your own postal cards, paper, or anything on "Printomatic Self-feeding Rotary Postal Card Stencil Duplicator." Only \$9.50 with \$2.35 worth of supplies, stencils, ink, etc. Literature free. Pittsburgh Typewriter Supply, 336-RB Fourth Ave., Pittsburgh 22, Penna.

RUBBER STAMPS, OFFICE SUPPLIES

THREE Lines, cushioned, indexed, knob handle, \$1.00. Additional lines 25c each. Ideal Rubber Stamp Co., Detroit 8, Mich.

RUBBER Stamps, 25c line, any size. Parcel Press, 53 Astor Sta., Boston, Mass. 3 LINES 35c; Signature \$1.50; pads 25c. Stamprite, Wauwatosa, Wis.

DATING Stamp and inking pad \$1.00. Royal Ford, Bristol, Conn.

BETTER Rubber stamps. Write for Ezy-Order literature. Lee-Vall Press, Box 1242, Indianapolis 6, Indiana.

PROMPT Service. Cushioned, indexed, 1 line 25c, 2-35c, 3-50c. Stampcraft, 1707 Virginia, Gary, Indiana.

RUBBER Stamps, all kinds. Send for catalog. Excello, Box 500, Shreveport, La.

PRINTING, MULTIGRAPHING, MIMEOGRAPHING, GUMMED LABELS

GOOD Printing! Low prices! Small, large quantities. 250 letterheads, 250 envelopes, \$2.75. Joseph Johnson, 1382-A Fifth Avenue, New York City 29, N. Y.

QUALITY Printing prepaid: business, personal stationery. Letterheads, envelopes, statements. Prices reasonable. Samples. Mero Products, 100-A Morrison, Punksutawney, Penna.

CIRCULARS, Booklets, folders, stationery—quality workmanship, low prices; quick service. Get our estimate on your needs; pricelist free. Lonelm Publishers, Paulding, Ohio.

MIMEOGRAPHED Letters, 100—\$1.00. Printing, Haynescraft, 706 8th, Washington 1, D. C.

GET Our printing prices first. Crane, 3024 White, Kansas City 3, Missouri.

500 6 $\frac{3}{4}$ Envelopes \$2.50 FOB. Mango, 555-A South 20th, Newark 3, N. J.

MAKE Cuts with pencil only. Mats 4x5 inches, dollar dozen. Cleveland Pencil Mats, Weston, West Virginia.

QSL'S, Advertising cards, shop tags, other printing. Samples. Johnson, Box 93, Lansdowne, Penna.

QUALITY Printing at lowest cost. Free samples, pricelist. Adams, 30 West Washington, Chicago 2.

200 8 $\frac{1}{2}$ x11 HAMMERMILL letterheads, \$1.00 postpaid. Envelopes, billheads, business cards same. Race Printing, Hudson, New York.

250 IMPRINTED Approval sheets—\$1.00. Schultze, Box 41, Irwin, Penna.

LETTERHEADS, Envelopes or billheads—200 \$1.00. Benneville, 907 West Roosevelt, Philadelphia 40, Penna.

QUALITY Printing, reasonable. Send copy for estimate. Globe Print Shop, High Point, N. C.

500 GUMMED Shipping labels \$1.00; circular, samples. Presto, Dayton, Ky.

500 8 $\frac{1}{2}$ x11 HAMMERMILL Letterheads, 500 large envelopes, printed, prepaid \$5.00, 1000 each, \$9.00. Stump, South Whitley, Indiana.

FINE Printing—Reasonably priced. Prompt service. Samples. Treaster Printing, Milroy, Penna.

500 HAMMERMILL Letterheads 8 $\frac{1}{2}$ x11 or 6 $\frac{3}{4}$ envelopes \$2.50. Moye Press, Windsor, Vermont.

TRADEMARKS Designed, complete with cut, \$3.50. Sample sheet free. Preliminary sketches, two for 50c. Oakes, 5663 Military Drive, Dallas, Texas.

100 COLOR Letterheads, \$1. Samples, stamp. Mimeographing, typing. Horace Mohler, R-10, Dayton 9, Ohio.

BOND Letterheads 8 $\frac{1}{2}$ x11, envelopes 6 $\frac{3}{4}$, 200—\$1.00; 1000—\$3.90 or mixed. Postpaid, 24 hour service. Barnes, 6439 Hamilton Avenue, Chicago 45, Illinois.

1,000 ENVELOPES, 6 $\frac{3}{4}$, \$3.75 Postpaid. Booklets, pamphlets and publications at lowest prices. Courier & Digest, 201 Eighth Street, Charleroi, Penna.

SEND 10c Now, for our 36-page 1946 pricelist—refunded first order. McCall Press, 1326 S. 27th, Omaha, Nebraska.

QUALITY Printing; prompt, efficient service. Samples. Lakeside Press, Bolton Landing, N. Y.

100 MIMEOGRAPHED Letters (like typewriting) \$1.50; additional 100's, 50c. Accurate, same day service. Multico, Nine Cornhill, Boston 8.

MIMEOGRAPHING, 8 $\frac{1}{2}$ x11, 250, \$1.50; 500, \$2.50; 1000, \$3.75. Templeton Studios, Elgin 8, Illinois.

EMBOSSED Business cards, letterheads, envelopes. Spada, 10 Lexington, Wethersfield 9, Conn.

150 SHEETS 100 Envelopes \$1.00. Gene Smith, Beechwood, North Berwick, Maine.

"PRINTING That Satisfies." Samples free. Mail Printing, 93, Danvers, Mass.

BUSINESS Cards \$1.00 M. Maloney Sales, 36 St. Paul, Rochester 4, N. Y.

PRINTING Cards, envelopes, letterheads. Many \$1 items. Descriptive price list free. Michel, Box 76F, New York 16.

ATTENTION—Invest in prestige-building letterheads. Ace Printing, Brentwood, Md.

BETTER Grade printing reasonable. Estimates on anything. Economic Press, Leonia, N. J.

MIMEOGRAPHING—Any copy. Reasonable. Mailers Service, Box 606-A, Chicago 90, Ill.

500 3 $\frac{1}{2}$ x2 $\frac{1}{4}$ FOUR Line gummed stickers, 25c. Moritz Printery, Saginaw, Mich.

MIMEOGRAPHING—Letters, pricelists, formulas, instructions. Lowest prices. Lem's Letter Shop, 5710 Stanton, Detroit 8.

PRINTING OUTFITS AND SUPPLIES

PRINTING Press plans \$1.00. Details, samples of work, free. Homer De Sellier, 19 Stebbins St., Springfield, Mass.

PRACTICAL 6x9 Home-made printing press \$5.00. Plans to make it yourself \$1.00. Arthur Shults, 1703 N. Kaley, South Bend 16, Indiana.

PRESSES, Type, cabinets, supplies. List for stamp. Lincoln Press, 220-Y Hartwell, Fall River, Mass.

CUTS—Make real halftones, line cuts yourself! Samples 25c. Particulars free. Rapid Chemical Service, Edwardsville, Ill.

PRINTERS, Make cuts the Quick Etch method. Details free. Charles P. Medlock, Box 256C, Goodland, Indiana.

PRINTING Equipment, type and supplies. Send stamp for details or dime for complete illustrated supply book. Kelsey Inc., X-11, Meriden, Conn.

PRINT At home—Send 10c for catalogue—presses, type, supplies. Barnhard Co., 6 Columbia St., Newark 5, N. J.

INEXPENSIVE Home-made printing press. Details free. Novelty Shop, Downsville, Louisiana.

PATENT ATTORNEYS

DAVIES & Son, patents-trade marks, 7240 Wisconsin Ave., Washington 14, D. C.

INVENTORS—Take prompt steps to protect your invention. Delays are dangerous. Get new free book, "Protect, Finance and Sell Your Invention," and "Invention Record" form. Preliminary information free. Reasonable fees. Conscientious counsel. Easy payment plan. Learn how to protect and sell your invention. Write us today. McMorro, Berman & Davidson, Patent Attorneys, 134-L Atlantic Building, Washington 4, D. C.

INVENTORS—First things come first. Your first move toward securing a patent on your invention is acquiring full information on what to do. Our two books "Patent Protection" and "When and How to Sell Your Invention" contain this information and other helpful data. Get them immediately, together with our "Evidence of Invention" form. They cost you nothing, you assume no obligation. Write now to Victor J. Evans & Co., Patents, Trade Marks, Copyrights, 131-D Merlin Building, Washington 6, D. C.

PATENTS. Free preliminary advice. E. E. Vrooman, Patent Lawyer, Registered Patent Attorney, 871 Woodward Building, Washington 5, D. C.

PATENT Protection. Write for information and "Record of Invention" form, free. Registered Patent Attorneys. Randolph & Beavers, 21-C Columbian Bldg., Washington, D. C.

"INVENTOR'S Guide." 100 mechanical movements, free; advises on patenting, selling inventions. Frank W. Ledermann, 154 Nassau Street, New York 7.

*INVENTORS: Learn now—without obligation—how to protect and sell your invention. Write for free "Record of Invention" form and complete information for making disclosure and establishing date of your invention. We also send our new free "Patent Guide for the Inventor," containing complete information about patent procedure and how to sell inventions; giving illustrations of many successful inventions; over 150 basic mechanical movements. We assure you prompt, confidential service. Delays may be dangerous. Write today for your free "Patent Guide" and "Record of Invention" form. Clarence A. O'Brien & Harvey Jacobson, Registered Patent Attorneys, 61B-C, Adams Building, Washington, D. C.

PATENTS And trade marks. Wilfred E. Lawson, 1524 K Street N.W., Washington 5, D. C.

PATENTS—Trade marks. Irving L. McCathran, 315 McLachlen Bldg., Washington 1, D. C. Registered Patent Attorney.

INVENTORS—Before disclosing your invention to anyone send for form "Evidence of Conception"; Schedule of Government and Attorneys' Fees and instructions. Sent free. Lancaster, Allwine & Rommel, Registered Patent Attorneys, 411 Bowen Building, Washington 5, D. C.

PATENTS Obtained; selling service. Information, recording forms free. Labiner, World Building, New York.

C. A. SNOW & Co., M-427 Snow Bldg., Washington 1, D. C. Registered patent attorneys. Established 1875. Literature mailed on request.

FOR INVENTORS

DEPENDABLE Patent office searches \$10.00—complete with 10 patent copies. Ten days service guaranteed. Send sketch, description and fee at once—or write for free invention protection form. Address: Raymond L. Smith, Patent Searcher, 410-DM Bond Building, Washington 5, D. C. (Former U.S. Patent Office employee.)

SMALL Rubber factory is looking for new items to manufacture postwar. Do you have a patent or a good idea? Perhaps we can help you with design or financing. Reliance Rubber Company, 1515 Powell Street, Oakland 8, Calif.

INVENTORS—Take prompt steps to protect your invention. Delays are dangerous. Get new free book, "Protect, Finance and Sell Your Invention," and "Invention Record" form. Preliminary information free. Reasonable fees. Conscientious counsel. Easy payment plan. Learn how to protect and sell your invention. Write us today. McMorro, Berman & Davidson, Patent Attorneys, 134-M Atlantic Building, Washington 4, D. C.

INVENTORS—Information on what to do first toward securing a patent on your invention is of vital importance. "Patent Protection" and "When and How to Sell Your Invention"—two valuable, richly illustrated books—explain fully what to do first, and a lot more. Get this information quickly, together with "Evidence of Invention" form. All three will be sent to you free. Write immediately to Victor J. Evans & Co., Patents, Trade Marks, Copyrights, 132-D Merlin Building, Washington 6, D. C.

INVENTORS, Idea men and mechanics. Professional inventor has list of 21 practical inventions needed now and why. Many angles discussed—all new. Send \$1.00 for complete list. G. O. Leggett, 1205 N. La Salle St., Chicago.

PROMOTE Your invention with clean sharp photographs of your model. Don Bryan Studios, 53 W. Jackson Blvd., Chicago 4.

"CERTI-PROOFS" Protect unpatented inventions 1 year or longer! Patent later, 3 postpaid \$2.00. Patent searches \$5.00. Inventions marketed. Free particulars. Warner Co., 600 S. Michigan, Chicago.

WANTED: Practical inventions. Inventors Exchange, Research Division, B6, Hartford 1, Connecticut.

I SELL Patents. Established in 1900. Charles A. Scott, 773PM Garson Ave., Rochester, N. Y.

INVENTIONS Having profit possibilities in demand by specific manufacturers, cash or royalty. Free descriptive booklet, protective disclosure form, references, and how to safely disclose an invention for sale, upon request. Invention Reporter, 5A-11106 So. Longwood Dr., Chicago 43.

INVENTORS: Avoid unnecessary expense. Write for free booklet explaining how our consulting and advisory service can assist you in deriving greatest profit from inventing. Institute of American Inventors, Dept. 40-A, 1926-Eye St. N.W., Washington 6, D. C.

CASH For practical ideas and inventions. Mr. Ball, AB-9441 Pleasant, Chicago.

INVENTORS: Learn now—without obligation—how to protect and sell your invention. Write for free "Record of Invention" form and complete instructions for making disclosure and establishing date of your invention. We also send our new free "Patent Guide for the Inventor," containing complete information about patent procedure and how to sell inventions; giving illustrations of many successful inventions; over 150 basic mechanical movements. We assure you prompt, confidential service. Delays may be dangerous. Write today for your free "Patent Guide" and "Record of Invention" form. Clarence A. O'Brien & Harvey Jacobson, Registered Patent Attorneys, 61A-C Adams Building, Washington, D. C.

RANDOLPH & Beavers: Registered Patent Attorneys, 11-E Columbian Building, Washington, D. C. In order to protect your invention and reap the reward that should be yours, patent your invention without delay. Write for complete information and "Record of Invention" form, free.

INVENTORS: We design and market your idea or product. Gadget Designer, 725 Walnut St., Room 23, Philadelphia 6, Penna.

PATENTED. Unpatented inventions promoted. M. Joyce Humphries, 1424 Landtitle, Philadelphia 10, Penna.

INVENTIONS WANTED

INVENTORS Attention! Have you an invention patented or patentable of a novel electrical or mechanical device? Are you the owner of dies you wish to dispose of? If you have either or both give full particulars. We are highly rated manufacturing concern with a nation-wide distributing organization. Your rights will be scrupulously respected. Lion Manufacturing Corp., Dept. BS, 2650 Belmont Ave., Chicago 18, Illinois.

INVENTIONS WANTED: cash or royalty. Sell your invention—now. Patented or unpatented. We guarantee results. John D. & Son, 140-0 Spruce St., Box 3213, Bridgeport 5, Conn.

EARNINGS \$2,000 Year easy: inventing simple items for special cash markets. Ideas only. No patents. Write, Hendrickson, Argyle 7-A, Wisconsin.

I sell patented and patent pending inventions. Chemical composition, mechanical and design. I sell any type of an invention. Let me prove that I can sell your invention. Manufacturers write me often for new inventions. I know where I can sell. I guarantee my service. Long established. Leslie Buford Stratton, 216 West 69th Street, New York City, New York.

WANTED To purchase a patent right or patentable invention for a home furnishing or appliance. Will pay cash. Describe fully. Address—Mr. Kelley, 2448 Cedar Street, Berkeley 8, California.

INVENTORS: Hundreds of manufacturers have requested our assistance in locating marketable new products. Complete information, free. Institute of American Inventors, Dept. 40-D, 1926-Eye St. N.W., Washington 6, D. C.

WANTED—Patented, unpatented inventions having profit possibilities, all kinds. If will sell, reply immediately. Descriptive booklet, references, free. Invention Reporter, 5B-11106 So. Longwood Drive, Chicago 43.

INVENTORS! Have you good patentable idea? Write Mr. Metzler, 11 West 42nd, New York.

CASH For inventions, patented, unpatented. Mr. Ball, A-9441 Pleasant, Chicago.

MANUFACTURER Wants sensible mechanical device or idea with quick sales possibilities in low-priced field. Write Matt, 1412-D Great Northern Building, Chicago 4.

PATENTS FOR SALE

BEAUTY Supply manufacturers, all difficulties of spiral winding long hair, solved by new Bell winder. Contact Margaret R. Bell, Federal Hotel, Great Falls, Montana.

PATENTED Steel grinding block. Holds tool bits, correct angles, for thread cutting. Practical for unskilled help. Hart, 86 Braddock St., Springfield 9, Mass.

STAMPED Metal furring clip for block, brick or concrete walls, also as wall, floor or foundation anchor. Edward Toussaint, 6515 Bircher, Pine Lawn 20, Mo.

HAND Loom with desirable accessories. Patented. Write S. P. C. Porter, 666 Downington Ave., Salt Lake City, Utah.

PRACTICAL Shaving kit containing every shaving requisite including brush with self lathering device, razor, blades, comb, mirror in a convenient form that every traveler would welcome. Outright or royalty. Garriga, P.O. Box 748, San Francisco 1, California.

MANUFACTURERS. New self using electric hair clipper. Patent for sale, or royalty. Harry King, International Falls, Minn.

HEEL Lift protector, plastic or metal. Good chain store item. Van Sant, 8205 Harford Road, Baltimore, Md.

CASH Or royalty—patented unique sub-zero weather automobile starter circuit switch assembly. Applies twelve volts to starter only, very reliable and successful. Walter St. George, 704—6 Ave. S.E., Rochester, Minn.

INVENTORS: Test the commercial value of your patented or unpatented inventions, quickly and inexpensively. Write for free information. Institute of American Inventors, Dept. 40-B, 1926-Eye St. N.W., Washington 6, D. C.

MANUFACTURING

PLASTIC Fabricating—Any item or quantity. Products developed. Complete engineering service. Plastic Products Co., Dept. PM-1, Box 384, Massillon, Ohio.

INDUSTRIAL Diamonds \$1.50. Products wanted, models, production. Specialty Machine Shop, 2821 Mitchell St., Racine, Wisconsin.

MODELS—Small lot manufacturing. Metals, plastics, etc. Milburn, Burlington, Kentucky.

MODELS AND MODEL SUPPLIES

FLYING Helicopter—Instructions—Complete kit \$2.00. M. De Pauw, Helicopter-club, Babylon, N. Y.

MORTON 5-Cyl. 1/2-hp. radial model-plane engine, almost new. Weighs 12 oz., \$55.00. Beard, Box 1115, Lancaster, Penna.

BUILD Desk model famous landing craft diesel engine. Simplified (exploded) plans: 35c. Vetsmodel 22, Athens, Ohio.

LANDLOCKED Sailors! Here's a beautiful, richly illustrated, fully descriptive catalogue of famous model ships—whalers, slavers, corvettes, etc., authentic in every detail. Send for it today. Only 10c. Marine Model Company, Inc., Dept. C-13, Halesite, Huntington, N. Y.

GAS Motors. Ohlsson, Herkimer Forster, Rocket, Merlin, Vivell, Thor, etc. Wilco, 4608 1/2 N. Kedzie, Chicago 25, Ill.

MODELS—New catalog and order form. Almost 500 kits. Planes, ships, vehicles, accessories, 10c. Corristan Model Sales, Dickerson Run, Penna.

SHIP Models and yacht supplies complete. Large 64 page catalogue 25c. Bill Wild's, 510 East 11 St., New York City.

BIG Illustrated model engine catalog 10c. Active Products & Supply Co., 53 W. Jackson, Chicago 4.

GAS Engines, aircraft, ship, army vehicle models. List 10c, refunded first order. Hobby Center, 3324 E. Tenth St., Indianapolis 1, Ind.

BUILD Complete miniature circus 1/8" scale. Cage wagons, pole, baggage, callope, band wagons, 75c to \$1.25. Lions, tigers, giraffes, camels, elephants, bareback riders, cowboys, horses, drivers, tightrope girls, girl acrobats, spectators, attendants. Tents, main show, side show with banner line, menagerie. Illustrated literature 10c. Circus, 32 Main Street, East Orange, N. J.

MODEL Kits, all metal, list 10c. A. Lohley, Mt. Prospect, Ill.

MODEL Gas, Diesel or steam engines built to your specifications. Jet propulsions, experimental work or model of your invention built by experienced experts. Strictly confidential. Work guaranteed. Prices reasonable. Modelmaker, 114-111 229th Street, St. Albans 11, New York.

BRASS, Copper, aluminum, stainless steel, monel. List 10c. Hobby Supply House, Box 2014, Pittsburgh 30, Penna.

AIRPLANE Model kits, ship models, gasoline engines, accessories. Send stamp for catalog. Grove Hall Hobby Shop, 639 Warren St., Boston 21.

HI-SPEED Miniature four cylinder steam engine. Assembled or partly finished engines in production. Stamp for circular. Inland Marine Company, 7817 Grove Ave., Webster Groves 19, Missouri.

RAILWAY Models, complete line, informative catalog, HO and O Gauge, 79 pages, 25c. Walthers, 247 Erie, Milwaukee, Wisconsin.

MODEL Airplanes, Gas models, solid models, gliders, gas engines, ship models, supplies. Tools. Send 25c (includes refund coupon) for 68 page 8 1/2 x 11 illustrated model airplanes and gas models master catalog. General Modelcraft Co., Dept. M-3, 91-17 173rd Street, Jamaica 3, N. Y.

HIGH Speed model steam engines. Descriptive literature 10c. R. Looker, P.O. Box 105, Michigan City, Ind.

SHIP And yacht model fittings and blueprints. Hundreds of items to choose from. Send 25c for new illustrated catalog. A. J. Fisher, 1002 Etowah Ave., Dept. M, Royal Oak, Mich.

STEAM Engines, boilers, castings, blueprints, circulars 10c. Anton Bohaboy, 2297 Price, Rahway, New Jersey.

MINIATURE Steam locomotives, 1/4", 1/8", 3/16" scales. Castings, parts, rail thorough drawings with instructions. Catalog 25c. Little Engines, Wilmington, Cal.

CATALOGS (Illustrated) for modellers! Airplanes, 60 page book on solids. Features construction data, specifications, camouflaging, 15c; railroads: 128 page "HO" guide. Equipment, accessories, fittings, 25c (includes refund coupon). Send coin or stamps for each profusely illustrated catalog desired. Polk's, "Nation's Leading Hobby House," 314-PM Fifth Ave., New York City 1.

SHIP Model kits and fittings. Complete line Fisher model yacht equipment. All Boucher, Fisher, Marine Model and Ideal kits, fittings and blueprints at standard prices. Most complete stock in New England. Send 10c for price list. James Bliss & Co., Inc., 220 State St., Boston, Mass.

BOAT Models. P.T., cabin cruiser, speedboat. Free circular. All Star, 2003 Lincoln Ave., Chicago 14.

HOME CRAFTSMEN

SUEDE-COAT! Luxurious art finish, easily applied to any surface; in twelve colors. Introductory kit—three colors, applicator, adhesive, directions, \$1.00 postpaid including 10c craftsmen's supplies catalog. Technicraft, 1156 Commonwealth, Boston 34, Mass.

35 PATTERNS Of action pull toys, trucks, carts, toy furniture, etc., \$1.00. Continental Homecrafter, 907 Birch, Eau Claire, Wisconsin.

JIG Saw patterns, 10 beautiful, full size patterns postpaid, U.S. \$2.00. Join Pattern of Month Club, \$2.00 year. No C.O.D. Kraft Design Kreamers, 2331 Edwards St., Alton, Illinois.

STEEL Wagon chassis with wheels. Steel kiddie cars complete or parts. Circular free. Paradise Craftmen, Box 98, Bradley Beach, N. J.

FIRST Aid in refinishing furniture. Instructions for walnut, maple and various woods. Indispensable for shop or home. Complete with formula for making finish remover. No lye used. Send \$1 to Mary Thomas, Box 394, Burlington, Iowa.

CATALOG: Patterns plywood novelty furniture, letters, numerals, plaques, frames, weathervanes, silhouettes, lawn ornaments. 100 books and booklets on crafts and hobbies, picture frame mouldings, tools, large line decal transfers. Other lines. Hundreds articles finely illustrated. Write Wo-Met Shop, Ashburn, Ga.

KNOCKDOWN Cedar chest lumber veneers. Free price list. Giles-Kendall, Huntsville, Ala.

MAKE Shell jewelry—for gifts, as a hobby or start a business. Free catalogue and price list. Complete illustrated book of instructions 75c. Florida Shellcraft Company, Box 1840, Sarasota, Florida.

1000 TELUHOW Plans for homeworkers. List 10c. Charles King, E. Kingston, N. H.

INEXPENSIVE Novelty floor, wall, table aquariums. 6 plans \$1.00. Workshop, No. 466, Altona, Manitoba.

80 PATTERNS, 40 Lawn ornaments, 20 novelties, 20 silhouettes. \$1.00. 6 new hanging shelf patterns \$1.00. List 100 other patterns. Modern Woodcraft, Saginaw, Mich.

LEATHERCRAFT Kits, supplies. Leather samples and catalog 10c. Leroy Buckley, 2539 Devon, Chicago 45.

HEMOCRAFT Supplies: Jewelry findings, shellcraft, sequins, plastic, leather, metal, misc. Supplies. Illustrated catalog 5c refundable. Write us your needs. Marcrafft, 208 N. Wells, Chicago 6.

VENETIAN Blinds. "Manufacturing Booklet" \$1.25. Hardware, tape, cord. Catalogue 10c. "Roberta," Gloversville, New York.

\$ \$ 4 U—Lawn ornaments. Six 1946 designs never before marketed. All full size patterns high as 28 inches! Home craftsmen, start now to earn spare time cash by producing new appealing products. Send for free descriptive price list or save valuable time by ordering lawn ornament collection—\$1.00. Five positive action toys—\$1.00 or both for \$2.00 and we will include a free set of full color plates—they eliminate toy painting! Scully-Hall, 92-46 220th Street AD6, Queens Village 8, New York.

REDWOOD—Eureka! (I have found it.) Models will last forever. No deterioration, fire and rot resistant. Termite proof. Smart craftsmen demand the beautiful texture and light working ability that only genuine Redwood offers. Log cuts up to 8' diameter for table tops and lawn furniture. Dimensional Redwood up to 8 ft. shipped in package lots. Send for free price list. Redwood, Box 971, Eureka, California.

MAKE Chairside desk. Period design with patented folding leaf. Holds typewriter. Complete plans \$1.00. Foldadesk, 1904 No. 85th St., Milwaukee 13, Wis.

ENLARGE Plans, drawings, with Enlarge paper. Easier, more accurate than graph-squares. Generous supply 50c. Enlarge, 80 Putnam Circle, Springfield, Mass.

PATTERNS Of household projects. Send postal for list. Nelson Burbank, 5735 Winthrop, Cincinnati 24, Ohio.

CRAFTSMEN—Fast selling, make children and adults lawn chairs. Plans and instructions \$1.00. Summercraft Studio, Newton 58, Mass.

ALPHABET Beads for beadcrafter, shell jewelry, name plates, photographing titles, imbedding in plaster or cement. \$3.00 per hundred. John Grant, 114-111 229th St., Albans 11, N. Y.

CERAMIC Jewelry supplies, bar pins, ear screws, for ceramic and woodworkers, also, glass and sea shell assemblers. Free catalog. Phila. Badge Co., 1007 Filbert St., Philadelphia, Penna.

JEWELRY Accessories and findings. Plastic and metal screw eyes, pinbacks, clasps, chains, rings, etc. Prompt shipping service. Complete lists 10c. Doremby Company, Chisholm, Maine.

COLORED Plastic cements: for laminating or fabricating Lucite and Plexiglas. All colors of the rainbow: red, yellow, orange, violet, bronze, walnut, mahogany, navy blue, sky blue, light and dark green, and clear. Choice of any five with instructions—\$2.25 postpaid anywhere in U.S.A. Price lists of all plastic and supplies with drawings and construction sheets—25 cents. History and complete instruction book with photographs and step-by-step fabricating details—75 cents. B & H Plastics, 1425 Lincoln Blvd., Santa Monica, California.

LEARN Plastic fabrication at home. Instruction sheet with easy to make projects by well-known homecraft designer. Two pounds Lucite, Plexiglas and B-29 Laminate. Solvent cement included. \$1.50 cash or money-order only. \$1.75 west of the Mississippi, postage paid. Practical Plastics, Inc., 615 Broadway, Daytona Beach, Fla.

SHELL Jewelry supplies. Wholesale only. McFarland Plastic Co., Sarasota, Fla.

BUILD And sell lawn chairs. Plans \$1.00. We tell you how and where we sell. The Woodcraft Shop, Danby, Vermont.

JEWELRY Supplies. Shell metal and plastic parts for manufacturing. Free illustrated catalogue and detailed instructions on shell jewelry. Florida Supply House, 415 12th Street, Bradenton, Fla.

WHITTLES—20 Patterns, instructions, X-acto knife, wood. \$1.00. "Old Whittler," 1402 Charles, LaCrosse, Wis.

PATTERNS—Full size for rocking horse, swan rocker, doll stroller, cradle and boy's wheelbarrow. \$1.00 postpaid. Lincoln's Craft Shop, Farmington, Conn.

MAKE IT YOURSELF

BUILD Your own home. Save expensive labor, rent. We furnish complete construction materials estimate. Iron out any problems. 3c stamp brings details. L. F. Post, construction estimator, Box 1225, Clearwater, Florida.

BUILD Concrete block machine. Vibration and hand operated types. Easy, inexpensive. Sell blocks, build home, garage, barn at low cost. Free details. Horne, 206 West Wilder Tampa 3, Florida.

CONCRETE Mixer, efficient hand power, inexpensive from oil drum. Plans \$2.00. A. Mitkos, 8802 Corwin, St. Louis 21, Mo.

COPYRIGHTED Blueprints and instructions makes your lawnmower a gasoline powered machine. Send \$1.00 to Easyway Systems, 284-B State Park Drive, Bay City, Michigan.

INEXPERIENCED? Build your home yourself! My third year showing beginners. Sound construction. No fads. Your labor saves up to 60%. Valuable circular 25c. William Jackson, A.B., 1713 Howard, Port Huron, Michigan.

MAKE And sell leather goods, quarter for details. Palmer, Drawer 643, Asheville, North Carolina.

BUILD Novel lawn sprinkler, two beautiful little planes traveling in circle, spray acts as jet driving planes, 16-inch wing span, easily constructed from our plans, no machine work, ornamental, fascinating, useful, instructions \$1. No stamps please. Larry's Novelty Shop, P.O. Box 1771, Billings, Mont.

BUILD Your own power lawn mower and save \$50. Complete kit of precision factory-made parts and instructions for new-type, three-wheel whirling blade mower. Write B-M Mower Co., Box 66, Blue Mound, Kansas.

DISAPPEARING Wash poles: modernize your back yard this spring. Anyone can make, because no machines are necessary. Material cost is less than standard wash poles. Detailed plans \$1.00 (no stamps). Schengco, Box 1213, Milwaukee 1, Wis.

FLUORESCENT Lights. How to make your own 20 watt lights for less than \$1.00 each. Materials available. Complete, guaranteed, detailed instructions \$1.00 cash or money order. Checks \$1.10. Specialty Sales, Box 1086, Muncie, Indiana.

POWER Saw. Surprisingly simple. Anyone can build it. Cuts any angle. Working drawings \$1.00. J. A. Cross, 394 Raritan St., So. Amboy, N. J.

SOLAR Water heater system. See advertisement Business Opportunities.

AIR Compressor. Build from any automobile engine. High pressure. High c.f.m. output. Detailed prints and instructions \$2.75. Engineering Associates, 1621 North Grismer, Burbank, Calif.

WHEELS For your own construction of wagon, scooter, racer, wheelbarrow and bicycle trailer. Drawings 25c each. 8x2" and 10x1.75" all-metal wheels with puncture-proof tires and ball bearings. \$2.25 per 8" wheel. \$3.25 per 10" wheel. F.O.B. Akron. Send orders to Jim Brown's Toy Co., 868 East Tallmadge Avenue, Akron, Ohio.

METAL Wheels with rubber tire for your own construction of wagon or wheelbarrow for youngsters. 7½" diameter, 9/16" hole for axle. Price only \$1.00 each wheel or 4 for \$3.75. There are many uses for these wheels. Send order with 1/3 payment, balance C.O.D. to H. Dowd, 97 Main Street, South Acton, Mass.

EXPERIMENTERS! Hobbyists! Attention! Now available genuine B-29 bomber blister laminated plastic. Tough, shatter-proof, ½ inch thick, composed of Lucite and Butacite. Cost U. S. government \$1.35 a pound. Valuable for turning toy wheels, etc. Five pound assortment, good workable sized pieces, \$2.00 postage paid. \$2.50 west of the Mississippi. Cash or money-order only. Practical Plastics, Inc., 615 Broadway, Daytona Beach, Fla.

BEAT The heat! Build efficient, inexpensive air-conditioners to suit any space. Large profits selling to homes, stores, offices. Plans, instructions, \$1.00. Imperial, 10237 McQuade, Detroit 6, Michigan.

WATCHES, OLD GOLD, JEWELRY, ETC.

SPECIAL Offer. Genuine silver Air Force wings mounted on heavy metal bracelet. Veterans say they're tops. Only \$2.95. William Henderson, 1231 Roache St., Indianapolis 8, Ind.

WANTED—Old or broken jewelry. Cash paid immediately. Mail gold teeth, watches, rings, silverware, diamonds, spectacles. Satisfaction guaranteed or merchandise returned. Information free. Rose Smelting Co., 29 East Madison, Chicago, Dept. A.

SEND \$2.20 For high grade gents stainless steel expansion watch band. Lowe's, Holland Bldg., St. Louis 1, Mo.

ALARM Clock repair instructions complete, 50c. Clifford Jones, 1210 Dudley, Utica 3, N. Y.

WATCH Repairing. Reasonable, good service, full guarantee. Jos. F. Sroka Bros., 2422 South Drake Ave., Chicago 23, Ill.

GEMS, Precious and semi-precious, all genuine, from world wide sources. Deal direct, no overhead, save money. Catalog 10c. Hill Co., Route 7, Salem, Oregon.

WATCH Repairing: Complete course. Every part of watch fully explained. Many large pictures and drawings. Tools, material. Where to buy. \$2.75 money back guarantee. Park Place Supply Co., P.O. Box 1140A, Houston 1, Texas.

WATCH Repairing easy learned by our home study course. Watch repairers are in demand and are among the highest paid craftsmen today. Write for free information. Houston Chronometer & Watch Co., P.O. Box 5367C, Houston 12, Texas.

JEWELRY Findings, chain, links, etc. Metal and plastic. Send dime for catalog. George Sassen, 154 Nassau Street, New York City.

"JEWELRY, Gem Cutting, Metalcraft." Fascinating designs for hobbies and moneymaking opportunities. New, complete illustrated book covers cutting, polishing, mounting gems, metal, jewelry work, etc. 287 pages, \$2.95 postpaid. Money back guarantee. We supply tools, materials at lowest cost. Modern Technical Book Co., Dept. M2MC, 55 West 42nd St., New York 18.

WATCHES, Materials, tools, jewelry, diamonds—bought—sold. Catalogue. Gales, Box 1000, Chicago.

WATCH And clock repairing—complete practical course in modern horology. 66 illustrated self-instruction lessons. Just out! Low price. Fascinating 100-page illustrated catalog free! Write—Nelson Company, Dept. 8-02, Chicago 5.

RAZORS, BLADES, SHARPENING

WANT Sharp razor? Try Barbers 50 yr. experience with carborundum hone. Always sharp. Smooth shave, 50c. Dept. 2, Box 607, Anaheim, Calif.

TOBACCO, SMOKERS' SUPPLIES

BEAUTIFUL 4½-inch Aluminum plane mounted on ash tray. P-40, \$2.50, P-38, \$3.00. Alexson Co., 740 W. Market St., Lima, Ohio.

CIGARS, 50, Blended, rich flavor, \$4.00, postpaid. S. & E. Co., Red Lion, Penna.

CIGARS—Wholesale and retail. Free price list. Zibar Co., Roselle, N. J.

MAKE Smoking pipes, briar blocks, 50c. Stems, 25c. Michelson & Sternberg, 67 West 44th St., New York 18.

CIGARETTES—Popular brands; minimum 3 cartons. Price \$1.35 per carton, postpaid. Send check or money order. Ace Mail Order Co., East Orange 86, N. J.

TOOLED Leather cigarette case, pack size, made in Old Mexico, \$2.25 including postage and 20% federal tax. Sorry no c.o.d. Southwestern Import Co., P.O. Box 5052, Beacon Hill Station, San Antonio 1, Texas.

CIGARS—Finest quality Porto Rican, five inch londres, \$4.00 box fifty postpaid. Satisfaction guaranteed. Write for special get-acquainted offer on pipe and cigarette tobaccos. Pete Moberly, Box 993, Owensboro, Kentucky.

SMOKING Pipes repaired. Send for price list. The Humidor, 8129 Euclid, Cleveland, Ohio.

SURVEYING INSTRUMENTS

GUARANTEED Factory rebuilt transits and levels for sale (cash or terms) or rent (with purchase option). We will repair, trade, or buy old instruments. Ship prepaid for estimate and valuation. For complete information. Write for list M-24, Warren-Knight Co., (Manufacturers of Transits and Levels), 136 N. 12th St., Philadelphia 7, Penna.

FOR SALE OR EXCHANGE

MECHANICAL Drawing instruments—Veeco 4 piece, compact, precision set, brand new in lined case, value \$12.50, special, \$7.25—Deitzgen 11 piece set, \$10.00—Charvos 9 piece set, \$8.50. Army surplus slide rules, slightly used, 75c each. Hull auto compass, for accurate road direction, brand new, \$2.50. Brand new folding valise knapsacks made of heavy olive green duck, heavily bound and reinforced, repellent to fire or water. Inside 3 large snap fastened pockets, heavy webbed straps, hand and shoulder handles, size opened 22"x54", closed 22" rolled. Useful to hunters, Boy Scouts, hikers and for all traveling use. A \$7.50 value, special \$2.25, postpaid. Forward money with order. No C.O.D. shipments. Public Sports Shops, 13 S. 16th Street, Philadelphia, Penna.

BE Scotch—swap with your neighbor no matter where. Low cost. Write for list today. Traders Exchange, Chittanooga, N. Y.

FOR THE HOME

HOUSEWIVES Parchment dishcloths. Will not absorb grease, dirt. Twenty for \$1.00. Artistic, Plexiglas toilet racks, \$1.25 each. F. De Franco, 16404 Biltmore, Cleveland 20, Ohio.

KEYS Made, any four, \$1.00. One 35c. Wrap well. Superior Service, 101 Brighton, Burbank, Calif.

FREE Illustrated circular of new miniature negro head plaques. Made in Mexico. Expertly hand painted. Happily alive in appearance. Other decorative gifts. Write: Wilshire Company, 2112H West Tenth, Dallas 11, Texas.

ELIMINATE Down-draft, keep the chimney dry. Save fuel. See page 302 March issue. Chimney Umbrella, 1014 Washington St., Hoboken, N. J.

IMPORTED Argentine sheep-skin rugs \$4.95, India Numdah rugs 4'x6' size \$7.95. Mailed free in U.S.A. Altmeyer Home Store, New Kensington, Penna.

FOR SALE MISCELLANEOUS

AUTOMOBILE—Redispark coil booster, \$2. Blocks ignition leaks. Quick starting. Particulars free. Electronic Products, Walbrook, Baltimore 16, Md.

"LUCITE" Clear transparent sheets, rods, tubes. Color transparent, translucent, opaques, phosphorescent sheets. Any amount. Also kits. Manufacturers, craftsmen: send for free price list. Hamilton Plastics, 717 Cedar Lane, Teaneck, New Jersey.

PURE Bristle new paint brushes, one inch, three for \$1.00 including booklet on cleaning. Price on larger sizes sent. Money back guarantee. Harlem Brush Co., 1547 Park Ave., New York 29, N. Y.

THE Lord's coming! Get genuine proofs free. Join world's greatest non-denominational movement. Write International Evangelism, Box 263-X, Duluth, Minn.

ARMY Goods (used). Canteens, cups, covers and Mess kits \$1, set, jeep hats, overseas caps 10c, mask bags 25c, steel helmets \$1, gun slings, holsters 75c, cartridge belts 50c, waist belts 25c, rubber wading boots \$2.50, life suits \$5, portable buzzer phone \$2, spark coils \$3, raincoats \$1, leggings 25c, knapsacks \$1, tool boxes \$1, bolo knives \$3.75, canvas 7c foot. Minimum shipment \$1. No C.O.D. N. Y. Salvage, 144 Chambers St., New York City.

CUTTERS, Dental burs assorted, reclaimed job-lot, \$1.90 per gross. Wolf, 1924 E. Hartlane, Philadelphia, Penna.

WANTED MISCELLANEOUS

WANTED—Blueprint or plans for fence weaving machine; wood lath and wire, regular woven wire, various widths; self feeding, winding, painting. E. C. Evans, 851 South Shilling, Blackfoot, Idaho.

WANT To contact someone who has an article suitable to sell by mail. RFD addresses. C. Updike, 1204½ Wildwood, Jackson, Michigan.

WANT To swap, buy, sell anything? Get National Swappers Guide (monthly). It's crammed full eager swappers, buyers, sellers, coast to coast, and opportunities to swap, buy, sell almost anything under sun. Postpaid 5 months, \$1.00, year, \$2.00, single copy, 25c. National Swappers Guide, P.O. Box 415, Evansville, Ind.

JUSTICE Buys almost anything! List free. 9762 Santa Monica, Beverly Hills, Calif.

WANT Ammunition, .22 shorts. Any amount. Will pay \$40.00 per case. Distance no barrier. Immediate cash. Peerless Vending Machine Company, 220 West 42nd Street, New York 18, N. Y. (Wisconsin 7-6173.)

MERCURY—Highest prices. Free containers. Write. Wholesale Terminal, Norwood, Mass.

MERCURY (Quicksilver). Write for quotation stating quantity. Metallurgical Products Co., 35th and Moore Sts., Philadelphia, Penna.

PERSONAL

FUN! Pretend visiting Indianapolis 500-mile race. 2 postcard views, 25c. 12 for \$1.00. Address, return, we mail. Penn. Novelties, 2150 S. Penn. Street, Indianapolis, Ind.

MONEY Troubles? "Seven Cures for a Lean Purse". \$1.00. Redleg, One Wainwright Drive, Dayton 3, Ohio.

SAFETY Razor blades sharpened, 4 for 10c. Melrose Hone Service, 142-A East Bernice Drive, Melrose Park 3, Ill.

DANIEL Williamson, happy birthday. Please wire or phone collect. Family.

WANTED 1000 Foot sufferers to test custom made research foot balancers at our risk. Amazing foot relief awaits you. Send for free trial offer and free foot analysis chart today. Kindschi Foot Appliance Products, Dept. A3 321 W. Jefferson, Dallas 8, Texas.

AMAZING Mysteries of magic. Stage and parlor tricks. 64 pages. Pictured and explained so you can do them. Send a dollar bill today for your copy. Edition limited. J-T Service, 1216 Park Row Bldg., New York.

FALSE Teeth fit like new. Apply my improved dental plate liner at home easily. Perfect fit guaranteed. Descriptive literature free. No obligation. Dr. C. N. Reese, Dentist, Box 268H, Winnetka, Illinois.

"INSURANCE Man" life insurance agent's amazing experiences told factually and entertainingly in 25,000 word novel. \$1 postpaid. Underwriter Supply Bureau, College Park 1, Georgia.

VALUABLE Papers photocopied 9x12" or less, both sides \$1.00. Crystaloid, 4207 Grandriver, Detroit 8, Michigan.

MEXICAN Law. General practice atty. J. Cenicerros, 1203 Arizona St., El Paso, Texas.

DREAM Book explaining 500 dreams 10c. Kaybee, Crescent Beach, B. C., Canada.

LONDON. Letters mailed 30c, Montreal 25c, any U.S. city 20c. Receiving-forwarding. View cards, souvenirs, books. Brooklyn book, details 25c. Haller, 436 New York Ave., Brooklyn 25, N. Y.

NERVOUS? Bashful? "Fears?" Free, encouraging information. Jno. Englund, Ironwood, Michigan.

VISIT Hollywood by proxy. We send 3 post cards for 20 cents. You address, stamp, return for mailing from Loring Novelty Company, Box 9688, Station 27, Hollywood, California.

MEXICAN Law practice, L. Gonzalez, Box 236, El Paso, Texas.

I Dye suits, coats, dresses, drapes, etc., and G.I. coats, jackets, pants, etc. Lawrence Jacobson, 2825 N. Broad, Philadelphia 32, Pa.

POOR Penmanship corrected—few hours. New-way. Ozment, 9, St. Louis, Mo.

CONSULTING Psychologist. Confidential correspondence. Dr. Haynes, 706 8th, Washington 1, D. C.

HAIR Falling? Dandruff? Write Trichologist, 137 Lewis St., Phillipsburg, N. J.

MISCELLANEOUS

INCORPORATED Association of cost accountants (Inc. in Vic.) (Founded 1933). Designation of members: Fellows F.A.C.A., Associates A.A.C.A., Licentiates L.A.C.A. Write by air for full particulars. H. C. Brierley F.A.C.A., 10 O'Connell St., Sydney, N. S. W. Australia.

GENUINE Radium, self activating dots in transparent tape now available. Glow bright all night, stick on anything hard to find in darkness. Stick on fish hooks or lures, gun sights, dog collars, door bells, light switches, poison bottles. Catch most and biggest fish, get most coons. Send one dollar for ten dots, shipped prepaid. Dial Service, 13601 Blenheim Rd., Cleveland, O.

NEW Homes. Prefabricated; factory-made. Late report. Materials, methods, developments. Brief, factual. Information free. Research, Columbus, Indiana.

NAMES Of new mothers 1c each, year-old children 3c each. Von, 1319 Teneighth Way, Sacramento, Calif.

REVOLUTIONARY Tractor wheel; send dime for working model explaining principle. Land Gear, 211-82nd St., Niagara Falls, N. Y.

REMOVE Sewer roots scientifically. Send \$1.00 for complete information. P.O. Box 748, Minneapolis, Minn.

BLUE Plan booklet. Illustrating 10 small houses. Now 10c. Model Service, 4302 Oak, Kansas City 2, Mo.

"RECEIVE Mail." Moneymaking offers, opportunities, catalogs. Name listed 10c. Ideal Service, 104, Park Ridge, Ill.

WHITE Plaques to paint. Free price list. Graham Co., 4348 Bloomington, Minneapolis 7, Minn.

MAKE Money at home. Experience unnecessary. Twenty "nuggets" sent free. Copyrighted. Unique Service, Box 851-P, Minneapolis, Minn.

FISHERMEN—Catch more fish with a "fishin' gadget". \$1.00 refundable. Selman, 2460-A Quincy, Kansas City 1, Mo.

STAG Book matches, 10 for \$1.00. Logan Novelty Co., Bellefontaine, Ohio.

TATTOOING Outfits—Electric machines, stencils. Steele, 540 Leavenworth, San Francisco.

SOMETHING To swap? Advertise it free. Hurry! Swaplist, Bondsville, Vt.

TRADE Magazines—Business, vocational diversion. Classified directory 3343 publications with complete addresses and subscription rates, \$1.00. Commercial Engraving Publishing Co., 34C North Ritter, Indianapolis 1, Ind.

MAKE Your own Plastoplate printing cuts. Simple, easy process. Plastoplate, Argyle 1, Wisconsin.

DOLLARS. Receive mail. Moneymaking propositions, opportunities, homework offers, small capital business plans, magazines. Your name listed twelve months, 10c. Carter, Box 8-FB2B, Station A, New York 12.

NERVOUS? Bashful? "Fears?" Free, encouraging information. Jno. Englund, Ironwood, Michigan.

A PRINT of a Texan's idea of the map of the United States, 16"x20". Suitable for framing, \$1.00. Downing, 512 Lamar, Ft. Worth, Texas.

GOOD Jobs obtainable in Latin-America. High salaries. Interesting booklet, 3c. Vallesp, New York 13.

INFORMATION. Any subject. The Roxbys, 747 So. New Hampshire, Los Angeles, 5, Calif.

SQUARE Dance instructions, calls, \$1.00. Guide, 111-R, Eureka Springs, Arkansas.

ASTOUNDING Magnets—Small, powerful, permanent. Float in air defying gravity. Operate thru wood, brass, glass. Many uses, toy, stunt, gift, 4 for \$1.00. Also "Magnetic Wand" (4" long) 2 for \$1.00. "Toothpick Magnets" (size of toothpick) 8 for \$1.00. Eljay—Dept P.M. P.O. Box 891, Newark 1, N. J.

CATALOG Covering model railroad supplies and kits in OO- O- HO gauges, still 10c. Lionel and American flyer, new and used list in your gauge for stamp. Trilior Hobbyist, State Road, North Dartmouth, Mass.

WE Will purchase any native wildflower bulbs, plants or seeds—or any unusual saleable novelties, handmade or otherwise. If you have something different or a gadget you would like marketed, we will purchase in large quantities. Nothing too large or small for us to investigate. Write us today. Jo-Bee Co., 1023 Fox Theatre Bldg., Detroit 1, Michigan.

ATTENTION Spray painters. Convert old spray gun to spray any ready mixed paints, method tested, and in use three years. Send \$2.00 for plans. Harry Haisma, Wadsworth, Illinois.

QUIX-ET Cement stops masonry leaks, makes models, grouting, floor leveling hard as rock quickly. 3c stamp for details. 10 lbs. \$1 bill f.o.b. Macs Laboratory, 1528 W. 102 Pl., Chicago 43, Ill.

A SIX Room house \$2800.00, complete, ready for you to move in. Built anywhere. Send card to Low Cost Housing Co., Box 642M, Salem, Mass., for free particulars.

TREASURE Finders and mineral locators by Goldak, the world's largest manufacturer of supreme instruments, are again available. Goldaks have always been the world's champion locators and always will be. Wartime improvements have made Goldaks even better than before. Remember, every Goldak, even our lowest priced model, is moneyback guaranteed to detect buried gold, silver, metals and minerals at greater depth than any other make whatever, regardless of vague claims, price or design. When you get a Goldak you are certain of the finest. Write. The Goldak Co., 1544 W. Glenoaks, Glendale 1, Calif.

GIGANTIC Mails, magazines, samples, listing 10c, three times 25c. Waddell's Directory, 341 East 76th Street, New York 21.

NEW Personalities for old by correspondence. Results guaranteed. Personal development plan free. Write today. Personal Psychology, Incorporated, 1008 Washington Bldg., Louisville 2, Ky.

BUILD Your home as a hobby. No rent. No mortgage. Save 50%. Use spare time. No special skill required. Amazing facts sent free. H. C. Lightfoot, Civil Engineer, Richboro 1, Penna.

FREE—"Amazing New Book"—"Profits From Classified Advertising." Tells how and what to advertise. Be sure to read this book before you invest one cent in advertising. Remember—it's free! Write for your copy now. F. W. Johnson, Classified Advertising Manager, 200 East Ontario Street, Chicago 11, Illinois.

HIGH Class jewelers; manufacturers and exporters of standard popular Tortoiseshell articles, silver filigree ornaments, bone ivory, and various other kinds of the South Pacific Islands souvenirs viz., hand-icraft, necklaces, bracelets, brooches, earrings, cuff-links and buttons, etc. Coco-nuts and different varieties of the rare curios, including loose cat's eyes, sea shells, beads, picture views of the South Pacific. All in silver filigree designs, with cat's eyes mounted. Wholesale enquiries invited. Buy direct and save money. Parcels posted direct to any part of the world. Price-lists on application. Write to South-Sea Islands Souvenirs, G.P.O. Box 309, Suva, Fiji.

PRESERVE Your favorite snapshots, color pix, identification cards or other valuables in transparent, washable, dirt and dust proof plastic seal. Any item sealed in wallet size (approx. 2 1/2" x 3 1/2") only 50c, 3 items sealed for \$1. Enclose correct return address. Plasti-Kov, 7904 Santa Monica Blvd., Dept. PM-56, Hollywood 46, California.

YOU Need no priorities now or ever for Houses of Earth. The ground you stand on is your best building material. Easy to build—insulated against heat and cold. Ratproof—soundproof—termitproof and fireproof, approved, endorsed by U. S. Government departments. Lowest building and upkeep costs. Send today for "Houses of Earth," containing complete building instructions and 18 illustrations mailed upon receipt of \$1.00. A. B. Lee, Box 171, Washington, D. C.

WE Buy, sell, trade anything of value. Agents wanted. Estes, Box 155, St. Matthews Branch, Louisville 7, Ky.

LATEST Mail order propositions from many companies, sent steadily one year, 25c. Geo. Pfeiffer, Hackensack, N. J.

ANYTHING But your wife and kids bought, sold or traded. Satisfaction guaranteed. Farmers & Traders Exchange, Chittenango, N. Y.

EVERLASTING Bronze grave markers, signs, reasonable. Berg, Box 3162-A, Bridgeport, Conn.

IDEAL Gift. Rich hand carved mother-of-pearl lapel pins imported from South Pacific. Handsome fish designs \$2.00 postpaid. Marlene, Box 942, New Haven 11, Connecticut.

DESK Type fountain pen with base, \$1.25 postpaid. General Sales, 320 Ferry, La Crosse, Wisconsin.

MEXICAN Feathered bird pictures. Samples 25c. Large framed picture \$1.25. Particulars free. Foley's, 217 Grafton St., Brockton 6, Mass.

"FREE!" Perfumaire, homes, offices. Hirschfeld's, 130-A East 107th Street, New York.

RECEIVE Mails, samples, moneymaking opportunities, literature. Your name in several mailing lists, 10c. Rogowski, 3415 Broadway, New York 31.

CARPENTERS—Fast! Accurate! Calculator. Simplifies everything. Postcard brings particulars. Box 1414, Great Falls, Montana.

GOOD "Used" self-instruction educational books on all subjects bought, sold, rented, exchanged. Satisfaction guaranteed. Complete information and 100-page illustrated bargain catalog free! Write—Nelson Company, Chicago 5.

TAILORED Homes plan book. Sixty floor plans, one-story houses with your selection of Colonial, English, Spanish, Moderne exteriors, making hundreds of combinations! Price \$1.00. Distributors wanted. H. P. Jones, 486K Brandeis Bldg., Omaha 2, Nebr.

BIGGEST Money in tattooing now! No experience required. Complete instructions with outfits. Send for free literature. Tatuco, 651 South State, Chicago.

SEEK Buried treasure. Methods, mysteries, devices explained. Circulars free. Century Press, Box 151-B, Glen Ellyn, Ill.

"BIBLE Studies." 70 lessons 25c. Bulletin, Box 87, Station H, New York 25.

MEDICAL Laboratory technicians in great demand. We train you in your spare time, in your own home. You can practice while studying. Write for free catalogue. Imperial Technical Institute, Box 973-J, Austin, Texas.

MEXICAN-AZTEC Featherwork tropical bird picture cards. Samples 25c. Bulletin free. Mexican Products Co., 126 No. Main, Tulsa 3, Okla.

LUMINOUS Paint. Best quality. Glows bright blue in dark. 1 oz. each paint and sealer only \$1.39 postpaid. Black Light Products, 450 E. Ohio St., Chicago 11, Ill.

METAL, Mineral locators latest 1946 electronic type ready for immediate shipment. Fisher Research Laboratory manufactured 2 million dollars worth of electronic equipment for the U. S. Army, including some of the finest metal-locators. Experience gained is yours in the best metal, mineral locator. Free 16 page booklet upon request. Fisher Research Laboratory, Palo Alto, California.

HOME BIBLE COURSE
 Simple, helpful, instructive. Study entire Bible under personal guidance of experienced instructors.
TOTAL COST \$3
 includes textbooks, all supplies, regular examinations, certificate upon completing course.
 \$1.00 starts you, or simply request Prospectus
 The Bible Study School 382 VAN HOUTEN STREET PATERSON 1, NEW JERSEY

Now for EVERY WORK SHOP!
NEW Invention Electroplates by BRUSH
Easy to Plate CHROMIUM GOLD, SILVER, NICKEL, COPPER . . . For Pleasure and Profit!
 If you have a workshop—at home or in business—you need this new Warner Electroplater. At the stroke of an electrified brush, you can electroplate models and projects—you can replate worn articles, faucets, tools, fixtures, silverware, etc. with a durable, sparkling coat of metal . . . Gold, Silver, Chromium, Nickel, Copper or Cadmium. Method is easy, simple, quick. Everything furnished—equipment complete, ready for use. *By doing a bit of work for others, your machine can pay for itself within a week.* So make your shop complete by getting a Warner Electroplater right away. Send today for **FREE SAMPLE** and illustrated literature. **ACT AT ONCE! Mail Coupon.**
WARNER ELECTRIC CO., DEPT. H-7
 663 North Wells, Chicago 10, Illinois

FREE Details & Sample!
WARNER ELECTRIC CO., 663 North Wells, Chicago 10, Dept. H-7
 Gentlemen: Send Free Sample and Details to:
 Name _____
 Address _____
 City _____ State _____

AGENTS MAKING \$300 A WEEK SELLING AMAZING NEW PLASTIC FLOOR FINISH . . . ELIMINATES OLD FASHIONED WAXING PROBLEM!
FREE SALES KIT!
 Get in on the ground floor of one of the biggest money makers ever put out! Every home, office, store, restaurant, beauty parlor, church and factory a red hot prospect. Sells on sight. Anyone can apply. Just mop it on. Send for free sales kit today. Exclusive territory. Write our Mr. Thomas today.
FAIRCHILD CHEMICAL & COATINGS CO., INC.
 280 Madison Ave., New York 16, N. Y.

CONSULTANT ELECTRONICS—RADIO—TELEVISION
 Send Me Your Problems for Solution
 Reasonable Rates
LESLIE A. GOULD
 BOX 1151 GREENWICH, CONN.
START YOUR OWN BUSINESS!

Amazing Postwar Development Now Gives You the Opportunity to Make Money Fast!
 Startling scientific discovery, just now becoming available for general use, will enable you to start your own business and reap great profits!
 Plastics, one of the most revolutionizing and rapidly expanding industries, offers a great opportunity to all enterprising men and women. This is one of the few industries in which home manufacturers thrive and prosper. You can start even on a spare time basis in your own home, and expand rapidly into a full time business, paying good profits.
LIQUID MARBLE
 Make LIQUID MARBLE the amazing Plastic, with a thousand uses. LIQUID MARBLE can be poured into FLEXIBLE MOLDS for casting all kinds of artistic and serviceable articles such as: ornaments, novelties, desk sets, paper weights, book-ends, souvenirs, statuary, toys, etc.
FLEXIBLE MOLDS
 Make your own FLEXIBLE MOLDS. The cost is low—in fact, a large sized mold costs but a few cents. Hundreds of casts can be taken from a single mold.
NO EXPERIENCE NEEDED!
 No skill or previous knowledge is necessary. All you do is follow our easy-to-understand instructions.
UNLIMITED MARKET
 The market is literally unlimited. You will find steady year-round demand in your own community. Your problem will not be in selling but in supplying the huge pent-up demand. Moreover, we supply you with names of big buyers for your finished products.
WRITE TODAY
 Bing Products will show you how to start with a small investment and build a permanent, independent, profitable business! Don't fail to grasp this opportunity! Write today for **FREE CATALOG.**
BING PRODUCTS Dept. A3, 88 Broad Street BOSTON 10, MASS.

BARGAINS in WAR SURPLUS LENSES & PRISMS

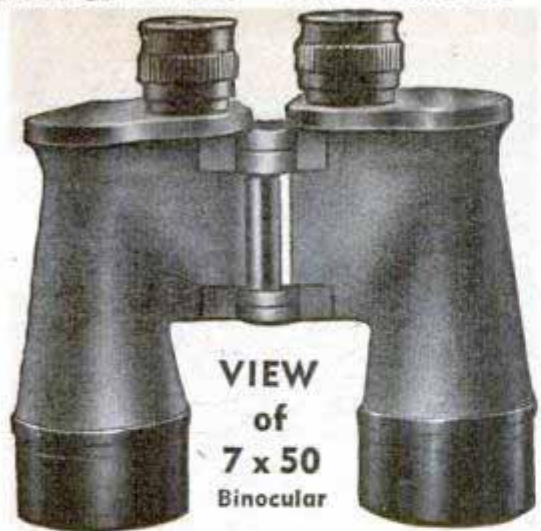

You Can Easily Make Telescopes, Magnifiers, Photographic Gadgets and Hundreds of Experiments with these Low Cost Lenses.

To translate millimeter measurements: 25.4 mm. equals one inch.

SPECIALS IN LENS SETS

Big 10-Page Project and Idea Booklet with all sets.

Set #1-H "Our Advertising Special"—15 lenses for \$1.60 Postpaid. For making your own powerful telescopes, low power microscope, strong magnifiers, drawing projector, photo cells, telephoto lens, dummy focusing camera, Kodachrome viewer, stereoscopic viewer, ground glass and enlarging focusing aids. For experimental optics, portraits of babies and small pets, copying, ultra close-up shots, and many, many other uses.

New 50-Page Idea Book, "FUN WITH CHIPPED EDGE LENSES" Contains wide variety of projects and fully covers the fascinating uses of all Lenses in set listed above . . . only \$1.00 Postpaid.

REMARKABLE VALUE!

\$141.01 WORTH OF PERFECT LENSES FOR ONLY \$10.00

Complete System from Artillery Scope (5X) . . . 9 Lenses, low reflection coated, **absolutely Perfect**. Diameters range from 1-1/3 inches to 2-1/5 inches. Used for making Telescope and hundreds of other uses.

Stock # 5019-H \$10.00 Postpaid

BIG DOUBLE CONVEX LENS—74 mm. diam., 99 mm. F.L. Weighs 9 oz. Made of borosilicate Crown Optical Glass. Used as spot-light Lens, Condensing Lens, etc.

Stock # 1048-H \$1.50 Postpaid

BIG DOUBLE CONCAVE LENS—74 mm. diam., minus 110 mm. F.L. Made of extra dense Flint. Used as reducing Lens, for trick photography, etc.

Stock # 1049-H \$1.00 Postpaid

MICROSCOPE SETS

Consisting of two Achromatic Lenses and two Convex Eye Piece Lenses which you can use to make a 40 Power Pocket Microscope, or 140 Power Regular Size Microscope. These color corrected Lenses will give you excellent definition.

Stock # 1052-H \$3.00 Postpaid

Consisting of Prism, Mirror and Condensing Lens. These used together with Stock #1052-H will make an excellent Microprojector enabling you to get screen magnification of 400 to 1000 Power according to screen distance.

Stock # 1038-H \$2.00 Postpaid

SPECTROSCOPE SETS . . . These sets contain all Lenses and Prisms you need to make a Spectroscope plus **FREE** 15-page Instruction Booklet.

Stock # 1500-H Hand Type Spectroscope . . . \$3.45 Postpaid

Stock # 1501-H Laboratory Type Spectroscope. \$6.50 Postpaid

RIGHT ANGLE PRISM—Flint Optical Glass, size 41 mm. by 91 mm by 64 mm. Use in front of camera lens to take pictures to right or left while pointing camera straight ahead. Also used in front of camera lens to reverse image in direct positive work. Two of these Prisms will make an erecting system for a Telescope.

Stock # 3076-H \$3.00 Postpaid

MISCELLANEOUS ITEMS

Stock No.	Item	Price
16-H	Level Vial, 48 mm. long.	\$.20 each
2024-H	10 Pieces Circular A-1 Plate Glass (Diam. 31 mm.—for making Filter)25
523-H	Six Threaded Metal Reticle Cells.25
624-H	Neutral Ray Filter, size 4 3/4" x 2 1/2"25
22-H	Inclinometer—Aircraft type.25 each
704-H	Lens Cleaning Tissue, one ream (480 sheets) size 7 1/2" x 11"	1.50
1030-H	2" Diam. Reducing Lens.25 each
2043-H	Crossline Reticle—Diam. 29 mm.50 each
1034-H	Burning Glass Lens25 each
535-H	Small First Surface Mirror.30 each
3003-H	Amici Roof Prism with Corrected Roof.	2.50 each
633-H	Combination Polarizing and Infra-Red Filters, diam. 20 mm.50 each

(Minimum order on above \$1.00)

TANK PRISMS—PLAIN OR SILVERED

90-45-45 deg. 5 3/4" long, 2 1/4" wide, finely ground and polished. Perfect condition. Would normally retail from \$24 to \$30 each.

Stock # 3004-H Silvered Prism \$2.00 Postpaid

Stock # 3005-H Plain Prism \$2.00 Postpaid

Illustrated Book on Prisms included FREE.

TANK PERISCOPE

Complete Set Mounted Components

Rugged, strong, originally constructed for U.S. Tank Corps. Consists of 2 fine Periscope Mirrors mounted in metal and plastic. Perfect condition. Would normally retail at \$40 to \$50.

Stock # 700-H \$2.00 Complete Set Postpaid

NOW! MAKE YOUR OWN BINOCULARS!

Complete Set of LENSES and PRISMS from Navy's 7 x 50 Model

SAVE UP TO \$150.00!

Here's an unusual opportunity to secure a fine set of Binoculars . . . at a tremendous saving of money. Build them yourself with all of the very same optics contained in the Navy's 7 Power Glasses . . . the Binoculars which received such wide acclaim during the war. Depending on your choice, you may buy a near perfect set of Lenses and Prisms for the Binocular construction job, or a set of seconds (exactly the same units, but Lenses are un cemented and have some imperfections). If, however, you wish to construct a Monocular (1/2 a Binocular) you may do so, choosing either near perfect components or seconds. The Monocular Sets comprise 1/2 quantities of the same optics required for the Binocular. The full near perfect Binocular Set comprises the following: 2 Cemented Achromatic Eye Piece Lenses, 17.5 mms. diam.; 2 Eye Field Lenses; 4 Porro Prisms; 2 Cemented Achromatic Objective Lenses, diam. 52 mms. Complete assembly directions included, but no metal parts.

Stock # 5102-H Near Perfect Binocular Set. . . \$25.00 Postpaid

Stock # 5103-H Near Perfect Monocular Set. . . \$12.50 Postpaid

Stock # 5105-H Seconds for Binoculars. . . . \$11.00 Postpaid

Stock # 5104-H Seconds for Monocular. . . . \$ 5.50 Postpaid

FLASH! JUST RECEIVED!

We now have Metal Parts and Bodies for Navy's 7X50 Binocular. Complete details sent with all orders for above sets or upon request.

SECONDS IN PLANO-CONVEX CONDENSING LENSES

Stock # 1061-H Diam. 6 1/2", F.L. 9" \$2.00 each Postpaid

Stock # 1068-H Diam. 4-7/16", F.L. 6 1/2"70c each Postpaid

We have a large supply of other seconds in Condensing Lenses for Spotlights and Enlargers—diam. from 3 1/2" to 6 1/2"—priced very low. Write for list!

MAGNIFIER SET . . . 5 Magnifying Lenses . . . Powers from 1 to 10. Various diam. for many uses. **Free Booklet** on Home-made magnifiers included.

Stock # 1026-H \$2.00 Postpaid

OPTICS FROM 4-POWER PANORAMIC TELESCOPE—Excellent condition. Consists of Objective Prism, Dove Prism, Achromatic Objective Lens, Amici Roof Prism, Eye Lens Set (. . . a \$60.00 value).

Stock # 5016-H \$6.00 Postpaid

35 MM KODACHROME PROJECTING LENS SET—Consists of Achromatic Lens for projecting, plus a Condensing Lens and piece of Heat Absorbing Glass with directions.

Stock # 4025-H \$1.95 Postpaid

ALL THE LENSES YOU NEED TO MAKE YOUR OWN TELESCOPE! ALL ARE ACHROMATIC LENSES

GALILEAN TYPE—Simplest to make but has narrow field of view.

Stock # 5018-H 4 Power Telescope. \$1.25 Postpaid

Stock # 5004-H Small 2 Power Pocket Scope. \$1.00 Postpaid

PRISM TELESCOPES—Uses Prism instead of Lenses to erect image. Have wide field of view.

Stock # 5010-H 6 Power Telescope \$3.00 Postpaid

Stock # 5012-H 20 Power Telescope \$7.25 Postpaid

Order by Set or Stock No. • Satisfaction Guaranteed • Immediate Delivery

EDMUND SALVAGE COMPANY, P. O. AUDUBON, NEW JERSEY

HOW TO MAKE MONEY BY MAIL

Down-to-earth facts, directions (illustrated) for running business profitably, using expertly for YOUR good fortune the employees, trains, planes which Gov't places at your disposal CHEAP. Get orders by mail, ship by express or freight or mail, get out of the kindergarten . . . 14th edition, enlarged to 576 pages, now selling. It's YOUR winner. Make this year and the following years worth more. . . . THIS knowledge really PAYS OFF.

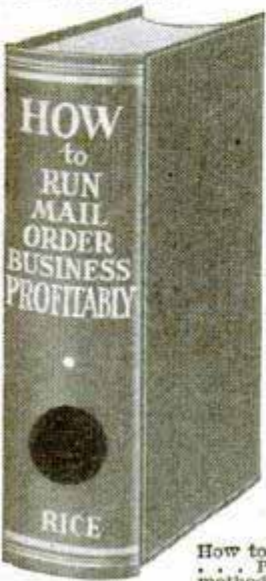

THE EASY WAY to start new or expand your present occupation. Do it NOW. Extraordinary plain, simple skill, know-how. No theory. Fact story of rich experience of author E. Rice day-by-day. How many times have we heard: "I wish I had some money, this patent would earn me a fortune," or "why can't my crop pay better?" or "I wish I knew how to sell this gadget myself," or "why should my boss alone do this when I too know how the money is made?" . . . Listen, you do not need money to start this Rice way. His method automatically pays all bills same day rendered, no bank loans, pay as you go, no borrowing from relatives or friends, no salesmen. Also no worry, quickly a home of your own all paid for. Rice paid off \$5000 in mortgages a year after using this skillful idea.

45 Years of PROOF

Sounds fishy? Sure, but this has been done steadily for 45 years, depression or no depression, by the author; that is why he wrote this book, to pass the good word along. Make it go with anything you have which is salable, or with what you are now doing. Rice made his pay plan go from the start when living in one room in a city lodging house. Turn your city or country home, your work, your hobby, into money. How to get orders coming steadily at cost of only \$4 for each \$100 taken in. The popular error to avoid in trying for sales. Business won free while others have to pay for it.

How to conceive the money-getting advertisement. . . . Profitable changes from ordinary ideas and methods. Not usual cut-and-dried pattern, 165 adventures, a dictated book in everyday talk by Rice doing day by day what he discloses in his book can be done by his method. No dictionary writing. . . . Read how others are profiting big.

Take a chance on this book being worth a fortune to you and yours and send \$2.95. Book mailed same day order is received. Or ask two friends to chip in 98 cents each with your 99c to get this book. Hundreds of buyers whose letters we show you declare emphatically its superlative goodness. Follow its easy pattern for success. Cloth-bound, 576 pages, 8 1/2 by 5 1/2. Best seller, 14th edition now selling. Cut out the \$2.95 HOW BOOK here, pin or stick it to sheet of paper bearing your name and address, mail in envelope with money order or check for \$2.95 to

HOW
\$2.95

HOWARD ST. HOUSE, Melrose 76d, Massachusetts

LAW STUDY AT HOME for PERSONAL SUCCESS and LARGER EARNINGS. 35 years expert instruction—over 108,000 students enrolled. I.L.B. Degree awarded. All texts furnished. Easy payments. Send for FREE BOOK—"Law and Executive Guidance."
AMERICAN EXTENSION SCHOOL OF LAW
Dept. 64-M, 646 N. Michigan Ave., Chicago 11, Ill.

WHEN BOOMS GO BUST
WILL YOU BE BROKE OR BUSY
...in a well-paying GOVERNMENT JOB?
(Thru CIVIL SERVICE)

CAREER TRAINING INSTITUTE will . . .



...prepare you NOW (Men and Women) at home thru broad, intensive, simple training to take tests for good jobs offered in Civil Service. Hundreds of classifications, many jobs for 1946, every chance to advance. Vacations with pay, pensions, sick leaves. No layoffs, no strikes, no discrimination. Our course is so inexpensive, no sensible person should delay mailing coupon TODAY.

CAREER TRAINING INSTITUTE, Dept. 202-A
1060 Broad Street, Newark 2, N. J.

Please send me FACTS regarding Government Employment (Civil Service), and how your course will help prepare me for tests.

Name _____
Address _____
City _____ Zone _____ State _____
Veteran? yes _____ no _____



VETERANS GET PREFERENCE

KILLS RATS OR YOUR MONEY BACK!

EASY
SAFE
CHEAP

New, improved K-R-O Ready-Mixed in Bis-Kit form is effective—it kills rats or your money back.

Easy to use. Nothing to mix. No mess. No bother.

Safe! K-R-O (Kills Rats Only) is a red squill product. Better to use around children, chickens, and farm animals.

Small cost—35c and \$1. Also K-R-O Red Squill Powder, 75c. At most drug, seed, and feed stores. Get K-R-O, today!

FREE "Rat Proofing Buildings and Premises," by U. S. Dept. of Interior. Send for your copy, now. The K-R-O Company, Springfield, Ohio, Dept. 43.

K-R-O KILLS RATS ONLY

CHAPMAN CHINCHILLAS

The originator of the first Chinchilla Farm in the United States. For information on purchasing the finest, selected breeding stock of these aristocratic animals that were virtually trapped to extinction write or visit—

Established 1919 **Chapman Chinchilla Farm**
4957 West 104th Street
Inglewood, California



52 BREEDS MRS. BERRY'S POULTRY BOOK
BERRY'S Champion-Mated, Hand-Picked CHICKS, also SEXED, STARTED, 52 Breeds, 7 HYBRIDS, All Iowa Inspected, BWD Tested, Over 400 Prizes—30 Shows! **LOW PRICES.** In Business nearly 50 years. Beautiful **POULTRY BOOK FREE,** stamps appreciated. **BERRY'S POULTRY FARM, Ex. 29, CLARINDA, IOWA**

WANTED

Home workshops, local shops, mechanics, mechanically inclined men and boys. Use engineering company plans to make and install household and auto utilities. Business of your own, or add to present business. Full or part time. ALSO: JET IMPULSION FOR AUTOS. JET ENGINE EXPERIMENTS. HELICOPTER INFORMATION AND INSTRUCTION KIT. Circular on plans. Rush name.

HOUSTON MAUPIN, Tipp City 12, Ohio

BRUSH PLATING OUTFITS

for re-plating articles in the home and shop. No tanks necessary. Free particulars.
GUNMETAL CO., AVE. M, DECATUR, ILLINOIS

MAKE MORE MONEY

Applying or Selling **ROOF LASTING COATING**

Extra profitable, easy to apply. Exclusive new formula makes this America's best roof coating for felt, composition, steel, slag, iron, gravel, concrete and metal roofs. Definitely superior in all climates, at all temperatures. Act at once!

DEALERS & AGENTS WANTED
Write for Details of Our Proposition



LASTING PRODUCTS COMPANY
MANUFACTURERS OF PAINTS, PUTTIES, PLASTICS
FRANKLINTOWN ROAD PLANT, BALTIMORE 23, MARYLAND

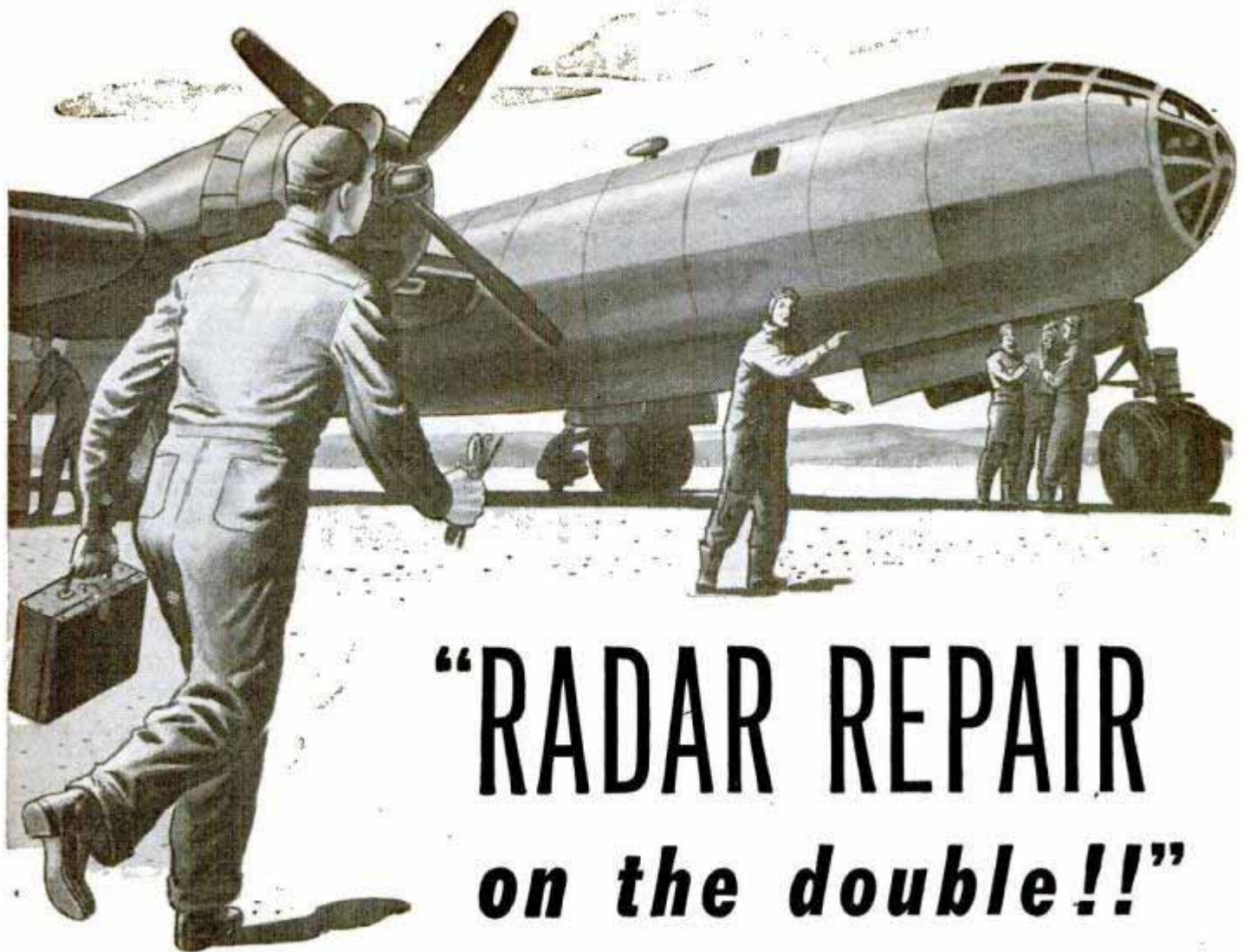

“RADAR REPAIR on the double!!”

• Peace now flies the sky-ways of the world. . . . Who keeps these giants flying? You, the skilled technician. . . .

• The Army Air Forces rely upon men on the ground to keep men in the air. Right now there is a *real need* for radar technicians, control tower operators, teletype operators and repairmen, radio operators, repairmen and mechanics. These are the men who stand watch over the heart, eyes and ears of our planes. . . .

• If you are between the ages of 17 and 34 and have an electrical or mechanical background, the Army Air Forces needs you. Enlist today.

• You will be sent to the finest aviation training schools in the world. Radar, radio, electrical systems, the latest internal combustion engines and jet propulsion are your new fields. And you will *earn as you learn*.

• A private starts at \$50 per month but skilled technicians can earn as much as \$200 per month. You are fed, sheltered and clothed. The finest medical and dental care is free. . . .

• Enlistments are for 1½, 2 or 3 years. You can choose your branch of the service and your overseas theater if you enlist for 3 years. There is 20% additional pay for overseas service and 50% for flight time. You get a 30-day paid furlough every year. There are generous family allowances for the dependents of men who enlist before July 1, 1946. After 20 years of service you can retire at half pay, increasing to three-quarters pay after 30 years of service.

• If you are physically qualified, enlist today. Find out more about this great opportunity to fully develop and use your skills in the Army Air Forces. Go to your nearest Army Recruiting Station today.

SEE THE JOB THROUGH

U.S. Army

BE A

“GUARDIAN OF VICTORY”

U. S. ARMY AIR FORCES

INVENTORS

Do Not Delay

Have you ever been startled by seeing a successful article on the market, and exclaimed—"Why, I invented THAT 5 years ago—I didn't think it valuable enough to Patent!"

The Patent Laws were intended for the Protection of the Inventor, and the Inventor who slumbers on his Rights may wake up to find someone else reaping the reward that could have been his.

Write NOW for Information and Record of Invention form FREE. RANDOLPH & BEAVERS, Registered Patent Attorneys, Columbian Bldg., Washington, D. C.

PERSONALIZED SERVICE — REGISTERED PATENT ATTORNEYS

RANDOLPH & BEAVERS

11-D Columbian Bldg., Washington, D. C.

Please send me full particulars on Patents, fees, etc., and "RECORD of INVENTION" form—FREE.

Name

Street

City

State



Save 1/2

MAKE YOUR SPARE TIME PAY!

Assemble These Beautiful Home Furnishings Yourself NO TOOLS... NO WORKSHOP NEEDED!

Your spare time is worth money! Make these smart, modern furnishings for your home... or as luxurious gifts for your friends! Styled by Paul Hudson Stanley, nationally known designer, these ultrane accessories combine the natural beauty of clear-grained Harvest Oak and the trim lines of sparkling Lucite!

IT'S EASY AND IT'S FUN! A tabletop Hobby! Each beautiful accessory comes in complete Kit form. All parts and materials of selected woods and gleaming Lucite are accurately pre-cut and ready for assembly. Nothing to cut, carve or shape... NOTHING ELSE TO BUY! Step-by-step instructions guarantee easy assembly, beautiful results!

HERE'S HOW YOU SAVE ONE-HALF! Leading stores now feature identical items at assembled retail prices exactly DOUBLE your cost for complete Hobby Kits! You SAVE ONE-HALF... make your spare time PAY by building these articles with your own hands! For Pleasure and Profit... write today for free details of this enjoyable new Hobby!

HOMECRAFTERS GUILD Dept. F-1
360 N. MICHIGAN AVENUE • CHICAGO 1

CRYSTAL CLEAR LUCITE AND GOLDEN GRAIN HARVEST OAK

Say you saw it in Popular Mechanics!

Study ACCOUNTING NOW—For Top-Pay Career

Fewer have trained for Accounting in recent years. Yet government regulations and taxes demand more bookkeepers and accountants. Good opportunity now to enter this growing, well-paying field. After short period of spare-time training, you can take accounting position and continue study on the job. Interesting, free 48-page booklet describes opportunities and requirements in Accounting and tells how you can prepare quickly and at moderate cost. Write for "Accountancy, The Profession That Pays."

LASALLE EXTENSION UNIVERSITY

A Correspondence Institution

417 S. Dearborn St., Dept. 464-H Chicago 5, Ill.

PATENTS

AND TRADE MARKS

C. A. SNOW & CO.

Registered Patent Attorneys Since 1875

Write for Free Book and "Certification of Invention" form

427 SNOW BUILDING, WASHINGTON 1, D. C.

PATENT YOUR IDEAS

SEND FOR FREE BOOK HOW TO OBTAIN A PATENT

Written by Former Member Examining Corps (1922-24) U. S. Pat. Office.

CARL MILLER, Registered Patent Attorney
Former Member Examining Corps U. S. Patent Office

Woolworth Bldg., Dept. 46-A New York — Bond Bldg., Dept. 46-A Washington, D.C.

PATENTS

Free preliminary advice

E. E. VROOMAN, Patent Lawyer

Registered Patent Attorney Since 1902

871 Woodward Building, Washington 5, D. C.

Get Ready for Big After War Opportunities!

I Will Train You at Home Until You Get a GOOD PAY JOB in

DRAFTING

Act now to get a better job with more pay and pleasant working conditions. Get into Drafting—the basic profession where all post war products will start. I will train you at home—give you experience—doing the same kind of jobs you will do with the best paying firms. I furnish instruments, drawing table and all equipment when you start. Write today for vital facts and FREE illustrated book. Give Age.

Engineer Dobe, Div. 14, Libertyville, Ill.

FENCING

EXCITING FUN HARMLESS

NEW—Clean—Healthful
Develops Strong Body—Alert Mind. Become best swordsman in your neighborhood. FREE BOOKLET (with foils) teaches Quickly—Easily. HARMLESS because the 3 ft. Spring Steel Foils (swords) have safety rubber buttons. Complete outfit 2 Steel Foils (swords) and FREE Instructions. Now Only \$1.98 postpaid. MAIL CHECK or M.O. today. Add 28c for Foreign Postage.

LEE PRODUCTS CO., 1613P-First Ave., New York 28, N.Y.

Learn TOOL DESIGN

Now, as never before, draftsmen and tool designers are needed to redesign for peacetime reconversion. Quality quickly. Many making \$100 to \$150 per week. More qualified men needed than available. Good pay jobs waiting. Rush name and kind of job wanted today for full free facts. State age.

OHIO INSTITUTE OF TECHNOLOGY, Box 306, Greenville 1, Ohio

FOOD ROUTE

I'LL START YOU in a...

LOAN ME \$100

Make extra money in full or spare time. Big assortment. Actual full sized packages sent for own use and to show friends and neighbors. Take orders. Big profits. Complete facts rushed to you. Be first in your territory. Rush name on post card.

FOSTER BROTHERS CO.
Dept. 164 Decatur, Illinois



USE OUR CAPITAL

NO SALES EXPERIENCE NEEDED

The biggest opportunity ever, to quickly establish a money-making, lifetime business, now awaits you as a McNess Dealer. Sell things farmers need and use up. Serve same families year after year. Pleasant work--no bosses--easy to do. We supply capital to work on. Also provide offers--advertising--premiums and trade secrets that bring sales.

First to apply get best trading areas. Don't wait--write us today for McNess proposition. Tell us county and state you want to serve. Ask for free McNess Book.

THE McNESS CO., 231 Adams St., Freeport, Ill.

END COLOR BLINDNESS

Over 90% of cases can be corrected. Don't spend your life in a world of gray--with the coming of the air age, color blindness assumes new importance. Most cases report all tests passed easily. New method makes scientific correction available BY MAIL. NO CORRECTION--MONEY REFUNDED. Write today.

COLOR BLIND CORRECTIVE SCHOOL

603 1/2 S. Mariposa, Los Angeles 5, Calif.

LEARN MOVIE PROJECTION THEATRE MANAGEMENT

The Motion Picture Theatre Business offers big opportunities for trained men. Get into a fascinating field with a post-war future. Train at home in spare time. Free Catalog. Established 18 years.

THEATRE INSTITUTE, 370 Washington St., Elmira, New York

MAKE MONEY CASTING AT HOME FREE FACTS SENT



Make hundreds of Plaster Casts, quick, easy. Sell output to stores, novelty shops, etc. Enormous profits. No experience. Very little capital needed. Start in basement, garage or workshop. Complete, simple instructions anyone can follow. Start now while merchants are begging for merchandise to sell. Rush. **PLASTIC ARTS STUDIOS, R.R. 5, Dept. 29, Muncie, Ind.**

RAFTER LENGTHS. A new vest pocket book for the carpenter, estimator. Gives lengths, Side cuts, Plumb cuts. Deductions. For all your rafters to fit any building from one inch wide to forty feet wide. Gives the numbers to cut on the square. Also gives degrees for same cuts for Radial Saws. All standard pitches from 1/4 to 5/8 are given. Just open book to pitch page and there in plain print are your lengths, side cuts, etc. Any one who knows what a jack rafter is can frame a roof correctly if he has this great book. Price one dollar, prepaid.

BUILDERS' TOPICS, Dept. M, Med. Arts Bldg., Seattle 1, Wash. Original teachers of the square in five easy lessons, by mail. Send for FREE list of plan books--Kamp Kabins to Mansions.



HEAR BETTER!

DON'T BE EMBARRASSED

PARAVOX ONE CASE - ONE CORD HEARING AID

All-in-one stylish small case with one cord and ear-receiver. As handy as a cigarette case or a compact -- superb hearing efficiency.

NO SEPARATE BULKY BATTERY CARRIER

Investigate this aid which gives a new outlook on life to the hard of hearing • Designed with watchmaker precision. Gives strong, clear amplification -- wide range in tone. Every set guaranteed for one year against material defect. Priced right.

Try a Paravox -- you be the judge.

SERVICE PROBLEM SOLVED

The new Paravox is built for utmost convenience -- no sending set to factory for service -- no bothersome loan sets. The Paravox organization takes care of your needs if you are a Paravox owner.

Accepted by the Council on Physical Medicine, American Medical Association

PARAPHONE HEARING AID, INC.
2045 East 4th St. Cleveland 15, Ohio



Get this booklet "New Satisfaction from Hearing Aids"



START \$1506 to \$2650 Year

Veterans get special preference

MEN--WOMEN

Prepare now for many 1946 Examinations

32-Page Civil Service Book FREE

Mail Coupon Today--SURE



FRANKLIN INSTITUTE
Dept. P79
Rochester 4, N. Y.

Gentlemen: Rush to me, FREE of charge list of U. S. Government big pay jobs. Send me FREE 32-page book describing salaries, vacations, hours, and full particulars telling how to qualify for these jobs.

Name.....
Address..... Vet?.....

COUPON

GUM GRIPPER

TIGHTENS FALSE TEETH

OR NO COST

Amazing NEW Plastic Reliner

LASTS FROM 4 to 6 MONTHS



NOW—in a jiffy—you can make loose, slipping dental plates fit snug and comfortable. Eat, talk in comfort, laugh freely—for "Gum Gripper" enables you to enjoy that feeling of almost having your own teeth again!

● APPLY IT YOURSELF — AT HOME

"GUM GRIPPER" amazing plastic Reliner tightens dental plates quickly, makes them hold firmly and fit like new! Just squeeze from tube, spread evenly, put plate in mouth, wear it while "Gum Gripper" sets in few minutes. No heating necessary.

● USE ON ANY DENTAL PLATE

"Gum Gripper" will not harm denture or irritate gums. Sanitary, tasteless, odorless. Keeps mouth sweet and clean, prevents sore spots. Application of plastic "Gum Gripper" is guaranteed to last 4 to 6 months—or no cost. Can be scrubbed or washed. Rev. A. J. Wigley, Pittsburgh, Pa., writes: "Best material I ever used. I have not relined my lower teeth for 2 months."

"Best I've Ever Used"

SEND NO MONEY—Order a tube today—it's only \$1.00. Fill out and mail coupon below. You'll be delighted! Satisfaction guaranteed or your money back.

FREE Generous size package Dental Plate cleaner included free of extra cost. Cleanses dental plates without brushing. Will not harm denture.

GUM GRIPPER 127 N. Dearborn St., Dept. 71-M, CHICAGO

GUM GRIPPER, Dept. 71-M, 127 N. Dearborn St., Chicago 2, Ill.

Send me a tube of "Gum Gripper." You guarantee it to satisfy—or it will not cost me a penny.

I will deposit \$1.00 plus postage with postman when package arrives.

Enclosed is \$1.00—You pay postage.

NAME.....

ADDRESS.....

CITY..... STATE.....

WATCHMAKING

Construction, repair adjustment. Your big opportunity. Learn this profitable trade at home through the most reliable book. New complete "PRACTICAL COURSE" for beginners and professionals. All essential steps. Theory, operation. Many test cases. Full coverage of tools, materials. Fully illustrated. Only \$2.95 postpaid. Money back guarantee. We supply tools, materials at lowest cost.

MODERN TECHNICAL BOOK CO. Dept. M3MC, 55 West 42nd St., New York 18

SILK SCREEN PROCESS

A PROFITABLE BUSINESS OF YOUR OWN



PRACTICE in your spare time!
We Send You Complete Kit of Supplies

Silk Screen Processed signs & displays needed everywhere. A lucrative future for you in the great advertising boom. Easy to do—quick to learn—you may make more than course costs before it's completed. BOOKLET with 3-color Silk Screen Processed Cover and samples sent FREE. . . Write now, California School Screen Process, Dept. PMD 2710 S. Spaulding, Los Angeles 16, Calif. 446

A High Profit Business — or a Thrilling Hobby

INTRODUCING-New Victory Model HANDIWELD ELECTRIC ARC WELDER

RETAILS ONLY \$1.95



PLUGS into LIGHT SOCKET

VICTORY Model Handiweld Arc Welder operates from 110 volts, A.C. or D.C. current same as other arc welders higher priced; generates tremendous heat to weld all metals. Not a toy welder that uses carbons, but actually uses standard coated rods—sizes 1/16" and 3/32". Generous quantity of 1/16" and 3/32" rods supplied with the welder. Guaranteed not to burn out. Repairs fenders, auto bodies, radiators, machinery parts, etc. Take Victory Model Handiweld anywhere to job, operate right from light socket. You'll find a thousand uses for this welder around your home, garage, workshop. Also in garages, factories, repair shops, tin shops; mechanics, inventors, plumbers, farmers, etc. Order a "VICTORY MODEL" HANDIWELD today!

SEND NO MONEY We'll rush one to you with rods, helmet, operating instructions, and all necessary parts with the exception of a large jar and small piece of extension cord; these most everyone has. Pay postman only \$1.95 plus few cents p'st'ge. If not delighted return Victory Model Handiweld in 5 days from receipt and money paid for it will be refunded promptly. Rush your order now.

KUMFY PRODUCTS, Dept. G-202, Cincinnati 25, Ohio

★ ★ **500 PERSONAL LABELS** Only **50¢**

COMPLETE NAME AND ADDRESS PRINTED ON EACH!

500 Personal Labels, only 50c Postpaid! Two-colors—handsome blue printing of your complete name and address on attractive white gummed label paper! Use on letters, envelopes, postcards, checks, books, tools, egg cases, etc. HUNDREDS OF USES! Wonderful for those in Service! Order today! FAST SERVICE. Limited supply. Money-back Guarantee.

WESTERN STATIONERY CO., Dept. 473-D, Topeka, Kan

SELL 15 OF THE MOST BEAUTIFUL GORGEOUS MOTTOES



Send no money, we trust your honesty. Sell 15 Beautiful Mother's Day and Religious Mottoes at 25c each. They are one of the world's fastest 25c sellers, they sparkle like diamonds. Size 7x11 inches. Just say send me 15 Assorted Mottoes to sell, and after you have sold all 15 send us \$2.25 and you keep \$1.50. Most everyone sells the entire 15 Mottoes in less than an hour's time.

J. L. COLLINS, 920 W. Manchester St., Lexington 40, Ky.

WHY WEAR DIAMONDS

When diamond-dazzling Zircons from the mines of far-away mystic Siam are so effective and inexpensive! Thrilling beauty, stand acid, true backs, full of FIRE! Exquisite mountings. See before you buy. Write for FREE catalog.

National Zircon Co., Dept. 20 Wheeling, W. Va.

Catalog FREE!

Burn Your Name On Tools Electro Name Etcher

PROTECT valuable tools from thieves and tool borrowers! Electro Etcher BURNS your name, any design, permanently on tools, instruments, dog collars, any metal. Easy! Simple as writing with pen or pencil. Rush order today—supply limited—no more when these are gone! **SEND NO MONEY!** Pay postman \$1.00 plus few cents postage on delivery. Use 5 days—money back if not delighted. Electro Etcher, Dept. F-600, Strader Ave., Cincinnati, O.



THE UNIVERSAL GUIDE

TO

FREE PUBLICATIONS

Keeps you informed regularly of free publications on the following:

- BUSINESS**
- CRAFTSMANSHIP**
- NATURE**
- SCIENCE**
- WORLD AFFAIRS**

(AND OTHER SUBJECTS)

Each monthly issue contains over 100 listings which are obtainable FREE OF CHARGE, thus enabling you to build your own personal library of valuable publications. The cost of this service is only \$1.00 A YEAR or \$2.50 FOR THREE FULL YEARS!

SEND FOR YOUR FREE SAMPLE COPY NOW!

Research Publishing Company

622-K Penfield Bldg. Philadelphia 7, Pa.

LAW...

STUDY AT HOME Legally trained men win higher positions and bigger success in business and public life. Greater opportunities now than ever before.

More Ability: More Prestige: More Money We guide you step by step. You can train at home during spare time. Degree of LL.B. We furnish all text material, including 14-volume Law Library. Low cost, easy terms. Get our valuable 48-page "Law Training for Leadership" and "Evidence" books FREE. Send for them NOW. **LASALLE EXTENSION UNIVERSITY, 417 South Dearborn Street A Correspondence Institution Dept. 464-L, Chicago 5, Ill.**

HERE'S A QUICK WAY TO MAKE A GOOD LIVING

Train at home thru our easy to learn courses, self-instruction and educational textbooks. Learn Refrigeration, Radio Servicing, Drafting, How to operate a Retail Store, Advertising, Engineering, Business Management, Aviation, Electricity, Diesel, and many others. Earn more money—be praised by others for your accomplishments, have more leisure and security for old age by knowing How-To-Do-It. Details in our FREE Opportunity Guide. We will also include a special list of FREE trade magazines, bulletins, booklets, information manuals, etc. FREE.

Write—HARRIS PUBLICATIONS, HARRIS BUILDING, MAHOPAC 2, NEW YORK

BE A PUBLISHER....



Your own business! We write, print your OWN Instruction Folders for 10c each... you sell by mail for \$1.00—Start spare time, at home. Send \$1.00 for complete plan. Money back if not pleased. Details free. E. H. Hill, Box 681, Fall River, Mass.



CARTOON TO SUCCESS!

Learn to cartoon! Big pay! Easy, enjoyable work! Cartoon course, gag course, anatomy course and business course full of plans, markets, ideas. Drawing set and criticisms. All one low price! Rush card for details! **HARTMAN SCHOOL, 2438 W ST., LINCOLN 3, NEBRASKA**

Fun and Mystery

OUR KIT of Professional MAGIC POCKET TRICKS will enable you to AMAZE and AMUSE others for fully 25 minutes. FOOL ANY—\$5.00 ONE hour after kit arrives. Guaranteed.

MARIAN DAY'S MAGIC STORE

811 Davis St. Evanston, Ill. "Chicagoland's Largest"

Your Idea Is Worth Money Whether your idea presents a problem in electrical, mechanical or civil engineering, let us solve it for you at a price you can afford. Complete engineering service—plans, investigations, research, reports. Write for FREE estimate. **JACQUES & FINDLAY, CONSULTING ENGINEERS Com'l Div., Zobel Bldg., Red Bank, N. J.**

OTTAWA TRACTOR SAW



350 CUTS PER MINUTE

Make money sawing wood. Use Ottawa—fastest cutting. Cuts large, small logs easiest way. Fells trees. One man operates. Thousands in use. Built to last with heavy, stiff saw blade. Positive safety clutch control: uses power take-off any tractor.

OTTAWA MFG. CO., D-427 Forest Ave., Ottawa, Kan.

FREE BOOK and Price List

FREE!



The famous 64-page, fact-packed book that has stimulated thousands of men!

"Forging Ahead in Business" is a practical, thoughtfully-written book with "punch" and common sense on every page. It carries a message of vital importance to every man who wants to make more money, get a better job and improve his station in life.

Partial Contents:

- Law of Success
- Highway of Achievement
- Forging a Career
- Making Decisions
- Organized Knowledge
- Failure and Success

Noted Contributors

Among the prominent men who have contributed to the Institute's training plan, which is described in "Forging Ahead in Business," are: Thomas J. Watson, President, International Business Machines Corp., Clifton Slusser, Vice President, Goodyear Tire & Rubber Co.; Frederick W. Pickard, Vice President and Director, E. I. du Pont de Nemours & Co.

Simply return the coupon below, and your FREE copy of "Forging Ahead in Business" will be mailed to you.

MAIL COUPON TODAY

ALEXANDER HAMILTON INSTITUTE
Dept. 409, 71 West 23rd Street, New York 10, N. Y.
In Canada: 54 Wellington Street, West, Toronto 1, Ont.
Please mail me, without cost, a copy of the 64-page book—"FORGING AHEAD IN BUSINESS."

Name.....

Firm Name.....

Business Address.....

Position.....

Home Address.....

BANG! with the Repeating G-BOY CAP PISTOL

ALL METAL — SILVER FINISH

- Shoots 50 caps automatically
- Rapid firing
- Looks like a real '45



De Luxe Model 7" Long

- Explodes with a "Bang"
- Actually smokes when fired
- Holds a 50 Cap Roll—easy to load
- Full sized plastic hand grip

ORDER NOW--SATISFACTION GUARANTEED

Enclose \$2.50 for G-BOY REPEATING CAP PISTOL and 20-50 Cap Rolls (1000 shots)—shipped express charges collect. Better include \$1.00 additional for 40 extra Cap Rolls (2000 shots). Satisfaction GUARANTEED!

GAMCO, 215 W. Illinois St., Dept. PM-4, Chicago 10, Ill.

PISTOL \$1.95 ONLY
PISTOL and 20-50 Cap Rolls \$2.50
EXTRA CAPS 40 Rolls (2000 Shots) \$1.00



Why be an ABCEDARIAN*

25c

*Webster says it's a tyro, a beginner, a novice, i.e., one who hasn't read Hodgman's 1946 Handy Book of Sportsmen's Secrets—the latest, biggest issue, sparkling with 198 pages of authentic, little known outdoor tricks—bulging with facts, crowded with dope on how to cram your creel and garnish your game bag. Order your copy now—it will be off the press soon. Only 25c—or a special DeLuxe edition for \$1.00.

HODGMAN RUBBER CO.
 Paul St. Framingham, Mass.



PLUMBING REPAIRS made EASY

This handy book is written for the man who likes to work around the house, yet is not sure he is doing right. This big book shows you how to repair every bit of plumbing in your home. Saves many dollars. One job more than pays for book. 248 pages, many illustrations and diagrams. Money back if not more than pleased. Send today . . . only \$2.50.

Only \$2.50

Send Today, Money Back Guaranteed

Gateway Book Co., Dept. P.M.-16-B
 32 N. State - Chicago 2, Ill.

FOR MOPPING FOR WAXING

FOR CLEANING RUGS

FOR WALLS FOR WINDOWS

FOR AUTOS

48" Long Handle

Hands Never Touch the Water—Can be put in Boiling Water. Housewives Like It.

... Quick Easy Way to BIG PROFITS

Read What Others Are DOING!

"Enclosed you will find 56 orders representing 9½ hours' work on Monday and Tuesday."
 "Enclosed are twelve orders secured after supper this p.m."

2 BIG SELLING PLANS

Sales are easy under TWO BIG SELLING PLANS . . . You can take Individual C.O.D. Orders from sample . . . Or you can buy in quantity and make your own deliveries . . . Distributors and Agents tell us they sell in 7 out of 10 calls . . . Housewives are enthusiastic.

• We Teach You How •

Gets down under and around for MOPPING, DUSTING or WASHING

DOES THE WORK OF 6 TOOLS IN 1

Get Choice Territory NOW!

Holds 20 times its weight in water.



Sales QUICK, EASY Every Locality

SALES ARE EVERYWHERE . . . Sells quick to Taverns, Clubs, Hotels, Hospitals, Stores, Restaurants, Large and Small Buildings and the Homes . . . Scores can be sold on a single street . . . Note the Drain Bracket in the illustration . . . This squeezes out the water so thoroughly that HANDS NEVER TOUCH THE WATER . . . Makes no difference what you ever sold, you will like this proposition . . . Your name on a Post Card will bring you FREE PARTICULARS.

CELL-U-MOP CO., Dept. P-4, FREEPORT, Ill.

1 DOLLAR BILL 1
Brings You
HUNDREDS OF HOBBY IDEAS FOR
FUN and PROFIT

How to have fun and make money at the same time—that's the good news you'll find in PROFITABLE HOBBIES, a monthly magazine that specializes in true stories of other people's paying hobbies. Just one issue may give you an idea that will add hundreds of dollars to your income. Send \$1.00 today, to PROFITABLE HOBBIES, 5077 Westport Station, Kansas City 2, Mo., for a four-month's trial subscription. After reading the first issue, if you don't agree that you're getting your money's worth, your dollar will be returned.



BUILDING HUMAN STATURE

"I grew 6 inches in a year through following instructions given in 'BUILDING HUMAN STATURE,'" says the younger man at left. "Now I am a head taller than my father."
 If you wish you were taller send for FREE outline of this remarkable book loaded with practical information.

CARILLON BOOKS, Dept. 15, Boerne, Texas

MOTOR RACING with MERCEDES-BENZ

Sensational book of Grand Prix Racing. 176 pages, includes 93 world's finest action race photos. Famous speedways, cars described. See and read about Caracciola, Rosemeyer, Seaman, Von Brauchitsch, Ruesch, Mays, Nuvolari, Fagioli, Chiron, Lang, others. Photos Mercedes-Benz, Auto-Union, Alfa-Romeo, Bugatti, Maserati, E.R.A., others. Graphic, thrilling race incidents. Postpaid, \$2.00; De Luxe cloth-bound, \$3.00.

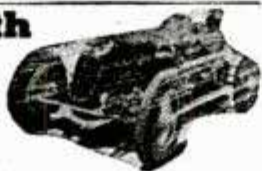

CLYMER, Dept. PM, 2125 W. Pico St., Los Angeles 6, Calif.

The SLIDE RULE

And How to Use It

Send for your copy now. Big book. 8 1/2 x 11 in. Cloth Bound. Slide Rule in case in book cover.

Wilcox-Follet Co., Dept. 24, 1255 S. Wabash Ave., Chicago 5

10 INCH SLIDE RULE FREE WITH EACH BOOK

Send for this sensational slide rule book and FREE Slide Rule now. Learn in a few hours to do lightning calculations. Do all problems. Find ratios, percentage, squares, areas, etc. Genuine Mannheim type Slide Rule with A, B, C, D and K scale and Lucite Magnifying Indicator included. Send only \$2.98 for full payment today or order on post card for C.O.D. delivery. Money back if not satisfied. Limited quantity. Rush Order.

SILVER DOLLAR SIZE

SELL BIBLE SOUVENIR
 METAL COINS, LORD'S PRAYER, ONE SIDE; JOHN 3:16 on THE OTHER—Quick Easy Sales—Very attractive pocket piece. Quantity Price \$6.00 per 100; \$27.50 per 500; \$30.00 per thousand. Don't Wait. Order Today. Sample Order 15 Coins with Display Card, \$1 Postpaid. LOUIS LE VITE, 21 E. Van Buren St., Dept. P4, Chicago 5.

200 MONEY MAKING IDEAS

Business plans. Rare formulas and trade secrets. Mail order tips. Facts—Success Schemes. Startling exposes. Unusual items. Large descriptive folio DIME. Particulars FREE. Write FORMICO SERVICE, BOX 572 PM, Dayton, Ohio.

LAWN ORNAMENT-NOVELTY PATTERNS

28 Lawn Ornament Patterns, 25c. Other patterns; 15-20" high; Dutch Girl, Dutch Boy, Pirate, Bull Terrier, Mexican Girl, Mexican Boy, Dwarf, Penguin, Flower Girl, 10c each. 25 Novelty Patterns, 30c. All 62 Full Size Patterns, \$1.00 Postpaid. Brother Pattern Service, Dept. E-8, Box 363, Belington, W. Va.

Practical Electricity and House Wiring



Discusses common electrical devices, principles of circuits, wires and insulation, grounding, fuses and circuits, wiring methods, planning installations, installing switches, fixtures, etc., wiring houses after they are built, alterations and additions, wiring farm buildings, home repair, etc. 200 pp. 227 illust.

C.O.D. \$2.25 Send Today, Money Back Guarantee Postpaid \$2.00
 The GATEWAY BOOK CO., Dept. PM-16-A
 32 N. State — Chicago 2, Illinois

YOUR OWN BUSINESS IN YOUR OWN HOME!

Start a big-profit business in your basement or spare room—repairing all makes of Vacuum Cleaners and other electrical appliances! Prospects are tremendous because new appliances are hard to get and everybody's old ones need repair! It's easy to fix 'em with the parts and tools we supply. We have huge stocks of parts on hand for all vacuum cleaners and appliances. You order as you need them—or send us the appliance and we repair for you at wholesale prices!

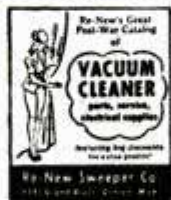

New 68-page catalog with wholesale prices on vacuum cleaner parts, service and electrical supplies. It's yours FREE—just mail coupon.

Send coupon for FREE Catalog with Wholesale Prices!

Re-New has helped thousands start in business, for thirty years! Don't let this chance to make easy money slip through your fingers! Mail coupon NOW! Get catalog by return mail! When available, we will have new and guaranteed rebuilt Vacuum Cleaners for you at wholesale prices! You'll be first in your town! Re-New Sweeper Co., 9591 Grand River Ave., Detroit, Michigan.

Re-New Sweeper Co., 9591 Grand River Ave., Detroit, Mich.

Please send me, without obligation, your free catalog. I am anxious to start my own appliance-repair business.

Name.....
 Address.....
 City..... State.....

LEARN WATCH & CLOCK REPAIRING At Home



STEADY WORK • SECURITY • HIGH PAY

Prepare yourself now for this fascinating high-grade occupation. You can earn while you learn. This UP-TO-DATE COURSE IN HOROLOGY shows you how to get the practical working experience you need for big-time success. THOROUGH SELF-INSTRUCTION TRAINING in American and Swiss watches, clocks, etc. Interesting LEARN-BY-DOING teaching method makes lessons easy. No previous experience necessary. Watchmaking is BASIC TRAINING for many scientific and mechanical precision jobs. Amazing low price. Satisfaction or money-back guarantee. Get into this fast-growing field NOW... big opportunities. Mail coupon for free information.

LOCKSMITHING & Key Making

Practical modern course for self-instruction. How to pick locks, de-code, make masterkeys, repair, install, service, etc., etc. For carpenter, fix-it shop, service station operator, hardware dealer, gunsmith, mechanic, home-owner, 53 easy illustrated lessons. Mail coupon for free details.

Practical ELECTRICITY

Quick course for men who demand how-to-do-it practical facts. Covers house-wiring, generators, storage batteries, telephones, lighting equipment, telegraphy, welding, etc. 55 lessons at surprisingly low price. Satisfaction guaranteed. Mail coupon below for complete interesting details.

SHORT-CUT Mathematics

How to be a "master mind!" This 2-in-1 self-study course teaches how to juggle figures, do baffling tricks with numbers. Also teaches practical mechanics... for every technically minded man who wants to get ahead. Used by stage magicians, expert accountants, etc. Only \$1. See coupon.

FREE! 100-PAGE BOOK! Mail this Now

NELSON CO., Dept. 2002, 1139 S. Wabash Ave., Chicago 5, Ill.
 Please send me—free and without obligation—big illustrated Success-Catalog containing complete information about subject (subjects) checked below. (No salesman will call).
 Watch & Clock Repairing Practical Electricity
 Locksmithing & Key making Short-Cut Mathematics
 Name.....
 Address.....

New HOSPITAL and SURGICAL POLICY

Protects Whole Family

Costs Only 3c a Day for Adults

Only 1½c a Day for Children

IT'S HERE! The new Family Hospital and Surgical Policy that insures whole family—mother, father, children, anyone now in good health, age 3 months to 65 years. Provides CASH to help pay for these bills: for hospital room and board up to 90 days for each Insured person in any one year; for other hospital expenses, such as medicines, X-ray, operating room, etc.; for doctor's fee for operations. Money Paid Direct to you—you select your own doctor and hospital. This special-value Policy issued at family group rates by Sterling Insurance Company, the reliable company with over \$2,000,000.00 surplus for policyholders' protection. Investigate! Send no money, but mail the coupon below quick for 10-day Trial Offer. No agent will call on you. There's NO OBLIGATION. ACT TODAY!

STERLING INSURANCE CO.

A-4867 STERLING BLDG., CHICAGO 11, ILL.

Send me 10-Day Trial Offer of LOW-COST Family Group Plan for Hospital and Surgical Insurance.

Name.....

Address..... Age.....

City..... State.....

Check here if you want details of new Life Insurance Plan at ½ cost for first 5 years.



Cowboy Spinning Rope

Such as I have used professionally for over 20 years plus complete book of instructions. Post- \$325 paid anywhere in U.S.A.

DICK NASH, 50 Florida Ave. N.E.
Washington 2, D. C.



FOOT PAINS STOPPED or Your Money Back!

Wear Guaranteed Proved ARCH-HEELERS in any shoes for aching feet, metatarsal pains, callouses, corns, weak arches. Must please you or Your Money Back! Specially shaped with soft cushions to gently lift bone joints, release nerve pressure, free blood circulation, align entire foot. Springy Air cooled Comfortable Users delighted "I wouldn't take \$5 for mine!" say many. Only \$1 a pair. Send price with order or will ship C. O. D. plus postage. State shoe size Money back if not pleased after 30 days.

ARCH-HEELER CO., Dept. 1 550 Council Bluffs, Ia.

HOW TO SIZE UP PEOPLE FROM THEIR HANDWRITING

Learn how to do it, in less than an hour, by reading my 32 page book on the subject. Fun at parties. Very practical in business. Send 50 cents in coin or stamps for book to

LORNE A. MILNE, HANDWRITING PSYCHOLOGIST
1710 Orrington Ave. Evanston, Illinois, U.S.A.

INS AND OUTS OF INSIDE BASEBALL

Vol. I—OFFENSIVE PLAYS—Vol. II—SCIENCE OF BATTING—Fully illustrated with (16) BASEBALL DIAMOND CHARTS—(41) pictures MAJOR LEAGUE STARS—NAMES AND LINE-UPS BIG LEAGUE CHAMPIONS—HALL OF FAME STARS. Books have (44) pages (each). 6"x9"—12,000 words (each)—3-Color paper bindings. Material is unique, detailed, authentic and product of author's 30-years' study and research. Price (each). \$1.00 Postpaid

NAME.....STREET.....CITY.....STATE.....

AMERICAN NATIONAL GAME, 1 South Fourth St., Columbus 15, Ohio

5 SECRETS... OF WINNING GOLF



Easy to Learn "Dynamic Swing" Every Pro Uses

PLAY IN THE 70's. Enjoy your game. Amaze your friends. Get out of the "dub" class by using golf's most powerful and accurate swing. Five basic secrets give you rhythm and power, eliminate hook and slice... make you MASTER OF EVERY CLUB. Easy to make long drives and beautiful approach shots. Learn in a few days—10 minutes' practice a day. COMPLETE COURSE NOW ONLY \$1.00 postpaid, or \$1.00 plus 24c for postage and C. O. D. fee. Your money back if you're not amazed with results, so order NOW!

THE SYLVAN COMPANY 125 Seventh Ave., Dept. L, LaGrange, Ill.

CARTOONING



BECOME CARTOONISTS QUICKLY with our NEW, EASY, 45 LESSON COURSE. Only \$2.85 postpaid. Sample LESSON PLATE, details on our FREE EMPLOYMENT SERVICE and BIG TRIPLE VALUE OFFER sent FREE. Rush name and address TODAY.

NATIONAL ARTISTS BUREAU

Dept. A-7, Box 4248* Dallas 8, Texas



makes False Teeth TIGHT

Makes loose dental plates fit snugly and comfortably. LASTS for MONTHS!

Simply squeeze on dental plate and put it in your mouth. Hardens and becomes part of plate. Money-back guarantee.

FREE Generous package of Dental Plate Cleanser with each order. Send \$1.00 or mailed parcel post collect.

Fit-Rite Co., 1573 Milwaukee Ave. Dept. 4P.M., Chicago, Ill.



CHANITE SELF-WELDING FLUX

REPAIRS ALL ELECTRIC HEATING ELEMENTS

So simple anyone can make repairs in your broken or burnt-out electrical appliances—irons, toasters, stoves, etc. Guaranteed nothing like it. From our mines to your appliances. \$1.00 per package. \$7.50 per doz. Stick form 25c. \$2.00 per doz. CHANITE SALES COMPANY, 914 So. Main, Fort Worth 4, Texas

SIGN MEN EARN WELL

Tremendous demand always for glass and electrical sign men. Post war expansion assures growing need for more sign men. Only small investment required to start own business. Write today for full FREE particulars. SIGN SERVICE, 5944 Newark, Dept. S-101, Chicago 31, Ill.



THIS BOOK SHOWS HOW TO DO IT

STEEL SQUARE POCKET BOOK

Completely Revised

This concise and handy little book illustrates and describes the best methods of using the carpenter's steel square in laying out all kinds of carpentry work. It is easy to understand as a picture of the square laying directly on the work shows exactly how the various cuts are made. Its compact and handy size makes it convenient to carry in the pocket for quick reference.

Price \$1.00 Postpaid

POPULAR MECHANICS PRESS

DEPT. 627 200 E. ONTARIO, CHICAGO 11, ILL.

Be Your Own Boss . . .
GET INTO PLASTICS



LEARN
Plastics
Fabrication & Casting
For Financial Security

START AT HOME-SMALL CAPITAL NEEDED
Start your own Plastics business . . . with small capital . . . at home. Grow with this giant industry as you increase your "know-how" and skill. Plan now for your own business or prepare for exciting post-war Plastics jobs. Our revolutionary teaching plan covers production phases of fabrication, casting, cementing methods, mold making, compounding, dyeing, etc. You actually work with many types of Plastics materials. We supply everything. Check information desired. Home Training. Resident Course in Plastics Eng. Send this ad with your name and address in envelope or paste on 1c postcard to Dept. PM

VETERANS: Check here for special information
Plastics Tech. School of America, Inc.
5200 Euclid Avenue CLEVELAND 3, OHIO



CHERISHED PICTURES PRESERVED FOREVER

New EVERBRIGHT process congeals picture to glass protecting it from moisture, dust, and sunlight. Your most cherished photos can now be preserved FOREVER. Send picture or negative. We will send you an exact copy, black and white, mounted in a beautiful 5"x7" Lucite frame for only \$5. (\$2.50 with order, balance C.O.D.) or write for folder.
PHOTOGRAPHIC SPECIALTIES CO.
DEPT. M, BOX 29, COUNCIL BLUFFS, IOWA

The ALL-PURPOSE ARC WELDER



Weld, braze, solder, preheat any type metal. Full size (75 lb. shipping wt.) 110 volt A.C. arc welder for home work shop, garage or small repair shop. 125 AMP output. Fully equipped. **\$45**
FORNEY MFG. CO.
FORT COLLINS COLO.

THERE'S MONEY IN CARTOONS!

RAYE BURNS will teach you HOW to CREATE ORIGINAL CARTOONS at home that you may SELL! Course contains 26 lessons and over 600 illustrations. All for Only **\$285**
Send name and address for free details.
RAYE BURNS SCHOOL, Dept. M, Box 3583, CLEVELAND, OHIO

YOU CAN MASTER MATHEMATICS

Key to the Electronic, Atomic age. Mathematicians in great demand. \$200 to \$500 per month. Literature free.
O-UNIVERSAL SCHOOL OF MATHEMATICS
623 Walter Story Bldg., So. Broadway, Los Angeles, Calif.



BE YOUR OWN BOSS! MAKE MORE MONEY

\$1.00 VALUE
25¢
68 PAGES
40,000 WORDS
In "CASH IN" you get ALL the real money-makers—dozens of profitable tested mail order plans, confidential business secrets, dozens of practical tested formulas, successful tested schemes—actual experiences of men who have started on a shoestring—with less than \$10 capital.
25c a copy postpaid. Send U. S. stamps, money order, or coin.

MONEY BACK GUARANTEE
NATIONAL PLANS COMPANY
P. O. Box 26A, Station N, New York 23, N. Y.

Become a
Diesel
SPECIALIST



When you become a specialist—a man with technical training—you automatically increase the demand for and the value of your services. This is especially true in the field of Diesel where technical knowledge is of utmost importance.

The Diesel engine, as a low cost power factor, has become increasingly important in commerce and industry and the development of new uses for Diesel power during war years has been speeded several decades. This means new and greater opportunities for men and young men who realize that now is the time to become a Diesel specialist.



In ships, buses, trucks, railroads, tractors, factories and virtually every industry, new installations are being set up daily—and each new installation means the creation of new employment opportunities which private industry must bring into being to avoid unemployment similar to that which followed the first world war.

This is your opportunity to get ready—yes, to assure yourself of interesting, worthwhile employment in times when a steady job, at good pay, means so much to one's personal security and well-being.

TRAIN AT HOME

Under the Hemphill System of Home Training you can easily master the fundamentals of Diesel operation, repair, service and maintenance without giving up your present work or income. Eighteen years of practical teaching



experience have gone into the development of the Hemphill System of Home Training. Individual lesson assignments, profusely illustrated and written in simple, everyday language, show you how to operate, repair, service, and maintain popular types of Diesel engines, and special emphasis is given to fuel systems, installation of auxiliary equipment, servicing of accessories and other details. The Hemphill System of Home Training has been completely revised to take advantage of all the new wartime developments.

VETERANS—SERVICE MEN
Find out how you can obtain Hemphill Diesel Training under the G. I. Bill of Rights.

ACT NOW . . . BE READY FOR OPPORTUNITIES AHEAD



Find out about the Hemphill System of Diesel Home Training . . . new booklet gives full information . . . mail the coupon today for free copy.

HEMPHILL DIESEL SCHOOLS
New York • Chicago • Memphis • Los Angeles

SEND THIS COUPON TODAY

HEMPHILL DIESEL AND AUTOMOTIVE SCHOOLS
P. O. Box W, Eagle Rock Station
Los Angeles 41, Calif. Dept. PM-4
Please send free booklet and information about your Diesel Home Training, without obligation.

Name _____ Age _____
Address _____
City _____ Zone _____ State _____
 Veteran In Service Civilian Under 18

Little Library of Useful INFORMATION

5 for \$1.00
12 for \$2.00
25¢ Each

Here at amazingly low cost is the practical help and information you have always wanted. Articles in previous issues of Popular Mechanics have been classified according to subject and are now available in these handy reprint booklets. Check Titles wanted, clip ad and mail today.

BOOKLETS ON WORKSHOP EQUIPMENT

- Power-Driven Saws—74:** Complete details on scrollsaw, two circular saws, sliding cut-off saw, bandsaw.
- Drill Presses, Plane, Grinders—79.**
- Sanders—80:** Complete constructional details on 8 useful machines.
- Wood & Metal-Turning Lathes—81:** Two wood lathes, small metal-turning lathe.
- Filing Machine, Hacksaw, Cutoff Wheel, Shaper—82.**
- Metal Lathe Tools You Can Make—101.**
- Workbenches & Tool Cabinets—47.**
- Spray Painting—84:** Constructing spray guns, compressor, using spray gun.
- From Pattern to Casting—91:** How to make your own patterns and small castings.

BOOKLETS ON SHARPENING—USING TOOLS

- Correct Measurement—106:** How to use micrometers, gauges, calipers, etc.
- Tool and Saw Sharpening—92.**
- Using & Sharpening Drills & Wood Bits—90.**
- Successful Wood Turning—32:** All the information you need to master this art.
- How to Read Blueprints—71:** Tells you how to understand signs, symbols, and lines.
- Metal Turning Lathe Kinks—99:** Simple homemade tools, time and labor-saving shortcuts you can use.
- Operating a Metal Turning Lathe—100.**
- Heat Treating & Case Hardening—102.**
- Working with Glass—103:** Cutting, drilling, etching, blowing.

ELECTRICAL BOOKLETS

- Rewinding & Servicing Electric Motors—73:** Repairing and rewinding a.c. and d.c. motors. Locating trouble. Converting auto generators into 110 v. a. c. motors.
- House Wiring—89:** All the information you need to do a complete wiring job or install extra outlets.
- Electromagnets & Solenoids—44:** Designing and building.
- Transformer Construction—41:** Easy-to-understand instructions for all kinds of transformers.
- The Boy Electrician—43:** Easy-to-build motors, experiments.
- Soldering & Brazing—17.**
- Arc & Spot Welders—5:** Building and operating 110 v. a. c. arc and spot welders.
- Treasure Finders—13:** Build your own treasure finder and metal locator. Details for both large and small radio types.

ELECTROPLATING BOOKLETS

- Electroplating with Copper, Nickel, Chromium, Lead, Zinc, Cadmium—86.**
- Plating Leather & Other Non-Metallic Objects—Plating with Gold, Silver, Alloys—87.**

HOME IMPROVEMENT BOOKLETS

- Simple Home Improvements—104:** Modernizing; making storm sash, ironing boards, etc.
- Building Extra Rooms in Attic—23.**
- Attractive Basement Playrooms—24.**
- Lower Your Fuel Cost—31:** Practical kinks that will save you hundreds of dollars.
- Hanging Wallpaper—38:** Tricks of hanging wallpaper, removing old paper, etc.
- Curing Leaky Basements—45.**
- Fitting Home Game Room—55:** Construct own game & tennis tables, shuffleboard court, action game, portable playrooms.

- Widding the Home of Insect Pests—107:** Exterminating and protecting against moths, flies, termites, mosquitoes, etc.
- Built-in Fixtures—78:** Step and space-saving kitchen units, built-in beds, corner cabinets, vanities, linen chest.
- Constructing Indoor & Outdoor Fireplaces—88:** Stone fireplaces, portable mantels, garden fireplaces.

GARDENING BOOKLETS

- Backyard Gardening—39:** Selecting, planning and getting the best results.
- Lawn & Garden Novelties—72:** Jig-sawed ornaments, parkway numbers, sundials, flower boxes.
- Trellises, Pergolas, Fences—76.**
- Lawn & Garden Furniture—77:** Modern bent-tube furniture, arbor and seat combinations, swings, lawn chairs.
- Playground Equipment—73:** Two playhouses, ferris wheel, roller coaster, treadmill, play store, slide, two merry-go-rounds.
- Colored Concrete Garden Furniture—8:** Garden benches, pottery, flower boxes, bird baths and sundial pedestals in colored concrete. How to build small concrete mixer.
- Bird Houses—7:** Easy to build homes for all kinds of birds.
- Farm & Garden Tractors—8:** Two tractors you can build from old automobile parts.

CRAFT WORK—HOBBY BOOKLETS

Complete how-to-make-it instructions for hundreds of practical projects.

- Working with Plastics—61:** Using brilliantly-colored plastics in craftwork.
- Magazine Racks—49:** Ten attractive racks.
- Clock Cases—50:** Large Hall, Colonial wall and mantel, ship's wheel, miniature grandfather, desk, Spanish style banjo.
- Serving Trays for Every Occasion—53:** Fourteen different designs.
- Children's Room Furniture—51:** Twelve attractive pieces.
- Book Ends—52:** Ten designs offer good selection.
- Small Tables—54:** Modern and colonial styling.
- Smoking Stands—56:** Seven designs given.
- Jigsawed Novelties—57:** Sewing kits, string holders, place-card holders, plywood kitchenware, plant and flower holders, coin banks, door stops, drawer pulls.
- Desks—58:** Colonial writing desk, two modern-type desks, student's study desk of plywood, combined chest and writing desk.
- Book Cases—59:** Eight designs.
- Doll House & Doll Furniture—60.**
- 25 Shelves You Can Make—64.**
- Novelties Turned on Lathes—62.**
- Inlay Pictures—Veneering—63.**
- Whittling and Wood & Soap Carving—65.**
- Action Toys—66:** 21 easy-to-make toys.
- High Flying Kites—67.**
- Windmills & Weathervanes—68.**
- Lamps in Wood, Metal, Plastic—69:** Selection of 14 designs.
- Metal Craft—28:** Brass tapping and making of novelties both decorative and useful.
- Small Looms—37:** Building hand looms for weaving rugs, etc.; leather novelties.
- Plain & Novelty Wood Finishing—40.**
- Gem Cutting—42:** How to cut and polish semi-precious stones.

BOAT BUILDING BOOKLETS

Build a boat at home—you can do it

- 14 Ft. Outboard Runabout—2:** Here is a fast 14 foot V-bottom boat. Suitable for motors of 4 to 24 hp., estimated cost, \$30 to \$40.
- 14 Ft. Sailing Dinghy—26:** This 14-foot boat combines strength and light weight. It carries 140 sq. ft. of canvas and weighs about 350 pounds. Actual photographs and diagrams illustrate every detail.
- 21 Ft. Sloop—46:** Every fact needed by the amateur boat builder to construct this craft which carries eight to ten persons.
- Rowboats, Bicycle Boat, Small Dinghy—83:** All the information you need to construct four low-cost boats.
- Small Sail Boats—84:** 12-ft. sailing dinghy, 6-ft. "training ship" for young sailors, how to sail a boat.
- Two Outboard Runabouts—85:** 14-Ft. family outboard weighs about 400 lbs. and 12-ft. plywood outboard weighs about 110 lbs. Both are V-bottom type.
- Build Your Own Canoe, Kayak, Surfboard—30:** Complete details on 16-ft. Canadian-type canoe, 17-ft. kayak, and 12-ft. hollow surfboard.
- Fast Class-E Ice Yacht—22:** Build your own Class-E ice yacht. Every detail of construction carefully explained.

AUTOMOBILE BOOKLETS

- Automobile Kinks and Shortcuts—10:** Money-saving hints on upkeep and operation.
- Building Trailers—27:** Small Streamlined house trailer; several utility trailers.
- Motor-Driven Midget Car & Scooter—34:** Both use gas engine of washing machine type.
- Curing Auto Electrical Troubles—95.**

PHOTOGRAPHY BOOKLETS

- Save Money by constructing your own photo equipment.
- Photo Enlargers—1:** Condenser lens type; simple vertical; horizontal.
 - Photo Printers & Dryer—25:** Describes three practical printers, timer and negative dryer.
 - Photo Darkroom Equipment—96:** Cabinets, light-tight box, timer, agitator, washer, trimmer.
 - Picture Projector, Trick & Table Top Photography—97:** Projectors that enlarge magazine illustrations and shop drawings. Tips for table toppers, photomontages, tricks.
 - Photo Kinks—98:** 63 time and money-saving ideas you can use.

FORMULA BOOKLETS

- Transform simple ingredients into useful products
- Cleaning Preparations—11:** Easy-to-make cleaners for walls, glass, etc. Removing fabric stains.
 - Cosmetic Formulas—12:** Hand lotions, creams, rouge, bath salts, beauty clay, lipsticks, etc.
 - Re-Silvering Mirrors—70:** Formulas for silvering and coloring.

MISCELLANEOUS BOOKLETS

- Knots and Ropework—105.**
- Chemical Experiments—93:** Easy-to-perform experiments. Inexpensive lab.
- Taxidermy—9:** How to prepare skins and obtain life-like poses.
- Log Cabins & Tourists Cottages—14:** Year-round log cabins; inexpensive tourists' cabin.
- Magic for Everybody—29:** Simple tricks to puzzle your friends.
- Trapping Small Animals—33:** How to lure fur bearers, prepare bait and traps, dress skins.
- Tricks of Training Your Dog—35.**
- Small Furnaces—36:** Build own gas or electric.

POPULAR MECHANICS PRESS,
 200 E. Ontario St., Chicago 11, Ill.

I enclose (U. S. bills may be mailed if carefully wrapped)
 for "Little Library" booklets numbers:

.....
 Name
 Address Zone.....
 City..... State.....



YOU

IF WERE A HARDWARE DEALER

... your favorite customers would be active, alert men with eyes wide open for new ideas ... men who use their heads and hands to create and improve ... men who read *Popular Mechanics* and have the "P.M. MIND."

Your hardware dealer knows that you are just that kind of man. He knows he doesn't have to tell you the importance of *quality* when you're buying tools and other hardware items. You learned that a long time ago.

Whatever you're shopping for, it's got to be good or you won't spend your

money. Your hardware dealer appreciates that—and likes you for it—because he's quality-minded himself.

You can always count on your hardware dealer to have in his store the latest and the best of all the thousands of products in his field. And he can always count on you to know a good thing when you see it.

**YOUR HARDWARE DEALER sells QUALITY Tools and Hardware
... BUY FROM HIM**

**POPULAR
MECHANICS**

IF  **FALSE TEETH SLIP OR DROP**

USE REFIT MAGIC PLASTI-LINER
MAKES ALL PLATES FIT PERFECTLY OR PERMANENTLY MONEY BACK

ONE APPLICATION LASTS FOR LIFE OF PLATE

PLASTI-LINER is a professionally developed re-liner for home use that ends forever the mess and bother of temporary applications that last for only a few hours or a few months. It is NOT a paste, nor a powder; but a strip of genuine dental plastic!

SAFE AND EASY TO USE

PLASTI-LINER is non-toxic, pure, non-irritating, harmless, odorless, tasteless, smooth, molds to mouth. No heat necessary. Just 3 easy steps.

"Excellent Results" say users

"I bought your product over a year ago. Have had no trouble with my plates since. I have told my friends and now all of us with false teeth use PLASTI-LINER. It really works." Mrs. E. S., Brooklyn, N. Y.

FREE! Our competent staff dentist will answer all your plate problems.

SEND NO MONEY — ORDER TODAY

PLASTI-LINER CO. Dept. 53
 617-619 Main St., Buffalo 3, N. Y.

Rush PLASTI-LINER with complete directions. I will pay Postman \$_____ plus postage charges. I may return package for refund if I am not satisfied.

\$1 for UPPER or LOWER \$2 for Both

Name _____

Address _____

City _____ Zone _____ State _____

You Save Postage by Enclosing Money

SAY YOU SAW IT IN POPULAR MECHANICS

Electric Heating Element

FLUX

Repair burned out electric elements of coffee urns, electric stoves, flat irons, toasters, and other electrical appliances. Simply apply Christy Electric Heating Element Flux to the break, turn on the current and PRESTO the job is done and your appliance is ready again for years of satisfactory service. Generous size package (enough to repair 50 elements) sent postpaid for only \$1.00.

ELECTRICAL APPLIANCE REPAIR PARTS

- RENUALL Iron element. Guar. 1 year. Package of 6.....\$3.12
- Toaster element forms. Clear Mica. Fits most toasters. 10 for. 1.80
- Heating element wire 10 ft. coiled 3/4" O.D. No. 20..... 2.55
- Heating element wire 10 ft. coiled 3/16" O.D. No. 22..... 1.77
- Appliance cord. Rubber covered. Stranded copper wire. 100 ft. 4.50
- Ribbon element heating wire. Std. size. 100 ft..... .75
- Percolator elements. Universal. Flat type. 1 yr. guar. 2 for.. 1.20
- Element cement. Withstand 3000° F. 1 lb. pkg. \$1.00, 5 lb. pkg. 3.50
- Lead wire. Asbestos covered heater hook-up wire. 10 ft..... 1.00
- Iron Cord Sets with complete plug attachments. 10 for..... 5.00
- Carbon brush set. Assorted. 104 brushes, 15 springs. Complete set 3.00
- Screw removers. Complete set 6 removers, 6 drills, 3/8" to 1" . 4.20

APPLIANCE REPAIR TOOLS & SUPPLIES

- Bearing tools. Enable you to install all sizes motor bearings from 1/2" to 1 1/2" O.D. Complete with 7 adapters and instructions. \$ 6.69
- Adjustable Reamers. High-speed steel blades. Complete set of 11 reamers ranging from 8/32" to 27/32"..... 38.00

Here is your opportunity to save on repairing your own appliances and to earn extra money repairing appliances for friends and neighbors.

CHRISTY SUPPLY COMPANY
 2835 N. Central Ave. Dept. T-150 Chicago 34, Ill.



THIS IS DIFFERENT!

A collection of the greatest, modern money making projects you ever imagined it possible to obtain. Copyrighted 1946, and created to meet to-days conditions TO-DAY. FOLDER OF AMAZING facts FREE.
 R. P. MOREY, 067 Somerset, Springfield 8, Mass.

Real Relief

for Rupture Sufferers!



The Web Truss has brought comfort to thousands of satisfied users. Enthusiastic letters tell us it gives the wearer **real relief**. Scientifically shaped to do the job, made of strong washable materials, the

Web Truss gives the **RIGHT** support WHERE **NEEDED**. Satisfaction **GUARANTEED**.

Write for **FREE** descriptive literature, or ask your druggist about the Web Truss.

The **WEB Truss Co.**, Dept. M18, Hagerstown, Md.

WANT A GOVERNMENT JOB?

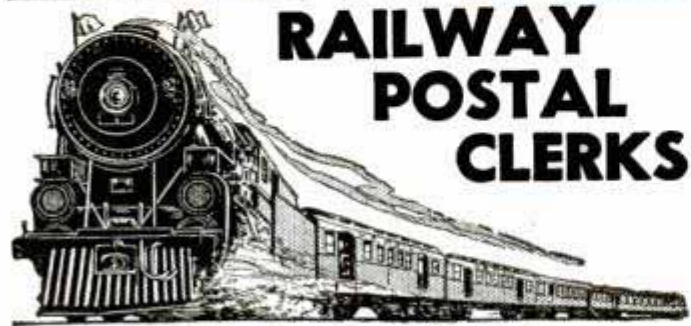

RAILWAY POSTAL CLERKS

City and Rural Carriers—Postoffice Clerks—Inspectors — Accountants — Stenographers — Typists — Many other Government Jobs.

\$1,506 to \$2,650 First Year

Prepare now for Coming Examinations

FRANKLIN INSTITUTE Dept. P86 Rochester 4, N. Y.

Sirs: Rush to me, without charge, copy of 32-page book, "How to get a U. S. Government Job," list of positions, and full particulars telling how to qualify for them.

Name.....

Address..... Vet?.....

WHAT'S YOUR HOBBY?



1. IT'S FUN TO DRAW

A Complete Self-Instruction Course in 9 Divisions of Art

Anyone who has learned to write can learn to draw! This helpful book removes the mysticism that has surrounded art. By reducing the elements of drawing to its simple steps, it teaches THE BEGINNER to draw, and then to advance into more difficult subjects. For the practiced artist, it is a source book and veritable mine of information. This book guides you from the first stroke on paper to selling the finished work. Includes specific instruction, advice, tricks, on—Still Life, Animals, Human Figure, Art Anatomy, Faces and Portraits, Lettering, Layouts, Cartooning, Advertising and Commercial Art, Illustrations, Color in Art, etc., etc. Profusely illustrated with over 1000 SKETCHES and DRAWINGS. **SPECIAL \$1.00**

2. A SMALL BUSINESS OF YOUR OWN

With Capital Investment From \$100 to \$2,000 By Harold S. Kahn

A comprehensive survey containing 1,000 tried and proven ways for the individual having little or no capital to build a modest, dependable business. The plans set forth are true reports of the various ways in which thousands of men and women right now are earning money by their own initiative. CONTENTS include:—BE YOUR OWN BOSS (with 98 different small businesses described and explained), GET A CIVIL SERVICE JOB (how to go about getting a lifetime government job), BEST POST WAR JOB OPPORTUNITIES (with information on the newest industries), A FARM OF YOUR OWN. START A MAIL ORDER BUSINESS. 200 SPARE TIME IDEAS. **PRICE \$1.00**

3. CRAFTSMAN'S INSTRUCTION HANDBOOK

Here are more things to make and do than have ever been crammed into a single volume at this low price. From a simple metal ashtray to a 9x12 hooked rug, 250 projects in paper, leather, glass, metal, wood, fabric, plastics, and clay are clearly explained with equipment needed. Simplified working drawings and step by step instructions make it very easy to turn out beautiful finished handicraft that everyone is sure to admire. Full instructions in batik, basketry, carving, etching, jewelry, metal craft, stenciling, and sixteen other crafts. Shows you how to make albums, moccasins, toy furniture, dog leashes, ash trays, gloves, jewelry, waste baskets, lamp shades and hundreds of other useful and artistic articles. **PRICE \$1.50**

4. BUILD IT YOURSELF By Michael Rothman

Even if you've never handled tools in your life—you can follow the simplified picture-directions in this helpful book. For it guides you through the ABC's of every basic step and process right to the finished job. And so easy you can't possibly go wrong, thanks to its clear easy-to-understand, non-technical language. Hundreds of practical projects, ideas and suggestions for building such things as window seats, cupboards, closet fittings, panels, bureau drawers, boxes and chests, benches, magazine racks, bookshelves, trick stuff (folding bar, secret compartments, etc.) and scores of other useful and important devices found in every home. Full instructions in painting, lacquers, stains, shellacs, etc. Important information on how to buy lumber, tools, etc. **\$1.75**

5. HOUSES FOR HOMEMAKERS

By Royal Barry Wills

(America's foremost architect of small houses) Whether your dream home is as modern as tomorrow or in traditional American style, you will want it to be comfortable, up-to-date and convenient. Royal Barry Wills gives you the advice you need, whether you plan to spend \$2,500 or \$12,000 for your new home. Contains 50 plans and sketches of complete homes—100 hints for home builders from choosing the site to papering walls, illustrated from the architect's scrapbook—10 pages of details, complete drawings of finishing touches that make a house a home. Also advice on forthcoming designs, gadgets, materials, heat, bathrooms, kitchens, etc. **\$1.00**

6. METALCRAFT & JEWELRY

By Emil F. Kronquist

The primary purpose of this book is to acquaint the reader with the metals and methods used by the craft worker—silver, brass and copper. This book gives complete and unusually clear instructions for making and designing beautiful jewelry, decorative and useful objects. Complete instructions, and designs for the making of: brooches, pins, rings, bracelets, chains, candlesticks, letter openers, desk sets, etc. Also includes instructions on: Wire drawing and Wire Work—Soldering Stones & Metals—Hammered Work—Raised Work—Metal Coloring etc. Little equipment is required and this hobby can easily be mastered by **\$2.75** any careful worker. **PRICE ONLY**

7. THE ART OF WHITTLING

By Walter L. Faurot

Whittling toys and queer things out of wood is an ancient pastime and a wholesome one. For twenty or more years the author of this book has been collecting information on whittling. Simple instructions, illustrations and patterns for starting you off on such favorites as:—Toys—Animals—Puzzles—Fans—Ship in Glass Bottle—Movable Wooden Scissors—Trick Puzzles—Interlocked Hearts—Wooden Chain, etc. Any whittler or would-be whittler will find this book full of stimulating suggestions and practical instruction. **PRICE \$1.50**

8. GLASS AND GLAZING. Directions for working with glass in windows, mirrors, etc. Tells how to cut glass, reset window glass, and resilver mirrors. Fully illustrated. **\$2.00**

9. DECORATIVE WROUGHT IRON WORK. Simple but unusual attractive designs, tools and methods for making votive lights, door knockers, latches, andirons, etc., from wrought iron, brass and copper. By one of the leading craftsmen in the field of art forging. **\$1.00**

10. BOATS, AIR PLANES, AND KITES. The best flying and sailing models for any boy to make. Model yachts and motor boats, basic aircraft models, and various kites, with full instructions and discussion of use for each model. **\$2.50**

11. FUNDAMENTALS OF MACHINERY. Describes and explains such basic elements and ideas as atoms, matter, motion, liquids, gases, solids, force, gravity, measurement, etc. Explains clearly how scores of different machines such as the automobile, Diesel engine, steam engine, hydraulic press, jet propulsion, etc. work. 188 pages, 40 chapters and only **50c**

12. WATCHES. An up-to-date, useful and interesting book dealing with modern methods of repair, adjustment, and timing. **\$2.50**

13. SELF INSTRUCTION IN THE PIANO. You will play a song in half an hour. **\$1.00**

14. QUICK FREEZING. Gives all necessary information on function, purchase and operation of your home freezer; tells how to prepare and package for freezing and storage all kinds of meats, fruits, vegetables, syrups and juices. **\$1.00**

15. HANDBOOK OF KNOTS. The handy pocket-sized introduction to rope work. How to tie over 400 knots, told in text and timing. **\$1.00**

16. RIDING. This authoritative book covers everything from the fundamentals to the advanced techniques of riding. **\$1.25**

17. ROPING. Roping and rope spinning! How they intrigue the imagination. Read and learn about this little known, well liked sport. **\$1.25**

18. THE CERAMIC ARTS

By W. H. Johnson and L. V. Newkirk

Ceramics—including as it does work with clay, plastics, glass, alabaster, and cement—is one of the most important of all modern industries. This is a basic book on the subject, offering simple and detailed explanations of how to make things with those materials. So thoroughly are the various principles and procedures presented that the book provides an adequate foundation course for anyone wanting to take up ceramics as a vocation. It is also suitable for people who merely wish the fun of being able to make things which are both attractive and useful. The book contains 25 photographs illustrating processes in the ceramics industries, and 57 diagrams of tools, of step-by-step procedures, and of suggested designs. **PRICE \$2.50**

19. CIVIL SERVICE HANDBOOK

This volume contains a wealth of information on how to go about getting yourself on the Government payroll, detailed Home Study Courses, including 1000 Questions and Answers of former tests, 30 actual previous examinations (with correct replies) for such positions as postal clerk, mail carrier, stationary engineer, factory inspector, electrician, librarian, fireman, bookkeeper, prison keeper and many others. It tells the mistakes to avoid in arithmetic, grammar, spelling, geography, history, civics—just the type of information called for in civil service examinations. **PRICE \$1.00**

20. SQUARE KNOT, TATTING, FRINGE AND NEEDLEWORK

By Raoul Graumont and John Hensel

There has long been a need for a working guide to the various things of beauty and practical value that can be made by plaiting or knotting threads together—the process known as Square Knotting. After the rudiments of this work have been mastered, the most intricate designs may be worked out by even the beginner. A tremendous variety of designs appear in this book. Designs for various types of men's belts and ladies' handbags, dog collars, cigarette cases, key cases, men's ties, bath slippers, pillow tops, tatting, mats, etc. 7 x 10—113 Pages with 64 Full Page Illustrations. **\$2.00**

21. MAGIC By Barrows Mussey

Here is a fascinating book which shows you how to master conjuring tricks for your own pleasure and the entertainment of your friends. Not one of them requires elaborate equipment or unusual agility. **PRICE \$1.25**

22. ADVENTURES WITH A MICROSCOPE

In fifty-nine simple experiments, or "adventures" the reader is introduced to many fascinating discoveries; it is told how to find the material, just what he will see and just what it means. With complete instructions on using a microscope. **PRICE \$2.00**

23. FUN IN BODY BUILDING

Wouldn't YOU like to have a healthy, mighty handsome body that women will admire and men envy? A powerful physique that can dish it out and take it too. Muscles of steel in your arms, legs, back—and every part of your body. Now book just published—"FUN IN BODY BUILDING" tells you simply and surely how you can change yourself into a Mighty Man! Shows you how to increase the size and power of your muscles, in very short time. GIVE YOU COMPLETE COURSE OF EXERCISES, which you can perform in the privacy of your home, and which are GUARANTEED TO ADD INCHES AND MIGHT TO EVERY MUSCLE AND PART OF YOUR BODY! Book also contains information on food, sleep, functions, clothes, anatomy, organs, etc. FREE—with every order a copy of "Secrets of Strong Man Feats" which shows you how to perform strong man stunts. **\$1.00**

24. FUNDAMENTALS OF LEATHERCRAFT

By Ross C. Cramlet

Here's an introduction to leathercraft that tells exactly what to do and how to do it, to make some clever and useful articles like bookmarks, key cases, key holders, coin purses, comb case, belts, book cover, etc. Every step in the process is so clearly set forth in picture, drawing and easy to understand language that it's no trick at all for the amateur to select the proper material, prepare it for the tooling process, transfer his designs to the leather (a number of interesting designs are suggested by the author), perform the actual tooling, insert linings, lace, and put the final expert finishing touches to the work. **ONLY \$1.25**

HOW TO ORDER

HOW TO ORDER: Fill out coupon and mail today. Order books by number—Circle the numbers of the books you wish to purchase. All books guaranteed satisfactory, or money back at once. If remittance enclosed, we pay postage. If C.O.D., sent plus postage. **MONEY BACK GUARANTEE!** If not completely satisfied for any reason, return books and get money back at once.

HOBBY BOOK MART, 150 Nassau St., Dept. P-11, New York 7, N. Y.

Gentlemen: Please send me the books whose numbers I have circled. If I am not satisfied I may return them within 10 days and get my money back.

Payment enclosed Send C.O.D. plus postage

Name..... 13 14 15 16
Address..... 17 18 19 20
City..... State..... 21 22 23 24

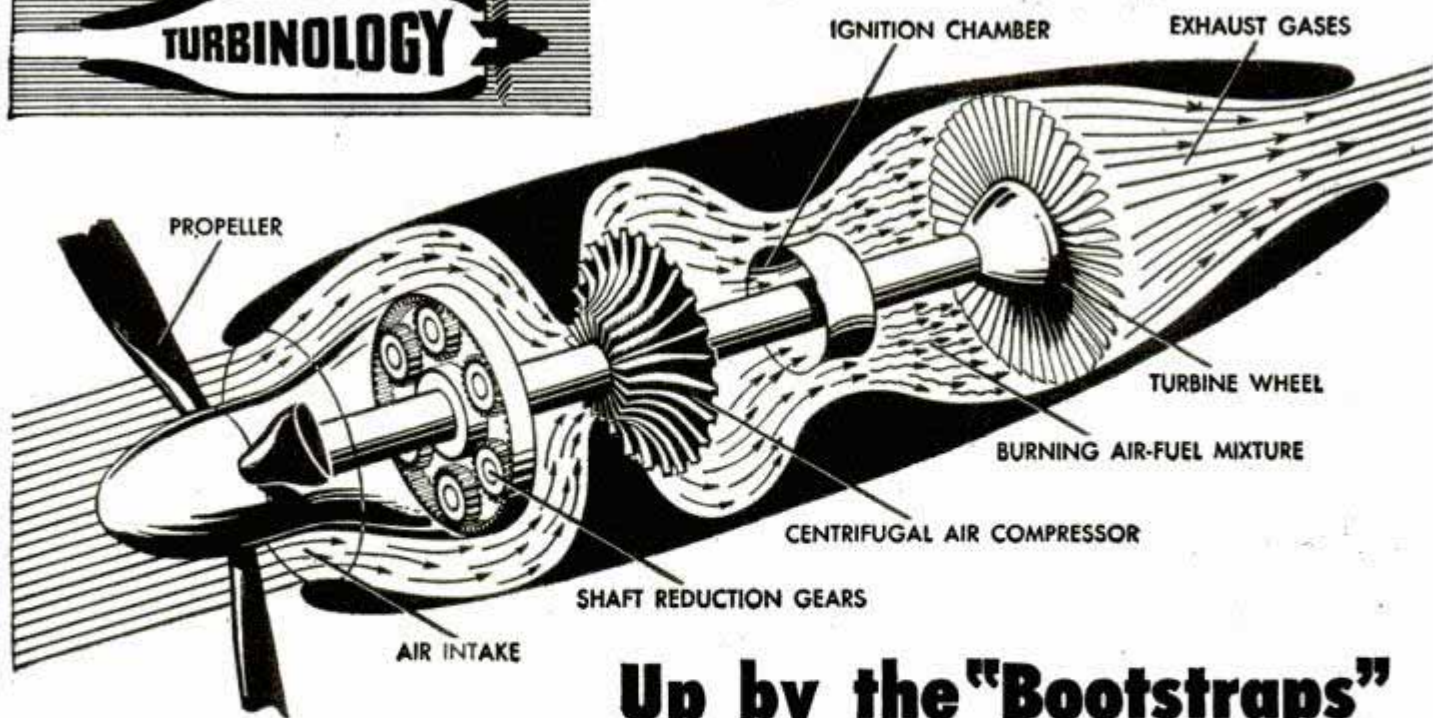

Up by the "Bootstraps"

At first glance, the new Wright Aeronautical propeller turbine for fast, long-range air giants resembles a man lifting himself by his boot straps. For the two main working units in this power plant are a compressor which supplies energy to a turbine wheel, while the turbine wheel in turn drives the compressor.



There's an "X" added, however. The "X" is the heat energy of gasoline or other fuel. Burned with compressed air, it creates a tornado of expanding gases—hot gases powerful enough to spin turbine blades, drive a propeller, turn the air compressor and still have unused force left over to jet out the exhaust for extra thrust.

The diagram above shows a schematic drawing of a Wright turbine. From left to right, here's what happens:

Air enters through an intake around the propeller hub. It is snatched up by the blades of an "impeller", the main part of a "centrifugal" air compressor. The air is hurled off the blade tips at high velocity, but without much pressure. Curving passages leading to the combustion chamber slow it down, build up pressure.

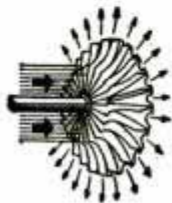

Imagine a double-lane express highway, with cars spaced well apart doing 80 miles per hour. That's velocity. If the express highway ends abruptly in a parking lot, the cars pack up bumper to bumper. That's velocity changed to pressure and is exactly what happens to air moving through the compressor of a Wright turbine.

In the combustion chamber, part of the air is burned with gasoline, producing a flame double the temperature of molten aluminum. This raging heat expands the rest of the air. Being compressed, it has further to expand. It's like adding a pinch of dynamite to a steel spring as it is released from full pressure. Just as air caged inside an inner tube blasts through any available opening, so this inferno of hot gases fights to get out into the open. The only way out is through the openings between the turbine blades. On its curved

surface, each blade takes the full impact of this gaseous force.

The only way it can "roll with the punch" is to turn. And turn it does, with all the other blades on the turbine wheel and shaft. Enough power is put into the shaft to drive

the geared propeller and the compressor both. Major part of the power goes to the propeller. The compressor takes only a small part of the total.

That, basically, is the way a Wright turbine works. Some models have different types of air compressors. Models will vary from 5,000 to up towards 10,000 HP. But all will work on the same principle of compressor-combustion chamber-turbine wheel. And all will mean new advances in both military and commercial aviation.

This is one of a series of explanatory ads on the propeller turbine of the Wright Aeronautical Corporation.

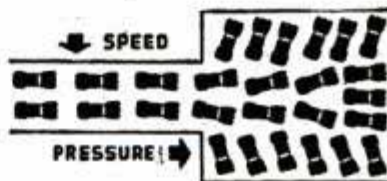

WRIGHT

AIRCRAFT ENGINES

DIVISION OF
CURTISS WRIGHT
FIRST IN FLIGHT

Wright Aeronautical Corporation • Paterson, New Jersey, U.S.A.

By Aubrey O. Cookman, Jr.

ONE hundred and three ships of war, from the 33,100-ton battleship Pennsylvania down to squat LSTs, will be grouped in a Pacific Ocean lagoon next month for the first of three atomic bomb trials to determine the future of modern seapower. The lagoon's 250 square miles of anchorage will be a mammoth test tube where leading scientists, military experts and government representatives will observe the bomb's yet-unproved effects on naval targets.

Contrary to popular supposition, the tests are not expected to result in wholesale destruction of the entire armada or even a majority of it. Nor will they represent an attempt to demonstrate the fullest destructive power of the atomic bomb. That could be done by filling the air with planes laden with atomic bombs or preparing more powerful bombs. Probably not more than half the ships involved will be destroyed or damaged beyond repair at the end of all three phases of the experiment.

What the experimenters can learn, under the ideal test conditions being set up, is

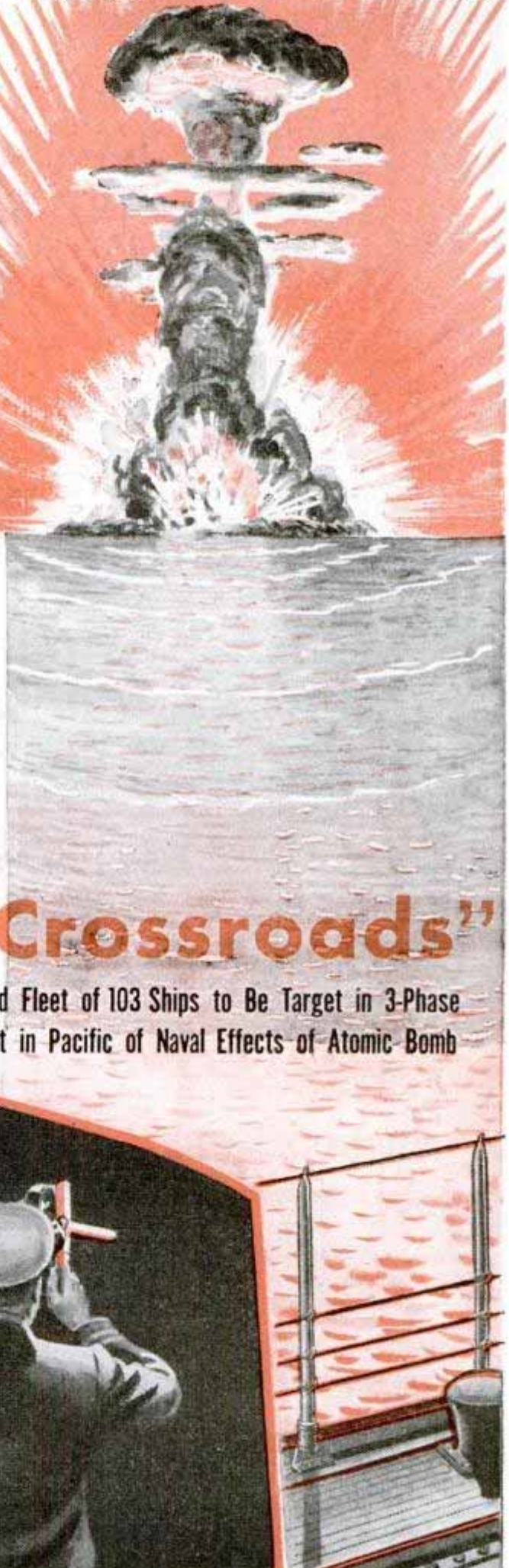

"Operation Crossroads"

Unmanned Fleet of 103 Ships to Be Target in 3-Phase
U. S. Test in Pacific of Naval Effects of Atomic Bomb



HERE IS THE SETTING FOR

When history's most important explosion occurs on or about May 15 at Bikini Atoll the target will be an assembly of more than 100 unmanned ships totaling approximately 200,000 tons and representing an estimated \$500,000,000. As the atomic bomb hurtles down to its detonation point several hundred feet above the fleet, every conceivable means of gauging the extent, character and effect of the blast will be poised for action. Sturdy steel and concrete towers on surrounding islands will house batteries of movie, television and photographic equipment to record the scene thoroughly, while pilotless planes will be guided even closer in the quest for scientific data and pictures.

At safe distances trained observers in ships and planes will focus their attention on the target area, for what happens in this test, and in the surface and underwater blasts to follow, will have a profound effect on mankind's future.

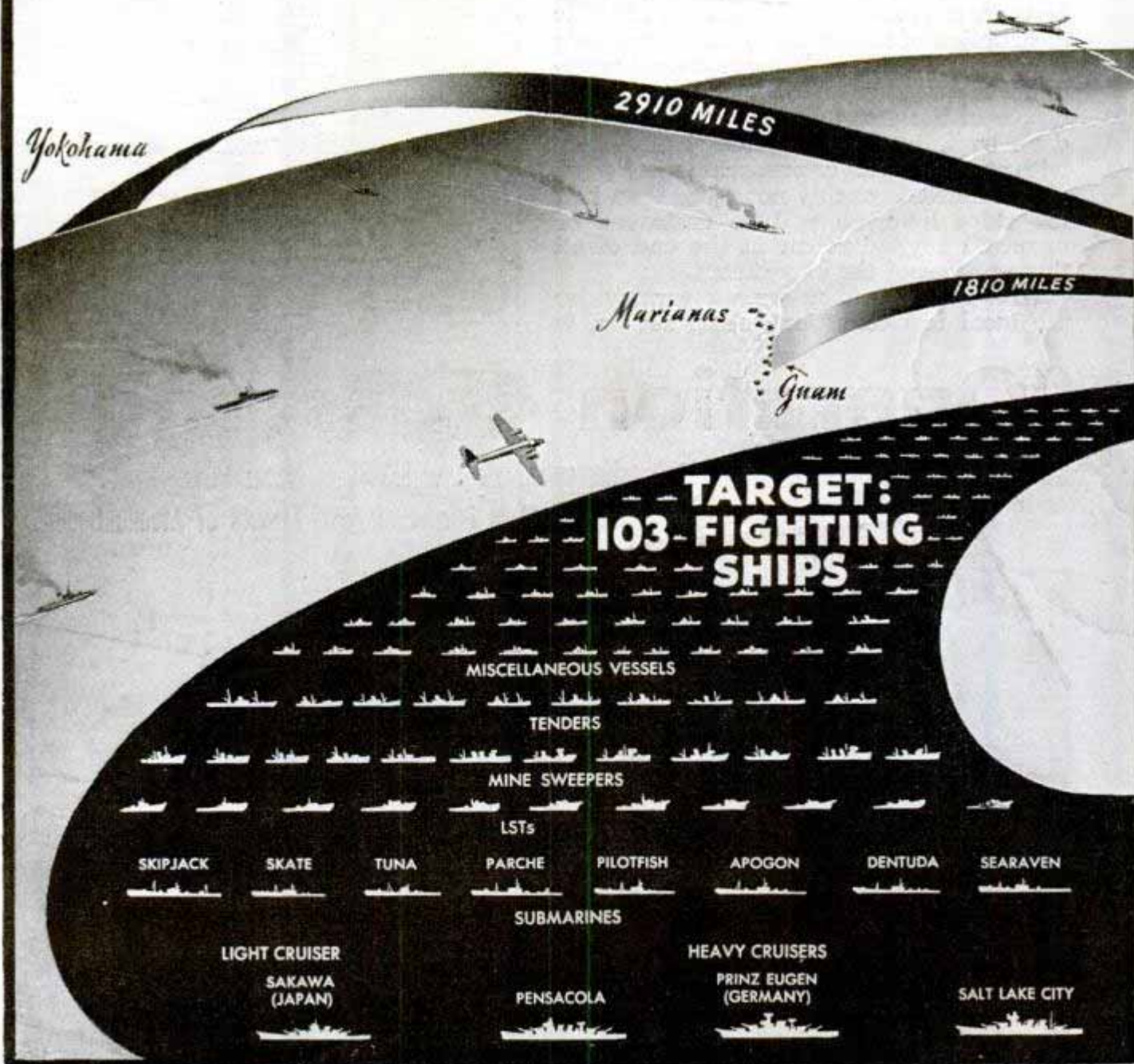

"OPERATION CROSSROADS"

Here are measurements of major ships designated for atomic bomb experiment:

BATTLESHIPS

	Tonnage	Length (in feet)
Arkansas	26,100	562
New York	27,000	573
Nevada	29,000	583
Nagato (Japanese)	32,720	700
Pennsylvania	33,100	608

HEAVY CRUISERS

	Tonnage	Length (in feet)
Pensacola and Salt Lake City....	9100	585
Prinz Eugen (German).....	10,000	654

AIRCRAFT CARRIERS

Saratoga	33,000	909
Independence	11,000	610

In addition, the 6000-ton Japanese light cruiser Sakawa, destroyers and submarines will be included. There will also be an unspecified number of landing craft and miscellaneous small vessels in the fleet. Although exact placement of the ships has not been revealed, task force officials said that some of the larger ones would be spotted in the center of the target area.

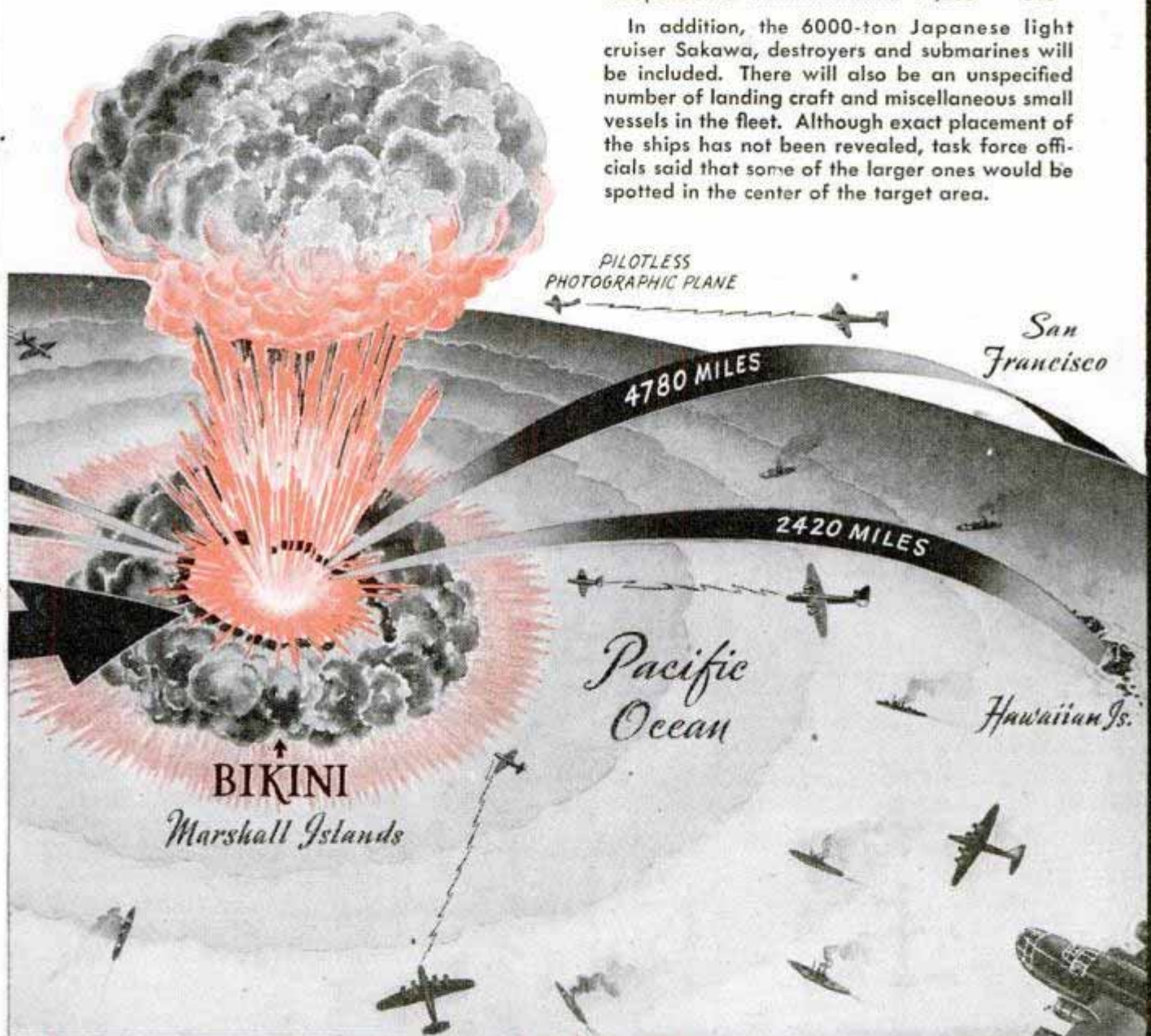

DESTROYERS

MAYRANT

TRIPPE

STACK

RHIND

BAGLEY

HELM

RALPH

TALBOT

MUGFORD

LAMSON

FLUSSER

CONYNGHAM

SMITH

ANDERSON

MUSTIN

WAINWRIGHT

HUGHES

AIRCRAFT CARRIERS

SARATOGA

INDEPENDENCE

ARKANSAS

NEW YORK

NEVADA

PENNSYLVANIA

NAGATO (JAPAN)

BATTLESHIPS

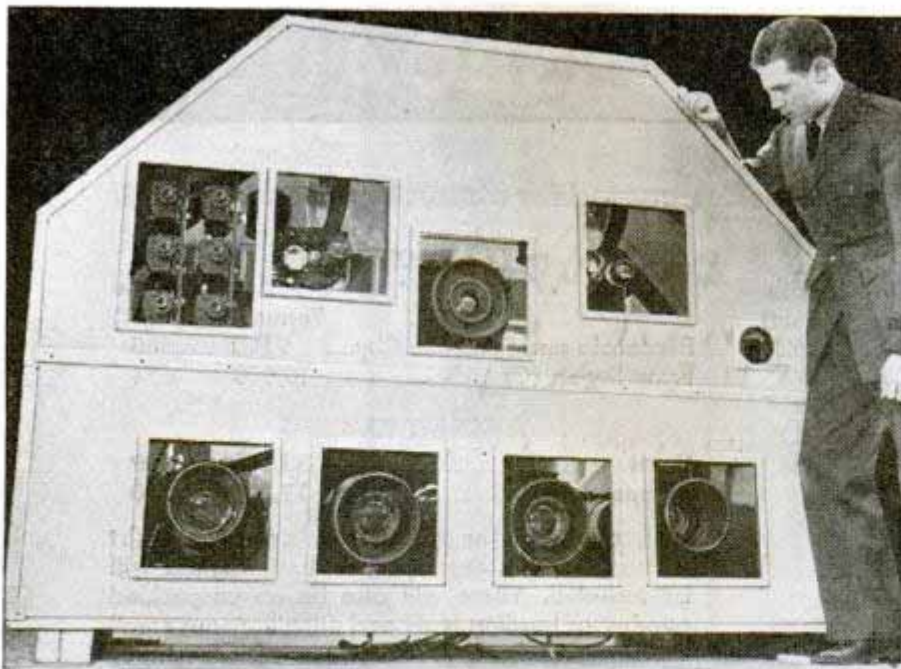

Platform containing batteries of radio-controlled cameras to be stored atop 100-foot steel towers on islands near the blast site. In the event radio control fails the cameras will be operated by a "magic eye" set in motion by the flash of the bomb itself. Below, rear view of the platform

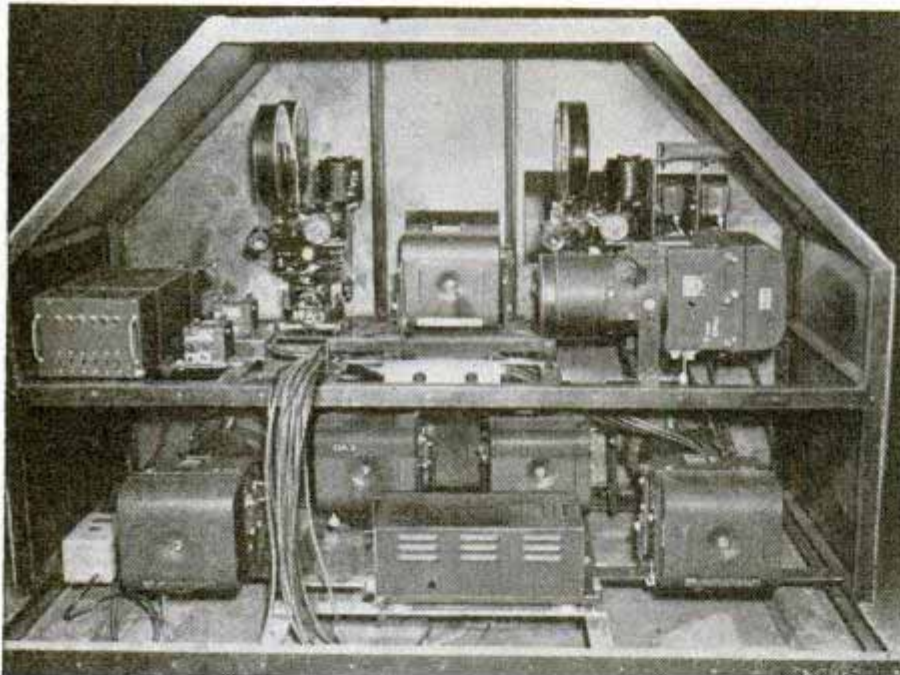

what the bomb can do against an untried adversary. This can best be done if there is evidence, in the form of ships, left to examine. Once a gauge of the bomb's destructive power at sea is reached, it becomes possible to forecast what more bombs or improved versions would do if used in an "all-out" effort against greater numbers of ships. This measurement of potential could go on to determine the probable effect against even more powerfully built ships. The test results may make obsolete many combat theories involving the use of massed ships and radically affect the types of vessels that make up future navies.

Would a ship hit dead center vaporize like the experimental steel tower did in New Mexico? Would thick hulls crack like eggshells? How would ships' superstructures withstand mountainous waves the bomb is expected to create? And what damage would 500 to 1000-mile-an-hour winds do? How would a subsurface atomic explosion compare with a conventional depth bomb? How far-reaching and damaging would be the effect from the terrific heat of the blast? These are a few of the vital questions to be answered.

Although some of the results probably will be kept secret because of their military value, most of the findings are expected to be made public. Facts about the relative placement and loading of the ships, their quantities of ammunition and fuel, whether they have steam up, what hatches and how many are open or closed, and details about the bombs to be used, have not been announced and very likely may never be revealed.

The experiment is being conducted by the United States government, not the armed services, with Vice-Admiral W. H. P. Blandy commanding the 20,000 men of Joint Task Force One who will participate. There will be about 50 ships in the force, exclusive of the 103 target ships. Deputy for aviation is Major General William E. Kepner of the





The USS Mt. McKinley, Task Force One flagship, is fitted with elaborate communications gear for the assignment

Army Air Forces, with Rear Admiral W. S. Parsons, deputy for technical direction, Major General A. C. McAuliffe, Ground Forces adviser, and Dr. R. A. Sawyer of the Manhattan District, technical director.

Bikini Atoll, site of the test, is in the Marshall Islands, 170 miles east of Eniwetok and the same distance northwest of Kwajalein, where the B-29s and other planes taking part will be based. It consists of more than 20 coral islands in a roughly oval pattern enclosing a shallow lagoon, 20 by 12 miles, where the target ships will be anchored. Bikini's 161 residents and about 250 at Eniwetok will be evacuated prior to the experiment. The atoll is 4150 miles from San Francisco and 2442 from Yokohama.

The test begins next month with a single bomb of the type used at Nagasaki, more powerful than the one that killed 78,000 at

Hiroshima; dropping on the assembled "ghost fleet" from a B-29 Superfort. Security prevents official announcement of either the exact altitude of release or the height at which the bomb will explode, but it is estimated that the plane will fly at about 30,000 feet and the bomb will be detonated a few hundred feet above the target.

The AAF's famed 509th Composite Group, deliverers of the bombs at Hiroshima and Nagasaki, is training for the test, with the lone plane and crew for the job to be designated on the eve of the flight. Another project of the air forces unit is the preparation of four B-17 Flying Fortresses to serve as pilotless "drones" for radio-controlled flight through the atom cloud after the bomb is detonated. The Forts will carry scientific apparatus to measure the effect of the blast, including bags which will open

(Continued to page 246)

Largest of the target ships is the 33,100-ton USS Pennsylvania, 30-year-old veteran of 13 amphibious landing operations in the Pacific. Her deck will be covered with war materiel lashed there to undergo tests in the atomic bomb experiments

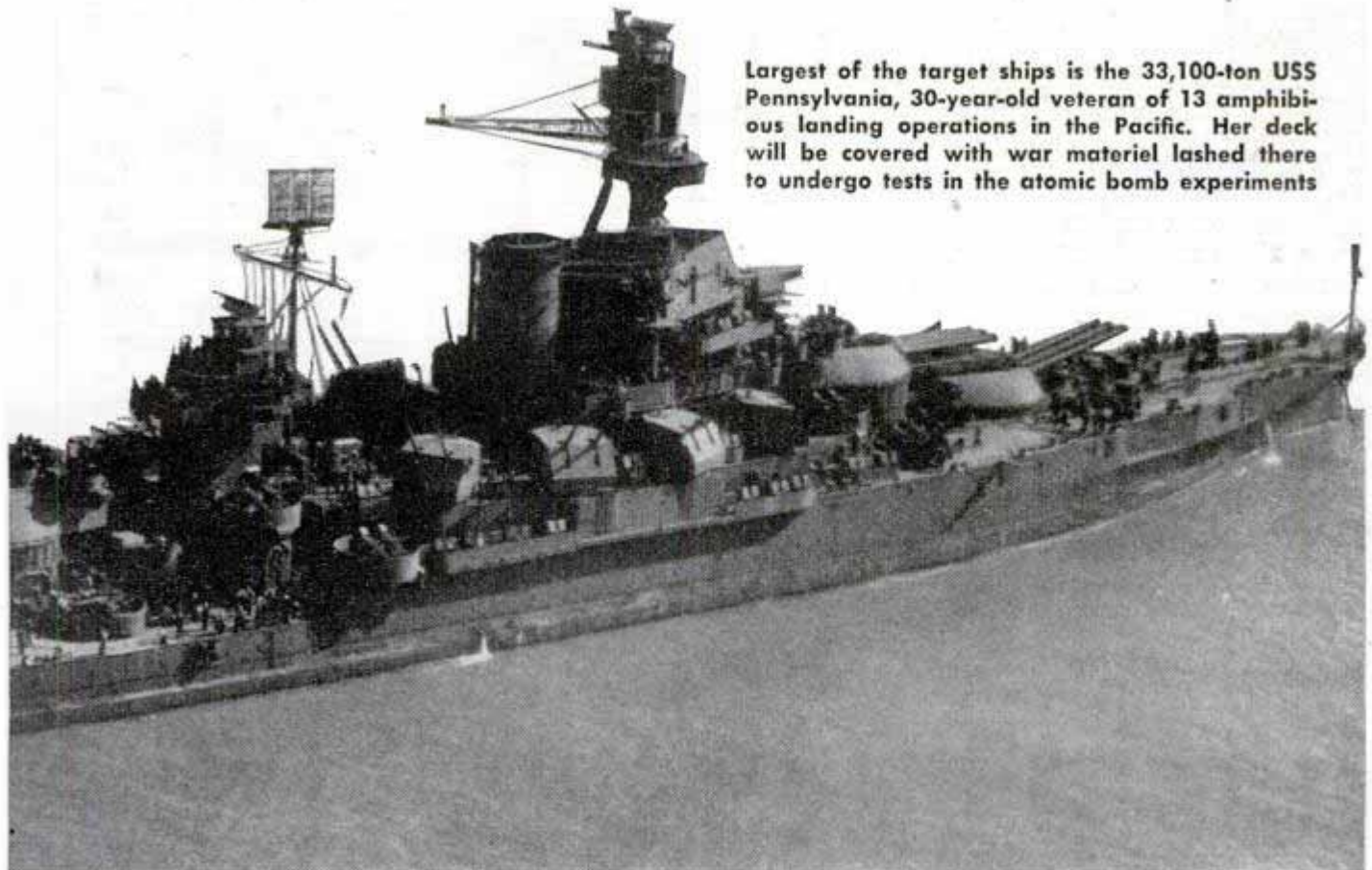

Two-Way Lamp Heats or Tans

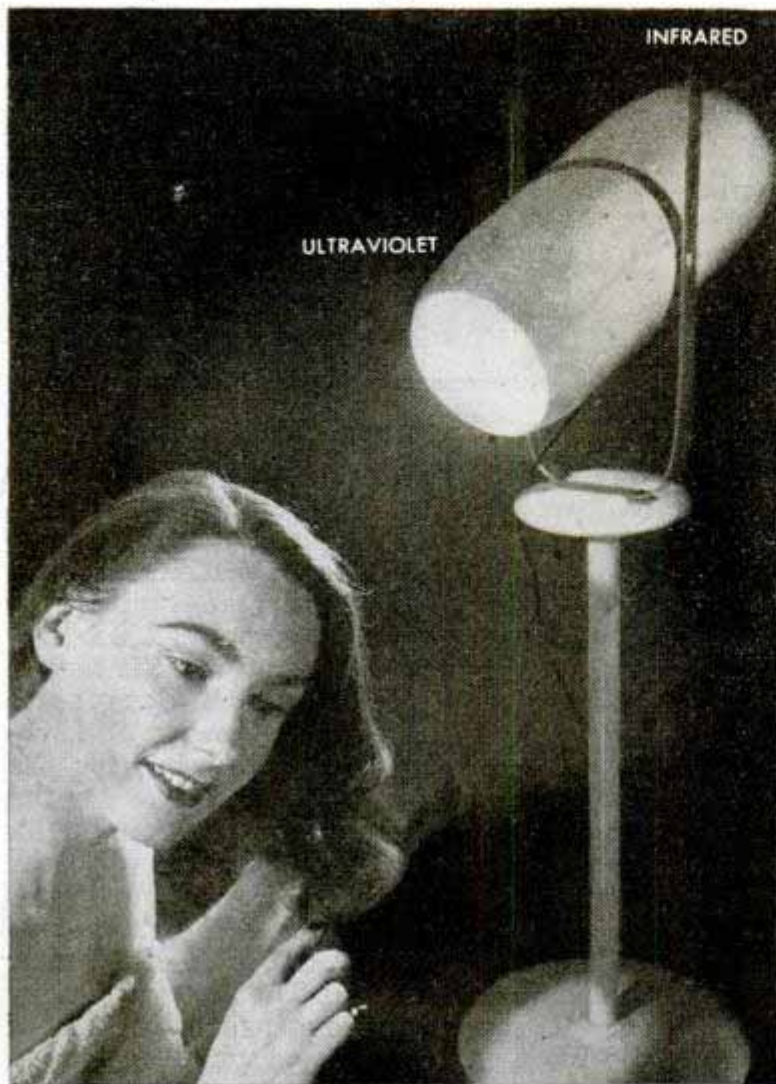

Infrared heat lamp and ultraviolet sun lamp are combined in one unit designed by the Westinghouse Electric Corporation for home use. Resembling a streamlined automobile headlight, the adjustable lamp delivers heat rays from one end and "tanning" light from the other. It has a two-way three-position notch. The heat lamp has an operating life of 5000 hours while the sun lamp will provide more than 400 applications. Five minutes under the sun lamp gives a person more sun tan than 15 minutes under a hot July sun.

Depth Bombs Locate Ship Survivors

Survivors of ship and plane disasters now can be located 2000 miles from land by means of an underwater sound system developed by the Navy and the Woods Hole, Mass., Oceanographic Institution. Called SOFAR, for Sound Fixing and Ranging, the system

utilizes a recent discovery that there is a "speaking tube" effect between the 2000 and 6000-foot sea depths which permits transmission of sound up to 3100 miles. The survivor drops a five-pound TNT bomb timed to explode at a depth of from 3000 to 4000 feet. The detonation then must be picked up by three widely separated shore stations using hydrophones at the same depth. By comparing the times when the signal was received and referring the differences to special charts, the explosion and the position of the survivor can be located within a square mile in a few minutes. The explosion, which lasts less than a second, is heard for 24 seconds 2000 miles away, building up like the roll of kettledrums to a sharp finale. This sharp concluding sound permits timing the blast to one tenth second.

8-in-1 Gardening Tool Sharpens Own Blade

Eight tools in one are provided by an adjustable head for a garden tool. By setting the lightweight steel head in various ways, the device can serve as hoe, rake, edger, shovel, weeder, scraper, furrower or cultivator. The self-sharpening blades are made of chrome steel.



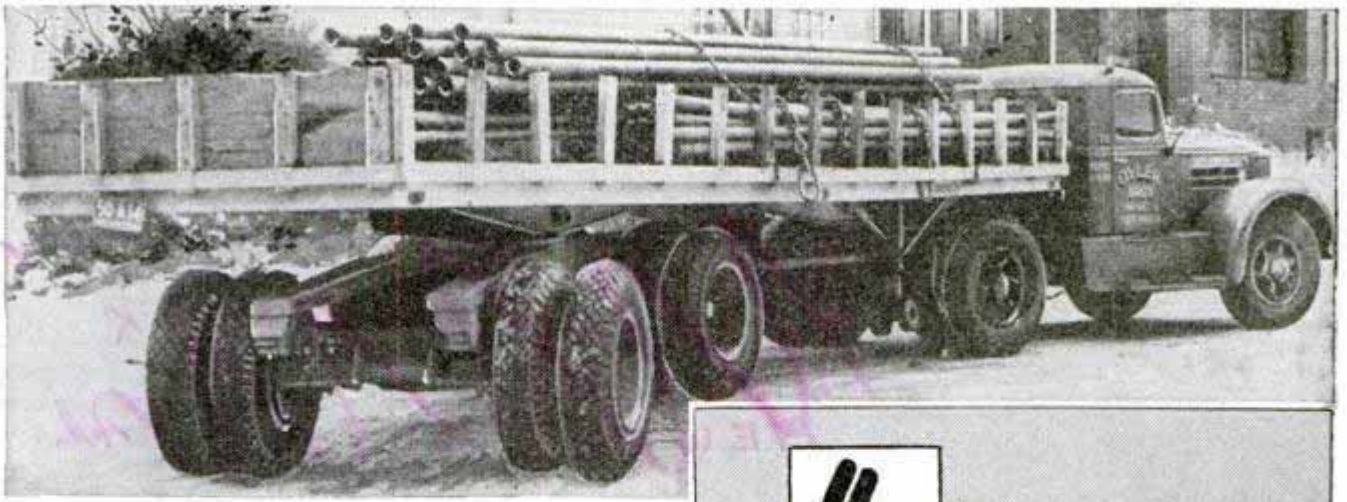

Trailer Wheels That Turn in Sets Allow Increased Truck Loads

Truck trailers, previously limited in length by low maneuverability, can be extended to increase loads 40 percent by a four-wheel undercarriage that automatically follows the truck in turning. The device enables truck drivers to wriggle through traffic with relative ease. The front wheels swing independently, following the tracks of the truck. Pull is exerted on the rear set of wheels, which "follow the leader" in turning. Thus the load is distributed evenly over the unit, yet each set of wheels turns individually to increase maneuverability. Trucks equipped with the unit can turn a right angle from one 15-foot street into another of the same size without any of the tires scuffing the curb. Each set of wheels, suspended independently, absorbs bumps, an advantage in transporting frangible items. The manufacturer claims the undercarriage improves tire mileage.

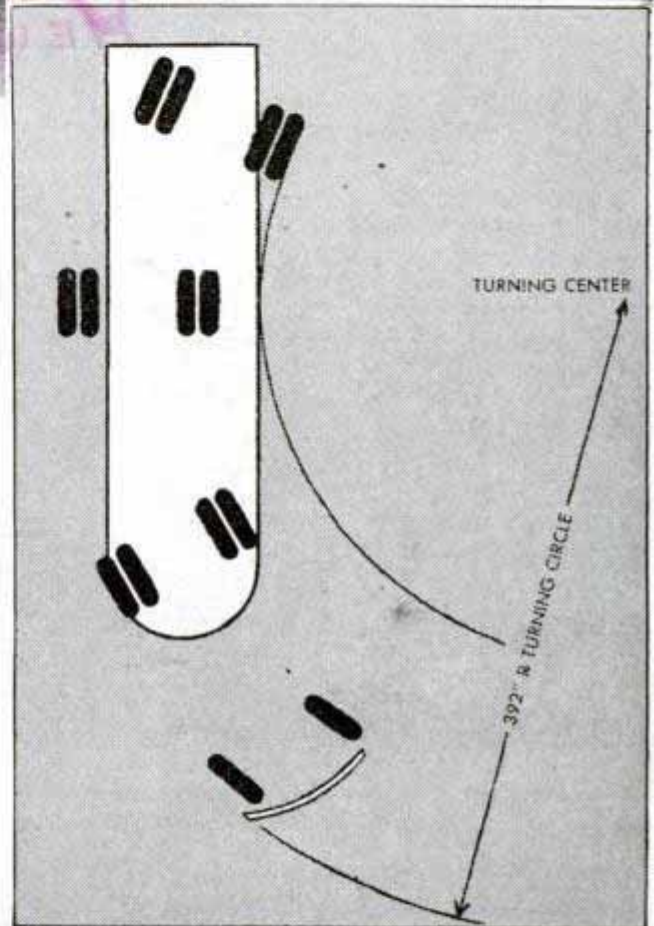

Multipurpose Lamp Tilts on a Swivel

Versatility is the keynote of an all-metal lamp that can stand or be hung and is useful as a spotlight, floodlight or for therapeutic purposes. It is also adjustable, tilting and making complete turns on a swivel joint. The lamp takes 150 or 300-watt bulbs or infrared bulbs. Since a beam of light can be cast in any direction and the lamp is easy to install, it can be used to illuminate lawns, tennis courts and gardens, for store displays, photographic lighting, in machine shops and garages.

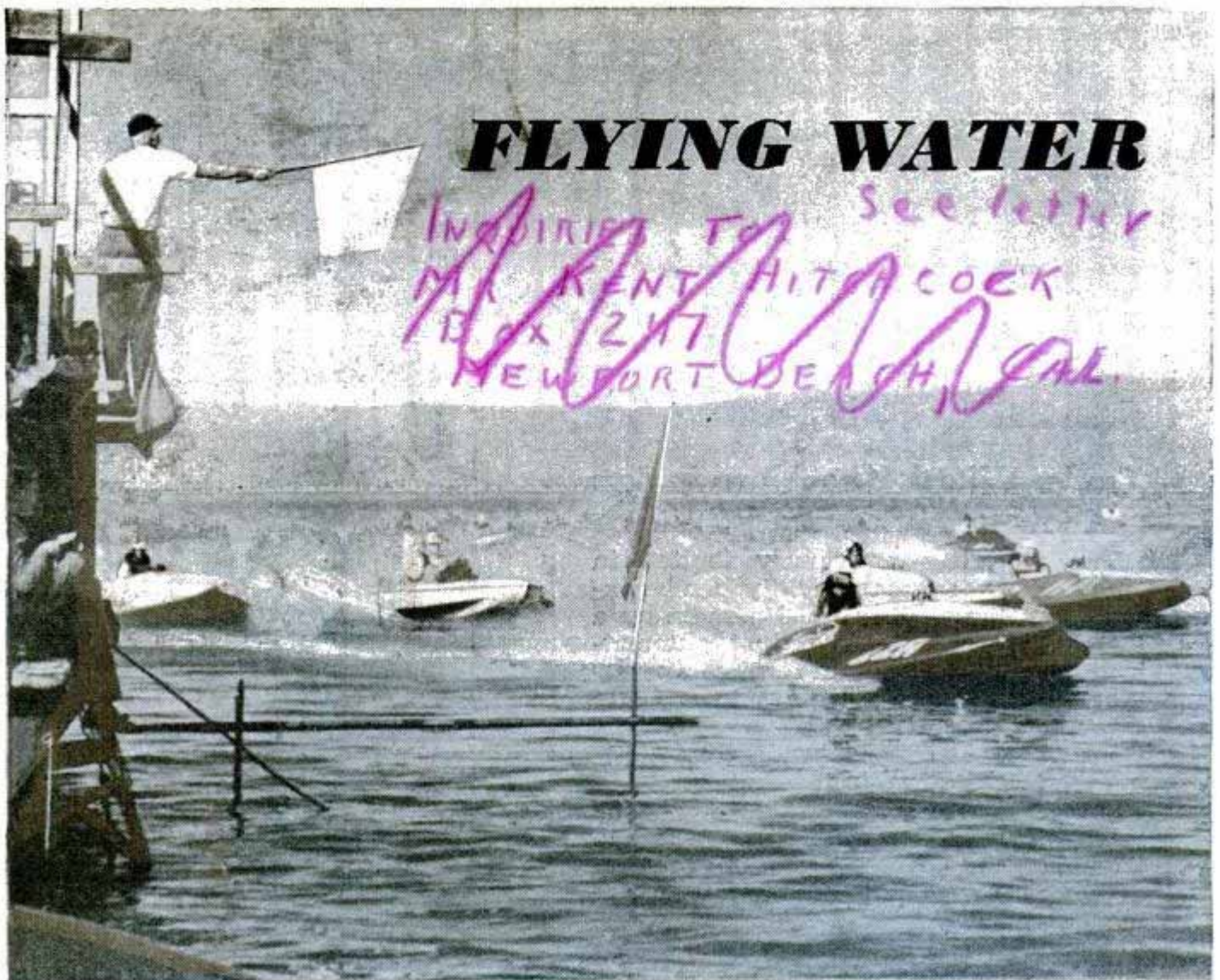

Racers watch the flag as they cross the starting line. Inside the long tube below the starter is an electric eye for timing the race. Below, an aircraft-type rudder works with the water rudder in controlling the boat

AMERICA'S race boat drivers expect to smash every record on the books.

They have an excellent chance to succeed, for numerous improvements in hulls and motors that were developed just before or during the war now are being used. Already many drivers are being clocked at speeds that would have seemed fantastic a few years ago.

Ten years ago, for example, the world speed record in the inboard 135-cubic-inch class was 53 miles per hour. That was fast time, considering that the 135s are small boats of limited horsepower.

But last November Tommy Hill of Oakland topped that speed by 27 miles per hour. His 14-foot boat averaged 80.178 miles per hour back and forth over a measured mile on the Salton Sea, California. He did it with a Ford V-8 "60" engine, hopped up to about 120 horsepower, in a 243-pound hull designed and built on the new three-point suspension principle.

A three-point boat is unlike any other craft you've seen. It has wide and deep winglike sponsons that flare back from its



BUGS



The radical hull of this hydroplane was designed to lift boat almost free of water. The boat below broke record with speed of 77 plus m.p.h.

bow. When the boat gets under way it rides on its stern and the two sponsons. Air is admitted under the forward end of the hull. At extremely high speeds the sponsons themselves begin to lift from the water and the boat takes on a slight side-to-side teetering motion as first one sponson and then the other touches the surface.

Three-point suspension had its beginning a number of years ago, but the war delayed full development of the principle by amateur racers. The design is covered by patents held by Ventnor Boat Works, builders of racing hulls and pleasure speed boats, but individual drivers have made use of the principle without infringement in building boats for their own use. Practically all inboard and outboard racing hydroplanes being built today are three-point suspension craft.

Another improvement in design is the cambering of the deck





Between races mechanics tune up V-8 "60" engine of 135-cubic-inch class boat



graphite; a plywood bottom is as slick as glass. Frames and other strengthening members also are cut from plywood and are as strong as the heavier beams formerly used.

New propellers that will stand up under the terrific punishment they receive in a race will be an important postwar development. Bronze blades are satisfactory at slow speeds but they tend to straighten out at the high rotational speeds being attained today.

A driver may wonder why his speed falls off shortly after the start of a race. Later he discovers that his propeller blades were pulled as much as two inches out of pitch when he opened his throttle and started winding up above 6000 r.p.m. New shapes and harder metals have been tried but most of them proved to be too brittle. One driver lost three

Left, the extreme lines of this three-point boat show how water resistance is reduced. Below, a timer connected with an electric eye shows the speed of each boat to 1/1000 second

to provide an airfoil type of lifting surface. Such a refinement was unimportant in the slower boats of the past but there is good evidence that at present speeds an airfoiled deck furnishes some lift. It has the effect of lightening the boat, thus reducing the amount of weight that the propeller must push through the water.

Some drivers are experimenting with air rudders in conjunction with underwater rudders. This combination provides positive control under all circumstances, since underwater rudders alone aren't always instantly effective in choppy water or when the stern rises momentarily into the air.

New phenolic-bonded plywoods that were developed during the war also are helping to produce more speed. They are lighter and stronger than the woods that were available previously. Plywood can be shaped to the exact lines desired without the seams and slight inequalities of a planked hull. With a coat of lacquer and a coat of racing wax or

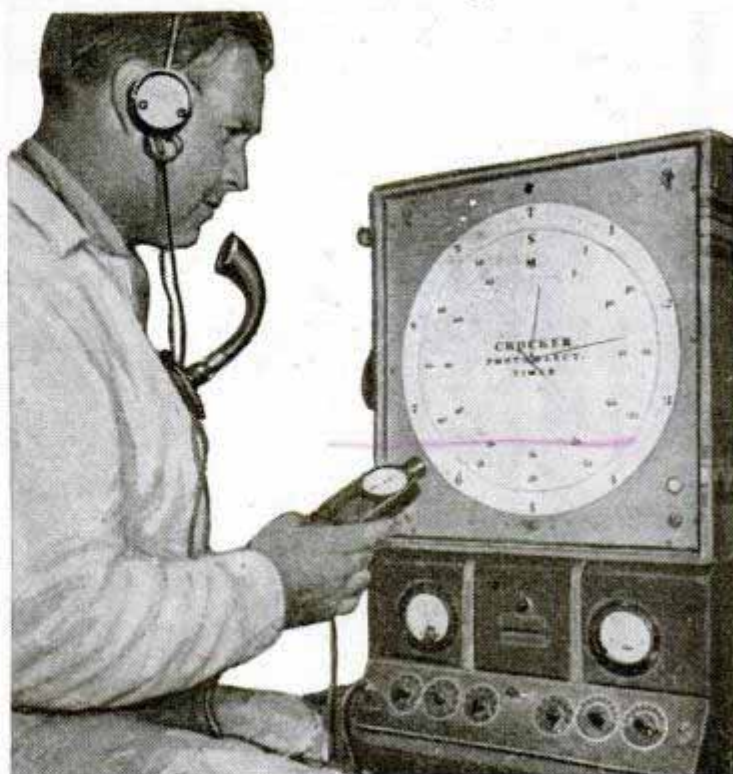

blades in one day of racing, the last one smashing through his hull as if it were made of tissue paper. Now several propeller manufacturers have announced that they are testing new alloys expected to stand up without flying apart or pulling out of shape.

All classes of racing boats, both inboard and outboard, are classified according to the weight or dimensions of the hull, the cubic-inch displacement of the motor and other restrictions. These specifications provide a relatively even basis for all contestants and yet leave plenty of leeway for boat owners and their helpers to work out their own ideas.

Rebuilding a stock engine so that it winds up to a much faster r.p.m. is part of the secret of speed. The popular 135-cubic-inch displacement class, for example, is powered almost exclusively by V-8s that have a factory rating of 60 horsepower, yet these engines are rebuilt to deliver as much as twice that power.

Eddie Meyer, one engine expert who used to race automobiles and who now finds racing on water much more exciting, uses the stock block, crankshaft, connecting rods, wrist pins, valves and valve springs in his

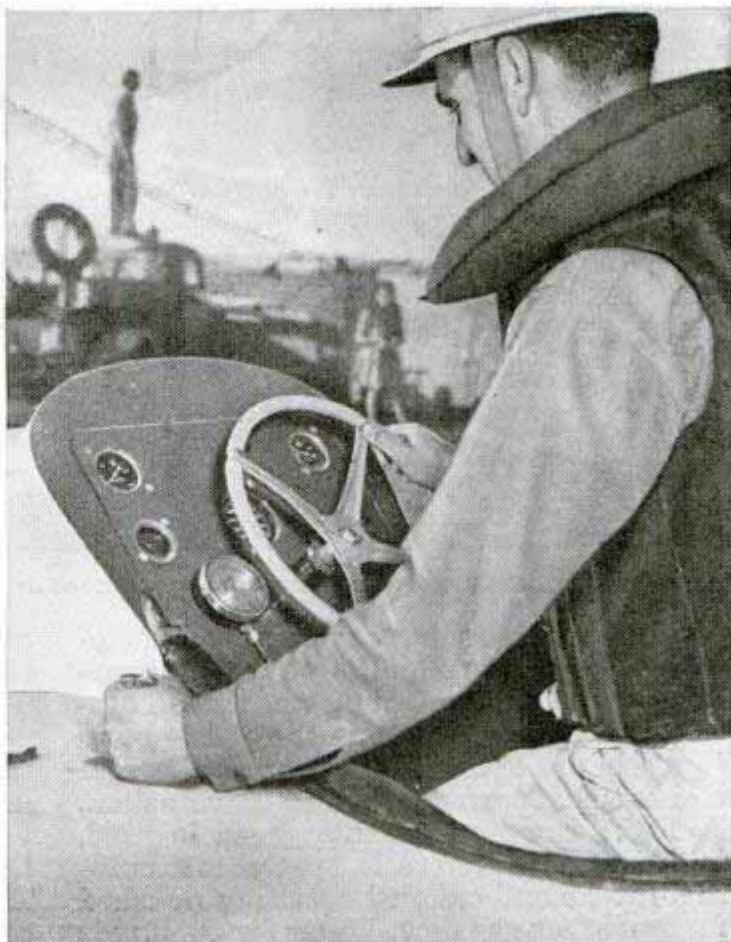

Driver operates the fuel control with his left hand. In the event of spill or collision, the control shuts off automatically. Below, drivers get their boats ready for the next race

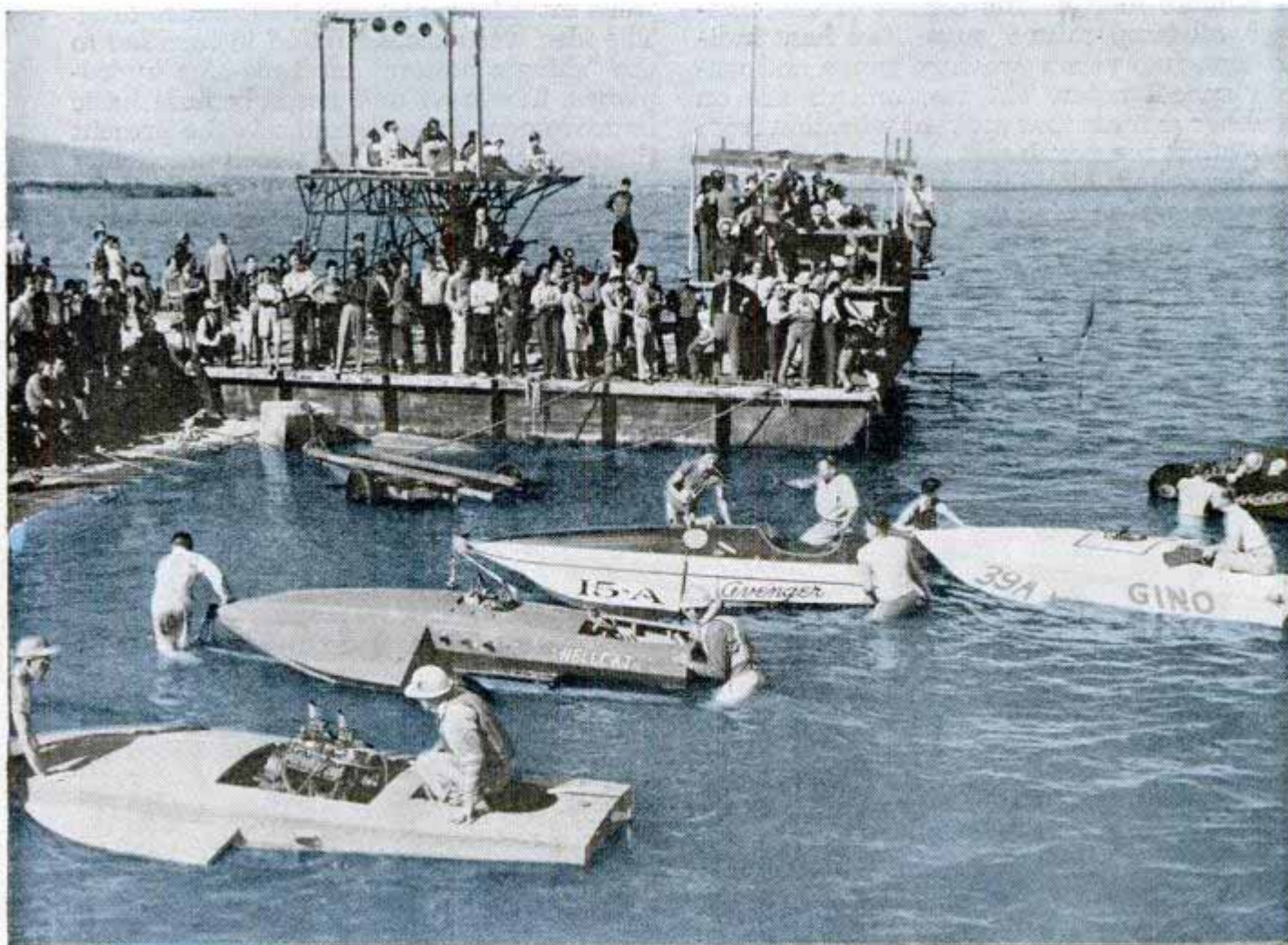



Three-point hydroplane teeters between bow sponsons on either side as speed lifts the craft from the water

135-cubic-inch racing motor, but most of the other parts are built especially for racing. Special lightweight pistons and all other moving parts including the eight-pound flywheel are dynamically balanced. A special camshaft provides faster valve action. A 10.5:1 compression ratio head is used, with two carburetors in special manifolding. Intake and exhaust areas are polished for smoother gas flow. Water for cooling is taken in through a small orifice in one sponson and is circulated across the bottom of the crankcase to cool the oil before it passes through the engine block.

Engine instruments consist of tachometer, oil temperature gauge, two heat indicators, fuel pump pressure gauge and water speedometer. The instruments are on rubber mounts that prevent vibration from affecting the readings.

Reworked like this, an engine can be wound up as high as 7000 r.p.m. Direct drive is used to turn the propeller at the same speed through a solid $\frac{3}{4}$ or $\frac{7}{8}$ -inch shaft eight or nine feet long. The $\frac{3}{4}$ -inch shafts sometimes snap under the heavy loads, so a number of drivers have gone

over to the larger size. Distributors, similarly, are not always efficient at high speed and are being replaced by magnetos.

Getting the most out of the motor is not the whole secret of speed, of course. The angle at which the sponsons ride in the water, the propeller's angle of attack and the way the boat is balanced all play a part. The first competitive race boats depended on brute horsepower alone for their speeds, before it was learned that hull and engine efficiency both contribute to speed. Hull efficiency went up when the amount of drag was reduced. The one-step hydroplanes were invented in an effort to reduce drag. The idea was successful and in turn led to the "shingle bottom" multiple-step hydroplanes. The next and possibly final basic improvement in hull design is the present three-point suspension in which practically all of the hull rides in the air. The amount of wetted surface at high speed approaches the irreducible minimum. Lifting the whole hull out of water and leaving only the propeller and rudder submerged might be possible if controllable air vanes were used,

(Continued to page 244)

This three-point boat climbs into the air with only stern touching the surface as it streaks toward finish line



Gripper Jaws Take 8000-Pound Bite to Lift Steel Barrels

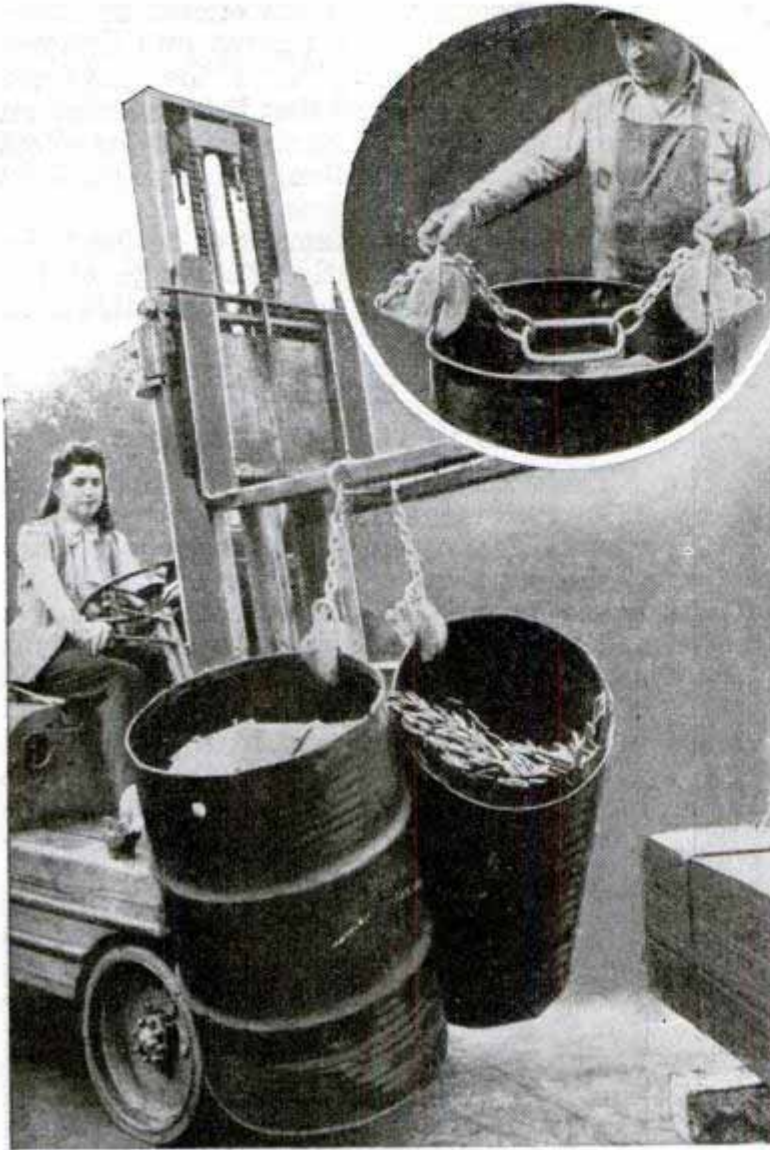

Steel plate or heavily loaded steel barrels are picked up with ease with a cam lever mechanism that is attached by a chain to an industrial lifting truck or crane. Although they have no teeth, the $\frac{3}{4}$ -inch jaws of the gripper hold tightly; in fact, the grip becomes tighter as the load is increased. Consisting of two stamped steel alloy parts and a heavy chain, the lifting device is capable of picking up a four-ton load. The jaws of the gripper release immediately when the load is set down.

19-Story Drop Test

Scientists found a better way to make high-octane gasoline by dropping an oil-cracking catalyst from the top of a 19-story elevator shaft. Chemists of the Standard Oil Company of Indiana tried the experiment to find out if a long drop would cause particles of a new catalyst, used in cracking gasoline, to form in spherical instead of doughnut shapes. They sprayed the mixture into the air at the top of the elevator shaft and collected the particles at the bottom. They were spherical. So now the company may build a 200-foot tower to drop the catalyst.

Sturdy "Screw-On" Aluminum Legs Serve for Benches and Stands

Aluminum legs $27\frac{1}{4}$ inches high are now available for building power tool stands, work benches or garden tables. Made of airplane tempered stock having approximately the same structural strength as steel, the legs are equipped with castings at top and bottom. The top castings have holes countersunk on the underside for screws to attach to the work surface. The bottom castings contain holes for screws or bolts to secure the stand or bench to the floor. Midway between the top and bottom of the legs are holes for shelf brackets.

X-Ray Spots Flaw in Shell

Why an armor-piercing shell failed to penetrate the target was revealed when its flight was examined by a Westinghouse high-speed X-ray device. The projectile's cap, designed to pierce case-hardened armor plate, was found to rip free from the bullet on leaving the barrel. The bullet later overtook and destroyed the cap and went on to a futile meeting with the target.

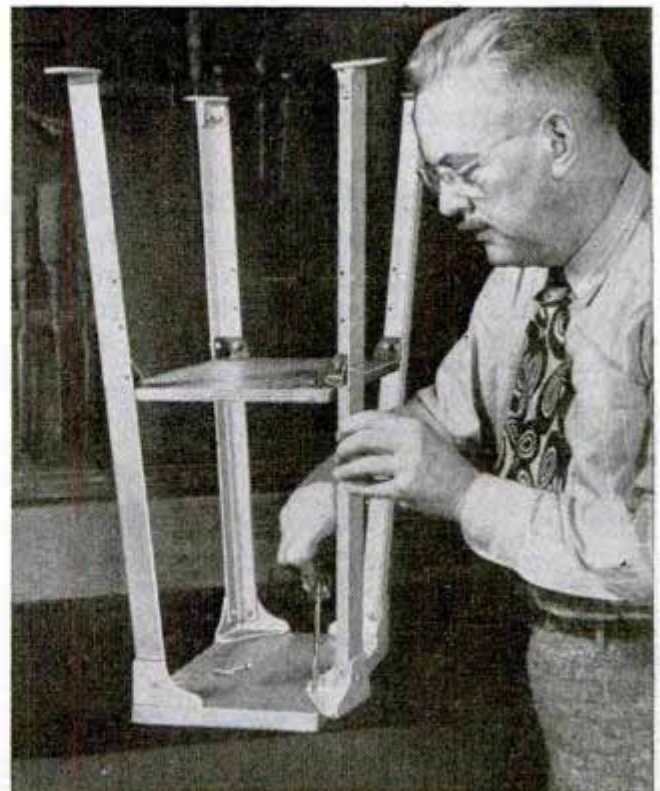

Steel Support With Built-in Jack Levels Sagging Floors



Sagging floors are leveled and their accompanying squeaks eliminated with a steel post which has a built-in jack. Supporting up to 20,000 pounds, the post can be adjusted gradually each week to bring the floors slowly back to level. The post, weighing 28 pounds, is of telescopic construction and can be adjusted to fit basements with five-foot seven-inch to eight-foot four-inch ceilings. In addition, the jack part of the post is adjustable.

"Bent" Light Illuminates Sign

Easy-to-change letters employ refracted light as illumination for an advertising display sign. Fluorescent light tubes are concealed in a metal cabinet, slotted at the



front. The slots, covered with plastic flaps when not in use, hold the curved ends of plastic inserts which are etched or sand-blasted with letters, figures and designs. These curved inserts "bend" the light from inside the cabinet so that it is reflected on the etched letters. The sign gives the effect of brilliant illumination, although no light is seen directly. A glass at the top may be etched with any trademark or design to be displayed permanently. The edge of the glass picks up the illumination for this part.

Air-Cooled 'Lighthouse in Tube' Triples Glow of Lamp

Three times the light of a conventional 1000-watt incandescent bulb is produced with a Westinghouse mercury vapor lamp of the same wattage. The air-cooled "lighthouse in a tube" is designed for sports arenas and high-ceiling factories. The light source is an arc stream the diameter of a cigarette and twice as long. It is enclosed in a quartz tube enclosed, in turn, by a hard glass exterior tube. Overall, the lamp is 14 inches long and less than four inches in diameter. Boosting the mercury vapor pres-



sure inside the tube four times beyond pressure levels used previously has resulted in tripling the light output. Efficiency, on the basis of light produced for electricity consumed, has been increased as much as 50 percent, according to the designers. Formerly such lamps were cooled by forced air or water. The new bulb, operating at 1100 to 1300 degrees Fahrenheit, is cooled by the surrounding air.

Bottle Opener and Recapper Combined Into One Unit



Bottle opener and recapper are combined in a handy device that fits into a person's palm. The opener removes caps without bending or mutilating them, and the recapper puts them back on nearly as airtight as when the beverage originally was bottled. Models are available in gold plated, silver plated and nickel plated finishes.

Box 01017
Pittsburgh 30 Pa

Pocket Tester for Booby Traps Checks Electrical Circuit

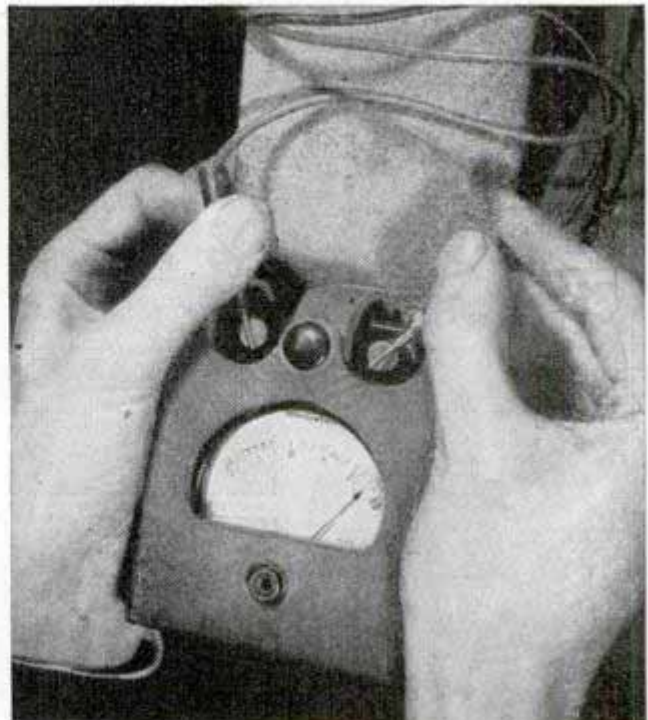

No larger than a cake of laundry soap, a compact testing device enabled American explosive engineers to be certain that every booby trap and land mine would explode after being planted. A miniature ohmmeter checked the electrical circuit without exploding the mine. The unit is self-contained and is adaptable to peacetime use.

Portable Power-Light Unit for Emergencies Is Adapted From PT Boat

Portable all-weather generators developed to charge aircraft batteries and supply auxiliary power for PT boats now are being used to provide emergency light and power during disasters, for construction work and for rush farm jobs. Powered by a gasoline

engine, one unit weighs 105 pounds, and generates 2000 watts of direct current at 120 volts. The engine has a $\frac{1}{4}$ -inch Hycar synthetic rubber seal around the needle valve in the carburetor which makes it possible to use any grade of gasoline.

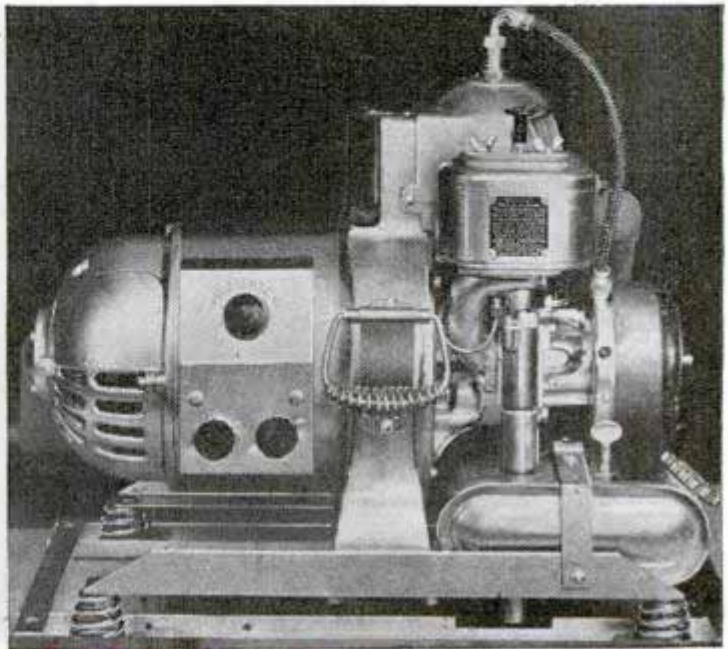

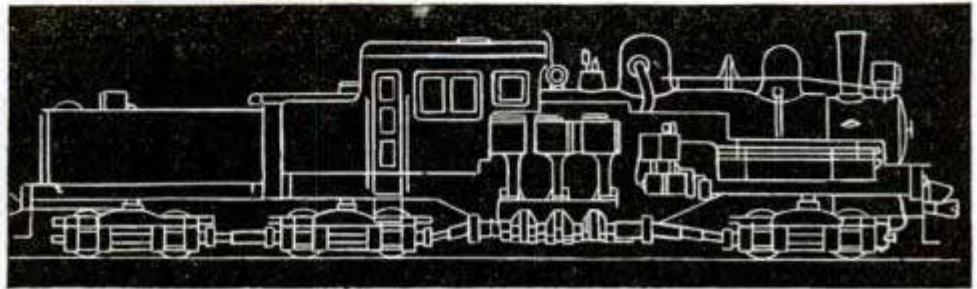
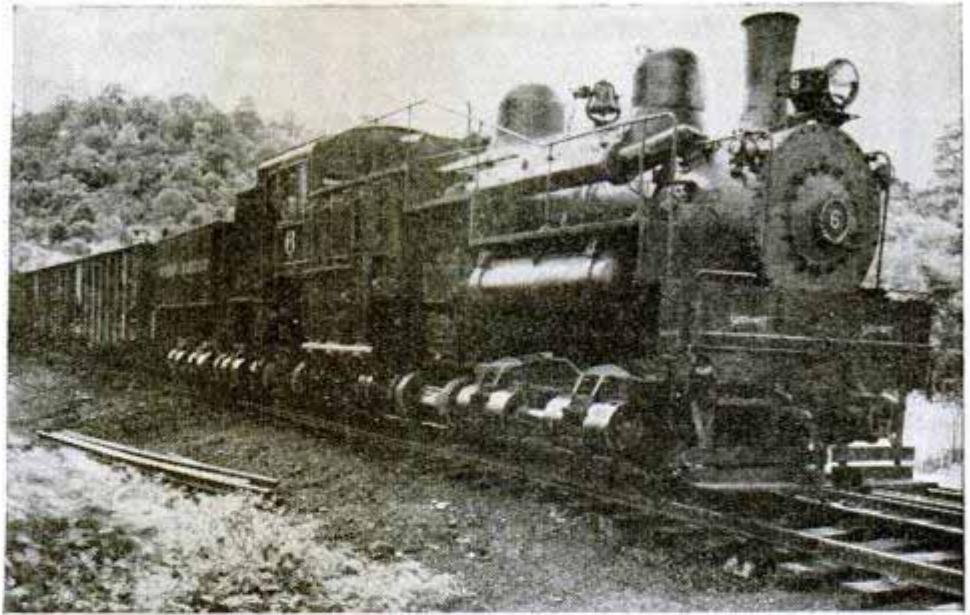
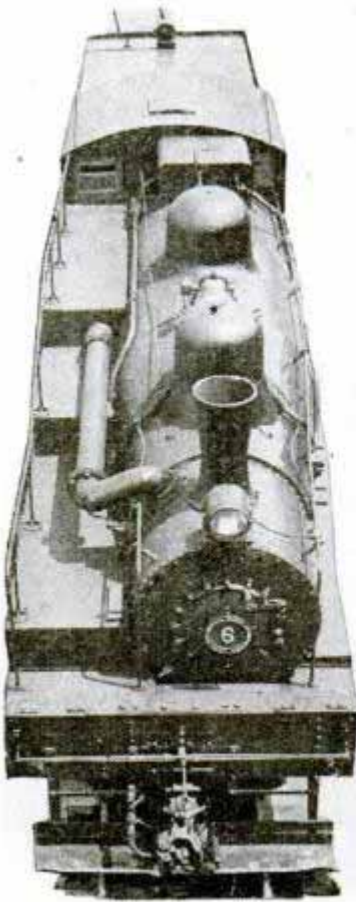

Quick starts with heavy loads and increased power on steep grades are the forte of the lopsided Shay locomotive, one of the latest of this type having been built by the Lima Locomotive Works for the Western Maryland Railroad. The boiler is $14\frac{3}{4}$ inches off center to the left to counterbalance three cylinders and other machinery grouped on the right. The three cylinders are mounted vertically and drive a crankshaft connected through couplings and sleeves with line shafts extending forward to the front truck

Lopsided Locomotive Has Off-Center Boiler

and backward to the two rear trucks. The line shafts have pinions that engage gears attached to the wheels, all of which are driving wheels. Ordinary steam locomotives with two cylinders have four impulses from the pistons for every revolution of the drivers. The off-center locomotive with its three cylinders provides 12 to 18 impulses for every revolution, depending upon the gear ratio, and its weight is distributed evenly over three four-wheel trucks. It was designed for short hauls and switching service.

One-Finger Reel Aids Maimed Vet

Loss of all fingers except one on his right hand fails to prevent a soldier-sportsman from operating a fishing reel. A specially designed reel has two indented cups, mounted on ball bearings, which enable him to spin the reel. The cups prevent his finger from jumping off the disk and the ball bearings assure easy operation and eliminate the possibility of finger burns that might be caused in spinning the metal disk.

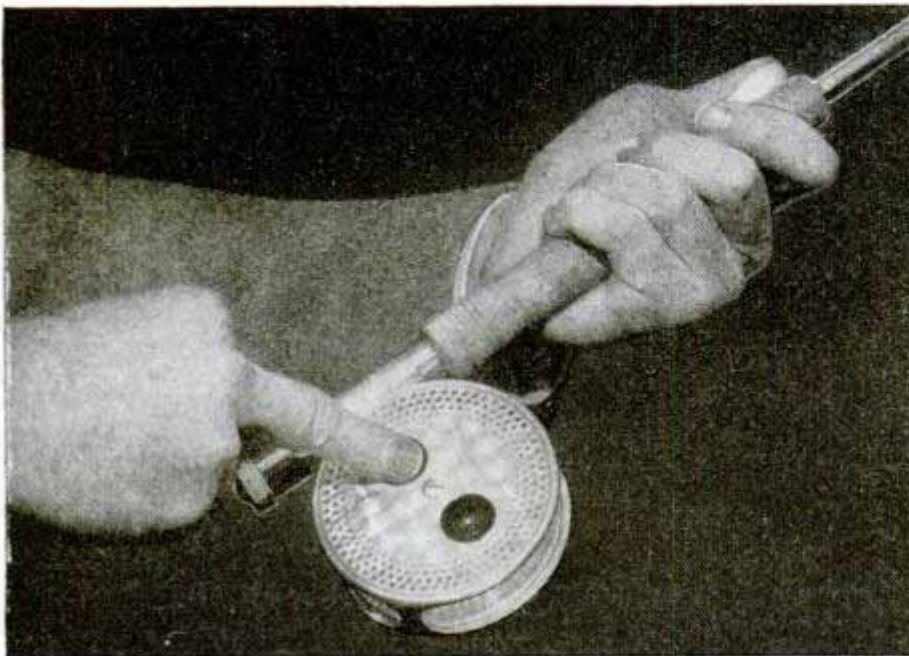

SALT WATER *Butterflies*



HOUSE OF TREASURES

Snail shells, Tahiti jets and abalones from the Pacific ocean floor are transformed by craftsmen into mother-of-pearl costume jewelry. Cut in two by a water saw (top left), shells have their "bark" removed and are ground and polished (left). Delicate lines are added to ornamental butterflies (below) and wire frames are attached. Some are dyed in various colors

114 E 32ND ST N.Y., N.Y.



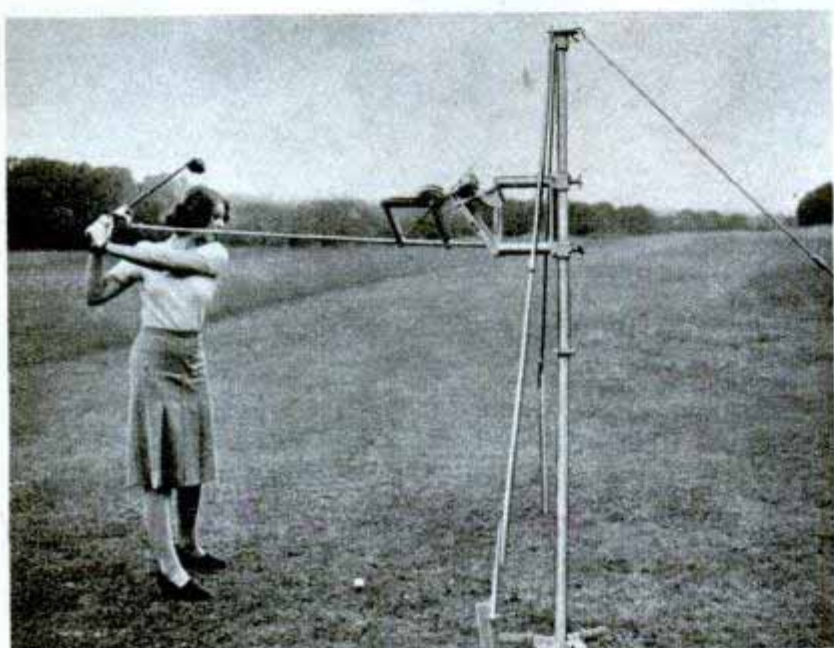
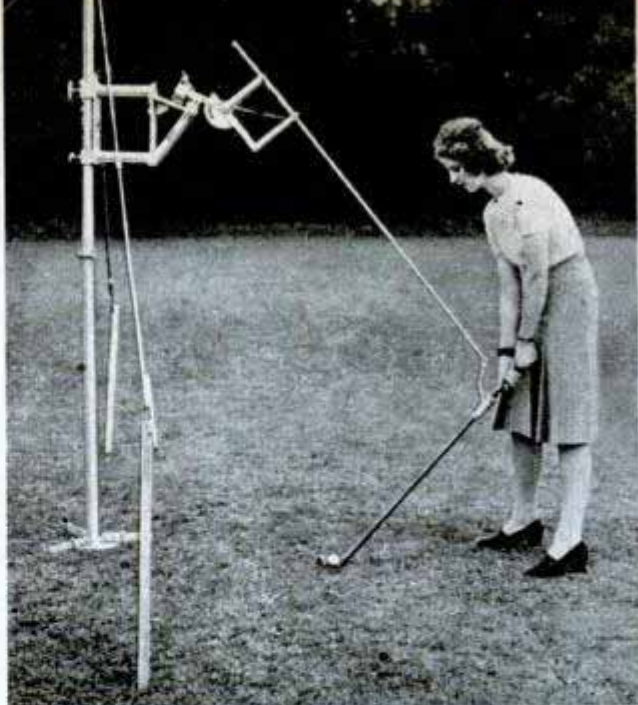

A mechanical golf pro helps golfers swing in the perfect arc necessary for accuracy and distance. R. F. Cottingham of Scunthorpe, Lincolnshire, England, designed the unit

The device can be set at any angle to suit the individual golfer's height, strength and movements. At top left, mechanical guidance of the putting stroke sends the golf ball in a straight line toward the cup

Another version of the mechanical pro guides the driver, top right. Improved distance results from a proper swing. The machine makes an improper swing impossible, center. A brake can be applied to impress the correct swing on a student as in the follow through, bottom photo

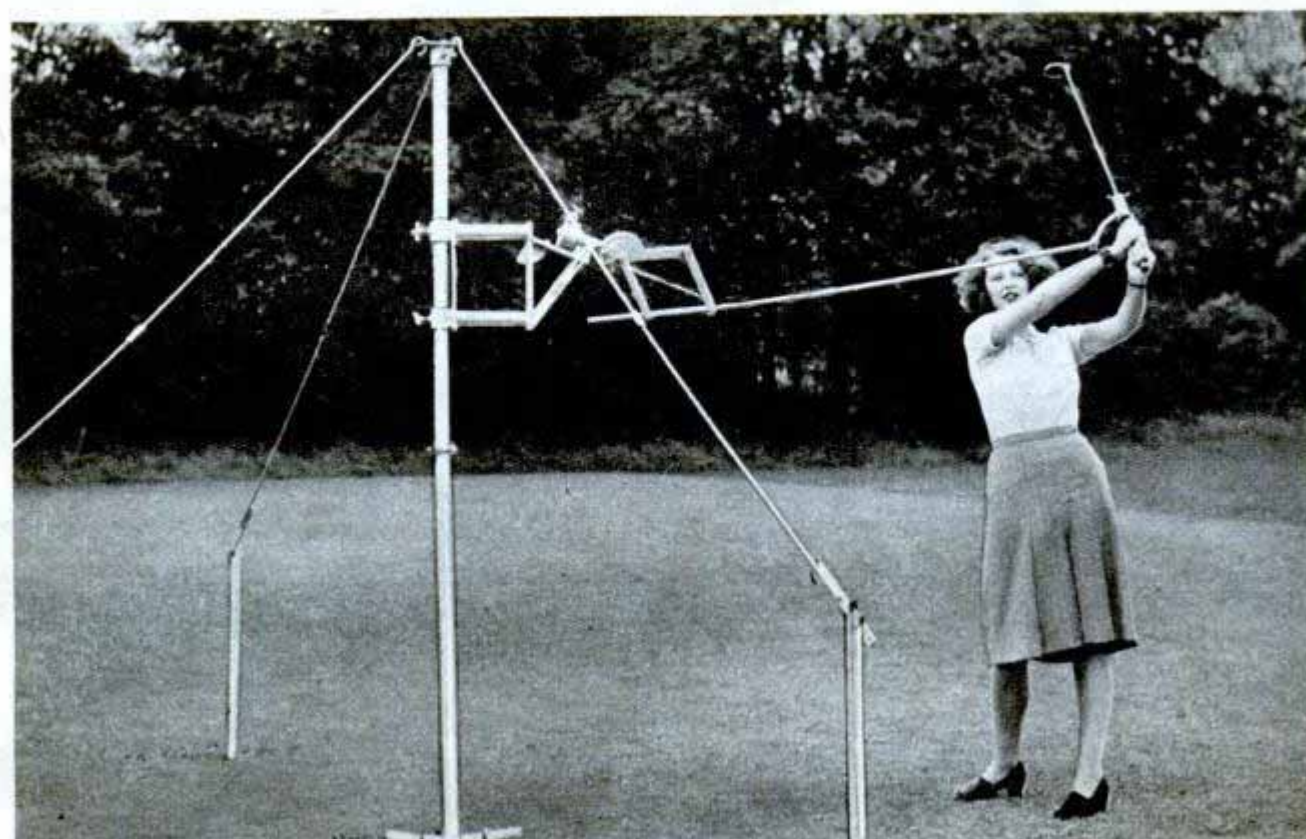

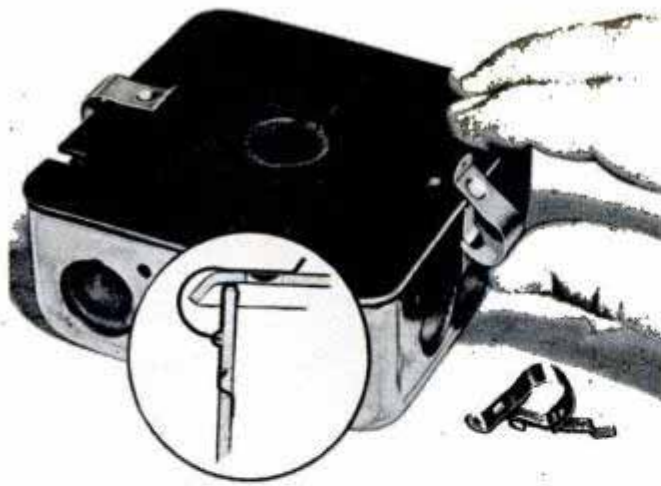

Box Tops Are Held Tightly by a steel clip fastener that eliminates the need for screws or nuts and requires no tools for attaching. The clip is snapped on by hand, with the lower part fitting into holes in the side of the box, and holds the cover securely. A slight push with the thumb detaches the clip and permits removal of the cover.

Britain's New Kendall Car, designed for low fuel consumption, has a three-cylinder engine mounted at the rear. The streamlined car will sell for approximately \$750.

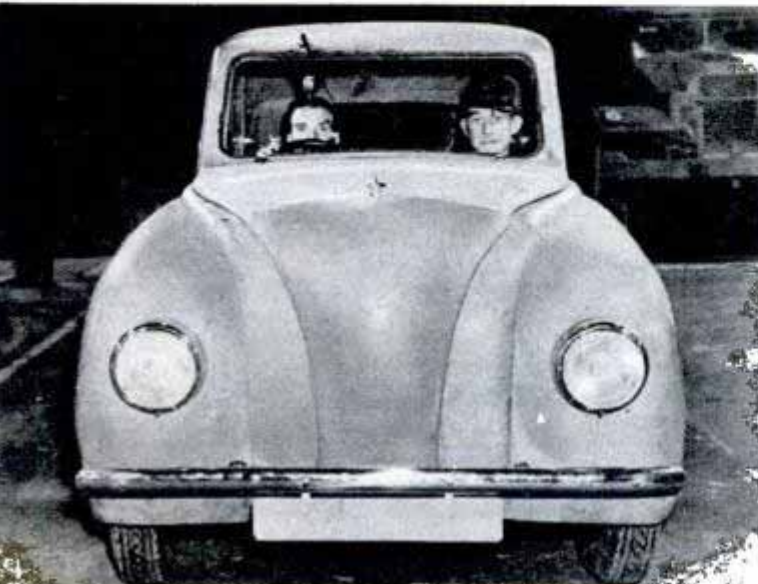
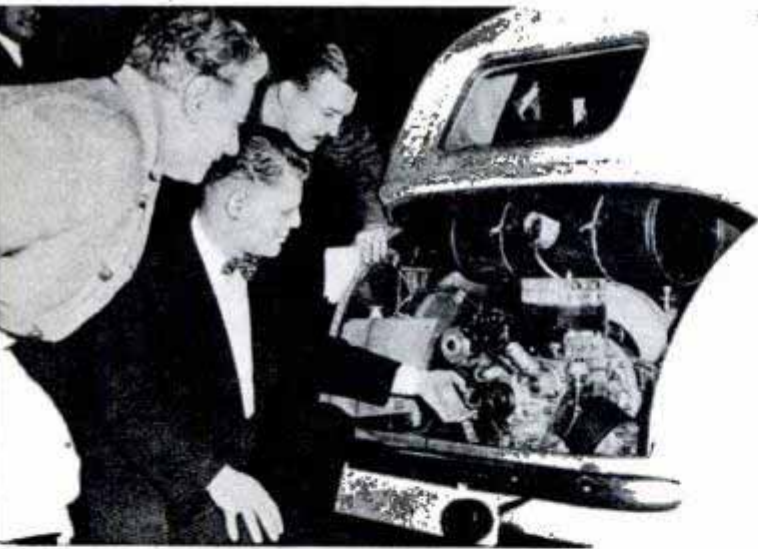

Synthetic Nonpetroleum Lubricant is reported to give all-weather starting ease, greater engine cleanliness, improved performance and freedom from wax. Called Prestone motor oil, it is one of a series of synthetic oils made from natural or other hydrocarbon gases. It will flow freely at a temperature as low as 30 degrees below zero Fahrenheit, where ordinary petroleum would freeze solid. The oil is more expensive to produce than petroleum lubricants and is being marketed on a limited basis.

Midget "Leakage" Tester, small and compact, operates on an electronic circuit and requires only one hand to operate. The unit tests insulation properties of plastic paints, varnishes or lacquers. It also shows leakage resistance caused by moisture absorption, insulation leakage in motors, machinery and cables, or it will test safety shoes, floor covers and other safety devices for electrical conductivity. To save battery and tube life, the unit has a "press to read" switch which operates only when in use.

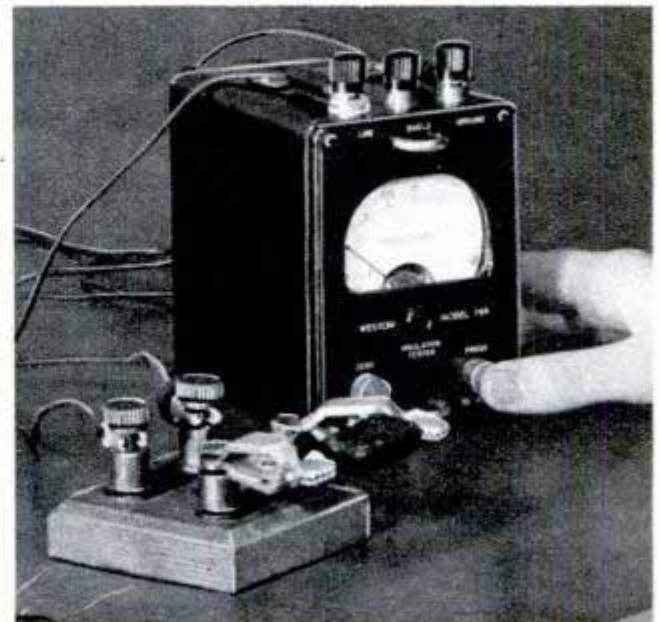

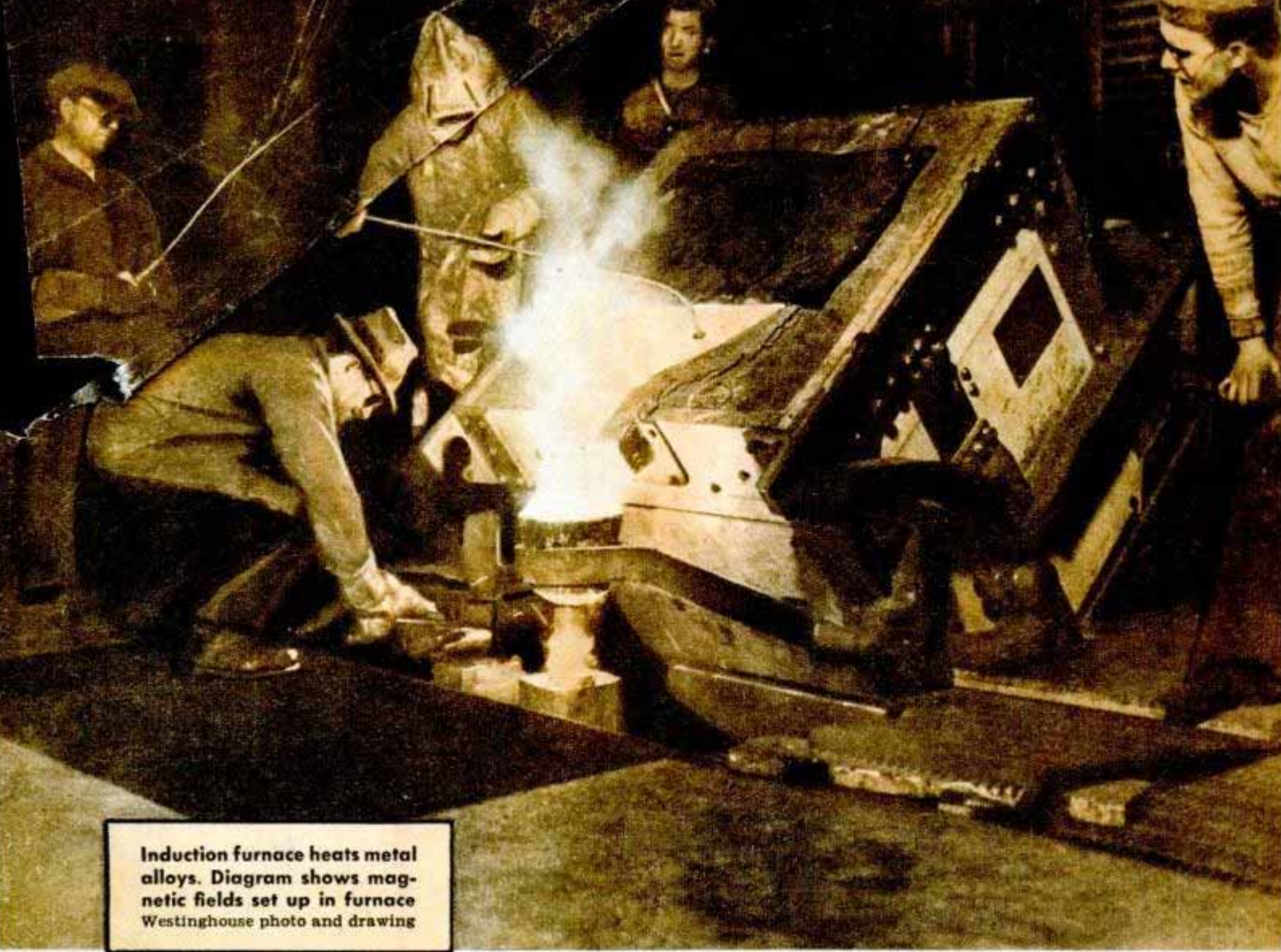

Induction furnace heats metal alloys. Diagram shows magnetic fields set up in furnace Westinghouse photo and drawing

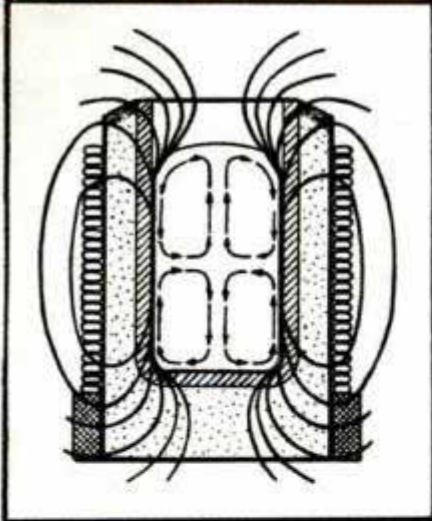

INDUSTRY Cooks with Electrons



By Thomas E. Stimson, Jr.

Once upon a time radio meant a tune in the parlor or a news broadcast. Now radio frequencies are industry's cookstoves, melting metals and molding plastics, bonding plywood and killing bugs

Cooking hot dogs with radio waves, a popular act at electronics shows, is a spectacular introduction to new and important uses for high-frequency electricity.

Today radio waves are defrosting foods in a few minutes, "welding" plywoods and veneers in minutes instead of hours and vulcanizing rubber tires in a fraction of the usual time.

High-frequency electricity in the radio and radar bands is used to sew plastic fabrics and synthetic fabrics together without the use of thread. It cures the glue in ladies' shoes and doesn't scorch the leather. It creates an artificial fever in

N.C.A. DIST. CE. IN



INDUCTION HEATING: Agricultural mower blades are hardened electronically. The sketch shows work in the magnetic field that is created by current in an induction coil

quency electricity is applied, the alternating force of the current causes a molecular agitation in the material. This agitation develops friction and this in turn creates heat in the same way that rubbing your

metal. The solder that secures the spout to your can of household lubricating oil was probably flowed into place by inductive heat. Westinghouse Electric Corporation, one of the leaders in the inductive heating field, has developed circuits for induction brazing that now are widely used.

Dielectric heating works in a direction just opposite that of induction heating. It heats from the inside out when applied to materials that are nonconductors or poor conductors of electricity. When a dielectric material such as wood is sandwiched between two electrodes to which high-fre-

quency electricity is applied, the alternating force of the current causes a molecular agitation in the material. This agitation develops friction and this in turn creates heat in the same way that rubbing your hands together warms them. The energy is absorbed by the material in relation to its conductivity. Hence a glue line in wood, or weevils in dry cereal, rapidly become hot while their surroundings remain cold. Within mechanical limits thickness doesn't matter. Plywood beams that are more than a foot thick consisting of 148 layers of birch veneer to which phenolic resin glue has been applied can be cured quickly with dielectric heat, permitting immediate use.

Electronic heating promises to revolutionize the rubber industry. Authorities say it is six times as fast as earlier methods and

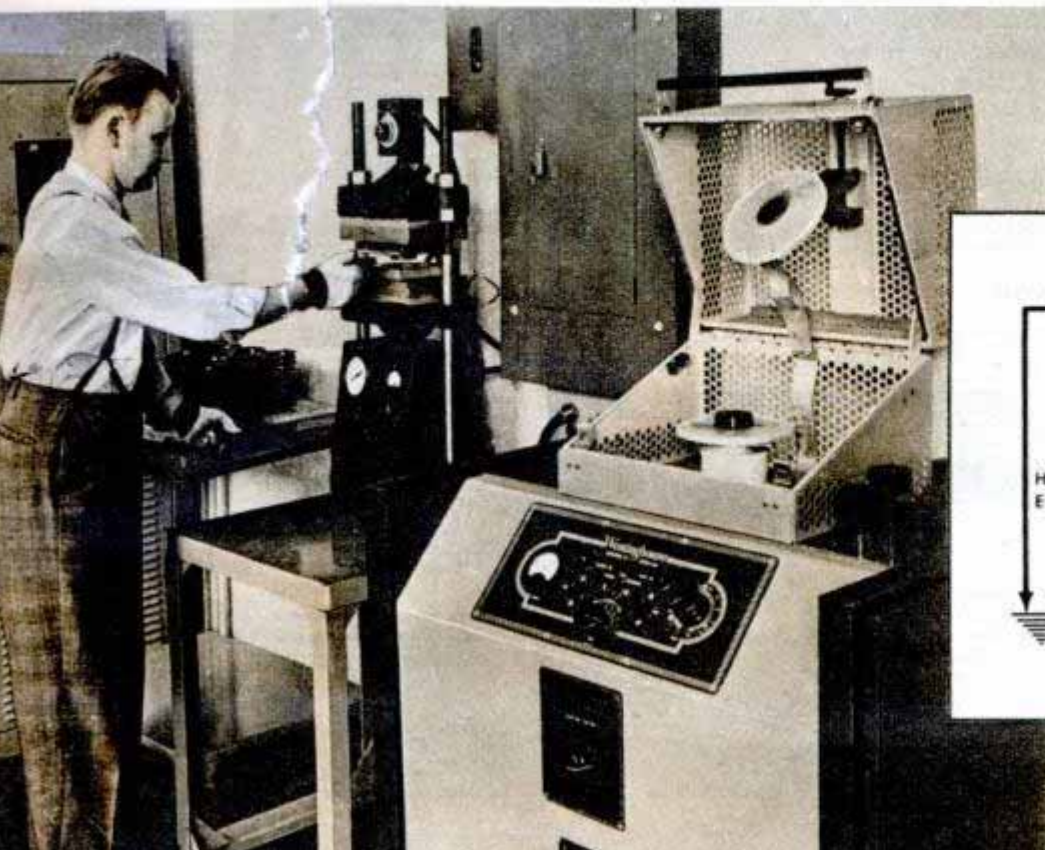

DIELECTRIC HEATING: Plastic preforms are heated by placing them between two electrodes carrying high-frequency current as shown in the sketch Westinghouse photos and drawings

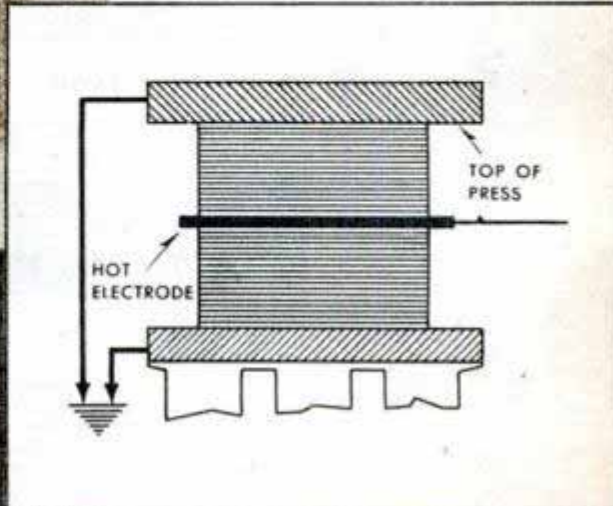

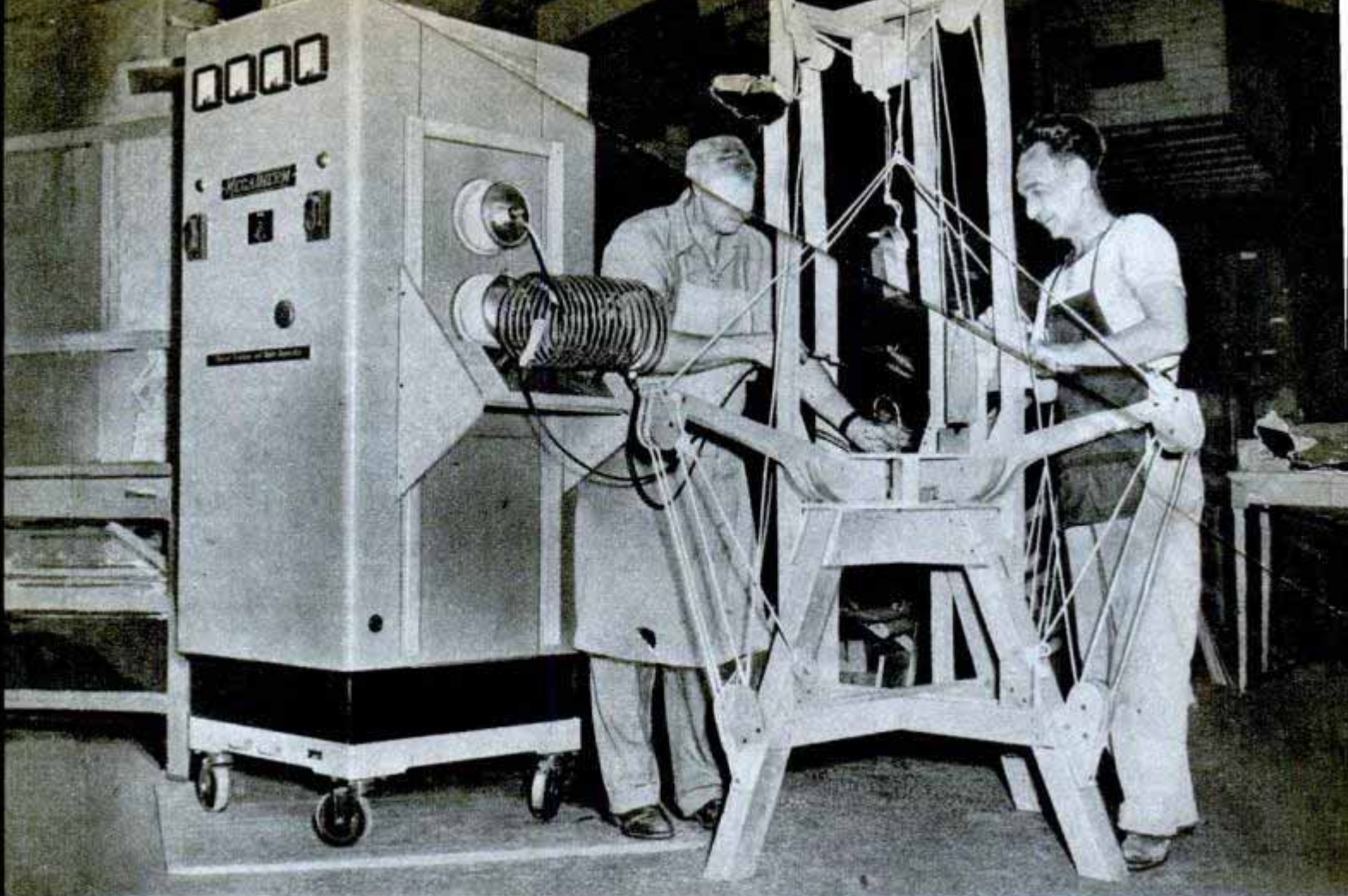

This complicated machine tests the strength of wood reinforcing angles after they are bonded by radio heat. Right, a heat "gun" cures glue inside wooden furniture

shafts for aircraft, tank and Diesel engines now are hardened inductively. It takes about two minutes to place the special inductive collars around a 13-bearing crankshaft, heat the bearing surfaces red hot and quench them. Rocker arm shafts for aircraft engines are hardened similarly at the rate of 1000 per hour. Interiors of automobile hubs are hardened by inductive heat, and even the cutting edges of chisels receive a local heat treatment that doesn't affect the toughness of the rest of the

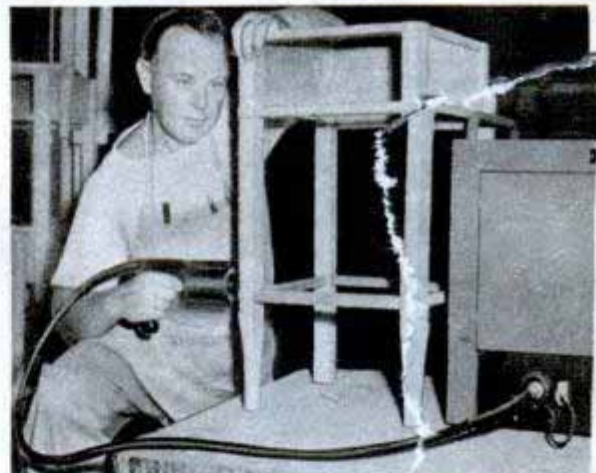
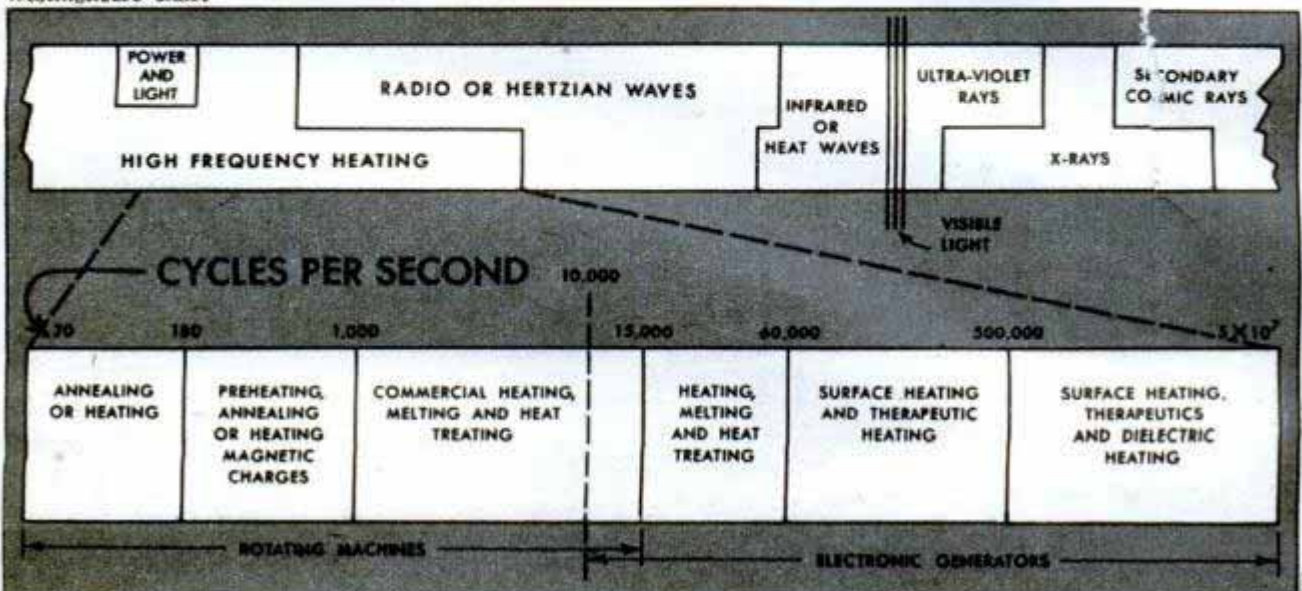
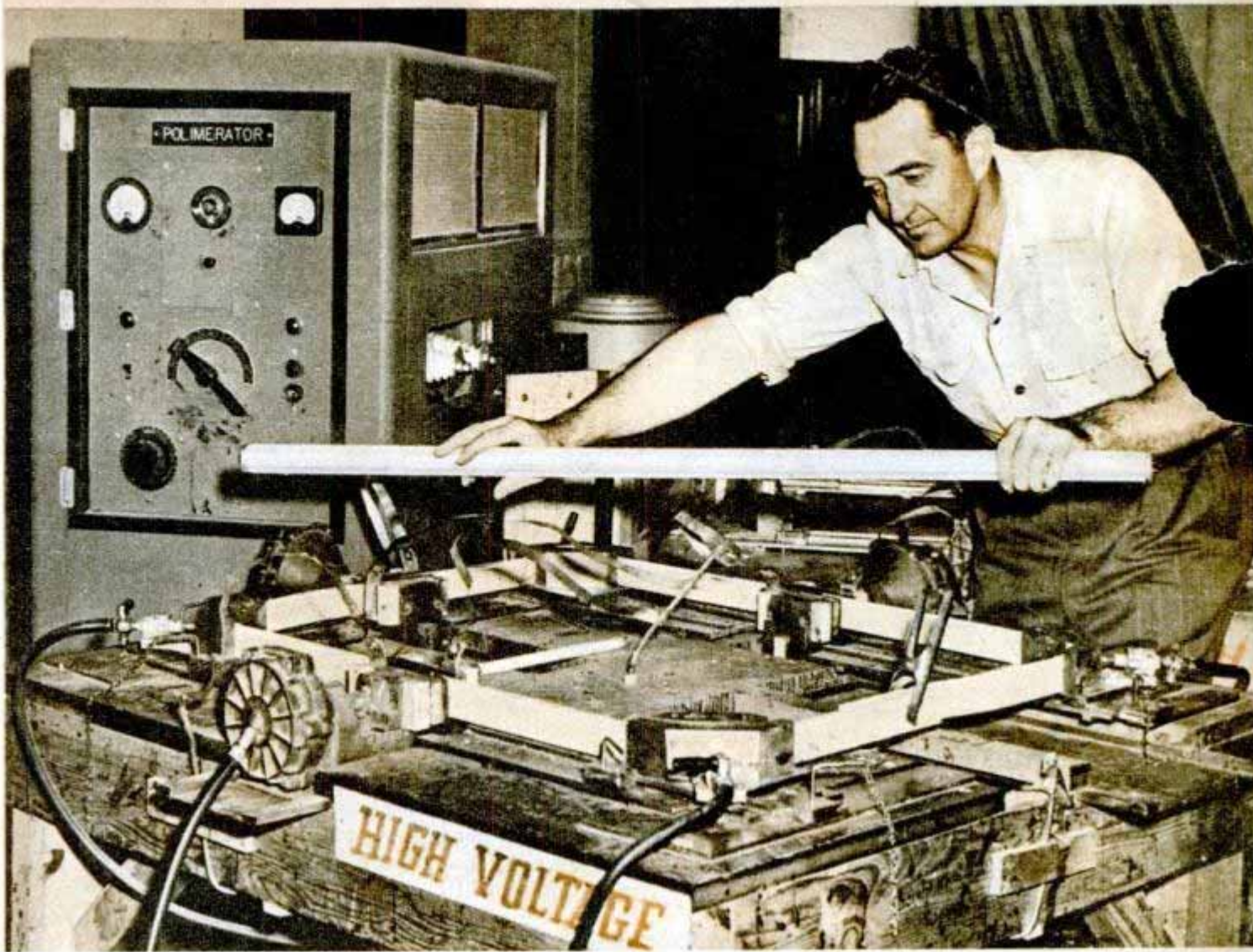

Diagram shows that part of the high-frequency radio wave spectrum that can be used for electronic heating Westinghouse chart





Fluorescent tube glows when held near wood-bonding machine. Below, cooking muffins on a "radio" stove

the human body for relieving pain and fighting infection.

Radio heat hardens the bearing surfaces of crankshafts and puts a superhard finish on the cylinder walls of internal combustion engines. It solders metals faster than they can be soldered by hand. In a single operation alone, that of "flowing" electrically deposited tin plate to smooth and brighten its surface, more than $2\frac{1}{2}$ times the power of all the radio broadcasting stations in the United States is used.

The 92 miles of wood reinforcing angles that were used in the construction of the 225-ton Hughes flying boat were manufactured by means of radio heat. The sturdy laminated beams used in the hull and the subassemblies of the boat were joined with the same high-frequency heat.

Soon radio may be used in the construction of homes by immediately curing the glues that are replacing nails for some purposes. It promises to kiln-dry lumber in less than an hour. Green lumber is put into a kiln to which a high-frequency current is applied for a short time; this draws the lumber's moisture content down to any desired amount without checking or



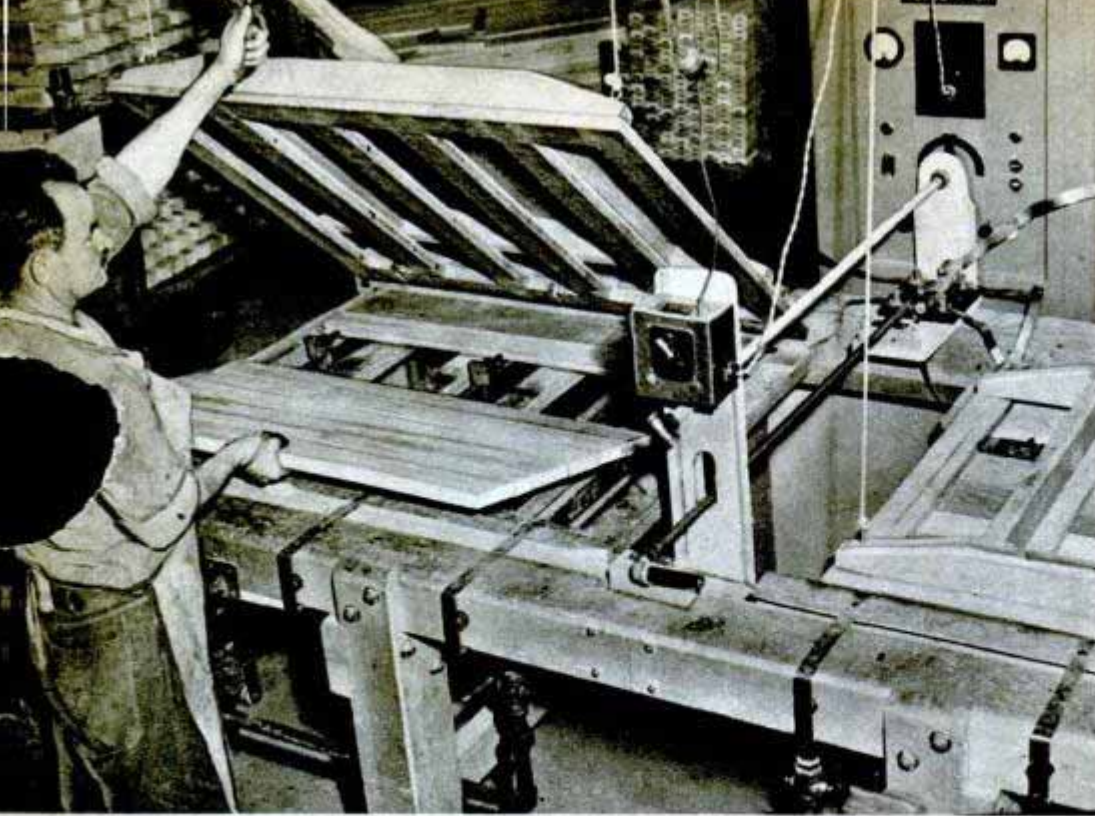

Glue in wood table top is cured in two minutes in a high-frequency heating jig. Below, these curved plywood beams were bonded by radio heat for use in building the giant Hughes flying boat

category. It's possible in theory but would be too expensive at present.

In the past, heat usually has been applied by conductive methods, that is, transferring heat by contact. In some applications conductive methods do more harm than good. Wooden furniture, for example, would have its outer surfaces burned if enough heat were applied to dry out its interior glues in a hurry. To avoid this the furniture must be set aside for days to allow the glue to dry. If heat is applied by ordinary methods to the teeth of a gear wheel to harden them, the whole wheel absorbs the heat and becomes brittle.

High-frequency heat, on the other hand, is applied just where it is needed—internally in the case of the furniture, externally in the case of the gear wheel. The surfaces of the gear teeth become red hot in a couple of seconds; the metal then is quenched before the heat affects the interior.

Heat is "crowded" onto the surface of a metallic conductor such as the gear wheel by the induction method—placing the wheel in the magnetic field of a high-frequency induction coil. Heat is created inside a nonconducting substance such as wood by the dielectric method—placing the material between the plates of a condenser to which high-frequency electricity is applied, causing molecular agitation.

Induction heating has become a standard industrial process. It melts tool steels and other special alloys. It is used in annealing and heat-treating processes. A low-frequency current of about 1000 cycles is the most efficient for such work. At higher frequencies the heating effect is shallow and at ultra-high frequencies the direct heating action affects the skin of the material only, without heating the interior.

Electrical engineers put this phenomenon to work in a dozen different ways. The bearing surfaces of practically all crank-

warping. Electronic heat may be used for the curing of alfalfa and other hays that are subject to spontaneous combustion during the drying process. It has been used to sterilize cereal foods and other packaged products. It shells cocoa beans and roasts both cocoa and coffee beans.

An electronic stove for the housewife has been proposed, but engineers are not yet ready to concede that it would be practical. The cooking of nonhomogeneous foods such as meat that contains fat and bone still requires further investigation. Heating your home electronically is in the same cate-



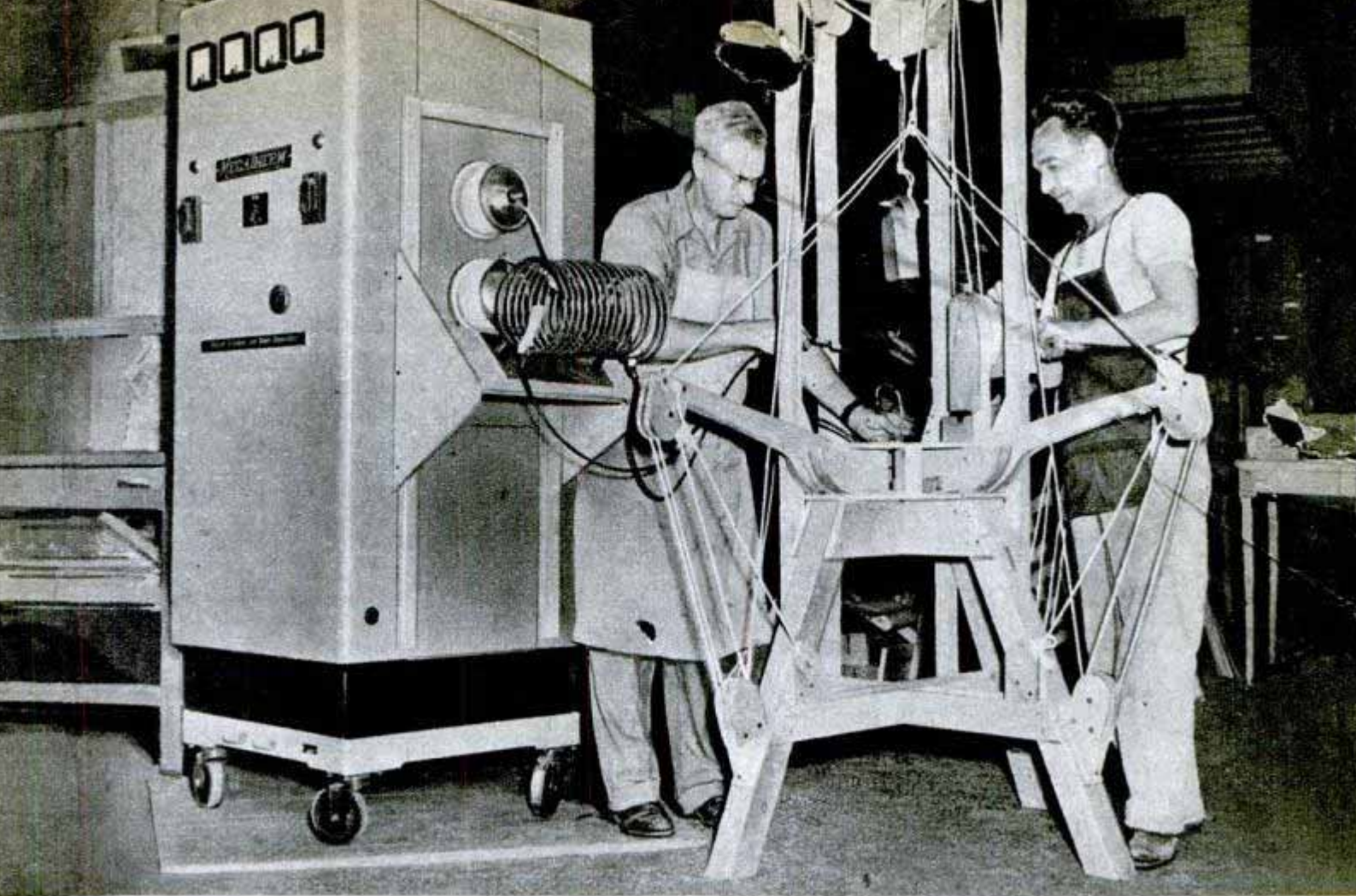

This complicated machine tests the strength of wood reinforcing angles after they are bonded by radio heat. Right, a heat "gun" cures glue inside wooden furniture

shafts for aircraft, tank and Diesel engines now are hardened inductively. It takes about two minutes to place the special inductive collars around a 13-bearing crankshaft, heat the bearing surfaces red hot and quench them. Rocker arm shafts for aircraft engines are hardened similarly at the rate of 1000 per hour. Interiors of automobile hubs are hardened by inductive heat, and even the cutting edges of chisels receive a local heat treatment that doesn't affect the toughness of the rest of the

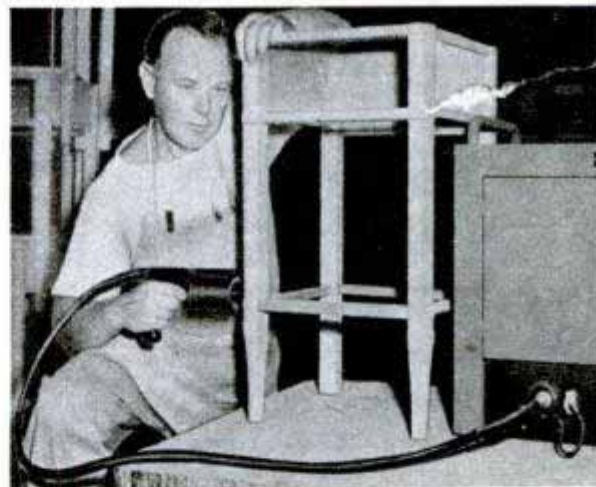
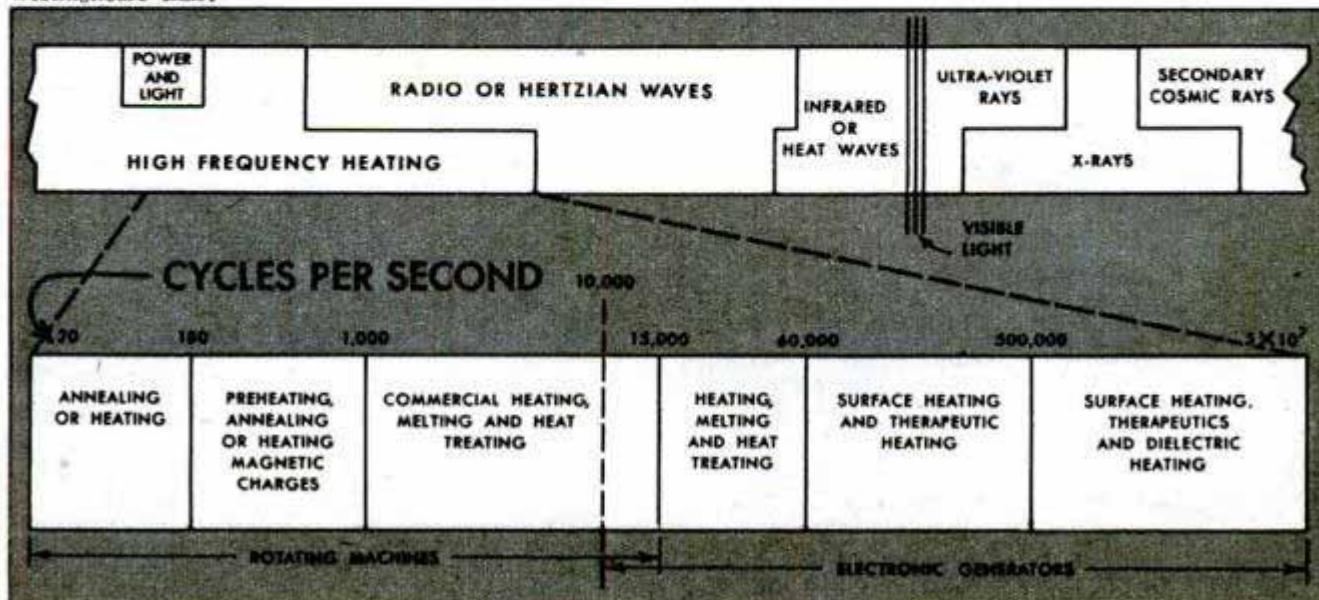
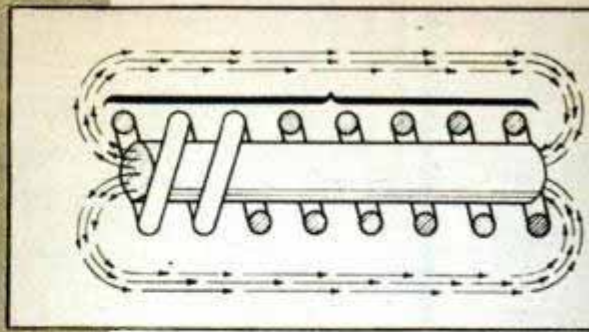

Diagram shows that part of the high-frequency radio wave spectrum that can be used for electronic heating Westinghouse chart





INDUCTION HEATING: Agricultural mower blades are hardened electronically. The sketch shows work in the magnetic field that is created by current in an induction coil

quency electricity is applied, the alternating force of the current causes a molecular agitation in the material. This agitation develops friction and this in turn creates heat in the same way that rubbing your

metal. The solder that secures the spout to your can of household lubricating oil was probably flowed into place by inductive heat. Westinghouse Electric Corporation, one of the leaders in the inductive heating field, has developed circuits for induction brazing that now are widely used.

Dielectric heating works in a direction just opposite that of induction heating. It heats from the inside out when applied to materials that are nonconductors or poor conductors of electricity. When a dielectric material such as wood is sandwiched between two electrodes to which high-fre-

quency electricity is applied, the alternating force of the current causes a molecular agitation in the material. This agitation develops friction and this in turn creates heat in the same way that rubbing your hands together warms them. The energy is absorbed by the material in relation to its conductivity. Hence a glue line in wood, or weevils in dry cereal, rapidly become hot while their surroundings remain cold. Within mechanical limits thickness doesn't matter. Plywood beams that are more than a foot thick consisting of 148 layers of birch veneer to which phenolic resin glue has been applied can be cured quickly with dielectric heat, permitting immediate use.

Electronic heating promises to revolutionize the rubber industry. Authorities say it is six times as fast as earlier methods and

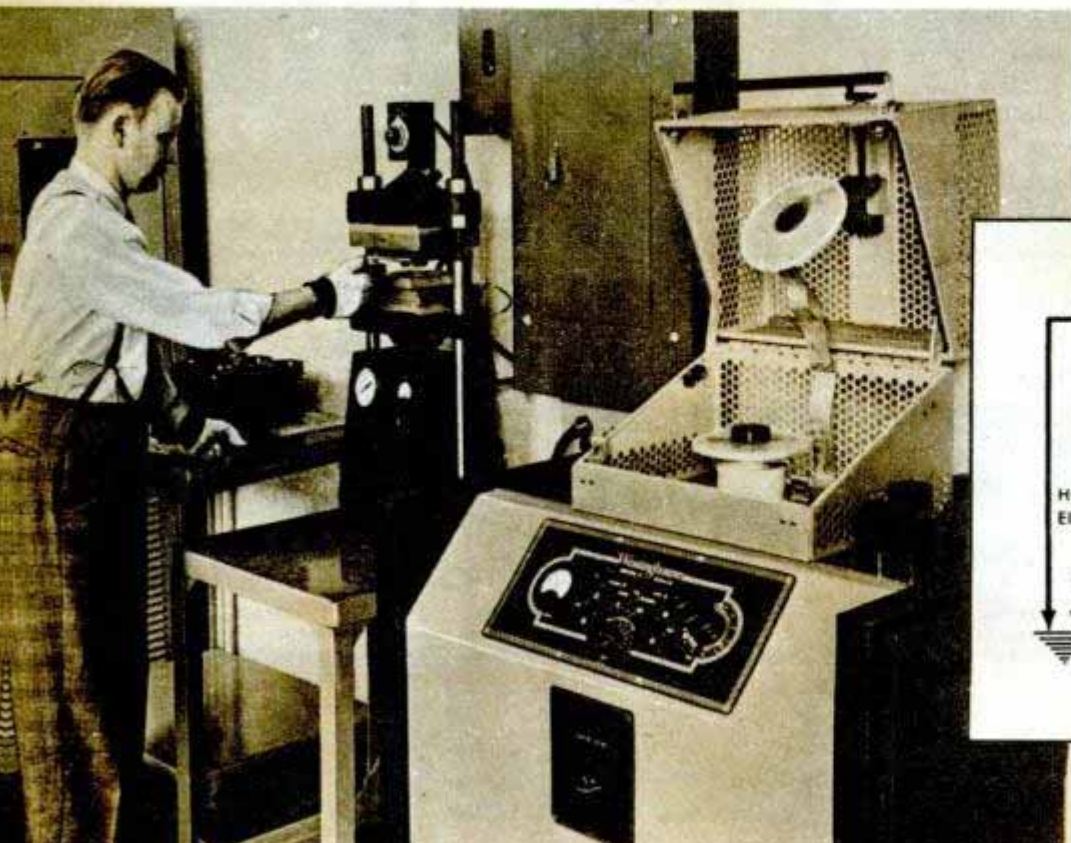

DIELECTRIC HEATING: Plastic preforms are heated by placing them between two electrodes carrying high-frequency current as shown in the sketch Westinghouse photos and drawings

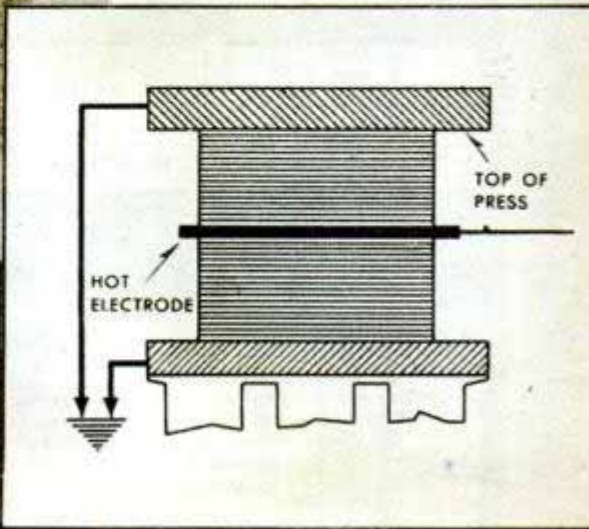

turns out better products. It is applicable to the manufacture of either natural or synthetic rubber.

One of the important factors in making rubber is the even heating of the materials to prevent flaws. Electronic heating promises to be ideal for this work. In addition, it bonds the sulphur and rubber molecules more completely by agitating them. At present, heating by radio in the rubber industry is confined to the production of cushions, upholstery, mattresses and other sponge rubber articles. But experiments have been conducted with electronic curing and drying of automobile and airplane tires, elastic thread, tank track treads, rubber wheels for industrial trucks and brake blocks of resin and asbestos.

Electronic heating makes possible a further saving of time in drying the molded rubber. Twelve hours were required to dry molded rubber seat cushions in a steam oven. Today they are dried thoroughly by a one-minute electronic treatment followed by one hour in a drying tunnel.

In the plastics industry dielectric heat is widely used for preheating plastic material before it goes into the molds. A large quantity of the material can be heated throughout without overheating the exterior. Dielectric heat is also a boon to cabinet-makers who now can avoid using nails and other fastenings that require concealment. It promises to put furniture manufacture on a production line basis by eliminating drying time delays. Its possible use



This plywood shape for an article of furniture was molded in only two minutes by high-frequency heat. Below, engineer inspects machine that generates heat in dielectric substances by beaming waves of energy in the radio spectrum

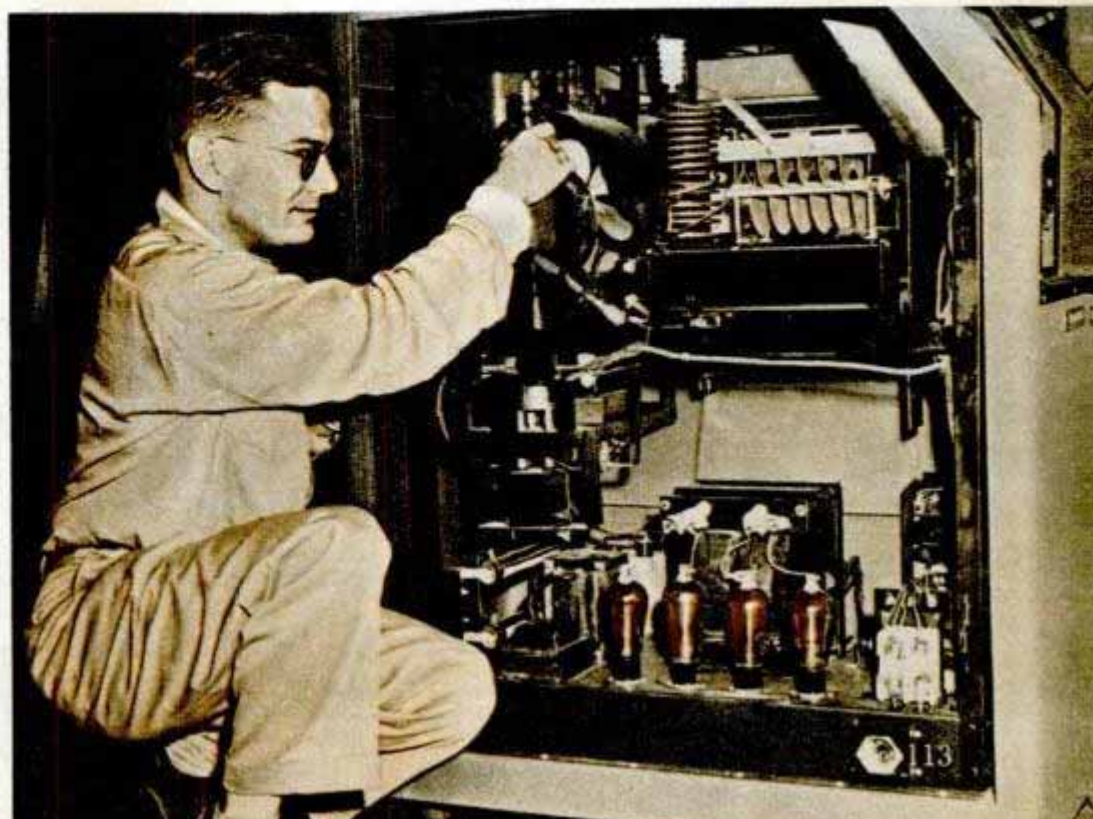

Electronics 306 4th and Pittsburgh Pa

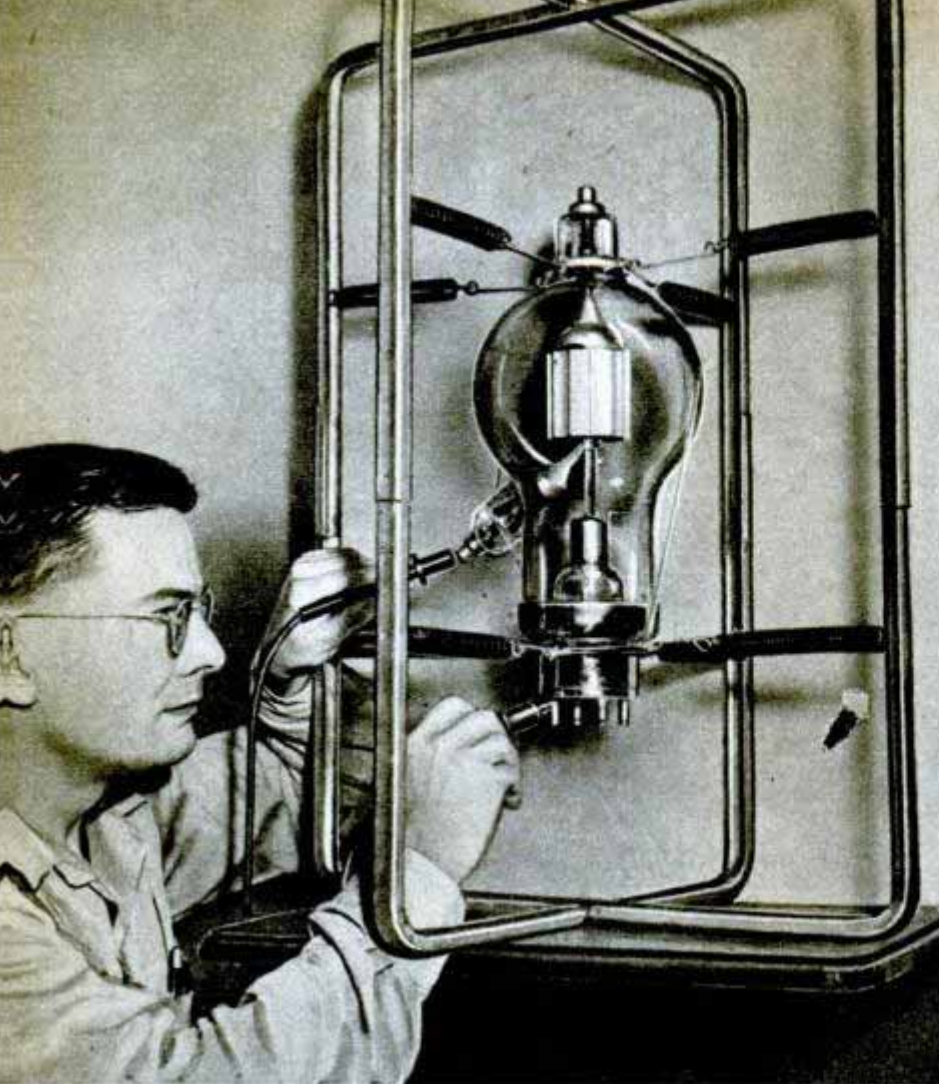

A technician tests the circuits of a large electronic tube that generates high-frequency waves. The waves are approximately the same length as those used by short-wave broadcasting stations

is being studied in the fields of dehydration, the drying of oils and in creating chemical reactions requiring "inside" heat.

Merit Shortwave Diathermy Company of Los Angeles, a manufacturer of artificial fever machines for medical use as well as industrial dielectric units, has developed

an electronic heat gun that dispenses with the two electrodes that are usually required for dielectric heating operations. The gun consists of one electrode at the end of a coaxial cable. It produces heat in a dielectric material when it is held against the material and the trigger pressed. Adapted for heat "tacking" and for curing glues in furniture manufacture and residential construction, the gun contains a small neon lamp that glows bright red as soon as the glue is set. Thin pieces of wood and glue are permanently bonded by the gun in a couple of seconds and thicker material "welded" in less than a minute.

Explosive rivets have been developed to facilitate riveting where only one side of the rivet can be reached. By applying heat to that side, a small explosive charge is set off that completes the riveting job instantly by spreading the "blind" end. Heating the heads of these rivets is now done quickly and simply by use of a radio-heat gun that induces electric currents in the rivets.

Electronic heating of high explosives is much more satisfactory than other heating methods. It is easier to control and heats such dangerous materials much more uniformly, an important safety factor.

One of the major advantages of dielectric heating is its speed. During the war airborne plywood rescue boats weighing over 1½ tons were developed to be dropped by parachute to flyers lost at sea. The total production time of each boat with original

The induction heating process is applicable to materials that will conduct electricity. Below are shown some of the uses of this "broadcast" heat. The highest wave frequencies are required for heating only the surfaces

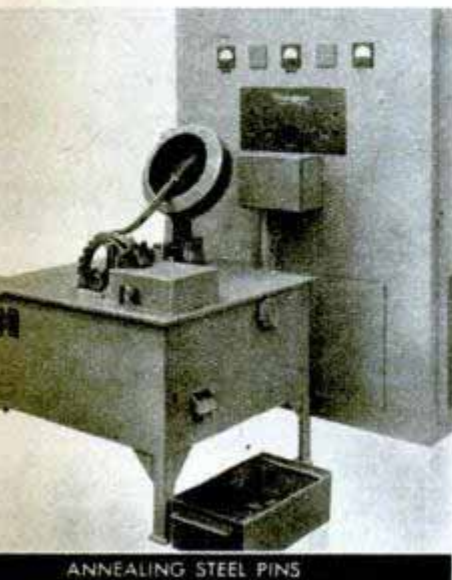

ANNEALING STEEL PINS

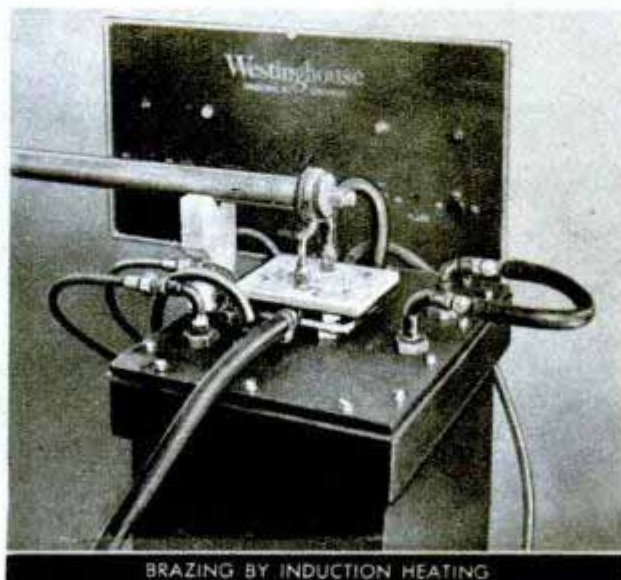

BRAZING BY INDUCTION HEATING

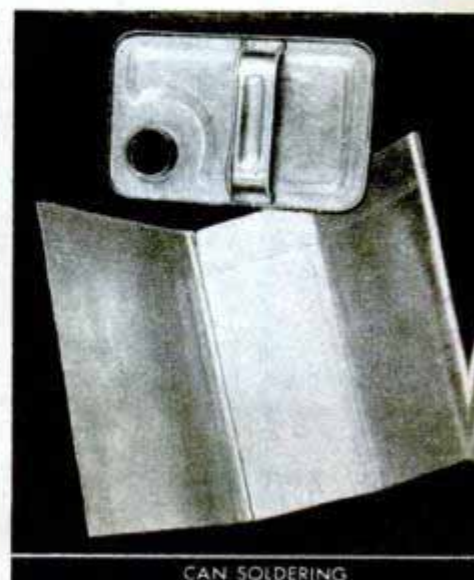

CAN SOLDERING

methods of construction was six months. With an electronic generator, production time dropped to 26 days. And rejected work was reduced from 40 percent to 2 percent.

High-frequency electricity for either induction or dielectric heating is created by electronic generators of the vacuum tube type. The circuits are essentially those of short-wave radio transmitters. Frequencies are confined to bands that will not interfere with short-wave radio communication. Certain frequencies appear to be the most effective for heating certain materials although in a general way the greater the frequency the more rapid is the heating effect.

Radio heat is much more efficient than most conventional kinds of heat. An electronic generator normally is 50 to 75 percent efficient, the remainder of the power being disposed of as waste heat. An automobile engine is only about 30 to 35 percent efficient, an incandescent lamp less than 10 percent and a steam locomotive about 8 percent.

Because electronic heating devices have few moving parts they require little maintenance. Tubes often give a year or more of uninterrupted service. The equipment for radio heating does not produce vibrations which might have a serious effect on the material being treated.

High-frequency heating of either type is quite expensive. It's far cheaper, for example, to boil water by building a fire under the pot than it is to boil the water by using radio waves. High-frequency heating has little advantage in operations where temperatures are not critical. On the other

Sinus patient dons mask equipped with rubber-padded electrode to take treatment from radio fever machine



hand it often produces a result that is impossible with other heating methods, it increases the speed of a process, confines the heat to the desired area, and is clean and compact.

Not all of its possible applications have been investigated yet. Further uses are being developed. For this purpose Westinghouse Electric is opening three regional high-frequency heat laboratories where the practicability of heating various products electronically by beaming short waves to them is being studied.

A typical surface hardening block for induction heating is diagrammed below. It includes openings to cool the work quickly by quenching it after heating. At right, hacksaw blades are hardened by a similar block

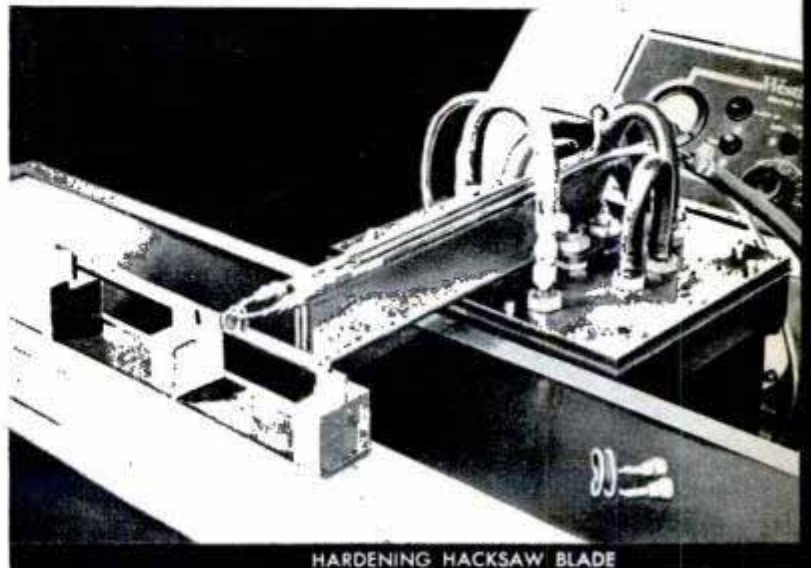
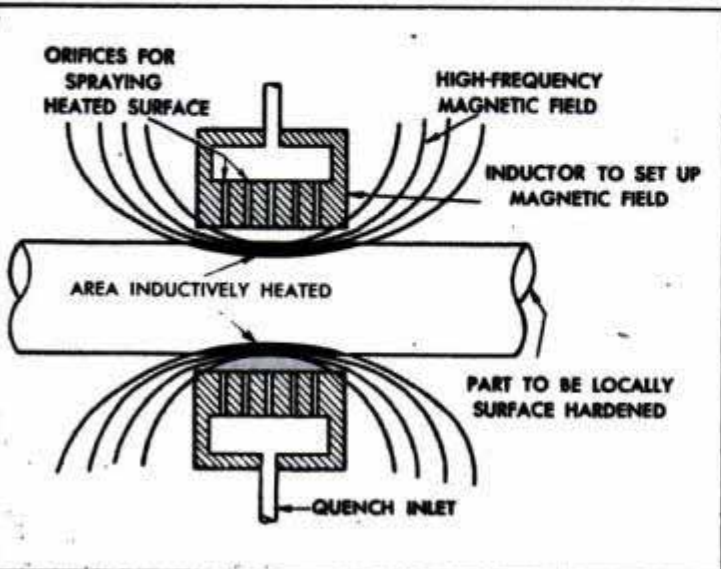

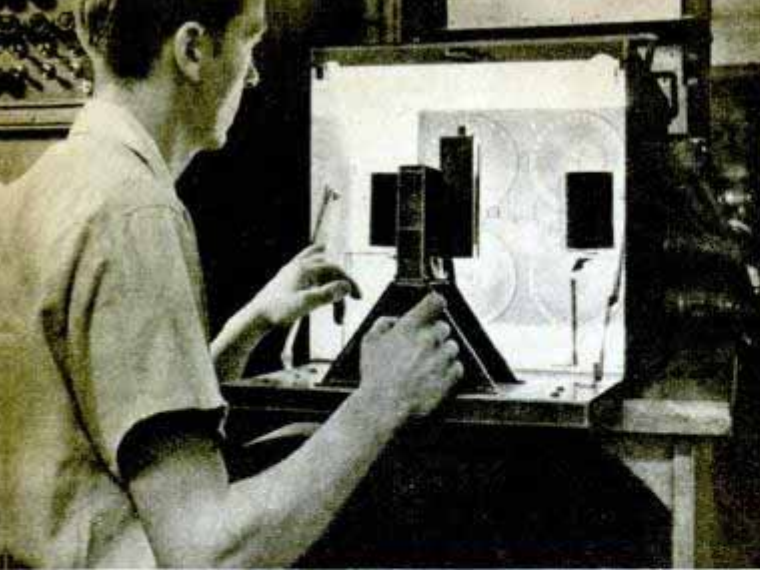

"TWO-EYED" MOVIE CAMERA made by Western Electric recorded results of tests on electrical gun directors. Using a 16-millimeter film, the camera takes 50 feet of movies and photographs dials and moving target



DIRECT-WRITING ELECTROCARDIOGRAPH records patient's heart action as it "listens," eliminating photographic procedure required with former machines. New instrument magnifies heart action about 14,000 times



GAUGES for a thousand precision checking jobs are made up from instruments packed in case 20 inches long. They are used in conjunction with gauge blocks

PLUMBER'S "STETHOSCOPE" locates underground leaks in water pipes and leaks in steam pipes behind walls and under floors. Air chambers amplify sound



INCLINED FLOORS provide workers with plenty of room to install ailerons, wing flaps and other subassemblies in the wings of giant Lockheed Constellations

AIR-COOLED DIESEL ENGINE only 28½ inches high develops 3¾ horsepower. It was produced for powering communication systems, pumps and conveyors

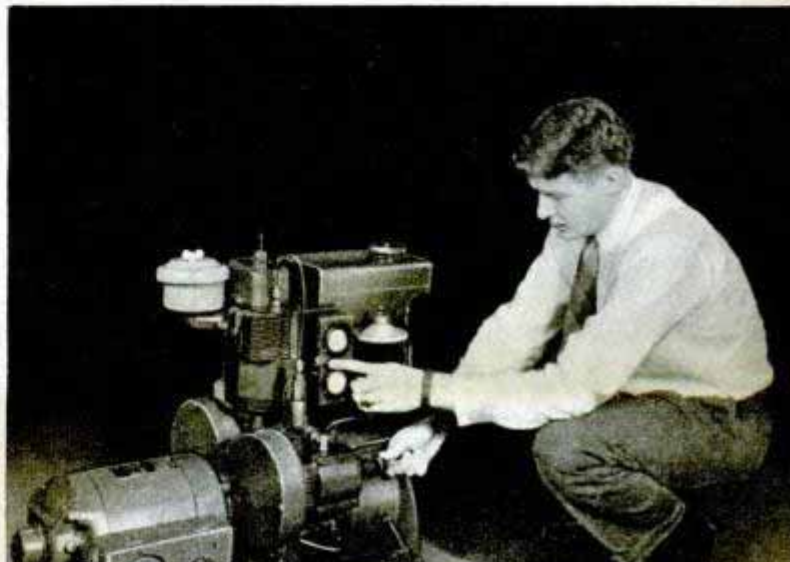



Information board held up in pits tells the driver the number of laps he has run—a scene at one of the last prewar races

They're Warming Up for the *SPEEDWAY*



HALF a dozen theories on how to win the Indianapolis race will be put to the test on Memorial Day.

Some drivers, burning straight high-octane gasoline, hope to finish the 500-mile classic without one stop at the pits. Others will use alcohol or alcohol-gasoline blends and will depend on flashier speeds to carry them to the winner's flag even though they must stop en route for more fuel and a tire change. One fast stop in the pit consumes about as much time as driving one lap.

Some drivers will do their best to "get in front and stay in front," strategy that is most likely to pay off if wet weather causes part of the race to be run under the yellow

flag that means "Caution—hold your position." Still other drivers will strive to maintain the exact speed that they have estimated the winner will average. Driving more conservatively, they reduce the chance of mechanical failure.



By Thomas E. Stimson, Jr.

Four years' improvements are being built into cars that will compete for the checkered flag in the first Indianapolis classic since 1941



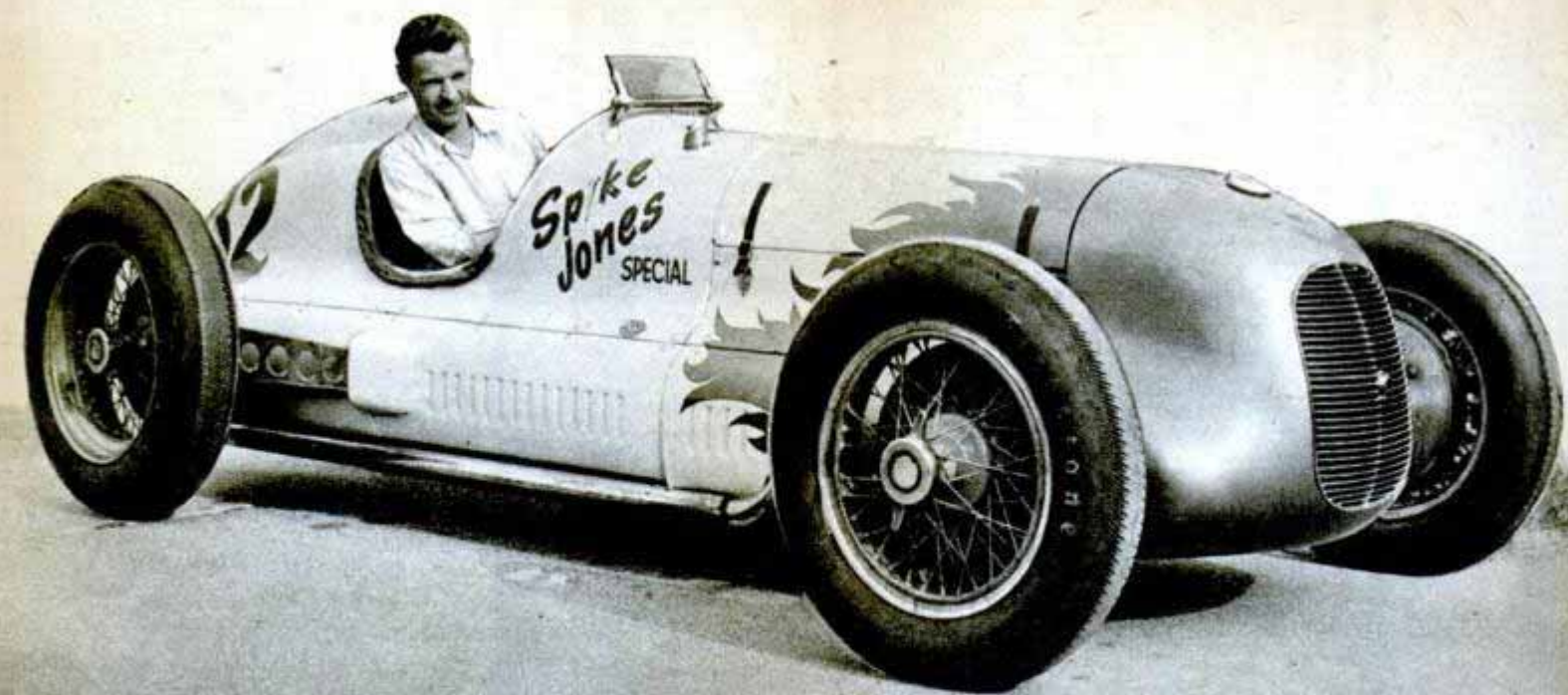

These two views of a "special" show the stable low-slung chassis and the supercharged 16-cylinder engine

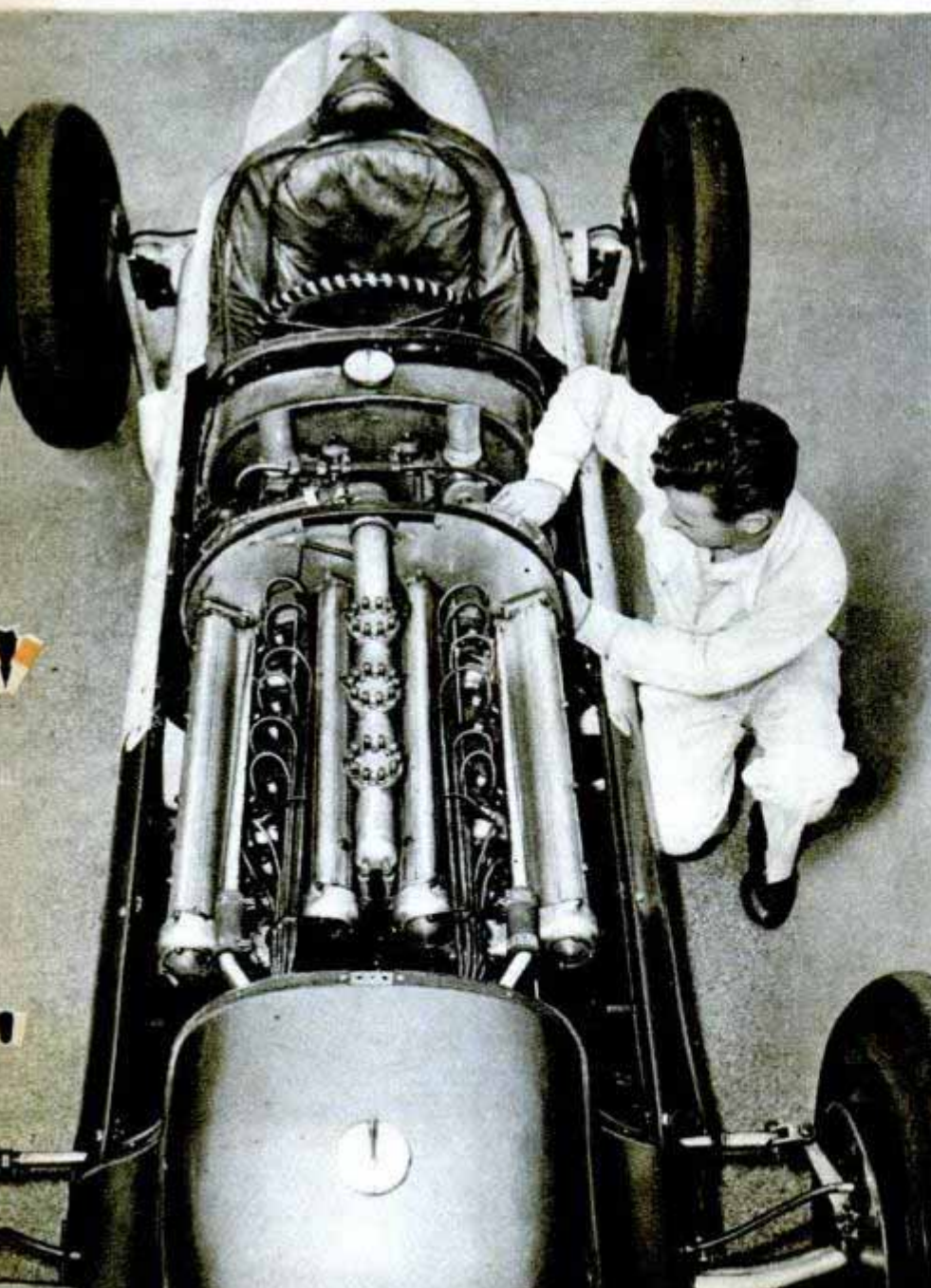

Slowing down for the turns has always been a handicap. A car that can do 175 miles per hour in the stretches must slow to around 110 miles per hour for each of the four corners on the Indianapolis track. A few miles per hour extra speed in the turns would be a tremendous advantage, and each driver has his own idea for getting that extra speed this year.

Some have lowered the center of gravity of their cars so that they can take the turns faster and still stay on the track. Some are depending on front-end-drives to pull them through the corners faster than ever before without broadsiding. And at least one car now under construction will have power on all four wheels to provide the traction that is needed.

There will be no jet engines or other radical innovations among the competing cars. It takes a good nine months of engineering and shop work to put a new racing car together. Although a few owners are building brand new cars for this year's race, most of the cars are veterans of one or more prewar races. These include fours, sixes and eights, supercharged and nonsupercharged, plus the Spike Jones Special. This car, to be driven by Gordon Schroeder, is powered by a 16-

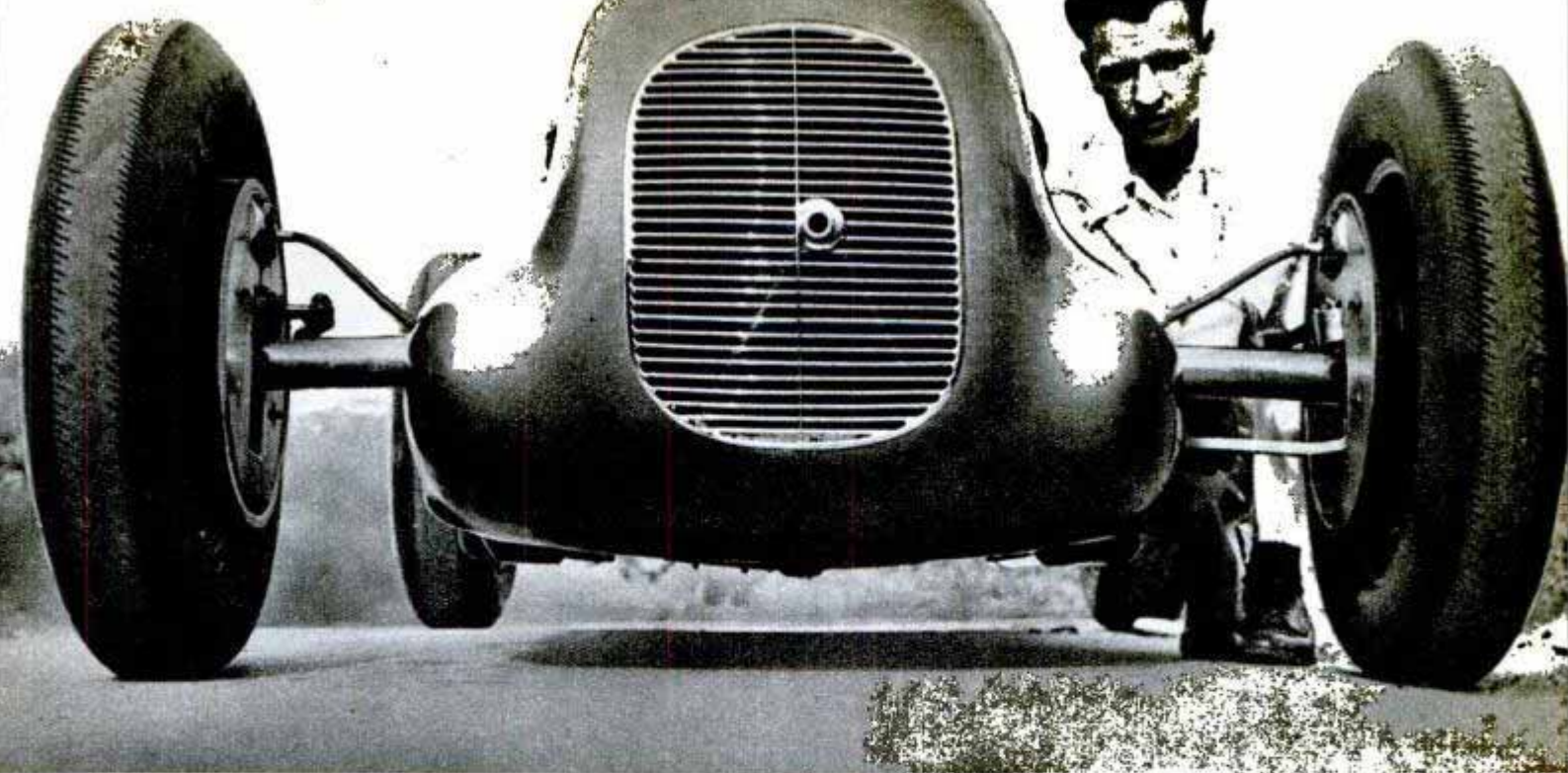

Wheels of the Spike Jones Special are almost as high as the buglike front end. Note the extremely low ground clearance

cylinder supercharged engine of 183 cubic inches displacement. The engine was used originally in the Stutz in which Frank Lockhart was killed at Daytona Beach in 1928. In spite of its age it is considered new, for it has been raced for only a few thousand miles.

Minor changes are being made in nearly all of the older cars to increase their power and improve their handling in the turns. Radiators and clutches, two weak points that have caused numerous cars to drop out of past races, have received special attention in this year's prerace overhauls.

One of the various new cars under construction this spring will have twin power plants. Planned by Lou Fageol, the car will have one standard midget racing engine over its front axle, delivering power to the front wheels, and a duplicate engine in the rear for powering the rear wheels. Both engines will be supercharged and the total power of the combination will amount to about 300 horsepower.

Two cars recently were built in the same shop in Chicago. They are owned by Joe Lencki. One is a six-cylinder job that will be driven in the race by champion Mauri Rose, cowinner of the

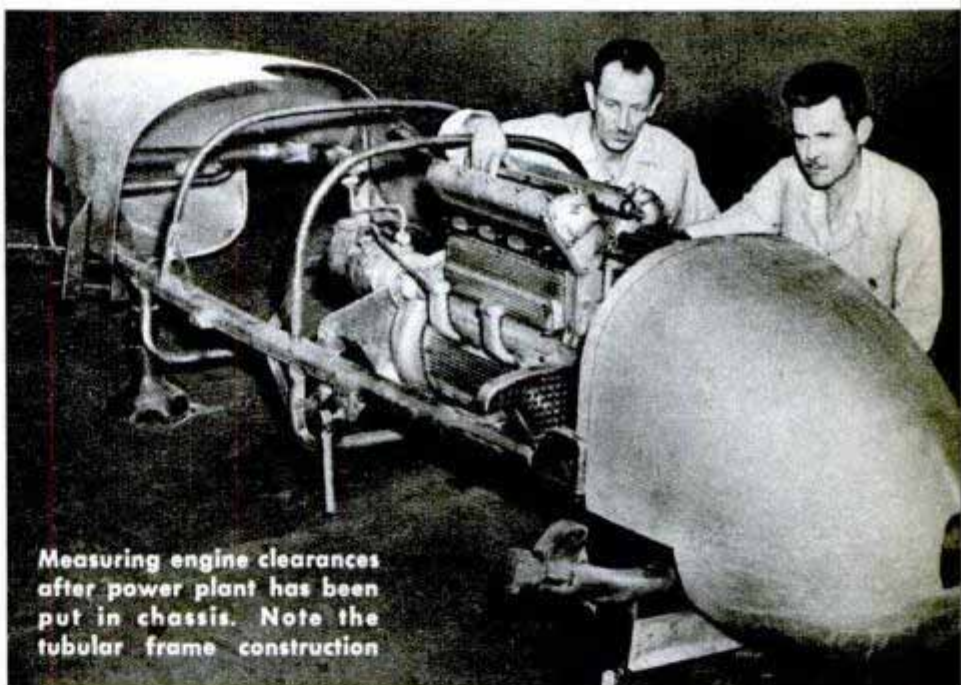

Measuring engine clearances after power plant has been put in chassis. Note the tubular frame construction

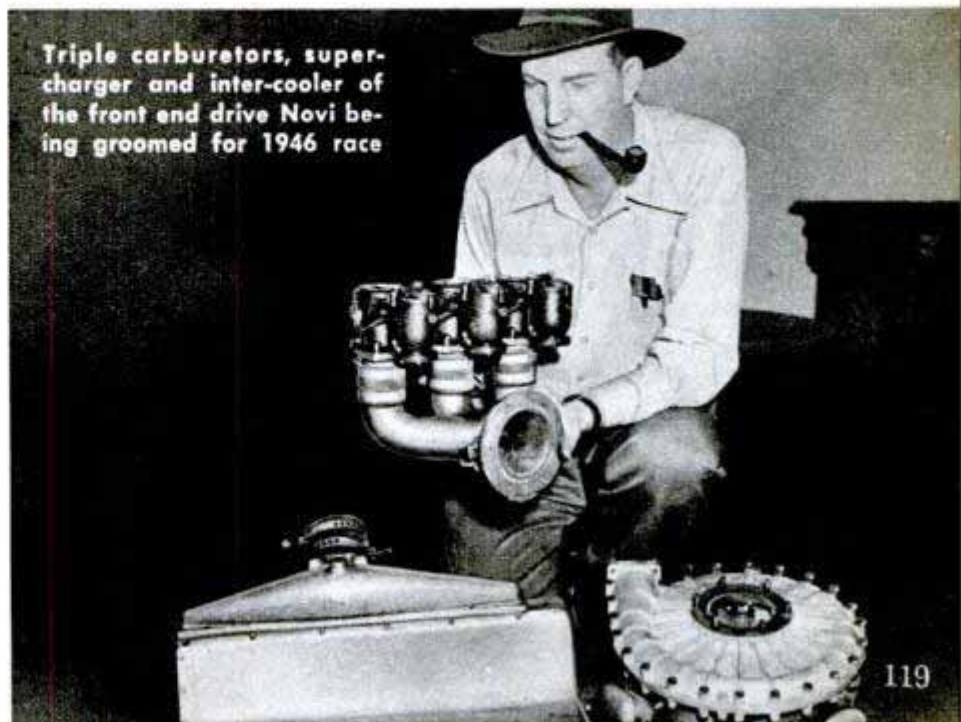

Triple carburetors, supercharger and inter-cooler of the front end drive Novi being groomed for 1946 race

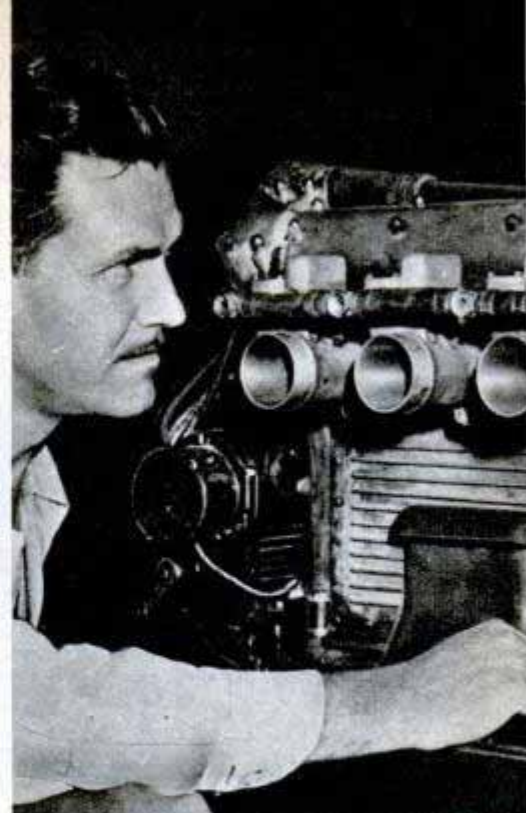
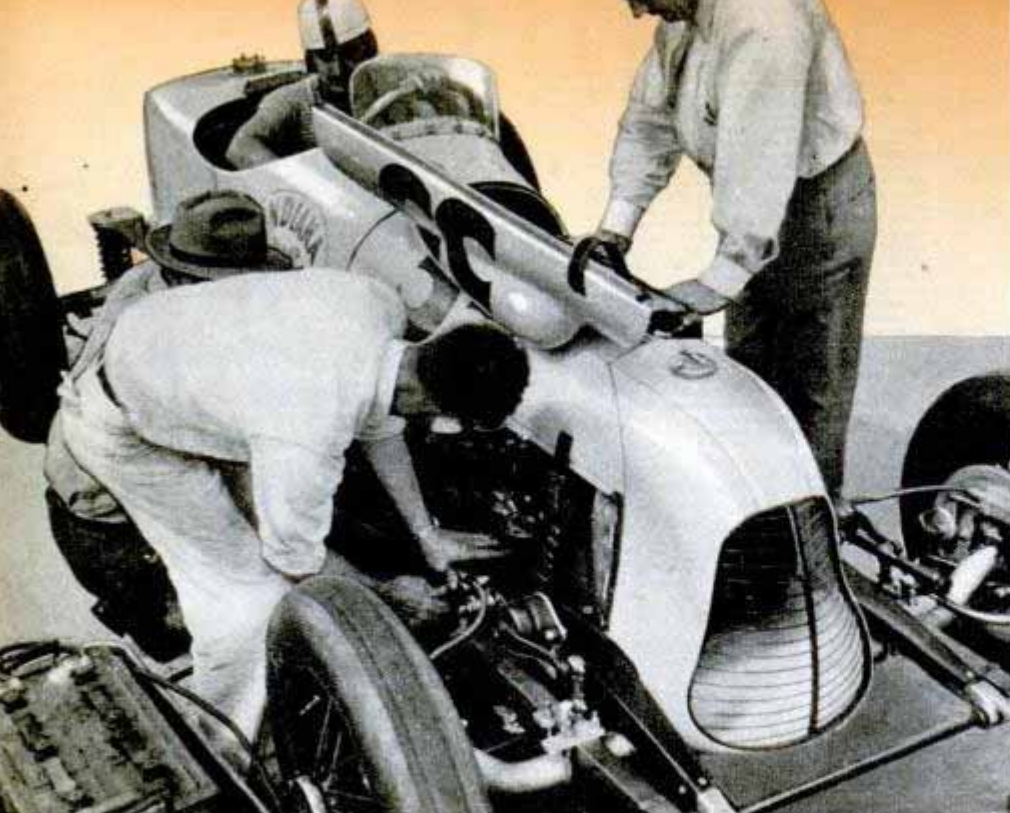

Pitmen give an Indianapolis car a last minute tuneup. During the race they coach the driver from the pit

last international speed engagement. Its four-cylinder mate will have Tony Bettenhausen at the wheel.

Both cars are equipped with new disk brakes, compound carburetion, oil cooling and other late improvements. The power plants are of the high compression (16 to 1) high speed type, developed to reach maximum efficiency without supercharging. Both are rated at 265 cubic inch displacement, the six turning up to 6000 revolutions per minute and the four to 5000.

The "Lencki Cocktail," a secret formula of alcohol-petroleum fuel, will power the engines. Both cars were designed so that they can be adapted to dirt track racing as well as the Indianapolis run.

Another new car that incorporates a number of advanced ideas is the Novi Governor Special, a low, bullet-shaped front-end-drive job designed and engineered by Bud Winfield and Leo Goossens of Los Angeles for an eastern owner. The two engineers also designed the 500-horsepower supercharged V-8 engine that will power the car. Doc Williams has been named as tentative driver.

The tallest part of this car stands 36 inches above the track and the car's hood is an inch lower than its 33-inch diameter tires. Clearance under the crankcase is only 5¼ inches.

Weight is concentrated at the front end to an unusual degree to provide the best traction under all circumstances. The engine is ahead of its usual position, the oil tank and oil radiator are carried in the pro-

jecting front end, and the three-speed transmission is slung under the front axle. Front tread is 62 inches, six inches wider than the rear tread.

All of these features are designed to allow the driver to take the turns some 15 miles per hour faster than usual without excessive sliding.

Body of the Novi Governor Special is of sheet aluminum over a "chrome moly" frame. One innovation is the use of steel castings for the steering knuckle and steering knuckle support instead of conventional forgings. Modern steel castings, developed during the war, are as strong or stronger than forgings after heat treatment. They can be cast to within 1/64 inch of final dimensions and thus eliminate much of the usual machining, and they contain no blow holes or other flaws. They are X-rayed and Magnaflux inspected prior to use.

The overhead valve V-8 engine that will power this car develops 500 horsepower at

Front view of the Novi Special front-end-drive car

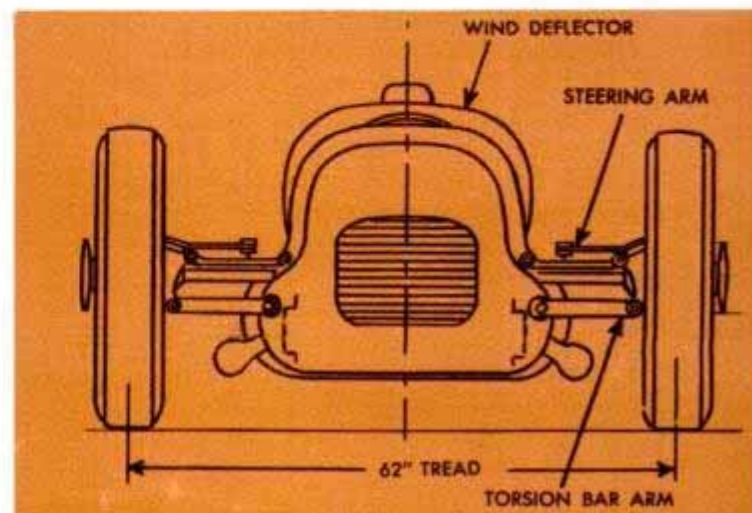

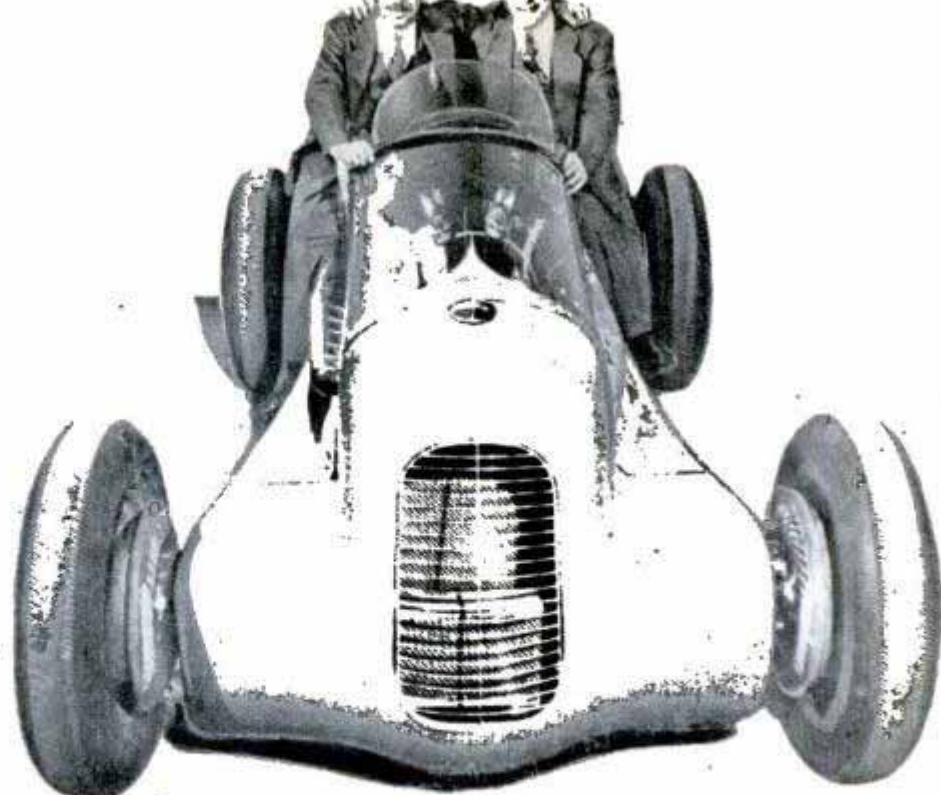
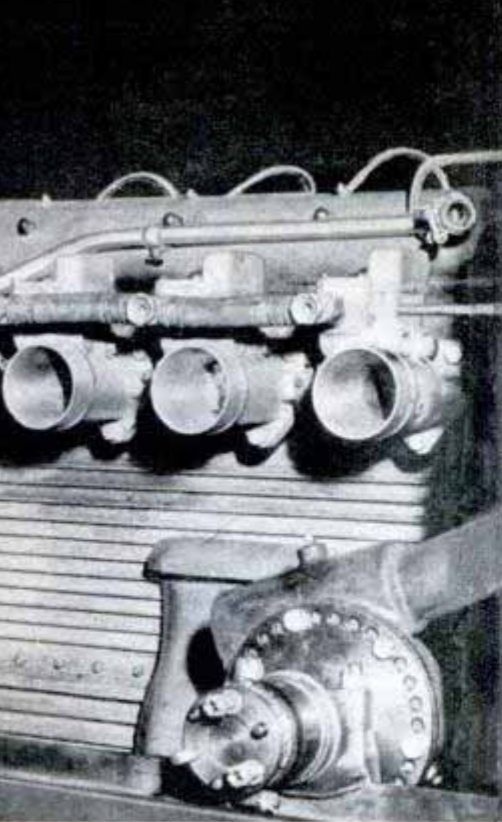

Engine (above left) has six carburetors. Mauri Rose, cowinner of last race, sits at left in his latest entry

8000 revolutions per minute, nearly three horsepower per cubic inch of displacement. Supercharged, it pulls 90 inches of manifold pressure. This engine, built by Offenhauser, placed fourth in the last Indianapolis race in 1941 when it was raced on a different chassis.

Fifteen gallons of mineral oil are carried by this car in an aluminum tank forward of the front axle, and 75 gallons of alcohol-gasoline blended fuel are carried in a tank over the rear axle. One gallon of fuel will carry the car four miles at high speeds. The cooling system is sealed under pressure and uses ethylene glycol as coolant.

Another low-slung car, being built by Frank Kurtis of Glendale, Calif., for Ross Page, stands only 34 inches above the track. Chassis and body frame were put together by aircraft technique, using "chrome moly" steel tubing up to 2 $\frac{5}{8}$ inches in

diameter. The entire car weighs only 1650 pounds, some 300 pounds less than average. It is powered by a four-cylinder 183-cubic-inch Offenhauser engine equipped with a Roots blower. The 72-gallon fuel tank is in the shape of a long narrow box beside the driver and is equipped with interior anti-surge baffles. This tank arrangement gives the car identical handling characteristics no matter whether the tank is full or practically empty.

There have been few race cars at Indianapolis for years that didn't have in them somewhere a few shackles or other parts made for standard cars. All race car designers make use of standard automotive parts wherever they can. Stock parts are cheaper and just as dependable as any that must be built especially for a specific car and are to be found in racing creations that cost as much as \$25,000.

Cutaway plan view of the Novi. As much weight as possible is centered above front wheels to improve traction

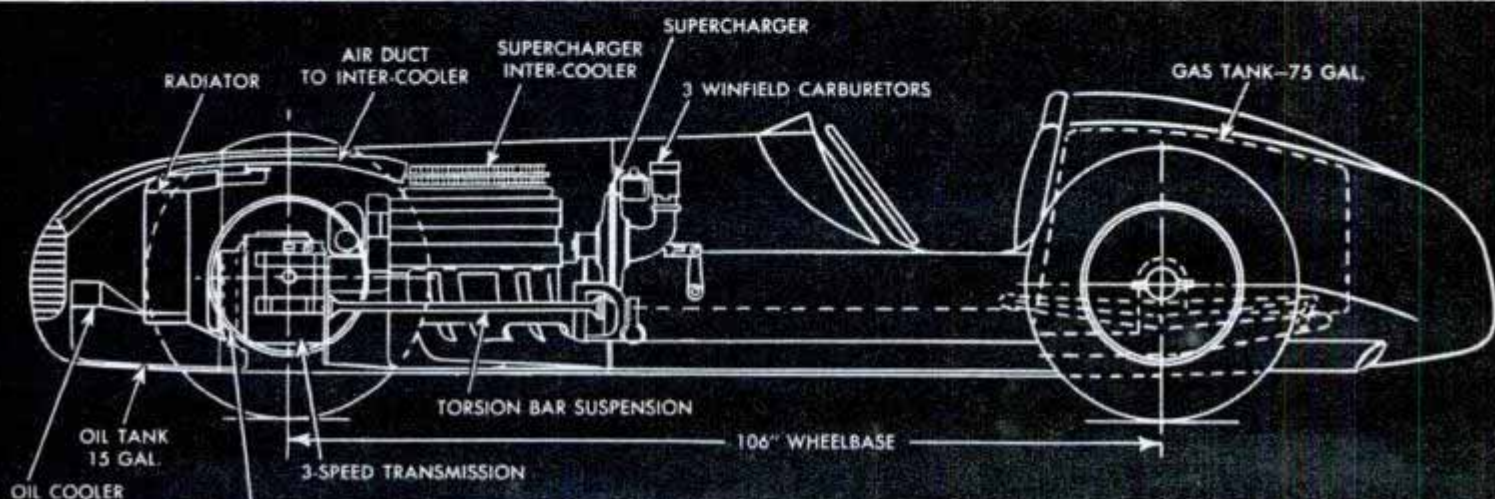

822 Santa Fe Ave



"On the - Koshare and the Santa Fe"

La Junta, Colo., division point on the Santa Fe, is the site of the Koshare, Atchison, Topeka and Santa Fe—model line built by young railroaders, many of them sons of Santa Fe men. "Koshare" is Indian for "playmakers"

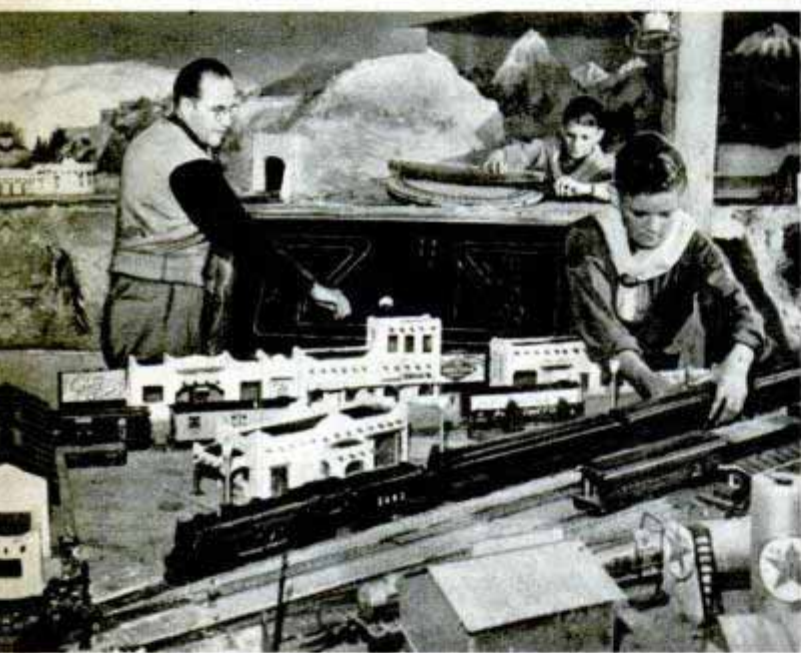

Photos courtesy Santa Fe Ry. Boy Scouts built the railroad and much of its equipment during the past seven years in the home of J. F. Burshears, scoutmaster. Trains patterned after those of the Santa Fe operate on the "Koshare" branch which includes a typical Colorado mountain background. The track runs through two miniature towns, El Rito (little valley) and Cemi del Mundo (on top of the moon). The control board includes a sketch of the layout. When one section of the road was completed, a pin-sized golden spike was driven and a monument erected on the spot



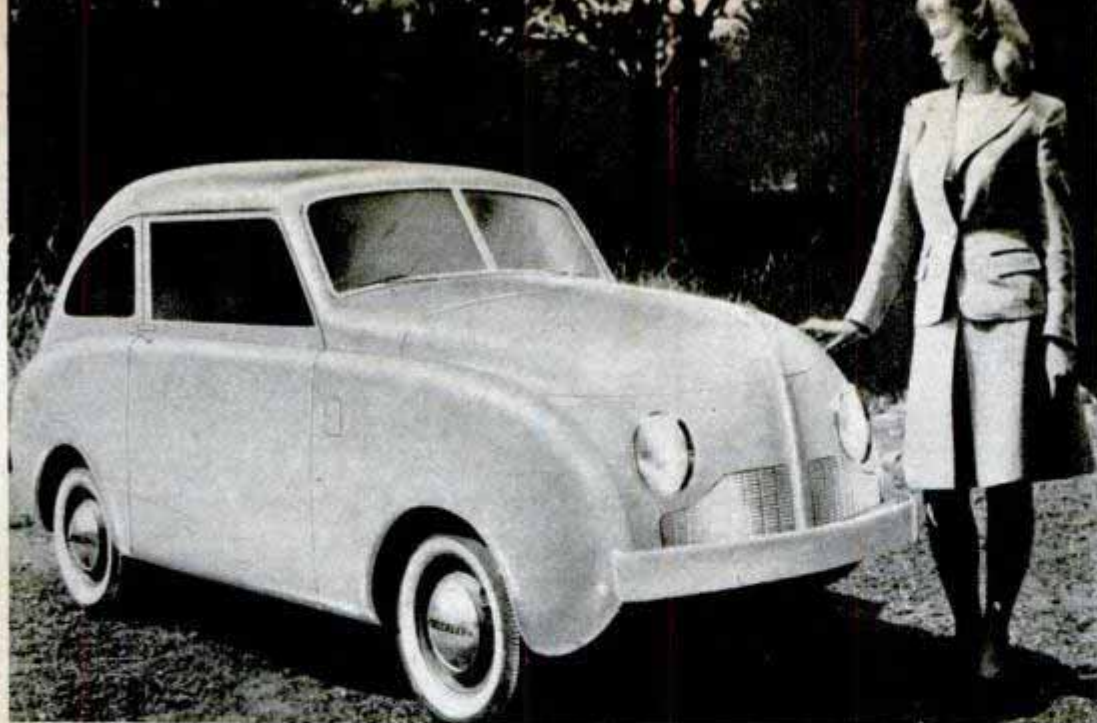

Speeds up to 60 miles per hour are possible with the new Crosley automobile that will operate 50 miles on a gallon of ordinary gasoline. Aluminum has replaced steel in construction reducing total weight to only 1000 pounds. Streamlined in appearance, the car is given an etched satin finish that resembles the highly polished fuselage of an airplane. The engine is not much larger than a standard typewriter, yet produces 26 horsepower at 5000 revolutions per minute. It is built of thin sheet-steel stampings instead of heavy forgings and castings. The stampings are crimped

Aluminum Car With Tiny Engine Goes 50 Miles on Gallon of Gas

together and braced by means of copper into joints. These engine walls permit efficient cooling of cylinders. Low fuel consumption is possible because of the high ratio of compression. Although the pump forces 12 gallons of water through the cooling system per minute, the engine and radiator hold only five quarts. The automobile has two seats in front, two in back, and a luggage space 25 by 40 inches. From bumper to bumper it measures 145 inches, with a 40-inch tread. The gear shift is standard with three speeds forward and one reverse.

"Canned" Army Equipment Passes Dunking Test—Huge metal cans, built to serve as protective containers for U.S. Army equipment while in storage, recently passed a dunking test in the Ohio River. The waterproof containers can be tossed overboard where there are no dock facilities and then be towed ashore by small boats or allowed to wash ashore.

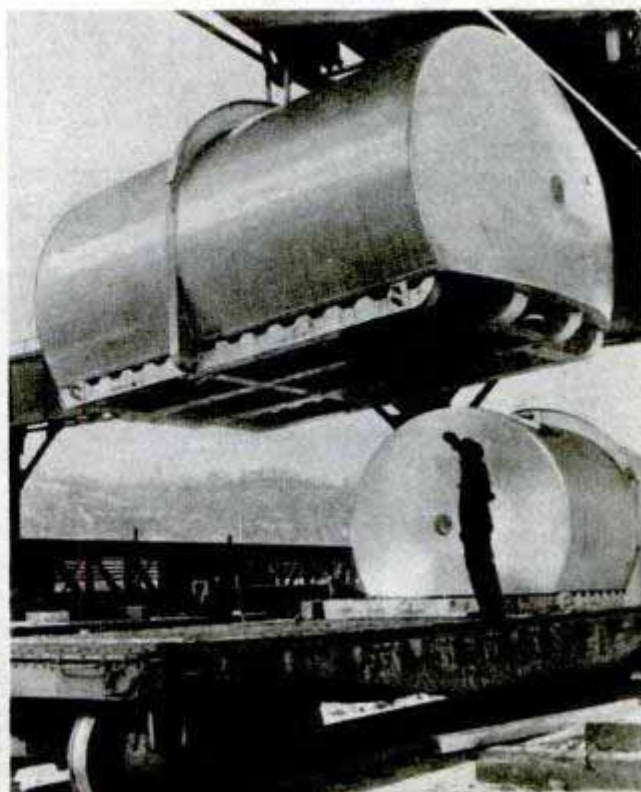
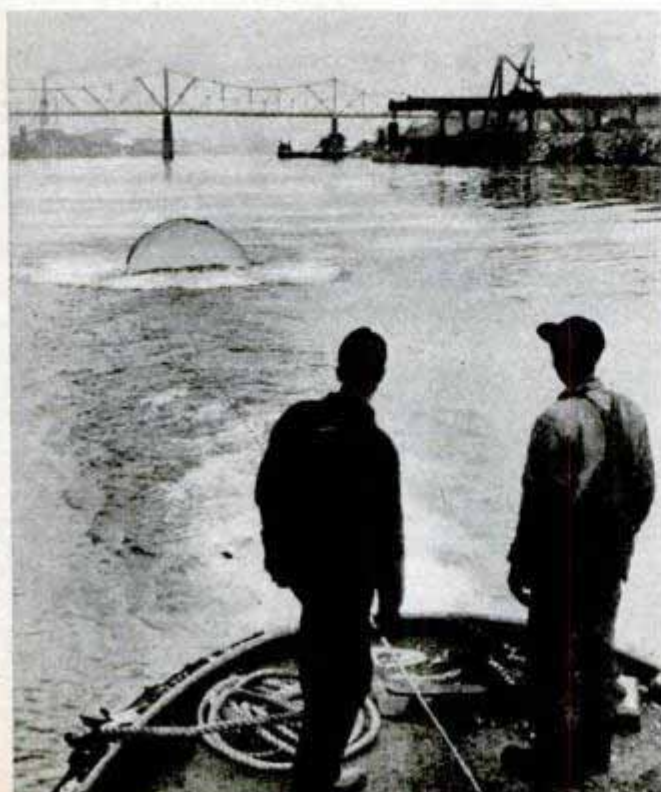

POSE YOUR ACTION PHOTOS!



The camera was on the ground for this low-angle shot of a galloping flagbearer. Shutter speed was 1/1000. The fast action captured in the log-rolling contest was the result of many tries

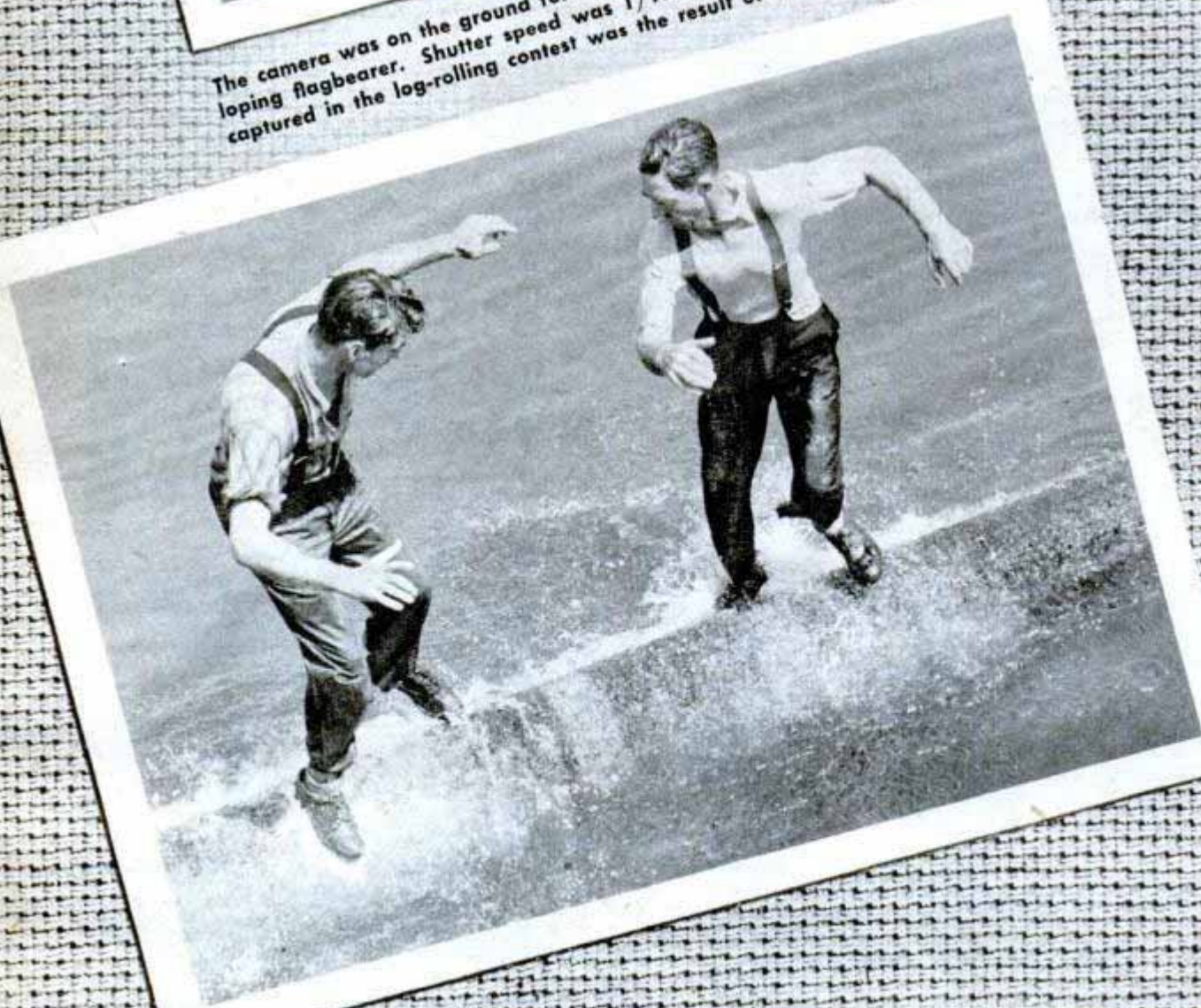



Big Brother forgot about being camera shy when told to steal some of Little Brother's ice cream. Two flash bulbs provided light

MOST of those wonderful action shots that excite every photographer didn't just happen in front of some lucky amateur's camera. They were planned, posed pictures. No, they don't look it! But that's where scheming comes in.

To shoot those flesh-and-blood, panting, action pictures you have to do a little scheming. Perhaps not always, because once in each photographer's lifetime the action that gives him the picture to end all pictures occurs right in front of his poised shutter. But before you grow old waiting for that great moment, try your hand at posed action shots.

When planned correctly, posed action pictures look fresh without being stiff. They are almost certain to have photographic qualities superior to that once-in-a-lifetime classic.

Posed action is planned this way: (1) Choose a location. (2) Focus on a target spot. (3) Rehearse action across

By Richard W. Emery

the target. (4) Shoot plenty of negatives.

All the accompanying photos are posed action shots, planned in strict accordance with the ABCs of photography. They were selected to illustrate two points—that an action picture has more sparkle and permanent life than a picture without action, and that it is possible to pose an action shot which will look natural.

By posing action you can shoot slower, an advantage if your camera does not have a fast shutter speed. Action coming toward the camera can be shot at half the speed of action crossing the camera's field. With the new cameras, advanced amateurs will have as good equipment as the professionals. Using professional scheming, amateurs can snap as good pictures as anyone.

Here's the routine:

Choose a location. Select a logical background suitable for the mood of your picture. Check the source of light. It

Photographs by Ray Chapin



This picture didn't just happen. The surfboard riders worked with cameraman. Twelve rehearsals were staged before the photographer got what he wanted

should be behind you—unless you're shooting some trick picture with speed-gun or reflectors. Everything in the picture must harmonize with the model or models and the planned action.

Select the exact spot where the model or models will stand. This spot is your target. Put the model on the spot, set up the camera and get the model in focus. Decide on your camera angle—whether you want a low angle shot, which will accent action, slim the model and lower the horizon; or a higher spot which will deepen the foreground and show, for example, all the people in a big group, but make your models look top-heavy.

Rehearse the action. Arrange composition to fill the negative almost completely. Get close. Study the rehearsals so that you will know the split second when the action is best, and rehearse

until that action occurs on the target.

Some kinds of action will permit the model to stay in one place—Junior feeding the dog, or Grandpa lighting his pipe. Violent action, such as running or fast walking, calls for target shooting. You may be able to mark out the target for your models. They rehearse by walking, running, riding horseback, sailing a boat—or whatever they're doing—from a point out of range, directly across the target and out of range again.

Coach your model or models to ignore the camera. If several persons are in your picture, have them walk in step and look at some designated object out of line with the camera. Or have them strolling out of step, talking to each other. If the picture is to show a person working, have him watch his work. "Mugging" stamps a picture as posed.



The right background is very important to successful photography as demonstrated by the picture of golfers framed by palm trees and outlined against the sky. To get "Yip-ee" atmosphere in shot below the photographer tore down a fence so the riders could speed up

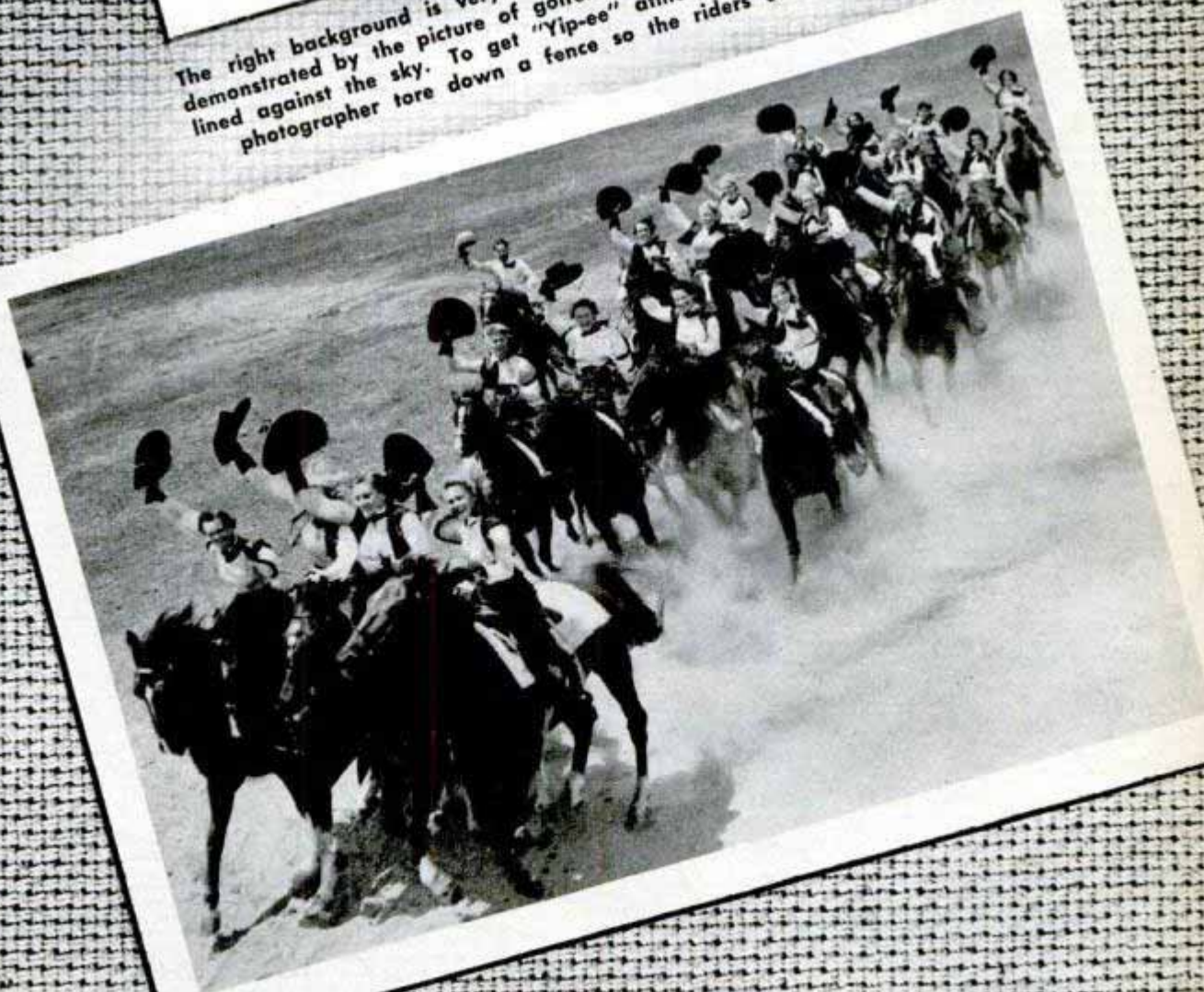



"One, two, three, four," counted the photographer so the drum majorettes would be in step. The problem was to shoot fast enough while the diaphragm was closed way down for depth of focus. It took an hour of shooting to "catch" the speedboat in air

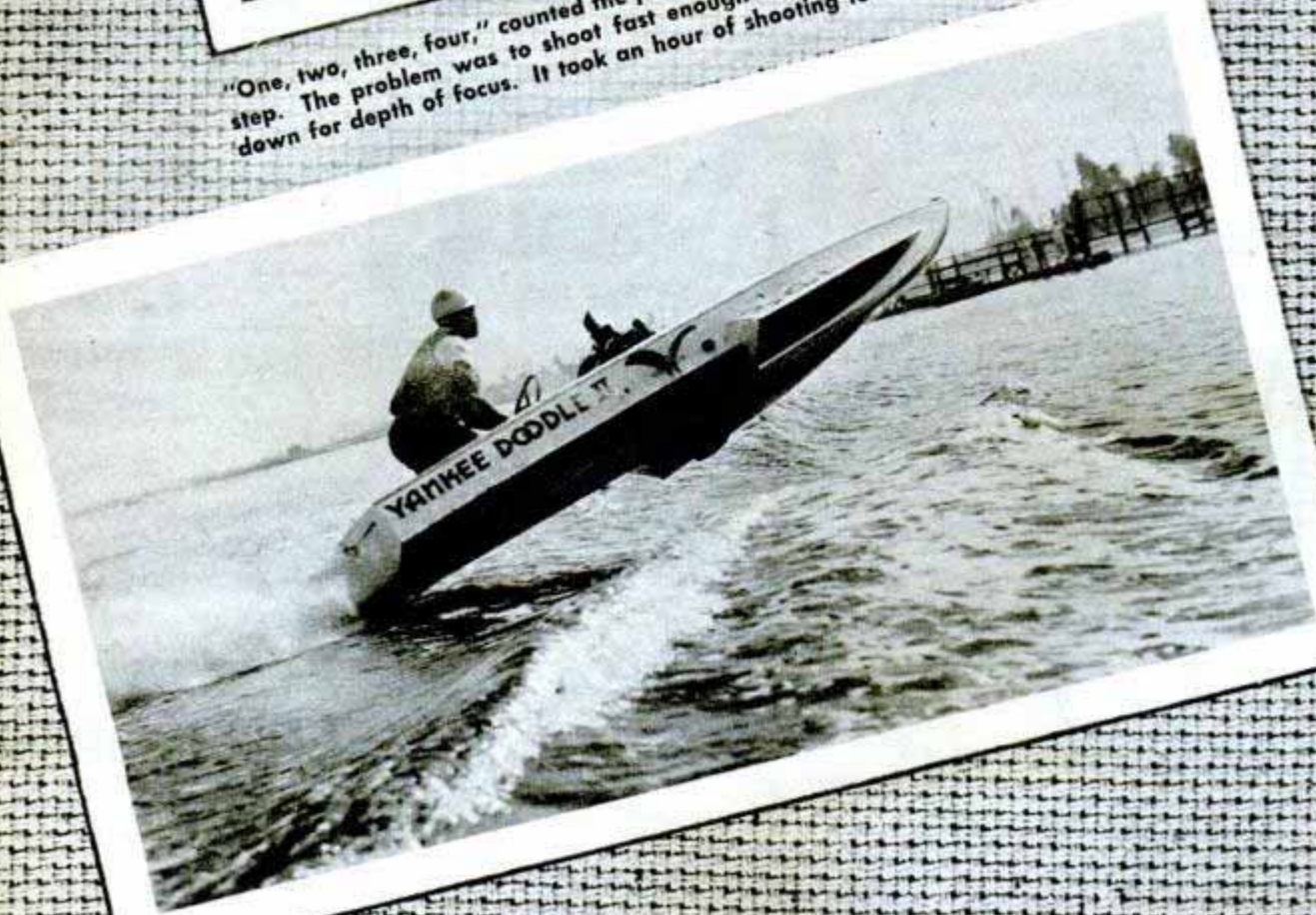

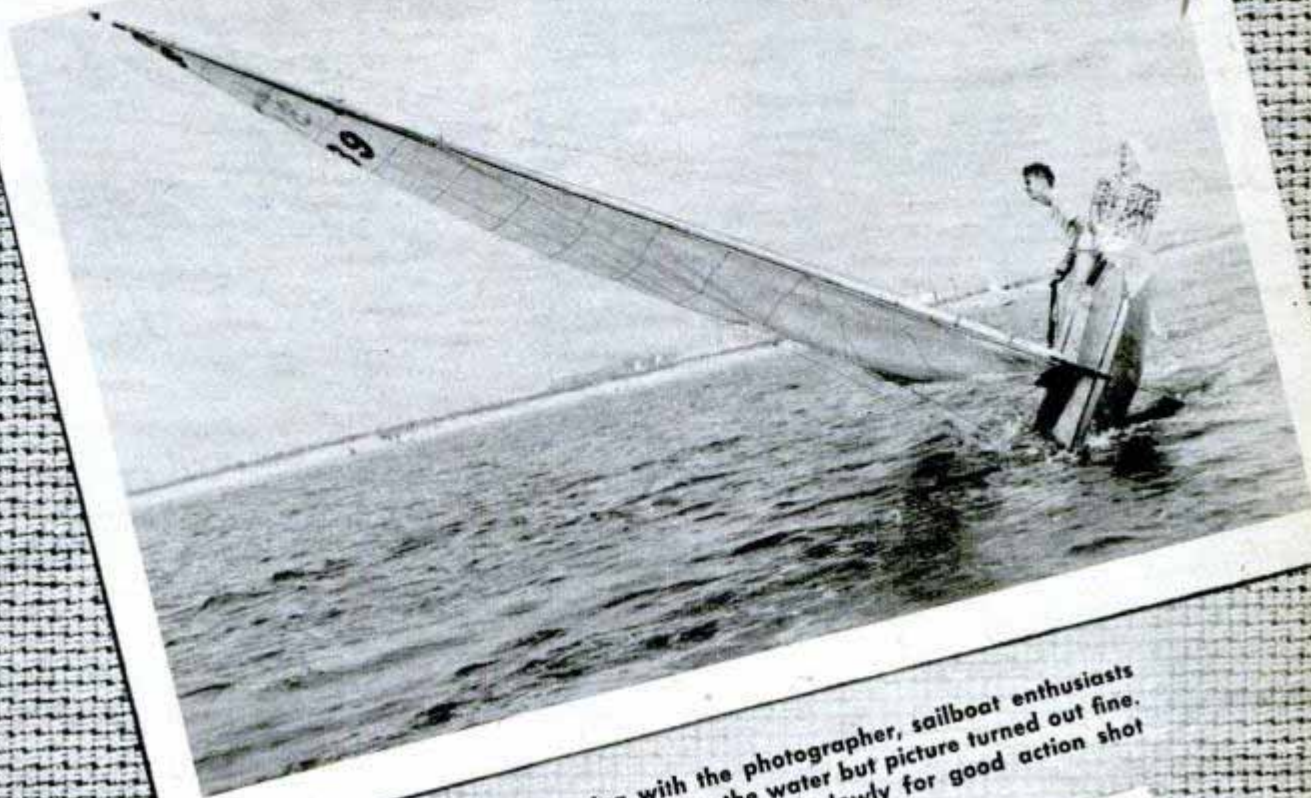

Cooperating with the photographer, sailboat enthusiasts almost toppled into the water but picture turned out fine. Shiprigger (below) worked slowly for good action shot

Shoot the picture. But don't stop at one shot. Shoot the same action a half-dozen times or more. There are several reasons for making a number of shots. One is that you may have to discard negatives because of grotesque or awkward poses or facial expressions. Another is that some negatives may show your models with faces hidden, or with arms or legs reaching beyond the picture. And a third big reason is that one of the negatives will be much better than any of the others.

That's the scheming. It turns out posed action pictures that move and breathe. It gets away from totem-pole shots. It gives the old family album a new flavor. It makes the photographer blush with pride and it saves a lifetime of waiting.



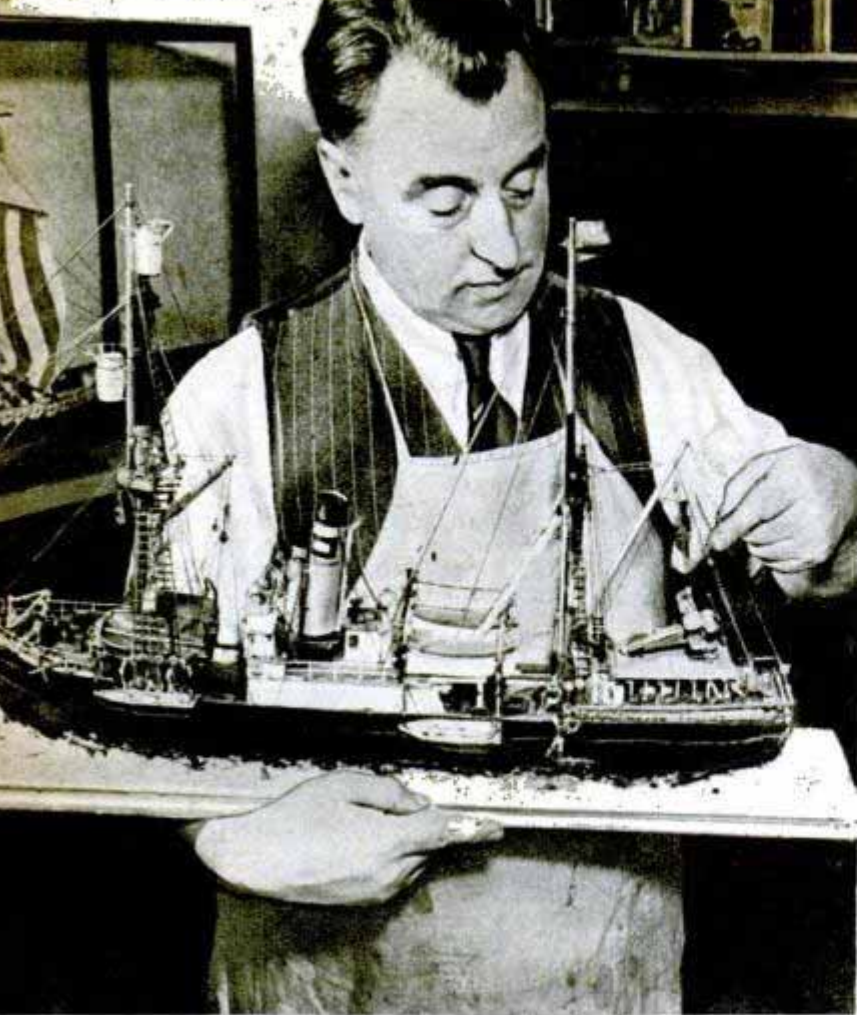

Ernest Maunder of St. John's, Newfoundland, with his model of the lost sealing vessel, the Neptune

By Frank Cowles

WORKING in his basement hobby shop during spare time, Ernest Maunder of St. John's, Newfoundland, has recreated many of the sturdy old ships which made up Newfoundland's once-flourishing fleet of sealing vessels.

With most of the ancient ships now in Davy Jones' locker, Maunder's scale models are vivid reminders of the days when sealing was the biggest and most dangerous business in Newfoundland.

One model is a miniature replica of the sealing steamer Terra Nova, the grande dame of the sealing fleet for over half a

century. She helped rescue the ice-bound Scott expedition in the Antarctic in 1903, and was lost two years ago while freighting supplies to bases in the Far North.

Another model figured in a court inquiry after the original ship, the Viking, exploded at sea with a heavy loss of life while being used by an American, Varick Frissell, to make motion pictures of the seal fishery. Other replicas in Maunder's realistic collection include the Blue Nose, the Spray, in which Captain Joshua Slocum sailed alone around the world, and the Neptune, a Newfoundland sealer which took Peary on an expedition to the North Pole.

After deciding to make a model of a cer-

Left, from block of wood Maunder chisels nest of dories for model ship. Right, he checks mast measurements

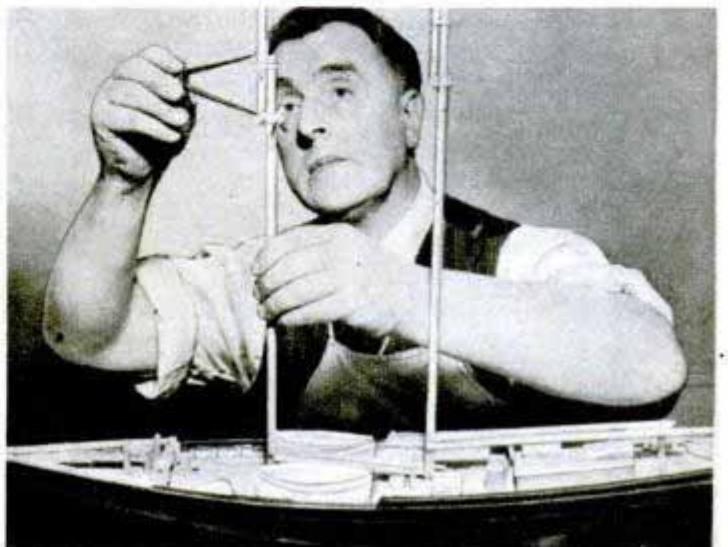

tain ship, Maunder goes aboard, preferably on a quiet Sunday afternoon when he can browse undisturbed. He makes careful sketches of cabins, rigging, masts, lifeboats and other details, noting the exact measurements. Other specifications he secures from the skipper. Coloring of deck, hull and cabins is noted to insure authenticity.

In addition, Maunder makes photographs to supplement his drawings, using a battered Graflex which is a relic of the days when he covered early transatlantic flights for the Associated Press.

With his information complete, Maunder determines the scale, usually one-eighth or one-sixteenth inch to a foot. Then he saws to rough shape a piece of clear, dry soft pine. After he makes a set of templates, or cardboard patterns, from the drawings and photographs, Maunder is ready to begin his real work. First he roughs out the hull fairly accurately, using gouges, chisels and several sizes of files.

The next stage is digging out the hold to the proper depth, a job which is finished with sandpaper. The deck, also of pine, is put in place, after which cabins, hatches, dories and other fittings are added. The final stage is painting and rigging.

Maunder makes his sails of shirting, cut from patterns. To give them a weathered look, he rinses the shirting several times in water to which a pinch of dirt has been added. Ordinary twine or fishline is used for the rigging. Accessories—anchors, wheels and blocks—usually are bought, but the builder often makes his own.

Hoops for the mast are made by smearing with glue a 6-inch plane shaving and rolling it tightly around a stick. Maunder lets this dry in a cylindrical shape, smooths it inside and out with sandpaper, and slices off hoops of the desired thickness. These are dipped in shellac to bind them.



Rigging a model ship is the final step in building it

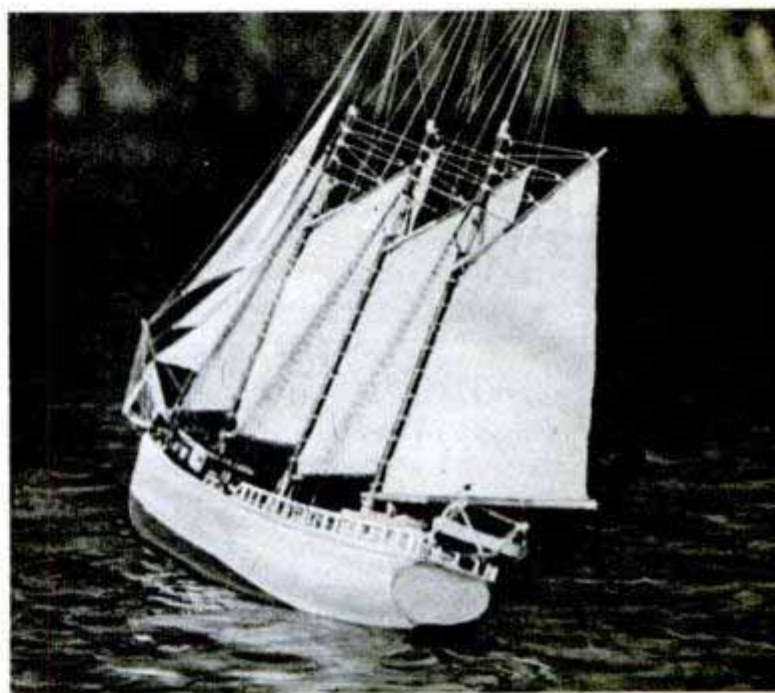

Miniature schooner heels over in light breeze. Below, davits are fitted on a scale model of the Vanguard

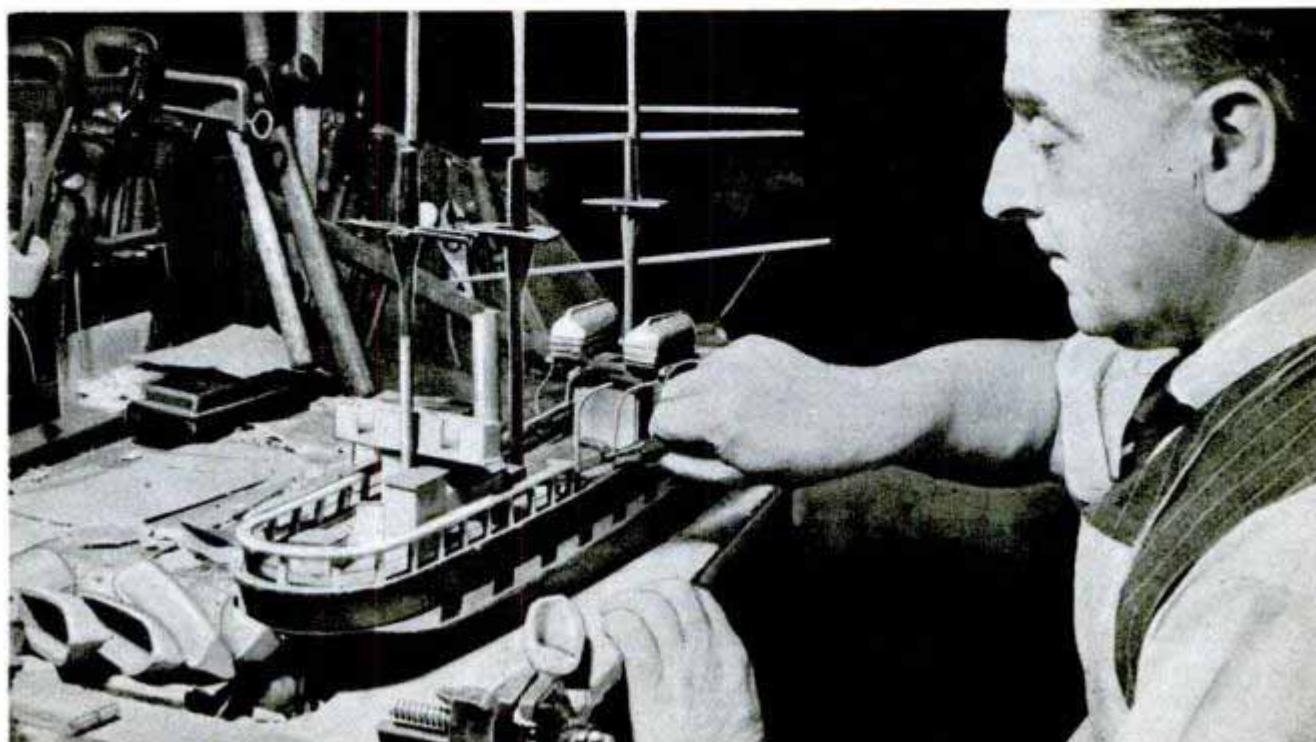

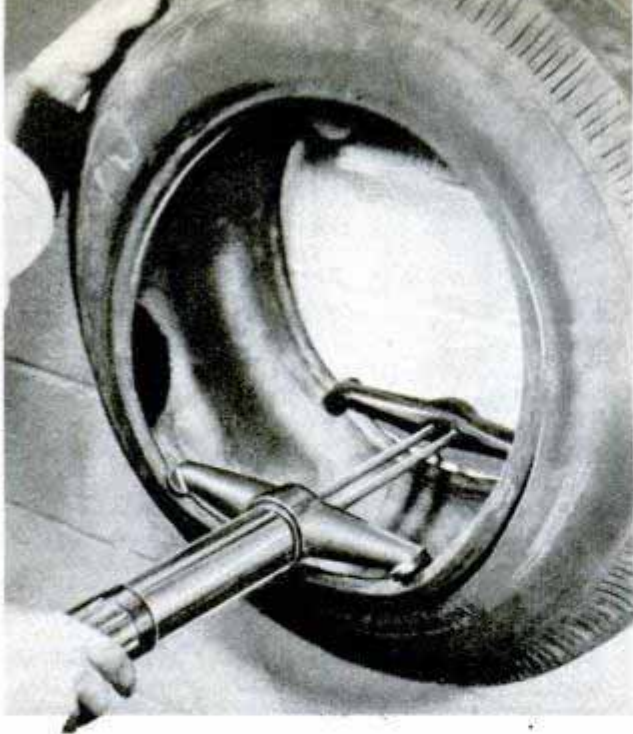

Air-Operated Tool Spreads Tires

For quick inspection and repairs on the inside of tires, an air-operated tool spreads a tire in two seconds. This permits the repairman to find cuts, bruises and loose cords and make repairs. Another twist of the tool and the tire resumes its closed position without wrinkling the patching job. The unit consists of the spreader, two wall-mounted rollers and a light to illuminate the inside of the tire. The tool can be used to demonstrate new and used tires.

Fast Operating "Push-Pull" Vise

No winding or unwinding is necessary with a screwless vise equipped with a movable jaw. The operator simply pushes or pulls a knob until the jaw is in the desired position. Then he presses down on a locking lever and the jaw is held securely in place. Available with jaw openings from 3 to 9 inches, the vise has built-in, recessed parallels to hold work pieces in position.

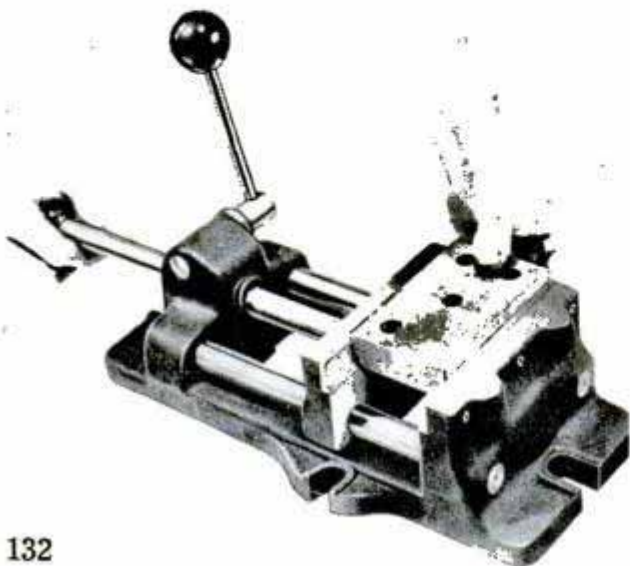

Inflatable Cushion for Auto Seat

Borrowing several features from rubber life rafts and life belts, an inflatable seat cushion now is being manufactured for automobiles. Designed to fit a car seat and back, the cushion has two valves—one for each section. When deflated, the cushion can be folded compactly and stored in the glove compartment.

Tricky Holder for Baby's Bottle

Made of aluminum and weighing only 10 ounces, an automatic baby feeder invented by A. D. Bloom of Los Angeles saves mothers the trouble of either getting the baby out of bed for feeding or holding the bottle over a crib, buggy or bassinet. The holder is equipped with a semicircular supporting frame with ends curved to a 90-degree angle to serve as the base. Suspended from the top of the frame is a wire cage which holds the bottle in the correct position but permits it to be moved.



Front Page FARM NEWS

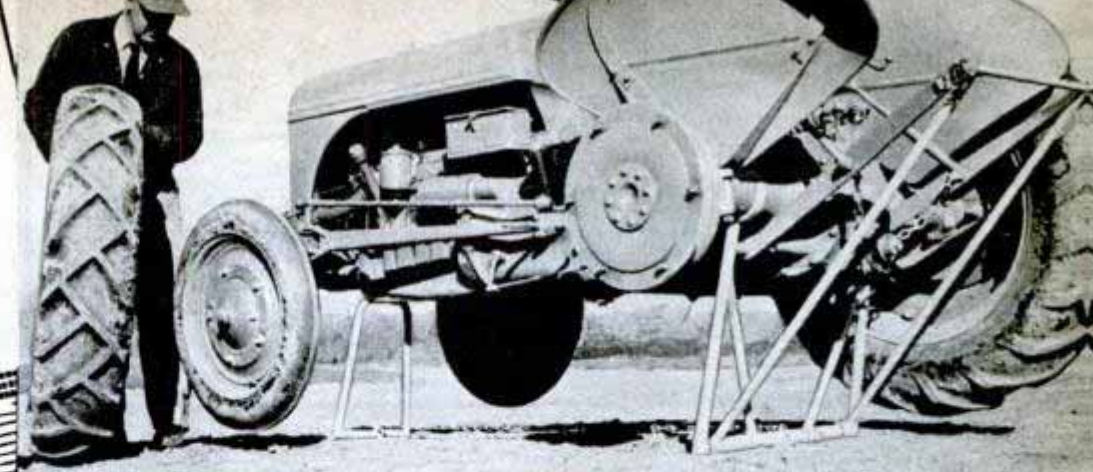

Tractor lifts itself by its own "bootstraps" (top). Fingertip controlled hydraulic mechanism raises tractor in two minutes for tire changes

Barbed spindles of mechanical cotton picker (see cutaway drawing) pick cotton from both sides of plant. Rubber doffers remove cotton from spindles, drop it into air conveyor. The machine cleans the cotton, drops it in wagons

Vegetable planter attached to "Cub" tractor (lower left) makes gardening an easy job

Drawn by a Diesel "crawler," a subsoiler (right) breaks up hard pan and enables moisture to penetrate to plant roots, thus increasing productivity and workability

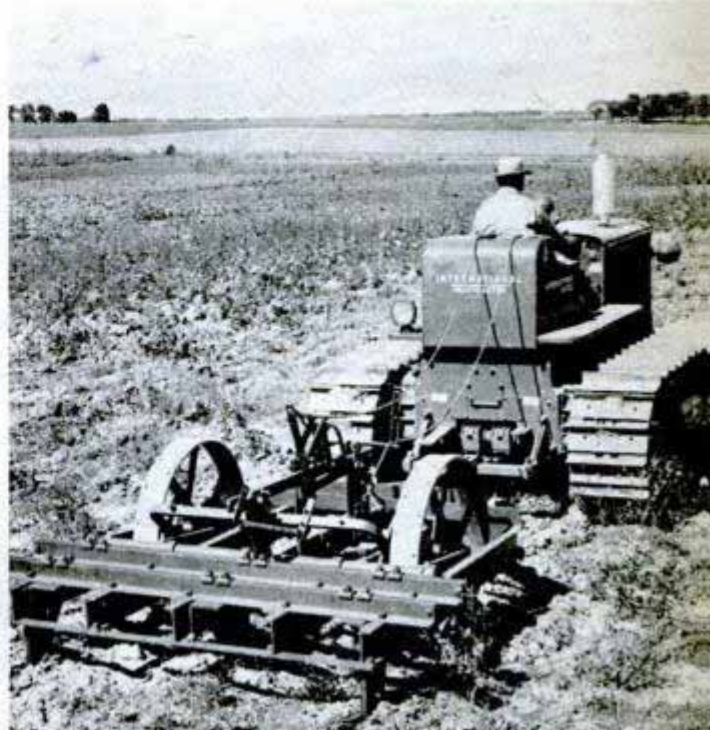
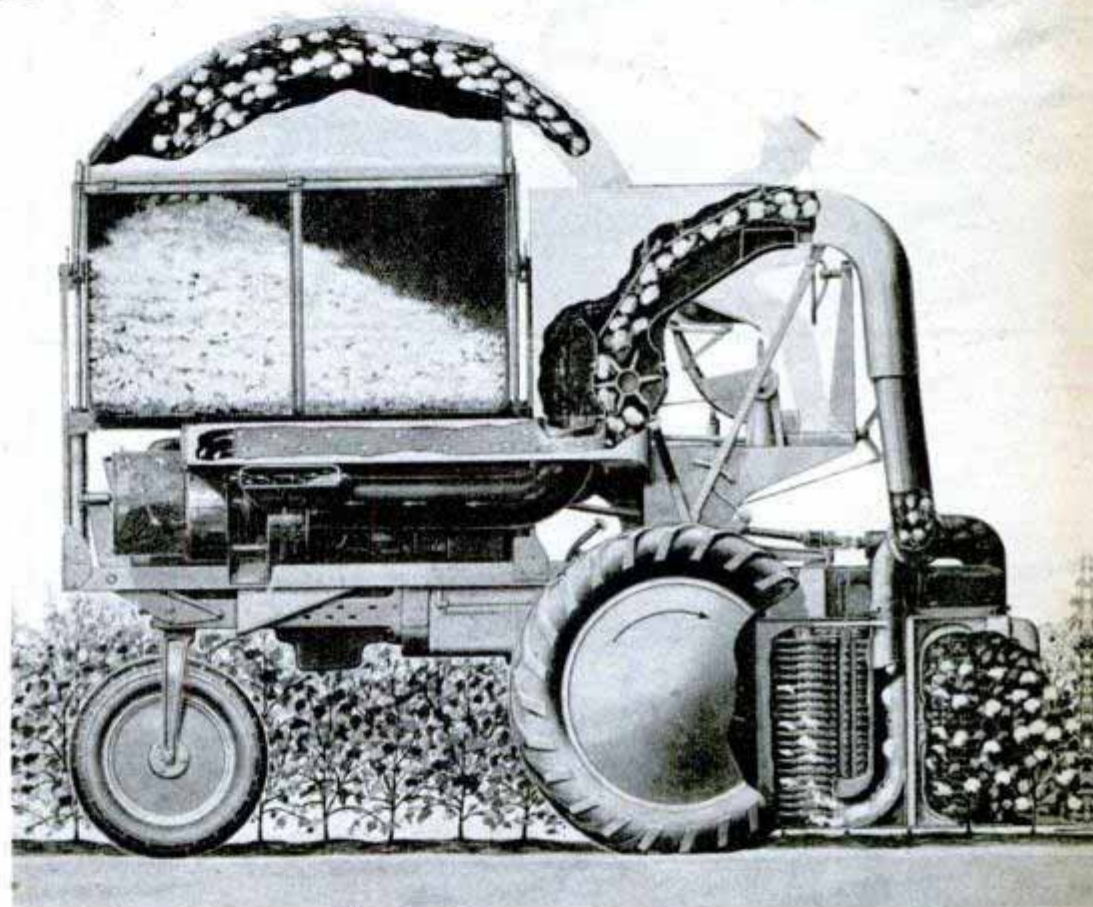

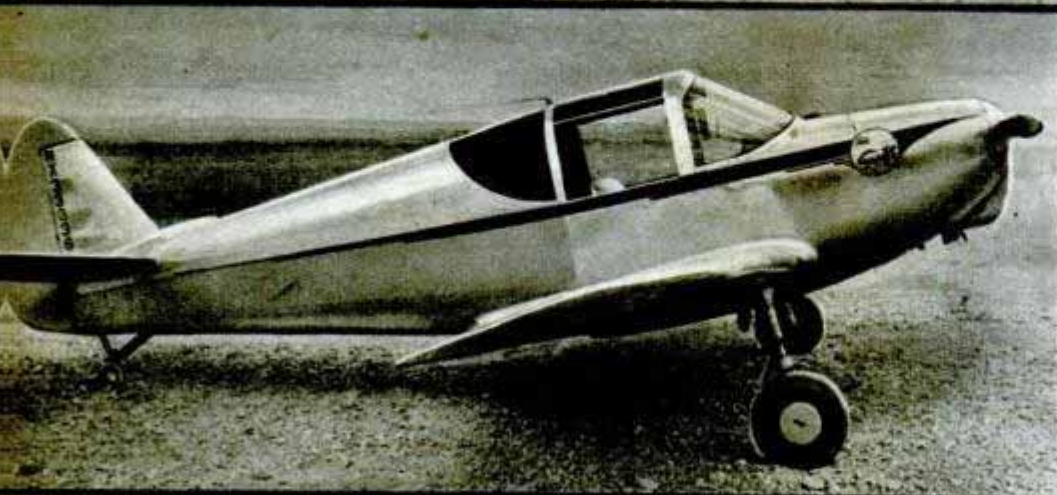

What Will

Here's What 15 Major

STINSON Voyager 150

Four-place, 150-hp. Franklin engine, fixed landing gear, range 500 mi., cruises 125 m.p.h., span 34', length 23'6", gross weight 2150 lbs. Sells for \$5000.

GLOBE Swift

Two-seater, either 85 or 125-hp. Continental engine, former's range 700 mi., cruising speed 125 m.p.h., gross weight 1570 lbs., length 19'7", span 29'4". Priced \$3495-\$3995.

KAISER-HAMMOND

Seats 4 or 5, Lycoming 220-hp. 6-cyl. aircooled engine, span 40', length 27', gross weight 2925 lbs., estimated speed 140 m.p.h., range 550 mi. Price not determined.

H.J.
LATHAM 36, BURG
OAKLAND 12
CAL.

FAIRCHILD F 24

Ranger 175-hp. or Warner 165-hp. engine, seats 4, range 600 mi. plus, cruising speed 118 m.p.h., span 36'4", length 23'10", gross weight 2562 lbs. Sells at \$8500-\$8875.

TAYLORCRAFT Twosome

Continental 65-hp. 4-cyl. engine, range 375 mi., cruising speed 95 m.p.h., span 36', length 22', gross weight 1200 lbs. Costs \$2295.

You Fly?

Plane Builders Offer

AERONCA Champion

Tandem type 2-seater, 65-hp. engine, range 270 mi., cruising speed 90 m.p.h., span 35', length 21'6", gross weight 1220 lbs. Price \$2095.

CULVER Model V

Continental 85-hp. fuel injection engine, seats 2, span 29', length 20'6", range 700 mi. plus, useful load 681 lbs. Sells for \$3750.

CESSNA Model 140

Continental 85-hp. engine, seats 2, cruising speed 100 m.p.h., range 4 hours, features steerable tail wheel and safety landing gear. Priced at \$2495.

COMMONWEALTH Skyranger

Two-passenger, Continental 85-hp. engine, cruising speed 103 m.p.h., range 700 mi., span 34', length 21'5", gross weight 1450 lbs. Sells at about \$2800.

PIPER Skycoupe

Two-place, Franklin 4-cyl. aircooled engine, cruises 100 m.p.h., range 532 mi., span 30', length 21', gross weight 1597 lbs., fixed tricycle gear. Price not announced.

(Continued to page 136)

APRIL 1946





What Will You Fly?

(Continued from page 135)

ROCKET Model 185

Three-seater, Lycoming 185-hp. 6-cyl. engine, estimated range 1000 mi., speed 185 m.p.h., retractable tricycle gear, span 30'10", length 21'6", gross weight 2200 lbs. Price \$5000.

ROCKET A/C SALES CORP
FORT WORTH 6
TEXAS



ERCOUCPE

Two-place, Continental 75-hp. engine, cruises 110 m.p.h., range 500 mi., certified spinproof by CAA, span 30', length 20'9", gross weight 1260 lbs. Sells at \$2995.

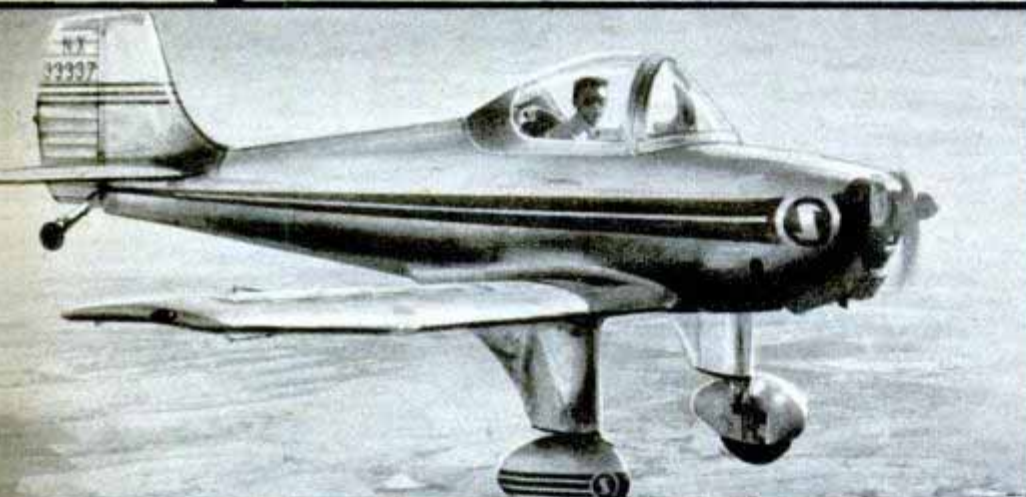

LUSCOMBE Model 10

Single-seater, 65-hp. Continental engine, cruises 120 m.p.h. plus, span 25', length 17', loaded weight 845 lbs., fixed landing gear. Price announcement pending.

LUSCOMBE AIRPLANE CORP
BOX 1040
TRENTON, N. J.



WACO

Prewar model seating 4-5, Continental engine, range 400 mi. plus, span 33'3", length 23'. Sold in \$6000 class.

WACO AIRCRAFT
TRUCK
OHIO



NORTH AMERICAN Navion

Four-place, Continental 185-hp. engine, retractable tricycle gear, steerable nose wheel, tentative top speed 150 m.p.h., tentative range 700 mi. Expected to be in \$5000-\$6000 group.

NORTH AMERICAN AVI INC
POPULAR MECHANICS
INGLEWOOD

Germ on Groceries Killed by Rays

Housewives now can return home from shopping with germ-free groceries. A new "germ-killer," designed for use in food stores, bathes the groceries in ultraviolet light. The unit is a plywood box with a large opening at one end. Baskets or carts of groceries, contaminated by handling, are placed in the box through the open end. Inside are three ultraviolet lamps that pour "condensed sunshine" over the foods. After 30 seconds the foods are withdrawn germ-free.



"Jackknife" Screwdriver

Fitting snugly in the handle of a large screwdriver, a smaller screwdriver can be opened up to provide additional leverage in operating the main tool or for performing work in confined areas. The shanks of both screwdrivers are made of tool steel and the handle is plastic. In the photograph at the left, the versatile tool is shown with the small screwdriver folded into the handle (center) and in two views with the attachment opened.

Silicone Oil Bath for Dry Flies

Silicone oil, new product developed from sand and coal in combination with brine, will keep a fisherman's dry flies from becoming water-soaked for long periods, according to Westinghouse researchers. Extremely water repellent, the silicone oils, which were developed for insulating purposes, also have qualities which keep them from freezing at 70 degrees below zero or breaking down at 300 degrees above, and which cause them to cling to the fly. The scarce supply of silicone oil went to top priority industries during the war.

Outdoor Lamp Repels Insects

Emitting only the yellow rays which repel insects, but still providing adequate illumination, a lamp for outdoor use combines a special pigment with transparent powdered glass. This filters out the portion of the light spectrum which attracts night flying insects.



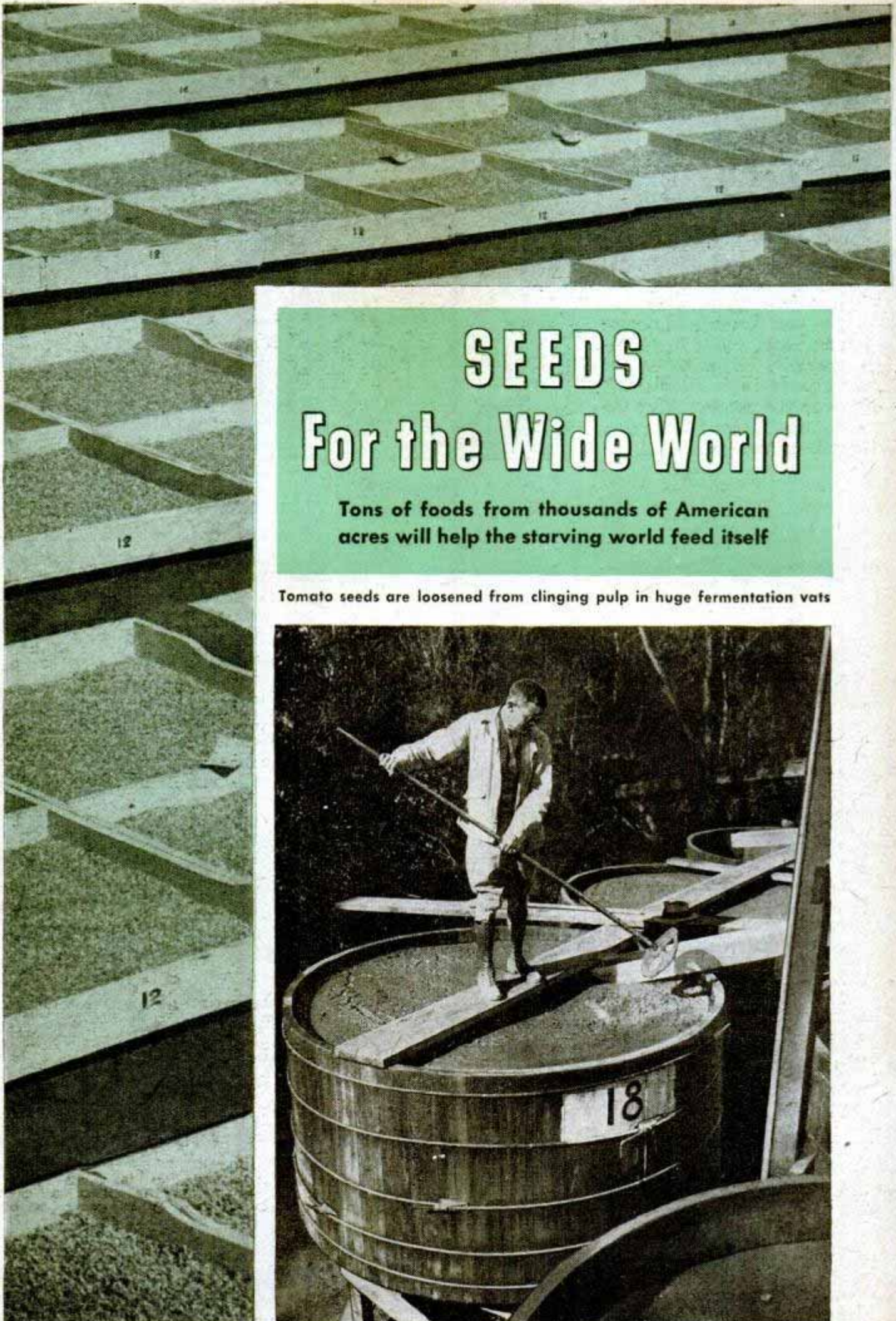

SEEDS For the Wide World

Tons of foods from thousands of American acres will help the starving world feed itself

Tomato seeds are loosened from clinging pulp in huge fermentation vats

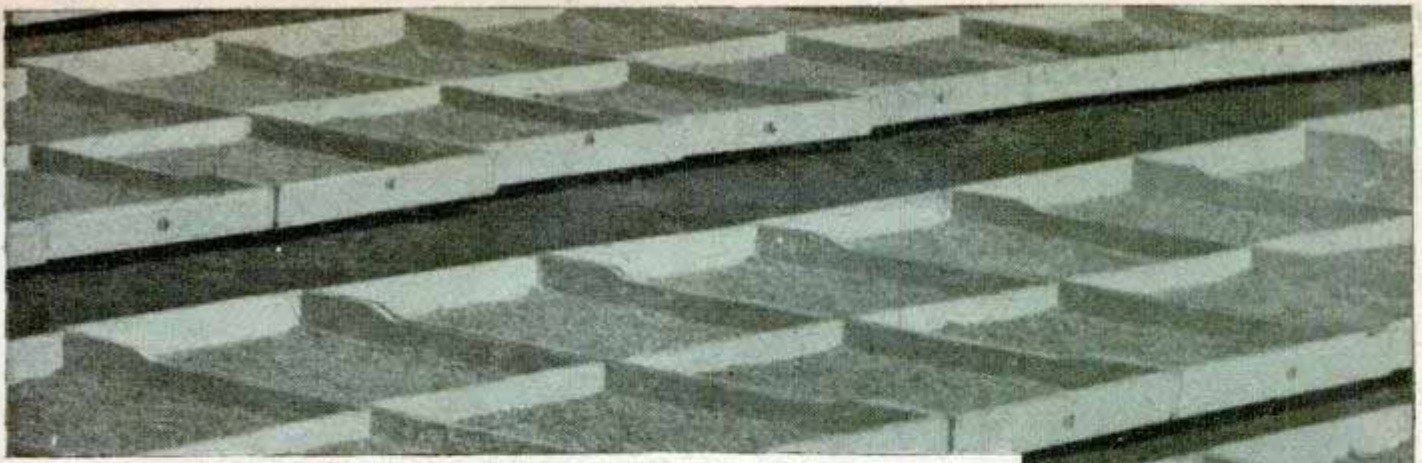

PEOPLE in many parts of the world will eat better vegetables because of vast quantities of top quality vegetable seed the United States has furnished Europe, India, China and the South Pacific as part of its war and rehabilitation efforts.

Succulent red tomatoes, tasty melons, crisp carrots, juicy beets and a dozen other high grade vegetables of disease-resistant varieties are being grown today in regions that used to depend on poor, native-bred strains. Some of the vegetables common in this country were completely unknown in these areas until now.

The excellence of American vegetables is the result of

Trays of seed dry in sun, above. Below, suction tubes of experimental vacuum-cleaner harvester designed to pull dry seeds from their stalks

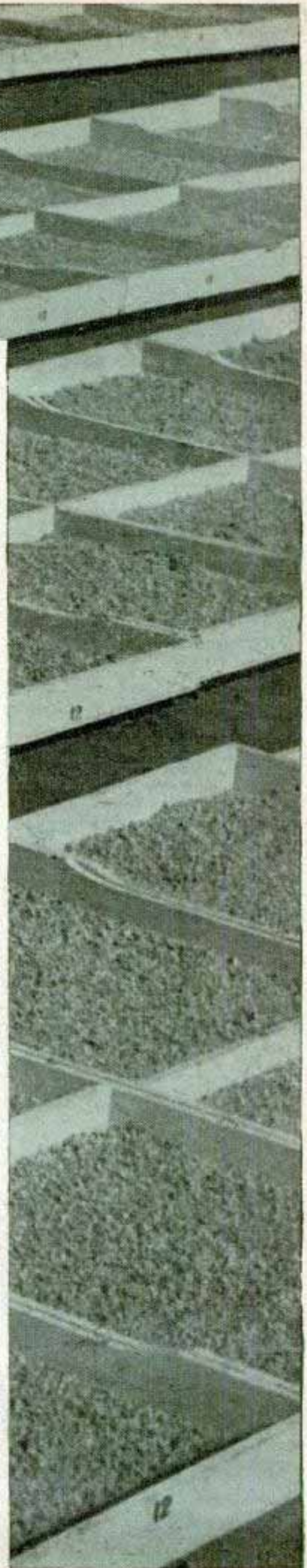



Separation of onion seed, above, from chaff is easy. In water the seed sinks and chaff is skimmed off

scientific breeding for sturdiness, size, taste, coloring and resistance to diseases. For years Europe has purchased the seed for its favorite brown head lettuce in California, for the climate on the continent is too uncertain for lettuce seeds. Similarly, England buys much of its onion seed in California. The onions flourish in England but the climate there, is too cool for good seed production.

Normally the United States produces about 130 million pounds of pea, bean, corn

and other large seeds and about 70 million pounds of the smaller vegetable seeds. This production was tripled and quadrupled during the war. It is much better to ship seed abroad, to be raised into edible crops, than to transport bulkier food. Early in the war such increases in production didn't seem possible because most seed harvesting jobs were done by hand labor, and hand labor was rapidly disappearing from the farms as the busy war plants beckoned. Leaders in the industry turned to mechan-

Men feed harvester which separates seed from melon pulp



ization and devised new types of automatic equipment for harvesting.

One type of thresher developed by Ferry-Morse speeds the harvesting of seed from cantaloupes, cucumbers, pumpkins, squashes and watermelons. The thresher smashes the melons by means of ribbed cylinders and then throws the pulp inside a large rotating screen. The seeds and a small amount of pulp fall through the screen into sacks while the rinds and the balance of the pulp are discharged. The sacked seeds go to a mill for washing and drying.

The latest thresher, adapted from Army equipment, is built on a 1½-ton four-wheel-drive truck chassis and uses hydraulic pressure supplied by its engine to operate hydraulic motors that turn the conveyors, cylinders and drums.

Head lettuce won't go to seed unless the mature heads are chopped open to allow the seed stalks to push their way through. Once done by field labor, now a mechanical header with rotating disk blades is drawn down the rows, slicing open the heads of lettuce as it moves. After

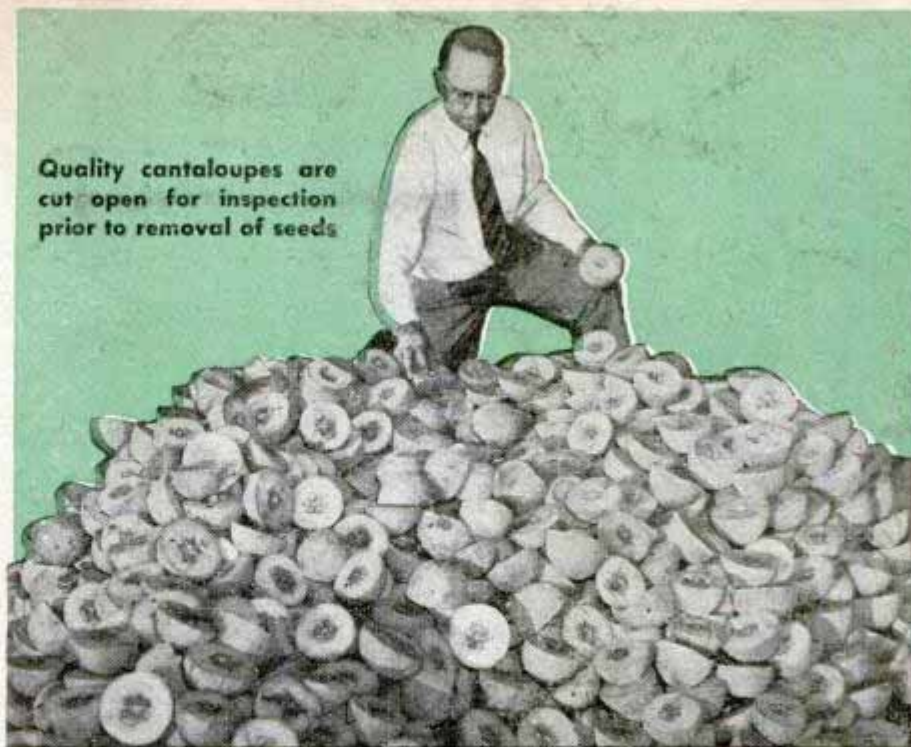

Seed breeder, above, makes lettuce cross on Ferry-Morse Seed Farm in California. Below, rotating screen separates tomato skins and most of pulp from tomato seeds before they go to fermentation vats for further cleaning



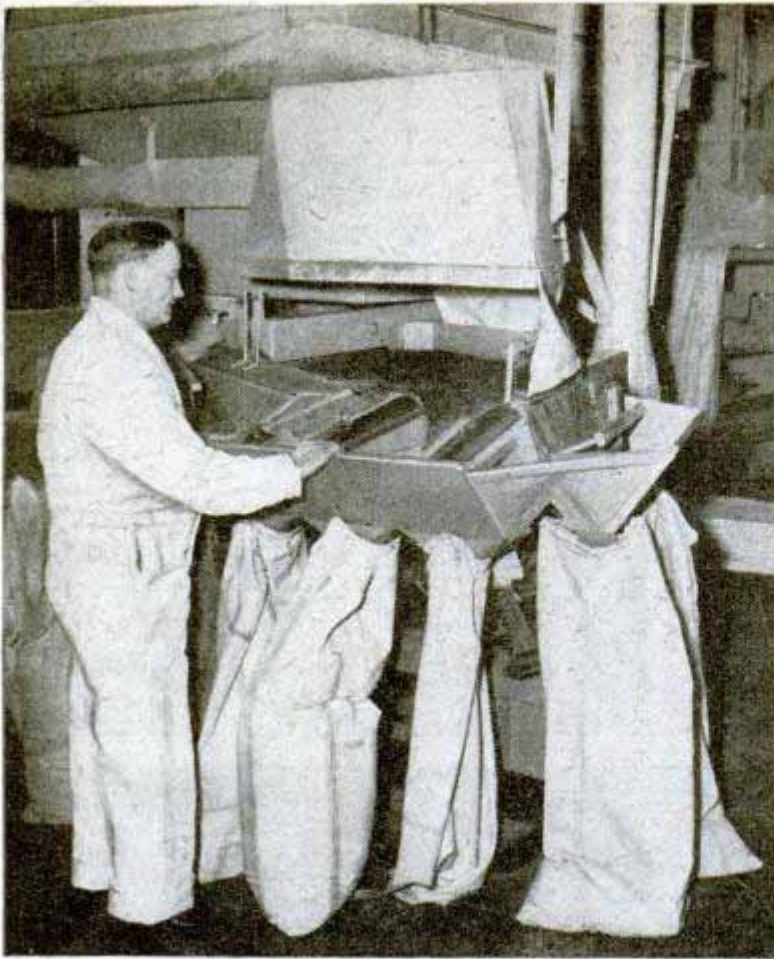

Vibrating table drops seeds in some sacks, chaff in others. "Selfing cage" below prevents contamination by other plants



the seed stalks have matured, a mechanical harvester cuts them down and dumps them into a trailer for hauling to the drying sheets.

One new piece of equipment is a "land planer" that shaves the ground to billiard-table smoothness. Most fields have slight hills and valleys that cause a drill seeder to plant some seed too deep and some too shallow. The land planer is a tractor-drawn iron framework 12 feet wide and 60 feet long, with a wide scraper blade at its center. Its long wheel-base permits the scraper blade to remove slight rises in the ground and to fill in depressions.

Chemical weeding has replaced most hand weeding of narrow-leaved seed crops. Sprays of light stove oil, as much as 100 gallons per acre, kill 80 percent of the early weeds in such crops as carrots, parsnips and parsley.

One of the largest producers of vegetable seed in the world raises nearly 500 separate varieties of 50 different vegetable seeds on 50,000 acres in California and other states. Some seeds are almost microscopic in size, others are as large as your thumbnail. Each is a separate problem to the mill men who must remove all chaff, stems, dirt, weed seeds and other field debris. Seeds from any of approximately 3000 weeds may need to be removed.

Three types of separation machines are used for most seeds. Fanning mills employing air pressure blow away chaff, light seeds and dust. Next, vibrating screens allow the seed to fall through while trapping all larger material. The final step, usually, is a gravity mill that has a rapid up and down and sideways motion. An air blast

Scraper of land planer levels fields for seed crop

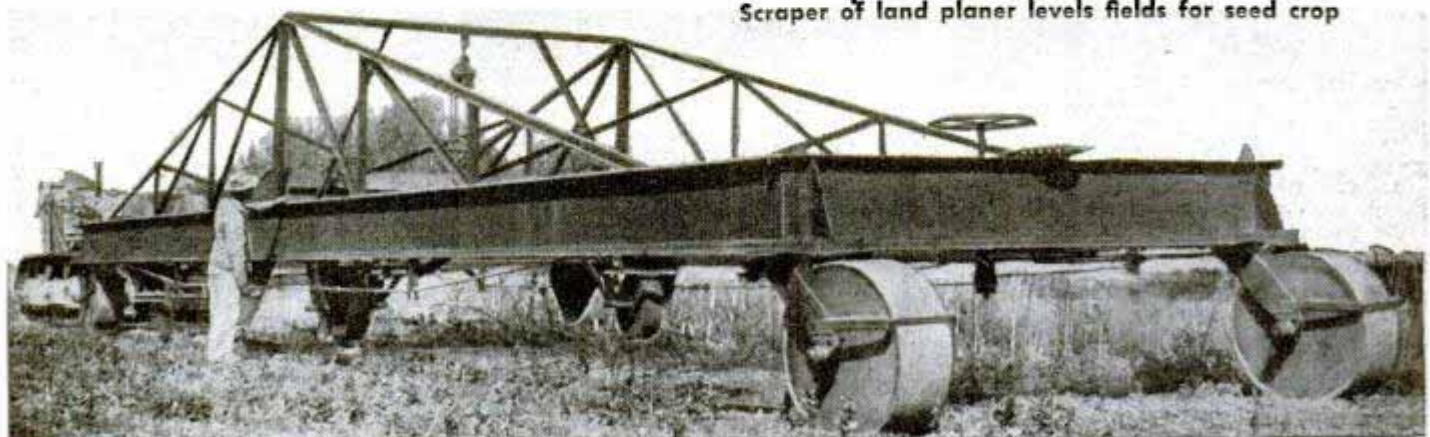

from underneath the deck keeps the seed in partial suspension as it jogs and bounces along. The heavy seeds slowly concentrate at one side of the table and the lighter seeds, chaff and dirt are carried off at the other side.

Good onion seed is separated easily in water. The onion seed sinks and the chaff and light weed seed can be skimmed off. Beet seed is cleaned by a "hill climber" machine resembling a mechanical laundry ironer. Beet seeds roll down the canvas or rubber belt and are collected in a hopper while sticks, chaff and some weed seeds are carried away.

Tomato seeds are embedded in pulp, hence they cannot be cleaned by any of these methods. Ripe tomatoes are broken up and placed in a large rotating screen that retains the skins and most of the pulp, allowing the tomato seeds and the pulp that clings to them to fall through. This material is fermented in large vats for several days. After fermentation has loosened the seeds from the pulp the material is flowed down long sluice boxes similar to those used by placer miners in extracting gold from river sands. The seeds sink and are caught behind riffles in the bottom of the sluice box.

Ferry-Morse keeps a constant check on the quality of its seeds at laboratories in San Francisco and Detroit, trial grounds at Salinas, Calif., and a greenhouse and test garden near Rochester, Mich. A sample from each shipment of seeds goes to the nearest laboratory where it is checked for noxious weed content. Garden pea, cabbage, corn and tomato seed receive disinfecting treatment to protect them against ground rot after they have been planted.

The laboratory also makes germination tests of each shipment, in some cases placing a sample of freshly harvested seed in an icebox for several days to duplicate the winter cold weather effect. A number of the seeds then are placed on moist sterile blotters and germinated under controlled conditions of light and heat.

Similar tests are made of samples from each batch of seed after the milling and cleaning operations and again just before the seed is packaged. All lots of seed receive germination tests every five months as long as they are in storage.

Meanwhile, samples of seed are planted at the Salinas and Rochester trial grounds and the plants are checked for size, quality and trueness to type.

By penetrating the microscopic pores of glass, a new preparation prevents fogging, steaming and frosting of goggle lenses, face shields, welding plates and all types of glass surfaces.

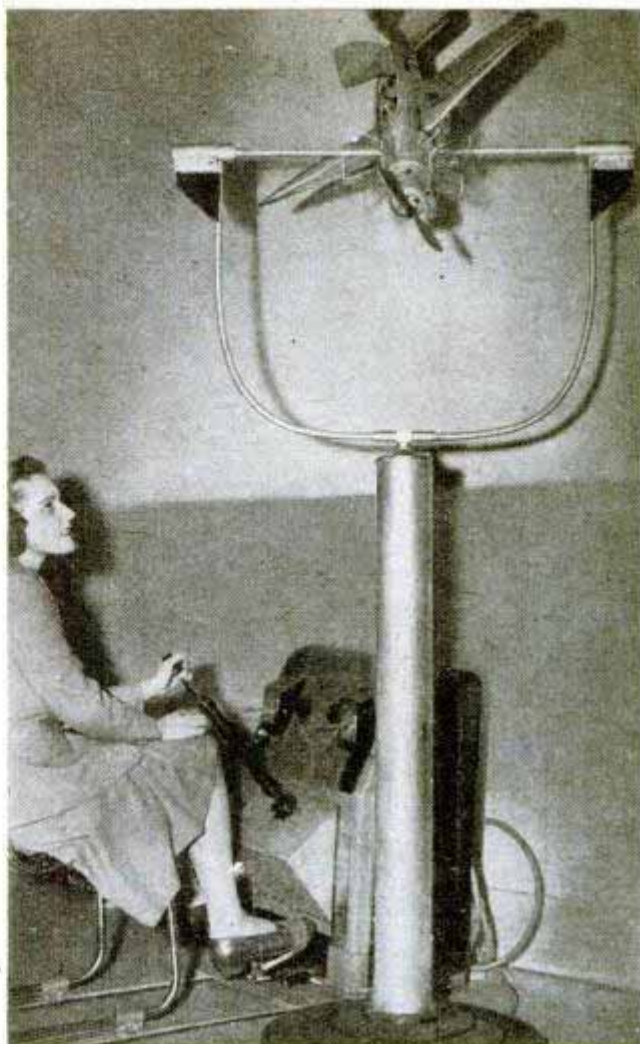

TOY-SIZED PLANES mounted on an electrically operated arm go through various maneuvers, just like real aircraft, to help train student pilots. The pilots sit at the control board—similar to that of an actual plane—and put the model through its various paces

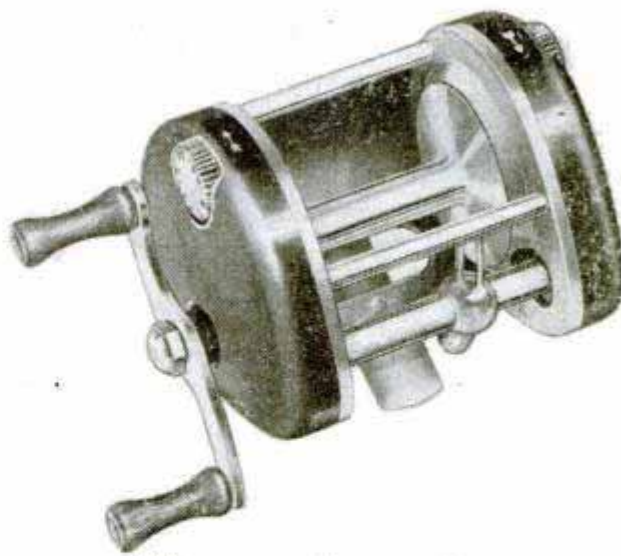

FISHING REEL equipped with a centrifugal governor eliminates backlash and automatically controls line speed. A recessed fingertip control knob on the left side of the reel has 10 settings for different types of casting. Another feature is a dual "click and drag" assembly which can be adjusted for desired tension to prevent the line from running out when trolling with heavy baits or where there are strong currents



ADJUSTABLE TYPEWRITER STAND for hospital bed patients tilts forward, supporting the typewriter at an angle to overcome the user's handicapped position



PLASTIC "LUNG" weighing only 60 pounds frees arms and legs of patients needing respiratory assistance because of polio and various circulatory diseases

UNIQUE BED TELEPHONE was developed for use of Army veterans unable to use their arms. Both receiver and mouthpiece are supported without manual aid



NEW "EYES" FOR THE BLIND are two motion picture camera lenses equipped with photoelectric cells that give off buzzing sounds when objects are approached



*Braille Inst. of America
741 N. Vermont
Los Angeles, California*

4453 Elm Linn - Road

Hit the Trail by Trailer

Alameda 4, California



Such touches as a front porch and shutters give "Cottage Home" trailers the charm of a home of your own

Forget about the housing shortage. Get yourself a 'Cottage on Wheels,' hook it up to your car and hit the road. The new trailers have three rooms and a bath, plus many new improvements

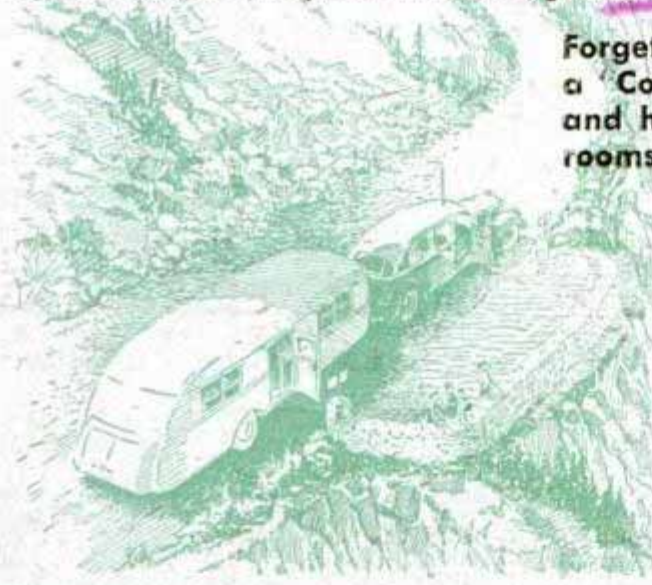

TRAILER coach manufacturers are thinking up new ideas for the combination mountain cabin, lake cottage and beach home that you've been planning to hitch behind your car for vacation trips.

Molded plastic trailers on aluminum or magnesium undergear, weighing considerably less than current models, are in the offing. Some will be equipped with tricycle running gear similar to the landing gear of aircraft for better roadability.

Electric hot water heaters, shower baths,

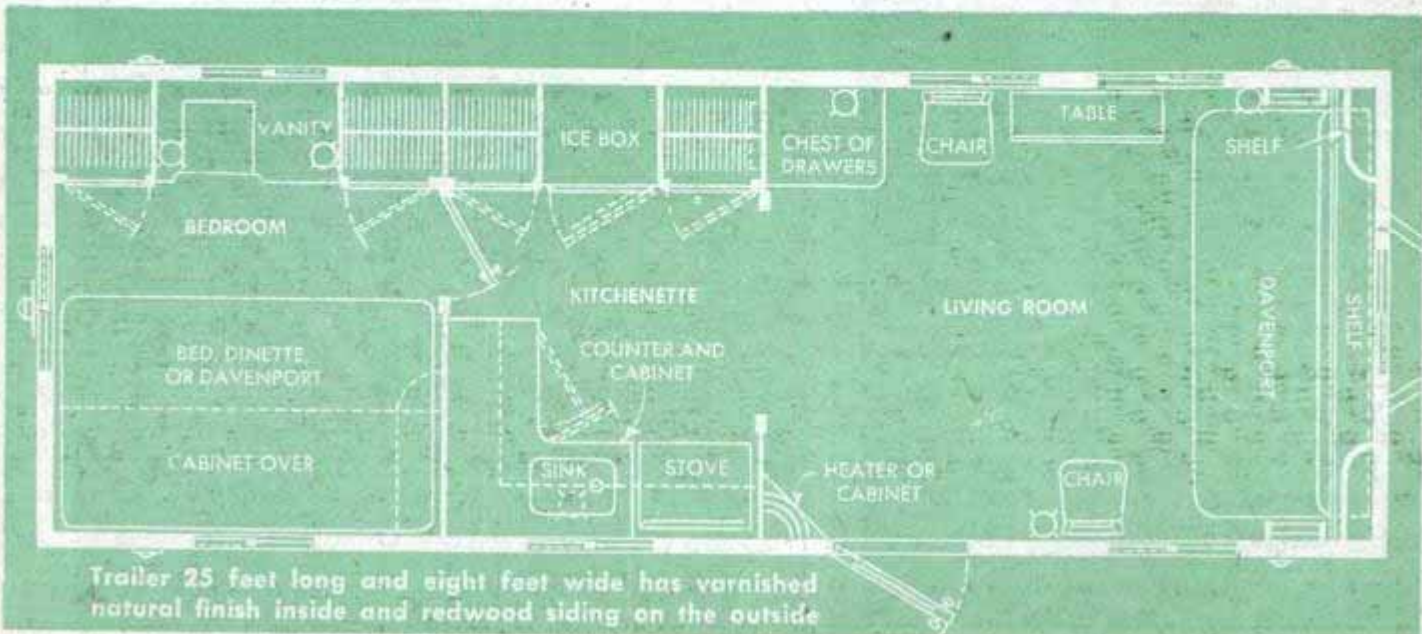

Trailer 25 feet long and eight feet wide has varnished natural finish inside and redwood siding on the outside

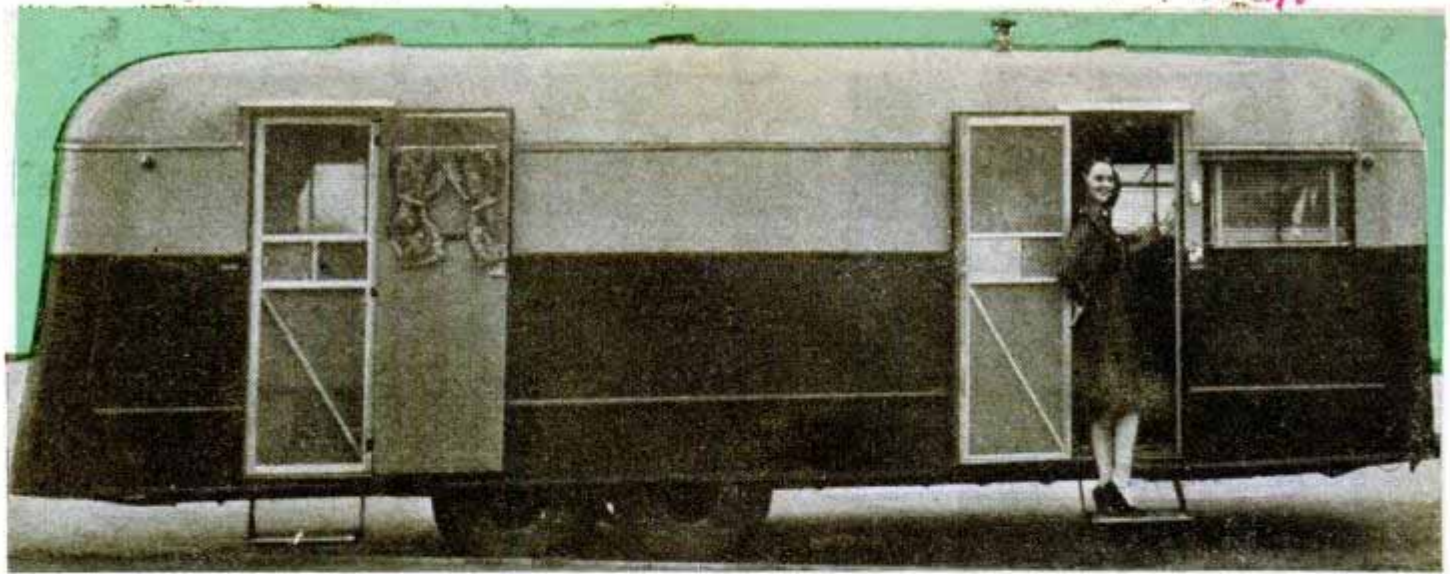

Crown Prince Emir Abdul-Allah of Iraq recently purchased this Schult "Luxury Liner" and the jeep to pull it

more practical toilets, fluorescent lighting and stoves with ovens and four-burner tops that use bottled gas instead of gasoline or kerosene are features of some of the new trailers.

Permanent paint jobs that require no maintenance, interior surfaces of cloth or paper bonded to fiber sheets and upholstery of synthetic materials that are easy to clean are on their way.

At least one manufacturer is planning a stand-by butane system for all cooking, heating and lighting purposes, making the trailer self-sufficient when parked in remote spots. A combination electric refrigerator and ordinary icebox that can be

plugged into a trailer park's electric system and that also has space for an ice supply when parked away from electrical connections is about ready for market. Hydraulic brakes that operate directly from the master cylinder of the towing car are another postwar improvement.

Modern trailers got their start about a decade ago in answer to the demand of vacationists who wished to carry their eating and sleeping facilities with them on the highway. Vacations in the homes-on-wheels boomed, then the war stopped pleasure travel.

But trailer construction continued and trailer design improved by leaps and

Air cooler, icebox and shower bath fit in compactly (left). Double-deck bed with single "upstairs" sleeps three



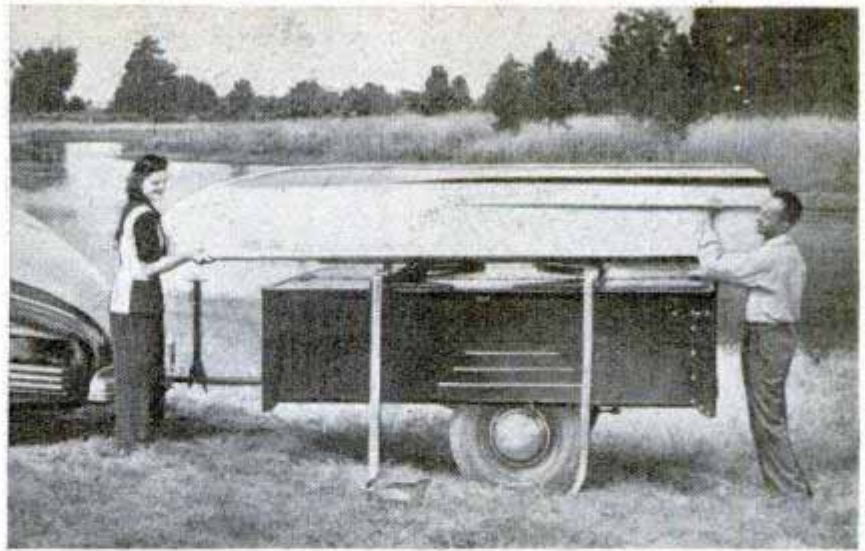
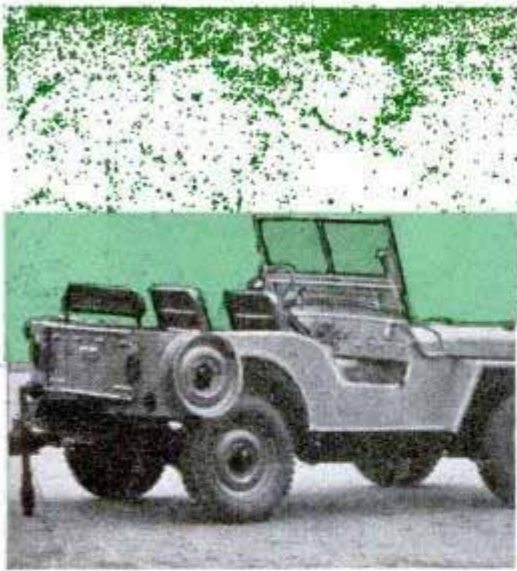

Higgins tent folds into a trailer (top) for towing, is easily erected (below)

bounds during the war because of the need for "stop-gap housing." Federal agencies alone bought nearly 50,000 units of various stock designs for workers who needed temporary shelter.

Dozens of villages adjacent to lonely ordnance works and construction jobs were composed almost entirely of trailers. The village policeman operated from a trailer, the town hospital consisted of several trailers, and the communities often had their

Kitchen has running water, sink, electric lights, stove, cupboard, icebox



trailer-churches, trailer-schools and trailer-laundries.

Most of the wartime trailer coaches were built of plywood or wood fiber materials over steel reinforcing. They were seven or eight feet wide with an average length of 22 feet and most of them weighed 2800 pounds or more. A typical design had a living room at one end and a bedroom at the other, each containing a bed or bed-davenport, and separated by a kitchen space equipped with sink, cupboards, cooking stove and icebox. Connections for hooking into the trailer park's water and electric systems were provided. Sliding or folding doors closed off the rooms.

The war trailers had one or two entrance doors and all doors and windows were screened. The glass windows pushed outward and up, being hinged at the top, and served as transparent awnings to keep out the rain when left open. Some had oil-burning heaters with warm air conduits piping the heat under the floor to various parts of the trailer, and some also carried built-in evaporative coolers for hot weather.

Some were equipped with electric blowers for forced draft ventilation and almost all contained lightweight insulation materials in the walls and roof. Many had electric or air brakes, operated from the towing car, a requirement in many states.

One unique "Cottage Home" model is built to resemble an actual cottage on wheels, having a 25-foot-long exte-

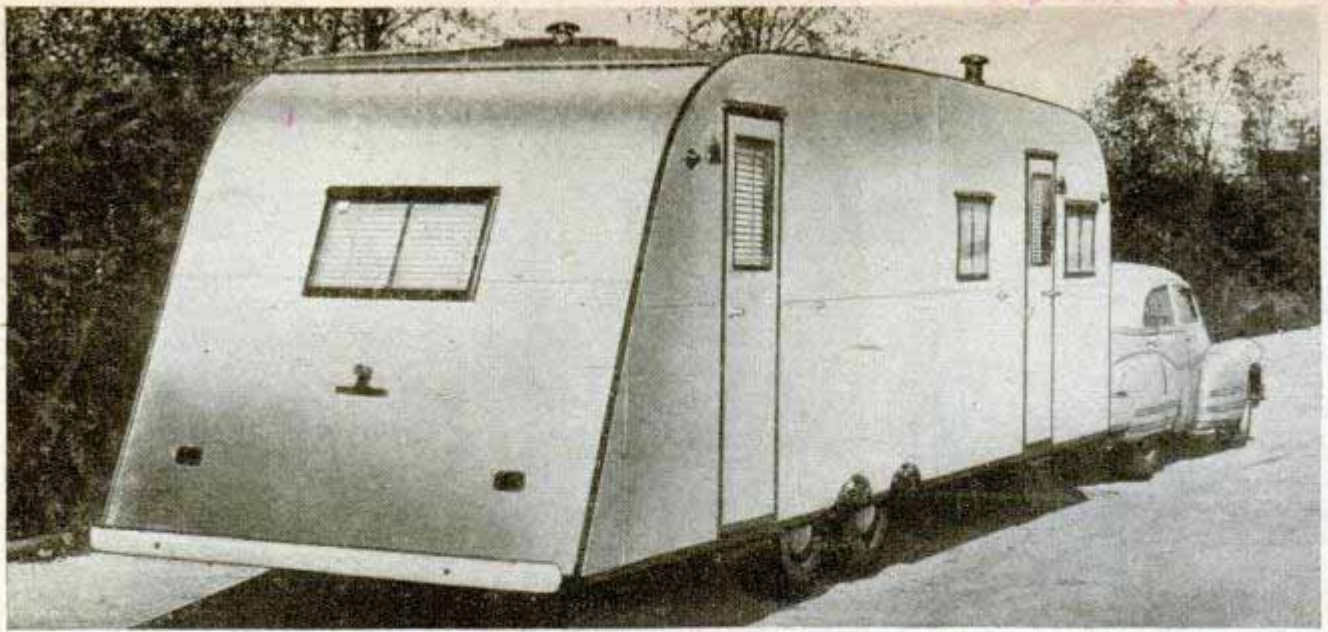

Duo aluminum trailer (above) is 600 pounds lighter than most 28-foot units. Interior (left) of the trailer

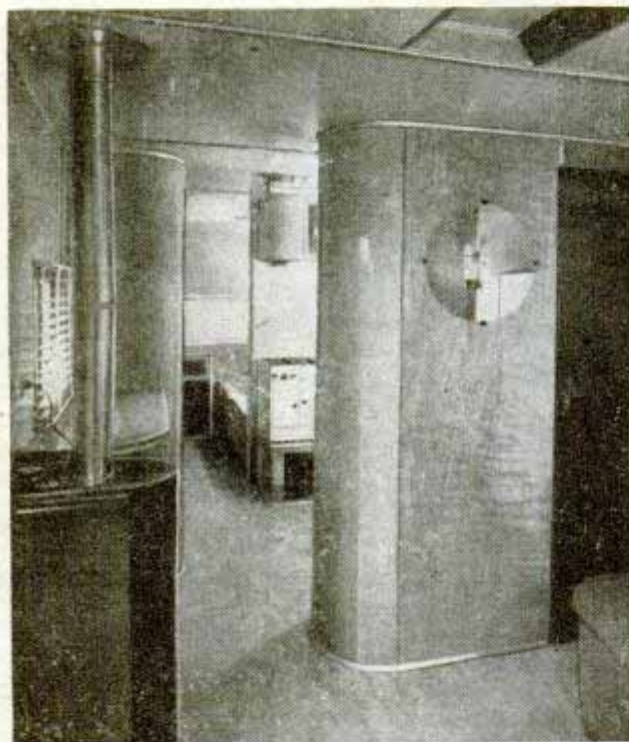

rior that consists of painted white siding with shuttered windows and a roof of green asphalt shingles. The "attic" above the inside ceiling is vented to draw off hot air.

Depending on its size, accommodations and age, you can buy a trailer coach for from several hundred to several thousand dollars. You can spend upwards of \$15,000 for a custom-built de luxe "land yacht" or you can build a trailer yourself in your back yard. Plans and specifications are available for one light design, only 10 feet long, that contains a combination lounging, eating and sleeping room in its interior. Cooking facilities, including stove, are reached from the rear by lifting up the trailer's rear panel. Intended for week-end camping trips, the trailer has nearly all the conveniences of a full-sized trailer coach.

The trailers that the government pur-

Criss-cross coupler permits trailer to be parked parallel with the automobile to which it is attached

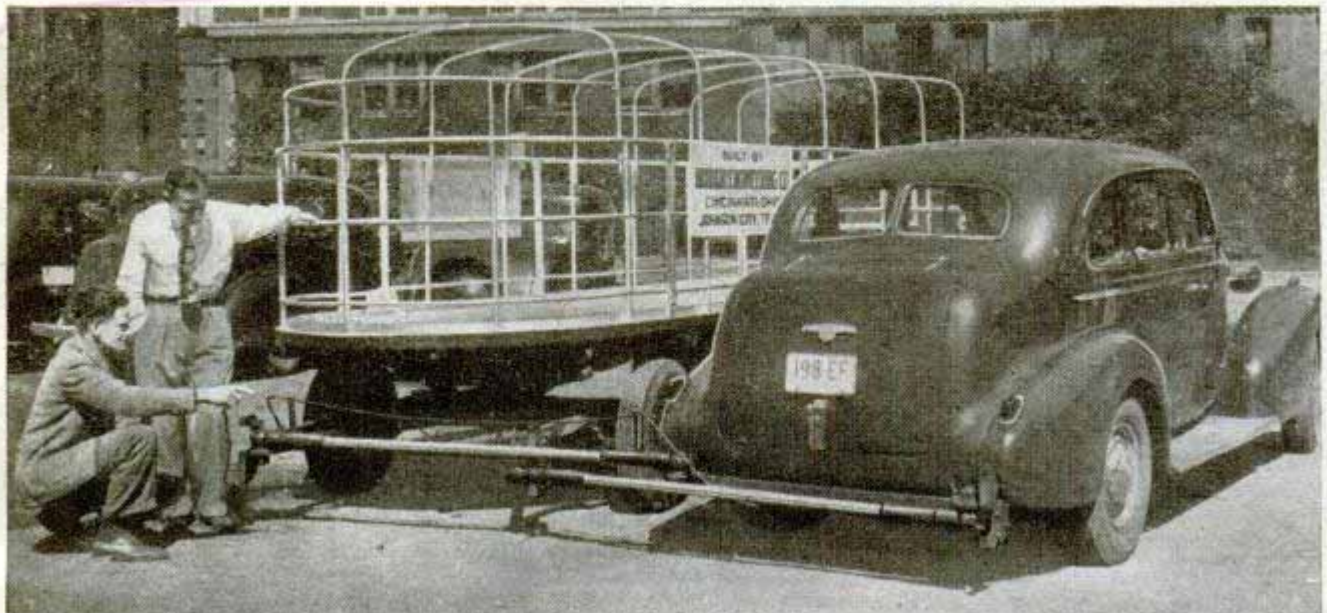

chased during the war will soon be placed on the market, it is expected, through regular dealer channels. Their average new cost was about \$1000 each. Some are in good condition, others have had considerable wear and tear.

The Army used hundreds of huge trailers as traveling repair shops during the war. Shoes were repaired in special trailers that moved with the troops; clothing was salvaged and reissued in others; tires were repaired in trailers carrying vulcanizing equipment, and ordnance trailers served as workshops for repairing guns.

In addition to new comforts and conveniences, the latest trailers promise vastly improved roadability over earlier models. This is being attained by weight reduction and use of a one or two-wheel auxiliary dolly under the nose of the trailer, providing a third point of contact with the road and reducing by two thirds the weight that rests on the rear springs of the towing car. The dolly does away with the need for overload springs and eliminates the swaying and pitching action that is often encountered at high speeds. Some of the first dollies to be marketed had a tendency to shimmy, an objection that is being overcome. Backing a car and trailer is sometimes more complicated with a dolly.

Heavy trailer coaches offer more difficult towing problems than do light trailers and

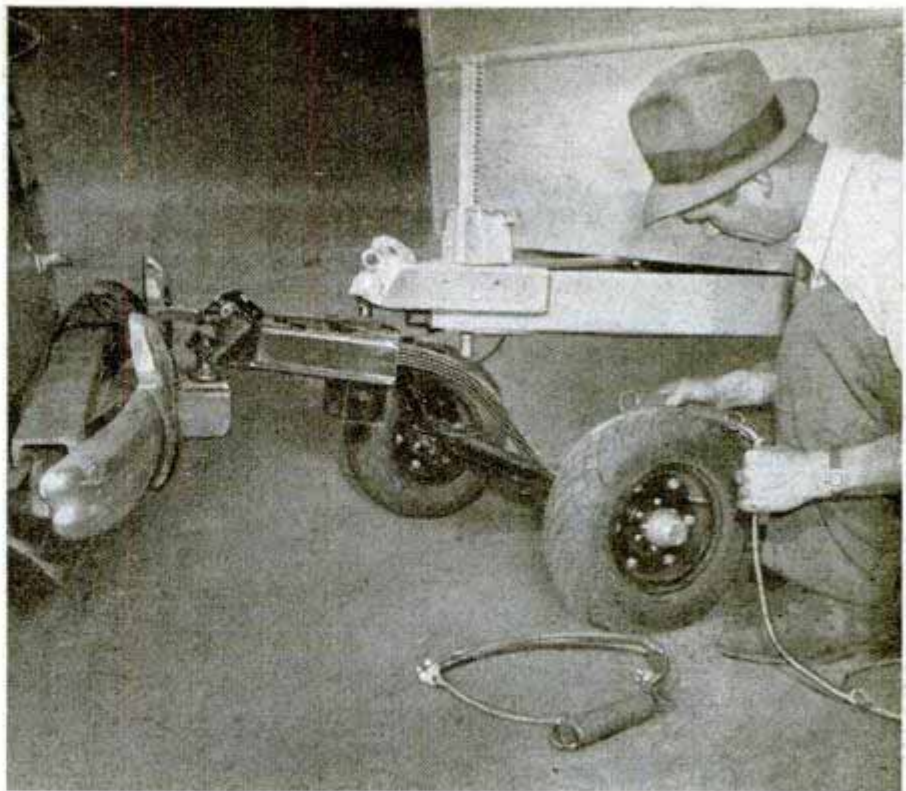

Dolly wheels at nose of trailer take most of weight off car. Diagram shows installation of Nelson dolly under front end of the trailer

*Nelson dolly
with trailer
1/2 m. 4/11*

are harder on fuel consumption and tow car maintenance. The trend is toward reducing the weight of present designs by as much as one fourth without reducing the amount of interior accommodations. One way is to take advantage of aircraft construction design instead of the ordinary house construction methods. Wood-plastic laminated materials are to be used, and one manufacturer is preparing to utilize surplus aircraft aluminum sheet stock for walls and roof with built-in insulation. Aluminum mills are rolling structural shapes for running gear and floor support girders.

More built-in gadgets and conveniences are being provided, especially in the way of kitchen ap-

(Continued to page 236)

View of the criss-cross coupler which eliminates sidesway and zigzagging

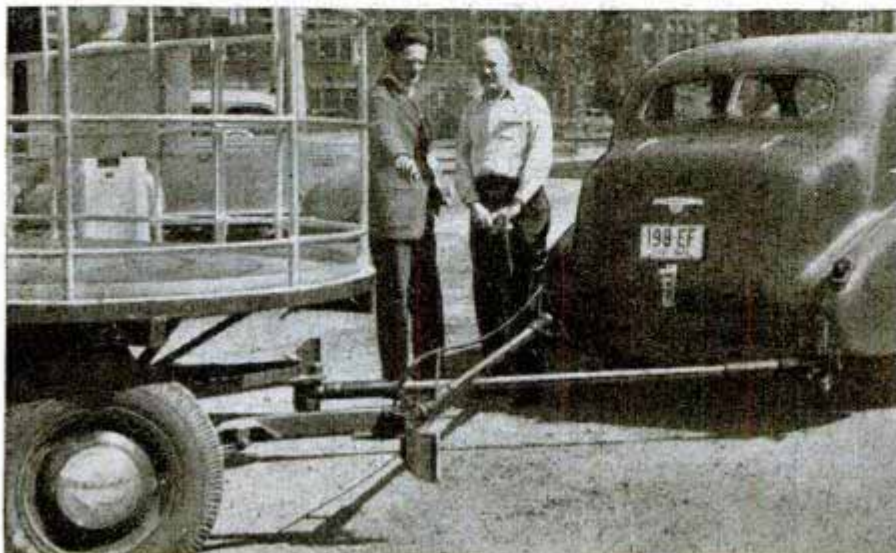

Motorcycle Truck Hauls 1000 Pounds

Equipped with fluid drive that eliminates gears and levers, a three-wheeled motorcycle truck is designed for light delivery service. It can haul 23 cubic feet of cargo weighing 1000 pounds. Powered by a two-cylinder air-cooled motor that develops $8\frac{1}{2}$ horsepower, it travels up to 35 miles per hour and goes approximately 60 miles on a gallon of gasoline. The motor is designed so that its parts can be replaced by parts for several automobiles. The motorcycle truck weighs 600 pounds, is 92 inches long, 50 inches wide, has a 66-inch wheelbase and a turning radius of 14 feet.



Plastic Auto Top Is Removable

Tradition is disregarded in a custom-built automobile body designed by Raymond Loewy and equipped with a transparent plastic top for the driver's seat which can be removed for warm weather motoring. Built on a standard 1942 Lincoln Zephyr chassis, the body is six inches lower than conventional cars. Blue glass portholes are fitted into the rear dome, and

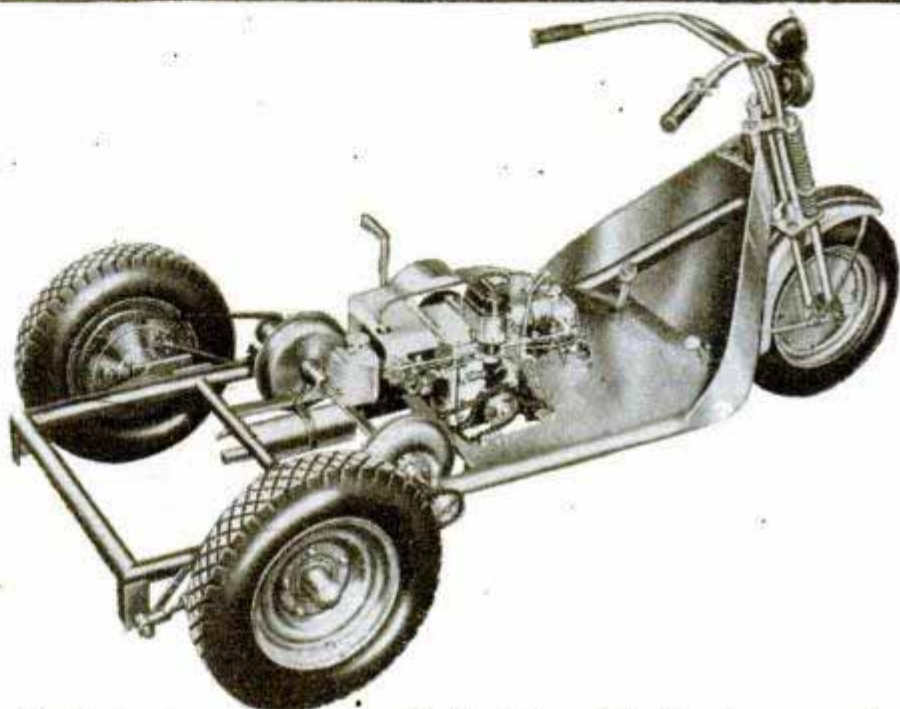

a plastic shield—hinged to the top—can be lowered between front and rear seats. A rear spotlight aids in backing up.

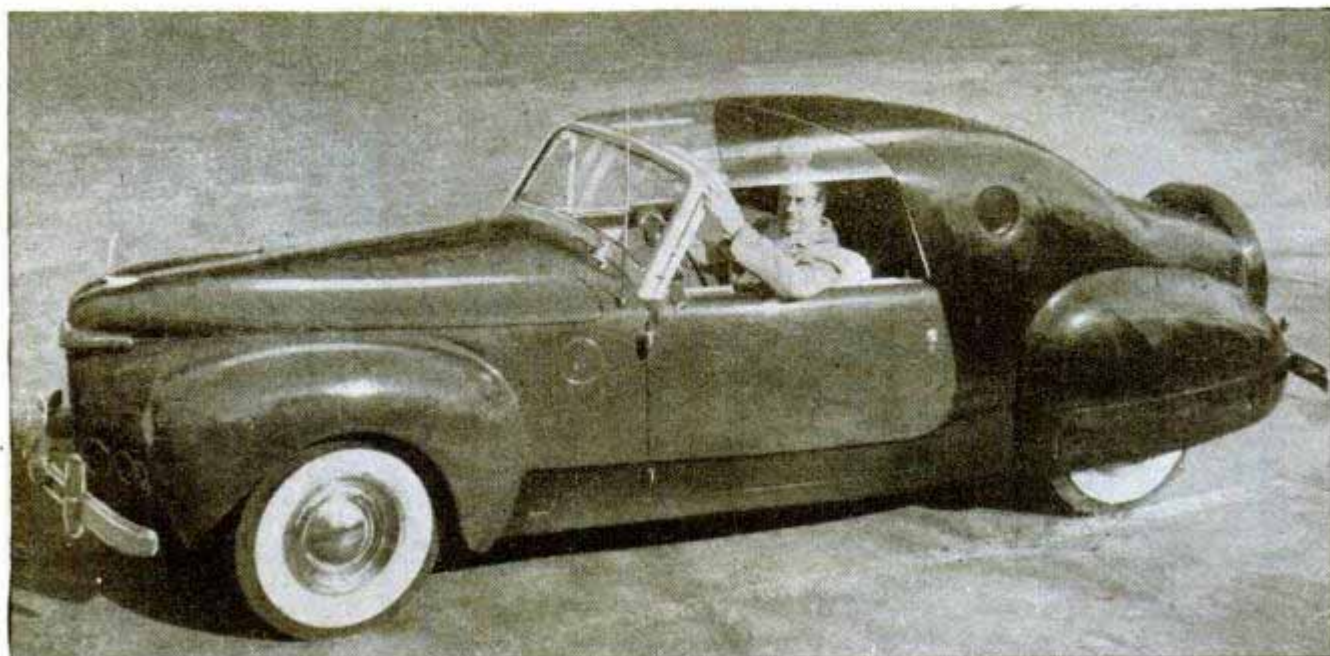

"Double Boiler" Developer

Film processing is streamlined and simplified for the advanced amateur or professional photographer by a new system which eliminates handling film from loading to drying. Equipment consists of a light-tight container and cover, three two-gallon developing tanks and two floating covers, all made of black plastic. A tank is loaded with film in a darkroom and then lowered into one tank after another through the successive steps of developing, washing, fixing and rewashing. The developing and fixing solutions seep upward through a maze of lightproof grids. Washing is com-

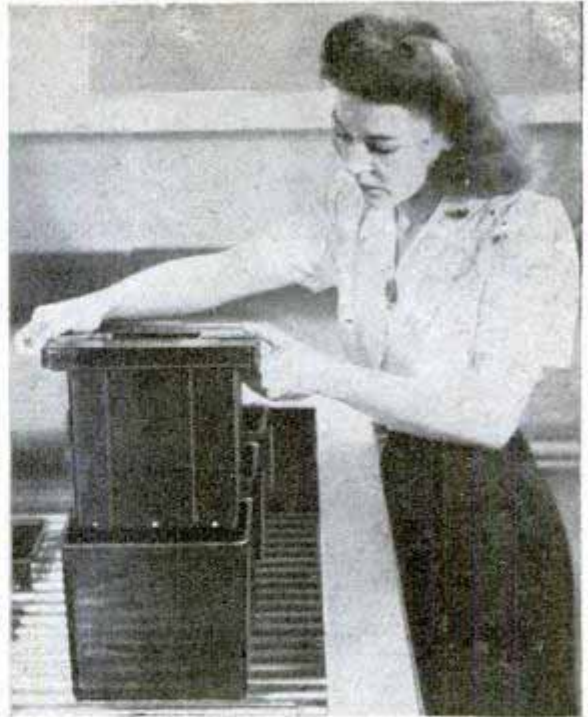
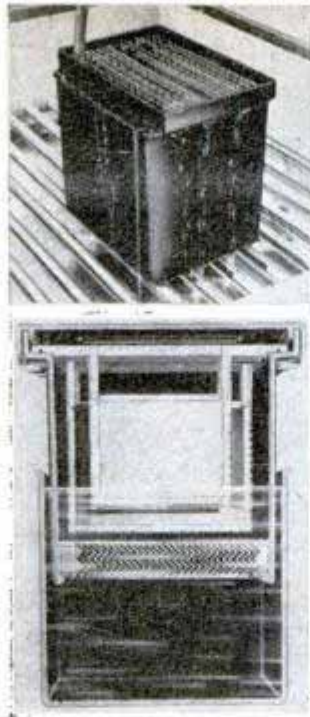

pleted in five to 10 minutes and the solutions can remain in the tanks—protected with floating covers—ready for future use.

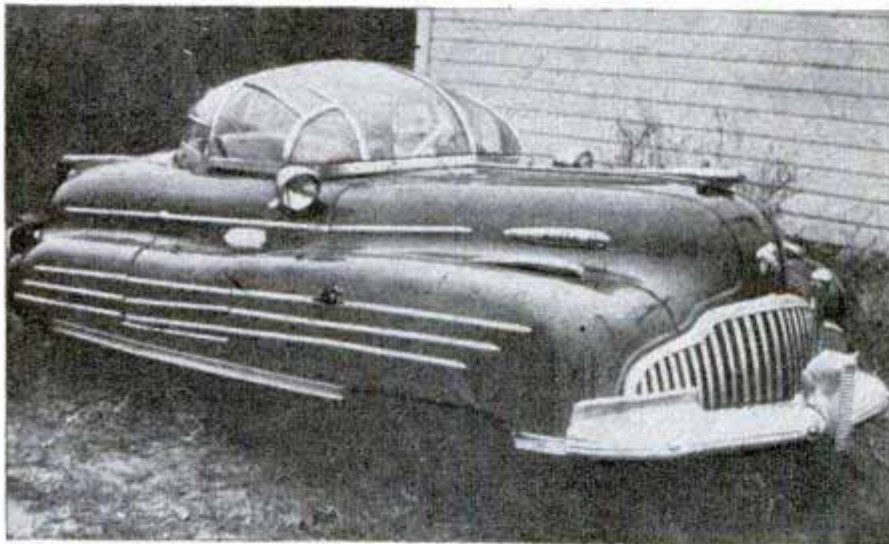

"Bubble" Top Auto

Anticipating that cars of the future will have all-around vision, George Bartell of Detroit built a streamlined automobile with a transparent plastic top similar to an airplane gun turret or "bubble" canopy. Named the "Hollywood Streak," the car is 48 inches high, 60 inches wide and 140 inches long from bumper to bumper. It is powered by a 100-horsepower motor.

Mower Keeps Itself Keen With Simple Sharpener

Grinding wheel principles are applied to a simple lawn mower sharpener invented by Rudolph Schneider and Bernard Marr, Milwaukee machinists. Blades of the mower act as the grinding wheel while the sharpener, a curved piece of metal containing emery cloth on the concave side, remains stationary. A rod at the base of the sharpener fits between the roller and stationary cutting bar of the mower, with the emery side facing the blades. The sharpener curves over the blades and its top is hooked to the mower's connecting bar by two springs which hold

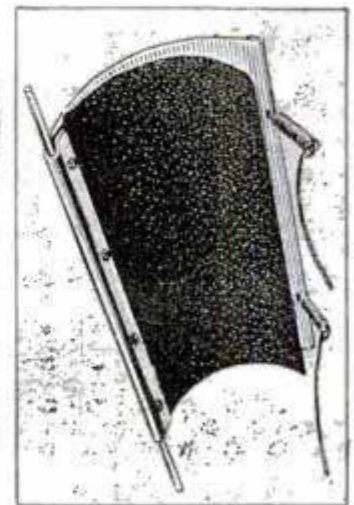
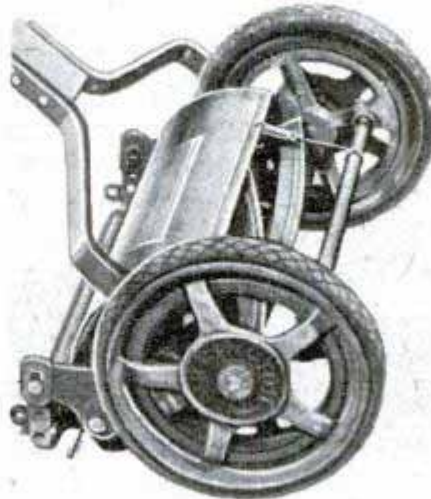

it firmly in place. By pushing the mower 20 to 30 feet, blades whirl against the emery and are ground to a razor's edge.

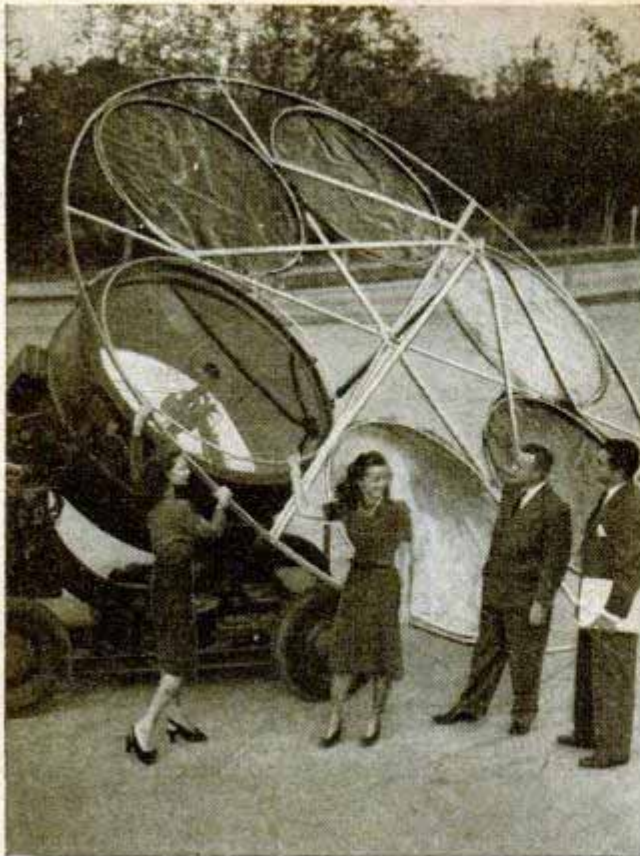

COLOR WHEELS were fitted over 800,000,000-candlepower Army searchlights to produce spectacular rainbow effects at a celebration in the Los Angeles Coliseum. Forty-two of the huge lights circled the field



MORE POWER than from other engines of similar displacement is reported developed by this 16-cylinder inverted V-type engine built by Chrysler for the AAF. Liquid cooled, the engine develops 2500 horsepower

PIPE HOLSTER gives protection against stem breakage. Worn over the belt or a suspender button, it will also hold pen, pencil, pliers, ruler or fishhooks. A sanitary plastic cup holds the stem in place

NEW TIMER automatically controls "on" and "off" timing when plugged into developing, printing, enlarging or photoengraving equipment. It has eight-inch dial and operates on 110-volt, 60-cycle current



There's Gems in Them Thar Hills!

Amateur '46ers go prospecting for rubies and amethysts they can polish for rings and brooches. Once in a while the gem turns out to be mastodon ivory or the tooth of a prehistoric horse

TAKE a look at that anthill!" The two prospectors bent down and saw, among the litter of small pebbles brought up by the big red ants, a gleaming chunk of what looked like purple glass. Some shrewd deduction, plus ample use of pick, shovel and dynamite, eventually led them to a small fortune in massive, rod-like crystals of gem-quality tourmaline. Amateur prospectors had learned another trick.

The Indians already knew it, for many a fine pyrope garnet has been gathered from Arizona anthills by keen-eyed Navajos. But if you're going to join the army of amateur gem prospectors tramping over U. S. plains and deserts, you'll need to

By Maxwell Reid Grant

learn many of these tricks.

You need to know, for example, that you test a gem for its ability to take a polish by scratching it on a bottle. You must learn how to chip garnets deftly out of their hard matrix rock, how to spot agate-lined "thunder eggs" under their warty outer shell, and how to slice a rock with a "mud saw" or turn a neat facet.

Almost any week end when the weather's good, amateur gem hunters are out combing hills, deserts, lake shores and stream beds in search of material. When luck is good they may bring back garnets half as big as your fist; volcanic bombs, thrown from ancient exploding craters; amethysts in clusters eight or 10 inches long, or hollow,

Amateur gem hunters search desert hills for precious stones on mass prospecting expedition. They traveled 1600 miles

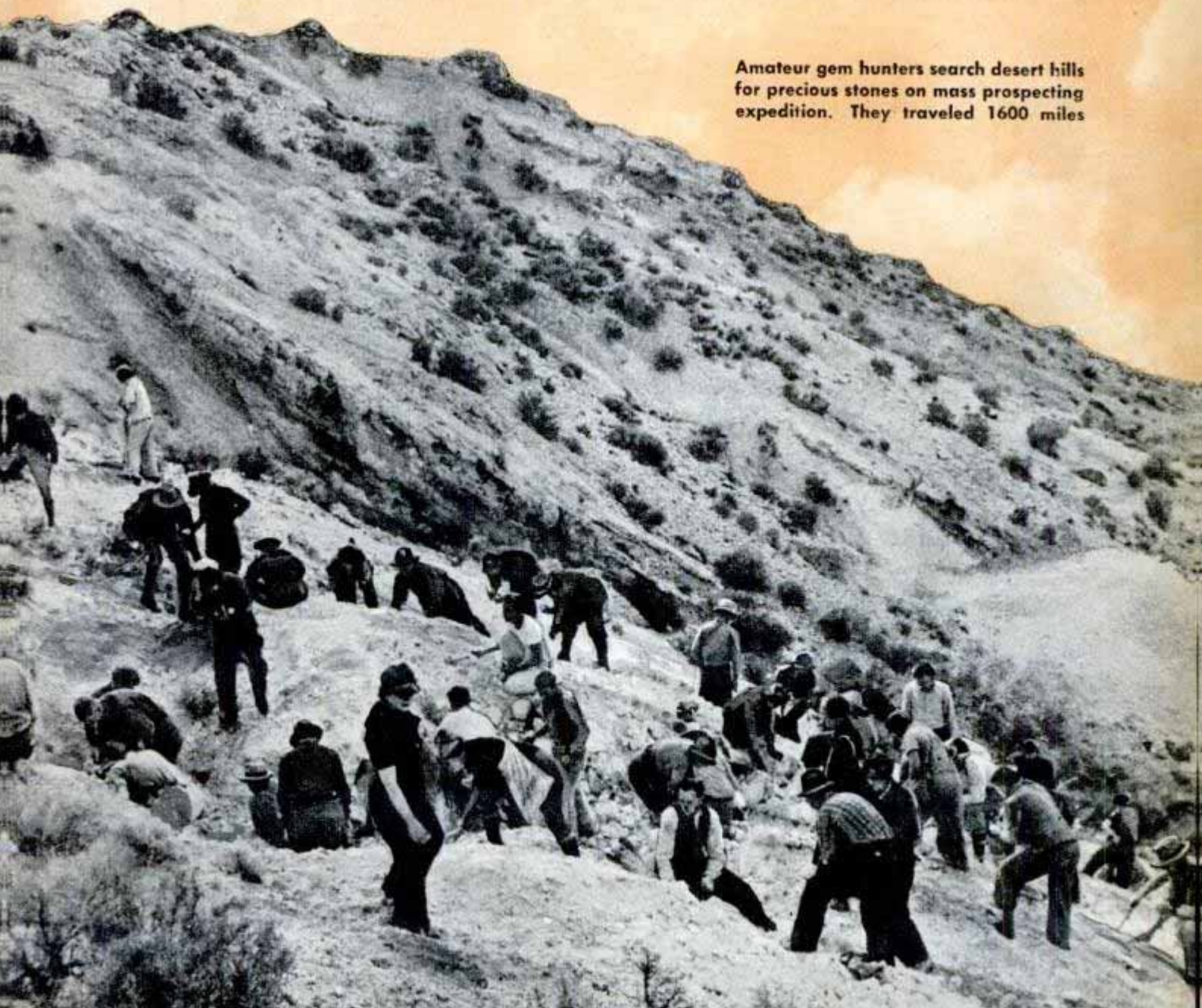

melonlike geodes, lumpy and drab outside but with a fine gem inside.

Believe it or not, gem stones aren't rare—they're plentiful. From coast to coast, our land abounds in rocks that your backyard workshop can polish to a high luster for brooches, pins or rings. When winter comes, gem polishing is a pastime for the long evenings, and blizzards don't stop enthusiasts from swapping specimens by mail.

Every now and then an amateur prospector makes a big strike. Just before the war, genuine emeralds, the first to be found in the United States, were discovered by a man near Rye Patch, Nevada. Another ran into a deposit of diamonds, some as large as a third of a carat, as well as some garnets and sapphires. A woman prospector, digging away on her gem-stone beryl claim, suddenly struck a vein of heavy, black, glossy rock. She sent in a sample for analysis and learned it was pitchblende, mother ore of uranium—then an obscure mineral but now the object of world-wide search as raw material of atomic power!

Amateur mineralogists are rallying once more to club expositions where enthusiasts exhibit their fine stones and learn what's new in prospecting.

If you were to visit one of these meetings, you'd see long tables covered with strange and beautiful rocks. Each is correctly labeled—a point of honor with the dyed-in-the-wool fan. Before your eyes, amateur

collectors open paper envelopes lined with cotton and pour out gleaming sapphires, rubies, opals, amethysts and topazes, ranging from pinhead to bird's-egg size and polished to perfection on homemade equipment. Collectors buy for their home museums and often you can pick up tiny uncut sapphires at a nickel apiece; garnets go three for a quarter, a huge flawless gem of kunzite for \$2500. Many of the rare items money couldn't buy.

In the darkroom next door, chunks of drab rocks are piled high on a table. When the room lights are switched off, these minerals miraculously awake to gleaming radiance of purple, green and gold as they lie bathed in the beams of hidden ultraviolet lamps. These are the magic luminescent rocks, and two of them are rare prizes.

One, a coal-black piece of fluorite, changes to dirty gray under the ultraviolet rays—but in total darkness you can see it gleaming like a dazzling white snowball. Afterward, by its light, you can read your watch, for the mineral phosphoresces like a glowworm.

The other, a fragment of opal on chalcedony, also is a rare specimen. To get it, the prospector spent a whole day climbing a mountain, then a second day lowering himself on a rope from the edge of a cliff, where, suspended in midair, he chipped off bits of the rock with a pick. Under the ultraviolet rays it flares out a brilliant emerald green.

Fossilized footprints in what once was muddy lake bottom, now slab of stone



There may be an auction of donated specimens to raise funds for the club's treasury. There's an emerald lying imbedded in a chunk of schist from Europe, a fragment of malachite from Africa, a flashing white zircon imported from Siam.

Another group watches demonstrations of the latest gem-polishing machine. Here's the real secret of the boom in amateur gem prospecting. With a few inexpensive gadgets any one can do his own cutting and polishing at home. The craft is being introduced in city playgrounds and at civic groups and hobby clubs where members chip in to buy their equipment or make their own from junk.

"This hobby pays its own way," says one young prospector. "There's always a steady demand for the more common stones. Any manufacturing jeweler probably will tell you he

Stones must be cut and polished carefully before all their brilliance and color can be brought out

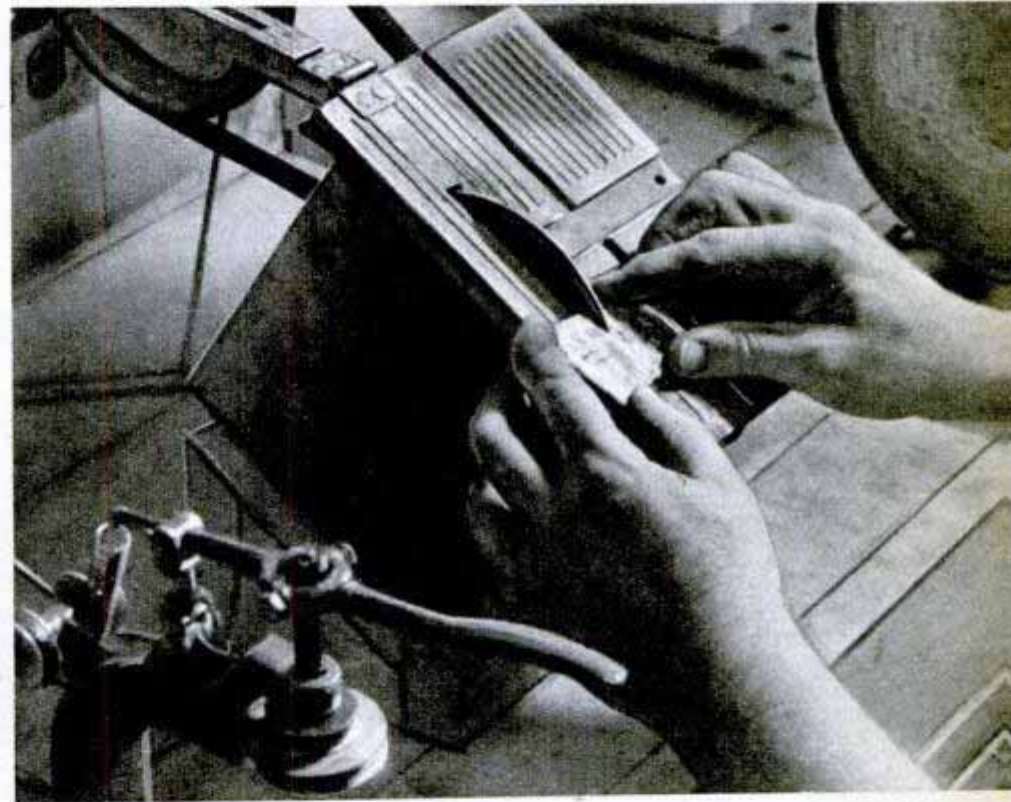

Cutting stone, above, with metal disk "mud saw." Gem prospectors, left, chip garnets from rock matrix in which the precious stones are imbedded. Collection of opals, topazes and amethysts, below. Collectors always use tongs to handle gems



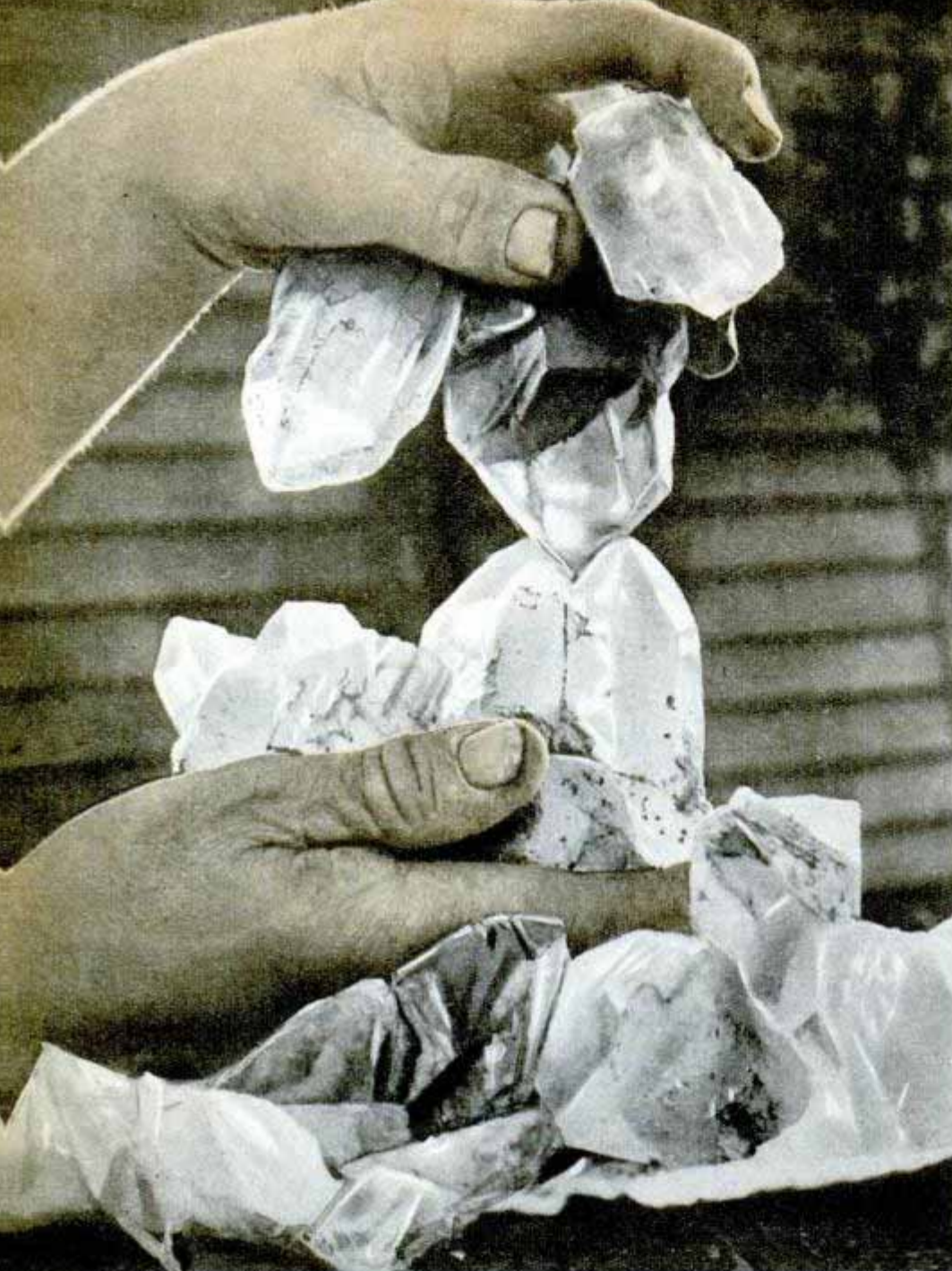

Quartz crystals, above, found by amateur prospector. If the stones will scratch glass they will take a polish. Below, testing a stone on a glass bottle



can use some well-polished stones suitable for costume jewelry. These stones can give you practice and provide money to build up your own collection or add to your equipment."

But the biggest thrills come in actual prospecting, and you'll not have to go far to start. Any lake shore, any stream bed is a likely place to look. Jasper, for instance, abounds in almost every state, and rubies and sapphires, strangely enough, are fairly common.

Never waste time on a stone unless it is hard enough to cut glass, for it won't polish. Carry a small, flat bottle to try rocks on. For quick identification, a mineral handbook is helpful. Judge rocks by their hardness as well as by their "heft." Minerals are rated on a numbered scale ranging from "1" and "2" for those like talc, which can be scratched with the fingernail, to "3," "4"

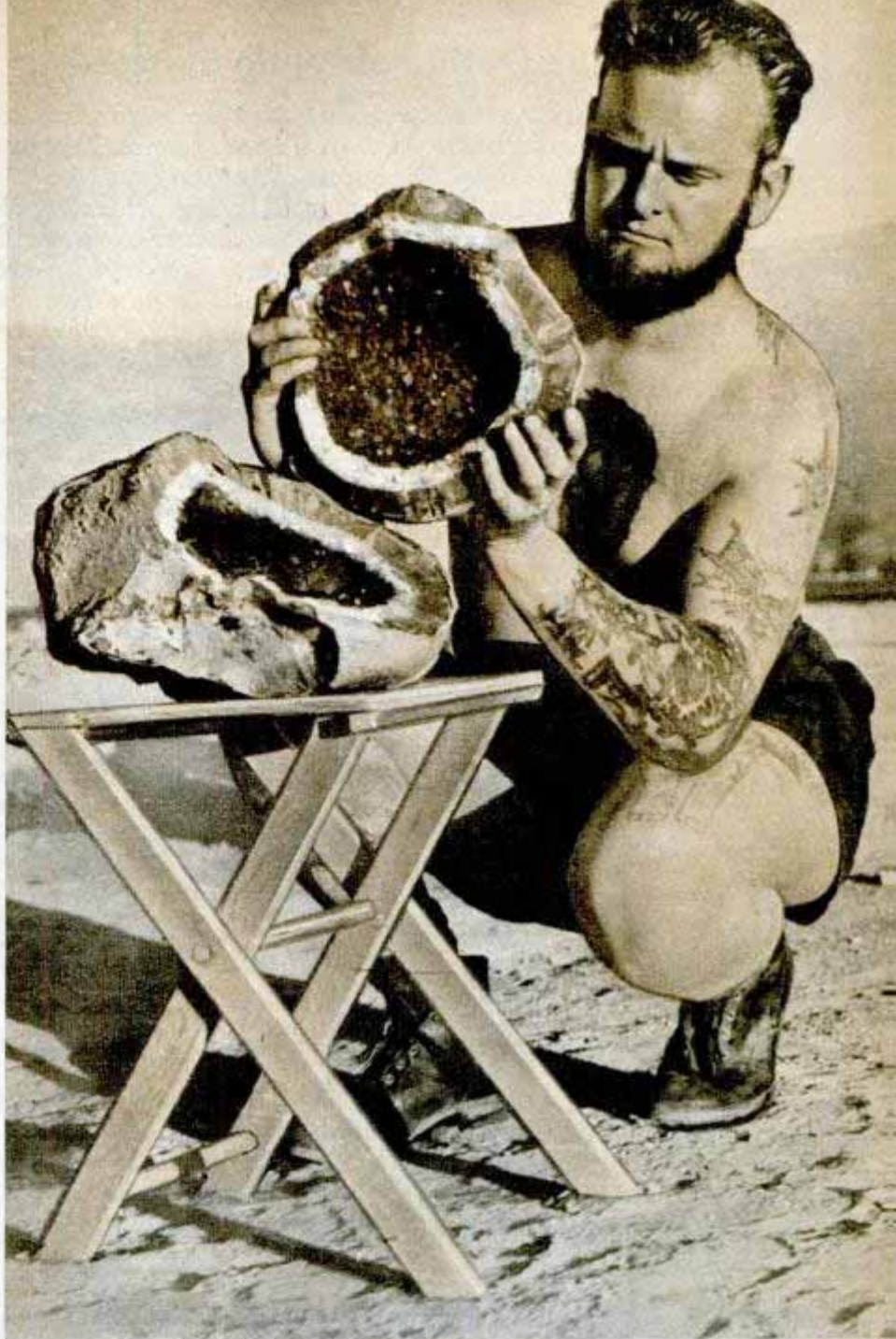

Gem hunter, above left, explores crevice in rock wall for mineral specimen. Chuckawalla Slim, gem prospector and dealer, right, exhibits a huge geode, a hollow rock lined with amethysts. It is worth about \$300

and "5," that you can mark with a knife, while "6" is as hard as the knifeblade itself, and only a steel file will scratch quartz, "7." The diamond tops the list at "10." Color is another guide, but don't depend on simply looking at the rock—rub it on a piece of unglazed floor tile. It will leave a streak showing its true natural color.

Don't pass up the fossils, for fossil pine cones, corals and bones of prehistoric animals are gems in their own right. One amateur discovered a deposit of agatized dinosaur bones, many of them lined with crystals gleaming like diamonds. Another worked fragments of mastodon bones into handsome "ivory" bracelets, dress ornaments and cigarette holders whose unusual nature gave them high market value. Ancient whalebone sometimes looks like blue

chalcedony etched with the delicate pattern of the bone structure.

Recently a California amateur found some "gems" which he cut in sections and polished to a beautiful lustre, only to learn they were teeth—from the three-toed horse that once roamed the Mojave Desert in prehistoric eras!

Where you find one amateur prospector, you're likely to find a dozen, for mass prospecting is now the fashion. Groups of week-enders toss pick and geologist's hammer into their cars and head for the open country. A 60-car caravan swung around a 1600-mile loop on an eight-day prospecting tour. Most of the tour was on paved highways but they came back with car springs groaning under the weight of specimens.

(Continued to page 242)

Barbecue Outfit Folds Into Suitcase

Carried like a suitcase, a steel barbecue outfit can be set up in your back yard in a few seconds—ready to cook an entire meal. Weighing only 20 pounds, the unit is encased in a steel container 12 inches wide, 9 inches deep and 20 inches long. The cooking area on the grill is 10 inches wide and 17 inches long. The hand-carried model includes an ash tray with lighter box, two draft control units and solid steel legs. A special fuel which leaves no soot is supplied with the portable barbecue for use in the lighting unit. Another feature is a "stay put" skewer which can be set in any position to hold the barbecue meat to insure even cooking. The plate warmer provides ample room for chinaware to warm during the cooking period and the cutting board offers a wide surface for carving and serving the barbecue.

Concrete made with coral and salt water solved a wartime building problem in Bermuda.

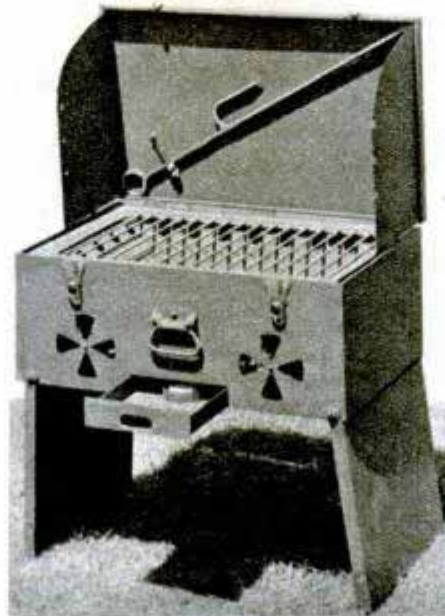

Photos Printed on Wood, Cloth, Leather or Plastics With Sensitized Coating

Photographers will soon be able to print their pictures on metal, wood, cloth, leather, plastics or any other material with a suitable surface, freeing themselves of the

limitations of commercial printing papers. The process is based on a thin, jellylike emulsion, which becomes a liquid when heated to 125 degrees and can be applied to many materials with a brush, soft sponge or rag. Application of the emulsion and printing of the sensitized material, either by contact printing or enlargement, must be done in a darkroom under ruby lights. The technique was developed by the Glenn L. Martin Company for the projection of drawings on work surfaces. Many applications, for professionals as well as amateurs, are foreseen. Photographs can be printed in almost indestructible form; outdoor signs can be made with a lacquered or varnished finish; photomontages may be made more easily, and greeting cards, jewelry, leather goods and other personal effects can be decorated photographically.

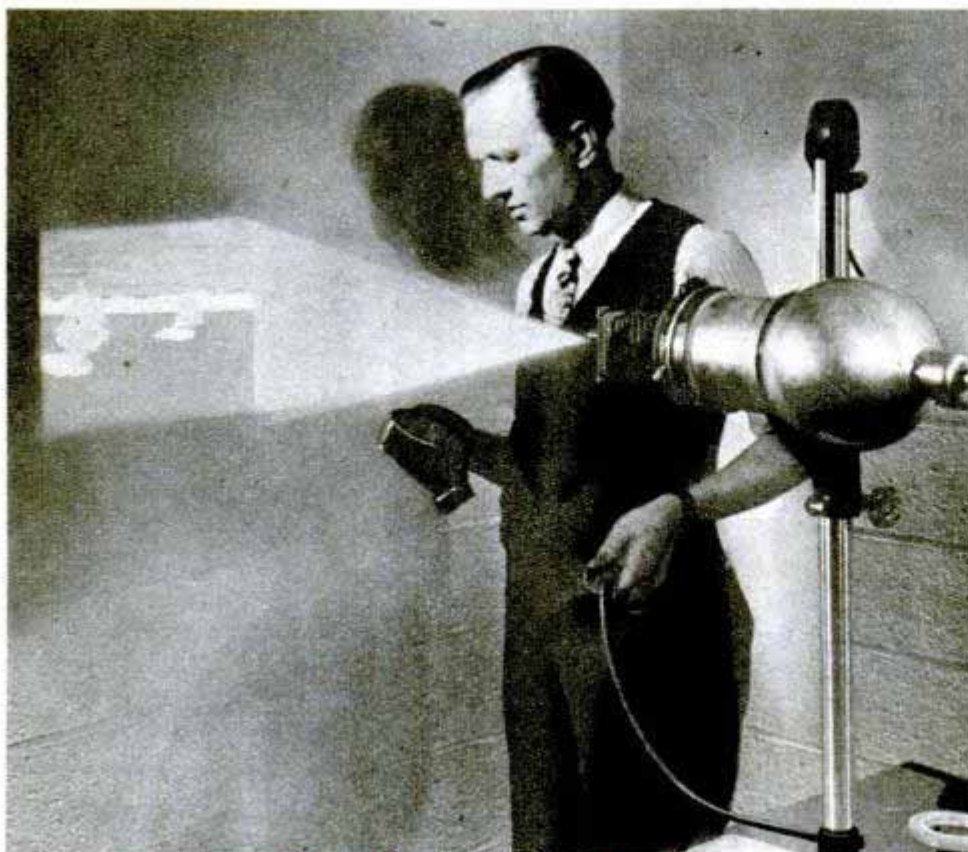



COMPUTING MACHINE invented by Sgt. James T. Patterson figures years, months and days of service to aid soldiers in totaling up their "points" for discharge



FISHING FROM A JEEP is a new pastime in Florida. A sportsman converted one of the vehicles into a small boat complete with splashboards to keep out water



THREE KINDS OF POWER, electricity, compressed air or a flexible shaft, will drive a handy tool for sawing and filing that will reach into awkward corners

HANDY SNAP GAUGE with dial covers measurements up to three fourths inch and replaces several solid ones that were previously used in covering this range

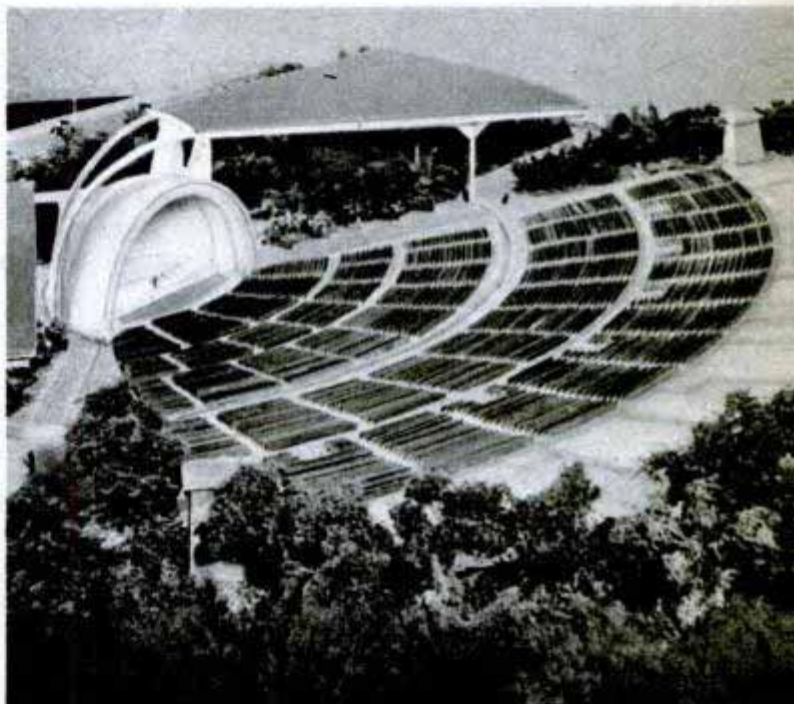

A COMMUNITY "UMBRELLA" for a proposed Chicago amphitheater will be formed by two roof sections that will roll together to cover 10,000 people when it rains

EXPERIMENTAL "BLOWTORCH" resembling a xylophone beams radio waves instead of concentrated flame to heat any object uniformly, regardless of shape

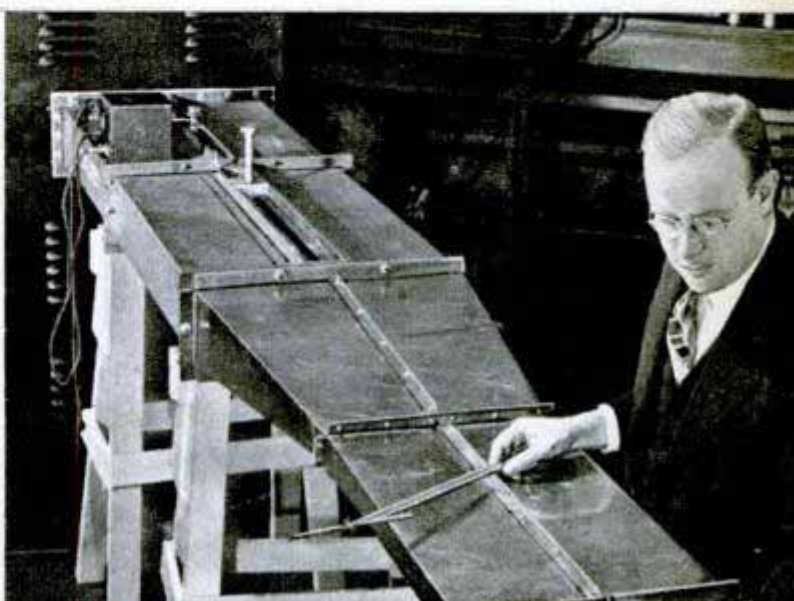
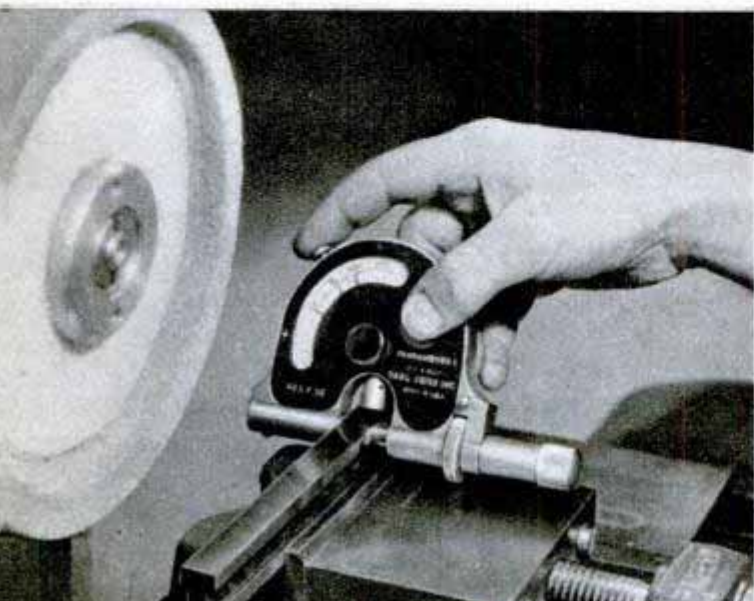

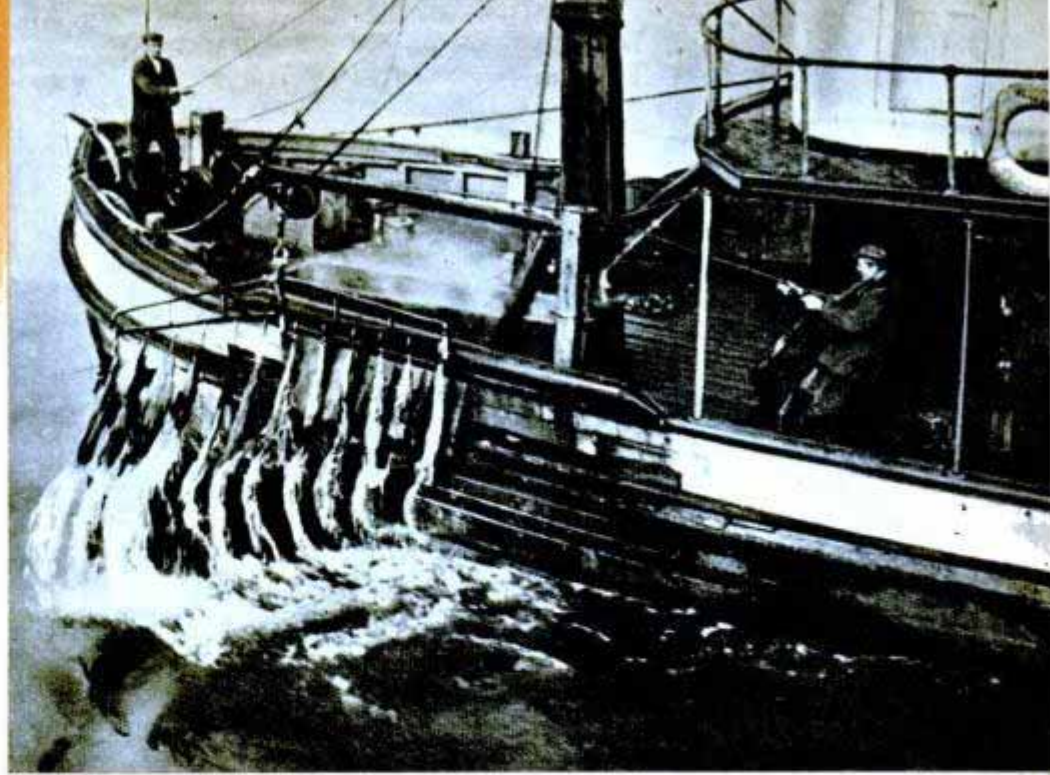
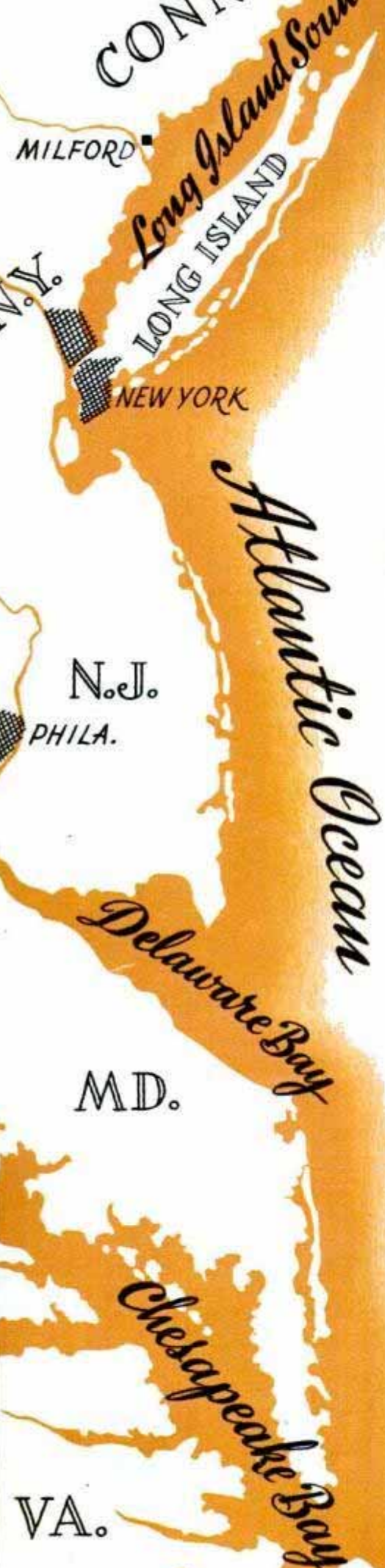

Starfish cling to huge rope mops as they are hauled aboard an oyster boat

Mopping Up

Oystermen are waging an unceasing war on the shallow ocean floor just off our coasts with boiling water, vacuum cleaners, quicklime and mops as weapons. The enemy, which so far has not succumbed to relentless attack, is the starfish, whose depredations against the nation's oyster beds cause losses of millions of dollars each year.

In Long Island Sound alone, starfish consume several hundred thousand bushels of oysters. Beds in New York, Rhode Island and Massachusetts suffer heavily. In addition, the loss of spat, or infant oysters, upon which even young starfish feed, is beyond calculation.

To safeguard the supply of oysters, the industry, with assistance from the Fish and Wildlife Service of the Interior Department, fights the predatory starfish continuously. In attacking oysters, which with clams and mussels supply most of its food, the starfish first must open them. This it does by fixing the suckers of its arms to the shells and patiently pulling them apart. This may appear difficult to a person who has tried to open live oysters with a knife or other implement, but the starfish's secret is persistence. The oyster cannot resist a long, steady pull and it is this kind of pressure that the starfish exerts. Once inside the shell, the starfish consumes the oyster by wrapping its stomach around the meat. A single medium-size starfish will eat as many as five one-year-old oysters a day.

Oyster dredges often pull in almost as many starfish as oysters. When this happens the oysters are saved and the starfish killed in large wooden vats of boiling water. In other cases, boats are sent out to clean the oyster beds with starfish mops. These consist of an iron bar up to 10 feet long to which are chained 12 to 16 bundles of rope yarn.

Each starfish boat has two mops, one on each side. These are lowered into the water and dragged along the bottom. The starfish cling to the mops by the thousands. When hauled to



Mops carry the starfish to death in vats of boiling water



This is the enemy in oyster bed battle

Starfish

the surface, the mops and the starfish are dipped into boiling water. Dredging of seaweed also is helpful in ridding the oyster beds of the pests because young starfish cling to the seaweed.

A suction dredge, which operates like a vacuum cleaner, removes more of the encroaching starfish. The dredge draws up loose material from the beds through a flexible pipe and deposits it in a rotating drum where it is screened into a sediment tank. Oysters caught in the tank are returned to the beds while the starfish are removed and destroyed.

Sometimes it appears to the oystermen that they are losing the battle to the starfish, whose numbers never seem to lessen. But new techniques for eradicating the pests have been devised by the Oyster Institute and by the Fish and Wildlife Service. At the government laboratory at Milford, Conn., Dr. V. L. Loosanoff declared chemical warfare and spread quicklime over starfish infested beds. While the caustic action of the lime has no effect on the oysters, it burns the covering membranes of the starfish and causes their eventual death.

The lime is distributed uniformly on the bottom by a unique lime spreader.

(Continued to page 238)



Oyster Institute of North America photo
Dead starfish, above, piled on deck of an oyster boat

Quicklime spreader is unique chemical warfare weapon

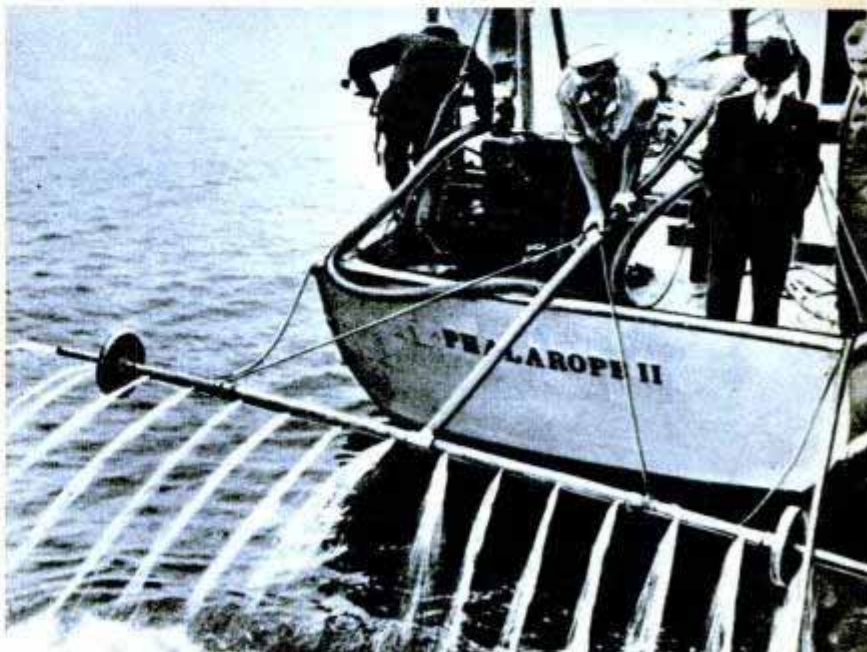

Chrysler Features Safety Rim Wheel

Special wheels on the 1946 Chrysler car reduce the hazards of blowouts by gripping the tires when they are deflating so they will not come off the rim. The size of the wheels has been reduced from 16 to 15 inches. Plated aluminum pistons have replaced the cast-iron pistons installed in the 1942 models. Front and rear bumpers have been extended around the sides of the fenders for greater protection. Bumper back bars and guards are heavier and stronger. Six models of the car are powered by six-cylinder engines and

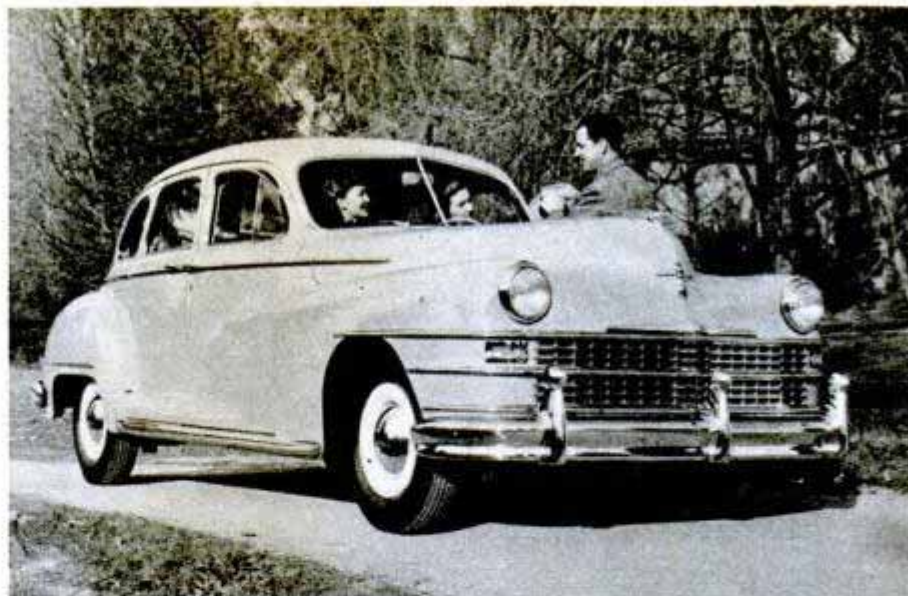

three heavier models by eight cylinders. Twenty-six different body styles of the models are offered in 13 standard colors.

Flagpole Washing Machine Operated by Steeplejacks on Ground

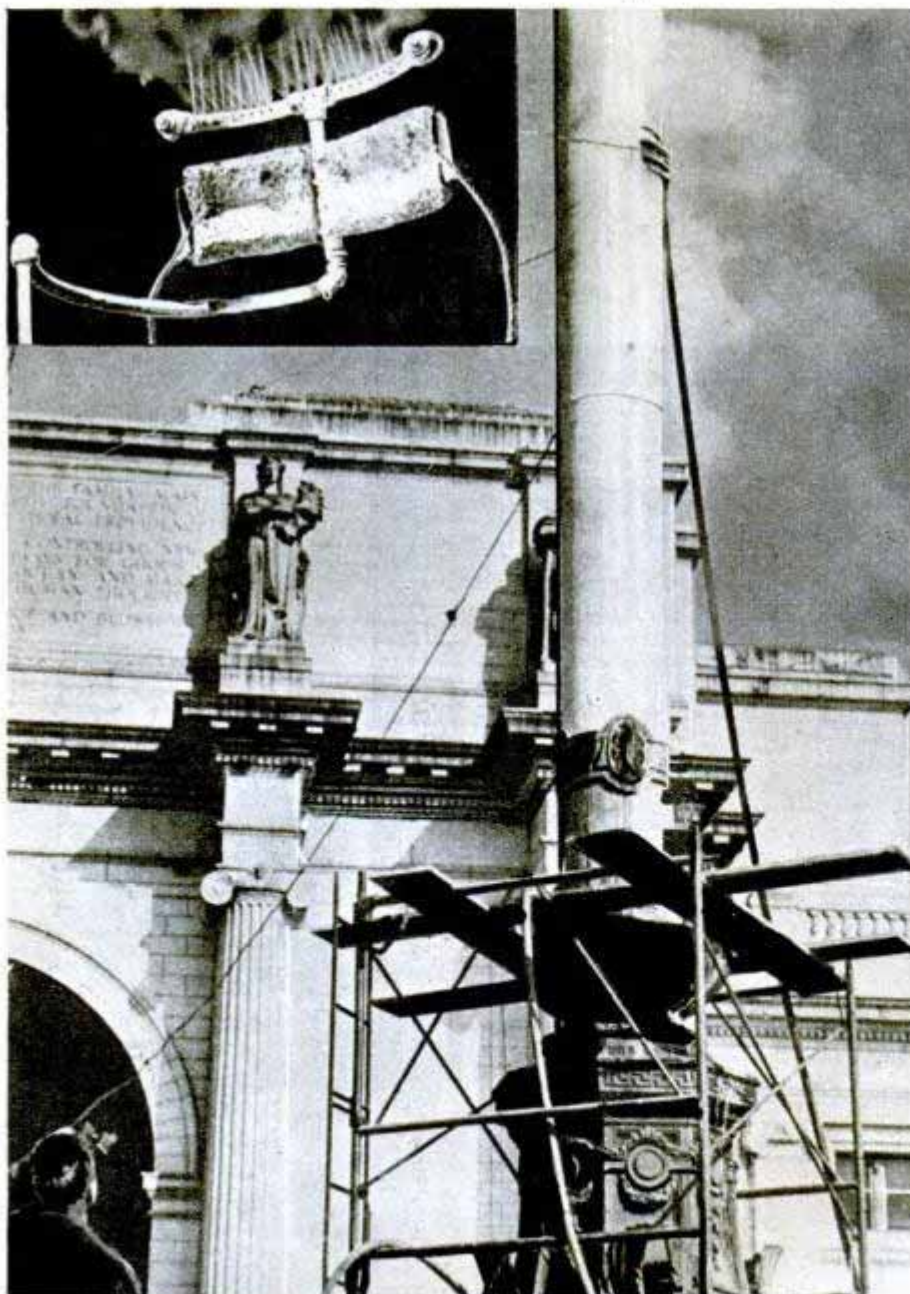

Steeplejacks stay on the ground when they use a device improvised for washing flagpoles of the nation's capital. The flagpole "washer" consists of a double ring of pipes that partially encircle the pole. The top ring is perforated with small holes. The lower ring has a sponge rubber facing. A long rubber hose attached to the rings is connected to a truck on the ground. The rings are drawn up and down the pole with the flag lines, which ordinarily raise the flag. Steam, boiling water and cleaning powder are forced up the rubber hose and through the holes in the top ring. The dirt is brushed down the pole by the sponge. The device is used by the National Capital Parks Bureau.

Skeeters in Color

U. S. Public Health Service scientists spray mosquitoes with blue, red and green fluorescent compounds to identify the insects, trace their flights at night and acquire more knowledge to fight them.



Most powerful single-unit Diesel engine built by Baldwin Locomotive Works for Seaboard Air Line Railway develops 3000 horsepower

Model (right) of 101-foot electric locomotive which General Electric Company is building for Great Northern Railway. Largest single-cablelectric locomotive in the world, it will generate 5000 horsepower

Great Northern's new Diesel service shop at Havre, Mont., has a drop table (lower left) and track pit 205 feet long (right). Design was adapted from Italian railway

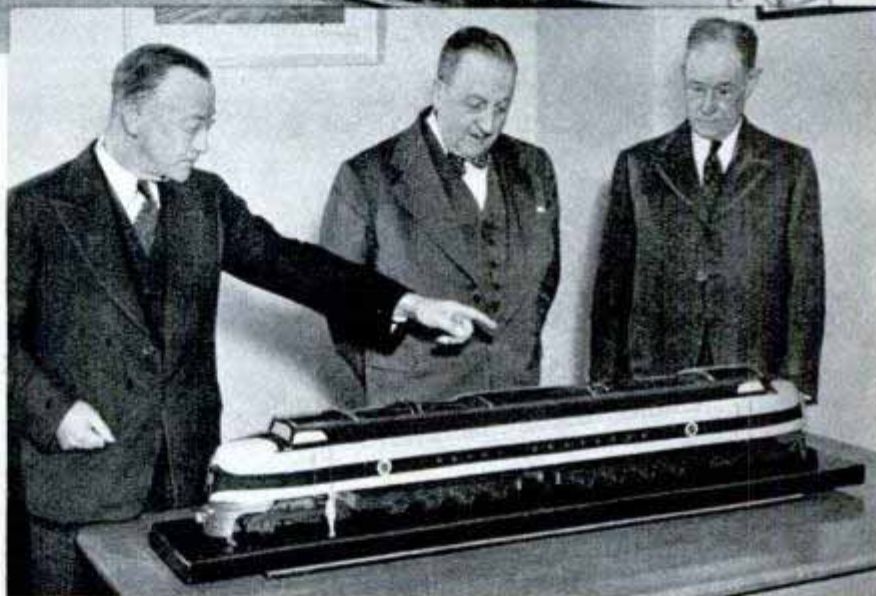

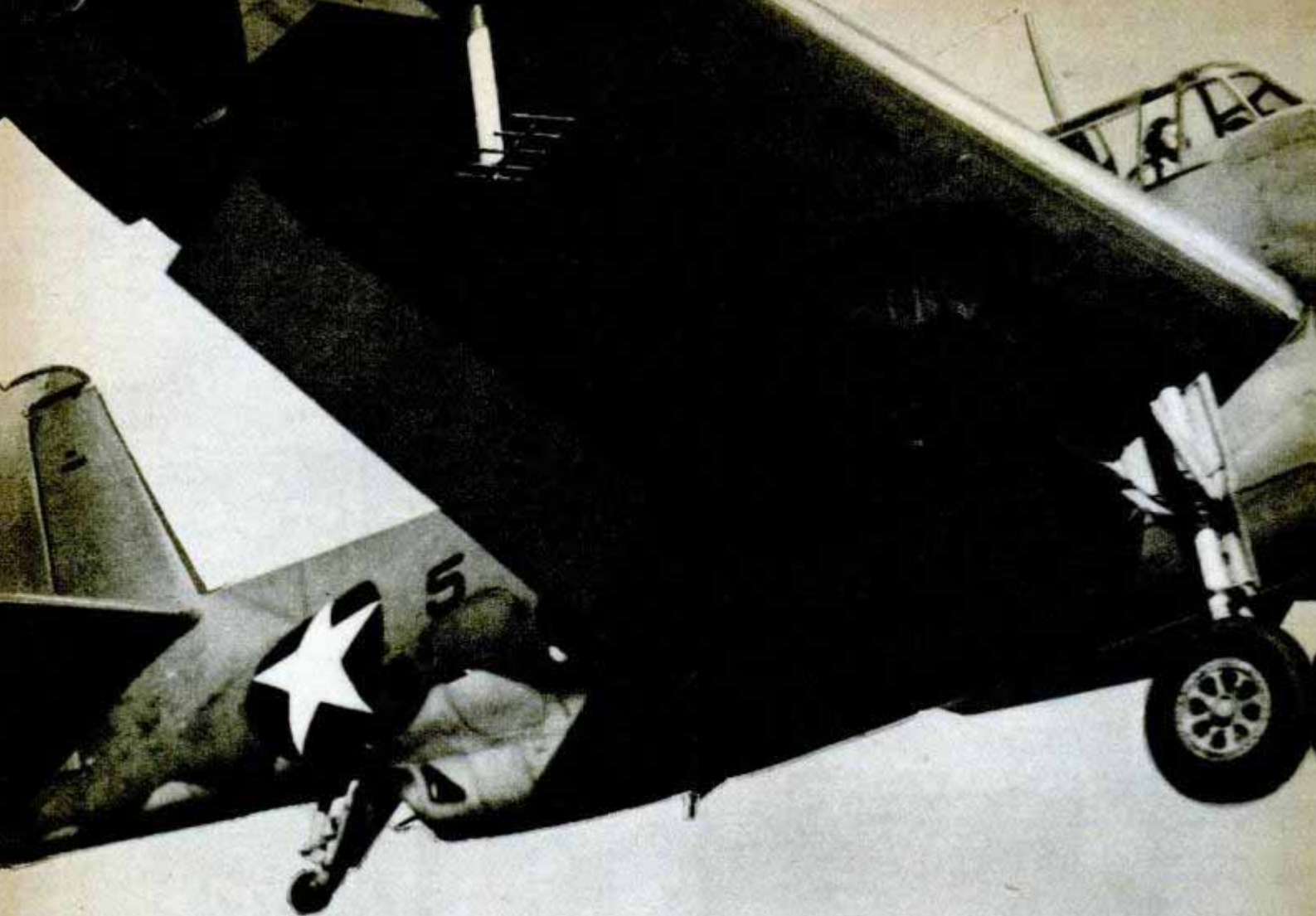

PART 3

RADAR *Cues the Navy Fighters*

By Lieut. Comdr. James S. Hunter, USNR
and Lieut. (j.g.) Max Hodge, USNR

THE stories of night fighter direction are endless. One, perhaps, will suffice to illustrate its importance to the Fleet.

In mid-January it was decided by the high command that Admiral Halsey's Fleet would make a sweep into the China Sea to ferret out shipping and aircraft and protect the landings at Lingayen Gulf on Luzon. Geographically, the China Sea, as map gazers know, is a gray and turbulent body of water whose approaches from the Western Pacific are through narrow channels to the south between Borneo and the lower

Philippines, and to the north between Formosa and northern Luzon. Both channels were heavily patrolled by the Japanese. With the situation in the China Sea highly uncertain, it was imperative that all precautions be taken to avoid discovery on the initial entrance to the China Sea which, command decided, would be through Balingtang Channel—a narrow strip of water just north of Aparri on Luzon and just south of the Jap stronghold of Formosa.

The task force entered the channel at dusk. During the night, CIC watch officers



Radar antenna projecting from lower surface of wing helped guide Avenger back to carrier

noted on their radar screens the white outlines of the southern tip of Formosa slide past, tensely waiting for the telltale trace of Jap snoopers. The hours ticked by. The radar screens, except for the occasional thin trace of cloud, remained blank. Then at 0555, with dawn scarcely more than a premonition on the horizon, the first Jap appeared 60-odd miles to the south. Immediately his course was noted—zero-one-zero, a straight line toward the strong Jap bases on southern Formosa. Immediately

the task group fighter director officer went into action and the raid was assigned to the USS Independence whose night fighters were airborne.

In the CIC of the Independence the night fighter director, Lieutenant Commander Eliot Thompson of Monro, Louisiana, set to work. It was important—all important—not to miss! Within minutes the night fighter pilot was on his way. On the bridges of the carriers and battle wagons, and most particularly in the flag plot of Admiral Halsey's flagship, command stood by, listening to the reports of the interception coming up from their CICs.

Within short minutes—at 0620—another bogey popped up to the south and 15 minutes later still another, arrowing northward from Luzon. Dawn crept over the fantails of the task group—first a lightening in the grayness, then sudden bursts of incredible orange. But no one bothered to admire it. In a few swift minutes, perhaps, the whole carefully laid strike into the heart of the Jap's inner empire might be threatened.

Above the crackle of static in the plane-to-ship radio circuits the orders went out to the planes:

"Hello, Two. Buster . . . Hello, One. Vector starboard zero-two-zero . . ."

Finally—and it seemed to the waiting ships a long finally—the reports came in: at 0630 splash one; at 0647 splash another; at 0706 splash number three—a clean sweep!

Melodramatic? Perhaps . . . but wars are fought, as all fighting men know, in an atmosphere compounded of melodrama and long boredom. At any rate, fighter direction rang up another score to its credit on that early morning of January 10 and the Fleet went in undisturbed to unleash a fury of strikes that sank a still-standing record of Jap shipping.

Up to now, fighter directors have been shown as men who direct planes away from the ship or island base to intercept enemy raids. But there is another function that FDOs perform—a function that, to our own Navy pilots, may well be considered the most important of all. This is the fighter director's use of radar as a device for homing lost planes.

In the vast reaches of the Pacific, rain squalls move like ceaseless shadows across the seas. Particularly in areas off the land masses in which carriers habitually operated, weather is a constant factor and a constant menace. From the deck of a battleship or a carrier, another carrier may loom up large. But from 10,000 feet up in the air, from 10 miles away on a bad day, a task force is just a collection of smallish dark shapes on the face of a monotonous gray waste of water to the returning pilot.



Silhouette of USS Independence, left, and radar scope photo of Nantucket Island, with land white, water black

Under such circumstances, pilots not infrequently get lost despite the fact that they have homing devices and have carefully worked out their navigation. When this happens, radar steps in. If the pilot is in radio touch with his parent ship, he calls in, giving his approximate position. The CIC fighter director or watch officer notes whether he has a plane in that vicinity. If he does not have planes in that vicinity, but does have several blobs of light that might be the lost plane, he may choose to locate the plane by means of a series of "steers." It is a simple enough process. By giving the pilot several "vectors", first north, then west, then south, then east, for instance, the CIC officer can check on the screen or scope to see which blob of light seems to be flying in this "square" formation. By determining which contact is the

lost plane, he can easily give that particular plane a steer to the base. Another method that is used often in the Fleet is to direct the pilot to flash a signal on the IFF gear in his plane which shows a characteristic response on the ship's radars.

The number of pilots who owe their lives—the number who have had to go in the drink and whose position has been noted by radar operators for a subsequent pickup by a float plane or rescue destroyer—runs into many thousands. What this locational device now can mean in peacetime aviation is incalculable.

How important a role radar has played as a lifesaving device perhaps can best be illustrated in another untold tale of the crucial battle of the Marianas. Newspaper readers with a long memory may recall that shortly after the "Turkey Shoot", Task

RADAR "EYES" OF THE FLEET



Radar operator peers into scope as he "peaks the echo" to determine distance and range of his target



Busiest man aboard a night flying Catalina is the radar operator as he "tunes in" various instruments

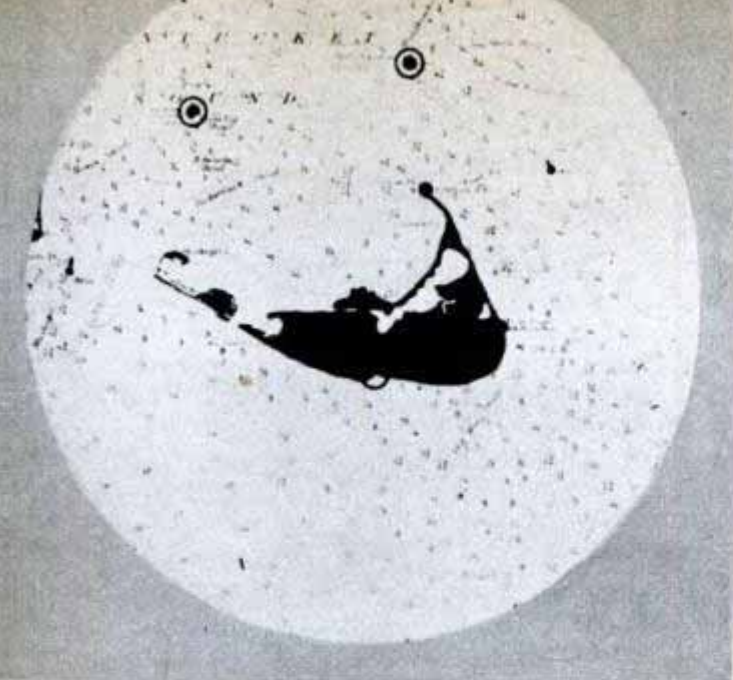

Compare this actual chart of Nantucket Island with Army Air Forces radar scope photo on opposite page

Force 58 was able to locate the bulk of the Japanese Fleet fleeing with its train toward the protection of the home islands after the disastrous raids of June 19. What readers do not know is that the verified contact with the Japanese Fleet came late in the afternoon and that the main body of the enemy force was some hundreds of miles to the west of our carrier force, at the extreme range of our torpedo and bombing planes. A decision was called for. Should Task Force 58 run west through the night, running the risk of losing the Japs, or should the attack be launched immediately? If launched, simple arithmetic indicated that the returning strike planes very well might not be back at the recovery point until well after dark and because of the range when they did get back both

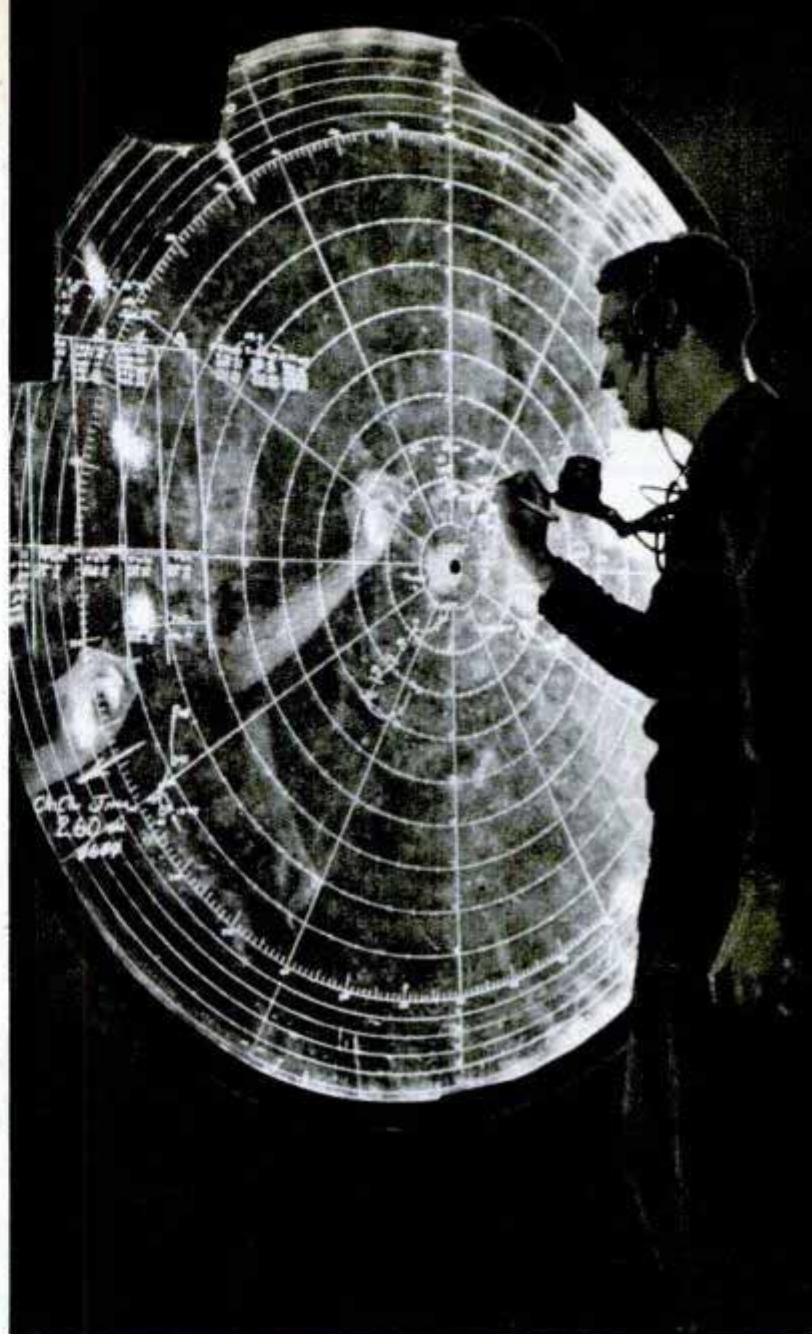

Radar information is entered on transparent vertical chart. More data is being marked on back of chart

PENETRATE FOG AND DARKNESS



Battle stations for this radar team are in the Combat Information Center as carrier planes chase foe



PPI at right shows objects picked up; beam rises in A-scope at left to a peak when the echo comes back



Catapulted by JATO (Jet Assisted Takeoff), Avenger wings its way from a carrier deck out over the Pacific



Communications experts on amphibious force flagship keep in touch with all other ships of assault armada. Below, sandbags protect radar station on Pacific isle



bombers and torpedo planes probably would be very low on gas.

Every carrier man knew what the factors were. Landing planes at night is a tricky business at best and landing planes low on gas, operated by pilots who were essentially day flyers, was fraught with danger not only to the pilots but to the ships themselves.

Because such decisions must be made and risks are part of the tactics of warfare, command decided to launch immediately. It was a chance, yes, but for many months our whole aim had been to establish contact with and destroy the Japanese Fleet. If we missed it . . .

What airmen accomplished in the attack now is safely niched in history as the Battle of the Philippine Sea. In the CICs of the ships of TF 58, officers and men listened to the faint, far ghost voices reporting the death of the Jap carriers—one exploding in a mile-high flower of dark smoke, another down at the bow and dead in the water, cruisers viewed from circling planes, like toy ships on the bomb torn face of the sea, turning in wide, crazy circles, first of evasion and then out of control. It didn't take long.

Because the attack took place out of radar's range, the returning planes were not picked up at once. When they did begin to appear on the screens—100, 125 miles away—the reports of the torpedoes and bombers began coming in:

“. . . estimated ETA 2030, but I am low on gas . . . estimated ETA 2045, fuel down to 40 . . . can't make it, out of gas . . .”

By nightfall, short minutes later, the reports began to take on a more somber note, and on the plotting screens of the CICs the Emergency IFF symbol began to show up. One by one, at distances varying from 30 to 75 miles, the torpedoes and bombers began dropping into the sea. Those who got back—mostly the fleet F6Fs—began coming aboard in one of the most spectacular and harrowing nights of the carrier war. The blackout went overboard, despite the nearness of the enemy. Carriers turned on their lights, flung searchlights into the air. Some even lined their flight decks with strings of battle lamps in an all-out effort to get the planes back aboard. Some planes crashed; others skidded to the barriers, teetering crazily against the wires while flight deck crews fought to clear them. By the twin miracles of effort and that matchless skill which took the Navy's carriers from Pearl Harbor west to Honshu, the vast majority of those who got back to the carriers landed safely aboard.

Meantime, in the CICs of the carriers—who, as the control towers of the Fleet, also

(Continued to page 238)

Small Gardens Are Turned Quickly With Pull-Type Plow

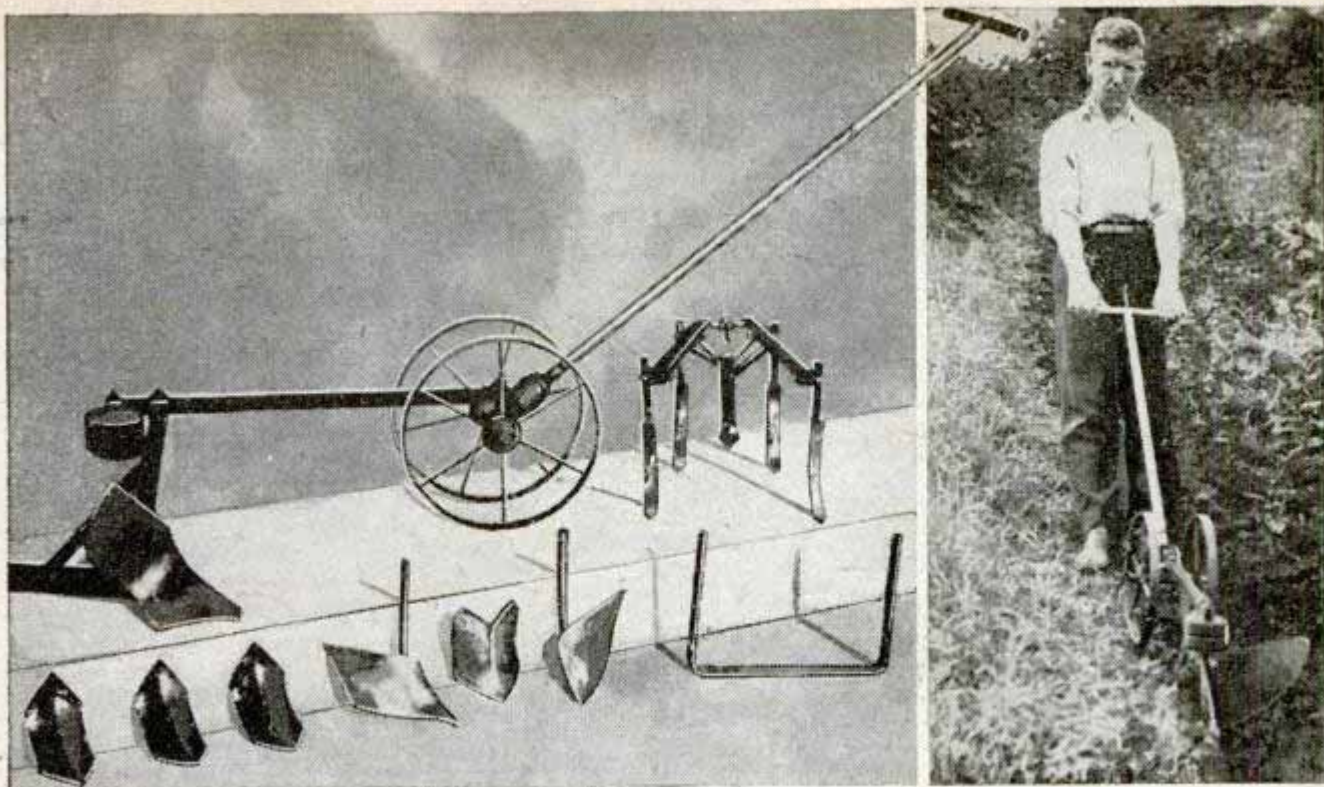

Gardens which are too small for a plow drawn by a horse or tractor can be turned over quickly with a pull-type hand plow. With this plow a gardener can work 10 times faster than with a spade. By pulling the plow instead of pushing it the operator uses the weight of his body to furnish the power. Because he works in front of the

plow he does not trample ground that has already been turned. Attachments include hillers, markers, shallow cultivating sweeps and a guide handle that permits two-man operation. An adjustable five-tooth cultivator works rows only a foot apart. The plow is intended only for ground that has been previously worked.

Reconversion Bulletin — From Solar Still to Beach Ball

Reconversion is no problem for the manufacturer of solar stills, war-born devices that made drinking water from salt water for men afloat on rafts. The stills, made of "Vinylite" plastic of various thicknesses electronically sealed together, are two feet in diameter. They utilize sun rays as heat to remove salt from the water. The same

patterns and dies that were used in making the stills are now producing beach balls of comparable size and made of the same material. Despite their light weight, only a quarter of a pound, the balls are strong enough to support a 250-pound man. Semi-deflated, they can be used as "rafts" or water wings for children.



★ Designs



LOOK around your home. Study the appearance of your radio, refrigerator, bathroom scale or even that tube of toothpaste in the medicine cabinet.

Maybe they look O.K. to you, but not to an army of engineers, research experts, artists, sculptors, draftsmen and model makers who are busy right now figuring out ways

By John R. Kinsey

to make those products—and thousands of other things—

look better, work better and sell better.

“Nothing made by man is perfect and, besides, a competitor may come out with some improvement”—that seems to be the philosophy of the industrial designer who is either a combination of these craftsmen or an employer of their services.

for BETTER LIVING



Pictured on opposite page, model of modern kitchen designed by Jean O. Reinecke has refrigerator drawers (one open) and a built-in electric range (under clock). Don Hadley (above), designer for Westinghouse Electric Corp., measures model of streamlined steam turbine

Today, industrial designers are working harder and faster than ever before. Employed by big and little manufacturers anxious to meet the pent-up demand for automobiles, household appliances and other articles, designers literally are shaping the things to come.

To correct a common misconception, it should be stated here that an industrial designer is not just someone who draws pretty pictures of sleek streamlined automobiles, airplanes and locomotives.

Some people describe industrial designers as artist-engineers. It is obvious that designers sought by successful manufacturers must be practical men whose creations, although representing improvement, avoid startling the public.

The automobile industry had a notable experience with a too-advanced model 12 years ago. One manufacturer introduced a car whose streamlining was years ahead of current models. Customers stayed away in droves. Yet most cars today incorporate many of the streamline features of this

trail blazer. To gain consumer acceptance, design changes have to come slowly and gradually—not all in one jump.

Another requirement for industrial designers—if they want to stay in business—is the ability to fashion improved products that don't necessitate too much change in a manufacturer's production equipment. It stands to reason that an industrialist can't change his whole factory every time his designer gets an idea for a fancier looking coffee pot, for example.

A third "must"—probably the most important—is that industrial design firms find how to improve the performance of various products. Make them lighter for easier handling. Make them operate more efficiently, more economically. Make them better!

Designers often come up with a suggested appearance change that in itself will make some device more useful. And sometimes it takes years to sell these ideas to a manufacturer, possibly because all his competitors are still following the same old pattern.

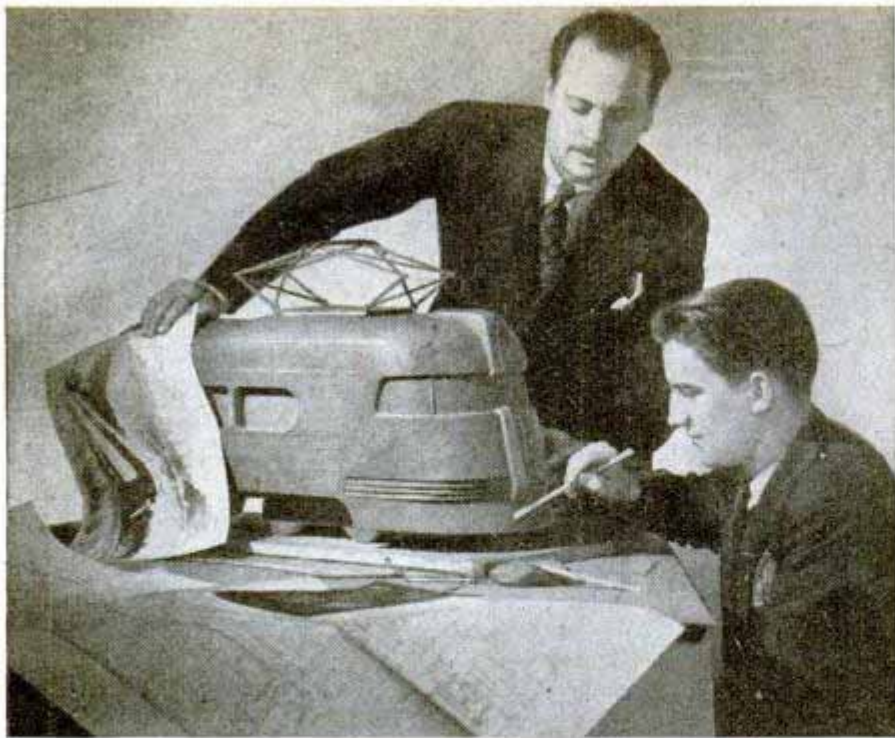

Harper Richards (standing) with clay model of electric train he designed

Here's an example. In the early 1930s most electric refrigerators stood on legs about four inches high. One firm called its model the "broom high" refrigerator and extolled the advantages of housewives being able to sweep under the appliance.

One farsighted designer asked the company's top executives, "Why don't we eliminate the legs and put the refrigerator flat

Chicago industrial design firm, has been a leader in this field. Here are a few of some 300 fast reconversion jobs engineered by James Barnes and Jean Reinecke, both still in their thirties:

During the war, a small manufacturing plant kept busy day and night turning out aluminum parts for bombers. Came the contract cancellation and the humming of

production machines stopped abruptly. Barnes and Reinecke were summoned. They made a survey of the plant, studied the production machines, raw material on hand, the skills of the workers. In 48 hours, the two designers and their engineering staff had a rough reconversion blueprint ready for the distraught manufacturer. It included sketches and tooling and production layouts for making a streamlined, step-on-a-pedal garbage pail from leftover bomber segments.

Another small firm went out of the war business and had on hand a large supply of fuselage steel. Production equipment included paint spraying outfits and machines to stamp out metal parts. "Why not start making metal toys for children, perhaps a

Model of their proposed "design factory" is examined by James F. Barnes (left) and Jean O. Reinecke, young Chicago designers and engineers

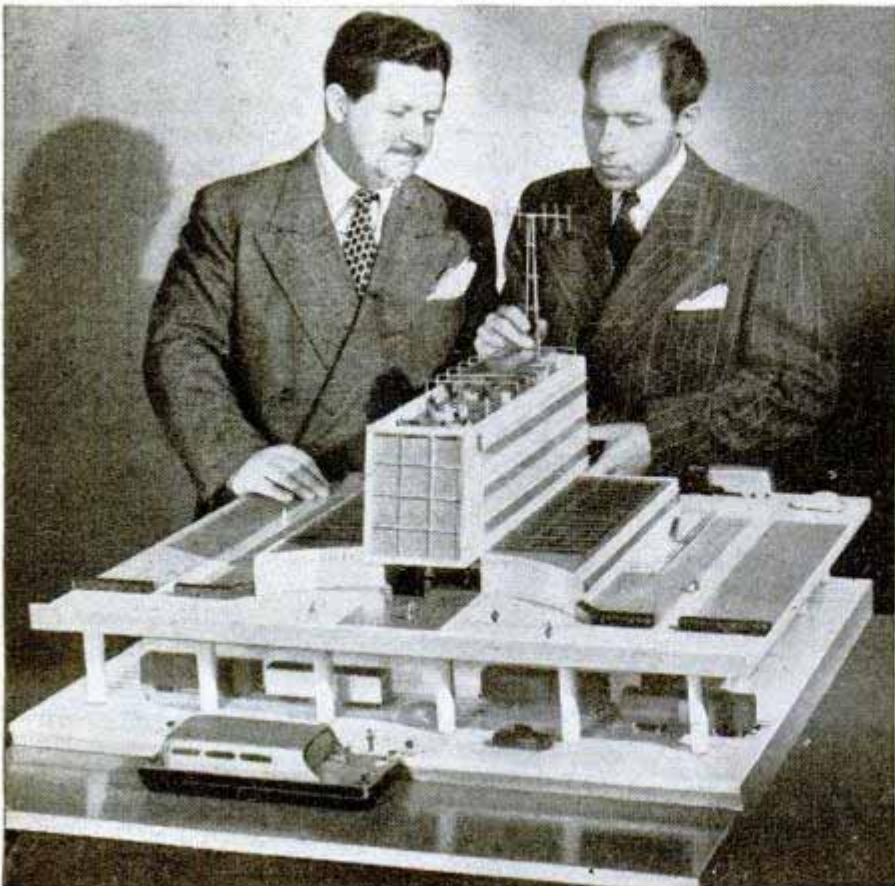



Wooden model (above) receives final touches from associates of Dave Chapman, Chicago designer, as guide for industrial truck below

streamlined auto racer?" Jean Reinecke asked. The manufacturer said the idea sounded good to him. The designers fashioned the model of a toy auto, and soon it was in production.

The changeover in a third war plant resulted in a switch from aircraft parts to a device which recaps bottles of ginger ale and other carbonated drinks to preserve the "fizz." Most hardware stores are anxious to get these items.

And now for a peek into the future to see what industrial designers are planning for the days that lie ahead. In the first place, most designers agree that the appearance trend for the future will be toward simplicity. From door knobs to locomotives, the accent will be on neat, clean lines, with a definite avoidance of fancy frills. "Things will be better propor-



*General Electric Truck
Powerful and simple*



Idea for future washing machine (above). From an old-fashioned scale (below) emerged this trim model created by Product Designers, Chicago



Student at Chicago Institute of Design fashioned this chair



tioned," was the way one top-ranking designer put it. To get down to cases, here are some forecasts of possible future trends by two design firms:

W. C. Nichols and Walter F. Nessen, of Product Designers, Chicago, predict increased use of lightweight metals, particularly aluminum and magnesium alloys, in building automobiles.

The versatility of these metals, the designers point out, has been demonstrated by many types of warplanes and other equipment. And the public is anxious to reap the benefits of these lightweight metals in products with reduced weight and improved performance.

"To realize full benefits from the use of light metals," Nichols explains, "products must be engineered from one end to the other. Experience has shown that partial use of light metals does not provide the full benefits that we are seeking."

As an example of what he contends can be done in the automotive field, Nessen has prepared a group of design studies of new automobiles.

"In approaching this assignment," Nichols reports, "we set aside all conventional ideas to develop a design that would incorporate the use of light metals from bumper to bumper and at the same time lend itself to mass production techniques." These lightweight cars would have extremely wide aluminum doors; grilles made from rolled aluminum rather than being stamped or die cast; bumpers made from an aluminum stamping, or cold formed, rolled aluminum alloyed to a structural strength equal to the same gauge thickness

and approximately the same cross-section of steel. The weight saved on the front bumper would permit an extension of a bumper all the way around a car without increasing car weight. Further weight reduction would be achieved by the use of lightweight metals for hoods and wheels.

Turning from automobiles to homes, here is an interesting idea for the kitchen of tomorrow as expressed by Ralph

Kruck, New York designer:

"It wasn't so many years ago that houses were built without storage and clothes closets, without centralized heating. It is only of recent date that dish closets, broom closets and the like were built as part of the kitchen.

"The kitchens I see in the future will carry this scheme still further. Kitchens will be sold as a whole to home builders. The day will come when housewives would no more think of buying a stove here, a refrigerator there, and a sink from someone else than they would buy an engine from one manufacturer, four wheels from another and a body from a third and expect it to work as well as a properly integrated modern automobile.

"We know that a kitchen designed as an entity will have the same proportionate increase in efficiency that a modern automobile has over a casual assemblage of parts and wheels. It should be understood that this integrated kitchen I am talking about will never be a complete rigid unit. It should never be necessary to tear your home apart in order to insert the square box of a 14 foot by 14 foot standardized kitchen. Cabinet and basic units will naturally be made sufficiently flexible to be set up in rooms of various shapes."

Kruck visualizes the manufacture of appliances which incorporate a refrigerator and a range, or other equipment, in one unit. An electric cooking unit would be so designed that it could slide out of sight after food was cooked.

Stick around, folks, a great day is coming!

'Wobble' Roller Packs Earth on Airfield

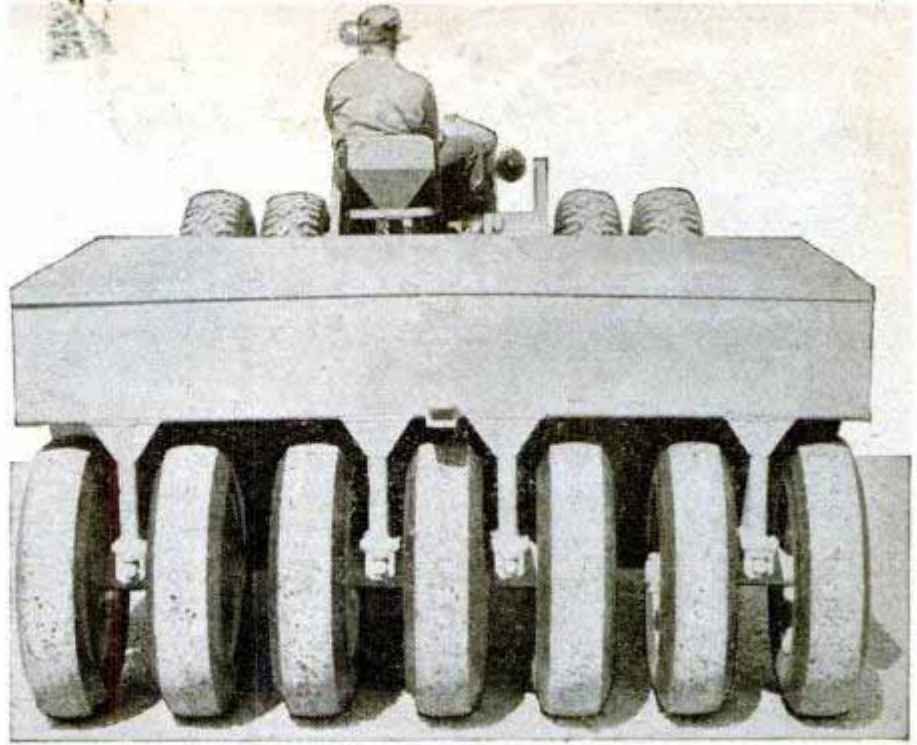

Wobbling from side to side, multiple wheels of a surface roller pack the earth for smooth airfield runways. Each wheel is individually mounted on an off-center hub which causes a one-inch wobble. In this way the wheel makes a wavy line, eliminating ridging. It can be used to pack earth fills, roll crushed rock bases, compact stabilized roads and finish bituminous surfaces.

Rubber Web in Drill Chuck Gives Wider Range

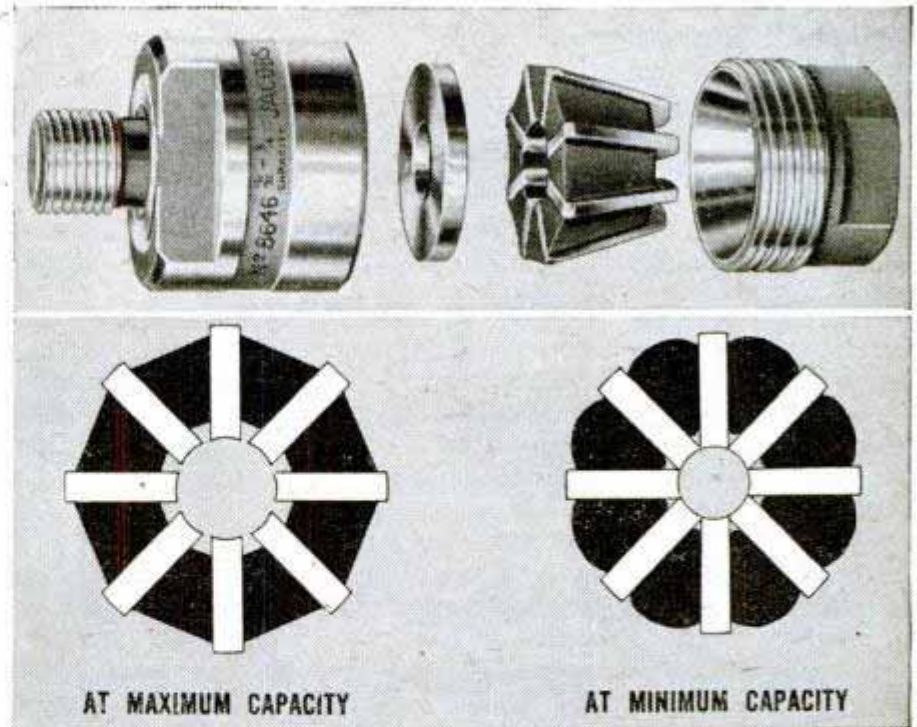

Tough synthetic rubber replaces the steel shank in the inner socket of a heavy duty drill chuck. The rubber passes through anchoring holes in the jaws to form a conical unit tightened by a screw mechanism. When the chuck is loosened the web pushes the jaws apart to release the drill shank. A wider range of drill sizes can be handled with one chuck and the jaws are said to have a powerful grip.

Waste Sawdust Makes Inexpensive Wallboard

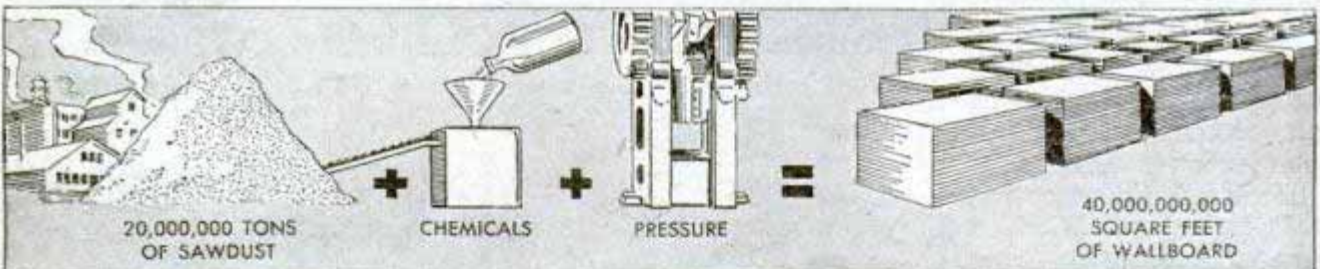
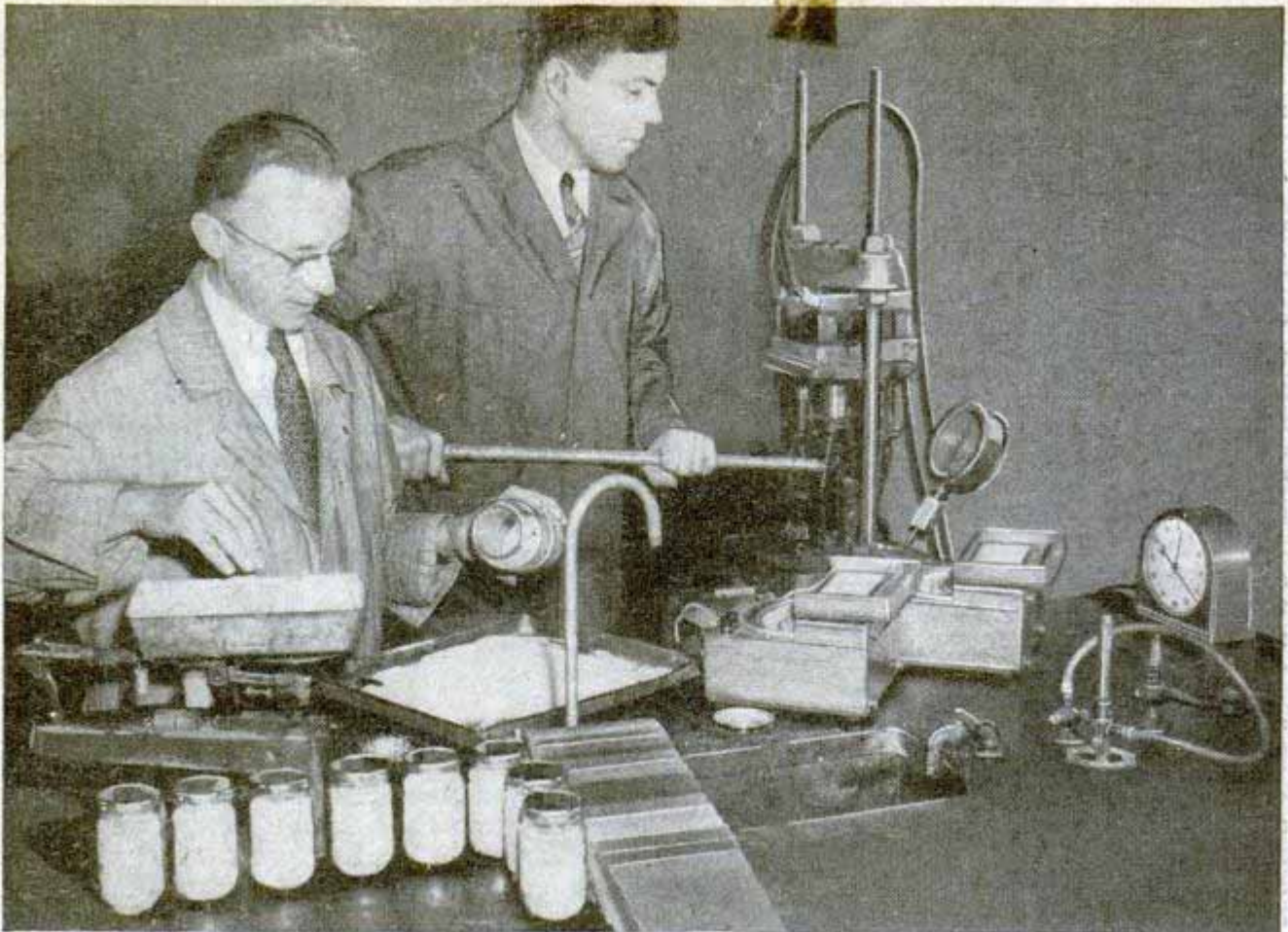

Sawdust and a chemical derived from wood waste are mixed by Warren R. Smith as Dr. Donald F. Othmer squeezes the compound in a hand press. The process may salvage 20,000,000 tons of sawdust wasted each year

Forty billion square feet of hard wallboard, enough to construct a million vitally needed houses for America, can be made by a method that utilizes sawdust and other wood waste. The cost of one square foot of the new wallboard would be less than one tenth of one cent. The process was developed by Warren R. Smith, research engineer of Crown Point, N. Y., and Dr. Donald F. Othmer of the Polytechnic Institute of Brooklyn, *2, New York*

Lumber-using industries of the United States waste about 20,000,000 tons of sawdust, fine shavings and chips each year. In some industries 75 percent of the wood is wasted. One ton of this waste, processed by the new method, will yield 2000 square feet of strong, water-resistant wallboard. "Bagasse," the waste material of sugar cane, also can be used.

At present, hard wallboard is made by

breaking new logs into individual fibers. In the new method, sawdust is mixed with an inexpensive chemical, derived from other wood waste, that combines the particles, and the resultant mixture is squeezed in a hydraulic press under relatively low pressures. Sawdust can be conveyed directly from the saw to a mixer where the chemical is added. Pressing requires about 10 minutes. Less than 15 minutes after the waste comes from the saw it is finished board.

Wallboard produced by this method is resistant to termites, rot, moisture, warping, swelling and shrinking. It may be nailed and finished like ordinary wood. Molding it like plastic into any shape required gives it an advantage over present types. One-piece duck boats, doors finished and trimmed, and complete prefabricated walls, floors and ceilings are possible.



SMOKING STAND *of contrasting woods*

By Benj. Nielsen

THE light color of maple contrasting with the dark color of walnut or mahogany gives this all-wood smoking stand an unusually attractive appearance. The base and top or tray are 12-in. disks turned from 1-in. stock. The top surface of the tray is turned out to form a narrow rim around the edge, and a recess is turned in the underside surface to take a supporting disk of maple, which is set in as in the lower left-hand detail.

The base also is turned on the underside to form a $\frac{1}{2}$ -in. rim, and the upper surface is recessed for a maple disk similar to the tray. Then the base is trimmed at the edges as indicated in the lower right-hand detail. Trimming removes the rim at the sides, but leaves it at the corners where it serves as feet. The column, or standard, and the handle are built up of maple and walnut assembled as indicated. Note in the left-hand detail that the walnut portion at the upper end of the standard has a long tenon over which the maple portion is slipped, this latter piece being glued into a hole in the disk under the tray. Assembly to the base is somewhat similar, as you will notice in the right-hand detail: Finish in the natural colors with filler, sealer, varnish and, finally, a paste wax.

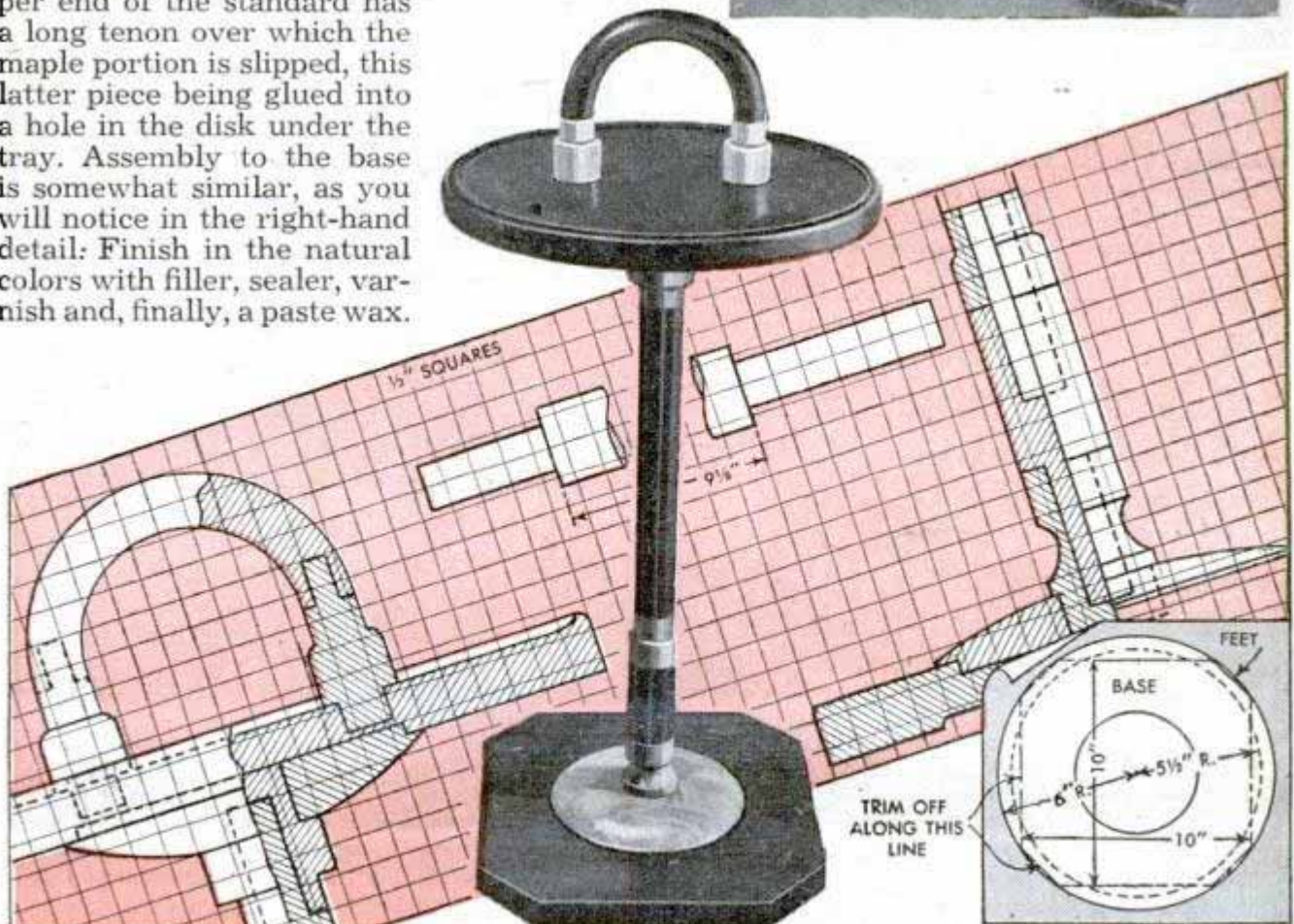

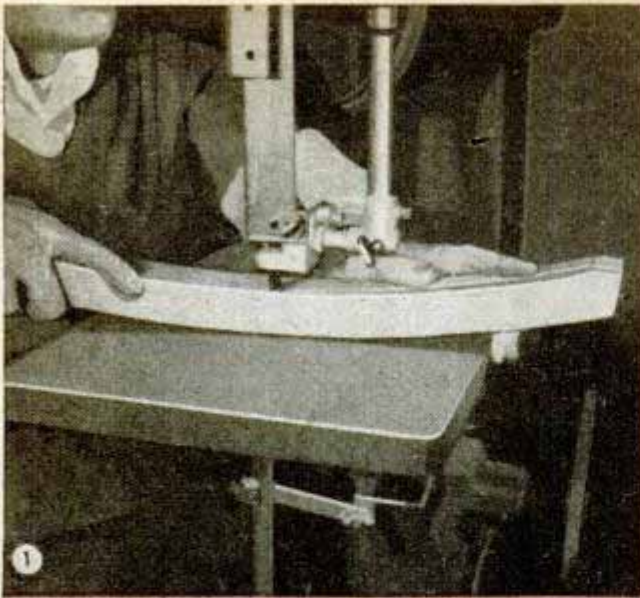

1 In bandsawing the first and second cuts care should be taken to keep the blade just outside the dimension line. This will allow for finishing to exact size

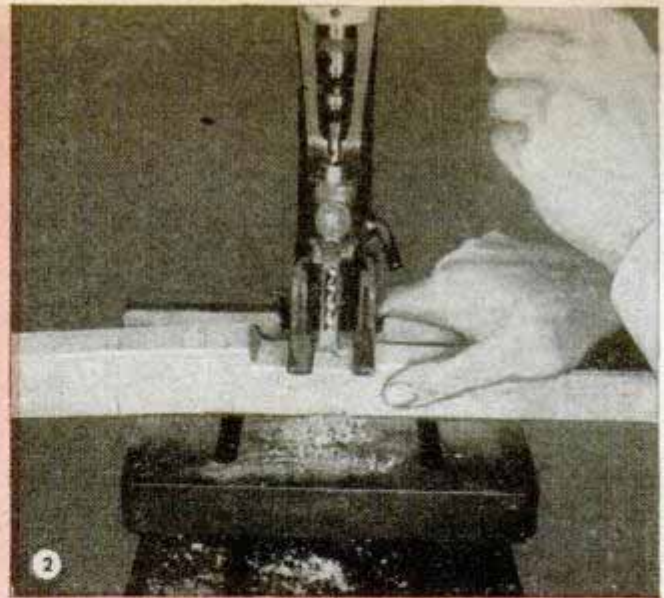

2 In making mortise-and-tenon joints a close fit assures strength equal to that of the wood itself. Be sure that the square chisel is tight in the holder

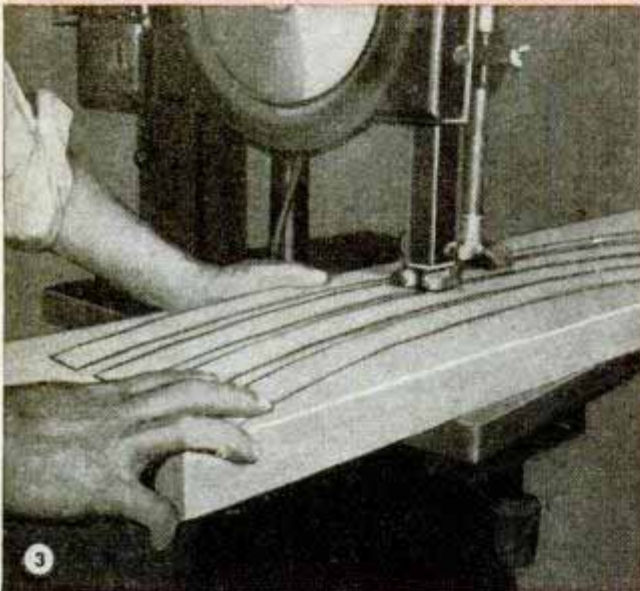

3 The back posts or legs are rough-sawed from a single piece of solid stock. This piece should be uniform in grain otherwise defects may show in the work



4 A small sanding drum mounted in the drill press is just the thing for smoothing the curved surfaces of the rough-sawed legs and rails to finish size

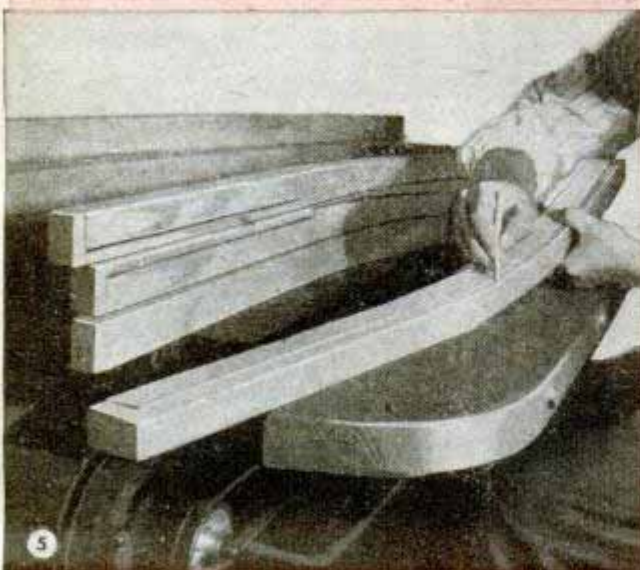

5 Use a sheet-metal or cardboard template to mark the parts for the second bandsaw cuts. Saw cut should be kept outside the line in the waste wood

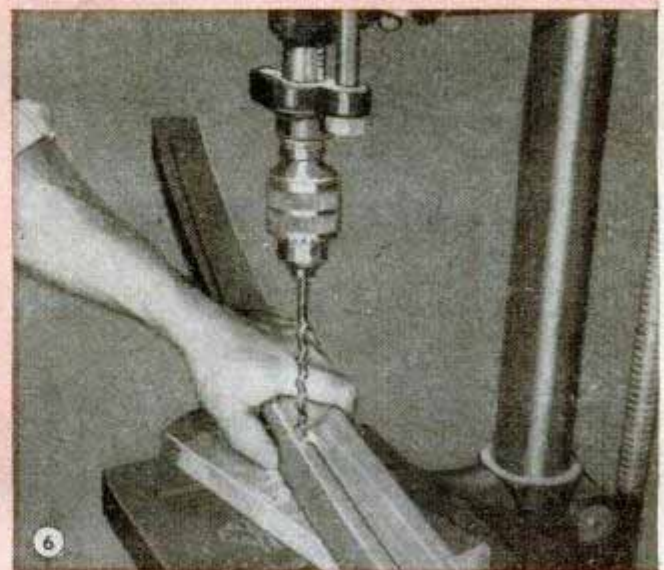

6 The hole forming the curved offset in the back leg is drilled before bandsawing. Select a bit of the same radius as the curve indicated in the details

OCCASIONAL CHAIR in Sheraton styling

By Henry E. Belden

THERE'S just enough handwork on this fine chair to give it the professional touch of the individual craftsman. Fine cabinet wood such as mahogany or walnut should be used. If more than one chair is desired, simply duplicate the parts. Important steps in the construction procedure are shown in Figs. 1 to 6 inclusive. First, full-size patterns of the back posts are cut from heavy paper or thin cardboard for transferring to the work. You'll note in Fig. 9 that the right and left-hand patterns are duplicates; one will serve to lay out both posts by merely turning it over. Saw cuts "A" are made first, then the waste is tacked back on, the second pattern traced and cut "B" is made. Edge "C" is straight. Before making cut "B" it is a good idea to drill a $\frac{3}{8}$ -in. hole as shown in Fig. 6. This assures a well-rounded notch.

The posts now are ready for mortising, which can be done by hand or with a drill press and mortising attachment as in Fig. 2. Use a $\frac{3}{8}$ -in. hollow chisel and adjust the fence so that the cut will be in the center of the wood and parallel with the edge. The seat-rail mortises also are cut with the $\frac{3}{8}$ -in. hollow chisel. Use the scraps left from bandsawing to block up the work so the face of the mortise will be square with the chisel. The front legs are somewhat longer than the back ones, which gives a slight rake to the back and seat. Next cut the mortises for the stretchers. It will be necessary to block up the work so the chisel will cut at right angles to a center line and parallel with the floor line of the assembled chair. The mortise should be cut parallel with the straight or outside edge of the back post, this edge being held against the fence. The mortise for the lower cross rail is cut with the straight or outside edge of the leg resting directly on the drill-press table so that the chisel is at right angles to this surface.

Each chair requires two side rails made from 2-in. stock in accordance with the pattern in Fig. 9. The tenons on the side rails measure $\frac{3}{8}$ in. wide, $\frac{7}{16}$ in. deep and $1\frac{1}{2}$ in. long. The mortises on the front legs, Fig. 9, should be cut before the legs are tapered. Start each mortise $\frac{1}{4}$ in. from the top of the leg and $3\frac{7}{8}$ in. from the bottom. Before cutting the lower mortise be sure you have selected the correct face of the leg.

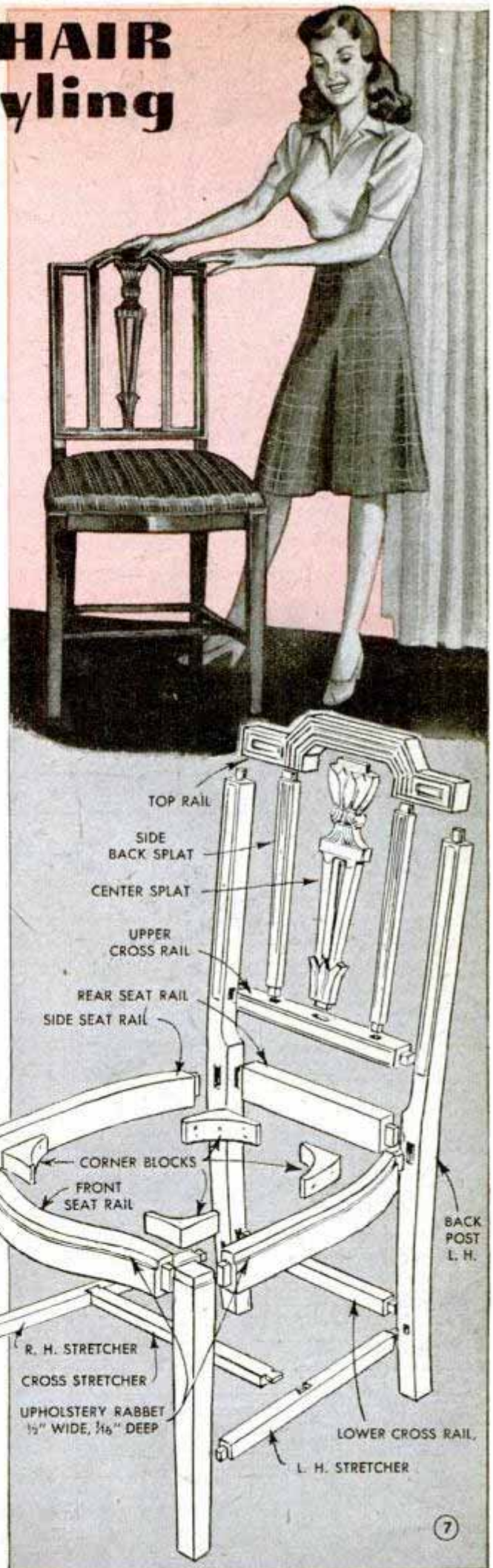

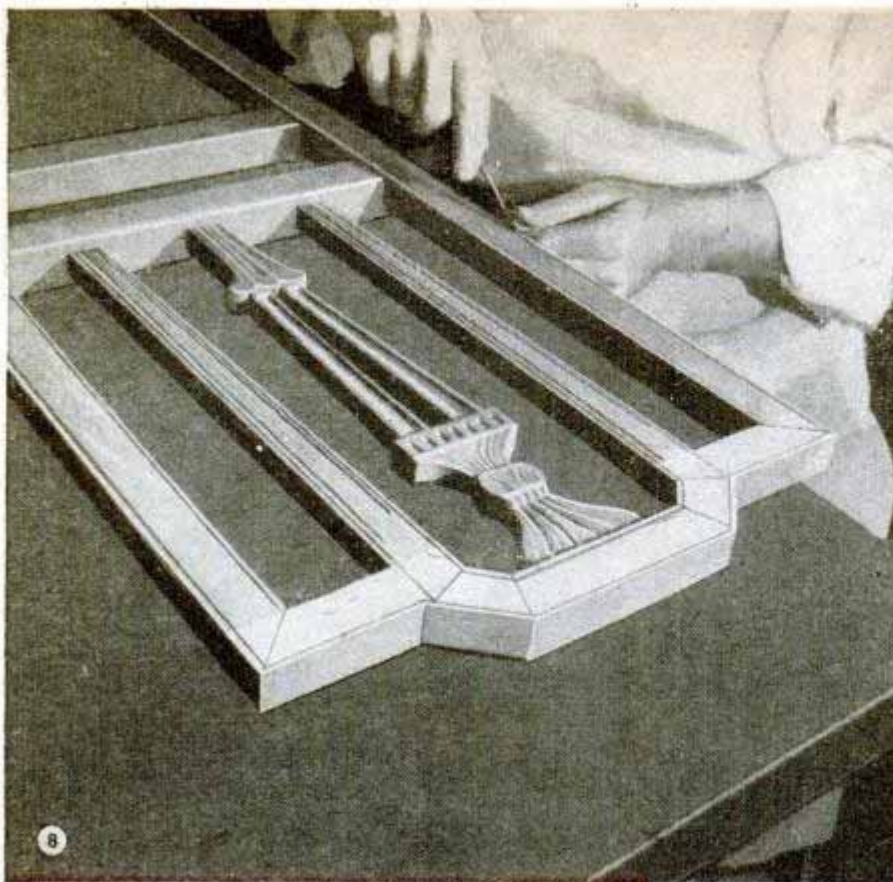

The front legs are tapered on the circular saw by the "notched-stick" method. Take a piece of stock slightly longer than the leg and nail a block near one end. This block should have two step-like notches cut in it. The first one is $\frac{3}{8}$ in. and the second $\frac{3}{4}$ in., both measured from the inside face of the stick. Place the lower end of the untapered leg in the first notch with the stick next to the ripping fence. After the first cut is completed turn the leg completely over so the saw engages the opposite edge and place the lower end of the leg in the second notch. In each instance the fence should be adjusted so that the saw engages the leg at a point $2\frac{1}{16}$ in. below the upper end, as in Fig. 9.



Next, an upholstery rabbet is cut in the seat rails and across the front legs, Fig. 7, making it slightly deeper on the legs. The front legs now can be glued to the front seat

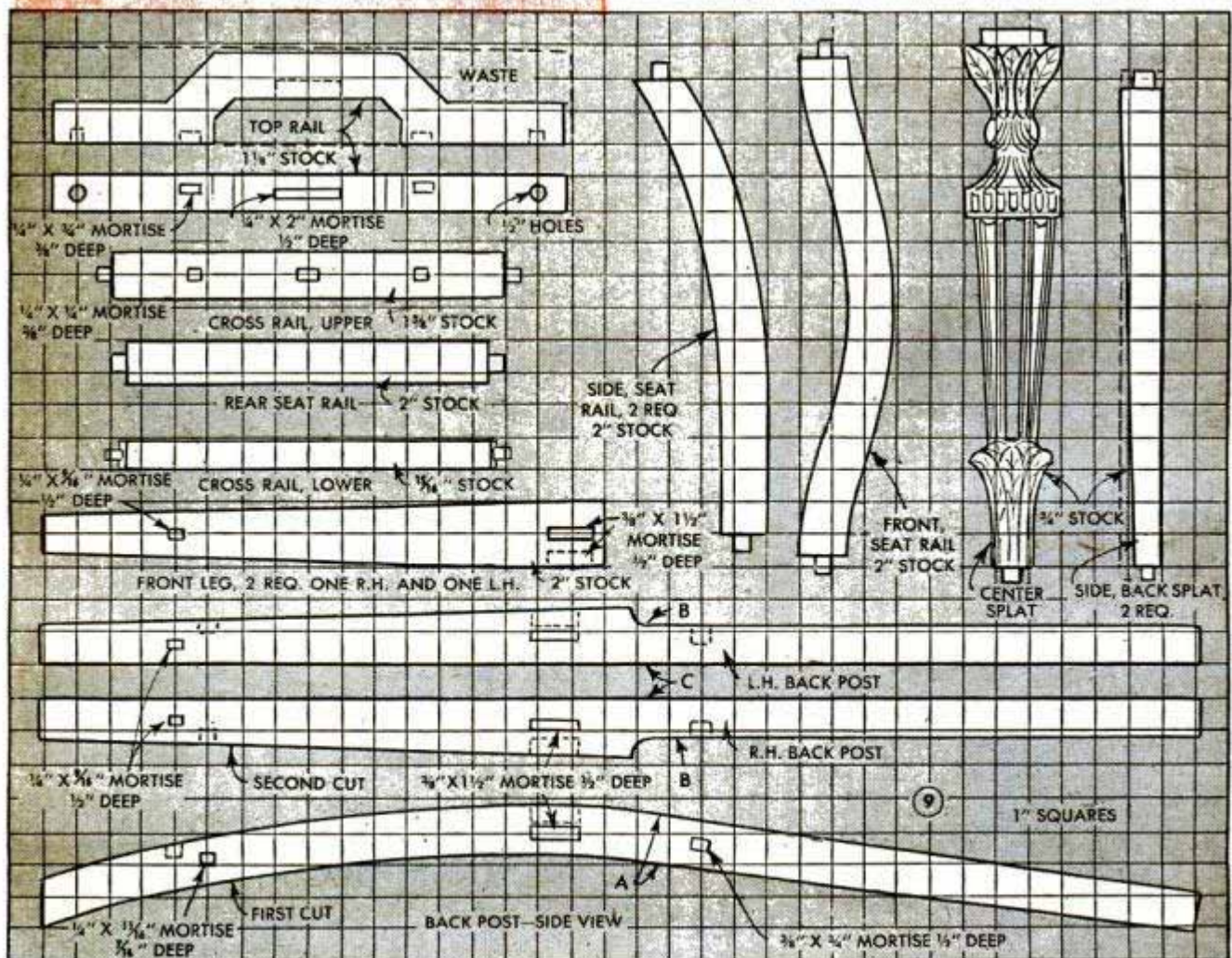

rail and the back posts glued to the lower cross rail, the seat rail and the upper cross rail. It's a good idea first to try assembly without glue. Do not glue any other parts at this time. Two side back splats are required, which are tapered, as shown by the dotted lines in Fig. 9, to leave a $\frac{1}{4}$ -in. shoulder around the tenon at the lower end of the splat. The back-splat pattern, Figs. 9 and 11, is traced on a piece $\frac{3}{4}$ by 3 by $16\frac{1}{16}$ in., then sawed to shape. In carving the splat, work from the sectional views in Fig. 11.

The top rail, Figs. 7 and 9, is cut from $1\frac{1}{8}$ -in. stock. The offset over the center splat is cut out first, then $\frac{1}{2}$ -in. dowel holes are drilled 1 in. from each end and mortises are cut for the splats, after which the sawing can be completed. Do not cut this to exact length until after assembly. After drilling the top of the posts for dowels, the parts are ready for gluing and clamping to the rest of the back. When the glue has hardened, the back assembly is clamped to a bench so that the back may be fluted as in Fig. 8, making the cuts as indicated in the sectional views. Use a very shallow veining to simulate the mitered effect in the top rail. After the stretchers, Fig. 12, have been fitted, assemble the chair in clamps for a trial fit as in Fig. 10. Then apply glue and clamp the parts together. Corner blocks glued and screwed in the seat complete construction.

To finish, coat the wood with an oil stain. Allow to dry for 24 hours, then seal with a coat of thinned white shellac or prepared sealer. Next fill the grain with a paste filler colored a shade darker than the stain and thinned with turpentine to the consistency of thin varnish. The filler should be well rubbed in and wiped off across grain with a coarse cloth. The wiping is done when the filler begins to flatten. If one coat does not fill the pores completely apply a second coat. The "heel" of the hand is good to pack the filler level with the surface before wiping. Let dry for 36 hours, after which any rough spots should be sanded lightly. Follow with a full-bodied coat of white shellac and when dry rub with fine steel wool. Finish with several coats of paste wax rubbed to a fine gloss. A hair-bristle brush will polish the carved surfaces. The simplest upholstery job is a foam or sponge-rubber cushion supported on a bottom of $\frac{3}{8}$ -in. plywood. This is covered with a layer of muslin and tapestry in whatever pattern you wish. The edges of the top covering are nailed in the upholstery rabbet and the job is finished with upholstery gimp applied to the edge of the seat to conceal the tacks and provide a neat finish to the raw edges of the covering on all sides.

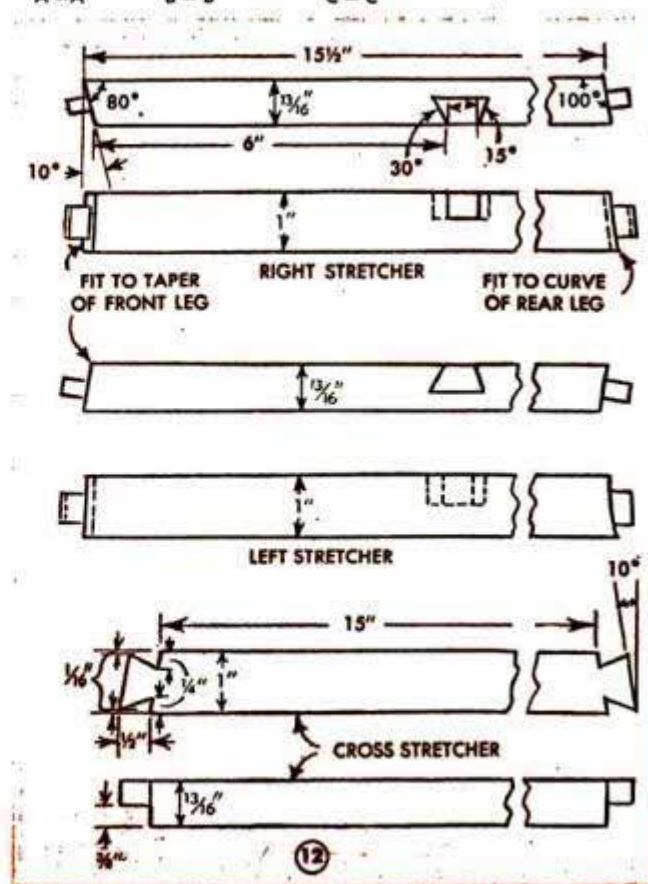
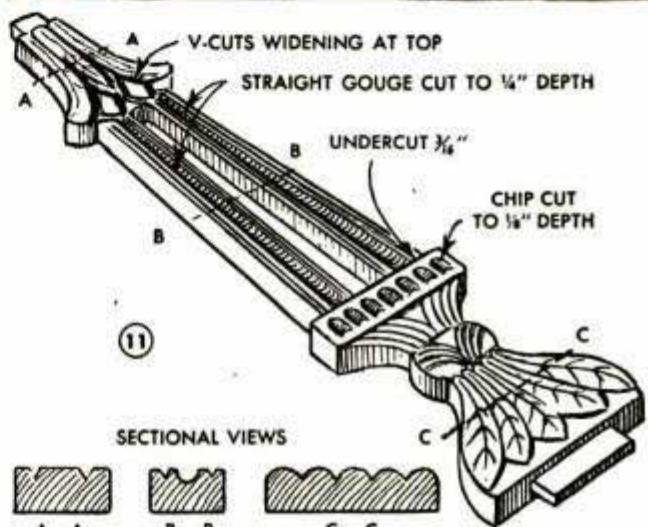
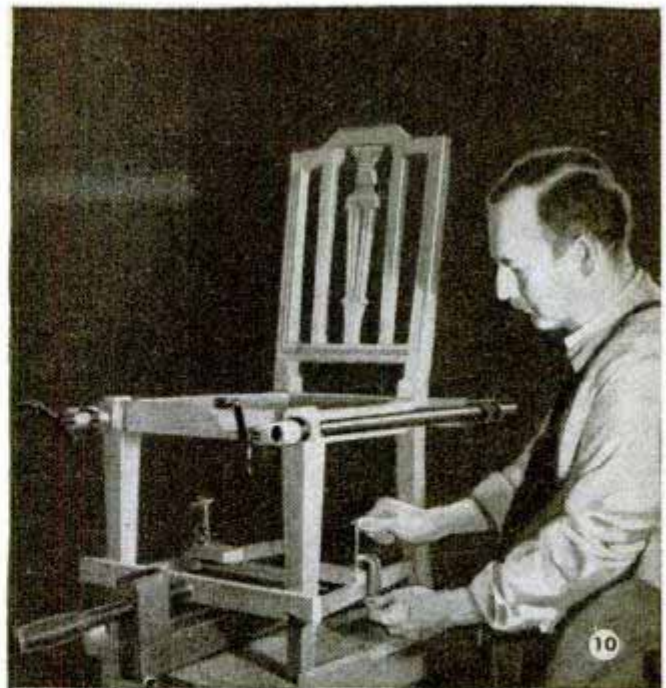

Rest on Bow Eliminates Danger of Feather Cuts

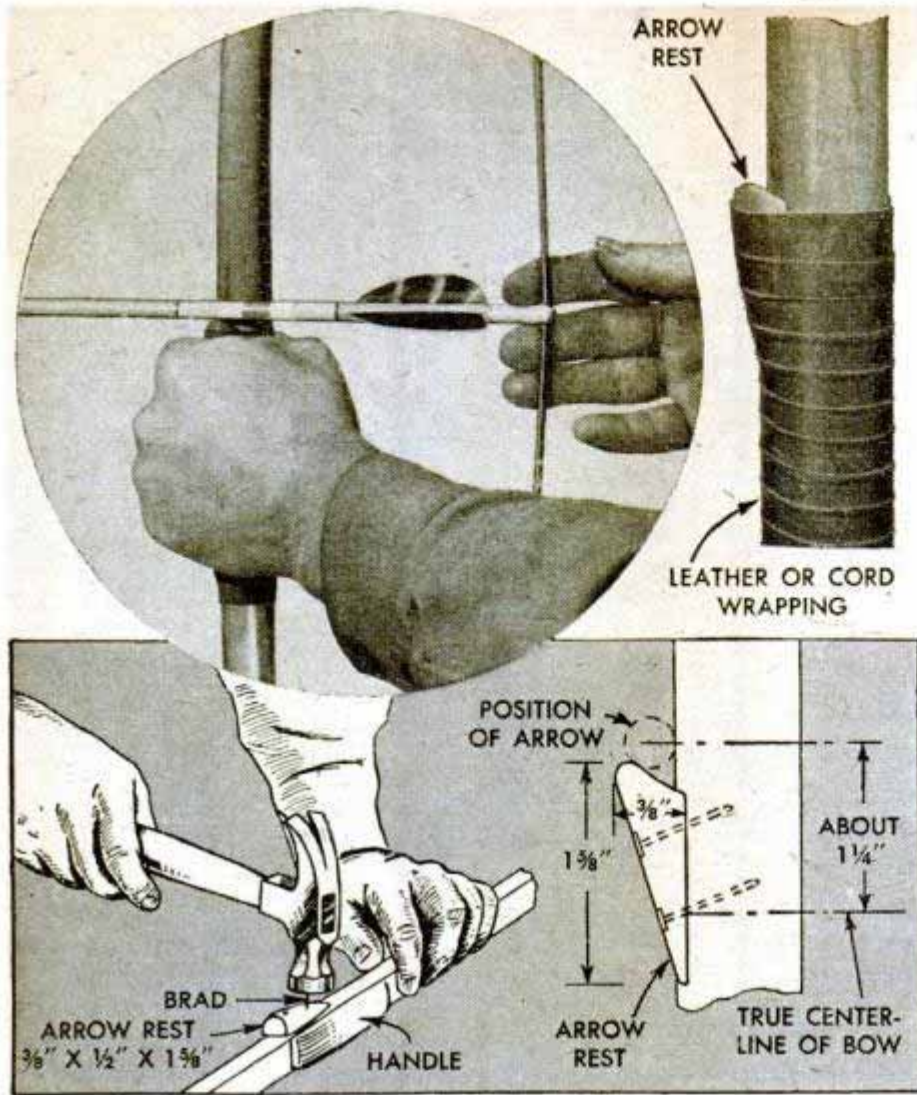

By fitting an arrow rest on the hand grip of an archery bow you can improve your aim as well as eliminate danger of the feathers on the arrow cutting your hand. The rest is a small piece of hardwood or plastic shaped to fit the side of the bow and nailed in place so that the arrow will rest about 1 1/4 in. above the true center-line of the bow. The illustrations show the rest fitted to an English or long bow, but it can be fitted to flat or semiflat bows just as well. The small brads used to hold the rest in place do not weaken the bow. A workmanlike job is done by wrapping the grip with leather or cord as shown. A short length of red thread wound around the bowstring at the nocking point will serve as a guide in nocking the arrow at the same angle for each shot.—Sam Brown, Marion, Ohio.

Metal Point on Plastic-Tipped Arrow Increases Penetration

If you have plastic-tipped arrows in your archery kit, deep-penetration points can be made for them with screw hooks similar

to the one illustrated. The end of the plastic tip is ground flat, center-punched and drilled to receive the screw. After the screw is fastened in the tip, the hook is cut off and a sharp point is filed on the flank. The adaptation is especially effective for light bows because of increased penetration when used against wooden objects or for hunting and also because the arrow will not tear a straw-backed target to pieces as quickly as will one with a broader head. With heavy bows a broader head is superior.—John L. Story, Fort Worth, Tex.

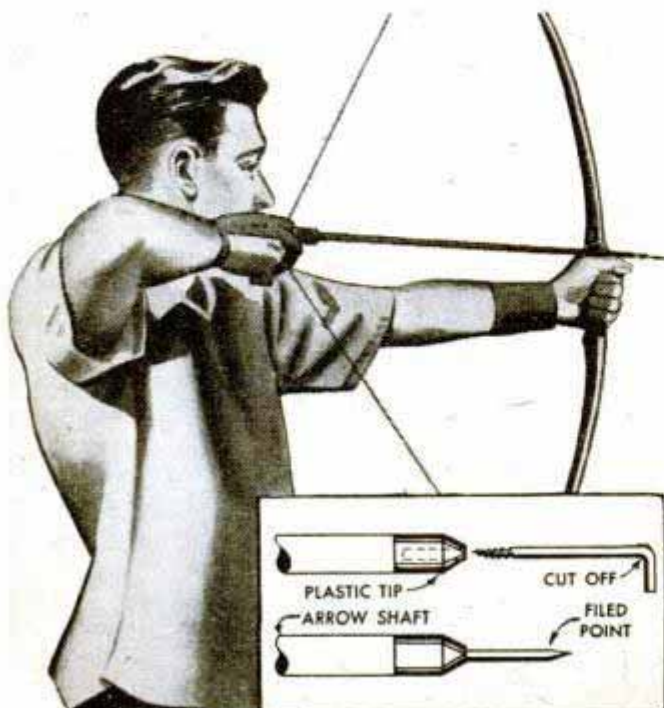

Woodchuck Trap Is Concealed By Log at Burrow Opening

Woodchucks, which are difficult to trap, can be caught if a log is placed before the entrance of the burrow some time before the trap is set. The animal becomes accustomed to the log and will jump over it to get out. Then a trap is placed on the side of the log away from the burrow opening so that the animal will jump into the trap.

Motorize Your LAWN MOWER

LLB #129

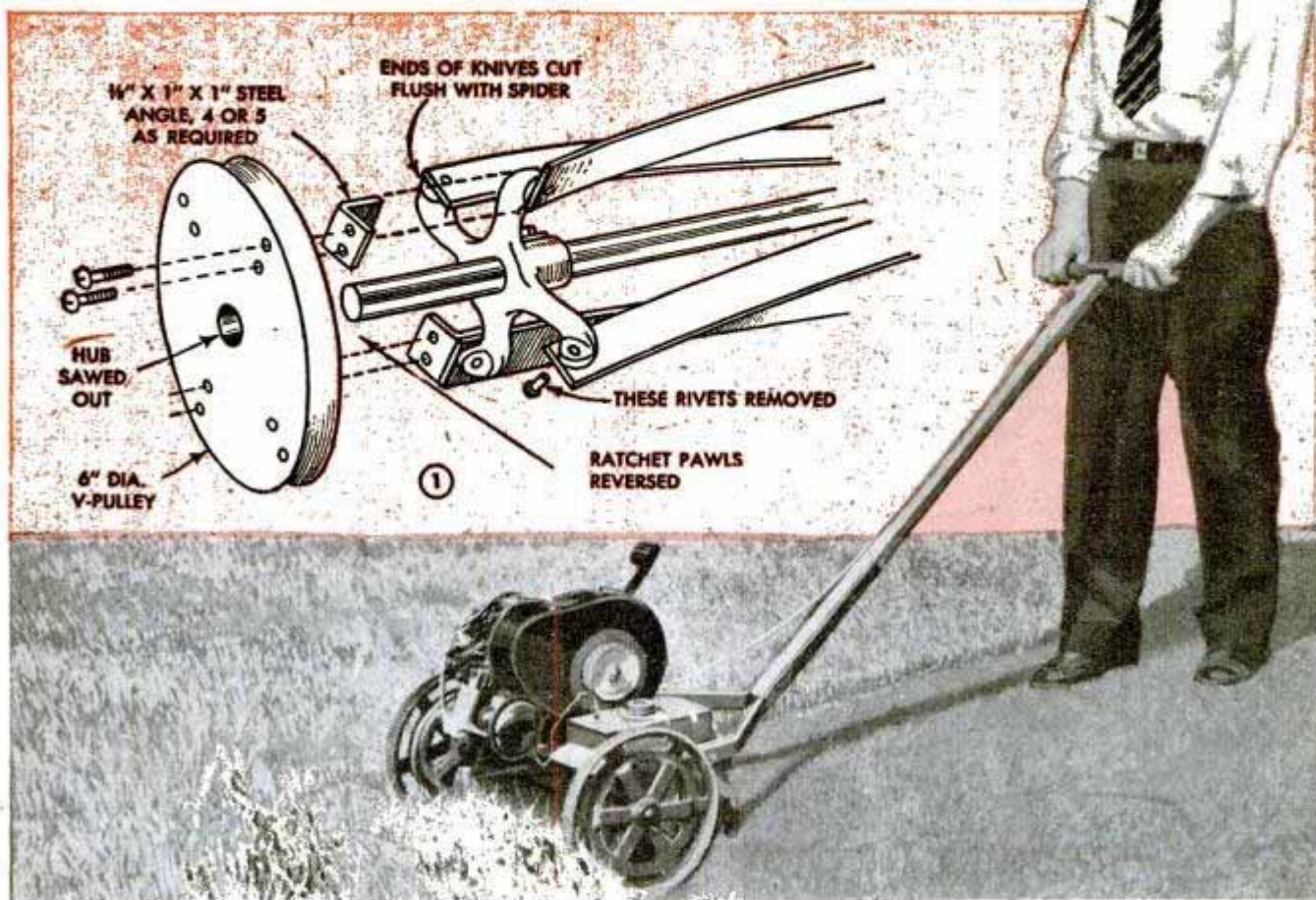

By Sherman Butler

IT'S easy to take the "push" out of a hand-power lawn mower with a $\frac{5}{8}$ or $\frac{3}{4}$ -hp. gasoline engine and a few pieces of flat iron. These small, compact engines can be mounted on almost all hand lawn mowers of 18-in. cut or wider. Due to the relatively higher speed and steady forward movement over the ground the grass is cut more cleanly and uniformly. Moreover, the mower will handle taller and heavier growth than can be cut by hand power alone. In this particular type of drive the motor is belted directly to the cutting reel so there's no need to bother about "differential" or a clutch with a complicated throw-out mechanism. Needed differential is taken care of by slippage of the drive wheels in turn by a light downward pressure on the handle as you steer the mower in the direction desired. Declutching is accomplished simply by bearing down on the handle when you want to stop or make a sharp turn. This, in turn, raises the drive wheels and shifts the weight to the roller, allowing the mower to be turned in any direction or pulled backward to clear a fence, shrub or other obstruction.

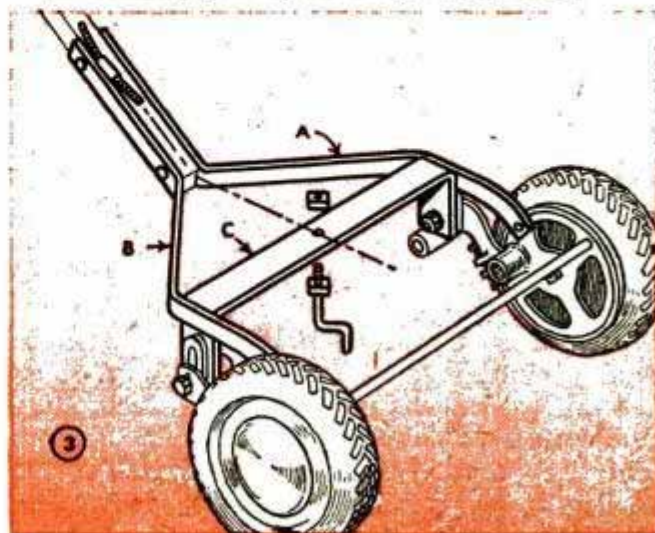
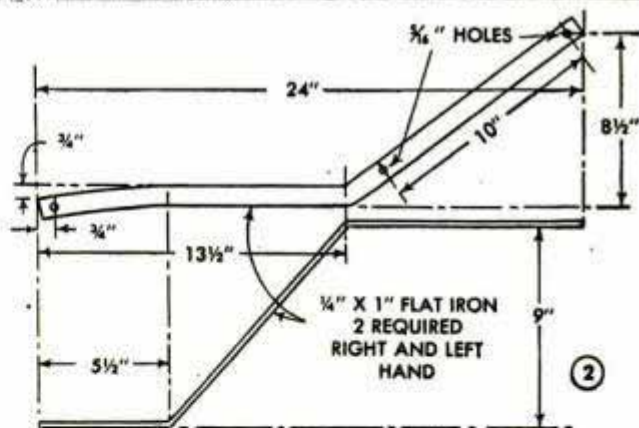

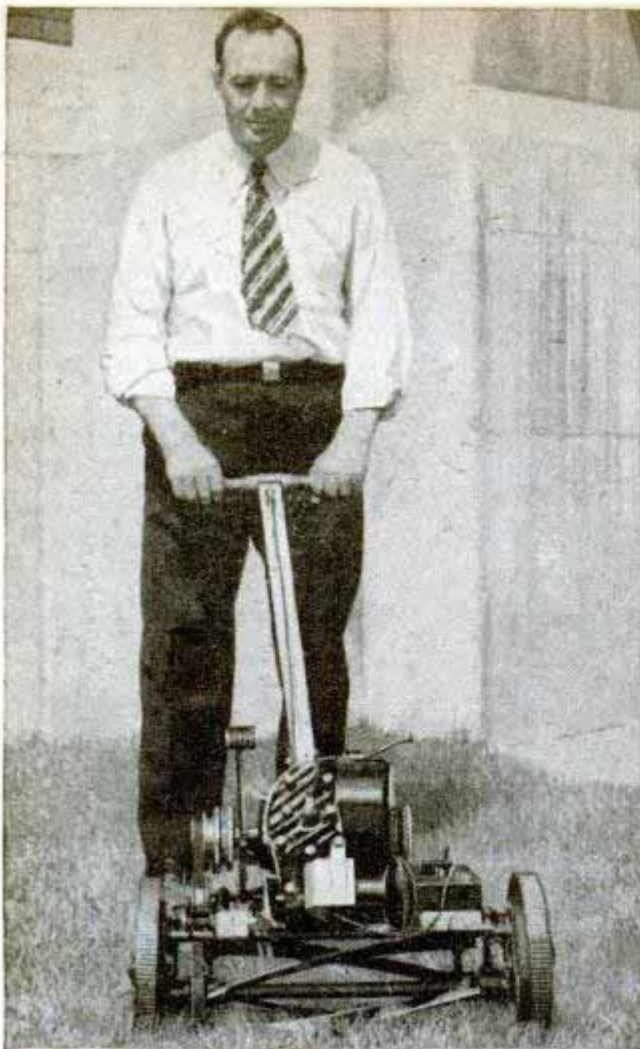

The first thing to do when installing the power drive is to disassemble the mower, removing the reel and the handle. Save the wood section of the handle assembly. Usually, because of the nature of the installation, it will be necessary to make a new yoke, Fig. 2. When removing the reel be careful not to lose or damage any part of the bearings. Fig. 1 shows the method of attaching a pulley to the end of the reel. Diameter of the pulley may have to be varied to suit the mower at hand. The four-blade reel shown in Fig. 1 is not standard as some mowers are fitted with five blades. Ends of the blades projecting beyond the spider are cut off flush and the rivets removed as shown. Steel angles are attached to the spider with stove bolts which pass through the rivet holes. Although a standard metal V-pulley can be used as in Fig. 1, it may be necessary to cut the hub to obtain a free fit between the spider and the inner end of the reel-shaft bearing housing. A pulley also can be turned from $\frac{3}{4}$ -in. hardwood or waterproof plywood of the same thickness. Use lock washers on all bolts in this assembly.

Fig. 3 shows the flat-iron parts which are made and attached to the mower frame. The two parts of the handle yoke, A and B in Fig. 3, are detailed in Fig. 2. However, the dimensions and the bends indicated are

intended merely as a rough guide to the size. Different types of mowers will require some variation. Measure the mower at hand to determine the dimensions required before cutting material.

Connect Fig. 3 with the details in Figs. 4 and 5 and you will readily see how the additional parts of the engine support are fitted on the mower frame. Note that the engine sub-base, made from a steel plate, is hinged on the mower shrub bar as in Fig. 5, and rests on the end of the belt-tightener screw, Fig. 4. This simple arrangement allows easy adjustment of the belt tension. With these parts made and fitted, reassemble the mower with the ratchet pawls reversed in the drive pinions. Be sure to slip the V-belt over the reel pulley first. Bolt the engine and fuel tank in position as in Fig. 4, making sure that the pulleys align properly. Size of the engine drive pulley will depend on the average speed of the engine and you can easily calculate the required diameter of the pulley once the speed of the engine is known. By installing a throttle control on the handle as in the photo, Fig. 1, the engine speed usually can be controlled so that the mower is driven at a comfortable walking pace.

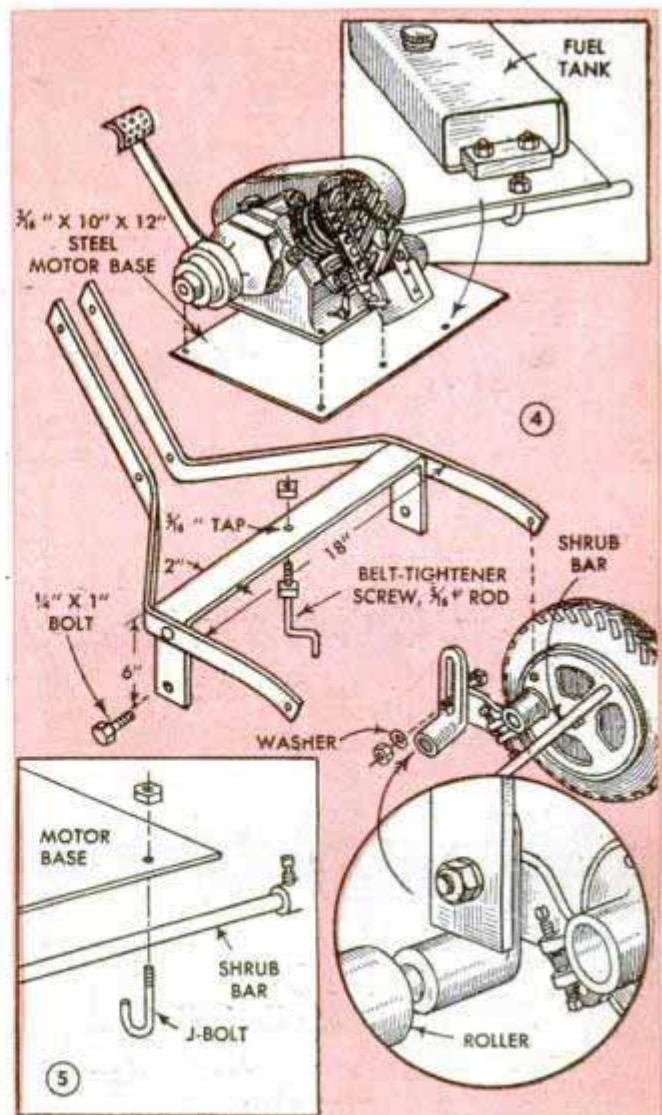

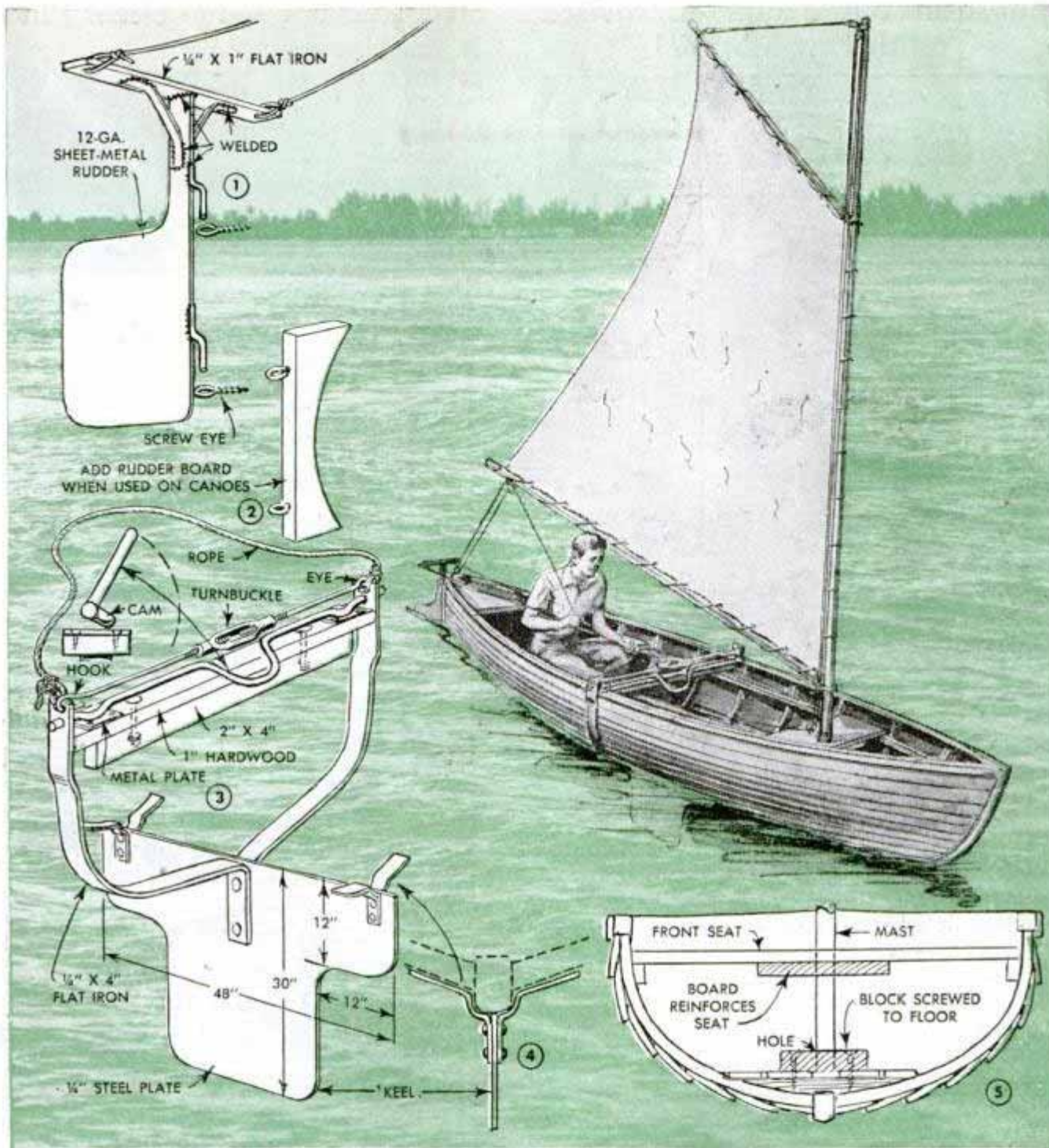

Once this detachable keel is installed on your rowboat and locked in place with the camming arrangement shown you not only can run free before the wind with a suitable sail but you also can do systematic tacking in any safe sailing waters. For fishing or other uses where the rowboat's shallow draft is necessary or desirable, simply unclamp the keel assembly and slide it over the stern, then unstep the mast and there you are, ready for the oars again. Only general dimensions are given in the details, Figs. 1 to 5 inclusive, as the clamping yoke and saddle arrangement must be made to fit the boat at hand. The halves of the saddle are shaped to fit the

Let the Wind Give You a Thrill

curves of the hull near the midship section and the top ends of the halves are offset slightly as shown to clear the gunwales. After bending to shape, the parts are riveted to the keel as in Fig. 3. Projecting "ears" or pads also are riveted to the ends of the keel, Fig. 4, to give a more rigid bearing. Of course you must have a rudder, Fig. 1, and, if attaching the keel to a canoe, you will need the rudder board, Fig. 2. Usually the front seat can be utilized as a mast step where indicated in Fig. 5. Only one method of rigging the sail is shown. There are, naturally, other rigs which are equally simple and safe.

C. L. Meehan, Lakeview, Ont., Can.

Substitute Pantograph Improvised With Few Materials

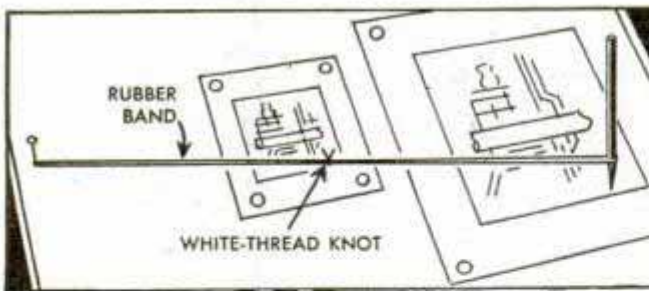

Although a pantograph is used ordinarily to enlarge drawings and sketches, when one is not available a substitute can be made by employing a rubber band, a pin and a pencil. The sketch to be enlarged is placed on the center of the drawing board and the pin is fastened to the left of the sketch. The paper for the copy is thumb-tacked to the right. Then the rubber band is looped over the pin and the pencil, and a piece of white thread is tied around the center of the rubber. The thread functions as does the stylus on a pantograph. When the rubber is stretched by the pencil and lines are drawn with the knot following lines on the original, the enlarged sketch is recorded on the copy. Some practice may be necessary before the proper degree of skill is acquired.

Hole in Golf Score Card for Pencil Keeps Both Together

By creasing the center fold of a golf score card, as shown, and punching the corner, a pencil can be kept in the hole so it will always be at hand for marking scores. Held in this way, the pencil is not so likely to be lost as when carried loose in a pocket, from which it may be jerked when the score card is withdrawn. —Darwin Curtis, Winnetka, Ill.

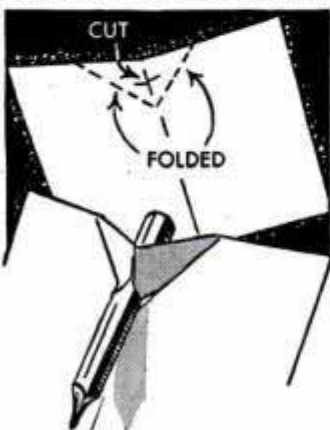

Steel Rod Is Used as Shear Pin

If you have no standard bronze shear pin for your outboard motor, you can make one from any kind of steel rod of the proper diameter by sawing the rod halfway through in two places. The



two cuts should be spaced a distance equal to the diameter of the propeller shaft and should be positioned to come on a line between the shaft and propeller hub. Weakening the steel pin gives it about the same shearing strength as a bronze pin.

Cushion Is Fashioned From Tube Of Automobile Tire



An old inner tube makes a good boat cushion when fishing. A section of the tube is removed and the ends are vulcanized together to make a "doughnut" of the proper size. If the valve core is removed, the tube can be inflated by mouth and sealed by screwing a valve cap on the stem. When not in use, the tube is deflated so that it can be carried in a small space. An added feature of this type of cushion is that it can be used as a life saver in an emergency.

Wax Protects Window Sills

If wax is applied to window sills that are painted, the coating will protect the paint from dirt and the surface can be cleaned without streaking. Wipe the sills with a dry cloth two or three times a week and it will seldom be necessary to wash them.

Joseph G. Cleveland, Minneapolis, Minn.

Electric-Clock Wall Outlet Hidden From View

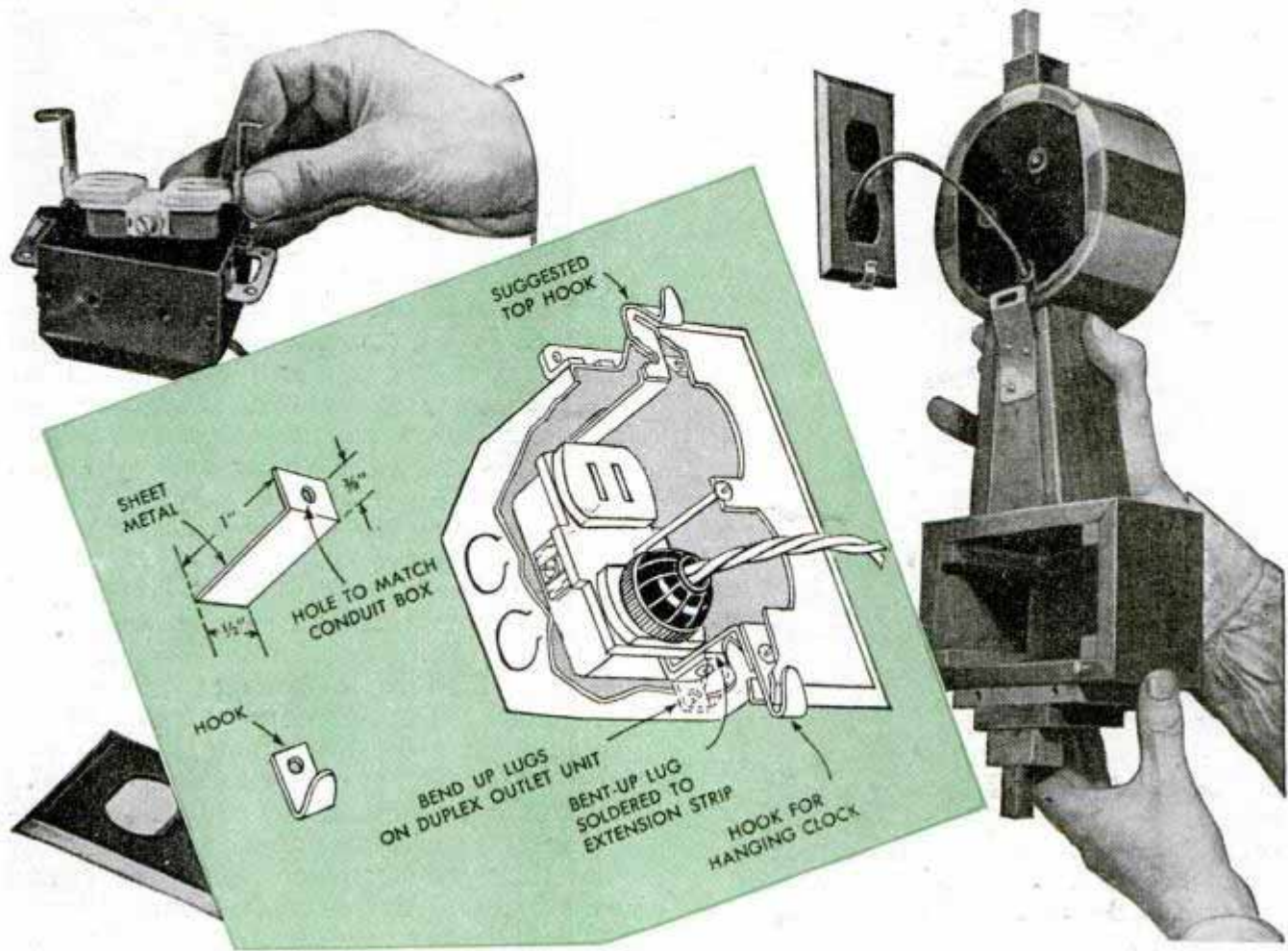

The simple conversion of an ordinary duplex receptacle makes this combination outlet and hanger for your electric wall clock. First bend the mounting lugs of the duplex unit upward so they stand at right angles to their former position. This allows the unit to slip into a standard outlet box. Two strips, cut from $\frac{3}{64}$ -in. flat steel to the same width as the original lugs, are soldered to the latter to form extensions. In the regular-size outlet box these will be

about $1\frac{3}{8}$ in. long. Bend $\frac{3}{8}$ in. of the top end of each extension at right angles to form mounting lugs and drill holes duplicating those in the originals. Then assemble, making a hook and, if necessary, a bracket for hanging the clock. Cut the clock cord about 6 in. long and attach a plug that will pass through the holes in the cover plate. You may have to bend the hook to clear the starting and setting knobs and the cord.

Walter E. Burton, Akron, Ohio



Durable Bathinette Cover Is Made With Canvas and Clothesline

A durable bathinette cover that can be removed and washed is easily made from a piece of light canvas approximately 5 in. longer and wider than the top of the baby's bath. The sides and ends should have a hem $1\frac{1}{4}$ in. wide in which twelve notches and the corners are cut as shown. A length of clothesline is threaded through the hem and hooked over the corners and also over twelve screws driven into the sides and ends of the frame, or better still, into the underside. Then the rope is drawn tight to make the cover secure.

Richard C. Hare, Grafton, Mass.

☛ For added strength in thread used for sewing buttons, draw it through beeswax.

25 Insect and how

By W. Clyde Lamme

WHEN suddenly you find seedlings, transplants or carefully nurtured perennials wilted, drooping or otherwise just managing to live in a half-hearted fashion, and you know your cultural methods are approved, then usually there's only one other answer—bugs. Worst of all, you don't always know just when or where the pests are going to strike. That's why experienced gardeners always keep a "loaded" sprayer or duster handy, just in case.

Insect pests that damage your garden generally are of two kinds—sucking and chewing, the terms referring to the manner of feeding. Depredations of most of the common chewers show up quickly and usually the offenders are discovered easily and put out of business. But certain of the sucking insects work less openly and are so tiny that they are not discovered by a casual examination. Moreover, they generally are controlled only by sprays or dusts that kill by contact, that is, the spray or dust must strike the body of the insect to be effective. Against certain other spreading pests, such as the European corn borer, only preventive methods are used at present, although these insects doubtless soon will be brought under a measure of control by newly developed sprays and dusts now used experimentally. Of course, manufacturers do not market these new products until they know what they will do, hence most of the old stand-by sprays and dusts still are recommended for effective control measures. Many of these as originally known have been newly compounded to give greater effectiveness. For the vegetable garden one of the most efficient insecticides at present is that containing rotenone and pyrethrum in combination. Used either as a spray or dust, it kills the common sucking and chewing insects and is relatively nonpoisonous. In a general way, dusting is fully as effective as spraying in the vegetable garden

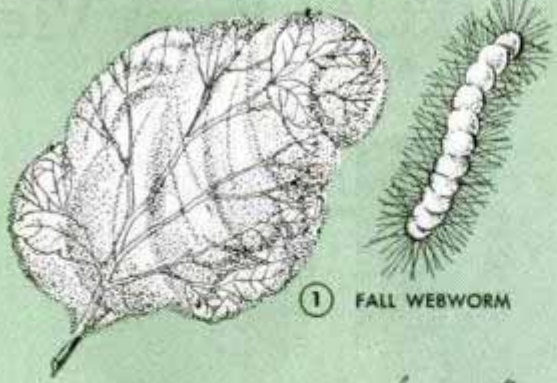

1 FALL WEBWORM



2 THRIPS



3 LEAF ROLLER



4 ROSE SLUG

5 LINED PLANT BUG



6 ROSE LEAFHOPPER



7 ROOT APHIDS

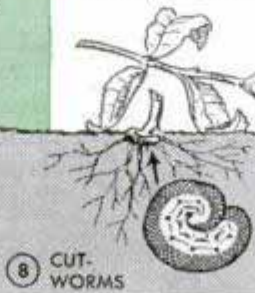

8 CUT-WORMS

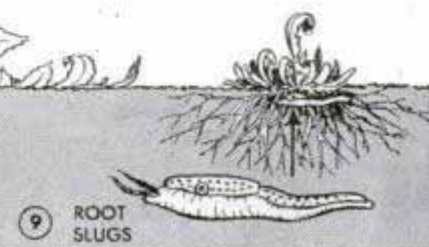

9 ROOT SLUGS

Pests to control them



and it requires less expensive equipment.

Only general recommendations have been given below for the proportions of the sprays and dusts named. In many instances somewhat different proportions of the materials have been found to be more effective in a given locality. Your state agricultural experimental station will recommend spray or dust compounds which have been found most effective under local conditions and also will advise you in the best use of new insecticides. Should manufacturer's directions for compounding sprays or dusts differ from those given, follow the maker's recommendations.

Figs. 19 and 33 show an important point in dusting or spraying low-growing plants. Fig. 19 shows the three positions of the spray nozzle necessary to cover both the top and underside of the leaves. This is essential when spraying such plants as potatoes. A similar procedure is necessary in dusting most low-growing plants, Fig. 33. When dusting, use the deflector nozzle as in Fig. 32. Figs. 18, 29 and 34 show three types of sprayers suitable for use in the average garden. For the larger plots and where a small orchard is included the wheelbarrow sprayer, Fig. 34, is perhaps the best selection, as higher nozzle pressures are possible with this type. Figs. 30 and 31 show three types of dusters. The small hand types, Fig. 30, are suitable where only a few plants or shrubs are to be treated. The larger "knapsack" type, Fig. 31, is better for larger areas, as it delivers a greater volume of dust and gives better coverage.

Only 25 of the principal insect offenders are listed here. There are many others, of course, but they are not so bothersome. Among the first dozen or so are several species that are especially troublesome in the flower garden but also attack many other plants and shrubs.

Fall webworm, Fig. 1. Ties a silken web around leaf clusters on which the worms

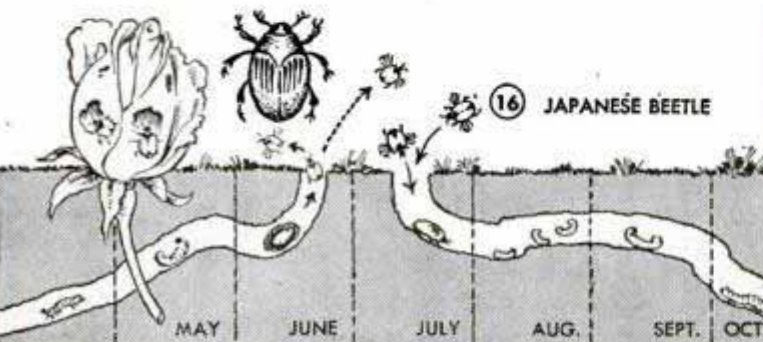
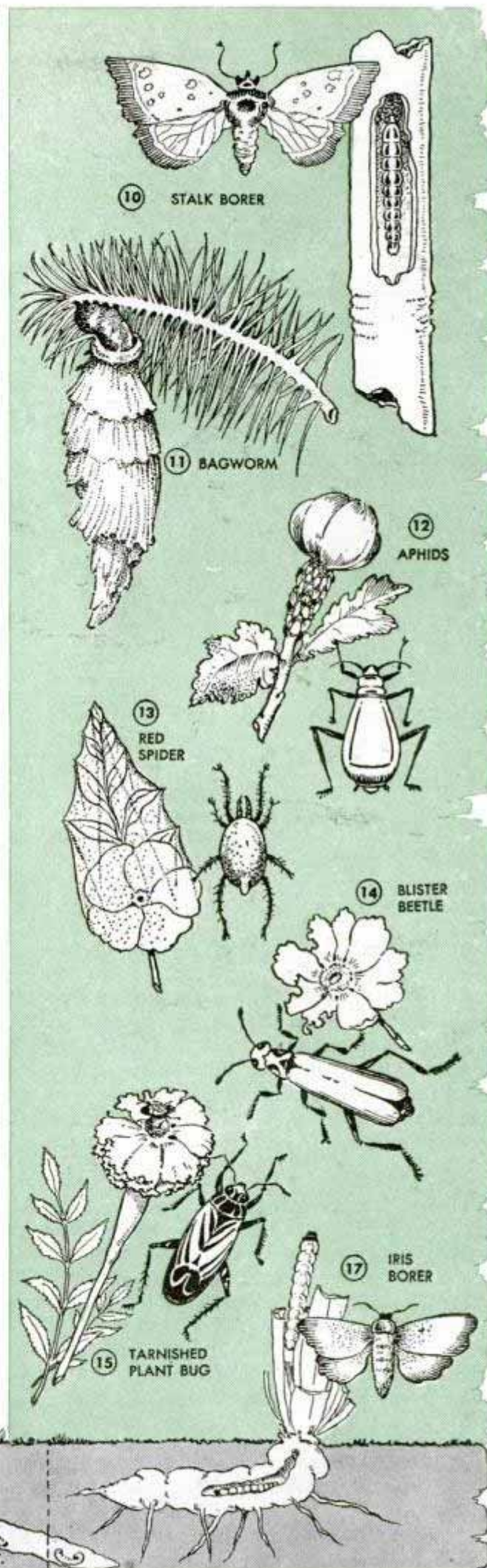

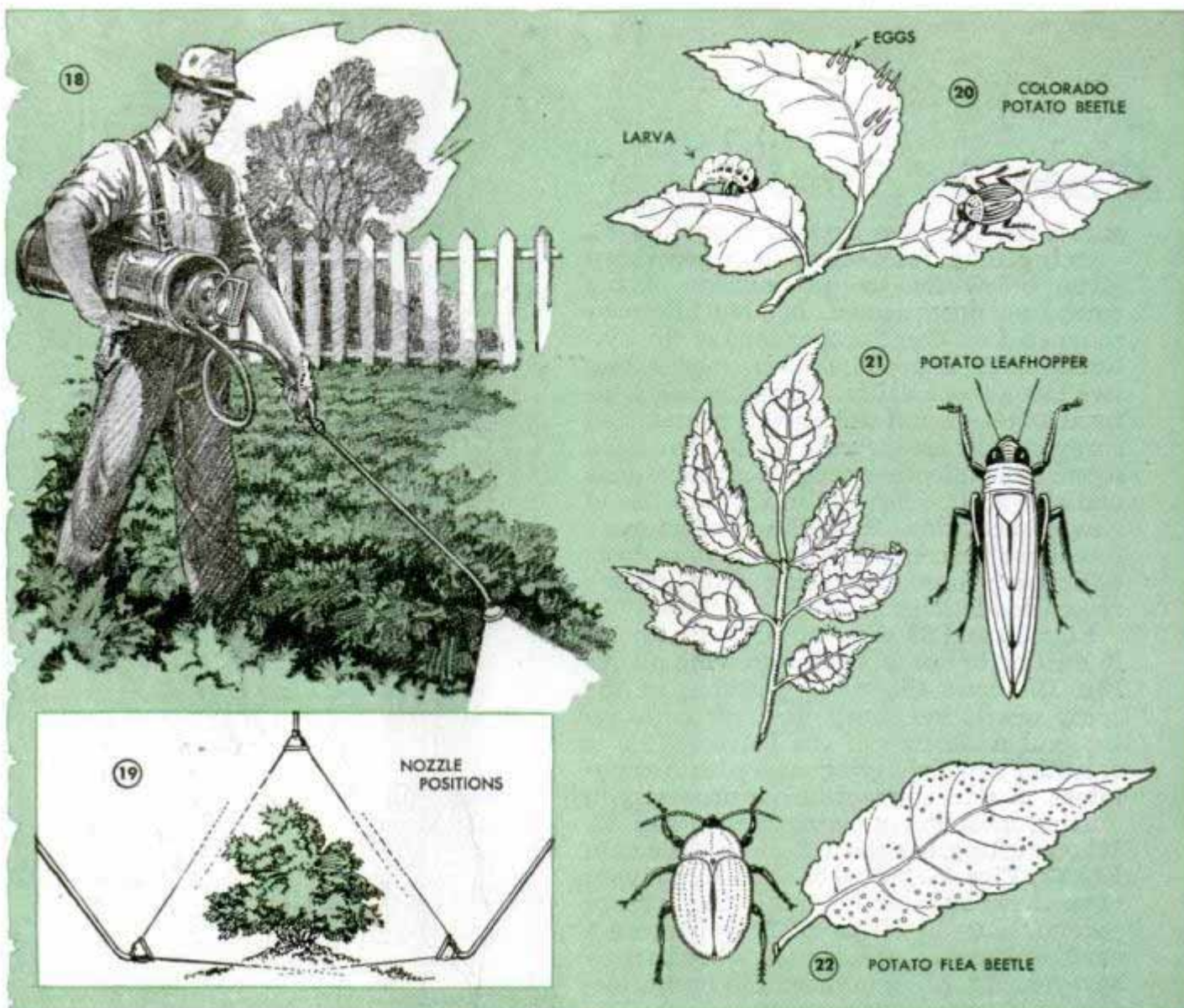

feed. Attacks shrubs, fruit and shade trees. One effective control measure is to cut off and burn the webs, making sure that every worm is destroyed. Or spray foliage with lead arsenate at intervals, a general recommendation for the solution being 1 to 3 level tablespoonfuls to the gallon of water. Less destructive generally are the garden webworm and the parsnip webworm. Control by dusting with calcium arsenate.

Thrips, Fig. 2. Minute flylike insects, less than $\frac{1}{8}$ in. long. Larvae of the gladiolus thrips winter on the corms. Store the corms in sealed paper bags containing naphthalene flakes at the ratio of 1 oz. of flakes to 100 corms. During the growing season spray foliage with a 1 to 200 dilution of pyrethrum or with a solution of 1 rounded tablespoon Paris green, 2 lbs. brown sugar and 3 gals. water.

Leaf roller, Fig. 3. In three common varieties, the oblique-banded fruit tree roller, the red-banded roller and the strawberry-leaf roller. Watch for them on fruit trees and strawberry plants and spray early with

lead arsenate to catch the worms at the first infestation.

Rose slug, Fig. 4. Larvae of rose sawflies, of which there are three common species. Slugs skeletonize the leaves as shown. Can be controlled with a dust composed of 9 parts fine dusting sulphur and 1 part arsenate of lead, a 3-in-1 copper spray, or nicotine sulphate, 1 teaspoonful to 1 gal. water and 1 oz. soap.

Lined plant bug or squash beetle, Fig. 5. An active, destructive pest. Attacks several common flowers including zinnias. Also skeletonizes leaves of squash, cucumber and melon vines. Cover vines and leaves with dust containing rotenone.

Rose leafhopper, Fig. 6. A tiny sucking insect attacking nearly all varieties of roses. Spray with nicotine sulphate and soap in proportions given for rose slug, or use spray containing pyrethrum.

Root aphid or root lice, Fig. 7. Attacks roots of asters principally. Mix wood ashes with soil when setting out seedlings. Pour

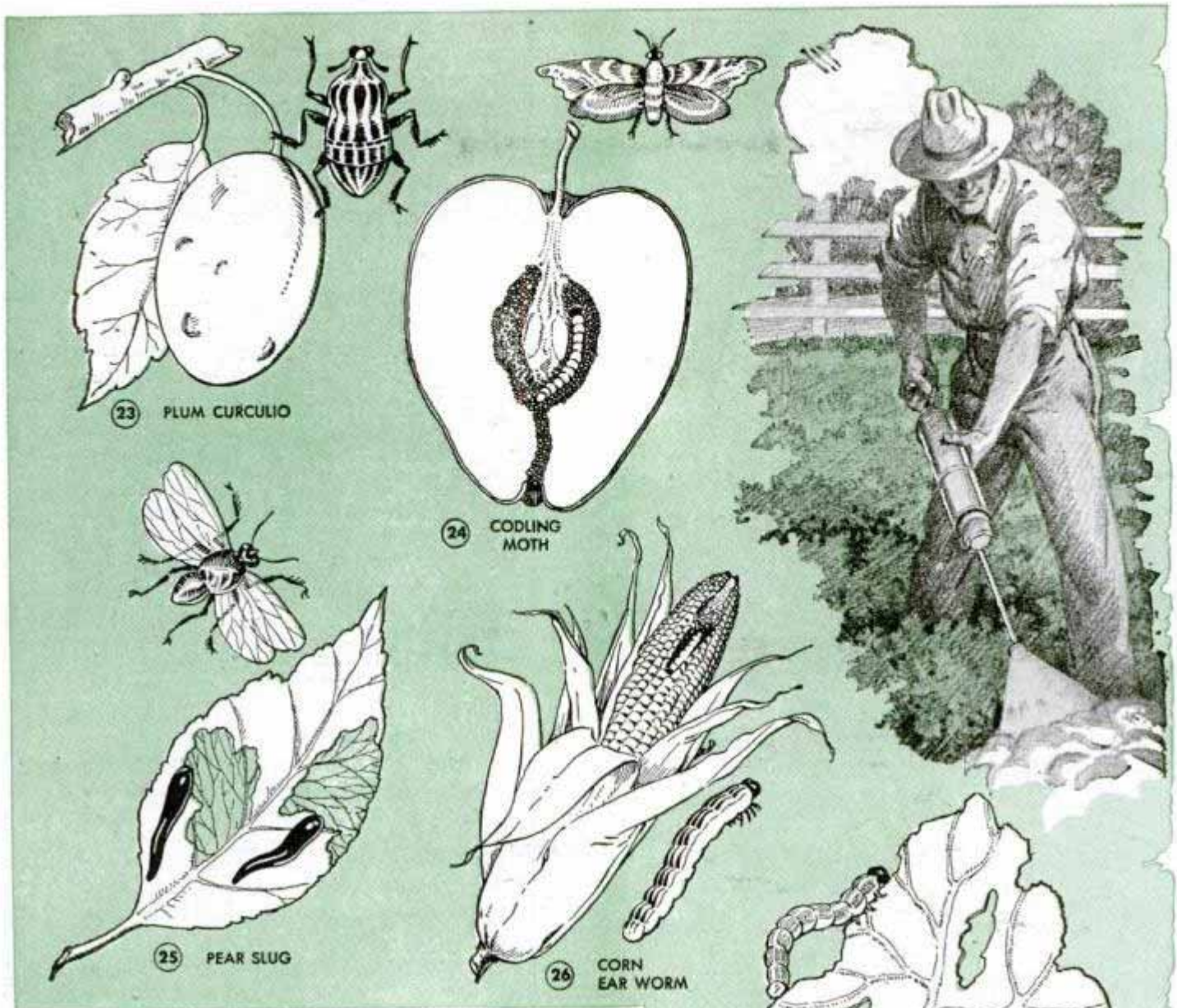

nicotine sulphate solution or carbon bisulphide around base of plants, covering a space roughly equal to root area. If you use carbon bisulphide for this or any other purpose keep the fire hazard in mind and do not inhale the fumes.

Cutworm, Fig. 8. Specializes in lopping off tender seedlings at the ground level. Scatter poison bran made by mixing 1 oz. white arsenic, 1 lb. dry bran and 2 tablespoonfuls molasses in 1 qt. water. To protect songbirds place the bait under wide boards laid in line and close to the plants.

Root slug, Fig. 9. Especially bothersome on young delphiniums. Spread air-slaked lime, tobacco dust, soot or wood ashes around the plants. Mix lightly into the top soil. Dust slices of raw potato with Paris green and place near plants.

Stalk borer, Fig. 10. A serious pest in valuable growth because damage is done and the plant wilted or toppled over completely before borer's presence is known. Common native borer works in stems of any plants large enough to shelter it. There

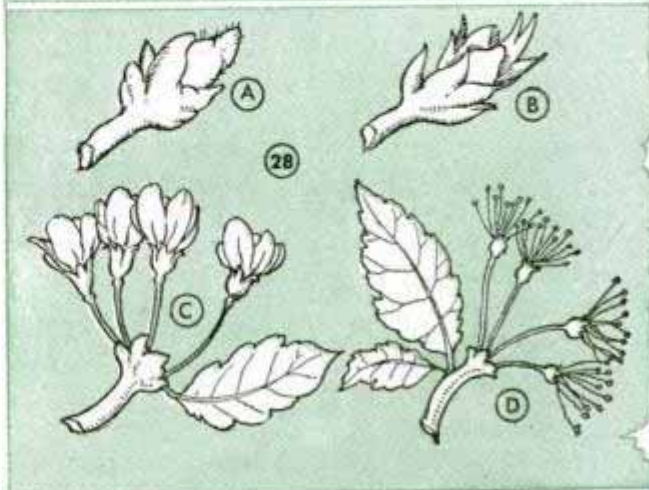
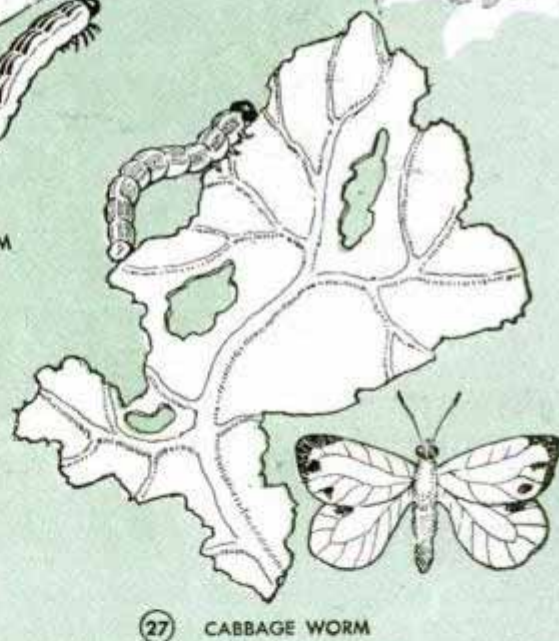

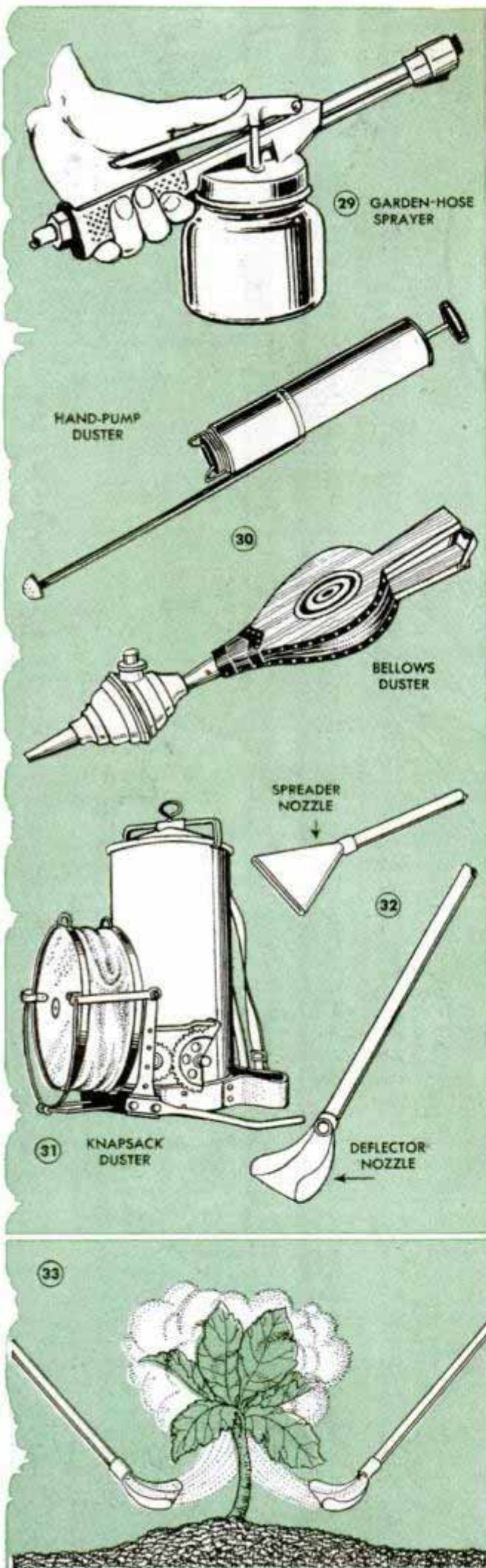

is only one yearly generation or "hatch." But the newer and more menacing European borer, or corn borer, as it is generally known, produces a second and sometimes a third generation in a single season. The European borer does not confine its ravages to corn alone, but attacks a variety of plants, dahlias, zinnias, garden sunflowers, potatoes and gladioli being among the chief sufferers. At present control methods are generally preventive—burning or plowing under infested growth and any stalks, or trash in which the pest winters. During growing season the borers can be killed in individual plants by slitting the stalk just above the point where the borer entered and injecting a few drops of carbon bisulphide or nicotine sulphate. Tall plants so treated must be supported with a stake or by other means. Sprays, dusts and other control methods now being developed promise more certain control of this pest in the near future.

Bagworm, Fig. 11. Destructive shrub and shade-tree pest in certain sections of the United States, and an especial enemy of evergreens. Gather and burn the conspicuous "bags" and spray infested growth with lead arsenate during spring and summer months when larvae appear.

Aphids, or plant lice, Fig. 12. Aphids attack almost any garden or greenhouse crop. Heavy infestations are particularly serious because the tiny lice act as carriers for many plant diseases. Pyrethrum-rotenone compounds used as spray or dust and nicotine sulphate-and-soap sprays are effective on practically all growth.

Red spider, Fig. 13. Not really a spider at all, or even an insect, but rather a tiny mite weaving almost invisible spiderlike webs on the underside of leaves of many vegetables, ornamental plants and evergreens. Hosing evergreens with water under high pressure will discourage the spiders, but a better method is dusting with fine dusting sulphur, being careful to cover the growth thoroughly. Pyrethrum-rotenone sprays or dusts are effective on other plant growth, but care should be taken to assure that the spray or dust hits the undersides of the leaves as well as the tops.

Blister beetle, Fig. 14. Slim-bodied, lively beetles about $\frac{3}{4}$ in. long. Voracious feeders on the foliage of many vegetable, flower and field plants. Spray foliage with lead arsenate solution. Where flowers are infested knock the beetles out of the blooms into a pan containing kerosene.

Tarnished plant bug, Fig. 15. An active but inconspicuous bug about $\frac{1}{4}$ in. long, brown-mottled in color. Feeding habits

cause wilting and blackening of leaves and twigs. Difficult to control ordinarily but pyrethrum sprays or dusts generally are sufficiently effective to permit near-normal growth of most plants.

Japanese beetle, Fig. 16. A serious, spreading pest against which many control methods have been tried and discarded. However, recently it has been discovered that soils can be inoculated with spores of a disease fatal to larvae of the beetles. Methods have been developed of producing the spores in quantity. Probably these materials eventually will be available to inoculate infested soils. Dry lime applied thickly to foliage has been found an effective repellent of the adult beetles. Valuable sod can be protected from ravages of the larvae by spreading 5 to 7 lbs. of lead arsenate to each 1000 sq. ft.

Iris borer, Fig. 17. Before growth starts cover beds with straw or dry trash and burn to destroy the eggs. Always keep the fire hazard in mind when burning beds. Spray new growth with arsenate of lead.

Colorado potato beetle, Fig. 20. Perhaps the best known of the insects damaging the potato crop. Spray or dust foliage with arsenate of lead, calcium arsenate or any of the preparations sold as "potato spray."

Potato leafhopper, Fig. 21. Recognized as one of the most serious pests of the potato. About $\frac{1}{8}$ in. long, generally light green in color. Causes the damage to the foliage known as "hopper burn," in which the edges of the leaves curl and become dry and brittle. On small plots use a prepared bordeaux mixture or a prepared potato spray. In either case follow the directions of the manufacturer for small quantities.

Potato flea beetle, Fig. 22. Tiny black beetle a little larger than a pinhead. Eats small round holes in the leaves, giving them a sievelike appearance. Bordeaux mixture, which controls the leafhopper, acts as an effective repellent but must be applied much earlier, when the plants are 3 to 6 in. high. Plants should be sprayed at least five times at intervals of two weeks or oftener during the growing season.

Plum curculio, Fig. 23. Cuts crescent-shaped marks in the fruit. Spray with lead arsenate just after the petals fall. Repeat in a week to 10 days.

Codling moth, Fig. 24. Cause of the familiar wormy apples. Also attacks pear, crabapple, quince and black and English walnut. Spray with lead arsenate, the most important application being that known to orchardists as the "calyx spray," the term referring to the calyx stage or petal fall



of the apple blossom. See D in Fig. 28. To be effective this spray must be carefully timed and used in combination with other spray materials. The first apple spray is known as the "dormant spray" and begins when the fruit buds appear as at A in Fig. 28 and must end before the leaves are $\frac{1}{4}$ in. long, B in Fig. 28. For this spray mix 1 gal. concentrated lime-sulphur and 5 tablespoonfuls nicotine sulphate, 40 percent solution, in 10 gals. water. Or use oil emulsion according to manufacturer's directions. For the "pink-bud spray," C in Fig. 28, use lime-sulphur, 1 qt., and lead arsenate, $1\frac{1}{4}$ cups in 10 gals. water. For the petal fall, or calyx spray, use lime-sulphur, $1\frac{1}{2}$ pints, and $1\frac{1}{4}$ cups lead arsenate. Repeat the calyx spray after 10 days and again 3 to 4 weeks after petals fall. These successive sprays are a recommended procedure for protecting both fruit and foliage of the apple from several insects and diseases, including codling moth.

Pear slug, Fig. 25. Spray with nicotine sulphate or arsenate of lead, making sure that spray covers both sides of leaves.

Corn ear worm, Fig. 26. Attacks when ears are in the silk. Dust silks with a mixture of 1 part hydrated lime to 2 parts lead arsenate, beginning when the silks first show and continuing at intervals. Or use the new corn ear-worm insecticide now available in ready-to-apply form and apply when the silks start to turn brown.

Cabbage worm, Fig. 27. Riddles the first leaves of both cabbage and cauliflower and later on attacks the outer leaves of the formed cabbage heads. Use a combination pyrethrum-rotenone dust. In heavy infestations it is necessary to keep the growth covered at all times.

Can of Tennis Balls Is Carried On Side of Racquet Press

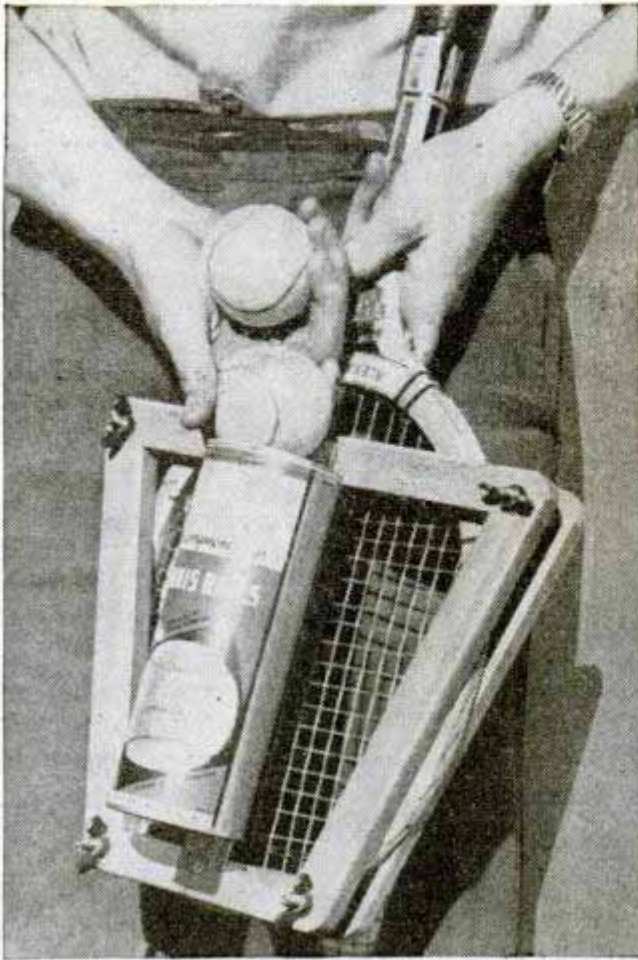

By riveting a strip of metal to the can in which tennis balls come and screwing the strip to the racquet press you will provide a handy place for carrying tennis balls. Squeezing the can so it is slightly out of round near the opening will prevent the balls from rolling out if the racquet is laid on the ground.

E. H. Crook, South Pasadena, Calif.

Windmill Drives Away Gophers

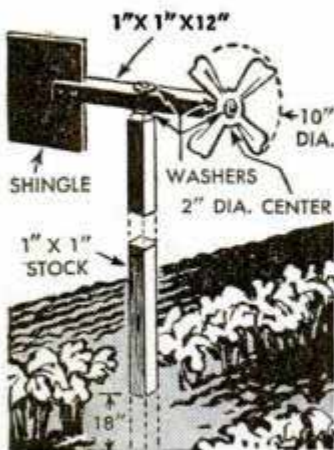

An effective way to rid a plot of ground of gophers is to set up a windmill consisting of a sheet-metal propeller rotating on a stick that pivots on a standard driven into the ground. Movement of the propeller will create vibration that is transmitted to the

ground. This causes gophers to leave because the vibration is irritating. For this reason the propeller should not be balanced for smooth operation. A 10-in. propeller cut from light sheet metal is about

the right size. The rudder can be a shingle or a piece of heavy cardboard, and the arm on which rudder and propeller are mounted should be balanced on the standard so that it will veer easily into the wind. The standard may be as high as desired, but it should be long enough to extend at least 18 in. into the ground, with enough above ground to raise the propeller above shrubbery and other vegetation that might screen it from the wind.

W. Stanley Milam, San Francisco, Calif.

Chemical Test for Hard Water

A simple test to determine whether water is hard or soft is to use a solution made by dissolving chemically pure mercurous nitrate crystals in distilled water. A tablespoonful of the crystals is dissolved in a cup of water to make the test solution. If the water to be tested is hard, it will become cloudy when a small amount of the solution is poured into it, but if it is soft it will remain clear. The unused solution may be stored in any nonmetallic container for future use.—J. A. Knoll, Stevenson, Wash.

Fence Posts Held in Hollow Tile Are Removed to Mow Lawn

One home owner sank hollow building tiles in his lawn slightly below ground level and cemented them in place to support the posts of a low fence. The tiles do not interfere with the lawn mower and the fence can be removed easily for this purpose as well as for storage during the winter. As the tiles are open at both ends, rain passes through them into the ground so that the posts do not decay.

Duke D'Ambra, Lawrence, Kans.



A Play Kitchen Ensemble for the Young Miss

Eyes will sparkle and the dinner call will ring through the house frequently if you present this kitchen ensemble to that tiny feminine member of your family. With these three pieces a play kitchen can be set up almost anywhere in the house. As an average overall size, the stove, Fig. 1, can be made 19 in. high, 21 in. wide and 13 in. deep; cabinet, Fig. 2, 30 in. high, 18 in. wide and 10 in. deep in the lower section, and the refrigerator, Fig. 3, 30 in. high, 16 in. wide and 12 in. deep. Although solid stock can be used in the construction of all pieces, $\frac{3}{8}$ or $\frac{1}{2}$ -in. plywood is perhaps best as the larger panels can be cut in one piece. If plywood is used, the assemblies should be reinforced with triangular corner blocks glued and screwed to the panels at the joints. While doors on the stove and cabinet are imitated with paint and handles, you can make real doors from plywood reinforced with cleats of solid stock where the hinges are attached. Stove burners also are painted on, but radio snap switches to

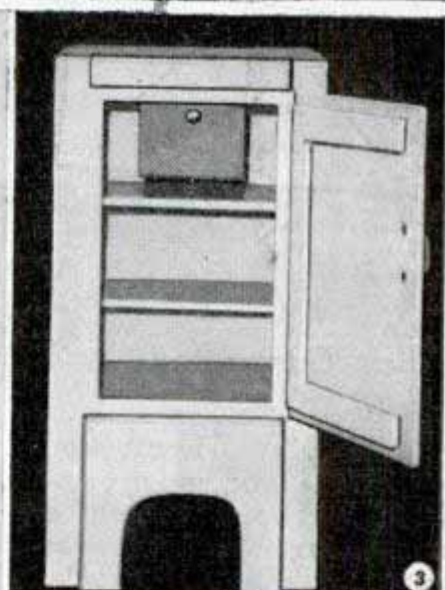
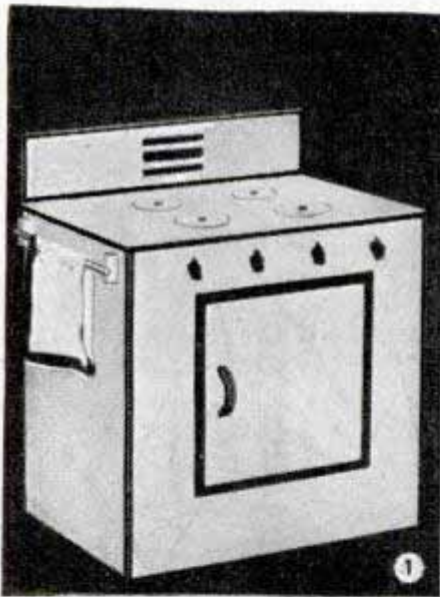

operate the burners add realism to the stove as the "gas" turns off and on with a loud click. The oven-door handle is the carrying handle from a portable radio set.

Real doors in the cabinet, of course, will provide storage space for cooking utensils. Spring-type hinges on the refrigerator door will make it self-closing, and inexpensive weather stripping around the door will serve as a gasket if the little owner insists that the refrigerator is not "cold" enough. The surfaces should be sanded smooth before applying the finish, using coarse, medium and fine grades of sandpaper progressively. Color scheme can be any that matches the playroom, or plain white enamel with contrasting trim.

Francis J. Comegys, Wilmington, Del.

Discarded Garden Hoe Cut Down To Make a Weeding Tool

By cutting off the ends and truing the bottom edge of an old garden hoe, one man improvised a tool that was excellent for weeding between closely spaced rows of vegetables. Cutting can be done with a hacksaw or cold chisel. The lower edge of the hoe should be well sharpened for effective use.—Fred Cornelius, El Paso, Tex.

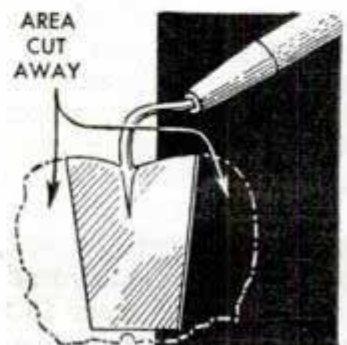

FOLDING Is Fun For



B-E. Now turn the whole thing over and make similar folds by bringing corners H and G to crease line D-X. It now should look like Fig. 3, the arrows showing the direction of the folds. Next place the paper flat on the table with corners E and F showing and mark the pencil line I-J. Place the fingers of the right hand along the edge of the pencil line so that the palm covers point X and with the left hand fold corners E and F outward. Grasp corner A with the left fingers and fold and crease it at line I-J as shown by the arrows in Fig. 4. After this fold corner A flat over corner X. Corners E and F will open up by first swinging out and then back again so that E and F will come together in the center as shown in Fig. 5. Turn the paper over and do the same thing with corner D. Now place the paper on the table with E and F showing and following the dotted lines and arrows in Fig. 6 fold tips C and B upward and outward to form crease N at approximately the

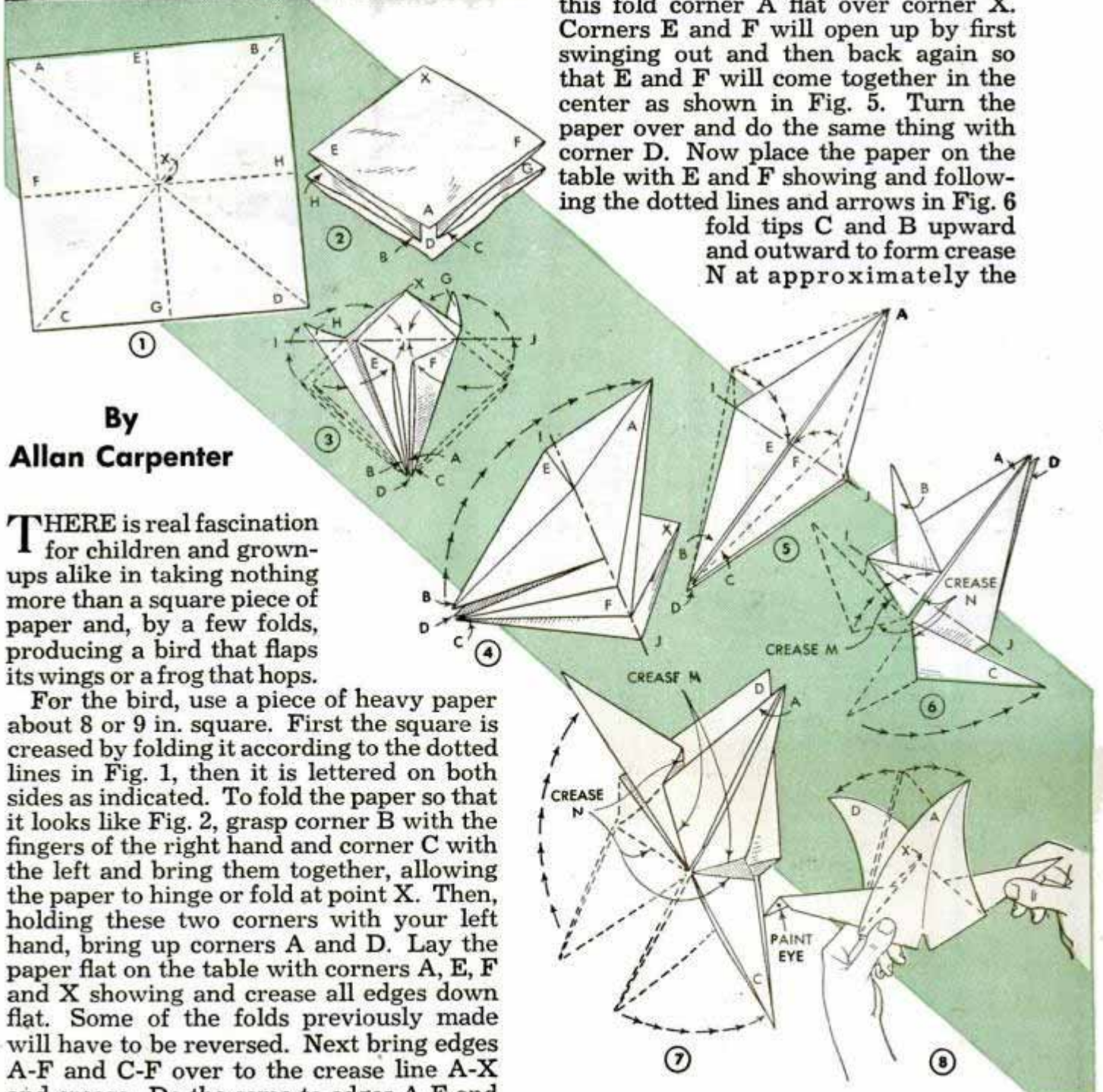

By
Allan Carpenter

THERE is real fascination for children and grown-ups alike in taking nothing more than a square piece of paper and, by a few folds, producing a bird that flaps its wings or a frog that hops.

For the bird, use a piece of heavy paper about 8 or 9 in. square. First the square is creased by folding it according to the dotted lines in Fig. 1, then it is lettered on both sides as indicated. To fold the paper so that it looks like Fig. 2, grasp corner B with the fingers of the right hand and corner C with the left and bring them together, allowing the paper to hinge or fold at point X. Then, holding these two corners with your left hand, bring up corners A and D. Lay the paper flat on the table with corners A, E, F and X showing and crease all edges down flat. Some of the folds previously made will have to be reversed. Next bring edges A-F and C-F over to the crease line A-X and crease. Do the same to edges A-E and

PAPER Everyone

same position and angle as indicated in Fig. 6. Crease M, extending from the inside corner formed by crease N to the outside corner of I-J line, is folded in a similar manner, except that the paper is folded upward and inward. Return tips C and B to their original positions, as the creases merely serve as guide lines. Now, holding the paper in the left hand with G and H showing, you will find a small triangle between points A and D. Open the right-hand side of the triangle and with the right hand grasp the two edges of tip C just below crease N and move them upward as shown by the arrows in Fig. 7. You will notice that creases N and M on one side of tip C will

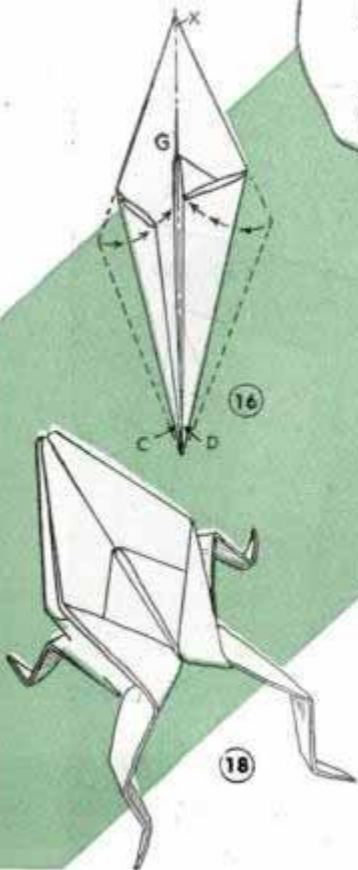
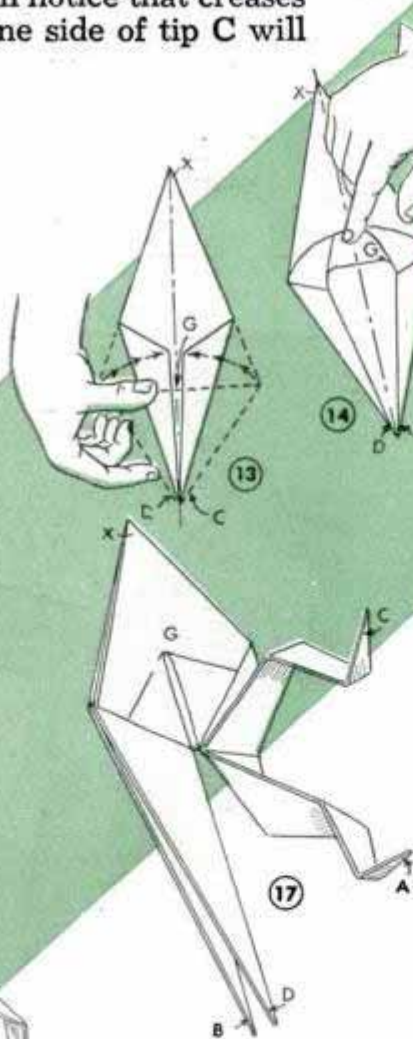
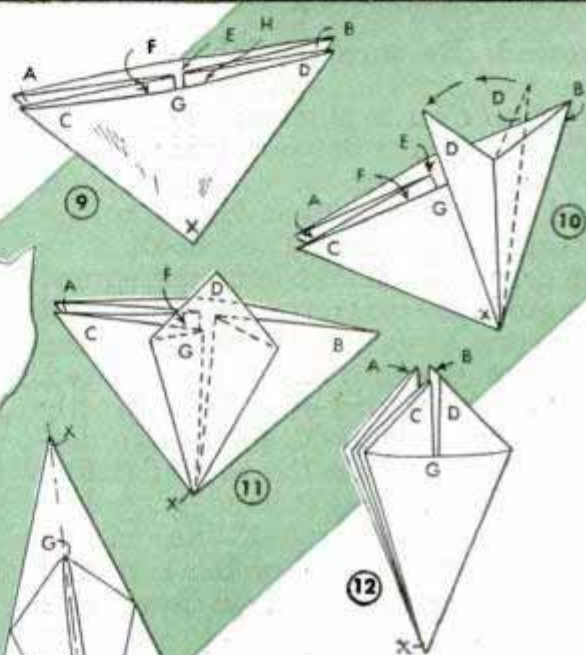

have to be reversed to allow crease N to be folded to the center between the two sides of the small triangle. Turn the paper around and do the same to tip B. Points A and D are curved downward to represent wings, while the protruding points form the neck and tail. Fold one of the extending tips to form the head and paint eyes on both sides. Holding the bird as shown in Fig. 8, the wings are made to flap realistically by pulling the tail.

A square folded and labeled as in Fig. 1 also is used to make the hopping frog detailed in Figs. 9 to 18 inclusive. To fold the paper as in Fig. 9, grasp the creased line H with the right fingers and creased line F with the left fingers and bring them together, allowing the paper to fold at point X. Then, holding these corners with the left hand, bring up the crease lines E-G. Lay the paper flat with corners C, D and X showing, and crease all edges down flat. Notice that some of the folds will have to

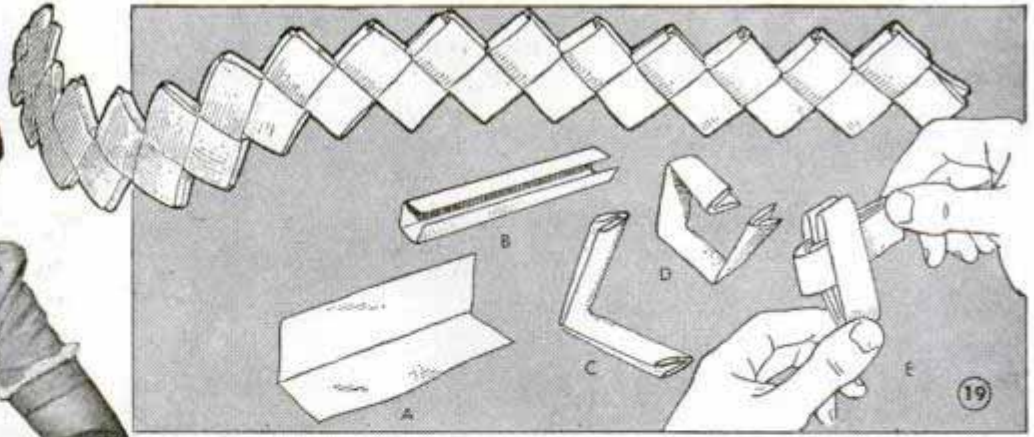

be reversed. Be sure the labeled crease lines are positioned as in Fig. 9. Edge D-X then is folded over to align with crease line G-X, Fig. 10. Crease this new fold which is to serve as a guide crease when folding as in Fig. 11. This is done by unfolding corner D to its original position. Then, holding the paper at corner X with the left hand, spread the two guide creases apart with the right hand, starting at corner D. Note that the left-hand guide crease has to be reversed. Now flatten the folded edge D-X directly over the folded edge G-X, shown as a dotted line in Fig. 11. Place the paper flat, Fig. 11, and lift up the right-hand guide-line crease so it hinges on the D-X line and fold it over, placing it on top of the left-hand guide-line crease. This exposes crease line H-X. Edge B-X is then folded over so it aligns with crease line H-X and is creased

to form guide lines. Then open up and form it as was done with corner D. Now turn the paper over to show corner A and crease line E-X and repeat the above guide creasing and folding, first to corner A, then to corner C. Grasp the paper with the left hand at point X and fold over the right-hand guide-crease edge from right to left, exposing crease line G-X and corners C and D, Fig. 12. Turn the paper over and repeat, exposing crease line E-X and corners A and B.

The paper then is laid flat with point X away from you and corners C and D showing. Now fold in the top right and left-hand unmarked corners to the center crease line

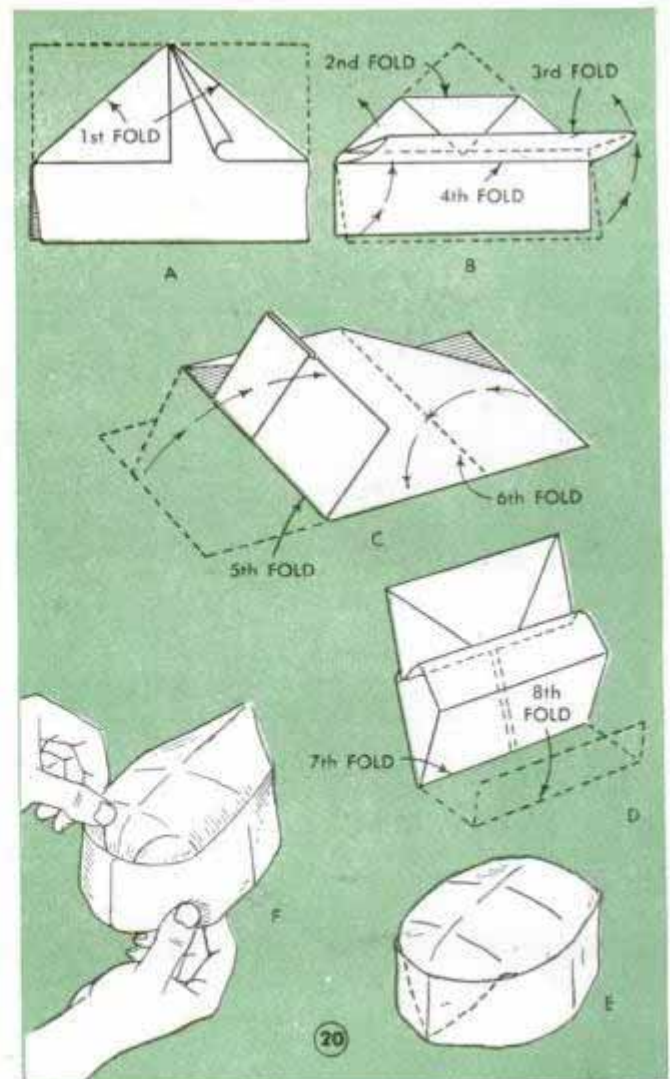

G-X and crease as in Fig. 13. These two new folded edges are used as guide creases in the next step, which is somewhat similar to a process in making the bird. Draw a line across the newly formed right and left corners at right angles to the crease line G-X. Then unfold them to their original positions and with your right hand lift up edge G as in Fig. 14 and fold it back along the pencil line, which is creased as in making the bird. The cut edges of the paper will fold in to the center, after which the small kite-shaped folds are pressed flat against the paper, Fig. 15. Turn the paper over to show edge E and repeat the above process. Then locate edges F-H and do the same thing.

Now hold the paper in your left hand with point X at the top and arrange the eight unmarked corners so that the small kite-shaped folds marked G are facing you and the ones marked E are at the back. The two lower tips facing you will be labeled C and D, the back two A and B. Lay the paper flat with G showing and fold the two upper right-hand unmarked corners to the center and crease the fold to taper to a point at tip C. Do the same to the two upper left-hand unmarked corners and crease to tip D, Fig. 16. Turn the paper over, showing corner E, and repeat the above, folding and creasing to tips A and B. Then turn the paper over again and fold tips C and A as in Fig. 17. Fold tips D and B so they project out to the left. A smart tap on the back will make the frog, Fig. 18, jump vigorously.

With heavy wrapping or colored craft paper, any youngster can make a decorative belt. Sixty or seventy pieces of paper about $4\frac{1}{2}$ by $2\frac{1}{4}$ in. in size are required. Each piece is folded lengthwise as in Fig. 19, A, after which each edge is folded to the center crease, B. The ends of this strip are brought together, C, to make the center crease. Then the ends are folded to this crease, as at D. This piece is joined to another, made the same way, by inserting the ends of the latter between the folds, E, and pulling both together firmly. Other pieces are added similarly to produce a belt of the required length.

The cap shown in Fig. 20 is made from a double newspaper sheet. The size can be varied by increasing the size of the paper proportionally. To start, fold down the corners of the paper so that the edges meet, as at A. Then the second, third and fourth folds are made as at B, and the paper turned over before making the fifth fold at C. The latter is really two separate folds. After the sixth and seventh folds are made, C and D, the remaining flap is tucked into a pocket formed by the third, fourth and fifth folds, detail E. Finally, the peaks are tucked under the band at both ends, as in Fig. 20, detail F.

Tires for Model Work Are Wound On Dowel or Rod



Rubber tires for model airplanes and cars can be made with rubber splicing tape of the kind used by electricians. For a form, use a dowel or rod of the same diameter as the wheel on which the tire is to fit, detail 1. The thickness of the wrapping will determine the size of the tire. Then roll the tape off the rod, detail 2, to form the finished tire, detail 3, which then is ready to be put on the wheel.

Rubber Ball Forced Over Nozzle Protects It When Dropped

When used around cement walks, garden-hose nozzles may become nicked or cracked if they are accidentally dropped. As a precaution against this, a sponge-rubber ball can be pierced to slip over the tip of a nozzle so that if the hose is dropped the ball will prevent the nozzle from coming in contact with the pavement.

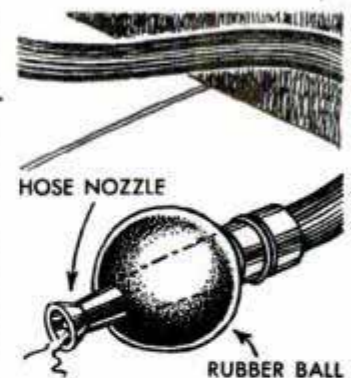

☐ If boiled and fresh eggs accidentally are stored in the same container, the boiled ones can be distinguished from the others by twirling them on a table. A fresh egg will turn slowly for only a short time, but a hard-boiled egg will continue to spin.



Feet on Legs of Swing Provide Firm Base

Wooden feet attached to the legs of a child's lawn swing and slide will support the swing frame on loose soil and prevent the legs from sinking into the ground. Also, the feet will adjust to uneven ground. Each foot is made by assembling lengths of hardwood to form a channel, the side members being drilled to take a pin, as indicated in the detail. On swings where the legs slant inward the holes will have to be drilled parallel with the bevels at the bottom of the legs so that the feet will rest flat on the ground.

Theodore Welge, St. Louis, Mo.

Bell Attached to Shoe or Lace Indicates Child's Presence

Belling the cat to warn birds of its presence is an old custom, and belling the child, one parent has found, is an excellent way of knowing the little tot's whereabouts. A small bell can be attached to the youngster's shoe or shoelace, and as long as the tinkling sound caused by his movements at play can be heard it will show that he has not wandered.—I. M. Fenn, Chicago.

For a rainy day's entertainment or during a period of convalescence, challenge your child's interest with a half cupful of alphabet noodles. These will prove to be instructive as well as amusing, as anagrams, words and whole sentences may be spelled out with the letters.

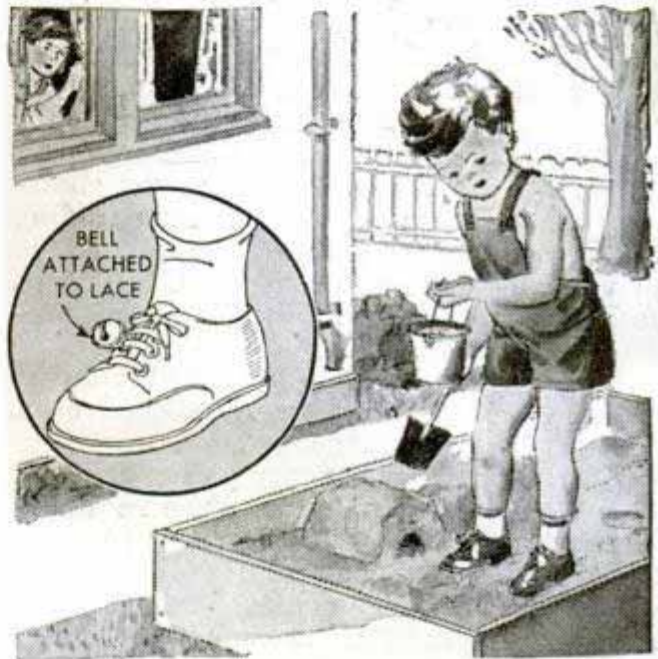

Swing Safety Chain Prevents Fall If Hanger Breaks

The hangers on children's swings frequently become worn and break because of friction between the rigid and the pivoting members of the hanger. As a measure of protection if this does occur, these safety chains may be used. One end of the chain is fastened around the crossbar supporting the swing, as shown, and the other end connected to the top link of the swing chain. Then, if the hanger breaks, the swing will drop only far enough to take up the slack in the safety chain. If rope is used instead of chain to support the swing, the same idea can be employed, one end of a safety rope being looped around the crossbar and the other being spliced to the swing rope. Very little slack is necessary in either case.

R. M. Anthis, Twin Falls, Idaho

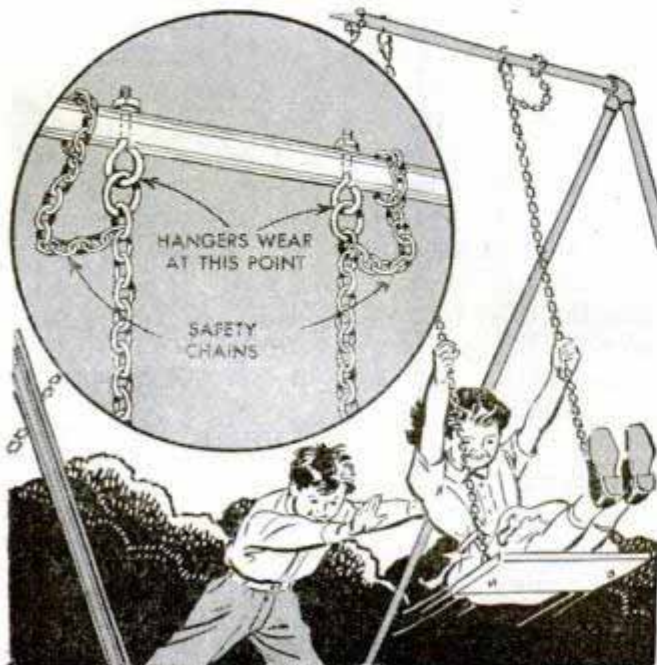

Toadstools "Grow" in Garden the Year 'Round



These "plants" are not affected by frost, snow or the change in seasons. If your garden arrangement changes from time to time you can transplant 'em anywhere. Durable, too, because they're cast in concrete of a special mix. First, you make a pattern of modeling clay, working the clay to the size and shape desired on a board. Use a live toadstool as a model. Then make a bottomless box about 2 in. larger each way than the overall size of the pattern. Place the box over the pattern board as in Fig. 1. Mix plaster of paris to the consistency of pancake batter and pour the box full as shown. Level the plaster carefully and allow it to harden. Then remove the box and the clay pattern and apply two coats of shellac to the plaster mold. Next, mix dry, 1 part fine clean sand, 3 parts portland cement and 2 parts plaster of paris. Add water to a quantity of the dry cement mix and stir until it is thin enough to pour easily. Coat the inside of the mold with light motor oil and pour it full, troweling the mixture to work out any air bubbles. Wire of various sizes in lengths of 6 to 10 in. is used for the stems of the smaller toadstools while iron pipe in the smaller diameters is used for the stems of the larger ones. Bend a hook shape in one end of the wire stems and insert the hook end in the center of the cast cement. Trowel around the wire stem, and then shape ribs on the underside of the casting as in Fig. 2, using a putty knife. After the cement sets, lift the casting out of the mold and submerge in water for 24 hours. Paint the underside of the casting a chrome yellow and the stem and the top of the casting a light cream color. While the paint is still wet blend in a small quantity of burnt umber, beginning at the center and working down to the edges.

Dick Hutchinson, Alhambra, Calif.

Removing Plant From Flowerpot

An easy way to remove a plant from a flowerpot without disturbing the roots is to insert a length of stiff wire through the hole in the bottom of the pot and rotate it

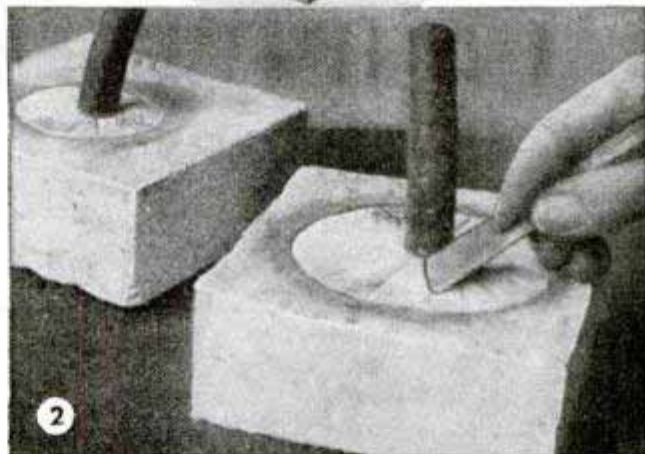

at a low angle to loosen the soil from the bottom. Then the soil at the sides of the pot is loosened with a knife blade and the plant is lifted out with the soil intact.

Robert Kane, Chicago

Quick Way to Paint Puttied Sash

When puttying around window sash, press a piece of tin along the upper edge of the putty to form a slight ledge. Later, when you paint the putty, the flattened surface thus formed will provide a good rest against which a cardboard mask can be held to keep paint off the glass window pane and thus speed the work considerably as well as make it easier.

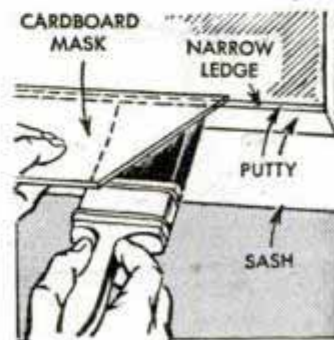



Solving Home Problems

- 1 If it is impractical to use hooks when stringing a clothesline in your basement, C-clamps can be used for any number or arrangement of lines and they will not damage the joists
- 2 Spread over the labels of medicine bottles, a thin coat of colorless nail polish will protect the writing on the labels from damage by water and keep them clean and readable
- 3 Attach rubber washers to the bottom of the dishpan to avoid leaving black marks on the sink and drainboard. A waterproof glue, such as airplane cement, will hold the washers
- 4 Measuring tape glued to the inside of the wooden frame of a knitting bag is a convenience when measuring work. The tape should be given a coating of shellac for durability
- 5 There is no need to waste time looking for a misplaced cap when returning the milk bottle to the refrigerator; simply place an egg in the bottle mouth and the job is done
- 6 Because of the suction action, the lids on powder boxes and candy boxes are often hard to remove. If a number of pinholes are punched in the cover, the trouble is remedied

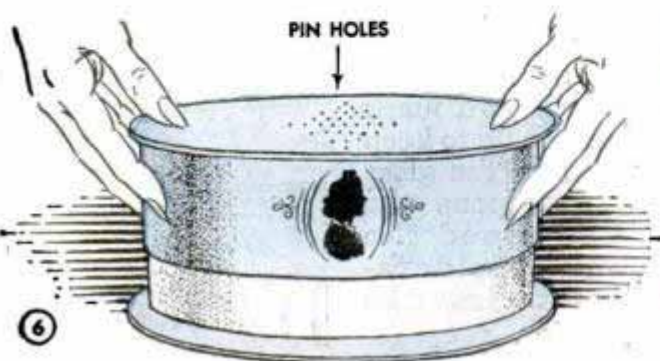
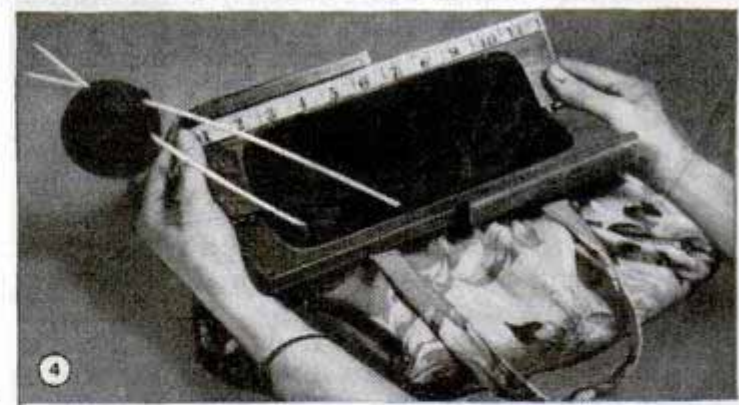
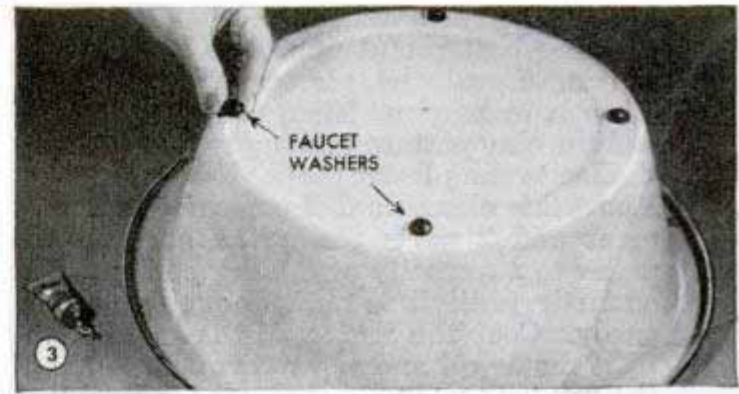



7 A child's plastic bank is a handy container for discarded razor blades. These banks come in a variety of shades so that one may be chosen to match the bathroom color scheme

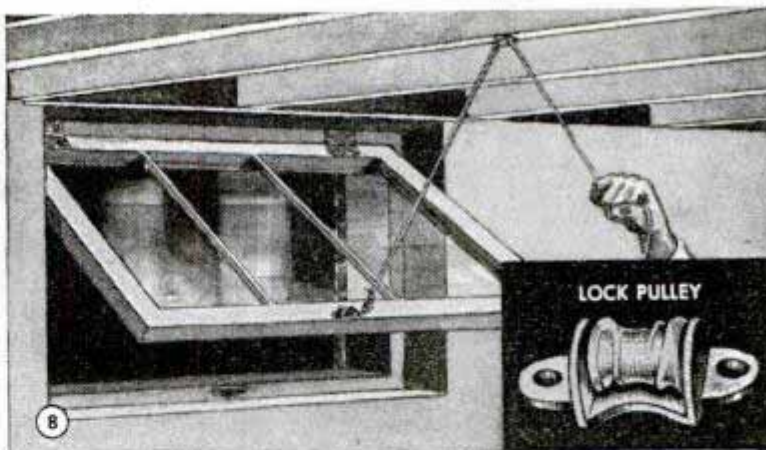

8 An inexpensive lock pulley, such as is made for window shades, can be used to hold basement windows fully or partially open. The pulley is screwed to a joist near the window

9 As a safe container that will prevent scratching your hands, use a large crutch tip to hold a ball of steel wool. Most of the wool can be kept out of the way inside the crutch tip

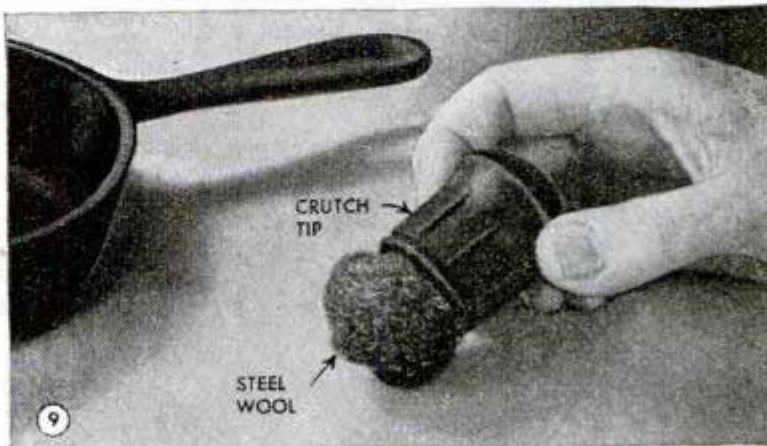

10 To simplify an otherwise difficult task, use a ball of putty to pick up bits of broken glass. If putty might stain the surface under the broken glass use wallpaper cleaner instead

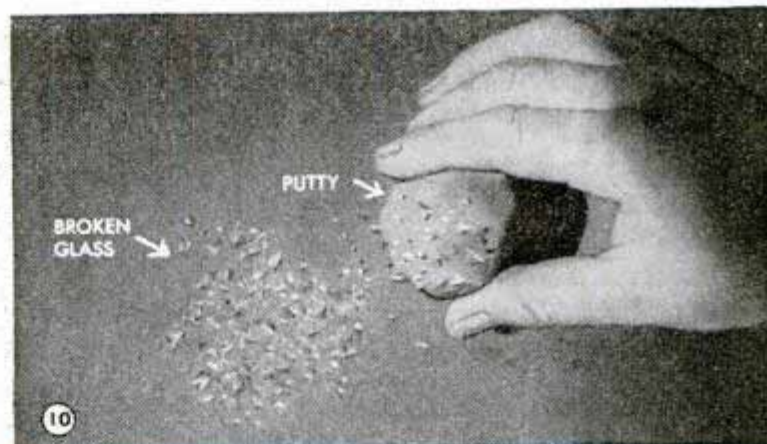

11 When a vacuum cleaner hose leaks so that loss of suction results, slip a discarded bicycle inner tube over the hose to stop the leak. Wire is wrapped around the tube at both ends

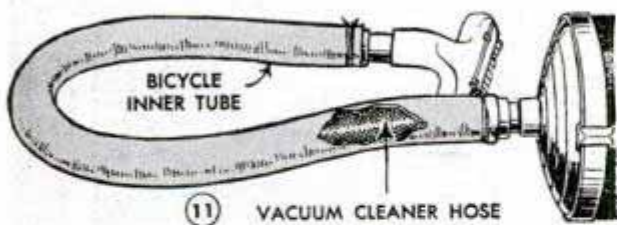

12 Ordinary plaster will not hold the screw hooks that are used in hanging pictures, but if a hole is drilled in the wall and filled with plastic wood, the hooks will stay in the wood

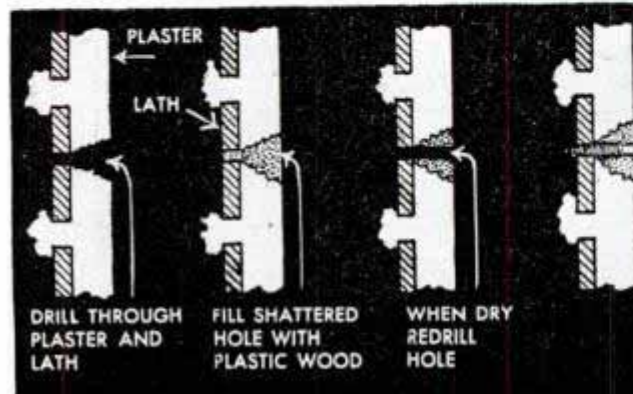

You Can "Bring 'Em Back Alive" In This Fish Tank



If you want to keep your fish alive until ready to start home, use a fish tank like this one. It collapses for easy storage and floats on the water when tied to the boat or pier. The tank consists of a round canvas top and bottom, in the hems of which are inserted screen-door springs to keep the tank shaped. The side walls are of fine-mesh fish netting. A slit at the top fitted with a slide fastener provides an opening for inserting or removing fish. An inflated bicycle inner tube cut down to size and attached to the tank at the top provides the necessary buoyancy to float the tank. When collapsed, the tank can be folded easily and carried in the pocket.

Marking Gauge and Circle Scriber

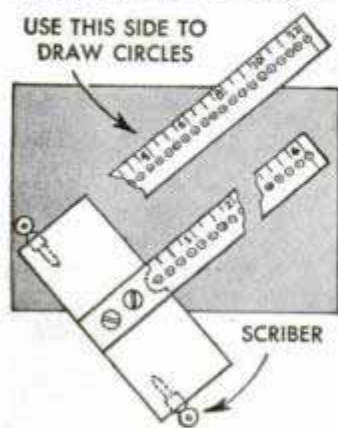

Here's a simple combination scriber and marking gauge that anyone can make in a short time. Square up a suitable block of wood for the head and then screw a wood strip, or arm, to the head at right angles. Lay off a scale in inches on one side

of the arm to be used as a marking gauge, starting with zero at the junction of the block and strip. Since the gauge must be turned over when scribing circles so that

the arm will lie flat, a scale also must be laid off on the other side. Then drill small holes through the strip at the desired intervals to take a scriber point. Scribes can be turned or filed from metal and carried in holes drilled in opposite ends of the head. Charlie Gill, Shawinigan Falls, P. Q., Can.

Paper Can Be Made Transparent By Applying Cleaning Fluid

If you have no tracing paper on hand when you wish to trace a pattern or drawing, you can make ordinary paper transparent by coating it with cleaning fluid. A good way to apply the fluid is to use a stamp moistener of the type having a glass tube with a sponge-rubber applicator. The paper will become opaque again as soon as the fluid evaporates.

Dorothy Burgess, Portland, Ore.

W.T.M. Concrete Iron Pipe Laid in Concrete Floor To Provide Door Threshold

When laying concrete in doorways of garages, a $\frac{3}{4}$ -in. pipe provides a threshold that has no sharp edges or bulkiness to injure auto tires. Leveled properly and anchored to the door frame, the pipe will not bend when concrete is poured over it. It acts as a straightedge and guide for an even finish. The surface of the concrete inside the building should be almost flush with the pipe. On the outside it should be lower, slightly above the longitudinal center of the pipe and sloped downward to provide a watershed. Less than half of the pipe should be exposed to be sure of proper anchoring. The threshold will serve either overhead or hinged doors.

Michael Ligocki, Gary, Ind.



How To Recondition Bamboo Rods

By Robert Page Lincoln

WHEN fighting trout or bass take the fly, or when the deep-sea heavyweights hit the lure, from there on out everything depends on your skill as a fisherman and on the strength and reliability of your tackle.

After several seasons of hard usage a bamboo rod may appear rather shabby and unkempt. Perhaps the tip section has taken a "set" or bend; likely the varnish is chipped or cracked badly, and probably the guides are worn and the windings are beginning to fray at the edges. If allowed to go without repair these defects will affect the efficiency of the rod.

The first thing to do in refinishing a rod is to make detailed notes of the position of the windings and guides as in Fig. 1. Note also the width and color of the windings. Then cut through the thread with a sharp razor blade as in Fig. 2. Usually the old varnish can be removed quite easily by scraping with either a razor blade or a sharp knife as in Fig. 3 but be careful not to round the corners of the hexagon section or to cut any deeper than the varnish coating. Don't use a varnish remover; however, nail-polish remover can be used

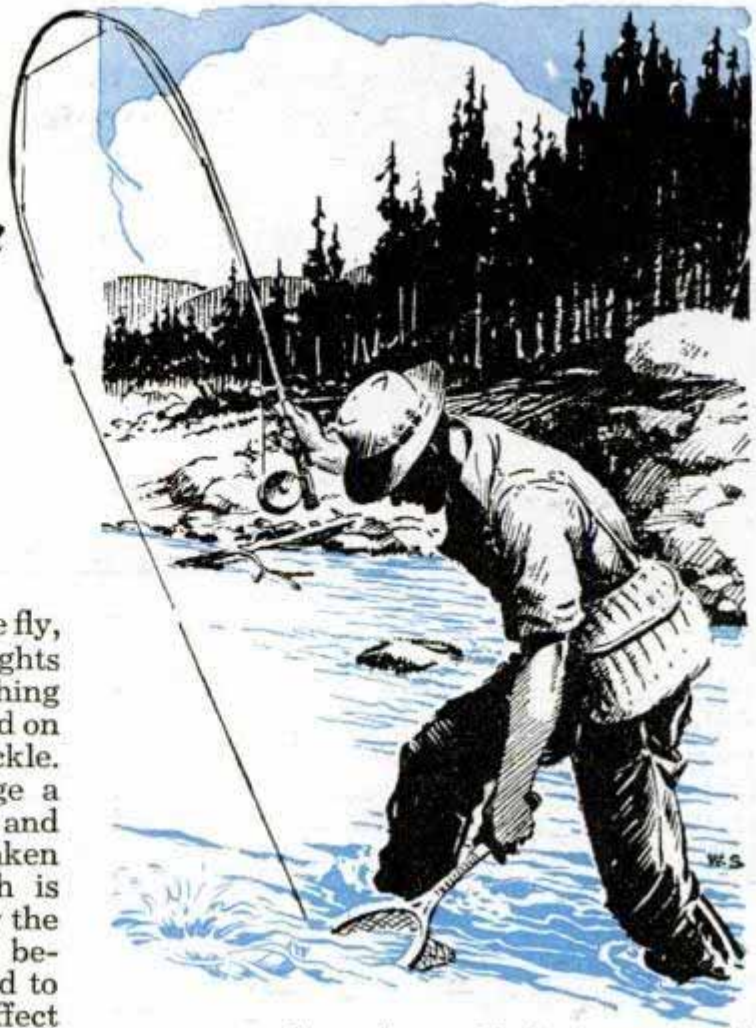

very sparingly to clean off what remains of the varnish, after a thorough, careful scraping. If the ferrules are loose, remove them as in Fig. 6. Then scrape off the old cement, melt new cement, which comes in stick form, and apply in an even coating. Force the ferrule back in place, Fig. 9, and give it a quarter turn to spread the adhesive uniformly. Wipe off all surplus which may be forced out. Sometimes on old rods the bamboo segments will be separated at places along the length, especially near the ferrules. Treat this condition as in Figs. 7 and 8, and be sure to allow plenty of time

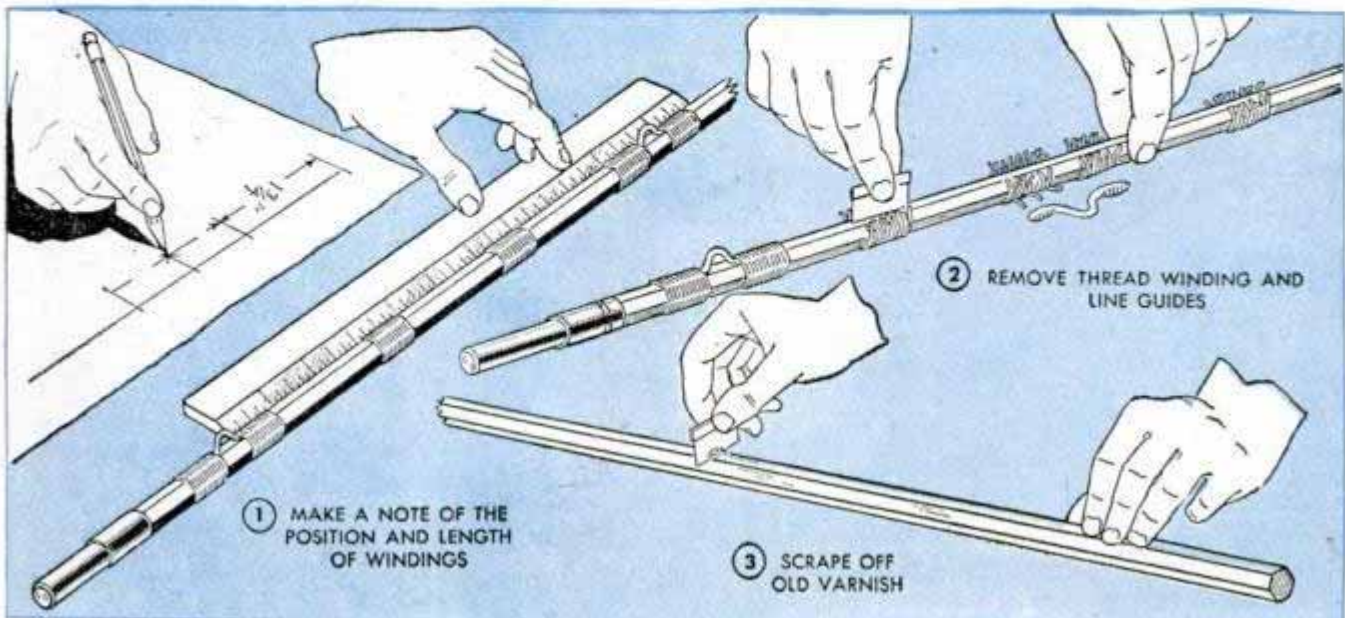

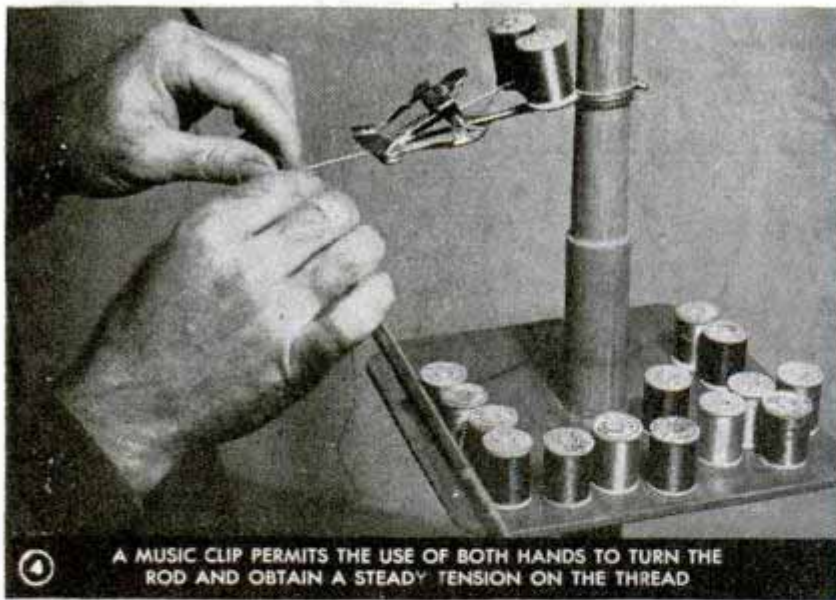

4 A MUSIC CLIP PERMITS THE USE OF BOTH HANDS TO TURN THE ROD AND OBTAIN A STEADY TENSION ON THE THREAD

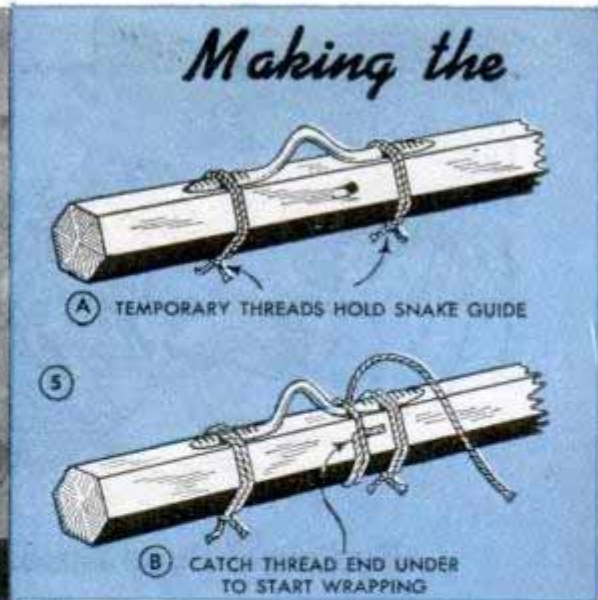

A TEMPORARY THREADS HOLD SNAKE GUIDE

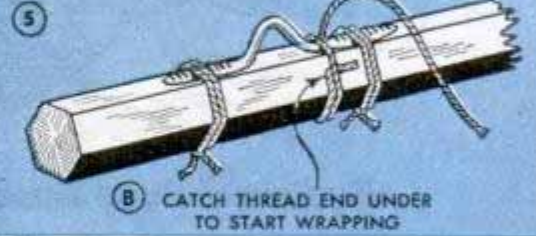

B CATCH THREAD END UNDER TO START WRAPPING

for the glue to dry before unwinding the "clamping" thread. Wipe off surplus glue with a damp cloth before it dries. In this operation, it's important that the segments fit true, otherwise that section of the rod may show up a bend or "kink" which will affect its usefulness.

Now's the time to make sure that the ferrules fit properly. Often old ferrules tend to stick due to accumulated dirt and corrosion of the sliding surfaces. A buffing wheel will polish the parts to a velvety fit, but you have to be careful that the metal is not heated to the point where the cement will be softened. Badly roughened or corroded ferrules will have to be smoothed with very fine emery or "crocus" cloth, Fig. 11, before buffing. It's necessary to be careful that you don't polish away the metal to the point where the parts fit loosely. With the work completed to this stage, check the location of the guides from the reference sketch previously made as in Fig. 1, and mark lightly on the rod the position of each. If there is a set or bend in either or both of the rod tips—most fly rods are provided with two

tips—the bend can be worked out by gently straightening the tip against the original set, using both hands. This takes a bit of patience, but the method is effective. Another way is to hang the tip from the ceiling with a weight attached to the lower end. Guides should be replaced on the underside of the bend. Many rods are fitted with the so-called "snake" guides, and any of these that show undue wear or other damage should be replaced with new parts. This also is particularly true of the reel guide and the tip-top guide. If these are worn or grooved they will damage the line.

Fig. 5, details A to D inclusive, shows how to tie an invisible knot when making the new windings. First give the rod a thinned coat of special rod varnish and allow this to dry thoroughly. You'll note in Fig. 4 an arrangement for maintaining a uniform tension on the thread when making the windings, the thread being pulled through a music clip attached to a standard. Jaws of the clip should be smoothed so that they do not tear the strands of the silk thread. Use the same color and size of thread as the

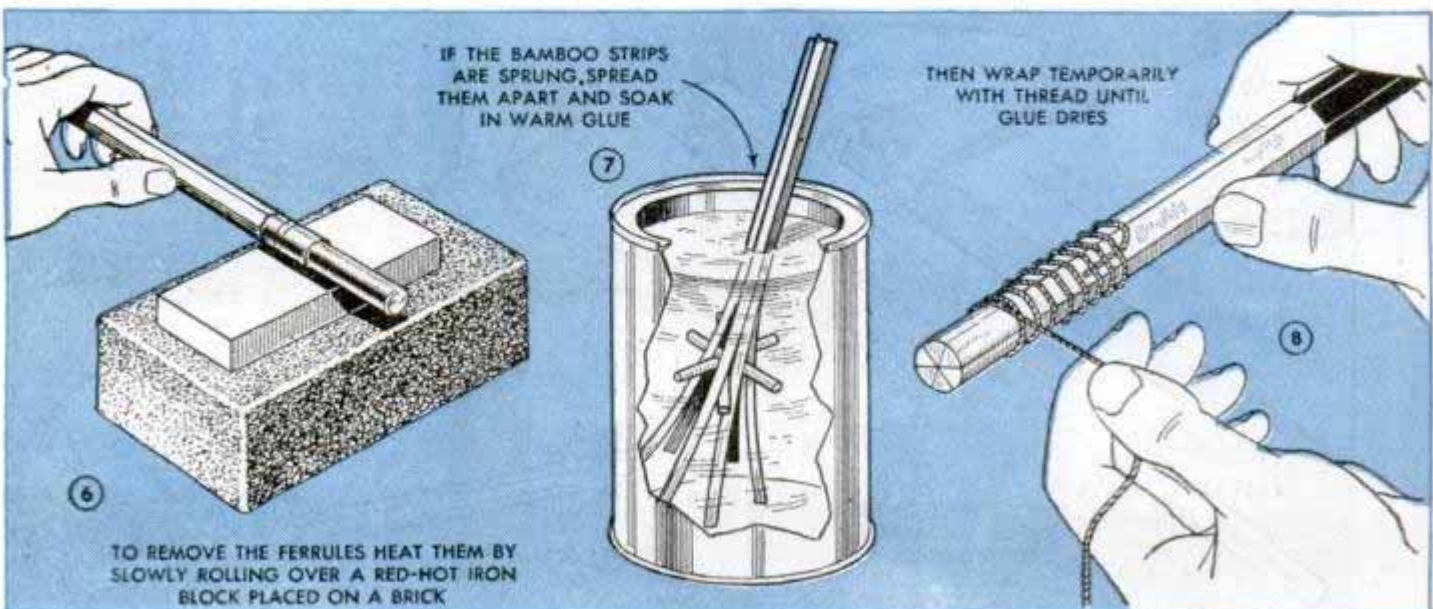

IF THE BAMBOO STRIPS ARE SPRUNG, SPREAD THEM APART AND SOAK IN WARM GLUE

THEN WRAP TEMPORARILY WITH THREAD UNTIL GLUE DRIES

TO REMOVE THE FERRULES HEAT THEM BY SLOWLY ROLLING OVER A RED-HOT IRON BLOCK PLACED ON A BRICK

Invisible Knot

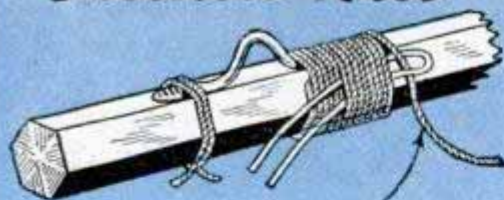

C END OF THREAD INSERTED IN LOOP

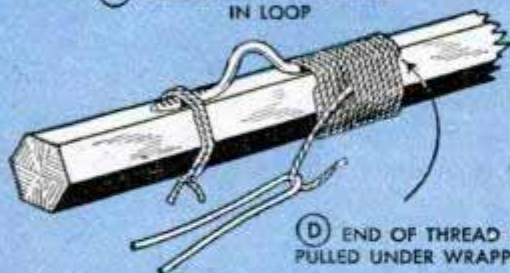

D END OF THREAD PULLED UNDER WRAPPING

original windings. It should be remembered that the windings add "tension" to the rod and that's why it's important to duplicate the position of the originals. Although the number of turns may vary, 25 turns per winding is a good average. Some refinishers space in an extra winding to stiffen an old rod, but usually this is not necessary.

Apply thinned white shellac to the windings and when dry follow with several coats of clear collodion or a special silk-thread color preservative. Use your finger for these applications as a brush picks up too much of the finishing material. Follow with three to five coats of rod varnish applied with a small brush as in Fig. 10. Hang the sections of the rod by fitting a wood plug and screw eye in the ferrules. Allow the varnish to dry several days between coats. Rub down the last coat with fine pumice stone and water and finish with dry rottenstone rubbed with chamois. If you wish to

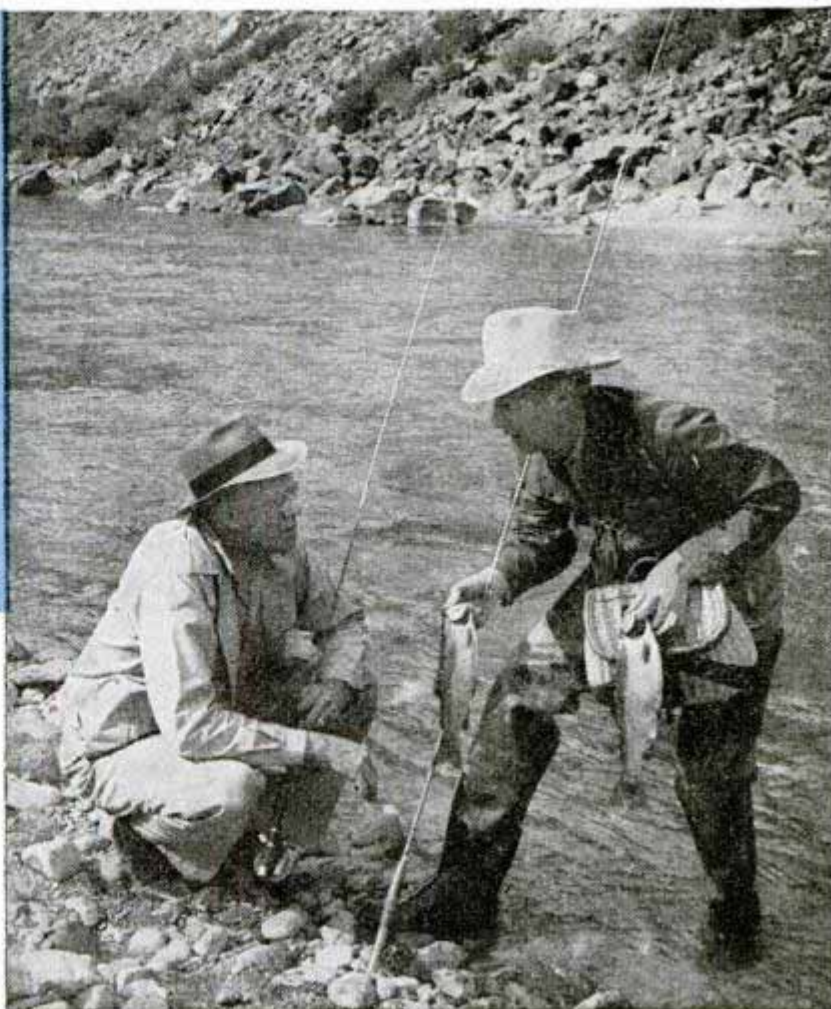

produce an exceptionally fine finish rub down each coat after a thorough drying, using pumice stone only. This leaves the surface slightly rough so that succeeding coats will bond properly. However, the principal purpose of rubbing down each coat is to level the varnish to a film of uniform thickness. After each rubbing clean the rod thoroughly with a damp rag and allow to dry before applying fresh varnish. When not in use the rod should be kept in a case to protect it from breakage, scratches or other damage. A tubular metal case is generally preferable to a cloth one.

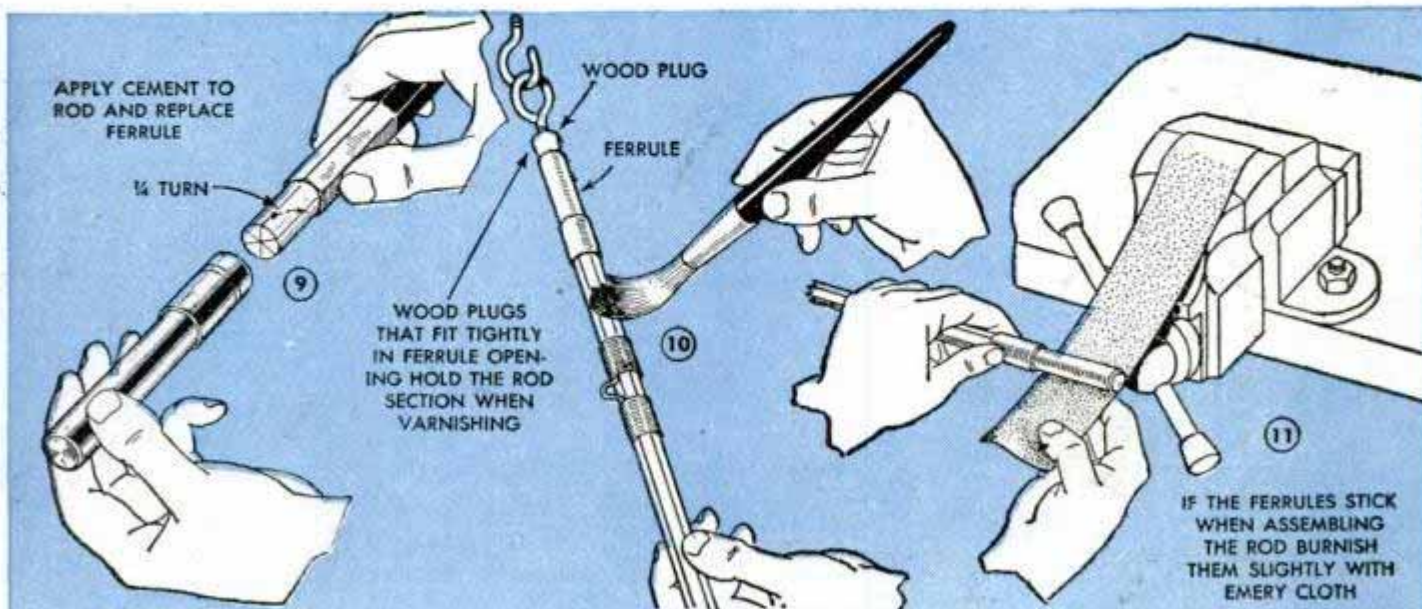

Carrying Case for Small Cameras Utilizes Tobacco Pouch



An ordinary tobacco pouch, lined with soft flannel cloth, may be used as a convenient camera case for smaller cameras. Such a case can be carried in a pocket as it eliminates the bulk typical of stiff leather cases.
H. Leeper, Canton, Ohio

Applicator for Warm Developer

Occasionally a photographer will have a contrasty print in which a particular area is so dense that it comes up too slowly in

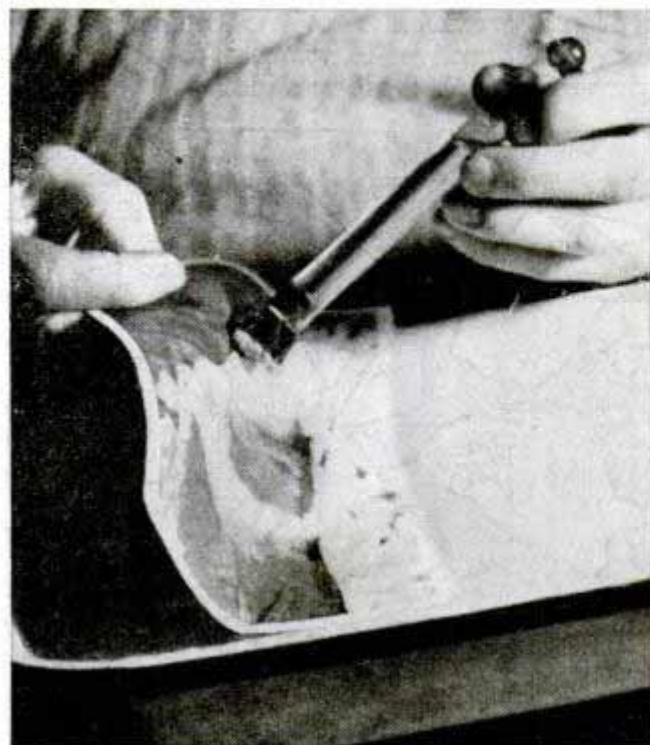

the developer to bring out the wanted detail. If warm developer is applied to the area with an applicator used to moisten stamps and envelopes, a print may be saved that otherwise would be discarded.

Identifying Paper in Darkroom

As a precaution against placing the cover of one box of printing paper on the box of a different grade of paper and thus confusing the grades, mark the grade number of each type of paper on the bottom of the box. A black crayon mark is easily seen in the red or amber light of the darkroom.

Henry P. Cesary, Syracuse, N. Y.

Paper Is Used as Ground Glass To Check Focus

Not all cameras have a ground glass screen to check the bed scale on the camera. However, if the back of the camera is removed and waxed paper is threaded over the film spools, this will serve as a ground glass. To test, open the lens and measure to objects that are the same distance from the

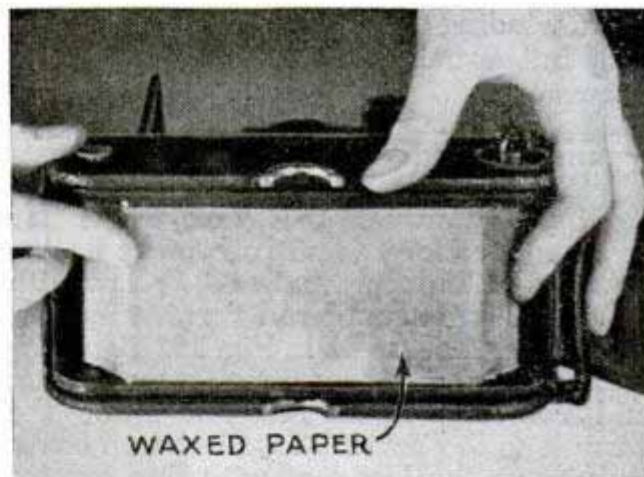

camera as the gradations on the scale. Each measured object should be in sharp focus on the screen when the camera is set for the corresponding distance.

Tape Mends Camera Bellows

A camera bellows with cracks or pinholes can be mended effectively with cloth-mending tape. The bellows is opened fully so the creases are flattened and the tape is applied to the inner surface over the hole to be patched. Then a small block of wood is pressed against the tape and a moderately warm soldering iron is rubbed on the outside of the bellows over the hole. The tape will adhere to the cloth and prevent further leaking of light. To test the bellows after such repair, a lighted flashlight is held inside the camera in a darkened room.

J. Buford Gooch, Key West, Fla.

THE PICTURE MEANS MORE— *when you do your own developing*

By Fred G. Korth

ALTHOUGH you can have your negatives developed by photo finishers, there is a satisfaction that comes from doing your own work, as well as knowledge gained that will enable you to take better pictures. Developing is interesting, the chemicals are inexpensive and the required darkroom space is available in almost every home.

To begin, the room that is used must pass a much more rigid test than a room that is used only for printing and enlarging. Seal all windows and doors with cardboard and tape, blankets or by any other means available. Then spend about 6 min. in the room. If, at the end of that period, you can detect a white ceiling or a white piece of paper near a window, the room is not dark enough for the processing of modern panchromatic film. If any cracks show or if a slight amount of light is allowed to filter into the room, the film will be fogged.

Various tray and tank developments are available, their suitability being determined by the type of negative being processed. However, since roll film, cut film and film pack all can be developed in trays, this procedure will be explained first. Three trays are needed, one for the developer, one for the rinse and one for the fixing solution. This type of tray is shown in Fig. 4. The chemicals to use are those recommended by the film manufacturer. If your camera takes very small negatives that are enlarged to more than four diameters, fine-grain developer in solution is better. Otherwise ordinary powder developer can be used.

When developing roll film, it should be made as flexible as possible before bringing it into contact with chemicals. This is done by removing the paper from the roll, fastening a clip to each end of the film and immersing it in clear water at the same temperature as all of the chemical solutions, 65 to 72 F. After the film has been softened, it is immersed in the developer and moved slowly

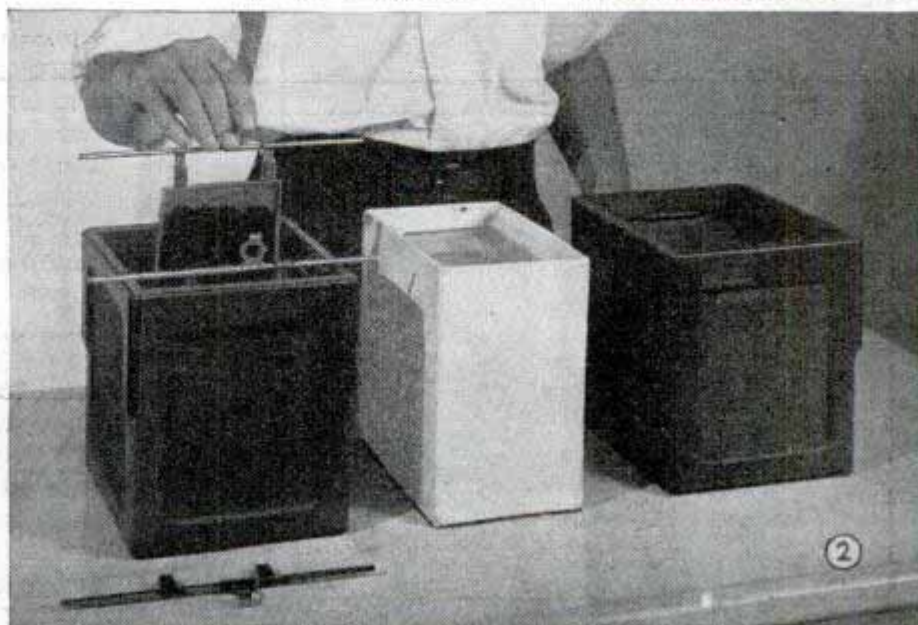

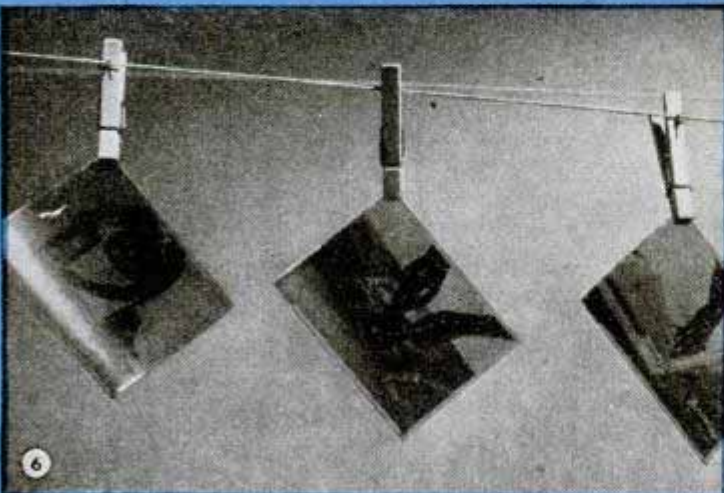
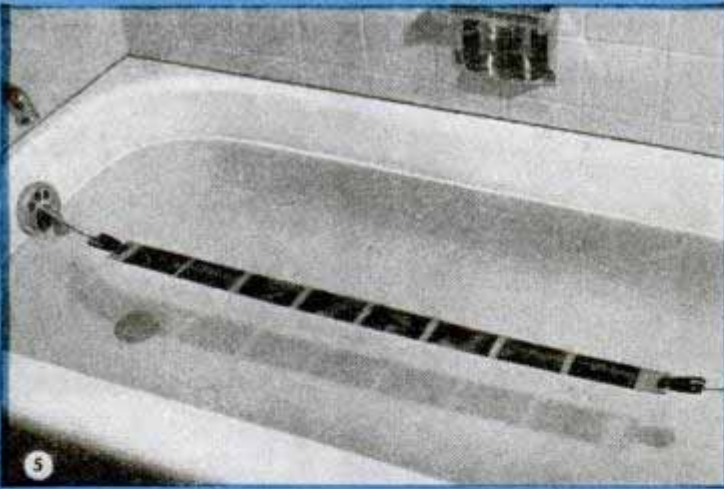
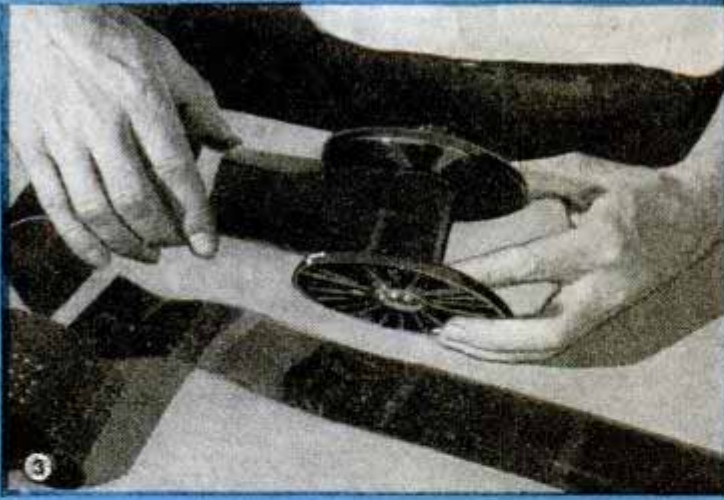

and evenly through the tray with a see-saw motion, Fig. 4. Keep the emulsion side up. Usually the makers of film and developer give the length of developing time, which should be followed closely, but if a wide range of time is given, for example 3 to 5 min., it may be better to stay on the short side, say 3½ min. Note that fine-grain developers may require up to 20 min. or more. For every 3 degrees above the recommended developing temperature, the time should be decreased 10 to 15 per cent, but do not allow the temperature to rise above 75 F. In all cases the specific instructions of the manufacturer should be followed. A darkroom or kitchen timer with a nonluminous dial can be used for accurate work.

When the time of development is over, the film is taken to the center tray, which contains water, and rinsed for about a minute. It then is moved to the fixing bath, or acid hypo, where it remains for about 15 min. After 4 min. it should be fixed sufficiently for inspection with light. An alternate method of developing roll film is to use the type of tank illustrated in Fig. 3. First practice loading the film in daylight, using film that has been processed. Learn to handle the film so it does not buckle and be sure not to touch the emulsion.

After the fixing is complete, suspend the film in running water, Fig. 5, for about 30 to 40 min. A bathtub is ideal for this purpose. When the washing is done, hang the film on a string with a clip and use an almost dry sponge or chamois to remove most of the moisture from the film, Fig. 1. Care must be exercised because the emulsion is very soft and will scratch easily. Leave the film hanging to dry in a dust-free room with fair ventilation.

Cut film and film pack are developed best in tanks similar to those shown in Fig. 2. The same timing and temperature rules that apply to roll film apply equally well to these types of films. Likewise, when developing the film, it is necessary that the negative be moved in the solution. Cut film is held in a hanger and may remain there until ready for drying. Both types are held in wooden clips for drying as shown in Fig. 6.

Print Developer Kept at Proper Temperature

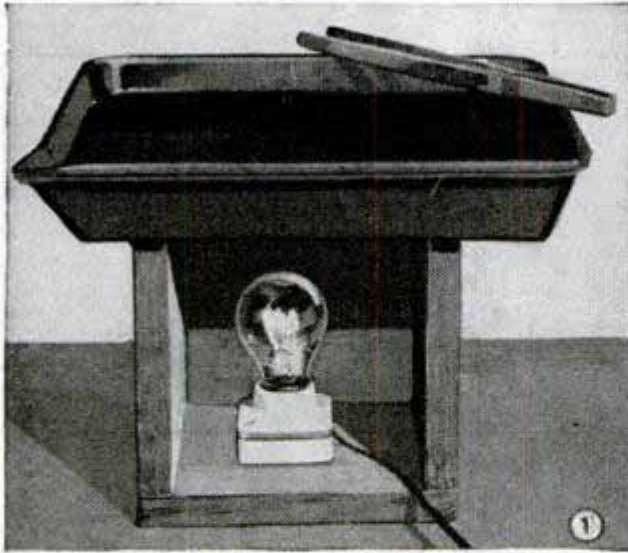

Some means of correcting and holding the proper temperature for print developers is needed in most home darkrooms. Where hot and cold water are not available, an ordinary lamp mounted in a three-sided box as in Fig. 1 can be used to regulate the temperature. Probably some experimenting will be necessary to determine the proper size of lamp to use. In some cases it may be desirable to enclose the open front of the box with a hinged door. With hot and cold water at hand one method that usually is satisfactory is placing the developer tray inside a larger tray. Cold or warm water then is added to the outside tray as needed. Where necessary, ice cubes can be used for cooling as in Fig. 2.

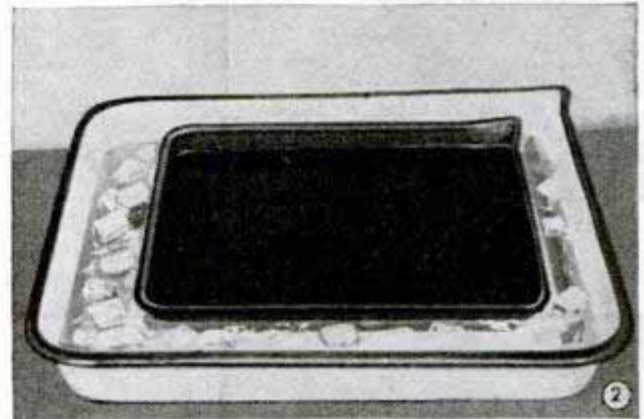

Electric Fan Mounted on Spotlight Housing Cools Lamp

Heat generated by a spotlight or a floodlight can be dissipated if a small fan is installed in the light housing to force cooling air over the bulb and thus increase the efficiency and safety of the lamp. The fan and motor from a car heater, with a few alterations, will adapt itself to this job if the proper power is available. A better solution, however, would be to use a motor that

will run on standard current and fit it with a fan. The motor should be mounted on extension brackets so that it will not block the free flow of air into the housing by being too close to the vent holes. Small strips of flat iron can be bent and drilled to form brackets which attach to the motor and the light housing with self-tapping sheet-metal screws. It may be necessary also to add an extension to the shaft since the standard for motors of this size is fairly short. As a safety precaution, to be sure that the fan is running when the light is on, wire the motor in parallel with the light switch. This cannot be done, of course, if there is a separate source of power for the fan. — Lyn Grover, Los Angeles, Calif.

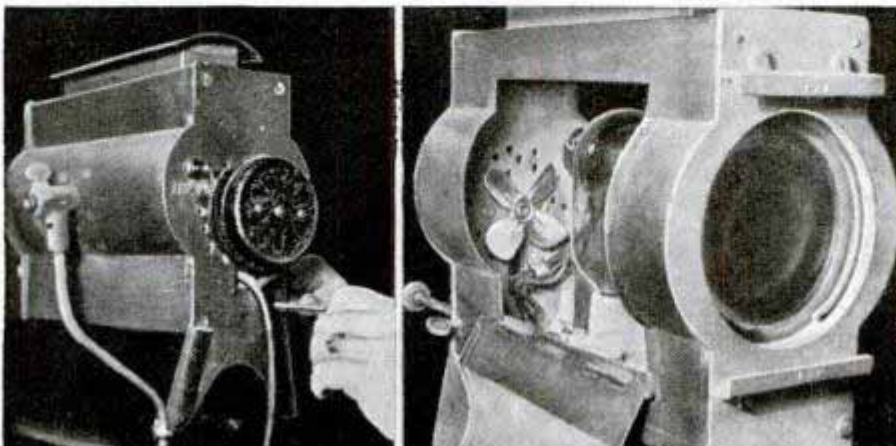

CRAFT QUIZ



1. Work on this galvanvanized iron box is—
 (a) Hard soldering (c) Brazing
 (b) Soft soldering (d) Silver soldering

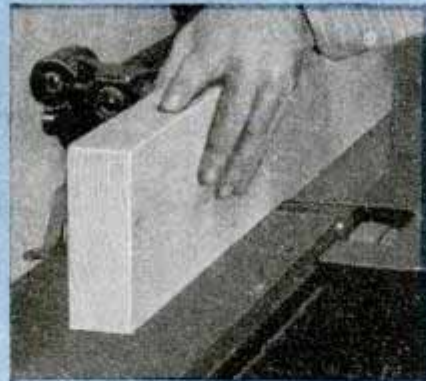

2. Before jointing you should look at—
 (a) Face grain (c) Rear table
 (b) End grain (d) Motor



3. This molding is—
 (a) Ogee (c) Ovolo
 (b) Scotia (d) Beaded



4. The tool being ground is a—
 (a) Parting tool (c) Skew chisel
 (b) Gouge (d) Beading tool

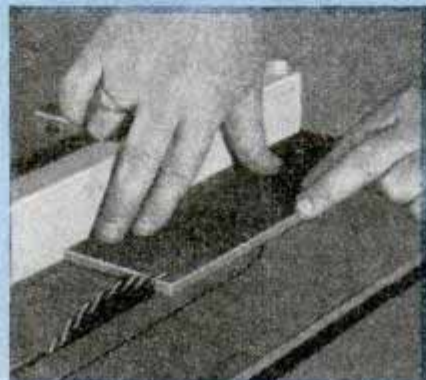

5. For sake of safety he should use a—
 (a) Pinchbar (c) Compass
 (b) Push stick (d) Dado saw

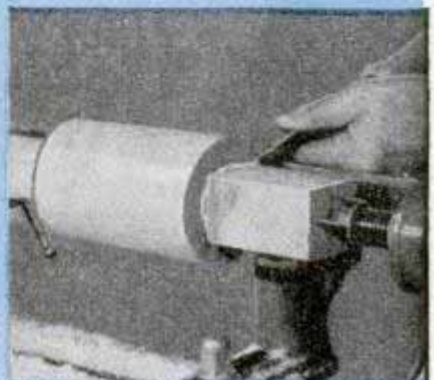

6. You can tell he knows about—
 (a) Fluting (c) Post blocking
 (b) Skiving (d) Taper turning



7. This model maker is working with—
 (a) Lag screws (c) Bolt clippers
 (b) Corving tools (d) Escutcheons



8. Circular saw is being used for—
 (a) Cove cutting (c) Molding
 (b) Ovaling (d) Hollowing

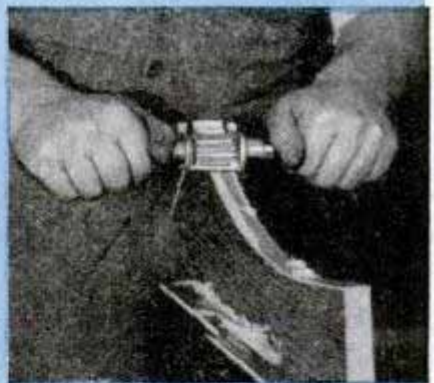

9. Work is being done with a—
 (a) Draw knife (c) Spoke shave
 (b) Veneer scraper (d) Router

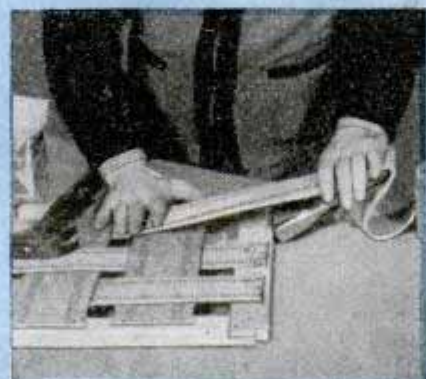

10. He is using a—
 (a) Crab stretcher (c) Tack claw
 (b) Seam presser (d) Webbing stretcher



11. Operator is cutting a—
 (a) Bead (c) Dado
 (b) Dentil (d) Davetail

ANSWERS: 1-b; 2-a
 (to join with the grain);
 3-a; 4-c; 5-b; 6-c
 (pieces are glued
 around center post,
 hence, post blocking);
 7-b; 8-a; 9-c; 10-d;
 11-c

TRACTOR SCRAPER

made in farm shop



YOU can make this tractor scraper easily in your farm shop at low cost for materials. It's especially designed for moving loose soil, leveling large areas before planting, light grading, preparing fields for irrigation—any leveling or filling job where loose dirt, gravel or sand must be moved or leveled quickly at a minimum cost in labor and time. Although shown arranged for two-man operation it can be handled by one man on occasional jobs by fitting a foot-lift mechanism as suggested in Fig. 1, which shows a lift linkage designed for hand or foot operation. With minor changes this linkage can be fitted to most tractors of cultivating height and having side-mounting frames.

Fig. 1 also shows the assembly of the scraper body, which consists of a steel scraper blade and two hardwood boards held in place

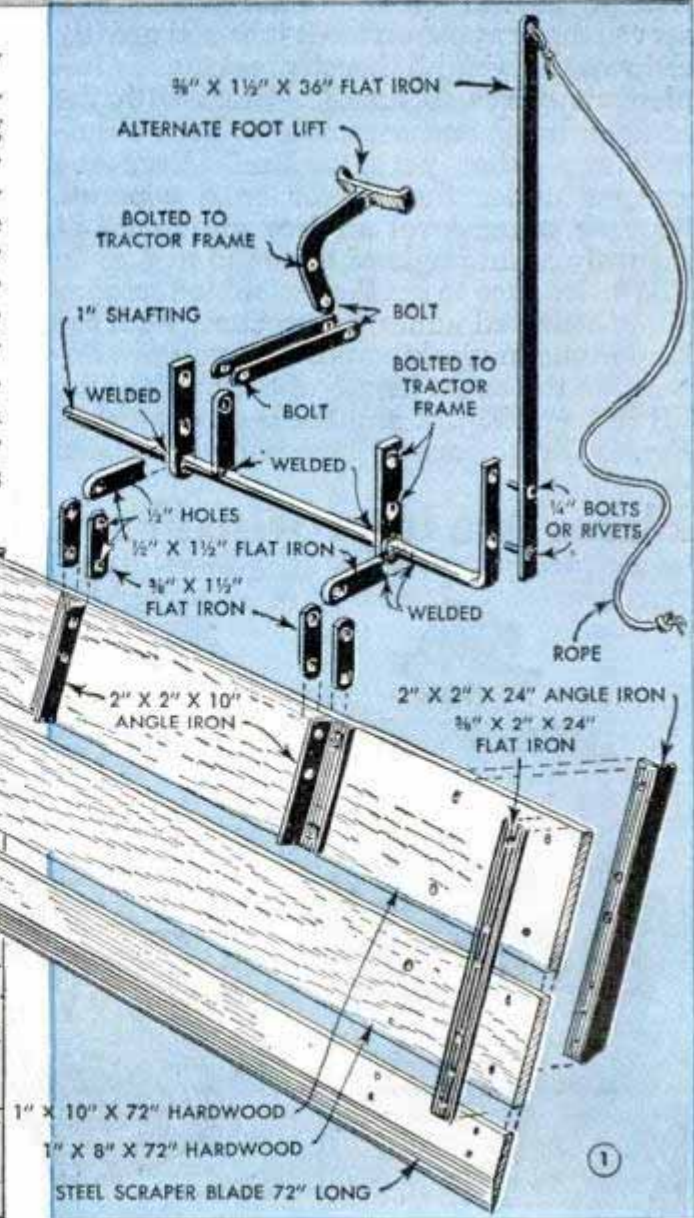
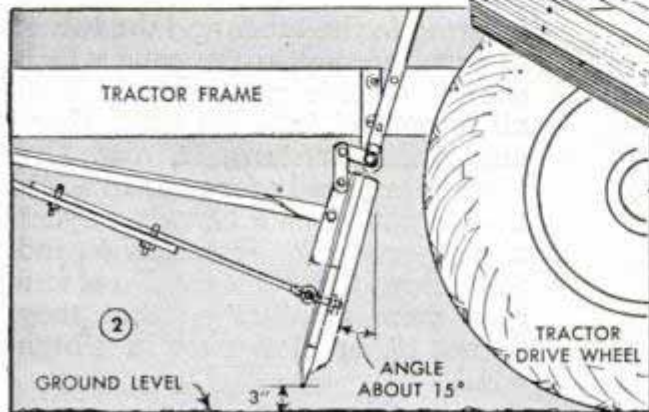

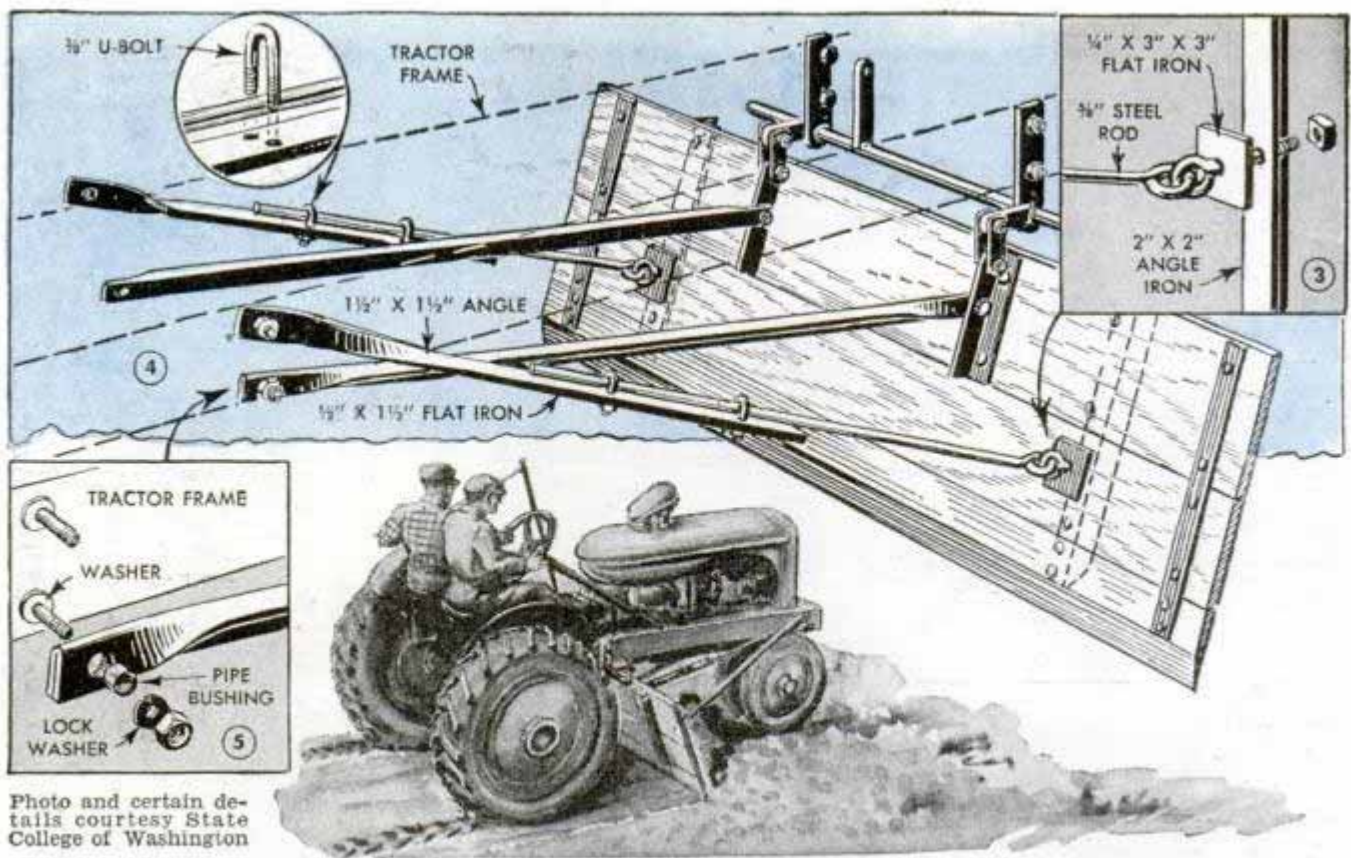

Photo and certain details courtesy State College of Washington

with angle-iron "cleats." This construction serves the purpose on most jobs and greatly reduces the weight, thereby making the implement easier to handle. Start with the scraper body and assemble it before cutting any other parts to size. Place the scraper under the tractor on a concrete floor or other level surface and block it securely at an angle of about 15 deg. as in Fig. 2. Be sure to get the assembled scraper blade centered under the tractor. With the blade thus in working position you can determine the exact length of the parts of the lift linkage, Fig. 1, and the dual drawbars, Fig. 4. Dimensions of these parts have been

purposely omitted as these measurements must be taken direct from the tractor on which the scraper is to be mounted. Ordinarily the lift linkage should be so assembled as to give a lift of about 3 in. above the ground when the tractor is on the level, Fig. 2. Of course, a higher lift can be arranged if desired. On some tractors it may be necessary to make the scraper body of a lesser height than indicated in order to allow room for the higher lift. Figs. 3 and 5 show how the drawbars are attached to the scraper and the tractor frame. Use lock washers under all nuts so that parts do not jar loose.

Flares Are Improvised From Cans and Thin-Wall Tubing



One contractor, suddenly having need for a large number of road flares, found that he could improvise them from cans and thin-wall tubing. Half-gallon syrup or lard pails are used. The tubing is cut so that it is 1 in. longer than the height of the can. Then wicks are inserted in the tubes and the tubes, in turn, are set in the cans which are filled with coarse sand. Fuel oil is poured into the sand, thoroughly saturating it, and the torches are ready for use. In addition to acting as a carrying agent and reservoir for the oil, the sand also serves to weight the flares and give them stability so that they do not tip or blow over in a high wind.

Switch on Electrode Holder Decreases Line Load

In almost any welding shop and especially on construction jobs there are intervals when the welding machine continues to run without actual welding being done. At such times the load on the primary line to the machine can be lessened considerably by breaking the excitation current to the shunt fields of the generator by means of a button or other pressure-type switch on the electrode-holder handle as shown in the detail. The saving on a 300-ampere welding machine amounts to approximately 6 amperes at 220 volts. Moreover, this arrangement renders both the holder and rod "dead" when not in the hands of the operator, thus preventing any accidental "short" which might be produced between the rod and the work or ground. On any of the self or externally excited motor-generator sets the switch may be attached by disconnecting the rheostat from one terminal and connecting a wire from the rheostat to the switch on the electrode holder. Then connect another wire of equal length to the other terminal of the switch and lead this back to the rheostat terminal as shown in the detail. Any ordinary rubber-covered wire of No. 14 ga. will do since the amperage carried in this circuit is relatively low.

The wires are taped to the welding line at intervals as shown. Any type of toggle or push button switch may be used as long as



it has a carrying capacity of 6 amperes at 120 volts.

Wm. R. Lewis, San Francisco, Calif.

Drafting Board Has False Edge to Handle Long Tracings

By attaching an extension edge to a drawing board with blocks at the corners, tracings of any length may be fastened to the board and not interfere with the use of the T-square which rests against the false edge. The corner of the edge of the board should be rounded so the tracing paper will slide over it easily and the false edge should be planed perfectly straight. A 2-in. piece of hardwood is most satisfactory for this purpose.

Removable Poultry-House Roosts

Poultry roosts can be removed for cleaning and put up again quickly if they are fitted with storm-sash hangers. The hanger hook is screwed to the poultry-house wall and the eye is attached to the roost to hold it.—Charles Swope, Danville, Pa.

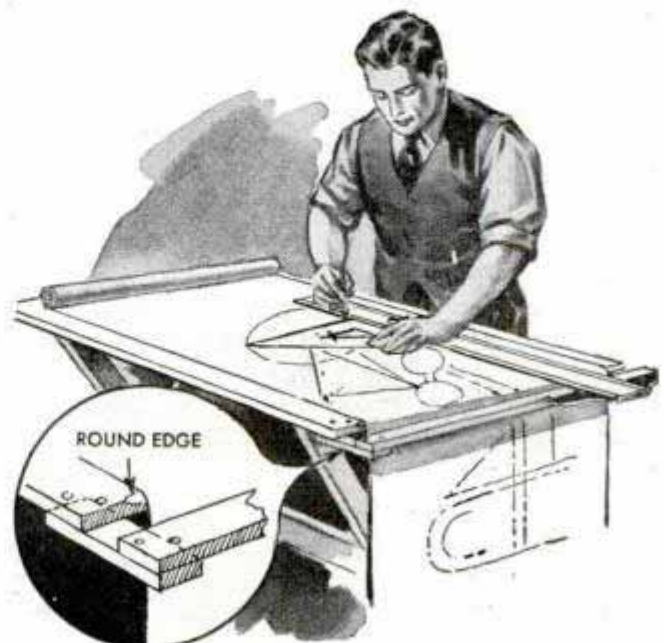

Walk Is Built of Concrete Blocks Without Preliminary Fill



Here is a walk of concrete blocks that is laid quickly with a minimum of effort. The blocks are placed as indicated and a board is driven into every other hole for a tight fit. The wood used should be creosoted or treated with some similar preservative. Because of the cracks separating the blocks, water will drain from the surface and the walk can be laid either on leveled ground or in a trench.

Shop Drawers to Hold Small Parts Made From Baking Pans

Waste space beneath a shelf can be put to use by installing drawers made from small baking pans. Cut and rabbet wood strips so that, when they are fastened to the underside of a shelf, they form grooves in which the projecting edges of the pans slide. Make all these pieces the same length



and nail another strip across the ends to act as a stop for the pans. No handles or knobs are needed on the pans since they are easily grasped with the fingers. One way of labeling the drawers is to slip a lettered card under the end folds of the metal. Another is to solder or otherwise fasten to the end of each drawer a sample of the contents which are contained in the drawer.

Walter E. Burton, Akron, Ohio

Lip on Scoop Prevents Splintering

In order to avoid digging splinters of wood from a granary floor, fit the leading edge of the grain scoop with a section cut from a flat curtain rod. Cut it lengthwise into halves and shorten it to the width of the scoop. After fitting the rod in place, lay the scoop on a solid metal surface and peen the lip to a tight fit with a hammer.

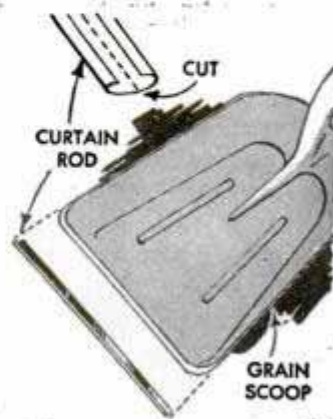

Postal Card Holder Aids Typist

To keep postal cards straight in a typewriter and to utilize the full space on the card, as cannot be done ordinarily, one typist slit a larger sheet of light cardboard with 45-deg. corner cuts. The postal card is inserted in this holder, which in turn is fed into the typewriter like a regular sheet of paper.

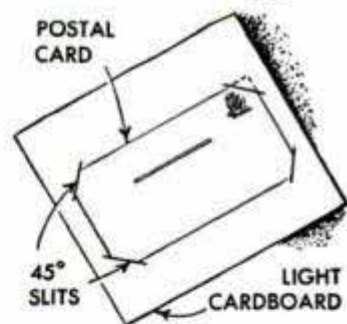

James D. Callahan, Lincoln, Nebr.

Brush Is Soaked in Tilted Jar

To minimize the amount of turpentine needed to soak a paintbrush, support a glass jar on a block of wood, as shown, and lay the brush inside the jar. Only enough turpentine to cover the bristles is necessary. This method will save one half to one third the quantity of turpentine required as compared with an upright jar. —D. J. Bachner, Jackson Heights, N. Y.

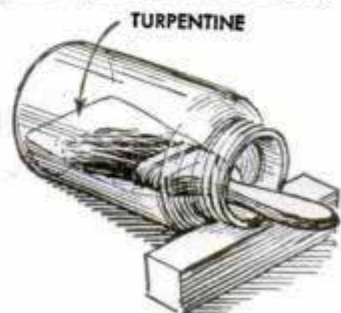

Bookbinder's Paper Trimmer Used Like a Hand Plane

Here's a solution to the inexperienced bookbinder's greatest problem, that of neatly trimming the book after stitching. This trimmer consists of two principal parts, one a clamp for holding the work as in Figs. 1 and 2 and the other a "plane," Fig. 3, fitted with a special shearing blade so mounted that it can be swung on a radius for making successive cuts. One jaw of the clamp, Fig. 2, bolts to the edge of a table or bench top and the movable jaw slides on hardwood guide pins. Clamping pressure is supplied by C-clamps, one at each end of the jaws. The plane should be made of hardwood for durability. The shearing blade, Fig. 3, can be shaped from an old plane iron or any flat steel which will hold a sharp edge. The blade is attached to the pivoted arm by a bolt fitted with a spring tension adjustment as shown. A second bolt passing through flat-iron arms attached to the rear of the plane body provides adjustment for depth of cut. When the setup is made as in Fig. 1, the stitched book is clamped in place with the amount to be trimmed projecting above the top of the clamp jaws. The blade trims flush so it is necessary to be quite particular in making this setting. The plane bears against a guide strip attached to the fixed jaw and the cutter is adjusted to shear 4 to 6 thicknesses of paper at each stroke. A greater depth of cut might cause tearing. Of course, the cutter must be reground and rehed to a razor edge frequently to produce a neat, smooth job.

William A. Lawrence, Chattanooga, Tenn.

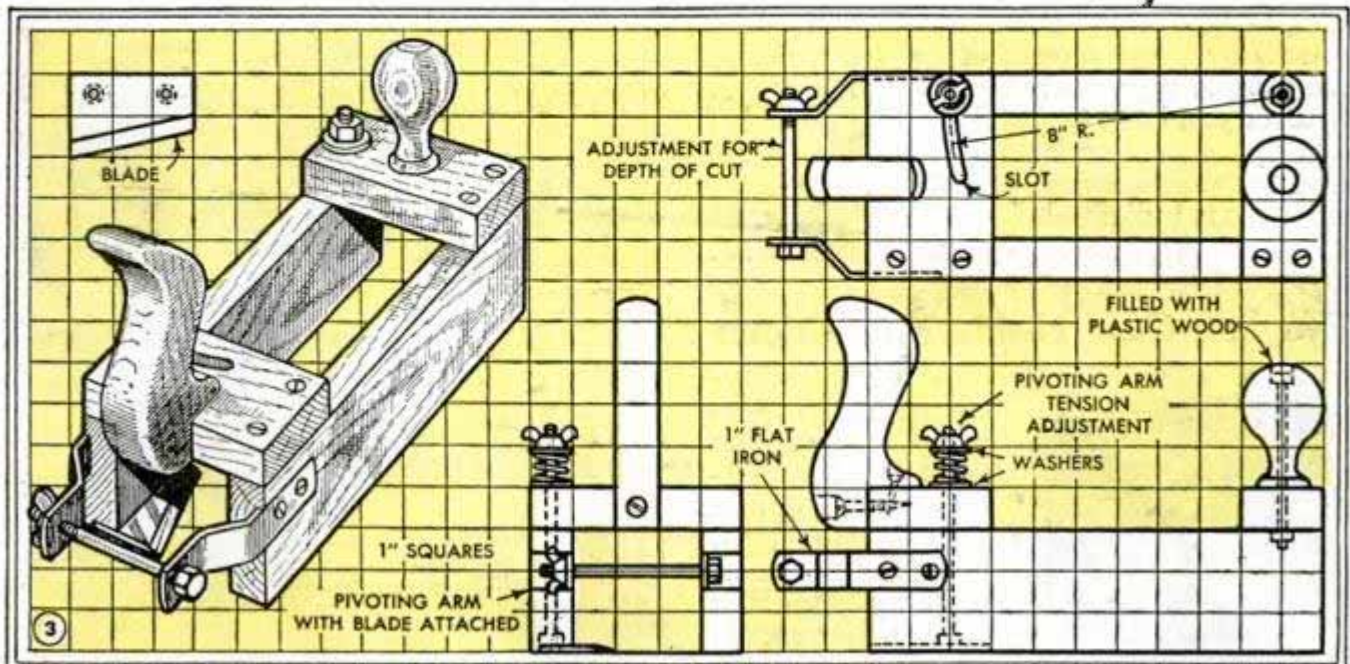
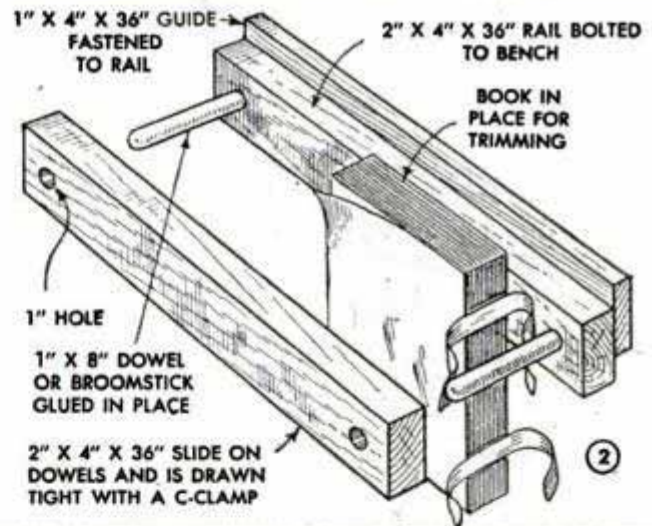
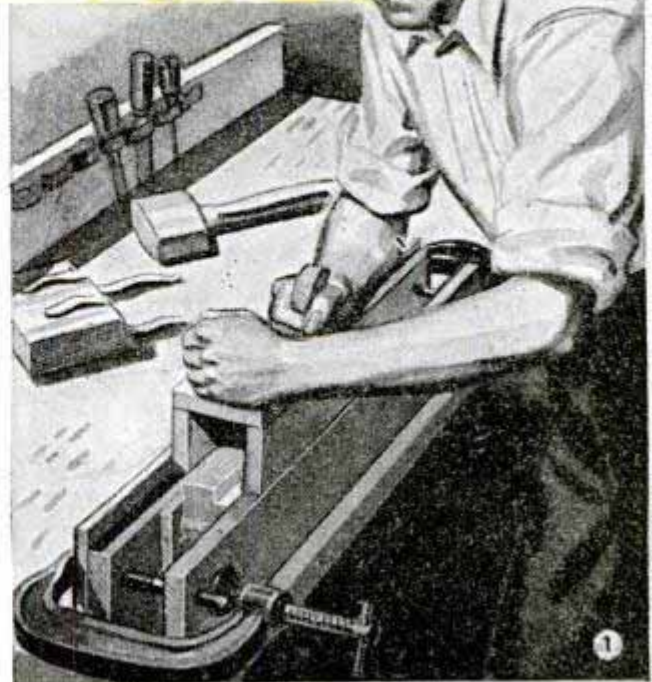

Rep. 22B#12

Build Your Own RELAYS

PART 2-A.C. RELAYS

By C. A. Crowley

RELAYS made according to instructions given in Part I will not operate satisfactorily on alternating current. However, with minor changes in design, they can be made to operate on a.c. if they are connected in series with a dry-disk rectifier, as shown in Fig. 16. In such cases, the relay must not be operated at a.c. voltages higher than the rating of the rectifier used. Since that is usually less than the line voltage, the relay must be operated with low voltage from a transformer. The type of connection shown in Fig. 16, having a full-wave bridge type of rectifier, should be used. To design a relay to operate on rectified a.c., it is necessary to calculate the pull and ampere turns as for a d.c. magnet. Then divide the ampere turns by the a.c. voltage and multiply by 1.35 to get the design factor. This design factor can be used in the same way as for a d.c. relay to determine the wire size from the chart, Fig. 21. The coil then can be wound as described in Part I.

If the relay is to be operated continuously, frequently, or on a voltage of more than 25, it is best to use a coil wound on a laminated core. A

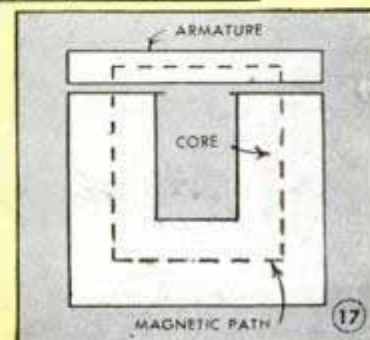
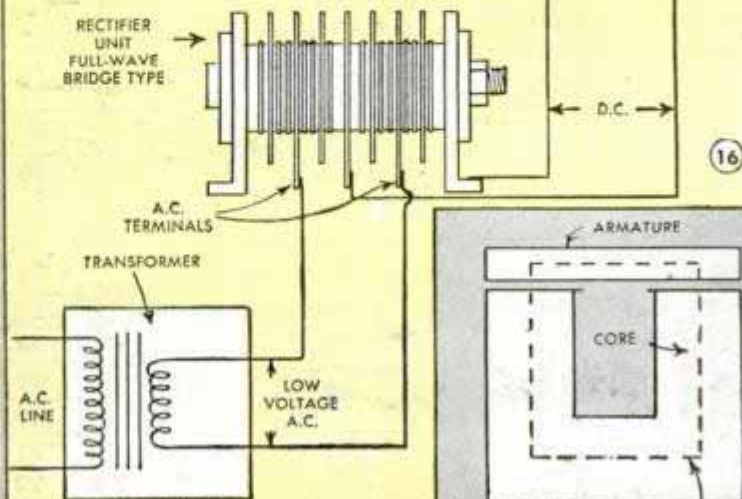
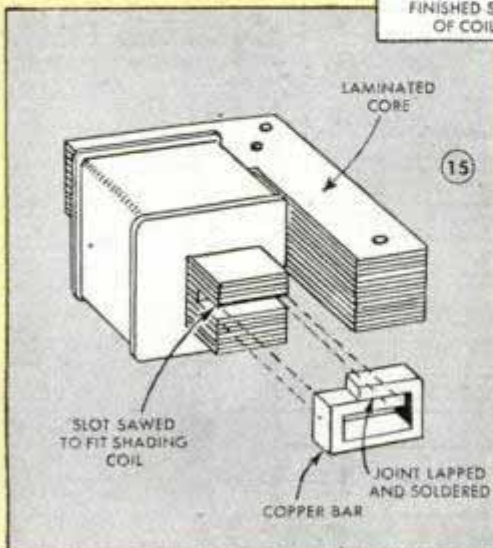
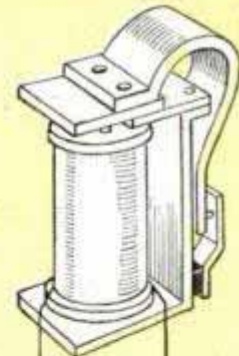
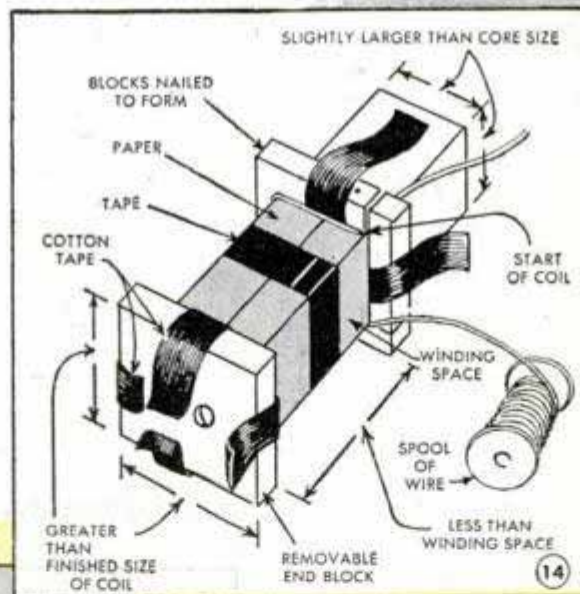
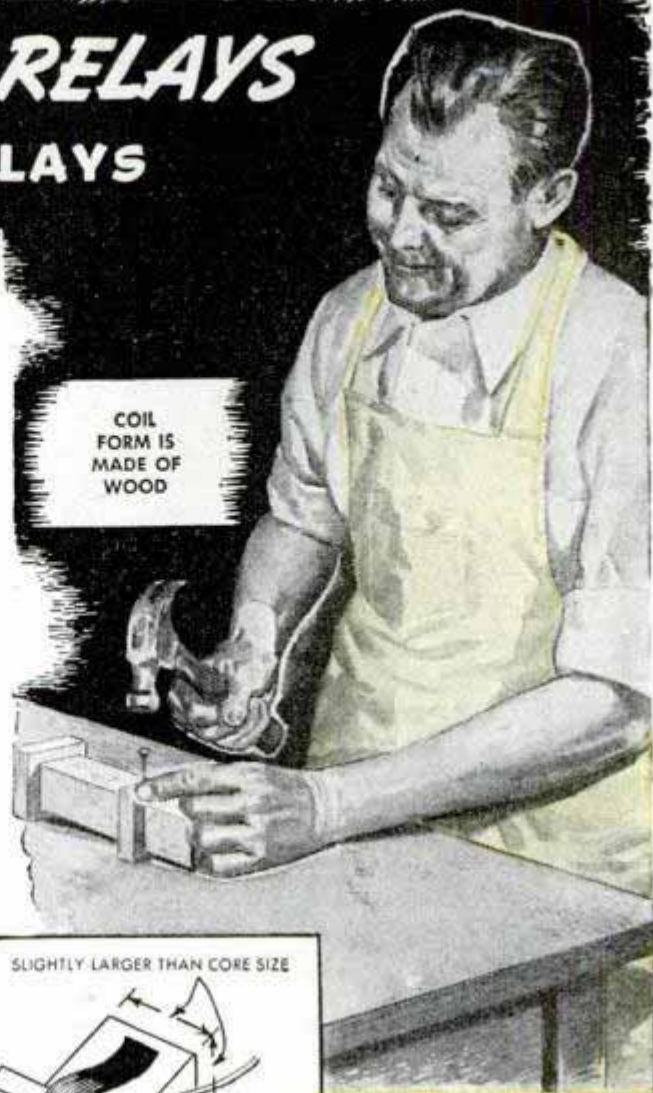



WINDING THE COIL

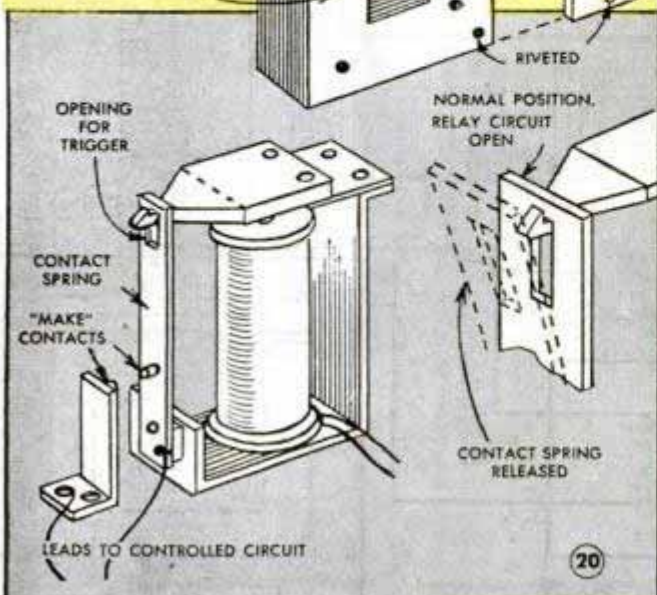
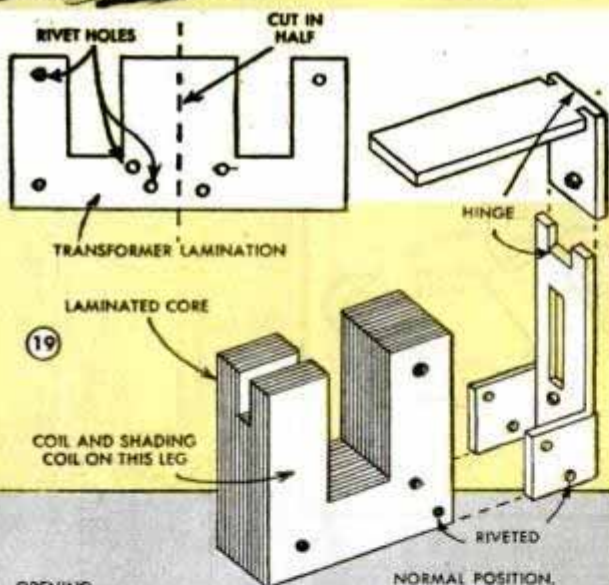

laminated core taken from an old radio transformer will be suitable but will require some alteration. The laminations can be sawed in half as in Fig. 19 to make a U-shaped core. The number of turns required to wind the coil for 60-cycle current can be found by multiplying the voltage by 4.7 and dividing by the winding-core area. For example, if the core is $\frac{1}{2}$ in. thick and $\frac{1}{2}$ in. wide, the core area is 0.25 sq. in., and to operate the relay on 110 volts a.c. will require 110 multiplied by 4.7 divided by 0.25 or 2070 turns.

On 25-cycle current, the number of turns is equal to 11.3 times the voltage, divided by the winding-core area. The wire size can be calculated by measuring the magnetic path, indicated in Fig. 17, dividing by the number of turns and multiplying by 50,000. This gives the required wire size in circular mils. Assuming that the magnetic path measures 4.25 in., the wire size required is 4.25 divided by 2070 multiplied by 50,000, or 103 circular mils. The corresponding gauge number can be found by referring to the chart, Fig. 21. Here you can see that the closest size to 103 circular mils is No. 30 wire, which has a cross-sectional area of 101 circular mils. Using this wire size, which is only a little smaller than the calculated size, will slightly reduce the pull of the relay and also will reduce its operating temperature. Since a slight reduction in pull will be satisfactory in this case, the relay can be wound with No. 30 wire. If the next larger size of wire above the calculated value is used, the pull of the relay will be increased, which is not necessary, and the relay also will heat more, which is undesirable.

The coil can be wound directly on the core if desired, using essentially the same method as for a d.c. relay coil. However, due to the shape of the laminated core, it will be necessary to wind the coil on the

(21) WIRE SIZE AND GAUGE NUMBERS

B & S Gauge	Area (Circular Mils)	B & S Gauge	Area (Circular Mils)
10	10380.	24	404.
11	8234.	25	320.
12	6530.	26	254.
13	5178.	27	202.
14	4107.	28	160.
15	3257.	29	127.
16	2583.	30	101.
17	2048.	31	80.
18	1624.	32	63.
19	1288.	33	50.
20	1022.	34	40.
21	810.	35	32.
22	642.	36	25.
23	510.		

bottom of the "U." Another method is to wind the coil on a form and then slip it onto one of the arms of the core. In this case, the form should be constructed as shown in Fig. 14, about $\frac{1}{16}$ in. larger each way than the core on which the coil will be fitted, and with the winding space between the end blocks slightly shorter than the space for the coil on the relay core. The form should be long enough to be held in the hand, Fig. 22, or in a lathe, Fig. 18, while winding. Small blocks are nailed to the form at the proper place, leaving a slight space between two of the blocks for the start end of the coil. The end block is attached with screws for easy removal, and the form is tapered slightly toward that end so that the finished coil can be slipped off the form without binding. Four pieces of plain cotton tape then are placed lengthwise in the winding space, and a strip of brown paper is wrapped two or three times around the form, Fig. 14. It is held in place by a band of friction tape. The coil is wound to the required number of turns in tight, even layers. After each layer of windings is finished, a layer of brown paper should be wrapped around the coil as additional insulation, Fig. 27. If space is lacking, use a layer of brown paper over every second or third layer of wire. When the required number of turns has been wound, the ends of the cotton tape are brought together over the coil and tied tightly. After removing the end block from the form, the coil can be slipped off and placed in correct position on the core.

The shading coil, shown in Figs. 15 and 24, is very important, as without this an a.c. relay will hum. The shading coil can be installed by sawing a slot in one of the poles of the magnet, Fig. 30, and inserting a flat copper bar. This is looped around the laminations, Fig. 25, and the ends of the bar are lapped and soldered together. Un-

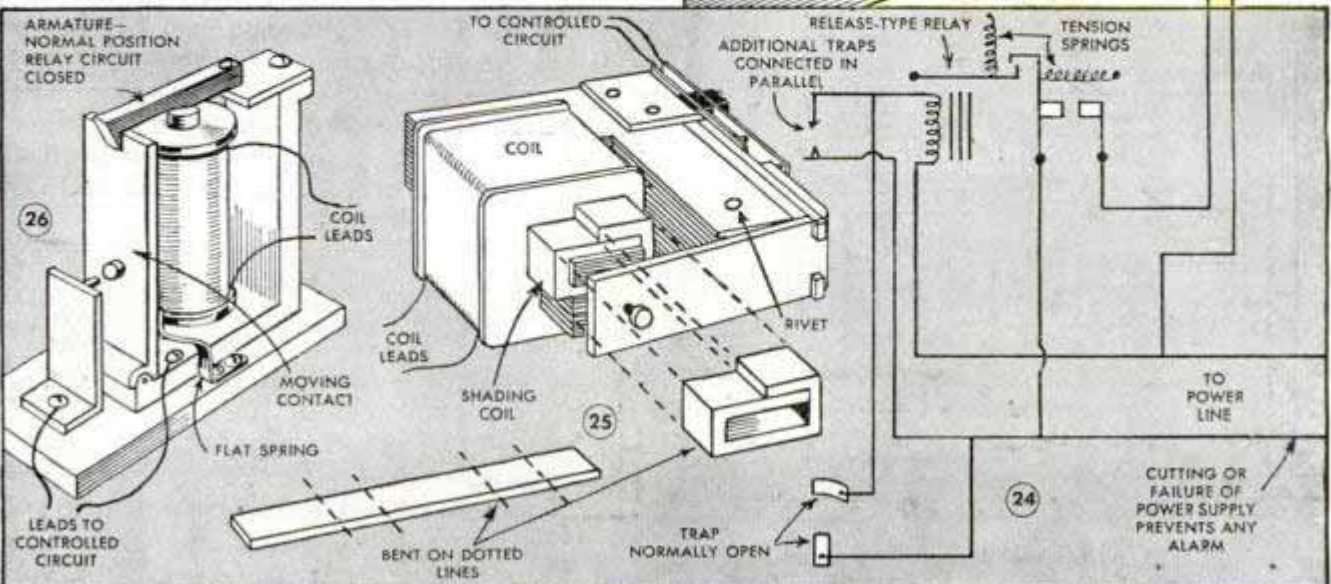
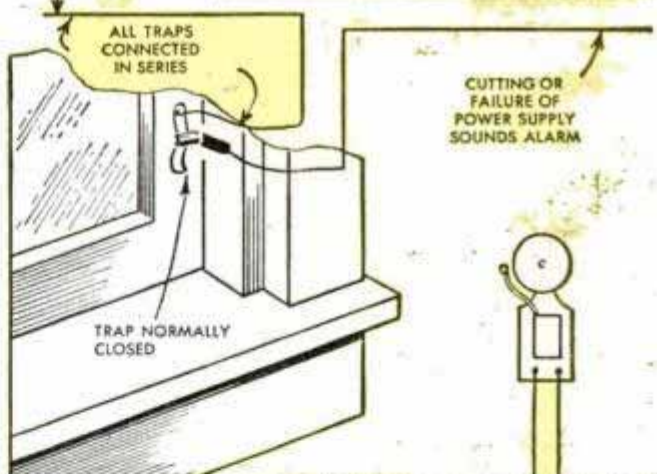
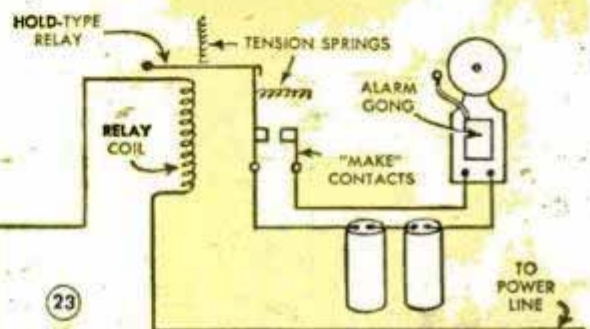

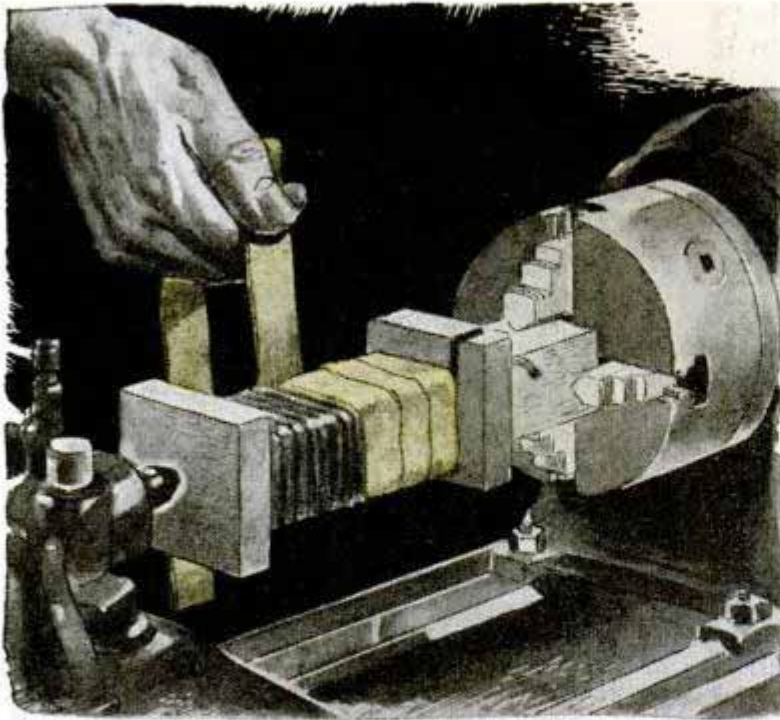

27 EACH LAYER OF WINDING WRAPPED WITH BROWN PAPER

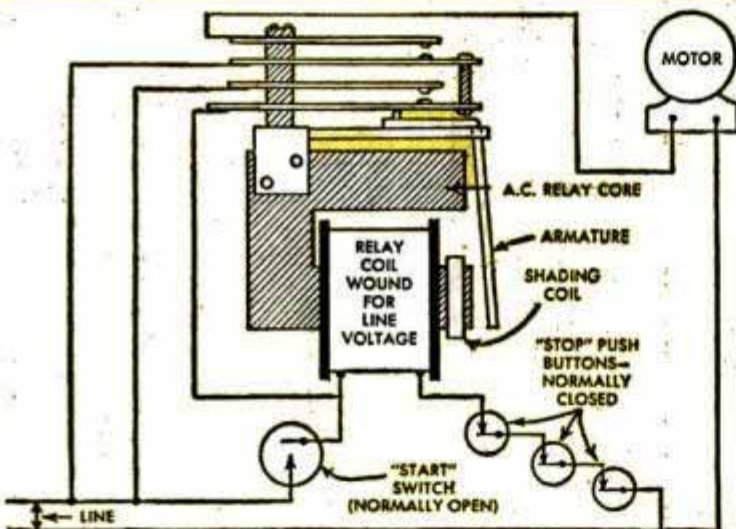

28 SAFETY MOTOR RELAY

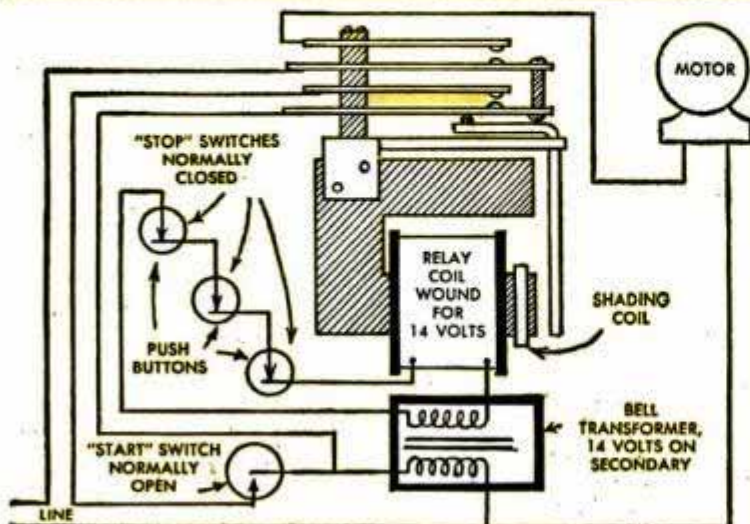

29 LOW-VOLTAGE MOTOR RELAY

less the joint is lapped and soldered, the shading coil will not perform its function properly.

The armature of the relay can consist of a piece of flat iron of suitable dimensions, hinged as shown in Fig. 19 or in some other convenient way. Other methods of armature attachment were given in Part I. The armature can be used to operate spring contacts in the same way as shown for d.c. relays in Part I. A.c. relays offer the advantage of convenience of power supply and, if properly designed and built, can be made to operate satisfactorily.

Numerous special types of relays will be found valuable in a number of applications. The "release" type relay shown in Figs. 20 and 24 can be adapted to alarm systems and the like. The advantage of relays of this type is that they do not require any power except when the traps are sprung. When the armature is pulled down, it releases the spring arm which closes the circuit and sounds the alarm. Once started, the alarm will continue to sound until the relay is reset by hand. The "hold" type relay shown in Figs. 23 and 26 is similar in action except that the contact spring is held as long as the relay current flows. The contact spring is released whenever the relay current is interrupted, and remains in that position until reset by hand. This type can be applied advantageously to burglar-alarm systems, as in Fig. 23, and has the advantage that cutting the power supply to the relay will sound the alarm. By use of fusible strips of metal foil in the circuit, the "hold" type relay also can be used for fire alarms. Although these types of relays generally are designed for d.c. current they can be operated on a.c. with dry-disk rectifiers, or if desired can be designed for a.c., using a laminated core as described.

Figs. 28 and 29 show two systems for control of motors which add to shop safety. The system shown in Fig. 28 uses an a.c. relay, operated directly off the line, to control the motor. Pushing the "start" button, which is a normally open push button, operates the relay and starts the motor. The second pair of contacts on the relay energizes the coil and holds the relay in closed

position. The "stop" push buttons, which are normally closed push buttons connected in series with the relay as shown, should be placed in convenient locations near every machine operated by the motor and convenient to every operator. Double-contact push buttons can be used for the stop switches if only the top contacts are used. Pushing any one of the stop switches disengages the relay and stops the motor. The motor then can be restarted only from the main control station where the start switch is installed. If the stop button is blocked down, it is impossible for any worker in the shop to restart the machine until the block is removed. This is very important when a repair is being made to a saw, press or other machine which might cause a serious accident if it were started while repair work was being done on it. The system shown in Fig. 29 accomplishes the same result; however, the relay and stop buttons are operated on low voltage and therefore the control wiring can be installed with ordinary bell wire, without using conduits or fittings required with 110-volt installations.

Another very useful type of relay is that shown in Figs. 31 and 32. This consists of a pair of solenoids, with the plunger operating a toggle switch. The coils are best wound on a fiber or bakelite thin-walled tube, with washers of the same material at the ends. The coil dimensions are calculated just as for an ordinary d.c. relay. The contacts can be arranged in any desired way, using single or double-throw and single or multiple-pole arrangement. It is important to adjust the length of the fixed and moving cores as designated in the plan-view, Fig. 32. The solenoid-type relay can be used to stop and start a motor with push buttons, and has the advantage that current need not flow through the relay except during stop and start operations. Those uses of relays which have been described thus far doubtless will suggest other applications in which relays of different types can be made to serve a practical purpose in controlling circuits or appliances about the home, office or manufacturing plant. By using these fundamental suggestions it is possible to build much more elaborate control systems than those described.

(Continued next month)

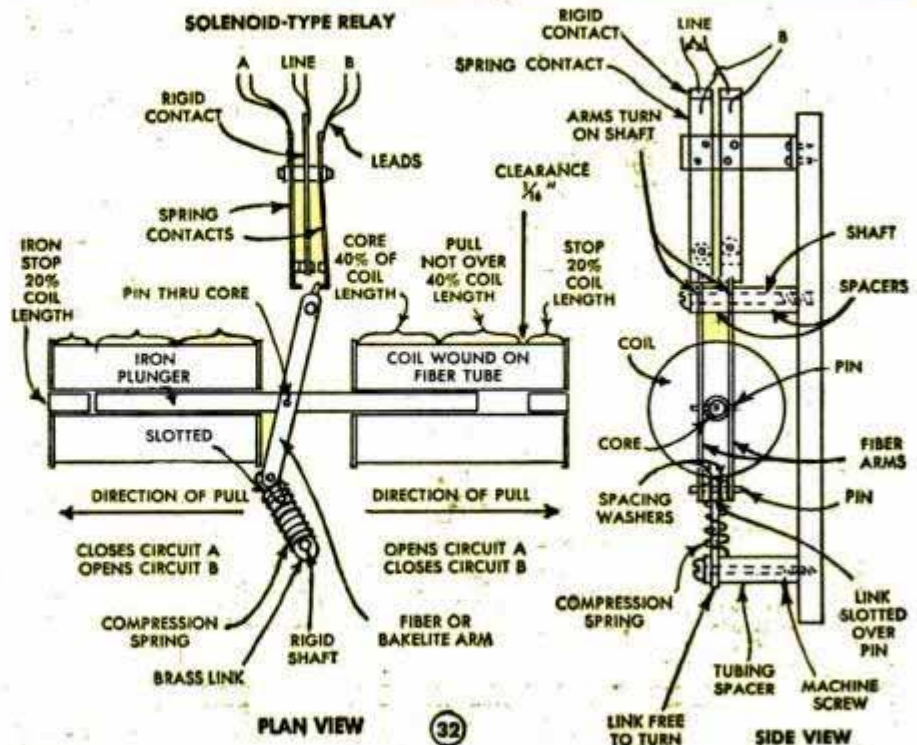
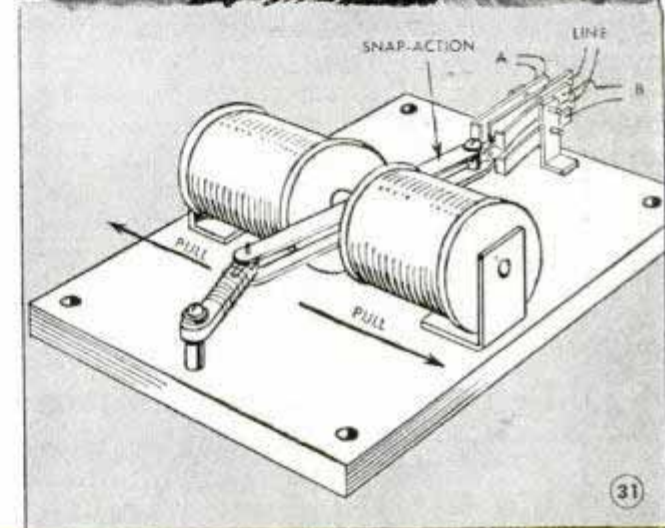
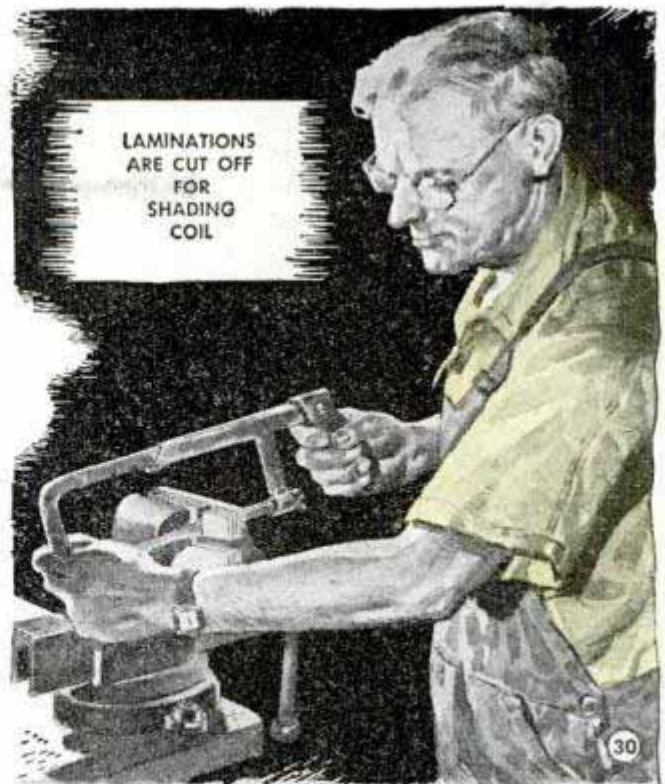

Plywood Pocket on Work Table Stores Drawings Safely



Students of mechanical drawing often have difficulty in storing their finished work so that it will not become creased or otherwise damaged. A good storage place can be provided by making a container or pocket of plywood like the one shown and attaching it to the end of the work table. This will hold the drawings safely and permit the student to refer to them without leaving the table.—Lee H. Nichols, Chicago.

Metal Belt Clip to Carry Hammer

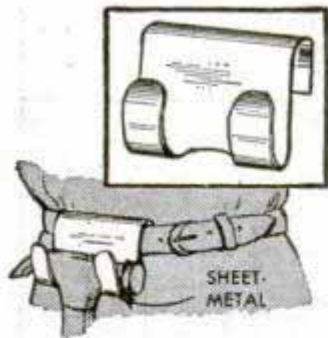

Instead of slipping a hammer handle through your belt to carry it on the job, use a hook like the one shown here. It is cut from a small piece of light sheet metal, one end of the holder slipping over the belt while the other is bent and cut to receive the hammer head.

Ken Murray, Baltimore, Md.

Lubrication Tips for Automobiles

There are a number of places on a car where lubricant, while not essential for trouble-free performance of the car's power plant and transmission, nevertheless is necessary for smooth operation. Some of these require oil, others grease or a similar lubricant. The stems of door handles, window handles, windshield wiper blades, compartment handles, hood latches, hinges and other linkages require a drop or two of oil about once every six months. The radio

antenna, if of the collapsible type, should be lubricated with oil. First extend it to its greatest length, then put a few drops of motor oil on a clean cloth and wipe the entire surface to deposit a thin film of lubricant on it. Following, collapse the antenna fully to oil the inside surface. Clean grease should be applied to the door-latch strike plates and strikers as well as the radiator and gas tank cap latching surfaces. The interiors of locks are lubricated with powdered dry graphite about once a year. This can be blown in.

Thomas Trail, Baltimore, Md.

Tire Insulators on Electric Fences

Because porcelain insulators for his electric fence were always being broken, one farmer found that old tire casings could be used to better advantage. Pieces were nailed around the post, as shown, and the wire was stretched tightly over the rubber. Then another, but narrower, strip was cut and nailed over the wire to hold it in place. The nails should be spaced so they do not come in contact with the wire and cause a short circuit.

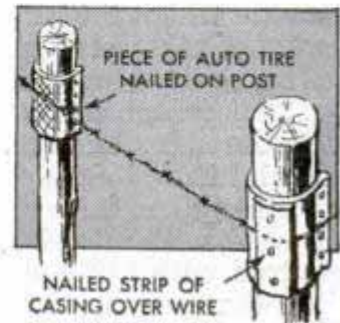

A. H. Waychoff, Phoenix, Ariz.

Posts and Chains Form Stand That Supports Oil Barrel

Temporary stands for barrels and oil drums can be constructed quickly with four metal fence posts and two short lengths of chain for each stand. The posts are driven into the ground to the desired depth and the chains are bolted to the tops to form two slings. The drum rests between the four posts, supported by the chains.—Sgt. Lyman B. Huntington, Avon Park, Fla.

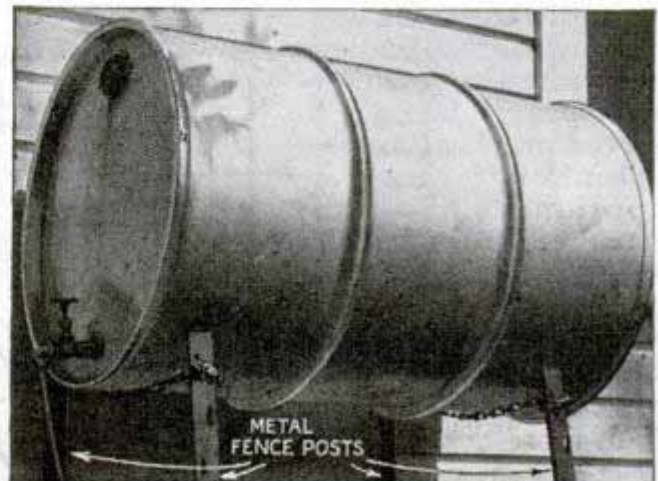

PORTABLE ROAD-SIDE STAND

For the Business Go-Getter



Because of the unusual wing-nut-and-hinge-pin "joinery" it takes one man only a few minutes to set up this roadside stand where the business is best. The whole affair consists of six waterproof plywood panels which make the top, ends, back and divided front. Tongued-and-grooved boards nailed to a 2 by 2 frame make the floor. At closing time the hinged counter swings up and the canopy comes down, closing the stand weather-tight. Exit is through a door at the back.

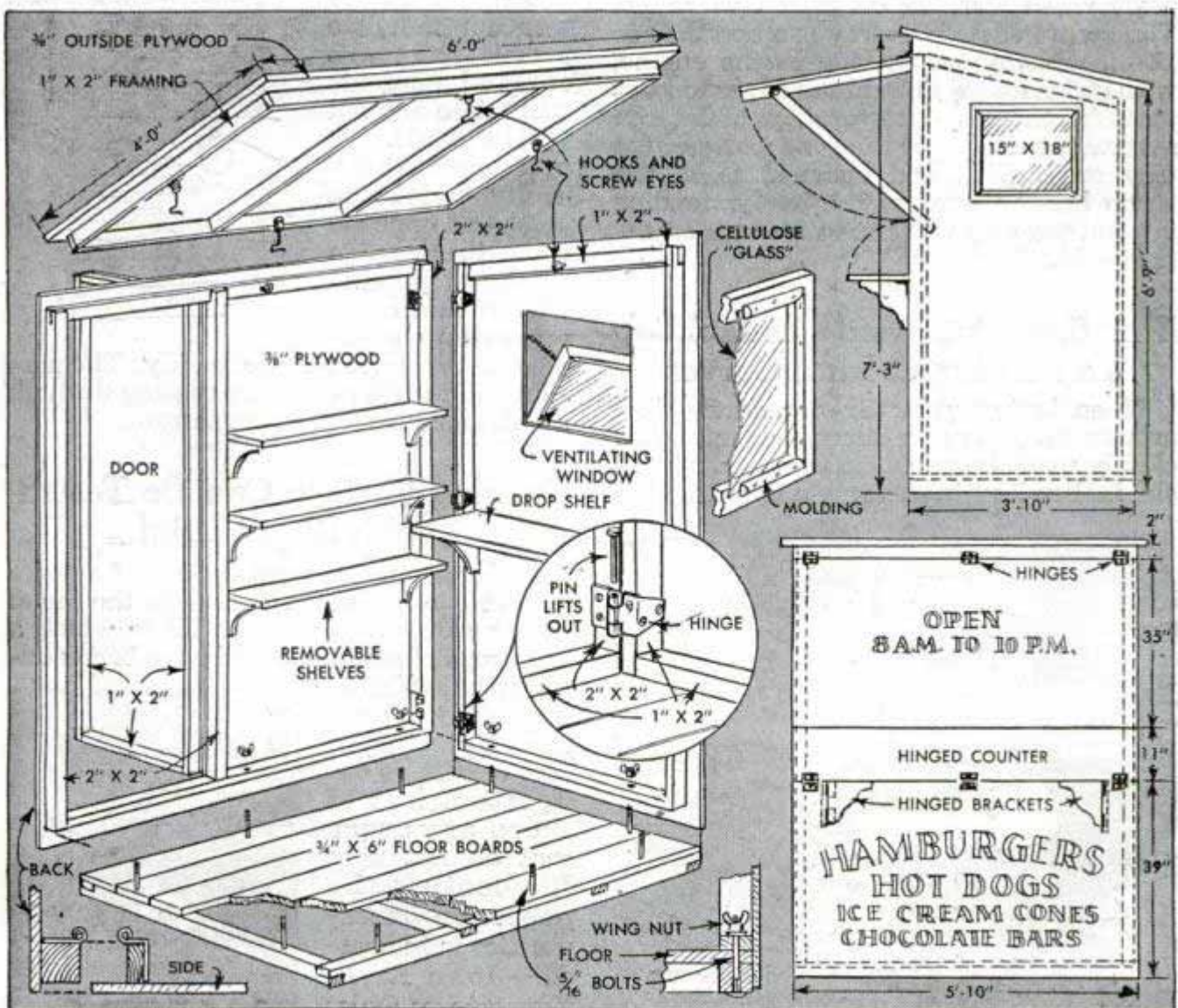

Tray Held on Engine-Block Studs Keeps Tools Handy



Here's a handy tray to hold tools and parts when working on your car engine. The main body of the tray is a board 10 or 12 in. wide, about as long as the engine, with strips nailed around the edges to keep parts from rolling off. Two strips of flat iron several inches longer than the width of the tray are drilled and fastened to it, the strips being spaced so the part extending beyond the tray will slip over studs on the engine block.

Fine Saw Cuts Made in Molding To Bend It Around Curves

When laying quarter-round molding around the base of a curved object, a few closely spaced saw cuts in the molding will aid in bending it. After the molding has

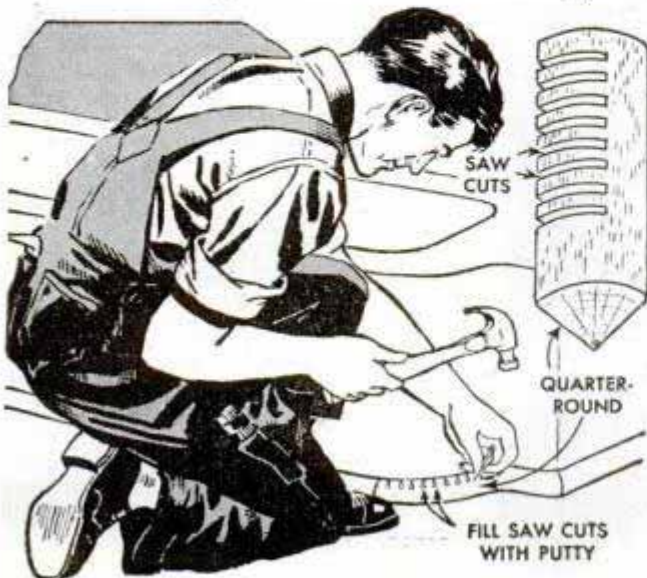

been nailed securely so that it will not spring, the cuts can be filled with putty. Painting will cover the saw marks completely.—Pfc. Lloyd A. Grover, Pratt, Kans.

Children Cannot Burst Paper Bag When Holes Are Punched in It

The annoyance caused by children bursting empty popcorn bags in a moving picture theater was prevented by one manager who had the manufacturer of the bags punch several fairly large holes in each one. This prevented the bags from being inflated yet the holes were not large enough to allow the popcorn to escape.—J. M. Callan, Camp Beale, Calif.

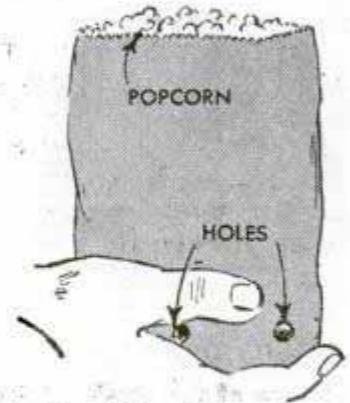

Paraffin Coating Protects Pencil During Damp Weather

During rainy weather indelible pencils that are carried outdoors will soften and not write well. To overcome this difficulty, twirl the point and opposite end of the pencil in a cake of paraffin which has been softened to a degree where it will adhere readily. The paraffin will form a protective coating through which moisture will not penetrate.

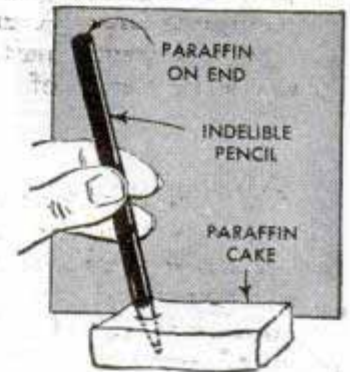

Bearing Surface Can Be Tested With Blue Vitriol

To determine that the surface of a bearing is clean for babbitting, swab the metal with a solution of blue vitriol to which a few drops of sulphuric acid have been added. If the surface is chemically clean an even coating of copper will be deposited, but if there are areas that do not take the coating the presence of impurities is indicated.—John Krill, Youngstown, Ohio.

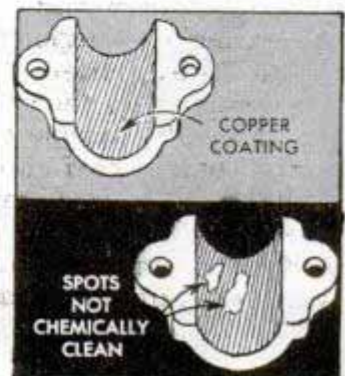

ATTENTION-GETTING DISPLAYS

A VENETIAN BLIND in a larger size makes a good interchangeable sign for a show window in a garage. Remove the slats from the blind and sew the straps so they hold the slats in the position shown. Slats should be a free sliding fit in the "pockets" sewed in the straps. Paint the slats black or white in contrast to the color of the lettering you are going to use. The spaces between the slats will still permit automobiles in the showroom to be viewed from outside the window

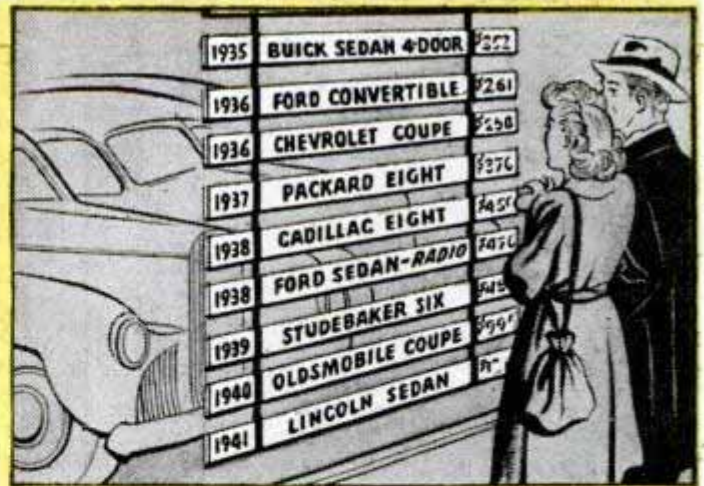

TWO EGG BEATERS, with covers which fit snugly into oil cans, are the principal parts needed for setting up this graphic demonstration of the need for seasonal changes of lubricating oil. Fill one can with summer-grade oil and the other with oil of winter grade and place on a suitable bench outside the garage or station so that the display is exposed to seasonal changes in temperature. A sign invites the prospective customer to see for himself how the viscosity of the oil is affected

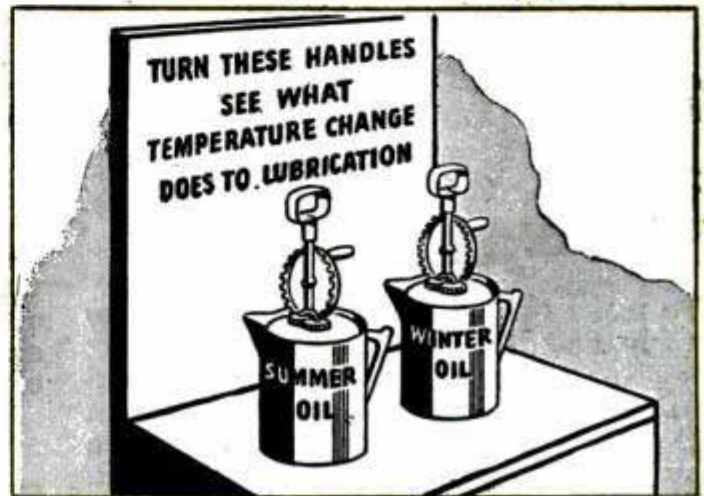

BASIS of this action display of the value of antifreeze is a small motor-driven centrifugal pump housed inside a metal drum. A discharge pipe or tube is attached to the pump and a piece of corrugated-steel roofing is soldered to the side of the drum at an angle, its center being directly under the open end of the pipe. Placed outside in front of the station in a metal tray partly filled with antifreeze the pump circulates the liquid continuously even at very low temperatures

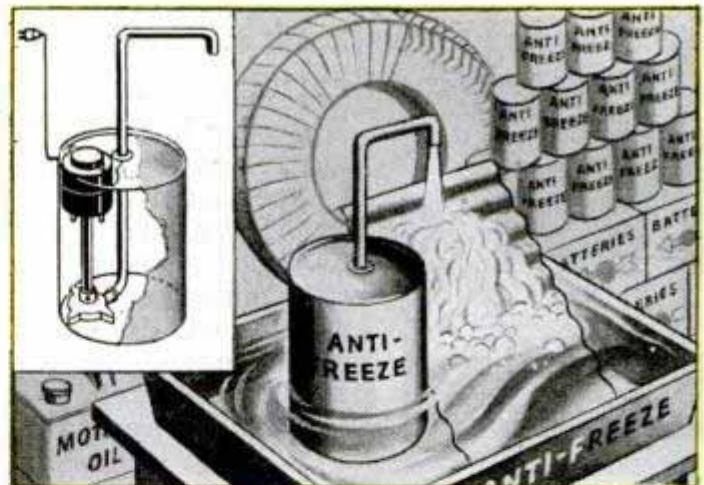

BY MEANS OF two oil filters suspended side by side from shelf brackets, this simple display effectively conveys at a glance the importance of regularly changing the oil-filter cartridge. The greater weight of the used filter, shown by the spring scales, demonstrates the purpose of the filter in removing dirt and other foreign particles from the crankcase oil. A sign by the filters can carry the wording suggested or any other that may better suit the purpose you have in mind



Scale Fastened on Drawing Board Aids in Ruling Lines

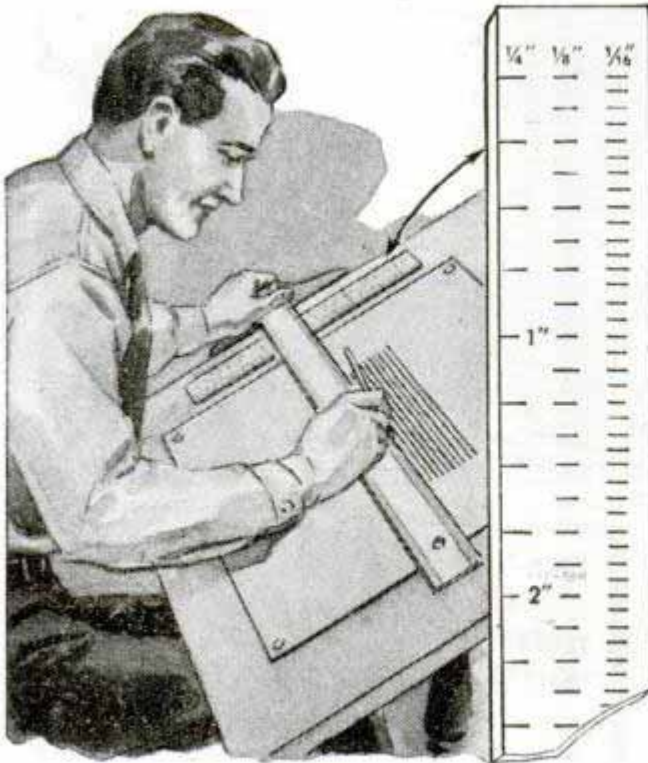

To make evenly spaced horizontal lines quickly, one draftsman uses a scale having three columns divided into $\frac{1}{4}$ in., $\frac{1}{8}$ in. and $\frac{1}{16}$ in. This is fastened to the left hand side of the board and used as shown in the drawing.—M/Sgt. M. C. Hunter, New York.

Sheet Folded Over Stack of Paper Prevents Wind Scattering It



the side of the stack. The protected side faces into the wind.

G. E. Hendrickson, Argyle, Wis.

Clip Connects Electric Circuits

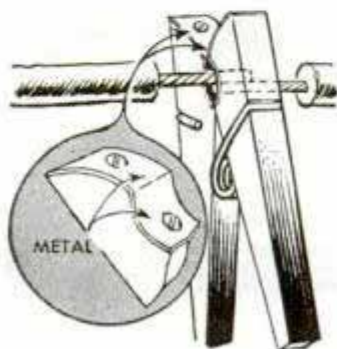

A spring-type clothespin will be found handy at an electrical experimenting bench for temporarily connecting wires carrying low voltage current. The pin jaws are faced with thin sheet copper

which is screwed in place. In use, the bared ends of the wires to be connected are gripped with the pin, the copper facing serving as a current conductor should the wires not be held in good electrical contact by the pin. The clip should not be used on electrical circuits that are carrying more than 24 volts.

Oily Rags Kept in Metal Can To Reduce Fire Hazard

Oily rags used in the commercial workshop should be kept in covered metal containers to reduce the fire hazard should the rags suddenly catch fire. Handy containers for this purpose can be

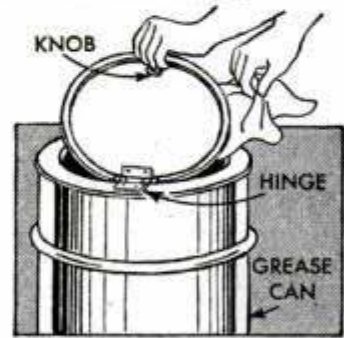

made inexpensively from empty 5 and 10-gal. grease cans. These are cleaned thoroughly and the covers are hinged and provided with lifting knobs. Such containers also are handy for clean rags used in the shop. A can may be painted one color for clean rags and another for oily ones.

D. E. Horn, River Forest, Ill.

Temporary Support for Sign Card Improvised With Paper Cups

If a temporary sign-card holder is needed, one can be improvised using two paper cups of the rigid type. The cups are slit halfway across the bottom and down one side to serve as holders, one on each side of the sign. The larger the cups, the larger the sign they will be able to support.

Hillard J. Kowalski, Chicago



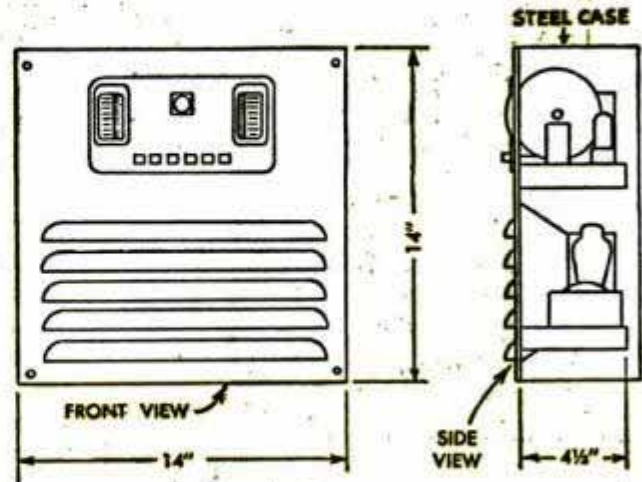

①

Built-in Radios for Every Home

DESIGNED for built-in installations where room space is at a premium, these ultramodern receivers are assembled on heavy steel panels and require only 4½ inches of wall depth. This permits installation in the walls of both new and old homes. Closet doors also offer a convenient location and simplify installation in older homes. Proper ventilation is provided and all controls are standard.

Sketch A shows a living room with a 7-tube superheterodyne in a handy wall location directly above a writing desk or table. This set, detailed in Fig. 1, is a stand-

ard a.c. broadcast band receiver with 6 station push buttons. It employs a 6-in. speaker and has an audio output of 5 watts. Connections are provided for a record player if desired.

A 17-tube Ansley "Paneltone" installation is illustrated in sketch B and the dimensions are given in Fig. 2. It will be noted that this unit has a top section that tilts out to bring the control panel to a convenient position. The receiver includes FM, broadcast and short-waves, push button tuning and phono connections. It uses a 12-in. speaker and has an output of 15 watts.

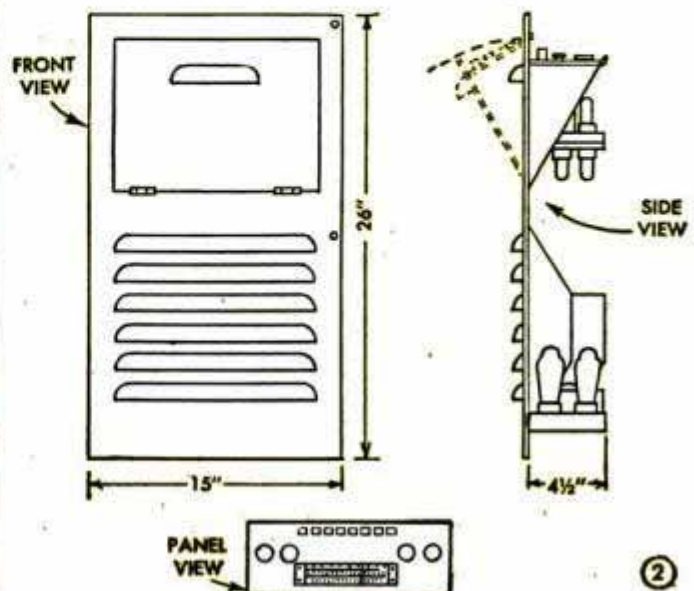

②

ELECTRONIC VOLT-OHM READER

By Arthur I. Rattray

THIS electronic voltage and resistance reader is built with inexpensive parts and features a "magic eye" electron-ray tube. As there is no delicate meter to burn out it provides a rugged and efficient test instrument for advanced students and experimenters. A.c. and d.c. voltages may be read up to 1000 volts; one resistance range reads to 1000 ohms and the other extends to 3 megohms.

If the 1-1 ratio, tapped, line isolating transformer T1 is not easily available, use the two filament transformers with paralleled secondaries as shown in Fig. 1-A. The MEA6 "Amphenol" electron-ray tube socket assembly has a tiny 1-megohm resistor in the socket; remove this and substitute R7. Details for the shielded positive test prod appear in Fig. 2; tiny resistor R11 is connected inside the lower end. The "ground" prod is standard.

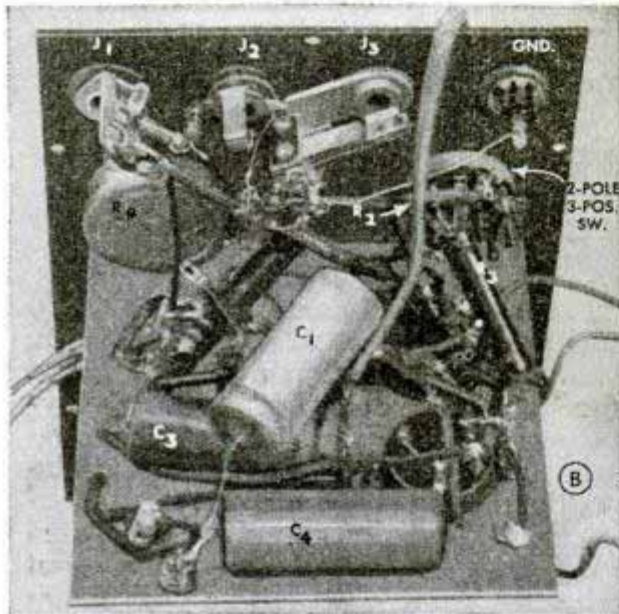
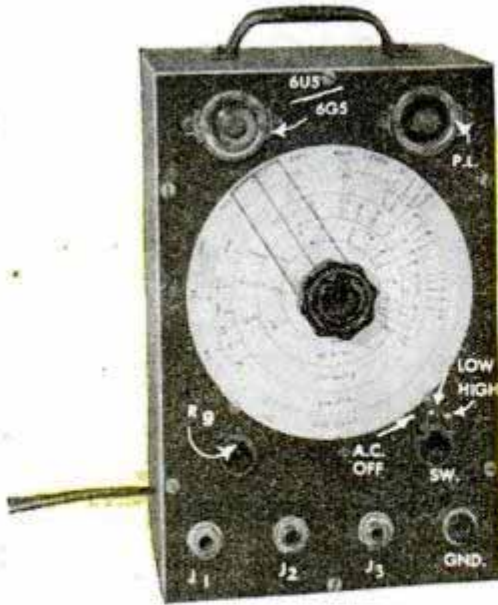

- RESISTORS**
 R1 & R2—5 megohms ½ watt
 R3 & R10—1000-ohm (WW) 10 watts
 R4—1 meg. pot. Centralab N-104
 R5—50M-ohm pot. (WW) Mallory M50MP
 R6—1 meg. ½ watt
 R7—500,000 ohms ½ watt
 R8—40,000 ohms (WW) 10 watts
 R9—7500-ohm pot. (WW) Mallory "F"
 R11—10-meg. ½ watt (in prod.)

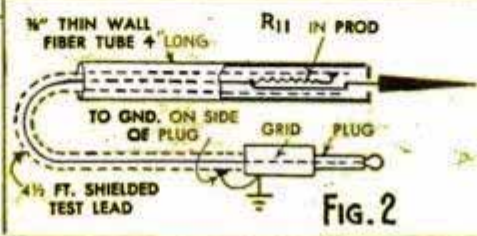
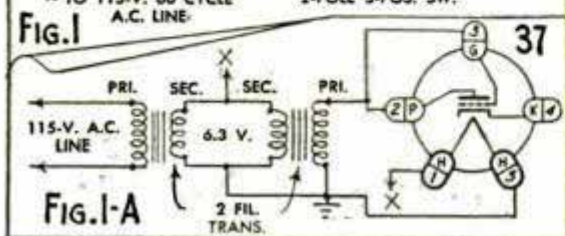
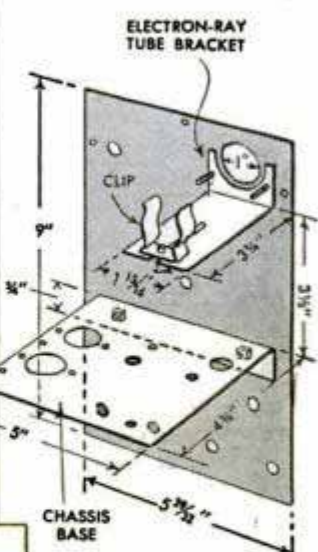
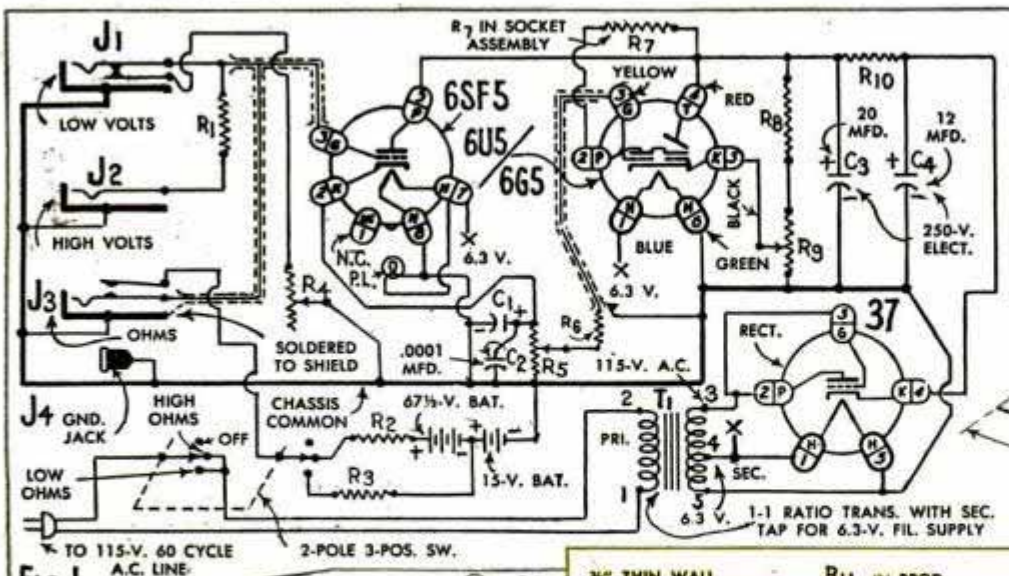
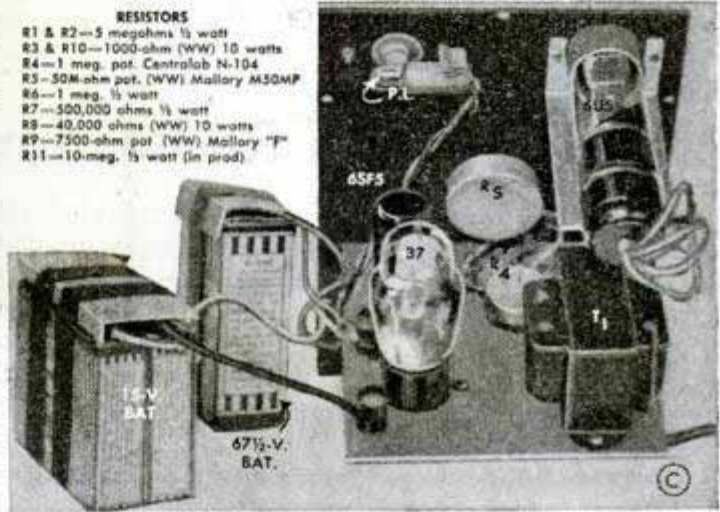

FIG. 3
 DETAIL OF 1/16" METAL
 PANEL AND BASE

Ultra-Sensitive Television "Camera" Pickup Tube

By F. L. Brittin

K EEN "eyesight" is necessary if television pickup tubes are to match the sensitivity of the human eye under varying lighting conditions. RCA engineers have solved this problem with the image orthicon tube that automatically adjusts pickup sensitivity to include extremely low light levels. In other words, what the television camera "sees" at the remote pickup point no longer need be brilliantly illuminated in order to provide a good clear video picture in the home television receiver, as illustrated in photos A and B. The light from the flame of a match was sufficient. A further convincing candle-light demonstration was given at the recent I.R.E. winter technical meeting held in New York City.

The iconoscope "camera" tube, described in the October 1944 issue of this magazine, operated as a video transmitter under strong illumination; the orthicon tube was a second step in sensitivity and now the compact image orthicon, photo C, takes over. The iconoscope, or usual television pickup tube, has an electron gun, a photo-sensitive mosaic or "target" and a means for vertically and horizontally controlling the sweeping beam. The image orthicon retains these features and adds several more. An electron multiplier, built into the tube, multiplies the modulated stream of electrons that is returning from the "target," as indicated in Fig. 1, before feeding the output signal into the "camera" amplifiers. A two-sided "target" for higher photo-sensitivity permits the charge pattern to be formed on one side while scanning takes place on the other. These improvements greatly increase overall sensitivity and provide stable operation over a wide range of shifting light conditions.

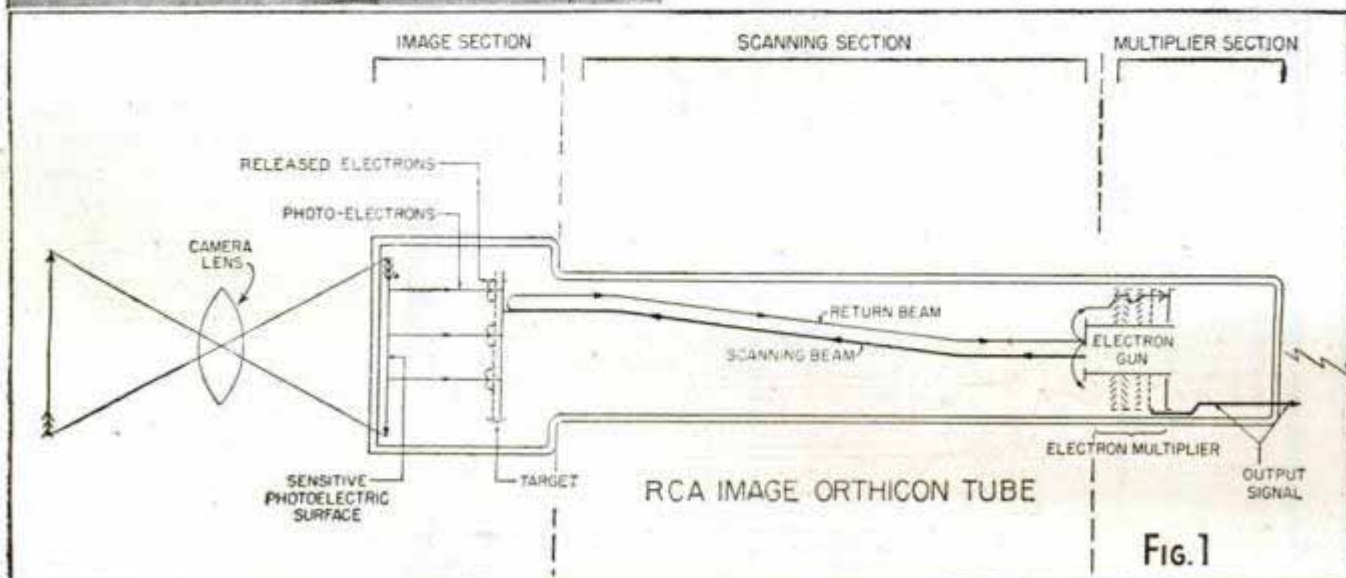
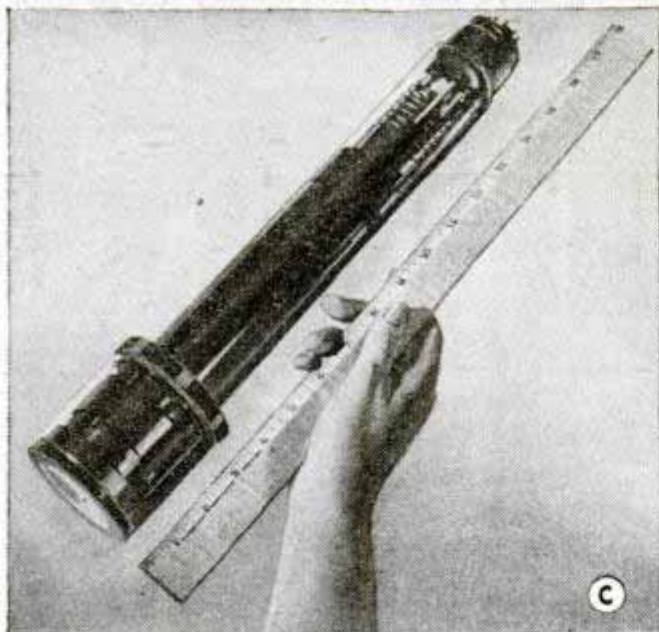



Cars shouldn't smoke, either!

SMOKE from a car means burning oil, wasted power, cumulative damage to cylinder walls. All these can be cured by reconditioning the engine and installing new Sealed Power Piston Rings. They lengthen engine life, restore original power, save oil, save gas.

Whatever the make, model, or degree of cylinder wear in your engine, there's a Sealed Power Ring Set specifically engineered to do the best possible job. Sealed Power people are proud of their product and its 34-year record of preference by leading car, truck and engine builders. Ask your favorite repairman to install a Sealed Power Individually Engineered Ring Set in your car now! Sealed Power Corporation, Muskegon, Michigan and Stratford, Ontario.

KEEP YOUR WAR BONDS! GET \$4 FOR \$3!

© 1946, Sealed Power Corp.

For better results 26 Basic Ring Designs

No one piston ring design can meet all replacement needs. Sealed Power Individually Engineered Ring Sets are made up from twenty-six (26) basic ring designs, which permit each set to be specifically engineered to do the best possible job in a particular make of engine.

These ring sets are engineered to save gas without sacrifice of oil economy, to save oil without inducing friction and cylinder wear. Each set gives *balanced* performance in a particular engine.

Piston Rings
Pistons
Cylinder Sleeves
Valves
Water Pumps
Chassis Parts



SEALED POWER PISTON RINGS

BEST IN NEW CARS! ★ BEST IN OLD CARS!

HAWAIIAN WIGGLERS

Get Bass!



Shallow Running
No. 2 Hawaiian Wiggler — \$1.10

Favorites at Fishing Camps For Large and Smallmouth Bass

At left is photo of Elmo Hurst, who runs a fishing camp on the White River near Cotter, Arkansas. He reports that the deep running No. 1 Hawaiian Wiggler is a killer for smallmouth in the White River and its tributaries. This catch of largemouth was taken on the shallow running No. 2 Hawaiian Wiggler at nearby Norfolk Lake. He reports that weedless Hawaiians with their quivering hula skirts are favorites with the anglers at fishing camps along the White River.

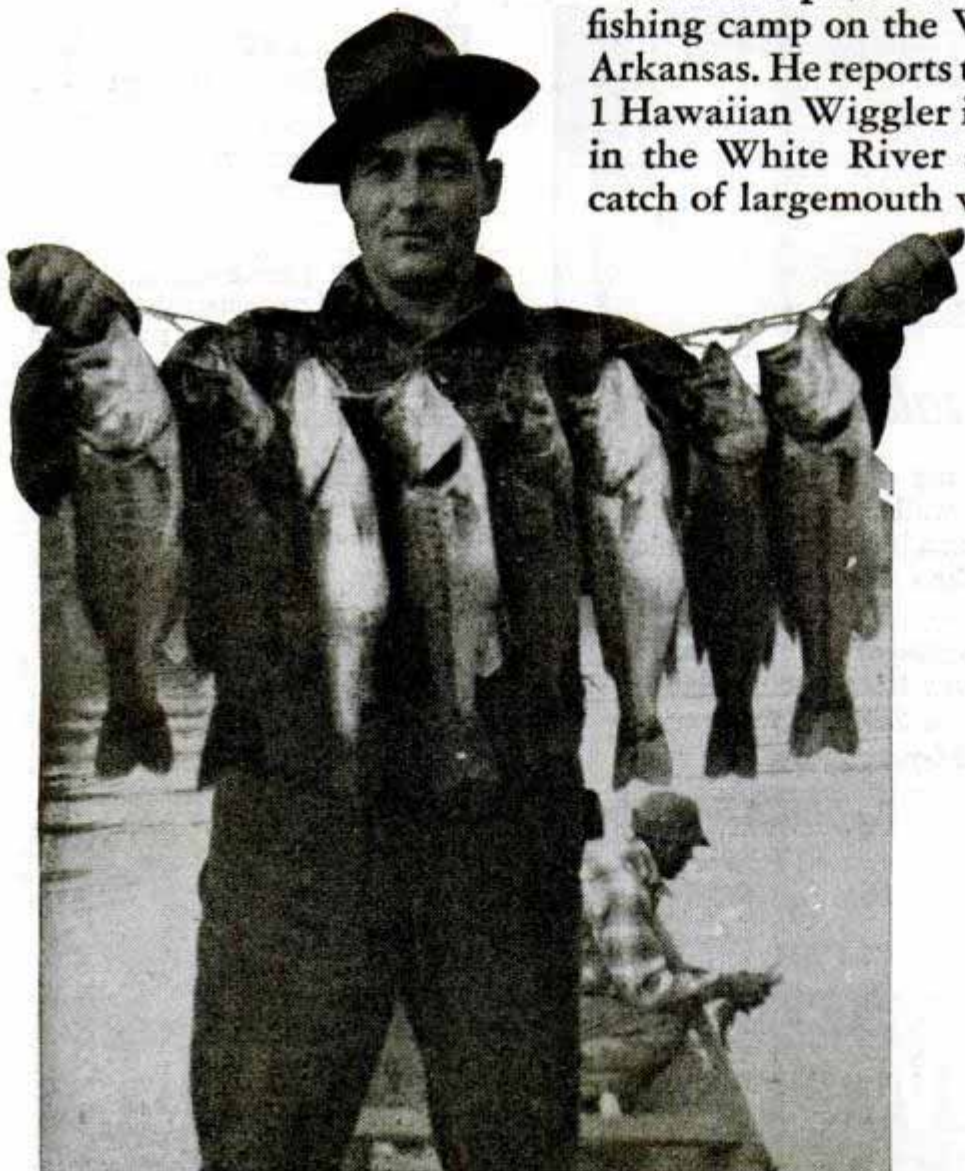

Elmo Hurst with bass caught on No. 2 Hawaiian Wiggler

Send for Free Catalog

If you want some fascinating and informative reading, send for my free catalog that is loaded with photographs and letters from fishermen telling where and how record catches have been made with Hawaiians. It also gives the latest information on Jitterbug, my surface bait that is ideal for calm waters day or night.

FRED ARBOGAST & CO.
1604 North St., Akron 3, Ohio

How to Fight the Menace of **FIRE**

...A Wet Towel and a Flashlight may save your life!
—says the National Safety Council



1 Fire is always dangerous—especially dangerous at night, when you may be asleep. And most fires *do* occur at night! If you smell smoke, reach for your "Eveready" flashlight *first*. *Feel doors before opening them*, for a single breath of fiery air can kill you! If a door is *hot*, don't open it!

2 Wet a towel or cloth; cover your face and arms. Close doors to reduce drafts that may fan the flames. If heat is severe, remember that heat rises—*crawl!* If trapped on upper floor, make a rope of bedclothes. As a last resort only, throw out a mattress and jump down onto it.



For

**EXTRA POWER,
EXTRA LIFE
—AT NO
EXTRA COST**

NO. 950
EVEREADY
TRADE-MARK
EXTRA LONG LIFE BATTERY
A NATIONAL CARBON COMPANY PRODUCT

FOR BEST RESULTS PUT IN SERVICE BEFORE SEPT. 1946

3 To avoid danger, you have to *see* it—so keep your flashlight with you until you're safe! Watch for collapsing ceilings... But the best way to avoid fire is to *prevent* it! Your flashlight—with fresh "Eveready" Batteries—gives a much *better* light than matches or a candle, and it's much *safer* too!

4 To help fight fire—or for *any* flashlight need—rely on "Eveready" Batteries. Ask your dealer for them by name. The days when you had to accept "second choice" batteries—or none—are past. "Eveready" Batteries have no equal—that's why they're the biggest-selling flashlight batteries in the world!

NATIONAL CARBON COMPANY, INC.
Unit of Union Carbide and Carbon Corporation
30 East 42nd Street, New York 17, N. Y.



EVEREADY
TRADE-MARK

The registered trademark "Eveready" distinguishes products of National Carbon Company, Inc.

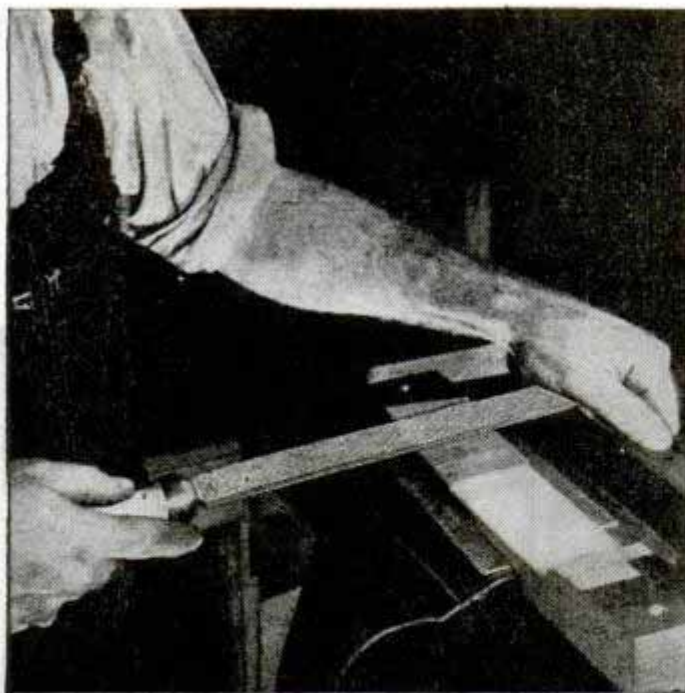

A Nicholson 12-inch Flat Second Cut File is being used here in filing a punch die.

TOOLMAKERS' files must be right for the job

Dies, jigs, fixtures, gauges, cams, trips, holders, spindles—the closer the tolerances to be worked out by hand, the more careful should be the selection of files. . . . Second Cut files instead of Coarse or Bastard; Smooth instead of Second Cut; Swiss Pattern or Special Purpose instead of Regular types.

Nicholson is virtually a "file engineering laboratory"—an establishment where the requirements of files for different purposes and metals are a never-ending study. Every day presents new opportunities for tool, die, and other work-bench specialists who *know their files*.

THE MILL SUPPLY and HARDWARE houses selling Nicholson or Black Diamond files are good places to learn about and obtain *the right files for EVERY job*. And Nicholson's "FILE PHILOSOPHY" is a 48-page book worth writing for.

NICHOLSON FILE CO., 22 Acorn St., Providence 1, R. I.
(In Canada, Port Hope, Ont.)

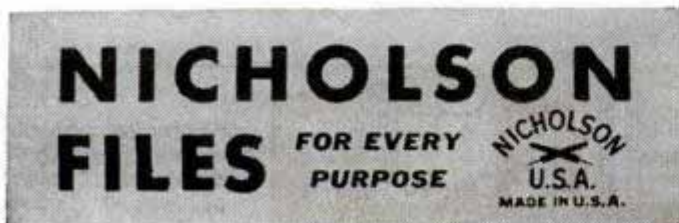

Electronic Volt-Ohm Reader

(Continued from page 231)

Always starting with the eye closed, your prod will open the eye, then you adjust R5 to close it and mark that known voltage. For high voltage scales, adjust known voltage to 100 volts; then plug your positive prod into the high volts jack. Now set R5 pointer to 10 volts on the low volts scale; adjust R4 until eye closes. This automatically calibrates the high volts scale. After this adjustment, to read high volts merely multiply the low volts scale by ten for voltage value across prods. A.c. voltages are calibrated in the same way except a line cord with plug is attached to the 50,000-ohm potentiometer instead of the radio's "B" supply; start from closed eye position and carry out the same procedure.

To calibrate ohms, check resistors of various values with borrowed meter; insert positive plug in your "ohms" jack and note that the eye is opened by the battery. Adjust to zero, as in first step; separating prods will open eye again. Clip known resistance across prods, set range switch and adjust R5 to close eye at calibrating point on dial. Repeat for both ohms scales. Detailed student material list is R-343.

Hit the Trail by Trailer

(Continued from page 149)

pliances, with adequate storage lockers for carrying clothing.

Trailers are being put to various uses. A camera company is using a fleet of trailers as traveling service stations; circulating libraries use trailers for carrying books; ministers reach remote regions in trailer-chapels, and several police departments have trailers converted into traveling crime laboratories outfitted with fingerprinting, ballistics and cast-making equipment. One school system has a domestic science trailer with a modern kitchen which is towed from school to school.

You don't need to wait until exactly the right trailer that fits your ideas and needs comes along. Like your automobile, you can always turn in your present trailer on a newer model. You can tow a trailer to practically any spot that you can reach by automobile, even to the top of Pike's Peak. You can stop nearly anywhere off the highway for overnight parking, and there are some 4000 trailer parks in the United States that you can use for longer stays. "Three rooms and a bath" that you can tow comfortably and safely at 60 miles per hour are here today.

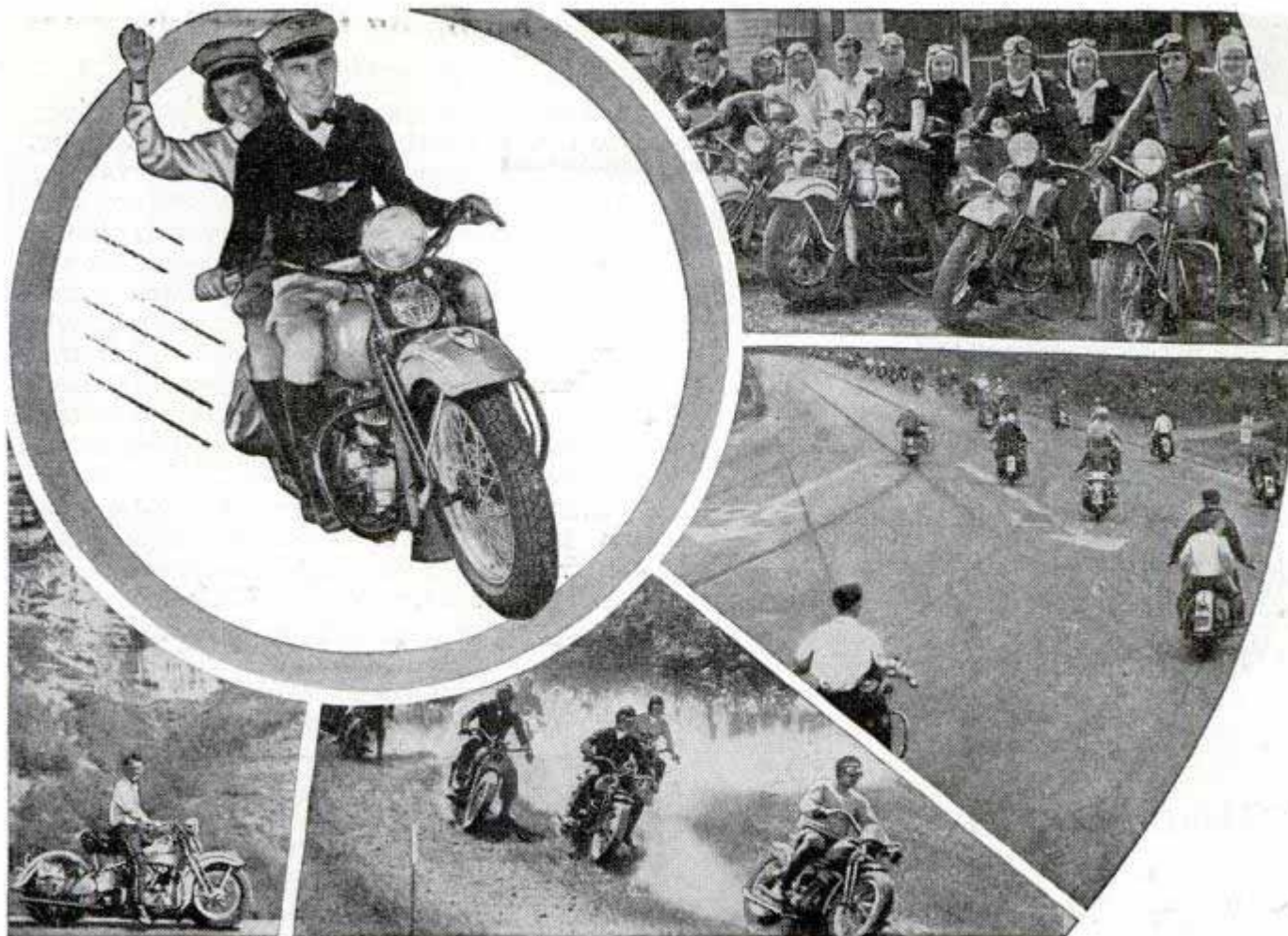

FOR THRILL-PACKED EVENINGS • WEEKENDS • VACATIONS

Ride A HARLEY-DAVIDSON

PACK every spare hour brim full of pleasure—swing into the saddle of a Harley-Davidson and go *where there's fun!* Join other Harley-Davidson fans in the world's greatest sport — motorcycling. Ride along shimmering lakes and rivers — see majestic hills and forests — visit the country's many natural wonders and beauty spots. Go when-

ever you get the urge—stop wherever you choose — with no timetables to follow. What's more, there's always plenty of excitement and thrills when you ride a world famous Harley-Davidson on tours and endurance runs — or take in race meets, hillclimbs and other motorcycling events. See your Harley-Davidson dealer **AT ONCE!**

HARLEY-DAVIDSON

Motorcycles

HARLEY-DAVIDSON MOTOR CO., Dept. P, Milwaukee 1, Wisconsin

Please send at once free copy of 24-page "Enthusiast" Magazine, filled with motorcycle action pictures and thrilling stories.

Name.....

Address.....

City..... State.....



Coming YOUR Way!

Here are the South Bend reels that are *now* in production; some may be on their way to your dealer. We suggest you keep in touch with him for early delivery of the reel of your choice.

THE PERFECTORENO—For Bait Casters

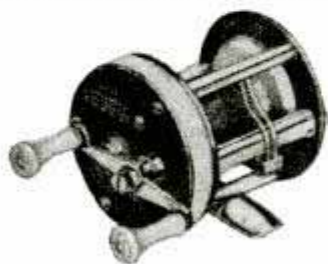

Now, Fishin's Fun—For Every One! Any one can cast, without backlash, with a Perfectoreno. Needs no thumbing—makes casting easy, effortless, a real pleasure. Two models are now in production:

No. 775, Nickel Silver Frame; Mottled Pearl Grips.
No. 760, Maroon Anodized Aluminum and Smoky Pearl.

THE OREN-O-MATIC—For Fly Rod Anglers

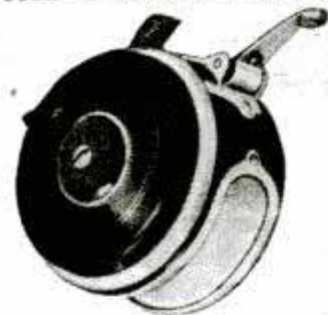

Most popular-automatic fly rod reel ever made. Hangs vertically from the rod, in natural, balanced position. Extra long, extra strong spring; anodized aluminum frame. Two of the most popular models of Oren-O-Matic reels are being made first:

No. 1130, Rich Maroon, Capacity 50 yards. "G" Line.
No. 1140, Rich Maroon, Capacity 80 yards. "G" Line.

ANTI-BACK-LASH REELS—The Original and Genuine

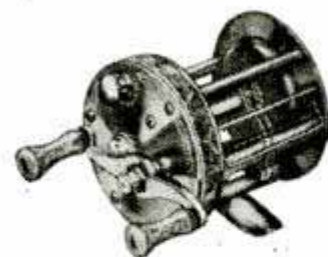

These are the original Anti-Back-Lash Level-Winding bait casting reels, the reels that first did away with discouraging snarls and tangles of line. So well are they made that some have been used more than 30 years, many handed

down from father to son. Two popular models are now in production—No. 1000 and No. 450. No. 1000 is illustrated.

SOUTH BEND BAIT COMPANY

891 S. High St., South Bend 23, Ind.

SOUTH BEND

A Name Famous in Fishing

Mopping Up Starfish

(Continued from page 161)

It is simply made of two lengths of pipe, two small wheels and a rubber hose. The spreader pipe is perforated at intervals to distribute the lime. At each end of the spreader pipe is a small wheel which allows the device to roll along the ocean bottom. At right angles to and in the center of the spreader pipe is the feeder pipe through which a two-inch rubber hose feeds the quicklime. From 500 to 700 pounds of quicklime are used per acre of bottom and the corrosive action of the lime kills most of the starfish there.

Starfish travel about while oysters do not. In an effort to discover just how far they range each year, Dr. Loosanoff stained starfish with a blue dye and released them. Although moving only a few inches per minute, some of the colored starfish were found nearly a mile distant from the starting point 10 months later.

Radar Cues the Navy Fighters

(Continued from page 168)

were charged with the weighty responsibility of aiding in the recovery of the planes overhead—the positions of the downed aircraft were being carefully noted—bearing, range, latitude and longitude of the emergency radar signals and the pilots' reports. Transmitted to the bridge and the flagship, this information was used as the basis for the search that followed in the next two days. That more than 80 percent of the downed pilots were recovered was in no small part due to radar in its role as life-saver. The number of pilots who were aided back to the lighted carriers through the Pacific night never was tallied. But there were many.

The story of radar's scientific development and tactical employment in time will be a thrice-told tale. It is doubtful, however, if many except those who were in it will remember much of the role played by the thousands of reserve officers who manned the CICs of the Fleet or lived on K rations and hope in island tents, and who, so to speak, wielded radar as a weapon.

The word "wield" is used advisedly, for oddly enough, despite its delicate, scientific complication the radars of the Navy have been operated not by technicians but by the butcher-baker-candlestickmaker majority who have made up the enlisted and officer personnel of the shore and sea radar establishments.

There are, of course, the technicians—

(Continued to page 240)

NEW ALL-METAL, FAST, FREE-FLYING GAS MODEL

BUILD AND FLY THE MODERN

Metaline

SKY-VAHL



Designed by Harold R. Johnson

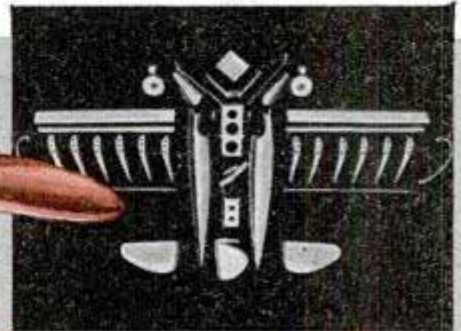

All the parts above are stamped out ready for finishing and assembly. Purchase price includes everything but engine and propeller. Wingspan is 59"; length 35". The Metaline SKY-VAHL, pilot-designed, will give you many days of fun and good, sound experience in metal-working and flying.

Here's fun with a profitable future

LEARN THE FINE POINTS OF FLYING - Model building is a sure way to prepare yourself in aviation. The all-metal SKY-VAHL flies and maneuvers like the big commercial and military planes. Take-off and landing characteristics are the same and your practice and control adjustment for normal flight make model flying one of the most important phases of learning the science of flight.

A METAL-WORKING EDUCATION - Right in your own home workshop you can learn the fine art of the metal worker. Commercial and military aircraft are all-metal . . . so is the SKY-VAHL! Assembly time runs from 8 to 12 hours. All parts, including all rivets and screws, are supplied. You need only a few standard tools used in every home. Full instructions and drawings guide you. Everything durable is made of metal . . . the SKY-VAHL is the first all-metal model plane. *Be the first to build it in your neighborhood!*

A FASCINATING HOBBY IN AN AIR AGE - Everyone has a hobby. Your hobby can be the most interesting imaginable. Hours of fun, in your workshop and in the field, are yours when you build and fly the Metaline SKY-VAHL!

RUGGED—ALMOST INDESTRUCTIBLE - No wood-and-glue job is this! The Metaline SKY-VAHL will take many a hard landing. You just make repairs right on the field and she'll keep right on flying!

ORDER FROM YOUR DEALER OR SEND THIS COUPON NOW!

DEALERS & JOBBERS
The SKY-VAHL is one of the New METALINE Products and is now in large production. It's a fast seller at a good profit. Order now for early delivery.

SKY-VAHL
Manufactured by
VAHL ENGINEERING COMPANY

VAHL ENGINEERING COMPANY pm 446
505 Court St., Brooklyn 31, N. Y.
Please RUSH, postpaid, 1 Metaline SKY-VAHL Kit. I remit payment as follows:

Enclose check (or money order) for \$23.75
 Enclose \$3.75. I will pay balance of \$20 on delivery plus few cents C.O.D. charge.

Name.....
Address.....
City..... State.....

SELF-POLISHING

Crystal-Clear Charm

**FOR
YOUR FLOORS**



**Gives the Same Long-Lasting
Beauty So Famous For Cars**

Your floors take on luxuriant richness with Self-Polishing SIMONIZ. Crystal-clear so natural floor beauty "shows through." Longer lasting, too . . . dirt and spilled things wipe up with a damp cloth . . . restoring original brightness. Spreads evenly with cloth or applicator . . . actually shines itself to an exciting brilliance . . . without rubbing or buffing. For lovelier floors with less care . . . get Self-Polishing SIMONIZ today!

Shines as It Dries . . .

Self-Polishing SIMONIZ is ideal for use on linoleum, asphalt or rubber tile, or finished wood floors. Sold by grocery, hardware, drug, paint, 5 cents to \$1, auto accessory or department stores.

THE SIMONIZ CO., CHICAGO 16, ILL.
Recognized for over thirty years as authorities on preservation of fine finishes.



Self-Polishing
SIMONIZ
FOR FLOORS



graduates of the country's engineering schools—MIT, California Tech, Carnegie Tech, Virginia Polytech and a dozen others. Without them and their untiring vigilance in keeping the gear going, the CIC officers of the Fleet could not have carried on. The fighter director and CIC officers, however, were carefully and deliberately chosen . . . for their seemingly complete lack of scientific training.

Typical in its CIC personnel was the complement of the USS Wasp, of which one of the authors was FDO. Of the eight officers in the CIC complement, one, the original FDO, was an able young fighter pilot, one was a former college professor of English, one an erstwhile graduate student in forestry, one a high school principal, one a meat salesman, still another a sometime lawyer, another an insurance salesman and one a recent college A.B. And of the top-notch task force and group fighter directors none was more esteemed than Lieutenant Commander "Jimmy" Winston, New York broker, former Master of the Hounds of a Long Island Country Club, holder of the Legion of Merit, who went to his death in the flames that swept the USS Franklin.

By what military osmosis did these men become radar officers? Actually—and this is one of the abiding and little sung miracles of this war—the fact that people with such disparate backgrounds should meet in the CICs of combat vessels is not much more surprising than the fact that the flight deck officer of the Wasp should have been—as he was—a former New Orleans lawyer and the hangar deck officer a millionaire New York broker.

The process which turned them into radar tacticians is a story in itself—of initial make-do when both radar equipment and instructors were gourd green—of gradual experimentation and intelligent application of sorely won battle lessons and, above all, of the determination and effort of thousands of unsung and unheralded reserve officers who, like all Americans in battle, turned their hands to the nearest or the assigned task—and got it done. The skill, bravery and fortitude of our Navy pilots never can receive too much praise, and certainly in the annals of sea warfare the names of our captains and admirals of this war already hold exalted places. It is no disrespect to them nor does it detract from their manifold achievements to say that, without radar, much that they were able to accomplish would have been impossible.

It is difficult to imagine how the sea assault on the Jap's far-flung empire might have been conducted had there been no

(Continued to page 242)

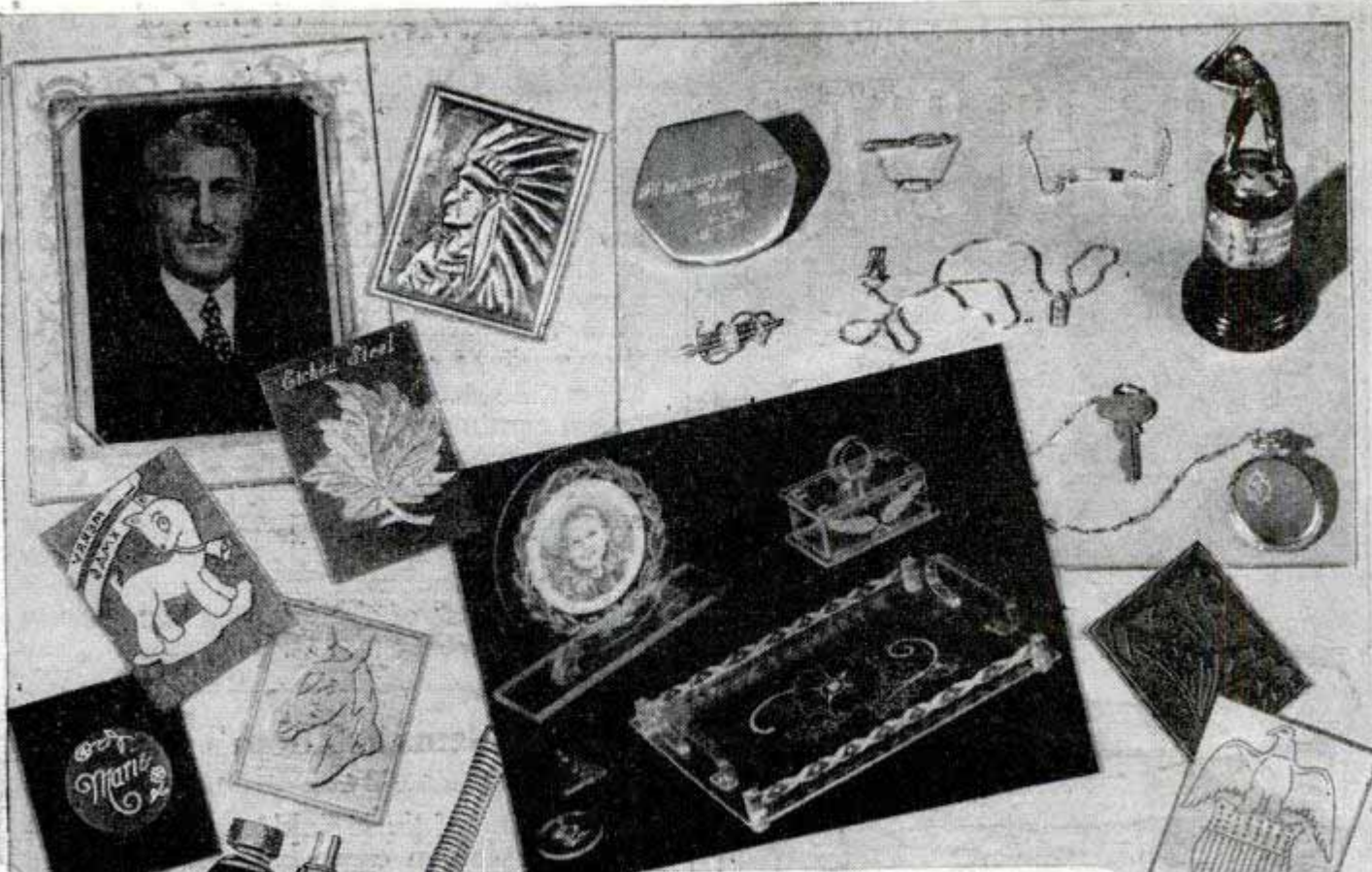

*Do all these jobs and
more with the*
**BURGESS
vibro-tool**

Trademark Reg. U.S. Pat. Off.

To do craft work without limit . . . engraving, carving wood, decorating metal or plastics, putting designs on glass, etching on steel, *You need a Vibro-Tool!*

It is like owning a whole kit of tools, all fitting into one small package. Pictures illustrate a few of hundreds of results achieved with the Vibro-Tool alone.

The Vibro-Tool operates by vibration, 120 strokes per sec., 60 cycles AC., 110 V.

The Vibro-Tool with engraving needle \$7.50; with set of attachments \$16.15.
SEE YOUR DEALER TODAY, OR ORDER DIRECT

HANDICRAFT DIVISION

BURGESS BATTERY COMPANY

166 N. WABASH AVE.

CHICAGO 1, ILLINOIS

The **vibro-tool** ADDS POWER
TO YOUR CRAFT SKILL!

NEXT TIME SAY BRIGHT STAR

and you will get a
FLASHLIGHT & BATTERIES
famous since 1909
for QUALITY,
STYLE and
SERVICE



BRIGHT STAR BATTERY CO. CLIFTON N. J.

radar. History is full of "ifs", of course. And Navy historians, analysts and strategists will be deploying today's long vanished fleets in the eternal game of might-have-been long after radar has taken its place as the crude progenitor of scientific apparatus yet unborn. It is a truism, too, to say that without the skills and teamwork of the millions of gunners, mess cooks, plane pushers, engineers and a thousand other occupational activities of hundreds of thousands of officers and men we would, at best, be sitting hemmed in and impotent in the continental U. S. A.; yet it is hard to see how we could have moved forward at all without radar. Certainly it may be said without exaggeration that the development of CIC as a function of command is up with the leaders in "most important new developments" of the extraordinary naval warfare of World War II.

There's Gems in Them Thar Hills!

(Continued from page 157)

From one of these field excursions a 75-year-old woman came brightly lugging a huge chunk of agate weighing at least 40 pounds. "I'm going to have a pair of book-ends out of this if it kills me," she gleefully told fellow prospectors. Another enthusiastic gem hunter, before the war, traveled 12,000 miles on a lone prospecting trip through 38 states.

No road's too long if there's promise of gems at the other end. Wendell O. Stewart and Earl Calvert of Los Angeles once went into Mexico on a trail of rare selenite crystals, reported in an old silver mine. The auto road ended at Chihuahua, but on into the desert they plunged—bumping 80 miles over a narrow oxcart trail, fording rocky river beds, gambling on the depth of the water. Seven hundred feet underground, they found caverns lined with shining, ice-clear selenite crystals, some of them six feet long, some actually showing a water bubble inside where the six-sided crystal had not yet grown to maturity.

One western amateur converted an ancient Dodge truck into a desert car with a 20-gallon water and a 60-gallon gasoline tank and huge tires to take him over soft sand. A single trip yielded him 800 pounds of petrified palm, a beautiful mineralized wood, and a quantity of rock speckled with small circular rings—hollow reeds once growing in prehistoric lake bottom mud.

If the amateur is searching for magnetite, the "lodestone" of the ancients, he carries an indicator, a large sewing needle dangling on a string. Sold in bulk, the rock

(Continued to page 244)



WOULDST CARVE WOOD?

You'll Find X-acto Knives "Indispensable" Says Famous Wood Sculptor

Visitors to the Open Air Art Show in New York's Washington Square last Fall were fascinated by the sight of a sculptor carving sophisticated modern figures with a small metal knife.

The sculptor was Nicholas Mocharniuk, whose work has won acclaim in galleries and art centers throughout the country. And the knife he was using was a No. 6 X-acto!

Mr. Mocharniuk uses X-acto Knives because he says, "they give the best results with the hard wood I use . . . they are especially suited to cutting away areas usually hard to get at."

You Can Take It With You

Another advantage Sculptor Mocharniuk points out about X-acto, is that he can take it with him and get in a bit of extra work while sitting on subways,

trains or park benches.

Whether you work in hard or soft wood, in your workshop or out in the park, you too will find this removable-blade hobbycraft knife the handiest little tool you ever had.



CHOICE OF EXPERTS IN EVERY FIELD

With its 13 scientifically designed blade shapes, and 3 all-metal handle styles, X-acto is the perfect tool for the most difficult or delicate cutting job. Blades are of fine surgical steel, scalpel-sharp. Model builders, artists, whittlers, photographers, swear by easy-to-use X-acto.



X-acto

KNIVES & TOOLS

X-acto Knives & Knife Chests From 50c to \$5.00

* Buy where you see this sign. At better hardware, hobby and gift shops — or if not available write direct to X-acto Crescent Products Co., Inc., 440 Fourth Avenue, New York 16, N. Y.

*Reg. U. S. Pat. Off.

You Have
"The Last Word"
with X-acto!



To keep our Knives and Tools the "last word" in hobbycraft, we're always making them even *better* than they are. Here are some new points about X-acto Knives and Tools and how to enjoy them:



NEW CHUCK COLLET—Grips blade even more firmly, tightens it with less pressure, gives it a longer reach.



NEW BLADES—2 new chisel blades for working those hard-to-reach flat surfaces. No. 17 is $\frac{1}{4}$ " wide; No. 18 is $\frac{1}{2}$ ".



NEW BOOKLETS—(1) "Building Your First Flying Models". (2) "Whittling Is Easy With X-acto". Each 32-pages, illustrated, 10¢ a copy.



NEW TOOL—Small size Spokeshave for fine shaving, rounding, shaping where block plane can't reach. Solid one-piece handle, all metal and surgical steel blade. 50¢.



NEW SET—No. 85 Tool Chest, containing 3 all-metal knives, with full assortment of blades; saw; sander; stripper; planer; 2 drill holders; 10 drills; 6" steel ruler. Complete in wooden chest, \$12.50.

DUST INVITES GERMS



Ordinary dust raised in sweeping carries myriads of germs which can remain virulent for weeks and even months. That is one reason why thousands of factories, shops, stores, and schools are adopting "Dustless" sweeping. Daily sweeping with a Dustless brush and Arbitrin sweeping fluid reduces bacteria in the air as much as 97%. You ought to know all about this better method of sweeping. Write for complete facts today.

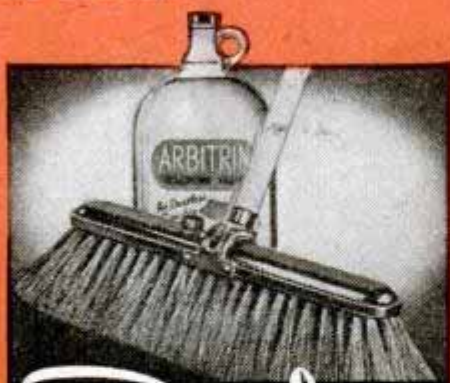

Dustless
DOES MORE FOR LESS

- Dustless
- Speed Sweep
- Speed Wash brushes

MILWAUKEE DUSTLESS BRUSH COMPANY

528 N. 22nd Street • Milwaukee 3, Wisconsin

brings \$30 and more a hundredweight—and it's worth it, the prospector says, after toting a 90-pound piece on his back for three-quarters of a mile to his truck.

Another noted gem prospector is Chuckawalla Slim, who carries several tons of rare rocks in a long yellow trailer which serves as traveling museum and store. This load is just a sample, for he has a much larger stock in his Alhambra, California, home, where he conducts a world-wide mail-order business with collectors. He was the first mineral dealer to bring his goods direct to the customer's doorstep, and he says he carries every known kind of stone except gallstones!

Flying Water Bugs

(Continued from page 100)

but racing rules forbid such vanes. Besides, such a hull would be considered as much an airplane as a boat.

Time trials for new records are clocked by photoelectric timers that are far more accurate than manually operated stopwatches. Drivers use water speedometers for testing out their boats in practice runs, but they remove the attachment before going into competition. The underwater drag would slow them down.

Another way a driver estimates his speed is by how much he "cries." A speed boat racer will tell you that "crying speed" starts at about 60 miles per hour and that drivers cry more as they go faster. This is because most of them dislike wearing goggles. Spray may splatter the glass just as vision is needed for watching the starter's flag or for rounding a marker in traffic. They prefer to race with their eyes unprotected even though the wind makes them weep as they approach mile-a-minute speed.

The fastest water in the United States seems to be that of the Salton Sea in southeastern California, 250 feet below sea level. It has an extremely high specific gravity as its mineral content is much greater than that of sea water. Both the heavy water and the heavy air contribute to speed, although motors and propellers must be "tuned" to these conditions. Twenty-one of the present world records were set at the fall regattas conducted by the Associated Speedboat Clubs of Southern California at Salton Sea, with entries from most parts of the U. S. A.

Man's highest speed on the water is 141.74 miles per hour, a record set in 1939 by Sir Malcolm Campbell in a special three-point hull powered by an aircraft-type Rolls-Royce engine developing 1050 horsepower.

All of the recent refinements that con-

(Continued to page 246)

NO-BATTERY FLASHLIGHT

**ARMY AIR FORCE
SENSATION**

The Light Everlasting

The army airmen dared not rely on batteries—because a dead flashlight might mean a dead flier. Then came DACO-LITE—the magic light that generates its own brilliant beam *without* batteries, the patented light that bears a **LIFETIME GUARANTEE**. Shock-proof, corrosion-proof, cold-proof, heat-proof—*never-failing*. Built with precision of fine watch; war-tested, absolutely fool-proof, trouble free: money back if not satisfied. Sure fire in every emergency.

LIFETIME GUARANTEE

Lifetime service guarantee by makers; you take no chances. Colorful plastic case, streamlined; fits palm of hand. Each light carries "spare" bulb inside; send only \$4.95, check or money-order (we pay postage) to **SCIENCE ASSOCIATES, INC.**, 65 Sena Plaza, Santa Fe, New Mexico.

HALF MILLION DELIGHTED USERS



SMOOTH Alternate Firing

A sweet running motor is half the fun of boating. That's why you surely want Johnson's Perfected Alternate Firing. It gives you that silken smooth flow of power that makes Sea-Horse motoring something special!



DUAL CARBURETION

You've heard of the motor that packs real power—smooth power—at high speed, yet gives you velvet smoothness at a crawl? That's Johnson. Johnson Dual Carburetion (one of the "big three" of outboard motoring) accounts for this beautiful performance.

REVERSE with 360° Steering

Of course you need reverse. Reverse is one of the "big three" of outboard motoring. Sea-Horses have it. Steer forward, sidewise, turn around or back up. That's maneuverability!

JOHNSON SEA-HORSES FOR DEPENDABILITY

Free

HANDY CHART



Sea-Horses are strictly quality motors—built with dozens of refinements. In addition to the "big three" described above, there is Patented Co-Pilot which "takes hold of the motor when you let go," Synchro-Control for one lever operation, Ready Pull Starter, Rubber Rotor Force Pump—and much, much more. » There is something else, too, which is mighty important. That is expert Johnson *service*—available wherever outboard motors are used. » See your Johnson dealer. Look for his name under Outboard Motors in your classified phone book. Or write for a copy of the Sea-Horse Handy Chart which gives specifications on the entire line. **JOHNSON MOTORS, 400 PERSHING ROAD, WAUKEGAN, ILLINOIS**

JOHNSON BUILDS SEA-HORSE MOTORS ONLY—NO OTHERS

THERE IS NO SUBSTITUTE FOR EXPERIENCE



STILL
THE
CHAMP!



It takes far-sighted engineering and superlative craftsmanship to build a radio receiver which will not become obsolescent in a year or two. National's famed HRO model first won its spurs in 1934 and hundreds of those early models are still giving dependable service all over the world.

The new post-war National HRO naturally contains many advanced, war-tested features not embodied in the earlier models—features which will insure its continued leadership in the field of radio reception.

For further details about the HRO, the NC-2-40C, the NC-46 and other National radios which bring you the finest in radio reception, see your local National dealer.



NATIONAL COMPANY

EST.  1914

MALDEN, MASS

THE MOST DISTINCTIVE NAME IN RADIO COMMUNICATIONS

tribute to speed can be applied to racers of unlimited specifications, suggesting that a new world record of around 160 miles per hour is possible by using one of the new liquid-cooled high-powered engines of 2000 or more horsepower that were developed for aircraft during the war.

Top speeds that approach 200 miles per hour no longer seem impossible if airfoils or hydrofoils are used to prevent boats from actually taking off from the water during their runs.

"Operation Crossroads"

(Continued from page 93)

and close automatically to trap particles from the radioactive cloud that results.

Phase two is scheduled for July, when a bomb will burst at the surface among the remaining target ships, probably creating waves 100 or more feet high. Phase three, a deep underwater explosion at open sea, won't take place until 1947 because of the many technical difficulties involved, according to Admiral Blandy. Indications are that the bomb will be radically modified for this final effort and put in a watertight container, perhaps something like a bathysphere. Many believe the deep-water blast will be the most destructive and by far the most important if the bomb is detonated at least a third of a mile under water, producing the only completely unknown and unmeasured effects. It is expected to be the most effective in area of damage.

The principal ships, with the exception of the crippled Japanese battleship Nagato, will move to the test site under their own power. At Bikini they will be anchored in a spread-out pattern calculated to give effects varying from probable destruction, for those near the core of the target, to little or no damage for those at the perimeter. Task force officials explained that both large and small ships would be divided up so that some of each type would be equally exposed to damage.

Limited quantities of ammunition will be left aboard in order to determine the effects of atomic power on a warship's magazines. The decks of some ships will be covered with Army trucks, tanks, weapons, clothing, rations, radar and radio sets, and other miscellaneous equipment to be tested by exposure to the blasts.

At predetermined safe distances from the explosion will be stationed the official observation ships, including the USS Mt. McKinley with the task force staff aboard, and planes carrying additional visual observers and long-range aerial cameras to

(Continued to page 248)

For Men who Really Know Pipes



MOUTHPIECE TUBE
prevents backflow
of moisture

CONDENSING CHAMBER
traps and holds bitter
juices and sediment

BOWL GUARD
keeps shank
and bowl dry

REMOVABLE SECTION
eases thorough cleaning

CHAMBER GUARD
bars tobacco fragments
from bit

Patented

\$1.50

Selected
Briar

Royalton CROWN

HOW DRY I AM is the happy theme song of a Royalton Crown. This wonder pipe stays dry. Its exclusive condensing well and other patented features exclude bitter juices and tobacco slugs from bowl and mouthpiece . . . Enjoy the cool sweetness of ever-dry smoking with the remarkable Royalton Crown, the only pipe of its type

HENRY LEONARD & THOMAS, INC., OZONE PARK, NEW YORK 17, N. Y.

**\$1 RIDES YOUR LAWN
OF UGLY WEEDS!**



WEED-NO-MORE

Magic Weed Killer

Destroys Ugly Weeds but Won't
Harm Common Lawn Grasses!

NO MORE back-breaking digging! Destroy ugly leafy weeds with WEED-NO-MORE!

The 8-ounce lawn-size package treats 1600 square feet! Now you can enjoy a beautiful weed-free lawn for only \$1!

WEED-NO-MORE kills dandelion, plantain and other ugly weeds—yet won't injure soil.

Get it today! Rid your lawn of ugly weeds for only \$1. Just spray on . . . WEED-NO-MORE!

On Sale at Paint, Hardware, Garden Supply, Department and Drug Stores

WEED-NO-MORE

THE AMAZING NEW WEED KILLER

Made by THE SHERWIN-WILLIAMS Co. Cleveland, Ohio

"Adventures in Fishing"



That's the title of a new P & K Booklet that is just off the press, is now ready for distribution. Splendid articles by Cal Johnson, well known outdoor writer and fishing authority, on *Boys and Fishin'*, *The Sport of Bait Casting*, *Angling for Deep Water Bass*, and *Game Fish on The Fly Rod* make this booklet of real value to all fishermen, experts and amateurs alike.

In addition, this booklet illustrates in full color, the complete 1946 P & K Line of Tested & Proved Lures and Fishing Accessories. Such outstanding new lures as Walkie Talkie, and Bright Eyes are shown in 8 beautiful color patterns—Spinning Minnie in 4 patterns. Truly a DeLuxe booklet, each of its 32 pages crammed full of interest to fishermen. This is a booklet that you **MUST** have, and will treasure after you receive it.

HERE'S HOW YOU GET IT!

Send 10c, for which you will receive a regular 10c package of Rap-a-Round, the Invisible Ribbon Sinker, a necessity in every Tackle Box—and a copy of this new, amazingly beautiful and instructive booklet. Be first. **SEND YOUR DIME TODAY.**



PACHNER & KOLLER, INC.
3428 Archer Ave. Chicago 8, Ill.

TESTED AND PROVED LURES AND FISHING ACCESSORIES

FOR TROUBLE-FREE GRINDING . . . in your Home Workshop



Smooth operating and sturdy, the No. 155 Millers Falls grinding head will give years of perfect service in your home workshop.

Here are a few of its many features: designed to drive from above, behind, or below . . . has "Oilite" bronze bearings, a $\frac{3}{4}$ -inch spindle, and carries two wheels up to seven inches in diameter, a $\frac{3}{8}$ -inch capacity chuck and a taper thread spindle . . . bearings are lubricated through good-sized spring top-oilers.

A complete line of heads is offered by Millers Falls to meet every grinding and polishing need. All are rugged, modern in design, and of advanced construction. All will make your work easier and quicker. See them at your dealers today.

One thing in common — Quality!



MILLERS FALLS COMPANY
GREENFIELD, MASSACHUSETTS

record the scene. Pilotless "drone" planes equipped with automatic cameras will hover nearest the fleet to try for closeups of radioactivity.

Still other motion picture cameras, controlled from ships and planes, will film the experiment from lead-shielded shelters atop 100-foot steel and concrete towers on the islands ringing the atoll. Inside this heavy housing the cameras will be in airtight, waterproof cases fitted with windows. The photos will be shot through the win-

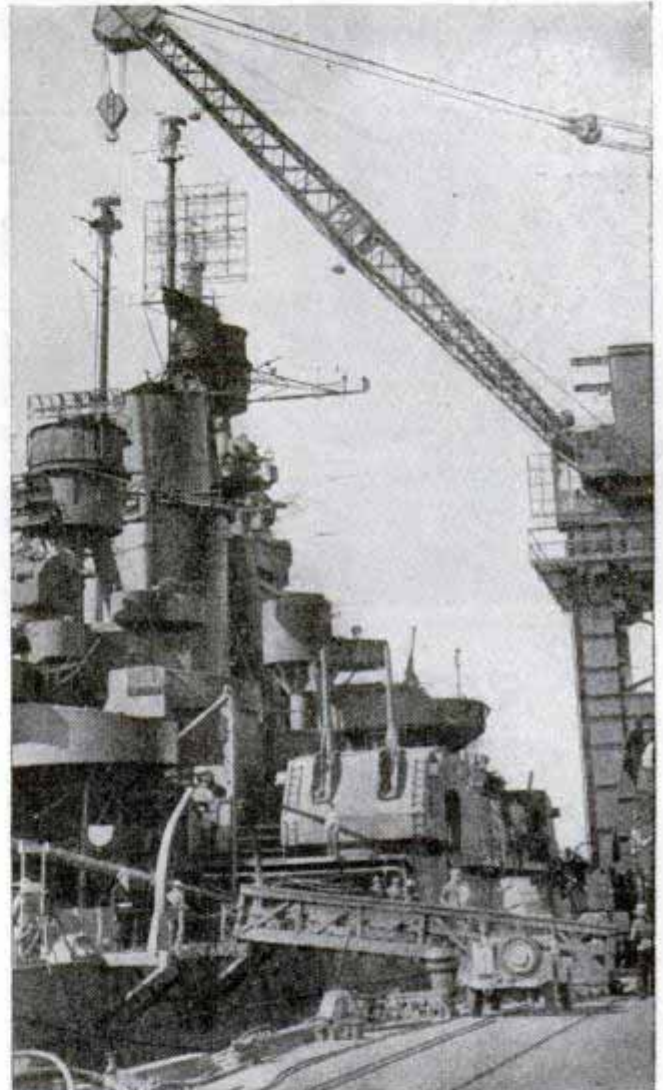

Preparing to lift guns from USS Nevada, another old battleship being readied for atomic bomb tests. During this war she fought in both Atlantic and Pacific

dows, further protected by portholes that will flip open just for the instant the action is filmed.

Every precaution will be taken to shield the cameras from the small radioactive particles that might drift through openings and damage the pictures. Photographic film requires better protection than do human beings, because the emulsion is very sensitive to fogging by even a slight excess of radioactive rays. Special filters that

(Continued to page 250)

The word for it is **Performance!**

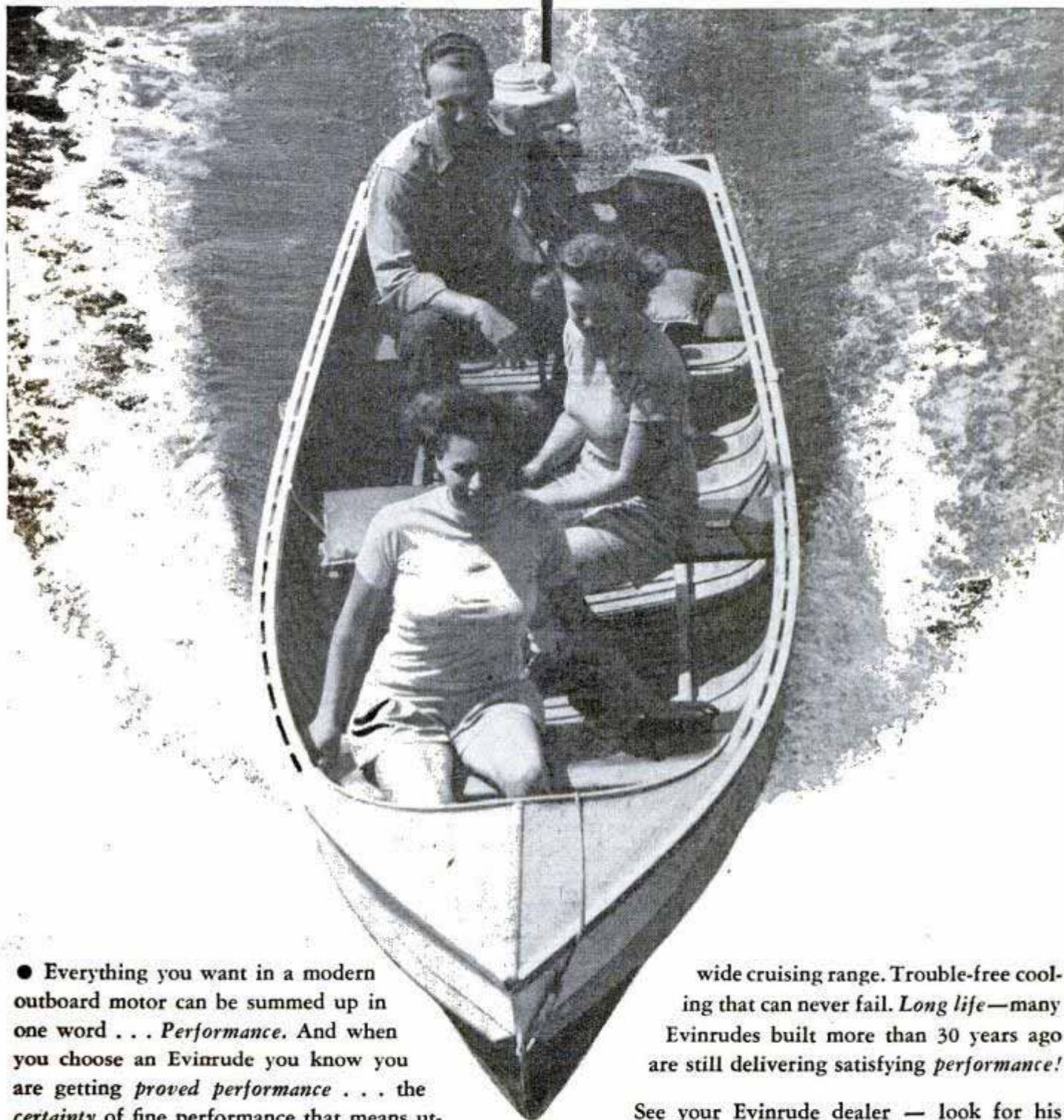

● Everything you want in a modern outboard motor can be summed up in one word . . . *Performance*. And when you choose an Evinrude you know you are getting *proved performance* . . . the *certainty* of fine performance that means utmost enjoyment and satisfaction for the years ahead. *Starting ease* so sure and eager that it seems almost automatic. Superbly smooth power, with motors floated in vibration-absorbing bearings. Co-pilot steering. Large capacity fuel tank for

wide cruising range. Trouble-free cooling that can never fail. *Long life*—many Evinrudes built more than 30 years ago are still delivering satisfying *performance!*

See your Evinrude dealer — look for his name under "Outboard Motors" in your classified telephone directory. Catalog of the complete Evinrude line sent on request — write for it today! EVINRUDE MOTORS, 5215 North 27th Street, Milwaukee 9, Wisconsin.

EVINRUDE
OUTBOARD MOTORS

Q. Why is this the **WORLD'S MOST CAREFREE WATCH?**



A. **CROTON AQUAMATIC WINDS ALL BY ITSELF!**

Just imagine the sheer delight — the gay and happy carefree feeling that comes with wearing this 17-jewel master timepiece! Croton Aquamatic is one watch you don't have to "baby". You just strap it to your wrist and forget it, except to consult it with absolute confidence whenever you want to know the time. You never have to wind your Croton, because it winds itself just by the natural motions of your wrist as you wear it!

It's **CERTIFIED Waterproof!**

You can go right ahead and wear your Croton Aquamatic when washing, bathing, swimming—because it's completely waterproof. Wear it in any kind of water—hot, cold, fresh or salt. And that's not all! This 17-jewel beauty is dust-proof, doesn't tarnish, and the glass crystal can't break. It has a sweep-second hand, radium dial, waterproof strap. Whenever it's gift-time, remember that Croton Aquamatic will make him very happy. The price? Only \$49.50.

P. S. If not now available at your dealer, write for Free Booklet.
Croton Watch Co., 48 W. 48th St., N. Y. 19

Croton 

WATERPROOF AQUAMATIC

screen out hot rays will afford another check against damage from the heat of the explosive flash, which will be millions of degrees Fahrenheit. It may be several weeks after the test before any human beings can approach the camera towers because of radioactivity in the water.

On-the-spot-observation also is planned by television, with transmitters located in protected shelters on the atoll about five miles from the explosion sending images to screens on the task force flagship and the press ship, both approximately 20 miles distant. Some thought has been given to placing a transmitter in the nose of the B-29 dropping the bomb, but this possibility probably will be discarded because of the large amount of technical equipment the plane will be required to carry.

Every known scientific technique and item of equipment to observe, measure and record the effect of the three bombs will be utilized. Specially built instruments for this purpose will be installed on the ships themselves, to be recovered by divers in the event the ships are sunk in the shallow bay. Goats, sheep and pigs will be tethered aboard the target ships to serve as stand-ins for human beings. This is expected to add to our present extremely sketchy knowledge of the biologic effects of the blasts.

There will be repair facilities for ships damaged but not sunk in the first test, while salvage crews will make seaworthy any targets which could be returned to the United States after the second trial. They also will destroy any battered ships which might be hazards to navigation. Adequate safeguards will be established to protect all engaged in the test, observers, chance sea and air travelers, as well as inhabitants of the area, from the deadly radiation of the atomic bomb. Special protective gear, still on the secret list, has been devised for all personnel. The Bureau of Fisheries has stated that the test area is not the location of a spawning ground and the damage to fishing resources will be very slight.

A board consisting of two civilians, two Army men (one an aviator), two Navy representatives (one an airman) and one representative of the Manhattan District will evaluate the results and also analyze the report that the task force commander is required to make. The board will report directly to the Joint Chiefs of Staff.

"Operation Crossroads" is the code name for the epochal experiments, deliberately chosen, Admiral Blandy explained, because of its "possible significance"—that seapower, airpower and, perhaps, humanity itself were at the crossroads. And the Pacific tests may supply the answer!

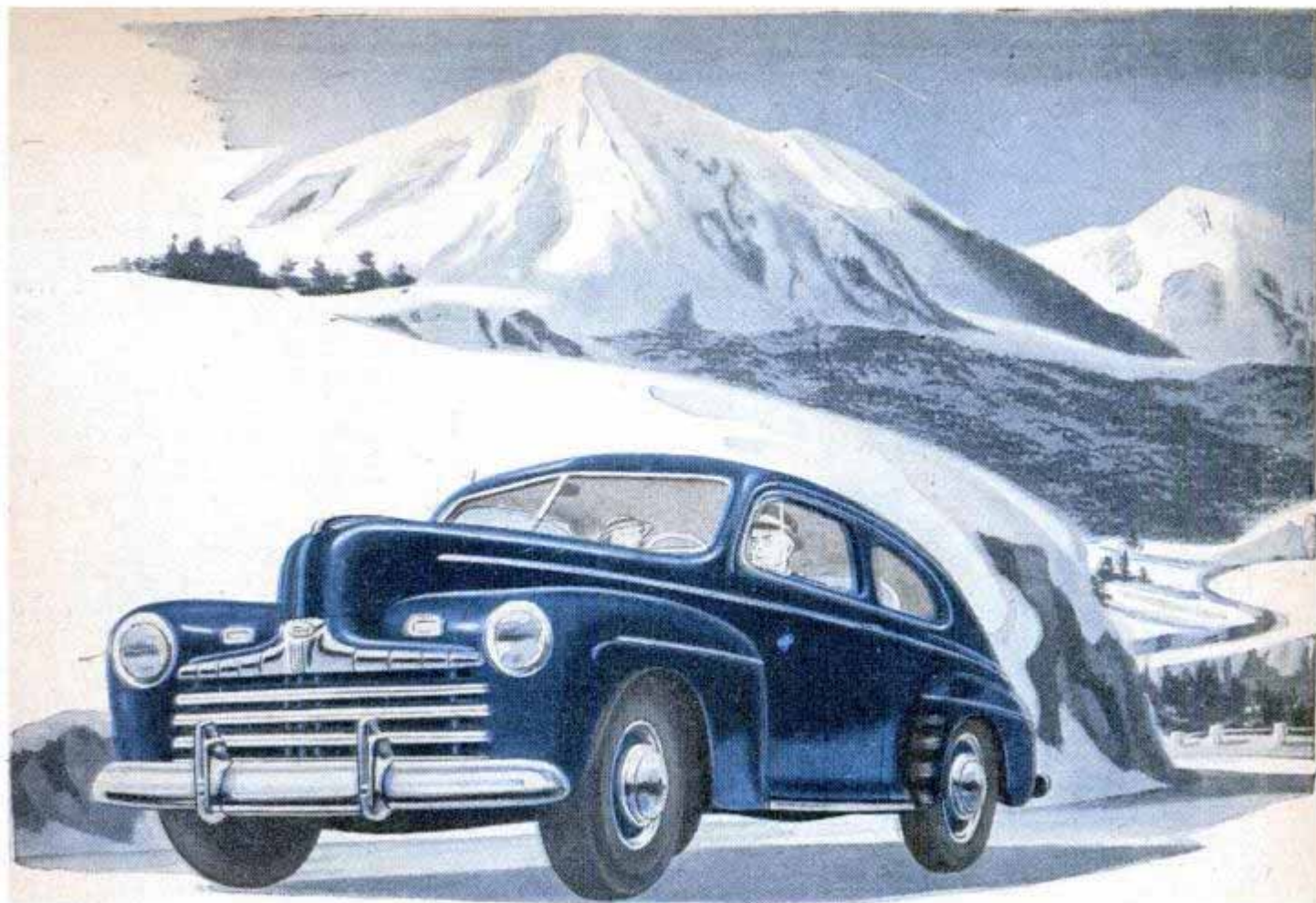

Ford's out Front

WITH THE BIG 100 H.P. V-8 ENGINE

No other car in its price class performs like the 1946 Ford because no other car has a V-type 8 cylinder engine . . . no other has 100 h.p.!

Ford's also out front with new beauty . . . with lower, wider appearance . . . with new two-toned interiors . . . with a sleek new instrument panel . . . with colorful plastic appointments . . . with ample roominess!

And Ford's out front with heavy-gauge steel bodies with long-lived, baked enamel finishes. See it at your Ford dealer's.



"MORE POWER TO YOU!"

This big new "100 horse" V-8 has new 4-ring aluminum pistons that make it thrifty on gas and oil! Also new balanced carburetion!



TUNE IN... The FORD-Bob Crosby Show—CBS, Wednesdays, 9:30-10 p.m., E.S.T... The FORD Sunday Evening Hour—ABC, Sundays, 8-9 p.m., E.S.T.

A Stanley Plane

PUTS SKILL INTO YOUR HANDS



Examine a Stanley Plane and you'll note how well it conforms to its use—hand-fitting handles solidly set—adjusting features simple, fast and dependable—cutter solidly supported and firmly clamped against looseness and chatter. And consider, too, that the edge of the cutter is of extra high carbon crucible steel fused to a backing of softer steel—combining a long-lasting, super-keen, easier honing edge.

No other partnership between tool and craftsman can compare

with the record of Stanley Planes used by generations of woodworkers. Be guided by that and ask for Stanley Planes.

WOODWORKING IS FUN

Send for Stanley's free booklet, "The Joy of Accomplishment". It includes a primary list of tools and a special list of tools to be added as needed. You'll also find the big Stanley textbook, "How To Work with Tools and Wood," constantly useful. It's yours for only \$1.00. Mail coupon today.

MAIL NOW

Stanley Tools, 146 Elm St., New Britain, Conn.

Please send by return mail

() The FREE booklet: "The Joy of Accomplishment".

() 188-page book: "How to Work with Tools and Wood". \$1.00 enclosed.

(In Canada: Send to Stanley Tool Co. of Canada, Ltd., Roxton Pond, Quebec)

Name.....

Address.....

City.....

State.....

STANLEY

THE TOOL BOX
OF THE WORLD

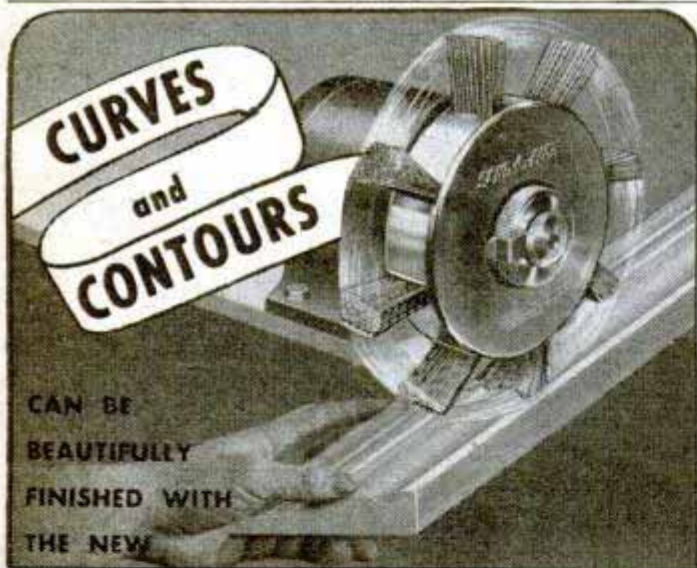

CURVES
and
CONTOURS

CAN BE
BEAUTIFULLY
FINISHED WITH
THE NEW

SAND-O-FLEX

Here is a low-cost sander that really reaches into recesses, around edges, and handles all those tedious jobs that were formerly done only by hand. Eight bristle brushes "cushion" the abrasive cloth and force it "down in" and "evenly over" all wood and metal surfaces. The central magazine houses the strip abrasive which is fed out as needed. Refill abrasive cartridges are supplied in various grits for all types of work. Loads in less than a minute. Weight 2 3/4 lbs. Diameter 8", including brushes. Slips onto your motor shaft and produces miracle finishes on curves and contours. See your dealer or write for catalog today.

SAND-O-FLEX CORPORATION
4373 Melrose Ave. • Los Angeles 27, Calif.



HUNTER'S COMPASS

Hunting Case,
Watch Type, All \$3.50
Metal, Jeweled

Engineers All Metal Army
Type Hand-Sighting

LEVELS
\$1.50



PUBLIC SPORT SHOPS

13 S. 16th St., Phila. 2, Pa.

No COD's

PREVENT WASHDAY MISHAPS with TITE-LINE Clothes Line Holders



String your clothes line on TITE LINE clothes line holders. It's quick. It's easy. It's the surest way to prevent that exasperating washday disaster—broken clothes lines. Each section is securely gripped—a line break affects only one section.

EASILY INSTALLED ON FLAT OR ROUND SURFACES

TITE-LINE clothes line holders are used in attics, basements, outdoors—wherever clothes line is used. Saves line, saves time, prevents knots and kinks, holds line tight, no tying. Get TITE-LINE at your favorite hardware or variety store. If not in stock, send us your dealer's name.



THE MIDLAND COMPANY
SOUTH MILWAUKEE, WISCONSIN

V-8 DUALS AND SINGLES

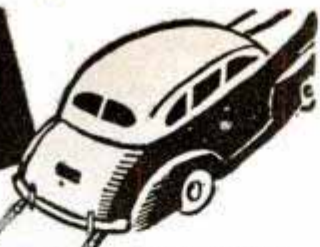

A genuine steel pack muffler WITH A BEAUTIFUL MOTORBOAT TONE. Sandee Mufflers feature improvements far in the lead, years ahead of competition. Increases mileage and power, reduces back pressure and gives better performance. Savings in gasoline will pay for a Sandee Muffler.

V-8 FORD AND MERCURY DUALS **\$17.50**

SINGLES—FIT IN PLACE OF REGULAR MUFFLER

Chev., V-8 Ford, Plym., \$5.00 Chrys., Olds., Buick, etc., \$7.00

These mufflers will outlast two regular stock replacements.

Dealers Wanted

SANDEE MUFFLER CO.

7523 S. WESTERN AVE. LOS ANGELES 44, CALIF.

TURNER

VT-73

DESK MICROPHONE

Here's the mike you want for your rig. It's got looks, it's tough, and man, oh man how it performs. It's a TURNER! Ask your dealer or write for Free Literature on other low cost Turner Microphones.



THE TURNER COMPANY

921 17th St., N.E., Cedar Rapids, Iowa

Available Now! New ALL-PURPOSE MOTO-SCOOT

We are now making deliveries on MOTO-SCOOTs. Amazing new improved MOTO-SCOOT world's most economical form of motorized travel—up to 80 miles per gallon!

Completely enclosed package compartment. Both "Solo" and "Delivery" Models ideal for utility and sport. To assure prompt delivery place your order at once. Write for colorful illustrated booklet giving full details.

AMERICAN MOTO-SCOOT CO., Dept. 4PM
1305-23 W. Carroll Ave., Chicago 7, Ill.



**DEALERSHIPS
OPEN NOW!**

Enter this profitable selling field. Some franchised territory open to responsible parties. Inquire today!

Thompson BEATS the World on BOATS

Safe Boats With Full Length Spray Rails

Keep passengers perfectly dry—even at high speeds. Catalog also shows two new models of "Take-Along" Boats. Two big factories—save you freight.

CATALOG FREE Write for your copy. State kind of boat in which you are interested.

THOMPSON BROS. BOAT MFG. CO. (151)
213 Ann St. PESHIGO, WIS. (Write to either place) 113 Elm St. CORTLAND, N.Y.



Better Built
Lower Prices



Light Boat for Auto.

THE MAKING OF

Marlin GUNS

Marlin brings to sportsmen, through this series of advertisements, interesting facts on gun-making—to enhance appreciation of fine sporting firearms and to encourage their thoughtful handling and care.

RIFLE'S HEART • Inventive genius and fine craftsmanship mark firearms actions which have stood the test of time. The action is the main "works" of the rifle. Mechanism which carries cartridge from magazine to chamber...locks action...strikes firing-pin...pulls out and ejects cartridge...is so compact that it fits into a man's hand. All working parts are heat-treated for lifetime wear. Assembling is entrusted only to craftsmen of great experience and skill. All actions are tested before shipment.



Assembling action of the Marlin 39-A Rifle.



Testing actions at Marlin Firearms Plant.

SOLID TOP RECEIVER • A major advance in firearms design and the invention of J. M. Marlin. Solid top permits lowest possible mounting of telescope sight. Cartridge cases are ejected at side, cannot fly in shooter's face.

AT RIGHT are shown the "insides" of the Marlin 39-A Rifle. Its famous action has been continuously improved over half a century. Note solid top receiver, simplicity of mechanism.



ALL WORKING PARTS of Marlin's 39-A are exposed for cleaning and oiling by turning a single take-down screw. This Marlin is the only lever-action, .22 cal. repeating rifle made.

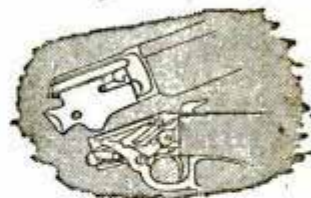

(The next advertisement in this Marlin series will reveal more interesting facts on fine gun-making.)

THE *Marlin*

FIREARMS CO.

NEW HAVEN, CONNECTICUT, U. S. A.

BE SURE TO SEE MARLIN 1946 MODELS ON DISPLAY AT YOUR DEALER'S

"1001" Re-Blade Knife*

with interchangeable surgical steel blades!



**KEEN!
EVER SHARP!
EVER READY!**

"1001" Knife
as above, \$1.29

Knife with 3
extra, differ-
ent blades
and honing
stone, \$1.59



The first really "balanced" craft knife

Whether you're an expert craftsman or just a passably fair workman or hobbyist, you'll do better work faster and easier with "1001"—the re-blade knife of 1001 uses! For "1001", thanks to its light, perfectly balanced, colorful plastic handle, is second to none for easy and exact whittling, chiseling, modeling and cutting of all sorts. Its patented, scientifically designed chromium finish blade holder simplifies the insertion and removal of "1001's" all-purpose blades, and keeps them firmly locked in place. Yourself—get a "1001"—feel the difference, see the difference in your work. It's as easy to handle as a pen or pencil.

• Buy "1001" wherever hobbycraft tools are sold. If your dealer cannot supply you, send check or money order for \$1.29 (or \$1.59) direct to

SOMAR SPECIALTY CORP.
Dept. M12—630 Fifth Ave., New York 20, N. Y.

*PAT. PENDING

Say you saw it in Popular Mechanics

Test-O-Lite the MODERN TROUBLE SHOOTER



THE NEON GLOW

... LOCATES TROUBLE INSTANTLY in electric circuits, fuses, cut-outs, motors, radios, appliances. Tests everything electrical from 100 to 550 volts. Indicates hot or grounded wires. Tells AC from DC. Engineers prefer it because it has patented safety features.

PUTS "FINGER" ON THE TROUBLE SPOT -- QUICKLY

Far superior to ordinary clumsy test bulb. Saves precious time. Indispensable in shop or home. Vest pocket size. Lifetime guarantee. List \$1.50 (Pat. No. 1,778,883) Purchase through regular electrical dealers.

L. S. BRACH MFG. CORP.

200 Central Ave. Newark, N. J.



FUSES



MOTORS



OUTLETS

LARSON for Leather

HANDICRAFTS HEADQUARTERS

Make Belts, Moccasins, Purses, Gloves and other useful things

for profit

We regret that our stocks are incomplete for the time being.

Send 10c for catalog

J. C. LARSON & CO.

180 N. WACKER DRIVE — DEPT. D
CHICAGO 6, ILLINOIS

HAUCK FLAME GUN KILLS WEEDS ★



2000° F controlled heat quickly, easily destroys seeds, roots, brush, poison ivy, wild morning glory, Canada thistle, other unwanted growths. Many uses: splitting rocks, burning stumps, sterilizing poultry houses. Burns kerosene. Does the work of 4 men. Safe, easy to use. 10 day trial. Satisfaction guaranteed. Free catalog.

HAUCK MFG. CO.

121 Tenth St.

Brooklyn 15, N. Y.

KEEP YOURSELF UP-TO-DATE ON WOOD VENEERS LUMBER & SUPPLIES

with CONSTANTINE'S MASTER MANUAL

Published by the leading suppliers to wood workers, the most complete book ever offered. More than a catalog, contains valuable information on lumber inlays, veneers, wood finishing, etc. 88 inlay border designs in full color, 6 pages of full color inlays plus a wood identification chart showing over 60 rare woods in natural color. Send only 25c today and we will include FREE a year's subscription to our publication, Chips & Chats.

ALBERT CONSTANTINE & SON, INC.

791H E. 135th Street, New York 54, N. Y.



GOODBYE PUTTY!

MASTIC-GLAZE
REGISTERED U. S. & CAN. PATENT OFFICE
IN COLORS

Successor to Putty!

- NEVER CRACKS!
- NEVER FALLS OUT!
- NO PRIMING!
- NO PAINTING OVER...
the COLOR is right in it
- EASY TO APPLY!



**BUY TREMCO
 MASTIC-GLAZE**
 at Hardware, Paint & Dept. Stores

**A TOOL—
 NOT A
 BRUSH**



**PAINTERS'
 STRIPING**

TOOL

**ONLY
 \$1.00
 POST
 PAID**

As easy to use as a pencil! Draws parallel lines, straights, curves, circles with paint, enamel, lacquer. Use to stripe autos, furniture, toys, bikes, model planes, signs, bulletin boards, linoleum. (Makes wall board look like tile.) Every painter and craftsman should own one! Type "S" MASTER Painters' Striping Tool with instructions, adj. guide, 1/16" tip, complete only \$1.00. C. O. D. 25c extra. Order Today! PAINT DEALERS! WRITE FOR LITERATURE, ETC.

WENDELL MFG. CO., 4234-B, Lincoln Ave., Chicago 18, ILL.

Van's BOOT SAVER



Here's the smart way to dry your boots and other outdoor footwear quickly—also to store them to save folding and prolong life. Indispensable to hunters, fishermen, farmers and all outdoor workers and sportsmen. On trips carry in coat pocket.

\$1.25 prepaid in U. S. A. if your dealer can't supply you.
NOEL VAN TILBURG CO.

1029 Washington Ave. S. E., Minneapolis 14, Minn.

**SIGNS EASILY AND EXPERTLY
 PAINTED WITH LETTER PATTERNS**
 AND SHOWCARDS **MANLY SIZES & STYLES
 WRITE FOR FOLDER!**
JOHN F. RAHN
 1330-31 N. Central Ave.
 CHICAGO 51, ILL.

Say you saw it in Popular Mechanics

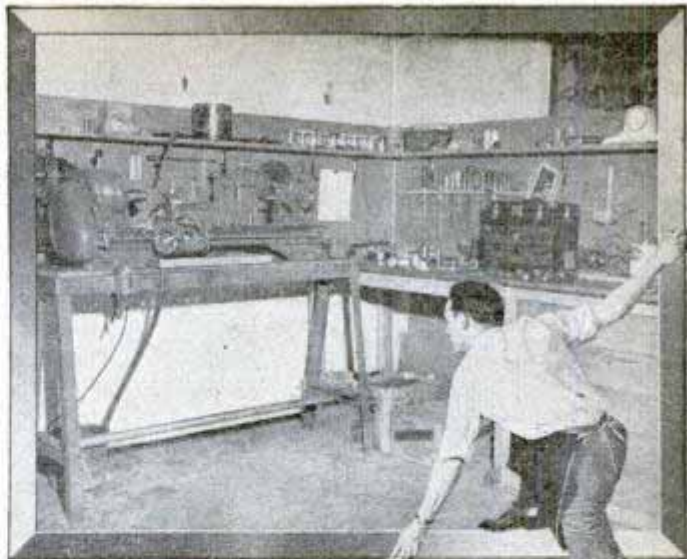

**GET INTO THIS
 HAPPY PICTURE**

A well equipped home shop is the dream of many a man. It's the best hobby of all if you like to use tools. Most practical, too, when you consider the hundreds of useful articles you can make for your home—and the time and money you can save by repairing your own home appliances and equipment.

Atlas tools are ideal for such a shop—engineered for precision workmanship, and ruggedly constructed to give you a lifetime of service. They are built with modern production techniques to give you exceptional values.

Long-standing industrial reconversion orders will soon be filled. Keep in touch with your Atlas distributor.

Send for this fully illustrated catalog to make your plans.



ATLAS PRESS CO.

443 N. PITCHER ST.
 KALAMAZOO 13D, MICH.



6"-10" Lathes Milling Machines Shapers Drill Presses

SWIVEL-HEAD

FLASHLIGHT

nothing else like it!

**HEAD TURNS
LIGHT AT
ANY ANGLE**

Greatest advance in flashlight design in a generation. Turn powerful pre-focused beam where you want it . . . stand it up . . . clip it on . . . both hands are free. A handsome, durable, all-purpose flashlight for everyone. Ask your dealer.



**\$2 LESS
BATTERIES**



No. SW-22
Patented

No. 75 Heavy-Duty Dated Cell. Fresh Lasts longer. 10¢

Flashlights & Batteries

If dealer cannot supply, send \$2.00 to Dept. P UNITED STATES ELECTRIC MFG. CORP., New York 11, N. Y.

*USA LITE Red-Head Safety Flashlight—a "MUST" for the motorist.

KEEP A CAN OF BOTH ON HAND!

Heavy 3-IN-ONE

Light 3-IN-ONE

Refrigerators, mixers, motors, power tools, lawn mowers, ironers.

Sweepers, sewing machines, hinges, guns, locks, metal drawers.



For over 50 years America's accepted household oil!

SOLD EVERYWHERE IN 1 AND 3 OUNCE CANS



3 - IN - ONE Oil

WRITE
For
FREE
Literature



**BUILD YOUR OWN
POWER LAWN MOWER**

**WHY BREAK YOUR BACK
MOWING FIELD OR LAWN?**

Now anyone can save time and effort mowing field or lawn, by building their own whirl type power mower. We furnish complete information, and whirl type blade attachment. Write today.

THE RITE-WAY
MOWER ATTACHMENT

T & H Mfg. Co.

811 E. 31. Dept. B-1. Kans. City 3, Mo.



**"WONDER"
ELECTRIC BUTTON**

Most interesting electrical apparatus ever discovered. Make your own Telephone-Amplifier Detectaphone. Transmit your voice or music to distant rooms. Perform hundreds of fascinating experiments. So tiny it can be concealed in dozens of places. Send \$1 now for button and free 5,000 word instruction booklet with 50 illustrated experiments. SPECIAL OFFER 6 buttons and booklets sent post-paid for \$5.

BUCK MFG. COMPANY, Box A-28, No. Aurora, Ill.

ENGINES IN STOCK: ONLY \$9.95



The G. H. Q. miniature gasoline engine that really operates is available. Over 100,000 sold to date. 1/5 H. P. Complete with coil and condenser and full illustrated instructions for only \$9.95. Fully bench tested and ready to run. Power for all models. Send only \$1.00—Shipped Collect C.O.D. same day. Send for free illustrated Catalog of hundreds of hobby items.

GHQ MOTORS, Dept. BX46, P. O. Box 193, Station O, N. Y. 11, N. Y.

Authenticast SCALE MODELS OF TANKS AND SOLDIERS!

PERFECTLY CAST—ALL METAL

AUTHENTICAST scale models are scoring a direct hit with hobbyists everywhere! Ask your hobby dealer to show you the complete AUTHENTICAST collection of tanks, jeeps, scout cars, half tracks and soldiers. Tanks \$1.10 to \$2; Men \$1.85 box of 12 asst'd. Scaled to match, 1 in. to 9 ft. Send 35¢ in coin for 32-page color catalog.



GI's with bazookas, tommy guns, rifles — machine gunners, anti-tank crews behind the famous M12 — 155mm "Long Tom"



132-01 91st Ave., Richmond Hill 18, N. Y.



STOP LEAKS!

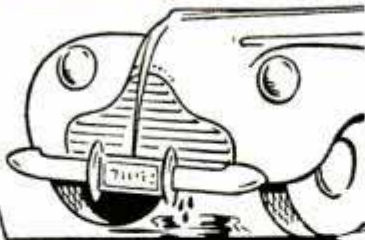

Cooling Systems Made Leak-Proof QUICKLY

WARNER LIQUID SOLDER—Non-Metallic—Deposits Tiny Fibers to Repair Leaks Anywhere in Cooling Systems. Simply pour in! Finds and REPAIRS every crack or hole. Do it yourself—or see your service man.

Warner-Patterson Co., 920 S. Michigan Ave., Chicago 5

★ Build These Cleveland Models ★

 Lockheed "Lightning" P-38 38 3/4" model of one of the AAF's most sensational fighters. MFM Kit SF-85... \$4.00	 Cleveland Tether "SHARPIE" Lowest price line-controlled gas model yet offered. A, B, C, engines. Kit GPL-5023 (less motor and hdwe.) \$1.00
 Boeing B-17 "Flying Fortress" Known as most famous plane of World War 2. Perfect memento of the AAF. 7 1/4" span. MFM Kit SF-100 \$12.50	 36" Industrial Train Model, Kit T-85.... \$1.50

SEE YOUR DEALER FIRST. In ordering direct, add 20c extra for packing-postage. **CATALOG 5c** (Circular free)

CLEVELAND MODEL & SUPPLY CO.
 4508F35 Lorain Ave. ★ ★ ★ Cleveland 2, Ohio, U. S. A.

REPAIR YOUR OWN ELECTRIC APPLIANCES WITH NEW AMAZING NICHROCITE



Handy for Home or Industrial Use



Simply overlap ends, apply Nichrocite paste and turn on the current—a perfect weld results. Used by big utility companies and repair shops. Just the thing for that broken or burned out heating element in your electric iron, stove, toaster or heater. Does the job in a jiffy. Trial order, \$1; 4 ozs., \$2.50; 1 lb., \$8.00.

ARMSTRONG ELECTRIC CO., Box 861-MP, Minneapolis, Minn.

METALLIZE BABY SHOES

Learn this easy, money making business from nationally recognized consultant. Small investment; perpetual market. For free details write Joseph B. Kushner, B.S. Ch.E., Metal Finishing Consultant, Stroudsburg, Pennsylvania, R.D. 3C.

FREE RADIO CATALOG



Latest radio and electronic parts and devices, newest ham gear, gadgets, war surplus items. All in this new FREE catalog. Don't delay,

BURSTEIN-APPLEBEE CO.
 1012M McGee, Kansas City 6, Mo.

A TOOLSHOP IN YOUR HAND!

- GRIND • DRILL • ROUT
- POLISH • ENGRAVE
- CUT • SAND • SAW, etc.

Make Things From Wood—Plastics—Metals—Glass—Linoleum—Leather—Alloys—Horn—Stone—Bone, etc.



HANDEE TOOL OF 1001 USES

Smooth, steady power at your fingertips! You can turn out professional looking projects for pleasure or profit—ship, plane or train models, costume jewelry, wood carvings, puppets, initialed tumblers, etc. Handee, first small portable tool and today's finest, uses 300 different accessories. AC or DC. 25,000 r.p.m. Weight, 12 oz. With 7 accessories, *postpaid*..... **\$18.50**

GET A GOOD START

Get the **HANDEE KIT**



amazed at what you'll accomplish!
Complete, postpaid, \$25.00

FOR YOURSELF OR A FRIEND...
 THE GIFT OF A LIFETIME!

HANDEE PRECISION ATTACHMENTS

Magically, easily, your offhand carving, routing, shaping, etc. will be perfect as to depth of cut, accuracy of line. These remarkable new tools for novice or experienced craftsman fit Handee only. Set of 6 attachments, with full instructions, *complete, postpaid*..... **\$7.95**



ORDER NOW—
 USE COUPON

FREE 64-PAGE Catalog

CHICAGO WHEEL & MFG. CO.
 1101 W. Monroe St., Dept. PM
 Chicago 7, Ill.

Send me HANDEE TOOL HANDEE KIT
 PRECISION ATTACHMENTS
 Remittance enclosed. Send C.O.D.
 Send 64-page Catalog.

Name

Address

Only Forecaster Superb Pipes have this

NEW FILTER

**Cleans, cools, filters smoke •
Traps nicotine • Prevents drip**

Enjoy a clean, cool, dry smoke always from a Forecaster • The exclusive aluminum winder can be removed in a jiffy—change cleaner as often as you like. • Choice, rich-grained briar, in a variety of popular shapes. • Ask to see the Forecaster Pipe display at your favorite dealer.

\$1.50

Sir Sheldon Pipes, \$2.50



*Pat. App'd For

NATIONAL Forecaster SUPERB

NATIONAL BRIAR PIPE CO • JERSEY CITY, N. J.



Superior Quality
ROTARY FILES

FOR HOME CRAFTSMEN

The nationally famous Ford Rotary Files, used for the past 25 years by leading precision manufacturers, are now available for the home craftsman in a handy dust proof case which contains six popular shaped tools.

The tools are made of the finest quality high-speed steel, hardened and tempered for maximum life. These ground cutters are efficient on steel, aluminum, brass, plastic or wood. The shapes will meet most home craftsman applications. These tools are made with standard 1/8-inch shank. Additional shapes and sizes are available.

Money with order prepaid
C.O.D. — postage extra

**SIX TOOLS in
Dust Proof Case \$6-25**

M. A. FORD MFG. CO.

800 WEST FIRST STREET
DAVENPORT, IOWA

PLASTICS

There's fun and profit in making plastic jewelry, novelties, and furnishings, in your home workshop! We have every material you need — Plexiglas, Lucite, Bakelite, Lignolite, Tenite II, Lumarith, in a large variety of sheets, rods, tubes, and special shapes. Also dyes, cements and other plastics supplies and accessories. Send 10 cents today for complete catalog.

CARMEN-BRONSON CO.

165 East 3rd St., Dept. 4-B Mt. Vernon, N. Y.

HULL AUTOMOBILE COMPASS

You're on the right course always with a HULL AUTOMOBILE COMPASS. No lost directions, backtracking, delays. Reliable for years, out of the war with improved accuracy. Ask your dealer for a HULL—the leader. Circular free. Price \$3.50.



HULL MFG. CO.

P. O. BOX 246-D5

WARREN, OHIO

WORK BENCH

Ideal for hobbyist or shop worker, this sturdy, useful bench makes home handiwork a joy! Heavy top, 2 large drawers. Tool rack, strong shelf, bins for nails and bolts, 59" long—23" wide—36" high. Shipped unassembled, easily set up (from instructions). F.O.B. Phila. factory. Check or money order. Money back if not satisfied.



\$13.95

J. B. NOLAN, Dept. M

5040 WALNUT STREET

PHILADELPHIA 39, PA.

**DIE-LESS
DUPLICATING**

Many small parts can be formed without dies, to duplicated accuracy of .001" with DI-ACRO Precision Machines,—Benders, Brakes, Shears. Save die expense and time delay. Ideal for experimental and research work, making samples, models, etc., as well as regular production runs. Write for descriptive literature.

O'Neil-Irwin Mfg. Company

341 8th Ave. South
Minneapolis 15, Minn.



SHEAR



BENDER



BRAKE

for Power that Zooms in the spring..tra la!

● It's Spring again! And what a Spring—with gasoline galore and never-ending roads. With valleys and lakes, mountains and woodlands, all beckoning you to come on out and really live again.

It's what you've hoped for and dreamed about—and here it is, all yours!

But before you start out, you'll want Casite in your motor, whether it's old or new. Casite tunes up older motors—restores smoothness and power. And it protects new motors during the critical break-in period.

Casite carries oil quickly to the tight spots . . . retards for-

mation of sludge and gum . . . reduces engine wear . . . keeps motors clean and full of zip!

Millions of motorists have used Casite . . . and keep coming back for more. Put a pint in the crankcase every oil change and a pint through the air intake every three months. It's sold by service stations, car dealers and garages.

THE CASITE CORPORATION
HASTINGS, MICHIGAN

CASITE



65¢ A PINT

BETTER AND SMOOTHER PERFORMANCE OR DOUBLE-YOUR-MONEY-BACK

GUARANTEE—Add Casite to crankcase and run through air intake according to instructions, then drive your car 100 miles or for 60 days, whichever is first. If not convinced that Casite gives you better and smoother performance, you get

double-your-money-back by filling out guarantee certificate and mailing it to The Casite Corporation, Hastings, Michigan. Maximum refund is \$1.30 per pint, twice the nationally advertised price of Casite.





LIVE and TRAVEL in Comfort

SOLVED—your housing problem—with a modern, mobile, Schult Luxury Liner. Has every facility of a 2-bedroom home, scientifically arranged for comfortable living. Sliding doors afford 3-room privacy for guests or night-shift workers.

COMPLETELY FURNISHED

● Generous-sized wardrobes and drawers for clothes, linens, supplies. Oven cooking range, refrigerator, double sink make full meals easy. Built-in real bed, plus sofa-bed gives 2-bedroom utility.

See your Schult dealer today, or write for new booklet on 1946 models. SCHULT CORPORATION, Dept. 3204 ELKHART, INDIANA. Member: TCMA. Attend National Trailer Coach Show, Chicago Coliseum Mar. 16-24

SCHULT Trailer Coaches



CUSTOMER:
"That's a beautiful job, Pete."
PETE: "Yes, you can't beat the Foley for turning out a perfect cutting saw."

SAW FILING

is a Good Business

With the Foley Automatic Saw Filer you can have a fine cash business with steady customers and make a good living. The Foley automatically joints the saw, making all teeth even in size, shape, spacing. The Foley is the only machine that files all hand saws, also band and cross-cut circular saws.

SEND FOR FREE PLAN—Shows how to start a saw repair shop. No canvassing. Send coupon today.

FOLEY Automatic SAW FILER

FOLEY MANUFACTURING CO.
416-6 Foley Bldg., Minneapolis 13, Minnesota
Send Free Plan on Saw Filing business, no obligation

Name _____

Address _____



Fuse Puller — Circuit Tester

For
Home
or
Factory

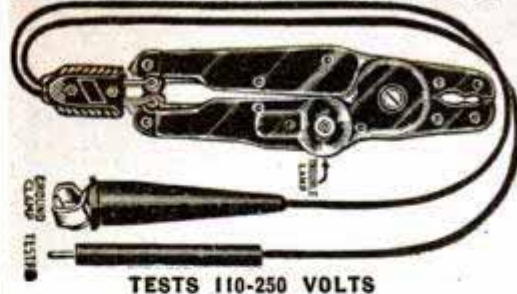

TESTS 110-250 VOLTS

When motors stop and lights go out, this tool quickly **LOCATES DEAD CIRCUITS** and safely removes blown Fuse. The Star Test Pocket Plier is made of a Transparent Plastic having in one of the legs a small lamp in series with a resistance and can be used to test 110 to 250 volts circuit. The Plier will pull fuses from 10 to 100 Amperes. Thousands of Electricians find this tool handier than Test Lamps. Price \$2.75 each without Leads, \$1.50 additional for Leads. Can be obtained from General Electric or Westinghouse Stores or from your local dealer or jobber. Order NOW. **STAR FUSE CO., 235 Canal St., New York 13, N. Y.**



Made From IMPORTED BRIAR

BULLDOG SADDLE



Enjoy unmatched sweet smoking quality, outstanding fine grains, in modern designs.

Write for FREE illustrated booklet. **\$3.50 to \$10**

C. B. WEBER & CO., 141 Cator Ave., Jersey City 5, N. J.

Hobby Room to Upstairs .. Basement to Attic!



TWO-WAY INTERCOM SYSTEM Now Priced Within YOUR Reach

Saves endless steps. Clear reception to 1000 ft. Beautiful steel cabinet; 3-tubes; send-receive button; 110 AC. Mailed Cash or C.O.D.

VINCE ANDERSON COMPANY
20 Ross Ave. . . Fort Mitchell, Ky

\$1795

MARCOT KEY MACHINE

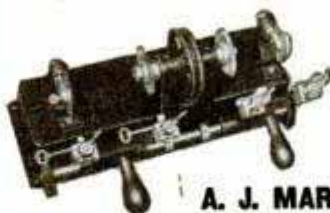

Marcot No. 8 Key Machine
Mounted on Cabinet.....\$ 75.00
Book on Modern Locksmithing 3.95
Auto Code Book and Depth Keys 12.50
2592 Assorted Key Blanks. 77.76
Set Key Files, Tools, Pins, Springs, Thimble 10.50

\$179.71

A. J. MARCOTTE CO., 1200 N. Kedzie Ave., CHICAGO 51, ILL.



DRILL-INDEX A compact container for indexing and filing twist drills. Eliminates search. Made entirely of steel in nine sizes. See your dealer or write to

HUOT MFG. CO.
Foot Schultz Bldg. St. Paul 1, Minn.

KEEL-GUIDED BOAT ROLLER



FOR BOATS and CANOES. Easily mounted to dock, pier, trailer. Boat rolls on even keel, simplifies handling. Cuts damage and repair cost. Rollers of hard durable rubber. Assembled ready to use. \$7.95, F.O.B. FREE FOLDER. See your dealer or order from **BERG'S Madison 4, Wis.**

SAY YOU SAW IT IN POPULAR MECHANICS

Mows and Trims Lawns



In One Simple
Easy Operation

8 1/4 Lbs.



Save Time
and Labor with a
MONTAMOWER

New model. New type metal handle has special device to adjust cutting height. Drive shaft now mounted on free rolling, factory lubricated, and sealed ball bearings. No tired backs or aching arms. 8 1/4 lbs. of live precision made mechanism that first gathers, then cuts smoothly a clean 16" swath through grass, dandelions, spike grass and weeds. No noise or clatter. As modern and efficient as your electric razor. Cuts right up to walls, fences, trees or posts; leaves no fringes to be trimmed by hand. Cutters are self-sharpening. Built to last many years. Many thousands in use. Sold direct from factory. Costs little. Write at once for guarantee information and literature.

MONTAMOWER DISTRIBUTING CO.

822 Keeler Bldg.

GRAND RAPIDS 2, MICHIGAN

STOP THAT DRIP

NO Drip
TAPE



EFFECTIVE IMMEDIATELY

New—for homes! A sure cure for condensation drip from cold water pipes. Pliable, cork-filled NoDrip Tape eliminates wet floors, makes idle space usable!

Quick, Clean, Easy to Apply—No tools needed. Covers joints as well as straight pipes.

At hardware, dept. stores, lumberyards.

Roll, enough for 7 feet of 1/2" pipe.

Higher west of Rockies and Canada

FREE CIRCULAR

J. W. MORTELL CO. 522 BURCH ST., KANKAKEE, ILL.

\$1.25



BRASS RODS For Home Work Shops

For use on model boats, airplanes, etc., keep a supply of these free-turning brass rods on hand. Each kit contains a complete assortment of sizes.

KIT 1 . . . \$1.00 KIT 2 . . . \$4.00

plus postage, 7 pes. plus postage, 5 pes.
12" long, 1/8" to 1/2" diameter by 1/16ths. 12" long, 1/2" to 1" diameter by 1/8ths.

MEIER BRASS & COPPER CO. 1320 E. Larned, Detroit 7, Mich.

NEW! FOR ALL THOSE PIPE REPAIR JOBS
NO MESS—NO WASTE

Handy—
Easy to Use



PIPE JOINT COMPOUND—HANDY AS A PENCIL
TRADE MARK. PAT. APP. FOR

FEATURES!
• Withstands gasoline, oil, butane, propane, Freon, air, water, steam, acid, gas, brine.
• Lubricates and completely seals pipe joint threads, nuts, bolts, gaskets, turnbuckles, etc.
• Contains no lead. Contains no injurious ingredients.

SEND 15c

TIGHT JOINTS ASSURED
HANDY AS A PENCIL

Just rub 3 or 4 strokes across pipe threads. It spreads and fills threads when turned.

AT MOST GOOD HARDWARE COUNTERS—DEALERS INVITED
©Lake Chemical Co., Dept. P.M., 607 N. Western Ave., Chicago 12, Ill.

YOUR WET CELLAR made DRY from the Inside!

This spring make up your mind to get rid of the drippings, dampness, and mustiness that come from cracked or porous cellar walls and floors, for good. Waterproof them with Smooth-On No. 7 Iron Cement. Do it yourself—save delay and expense. Apply Smooth-On like paint—goes on wet walls or dry, on stone, brick, concrete. Hardens in 24 hours, expands to fill cracks and crevices, forming a tight metallic seal.

Equally effective for waterproofing cisterns, troughs, tanks, fountains, swimming pools, stables, garages, outbuildings and for smoothing up concrete floors.

Comes in 1-, 5-, 25-, and 100-lb. sizes. 25 lbs. covers 100 sq. ft. Ask for Smooth-On No. 7 at your neighborhood hardware store. If they haven't it, write us direct.

FREE REPAIR HANDBOOK

Besides full directions for waterproofing your cellar, this free, 40-page, pocket size manual will give you information and instructions for stopping leaks, sealing cracks and tightening loose parts in heating and plumbing systems and other home equipment. 170 diagrams. Just send coupon.



— Sign and Mail NOW —

Smooth-On Mfg. Co., Dept. 37
570 Communipaw Ave., Jersey City 4, N. J.

Please send me Smooth-On Handbook

Name

Address

4-46

Free

Do it with **SMOOTH-ON**

SAY YOU SAW IT IN POPULAR MECHANICS

For a **HIGH LEVEL**
of Smoking Pleasure



Satin Smooth Finish
Handsome Grains
Smart Styling



\$1.50
\$2.50 Also \$5.00
\$3.50 to \$15.00

Briar House Policy:

To provide in Edwards Pipes the greatest possible smoking pleasure... to make fine quality briar pipes at lowest prices... to merit your Good-Will and Confidence. Buy EDWARDS... greater values than similarly priced pipes.

Exclusive Patented Aluminum Filter



Briar House

1052 GREENE AVENUE INCORPORATED BROOKLYN 21, N. Y.

REMOVES ALL FINISHES



New type semi-paste remover quickly lifts off paint, enamel, varnish, shellac, lacquer, bakelite and other synthetic resin finishes. (Removes emulsified resin water paints, too.) Stays wet longer — stays put on upright or overhead surfaces — strips clean, quick. One coat usually enough (apply with brush or spray). Contains no benzol, acid, caustic, alkali, or wax — harmless to hands, bristles, surface stripped. All sizes (pint 65c) at paint and hardware stores.

FREE CIRCULAR

"How to Remove Paints, Varnishes, Lacquers, etc." Also describes other Savogran Products: Heavy Duty Cleaner, Crack Filler, Wood Putty, Remover & Bleacher (renews floors), Paint Brush Cleaner, Coldfoam Soapless Soap Powder.

It's Orange!



NO BENZOL-ACID-CAUSTIC-ALKALI-SAFER TO USE

THE SAVOGRAN CO. DEPT. 30, BOSTON 10, MASS.

SAVOGRAN STRYPEEZE

IN EVERY WELL-EQUIPPED HOME WORKSHOP

ELECTRICITY FOR ANY JOB ANYWHERE



Reliable, economical electric service anywhere, anytime, with an Onan Electric Generating Plant. Driven by Onan built, 4-cycle, gasoline engine, these power plants are of single-unit, compact design and sturdy construction. Suitable for all types of service.

Models range from 350 to 35,000 watts. A.C. types from 115 to 660 volts; 50, 60, 180 cycles, single or three-phase; 400, 500 and 800 cycle, single phase; also special frequencies. D.C. types range from 6 to 4000 volts. Dual voltage types available. Write for engineering assistance or detailed literature.

ONAN

D. W. ONAN & SONS, 2516 Royalston Ave., Minneapolis 5, Minn.

Sand Casting—Forging—Heat Treating—Case Hardening
BRONZE FOUNDRY



is again available in limited quantity without priority. Orders filled in sequence as received. INVENTORS—SCHOOLS—CRAFTSMEN use FOUNDRYETTE for making castings quickly for new inventions, for instruction, and general purpose. Order now for early delivery. Three sizes are available capable of making bronze castings of 1 1/2, 3, and 6 pounds weight, aluminum, copper, brass, etc., \$17.50, \$24.00, \$34.50, f.o.b. Kansas City. Domestic gas supply and 110 volt AC or DC energy required for operation. Write for circular.

KANSAS CITY SPECIALTIES CO.

Box 6022, Dept. P-65

Kansas City, Mo.

MOTORIZE YOUR LAWN MOWER WITH A GASOLINE OR ELECTRIC WASHING MACHINE MOTOR

ENJOY CUTTING GRASS AND MAKE MONEY RENTING YOUR MOWER. SEND FOR OUR GUARANTEED COMPLETE INSTRUCTIONS ILLUSTRATING EVERY DETAIL OF BUILDING THIS MACHINE.



PRICE \$1.00

ZETCO PRODUCTS CO., BELLEFONTAINE, OHIO

SMALL HOLE SET OF THREE TOOLS



A fine set of hardened, ground and polished precision tools—ALLENIZED to resist acid stains etc.—for measuring holes, slots etc. 3/32 to 5/16 inch. We will ship in a nice VELOTEX case at \$1.00 additional.

ALCO SHOP, Dept. 6, Box 2214, Terminal Annex, Los Angeles 54, Calif.



GEARS

In Stock - Immediate Delivery

Gears, speed reducers, sprockets, thrust bearings, flexible couplings, pulleys, etc. A complete line is carried in our Chicago stock. Can also quote on special gears of any kind. Send us your blueprints and inquiries.

Send for Complete Catalog No.10

CHICAGO GEAR WORKS
440-50 N. Oakley Blvd., CHICAGO 12, ILL.

ANYONE CAN FIX ZIPPERS

in 10 minutes. No special tools required. **BIG 30 page BOOK** of STEP-BY-STEP INSTRUCTIONS, 39 SKETCHES, shows you how. Details free or mail \$1.00 now.

Morehelp, A46, Box 140, Lakewood, N. J.

COLOR CONCRETE WITH CHEMICALS

A business of your own. Big money making Hollywood style pottery and birdbaths without moulds. Washing-wells, stucco-rock, benches. Marbling and cement water-paints. 10c brings sample, literature, pictures. Hollywood CementCraft, 8529 Wonderland Ave., Hollywood 46, California

SHELDON

No. 1026 BMWQ

If you plan a
"better-than-usual"
home workshop

If you are setting-up an ideal home workshop . . . a shop equipped to do real precision work of industrial size and quality, your logical first machine tool is a Sheldon No. 1026 BMWQ.



Fundamentally an industrial tool room lathe, this precision lathe with its 10 1/4" swing and 26" center distance is capable of doing not only ordinary home workshop "projects" but close tolerance precision, industrial, tool room and production work.

Complete with motor drive, motor and reversing switch \$501.00

Heavy top. Rigid steel lathe bench (containing 4 drawers and large cabinet) \$110.00 extra.

SHELDON MACHINE CO., INC.

4266 N. KNOX AVE.

CHICAGO 41, U.S.A.

IT'S EASY! IT'S FUN!

Build Your Own

- Transmitter Kits • Phono Amplifier Kits
- Antenna Kits • Crystal Sets and many others.

FREE! 52 PAGE CATALOG

Tube and Circuit Book 10c
Giant Radio Reference Map 15c
Handy Tube-Base Calculator 25c

Address PM-4, Council Bluffs, Iowa.
Formerly Wholesale Radio Laboratories

World Radio
LABORATORIES INCORPORATED

EXPERIMENT WITH BLACK LIGHT!

FUN! THRILLS! PROFITS! See seven page article on this fascinating science in June 1945 issue of Popular Mechanics. We furnish all supplies. Trial Kit of 8 lacquers only \$6.25. Black bulb for testing, \$2.00. Lamps, lacquers, crayons, fabrics, etc. Write for descriptive list and full details today!

BLACK LIGHT PRODUCTS, 450 East Ohio Street Chicago 11, Illinois

SIMPLIFY HOME WOODWORKING!

LOCATE DOWEL HOLES EASILY...

KENKRAFT Metal Dowel Centers leave clear, accurate impressions on mating piece. Mating holes easily drilled to accurate fit. Made for 1/2", 3/4" and 1" dowels. Two of each size (set of 6) prepaid \$1.00

KENKRAFT
BOX 596
MANHATTAN BEACH, CALIF.

WOOD WORKERS

LUMBER — PLYWOOD AVAILABLE

Harold Hunt wants to send new No. 15 catalog. Over 124 pages of woodworking ideas. **UNEQUALLED BARGAINS** in imported and American woods, supplies, hard-to-find hardware. Send only 10c to cover postage and handling.

CRAFTSMAN WOOD SERVICE CO.
2729 S. Mary St., Dept. A-68, Chicago 8, Ill.

only 10¢



All Williams Clamps are DROP-FORGED

• The more-than-usual holding power of Williams Clamps results from a combination of sound design and drop-forged strength. Despite their relative lightness in comparison with clamps made by other processes, you'll find Williams Clamps won't spring or twist under severe load. All Clamps are forged from selected steel and heat-treated; screws, of special steel, are hardened and tempered. Available in a wide range of sizes. Write Dept. M-46 for free Tool Data Sheets.



J. H. WILLIAMS & CO.
BUFFALO 7, NEW YORK

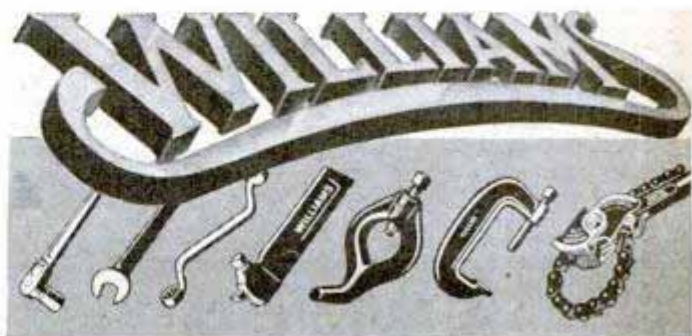

DROP FORGINGS AND DROP-FORGED TOOLS

RED-ITCHY SKIN?

watch out—it's often

ECZEMA

**'Invisible'
Liquid
Promptly
Relieves
Torture!**



First applications of wonderful soothing Zemo—a Doctor's highly medicated invisible liquid—quickly relieve intense itching burning of Eczema, Psoriasis and similar annoying skin and scalp irritations due to external cause. Zemo also aids healing. Amazingly successful for over 35 years! Apply any time—doesn't show on skin. First trial of clean, stainless liquid Zemo convinces! Buy Extra Strength Zemo for mean cases. At all drugstores.

ZEMO



GERSTNER Tool Chests

No equal for GERSTNER chests in the past 40 years. They please because they are better. Free Catalog for Tool and Die Makers.

GERSTNER TOOL CHESTS
446 Columbia St., Dayton 7, Ohio

AMMCO 7" SHAPER

"A Precision Machine of a Thousand Uses"

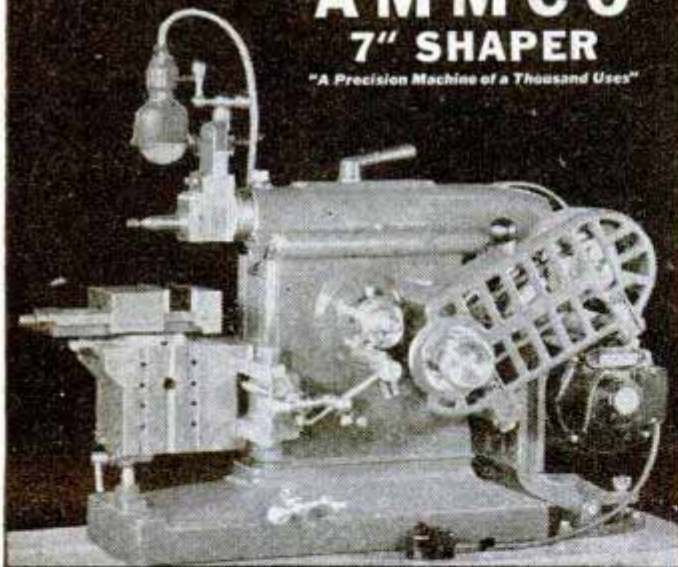

A wide variety of jobs can be done accurately, quickly, easily, and economically on the AMMCO Shaper (7" stroke). Construction incorporates many features you would expect to find only in larger, more expensive machines... For example: WAYS of ram, tool head, and front face of the main frame are of the "VEE" type, hand scraped to insure accuracy and long life. Available for stationary installation or as portable unit.

Write today for specifications and prices

AMMCO

2140 Commonwealth Ave. North Chicago, Ill.

Army-Navy Type HEADPHONES

TYPE HS-23



Genuine U. S. Signal Corps headphones, better \$10.00 type. Leather-covered headband, detachable rubber cushions. It. wt., impeded. \$2.95
ance 8000 ohms. Ea.

TELEGRAPH KEY

Genuine U. S. Signal Corps key with cutout switch, silver contacts 95c

3 1/2" G. E. AUTOMATIC TIME METER

60 cycle 110 volts. This time meter consists of a cyclometer driven by a telechron synchronous motor. Connect to an electric circuit: it will measure and indicate the number of hours, tenths of hours or minutes that the circuit is in use. Shipping wt. 6 lbs.—list \$17.00. Your Cost \$6.95

2500 mfd. 3 volt F.P. condensers, each 69c

Write for our Illustrated literature of radio parts.
Plus shipping charges.

Arrow Radio Co., Dept. G, 2205 W. Division St., Chicago 22, Ill.



POKER PLAYERS

Here's something NEW!

ALUMINUM POKER CHIPS

- Has the "ring" of real silver money.
- Interlocking for ease in stacking.
- Electroplated in 4 beautiful colors.
- Silver, Gold, Blue and Red.

Attractive box of 100 chips \$3.95 POST PAID

Send check or money order now to

R & E SALES, 4702B Vesper, Van Nuys, Calif.

SILVER SOLDER KITS!

For Silver Soldering ALL METALS



All welding, brazing and general repair shops, garages, toolmakers, machine and engineering establishments, etc., need this convenient silver solder kit.

\$1.00
POST-PAID

KIT INCLUDES

One 3 oz. Tube XCEL-FLUX "SS" Silver Solder Paste. Nine 5 inch lengths (total 45 inches) of SIL-FOS and EASY-FLO Silver Brazing Alloy—1/8" - 1/16" and 1/32" wires, and one EASY-FLO .005" x 1" strip. ECONOMY SIZE with 100 in. Silver Solder Wire \$2. American Products Corp., 815 Lowell Bldg., Chicago 6, Ill.

BUILD AN ARC WELDER



We Show You How to build this new powerful welder without rewinding. For light or heavy work. Uses coils taken from old auto generators. Works on 110 or 220 volts A. C. Has 20 different heats. Send 35c for complete PLANS and valuable Catalog. Write today. LEJAY MFG. CO., 1347 LeJay Bldg., Minneapolis 8, Minn.

LAW

STUDY AT HOME for PERSONAL SUCCESS and LARGER EARNINGS. 35 years expert instruction—over 108,000 students enrolled. LL.B. Degree awarded. All texts furnished. Easy payments. Send for FREE BOOK—"Law and Executive Guidance."

AMERICAN EXTENSION SCHOOL OF LAW
Dept. 64M, 646 N. Michigan Ave., Chicago 11, Ill.



LOCATES TROUBLE INSTANTLY IN ALL ELECTRICAL DEVICES

HANLAN APPLIANCE TESTER

In this single unit are combined all the necessary tests for examining every appliance. Checks thermostats under actual working conditions. Tells instant it opens or closes. Controls the heat on soldering irons. Prevents over-heating. Tests continuity, open circuits, etc. Checks automatic irons, vacuum cleaners, motors, shavers, bulbs, appliances with 3-way switches, etc. Great time, effort and money saver! ONLY \$9.50 COMPLETE.

Pat. Pend.

FREE with each Tester. New, Complete Practical Course in electrical appliance repairing. WRITE FOR CIRCULAR.
HANLAN CO., 1419-A, West Jefferson, Los Angeles 7, Calif.

Say you saw it in Popular Mechanics

POPULAR MECHANICS

Delivered
to your home six
times a year!

Easy-to-understand Plans . . .
Projects . . . Pictures — for
more fun from woodworking

. . . in the popular hobbyists'
magazine that packs plenty
of pleasure into every page—

THE *Deltagram*

A whole year's
subscription
6 Big Issues
only **50¢**

Every issue full of how-to-do-it
information that is useful to you!

Page after page of tested
ideas on what to make
and how to make it!

THE biggest half-dollar's worth
in the woodworking hobby field!

You get *six big issues* of The
Deltagram. Enough plans, projects,
designs, pictures, news for a
whole year of fun — building
furniture, toys, novelties, lamps, etc.

Clear and Complete

The Deltagram leaves nothing to
guesswork. Everything is *detailed*
and *specific*. Complete, step-by-step
instructions are in common, every-
day language. Even a beginner can
follow them, without costly waste
of time and materials.

Here's some of the best knowl-
edge available on homecraft sub-
jects. It's useful information that
helps you to improve your skill
...to turn out finer, professional-
looking work—and to do it more
easily, more quickly, more safely.

Get Your Subscription In!

Don't miss a single issue of this
guide to exciting woodworking
fun. Subscribe to The Deltagram
right now.

Fill out the coupon below and
mail today with 50 cents in coin,
postal note, or money order.

Tear out coupon and mail today!

THE DELTA MANUFACTURING CO.
681D E. Vienna Ave., Milwaukee 1, Wisconsin

Enclosed is 50¢ in payment for a whole
year's subscription to *The Deltagram*.

Name.....

Address.....

City..... (.....) State.....

DELTA
MILWAUKEE
REG. U.S. PAT. OFF.

HOMECRAFT
POWER TOOLS

A Fine, Precision EXPOSURE METER



\$11.50
WITH
LEATHER CASE
Tax Extra



The Sign of Precision

Make your camera take better, sharper photos. Eliminate guess-work, lost pictures and wasted film with a precision-built SKAN Exposure Meter. A *must* for color—still or movies. Be right in *any* light—day or night. Simple to use.

FREE—Write for descriptive literature. Please give nearest dealer's name. G-M Laboratories Inc., 4290 N. Knox Ave., Chicago 41, Ill.



EXPOSURE METER

Build Your Own RADIO RECEIVER

Learn while you build! It's easy and fun with this Kitcraft Radio set kit. Complete crystal assembly. All building and operating instructions. Base and legs of Lucite plastic. No soldering, no batteries required. Uses any type head phone, even old telephone receiver. Brings in stations clear as a bell. Thousands in use. **MONEY BACK GUARANTEE.** Sent prepaid or C. O. D. plus postage. **ORDER TODAY!**

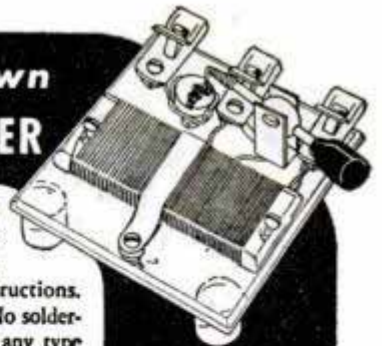

only
\$2.95
complete
less phones

LACO PRODUCTS, INC., 614 N. San Vicente, Los Angeles 46, California

WREN HOUSE and 5 COLORFUL GARDEN BIRDS

Assemble House Yourself

Birds, true types. Weatherproof colors. No assembly. Flexible legs, just twist on bush or shrub. A fine improvement for any garden. Authentic model house. Complete instructions for assembly. All material, hooks, hardware included. Nothing to cut, saw, or paint. **PREPAID** Attaches to wall, post, tree. Will attract wrens. Immediate shipment.

STAR MFG. CO.
LINCOLN, NEBRASKA

\$1.00

FIND UNDERGROUND MINERALS and METALS with M-SCOPE

Employs same principle as Army Mine Detector. Unsurpassed in Efficiency. Write for Free 16 page booklet.



FISHER RESEARCH LABORATORY
PALO ALTO CALIFORNIA

Kill Dandelions Easily



New Spray Treatment Kills Dandelions and Does Not Kill Grass. Simple, inexpensive, and easy to use. Quick, permanent results. **NON-POISONOUS.** Rid your lawn of dandelions. Have beautiful green grass. Write Today for Illustrated Booklet. It is **FREE**—no obligation.

AMERICAN HOMEGROUNDS INSTITUTE
Dept. 16 Columbus, Kans.

YOU NEED THESE CRAFTSMAN'S TOOLS

SUPER DRILL GRINDER



Sharpens round shank drills from 3/32" to 1 1/16" diameter. Grinds Old Drills like new in 4 different drill point angles. Grinds Short, Medium and Long Twist Drills from 1 1/4" up to 11" long, for hand or power grinding wheels.

70,000 NOW IN USE!

Grinds your drills like factory in 25 seconds. Gives perfect center and clearance. Saves drills, time and money. No shop should be without the Super Drill Grinder. Guaranteed, to do the work or money back. The Grinder that gives a round point!

Only
\$2.95

SUPER ARBOR

(PATENT PENDING)

A combination drilling or grinding wheel attachment for 3/4" motor shafts. Will take grinding wheel with 1" hole on shaft and 3/8" hole on small end. Extension can be used for rag or wire wheel, or 3/8", 24-thread drill chuck which holds drills from No. 60 to 3/8" in diameter. Right hand thread only.

Price Only

\$1.50



SUPER HACKSAW

AND FLAT DIE FILE HOLDER



The tool with 100 uses! Holds broken hacksaw blades—used by mechanics, electricians, plumbers, auto mechanics, hobbyists and repairmen. Perfect for all-round household needs; ideal for difficult close-quarter work. Nothing like it for tool and die men. Price, without saw blade.

Only
95c

At Your Dealer's or Postpaid
CRANDALL MFG. CO.
1512 West Slauson, Dept. FA-4
Los Angeles 44, Calif.

Electrically Welded Endless

Paramount

**BAND
SAW
BLADES**



Made in widths from 1/8" to 1-3/4"

Make your band saw do more work for you. The proper width of blade will extend the scope of this important machine. Burrill's Paramount Blades are made from tough Nickel Alloy Steel properly tempered. Teeth accurately set and filed, and all saws carefully straightened. Send order and check today. Delivery will be made as promptly as conditions permit, from a few days to a week or two. You can obtain these saws at the following prices:

1/4"-3/16"-1/2"-3/4" wide, 5'6" long.....\$.90 each
 1/2"-3/16"-1/2"-3/4" wide, 6'6" long..... .95 each
 3/4"-3/16"-1/2"-3/4" wide, 7'6" long..... 1.10 each

Other sizes at proportional prices

ALSO METAL CUTTING BAND SAWS

Made in widths from 1/8" to 3/4"

Your satisfaction is guaranteed

BURRILL SAW & TOOL WORKS

407 E. Main St., Ilion, N.Y.

Here's One Way to Smoke...



This native of Bechuanaland is smoking tobacco in a sand pit

From an old print.— Bettmann Archives

...Here's a Lot Better Way

smoke an



Millions of men prefer to smoke an LHS pipe, just as their fathers and grandfathers have for nearly 50 years. Select any LHS and you buy not only wood and bit, but the pipe knowledge and experience of half a century.

A good pipe is an investment in daily pleasure.

IMPORTED BRIAR

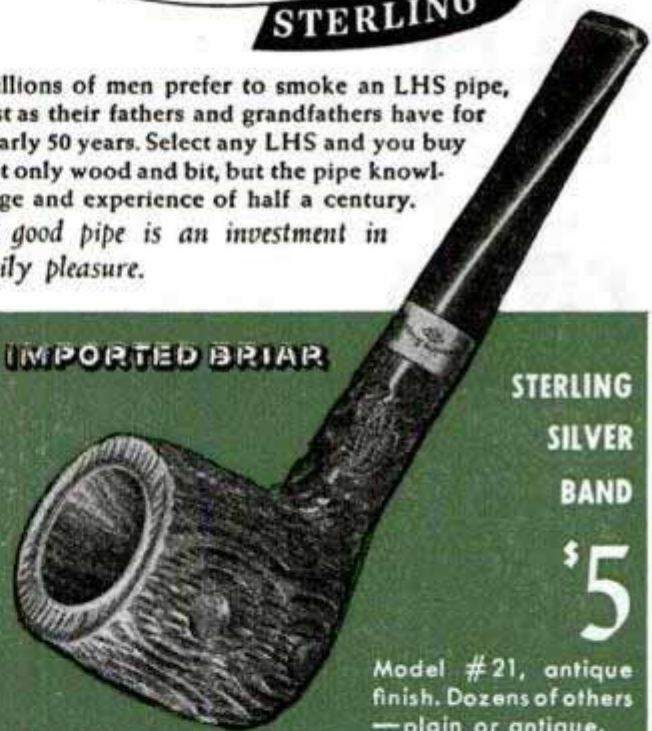

STERLING
SILVER
BAND

\$5

Model # 21, antique finish. Dozens of others—plain or antique.

Other LHS Pipes
Imported Briar

LHS Sterncrest Ultra-fine \$10.00
 LHS Sterncrest 14K 7.50
 LHS Certified Purex 3.50
 LHS Purex Superfine (Domestic Briar) . 1.50

of good
dealers
everywhere



Zeus Filter
Cigarette
Holders are
back in
ALUMINUM
with handy
ejector.

FREE. Write for "Pipes— for a world of pleasure."

L & H STERN, INC. • 56 Pearl Street, Brooklyn 1, N. Y.

**WISE-GRIP
WRENCH**



Gives Your Hand
a TON-GRIP

Does more things, easier and quicker, than any other tool! Remains locked to the work with hands removed.

Holds anything, any shape, with a Ton-Grip that never slips. Built with strength to back up its power. Is actually Hand-Vise, Clamp, Super-Plier, Adjustable End-Wrench, Pipe-Wrench, Locking Wrench and Toggle-Press—ALL IN ONE! Light, trim, handsome. Made of fine alloy steel. Zinc plated. 2 sizes.

Sold through Tool Jobbers and Dealers
 PETERSEN MFG. CO., Dept. P-46, DeWitt, Nebr.

DO YOU

WANT a permanent business profession of your own? Then BECOME A FOOT CORRECTIONIST.

Earnings in this greatly needed profession run as high as \$50-\$100 weekly after a few weeks home training—not medical or chiropractic—no further capital needed, no goods to buy. 50th year. Write for free booklet.

Stephenson System of Foot Correction

28 Back Bay, Boston, Mass.

**BIG PROFIT BUSINESS
of YOUR OWN!**

START A ROUTE OF
1c MATCH VENDERS

DEALERS, SALESMEN, AGENTS, VETERANS, WAR WORKERS . . . Here's the answer to your post war plans . . . Nothing to get out of order . . . Simple and easy to operate . . . No rents to pay . . . Tax free . . . Matches are always in demand . . . Build up a route or sell the machines outright to Drug Stores, Taverns, Night Clubs, Pool Halls, Tobacco Stores, in fact any store will welcome a 1c Match Vender . . . BETTER HURRY! SUPPLY LIMITED!

PROFITS
From
Matches Are
Tremendous

Sample \$6.50
All Metal
Construction



\$6.00 in lots
of 10 or more.

F.O.B. Montgomery

AMERICAN MERCHANDISING COMPANY

Dept. PM-V 703 Vandiver Bldg. MONTGOMERY 4, ALA.

NEW KIND OF POWER SAW



**Easy to Handle!
Triples Production!
Low Cost Upkeep!**



FELLING TREES

30" Oak felled in two minutes and fifty-two seconds with the Lowther C-Saw—11" Pine in fifteen seconds.



CUTTING LOGS

Cutting 10 to 20 cords of wood a day—on only 3 gallons of gasoline.



CLEARING LAND

Transforms brush covered wasteland into valuable pasture—Quickly and Easily.



HARRY A. LOWTHER COMPANY

141 West Jackson Boulevard Chicago 4, Illinois

Send Me Circular No. 405

Name

Address

SAY YOU SAW IT IN POPULAR MECHANICS

Your Rust Troubles are Over CORODEX Rust Remover

is the war-time miracle liquid which cleaned millions of parts during war effort. CORODEX positively removes RUST and CORROSION regardless of depth, from iron, steel, brass, bronze, copper, chromium and nickel. Cleans tools, hardware, sports equipment, household utensils, etc., for a few cents a piece. No RUBBING or hard work.

CORODEX IS UNCONDITIONALLY GUARANTEED TO REMOVE RUST WHEN DIRECTIONS ARE FOLLOWED. Valuable Manual of Rust Control free with order.

At Sears Chicago, Suburban and Gary stores, 50c and \$1.00. Mail orders **QUART SIZE ONLY \$1.00** Money Order or Check F.O.B. Chicago Express to:

SEARS, ROEBUCK AND CO.
403 SO. STATE STREET, DEPT. 8500-9, CHICAGO 5, ILLINOIS
(CorOdeX is made by Allied Products Co., 1133 Newport Ave., Chicago)



WELD ANYTHING ANYWHERE ANYTIME

ALL PURPOSE ARC WELDER
9 Models . . . 32 Volt D.C., 110 to 440 A.C.

A complete workshop in itself! Weld, cut, braze or solder any type metal; iron, castings, aluminum, steel, bronze . . . in any gauge or weight, with equal ease. Compact, complete, as sturdy as the Rockies. Formed steel and cast aluminum case, welded steel base, 4" cast wheels. Built with voltage control. Better on R.E.A. lines. Completely equipped. No instructions needed. Sold throughout the world. Several dealer territories open. Write:

FORNEY MFG. CO.
FORT COLLINS 2, COLORADO

Fine
PLYWOOD

CAN ADD BEAUTY AND VALUE TO YOUR WORK!

People will double their admiration of your work when you give it the beauty advantage of Carmen-Bronson fine plywoods—Mahogany, Walnut, Curly Birch, Bird's Eye Maple, Havello! We offer a large selection of cabinet and paneling plywood in thicknesses from 1/32" to 1" in many standard and popular panel sizes. Also wide assortment of thin Aircraft bending stock and wood items and supplies for your workshop. Send 10c today for our complete catalog.

CARMEN-BRONSON CO.
165 EAST 3RD ST. Dept. 4-B MT. VERNON, N.Y.

Fishing Worms \$1.00 POST PAID!

ALWAYS AVAILABLE WITH THIS UNIQUE ELECTRICAL APPLIANCE WHICH BRINGS DOZENS TO THE SURFACE IN SECONDS, MAIL A DOLLAR FOR COMPLETE SET WITH INSTRUCTIONS.

AMERICAN ELECTRO BAIT CO. DEPT. A,
P. O. BOX 4455 WASHINGTON 17, D. C.

**DECORATIVE
DECALCOMANIA**

TRANSFERS Imported Designs of all Sizes & Types—Flowers, Fruits, Figures, Silhouettes, Birds, Dogs, Horse Heads, Ships, Juvenile, Tropical, Chinese, Peasant, Colonial, Patriotic, Inlay, Borders, initials, etc., for Furniture, Doors, Walls, Trays and what not. Catalog with 800 illustrations in Color sent for 25c. Also carry French Prints; leaflet, 6c. **L. C. WELLS,** Dept. PM-64, 25 E. 26th St., New York 10.

POPULAR MECHANICS

LORRAINE LIGHTER

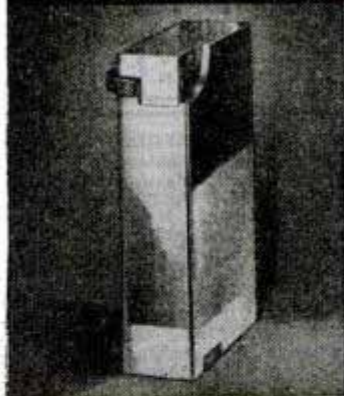

Streamlined, smart, sure-fire. Precision-made of gleaming hi-polish dural-aluminum. Triple capacity gives three times longer use without re-filling. Lightweight: 1 1/4" x 2" x 7/16".

DISTRIBUTORS WANTED

Gross Lots or more
\$12 Doz.

Less than Gross Lots
\$15 Doz.

LORRAINE INC.

115th & Alameda Sts., Los Angeles 2, Calif.

CRYSTAL
CLEAR
PLASTIC

PLEXIGLAS

SHEETS
RODS
TUBINGS

Transparent and Colored Sheets—All Thicknesses and Sizes

1/4 in. \$2.31 and 1/8 in. \$1.61 per sq. ft.

Write for Free Literature and Price List
Mail Orders Filled Promptly

HOUSE OF PLASTICS, 7604 Fenkell Ave., Detroit 21, Mich.

PRINT-O-TYPELESS PRINTERS

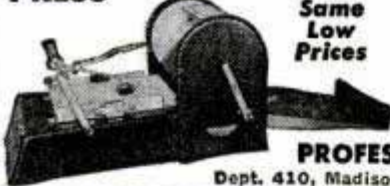

Same
Low
Prices

These stencil duplicators available again at lowest pre-war prices. Letter, legal or post-card sizes. Hand or automatic feed. Also lowest prices on supplies. Send for samples of work.

PROFESSIONAL PRODUCTS

Dept. 410, Madisonville, Cincinnati 27, Ohio

THE GEM MAKER

Amateurs or professionals . . . hobbyists or jewelers . . . Polish your own gems with a B&I Gem Maker. You will find this a profitable adventure. All necessary lapidary equipment is furnished, including a super-charged diamond blade for sawing, and all wheels for grinding, shaping and polishing, also complete instructions. The complete equipment as shown, less motor and belt, for only \$29.50, f.o.b., Burlington, Wis. Write today for information and literature on the Gem Maker and accessories. B&I MFG. CO., Dept. S, Burlington, Wis.



CUT ANY SIZE HOLE

IN METAL • WOOD • PLASTICS

Bruno Adjustable Hole Cutter for home users, mechanics, farmers, technicians! High speed steel blade cuts clean holes quickly. Fits drill press, portable drill or hand brace. Money back guarantee! At all hardware stores or write direct, Dept. PM-4.

Model No.	Shank Size	Cutter Expansion Capacity	User's Price
100	1/2" straight shank	3/4"-1 1/4"	\$2.95
100-B	Square Bit Stock	3/4"-1 1/4"	\$2.95
101	3/4" straight shank	1"-2 1/4"	\$4.95
101-B	Square Bit Stock	1"-2 1/4"	\$4.95

Model
No. 100



\$2.95

BRUNO TOOLS
BEVERLY HILLS, CALIFORNIA

You thread
1" to 2" pipe more
easily, quickly with
this self-contained
RIGID No. 65R

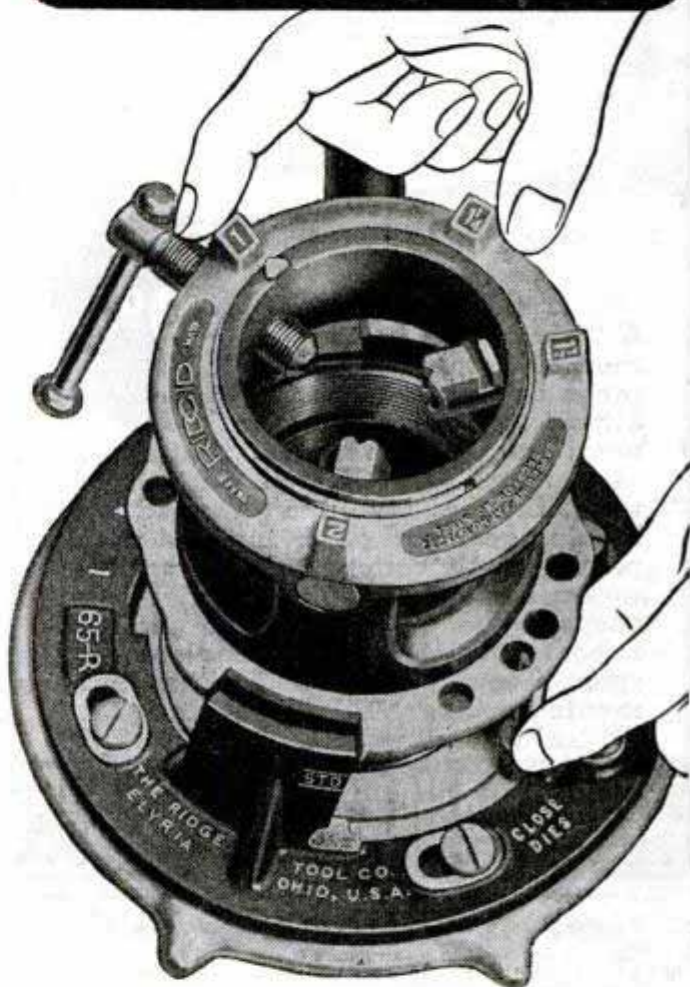

• No wonder this threader is popular. It cuts perfect threads on 1", 1 1/4", 1 1/2" and 2" pipe with new ease and speed. One set of high-speed steel chasers threads all 4 sizes—set to pipe size in 10 seconds. Workholder sets instantly—no bushings. For a smart work-saving tool you enjoy using, try this steel-and-malleable **RIGID** at your hardware or supply house.

RIGID

WORK-SAVER PIPE TOOLS

THE RIDGE TOOL COMPANY • ELYRIA, OHIO, U.S.A.

SAY YOU SAW IT IN POPULAR MECHANICS

NEW! COMET

WHIZZER

CONTROL MODEL



Designed by

Carl Goldberg

A "whiz" of a control model! Combines utmost in Appearance, Simplicity and Ruggedness! Unique "flap control"; balsa fuselage shaped and hollowed out; shaped wing, fin and stabilizer; formed wire landing gear and other finished metal parts; plastic canopy; plastic spinner; upper shell, held with special lock, snaps off and on instantly; streamlined rubber wheels; parts for handle. Wingspan 30 inches. Meets A.M.A. requirements for Class "B." Takes class "A," "B" or "C" engines. *Standard Kit \$7.50*

DE LUXE MODEL

\$9.95

KIT No. T8-D

COMET MODEL AIRPLANE & SUPPLY CO. INC.,

129 W. 29th STREET, CHICAGO 16, ILL.

1170 BROADWAY, NEW YORK 1, NEW YORK



BRASS DOG TAGS

25c coin each, 5 for \$1.00. Collar plates (5/8 x 2) 35c, 3 for \$1.00. Key tags 25c coin. We make tool tags, and tool box plates.

MAIL PRODUCTS, Box 97E, MENDOTA, ILL.

SAY YOU SAW IT IN POPULAR MECHANICS

RAINBOW MIXTURE GLADIOLUS 60 Bulbs \$1.89



Money Back Guarantee
Flower first year. Satisfaction guaranteed. Michigan's finest. All State inspected. First quality — Picardy, Minuet, Maid of Orleans and other radiant colors create a "Blaze of Glory". Same varieties in older bulbs worth up to 20c each. Planting guide included free.

Early Order Bonus

Same varieties 200 bulblets. 1st year growth provides your bulb supply for years. Limited supply.

SEND NO MONEY

ACT NOW — WRITE TODAY
Pay later, plus C.O.D. and postage, or send \$1.89 and we ship prepaid. Ref. any bank in U.S.A.

337 SMITH BLDG., GRAND RAPIDS 2, MICH.

SMITH BULB CO.



MODEL: Gasoline Engine Ready to Run

A precision built and engineered single cylinder **FOUR-CYCLE** model gasoline engine. Bench tested and ready to run. Available with stationary or marine engine base. Full instructions. Lots of fun. Engine \$27.50. Coil and condenser \$2.75. Immediate delivery.

The THOMPSON ENGINEERING CO.
206 Winchester Place, Grand Rapids, Mich.

7 3/4" high—3" wide

King of ELECTRIC SWITCHES



Versatile Switch of a Thousand Uses Millions in Post War Applications

Floodlights your porch when the door is opened—sounds alarm when window is opened—signals arrival of mail—controls heating of furnace—filling of water tank, these and many other services are performed by this versatile switch. Shipped with instruction sheet showing numerous illustrated uses for this device at the low price of \$1.00 postpaid.

KING PRODUCTS COMPANY

BATAVIA 2, ILLINOIS



SMOKE IN BED?

DON'T—unless you use the sensationally new **6 IN 1 CIG-SMOKER**. Designed scientifically for safe-clean-filtered cigarette smoking. See the Cig burn inside this miracle, durable Silverglass creation. It combines a Holder, Filter, Fire Shield, Ash Guard, Smoke Cooler and Automatic Snuffer. **PREVENTS** fires, burns, ash mess, accidents, and irritating smoking. It's weather and windproof. New thrills in smoking . . . nothing else like it.

Sample Cig-Smoker \$1.00 post- A Guaranteed
100 Cig-Filters 1.00 paid Product

Agents, Dealers,
Exporters, Write

Pat. & Mfr., **SAFE-GARD MFG. CO.**
21 Perry-Payne Bldg. Cleveland 13, Ohio

WRITE FOR YOUR FREE COPY OF THE NEW KRW HYDRAULIC PRESS BOOK

Describes all manner of Production and Shop Work on KRW Hydraulic and Bench Type Arbor Presses. 32 pages illustrating the new KRW Hand-operated, Electric-operated and Air-operated Hydraulic Presses. *Write for your copy today.*

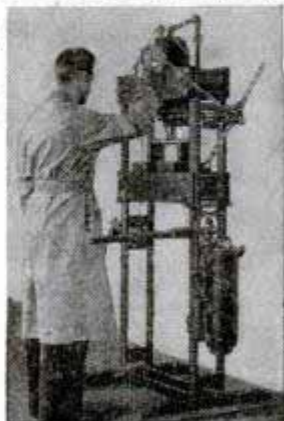

K. R. WILSON, DEPT. 17, 215 MAIN ST., BUFFALO 3, N. Y.

Builders of Shop Equipment for Ford Dealers Since 1916



MOTO-TOOL ★ THE "POCKET-SIZE" MACHINE SHOP

PUT THIS "WAR VETERAN" TO WORK *Approximately 27,000 R.P.M.*

READ MOTO-TOOL'S RECORD

Long before Pearl Harbor Dremel Moto-Tools had won their spurs in tool rooms, machine shops, home workshops. Now they have the respect of every branch of the armed forces. And thousands of them helped establish production records at General Electric, Westinghouse, Remington Arms, Ford, Nash-Kelvinator, Consolidated Aircraft, Douglas and others.



MOTO-TOOL KIT

Kit No. 2 with 23 high grade accessories and Model 2 Moto-Tool, in hardwood case, \$23.50
Model 2 Moto-Tool, with 1 accessory, \$16.50

Now that priorities have been lifted, Moto-Tool can work for you. Moto-Tool owners daily discover new jobs that can be done more expertly in less time. In fact, new purchasers find dozens of uses in addition to those they had in mind. So great is the saving of time and labor with Moto-Tools, thousands of mechanics and craftsmen would find it difficult to get along without their "mighty little midgets."

ONLY MOTO-TOOLS HAVE ALL THESE FEATURES

A Model 2 Moto-Tool develops a speed of approximately 27,000 rpm. Weighs only 13 oz. Shaped to fit the hand. Sturdily built with shock-proof bakelite housing. Balanced for vibrationless operation. Uses 110-120 AC or DC current.

10 DAY TRIAL—MONEY BACK GUARANTEE

Ask your dealer today about Dremel Moto-Tools and Accessories. If he does not handle them, order direct from factory on 10 day trial. We ship postpaid if cash in full accompanies order. If you prefer to send only \$2.00, Moto-Tool will be shipped C.O.D. for balance plus postage. Catalog sent FREE.



Model 2 Illustrated

A FEW OF THE JOBS THAT MOTO-TOOL CAN DO FOR YOU

- | | | |
|--------------------------------------|-------------------------------------|-----------------------------------|
| <input type="checkbox"/> Sharpening | <input type="checkbox"/> Burring | <input type="checkbox"/> Cleaning |
| <input type="checkbox"/> Finishing | <input type="checkbox"/> Grinding | <input type="checkbox"/> Routing |
| <input type="checkbox"/> Touching Up | <input type="checkbox"/> Polishing | <input type="checkbox"/> Cutting |
| <input type="checkbox"/> Sanding | <input type="checkbox"/> Burnishing | <input type="checkbox"/> Rasping |
| <input type="checkbox"/> Drilling | <input type="checkbox"/> Inlaying | <input type="checkbox"/> Carving |
| <input type="checkbox"/> Mortising | <input type="checkbox"/> Sawing | <input type="checkbox"/> Brushing |
| <input type="checkbox"/> Engraving | <input type="checkbox"/> Scoring | <input type="checkbox"/> Dressing |

WATCH FOR THE RETURN OF MOTO-SAW

Dremel Moto-Saw . . . the sensational electric scroll saw . . . will be back as soon as materials are available.

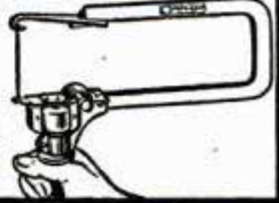

DREMEL MFG. CO. 116-D RACINE, WIS. U.S.A.

BOY IT'S KEEN! A REAL METAL RAPID FIRING "G-BOY" REPEATING CAP PISTOL



RAPID FIRING
SMOKES ON FIRING
LOUD EXPLOSIVE REPORT

\$1.95
GUN ONLY

It's a real thriller. Yes! Looks and feels like the Automatic '45's" carried by our Army Officer . . . It's made of strong lightweight aluminum . . . with a plastic "Pearl" handle. It's easy to reload. Any boy would gladly give his entire allowance for one of these.

ORDER DIRECT . . . TODAY . . . PROMPT SHIPMENT

Satisfaction is guaranteed. Send check or money order for immediate shipment—express charges collect. (Smallest order accepted \$1.00 No. C.O.D. orders.)

★
Genuine Cowhide Holster for Famous "G-Boy" Gun \$2

★
Box of 5 rolls caps only . . . 15c
7 Boxes . . . \$1.00

UTILITY STORES 117 S. Wabash, Dept. DD-11, Chicago 3, Ill.

I enclose \$_____ Ship at once via express, charges collect, _____ G-BOY Repeating Cap Pistols, _____ rolls of caps, and _____ holsters.

Name _____
Street or R.F.D. _____
City _____ State _____
(Established 1906)

Announcing . . . New Style Hi-Speed Router & Round End Mortising Bits

BARRON SPIRAL FLUTE ROUTER BITS



A brand new double spiral fluted design—ground from finest hi-speed Mo-Tung tool steel—with special radial shaped flutes for faster, smoother, easier routing, grooving, carving, and round-end mortising. Insures true, straight walls and smooth bottom surfaces. Extra long cutting flutes for deeper operations. The router bit that's different—AND BETTER. $\frac{3}{8}$ "—\$1.10, $\frac{1}{2}$ "—\$1.40. Set of 6 sizes up to $\frac{3}{4}$ "—\$8.25 shipped prepaid.

THE BARRON ROTARY SURFACE SANDER

\$5.95
COMPLETE



Note these Special

Features—Made of Alcoa aluminum. Machined and balanced for smooth operation in drill press chuck. For surface sanding woods, plastics or polishing metal surfaces. Complete with 20 instantly removable sanding cup discs. No messy glueing needed. Leaves an agate smooth, absolutely true surface finish. Does not leave waves, ripples, steps or striations in work piece. The only tool of its kind. Shipped prepaid on 10 DAY MONEY BACK GUARANTEE for \$5.95.



The IMPROVED Barron Multi-Purpose Drill Press Planer .. \$7.50

Not only surface planes toughest woods and plastics to precision limits—but rabbets, routs, tenons, panels, grooves, beads. Will cut rabbets, tenons, panels, etc. to a depth of 1" with special Barron extra long hi-speed cutter blades. Thousands now in use. Made of Alcoa aluminum, machine finished thru-out. Vibrationless. Fits any drill press. Shipped prepaid on 10 DAY MONEY BACK GUARANTEE on receipt of cash, money order or C.O.D. for \$7.50.

Barron ALL-METAL Auxiliary DRILL PRESS Table .. \$8.85



Hard Alcoa aluminum die casting heavily ribbed—machined both sides. Has 234 sq. inch extra large working surface. Equipped with Barron Steel Planer Fence. Can also be used for shaper operations, innumerable other drill press uses. A real buy at \$8.85, express collect.

See Your DEALER . . . Or Write For CATALOG
BARRON TOOL CO., INCORPORATED
369 Architects Bldg.: Detroit 1, Mich.

BARRON PRECISION WORK SHOP TOOLS

SAY YOU SAW IT IN POPULAR MECHANICS

NEW DESIGN

You can lock both rod and reel in the handle—IN ONE OPERATION. Universal, Offset Handle of bright, solid aluminum, highly polished; cork grip shaped to fit your hand. HANDLE \$4.80; STEEL ROD \$7.50; ROD AND HANDLE COMPLETE \$12.30. BISHOFF REARSITE FOR SHOT GUNS, a new aid to accurate shooting. Kill your game; price \$1. Cash or pay postman few cents extra if ordered C.O.D. Dealer inquiries invited.

BAIT CASTING ROD

Immediate Delivery

OFFSET
BISHOFF MFG. CO., 3517 Gratiot, Detroit 7, Mich.



Now! YOUR DOG TAG HEAVILY SILVER-PLATED

MADE INTO SOUVENIR IDENTIFICATION KEY TAG WITH CHAIN

JOHN R DOE
87439622 T45 4S A

DOG-TAG GENUINE

SILVER-PLATED

gleams with beauty!

WONDERFUL SOUVENIR!
Finest identification! Proof of your Service!
MAKES APPRECIATED GIFT!

VETERANS! SERVICEMEN! ARMY, NAVY, MARINE! SEND ONE DOG-TAG TODAY! Just think! Your own DOG-TAG heavily plated with GENUINE SILVER, then lacquered and made into everlasting souvenir identification key tag with sturdy polished nickel silver key chain. AN IDEAL GIFT! Tell your friends! SEND NOW! Send one DOG-TAG with ONE DOLLAR. Your DOG-TAG will be returned to you (with sturdy key chain) lustrous and gleaming with silvered beauty—a souvenir to cherish! and to use! (Offered by a veteran.) Send today!

\$1.00
COMPLETE POSTPAID

THE DOG TAG MAN, 308 W. Washington St., Dept. M, Chicago 6, Ill.

PERMANENTLY WRITE IN METAL ELECTRICALLY ELECTRONIC SCRIBER

BURN SIGNATURE OR DESIGN IN ANY METAL, HARDEST TOOL, GUN, TACKLE, TRAP, CREAM CAN, PITCHFORK, BICYCLE, INSTRUMENT, KEY, SAFE AND SIMPLE. AC-9C, 4 VOLTS, 4 AMP. \$3.50 PREPAID. (NO C.O.D.)
JAMES HAMMERS CO., ABERDEEN, SOUTH DAKOTA
Also Sold in Montreal, Quebec, St. Louis and Environmental Dept.

\$3.50
PREPAID



PROTECT YOUR TOOLS

IT VIBRATES!

BUILD YOUR OWN FAST FREEZER

PLANS \$1.00

It's easy to build this household appliance and profitable to use. Save up to 75%. Operates on 110 or 32 volts. Plans show 5 sizes and are easy to follow. ENJOY MAKING ONE of these freezers from new or used parts. No expert knowledge needed. Mail \$1.00 bill or check for complete plans and catalog.



LE JAY MFG., 447 LeJay Bldg., Minneapolis 8, Minn.

5 sizes
8 to 40 cu. ft.

New Designs in

FRANZITE GRIPS

Modernize Your Gun! Improve Your Score!

Most durable grips made. Positively unbreakable! For Colt, Smith & Wesson, Hi-Standard, Ortgies, Luger & Mausers in a wide choice of beautiful designs in ivory, pearl, walnut, onyx, etc. Low prices. FREE CATALOG. Dealers Wanted.

SPORTS, INC., (Mrs.) 5501 Broadway, Dept. P-4, Chicago 40, Ill.



PICNIC STOVE and TRASH BURNER

Tree stump of durable reinforced Haydite concrete with grill, charcoal pan, grate. Burns trash safely.

Only \$29.45

Freight prepaid east of Rockies

For descriptive circular write to

W. O. JOHNSON CO. Omaha 6, Neb.



RACER

HIGHLY POLISHED CAST ALUMINUM

8½ inches long. Heavy single unbreakable casting. Free running 2 inch rubber wheels. Can't rust. Trim, sleek lines. Looks like models selling up to \$12.00. Form a racers' club today! Every youngster wants one.



Send
\$2.98

BARTON INDUSTRIAL PRODUCTS CORP.

Postpaid in U.S.A.
Dealer Inquiries Invited
35 EAST WACKER DRIVE
CHICAGO 1, ILLINOIS

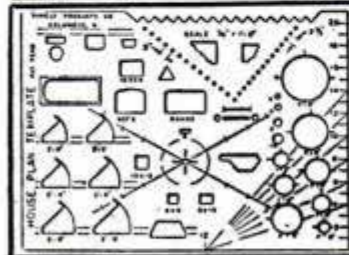

HOUSE PLAN TEMPLATE

Made of clear sheet plastic, with accurate cut-outs for drawing door-swings, plumbing and electric fixtures, fireplace, stairs, moldings, roof-pitch, etc. Standard ¼" equals 1'-0" scale. AT YOUR DEALER **\$1.50** or mailed postpaid

TIMELY PRODUCTS CO.
Box 206C, Columbus 9, Ohio

NOW AVAILABLE!

Crosman Silent Rifles—America's favorite compressed air rifles for indoor and outdoor shooting are back again! Available in 22 cal. single shot and Magazine Loading Types. At your dealer—or order direct. Ask for Crosman SUPER-PELLS too—the better ammunition for all compressed air rifles. .177 Cal.—\$1.80 per M. .22 Cal.—\$2.00 per M.

CROSMAN ARMS CO., INC. • Rochester 7, N. Y.

EXPERIMENT WITH LUMINOUS PAINT

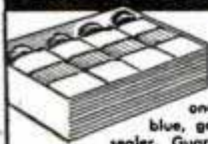

Complete kit of luminous points in colors. Paint artificial flowers, lapel ornaments, novelties, house numbers, light switches, etc. Kit of one oz. each of 3 lasting colors, bright blue, gardenia and charrreuse, one ounce sealer. Guaranteed best quality.

COMPLETE KIT WITH 3 COLORS AND SEALER **\$3.95** PRE-PAID

BLACK LIGHT PRODUCTS • 450 E. Ohio St. • Chicago 11, Illinois

RADIO PARTS GRAB BAG!

\$25 original value assortment of Coils, Condensers, Transformers, Resistors, Controls, etc. An experimenter's dream. While they last, only.....

\$3.98

MARKO SUPPLY, Dept. P.M. 4
2924 Logan Blvd. Chicago 47, Ill.

BALL BEARING CENTERS

WITH NO. 2 MORSE TAPER

ONLY \$2.75 at your Dealers or Post Paid

ME-RE-LAB., 57 Bergen Turnpike, Little Ferry, N. J.

DUPLICATING MACHINE for \$4.00!

Earn Big Money making photographically exact copies of letters, certificates, photos, etc. Build clever machine in one evening with hand tools for less than \$4.00. Clearly illustrated instructions plus plan for operating your own copy business—\$1.00 postpaid.

J. P. KILMAN, 1301 SCOTT ROAD, BURBANK, CALIFORNIA



MANY-USE Electric VOLT-TESTER

Indicates whether 110, 220, or 440 volts, like thermometer. CHECKS whether AC or DC, if 25 or 60 cycles, if broken circuit. LOCATES TROUBLE—from 60 to 550 volts in all appliances, fuses, radios, meters, spark-plugs. Dealer rates.

\$1.75 complete

American Standard Labs., 1924 E. Martiano, Philadelphia 34, Pa.

UNIQUE VALUE Men's Wrist Watch

Swiss movement, very handsome looking, durable chrome plated case. **SEND NO MONEY.** Pay postman \$8.50 plus postage and 10% Federal Excise Tax. Wear 10 days, money back if not satisfied.

Jerome Products Co., 1744 W. Roosevelt Rd., Dept. M4, Chicago 8, Ill.

ANCO RAIN-MASTER

"Dead-Locker"

WINDSHIELD WIPER ARMS and BLADES

BLADE SNAPS ON... STAYS PUT

FINGER-TIP RELEASE

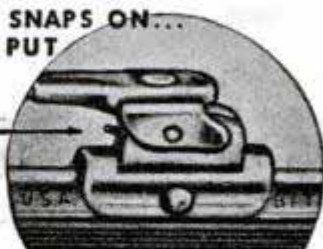

CAN'T FALL OFF
CAN'T BLOW OFF

(A war-born invention—by ANCO—first) for military aircraft—now for your car.)

DON'T SHOOT YOUR GAS-PUMP MAN!

He's doing the best he can. Sure, he knows how dangerous it is for you to drive your car... in stormy weather... with your dull old windshield wipers that smear and smear. He'd gladly put on for you quickly a pair of keen new ANCO RAIN-MASTER Wiper Blades and Arms. He has them—Newest Models! But he forgets to remind you? Too busy? You can't shoot him for that!



After all, it's *your* car to protect. So you remind *him*. Get RAIN-MASTERS... patented features... original equipment on many makes of high grade cars and trucks... used in war—on our fighting tanks and trucks and ships and bombers too... because ANCO RAIN-MASTERS clean quicker, clean cleaner... last longer. May save you a costly smashup.

Ask for RAIN-MASTER Windshield Wiper Arms and Blades next time you buy gas.

THE ANDERSON COMPANY

Established 1918

GARY, INDIANA

MAKE MONEY

Selling
FLUORESCENT SAVES 1/2

on Electric Light Bills

INTO SOCKET JUST LIKE BULB!

SALESMEN!

Once expensive—once costly to install—out of the reach of most people, Fluorescent Lights still sold in millions. Experts now predict war starved market of 3 1/2 BILLION, and with invention of fixture that screws in like an ordinary light bulb, a fixture that can be installed in an instant, a fixture that sells complete with tubes at a new low price—the most spectacular sales opportunity of the decade has been opened up for salesmen and distributors. Enormous advance commissions. Exceptional factory co-operation includes financing big orders, shipping open account, furnish local advertising.

FREE If earnings of \$5,000, \$10,000 and \$15,000 a year don't scare you, rush your name by fastest way for sensational facts—sales plans—complete line with pictures and prices. This is the hottest item in direct selling today. Even if you don't answer another ad in this magazine, rush your name on this one—right now.

North American Mfg. Co., 5042 Cottage Grove, Dept. 34, Chicago 15, Ill.



MENDS

CHINA, GLASS, WOOD, LEATHER and FABRICS

There are scores of uses for Du Pont DUCO CEMENT... for mending toys, dishes, furniture... for repairing luggage and books... for making models. It is water-proof, transparent and flexible. Get a tube today.



DU PONT DUCO CEMENT

Just Plug in and Light



NO MORE
Extra equipment. No more Special Wiring.

Screws

SMALL EFFICIENT SPEED REDUCER

Sturdy, compact (see dimensions). Proved in thousands of industrial installations. Case of semi-steel. Gears, SAE 65 (British Gear) Bronze. Worm of case hardened steel. Timken Bearings throughout. Available in 4 different assemblies (shown below) and in these standard ratios:

4-1	25-1	64-1	200-1
8-1	30-1	75-1	300-1
10-1	40-1	80-1	400-1
16-1	50-1	100-1	600-1
20-1	60-1	150-1	800-1

Torque capacity 100 inch pounds. Especially suited for bench work, home work shops, light production, animated displays, etc. When ordering be sure to specify assembly and ratio required. Shipping weight in carton, 8 lbs. Full money back guarantee. Prompt deliveries.



\$15.12

Ceiling Price
F. O. B. Cleveland

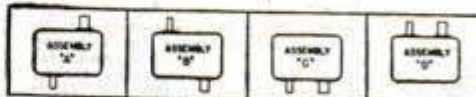

THE OHIO GEAR CO.
1400 EAST 179th ST. - CLEVELAND 10, OHIO

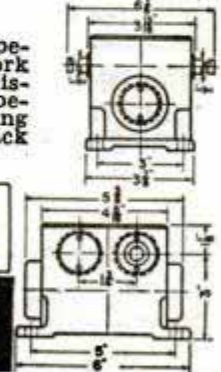

VETERANS-SERVICEMEN! Wear a "SHOULDER PATCH" PIN

Show your pride in your old outfit by wearing a full color enamel lapel pin. Available for all Army divisions and Air Forces. Finely made with safety catches for lifetime wear. Just send name of your outfit and \$1.00. We deliver at once, postpaid. (No C.O.D. or stamps, please). **COLLECTORS:** Send 10c for illustrated catalogue and special quantity prices.

ZEV SALES CO.

153 Hart St., (Dept. PM 3) B'klyn 8, N.Y.



Build your own grinder with this combination pulley and arbor. Fits 1/2" shafts. **75c** Postpaid U.S.A.

AGENTS INVITED

F. ROESCH

502P - 1st St. Hoboken, N. J.

CRESCENT TOOLS

Give Wings to Work

ASK YOUR
HARDWARE
DEALER



Shotgun shells, rifle cartridges, pistol ammunition and guns. Send 35c for valuable Gunsmith Manual and Catalogue. **NEW YORK CO., 10800-10900 W. RIDGWAY BLOCK, RIDGWAY, PA.**



Balance 4" x 9" Base. With either Metric or Avoirdupois Weights... **\$6.00**

Catalog with 3000 Illustrations of Laboratory Apparatus sent for 75 cents. Catalog listing 10,000 chemicals, drugs, minerals, etc. and 1700 scientific books sent for 25 cents. 100 scientific books, 10 cents. **LABORATORY MATERIALS CO.**
7321 Vincennes Ave. Chicago 21, Ill.

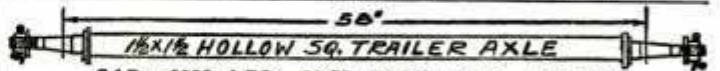

CAP.—2000 LBS.—\$6.75 EACH F.O.B. DETROIT

STRONG MACHINE & AXLE COMPANY
9710 Lumpkin Hamtramck 12, Michigan

ONE-MAN SAWMILL LESS THAN \$200.00

Easy To Turn Trees Into Money

Makes lumber, ties, shingles, crates, lath, studding, siding.

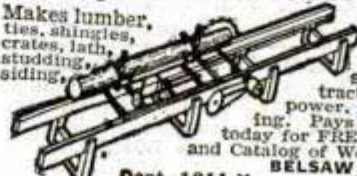

Belsaw Models

In 10, 14, 20, 24 ft. sawing lengths. Patented Mechanical Feed, accurate set works and positive dogs. Use tractor or old auto engine for low cost power. Thousands used for commercial sawing. Pays for itself quickly. Send post card today for FREE booklet, "How To Make Lumber" and Catalog of Woodworking Equipment.

DEPT. 1811-Y BELSAW MACHINERY COMPANY
3542 Main Street, Kansas City, Mo.

PRINT-O-MATIC POST CARD SIZE STENCIL Duplicator

COMPLETE
WITH SUPPLIES

\$950

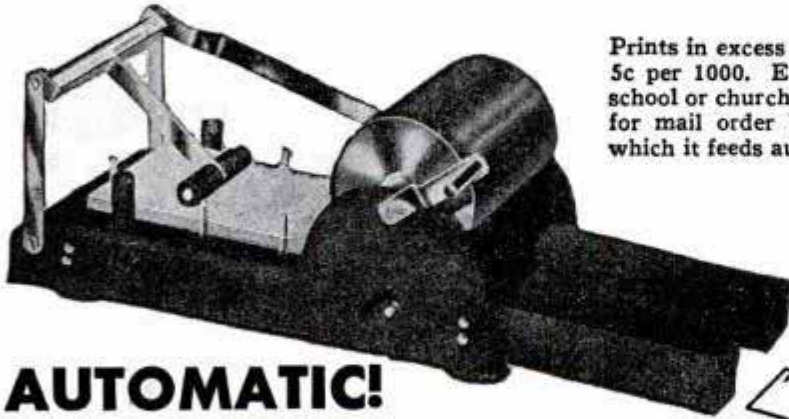

Prints in excess of 3000 clear legible cards per hour at an average cost of 5c per 1000. Easy to operate and entirely automatic. Ideal for clubs, school or church announcements, special bulletins, sale notices, etc. Ideal for mail order business. Permanently adjusted for U. S. post cards, which it feeds automatically. The price includes

- 1 lb. Can Special Formula Ink. 1 Writing Plate.
- 1 Stylus. 1 Bottle Correction Fluid.
- 1 Inking Brush. 1 Cloth Pad.
- 4 Special Quality Cellulose Print-O-Matic Stencils.

AUTOMATIC! SELF-FEEDING! PRINT TYPE AND ILLUSTRATIONS

You can print typewritten matter, handwriting or illustrations or a combination of all three. No plates or engravings necessary! You type, draw or trace your own stencils, then print! Quick, easy, economical. Thousands in satisfactory use daily.

PRUITT Dept. DD-16, 437 N. La Salle St.
CHICAGO 10, U. S. A.



PRUITT OFFICE MACHINE CO. (Est. over 25 years)

425 N. La Salle St., Dept. DD-16, Chicago, Ill.

Gentlemen: Enclosed find my remittance for \$..... Ship at once the Print-O-Matic Duplicator complete as advertised.

Name..... Please Print

St. or RFD.....

City.....Zone.....State.....

Send FREE Money Saving Catalog.

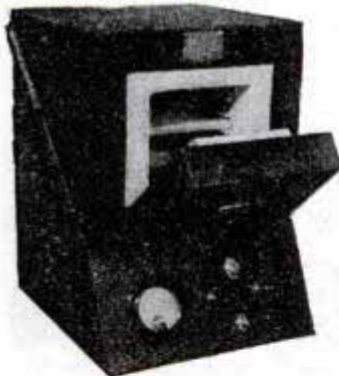

THE LUCIFER HEAT TREATING FURNACE

for 110-volt operation

\$102.50

F.O.B. PHILA.

Do your own heat treating—make your own heat tools and parts. Muffle size 5 1/2 x 5 1/2 x 6" deep. Temperature range from 0° to 2000° F. Equipped with pyrometer, pilot light and control switches and AUTOMATIC HEAT CONTROL. Select the heat you desire for hardening, tempering or drawing. Complete—all ready to plug into 110-volt AC-DC outlet. Costs approximately 3¢ an hour to operate.

(Without Automatic Control—\$75.00)

WITH AUTOMATIC HEAT CONTROL

for 220-volt operation

\$222.50

F.O.B. PHILA.

This is the big job for larger work. Muffle size 12 x 12 x 10" deep. Equipped with pyrometer, pilot light and control switches. Range 0° to 2000° F. AUTOMATIC HEAT CONTROL. Ideal for larger pieces or volume hardening of small parts.

(Without Automatic Control—\$180.00)

Sole Selling Agent

GILBERT S. SIMONSKI

403 N. BROAD STREET
PHILA. 8, PENNA.

Distributors Wanted



Useful
TOOLS

SET
T-52
Deluxe
Electrical
Ignition
and
Radio Set

All For \$13.00
List Price

See your dealer or write us

SPINTITE SET

A Positive Need in Every RADIO,
HOME and ELECTRICAL SHOP.

Contains Chuck Type Handle, Reamawl, 3 Screw Drivers,
2 Pliers, 7 SPINTITES and Insulated, **WALDEN**
WORCESTER
Neutralizing Alignment Wrench.

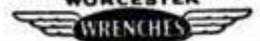

STEVENS WALDEN, INC.

WORCESTER 4, MASSACHUSETTS

Quick Change Gear Box for Atlas, Logan, Craftsman and Power-Kraft Lathes

Cut threads from
4 to 224 per inch

Approximately .003 feed
for fine turning

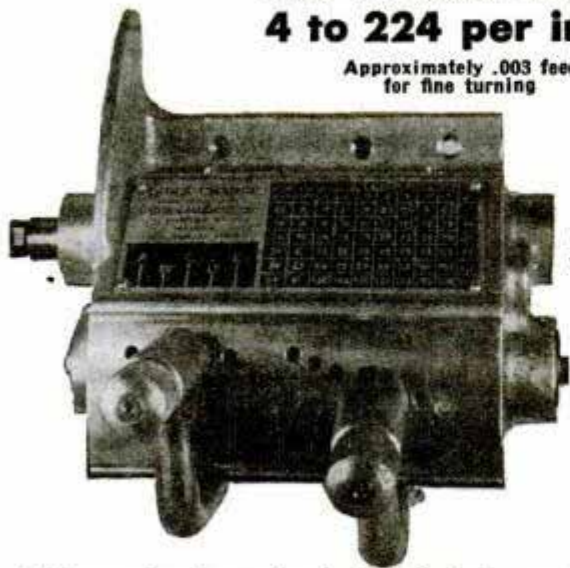

Only
\$75.00

F.O.B.
Chicago

Sold on
money-back
guarantee
if not
satisfied.

This gear box is constructed of all-steel gears in aluminum casting with bronze bearings throughout. Easy to install. Full instructions with shipment. Speedy production; maintained accuracy. Easy to set. Prompt delivery. Write Today!

THE O'BRIEN MACHINE CO.
Dept. PM-4 1620 Highland Ave. Chicago 26, Ill.

SPORTSMEN!

"GET ACQUAINTED" BARGAINS

Here are only a few of the hundreds of BESTLINE bargains that save you real money. All are guaranteed to be of the finest quality... favorite sporting goods items or your money back. If you don't find what you're looking for described below, send for our new FREE folder. It's chock full of the favorite sporting goods items you've been waiting for.

ORDER FROM THIS LIST NOW

NEW NYLON CASTING LINE

DePont Nylon, black water proofed, soft and multibraided. Will outwear ordinary silk lines. Special bargain price.

15 pound test..... per spool..... 1.49
20 pound test..... per spool..... 1.75

SEND FOR FREE CATALOG

POPULAR BASS LURE



JOHNSON
SILVER
MINNOW

The favorite lure of the best fishermen. Weedless. A killer for Bass, Pike or Muskies. Body Silver plated, 2 7/16" — 1/2 oz. ONLY..... **75c**

It floats and dives... a perfect killer for bass or pike. Has a red head and white body 3 3/4" long. Special..... **59c**



LIGHTER

Beautiful all aluminum lighter — highly polished, rich appearance, lights every time with a flick of the thumb. 2" high. ONLY..... **1.25**



POSTAGE PREPAID — MONEY BACK GUARANTEE
BESTLINE SPORTING GOODS CO. 4902 N. MONTICELLO Dept. PM-4, Chicago 25, Ill.

ARROW HEART



8-INCH TILTING
TABLE SAWS

\$47.50 LESS
BLADE

Full Details Upon Request

Arrowheart Industries, Box 126, Detroit 19, Mich.



YOU CAN HAVE THE FINEST COLLECTION OF
U. S. MILITARY SHOULDER PATCHES
Decorate your den, your club room. Over 300 different shoulder patches. Assortment of 6 (no duplicates) for only \$1.00 or send 10c for illustrated catalog. **6 FOR \$1.00** POST PAID
AMERICAN MILITARY OUTFITTERS, 14 N. Franklin St., Chicago 6, Ill.
See our ad for Longline Compasses pg. 287—Flexible Watch Bands pg. 289.

RADIO MICROPHONE

SING-TALK THROUGH YOUR OWN RADIO

Broadcast your voice through your radio from any part of the house. Cut into programs, make announcements, sing. Good Practice. Easily attached to any radio. Shipped Postage Paid if you send \$1.98. If ordered C.O.D. you pay postage and fees.

\$1.98
DISCO SALES, INC.
154 Nassau St., Dept. P. M. 2, New York 7

Machine Tools & Machine Shop Equipment

DRILLS	We can supply all your machine shop needs with fine tools made by leading U. S. manufacturers. Mail orders will be promptly dispatched. We invite you to send for our complete and illustrated catalogue—40c—which sum will be refunded on first order of \$10. Write to the	ELECTRIC TOOLS
TAPS		GRINDERS
DIES		COLLETS
REAMERS		VICES
CUTTERS		CHUCKS
SLEEVES		MICROMETERS
ARBORS	Veteran Tool & Supply Co., Dept. A 88 Baxter Street, New York, N. Y.	SURFACE PLATES

AMAZING NEW TRAP

Can't harm children, pets, birds or poultry

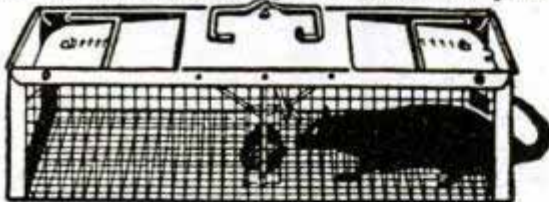

Open at both ends. Animal walks in unsuspectingly.

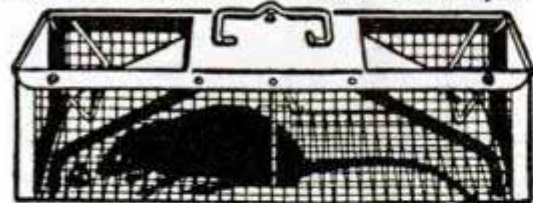

Both ends shut. The animal is caught unhurt.

Children have lost fingers, dogs and cats have had their paws crushed, in old-fashioned spring and box traps.

But now, an amazing new, all-metal, long-lasting, galvanized trap — called the Havahart — will catch rats, squirrels, and other vermin without fail... yet it can't hurt children, pets, poultry or birds. Domestic animals if caught, can be turned loose unharmed.

The humane Havahart has no springs to rust or break — so simple a child can set it. It is open at both ends. This gives the animal complete confidence. He marches straight in to get the bait — both ends close and he's caught. Guaranteed in full.

No. 1 5 x 5 x 18 For rats, weasels, etc. **\$2.75**

No. 2 7 x 7 x 24 For squirrels, rabbits, etc. **\$3.95**

ORDER BY MAIL
POSTPAID

636 BRECK BLDG.
BOSTON 9

SEEDSMEN SINCE 1818
BRECK'S

NEW PORTABLE ICE BOX



Here is something new in a convenient, portable insulated ice box that can be used on fishing trips, motor trips, picnics, etc. These boxes are beautiful in appearance, with stainless steel and chrome fittings. Made in two sizes: 26½" x 14" x 15¾", and 23" x 12" x 13¾". A descriptive circular will be mailed upon request.

Manufactured by

ARMSTRONG & GALBRAITH, INC.

"BOATS, MOTORS & EQUIPMENT"

623K AVENUE OF THE AMERICAS, NEW YORK 11, N. Y.

BUILD Boucher MODELS



CLIPPER TANKER FREIGHTER
Everything for the Model Ship Builder Since 1905

34 DIFFERENT
MODEL KITS
\$5 to \$35

Send 35c for 96
PAGE ILLUSTRATED
CATALOGUE

BOUCHER SHIP MODELS 36 EAST 12TH ST. NEW YORK, 3, N.Y.

LIQUID MARBLE COLORED POTTERY

Different! Marvelous! Color-glazed. Brush, spray, mold tiles, table-tops, ornaments! **SANITARY COMPOSITION FLOORING**—Dustless, noiseless; put on like plaster, plain or tile designs; yielding as cork, lasting as stone. **RUBBERELASTIC Mold Compound**—For plaster casting, novelties, statuary, toys, plaques, dolls. **TILEX Colored Roofing**. Build Modern **PLASTIC HOMES**. Illustrated literature free. **RAPID MARBLEIZING SERVICE**, Dept. 10-A, Edwardsville, Illinois



New! Complete!
RADIO
CATALOG

READY NOW! Send For Your FREE Copy!

Radio sets...radio kits (including 19 Popular Mechanics Kits)...radio parts...electronic equipment...amplifiers...complete, standard lines of post-war designed equipment and supplies; pages and pages of what you've been waiting for...in the new Concord Catalog, ready now! Rush coupon for your copy...sent FREE!

CONCORD RADIO CORP.

LAFAYETTE RADIO CORPORATION
CHICAGO 7, ILL. 901 W. Jackson Blvd. • 265 Peachtree St. ATLANTA 3, GA.

CONCORD RADIO CORPORATION, Dept. P-46
901 W. Jackson Blvd., Chicago 7, Ill.
Rush FREE copy of new, complete Concord Catalog.

Name.....
Address.....
City..... State.....

SAY YOU SAW IT IN POPULAR MECHANICS

POWER KING TOOLS ARE BACK!

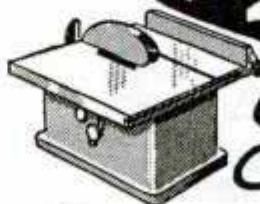

Skillful

"EXTRA HANDS"

FOR YOUR
WORKSHOP

Soon your workshop can hum again to the tune of Power King Tools—skillful "extra hands" to save you time and increase the number of useful projects you can make in your leisure hours.

Several of the tools shown at the left are in production and will soon be on the way to dealers.

You'll be amazed at their many new construction features and smooth efficient operation, and the unusual values that bring a complete Power King equipped shop within reach of all.

FREE CATALOG SHEETS

Write today for descriptive literature to help you make your new power tool shop plans. Keep in touch with your Power King dealer to see the new tools when they arrive.

POWER KING TOOL Corp.
420 Cleveland St., Warsaw, Indiana

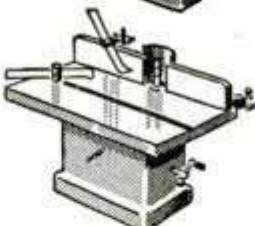
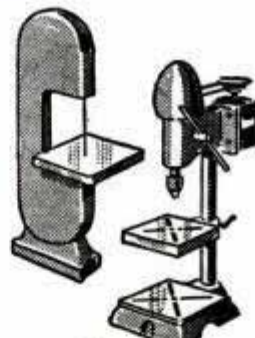

NEW TOOL READY!

War Industry's Handy, All'Round Machine
Now Available
To Home Shops!

The world-famous Mead Bandsander—invented for and used by hundreds of war plants—is at last available to you for home workshop use! This remarkable machine quickly shapes, sands, carves and polishes wood, metal, plastics! Works equally well on inside cut-out openings or irregular outside edges. Gets at places no other can! Tilting table for bevelling, chamfering. Rust-and-sweat proof top. Ball bearings. Saves time, labor, money on jobs in any home or industrial shop. Invaluable to home-craftsmen, makers of patterns, tools, dies, signs, costume jewelry, castings, forgings, ornaments, radio and electrical parts, stampings, etc. Nothing else like it. Sold on 5 Day Trial, money back guarantee.

Circular Free!
Cuts Fast and Clean . . .
Saves Filing, Sanding Work

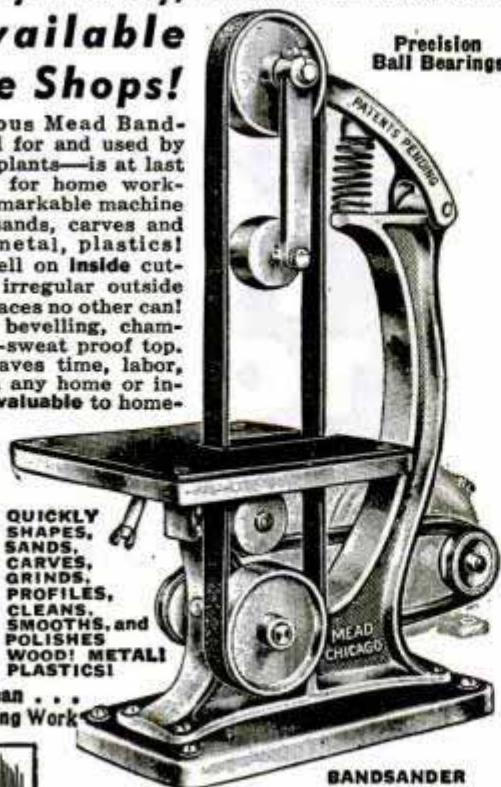

QUICKLY SHAPES, SANDS, CARVES, GRINDS, PROFILES, CLEANS, SMOOTHS, and POLISHES WOOD! METAL! PLASTICS!

BANDSANDER

Write for FREE Circular
Send for free details on "the machine that amazed the experts!" Rush a postcard today for Circular, surprisingly low price. Hurry!
MEAD SPECIALTIES CO.
4114 N. Knox Ave., Dept. 14, Chicago 41, Ill.



30 PIECE GRINDING WHEEL ASSORTMENT

FOR INDUSTRY & HOME SHOP

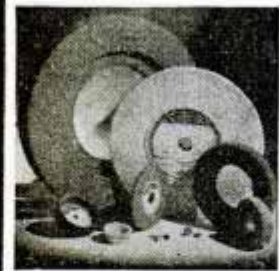

WAR SURPLUS ALL NEW!

Known names—NORTON—CARBURUNDUM—MACKLIN—MANHATTAN includes assortment of sizes invaluable for industry and home-workshop. If wheels were bought singly, value would be over \$30.00. Amazingly low price for complete assortment of 30 new grinding wheels only \$4.95 postpaid. Send check or money order today.

ONLY \$4.95 POST PAID
MOUNTED GRINDING POINTS— all new! Special "Hurry-up" offer gets you SEVEN mounted grinding points. **ONLY \$1.00** postpaid

GROBAN SUPPLY CO.
1522 SO. MICHIGAN AVENUE, CHICAGO, ILL.

SPEAK THROUGH ANY RADIO

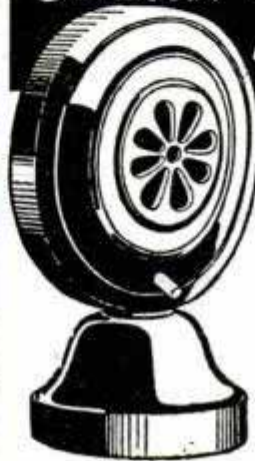

WITH Mike Jr.

Broadcast your personal message, birthday greetings, etc., from another room. Fun at parties. Tell the kiddies stories, etc. Easy to connect. Full instructions included. **\$1.00** Postpaid
Dealer Inquiries Invited
UTILITY STORES, 117 So. Wabash Ave.
Dept. DD-17 Chicago 3, Illinois

BURN YOUR NAME ON TOOLS

WITH THE ARKOGRAF

PROTECT YOUR TOOLS FROM THEFT
Write with electricity any name or design on the hardest and finest tools and instruments or any metal, like writing on paper with pen or pencil. Thousands used by mechanics, garages, machine shops.
Complete Outfit \$3.50—Prepaid Anywhere.
Interesting illustrated circular free. Write today.
ARKOGRAF PEN CO., 3927 S.E. Stark, Portland 15, Ore.



MARKS EVERYTHING!

IDEAL ELECTRIC MARKER

7200 Cutting Strokes a Minute



Not a toy, but a sturdy, dependable tool—built to highest industrial standards. Permanently marks everything—metals, plastics, ceramics, marble, etc., and even glass. Ideal for permanently writing your name, size and other identification on tools and parts. Powerful marking stroke operates like a small electric hammer. Light in weight (weighs only 10 oz.) and shaped to fit the hand, it is as easy to use as a pencil. Price with steel point, only \$9.90. **ALSO AVAILABLE WITH DIAMOND POINT.**

IDEAL has the most complete line of Etchers and Markers on the market

SOLD THROUGH WHOLESALERS

IDEAL INDUSTRIES, Inc. 5136 PARK AVENUE
SYCAMORE, ILLINOIS

(successor to Ideal Commutator Dresser Co.)

1641

MAKE YOUR OWN POWER TOOLS at Low Cost

from old Auto Parts, etc.

A New Edition Featuring TOOLS of WOOD

Now you can have a good lathe, drill press, circular and band saw and other power tools in your home workshop, at a cost of only a few dollars each. Make them yourself from old auto parts, discarded sewing machines and other odds and ends that cost little or nothing. Get this new book—"Forty Power Tools You Can Make." Costs only \$1.25 postpaid. This book gives every detail in plain language you can understand and follow. Hundreds of pictures and plans show every step to follow in making the power tools you want. Actual photographs of finished machines included. Send \$1.25 today. Money back if not satisfied.

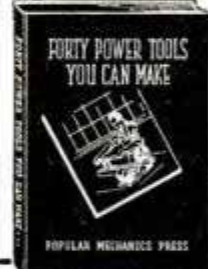

MAKE EVERY POWER TOOL NEEDED IN YOUR HOME WORKSHOP

- Some of the power tools you can make are:
- | | |
|--------------------|------------------------------|
| 2 Band Saws | 2 Drill Presses |
| 9 Sanding Machines | 1 Scroll Saw |
| 2 Circular Saws | 2 Wood Turning Lathes |
| 1 Metal Lathe | 3 Grinders |
| 1 Power Hack Saw | 1 Shaper or Moulding Machine |
| 1 Jig Shears | 1 Vibrating Pencil |
| 1 Cut-Off Wheel | and others |
- Information too, about pulleys, belts, motors and drive methods. Just published. No other book like it. Order today.

POPULAR MECHANICS PRESS

Dept. 621

200 E. Ontario Street, Chicago 11

Better Tools . . . Better Production

"Yankee" Tools are in the thick of production . . . their ingenuity enabling every user to do faster, easier, and better work. And soon, every workman who wants "Yankee" Tools can have them. In the meantime, keep asking your dealer for "Yankee" by name. They've got what it takes to save time, labor, and money on countless jobs.

"YANKEE" SPIRAL SCREW DRIVER No. 130A
A Size for Every Purpose

"YANKEE" TOOLS
make good mechanics better
North Bros. Mfg. Co., Phila. 33, U. S. A.
Established 1880

Makers, also, of "Yankee-Handyman" Tools

LENSES 500,000 OF THEM
Buy them for a fraction of their original cost.
U. S. ARMY & NAVY surplus lenses and prisms.
PERISCOPE EYE PIECE SET—1" Dia.ea. \$ 1.50
BINOCULAR PRISM ERECTING SETea. 2.00
5 LBS. OPTICAL GLASS (Lens Blanks), index plainly
marked on each piece 4.75
ACHRO. OBJ., 32 m/m Dia., 130 m/m F.L., cemented . . .ea. 1.50
RIGHT ANGLE PRISM, 1" sq. faceea. 1.25
5X TANK TELESCOPE (M71), brand new, complete . . .ea. 22.50
Send Money Order or Check—3 cent stamp for list
A. JAEGER, BOX 84 P, SO. OZONE PARK 20, N. Y.

**MAKE YOUR OWN
COSTUME JEWELRY
BIG EARNINGS AT HOME**

YOU can make costume earring and pin sets, brooches, necklaces, dress clips, cameos, etc.
WE supply the jewelry findings; bar pins, ear screws, jump rings, chains, screws, stone sets, sequins, shells, boxes, cement, cards, etc.
WRITE FOR FREE CATALOGUE
PHILADELPHIA BADGE, 1007 FILBERT ST., PHILA. 7, PA.

TRAILER AXLES, HITCHES, AND PARTS

• If you are interested in purchasing trailer axles, hitches, and other trailer parts, contact us promptly. **Write for free literature.**

HAMMER BLOW TOOL COMPANY, Dept. 104, WAUSAU, WIS.

You CAN'T WORM WRONG

for tape, hook, whip, round (ascaris) worms when you worm your dog as directed with Pulvex Worm Capsules, a combination treatment which insures your worming right. Used by leading breeders. Packaged 2 ways: for puppies, for dogs. Either, 50¢; double-size, 75¢
At pet, drug, department stores.

PULVEX
★ COMBINATION TREATMENT
WORM CAPSULES



When you want to fix things fast...remember Weldwood Glue. It's quick to mix... easy to use...tremendously strong... stain-free... rot-proof...and permanent. At hardware stores, lumber yards, chain stores.



WELDWOOD PLASTIC RESIN
WATERPROOF GLUE
UNITED STATES PLYWOOD CORPORATION, New York 18, N. Y.

6 handy tools in ONE!

- 1 MITERING GUIDE
- 2 DIAMETER GAGE
- 3 ACCURATE SQUARE
- 4 MARKING GAGE
- 5 CENTER FINDER
- 6 CONVENIENT RULER



\$1.50
POSTPAID



MITER-MASTER

Miter Master takes the place of an expensive miter box accurately set to any angle. Scale marked for mitering 5, 6, and 8-sided frames. Steel construction. Built to last a lifetime. If your dealer can't supply you we will send it postpaid anywhere in the U. S. for \$1.50. (Foreign \$1.75.) Unconditional guarantee. If not satisfied within ten days for any reason whatsoever, your money will be refunded.

MASTER SPECIALTY COMPANY
3018 EAST LAKE ST. • MINNEAPOLIS 6, MINN.

MILL IT ON YOUR LATHE



WITH A PALMGREN MILLING ATTACHMENT

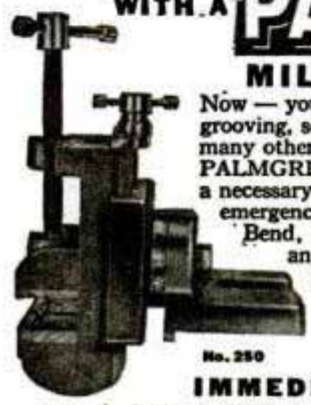

Now — you can do milling, slotting, grinding, grooving, squaring shafts, sawing at angles, and many other important operations on your lathe. PALMGREN MILLING ATTACHMENT is a necessary fixture for small shops, schools and emergency work in large plants. Fits South Bend, Atlas, Craftsman, Logan, Sheldon and all other makes. It has 360° graduation for rotary angle adjustments, also graduated feed and adjustment screw. Easily mounted by straddling lathe's regular tool post. Try one—it will quickly pay for itself.

IMMEDIATE DELIVERY

No.	Width Jaws	Depth Jaws	Jaws	Weight Pounds	Base Opening	Price F. O. B. Factory
150	1 1/4"	1"	1 1/2"	6 1/2	1"	\$18.75
250	2 1/4"	1 7/8"	2 1/4"	11	1 1/4"	24.75
400	4"	1 1/2"	2 3/4"	25	2"	39.75

Order from your dealer or jobber. Write for circular No. 349

CHICAGO TOOL AND ENGINEERING CO.
Mfrs. of PALMGREN PRODUCTS for Over 28 Years
8365 South Chicago Avenue • Chicago 17, Illinois

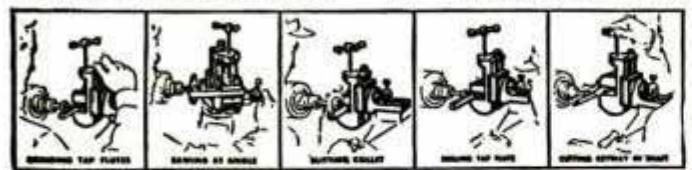

DEXTER UNIVERSAL LATHE CHUCK

well-made, accurate, strong, serviceable



2"—\$12; 3"—\$14; 4"—\$17; 5"—\$21; 6"—\$27; complete with two sets of jaws, no adapter required

Includes inside and outside jaws
State spindle size and threads per inch
Distributors Wanted

THE LEAVITT MACHINE COMPANY
ORANGE • MASSACHUSETTS

MACHINE SHOP EQUIPMENT



Every man who owns a workshop should have a copy of this new, authentic catalog of Machine Shop Equipment... the latest tools made by the biggest manufacturers in the United States. Replete with illustrations, descriptions, prices. Prompt delivery on most tools listed in this catalog. Available at the cost of printing—50c a copy—Get yours today! Price of Catalog Refunded on First Order over \$5.00. Send check or Money Order to

CENTER TOOL CO.
154 Centre St., New York 13, N. Y.

SAVE MONEY ON GASOLINE

FITS ALL CARS

Now you can get up to 30% extra gasoline mileage with a Vacu-matic on your car. Quicker pick-up, smoother running, added power saves money every day. Guaranteed.



Automatic Supercharge Principle
Vacu-matic is entirely different! Operates on the Supercharge principle. Saves gas. Automatically provides a better gas mixture. Guaranteed to give up to 30% extra gas mileage, more power and better performance.

SALESMEN WANTED

Big profits. Every Car a Prospect. Send name and address for FREE PARTICULARS and how you get yours for introducing.

Vacu-matic Co., 7617-1272 W. State St., Wauwatosa 13, Wis.

SAY YOU SAW IT IN POPULAR MECHANICS

The Chief WORK BENCH

Built to Last a Lifetime!

With Bottom Shelf and 18" Sq. Drawer. 2"x6", Solid Plank, Grooved and Dovetailed Top and 1"x8" Back Rail, Shellacked to a Smooth, Satiny Finish.

MOHAWK LUMBER CO. Dept. 32
14525 W. Chicago Blvd. Detroit 27, Mich.
Enclosed Check Money Order for \$.....
Ship..... CHIEF WORK BENCHES at
Quantity.....
\$16.95 each, F.O.B. Detroit, Mich.
 Send C.O.D., \$5 Deposit Enclosed.

NAME.....
ADDRESS.....
CITY..... STATE.....
No Priority Necessary!

• 6 Ft. Long • 34" High • 26" Deep. Shipped Knock-down, with Bolts, Nuts and Screws and ABC Chart for Quick, Simple Assembly.
Prompt Delivery
MOHAWK LUMBER CO.
14525 W. Chicago Boulevard
DETROIT 27, MICHIGAN



\$16.95
F.O.B. DETROIT

Send Check or Money Order, or Will Ship C. O. D. (\$5 Deposit)

HOME CRAFTSMEN! add to your skill with turner PLASTIC HAMMERS



Every workshop should be equipped with Turner Plastic Hammers—the safest, softest hammers for any type of metal or wood

Get this Set
SAVE 20%
Only \$3.95
for all 3!

work, choice of the aircraft industry and fine metal trades for years. Statically balanced—economical—outlast other hammers; worn tips easily replaced. Tough hickory handles wedged and keyed into solid steel rust-proof heads. No twist or turn.

Order your hammers today. Shipped prepaid or C. O. D. plus postage.

MONEY BACK GUARANTEE!

turner tools, Dept. PM-4

3911 SAN FERNANDO ROAD
GLENDALE 4 CALIFORNIA

No.	Length	Head Wt.	Each
3	11"	4 oz.	\$1.15
7	13"	9 oz.	1.55
15	13"	12 oz.	2.25

TOOLS MATCHED TO YOUR SKILL XCELITE



Maybe that's why we are still unable to meet the demand for Xcelite Tools—and also why we'll dispense with sales talk. However, new equipment is being installed which will double present Xcelite production—and before very long. Our new catalog will be off the press shortly. Ask your dealer—or write for free copy. Dept. J.

PARK METALWARE CO., INC.
ORCHARD PARK NEW YORK



QUALITY TOOLS
PREFERRED BY THE EXPERTS



SHOE REPAIRING "IT'S PROFITABLE"

AS A HOBBY OR OWN YOUR OWN SHOP Now any one can repair shoes with our simplified instructions and our complete outfit, consisting of jack and last, 2 knives, hammer, pliers, punch, rasp, grade "A" leather and rubber heels to repair 3 pairs of shoes, rubber cement and 3 pairs of tacks. **COMPLETE KIT \$12.75**

First repairs practically pay for the kit. Send Money Order or Check. No C.O.D.'s.

Sold on a Money Back Guarantee. Save by getting your shoe repair supplies from us.

Brooklyn Leather Co., 1185 E. 15th St., Brooklyn 30, N. Y.

SUPER MYSTERY BUTTON

Many times as sensitive as our regular mystery button. Can be used for the same experiments and uses as the mystery button but with far better results. Needs no diaphragm of any kind. Ideal for musical instruments, intercommunication, recording, talking thru radio, and many other uses. When used with small head phone it makes an ideal inexpensive hearing aid. Shipped with 5000 word, 12 page booklet showing diagrams for dozens of uses, postpaid \$2.00.

Electronic Products Company
Saint Charles, Ill.

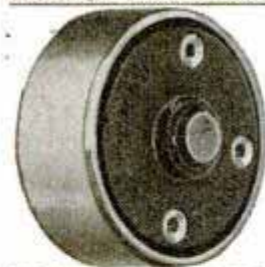

TENNIS SAVE ON OUR LOW PRICES

• Gut Tennis and Badminton Strings direct from factory to you.

• Vises & Frames • Tennis Equipment

H.E. WILLS CO. Catalog FREE

1047 W. 47 St.
Dept. PM-46
Chicago



Big Money for Workers In Home or Shop



Licensed Concrete Specialists wanted. No experience needed. Make *Colorglazed* concrete pottery without molds. New, low cost, patented method. Cemetery products, novelties, tiles, etc. Basement leaksealing. Other big pay projects. Booklet, details free. Men only.

NATIONAL POTTERIES COMPANY

542 Lincoln Avenue Fergus Falls, Minnesota

APRIL 1946

PLASTIC WOOD ...

"a tool kit in itself"

for the

Home Workshop

Enables you to achieve a more professional finish on:

- Cabinet work
- Furniture repairs
- Remodeling

Handles like putty ...

Hardens into wood

Plastic Wood can be carved, sanded, sawed, drilled, nailed, painted or varnished.

Keep a supply of PLASTIC WOOD SOLVENT on hand to control the consistency of PLASTIC WOOD for special purposes.

On sale at all Hardware, Paint and 10¢ Stores in tubes, quarter-pound and one pound cans.



A CELLULOSE FIBRE FILLER
PLASTIC WOOD

SAY YOU SAW IT IN POPULAR MECHANICS

New

TUFFY

Power-Arm Driver

**Loosens! Tightens!
Faster... Easier!**

See! Try This Amazing Tool!

Frozen, rusted-over screws are no problem for Tuffy Power-Arm Driver! Tuffy's terrific leverage loosens them easily and quickly in a jiffy. And for tightening screws "that last quarter-turn" Tuffy's power will amaze you! Then snap Power-Arm shut and presto!... a regulation screw driver. See yourself how Tuffy greatly increases turning power over "one-handed" driving.

Durable aluminum handle, forged steel blade plated to ward off rust. Available in 3 sizes: 5 inch blade \$1.95, 6 inch blade \$2.25, 8 inch blade \$2.65. Complete set of all 3 sizes packaged in kit box, \$6.85. If your dealer can't supply you, send us his name.



With Power-Arm Folded Back Tuffy Becomes Regulation Screw Driver

PACKS EXTRA POUNDS OF POWER!

Set of 3 popular sizes only \$6.85. Order TODAY

SWALLOW AIRPLANE CO., INC.
901 Lincoln Ave., Wichita 1, Kansas

ELECTRIC HAND DRILL

BRAND NEW

3/4 in. Cap. Portable complete with Keyless Chuck—8 ft. cord, die-cast alloy body—operate on A.C. or D.C.—115 Volt (Approx. weight 5 lbs.). Send cash with order postage prepaid.



\$22.50

ESSANESS SALES SERVICE
Rm. 304, 20 W. Jackson
CHICAGO, ILLINOIS

Two Mature Salesmen or Businessmen

Wanted Immediately



**\$5,000-\$10,000 in a Year
to Producing Salesmen**

Our product saves buyers up to three times its expected cost. It is essential, guaranteed, and in great demand. That's why, last year, our top man earned \$17,455.30. Together, our leading salesmen drew gross profits of \$104,065.53. Among them, the lowest individual earning was \$7,075.86. (All figures certified by sworn affidavits.) Our corporation is long-established, progressive with A + A1 credit rating. Orders you get will run up to hundreds of dollars apiece. Prospects unlimited. Long credit terms. No down payment. You don't bother with deliveries or collections. Previous experience in our line unnecessary. No car, investment, or bond required. Our product patented. Earnings are exceptional, steady. Our established policy is close, cordial cooperation with you to lift your earnings. Learn how you can qualify for this unusual, money-making opportunity. Rush name and address to...

PANTHER OIL & GREASE CO.

SALES MANAGER, DEPT. 711P

FORT WORTH, TEX.

... in Each of the
Following States —
Wyo., Mont., Ida.,
S. Dak., N. Dak., Neb.,
Me., N. Hamp., Vt.,
and other states.



IDENTIFICATION BRACELET only \$1.95. Heavy silver plated, name engraved without extra charge. Orders shipped same day. We also make these with a STERLING SILVER tag, heavy weight, with nickel silver chain, each boxed, \$2.95. We pay tax and postage.

MONT PETIT MFG. CO.
15 E. Pearson St., Dept. B Chicago, Ill.

Say you saw it in POPULAR MECHANICS

It's Back Again! WOOD BURNING PEN

Complete ELECTRIC Wood Burning Outfit—Burn Beautiful Designs in Wood—Comes Complete! Safe, Constructive, Educational Wood Burning Pen is equipped with the Sta-Kool Handle. Burn and etch deeply on wood in rich shades of brown. It's real fun. Comes complete with 10 different plywood plaques, design imprinted, and 1 plain plaque. All for only..... **\$2.50**

Send check or money order to UTILITY STORES, Dept. DD20 117 S. Wabash, Chicago 3, Ill.



AMAZING ELECTRIC SWITCH

ELECTRIC SWITCH OF A THOUSAND USES
MILLIONS NOW IN USE



Turn on your porch light when you open the door—sound an alarm when the mail is put in the box—shut off the water when the tank gets full, these and many other services are performed with this amazing switch. Shipped with an instruction sheet showing more than 40 illustrated uses for this device, at the bargain price of \$1.00 postpaid.

ELECTRONIC PRODUCTS CO.

St. Charles 10, Illinois

RADIO SET anyone can build



Only
\$2.98
What
a gift
for a
Real
Boy!

A workable radio receiving set any boy can build. Kit complete with diagram, parts, instructions. No electrical outlets or batteries needed. When set is assembled attach serial-tune in. Better order two (one for Dad). Sent C.O.D. plus postage or send \$2.98 and we pay postage.

DISCO SALES, INC.

Dept. P. M. 1, 154 Nassau St., N. Y. 7.

Money Making Pay Raising BOOKS Catalog FREE

SEND NAME AND ADDRESS TODAY—Selected books covering all trades, office helps, home workshop, spare time work, hobbies, etc. Learn how to earn more. 1946 edition. Popular Mechanics Press 200 E. Ontario St., Chicago 11



New 1946 SHOP NOTES Now Ready!

FOR EVERY MAN WHO USES TOOLS

One of these books is issued each year and is a reprint of articles published in our Shop Notes Department. It contains the cream of experience of years, of hundreds of our country's most successful mechanics. 50c per copy at your News Dealer, or send 60c to

POPULAR MECHANICS PRESS

Dept. 618 200 E. Ontario St. Chicago 11

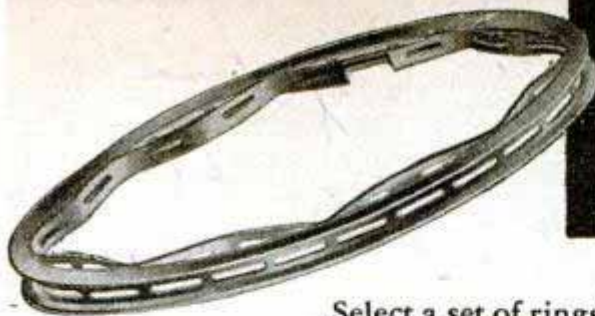

HOW TO SAVE *Money* ON A RING JOB....

Select a set of rings that can "take it"—a matched set, designed to put new life in old motors. And choose a set that's easy to install—easy on the pocketbook.

HERE'S HOW—DO IT WITH SIMPLEX PISTON RINGS

✓ **Buy a ring that stops oil pumping** ... The longer, wider, oversize shots on Simplex rings won't clog with carbon. Straight-through flow eliminates trapped oil and keeps the ring washed clean. There are no square corners where carbon can collect.

✓ **Buy a ring that stops "blow-by"** ... Simplex rings fit better—even on cylinders worn out of round. Patented four-piece all-steel construction allows the ring to breathe as a unit.

✓ **Buy a ring that cuts down on cylinder wear** ... The multiple edges of the Simplex compression ring provide multiple traps or reservoirs of oil that lubricate the cylinder wall to reduce cylinder wear—the same principle as the modern windshield wiper. This trapped oil also hydraulically seals the ring and cylinder against compression loss or "blow-by".



NOW AVAILABLE
Red Latex Molding Compound
 Make your own molds for plaster objects
 Write for information and prices
COLUMBUS GLOVE MFG. CO.
 474 Lilley Avenue Columbus 5, Ohio

TUBULAR AXLES for TRAILERS, FARM WAGONS, TRUCKS and PICK-UPS
 3,000 lb. capacity—Spindles ground and threaded—fit standard front auto hubs—58 inch track.
 Drop center or special types quoted on request.
 SEND CHECK OR MONEY ORDER TODAY **\$675** F.O.B. DETROIT
SPARTAN INDUSTRIES
 8215 McDougall • Detroit 11, Michigan

FLEXO-COMFY, MAN'S EXPANSION WRIST BAND
 5 DAY Money Back Guarantee
 Stainless Steel—Fits every wrist—will not tarnish or rust. Send for this beautiful band today!
\$2.00 Tax Paid—Postage Paid Also available Gold Plated with stainless steel back.....\$3
CARY ROSS ENTERPRISES
 4542 N. CENTRAL PARK CHICAGO 25, ILL.

New Invention: PARALLEL CLAMP VISE AND "V" BLOCK
(OVER 100 USES)
4 1/8 x 1 3/8 A Real Addition To Your Work Shop!
ONLY \$3.25 Postpaid Shipping Weight 2 pounds
 ANYWHERE IN U.S.A.
OPENS ONE INCH Made of High Grade Steel. No Castings. Perfectly Machined.
FOREIGN ORDERS— Send Extra Postage. Sent Customs Collect.
SAVES TIME AND MONEY—DOES IT BETTER
Sets Flat on Drill Press or Fastens to Lathe
 Forged jaws and "V" block for drilling and holding round work. Sets flat on drill-press bed or any working surface. No projecting screws through base. Marvelous for:—
 (1)—DRILLING END OF ROD STOCK
 (2)—DRILLING ROUND STOCK
 (3)—DRILLING METAL SHEETS IN MULTIPLE
 (4)—DRILLING SQUARE STOCK
 Stud and Wing Nut Included to Fasten to Table or Drill Press
WRIGHT MFG. CO., 21 N. Commonwealth Ave., Dept. P.M.-4, Elgin, Ill.

you'll do faster, better work with this
EFFICIENT SHOP TOOL

THE
**Bantam
GRINDER**



Polishing
Grinding
Carving
Drilling
Buffing
Plastic
Glass
Metal
Wood
Bone



You'll enjoy doing many shop jobs with the Bantam Grinder. Correctly balanced for easy handling. Precision-built of quality materials for dependable, long-life service. Operates on 110-115 Volt AC-DC. Speed approx. 20,000 R.P.M. Internal ventilating fan. Fingertip switch. Weight—15 oz. With 8-ft. cord and plug, 23 accessories, substantial gift box... **\$25**

If your dealer doesn't have it, write us.

Small Motors, Inc.

Dept. 80, 2068 Elston Avenue • Chicago 14

Manufacturers of special small universal, fractional H. P. motors, shaded pole motors, heater motors for industrial and appliance uses.

Now!
A Better Soldering Tool...
THE
VANATTA
KWIKHEAT

Has Built-in
Thermostat
Control!

THERMOSTATIC SOLDERING IRON



6 TIP STYLES

- #0—\$1.25
- #1—\$1.25
- #2—\$1.25
- #3—\$1.25
- #4—\$1.75

#5—Soldering Pot for tinning—\$1.25

HOT, READY FOR USE ONLY 90 SECONDS after plugging in! Kwikheat is the only soldering iron with a thermostat built into the tool itself*—maintaining the proper level of heat for most efficient, economical operation. SAFE! ... Cannot overheat—ECONOMICAL! ... Lasts longer—saves tips and requires less retinning. POWERFUL!—225 watts—yet exceptionally light weight (14 oz.). Well-balanced with cool protecting plastic handle. Modern streamlined design. Six interchangeable tip styles adapt one Kwikheat Iron to all your soldering jobs. You will be proud to own America's finest and most versatile soldering tool... from tip to plug Kwikheat is in a class by itself. Ask your dealer to demonstrate the quick-heating feature now!

*patented
Kwikheat Iron with choice of any one tip... \$11.00
Set of 5 Tips, consisting of #0, 2, 3, 4, and 5... \$5.00



Dept. PM-4, Kwikheat Division of
SOUND EQUIPMENT CORP., 3903 San Fernando Rd., Glendale, 4 Calif.



Doorstop on hinge controls half or full opening door and eliminates need for door stops attached to floors or walls. Hinge doorstop consists of a stop nut which slips over the top knuckle of house door hinges.

Rivet wears aluminum collar which protects it from corrosion. Widely used in building warplanes, the rivet is a two-unit fastener composed of a headed steel shank with a single groove in the end and a cylindrical aluminum collar. The rivet has strength equal to high tensile steel aircraft bolts.

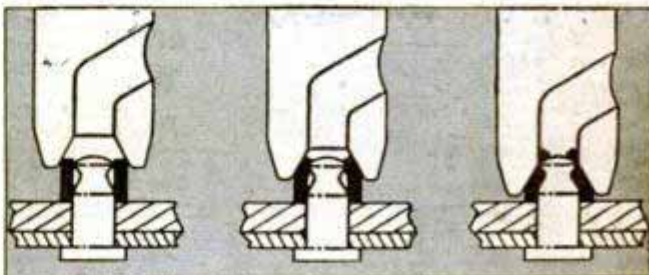
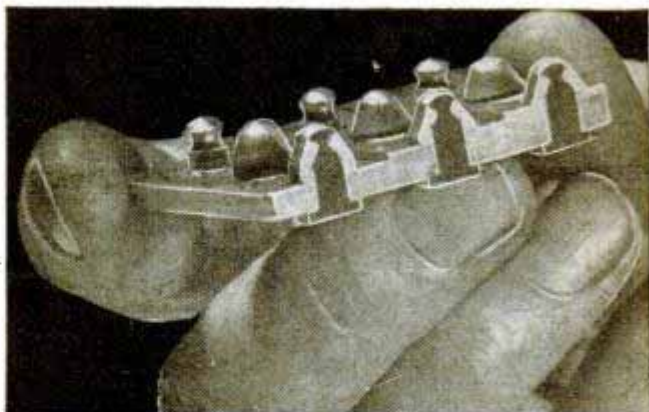

63½% Prefer Filter Pipes*

- 1 Cleaner, cooler smoke enters your mouth, because—
- 2 Sensational filter whirl-cools smoke, collects flakes and slugs, absorbs juices.
- 3 Replace filter when discolored.

Frank **MEDICO**

THE LARGEST-SELLING FILTER PIPE

\$1

with box of 10 filters



X-RAY VIEW

Genuine filters for MEDICO Pipes, Cigarette & Cigar Holders Packed Only in this Red and Black Box.

*American Legion Magazine Survey No. 2 "The Man Who Was GI Joe"



S. M. FRANK & CO., Inc., NEW YORK 22, N. Y.



THE S-K-W PLASTIC PRESS \$110.00

INDUSTRIAL For developing experimental parts and producing plastic accessory products.

HOME WORK SHOP Usable for the production of diversified items. Costume jewelry—plastic toys—novelties—etc.

BUILD IT YOURSELF Plans, machining and operating instructions on machine and molds \$2.95.

Write for Descriptive Folder

S-K-W Manufacturing Co., 4448 W. Harrison St., Chicago 24, Ill.

WET BASEMENTS Start your own waterproofing business with Seal Seep. New—patented. Seals from inside. Easy to apply. *Guaranteed.* Big Profits—exclusive territory. Free offer. **SEAL SEEP CO., 410 Dawson Road, Cincinnati 27, Ohio**

SAY YOU SAW IT IN POPULAR MECHANICS

AUTO ENGINE SPEED CONTROL GOVERNORS (REGULADORES)

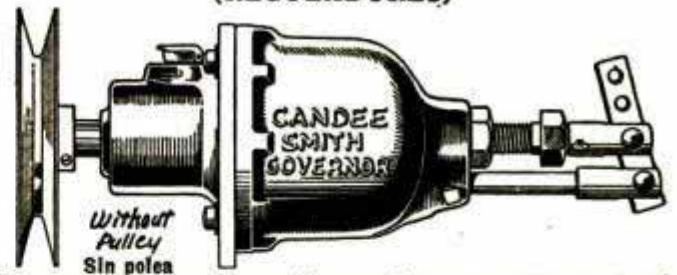

Without Pulley Sin polea

Give constant or changeable speed to any auto or truck engine, when used for power. Guaranteed. Instructions. Oil ring bearing, \$12.50. Full ball bearing, \$19.00. Postage west of Miss., 50c; east of Miss., 85c. Sent COD or—Postage to any country in the world \$1.00 each. Pulleys to 3", \$1.00, wt. 1 lb.; to 6", \$1.50, wt. 1½ lb. Governor speed 1400 to 2400 rpm. Figure your pulley size.

Agents Wanted: Parts and Implement Dealers, Garages, Welders, Wreckers, Catalog and Mailing List Houses, etc.



These valves used where carburetors have outside attachments. State size of opening and distance between bolt holes. 1", \$3.75; 1¼", \$5.25; 1½", \$6.50; 1¾", \$7.50; V8, \$7.00. Mailing weight, 3 lbs. If remitting, enclose for postage. You may order from this ad, or we will send circulars. Stocks carried: In Montreal 15, Canada: 7546 Wiseman St. In Skaneateles, N. Y.: Eugene Horle.

CANDEE, Dept. J, 2641 S. Hill, Los Angeles 7, Calif.

Build PRACTICAL PROJECTS FROM CRAFTSMAN PLANS

Easy to follow, completely dimensioned

ATTRACTIVE BIRD HOUSES

- M20 Mt. Vernon Style—31 Family House—Plans \$1.00
- M15 Tower Style—12 Family (illustrated) " .75
- M10 Castle Style—8 Family Martin House " .50
- BH5 Group of 4 Houses—2 Wren—Woodpecker—Bluebirds. All 4 on 1 Plan .50



CAPE COD CHAIRS



TRELLISES, ARBORS, FENCE PICKETS, GATES, LAWN FIGURES, ETC. Chairs Styles B, C, A, Plans 50c each. All 3—only.....\$1.00
12 different trellis designs. Plans of all 12 only..... .50
Four fine lawn figure patterns: Dutch Boy, Tulip Girl, Holland Pair and Sunbonnet Girl—all four patterns only.....\$1.00
SEND 10c for your copy of our new 1946 Catalog illustrating many fine home and garden items, plans, knock-down kits, completed projects, also a fine line of fence pickets and gates.

CRAFTSMAN'S MODEL CO. Dept. P90, 2030 N. 41st St. MILWAUKEE 8, WIS.

1361 New York St. L. A. Cal.

Winding Tool Permits Fishermen To Make Neat Wire Leaders

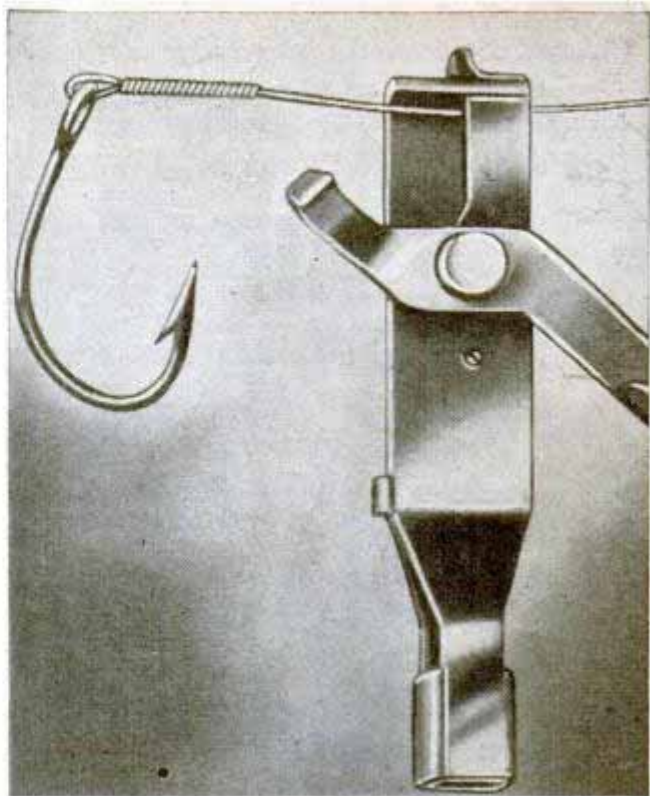

Fishermen can make their own wire leaders neatly and quickly with a winding tool about the size of a pair of nail clippers. The tool has two clamps and guides that hold the leader wire in position while turns are made around the length of the wire by rotating the device with the fingers. Any steel wire from .008 to .015 inches in diameter can be used. The tool has a small hole in the center through which wire is threaded for cutting.

Kamikazes Spotted Electronically

Electronic "brains," guided by radar, gave two automatic blind-firing antiaircraft gun directors the superhuman "intelligence" needed to meet the Japs' Kamikaze attacks in the Pacific. The Mark 57 is an eight-foot, one-ton robot which is equipped with optical lenses and a radar tracking device and was manually operated with a set of handles resembling a bicycle steering gear. Produced by the Eastman Kodak Company and the Submarine Signal Company, it accounted for a number of Nip suicide planes. The electrically controlled Mark 61, produced by the Norge Division of Borg-Warner Corporation, takes into consideration the target's range, course and speed, the speed of the ship on which it is mounted, wind velocity and trajectory. The "brain" then points the gun at the spot where the target will be when the shell arrives. Both gun directors were developed by Johns Hopkins University.

Build a profitable business quickly with...

HOBART "Simplified" arc welding

They Bring in the Big Pay Jobs to Hobart Owners
You're equipped to do all kinds of jobs when you have a Hobart welder — you're not limited to just a few types of work. Used by the U. S. Army and Navy. If you were in Service you'll understand why. With Hobart you'll be able to demand higher prices because it's really easy to get both speed and quality with Hobart "Simplified" Arc Welding. Some reasons are:

DUAL CONTROL. Gives choice of 1000 combinations of voltage and amperage, offering you the exact welding heat for every type repair or construction job. Guarantees superior welds!

REMOTE CONTROL. Another exclusive Hobart feature that lets you control the welding heat at the work—no matter how far away it may be from the welder. Speeds up welding!

IT'S SIMPLIFIED! It's surprising how quickly one can learn to obtain professional welds with Hobart "Simplified" Arc Welding. Nothing is complicated to do or understand—another reason for the big success of Hobart Welders. Clip coupon now. Let us tell you about it.



YES, YOU CAN "BUILD YOUR OWN" Hobart Gas Engine Drive Arc Welder



With a Hobart generator and easily-obtained auto parts you can build your own gas drive arc welder that lets you go out after every welding job right in the field—and save hundreds of dollars, or you may purchase a complete factory-built unit. Clip coupon for the details.
HOBART BROTHERS CO.
BOX M-46, TROY, OHIO
"One of the World's Largest Builders of Arc Welders"

Free!
Valuable "Vest Pocket Guide" Mail coupon.
REACH FOR YOUR SCISSORS

HOBART BROS. CO., BOX M-46, TROY, O.

Send me information on the Hobart "Simplified" Arc Welder—without obligation. Also items I've checked.

Vest Pocket Guide Booklet Info on Welding School
 Info on "How to Build Your Own"

NAME _____
ADDRESS _____



LONGINE

WATCH COMPASS

Genuine U.S. Army Compass. Made according to Gov't Specifications by the Longine Wittnauer Watch Co. Packed individually in sealed boxes.

\$2.95
Post Paid

NEW LONGINE WATCH COMPASS...each only

LONGINE, WALTHAM, TAYLOR WATCH COMPASSES SLIGHTLY USED.....each only

\$2.45
Post Paid

AMERICAN MILITARY OUTFITTERS

14 N. FRANKLIN ST., CHICAGO 6, ILL.

See our ads for Shoulder Patches pg. 276—Flexible Watch Bands pg. 289.

LIFE PRESERVERS

Surplus Government Stock



Pneumatic life vest. Built to rigid army specifications and inspection. Heavy, bright yellow twill. Bladder of all new stock neoprene. Easily and quickly inflated by valve, located near mouth. Knurled lock nut prevents deflation. Special connection for inflating with automatic cartridge (not included) as used by aviators. Design keeps head from submerging. Complete with zipper, bladder, webbing strap with neck and D ring fasteners. Weighs but a few ounces. Easily stored. Play safe! Have the protection afforded our army fliers. As illustrated. \$5.00 postpaid. Supply limited to quantity on hand, so order today. Money Back Guarantee.

ROCK CORPORATION

2182 Beaufait, Detroit 7, Mich.

FOR DEALERS
Packaged 12 to carton. 12 cartons to case.

Type B-5, double, as used by U. S. Aviators, complete with automatic charger, holder and cartridge, \$13.00 postpaid.

SAY YOU SAW IT IN POPULAR MECHANICS

Wonder-Shave BRUSHLESS SHAVING AT IT'S BEST

All over the country, men are hailing this new, different shave cream. Contains ALL FIVE essentials for clean, comfortable shaving. You too, can enjoy cool, zippy shaves. Trial size 10c. Agents wanted.

ROYAL-JAY PRODUCTS CO. Box 337-A Mamaroneck, N. Y.

ANY ONE CAN MAKE REAL LEATHER LINK BELTS

"It's Fun and Profitable." Complete outfit, including buckle and easy instructions. No tools required. **50c ea.** Send Money Order or Check. No C.O.D.'s. \$4.80 doz. kits Money Back Guarantee if not satisfied.

Brooklyn Leather Co., 1185 E. 15th St., Brooklyn 30, N. Y.

BOYS! SPORTSMEN! SCOUTS!

The Trailblazer

LUMINOUS DIAL AVIATOR'S COMPASS

FOR BOY SCOUTS CAMPERS HUNTERS BOATMEN

- UNBREAKABLE ● Leather Strap
- ACCURATE ● WATERPROOF
- EASILY READ ● SHOCKPROOF

WEAR IT LIKE A WATCH!

ALEXANDER WORLDWIDE MERCHANDISE CO.
Box No. 1, Morris Hts. Sta.,
New York 53, N. Y.

- Enclosed is \$2.00
- Send C.O.D. Plus Postage

Name

Address

P-4

ONLY
\$2.00
POSTPAID



GET READY FOR SPRING

1. CLEAN RUST OUT OF YOUR RADIATOR



with DU PONT

Cooling System CLEANSER

Drain out your anti-freeze, and clean out winter's accumulation of scum, scale and rust. Neglect now may mean trouble and costly repairs later. Just pour a can of DU PONT COOLING SYSTEM CLEANSER into your radiator, run the engine 30 minutes or more, and drain.



2. MAKE IT RUST-PROOF

with DU PONT Acid and Rust INHIBITOR

After cleaning out the radiator, you can keep it free from rust all season by pouring in a can of DU PONT ACID AND RUST INHIBITOR. It prevents rust forming, and keeps out acid, too.



3. MAKE IT LEAK-PROOF

with DUPONT Cooling System SEALER

You can stop leaks quickly and securely—and make the cooling system LEAK-PROOF—by pouring in DU PONT COOLING SYSTEM SEALER. It will not clog the radiator.



MAKE YOUR CAR LOOK NEW

with DU PONT NO. 7 POLISH

Clean away dull traffic film—restore the original lustre and beauty of the finish. A little rubbing with No. 7 Polish will make a wonderful improvement in the car's appearance. It's quick, easy and safe.



BETTER THINGS FOR BETTER LIVING

... THROUGH CHEMISTRY

ONE MOTION LIGHTS IT



\$1

at your dealer

THE only one-motion stainless steel lighter at \$1.00. New wheel and flint adjustment for velvet-smooth action.

PARKER SERVICE LIGHTER

PARKER OF LONDON LTD., NEW YORK.

ELECTRICITY

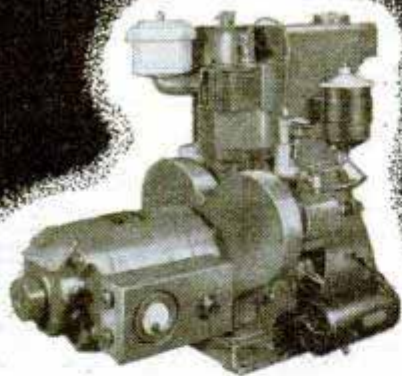

FOR YOUR Summer Camp

Electric appliances . . . running water . . . even ice cubes for drinks . . . can be enjoyed miles from the nearest power lines by simply installing a Sheppard Diesel 2,000-watt Generating Set. Electric lights for outdoor sports will add hours to precious vacation days, weekends and holidays.

A 2,000-watt Sheppard Set . . . air-cooled for easy maintenance . . . operates on low-cost Diesel fuel oil. Does away with hazardous use of gasoline . . . bothersome task of refilling stoves and lights. Life "in the rough" is more fun when the edges are smoothed off with a Sheppard Generating Set. Write for details today.

Other models ranging from 2 to 36 K.W.

R. H. SHEPPARD CO., INC., 48 Middle St., Hanover, Pa.

DIESEL'S THE POWER-

Sheppard's
THE DIESEL!

Hobbyist Builds With Toothpicks

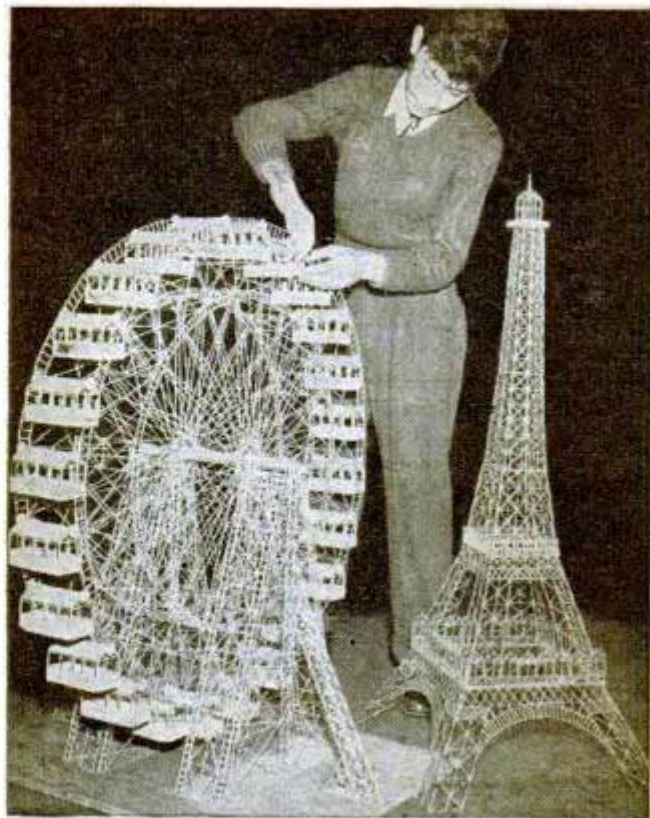

Building with toothpicks is the hobby of 14-year-old Martin Roberts who showed his models of a Ferris wheel and the Eiffel Tower at a New York hobby show. For the Ferris wheel he used 27,000 toothpicks.

Battery Terminal Lubricator

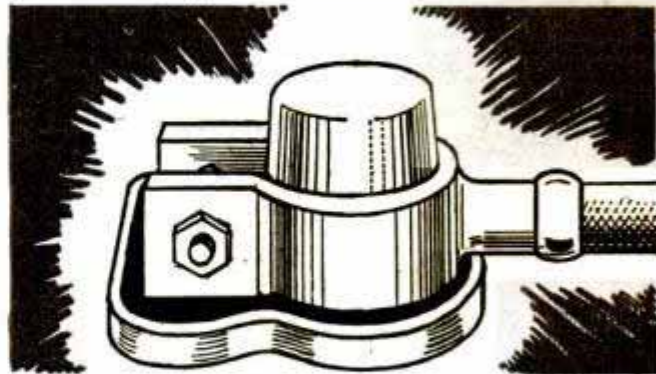
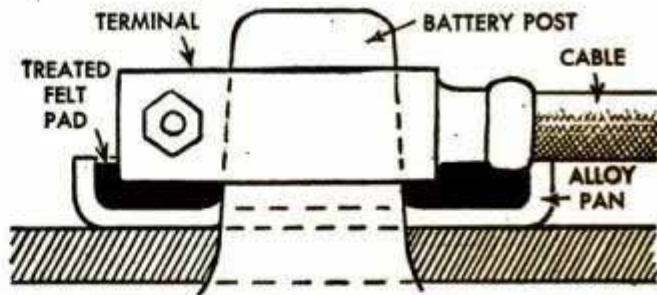

Battery terminal lubricators installed over battery posts help prevent corrosion and thus lessen automotive electrical troubles. Consisting of a flanged alloy pan and a wool felt pad, the lubricator forms a tight joint and keeps out acids and gases.

REPAIR FURNITURE

(WITH THE GLUE THAT MANUFACTURERS USE)

FRANKLIN GLUE

GENUINE LIQUID HIDE GLUE
READY-TO-USE

Makes joints stronger than the wood itself. No mixing — No heating — No unpleasant odor — No chilled joints.

THE FRANKLIN GLUE CO., COLUMBUS 15, OHIO
AT YOUR HARDWARE DEALER



CASH for practical ideas for Screw Machine Products

We want new items, 1/8" to 2 3/8" in diameter that can be produced by our automatic screw machine batteries. Big or small, complicated or simple, if it can be sold and AUTOMATIC SCREW MACHINES can make it, we want it.

Send complete data, blue prints, in strict confidence to

HARVEY MACHINE CO., INC.
6200 Avalon Boulevard
Los Angeles 3, California



WORLD'S MOST COMFORTABLE WATCH BAND FLEXIBLE WATCH BAND \$1.95

Feather-lite flexible stainless steel watch band—self-expanding to fit your wrist. Mirror finished! Beautiful Order at this low price..... EACH

POST PAID

AMERICAN MILITARY OUTFITTERS, 14 N. Franklin St., Chicago 6, Ill. See our adv. for Shoulder Patches pg. 276—Longine Compresses pg. 287.

UNITED WHEELS Wheel Barrow Wheel Kit. One 7 x 3/4 rubber tired steel disc wheel, axle and fittings complete \$1.98 plus postage. Wagon Kit, four 8 x 3/4 wheels, axle and fittings complete \$7.00 plus postage. Also available 10-8-6-5 Steel Ball Bearing Wheels. Order today. Cash, Money Order or C.O.D.
UNITED WHEELS MFG. CO., 11727 La Fayette Ave., Chicago 28, Ill.

OWN A BATTERY BUSINESS

We show you how to recast junk batteries into new. Latest Achievements

BATTERY LAB, MINNEAPOLIS 13, MINN.



THE TRUTH ABOUT SHAVING

Just turn the crank
Smart shavers say . . .
To SHARPEN blades
The Barber's Way!



Twinplex makes double-edge blades barber-sharp by accurately flexing and stropping them on genuine barber-strop leather. "Just turn the crank."

The famous Twinplex Stropper will keep a keen cutting edge on your blades by mechanically stropping both sides like the barber manually strops his "straight-edge." MEN . . . it's not the brand of beard softener or blade that cuts whiskers off . . . it's the blade edge . . . and that's the truth! So keep that edge super-sharp. Use Twinplex for easy, quick, smooth, perfect shaves. Only \$2. Ideal for gifts. Ask your dealer for a demonstration today.



TWINPLEX MANUFACTURING CO., CHICAGO

OWNERS BRAG ABOUT

Twinplex

BLADE STROPPER

USED BY MILLIONS SINCE 1915

Marvelous New 3 WHEEL ROLLER SKATE

• Faster, Smoother, Easier Skating •



\$4.25 pair

Plus 35c for Postage & Handling. Give Size. Higher in Canada.

SALES . . . SALES . . . EVERYWHERE . . . No matter where these outstanding 3 Wheel Roller Skates are shown they win instant approval . . . Lighter in weight makes for Easier Skating . . . The Streamlined principle gives more SPEED and Smoother Skating . . . For Rink, Figure and Sidewalk Skating . . . Fully Chrome Plated. EXCLUSIVE FEATURE: Has a Brake for quick stopping.

Sales Are Tremendous!

This is an unusual opportunity for QUICK, BIG VOLUME SALES and we want wide-a-woke Distributors and Local Agents to take care of this business in their territory . . . The interesting part of this BEB Skate is . . . it is interchangeable to Ice Skating in a few minutes . . . Ice Skate Attachment \$1.90 extra.

DISTRIBUTORS . . . AGENTS WANTED EVERYWHERE

We want every territory covered . . . Dealers are enthusiastic and order in large quantities . . . We want Go-Getters to supply this demand and offer a BIG MONEY-MAKING Proposition.

BEB SKATE CO., Dept. P4, 4529 Ravenswood Ave., CHICAGO 40, ILLINOIS

THREE BALL BEARING WHEELS in line gives MORE SPEED with LESS EFFORT . . . Simply raise the toe to STOP QUICK.



CHANGEABLE FROM ROLLER TO ICE SKATES

WORKSHOP WISDOM

Laminating waste stock for turning

MAKE use of your waste stock by laminating scrap pieces with CASCAMITE, because it's *strong, stain-free, and highly water-resistant.*

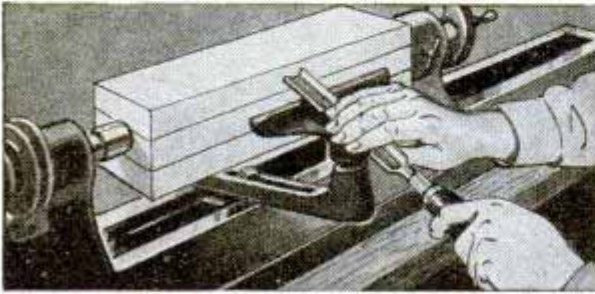

To laminate waste stock

Choose pieces of stock to roughly approximate finished size and shape. Plane surfaces to be glued so that they are perfectly smooth. Spread a thin film of CASCAMITE on the surfaces to be glued. Clamp and let set (at 70°F. or warmer) until glue is hard.

CASCAMITE is also recommended for laminating stock for table and chair legs, banisters, deep wooden bowls—wherever large dimensions discourage use of solid stock.

A "cinch" you'll prefer—CASCAMITE

Easy to mix. Just add CASCAMITE to cold water and stir.

Strong. CASCAMITE forms a bond stronger than the wood itself.

Thrifty too! Mix CASCAMITE as you need it. No waste.

Get CASCAMITE urea-resin glue—and CASCO, the standard casein household repair glue, at your hardware store in 10¢, 25¢, and larger sizes. For outdoor and boat work, use CASCOPHEN, the new, completely durable, waterproof resorcinol-resin glue.

FREE GLUING GUIDE containing complete gluing directions plus helpful hints for household repairs. Free on request. Address a post card to Casein Company of America, Dept. PM-46, 350 Madison Avenue, New York 17, N. Y.

CASCAMITE



Dry Powder Urea Resin Glue

HONING
BLADE

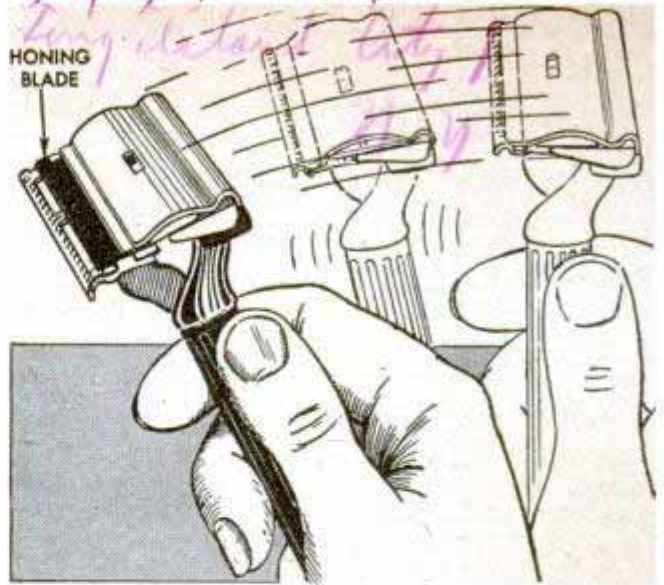

Shaking sharpens razor blades used in a new razor containing a hone, impregnated with diamond dust, hidden behind the blade guard. When the razor is shaken back and forth the hone flicks over the bottom blade edge on a pivot and sharpens it. A spring holds the hone against the blade with the necessary pressure. Any double edge blade fits the razor.

Vacuum removes metal chips as fast as they form during cylinder reboring. With suction centered around the tool bit, the chips are removed before they can drop into the crank case where they might otherwise cause damage. In addition, the circulating air keeps the bit cool and insures more accuracy in cylinder reboring. The chips then are collected in a container for easy disposition.

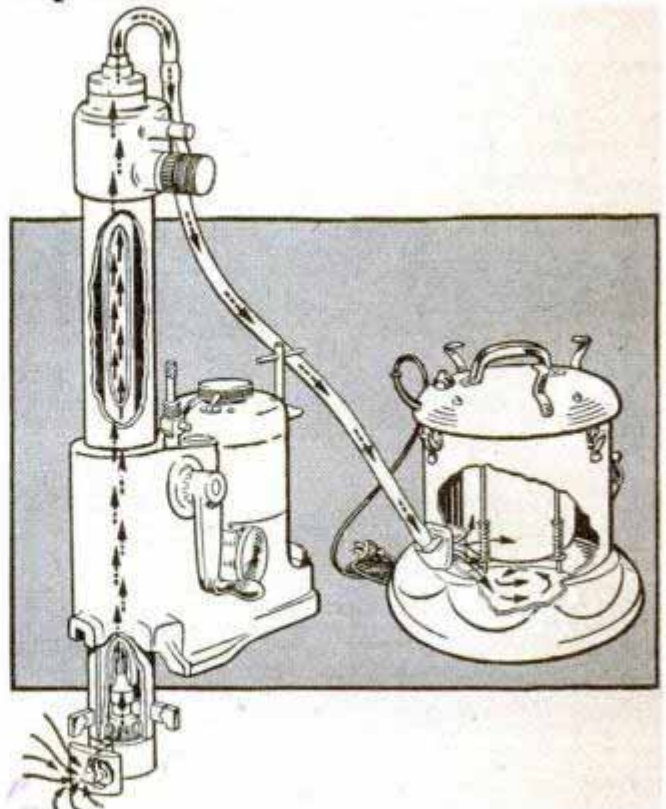

WORLD'S LOWEST PRICED ADDING MACHINE

**VEST POCKET SIZE
IDEAL FOR BUSINESS OR PERSONAL USE**

**FREE TRIAL
ONLY \$2.50**
TOTAL COST
SEND NO MONEY

Each Baby Calculator in Beautiful, rich-looking Leatherette case—at no extra cost. **FREE!!**



Fits vest pocket or purse. Guaranteed accurate. Operated as easily, and as reliable, as machines costing many times as much. Not a toy. Substantially made of 28-gauge steel—guaranteed for life against defects in construction. You positively can't buy a calculator of equal quality for as little money. **ACCEPTED AS THE FINEST LOW PRICED CALCULATOR FOR OVER 30 YEARS!** Operates with a flick of your finger. Adds, subtracts, multiplies, divides—counts up to ten million. Pays for itself over and over in mistakes avoided, and time saved. **MAKES IDEAL GIFT.**

Sold on a positive money back guarantee. Send only \$2.50. Calculator sent postpaid, or send name and address and pay postman \$2.50 plus postage. **MONEY BACK IN 10 DAYS IF NOT DELIGHTED!** (If outside U. S. send \$3.00.) **AGENTS WANTED.**

CALCULATOR MACHINE CO. (Mfrs.)
Dept. 177, P. O. Box 248, Glenview, Illinois

Low Price The OTTAWA "Buzz" Master

CLEARs LAND FAST! Powerful 6-HP motor with friction clutch for safe operation. Cuts down timber, brush and hedge; turn blade vertical; saw logs to length. Can be equipped to fell largest trees. Has clutch pulley for belt work; guaranteed.

FREE Details

OTTAWA MFG. COMPANY, 427 Brush Ave., Ottawa, Kans.

**New - Improved
OIL FOR ALL ---
HOUSEHOLD - SPORTSMAN - MECHANIC
Lubricates - Prevents Rust - Cleans Metal**

3 oz. 40c

FIENDOIL

PRESTO! ANYONE CAN MASTER GLAZE

GRAVES HARD GLASS-LIKE FINISH.
SEALS THE PORES OF THE SURFACE.
EASY TO APPLY
PROTECTS THE SURFACE
WILL NOT FINGER-MARK
EASY TO KEEP CLEAN
NO OILY FILM AS WITH POLISH
NO SMEAR OR STREAKS AS WITH WAX
LASTS SIX MONTHS TO A YEAR
SAVE YOU MONEY

Car Owners! Meet Master Glaze—the sensationally different luster for new and used cars! Not a wax—not an oil polish—not a paint!—nothing that “smears” over the surface.

MASTER GLAZE is a unique discovery—a creamy liquid—quick and easy to apply! Gives a hard, glass-like surface. Even gasoline cannot dull it! Lasts six months to a year! Amazing luster—beautiful, sparkling clean and brilliant! Doesn't finger-mark—doesn't smear! A match box full glazes an entire car. Seals the pores—protects! **NOTHING LIKE IT!**

AGENTS
An unusual opportunity! Quick, flashy demonstrator. Big profits. Good territory. Write today!

FREE SAMPLE
Just send your name and address today to
MASTER GLAZE CO., 7720-541 W. Harwood Ave., Milwaukee, Wis.

Build Things WORTH WHILE!



The **LEJAY MANUAL** has a Special Appeal for the Amateur Who Likes to Make Things that Work

FOR ONLY \$1.50
WORTH \$12.35

**SHOWS YOU
HOW TO BUILD
TRANSFORMER
WELDERS**

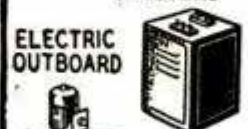

**ELECTRIC
OUTBOARD**



POWER TOOLS



LIGHT GENERATORS



**INSECT
KILLERS**



WIND PLANTS



**ELECT.
GO-BIKE**



ARMATURE WINDING



**ELECTRIC
FENCERS**



**TRACTOR
LIGHTS**



MOTORS

AMAZINGLY SIMPLE PLANS for PRACTICAL PROJECTS

You will have no trouble in working out the plans detailed in the LeJay Manual and you will get a lot of enjoyment from them. Whether or not you are mechanically inclined, the projects in these plans will appeal to you for their usefulness and practicability. They will save you money and make money for you, too, in jobs and repairs for neighbors and friends, because the plans embody all kinds of electrical devices.

NO EXPENSIVE TOOLS or MATERIAL NEEDED

The tools you have around the house are all you need for these projects and most of the necessary material can be found around garages, workshops and scrap yards. Being able to make your own welder helps a lot in doing other jobs, and the LeJay Manual shows you how easy it is to do this. Also, how to make:

- 200 Amp. Generator Welders
- Large Transformer Welders
- Gunsmith's Carbon Welder.
- 6, 12, 32, 110-Volt Motors
- Electric Outboard Motor
- Wind-driven Light Plant
- Electric Fencers
- Electric Drills
- Bench Grinders
- Electric Scooter
- Armature Rewinding
- Insect Electrocutors
- Electric Bicycle Pusher, etc.

SEND NO MONEY—BUT

Send a postcard with your name and address and a request to send the LeJay Manual C.O.D. and the postman will deliver it at your door. If you are not entirely satisfied after 3 days' perusal, send it back and we will refund the \$1.50. Bear in mind, however, that C.O.D. fees have been considerably increased, so if you prefer to save this expense, send \$1.50 now, under the same guarantee. In Canada, \$1.75.

LEJAY MFG. CO

47 LeJay Building
MINNEAPOLIS - 8 - MINN.

**3 DAY
TRIAL**

MAKE EXTRA PROFITS

by Multiplying

YOUR LATHE CAPACITY

CONVERT YOUR BENCH LATHE
FOR TURRET OPERATIONS WITH

Enco

**MULTIPLE
TOOLHOLDERS**

and Turn Your Hobby Into PROFITS!

For all bench lathes. Equip your shop for fast precision production. Do a greater variety of jobs in your work shop. These sturdy, versatile turrets mount on compound and tailstock. Together, they hold ten tools instead of two. Save 50% on tool changing time. Install quickly without machining.

ENCO Toolpost Turret

Model 234-S. Clamps rigidly in compound T-slot. 12-station, 30° indexing. Holds four tools. One tool performs three operations. Provides speedy set-up for threading. Made from solid hardened steel. Price (without tools).....

\$23⁰⁰



ENCO Tailstock Turret

Model A mounts six tools. Eliminates single chucking. For drilling, counter-boring, tapping, reaming, etc. Finger tip control. Price (without tools).....

\$18⁹⁵

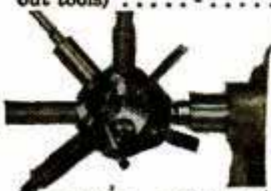

**SPECIAL COMBINATION PRICE \$39⁵⁰
FOR SET OF TWO TURRETS**

ORDER TODAY... PAY THE POSTMAN

ENCO MFG. CO.
4522-24 Fullerton Ave.
Chicago, Illinois

Lathe.....
Swing.....

Please send me a PRODUCTION TOOL set C.O.D.—plus postage—for the lathe indicated above. (Postage prepaid, if remittance accompanies order).

Kindly mail illustrated leaflets describing ENCO Toolholders.

Name.....

Address.....

Town..... Zone..... State.....

Dealer.....

WRIST WATCHES!

Guaranteed

Send No Money



Thin Wafer Model

Radium Hand & Dial

Special! Man's precision built wafer-thin chrome case watch, with stainless steel expansion wrist band. Red sweep second hand. Money back if not satisfied within 10 days. Send no money—mail coupon!

\$12⁹⁵

Plus 10% Fed. Tax
Plus Postage

BURTON SALES CO., 809 W. Madison St., Dept. A-105, Chicago, Ill.

Please send watch as described. I will pay postman \$12.95 plus 10% Federal tax plus postage.

Name.....

Address..... City..... State.....

Clamp for Cables Slips On; Saves Drilling and Riveting

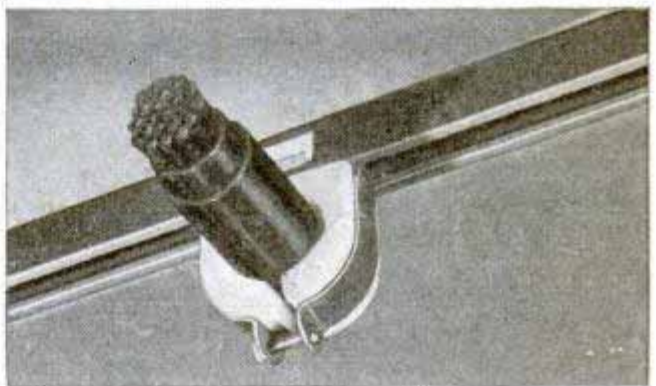
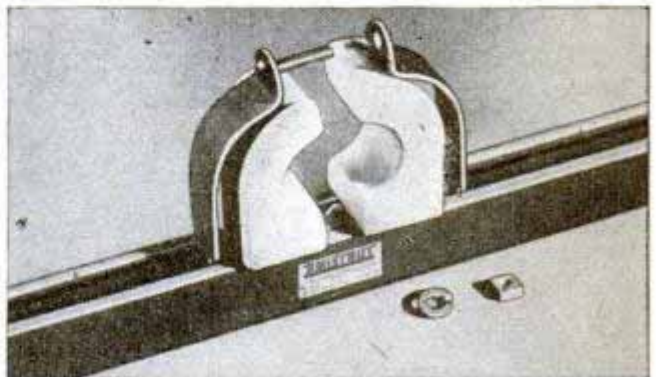
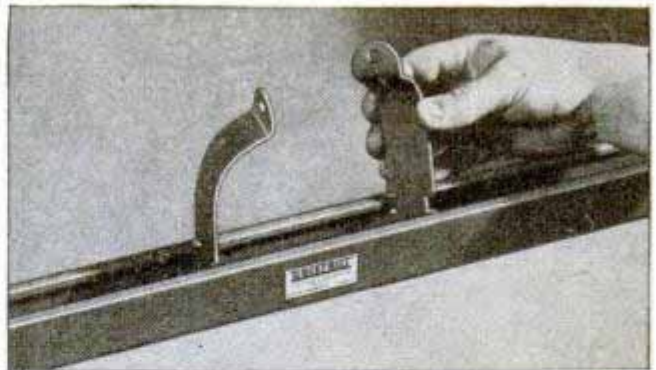

No hole drilling, riveting or welding is necessary to install one type of clamp for cables, conduit, pipe or wires. The clamp is located at the desired point on a hollow-square support member where it is fastened by tightening a single bolt. After the top part of the cable clamp straps are inserted between the overhanging lips of the support member, the insulating clamps are placed against the cable, the bolt is inserted and the nut turned up tight. The porcelain insulators are omitted for conduit or pipe.

Chrome-Finish Tire Paint Matches Trim of Car

Chrome-finish tire paint that matches the shining trim of most cars is now available. The new paint is said to be elastic to conform to the flexibility of the tire. Only one coat of the paint is required. It can be applied with either brush or spray.

WAR

SURPLUS BARGAINS

* * * * *

SENSATIONAL VALUES FOR QUICK LIQUIDATION

BOMB PARACHUTES



Of fine white nylon fabric 5 x 8 feet in diameter with split seam for directional dropping. Designed for dropping fragmentation bombs, emergency rations, etc. Each packed in a metal container. Weight 13 lbs. No. R-162 Each only... **\$1.95**

NEW SACHEL POUCHES



Brand new shoulder type duffel bag pouches, ideal for luggage, school books, lunches, etc. Measures 11 x 12 inches. Of heavy canvas duck with taped edges. Weight 2 lbs. No. X-113 Each **\$1.69**

AIR CORPS PLASTIC FLASK SETS



Two handy, transparent plastic flasks with canvas case. Used by the U. S. Air Corps. Holds any kind of liquid. Each flask measures 4 1/4 x 8 1/4 inches. Has clamp-on top plus screw cap. Fine for use on camping trips, picnics, etc. Weight 1 lb. No. R-179—Set only **\$1.49**

DIRECTIONAL COMPASS



For all outdoorsmen, boy scouts, etc. Liquid type, free acting and accurate. Gives direct reading. Tells you immediately what direction you are traveling. Plastic body measures 3 1/2 x 1 1/2 inches. Has waterproof compartment for matches. No. R-208 Each only **\$1.49**

BOOBY TRAP FIRING PIN



Consists of trigger and trip arrangement with cord for remote firing control. Has powerful spring action. Ejects a pencil 8 to 10 feet. Has many uses such as burglar alarms, etc. Brand new! No. R-178 Each **49c**

POPULAR RECORD ASSORTMENT



This assortment of 50 records includes current dance, race, blues and hillbilly selections. These records have been used in juke boxes—but all are guaranteed perfect and playable. No two alike. Many famous name bands and artists included. Shipped express collect only—no exchanges, trades or refunds at this low price. Wgt. 28 lbs. No. A-303—50 records..... **\$9.64**

DECORATIVE CHROME STRIPS



For your car, boat, furniture, etc. Highly polished chrome finished strips with clinched edges for flush mounting to any surface. The 3 pound kit provides approx. 43 pieces in lengths from 4 inches to 3 feet and 1/4 to 3/4 inches wide. Wgt. 4 lbs. No. R-224—3 lb. Assort. only... **\$2.00**

MESS KITS



Regulation Army Mess Kits. Ideal for campers, boy scouts, etc. Slightly used but guaranteed perfect. Two pieces. Folding handle. A-116—Each..... **69c**

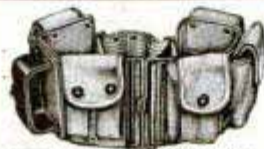

GI POCKET BELTS

Of heavy canvas. Adjustable waist size. Each with 5 pockets and metal recoil fitting. Brand new. Fine for hunters, boy scouts, etc. A107..... **98c**

7-LB. EXPERIMENTERS PARTS ASSORT.

A "gold mine" for the radio serviceman. Hundreds of valuable radio parts, new radar and electronic parts and sub-assemblies, coils, resistors, screw machine parts, etc.—worth many times this low price. A130R—7 LBS. **\$1.79**



Regular U. S. Gov't issue canteens. Plastic screw top cap chained to body. Slightly used. A117—METAL BODY. Each... **69c**

A118—PLASTIC BODY. Each..... **69c**
A109—Canteen Covers. New. Each..... **69c**
A119—Canteen Covers. Used. Each..... **35c**
A120—Canteen Cups. Used. Each..... **25c**



MICROPHONE BUTTON

Brand new! For experiments in radio, electronics and other electrical apparatus. Used in telephone, amplifier and detectaphone work. Diameter 2 1/2 inches. New. A512—EACH..... **98c**

AMMUNITION BOX

Fine for storing valuables, carrying lunches, etc. Of heavy gauge 7 1/2 x 11 x 4 inches. Fireproof. Hinged lid with folding handle. Olive drab finish. Used, but perfect. Shipping wt. 4 lbs. A525—EACH..... **25c**



PLASTICS—LUCITE AND PLEXIGLAS

In sheet form. Good workable sizes. Transparent. For costume jewelry, etc. Easy to work and polish. A280—5 LB. ASST..... **\$4.75**

CATALAN—ASST. COLORS

Extruded shapes, rounds, half rounds, etc. Easy to machine. Furnished in assorted colors, shapes and lengths. A281—5 LB. ASST..... **\$4.75**



U.S. Govt. BOLO KNIFE

Extra heavy. For farm, home or jungle use. Blade of Gov't. formula cutlery steel. Walnut riveted handle. 3 1/2 inch hilt. 10 1/2 inch blade. You'll find hundreds of uses for a Bolo knife. Blade will take and hold a keen cutting edge. Wt., 2 lbs.

A112—with Army Sheath..... **\$4.95**
A212—Leather Sheath, extra..... **\$1.50**



PUP TENTS

Regulation Army Pup Tents of durable, brown canvas. Used, but in good condition. Fine for campers, outdoorsmen, boy scouts, etc. Grand Xmas gift for children. A1—Tent Only... **\$3.95**
A110—Tent, new... **\$7.95**
A101—Ropes, wooden poles and stakes for above. Per set..... **\$1.00**



BIG SHIPS BELLS

Purchased from U. S. Maritime Comm. Measures 10 inches high, 9 3/4 inch flare. Big 6 inch clapper. Weight 15 lbs. Fine for farms, clubs, estates, etc. All new. Ship. wt. 10 lbs. A541—ONLY..... **\$9.85**

PROF. TELEGRAPH KEY

Purchased from the gov't. Finest design and construction. Base measures 3x4 3/4 inches. Original value \$2.50. All parts of instrument brass. Adjustable. A147—Each..... **98c**

MEDICAL STERILIZER



Consists of alcohol burner and sterilizing tray in hinged metal case 1 1/2 x 1 1/2 x 2 1/2 inches. Burner may be used separately. Bright nickel finish. All brand new. A125—Each..... **98c**



ARMY BANDOLEERS

Of fine heavy khaki. Big roomy pockets with snap button fasteners. Fine for hunters, campers, boy scouts, etc., also for shop work in carrying small parts, etc. Material alone is worth this price.

11 Pocket Type No. 129 **49c** Each...
5 Pocket Type No. 110 **29c** Each...

ORDER DIRECT FROM THIS AD

Values galore! Hundreds of hard-to-find items for home, shop and outdoors. Make remittances by money-order, bank draft or personal check. Send 25% deposit on C.O.D. orders. No C.O.D.'s on orders for less than \$5.00. Include sufficient postage on parcel-post orders—any overage will be promptly refunded. All quotations F.O.B. Chicago. Used items and materials are guaranteed serviceable and as described. Your money back if not more than satisfied.

BIG ILLUSTRATED CATALOG FREE

STARK'S Dept. PM446
509 So. State St.
CHICAGO 5, ILL.

STILLS



Distill your own water with one of these fine portable stills. Purchased from the Gov't. Completely self contained. Has 1 gallon capacity; output 1 1/2 gal. per hour. Fitted with genuine Coleman double burner stove. Operates 5 to 7 hrs. on one filling. Heat output 20,000 BTU's. Stove alone is worth this price. All new and guaranteed. Instr. included. Weight 109 lbs. No. 206 **\$59.50** Each...

10 ASSORTED CUTTERS } ONLY **\$4⁹⁵**



100 ASSORTED \$45

**JARVIS & KELLER
HIGH SPEED MIDGET MILLING CUTTERS
& ROTARY FILES - NEW & RECUTS**

Great for die makers, mechanics, repair men — for routing, deburring, grinding. Used in drill presses, electric hand drills and hand grinders. Worth \$1.50 to \$3.50 each at original list price. Satisfaction guaranteed. Immediate shipment subject to prior sale and quantity now on hand. Going fast, order at once to insure delivery. Send check or money order to

UNITED LAMP CO.

3811 E. 67th ST.

KANSAS CITY 3, MO.

**The O'BRIEN
ALL-STEEL
HYDRAULIC
BUMPER-JACK**

**Built
to Lift
2 Tons**

• • •

With Finger-Tip Pressure

LATEST, FINEST ENGINEERED, MOST

- 1—All Steel Construction.
- 2—Solid Steel Piston—3 Telescoping Steel Tubes Quadruples its strength.
- 3—Adjustable Hook—Over 15 inch range.
- 4—Finger Pressure Hydraulic Stroke.
- 5—No Screw Parts To Rust.
- 6—17 1/4 inch Hydraulic Hoist.

**RUGGEDLY
CONSTRUCTED
JACK ON
THE MARKET**

•
**A
LIFE-TIME
ACCESSORY**

**LIFETIME GUARANTEE AGAINST
DEFECTS. PERFECT WORKMANSHIP.**

\$12.50

If your dealer can't supply you, remit \$12.50 and we will ship immediately. Money cheerfully refunded if not satisfied.

Plus 50c
Postage
in U.S.A.

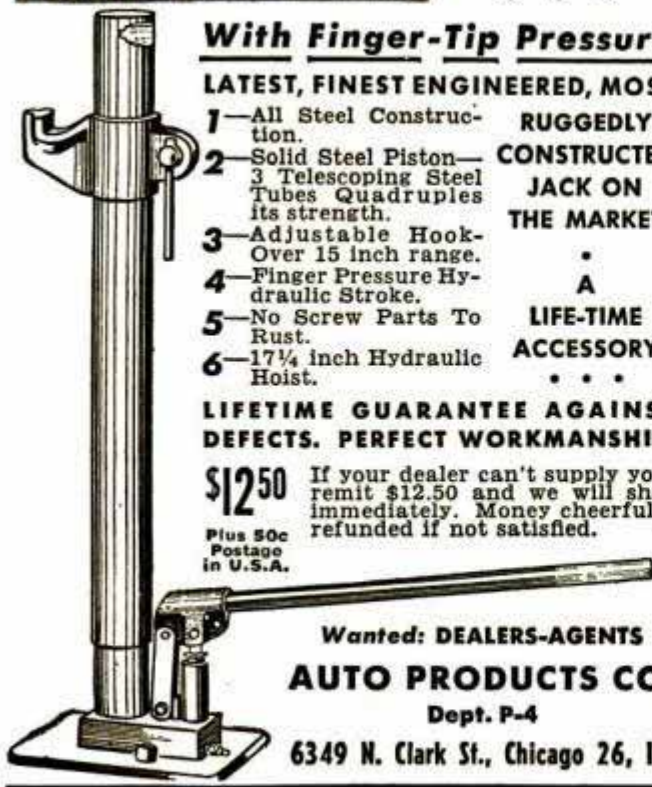

**Wanted: DEALERS-AGENTS
AUTO PRODUCTS CO.**

Dept. P-4

6349 N. Clark St., Chicago 26, Ill.

Chessmen Made of Used Shells



Salvaged .45-caliber and .50-caliber ammunition cases were used by Lieutenant George A. Lundburg to form an unusual set of chessmen during his off duty hours while he was stationed in the Solomon Islands. Pawns of the set are .45-caliber cases. Other pieces are .50-caliber cases. He spent 50 hours in making the set.

**Cigar-Size Pneumatic Tool
Drives Small Screws**

Manufacture of radios, cameras and other products that use screws is speeded by an air-driven screwdriver about the size of a cigar. Weighing only eight ounces, the pneumatic tool handles screws from No. 1 size to No. 6. It starts automatically when applied to work and adjusts itself to various driving conditions. The operator increases pressure slightly as larger screws are encountered. The tool has a rotary-type motor, four-blade construction, ball bearings throughout and hardened and ground steel rotor and cylinder.



IDEAL FOR Auto-Home Appliance and Farm REPAIRS

Now A DYNAMIC HEAVY DUTY INDUSTRIAL WELDER

Available Now Without Priorities!

Designed to Do High-Grade Welding *Inexpensively*

Maintenance men, farmers, mechanics, machine shops, foundries, auto, general repair and job welding shops using the DYNAMIC WELDER find it so indispensable and useful that they cannot afford to be without it. If inexperienced you can easily learn to do a variety of high-grade welding jobs by following the practical, simplified operating and welding instructions furnished.

WORKS ON IRON, STEEL, BRASS, BRONZE and OTHER METALS

Has eight metallic and carbon arc welding heat stages. Does work you would think only possible with a larger, more expensive machine.

READ WHAT USERS SAY...

Repair Shop Owner says, "It will do more than you say"

"I want to say I operate a repair garage and am more than satisfied with the welder. It will do more than you say." C. P., Butler, Ohio

It's the Greatest Portable Outfit

"Now I am equipped for all kinds of welding and I must say it's the greatest portable outfit for welding any man could ever wish to own. I wouldn't sell mine for the cost of plenty welders I have seen which were very high in cost but not in convenience. You may put me on file as a booster of your wonderful welding product." W. J. B., St. John, N. B., Canada

Better Than I Expected

"I have done quite a little welding with my welder and will say it is better than I expected. The price, convenience, and variety of work that can be done with the Dynamic are the attractive points." W. R. P., Portland, Ore.

EASY TO OPERATE!

DYNAMIC SUPERCHARGED WELDER

GET DETAILS ON OUR 10-DAY TRIAL OFFER!

Once you see a DYNAMIC in operation you won't want to be without it. Its simplicity will amaze you. In a year the DYNAMIC only costs you about 6c a day. Comes complete, ready to operate, with helmet, rods, cables, electrode holder and operating instructions, etc. Nothing else to buy. Write today for Free particulars. Act now and get details on our amazingly low priced Dynamic Welder and 10 day trial offer.

DYNAMIC WELDER CO.

13 East 23rd Street—FD

CHICAGO 16, ILLINOIS

FOR ONLY
\$23⁵⁰
COMPLETE

AMAZINGLY SIMPLE TO OPERATE!

This portable Dynamic Welder, easily carried right to the job, can be operated from any convenient, properly wired 110 Volt 60 cycle line. Can also be supplied for 220 Volt 60 cycle operation and for other voltages and cycles at slight additional cost.



MORE VERSATILITY

FROM SOUTH BEND LATHES WITH THESE ATTACHMENTS

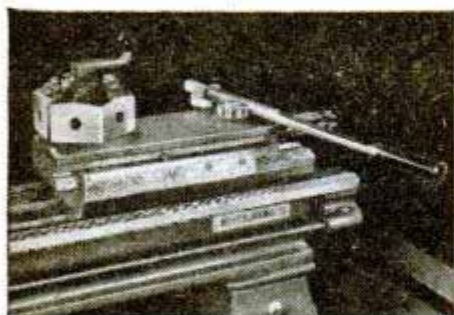

Handlever Bed Turret for 9" or 10" lathes multiplies their versatility through multiple tooling for repetitive operations.

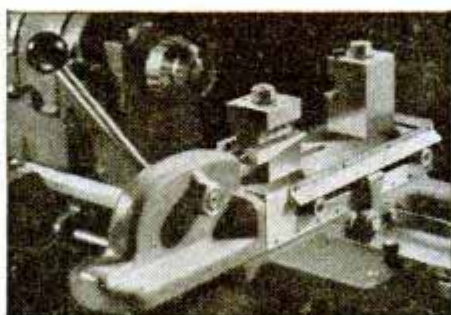

Handlever Double Tool Cross Slide for 9" or 10" lathes speeds up successive operations through the use of three cutting tools.

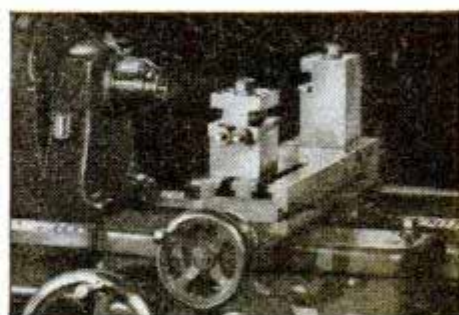

Screw Feed Double Tool Cross Slide for 16" lathes has both manual and power cross feed. Large graduated feed dial.

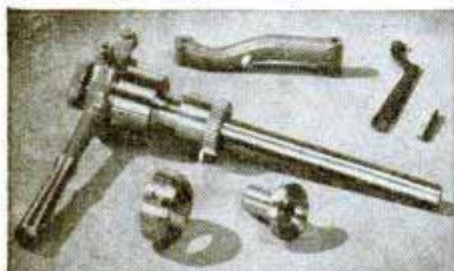

Handlever Draw-in Collet Attachment saves time on bar work. Collet can be operated and stock fed without stopping spindle.



Handwheel Draw-in Collet Attachment is ideal for production and toolroom work that requires extremely close tolerances.



Collets from 1/16" to 1" in 1/64" steps. Complete sets of collets will save time.

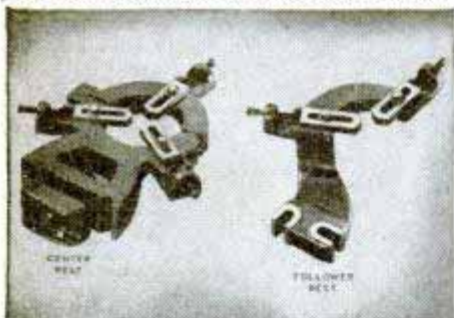

Center Rest and Follower Rest for supporting long bar work while turning, threading, drilling, boring, etc.

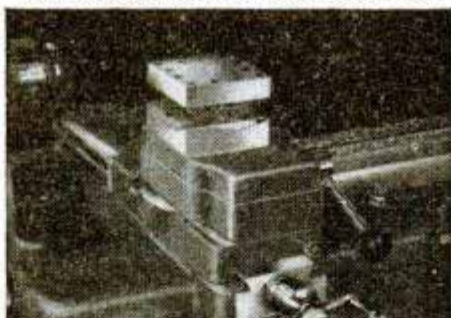

4-Way Turret Tool Block permits use of four cutting tools which simplifies tooling for repetitive operations.

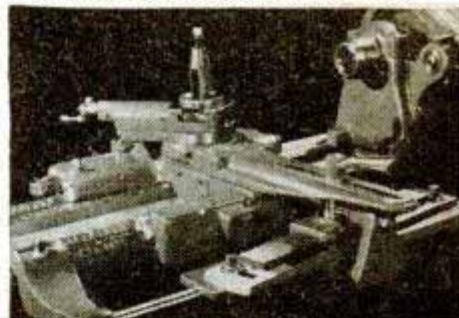

Taper Attachment for accurate taperturning and boring. Quickly engaged. Graduated in both degrees and taper per foot.

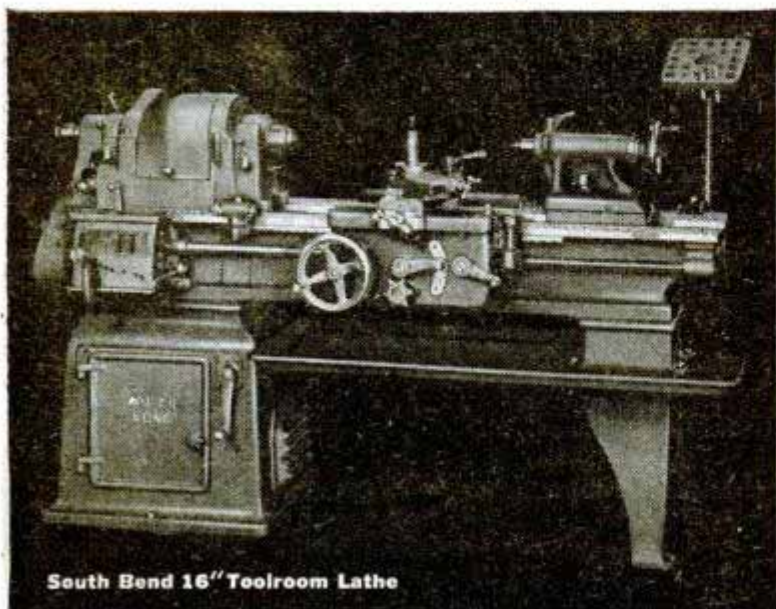

South Bend 16" Toolroom Lathe

These and other practical attachments greatly increase the capacity of South Bend Lathes for a wide variety of operations. They simplify difficult set-ups, save time and effort, and often eliminate delay and expense of making special fixtures.

Write for Catalog 77R in which all South Bend Attachments are illustrated and described. Also, state size and type of lathe for which required. Attachments only available for use on South Bend Lathes.



**SOUTH BEND
LATHE WORKS**

Lathe Builders Since 1906

455 E. MADISON STREET, SOUTH BEND 22, INDIANA

You look **SHARP**

because you get the best-looking Shaves any man ever had!

look **SHARP**



You feel **SHARP**

because Gillette Blue Blades give you the quickest, most refreshing shaves of your life!

feel **SHARP**



You are **SHARP**

when you buy Gillette Blue Blades with the **SHARPEST** edges ever honed, because you get more shaves per blade and save money!

be **SHARP**
use



Gillette
Blue Blades

with the **SHARPEST** edges ever honed!

Copr. 1946 Gillette Safety Razor Co.



GILLETTE'S CAVALCADE OF SPORTS presents the major boxing event of the week every Friday night over American Broadcasting Company stations at 10 o'clock E.S.T. Gillette Safety Razor Company, Boston 6, Mass.

There is a Doctor in the House



—and it took
a minimum
of \$15,000
and 7 years' hard
work and study
to get him there!

PROUDLY he "hangs out his shingle," symbol of his right to engage in the practice of medicine and surgery. But to a doctor it is more than a right: it is a privilege—the privilege of serving mankind, of helping his fellow man to a longer, healthier, and happier life.

R. J. Reynolds Tobacco Co., Winston-Salem, N. C.

According
to a recent
Nationwide
survey:

MORE DOCTORS SMOKE CAMELS THAN ANY OTHER CIGARETTE!



FAMILY physicians, surgeons, diagnosticians, nose and throat specialists, doctors in every branch of medicine... a total of 113,597 doctors... were asked: "What cigarette do you smoke?"

And more of them named Camel as their smoke than any other cigarette! Three independent research groups found this to be a fact.

Next time, get Camels. Compare them in your "T-Zone."



The
"T-ZONE" Test
Will
Tell You

The "T-Zone"—T for taste and T for throat—is your own laboratory, your proving ground, for any cigarette. For only your taste and your throat can decide which cigarette tastes best to you... and how it affects your throat.

CAMELS Costlier
Tobaccos