

POPULAR MECHANICS

MAGAZINE

WRITTEN SO YOU CAN UNDERSTAND IT

REGD. TRADE MARK, GREAT BRITAIN, NO. 410426

REG. U.S. PAT. OFF.

MARCH
1946
25 CENTS
30c IN CANADA

YANGTZE DAM
PAGE 100

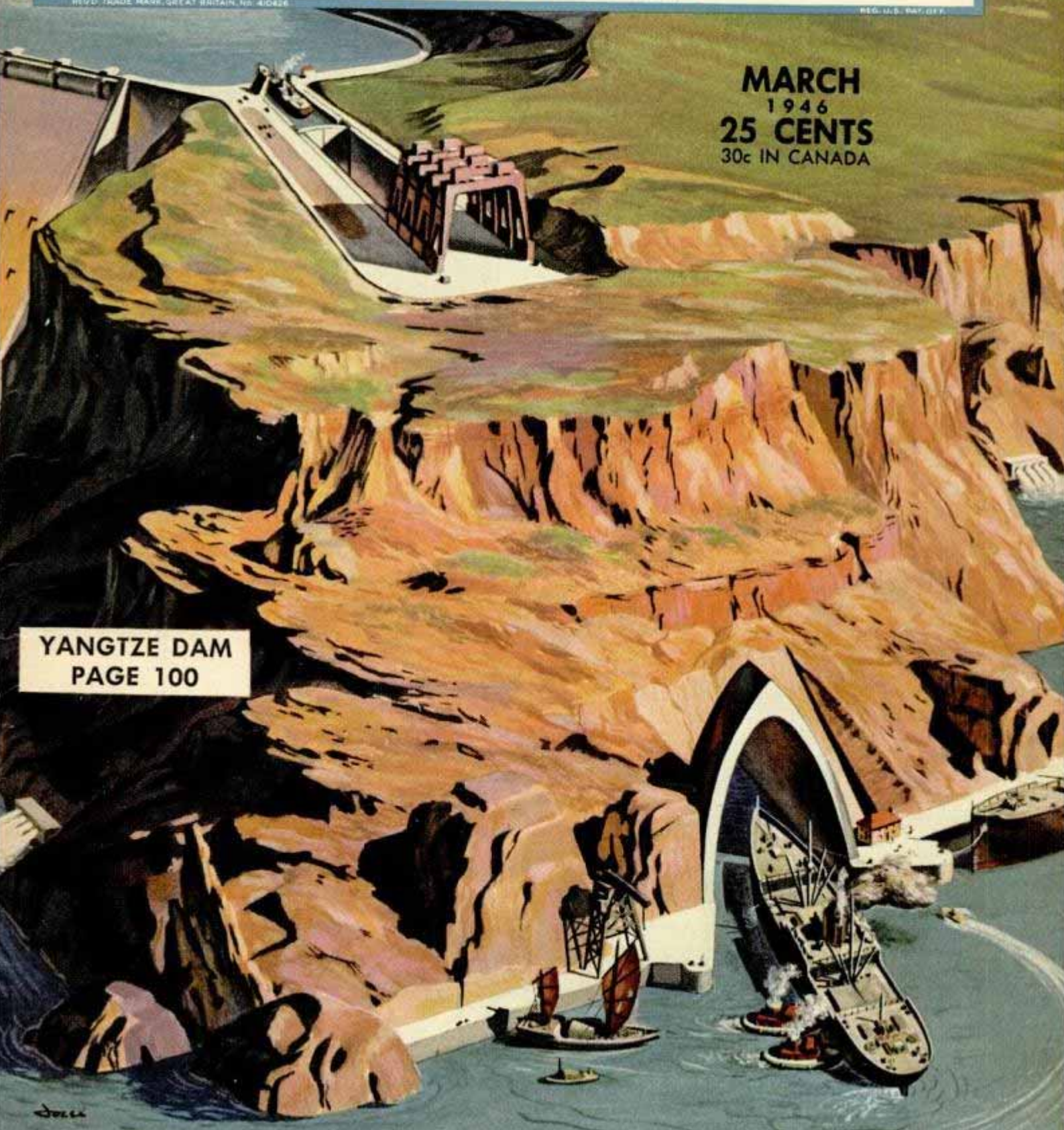

NOW Being Delivered!

SHAW "DU-ALL" and "Peppy-Pal" TRACTORS

Buy Thru Dealer or Direct from Factory

DO ALL KINDS OF BELT JOBS

**WALKING and RIDING MODELS
1 to 9 H.P.**

**EASY TO OWN
EASY TO OPERATE**



**Ideal for Small Farms,
Gardens, Estates,
Cemeteries,
Nurseries,
Poultry Farms,
Golf
Courses**

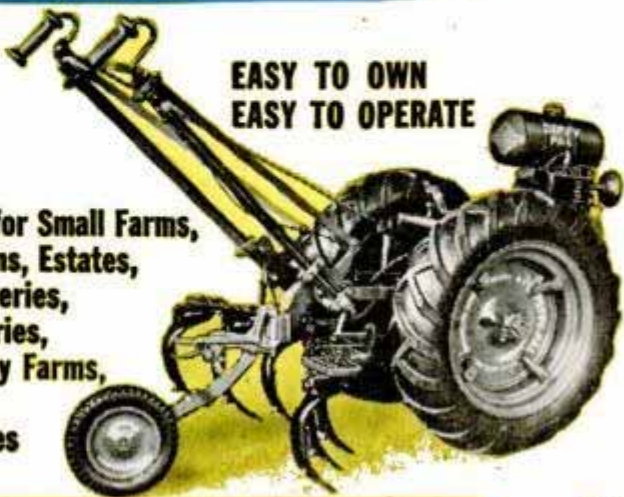

BACKED BY 43 YEARS OF MANUFACTURING KNOW-HOW

NOW is the Time to Order Your SHAW!

• Once again they're coming off our production line . . . famous SHAW "Peppy Pal" and "Du-All" Tractors . . . the little machines that do big labor-saving, time-saving, money-saving jobs in the garden and on small farms! Deliveries are NOW being made! Orders are being filled in rotation as received. So get your order in early! Be among the first to get one of these tried-and-proven 1946 Model Tractors. The name SHAW is your guarantee of quality, dependability and workability . . . backed by 43 years of manufacturing know-how and a thorough knowledge of agricultural problems.

DO MANY JOBS AT LOW COST

For many years SHAW Tractors have proved dependable, versatile, low-cost helpers on scores of jobs . . . ideal workers on small farms, in gardens, truck farms, nurseries, orchards, cemeteries, golf courses, poultry farms and estates. They are used for plowing, cultivating, discing, mowing, seeding, spraying, harvesting. They are always ready with willing power on belt jobs . . . sawing wood, pumping water, grinding feed and running belt machinery of various kinds. First cost is low and low operating cost will surprise and please you.

A SIZE TO FIT YOUR NEEDS - 1 to 9 H.P. You'll find a SHAW "Peppy Pal" or "Du-All" Tractor just fitted to your needs . . . 1 to 9 H.P. And you'll find that a SHAW will do things a big tractor can't. Easy to operate by elderly persons, boys and girls. Easy to change from one piece of equipment to another. We can supply many attachments at low prices.

GET ALL THE FACTS . . . MAIL COUPON NOW! Get all the facts and you'll get a SHAW! Plan now to do your hard jobs the easy way. Have a SHAW Tractor to do a better job . . . easier and quicker. It will serve you well . . . it will give you years of satisfactory, trouble-free, willing service . . . at amazingly low cost. Fill out and mail coupon now for **FREE Folder**, prices, etc. Get all the SHAW Facts now!

SHAW MANUFACTURING CO.
4503C Front St. Galesburg, Kansas
668GC North 4th St. Columbus, Ohio



PLOWING



PLOWING



CULTIVATING



CULTIVATING



MOWING



MOWING

FREE FOLDER!



"PEPPY-PAL" SAWING WOOD

CLIP AND MAIL COUPON -
SHAW MANUFACTURING CO.
4503C Front St. Galesburg, Kansas
668GC North 4th St. Columbus, Ohio

Send me Free and Postpaid Descriptive Literature on SHAW "Du-All" and "Peppy Pal" Tractors

Name _____

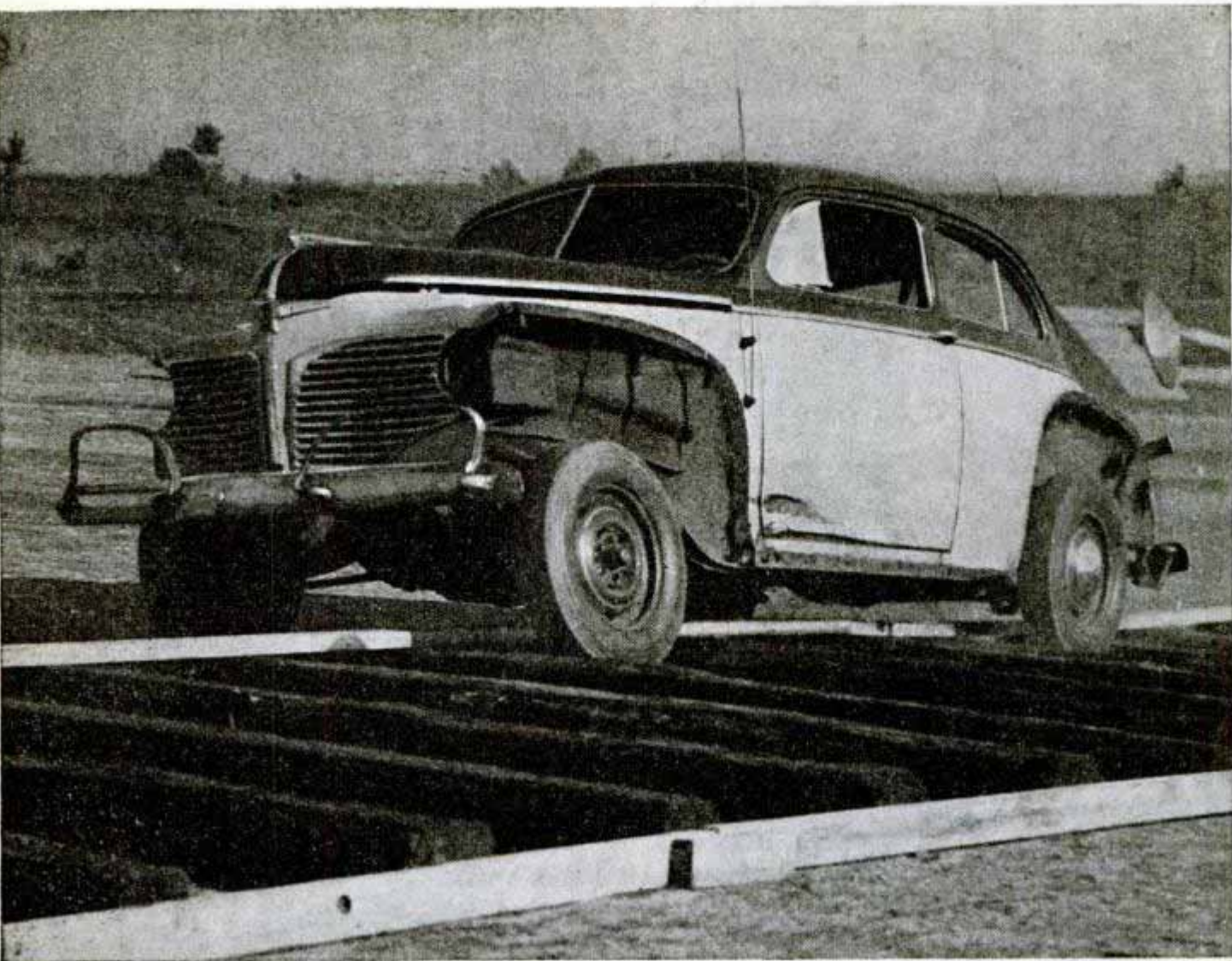

Stunt driver tests new tire that

OUTWEARS PREWAR TIRES

It's the new B. F. Goodrich tire for passenger cars

HERE'S Jimmie Lynch, stunt driver, giving the new B. F. Goodrich Silvertown tire the beating of its life. The photo was taken at one-thousandth of a second. You can't see Jimmie, he's crouching too low, but you can see that hub cap sent flying into the air by the jolting impact of the railroad ties.

What does it prove? It proves that the new tire will stand worse treatment than you're ever likely to give it. In laboratory tests it has resisted bruising better than prewar tires.

It outwears prewar tires. Tests prove that, and most of these tests

were made at high speeds. The new tire has had nearly 17 million miles of tests on B. F. Goodrich test cars, taxi fleets, and police cars. They were made in all kinds of weather, on all kinds of roads.

If you could get a closer look at the tire, you'd see that its tread is slightly wider and flatter than most tires. This new tread design spreads the wear over the whole face of the tire. Engineers had wished for years to make a tire with a flatter tread, but that shape always set up strains in the tire body, or "carcass," as it is called. B. F. Goodrich developed an entirely new and stronger cord,

designed it into a carcass that stands these strains and permits the use of the flatter, longer-wearing tread.

We hope it will not be too many weeks before you are able to buy one of these new tires. Supplies are still very limited, of course, but we hope to have much larger quantities in the hands of most dealers within the next few months. *The B. F. Goodrich Company, Akron, Ohio.*

More miles with

B.F. Goodrich

FIRST IN RUBBER



Wave Makers

"A leaping trout awakens the still pool to life in waves that move in silent rhythm."

In the same way, when you speak over the telephone, vibrating electric currents speed silently away with the imprint of your voice over the wire and radio highways of the Bell System.

Tomorrow, the vibrations will be the living pictures of television. All are examples of wave motion.

How to produce, transmit and receive

electrical wave motion is the basic problem of the communication art.

Bell Telephone Laboratories, which exist primarily to invent and develop better communications for the Bell System, devote the teamed efforts of physicists and mathematicians to the production and control of electric waves in all forms.

Out of these studies have come discoveries which keep the Bell System at the forefront of the communication art.

BELL TELEPHONE LABORATORIES

*EXPLORING AND INVENTING, DEVISING AND PERFECTING,
FOR THE CONTINUED IMPROVEMENT OF TELEPHONE SERVICE*



Popular Mechanics Magazine

Registered in U. S. Patent Office and Canada

H. H. WINDSOR, Founder

H. H. WINDSOR, Jr., Editor and Publisher



Thomas E. Stimson, Jr. Bill Reiche

Meet the Western and Eastern Editors of Popular Mechanics. *Bill Reiche* joins the staff as Eastern Editor with offices in the Empire State Building, New York City. He was formerly manager of the central publicity division of Westinghouse Electric Corporation and has won a national reputation for brilliant reporting of scientific and mechanical news. *Thomas E. Stimson, Jr.*, our Western Editor, has been a contributor for 15 years and is recognized as a leading writer in the field.

Next Month

THIS being a land of tourists, some hundred million Americans are dreaming now about hitting the highway. The folks who build trailers tell us you're going to vacation in cottages on wheels with fluorescent lights and shower baths. An article in the April issue gives you a foretaste of trailer travel next summer.

POPPING corn by radio waves is old stuff. Now radio heat "sews" plastic fabrics, hardens metals, may some day replace nails. An article next month tells how "Industry Cooks with Electrons."

"PLANT two seeds—one for the bugs and one for yourself" is an old maxim of gardeners; but the Craftsman Section in April offers advice to those who'd rather fight insects than feed them.

REMEMBER 'way back when the Indianapolis Speedway was the capital of the world on Memorial Day? The classic is coming back this year, and in our next issue you'll see the track demons souping up their two-miles-a-minute racers for the grand reopening of the 500-mile grind.

Volume 85 MARCH 1946 Number 3

Managing Editor.....Roderick M. Grant
Assistant Managing Editor.....Wayne Whittaker
Shop Notes and Crafts Editor.....James R. Ward
Radio and Electronics Editor.....Frank L. Brittin
Aviation Editor.....Aubrey O. Cookman
Associate Editor.....John R. Kinsey
Eastern Editor.....Bill Reiche
Western Editor.....Thomas E. Stimson, Jr.
Art Director.....Frank Beatty

Assistant Editors
Clifford B. Hicks Maston M. Jacks Virgil T. Swanson
Assistant Editors, Shop Notes and Crafts
W. Clyde Lamme John F. Shrock Arthur E. Youngquist

In This Issue

Unlocking the Universe	89
Damming the Yangtze	100
Mechanics Are Popular on the Farm	108
Radar Cues the Navy Fighters	120
Bantamweight Challengers	131
Tips on Tackle	138
Cuppa Coffee, Chum?	148
Twice as Natural	153
All the Answers at Your Fingertips	164
Raising the Dead Ships	169

For the Craftsman

It's Time for the Birds Again	176
What to Do Before You Paint	186
Six Good Kites	197
Kiltie—Model Racing Yacht	201
How to Make Your Own Movie Titler	207
Build Your Own Relays	218
Radio and Electronics	229

Other items, and manufacturers of available products described, are listed on pages 8 and 10

Published monthly by POPULAR MECHANICS COMPANY, 200 East Ontario Street, Chicago 11, Ill. H. H. Windsor, Jr., president; Paul H. Dunakin, vice president and general manager; D. F. Windsor, vice president and secretary-treasurer; William Harrison Fetridge, assistant to the publisher; Clover L. Perkins, advertising manager; Alan M. Deyoe, circulation manager. Single copy in the United States, 25 cents; subscription rates in United States and possessions, and countries of the Pan-American Postal Union, 1 year, \$2.50; 2 years, \$4.50; 3 years, \$6.00. Single copy in Canada, 30 cents; subscription rates, 1 year, \$3.00; 2 years, \$5.50; 3 years, \$7.50. To all other countries add \$1.00 a year over United States prices for overseas postage. If you plan to move, notify us at least 60 days in advance so you will not miss an issue. Give both old and new addresses. Entered as Second Class Matter, September 15, 1903, at the Post Office at Chicago, Illinois, under Act of March 3, 1879. Entered as Second Class Matter at Post Office Dept., Canada. Copyright 1946, by Popular Mechanics Company. Copyright under International Copyright Union. All rights reserved under Pan-American Copyright Union. Printed in the United States of America.

Ingenious New Technical Methods

To Help You with Your Reconversion
Problems

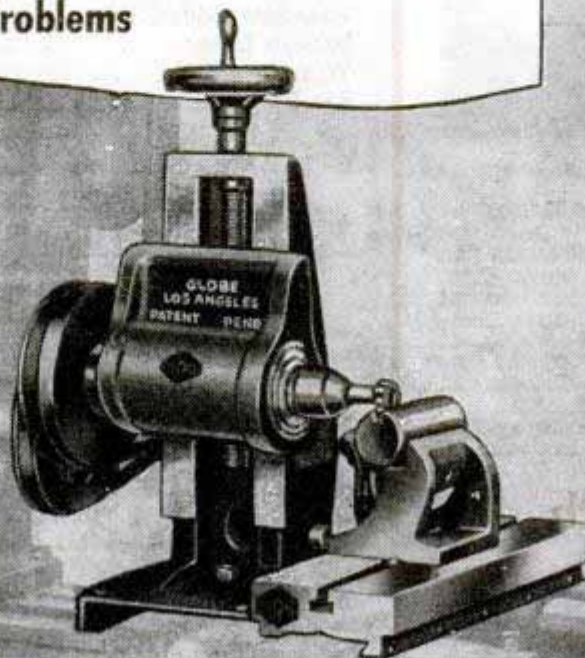

New Unit Makes Milling Machine Out of Lathe in 3 Minutes!

The Globe Miller, a unit quickly attached to a standard lathe, performs the same operations as a costly milling machine. Installed in 3 minutes or less, the Globe Miller operates almost identically to a standard milling machine. All controls are simple, highly accurate—and the miller is designed to utilize all speeds and feeds of the lathe.

It is accurate, durable and highly versatile. With minor adjustments and accessories, the miller will face castings; cut slots, keyways, and gears; perform slitting operations, etc. Quality materials and rugged construction enable it to stand the hard-

est use. It costs but a fraction as much as a standard miller. Its compact design makes storage possible underneath the lathe. Proved performance in wartime production, assures dependable service.

Performance has also proved that chewing gum helps you on the job—by seeming to make work go easier, time go faster. Today, you'll see good chewing gum on the market. But a shortage still exists. Wrigley's Spearmint Gum is taking this space for your information, and for now, we'd like to suggest that you use any good available brand. Remember: It's the chewing that's good for you.

*You can get complete information from
Globe Products Mfg. Co., 3380 Robertson Boulevard
Los Angeles 34, California*

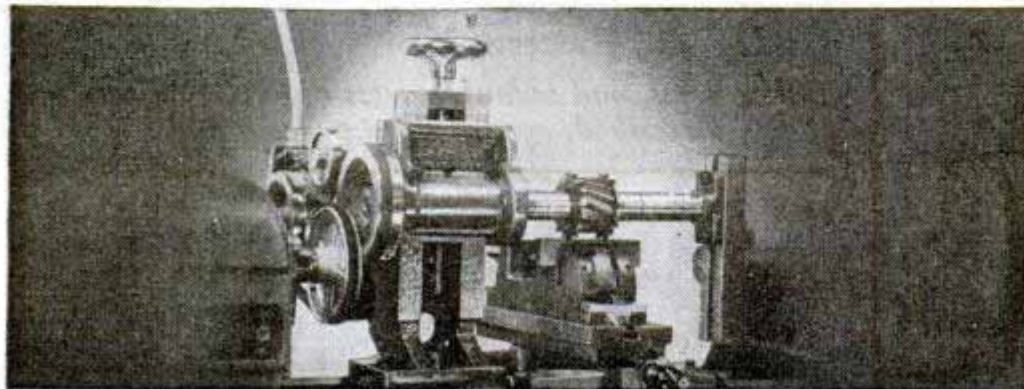

AA-58

IT'S A GRAND FEELING
TO "TURN YOUR OWN"

IT'S A GRAND FEELING, TOO,
WHEN YOUR CAR IS
CUSHIONED WITH MARFAK
CHASSIS LUBRICATION



THERE are many good reasons why your car acquires that "cushiony" feeling when you specify *Marfak* Chassis Lubrication.

Most important reasons are the adhesive and cohesive qualities that make *Marfak* resist wash-out, jar-out and squeeze-out. And because *Marfak* sticks to the job, that "cushiony" feeling lasts miles and miles longer.

Marfak clings to bearing surfaces and seals out dirt and grime.

That's why it's a grand feeling when your car is "cushioned" with *Marfak* Chassis Lubricant. See your Texaco Dealer today, and say: "*Marfak*, please!"



With ordinary grease . . . you're taking the road shocks again after a few hundred miles.



Marfak stays on the job hundreds of miles longer — means more velvet smooth riding.

You're welcome at

TEXACO DEALERS



FIRE-CHIEF
GASOLINE



SKY CHIEF
GASOLINE



HAVOLINE AND TEXACO
MOTOR OILS



MARFAK
LUBRICATION



THE
TEXAS
COMPANY

Tune in the TEXACO STAR THEATRE with JAMES MELTON Sunday Nights ★ METROPOLITAN OPERA BROADCASTS Saturday Afternoons

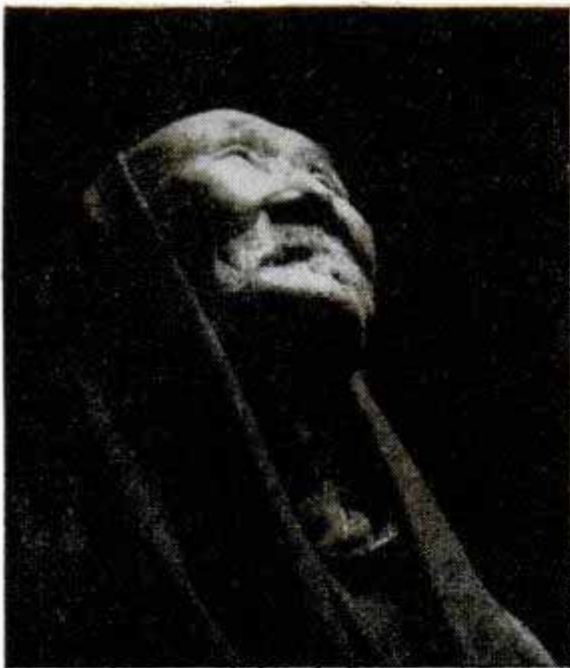

I Have Lived Before--

Says Aged Lama

CAN WE RECOLLECT OUR PAST LIVES?

IS THERE a strange familiarity about people you have met for the first time? Do scenes and places you have never visited haunt your memory? Are these proof that the personality—an immaterial substance—can survive all earthly changes and return? How many times have you seemed a *stranger to yourself*—possessed of moods and temperaments that were not your own?

Prejudices, fears, and superstitions have denied millions of men and women a fair and intelligent insight into these *yesterdays of their lives*. But in the enigmatic East, along the

waters of the once sacred Nile, and in the heights of the Himalayas, man began a serious search beyond this veil of today. For centuries, behind monastery walls and in secret grottoes, certain men explored the *memory of the soul*. Liberating their consciousness from the physical world to which it is ordinarily bound, these investigators went on *mystical journeys* into celestial realms. They have expressed their experiences in simple teachings. They have disclosed whereby man can glean the true nature of self and find a *royal road* to peace of mind and resourceful living.

This Fascinating NEW Book Free

Today there is no greater—or more respected—perpetuator of these ancient teachings and startling truths than the Rosicrucians (not a religious organization). Let them send you a free copy of the book, *The Mastery of Life*. It explains how you may receive, for *fascinating study* in the privacy of your home, this useful knowledge which will enlarge your mental vision. By means of its simple principles, you can learn to remove doubts and fears and to establish self-confidence in these troubled times. It will reveal how to exercise the powers of self—which perhaps have remained a mystery to you. *Write today*. Use the convenient coupon below. Don't delay!

The ROSICRUCIANS
[AMORC]
SAN JOSE, CALIFORNIA, U. S. A.

Scribe A. B. Z.
THE ROSICRUCIANS, AMORC
San Jose, California

Please send me the free, sealed book. I am interested in knowing how I may obtain the masterful Rosicrucian teachings.

Name.....

Address.....





If YOU were Boss would YOU promote "YOU"?

Be honest now—

suppose that a better job had opened up in your company—carrying with it promotion and more money—could you qualify?

If you were boss, would you select "YOU" for that better job?

Consider before you answer.

First of all, could you *fill* the job? Has your experience fitted you for the step forward—have you been preparing for promotion apart from experience gained on the job?

Or have you just been filling a niche, doing daily tasks well but making no real and intelligent effort to learn and qualify for the job ahead so that if an opening should occur you would be ready to fill it?

The man who gets real promotion is the one who makes his own breaks—the man who slaves in the ordinary job at low pay just wishes and dreams of promotion and more money. Which are you?

Business is always willing to pay the man who knows—and pay him well. The man who is ready and willing to take responsibilities—and capable of

directing the efforts of other men is a valuable asset to any business organization. He never wants for a good

job and above average earnings. He gets ahead.

We have helped thousands of men achieve promotion and more money—success sometimes beyond their dreams—a success that was started by a coupon similar to the one below.

Get out of that rut—don't be satisfied with a mediocre job at small pay—be a success in business—this coupon may be your first step.

So send it today—right now—tomorrow never comes for the man who consistently puts things off.

La Salle Extension University A Correspondence Institution

Dept. 364-R

417 S. Dearborn, Chicago 5

If you can help me get the ability and knowledge for real promotion, I want to know it. Please send me your free 48 page booklet telling how I can succeed in the field I have checked below. I understand you will send this without obligation to me.

- | | |
|--|--|
| <input type="checkbox"/> Accounting | <input type="checkbox"/> Law: LL.B. Degree |
| <input type="checkbox"/> C. P. A. Coaching | <input type="checkbox"/> Foremanship |
| <input type="checkbox"/> Bookkeeping | <input type="checkbox"/> Industrial Management |
| <input type="checkbox"/> Business Management | <input type="checkbox"/> Traffic Management |
| <input type="checkbox"/> Effective Speaking | <input type="checkbox"/> Business English |
| | <input type="checkbox"/> Stenotypy |

Name.....Age.....

Position.....

Address.....

City and State.....

This One

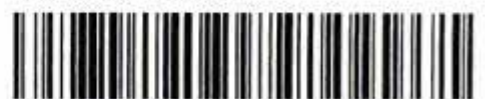

DU6A-XZG-FTSY

Here is
what...



will do for
your car...



Maintain an oil film on your cylinder walls... Reduce "metal to metal" wear... Prevent extra battery load in starting... Make starting easier... Prevent formation of sludge and carbon.

Ask your gas station attendant to add Pyroil W, next time you stop for oil. (Pyroil W, is Winter grade of Pyroil B.)

PYROIL FOR AIRCRAFT ENGINES—Use Aircraft Pyroil B for lubricating oil, Aircraft Pyroil A for gasoline.

Manufactured and Guaranteed by Pyroil Company, W. V. Kidder, Founder, 53 Pyroil Bldg., La Crosse, Wis.

PYROIL COMPANY

53 Pyroil Bldg., La Crosse, Wisconsin.

I want my car to last and run properly. Please tell me more about Pyroil and how it can accomplish this for me.

Name.....

Address.....

City or Town..... State.....



Jerry, the talking dog, is entertaining hospitalized veterans by courtesy of the PYROIL Company.

WHERE-TO-BUY-IT INDEX

Manufacturer's name and address appear in parentheses directly after items believed by us to be commercially available

AUTOMOTIVE

- Delivery truck has detachable motive unit (Marmon-Herrington Co., Indianapolis, Ind.).....103
- "Bubble" top on auto gives all-around vision.....103
- Miniature bomber engine powers British car.....104
- Rear-engine German "Volkswagon" rolls off assembly line.....115
- Auto jack operates by dashboard dial (Automatic Jacks, Inc., 1611 Book Tower, Detroit, Mich.).....130
- Three-wheeled midget auto made of scrap cost \$150.....159

AVIATION

- First Navy jet carrier plane.....94
- Biggest photo reconnaissance plane.....98
- Navy's P2V Neptune is fastest, longest-ranged patrol bomber.....107
- Sealed motor snuffs out sparks and flames.....106
- Indicator guides pilots in landing planes.....126
- Computer aids air navigation students.....146
- Transport-bomber dwarfs B-29 in size and cruising range.....152
- Swordfish-nosed bomber has speed of fighter plane.....158
- Radar "bat" bomb chased Jap ships.....162
- Sound movies for passengers on transatlantic clipper.....162
- 4-cylinder Diesel engine (Shaffer Tool Works, Brea, Calif.).....163
- "Parapups" drop from plane to aid snowbound flyers.....168

FARM

- Spool on tractor unreels barbed wire (International Harvester Co., 180 N. Michigan Ave., Chicago).....159
- "Cub" tractor weighs 1050 pounds (International Harvester Co., 180 N. Michigan Ave., Chicago).....159
- Plastic seed bed covers (Green Thumb, 44 Wall St., New York) 159

HOUSE AND HOME

- "Inside stuff" for your home.....96
- Flexible pipe for hot air ducts (Arrowhead Rubber Co., 2244 E. 37th St., Los Angeles 11, Calif.).....136
- 100-watt light bulb heats baby crib (Wilbur L. Townsend, 3326 Allen Pl., N.E., Washington, D. C.).....163

INDUSTRY

- "Skull-crackers" drop 96 feet to make scrap of castings.....118
- Plastics glow eight hours after exposure to light (Monsanto Chemical Co., Springfield, Mass.).....126
- Experts "sharpen" huge millstones.....130
- Hydraulic-drive fish net (Invented by Morris Whaley, Hodgson-Greene-Haldeman, Long Beach, Calif.).....143
- Ice-water solution kills bacteria (Tucker General Sales Agency, 90 Dearborn, Seattle 4, Wash.).....147
- "Overcoat" airtight zipper (B. F. Goodrich Co., Akron, Ohio).....152
- Self-propelled drills (Rogers Iron Works, Joplin, Mo.).....159
- Ray lamp kills bacteria in a minute.....168
- Push-pull shaft slides on ball bearings (Thomson Industries, Inc., 29-05 Review Ave., Long Island City, N. Y.).....174

PHOTOGRAPHY

- Handy packet holds chemicals for developing snapshots (Eastman Kodak Co., Rochester, N. Y.).....96
- Camera "stops" flying shells (Bell Telephone Laboratories, 463 West St., New York 14).....118
- Hand flash for photographers (Mendelsohn Speedgun Co., 457 Bloomfield Ave., Bloomfield, N. J.).....136
- Automatic camera supplies own flash.....147

RADIO AND ELECTRONICS

- Radar beams reach the moon.....127
- Personal radio fits topcoat pocket (RCA Victor Division, Camden, N. J.).....141
- Table type radio-phonograph (Stewart-Warner, 1828 W. Diverser, Chicago 14).....141
- Seven-tube phono-radio combination in period console (Westinghouse Electric Co., Sunbury, Pa.).....141
- Adjustable speaker cone unit (Quam-Nichols Company, 33rd Pl. and Cottage Grove Ave., Chicago).....144
- Tube "puller" for service men (BMP Co., Boonton, N. J.).....144

SPORTS

- Golf-bag folding cart fits in small locker (Jarman-Williamson Co., 801 N.E. 28th St., Portland 12, Ore.).....115
- Realistic game birds carved out of wood.....116
- Canoe to fit auto trunk is assembled in 10 minutes (Link Aviation Devices, Inc., Binghamton, N. Y.).....119
- Sight projects bull's-eye on target (Swain Nelson Co., Glenview, Ill.).....158

TOOLS

- Electrical tachometer has no gears (Metron Instrument Co., 432 Lincoln St., Denver 9, Colo.).....94
- Slip-on handles insulate pliers (R. J. Miller Equipment Co., Franklin, Pa.).....126
- Beam compass equipped with knife (Mark Specialty Co., 406 Temple Bldg., Rochester, N. Y.).....136
- Pistol air hammer strikes 13,000 blows a minute (Superior Mfg. Co., Public Square Bldg., Cleveland 13, Ohio).....136
- Battery tester is easy to use (Hickok Electrical Instrument Co., 10534 Dupont Ave., Cleveland 8, Ohio).....143
- Tool binds cable ends (Copperweld Steel Co., Glassport, Pa.).....143
- Magnets made of iron rust (General Electric Co., Schenectady, N. Y.).....143

MISCELLANEOUS

- "Snake" blows up land mines to clear path for tanks.....95
- "Huff-Duff"—high-frequency radio direction finder.....99
- Pressure-welded rails for railroads.....105
- Drinking-glass milk bottle (Invented by R. L. Smith, 5148 Benton Pl., San Diego 4, Calif.).....106
- Dual-purpose aluminum pencil (Mark Specialty Co., 406 Temple Bldg., Rochester, N. Y.).....106
- Scrapped bus makes compact home.....107
- Light in magnifying lens diffused for open eyes (Boyer-Campbell Co., 6540 Antoine St., Detroit 2, Mich.).....115
- "Coat" for concrete prevents too-quick drying (Truscon Laboratories, Caniff and Plumb Sts., Detroit 11, Mich.).....118
- Police official builds model warships in spare time.....128

(Continued to page 10)



Reports on



"Conscientious study of I. C. S. Courses proves their value beyond doubt."

R. D. CHARLES
Maintenance Superintendent
Africa-Orient Division
Pan American World Airways

RECORDS of Pan American World Airways tell you plenty about the value of I. C. S. Aviation Courses. They show that hundreds of Pan American pilots, co-pilots, flight engineers and maintenance men have taken I. C. S. Courses.

Now flying for just one division of the airline — Latin American — are 336 pilots and co-pilots who are holders of I. C. S. diplomas.

What better endorsement could there be of any institution offering training for Aviation careers?

If you are planning for a place in Aviation, you owe it to yourself to mail the coupon today for full information on the famous I. C. S. Courses. Do it now!

INTERNATIONAL CORRESPONDENCE SCHOOLS



BOX 5572-K, SCRANTON 9, PENNA.

Without cost or obligation, please send me full particulars about the course *before* which I have marked X:

- | | | | |
|--|--|---|---|
| <input type="checkbox"/> AIRCRAFT ENGINE MECHANICS
<input type="checkbox"/> PRIVATE PILOT
<input type="checkbox"/> COMMERCIAL PILOT
<input type="checkbox"/> FLIGHT ENGINEER
<input type="checkbox"/> AERONAUTICAL ENGINEERING
<input type="checkbox"/> AIRCRAFT DRAFTING
<input type="checkbox"/> WEATHER OBSERVING
<input type="checkbox"/> ELECTRONICS
<input type="checkbox"/> RADIO
<input type="checkbox"/> TRAFFIC MANAGEMENT
Air Conditioning and Plumbing Courses
<input type="checkbox"/> Air Conditioning
<input type="checkbox"/> Heating <input type="checkbox"/> Plumbing
<input type="checkbox"/> Refrigeration <input type="checkbox"/> Steam Fitting
Chemistry Courses
<input type="checkbox"/> Chemical Engineering
<input type="checkbox"/> Chemistry, Analytical
<input type="checkbox"/> Chemistry, Industrial
<input type="checkbox"/> Chemistry, Mfg. Iron & Steel
<input type="checkbox"/> Petroleum Refining <input type="checkbox"/> Plastics
<input type="checkbox"/> Pulp and Paper Making | Civil Engineering, Architectural and Mining Courses
<input type="checkbox"/> Architectural Drafting
<input type="checkbox"/> Architecture
<input type="checkbox"/> Bridge and Building Foreman
<input type="checkbox"/> Building Estimating
<input type="checkbox"/> Civil Engineering
<input type="checkbox"/> Coal Mining
<input type="checkbox"/> Contracting and Building
<input type="checkbox"/> Highway Engineering
<input type="checkbox"/> Lumber Dealer
<input type="checkbox"/> Reading Structural Blueprints
<input type="checkbox"/> Sanitary Engineering
<input type="checkbox"/> Structural Drafting
<input type="checkbox"/> Structural Engineering
<input type="checkbox"/> Surveying and Mapping
Electrical Courses
<input type="checkbox"/> Electrical Drafting
<input type="checkbox"/> Electrical Engineering
<input type="checkbox"/> Electric Light and Power
<input type="checkbox"/> Lighting Technician
<input type="checkbox"/> Practical Electrician
Internal Combustion Engines Courses
<input type="checkbox"/> Auto Technician <input type="checkbox"/> Aviation
<input type="checkbox"/> Diesel-Electric
<input type="checkbox"/> Diesel Engines <input type="checkbox"/> Gas Engines | Mechanical Courses
<input type="checkbox"/> Foundry Work
<input type="checkbox"/> Heat Treatment of Metals
<input type="checkbox"/> Industrial Engineering
<input type="checkbox"/> Industrial Metallurgy
<input type="checkbox"/> Machine Shop
<input type="checkbox"/> Mechanical Drafting
<input type="checkbox"/> Mechanical Engineering
<input type="checkbox"/> Mold-Loft Work
<input type="checkbox"/> Patternmaking—Wood, Metal
<input type="checkbox"/> Reading Shop Blueprints
<input type="checkbox"/> Sheet-Metal Drafting
<input type="checkbox"/> Sheet-Metal Worker
<input type="checkbox"/> Ship Drafting <input type="checkbox"/> Ship Fitting
<input type="checkbox"/> Tool Designing
<input type="checkbox"/> Toolmaking
<input type="checkbox"/> Welding—Gas and Electric
Railroad Courses
<input type="checkbox"/> Air Brake <input type="checkbox"/> Car Inspector
<input type="checkbox"/> Diesel Locomotive
<input type="checkbox"/> Locomotive Engineer
<input type="checkbox"/> Locomotive Fireman
<input type="checkbox"/> Railroad Section Foreman
Steam Engineering Courses
<input type="checkbox"/> Boilermaking
<input type="checkbox"/> Combustion Engineering
<input type="checkbox"/> Engine Running | <input type="checkbox"/> Marine Engineering
<input type="checkbox"/> Steam Electric <input type="checkbox"/> Steam Engines
Textile Courses
<input type="checkbox"/> Cotton Manufacturing
<input type="checkbox"/> Rayon Weaving
<input type="checkbox"/> Textile Designing
<input type="checkbox"/> Woolen Manufacturing
Business and Academic Courses
<input type="checkbox"/> Accounting <input type="checkbox"/> Advertising
<input type="checkbox"/> Arithmetic <input type="checkbox"/> Bookkeeping
<input type="checkbox"/> Business Correspondence
<input type="checkbox"/> Business Management
<input type="checkbox"/> Certified Public Accounting
<input type="checkbox"/> Commercial
<input type="checkbox"/> Cost Accounting
<input type="checkbox"/> Federal Tax
<input type="checkbox"/> First Year College
<input type="checkbox"/> Foremanship <input type="checkbox"/> French
<input type="checkbox"/> Good English <input type="checkbox"/> High School
<input type="checkbox"/> Higher Mathematics
<input type="checkbox"/> Illustrating <input type="checkbox"/> Motor Traffic
<input type="checkbox"/> Postal Service
<input type="checkbox"/> Salesmanship <input type="checkbox"/> Secretarial
<input type="checkbox"/> Sign Lettering
<input type="checkbox"/> Spanish <input type="checkbox"/> Stenography |
|--|--|---|---|

Name _____ Age _____ Home Address _____
 City _____ State _____ Present Position _____ Working Hours _____ A.M. to _____ P.M.

Canadian residents send coupon to International Correspondence Schools Canadian, Ltd., Montreal, Canada.

British residents send coupon to I. C. S., 71 Kingsway, London, W. O. 2, England.

A DISCOUNT TO DISCHARGED VETERANS—SPECIAL TUITION RATES FOR MEMBERS OF THE ARMED FORCES

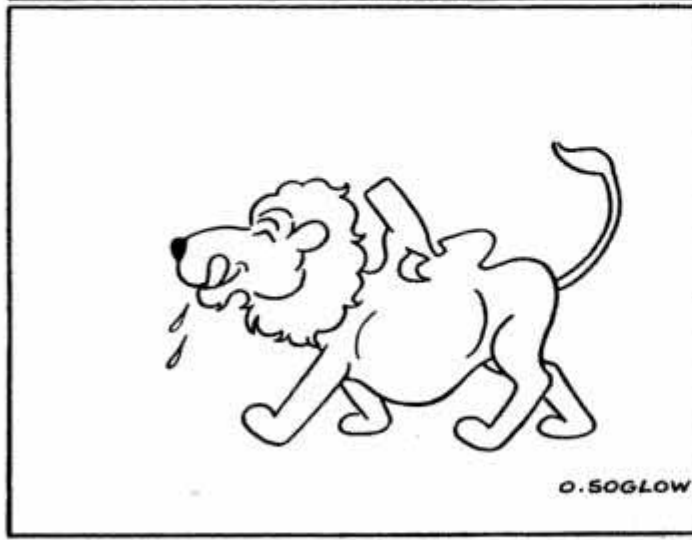
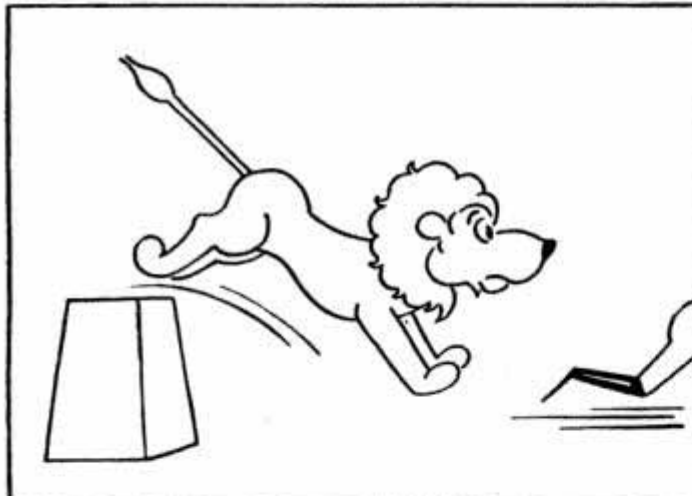

O. SOGLOW

Largest piece of optical glass brings stars out of hiding.....137
 Prisoner makes hospital equipment with jackknife.....144
 Powered rudder unit turns towboat "on a dime" (Missouri Valley Bridge & Iron Co., Leavenworth, Kans.).....146
 Buildings in miniature village have real elevators.....159
 Flirting with death.....160
 French locomotives hidden from Nazis are running again.....163
 Salvage machine in Germany cuts waste from bricks.....163
 Four-way fire fighter throws smoke shield (George E. Sleeper Co., 2608 Ninth St., Berkeley 2, Calif.).....174

Craftsman and Shop Notes Index

ART AND ARTIST

Pen and ink etchings from photographs.....192
 Guide used to measure and cut drafting paper.....217
 Plastic disks prevent triangle smudge.....222
 T-square blade pivots for drawing lines at angle.....227

CAMPING, HUNTING AND FISHING

Homemade trap throws targets for shotgun.....185
 Slip-on cover protects trap release.....200
 Wire ring on fishhook grips line.....200

FARM

Oil can makes double feed trough for poultry.....185
 Post-hole auger driven by tractor.....225
 Chicken coops and rabbit hutches neutralized with gypsum...228

HOUSE AND HOME

Hand washer replaces "rubbing" board.....179
 Artificial flagstopes cast from cement.....180
 Solving home problems.....182
 Putty knife is efficient tool when removing flooring.....184
 Storing sewing patterns for quick and easy reference.....184
 Brackets make concealed hinges for kitchen cabinets.....192
 Pipe standard holds removable house numbers.....192
 Laundry tubs can be converted into useful containers.....193
 Fitting linoleum to odd-shaped corners.....196
 Opening in house wall provides storage space for rubbers.....196
 Pivoted gate can be opened by a dog.....200
 Repair for broken coal-stove lid.....206
 Manicure pencil is marker in dressmaking.....226
 Colored float in water-gauge tube shows height of column...226

METAL WORKING

Round-head screw flares copper tubing.....184
 All-metal wrist band holds watch securely.....193
 Flat iron slotted by holes driven from opposite sides.....216
 Rolled metal strip forms spacers.....216
 Compass can be adapted for cutting patterns.....217
 Resistance unit for welding light sheet metal.....223
 Steel-wool "nest" aids in welding irregular shapes.....224

OFFICE, STORE AND SHOP

Arrow indicates latest notice on bulletin board.....222
 Oil drum converted to rack for greasy mops.....224
 Extension on office stapler for tacking large work.....226
 Rubber grip affords better grip on large cans.....228

PHOTOGRAPHY

Camera is adapted for color transparencies.....211
 Checking the accuracy of an exposure meter.....211
 Pistol grip facilitates snapping fast photos.....212
 Noise of water in tray reduced by using handkerchief.....212
 Prints will not crumple on tin if held under newspaper.....212
 Corners of negatives are trimmed with nail clipper.....212
 Wiper blade is paste spreader.....212

RADIO AND ELECTRONICS

Postwar sets of advanced design.....141
 1946 "Little Giant" student set uses dual-purpose tubes.....142
 How to handle loudspeakers in servicing.....144
 Checking and recentering speaker voice coil.....144
 Taping small wires correctly.....144
 How to detect shorting plates in variable ganged condensers...144

TOOLS

Narrow hacksaw frame for working in restricted places.....206
 Bolt helps drive nails in hard-to-reach places.....206
 Care and use of a micrometer.....213
 Inside-outside turning on a lathe done without template.....215
 Fixture for soldering jewelry chains.....216
 Proper rotation for crossed-belt drives.....217
 Canvas cover protects lathe bed from metal filings.....222
 Tongs to grip tapered work.....224
 Increasing efficiency of caliper.....224
 Sharpened edge of chopping blade improves mattock.....228
 Grease holds chips in tap flutes.....228
 Cigarette box is ideal container for taps and dies.....228

WOODWORKING

"Flying-horse" swing has dual controls.....181
 Attractive accessories made from discarded bowling pins.....194
 Sawing rectangular opening with round corners.....205

MISCELLANEOUS

Electric motor mounted over car engine recharges battery....180
 Plastic bottle cap serves as umbrella tip.....180
 Soldering ladle improvised from pipe fittings.....184
 Shoe brush holds polish and cloth.....196
 Paper noisemakers for children are safe.....200
 Plastic cigarette box has tilting cover.....205
 Running-water supply for home laboratory.....206
 Transmission is removed by one man with hoist.....215
 Multiple outlet box for light power tools.....216
 Match book used as sandpaper block.....222
 Slit cut in mitten helps surveyor make transit adjustment...226
 Handy sight level made from C-clamps and carpenter's level...227

IMPORTANT NOTICE

It is the intention of this magazine to provide its readers with information regarding the latest developments in the mechanical arts. We take no responsibility as to whether the disclosures contained in our articles are covered by patents and advise readers to investigate this subject before making, using, or selling any of the products, machines, or processes described in order to avoid possible liability for patent infringement.

AUDELS REFRIGERATION & AIR CONDITIONING GUIDE.....\$4

New from Cover to Cover—1280 Pages, Fully Illus. Covering basic principles, servicing, operation & repair of household, commercial & industrial refrigeration & air conditioning. A gold mine of essential important facts for engineers, servicemen, users.

AUDELS CARPENTERS & BUILDERS GUIDES—4 Vols.\$6

A practical illustrated trade assistant on modern construction for carpenters, joiners, builders, mechanics and all woodworkers. 4 vols., 1600 pages, 3700 illustrations, flexible covers. Pocket size. Each volume sold separately \$1.50 a vol.

AUDELS AUTOMOBILE GUIDE.....\$4

A practical quick ready reference book for auto mechanics, service men, operators & owners. Explains theory, construction & servicing of modern motor cars, trucks, buses & auto type Diesel engines. 1540 pages, fully illustrated. 55 chapters. Indexed. A standard book for mechanics. New fluid drive covered.

AUDELS DIESEL ENGINE MANUAL.\$2

A practical, concise treatise with questions and answers on the theory, operation and maintenance of modern diesel engines including General Motors 2 cycle Diesel. 384 pages, fully illus., flexible binding, pocket size. All details plainly brought out, this book is of extreme value to engineers, operators & students.

AUDELS WIRING DIAGRAMS.....\$1

210 Pages. Illustrated. Gives practical facts on wiring of electrical apparatus. It shows clearly how to wire apparatus for practically all fields of electricity. Each diagram is complete & self-explanatory. Highly Endorsed Pocket Companion.

AUDELS PLUMBERS & STEAMFITTERS GUIDES—4 Vols.\$6

A Practical Trade Assistant & Ready Reference. Explains in plain language & by clear illustrations, diagrams, charts, graphs, pictures principles of modern plumbing practice including Marine Pipe Fitting and Air Conditioning. 4 Vols.—1670 Pages—3842 Diagrams. Pocket size. Each Vol. Sold Separately \$1.50 a Vol.

AUDELS SHEETMETAL WORKERS HANDY BOOK.....\$1

Practical inside information. Fundamentals of Sheet Metal Work. 388 pages. Illustrated. 11 sections. Clearly written. Essential & important facts, figures, pointers in everyday language. Ref. Index.

AUDELS SHEETMETAL PATTERN LAYOUTS.....\$4

Developed by Experts for Sheet Metal Workers, Layout Men & Mechanics. A Practical Encyclopedia in 10 Sections, size 7 x 10 x 2—1125 Pages—350 Layouts—1600 Illustrations. 1001 Key Facts. Fully indexed for ready reference in answering your layout problems. Covers all phases of sheet metal work including Pattern Cutting, Pattern Development & Shop Procedure.

AUDELS ANSWERS ON BLUE PRINT READING.....\$2

For Mechanics & Builders. Covers all types of blue print reading including ship & airplane. 376 pages, fully illustrated.

AUDELS NEW MACHINIST & TOOLMAKERS HANDY BOOK....\$4

Covers modern machine shop practice in all its branches. 5 practical books in 1. New from cover to cover. Tells how to set up & operate lathes, screw and milling machines, shapers, drill presses and all other machine tools. 1600 pages, fully illustrated, 5 x 8 1/2 x 2. Indexed. 5 sections. 1—Modern Machine Shop Practice. 2—Blue Print Reading & How to Draw. 3—Calculations & Mathematics for Machinists. 4—Shop Physics. 5—How to Use the Slide Rule. 60 chapters. Easy to read and understand. A shop companion that answers your questions.

AUDELS MATHEMATICS & CALCULATIONS FOR MECHANICS \$2

Mathematics for home study or reference. 700 pages, 550 illus. Practical mathematics from beginning. How to figure correctly. Easy, correct methods covering a complete review. Ill. & Indexed.

AUDELS HANDY BOOK OF PRACTICAL ELECTRICITY.....\$4

For maintenance engineers, electricians & all electrical workers. 1440 Pages, 2800 Illus. Covers important electrical information in handy form—including Marine Wiring, Radio Principles, Welding. Indexed. A Key to a practical understanding of electricity.

AUDELS RADIOMANS GUIDE.....\$4

A key to the practical understanding of radio including Frequency Modulation, Television, etc., Aircraft & Marine Radio. For radio engineers, servicemen, amateurs. 772 pages. 400 illustrations & Diagrams. Photos. Review Questions & Answers, Reference Index. Authentic, clear, concise.

AUDELS ELECTRONIC DEVICES...\$2

Tells What You Want to Know About Electric Eye. Easily Understood. Covers photo-electric cells & their applications. Amplifiers, illumination, frequencies, voltage, photocell, tubes, Ohm's Law, wiring diagrams, etc.

AUDELS WELDERS GUIDE.....\$1

A concise, practical text on operation & maintenance of all welding machines for all mechanics. Over 400 pages, illustrated. Covers all methods of electric and acetylene welding including airplane work.

AUDEL, Publishers, 49 W. 23 St., N. Y. 10

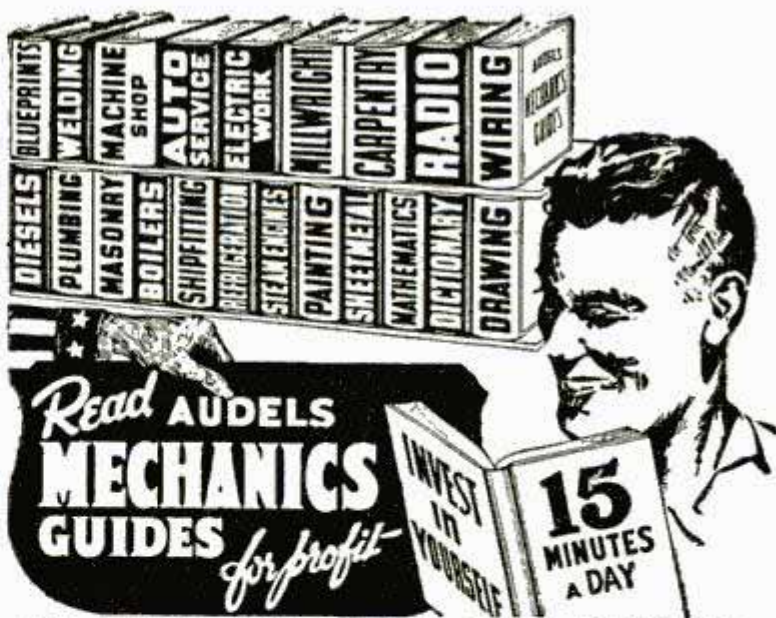

AN AUDEL GUIDE IS A GOOD FRIEND!

Use the brains and experience of others in these Guides of the Trades. Save time and money with right methods, short cuts, labor saving ideas. CHECK NOW! You can look over any Audel Guide in your home. Start the Easy Payments if satisfied.

CUT HERE MAIL ORDER

THEO. AUDEL & CO., 49 W. 23 St., New York 10, N.Y.

Please mail me for 7 days' free examination the books marked (X) below. I agree to mail \$1 in 7 days on each book or set ordered, and to further mail \$1 a month on each book or set ordered until I have paid purchase price.

If I am not satisfied with Guides I will return them.

- Audels REFRIGERATION & Air Conditioning Guide . \$4.
- Audels POWER PLANT ENGINEERS GUIDE . 4.
- Audels PUMPS, HYDRAULICS & AIR COMPRESSORS . 4.
- Audels WELDERS GUIDE . 1.
- Audels BLUE PRINT READING . 2.
- Audels SHEET METAL WORKERS Handy Book . 1.
- Audels SHEET METAL PATTERN LAYOUTS . 4.
- Audels AIRCRAFT WORKER . 1.
- Audels MATHEMATICS and CALCULATIONS . 2.
- Audels MACHINISTS & TOOLMAKERS Handy Book . 4.
- Audels MECHANICAL Dictionary . 4.
- Audels AUTOMOBILE GUIDE . 4.
- Audels DIESEL ENGINE MANUAL . 2.
- Audels MARINE ENGINEERS Handy Book . 4.
- Audels SHIPFITTERS Handy Book . 1.
- Gueths MECHANICAL DRAWING COURSE . 1.
- Rogers DRAWING and DESIGN . 2.
- Audels MILLWRIGHTS and Mechanics Guide . 4.
- Audels CARPENTERS and Builders Guides (4 vols.) . 6.
- Audels PLUMBERS and Steamfitters Guides (4 vols.) . 6.
- Audels MASONS and Builders Guides (4 vols.) . 6.
- Master PAINTER and DECORATOR . 2.
- Audels GARDENERS & GROWERS GUIDES (4 vols.) . 6.
- Audels ENGINEERS and Mechanics Guides Nos. 1, 2, 3, 4, 5, 6, 7 and 8 complete . 12.
- Audels Answers on Practical ENGINEERING . 1.
- Hawkins Aids to ENGINEERS EXAMINATION . 2.
- Audels ELECTRICIANS EXAMINATIONS . 1.
- Audels WIRING DIAGRAMS . 1.
- Audels Handy Book of PRACTICAL ELECTRICITY . 4.
- Audels ELECTRICAL POWER CALCULATIONS . 2.
- Hawkins ELECTRICAL Guides at \$1. each . 10.
- Audels ELECTRONIC DEVICES . 2.
- Audels ELECTRIC Dictionary . 2.
- Audels RADIOMANS GUIDE . 4.
- Audels NEW ELECTRIC LIBRARY at \$1.50 a Volume Vols. I, II, III, IV, V, VI, VII, VIII, IX, X, XI, XII.

Name.....

Address.....

Occupation.....

Employed by.....

**For Personal
Success... Study**

LAW

Study at Home in Spare Time

Whatever your status is at the moment, Legal Training will help you assume a more important position in life, create opportunities that lead to larger earnings. For more than 37 years, ambitious men and women of all ages and occupations have been benefiting through A. E. S. L. specialized instruction.

Over 108,000 Students Enrolled

Why not find out now how simple it is to follow the A. E. S. L. lessons and guidance—how the expert instruction takes you step-by-step to the LL.B. Degree. Our free book, "Law and Executive Guidance," tells all about the course—how you may enroll, how you may profit by Law and explains our easy payment plan.

Write for **FREE Book Today!**

AMERICAN EXTENSION SCHOOL OF LAW

Dept. 3, 646 N. Michigan Ave., Chicago 11, Ill.

Do you want

- ..to go to College?
- ..or to enter a Profession?
(Such as Accounting, Architecture, Nursing, Dentistry, Teaching, Social Work, Osteopathy, Beauty Culture, Optometry, Embalming, Chiropractic, Law, Medicine, etc.)
- ..or get an Office Position?

To get anywhere, you practically **MUST** finish High School **FIRST**. You can complete our simplified High School Course in SPARE time at home, as **FAST** as your time and abilities permit. Equivalent to resident school work—prepares you for college, pre-professional examinations, business, industry. Standard texts furnished. Diploma. Credit for H. S. subjects already completed. Single subjects if desired. Low tuition, easy terms. American School, Chicago, est. 1897—endorsed by educators. Finish your high school education **NOW**. Write **TODAY!**

High School Course at Home

Many Finish in 2 Years

American School, Dept. H345, Drexel Ave. at 58th St., Chicago 37, Ill.

Gentlemen: Send me **FREE** information covering special training in subjects checked below. No obligation on my part.

- | | |
|--|--|
| <input type="checkbox"/> High School Course | <input type="checkbox"/> Diesel Engineering |
| <input type="checkbox"/> Architecture and Building | <input type="checkbox"/> Drafting and Design for Men & Women |
| <input type="checkbox"/> Automotive Engineering | <input type="checkbox"/> Plastics |
| <input type="checkbox"/> Business Management | <input type="checkbox"/> Private Secretary |
| <input type="checkbox"/> Electrical Engineering | <input type="checkbox"/> Mechanical Engineering |
| <input type="checkbox"/> Elec. and Gas Refrigeration | <input type="checkbox"/> Aviation |
| <input type="checkbox"/> Air Conditioning | <input type="checkbox"/> Salesmanship |
| <input type="checkbox"/> Railway Training | <input type="checkbox"/> Radio |
| <input type="checkbox"/> Electronics, Industrial | |

Name.....

Address.....

SAY YOU SAW IT IN POPULAR MECHANICS

Learn to Write

Short Stories, Mysteries, Novels, Articles—at home in spare time

THE demand for writers is creating great new opportunities for people with an urge to write. It's not as hard to succeed as you may imagine. Most famous authors come from ordinary walks of life. At home, you too may learn fiction writing, the best basis for all fields—short stories, novels, features, articles, radio scripts. Palmer Institute's Home Study Training (Established 1917) is endorsed by Rupert Hughes, Ruth Comfort Mitchell, Gertrude Atherton, Katharine Newlin Burt and other famous authors and by scores of successful graduates. Complete instruction material and professional coaching to develop your own style. **FREE** book explains how you may enjoy an ideal part time or full time career. Write today (no salesman will call).

PALMER INSTITUTE OF AUTHORSHIP, Desk T35

Palmer Building, Hollywood 28, Calif.

"YOU ARE UNDER ARREST!"



Help Bring Crooks to Justice Through Scientific
CRIME DETECTION!

I have taught thousands this exciting, profitable, pleasant profession. Let me teach you in your own home. Learn Fingerprinting, Firearms Identification, Police Photography, Criminal Investigation thoroughly, quickly, at small cost. 53% of all American Bureau of Identification employ I. A. S. students or graduates. I can prepare you for this fascinating work, during spare time. Write today, stating age, for "Blue Book of Crime."

INSTITUTE OF APPLIED SCIENCE, 1920 Sunnyside Ave., Dept. 1353, Chicago, Ill.

PHOTOGRAPHY

For Today's & Tomorrow's

**BIGGEST
OPPORTUNITIES**

Nationwide opportunities, sound future career waiting for trained photographers. N.Y.I. graduates winning success from coast to coast. Success-proved home study courses. Also resident. Start now. Write today.

NEW YORK INSTITUTE OF PHOTOGRAPHY
Dept. 49 10 West 33 St. New York 1, N. Y.

BE PREPARED FOR SICKNESS or ACCIDENT



THIS HOSPITALIZATION PLAN
PROTECTS YOU AND
YOUR FAMILY

Costs only

3¢ A DAY - EACH ADULT
1 1/2¢ A DAY - EACH CHILD

Benefits begin the day you enter a hospital

FOR SICKNESS or ACCIDENT
Hospital Expenses paid, up to \$540.00
FOR ACCIDENT
Doctor Expense paid, up to \$135.00
Loss of Wages reimbursed, up to \$300.00
Loss of Life by Accident \$1000.00
WAR COVERAGE AND EXTRA BENEFITS
Childbirth Expense paid, up to \$75.00

• It's easy to run into debt when sickness or accident hit. Under the Family Mutual Plan, you'll be able to pay your hospital bills. And in case of accident, you'll be reimbursed for your doctor expenses, for loss of time from work. You can enter any hospital in the United States. Your family doctor may attend you. Benefits applying to children are 50% of those paid adults.

MAIL COUPON TODAY—No Agent Will Bother You

FAMILY MUTUAL LIFE INSURANCE CO., WILMINGTON 99, DEL

Family Mutual Life Insurance Co. PM-12
601 Shipley St., Wilmington 99, Del.

Please send me, without obligation, complete information on your Economical Hospitalization Plan.

NAME.....

ADDRESS.....

CITY..... STATE.....

POPULAR MECHANICS



I Will Show You How to Learn RADIO by Practicing in Spare Time

I Send You 6 Big Kits of Radio Parts



KIT 1

I send you Soldering Equipment and Radio Parts; show you how to do Radio soldering; how to mount and connect Radio parts; give you practical experience.



KIT 2

Early in my course I show you how to build this N.R.I. Tester with parts I send. It soon helps you fix neighborhood Radios and earn EXTRA money in spare time.

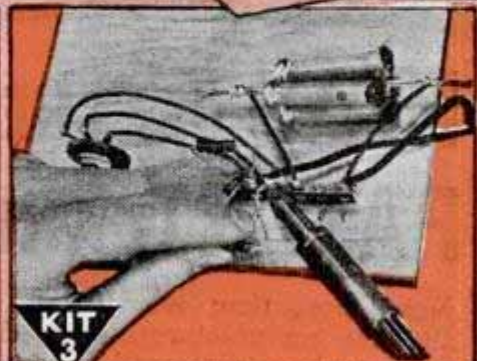

KIT 3

You get parts to build Radio Circuits; then test them; see how they work; learn how to design special circuits; how to locate and repair circuit defects.

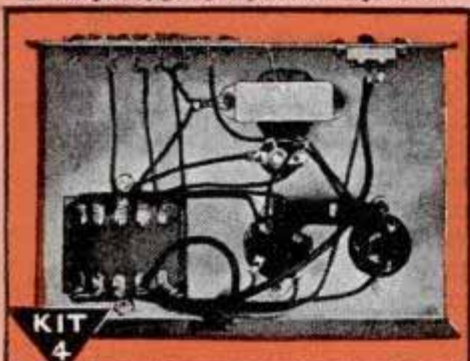

KIT 4

You get parts to build this Vacuum Tube Power Pack; make changes which give you experience with packs of many kinds; learn to correct power pack troubles.



KIT 5

Building this A. M. Signal Generator gives you more valuable experience. It provides amplitude-modulated signals for many tests and experiments.



KIT 6

You build this Superheterodyne Receiver which brings in local and distant stations—and gives you more experience to help you win success in Radio.

KNOW RADIO - Win Success I Will Train You at Home - SAMPLE LESSON FREE

Send coupon for FREE Sample Lesson, "Getting Acquainted with Receiver Servicing," and FREE 64-page book, "Win Rich Rewards in Radio." See how N.R.I. trains you at home. Read how you practice building, testing, repairing Radios with SIX BIG KITS of Radio parts I send you.

Future for Trained Men is Bright in Radio, Television, Electronics

The Radio Repair business is booming NOW. Fixing Radios pays good money as a spare time or full time business. Trained Radio-Technicians also find wide-open opportunities in Police, Aviation, Marine Radio, in Broadcasting, Radio Manufacturing, Public Address work, etc. Think of the boom coming now that new Radios can be

My Course Includes Training in TELEVISION - ELECTRONICS

made! Think of even greater opportunities when Television, and Electronics are available to the public.

Many Beginners Soon Make \$5, \$10 a Week, EXTRA in Spare Time

The day you enroll I start sending EXTRA MONEY JOB SHEETS to help you make EXTRA money fixing Radios in spare time

Our 32nd Year of Training Men for Success in Radio

while learning. MAIL COUPON for sample lesson and 64-page book FREE. It's packed with facts about opportunities for you. Read about my Course. Read letters from men I trained, telling what they are doing, earning. MAIL COUPON in envelope or paste on penny postal. J. E. SMITH, President, Dept. 6CP, National Radio Institute, Pioneer Home Study Radio School, Washington 9, D. C.

Good for Both - FREE

MR. J. E. SMITH, President, Dept. 6CP, National Radio Institute, Washington 9, D. C. Mail me FREE, your sample lesson and 64-page book. (No salesman will call. Please write plainly.)

GETTING ACQUAINTED WITH RECEIVER SERVICING

Win Rich Rewards in Radio

Name.....Age.....

Address.....

City.....State.....4FR

(Please include Post Office Zone Number)

INVENTOR

NOW IS THE TIME TO PATENT AND SELL YOUR INVENTION

Now, more than ever before, is the right time to patent and sell your invention. Why? Because manufacturers everywhere, in striving to keep ahead of competition, are looking for new inventions and buying up the patent rights thereon so that they will have better and more attractive items to make and sell. Hence, the wise thing for you to do is also to act at once. Protect your invention—and yourself—by applying for a patent now.

FREE "PATENT GUIDE" EXPLAINS WHAT TO DO

Our Free 48 page "Patent Guide for the Inventor", containing complete information about patent procedure and selling inventions, answers many important questions concerning Patents that inventors constantly ask. It tells what facts, details, drawings, sketches, etc., are necessary to apply for a Patent; how to protect your invention through dated and witnessed disclosure; how to do this at once to safeguard your rights; how Patent Office Records can be checked to determine whether the invention is probably patentable before filing fees need be paid; discusses costs involved and a practical way these can be paid as the application progresses. It tells how some inventors secured financial backing; how many simple inventions have proved large commercial successes; how Patents covering improvements also can be profitably utilized and marketed; and countless other facts that every inventor will want to know. And in addition, our "Patent Guide" contains illustrations of over 150 basic mechanical movements.

WHY YOU NEED EXPERT ASSISTANCE

The Patent Laws were enacted for your benefit—to give you protection for the features of your invention which are Patentable. But these features must be legally and concisely set forth in the form of "claims". This phase of the procedure is so complex that the U.S. Patent Office advises the Inventor to engage a competent Registered Patent Attorney. We maintain a large staff—carefully trained registered patent attorneys—expert draftsmen—experienced searchers—to serve you. We have been serving inventors for more than twenty years. Write for a free copy of our "Patent Guide for the Inventor" today. Clarence A. O'Brien & Harvey B. Jacobson, Registered Patent Attorneys, 61-C Adams Building 4, Washington, D. C.

**CLARENCE A. O'BRIEN
& HARVEY B. JACOBSON**

REGISTERED PATENT ATTORNEYS

Free Book
for

TORS

48
PAGES
Over 150
Mechanical
Movements

FREE "RECORD OF INVENTION"

With our free "Patent Guide for the Inventor" you will receive also free a "Record of Invention" form. This "Record of Invention" enables you to conveniently make a proper, dated disclosure of your invention before you file your patent application, which will prove of great value to you, should the occasion for evidence arise.

TAKE FIRST STEP NOW

Remember, in Patent matters action is important. Delay can be costly. Therefore, take your first step now—toward protecting your invention. Send for your free copy of our "Patent Guide for the Inventor" containing complete information about patent procedure and selling inventions. At the same time, receive a free "Record of Invention" form with complete instructions for making a disclosure of your invention and establishing its date. This step costs you nothing—yet may be vital to your success. Mail the coupon in an envelope, or paste it on a penny postcard—now.

*Worthy of
Your Trust*

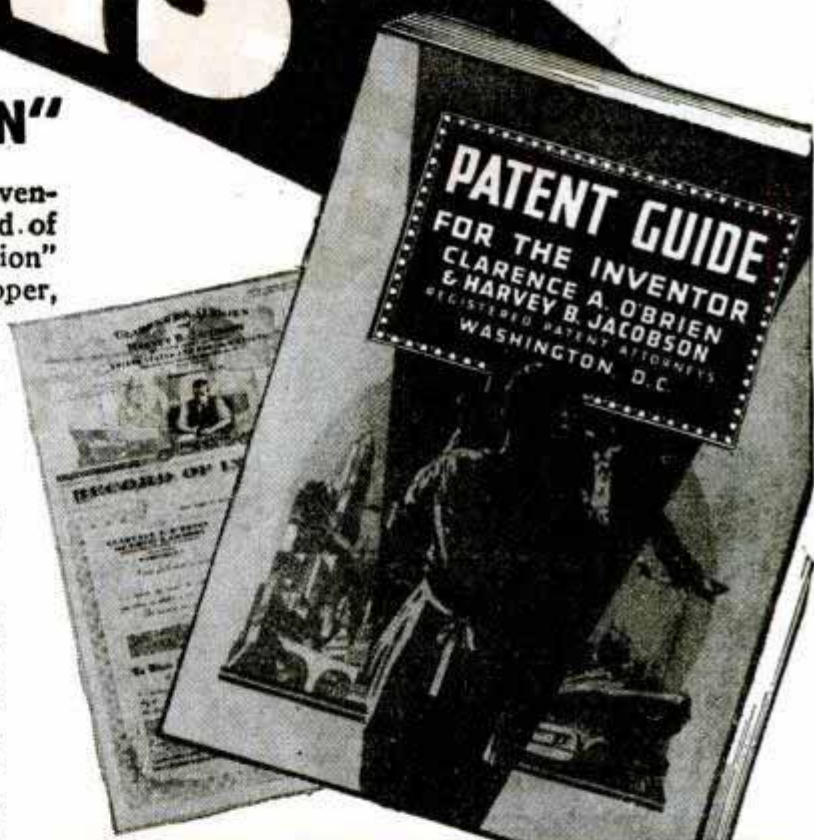

CLARENCE A. O'BRIEN & HARVEY B. JACOBSON

CLARENCE A. O'BRIEN & HARVEY B. JACOBSON
Registered Patent Attorneys before the United States Patent Office
61-C Adams Building, Washington 4, D. C.

Please send me your 48-Page "Patent Guide for the Inventor" and your specially prepared "Record of Invention" form FREE. This request does not obligate me.

Name.....

Address.....

City..... State.....

(Please write or print plainly.)

I'LL SHOW YOU HOW TO SUCCEED IN RADIO

Here's the right training for Big Post-War Pay!



F. L. Sprayberry, one of the country's foremost Radio Teachers.



A RADIO SERVICE BUSINESS OF YOUR OWN



A GOOD JOB IN RADIO & TELEVISION BROADCASTING



RADIO-ELECTRONIC SERVICE ENGINEER

BE A RADIO-ELECTRONICIAN

NOW! YOU CAN PREPARE AT HOME IN SPARE TIME FOR AMAZING OPPORTUNITIES AHEAD IN **RADIO • ELECTRONICS • TELEVISION**



I SUPPLY A FULL RADIO SET for practical Easy LEARNING



The offer I make you here is the opportunity of a lifetime. It's your big chance to get ready for a wonderful future in the swiftly expanding field of Radio-Electronics INCLUDING Radio, Television, Frequency Modulation and Industrial Electronics. Be wise! NOW'S the time to start. Opportunities ahead are tremendous! No previous experience is necessary. The Sprayberry Course starts right at the beginning of Radio. You can't get lost. It gets the various subjects across in such a clear, simple way that you understand and remember. And, you can master my

entire course in your spare time. It will not interfere in any way with your present duties. Along with your Training, you will receive my famous **BUSINESS BUILDERS** which will show you how to make some nice profits while learning.

Prepares You for a Business of Your Own or Good Radio Job

My training will give you the broad, fundamental principles so necessary as a background, no matter which branch of Radio you wish to specialize in. I make it easy for you to learn Radio Set Repair and Installation Work. I teach you how to install and repair Electronic Equipment. In fact, you'll be a fully qualified **RADIO-ELECTRONICIAN**, equipped with the skill and knowledge to perform efficiently and to make a wonderful success of yourself.

JUST OUT! FREE!

"How to Read Radio Diagrams and Symbols"

... a valuable new book explaining in simple English how to read and understand any Radio Set Diagram or circuit. Includes translations of all Radio symbols. Send for this FREE book now, and along with it I will send you another big FREE book describing my Radio-Electronic training.



GET FREE BOOKS

SPRAYBERRY ACADEMY OF RADIO

F. L. Sprayberry, President
Room 1036, Pueblo, Colorado.

Please rush my FREE copies of "How to MAKE MONEY in RADIO, ELECTRONICS and TELEVISION," and "HOW TO READ RADIO DIAGRAMS and SYMBOLS."

Name..... Age.....

Address.....

City..... State.....

(Mail in plain envelope or paste on penny postcard)

SPRAYBERRY TRAINING GIVES YOU BOTH TECHNICAL KNOWLEDGE—SKILLED HANDS

There's only one right way to learn Radio Electronics. You must get it through simplified lesson study combined with actual "shop" practice under the personal guidance of a qualified Radio Teacher. It's exactly this way that Sprayberry trains you... supplying real Radio parts for learn-by-doing experience right at home. Thus, you learn faster, your understanding is clear-cut, you acquire the practical "know how" essential to a good-paying Radio job or a Radio business of your own.

I'll Show You a New, Fast Way to Test Radio Sets Without Mfg. Equipment

The very same Radio Parts I supply with your Course for gaining pre-experience in Radio Repair work may be adapted through an exclusive Sprayberry wiring procedure to serve for complete, fast, accurate Radio Receiver trouble-shooting. Thus, under Sprayberry methods, you do not have one cent to outlay for manufactured

Test Equipment which is not only expensive but scarce.

Read What Graduate Says "One Job Nets About \$26.00"

"Since last week I fixed 7 radios, all good-paying jobs and right now I am working on an amplifier system. This job alone will net me about \$26.00. As long as my work keeps coming in this way, I have only one word to say and that is, 'Thanks to my Sprayberry training' and I am not afraid to boast about it."—ADRIEN BENJAMIN, North Grosvenordale, Conn.

DON'T PUT IT OFF!

Get the facts about my training—now! Take the first important step toward the money-making future of your dreams. All features are fully explained in my big, illustrated FREE Catalog which comes to you along with another valuable FREE book you'll be glad to own. Mail Coupon AT ONCE!

Yes! I Turn Weaklings into HE-MEN!

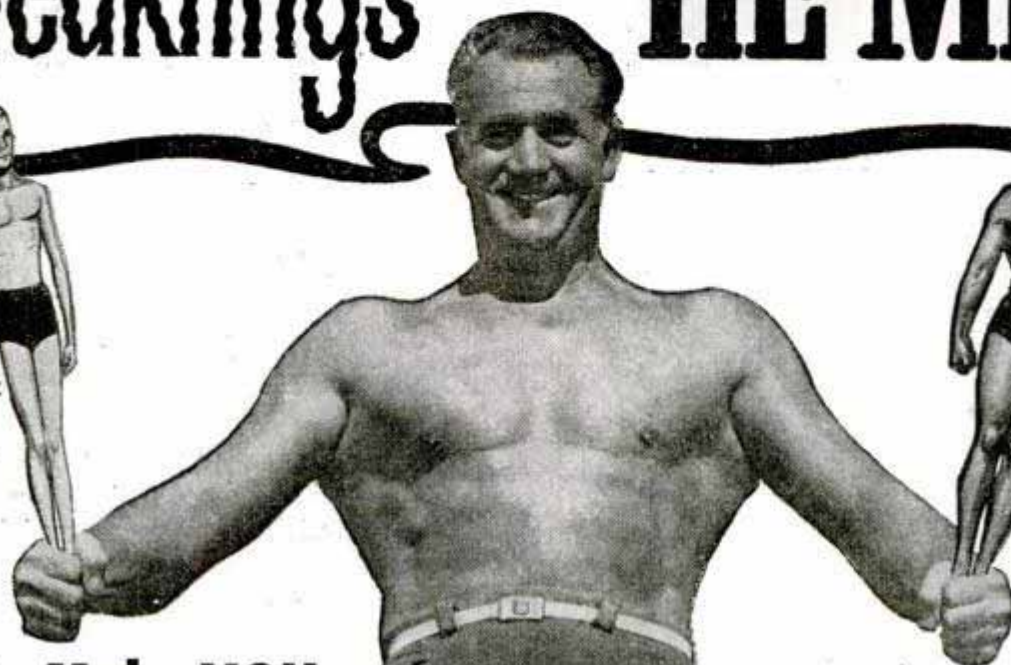

Let Me Make YOU a NEW MAN

—in Just 15 Minutes a Day!

YES, Sir, *that's my job!* I RE-BUILD" skinny, run-down weaklings — fellows so embarrassed by their second-rate physical condition that they always hang back, let others walk off with the best jobs, the prettiest girls, the most fun and popularity. I turn weaklings like these into HE-MEN — REAL SPECIMENS OF HANDSOME, MUSCULAR MANHOOD — overflowing with pep, power, vitality! I'll PROVE that, in only 15 minutes a day, I can make YOU a NEW MAN too!

I'LL PROVE What I Say

I know what it's like to have a body others laugh at. I myself was once a 97-pound weakling—timid, ill-at-ease, ashamed to strip for sports or a swim.

Then I discovered "Dynamic Tension." It changed me from a scrawny "stringbean" into the winner of the title, "THE WORLD'S MOST PERFECTLY DEVELOPED MAN." Since then my "Dynamic Tension" has transformed thousands of other weak, no-muscle men into real Atlas Champions!

Charles Atlas

Holder of title, "The World's Most Perfectly Developed Man."

What I'll Do For YOU!

Where do YOU want solid, tough LIVE MUSCLE? Are you fat and flabby? Or skinny and gawky? Are you short-winded, sluggish, always tired? I'll give you a sledge-hammer fist and mighty forearm. Add inches to your biceps. Put a coat of muscle straight across your stomach. Change those legs that are "always tired" into mighty, vigorous columns of speed and stamina. You'll begin to know what it feels like to really LIVE!

SEND FOR FREE BOOK

Mail coupon right now. I'll send you a FREE COPY of my famous illustrated book, "Everlasting Health and Strength." In it I talk to you in straight-from-the-shoulder language—show you actual photographs of myself and other fellows who became NEW MEN, my way. You'll read the story of "Dynamic Tension"—what it has done for others, what I'm ready to PROVE in only 15 minutes a day, it can do for YOU! Send for this book today! AT ONCE! Address me personally. CHARLES ATLAS, Dept. 8C, 115 East 23rd Street, New York 10, N. Y.



CHARLES ATLAS, Dept. 8C
115 East 23rd Street, New York 10, N. Y.

I want the proof that your system of "Dynamic Tension" will help make a New Man of me—give me a healthy, husky body and big muscular development. Send me your free book, "Everlasting Health and Strength."

Name.....
(Please print or write plainly)

Address.....

City..... Zone No. (if any)..... State.....

Check here if under 16 for Booklet A.

INVENTORS

LEARN HOW TO
PROTECT and SELL
YOUR INVENTION

GET NEW FREE BOOK



FREE

Invention Record
Know How Successful
Inventors Protect and
Sell Their Inventions

Our new **FREE** Book is a book every inventor should have. Mail the coupon today for "How to Protect, Finance and Sell Your Invention" and learn . . .

- How to know if there is a prior U. S. patent on your invention.
- How to save steps in getting patent action.
- How to prepare your application for presentation to the Patent Office.
- How you may patent an improvement on something in use now.
- How to obtain funds to patent and promote your invention.
- How to find a buyer or backer for your invention.
- How to protect yourself in making royalty agreements.

MODERN BUSINESS WANTS INVENTIONS
Practical and novel inventions are in big demand today. The opportunity for quick money is enticing. Sales sources are many if your invention has merit. But, be *sure*—before you place your device in strange hands—that it is fully protected. A United States Patent gives you this protection. *The first step toward inventive success always is—and always has been—the application for a U. S. Patent. There is no other way to protect your invention in accordance with the laws of this country.*

MAKE THIS RECORD NOW If you have an invention, and wish to secure it for the future, act at once. Have it dated now and recorded in our office. We will send you this **FREE** Invention Record Form for the purpose. Fill out the Invention Record Form fully describing the nature of your invention. Make a sketch of its main features. Mail it to us and we will record the date it was received in our office. The earlier the date the better your chance of combating rival inventors who may lay claim to your idea later. *Don't delay a single minute in taking this important step. Your whole future may depend upon it. Mail the coupon for our FREE Invention Record Blank and New FREE Book today!*

HOW WE SERVE YOU AS REGISTERED PATENT ATTORNEYS

The U. S. Patent Office strongly recommends—unless the inventor is familiar with such matters—that he employ the services of a Registered Patent Attorney in the preparation of his Patent Application. We are Registered Patent Attorneys fully qualified to represent you at the Patent Office. We have had long experience in studying hundreds of types of inventions. This gives us the ability to judge your invention and to describe it accurately and convincingly in technical language. It gives us the perception to center arguments upon those details of your invention which, in our judgment, will be looked upon most favorably by the Patent Office Examiner.

Mail the coupon today for our new **FREE** Book, "How to Protect, Finance and Sell Your Invention," and our **FREE** Invention Record Form—maybe this step will pave the way to future security for you and your family. Act Today!

McMORROW & BERMAN

REGISTERED PATENT ATTORNEYS

135-M ATLANTIC BUILDING, WASHINGTON 4, D. C.

Send me your new **FREE** book, "How to Protect, Finance and Sell Your Invention"—and "Invention Record" form at once. I understand that this request does not obligate me.

NAME

ADDRESS

CITY..... STATE.....

(Write or print name clearly)

McMORROW & BERMAN

Registered Patent Attorneys

135-M Atlantic Building, Washington 6, D. C.

THE TOP MEN in Industrial Posts often are I. C. S. graduates

THE men holding the top industrial jobs didn't get there by wishful thinking. They had ambition and intelligence . . . and they applied them to obtaining essential *training*. Many enrolled with the International Correspondence Schools, famous for 54 years as a training system for industry and commerce.

When a committee of ranking U. S. scientists voted Modern Pioneer medals to the outstanding inventors of the past 25 years, 59 of the award winners

stated over their own signatures that they had studied I. C. S. technical courses.

Successful I. C. S. graduates are numbered by the thousands and they include presidents, production managers, chief engineers, head chemists of some of the greatest airplane, railroad, steel, chemical and electric companies in the nation.

You have ambition and intelligence. I. C. S. has the training you need to get to the top. Mail the coupon today.

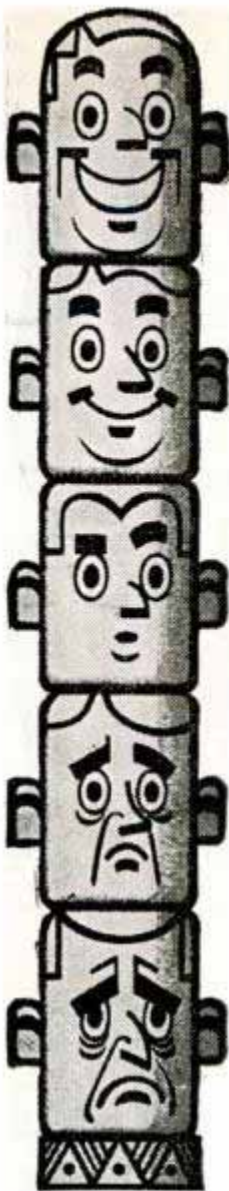

INTERNATIONAL CORRESPONDENCE SCHOOLS



BOX 5573-K, SCRANTON 9, PENNA.

Without cost or obligation, please send me full particulars about the course *before* which I have marked X:

- | | | | |
|--|--|---|--|
| <p>Air Conditioning and Plumbing Courses</p> <ul style="list-style-type: none"> <input type="checkbox"/> Air Conditioning <input type="checkbox"/> Heating <input type="checkbox"/> Plumbing <input type="checkbox"/> Refrigeration <input type="checkbox"/> Steam Fitting <p>Chemistry Courses</p> <ul style="list-style-type: none"> <input type="checkbox"/> Chemical Engineering <input type="checkbox"/> Chemistry, Analytical <input type="checkbox"/> Chemistry, Industrial <input type="checkbox"/> Chemistry, Mfg. Iron & Steel <input type="checkbox"/> Petroleum Refining <input type="checkbox"/> Plastics <input type="checkbox"/> Pulp and Paper Making <p>Civil Engineering, Architectural and Mining Courses</p> <ul style="list-style-type: none"> <input type="checkbox"/> Architectural Drafting <input type="checkbox"/> Architecture <input type="checkbox"/> Bridge and Building Foreman <input type="checkbox"/> Building Estimating <input type="checkbox"/> Civil Engineering <input type="checkbox"/> Coal Mining <input type="checkbox"/> Contracting and Building <input type="checkbox"/> Highways Engineering <input type="checkbox"/> Lumber Dealer <input type="checkbox"/> Reading Structural Blueprints <input type="checkbox"/> Sanitary Engineering <input type="checkbox"/> Structural Drafting | <ul style="list-style-type: none"> <input type="checkbox"/> Structural Engineering <input type="checkbox"/> Surveying and Mapping <p>Communications Courses</p> <ul style="list-style-type: none"> <input type="checkbox"/> Electronics <input type="checkbox"/> Practical Telephony <input type="checkbox"/> Radio, General <input type="checkbox"/> Radio Operating <input type="checkbox"/> Radio Servicing <input type="checkbox"/> Telegraph Engineering <p>Electrical Courses</p> <ul style="list-style-type: none"> <input type="checkbox"/> Electrical Drafting <input type="checkbox"/> Electrical Engineering <input type="checkbox"/> Electric Light and Power <input type="checkbox"/> Lighting Technician <input type="checkbox"/> Practical Electrician <p>Internal Combustion Engines Courses</p> <ul style="list-style-type: none"> <input type="checkbox"/> Auto Technician <input type="checkbox"/> Aviation <input type="checkbox"/> Diesel-Electric <input type="checkbox"/> Diesel Engines <input type="checkbox"/> Gas Engines <p>Mechanical Courses</p> <ul style="list-style-type: none"> <input type="checkbox"/> Aeronautical Engineering <input type="checkbox"/> Aircraft Drafting <input type="checkbox"/> Flight Engineer <input type="checkbox"/> Foundry Work <input type="checkbox"/> Heat Treatment of Metals | <ul style="list-style-type: none"> <input type="checkbox"/> Industrial Engineering <input type="checkbox"/> Industrial Metallurgy <input type="checkbox"/> Machine Shop <input type="checkbox"/> Mechanical Drafting <input type="checkbox"/> Mechanical Engineering <input type="checkbox"/> Mold-Loft Work <input type="checkbox"/> Patternmaking—Wood, Metal <input type="checkbox"/> Reading Shop Blueprints <input type="checkbox"/> Sheet-Metal Drafting <input type="checkbox"/> Sheet-Metal Worker <input type="checkbox"/> Ship Drafting <input type="checkbox"/> Ship Fitting <input type="checkbox"/> Tool Designing <input type="checkbox"/> Toolmaking <input type="checkbox"/> Welding—Gas and Electric <p>Railroad Courses</p> <ul style="list-style-type: none"> <input type="checkbox"/> Air Brake <input type="checkbox"/> Car Inspector <input type="checkbox"/> Diesel Locomotive <input type="checkbox"/> Locomotive Engineer <input type="checkbox"/> Locomotive Fireman <input type="checkbox"/> Railroad Section Foreman <p>Steam Engineering Courses</p> <ul style="list-style-type: none"> <input type="checkbox"/> Boilermaking <input type="checkbox"/> Combustion Engineering <input type="checkbox"/> Engine Running <input type="checkbox"/> Marine Engineering <input type="checkbox"/> Steam Electric <input type="checkbox"/> Steam Engines | <p>Textile Courses</p> <ul style="list-style-type: none"> <input type="checkbox"/> Cotton Manufacturing <input type="checkbox"/> Rayon Weaving <input type="checkbox"/> Textile Designing <input type="checkbox"/> Woolen Manufacturing <p>Business and Academic Courses</p> <ul style="list-style-type: none"> <input type="checkbox"/> Accounting <input type="checkbox"/> Advertising <input type="checkbox"/> Arithmetic <input type="checkbox"/> Bookkeeping <input type="checkbox"/> Business Correspondence <input type="checkbox"/> Business Management <input type="checkbox"/> Certified Public Accounting <input type="checkbox"/> Commercial <input type="checkbox"/> Cost Accounting <input type="checkbox"/> Federal Tax <input type="checkbox"/> First Year College <input type="checkbox"/> Foremanship <input type="checkbox"/> French <input type="checkbox"/> Good English <input type="checkbox"/> High School <input type="checkbox"/> Higher Mathematics <input type="checkbox"/> Illustrating <input type="checkbox"/> Motor Traffic <input type="checkbox"/> Postal Service <input type="checkbox"/> Salesmanship <input type="checkbox"/> Secretarial <input type="checkbox"/> Sign Lettering <input type="checkbox"/> Spanish <input type="checkbox"/> Stenography <input type="checkbox"/> Traffic Management |
|--|--|---|--|

Name..... Age..... Address.....
Home
Present
Position

City..... State..... Working Hours..... A.M. to..... P.M.

Canadian residents send coupon to International Correspondence Schools Canadian, Ltd., Montreal, Canada.
 British residents send coupon to I. C. S., 71 Kingsway, London, W. C. 2, England.

A DISCOUNT TO DISCHARGED VETERANS—SPECIAL TUITION RATES FOR MEMBERS OF THE ARMED FORCES

Men! Why Trust to Luck for Your Future?

Choose the Field that Offers

**GOOD JOBS, STEADY
WORK, a REAL FUTURE!**

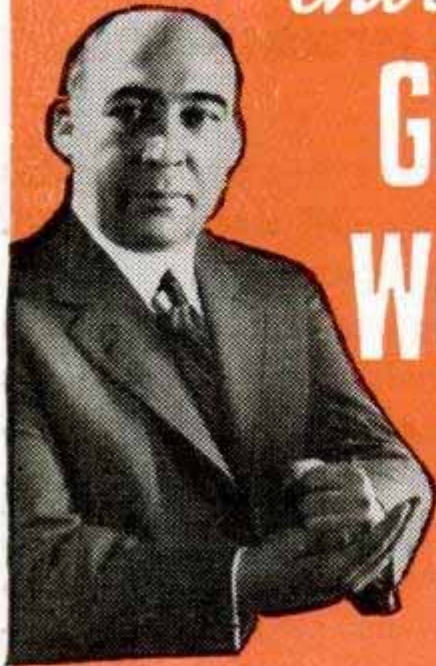

Then Get Practical Shop Training
at COYNE in Chicago..and Get Out
of the "One-Operation" Job Rut!

**Be Ready in a Few Short Weeks
FOR A LIFETIME OF BETTER JOBS, BIGGER PAY!**

This big fireproof building
was built and is occupied
entirely by COYNE—
America's headquarters for
practical Electrical and
Radio Training.



"Learn by Doing"
on Full-Size Equipment

You need training TODAY for the better jobs of TOMORROW. Not just any training, but practical, do-it-yourself instruction on full size equipment with the necessary theory given by interesting practical lectures, black-board work and demonstrations—in a field that offers a real future. That's what you get here at COYNE. When you come to Chicago for my course in Radio-Electronics, you can make rapid strides in my famous "Learn-by-doing" shops.

COYNE training is quick, streamlined. You work on real equipment, the same kind you'll use later on the job. Expert instructors guide every step. In a few short weeks you have knowledge that will aid you to a lifetime of steady work, advancement, better pay!

See What COYNE can do for YOU

RADIO -ELECTRONICS and TELEVISION

THIS TRAINING INCLUDES:

Radio and Electronics principles; circuits, tubes, condensers, coils, volume controls; assembling, wiring and trouble shooting on radio receivers; auto radio; F.M. (frequency modulation); public address, sound and television; how to set up a radio business of your own.

Leading to such jobs as:



RADIO MFG.



RADIO RECEIVERS



FM (Frequency Mod.)



ELECTRONICS



SOUND SYSTEMS



TELEVISION

SEND COUPON FOR BIG FREE BOOK

COYNE Gives "All-Around" Training

Many fellows have what they consider a good job, yet it may be actually only a "one-operation" type of work. They are not able to go into other branches of the same field because they lack training. At COYNE you learn many branches of Radio-Electronics. You get "all-around" knowledge to prepare you for the BEST that the future has to offer!

Student Finance Plan

I make it easy for you. If you don't have much cash, I'll arrange to finance most of your tuition and you can pay it in small monthly installments after you complete your training. We'll even help you get a part time job if you wish, so you can earn while learning. My Lifetime Employment Service is free to Coyne graduates whenever you need it. I have many plans to help you. Coupon brings all details. MAIL IT NOW!

INCLUDED!

INDUSTRIAL ELECTRONICS and Electric Refrigeration Included — No Extra Cost.



VETERANS!

Coyne is also equipped to train those who qualify for training under the G.I. Bill of Rights. Check the coupon for special G.I. Bulletin.

Also facilities for men with physical disabilities, whether due to war or other causes. Check coupon for special information.



Dozen of Pictures and Vital Job Facts . . . Yours FREE

I have a big FREE BOOK on my training in Radio-Electronics. It shows dozens of scenes in my famous shops—tells how easily and quickly YOU can prepare for a wonderful future. Just fill in coupon below, then mail in envelope or paste on post card.

No salesman will call. YOU will be the sole judge. Your future is at stake—don't delay. Rush the coupon to me—NOW.

H. C. LEWIS, Pres., Radio-Electronics Div.

COYNE ELECTRICAL SCHOOL
500 S. PAULINA ST. Dept. 36-3H CHICAGO 12

FREE BOOK COUPON

H. C. Lewis, Pres.,
COYNE ELECTRICAL SCHOOL, Radio-Electronics Div.,
500 S. Paulina St., Dept. 36-3H, Chicago 12, Ill.

I want to build a REAL FUTURE for myself. Send your big FREE BOOK on Radio-Electronics, also details of your Student Finance Plan. Check if you are interested in information on the following:

Send special G.I. Bulletin Physical Disability details

NAME.....

ADDRESS.....

CITY.....STATE.....

...MAIL THIS TODAY!

HOW YOU CAN BUILD A MIGHTY BODY

Quickly! Easily! Pleasantly
—in 10 minutes a day in your own home

"The World's greatest molder of men"—at last reveals to you in these five complete book-courses (value \$5 each).

1. How YOU Can Build a Mighty ARM!



A. PASSAMONT
First prize for physical perfection.

house of energy. Ferris writes, "I want to add my sincere gratitude to that of thousands of pupils for wonderful results from your course. Your course is by far the best." If you have a narrow, sunken chest I can improve it so that you will be proud to show it off.

Let me give YOU, TOO, such a pair of chain-breaking biceps. The strongest-armed man in the world, George F. Jowett, planned this course for you. His great experience stands as proof that YOU, TOO, can get the arms men respect and women admire.

Complete Arm Course 25c

2. How YOU Can Build a Mighty CHEST!



REX FERRIS
Champion of South Africa, says, "I owe everything to Jowett Methods."

Look at the Heroic Chest of this Jowett Pupil. A powerhouse of energy. Ferris writes, "I want to add my sincere gratitude to that of thousands of pupils for wonderful results from your course. Your course is by far the best." If you have a narrow, sunken chest I can improve it so that you will be proud to show it off.

Complete Chest Course 25c

3. How YOU Can Build a Mighty BACK!



CHAS. SCHAFER
an amazing Jowett product. Once a puny weakling. Now versatile athlete.

Look at his rock-like Back now! He says, "You have worked wonders for me. You are head and shoulders above the rest in your profession." Let me help YOU, TOO, build a back of power. Square shoulders with enviable military spread. A spine as strong as a steel shaft.

Complete Back Course 25c

4. How YOU Can Build a Mighty GRIP!



W. BURNS
A Jowett-made Olympic Strength Champion.

YOU, TOO, can have a Manly Grip like this Jowett pupil. What would you give for a forearm like that, with its bone-crushing grip? Fingers strong as steel pincers. A hand like an iron vise. YOU, TOO, can get these symbols of real manliness. I have proved to thousands this is no mere dream. Let me mold a pair of arms like this for you . . . with a grip of might. A handshake that will win friends—success.

Complete Grip Course 25c

5. How YOU Can Build Mighty LEGS



BOB MITCHELL
A Jowett Champion—not in words but by ACTUAL RECORDS.

What would you give to have the all-round he-man strength of Bob Mitchell? It's reasonable to assume that what I have done for thousands, I can do for you. I myself increased my thighs by 8 inches, my calves by 5 inches, by this simple, unbeatable method. I'll help you build legs that are real props of leaping, tireless power!

Complete Leg Course 25c

Last Chance! Get All 5 Picture Courses for \$100

Send for them now and learn the "World's Greatest Secrets of Body Building." FREE! Marvelous Photo Book of Famous Strong Men, "Nerves of Steel—Muscles like Iron".

RUSH COUPON NOW.

BOOK WITH PHOTOS OF FAMOUS STRONG MEN MAIL COUPON NOW

FREE



George F. Jowett
Champion of Champions

Jowett Institute of Physical Culture
230 Fifth Avenue, Dept. 951, New York 1, N. Y.
George F. Jowett: Your proposition looks good to me. Send by return mail, prepaid, the courses checked below, for which I enclose (). Include FREE book of PHOTOS.
 All 5 courses for . . . \$1 Molding Mighty Legs 25c
 Molding a Mighty Arm 25c Molding a Mighty Grip 25c
 Molding a Mighty Back 25c Molding a Mighty Chest 25c
 Send all 5 C.O.D. (\$1 plus postage.) No orders less than \$1 sent C.O.D.

NAME Age
(Please print plainly. Include Zone Number.)

ADDRESS

Do You Make These Mistakes in English?

MANY persons say "between you and I" instead of "between you and me"—or use "who" for "whom"—or don't know whether to spell certain words with one or two "e's" or "m's" or "r's," or with "le" or "el," etc. Every time you speak or write you show what you are. Mistakes in English reveal lack of education, refinement. Lack of language power prevents you from presenting your thoughts in the strongest way. Real command of English will help you reach ANY goal. Stop making mistakes in spelling, punctuation, pronunciation, grammar. Increase your vocabulary.



Sherwin Cody

WONDERFUL INVENTION

Only 15 minutes a day with Sherwin Cody's new invention—and you can actually SEE your English improve. It teaches by HABIT—makes it easier to do the RIGHT way. Wonderful self-correcting lessons.

FREE BOOK ON ENGLISH Lack of language power may be costing you friendships, income, every year. See what Mr. Cody can do for you: it costs nothing to find out. Write this very minute for free book, "How You Can Master Good English in 15 Minutes a Day." It will prove a revelation. WRITE NOW. Sherwin Cody School of English, 53 B & O Bldg., Rochester 4, N. Y.

LEARN MONEY-MAKING CARTOONING

IN SPARE TIME — by Easy Picture Chart Method

Same Simplified Method that has helped train creators of "Terry & Pirates," "Freckles," "Out Our Way," "Winnie Winkle," "Reg'lar Fellers," "Strange As It Seems," "The Neighbors," and many others. Earn while learning. Send 10c for Picture Chart (to test your ability), and full details. (State age.)



Landon School of Cartooning, Dept. 4603 Philadelphia (1) Pa.

NEW WRITERS NEEDED

New writers needed to re-write ideas in newspapers, magazines and books. Splendid opportunity to "break-into" fascinating writing field. May bring you up to \$5.00 per hour spare time. Experience unnecessary. Write today for FREE details. NO OBLIGATION. Postcard will do.

FREE DETAILS

COMFORT WRITER'S SERVICE

200-T40 South Seventh (2)

St. Louis, Mo.

LEARN WATCH REPAIRING



AT HOME. By our modern and original system of instruction you can learn every part of the **WATCH REPAIRING TRADE AT HOME.** Prepare yourself for a well-paying position or start in business after completing our course of instruction. Good watch repairers are in demand and generally earn very good salaries. For particulars apply to the Wisconsin School of Watch Repairing 759 North Milwaukee St., Milwaukee 2, Wis.

ANALYZE HANDWRITING

Qualify for Certified Grapho-Analyst Degree. New uncrowded, fascinating field of service. Gratifying earnings reported by graduates in Employment, Credit, Social Service, Police and Judicial, and Entertainment fields. Others have developed profitable private practice, full or sparetime, as Personal Problem and Vocational Counselors. Send for 5000 word test lesson and Grapho-Analyst

FREE

ADDRESS A. I. G. A. Inc. 120 NOEL, MO.

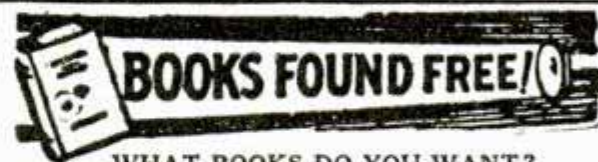

WHAT BOOKS DO YOU WANT?

We quote the lowest market prices. No charge for locating Hard-to-Find and Out-of-Print Books. All books, OLD or NEW, mailed POST-FREE.

SEARCHLIGHT BOOK CLUB, 22 East 17th St., New York City

Inventions Wanted

Patented or Unpatented

Inventions can now be safely sold without patenting expense. If you have a practical, useful idea for sale, either unpatented or patented, write

INSTITUTE OF AMERICAN INVENTORS
Dept. 4, 1926 Eye St., N.W. Washington 6, D. C.

WHICH OF THESE *Opportunities* INTERESTS *You* MOST?

Accounting & C. P. A.
Air Conditioning
Architecture & Building
Automotive Engineering
Aviation—Practical
Aviation Drafting & Design
Better Foremanship
Bookkeeping
Business Management
Contracting

Diesel Engineering
Drafting & Design
Electrical Engineering
Electricity—Practical
Electronics, Industrial
High School Courses
Machine Shop Operations
Mechanical Engineering
Plastics Engineering
Plumbing—Practical

Private Secretary
Radio Operating & Servicing
Railway Training
Refrigeration
Sheet Metal Pattern Drafting
Shop Management
Surveying & Topographical
Drafting
Tool Making

THINK! LOOK FORWARD!

Business is making big, new plans

Men and Women are preparing for the future

WHAT ARE YOU DOING ABOUT YOUR TOMORROWS?

● *Today*, choose the job you want—and prepare for it. Or if you are already engaged in the work you like best, start training *now* for quicker promotion. Acquire the knowledge that will help you to get ahead faster, make more money and have greater security.

Invest part of your spare time in more rapid progress. Start training now, in spare time in your own home. Be ready to grasp your opportunity and step out ahead of those who lack the ability you have attained.

American School, founded in 1897 as an educational institution *not for profit*, can help you to reach your goal just as it has helped others during the past forty-nine years. Give serious thought to the list above. Pick one or more subjects that interest you. Then check the coupon at right, add your name and address and mail it at once. The school will send you details on its training plan and outline of study prepared by specialists. There is no charge, no obligation, so send the coupon immediately.

PRACTICAL, EFFECTIVE HOME - STUDY TRAINING SINCE 1897

Take This First Easy Step

CHECK, CLIP AND MAIL COUPON NOW

AMERICAN SCHOOL, Dept. G345, Drexel at 58th, Chicago 37, Ill.
Without obligation, Please send FREE and postpaid, bulletin and details of the Subject checked.

- | | | |
|--|---|--|
| <input type="checkbox"/> PLASTICS ENG'R | <input type="checkbox"/> Accounting & C.P.A. | <input type="checkbox"/> Drafting and Design for Men and Women |
| <input type="checkbox"/> Refrigeration | <input type="checkbox"/> Electrical Engr. | <input type="checkbox"/> Radio |
| <input type="checkbox"/> Architecture and Building | <input type="checkbox"/> Electricity-Pract. | <input type="checkbox"/> High School |
| <input type="checkbox"/> Contracting | <input type="checkbox"/> Electronics, Industr. | <input type="checkbox"/> Air Conditioning |
| <input type="checkbox"/> Practical Plumbing | <input type="checkbox"/> Bookkeeping | <input type="checkbox"/> Mechanical Eng. |
| <input type="checkbox"/> Automotive Engineering | <input type="checkbox"/> Private Secretary | <input type="checkbox"/> Shop Management |
| <input type="checkbox"/> Aviation Drafting | <input type="checkbox"/> Diesel Engineering | <input type="checkbox"/> Tool Making |
| <input type="checkbox"/> Aviation | <input type="checkbox"/> Surveying & Topographical Drafting | <input type="checkbox"/> Better Foremanship |
| <input type="checkbox"/> Business Mgmt | <input type="checkbox"/> Sheet Metal Pattern-Drafting | <input type="checkbox"/> Machine Shop Operations |
| <input type="checkbox"/> Railway Training | | |

Name..... Occupation.....
Address..... Age.....
City..... State.....

AMERICAN SCHOOL

Dept. G345, Drexel at 58th Street, Chicago 37



AUTO

BOOKS ON APPROVAL

SEND NO MONEY. Just mail the coupon for a complete set of Six Big Auto Books, 20th Edition. Whether you are a mechanic or helper, expert or apprentice, auto owner or driver, take immediate advantage of this **FREE EXAMINATION OFFER.**

MAKE GOOD MONEY NOW HOLD A PERMANENT JOB
America wants its automobiles kept in good repair. Men with "know how" are in demand, at big pay. These books will help you get and hold an important job, or give you a chance to go into business for yourself now or later. Any man who half tries to improve himself can learn auto servicing and repairing by this quick reference method. Use the **JIPFY INDEX** to find easily understood answer to any auto problem. These wonder books prepared by eleven of America's great automobile engineers. Many hundreds of valuable illustrations. Send the coupon **TODAY.**

A year's consulting privileges with our engineers now given with these books without extra charge.
Vocational Publishers Since 1898

CAN YOU FIX IT?

These wonder books tell step by step **HOW** to make difficult repairs and adjustments, how to keep a car at maximum efficiency, including latest improvements in car design and operation. Engine troubles and how to correct them well covered.

6 BIG VOLUMES
2800 pages, 2000 illustrations, wiring diagrams, etc., including Diesel engines. Beautiful modernistic, washable cloth binding.

AMERICAN TECHNICAL SOCIETY, Dept. A319
Drexel Ave. at 58th St., Chicago 37, Ill.

I would like to examine your Six-Volume Set of Auto Books. I will pay the delivery charges only, but if I choose I may return them express collect. If after 10 days' use I prefer to keep them, I will send you \$2 and pay the balance at the rate of only \$3 a month until \$24.80 has been paid. Please include consulting service as offered above.

Name

Address

City State

Please attach a letter stating your age, occupation, employer's name and address, and name and address of at least one business man as a reference. Men in service, also please give home address.

AUDELS Carpenters and Builders Guides

4 vols. \$6

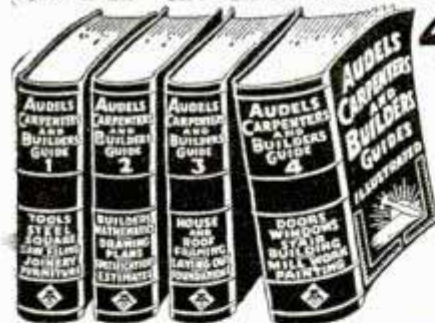

Inside Trade Information On:
Carpenters, Builders, Joiners, Building Mechanics and all Woodworkers. These Guides give you the short-cut instructions that you want—including new methods, ideas, solutions, plans, systems and money saving suggestions. An easy progressive course for the apprentice and student. A practical daily helper and Quick Reference for the master worker. Carpenters everywhere are using these Guides as a Helping Hand to Easier Work, Better Work and Better Pay. To get this assistance for yourself, simply fill in and mail the **FREE COUPON** below.

Inside Trade Information On:
How to use the steel square—How to file and set saws—How to build furniture—How to use a mitre box—How to use the chalk line—How to use rules and scales—How to make joints—Carpenters arithmetic—Solving mensuration problems—Estimating strength of timbers—How to set girders and sills—How to frame houses and roofs—How to estimate costs—How to build houses, barns, garages, bungalows, etc.—How to read and draw plans—Drawing up specifications—How to excavate—How to use settings 12, 13 and 17 on the steel square—How to build hoists and scaffolds—skylights—How to build stairs—How to put on interior trim—How to hang doors—How to lay floor—How to paint



THEO. AUDEL & CO., 49 W. 23rd St., New York City

Mail Audels Carpenters and Builders Guides, 4 vols., on 7 days' free trial. If O.K. I will remit \$1 in 7 days, and \$1 monthly until \$6 is paid. Otherwise I will return them. No obligation unless I am satisfied.

Name

Address

Occupation

Reference



DRAW CARTOONS BIG MONEY!

EASY . . . PLEASANT WORK!
Let CHAS. H. KUHN, with 25 years actual experience in drawing a daily newspaper cartoon, teach you how to create, draw and sell your work. 52 complete lessons—one sent each week. Professional criticism on every lesson. Write today.

KUHN SCHOOL OF CARTOONING
420 MURPHY BUILDING Dept. M INDIANAPOLIS 4, INDIANA

LAW STUDY AT HOME

Legally trained men win higher positions and bigger success in business and public life. Greater opportunities now than ever before. Big corporations are headed by men with legal training.
More Ability: More Prestige: More Money

We guide you step by step. You can train at home during spare time. Degree of LL. B. Successful graduates in every section of the U. S. We furnish all text material, including 14-volume Law Library. Low cost, easy terms. Get our valuable 48-page "Law Training for Leadership" and "Evidence" books FREE. Send for them NOW.

LASALLE EXTENSION UNIVERSITY, 417 South Dearborn Street
A Correspondence Institution Dept. 364-L Chicago 5, Ill.

PLAY GUITAR LIKE THE COWBOYS DO... 8 1/2¢ A LESSON

Just out—very latest guaranteed, simple, easy method. Play cowboy songs the Western way in a few minutes by ear. Surprise and amaze your friends. Be in big demand at parties, camps, public entertainments, on the radio, etc. 12 Complete Lessons.

SEND NO MONEY. Pay postman only \$1.00 charges, or send \$1.00 plus postage and C.O.D. all postpaid. (Canada, \$1.25 money order only.) Nothing else to buy. Positive money back guarantee. *Rush order today.*
WESTERN RANGER STUDIOS, Dept. 153, Hutchinson, Kans.

Learn Penmanship

You can learn plain, rapid writing or fancy ornamental writing for social and business advancement, right in your own home during spare time by my Simplified Method. Write for my free book, "How to Become an Expert Penman," which shows what others have accomplished by taking my Courses. Send 10c for one of my favorite Pen Points and your name with a beautiful feathered bird written on a card. Write today. T. M. Tevis, Box 25K, Chillicothe, Mo.

HOW TO GET A BIG PAY JOB IN Real Estate

Tremendous real estate boom predicted. Big-pay, permanent jobs or your own 6-profit business. Salaries up to \$2,500 to \$10,000 a year in property management, brokerage, appraisal, loans, insurance, building. Many make fortunes selling real estate. Thousands of trained men, women, required yearly by real estate firms, insurance companies, banks, Federal agencies. Rush post-card for 32-page QUIZ BOOK—mailed FREE with full details on new and only 5-volume library, MODERN REAL ESTATE PRACTICE! Lane Books, Dept. B-3, 100 East Ohio St., Chicago 11, Illinois.

Write for FREE BOOK!

FLIGHT JACKET INSIGNIA
With your own first name **50¢** each
Come and get 'em, only... Postpaid

Dress up your sweater, blouse, or lumber jacket and look just like the men that fly our big bombers. Indicate selection by number and print carefully your first name, or your nick name. Mail with 50¢ today. Agents Make Money—Take orders. Sell for \$1.00. Illustrated book of all Army Insignia Emblems only 25¢.

INSIGNIA MART
703 Broadway, Dept. P, New York 3, N.Y.

MONEY for MEN ALL DATA FREE

THE PLASTEX Industry needs manufacturers on small scale and for big production of Lamp and Clock Stands, Art Goods and Novelties in Plastex and Marble imitation. Experience unnecessary. 1/2c material makes regular 10c store sellers. Rubber moulds furnished for speed production. Small investment brings good returns. Big chain store orders now being placed. Ambitious men have chance for real prosperity. Our Free booklet will interest and benefit you.

PLASTEX INDUSTRIES, Dept. P, 1095 Washington Ave., New York, N.Y.

SOON WE'LL PHONE HOME FROM AUTO

RADIO INDUSTRY POISED FOR BIG BOOM

Big Boom in FM Broadcasting

MARKET FOR 100 MILLION RADIOS REVEALED BY PENNSYLVANIA SURVEY

COAST TO COAST NETWORK BEING PLANNED FOR FM

Let TODAY'S HEADLINES Guide You to TOMORROW'S OPPORTUNITIES

Learn RADIO ELECTRONICS DeFOREST'S MODERN "A-B-C" WAY .. at Home



YOU CAN BUILD 133 FASCINATING EXPERIMENTS WITH THIS EQUIPMENT

Plan your future the way business men do: Watch the headlines! Pick a field that's "in the news"—one with many opportunities for interesting, PROFITABLE EMPLOYMENT or a good chance for establishing a BUSINESS OF YOUR OWN with little capital. Pick a field that offers a variety of interesting opportunities—a field with one of America's most promising futures . . . and see how you may MAKE YOUR START TOWARD A PLACE IN THIS FIELD BEFORE JOB COMPETITION BECOMES ACUTE. Write for DeForest's Big, Free, Illustrated Book—"VICTORY FOR YOU." Learn how DeForest's prepares you at home, in your leisure time—without interfering with the work you are now doing—then helps you make your start in the vast BILLION DOLLAR Radio-Electronics field.

You Get EMPLOYMENT SERVICE

DeForest's Employment Service offers you the advantage of long and favorable contacts with some of America's foremost Radio-Electronics concerns. "VICTORY FOR YOU" tells you how this Service has helped many to their start in Radio-Electronics. You'll see how DeForest students and graduates are prepared to win and to hold good paying jobs—how DeForest students start businesses of their own with little, if any capital.

A You "LEARN-BY-DOING" at Home with Practical Equipment

Enjoy a "Home Laboratory." DeForest's provides 8 BIG KITS OF RADIO ASSEMBLIES AND PARTS to give you valuable practical experience at home. Build modern Radio Receivers and Circuits that operate. Build Electric Eye Devices, an Aviation Band Receiver, a Public Address System, a Wireless Microphone and numerous other fascinating experiments—in fact, 133 in all, in your spare time at home. NEW colorful Kit Supplement tells you about DeForest's "Home Laboratory," and how you use valuable Radio parts and sub-assemblies to get real practical experience as you learn.

B Home MOVIES Help You Learn FASTER...EASIER



With DeForest's, you use a genuine DeVRY 16 mm. Motion Picture Projector and exciting training films to help you learn some of Radio's fundamentals FASTER . . . EASIER. SEE what happens inside of many circuits you are working on. SEE how electrons function. SEE how RADIO waves are changed into sound. Get DeForest's big, free book! Use it as a key to show you the way to Radio-Electronics job opportunities of today and tomorrow—the opportunities the headlines tell about.

Send for FREE BOOK & SUPPLEMENT TODAY!

C ILLUSTRATED LOOSE-LEAF LESSONS

VETERANS! Big things are happening at DeForest's for veterans! See how we can prepare you WITHOUT COST for a GOOD JOB or a BUSINESS OF YOUR OWN in the vast Radio-Electronic opportunity field.

DeForest's provides 90 loose-leaf lessons prepared under the supervision of the man often referred to as the "Father of Radio"—Dr. Lee DeForest, inventor of the Audion Tube, and holder of over 300 important patents. . . . ACT PROMPTLY! See how you can learn Radio the modern A-B-C DeForest's way by Reading . . . by Doing . . . by Seeing—at Home. Mail coupon Now!

DeFOREST'S TRAINING INC., Chicago, Ill.

DeFOREST'S TRAINING, INC., 2533-41 N. Ashland Ave., Dept. PM-C3, Chicago 14, Illinois, U. S. A. Send me both your big book "VICTORY FOR YOU" and Kit Supplement, showing how I may make my start in Radio-Electronics with your modern A-B-C home training plan. No obligation.

Name _____ Age _____
 Address _____
 City _____ Zone _____ State _____
 If under 16, check here for special information. If a discharged veteran of World War II, check here.





SO IT NEEDS FIXING

By S. T. CHRISTENSEN
the "Fix-it Man"

"WELL, I guess I'm the fellow to see, for I've repaired thousands of refrigerators (home and commercial both), vacuum cleaners, radios, washing machines, irons, fans, lamps, mangles, motors, etc. In fact, many of my customers call me their "electrical appliance doctor." And, "doctoring," I might add, has paid me a good substantial income for quite a few years. Funny, in a way, how I got started. Always liked to tinker and by experimenting around I found that most electrical appliances had many things in common. That, regardless of what the appliance was used for, or who the manufacturer was, the basic principles were much the same. From fixing my own appliances to fixing friends' and then for strangers at a fee, seems now to have been but a small step.

What to Charge?

At first, I let the owner decide the charge and, frankly, I was amazed at what I earned per hour. But then, when one figures what initial costs are involved in buying most electrical appliances, one can readily see that spending extra dollars for repairs is well worth while. Before long I was making more in my spare time repairing than from my regular job. The result . . . I went into business for myself. When war came, business boomed, for new appliances were not available.

For a while, repair parts (needed on some

jobs) were a little difficult to get. But that situation quickly adjusted itself and many repair parts were given the high priority rating of AA2. After all, we had to provide for the health and well-being of our civilian population.

The Future Offers

Friends ask me about my future. And, I think I've got a grand one. Age is no handicap in repairing. I have in my files enthusiastic letters from repairmen ranging in age from 18 to 79 years. Now the war is over we are certain to see hundreds of new products on the market . . . products that the average person never dreamt of. These new products and our old appliances are all going to need at some time or other "fixing." Well, I'll still be the fellow to do it. The field open for appliance repairmen is unlimited. I don't worry at all about too much competition.

If You Are Ambitious

To the contrary, I've prepared a complete course, chuck full of simple, easy to understand photos and drawings and written in the same non-technical language as this article. I know the course is good, because I have hundreds of men all over the country writing to me telling me how the course has helped swell their pockets with cash. If you too want to prepare now for your future, I suggest you read the next page and send me the handy coupon."

Advertisement



**BIG MONEY
INDEPENDENCE**
*A PROFITABLE
LIFETIME
BUSINESS
OF
YOUR OWN!*

LEARN ELECTRICAL APPLIANCE REPAIRING

PREPARE NOW FOR THE FUTURE

If now employed, start your home appliance repair business NOW in your spare time and be set with a business of your own no matter what happens. You don't need elaborate fixtures or expensive equipment to be a successful repairman. Operate from your garage, basement, vacant store, etc. Work as many hours as you wish—the home appliance repairman is his own boss. It is a profitable occupation for on many types of repairs it is not unusual for a repairman to charge on the basis of \$5.00 to \$6.00 per hour. Don't gamble with your future—learn a trade that will always support you. Remember, as long as electrical appliances are used, there will be a need for electrical appliance repairmen.

If you are at all mechanically inclined—can hold and use tools—then you have all of the qualifications required for becoming a big money earning home appliance repairman. It does not matter if you have not had a great deal of schooling or had previous experience along these lines—WE WILL TEACH YOU. Age should be no barrier—nor should any minor physical handicap.

New Course Tells All

Profusely illustrated, our new course shows you in simple, easy to understand language and drawings how to make each repair on refrigerators, vacuum cleaners, washing machines, motors, etc. Explains and gives you a working knowledge of electricity, welding, nickel plating, etc. Shows you how to build the power tools you need and how to solicit and keep business coming to you. Not a theory course but an honest to goodness course written by and used by repairmen the country over. Price of course is so low that the savings on your own household appliance repairs will quickly pay for it. Act now! Mail the handy coupon below today.

----- Read What Our Students Say About Course -----

I really believe your course the best investment a mechanically minded man can make.—Claude E. Allen, Indianapolis, Ind.

I have received your Course in Appliance Repairing and I must say I am well pleased with same. I am only sorry I did not have said Course some years ago. I have learned so much more through this course I would not part with it.—Charles Schwarz, Hamilton, Ohio.

The Course in Appliance Servicing arrived a few days ago. Want to take out a few minutes of my valuable time to let you know that this is just what I have been looking for ever since I opened up my Fix-It shop. I must admit that you told the truth when you said that it contains quite a bit more information than I bargained for.—P. J. Bretl, Sebring, Ohio.

I am a mechanic for the Western Union Telegraph Co. Three days after receiving the lessons in refrigeration I earned the exact cost of the course.—Henry S. Lee, Washington, D. C.

I work day times at the shipyard and after 4:00 P.M. I operate from my cellar and garage. I average \$10.00 to \$15.00 clear every day.—Walter Hanhy, Brockton, Mass.

GET STARTED TODAY — MAIL THIS COUPON

CHRISTY SUPPLY CO.
2835 N. Central Ave., Dept. D-3103
Chicago 34, Illinois

Please send me free illustrated literature about America's Fastest Growing Industry — ELECTRICAL APPLIANCE REPAIRING.

Name.....

Address.....

City.....State.....

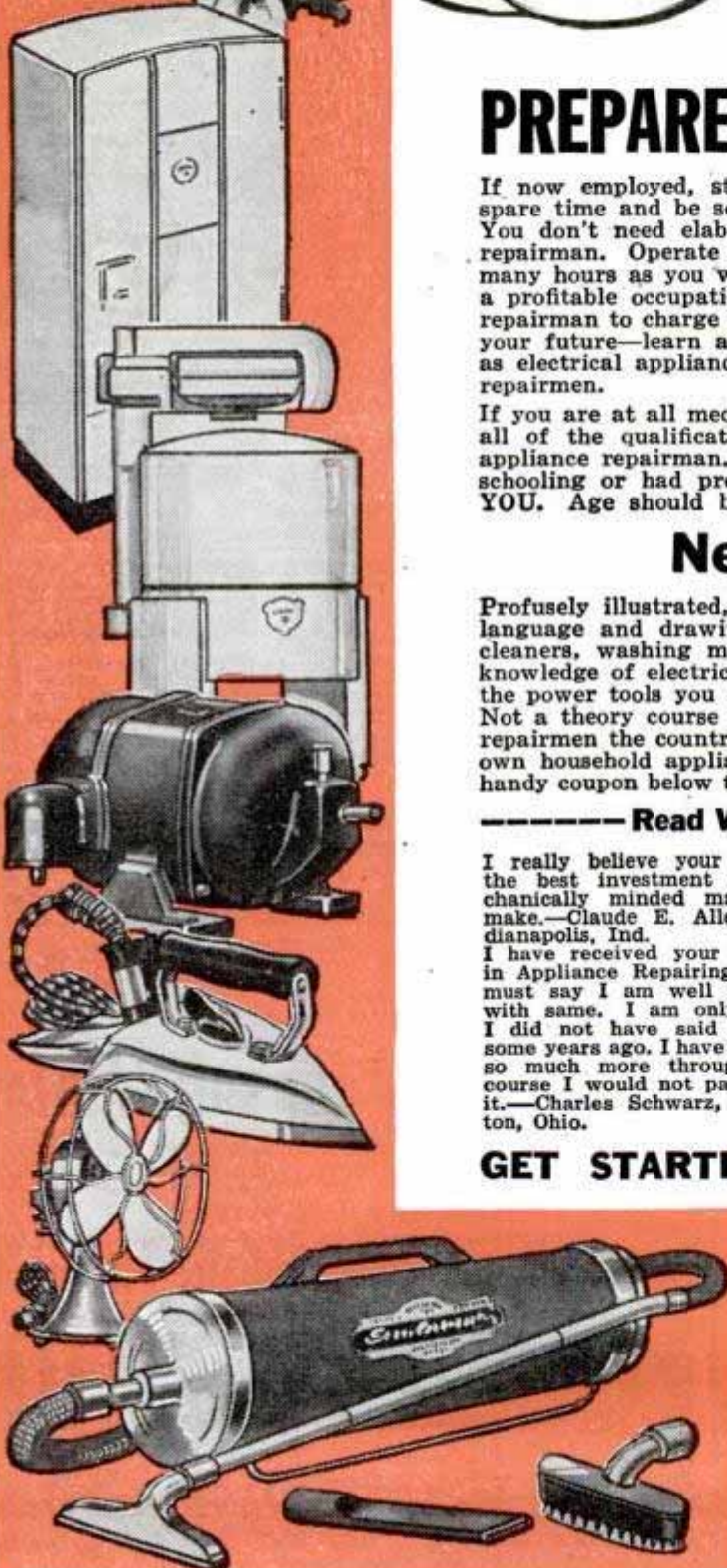



BE A
**DIESEL
EXPERT**
Training Books
on Approval
Send No Money

Prepare NOW for the BIG opportunities in Diesel Power—revolutionary power for railway trains, trucks, buses, tractors, boats, power plants, construction equipment, etc. Fit yourself for a better, more permanent job.

Latest 6 Volume Edition

is packed full of up-to-date and easy-to-learn facts about Diesel design, manufacture, operation and repairing. Written in simple language by prominent Diesel authorities. Over 3400 pages. Hundreds of illustrations and diagrams. Durable bound. Start at once to master this New, Big-Pay Profession. Send the coupon. Examine the books. If you are not thoroughly satisfied, return them and you'll not owe us a cent. Don't delay. Send today.

AMERICAN TECHNICAL SOCIETY, Vocational Publishers Since 1898
Dept. 0319, Drexel at 58th Street, Chicago 37, Ill.
Send for 10 days' free trial, 6 volumes on Diesel Engineering. I will pay delivery charges only. If I decide to keep them I will send \$2.00 in 10 days, then only \$3.00 a month until \$29.80, total price, is paid. If not satisfied, I will return books in 10 days and owe you nothing. Include Consulting Service Privilege.

Name.....
Address.....
Please attach letter stating age, occupation, employer's name and address, and name and address of at least one business man as reference. Men in service, also please give home address.

**PLUMBERS
& STEAM FITTERS**
Audels Plumbers and Steamfitters Guides
4 Vols. \$6



A practical, illustrated, Reference Library and Study-Course for Master Plumbers, Journeymen and Apprentice Steamfitters, Gas Fitters and Helpers, Sheet Metal Workers, Draughtsmen, Master Builders, Engineers and all Building Trade Students. This valuable set of handy, pocket-size Guides explains in practical concise language and well-done illustrations all the principles, advances and short cuts of the Plumbing and Heating trade—based on modern practice. Contains careful, detailed instructions

on how to figure and estimate various jobs. Use FREE COUPON below to examine, without obligation, this valuable work.

INSIDE TRADE INFORMATION ON:

Soldering, tinning. Joint wiping, bending, beating. Pipe—iron—steel, threading. Mathematics, tables, physics. Materials—iron, steel, copper, brass, lead, tin, antimony, etc. Sheet metal—galvanized—plate. Sanitation, siphonage, tanks. Drainage, sewage, purification. Fixtures—bath—kitchen. Pipe fittings, soil pipe, tools. Laying out work. Roughing. Screwed fittings, flanges, joints. Pipe bending, examples. Elbows. Heating, ventilation, air conditioning, refrigeration. Water supply, mains, wells, tanks. Gas-fittings. Sheet metal work, problems, methods. Brazing, heating, lead burning. Welding, various welds, methods. Blacksmithing, forges, tools. Air Conditioning.

THEO. AUDEL & CO., 49 W. 23rd St., New York City

Mail Audels Plumbers Guides, 4 vols., on 7 days' free trial. If O. K. I will remit \$1 in 7 days, and \$1 monthly until \$6 in paid. Otherwise I will return them. No obligation unless I am satisfied.

Name.....
Address.....
Occupation.....
Reference..... PM



NO Waiting to LEARN
Start at Once to EARN!
This BIG BOOK SHOWS HOW

If it's Results you want, you can get action quickly with this practical book. Never before has a more helpful book been printed for those planning a business of their own. Gathered in this large illustrated volume are the formulas, recipes, facts and secrets that have contributed so largely to America's great industrial progress. Capitalize on this information for making most any conceivable product without experience, special equipment or previous knowledge of chemistry. Start at home, expand with profits—build for a profitable independence.

The experts who compiled this book are authorities, and present this information in simple, understandable language. They also give you wholesale supply sources for needed material, short cuts and economy methods for the most profitable results. Hundreds of good paying businesses have been built on a product made from a simple recipe. Opportunities in this field exist everywhere. Choose from any of the 162,000 facts and 10,000 formulas of which the following are only a very few: Adhesives, Alloys, Anti-Freeze Solutions, Cosmetics, Beverages and Liquors, Candy, Gum, Casein, Celluloid, Ceramics, Cheese, Cleaning Preparations, Concrete, Copper, Cotton, Dentifrices, Depilatories, Dyes, Embalming Fluids, Eosmelling, Glass, Glazes, Household Formulas, Inks, Insecticides, Iron, Jewellers' Formulas, Lacquers, Laundry Preparations, Leather, Linoleum, Lubricants, Manicure Preparations, Marble (artificial), Metals, Mirrors, Oils, Ointments, Paints, Paper, Perfumes, Photography, Polishes, Powders, Remedies for Man, Beast or Fowl, Rubber Products, Refrigerants, Soaps, Solder and Soldering, Tooth Cements, Transfers, Transparencies, Varnishes and Thousands of others for making all sorts of profitable and practical things.

**10,000 FORMULAS, RECIPES
SECRET PROFIT IDEAS**



Cloth Bound
Size 5 1/2" x 8 5/8" x 2 1/4"

Prepare for "After-War-Business"

Especially recommended for ex-Servicemen and ex-War Workers planning a profitable business of their own. This comprehensive book is an accepted authority by chemists, schools, industry, etc. and is the largest and most comprehensive book of its kind ever issued. Nothing else like it in existence. A single formula has been worth a thousand times this book's small cost to countless owners. Crammed with money-making ideas, invaluable for reference. Ideal for Factory, Home, Farm, Office or Workshop. As necessary as the dictionary and more useful for manufacturers, chemists and salesmen who put up products for profit.

This Complete Book Only
\$2.98
POST PAID

Worth More

ALSO INCLUDED! Formulas for "D.D.T." Insecticide. Also our New Book of Money Making Facts: "The More You Know the More You Can Earn—Easier and Quicker." Ambitious Folks! Profit by this valuable information.

Immediate Shipment—Safe Delivery Guaranteed, \$2.98 postpaid, Canada or Foreign, \$3.25 U. S. Funds. (C.O.D. shipments U. S. A. only.)
ADAMS BROWN COMPANY Books of Applied Science
Dept. 303, Chestnut Hill 67, Massachusetts, U. S. A.

ENGINEERING DEGREE IN 27 MONTHS
INDIANA TECHNICAL COLLEGE
Aeronautical, Chemical, Civil, Electrical, Mechanical, and Radio Courses, B.S. degree, 1-yr. diploma in Electrical, Mechanical, and Radio Service; Drafting, Prep. courses, Gov't. approved for GI's. Low rate. Earn board. Large industrial center. Demand for graduates. Enter March, June, Sept., Dec. Catalogue, 536 E. Washington Blvd., Ft. Wayne 2, Ind.

THERE'S MONEY IN CARTOONS!
RAYE BURNS will teach you HOW TO CREATE ORIGINAL CARTOONS at home that you may SELL! Course contains 26 lessons and over 600 illustrations. All for only.....
\$2.85
Send name and address for free details.
RAYE BURNS SCHOOL, Dept. M, Box 3583, CLEVELAND, OHIO

What Every Mason Wants
We have important Masonic books for Blue Lodge, Chapter, Commandery, Scottish Rite, and Shrine.
Our Rituals Are Used the World Over. Send for free catalog of books and rituals for Masons, Odd Fellows, Knights of Pythias, Knights of Columbus, etc.
EZRA A. COOK, Publisher, P. O. Box PM, Chicago 90, Ill.

LEARN MEAT CUTTING At Home—In Spare Time
Get into the vital meat industry. Concise, practical Home Training based on 25 years proven instruction methods used at National's famous resident school. Prepares you for bigger pay as Meat Cutter, Supervisor, market manager or more money in your own store. Go as rapidly as your spare time permits. Diploma. Start NOW to turn your spare hours into money. Send for FREE bulletin today. No obligation.
National School of Meat Cutting, Inc., Dept. U-67, Toledo 4, Ohio

INVENTORS

... THE TIME IS RIPE FOR

Action!



You men . . . and women . . . with ideas for patentable inventions—OPPORTUNITY IS KNOCKING! American industry WANTS your ideas for new products, new processes, time-and-labor saving devices to offer to a public with money to buy after the war is won. You see evidence of this every day in the newspapers . . . MANUFACTURERS

ACTUALLY ARE ADVERTISING FOR IDEAS! And they want them NOW.

Don't wait! Get going now! Have your patent application prepared and prosecuted just as quickly as you can—and be in a position to cash in. Remember—most manufacturers will consider an idea ONLY if you have taken steps to protect it with a patent.

HOW WE HELP INVENTORS

For 48 years, Victor J. Evans & Company, has helped inventors secure strong patents. Our experienced staff does all the work for you—makes the search, prepares the drawings for submission to the United States Patent Office, prepares all necessary papers, pushes the prosecution of your claim to a speedy conclusion. *And reports to you every step of the way.*

Sure—you can do it yourself. But think of the lost time, the travel expense, the lost motion! Many successful inventors use—and recommend—the services of an experienced patent attorney.

You can't go wrong when you select Victor J. Evans & Company—a firm that has helped inventors for nearly 50 years—to handle your patent application for you.

HERE'S THE FIRST THING TO DO...

Send coupon below for FREE BOOKS

that tell you everything you should know about patent procedure . . . outline and illustrate clearly every step you should take . . . illustrate 115 fundamental mechanical movements, information that may help you complete your invention. And they're yours for the asking!

With books we also send FREE Evidence of Invention Form that may help you establish your claim.



MAIL THIS COUPON TODAY FOR QUICK ACTION!

VICTOR J.
EVANS & Co.

Merlin M. Evans

REGISTERED PATENT ATTORNEY

130-C Merlin Building
Washington 6, D. C.

Please send me your books, "Patent Protection" and "When and How to Sell Your Invention"—also important "Evidence of Invention" form, without cost or obligation.

Name.....

Address.....

City and State.....



For Men Who are Trained in **AUTO BODY & FENDER WORK**

Men 18 to 60. Want a future with good pay, perhaps a business of your own later? If you are mechanically inclined, start now to learn to become an auto body mechanic and fender repair man. This fast growing field has great possibilities for trained men with experience. U.E.I. spare time, home-study training combined with actual shop practice gives you sound, basic knowledge of latest, best methods so you may get the experience which may bring you big pay. Capable instructors supervise your studies and actual practice on automobiles. Course includes acetylene welding, spray painting, use of hand and power tools.

THOROUGH, RELIABLE TRAINING

U.E.I. has trained men for new opportunity fields since 1927 and many students are now making good. Auto body and fender repairing is one of the best profit-makers in any garage or service station. Little capital required for mechanically inclined men to get into this business. Free employment placement service, or we will show you how to start your own shop. Get the facts FREE, without obligation. Write today.

UTILITIES ENGINEERING INSTITUTE

AUTO-CRAFTS DIVISION
1314 Bolden Avenue, Dept. 136X Chicago 14, Ill.

Gentlemen:—YES! I want to get into profitable Auto Body and Fender Repair Work. Please send me FREE FACTS at once. This inquiry does not obligate me in any way.

Name _____ Age _____
Address _____
City _____ Zone _____ State _____

Learn this Profitable Profession



**IN 90 DAYS
AT HOME**
**Money-Making Career Open
to Men and Women, 18 to 50**

Hundreds of men and women between 18 and 50 make \$10 to \$20 in a single day giving scientific Swedish Massage and Hydro-Therapy treatments. There is big demand from doctors, hospitals, sanatoriums and clubs. Graduates earn large full time incomes from these or in private practice in their own offices. Others make good money from home treatments given in spare time. Learn this interesting, money-making profession in your own home, through our home study course. Same instructors as in our nationally known resident school. You can win independence and prepare for future security by qualifying for your Diploma. Course can be completed in 3 to 4 months. Many earn while they learn. Begin your training at once.

Anatomy Charts & Booklet FREE

Enroll now and we will include, at no extra cost, many needed supplies. Fit yourself to help meet growing demand for Scientific Swedish Massage. Send the coupon at once for complete details. Anatomy Charts and 32-Page Illustrated Booklet, FREE, postpaid.

THE COLLEGE OF SWEDISH MASSAGE
Dept. 664-C, 100 East Ohio St., Chicago 11, Illinois

Please send me FREE and postpaid, Anatomy Charts, 32-page Booklet and complete details on Home Training.

Name _____
Address _____
City _____ State _____



Get Started in Radio

TEN "HOW-TO-DO-IT" BOOKS

Get a solid foundation in radio by means of these 10c timely text books. Each clearly written, profusely illustrated, contains over 15,000 words. You'll be amazed at the wealth of information packed into these handy books. Excellent for reference—ideal for technical library. Your money back if not satisfied.

5 Books for 50c - 10 Books for \$1
SENT TO YOU POSTPAID

- No. 1—How To Make Short Wave Sets
 - No. 2—How To Make Popular All-Wave Tube Receivers
 - No. 3—Alternating Current for Beginners
 - No. 4—All About Aerials
 - No. 5—Beginners' Radio Dictionary
 - No. 6—How To Have Fun With Radio
 - No. 7—How To Read Radio Diagrams
 - No. 8—Radio for Beginners
 - No. 9—Simple Electrical Experiments
 - No. 10—Television
- Remit by check or money order—register letter if you send cash or stamps.
RADIO PUBLICATIONS, 23M West Broadway, New York (7)

Learn LANDSCAPE GARDENING!

Prepare for the giant postwar home-building program. A thorough, constructive, interesting home-training for those who wish to become LANDSCAPERS, DESIGNERS, GARDENERS, etc., for profit or pleasure. Write today for FREE INFORMATION, without obligation, to

NATIONAL LANDSCAPE INSTITUTE

Dept. P-3 756 So. Broadway Los Angeles 14, California

MAGIC LIQUID Prints Photos

On Wood, Leather, Cloth, Cards Letterheads or almost any surface. Use any snapshot or other negative. Make hundreds of prints without harming negative. Won't wash off. Easy to use. Complete kit for 100 or more photos now only \$1.00 postpaid, or \$1.29 C.O.D. (Canada \$1.50 money order only; no C.O.D.'s). Satisfaction positively guaranteed. Rush order today for the original, big, complete Magic Photo Printing Outfit.

L. & M. PHOTO CO.
Dept. 300-H, 229 W. Breckinridge, Louisville 3, Ky.

ACCOUNTANT

BECOME AN EXPERT

Executive Accountants and C. P. A.'s earn \$2,000 to \$10,000 a year. Thousands of firms need them. We train you thoroughly at home in spare time for C. P. A. examinations or executive accounting positions. Previous experience unnecessary. Personal training under supervision of staff of C. P. A.'s. Placement counsel and help. Write for free book, "Accountancy, the Profession That Pays."

LASALLE Extension University, 417 So. Dearborn St.
A Correspondence Institution Dept. 364-H Chicago 5, Ill.

ARTISTS MAKE MONEY

Do you like to draw? Send name, address, age and occupation for FREE ART TEST, to find out your ability.

ART INSTRUCTION, Inc.
3136 ART INSTRUCTION BLDG., MINNEAPOLIS 15, MINN.

LAW

STUDY AT HOME FOR PERSONAL SUCCESS and LARGER EARNINGS. 35 years expert instruction—over 108,000 students enrolled. LL.B. Degree awarded. All texts furnished. Easy payments. Send for FREE BOOK—"Law and Executive Guidance."

AMERICAN EXTENSION SCHOOL OF LAW
Dept. 63M, 646 N. Michigan Ave., Chicago 11, Ill.

Photography

for **PLEASURE or PROFIT**

Learn at home. Spare time. Practical basic training. Long-established school. Many have earned while learning. Send coupon below for free booklet, "Opportunities in Modern Photography" and full particulars.

AMERICAN SCHOOL OF PHOTOGRAPHY
1315 Michigan Avenue Dept. 1353 Chicago 5, Illinois

Send booklet, "Opportunities in Modern Photography," full particulars and requirements.

Name _____ Age _____
Address _____
City _____ Zone _____ State _____

AVIATION *Career*

MAXIMUM TRAINING IN MINIMUM TIME

**CAL-AERO TECH. TRAINING will ADD DOLLARS
to YOUR pay check all the rest of YOUR life!**

Your future **EARNINGS** depend upon your *training*. A wise investor always determines in advance what the return on his investment will be before he puts cash "on the line." You who plan to invest in a course of training, for a future career, **MUST** do the same. It is even more important to you, because your choice of training will determine **HOW MUCH MONEY YOU WILL MAKE THE REST OF YOUR LIFE**. Specializing in *Aeronautical Engineering* and *Master Aviation Mechanics* since 1929, Cal-Aero Technical Institute training is carefully designed to do just **ONE THING—MAKE MORE MONEY FOR YOU**. An alumni of over 6000 proves that **CAL-AERO TECHNICAL TRAINING** can get results and increase your pay check. **CAL-AERO** has provided its graduates with a profitable occupation, and secure future since it trained them in advance for the highest position they could ever expect to occupy. **IT CAN DO THE SAME FOR YOU.**

We invite your consideration, investigation and comparison. Send coupon **TODAY**.

VETERANS

Train in Sunny Southern California. Cal-Aero Technical Institute is on the list of approved schools on file with the Veterans' Administration, making discharged servicemen attending Cal-Aero eligible for the educational benefits, as provided under the "G. I. Bill of Rights."

Write us—we will be happy to help you with your future plans. Many ex-servicemen are now enrolling and taking advantage of these benefits here at Cal-Aero.

CAL - TECHNICAL  **AERO INSTITUTE**

MAJOR C. C. MOSELEY

PRES. SINCE 1929

FORMERLY CURTISS-WRIGHT TECHNICAL INSTITUTE

**GRAND CENTRAL AIR TERMINAL
GLENDALE 1, CALIFORNIA
LOS ANGELES COUNTY**

"DON'T MISS THE BOAT" — MAIL THIS COUPON TODAY!

Cal-Aero Technical Institute, Grand Central Airport, Glendale 1, California
Please send full information and illustrated catalog on Aviation Training
FREE—without obligation. Dept. PM-3

NAME _____ BIRTH DATE _____

STREET _____

CITY _____ STATE _____

I PLAN TO ENROLL—Month _____ Year _____

AVIATION'S MOST DISTINGUISHED SCHOOL OF AERONAUTICS

OFFERS LOW COST LIFE INSURANCE

Postal Life offers \$1724. in Protection for \$2.00 monthly (age 21). Other Ages in Proportion

THIS PREMIUM HALF PERMANENT RATE

Policy Fully Paid-up in 30 years

NEW YORK, Saturday. Postal Life of New York, unique among important Old Line, Legal Reserve Life Insurance Companies, is again offering this special modified policy, already owned by thousands of American families. You pay half the permanent rate until the 6th year; \$2.00 monthly for substantial amounts of Protection, depending on age! \$2.00 monthly pays for \$1754. of life long protection at 20; \$1142. at 40; \$5.00 monthly buys \$3650. at 30, etc. Proportionate amounts at other ages. You pay no premiums after 30 years; policy fully paid-up and in force your entire life.

For your convenience we print below a coupon that can be clipped and sent to Postal Life. Full information, rates, etc., will be sent to you promptly. There is no obligation to buy but we advise immediate action. Life Insurance is vital to your future and your family's welfare. Postal Life Insurance Company, 511 Fifth Avenue, New York 17, N. Y.

Postal Life Insurance Company
511 Fifth Ave., Dept D-549, New York 17, N. Y.

Mail rates and full details about your "\$2.00-per-month", 30-Payment Life Policy at my age.

Name _____
Occupation _____ Date of Birth _____
Address _____

Include P. O. District Number, if any

AIR RIFLES BENJAMIN **AIR PISTOLS**

ORDERS NOW ACCEPTED

EARLIEST POSSIBLE DELIVERY REALLY ASSURED—ACT NOW!

ORDER Latest Models BENJAMIN AIR RIFLES & BENJAMIN AIR PISTOLS AT ONCE. Send for our FREE ILLUSTRATED FOLDER and complete Specifications TODAY. BOTH CALIBRE BENJAMIN H-C PELLETS ARE AVAILABLE NOW.

BENJAMIN AIR RIFLE CO., 812 MARION ST., ST. LOUIS 4, MO.

FIX TYPEWRITERS

A Simplified Practical Homestudy Course. Many of our Students now have their own Business—Many Repair for others. Repair Shops Swamped. Health or Age no handicap.

WEBER TYPEWRITER MECHANICS SCHOOL
Box 269, Osborn, Ohio



HUNTING and FISHING



HUNTING and FISHING

is a monthly magazine crammed full of hunting, fishing, camping, dog and boating stories and pictures, invaluable information about guns, fishing tackle, game law changes, best places to fish and hunt—countless ideas that will add more fun to your days afield.

Special Trial Offer

Send 25c in stamps or coin and we will send you Hunting & Fishing for six months.

HUNTING & FISHING MAGAZINE

251 Sportsmen's Bldg., Boston, Massachusetts

INTRODUCING—New Victory Model
HANDIWELD ELECTRIC
ARC WELDER

RETAILS ONLY

\$1.95

FULLY GUARANTEED



PLUGS into LIGHT SOCKET

VICTORY Model Handiweld Arc Welder operates from 110 volts, A. C. or D. C. current same as other arc welders higher priced; generates tremendous heat to weld all metals. Not a toy welder that uses carbons, but actually uses standard coated rods—sizes 1/16" and 3/32". Generous quantity of 1/16" and 3/32" rods supplied with the welder. Guaranteed not to burn out. Repairs fenders, auto bodies, radiators, machinery parts, etc. Take Victory Model Handiweld anywhere to job, operate right from light socket. You'll find a thousand uses for this welder around your home, garage, workshop. Also in garages, factories, repair shops, tin shops; mechanics, inventors, plumbers, farmers, etc. Order a "VICTORY MODEL" HANDIWELD today!

SEND NO MONEY We'll rush one to you with rods, helmet, operating instructions, and all necessary parts with the exception of a large jar and small piece of extension cord; these most everyone has. Pay postman only \$1.95 plus few cents p'st'ge. If not delighted return Victory Model Handiweld in 6 days from receipt and money paid for it will be refunded promptly. Rush your order now.

KUMFY PRODUCTS, Dept. F-202, Cincinnati 25, Ohio

Correspondence Courses in
RADIO and ELECTRICAL ENGINEERING

LOW AS \$25

LEARN TO ASSEMBLE THE AMPLIFIER

ELECTRICAL ENGINEERING. Get good grasp of wide electrical field. Modern. Very understandable. Theory made easy.

RADIO ENGINEERING. Extra fine course in radio, public address, photo-electric work. Trains you to be super-service man, real vacuum tube technician. Tuition ONLY \$25, either course. Deferred payment plan. Services needed badly.

FREE Write for free copies of school catalogs, student magazines, etc.

FREE LINCOLN ENGINEERING SCHOOL, Box 931-P87, Lincoln, Nebr.

Learn Public Speaking

Learn theory and fundamentals at home—in spare time. Then acquire actual experience and practice. Send for FREE booklet "Power of Effective Speech."

North American School, Dept. 1353
1315 S. Michigan Ave., Chicago 5, Illinois

Learn BAKING At Home



Baking is one of America's high industries in wages. Nearly depression-proof. Thorough basic home course lays sound foundation. If you have aptitude, write for FREE BOOKLET, "Opportunities in Commercial Baking."

National Baking School, 1315 Mich. Ave., Dept. 1353, Chicago 5

STAMMER?

This new 128-page book, "Stammering, Its Cause and Correction," describes the Bogue Unit Method for scientific correction of stammering and stuttering—successful for 45 years. **Benj. N. Bogue, Dept. 1834, Circle Tower, Indianapolis 4, Ind.**

GET THIS FREE BOOK!

PRINT ANY PHOTO

on Paper, Cloth, Leather or Wood

SIMPLE, EASY TO USE

Magic liquid takes only 2 minutes to reproduce any snapshot you have on to stationery, handkerchiefs, ties, scarfs, etc. Won't wash off. Won't hurt negative or fabric it's used on. Personalize your belongings! An ideal gift. Complete outfit enough to transfer 100 photos—only \$1.00 postpaid. Sent C.O.D. for \$1.21.

CHRISTY PHOTO SUPPLY, Dept. 2310
2835 N. Central, Chicago 34



NOTICE: Over 100,000 ambitious men have been helped to higher paying jobs with the aid of books listed on this page.



Which of these books can help you GET A BETTER JOB AND MAKE MORE MONEY

CHECK THIS LIST OF MONEY-MAKING BOOKS

WOODWORKING

- 1. **CARPENTRY CRAFT PROBLEMS.** 320 pages explain and illustrate hundreds of practical solutions to all types of carpentry problems met by the amateur and professional woodworker. Complete in every detail...\$2.50
- 2. **BUILDING—FORMS, STAIRS, ROOFS.** Latest information on how to build forms, staircases, roofs, etc., correctly. For carpenters and their helpers. 250 pages, illus....\$2.50
- 3. **WOODEN BOAT AND SHIP BUILDING.** Solves every type of problem in building wooden boats and ships. 244 pp., illust...\$2.25
- 4. **HOW TO MAKE RUSTIC FURNITURE.** Hundreds of ideas and plans on making all types of rustic furniture for the home. Completely illust., thoroughly described.....\$2.00
- 5. **WOOD TURNING.** An excellent book for every home craftsman. Tells and shows how to do the most artistic work. Numerous photos and many detailed drawings.....\$2.50
- 6. **MODERN HOMECRAFT.** 240 pages of ideas for modern home furniture and how to make it. Scale drawings, fully illust...\$3.50
- 7. **BLUE PRINT READING.** A practical book that shows how to read and interpret blue prints. 111 pages, 69 illust.....\$1.50
- 8. **CONCRETE DESIGN AND CONSTRUCTION.** 508 pages, 251 illust. A new and enlarged edition covering all phases of concrete work and how to do it.....\$4.75
- 9. **HOME REMODELING.** An excellent book for those planning remodeling. Gives hundreds of ideas that save money and add beauty to the finished job. 528 pages, 319 illust. and 12 tables.....\$5.00
- 10. **HOW TO PLAN A HOUSE.** Here's a book for every person who ever intends to build their own home. This book shows how to design every single part of a modern house to save you the most money. 525 pages, 8 full size blueprints.....\$5.00

PAINTING

- 11. **HANDBOOK OF ORNAMENT.** For artists, designers, jewelers, architects, etc. Topics covered include: Elements of Decoration, Decorated Objects, and Ornaments as applied to Features. 3,000 illus., 548 pages.....\$5.00
- 12. **INTERIOR WALL DECORATION.** Practical working methods for plain and decorative wall finishes. 185 illus., 491 pages.....\$3.00
- 13. **THE MIXING OF COLORS AND PAINTS.** How to mix colors for interior decorating, arts, crafts, general mixing methods. 302 pages, fully illust.....\$2.50

SPECIAL If your purchase totals \$10.00 or more, and remittance is enclosed with order, we will send you any \$2.00 book you choose absolutely FREE.

- 14. **SPRAY PAINTING.** Spraying technique and operating instructions on paints, materials, finishes. 125 fully illust. pages....\$2.00
- 15. **HOUSE PAINTING METHODS.** 400 pages and 150 illust. cover the subject of house painting (of any surface) thoroughly....\$2.50
- 16. **WOOD FINISHING.** Wood finishes and problems, tools, materials... 353 illust...\$2.50
- 17. **GRAINING.** A 240 page comprehensive book of instruction on the art of graining all surfaces. Many natural color plates....\$3.50

- 18. **CYCLOPEDIA of PAINTING and DECORATING.** Covers methods, tools and materials for the home and workshop, including every branch of painting and decorating. Any particular job is fully explained with large illustrations to clarify text. 350 pages.....\$3.50
- 19. **PAPERHANGING.** A practical book that shows you how to do your own papering and save many times the cost of this book. Plenty of illustrations. Over 200 pages.....\$2.50
- 20. **FURNITURE, FURNITURE FINISHING, DECORATION and PATCHING.** Practical new book that covers Period Furniture, Furniture Decoration, Patching, Finishing and many special finishes. 580 pages, 360 illust.....\$5.00

Guarantee

Gateway Books are guaranteed to be absolutely satisfactory in every respect, or your money will be cheerfully refunded.

**The GATEWAY BOOK CO., Dept. PM-15
32 N. State — Chicago 2, Illinois**

AUTOMOTIVE SERVICE MANUALS JUST RELEASED!

Just released as Civilian Editions published for the most complete and authoritative information available. They cover all phases of repair and service and are specifically designed to be a source of information for all interested in automotive work. Books may be bought separately or in the money saving sets. Order books and sets by specific number.

SET NO. 1

- 21. **VOL. 1: The Service Station, frames, wheels, suspension, steering and ride control, transmissions, clutches, universals, front and rear systems and brakes.** App. 550 pages.\$4.00
- 22. **VOL. 2: Power Plants, Oil and Cooling Systems, Engine Repair and Maintenance, Fuel and Ignition Systems, Automotive Electricity.** Over 600 fact filled pages to help you...\$4.50
- 23. **Combination Price, the above two vols. \$8.00**

SET NO. 2

- 24. **The Engine**\$1.50
- 25. **Cooling, Lube and Fuel Systems**...\$1.50
- 26. **Automotive Electricity**\$1.50
- 27. **The Power Flow**.....\$1.50
- 28. **Chassis Units**\$1.50
- 29. **Combination Price, the above 5 volumes bound in paper, app. 300 pages.....\$6.75**

REFRIGERATION - PLUMBING AIR CONDITIONING

- 30. **REFRIGERATION SERVICE MANUAL.** Domestic and Commercial refrigeration used in markets, milk depots, soda fountains, home refrigerators are all covered so you can service any of these and many other units easily.\$2.50
- 31. **PLUMBING INSTALLATION and REPAIR.** Practical 236 page book tells how to repair leaky faucets, clogged toilets, drains, pipes, traps, vents etc. 153 illust.....\$2.50
- 32. **HEATING COOLING and AIR CONDITIONING.** 706 pages on heating of all types, cooling, Air Conditioning, equipment, furnaces, controls, etc. 64 charts, 351 illus...\$4.50

ELECTRICITY

- 33. **PRACTICAL ELECTRICITY and HOUSE WIRING.** An ideal book for around the home because it debunks all the mysteries of electricity and shows you how you can save plenty by doing all of your own wiring...\$2.00
- 34. **ARMATURE and MAGNET WINDING.** The construction of armatures and their repairs are fully covered with illust....\$2.00
- 35. **HOUSE WIRING MADE EASY.** Layout and plans for all phases of house wiring...\$1.50

METAL WORKING

- 36. **WELDING.** Arc, spot, butt and electric welding, etc. 280 pages, illust.....\$2.00
- 37. **SHEET METAL WORKERS MANUAL.** Complete instructions and information on every phase of sheet metal working. Includes many tables. 552 pages, 375 illust.....\$3.00
- 38. **METAL SPINNING.** A new art of proven popularity. Step-by-step descriptions of the various phases of the craft show you how to make the most out of your metal work...\$1.75
- 39. **METAL SPINNING PROJECTS.** Tells how to make bowls, lamps, serving dishes, book ends, candle sticks, etc. Complete working patterns and instructions.....\$2.75

HOBBIES

- 40. **TIN CAN PROJECTS.** Tells how to turn tin cans into objects of beauty that command high prices and praise. This handy book has all the working patterns and designs...\$1.50
- 41. **LEATHER WORKING.** Tells of tools, materials and equipment needed. Gives working drawings of key holders, billfolds, book marks, coin purses, belts, frames, etc...\$2.00
- 42. **HOW TO WHITTLE AND CARVE.** Complete directions for all types of whittling and carving of toys, jewelry, and novelties, etc. Illustrations simplify the work.....\$2.75
- 43. **CREATIVE CRATE CRAFT.** Tells how to make clever and useful pieces of furniture from discarded crates and boxes.....\$2.00
- 44. **IDEAS FOR THE YARD.** Novel book that gives hundreds of suggestions and plans for things you can make for your yard...\$1.50

CHECK, CLIP AND MAIL THIS COUPON NOW

THE GATEWAY BOOK CO., 32 N. State St., Dept. PM-15, Chicago 2, Illinois

Please send the books I've circled. If C.O.D., I'll pay postman cost of books plus few cents postage and handling charge. If prepaid, Gateway pays all charges. If any book is not satisfactory, I will return it in 10 days and you will refund my money. No C.O.D.'s outside the U.S. Remit in U.S. funds.

1 2 3 4 5 6 7 8 9 10 11 12 13 14 15 16 17 18 19 20 21 22
23 24 25 26 27 28 29 30 31 32 33 34 35 36 37 38 39 40 41 42 43 44
(Please print name clearly)

Name.....
Address.....
City.....Zone.....State.....

How to Make Money by Mail

Down-to-earth facts, directions (illustrated) for running business profitably, using expertly for your good fortune the employees, trains, planes which Gov't places at your disposal **CHEAP**. Get orders by mail, ship by express or freight or mail, **get out of the kindergarten**... 3rd printing of this book now selling. It's **YOUR** winner.

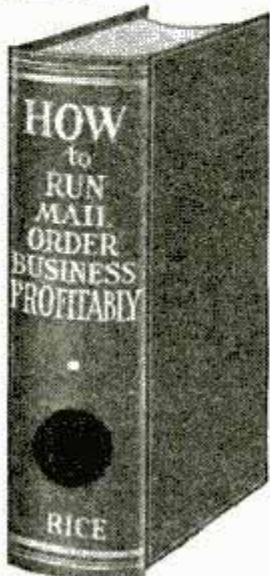

THE EASY WAY to start new or expand your present occupation. **Do it NOW.**

Extraordinary plain, simple skill, know-how. No theory. Fact story of rich experience of author E. Rice day-by-day. How many times have we heard: "I wish I had some money, this patent would earn me a fortune," or "why can't my crop pay better?" or "I wish I knew how to sell this gadget myself," or "why should my boss alone do this when I know too how the money is made?"... **Listen, you do not need money** to start this Rice way. His method **automatically** pays all bills same day rendered, no bank loans, pay as you go, no borrowing from relatives or friends, no salesmen. Also no worry, quickly a home of your own all paid for. **Rice paid off \$5000 in mortgages** a year after using this idea.

44 Years of PROOF

Sounds fishy? Sure, but this has been done steadily for 44 years, depression or no depression, by the author: that is why he wrote this book to pass the good word along. **Make it go with anything you have** which is salable. Rice made his plan work when living in one room in a city lodging house. **Turn your city or country home, your work, your hobby, into money.** How to get orders at cost of **only \$4** for each \$100 taken in. The popular error to avoid in trying for sales. **Business won free** while others have to pay for it. How to conceive the money-getting advertisement... Profitable changes from ordinary ideas and methods. Not usual cut-dried pattern. 60 adventures, a dictated book in **everyday talk**, no dictionary writing.

Take a chance on this book being worth a fortune to you and yours and send \$2.50. Book mailed same day order is received. Or ask two friends to chip in 25 cents each with your \$4c to get this book. Hundreds of buyers whose letters we show you declare emphatically its superlative goodness. Follow its easy pattern for success. Cloth-bound, 612 pp., 8 1/2 by 5 1/2. Best seller, 3rd edition now selling. Cut out the \$2.50 **HOW BOX** here, pin or stick it to sheet of paper bearing your name and address, mail in envelope with money order or check for \$2.50 to

HOW \$2.50

HOWARD ST. HOUSE, Melrose 76d, Massachusetts

RADIO ENGINEERING, Broadcasting, Servicing, Electronics, Aviation, Marine & Police Radio taught thoroughly. 48 weeks' Engineering course equivalent to 3 years' college radio work. Approved Veteran Training. Co-educational. Catalog free. **VALPARAISO TECHNICAL INSTITUTE, Dept. D, Valparaiso, Ind.**

YOU CAN LEARN TO DRAW

Be An Artist—We Train You at Home—in Your Spare Time
Plan your future career now in a field where training pays. We teach Art from the beginning and prepare you for a commercial art career. Trained artists are capable of earning \$30-\$50-\$75 A WEEK!

COMMERCIAL ART DESIGNING ALL IN ONE COMPLETE COURSE CARTOONING

Many of our most successful graduates never studied Art before enrolling with W.S.A. Since 1914 our well known, practical method has been training men and women for successful Art Careers. 2 ART OUTFITS with course. **FREE** book—"Art for Pleasure and Profit" tells all about our step by step training, what graduates say and commercial opportunities for you in Art.

FREE BOOK gives details

Washington School of Art, Studio 1230
1115—15th St., N.W., Washington 5, D. C.
Send me your free booklet and full particulars.

Name.....AGE.....
Address.....
City.....Zone (.....) State.....

STUDY AT HOME

With An Educational Institution
Men with specialized training win higher positions, insure larger earnings, and are bigger successes in business and public life. Opportunities NOW greater than ever before. Send for our Catalog.

ARTS and SCIENCES

Courses in Philosophy; Education; Letters; Public Health; Medical Jurisprudence; Psychology; Sociology; Physics; Chemistry; Plastics; Geology; Political Science; Theology; Business and Commerce; Accounting; Mathematics; Statistics; Agriculture.

ENGINEERING

Courses in Electrical, Civil, Mechanical, Drafting, Architectural, Steam, Aeronautical, Radio, Structural, Mining, Industrial, Petroleum, Marine, Chemical, Diesel, Automobile, Refrigeration, and Air Conditioning Engineering.

LAW

Complete Professional Law Course includes 20 Hornbook Series college grade textbooks. Courses also in Commercial Law, Patent Law and Medical Jurisprudence. **McKinlay-Roosevelt Incorporated, 4610-K, Sheridan Rd., Chicago 40, Ill.**

INVENTORS

WITH GOOD INVENTIONS

Should write us without delay for **FREE BOOKLET**, Protective Disclosure Form and facts about The Inventor's Most Logical Markets. Patented, Unpatented inventions, all kinds. Cash, Royalty, needed by specific manufacturers. If your invention is for sale, write today for full particulars. A Post-Card will do! Address:

THE INVENTION REPORTER
5C-11106 South Longwood Drive Chicago 43, Illinois

TRAIN Your VOICE!

Results GUARANTEED
We build, strengthen the vocal organs—not with singing lessons—but by sound, scientifically correct silent and vocal exercises and absolutely guarantee complete satisfaction with results. Write for Voice Book, **FREE**. Sent to no one under 17 years old unless signed by parent. **Perfect Voice Institute, Studio 1353, Kimball Hall Bldg., Chicago 4, Ill.**

WATCHES WANTED Broken or Usable
—all kinds, even Ingersolls. Highest prices paid for jewelry, rings, spectacles, gold teeth, etc. Cash mailed promptly. Write for Free Shipping Container. **LOWE'S, Holland Bldg., Dept. PM, St. Louis 1, Mo.**

Learn to Write

Begin today. Write now for our Free Book, "How to Become a Good Penman." It contains specimens and tells how others learned to write in spare time. Enclose 10c for your name beautifully written and a pen point suitable for shaded writing. Write today.
THE TAMBLYN SCHOOL OF PENMANSHIP
N-441 Ridge Building, Kansas City, Mo.

Say you saw it in POPULAR MECHANICS

DRAFTING SPRINGBOARD TO SUCCESS!

Increased salary, larger responsibilities, a real career instead of just a job—these are to be had by the trained draftsman. I.C.S. makes the way to thorough, practical training open to you. Check up and you'll find that nearly every "big name" American in engineering and production acquired experience at the drafting board. Many of them started by writing for the I.C.S. free booklet. Send for it today! It can be the most important act of your life.

INTERNATIONAL CORRESPONDENCE SCHOOLS BOX 5574-K, SCRANTON 9, PENNA.

Send me full information on the following subject:

Name.....Age.....
Home Address.....
City.....State.....
Present Working Position.....Hours.....A.M. to.....P.M.

**LEARN
AT HOME**

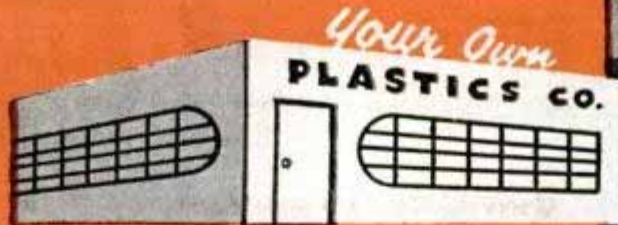

START YOUR OWN BUSINESS

PLASTICS

FABRICATION

New - Profitable Industry!



**MAKE PRODUCTS
LIKE THESE**

YOU'LL really enjoy learning plastics this new, interesting way! For you'll actually make beautiful, useful plastics articles during your home study training with Plastics Industries Technical Institute.

NOW'S YOUR OPPORTUNITY—Yes, the exciting age of plastics is here! Demands of war have caused phenomenal growth in the plastics industry—creating exceptional opportunities for those who know plastics. If you are a person with an eye to the future, you won't remain on the outside looking in—you'll want a choice position in the growing, expanding plastics field—or a plastics business of your own.

WE SUPPLY MATERIALS—For your interesting and practical work with plastics, we supply handsome, colorful, transparent rods, sheets and tubes of plastics from which you make useful, attractive creations. You saw, cement, machine, buff, form, dye, decorate, cast and laminate various types of plastics.

You also design your own plastics articles—develop your own ideas—express your originality. Earn money while learning.

A COMPLETE COURSE—This practical training in plastics fabrication is only *one* part of the Plastics Institute home study course. In addition, you learn about the many types of plastics, their manufacture, characteristics, properties and uses—intensive coverage of molding and mold design—testing and cost analysis—everything to help prepare you for your place in plastics.

START YOUR FUTURE TODAY—Mail the coupon below now! We will send you an interesting, illustrated free booklet with valuable information about plastics. We'll tell you how, at small cost, you can prepare for a future in this important industry while carrying on your present work. Don't put it off. Clip the coupon and mail it today!

VETERANS: ASK ABOUT G.I. TRAINING



FREE BOOKLET
Send For It Today!

NEW YORK

Dept. PM6-3, 122 E. 42nd St.

CHICAGO

Dept. PM6-3, 221 N. La Salle St.

LOS ANGELES

Dept. PM6-3, 1601 S. Western

SPECIAL RATES FOR SERVICE MEN

Plastics
INDUSTRIES TECHNICAL INSTITUTE

Plastics Industries Technical Institute
221 N. La Salle St., Dept. PM6-3, Chicago 1

Mail in Envelope or
paste on penny postcard

Gentlemen: Please send me the booklet "World of Plastics" and information on your training program. I understand there is absolutely no obligation.

Name.....Occupation.....

Street.....Age.....

City.....Zone.....State.....

Veterans: Check for special information. If under 18: Check for special booklet.

TRAIN for SUCCESS in the Poultry Business



Study at home in spare time. Earn extra while learning.

YOU CAN MAKE MONEY FROM POULTRY

Get ready now—the easy, scientific, inexpensive way! For 25 years, we've been helping thousands to greater success. During 25 years we have trained thousands of students, showing them how to establish poultry farms—how to avoid mistakes—how to cut losses—how to increase profits on established plants—how to have their own small profitable breeding plant and make a good living at it.

Proper management and "know-how" makes profits ANY season, for life. Our courses cover all phases of poultry raising, including plans for buildings, breeding, hatching, culling, sexing, caponizing, marketing, judging, exhibiting, and many others, etc., as planned by Harry M. Lamson, former Senior Poultryman for the United States Dept. of Agriculture. Endorsed by leading colleges, poultrymen everywhere. Write today for this Free Catalog "How to Raise Poultry for Profit." It fully describes courses, methods, service, opportunities, and easy payment plan.

National Poultry Institute
Dept. 50-H, Adams Center, N. Y.



YOU CAN SUCCEED....
Send For this Book Today!



Your Own PHOTOCOPY Business!

No Training Needed

AS LITTLE AS \$100

starts you in business for yourself

Start Right Out Making Money

Make photoexact copies of important papers, letters, drawings, photos, veterans' discharges, etc.—for local firms, lawyers, real estate men, accountants, advertising men, engineers, others. Every business is your prospect for error-proof, low-cost photocopies. New, amazingly simple method requires no lens, darkroom or training. For only \$100 you own your own business—with APECO, "America's Most Widely Used Photocopy Equipment." Easy to start... many prospects... quick results... pleasant work. A real money-making opportunity, good for a lifetime!

Get Full Information! MAIL COUPON NOW

AMERICAN PHOTOCOPY EQUIPMENT CO.
2849 N. Clark St., Dept. GF36, Chicago 14, Ill.

Please send me your illustrated book and details about the APECO business opportunity.

NAME.....
STREET.....
CITY & STATE.....

BECOME A SERVICE EXPERT

REFRIGERATION and AIR CONDITIONING

Millions of Older Units Need Expert Service. Big After-the-War Expansion Will Create Even More Opportunities

Approved for Veterans "G.I." Training

Now, not "next week," is the time to start training for a top-pay job in this vital field. A drastic shortage of trained service experts exists. Many thousands more will be needed for big post-war expansion caused by new industrial uses. Train NOW to get your pick of best jobs. We will give you the practical training you need. For 2 years we trained men and women for the Army and Navy only, in fine-precision aircraft instrument work. So our methods must be right. Common schooling is all you need. Our unique system makes everything easy to grasp. You can train at home and in our big Chicago shops. Write for full facts TODAY, without obligation.

INDUSTRIAL TRAINING INSTITUTE

2150 Lawrence Avenue, Dept. PIP, Chicago 25, Illinois

WHY DON'T YOU WRITE?

Writing short stories, articles on business, homemaking, hobbies, shop crafts, local and club activities, etc., will enable you to earn extra money. In your own home, on your own time, the New York Copy Desk Method teaches you how to write—the way newspaper men learn, by writing. Our unique "Writing Aptitude Test" tells whether you possess the fundamental qualities essential to successful writing. You'll enjoy this test. Write for it, without cost or obligation.

VETERANS: This course available for Veterans' Training.
NEWSPAPER INSTITUTE OF AMERICA
SUITE 559-C, ONE PARK AVENUE, NEW YORK 16, N. Y.



LEARN MOVIE PROJECTION THEATRE MANAGEMENT

The Motion Picture Theatre Business offers big opportunities for trained men. Get into a fascinating field with a post-war future. Train at home in spare time. Free Catalog. Established 18 years.

THEATRE INSTITUTE, 370 Washington St., Elmira, New York



Fix Your Own ALARM CLOCKS

New, practical home course. Just out. Makes interesting hobby—profitable too. Save money by doing your own repairing at home. Easy if you know how. Price now only \$1.00. Details FREE. Send postcard.

THIES JEWELRY STORE, Genoa 3, Illinois

FREE PUBLICATIONS

"THE UNIVERSAL GUIDE TO FREE PUBLICATIONS" on science, nature, mechanics, homemaking, etc. Only \$2.50 for 26 issues. SAMPLE FREE ON REQUEST.

RESEARCH PUBLISHING COMPANY
Room 622-P, 1328 Chestnut St. Philadelphia 7, Pa.

NOW . . . ELECTROPLATING

Learn this profitable, interesting trade. Hobby or full time business. Chromium, Nickel, Gold, Silver, etc. Postcard brings full details, FREE.

PLATER HYDE, Dept. M, P.O. Box 176, National City, Calif.

YOU CAN ADVANCE IN PLASTICS!

Plastics can be the next great industry . . . expanding as swiftly and largely as the automotive, radio and aviation businesses. Already, it is an important industry and a growing one. With I. C. S. training, you can take advantage of the many opportunities in Plastics today. At the same time, you prepare for the vast possibilities of tomorrow. Write for the free booklet containing full information! Do it right now!

INTERNATIONAL CORRESPONDENCE SCHOOLS
BOX 5574-K, SCRANTON 9, PENNA.

Send me full information on the following subject:

Name.....Age.....
Home Address.....
City.....State.....
Present Working Position.....Hours.....A.M. to.....P.M.

GET THIS
NEW BOOK
FREE

Just for
Examining this
New 1946 Electrical
**TROUBLE
SHOOTING
MANUAL**

COYNE
ELECTRICAL and RADIO
**TROUBLE
SHOOTING
MANUAL**

500 SHOP PRINTS and WIRE DIAGRAMS
HOW TO READ AND USE THEM
COYNE & LEWIS, INC. CHICAGO, ILL. 1946
NEW 1946 EDITION "TRUBLE SHOOTING MANUAL"
ELECTRICAL and RADIO TROUBLE
SHOOTING MANUAL

Sensational new 612-page "Coyne Electrical and Radio Trouble Shooting Manual". 500 shop prints and "how to use them"—plus many other practical features—all in one giant 8½" x 11" handsomely bound volume. New time saving, easy-to-follow methods of shooting trouble. Includes D. C. and A. C. Motors, Armatures, Switchboards, Electronic Controls, Radio Receivers; Auto Ignition, Refrigeration and Air Conditioning, etc. Most amazing book of its kind ever published. You get it FREE for 10 day trial *plus* the new book "Starting and Operating a Profitable Electrical or Radio Shop" as our outright gift to you. Rush coupon today for this amazing offer.

**... FREE with
TROUBLE SHOOTING MANUAL**

Act now and I'll include 1 full year of personal counsel from the Coyne Staff—technical advice by mail on any Electrical or Radio problem. A real help in your daily work.

ALSO FREE: 1 year subscription to Coyne Technical News—latest facts on Electrical and Radio Progress, illustrated and explained.

COYNE H. C. LEWIS, President
ELECTRICAL SCHOOL
500 S. Paulina Street, Dept. 36-R6, Chicago 12, Ill.

**JUST OFF
THE PRESS**

Starting and
Operating a
Profitable
**ELECTRICAL
or RADIO
BUSINESS**

SEND NO MONEY

Yes, that's right! You get Coyne's sensational new book "Starting and Operating an Electrical or Radio Shop" FREE—HERE'S MY OFFER—Mail the coupon below—and I'll rush you a copy of 1946 edition of Coyne "Electrical and Radio Trouble Shooting Manual" for 10 days free trial—*plus* FREE copy of my "Starting a Shop" book. Examine the "Trouble Shooting Manual" 10 days, *then* DECIDE. IF NOT 100% pleased return the manual and owe nothing—if you keep it, pay according to terms in coupon below. But **REMEMBER**, whether you keep the "Coyne Electrical and Radio Trouble Shooting Manual"—or return it—the "Starting and Operating an Electrical or Radio Shop" book is yours to keep FREE.

10 DAYS' FREE TRIAL

"Starting and Operating a Profitable Electrical or Radio Shop" tells you how to start full or part time Electrical or Radio Shop on small capital. Explains how to finance, choose a location, how and what to buy, advertising, salesmanship, business and legal angles, record keeping. For a Limited Time this amazing new book is given absolutely FREE... just for examining the sensational new 1946 edition of Coyne's "Electrical and Radio Trouble Shooting Manual" 10 days at our expense. ACT NOW—mail the 10 days' FREE TRIAL coupon today!

MAIL COUPON FOR FREE BOOK

H. C. LEWIS, President, COYNE ELECTRICAL SCHOOL, Dept. 36-R6, 500 South Paulina Street, Chicago 12, Illinois

O.K.—send me your new Coyne Electrical and Radio Trouble Shooting Manual, post-paid along with my FREE COPY of "Starting and Operating a Profitable Electrical or Radio Shop." Within 10 days after the books come I'll either return the "Trouble Shooting Manual" to you AND OWE NOTHING or send \$3.00 and \$3.00 a month until a total of \$8.95 is paid. Either way I keep the "Starting and Operating an Electrical or Radio Shop" book as my free gift.

Name _____

Address _____

Town _____ Zone _____ State _____

Occupation _____

SAVE 10% Send cash price, \$8.00 — you save over 10 percent. Same 10-day free trial and MONEY BACK SATISFACTION GUARANTEE.

Invitation to success!

We invite you to increase your chances of success in the electrical maintenance and repair field by studying these five books. Are you satisfied that you know all you can—to install all types of motors and generator units—make tests of switchboards—"trouble-shoot" on all kinds of electrical machinery?



The man who can tackle any wiring or motor problem can double-time march into a better paying job. You can get the "know-how" confidence you need from these experts—in five books thoroughly treating the very problems that may be worrying you now or that will come up tomorrow.

THE LIBRARY OF ELECTRICAL MAINTENANCE AND REPAIR

5 vols., 1826 pages, 1724 illustrations

These books were written by men who have been through practical shop stages of the game and have worked their way up to experts. They show you HOW—to install all types of motor and generator units—to inspect and repair motor starters and generators—to diagnose motor and generator troubles—to figure new windings for old cores—DC and AC windings—to test armature windings—test induction motors, etc., etc. One book is full of trouble-shooting charts that show quickly symptoms, causes, specific remedies, etc.

Help yourself to knowledge — Mail this coupon TODAY
No money down—special price—easy payments—FREE trial

McGraw-Hill Book Co., 330 W. 42 St., New York 18, N. Y.
Send me for ten days' free examination the Electrical Maintenance and Repair Library. If satisfactory I will send you \$1.00 in 10 days and \$2.00 monthly until the price of \$15.00 is paid. If not wanted I will return books postpaid. (To insure prompt shipment write plainly and fill in all lines.)

Name.....
Home Address.....
City and State.....
Company.....
Position..... PM-8-46

JUST OUT! NEW FROM COVER TO COVER

AUDELS REFRIGERATION and AIR CONDITIONING GUIDE



4 Books in One! Covering:
Basic principles, Servicing, Operation, Repair of
1—Household Refrigeration
2—Special Refrigeration Units
3—Commercial & Industrial Refrigeration
4—Air Conditioning Systems
A gold mine of essential important facts for ENGINEERS, SERVICEMEN & USERS.
A Good Book is a Good Friend! Here you have at your fingers' ends a Complete Library in ONE VOLUME, the necessary data you have been looking for on: MODERN UNITS, SYSTEMS & MACHINES, REFRIGERANTS, including Freon, Lockers, Water Coolers, Quick Freezing & Air Conditioning Systems.
1280 Pages, 46 chapters all Fully Illustrated & Indexed for Ready Reference.
ANSWERS YOUR QUESTIONS
Get This Information for Yourself. Mail Coupon Today. No Obligation Unless Satisfied. ASK TO SEE IT.

\$4 COMPLETE • PAY ONLY \$1. A MONTH ←
AUDEL, Publishers, 49 W. 23rd St., New York 10, N. Y.
MAIL AUDELS NEW REFRIGERATION GUIDE for free examination. If O. K. I will send you \$1 in 7 days; then remit \$1 monthly until price of \$4 is paid. Otherwise I will return it.

Name.....
Address.....
Occupation.....
Employed by..... PM

MUSIC LESSONS

LEARN... PROGRESS... EARN MORE... \$... SUCCEED... \$

Your own achievement, popularity, success through music. Learn in your home. Check course: Piano, Violin, Cornet, Saxophone, Clarinet, Guitar, Harmony, Arranging, History. If juvenile, parent's signature must accompany inquiry. Low cost. Easy Terms. FREE catalog. Suite U-340 765 Oakwood Bl. Chicago 15

UNIVERSITY EXTENSION CONSERVATORY

"How to Make Money With Simple Cartoons"

A book everyone who likes to draw should have. It is free; no obligations. Simply address

CARTOONISTS' EXCHANGE

Dept. 93-D Pleasant Hill, Ohio

Burpee Big Zinnias

Flowers up to 6 1/2 inches across!
Richer colors—apricot, rose, salmon, yellow, orange, scarlet. Some have curled petals like chrysanthemums. Sturdy 3-ft. plants, easy to grow. SPECIAL for all to enjoy Burpee's Big Zinnias—75c Super Pkt. Seeds for 10c—Send Dime Today!

75¢ PACKET for 10¢

W. ATLEE BURPEE CO.
505 Burpee Bldg. OR 505 Burpee Bldg.
Philadelphia 32, Pa. OR Clinton, Iowa

Thrilling Work COLORING PHOTOS

Fascinating vocation learned at home by those with aptitude. Thrilling pastime. National method brings out life-like colors. Free booklet.

EASY TO LEARN NATIONAL PHOTO COLORING SCHOOL
1315 S. Michigan, Dept. 1353, Chicago 5

200 MONEY MAKING IDEAS

Business plans, rare mfg. formulas and trade secrets. Mail order tips, schemes, unusual items. Descriptive folio dime. Particulars free. Write

FORMICO SERVICE, Box 572-PM, Dayton, Ohio

MAKE MONEY AT HOME

RUBBER MOLDS

Low as 6¢ EA.

Amazing rubber mold-making outfit makes perfect flexible molds of plaques, ash trays, book-ends, etc. Molds cost 6c to 25c each. Each mold makes hundreds of novelties and gifts to sell for \$1.00 apiece and more! No experience necessary. Everything furnished. Quick and easy. Start profitable business in your home—sell to stores, gift shops, friends, resorts, road stands, by mail. Full or spare time. Write for complete FREE details and easy instructions.

SOLO WORKS, Dept. D-800, Loveland, Ohio

RUPTURED?

Get Relief This Proven Way

Why try to worry along with trusses that gouge your flesh—press heavily on hips and spine—enlarge opening—fail to hold rupture? You need the Cluthe. No leg-straps or cutting belts. Automatic adjustable pad holds at real opening—follows every body movement with instant increased support in case of strain. Cannot slip whether at work or play. Light. Waterproof. Can be worn in bath. Send for amazing FREE book, "Advice To Ruptured," and details of liberal truthful 60-day trial offer. Also endorsements from grateful users in your neighborhood. Write:

CLUTHE SONS, Dept. 31, Bloomfield, New Jersey

WIN SUCCESS & SECURITY

in Radio

TELEVISION ELECTRONICS

Win and Hold a Big Job in Industry. Own Your Own Business with Little or No Capital. Make Your Start Now with Modern



SHOP METHOD HOME TRAINING OF THIS GREAT, ESTABLISHED RESIDENT SCHOOL

YOU read and hear about the great progress made during the war in Radio, Electronic power and control, Television. Do you ever think what all this means to YOU—PERSONALLY—right now and in the future? Compare the job you now have with the opportunities in RADIO, TELEVISION and ELECTRONICS.

1. Thousands of technicians needed in Radio and Television stations and communication companies to operate, repair and maintain equipment.
2. Radio has grown from \$100,000,000 to \$5,000,000,000 and is still growing.
3. Experts say Television offers the astounding number of 500,000 jobs right in the start.
4. Electronics in industry and the home opens a brand new unexplored field.



Build Hundreds of Experiments with Equipment that Comes with Your Course

You actually LEARN BY DOING when you train with National for you are furnished with the latest Radio-electronic equipment, right out of the shops and laboratories of National Schools to work with in your own home. Build receiving sets, testing instruments, signal generators and other devices. With this equipment you REALLY ARE AN EXPERIENCED RADIO TECHNICIAN when you have completed your National training.

Get Started Now

In a few months—perhaps only weeks—you may start making good money in Radio—accept A BIG PAY JOB in industry—GET INTO A PROFITABLE, LIFETIME BUSINESS OF YOUR OWN with little or no capital. Take the first step now. Fill out and mail the coupon immediately.

NATIONAL GRADUATES MAKE SUCCESS RECORDS

LeRoy Murray, Highlands, Calif.: "Due to thorough training at National I have been constantly employed. I am now with the radio experimental department in aircraft."



Joe Grumich, Lake Hiawatha, N. J., writes "My latest offer was for \$5,800.00—but I am doing well where I am now engaged. I am deeply indebted to National."

O. K. Ivey, Washington, D. C., writes in a letter of recommendation: "I believe National offers the best course to be had in radio. Keep up the good work!"



R. R. Wright of Blackfoot, Idaho: "Due to my training at National I was selected to instruct in the laboratory work of the Navy and Marines."



Send the Coupon and prove to yourself what YOU can do in RADIO!

Now, the amazing speed-up training, that proved so successful in war time is available, at last, to you in Radio, Television and Electronics. Send the coupon. Learn the facts about this educational development. Try out the FREE sample lesson and see for yourself what you can accomplish in a surprisingly short time by SHOP METHOD HOME TRAINING.

Back of this course are the great training shops and experimental laboratories of National Schools—one of the oldest and finest technical training institutions in the world. Here instructors, engineers and research men are actually working with students and technicians to bring you, right in your own home, the most sound, practical and advanced training methods.

You have the advantage of the latest developments—the newest and most improved methods. Yet you can continue with your present job—carry on with what you are doing.

Look Ahead to the Future

Face Facts! What does your present job hold out for you? What opportunities does it offer? How long will it last? RADIO IS A BIG SOUND ESTABLISHED BUSINESS NOW. Television is already started. FM is here to stay. Radar is a 2-billion dollar industry. ELECTRONICS IS SET FOR THE BIGGEST INDUSTRIAL BOOM IN HISTORY. Will you share in this great march of progress?—step proudly ahead as a trained expert in a new field? Learn all about your OPPORTUNITIES. Read the book National Schools will send you. FILL OUT AND MAIL THE COUPON.

NATIONAL SCHOOLS

LOS ANGELES 37, CALIFORNIA EST. 1905



MAIL OPPORTUNITY COUPON FOR QUICK ACTION

National Schools, Dept. PH-3
4000 South Figueroa Street
Los Angeles 37, California

(Mail in envelope or paste on penny post card.)

Mail me free the Sample Lesson and Opportunity Book. I understand no salesman from National will call on me.

Name..... Age.....

Address.....

City..... Zone..... State.....

Thanks, I can eat Steak again!

↓
•Fit-Rite
•makes
•FALSE
•TEETH
•tight!



REFITS and
↓ RELINES
DENTAL PLATES!



Makes
**False Teeth
TIGHT!**
Improved Newest
Plastic Reliner

LASTS FOR MONTHS!

FIT-RITE quickly makes loose, slipping, clattery dental plates fit snugly and comfortably. Eat, talk and laugh naturally and confidently!

FIT-RITE you apply — at Home

Simply squeeze FIT-RITE on your dental plates and put it in your mouth, where it hardens and makes false teeth feel and fit like new. No fuss, no muss—no heating. Not a paste or powder. Becomes a part of plate. You apply it yourself.

FIT-RITE IS 100% O.K. ON ANY DENTAL PLATE

FIT-RITE won't harm any denture or your gums. Tasteless, odorless, sanitary—cleanses and sweetens the mouth and helps prevent gum soreness. It won't come off with scrubbing or washing. EVERY APPLICATION GUARANTEED TO LAST FOR MONTHS OR NO COST.

SEND NO MONEY Send for a tube today, for only \$1.00. Use coupon below. Enjoy teeth like new again. 100% satisfaction guaranteed or money back.

FREE TRIAL OFFER!

SPECIAL—generous package of dental plate cleanser included absolutely free. This instant, brushless cleanser WORKS LIKE MAGIC and will not harm any denture. Try Fit-Rite first.

FIT-RITE CO. 1573 MILWAUKEE AVENUE
Dept. 3-PM, Chicago 22, Ill.

Mail This COUPON -----

FIT-RITE COMPANY, Dept. 3-PM
1573 Milwaukee Ave., Chicago 22, Ill.
Send 1 tube of FIT-RITE Dental Plate Reliner that you guarantee to satisfy 100%—or it won't cost me a penny.
 I will deposit \$1.00 plus postage with postman when package arrives.
 Enclosed is \$1.00—You pay postage.

NAME.....

ADDRESS.....

CITY.....STATE.....

P.S.: — RUSH THIS ORDER TODAY!

HIGH SCHOOL AT HOME

Most well-paid positions demand high school training. Without it, or equivalent, you can't advance to the full extent of your abilities in any trade, business or profession. Whatever your age, however you're situated, IT ISN'T NECESSARY TO STRUGGLE UNDER THAT HANDICAP. I.C.S., famous for more than 50 years, enables you to start your own high school in your own home. You're in a class by yourself—study in your spare time—acquire a high school education at astonishingly low cost. Authoritative texts! Rapid Progress! Write today for free booklet.

INTERNATIONAL CORRESPONDENCE SCHOOLS
BOX 5574-K, SCRANTON 9, PENNA.

Send me full information on the following subject:

Name.....Age.....

Home Address.....

City.....State.....

Present Working Position.....Hours.....A.M. to.....P.M.

SCREWS NUTS, BOLTS,
RIVETS, SPRINGS,
WASHERS, Etc.



5 POUND ASSORTMENT
More than 1000 pieces. Great for mechanics, repairmen, hobbyists, experimenters. Worth double. Satisfaction guaranteed. Order now. Write for bargain list of fiber, bakelite, rubber, felt washers, pads; radio lugs, clips, connectors, etc. Send your order for one or more of the above assortments within the next ten

\$1.98
Two for \$3.69

days and receive our giant wood screw assortment (Different Sizes, Lengths, Heads) for an additional 22c each (limit 2 to a customer). One pound to each assortment.

HUDSON TRADING CORP'N M1521 N. Wells St., Chicago 10, Ill.

MAKE MONEY CASTING AT HOME
FREE FACTS SENT



Make hundreds of Plaster Casts, quick, easy. Sell output to stores, novelty shops, etc. Enormous profits. No experience. Very little capital needed. Start in basement, garage or workshop. Complete, simple instructions anyone can follow. Start now while merchants are begging for merchandise to sell. Rush.
PLASTIC ARTS STUDIOS, R.R. 5, Dept. 29, Muncie, Ind.

ELECTRICAL TRAINING

8 months intensive residence course in fundamentals of industrial electrical engineering, including radio, electronics. Prepares for technician, engineering aides. Approved for veteran training. Enter July 8, Oct. 31. 53rd year. Catalog.

BLISS ELECTRICAL SCHOOL
133 Takoma Ave., Wash. 12, D. C.



LEARN MASTER MACHINIST MECHANICAL DRAFTING

Expert training on Lathes, Milling Machines, Shapers, Grinders, etc. Allied shops are completely equipped and modern. Approved for G. I. Training. Days, Evenings.

ALLIED SCHOOL OF MECHANICAL TRADES
1330 South Michigan Avenue Chicago 5, Illinois

Train Your Own HORSES!

Colts - Stock Horses - Circus Horses
Gait Show Horses — Write for FREE BOOK
ANIMAL LOVERS' ASSOCIATION
Box KA-111, Tarzana, Calif.



WONDERFUL INVENTION — Corrects poor penmanship in few hours. No failures. Helps one get better job. Write Osment, 34, St. Louis, Mo.

FREE 32-PAGE BOOKLET ABOUT MODEL RAILROADING
THE WORLD'S MOST FASCINATING HOBBY



FREE 32-PAGE BOOKLET tells all about this absorbing hobby for skilled tradesmen, business and professional men. Give yourself hours of satisfaction and relaxation building your own scale model railroad which performs and looks like the real thing. It's easy and relatively inexpensive. Get started now. Send at once for our free booklet "Your Model Railroad."

MODEL RAILROADER MAGAZINE
DEPT. MR MILWAUKEE 3, WISCONSIN

TIE UP YOUR FUTURE *with these* Growing Industries



AIR CONDITIONING and REFRIGERATION

Air Conditioning and Refrigeration are among the great industries of today and tomorrow. Installations everywhere—in restaurants, shops, homes, etc., need service. Thousands of businesses are waiting for new installations. Today, more and more homes are being air conditioned. The Refrigeration and Air Conditioning industries are headed for greater prosperity and men who have the "know how" and experience should ride along.

TRAIN NOW Before the Expected Expansion Begins

Experts predict large demand for men to install and service Air Conditioning and Refrigeration equipment : : : Rise to the kind of job which requires a competent, trained man who can carry the responsibilities of installing costly equipment and maintaining it. If he knows the answer when he is called in for consultation, his reputation grows and his pay should grow also.

FOLLOW THIS WAY TO KNOWLEDGE

If over 17, and under 60, here's all it takes to get you ready for experience in this modern industry. Just invest a limited amount of your spare time—while you are still on your present job. Through our balanced training, you learn first through home study, how to handle Installation, Maintenance & Service Work on Refrigeration and Air Conditioning equipment. Then you can get practical training in our big shops under capable instructors—experienced men who'll take a personal interest in helping you learn. When you're through you should have knowledge that enables you to get started in this vast industry.

WANT YOUR OWN REPAIR SHOP?

UEI training is easily understood by mechanically inclined men. You gain experience when you complete your course. Equipment, tools and personal following can accumulate as you progress. Soon you may find it wise to set up your own shop.

Get Free Facts Right Now!

It costs you nothing to get all the facts about this great field. Simply mail the coupon below and we'll tell you, without obligation, the whole, sensational story of what's ahead in Refrigeration and Air Conditioning. Mail the FREE coupon now.



REFRIGERATION
TRAINING
Since 1927

UTILITIES ENGINEERING INSTITUTE

1314 W. Belden Ave., Dept. 136, Chicago 14, Ill.

UTILITIES ENGINEERING INSTITUTE

1314 W. Belden Avenue, Dept. 136, Chicago 14, Ill.

Please send me the FREE FACTS about opportunities in Air Conditioning and Mechanical Refrigeration. I have marked the one that interests me most.

Air Conditioning

Mechanical Refrigeration

NAME.....AGE.....

ADDRESS.....

CITY.....ZONE.....STATE.....

4 WAYS To Be Your Own Boss!

NOW, more than ever before, is the **right** time to start a small profitable business of your own... or train yourself for a practical money-making trade in which you can be **independent**. TODAY take your first step, without cost or obligation. Just mail coupon—and by return mail you will get full information on the courses listed here.

watch and clock repairing



Learn at Home—In Your Spare Time

Prepare for a happy future of prosperity, security... and get a big-pay job now. Fascinating, high-grade occupation. You can **EARN WHILE YOU LEARN**. Excellent field for part-time work at home.

Practical Course in HOROLOGY

Thorough self-instruction training in American and Swiss watches, clocks. Special sections on alarm clock repairs. Interesting. **LEARN-BY-DOING** instruction method. Learn **QUICKLY**, easily. No previous experience necessary. **BASIC TRAINING FOR AIRCRAFT INSTRUMENT WORK** and other scientific precision jobs.

Amazing Low Price! • **Money-Back Guarantee!** Get into this fast-growing field NOW... big opportunity... don't delay. Mail coupon below for **FREE** information. No obligation.

locksmithing and key making

PRACTICAL UP-TO-DATE COURSE

How to pick locks, de-code, make master-keys, repair, install service, etc. New, self-instruction lessons for every handyman, home-owner, carpenter, mechanic, service station operator, fix-it shop, hardware dealer, gunsmith.

53 Easy Illustrated Lessons

Low Price! Satisfaction guaranteed or money back. Write now... no obligation!

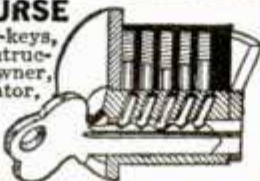

practical RADIO servicing



SELF-INSTRUCTION COURSE

Teaches you the **practical** side of radio.. repair, adjustment, operation, alteration, trouble-shooting. No previous knowledge necessary. Large clear illustrations, diagrams, charts, etc. • **INTERESTING STEADY WORK!** Set up a radio repair shop of your own—or prepare for booming industrial electronics. This useful, how-to-do-it course brings you all the fundamentals, including mathematics, review questions, problems, answers. Strictly up-to-date. Low price. Coupon below will bring you full information you want immediately. Mail it in today!

MAIL ORDER BUSINESS

Your Big Opportunity!

34-lesson course on proved, tested, up-to-date, **profitable** methods. Amazing treasure-house of the best mail order plans and practices. How to start your mail order business on a small one-man scale... how to keep it growing more and more profitable month after month. Money-making **FACTS**.

WRITE FOR COMPLETE DETAILS ON ANY OF THESE COURSES. Send Coupon for World-Famous Copyrighted Success-Catalog—IT'S FREE!
NELSON CO., Dept. 3C02, 1139 S. Wabash Ave., Chicago 5, Ill.

FREE details... mail coupon!

NELSON CO., Dept. 3C02, 1139 S. Wabash Ave., Chicago 5, Ill. Please send me—FREE and without obligation—illustrated Success-Catalog containing information about the course (or courses) I have checked below. No salesman will call.

- Watch and Clock Repairing. Locksmithing and Key Making.
 Practical Radio Servicing. Mail Order Business.

NAME.....
ADDRESS.....
CITY..... STATE.....



A New Hobby!



COLLECT GENUINE
U. S. MILITARY
SHOULDER PATCHES



Make your den or lodge room the center of attraction with this fascinating hobby! Over 300 authentic military shoulder patches in stock, from 15c to 50c each! Send only 10c in coin for illustrated folder and price list.



MIDWEST SALES CO.
Dept. C-15
P.O. Box 1092 Omaha, Nebr.

SILK SCREEN PROCESS A PROFITABLE BUSINESS OF YOUR OWN



PRACTICE in your spare time!
We Send You Complete Kit of Supplies

Silk Screen Processed signs & displays needed everywhere. A lucrative future for you in the great advertising boom. Easy to do—quick to learn—you may make more than course costs before it's completed. **BOOKLET with 3-color Silk Screen Processed Cover and samples sent FREE...** Write now, California School Screen Process, Dept. PMD 2710 S. Spaulding, Los Angeles 16, Calif. 346

JIU-JITSU HOW TO BECOME EXPERT, Keep Health, Have

Fun. Teaching 35 years. Free information. Write

MODERN SCHOOL JIU-JITSU, Dept. EE, 5 W. 52nd St., N.Y.C. 19

WELDERS VETERANS—Ask about G. I. Training.

WANTED! Earn up to \$12 a day or start your own business. Learn Welding by actual shop work. America's leading school.

Established 1902. 41,000 graduates. Write for "Welding Facts."
Greer Shop Training, Dept. 336, 460 S. State St., Chicago

FEET HURT? Try Dr. BARRON'S New Foot Cushion



Many with tired, aching feet have found happy relief! So comfortable—LIKE WALKING ON A PILLOW! Made of fine, soft spongy material, leatherette covered. So light, flexible—cushions and helps relieve your feet from heel to toes. If you suffer from metatarsal callouses, corns, foot pains or fallen arches, try Dr. Barron's Foot Cushion. Wear in any shoes—helps make walking a pleasure. Doctor says: "I recommend Foot Cushions to foot sufferers." Send only \$1.98 for A PAIR—or will ship C. O. D., plus postage. **STATE SHOE SIZE AND IF MAN OR WOMAN, 30 DAY TRIAL GUARANTEE.** Money back if you don't get blessed relief!
ORTHO CO., 111 W. 83rd St., Dept. 49-C, New York City 24

do you WORRY?

Why worry and suffer any longer if we can help you? Try a Brooks Patented Air Cushion. This marvelous appliance for most forms of reducible rupture is **GUARANTEED** to bring YOU heavenly comfort and security—day and night—at work and play—or it costs you **NOTHING**. Thousands happy. Light, neat-fitting. No hard pads or springs. For men, women, and children. Durable, cheap. **Sent on trial** to prove it. Not sold in stores. Beware of imitations. Write for Free Book on Rupture, no-risk trial order plan, and proof of results. All Correspondence Confidential.



Brooks Company, 359 State St., Marshall, Mich.



Now ANY **AUTO REPAIR JOB** Can Be "Duck Soup" For You!

**MoToR's New AUTO REPAIR MANUAL
 Shows You How to Service and Repair
 ANY Part of ANY Car!**

**FREE 7-DAY
 OFFER!**



USED BY
 U. S.
 ARMY

NOW you can "polish off" the **HARDEST** jobs the **EASIEST** way! MoToR's **AUTO REPAIR MANUAL** is ready to show you how to repair anything from carburetor to rear end—with the *least* possible amount of time and effort!

Suppose plain-talking car engineers from every auto plant in America got together and showed you all the things you needed to know about repairing and servicing the cars *they* had designed and manufactured! That's really what you get in this big manual! Right at your fingertips, the main "dope"

from *150 Official Factory Shop Manuals*, covering every make car built since 1935!

Easy to use, too! Quick-index leads you to right page in jiffy! Just follow simple instructions step-by-step.

SEE HOW MUCH YOU GET!

764 pages, 8½x11 inches, bound in sturdy covers. 200,000 service, repair, adjustment, replacement, tune-up facts on all makes and models, 1935 to 1945. More than 1000 cut-away photos, diagrams, drawings show you exactly **WHAT** to do and **HOW** to do it. Used by U. S. Army, trade and technical schools everywhere, thousands of auto servicemen.

Now **YOU**—without cost—can see for yourself what a wonderbook MoToR's Auto Repair Manual really is. **TRY it—FREE** for 7 days! Learn first-hand how it can pay for itself the first few times you use it.

**SEND NO MONEY
 7-Day Free Examination**

Just mail coupon at right, without money! When the postman brings your book, pay him nothing. First make it show you what it's got! Unless you agree this is the greatest time-saver and work-saver you've ever seen—return book in 7 days and pay nothing. Mail coupon today! Address: MoToR Book Dept., Desk 1C, 572 Madison Ave., New York 22, N. Y.

Published by MoToR, The Leading Automotive Business Magazine. MoToR's manuals assure high standards of repair work.

Covers
 All These
 Makes!

- | | |
|-----------|------------|
| American | Lincoln |
| Bantam | Lincoln |
| Auburn | Zephyr |
| Austin | Mercury |
| Buick | Nash |
| Cadillac | Overland |
| Chevrolet | Oldsmobile |
| Chrysler | Packard |
| Cord | Pierce |
| Crosley | Arrow |
| De Soto | Plymouth |
| Dodge | Pontiac |
| Ford | Reo |
| Graham | Studebaker |
| Hudson | Terraplane |
| Hupmobile | Willlys |
| Lafayette | |
| La Salle | |

**Clear, Pictured Facts on
 Every Job on Every Car
 Built Since 1935!**

Nearly 200,000 service and repair facts on all 31 makes. 764 big pages; including 50 pages of carburetor text, charts, illustrations, covering all models. Over 500 charts, tables; Tune-up Chart; Valve Measurements; Compression Pressure; Torque Wrench Reading; Starting Motor; Engine Clearances; Generator; Clutch & Brake Specifications; Front End Measurements, etc.; Engines; Electric, Fuel, Cooling, Lubricating Systems; Transmissions; Universals; Front Ends; Wheels; Rear Ends, etc.

**Same FREE 7-Day Offer
 Applies on MoToR's
 TRUCK REPAIR MANUAL**

For mechanics, truck specialists, service stations, fleet owners. Covers EVERY job on EVERY truck made since 1936! 1400 pictures, 914 pages. 300,000 facts. Used by Armed Forces.

All types Gasoline Engines, Diesels, Hesselman, Fuel Systems, Governors, Lubrication Systems, Ignition Systems, Starters, Generators, Clutches, Transmissions, Axles, Torque Dividers, Transfer Cases, Brakes, Steering, etc.

ALSO SERVICES buses, farm and industrial tractors, contractor and road building equipment, stationary power machinery, etc. (on all parts described in Manual.) Check box in coupon at right.



MAIL COUPON NOW FOR 7-DAY FREE TRIAL

MoToR Book Dept., Desk 1C, 572 Madison Ave., New York 22, N. Y. Rush to me at once: (check box opposite book you want).

MoToR's **AUTO REPAIR MANUAL**. If O.K. I will remit \$1 in 7 days, \$1 monthly for 4 months, plus 35c delivery charge with final payment (\$5.35 in all). Otherwise I will return book postpaid in 7 days. (Foreign price, remit \$7 cash with order.)

MoToR's **TRUCK REPAIR MANUAL**. (Described at left.) If O.K. I will remit \$3 in 7 days, and \$2 monthly for 3 months, plus 35c delivery charges with final payment (\$8.35 in all). Otherwise I will return book postpaid in 7 days. (Foreign price, remit \$11 cash with order.)

Print Name.....Age.....

Print Address.....

City..... Zone No. State.....
 (if any)

Occupation.....

SAVE 35c! Check here if enclosing full pay. (check, m.o., postal note) WITH coupon. We pay 35c shipping cost. Same 7-day return-refund privilege.

Keep that "TICKING"
Car

7 DAYS
FREE TRIAL

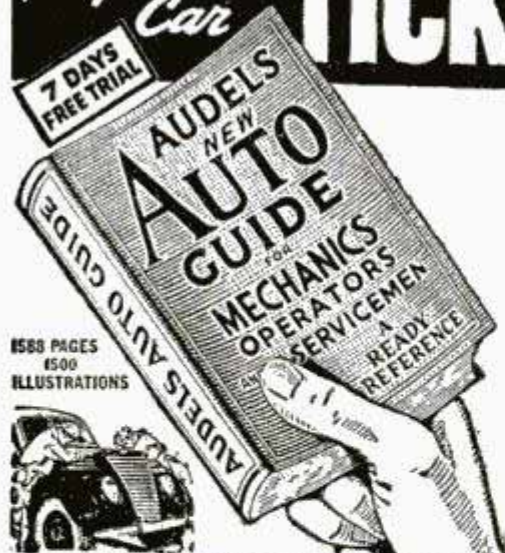

5888 PAGES
1500
ILLUSTRATIONS



Every operator and mechanic needs AUDELS AUTO GUIDE.

This book saves time, money and worry. Highly endorsed. It presents the whole subject of auto mechanics:

- 1—Basic principles
 - 2—Construction
 - 3—Operation
 - 4—Service
 - 5—Repair
- Handy Size. Easily understood.

NEW FLUID DRIVE, HYDRAULIC SHIFT AND DIESEL ENGINES FULLY COVERED

Over 1500 pages—1540 illustrations showing inside views of modern cars, trucks and buses with instructions for all service jobs.

ASK TO SEE IT!—To Get This Assistance for Yourself Simply Fill in and Mail Coupon Today.

4 COMPLETE • PAY ONLY \$1. A MONTH ←

AUDEL Publishers, 49 West 23rd St., New York
MAIL AUDELS NEW AUTO GUIDE for free examination. If O.K. I will send you \$1 in 7 days; then remit \$1 monthly until price of \$4 is paid. Otherwise I will return it.

Name.....
Address.....
Occupation.....
Employed by..... PM

SILVERPLATE
Electrically by Brush!

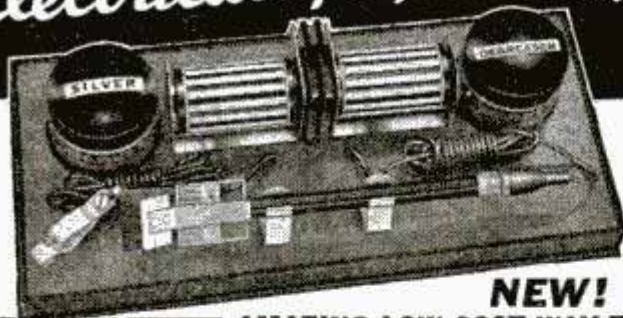

NEW!

AMAZING LOW COST WAY TO PLATE GENUINE SILVER ON Models, Projects, Worn Fixtures

Hundreds of uses for this complete Silverplating Outfit! New, patented electrified brush and concentrated compound of **Atomic Silver** work like magic. Easily and quickly, you can apply a heavy, permanent coat of *Genuine Silver* to any conductive surface . . . on models, projects, silverware, jewelry, etc. Outfit includes Degreaser, **Atomic Silver Compound**, Battery Power-Pack, *Nylon-Lucite Electrolytic Brush*, **Solid Silver Anode**, Leads, Connectors and simple Instructions in compact carrying case. *All at amazing low cost!* Small shipping charge collected on delivery. **ORDER TODAY.**

Homecrafters, Dept. E-6
360 NORTH MICHIGAN AVE.
CHICAGO 1, ILLINOIS

ONLY \$12.50

The Tool of a
101 USES



COMB-A-TRIM
THE NEW QUICK TRIMMER

Something New! Trim your hair without any experience. It's easy! The excess hair comes off smoothly and easily by just pulling trimmer through hair like an ordinary comb. Also removes hair from legs—armpits. Save on hair-cut bills . . . Trim your own hair or the whole family's. Send 59c and your Comb-A-Trim will be sent at once.

59c



SPECIAL OFFER
Send \$1.00 for 2
Comb-A-Trims
and save 18c. **2 for \$1**

5 Extra Blades
(Year's Supply) 25c

COMB-A-TRIM CO.
Cincinnati, O.

1734 Carew Tower

Dept. R-4

GENUINE U.S. BARGAINS



Army O. D. Wool Blankets, 5 lbs. . . . \$5.95
Army Pocket Knife, Scout Style. . . . \$2.50
Pup Tents, Poles and Pegs, Used. . . . \$4.85
Mess Kit—Knife, Fork and Spoon,
Used \$.50
Thousands of Other Bargains in Military,
Outdoor & Sport Goods for Hunter, Farmer,
Scout. Send 10c for 32-page catalog re-
turned with first order.

A and N SUPPLY CO.
4720 LESTER ST. RICHMOND, VA.

EST. 1868

**COLLECT U. S. ARMY
Shoulder Patches**



Fascinating hobby. Patches 10c to 50c each.
Complete set of 257 for \$36. Official patches
available for every major Army and Air
Corps unit. Send \$1 for sample assortment
of patches and illustrated patch catalogue.

SPRINGER'S
275 San Francisco St. EL PASO, TEXAS



YOUR OWN BUSINESS!



MAKE MONEY in your own home, spare room, basement, garage! Manufacture popular "Plastex" novelties. 5c materials make \$1.00 sellers! Start in spare time. Pleasant business—small capital—\$10 profit!—Write for FREE folder, "Profits in Plastex Manufacturing"—**PLASTEX, 46-P King St., Dorchester, Mass.**

WINDOW SIGN LETTERS

For Store Fronts and Office Windows. Anyone can put them on. Samples furnished. Genuine Gold and Silver. **METALLIC LETTER CO., 430 N. Clark St., Chicago 10**

The GLENWOOD MEMORIAL

Freight Paid Anywhere in U.S.A.
In all its beauty and durability is pictured in our free catalog of genuine Marble and Granite. Write for yours today.
U. S. MARBLE & GRANITE CO., A-18, Gneco, Fla.

**FALSE TEETH
FIT TIGHT
with Dentyte**

Soften DENTYTE by warm-
ing—spread it on your plate
—put in mouth and bite to
make a perfect impression.
Remove plate — and allow
few minutes to "set." You
get an absolutely perfect
fit. Sore gums vanish — no
more slipping or loose teeth.
DENTYTE is firm but resilient. For
both Uppers and Lowers. Each lining lasts for
months. Immediately removable with fingers.
Full size jar—(a year's undreamed of comfort
per plate), postpaid only \$1. Send dollar bill
at our risk. Easy to order. Easy to use.
Unconditionally Guaranteed.
Dental Products Corp. Dept. PM-55, Manheim, Pa.





Paul Davis, B. S. M. E.
Founder of the first Plastics
Fabrication Home
Training Course

Let me send you
FREE
the whole exciting story
of your opportunity
in **PLASTICS**

by practicing at home



Get the full free story at once on the amazing new opportunity plastics holds for you today—in your own business or on the job. Learn how to do fascinating experiments in your own home with interesting materials like those shown at left. It's easy and it's fun. And it means either more money or being your own boss, to come and go as you please.

Many Beginners Make \$10 to \$20 a week in spare time while learning

One Texas Student, though only 1/3 finished with his training has already sold his first large order to a local dept. store. You too may do the same. A wonderful opportunity for spare time cash is yours for the asking.

Learn PLASTICS

FABRICATION AND CASTING!

THIS EASY WAY IN SPARE TIME



Mail coupon at once, and we will immediately send our new book showing your opportunity for success in plastics, and with it a sample part of our actual lesson material to show you how easily you can learn by actually doing the work.

BUILD YOUR OWN FUTURE — In Your Own Business — As Your Own Boss!

Send the coupon today. Learn how you can start at home, with little money, to build your own big paying business. Discover your future. We give you at home at your own convenience the fundamental knowledge of plastics you need for success. And also the practical experience. You will learn to fabricate, shape, form, finish, cement, cast, compound and make molds.

You make products like these early in the Course.



VETERANS: Check Coupon for G. I. Training

Learn of our exclusive
"SET YOU UP IN BUSINESS"
Contract Arrangement

When you finish your course, we have an exclusive contract ready which sets you up for production and gives you first bona-fide order — at a profit! You cannot lose!

MAIL COUPON TODAY!

This may be opportunity at your door. Don't miss it. Just mail coupon in an envelope or paste on penny postcard. Do it now!

PLASTICS TECH
SCHOOL OF AMERICA, INC.
BE FIRST IN PLASTICS
Dept. PMM, 5200 Euclid Ave., Cleveland, O.

GET SAMPLE LESSON MATERIAL FREE 1946 SUCCESS BOOK

PLASTICS TECH, Dept. PMM
5200 EUCLID AVENUE, CLEVELAND 3, OHIO

Mail me **FREE**, without obligation, Actual Lesson Material and 1946 Opportunity Book in Plastics. Please check Veteran Civilian

Name..... Age.....
Street..... Zone.....
City..... State.....

I am interested in: Home Training Resident School Training
FIRST RECOGNIZED PLASTICS SCHOOL IN THE EAST

BIG MONEY and YOUR OWN BUSINESS

in LIQUID MARBLE!

FREE INFORMATION ON THREE BIG NEW MONEY-MAKING OPPORTUNITIES



Regardless of your age, sex, previous experience, and whether you are an ex-serviceman or not, we will send you astonishing free facts about the unlimited possibilities—in your own business—with amazing **LIQUID MARBLE** and our other marvelous new products. To secure this information, absolutely free, fill in coupon below or send a letter or postcard. No salesman will call on you, now or ever. Write **TODAY!** Offer limited.

- 1 **LIQUID MARBLE.** Make beautiful artificial Marble Slabs. Four from liquid state. Glazed or unglazed. This marble may be mottled, veined, multi-colored or left in original snow-white state. The color is actually a part of the marble! Does not fade or wear away. **LIQUID MARBLE** is unsurpassed on kitchen or bathroom walls. Easy to make and install.
- 2 **PLASTIC FLOORING.** May be made in any color or combination of colors. Gives a lifetime of wear. Dustproof. Soundproof. Verminproof. Resilient to the tread. Lay out solid from wall to wall or in pattern design of various shaped blocks.
- 3 **FLEXIBLE MOLDS.** For plaster casting. Make your own molds for few cents each. \$1.00 in raw materials will make up to \$25.00 worth of finished goods. We furnish names of buyers.

FREE! EXTRA! If you write us promptly we will include free information about our other big money-making businesses. These include Compo-Tile Roofing and Caen Stone, Plastic Wood, Artificial Marble and Granite, Stone and Metal Solder, Plastic Tile Cement, Papier Mache, and many others.

FREE INFORMATION COUPON!

COMPO-TEX, Box 786-SS, St. Louis, Mo.

Please send me free details of your **BIG THREE** Money-Making Propositions including **LIQUID MARBLE**. Also include information about the additional new business possibilities given directly above.

Name.....
Street.....
City..... State.....

Greatest Opportunities NOW!

With reconversion going ahead at full speed. **NOW** is the time to line up your own money-making business. We offer you our **BIG THREE** money-making opportunities together with other equally profitable businesses. (See paragraph at right.) Get the **FREE** facts **TODAY!**

COMPO-TEX, Box 786-SS, St. Louis, Mo.

INVENTORS

Do Not Delay

Have you ever been startled by seeing a successful article on the market, and exclaimed—"Why, I invented THAT 5 years ago—I didn't think it valuable enough to Patent!"

The Patent Laws were intended for the Protection of the Inventor, and the Inventor who slumbers on his Rights may wake up to find someone else reaping the reward that could have been his.

Write NOW for Information and Record of Invention form FREE. RANDOLPH & BEAVERS, Registered Patent Attorneys, Columbian Bldg., Washington, D. C.

PERSONALIZED SERVICE — REGISTERED PATENT ATTORNEYS

RANDOLPH & BEAVERS

11-D Columbian Bldg., Washington, D. C.

Please send me full particulars on Patents, fees, etc., and "RECORD of INVENTION" form—FREE.

Name

Street

City State

GLOWS in the DARK

MAKE BIG MONEY Selling Luminous Pictures

Your customers will gasp with wonder at these amazing new luminous pictures, statues novelties. Be the first to sell them! Religious, nursery, glamour and other subjects. Sell on sight

WRITE FOR Free SAMPLE

Madison Mills, 303 Fourth Ave., New York 10 N. Y.

2 Bushels of Ripe TOMATOES from ONE VINE



2 or 3 vines will produce enough tomatoes for the average family.

New BURGESS CLIMBING TRIP-L-CROP

TOMATO rapidly grows to a height of 10 to 18 feet. Grow on trellis, side of house or barn or as a bush in garden. Beautiful crimson, solid, meaty fruits of best quality, some weighing over 2 lbs. each. The most productive of all tomatoes. Trial packet 10c—3 for 25c, postpaid.

CASH PRIZE CONTEST

Send for FREE Garden Book giving full details about CASH PRIZES to growers of this wonderful tomato.

BURGESS SEED & PLANT CO. 217 C.T., GALESBURG, MICH.

PATENTS AND TRADE MARKS

C. A. SNOW & CO.

Registered Patent Attorneys Since 1875
Write for Free Book and "Certification of Invention" form
427 SNOW BUILDING, WASHINGTON 1, D. C.

PATENT YOUR IDEAS HOW TO OBTAIN A PATENT
SEND FOR FREE BOOK

Written by Former Member Examining Corps (1922-24) U. S. Pat. Office.

CARL MILLER, Registered Patent Attorney
Former Member Examining Corps U. S. Patent Office
Woolworth Bldg., Dept. 36-A, New York — Bond Bldg., Dept. 36-A Washington, D.C.

PATENTS

E. E. VROOMAN, Patent Lawyer

Registered Patent Attorney Since 1902
871 Woodward Building, Washington 5, D. C.



Balance 4" x 9" Base. With either Metric or Avoirdupois Weights ... \$6.00

Catalog with 3000 Illustrations of Laboratory Apparatus sent for 75 cents. Catalog listing 10,000 chemicals, drugs, minerals, etc. and 1700 scientific books sent for 25 cents. 100 scientific books, 10 cents.
LABORATORY MATERIALS CO.
7321 Vincennes Ave. Chicago 21, Ill.

Practical Electricity and House Wiring

Discusses common electrical devices, principles of circuits, wires and insulation, grounding, fuses and circuits, wiring methods, planning installations, installing switches, fixtures, etc., wiring houses after they are built, alterations and additions, wiring farm buildings, home repair, etc. 300 pp. 227 illust.

G.O.D. Send Today, Money Back Guarantee Postpaid \$2.25 \$2.00

The GATEWAY BOOK CO., Dept. PM-15-A
32 N. State — Chicago 2, Illinois

NEW OTTAWA Wood Saw

FOR TRACTORS Makes wood sawing fast; easy. Cuts enough wood to pay for itself quickly. Easily moved while attached. Big blade; send for FREE details.

LOW PRICE

OTTAWA MFG. CO., W377 Oak Ave., Ottawa, Kans.

WANTED ... IDEAS

You can make money quickly and easily with your ideas. Be independent and enjoy life while your ideas work for you. Manufacturers are looking for new ideas. Read Howard Hill's amazing new book—"What's the Big Idea"—voted the best book to date on getting ideas. Contains 12 tested plans for developing ideas. 38 ways to analyze your ideas. Send \$1 today for this book. DON KEELER PUBLISHING CO., 718 S. Flower St., Los Angeles 14, Calif.

FALSE TEETH

KLUTCH holds them tighter

KLUTCH forms a comfort cushion; holds dental plates so much firmer and snugger that one can eat and talk with greater comfort and security; in many cases almost as well as with natural teeth. Klutch lessens the constant fear of a dropping, rocking, chafing plate. 25c and 50c at druggists. . . . If your druggist hasn't it, don't waste money on substitutes, but send us 10c and we will mail you a generous trial box.

© I. P. INC.
KLUTCH CO. Box 4693-C ELMIRA, N. Y.

NEW CHEAP OIL BURNER

FOR COOKING & HEATING STOVES-FURNACES
HEAT YOUR HOME, COOK YOUR MEALS WITH CHEAP FURNACE OIL

NO MORE SHOVELING COAL OR ASHES. New Fuelizer Starter Vaporizing System turns Cheap 130 Flash Furnace Oil into Oil Gas heat without clogging up. LIFE-TIME GUARANTEE against defects. \$1.00-BONUS OFFER FOR TESTING. We will let you try it in your own stove or furnace for one month. Get Yours for introducing. Big profits. Be first. Send in your name today.

NORTHWEST MFG. CO. 561-C 5th Ave. Mitchell, So. Dak.



H. T. ARMSTRONG
General Manager

**START YOUR OWN
APPLIANCE REPAIR SHOP
Be Independent!**



**YOUR JOB IS SAFE
IF YOU HAVE
YOUR OWN SHOP**

No new-fangled machine can ever take your place in this work . . . for it takes hands to fix appliances. So you will never be out of a job. Further, everyone needs a repair man from time to time . . . so everyone is literally a potential customer. Yes, and everyone respects and admires a man who can fix things . . . so there is a lot of satisfaction being in this business. But there's even more satisfaction in knowing you and your family will never be out on a limb . . . because you will never be out of a job. Let's talk it over by mail.

**NEW BOOK
"HOW TO START YOUR
OWN BUSINESS"**

**Sent at No Extra Cost
If You Act Promptly**

This valuable book covers locating your shop, contains drawings of how to build and wire work-benches, where and how to advertise, what to charge, how to hire solicitors, etc. Let's hear from you, TODAY.

**FREE BOOKLET
MAIL THIS COUPON
TODAY**

Learn **at HOME in
Your Spare Time**
**How To REPAIR & SERVICE
ELECTRICAL
APPLIANCES**

Our practical, thorough course teaches you this interesting, good-paying business AT HOME, DURING YOUR SPARE TIME. A grade school education is all you need. We teach repairing electrical appliances, motors and house wiring. And from long, daily experience we know how to make our lessons understandable and easy to grasp . . . and how to give you the answers to the questions you'll want to ask. For the man who is handy with tools, and likes to work with his hands as well as his head, there is a WIDE OPEN OPPORTUNITY today, in this great growing field.

**YOU CAN PAY FOR YOUR TRAINING
WITH JUST ONE GOOD REPAIR JOB**

It's a fact! One good repair job can more than pay the cost of the entire course of training. And here's a business you can start as small as you like, in your basement or garage . . . work when you want to . . . and grow as big as you like. Or, you can take a well paid job most anywhere, to start . . . as the need for service mechanics is tremendous in this field and will grow bigger as more and more appliances are released.

AN INDUSTRY WITH A FUTURE

Just think! Despite war, shortages, priorities and restrictions, nearly 3,000,000 more U. S. homes were wired for electricity for the first time . . . since 1940. It's almost like discovering a new continent filled with customers . . . added to the millions already here. And electrification is in for a big boom with government projects in plan for all over the nation.

H. T. ARMSTRONG, General Manager,
PACIFIC TRAINING SCHOOL, Dept. P-3,
7217 So. Broadway, Los Angeles 3, Cal.

Dear Sirs: Please send me, without obligation, your FREE BOOKLET, and full details.

Name.....

Address.....

City..... State.....

MAKE MONEY FIXING RADIOS

AND OTHER ELECTRONIC EQUIPMENT

Tells **WHAT** to do...
Exactly **HOW** to do it

If you like to repair radios at home in spare time, Ghirardi's **RADIO TROUBLESHOOTER'S HANDBOOK** offers you a new, fast way that makes the work easy—without previous experience or scarce, expensive test equipment. Or, if you are a professional radio man, it helps you repair two sets in the time normally required for one, train new helpers, etc., etc.

NOT A "STUDY" BOOK

You don't study this Handbook—you simply look up the radio's Make, Model and the Trouble Symptom... and go to work! Clear instructions tell you exactly **WHAT** the trouble is... and exactly **HOW** to fix it. This **BIG 744-page HANDBOOK** brings you repair data for practically every radio in use—over 4,500 models! Pays for itself first time used!

In addition, there are hundreds of pages of helpful repair charts and data on tuning alignment, transformer troubles, tube substitutions, color codes, etc. 5-day Money-Back Guarantee.

LEARN PROFESSIONAL SERVICE WORK AT HOME

Study now for a good job as a Radio-Electronic repairman! It's easy to learn from Ghirardi's 1300-page illustrated **MODERN RADIO SERVICING** book that costs you only \$5 dollars complete! Covers all phases of the work! Explains all necessary test instruments and how to build your own; how to troubleshoot all makes of receivers, analyze their circuits, test components; make adjustments; repairs, etc. ... all step-by-step. Even explains How to Start a Radio-Electronic Service Business. See Money-Saving Combination offer below.



A complete guide to quick, easy troubleshooting and repair of practically every radio model in use today.

Complete Only **\$5**

COMPLETE BASIC RADIO ELECTRONIC TRAINING FOR BEGINNERS

Easily worth \$50 if you bought it as a course

\$5

Ghirardi's famous 972-page **RADIO PHYSICS COURSE** book with its 500 illustrations and self-testing review questions has given more beginners their start in Radio-Electronics than any other book or course ever published. It will do the same for you! Nothing is omitted, nothing

condensed. Everything made easy as A-B-C. Ask any radio man! You'll be amazed how quickly you'll master the subjects other courses make seem very complicated. Examine this truly great book for 5 days—and get every cent of your money back if not more than satisfied!

More universally used for home study, by more Signal Corps, Navy and civilian schools than any book of its kind!

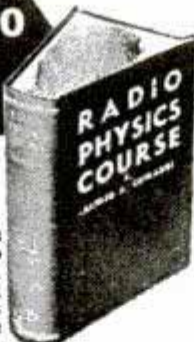

LEARN AT HOME — WITHOUT AN INSTRUCTOR!

5-DAY MONEY-BACK GUARANTEE

MURRAY HILL BOOKS, INC.

PM-36, 232 Madison Ave., New York 16, N. Y.

- Enclosed find \$.....for books checked; or send C.O.D. (U.S.A. only) plus postage. If not fully satisfied, I may return books within 5 days and get my money back.
- RADIO TROUBLESHOOTER'S HANDBOOK \$5** (\$5.50 foreign) **MODERN RADIO SERVICING \$5** (\$5.50 foreign)
- RADIO PHYSICS COURSE \$5** (\$5.50 foreign) **MONEY-SAVING OFFER—Modern Radio Servicing AND Troubleshooter's Handbook, \$9.50 for the two (\$10.50 foreign)**

Name.....

Address.....

City & Dist. No.....State.....

(Please write or print plainly)

LET US TEACH YOU TO Mount Birds



Animals, Fish, Heads; to **TAN**. Hunters, Trappers, be a **Taxidermist**. Let this old reliable school teach you—at home, in spare time. Our school has over 300,000 students. Save your fine trophies. Mount and keep **ducks, deer, ALL wild-game**. Tan skins, make robes and rugs, **double your interest in HUNTING AND FISHING**. Have a home museum.

Free Book

Yes, **FREE**, this great **strange book**, with 100 fine wild-game pictures. Tells how **YOU** can become a real **TAXIDERMIST**, easily and quickly. It is amazing, thrilling, and may bring you a lifetime of **PLEASURE and PROFIT**. **SPORTSMEN**, grasp this opportunity. **SEND NOW**. A postal will do. But **WRITE TODAY**—don't fail. State your age. **N. W. SCHOOL OF TAXIDERMISTRY**
DEPT. 3373 OMAHA 2, NEBR., U. S. A.



BE YOUR OWN BOSS! MAKE MORE MONEY

\$1.00 VALUE
25¢
68
PAGES
40,000
WORDS

In "CASH IN" you get **ALL** the real money-makers—dozens of profitable tested mail order plans, confidential business secrets, dozens of practical tested formulas, successful tested schemes—actual experiences of men who have started on a shoestring—with less than \$10 capital.

25¢ a copy postpaid. Send U. S. stamps, money order, or coin.

MONEY BACK GUARANTEE

NATIONAL PLANS COMPANY

P. O. Box 26M, Station N, New York 23, N. Y.

DRAFTING



More good jobs now in Drafting. Learn **AT HOME** in spare time (or at our Chicago School). Send postcard for **FREE TRIAL LESSON** and see how easy to learn and get a good job.

CHICAGO TECHNICAL COLLEGE
C-207 Tech Bldg., 2000 S. Mich. Ave.
Chicago 16, Ill.

MINK Easterns Labradors Yukons \$4000 EACH

All shipments made subject to 5 days' inspection before acceptance.

The quality of my mink is indicated by the fact that I have netted an average of \$20.00 a pelt on all mink skins sold during the past 5 years.

WHITE, SILVERBLU, and BLACK CROSS MINK Priced on Request
WHITE FACE, PLATINUM SILVER, and PEARL PLATINUM FOX

BOOK "Domestic Mink" \$1.00

HARRY SAXTON'S MINK RANCH, Bemus Point, N. Y.

BRUSH PLATING OUTFITS

for re-plating articles in the home and shop. No tanks necessary. Free particulars.

GUNMETAL CO., AVE. M, DECATUR, ILLINOIS

FIBRE ARMS AND LEGS!

Light, correctly fitted, strong and comfortable. Natural appearance. Braces for all deformities. Scientific design. Fair Terms.
BUCHSTEIN-MEDCALF 610-3rd Av. S., Minneapolis, Minn.

**WORLD'S
BEST
WANT AD
MEDIUM**

CLASSIFIED Advertisements



Advertisements in this section 50 cents per word, each insertion, minimum 10 words, payable in advance
To be inserted under proper classification in April issue, copy should be in our office March 4th

April issue on sale April 1st

F. W. Johnson, Manager, Classified Advertising
Popular Mechanics Magazine, 200 East Ontario Street, Chicago 11, Illinois

1507 CLASSIFIED ADVERTISEMENTS 1507 OPPORTUNITIES FOR YOU

AUTOMOBILES, MIDGET CARS

PHOTOS Famous race car drivers with their cars. Today's fascinating hobby for everyone. Present these pictures at races to be autographed. Experience new thrills. Pictures taken by Frank Smith, famous retired race driver. Special offer, assortment 7 famous drivers, size 4x5—\$1.00, including free autographed photo of Ted Horn. Photo Ted Horn only 25c postpaid. Midland Park Studio, Midland Park, N. J.

HENRY Ford—His Life, His Work, His Genius. Wonderful new 384 page Ford History book. Unusual photographs, illustrations, early and late Ford cars. \$3.00 postpaid. Cloth bound edition \$4.00. Clymer, 2125 W. Pico, Los Angeles 6, Calif.

DYNAMIC Power thru water injection. The same principle that gives our fighter planes their terrific, smashing power can now be applied to your automobile. The Hydro-Meter reduces carbon, eliminates ping, adds speed, power and increases gas mileage. Installed quickly by anyone. Hydro-Meter complete with instructions \$9.95 postpaid. Enterprise Laboratories, Box 390, New Haven 11, Connecticut.

JET Impulsion now for automobiles. Complete installation instructions. \$1.98. Wayne Engineering, Greenville 1, Ohio.

1946 **SUPER-IGNITIONER** \$5.50. Faster starting, pep, mileage. EG Mfg. Co., 355A East 149th St., New York.

GARAGE Doors, all types, controlled from dashboard. Complete "Build Yourself" plans \$1.00, refundable. Vital parts now available. Kaytor Laboratories, Lynwood, California.

REPAIR Your car. Motor parts for all engines, chassis parts, ignition and carburetor parts, etc. New replacement parts. Genuine and highest quality at manufacturers' retail prices. F.O.B. Chicago. No body parts. B & N Engineering Co., Box 3454 Merchandise Mart P.O., Chicago 54, Illinois.

BLUE Prints for regulation midget race car \$1.00. M & M Machine Co., 207 S. Henrietta Ave., Rockford, Ill.

PROFESSIONAL Midget racer, motor-scooter, midget roadster, and midget motorcycle. Plans, specifications for all four contained in illustrated handbook, 25c. Big list used motors, motorscooters, Servicycles, etc., included free! Midwest, 3839 Drummond, Toledo, Ohio.

NOW Ready! Floyd Clymer's Historical Motor Scrapbook Number Three, entirely different from Editions One and Two. Ads, photos, descriptions, specifications over 200 early autos, including Rolls-Royce, Owen Magnetic, Fordmobile, Revere, Ruxton, Cord, Roamer, Diana, Adler, Mercedes-Benz, Stutz Bearcat, Marmon, Stout, Flint, Lozier; steam and electric cars, many others. Motorcycle section includes early Cleveland, Henderson "6," Peerless, Wagner, Crocker, AMC, BMW, Excelsior, Ariel, Flanders, others. Pike's Peak races, many interesting incidents early automotive days described. Profusely illustrated. Continues Floyd Clymer's interesting autobiography. \$1.50 postpaid; Deluxe cloth-bound, \$2.50. (Editions One and Two also available at these prices.) Clymers, 2125 W. Pico, Los Angeles, Calif.

PHOTOGRAPHS, World's finest automobiles. List 10c. Box 1028, Minneapolis, Minnesota.

BUILD Midget racer from castoff parts! Plans, specifications, construction information. \$1.00. Motor Supply, Box 1682-CS, Toledo, Ohio.

SENSATIONALLY Easy to build inexpensive midget two-passenger "Jeep" from readily available materials! Large working plans, construction information, \$1.00. Universal, 2671 Algonquin, Toledo 6, Ohio.

CUSTOMIZE Your automobile. Illustrated, new restyling ideas, instructions, suggestions, specific model changes by simple methods. \$1. Speed Wheel, Box 723-E, Arcadia, California.

INTERESTING, Educational, illustrated English "Motor" magazine on foreign automobiles. 50c postpaid. Clymers, 2125 W. Pico, Los Angeles 6, Calif.

STEAM Car Scrapbook. Compiled by Floyd Clymer. Historical, authentic, amusing. Ads, photos, descriptions 250 early steam cars, with fascinating story by one-time world's youngest auto dealer. Postpaid \$2.00. Deluxe cloth-bound \$3.00. Clymers, 2125 W. Pico, Los Angeles 6, Calif.

AUTOMOBILE Racing book, fifth edition, well illustrated. Instructions on building bodies, frames, engines. Ford A and B conversions. Plans, AAA rules, specifications. Roadster racing, Indianapolis cars. \$1.00 postpaid, \$1.30 C.O.D. Ray Kuns, Dept. 47, Madisonville, Cincinnati 27, Ohio.

AUTO SUPPLIES AND EQUIPMENT

AIR Compressor outfits, complete with quart size spray guns, less motors. Use your own 1/4 horse power motor. Limited quantity. Write for details. Box 172, North End Station, Detroit 2, Michigan.

AUTO Parts for all autos and trucks. Trans., motors, differentials, fenders, carburetors. Also body parts. Security Auto and Truck Parts, 1941BJ Eddy, Chicago 13.

NUPLA Hammer hard hitting softie 1 1/2 head size 2 lbs. Gas and oil proof no cutting—marring \$4.00. Nupla, 1017 No. Sycamore, Hollywood, California.

NO More worries about flat tires! Ernie airline tire inflater! Send \$1. Distributors wanted. Box PM3145, Euclid 17, O.

SAVE Gasoline, new invention using gasoline your motor now wastes, only \$7.50 for popular cars. Can supply few more agents. Self addressed envelope for pamphlet. H. H. McDowell Co., 2000 N.E. Union, Portland 12, Oregon.

HAVING Engine trouble? Avoid these costly repairs. Get your copy of Automotive Trouble Shooting: plus 500 questions and answers, only \$1.00 postpaid. Chas. Nelson, 2908 Washington Ave., Santa Monica, Calif.

BATTERY Charger. Simple construction. Easily built from scraps. Cheap, reliable. Complete plans 25c. McMenemy, Box 3182, St. Paul 1, Minn.

DRIVE In and drive out; garage turn table; save your car; plans single \$2.50, double \$3.00 P.P. Vern Makee, R.D. 3 Fairgrounds Rd., Painesville, Ohio.

1000 MOTORISTS Needed to make gas saving test. Up to 30% savings. For trial test offer write Vacu-matic Carburetor Co., 7617-1268 W. State Street, Wauwatosa, Wis.

WHIRLGAS Turbinator. \$3 carburetor amplifier, increases mileage, power. Universities verify. Auto make, year required. John Hanley, 5719 Loraine, Detroit 8, Mich.

HAVING Car trouble? New, used, guaranteed auto, truck parts save money. Transmission specialists. Describe needs; immediate reply. Victory, 2930 1/2 North-western, Chicago 18.

AUTO Parts for all autos and trucks. Trans., motors, differentials, fenders, carburetors. Also body parts. Security Auto and Truck Parts, 1941 BJ Eddy, Chicago 13.

GASOLINE Saving device. Chevrolet, Ford 1932-1942, Dodge, Plymouth, 1933-1938. Walert Company, 3429 North 10th Street, Milwaukee 6, Wisconsin.

GRILLES For all cars. Meyers Auto Parts, 820 Dryades, New Orleans, La.

OIL Pumping motors—Brought back to normal without ring job. Write for particulars. Joe Mullner, Box 3102, St. Paul 1, Minn.

PLATING Outfits for auto parts. Connect to a battery. No tanks used. Free particulars and proofs. Gunmetal Co., Ave. J, Decatur, Ill.

AUTO TRAILERS

AUTOMOBILE-Trailer Travel, monthly magazine, \$1 year. Kimbel, Plant City, Fla.

BUILD Streamlined trailer coach. Has everything. Large manual, drawings \$1.00. Circulars 10c. Craftsmann Books, Box 1153-P3, Milwaukee 1, Wisconsin.

BUILD Your own trailer! Save money! Have every feature you want! Plans for house, sport, camp and utility trailers. Catalog describing 9 models 10c. 15c in Canada and overseas. Jim Dandy, Box 125-A, Wausau, Wisconsin.

MOTORCYCLES, BICYCLES, MOTOR-SCOOTERS AND SUPPLIES

"MODERN Motorcycle Mechanics" enlarged, revised, second edition, 560 pages, 300 illustrations. The most up-to-date and complete motorcycle book published. Extensively covers design, operating, and servicing Harley-Davidson, Indian and English makes. Price \$3.00 postpaid. Nicholson Brothers, Motorcycle Engineers, Saskatoon, Canada.

HARLEY-DAVIDSON Service, parts, accessories. Buddy seats \$17.75, tandems for 45" models \$12.50 (shipping paid). Can be fitted to other models. Send \$2.25 for Army Motorcycle Manual, 10c for bulletins. Knuth's (Harley-Davidson factory dealer), 2491 W. Fond du Lac, Milwaukee 6, Wis.

BICYCLES Brand new, men's, ladies', boys' and girls'. Accessories. Send dime for list. Century Cycle Company, 3447 Lawrence Ave., Chicago 25, Illinois.

MOTORSCOOTER Plans for boys. Speedy. Simple to build. Uses washing machine gas motor. \$1.00. Strachan Scooter Shop, Howard 2, Kansas.

MOTORCYCLES—How to Manage Them. 288 pages, 175 illustrations, drawings. 29th edition now available. Read and become better motorcyclist. Expertly written. \$1.50 postpaid. Clymer, 2125 W. Pico, Los Angeles 6, Calif.

BOLENS Factory-built midget racer \$40 complete; boys midget car less motor \$8; twin-cylinder motorbike \$35; Indian twin motorcycle \$60; Harley \$70; motorscooters \$35 up; Briggs-Stratton motors as low as \$5. Over 1500 balloon tires for midget cars and motorscooters in stock \$1.50 up. Parts plans. Mailorder only. Send 25c for big war-bargain catalogue Number 12 just out listing the above and almost 400 other motorized bargains. (35c by first class mail.) Midget Motors Directory, Athens, Ohio.

NEW Bikes, \$34.50 delivered. Tricycles, speedometers, chromium handle bars, luggage carriers. Hillman Cycle Co., 142 Wilson St., Havre De Grace, Maryland.

BICYCLE Book, how to buy, rebuild, sell used bicycles 50c. John Collett, Handley, Texas.

BUILD Scooters, trailers, midgets, conversions. Large manual \$1.00. Circulars dime. Craftsmann Books, Box 1153-P2, Milwaukee 1, Wis.

BOYS, illustrated "Bicycle Repair Manual" teaches brake repairing, re-spoking wheels, etc. Dealers wanted, 65c. Robt. Klausner, Shelbyville, Ill.

GENUINE Moto-Scoot parts. Complete wheels, tires, tubes, 4:00x7, 3:50x6. AMSCO centrifugal clutch. Windshield, side cars. All other parts and accessories. Write for parts list. Also genuine engine parts for Briggs and Stratton, Lauson, American Moto-Scoot Co., 1319 W. Carroll Ave., Chicago 7, Ill.

MOTORSCOOTER \$10. Motor \$3, tires \$2. New catalog, 25c, lists these and many other sensational bargains in motors, wheels, motorscooters, and motorbikes! Associated, Box CS-1764, Toledo, Ohio.

COMPLETE Motorcycle parts list, 10c. All models Indian and Harley. Pistons, chains, sprockets, generator repairs, carburetor rebuilding, motor rebuilding, repair manuals. Bootz, 622 E. Grand, Des Moines 9, Iowa.

MOTORCYCLE Cams ground for speed and power. For information write Harold Schaller, 247 West Main, Turlock, Calif.

FLOYD Clymer's Motorcycling Manual, 120 illustrations. Information, specifications, descriptions dozens motorcycles. Engines, transmissions, carburetors, square four, two piston singles, overhead camshafts, spring frames, hydraulic forks, sidecars, riding instructions. Two cycle engines and power bicycles described, illustrated. \$2.00 postpaid. Clymers, 2125 W. Pico, Los Angeles 6, Calif.

PARTS, Accessories, pistons, chain Harley Davidson motorcycles. George's, P.O. Box 114, El Paso, Texas.

LARGE Stock Indian parts. Expert motor rebuilding. Indian Motorcycle Sales, Kansas City 1, Mo.

BUILD America's lowest priced motor-scooter speedster! Complete plans, specifications, \$1.00. Big list used motors, etc., included free! Motor Supply, Box 1682-CS, Toledo, Ohio.

FLOYD Clymer's popular motorcycle, automobile books. See advertisement under Automobiles! Clymers, 2125 W. Pico, Los Angeles 6, Calif.

TIRES, Tubes, wheels, for industrial trucks, carts, wheelbarrows, scooters, midget cars, coaster wagons. Nationally known makes, first-line quality. Sizes 8" to 18" o.d. in 2, 4, and 6 ply tires, separate inner tubes, heavy duty demountable wheels. Also caster forks, straight and swivel types. Free illustrated circular and prices. Jahant Co., 626 East Exchange Street, Akron 6, Ohio.

ENGLISH "Motorcycling" Magazine. Interesting, educational, foreign motorcycles. Racing, new-old models, advertisements. 50c sample copy. Clymers, 2125 W. Pico, Los Angeles 6, Calif.

PLANS, Scale drawings, specifications, illustrations for building attractive motor scooter complete \$2.00; plans electrically driven bicycle \$1.50. Postpaid. Clymers, 2125 W. Pico, Los Angeles 6, Calif.

TIRES And industrial wheels, suitable for scooters, wheelbarrows, farm equipment, etc. All sizes. Bicycles and accessories. Largest assortment in America. Send dime for list. Cycle Transport Company, 1241 So. Michigan Ave., Chicago 5, Illinois.

AVIATION

FLEECE Lined air forces leather helmets \$2.95, small, medium, large. Wool lined air forces dark brown leather gloves 8 and 9 \$2.95. Mae West life preserver vests \$3.95. All new. Prices postpaid. Send money order, certified check or cash. E. K. Cargill, 654 Mulberry Street, Macon, Georgia.

ALUMINUM Airplane floats, dandy for air driven or water propelled amphibious craft and catamarans. Two cylinder 8 h.p. aircooled engines. Small pneumatic tired wheels. Airplane wings. Write for literature. Karl Ort, York, Pa.

JET Propulsion circular sent builders bikes, airplanes. Byrum, Buffalo, Okla.

AERO-SLED Blueprints, open job, \$3.00. Adastik Bros., Grand Rapids, Mich.

PROPELLERS—Airliner 3 blade, fit any motor. Ice-snow sleds, boats, aircraft. Lists free. Fast delivery. Aircool conversion diagrams 50c. Illustrated light-plane literature. Standard Aircraft, Ft. Worth, Texas.

\$200.00 ON Up, Cubs, Taylorcraft, Aronca, Interstates, Motors, parts, parachutes, gliders, hangers, propellers, flying suits, caps, tires, everywhere in United States. Send 25c for big catalogue. Aircraft Bargains, Box 409, Aberdeen, Idaho.

HELICOPTER Plans, Rush name for free literature. Wayne Engineering, Greenville 1, Ohio.

SEND 25c For big war-bargain catalogue of used airplanes located everywhere, some probably near you. (35c by first class mail.) New issue just out. Used Aircraft Directory, Athens, Ohio.

PORTERFIELD \$275, Waco \$125. New catalog, 25c. Lists thousands of sensational bargains in airplanes, motors, parts; parachutes, supplies. Aviation "Business Opportunity" section included free! National, Box 1682-CS, Toledo, Ohio.

LIGHTPLANE! How to build them. Illustrated circular 20c. Craftsmann Book, Box 1153-P1, Milwaukee 1, Wis.

JET Propulsion experiments. New principle to drive boats, bicycles, model helicopters. Circular on plans. Rush name. Houston Maupin, Tipp City 53, Ohio.

WELDING, SOLDERING, PLATING

NEW Model electric welder 110 volt a.c.-d.c.; will weld all metals; easy to use; full directions. Complete with power unit, flame and metallic arc attachments, carbons, fluxes, rods, mask; all for \$19.95. Used by the navy. Magic Welder Mfg. Co., 239-MP3 Canal St., New York City.

ACETYLENE Welding outfits, used \$25.00 up; arcwelders, acetylene generators. Eagle Welding, Dept. PM, 5085 Broadway, Chicago 40, Ill.

ARC Welders wanted by the thousands. Learn with 516 page lessons manual. Over 500 how-to-do-it photos. \$2.00 copy. Money-back guarantee. Hobartweld, Box M-364, Troy, Ohio.

ACETYLENE Generator plans that equal the commercial product. Detailed plans \$1.50. Hasco, Box 103, Hastings, Nebr.

WELDING Shops. Build and sell all steel rubber tired farm wagons, dual wheel tractor trailers, utility type trailers. Plans \$1.00 each, all three \$2.50. "Doc" Fixit's, Mt. Vernon, Ohio.

FARMERS, Garagemen, repairmen: guaranteed 110/220 volt, 10 to 125 amperes, a.c. welder handles 1/16" to 5/32" rods, complete supplies, \$68.00 F.O.B. Chicago. Details free. Others to \$245.00. Williams Sales Co., Box 4100, Portland 8, Oregon.

BUILD 110 Volt a.c. welder. Plugs in socket. Plans \$1.00. Easily built. Frank's, Box 555, Louisville, Ky.

OKINAWA "Flame thrower" slip-on soldering tip for fender men. Fits all torches. Postpaid anywhere in U. S. \$2.35. L. E. Kelly, 1947-19th Avenue, San Francisco 16, Calif.

ANY Handyman can make a heavy duty a.c. arc welder using field coils from old auto generators. No extra wire or rewinding. Instructions \$1.00. Excel Electric, Route 4, Box 586, Traverse City, Michigan.

WELDING, Cutting, aircraft welding and soldering equipment. Electric arc welders. Superior Oxy-Acetylene Co., Hamilton, Ohio.

"THUNDERBOLT"—Transformer welder, dial-control, 3 heat stages, 60 amps., 110 volts-a.c., takes up to 3/32 rod, carrying case, all accessories, illustrated instructions. Professional heavy duty welding, brazing outfit. \$39.50. Also light-work welder, 110-volts, a.c.-d.c. \$19.95. Save 2%, send check. Or order C.O.D. Super-Welder Mfg. Co., Dept. PMC, 23 E. 20th St., New York 3, N. Y.

BUILD D.C. arcwelder without rewinding armature. Plans \$1.00 each. 25 to 600 amperes from automotive d.c. motors, light plant generators, automobile starter-generators. Welders Club, AB-3432, Chicago 54.

ELECTRICAL SUPPLIES, EQUIPMENT

STAR Fuse tester and plier. Tests home electric outlets, locates and removes blown fuses. For home owners, electricians, maintenance men. Replaceable lamp tests 110 to 250 volts. Pulls fuses 10 to 100 amperes. Transparent shockproof plastic. Obtain from General Electric, Westinghouse stores, or your local dealer at \$2.75. Leads \$1.50 additional. (10c postage.) Star Plier Company, 233 Canal Street, New York.

ROYAL Beauty electric irons \$5.30, electric heaters \$4.95, electric broilers \$13.95, 8" a.c. 110V fans \$8.95. Two burner electric stoves \$6.95. Jeannette Electric Co., Inc., 159 West 23rd St., New York 11, N. Y.

ELECTRIC Wire—Improve your product with glass covered plastic insulated wire. Tinned copper strands. Single conductor; No. 16, No. 20 and No. 22 gauges. Coils 250 ft. to 1000 ft. One cent per foot postpaid. Specify size. Write for quantity prices. Penn Electric Company, 461-8th Avenue, New York 1, N. Y.

3 ALNICO Magnets, \$1.00. Will lift 2 1/2 pounds. Satisfaction guaranteed. Ronald Eyrich, Box 849, Milwaukee, Wis.

HEATING Element welding flux. Free sample. Raymond Dow, 2922 164th Street, Flushing 31, N. Y.

ELECTRICAL Appliance repair. Open your own shop. Learn house wiring; electric motors, vacuum cleaners, washers, etc. Complete illustrated course shows how. Free booklet. Pacific Training School, Dept. AP-2, 7217 So. Broadway, Los Angeles 3, Calif.

WRINGER Rolls as low as \$1.98 each. Also most washing machine parts. Write for details. Hoover Elect. Shop, 1 N. Main St., New Madison, Ohio.

NOW—Repair your own electrical appliances with Chanite Self-welding Electrical Heating Element Flux. Instructions delivered, price \$1.00. Stick form 25c ea., \$2.00 doz. Chanite Sales Company, 914 South Main, Fort Worth, Texas.

"IDEAL" Electrical tools, BX armor cutter, cuts BX easily without injury to wire insulation \$3.50; wire stripper and cutting pliers, strips wire quickly, cleanly \$5.50; pocket size fuse pullers \$1.25; test Glo Neon circuit tester \$1.50. All prices postpaid. Send POMO to H. H. Barnes, P.O. Box 301, Plainville, Conn.

FREE Catalog of welders, welding supplies, generators, fencers, and other electrical items. Write LeJay Company, Minneapolis 8, Minn.

FLUORESCENT Tubes burned-out? You can relight and use indefinitely. Complete instructions \$1.00. Wallingford, 121 Burlington, York, Nebr.

ELECTRIC Pencil: Writes-engraves all metals \$1.00 postpaid. Beyer Mfg., 4515-H Cottage Grove, Chicago 15.

BROKEN—Burned out electrical heating elements quickly repaired. Use new amazing Nichrocite Paste, simply overlap ends and turn on current. Family size \$1.00 bill. Satisfaction guaranteed. Armstrong Mfg., 861-X, Minneapolis, Minn.

MACHINERY, TOOLS AND SUPPLIES

SAW-ARBORS 5/8 Shaft double bearing block \$1.98. Single block \$1.00. Pillow blocks 40c. Grinding arbors 70c. 100.000 other items. When ordering include 10% for postage. Sorry, no C.O.D.'s. All merchandise 30 day money back guarantee. For list and assorted samples send 10 cents. Describe your needs. Wilson Manufacturing & Sales, 2233 Summit St., Columbus 1, Ohio.

GEARS For inventors, experimenters, model makers, schools, work shops, laboratories, etc. Government surplus made of brass, bronze, dural, steel, and stainless steel. 12 matched pairs; 24 gears, bevel, spur and ratchet. List price \$12.00, our price \$2.50. 25 matched pairs; 50 gears, includes larger gears, also sets of worm gears. List price \$30.00, our price \$5.00. 50 matched pairs; 100 gears better assortment, including internal set and worm sets. List price \$75.00, our price \$10.00. Limited quantity. Order now. Write for our bulletins on ball bearings, rectifiers, Selsyns, Horns and government surplus materials. Met Exchange, 323 Canal Street, New York.

DRILL Grinder—Grinds drills to factory accuracy. Callipers with direct reading scales. Circle cutters. New tool grinder. Lowest prices. Free literature. Factory; 811-B East 31st, Kansas City 3, Mo.

HOBBYISTS! You can equip your workshop at a fraction usual cost by building your own mill, shaper, drillpress, bandsaw and other shop tools for metal and wood-working from Lewis castings, materials and blueprints. Easy to complete, and ideal for home use. Send 10c to cover cost of mailing latest catalog describing 23 items. Lewis Machine Tool Co., P. O. Box 116, Station A, Dept. M-62, Los Angeles 31, California.

FAST, Easy, smooth running portable bench grinder, 5" wheel. For home, garage and shop use. Postpaid \$5.95. Hardware Sales Corp., 242 Canal St., New York 13, N. Y.

TREASURE Finders. See Goldak advertisement in Miscellaneous section.

"PEPY" Governors make automobile motors power units. \$9.50 up. Circular, Harris Machinery, Minneapolis 14, Minn.

TURBINE Water motors. Attaches to faucet. \$7.75. James Woodward, Jackson, S. C.

TOOLS, Hardware, taps, drills, pulleys, saw mandrels, brass, steel. Catalog 10c. Terek, 6304 Patterson, Chicago 34.

WAR Surplus, machines, tools, etc. Rush name for free literature. Wayne Engineering, Greenville 1, Ohio.

DRILL Grinder for twist drills \$2.95, and other craftsman's tools. See ad on page 277.

EVERY Shop can use assorted aluminum rivets for models and repairs. 3 pounds 69c. Arizona Mfg. Co., Box 2091, Phoenix, Arizona.

EXPERIMENTERS—400 Valuable new springs, 75 kinds, numerous sizes, 10,000 uses. \$2.00. Deluxe assortment, \$3.00. Jumbo, \$5.00. Guaranteed. Technico, Box 246-A, West Hartford, Conn.

HIGH Speed drills, taps, milling cutters, end mills, tungsten carbide tipped tool and lathe bits, etc. Reasonable prices. Send for price list. Box 212, Milwaukee 9, Wis.

SELSYN Motors, weight 5 lbs. each., set of 4—2 differentials, 2 transmitters, 110 volts, 60 cycles, a.c. special \$25.00, charges prepaid within the U. S. Manufactured by Bendix, suitable for remote control, beam antennas, bingo signalling, wind indicators and many other uses. .06 h.p. Westinghouse motors 115 volts, 60 cycle, a.c., 3 phase, 945-1145 intermittent speed \$12.50, charges collect. Also complete oil gear unit for elevation model M-1. .06 h.p. motor, 115 volt, a.c., 3 phase, 945-1145 Intermittent speed motor, 1 set Selsyn motors, \$35.00, charges collect. Weight 172 lbs. Alnico magnets, gap 16 m/m, 20 m/n, pole faces, 4860 Gauss. Charges prepaid, \$7.50 ea. Columbo Trading Co., Inc., 304 Canal St., New York City 13.

INDEX Heads for sale. Very inexpensive. Sixty-two different divisions. Used on small lathes, drill press, milling machines, etc. Make gears, hobs, cutters, etc. Very accurate, and durable. Not a toy. Used by defense schools and hobbyists. Write for free folder. Long's Index Heads, 2117 East B St., Torrington, Wyo.

ROTARY Vacuum pumps \$60.00. 28" vacuum 3 c.f.m. at 850 r.p.m. William Reid Co., Chicago 14, Ill.

ARBORS. Ball bearing, 5/16" to 1" shaft. Specifications on request. Don G. Jennes Co., 1017 Santa Fe Ave., Los Angeles 21, California.

ENGINES, MOTORS, DYNAMOS

BIG Pay jobs in welding. Complete welding lessons and reference books. 516 pages. 41 lessons. \$2.00 copy. Money-back guarantee. Hobartweld, Box 365-M, Troy, Ohio.

SELSYN Motors. Write for illustrations, description, etc. J. A. Weber, 150A Maple, Hershey, Penna.

150 AMPERE Generator for welding \$47.50. Extra flexible cable, 10 ft. lengths \$2.75. Other bargains. Butler Electric Company, 1885 Milwaukee, Chicago 47.

COMPARE Our catalogue on engines, etc., 10c. Howard-A3, 2417 N. Ashland Ave., Chicago 14, Ill.

NEW Kohler electric plants a.c. and d.c. Other electric plants rebuilt. Write E. P. Schmalz, 314 Wyoming Ave., Kingston, Penna.

WINDING Data, listing 225 motors, single and three phase, \$1.00. Motor Data Co., Box 7631, Kansas City 3, Mo.

BOATS, OUTBOARD MOTORS, ETC.

TENTS For body scouts, wall tents, car-bide lamps, Swedish kerosene stoves, canvas for canoes, kayaks, airplane dope, cement, paints, canoe enamels. Alan-Clarke, 96 Chambers, New York City 7.

OUTBOARD Cabin cruiser plans. Fast. Simple to build. Sixteen foot. \$3.00. Strachan Boats, Howard 2, Kansas.

MOTOR Installation instructions, fishing boat, skiff, barge and houseboat plans, each \$1. Albert Schantz, Baden, St. Louis, Mo.

USED Outboard motor parts. Outboard Exchange, 1194 Remsen Ave., Brooklyn, 12, N. Y.

REBUILT 22 H.P. Johnson outboard motors; many others; new and used marine engines; propeller straightening and balancing; parts for most all makes; boat paints; marine hardware; Ford conversion kits; new propellers. W. L. Masters and Son, 214 W. Chicago Ave., Chicago, Ill.

RUBBER Boats! Holds four men. About 10 ft. long, 5 ft. wide. Deflated it collapses into carrying case 3 ft. long, weighing 40 lbs. These boats are new and unused, but slightly shopworn. Complete with automatic instant inflation equipment also hand pump, oars and carrying case. Just like the boats which kept Rickenbacker afloat for twenty-one days. Original cost about \$300.00. They're a real bargain at \$89.50. Boat only without inflation equipment, oars, pump or carrying case \$69.50. Other types: new one-man size complete with 17 accessories and automatic inflation cylinder weighs 18 lbs., collapses into package 13"x15"x4", \$39.50. New Navy type dual automatic inflation life belts, 98c each without inflation cartridges. New pneumatic Mae West life saving vests, \$3.95 without inflation cartridges. Satisfaction guaranteed or money back. Cartridges for inflating belts and vests \$1.00 per dozen. Order from this ad or send for literature. Dealers wanted! Karl Ort, Dept. PM-8, York, Pa.

FORD-Mercury-Zephyr marine conversions. Catalog 10c. Lehman Manufacturing Company, Dept. D, Newark 2, N. J.

MARINE Muffler—Simple, low cost, cinch to install yourself. Guaranteed. Send for free folder. Savage Marine Co., P.O. Box 772, Boston, Mass.

WANTED, Experimenters to work with jet propulsion. Free literature. Shea, 374 Grant, San Lorenzo 16, California.

OUTBOARD Motor brackets—New models for canoes, rowboats, sailboats. Send for free descriptive folder. Outboard Motor Brackets Co., P.O. Box 772, Boston 2, Mass.

ONE-MAN Boats—Ideal for hunters, fishermen. 7½ foot long. Weighs only 30 pounds. Easily carried. Army surplus auxiliary fuel tank sections, of Terne plate steel, that convert easily to one-man boats. Approximately \$1.00 worth of welding will seal fuel outlets. Only \$4.75, prepaid anywhere in U. S. Address: Irving Goodman, P.O. Drawer 191, Galesburg, Illinois.

PLASTIC Boats now! Make your own for pleasure or sale with these streamlined 9'x4' one-piece reinforced molded hulls. Makes Adirondack car-top boat, sailing dinghy and ten other craft. Won't leak. Won't crack. Won't rot. Plastic Boats, Box 187, Lake Placid, N. Y.

BUILDING The Small Boat, new book, due out in March, by Cliff Bradley, 74 pages, sent C.O.D. \$2.50 plus fees when ready. Kimbel, Plant City, Fla.

MARINE Power—Easily convert any Jeep or Ford Motor (domestic and foreign) with Convo parts and kits. Complete catalogue 25c (coin). Osco Motors Corp., Dept. M, 2020 E. Orleans St., Philadelphia 34, Penna.

BOATS And all about them. How to select, build, repair and operate. For 40 years the leading practical boating magazine. Trial subscription, 12 issues for \$1.00. Motor Boat, 62 Gold Street, New York 7.

OUTBOARD Motor parts for all makes. We have a good stock of new parts for Neptune, Waterwitch, Champion, Seaking, Mercury, Lauson, etc. Our stock of used parts are too large to list, write for quotation giving us the model and make. New pistons standard and oversize for all outboards. Outboard Motor Mart, Inc., 315 Atlantic Ave., Boston 10, Mass.

BOAT Designers are highly paid professionals. Complete course by mail. Catalog. Westlawn, Montville, N. J.

FULL Size, cut to shape boat patterns, blueprints. 7½ - 38 feet. Illustrated "Build a Boat" catalog, 10c (coin). "How to Build Boats" book, \$1.00. Cleveland Boat Blueprints Co., Dept. A-66, Cleveland, Ohio.

NINE Plywood boat plans 50c. Catalog boat building plans 10c. The Rudder, 15 Murray Street, New York.

USED Marine motors, propellers, marine fittings, conversion manifolds. Stokes Marine Supply, Coldwater, Michigan.

2 PLACE, 12 foot Kayak kit, complete for assembly in one evening. All parts, canvas, paint, instructions, \$29.95 f.o.b. factory. Your dealer or send check or money order to: Westin New Haven Co., Inc., Mt. Carmel, Conn.

ATHLETIC EQUIPMENT, BODY BUILDING COURSES

BARBELLS—Deluxe exercise equipment. Hundreds of West Coast athletes have developed their terrific strength by using Marcy exercise equipment. Write immediately for details. The Marcy Co., Dept. A, 1519 Riverside Dr., Los Angeles 31.

"COMPLETE Muscle Building Course" 50c. Harold Ansong, 619-P Watson, Grand Rapids, Michigan.

BODY Building equipment. Develop muscles that will be the envy of all your friends. Detail plans of ten exercisers built from materials available in most homes \$1. Lyall Bush, 1411 Eggert Road, Eggertsville, New York.

LEARN Hand-balancing quickly. W. Power, 923 W. Vine, Kalamazoo, Mich.

DEFEAT A boxer. Secret Ju-Jitsu defense. Complete instructions 25c. Dr. Malcolm Smith, 1104 Union Ave., Montreal 3, Canada.

PHYSICAL Perfection courses \$1.00 (guaranteed). Barbell Equipment, Sid's System, Southgate, California.

DEADLY Judo—Fiercest fighting technique. Jitsu, wrestling, foot-fighting, police tactics. Complete course (186 photographs). Special \$1.00. Variety House, Box 46-BD, Wall Station, New York City.

BARBELLS Exercise equipment. Courses. Special offers! Free booklet. Good Barbell Co., Reading, Penna.

SPORTING GOODS, GUNS, FISHING TACKLE, TRAPPING, ETC.

GUNS Refinished like new by factory methods, as used by leading gun manufacturers. Send for circular. Middletown Metal Finishing Company, 45 River Road, Middletown, Connecticut.

PUP Tents U. S. Gov't surplus, sleeps two, slightly used \$2.95, new \$6.95. Ideal for campers. When ordering add 35c for postage. Satisfaction guaranteed or money back. United Trading Co., 50 Myrtle Ave., Brooklyn 1, N. Y.

SWAPPING Guns is as easy and economical as trading in your car. Try Klein's simple Trade-By-Mail plan. Write today, fully describing your gun. By return mail, we will quote our highest "Blue Book" cash or trade offer. We pay more, sell for less. Send 25c (refunded first order) for "guaranteed bargain catalog" and current Swap List. Klein's Sporting Goods, 506-TH South Halsted, Chicago 7.

BOWS, Arrows for recreation, hunting, fishing. Beautiful Archery Instruction Book. 70 pages, 50 illustrations, only 50c. Illustrated catalogue 10c. Archery Sales Service, 617 So. State, Chicago.

SCOUTS Attention, Indian war bonnet kits, archery kits. Charles T. Schneider, Whitehall, Michigan.

ARMY Head nets. Protection against mosquitoes, flies, bees. Mildew-proof, water-proof. \$1.00. Continental, Box 5A, Kensington Station, Detroit 24.

"AMMUNITION"—New and used "shot-guns," "rifles," "handarms." List 10c. Rudolph's, Atchison, Kansas.

GOLFERS—Make the hole with putter almost every time. Amazing invention (accurate aimer) attached to putter does the trick. \$1.00 postpaid. Moneyback guarantee. Aimer Co., 7065 N. Mason, Chicago 30.

FINEST Glass eyes; taxidermy supplies. Catalog free. Elwood Supply Company, Dept. 234, Omaha, Nebr.

GUNS! Antique and modern, 52 page catalog, 25c. Retting, West Hurley, N. Y.

ATTENTION Sportsmen! Have fun Kayaking! Complete kits. Easily constructed. Literature. Play-yacks, Dedham, Mass.

CHUM (Unattached bait) attracts food and game fish—from 6 or 7 miles—to your hooks. Fresh or salt water. Cheap! Easy! Make 6 Rigs. Learn 8 secrets. Use 10 methods. Know 55 best chums. Send \$1.00 for a U. S. Chumming Guide. Fish Research, 5912D Thompson, Philadelphia 31, Penna.

2000 BARGAINS, Firearms, binoculars, war relics, catalog 30c. Smith Firearms, Runnemedede, New Jersey.

SEND 10c For list 100 used guns. Frayseth's, Willmar, Minnesota.

USED Guns, bought, sold, exchanged. List stamp. Howe Fur Company, Coopers Mills, Maine.

FIELD GLASSES, MICROSCOPES, TELESCOPES, MAGNIFIERS

TELESCOPES 18 Inch, 2-section 8 power, precision ground and polished lenses. Individually packed \$1.50. 36 inch, 3-section 17 power, precision ground and polished lenses including carrying case \$2.50 postpaid. Criterion Co., Box 1285, Hartford, Conn.

TELESCOPES 17 Power, \$3.00. Candid cameras, \$3.98. Cardone, 1324 Sheffield, Pittsburgh 12, Penna.

TELESCOPES. Real 17 power \$3. United Co., 2309-PM Lawrence, Toledo, Ohio.

POWERFUL, Efficient telescope easily made. Perfect lenses and instructions for making clear vision telescope. Includes lenses for 100 power terrestrial eyepiece, 100X, 200X, 400X, 600X astronomical eyepieces. Kit of eight lenses and instructions \$4.00 postpaid. Instructions alone 10c. Carl Jamer, Manorville, N. Y.

POWERFUL Compound microscope 800 diameters magnification easily made. Lenses and instructions \$3.00. Instructions alone 10c. Carl Jamer, Manorville, N. Y.

REFLECTING Telescopes, complete. 3½" diameter, equatorially mounted. View planets, stars, \$19.75. Write Skyscope Company, 475-P 5th Ave., New York.

BINOCULARS, Telescopes, watches. Buy, sell, trade. Paul Schweer, Donnellson, Iowa.

BUILD Your own reflecting telescope. Complete plan with each kit. Send for free catalog. Mayflor Products, Katonah 1, N. Y.

TELESCOPES, Microscopes, cameras, binoculars: bought, sold, repaired. Lists 10c. Specify instrument wanted. Rasmussen and Reece, 41 Market, Amsterdam, N. Y.

ANTIQUES, RELICS, INDIAN GOODS, CURIOS

MUSEUM Specimens. Indian relics, curios, den decorations. Illustrated catalogue, identification chart 25c. We also buy. Museum Supplies, 6601 Oshkosh, Chicago 31, Illinois.

GENUINE Fairy crosses, Roman and Maltese types 50c each postpaid. Curio catalogue 10c. Gordon Bower, Route 15, So. Richmond, Virginia.

4 FINE Perfect ancient arrowheads \$1.00. Ancient tomahawk \$1.00. List free. Lear's, Box 569, Galveston, Texas.

SEASHELLS, Ten different \$1.00 postpaid. Tim West, 6431 Buford, Houston 12, Texas.

DECORATE And sell unpainted plaques, statuary, etc. Pioneer, Austin 3, Minn.

INDIAN Relics, coins, minerals, glassware. Catalog 5c. Sistershop, Northbranch, Kansas.

ANTIQUÉ Firearms wanted—entire collections. Generous reward for productive information. James Serven, Santa Ana, Calif.

WINDOW Box cactus garden, 6 varieties \$1 postpaid. P.O. Box 1059, Rialto, Calif.
50,000 **INDIAN** Arrows, tools, rainbow variations. Don McKillop, Regina, Sask.

DOGS, PETS, BIRDS, RABBITS

WILD Geese, ducks, peafowl, pheasants, pigeons. Prices free. Jewel Game Farm, Danville, Ill.

\$500.00 A Year raising canaries. Details free. George Gundrum, LeRoy, Michigan.

ANGORA Rabbits supply living from wool, meat. House of Angora, Springfield, Ill.

RAISE Birds for us. Canaries, love birds, finches, and others. Interesting, profitable spare time work. Breeders supplied. Catalog and instructions free. Universal Aviaries, 1216 So. Michigan St., South Bend 18, Indiana. "Successors to Tom and Ann."

MONEY Raising rabbits. Investigate. Folder 10c. Close Rabbitry, Tiffin, Ohio.

HOP On to "Easy Street" with tadpoles, frogs. Dime brings valuable booklet. Chariton Corp., Century Bldg., Chicago 4, Ill.

RAISE Guinea pigs. Profitable, low-cost feeding, small space required, small investment. Complete details 25c. Guinea Pig Farms, 3456 West 116th St., Chicago 43.

RABBIT Skins wanted. Prices, shipping tags, instructions. Rabbit Products of America, 1113-B Walnut, Sangabriel, Calif.

FREE List hundreds pet, farm, breed magazines. Kimbel, Plant City, Fla.

RAISE Diamond seal rabbits. We pay \$25 to \$50 each. We buy all you raise. Literature 10c with hutch plans \$1. Automatic cleaning, watering, feeding. 31 drawings, patterns. Hansen's Rabbitry, 1347 Miller Ave., Salt Lake, Utah.

REPTILE List 5c, eight issues 25c. Hobby catalogue 10c. Chameleon 25c. Quivira Specialties, Topeka, Kansas.

RAISE New Zealand white rabbits. Money makers. Winfield Harrison, Fitzgerald, Georgia.

ANGORA Rabbits, giant chinchillas—finest pedigree. Valuable wool \$15.00 pound; gorgeous two-tone furs. Raised anywhere. Literature free. Grinsteeds, Edwardsville, Illinois.

—RAISE Giant Chinchilla rabbits. Willow Farm, R15C, Sellersville, Penna.

RAISE Giant Chinchilla rabbits. Valuable fur. Delicious meat. Easily raised. Pleasant pastime. Large profit. Free booklet shows amazing profits from small investment. Willow Farm, R15C, Sellersville, Penna.

BEAUTIFUL, Useful collie-shepherd pups \$11. Paul Schultetus, New Liberty, Illinois.

FANCY And utility pigeons. Illustrated catalog five cents. William Howe, Princeton, Illinois.

RACCOONS, Minks—bred females. Baby skunks. Instructive art-colored catalog. 25c. Shady Fur Farm, Springfield, Minnesota.

CHINCHILLA Giants, real. Most profitable. Prolific, easily raised anywhere. Breeders supplied reasonable. Satisfaction guaranteed. Free literature. Large illustrated catalogue, 25c. Fur samples, 25c. Chin-Chin Farms, Melvin Behrens, Gen-Mgr., Dept. 4, 44 Chester Pike, Darby, Pa.

RAISE Moneymaking Angora rabbits. Wool \$15.00 pound. Plenty markets. Cash income. Future prospects bright. Particulars free. White's Rabbitry, Lawrence, Kansas.

PIGEONS, Rabbits, 30 varieties. Catalogue 10c. Jim Houck, Tiffin, Ohio.

ST. BERNARD Pups: Champion sirel beauties. Franklin Young, R4, Riverhead, Long Island, New York.

RAISE Guinea pigs. Make money at home. Big demand. Free booklet. Taylors Guinea Pig Farm, Hapeville, Georgia.

STANDARD Rabbit Journal, Milton, Pa. 3 years \$1.00, sample dime.

A LIVING With rabbits and cavies. Markets waiting. Magazine 10c. Book describing twenty breeds and magazine 25c. Book and magazine (monthly) one year 50c. Address Small Stock, Dept. 2, Pearl River, N. Y.

SEEDS, PLANTS, NURSERY STOCK

GROW Christmas trees on vacant land at low cost. Big demand. Large profit. Planting information. Planting stock prices. Suncrest Evergreen Nurseries, Johnstown, Penna.

GINSENG Growing, instructions dime, seeds reasonable. Specialty Farm, Rockford, Minn.

FARMS, FARM LAND, REAL ESTATE

40 ACRES Virgin Missouri land \$125. Terms and complete Ozark information. Write Armstrong, Shook, Missouri.

STROUT'S Farm Catalog—Over thousand bargains—25 states—from Maine to Florida, west to California, Oregon and Washington. Free! Write now for this big 132-page book. Strout Realty, 255-P 4th Ave., New York 10, N. Y.; 7 So. Dearborn St., Chicago 3, Ill.; 453 So. Spring, Los Angeles 13, Calif.

CANADIAN Tax sale lands for a dollar an acre and up. Small monthly payments. Farms, timber, hunting and fishing camps, minerals. Limited number of properties. Write at once for free catalogue. Tax Sale Service, Room 613, 72 Queen St. W., Toronto 1, Canada.

FERTILE South-American lands obtainable free. Homesteads. Plantations. 25,000 acre ranches. Interesting information, 10c. Vallesp, New York 13.

WISCONSIN, Minnesota water frontages. \$5 down, \$5 month. 3505-K So. Hope, Los Angeles 7, Calif.

"HOW To Buy a Farm or Ranch." \$1. Wm. M. Wells, licensed broker, 105-P No. Ave., No. 56, Los Angeles 42, Calif.

DON'T Buy a farm till you have the Real Estate Buyer's Hand Book. Tells how to pick a farm, all about titles, abstracts, line fences, and hundreds of other important facts. A dollar post paid. National Tax Service, Majestic Bldg., Detroit.

WEST'S 1946 Catalogue. Hundreds farm bargains, business opportunities. Pennsylvania, New York, New Jersey, Ohio, Delaware, Maryland. Free copy. West's Farm Agency, HE, Pittsburgh 16, Penna.

FREE Catalog, farm bargains, 8 midwest states. Many fully equipped for convenient quick start. Many pictures. Special service to help you locate quickly, if you state requirements, payment plan and general location desired in first letter. United Farm Agency, 1796-MP Arcade Bldg. 1, St. Louis, Mo.

GOOD Farms—ranches. Washington, Minnesota, Montana, Idaho, Oregon, North Dakota. Dependable crops, favorable climate. Write for literature, lists describing typical postwar farm opportunities. Specify which state. J. W. Haw, 119 Northern Pacific Ry., St. Paul 1, Minn.

OZARK Lands for all purposes. Actual River frontages. 5 acres \$75.00 and upwards. Free list and literature. Hubbard, 424PM, Minnesota Ave., Kansas City 4, Kansas.

HOMESITES \$450—Low terms. California's finest garden spot. On Morro Bay's wooded shores. Wonderful fishing, hunting, boating, etc. Fertile soil, soft water, temperate climate, congenial community. Free literature. Richard M. Otto, 6560 Hollywood Blvd., Hollywood 28, Calif.

OZARK Farms, ranches, resorts. List free. Farm Finders, Lonsdale, Arkansas.

\$5.00 MONTHLY Buys 40 acres near town; price \$175.00. Free list. Box 425-P, Carthage, Mo.

OZARKS Guide, Lonsdale, Arkansas. Magazine for homeseekers, sportsmen, year, \$1.00.

OZARK Farm bargains. 5 to 5000 acres. Frank, Mountain View, Mo.

POULTRY AND FARM SUPPLIES

YOUR Greatest poultry problem will look simple when you read American Poultry Journal regularly. 500,000 poultrymen do, why not you? 2 years 50c, 5 years \$1.00. American Poultry Journal, 539 South Clark, Chicago.

50 "FANCY" Breeds, large and bantams. List 4c. Empire, Corona, New Mexico.

BABY Chicks, champion mated. 52 varieties, 7 hybrids, licensed, inspected, blood tested. Rush postal, large colored book, low prices. Berry's Farm, Route 12, Clarinda, Iowa.

BOTH Free! Four color catalog with full page pictures. Valuable chick raising book. Rock bottom prices on all baby chicks. Colonial Farms, Pleasant Hill, Missouri.

CHICKS For broilers or layers. Pure breeds, crossbreeds. Write for folder, prices. Amstutz Hatcheries, Box 100, Orrville, Ohio.

KNOW How to raise poultry for profit. Read Northeastern Poultryman. Every issue packed with helpful hints and practical suggestions. Latest articles on breeding, feeding, and management. Read nationally. Subscribe now. 1 year 65c; 2 years \$1.00. Northeastern Poultryman, Dept. M, 376 Boylston St., Boston 16, Mass.

ROTARY Vacuum pumps for milking machines, pump only \$60.00. William Reid Co., 2271 Clybourn, Chicago 14, Ill.

RAISE Turkeys the new way. Write for free information explaining how to make up to \$3000.00 in your own backyard. Address National Turkey Institute, Dept. 3, Columbus, Kansas.

PROFITABLE OCCUPATIONS

EARN While you learn the clock repair business! With our method of instruction, your income starts immediately. For details write Akron Clock Clinic, 964 Wye Drive, Akron 3, Ohio.

MAKE Beautiful lifetime bracelets from stainless steel rod, sell \$10.00 up. Easy instructions, drawings \$1.00. G. W. Osborne, Opportunity, Wash.

TADPOLES Make frogs—both make money. Dime and this ad brings valuable information booklet. Chariton Corp., Century Bldg., Chicago 4, Ill.

QUALIFY For new type radio work! Write Topical Emprise Corporation, 1527 Highland, Box 42X, Louisville 4, Ky.

"12,000 ALASKAN Job opportunities." Mechanics, carpenters, fishermen. Earn years pay in four months. \$1 brings copyrighted folio explaining where to apply with listing of firms. Information on business opportunities and government homesteading lands included. Transcontinental Research Box 2147-PM, Hollywood, Calif.

DOES \$100 Weekly from your own collection agency business, interest you? We can show you how. Write: Cole Associates, Syracuse 2, N. Y.

MECHANICALLY Inclined men—Own and operate general appliance repair shop. Complete, illustrated course shows you how. Welding, refrigeration, motor repair, how to get business, etc., all phases covered. Free literature. Christy Supply, Dept. 462, 2835 N. Central Ave., Chicago.

WELDING Pays. Learn with 1942 trade school text manual. 516 pages. Over 500 photos. \$2.00 copy. Money-back guarantee. Hobartweld, Box M-363, Troy, Ohio.

"FROG Raising!" New book tells how. Profitable. Marlboro House, 1035 Marlborough, Detroit 15, Michigan.

"77,000 EXCELLENT Foreign Job Opportunities" including South and Central America. \$1.00 brings copyrighted folio explaining how, when, where to apply with listing of 300 firms with foreign interests. L. J. Enterprises, Box 2549-PM, Hollywood, Calif.

SOILESS Gardening. Instructions 50c. Chemicals \$1.00. Gordons, 553 Williams, Winnipeg, Manitoba.

MAKE Good money repairing cracked cylinder heads and cleaning clogged radiators, no special equipment needed, method used successfully by large operators, necessary material available anywhere, complete instructions \$1.00. C. H. Pickett, 3937 3d St., Des Moines 13, Iowa.

LEATHERCRAFT Kits for hobby or profit. Guaranteed satisfaction, complete with all necessary tools, leather, accessories, instructions, patterns and projects. Prepaid. Beginners kit \$5.15. Advanced kit \$10.25. Professional kit \$25.00. Art Craft Supply Co., P.O. Box 148, Fort Worth, Texas.

RAISE Fishworms, daily income. Indoor method \$1. Stoner's, Chattanooga 6, Tenn.

BUY Unpainted plaques, statuary, etc. Decorate; sell locally. Good profits. Small cost. List free. Samples \$2.00. Artists' brushes, paints, instruction books available. Pioneer Plastex Art Products, Austin 3, Minnesota.

YOUR Guide to success, complete, 82 section mail order course \$5.00. Mammoth information portfolio \$3.00. Learn money-making facts, other inside information. Remit for one or both or write. Free information. J. J. Parcell Market, 2701 South Main, Elkhart, Indiana.

SHELL Jewelry, novelties. Easy to make at home as hobby or to sell. Beginners kit \$1.00. Catalog 5c. Burton, Dept. M-2, Box 27, Station A, St. Petersburg, Fla.

OPERATE A children's positive foot print identification system from your home. Parents welcome this service. Free information. The Smith System, 217 W. Keefe Ave., Milwaukee 12, Wisconsin.

RAISE Bean sprouts in dark room. Pays well. Free information. Mrs. Nickell, Route 1, Box 456, Bend, Ore.

MAKE Sparkling chipped glass nameplates and signs. Details free. J. Anderson, 3843 Jasmine, Culver City, Calif.

PANNING Gold—Vacation expenses—Occupation. New 160 page beginners book and three large blueprints—modern equipment \$3.00. Free literature. Old Prospector, Box 21889, Dutch Flat, Calif.

ANNOUNCING Home study course in commercial baking. Practical basic training. Good field for those with aptitude. Nearly depression proof. Send for free booklet, "Opportunities in the Baking Industry." National Baking School, 1315 Michigan Ave., Dept. 3432, Chicago 5, Ill.

LOCKSMITHING—Profitable business or hobby! New course teaches you how to pick locks, fit keys, de-code, masterkey, etc. Easy self-instruction lessons. Bargain price. Fascinating 100-page illustrated catalog free! Write—Nelson Company, Dept. 2-02, Chicago 5.

TWELVE Service trades paying big money now and can be combined in small communities. Course includes rug cleaning, sanding, janitorial, gardening. Instructions \$1.00. If not pleased, return for refund in three days. United Business Service, 137 Cordova, San Francisco, Calif.

EARN At home, learn at home. Short, easy course trains you in professional negative retouching. Free booklet. Duval School, Dept. A, 8519 Sunset, Hollywood 46, California.

PAINTING Flagpoles often pays \$50.00 daily. Particulars free. The Skyline Co., P.O. Box 1601 B, Uniontown, Penna.

GROW Green vegetables in cellar, six days. Sell hotels, grocers. Instructions, seed \$2.00. Temple, Pinnellas Park, Fla.

\$40.00 WEEKLY Made growing mushrooms, fresh, dried. Dominion patent 331583. Free spawn. North American, 169P Yonge, Toronto, Canada.

TYPEWRITER Repairing—Original course, simplified home study. Weber Typewriter Mechanics School, Box 269, Osborn, Ohio.

MUSHROOMS Grown: boxes, barrels. Instructions 50c. Spawn \$1.00. Gordon, 553 William, Winnipeg, Manitoba.

GOLD-STAMPING. Exceptional post-war opportunity. Free booklet. Home City Specialties, Dept. 1273, Springfield, Massachusetts.

BOOKS, PERIODICALS, PICTURES, POSTCARDS

2x2 COLOR Slides: "Marsh Birds," 10 views \$5.00; "Yosemite," 14 views \$7.50; "Climbing Mt. Whitney," 18 views \$9.00. Philp Photo Visual Service, 1954 Pasadena, Long Beach, California.

CHINA, Burma, India photographs for your albums. Write for free list and prices. Sydney L. Greenberg, World Photo's, 1856 47th Street, Brooklyn 4, N. Y.

SECRETS That make millionaires. Fascinating book. Practical, simple, easily workable. Satisfaction guaranteed. \$1.00 postpaid. Success Publications, Box 513, Berkeley 1, Calif.

\$3.50 BRINGS "Soldier of Democracy: General Eisenhower's Biography," postpaid. Hundreds new books, Publishers' advertised prices, postpaid. Fiction, non-fiction, technical. Send list books wanted. Prompt, courteous service. Hutchins Book Store, 1153 Commonwealth Avenue, Boston 34, Massachusetts.

BOOKS . . . New, used, rare. 6c brings "Bookfinder." 319 So. Marengo, Pasadena, Calif.

AGENTS—Ship picture postcards. World War II. Liberty Picture Co., P. O. Box 3797, Portland 8, Ore.

WHAT Every Mason wants. We have Masonic books for Blue Lodge, Chapter, Commandery, Scottish Rite and Shrine. Our rituals are used the world over. Send for free catalog of books and rituals for Masons, Odd Fellows, Knights of Columbus, etc. Ezra A. Cook, Publisher, P.O. Box 796-PM, Chicago 90, Ill.

TRADE Magazines—Business, vocational, diversion. Current single copies, 200 fields to choose from. Free price-list. Commercial Engraving Publishing Co., 34C North Ritter, Indianapolis 1, Indiana.

FREE Catalog. Current books. Happiness Books-PA, 41 Union Square, New York 3, N. Y.

LEMURIA, Unusually amazing mysterious story. Description free. Eugene MacLean, Eureka, California.

WHOLESALE Directory—Classified list to direct sources of supply 10c. J. Holmes, Box 12-A, Oaklandon, Indiana.

98 DANCING Lessons—Swing, waltz, tap, \$1.00 Hirsch, Spring Valley 2, N. Y.

BEAUTIFUL Colored pictures. Dozen 10c. Curtis, Box 1916A, Denver 1, Colo.

BOOK Bargains. New, used. Free catalog. 6,000 titles. Fiction, non-fiction. Bookland 96, College Point, N. Y.

MONEY, Success, improvement. Read self-help books. Free circular. Write, Saulsbury, 2942 Markbreit, Cincinnati 9, Ohio.

TARAWA! Unpublished photos: guns, emplacements, natives, etc. \$1.00. Duffy, S51, Covington, Ky.

ARCHITECTURAL. Fine art and handcraft books. Most complete catalog ever published. 10 cents. Artcraft, Box 6827, Baltimore 4, Maryland.

FREE Copy "Success-Today." Helpful. Instructive. Florence Hall, Rising Sun, Md.

"A History of the Second World War." New 60,000 word book by great historian. Only \$1.00. Descriptive literature free. Elmer Swanson, Niagara, No. Dakota.

UNPUBLISHED Pictures. List for stamp. Art Martin, B188 Riverside, California.

ATOM Bombed Nagasaki fifteen actual photographs. \$1.00 postpaid. Makins Pictures, 538 1/2 Washington, Bremerton, Wash.

DICTIONARY Of Abbreviations. Something everybody needs. \$1.75. Science Hobbies, 1807 H Street N.W., Washington, D. C.

JOBS By the thousands in the Foreign Employment Digest. Mail \$1.00 to Industrial Research, Ltd., 403 Broadway Bldg., San Diego 1, Calif., for 1946 edition.

WHY Pay \$3.00 for a book when you can rent it for 25c. Free information. Emile Jeunesse, 5706 Dauphine St., New Orleans 17, La.

FREE Catalog—Semi-technical books for home study, reference, schools. Livingston, 4034 Keystone, Chicago.

SUBSCRIPTIONS. Any magazine, trade journal printed. Misc. catalog 10c. Special list any trade 25c. Cassell Publishers, Westfield, New Jersey.

JOIN New technical book club—free! Members receive current literature, guidance on all book problems, premiums. No obligation. All technical, scientific, home-craft books, etc. Specify subject for free information. Modern Technical Book Co., Dept. MMC, 55 West 42nd St., New York 18.

RATIONAL View of Life \$1.00 (Book). Benjamin Seibert, Urbana, Ohio.

EXCLUSIVE Books of instruction. How to Read Character, Religions of All Nations, How to Write Stories That Sell. \$1.00 each. Free literature. Davis Specialty Shoppe, Box 213, Venice, Calif.

MACHINIST'S Compact reference book. Tables, drafting, tempering, shop trig., 3 wire thread measurement. \$1.00 postpaid. G. A. Knudsen, 523—48th St., Brooklyn 20, N. Y.

TAILORED Homes—the modern plan book. Ad under heading Miscellaneous.

GOOD "Used" self-instruction educational books on all subjects bought, sold, rented, exchanged. Satisfaction guaranteed. Complete information and 100-page illustrated bargain catalog free! Write—Neison Company, Chicago 5.

BOOKS Wanted supplied; first editions scarce, technical, rare. Reasonable. Classic Bookshop, 218 John R, Detroit 26, Mich.

BOOKFINDERS' (Scarce, out-of-print, unusual books). Promptly supplied. Send wants Clifton, Box 1377pm, Beverly Hills, Calif.

FREE—100 Page catalog of new and used college and home study text and reference books at a saving. Est. 1902. Long's College Book Co., Dept. M. Columbus 1, Ohio.

SELF-EXPLAINING Bible: Illustrated circular free. Box 446-P, Minneapolis, Minn.

NATIONAL Geographic Magazines, 1838-1945, any issue. Periodical Service, Dept. PM, Swarthmore, Penna.

BOOKS. (Out-of-print, new, used) quickly supplied. Many 35c bargains. Catalogue. Mid-West Book Service, 18870 Marx Ave., Detroit 3, Mich.

RARE, Out-of-print books located. Bookfinders, 1210N 11th Ter., Birmingham, Ala.

BIG Profits taking subscriptions for all magazines. Agents' confidential catalog listing over 2500 periodicals and complete starting supplies free. Pines Subscription Agency, Flushing, New York.

MAGAZINES (Back dated)—foreign, domestic, arts. Books, booklets, subscriptions, etc. Catalog 10c (refunded). Cicerone's, 863 First Ave., New York 17, N. Y.

"100,000 POST-WAR Jobs Abroad"—South America, China, India, Burma, Japan, Russia, Malaya. How, when and where to apply. Post-war U. S. participation in world reconstruction and trade demands thousands of American-trained mechanics, salesmen, technicians, engineers, foremen, laborers and business representatives—every trade needed. Our 15,000-word copyrighted forecast—compiled from business, professional and government sources—lists over 200 big U. S. firms with foreign interests, gives job information, salary brackets, contract tips, application letters, passport information, climatic conditions, etc.—everything needed for your immediate application. \$1.00. Return for refund in 7 days if not satisfied. Pacific Industrial Research Bureau, 202-E Studio Building, Portland 5, Oregon.

REBINDING: We bind magazines, old books, Bibles, hymnals. Heckman Bindery, Dept. D, North Manchester, Indiana.

GAMES AND ENTERTAINMENT

PLAY Duck Rummy—3, 4 or 5 players use regulation card deck. Rules mailed postpaid 30c each, no stamps. Ed. Strandberg, 7729 Montgomery Rd., Cincinnati 27, Ohio.

WHO'S This man? New national pastime in book form. \$1.50. Books Limited, 4708 Cass, Detroit 1, Michigan.

NEW Checkerboard trick copyrighted. Take two checkers, keep opponent out of kingrow \$1.00. Taulton, 1911 Clarence, Dayton 10, Ohio.

FASCINATING New card game. Free. P.O. Box 842, Denver 1, Colo.

MAGIC TRICKS, PUZZLES, JOKER NOVELTIES

LARGE Catalog. Hundreds of new magic and mental effects, with excellent trick 35c. Marian Day's Magic Store, Evanston, Ill. "Chicagoland's Largest."

MAGIC Is our business. Free bulletin describing easily workable modern magic, tricks and illusions. California Magic Company, 5312 South Vermont Avenue, Los Angeles 37, California.

DOUBLETALK. A riot of fun. Learn quickly. Simplified instructions 25c. Illustrated novelty lists included. Cable's Novelty Shop, 3166 B3, W. 25th, Cleveland 9, Ohio.

SLICK Tricks you perform easily in new magic magazine. Only 10c with latest catalog. Magic Fun, Box 35A, Irvington 11, N. J.

CLEVEREST Trick of year. Send dime. Box 333, South Pasadena, Calif.

MAKE Money with magic. Details free. Alfred Ellis, 76 Sagamore Ave., Winthrop 52, Mass.

ATOMIC Card mysteries 50c; amazing money trick 50c. American Magic, Box 2485, Kansas City, Mo.

AMAZING Tricks with dice. Magical secrets exposed. Send for information. W. Hansen, P.O. Box 1746, Dallas 1, Texas.

RADAR Pencil locates cards hidden in deck not touched by performer \$1.00. Ten trick magic kit \$1.00. Kogel's Magic Novelty Co., 6751-A Colbert St., New Orleans 19, La.

LATEST Novelties, etc. Lists—3c stamp. Hughes Service, Shillington 7, Pa.

TRICKY Dogs—Have lots of fun with these magnetic dogs. Watch them twirl when pushed up to each other. 50 cents pair, postpaid. (Refundable.) Select Products Co., 1219 Halsey Street, Brooklyn 27, N. Y.

"101 TRICKS" Book, quarter. Free trick included. Donnelly, 90 Barkley, Clifton, N. J.

TRICKY Dogs! They move. Amusing, mystifying. Quick seller! 3 pair dogs \$1.00. Sample pair 50c. Leart Sales, 7438 So. Chappel, Chicago 49, Illinois.

FORTY Amusing, confusing mathematical puzzles. 25c. Howar, Box 128MC, Westport, Conn.

BE A magician! Book of 80 professional tricks. These are baffling, mystifying, professional tricks—Not junk. Well illustrated. Get your copy now! Only \$1.00 postpaid. William Hill, Box 413-A, Akron 9, Ohio.

WO Lung's mystery—three balls pass right through solid cup. Easy to do. Your friends say "impossible." Sent complete with instructions—\$1.00. Treasure House, Box 259, San Francisco, Calif.

SENSATIONAL! Pocket pinball game 50c. Simplified card tricks 25c. C&H, 2095 Concourse, New York 53.

FREE Trick and illustrated magic catalogue 10c. Delbert Eubank, 1816 19th, Lubbock, Texas.

FREE! Twelve catchy tricks; magic catalog. Send stamp for postage. Lee's 2231-M McKinley, Berkeley 3, Calif.

AMAZE And mystify your friends with highest quality magic. New catalogue 25c coin. Mazda Magic Co., Mt. Sterling, Ky.

FREE Magic trick if you send 25c for magicians book. Riddles, 1811 Arthur, Fresno, Calif.

MAGIC, Novelty catalog, and one trick, 10c. Wencel, 2615 Evaline, Hamtramck 12, Mich.

NEW! Simplified card tricks! Amazing self-working bafflers \$1.00 postpaid. James W. Roundtree, 529 Elliott St., River Rouge, Michigan.

ENTERTAIN! Mystify! New, bigger magic catalog and 4 secret tricks 25c. Herbert, P-192 N. Clark, Chicago 1.

WORLD'S Largest professional magic shop keeps you in touch with latest tricks. To receive mailings send 25c for new catalog. Holden, 220M W. 42nd St., New York.

TRICKY Match box, it turns around! It stands up! and it opens, most weird uncanny magic novelty trick. Complete ready to do. 25c. The Magician, 2463-M, Kensington Ave., Philadelphia, Penna.

MAGIC: Big 160 page illustrated Catalog Latest Magic Goods, 25c. For over 1/3 century we have supplied Professional as well as Beginner. Chicago Magic Co., 2300 N. Mason, Chicago 39.

EARN Money in any crowd. Call names of strangers, tell unspoken questions. Professional course mind reading, faked spiritualism, etc., \$1. Henderson, Box 341, San Bernardino, Calif.

SURPRISE, Astonish, thrill, with empty hands, make clouds of smoke appear from fingertips or huge snow flakes float in air also make a five foot ribbon with empty hands, etc. Easy to do with Magic Paste, special 2 tubes enough for 70 tricks \$1.00 postpaid with big magic catalog. The Magician, 2463-M, Kensington Ave., Philadelphia 25, Penna.

"MAGIC Vanishing card." Throw it into air, it completely disappears, reproduce it later from spectator's pocket. Easy to do. Complete 25c with magic catalog. The Magician, 2463-C Kensington Ave., Philadelphia 25, Penna.

LEARN Ventriloquism, 3c stamp brings particulars. Smith, 801 Bigelow, Peoria, Ill.

FREE! Large catalog of magical apparatus if you remit 25c for book "102 Easy Tricks." Robbins Co., 152-P West 42nd Street, New York.

500 TRICKS You can do! Douglas' famous catalog of 500 tricks, now only 10c. America's fastest service on magic for pocket, parlor, stage, professional, amateur. Douglas Magic Shop, Box 274, Dallas, Texas.

VENTRILLOQUISM. Complete course only \$1. LeSueur, 77 Wellesley, Toronto, Canada.

BE A magician. Large professional magic catalogue of latest tricks 25c. Ireland, C-109 North Dearborn, Chicago 2.

NEW Vanishing key and catalog 25c. Sterling Magic, 345 John R, Detroit, Mich.

MAGIC Tricks, puzzles, books, cards, punch boards. Catalog 10c. Specialty, Box 671, St. Louis 1, Mo.

COINS, TOKENS, CURRENCY

MILITARY Medals, decorations, enameled orders bought, sold. Collections purchased. Kenneth Lee, Security Bldg., Glendale 3, Calif.

WASHINGTON Medals, fine likeness of our first president. Brass 2½ inches diameter \$1.00 postpaid anywhere. Sherman Park Antiques, 5088 Easton Ave., St. Louis, Mo.

BIG Trading, selling list. Indianhead 1880's 15c. Leo Greenstreet, Union, Mo.

WORLD Coins, large itemized descriptive list 10c. Harry Elsholz, Box 9014A, Pittsburgh 24, Pennsylvania.

FREE—Coin collectors write for our special monthly lists. DuBose, Box 993, Atlanta, Ga.

20 DIFFERENT Coins \$1.00. 20 different bills \$1.00. Oddehon, Box 462, St. Louis, Mo.

4 FOREIGN Bills, 25c; 20 different, \$1.00. Beffel, Box 37-A, Ottawa, Ill.

WILL Pay \$10.00 each for certain Lincoln pennies! Indianheads \$50.00; dimes \$1,000.00. Catalogue 10c. Federal Coin Exchange, 3-PM, Columbus, Ohio.

COMMEMORATIVE \$½, Oregon, Texas, Kentucky, Cleveland, Long Island, \$2.00 ea. Illustrated catalogue 25c. Norman Shultz, Salt Lake 9, Utah.

JAP Money, \$5, \$10 and \$100 notes. The set \$1 postpaid. Mathewson's, Jackson, Ga.

50,000 COINS, Colonial, Confederate, Philippine invasion currency. Illustrated lists free. Nagy, 8-F South 18th, Philadelphia 3, Penna.

OLD Money wanted. Will pay \$100.00 for 1894 dime, S. mint, \$50.00 for 1913 Liberty head nickel (not buffalo). Big premiums paid for all rare coins. Send 4c for large coin folder. May mean much profit to you. Numismatic Co., Dept. 20, Fort Worth, Texas.

ROOSEVELT Dimes 15c each. 7 \$1.00. Oliver Arnold, Macon, Mo.

GET Profit and pleasure in collecting old coins. Send 10c for 56-page illustrated coin catalog. You'll be delighted with it. Send for it now. B. Max Mehl, 370 Mehl Building, Fort Worth, Texas. Largest rare coin establishment in U. S. Established 46 years.

WE Pay from \$2.00 to \$50.00 each for hundreds old, odd coins. Indian and Lincoln cents wanted. Keep all until posted. Send 10 cents for illustrated coin value book 4x6. Buying and selling prices. 40 years in business. Coin Exchange, 5, LeRoy, N. Y.

QUICK Service; reasonable prices. United States catalog 10c. Foreign catalog 10c. Ben's Coin Company, 72 West Washington, Chicago 2, Illinois.

FREE! Foreign coin, banknote and coin collectors illustrated catalog to approval service applicants. Send 3c postage. Tatham Coinco, Springfield-125, Mass.

STAMPS Wanted by thousands of our readers. Your ad in this space will bring you some nice orders. One advertiser sold 150,000 stamps. Write for positive proof. F. W. Johnson, Classified Advertising Manager, Room 301, 200 East Ontario St., Chicago.

OLD STAMPS WANTED

I WILL Pay \$100.00 each for 1924 1c green Franklin stamps, rotary perforated eleven (up to \$1,000.00 each unused). Send 6c today for large illustrated folder showing amazing prices paid. Vernon Baker, (PM-63), Elyria, Ohio.

STAMP COLLECTING

THRILLING Airmails! Valuable packet scarce, all different airmail stamps, including Uruguay "flying horse"; Indo-China (Bomber!); Ifni (new country!); Paraguay; Costa Rica; Cape Juby; many others. This unusual packet catalogs over \$1.50 and regularly sells for \$1.00 net. Price to serious applicants for our quick-service approvals—only ten cents! One to a customer. Double your money back if not delighted! Littleton Stamp Co., Box 1, Littleton, New Hampshire.

UNITED Nations, scarce 5c U. S. commemorative and packet 30 different U. S., including airmail, commemoratives, revenues, etc. Catalogs 65c—to approval applicants for 5c. Curhan Stamp Company, Dept. H, Gloucester, Mass.

GIANT Stamp packet all different, catalog value over \$2.00, absolutely free with approvals. Quality First, Rm. 6-Fitts Bldg., Farmingham, Mass.

POSITIVELY Greatest free offer—Latest Scott's International \$5.00 stamp album—covering entire world, contains 36,000 illustrated, descriptive spaces; Scott's 1946 Standard \$5.00 catalogues "Philately's Encyclopedia"—absolutely free to applicants for foreign approvals becoming customers. Bargain Stamp Service, Palm Springs, California.

PERSIA 1938, 15 Values complete. Catalogs 57c. To approval applicants, 15c. Franciscan, 376 Oak, San Francisco 2, Cal.

BEGINNERS Only! Our progressive U. S. approvals, postage or precancels, are guaranteed to please. Write today! Richard Cole, 43 Rinewalt, Williamsville, N. Y.

200 DIFFERENT U. S. including civil, revenues, air mails and commemoratives \$1.00 or 75 different 25c to approval applicants. AAA Stamp Company, Arcade Building, St. Louis, Mo.

45 DIFFERENT Unused U. S. commemoratives \$2.00. 100 interesting foreign \$1.00. Other stamps on approval. Charles Mekeel, 2101 East Market, York, Penna.

ERITREA Wild animal set given to approval applicants for 10c. Service, Box 108, Rocky Mount, Virginia.

ZOWIE-E! A barrel of fun for only a dime. 500 United States stamps—absolutely unpicked and unsorted—just as received from church missions. Many varieties, including large commemoratives, airmails, high denominations up to \$5.00! Stampdom's biggest package of fun—and you might find something really valuable! Price only 10c to serious approval service applicants. Money back if not delighted. Illustrated bargain lists with each order. Mystic Stamp Company, Dept. 80, Camden, New York.

TRADERS—Exchange your duplicates. Any stamps accepted. Postcard brings full information. Comet, GPO Box 517P, Brooklyn, N. Y.

GET Stamps you want without spending money. Write: Victory, Dept. P26, Box 1501, Des Moines, Iowa.

WHAT Have you to offer? A collection? A "shoe box" accumulation? Anything in stamps. We urgently need them. Spot cash paid. Cosmopolitan Stamp Co., 1457 Broadway, Dept. 3-E, New York.

FREE! Dominica bi-color "Columbus Ship," "Tom Thumb" triangle, Canal Zone, Java, Lebanon, Chaco, Jungland, Bibleland, others—free for 3c postage. Approvals. World Company, Box 1327, Chicago, Ill.

125 ALL Different U. S. \$1.00. Old, new issues—Comms., postage, dues, famous Americans, airmails, etc. Good condition. Lightly cancelled. Guaranteed to please. Try our foreign packets 10c each, 3 for 25c. 14 packets \$1.00. All different. Bargain. Armour Stamp Co., St. Albans, N. Y.

APPROVAL Sheets. Frederick B. Driver, 401 Finance Building, Philadelphia 2, Pa.

AIRMAILS Of world—19 different including Bolivia triangle, world's fair, commemoratives, new issues, 5c with approvals. Continental Company, (Dept. B), Box 639, New Rochelle, New York.

50 DIFFERENT United States, 10c. Price-list free. Seidenberg, Cassopolis, Mich.

FREE—Abyssinia, Cayman Islands, Tuna triangle, Indochine, Syria, Ivoire, Philippines (Jap "shame" issue), Turkish harem, Damascus, Cambodia, African "beauty," Pirate Islands, Colonials, others—All free for 3c postage with approvals. Belmont Stamps, Washington 10, D. C.

FREE, 30 Different Liberia "hippopotamus" triangle, half-stamp triangle, Maya, others. Approvals. Postage 3c. Pilgrim Co., 6406 Old Harford, Baltimore 14, Md.

FREE Bulgaria packet to approval applicants sending 3c postage. Bennick, 3738P West 16th Street, Chicago 23, Ill.

TEN German Hitlers 10c to approval applicants. Raymond Myers, 2232 Emerson, Dayton 6, Ohio.

30 STAMP Mystery packet, 3c with approvals. Keen Stamp Co., Vermillion, S. Dak.

37 DIFFERENT Leewards, Iceland, triangle, Thailand, Morocco, Arctic, others. All 5c. Approvals. Kipp's, Laanna, Penna.

CUTE Australian Kola Bear stamp free with approvals. Clouse, 430 Glessner, Mansfield, Ohio.

FLASH! Amazing value! Djibouti, Bechuanaland, Camerouns, Dominica, others, all 6c, approval applicants only. Southwest Stamps, Box 117, Long Beach 1, Calif.

DOLLAR Each—1500 foreign, 2000 British, 2000 Canada, Seiden, 1331 Intervale, New York 59.

55 DIFFERENT United States—5c. Approvals. Utechts, 1143C North Keeler, Chicago 51.

GLOBAL Packet 40 stamps all different 10c. Eclipse, Box 635, St. Louis 1, Mo.

FOREIGN. Different. 100—50c, 400—\$1.50. Slotin, 328 Bannerman, Winnipeg, Manitoba.

ONE, Two, four, five dollar U. S. stamps free to approval applicants. United Stamp Service, Box 1789-M, Miami 10, Florida.

FIVE Beautiful Belgian charity stamps. 12c with approvals. Watson's, Coddington Ave., Staten Island 6, N. Y.

LIBERIA Airmail set complete, 6 triangles, 15c to approval applicants. J. Durak, 3229 W. Thomas St., Chicago 51, Ill.

U. S. And foreign bargains galore! Write for list. Crane, Rutland, Massachusetts.

500 DIFFERENT 25c. Corryville Stamp Exchange, 119 St. Clair, Cincinnati, Ohio.

CANADA—75c Diff. 25c. Approvals. Lists. Victoria Stamp Co., London 4, Canada.

25 DIFFERENT 10c With approvals. Tunis Carpenter, Wakeman Ave., Newark 4, New Jersey.

10 DIFFERENT U. S. Over 40 years old, 5c. Foreign. U. S. approvals. Scott, 30 Baker Ave., Lexington 73, Mass.

HITLER Heads Germany mint set (5) 10c to approval applicants. Collins, 71 Coleridge, San Francisco 10, Calif.

COMMEMORATIVES, Foreign, 20 different 5c. Helen Hayek, 1580 East 19 St., Brooklyn 30, N. Y.

EXCHANGE Your duplicates for others you need. Particulars and one ancient U. S. revenue for dime. McPherson, Branch, Mich.

MINT Black Harding ten cents to approval applicants. Louis Merrill, 1623 5th, Portsmouth, Ohio.

PACKETS 500 Different \$1.00. H. Staub, 45 Southampton, Buffalo 8, N. Y.

FREE! Beautiful pictorial set to approval applicants. Riverside Stamp Co., Box 1565, Miami 35, Florida.

FOREIGN Penny approvals for serious collectors. Box 2532, Minneapolis 14, Minn.

FREE Wonder packet to approval applicants. Detroit Postage Stamp Co., Dept. M, Detroit 19, Mich.

SURPRISE Packet 10c. Approval applicants. Standard, 3817 Sackett, Cleveland 9, Ohio.

HITLERS (19 Varieties complete) 50c. Approvals. Millhiser, 7724 Abbott, Pittsburgh 21, Pa.

"BETTER" United States approvals. Request them today. Box 488, Minneapolis.

SPECIAL Notice. Discounts, worthwhile premiums free to approval applicants. Box 2068, Miami Beach 40, Fla.

AIRMAIL Packet free to approval applicants. Deane Stamp Co., Box 1002, Miami Beach 39, Florida.

BARGAIN! Mint Lundy Island stamp, 10c request approvals. Whaley, Deansboro, N. Y.

NEW Monthly hobby magazine. 50c a year. Hobby-Swapper, Camden, Ohio.

WILL Rogers airmail set 5c. Foreign approvals accompany. Yokums, Box 1327, San Antonio 6, Texas.

SURPRISE Packet, 10c, U. S., foreign approvals. Hanover Stamps, Brown's Mills, N. J.

U. S. Commemoratives! 100 different—\$1.00. 500 different world—\$1.00. Vanvoorhis, Ada, Bowlinggreen, Ohio.

CHOICE Approvals 1/2c up. Stamps, 1267 Tutwiler, Memphis 7, Tenn.

500 MIXED U. S. Old and new 10c.

SCARCE U. S. Seconds. Approvals. Slightly defective, bargain prices. Herrinfields, 551 Clinton, Newark 8, N. J.

GERMAN, Finland approvals including war issues. Kataja, Sherbrooke Ave., Hartford 6, Conn.

STAMPS! 1000 Different \$2.50. 2000 different \$7.50. Ransom, 1333 Pontiac, Ann Arbor, Mich.

NAVY Ship cover. Two complete pictorial sets, 10c. Approvals. Barton, Box 321, Elizabeth, N. J.

ATTRACTIVE Approvals for beginners, advanced collectors. Jacobsen, 59-M Nagle Ave., New York 34, N. Y.

WORLDWIDE 75c. Airmails \$1.00. Pictorials \$1.50. Slotin, 328 Bannerman, Winnipeg, Manitoba.

WOW! \$10.00 Worth of fun only 10c. What a treasure hunt! Big package 500 foreign stamps—just as received from foreign missions other sources. Includes stamps from Africa, South America, Philippines, Free French, Cape Juby, Palestine, etc., including airmails, commemoratives, and stamps worth up to 50c and 75c. This amazing offer is given for 10c to serious approval applicants only. One to a customer, money back if not more than delighted. Jamestown Stamp Co., Dept. 22, Jamestown, New York. Stamps—valued up to 50c and 75c each.

BARGAIN List stamps and coins. Less than wholesale. No approvals. Higgins & Gage, 6727 Hollywood Blvd., Hollywood 28, California.

MAGNIFYING Glasses for stamp collectors. 25 cents postpaid. Capitol Sales, Box 1501, Des Moines, Iowa.

VENEZUELA, Fourteen different mint only 5c with approvals. James Mohl, Petersburg, W. Va.

PHILIPPINE Victory mint sets, 9 values \$1.15; 5—35c; Jap surrender covers 50c; 1000 bargains. Lists free. Nagy, 8 South 18th, Philadelphia 3, Penna.

I Am a discharged veteran and have thousands of sets and singles to send on approvals. Edward Moore, 1129 Wesley, Oak Park, Ill.

EXTRAORDINARY Opportunity. Veteran offers plan that brings you many thousands of stamps. Easy, inexpensive and profitable. No approvals. Send 25c for complete details. Veteran, 4103 Hings-ton Ave., Montreal 28, Que., Canada.

U. S. Mixture. Guaranteed to contain \$1 Presidential 50c per lb. postpaid. Stamphouse, 7235-A Sheridan, Chicago 26.

CONFEDERATE State (facsimiles), U. S. 70 yrs. old. Birds, ships, airmails, etc. 4 Hitlers 10c. Valentini, Box 1069, St. Petersburg, Fla.

50 CANADIAN, Newfoundland, including earlier, commemoratives, 10c. Approvals. Reede, 696 Gerrard, Toronto.

FLAG Stamp free with U. S. approvals. Wenigman, 929 Oakdale, Chicago.

FREE! Rare Eastern Rumelia set, "Big Chief," "Mosquito," "Coffee," "Map," "Dragon," British, French Colonies. Also 25 different Canadian stamps, etc. 5c for postage with approvals. Jefferson Stamps, 1300 Jefferson Street N.W., Washington 11, D. C.

18 DIFFERENT Vatican City—special \$1.00. U. S. Occupation Italy 9 val. comp. \$1.00. Austrian 16 val. comp. \$1.00. George Creed, 22 So. 10th St., Philadelphia 7, Pa.

FOREIGN Stamps packet 3c. Approvals. Smith, Box 71-A, Roselle, N. J.

FREE: Canal Zone mint set included with our first approvals. 20th Century, P.O.B. 3413, Philadelphia 22, Pa.

FREE! Over 200 stamps. Giant, triangle, midget, diamond shapes included. With approvals only. Not mission mixture. Stamps free from envelope paper. Ready for hinging into album. Send 8c to cover postage and handling. Regent Stamp Company, Department PA, 316 Flatbush Avenue, Brooklyn 17, New York.

RUSSIA Mint 1924 issue "Lenin Facsimile." Beautiful mint bi-color imperfs 4 stamps catalog \$1.40. 5c with world approvals. Watson, 912 Kenwood, Lansing 10, Michigan.

FLAGS! Flags! Flags! Beautiful collection flag stamps (value 25c). Manchukuo Census set (value 8c). Packet 25 countries (value 57c) including scarce Borneo, Pahang, etc. Perforation gauge (value 10c). Total value \$1.00. All—10c to approval applicants. Odd Stamps Co., Dept. A, 5391 Metropolitan Station, Los Angeles 55.

GORGEOUS Colors, scarce airmail surcharges, charities, sets, etc. All in our big premium packet only 3c to approval buyers. Dixie Stamp Company, Dept. M, Mil-

SPAIN'S Nude Goya set 25c with approvals. Royal Stamp Company, Tamaqua, Penna.

LATIN-AMERICA, 65 Diff., pictorials, airs, etc., 10 countries, 10c with approvals. Crescent Stamps, London, Canada.

STAMPS From forty countries, including Mozambique 10c. 25 different Russia 20c. 75 different Germany 40c. No approvals. Elsea, Bowling Green, Ohio.

U. S. And foreign approval departments. Return postage paid. Atwater, P.O. Box 1583M, Miami 35, Florida.

1000 MIXED U. S. on paper 25c. Jem Stamps, Port Jefferson, N. Y.

"HITLER And Mussolini" free with general approvals. Suburban Stamp Sales, St. Louis 14, Mo.

SPAIN—Five airmails 10c. Approvals. Buchanan, 307 East 23rd, New York 10.

GOOD Foreign approvals reasonably priced. John Bruno, 1442 South Kenneth Avenue, Chicago 23, Illinois.

CAYMAN Mint set (4) only 6c to serious collectors requesting low priced mint British Colonies on approval. Forest D. Wilson, 711 North A St., Tampa 6, Fla.

GIVEN Away. Valuable collection of 300 different stamps (catalog value over \$6.00) for introducing new postwar product to friends. Send name and address on postcard today. Victory, Dept. P36, Box 1501, Des Moines, Iowa.

U. S. Collection—Thirty three different mint unhinged commemoratives 1893-1939 only \$1.00 to approval applicants. Orange Stamp Co., Albany 7, New York.

U. S. On approval. Largest varieties. America's lowest selling prices. Stamp Company, Albany, New York.

WANTED Unused U. S. postage stamps, small discount. Advance Stamp Company, 24 East 23rd Street, New York.

\$1.00 WILSON—25 Others, approvals, 6c. O. Burgett, Lima, Ohio.

FREE! Big stamp outfit, Stamp tongs, perforation gauge, hinges, giant packet airmail, commemorative, triangular stamps, 3c postage. Approvals. Auburn Stamp Co., Auburn, Mass.

100 DIFFERENT—Commemoratives, airmails, triangles, diamonds, 10c. Approvals. Kostillo, D-386, Bellaire, Ohio.

FREE—10 Stamps from first approvals. Quality Stamp Service, Waverly, N. Y.

100 U. S. commemoratives, etc. 10c. 500—25c. P.O. Box 457, Newark, N. J.

FINE Approvals, freshly mounted. Fast, personal service. Tell me what countries you prefer and I'll send their stamps. Skinner, 438 Locust, Long Beach 2, Calif.

25 DIFFERENT 3 cents with approvals. Box 666, Oakland 4, California.

FRENCH Colony packet free to approval applicants. Astoria Stamp Co., 20-55 29th Street, Long Island City, N. Y.

NORWAY: Six mint commemorative sets for dollar bill. Uno Linde, Goteborg, Sweden.

GET A shoebox full of stamps! Almost three pounds U.S.A. and foreign mixture, \$1.03 postpaid. Leigh Dutton, 509 Citron, Anaheim, Calif.

100 DIFFERENT Argentina 75c. Approvals. Stoneham Stamp Co., Stoneham 80, Mass.

ZANZIBAR, Palestine, Manchukuo, Azerbaijan, Haiti, Iraq, Siam, Victoria, Hitler stamp 5c. Approvals. Postzegel, Windham, N. Y.

PENNY Approvals by country. M. H. Hoerning, 215, Farmington, Ark.

SPECIAL Offers to applicants for better approvals. Yarnall, 1648 May, Dearborn, Michigan.

FREE! Two Cuba Imperforates, 1/2c up approvals. Marjay Stamps, Box 14, Station B, Brooklyn 16, N. Y.

EDW. 8th—11 vals. (mint) 33c. 30 diff. U. S. comm. 24c. 35 Cuban 23c. Westlake Stamp House, 12056 Rutland, Detroit 27, Michigan.

CHINA—Beautiful new Chiang Kaichek set unused, four values—\$17 face value—only 33c with bargain approvals. Ray Boward, Cheyenne, Wyoming.

ILLUSTRATED Price list, American and foreign complete sets, many Italian specials, free. Kuley, 2 Cray Avenue, Mount Vernon, New York.

RICH Man's approvals, poor man's prices. Grand value packet containing five foreign sets, free with approvals. Stoll Stamp Service, 2630B West Burnett, Louisville 10, Kentucky.

MARCH 1946 55

UNITED States approvals complete coverage, fine quality, attractive prices. Seminole Stamps, Box 378, Coconut Grove, Florida.

TO Introduce our approval service, The Lotus Exchange, our monthly bargain lists, send 10 cents for 35 different commemoratives, 15 different Brazil, 2 mint Canada catalog 22c, old Spanish stamp catalog 20c. Only a dime. Lotus Concern, Kalamazoo, Mich.

DISABLED Veteran performs greatest service. Lowest cost. Send postcard for particulars. Swapper's, 614 East Weatherford, Fort Worth 3, Texas.

NEW Zealand 48 good, including rare mints \$1. W. Lovell, Taupiri, New Zealand.

50 FREE, Pictorial, etc., stamp dictionary, list. Bullard, Newcastle, Maine.

FREE! Jamaica "Constitution" stamp. Approvals. George Keating, Miami Springs, Florida.

100 DIFFERENT U. S. 20c with approvals. W. J. Lange, Marion, Iowa.

MINT Will Rogers set from Nicaragua 3c with approvals. Brown, Box 2024, Evansville, Ind.

EACH Set 75c, 20 German Hitler stamps, 6 Italian Hitler-Mussolini stamps, 10 French Petain stamps. Lists free. Bradford, Box 636, GPO, Brooklyn, N. Y.

FREE! Negro Triangle; Turks Islands "Cactus"; Dakar; Guinea; Palestine; "Fairy Tale," Pirate Chart, Map, Ship, Sea Lion and Snake stamps; French, British, Portuguese Colonies, etc. Free for 3c postage. Approvals. Potomac Stamps, Washington 10, D. C.

FREE! Leeward Is., Cayman Is., Turks and Caicos plus 54 different mint World's Fair poster stamps, to approval service applicants sending 3c postage. Tatham Stamp Co., Springfield 30, Mass.

PERSONALIZED Approvals. "Tailored" to fit your needs. Schlotzhauer's, Shenandoah, Virginia.

25 DIFFERENT India, 3c with approvals. Premiums with purchases. Brandwein Stamp Company, Box 92H, Bayonne, N. J.

CANADA War set 10 var. 10c with interesting approvals. Rheau, 8949 Routhier, Montreal 12, Canada.

NUDE Duchess set (two varieties) 5c, approvals. Masters, Clifton and Kernan, Baltimore 7, Maryland.

UNITED States approvals. Fine quality, wide variety. George Klein, Vincennes 2, Indiana.

HITLER Set free with approvals. Bengtson, Box 13, Minneapolis 1, Minnesota.

GLORIOUS Lot from Shanghai, Hawaii, etc., 10c with approvals. Western Stamps, Box 4042, Los Angeles 24, California.

100 WORLD Wide assortment \$1.00. Stamp Shop, Box 308, Harriman, Tenn.

MIXTURES. Worldwide accumulations 1,500 for \$1. Missions Outlet, Rev. Marshall, Paterson 1, N. J.

AIRMAILS Only on approval. Mint and used. References required. Gerspacher, 159 Irving Terrace, Kenmore, N. Y.

EXCHANGE Duplicates. Swappers everywhere. List free. Box 2166, Denver 1, Colorado.

NEWFOUNDLAND! Collectors most popular country; 16 different, includes Jubilee, Coronation, 10c with approvals. Lyman, 95 Nassau St., New York 7.

EXOTIC Pictorial collection, including Tahiti Spear Fishing, Melanesian Idol, Carib Archer, Malagasian Farmer and many other scarce stamps from strange countries. Everything only 5c. Imperial Stamp Co., Yonkers, N. Y.

50 DIFFERENT Including scarce diamond-shaped airmail 3c to approval service applicants. Avalon Stamp Co., Dept. M, Springfield 8, Mass.

75 COUNTRIES! Packet containing stamps from 75 countries to approval applicants sending 10c for mailing expenses. Quality Stamp Company, Department M, Box 202, Station F, Buffalo, New York.

50 DIFFERENT Stamps from 50 different countries—airmails, commemoratives, pictorials! 5c to approval applicants. Thiem, 1100 1/2 St. Paul, Rochester, N. Y.

19th CENTURY U. S. Commem., Civil War—Battleship revenues, \$5 and \$10 stamps free to U. S. approval applicants. Metropolitan Stamps, 198C Broadway, New York.

LOW Priced United States approvals. Steger, 1165 Downing, Denver 3, Colorado.

FIFTY British Colonies. Free to approval applicants. Pelican Stamp Co., 1609 S. W. 8th St., Miami, Fla.

5 HITLER Stamps 3c, with approvals. Lists. Gaydos, Kenosha, Wis.

BRITISH Colonies and South America on approval. Theo. Stevens, Box 3705, Kercheval Station, Detroit 15, Mich.

MOZAMBIQUE Triangles, unused. Set 10c with approvals. Vargo Stamps, 6044 South Fairfield, Chicago 29, Ill.

BECHUANALAND Protectorate, gorgeous Tonga, exotic Pitcairn Isle, beautiful French Colonies—Everything 3c with approvals! Saxons, Walden, New York.

LIBERAL Offer, thick packet with Seychelles, Fiji, U. S. commemoratives, Tete, Djibouti, Inini, Congo, Porto Rico, Philippines and multitude others. Everything only 10c to approval applicants. Burmaster, Box 1910 A, Los Angeles 53, Calif.

DANDY United States approvals. Write immediately. Sullivan, Endicott Building, St. Paul 1, Minn.

1000 GRABAGS 15c Each. Super bags 25c. Zandy, 630 Bingaman, Reading, Pa.

30 BEAUTIFUL Airmails, 10c. Selected approvals. Louis Morrison, Milmont Park 1, Penna.

BOX Stamps containing hundreds all different, cataloging up to 25c each. Everything \$1.00. Longacre Shop, 108 West 42nd, New York City.

SCARCE "Pole to Pole" packet! Stamps from strange, mysterious countries only—Greenland (North Pole), Solomons, Spanish Morocco, Bhopal, Patiala, Siberia, Grahamsland (South Pole), Djibouti, Zanzibar, etc., and including stamps cataloging up to 25c each! Our price only 5c to approval applicants. Big dime packet list free! Methuen Stamp Service, Inc., Dept. 136, Lawrence, Mass.

TURKS, Caicos, Grenada, Brunei, Dominica, Caymans; everything 3c with approvals. Viking, 130(Z) Clinton St., Brooklyn, N. Y.

U. S. Price list. Send postage. State Stamp Service, 1225 Park Building, Pittsburgh 22, Penna.

FREE U. S. price list. Postage 3c. Mark Hanna, 335 - 5th Avenue, Pittsburgh 22, Penna.

1000 WELL Mixed U. S. 25c. Monjar, 1750 Fairmount, Cincinnati, Ohio.

TRIANGLES—(Mozambique Co.) other beauties, 10c. Approvals. Reuter, 611-C West 40th, Los Angeles 37.

FREE Packet with attractive approvals that satisfy. Pearl Field, Derby, Maine.

25 DIFFERENT Guatemala 10c with 1/4, 1/2, 1c approvals. Carroll's, 4357A S. Hoover, Los Angeles 37, Calif.

FREE—Pick 25c worth of stamps from our first U. S. approval selection. Approximately 100 stamps to choose from. Excellent value. No obligation to buy. Lists illustrating the most popular U. S. stamps—at prices you can afford—will be included. Don't miss this opportunity! Write today. S. C. Engel Co., 38 Park Row, New York City.

114 DIFFERENT Stamps from far away countries including airmail and Free Fighting French to approval applicants for 10c. Reich Stamp Co., 4647 Kenmore, Chicago 40, Dept. M9.

COMPLETE "United States" catalog with 1000 illustrations! Send 10c for mailing. Harris & Co., 137 Transit Building, Boston, Mass.

AMAZING Offer! Assortment each of giant stamps, midget stamps, flag stamps, airmail stamps, Free French Colonies, U. S. commemoratives and numerous others. Everything only 10c to approval applicants. Simon, Box 214, Iraan, Texas.

FREE! Western Hemisphere packet. Postage 3c. Owens, 806 Welsh, Bay City, Michigan.

FREE! Pony Express set (facsimiles). Postage 3c. Roberts, 406 Building, Bay City, Michigan.

DEALERS—Wholesale list. Postage 3c. Frank, 5031 Queensberry, Baltimore 15, Md.

FREE! British Empire packet. Postage 3c. Williams, 606 Archer, Bay City, Mich.

SCARCE 1890 U. S.—Hussey local carrier stamp; listed at 15c. Also Costa Rica No. 65 listed at 40c. Both sent free to approval buyers sending 3c postage. Pladon Stamps, 1717-M Idaho, Toledo 5, Ohio.

WORLD'S Largest diamond and triangle stamps, free stamp magazine, stamps from fighting Free French, 20 stamps from 20 different countries, pictorials, airmails, big bargain 5c with approvals. Capital Stamps, Dept. 2, Little Rock, Ark.

118 DIFFERENT Stamps including commemoratives, charities, airmail sets, etc., only 3c to approval buyers. We buy collections. Badger Stamp Co., Milwaukee 3, Wis.

FRESHLY Mounted approvals for collectors using Scott's International Junior album. Wlaschim, 55 Nagle Ave., New York 34.

VICTORY Packet free—Includes stamps from Tanganyika, British Cayman Islands, animal, scarce babyhead, coronation, early Victorian, airmail, map stamps, with big catalogue—all free. Send 5c for postage. Gray Stamp Company, Dept. PM, Toronto, Canada.

FREE! Canadian sets, royal visit, George VI, George V, coronation, jubilee, others, to approval applicants. Ensign, Box 118-M, South Orange, N. J.

FREE! The Stamp Finder! Send today for the big new edition, fully illustrated, enabling you instantly to identify all difficult stamps! Also fine packet strange, fascinating stamps from Bosnia-Herzegovina, Monaco, Patiala, Cyprus, etc., including maps, ships, animals and strange scenes. All free to approval applicants inclosing 3c postage. Garcelon Stamp Company, Box 900, Calais, Maine.

HOBBIES AND COLLECTIONS

FOOL'S Gold—From famous gold camp, 10c per sample. Also mineral specimens from famous local mines. Martin's Snap Shop, 506 Harrison Ave., Leadville, Colo.

"GEM Cutting" profitable, interesting hobby. Instructive illustrated booklet. Dollar. Mineral Specimens Company, Box 1191, Santa Monica, California.

CUTTERS, Collectors, mixed, pound, Agates, Jasper, wood \$1.00. Smith, Box 422F, Albany, Oregon.

LEATHER Scraps (suede cape and horse) suitable for hobby and craft workers. Six pounds for \$2.00. Northern Supply Co., Sheboygan, Wis.

INDIAN Head penny with list 10c. Charles Banker, Salina, Kansas.

HOBBY And novelty catalog free. Barrington Smith Company, Halfwaytree, Jamaica, B.W.I. (Postage to Jamaica 5c.)

COLLECTING Hobbyists. Exchange duplicates. Swappers directory 10c. C. Bishop, Route 8, Kalamazoo 88, Michigan.

"THAR'S Gold in these hills." "Fool's gold" chunk 25c. Minerals, Box 2166, Greenway Sta., Tucson, Ariz.

MINIATURE Bottles, beautiful, hand blown, tiny. 50c each, 3 different \$1.00, 6 different \$2.00. Williams, Box 473, Alpine, Texas.

FREE Itemized list of over 700 American, foreign and squadron shoulder patches. Complete your collection with new numbers. Insignia made to order. The Patch King, Box 101, Madison Square Station, New York 16, N. Y.

RAISED Metal designs, figures, emblems, on brass or copper shell casings, vases, bowls, plaques. Interesting, profitable hobby. Easy to follow, fully illustrated, detailed instructions and projects one dollar bill or m.o. Perma-Craft, Box 608, Mt. Kisco, N. Y.

COLORFUL Military patches and insignia—American and foreign. Gigantic illustrated catalogue plus free premium 15c (refunded with order) or send \$1.00 for "get acquainted" bargain offer. Hobby Crafters, (Dept. PM1), Box 178 Sta. A, Brooklyn 6, N. Y.

INSIGNIA Collectors, Army, Navy and Marine, send for list of 444 different shoulder patches. No charge. Box 228, New York 10, N. Y.

EARN Cash collecting plants for me. Details free. G. Elbert, P.O. Box 414W, Vandyke, Mich.

"HOW To Make Money With Hobbies." Easy, exciting, profitable. Cornell, Sandston, Va.

COLLECT Colorful Army patches. Pictures, prices and sample patch only 10c. Insignia Mart, 703 Broadway, N. Y.

FOREIGN Military insignias: Sample; prices. Send 15c. Hobbyguild, P35 West 32nd St., New York, N. Y.

WHITTAKER'S—20 Patterns, instructions, X-acto knife, wood, \$1.00. "Old Whittler," 1402 Charles, LaCrosse, Wis.

UNUSED Match book covers, 100 all different \$1.00. 35 Royal Flash covers \$1.00. Free list. Charles Edelman, 1311C East 84, Cleveland 3, Ohio.

JEWELRY Stones removed from rings, etc., 100 assorted \$2.40; 50 large ones \$2.40. B. Lowe, Holland Bldg., St. Louis 1, Mo.

HOBBY Books. Latest titles. Catalog free. Popular Mechanics Press, (C-43), 200 E. Ontario, Chicago.

CAMERAS AND PHOTO SUPPLIES

FLASH Synchronizers, projectors, meters, film, flash bulbs, paper. Photoking Supply Shop, 6803 N. Clark St., Chicago 26, Ill.

WAR's greatest pictures. 20 selected full frame slides \$1.00 5 samples, list 25c coin. Slides made from your photographs 20c each. Rogers Studio, Box 134, San Diego 5, Calif.

PHOTO-RING-KIT Makes 10 thermo-plastic rings valued at \$10.00. \$1.10 postpaid. Refundable. Beck Manufacturing, 13401 Cerise, Hawthorne, California.

NEW Candid camera. Free details. Ropicki Company, 5117 Roosevelt, Philadelphia 24.

NEW! Canadian Camera Magazine, 25c. Publisher, Box 685, Victoria, B.C. Canada.

PRESERVED Forever, photos, certificates, identification cards, etc., laminated in crystal clear, unbreakable plastic. Sizes up to 7 $\frac{1}{2}$ " square. 5c per square inch. Liberal quantity discounts. "MS" Plastics, Logan, Utah.

CASH! Spot cash for cameras, lenses, binoculars, movie or still, sound projectors. Send full description by mail, or wire for prompt cash offer. Over 30 years of dependability insures honorable dealings. 35c postpaid for 100 page book "Military & News Photography" by Jack Price. Up to the minute information. Bass Camera Company, 179 West Madison Street, Chicago, Illinois.

EXPOSURE Meters: Just received: General Electric meter Model DW 58 with case \$24.75. De Jurr Critic and case \$20.50. De Jurr Autocritic \$23.85. GM Photocell meter \$13.50 with case. We also have 2x2 slide projectors, Argus 2x2 featured 100 watt \$27.75 with rotary slide carrier. Extra strip film holder \$4.75. Conway Camera Co., 34 N. Clark, Chicago 2, Ill.

FILMS, Surplus Kodak Panchromatic. 3 rolls, 127, 85c. 120-620 \$1.05. 116-616 \$1.20. Postpaid, no limit. Cameraman, 542x Fifth Ave., New York 19.

GREATEST Value ever offered—14 handbooks, journalistic photography, illustrated. \$7.95 prepaid. Darkroom, studio equipment. Trades, Mogull's, 68-M, West 48th St., New York 19.

CAMERAS, Enlargers, lowest prices. Free catalog. Cavalier Camera, 1822 Center, Pittsburgh 19, Penna.

OIL Coloring photographs can be a fascinating hobby or profitable sideline for those with artistic talent. Learn at home. Easy simplified method. Send for free booklet. National Photo Coloring School, 1315 Michigan, Dept. 3432, Chicago 5, Ill.

ENLARGERS—Build your own. Kit of parts, \$6.00. Free particulars. Krescent Engineering, Box 586-P, North Hollywood, Calif.

CANDID Camera, takes 16 pictures, 2 rolls 127 film, \$3.98 postpaid. Cavalier, 1822 Center, Pittsburgh 19, Penna.

ARROW Films. Can be used for indoor and outdoor snapshots. Packages of 5 rolls. No. 127, \$1.45; No. 120 also No. 620, \$1.75; No. 116 also No. 616, \$2.00, postpaid. Empire Photos, Newark 8, New Jersey.

PHOTOGRAPHY For pleasure or profit. Learn at home. Practical basic training. Long established school. Write for booklet. American School of Photography, 1315 Michigan, Dept. 3432, Chicago 5, Ill.

USED Camera Directory, Box 1031-M, Canton, Ohio—lists hundreds of war-bargain used cameras—35mm., Speed Graphics, Kodaks, Rolleiflex—many others. Send 25c for latest issue.

HANDSOME Jointless aluminum light, proof photographic paper storage box \$4.95. Box 171, Glendale, Calif.

BASS Says: War time proves Bass leadership. Amazing selection of finest still cameras—Leica, Contax, new and used still available. Write for quotations. Satisfaction guaranteed or your money refunded. Bass buys 'em, sells 'em, trades 'em. 35c postpaid for 100 page book "Military & News Photography" by Jack Price. Up to the minute information. Bass Camera Company, Dept. AG, 179 W. Madison St., Chicago, Illinois.

HAVE You a camera? Improve your hobby of photography and learn how to make better pictures. Write today for our latest book catalog and sample copy of American Photography, containing articles and pictures by the world's foremost writers and photographers. Camera House, 601, 353 Newbury St., Boston 15, Mass.

ENLARGER. Build your own. Have fun enlarging snapshots. Make money doing work for others! Complete blueprints, specifications, instructions for building inexpensive enlarger. Send \$1.00. Enlarger-craft, Suite 93, 120 E. 233 Street, Euclid,

PHOTO FINISHING

FREE Snapshots! Free album! Mail this ad and two negatives for free snapshots complete in album! When you see these free samples you'll want more. Artisto, Dept. 131, Drawer 220, Regina, Sask.

BIGGEST \$1.00 Value in 35mm. finishing today. 36 exposure fine grain 3 $\frac{1}{4}$ x4 $\frac{1}{2}$ enlargements; deckled, embossed margin and date. Eighteen exposures 75c; 16 exposure splits 55c; 36 exposure reloads 50c. Special: return this ad with \$2.00 and we will send five 36 exposure reloads. Free mailers. 8 exposure rolls in beautiful, deckled contact finish with embossed wide margin, 25c. Mailbag Film Service, Box 5440A, Chicago 80, Ill.

35MM. Film developed free. Prints 5x7 only, 15c each. Work C.O.D. Kaybet Developing Co., Box 4967, Philadelphia 19, Penna.

CONFIDENTIAL Developing 25c. Two prints each negative. Royal Photos, 1718 North Sixth, Harrisburg, Penna.

PHOTOGRAPHS Colored. Charcoal portraits sketched. M. Mickey, 23 Laurel Avenue, Maplewood, New Jersey.

IT'S Here! Technifinish for all camera films. Any 8 exposure roll developed and 8 enlargements only 25c. 35mm. films, fine grain developed and 36 enlarged prints only 90c, 18 exposures 55c. Credit given for non-printing negatives. Reloads for 35mm. cartridges, 36 exposures 35c, 18 exposures 20c. Printon color prints, large size 3 $\frac{1}{4}$ x4 $\frac{1}{2}$ with exclusive white borders, only 65c, 5x7 \$2.00, 8x10 \$3.00. Black-and-white negatives and 10 3 $\frac{1}{4}$ x4 $\frac{1}{2}$ black-and-white prints from your Kodachromes, only \$1.00, 3 for 50c. Black-and-white positives from all 35mm. films, 36 exposures 50c, 18 exposures 35c. Write for sample print, mailing bag, and complete information. Technifinish, Dept. 112A, Rochester 3, New York.

ENLARGING, Printing, developing easily learned. Simplified instructions \$1.00. Fred Carpenter, Box 264, Hamlin, Texas.

10 ENLARGER Reprints 25c. Double weight enlargements, 4x6, 10c, 5x7, 15c, 8x10, 25c. Macdonald's, Box 28, Congress Park, Illinois.

35MM. Film fine grain developed. Enlarged 3 $\frac{1}{4}$ x4 $\frac{1}{2}$, 36 exposure \$1.00, 18 exposure 60c. Roll film developed and printed 30c. 6 to 8 exposure. Reprints 3c each. Overnight service. Laboratories, Box 1351, Kingston, Penna.

CUSTOM Enlargements on DW matt paper, cropping instructions followed. Two 8x10 \$1.00 prepaid. Sepiatoned 50c each. Send money and negative to Photo Craft, P.O. Box 6, East Williston, N. Y.

GLOSSY Contact prints 3c each from any size roll film negative except 35mm. Photo Prints, 136 Maple Ave., Haddonfield, N. J.

DELUXE Enlargements. Highest quality service, on finest DW matt paper. 5x7—25c. 8x10—45c. 11x14—\$1. From photos 50c extra. Remit in full plus 15c mailing. Helio Photo Service, P.O. Box 521, Church Str. Station, New York 8, N. Y.

ANY Size picture reproduced postage-size, 100 photostamps \$1.50. Artcraft, 1602 Coney-Island, Brooklyn 30, N. Y.

ENLARGEMENTS. Two 5x7 enlargements and one mount for \$1.00. Two 3x4 enlargements and one mount for 50c. Burgess Photo Shop, 106 $\frac{1}{2}$ -B Forsyth St. N.W., Atlanta 3, Ga.

MONEY Back guarantee—All this for 25c; roll developed 8 bigger deluxe prints also 8 regular prints, plus two beautiful enlargements and tasteful leather-tone frame. Reprints low as 1c. Lifetone Photo Company, Dept. 339, Des Moines, Iowa.

PRINTING And developing done 25c a roll. Send in your roll today. Beauti-Craft, 92 Woodrow Ave., Dorchester, Mass.

ENLARGE Without a negative! Revolutionary, new design enlarger—only one of its kind. Tested and proven by 324 enthusiastic professionals and amateurs. Makes true-image copies from either natural or reversal originals—direct from the original—no negative necessary! Synchronized focusing. Enlarges up to 16"x20" from any original up to 4"x5". Use your favorite enlarging paper or super-speed quick-finish. Only \$95.00 including tax and test paper, f.o.b. Rochester. Money-back guarantee. Marks & Fuller, Inc., 70-B Scio St., Rochester, N. Y.

PROFESSIONAL Enlargements, two 8x10, \$1.00 postpaid. Work guaranteed. Send money and negative to Projectaprints, Box 1114, Lansing, Michigan.

FAST Delivery, satisfaction guaranteed. 16 prints 30c, 8 jumbo size 35c including developing 8 exposure roll. Pioneer Serv-

NOW! Glossy photo finishing in gorgeous colors. Any 6-8 exposure roll 35c (coin). Colorcraft, Avoca, N. Y.

8 VELOX Prints and two professional enlargements 25c. Send roll or negatives for trial offer. Young Photo Service, 405-C, Albany 2, N. Y.

2 BEAUTIFUL Hi-Gloss prints each good negative and enlarging coupon with each 6 or 8 exposure roll developed, 28c. Owl Photo Co., Weatherford, Okla.

ROLL, Developed, printed, 25c. Reprints 75—\$1.00. Howard's, 3760 Fremont, Chicago 13.

50 REPRINTS \$1.00. No limit. Studio, 1408-M Bond, Rockford, Ill.

GLOSS Finish enlargements. 4 5x7 from negative 50c. 3 5x7 from photo 50c. Robert Renshaw, Jr., P.O. Box 478, Chester, Penna.

PHOTOGRAPHY For pleasure or profit. Learn at home. Practical basic training. Long established school. Write for booklet. American School of Photography, 1315 Michigan, Dept. 3451, Chicago 5.

PINER Photo finishing specials 25c. Eight exposure rolls developed with two prints each good negative or one enlarged print of each. Try today's quicker, finer Moen-Tone Enamel finish. Satisfaction since 1898. Moen Photo Service, 452 Moen Bldg., LaCrosse, Wis.

8 EXPOSURE Rolls 25c, over 8 exposure 40c, for one Velox print each and free enlargement coupon. Reprints 3c, minimum 25c. Fred D. Eastman, Bode, Iowa.

6-8 EXPOSURE Rolls developed and enlarged mammoth size 30c. Reprints 3c. Thrifty Photos, Box 46, South Gate, Calif.

CENTURY Delivers work and service that can't be beat. 8 exp. roll 25c with two professional enlargements free. Century Photo Service, LaCrosse, Wis.

ROLLS Developed and printed 25c. Reprints 2c; 5x7 enlargements, 15c; 8x10, 25c. Davis Studio, Guthrie, Okla.

8 PRINTS, All enlarged to nearly postcard size, from your roll or negative, 25c. Willard Studios, Box 3535A, Cleveland 18, Ohio.

AT Last! Roll developed, all your snapshots hand-colored as beautiful as most actual colored photography 35c. Hand-colored reprints 4c each—12 for 45c. National Photo Art Company, Janesville 26, Wis.

SENSATIONAL Introductory offer! Send snapshot or negative, this ad, and 3c. We'll send you a beautiful 7"x5" enlargement! Or, Kodak roll developed with 16 guaranteed deckled-edge velox fade-proof prints or 8 double-size prints, 25c! Special! From your negatives, 16 regular-size or 8 double-size reprints, 25c! Candid rolls—36 exp. 35mm. developed, vaporated, enlarged to 3x4, \$1.00! 18 exp. 50c. Reprints, 3x4, 3c each. We have new, perfect 35mm. film. Low prices. Free mailers, details on request. American Studios, Dept. 279, LaCrosse, Wis.

EVERY Picture an enlargement! 8 sparkling deckle-edge enlargements and roll developed 25c coin; 116 size or smaller; enlarge reprints 3c. Enlarge Photo, Box 791D, Boston, Mass.

BEAUTIFUL Double-size pictures 3 $\frac{1}{2}$ x5 each, from 116 and 120 negatives, 3 $\frac{1}{4}$ x4 $\frac{1}{2}$ from all other sizes. All work guaranteed. Overnight service. Roll developed and 8 pictures 30c. Roll 12 pictures 45c. Roll 16 pictures 60c. Enlargements on double weight portrait paper 5x7—30c, 8x10—50c. Copies made from any picture 75c. Pacific Photo Service, Box 666, San Francisco, Calif.

MOTION PICTURES AND SOUND EQUIPMENT

NEW 16MM. motor driven projectors \$13.50. Send stamp for 16mm., 8mm. catalogue. Sterling's, 679 Northampton, Easton, Pennsylvania.

LOW Cost 8 16mm. movie rentals, sales. Camera film. Large lists, sample, 10c. Warrington, 1418 Knecht Ave., Halethorpe 27, Md.

FRESH Movie films 100' 16mm. \$2.25, three rolls \$6.00. 25' double 8mm. \$1.25. Developing included. Ambassador, 479-A, Quincy Street, Brooklyn, N. Y.

ATTENTION Home movie fans! Send for our free illustrated catalog of camera film, subjects, supplies, rental library, lowest prices! Solar, 4247 South Kedzie, Chicago 32, Illinois.

100' 16MM. used sound film, \$1.00. One reel sound cartoons, used, \$9.95. We buy, sell, trade. Ask for list. Blackhawk Films, Dept. PM23, Davenport, Iowa.

SWAP Your 16mm. sound films. Send \$2 bill or money order with any Castle sound film and we will send you any Castle film of your own choice in exchange. Films must be in good condition. Eanrob Exchange, Box 583, New Bedford, Mass.

FILM: Free processing, 25 ft. Double 88 Weston 6, \$1.35; Weston 24, \$1.89; Weston 64, \$1.99. 100 ft. 16mm. Weston 6, \$2.95; Weston 24, \$4.85; Weston 64, \$4.95. Write for circular. Fromader Genera, Davenport 7, Iowa.

16MM., 8MM. films. Kodachrome slides. Thompsons, 2 Southeast Fifth, Evansville 9, Indiana.

16MM. Bell & Howell, Ampro, Victor, sound projectors. Lists dime. Film rental lists available. Movico, 482, Ithaca, N. Y.

GUARANTEED Fresh movie film! Three spools double 8mm. \$3.45! Six spools single 8mm. for Univex cameras \$3.50! Processing free! Postpaid. (\$1.00 deposit C.O.D.'s.) State camera make. New catalog. ESO-S, 4038 Broadway, Kansas City 2, Missouri.

LEARN Professional motion picture technique at home. Free catalog. Motion Picture Institute, Birmingham 4, Mich.

\$1 BRINGS "Surprise" assortment 8mm. colorful titles! Guaranteed. LeMoine Films, Nevada, Missouri.

FINEST Movie screens, inexpensive, make them yourself. Free literature. Snow White Screen Company, Danville, Illinois.

WANTED Bell Howell, Ampro, Victor 16mm. sound projectors. Cash paid day your projector arrives. Used film bought. Movico, 482, Ithaca, N. Y.

1946 FILM Catalogue Free; samples 10c. Cameras, projectors, enlargers, photographic items. Goodwill Company, Jackson, Tennessee.

FREE Movie film catalogs. Samples 10c. William Richardson, Wyoming, Penna.

NOW! Home movies in full color! Low in price, too. Catalog, 25c. Projection length Kodachrome scenes, "Waikiki Hula," only \$1.00. Specify width. World in color, Box 392-F, Elmira, N. Y.

UNUSUAL 8-16 mm. Film subjects. Big catalog with sample film, 10c. National Film Exchange, Broadway Sta. E, Toledo, Ohio.

MAKE \$8 To \$10 net profit daily with your 8mm. or 16mm. projector. Details free. Metcalf, 10806 Glenroy Ave., Chicago 43, Ill.

16MM. Sound silent film rental catalog, 153 pages, latest features. One dollar. Movico, 482, Ithaca, N. Y.

8MM. Movies bought, sold, exchanged. List free. Mail Values, Woodbury, Conn.

16MM. And 35mm. sound films for sale. 16mm. sound machines for sale. Stamps for listings. Mertz's Films, Springfield, Ill.

MOVIE Films, 100' outdoor 16mm. \$2.25; three rolls \$6.00; 100' indoor film \$4.25. Ambassador, 479-A, Quincy Street, Brooklyn, N. Y.

FREE Membership—Movie film rental library. 8-16-35mm. sound, silent projectors, cameras. Movie film, 8mm. \$2.25; 16mm. \$2.45. Trades accepted. Mogull's, 68-L West 48th St., New York 19.

RENT 16 MM. sound films 50c reel. Large selection; free catalog. Film Service, 128 Chestnut Street, Roselle Park, N. J.

SAVE: Rent 16mm. silent films by the week. \$2.00 reel. Robert Salmon, 3558 So. 11th East, Salt Lake City, Utah.

WORLD'S Greatest clock, 6000 pounds, 15,000 parts, 16m.p.m., silent, 125 feet \$4.50. Nu-Art Films, 145W, 45 St., New York City.

UNUSUAL Home movies—travel, adventure, sports, news, war films. Many film bargains. Big 1946 catalog and sample, dime. Audet, Box 6520-BG, Philadelphia 38, Penna.

8MM. Films for sale, exchange. List of popular subjects, sample, dime. Arnett, 820 Gordon, Piqua, Ohio.

8MM., 16mm., 35mm. films. Samples 10c. Lists free. Paramount Films, Monmouth, Illinois.

NEW Catalogue 35mm. motion picture productions. Roadshow attractions. Westerns. Gangster. Medicals. Any type picture you want. Low prices. Catalogue 25c. Bussa Film Exchange, Friendship, Ohio.

35MM. Sound features, projectors. A Savarese, Woodcliff Lake, New Jersey.

"THE World's Greatest Passion Play," all sizes sound and silent. Write Hemenway Film, 33-F Melrose St., Boston 16, Mass.

HOME Movie rentals, sales, exchange, 8-16mm. and sound. Latest releases—Money-saving rates. Details for stamp. Midland Film Exchange, Box 429, Oak Park 4, Illinois.

BEAUTIFUL Kodachrome slide and list, 25c. Art Slide Co., M-1, Canton, Ohio.

LEARN Movie projection, management. Free catalog. Theatre Institute, Elmira, N. Y.

MOVIE Camera films, 100' 16mm. \$2.50. 25' double 8mm. \$1.25. Free developing. Better Films, 742 NewLots, Brooklyn 7, N. Y.

MOVIE Projectors bought and sold. List 10c. United, 2309-A Lawrence, Toledo, O.

SPECIAL Movie film, 8mm., 25 feet double-Weston 8, \$2.00. Super double X. Pan indoor 60, outdoor 100, 16 mm.—\$6.50. Super X Pan indoor 24, outdoor 50, \$5.75. Pan Weston 12, \$5.00. 16 mm. 100 feet Weston 6, \$4.00. Free developing. Exhibitors Film Exchange, 630 9th Ave., New York 19, N. Y.

BASS Says: Leadership in the cine field is apparent in war times. Here ready—your choice of 8 mm. and 16 mm. apparatus. Write for quotations. Your old equipment is worth real money in trade—describe please. Or we buy for cash and pay immediately on receipt. Write to headquarters. Bass'buys 'em, sells 'em, trades 'em. Satisfaction guaranteed or your money refunded. 35c postpaid for 100 page book "Military & News Photography" by Jack Price. Up to the minute information. Bass Camera Company, Dept. A, 179 W. Madison St., Chicago, Illinois.

MUSIC AND MUSICAL INSTRUMENTS

GUITARISTS—Modernistic set, run-breaks, modulations, introductions, futuristic chords. Strictly professional material, makes you outstanding. Notes, fingering, diagrams, \$3.00. Beginners inquire, personalized lessons. Guitarist, Box 596 PMC, Brooklyn 1, New York.

ACCORDIONS—Dealers' prices. New or used. All sizes and makes. Free catalog. Metro Accordion Co., 31 South Cicero, Chicago 44, Ill.

SUBSCRIBE To "The Guitarist and Mandolinist," monthly publication devoted to players of all string instruments. \$2.50 year. Sample 25c. Ricardo, Geneva, N. Y.

YOU Can learn to play the piano by ear in one week. Write today. Carol Specialty Co., 1324 E. 111th St., Cleveland 8, Ohio.

LEARN Piano in 5 lessons. Complete course \$1. Neale, 1616 Carl St., Cincinnati 25, Ohio.

PIANISTS—Quickly improve technique, sightreading, accuracy, memorizing, playing through mental-muscular coordination. Free booklet. Broadwell Studios, Dept. 46-C, Covina, Calif.

GUITAR—Learn to play through Applied Psychology of Mental and Muscular Coordination. Spanish guitar, Hawaiian Guitar or piano in twenty lessons \$2.00. Frank's Musicians Supply, 732 Jersey Ct., San Diego 8, Calif.

SONGWRITERS: Collaborate with nationally famous composer of "Boots and Saddles." Send poems for free examination. Get free instructive booklet. Hollywood Harmony House, 126 South La Brea, Studio M-8, Los Angeles, California.

SONGWRITERS. Have your songs or lyrics completed by an honest, experienced arranger. Free analysis report. Tommy Kilbourne, Box 1253, Bakersfield, Calif.

SONGWRITERS! Amazing, outstanding ethical offer. Hibbler, C5, 2157 N. Avers, Chicago.

MUSICAL Manuscripts reproduced and copyrighted. Economical. Write. R. Daley, 19 South LaSalle, Chicago.

SONGWRITER'S Publishing agreement free. Stuckmann Music Press, 5426 Broadway, Chicago 40.

NEED Music printing? Write A-1 Music, 16 East 43rd Street, New York.

SONGWRITERS: Collaboration, consultation, criticism. "Hit Parade Writer," 37 Teresita, San Francisco.

SONGWRITERS. A limited amount of musical compositions wanted for radio distribution. Tin Pan Alley, Inc., 1650 Broadway, New York 19, N. Y.

VOCALIST Pay well. Amazing home method. Details free. Vocalto, Madison Hotel, Box 132A, Atlantic City, N. J.

HARMONICAS C \$1.50, \$2, \$2.90, double row \$3, \$5. Guitars, drums \$10 up. Instrument lists free. Musician's Shop, 2 E. Centre Street, Baltimore 2, Md.

SONGWRITERS! Poems set to music. Billy Hannon, 6703 N. Oshkosh, Chicago 31.

POEMS Wanted! I'll compose special music. Send poem for free examination. Eliot Wright, Master Composer, 107 Rivoli Theater Building, Portland, Oregon.

YOUR Poem artfully set to music, \$5.00. Thompson Tunes, 2 Southeast Fifth, Evansville 9, Indiana.

SONGS Published. Music free. National Songwriters, 1587B Broadway, New York.

POPULAR Piano in 12 lessons, guaranteed. Beginners, advanced. Kelly School, 1734 30th Ave., San Francisco 22, Calif.

SONG Poems wanted, for musical settings. Send poem for free examination and outstanding offer. Write for free instructive booklet outlining opportunities. United Music, Salem 3, Indiana.

NEW Songs and lyrics wanted for popular radio program and professional promotion. Free examination. Transradio Music Inc., Dept. P., 1650 Broadway, New York.

SONG Poems wanted—All subjects. Send your best poems today for free examination, or write for free booklet "Getting Ahead in Songwriting." Song Service, 331-C West 46th, New York.

MUSIC Composed to song-poems. Address: Frank Wildt, Lancaster, Penna.

SONG Writer's attention! The amazing demand for phonograph records, accelerated by more than 300,000 juke boxes and the hits popularized warrants your immediate consideration. We are offering song-poem writers the rare opportunity of having established composers collaborate on appealing material received this month. Recola Records, Box 987P, Hollywood 28, Calif.

POEMS Wanted for immediate musical setting. Free examination; any subject. Well known music publisher in urgent need of original material. Send poems to: Composers' Guild of America, 545 Fifth Avenue, New York 17, N. Y.

LEARN To write music, words, arrangements and publishing. The Complete Songwriter tells how. Send \$2.00 M.O. postpaid to Puritan Publishing Co., Inc., 343 So. Dearborn St., Chicago 4, Ill.

POEMS Wanted for musical setting. Send poem for immediate consideration and free rhyming dictionary. Richard Brothers, 24 Woods Building, Chicago.

SONGWRITERS—Send poems for immediate examination and free book, "Your Future in Songwriting." Radio City Music Academy, 1674 Broadway, New York City 19.

WANTED! Lyrics, melodies for songs. We arrange, publish, sell. Superior Song Studios, Passaic, N. J.

ACCORDIONS. New and used at wholesale prices. Save up to \$100.00. Buy direct from factory. Del Principe, 307 So. Wabash, Chicago.

BEFORE Sending your poem to be set to music, know your composer. Free folder. Al Moquin, 5333 La Cresta Court, Hollywood 38, Calif.

POEMS Wanted for musical setting. Send poem for immediate consideration. Five Star Music Masters, 630 Beacon Building, Boston.

SONG Poems wanted. Free examination. McNeil, Master of Music, 510-PM South Alexandria, Los Angeles, Calif.

WRITE Songs. Big money and reputation. Write for information. J. Gordon Pub Co., 201 N. Hoyne Ave., Chicago.

RADIOS AND SUPPLIES

BRAZILIAN Quartz crystal plates. Control radio frequency oscillating circuits. Kits for experimentation and study. \$2.00, \$3.00, and \$5.00 with instructions. Postpaid. Leuck Crystal Laboratory, Dept. A, Lincoln 8, Nebr.

RADIOS, New 1946 "Electro" six tube superheterodyne, a.c. d.c. built in antenna \$26.25. 20% deposit, balance C.O.D. Jeannette Electric Co., Inc., 159 West 23rd Street, New York 11, N. Y.

YOUR New free catalog is ready! Radionic's catalog lists hard-to-get radio parts and books. All available for immediate shipment. Send today to: Radionic Equipment Co., Dept. 3D, 170 Nassau St., New York 7, New York.

TEN, Simple, easy to build crystal radio diagrams and crystal 25c postpaid. Potter, 1314 McGee, Kansas City 6, Mo.

BEGINNER'S Radio repair booklet 25c. Radio, Box 311-T, Benton Harbor, Mich.

FAMOUS "Foxhole" radio—plays anywhere. Plans, quarter, National, 322M Union Avenue, Brooklyn 11.

BUILD Latest, extra-loud crystal set. Instructions, 20c. "All About Crystal Sets," booklet, 45c. Amorose Radio, R-4, Hungary Road, Richmond, Virginia.

BUSINESS OPPORTUNITIES

REVISED Plans 18 long distance crystal sets, including "Radiobuilder"—25c. Laboratories, Box I-c, San Carlos, California.

RADIO Tubes, parts, condensers. Free bargain lists. Potter, 1314 McGee, Kansas City, Mo.

FOXHOLE Radio simple illustrated plan 50c. Gadgets, Box 28k, Jackson Heights, N. Y.

GENERAL Electric 2000 ohms plate circuit relay, nominally closed one fifty-nine. Vibrating reed type sixty cycle frequency meter, used as basic, four forty five. Leach 115T time delay adjustment, 5—20 seconds for Ham, \$5.13. Dynamic headphones and mike \$6.45. Free list Ham experimenters. Radio City Labs., 30 Church St., New York 7, N. Y.

FREE Telephone plug, rugged construction, short type. Send two dimes to cover postage and packing, regular fifty nine cents. Electric tester with neon lamp for radio circuits, a.c.-d.c. motors, electrical devices—110-550 volts, thirty nine cents prepaid. Free bargain list. John Barron, 662-85th Street, Brooklyn 9, N. Y.

RADIO Radar government surplus:—BC 412 5" oscilloscopes, with tubes, \$54.50; range units, pulse amplifiers, HV condensers, HV transformers, relays; Radar receivers BC 406, \$29.50. Microphones—lip buttons, \$2; throat buttons, \$1. 1000 other items. Send for flyer. Communications Equipment, 131A Liberty Street, New York City.

BUILD This world's smallest a.c.-d.c. radio with built in loudspeaker! Uses one tube! Easily fits in ladies' handbag or briefcase. Send 50c for plans, photos, instructions. Louis Toth, P.O. Box 110, Station H, New York 25, N. Y.

CRYSTAL Radio kit. Parts complete—earphone, crystal, diagram and instructions. Anyone six to sixty can enjoy it! At your dealer or sent postpaid for \$3.20. No C.O.D. Wm. Walter, Box 412, Lima, Ohio.

HEADPHONES: New lightweight sensitive 2000 ohms, complete with headband and cord \$1.95. Naval aircraft control boxes \$2.00 per pair, worth \$10.00 for parts. Ask for bargain sheet with your order. Van Sickle Radio Supply Co., Indianapolis 6, Ind.

BUILD Your own two tube Walkie Talkie. Low cost. Plans \$1.00. Electronic Devices, 942 Market Street, San Francisco, Calif.

PORTABLE Electric amplified record player. Detailed plans, instructions 50c. Addis Radio, Kimmell, Indiana.

RELEASING Surplus salvaged radio parts, tubes, speakers, transformers, etc., from dismantled equipment, seen service. Pot luck package 5 lbs. \$4.95; 10 lbs. \$7.50. Radionic Salvage, 18518 Winthrop, Detroit 19, Mich.

PLASTIC Crystal radio, batteryless, tubeless. Sensational, complete kit includes lucite plastic, solvent, detector, wire, hardware, headphone, aerial, instructions, etc. Send \$4.50 to Hallock-Busse Co., Products Division, Waseca, Minn.

WAR Surplus condensers, resistors, rectifiers, meters, chokes. Send five cents for list. Campbell, 3800 Kinzie, Racine, Wisconsin.

RADIOS: New or used. Immediate delivery. Tubes galore. Hagedorn, 2250 North 27th, Milwaukee 8, Wisconsin.

FAMOUS "Allen" Midget Semi-Fixed Crystal Detector, set building plans and 100 late crystal set distance reports all for 50c postpaid. Allen, 427-P, Clinton, Mo.

MAKE Simple, tubeless, batteryless, distance-getting crystal radios. Crystal and illustrated instructions 25c postpaid. Allen, 427-P, Clinton, Missouri.

FM Can now be heard on old radios! Very simple adaptor! Send postcard for free data! Topical Emprise Corporation, 1527 Highland, Box 42, Louisville 4, Ky.

BUILD Radio. Complete kit with tubes \$10.95. Details. Radio, 9418e Avenue "A," Brooklyn, N. Y.

RADIO Service men and experimenters send stamp for our giant radio catalogue. Save dollars. United Radio Co., (1000-V) Newark 1, N. J.

RADIO Service flat rate schedules solve pricing problems. Compiled from 20 years experience. Write for information. Radio Equipment Co., 1415 W. Franklin Ave., Minneapolis 5, Minn.

FAMOUS Razor blade radio! Illustrated plans 35c. New Radio, Lohrville, Iowa.

RADIO Technician and radio service courses. Training for federal licenses. American Radio Institute, 101 W. 63 St., New York City. Approved under G. I. Bill of Rights.

IF You have a hobby with commercial possibilities or operate a small business which developed from a hobby—I am interested in your story. Cash awards will be paid for acceptable material. Write for particulars. Leon Cutler, Publisher, 20 E. 35th St., New York 16, N. Y.

HIGH School seniors: Make good money selling our graduation name cards. Biggest commissions! Season starting . . . Hurry! Craftcards, Box 235-AL, Pittsburgh, Penna.

TRADE Magazines—Business, vocational, diversion. Classified directory 3343 publications with complete addresses and subscription rates \$1.00. Commercial Engraving Publishing Co., 34C North Ritter, Indianapolis 1, Indiana.

10c BRINGS You lots of mail. Catalogs, magazines, money making ideas, samples. Gardenville Publishers, Gardenville 1, N. Y.

PREPARE Now to start own business making Venetian blinds. Splendid prospects. Illustrated instruction book \$1.00. Elwert, 6900 North Ashland, Chicago 26.

LEARN Shell jewelry manufacturing. Complete, simplified home instruction course, beautifully illustrated, shows 45 styles pins, earrings, brooches, sprays, hair ornaments. Includes pearling, dyeing, gilding, glow-in-dark methods. No tools needed! Learn-earn within a week. Only \$1 postpaid, including wholesale prices of all raw materials. House of Gifts, Box 4550-RF, Coral Gables, Fla.

MAKE Flexible Molds, Statuary, Art Goods, Novelties, Artificial Marble Flooring, Liquid Marble. Literature free. Kemico, Park Ridge (3-M), Ill.

MAIL Order opportunities. Read oldest trade journal. Copy 25c. Mail Order News, Somerville 35, N. J.

GUARANTEED Income! Grind lawn mowers. Instructions \$1.50. De Lambert, Janesville, Wis.

LIBRARY Of business opportunities contains 3 books. Will make money for you. \$2.00. D. Thompson, 6625 Lowell, Springfield, Ill.

PROFITABLE, Fascinating profession manufacturing picture projectors. Easily built, valuable machine costs \$1.50—sells \$20.00. Projects drawings, photos, etc., any screen. No special lenses, slides, required. Complete plans, instructions, \$1.00. Gladwal Engineering Co., 61 Ashdale, Toronto, Canada.

BUILD Your own independent, fascinating and very profitable business at home, spare or full time. \$50.00 and up weekly easily possible decorating beautiful imitation marble novelties and religious figures. Fast sellers by you, through agents, stores. Quickly learned and few dollars starts you making real money. We tell you how, as manufacturers, and furnish everything. Be our representative in your territory. Write for full information at once. Inghram Company, 2845 Sixth Street, Detroit 1, Michigan.

DISTINGUISH Your product with a good trade-mark. Find out if registrable in U. S. Patent Office. Any word or name checked and information given for \$2.50. State kind of product. Address: Raymond L. Smith, 410-TM Bond Building, Washington 5, D. C.

BOOKKEEPERS. Be your own boss. Operate profitable bookkeeping service. Start small, grow big. Details free. Bourque, 3712 Fifth, Marrero 1, Louisiana.

PROFITABLE Mail order plans, ideas, write today, free literature. Frank J. Artz, 1060C Harding Drive, Toledo 9, Ohio.

OPERATE Profitable mail order business. 75c profit each dollar. Powell Service, 5713 Euclid, Cleveland 3, Ohio.

PAINTED And unpainted plaques, bookends, shelves and whatnots—Free list. "Homemaker" Art Craft Co., Dept. 4, 338 Sibley St., St. Paul 1, Minn.

CONCRETE Brick are a profitable product with a well established consumer demand. This is your opportunity to enter the concrete products field with the minimum equipment expenditure. R. S. Reed Company, Three Rivers, Mich.

MAKE Soap at home. No machinery. Profitable. Literature free. Kemico, Park Ridge (SM-3), Ill.

ELITE Collection contains 137 practical money-making plans; local and mail order. New edition. Particulars free. Elite Co., 220-A Grand St., New York 13.

WHOLESALE Catalog and directory 10c (refundable). Thousands of articles. Stafford, Sunnyside-A, Indianapolis 44, Ind.

FREE Literature upon request, describing many moneymaking plans. Island Mail Service, Box 162-G, Jamaica 4, New York.

BABY Shoes preserved. Complete instructions. Exclusive rights. M. E. Watson, Bellefontaine, Ohio.

DO-It-yourself! Fame, independence impossible? Lifetime business "pulls" money without schemes or capital. Different! Complete! Airmail dollar. Results or refund. Zigzag Corporation, Box 101-W, Guatemala, Central-America.

ANGORA Rabbits supply living from wool, meat. House of Angoras, Springfield, Illinois.

EARN Money at home! Profits! Freedom! Write Successful Income Builders, 508-A, Hollywood 28, California.

MAKE Liquid Marble, Plaster Plaques, Statuary. Instructions, formulas, \$1.00. Ideal Service, 179-M, Park Ridge, Ill.

TREMENDOUS Profits mailing literature. Dealers information 3c. General-print, East Orange, N. J.

SUPPLY Crying demand for new composition figures, bookends, wall brackets, gift novelties, unpainted, five cents up, one to eighteen inches high, paint em yourself, distribute to stores, large profits, sample assortment three dollars. Starts you in business. Paris Art Novelty Co., 611 West 7th Street, St. Paul 2, Minn.

BRILLIANTINE—Perfume manufacturing business, little capital, good profits. Particulars free. Bob Celaya, 907 Adams, Brownsville, Texas.

MAKE Mirrors, mirrored signs, table-tops, etc., for pleasure, profit. Illustrated instructions, formulae, 50c. Details free. Specialties, Box 599, Grand Rapids 1, Michigan.

MOULDS For lead toys. Catalogs 10c. Dandridge, 1557 Essex St., Rahway, N. J.

"INSIDE Secrets" on making quick cash. Folder free. Write. J. Martino, 1228 Wilshire, Los Angeles, California.

1500 QUANTITY Buyers plaster statuary, plaques, novelties, \$5.00. W. Pine, 1515 South Figueroa, Los Angeles, Calif.

MEN—Women start own business, home or office; no peddling; little or no investment. Particulars free. Paisley, Box 5307, Los Angeles 55, Calif.

MAKE Strange new plastic—1c pound. Makes durable, attractive floors, walls, roofs. Build for half. Bays Laboratory, Oklahoma City 9.

"BARGAIN Buyers Guide." 64-page guide to the direct source of supply. \$1.00. Latshaw, Sunnyside, Indianapolis, Ind.

YOUR Name in National Opportunities Directory one year 25c. Mail-order treatise included free. Marshall, 7220 So. Lowe Ave., Chicago 21, Ill.

DOLLARS Daily! Start home; mailorder businesses. Details free. Duffy, S56, Covington, Ky.

RUBBER Molds for fast selling plastic numbers. Molds for casting composition and white metal made to order. Art Products, 415 Earle Rd., Cuyahoga Falls, Ohio.

PLASTICS. Start your own business immediately with small capital. Complete equipment for permanently sealing in transparent plastic, all types valuable papers, discharge certificates, photos, identification cards, badges, etc. Write or wire for free folder. Kingsbacher-Murphy Co., 683 Santa Fe Ave., Los Angeles 21, Calif.

START Mailing service business at home in spare time 25c (refundable) brings success booklet. Riegel, 1111 Harrison, Philadelphia 24, Penna.

TYPIST Profitable business at home. Complete information 50c. Gaunt, 3521 Broadway, Chicago, Ill.

LIQUID Marble—make in any color. Soundproof plastic flooring. Flexible molds. Cast novelties, plaques, statuary. Big money—your own business. Catalog free. Write—Bing Products, 88-AG Broad Street, Boston 10, Massachusetts.

137 WAYS To make money, in home or office, business of your own. Full particulars free. Elite Co., 220-A Grand St., New York 13.

AT Home—Your own manufacturing business; making popular \$1.00 novelties. Cost you 3c to 15c. Everything supplied. Write So-Lo Works, Dept. C-600, Cincinnati, Ohio.

POSTWAR Security! The greatest legitimate scheme ever devised to secure a big mailing list and a stream of dimes. Free particulars. Jack Killion, 7922 South Vermont Ave., Los Angeles 44, California.

FINEST Quality liquid molding rubber. Sample mold free. Cost more, worth more. \$3.00 quart, \$10.00 gallon. W. Wooley, 115-A Donald, Peoria, Ill.

IF It's business capital you need, write me fully. Probably I can help you. G. Hartwell Cole, Box 505, Syracuse 1, N. Y.

PLASTICS Guide listing dealers in plastic materials, molds, equipment, machinery, supplies. \$1. Save time, money. *Plastics Digest*, 3937P Tracy, Kansas City 4, Mo.

BOOKKEEPERS: General ledger and tax report experience. Operate permanent, profitable accounting service for the smaller business. Part or full time. Simplified method. Write now! L. A. Bell, 1404 West 25th Street, Cleveland 13, Ohio.

BOOKKEEPERS—Collectors. Double your pay checks quickly, easily. Make extra dollars immediately. Details free. Profit Builders, 305-R West 8th, Los Angeles 14, Calif.

BUSINESS-BUILDING Consultation for financially sick businesses. Free analysis. Raymond Dow, 15 Park Row, New York 7.

MAKE Your fortune in great new industry manufacturing and marketing products containing "DDT," wonder-working insecticide. World-wide waiting market. My Ten Master DDT Formulas and simplified manufacturing and marketing instructions for starting on small capital. Rush request for full details, free. Howard Robinson, Ph.G., 1304-C S. Ohio, Sedalia 10, Mo.

MAKE And mold genuine plastics. Send \$1 today for 40 profusely illustrated worksheets explaining simple, authentic methods—processes. Money-back guarantee. *Plastics Digest*, 3937M Tracy, Kansas City 4, Mo.

MECHANICALLY Inclined men—Own and operate general appliance repair shop. Complete, illustrated course shows you how. Welding, refrigeration, motor repair, how to get business, etc., all phases covered. Free literature. Christy Supply, Dept. 162, 2835 N. Central Ave., Chicago.

TREASURE Finders. See Goldak advertisement in Miscellaneous section.

SIX Mail order trade publications 25c. Full of articles, plans, schemes, wholesale offers. Kraft, 3114-S1 Walnut, Chicago 12, Illinois.

WANTED! Dealers to handle fast-selling money-making folios. Great opportunity. Karr Ross, De Ridder, Louisiana.

VETERANS! Operate your own advertising agency. Small capital starts you at home. No stock or equipment to buy. Details and proof to sincerely interested. Jackson Enterprises, 1108E So. St. Nicholas Avenue, Siloam Springs, Ark.

SELL Books by mail. Nice commissions! New titles! Big demand! Details for stamp. Elmer Swanson, Box 201, Niagara, North Dakota.

HOW To sell by mail 25c. Rieder, 71st Drive, Forest Hills, New York, N. Y.

OPERATE Profitable credit-collection agency business; many earn \$5,000-\$10,000 upwards annually; fulltime-lifetime vocation; sparetime possibilities; postcard brings interesting literature free. Write, Educational Extension Service, Department 101, Los Angeles 36.

SELL Books by mail. Learn how it's done. Start small, grow big. Grand opportunity to establish clean, legitimate mail order business. "How" booklet 10c. Kraft, 3114-S1 Walnut, Chicago 12, Ill.

PERSONAL Publicity will help you in your business or profession. Write for details. John B. Martin, 1101 West State, Jacksonville, Illinois.

HAVE More! Do more! Be more! Get out of the rut you're in! Riches and happiness don't "just happen." They are caused. Read "The Magic Story." Attain very things you want. Your future is what you make it. Build belief in yourself. This is not a sermon nor weary preaching. The Magic Story could be expanded into a course of 20 lessons and sold for many times its present low price. It has actually changed the course of many men's lives. Develop that "gift of getability." \$1 brings amazing "Magic Story" literature free. Donald Kelly, 1080 Cosgrain, Detroit 9, Michigan.

THOUSANDS Will buy "Businessman's Guide" (copyrighted). 25c brings copy, wholesale prices. Weyl, 1526-B Bryden, Columbus 5, Ohio.

MOLDS For plaques and statues easily made with our new liquid latex \$2.75 quart, \$9.75 gallon. Apex Plastic Products, 1740 Estes Ave., Chicago 26.

GOING To continued your "fat pay envelope" now the war is won? We can help you land paying job. No obligation. Write today. Davis Service, 32 W. Randolph St., Chicago.

WHY Money worry? Own—operate typewriter repair business. Low capital required. Large earnings! Qualify quickly. Easy direction. Write Athey's Typewriter Supply, Desk P, Tarentum, Pa.

125,000 FOREIGN Job opportunities. Central and South America, Africa, Asia, Europe, etc. Information explaining where and how to apply with list of over 350 select firms with foreign interests \$1.00. Industrial Trade Surveys, Dept. B-11, P.O. Box 4151, Los Angeles 24, Calif.

EX-SERVICEMEN—Start a business of your own. Small investment. \$2.98 for plans. Satisfaction or money refunded. Details free. Star, 783-1, LaCrosse, Wis.

EXPORT. Import, represent manufacturers. Deal with South America, Africa, China, Europe. War-peace time big business. Uncrowded fields. Unlimited opportunities. Deposit one dollar for two bulletins. Money back if unsatisfied. P. Benko, 246 Fifth Avenue, New York 1.

TESTED Success plans. Details free. Dunn, Box 955, Hartford, Conn.

SILVERWARE Cleaner dissolves tarnish. No rubbing. No scratching. Finest silverware safe. One dollar brings information. Manufacturers Research, Nevada, Iowa.

PROFITS And experience will come easier if you study the most talked about book in the mail order field. New enlarged edition, 576 pages of facts and directions for operating any mail business. Thousands satisfied buyers each year on money back guarantee. Write postal for details. Capitol Industries, 335-A Rock Creek Church Road N.W., Washington 11, D. C.

WHY Spend many dollars to find sources of supplies. Save money and time. Details free. Business Plans Foundation, P.O. Box 56-B, New York 10, N. Y.

OPERATE Profitable home mail order business. \$5 required. Details free. Bieber, 1611 High St., Ft. Wayne 7, Ind.

AT Last! Real \$25 weekly opportunity! Work from home! Rush stamp! MacCormac, F-300, Madeira, Ohio.

BE Your own boss. Triple your investment. Quick sellers. Write for particulars and be convinced. Nite Glow Products Co., 106 W. 46 St., New York City.

MAKE Money by mail. Successful plan, sure-fire profits, particulars for stamp! Specialties House, Lafayette 15, Indiana.

INSECT Sprays: profitable, concentrate. Particulars. Kaplann, 13 South Eden, Baltimore, Maryland.

OPERATE Mail order business profitable on \$5 capital. Details free. Valence, 119 Dedham, Needham, Mass.

JOKES, Tricks at wholesale. Make your store the hottest spot in town. 10 different samples \$1.00. 50 different \$5.00 with wholesale price list. Schwamm, 237 East Ninth St., New York 3.

PROFITABLE Business right at home. Be our agent for leading magazines taking subscriptions in your spare time. Send card for supplies. American Readers Service, Gwynedd, Penna.

YOUR Own business—As little as \$100 starts you now! No training needed! See our ad on page 36. American Photocopy Equipment Co., 2849 N. Clark St., Dept. GF36, Chicago, Ill.

HOME Mail business will pay big profits. Small capital. Spare or full time. Full particulars and starting offer free. Charles Service, 117 East Second Street, Girard, O.

PLASTIC Homes—Build yourself! Resurface old buildings! Wonderful building material. Particulars free. Marbleizing Service, Edwardsville, Illinois.

MAILING List! 5000 women mailorder buyers. \$25.00; 3000, \$15.00; 1000, \$6.00. Guaranteed accurate! Try them! Woods Remants, Bedford, Penna.

EARN More money. Hundreds of live business, formulas, secrets, manufacturing, plans. "Inside" supply sources of buying home, or business needs, at lowest possible prices. Booklet and literature, 25 cents. Charles Service, 117 East Second Street, Girard, Ohio.

MONEYMAKING Mailorder opportunities. Successfully operating 44 years. Little capital needed. Sure-fire profits. Consultation. Trial. Astonishing testimonials, particulars free. Raymond Dow, 2922 164th St., Flushing 31, N. Y.

BOOKKEEPER Double your income operate bookkeeping service part or full time your city. Write Tax-Saver System, Dept. A, Fort Worth, Tex.

DOLLAR Orders filled free. Fastest selling mailorder line. Darrah, Orono, Maine.

HOME Mail order profits. Learn how. Free details. Hetrick, 514B West Mahoning Street, Punxsutawney, Penna.

LIQUID Marble—Colorful, glazed! Molded, brushed, sprayed! Composition floors. Rubberlastic molds. Particulars free. Marbleizing Service, Edwardsville, Ill.

ESTABLISH Home mailorder business. Write Smith, 72-B Southbourne, Boston 30, Mass.

OWN A mail-order paper products business. Sell envelopes, tags, bags, boxes by mail, wholesale. Tremendous demand. Steady profits. No capital necessary. Write Omaha Envelope Service, Dept. 132, 4721 California, Omaha 3, Nebr.

FINKLE Knows mailorder advertising! Nationally known creator guarantees powerful letters, literature, selling campaigns. Big positive results! Postcards ignored. Finkle Advertising, 1201½ South Ogden, Los Angeles 35, California.

DO You want to buy or sell? Then write explanatory letter. 452, Albia, Iowa.

MAKE Your money "on the spot." The front-money is yours on every order you take for a beautiful Plastic-Craft Plaq, a reproduction in plastic of any snapshot or photograph. It sells itself. Unlimited field. Send \$2.00 for sample kit. Plastic-Craft, Dept. 346, P.O. Box 1221, Philadelphia 5, Penna.

NAME Lists 1,000 new names \$2.00. Franklin, Box 342, Rock Hill, S. C.

CIRCULARS Mailed \$1.50 per thousand. Up to 6x9. Franklin, Box 342, Rock Hill, S. C.

MAKE Up to \$10,000 and more a year. Enter a new profitable professional business in 60 days. Small investment. Suite 844, Dept. M, 127 North Dearborn St., Chicago 2, Ill.

SUCCEED With business mailorder magazine, money-making ideas, editorial advice. Also big mail literature on mail-order courses, information portfolios, small capital plans, amazing profits, repeat business from home, shop, store, office. Also 12,000 word book "How To Sell By Mail" included. Mail now \$1.00 to Opportunity Department P.M., Rieder Publications, 93-20 71st Drive, Forest Hills, N. Y.

GET Dollars by mail. You keep the dollars. Complete information 10c. Terrill, Bogard 2, Mo.

BUILD Neon signs and neon lighting. Easy to learn. Very small capital required. McMaster Sign Co., 730 State St., Bellingham, Wash.

SELL Exclusive books of instruction by mail. Assorted subjects. Popular prices. 70% profit. Rush name. Free sample imprint circulars and selling instructions. Financial Education, 404F Mack Building, Denver 2, Colorado.

CAST Bookends, novelties. We furnish rubber molds. Sell unfinished castings to us. Free information. Mold Craft Industries, Morris Plains, N. J.

START Your own business; six money-making formulas free. Box 68, Palestine, W. Va.

VENETIAN Blinds, "Manufacturing Booklet" \$1.25. Hardware, tape, cord. Catalogue 10c. "Roberta," 423, Gloversville, New York.

METALLIZE Baby shoes! Learn "know how" from nationally recognized consultant. See Kushner ad page 276.

—RAISE Giant Chinchilla rabbits. Willow Farm, R 15A, Sellersville, Penna.

GIANT Chinchilla rabbits. Valuable fur. Delicious meat. Easily raised. Pleasant pastime. Tremendous demand. Small investment. Large profit. Willow Farm, R15, Sellersville, Penna.

LET Us form a national association of business promoters. Applicable to many businesses, especially mail order. Send card or letter for my proposed charter and other details. Earl Whitaker, Box 53, Sand, Texas.

MEN. Women, start own business, home, office; no peddling; little or no investment. Folder describing collection of 137 plans free. Saunders, Box 246, Ambridge, Penna.

YOUR Own mail order business at home. Large profit! Carry no stock. Unique plan. Start spare time, now. Write: Dante A. Antonelli, 1301 Commonwealth Ave., Boston 34, Massachusetts.

SELL Merchandise and service. Start your own mail order or agency business. Quickly, easily, successfully. Complete detailed, sample directive 25c. Particulars free. Ruscher, 4442 No. Damen, Chicago 25, Ill.

FELLOW Workers—Down with bosses. Start own business. Be independent. Booklet describing 137 tested plans, free. P. Padney, 307 York St., Jersey City, N. J.

BOOKKEEPERS—Operate popular "Dollar-A-Week" bookkeeping and tax service. Full or spare time. Details free. Mutual Service, 180 Cedar, Dept. 316, Concord, N. C.

HOMEWORKERS Opportunities—\$1.00 co-publishes, under your name, 80 page, 25c mailorder magazine, chock-full of plans, schemes, secrets. Free sample. Raymond Dow, 2922—164th Street, Flushing 31, N. Y.

PLASTICOAT—Covers, protects, glazes plaster castings, etc. Any color. Sample pint \$1.00. Plastic Art Products, 1321 Belmont, Chicago.

ELECTRICAL Appliance repair. Open your own shop. Learn house wiring; electric motors, vacuum cleaners, washers, etc. Complete illustrated course shows how. Free booklet. Pacific Training School, Dept. AP-1, 7217 So. Broadway, Los Angeles 3, Calif.

BUILD Mail order business of your own—anywhere! Free illustrated prospectus on "Modern Mail Merchandising." Write at once. Mail enterprises, Inc., 316-A Fox Building, Detroit 1, Michigan.

HANDY Men—Earn money home operating Community "Fix-It" Shop. Write Stafford, 708 Rawlings, Carbondale, Ill.

YOUR Own business. Big profits, very small capital. National organization teaches, helps, supplies everything. Interesting service business. Big demand everywhere. Americlean, 211 North 7th Street, St. Louis 1, Mo.

OPERATE Postage stamp vending machines. Legal! Steady profits! Free details! Adair Company, 6924 Roosevelt, Oak Park, Illinois.

THERE Is big money in collecting delinquent accounts for business firms and doctors. Write us for free details. Cole & Associates, Syracuse, N. Y.

MAIL Order beginners! "How to Build Your Own Mail Order Business." Noted specialist's 10,000-word treatise, shows step by step—how to make it pay, on small-capital start. 25c, satisfaction guaranteed. Maupin & Maupin, LaFayette 3, Indiana.

GOT \$24,500 Using "schemes" from "Schemer" Magazine, Alliance, Ohio. 48th year. \$1.00; 4 samples, 30c.

WORK For yourself. Average \$1.00 hourly. Absolutely no selling. Pleasant spare-time work. Convincing particulars free. American Business Service, Nescopeck, Pa.

RUBBER—Airlastex liquid, pre-war quality. "Makes molds overnight." Sample pint, instructions \$1.50. Gallon \$9.00. 20th Century Products, 3151-3 Southport, Chicago.

WANT To make \$100.00 weekly? History of World War II. Your opportunity; write today. Better still, send \$3.85 for sample history and order taking outfit. Wilkin & Co., 118½-PM E. Main, Hillsboro, Ohio.

HOMEWORKERS—Attention veterans! Castwood plastic gifts, novelties; material and instructions furnished. Sample quart with mold model, \$2.00. 20th Century Products, 3151-3 Southport, Chicago.

PLASTIC-Intermix, makes ordinary casting plaster shatterproof. Pint develops 100 pounds, \$1.25 postpaid. Plastic Material Supply, 1416-N2 Fletcher, Chicago.

FREE Booklet describes "Collection 137 Tested Plans"—full or spare time. Fully illustrated. Kakay & Co., Box 1032, Tampa 1, Florida.

HOW To operate your own advertising agency profitably. New, different, copyrighted manual reveals all. Learn how to start in spare time, at home, with few dollars capital. No stock or equipment to buy. Earnings unlimited. Sincerely interested send stamp for special folder. P. Snyder, Box 4907-A, Philadelphia 19, Pa.

RUBBER-LATEX Molding liquid. "The real thing." Sample quart, directions \$2.95. Gallon \$9.50. Plastic Material Supply, 1416-N2 Fletcher, Chicago.

BUSINESS Machine repairing. Self teaching course. First lessons teach how to make money in garage or basement. Office Machines Service School, University Station, Box 134, Seattle 5, Washington.

HAVE Your own business, full or part time, selling Ramsay Simplified Bookkeeping Systems. Practical, easily operated, moderately priced. Furnishes complete, accurate information required by government. Every business a prospect. Excellent opportunity for accountants and bookkeepers to service clients. Liberal commissions paid daily. Write for details. Ramsay Systems, Inc., 192 Lexington Ave., New York 16, N. Y.

PRINTING Price list free. Fletcher, 639 Bushwick Ave., Brooklyn 6, N. Y.

BE Independent. Start a business of your own and enjoy financial freedom. Little or no cash required. 3c stamp brings full details. W. M. Drexler, 258 Broad, Newark 4, N. J.

BOOKKEEPERS—Operate your own "Dollar-A-Week" bookkeeping and tax service. Full or spare time. Details free. Ellis, Box 200, Cedar Grove, No. Carolina.

MAIL Order business course shows you how to make money, spare or fulltime. Teaches professional mail order technique—not penny-snatching schemes. Fascinating 100-page illustrated success-catalog free! Write—Nelson Company, Dept. 4-02, Chicago 5.

SELL Cosmetics by mail. Women spend millions on beauty. You can make your share of this cosmetic money. Let us show you how. Details free. Frank J. Artz, 1060 Harding Drive, Toledo 9, O., Dept. A.

BECOME A finance man. Particulars free. George Lenhoff, Lincoln 8, Nebr.

FREE Hot water the year 'round. First cost is last cost. Build your own solar water system. Average cost less than seventy dollars. Good business opportunity sell solars in your community—it's easy. Complete instructions and drawings send two dollars. Will produce hot water any locality. Miami Solar Water Co., P.O. Box 175, Coral Gables, Florida.

CASH By mail. Either sex. 10c brings offers. Bargain. Specialty Company, Box 635BO, Modesto, California.

PLASTICS. Make your own at home. Formula and moulding instructions \$1.00. Box 84, Station K, Toronto, Canada.

TAILORED Homes—the modern plan book. Ad under heading Miscellaneous.

MANUFACTURE Nameplates, house numbers, electric signs. Box 221, Newport News 6, Virginia.

START A home business in spare time. Make extra money. Experience not essential. Literature free. Rolf S. Iverson, Box 916A, Grand Central Annex, New York 17, N. Y.

BUILD Miracle homes. Yours. Others. Chamberlain, Fitzsimons Building, Pitts- burg 22, Penna.

FREE Literature. Hundred money-making ideas. Wolf's, 3240 Glenview Street, Philadelphia, Penna.

LATEX For making flexible rubber moulds. Thoroughly tested. No shrinkage. Complete instructions with each order. Stoneham Rubber Co., Box 244, Stoneham 80, Mass.

\$5,000 YEARLY Possible, selling books by mail. Distributors proposition. Nichols Publishers, Box 831, Pine Bluff 1, Ark.

MEN — Women — "Everybody Likes Candy." Learn to manufacture professionally at home. (Our 35th year.) Ragsdale Candies, East Orange 2, N. J.

WANT More money—better job? Scientific way, using basic principles explains exactly how to get what you want. Details free. Kindig, 1629 Vine St., Philadelphia 3, Penna.

START Home business making statuary, plaques, novelties, garden furniture, artificial marble flooring, liquid marble. Make your own flexible molds. Amazing profits. Folder free. Creative Publishers, Box 236-L, Winnetka, Illinois.

We Start you in business, at home, sparetime, earning \$10-\$30 weekly selling by mail. Stamp appreciated but not necessary. Driscoll Sales Service, Box 2771-A, Denver, Colo.

FREE Valuable money-making self-help books. For particulars write, Mae Specialties Company, P.O. Box 23, Station L, New York 35, New York.

SPARE Time mail business earned \$1400 monthly. Copyrighted instructions \$1.00. Wm. Boyd, 331 Fourth, Pittsburgh 22, Pa.

RUBBER Moulds for casting novelties. Latex for making moulds. Use thoroughly tested and approved products. Eastern Latex Laboratories, Box 153, Mattapan 26, Mass.

SELL By mail with Elfco Ready Made Circular Service! Large profits! Catalog free! Elfco, 434 North Wells, Chicago 10.

AMAZE Others. Add columns instantly. Add faster than adding machine. Free details. Math Institute, Box 633, Mobile 4, Ala.

BUILD Own business mailing penny post cards; six profitable plans with information for starting. Gordin Publishers, Box 23, Pawtucket, R. I.

"HOW To Make Simple Molds and Plaster Plaques." Profitable business or hobby! Instructive booklet 25c. Plastercraft, 1406 East 43rd Street, Cleveland 3, Ohio.

WORK For yourself. Your own business. Operate entirely by mail—direct from your home in spare time. Few dollars starts you. Literature free. Albert Wilcox, PM21, Nicholls, Georgia.

"10,000 ALASKA Fishing jobs." Alaska's largest industry regularly employs thousands of men and women in seafoods production. Possible earnings up to \$5,000 in few weeks. Authentic 7,000-word copyrighted report gives job information, union requirements, sample application letter, names and addresses over 40 Alaska fisheries. Newest edition includes similar information on California, Oregon and Washington fisheries. Vital facts for immediate application in a permanent industry. \$1.00. 7-day refund privilege. Pacific Industrial Research Bureau, Dept. PM-9, 202 Studio Building, Portland 5, Oregon.

FLORIDA Opportunities—Pensacola offers exceptional opportunities for small industries, especially in the field of mahogany novelties and woodware, perfumes, soap, chemicals. Delightful year-round climate. Wonderful fishing, hunting, beach sports. For information write: Industrial Development Division, Municipal Advertising Board, Pensacola, Florida.

START Profitable sideline business now! Complete free details and premium offer available. Write Sheboygan Publishing Co., Sheboygan, Wisconsin.

RECAST Old batteries into new. Latest achievements. Battery Laboratories, Minneapolis.

\$25 WEEKLY Working two hours daily. No canvassing. No manufacturing. Lycke, Box 2471, Cleveland 12, Ohio.

TYPEWRITER Repairing—Original course, simplified home study. Weber Typewriter Mechanics School, Box 269, Osborn, Ohio.

QUICK Money! "Repairing Car Batteries." At home. Easy too. Write Batteryman, 901 South Avenue, Grand Junction, Colo.

START Mailorder bookshop—Everything furnished; publisher cooperation. 25c brings booklet, exclusive setup, samples, exciting ideas. General Publications, Ossining, N. Y.

BECOME An "Attritionist Masseur." First improvement over Swedish massage in 100 years! Results unbelievable! Dr. Swearingen, 9128M, Station S, Los Angeles.

COLORGLAZED Concrete pottery made without molds. New, low cost, patented method. Cemetery products, novelties, tiles, floors, etc. Basement leaksealing. Other moneymaking projects. Booklet, details free. Men only. National Pottery Company, Fergus Falls, Minnesota.

BIG Money making Hollywood style pottery, bird baths, wishing-wells, benches, stucco-rock. New method. Clever designs. Color with chemicals, water-paints. Marbling, colored glaze effects. Dime brings samples, pictures, literature. Hollywood Cementcraft, 8527 Wonderland Ave., Hollywood 46, California.

HOW And where to obtain capital. Fully explained. Particulars free. Star Service, Wapakoneta, Ohio.

LIQUID Marble; snow-white, multi-colored. Glazed. Unglazed. Composition flooring. Lifetime wear. Any color. No priorities. Flexible molds. Plaster casting. Get into the big money now. Full information given free. Write Compo-Tex, Box 786-R, St. Louis, Mo.

BRUSH Plating outfits connect to a battery. No tanks necessary. Good paying business at home plating autoparts, bathroom fixtures, bicycles, reflectors, silvering mirrors. No shop or experience required. Outfits furnished. Free booklet. Gunmetal Co., Ave. H, Decatur, Ill.

AGENTS—To mail our literature. Good profits. Home business. Maywood, 1133 Broadway, New York.

RAISING Canaries pays good profits. Valuable bird book—"Its Care, Breeding and Training." Price \$1.00. American Canary, 2839 N. Halsted, Chicago.

EXPERT Shoe fitting learned quickly, inexpensively. Pleasant, profitable work. Details free. Mountain, Pisgah, Alabama.

MONEYMAKING OPPORTUNITIES

EARN Money at home! Thousands do! "Home Worker Magazine" tells how. Sample, 25c. Sizemore, Box 7, 4917 North Kostner, Chicago.

PROFITABLE Spare or full time opportunities to operate your own modern business. Amazing details free. Morey, 7 Somerset, Springfield 8, Massachusetts.

MECHANICALLY Inclined men — Own and operate general appliance repair shop. Complete, illustrated course shows you how. Welding, refrigeration, motor repair, how to get business, etc., all phases covered. Free literature. Christy Supply, Dept. 1162, 2835 N. Central Ave., Chicago.

MAKE Money at home. Paint and decorate wall plaques, brackets and book ends at home, no skill required, sell to stores, friends, bazaars, etc. Big demand, good profits. We furnish you with the plaques at very small cost. Write today. Marble Art Company, Ames Station, Box 53-P, Omaha, Nebraska.

FORTIFY The future! Start own business; home, office. Booklet describing "Collection of 137 Tested Plans" free. Elite Co., 220-A Grand St., New York 13.

PROFITABLE Home business — manufacture fast-selling candies. Professional instructions. Big earnings! Spare, full time. No experience! Literature free. Coates Service, 46-M King, Dorchester, Mass.

300 OR More mail business starting offers monthly for whole year. 25c. Thomason, 857 E. Jessamine, Fort Worth 3, Tex.

GET Small capital mail order business ideas, plans, supply sources in each big issue of Mail Buyers Directory-Magazine. Copy 25c. Lakeside Publishers, P.O. Box 3755, Detroit 15, Mich.

AMATEUR Or advanced cartoonists and artists, cash in on your ability. Write Hamilton, Box 4KA, Woolsey Sta., Astoria, N. Y.

MAIL Order business pays big dividends. Postal brings free details. Personal Service, Box 2252-NS, Bridgeport 8, Conn.

THOUSANDS Articles wholesale. "Supply Source Directory" 10c. Ideal Service, D-3, Park Ridge, Ill.

EXCITING, Splendid money-making opportunities in brand-new, authentic, copyrighted booklet, "Postwar Ways to Boost Your Income"—25c brings copy! Rayco, Box 124, Newport News 1, Virginia.

SALES; Organization of your own, sell hardware and gift shops wholesale. Write: Raymond Rose Sales Associates, 5260 W. Pico Blvd., Los Angeles 35, Calif.

100 AND More ideas make money home. Big profits. Large folder free. 20th Century Service Co., 505 Fifth Avenue, New York.

FREE Literature — hundreds profitable business ideas for small capital. Write Box 3504-R, Orlando, Florida.

MAKE Big money buying goods for others, as well as yourself at wholesale. We show you how. Gerald Bond, Mounds 1, Okla.

START Profitable credit-collection agency business; home, office, sparetime, full-time vocation; investigate Educational Extension Service advertisement under Business Opportunities.

MAILS galore, literature, samples, listing, 10c; three times, 25c. Boucher, Box 1391, Yakima, Washington.

SELL By mail to negroes. Big, over-prosperous mail order market! 3c stamp brings eye-opening information! Elmer Swanson, Box 201, Niagara, No. Dak.

BE A novelty manufacturer, fascinating, interesting work. Exceptional profits. No expensive equipment needed, quickly learned, use garage or basement, inexpensive materials. Successful manufacturer shows how, orders waiting. Literature free. State age. Plastex Products, 127 Clement, San Francisco 18, Calif.

WANT Financial independence? I've helped thousands. Dr. Tibolt, 64M, Philadelphia 20.

EARN Money evenings, copying and duplicating comic cartoons for advertisers. Adservice, Argyle 1, Wisconsin.

"LITTLE Money-maker." New magazine chock full of practical small business ideas. Sample 25c. Small Business Magazine, 3825-A Tenth St., Northwest, Washington 11, D. C.

500,000 ARTICLES—Wholesale directory, dime. National, 322P Union Avenue, Brooklyn 11.

GET Job you want. Shows where, how. Information free. Kinasewitz, 126 Lexington Ave., New York.

\$1 MATERIAL Brings \$20.00. Unlimited possibilities with concentrate cosmetics. Sample—10c. Details free. Money back. Kohen, 506 W. 45th, Chicago 9.

MAIL Business booming! Money-making magazine, 10c. Hawkins (Lasanimas), Colorado Springs, Colo.

WHAT Makes you think you couldn't sell by mail? We're doing it happily! New! Different! Exclusive! Alive with money-making opportunity. Full particulars free. Investigate! Compare! The What-To-Do Shop, Box 1082, Tacoma, Wash.

MONEY MAKING Tips, offers and sources for homemakers, mailorder minded in "Mail Merchandise Mart Magazine." Dime brings copy. AP-Chervence, Lock Box 791, Chicago 90.

PAINT Plaques. Seven and one half cents up. Circular. Northern Statuary, 416 No. Prior, St. Paul 4, Minn.

WHOLESALE Catalog, other valuable information 10c. Latshaw, Sunnyside, Indianapolis, Ind.

START Your own business! Big money manufacturing novelties, plaques, statuary. Catalog free. Write Bing Products, 88-AF Broad Street, Boston 10, Mass.

1,500,000 ARTICLES Wholesale! Free directory! Micell, 412-B Massachusetts, Buffalo 13, New York.

BE Your own boss. Start at home. Amazing profits. Descriptive booklet 25c refundable. Ace Sales, 920A3 Quilom Ave., Chicago 13, Ill.

SWAP; Trade. Information. Write "Swappers' Gazette," 2836-PM Slevin, Louisville 12, Ky.

\$18,000 YEARLY Gross profit reported! Business most anyone can start! Small capital! Details free. Upham and Son, 939-A Ravine Drive, Cleveland 12, Ohio.

HOW To make money with hobbies. Send today for details of this interesting book. Stoll Specialty Service, 3103 East Ninth, Joplin, Missouri.

OPERATE Profitable home mail-order business. Details free. Billings, 210 Fifth Avenue, New York.

RECEIVE Big mails, catalogs, magazines, samples, moneymaking offers. Your name listed in Illustrated Agents-Opportunity Seekers Directory, 25c, with free directory. Promptness, satisfaction guaranteed. National, R5, Saginaw, Michigan.

\$200 MONTHLY With camera! Guide, 50c. Foto-Diary, comprehensive record for photographs, 50c. Frank Dickson, 808 Elizabeth Street, Anderson, South Carolina.

OPERATE The mailorder way. It's new. Repeats. A real money maker. Write for special bargain offer. R. E. Raines, 13516 Ashburton Rd., D. 24, Cleveland 10, Ohio.

BOOKENDS, Plaques 2½c up. Burgermaier, 15 Carl St., Dayton 3, Ohio.

INSURE Your future against poverty—failure, become successful, independent, no money needed. Remarkable results. Free information. Gilbert Service, Box 1464, Mobile 8, Alabama.

MAKE Real money selling spectacular bubble liquid. \$1.00 brings formula. Northwest Specialty "A," 7926 46th Ave. So., Seattle 8, Wash.

HARMONICAS \$10.80 dz. \$21 dz. Ocarinas \$7.20 dz. Jews harps \$2.40 dz. Harmonicas Wholesalers, 11 E. Centre Street, Baltimore 2, Md.

\$1 BRINGS You hundreds of dollars worth of information. Revealing book just out describes the how of many moneymaking opportunities. For your copy rush one dollar to Andrew J. Massey, 64 Sterling St., Franklin, New Jersey.

RECEIVE Mails, magazines, moneymaking offers galore. Warren, Freeland 10, Mich.

BIG Mails. Latest offers one year 25c. Franklin, Box 342, Rock Hill, S. C.

MAKE Up to \$10,000 and more a year. Enter a new profitable professional business in 60 days. Small investment. Suite 844, Dept. N, 127 North Dearborn St., Chicago 2, Ill.

NEED Extra cash? Two valuable books. Money from hobbies and selling by mail including free gift certificate, all for \$1.00. Ives Merchandise System, Office 622, 1328 Chestnut St., Philadelphia 7, Penna.

WIN Contest money. General contest bulletin shows how. Sample 25c. 1609½ East 5th, Duluth 5, Minn.

\$—RAISE Giant Chinchilla rabbits. Willow Farm, R 15B, Sellersville, Penna.

10c INCLUDES Your name in numerous mailing lists for opportunities, moneymaking offers, magazines. New Age Enterprises, 578-A Prospect, New York City 55.

BOOKKEEPERS — Interested in more money spare time. Postwar opportunity. Journey, 1003 Fourth, Orange, Texas.

READ "How to Go into Business for Yourself." 64 pages of eye-opening information. Rush one dime. George A. Simon, 6343 Jonathon, Dearborn, Mich.

"HOW To Make Money with Big Mails" booklet 25c. Frank J. Artz, 1060p Harding Drive, Toledo 9, Ohio.

MONEY Made office, home or room. 10c brings envelope opportunities. Bargain Specialty Company, Box 635C, Modesto, California.

LEARN Battery repairing, rebuilding. Engineer offers money making methods. Battery Bureau, 2225 North 44th St., Milwaukee, Wis.

EARNINGS \$2,000 Year easy; inventing simple items for special cash markets. Ideas only. No patents. Write, Hendrickson, Argyle 7, Wisconsin.

BIG Profits. Manufacture custom arch supports. Jul Corssen, 2638 Geyer, St. Louis 4, Missouri.

YOUR Big mail order opportunity—No time has ever been as good as right now. Get your start right. Let me show you how, what to sell and who will buy. Big profits, easy work at home. Write: H. S. Smith, 3139A So. Mabbett Avenue, Milwaukee 7, Wisconsin.

PUBLISH Your own magazine. Hand-some 52 page format, well edited, illustrated. Cost low as \$1.00 month. Brings you prestige, profits. 25c brings sample. Details, National, Ord. Nebr.

I MAKE Big money in the mail-order business. You can do the same at home with my copyrighted system. Write me. I'll tell you how. F. Little, Box 8, Glenshaw P.O., Pittsburgh, Penna.

LEARN Metascience. Remarkable drugless healing. No manipulation. No apparatus. Unbelievable simplicity and results. Inexpensive correspondence course. Write Metascience, De Land, Florida.

FORMULAS, PLANS, ETC.

AMAZING Furnace melts all metals. Built cheaply. Detailed plans \$1.00. Aladdin Laboratory, 9955 C Street, Oakland 3, California.

MANUFACTURE Paints. No equipment, capital needed. Complete instructions, formulas, \$2.00. Industrial Chemist, 1826 60th, Kenosha, Wis.

MANUFACTURE Fast-selling Products yourself. Bubble blowing liquid \$1.00. Formula catalog free. Kemico, Park Ridge (16), Ill.

AUTHENTIC Formulary. 924 page illustrated book. 10,000 scientific formulas, recipes, secrets, instructions for most any product. Countless profitable business opportunities, including D.D.T. new insecticide. And our new book: "The More You Know the More You Can Earn." \$2.98 postpaid (c.o.d. U. S. only). Foreign \$3.25 delivered. Adams Brown Company, Dept. 365, Chestnut Hill 67, Mass.

ANY Formula or trade process supplied, \$1.00. Jackson, Newfoundland 3, Ky.

FORMULAS—Real scientific. Selected. Free literature. G. B. Hanson, 431-G Ryan Hotel, St. Paul 1, Minn.

"LUMINOUS Paint," resilvering mirrors, 100 other formulas—50c. D.D.T. insecticide \$1.00. Soap making, (20 formulas) \$1.00. Ideal Service, 303 Park Ridge, Ill.

FORMULAS 25c Each. What do you want to make? Nunn, 659 E. Oxnard, Calif.

MECHANIC'S Soap, roach exterminator; 108 other formulas, \$1.00! (Request formulas \$1.00!) Galluzzo, 923 Milton, Pittsburgh 18, Penna.

LOOK! The largest and most comprehensive book of its kind ever issued. Endorsed by universities. More than 10,000 clearly described formulas, receipts, moneymaking ideas and trade secrets. Thousands from coast to coast have found this book a starting point for their own business. Get the best. Only \$2.98 postpaid. Literature free. Jordans, 3116-A N.W. 27th, Oklahoma City 7, Oklahoma.

BOOK Of 110 money-saving formulas. Only 50c postpaid. William Hill, Box 413-B, Akron 9, Ohio.

MAKE And sell Magic Bubbles. Formula \$3.00. Oakland Lead Products, 2721 East 11th, Oakland, California.

"LUMINOUS Paint" formulas \$2.00. Heitman, 1319 Park Road, Washington, D. C.

EXCLUSIVE Formulas. List free. Ruch Research, 136 S. Crescent, Rome, N. Y.

10,000 AUTHENTIC, Scientific formulas, secrets. 924 page illustrated book. Earn immediately. Build profitable independence. Produce any conceivable product. Latest discoveries! Genuine bargain \$2.49 postpaid. (C.O.D. — U.S.A.) Literature free. Continental Publications, 79-02m Woodside, Elmhurst, New York.

FIFTY Formulae, recipes for one cent. Details free. Pauline, 924 Southern Blvd., New York City 59.

MANUFACTURE New products inexpensively. Free literature. Commercial Projects, St. John 2, N. B.

NEED Chemists? Formulas. Analyses. Ideas. Consulting Scientific Company, Swarthmore, Pennsylvania.

REAL Manufacturing formulas. Lists free. Cummings, Chemist, Gordon Ave., Syracuse, N. Y.

FORMULAS — Latest, best. Analysis. Literature free. Belfort, Engineering Building, Chicago.

PLASTICS

PLEXIGLAS And Lucite Kit Assortments, including cement, working drawings, instructions. 1 pound \$1.25; 6 pounds \$5.00; 25 pounds \$18.75. Masked sheets 12x12— $\frac{1}{8}$ " \$2.50; $\frac{3}{16}$ " \$2.75; $\frac{1}{4}$ " \$3.00. Plexiglas rods: $\frac{1}{8}$ "— $\frac{1}{4}$ " 8c— $\frac{1}{2}$ " 15c. Lucite rods: $\frac{1}{8}$ "— $\frac{1}{4}$ " 40c; $\frac{1}{2}$ " 65c; $\frac{3}{4}$ " \$1.25; $1\frac{1}{2}$ " \$2.25. Lucite tubes: $2\frac{1}{2}$ "— $1\frac{1}{2}$ " \$2.45; $2\frac{1}{2}$ " \$2.95; $3\frac{1}{4}$ " \$4.75. Six ounces Plastiset fast-drying cement, \$1.00. Eight ounces red, blue, yellow, gold, green dye, \$1.00 each. Please remit with order. Add 10% to cover postage. Satisfaction guaranteed. Carmen-Bronson, 165 East Third, Mount Vernon, N. Y. Dept. 2-B.

PLASTIC Stock and kits. Plexiglas sheets: New, per square foot, following thicknesses: $\frac{1}{16}$ " \$1.60; $\frac{1}{8}$ " \$2.00; $\frac{3}{16}$ " \$2.25; $\frac{1}{4}$ " \$2.75; $\frac{3}{8}$ " \$3.75; $\frac{1}{2}$ " \$4.75; $\frac{3}{4}$ " \$7.50; $1\frac{1}{2}$ " \$9.50. 5% discount on orders over 5 square feet and 10% over 10 square feet. Other plastic supplies. Plastic kits: \$2, \$5 and \$10 each. We pay shipping charges. Send money order to—Plastic Supply Co., 2618 St. Louis Ave., St. Louis 6, Mo.

PLEXIGLAS. New, clear, masked, $12\frac{1}{2}$ "x12"; $\frac{1}{16}$ " \$1.50, $\frac{1}{8}$ " \$2.25, $\frac{1}{4}$ " \$2.75. Dyes—red, blue, yellow, 4 oz. 60c; other colors. Cements. Postpaid. List free. G. Baker Company, 685 Center Ave., River Edge, New Jersey.

PLASTICS Galore! Lucite, Plexiglas, Catalin, sheets, rods, tubes, kits, dyes, cements, designs, cast resins, compounds. Catalogue 10c. Plastic Products Co., Box 384-M, Massillon, Ohio.

MAKE Mold new plastic at home! Instructions \$1.00. Tirekop (E3), Madeira, Ohio.

LUCITE—Complete supplies. Price list, instructions free. Lucite sample 35c. M. F. Lannon, Postoffice Box 686, North Hollywood, Calif.

PROFITS In plastics! Use factory like methods. Details for stamp. Craft Co-op, 3829 Dumaine, New Orleans, La.

MAKE Rubber molds. New easy way. Circulars. Shuman Tackle, 3 Green Terrace, Kent, Ohio.

CONSULTING Chemist: plastics, organic chemicals, adhesives. Reasonable fee. 239 Burr, Rochester 13, New York.

ONE Dollar brings rubber mold and model of beautiful $3\frac{1}{2}$ "x5" plaque of Capitol. If you have a good model let me make your mold. Write today. Robert Fitzpatrick, 15825 Wormer Ave., Detroit 23, Mich.

MOLD Model aeroplanes, propellers, golf tees, fishing lures, toys, costume jewelry, and novelties on a hand operated two ounce capacity injection molding machine you can build yourself. Only nine inch lathe and bench drill press required. Plans \$2.00. Post Office Box 503, Toledo 1, Ohio.

KITS, Picture frames, plaques, etc., includes glass, plexiglas, etc., \$1.00 up. Cutoffs, sheets, rods, tubes. Tools, drill rod, brazing materials, screws, bearings, etc. Catalogue 10c. Metiplas Supply Company, 1420 S. 16th, Maywood, Illinois.

CHEMISTRY

WINN'S New idea champion chemical-kits, apparatus-outfits and supplies for students home experimenting. (Established 1931.) Send 10c for catalog. John H. Winn, 124 W. 23rd St., Dept. 503, New York, N. Y.

50 "POISON" Gummed labels, 10c. Ultra, 264 Ninth, Paterson 4, N. J.

TESTUBES And laboratory glassware. Wm. Frioli, Route 20, Indianapolis 44, Ind.

APPARATUS, Chemicals, ounce quantities, catalog 5c. Fleischer's Laboratories, Everett 49, Mass.

SEMI-TECHNICAL Chemistry brochures. Literature free. Lankton, 310 Westmoreland, Lansing 15, Mich.

FREE Catalog, Chemistry, mineralogy, biology, optics. Tracey Laboratories, Evanston, Illinois.

HANDBOOK For chemical experimenters, illustrated, hundreds of experiments, 50c. Experiment booklet 15c. 1946 chemistry catalog 5c. Reading Scientific Company, Reading, Penna.

NEW 36 Page chemical apparatus order book. Complete line of chemical glassware, apparatus and chemicals. Send 10c for this book. Standard Science Supply Co., 1232 N. Paulina St., Chicago.

CHEMICALS And apparatus for industrial, analytical, and private laboratories. Complete supply service for correspondence school students. Send 3c for catalog. Dept. M-43, Biological Supply Co., 1176 Mt. Hope Ave., Rochester 7, New York.

LABORATORY Supplies at wholesale prices: Chemistry, biology, physics. Catalogue 10c. National Scientific Co., 2204 W. North Ave., Chicago. Established 1908.

HELP WANTED

WANTED: Modelmakers and product design men to work in research dept. of old established, progressive electrical appliance concern in Philadelphia. Good pay, steady employment, pleasant congenial working conditions, splendid opportunities for advancement, and bonus for new ideas accepted. Requirements: Ability to use small machine and hand tools, understand blueprints, experience in amateur or professional model or tool making. Write to Proctor Electric Co., 3rd St. and Hunting Park Ave. Philadelphia 40, Pa., stating full particulars including age, salary expected, experience, marital status, hobby, snapshot, etc.

DEALERS And installation men to sell and install gas conversion burners. Large profits. Peerless, 4322 Sheridan, Lincoln 6, Nebr.

OIL Fields offer good paying pleasant jobs from Boom Town to city office. Names, addresses, 100 companies. List of jobs and pay rates. Research Service Company, Box 174, Victoria, Texas.

OPPORTUNITY Of lifetime supplying DDT and other profitable products to farmers. No experience or capital required. Must have auto and good references. Permanent. Write or wire McNeess Company, Dept. 712, Freeport, Illinois.

AGENTS WANTED

\$1 STARTS You in business. Sell deluxe five fold ties. 100% wool interlining. Cost you only \$7 per dozen, you make \$5 dozen. Send \$1.00 for special introductory offer two five fold ties. Catalog complete line free. Phillip's Neckwear, 20 West 22nd St., Dept. K-24G, New York 10.

NEW Year 'round extra money plan. Show friends exclusive greeting card assortments. Up to 100% profit. Request all occasion \$1.00 assortment on approval. Also show birthdays, social notes, gift wrappings. Free sample personalized stationery. Thomas Terry Studios, 140 Union Ave., Westfield, Mass.

SELL Greeting cards. Easy money showing gorgeous all occasion, birthday, religious, humorous, Easter box assortments. Wrappings, stationery, correspondence notes. Special offers. Experience unnecessary. Quick service. Request \$1.00 everyday assortment on approval. Hedenkamp, 343 Broadway, Dept. PMM, New York 13, N. Y.

BIGGEST Money selling to colored. Keystone (the Old Reliable) Company's proved plan. Fast, easy, millions of customers. Write quick for details. Keystone, Dept. POP1, Memphis, Tenn.

TODAY'S Sensational seller. Distributors reaping harvest. Complete History World War II. Memorial edition, 1,100 pages; 200 photos. Elaborate outfit supplied. Every home, office prospect. Big cash profits daily. Universal House, 1006G Arch Street, Philadelphia, Penna.

FASCINATING Year 'round income building plan. Take easy orders from friends, fellow workers, church organizations for 10 fast selling greeting card assortments. Sell for \$1.00 each—cost you 50c up. Extra bonus. Experience unnecessary. Request foremost \$1.00 All Occasion box on approval, free Correspondence Notes samples. Special offer. Bluebird Studios, Dept. 16-E, Fitchburg, Mass.

SCHOOL Seniors! Your postal will bring our wonder, Kwick-Sell Cardalog of popular graduation name cards. Biggest profits! Only firm giving free souvenir chest and card case. Don't miss out! Hurry that postal! Craftcards, Box 235-L, Pittsburgh 30, Pennsylvania.

GOOD Income spare time selling pad pencil fun packet to hospitalized veterans. Details, samples, 10c. Puzzlemasters, Box 26, Weaverville, N. C.

SILVER Plating liquid. (NuSilver trade mark.) Apply with a cloth. Simply rub-on with a saturated cloth, dry-off and buff-up bright with a dry soft polishing cloth. All done in 1 minute. It cleans, silverplates and polishes from the one application. Easily done at home or in the office by anyone. NuSilver Plating Liquid is a more than 50% ($\frac{1}{2}$ plus) genuine U. S. government treasury department domestic silver solution, 1000 fine (pure silver), sterling. It renews all sterling and plated silverware. It also silverplates onto brass, copper, bronze, zinc, nickel-silver, german-silver, and some other composition metals. Over 100 uses listed to date. NuSilver is a permanent lasting finish. Won't wash off. Won't brush off. Won't boil off. Once applied as directed it is there to stay. NuSilver Plating Liquid is a widespread and intensive seller. Working sales distributors are wanted for areas not now being worked. Easily sold to merchants in dozen lots by a sales set-up which furnishes free printed guarantees, printed advertising leaflets and one store counter display card for each one dozen, any kind of a store or business place can sell NuSilver. Any kind of an average distributor-Salesman can sell NuSilver. You sell, deliver and collect your big cash profits as you work. Details by letter-mail. For U.S.A. territory only. Can sell both wholesale and retail, and to jobbers, or any way you like. NuProcess Products Laboratories, Dept. 210, Aurora, Ill.

AT Last! Something new and sensational in everyday greeting cards. Gorgeous "glass bead" designs never before offered. Get orders fast. Up to 100% profit. Other fast-selling box assortments. Samples sent on approval. Write today. Puro Company, Inc., 3041 Locust, Dept. 640-C, St. Louis 3, Mo.

WE Pay you \$25 for selling fifty \$1.00 assortments birthday, all occasion cards. Tremendous demand. Sell for \$1.00—your profit 50c. It costs nothing to try. Write for samples. Cheerful Card Co., 89, White Plains, N. Y.

SELL Ultra-blue store stock signs. 35c sellers. Cost 5c—\$1.00 brings 15 samples postpaid. Lowy, 8 West Broadway, New York, Dept. 271.

WHOLESALE, Cigarette lighters, flashlights, leather billfolds, tobacco pouches, etc. Write for illustrated price list. National Sales Co., 221 Page St., Dept. 113, Flint 5, Michigan.

AGENTS! Earn big money, selling personalized soap with names and designs that will not wash off. Sells on sight. Particulars free. The D. & P. Sales, P.O. Box 1471, Dept. P. Uniontown, Penna.

SALESMAN Calling on farmers, garages, protected territory, leads, commission. Eagle Welding, 5085 Broadway, Chicago 40, Ill.

25 WAYS To make money with luminous paint (shines in dark). Rush only 25c for profitable details and luminous color sample. Lite-Saver, 97C, Saybrook, Conn.

DISCHARGE Wall plaques and auto emblems appeal to millions. Sample \$1.00. Literature free. L. Brown, 344 E. 25th St., Baltimore 18, Md.

GOG-L-WIPERS Are new. Liberal profits. Postcard brings sample. Shaws', 160 Homer Ave., Palo Alto, California.

BEAUTIFUL Gold embossed honor scroll for veterans. Most beautiful service memento anywhere regardless of price. Sells on sight for \$1.00. Up to 85c profit for agents. Three saleable samples \$1.00 postpaid. Particulars free! Levine's, Box 15-X, Boulevard Station, New York 59, N. Y.

BIG Profits packaging, distributing, amazing cleaner. Steady repeater. Everything furnished. Sample 25c. Linnell Co., Box 1720, Cleveland 5 Ohio.

FREE—Mexican novelty curiosities. Fast seller. Big profits. "Cedimex," Orozco y Berra 1-301, Mexico, D. F.

300% AND 400% Profit. Sell the best in tinsel mottoes, calendars, etc. Lamey Motto Service, RR3, Versailles, Ohio.

FREE Wholesale catalog, hard to get merchandise. American Merchandising, PM-3 Vandiver Building, Montgomery, Alabama.

MAKE Money at home by mail. Sell books. Send 3c stamp for complete set-up. Business Plans Foundation, P.O. Box 56R, New York 10, N. Y.

137 COMPLETE Plans for starting own business: local—mail order. Particulars free. Elite Co., 220-A Grand St., New York 13.

NEW Offers—Write Thriftmaster, Box 61, Times Square Station, New York.

THERE'S Profit in taking magazine orders from neighbors and friends. Helps furnished, liberal commissions. Voluntary repeat sales, wholesale catalog free. Write today! McGregor Magazine Agency, Dept. PM6, Mount Morris, Ill.

EASY Money during leisure time. New item everyone wants on sight. Details, sample. International Industry, Culver City, Calif.

MAKE Tremendous profits selling specialties, preparations, etc. Renschler's, Carrollton, Kentucky.

PROFITABLE Sideline—Sell magic polishing cloths in stores or homes. A demonstration sells. Samples 25c. Details for exclusive territory free. Jay-Cee Products, Nashville, Tenn.

AGENTS—Big, easy-to-sell, profitable line. Soaps, cosmetics, remedies, food products. National advertising. Hurry! Write for special offer. Sayman Products Co., Dept. B-2, St. Louis, Mo.

FREE List multi-colored tinsel, biblical wall mottoes. Trial order, 10 for \$1.00. Empire Sales, 340 S. Main, Memphis, Tenn.

COLORFUL New sign sells on sight to cafes, bars. \$1.00 brings samples. Satisfaction guaranteed. Kolortone, 328 Oak St., Detroit Lakes, Minn.

UP To 100% profit selling friends sensational \$1.00 all occasion greeting card assortment. Costs you 50c up. Birthday, baby, gift wrapping, humorous, scripture boxes 35c up. Extra bonus. Request \$1.00 box on approval, free personal stationery portfolio. Special offer. Elmira Greeting Card Co., M-73, Elmira, N. Y.

AGENTS Sell infrared therapeutic lamps to housewives. Good profit, small investment. Electric Sales, 5525 Jackson, Chicago 44, Ill.

AGENTS. Reverting manufacturer has territories available. Highest quality products for distribution to retailers and household salesmen. Substantial, repeat, profits. Halberstadt Company, Terre Haute, Indiana.

DOUBLE-DUTY Shopping bag. Zips open. Instantly changes from small to large size. Lightning seller. Samples sent on trial. Kristee 123, Akron, Ohio.

NEW Honorable discharge frame. Golden inscription, for Army-Navy-AAF-Marines-Coast Guard. Handsome mahogany wood finish. Selling sensation. Millions of prospects. Details free. Sample any branch of service \$2.00 postpaid. National, Dept. 1-A, 4109 N. Kedzie Avenue, Chicago 18, Illinois.

MOVIE-STAR Statuettes, big profits, latest fad. Agents wanted. Free details. Danel's, Box 1700, Los Angeles 36.

AGENTS, Beautiful cigarette lighters. Sensational sellers. Low prices. Big profits. Economical Distributors, Box 1402, Albany, N. Y.

"SOLVEX" Cleans dirty hands without water. Sample free. Solvex, Monticello, Iowa.

EVERYDAY Cards. Make \$5.00 with every ten \$1.00 assortments you sell. Also fancy note paper and everyday wrappings. Unusual demand. Send for samples today. Howard P. Ellis, Dept. PM-3, Pitman, N. J.

POWERFUL Mile stretcher! Increases bank mileage! Increases power! Increases bank accounts! Tremendous profits. Thermox-wks, Peoria 4, Ill.

SELL Individualized belts, buckles. Over thousand emblems to choose. Fast money maker. Repeat business. Write today special outfit offer. Hook-Fast Specialties, Box 1425, Providence, Rhode Island.

SELL The cosmetic line backed by advertising right in your own territory. Fast-selling cosmetics, toiletries, shampoos, etc. Write for free particulars. Huthnance Products Co., 201 E. Holbrook Ave., Flint, Michigan.

NEW 1946 Greeting card box assortments. Easter, Mother's, Father's Day cards. Stationery, gift wrappings, novelties. 4154g Fifth Street, Philadelphia 40.

JOKERS Novelties. Wholesale. Hundred pieces dollar. Pauly, 2295 Concourse, New York City 53.

SENSATIONAL Seller. 400% profit. Housewives buy eagerly. Sample 25c. 1000. \$40.00. Book Emporium, 325 West Genesee, Buffalo 2, New York.

AGENTS, Jobbers distributors, make big money selling manufacturers products to stores. Write for details. Evans, 6362 Hollywood Boulevard, Hollywood, California.

MAKE Quick clean-up selling perfume beads. Particulars free. Mission, 2328 W. Pico, Los Angeles 6, Calif.

AGENTS Sparetime, sideline. Take orders for show cards, nameplates, house numbers. Big profits. Samples. Ace, Box 223, Bedford, Ohio.

REVOLUTIONARY Ever wearing sharpening strop. All purpose. Profits repeat. Ever-Edge Products, Dept. P, 36 W. Randolph, Chicago 1, Ill.

NOT For sale—Central Illinois! \$1100.00—30 days! Thousands yearly. Tiny business just 2 years ago! Simple—either sex. Part-time. Home. Ferguson, Decatur, Ill.

ELECTRIC Ironing cords with indicator light. Iron-So-Ezee Company, Mt. Washington, Ohio.

REPRESENT Us in your city in the sale of Angeline Cosmetics. Write for complete information so you too can enjoy the large earnings possible. Angeline Laboratories, 733 North 35th Street, Milwaukee 8, Wisconsin. Dept. 4.

JUST Out! History of World War II. Huge volume. Popular price. Authentic text. Official photographs. Big profits. Riverside Book Company, Iowa Falls, Iowa.

200 MONEY Making plans. Formulas. Schemes. Free folio. Formico Service, Box 572, Dayton, Ohio.

90c PROFIT Each \$1 sale. Sell permanent mothproofing solution to housewives, stores, agents. Experience unnecessary. Postal brings details. Kinford, Wayne 3, Penna.

SCHOOL Seniors: Sell classmates superb Craftcards for super profits. Write Craftcards, Box 235-AK, Pittsburgh, Penna.

SELL New-Used clothing from home, auto, store. Mens suits \$1.17. Leather Jackets 85c. Overcoats 62c. Dresses 17c. Ladies coats 38c. Other bargains. Catalog free. S & N, 565A Roosevelt, Chicago.

MEXICAN Feather pictures. Unusual novelty. 50c (stamps) bring \$2.00 worth samples, details. Refunded if unsatisfied. Aztec Art, Apartado 762, Mexico City.

AGENTS! Register your name, address with us and receive latest mail order propositions. Free listing. Mail-Way Agency, 10P-620 William Ave., Winnipeg, Manitoba, Canada.

\$7.50 START Engraving jewelry, leather, glass, cuts wood, plastic, etc. A.C. current. Bonomo, 25 Park St., Brooklyn, N. Y.

MAGIC Cleaner and laundry soap deal. Hotter than a firecracker. Big profits. Sample free. Bestco, 5007 Irving Park, Chicago.

\$3 FIRE Extinguisher; quick sales, wholesale or direct; liberal profits. "Fire-Killer," 109 N. Franklin, Syracuse 1, N. Y.

NOW You enjoy double profits selling Rukleen and Moothex Concentrates to homes, hotels, rooming houses, etc. Send for new complete offer. Tremendous profits. Year round repeat business. Products used daily in every home. The Russell-Johnson Service, Clarksfield, Minnesota.

SIMPLE, Dramatic demonstrations insure easy sales. Sensational \$3.00 fire extinguisher. Liberal discounts. Other products. Molonite Company, 5713 Euclid, Cleveland 3, Ohio.

SCHOOL Seniors—Sell classmates America's most beautiful, distinctive graduation name cards. Positively highest commission. Largest selection. Lowest prices. Free cards and sample kit. Printcraft, 1423 East Elm Street, Scranton 5, Penna.

GOLD Lacquered window sign letters. New foils, styles, absolutely beautiful. Free samples. Atlas, 7941 Halsted, Chicago.

WAR Honor scroll: All branches of service represented. 12 by 16. Space provided for name and photograph. Truly beautiful. Agents make big money. Sample 25c. E. Condon, Dept. 6, Upper Darby, Penna.

SELL "Petite picture notes." Something really different in greeting cards. Sample free. Dunbar Cards, New Brunswick 20, N. J.

AGENTS: Stamping names on pocket-key protectors. Sample check with your name, address, 25c. Stamping outfits. Emblem checks, check-fobs, name plates. Hart Mfg. Co., 303 Degraw St., Brooklyn, N. Y.

AGENTS—Big line including food products. Fast selling premium and bargain deals. Low prices. Send card for big outfit offer with gift. Ho-Ro-Co, 2768 Dodier, St. Louis 7, Mo.

WHOLESALE Sources. 500,000 articles. Free directory. Maywoode, 1133 Broadway, New York.

PLATING Outfits for autopaarts, reflectors. Connect to a battery. No tanks necessary. Free booklet and particulars. Gunmetal Co., Ave. N, Decatur, Ill.

BIG Profits taking subscriptions for all magazines. Agents' confidential catalog listing over 2500 periodicals and complete starting supplies free. Pines Subscription Agency, Flushing, New York.

EXCELLENT Sideline for printing salesmen. Decalcomania name plates in small quantities. Also, make money applying initials on automobiles. Free samples. "Ralco," X-164, Boston (18), Mass.

FREE Water and our concentrates, makes flavors, lotions, shampoos. 72 products, labels, bottles furnished. Qualco, E-20030 Russell, Detroit.

AGENCIES WANTED

APPOINT "William Finau Store," Nukualofa, Friendly Island, your business agent. Our annual sale: \$15,000. Bankers, Bank of New Zealand, Auckland.

HIGH GRADE SALESMEN

EXTRA Profit opportunities selling Highlander counter-carded novelties and necessities to dealers. Be a wholesaler, using tested success plans. Write for territory. Highlander, Dept. 4C, 4613 North Clark, Chicago, Ill.

SALESMEN—Would you like to make up to \$75 cash commission weekly? Address Schutt Co., 244 East Ohio Street, Indianapolis 4, Indiana.

BEAUTIFUL, Red, white and blue, stars and stripes, welcome home pennant, size 15" x 35". Send 25c for 2 pennants and wholesale prices. Welcome Home Pennant Co., 30 W. Harrison, Chicago.

LOOK Here! Wanted—Men and women to start in business on our capital. Sell some 200 farm-home products. Thousands our dealers now make quick sales, big profits. For particulars write Rawleigh Co., Dept. C-192-PPM, Freeport, Ill.

AMAZING New zipper shoe sells on sight. Big profits for salesmen. Leads line 200 splendid styles. Territories open. Get free sample outfit. Write Consolidated Shoe, Dept. S-151, Chippewa Falls, Wis.

MAKE Up to \$25 a day selling desk calendars. Ideal side line. Details free. Steel Advertising Service, P.O. Box 596, Richmond 5, Virginia.

JUMBO Hershey deal on 2 1/2c board. Leave us face it. Candy is scarce. Hersheys are scarcity—if salesboards are allowed in your territory or adjoining territory. Write Jay Wico Products, Logansport, Ind.

MAKE Money as I do. Geo. S. Parker, New Brunswick, N. J.

FREE! Latest issue Opportunity Magazine. Salesman's Guide. Inspiring, constructive. Shows how to earn money selling for others or in your own business. Hundreds postwar opportunities. Send name and describe what you have sold or are selling. Illustrated copy sent free. Opportunity Magazine, 620 N. Michigan, Dept. 17, Chicago 11, Ill.

EDUCATIONAL AND INSTRUCTION

SHORTHAND In 6 weeks at home. Famous Speedwriting system, no signs or symbols. Easy to learn; easy to write and transcribe. Fast preparation for a job. Surprisingly low cost. 100,000 taught by mail. Used in leading offices and Civil Service. Write for free booklet. Speedwriting, Dept. 1503-6, 55 W. 42 St., N. Y.

"HOW To Break and Train Horses"—A book every farmer and horseman should have. It is free; no obligation. Simply address Beery School of Horsemanship, Dept. 1103, Pleasant Hill, Ohio.

WE Guarantee you can learn touch type-writing at home in ten hours by the "Analytical-Psycho Method"; also: shorthand and bookkeeping, ninety hours each. Osborne College of Short Methods, Los Angeles 13, California.

LEARN To be a landscape architect. Hundreds now manage own businesses as successful landscapers. Steady income. Home study course—45 beautifully illus. lessons. Course can be completed in 8-12 months. 29th yr. Send for free bklet. American Landscape School, 6339 Grand Ave., Des Moines, Iowa.

REMEMBER Without effort. Easy 5 lesson memory course \$1.00. Money-back guarantee. Particulars free. Mighty Midget Publications, Box 352, South Omaha, Nebraska.

WELDING—Electric arc. Learn profitable trade quickly through actual practice. Individual welder instructions at bare cost of materials. Full particulars free. Valuable welding lessons book 50c. Hobart Welding School, Box M-362, Troy, Ohio.

NEW, Used, practical books, courses, catalogs, dime-refunded, Westway Educational Service, Box 58C, Los Angeles 35, Calif.

RENTAL Library offers real value in mail order reading courses. Pays book dividends. Write for details and lists. Black Hawk, Box 249P, Rock Island, Ill.

BE An investigator—Send for price list of self-instructional courses at reduced prices. Perkins Publications, 300-I Brandeis Theatre Bldg., Omaha, Nebr.

WRITE Short stories at home for pleasure and profit. Fame, riches and happiness of achievement are rewards to be realized by students who acquire tested technique. Get free booklet from home study school with 50 years experience. Write today! Blackstone-Sprague, Dept. 13, 307 North Michigan, Chicago 1.

MAKE Up to \$25-\$35 week as a trained practical nurse! Learn quickly at home. Booklet free. Chicago School of Nursing, Dept. M-3, Chicago.

BECOME A Doctor of Psychology and Metaphysics. Teach secret of contentment, happiness. Win degree of Ps.D or Ms.D. Solve mental worries. Free book. College of Universal Truth, 5153-B North Clark, Chicago.

LEARN Fascinating credit-collection agency business; fulltime-lifetime vocation; investigate Educational Extension Service advertisement under Business Opportunities.

NERVOUS? Bashful? "Fears?" Free, encouraging information. Jno. Englund, Ironwood, Michigan.

FREE Facts about new games that will raise your child's arithmetic grade. Riddle Game Co., Box 1741, Louisville, Kentucky.

"STEADY Jobs with Uncle Sam as mail clerks or carriers." Help assure yourself the security a civil service job offers by preparing now for examinations to be held over the entire United States. "Postalex," a new practical course, approved and sponsored by a V.F.W. organization can be studied anywhere. One of the most outstanding courses ever prepared can be yours for only \$10.00, complete cost. Send check or money orders to the "Secretary" Corporal L. B. Hollywood Post No. 939, Dept. M, Alameda, California.

"UNCLE Sam" jobs! Commence \$125-\$220 month, men-women. Prepare now at home, for 1946 examinations. Full particulars and list positions, free. Write today. Franklin Institute, Dept. N55, Rochester 4, N. Y.

LEARN To type! Use the touch system. Free details. Emile Jeunesse, 5706 Dauphine St., New Orleans 17, La.

NEW Personalities for old by correspondence. Results guaranteed. Personal development plan free. Write today. Personal Psychology, Incorporated, 1008 Washington Bldg., Louisville 2, Ky.

LEARN Shoe repairing. Practical. Investigate. Modern Shoe Rebuilding School, 2935 Belmont, Chicago.

LEARN Bookkeeping, accounting. Free details. Basic home study accounting course. Western Home Study Institute, Box 2506, San Francisco 26, Calif.

SEEKING New job or promotion in present one? Learn new accepted way of presenting applications and naming salary. Send for complete course today. \$1.00 prepaid. Apton Company, Dept. A, Box 716, Augusta, Ga.

WHO Can become a good pianist? 10c. Wm. Otto, 4215 Park Ave., Union City, N. J.

HOME Bible course. Simple, helpful, instructive. Total cost \$3.00 includes textbooks, examinations, certificate. \$1.00 starts you, or simply request prospectus. The Bible Study School, 382 Van Houten Street, Paterson 1, N. J.

"KNOW How" books. Courses. Fiction. Free catalogue. Baker, 5509-B Winthrop, Chicago.

REAL Estate. Study through experienced brokers. Free bulletin. DeVoto Realty Schools, 35 Vicente, San Francisco 16, Calif.

USED Educational and technical books on all subjects bought, sold, rented. Catalog free. Educational Exchange, Henagar, Ala.

THOROUGH Testing will help you select the work you can do best. Test Bureau, [Rutherford Preparatory School, Box 347, Long Beach, Calif.

GOOD "Used" self-instruction educational books on all subjects bought, sold, rented, exchanged. Satisfaction guaranteed. Complete information and 100-page illustrated bargain catalog free! Write—Nelson Company, Chicago 5.

FINGERPRINT Course, illustrated, \$1.00. Frank Mashak, 4127 Westminster, St. Louis 8, Missouri.

GET Government job: Good salaries, permanent. Service men given preference. Low priced home study practice lessons help you make good grade. Write, Ozment's School, 75, St. Louis, Mo.

AMAZE With Super Memory! Facts, figures, names stick like burrs! Write A13, Thor Books, Box 1210, Chicago.

29 LANGUAGES By Linguaphone. Russian, Spanish, Portuguese—Direct conversational method for mastering any language quickly, easily, correctly at home. Send for free book. Linguaphone Institute, 83 RCA Bldg., New York.

LEARN Photo-engraving at home or in oldest, largest school in America. Work for newspaper or establish own profitable business. New Tasope' Photo-Engraving equipment available soon. Write for information. Veterans ask about G.I. training. The Aurora School of Photo-Engraving, Tasope' Bldg., Aurora, Mo.

INVESTIGATOR Training. Phillips Secret Service, 1917B North Kenneth, Chicago 39, Illinois.

LOCKSMITH Course. Lock picking, key fitting, etc. \$1.00 prepaid. Locksmith, Canadian, Texas.

MEDICAL Laboratory technicians in great demand. We train you in your spare time, in your own home. You can practice while studying. Write for free catalogue. Imperial Technical Institute, Box 973-E, Austin, Texas.

SECRET Investigation. Experience unnecessary. Investigators particulars free. George Wagner, M 125 West 86th, New York.

USED Educational books on all subjects sold, rented, also bought and exchanged. Moneyback guarantee. Write today for free catalog and details. Lee Mountain, Pisgah, Alabama.

PLAYS, STORIES, MANUSCRIPTS

I WANT New writers to cash hundreds of checks for \$1 to \$100, offered each month. The easiest way to write for pay. No previous experience necessary. Send for free details. No obligation. Saunders M. Cummings, Box 609-M, Colorado Springs, Colo.

COMPLETE Assistance for writers. Inquire National Writers Club, 1837 Champa, Denver 2, Colorado.

WIN Fame, success, security writing short stories, newspaper features. Easy-to-learn course shows you how. Exclusive details yours for a penny postal. Writer's Institute, 4-M South 15th Street, Philadelphia 2, Penna.

IMMEDIATE Income for writers, beginners or advanced. Learn how to write and sell short personalized stories. Profitable waiting market. Send stamp for literature and proof. P. Snyder, Box 4907-W, Philadelphia 19, Penna.

NEW Writers needed to rewrite ideas in newspapers, magazines and books. Splendid opportunity to "break into" fascinating writing field. May bring you up to \$5.00 per hour spare time. Experience unnecessary. Write today for free details. No obligation. Postcard will do. Comfort Press, Inc., 210-P South Seventh St., St. Louis 2, Missouri.

CARTOONING, COMMERCIAL ART, SHOWCARD WRITING, SIGN PAINTING

CARTOONIST'S Magazine. Lessons, plans, markets. 25c coin. Hartman, 2438 W. Lincoln 3, Nebr.

ARTISTS, Students, sign painters. Newest books, courses, supplies. Bargain lists free. Art Book Shop, Kimmswick-2, Mo.

CARTOONING pays big! Develop your talents! Complete modern practical course \$1.00. Information free. Chesley Studio, 1450 Broadway, Buffalo 12, N. Y.

"HOW To Make Money With Simple Cartoons"—A book everyone who likes to draw should have. It is free; no obligation. Simply address Cartoonists' Exchange, Dept. 93-C, Pleasant Hill, Ohio.

WE Print student's cartoons. Free literature. School of Cartoons, P.O. Box 3291, San Francisco 19, Calif.

NOW Make signs in six months, daily practice, simplified fundamentals, \$1.00. Jentzen, 252 West New York, New Jersey.

ANIMATED Cartooning. A new book just out. Write for free information. Cartoonimator Co., 5029 Illinois Ave., N.W., Washington 11, D. C.

CHALK Talks. Laugh producing program, \$1.00. Catalog 10c. Balda The Cartoonist, Oshkosh, Wisconsin.

MAKE Signs, letters, stencils. 9 complete alphabet pattern sets. 3 complete numeral pattern sets and catalog \$1.00. Sign Letter Distributors, P.O. Box 101, Mineola, N. Y.

CARTOON Course—22 easy lessons. 200 figure sketches. 25c coin postpaid. Snack-Pack Co., 32 E. Georgia, Indianapolis 4.

ADVERTISING AGENCIES, LETTER WRITERS, FOR ADVERTISERS

WRITER Wants work! Effective sales letters, folders, catalogs, booklets, courses, speeches, etc., written or revised, \$2 per typewritten page. Twenty years experience. Dudley Bunn, 126 Lexington Avenue, New York 16.

ADVERTISING That sells! You want that kind? Dynamic sales letters, ads, prospectus, etc. Written by mail sales specialist. 29 years experience. You'll get the business! Printing—from cards to catalogs. Any mailing list you want. Advice, suggestions free. Faultless Advertisers, 3439-P Michigan, Chicago 16.

ADVERTISE Profitably: \$20.00 reaches 5,000,000 Sunday newspaper readers with 24-word ad. Newspaper, magazine, mailing-list ratebook free. Chicago Advertising Agency, 20-PA W. Jackson, Chicago 4.

ADVERTISING Placed in any publication, anywhere. Write for mail-order rate sheet "M." LeGrand Advertising Agency, (Established 1923), Floral Park, N. Y.

SALES Letters—We'll write you a dynamic sales-producing sales letter for only \$5. Just tell us your proposition. Business Consultants, 28 East First, Hutchinson, Kansas.

ADVERTISE: 24 Words, 40 newspapers \$3.50. List free. Advertising Bureau, 4515-C Cottage Grove, Chicago 15.

ADVERTISERS Service—For men going in business. Put our experience in merchandising and advertising back of your products. Write Van De Mark, Times Star Bldg., Cincinnati 2.

24 WORDS In 64 weeklies \$4.96. H. J. Darnell, 730 Hays, Jackson, Tenn.

INCH Display adv. 50 magazines yr. \$24. Wood's Popular Services, Atlantic City, (N. J.)

ADS Placed in out of town newspapers and magazines. Low rates. Catalogue free. Ideas that pay. Baker Advertising Agency, Successors Ankrum Agency, 189 W. Madison, Chicago 2.

FREE—New Advertisers Rate Guide. 44 pages. Includes everything. Lowest rates. E. H. Brown Advertising Agency, Merchandise Mart, Chicago.

STRIP-O-GRAMS (Hidden messages) will increase mail sales. "The cleverest gadget in 20 years." Samples gladly. Reese, 915N 30th South, Seattle.

FREE—"Amazing New Book"—"Profits From Classified Advertising." Tells how and what to advertise. Be sure to read this book before you invest one cent in advertising. Remember—it's free! Write for your copy now. F. W. Johnson, Classified Advertising Manager, 200 East Ontario Street, Chicago 11, Illinois.

BUSINESS SERVICE

TO Whom it may concern: We will represent you in the principal cities of California; Florida; Illinois; Indiana; Louisiana; Maine; Massachusetts; Michigan; Missouri; New York; Ohio; Oregon; Pennsylvania; Texas; Washington; also Alaska, Canada and Mexico. Personal or business assignments \$1 per hour. James W. Farley, Citizens Bldg., Cleveland 14, Ohio. Note: Would appreciate hearing from someone who wishes to enter this business in your city.

NEW Orleans 18, La. Address mail forwarded correspondent reporter. J. Shroder, 2119 Lowerline Street.

SAN FRANCISCO—Business or personal service \$1 per hour. Bank references. Frank, Box 308, Burlingame, Calif.

CHICAGO Mail—Telephone service competently handled. Make your business information available in Chicago. Executives & Representatives Service, Chicago 2, Illinois.

HOLLYWOOD Or Los Angeles address for business or personal prestige, \$1.50 month. Hollywood Personal Services, Suite 218, 1154 No. Western Ave., Hollywood 28, Calif.

BOOKS, Speeches, etc. ghost-written. 10 years' professional experience. K. Benton, 310 E. 74th, Los Angeles, California.

BUSINESS Representation. Mail forwarded, \$15.00 yearly. United Business Service, 137 Cordova, San Francisco, Calif.

SPECIAL SERVICES

We furnish names and addresses of persons who have items you need and need what you have. Charge 25c. Williams Swap Service, 1431-58th Street, Brooklyn 19, N. Y.

HAVE Fun! Pretend visiting California, 3 postcard views 20c. Address, return, I remail. Letters mailed 15c. Free information. Ira Smith, 153 Liberty, San Francisco 10, California.

INTERSTATE Personal Services your New York City representative, save business trip, shopping, collecting, mailing address, nominal charge. Box 98, New Hyde Park, New York.

WANT Something from Mexico? Write Valencia, Rt. 37, Box 44, El Paso, Texas.

HOW To get your refund on income tax. Special worksheet and instructions with complete list of lawful deductions. Easily understandable. You may save up to \$100. Send 25c. Tax Service, Box No. 22, Jamaica 1, N. Y.

GOOD "Used" self-instruction educational books on all subjects bought, sold, rented, exchanged. Satisfaction guaranteed. Complete information and 100-page illustrated bargain catalog free! Write—Nelson Company, Chicago 5.

LETTERS Written for every purpose. Sales, business, personal, collection, etc. 17% direct orders from one letter mailed to ten thousand prospects. Hastings Letter Service, P.O. Box 467, San Francisco, Cal.

TYPEWRITERS, DUPLICATORS, OFFICE DEVICES

USED Typewriters and office equipment, details. North Specialty Co., Dept. 1, 708 Dewey St., Martins Ferry, Ohio.

HAND Operated envelope sealer. Capacity forty per minute. Guaranteed two years. Only \$2.50. Warner, 642 East Sixth Street, Jamestown, N. Y.

USED Typewriters, mimeograph, multi-graph, presses, supplies, appliances. Dixie-Graph. King, N. Car.

PRINT Your own postal cards, paper, or anything on "Prinomatic Self-feeding Rotary Postal Card Stencil Duplicator." Only \$9.50 with \$2.35 worth of supplies, stencils, ink, etc. Literature free. Pittsburgh Typewriter Supply, 336-RB Fourth Ave., Pittsburgh 22, Penna.

RUBBER STAMPS, OFFICE SUPPLIES

BETTER Rubber stamps. Write for Ezy-Order literature. Lee-Vall Press, Box 1242, Indianapolis 6, Indiana.

3 LINES 35c. Signatures \$1.50. Pads 25c. Prinrite, Wauwatosa, Wis.

PROMPT Service. Cushioned, indexed. 1 line 25c, 2-35c, 3-50c. Stampcraft, 1707 Virginia, Gary, Indiana.

YOUR Name and address on a three line, cushioned, indexed rubber stamp with knob handle \$1.00. Extra lines 25c each. Ideal Rubber Stamp Company, Detroit 8, Mich.

RUBBER Stamps, all kinds. Send for catalog. Excello, Box 500, Shreveport, La.

PRINTING, MULTIGRAPHING, MIMEOGRAPHING, GUMMED LABELS

1000 LETTERHEADS $5\frac{1}{2} \times 8\frac{1}{2}$, or statements \$2.50 postpaid. Circulars, folders, booklets at lowest prices. Courier and Digest, 201 Eighth Street, Charleroi, Penna.

SEND 10c Now, for our 36-page 1946 pricelist—refunded first order. McCall Press, 1326 S. 27th, Omaha, Nebraska.

QUALITY Printing; prompt, efficient service. Samples. Lakeside Press, Bolton Landing, N. Y.

FAST Service: 500 $6\frac{3}{4}$ envelopes or 500 $8\frac{1}{2} \times 11$ bond letterheads, \$3.00 postpaid. Royal Publications, E-715, Prospect Heights 2, Illinois.

MIMEOGRAPHING — Multigraphing. High quality, reasonable. Free lists. Letter Company, 109 East Ninth, Fort Worth, Texas.

100 MIMEOGRAPHED Letters (like typewriting) \$1.50; additional 100's, 50c. Accurate, same day service. Multico, Nine Cornhill, Boston 8.

500 HAMMERMILL Letterheads $8\frac{1}{2} \times 11$ or $6\frac{3}{4}$ envelopes \$2.25. 1000 either \$4.00. Moye Press, Windsor, Vermont.

LETTERHEADS Envelopes, statements, labels, tags, cards. Special, 500 each of any three items, \$6.35 postpaid. Get our quotation on your special work. Lonelm Publishers, Paulding, Ohio.

QUALITY Printing prepaid; business, personal stationery. Letterheads, envelopes, statements. Prices reasonable. Samples. Mero Products, 100 Morrison, Punxsutawney, Penna.

MIMEOGRAPHING, $8\frac{1}{2} \times 11$, 250, \$1.50; 500, \$2.50; 1000, \$3.75. Templeton Studios, Elgin 8, Illinois.

BUSINESS Cards, high quality, vellum finish, 5 line copy, blue ink, 1000, \$3.50. Includes beautiful card case. Artbeck Press, 662 Main St., Charlestown, Mass.

EMBOSSING Business cards, letterheads, envelopes. Spada, 10 Lexington, Wethersfield 9, Conn.

BEAUTIFUL Rag paper, white or colored. 100 envelopes, 100 letterheads \$1.50. Samples. Weedman Press, Madisonville, Kentucky.

$8\frac{1}{2} \times 11$ LETTERHEADS Or $6\frac{3}{4}$ envelopes; 200 \$1.00 postpaid. Benneville, 907 West Roosevelt, Philadelphia 40, Penna.

200 HAMMERMILL Bond noteheads, 150 envelopes \$2.00. Sim's, Saline 1, Mich.

150 SHEETS 100 Envelopes \$1.00. Gene Smith, Beechwood, North Berwick, Maine.

"PRINTING That Satisfies." Samples free. Mail Printing, 93, Danvers, Mass.

2,000 3×6 CIRCULARS \$2.50. 100 word limit. Schultco, Box 41, Irwin, Penna.

250 HIGH Grade letterheads and envelopes, \$1.98 postpaid. Shuttprint, Strasburg, Ohio.

500 BOND Letterheads, $8\frac{1}{2} \times 11$ \$2.00. Custumprint, Box 211-A, Springfield, Mo.

BOND Letterheads $8\frac{1}{2} \times 11$, envelopes $6\frac{3}{4}$, 200—\$1.00, 1000—\$3.90 postpaid. 24 hour service. Barnes, 6439 Hamilton Ave., Chicago 45, Illinois.

PERSONAL Stationery, 50 sheets, 25 envelopes, printed in Old English, 30c postpaid. Samples. G. W. Stevens, Dept. 25, New Milford, Connecticut.

150 BEST Bond letterheads $8\frac{1}{2} \times 11$ and 150 $6\frac{3}{4}$ envelopes \$2.00 postpaid. Estimates. Kay Printing Service, 395 9th Street, San Francisco 3, Calif.

200— $8\frac{1}{2} \times 11$ HAMMERMILL Letterheads \$1.00 postpaid. Envelopes same. Race Printing, Hudson, N. Y.

200 SHEETS $5\frac{1}{2} \times 8\frac{1}{2}$, 100 Envelopes, Hammermill bond, insignias, \$2.00 postpaid. Samoseet Press, Plymouth, Mass.

PRINTING? Lowest prices, samples free. Churchill, 172 Pond, Randolph, Mass. Agents wanted, to sell personalized novelties.

200 PERSONALIZED Postcards, neatly printed with your name and address on white cards, postpaid, \$1.75. 100 for \$1.00. Remit with order. Samples for stamp. Midwest, Dept. H, 1024 Quincy, Topeka, Kansas.

MIMEOGRAPHING Done quickly, economically, any copy. Schubert, 2614 Sunset, Los Angeles 26.

BUSINESS CARDS—1000 \$2.50 postpaid. Beautifully embossed. Samples free. Louis Norton, 324 13th Street, Oakland 12, Calif.

BUSINESS Cards \$1.00 M. Maloney Sales, 36 St. Paul, Rochester 4, N. Y.

500 BUSINESS Cards \$1.95. Reasonable printing quotations furnished. Scholler, 530 Dunlop, Pittsburgh 12, Penna.

150 $5\frac{1}{2} \times 8\frac{1}{2}$ LETTERHEADS Neatly printed, \$1.00 postpaid. Glennard Corn, Hendersonville, N. Car.

PRINTING Cards, envelopes, letterheads. Many \$1 items. Descriptive price list free. Michel, Box 76F, New York 16.

MIMEOGRAPHING — Letters, folios, price lists, etc. Lowest prices. Merritt Wells Pub. Co., Warwick, N. Y.

PERSONAL Stationery, 200 sheets 6×9 , 100 envelopes to match, 3 to 4 lines of type, \$1.00. Orders sent C.O.D. Cosme Press, P.O. Box 6, New Bedford, Mass.

CUTS, Your copy, 20c square inch. Schumacher, 5130 Cedar Springs, Dallas, Texas.

PRINTING Postpaid. 100 letterheads, statements or envelopes \$1.00. \$4.50 thousand. Samples free. Ace Press, 403 East Ostend St., Baltimore, Md.

NOVELTY Printing. Cheap. Send dime for samples. Bradley's Printing Shop, Providence, Kentucky.

500 HEAVY White $6\frac{3}{4}$ envelopes only \$2.35 postpaid. Pritchard, 73 Candia Road, Manchester, N. H.

LETTERHEADS, Envelopes. List free. Sam Wilson, 5423 No. Artesian Ave., Chicago 25, Ill.

ATTENTION—Invest in prestige-building letterheads. Ace Printing, Brentwood, Md.

FINE Printing. Reasonably priced. (Cut service.) Samples. Treaster Printing, Milroy, Penna.

PRINTING Price list free. Fletcher, 639 Bushwick Ave., Brooklyn 6, N. Y.

400 $5\frac{1}{2} \times 8\frac{1}{2}$ LETTERHEADS \$1.25. Mango, 555A South 20th, Newark 3, N. J.

1000 BUSINESS Cards, neatly printed, 2-color, \$2.00 postpaid. Globe Print Shop, Box 1062, High Point, N. C.

FIRST Class printing. Samples free. Walker Printing Service, Box 1298, Amarillo, Texas.

BETTER Grade printing reasonable. Estimates on anything. Economic Press, Leonia, N. J.

MIMEOGRAPHING — Any copy. Reasonable. Mailers Service, Box 606-A, Chicago 90, Ill.

500 $\frac{3}{4} \times 2\frac{1}{4}$ FOUR Line gummed stickers, 25c. Moritz Printery, Saginaw, Mich.

MIMEOGRAPHING—Letters, pricelists, formulas, instructions. Lowest prices. Lem's Letter Shop, 5710 Stanton, Detroit 8.

PRINTING OUTFITS AND SUPPLIES

SACRIFICE Multigraph guaranteed printing presses. Power-drive; automatic feed; automatic inker. Prints anything up to $8\frac{1}{2} \times 11$ " from type; linotype; cuts. 10 type cases; 10,000 new type, \$99.50 prepaid. Hand-fed, \$69.50. 50% deposit. Crystal Company, 1517 Marshall, Shreveport 50-1, La.

NO Experience needed—We'll successfully put you in the highly profitable printing business right in your own home—with a new professional press, plenty of type, easy understandable instruction course, proven order producing plans and ideas, complete layout for only \$237. You can start making at least \$50 weekly in any town under our successful supervision with profits unlimited. Write us right away. Printers Research, 28 East First, Hutchinson, Kansas.

CUTS—Make real halftones, line cuts yourself! Samples 25c. Particulars free. Rapid Chemical Service, Edwardsville, Ill.

PRACTICAL 6×9 Home-made printing press \$5.00. Plans to make it yourself \$1.00. Arthur Shults, 1703 N. Kaley, South Bend, Indiana.

PRINTING Presses, type cases, etc. Westminster, Box 510-T, Evanston 2, Ill.

PRINTERS, Make cuts the Quick Etch method. Details free. Charles P. Medlock, Box 256C, Goodland, Indiana.

PRINTING Equipment, type and supplies. Send stamp for details or dime for complete illustrated supply book. Kelsey Inc., X-11, Meriden, Conn.

PRINT At home—Send 10c for catalogue—presses, type, supplies. Barnhard Co., 6 Columbia St., Newark 5, N. J.

INEXPENSIVE Home-made printing press. Details free. Novelty Shop, Downs-ville, Louisiana.

PATENT ATTORNEYS

INVENTORS: Learn now—without obligation—how to protect and sell your invention. Write for free "Record of Invention" form and complete information for making disclosure and establishing date of your invention. We also send our new free "Patent Guide for the Inventor," containing complete information about patent procedure and how to sell inventions; giving illustrations of many successful inventions; over 150 basic mechanical movements. We assure you prompt, confidential service. Delays may be dangerous. Write today for your free "Patent Guide" and "Record of Invention" form. Clarence A. O'Brien & Harvey Jacobson, Registered Patent Attorneys, 61B-C, Adams Building, Washington, D. C.

INVENTORS—First things come first. Your first move toward securing a patent on your invention is acquiring full information on what to do. Our two books "Patent Protection" and "When and How to Sell Your Invention" contain this information and other helpful data. Get them immediately, together with our "Evidence of Invention" form. They cost you nothing, you assume no obligation. Write now to Victor J. Evans & Co., Patents, Trade Marks, Copyrights, 131-C Merlin Building, Washington 6, D. C.

PATENT Protection. Write for information and "Record of Invention" form, free. Registered Patent Attorneys, Randolph & Beavers, 21-C Columbian Bldg., Washington, D. C.

INVENTORS—Take prompt steps to protect your invention. Delays are dangerous. Get new free book, "Protect, Finance and Sell Your Invention," and "Invention Record" form. Preliminary information free. Reasonable fees. Conscientious counsel. Easy payment plan. Learn how to protect and sell your invention. Write us today. McMorrow & Berman, Patent Attorneys, 134-K Atlantic Building, Washington 4, D. C.

PATENTS And trade marks. Wilfred E. Lawson, 1524 K Street N.W., Washington 5, D. C.

PATENTS—Trade marks. Irving L. McCathran, 315 McLachlan Bldg., Washington 1, D. C. Registered Patent Attorney.

"INVENTOR'S Guide." 100 mechanical movements, free; advises on patenting, selling inventions. Frank W. Ledermann, 154 Nassau Street, New York 7.

PATENTS. E. E. Vrooman, Patent Lawyer, Registered Patent Attorney, 871 Woodward Building, Washington 5, D. C.

INVENTORS—Before disclosing your invention to anyone send for form "Evidence of Conception"; Schedule of Government and Attorneys' Fees and instructions. Sent free. Lancaster, Allwine & Rommel, Registered Patent Attorneys, 411 Bowen Building, Washington 5, D. C.

PATENTS Obtained; selling service, information, recording forms free. Labiner, World Building, New York.

C. A. SNOW & Co., M-427 Snow Bldg., Washington 1, D. C. Registered patent attorneys. Established 1875. Literature mailed on request.

FOR INVENTORS

INVENTORS—Information on what to do first toward securing a patent on your invention is of vital importance. "Patent Protection" and "When and How to Sell Your Invention"—two valuable, richly illustrated books—explain fully what to do first, and a lot more. Get this information quickly, together with "Evidence of Invention" form. All three will be sent to you free. Write immediately to Victor J. Evans & Co., Patents, Trade Marks, Copyrights, 132-C Merline Building, Washington 6, D. C.

INVENTORS—Take prompt steps to protect your invention. Delays are dangerous. Get new free book, "Protect, Finance and Sell Your Invention," and "Invention Record" form. Preliminary information free. Reasonable fees. Conscientious counsel. Easy payment plan. Learn how to protect and sell your invention. Write us today. McMorrow & Berman, Patent Attorneys, 134-H Atlantic Building, Washington 4, D. C.

INVENTORS: Avoid unnecessary expense. Write for free booklet explaining how our consulting and advisory service can assist you in deriving greatest profit from inventing. Institute of American Inventors, Dept. 40-A, 1926-Eye St. N.W., Washington 6, D. C.

INVENTORS: Learn now—without obligation—how to protect and sell your invention. Write for free "Record of Invention" form and complete instructions for making disclosure and establishing date of your invention. We also send our new free "Patent Guide for the Inventor," containing complete information about patent procedure and how to sell inventions; giving illustrations of many successful inventions; over 150 basic mechanical movements. We assure you prompt, confidential service. Delays may be dangerous. Write today for your free "Patent Guide" and "Record of Invention" form. Clarence A. O'Brien & Harvey Jacobson, Registered Patent Attorneys, 61A-C Adams Building, Washington, D. C.

RANDOLPH & Beavers: Registered Patent Attorneys, 11-E Columbian Building, Washington, D. C. In order to protect your invention and reap the reward that should be yours, patent your invention without delay. Write for complete information and "Record of Invention" form, free.

INVENTORS: We design and market your idea or product. Gadget Designer, 725 Walnut St., Room 23, Philadelphia 6, Penna.

DEPENDABLE Patent Office searches \$10.00—complete with 10 patent copies. Ten days service guaranteed. Send sketch, description and fee at once—nothing more is required. Address: Raymond L. Smith, Patent Searcher, 410-DM Bond Building, Washington 5, D. C. (Former U. S. Patent Office employee.)

"CERTI-PROOFS" Protect unpatented inventions 1 year or longer! Patent later. 3 postpaid \$2.00. Free particulars. Warner Company, 1413 Great Northern Bldg., Chicago 4.

PATENT Promotion. Selling, designing, engineering, modeling. Tell us your problems. Write today. Associated Manufacturers, 223 Sterrett Avenue, Covington, Ky.

PATENTED. Unpatented inventions promoted. M. Joyce Humphries, 1424 Land-tite, Philadelphia 10, Penna.

WE Have buyers for practical inventions. Details free. Inventors Exchange, Dept. 5B, Hartford 1, Conn.

INVENTORS—We will help you if you have a good idea. We supply the finances to patent your idea in your own name. You own the patent. We also arrange profitable manufacturing connections for inventions. Write without obligation. Patent Financing Corporation, 209H Hospital Trust Building, Providence 3, R. I.

I SELL Patents. Established in 1900. Charles A. Scott, 773PM Garson Ave., Rochester, N. Y.

INVENTIONS Having profit possibilities in demand by specific manufacturers, cash or royalty. Free descriptive booklet, protective disclosure form, references, and how to safely disclose an invention for sale, upon request. Invention Reporter, 5A-11106 So. Longwood Dr., Chicago 43.

HAVE Your idea or model developed now at pre-war prices. Forty years experience in developing, designing. Tool and die work. Inventors Laboratory, Madisonville, La.

CASH For practical ideas and inventions. Mr. Ball, AB-9441 Pleasant, Chicago.

INVENTIONS WANTED

WANTED To purchase a patent right or patentable invention for a home furnishing or appliance. Will pay cash. Describe fully. Address—Mr. Kelley, 2448 Cedar Street, Berkeley 8, California.

INVENTORS: Hundreds of manufacturers have requested our assistance in locating marketable new products. Complete information, free. Institute of American Inventors, Dept. 40-D, 1926-Eye St. N.W., Washington 6, D. C.

MANUFACTURERS Desire practical inventions and designs. Patented, or unpatented. Cash, or royalty basis. John D. & Son, 140-B Spruce St., Bridgeport 5, Conn., Box 3213.

INVENTORS! Your heading for the poorhouse. Send for details. "Your Invention You Can Keep It." F. Ambrose, 537 South Dearborn, Chicago.

WANTED—Patented, unpatented inventions having profit possibilities, all kinds. If will sell, reply immediately. Descriptive booklet, references, free. Invention Reporter, 5B-11106 So. Longwood Drive, Chicago 43.

CASH For plumbing specialty inventions. Chicago Specialty Mfg. Co., 2954 Lawrence, Chicago 25, Illinois.

MANUFACTURER Desires postwar products to make and sell through drug, hardware, department stores and mail order. Or will handle sales only. Reputable, nationally-known organization capable of promoting nationwide sales as well as manufacture of items. Prefer non-electrical products of metal, glass, plastics, etc. Write P.O. Box 1373, Indianapolis, Indiana.

INVENTORS! Have you good patentable idea? Write Mr. Metzler, 11 West 42nd, New York.

CASH For inventions, patented, unpatented. Mr. Ball, A-9441 Pleasant, Chicago.

MANUFACTURER Wants sensible mechanical device or idea with quick sales possibilities in low-priced field. Write Matt, 1412-D Great Northern Building, Chicago 4.

PATENTS FOR SALE

SELL Outright: patent safety spring for grease cups. Holds grease cups in place on vibrating machines. Box 405, Roundup Mont.

NEW Type swine catcher and holder. Automatic, light weight, patent pending. Willis E. Dixon, Monmouth, Illinois.

INVENTORS: Test the commercial value of your patented or unpatented inventions, quickly and inexpensively. Write for free information. Institute of American Inventors, Dept. 40-B, 1926-Eye St. N.W., Washington 6, D. C.

PRACTICAL Shaving brush with self lathering device including razor, blades, comb, mirror, in a convenient form. Gar-riga, P.O. Box 748, San Francisco 1, Calif.

NEW Much needed spiral winder patent, want to sell on royalty basis. Write Margaret R. Bell, Federal Hotel, Great Falls, Montana.

OUTRIGHT Or royalty basis. Patent that should make a big fortune for some one. Even wear rotating rubber heel. Not only will last longer but because of its evenness in wearing out will keep the shoe in good shape at all times and help to prevent many foot ailments caused by faulty shoes. Any fair offer will be given due consideration. P. H. Kellar, 1202 First Ave., San Diego, Calif.

EARTH Tamper. Pat. No. 2,266,204. Three sizes in one. Will sell good. P.O. Box 88, Mt. Healthy, Ohio.

MANUFACTURING

INDUSTRIAL Diamonds mounted \$1.50 models, small lot manufacturing metals etc. Specialty Machine, 2821 Mitchell, Racine, Wis.

MODELS—Small lot manufacturing. Metals, plastics, etc. Milburn, Burlington, Kentucky.

MODELS AND MODEL SUPPLIES

MODEL Airplanes, Gas models, solid models, gliders, gas engines, ship models, supplies, Tools. Send 25c (includes refund coupon) for 68 page 8 1/2 x 11 illustrated model airplanes and gas models master catalog. General Modelcraft Co., Dept. M-3, 91-17 173rd Street, Jamaica 3, N. Y.

LANDLOCKED Sailors! Here's a beautiful, richly illustrated, fully descriptive catalogue of famous model ships—whalers, slavers, corvettes, etc., authentic in every detail. Send for it today. Only 10c. Marine Model Company, Inc., Dept. C-11, Halesite, Huntington, N. Y.

MODEL Engine catalog, railroad supplies, 25c refunded. Simonsen, A-3054 Greenview, Chicago 13.

SHIP Models, complete authentic kits. Illustrated catalog sheets free. Corrison Model Sales, Dickerson Run, Penna.

SHIP Models—Clipper, Santa Maria, Viking, Pinta, Mayflower, and modern destroyer. Solid wood hulls, complete with sails, parts cut to size, full sized plans. \$1.25 postpaid. Skipper Co., Box 5827, Philadelphia, Penna.

INVENTIONS, Models, experimental equipment made. Candle moulds \$9. Baum's Metal Specialties, Kansas City, Mo.

LIONEL And American Flyer new and used tinsplate lists. Also catalog with 20 full pages of model railroad supplies and kits. Send 10c. What gauge? Trilior Hobbyist, State Road, North Dartmouth, Mass.

HI-SPEED Miniature four cylinder steam engine. Assembled or partly finished engines in production. Stamp for circular. Inland Marine Company, 7817 Grove Ave., Webster Groves 19, Missouri.

AIRPLANE Model kits, boat kits, gasoline engines, accessories. Send stamp for catalog. Grove Hall Hobby Shop, 639 Warren St., Boston 21.

BUILD Model gasoline engine. Castings supplied. Circular 10c. Roger Tully, 71 Chelsea Avenue, Newark 6, N. J.

HIGH Speed model steam engines. Descriptive literature 10c. R. Looker, P.O. Box 105, Michigan City, Ind.

SHIP And yacht model fittings and blueprints. Hundreds of items to choose from. Send 25c for new illustrated catalog. A. J. Fisher, 1002 Etowah Ave., Dept. M, Royal Oak, Mich.

MODEL Engines, aircraft, ship, army vehicle models. Catalog free. Hobby Center, 3324 E. Tenth St., Indianapolis 1, Ind.

WIZZ Electric motor: Assembles in a jiffy. Operates on flashlight cell. All parts complete. Instructions. Send 25c, plus 5c postage. Eltro, Box 171B, Deer Park, N. Y.

RAILWAY Models, complete line, informative catalog, HO and O Gauge, 79 pages, 25c. Walthers, 247 Erie, Milwaukee, Wisconsin.

STEAM Engines, boilers, castings, blueprints, circulars 10c. Anton Bohaboy, 2297 Price, Rahway, New Jersey.

MINIATURE Steam locomotives, 1/4", 1/2", 3/4" scales. Castings, parts, rail! Thorough drawings with instructions. Catalog 25c. Little Engines, Wilmington, Cal.

CATALOGS (Illustrated) for modellers! Airplanes, 60 page book on solids. Features construction data, specifications, camouflaging, 15c; railroads: 128 page "HO" guide. Equipment, accessories, fittings. 25c (includes refund coupon). Send coin or stamps for each profusely illustrated catalog desired. Polk's, "Nation's Leading Hobby House," 314-PM Fifth Ave., New York City 1.

SHIP Model kits and fittings. Complete line Fisher model yacht equipment. All Boucher, Fisher, Marine Model and Ideal kits, fittings and blueprints at standard prices. Most complete stock in New England. Send 10c for price list. James Bliss & Co., Inc., 220 State St., Boston, Mass.

BOAT Models. P.T., cabin cruiser, speedboat. Free circular. All Star, 2003 Lincoln Ave., Chicago 14.

HOME CRAFTSMEN

LEATHERCRAFT Kits, supplies. Leather samples and catalog 10c. Roy's Leather Shop, 6652 N. Clark, Chicago 26.

OUTSTANDING Patterns. Full size. Rocking horse, doll stroller, machine gun, wheelbarrow, lawn ornament, pull toy, \$1.00. Hartley Products, 1014BG Dakin, Chicago, Ill.

20 PULL Toy patterns 50c. 25 novelty patterns 35c. 35 bird house and lawn ornament patterns 25c. Continental Home-crafter, 907 Birch, Eau Claire, Wisconsin.

CRAFTSMEN—Fast selling, make children and adults lawn chairs. Plans and instructions \$1.00. Summercraft Studio, Newton 58, Mass.

PLYWOOD—Deluxe woods for paneling and cabinet work. Bird's eye maple, curly birch, havello, mahogany, walnut. Thickness 1/16" through 1"; large, small sheets. Complete catalog 10c. Carmen-Bronson, 165 East Third, Mount Vernon, N. Y. Dept. 3-B.

ALPHABET Beads for beadcrafter, shell jewelry, name plates, photographing titles, imbedding in plaster or cement. \$3.00 per hundred. John Grant, 114-111 229th, St. Albans 11, N. Y.

PLYWOOD Cut to dimensions, free estimate. Rexroat Woodcraft, Salem, Indiana.

PLASTICS—Plexiglas, Lucite, Bakelite, Lignolite, Lumarith, Tenite. Sheets, tubes, rods, and special shapes. Complete range of sizes. Also cements, dyes and other supplies. Complete catalog 10c. Carmen-Bronson, 165 East Third, Mount Vernon, N. Y. Dept. 3-B.

MAKE—Sell Lucite jewelry, beautiful items. Fabrication instructions, catalog, particulars, 10c refundable. Glassite, 625-P Atlantic, Monterey Park, Calif.

GAY Collections of the 1946 lawn ornaments designs now ready for home craftsmen. Included is the "musical flower border," the hit of the season! Turn your hobby into profit by starting now for the spring rush. Can be made easily with hand tools of super-production with a power saw. Send only \$1.00 for all full size patterns. Scully-Hall, 92-46 220th Street, AC6 Queens Village 8, New York.

PANTOGRAPHS, Enlarging drawing instruments, \$1.00. Professional hardwood size \$2.50 each. Gem Sales, Box 345, Wilkes-Barre, Penna.

CERAMIC Jewelry supplies, bar pins, ear screws, for ceramic and woodworkers, also, glass and sea shell assemblers. Free catalog. Phila. Badge Co., 1007 Filbert St., Philadelphia, Penna.

40 LAWN Ornament patterns, sunbonnet girl, Dutch Boy and Girl, 20 novelties, 20 silhouettes \$1.00, 4 hanging shelf patterns, 75c, 100 other patterns. List 10c. Modern Wood-Craft, Saginaw, Michigan.

JIGSAW Owners: Square foot of plywood yields \$46. Write: Woodart's, Bridgewater, Mass.

JEWELRY Accessories and findings. Plastic and metal screw eyes, pinbacks, clasps, chains, rings, etc. Prompt shipping service. Complete lists 10c. Doremby Company, Chisholm, Maine.

30 FULL Size toy patterns 50c. 25 novelty patterns 25c. 15 lawn ornament patterns 25c. Complete Plexiglas construction \$1.25 postpaid. Lynds, Medway, Mass.

PLEXIGLAS Lucite Craft Plastics, Box 129, Somerville, N. J., offers free listings. Prime sheets, rods, tubes: Handee tool.

12 JIGSAW Silhouette designs for wall pictures with instructions. \$1.00. A. G. Devine, Silhouette Workshop, 144 School Street, Watertown, Mass.

STAINLESS Steel assortment and plans for making rings, bracelets, pins and clasps. 1 lb. lot postpaid \$2.00. Harpers Machine Shop, 218 22nd St., Dunbar, W. Va.

REPLACES Sandpaper. Make your own sanding disk, or cover any wood or metal shape with abrasive. Curved surfaces, impossible to cover with sandpaper, are easy to coat with San-Dit. Send \$1.00 for kit and directions. San-Dit, Box 32, Wauwatosa, Wis.

COLORED Plastic cements: for laminating or fabricating Lucite and Plexiglas. All colors of the rainbow: red, yellow, orange, violet, bronze, walnut, mahogany, navy blue, sky blue, light and dark green, and clear. Choice of any five with instructions—\$2.25 postpaid anywhere in U.S.A. Price lists of all plastic and supplies with drawings and construction sheets—25 cents. History and complete instruction book with photographs and step-by-step fabricating details—75 cents. B & H Plastics, 1425 Lincoln Blvd., Santa Monica, California.

"LUCITE" Beautiful creations in kits. All machined and cut ready for assembly. Materials, directions supplied \$1.00 and \$3.00 specials. A & M Special Plastic Products, 898 River Road, Edgewater, N. J.

LEARN Plastic fabrication at home. Instruction sheet with easy to make projects by well-known homecraft designer. Two pounds Lucite, Plexiglas and B-29 Laminant. Solvent cement included. \$1.50 cash or money-order only. \$1.75 west of the Mississippi, postage paid. Practical Plastics, Inc., 615 Broadway, Daytona Beach, Fla.

SUEDE-COAT!—Luxurious art finish easily applied to any surface, in twelve colors. Introductory kit, three colors—covers fifteen square feet, applicator, adhesive, \$1.00 postpaid, including 10c catalog on plastics kits, supplies, tools. Technicraft Supply, 1156 Commonwealth, Boston-34, Mass.

SHELL Jewelry supplies. Wholesale only. McFarland Plastic Co., Sarasota, Fla.

BUILD And sell lawn chairs. Plans \$1.00. We tell you how and where we sell. The Woodcraft Shop, Danby, Vermont.

JEWELRY Supplies. Shell metal and plastic parts for manufacturing. Free illustrated catalogue and detailed instructions on shell jewelry. Florida Supply House, 415 12th Street, Bradenton, Fla.

MAKE Shell jewelry—For gifts, as a hobby or start a business. Free catalogue and price list. Complete illustrated book of instructions 75c. Florida Shellcraft Company, Box 1840, Sarasota, Florida.

WHITTLES—20 Patterns, instructions, X-acto knife, wood. \$1.00. "Old Whittler," 1402 Charles, LaCrosse, Wis.

PATTERNS—Full size for rocking horse, swan rocker, doll stroller, cradle and boy's wheelbarrow, \$1.00 postpaid. Lincoln's Craft Shop, Farmington, Conn.

MAKE IT YOURSELF

AIR Compressor—build from any automobile engine. High pressure, high CFM output. Detailed prints and instructions \$3.00. State engine make. Engineering Associates, 1621 North Grismer, Burbank, Calif.

BUILD Power drill press with Allankraft parts, plans, drawings, 25 cents. Allankraft, Box 366-S, Fond Du Lac, Wis.

BUILD A lathe the progressive way, very unique idea, three plans one dollar. Albert Losli, 501 South Navajo, Denver, Colo.

WEATHER Station—Build your own anemometer and wind direction indicator. Instruments on roof give readings on panel in room. Uses two pairs Bendix AY20 Selsyns plus other simple inexpensive equipment. Selsyns \$7.50 per pair. Instructions included. General Developments, 521 Fifth Avenue, New York City.

DIATHERMY Plans for building four different sets, magnetic and tube, one dollar. Kertz, 164-21 109 Road, Jamaica, N. Y.

WHEELS For your own construction of wagon, scooter, racer, wheelbarrow and bicycle trailer. Drawings 25c each. 8x2" and 10x1.75" all-metal wheels with puncture-proof tires and ball bearings. \$2.25 per 8" wheel. \$3.25 per 10" wheel. F.O.B. Akron. Send orders to Jim Brown's Toy Co., 868 East Tallmadge Avenue, Akron, Ohio.

BUILD Novel lawn sprinkler, two beautiful little planes traveling in circle, spray acts as jet driving planes, 16 inch wing span, easily constructed from our plans, no machine work, ornamental, fascinating, useful, instructions \$1 no stamps please. Larry's Novelty Shop, P.O. Box 1171, Billings, Mont.

METAL Wheels with rubber tire for your own construction of wagon or wheelbarrow for youngsters. 7 1/2" diameter, 9/16" hole for axle. Price only \$1.00 each wheel or 4 for \$3.75. There are many uses for these wheels. Send order with 1/3 payment, balance C.O.D. to H. Dowd, 97 Main Street, South Acton, Mass.

BUILD A power lawn mower, complete plans \$1.00. Eglie, 862 N.E. 119th St., Miami, Fla.

TIME Meter; rings bell, starts radio, turns off window lights, time set, no springs or wheels. Costs less than dollar to make. Plans \$1.00. Albright, 4625 Hilltop Drive, San Diego 2, Calif.

LEARN Code. Complete telegraph kit. Easy to assemble. Pair \$3.50, assembled \$4.50. Associated Model Manufacturers, 5 North Sixth Street, Philadelphia 6, Pa.

BUILD Your own printing press. Plans \$1.00. Details, samples of work done, free. Homer DeSellier, 19 Stebbins St., Springfield, Mass.

ELECTRIFIED Martin house keeps sparrows away, plans \$1.00. Oigard, 955 W. Central Ave., St. Paul 1, Minnesota.

EXPERIMENTERS! Hobbyists! Attention! Now available, genuine B-29 bomber blister laminated plastic. Tough, shatter-proof, 1/2 inch thick, composed of Lucite and Butacite. Cost U. S. government \$1.35 a pound. Valuable for turning toy wheels, etc. Five pound assortment, good workable sized pieces, \$2.00 postage paid. \$2.50 west of the Mississippi. Cash or money-order only. Practical Plastics, Inc., 615 Broadway, Daytona Beach, Fla.

NEW Magazine rack. Holds forty magazines. 50c for actual size pattern. Frank S. Rudy, 303 Otterbein Ave., Dayton, O.

TRUCKERS—Dump your loads with hoist from junk parts. Plans \$2.00. George Larson, Clearbrook, Minn.

BEAT The heat! Build efficient, inexpensive air-conditioners to suit any space. Large profits selling to homes, stores, offices. Plans, instructions, \$1.00. Imperial, 10237 McQuade, Detroit 6, Michigan.

POWER Hack-saw, using old pump-jack. Plans \$1.00. Albert Miedema, 1416 92nd St., R 1, Byron Center, Mich.

BUILD Your own power lawn mower and save \$50. Complete kit of precision factory-made parts and instructions for new-type, three-wheel whirling blade mower. Write B-M Mower Co., Box 66, Blue Mound, Kansas.

MAKE Home freezer from household refrigerator. Drawings, instructions \$1.00. Payne, Box 176, Wilbraham, Mass.

INEXPERIENCED? Build your home yourself. Your labor saves up to 60%. Valuable circular for beginners 25c. William Jackson, A.B., 1713 Howard, Port Huron, Michigan.

WATCHES, OLD GOLD, JEWELRY, ETC.

WATCH & Clockmakers Handbook by F. J. Britten \$5.79. Most complete on subject. For description, write for catalogue. Engineers' Book Service, 19 W. 44th St., Rm. 1002, New York 18.

GEMS, Precious and semi-precious, all genuine, from world wide sources. Deal direct, no overhead, save money. Catalog 10c. Hill Co., Route 7, Salem, Oregon.

JEWELRY Findings, chain, links, etc. Metal and plastic. Send dime for catalog. George Sassen, 154 Nassau Street, New York City.

"JEWELRY, Gem Cutting, Metalcraft." Fascinating designs for hobbies and moneymaking opportunities. New, complete illustrated book covers cutting, polishing, mounting gems, metal, jewelry work, etc. 287 pages, \$2.95 postpaid. Money back guarantee. We supply tools, materials at lowest cost. Modern Technical Book Co., Dept. M2MC, 55 West 42nd St., New York 18.

WATCHES, Materials, tools, jewelry, diamonds—bought—sold. Catalogue. Gales, Box 1000, Chicago.

WATCH Repairing. Send your watches for free estimate. Good service. Full guarantee. Karelin Watch Service, 86 Bowery, New York City.

NOW Available. "Expansion watch bracelets." Stainless steel \$2.00. 18K goldplated top \$3.00. Fits any wrist. (Refundable.) Doz. \$20.00. Latschaw, Sunnyside, Indianapolis, Indiana.

WATCH Movements, jewelled pocket watches, American and Swiss. Ideal for beginners practice \$1.00 each. "As is." Bezkor, 1491 Metropolitan Ave., New York 62, New York.

17 J. 2 DIAMOND Ladies watch \$65.00. 17 J. waterproof, shockproof, nonmagnetic men's watches \$38.50. Enclose cash with order. Or shipment will be C.O.D. Orville Fast, 1101 G St., Reedley, Calif.

WATCH And clock repairing—complete practical course in modern horology. 66 illustrated self-instruction lessons. Just out! Low price. Fascinating 100-page illustrated catalog free! Write—Nelson Company, Dept. 8-02, Chicago 5.

BURGESS Vibro-tool engraves jewelry, cuts and emboss \$7.50. A.C. current. Bonomo, 25 Park St., Brooklyn, N. Y.

WANTED—Old or broken jewelry. Cash paid immediately. Mail your watches, gold teeth, rings, silverware, diamonds, spectacles, cigarette cases. Satisfaction guaranteed or merchandise returned. Information free. Rose Smelting-Refining Co., 29 East Madison, Chicago, Dept. A.

GOLD \$35.00 Ounce—Mail old gold teeth, diamonds, jewelry, watches—receive cash by return mail. Satisfaction guaranteed. Free information. Dr. Weisberg's Gold Refining Company, 1500-Q Hennepin, Minneapolis, Minn.

RAZORS, BLADES, SHARPENING

FINEST Quality surgical steel blades. 150 double edge \$2.00. 100 single edge \$2.00. Postpaid. No C.O.D.'s. Nelson Co., Moore Bldg., St. Paul 2, Minn.

NATIONALLY Advertised razor blade sharpener. One blade lasts the writer one year or 365 clean shaves. Sharpens double edge blades only. Recommended by this agency. Send \$4.95. Nome Sales Agency, Box 87, Durham, Conn.

TOBACCO, SMOKERS' SUPPLIES

CIGARS—Finest quality Porto Rican, five inch londres, \$4.00 box fifty postpaid. Satisfaction guaranteed. Write for special get-acquainted offer on pipe and cigarette tobaccos. Pete Moberly, Box 993, Owensboro, Kentucky.

"LEKTROLITE," the flameless cigarette lighter, including bottle Lektrolite fluid, popular with armed forces, only \$1.25 while quantities last. Leart Sales, 7438 Chappel, Chicago 49, Ill.

CIGARS, 50, Extra quality \$4.00 delivered. S. & E. Company, Red Lion, Pa.

SMOKING Pipes repaired, hard rubber bits \$1.00. Send pipes. Returned postpaid and insured if prepaid. 3 day service. Steg, 413 City Bank Bldg., Syracuse 2, N. Y.

CIGARETTES—Popular brands. Orders shipped same day received; minimum 3 cartons. Price \$1.35 per carton postpaid. Send check or money order. Ace Mail Order Co., East Orange 86, N. J.

"SEE Miscellaneous for grenade lighter."

LIGHTER; Smart aluminum. \$1.00. Money refunded unconditionally. Marion Earl, W. Second, Moorestown, N. J.

CIGARET-I-KETS Make any ashtray safe snuffer type. Puts butts out ten seconds or less. Neat, attractive, 3 for quarter. Haven Specialty, Box 222, West Haven, Conn.

SMOKING Pipes repaired. Send for price list. The Humidor, 8129 Euclid, Cleveland, Ohio.

50 **MILD** Cigars prepaid \$3.15, \$4, \$5.50. Continental Cigars, Corning, New York.

FOR SALE OR EXCHANGE

BE Scotch—swap with your neighbor no matter where. Low cost. Write for list today. Traders Exchange, Chittenango, N. Y.

FOR THE HOME

FREE Illustrated circular of Mexican sleeping figure book-ends. Hand carved and brilliantly painted in romantic Old Mexico. Something new. Delightfully different. Write: Wilshire Gifts, 2112H West Tenth, Dallas 11, Texas.

HOUSEWIVES Parchment dish cloths. Will not absorb grease, dirt. Twenty for one dollar. F. De Franco, 16404 Biltmore, Cleveland 20, Ohio.

IMPORTED Argentine sheep-skin rugs \$4.95, India Numdah rugs 4'x6' size \$7.95. Mailed free in U.S.A. Altmeyer Home Store, New Kensington, Penna.

FOR SALE MISCELLANEOUS

MECHANICAL Drawing instruments—Veeco, 4 piece, compact, precision set, brand new in lined case, value \$12.50. Special, \$7.25—Deitzgen 11 piece set, \$10.00—Charvos 9 piece set, \$8.50. Army surplus slide rules, slightly used, 75c each. Hull auto compass, for accurate road direction, brand new, \$2.50. Forward money with order. No C.O.D. shipments. Public Sport Shops, 13 S. 16th Street, Philadelphia, Pa.

WHEELS! Wheels! for every use. Scooters, mowers, wheelbarrows, 10 inch by 1.75 rubber tire. 1/2 or 3/8 inch hub. Satisfaction guaranteed. \$3.95 each postpaid. Trulson Mfg. Co., 811 E. 31, Kansas City, Mo.

THE Lord's coming! Get genuine proofs free. Join world's greatest non-denominational movement. Write International Evangelism, Box 263-X, Duluth, Minn.

ARMY Goods (used) Canteens, cups, covers and Mess kits \$1, set, jeep hats, overseas caps 10c, mask bags 25c, steel helmets \$1, gun slings, holsters 75c, cartridge belts 50c, waist belts 25c, rubber wading boots \$2.50, life suits \$5, portable buzzer phone \$2, spark coils \$3, raincoats \$1, leggings 25c, knapsacks \$1, tool boxes \$1, bolo knives \$3.75, canvas 7c foot. Minimum shipment \$1. No C.O.D. N. Y. Salvage, 144 Chambers St., New York City.

MEN'S Fine used suits. Good condition. Get circular. Campbell Doggins, Box 949, Lexington, Ky.

GOLD Paint, half pint, \$1. postpaid. Shriber, 1822 Center, Pittsburgh 19, Pa.

"LUCITE" clear transparent sheets, rods, tubes. Color transparent, translucent phosphorescent sheets. All sizes. Any amount. Also kits. Manufacturers, craftsmen: send for free price list. Hamilton Plastics, 717 Cedar Lane, N. J.

CUTTERS, Dental burs assorted, reclaimed job-lot, \$1.90 per gross. Wolf, 1924 E. Hartlane, Philadelphia, Penna.

WANTED MISCELLANEOUS

WANT To swap, buy, sell anything? Get National Swappers Guide. It's chock full eager swappers, buyers, sellers, coast to coast and opportunities to swap, buy, sell almost anything under sun. Postpaid 25c. National Swappers Guide, 610 St. Joseph, Evansville 12, Indiana.

MERCURY—Highest prices. Free containers. Write. Wholesale Terminal, Norwood, Mass.

VETERAN Wishes to start manufacturing business of some kind. Has five thousand dollar capital. Robt. Mason, Forty Grant, Framingham, Mass.

WANTED: Auto tire cutting machine. Alvin, 3704 Gordon, Ft. Worth, Texas.

CRYSTALS From old chandeliers. 75c a pound. Send C.O.D. A. Palminterio, 4034 Dyre Ave., Bronx 66, New York City.

MERCURY (Quicksilver). Write for quotation stating quantity. Metallurgical Products Co., 35th and Moore Sts., Philadelphia, Penna.

PERSONAL

TREASURE Finders. See Goldak advertisement in Miscellaneous section.

DREAM Book explaining 500 dreams 10c. Kaybee, Crescent Beach, B. C., Canada.

LONDON, Letters mailed 30c. Montreal 25c, any U.S. city 20c. Receiving-forwarding. View cards, souvenirs, books. Brooklyn book, details 25c. Haller, 436 New York Ave., Brooklyn 25, N. Y.

LEGAL Matters in Mexico. Fred Morales, Box 449, Tijuana, Mexico.

VETERANS Protect your discharge certificate. 2 copies both sides popular handy billfold size \$1.00. Electro Photo, La Crosse, Wisconsin.

ATTRACTIVE Personal stationery. Free samples. H. J. Vrazel, Yoakum, Texas.

NERVOUS? Bashful? "Fears?" Free, encouraging information. Jno. Englund, Ironwood, Michigan.

ATTAIN Winning personality. Helpful in business and society. Book \$2.00. Renick, Holland, New York.

SLEEPLESSNESS Unnecessary—Sleep-Rite earstoppers insure quality sleeping, improve health. Write Raymond Dow, 2922-164th Street, Flushing 31, N. Y. Get free illustrated health secrets.

VISIT Hollywood by proxy. We send 3 post cards for 20 cents. You address, stamp, return for mailing from Loring Novelty Company, Box 9688, Station 27, Hollywood, California.

BREATH-PURIFIERS Banish offensive odors from breath. Free sample. Raymond Dow, 2922-164th Street, Flushing 31, N. Y.

PHOTOCOPY Of service discharge or other papers up to 8 1/2 x 11 inches in size. Only \$1.00 even if on both sides. Original and copy returned safely by registered mail. Milart, 365 Elm Ave., Lincoln Park, N. J.

MEXICAN Law practice, L. Gonzalez, Box 236, El Paso, Texas.

I Dye suits, coats, dresses, drapes, etc., and G.I. coats, jackets, pants, etc. Lawrence Jacobson, 2825 N. Broad, Philadelphia 32, Pa.

EXSERVICEMEN: Your dog-tags are excellent souvenirs of service. Have them gold-plated for use on key chain, etc. \$1 each, \$1.75 for two. Island Plating Service, 212 Fisher Ave., Staten Island 7, N. Y.

POOR Penmanship corrected—few hours. New-way. Ozment, 9, St. Louis, Mo.

CONSULTING Psychologist. Confidential correspondence. Dr. Haynes, 706 8th, Washington 1, D. C.

BOOK Bargains. Illustrated catalogs free. Rialto, 349-B, Sackett, Brooklyn, N. Y.

HAIR Falling? Dandruff? Write Trichologist, 137 Lewis St., Phillipsburg, N. J.

MISCELLANEOUS

YOU Need no priorities now or ever for Houses of Earth. The ground you stand on is your best building material. Easy to build—insulated against heat and cold. Ratproof—soundproof—termiteproof and fireproof, approved, endorsed by U. S. Government departments. Lowest building and upkeep costs. Send today for "Houses of Earth," containing complete building instructions and 18 illustrations mailed upon receipt of \$1.00. A. B. Lee, Box 171, Washington, D. C.

SOUTH-SEA Islands souvenirs, high class jewelers, manufacturers and exporters of popular genuine tortoise shell articles, glimpsing silver and silver filigree ornaments, bone, ivory and various other kinds of the Pacific Islands souvenirs viz., necklaces, bracelets and brooches, ear-rings and rings, tie pins, cuff-links and buttons, etc., coconuts and different varieties of the rare curus including cat's eyes, sea-shells and beads, picture views of the South Seas, etc. All in silver inlay design and with cat's eye mounted. Wholesale inquiries invited. Buy direct and save money. We can post your parcels to your home address. Posted direct to any part of the world. Price-lists on request. Write to—G.P.O., Box 309, Suva, Fiji Islands.

SIMPLIFIED Weekly bookkeeping record. Good for one year. Free tax bulletins. \$2.00. National Tax Service, 111 W. Jackson Blvd., Chicago, Ill.

VETERANS! Your honorable discharge emblem in beautiful 4" decal transfer. Adheres permanently. Address "Veteran," Box 2845, Dallas, Texas.

QUESTIONS Pertaining to all sports promptly answered. Enclose dime for reply. Sports Information Bureau, 4020 W. Hancock, Detroit 10, Mich.

TRADE Magazines—business, vocational, diversion. Classified directory 3343 publications with complete addresses and subscription rates \$1.00. Commercial Engraving Publishing Co., 34C North Ritter, Indianapolis 1, Indiana.

"RECEIVE Mail." Moneymaking offers, opportunities, catalogs. Name listed 10c. Ideal Service, 103, Park Ridge, Ill.

EASY Payments, buy unique merchandise, jewelry, beautiful Panama hats, free particulars. Anthony, Prado 109, Habana, Cuba.

COMBINATION Stapler and tacker strongly constructed. Guaranteed. \$1.50 postpaid. R. P. Maddox, 194, McLean, Virginia.

SECURE Financial independence. Let us help you. "Nuggets" sent free. Copyrighted. Unique Service, Box 851, Minneapolis 1, Minnesota.

PERSONALIZED Pencils. Individual or firm name. Dozen 60c. 2 1/2 dozen \$1.00. Gross \$4.32. Cash. Delivered. Pencil Market, 611-15th St., Knoxville 16, Tenn.

MAILING Lists: 1946 widows, parents, \$7.00 thousand. \$1.00 hundred, home owners, others. Send for list. C. Wells, Box 1291, Milwaukee 4, Wis.

WE Buy, sell, trade anything of value. Agents wanted. Estes, Box 155, St. Matthews Branch, Louisville 7, Ky.

STAG Book matches. 10 for \$1.00. Logan Novelty Co., Bellefontaine, Ohio.

TREASURE Finders. New powerful Goldak electronic locaters now ready. Amazing sensitivity. At last the war time developments in electronics can be yours for finding minerals and metals. Radically new type. New circuits; new principle of operation. Money back guaranteed locate gold, silver or any metal at greater depth than any other device. Write for full details. Send stamp. The Goldak Co., 1544 W. Glenoaks, Glendale 1, Calif.

MONOGRAM Your name or initials on cigarettes, tools, stationery, books, etc. Specially made to your order. Lasts indefinitely. Complete outfit \$1.00 postpaid. Prudential, 1234 Saint Johns, Box 109, Brooklyn 13, N. Y.

RUST Remover. Remarkable war development. Derusts automobiles, tools, housewares. Liquid one derusts; two inhibits, forms perfect paint base. 75c. Solvrust, 34 Mali, North Plainfield, N. J.

LATEST Mail order propositions from many companies, sent steadily one year, 25c. Geo. Pieger, Hackensack, N. J.

FUNDAMENTALS Of Mechanics: 188 page book of "how" and "why" of machinery. 40 chapters, hundreds of illustrations and diagrams. Material used by army personnel in training. Only 50c. Hurry! Supply limited. Hobby Books, 150-M Nassau St., New York 7.

MAKE Your own Plastoplate printing cuts. Simple, easy process. Plastoplate, Argyle 1, Wisconsin.

EARNINGS, \$2,000 Year easy; inventing simple items for special cash markets. Ideas only. No patents. Write Hendrickson, Argyle 7A, Wisconsin.

BURGLAR Alarms, electrical, mechanical. Fires shot. Flashes in dark. Sensational new invention. \$1.00. Automatic Alarm Co., 5942 Audubon, Detroit 24, Mich.

TALK Secretly. Silent system using only one hand. Simple, practical. Used by the deaf. Complete on wallet size card, 10c. Dietz, Dept. 2B, 1618 Westmont Avenue, Pittsburgh 10, Penna.

ANYTHING But your wife and kids bought, sold or traded. Satisfaction guaranteed. Farmers & Traders Exchange, Chittenango, N. Y.

COMIC Sketch made from your photo \$1.00. Photo returned unharmed with drawing. My hilarious cartoons are hum-dingers, suitable for framing. Birnbaum Studios, 282 Pulaski Street, Brooklyn 6, New York.

NEW Jersey mail address. Fool your friends. Send and receive your mail through me. 25c cash each letter. Particulars, write, T. Kent, 65 Devon St., North Arlington, New Jersey.

PREFABRICATED Housing. Fifty years of experiments. Methods, materials. Brief, factual. \$1.00 postpaid. Details free. Central States Research, Columbus 1, Ind.

SOMETHING To swap? Free advertising. Particulars, stamp. Swaplist, Bondville, Vermont.

VETERANS! Safeguard your discharge papers. Have photocopy made front and back. \$1 registered mail prepaid. Rapid Photocopy Co., 1214 New York Ave., Washington, D. C.

DOLLARS. Receive mail. Moneymaking propositions, opportunities, homework offers, small capital business plans, magazines. Your name listed twelve months, 10c. Carter, Box 8-FBB, Station A, New York 12.

MAIL Friends postcards from Niagara Falls. 10 for 50c. Address, stamp, return for mailing, Drdul, 358 Northumberland, Buffalo, N. Y.

EVERLASTING Bronze grave markers, signs, reasonable. Berg, Box 3162-A, Bridgeport, Conn.

STUNNING. Glossy finish photostamps. 100 only \$2.00. Different, beautiful. Free sample. Herman Neely, Somerset, Ky.

HANDGRENADE Desk lighter. Get an intriguing and novel desk lighter made from empty shell of real handgrenade and adapted with a good lighter. Grenade in olive drab lacquer and lighter in bright brass. Remit \$1.45 postpaid in U. S. M. Wahil, 1301 Williston Ave., Waterloo, Ia.

VENETIAN Blind tape 25c yard, cord 5c yard. Moore, Box 461, Kittanning, Penna.

IDEAL Gift. Rich hand carved mother-of-pearl lapel pins imported from South Pacific. Handsome fish designs \$2.00 postpaid. Marlene, Box 942, New Haven 11, Connecticut.

SEND \$1 receive 15 wrenches or 10 gears, prepaid. Mechanical, 150-06 Liberty Ave., Jamaica, N. Y.

RUTLAND Processed marble grave markers. U. S. Government standard; proof against moss; lettering perfect; always clean white, stainless, beveled polished job; special discount of 25% to wives, mothers, and others who lost dear ones in war. Write for prices and full information. Cast Marble Co., 25 Kempton Place, West Newton, Mass.—Alexander Brady, 30 years Basic Inventor, President. Please send card.

SURE Kill rat bait. A new type rat bait guaranteed to kill rats. Relatively harmless to human being and domestic animals. Made with the new, powerful, 500, 600 Mg. 1 Kg. Fortified Red Squill—the only kind approved by the U. S. Dept. of the Interior. Order yours today. 1,800 baits \$30. 4,500 baits \$50. 9,000 baits \$100. Send money order to Bennie Flanigan, 500 S. E. 3rd St., Des Moines 16, Iowa.

DESK Type fountain pen with base, \$1.25 postpaid. General Sales, 320 Ferry, La Crosse, Wisconsin.

NEW York City postcards. Sample and list 5c. Kogan, 515 West 122nd, New York 27, N. Y.

NEW Personalities for old by correspondence. Results guaranteed. Personal development plan free. Write today. Personal Psychology, Incorporated, 1008 Washington Bldg., Louisville 2, Ky.

ARCH Supports individually made. \$4.50 pair. Booklet, Archcraft Co., 600 West 164 St., New York City 32, N. Y.

COCKROACH Exterminator; dying like magic, with apparatus. \$3.00 complete. Colony Dancewax, Davenport, Iowa.

FITTED Arch supports, magic insoles and other foot remedies. Reynolds, 5510 Le Moyne, Chicago 51.

NAMES 1000 Rochester housewives \$2.00. Pinzer, 7 Bardin, Rochester, N. Y.

GLASSES Broken? Send pieces. Accurate duplications. Low rates. Optical Service, 1360 Peabody, Memphis, Tenn.

MEXICAN Feathered bird pictures. Samples 25c. Large framed picture \$1.25. Particulars free. Foley's, 217 Grafton St., Brockton 6, Mass.

LUMINOUS Nursery wall decorations, fascinating cutouts glow in darkness. Complete set 35c. Two glowing nursery pictures suitable framing 25c. Circulars. Luminovelties, 469 Irving, Brooklyn, N. Y.

TATTOOING Outfits, designs, colors. Write today. Zeis Studio, 728 Lesley, Rockford, Illinois.

"FREE!" Perfumaire, homes, offices. Hirschfield's, 130-A East 107th Street, New York.

WALKER'S Genuine sperm clock oil—guaranteed not to gum. Lubricates light machinery, even at zero temperature. \$1.00 per ounce postpaid. C. C. Walker, Long Prairie, Minnesota.

RECEIVE Mails, samples, moneymaking opportunities, literature. Your name in several mailing lists, 10c. Rogowski, 3415 Broadway, New York 31.

BOOMERANGS Real long distance, come back. Aboriginal type. Amazing, scientific, and lots of fun. \$3.00 postpaid. Over Seas Products Co., Box 190, Los Angeles 53, Calif.

RARE Seeds—Climbing tomato, climbing cucumber, squaggetti packets 25c each. List free. Mexican Products Co., 126 N. Main, Tulsa 3, Okla.

CARPENTERS—Fast! Accurate! Calculator. Simplifies everything. Postcard brings particulars. Box 1414, Great Falls, Montana.

YOUR Name in silver on 100 matchbooks \$1.25. Brookside Press, Antrim, N. H.

HELPFUL Aviation books. Catalog free. Popular Mechanics Press, (C-43), 200 E. Ontario, Chicago.

GOOD "Used" self-instruction educational books on all subjects bought, sold, rented, exchanged. Satisfaction guaranteed. Complete information and 100-page illustrated bargain catalog free! Write—Nelson Company, Chicago 5.

GIGANTIC Mails, magazines, samples, listing 10c, three times 25c. Waddell's Directory, 341 East 76th, New York 21.

TAILORED Homes plan book. Sixty floor plans, one-story houses with your selection of Colonial, English, Spanish, Moderne exteriors, making hundreds of combinations! Price \$1.00. Distributors wanted. H. P. Jones, 486K Brandeis Bldg., Omaha 2, Nebr.

BE A good conversationalist! Our practical course teaches you how! Details free. Nankers Company, Box 1222, Colorado Springs, Colorado.

BIGGEST Money in tattooing now! No experience required. Complete instructions with outfits. Send for free literature. Tatuco, 651 South State, Chicago.

SEEK Buried treasure. Methods, mysteries, devices explained. Circulars free. Century Press, Box 151-B, Glen Ellyn, Ill.

"BIBLE Studies." 70 lessons 25c. Bulletin, Box 87, Station H, New York 25.

MEDICAL Laboratory technicians in great demand. We train you in your spare time, in your own home. You can practice while studying. Write for free catalogue. Imperial Technical Institute, Box 973-J, Austin, Texas.

MEXICAN-AZTEC Featherwork tropical bird picture cards. Samples 25c. Bulletin free. Mexican Products Co., 126 No. Main, Tulsa 3, Okla.

LUMINOUS Paint. Best quality. Glows bright blue in dark. 1 oz. each paint and sealer only \$1.39 postpaid. Black Light Products, 450 E. Ohio St., Chicago 11, Ill.

SQUARE Dance instructions, calls, 25 sets, \$1.00. Rayburn, Lonsdale, Arkansas.

METAL, Mineral locators latest 1946 electronic type ready for immediate shipment. Fisher Research Laboratory manufactured 2 million dollars worth of electronic equipment for the U. S. Army, including some of the finest metal-locators. Experience gained is yours in the best metal, mineral locator. Free 16 page booklet upon request. Fisher Research Laboratory, Palo Alto, California.

START Plating business at home. Amazing profits. Make own outfit. Inexpensive. Illustrated instruction booklet 25c. Popular Mechanics Press, (C-43), 200 E. Ontario, Chicago.

BEES and FRUIT

Bees are necessary for profitable fruit production. Cool weather during fruit bloom makes long distance flying impossible. Hive should be located within 200 feet of fruit trees to insure pollination of blossoms.

Free Booklet: "BEES AND FRUIT"

Start now to get more money out of your fruit trees. Bees are easy to handle. Complete instructions given in our beginner's book.

"STARTING RIGHT WITH BEES"
96 pages, illustrated, ONLY 50 CENTS

GLEANINGS IN BEE CULTURE

64 page illustrated monthly magazine, one year, \$1.50. Both book and magazine for \$1.70 in the United States and Canada.

Root
QUALITY
BEE SUPPLIES

THE A. I. ROOT CO.
Dept. S MEDINA, O.

120 MILES PER GALLON

Complete motor ready to mount on ordinary balloon-tired bicycle. No mechanical skill required to install. No alteration of bike necessary. Easy to operate.



Can be pedaled by merely releasing clutch. Speed 5 to 40 M.P.H. Shipped prepaid complete with 4 cycle, 2½ H.P. motor, all attachments and heavy duty stand. Get complete facts about this low-cost, convenient transportation. . .

Write today for descriptive illustrated literature.

WHIZZER MOTOR SALES CO.
Dept. A, 3132 E. Washington, Los Angeles 23, California

**EASY to
PLAY**



**Order
Yours TO-DAY**

**The New Luellen
HARMONICA**

Most wonderful pocket instrument ever made is the harmonica. Easy to master, fun for Everyone. The Luellen has 10 holes, 20 notes. Key of C. Beautiful tone. Now ready. Postpaid Only..... **\$2.10**

INSTRUCTION BOOK. Simple for youngest child. No notes, scales nor exercises. Ten lesson charts show everything. Includes 75 popular songs. Price \$1.00. Here's our special introductory offer: The Instructor and the Harmonica, both postpaid, both for \$2.69. Send Check or Money Order Today.

JOHN LUELLEN & CO., 17034 Page Avenue, Dept. 303, Hazelcrest, Ill.

**3
NEW
CRAFT
BOOKS**



Make every stroke with authority; every tooling with adroitness; every carving with competence. These instructive books by experts tell how. All the tricks, all the short cuts, graphically illustrated.

\$1.00 each postpaid
HOUSE OF LITTLE BOOKS
80 E. 11th St., New York 3, N. Y.

FIX ANY RADIO
Amazing New Invention



**PRICE ONLY
\$1.50
COMPLETE**

Learn quickly to repair all radio sets. New, different Comparison method. No previous radio knowledge needed. Introductory training included. Simple, picture suggestions tell you where to look for faults and how to make the repair. No testers needed for most jobs. Manual 8 1/2 x 11 in., 63 job-sheets, 24 blueprints. Many hints. New edition. Order manual 3-P. Price only \$1.50 postpaid. Money back guaranteed.

SUPREME PUBLICATIONS 9 S. Kedzie Ave. Chicago 12, ILL.

LEARN



PORTRAIT PAINTING AT HOME

● Previous art training or talent NOT necessary. The Stuart System teaches you, in 11 easy-to-follow lessons, to (1) locate features exactly to correspond to model's features, (2) outline head and face to correspond to model's outline, (3) make each feature a true portrait of that feature in the model, (4) produce shadows and shading that exactly correspond to that of model's face, (5) mix flesh paint tints that are like living flesh. You, too, can make exact charcoal and oil likenesses. Send for free booklet **today**.

STUART STUDIOS

121 Monument Circle, Room 636, Indianapolis 9, Ind.
Please send me free book and outline of lessons.

Name _____
Street _____
City _____ State _____

**I'm no Wizard... BUT
I'll Teach YOU to
PLAY the PIANO
in 10 DAYS
Without Music**



OR MONEY BACK

Give me just 10 days and I'll prove that you, too, will be able to play piano "by ear." Latest song hits, waltzes, hymns—all quickly learned by my easy home study method.

**Thousands Have
Thrilled to This Quick, Easy
Way to NEW POPULARITY**

It's amazing how quickly you'll learn,—gain more poise, popularity, friends. Many have said, the Dave Minor way is sheer magic. Send coupon today. Complete course sent for your inspection, trial and approval.



**No Scales, No Long Exercises
START RIGHT IN WITH SONGS**

You start playing songs from the first lesson and, before you know it, you're Playing the piano surprisingly well. This sensational home piano course is complete, with pictures and all instructions, everything you need. And remember you must be able to play piano in 10 days or get your money back.



TWO FOR ONE OFFER!

If you act at once, you will get, in addition to the complete Dave Minor course of 25 lessons, his wonderful new 72-page book of 50 songs which you quickly learn to play the Dave Minor way. Don't wait, because this liberal offer may be withdrawn at any time due to present conditions.

SEND NO MONEY — MAIL COUPON

Fill in and mail coupon today. When Dave Minor's play-by-ear piano course arrives, just deposit \$1.49 plus postage through postman. Nothing else to pay. Follow the instructions for 10 days. Then, if you're not entirely satisfied with your progress, thoroughly thrilled, return your course and get your money back. So order today, and get the big book of 50 songs without extra cost. Rush coupon to

**DAVE MINOR, Room 49-C
230 East Ohio St., Chicago 11, Ill.**

**DAVE MINOR, Room 49-C
230 East Ohio St., Chicago 11, Ill.**

Send your complete "Play-by-Ear" Course of 25 lessons. Also 72-page Piano Song Book at no additional cost. I'll pay \$1.49 plus C.O.D. postage on arrival on your positive guarantee I may return course in 10 days for full refund. (If you prefer send \$1.49 with order and Dave Minor pays the postage.)

Name.....
Address.....
City.....Zone.....State.....

Say you saw it in Popular Mechanics

AVIATION EDUCATION



Now Available at
NORTHROP AERONAUTICAL INSTITUTE

Northrop Aeronautical Institute offers Veterans and civilians a practical, thorough education in Aviation... in a new school on Northrop Field. The Institute is a division of Northrop Aircraft, Inc., supervised by men experienced in designing, building, and operating aircraft.

AERONAUTICAL ENGINEERING

Learn Engineering as practiced in the industry... from the organization that developed many outstanding planes, including the P-61 Black Widow and the Flying Wing.

AIRCRAFT AND ENGINE MECHANICS

Training at Northrop is designed to prepare you for Airline Maintenance and other interesting, well-paid positions as a maintenance or service specialist.

VETERANS

The Institute is approved for training of veterans under the G. I. Bill of Rights. Complete your training for civilian aviation. Send coupon today.

NORTHROP AERONAUTICAL INSTITUTE

1527 E. Broadway, Hawthorne, California

SEND COUPON FOR FULL INFORMATION

NORTHROP AERONAUTICAL INSTITUTE

1527 E. Broadway, Hawthorne, California

Please send me your free, illustrated booklet and information, including starting dates and tuition rates, on the training courses checked below.

- Aeronautical Engineer Aircraft Mechanic
 Engine Mechanic Master Aircraft & Engine Mechanic (A & E)
 Home-Study Course, Aircraft & Engine Maintenance

NAME _____

ADDRESS _____ AGE _____

CITY _____ ZONE _____ STATE _____

Check one: Veteran; In Service; Civilian **PM-3**

Learn the business end of building construction with *The Rapid Estimator*.

Practical in any part of the world. Labor cost calculator, and modern methods, gives ways to clear the minds of builders on detail estimating in the following trades: Carpentry, Millwork, Lumber, Brick, Terra-Cotta, Cut Stone, Cobble Stone, or other stone, Concrete Construction, Plastering, Painting, Remodeling, Wrecking, Excavating, and Contractors equipment per hour. Once in your hand you will not part with it. Blue print, loose leaf, book form, pocket size. **\$12 MONEY ORDER.**

E. W. HOFFNER P. O. BOX 5026 CHICAGO, ILL.

IF YOUR TARGET FOR THE FUTURE IS... **SECURITY**

AIM at a GOVERNMENT JOB

(CIVIL SERVICE)

Thru CAREER TRAINING INSTITUTE

Men & Women **NOW!**

Prepare at home thru broad, intensive, simple training to take tests for good jobs offered in Civil Service. Hundreds of classifications, many jobs for 1946, every chance to advance. Vacations with pay, pensions, sick leaves. No layoffs, no strikes, no discrimination. Our course is so inexpensive, no sensible person should delay mailing coupon TODAY

CAREER TRAINING INSTITUTE, Dept. 202
1060 Broad Street, Newark 2, N. J.

Please send me FACTS regarding Government Employment (Civil Service), and how your course will help prepare me for tests.

Name _____

Address _____

City _____ Zone _____ State _____

Veteran? yes _____ no _____

VETERANS GET PREFERENCE

THIS GREAT BOOK

HOW to BREAK and TRAIN HORSES



FREE!

Every farmer, every lover of horseflesh should have a copy of it. This amazing book tells how to know horses—how to break them—how to train them—how to make money as a master horseman. Write for it today—FREE, together with my special offer of a course in Animal Breeding. If you are interested in Galting and Riding the saddle horse check

here Do it today—now. You'll never regret it.
BEERY SCHOOL OF HORSEMANSHIP
Dept. 1103-D Pleasant Hill, Ohio

COLOR BLIND? CORRECTION IN 90% OF THE CASES

Don't allow color blindness to handicap your chances for success. Have a job with a future. New scientific method of correction available now. All tests for jobs requiring accurate color recognition are passed easily in 90% of cases. BY MAIL. NO CORRECTION—NO PAY. Write today.

COLOR BLIND CORRECTIVE SCHOOL
603½ South Mariposa, Los Angeles 5, California

REFRIGERATION and AIR CONDITIONING



Train where the Army trained. Learn at home or in our big shops. Expert instructors—real machines. Easy to learn. Write for big FREE catalog today. No obligation. **COMMERCIAL TRADES INSTITUTE**, 209 W. Jackson Blvd., (Dept. M-23), Chicago, Ill.



VETERANS ASK FOR GI PLAN

ATTENTION!! Inventors

EXHIBIT YOUR MODELS OR DRAWINGS AT THE WORLD'S INVENTION EXPOSITION, CHICAGO ARENA, APRIL 11th, to 22nd. Here thousands of mfrs. will see your invention. Small rates for display space. Make reservations now. Write for folder. **WORLD'S INVENTION EXPOSITION**, Reservation offices, 155 N. Clark St., Chicago 1, Ill.

Learn TOOL DESIGN

Now, as never before, draftsmen and tool designers are needed to redesign for peacetime reconversion. Qualify quickly. Many making \$100 to \$150 per week. More qualified men needed than available. Good pay jobs waiting. Rush name and kind of job wanted today for full free facts. State age.
OHIO INSTITUTE OF TECHNOLOGY, Box 304, Greenville 1, Ohio

CODE SPEED SHORT CUT

Be an expert. Learn to be a Telegrapher or Radio Operator. Thousands of men needed. Intensely interesting work—good pay. Learn at home or wherever you are, quickly, easily with the famous Candler Speed System. Book of particulars Free.
CANDLER SYSTEM CO., Dept. 5-C, Box 928, Denver 1, Colo., U.S.A.



SIMPLE EASY INVENTION TRIMS HAIR AT HOME!

SAVES BARBER BILLS

Trims hair as it combs! Easy! Quick! Keeps men's, women's children's hair trim, neat, freshly-cut looking all the time! Trims, tapers, thins out uneven hair. Use like ordinary comb. Safe. Simple. No experience required. Fine for legs, underarms!



SAMPLES FOR AGENTS immediately to all who send name at once. A penny postal will do. **SEND NO MONEY.** Just your name. **KRISTEE CO.**, 683 Bar St., AKRON, OHIO

SAY YOU SAW IT IN POPULAR MECHANICS

POPULAR MECHANICS

DO ANY JOB.. EASIER.. QUICKER
MAKE MORE MONEY *in the*
BIG OPPORTUNITY
FIELDS

Here's the Help You Need
For Best Paying Jobs
Right NOW!

FREE TRIAL
IN YOUR OWN HOME

Used by Army, Navy, Other Government
Depts., 200 Schools and Industrial Firms.

SEND NO MONEY
 Select the Books
YOU Need Now!
 We Ship **C.O.D.**
 Anywhere in U. S.
 and Will Refund
 Amount Paid if
 Not Satisfactory.

Don't submit to tough, heartbreaking job competition, now that wartime jobs are over. Get into one of these big opportunity fields. Big money and many other advantages await you if you prepare now. Here is the help you need—**EASY—QUICK—AT LOW COST.** Thousands of men have already used these famous books. Beginners and experienced men alike have doubled and tripled their earnings with this help. You too, can now get the special knowledge you need for top pay, better jobs, or a business of your own. This is your **GOLDEN OPPORTUNITY.**

AIR CONDITIONING

Big air conditioning boom interrupted by war will be bigger than ever. It's ready to GO now! Get this non-technical book by international authority and be ready for your share of millions to be spent. Covers whole field. 450 pages. Illustrated. \$3.50.

AIRPLANE WELDING

All metal airplane building offers big peacetime opportunities

New 2nd edition of this famous book by J. B. Johnson, Materials Division, Wright Field. The authoritative and practical book on Airplane welding and materials brought right up to date. 420 pages, 193 pictures. \$3.50.



MODERN WELDING PRACTICE

Newest book on all types of welding and heat treatment of metals. Written by recognized specialists in training men for production jobs. **Practical and Non-Technical.** Covers everything you need to know. Prepare for best pay jobs now. Price \$4.00.

430 Pages
 277 Illus.
 Practical and Non-Technical

everything you need to know. Prepare for best pay jobs now. Price \$4.00.

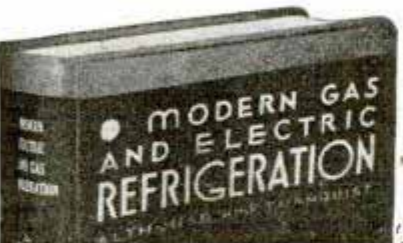

REFRIGERATION—Book of the Hour!
Biggest Opportunity in Many Years!

NEW PRINTING—ALMOST 1000 PAGES

408 Pictures—17 Diagrams in Colors Makes All Refrigerator Service Maintenance, Repairs Simple as A. B. C.

Thousands of Refrigerators need repairs! Owners will pay big for competent service which will be needed more and more. Get **MODERN GAS AND ELECTRIC REFRIGERATION**, the non-technical guide to all types of refrigerators and get your share of this new profit. Get a job or start your own service business. This book will help you make money anywhere. Price \$5.00.

BODY & FENDER REPAIR

Owners will spend big money to keep their good older cars looking like the new ones coming out. This is a practical money-making guide, ideal for shop owners and every man who wants a share of the millions to be spent in keeping old cars looking new. Tells how to get a good job or start business of your own with small capital. 325 pages, 232 illustrations. \$3.00.



DYKE'S FAMOUS CARBURETOR BOOK

This famous book has been the standard guide in the best paying auto work for a generation. It has helped thousands of men make money. New edition covers engine tune-up, compression, ignition, carburetion, fuel pump valves, etc. Use this book to specialize in this big field. 243 pages, 549 illustrations. \$3.00.

HOUSE WIRING
NEW 1945 EDITION

Get this new sixth edition of this standard and practical electrical wiring book. It gives complete practical instruction on every phase of house wiring in one handy volume. Goes further than most books on subject. Hand-book style. Gives National Electric Code. 400 pages, 669 illustrations. Electrical work will reach a new high with millions of new homes to be built. Get started now. \$2.50.

15 Million Refrigerators
Need Service and Repairs



NEW 20th EDITION
Leading Auto Book for Over 32 Years

World's Greatest AUTO BOOK
New Material on Transmissions, Trucks, Tractors, Diesels, Aircraft and Auto Engines

Now with millions of cars needing repairs and thousands of men needed to do the work, you need the famous **DYKE Auto Book** more than ever before. Brand new 20th Edition covers all principles, construction, repair, adjustments, testing, troubles and remedies of all cars. Over a half million copies of 20 editions of Dyke's have been sold. Gives specifications of old and newer cars. World's biggest book value, \$6.00. This big book, a complete auto library in one volume, has 1483 pages—4600 illustrations and diagrams—weighs 6 lbs.—equal to 4 ordinary books.

ENGINEERS HANDBOOK

World famous Bailey's handbook of universal questions and answers for Stationary, Marine and **DIESEL** engineers and firemen. Prepares for any license examination. This is the one book that men should have if they want to reach the top in installation, maintenance and operation of Diesel and steam plants. Pocket size, \$2.00.

Mail Coupon to

Goodheart-Willcox Co., Inc.
 209 S. Michigan Ave., Dept. 13, Chicago 16, Ill.

SEND NO MONEY! Mail Coupon

GOODHEART-WILLCOX CO.,

209 S. Michigan Ave., Dept. 13, Chicago 16, Ill.

Send books checked, C.O.D. I will pay postman, plus few cents charges. If not satisfactory I will return books in 5 days and you will refund money paid. (Outside U.S. or possessions remit with order.)

- Gas & Electric Refrigeration \$5.00
- Dyke's Auto Book \$6.00
- Dyke's Carburetor Book . \$3.00
- Modern Welding \$4.00
- Airplane Welding \$3.50
- Sheet Metal Layout \$3.00
- Air Conditioning \$3.50
- Engineers Handbook \$2.00
- Body and Fender Repair . \$3.00
- House Wiring \$2.50
- Shop Math. (2 vols.) . . . \$3.00

If remittance accompanies order we will pay all postage charges under same return privilege.

Name
 Address
 City State



SUCCESS!

How to Get Along in this World

Here, gathered together for the first time, are 5000 gems of worldly wisdom on how to live joyously, successfully . . . how to handle people, make money, be happy. Written out of actual experience by the best brains of mankind . . . during the past four thousand years! To-the-point, workable instructions on getting ahead. Only \$1. Included are lessons on how to use these quotations in your daily life. Clip and mail coupon below for FREE details today.

Short-Cut Mathematics

COMBINED WITH

Practical Mechanics Simplified

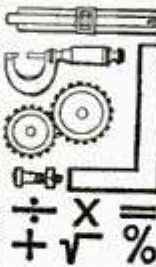

Be a "master mind." Learn how to juggle figures, do baffling tricks with numbers. Add long columns of figures this lightning-quick, short-cut way. Multiply 4 figures by 4 figures without old-fashioned multiplication. Here are speedy, simplified systems used by stage "wizards," expert accountants, engineers. Only \$1. Course includes illustrations, problems, answers. Mail coupon below!



SUPER JU JITSU

Now.. get tough DOUBLE-quick!

Step up your fighting power . . . Learn lightning-quick American SUPER JU JITSU. Develop your body—be dangerous! Big illustrated home-study course, reveals secrets on how to make deadly weapons of just your bare hands. Easy to learn. Get amazing details at once FREE—mail coupon below.

MAGIC AND CARD TRICKS



HOW to PERFORM for FUN and MONEY
Mystifying stunts made easy. **Secrets of magic** revealed in new illustrated course. Teaches tricks with coins, handkerchiefs, balls, ropes, etc. Shows you how to protect yourself from card sharks . . . their card manipulations exposed! Get the "inside" information on baffling stage performances. Learn how to be a magician and entertain friends. Mail coupon for FREE details.

CARTOONING MADE EASY

New Self-Instruction Course
Learn how to draw funny pictures for money—caricature, comic strip, gag-cartoon, political and editorial cartoon, etc. Practical simplified method takes out all the mystery. Step-by-step lessons for home-study. Excellent SPARE-TIME training for pleasure and profit. **FREE** interesting details on request. Just send name and address on coupon below.



how to write better letters

Make your letters CLICK! Learn to put warmth and sparkle into business and social correspondence. Practical **brass-tacks** instruction on writing successful job-getting application letters, exciting keen-witted friendly letters, etc. **ACTUAL EXAMPLES** show tested ways of packing your letters with vitamins. Fascinating details on request . . . **FREE**. Just mail coupon below today!

NELSON CO., Dept. 5C02, 1139 S. Wabash Ave., Chicago 5, Ill.
Write today for complete details on any of these **SELF-INSTRUCTION COURSES**. Send coupon below for the world-famous copyrighted Success-Catalog—it's **FREE**. on request.

FREE details . . . mail coupon!

NELSON CO., Dept. 5C02, 1139 S. Wabash Ave., Chicago 5, Ill.
Please send me—**FREE** and without obligation—illustrated Success-Catalog containing information about the course (or courses) I have checked below. No salesman will call.

- | | |
|--|--|
| <input type="checkbox"/> Success! | <input type="checkbox"/> Magic and Card Tricks |
| <input type="checkbox"/> Short-Cut Mathematics | <input type="checkbox"/> Cartooning Made Easy |
| <input type="checkbox"/> Super Ju Jitsu | <input type="checkbox"/> How to Write Better Letters |

NAME _____
ADDRESS _____
CITY _____ STATE _____

LEARN AT HOME TO MOUNT BIRDS



Animals, Heads, Fishes, Pets; to TAN.
Be a Taxidermist. Profit and FUN.
Hunters, save your valuable **TROPHIES**.
Mount ducks, squirrels, everything. Learn to **TAN** for leather and furs. Wonderful **HOBBY**
Have a **HOME MUSEUM**.—**BIG PROFITS**
mounting for others. **INVESTIGATE NOW.**
FREE BOOK With 100 fine
game pictures.
NOW absolutely FREE. Write TODAY.

Send Postal **TODAY** for **FREE BOOK**. State AGE.
N.W. SCHOOL OF TAXIDERMY, Dept. 3373, Omaha, Neb.



MOTOR HISTORY OF AMERICA

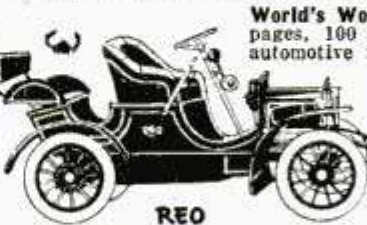

World's Wonder Book of Motor History. 416 pages, 100 illustrations. Authentic story of automotive industry since inception. Details careers of Ford, Willys, Dodge Bros., Haynes, Chrysler, Winton, Chalmers, Durant, Chapin, Nash, Olds, Flanders, Duryea, others. Lists over 1600 makes of cars. Contains "Scrapbook" supplement, with dozens original historical ads, by Floyd Clymer Postpaid \$3.00; cloth-bound \$4.00.

REO
CLYMER, Dept. PM, 2125 W. Pico St., Los Angeles 6, Calif.

PLUMBING REPAIRS

made EASY



This handy book is written for the man who likes to work around the house, yet is not sure he is doing right. This big book shows you how to repair every bit of plumbing in your home. Saves many dollars. One job more than pays for book. 248 pages, many illustrations and diagrams. Money back if not more than pleased. Send today . . . only \$2.50.

Only \$2.50
Send Today. Money Back Guaranteed Gateway Book Co., Dept. PM-15B
32 N. State - Chicago 2, Ill.



"MAGIC IS FUN"

A New Magazine for Amateur Magicians!
First issue on sale March 1st at news-stands and magic dealers. **CONTENTS:** 24 large pages of easy to do tricks with coins, cards, mind reading effects, stories of famous magicians, instructions in Showmanship, etc. If your dealer does not have **MAGIC IS FUN**, remit 25c for first issue or \$1.50 for 6 issues. Outside U.S.A. price 30c per copy, \$1.75 for 6 issues.

D. ROBBINS & CO., Dept. M.I.F.
152 W. 42nd Street New York 18, N. Y.

PICTURE RING \$1.

Exquisite Onyx-like Picture Ring—made from any photo. **Send No Money!** Mail photo with paper strip for ring size. Pay postman only \$1.00 plus postage. Hand tinted 25c extra. Photo returned with ring. Money back guarantee. Send photo and ring size now. **PORTRAIT RING CO., Dept. W-44, CINCINNATI, O.**

LAW

STUDY AT HOME for PERSONAL SUCCESS and LARGER EARNINGS. 35 years expert instruction—over 108,000 students enrolled. **L.L.B.** Degree awarded. All texts furnished. Easy payments. Send for **FREE BOOK**—"Law and Executive Guidance."
AMERICAN EXTENSION SCHOOL OF LAW
Dept. 63M, 646 N. Michigan Ave., Chicago 11, Ill.

I SEND THESE PRODUCTS

..to start you in a Food Business

Make extra money in full or spare time. Big assortment. **Actual full-sized packages** sent for own use and to show friends and neighbors. Take orders. **Big profits.** Complete facts rushed to you. **Be first in your territory. Write today.**

FOSTER BROTHERS CO.
Dept. 163, Decatur, Illinois

SAY YOU SAW IT IN POPULAR MECHANICS

IMAGINE THEIR JOY

WHEN THEY FOUND THEY COULD PLAY



LEARNED QUICKLY AT HOME

"I didn't dream I could actually learn to play without a teacher. Now, when I play for people they hardly believe that I learned to play so well in so short a time."
*H. S. C., Calif.



PLAYS AT DANCES

"Your lessons have been most satisfactory. I can play all of the popular songs. I have earned money playing at dances."
*E. N. J., New York.



PLAYS ON RADIO

"I can't keep from telling you that I have a good position playing from KTHS, Hot Springs, Ark., every morning."
*J. S., Okla.

What Instrument Would You Like to Play?

JUST name your instrument and we'll show you how you can learn to play it—quickly, easily, in spare time at home. Never mind if you don't know one note of music from another—don't worry about "special talent." And forget all you've ever heard about music being hard to learn.

The truth of the matter is that *thousands now play who never thought they could!* Yes, men and women everywhere have discovered this amazingly easy way to learn music at home. Now they are enjoying the thrilling satisfaction of playing the piano, violin, guitar, saxophone or other favorite instruments. Some of them are playing in orchestras and over the radio; others are teaching music, making money in spare or full time. And thousands are having the time of their lives playing for their own enjoyment and the entertainment of their friends.

LEARN TO PLAY BY NOTE

- Piano Guitar
- Violin Saxophone
- Organ Mandolin
- Tenor Banjo
- Hawaiian Guitar
- Piano Accordion
- Or Any Other Instrument

CARTOONING



BECOME CARTOONISTS QUICKLY with our NEW, EASY, 45 LESSON COURSE. Only \$2.85 postpaid. Sample LESSON PLATE, details on our FREE EMPLOYMENT SERVICE and BIG TRIPLE VALUE OFFER sent FREE. Rush name and address TODAY.

NATIONAL ARTISTS BUREAU

Dept. A-7, Box 4248 Dallas 8, Texas

HERE'S A QUICK WAY TO MAKE A GOOD LIVING

Train at home thru our easy to learn courses, self-instruction and educational textbooks. Learn Refrigeration, Radio Servicing, Drafting, How to operate a Retail Store, Advertising, Engineering, Business Management, Aviation, Electricity, Diesel, and many others. Earn more money—be praised by others for your accomplishments, have more leisure and security for old age by knowing How-To-Do-It. Details in our FREE Opportunity Guide. We will also include a special list of FREE trade magazines, bulletins, booklets, information manuals, etc. FREE. . . .

Write--HARRIS PUBLICATIONS, HARRIS BUILDING, MAHOPAC 2, NEW YORK

TRAVEL FOR "UNCLE SAM"!

\$1,506 to \$2,650 FIRST YEAR



RAILWAY POSTAL CLERKS

Veterans Get Special Preference

Many other Government Jobs. City and Rural Carriers — Postoffice Clerks — Patrol Inspectors — Accountants — Stenographers — Typists — etc. Prepare Now for 1946 Examinations.

FRANKLIN INSTITUTE, Dept. N54, Rochester 4, N. Y.

Sirs: Rush to me, without charge, copy of 32-page book, "How to get a U. S. Government Job," list of positions, and full particulars telling how to qualify for them.

Name.....

Address..... Vet?.....

No tedious study and practice, no tiresome exercises. You learn to play *by playing*—start right in with the melody of a simple tune! It takes only a few minutes a day; the cost is trifling. Does it sound too good to be true? Mail the coupon and get the FREE PROOF!

FREE PRINT AND PICTURE SAMPLE

Fascinating illustrated booklet answers all your questions; free Print and Picture Sample shows how method works. If interested, just mail coupon. U. S. School of Music, 73 Brunswick Bldg., New York 10, N. Y.

*Actual pupils' names on request. Pictures by professional models.

U. S. SCHOOL OF MUSIC 73 Brunswick Bldg., New York 10, N. Y.

I am interested in music study, particularly in the instrument indicated. Please send me your free illustrated booklet, "How to Learn Music at Home" and the Free Print and Picture Sample.

Name..... (PLEASE PRINT)

Address.....

Instrument..... Have you Instrument?.....

MAKE MORE MONEY

Applying or Selling ROOF COATING

Extra profitable, easy to apply. Exclusive new formula makes this America's best roof coating for felt, composition, steel, slag, iron, gravel, concrete and metal roofs. Definitely superior in all climates, at all temperatures. Act at once!

DEALERS & AGENTS WANTED Write for Details of Our Proposition

LASTING PRODUCTS COMPANY MANUFACTURERS OF PAINTS, PUTTIES, PLASTICS FRANKLINTOWN ROAD PLANT, BALTIMORE 23, MARYLAND

SAY YOU SAW IT IN POPULAR MECHANICS

Learn REFRIGERATION and AIR-CONDITIONING

ARE YOU HANDY WITH TOOLS?

Exceptional opportunity for men of all ages up to 60. The demand for repair and service mechanics in both REFRIGERATION and AIR-CONDITIONING is acute and will continue. You can easily and quickly—

Learn to Be a Service Mechanic at Home or in Our Shops

Our practical, thorough course is easy to grasp and can be studied at home in your spare hours. No previous experience is needed. A common school education is enough. Learn how to start your own business with \$50.00 worth of tools in garage or basement. Open up your own shop or take a well paid job in this active field.

START YOUR OWN REPAIR SHOP

Write for free booklet today. No obligation whatever.

MAIL COUPON TODAY



Send for FREE BOOKLET!

Mechanics Training School

4701 W. Pico, Dept P-3, Los Angeles 6, Calif.

Dear Sirs: Please send me, without obligation, your free catalog and full details.

Name _____

Address _____

City _____

State _____

SAY YOU SAW IT IN POPULAR MECHANICS

TELESCOPES MICROSCOPES BINOCULARS

War Surplus Lenses and Prisms

at a small fraction of cost

Assemble your own high quality optical instruments with these war surplus lenses and prisms which are far superior in quality to those found in the usual commercial instruments. Simple instructions come with each set. Some have minor edge chips which do not interfere with their use, and all are guaranteed to give perfect results.

Navy 7 x 50 prism binocular set. Each set makes a 7 x 50 monocular. Two sets make a binocular. The complete binocular sells for \$162.00. Set of lenses and prisms..... **\$2.75**

Complete achromatic lenses and prisms for 20 power 50 mm. prismatic telescope..... **\$2.90**

Complete achromatic optics to make 40 power terrestrial telescope..... **\$3.25**

Complete optics for making an adjustable achromatic microscope, 100 to 500 power.. **\$2.25**

Lens Assortments for Experimenters

Twenty assorted lenses, some with chips or minor defects, but all usable—excellent for making all types of optical instruments and magnifiers. **\$1.50**

Super assortment, including forty large and small plain lenses, achromatic lenses, and prisms. Approximately \$90.00 worth of optics for only **\$4.95**

We Pay the Postage—Prompt Shipment Guaranteed

BROWSCOPE CO., Dept. 3M, 24 West 45th St., N. Y. C.

Free! VITAMIN GUIDE BOOK

No longer need you pay \$4, \$5, \$6 or even \$10 per 100 capsules for the same vitamins your Doctor advises. After 20 minutes reading of this Guide Book, you will understand vitamins as you never have before. You will not be fooled again by confusing and mysterious labels; you will be able to pick up any vitamin product and know if you are getting your money's worth. Give up buying vitamins blindly. This revealing Guide Book will show you how to save up to 40%. It's absolutely free and without obligation. Send post card today to Vitamin-Quota, Dept. 377, Borden Ave. and 21st St., Long Island City 1, N. Y.

The SLIDE RULE

And How to Use It

Send for your copy now. Big book. 8 1/2 x 11 in. Cloth Bound. Slide Rule in case in book cover.

Wilcox-Follet Co., Dept. 23, 1255 S. Wabash Ave., Chicago 5

10 INCH SLIDE RULE FREE WITH EACH BOOK

Send for this sensational slide rule book and FREE Slide Rule now. Learn in a few hours to do lightning calculations. Do all problems. Find ratios, percentage, squares, areas, etc. Genuine Mannheim type Slide Rule with A, B, C, D and K scale and Lucite Magnifying indicator included. Send only \$2.98 for full payment today or order on post card for C.O.D. delivery. Money back if not satisfied. Limited quantity. Rush Order.

HAIR CAN BE SAVED

"GIVE YOUR HAIR A CHANCE"

is the amazing book by J. W. KING, Sc. B. on dandruff, baldness, thinning and graying hair. Much valuable information.—Ohio State Medical Journal, Best investment.—Science Education, Debunks hair fads.—Scientific American, Scientific Fact.—Sunset Magazine, Without commercial bias.—Teaching Biologist, Book of a scientist.—Home Acres, Enormous assistance.—Pictorial Review, Practical.—Science News Letter. Send only \$2.00 today for postpaid copy of this authentic instruction, on how to save your hair. 6th printing. Prompt refund if not helped.

BRADNER PUBLISHING CO. (EST. 1933) Dept. 74, Cambridge 42, Mass.

JET PROPULSION

Experimenters! New principle to drive boats, bicycles, model helicopters. Circular on plans. Rush name. H. Maupin, Tipp City 12, Ohio.



"WONDER" ELECTRIC BUTTON

Most interesting electrical apparatus ever discovered. Make your own Telephone-Amplifier-Detectophone. Transmit your voice or music to distant rooms. Perform hundreds of fascinating experiments. So tiny it can be concealed in dozens of places. Send \$1 now for button and free 5,000 word instruction booklet with 60 illustrated experiments. SPECIAL OFFER 6 buttons and booklets sent post-paid for \$5.

BUCK MFG. COMPANY, Box A-28, No. Aurora, Ill.



MRS. BERRY'S POULTRY BOOK

BERRY'S Champion-Mated, Hand-Picked CHICKS, also SEXED, STARTED. 52 Breeds, 7 HYBRIDS, All Iowa Inspected, BWD Tested, Over 400 Prizes—30 Shows! LOW PRICES. In Business nearly 50 years. Beautiful POULTRY BOOK FREE, stamps appreciated. BERRY'S POULTRY FARM, Ex. 29, CLARINDA, IOWA



Bia Profit AUSTRA-WHITES

Sensational MONEY MAKING HYBRID. Customers report broilers 8 weeks, laying 4 1-2 mos. Disease resistant. Hardy Layers. 50,000 chicks weekly. Started pullets. Profit Sharing Plan. FREE Book. Write today. BERRY BROS. FARMS, Box 582, ATCHISON, KANS.

HOW RUPTURE MISERY MAY DISAPPEAR

Don't go on day after day suffering the tortures of a clumsy truss that presses on your hips and back, gouches your flesh, slips and slides and leaves your rupture DANGEROUSLY UNPROTECTED.

Get the truth about rupture care and how the newly patented Vita-Pneumatic Nature-Ade (U.S. Reg.) appliance with its unique features can help your rupture misery disappear. Write at once for FREE booklet containing much valuable information.

PNEUMATIC APPLIANCE, 103 PARK AVE., N. Y. 17, N. Y., DEPT. 45F

SIGNS EASILY AND EXPERTLY PAINTED WITH LETTER PATTERNS

AND SHOWCARDS

MANV SIZES & STYLES WRITE FOR FOLDER!

JOHN F. RAHN
1330-31 N. Central Ave.
CHICAGO 51, ILL.

PRESTO! ANYONE CAN MASTER GLAZE

LEAVES HARD GLASS-LIKE FINISH
 EASY TO APPLY
 PROTECTS THE SURFACE
 NO SMEAR OR STREAKS AS WITH WAX
 LASTS SIX MONTHS TO A YEAR
 SEALS THE PORES OF THE SURFACE
 WILL NOT FINGER-MARK
 NO OILY FILM AS WITH POLISH
 SAVES YOU MONEY

Car Owners! Meet Master Glaze—the sensationally different luster for new and used cars! Not a wax—not an oil polish—not a paint!—nothing that “smears” over the surface.

MASTER GLAZE is a unique discovery—a creamy liquid—quick and easy to apply! Gives a hard, glass-like surface. Even gasoline cannot dull it! Lasts six months to a year. Amazing luster—beautiful, sparkling clean and brilliant! Doesn't finger-mark—doesn't smear! A match box full glazes an entire car. Seals the pores—protects! **NOTHING LIKE IT!**

Full and part time Salesmen wanted. Send name and address for full information and free sample.

MASTER GLAZE CO., 7720-533 W. Harwood Ave., Milwaukee, Wis.

PLASTICS

You can easily make hundreds of attractive gifts such as salad bowl sets, ash trays, novelties, knick knacks, etc., etc. No expensive tools needed. Just send 3c stamp for prices on all materials and details of our FREE course in “WORKING WITH PLASTICS.” Prefabricated parts furnished at special low prices.

HOUSTON PLASTICS CO., INC.
729 M & M BLDG. HOUSTON 2, TEXAS

THE SOLUTION

A practical book that explains how to build financial success and independence. It is written clearly and forcibly for the selected few with foresight, who earnestly desire to be master of money and who are diligently seeking the sound way to financial security. Prosperity should be yours. This book which is not available at book stores is released to the public by mail at this time, for only \$1.39 complete.

Post Office Box 249, East San Diego 5, California

BUILD a BOAT

Row Boat—12 Foot
 Dinghy—8 Foot
 Dinghy—14 Foot Sailing
 Training Ship—6 Foot
 Sea Sled—9 Foot
 Outboard—12 Foot
 Cruiser—18 Foot
 Bicycle Boat—Kayak
 Row Boat—Sectional
 Dinghy—Sailing
 Canoe—16 Foot
 Sailing—12 Foot
 Outboard—12 Foot
 Runabout
 Pontoon Ice Yacht

FOR PLEASURE OR PROFIT DESCRIBES 17 LOW COST BOATS
 Get this outstanding book and build a boat at home for your own use or to sell at a profit. You can do it. Just the boat you've always wanted—power, sail or row boat—17 different kinds and sizes.
 Order BUILD A BOAT on postal card and pay only \$1.50 plus postage on delivery. Return in 5 days if not pleased and get money back. Or send \$1.50 with order and we'll pay postage. (Outside U. S. \$1.70 with order.) Order today.
POPULAR MECHANICS PRESS
 Dept. 598, 200 E. Ontario, Chicago, 11

SAY YOU SAW IT IN POPULAR MECHANICS

LANGUAGE IS POWER

. . . Forge ahead, win special assignments, promotion, better job in global peace time opportunities through ability to speak a foreign language.
Speak
 FRENCH
 RUSSIAN
 GERMAN
 ITALIAN
 SPANISH
 PORTUGUESE

or any of 23 other languages by the LINGUAPHONE METHOD

The World's Most Approved Language Courses

It's all talk; natural every-day conversation. In your own home you can learn to speak any of 29 languages by the world-famous Linguaphone Ear-Eye Conversational Method. It is amazingly simple and practical. You HEAR voices of native teachers . . . they speak to you as often as you want them, never tiring . . . you REPEAT what they say, answer their questions . . . before you are actually aware, you are conversing in a foreign language.

Learn alone, or have the family or friends join you in a delightful pastime that pays dividends.

Save time, work and money, learn the Linguaphone Way which has helped thousands in the Army, Navy, Flying, Signal Corps and other services, as well as more than 1 million home-study students.

FREE—Get the facts about this time and money saving way to learn languages—send for the FREE illustrated Linguaphone Book.

LINGUAPHONE INSTITUTE

98 RCA Building, New York 20, New York

LINGUAPHONE INSTITUTE
98 RCA Bldg., New York 20, N. Y.
Send me the FREE Linguaphone Book.

Name

Address..... City.....

Language Interested.....

SHARPEN KNIVES

Amazing NEW WAY

ONLY \$2.95

New post-war wonder-invention! Sharpens any knife to keen, razor-like edge IN A JIFFY! Amazing WONDER KNIFE SHARPENER gives sharp, smooth-cutting edge—easily, quickly—by same principle used by expert professional sharpeners—grinding, smoothing and honing on an abrasive wheel. Just a few quick strokes through the WONDER SHARPENER gives a keen, sharp edge in 30 seconds. Strong, handsome, expertly engineered. Lasts for years. Nothing to get out of order.

SEND NO MONEY: Mail order TODAY. Pay postman only \$2.95 plus few cents postage, on delivery. If not delighted return in 10 days for money back. Order now.
WONDER SALES CO., 620 N. Michigan Ave., Dept. 73, Chicago 11, Ill.

GUM GRIPPER

TIGHTENS FALSE TEETH

OR NO COST

Amazing NEW Plastic Reliner

LASTS FROM 4 to 6 MONTHS

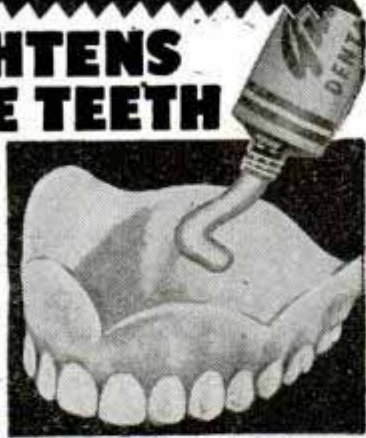

NOW—in a jiffy—you can make loose, slipping dental plates fit snug and comfortable. Eat, talk in comfort, laugh freely—for "Gum Gripper" enables you to enjoy that feeling of almost having your own teeth again!

● APPLY IT YOURSELF — AT HOME

"GUM GRIPPER" amazing plastic Reliner tightens dental plates quickly, makes them hold firmly and fit like new! Just squeeze from tube, spread evenly, put plate in mouth, wear it while "Gum Gripper" sets in few minutes. No heating necessary.

● USE ON ANY DENTAL PLATE

"Gum Gripper" will not harm denture or irritate gums. Sanitary, tasteless, odorless. Keeps mouth sweet and clean, prevents sore spots. Application of plastic "Gum Gripper" is guaranteed to last 4 to 6 months—or no cost. Can be scrubbed or washed. Rev. A. J. Wigley, Pittsburgh, Pa., writes: "Best material I ever used. I have not relined my lower teeth for 2 months."

"Best I've Ever Used"

SEND NO MONEY—Order a tube today—it's only \$1.00. Fill out and mail coupon below. You'll be delighted! Satisfaction guaranteed or your money back.

FREE

Generous size package Dental Plate cleaner included free of extra cost. Cleanses dental plates without brushing. Will not harm denture.

GUM GRIPPER 127 N. Dearborn St., Dept. 71-K, CHICAGO

GUM GRIPPER, Dept. 71-K, 127 N. Dearborn St., Chicago 2, Ill.

Send me a tube of "Gum Gripper." You guarantee it to satisfy—or it will not cost me a penny.
 I will deposit \$1.00 plus postage with postman when package arrives.
 Enclosed is \$1.00—You pay postage.

NAME.....
 ADDRESS.....
 CITY..... STATE.....

Learn Newest MONEY MAKING PROFESSION AT HOME IN 90 DAYS!



MEN AND WOMEN! 18 TO 60

No High School or previous training necessary. Large incomes from Doctors.

Become a Contact Lens Technician—Learn to fit the

newly improved unbreakable Contact Lenses (invisible eye glasses).

DIPLOMA UPON COMPLETION

Many Technicians make \$75.00, \$100.00 a week, and more! Prepare for a permanent big money future in this fascinating work!

Tremendous advantages await you! OPEN YOUR OWN OFFICE—BE A PROFESSIONAL MAN—gain the respect of your friends and community!

If you are ambitious to fit yourself in the higher money brackets—send for our FREE BOOKLET NOW!!!

ILLINOIS COLLEGE OF OPTICS
 127 N. Dearborn St., Dept. K Chicago 2, Illinois

WAR SURPLUS!

GAS MASKS

GREATEST TOY SENSATION IN YEARS. LOADS OF FUN

Real Gas Masks that originally cost \$2.50. This great toy value makes you look like a man from Mars. Fine for spraying paint, insecticides, etc. Has big plastic, shatterproof goggles, intake and exhaust valves, filtering canister, etc. Be the first among your playmates to own one. Big canvas carrying bag with shoulder strap and snap button fastener included FREE if you order now. Send dollar bill with name and address. Satisfaction guaranteed or money back. Send today.

1.00
POST PAID



DEALERS WRITE
 Salesmen and quantity users send for special prices.

HIMAD PROD. CO., Dept. PM 1
 404 N. Wells St., Chicago 10, Ill.

WATCHMAKING

Construction, repair adjustment. Your big opportunity. Learn this profitable trade at home through the most reliable book. New complete "PRACTICAL COURSE" for beginners and professionals. All essential steps. Theory, operation. Many test cases. Full coverage of tools, materials. Fully illustrated. Only \$2.95 postpaid. Money back guarantee. We supply tools, materials at lowest cost.

MODERN TECHNICAL BOOK CO. Dept. M3MC, 55 West 42nd St., New York 18

EXPERIMENT WITH LUMINOUS PAINT



Complete kit of luminous paints in colors. Paint artificial flowers, lapel ornaments, novelties, house numbers, light switches, etc. Kit of one oz. each of 3 lasting colors, bright blue, gardenia and chartreuse, one ounce sealer. Guaranteed best quality.

COMPLETE KIT WITH 3 COLORS AND SEALER \$3.95 PRE-PAID

BLACK LIGHT PRODUCTS • 450 E. Ohio St. • Chicago 11, Illinois

DISCHARGE RING



Regulation Gold Plated emblem mounted on heavy Sterling Silver ring. It's a beauty! Sent C.O.D., you pay postage and fees. Save fees by sending \$2.50 plus 50c tax (total \$3.00). Send ring size or piece of string that fits around finger. **ONLY \$2.50 PREPAID** plus tax

VETERANS SERVICE MART, Dept. P.M. 1
 "OPERATED BY A WORLD WAR II VET"
 304 THROOP AVE. BROOKLYN 6, N. Y.



NOW FOR CIVILIAN USE! NO BATTERY FLASHLIGHT

Developed and used for the army. Automatic electric generator. A quick, easy squeeze of the handle creates a strong beam. Can't wear out. Lifetime guarantee. Lens and case made of shockproof, corrosion resistant plastic. Sent prepaid if you send \$4.98.

ONLY \$4.98

FREE: EACH FLASHLIGHT COMES WITH SPECIAL COMPARTMENT CONTAINING SPARE 2 1/2-VOLT BULB

Direct Sales Co., Dept. P.M.1, 154 Nassau St., N. Y. 7

CHANITE SELF-WELDING FLUX

REPAIRS ALL ELECTRIC HEATING ELEMENTS

So simple anyone can make repairs in your broken or burnt-out electrical appliances—irons, toasters, stoves, etc. Guaranteed nothing like it. From our mines to your appliances. \$1.00 per package. \$7.50 per doz. Stick form 25c. \$2.00 per doz.

CHANITE SALES COMPANY, 914 So. Main, Fort Worth 4, Texas



BE A PUBLISHER...

Your own business! We write, print your OWN Instruction Folios for 10c each... you sell by mail for \$1.00—Start spare time, at home. Send \$1.00 for complete plan. Money back if not pleased. Details free. E. H. Hill, Box 681, Fall River, Mass.

ANGORA RABBITS Giant CHINCHILLAS

VALUABLE Angora Wool brings \$15.00 pound—plenty markets. Gorgeous two-tone CHINCHILLA Furs! Most profitable rabbits raised. Finest pedigreed breeders supplied. Guaranteed. Easily raised anywhere. Small space needed. Illustrated literature free. GRINSTEAD ANGORA COLONIES, EDWARDSVILLE, ILLINOIS

SAY YOU SAW IT IN POPULAR MECHANICS

BARGAINS in WAR SURPLUS LENSES & PRISMS

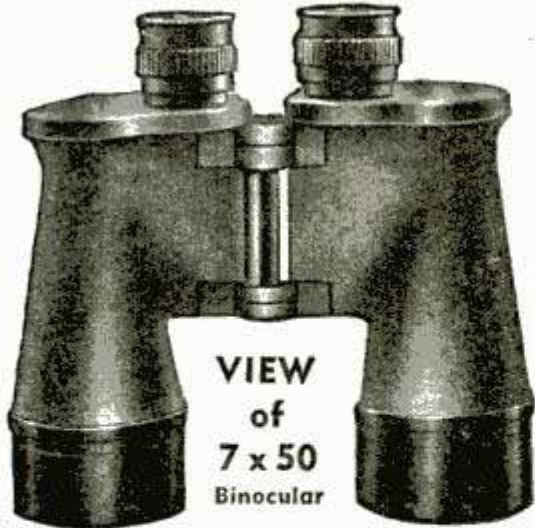

All Items Finely Ground and Polished but Edges Slightly Chipped or Other Slight Imperfections which We Guarantee Will Not Interfere with Their Use. Come Neatly Packed and Marked.

You Can Easily Make Telescopes, Magnifiers, Photographic Gadgets and Hundreds of Experiments with these Low Cost Lenses.

To translate millimeter measurements: 25.4 mm. equals one inch.

SPECIALS IN LENS SETS

Big 10-Page Project and Idea Booklet with all sets.

Set #1-H "Our Advertising Special"—15 lenses for \$1.60 Postpaid. For making your own powerful telescopes, low power microscope, strong magnifiers, drawing projector, photo cells, telephoto lens, dummy focusing camera, Kodachrome viewer, stereoscopic viewer, ground glass and enlarging focusing aids. For experimental optics, portraits of babies and small pets, copying, ultra close-up shots, and many, many other uses.

New 50-Page Idea Book, "FUN WITH CHIPPED EDGE LENSES" Contains wide variety of projects and fully covers the fascinating uses of all Lenses in set listed above . . . only \$1.00 Postpaid.

REMARKABLE VALUE!

\$141.01 WORTH OF PERFECT LENSES FOR ONLY \$10.00

Complete System from Artillery Scope (5X) . . . 9 Lenses, low reflection coated, absolutely Perfect. Diameters range from 1-1/3 inches to 2-1/5 inches. Used for making Telescope and hundreds of other uses.

Stock #5019-H \$10.00 Postpaid
BIG DOUBLE CONVEX LENS—74 mm. diam., 99 mm. F.L. Weighs 9 oz. Made of borosilicate Crown Optical Glass. Used as spot-light Lens, Condensing Lens, etc.

Stock #1048-H \$1.50 Postpaid
BIG DOUBLE CONCAVE LENS—74 mm. diam., minus 110 mm. F.L. Made of extra dense Flint. Used as reducing Lens, for trick photography, etc.

Stock #1049-H \$1.00 Postpaid

MICROSCOPE SETS

Consisting of two Achromatic Lenses and two Convex Eye Piece Lenses which you can use to make a 40 Power Pocket Microscope, or 140 Power Regular Size Microscope. These color corrected Lenses will give you excellent definition.

Stock #1052-H \$3.00 Postpaid
 Consisting of Prism, Mirror and Condensing Lens. These used together with Stock #1052-H will make an excellent Microprojector enabling you to get screen magnification of 400 to 1000 Power according to screen distance.

Stock #1038-H \$2.00 Postpaid
SPECTROSCOPE SETS . . . These sets contain all Lenses and Prisms you need to make a Spectroscope plus FREE 15-page Instruction Booklet.

Stock #1500-H Hand Type Spectroscope . . . \$3.45 Postpaid

Stock #1501-H Laboratory Type Spectroscope \$6.50 Postpaid

RIGHT ANGLE PRISM—Flint Optical Glass, size 41 mm. by 91 mm by 64 mm. Use in front of camera lens to take pictures to right or left while pointing camera straight ahead. Also used in front of camera lens to reverse image in direct positive work. Two of these Prisms will make an erecting system for a Telescope.

Stock #3076-H \$3.00 Postpaid

MISCELLANEOUS ITEMS

Stock No.	Item	Price
16-H	Level Vial, 48 mm. long	\$.20 each
3016-H	Pentagon Prism75 each
2024-H	10 Pieces Circular A-1 Plate Glass (Diam. 31 mm.—for making Filter)25
523-H	Six Threaded Metal Reticle Cells25
624-H	Neutral Ray Filter, size 4 3/4" x 2 1/2"25
22-H	Inclinometer—Aircraft type25 each
704-H	Lens Cleaning Tissue, one ream (480 sheets) size 7 1/2" x 11"	1.50
1030-H	2" Diam. Reducing Lens25 each
1031-H	Perfect 6 Power Magnifier—Diam. 28 mm.25 each
2043-H	Crossline Reticle—Diam. 29 mm.50 each
1034-H	Burning Glass Lens25 each

(Minimum order on above—\$1.00)

TANK PRISMS—PLAIN OR SILVERED

90-45-45 deg. 5 3/4" long, 2 3/8" wide, finely ground and polished. Would normally retail from \$24 to \$30 each.

Stock #3100-H Silvered Prism \$1.00 Postpaid
 Stock #3101-H Plain Prism \$1.00 Postpaid

Illustrated Book on Prisms included FREE.

TANK PERISCOPE

Complete Set Mounted Components

Rugged, strong, originally constructed for U.S. Tank Corps. Consists of 2 fine Periscope Mirrors mounted in metal and plastic. Perfect condition. Would normally retail at \$40 to \$50.

Stock #700-H \$2.00 Complete Set Postpaid

NOW! MAKE YOUR OWN BINOCULARS!

Complete Set of LENSES and PRISMS from Navy's 7 x 50 Model

SAVE UP TO \$150.00!

Here's an unusual opportunity to secure a fine set of Binoculars . . . at a tremendous saving of money. Build them yourself with all of the very same optics contained in the Navy's 7 Power Glasses . . . the Binoculars which received such wide acclaim during the war. Depending on your choice, you may buy a perfect set of Lenses and Prisms for the Binocular construction job, or a set of seconds (exactly the same units, but Lenses are un-cemented and have slight imperfections). If, however, you wish to construct a Monocular (1/2 a Binocular) you may do so, choosing either perfect components or seconds. The Monocular sets comprise 1/2 quantities of the same optics required for the Binocular. The full Perfect Binocular set comprises the following: 2 Cemented Achromatic Eye Piece Lenses, 17.5 mms. diam.; 2 Eye Field Lenses; 4 Porro Prisms; 2 Cemented Achromatic Objective Lenses, diam. 52 mms. Complete assembly directions included.

Stock #5102-H Perfect Binocular Set \$25.00 Postpaid
 Stock #5103-H Perfect Monocular Set . . . \$12.50 Postpaid
 Stock #5105-H Seconds for Binoculars . . . \$11.00 Postpaid
 Stock #5104-H Seconds for Monocular . . . \$ 5.50 Postpaid

FLASH! JUST RECEIVED!

Metal Parts and Bodies for Navy's 7x50 Binoculars

You get a Right and Left Body, 2 Objective Mounts, Left and Right Prism Shelves, Right and Left Cover Plate for Eye Piece mounting, miscellaneous Screws and Parts. This assortment represents nearly all the main parts you'll need for your Binocular construction. It's truly an exceptional War Surplus opportunity.

Stock #804-H Binocular Parts Set . . . \$10.00 Postpaid
 Stock #805-H Monocular Parts Set . . . \$5.50 Postpaid

NOTICE! If you buy both the Binocular Optics and the Binocular Metal Parts, your purchase becomes subject to 20% Federal Excise Tax. Be sure to add amount covering tax to your remittance or your order cannot be filled.

MAGNIFIER SET . . . 5 Magnifying Lenses . . . Powers from 1 to 10. Various diam. for many uses. Free Booklet on Home-made magnifiers included.

Stock #1026-H \$2.00 Postpaid

OPTICS FROM 4-POWER PANORAMIC TELESCOPE—Excellent condition. Consists of Objective Prism, Dove Prism, Achromatic Objective Lens, Amici Roof Prism, Eye Lens Set (. . . a \$60.00 value).

Stock #5016-H \$6.00 Postpaid

35 MM KODACHROME PROJECTING LENS SET—Consists of Achromatic Lens for projecting, plus a Condensing Lens and piece of Heat Absorbing Glass with directions.

Stock #4025-H \$1.95 Postpaid

ALL THE LENSES YOU NEED TO MAKE YOUR OWN TELESCOPE! ALL ARE ACHROMATIC LENSES

GALILEAN TYPE—Simplest to make but has narrow field of view.

Stock #5018-H 4 Power Telescope \$1.25 Postpaid

Stock #5004-H Small 2 Power Pocket Scope \$1.00 Postpaid

PRISM TELESCOPES—Uses Prism instead of Lenses to erect image. Have wide field of view.

Stock #5010-H 6 Power Telescope \$3.00 Postpaid

Stock #5012-H 20 Power Telescope \$7.25 Postpaid

Order by Set or Stock No. • Satisfaction Guaranteed • Immediate Delivery

EDMUND SALVAGE COMPANY, P. O. AUDUBON, NEW JERSEY

U.S. GOVERNMENT JOBS

START \$1506 to \$2650 Year
Veterans Get Special Preference!
Prepare Immediately FOR EXAMINATIONS
Railway Postal Clerks

Railway Postal Clerks get \$1,900 the first year of regular employment, being paid on the first and fifteenth of each month. (\$79.17 each pay day.) Their pay is automatically increased yearly to \$3,000 and \$3,200 in large organizations. Advance may be had to Chief Clerk at \$5,000 a year. (\$192.31 each pay day.) Men 18 to 35.



Travel for "Uncle Sam"

3 Days On — 3 Days Off — Full Pay

Railway Postal Clerks on long runs usually work 3 days and have 3 days off duty or in the same portion. During this off duty their pay continues just as though they were working. They travel on a pass when on business. When they grow old, they are retired with a pension.



City Mail Carriers Post Office Clerks

Clerks and Carriers get \$1,700 the first year of regular employment and automatically increase \$100 a year to \$2,700. Open to Men—Women 18 to 48.

Many Other Positions

Many other positions are obtainable. Rural Carriers—Stenographers—Typists—Assistant Statistical Clerks—Accountants—Messengers—Customs Guards—etc. Those wishing these positions should qualify at once.

Get Free List of Positions

Fill out the following coupon. Tear it off and mail it today—now, at once. This investment can result in your getting a big-paid government job.

FRANKLIN INSTITUTE, Dept. N53, Rochester 4, N. Y.
 Rush to me, entirely free of charge (1) a full description of U. S. Government Jobs; (2) Free copy of illustrated 32-page book, "How to Get a U. S. Government Job"; (3) List of U. S. Government Jobs; (4) Tell me how to qualify for one of these jobs.

Name.....

Address..... Vet?.....

Use This Coupon Before You Mislays It. Write or Print Plainly.

SAY YOU SAW IT IN POPULAR MECHANICS

REPAIR KIT AVAILABLE



Entire kit sent postpaid for only \$4.00 plus 18c postage.

Contains a complete assortment of terminals, pins, porcelain insulators, mica, etc. that will fit most flat irons and appliances. Practically every part necessary in the ordinary repairing of flat irons in one handy kit. Additional supplies obtainable so that your kit can be replenished.

Christy Supply Co. 2835 N. Central Ave. Dept. K-150, Chicago 34, Ill.

No More JOB WORRIES

Do you want a permanent and profitable business of your own? No selling. Uncrowded field. Become a specialist! Many proprietors of bureaus earn up to \$5,000 to \$15,000 per year. Learn at home by mail in 60 days. Easy lessons. Practically no capital required. Be your own boss and the boss of others. Prepare for the future. Have an office of your own.

write for FREE details today

Franklin Publishing Co. Dept. 33 Roanoke 7, Va.

1,471 WAYS TO EARN MONEY!

Year 1944, 500,000 persons made \$10,000 to \$25,000 each. New Copyrighted book No. 359,607 has 1,293 DRAWINGS, 1,471 PATENT NUMBERS. Shows how you can make what 1,471 Successful men and women made, as toys, gadgets, devices, compounds, etc. How you can obtain Patents, Designs, Trade-Marks and Copyrights. Book 8 by 11 has 110 pages. \$1. Postpaid. Satisfaction or money back. Free Particular.

S. L. Centofanti, PM-PUB. 25 S. Pearl St., Youngstown 6, Ohio.

PRACTICAL BOOKS ON HOME PLANNING BUILDING · REPAIRS

Plan Now—Build When You Can
 Books Sent C.O.D. Anywhere in U.S.A.

- Select from this list of helpful books. In U. S. books sent postpaid if remittance accompanies order. Outside U. S. include 15% extra for shipping charges.
- How to Plan a House.....\$4.50
 - House Construction Details.....\$3.00
 - Painting, Decorating.....\$1.50
 - Carpentry.....\$2.00
 - Painting, Furniture Finishing and Repairing Includes floor renewal.....\$1.50
 - How to Remodel a House Complete, practical.....\$4.75
 - Building Insulation.....\$3.50
 - Concrete Handbook Do work for yourself, others.....\$1.50
 - Blueprint Reading for Building Trades.....\$1.25
 - Practical Bricklaying.....\$1.75
 - Simplified Carpentry Estimating.....\$3.00

FAMOUS PLAN BOOKS
 Books contain floor plans, photos, descriptions of homes.
AMERICA'S BEST LOW COST HOMES. 125 designs.\$1.00
DE LUXE SMALL HOMES. 210 designs.\$1.00
OUR FUTURE HOME. Wide selection of residences, summer homes, garage apartments. \$1.00
MODERN HOME & GARDENING. 42 popular designs. Improvements, garden short-cuts, etc.50c

Set of Four Books \$3.50

Stair Building \$2.00

POPULAR MECHANICS PRESS
 Dept. 000 • 200 E. Ontario St., Chicago 11



Now Hear Better

THE AMAZING NEW

Beltone
WAY

COMPLETE IN
ONE POCKET-SIZE UNIT
(with cord and plug)

Beltone Mono-Pac brings you a new world of sound—amazingly clear, natural—perfected by advanced electronic research. One lightweight unit—about the size of a spectacle case—does it all. Weighs about one-half as much as old style hearing aids with no clumsy, separate battery pack, no battery wire. Such a sensational advance that already tens of thousands of hard-of-hearing people have been delighted with how splendidly they hear now with this tiny but powerful device.

Send Post Card Today for
FREE BOOKLET
with valuable information for hearing problems.

BELTONE HEARING AID CO., Dept. PM-3
1450 W. 19th Street, Chicago 8, Illinois



Be Your Own Boss! **LEARN**
MECHANICAL
DENTISTRY

Big Paying Profession

The **BIG** post-war permanent demand for trained Dental Technicians is on! Start now! Learn this profitable profession—a Lifetime career for men and women. Individual instruction on practical work—day or night. Attending students approve. Part time instructions also available.

Visit us or write for Free Booklet No. PM-3
NATIONAL SCHOOL OF MECHANICAL DENTISTRY
10 W. Jackson Blvd. Chicago 4, Ill.

Fun and Mystery

OUR KIT of Professional **MAGIC POCKET TRICKS** will enable you to **AMAZE** and **AMUSE** others for fully 25 minutes. **FOOL ANY-** \$5.00
ONE hour after kit arrives. Guaranteed.

MARIAN DAY'S MAGIC STORE
811 Davis St. "Chicagoland's Largest" Evanston, Ill.

ROLL FILM

No limit at present

Size	Price	Made to exacting U. S. Government standards, this fine tested war surplus film has just been released. Panchromatic high speed. 8 exposures. Orders filled by return mail. Please order a minimum of 4 rolls. Include 18¢ to cover postage and handling. No C.O.D.'s please. Refund on request. We suggest you send us your order today.
127	- 27c	
120	- 33c	
620	- 33c	
116	- 38c	
616	- 38c	

Howard West, 3 W. 42 St., New York 18, N. Y. Dept. C3

Every Day, More and More Copies of

The Merriam-
WEBSTER

are reaching book stores



WITH shortages eased, your dealer may be able to supply you immediately, or within short notice. Be sure you get the **MERRIAM-Webster**—the only unabridged dictionary completely revised and rewritten in 25 years. 3,350 pages, illustrations for 12,000 terms, and a total of 600,000 entries—122,000 more than any other dictionary. G. & C. Merriam Co., Springfield 2, Mass.

WEBSTER'S NEW
INTERNATIONAL
DICTIONARY
Second Edition

"The Supreme Authority"

SAY YOU SAW IT IN POPULAR MECHANICS

INVENTIONS WANTED!

100 Firms Offer Spot Cash for Practical Ideas

Now is the time to cash in on your ideas! Manufacturers everywhere are eager to buy new ideas, new products, new patents to open up new markets, or expand present lines. Many plants, built for war production, are ready for reconversion but don't have suitable products for civilian demands. They offer spot cash for new, acceptable ideas.

A Fortune May Await You!

If you have a sound, practical idea, a fortune may be awaiting you. Find out now! To assist inventors in selling their patents, we have compiled a select list of 100 firms offering to buy acceptable inventions for cash or on a royalty basis.

CASH FOR IDEAS TO MAKE:

- wire products
- lawn mowers
- radio equipment
- electronic devices
- sound recording
- vending machines
- television sets
- pressure gauges
- chemical products
- household items
- auto accessories
- toys and novelties
- food machinery
- aircraft devices
- kitchen utensils
- paper specialties
- optical goods
- hydraulics
- refrigeration
- power tools
- and scores of other products

Tells How and Where To Sell Your Ideas!

Under each firm's name and address is given the type of products wanted such as toys, household appliances, aircraft devices, or mechanical equipment; whether they prefer products to be made of wood, metal, plastics, rubber, cloth, leather, or paper; whether they have engineering, production, financing and sales facilities to promote your invention aggressively.

Special Sales Helps Insure Best Deal!

With each list, we include special instructions, including sample sales letters, research and marketing helps, for presenting your proposition in the most favorable way; how to protect your interests at all times and arrange a deal that will give you the greatest income. This may be your golden opportunity. Send \$1.00 now for our Inventor's Sales Bulletin—"How and Where to Sell Your Invention," and learn how to get spot cash for your ideas. Science and Mechanics Magazine, 154 E. Erie St., Dept. 125., Chicago 11, Ill.

MAIL THIS COUPON NOW

SCIENCE AND MECHANICS MAGAZINE,
154 East Erie St., Dept. 125, Chicago 11, Ill.

Enclosed is \$1.00 for which please send me a copy of your Inventor's Sales Bulletin giving the names and addresses of 100 firms offering to buy acceptable inventions.

NAME.....

STREET NO.....

CITY..... ZONE..... STATE.....

MECHANICAL DRAWING FOR BEGINNERS

Don't let lack of training in Mechanical Drawing prevent you from getting that promotion.

MECHANICAL DRAWING FOR BEGINNERS is published in 3 parts. It is arranged for those who want to start at the beginning and for those who have made the wrong beginning. NOT just another text book, but a logical arrangement in three parts of blue-print lessons for a right start.

FREE to the first 1000 purchasers of part 1. You may submit your work at 3 different times for author's criticism. Order Part 1 now! The price, including 3 criticisms, is only **\$5.00**

You are under no obligation to purchase Parts 2 and 3. Order Part 1 now!

BOOTH PUBLISHING CO.

11133 LONGWOOD DRIVE CHICAGO 43, ILLINOIS

EASY TO LEARN CODE

Learn or increase speed with an Instructograph—the Code Teacher that takes the place of an operator-instructor and enables anyone to master code without further assistance. Available tapes from beginners alphabet to typical messages on all subjects. Speed range 5 to 40 WPM. Always ready—no QRM. Thousands have "acquired the code" with the Instructograph System. Write today for convenient rental and purchase plans.



INSTRUCTOGRAPH COMPANY

4713 Sheridan Road, Chicago 40, Illinois

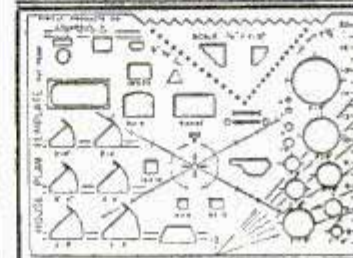

HOUSE PLAN TEMPLATE

Made of clear sheet plastic, with accurate cut-outs for drawing door-swings, plumbing and electric fixtures, fireplace, stairs, moldings, roof-pitch, etc. Standard 3/4" equals 1'-0" scale.

\$1.50 POSTPAID

TIMELY PRODUCTS CO.

Box 206D, Columbus 9, Ohio

RAFTER LENGTHS. A new vest pocket book for the carpenter, estimator. Gives lengths, Side cuts, Plumb cuts, Deductions. For all your rafters to fit any building from one inch wide to forty feet wide. Gives the numbers to cut on the square. Also gives degrees for same cuts for Radial Saws. All standard pitches from 1/4 to 3/8 are given. Just open book to pitch page and there in plain print are your lengths, side cuts, etc. Any one who knows what a jack rafter is can frame a roof correctly if he has this great book. Price one dollar, prepaid.

BUILDERS' TOPICS, Dept. M, Med. Arts Bldg., Seattle 1, Wash. Original teachers of the square in five easy lessons, by mail. Send for FREE list of plan books—Kamp Kabins to Mansions.

BUILD YOUR OWN ARC-WELDER

For Light or Heavy Work

No rewinding necessary—use coils taken from old auto generators. Works on 110 or 220 A.C. Has 20 different heats. Complete plans and BIG Catalog 35c.

LEJAY MFG. CO.

3347 LeJay Bldg.



Minneapolis, Minn.

START YOUR OWN BUSINESS!

Amazing Postwar Development Now Gives You the Opportunity to Make Money Fast!

Startling scientific discovery, just now becoming available for general use, will enable you to start your own business and reap great profits! **PLASTICS**, one of the most revolutionizing and rapidly expanding industries, offers a great opportunity to all enterprising men and women. This is one of the few industries in which home manufacturers thrive and prosper. You can start even on a spare time basis in your own home, and expand rapidly into a full time business, paying good profits.

LIQUID MARBLE the amazing Plastic, with a thousand uses. **LIQUID MARBLE** can be poured into **FLEXIBLE MOLDS** for casting all kinds of artistic and serviceable articles such as: ornaments, novelties, desk sets, paper weights, book-ends, souvenirs, statuary, toys, etc.

FLEXIBLE MOLDS Make your own **FLEXIBLE MOLDS**. The cost is low—in fact, a large sized mold costs but a few cents. Hundreds of casts can be taken from a single mold.

NO EXPERIENCE NEEDED! No skill or previous knowledge is necessary. All you do is follow our easy-to-understand instructions.

UNLIMITED MARKET The market is literally unlimited. You will find steady year-round demand in your own community. Your problem will not be in selling but in supplying the huge pent-up demand. Moreover, we supply you with names of big buyers for your finished products.

WRITE TODAY Bing Products will show you how to start with a small investment and build a permanent, independent, profitable business! Don't fail to grasp this opportunity! Write today for **FREE CATALOG**.

BING PRODUCTS Dept. A2, 88 Broad Street
BOSTON 10, MASS.

Learn WATCH REPAIRING



In Your Spare Time At Home EARN WHILE LEARNING

Now—with the manufacture of watches scheduled for enormous production to meet big demand—the need for watch repairmen will be greater than ever before. Our practical Home Training Course prepares men and women for a big-pay profession. Be the ace Watch Repairman in your territory. Write TODAY for details.

FREE WATCH working tools and watch included as part of our Watch Repairing Course.

ILLINOIS SCHOOL OF WATCH REPAIRING
6312 Huntington Street, Dept. PM-3, Chicago 30, Illinois

TRI-STATE COLLEGE

B. S. Degree in 27 Months

Distinguished for technical 2 1/4-year courses in Civil, Electrical, Mechanical, Chemical, Radio, Aeronautical Engineering; Business Administration, Accounting, and Secretarial Science.

ENGINEERING
VETERANS can complete work here in shortest possible time. Special Prep. Dep't. Also REFRESHER COURSES. 36-Week Courses in Surveying, Drafting. Low tuition. Low living costs. Cosmopolitan student body. 63rd year. Enter Sept., March, June, Jan. Catalog. 346 College Ave. **ANGOLA, INDIANA**

Get Ready for Big After War Opportunities!

**I Will Train You
at Home Until
You Get a GOOD
PAY JOB in**

DRAFTING

• Act now to get a better job with more pay and pleasant working conditions. Get into Drafting—the basic profession where all post war products will start. I will train you at home—give you experience—doing the same kind of jobs you will do with the best paying firms. I furnish instruments, drawing table and all equipment when you start. Write today for vital facts and FREE illustrated book. Give Age.

Engineer Dobe, Div. 13, Libertyville, Ill.

DO YOU

high as \$50-\$100 weekly after a few weeks home training—not medical or chiropractic—no further capital needed, no goods to buy. 50th year. Write for free booklet.

Stephenson System of Foot Correction

28 Back Bay, Boston, Mass.

Make Anything GLOW

IN THE DARK

New improved formula—makes anything glow in the dark like magic! Applies easily with a brush to any surface. Dries quickly. Glows all night. Lasts indefinitely. Will not rub off. Magi-Glo is supplied in concentrated form. Use as much or as little as needed. Has 101 different uses. Ideal for light switches, clock dials, house numbers, toys, ornaments, jewelry, dash boards, photo dark room equipment, fish flies, camp equipment, gun sights, flowers, ties, etc. Everyone in the family can use and enjoy MAGI-GLO. Safe for children. Send for your kit today!

SEND NO MONEY!

Complete Magi-Glo kit only \$1.29. Just send name and address and kit will be forwarded promptly. On arrival you pay postman plus postal charges. Or send cash, check or money order for \$1.29 and we'll ship postpaid. Either way, satisfaction guaranteed or money back.

MAGI-GLO

Dept. 105, 356 W. 63rd St.,
Chicago 21, Illinois

NEW and Ready for you

ALLIED'S 1946 CATALOG

of Radio and
Electronic Supplies

FREE
Send for it
NOW



BRINGS YOU LATEST, finest values in Radio! New receivers, phono-radios, Ham gear, parts, tubes, kits, code apparatus, tools, books, test instruments, public address—all types of equipment. Over 10,000 items. Leading makes. Guaranteed quality. Fastest service from the world's largest and most complete stocks under one roof. Send for your free copy of Allied's new 1946 Buying Guide now. *Save time and money.*



HELPFUL RADIO BOOKS

Radio Formulas & Data No. 37-752...10c
Dictionary of Radio Terms No. 37-751...10c
Radio Circuit Handbook No. 37-753...10c
Radio Builders' Handbook No. 37-750...10c
Simplified Radio Servicing No. 37-755...10c
Radio Data Handbook No. 37-754...25c
ALL SIX BOOKS No. 37-799.....75c
Parallel Resistance and Series
Capacitance Calculator. No. X37-960...25c

ALLIED RADIO

ALLIED RADIO CORP.
833 W. Jackson Blvd., Dept 5-CC-6
Chicago 7, Illinois

Date.....

- Send FREE 1946 CATALOG
 Send.... Books/Calculator No..... (\$.... enclosed)

Name.....

Address.....

City..... Zone..... State.....

Now for EVERY WORK SHOP!

NEW Invention Electroplates by BRUSH



**Easy to Plate CHROMIUM
GOLD, SILVER, NICKEL, COPPER
... For Pleasure and Profit!**

If you have a workshop—at home or in business—you need this new Warner Electroplater. At the stroke of an electrified brush, you can electroplate models and projects—you can replate worn articles, faucets, tools, fixtures, silverware, etc. with a durable, sparkling coat of metal . . . Gold, Silver, Chromium, Nickel, Copper or Cadmium. Method is easy, simple, quick. Everything furnished—equipment complete, ready for use. *By doing a bit of work for others, your machine can pay for itself within a week.* So make your shop complete by getting a Warner Electroplater right away. Send today for FREE SAMPLE and illustrated literature. ACT AT ONCE! Mail Coupon.

**WARNER ELECTRIC CO., DEPT. G-9
663 North Wells, Chicago 10, Illinois**

FREE Details & Sample!

WARNER ELECTRIC CO., 663 North Wells, Chicago 10, Dept. G-9
Gentlemen: Send Free Sample and Details to:

Name _____
Address _____
City _____ State _____

FENCING EXCITING FUN HARMLESS

NEW—Clean—Healthful
Develops Strong Body—Alert Mind.
Become best swordsman in your neighborhood. **FREE BOOKLET** (with foils) teaches Quickly—Easily. **HARMLESS** because the 3 ft. Spring Steel Foils (swords) have safety rubber buttons. Complete outfit 2 Steel Foils (swords) and **FREE** Instructions. Now Only \$1.98 postpaid. **MAIL CHECK** or **M.O.** today. Add 28c for Foreign Postage.

LEE PRODUCTS CO., 1613F-First Ave., New York 28, N. Y.



FOR MOPPING
FOR WAXING



FOR CLEANING RUGS

Hands Never Touch the Water—Can be put in Boiling Water. Housewives Like It.

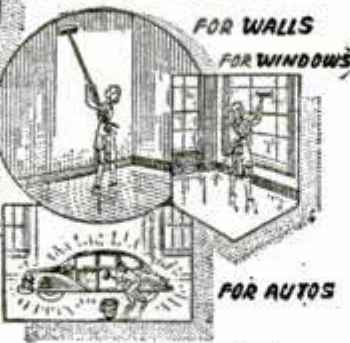

FOR WALLS
FOR WINDOWS

FOR AUTOS

48" Long Handle

Sales QUICK, EASY Every Locality

SALES ARE EVERYWHERE . . . Sells quick to Taverns, Clubs, Hotels, Hospitals, Stores, Restaurants, Large and Small Buildings and the Homes . . . Scores can be sold on a single street . . . Note the Drain Bracket in the illustration . . . This squeezes out the water so thoroughly that **HANDS NEVER TOUCH THE WATER** . . . Makes no difference what you ever sold, you will like this proposition . . . Your name on a Post Card will bring you **FREE PARTICULARS**.

CELL-U-MOP CO., Dept. P-3, FREEPORT, Ill.

**WE WILL PAY
\$50.00 to \$500.00**

each for original, practical, patentable
**IDEAS FOR NEW TYPES
OF FLOOR MATTING**

which we consider worthy of manufacturing. Any kind of available materials may be employed.

If ideas are accepted, and not already patented, we will defray cost of procuring same on assignment to us.

A hand made sample, or workable drawing from which a sample could be produced, should accompany each idea submitted.

In submitting any idea it will be understood that no obligation on the part of American Mat Corporation will be assumed or incurred in the event the submitted idea is refused for any cause.

**AMERICAN MAT CORPORATION
2021 Adams Street Toledo 2, Ohio**

FOOT RELIEF

Don't worry—No matter how many ordinary arch supports, pads and braces have failed. **CUSTOM MADE RESEARCH FOOT BALANCERS** have relieved foot pains for 25 years. Write for **FREE ANALYSIS FOOT CHART** and interesting literature TODAY.

KINDSCHI FOOT APPLIANCE PRODUCTS
Dept. A2 321 W. Jefferson Dallas 8, Texas



FREE

FALSE TEETH FIT LIKE NEW

SEND NO MONEY

RELINE your plate at home with Dentist's **NEW DISCOVERY**. Easy—quick. One application lasts. Perfect fit guaranteed. Write for descriptive folder **FREE**. No obligation.
Dr. C. N. Reese, DENTIST, Box 268P, Winnetka, Ill.

SAY YOU SAW IT IN POPULAR MECHANICS

Quick Easy Way to BIG PROFITS

Read What Others Are DOING!

"Enclosed you will find 56 orders representing 9 1/2 hours' work on Monday and Tuesday."

"Enclosed are twelve orders secured after supper this p.m."

2 BIG SELLING PLANS

Sales are easy under **TWO BIG SELLING PLANS** . . . You can take Individual C.O.D. Orders from sample . . . Or you can buy in quantity and make your own deliveries . . . Distributors and Agents tell us they sell in 7 out of 10 calls . . . Housewives are enthusiastic.

• We Teach You How •

Gets down under and around for **MOPPING, DUSTING or WASHING**

DOES THE WORK OF 6 TOOLS IN 1

Get Choice Territory **NOW!**

Holds 20 times its weight in water.



CLOSED

BARGAIN ASSORTMENTS

FROM HUDSON TRADING CORPORATION, CHICAGO.

**SCREWS — NUTS — BOLTS — WASHERS — RIVETS —
SPRINGS — COTTER PINS — AND OTHER FASTENERS**

All New, Clean Material!

SPECIAL 100-LB. KEG

Think of it—Less than 8¢ a lb.



This popular assortment contains a large variety of useful and necessary Screws, Bolts, Nuts, Washers, Rivets, and other fastening devices, mostly 1/4" and larger diameters, suitable for use on the farm, in the shop, garage, or wherever a

PRICE
\$7.98

large assortment is needed. Full 100-lb. keg of clean new fasteners in this Giant Assortment. Order No. 107. Shipping weight 110 lbs.

BIG 5-LB. TREASURE CHEST OVER 1000 PIECES



Radio servicemen, experimenters, hobbyists, homeowners, model-builders, mechanics will find this assortment extremely useful. Machine and Wood Screws,

PRICE
\$1.98

Nuts, Washers, Rivets, Eyelets, Lugs, Clips, Sheet Metals, and Set Screws, fibre and bakelite insulating Washers, and many other needed parts are included. Order No. 700. Shipping weight 6 lbs.

HEAVY DUTY FASTENERS



10 LBS.

PRICE
\$2.49

These Heavy-Duty Fasteners, such as Cap Screws, Machine and Carriage Bolts, Nuts, Lag Screws, Washers, Studs, Rivets, USS and SAE sizes, 3/16" diameter and up. Assorted lengths. Very useful for contractors, maintenance, camps, builders, mechanics, etc. Order No. 108. Shipping weight 12 lbs.

WASHERS



Need Washers? This handy assortment of 1000 Lock Washers and Flat Washers will satisfy your needs for any size from 1/8" to 1/2" hole. Includes steel, brass, copper, and aluminum. Order No. 201. Shipping weight 3 lbs.

PRICE
\$1.49

NEW! RECESSED HEAD SCREWS



500 FOR \$1.48

Very newest type screws. Replacement and repair parts for auto, radio, appliances, etc. Includes machine screws, sizes No. 4 to 1/4" diameter, in various head styles and lengths. Have these handy—you'll need 'em. FREE—special screw-driver with each order on this assortment. Order No. 203. Shipping weight 3 lbs.

OTHER POPULAR ASSORTMENTS

CAP SCREWS—An assortment of the most popular (USS and SAE) sizes from 1/4" up. 300 pieces. Order No. 205. Shipping weight 12 lbs. Price.....

1.95

SOCKET SCREWS—Set and Cap Screws. A "must have it" for every shop. From 6-32 to 1/2" diameter. Order No. 206. Shipping weight 1 lb. Big bargain of 100 pieces for

2.39

RIVETS—Solid, Split, and Tubular Rivets. Steel, brass, and copper. 1000 assorted pieces. Order No. 207. Shipping weight 2 lbs. Price.....

1.47

SPRINGS—200 small useful springs. Expansion, compression, and coil type. Very handy. Order No. 208. Shipping weight 1 lb. Price.....

98¢

LUGS, CLIPS, CONNECTORS, ETC.—Handy assortment suitable for radio set builders, repairmen, experimenters, almost everyone. Many shapes and types, suitable for a great variety of uses. Order No. 303. Shipping weight 1 lb. Price: 500 pieces for.....

96¢

Wonderful Money-Saving Opportunities For Mechanics, Experimenters, Garages, Farmers, Hobbyists, Repairmen, Shop Owners, Fix-it Shops, Model Shops, Home Owners—
A USEFUL ASSORTMENT FOR EVERY USE!

Study the display of assortments carefully—there are many you can use right now. Use the handy order blank at the bottom of the page for speedy action!

**HANDIEST ASSORTMENTS
WORTH THEIR WEIGHT IN GOLD WHEN
YOU NEED THEM — AND HOW!**

WOOD SCREWS



PRICE
99¢

Different types of heads in most diameters and lengths are included in this big five-pound assortment of wood screws. Many are rust-proofed. Order No. 301. Shipping weight 6 lbs.

SHEET METAL

Self-Tapping Screws



PRICE
\$2.19

A bonanza for metal workers, tin-shops, garages, radio repairmen, mechanics, etc. Over 1000 pieces assorted sizes, lengths, and head styles, gimlet and blunt point. Many rust-proofed. Order No. 109. Shipping weight 6 lbs. Price \$2.19.

FREE! Special offer! 1000 assorted cotter pins, various sizes and lengths, rust-proof, included free with every order amounting to \$10.00 or more.

ORDER COUPON—MAIL NOW!

HUDSON TRADING CORP.
M1521 N. Wells St.
Chicago 10, Ill.

Gentlemen: Enclosed please find \$....., plus \$..... shipping charges on the following BARGAIN ASSORTMENT.
(State number of assortments desired opposite each number)

.....No. 107—100-lb. keg.....\$7.98No. 206—Socket Screws —100.....\$2.39
.....No. 108—10 lbs. Heavy Duty Fasteners.....\$2.49No. 207—Rivets—1000.....\$1.47
.....No. 109—Sheet Metal Screws—1000.....\$2.19No. 208—Springs—200.....\$.98
.....No. 201—Washers, 1000.....\$1.49No. 301—Wood Screws, 5 lbs.\$.99
.....No. 203—Phillips Recessed Head Screws— 500.....\$1.48No. 303—Lugs, Clips, Connectors, etc.—500.....\$.96
.....No. 205—Cap Screws— 300.....\$1.95No. 700—Special Big 5-lb. Treasure Chest.....\$1.98

- Check here if your order amounts to \$10.00 or more to get FREE 1000-piece Cotter Pin Assortment as described above.
- Check here if you have any specific requests for Screws, Nuts, Bolts, Washers, Rivets, etc. Give us full description, sizes, quantities desired. Write your needs on a separate sheet of paper.
- Check here to put your name on our FREE BARGAIN MAILING LIST.

Name.....

Address.....

City..... Zone..... State.....

Little Library of Useful INFORMATION

5 for \$1.00
12 for \$2.00
25¢ Each

Here at amazingly low cost is the practical help and information you have always wanted. Articles in previous issues of Popular Mechanics have been classified according to subject and are now available in these handy reprint booklets. Check Titles wanted, clip ad and mail today.

BOOKLETS ON WORKSHOP EQUIPMENT

Power-Driven Saws—74: Complete details on scrollsaw, two circular saws, sliding cut-off saw, bandsaw.
Drill Presses, Plane, Grinders—79.
Sanders—80: Complete constructional details on 8 useful machines.
Wood & Metal-Turning Lathes—81: Two wood lathes, small metal-turning lathe.
Filing Machine, Hacksaw, Cutoff Wheel, Shaper—82.
Metal Lathe Tools You Can Make—101.
Workbenches & Tool Cabinets—47.
Spray Painting—94: Constructing spray guns, compressor, using spray gun.
From Pattern to Casting—91: How to make your own patterns and small castings.

BOOKLETS ON SHARPENING—USING TOOLS

Correct Measurement—106: How to use micrometers, gauges, calipers, etc.
Tool and Saw Sharpening—92.
Using & Sharpening Drills & Wood Bits—90.
Successful Wood Turning—32: All the information you need to master this art.
How to Read Blueprints—71: Tells you how to understand signs, symbols, and lines.
Metal Turning Lathe Kinks—99: Simple homemade tools, time and labor-saving shortcuts you can use.
Operating a Metal Turning Lathe—100.
Heat Treating & Case Hardening—102.
Working with Glass—103: Cutting, drilling, etching, blowing.

ELECTRICAL BOOKLETS

Rewinding & Servicing Electric Motors—75: Repairing and rewinding a.c. and d.c. motors. Locating trouble. Converting auto generators into 110 v. a. c. motors.
House Wiring—89: All the information you need to do a complete wiring job or install extra outlets.
Electromagnets & Solenoids—44: Designing and building.
Transformer Construction—41: Easy-to-understand instructions for all kinds of transformers.
The Boy Electrician—43: Easy-to-build motors, experiments.
Soldering & Brazing—17.
Arc & Spot Welders—5: Building and operating 110 v. a. c. arc and spot welders.
Treasure Finders—13: Build your own treasure finder and metal locator. Details for both large and small radio types.

ELECTROPLATING BOOKLETS

Electroplating with Copper, Nickel, Chromium, Lead, Zinc, Cadmium—86.
Plating Leather & Other Non-Metallic Objects—Plating with Gold, Silver, Alloys—87.

HOME IMPROVEMENT BOOKLETS

Simple Home Improvements—104: Modernizing; making storm sash, ironing boards, etc.
Building Extra Rooms in Attic—23.
Attractive Basement Playrooms—24.
Lower Your Fuel Cost—31: Practical kinks that will save you hundreds of dollars.
Hanging Wallpaper—38: Tricks of hanging wallpaper, removing old paper, etc.
Curing Leaky Basements—45.
Fitting Home Game Room—55: Construct own game & tennis tables, shuffleboard court, action game, portable playrooms.

Ridding the Home of Insect Pests—107: Exterminating and protecting against moths, flies, termites, mosquitoes, etc.
Built-in Fixtures—78: Step and space-saving kitchen units, built-in beds, corner cabinets, vanities, linen chest.
Constructing Indoor & Outdoor Fireplaces—88: Stone fireplaces, portable mantels, garden fireplaces.

GARDENING BOOKLETS

Backyard Gardening—39: Selecting, planning and getting the best results.
Lawn & Garden Novelties—72: Jig-sawed ornaments, parkway numbers, sundials, flower boxes.
Trellises, Pergolas, Fences—76.
Lawn & Garden Furniture—77: Modern bent-tube furniture, arbor and seat combinations, swings, lawn chairs.
Playground Equipment—73: Two playhouses, ferris wheel, roller coaster, treadmill, play store, slide, two merry-go-rounds.
Colored Concrete Garden Furniture—6: Garden benches, pottery, flower boxes, bird baths and sundial pedestals in colored concrete. How to build small concrete mixer.
Bird Houses—7: Easy to build homes for all kinds of birds.
Farm & Garden Tractors—8: Two tractors you can build from old automobile parts.

CRAFT WORK—HOBBY BOOKLETS Complete how-to-make-it instructions for hundreds of practical projects.

Working with Plastics—61: Using brilliantly-colored plastics in craftwork.
Magazine Racks—49: Ten attractive racks.
Clock Cases—50: Large Hall, Colonial wall and mantel, ship's wheel, miniature grandfather, desk, Spanish style banjo.
Serving Trays for Every Occasion—53: Fourteen different designs.
Children's Room Furniture—51: Twelve attractive pieces.
Book Ends—52: Ten designs offer good selection.
Small Tables—54: Modern and colonial styling.
Smoking Stands—56: Seven designs given.
Jigsawed Novelties—57: Sewing kits, string holders, place-card holders, plywood kitchenware, plant and flower holders, coin banks, door stops, drawer pulls.
Desks—58: Colonial writing desk, two modern-type desks, student's study desk of plywood, combined chest and writing desk.
Book Cases—59: Eight designs.
Doll House & Doll Furniture—60.
25 Shelves You Can Make—64.
Novelties Turned on Lathe—62.
Inlay Pictures—Veneering—63.
Whittling and Wood & Soap Carving—65.
Action Toys—66: 21 easy-to-make toys.
High Flying Kites—67.
Windmills & Weathervanes—68.
Lamps in Wood, Metal, Plastic—69: Selection of 14 designs.
Metal Craft—28: Brass tapping and making of novelties both decorative and useful.
Small Looms—37: Building hand looms for weaving rugs, etc.; leather novelties.
Plain & Novelty Wood Finishing—40.
Gem Cutting—42: How to cut and polish semi-precious stones.

BOAT BUILDING BOOKLETS

Build a boat at home—you can do it

14 Ft. Outboard Runabout—2: Here is a fast 14 foot V-bottom boat. Suitable for motors of 4 to 24 hp., estimated cost, \$30 to \$40.
14 Ft. Sailing Dinghy—26: This 14-foot boat combines strength and light weight. It carries 140 sq. ft. of canvas and weighs about 350 pounds. Actual photographs and diagrams illustrate every detail.
21 Ft. Sloop—46: Every fact needed by the amateur boat builder to construct this craft which carries eight to ten persons.
Rowboats, Bicycle Boat, Small Dinghy—83: All the information you need to construct four low-cost boats.
Small Sail Boats—84: 12-ft. sailing dinghy, 8-ft. "training ship" for young sailors, how to sail a boat.
Two Outboard Runabouts—85: 14-Ft. family outboard weighs about 400 lbs. and 12-ft. plywood outboard weighs about 110 lbs. Both are V-bottom type.
Build Your Own Canoe, Kayak, Surfboard—30: Complete details on 16-ft. Canadian-type canoe, 17-ft. kayak, and 12-ft. hollow surfboard.
Fast Class-E Ice Yacht—22: Build your own Class-E ice yacht. Every detail of construction carefully explained.

AUTOMOBILE BOOKLETS

Automobile Kinks and Shortcuts—10: Money-saving hints on upkeep and operation.
Building Trailers—27: Small Streamlined house trailer; several utility trailers.
Motor-Driven Midget Car & Scooter—34: Both use gas engine of washing machine type.
Curing Auto Electrical Troubles—95.

PHOTOGRAPHY BOOKLETS

Save Money by constructing your own photo equipment.
Photo Enlargers—1: Condenser lens type; simple vertical; horizontal.
Photo Printers & Dryer—25: Describes three practical printers, timer and negative dryer.
Photo Darkroom Equipment—96: Cabinets, light-tight box, timer, agitator, washer, trimmer.
Picture Projector, Trick & Table Top Photography—97: Projectors that enlarge magazine illustrations and shop drawings. Tips for table toppers, photomontages, tricks.
Photo Kinks—98: 63 time and money-saving ideas you can use.

FORMULA BOOKLETS

Transform simple ingredients into useful products
Cleaning Preparations—11: Easy-to-make cleaners for walls, glass, etc. Removing fabric stains.
Cosmetic Formulas—12: Hand lotions, creams, rouge, bath salts, beauty clay, lipsticks, etc.
Re-Silvering Mirrors—70: Formulas for silvering and coloring.

MISCELLANEOUS BOOKLETS

Knots and Ropework—105.
Chemical Experiments—93: Easy-to-perform experiments. Inexpensive lab.
Taxidermy—9: How to prepare skins and obtain life-like poses.
Log Cabins & Tourists Cottages—14: Year-round log cabins; inexpensive tourists' cabin.
Magic for Everybody—29: Simple tricks to puzzle your friends.
Trapping Small Animals—33: How to lure fur bearers, prepare bait and traps, dress skins.
Tricks of Training Your Dog—35.
Small Furnaces—36: Build own gas or electric.

POPULAR MECHANICS PRESS,
200 E. Ontario St., Chicago 11, Ill.

I enclose (U. S. bills may be mailed if carefully wrapped)
for "Little Library" booklets numbers:

Name
Address Zone
City State

Here's one of the **BEST JOBS IN THE WORLD!**

• Technicians helped win the war. Now technical skill will be a major factor in guarding the peace. . . . The Army Air Forces need your ability in the vital job of keeping America strong in the air. The possibilities of radio, radar, new types of engines and jet propulsion are unlimited. They must be developed.

• Men between the ages of 17 and 34 have a great future ahead of them in aviation. During the war the Army Air Forces established the finest technical schools in the world and now they are yours. Your special skill will be developed to the fullest extent in the excellent technical training schools maintained by the Army Air Forces. You will be trained by the finest men in modern aviation using the newest techniques. And you will earn as you learn.

• A private earns \$50 per month. Enlisted men's pay can rise to as much as \$200 per month. Promotions for tech-

nicians are rapid. You will receive the finest of medical and dental care without ever having to worry about a bill.

• Under the Army's new enlistment program, enlistments are for 1½, 2 or 3 years. Men who enlist for three years may choose their theater of operation and branch of service. There's a 30-day paid furlough each year. Service overseas brings 20% extra pay and flight pay 50%. There are generous family allowances for the dependents of men who enlist before July 1, 1946. You are offered the right to retire after 20 years of service at half pay, increasing to three-quarters pay after 30 years' service. All this while you are developing your special skill or trade!

• If you are physically fit you can enlist today. Stop in at your nearest Army Recruiting Station and let them tell you more about your big part in the post-war AIR FORCES.

SEE THE JOB THROUGH

U.S. ARMY AIR FORCES

BE A "GUARDIAN OF VICTORY"



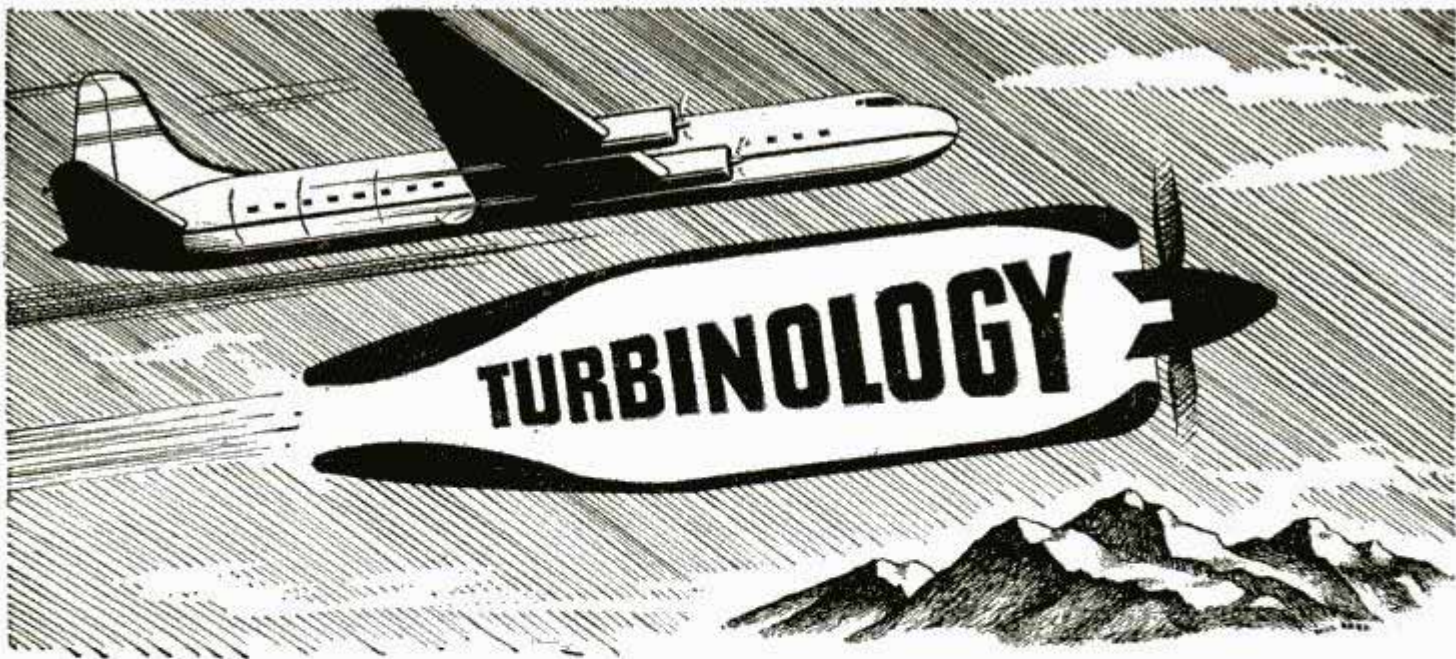

Wright Aeronautical Announces a New Type of Aircraft Engine . . . the Propeller Turbine

A tremendous and radically new source of aviation power, double the output of present engines is being developed by Wright Aeronautical. It is a propeller turbine, for use in gigantic new long-range planes racing through the stratosphere. The first Wright turbine will have double the power of today's largest Cyclone. Other models will be much larger.

WHAT IS A TURBINE?

Blow on the blades of an electric fan. They will begin to turn, though slowly. Direct the nozzle



FAN SPINS WITH WATER SPRAY

of a garden hose against the blades. They will turn faster. Or turn the air stream of a filling station tire pump on them. They will spin much faster.

In a regular turbine, much the same result occurs. There is a turbine wheel made up of fan-like blades placed close together.

A stream of super-heated steam or high-pressure water strikes against the blades with thousands of times the energy of a garden



DAMS HAVE TURBINES

hose and forces them to turn the turbine wheel and its shaft. In ocean liners, the rotary motion of the turbine is used to turn the ships' propellers. On land, the turbine is made to turn by steam or the force of water dropping over a dam or waterfall, and usually drives an electric generator.

NEW PROBLEMS ARISE

Lacking both waterfalls and boiler houses in the air, Wright Aeronautical had to devise a new method of creating a high pressure stream to strike the turbine blades and thus put power into a propeller shaft. Wright engineers turned to gasoline, burning it with compressed air. The result is a terrific expansion of exhaust gasses and air made to expand by heat. The only way the gasses can escape is through the turbine blades. Just as you set a revolving door in motion by pushing against it as you go through, so the gasses set the turbine wheel in motion by

pushing against the blades as they pass through.

The turbine is simple in theory but years of research have gone into making it a fact. New metal alloys were evolved, to withstand temperatures far above super-heated steam. To fill the job of waterfall or steam boiler, Wright engineers added an air pump, driven by the turbine shaft, to supply a constant source of compressed air. They geared down the furious turbine speed to a proper propeller pace.

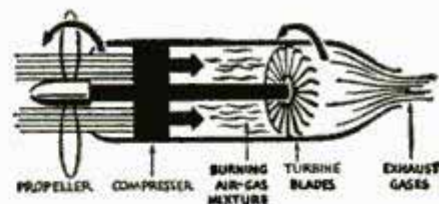

Their total result is a turbine of unprecedented horsepower. And just as the first Cyclone doubled, then quadrupled in power, so this first Wright turbine will be replaced by steadily larger models.

This is the first of a series of explanatory ads on the Wright Aeronautical propeller turbine.

WRIGHT

AIRCRAFT ENGINES

DIVISION OF

CURTISS  WRIGHT

FIRST IN FLIGHT

Wright Aeronautical Corporation • Paterson, New Jersey

CAN YOU IMAGINE a ray so powerful that it will penetrate a solid mass of lead as high as a four-story building, or as thick as five sixths of the distance between the pitcher's box and home plate? The cosmic ray does exactly that—

Unlocking the Universe

By William F. McDermott

and, even more, it gives promise of unlocking several of the major secrets of the universe.

Coming apparently out of the nowhere—possibly from the Milky Way, maybe from interstellar space beyond this universe—cosmic rays beat down upon us, day and night, like rain. In fact, 20 rays pass through your body—head to foot if you are standing—every second. Whether one climbs to the top of the highest mountain, hides away in the deepest mine, or plows the surface of the sea as a typhoon rages, the incomparably powerful

University of Chicago athletic field is launching site for balloons which will lift cosmic ray equipment into the stratosphere



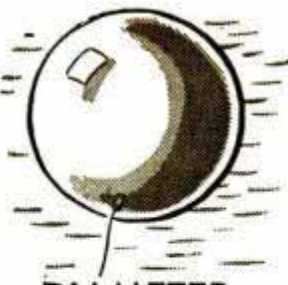
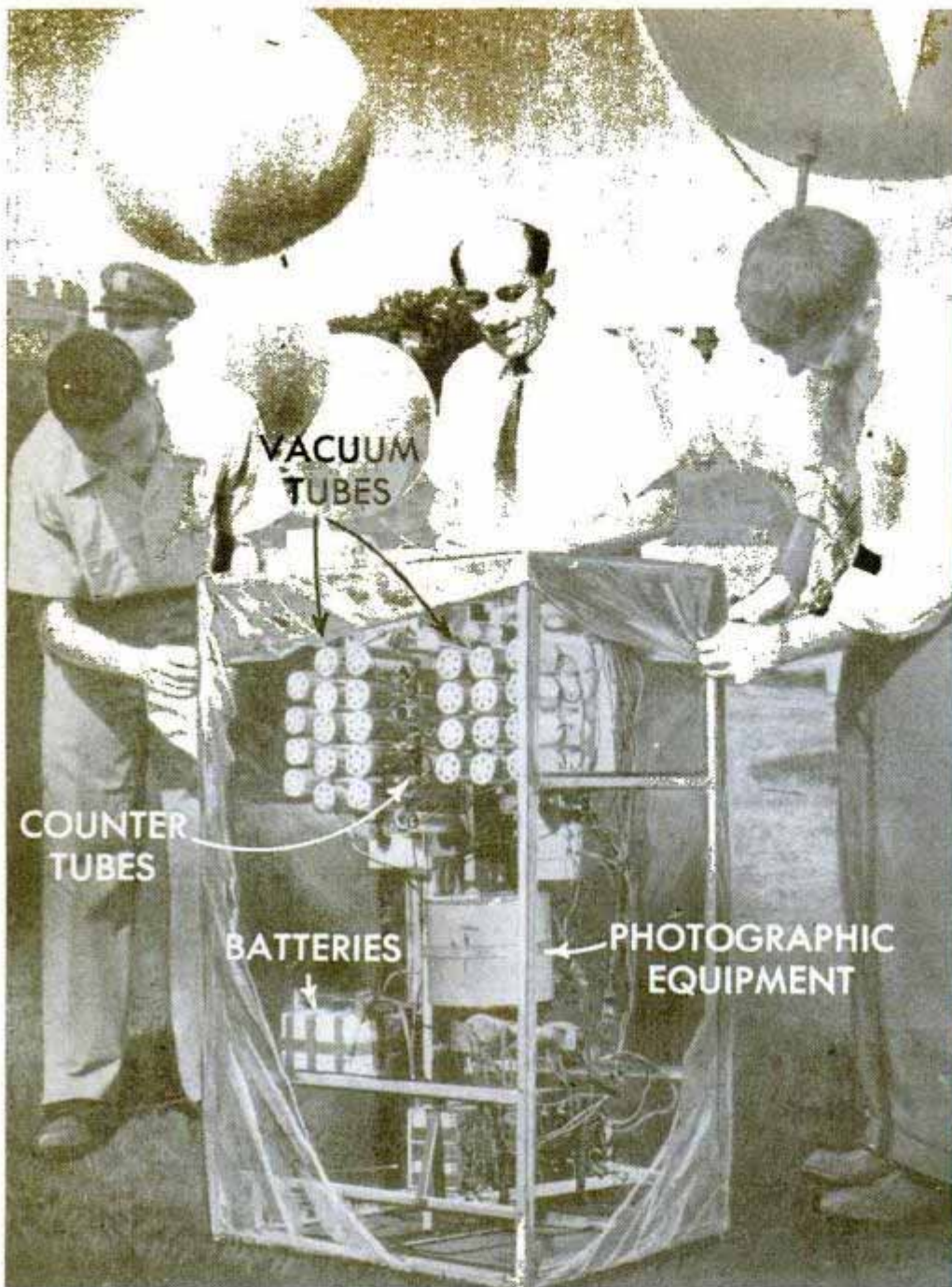

DIAMETER
20 FEET
AT 16 MILES



BALLOON FOR
COSMIC RAY
TESTS



DIAMETER
5 FEET
AT SEA LEVEL



Dr. Marcel Schein (center) inspects apparatus which makes photographic record of cosmic rays in sky

cosmic rays reach him. Radium rays, X-rays—even atomic rays—bow to the gargantuan might of this king of all radiations.

For more than two decades many of the world's greatest scientists have kept relentlessly on the trail of the cosmic ray. Expeditions have ascended great peaks, invaded deserts, ridden ocean liners for months at a time, ascended into the stratosphere by planes and balloons and sent delicate registering instruments higher into the sky than man has ever flown—all to fathom the mystery of the giant of rays.

In their quest to solve it, scientists have taken cosmic ray "soundings" in the Paris catacombs, in gigantic glacier cracks, in the fjords of Norway and inside the barrels of cannon big enough to hold the equipment and the researchers alike. They have gone down into brine pits to test the ray under

crystallized salts of the sea; they have invaded mines where iron, coal or copper are dug and they have dived deep into the sea for underwater registration of the rays.

They improvised watertight diving bells, complete with cosmic ray equipment from storage batteries to photographic apparatus and automatic registering instruments, which they sank from a quarter to a half mile deep, letting them lie there for days at a time. They built specially designed "cloud chambers" for high altitude studies. They improvised special instruments for registering the rays in the crevasses of glaciers.

The present stage is still that of the hunt. Until more is known about the cosmic ray, little can be done to harness it. To date, rays are controlled to the point of being heard over loudspeakers, operating delicate automatic photo equipment and light-

MOST PENETRATING RAY IN HISTORY



ABOUT 20 COSMIC RAYS PASS THROUGH BODY EVERY SECOND

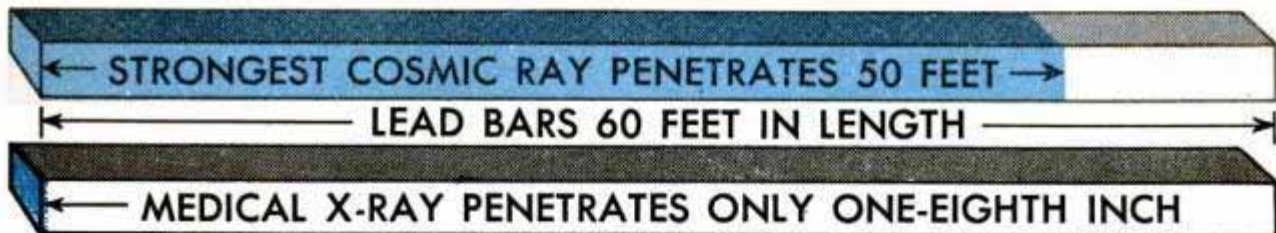
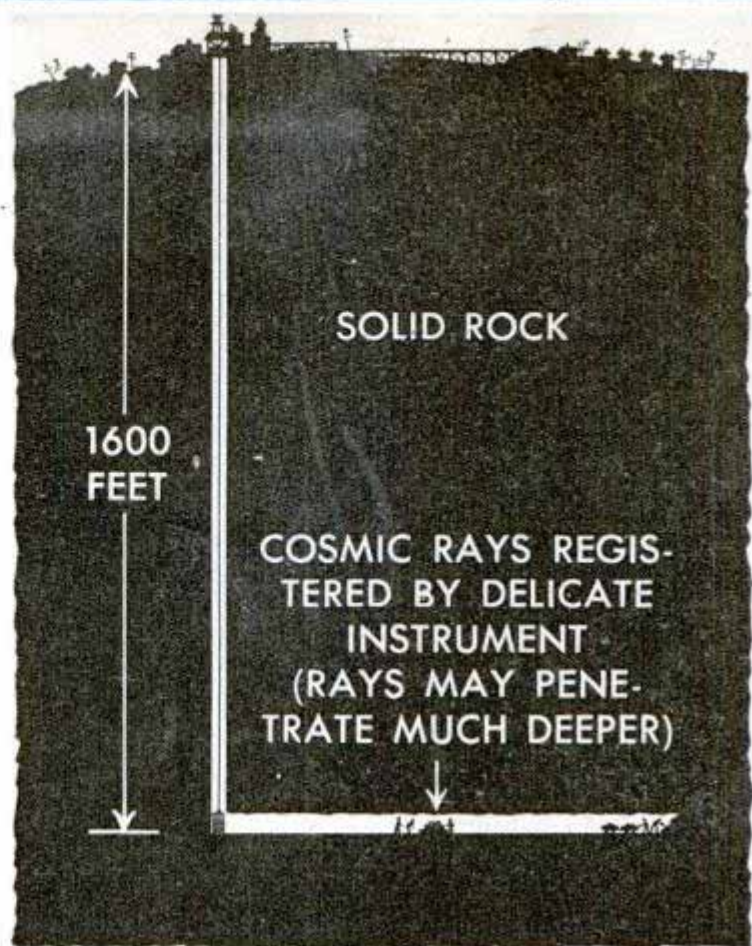

Cosmic rays raining down upon the earth penetrate everything with energy measured in billions of volts

ing up indicator lamps. But the world's best minds say that its secrets will be revealed, and then it may be mastered for the use of man. Scientists, with their usual caution, do not speculate on its practical possibilities. But they do admit that they are illimitable.

Those possibilities are as intriguing a subject as ever comes to the mind of man. Unlimited power is the key—not only that, but unlimited power already created and ready for use. We think of atomic energy, but realize mammoth machinery will be necessary to produce it—at present, an atomic energy driven auto would weigh at least 100 tons! But cosmic power may some day be pulled out of the air by a receiver, exactly as we pluck radio waves out of the air with our sets. In that near or distant day, put a cosmic aerial on your house or

your auto, and presto! Power flows in like a Niagara.

To those who puzzle over the composition of the universe, its age, and whether the universe is building up, self-sustaining, or running down, the cosmic ray holds fascinating potentialities. About unlocking the history of the universe, none other than Dr. Arthur H. Compton, one of the world's greatest physicists, Nobel prize winner for his research on the cosmic ray, and now chancellor of Washington University, St. Louis, had this to say:

“Very possibly cosmic rays are older than the earth itself, for their energies are so high that calculation shows that if a particle (cosmic ray) is once thrust out into space, it can continue, before it is stopped by the matter in interstellar space, for a time equal at least to the estimated age of

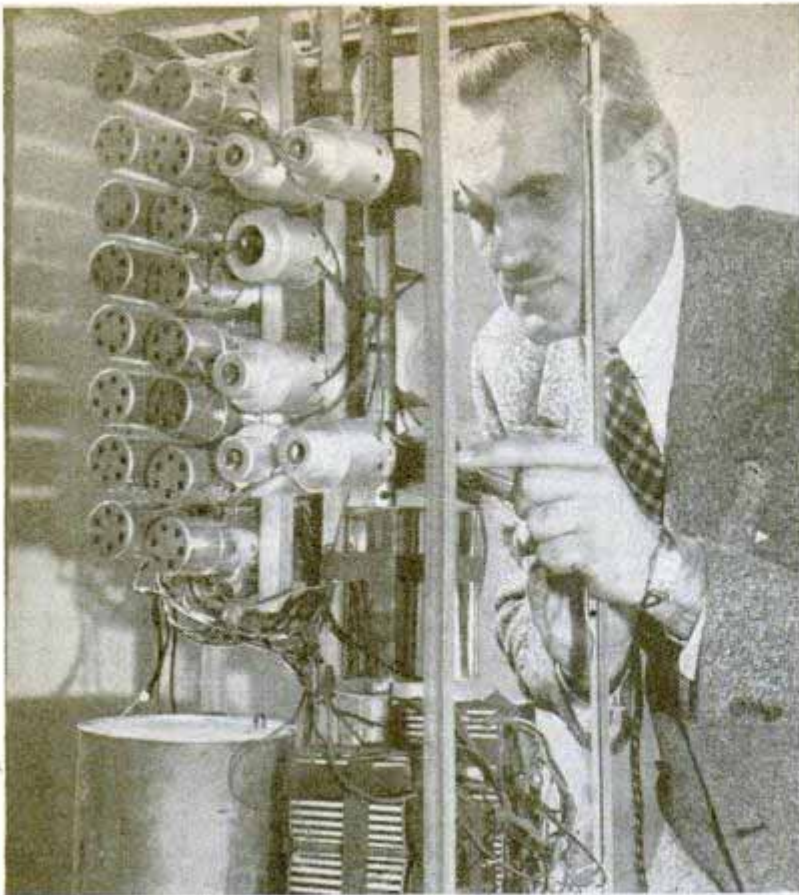

Dr. Arthur H. Compton adjusts cosmic ray counter before balloon test. Right, vertical streak is path of cosmic ray photographed in "cloud chamber." It has struck an electron (center) and knocked it out of orbit

the earth. Thus, there is reason to hope that future study of these rays may bring us valuable information regarding the ancient history of the universe."

Some physicists estimate the rays as 10 billion times stronger than radium rays; the most penetrating variety enter outer space with the energy of 15 billion volts.

Not only does the cosmic ray possibly contain the key to terrestrial antiquity, but it also may hold the solution to that even more fascinating proposition: What of the

future of the universe? One theory projected by scientists is that the cosmic ray is produced in the building up of atoms, thus indicating that the universe is perpetually renewing itself. Other eminent men hold to the opposite belief; namely, that the cosmic ray is produced in the destruction of atoms and that the universe is running down. Many affirm that cosmic rays are the basic form of energy.

The romance of the cosmic ray at the present stage is not in actual achievement

ALTITUDE AND DENSITY TABLE

Above

90,000 Feet . . . Primary cosmic rays, probably protons of unknown origin.

80,000 Feet . . . One half of primary cosmic rays have been absorbed in atmosphere. Rays here are a proton and mesotron mixture. A mesotron is a particle with mass between a proton and electron and can carry a positive or negative charge.

40,000 Feet . . . Primary cosmic rays practically nonexistent. Secondary rays are mesotrons and electrons. The latter originate from disintegration of the mesotrons. Ratio here is four electrons to one mesotron. Wherever electrons are found there are always approximately the same number of gamma rays.

25,000 Feet . . . Thinning of rays—fewer mesotrons and electrons. Ratio is three electrons to one mesotron.

Sea Level Ratio two mesotrons to one electron. The cosmic radiations known as mesotrons are the most penetrating particles in the history of scientific research. Protons and neutrons also are found in cosmic radiation but their contribution is unknown.

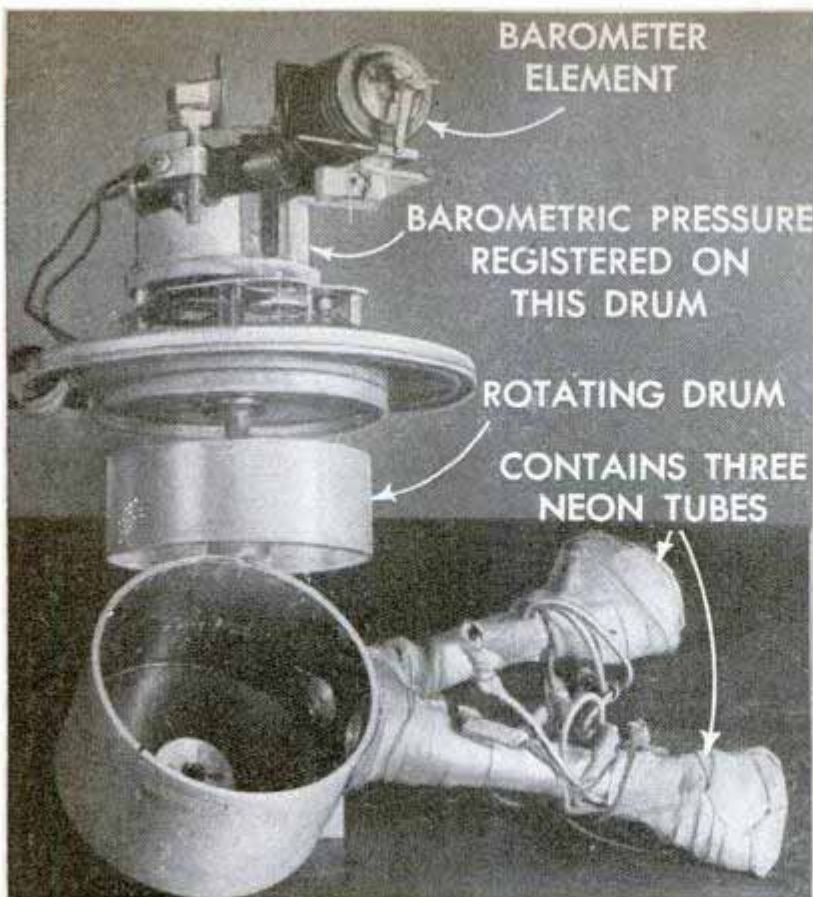

When cosmic ray passes through counter, photographic equipment is tripped to register dot on film attached to rotating drum

with it, but in the indefatigable and ingenious research for it. Twenty years ago, Dr. Robert A. Millikan, Nobel prize winner, professor of physics at the California Institute of Technology and pioneer in cosmic ray study, declared, after he had conducted research in the Andes mountains, that "we cannot even begin to assert what change in man's view of the universe this ray will bring about."

The rays, which have been ranging the cosmos for possibly a billion years or more,

first caught the attention of man about 1900, when it was found that nonelectrical gases, perfectly insulated, continued to act like electric current conductors. Scientists tightened up all possible leakages of electricity and radiations but found themselves against a blank wall of mystery.

Two scientists, Lord Rutherford and H. L. Cook, at McGill University in Montreal, buried an electroscope in five tons of lead, a metal then accepted as a substance through which no rays or radiations known to man could penetrate. Yet the delicate instrument continued to register a mysterious electrical action. They could discover no earthly connection. But they, and many others, refused to yield to what seemed inscrutable—their restless minds would not be conquered. In different lands, scientific pioneers kept on the elusive trail. They began to suspect dimly that something beyond terrestrial origin was

causing the "trouble." Spasmodically the search continued. In 1910 a notable contribution was made by a Swiss scientist, Dr. Gockel, who reached unparalleled altitudes in a balloon. His studies tended to show the rays came from somewhere out in space. A year later, V. F. Hess, an Austrian scientist who won the Nobel prize for his research, wrote of his investigations:

"During the past two years I have made seven balloon ascensions. I find no decrease

(Continued to page 252)

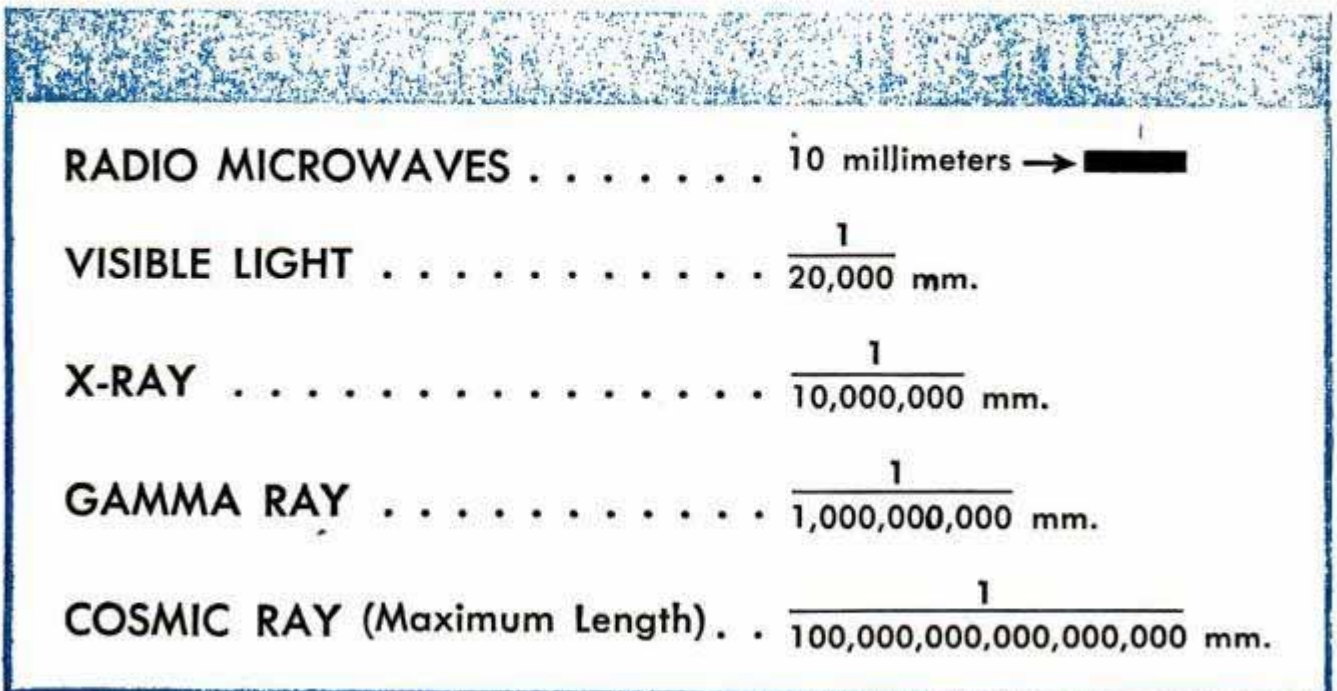

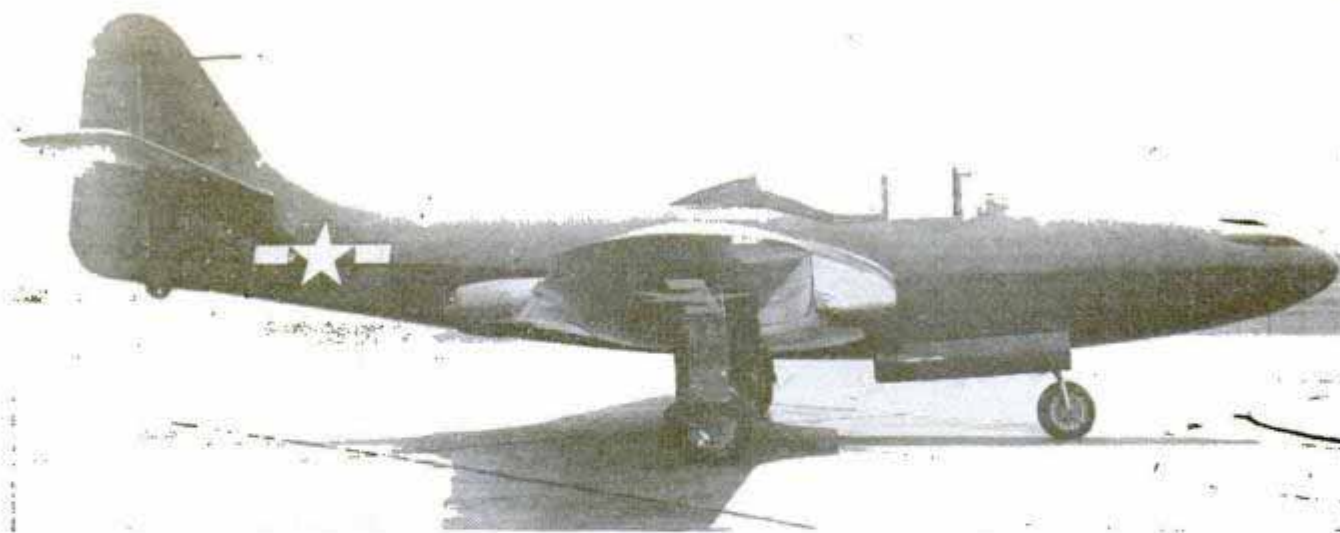

Navy's First Jet Carrier Plane Tops 500 Miles an Hour

First Navy fighter to exceed 500 miles an hour, the FD-1 Phantom also is the service's first exclusively jet-powered carrier plane. It has a service ceiling well over seven miles and a range of about 1000 miles. Built by McDonnell Aircraft, the Phantom is powered by twin axial-flow Westinghouse turbojet engines of American design. The plane is made of light aluminum alloy, polished to a glasslike finish, and weighs less than 10,000 pounds loaded for combat.

The tricycle landing gear is completely enclosed when retracted. With wings electrically folded for carrier storage the plane's width is reduced from approximately 40 feet to 16. Despite its swiftness, the new jet-propelled craft has a landing speed comparable to that of conventional carrier-based planes. For conditions where take-off assistance is necessary, standard carrier catapults or JATO, jet devices for an added boost, may be used.



Electrical Gearless Tachometer

No gears or gear shifts are used in a new type tachometer for measuring cutting speeds of lathes and milling machines, linear speeds of shapers and rotational speeds of motors, generators, turbines and engines. The instrument consists of a head, which is placed in contact with the rotating unit, and an electrical indicating unit to which the head is connected by electric cable. The head contains a rotating shaft which operates a set of contacts through a positive, straight-line-motion cam mechanism.

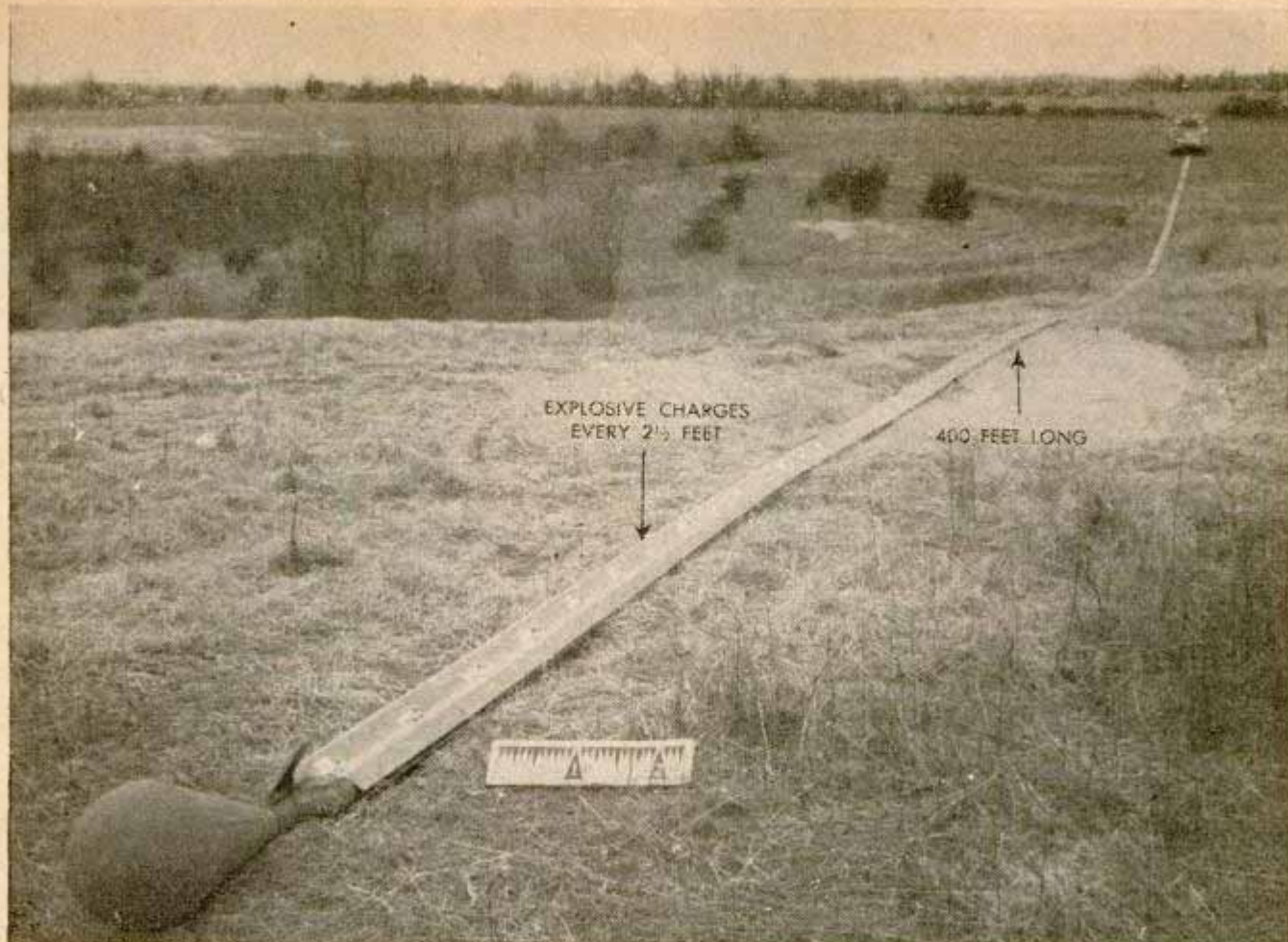

Snake Blows Up Mines To Aid Tank Charges

Slithering its 400-foot length through grass and underbrush at two miles an hour, a new type mine destroyer called the "Snake" was used by our Army in Europe to detonate enemy explosives and cut wires. In combat, it cleared a path for a column of tanks. The Snake is a metal trough loaded with explosive charges encased in corrugated aluminum plates and bolted together to form a rigid assembly which can be towed or pushed by a light tank. A pear-shaped flexible "nose" guides it over rocks and around trees. It is 14 inches wide and five inches high and weighs about 9000 pounds when fully loaded with 4480 pounds of special explosive cartridges. The cartridges are spaced in the trough at intervals of

Loaded with explosives spaced 2½ feet apart, "Snake" is pushed along by tank and, below, exploded by fuse detonated from tank



about 2½ feet and exploded by an impact fuse detonated by machine-gun fire from the propelling tank.

Record Horsepower Per Pound Set by Wright Cyclone Plane Engine

World's lightest aircooled engine per horsepower is the new Wright Cyclone 9HD being built for the Douglas DC-4, the Curtiss SC-2 Seahawk and several experimental military aircraft. The engine weighs 1352 pounds and develops 1425 horsepower,

or one horsepower for each .85 pounds. In the DC-4s, where it is "packaged" in a pre-fabricated nacelle that attaches directly to the wing, it is expected to add 25 miles an hour to the cruising speed, boost the payload half a ton and simplify maintenance.



"Inside Stubb"

for
Your Home

Pull out the center of this versatile and roomy chest and you have a writing desk. Below, ground glass seals rubberless coffee brewer. Right, proposed transparent bag would show when a vacuum cleaner needed emptying.

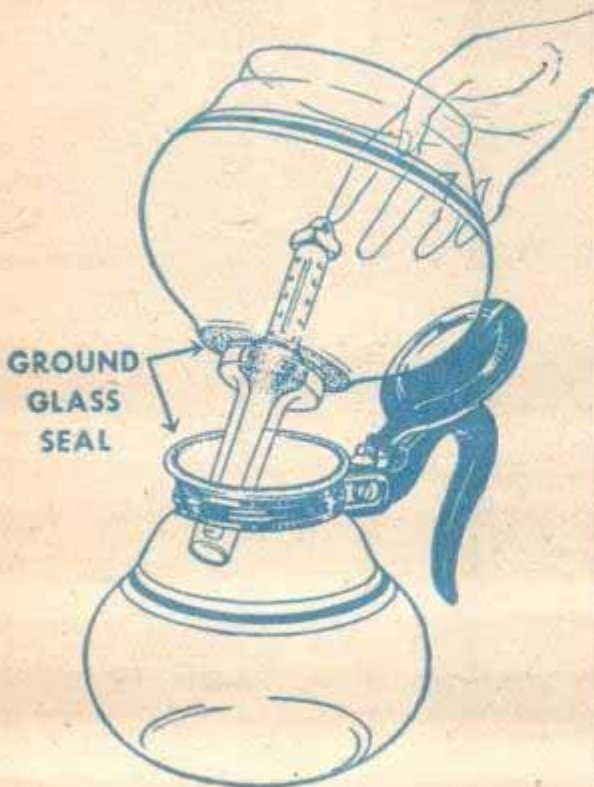



↑ A comfortable rocking footstool adjusts itself readily to every movement of the user. The rockers on the stool also keep it from sliding out of range of the feet

Steel mesh makes this ironing board → air-conditioned, with 61 percent of the surface open for ventilation, permitting faster ironing by allowing steam to escape

↓ Small luminous buttons can be attached to light switches and stair steps



↓ "Tripod" trays that can be pressed into bars of soap avoid waste by holding cakes above the surface of basin or bathtub

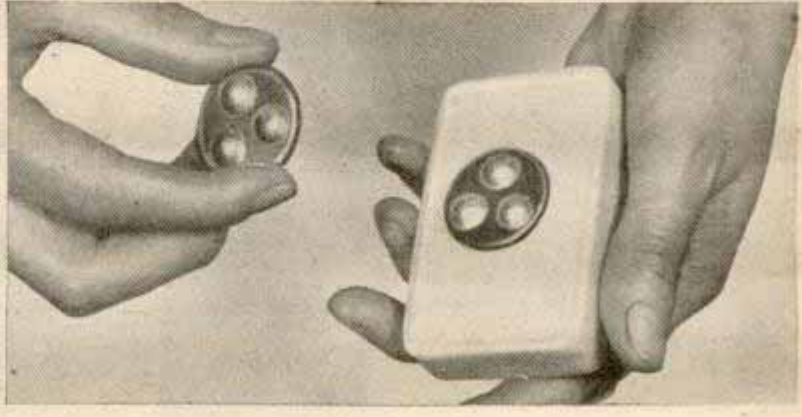
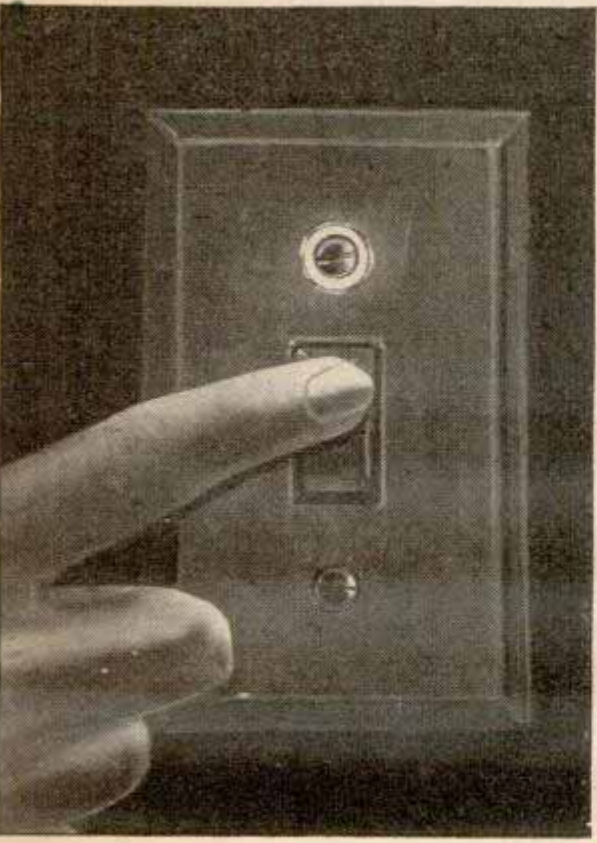

Biggest Photo "Recon" Plane Expected to Go 400 m.p.h.



Giant of all long-range planes built for photo reconnaissance, and believed capable of 400-mile-an-hour speeds, the AAF's new XF-12 has armor plating, three camera stations and dark room facilities for loading cameras and developing prints. Built by Republic, it is 98 feet nine inches long and has a wing span of 129 feet two inches. Each of the four Pratt & Whitney Wasp Major engines is equipped with two turbosuperchargers. Although the Army has not released performance data on the XF-12, it has been announced that its commercial version, the Rainbow, would cruise at better than 400 miles an hour at 40,000 feet, with a range of more than 4000 miles.



Handy Sealed Packet Holds Chemicals for Developing Snapshots



Hermetically sealed powdered chemicals for developing photographic film can be obtained now by snapshot enthusiasts in a compact packet about the size of a deck of cards. Each packet contains enough chemical to make 32 ounces of solution for tank development of film and plates or 12 ounces of solution for tray development of films, plates and papers. The sealed packet prevents deterioration of the chemicals.

Transport planes of the future may fly much higher and with greater safety when final development work is completed by the General Electric Company on an alternating current system to supply power for radios, landing gears, lights and navigation instruments. It will reduce weight of the power system 30 to 40 percent and overcome difficulties with brush wear and other motor damage at extremely high altitudes.

"HUFF DUFF" DOOMED SUBS



U. S. Navy photos

German submarines were spotted in the Atlantic with high-frequency radio direction finders which accomplished the "impossible"—fixing direction of short waves. Called "Huff Duff" (from the initials HF-DF) the sets were used on ships (above), planes and shore stations. Two or more huff duff bearings on a sub's radio made it a simple matter to plot position as shown in sketch. A streak of light on a cathode-ray tube shows the direction from which a signal comes. Transatlantic air-line pilots will be able to call huff duff stations for a "fix" on their position if they are lost over ocean

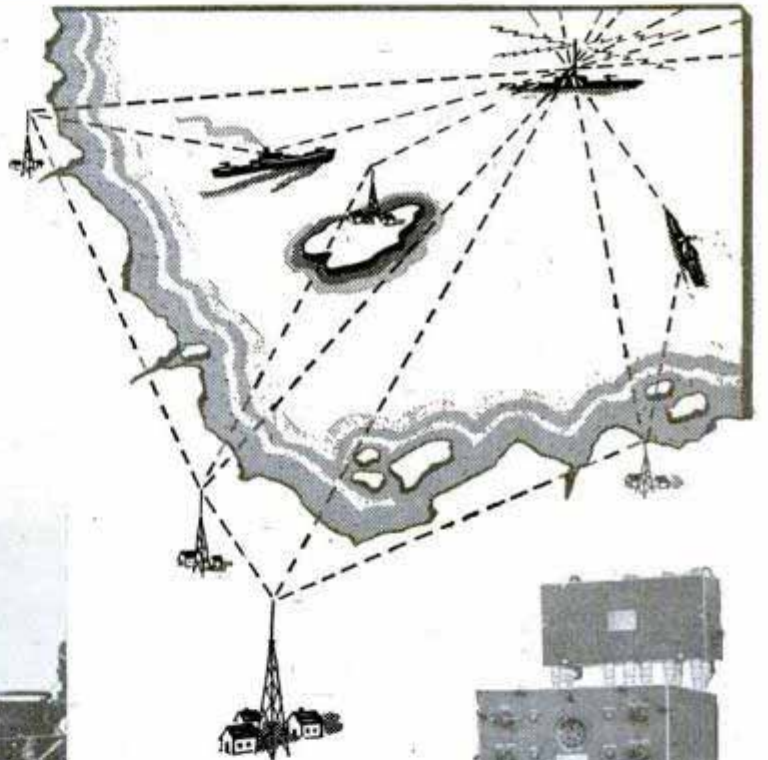

← Huff duff antenna on destroyer automatically scans entire horizon 20 times in one second. Germans used 15-second "squirt" signals from subs in effort to evade detection and failed. Control unit for direction finder used on ships is shown at the right. The cathode-ray viewing screen on finder is marked off with 360 degrees of circle

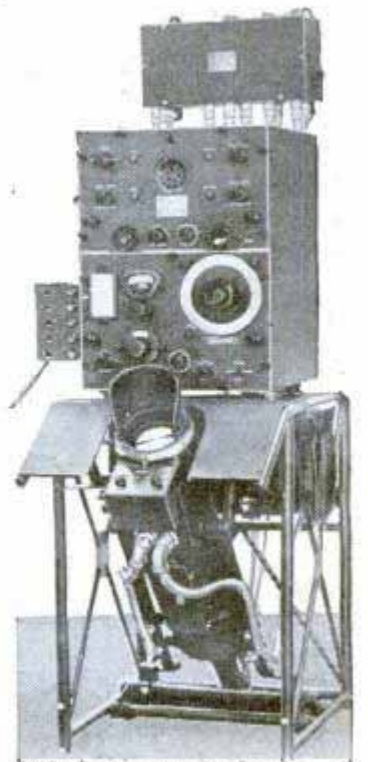

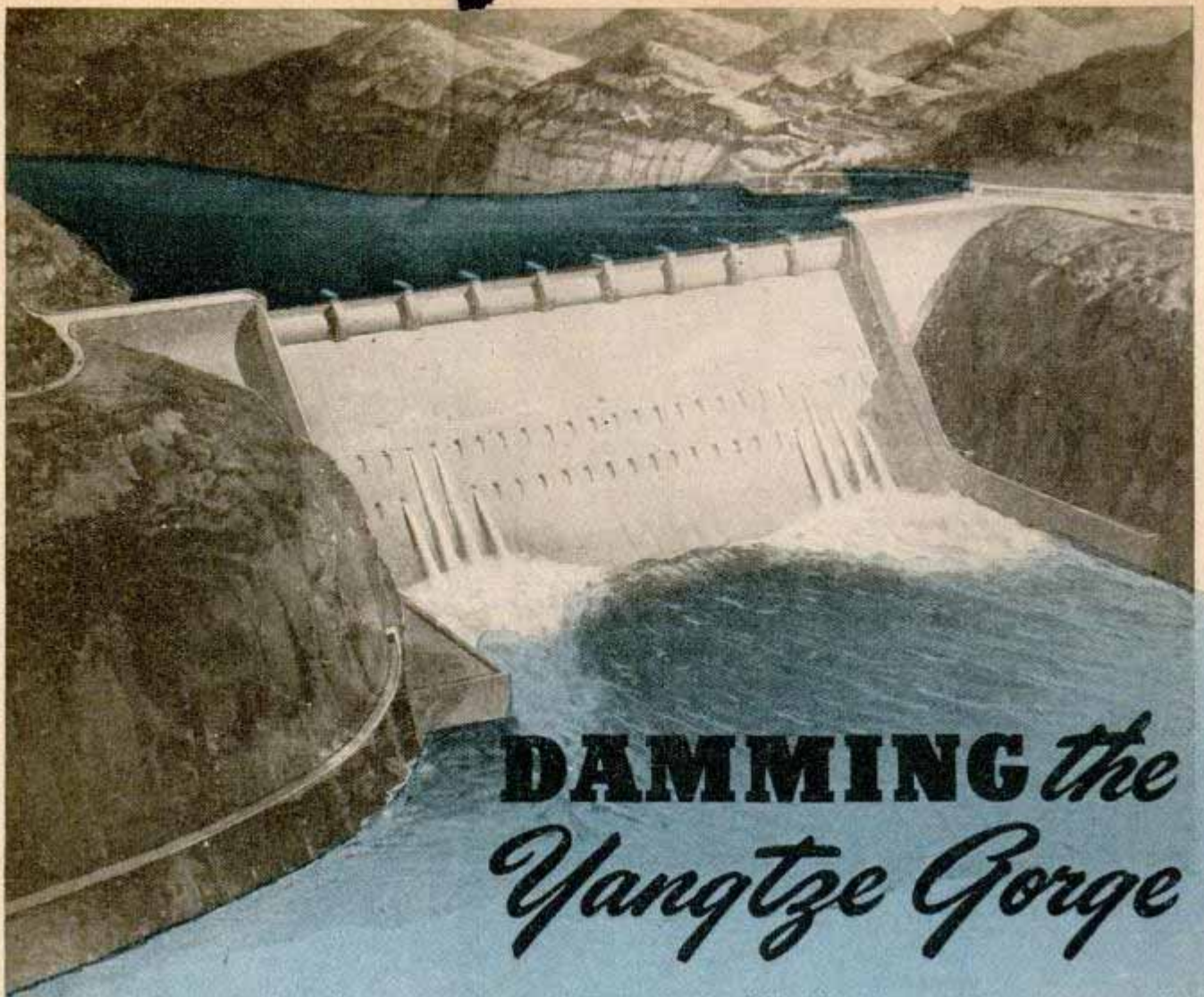

DAMMING the Yangtze Gorge

By Roscoe Fleming

IMAGINE, if you can, cranes so powerful they can pick up a 10,000-ton ship and hoist it over a lock 530 feet high.

Eight such cranes are conceived as part of a colossal plan for the world's largest dam across the Yangtze River in China which would supply irrigation water for some 10,000,000 acres of barren land and provide hydroelectric power to rebuild the nation.

The cranes, as visualized by American engineers "blueprinting" the project,

will straddle the dam and compensate for the 530-foot difference between water levels on each side of the structure. Ships going up or down the river will be raised or lowered like matchboxes and sent on their journey. Leaving the dam downstream, ships will pass through a ¼-mile tunnel cut through mountain rock and connecting with a tributary of the Yangtze.

Plans for the dam are being worked out at Denver by the U. S. Bureau of Reclamation with the assistance of Chinese government engineers. China is paying the United States \$500,000 to design the dam.

John Lucian Savage, former chief designing engineer for the Bureau and now its design consultant, is supervising the planning.

In bulk alone this giant dam will outmatch Grand Coulee, Shasta and Boulder. It will contain 23,000,000 cubic yards of concrete, as against 11,000,000 for



Artist's drawing (top) of world's largest dam, 750 feet high, planned for China's "Father of Waters"

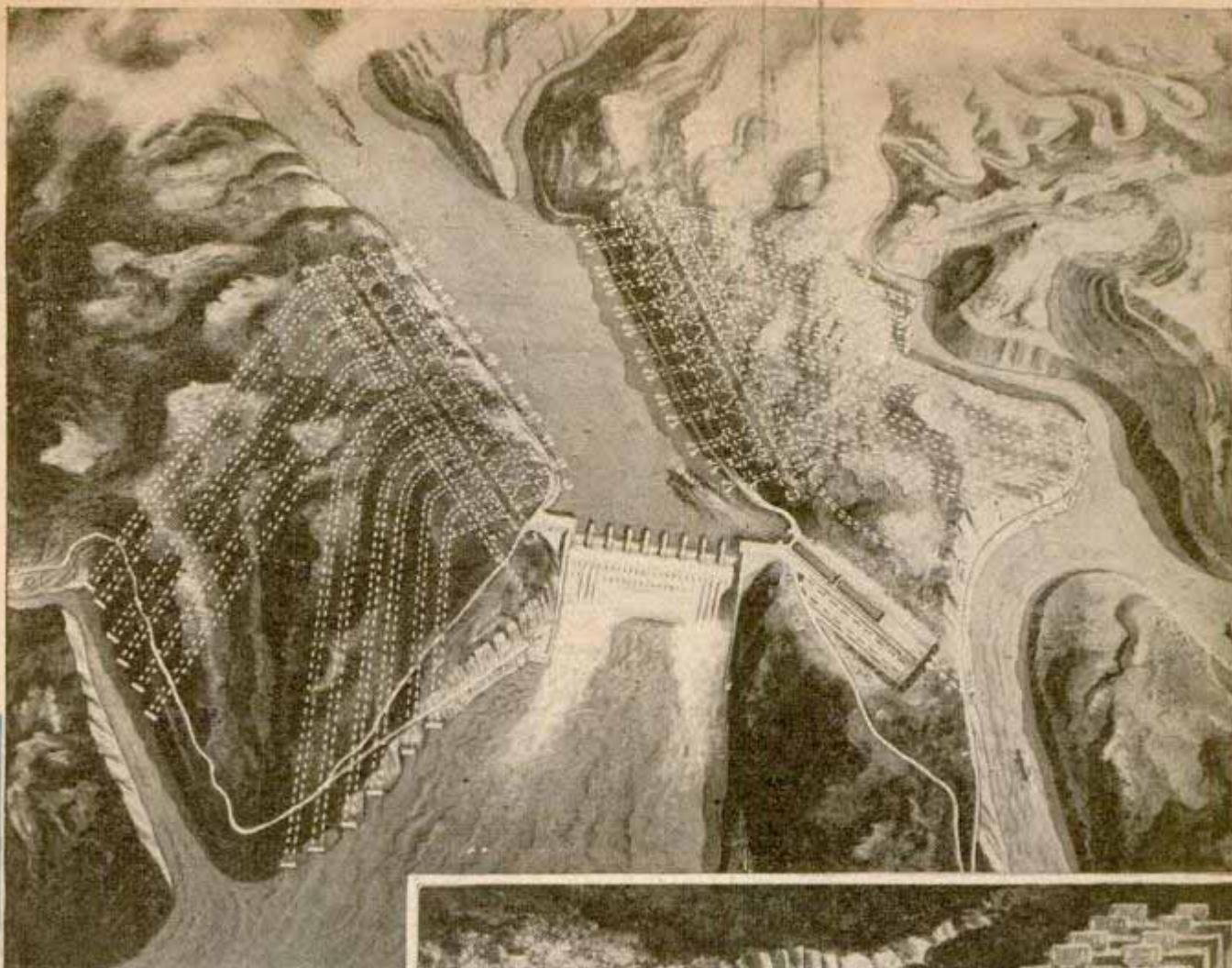

Tunnels (dotted lines) will carry water to the underground generators. The giant cranes at the right will raise or lower 10,000-ton ships

Grand Coulee. It will be 750 feet high, the world's tallest dam. Boulder is 726 feet high.

The Yangtze is as great a river as our Mississippi, yet the gorge at Ichang where it finally plunges out on the plains of Central China is so narrow that the dam will be only about a half mile long at its top. Behind this mighty bulwark, however, will be backed up 50,000,000 acre-feet of water, or 70 billion tons—enough to cover the state of Illinois to a depth of about 18 inches. The lake will reach back above Chungking, or more than 250 miles. From the pool level above the dam to the pool level below will be 530 feet, or just a little less than the height of the Washington monument.

The potentialities of the

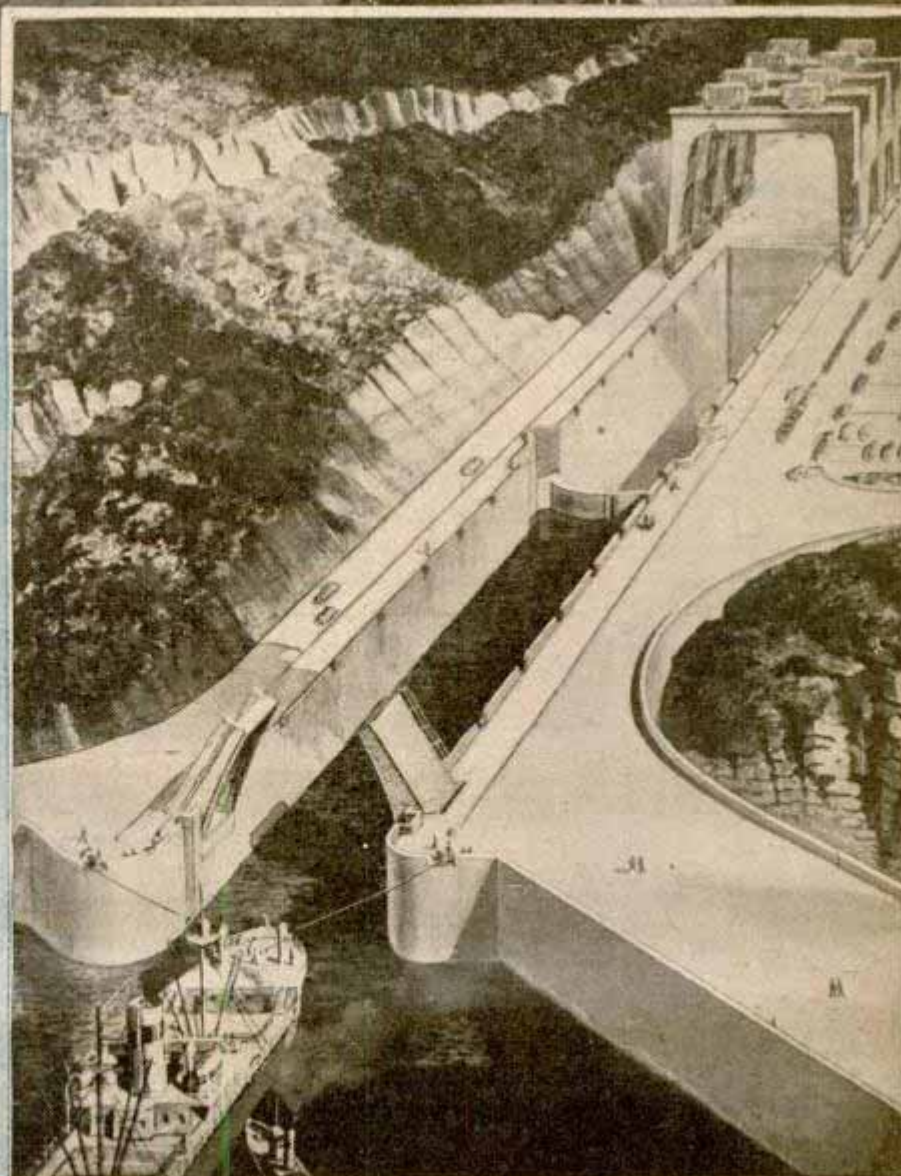

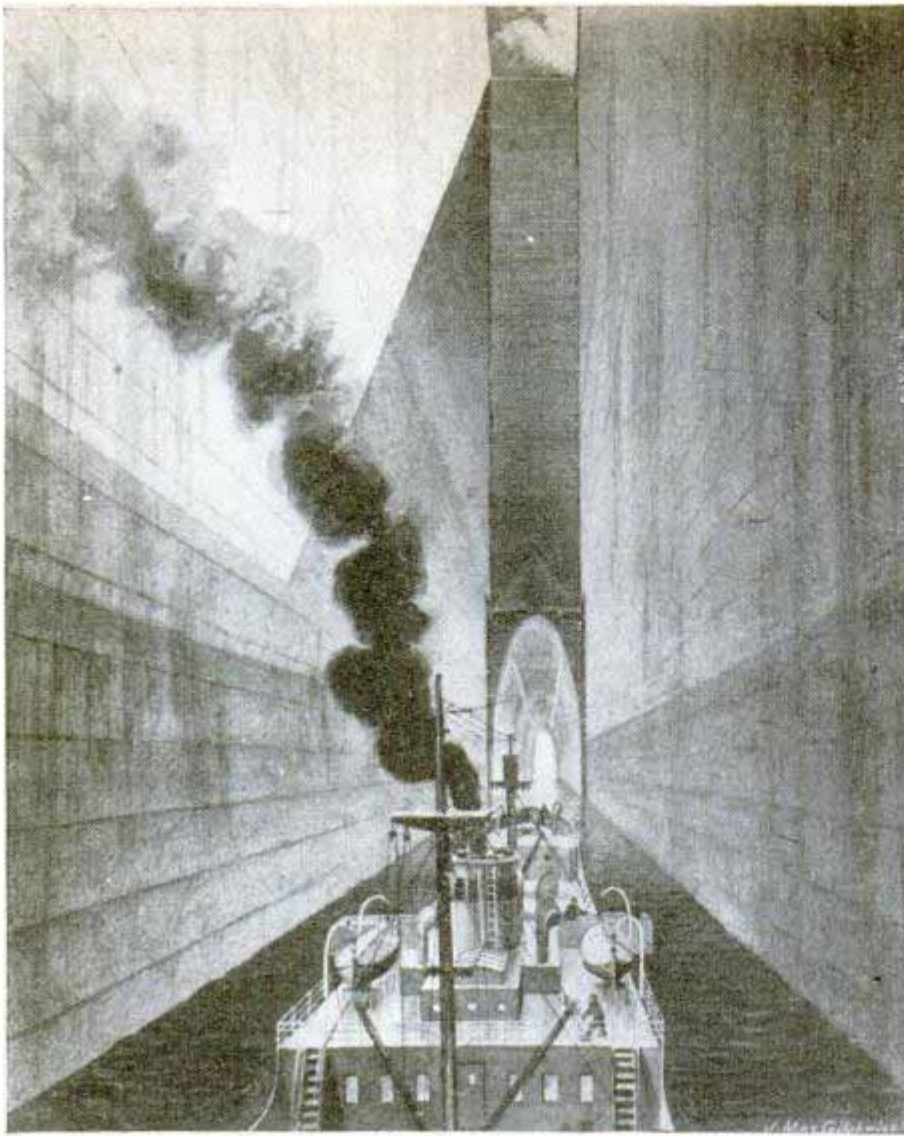

Drawings by courtesy U. S. Bureau of Reclamation
Below the dam, ships will pass through a tunnel and emerge in a tributary

dam are as huge as its size. It will produce 10,560,000 kilowatts of electric power (more than 14,000,000 horsepower). This is about five times the amount that ultimately will be available at Grand Coulee, now the world's biggest power plant.

From 96 mighty generators will come power to turn the wheels of China's new industry. It is only the master-work: China has plans under way for other great dams on the Yangtze and other river basins. But the Ichang dam is the first.

The reservoir will make available for irrigation some 74,000,000 acre-feet of water yearly which will permit two crops to be raised instead of one, besides irrigating lands now arid and draining the marshy malarial lakes below the gorge.

The dam will prevent floods which occur almost every year, the greatest of which, in 1931, caused \$478,000,000 in damage and drowned thousands of Chinese.

Lastly, the dam will be built to permit the movement of river traffic. Steamers of 10,000 tons or possibly even larger will go right up to, and perhaps beyond, Chungking.

Mr. Savage went to India in 1943 and later to China at the request of our State

Department to give advice on sites for dams and basin-wide developments. But at the Yangtze the Japanese held Ichang, just below the final gorge from which the river emerges. Detailed topographic maps were not available, but the Chinese general in command obligingly dug some up out of a file. They had been taken by the Japanese from the air and later captured by the Chinese.

The site is an engineer's dream. The giant Yangtze, after leaving the high mountains, runs for hundreds of miles through a succession of valleys and gorges, of which the last is the Ichang gorge, some 10 or 12 miles long.

Mr. Savage's concept, which has been accepted, reaches its most daring scope in two respects:

First, the dam will be the first to have its power and other auxiliary installations completely underground, protected by hundreds of feet of rock against possible bomb raids. Construction will

begin by the boring of 20 great tunnels, each 50 feet in diameter, from the river bed into two nearby tributaries of the Yangtze on opposite sides of the river. These are to carry the flow of the river past the site while the dam is being built. Then two or more large tunnels and possibly a smaller one will be dug on each side, or 26 in all. New inlets into the reservoir will be bored at a higher level, so the tunnels then will slant steeply down from the lake. At the bottom of this steep slant, in each of the 24 major tunnels, giant 108,000-kilowatt generators will be installed, four to a tunnel. Smaller turbines to operate the dam itself will be installed in the two smaller tunnels.

So much power will be produced that the cost of the dam will be small by comparison. Mr. Savage says sale of power at two mills per kilowatt-hour, and of secondary or part-time power at one-half mill, will more than pay for the cost of the project in less than 20 years. Meanwhile it will help produce a tremendous flood of goods, heavy and light, for the modernization and industrialization of China. Also it will help build other large dams and power works. Seen

(Continued on next page)

Wheel Out Engine In Servicing Truck

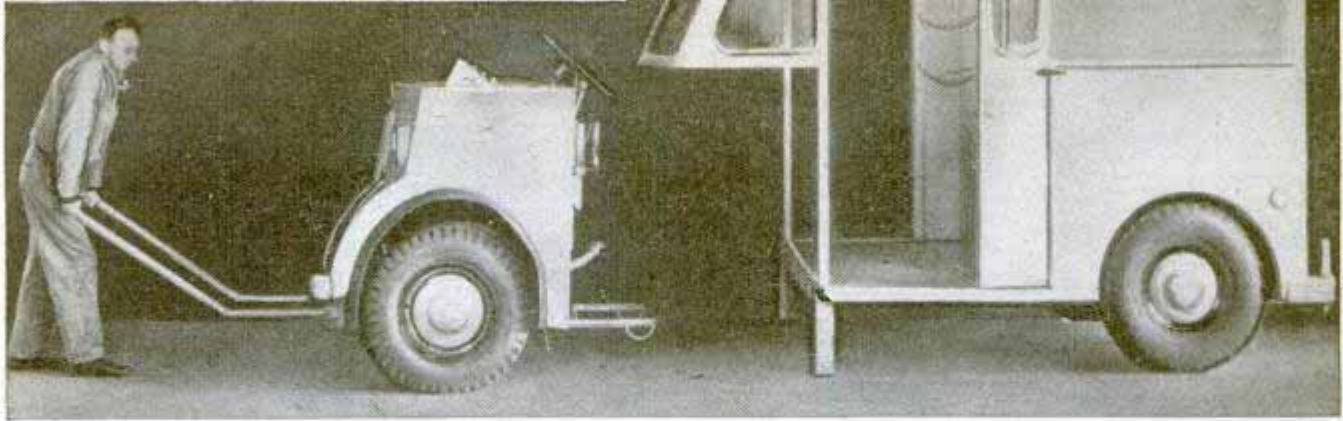

Like a horse moving in and out of its traces, the engine of a new delivery truck can be detached from the truck body and returned to its place quickly and easily for servicing. Engine, steering gear and operating controls are in one unit that may be wheeled away from the vehicle. A short wheelbase gives the truck exceptional ma-

neuverability. Other features include wide low entrances with folding doors, a large carrying compartment and driving controls that can be operated from either a standing or sitting position. The floor of the truck is only 13 inches above ground level to minimize driver fatigue. A four-cylinder, 60-horsepower engine provides power.

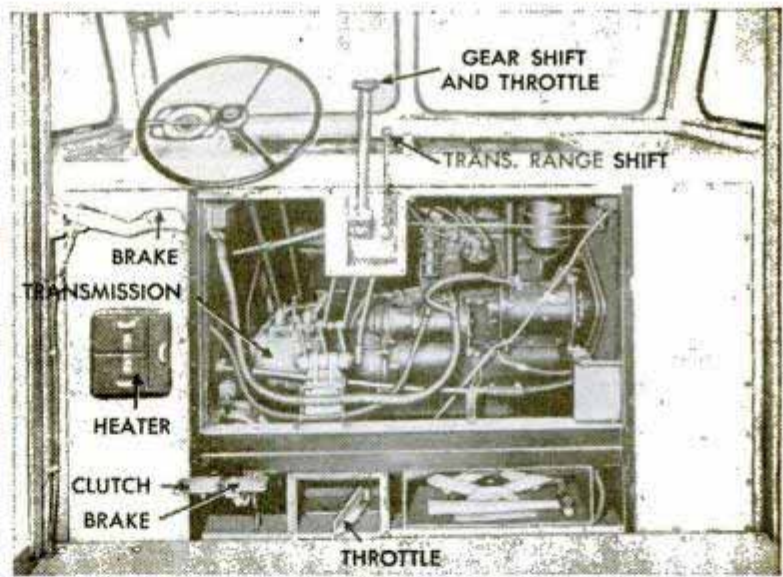
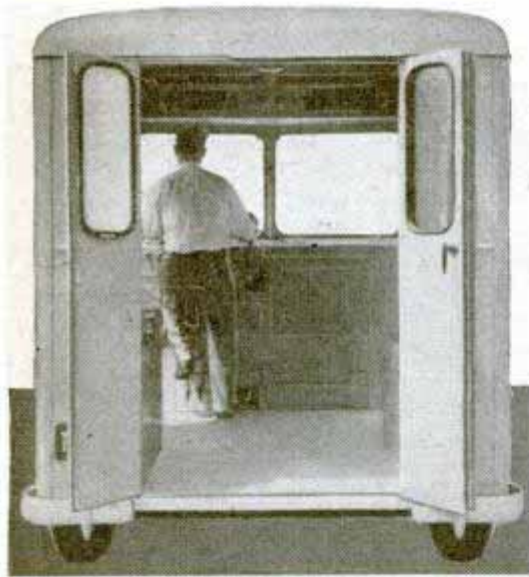

as a future possibility are industrial plants near the dam site, built with the machinery that built the dam, with lighter industry farther away. Completion will take a decade, but power will be available much sooner than that.

Second of the revolutionary features is the device that will enable 10,000-ton ocean steamers to go up and down the Yangtze despite the 530-foot difference in water level created by the dam.

Ships will be raised or lowered the entire distance—more than twice the height of Niagara—by just one lock, a wide "well" 530 feet deep. A ship entering the lower side will be lifted in one operation to steam out on the blue surface of the great reservoir and on up to Chungking. This origi-

nally called for gates of unexampled size and strength to handle the pressure of 530 feet of water in one column. Mr. Savage had these worked out.

Then he realized that after all it would take a lot of water to fill and empty a well of that size and depth several times daily. So the design now calls for eight huge gantry cranes which will run on rails and straddle the top of the "well." These cranes will waddle forward, lower slings into the water and under the keels of the ships, which will be lifted or lowered 530 feet. As for smaller craft, Mr. Savage's plan is to gather several of them up at once, in a sort of dock also equipped with slings or hooks, and lift or lower them as a housewife lifts a pan full of dishes from the sink.

Miniature Bomber Engine Powers British Car



Britishers will take to the highways in this lightweight car which carries luggage under the hood and the aircraft-type engine over the rear axle. Note the single headlight and the hammock seats on a tubular framework

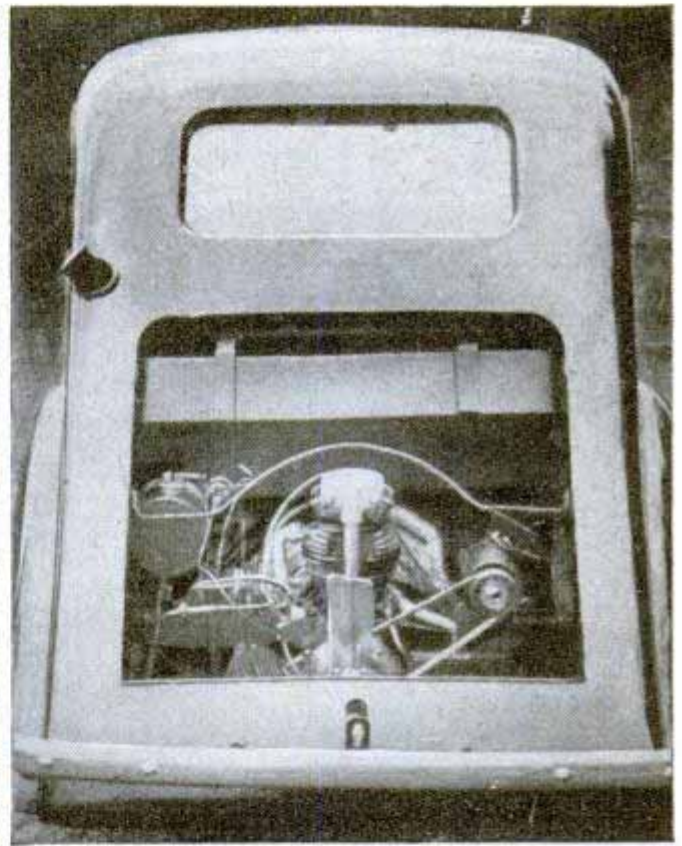
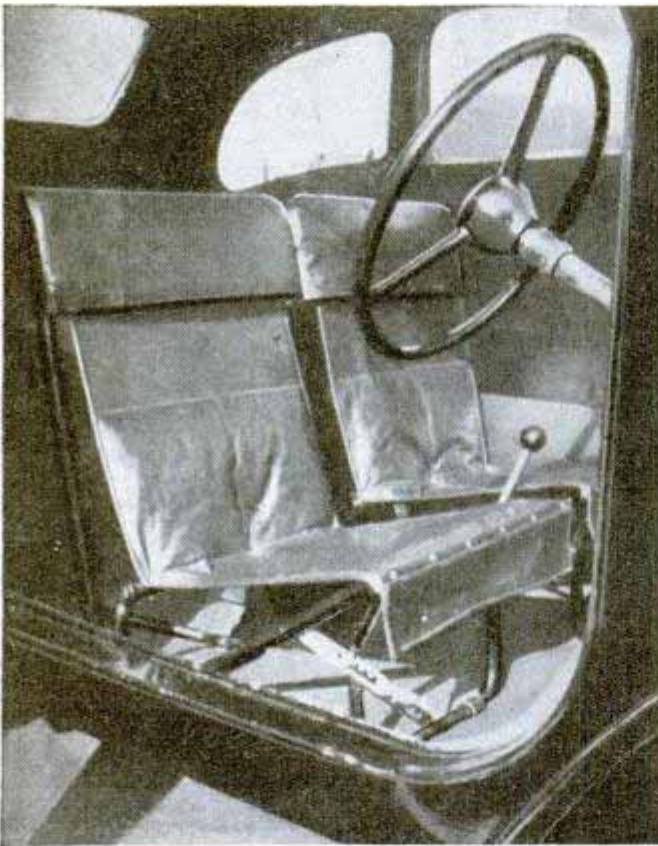

Built to sell for about \$400, a two-passenger British "People's Car" soon will be in mass production. Its many revolutionary features include a three-cylinder, radial, air-cooled engine which is similar in design to the huge multicylinder power plants in British bombers. The engine, mounted in the rear, will develop more than 20 horsepower. The car has a top speed of 60 miles an hour and will travel 40 miles on a gallon of gas, according to William D. Kendall, the manufacturer. The gasoline tank is above the engine and there is no fuel pump or radiator. Air to cool the engine passes through the dummy front and along a duct underneath the body. There are no springs in the car, which has a hydraulic suspen-

sion system, and each wheel is independently sprung. The pressed steel body and chassis are a unit and so are the engine, gearbox and transmission. A roomy luggage compartment is under the hood.

Barrage Balloons "Go to Work"

War-weary barrage balloons, now on sale by the government as surplus, are being converted to more than 40 different peacetime uses by enterprising purchasers. Whole balloons are used for advertising purposes. Others will be cut into raincoats, industrial aprons, tents and lampshades. One purchaser expects to use the fabric as a covering for houses on his chicken ranch.

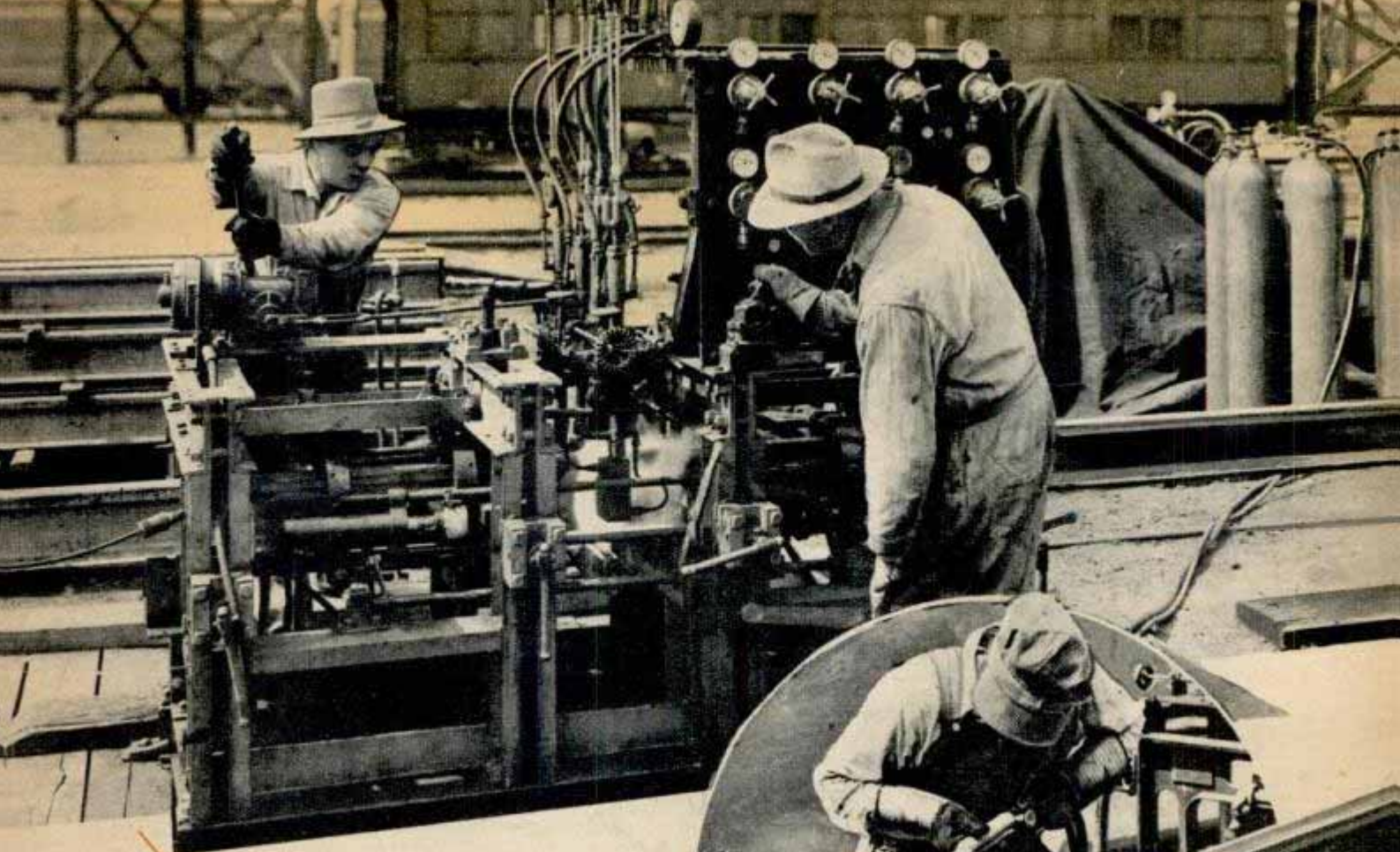

PRESSURE WELD Takes Click Out of Rails

If you hold two pieces of sealing wax over a flame and press the softened ends together until they become one, you are performing an operation similar to the one done above with an oxyacetylene pressure-welding machine. This machine applies about 2000 pounds pressure per square inch to join ordinary 39-foot rails into lengths of a mile or more. It not only takes that familiar click out of the rails but reduces maintenance costs. The wear on bolted joints is great. Workman at right is trimming off excess metal after welding operation. Below, polishing welded area. Drawings show welding principle
Oxweld Railroad Service Co. photos

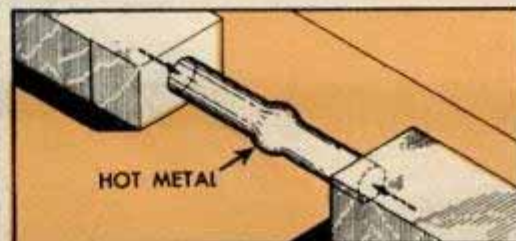
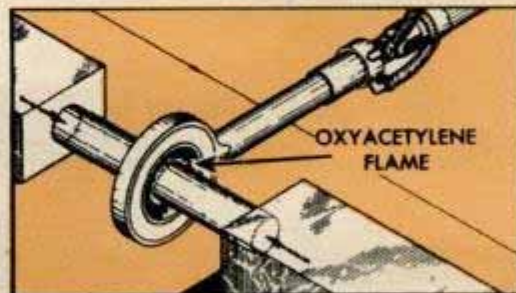
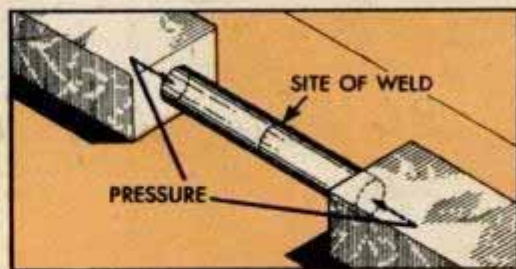
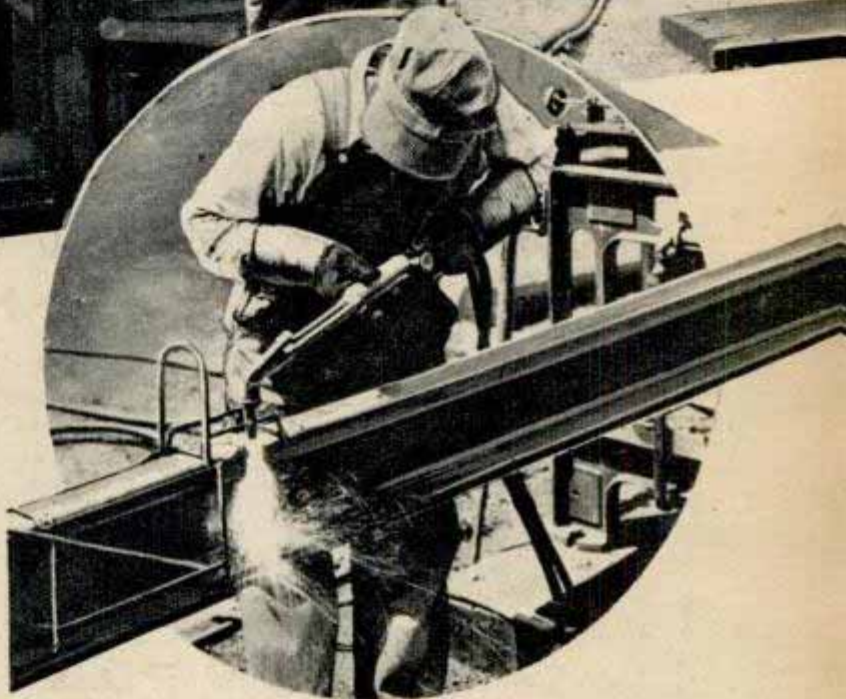



• Drinking-Glass Milk Bottle

Drinking milk directly from the bottle is easy and sanitary with a bottle designed as a drinking glass, invented by Ensign Robert L. Smith, commissary officer at the Hospital Corps School in San Diego, Calif. The container is especially suited to restaurants and cafeterias. A waxed paper leakproof cover fits over the drinking edge, extending 1½ inches down the sides of the bottle where it clamps around a shoulder in the glass. The top is discarded and the milk consumed directly from the bottle.

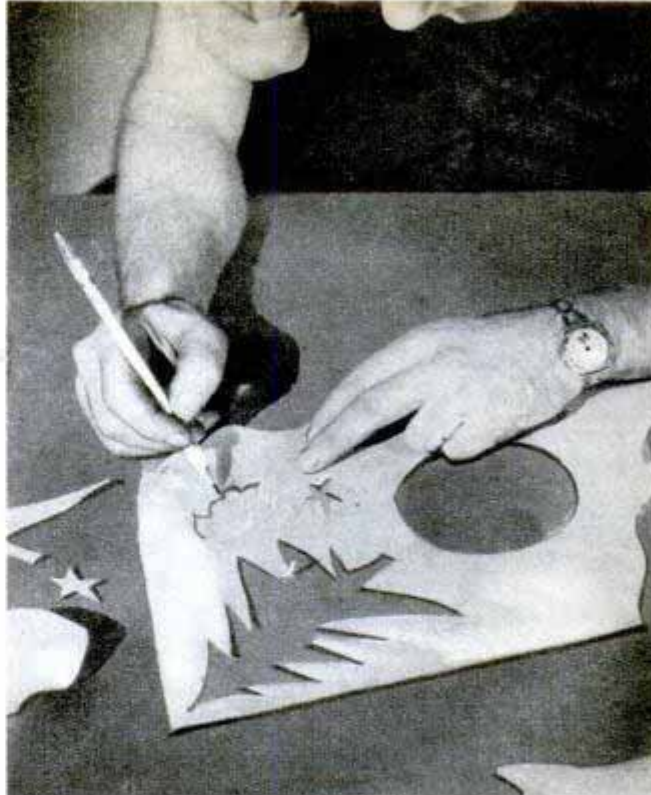

Dual-Purpose Aluminum Pencil

Equipped with a small knife blade, a double-end mechanical pencil permits marking and cutting with the same instrument. The pencil will be useful to model makers, as the knife is designed to cut light wood. The blade can be reversed for safety in carrying the pencil. Two pieces of lead run the length of the tube. Both ends of the pencil can be used to hold lead, with the knife blade inside. Six and three-quarter inches long, the pencil is made of aluminum to reduce weight.

Navy's P2V Neptune Is Fastest, Longest-Ranged Patrol Bomber

Reported to exceed any patrol and search bomber yet developed in speed, range and armament, the new Lockheed P2V Neptune

is the first land-based plane designed for the U. S. Navy for its specific assignment. Two Wright Duplex engines, same as those used on the C-69, B-29 and B-32, give the craft a speed above 300 miles per hour. Range with a full load is 3500 miles and with bomb bay tanks 5000 miles. It can carry 8000 pounds of explosives in addition to its armament of six 20-millimeter cannon, 16 five-inch high-speed aircraft rockets and four .50-caliber machine guns. The wing span is 100 feet and the length 75 feet six inches, with an overall height of 28 feet one inch, equivalent to a three-story building. It carries a seven-man crew including a radar operator.



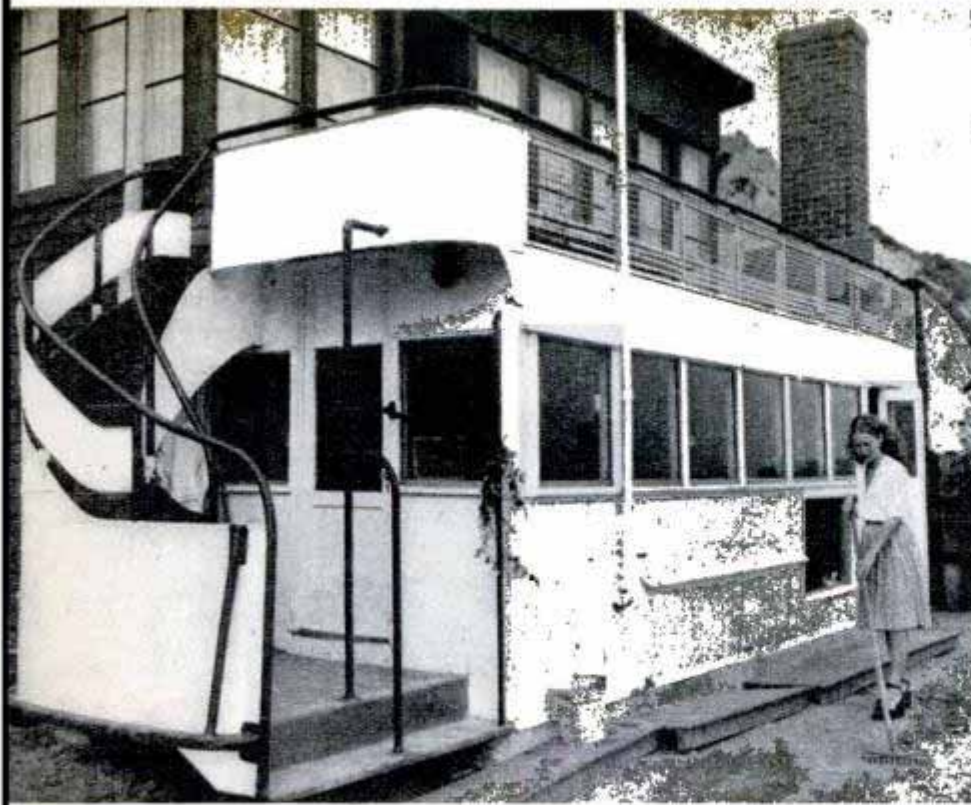

"Miss the Bus" on Housing? Scrapped Bus Makes Compact Home

With a little imagination, no one need "miss the bus" in the current housing shortage, according to Thelma Burnette of Santa Monica, Calif. She made a compact beach home of a scrapped double-deck bus which she purchased from a transit company for \$50. Her father, a carpenter, cut away the chassis and set the body into a cement foundation. One entire side and the motor

hood were removed. A bedroom, dressing room and bath were built on the open side. The bus itself provided a tiny living room and kitchen, with the top deck converted into a sun porch. A fireplace now occupies one end of the living room in place of the motor and hood. The ingenious owner sold the seats she removed from the bus for more than her original investment.

Sealed Motor Snuffs Out Sparks and Flames for Safer Airplanes

Inducing sparks into a tank filled with 100 octane gasoline vapor provides a convincing test for explosion-resistant electric motors designed for the AAF. The motors were developed for use in airplane compartments that might become filled with gasoline vapors if the plane were hit by flak. Their casings are made so that sparks and flame are snuffed out inside the motor before gas fumes on the outside can be

ignited. Necessary openings in the shell are very narrow with paths of such great length that gases, traveling along them, are cooled below the ignition point. In testing the motors, workers at Westinghouse Electric Corporation place them inside a tank into which gasoline fumes are blown. A spark plug ignites the vapor inside the motor. If the fumes fail to ignite, they are set off by hand to prove the mixture was explosive.

Motor is surrounded by gas fumes in tank. When vapor fails to ignite, spark explodes it to prove test

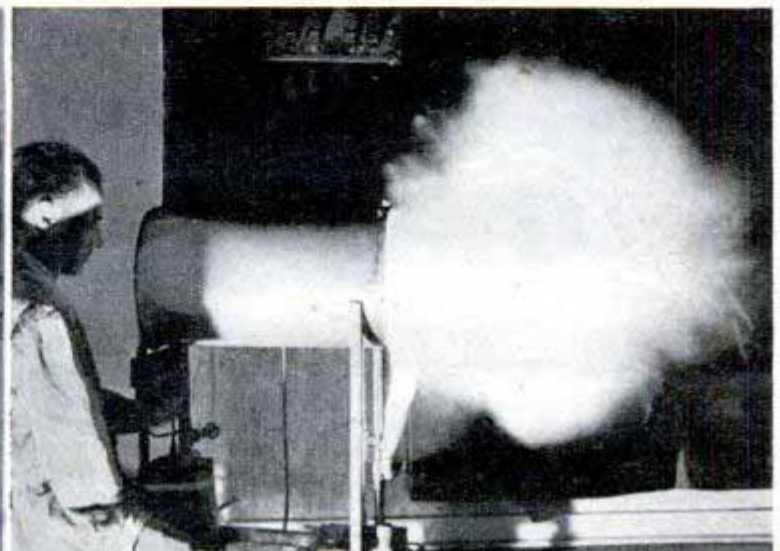

MECHANICS ARE POPULAR ON THE FARM

The city dweller is apt to phone the plumber or carpenter or electrician when something needs fixing. Not the farmer—he does it himself. Yankee inventiveness got its start on the American farm

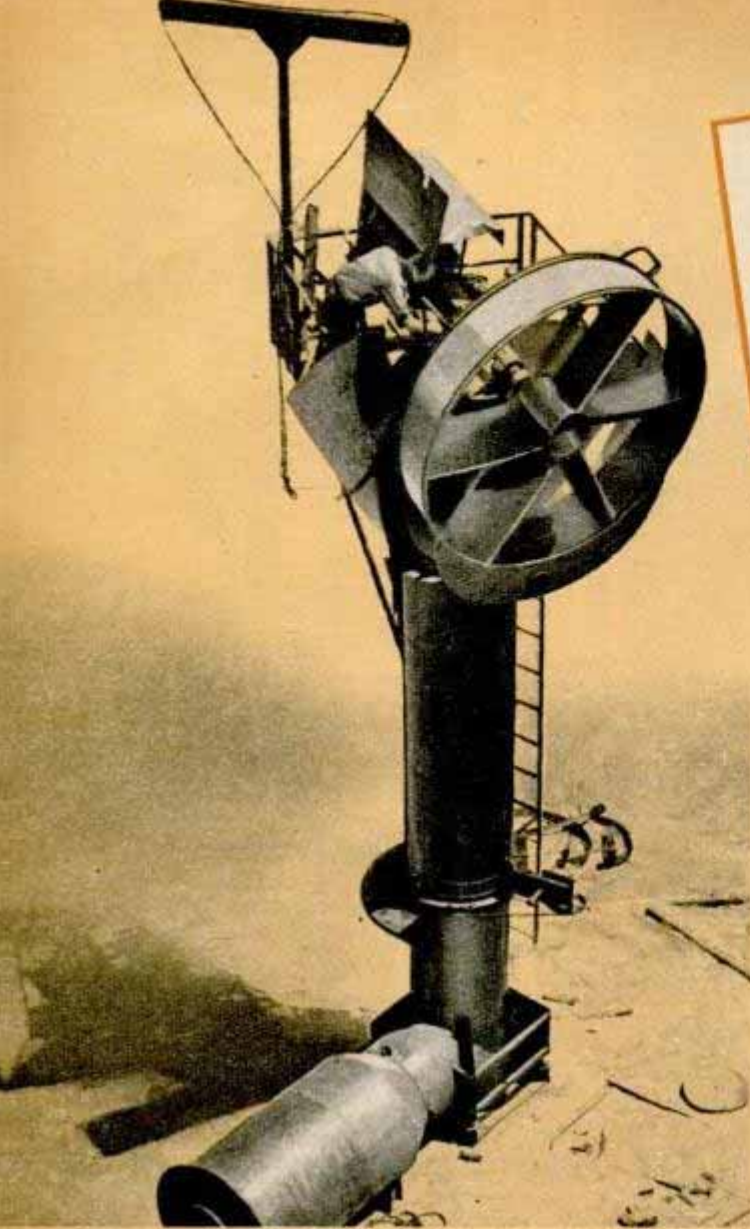

Hot air furnace with rotating fan at top of stack keeps citrus trees warm during frost periods. Below, Hugh James of Urbana, Ill., demonstrates weed cutter he developed. A 26-inch blade spins at 2000 revolutions per minute

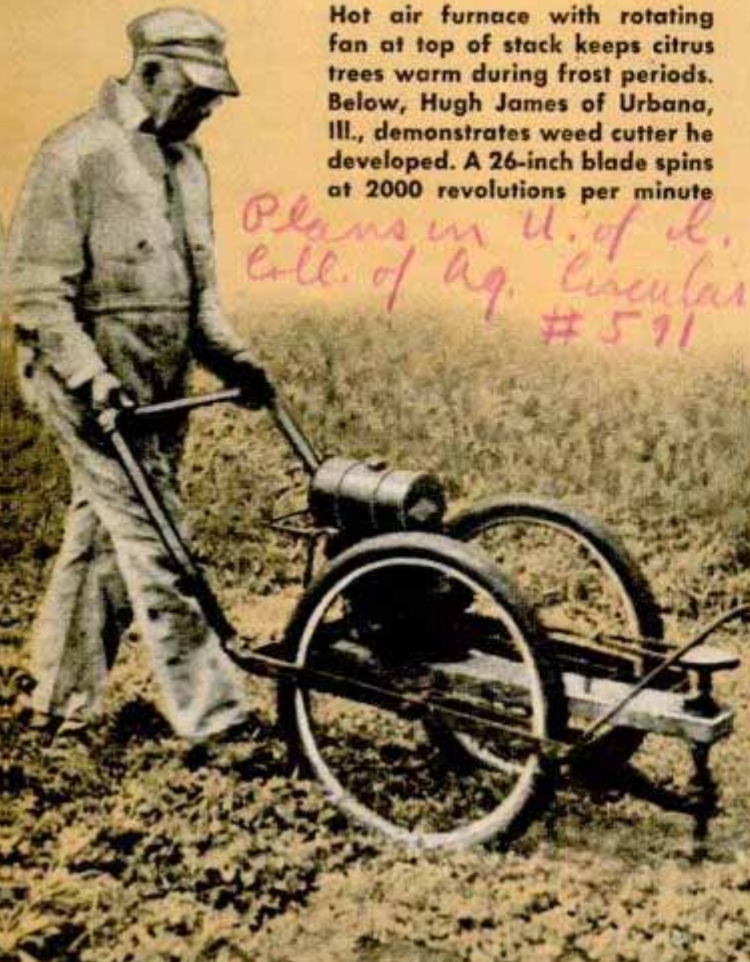

Plans in U. of C. Coll. of Ag. Circular #591



Electric huller has paddles that knock peas from hulls and deposit them in a tray. Homemade bale loader (below) is attached to truck to scoop up and load bales of hay quickly



Univ. of Cal. Col. of Agric. Agricultural Experiment Station Berkeley, Cal.



International Harvester Co. photo

Mechanical cotton picker with hydraulic lift dumps a load of cotton into a farm trailer in less than 30 seconds

PRUNES were ready for harvest on the farm

By Thomas E. Stimson, Jr.

of Guy McMartin in Tenama County, California, but instead of advertising for a large crew of pickers as he used to do, McMartin and his helper laid out a row of empty boxes under a prune tree, propped up a couple of big cloth-covered frames under the tree so that they slanted down to the row of boxes, and attached a cable from the tree to his tractor.

He started the tractor engine and threw in a clutch that yanked the cable back and forth. The cable shook the tree and the prunes fell to the slanting frames and rolled downhill into their boxes. Then McMartin was ready for the next tree. The first one had been picked clean, by two men, in 10 minutes.

The mechanical tree shaker and the portable catching frames are examples of the numerous labor-saving devices that farmers have invented during the last couple of years to help them produce food in spite of the shortage of farm labor.

Today mechanical tree shakers are being widely used for harvesting walnuts, apricots and other tree crops that ripen uniformly. The shaker consists of a reciprocating device powered by the tractor engine, with a cable that may be attached to small trees or with a long boom that can

reach up to the main limbs of a large tree. A hook-type collar holds the limb securely while it is being shaken.

The simple fruit catching frames consist of light lumber over which wire netting and thin canvas are stretched. Less fruit is broken and none is soiled by falling on the ground, and the frames may be wheeled easily from tree to tree.

Instead of using a row of boxes for catching the fruit, some orchardists place a pair of mechanically operated canvas conveyor belts between the frames, extending out from each side of the tree trunk. After being shaken from the tree to the conveyor the fruit is moved out to empty boxes at the end of the belt.

Common sense application of mechanical principles to typical farm needs has led to the development of a small fanning mill that separates leaves and twigs from fruit and nut crops, a portable chain drag elevator powered by a small engine or electric motor to move bulk grain to and from storage, and a handy puller for steel or wood fence posts that operates on the leverage principle.

A homemade loader that raises bales of hay from the ground to the bed of a truck, a pickup loader that does the same with sacked grain, and a "transport buck rake"



Apricots roll from the "catcher" to the crank-operated conveyor belt which carries them to a packing box. Below, two views of mechanical farm gate which can be opened and closed by a driver without alighting

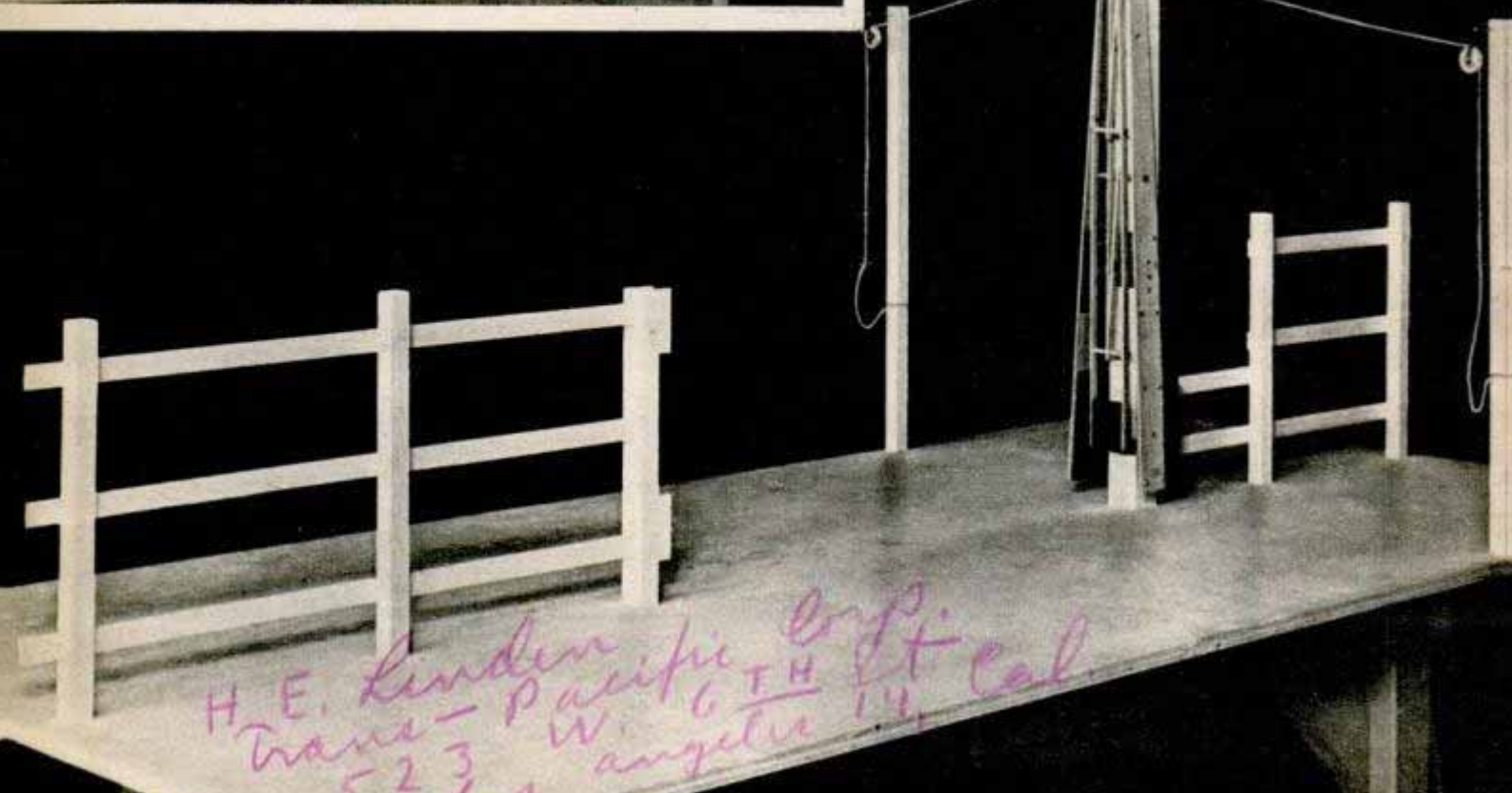
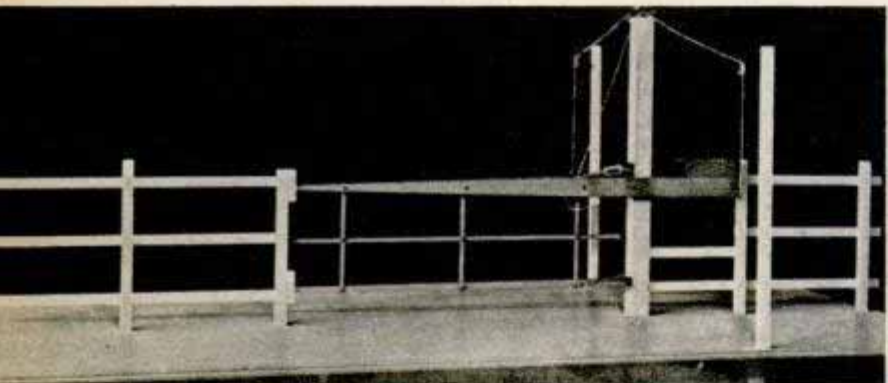

*George Mitchell
March 1946*

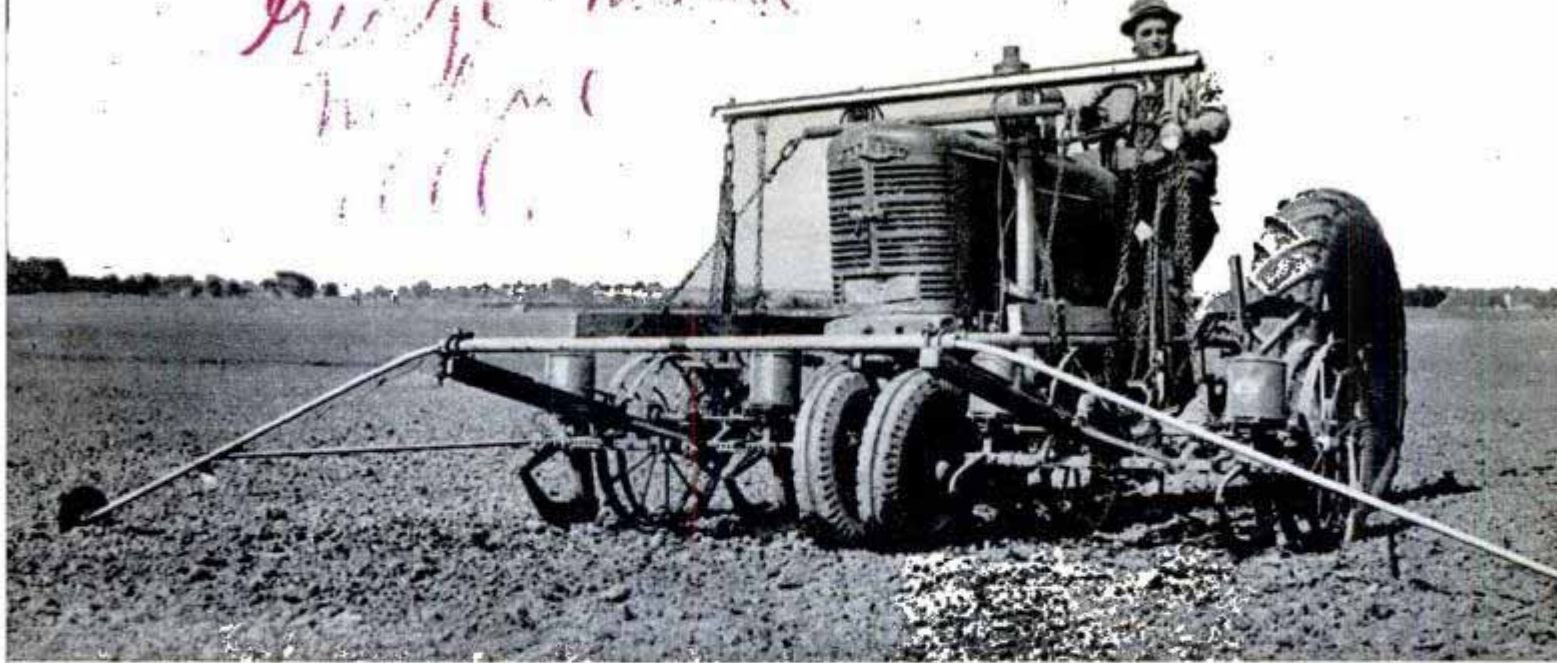

Four-row tractor planter is equipped with "floating" arm for covering uneven ground and making short turns

mounted on the back of a truck by which a large load of hay can be picked up and carried to the barn by one man are other machines developed to replace hand labor on medium-sized farms. Old automobile parts, standard black pipe and lumber are the chief materials required for most such equipment.

Depending on a farmer's individual needs, some of these devices pay for themselves in a short time although in other cases their original cost may make them just as expensive as hand labor. In the latter instances their value is that they can help get an operation completed faster than it can be done by hand, permitting a whole crop to be harvested at once at the height of its maturity, the peak of the market or in time

to save it from adverse weather conditions.

Construction details and plans for all of the above devices, including the tree shakers and catching frames, have been prepared by the College of Agriculture, University of California, and may be obtained by writing to the college at Berkeley, Calif.

Most agriculturists depend on general utility equipment for doing many kinds of jobs, but now the trend is toward the development of specialized mechanical devices to replace hand labor for particular tasks. Sugar beets, for instance, are an ideal crop in some parts of the Southwest and yet the cost of growing sugar beets, because of the necessary hand labor, has been so high that domestic sugar could not compete with sugar imported from abroad. The per-

Buck rake attached to rear of truck is operated by truck transmission. Operator drops rake, backs into windrow of hay and the rake picks up the whole load



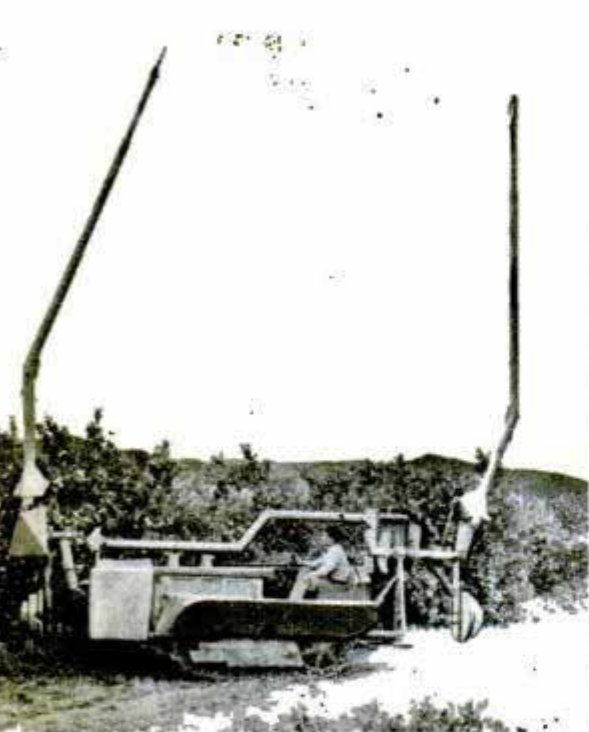

Fumigation tents are placed over citrus trees by a tent setter whose arms are raised by power from a tractor

fection of three machines now allows sugar to be produced in the United States with fewer man-hours of labor than anywhere else in the world. One of these machines is a precision planter, the second is a mechanical thinner, and the third is an ingenious harvester that cuts the tops off the beets, picks up the beets and shakes them clean, then delivers them to a storage bin.

Similarly, spraying machines now almost completely have replaced hand labor in the task of spreading insecticide over foliage. One typical "speed sprayer" performs work that once required 36 men, saving 85 percent of the labor and 20 percent of the materials once used. Towed by a small tractor, the spray machine ejects insecticide from numerous small nozzles, then uses a blast of wind from an enclosed airplane-type propeller to spread the spray into the foliage of trees. As much as 15,000 gallons of spray can be applied in a 10-hour day.

Another development for protection against both orchard and field crop pests is an Army smoke generator that volatilizes the insecticide. The generator produces a rolling cloud of fog that appears to reach every square inch of the surfaces of a crop. In one test this "death fog," consisting of atomized oil that contained DDT insecticide, completely killed a heavy infestation of citrus thrips in a 150-acre grove of grapefruit trees. Fogging a 32-acre beet field that was infested with thrips and cabbage loopers resulted in a 100 percent insect kill. The treatment took seven minutes and used five gallons of oil.

Some orchard pests are eliminated by a fumigation process during which the whole tree must be covered by a tent. Hauling the canvas tents over the trees once re-

quired a crew of five men but now this job is done better and faster by a mechanical tent puller consisting of two long steel arms that project from a framework mounted on a tractor. The two arms raise one end of the tent overhead, up and over the tree in one easy operation. Without such mechanical tent pullers, spraying machines and smoke generators, it would have been impossible to maintain the necessary pest-control program in some areas during the war.

Canned peas might have been a wartime casualty but for the development of a machine that shells peas on a tonnage basis, fast enough to insure the "vine fresh" quality needed for canning. This viner machine has removed practically all hand labor from harvesting peas. The vines are cut in the field and left in rows, after which a power-driven loader picks them up and deposits them on a truck. Then they are transported to the viner machine, which first separates the pods from the vines and then extracts the peas from the pods.

Nuisances in nearly all farming and ranching areas are the swinging road gates that are used to keep livestock from straying. An automobile driver or horseman who approaches such a gate must swing the gate open, move his vehicle or horse through it and then close the gate before he proceeds.

Most of this bother is avoided by a new patented type of road gate that operates something like the upswinging arm of a railroad crossing gate. It consists of a section of fence that folds together as it swings upward. It may be opened or closed without dismounting by pulling on ropes that are attached to posts at either approach. The gate is counterbalanced for easy oper-

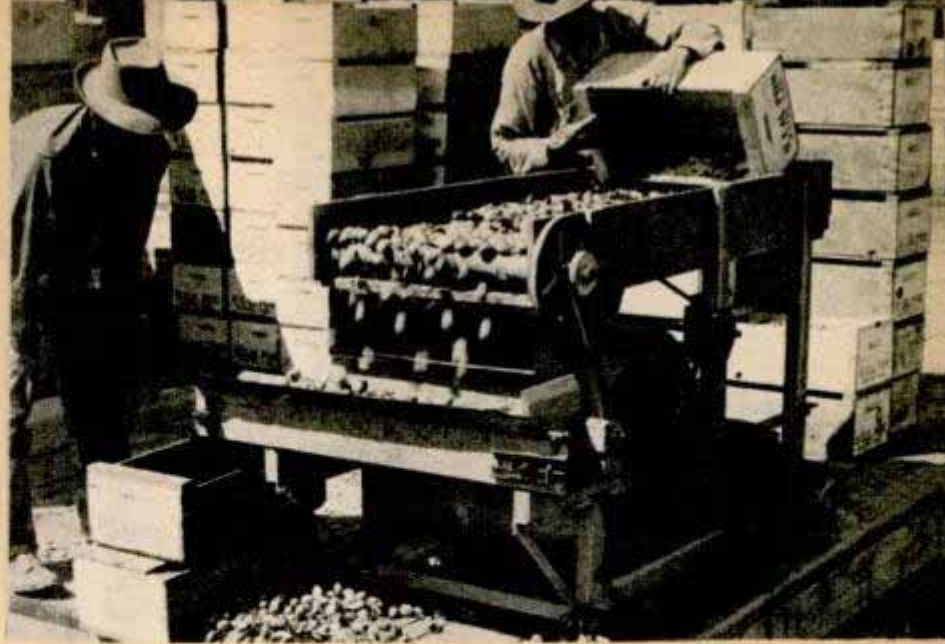
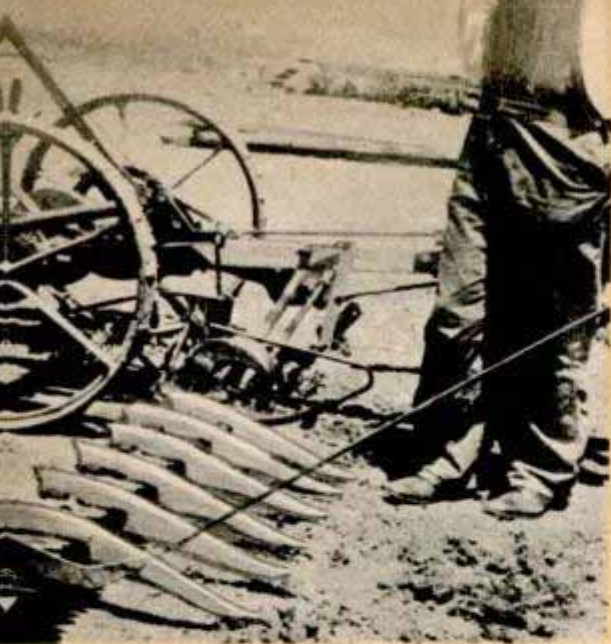

Prongs attached to blade guard of mowing machine lift up vetch and other crops for easy mowing

Leaves and debris are blown from fruit passing through fanning mill equipped with squirrel cage fan to provide blast



Tractor delivers a load of peas to a pea thrasher which also is powered by a tractor. Below, closeup and action views of steel fence puller with adjustable lever. Short chain replaces stirrup for pulling wooden posts

Plans from: U. of Cal. Agricultural Extension Service

Burbank, Cal.

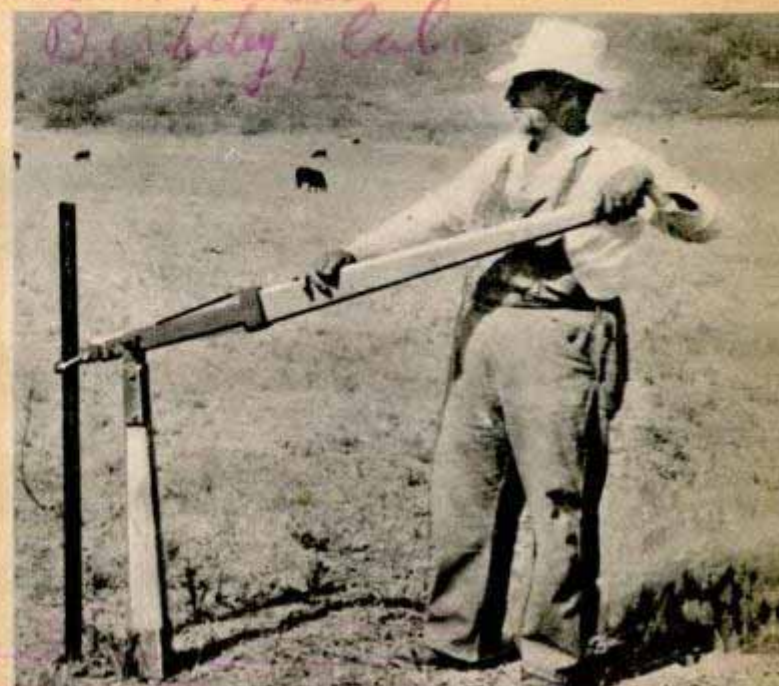
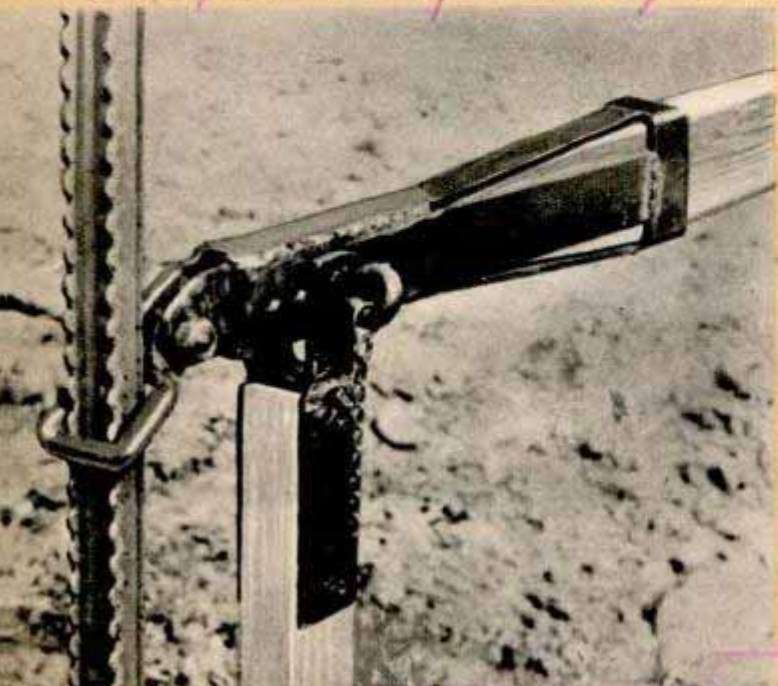

*University of Cal.
Berkeley, Cal.*

Clinton, Iowa



"Death fog" from Army smoke generator kills insects. "Till-master" (right) plows, disks and harrows at same time

ation, automatically locks into position, and its efficiency is not hindered by snow or weeds that must be cleared away from gates of the swinging type. It now is being manufactured.

for fruit and nut crops that fall on the ground.

Mechanization of individual farm jobs has hardly started. A practical machine for picking tomatoes on a mass basis, for instance, is one device that still is needed. A better way to harvest Ladino clover seed is being sought, as well as a good harvester

Even so, farm machinery is one of the important reasons why the United States was able to produce almost 50 percent more food in the last two years than during the comparable war years of 1917 and 1918. The amazing thing is that this increase was accomplished on about the same acreage and with some 4,000,000 fewer people at work on the farms.

Hay is picked up and cut into fine bits by chopping machine which deposits the feed into self-unloading wagon

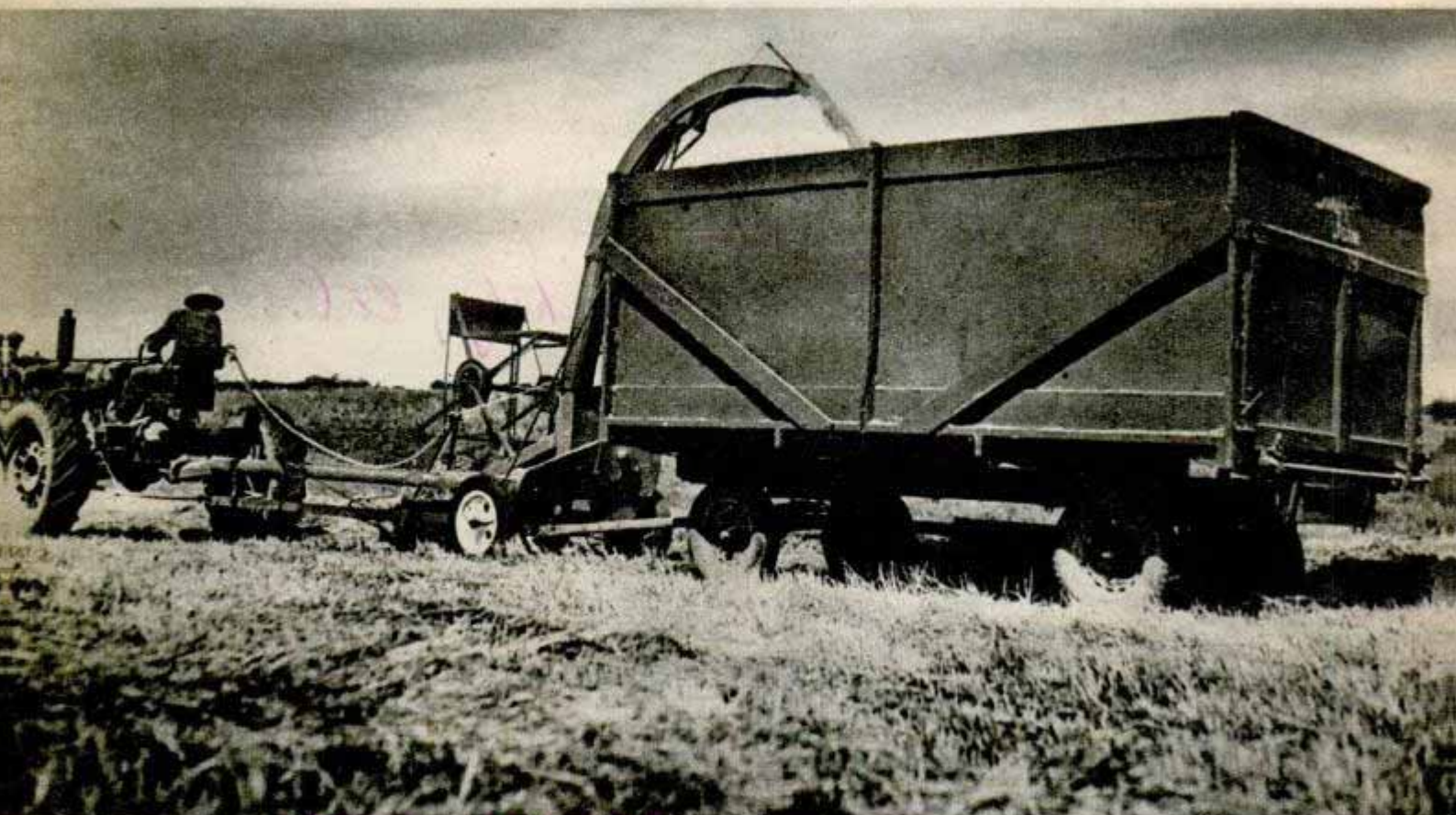

*Port Byron
Cloyd Walter
Lloyd Walter
University of Cal.
Berkeley, Cal.*

Golf-Bag Folding Cart Fits in Small Locker

Knee-action wheels on one type of golf-bag cart can be retracted like airplane wheels, forming a compact unit easily stored in a locker or automobile. The bag can be left on permanently, since it's not necessary to detach the bag before folding up the cart, which is made of strong, lightweight aluminum alloy.

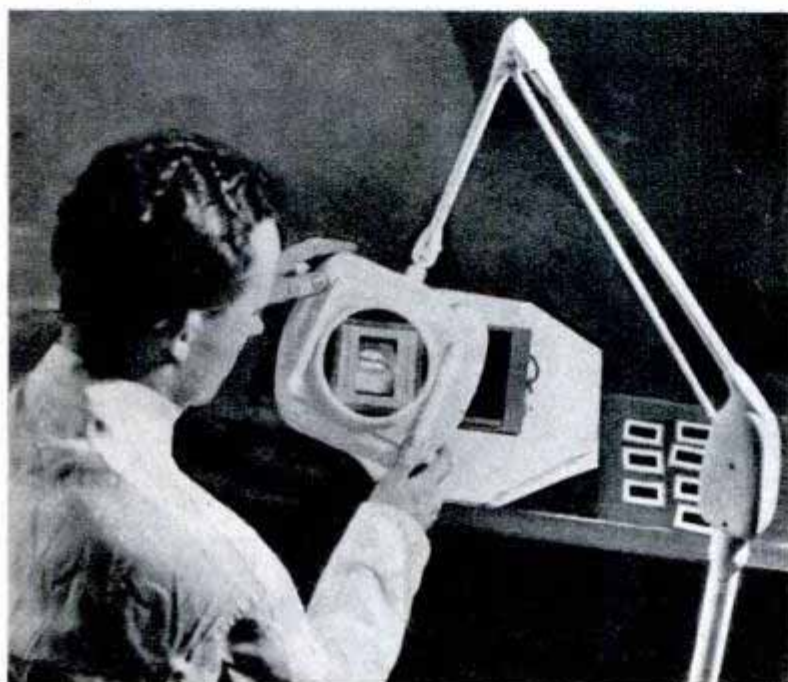

Light in Magnifying Lens Diffused for Open Eyes

Light and a magnifying lens are combined in an instrument recently devised for doctors, dentists and oculists. It also is useful for first aid or laboratory purposes. The light is so soft and diffused that open eyes can be examined through the instrument. Clamps, for table and wall installation, and floor braces are provided. The unit is so balanced that it can be moved with the fingertips to any position and it will remain there. Lenses are provided in either four or five-inch diameters. The instruments are available in either white or statuary bronze finishes.

Rear Engine German Auto Rolls Off Assembly Line

Hitler promised the Germans a lightweight "Volkswagen," or "people's car," before the war and even took initial payments, but the first ones to be mass produced recently rolled off the production line in the British Occupation Zone. A few for party favorites were made during the war. The engine is in the rear and the car is heated by exhaust gases.

Right, front view of "Volkswagen" and, below, how engine is housed in rear end

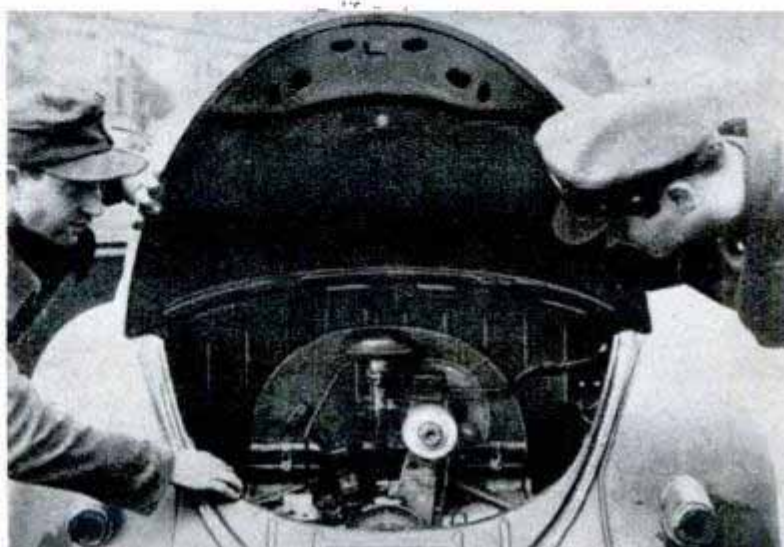

Electric eels long have employed principles somewhat similar to radar, sending out electric impulses which, upon striking such food possibilities as fish or frogs, bounce back and affect the senders' sensory apparatus.

Birds with **WOODEN FEATHERS**



A bird in the hand isn't worth as much as one in wood to John Lacey of New York. Lacey has converted his hobby, carving realistic game birds, into a prosperous business. At left he photographs real pheasant wing as it appears in flight to achieve exact scale reproduction

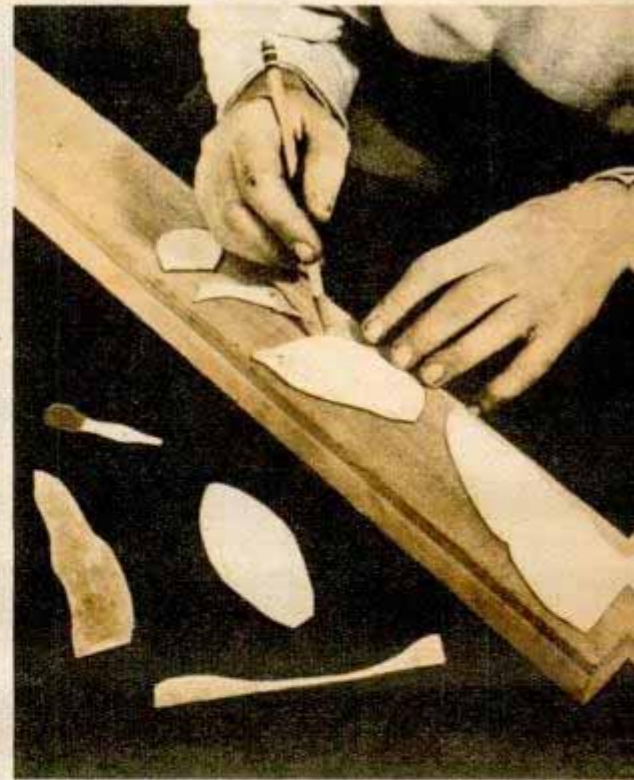

Left, jigsaw roughs out head and body of Canadian goose. Tail and wings will be fastened into notches later. Above, templates traced from photographs are cut from light plastic. They will be used as patterns in carving the wing parts, head and neck from wood blocks



Birds in majestic flight look alive when mounted against an imitation sky. Left to right are a bobwhite quail, a dainty pintail hen, and a mallard carved in graceful flight

Lacey's dog contemplates a pheasant wing critically as an assistant paints the finishing touches on a pintail





Flying howitzer shells and rockets are photographed on "still" film

by a camera which makes 120 exposures per second. The camera does not have conventional shutters. Exposures are made through slots in two concentric drums revolving in the same direction but at different speeds. The inner drum is connected directly to an electric motor and rotates 30 times a second; the outer drum is connected

Camera "Stops" Flying Shells 120 Times Per Second

by a gear and revolves 24 times per second.

This difference in rotating speed and the varying size of the solid sections of the drums produce exposures that record the movement of a projectile at various stages. The film is 3¼ inches wide and 35 inches long. Images are recorded from left to right on the film on narrow ribbonlike strips. About 200 exposures are made on each roll of film.



"Skull-Crackers" Drop 96 Ft. To Make Scrap of Castings

Six and eight-ton balls falling 96 feet crash down on large pieces of scrap, breaking them into furnace size for melting at the Sheffield Steel Corporation, Kansas City, Mo. Magnets powered by a 25 kilowatt generator lift the "skull-crackers" to the top of the hoist in 45 to 60 seconds. A Diesel engine operates the unit. The balls shatter 90 to 100 tons of large castings to furnace size each day.

Transparent "Coat" for Concrete Prevents Too-Quick Drying

Instead of building earth dams or covering newly laid concrete with moist sand to prevent quick drying — processes that require many hours of labor—a one-man machine is used. Mounted on wheels on a raised platform, the machine closely follows the finisher and lays a coating of membranous curing compounds. The transparent coating seals the water in the concrete and prevents too-rapid evaporation which causes minute cracks. It was used in building roads and concrete runways during the war.

CANOE TO FIT AUTO TRUNK IS ASSEMBLED IN 10 MINUTES



Full-length plastic canoe fits into two zipper bags. The 10 sections lock together and may be assembled in 10 minutes. A canvas sheath is strapped snugly in place over the hull to make the craft waterproof



Packing a full-length canoe into the trunk of an automobile is no magician's feat with a portable, sectional canoe. The 65-pound craft can be stowed in two zipper bags and carried as luggage. Its 10 sections require only 10 minutes to assemble. The sections are made of a light, durable plastic that is nonabsorbent, impervious to salt water and gasoline and will not warp. Sections are locked together with special metal clamps. To make the canoe waterproof, a canvas sheath is fastened snugly over the entire hull with elastic airplane shock cord. Even the paddles are sectional. When separated at a joint in the middle, they form the handles of the zipper carrying bags. Oarlocks and an attachment for an outboard motor

also are available. The craft was built by Ed Link, inventor of the famous Link Trainer for training airplane pilots.

Crater Believed Formed by Volcano

More than \$1,500,000 has been spent in searching for Arizona's famous Crater Meteor. The meteor never will be found, according to Dr. N. H. Darton of the U. S. Geological Survey, because he believes it never existed. The scientist says the crater was formed by a volcanic steam explosion instead of an enormous projectile from outer space. As supporting evidence, he points out that the region is volcanic and that a similar crater nearby has a cinder cone in its core.



PART 2

RADAR *Cues the Navy Fighters*

By Lieut. Comdr. James S. Hunter, USNR
and Lieut. (j.g.) Max Hodge, USNR

A former college English professor and a one-time advertising executive, turned Navy radar experts, continue their account of radar's brilliant role as the "eyes" for both carrier and land aircraft



Two Corsairs with short-range airborne radar gear on right wing's leading edge

SIMPLE in its essence yet so vital to the defense of the Fleet, the business of directing planes to intercept enemy planes is known as fighter direction. A mainstay of Fleet and island-seizing operations, it has been made possible by radar. How potent a weapon fighter direction can be is demon-

strated in the World War II files of the Army and Navy, which bulge with tales of its achievements.

Among the more notable of the Navy's heretofore untold stories concerns the role of fighter direction and radar in the now-famed Marianas "turkey shoot" of June

Radar makes a formidable team of the Avenger and the flattop as they search the skies together

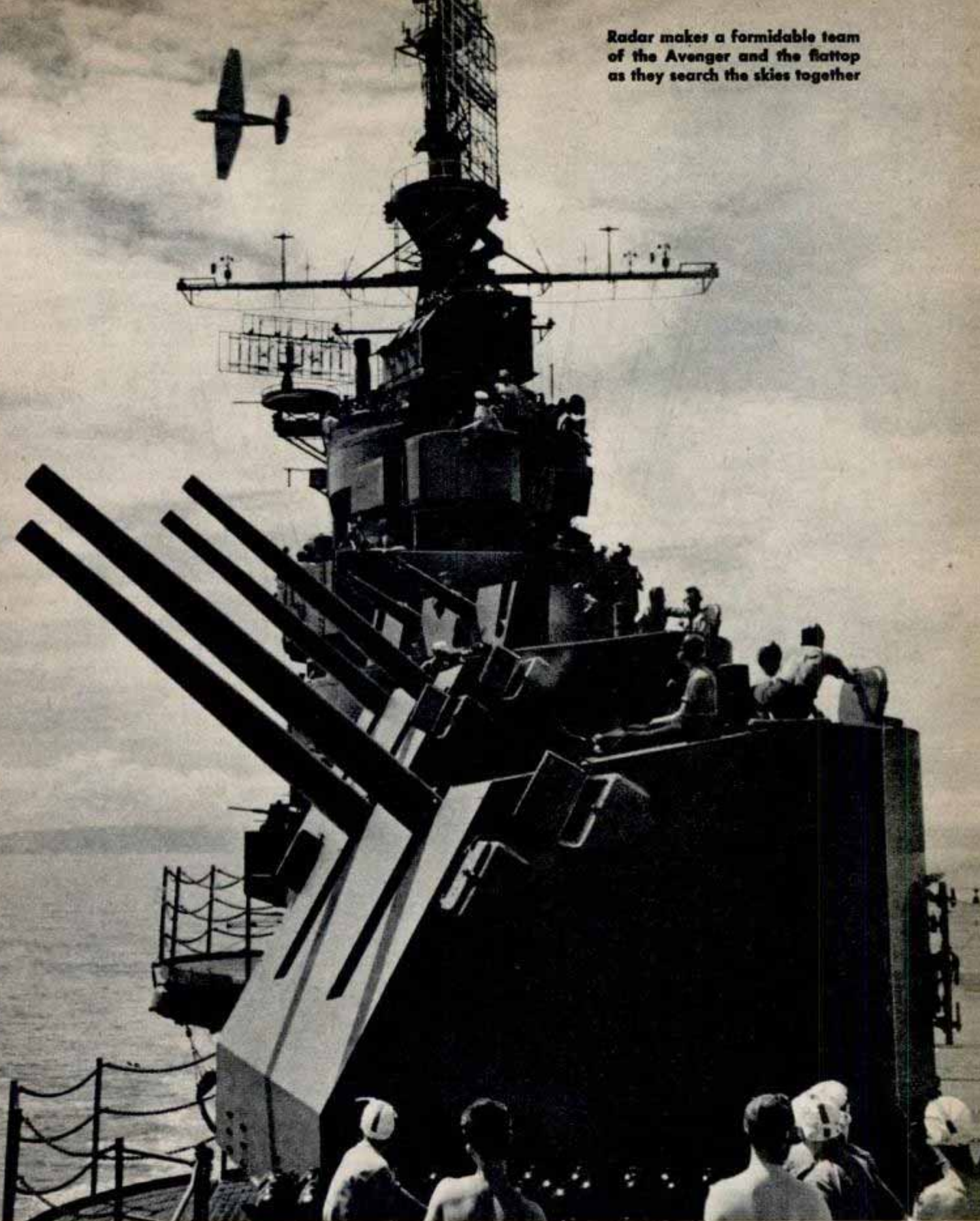

1944 when the Japanese lost the heart of their carrier aircraft in a day-long battle with Admirals Spruance's and Mitscher's Task Force 58. Warned by radar when the Japs were well over a hundred miles away, we were able to launch, in plenty of time, hundreds of fighter planes and use them to

such excellent effect that no more than a dozen planes ever broke through to the carrier task force. Of the 432 planes splashed on that momentous day, all but this dozen were downed 30 to 70 miles from the center of the force by pilots who located the enemy through fighter direction.



An Argus unit hits the beach with mobile radar unit. Some followed the marines a few hours after H-hour



Above, operators at the console in a radar van of a mobile unit. Below, Navy island radar post with both mast and radome type antennae for instructional use

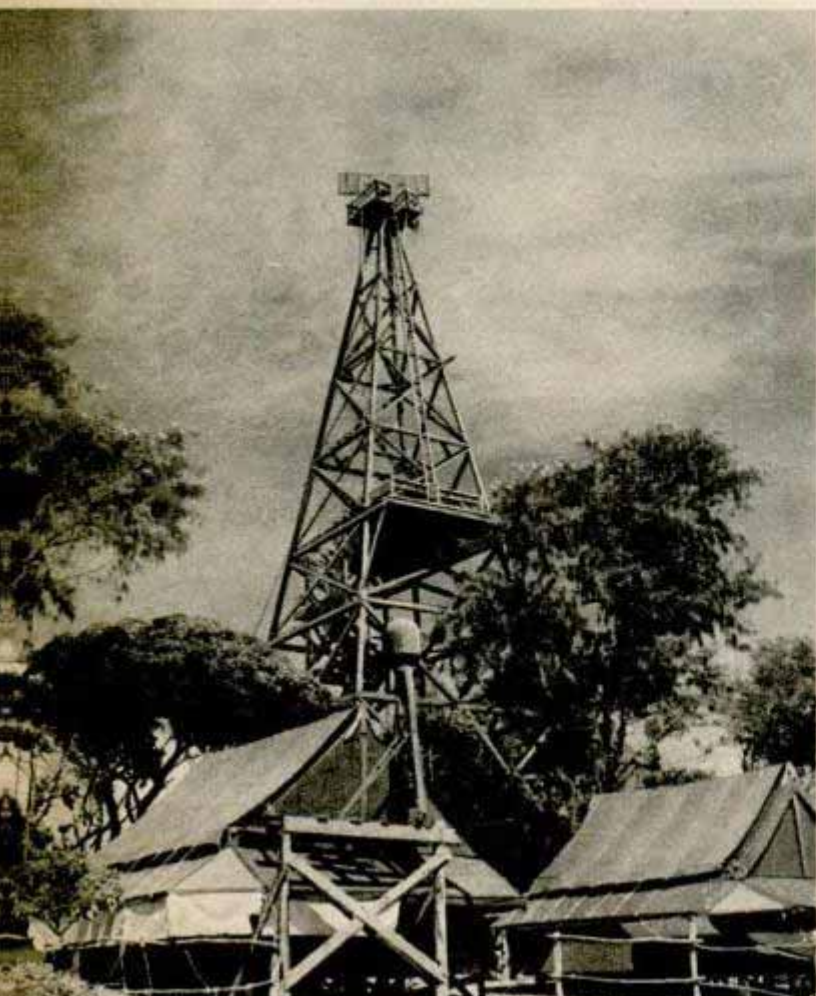

Packed in these same heretofore confidential Navy files on fighter direction are the reports of the once highly secret activities of the Argus units. Argus—"a thousand eyes in the night"—was the code name of the original land-based fighter direction units that went in with the marines at Tarawa, the Admiralties, Roi, Eniwetok, Peleliu—in most cases setting up radar gear a very short time after D-day.

There is the famous case of the unit at Rendova that was operating several hundred yards behind enemy territory—giving warnings of approaching Japanese aircraft to the amphib force landing on the beach. There is the story of the unit on Betio atoll, Tarawa, that set up and was operating a CIC (Combat Information Center) in a Japanese blockhouse that still held the Japanese dead. At Roi, in the Kwajalein atoll, the dead and wounded had to be removed by the men of Argus Unit 21 before the radar van could move into its proper site.

The shorebased CIC, or Air Defense Control Center—its official designation—was called Flops by the Argus unit personnel and for the first month on every island operation the name was suggestive of its appearance. On each invasion, a temporary, completely mobile radar unit was pulled up on the beach and put into operation as an air warning set for the first few days. This was a stopgap until heavy, more accurate radar equipment could be set up. Only a few fighter directors were needed to run the van; usually there were no air strips for planes to land on, or, if there had been a Japanese field, the big guns of the Navy made it slightly impractical for the time being. With no planes to direct, the duty of the fighter director in the radar van was to warn hard-working Seabees and marines of approaching enemy aircraft so they could hit the foxholes. The duties of the rest of the Argus unit those first few days after D-day were to dig foxholes, dig out space for CIC and dig graves to bury the dead.

Come with us into the CIC or ADCC on an atoll in the Gilbert Islands. You should be wearing shorts and as little else as possible for you are less than 20 miles from the equator. Perhaps you'll have to shove



Fully equipped Argus unit moving in on the heels of landing marines to set up vital early warning radar sets

your way through curious natives—Micronesians just released, as of two weeks ago, from under Japanese rule. Some of them still bow—a gesture they were taught by the Japanese—but others salute in the best Yankee fashion. Those are the ones who have been mingling with the marines. All wear grass skirts, men and women alike, and chatter in a language you never heard before. You know one word that sounds like “Sockabu” and you use it. They smile and repeat it after you, and it doesn’t matter too much that it means good-bye and not hello.

In contrast to the shipboard CIC, there are few shiny gadgets, no suggestion of Flash Gordon, nor any indication that here is the nerve center of the atoll. This is a small cave or dugout, five feet down in the tough coral topped with layers of coconut logs and sandbags. The dugout is no more than seven feet square with a plotting table in the center. Along one wall of the cave is a long line of field phones connected to the island commander’s headquarters, to the communication dugout, to lookouts in tree-high towers, to the marine headquarters and every gunnery post on the island. There are microphones and speakers, but the radio consoles are all in a tent a few yards away from the dugout, and the radar sets themselves are “dug in” at various points on the atoll.

Here, as in the shipboard CIC, enlisted plotters wearing earphones are plotting symbols on the table in the center of the dugout. The fighter director officers on duty are wearing a week’s growth of whiskers and green shirts and trousers that could use a hot iron. The plotters are stripped to the waist.

As you enter, a loudspeaker is blaring forth: “Hello, Copper base, this is Pastel base . . . Pastel base calling Copper base, over—”

An ensign picks up the hand microphone: “Pastel, this is Copper base, over—”

“Copper base, this is Pastel . . . we have a bogey for you—10 miles north of you . . . we are in condition red, over—”

The officer looks down at the plotting board as the plotter indicates with his pencil that our radar has picked up the bogey.

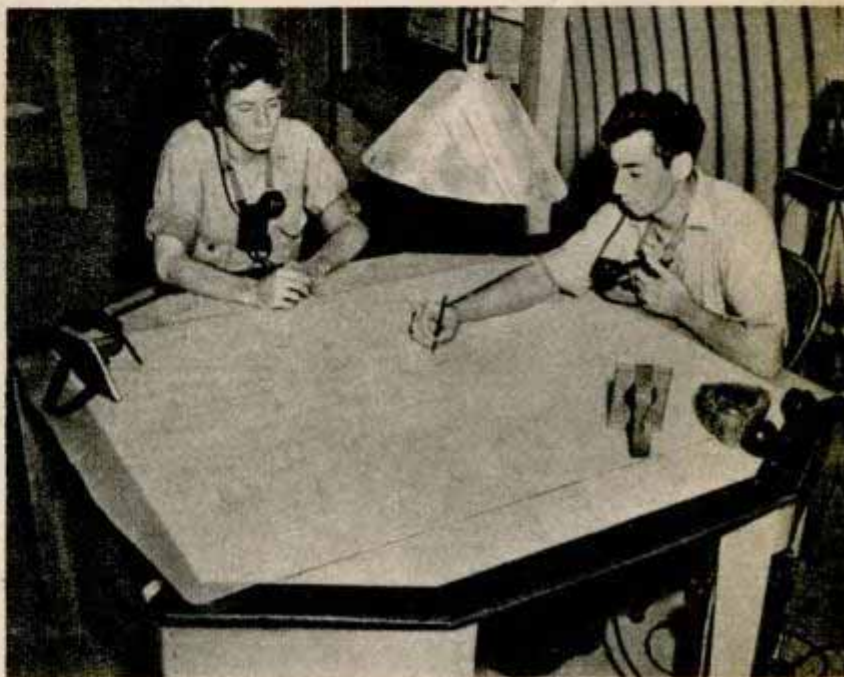

Radar plotting table in a Quonset hut. When Makin was taken during the Pacific campaign a Japanese radar station, below, was captured along with the bare atoll



RADAR VS. BOGEY

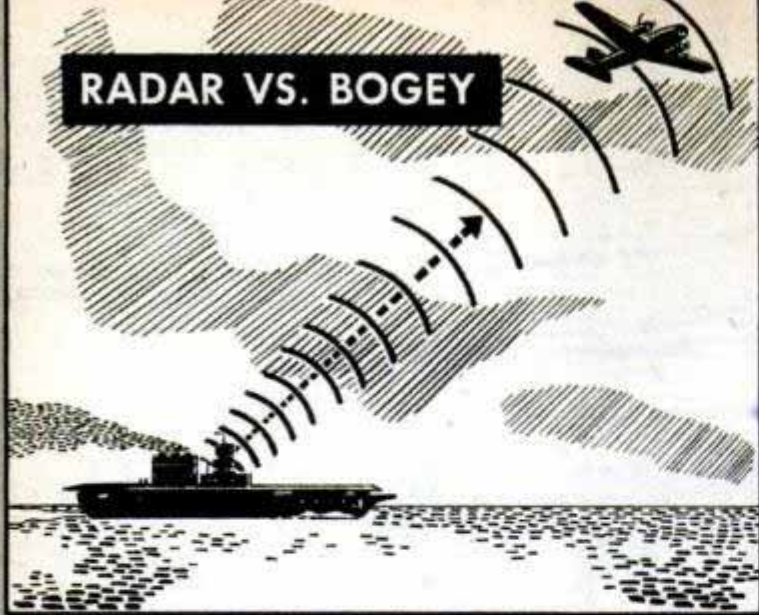

1 Radar beams traveling at speed of 186,000 miles a second push out in search of bogey

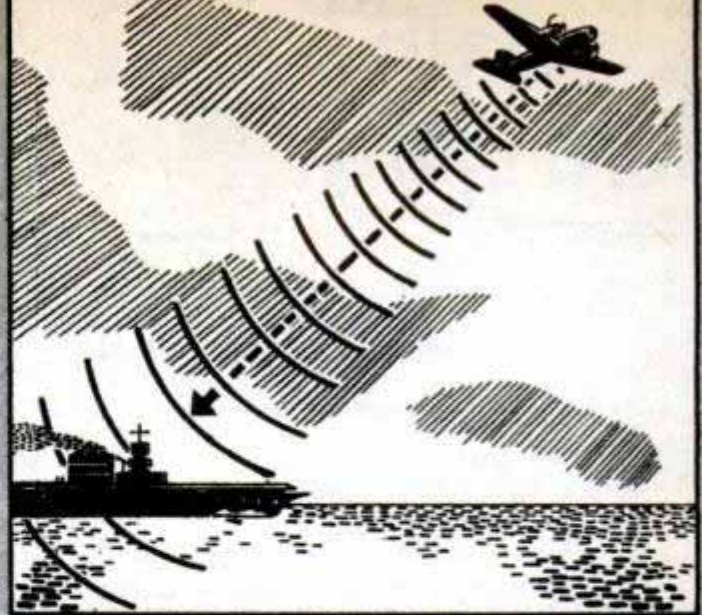

2 Ship's beams detect bogey and bounce back, revealing enemy presence to CIC observers

"Pastel from Copper," the officer speaks into the microphone. "We have the bogey—we are in condition red, out."

The ensign, tired and a little hungry looking, says: "Everyone's been alerted. It's another snooper—I think he's taking pictures of the island. Wish to hell we had some planes to send up after him—" He stops, nods, grins: "Wish to hell we had an air strip," he says. "That was Makin calling. You know, Makin takin'?"

Everyone's been alerted. That means that everyone on the island has been warned, by loud air raid warning sirens or some pre-arranged signal, that Japanese planes are in the vicinity. For the first week or two, the duty of the fighter director in an Argus unit is not to down enemy planes by directing friendly planes out for interceptions; rather his job is one of warning the men to hit the foxholes.

Revisit this Flops or landbased CIC a few weeks later after the air strip is completed and bombers are being sent out on strike missions. Now you go down a long ramp into a steel Quonset hut that has been buried completely in the coral. The Seabees have done a terrific job of camouflage—even to the extent of replanting coconut trees on top of the coral on the roof of the hut.

This approximates the spit-and-polish of the shipboard CIC with the big six-foot Plexiglas board, the PPI scopes, a large fighter direction platform and a radio room filled with elaborate consoles reminding you, somewhat, of the transmitter room of a small radio station back home. The men are cleaner—the officers are shaved. A gigantic status board takes up the entire bulkhead beside the fighter director's platform, and on this board are written the call numbers of the planes and the pilots flying

Left, Tokyo Bay on ship radar scope. Right, "shrubby" on wire net camouflages fighter director post on island

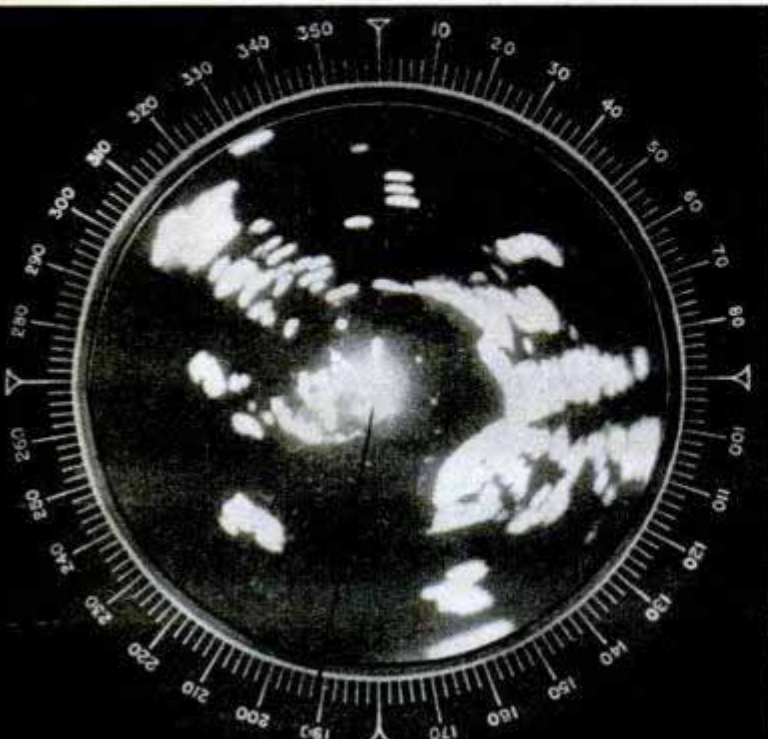



3 Small blob of light appearing on PPI scope gives interceptor officer warning of bogey



4 Location of bogey is plotted on Plexiglas "window" showing all aircraft in vicinity

the planes "somewhere 500 or 1000 miles north of here bombing hell out of the Marshall Islands."

One of the most important duties of the island-based fighter director is to keep track of every strike mission that goes out and try to locate those planes that may have been forced to land on some other island. Bombers take a lot of room for landing and they need a lot of light for night landings, so the fighter director controls the searchlights on the island. He controls the black-out conditions on the island, in direct contrast to the shipboard fighter director who almost always is working under blacked-out conditions. Captured islands have to be rebuilt in a hurry, which is a 24-hour-a-day proposition, and to black-out an island for an air raid represents thousands of work hours lost.

(Continued to page 240)

Sandbags shelter radar personnel from Jap snipers



5 Fighter director officer radios to pilot full information on the bogey's movements

6 Following FDO's instructions, the fighters intercept enemy planes and go into action



Indicator "Paints" Path in Sky to Guide Pilots in Landing Aircraft

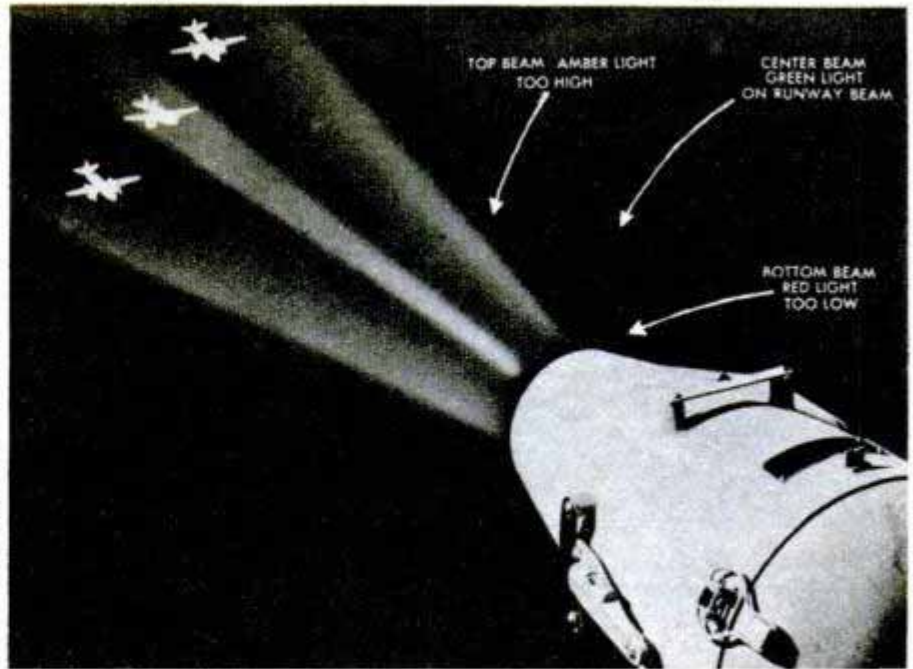

"Painting" a path in the sky for pilots to follow in landing their planes, an angle indicator uses colored lights as a guide in runway approaches. The indicator projects wedges of red, green and amber lights at predetermined angles above the runway. When a pilot sees only the green light he knows he is approaching properly. If the plane drops too low he sees a red glow. Amber indicates that his approach is too high. The path of light can be seen four to six miles under normal conditions. In low visibility the light appears at the same distance as contact lights on the runway. It is es-

pecially effective in guiding pilots in the last 50 to 100 feet before contact with the ground. The device uses only a 100-watt bulb as a light source with a reflector and lenses to separate the beam into the three colors. To avoid glare a shutter mechanism projects the light at a frequency of 40 times a minute. W. A. Pinnow, Westinghouse engineer who developed the indicator, predicts that pilots using it in training will learn to make good landings in one fifth the normal time. For planes equipped with radar, the indicator provides a visual link between contact and instrument flying.

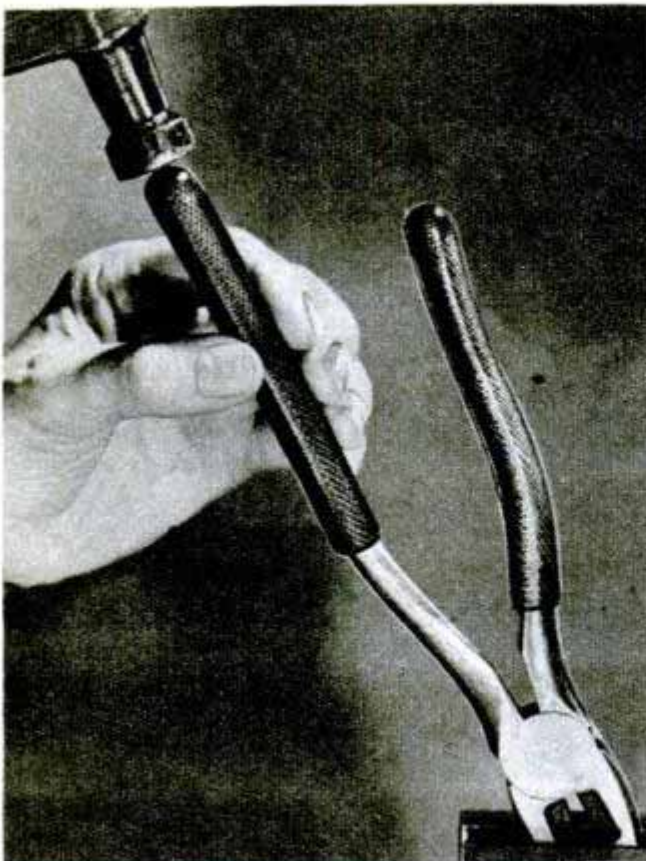

Slip-On Handles Insulate Pliers Against Electrical Shock

Pliers can be insulated with a pair of plastic slip-on handles. Conforming to all shapes and sizes of pliers, the red handles can be added to the pliers with ordinary tools and without heating the plastic. They insulate against average voltage, provide greater leverage, protect hands in cold weather and will not slip. The bright color of the handles makes it easy to find pliers in a toolbox or on grass or snow. Handles are available in 6, 7 and 8-inch lengths.

Plastics Glow Eight Hours After Exposure

Luminous plastics that glow from six to eight hours after exposure to sunlight or other illumination are being produced from phosphorescent compounds developed during the war. Colors available include green, green-blue, blue and bright blue, which have daylight colors ranging from green to gray. The plastics will be used for street markers, switch plates, clocks, instrument dials and door numbers.

BY RADAR TO THE MOON

THE MYSTERY about where cosmic rays come from (see [UNLOCKING THE UNIVERSE](#), page 89) may be solved by the ultra-high-frequency radar beams that recently were bounced off the moon. Rocket projectiles will carry counter tubes and other delicate instruments into solar space. Electrically recorded readings will be sent back to earth at the speed of light. To reach the moon with radar, the Army Signal Corps built a huge antenna at the Evans Signal Laboratory, Belmar, N. J. The pulse of energy hurled into space was so powerful that water-cooled vacuum tubes were used in the transmitter. The beam penetrated the ionosphere, the electrified outer area of the earth's atmosphere which turns back ordinary radio waves. This will make possible radar-guided rocket ships or missiles. It also will aid in mapping the planets.

238,857 MILES - 2 1/2-SECOND ROUND TRIP BY RADAR

ROUND TRIPS BY RADAR

Venus	—25 million mi. when closest to earth—	4 min. 29 sec.
Mars	—35 million mi. when closest to earth—	6 min. 16 sec.
Mercury	—50 million mi. when closest to earth—	8 min. 58 sec.
Sun	—92,900,000 mi.	—16 min. 39 sec.

World's Smallest Helicopter, With 25-Hp. Engine, Weighs Only 242 Pounds

Weighing only 242 pounds, the Roteron, designed by four Southern California men, is said to be the smallest helicopter in the world. A 25-horsepower motor of original design furnishes power for the midget from a position between the two sets of rotors,

thus eliminating many gears and clutches. Wooden blades are used on the rotors of the plane and the diameter of the larger rotor is only 15 feet. The designers expect the helicopter to cruise at 100 miles an hour and have a top speed of 110.

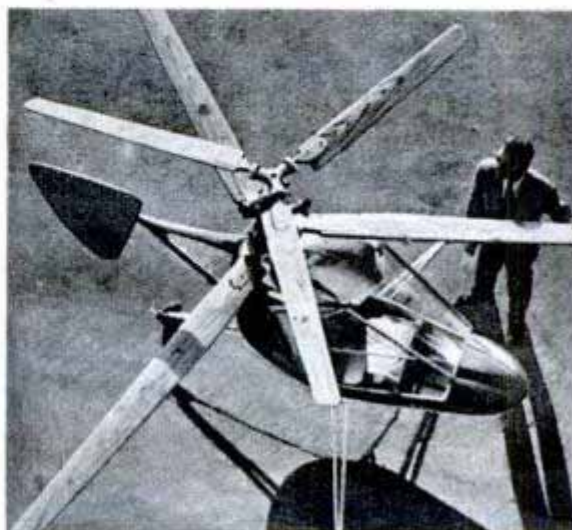

*Norman L. Goss
Roteron*

SPARE TIME NAVY

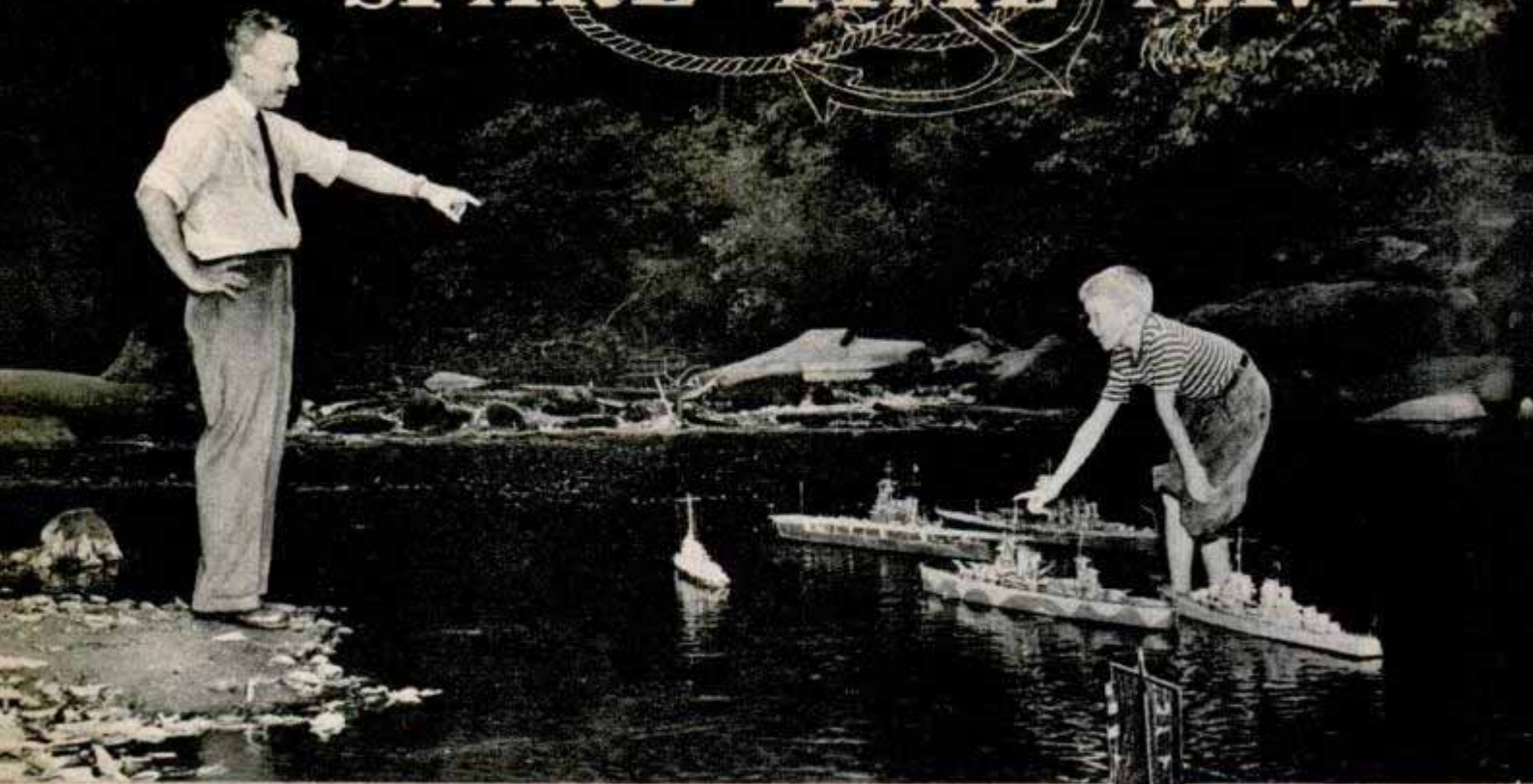

Police Magistrate Gordon R. Herr of Upper Darby, Pa., uses his spare time to build model warships from such odds and ends as old cigar boxes, discarded spools and even pieces of candy. Made to a scale of one inch to 13 feet, the ships float on an even keel and have working gun turrets. Right, two examples of Herr's precision work. In the foreground, the aircraft carrier USS Yorktown has a plane elevator that works and a complement of miniature planes. Smallest item on the ship is its bell, 1/16 inch in diameter. In the background is a camouflaged destroyer, the Aaron Ward

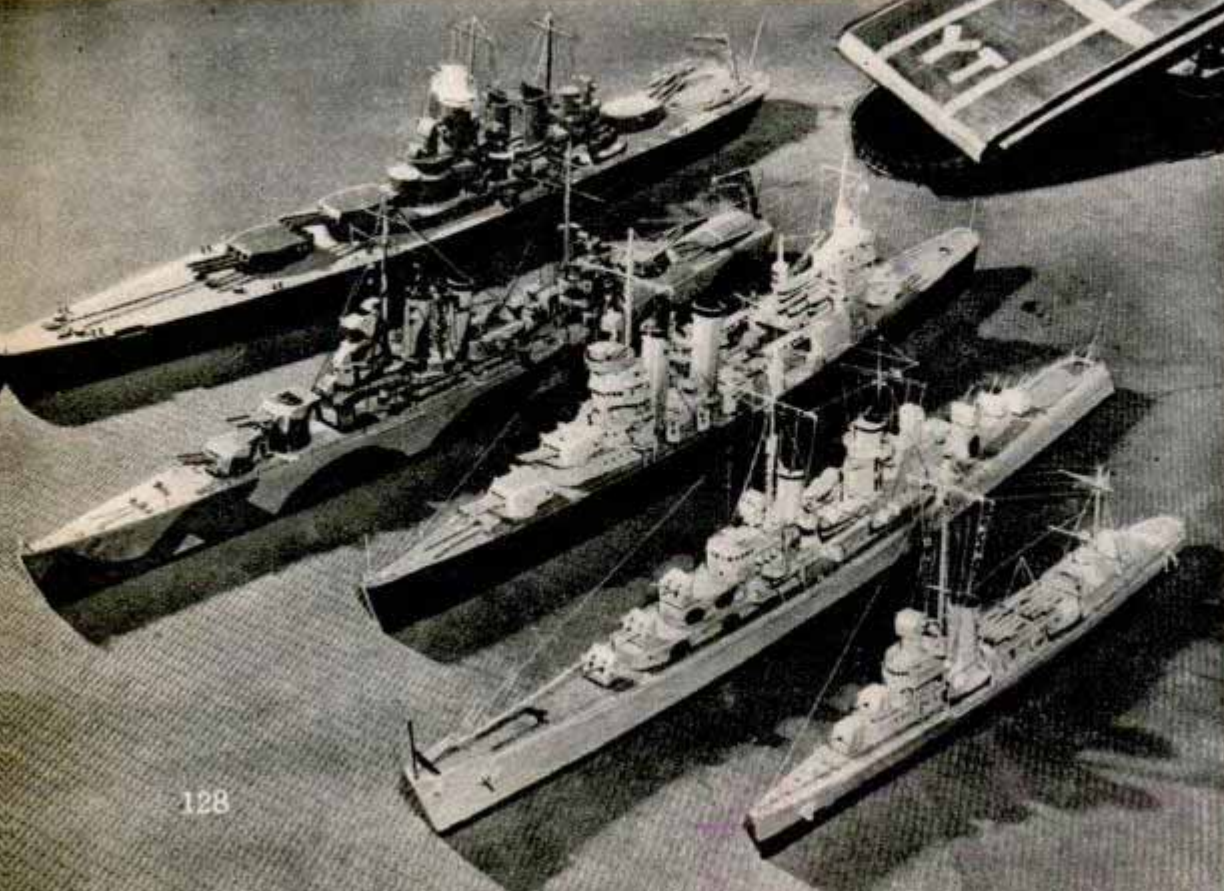

Five units of the magistrate's midget navy, front to rear, are Buck, Atlanta, San Francisco, Wichita and Washington. They are not powered. Herr tried experimental steam propulsion but gave up the idea after his model of the liner Kungsholm blew up in a bathtub. One cardboard model, made previously, ran by steam propulsion for 20 minutes. Herr now has a 36-ship navy. Six coats of enamel cover the trim ships



Battlewagon USS Washington made of gummed paper, wood, soda straws

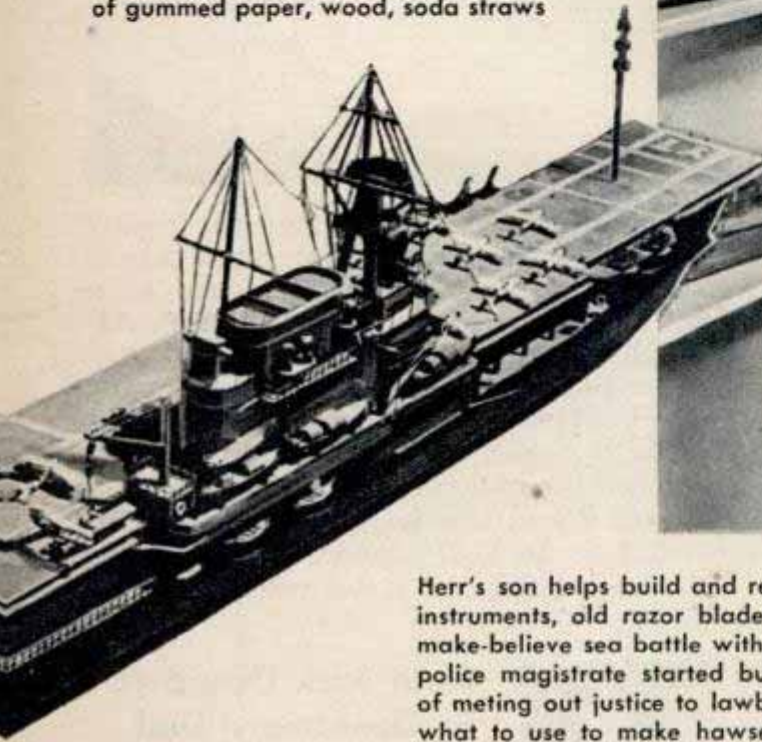

Herr's son helps build and repair the model ships, using for tools discarded dental instruments, old razor blades and scissors. Below, a youngster gets ready for a make-believe sea battle with four of Herr's handmade warships. The Pennsylvania police magistrate started building model ships in 1931 to relax from his duties of meting out justice to lawbreakers. For a while he found it difficult to figure out what to use to make hawsehole blisters. Transparent candy mints filled the bill



Experts "Sharpen" Huge Millstones to Carry on Century-Old Craft

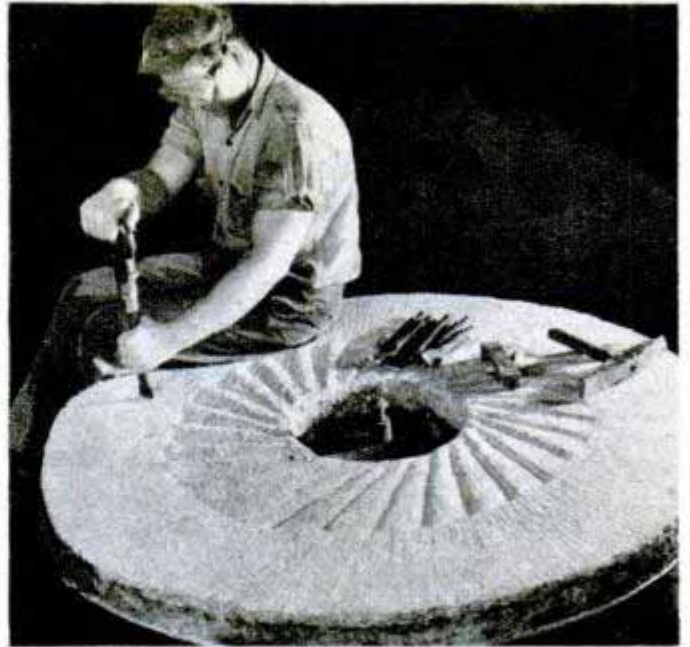

Exponents of an ancient skill, two stone dressers at a manufacturing plant in Decatur, Ill., "sharpen" the faces of huge gray millstones. The stones, some weighing nearly two tons, are still preferred in grinding corn kernels and other grains into fine powder from which syrup, starch and meal are made. Stone dressers, knowing every line of the surface, use special hammers to sharpen inner faces of the stone. Outer surfaces are sharpened by chiseling deep grooves at varying depths and distances.

The only modern improvements in the art include the use of power-operated chisels and electricity to turn the stones at a rate of 250 revolutions per minute. Although the profession remains relatively unchanged since long before the Pyramids were built, stone dressers are so rare that the A. E. Staley Manufacturing Company searched the nation to find one of the men, Edward Bland, who learned the trade from his father. R. V. Jungman, his coworker, has worked 12 years in the profession.

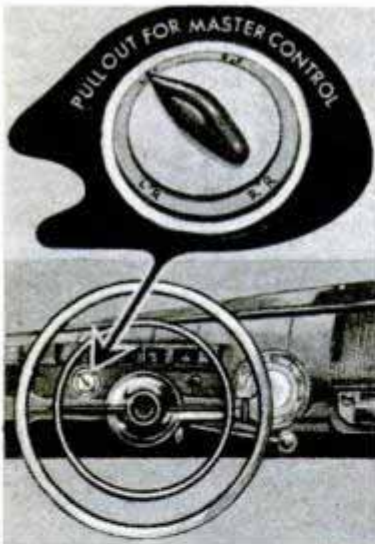

Auto Jack Operates By Dashboard Dial

Long a dream of motorists, an automatic jack system now can be installed in automobiles to raise one or all wheels in 90 seconds by the turn of a dial on the dashboard. The four jacks mounted between the body and each wheel are operated hydraulically by a pump driven by a $\frac{1}{35}$ -horsepower electric motor.

Vacuum Treatment Prolongs Life Expectancy of Cut Flowers and Plants

Cut flowers and plants stay fresh longer when given a vacuum treatment developed by the New York State Agricultural Experiment Station and Cornell University. Vacuum-treated narcissus flowers with six-inch stems were in good condition after six hours' exposure to bright sunlight at a temperature of 80 degrees. Untreated flowers wilted in 30 minutes and in five hours

their petals were dry and crisp. Lilac branches placed in water immediately after a vacuum treatment stayed fresh for five days, whereas untreated branches began to wilt in two days. The treatment consists of placing plants or flowers in a container of water and then putting this in a drier. Air is pumped out and replaced in the plants and flower stems with water.

Bantamweight Challengers



Aluminum and magnesium, the light metal twins, now compete with steel in every field from shotgun shells to ships

*Dow Chem Company
1000 S main St. Midland, Mich*
By Andrew Hamilton

"AL" AND "MAGGIE" have returned from battle and are beginning to assume an important role in the postwar world—which enthusiastic metallurgists already have dubbed "the age of light metals."

Production of aluminum and magnesium, the lightweight miracle metals (whose chemical symbols, Al and Mg, provide their nicknames), was a small industry before the war when compared with other American industries. But now the babies have become young giants.

Both featherweight metals will be fabricated into a multitude of peacetime objects that are pushed, propelled and picked up—automobiles,

Above, a magnesium griddle distributes heat evenly. Lower left, construction worker easily lifts 30-pound wheelbarrow of the same metal. Below, magnesium landing wheels for large aircraft resist sudden shock





Above, aluminum roofing requires no paint, resists corrosion. Two of the workers wear aluminum helmets. Below, stacks of lightweight utensils for postwar kitchens

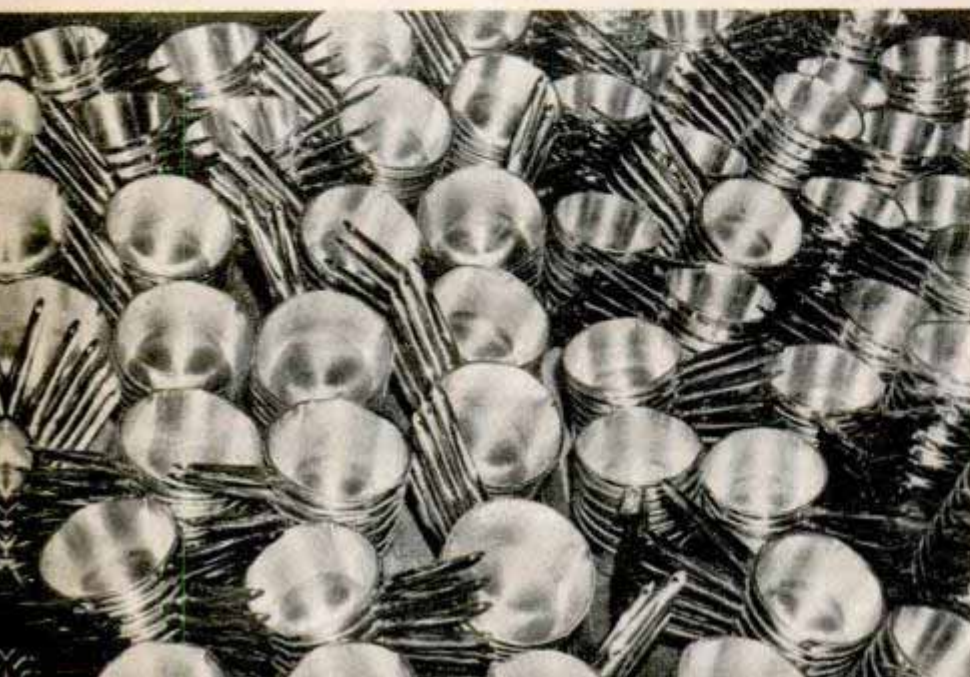

Shipping containers of aluminum, designed to reduce freight costs, are moved easily

vacuum sweepers, trains, baby carriages, furniture, sporting goods, airplanes, printing presses, trailers and countless others. More than 2000 objects, from ships to watch parts, have been earmarked to be built of aluminum alone.

In 1940 the United States produced 163,000 tons of aluminum and 3300 tons of magnesium. When war came the government invested \$670,000,000 in aluminum plants and \$389,000,000 in magnesium facilities. This

stepped up aluminum production seven times to a total of 1,119,000 tons and increased magnesium output almost 100 times to a total of 293,000 tons.

As war spurred production of the two light metals, prices fell. Aluminum ingots dropped from 20 to 15 cents a pound; magnesium slid from 27 to 20½ cents a pound.

The lightweight metals cannot compete in price on a pound for pound basis with steel. But experts point out that aluminum is one third the weight of steel while magnesium is one fourth. On a volume basis, therefore, "Al" and "Maggie" are seen as serious postwar competitors.

Improvements in light metal refining and alloy processing during the past five years have given aluminum and magnesium (1) amazing strength not heretofore possessed, (2) easier machining qualities and (3) new erosion resisting properties.

Both metals exist in abundance. Aluminum is the most plentiful



metallic mineral in the earth's crust. It is manufactured principally from bauxite at the present time, but experiments promise that it may be removed from other ores. Magnesium is the third most abundant metal and is manufactured from dolomite ore, underground brines and sea water. With conservationists pointing a warning finger at shrinking iron deposits it is comforting to know that the world has plenty of aluminum and magnesium on tap in earth and sea.

Fifty years ago "Al" was a curious product of the laboratory. It had no practical use until C. M. Hall, an American, and Paul Heroult, a Frenchman, working independently, discovered the electrolytic method of producing aluminum from bauxite. It took the war to change it from a metal of relative scarcity and limited utility to a metal of abundance and extreme usefulness.

Number 1 consumer of aluminum alloys is transportation. Since 1923 when Charles Ward Wall, consulting civil engineer, used the light metal in building a twin-float Navy seaplane to save 54 percent in weight, the aviation industry has been an enthusiastic convert to aluminum alloys.

Lightweight trains, trucks and buses made of aluminum already were speeding down the rails and highways of America before the war, but their numbers will increase sharply in the postwar period. Although 1946 model automobiles are similar in construction and appearance to their 1942 ancestors, several manufacturers are planning to manufacture lightweight cars next year.

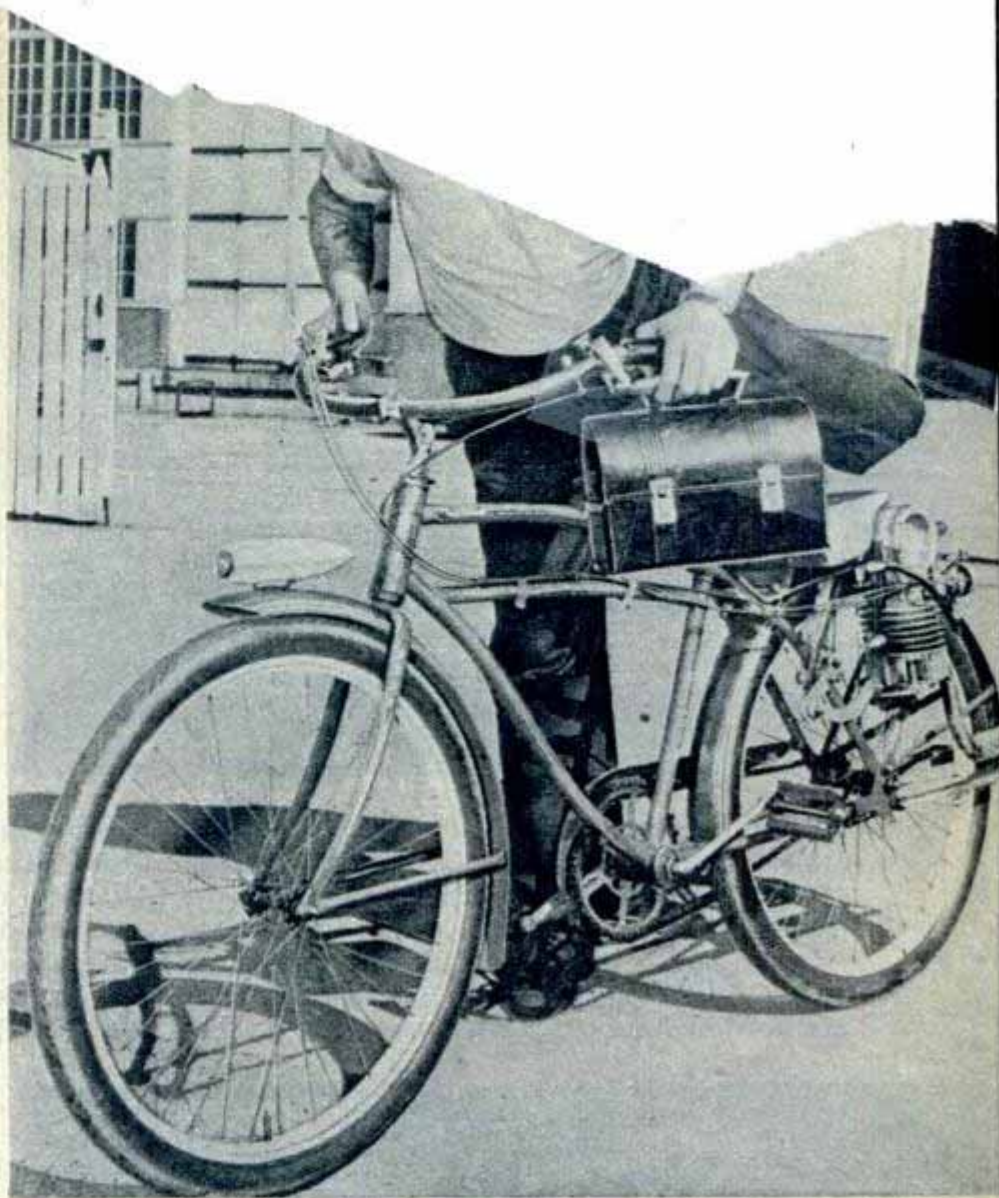

Above, all-aluminum bicycle engine weighing 32 pounds eliminates shimmying caused by heavier engines. Below, aluminum foil will be used in wrapping foods for storage



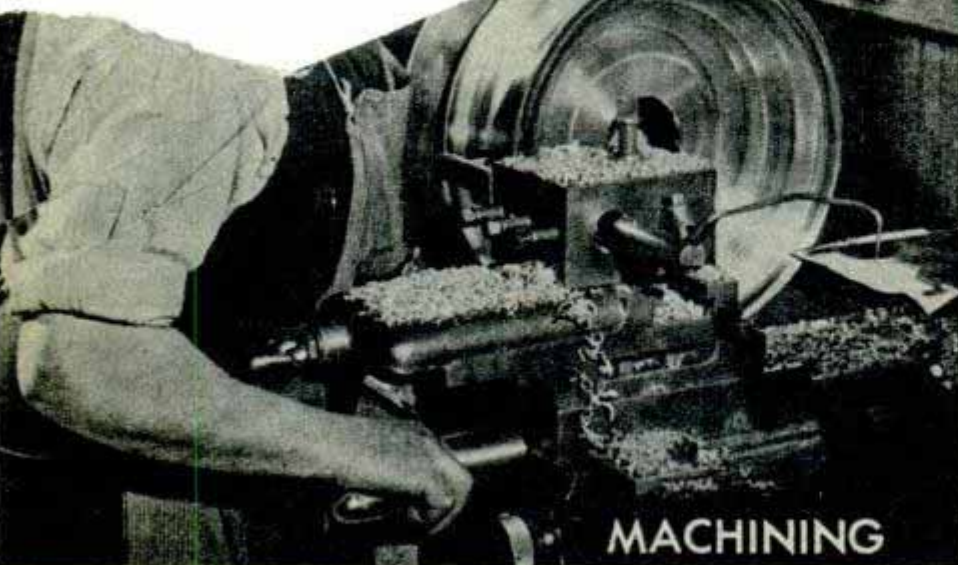

MACHINING



Photos from Dew Chemical Co.

Even marine transportation is looking thoughtfully in the direction of light metals. Complete plans for an aluminum alloy destroyer capable of 60 knots have been drawn and submitted to the Navy. Aluminum hulled cargo ships are said to distribute weight to better advantage. The

Grumman Aircraft Engineering Corporation already has converted wing assembly lines to manufacturing an aluminum alloy canoe—one half to two thirds the weight of the wooden type, nonsinkable because of air tanks in the bow, tough enough to deflect anything up to a bullet.

But aluminum supporters do not depend upon lightness alone for their sales appeal. New aluminum alloys have been developed with greater strength than that of most structural steels. They can be used for girders, supports and beams where both high strength and lightness are required—in the construction of large auditoriums, aircraft hangars, bridges and open-air markets, for example.

Aluminum alloys are high in heat transfer ability and electrical conductivity, important factors in designing jacketed kettles for canneries and meat packing plants, resin heat exchangers, varnish kettles and other industrial apparatus. Pound for pound, aluminum exceeds in conductivity other metals used for this purpose. For equal current carrying capacity "Al" weighs less than half as much as copper and is nonmagnetic and nonsparking.

Because aluminum alloys are resistant to fruit acids, fumes, smoke, salt, water and oil they can be used safely in the manu-

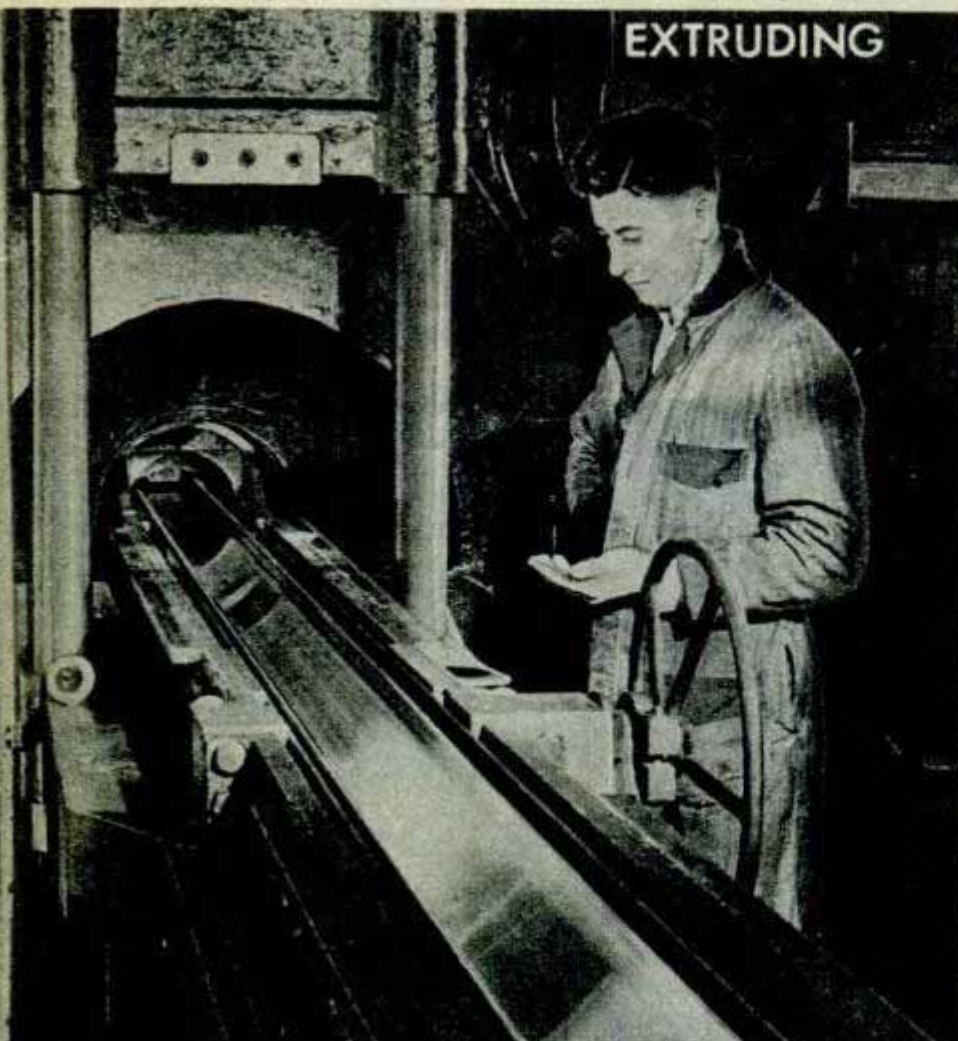

EXTRUDING

MAGNESIUM



ROLLING



FORGING

facture of chemical and food machinery and storage equipment. Other proposed uses for aluminum are:

Shotgun shells with aluminum cases; instead of discarding the shells the hunter will take them back for a refill.

Special lifetime awnings, shingles and window frames for postwar homes, guaranteed to outlast the house itself.

Aluminum beer barrels which require no pitching or coating on the inside, no painting outside.

Lightweight aluminum tents for circuses.

Aluminum foil packaging for food, tobacco, soft drinks and cosmetics.

Magnesium, the other lightweight twin, is a soft, white, silvery metal in its pure state. When combined with small amounts of manganese, zinc and aluminum, it produces an alloy of high strength and stiffness. "Maggie" formerly was considered temperamental because in powdered or chip form it readily caught fire, burning with a fierce white heat. But metallurgists have solved this annoying problem and today magnesium alloys are safe to handle.

Magnesium got off to a slower start than aluminum in the consumer field, but thanks to a fine war record is fast closing the gap.

In 1941 two German planes that

were shot down over England commanded particular attention. Scientists who examined them were astounded to find that their engines had forged magnesium alloy bearings five to six feet in length. This indicated that the Nazis had forging presses

(Continued to page 250)

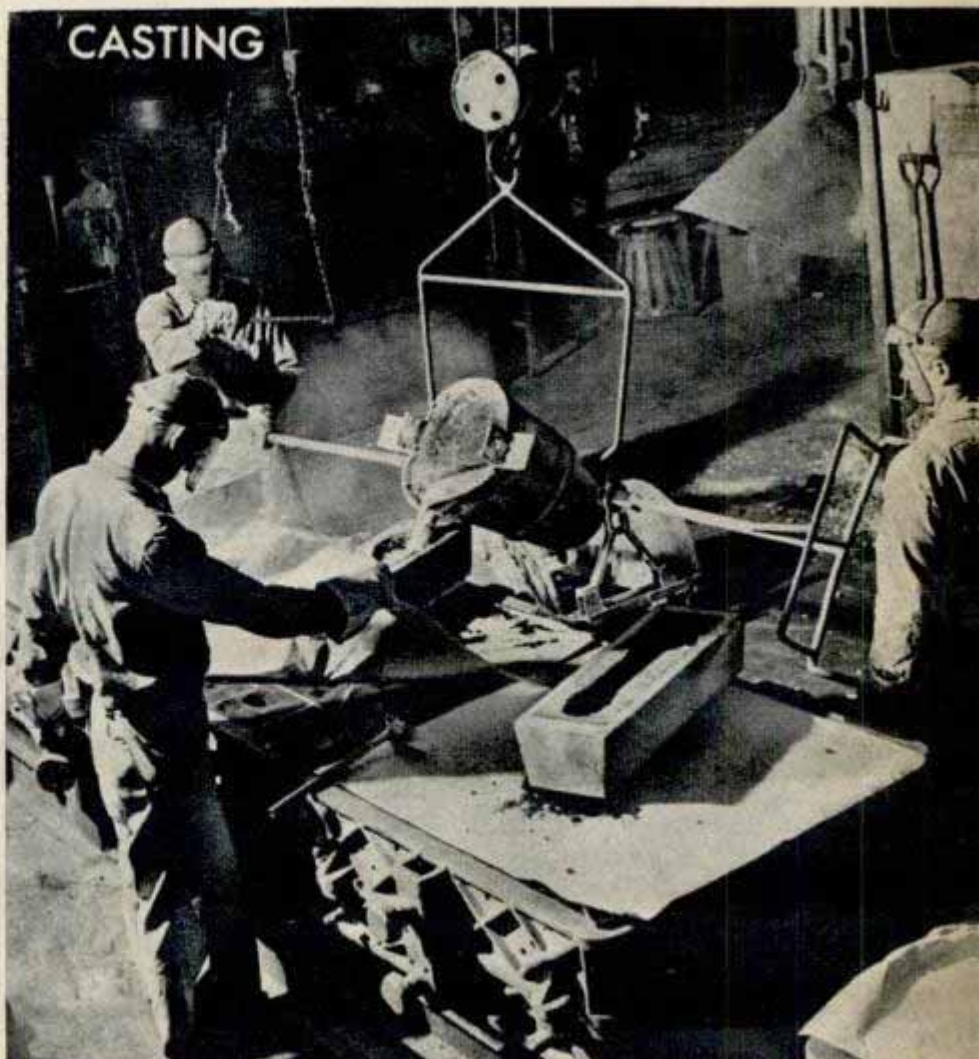

Compass Equipped With Knife



With a new beam compass, craftsmen can cut out circles as they trace them. A small knife that will cut paper, cardboard, or even light wood fits into an adjustable clamp on the beam. The clamp also will hold pencils or ruling pens. A similar clamp holds the pivot, which uses a removable phonograph needle as a point. The clamps permit easy adjustments in the diameter of circles from either end of the compass. The beam is a nickel-plated steel bar $\frac{3}{16}$ inch square and 18 inches long, although any length can be furnished.

Flexible Pipe for Hot Air Ducts

Made of glass, cloth and rubber, a material developed to insulate heating equipment in warplanes now is used for hot and cold air ducts in factories and office buildings. It withstands temperatures from 60 degrees below zero to 300 above and holds up under internal pressure of 50 pounds per square inch. It is unaffected by air, light, water, gasoline, oil and most acids. Its flexibility makes it useful where vibration is encountered.



Hand Flash for Photographers



Aluminum hand flash units for photographers who do not desire a synchronized flash in taking pictures are now available. The unit is designed so that it can be aimed easily without straining the wrist. The deep reflector, spun from a single piece of aluminum, has a brushed inner surface. The handle is in line with the bulb to facilitate aiming, with a "D" cell inside to touch off the flash. A switch at the end of the handle is under the thumb when the unit is aimed.

Pistol Air Hammer Strikes Fast



Trigger operated, a pistol-sized air hammer that weighs only two pounds can deliver 13,000 controlled blows—from featherweight to full strength—per minute. Operating on two cubic feet of air per minute, the hammer can cut metal, rip flash from welding joints, draw, bend or flatten steel, form light metal and clean castings.

Stars Come Out of Hiding

ONE of the largest pieces of optical glass ever manufactured in America is making it possible to photograph stars 100,000 times fainter than any star visible to the naked eye.

Produced by the Bausch & Lomb Optical Company, an objective prism 24.5 inches in diameter and weighing 280 pounds before grinding has been installed in a Schmidt-type telescope at the Warner and Swasey Observatory of the Case School of Applied Science at Cleveland.

As the result of this piece of glass—whose surfaces were checked to an accuracy of four millionths of an inch—star images in the form of threadlike spectra are reproduced on photographic plates, enabling astronomers to conduct studies to ascertain the elements present in stars, the degree of ionization, the surface temperature, color and brightness, or candlepower.

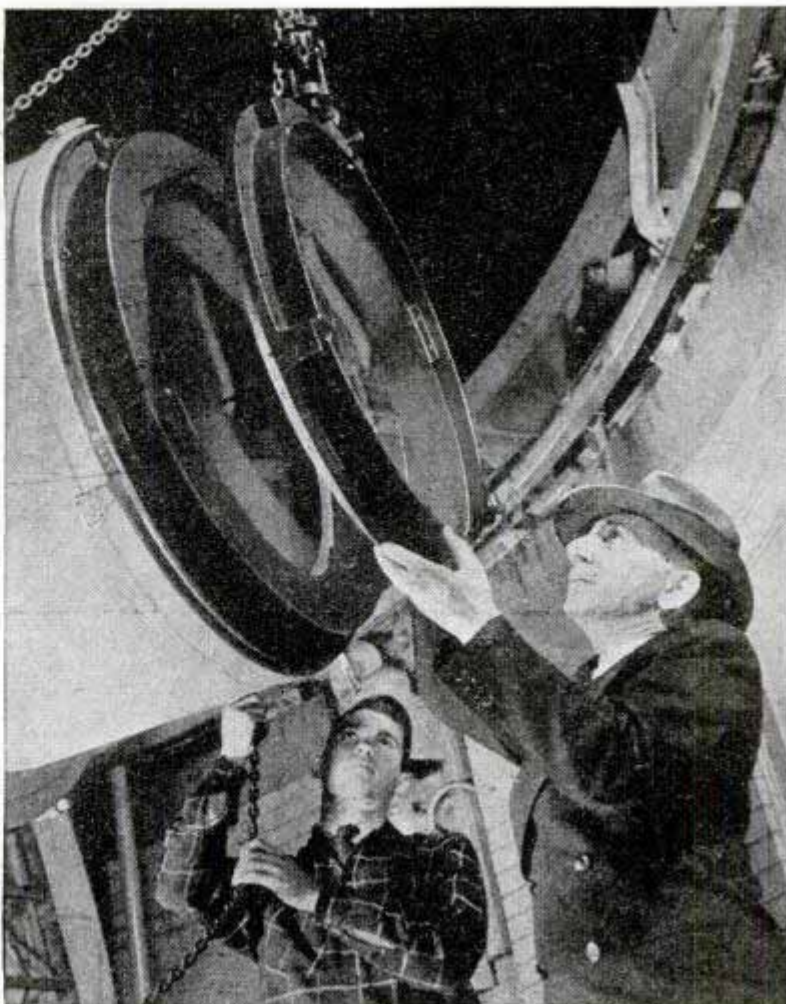

Mounting the 24-inch objective prism. Below, the powerful telescope photographs unseen stars, helps explore the unknown

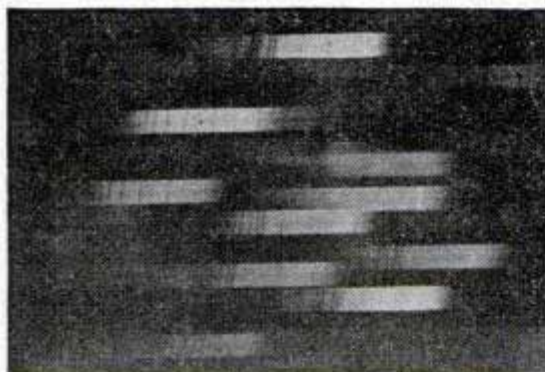

Photographs of stars appear as threadlike spectra. Below, prism blank inspected to an accuracy of four millionths of an inch

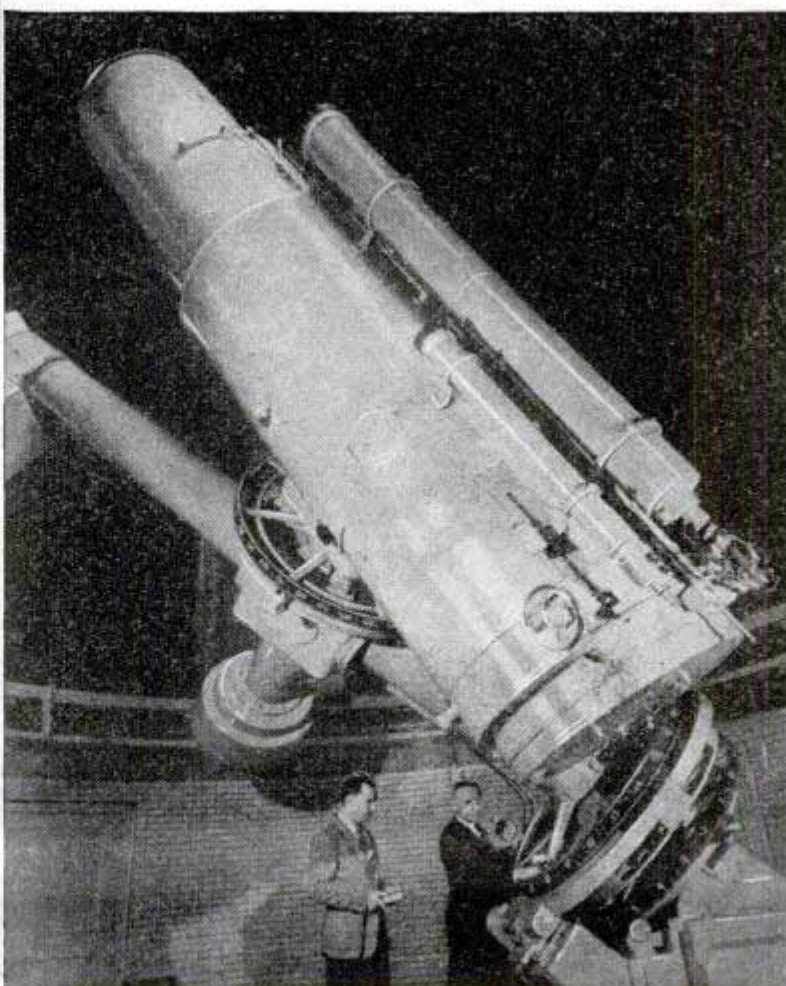

Tips on Tackle



1150 E. St. ...
By Claude M. Kreider

Photos by Ray Chapin

FISHING tackle, so long off the market, will be available soon and the wise angler should start preparing for that long-deferred vacation by assembling and trying out his tackle. New equipment should be chosen for the exact kind of angling you expect to do, for in all sport fishing, whether it be for bass, trout or pan fish, the best sport will be possible only with tackle designed for that use. And proper "balance," or matching of rod, reel and line as a smooth-working unit, is essential.

If you are uncertain on these points consult a fishing friend. Try out his proved and balanced outfit, and be guided by his advice. Trial casting on a lawn will tell you much, and actual practice at a pond, or park pool, is even better. Note the definite relation of the weight of a reel and the size of a line to the action of the rod. Many experienced anglers struggle along for years handicapped with poorly balanced tackle,

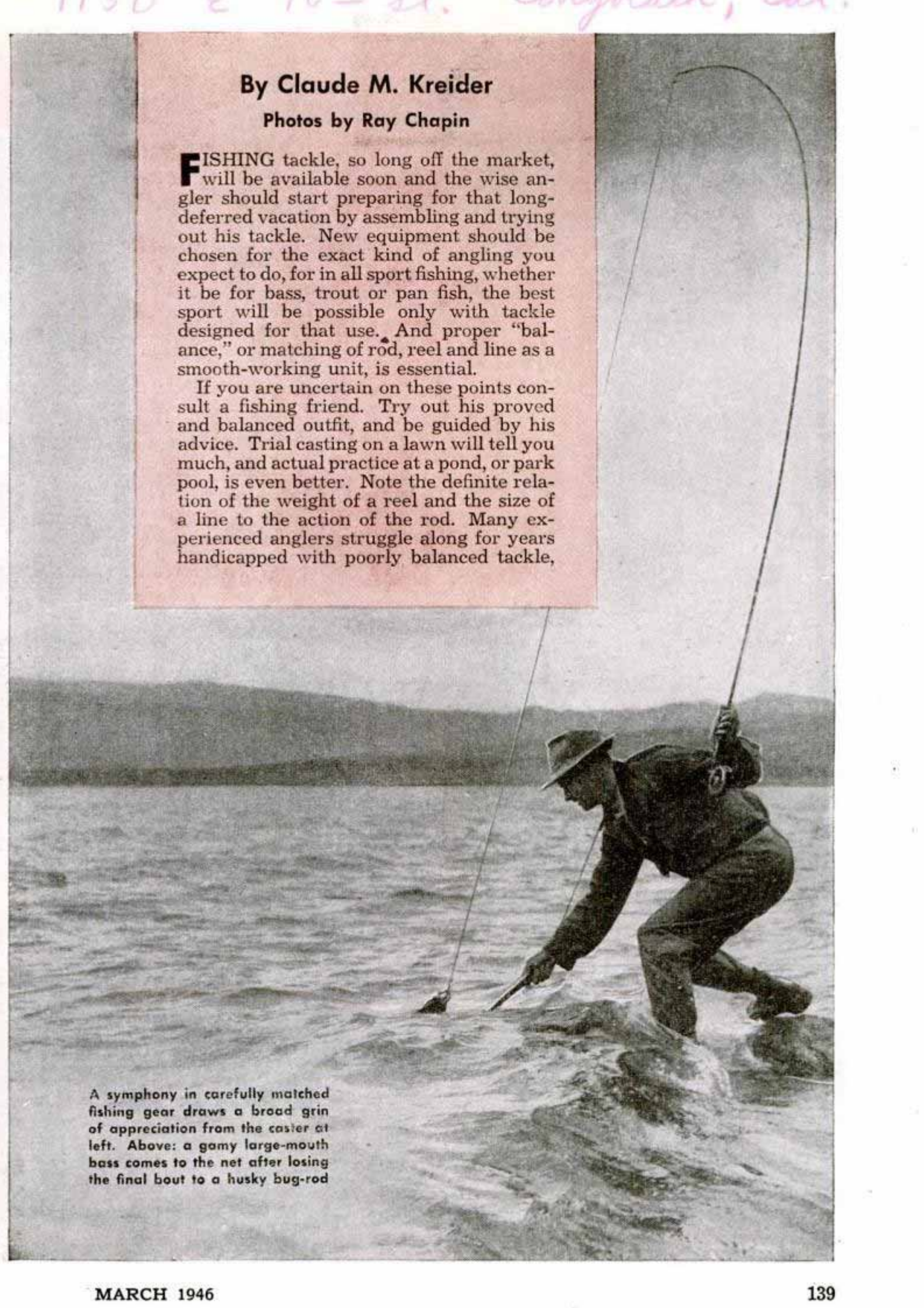

A symphony in carefully matched fishing gear draws a broad grin of appreciation from the caster at left. Above: a gamy large-mouth bass comes to the net after losing the final bout to a husky bug-rod

A rod should bend to suit its purpose

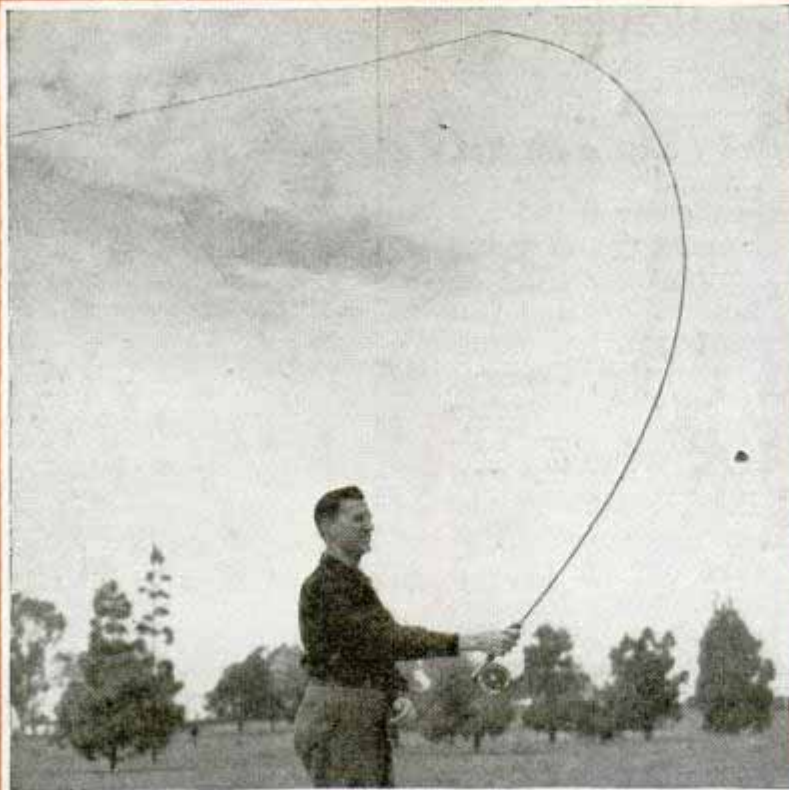

Angler tests back cast "pull," which powers long forward cast

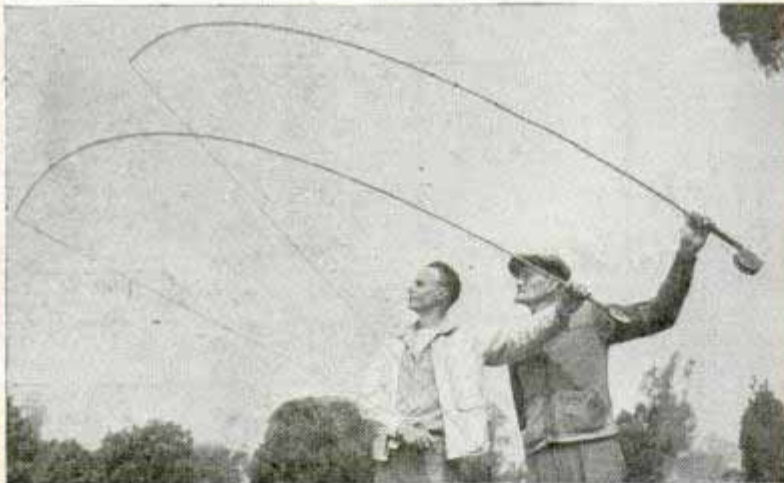

↑ Top rod suited for all-around fly fishing, bottom for pan fish.
↓ Flexible rod is for bass casting, stiff rod only for trolling

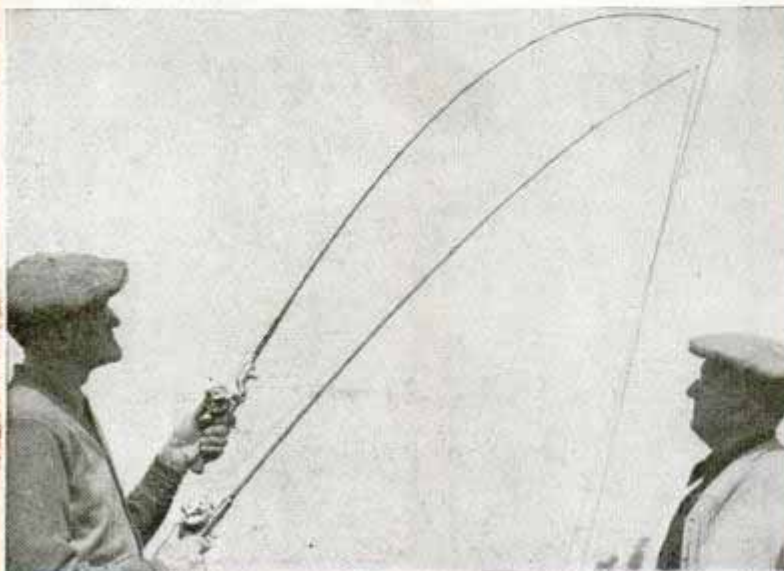

when perhaps one new line, or a trade for a different reel, would cure their troubles.

Let's consider fly fishing tackle first. Fly rods come in lengths from 8 to 9½ feet, weighing from about 4 ounces to 6½ ounces. The smaller rod is suitable for pan fish and small stream trout fishing. It should have a reel weighing not more than 5 ounces, which will just hold the 30 yards of enameled or oiled silk fly line to "fit" the rod. This means a line heavy enough to bring out the rod's action, but not so heavy as to strain—and soon ruin—the slender bamboo. A size "E" line, which measures by micrometer .040 inch thick, should be about right, but only an actual trial outdoors will tell.

The heavier 9 or 9½-foot rod for bass fly use needs a line of "C" or "B" size, measuring .050 inch or more, to permit easy, effortless casting. And this larger rod requires a reel with a spool about 3½ inches in diameter to hold sufficient line of the heavier size. You should make sure the line is the right kind for the reel before purchasing, remembering that a fly reel is really only a "line holder" and need not be expensive nor finely finished. The lighter its weight the better your fly rod will perform.

Fly rods of similar appearance and size often vary in action. Try out those you like by threading the line through the guides and pulling down the tip end of the rod to study its arc. Some will bend rather evenly throughout, a so-called "soft action." This is an all-purpose type of rod and is not easily damaged by legitimate use. It is good for wet fly and light spinner work and also will do for bait fishing. Other rods will have little bend through the lower part but a decided, sharp arc in the tip section. This denotes "dry fly" action, which is desirable for delicate dry fly fishing. Also, in modified form, it is a good design for all-around fishing. A rod so built, 9 feet

long, weighing $5\frac{1}{2}$ to $5\frac{3}{4}$ ounces, is the best you can find for all-purpose work. The comparatively light tip permits careful handling of small fish, yet the rod is capable of taking good husky trout or bass in big water.

Before final decision, examine the rod fittings. They are important. A good, screw-locking reel seat of either metal or plastic material is essential. The ferrules should be snug fitting and require considerable pressure to seat. They should be of nickel or German silver, rather than of nickel plated brass, for strength and long life. Guides should be of the "snake" type of hardened steel. A sufficient number of them, properly spaced for ease of casting, distributes strain throughout the rod, indicating a well-designed tool. Ten guides should be the minimum number on a 9-foot fly rod.

Now we take up bass casting tackle.

Rods for plug casting, so popular for large and small bass, pike, pickerel and other fish, come in practical lengths from 5 to 6 feet. The shorter ones are stiff and suitable only for trolling. A $5\frac{1}{2}$ or 6-foot rod with considerable "whip" to cast a lure effectively is the best choice. It too may be used for spinner trolling. Try the rod for arc, as suggested for fly rods. Then hang a standard $\frac{5}{8}$ -ounce bass plug from the tip and whip the stick to get the feel, remembering that smooth, flexible action, especially toward the tip, will permit accurate casting with little more than a flip of the wrist. Again, an outdoor casting test at a target—an old bicycle tire laid on the lawn is ideal—will give you a real analysis of your rod and reel.

The reel is your most important tool for this work if you would send that lure out 100 feet, straight and smooth, without troublesome backlashes, the bane of every bass angler. It should be precision built throughout with jewel or phosphor bronze bearings

Check guides, screw reel seat and ferrules



The number of guides determines strain on rod and wear on line

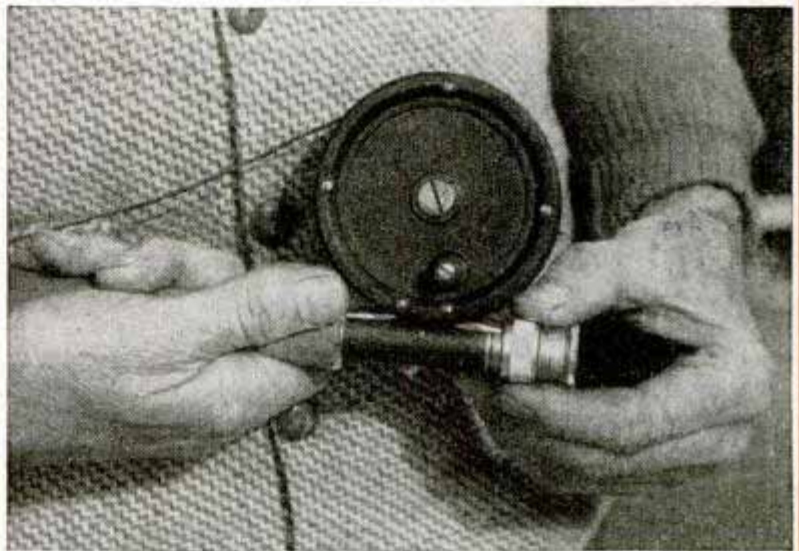

↑ Screw reel seat with duralumin fittings holds reel securely.
↓ Ferrules should fit snugly with sufficient length for long wear





Rod, reel and line should work as a team. Left, 9 1/2-foot bass-rod has heavy line. Smaller rod at right is all-purpose

and a well-designed level wind device to spool in the line accurately as you retrieve your lure. Choose a light, compact reel, for it will hold all the casting line of 12 or 15-pound test you will need. It should fit snugly in the locking device of the rod and be close to the cork grip to permit easy and natural "thumbing," the one delicate and all-important action in bass lure casting. Your practice sessions soon will demon-

strate that an "educated thumb" is the one great essential. Bass casting line needn't be so carefully fitted to rod action as the fly line but avoid the usual mistake of buying one too heavy. A 20 or 25-pound test line will cast poorly because of its actual weight and the increased friction as it leaves the reel and goes through the guides. One of 15-pound size—even 10-pound is entirely practical—is amply strong for any fish your rod could handle. Once more, this comparison of lines can be demonstrated best by actual trial. Either braided silk or nylon in soft finish is the best casting line and most of these now are cravenette finished in order to render them waterproof. In choosing your fishing tackle, never forget that equipment worth having is carefully made, that it is a sound investment that will last for years, and that it justifies the payment of a good price. A split bamboo rod, for example, is the product of numerous hours of fine craftsmanship. A good reel is built with watchlike precision and, if kept clean and well oiled, will last a lifetime. Yet, in a well-made standard grade, it need cost you only the price of a golf club. So shun the shiny but too-cheap one. And don't forget that one faulty, poorly made piece of fishing equipment may let you down, deep in the forest or mountains, and quite possibly spoil a long-planned trip.

Bait-casting reels are fitted with cork hand-grip to provide easy and natural "thumbing" of the spool when lure is shot out



Finally, with that cherished new outfit assembled, continue to practice with it beyond the initial "balancing up" stage. Take the old bicycle tire or a tin plate out on the lawn and learn through practice the art of scientific casting. There is no secret to it—practice pays big dividends when you seek the canny trout or bass. If there is a fly and bait casting club in your vicinity, visit it and talk to the experts there. They will be glad to offer advice and teach you the proper casting technique. Remember, "it is not all of fishing to catch fish."

Hydraulic-Drive Fish Net Makes Huge Mackerel Catch

Operated by hydraulic oil pressure, a mechanical fish net has been invented by Morris Whaley, Long Beach, Calif., to catch mackerel. The net, which resembles a cage and has steel rods for supports, is lowered from the side of a fishing boat as a floodlight is turned on the water and bait is tossed in to attract mackerel. The net picks up as much as 400 pounds of fish at one time. The device is operated by three hydraulic cylinders and a valve for each. One cylinder moves the net fore and aft, a second raises and lowers it, and the third swings it inboard and outboard.

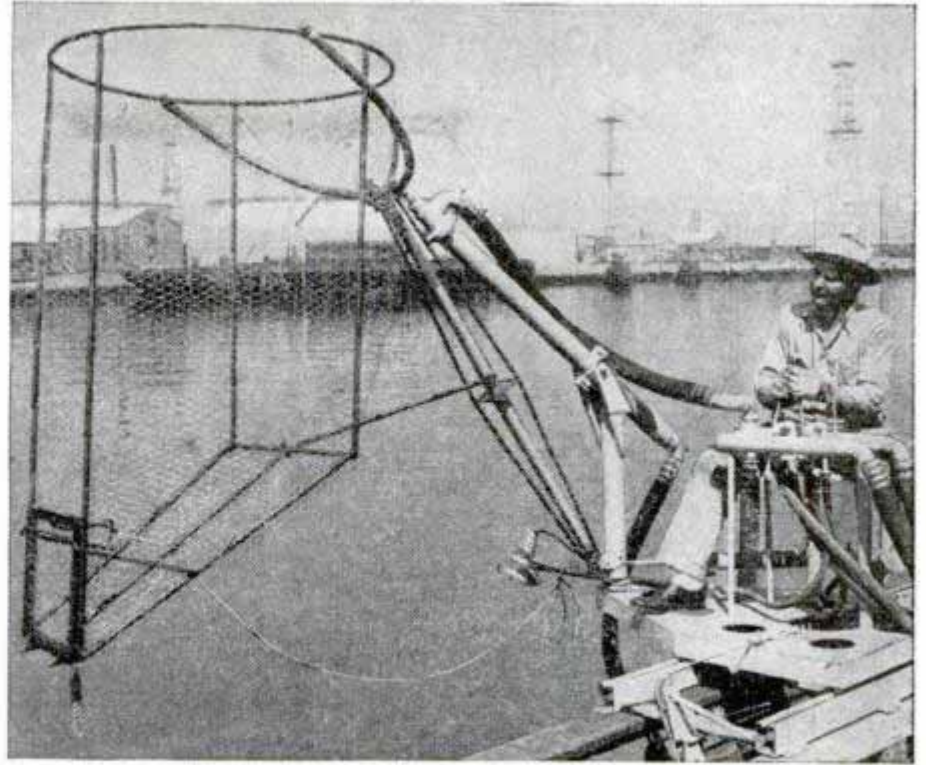

Easy-to-Use Tester for Battery Registers Charge on Dial

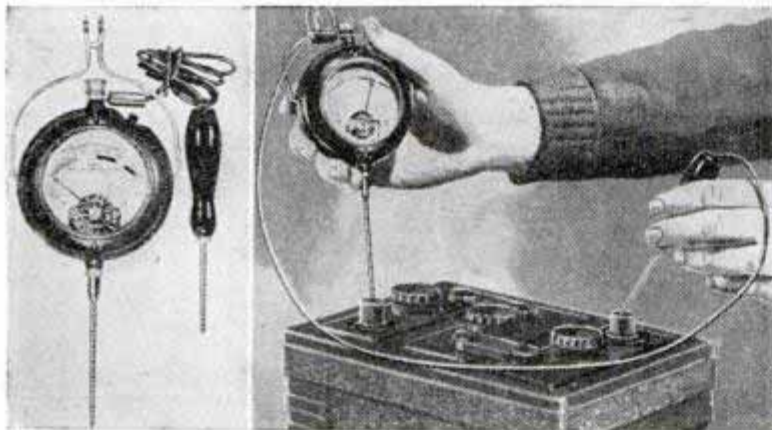

Batteries are tested without the use of acid-dripping hydrometers with an electrically operated tester. Without placing a load on the battery, the simple unit shows what charge rate to use for either trickle charging or high-rate charging. It also shows on a dial the percentage of charge and warns of overcharging. Weak or defective cells can be spotted before failure occurs. The unit can be used as a portable tester.

Revolving Tool Binds Wire

To hold looped wire to eyebolts and anchor eyes, a tool now available neatly wraps as many closely woven turns as necessary around the free ends of the strands. When the guy wire is doubled into a loop, the two loose ends are bound closely simply by revolving the tool, which is especially useful to linesmen for fastening dead-end guy wires to telephone poles.

Magnets Made of Iron Rust

Iron rust, the obstinate enemy of garden tools, now is being used to make small but powerful magnets that are said to be the lightest in weight ever developed. The new type magnet is a combination of iron oxide ore, chemically the same as iron rust, and cobalt oxide. The two oxides are mixed in powder form and then heat-treated.

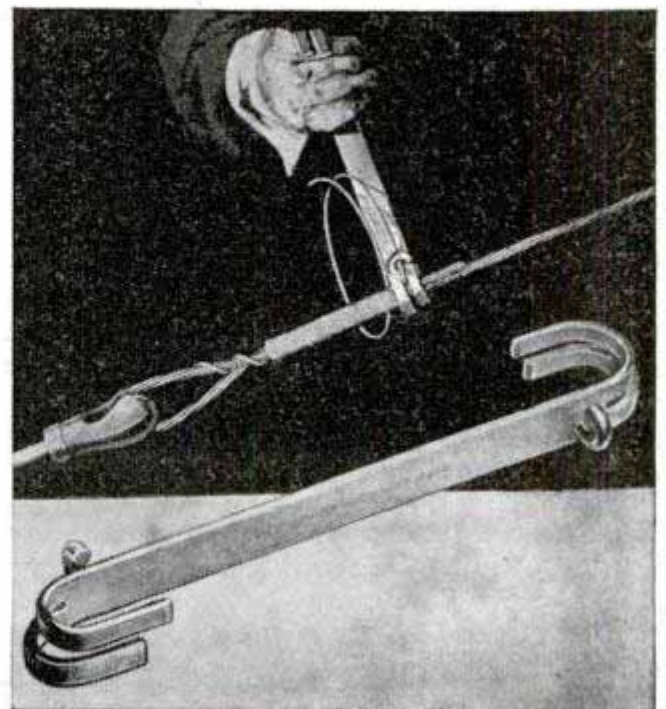

Harry Petterson points with his jackknife to sketch of first incubator made from fuel cans

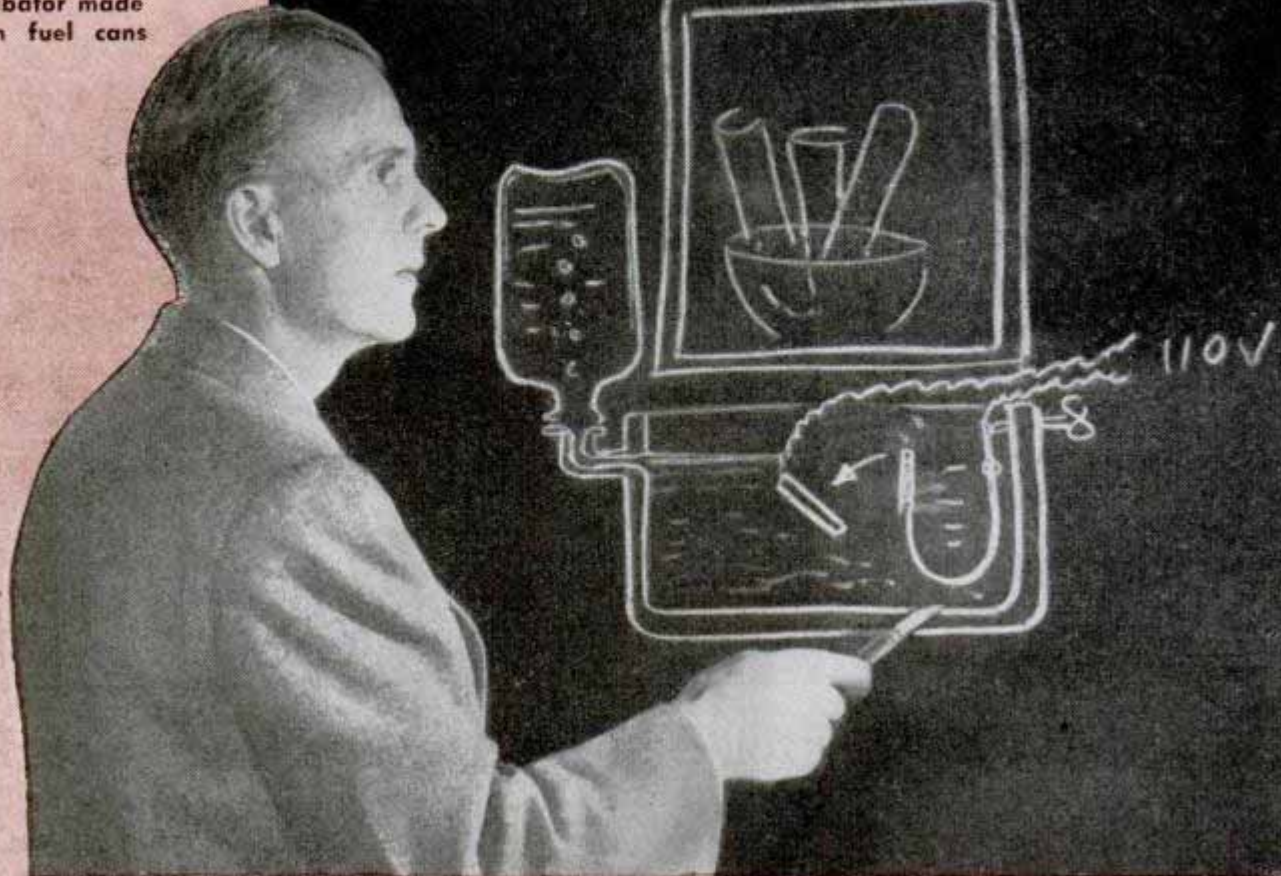

The Genius of Shinagawa

With a jackknife his only tool, a Norwegian in a Jap prison fashioned medical instruments that saved many American lives

MANY American inmates of Shinagawa, a Jap prisoner-of-war hospital, owe their lives to the mechanical genius of Harry Petterson, a Norwegian who was captured by a German submarine and taken to the prison.

Petterson made intricate surgical instruments of scrap metals. From gasoline cans, discarded safety razor handles and bits of brass came a motor-driven dental drill. He built an X-ray machine and an incubator for cultures with automatic temperature control. He fashioned the large American flag that greeted American forces when they arrived at Shinagawa.

From the Nazi submarine Petterson brought five sacks of food and medicine which the German captain had given him. These precious supplies he immediately turned over to the American naval officer who commanded the prisoners. Then, with a jackknife as his only tool, he went to work to make the Shinagawa prison enclosure a veritable hospital.

First he fashioned more tools. A metal strip, edged with teeth cut by his knife, provided a saw. A railroad spike was forged into a hammer—after he had built a charcoal furnace. These homemade tools produced all the hospital equipment. The dental drill relieved the suffering of over 100 men requiring dental treatment in the hospital. He fashioned spoons, the prisoners' most urgent need, from strips cut from gasoline cans, welded to handles of scrap wire.

But Petterson saved more lives with a "Rube Goldberg" contraption purposely designed so that it wouldn't work. Dr. Takuda, a Japanese medical officer now on trial for his "guinea-pig" experiments on prisoners of war, wanted to "cure" American patients by injecting into their veins an acid made from coconut oil. He demanded that Petterson build him a machine that would mix the acid with distilled water. When the mechanic consulted American surgeons they confirmed what he feared—the acid in-

By E. B. McLaughlin

Hand-made incubator for medical cultures. Temperature control A turns floating lever B to open or close vane C over air channels D. Inlet F lets in cold air to be warmed by lamp. E permits excess hot air to escape. Shaft G and knob H adjust temperatures. The ingenious device is credited with saving many lives

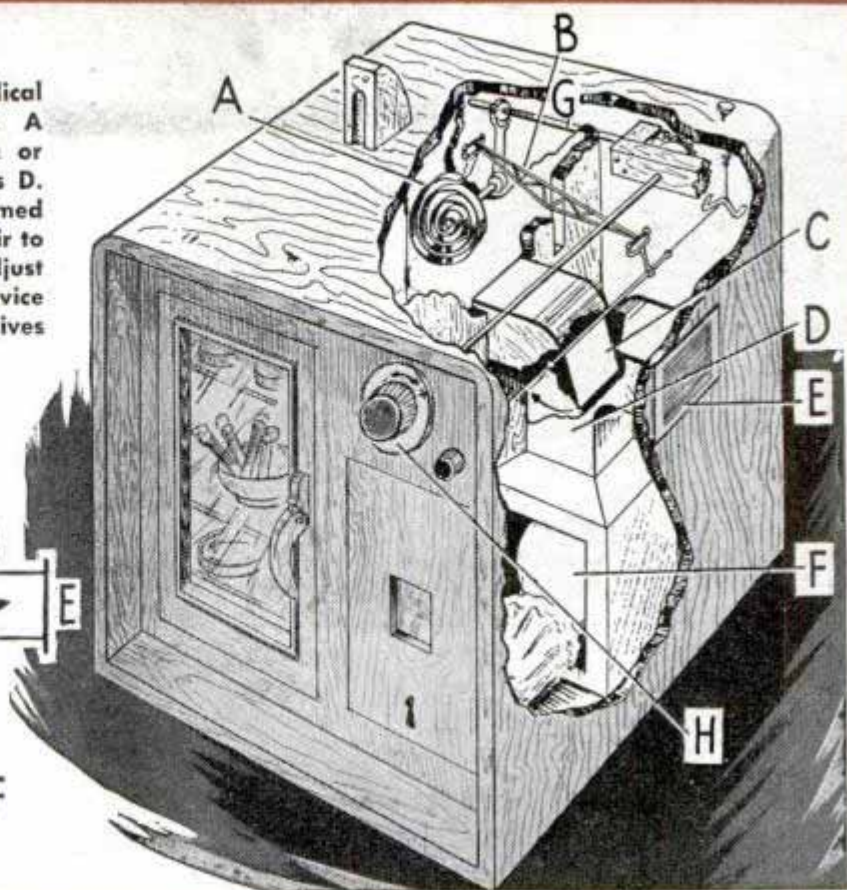
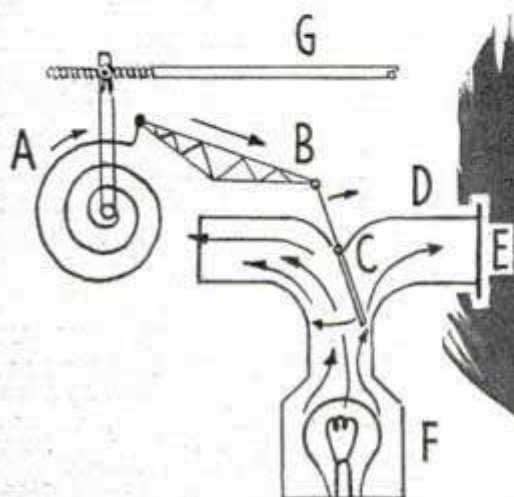

Author's own drawing shows work he did with jackknife

Dental drill was built from scraps. Handpiece A with changeable heads 1 and 2 and pushbutton 3 was made of razor and toothbrush. Flexible cable B came from speedometer of Jap truck. Discarded American motor C mounted on wall bracket D provided power. E is a water rheostat control

jections likely would be fatal.

He produced a machine that was an intricate mass of pipes with lights flickering on and off, steam bursting through openings, and a faucet that poured out a steady stream of the "mixture." Dr. Takuda was delighted. But when injections were started, none of the patients died. Only Petterson knew the secret. His machine steamed away the acid, leaving only pure water.

Petterson is now in the United States condensing a four-year mathematics course into three months before entering California Institute of Technology—probably still carrying his jackknife.

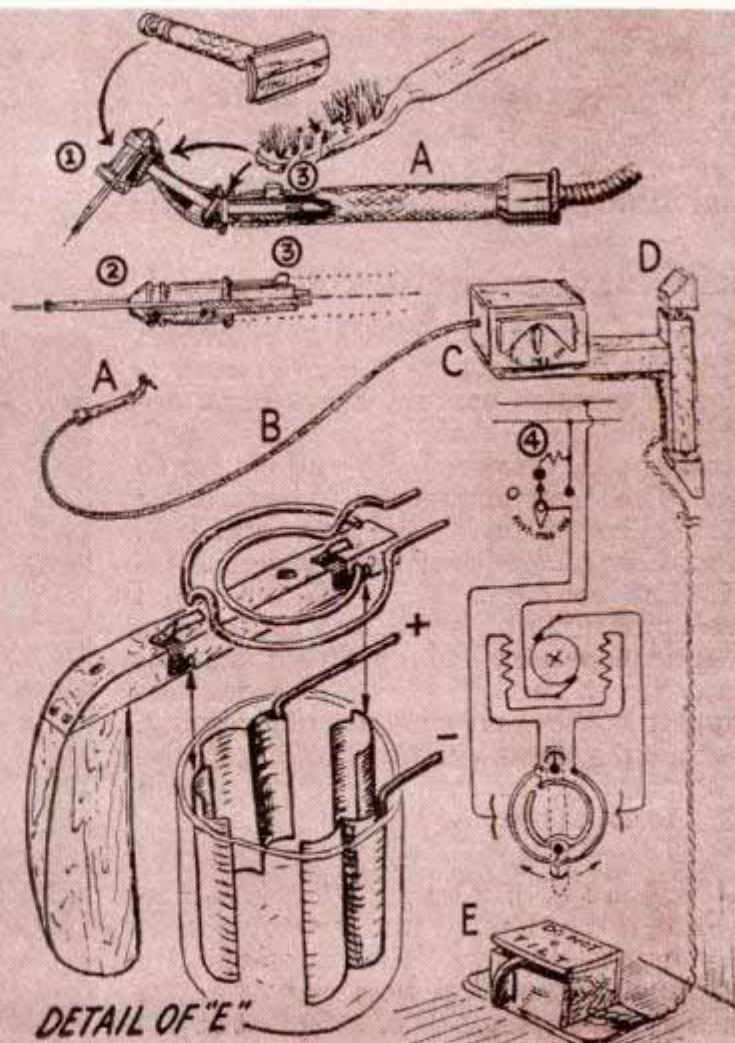

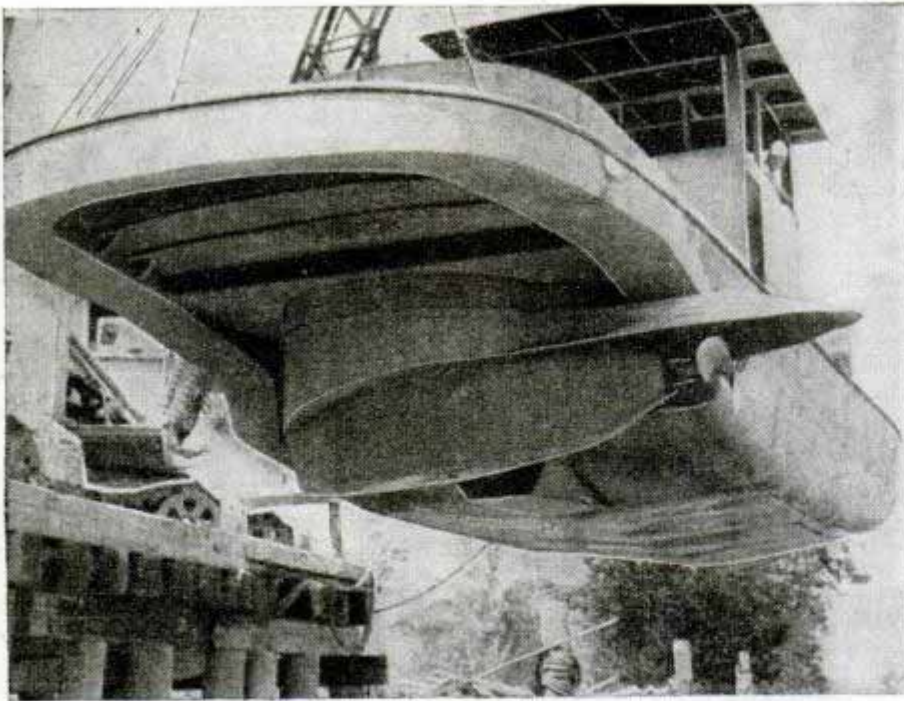

Towboat Turns "On a Dime"

Eliminating the need for a separate rudder, a power unit for towboat propulsion combines the engine, shaft and propeller in one housing that can be rotated through 180 degrees, permitting a full turn in the boat's length. The housing has a streamlined exterior to minimize water resistance. Other advantages are that propulsion power is increased, as is the steering power to push the stern in any direction. The unit can be removed easily for adjustment or repair. The manufacturer plans to use Diesel-electric engines up to 750 horsepower for power, with multiple units that would provide 2000 horsepower or more. Towboats of this type equipped with derricks to salvage seaplanes were built for the Navy.

Bottom view of towboat shows housing containing rudder and power unit. Start of a 360-degree turn is demonstrated at left

Aerial Navigation by 'Slide Rule' Teaches Pilots How to Steer Course

To overcome some of the bewilderment of students beginning the study of air navigation, a practice computer has been devised to plot an aircraft's true track speed, ground speed, wind velocity and course to steer. The instrument was designed by S. A. Walling of the British Navy and J. C. Hill of Cambridge University Press, England. The computer has a sliding panel made up of a fan of tracks and speed arcs, and a transparent "window" surrounded by a compass rose. By using the practice computer in the early stages of his training, the student gains an understanding of the workings of precision instruments which he will learn to operate later.

[No figment of the imagination is a man weighing a thousand pounds with blood as heavy as molten iron. That is essentially what an airplane pilot becomes when he makes a turn in a radius of 1000 feet at 300 miles an hour, according to studies made at the RAF Physiological Laboratory.

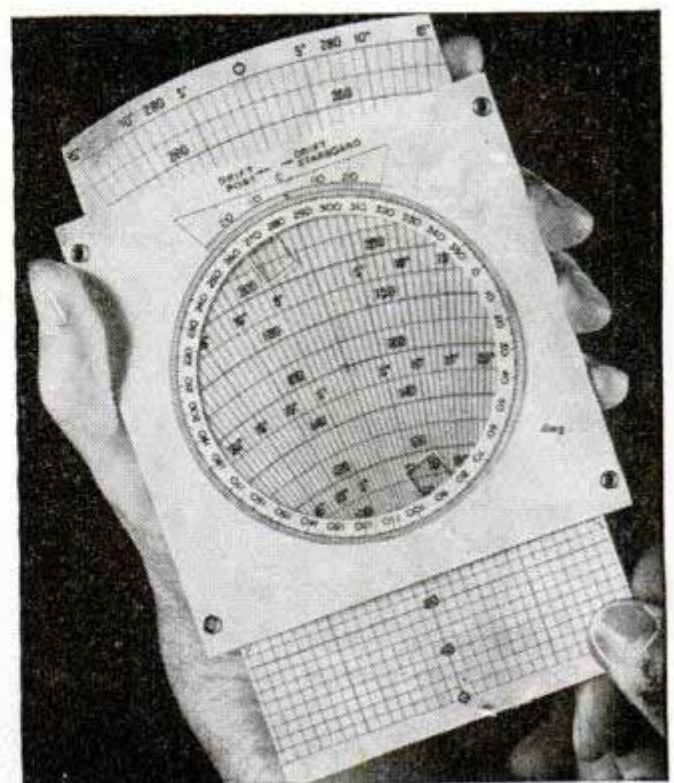

Ice-Water Solution Kills Bacteria

Ice treated with a special chemical compound produces a bacteria-killing solution as it melts and thus keeps foods fresh longer than does ordinary ice. Developed by the science department at Seattle Pacific College, the new ice is being used on fishboats to protect the freshness of halibut and salmon.

Automatic Camera "Freezes" Motion

Capable of "freezing" a moving fan blade, a 35-mm. camera developed by the Army's Pictorial Service uses an ultra-high-speed self-contained light source. Every step of picture taking except focusing and clicking the shutter is automatic. The device contains a coiled quartz vapor tube that supplies a "motion-stripping" flash, brighter than sunlight, of approximately 1/25,000 second duration. The camera weighs 5½ pounds and may be operated either from a portable electric power pack weighing 27 pounds or from an ordinary current line. Black and white or color photographs can be taken. The Medical Corps has used the camera to photograph open

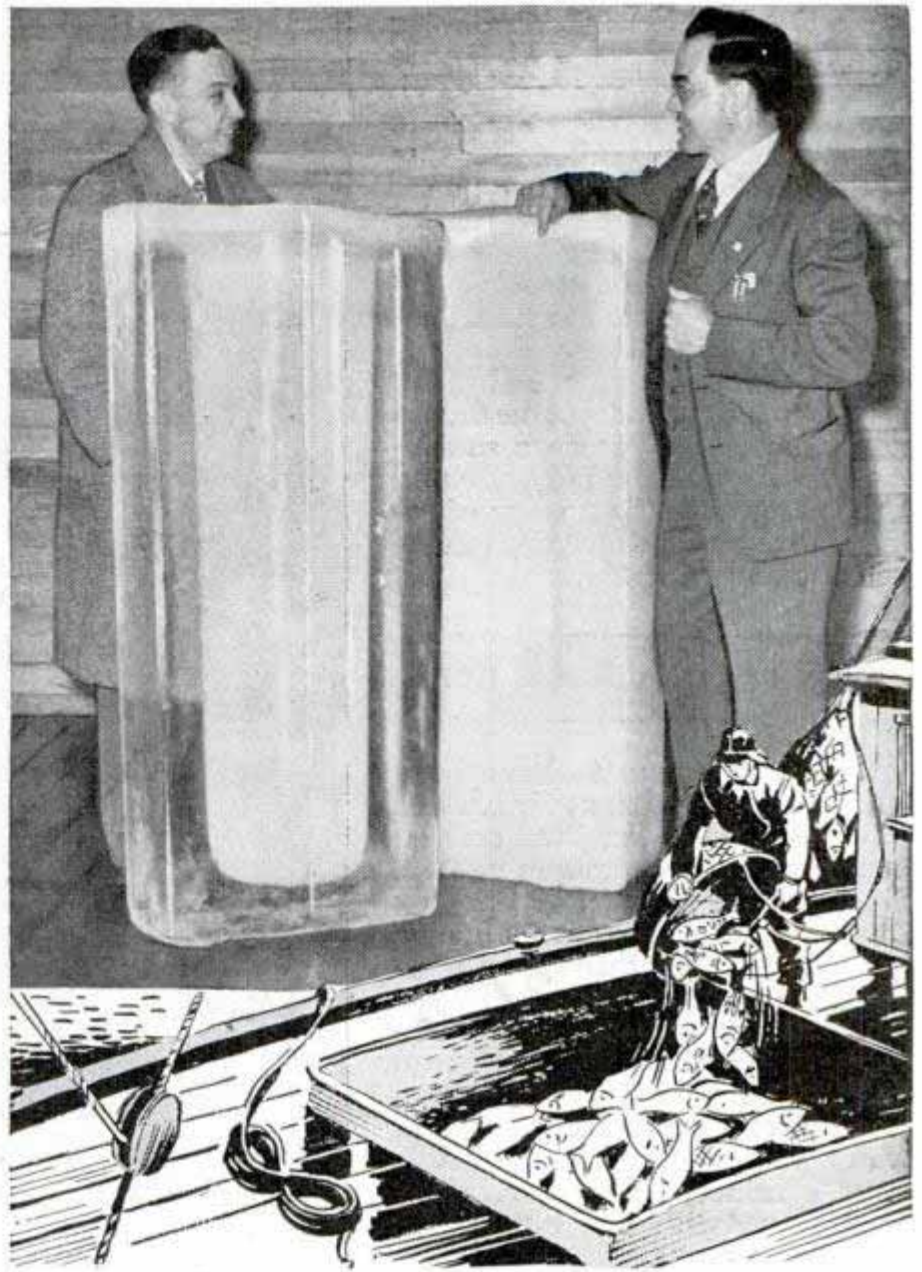

Chemically treated ice (right) is compared with a cake of ordinary ice

eyes at close-up ranges. Developed at the request of the Army's Surgeon General, the camera was conceived by Captain Rollin W. King and Emanuel Berlant.

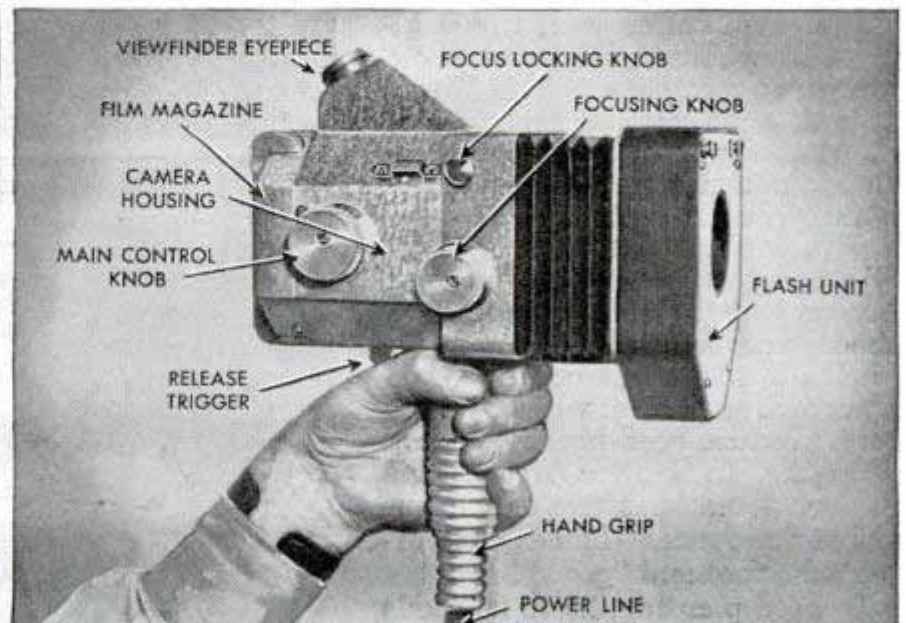
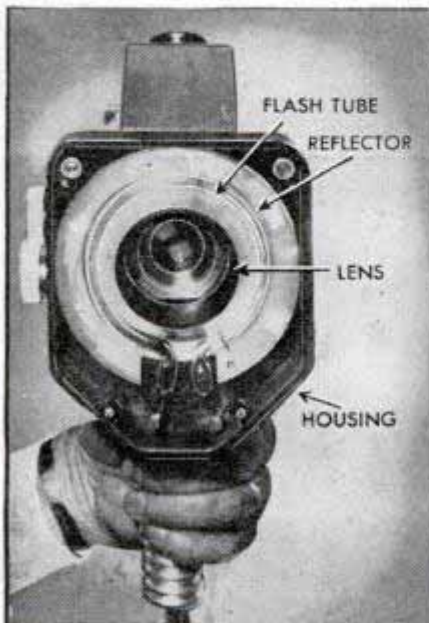

ON A LONELY OUTPOST in the Pacific, two of Uncle Sam's soldiers serving with the occupation forces exchange passwords in the cool night. One of them, relieved by the other after two hours as a sentry, heads for the mess hall's friendly lights. The soldier quickens his step as a familiar aroma meets his nostrils—coffee! Hot coffee!

As he sits at a scrupulously scrubbed mess hall table, he drinks a beverage once reserved as special privilege of the holy. Behind this "Cuppa Joe" is a story of romance involving intrigue, misadventure and hardship.

By Staff Sgt. John L. Kent

Coffee is known to have been cultivated in Arabia as far back as 575 A.D. The coffee plant arrived in America at Martinique in 1720. Sailing from France, Gabriel de Clieu, a captain of French infantry, brought with him three young coffee plants. A delay caused by a violent storm exhausted food provisions, and water was rationed daily to the passengers and crew. The officer sprinkled his share of water on the plants and, by this great sacrifice, finally arrived in Martinique with one out of the three original plants.

Seedlings were sent to plantations in Santo Domingo, Guadeloupe and other islands of the Caribbean. Today we find coffee growing in Mexico, all of Central America, the West Indies and practically all of South America.

Although coffee will grow almost anywhere in the tropical belt, it requires certain even conditions of soil, sunlight and moisture to flourish. It particularly likes earth rich in potash, so many of the best plantations are on the slopes of extinct volcanoes. Coffee trees usually are grown from selected seed, but propagation also is done from shoots and cuttings. In the latter method, slips are cut from the upright branches, which, taking root, produce seed-bearing lateral branches. In Central America the natives sometimes use coffee uprights for fences—fences that often take root and "grow"!

In seed planting, 10 to 20 seeds

..... **CUPPA**

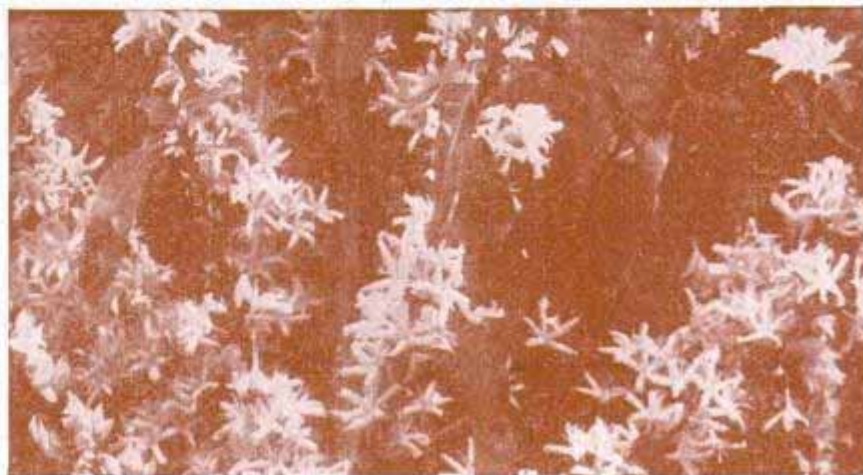

COFFEE, CHUM?



are dropped into a hole about 18 inches in diameter and two feet deep. They are covered lightly with dirt, and pieces of wood are placed over the hole to shade the young trees. The seeds germinate in six to seven weeks. Young trees are thinned down to four to eight per hole at the end of the first year. The trees grow rapidly after the first year, the four stems merging into one at the base. The tree begins to bear when three years of age, reaching its full strength in six or seven years and flourishing for about 10 more years.

Ever growing and ever green, the coffee tree produces beautiful blossoms with dramatic suddenness. The flowers soon disappear and in their place in about seven months ripe cherries develop. These cherries are the "fruit" of the coffee tree. The immature fruit is green in color and gradually turns red, later becoming dark red and, when fully ripe, almost black.

The cherries must be picked off the branches by hand. Examination for unripe and imperfect berries is carried on with amazing rapidity as the laborers deftly strip perfect berries from the branches.

Once off the branches, coffee cherries must be "cured," or have their pulp removed. This can be done by either a wet or dry process. In the wet process, cherries are dumped into tanks filled with water where they are washed and all foreign matter eliminated. The fruit then is put

In Burma or Tunisia, on Guam or Adak, the word is the same—"Cuppa coffee, Joe?" On opposite page, it's blossomtime on a coffee plantation. Left, an acre of beans drying in the sun

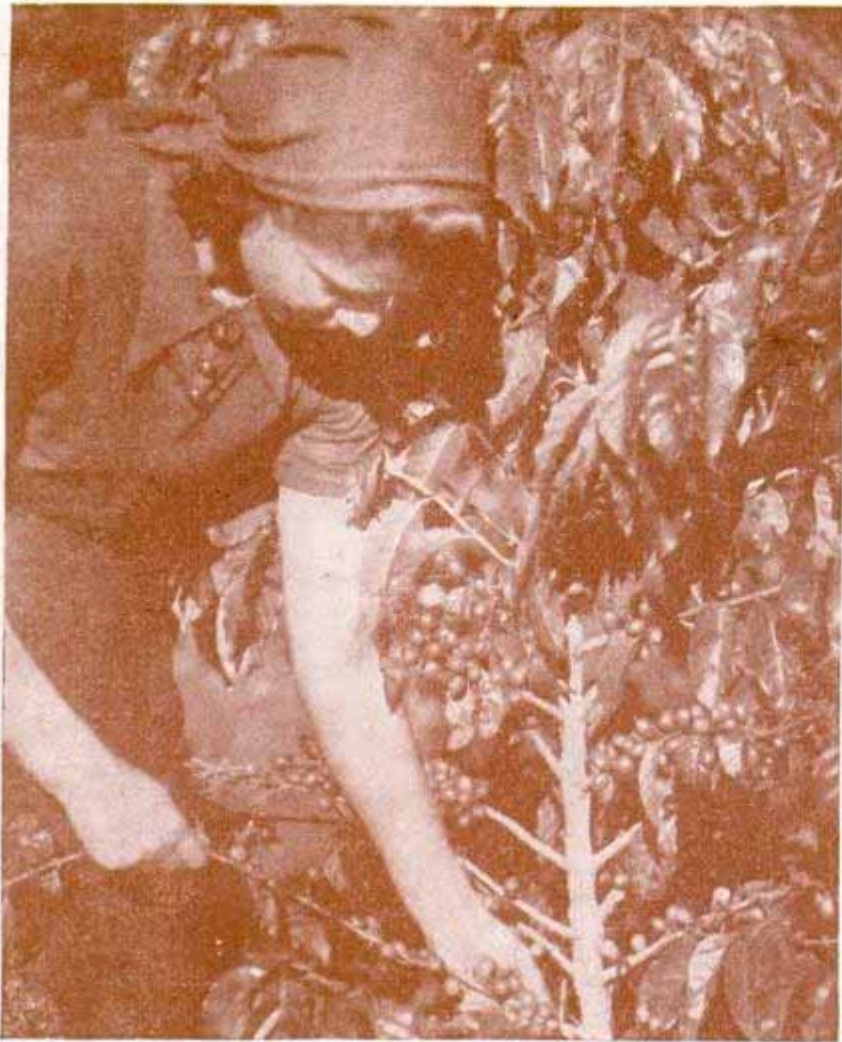

Skilled worker deftly strips only ripe cherries from the branches. Below, beans from roaster are dumped into huge pans for cooling

through a machine which removes the pulpy portion to liberate the two beans in each cherry. These beans are the seeds. Then the beans are spread out to dry.

In the dry process, the cherries, after having the impurities washed out, are spread on drying grounds for about 20 days, during which the pulp dries. Just as in the wet process, the cherries have to be hulled.

After hulling, a thick, resistant covering called parchment remains on the beans. This is removed in revolving cylinders. With the removal of the parchment, the beans still are covered by a thin layer, called spermoderm—the skin of the seed. This is removed either in polishing machines or during the process of roasting. The dry beans are airblasted to remove dust, graded according to size by automatic sorters, and hand-picked by skilled operators to remove discolored beans.

The product now is known as "green" coffee. Green coffee is packed for shipment in 132-pound bags and is sent



from plantations to coastal ports and markets.

Before consumption, coffee must be roasted. This is done in the consuming country just before the coffee beans are sent to retail markets, as roasted coffee begins to lose its aroma immediately. Roasting changes the appearance, consistency, smell, flavor and composition of the coffee. During roasting coffee loses from 12 to 20 percent of its weight, but increases its bulk by about a third. Because of this increase our Army decided to roast its own coffee. For, in addition to saving war-precious tin, ship space was saved by roasting coffee near points of consumption. One hundred pounds of roasted coffee occupies the same space as 150 pounds of green coffee.

At the height of the war, Army "coffee factories" operated in several overseas locations. One of these installations was in a factory in Marseilles, France, where 12,000 pounds of coffee a day were roasted for the troops in southern France.

(Continued to page 238)



Inspecting the "grind" of coffee coming from an Army roller mill. Below, roaster's heating unit was improvised from gasoline drum
Signal Corps photo

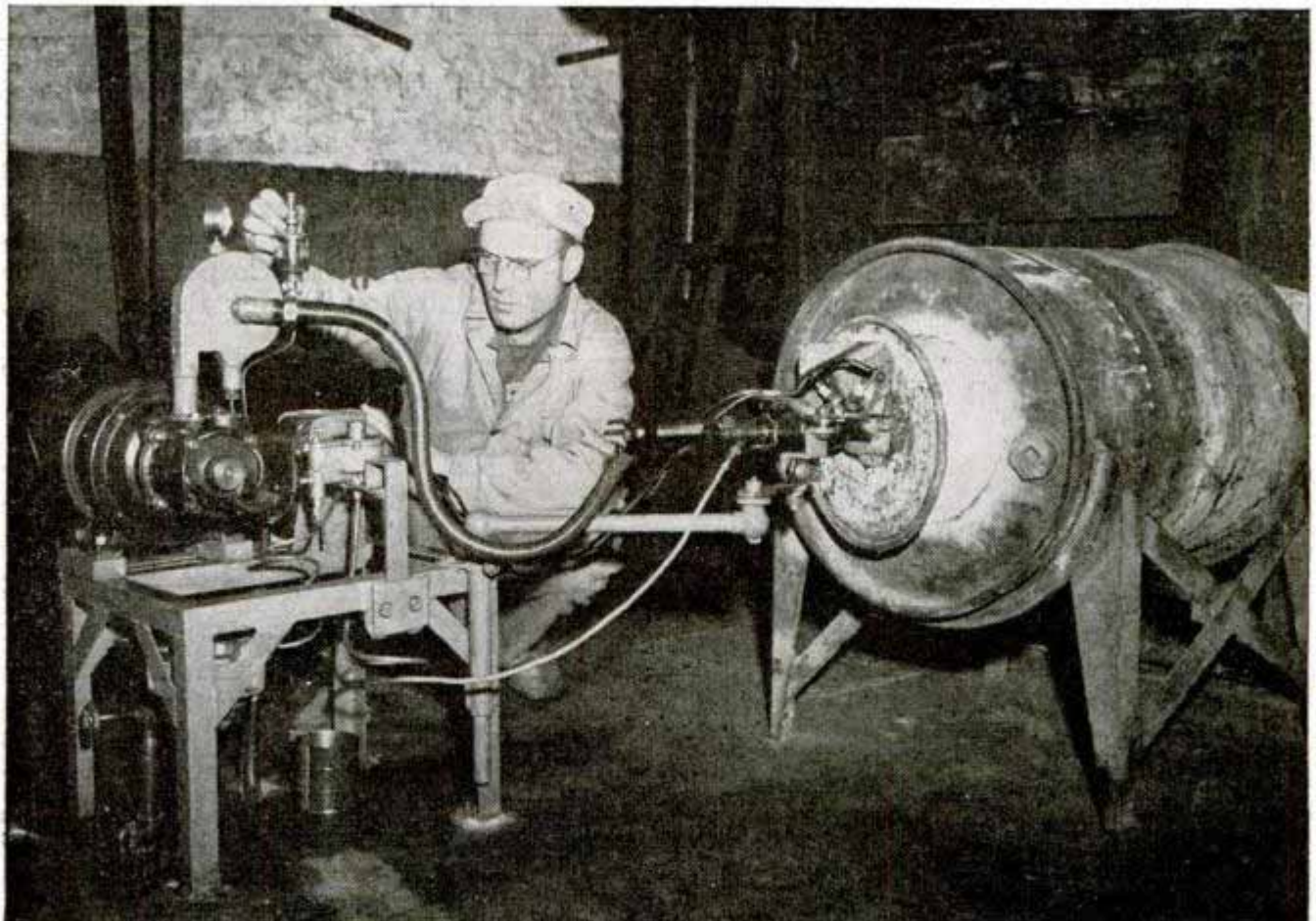

Transport-Bomber Dwarfs B-29 in Size, Cruising Range

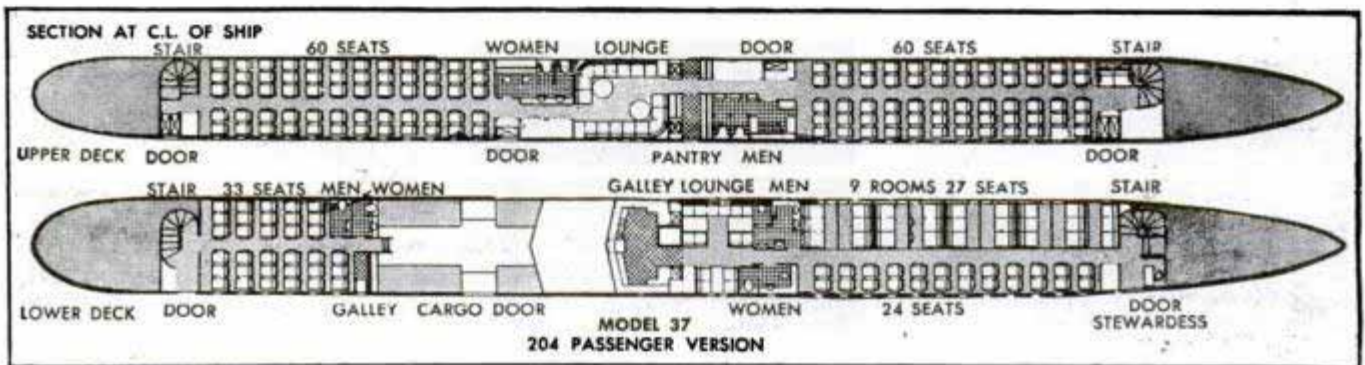

A new bomber that will put present "very heavy" types into the middleweight category is scheduled to be test flown by the Army Air Forces this summer. It's the 65-ton XB-36, equipped with six pusher-style Pratt & Whitney engines capable of producing more than 20,000 horsepower. By comparison with the B-29, which has a wing

span of 141 feet and a length of 99 feet, the XB-36's wing span is 230 feet and the fuselage is 163 feet long. It has a pressurized cabin and an anticipated range that will make Tokyo-New York flights routine operations. The manufacturers, Consolidated-Vultee Aircraft Corporation, have labeled the air line version the Model 37.



Zipper "Overcoat" Makes It Air-Tight

Attached to a rubber material, a metal slide fastener operated like a zipper can be used to seal flaps to prevent seepage of water, gas or air. The zipper is fastened between overlapping rubber lips which can withstand as much pressure as the zipper itself. It can be used on metal, fabric or sheet rubber. One application is for divers' suits.

TWICE AS NATURAL

and large as life are the animals mounted
by modern techniques in taxidermy

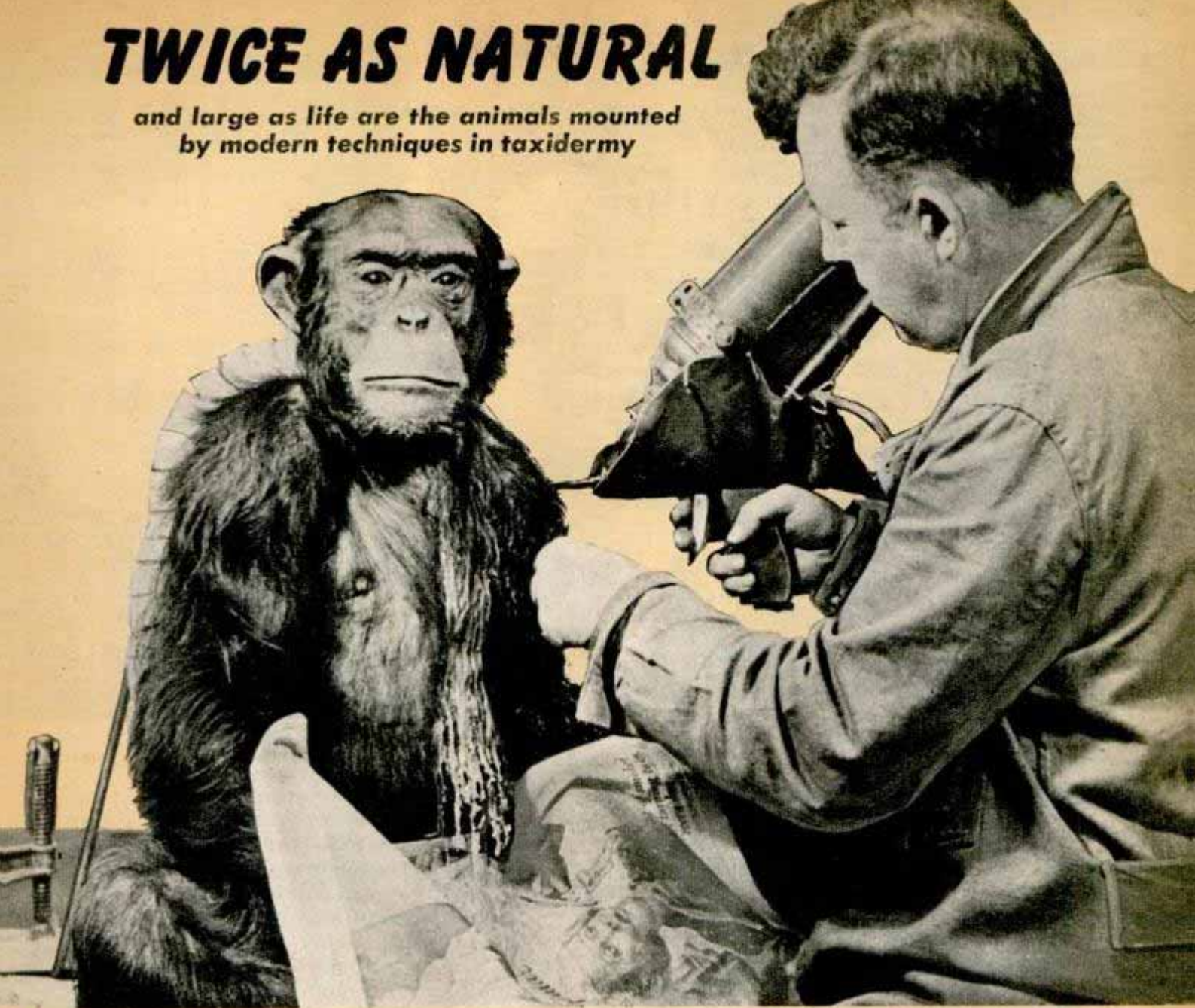

By M. J. Bauer

Chimpanzee specimen posed for molding gets a hot wax bath. The orangutan below has a tough celluloid hide

THE GREATEST compliments that can be paid taxidermists are to jump when you meet a stuffed gorilla and to recoil at sight of a synthetic cobra.

In the past, the public seldom was fooled. We are all familiar with the prized fish over the mantel, fins curled and shriveled, head oozing oil, and little resembling the freshly caught pride and joy of the sportsman; or the mounted pet squirrel with mangy coat and glazed eyes. No matter how expert the taxidermist, animal substances lose character, colors fade and the mounted animal looks exactly that.

Museum taxidermists have experimented with various techniques to achieve some startling results. Leon L. Walters and L. L. Pray of the Chicago Natural History Museum have brought the technique of making replicas of animals into the realm approaching perfec-

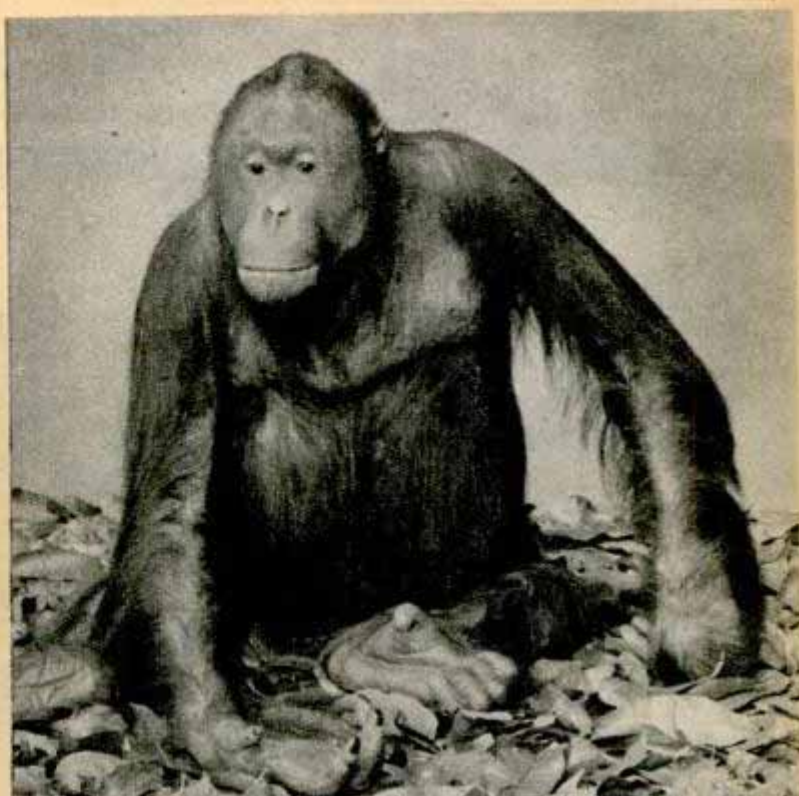

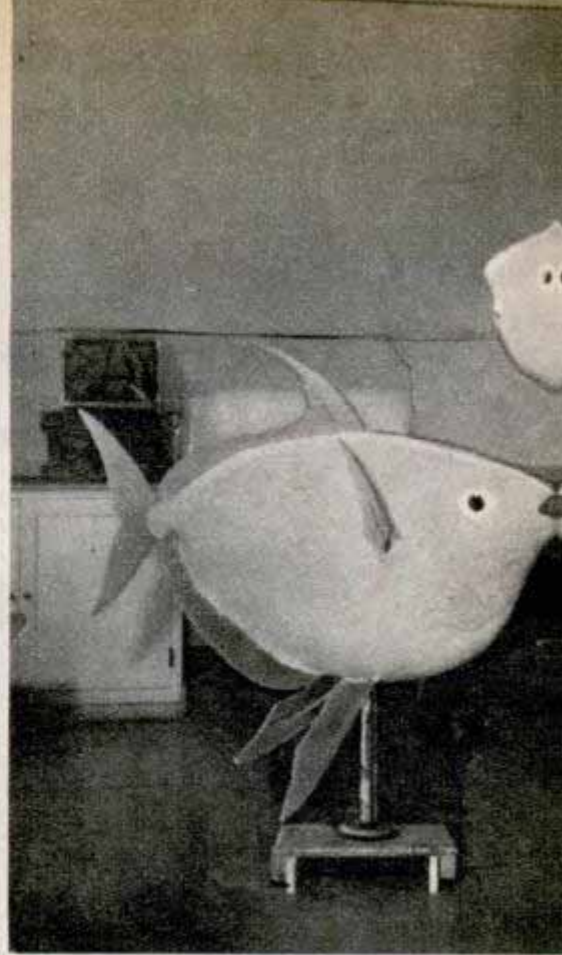
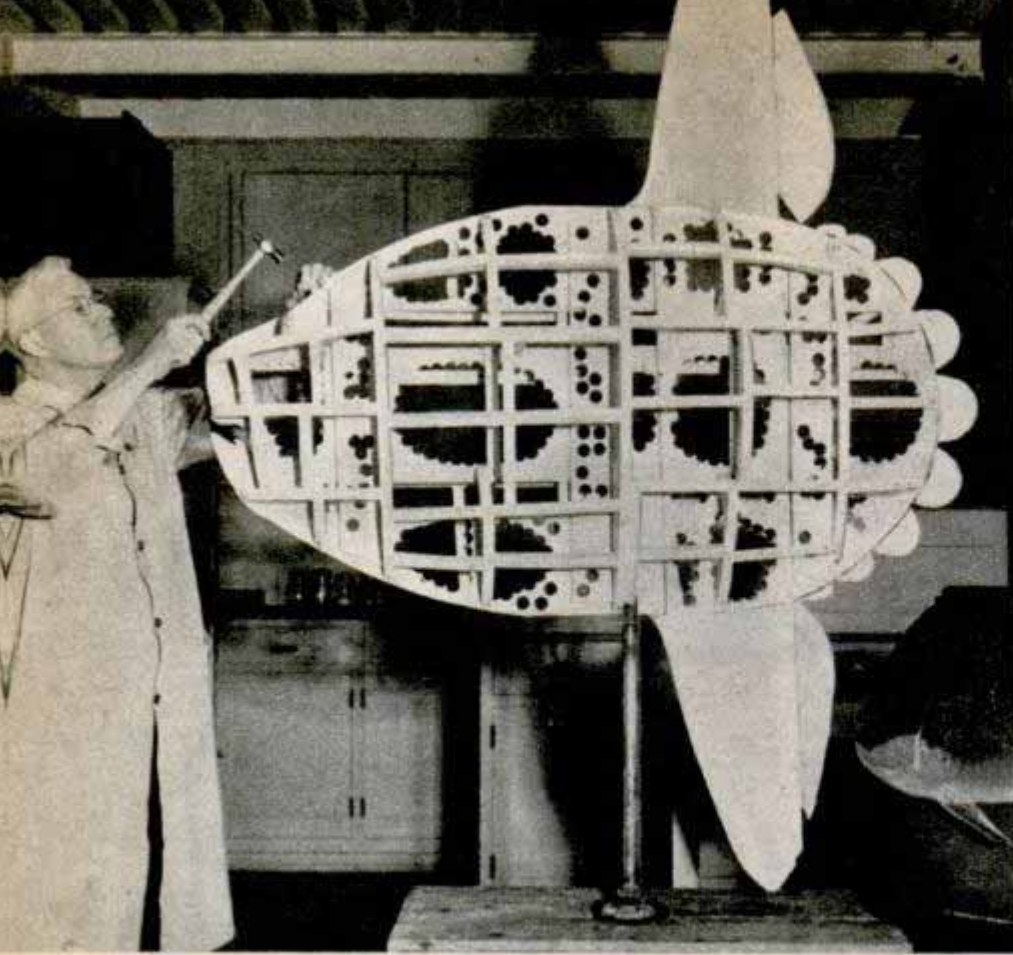

Chicago Natural History Museum photos

Wooden framework for rare mola is mounted on a pivot; next step is to cover frame with wire mesh and paint

tion. Mr. Walters, the originator and developer of the Walters celluloid process, began experimenting with plastics years ago. He foresaw that if an animal is to appear lifelike either its skin must be treated so that it will retain its true translucent color and plumpness, or a substitute skin must be made. As Mr. Walters believed that anything that had form and color could be translated successfully into other material, he discarded the idea of treating the original skin and concentrated on making a substitute. Plastics seemed the answer.

The result is that many of the animals now on exhibition in the Chicago Natural

History Museum are entirely ersatz. One museum visitor is reported to have come back three times to look at a Walters model of a boa constrictor to see if it had moved.

Mr. Walters concentrated first on skin replacement on reptiles. Mounting the skins of these creatures always has been a headache. The tanned skin little resembles the original, and the mounted skin invariably cracks. If possible, Mr. Walters obtains a live specimen and watches its behavior and the positions it takes. He takes careful color notes, often mixing his colors on the spot. After all the necessary notes have been taken, and a pose decided upon, the reptile

Here are steps by which vulture head changes its skin for celluloid; coating of hot wax is covered with plaster



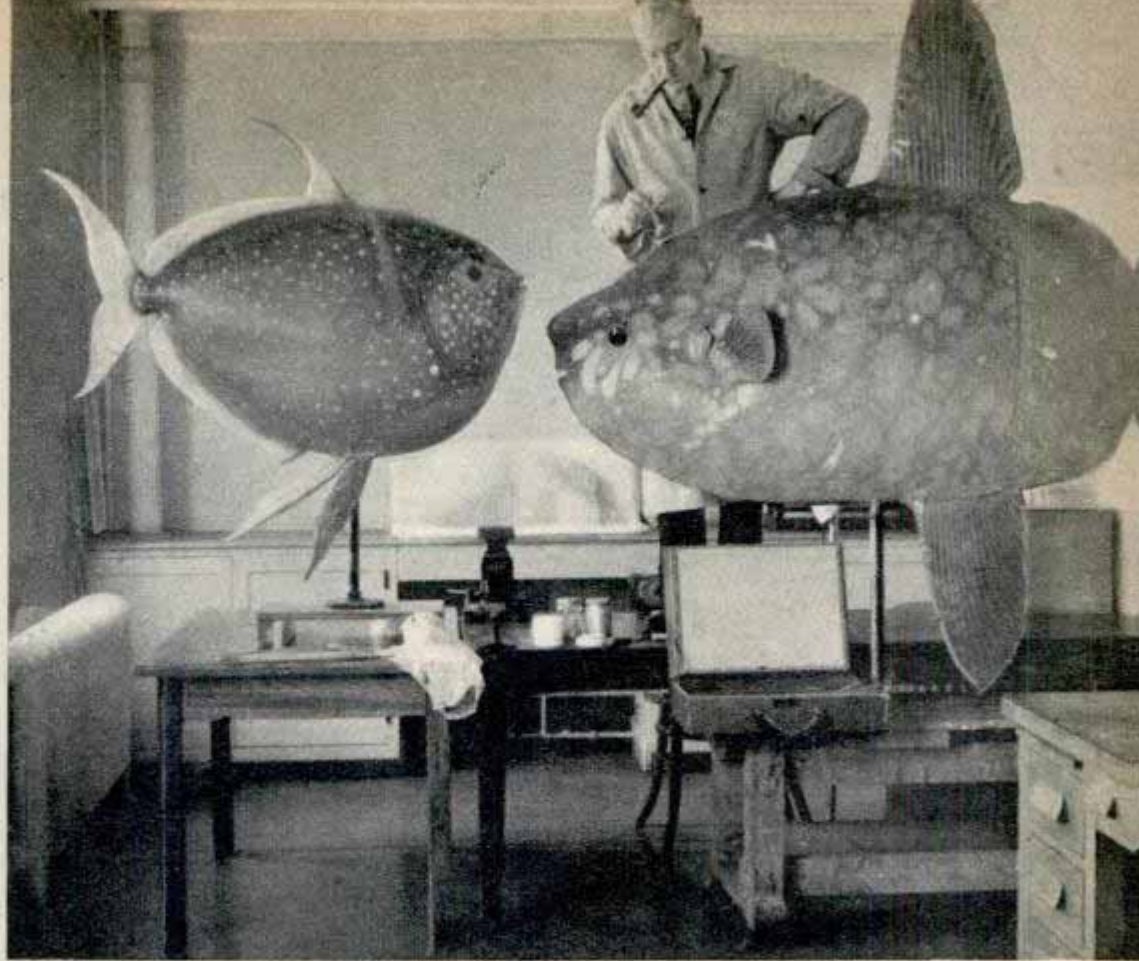

After casein paint is smoothed on, the lifelike models are tinted. Facing the big mola is an opah or moonfish

is killed. It then is posed and a mold is made before the skin dries or loses its freshness. This is done by pouring a creamlike mixture of plaster and water over the reptile. In most cases only a one-piece mold is necessary. When the plaster has hardened the reptile is removed from the mold. To the

impression on the inner surface of the mold Mr. Walters applies liquid celluloid, which previously has been colored to match the tones and shades of the original animal. With the dead specimen to guide him, plus the notes taken in life, Mr. Walters paints in the pattern of the animal with the colored celluloid. In many cases it is necessary to apply many differently hued coats to give the necessary translucent color found in real life.

After skin has been removed and feathers anchored with celluloid, wax is dissolved with gasoline, leaving finished head of griffin vulture



To permit the celluloid to dry evenly and to prevent it from destroying the pattern by flowing, Mr. Walters devised a large wheel, which revolves very slowly, synchronizing with the flow of the plastic. After the celluloid inner lining of the mold has dried thoroughly, it is strengthened with burlap, cotton, ground glass or whatever meets the need. The next step is the removal of the plaster shell, which must be done carefully. Usually, the mold with the celluloid model in it is soaked in water until the plaster has absorbed as much as it will take. The plaster then becomes soft and spongy. With careful chipping, the plaster mold then is removed, leaving a remarkably light and firm facsimile of the animal. The celluloid surface is hard

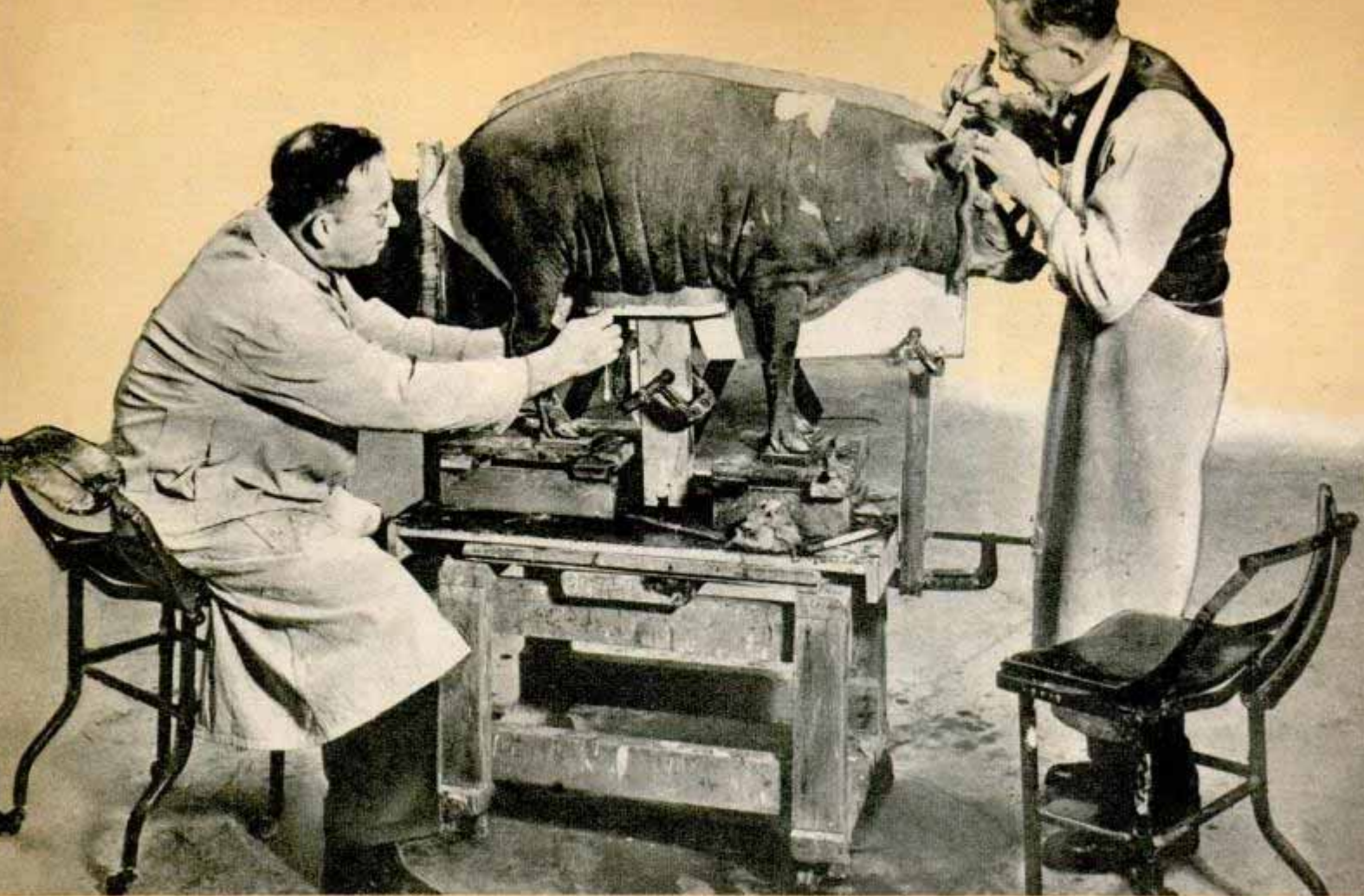

Clay model of a babiroussa is fitted with fresh skin; half of the model is covered with a plaster mold

enough to bear thorough brushing with a wire brush.

Sometimes it is impossible to obtain a live specimen. Then the taxidermist must work with an old mounted specimen, a dried skin, an alcoholic, a fresh salted skin or a skin in pickle. In such cases the skin is placed in a bath of salt water with an anti-

septic added to soften and freshen the skin. A clay manikin is made of the animal and the freshened skin is drawn over this. Then a mold is made and celluloid applied.

Mr. Walters now is using this same technique in the making of furred and feathered animals. Basically, the procedure is the same as with amphibians and reptiles. In-

Clay and skin are removed from inside of mold to make way for celluloid solution to form ersatz skin





Babiroussa model gets shower bath to soften plaster which is chipped away (right) from artificial hide

stead of plaster, wax is used in making the mold, and the original skin of the animal (whose hairs now are embedded in wax) is allowed to macerate. This skin is washed away, leaving the hair roots exposed on the inside of the mold. Liquid celluloid is painted into this mold just as was done for the cold-blooded animals. When the celluloid has dried and the cast has been strengthened with a lining of burlap or cloth, the wax is removed with benzine. The finished product has every single hair, formerly set

in its own follicle in the natural skin, set permanently in the celluloid skin.

Leon L. Pray specializes in fish taxidermy. He long had been dissatisfied with the usual method of scraping the fish skin free of flesh and mounting it on a wooden or papier-mache manikin. Such a specimen soon loses its lifelike appearance.

Mr. Pray began experimenting with plaster casts. When assigned to make a particular fish for exhibit, he first would obtain

(Continued to page 246)

This model of the rare latimeria (a fossil type fish) was made entirely from descriptions and photographs

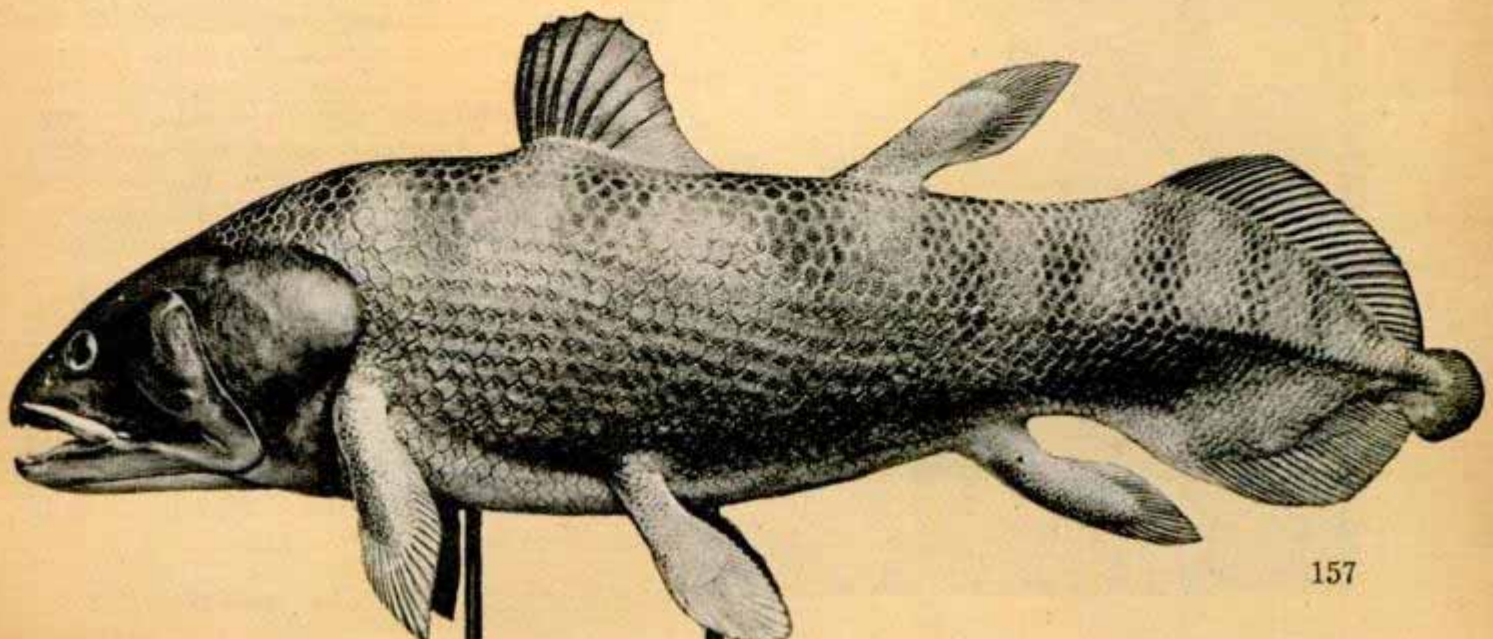



Swordfish-Nosed Bomber Has Speed Of Fighter Plane

Combining the size of a medium bomber with the speed of a fast propeller-driven fighter, a plane designated by the Army Air Forces as XA-38 was developed shortly before the war's end by the Beech Aircraft Corporation. The XA-38 was built around a 75-millimeter automatic cannon extending from the nose of the ship. The plane also mounts six .50-caliber machine guns. Pilot and gunner compose the crew. The craft was designed as an attack plane with a primary mission of destroying tanks, armored vehicles, light surface vessels, ground installations and submarines



by gunfire. By mounting bombs, depth charges and chemical tanks, the plane also is capable of bombing attacks and laying smoke screens. The ship weighs 23,230 pounds empty and 36,332 pounds when fully loaded. It is 51.7 feet long and has a wing span of 67.08 feet.



Bull's-Eye Projected on Target Improves Aim With Shotgun

One-eye sighting of shotguns no longer is necessary if a gun sight that projects a bull's-eye on the target is used. The new sight throws a ring and a dot on the hunter's line of vision. When the dot is on the target, the gun is properly sighted. Even though the eye is moved, the sight picture remains the same if the gun is stationary. The projected ring aids in "leading" moving targets. A similar sight was used during the war on airplane guns. The device is constructed of blue steel and can be mounted on both breakdown and automatic guns.

More of a boon to the pilot than the passenger, an automatic trim tab keeps a plane in level flight despite shifting of the center of gravity. Passengers can move about or cargo be shifted without the pilot having to trim ship. The tab, developed by Curtiss-Wright engineers for the C-46, adds only 10 pounds to the plane's weight.

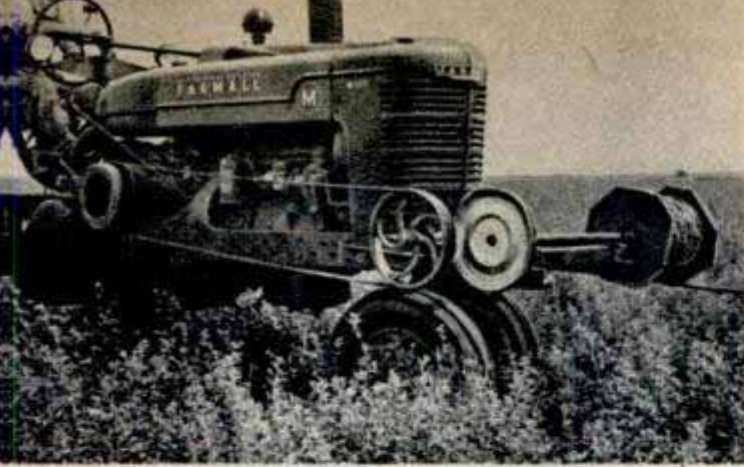

AUTOMATIC SPOOL attached to a tractor unreeles barbed wire for fence while the farmer sits at the wheel. The winder, which can be used on any tractor with a side pulley, also comes in handy to wind corn planter wire, electric light wire or telephone wire



THREE-WHEELED MIDGET AUTO built by Dr. Willard Geer, University of Southern California physics professor, is steered by a control wheel from a wrecked B-17 bomber. Total cost of parts, all salvaged materials, was \$150. The car can go 30 miles an hour



"CUB" TRACTOR weighing 1050 pounds (two thirds weight of previous small tractors) is capable of plowing three acres in 10 hours. Driven by a four-cylinder, 10-horsepower engine, it has three speeds forward

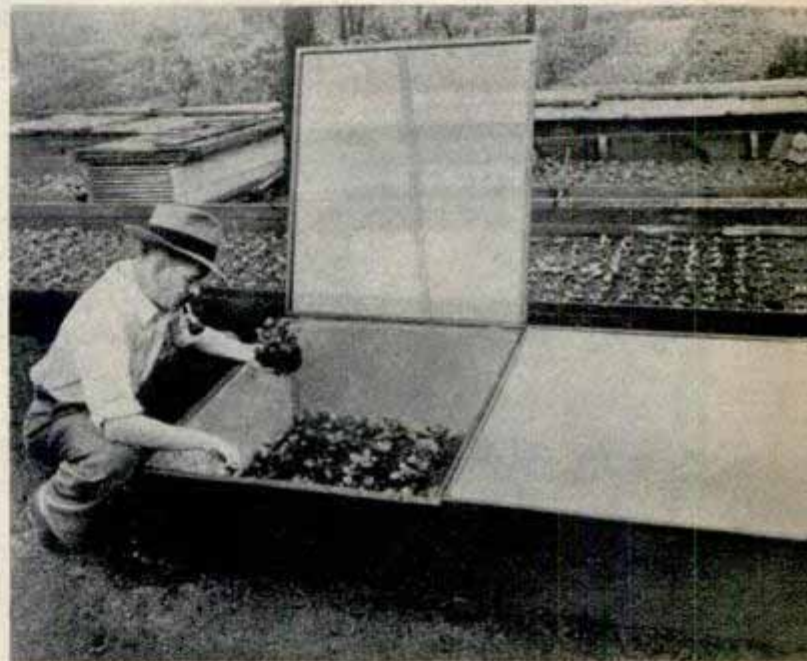

WIRE-REINFORCED PLASTIC COVERS protect seed beds from unseasonal cold, snow and hailstones. Lighter than glass, transparent 36-inch-square panel admits ultraviolet and infrared rays from sunlight

SELF-PROPELLED DRILLS mounted on a tractor replace conventional wagon-drill and jackhammer to bore holes in limestone mine at Independence, Mo. Drills make 16-foot holes for 500-ton limestone "shootings"

MINIATURE VILLAGE built of white pine by Marko Picio of Detroit has buildings equipped with tiny elevators that work. In structures are models of police, doctors and barbers posed to depict real action

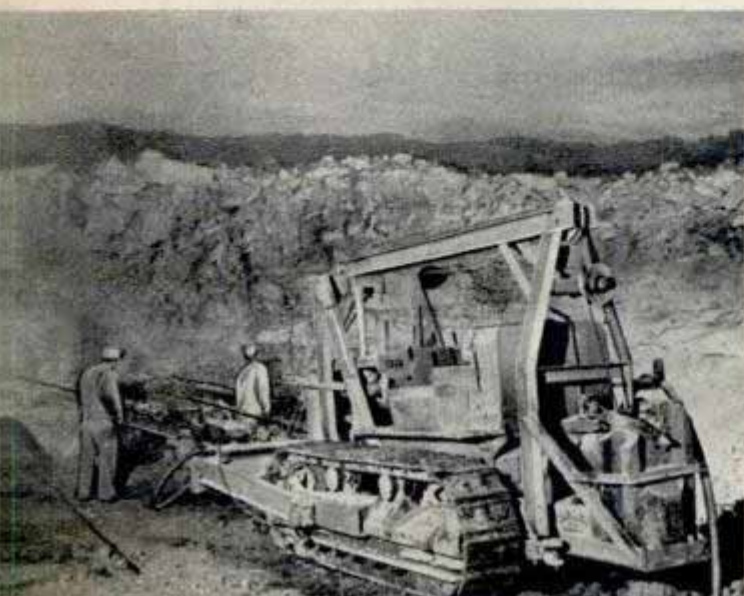

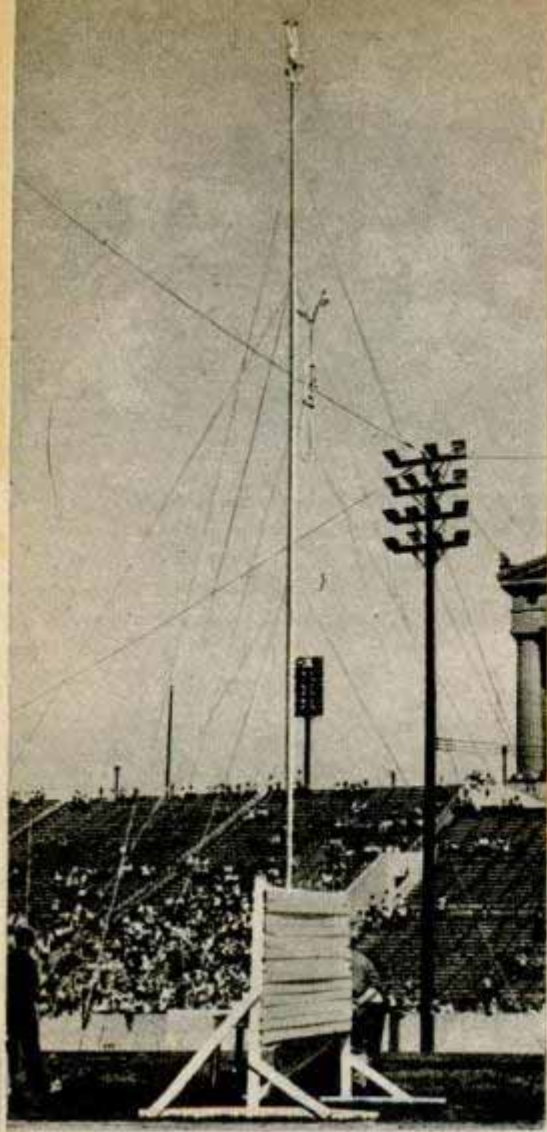

Risking life for a livelihood is the stock in trade of circus performers. Ace Lillard, member of one troupe of thrillers, stands on his head on the hood of a car traveling 30 miles an hour. Another performer stands feet up atop a 130-foot pole without a safety net. Below, Ace speeds his car up a ramp, sails over two buses and a pair of automobiles spanning approximately 80 feet of space, lands on a wrecked automobile and bounces to earth. He is strapped in the car and wears a football helmet

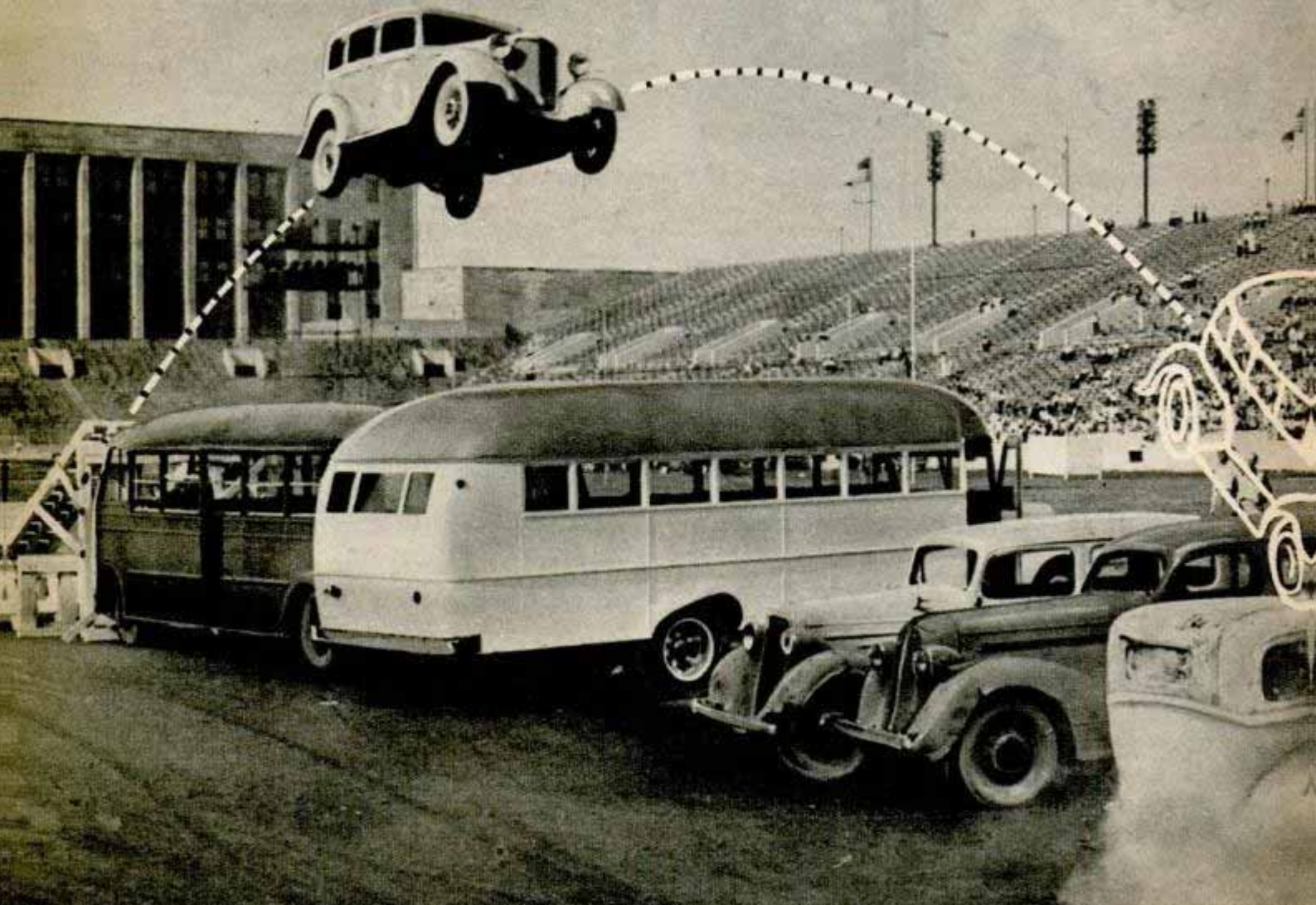

FLIRTING WITH DEATH



Ace Lillard drives an ordinary sedan through a flaming tunnel of fire at 35 miles an hour—and lives. Right, three members of the Hollywood Aerial Ballet perform daring antics on 130-foot-high trapeze and swings without any safety nets

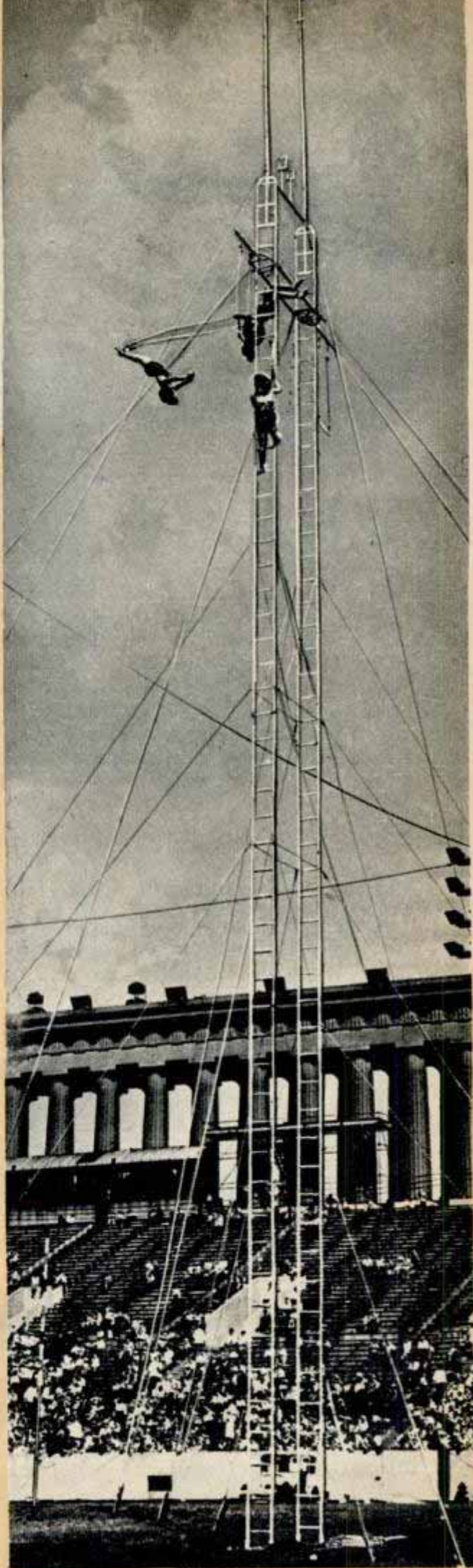

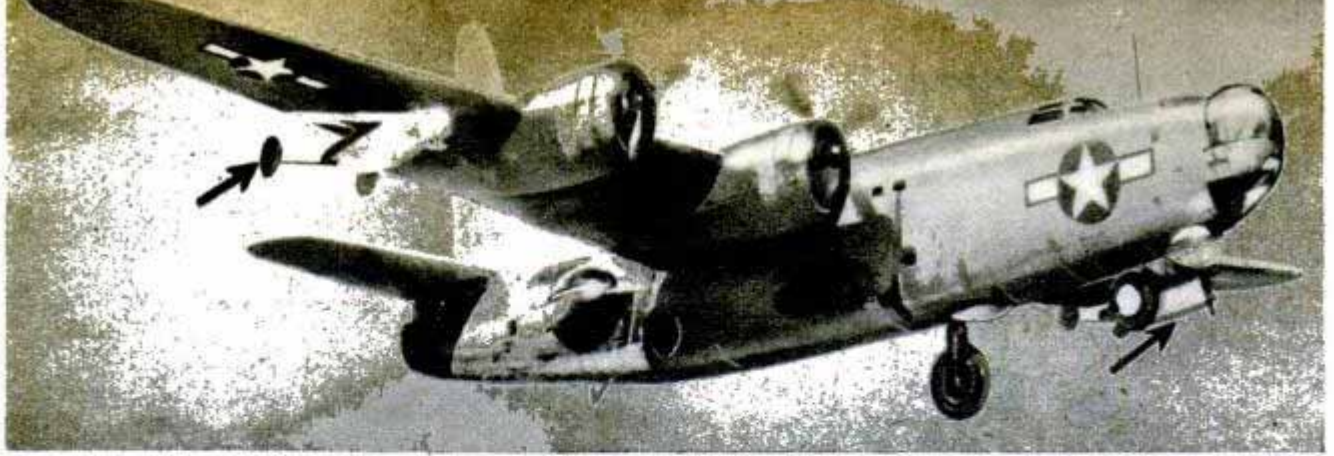

Radar "Bat" Bomb Chased Jap Ships

The "Bat," a self-guided missile launched from a mother plane, chased and exploded Japanese combat and merchant ships no matter how they turned or dodged. The Navy weapon destroyed many tons of Japanese shipping late in the war. The missile operates on the principle of near-blind live bats, which send out short sound waves, guiding themselves in flight by the echoes bouncing off objects nearby. Similarly, the "Bat" has an automatic radar pilot that sends out radio waves and is guided by the direction and time interval of their return. If the target dodges, the

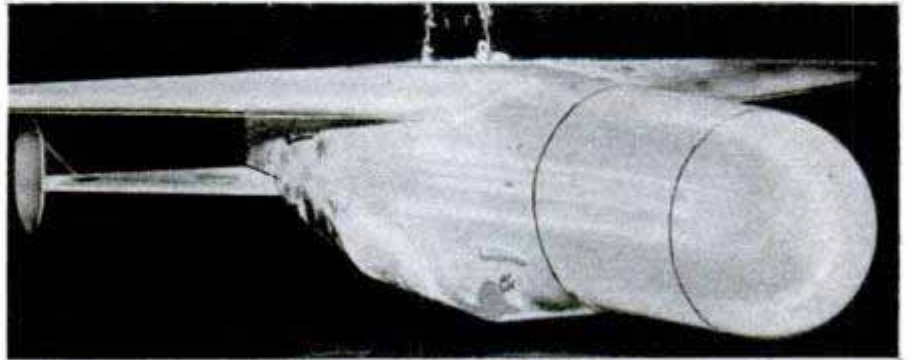

bomb turns with it. Much more efficient than the Jap "Baka" bomb guided by a human pilot, the "Bat" could see in darkness or fog and was quicker to react than a human being. Navy patrol bombers remained out of range of Japanese anti-aircraft fire to launch the bombs. The weapon, 12 feet long with a 10 foot wingspread, carries a heavy explosive charge.

Sound Movies Help Pass Time for Passengers on Transatlantic Clipper

Sound movies among the clouds now are enjoyed by passengers aboard Pan American World Airways' transatlantic clippers. The screen is placed at the front of the cabin, enabling travelers to view the pic-

tures from their seats. The flight stewardess operates the 16-mm. projector from the rear of the cabin. Each clipper's film library includes late Hollywood pictures, newsreels, short features and educational subjects.

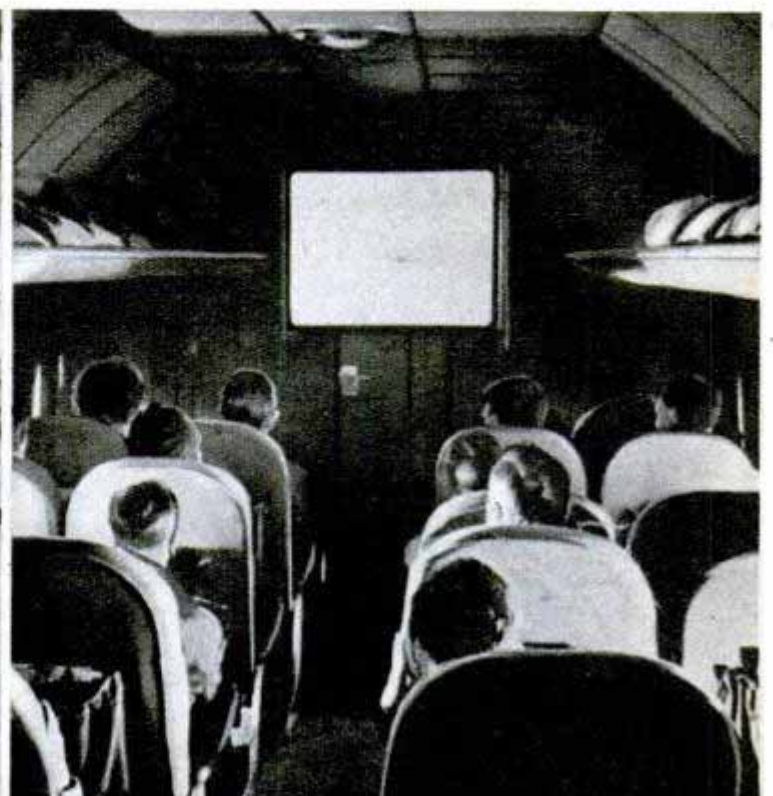



DIESEL LOCOMOTIVES are running again in France. The French kept them out of Nazi hands by dismantling them early in the war and hiding the parts. Now the mechanical "jigsaws" have been reassembled

SALVAGE MACHINE contrived by the Germans "rescues" brick from bombed ruins and aids in rebuilding bombed Berlin. Cutting blades shear waste from 1800 bricks per hour, compared with 40 cleaned by hand

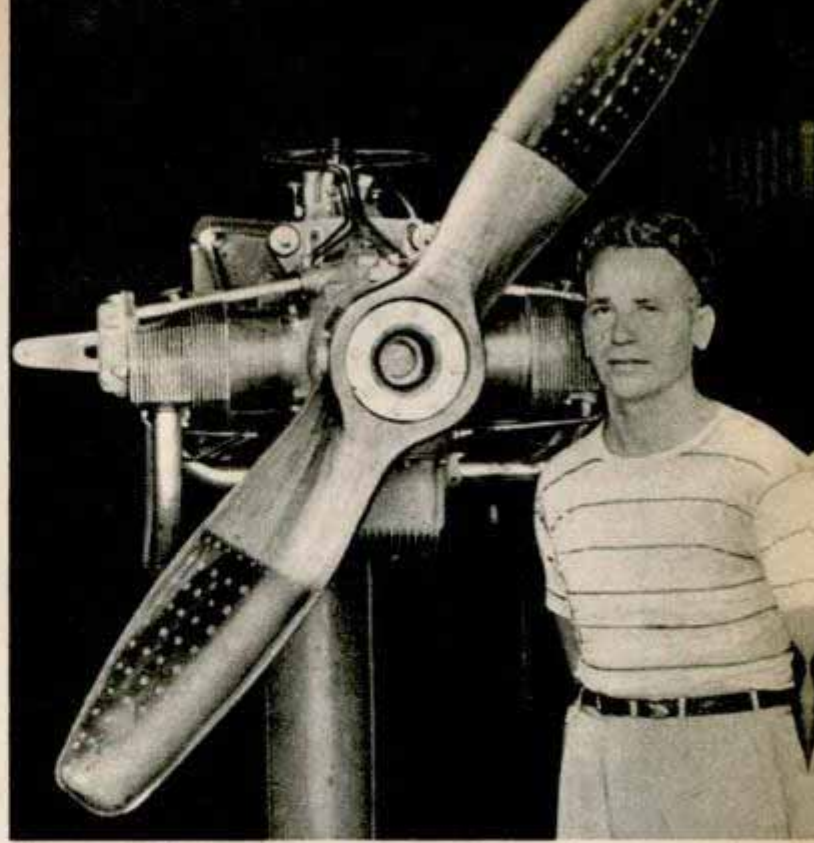
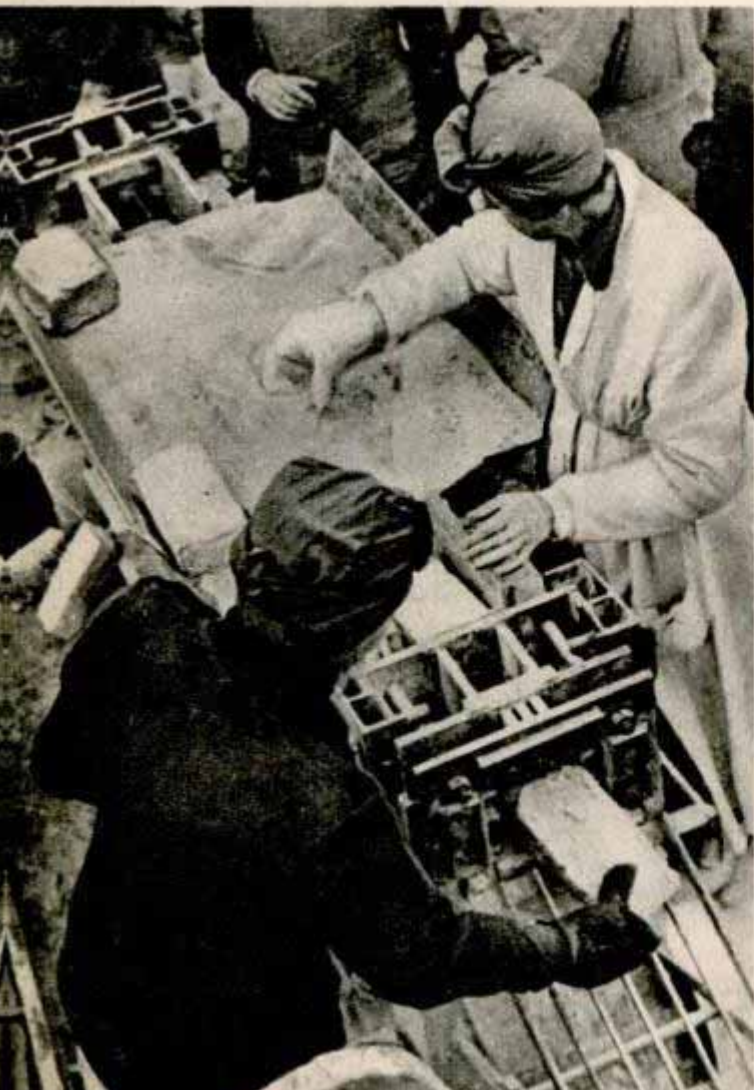

FOUR-CYLINDER Diesel engine built by Fred A. Thaheld of Brea, Calif., was designed to propel two or three-place planes 130 miles per hour on three gallons of fuel per hour is either 100 or 125 horsepower

HOME CRIB heated by 100-watt light bulb assists mothers in caring for sick babies. The mattress is set back from the side to let warm air rise. High side-walls insulated with fiberboard keep out drafts





Input table of the electromechanical differential analyzer where the operator "presents" the problem in graphic form to the machine. Below, maze of more than 200 miles of wiring connects machine's 150 motors

All the Answers

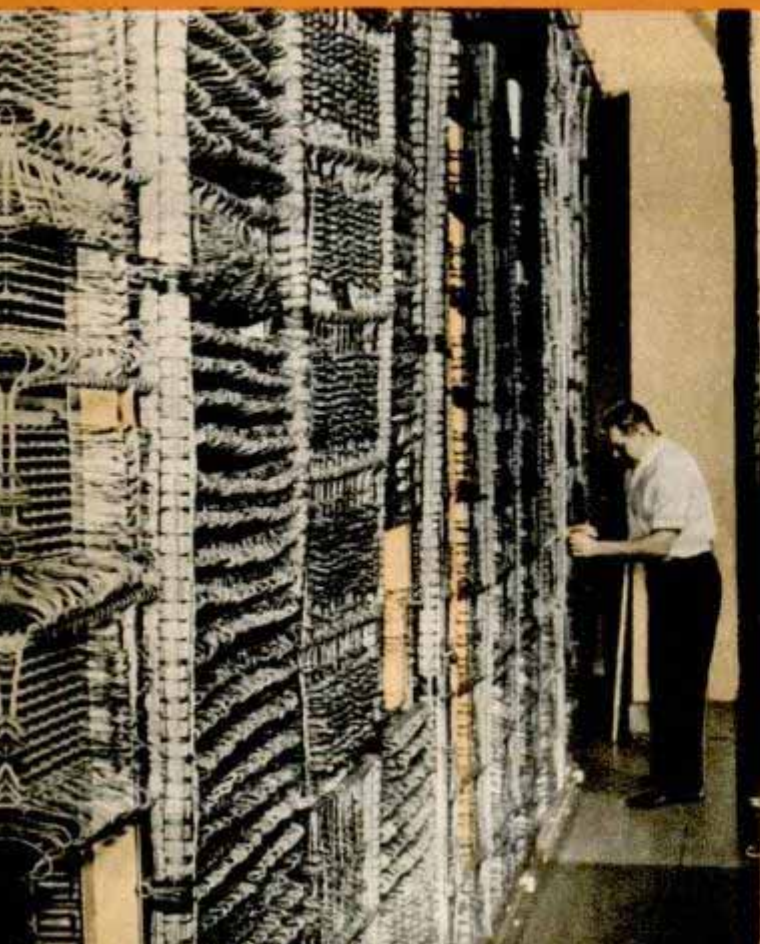

SEVERAL months ago a group of distinguished scientists, engineers and Army and Navy officers gathered at Cambridge to watch a man perform the most difficult of the three "Rs"—arithmetic.

In a specially built laboratory of the Massachusetts Institute of Technology they were given a demonstration of a new type of differential analyzer, a giant 100-ton calculating machine which during the war figured such complex problems as rates of change in chemical processes, computations associated with the design and operation of aircraft, analysis of radar wave patterns and atomic wave functions.

Yet, just a little over fifty years ago, in this same city of Cambridge, a patient inventor was putting together a machine which he hoped would at least add and subtract. In 1893, after many trials, the inventor, George B. Grant, produced a "calculating machine" which was manufactured and sold commercially. Because of its many outstretched operating parts it was referred to as the "Grasshopper Machine."

The differential analyzer is man's latest effort to free himself from the tedium imposed by mental calculation. The calculator is a mathematical automaton, designed not merely to relieve human brains of the time-consuming drudgery of difficult calculation and analysis, but to attack and solve mathematical problems which are economically beyond the reach of ordinary methods of solution. Some 2000 electronic tubes, several thousand relays and about 150 motors are part of the giant machine, which in operation generates so much heat that a special ventilating system had to be installed.

Since the earliest times man has endeavored to make mathematics easier. The counting of things began with the primitive Roman abacus, which stated an arithmetical problem in terms of physical counters and permitted the Romans to see their calculating while they were solving it mentally. Even today in some parts of the Orient the abacus is in use. It is given to children to help them visualize arithmetic.

The first refinement upon the abacus was in the 17th century, when Pascal designed a mechanical calculator which produced answers after a number of figure-setting disks were manipulated. By the middle of the 19th century key-driven calculators, roughly resembling those in use today,

at Your Fingertips

were invented. Many of these comparatively recent devices may be seen in the Smithsonian Institution in Washington.

One of the earliest is the Thomas Hill "Arithmometer," built in 1857. This key-driven calculator in appearance anticipated the really operative machines of 30 years later. Keys like those found on modern machines were used to push numeral wheels. But the machine lacked the essential provision for overcoming the great momentum of the wheels which resulted from the sud-



Above, microfilm camera photographs 400 cards per minute. Below, automatic punch reproducing machine



Below, tabulating Army morning report data on key punch unit. Left, inserting forms for posting in a Burroughs high speed automatic bookkeeping machine



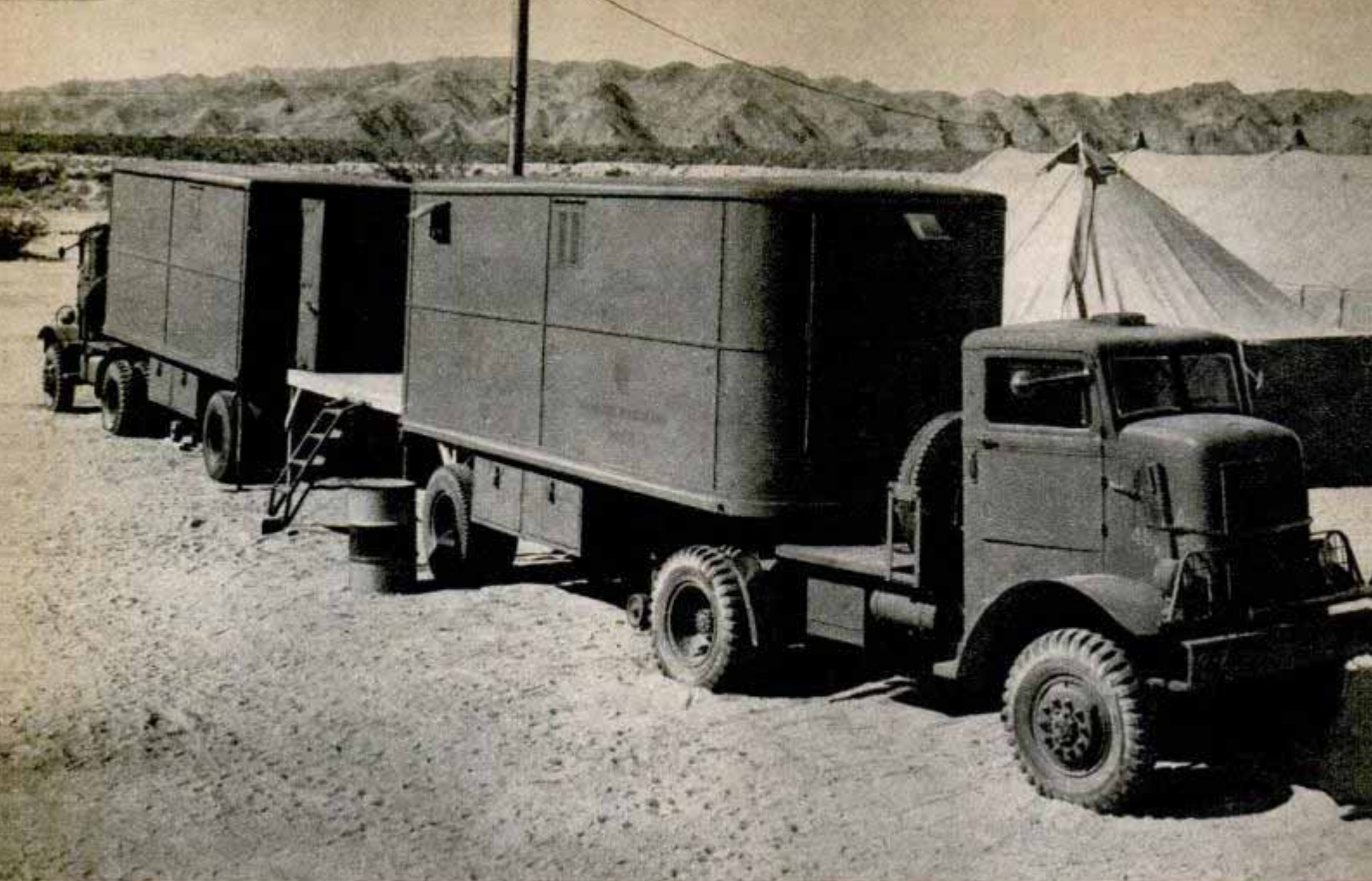

Two trailers, carrying the Army's mobile machine records units, in operation, with connection and steps in place

den whirl given them by a quick depression of a key. The user obviously had to pause for a second or two until the wheels stopped before he was able to continue. On modern calculating machines this action often is completed in 1/165 second.

During the latter half of the 19th century, inventors spurred by the need of expanding commercial operations continued working on mechanical calculators. Many models

Machine equipped to make photographic copies up to 24x36 in. of anything printed, drawn, typed or written



were built, but few were sold commercially. One improvement was that mechanical calculation was made automatic and the visualization feature was dropped.

This principle of sight-unseen problem solving was put to use during the 1880s by Dr. Hollerith, a noted statistician engaged by the United States Government as special agent during the taking of the 1880 census.

Owing to population increases, it was feared the next census would be worthless by the time the calculation of all facts could be completed, and some mechanical aid to expedite the complicated task was needed. Dr. Hollerith set to work and devised a system for transcribing the census data onto paper strips by means of holes punched instead of numbers written. The punched holes were made to actuate automatic tabulating machines by a very simple electromagnetic principle. The paper strip used by Dr. Hollerith later was replaced with a card. This card now is the basis of the punch card method of accounting and tabulating used on modern machines utilizing basic principles developed by Dr. Hollerith.

Did you ever wonder how the Army kept track of its millions of men all over the world without losing one occasionally? Well, punch card machines were the watchdogs. In 1940 the Army's adjutant general installed the electromechanical system at



Interior of an Army machine records unit trailer showing two sorters, printing punch and reproducing machine

headquarters. When our armies went overseas, these machines followed for the dual mission of keeping track of individuals and maintaining daily strength reports based on unit morning reports. Mounted in two large truck vans, the mobile machine records units followed on the heels of our advancing troops.

These machines speeded up the demobilization of millions of men. As each new critical score was announced, the magic machines went into action. The sorting machine, seeking men with the score making them eligible for discharge, ran through 400 cards per minute. This sorting machine is the heart of the punched card system. Without it there would be no widespread commercial application of this mechanical accounting.

The machine which starts the ball rolling, however, is the alphabetic printing punch, which records both alphabetical and numerical data on tabulating cards in punched and printed form. The depression of a key causes the machine to punch the card and at the same time to print the corresponding letter or figure at the top of the card above the column being punched. After the key is depressed, the card is advanced automatically to the next punching position. The operator merely depresses the keys as though typewriting and an experienced operator can punch 25,200 digits per hour.

During the war the use of tabulating machines for traffic control at ports of embarkation prevented a chaotic tie-up of traffic such as was experienced in World War I. At one time during World War I more than 200,000 loaded freight cars converged on eastern ports, paralyzing traffic as far back as Chicago for weeks and months while waiting to be unloaded. In World War II, tabulated reports were used

(Continued to page 250)

Lightweight, compactly built portable adding machine





Pilots flying air routes over the Far North can enjoy a feeling of greater safety, now that "Parapups" have joined the Alaskan Wing Search and Rescue Squadron. Parapups are huskies trained to parachute in pairs from planes. This unique rescue service was developed by Maj. Joseph F. Westover, commander of the squadron, who decided to experiment with the idea of dropping dogs by parachute to help downed flyers mush to safety. In the first test at Fort Nelson, British Columbia, two huskies were flown to a 1500-foot alti-

"Parapups" Drop From Plane To Aid Snowbound Flyers

tude, attached to a 28-foot cargo chute and pushed from the plane.

The dogs descended without a yelp and landed in perfect condition, ready to pull a sled carrying a flyer. In other tests, huskies bailed out in a temperature of 48 degrees below zero and stood ready for action. Parapups, which must weigh 100 pounds or more, are completely "GI." They have service records, serial numbers, enlistment papers and receive paratrooper wings after five jumps. They even are given special shots to guard against disease.



Ray Lamp Kills Bacteria in a Minute

Invisible rays sprayed by a U-shaped ultraviolet lamp reduce the bacteria count in milk cans as much as 96 percent in one minute, Westinghouse Lamp Division research workers recently discovered. Curved lamps 30 inches long were used to provide maximum radiation for the entire interior of milk cans, including the hard-to-reach areas in the shoulder. The lamps operate on standard 110-120-volt alternating current, consume less electricity than a 25-watt light bulb, and fit all conventional cans.

Zigzags Warn Pilot of Ignition Failure

Dancing lines projected on the small instrument panel screen of a British ignition analyzer inform an aircraft pilot of the performance of his ignition system while in flight. As long as the line pattern remains constant the flyer knows the system is performing efficiently. A sudden change to dark, zigzagging shapes indicates trouble and reveals whether it is in a spark plug, magneto or distributor.

Raising the Dead Ships

AS WEATHER PERMITS, hardy salvage men are attempting to retrieve valuable cargo from the torpedoed Netherlands freighter *Arundo*, sunk 15 miles off the New Jersey coast in water 150 feet deep.

Some mystery surrounds the cargo of the *Arundo* but it is known that she carried Diesel-electric locomotives worth millions and a variety of instruments and other supplies for the Allied Middle East Command at Alexandria. Operated by the British Ministry of War Shipping, the 5163-ton, 412-foot vessel sailed from New York on April 28, 1942, and was sunk that same night by a German U-boat lurking off Atlantic City.

The 37 survivors of the crew of 43 were picked up next day and the *Arundo* was undisturbed until last fall. The Diamond Salvage Company then put divers to work surveying the wreck with the goal of salvaging at least the more valuable parts of

By Tom Mahoney

the *Arundo's* mysterious cargo.

So many ships like the *Arundo* were sunk during the war that, based on World War I experience, it is safe to say that they will keep salvage crews busy for 20 years. Vessels of the Imperial German Fleet, scuttled in 1919, were still being salvaged at Scapa Flow when World War II began in Europe in 1939!

How many of the possibly 3000 ships sunk in the last five years will merit attention is a matter of conjecture. The price of scrap will determine whether those lying in deep water and valuable only for their metal will be disturbed. But where they are menaces to navigation or have valuable cargo like the *Arundo*, they are being steadily raised or cleared away. During the war, the U. S. Navy calculated that it recovered \$600,000,000 worth of sunken ships and cargo in coastal salvage operations.

Actual treasure is involved in many cases. As a sideline to the clearing of 600 wrecked

Navy divers go under water from barge alongside scuttled German ship preparatory to raising operations



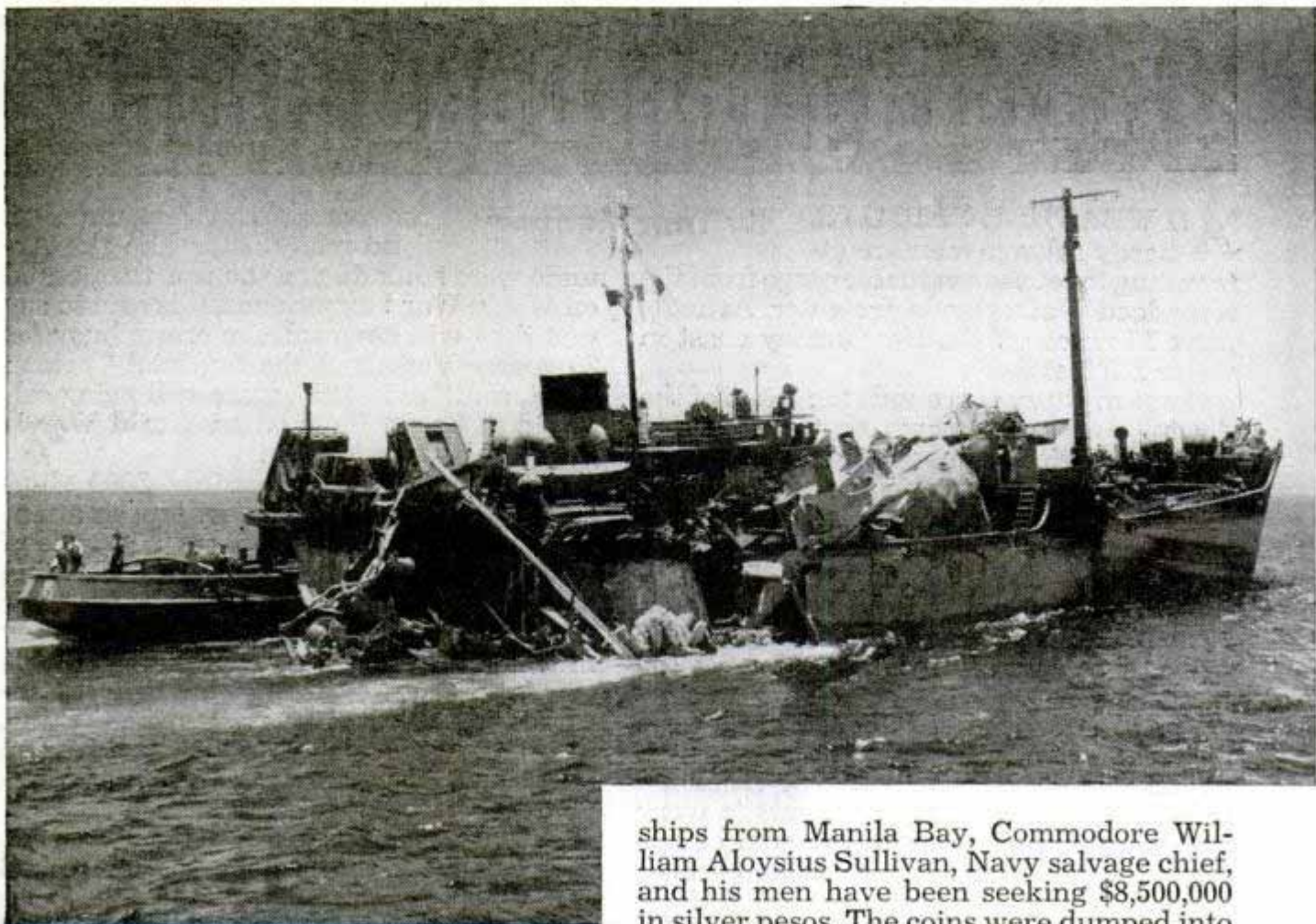

Demolitionists prepare to sink wrecked ship and eliminate navigational hazard. Below, Seabees examine visible portion of sunken freighter

ships from Manila Bay, Commodore William Aloysius Sullivan, Navy salvage chief, and his men have been seeking \$8,500,000 in silver pesos. The coins were dumped into water more than 100 feet deep by Philippine government officials just before Corregidor's surrender in 1942. Divers from the USS Teak, a converted Navy net tender, quickly recovered \$750,000 but there is evidence that the Japanese retrieved part of the treasure during their rule and it is doubtful whether much more will be found. Better luck attended the search for \$10,-

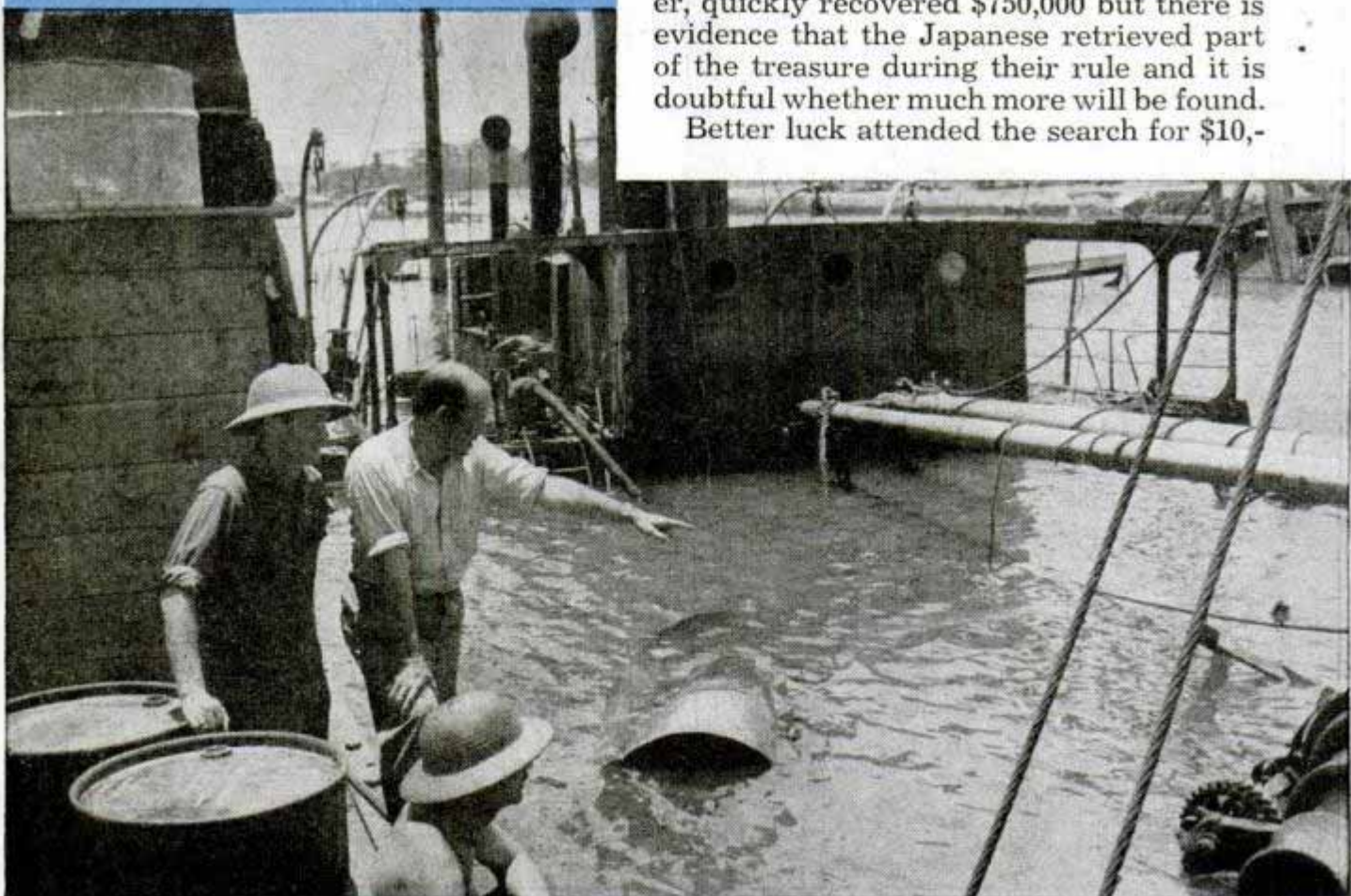



000,000 in gold that went to the bottom of the Pacific when the 13,400-ton liner Niagara, en route to Canada, struck a German mine after leaving Auckland, New Zealand, in 1940. Water in the vicinity was about 500 feet deep but Captain J. P. Williams, managing director of a Melbourne, Australia, salvage company, contracted to recover the gold.

A 40-year-old steamer, the Claymore, then rusting in Auckland harbor, was refitted and equipped with derricks, grabs and other machinery. An observation bell, a

The SS Elihu Thompson, being towed to harbor after striking mines, is back at sea. Below, diver goes down in Thompson salvage operations





Instructor describes uses of shallow-water diving gear to a group of students at the Navy diving school on New Caledonia

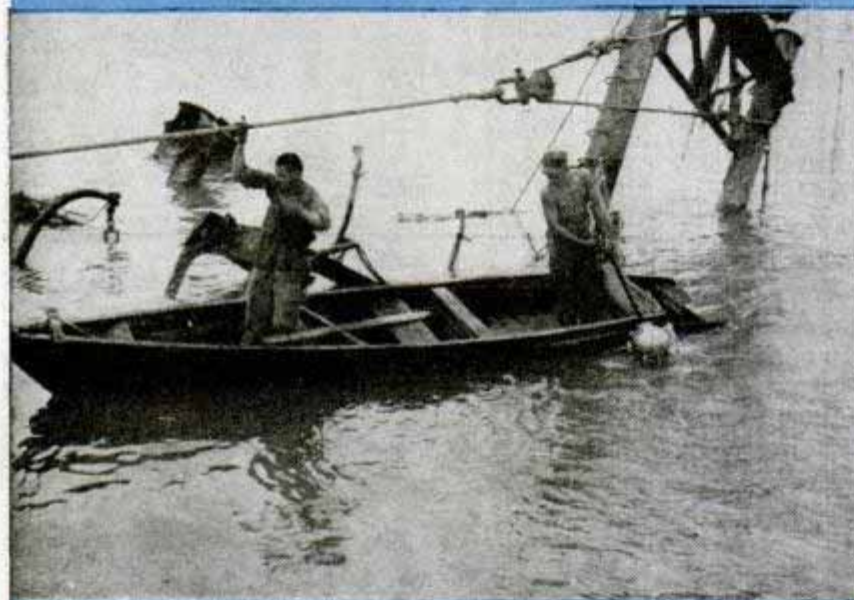

Army diver shown surfacing during joint salvage operations at Okinawa. Below, adding insult to injury, Seabees use captured diving gear to raise Jap hulk sunk during battle for island



steel cylinder weighing nearly three tons and equipped with plate glass windows that could withstand water pressure of 350 pounds to the square inch, was obtained for the diving. After seven months the Niagara was located lying on her side 438 feet beneath the surface, and the salvage ship anchored over the wreck.

With explosives lowered into place as directed by a diver and then detonated electrically after the bell had been pulled to the surface, the salvors began to blast their way into the wreck. Bad weather, wounded sharks and floating mines delayed the work but the door of the bullion room finally was blown away and the grabs began to bring up gold bars. Operations ceased 18 months after the sinking when eight tons of the metal, worth 2,397,900 Australian pounds, or roughly 94 percent of the \$10,000,000 treasure, had been recovered!

If the fantastic legends of ancient galleons are disregarded, only one ship ever yielded more gold than the Niagara. This was the old White Star liner Laurentic, torpedoed off Ireland in 120 feet of water in World War I, from which British Navy divers in seven years recovered \$19,000,000 in bullion.

A salvage record for bigness was established in righting the accidentally burned 83,423-ton liner Normandie, second largest ship in the world, in New York harbor during the war. In this epic operation, Navy men and workers of the Merritt, Chapman & Scott Corporation plugged 6000 underwater openings in the vessel and raised her at a cost of \$3,750,000, only to find that it would be uneconomical to make the additional repairs required and she therefore saw no war service.

For the Normandie job, however, a school for Navy divers was established and some 250 officers and 1500 enlisted men obtained priceless experience that since has helped speed operations in

North Africa, France, Italy and the Pacific. This force and the 700 trained workers of the Merritt, Chapman & Scott Corporation, under contract to the Navy, have done most of the ship salvage of the war years under the direction of Commodore Sullivan and Captain Bernard E. Manseau.

Army engineers and other companies likewise have performed some notable feats. At Naha, Okinawa and many other places harbor clearance has been a joint operation, with the Army engineers clearing docks and the Navy taking care of channels and harbors.

The crack Army 1055th Engineer Port Construction and Repair Group was given the job of removing a small vessel blocking a berth at Isigny, France, needed for supplying Allied troops. The divers went down with cutting torches and underwater demolitions, cleared the hulk and brought it to the surface. To their surprise and horror, they found that the vessel was a German flak ship and their torches and explosives had been used next to a cargo of high explosive flak ammunition.

Other American salvage men had a similar narrow escape in clearing the harbor at Massawa, Eritrea, on the east coast of Africa. They were just beginning to work on the 8000-ton freighter *Liebenfels* when an Italian waiter, grateful for a package of cigarettes, revealed that she and most of the 26 scuttled ships were booby-trapped. The explosives were removed and work proceeded in the blazing tropical heat until the harbor was restored as a base for the forces turning back Rommel.

A notable British salvage job in the Middle East was the raising of the 31,000-ton battleship *Queen Elizabeth*. Two Italian sailors in a midget submarine penetrated Alexandria harbor and sank the big ship at her moorings by attaching a delayed action bomb to her hull. Preliminary repairs were

(Continued to page 236)



Salvage diver being helped into complicated deep-sea gear. Below, student divers attend class in recompression chamber



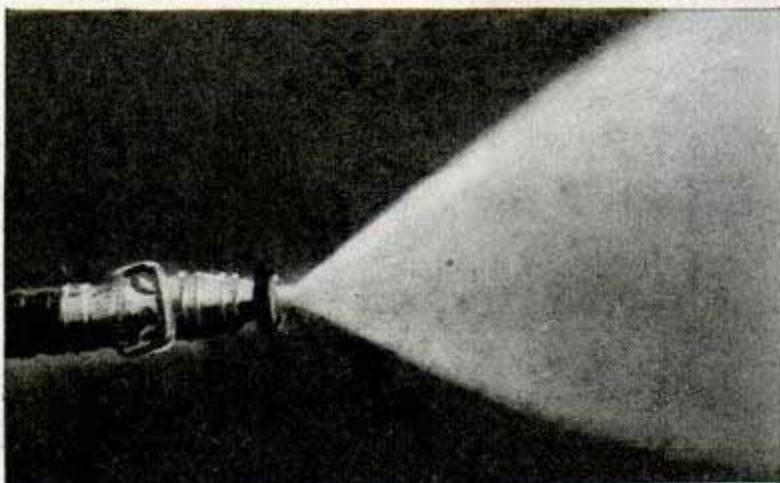

Four-Way Fire Fighter Throws Smoke Shield

Firemen are protected from heat and smoke by a hose nozzle that forms a water curtain. The curtain drives the smoke ahead and permits the firemen to reach the main source of the fire quickly. In addition, the nozzle can be adjusted to give a solid stream combined with the water curtain. Further adjustment provides a water fog with only 90 pounds of pressure. The fog, which floats through the air and smothers the blaze, is emitted in the form of a ball which is said to be superior to the hollow-cone-shaped stream from conventional nozzles. The diameter of this ball of moisture can be varied from one to 30 feet. This nozzle produces four different types of spray, saving firemen the inconvenience of carrying a variety of tips.

Fireman (top) demonstrates how the new nozzle combines a solid stream and water curtain. Solid stream only is shown in center and fog below

Some 441,000 officers and enlisted men of the Army Air Forces intend to seek jobs in aviation and 87,000 plan to buy personal planes, the AAF predicts from the results of questioning 1278 officers and 2215 enlisted men. The survey revealed also that approximately 62,000 officers wanted to remain in the service, but no interviewed enlisted men expressed such a desire.

Push-Pull Shaft Slides on Ball Bearings With Sealed-In Lubrication

Friction in push-pull reciprocating shafts is reduced to a minimum with a ball bearing bushing. The reciprocating member may be round or square and still gain the advantage ball bearings have long afforded rotating parts. The ball bushing contains a series of ball circuits. One side of the circuit carries the bearing load while the other side returns the balls in a clearance provided in the outer race member of the bushing. The continuous rolling contact and sealed-in lubrication give long life to the sliding parts. Ball bushings permit the use of smaller drive motors and otherwise reduce size and weight.

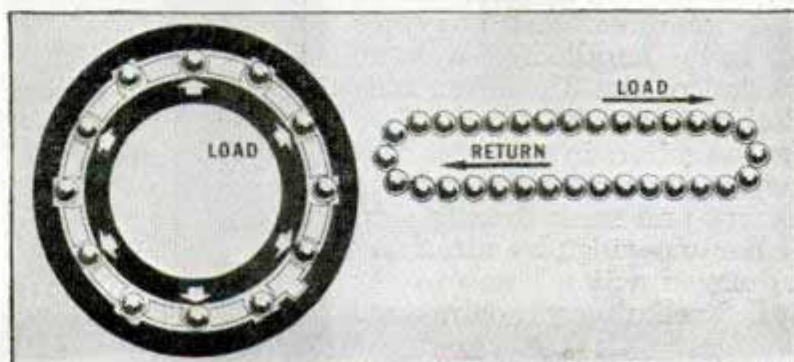
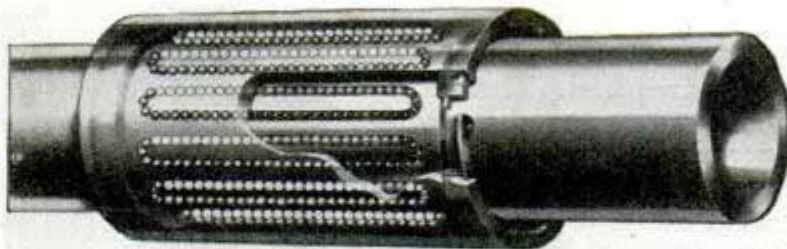

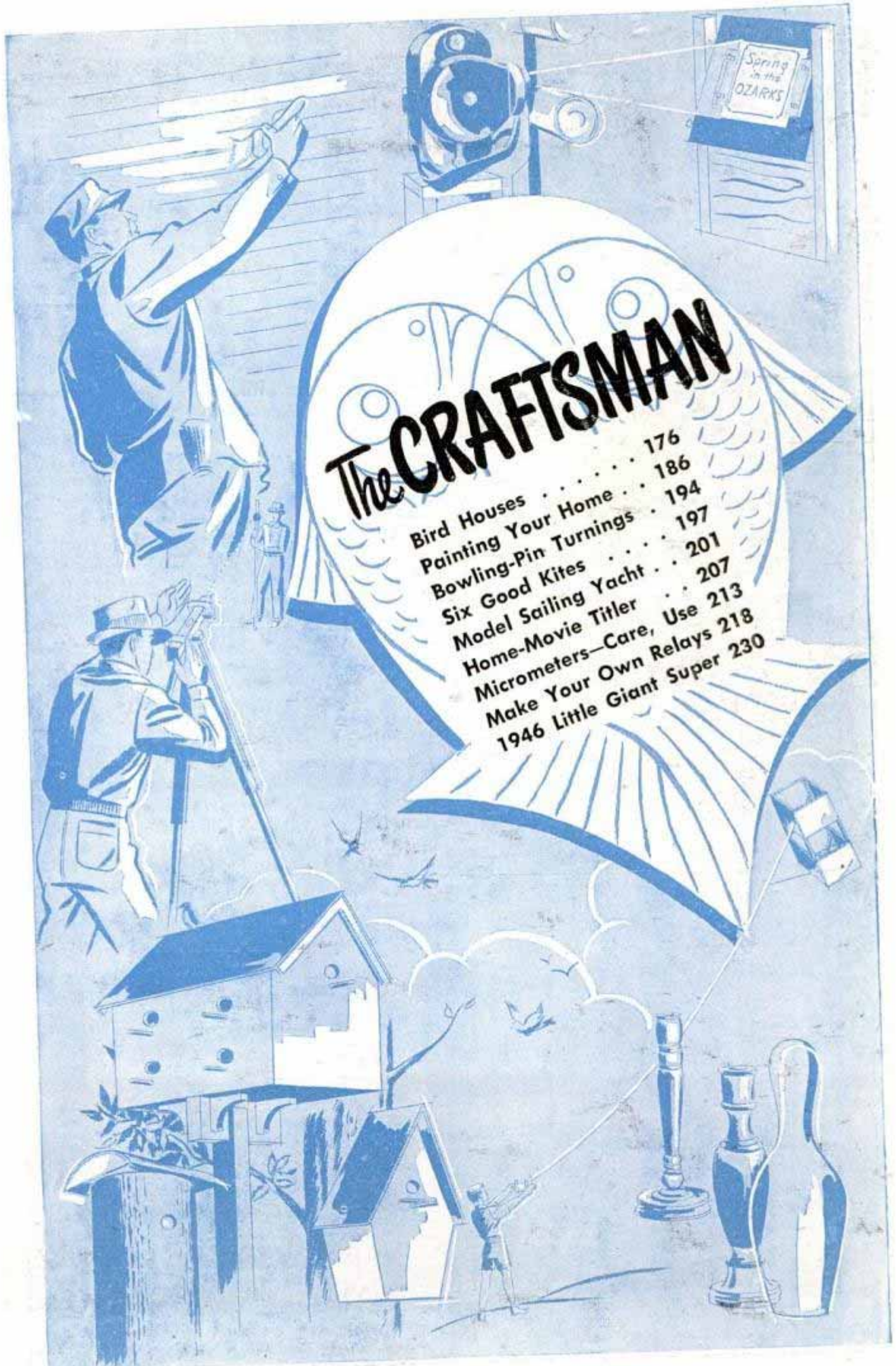

The CRAFTSMAN

Bird Houses	176
Painting Your Home	186
Bowling-Pin Turnings	194
Six Good Kites	197
Model Sailing Yacht	201
Home-Movie Titler	207
Micrometers—Care, Use	213
Make Your Own Relays	218
1946 Little Giant Super	230

It's Time for the Birds Again...

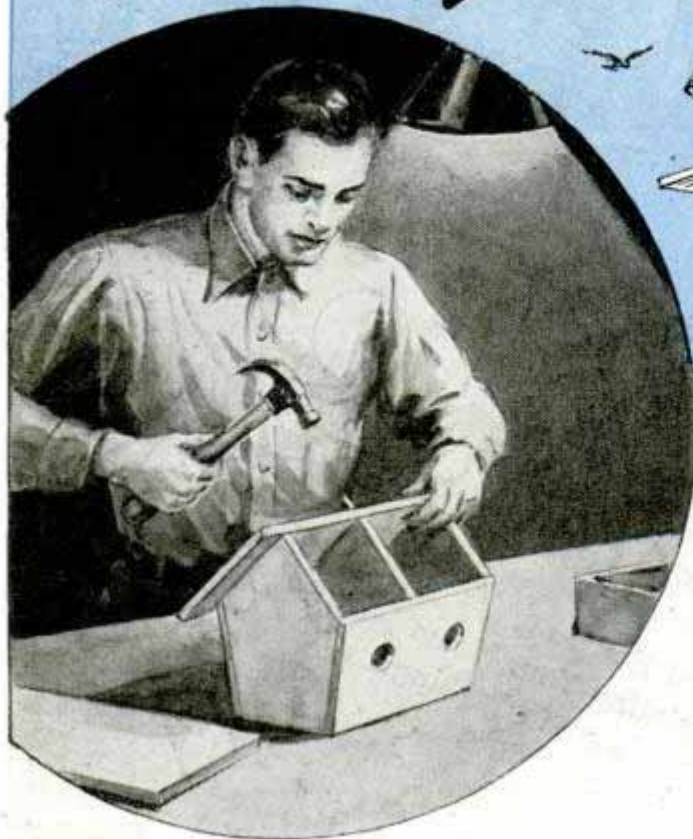

Migratory house-nesting birds will soon return to your garden. Properly located homes encourage them to stay for the season

MANY of the house-nesters have decided preferences. They require houses located near sources of food and water and nest-building materials. Also, the house they are to occupy for the nesting season must be placed at the right height to give all possible protection from natural enemies and, at the same time, give the occupant a sense of the natural habitat. Of course, the rules are not hard-and-fast, but, as an example, the well-known purple martin, Fig. 4, feels more at home in a colony house placed on a high pole or post in the open, well away from tall trees and buildings where it has plenty of wing-room in all directions. The martin does not object to "across-the-hall" neighbors; in fact, it prefers to live in large colonies. By way of contrast in habit and preference, many of the other house-nesters will occupy only a single-room home, and most of them are more or less "choosy" about where the house is placed. For instance, the bluebird, like the martin, prefers its home in the open but will take only the one-room type, which must be near the ground and some distance from any dwelling. Likewise, the flicker, screech owl, nuthatch and tree swallow inhabit only one-room houses, but these must be located in large trees and quite high above ground.

Fig. 1 shows a practical method of mak-

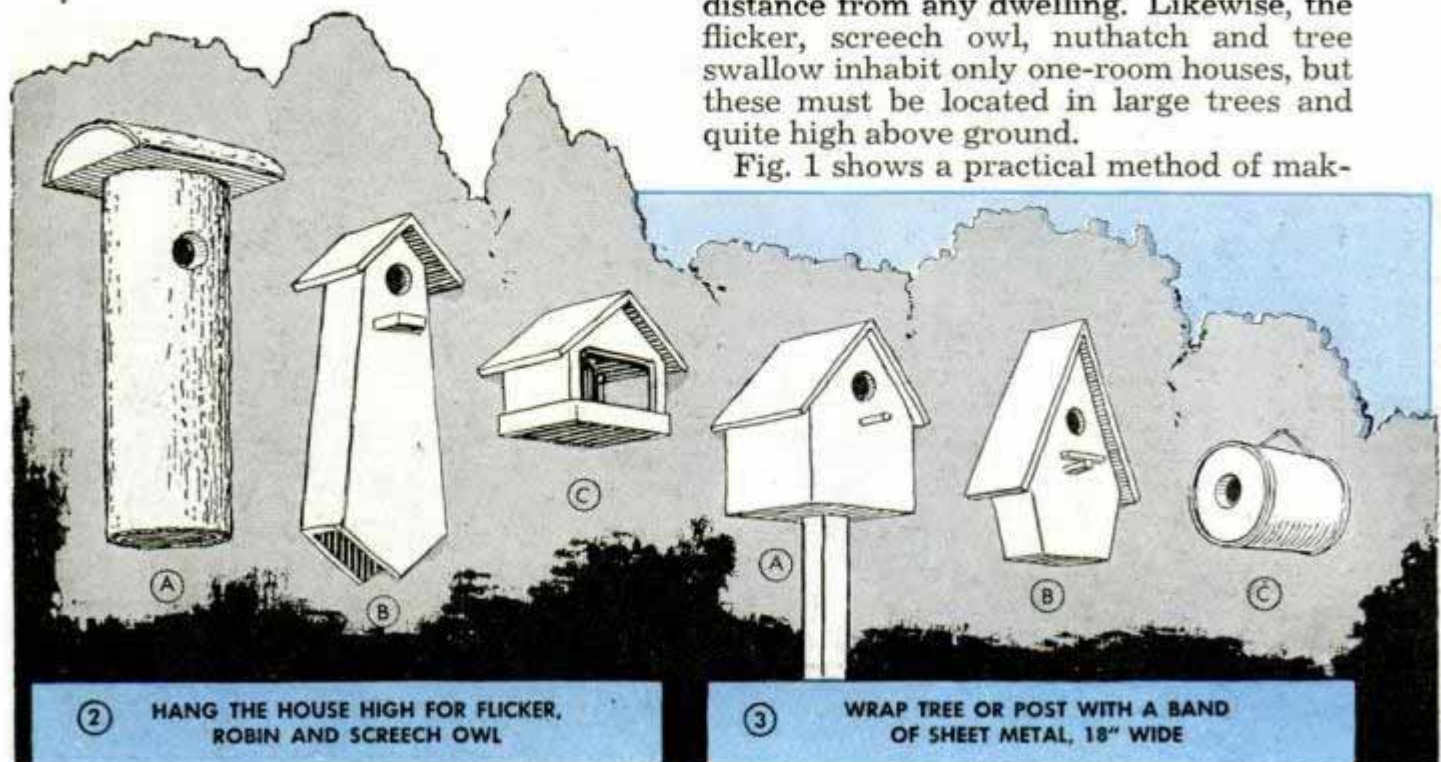
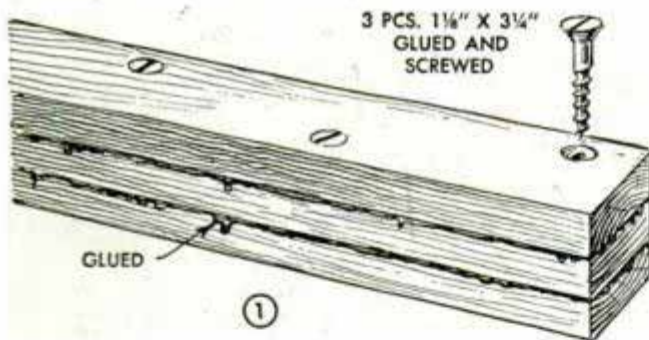

② HANG THE HOUSE HIGH FOR FLICKER, ROBIN AND SCREECH OWL

③ WRAP TREE OR POST WITH A BAND OF SHEET METAL, 18" WIDE

ing a sturdy post or "pole" for mounting a large colony house. Laminated in this way the pole is much stronger and stiffer than any of solid wood of equivalent size, thus providing better resistance to the wind. It can, of course, be made in various sectional sizes suitable for supporting large or small houses. Detail C in Fig. 10 shows how the pole may be mounted so that the house can be lowered for cleaning or eviction of undesirable tenants. A short creosoted post is set in concrete to project from 2 to 3 ft. above ground, Figs. 7 and 10, depending on height and size of the pole. Then the latter is attached with a bolt and heavy door hinge. Another way of mounting both large and small houses is shown in details A and B, Fig. 10. Here a 3-ft. length of pipe is set in concrete; a number of 1/4-in. holes are drilled through the pipe and short lengths of iron rod inserted as shown. This helps to reinforce the concrete column. For these supports it's usually best to use a mixture of equal parts sharp sand and cement. This will give the strength necessary to prevent the column being broken by action of the frost during winter months. The diameter of the concrete column should be at least three times that of the post for small houses at lower heights. Larger houses mounted high will require a larger column of concrete to give adequate support. Be sure before mounting the house that the concrete is thoroughly cured.

Where the house is to be placed in or near trees the height above ground is as important as is the location of the house. Fig. 2, A, B and C, show the type of house suitable for flicker, screech owl and robin, respectively. All three should be placed on or near the trunk of the tree and fastened securely so that they do not sway. The robin "shelf," detail C in Fig. 2, is simply a shelter open on two sides as indicated. Fig. 3, A, B and C, show smaller homes suitable



④ HOMES FOR THE PURPLE MARTINS SHOULD BE IN THE OPEN

⑤ BIRDHOUSE SPECIFICATIONS

Bird	Floor area in inches	Depth in inches	Diameter of entrance (ins.)	Height above ground (in ft.)
Bluebird	5 X 5	8	1½	6-10
Robin	6 X 8	8	(a)	8-15
Chickadee	4 X 4	8	1½	8-15
White Breasted Nuthatch	4 X 4	8-10	1¼	12-20
House Wren	4 X 4	6-10	¾	6-10
Tree Swallow	5 X 5	6	1½	10-15
Martin	6 X 6	6	2-2½	16-20
Red-Headed Woodpecker	6 X 6	10-12	2	12-20
Downy Woodpecker	4 X 4	8-10	1¼	10-20
Flicker	6 X 8	10-12	2¾	15-20
Screech Owl	8 X 8	12-15	3¼	20-25
Sparrow Hawk	6 X 8	12-15	2¾-3	20-25
Crested Flycatcher	6 X 6	10-12	2	12-20

(a) Two sides open

Note—Floor area and depth dimensions are only approximations

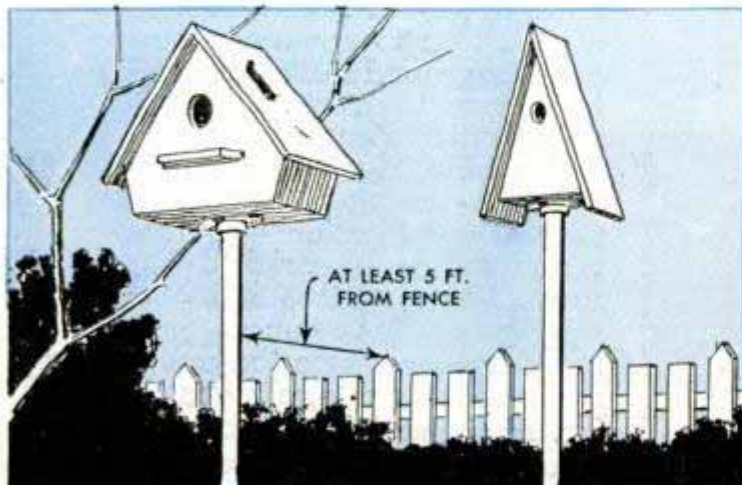

AT LEAST 5 FT. FROM FENCE

⑥ HOUSES NEAR SHRUBBERY OR FENCES SHOULD BE ON MOUNTINGS OF PIPE



⑦ USE LEAD-AND-OIL PAINT

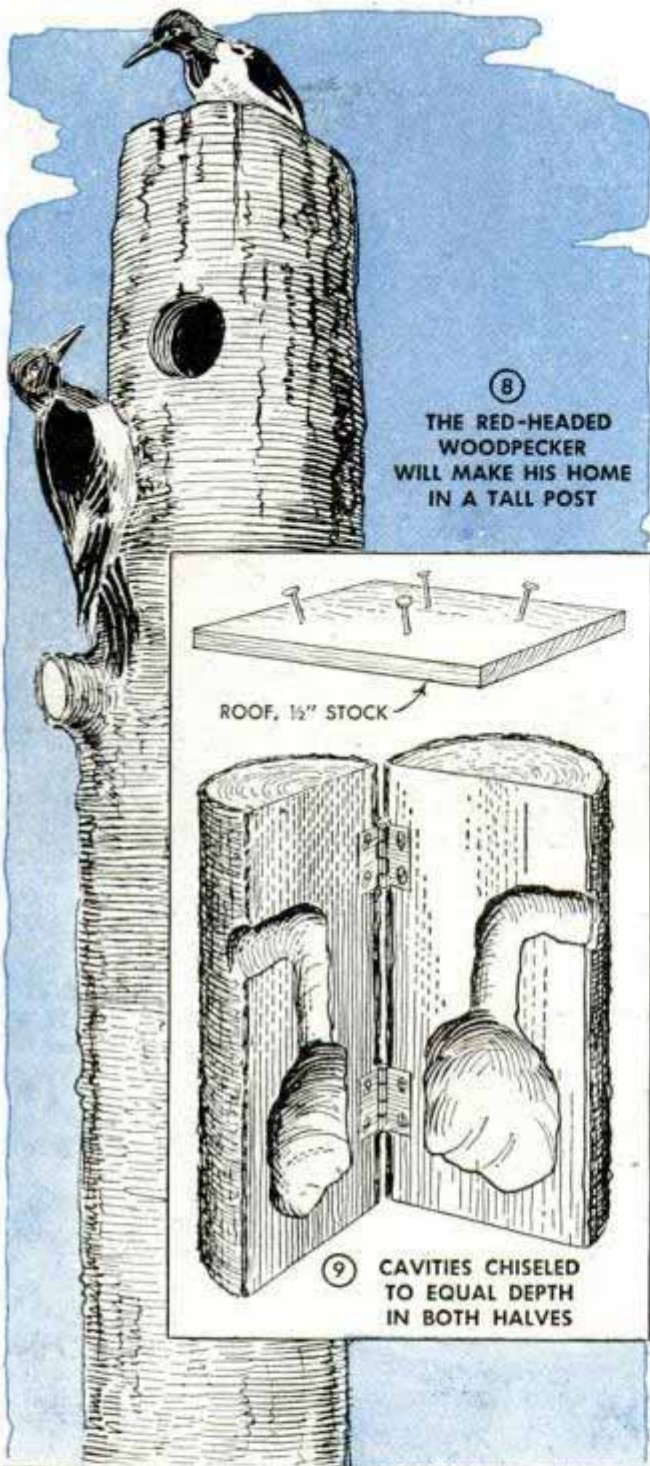

8
THE RED-HEADED
WOODPECKER
WILL MAKE HIS HOME
IN A TALL POST

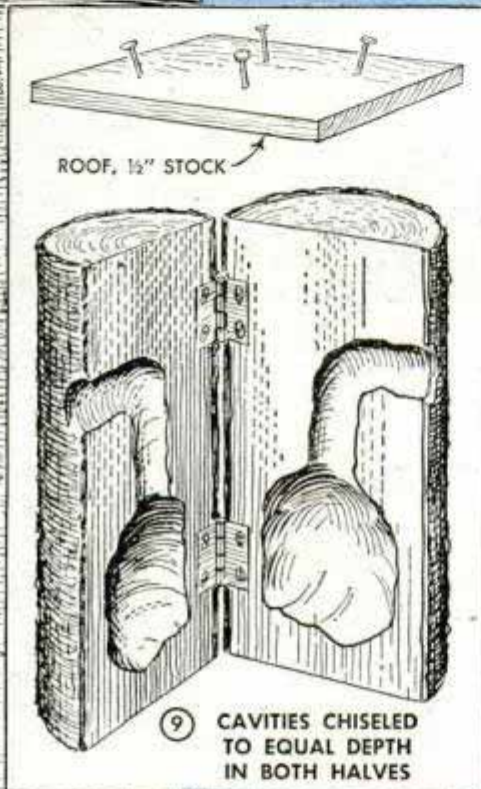

ROOF, 1/2" STOCK

9
CAVITIES CHISELED
TO EQUAL DEPTH
IN BOTH HALVES

for bluebirds, chickadees and brown wrens. For bluebirds, the first, A, should be placed on a pole in the open but for house wrens and others the two shown at B and C may be hung from a low tree limb or attached directly to the trunk. Wrens will occupy houses placed on low poles or posts but they should be located near shrubbery. The simple home shown in Fig. 3, C, may be made by wrapping roll roofing around two wood disks of suitable size, or it can be made by fitting a wood disk in the open end of a tin can. House wrens especially will be attracted to such a home.

Figs. 8 and 9 show two ways of making homes for both the red-headed woodpecker and the downy woodpecker. The first, Fig. 8, is simply a tall post—the trunk of a dead tree about 8 in. in diameter is just the thing—set securely in the ground in the open. Before setting up the post you can cut out an 18-in. section at the top and hollow out the two parts with a gouge to make a compartment with a proper-sized hole leading to it, similar to that shown in Fig. 9. Replace the piece which was cut away and fasten securely with wire or screws. Fill the crack at the top with roofing cement. Fig. 9 shows another way of making a home for the smaller woodpeckers by splitting and hollowing a section of a small log. The halves then are hinged together as indicated and a board over the top keeps out the rain. No need to be particular about the exact size or shape of the hollowed compartment, as Mr. and Mrs. Woodpecker will fix this up to suit themselves. However, if you make the entrance hole the right size to begin with it will encourage the birds to become tenants.

Bird homes placed low near fences or shrubbery should be mounted on posts made of pipe which gives protection against prowling cats, Fig. 6. Moreover, these mountings are exceptionally neat, thus adding an attractive feature to the yard, and are easily taken down in winter. If this is done, it's a good idea to screw a pipe cap over the ground section of the pipe to prevent the remaining section filling with water and dirt.

The table, Fig. 5, lists a number of house-nesting birds and gives general specifications for houses which should be provided for them. The variations in floor area refer generally to houses made of stock lumber where the compartment is nearly square or rectangular. However, in the rustic type of bird home, a close approximation is sufficient. Sizes given for the holes or openings always should be followed quite closely.

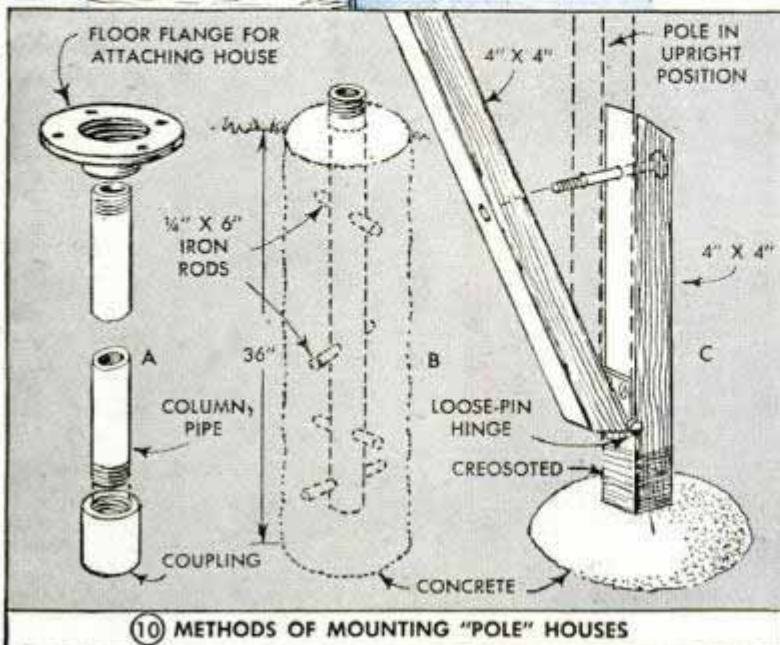

10 METHODS OF MOUNTING "POLE" HOUSES

Hand-Power Washer Replaces "Rubbing" Board

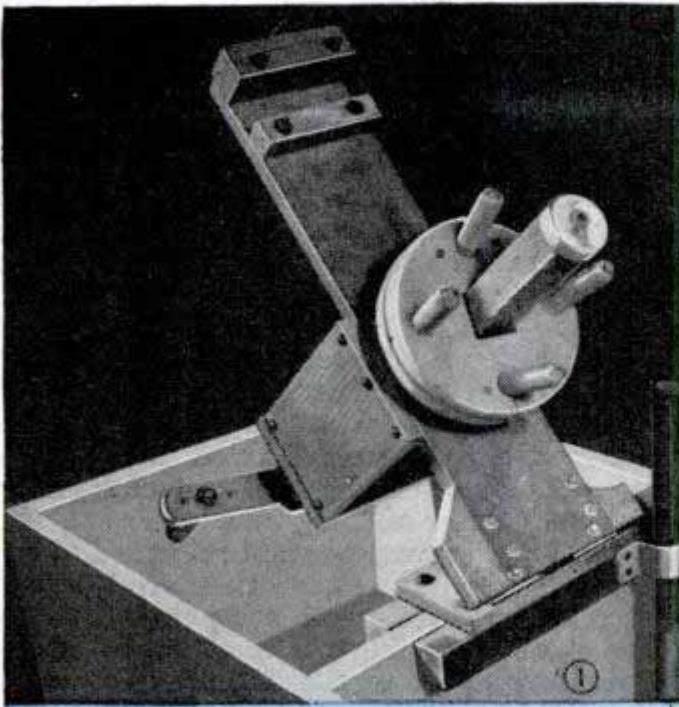

Where the facilities of a power washing machine are not available, this hand washer will fit over a laundry tub and enable you to do a washing without rubbing, and you can use water hot enough to assure clean clothes. The unit is light and compact for easy storage in a closet. One unusual feature of the washer is that the rubber stopper for the tub is fastened to a handle, detail A, Fig. 3, for easy removal from hot water. Fig. 1 shows the unit clamped in place with the agitator in the raised position and Fig. 2 shows the washer in use. In Fig. 3 and details A and B are given the construction dimensions, some of which are made to fit the tub on which the machine is used. Any light wood can be used and the hardware is standard. For a finish, several coats of shellac will protect the wood from the water. George W. Newton, Paxton, Ill.

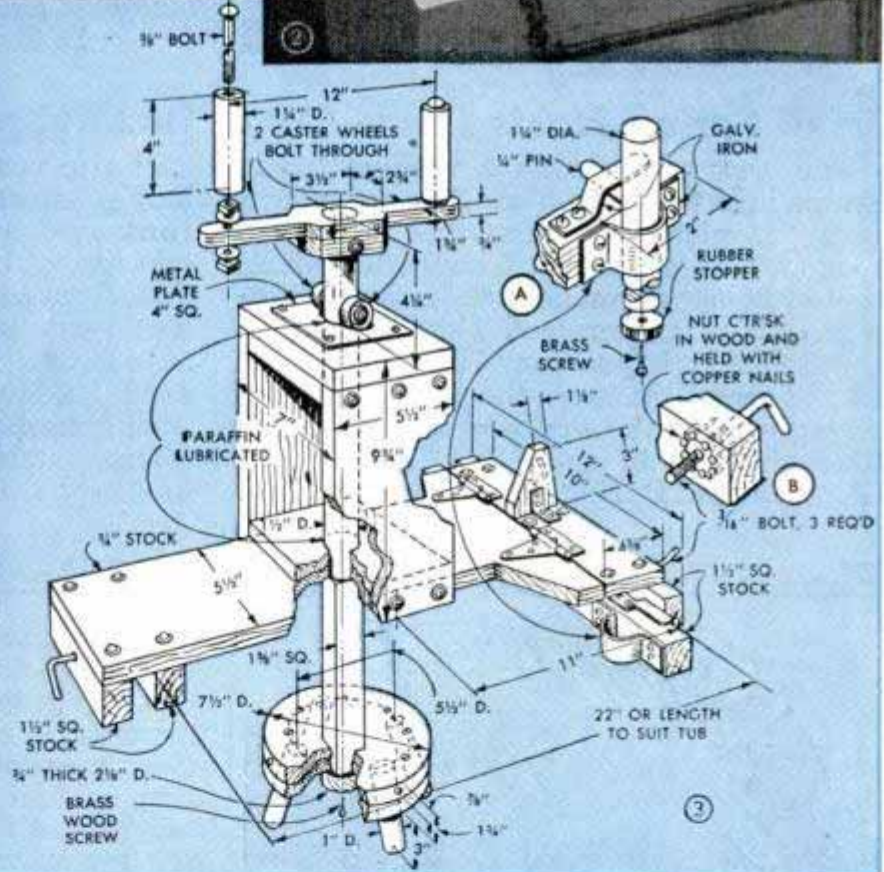

"Plunged" House Plants Grow Better in Porous Clay Pots

Potted house plants will grow better in unpainted clay pots if they are "plunged" instead of standing exposed to air as is usually done. A "plunged" pot is one sunk to its brim in sand or peat moss that is kept moistened. The soil in the flower pot draws moisture through the porous clay. This simplifies watering and holds the moisture content of the soil at a more uniform level. Also, there is less danger that the soil will pack too firmly for the good of the plant,

and the plant food will not leach away with surplus water. Water moves even more rapidly through the clay walls than through the soil. In plunged pots, water moves outward if the peat moss or sand is dryer than the soil and inward if the soil is dryer. Pots that are exposed to air require more frequent watering. For plunging house plants it is necessary to have a watertight container, perhaps of sheet metal, in which to place the pots.

Sheet-Metal Strips Used for Casting Cement Flagstones



Artificial flagstones of any shape, size and color can be made by using a strip of thin sheet metal as a form, filling it with cement and troweling in colored oxides. The strip, which can be taken from a packing case or cut from light sheet stock, need be only about $\frac{3}{4}$ in. wide. When bent to shape, the strip is held by sheet-metal fingers on which weights are laid to keep the form flat on the work surface, as indicated in the detail. The mix, composed of cement and plaster sand, should be medium rich and not too wet. When poured, it is floated flush with the form. To use the oxides sparingly, they are sprinkled over the cement and trowelled in with a steel finishing trowel. After a "flagstone" has set, the strip may be removed and reformed to another shape. The stones then are laid and the intervening spaces are pointed with a mix of contrasting color. A space of approximately 1 in. between flagstones is recommended.

D. Curtis, Santa Monica, California

Small Spring Holds Bottle Cork

The cork which seals a vacuum bottle can be held firmly in place if an expansion spring is placed between the top of the cork and the metal cap. The spring, which should be approximately $\frac{5}{8}$ in. long by $\frac{1}{2}$ in. in diameter, is screwed into the top of the cork to hold it in position. When assembled in the usual manner, the tension of the spring against the inside of the cap holds the cork firmly in place.

Frank D. Hammer, Altadena, Calif.

Bottle Cap Replaces Umbrella Tip

If the tip of a lady's umbrella is lost and a new one cannot be obtained, a plastic bottle cap may be substituted. The cap is held in place with household cement or some other colorless waterproof adhesive that will hold the tip on firmly.



Electric Motor Mounted on Board Recharges Auto Battery

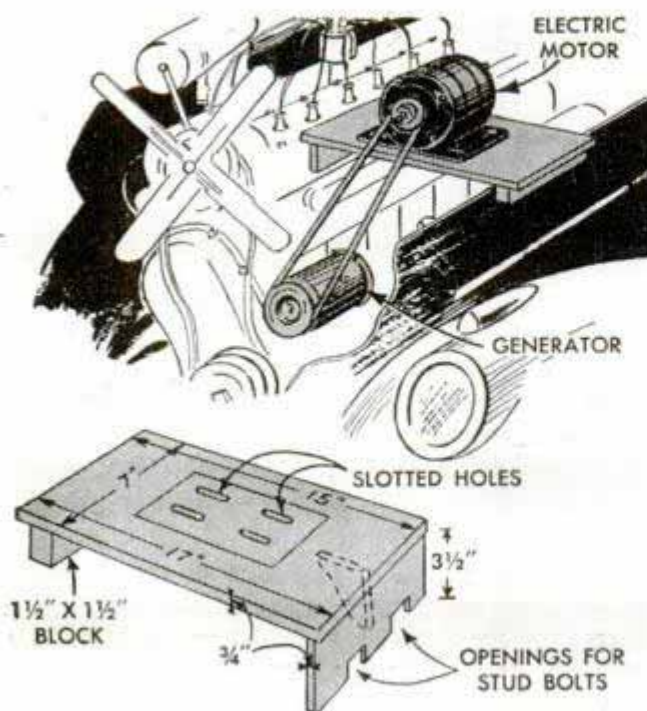

To keep an auto battery charged, a small electric motor belted to the car generator can be installed in a few minutes. The motor must rotate in the same direction as the generator, and is mounted on a board long enough to extend from the engine to one side of the hood. The board is slotted for motor mounting bolts and provided with end cleats high enough to keep it level when in use. It may be necessary to notch the end cleat resting on the engine block to fit over studs; however, installation will vary on cars of different design. To use the unit, remove the fan belt and slip the drive belt over the generator pulley to connect it to the motor. Correct tension is obtained by adjustment of the mounting bolts. In no case should the motor be used on automobiles not having current and voltage regulators unless the battery is watched closely for overcharging.

N. R. Bangert, Sacramento, Calif.

"Flying-Horse" Swing Has Novel Dual Controls

Suspended from the porch ceiling, a sturdy tree limb or, in winter, from floor joists in the basement play-room, this tandem swing will provide hours of safe fun for the children. It has controls and foot treadles so arranged that each rider has to do his share of the work. A special feature of the construction is the three-point suspension which helps to prevent the frame from tipping or swinging sidewise. Details show all the principal dimensions for a two-seated swing. Although any softwood can be used in the construction, the use of hardwoods, such as birch or oak, makes a more durable job that is easier to finish

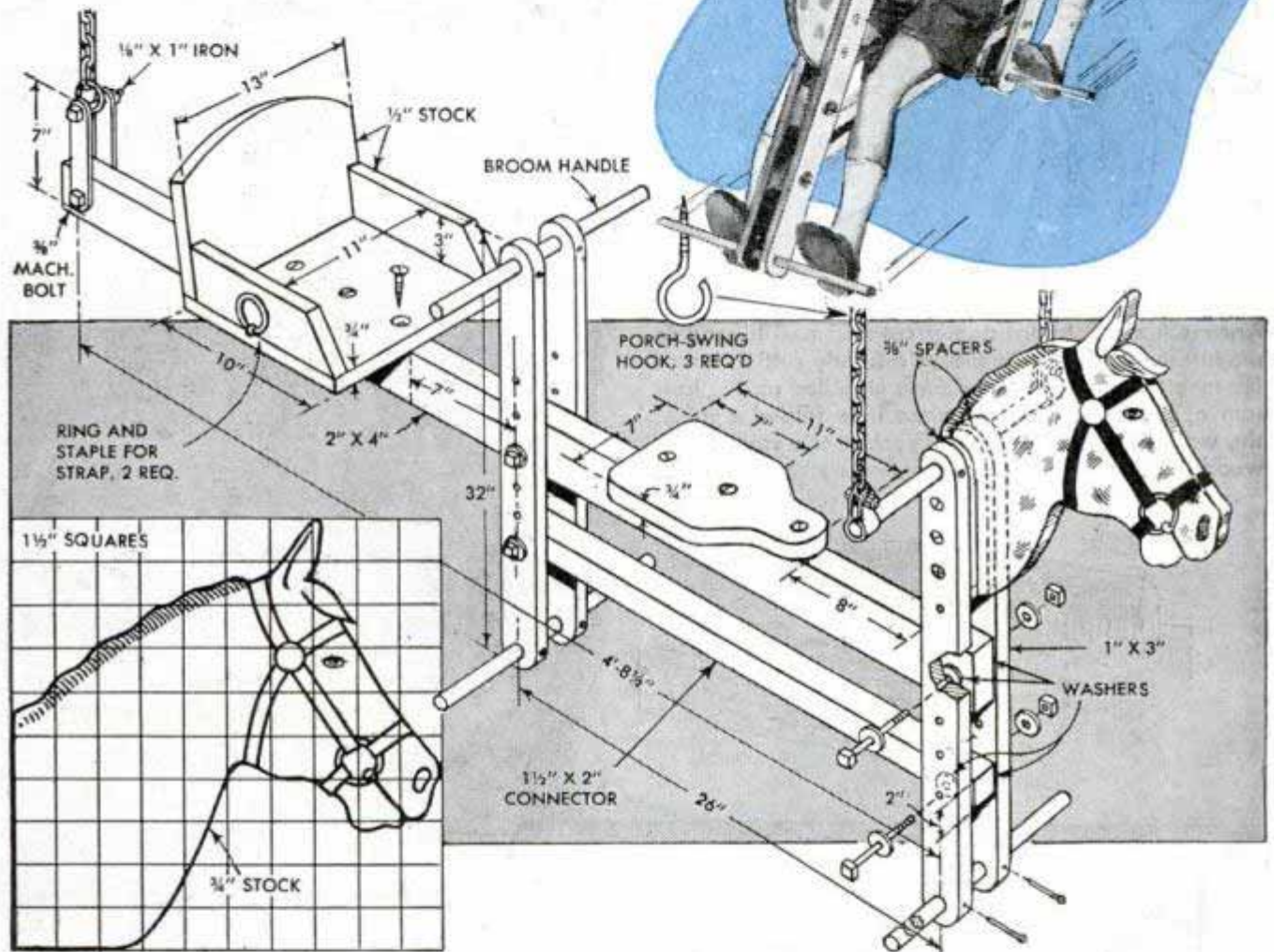
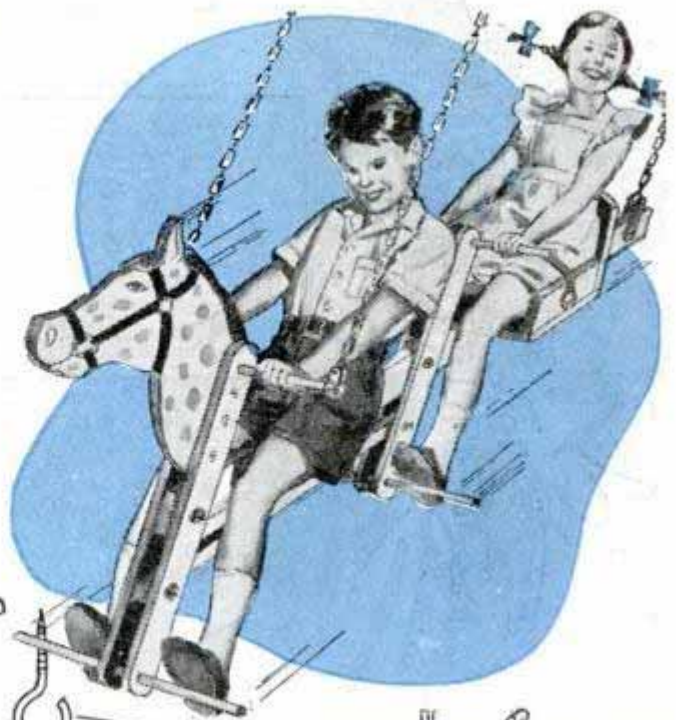

Tips That Will Help in Washing and Cleaning Your Car

If you are inexperienced in washing and cleaning a car, the following tips will help you do a better job and also avoid trouble afterward. To keep water under pressure from entering the brakes, set them before washing the car. This presses the shoes tightly against the drums and helps prevent the linings from getting wet, which might cause a temporary faulty condition.

Also, it is a good idea to protect the ignition coil with a rubber sleeve made from an inner tube. If water gets on the spark plugs, distributor, etc., spray the damp parts with carbon tetrachloride, which will remove the moisture. Insects, tarnish and other stains can be removed from plated

parts of the car by rubbing them with a compound used to cut lacquer finishes, which will leave a high polish. After the car has been washed, polish the plated parts with petroleum jelly. The thin film of jelly left on the metal protects it against moisture. If you have white-wall tires, they can be cleaned with lacquer thinner, which not only removes stains, but also light abrasion spots.

☐ After using polishing cloths, store them in an empty coffee can that has a tight lid. This prevents the polish from evaporating and also provides a place where the cloths may be kept out of sight.

Solving HOME



Above: A small board neatly covered and hinged to the kitchen-cabinet base makes a handy cutting board for meats and cheeses. A design stenciled on the bottom of the board shows when it is folded against the wall. Below: The grooved rack, made from fancy wood, holds combs neatly and protects the fine teeth

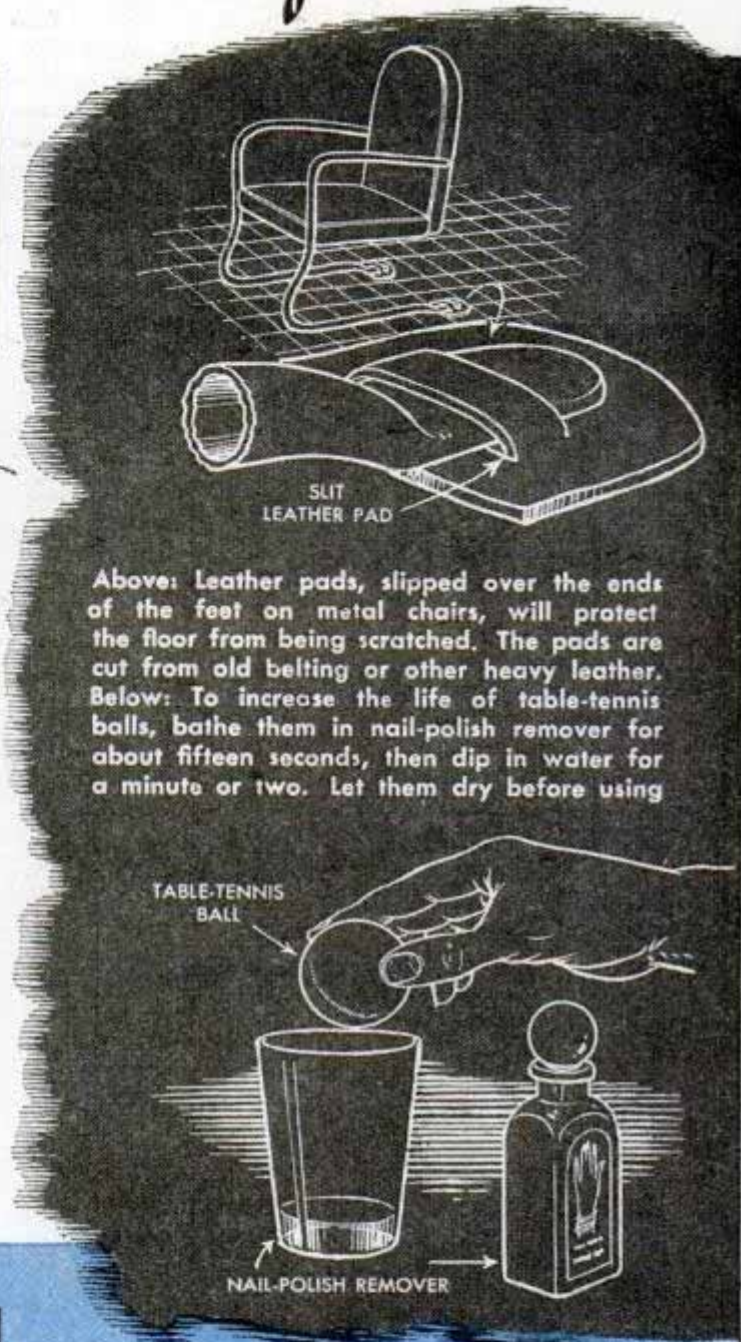
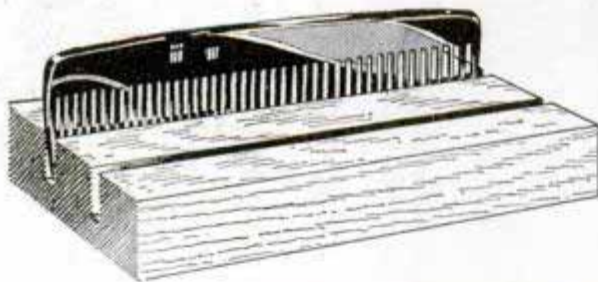

Above: Leather pads, slipped over the ends of the feet on metal chairs, will protect the floor from being scratched. The pads are cut from old belting or other heavy leather. Below: To increase the life of table-tennis balls, bathe them in nail-polish remover for about fifteen seconds, then dip in water for a minute or two. Let them dry before using

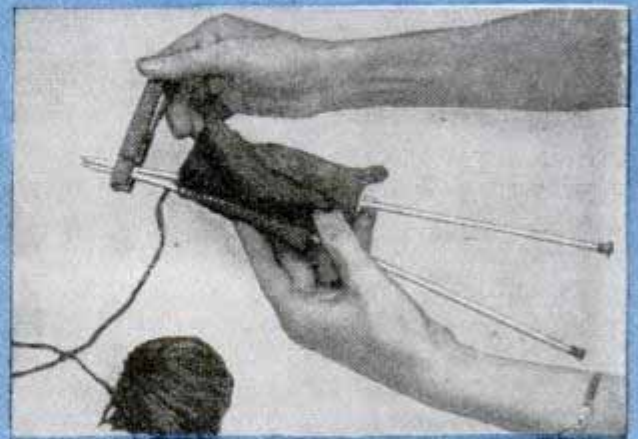

Left: Keep several bobby pins in your sewing basket and use them to prevent balls of crochet thread from unrolling. Each time you finish working, slip a pin over the loose end and over several adjacent threads. Right: If knitting must be put aside before a row is finished, clip a spring-type clothespin over the ends of the knitting needles. Then there is no danger of raveling. The clothespin is kept in the knitting bag

PROBLEMS

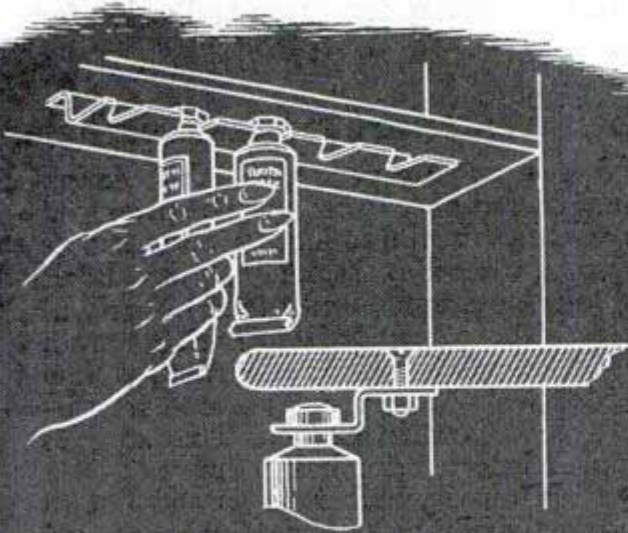

Above: Shaving cream and toothpaste tubes will not clutter the bathroom cabinet when they are suspended from this slotted rack. If the rack is made of aluminum, it will not rust. Below: One householder found that by cutting a rubber stop from an old tire and screwing it to the porch floor, he could prevent the door from banging during high winds

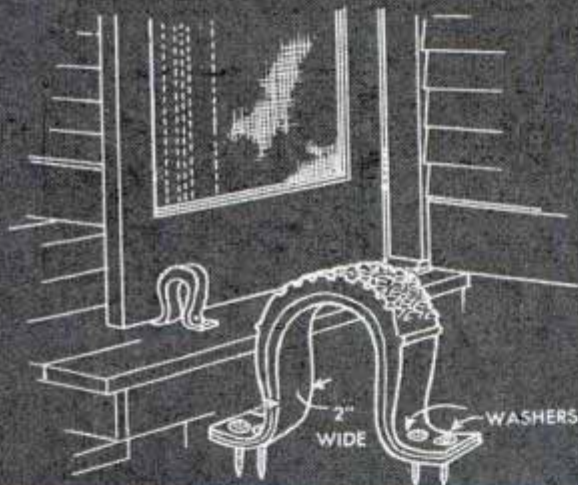

Above: When a mailbox is mounted on spring-steel brackets as illustrated, large envelopes, magazines and small packages are accommodated much more easily. Below: An oversize buttonhole on a hip pocket may cause loss of your billfold. A split washer slipped under the button will serve to "lock" the pocket

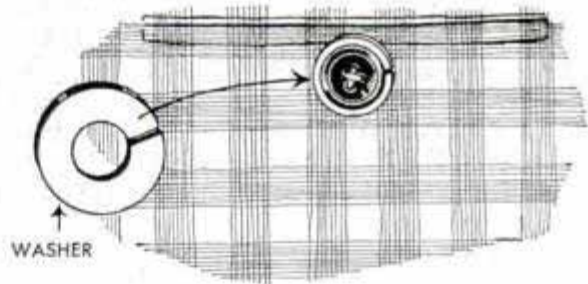

Left: Pencil erasers can be used for rubber stoppers in bottles containing volatile liquids that evaporate through cork stoppers. A small piece of dowel or wood section of pencil is inserted tightly in the eraser and cut off flush. Right: A wooden match dipped in ink is a good substitute for a pen when addressing packages. It will save using a fine pen point on coarse wrapping paper and the writing is bold and clear

Putty Knife Is an Efficient Tool When Removing Flooring



To get at piping or wiring concealed beneath tongue-and-groove flooring, a putty knife will aid in removing the floor boards. The blade is shortened about an inch and one edge is sharpened. To remove a section of flooring, locate the joists by tapping with a hammer and bore a hole at each one. Then saw across the boards, parallel with the joists, for the desired distance. The putty knife is inserted between the boards and used to cut the tongue off the flooring, permitting removal of the section. The flooring is replaced by nailing strips of wood to the joists and then nailing the section to these strips, as shown.

Joseph Roth, Chicago

Patterns Stored in Record Album

An old or discarded phonograph-record album will make an excellent file for keeping all the pieces of sewing patterns together for quick and ready reference. Slip the pieces of each pattern into a windowed compartment, then paste or cement a pic-

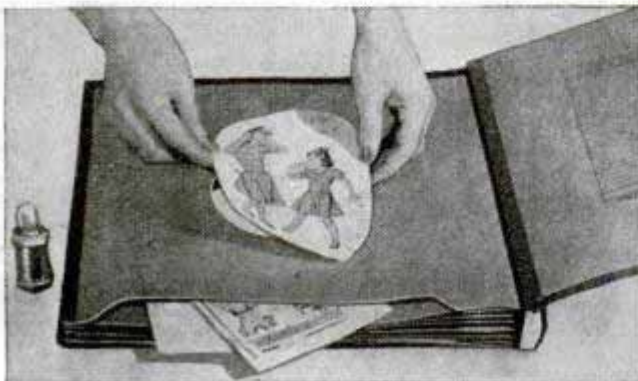

ture of the finished garment over the circular opening as illustrated, so that any pattern may be identified quickly. Nail polish can be used as a quick-drying adhesive for this purpose.

Paper Treated to Simulate Leather

Brown wrapping paper, which is tough and somewhat absorbent, may be prepared to resemble thin tinted leather and used as a covering over albums, lamp shades, book ends, picture frames and other household articles. The paper first is moistened in water, then splotches of red, green, yellow and blue water colors are painted irregularly over the entire surface. The paper is crumpled into a tight ball to squeeze out the water, after which it is spread flat to dry. When dry it will have a finely creased texture and an overall tint resembling leather. The paper is pasted over the object to be covered, then coated with clear shellac to protect it from wear.

Nathan Bogoch, Winnipeg, Man., Can.

Ladle for Solder Is Improvised From Pipe Coupling and Plug

If you have no ladle for soldering wire connections when installing electric fixtures one can be improvised from a pipe coupling, plug and a length of flat iron; or you can use a nipple and cap to hold the solder. The iron is clamped around the coupling with a bolt and nut, the other end of the iron being formed into a hand grip. Then the plug is screwed into the coupling, which is filled with solder ready for use.

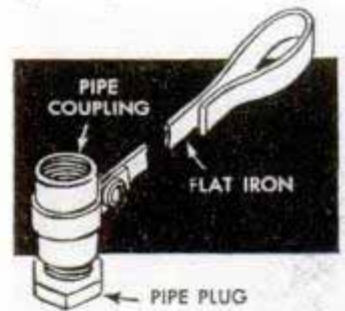

William Riederich, Elmhurst, Ill.

Roundhead Screw Flares Tubing

Roundhead screws can be used to flare copper tubing in an emergency if flaring tools are not available. Select a screw with a head of the desired diameter and drive it halfway into a block of wood. The head then is placed in the end of the tubing and the block is tapped with a hammer until the desired flare is obtained. —H. Klein, Pittsburgh, Pa.

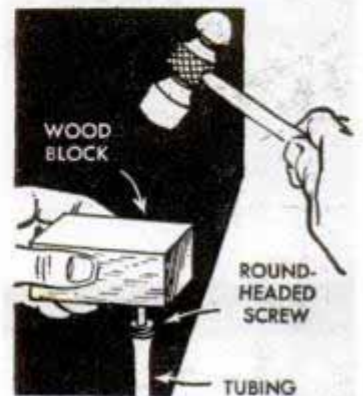

Between-Seasons Practice With Your Shotgun

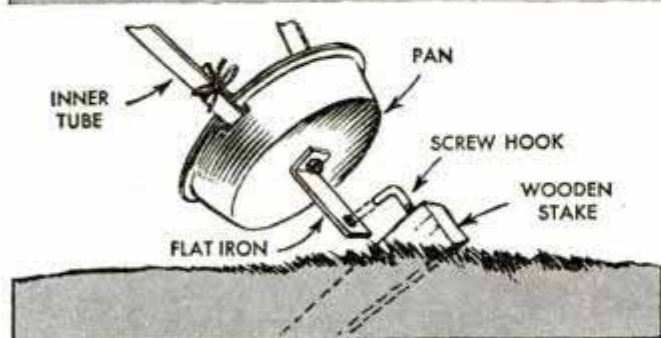

This simple "trap" throws tin cans, bottles and other small objects into the air in a high, curving flight. Getting away, the thrown object closely simulates the swift rise of a bird flushed in heavy cover, and in falling it presents an equally difficult target to the shotgun pointer—that of a live bird dropping steeply downhill. The sharp rise of the target teaches the beginner in shotgun handling the trick of swinging the gun muzzle above a rising bird, and shooting at the object as it falls is good practice in the knack of holding under a game bird dropping down from a height in a swift, curving flight. When two shooters alternate, one operating the trap, it's possible for the gunner to vary the angle of the shots by simply moving right or left or back to the range limit. The detail above shows

the construction of the trap, which is somewhat like a slingshot. Posts to which the rubber bands are attached should be spaced about 2 ft. The trap is released by pressing the iron catch off the end of the screw hook with the left foot. If you throw bottles or other glass objects locate the trap where the broken pieces will not injure anyone.

Double Feed Trough for Small Poultry Cut From Oil Can

A discarded oil can of about 2 gal. capacity will make a feed trough which is suitable for small poultry. With a pair of tin shears, cut and remove the prism-shaped portion which is shown unshaded. Then bend on the longitudinal center of the can to form the proper shape. Sharp edges of the trough can be turned for ease in handling. After completion, the trough should be painted so that it will not rust.

Ronald Eyrich, Milwaukee, Wis.

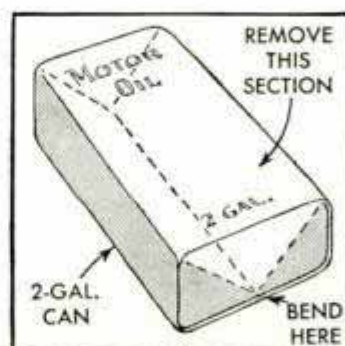

Paper Padding Preserves Oilcloth

When a kitchen table is to be covered with oilcloth, first place several layers of newspaper over the table. Then fold the paper over the ends of the table and tack the oilcloth over the paper. Oilcloth that has been put on in this manner will wear much longer.



WHAT TO DO BEFORE

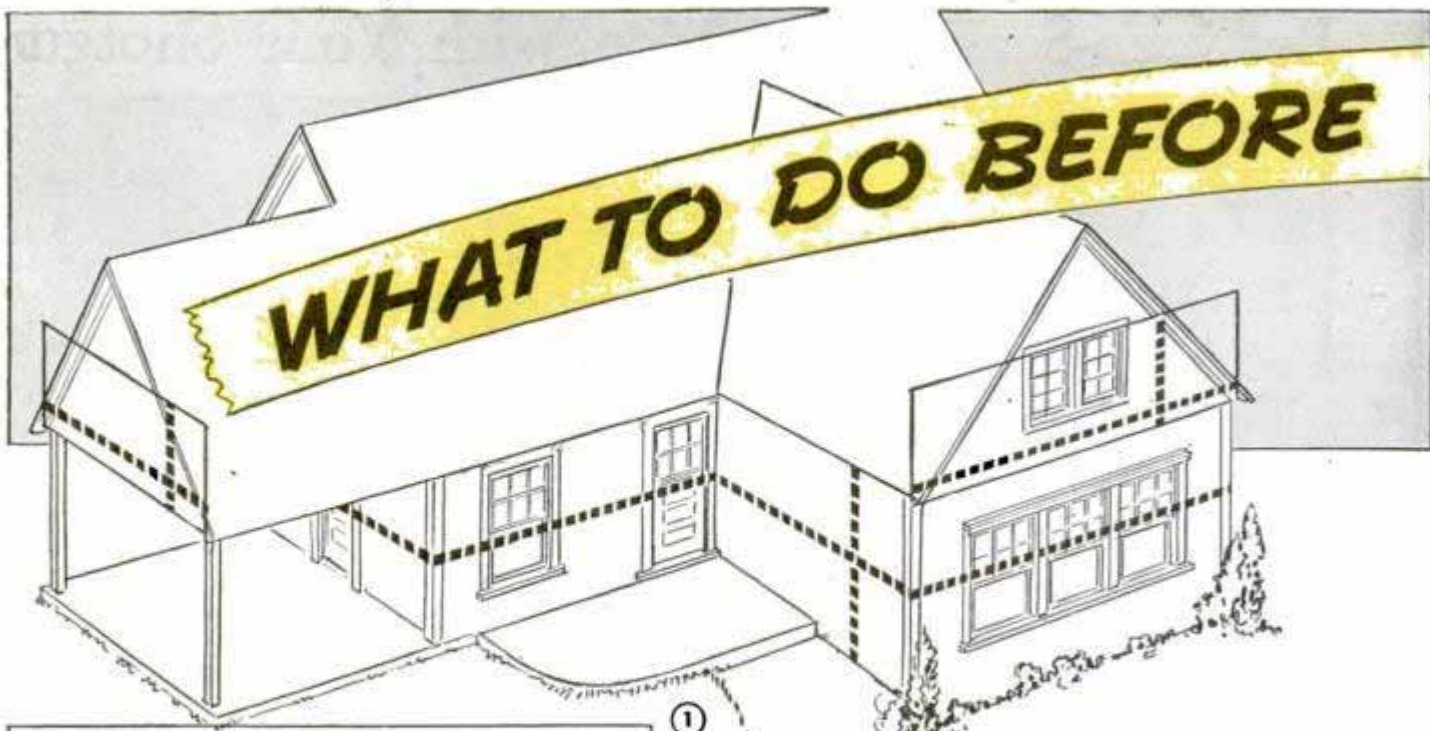

RULE FOR FINDING NUMBER OF GALLONS REQUIRED

Measure distance around house in lineal feet. Multiply by height to eaves. Divide by 600 where surface is in good condition—by 400 if surface is in poor condition. Measure width of gables and multiply by half the height

By W. Clyde Lamme

GOOD paint will stick to almost any surface—for a while. How long it stays on is something else, for in the matter of durability it's what's under the paint film that counts. In general, the appearance of a house is not always a reliable guide to the condition of the surface over which paint is to be applied. Rather, adhesion of the paint film, original quality and formula of the paint and the condition of the building structurally are usually the factors determining the amount of work it will take to get the surfaces in proper condition for repainting.

Old paint worn thin by slow chalking and weathering—both normal processes—may appear to be in poor condition. But because of tight adherence to the wood and a solid bond between what remains of previous coatings, it still will provide a good painting surface, Fig. 3. However, if the surface presents one or more of the defects shown in Figs. 4, 5, 10 and 11, which have been somewhat exaggerated for purposes of illustration, then the job of preparation

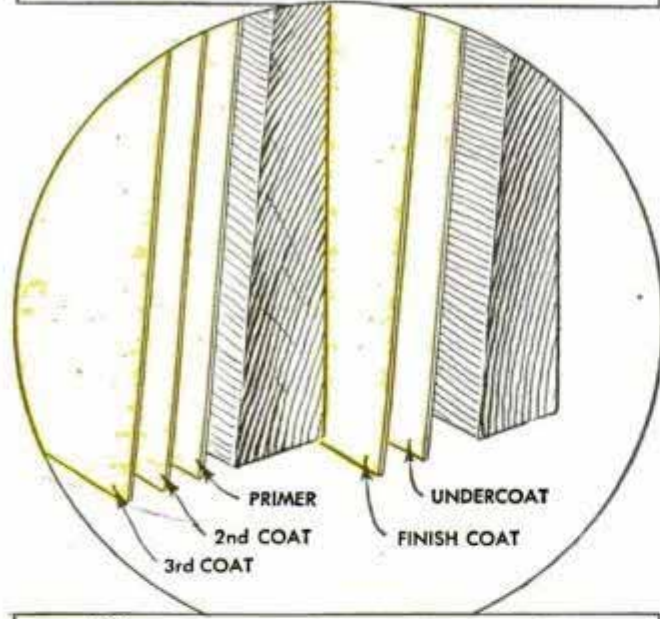

② TWO ACCEPTED METHODS OF PAINTING THE AVERAGE FRAME HOME

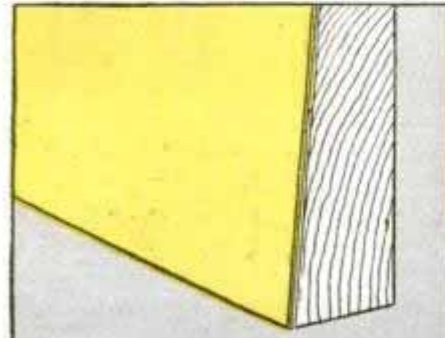

③ GOOD "OVER-PAINT" BASE

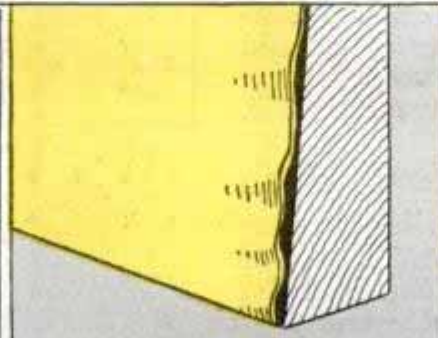

④ UNBROKEN FILM BUT WEATHERING

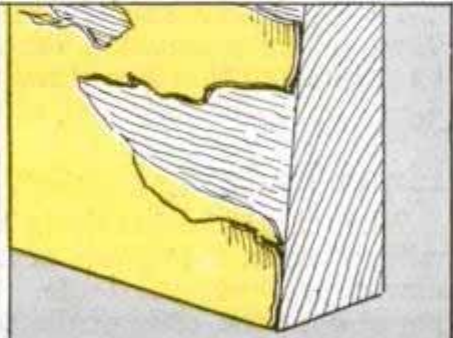

⑤ PEELING TO WOOD REMOVAL NECESSARY

YOU PAINT

CAREFUL ATTENTION TO
SIMPLE PREPARATORY
DETAILS WILL ASSURE
A LASTING JOB

for repainting will be more extended. Scaling paint can be removed by scraping or wire-brushing, after which the surfaces are treated similar to new wood. But extensive blistering of the paint film and the peculiar "alligator," or "crackled-lacquer," surfaces less frequently seen are among the most difficult of all defects to remedy. In most cases complete removal is necessary, but if a blistered area is small a thorough scraping and sanding to level the paint film which still adheres sometimes will suffice. Paint remover in the paste form also is effective on small areas. Likewise, the prepared remover may be used in cleaning off small spaces presenting cracked, chipped or alligator surfaces. It also is especially effective in cleaning up turnings, newels and ornamental work which frequently adorns porches and cornices of very old houses. However, where the area is large, such as a side or gable end of the building, burning off the defective paint film to the wood with a blowtorch, Fig. 6, is considered the best practice. Unless you are accustomed to the work it's best to get experienced help for this job. In any case, it's essential that the siding be tight, that the flame be directed against the surface at an angle and slightly downward, and that the torch be moved continually to prevent charring the wood. Follow the flame with a scraper to remove the softened paint immediately. And always work with the torch on a quiet day—never when it's windy.

Fig. 2 illustrates two accepted methods

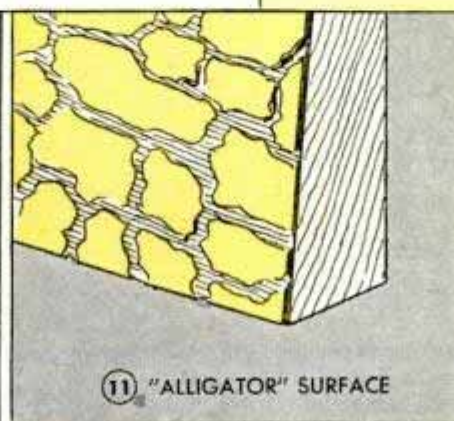
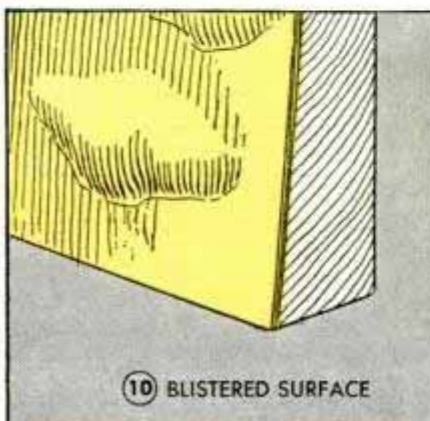
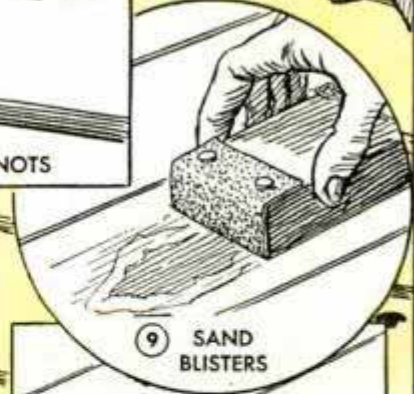
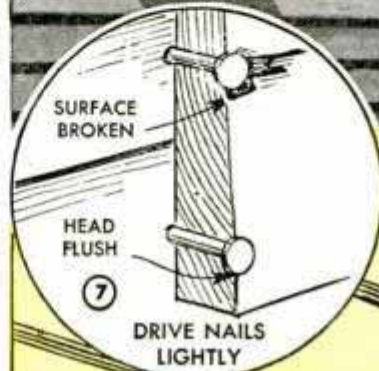
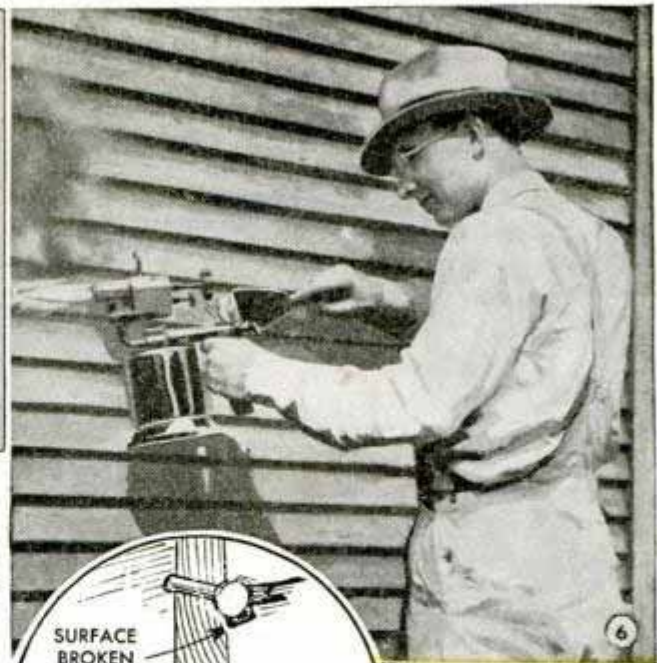

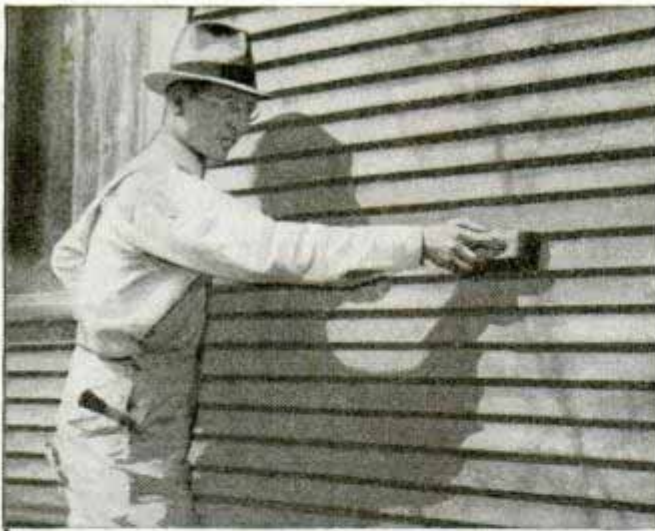

13 Siding should be thoroughly wire-brushed to remove all loose pigment. Follow wire-brushing with a light dusting immediately before applying fresh paint to the surface

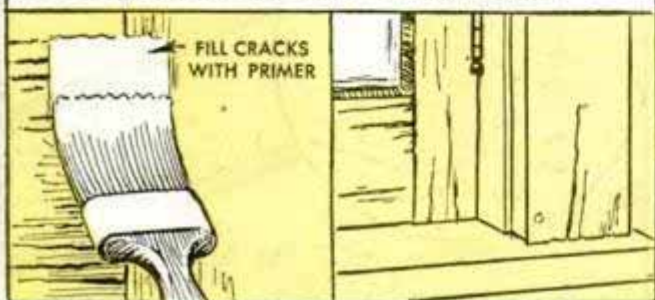

15 End checks and cracks in trim boards, door stiles and rails, sash and window frames should be cleaned and coated with primer before filling with white-lead putty

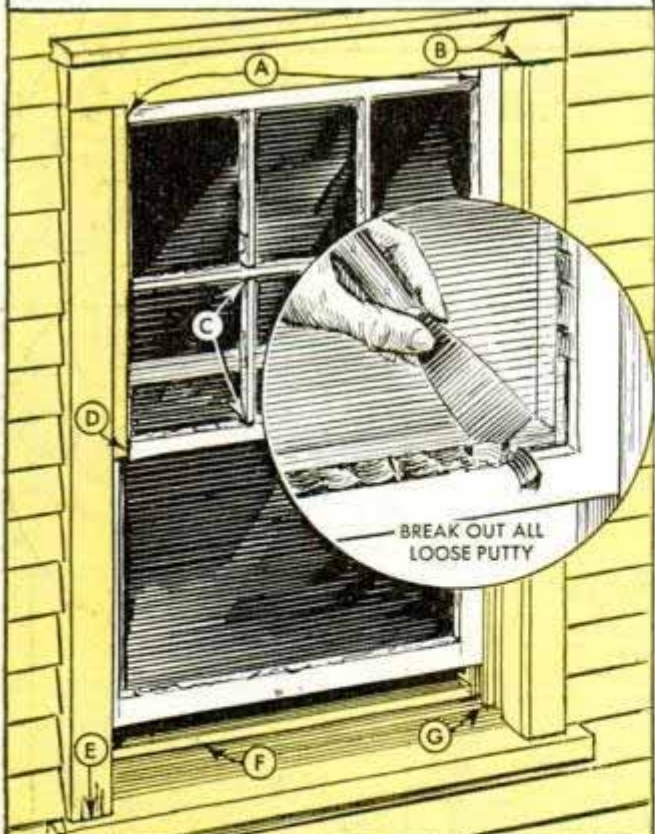

16 Reconditioning old sash and frames preparatory to painting involves breaking out all loose putty, priming and filling cracks and checks, and in some cases tightening up the sash frames by nailing loose rails to stiles

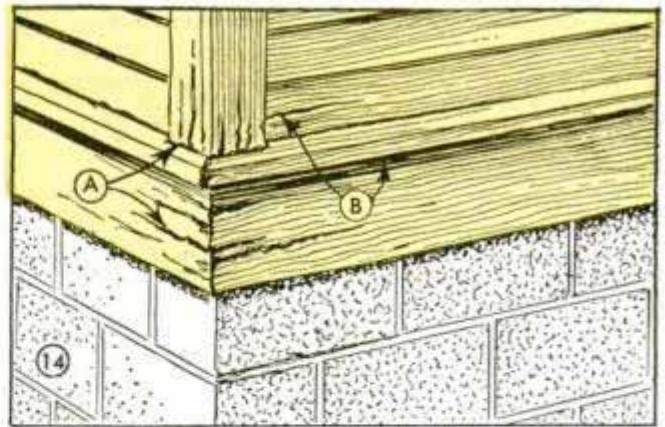

of painting the average frame home—two coats over a primer, or one finish coat over a prepared undercoater. If you paint at intervals of less than four or five years the latter method is sufficient. But if the painting schedule calls for renewal only once in five years or longer, the three-coat job usually is recommended. Preparation begins with an estimate of the amount of paint required for the job. Unless the surfaces are in unusually poor condition this can be calculated with fair accuracy by means of the simple procedure and formula shown in Fig. 1. Of course, in using the formula other factors should be taken into account. For example, where there are more than the ordinary number of windows or glass-paneled doors, it is safe to deduct the area of the glass. "Cut-up" gable construction and varying heights to the eaves also will affect the accuracy of the calculation.

Next, where the house is of frame construction, the siding comes in for a thorough going over. Often it will be necessary to renailed the siding, especially where it is exposed to weathering. Siding "cupped" outward between the studding calls for care in renailed. Use short, galvanized nails as these hold better when driven into the sheathing boards, and drill undersized pilot holes through the siding. Usually it's better to use two nails for each space between studs as in Fig. 7. Drive the heads flush, but do not sink them below the surface. After renailed go over all the siding, window frames, trim and cornices with a wire brush as in Fig. 13. This will remove any loose material that might flake off under the new coats of paint. It's a good idea to wear an approved respirator if you do much of this work. If any knots show through, sand off the paint and shellac as in Fig. 8. Some painters use spar varnish for this purpose. Any blistered spots where the paint chips off to the wood should be treated as in Figs. 9 and 12. Go over all sash and break out the loose putty as in the circular detail of Fig. 16. Conditions such as shown in Figs. 14, 15, 16, 17, 19 and 20 are quite common on the older houses. First clean the dirt out of all cracks and

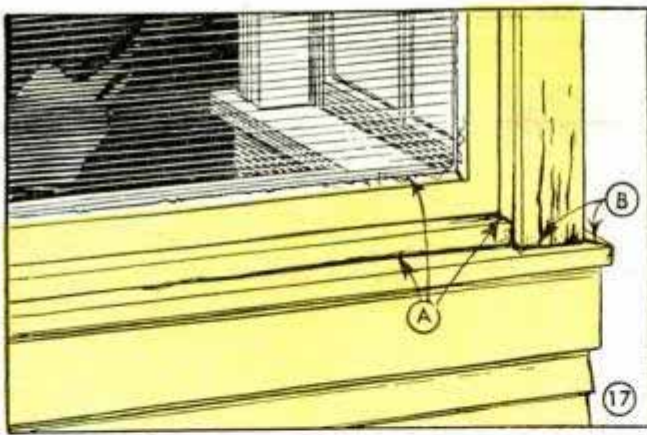

openings of the kind shown, then apply the first coat of primer as it comes from the container, without thinning. Brush at right angles to the cracks as in Fig. 15 to work the paint well into them. At the same time coat all bared spots on the sash where old putty has been removed as in Fig. 18. After this paint coating is thoroughly dry fill the cracks with a paste white-lead putty, using a regular glazier's putty only on the sash. Paste white lead as it comes in the container usually will serve, but if it should be too soft it may be brought to proper consistency by adding a small quantity of whiting. It's important to fill the cracks completely, otherwise the putty soon will loosen and drop out. At this stage some master painters remove all outside doors and prime-coat the bottom edges, first making sure that the doors close easily without sticking. When applying paint in the manner described it's essential to brush out all excess to a thin film so that it does not show through succeeding coats. Siding boards which are lapped at the corners frequently warp and split and the end grain weathers badly in time. No amount of paint will hide this unsightly defect. Treat these corners as shown in Fig. 20, first renailing if necessary. Siding boards mitered at the corners sometimes warp slightly and pull apart, opening the joint. Master painters often gently pry these joints open far enough to fill the space with white-lead putty. Then renailing will tighten the joints once more to a neat fit. In any of these preparatory jobs where white-lead or glazier's putty is used it is of the greatest importance that the putty be allowed to dry thoroughly before paint is applied over it.

Fig. 16, details A to G inclusive, show the common defects one finds on old sash and window frames, particularly where intervals between paintings are longer than average. Frequently the lower rail will be loose, perhaps dropped partially at one or both ends due to opening of the joints and weight of the glass, as at D. In many cases this defect can be repaired by wedging the rail back into place and nailing through into the stile, using a single large finishing nail. Paint the cracks in the trim boards and fill with the lead putty as already described. Do the same with the sash frame where necessary, Fig. 17, A and B. Also, you may find small openings where the siding boards butt against the

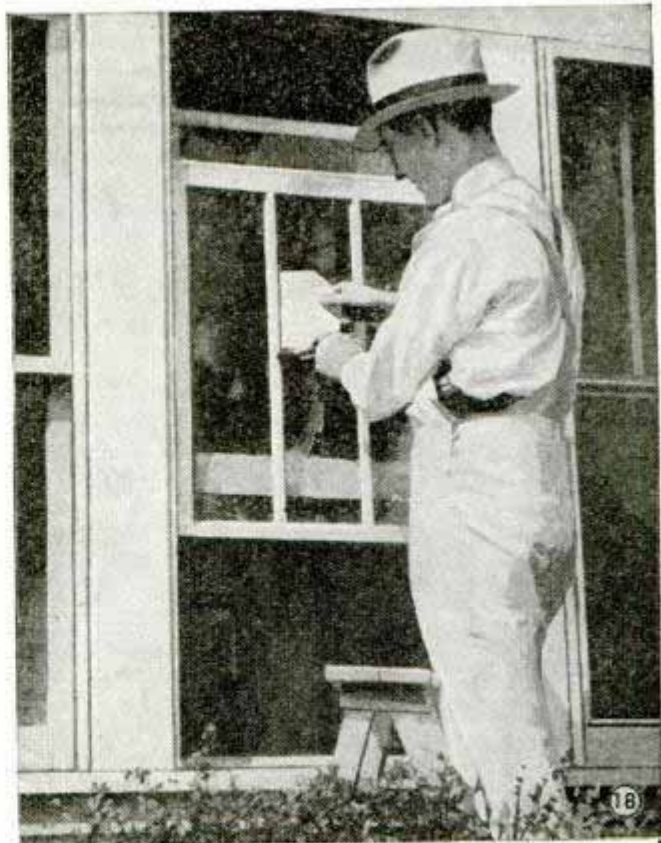

All spaces bared by removal of loose putty from sash should be coated with primer

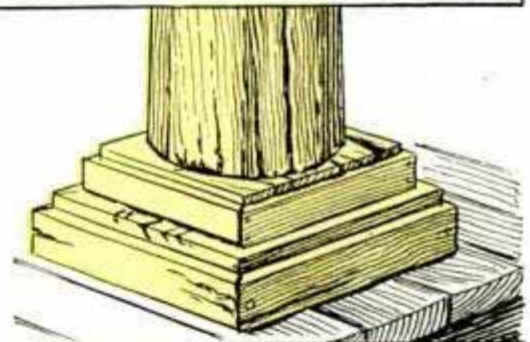

Cracks in old porch columns must be filled with white-lead putty before painting

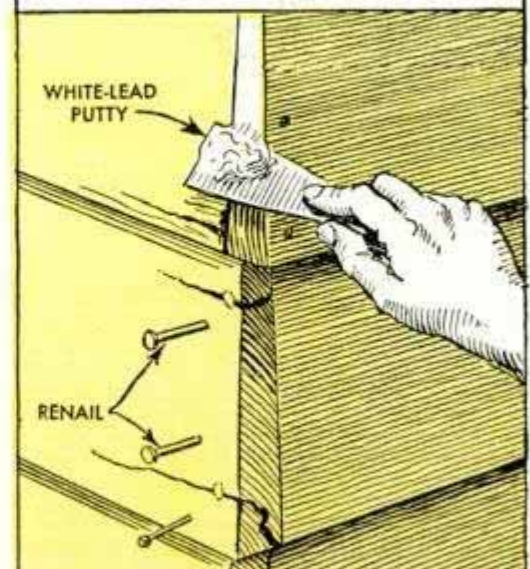

Coat the end grain of corner-lapped wide siding boards with white-lead putty and renail the corners if it is necessary to close wide cracks

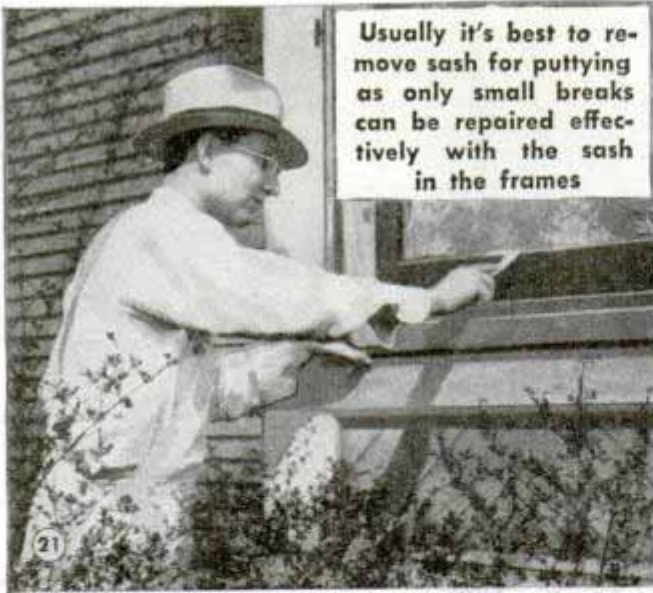

window frames or the corner boards, B in Fig. 14. Here's where the caulking gun comes in handy. Run a line of caulking compound into corner board and siding cracks and all around the window frames, also into the crack under the sill, as at A in Fig. 17. If the stops, G in Fig. 16, are loose, gently pry out the strip, prime-coat it and tap it back into place. Finally, putty the sash in the manner described, Fig. 21. In most cases, it is better to remove the sash from the frame for puttying, as it is easier to do the job properly with the sash flat and on a solid support. Smooth the putty into place with considerable pressure of the knife so that it will bond properly to both the wood and glass without any open spaces beneath. Open cracks usually will be found underneath boxed cornices, Fig. 27, and, although the wood is not subjected to weathering, the open cracks allow passage of cold air in winter and insects in summer. Fill with a caulking gun as indicated. If you find it necessary to seal the joint between a porch roof and the siding with roofing compound, Fig. 28, this should be done before painting. Such roofs should be flashed to the siding, of course, but in some instances it is easier to maintain the seal with roofing compound where flashing was not originally used.

Figs. 22 and 23 show two common defects, due largely to natural causes, which must be remedied before painting brick walls. Caulking around window and door

frames of brick buildings is a regular practice and usually the caulking should run all around the frame, including sills and thresholds, Fig. 24. Frequently, rather fine, irregular cracks following the mortar joints will be seen in brick walls. Those shown in Fig. 22 are quite common and are generally due to settling. Usually caulking compound gunned into such cracks makes a suitable repair as it will remain semiplastic after drying and will not break out even though there be slight movement between the edges. It also effectively keeps out water and frost. However, if the crack is wider than $\frac{1}{4}$ in. the repair generally should be made by pointing up with mortar. Likewise, brick walls in rather bad condition,

Fig. 23, with brick faces eroded and mortar crumbled out of the joints, should be pointed before painting. Buildings and homes of ornamental brick seldom are painted, but homes of all other types of brick—common, soft, pressed and de-aired—often are made more attractive architecturally and more durable by painting. Either the so-called white-lead-and-oil paints or the water-soluble paints made especially for outside masonry can be used satisfactorily on brick. The oil paint dries with a slight gloss on brick in good condition while the water paints dry with a flat, nongloss surface. Either paint is especially effective in "dressing up" old homes of brick. Except for the hard-pressed and de-aired

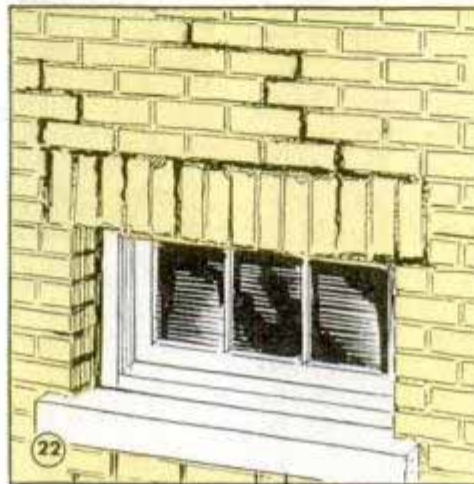

Caulking will effectively seal small cracks in both brick and stonework

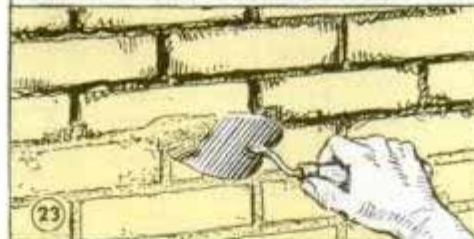

Brick walls in badly eroded condition should be pointed with mortar before painting



Window frames in old brick homes must be recaulked before painting. Be sure that the cracks are filled flush with the surface

types, brick is porous and absorbs paint faster than most kinds of unpainted wood. For this reason the coverage per gallon on brick painted for the first time generally is considerably less than on any bare wood.

If the brick is in good condition and all common defects have been repaired as previously described, there need be little other preparatory work, except that on very old brick homes a light wire-brushing is helpful in removing dirt and loose sand. Sometimes there are discolorations beneath windows due to rusty screens, soot or dirt. Usually a thorough brushing with a handled wire brush will suffice. Discolorations due to other causes, such as mildew or "sweating" chimneys, should be treated with a zinc-sulphate solution or white asphaltum before painting. Follow the manufacturer's directions when applying any of these preparations.

Before painting brick with a water-soluble paint it generally is recommended that the wall be kept moist just ahead of the paint application. This can be done with a wheelbarrow sprayer, wetting only a small area at a time. A damp wall retards drying, making it possible to apply these fast-setting paints without brush marks or laps showing. On the other hand, when applying a lead-and-oil paint it is essential that the brick be thoroughly dry.

Two more points to think of before you paint



"Before" and "after" views show how painting changes appearance

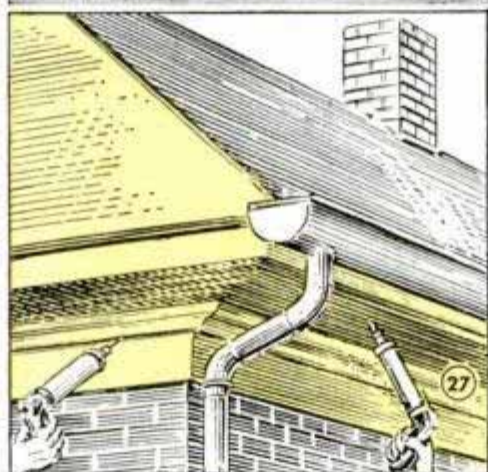

Cracks around cornices usually are best filled with a caulking gun. Be sure to force sufficient compound into the opening so that the soft material will bond to the wood



Joints between siding and roofs should be resealed with paste roofing compound before painting, or better, flashed to the siding if this was not done on the original work

are (1) the formula of the paint applied previously, and (2) how the paint you are to apply may change the appearance of the building. Using the lighter colors and white over a surface previously coated with a paint containing a tinting pigment of any of the so-called "earth" colors may under certain conditions cause "bleeding," that is, the darker color underneath may bleed through to the surface of the new paint, resulting in spotty discolorations. However, on old work in reasonably good condition where the previous paintings have been oxidized thoroughly, a good wire-brushing to remove all loose material down to the hard surface underneath and the use of

a prepared undercoater is sufficient precaution against the possibility of bleeding.

Figs. 25 and 26 are an example of how painting sometimes changes the appearance of an old house, of either brick or frame construction. Note in this instance how certain constructional details have been almost completely hidden by the paint job, while other features, particularly the size of the house, have been emphasized. Generally the lighter colors, including white especially, will tend to make the house appear larger in its setting. It's always well to bear in mind that painting can be used to accentuate or minimize certain details of a structure as well as to preserve its surface.

Brackets Make Concealed Hinges For Kitchen Cabinets

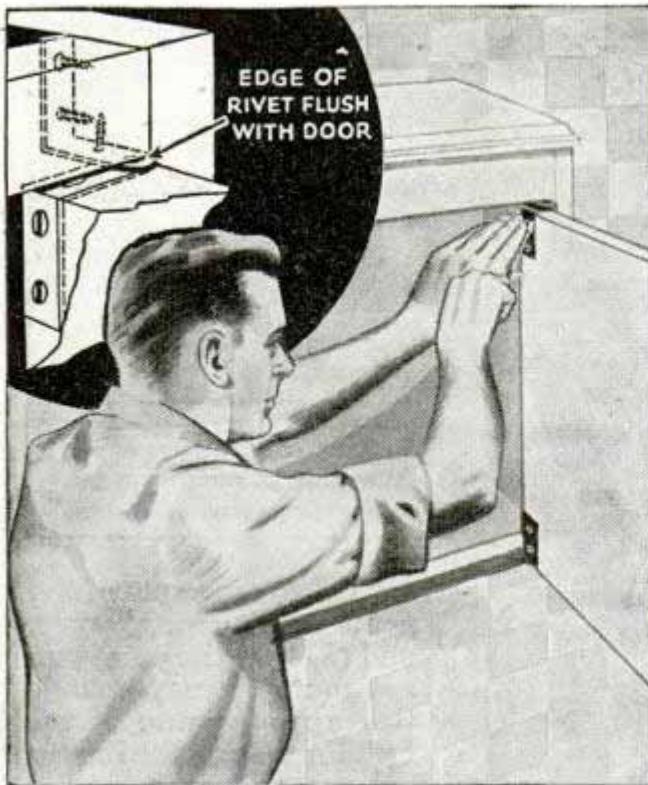

Hinges for kitchen cabinets are made easily with small right-angle brackets, and they have the advantage of being concealed. It may be that the brackets you get will have to be drilled and countersunk if they are not provided with holes of the right size and number to take two screws in one leg and a screw and a rivet in the other. If brackets are not available, they can be formed from strips of sheet metal and then drilled. After this has been done, place the brackets as indicated to form a hinge. Then rivet them together through the outer holes and round the corners of the ends. The hinges are fastened to the back of the door and inside the front of the cabinet with flathead wood screws.

House Number on Pipe Standard Removed When Mowing Grass

Two lengths of 1-in. pipe joined by a coupling will support a house number on the front lawn where it will be seen easily, and will allow it to be removed when the

grass is mowed. Split an 8-in. length of pipe at one end with a hacksaw and spread it to fit over the number, which then is bolted to it. The other length of pipe, which carries the coupling, is set in cement so that the

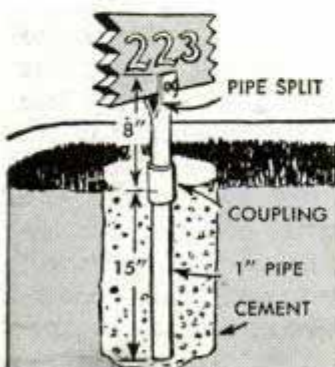

coupling is flush with the ground surface. The sign should be at right angles to the house to be visible from the street.

Pen-and-Ink Drawing From Photo Resembles Etching

You can make a pen-and-ink drawing from a photograph by inking in the image with waterproof ink and then bleaching out the photographic image. To do this, thumb-tack the photoprint to a drawing board and, with a fine pen and India ink, trace the lines and then work in the shading and texture. When the ink is dry, soak the print in water, then bleach out the photographic image by immersing the print in a solution made by mixing resublimed iodine, 1 teaspoonful, in water, 16 oz., and adding potassium iodide, 1 teaspoonful. These chemicals are available at photo supply houses. Or you can use tincture of iodine, 1 part, in water, 5 parts, leaving the print in the solution for about 5 min., after which only the pen-and-ink lines will remain. The lighter the print, the sooner it will become bleached. The chemicals will stain the print a deep brown, but if you wash it in water and place it in



a hypo fixing bath, the discoloration will disappear. The picture now should be washed in clear water to remove the hypo, after which it is dried.

Chalk Paste Removes Grease

To remove a grease spot from wallpaper, French chalk is mixed with dry-cleaning fluid to the consistency of a thick paste and applied to the spot. After remaining overnight, it then is brushed off carefully. The process can be repeated if the spot is still visible. — Joseph Greene Cleveland, Minneapolis, Minn.

Hammered-Metal Wrist Band Holds Your Watch

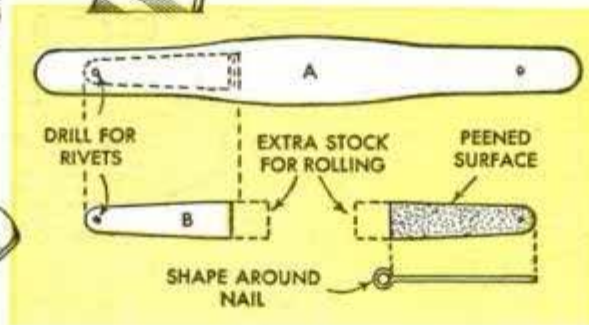
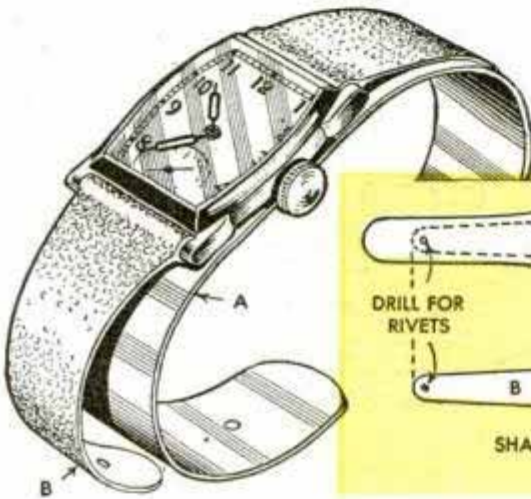

You can make this attractive watch band from 24-ga. stainless steel, half-hard aluminum or spring brass. First cut a paper pattern to a shape similar to that shown in detail A above. Use this pattern and measure your wrist to determine the size and length of the band desired. Cut the band to outline from the sheet metal and bend over an oval form of wood, hammering the

metal to shape with a small rawhide mallet. Smooth and round the edges with fine emery cloth and polish the band with fine steel wool. The secondary bands or "keepers," detail B, which fasten to the watch are cut to the shape indicated and then are peened lightly on one surface. Bend an eye in one end of each and determine the location of the rivet holes with the watch and keepers in position. Drill the holes and rivet the keepers in place, then lightly peen the rivets also. This type band holds the watch securely and is perspiration proof.

Pfc. Stanley J. Drazek, Tyndall Field, Fla.

Damaged Laundry Tubs Can Be Converted Into Useful Containers

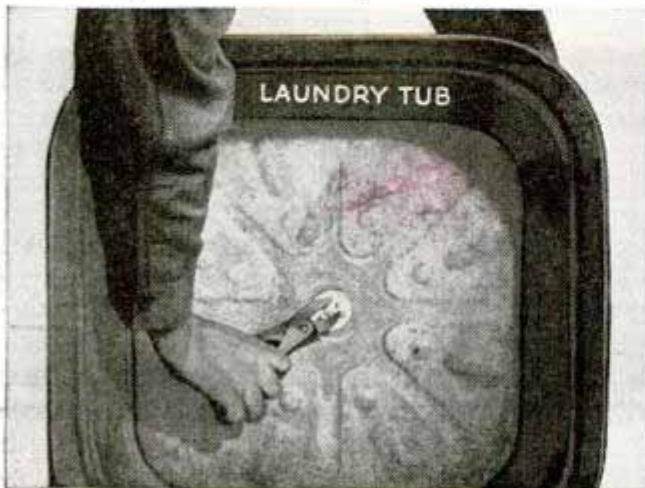

Laundry tubs having hose connections that are broken can be converted to other uses by removing the connection and stopping the opening. The original hose attachment is removed and the hole is plugged with a metal patch of the type used by electricians for closing knockouts in outlet and fuse boxes. A gasket should be inserted between the patches to prevent leakage.

H. Leeper, Canton, Ohio

☞ Since warm furniture polish penetrates wood pores faster, you can do a more efficient polishing job by first warming the bottle of polish in hot water.

DISCARDED Make Attractive

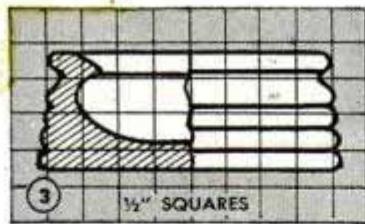
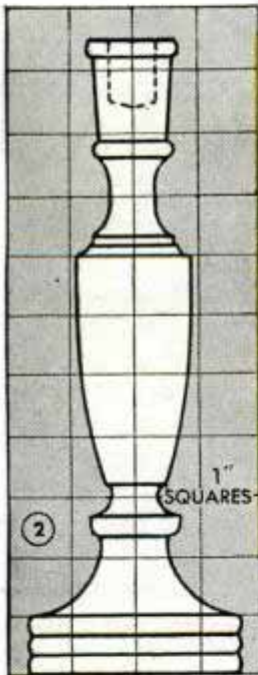

Photos courtesy Chicago Servicemen's Center

MADE from the highest grade seasoned hard maple, discarded bowling pins are an excellent source of material for wood turnings. In the average bowling alley the life of the pins is only a couple of months or so. Of course, this may vary somewhat, depending on the activity of the alleys, but in all cases the pins must be replaced at regular intervals. Usually, the owner of your local alley will be glad to give you the discarded pins.

Their size and shape make them especially suitable for a variety of useful and attractive articles, such as those shown in Fig. 1, photos A to G inclusive. In addition to these there are a number of other practical accessories which can be made from the discarded pins, among them being large

buttons, wheels for small wagons or shopping carts, knife handles, coasters, etc. Standard pins have an overall height of $14\frac{3}{4}$ in. but most of them have a tapering hole at the bottom about $1\frac{5}{8}$ in. deep. For most uses the hole must be cut away, so the net height for all practical purposes is approximately $13\frac{1}{8}$ in. The largest diameter usually is $4\frac{3}{4}$ in. and the smallest diameter is about $1\frac{1}{2}$ in. Thus the range of single turnings or one-piece articles to be made from pins is limited by these dimensions, although articles of larger size, such as the blotter, Fig. 1, B, can be produced by cutting two pieces from a single pin. Being made originally from selected stock, the condition of used pins generally permits working close to the overall size, but occasionally there will be one with splits, checks or other damage due to severe usage. This defect will prevent it from being used for any turning that requires a full dimension near to the overall diameter of the pin. All old pins should be examined carefully to make sure that splits, checks or other defects do not go so deep as to spoil the work being planned. Some pins with only minor defects, especially those from which turnings are to be made, can be repaired with colored stick shellac or "wood-turner's ce-

BOWLING PINS

Home Accessories

By E. N. Moore

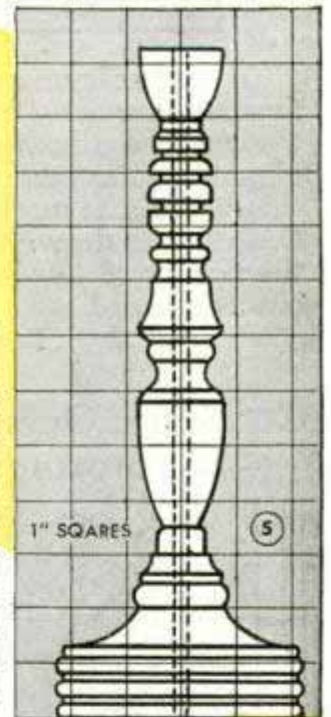
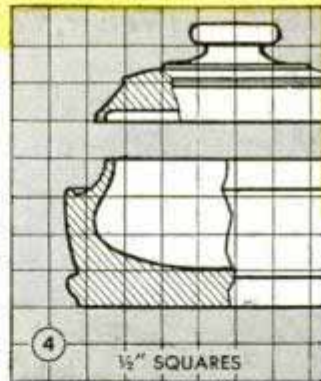
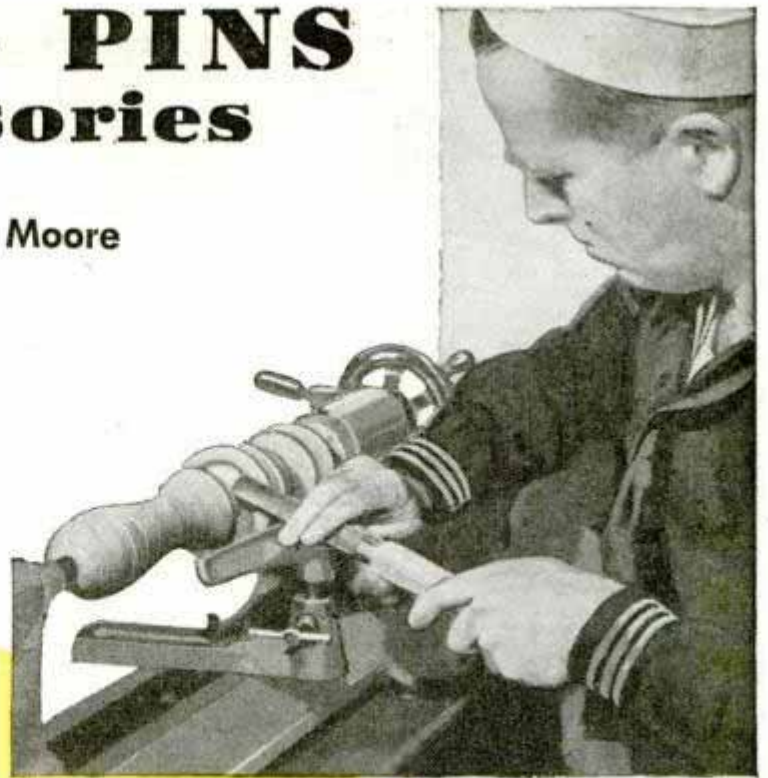
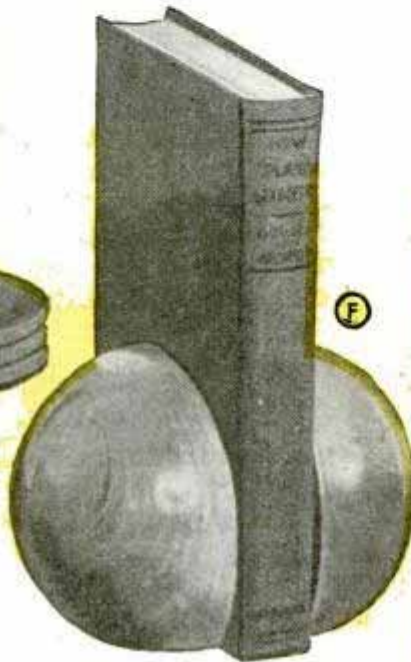

ment." Melt it into narrow checks, cracks, or deep dents with a soldering iron heated to low temperature.

Among the most popular and attractive articles that can be made from bowling pins are candleholders and lamp bases, Figs. 1, 2 and 5. In making either of these the first step is to mount the work in the lathe and turn to the style desired. Next you sandpaper to a glass-smooth finish, using progressively finer grades of sandpaper. Run the lathe at a moderate speed for sanding. Then apply linseed oil and a paste wood filler, or, if it is desirable to darken the wood, mix a stain with filler and omit the oil. In any case, allow the filler to dry thoroughly, then sandpaper again lightly to remove the surplus. Finish with several coats of paste wax. Polish the wax with a folded piece of cheesecloth or muslin, and run the lathe at a comparatively slow speed for polishing.

Drilling holes for the lamp cord and candle socket comes next. A candleholder should have a hole at the top approximately $\frac{3}{4}$ in. in diameter and $\frac{3}{4}$ in. deep. Use a $\frac{5}{16}$ -in. drill to make the hole for the lamp cord. Drilling usually can be done from both ends, that is, halfway in from the top and then finishing from the bottom.

Powder and jewel boxes and ash trays, A and G in Fig. 1, are easy to turn from the large portions of the pins. Figs. 3 and 4 give the cross-hatched patterns. One of the simplest of all the projects, the semicircular book ends, F in Fig. 1, can be turned first to the spherical form and then cut in half with a parting tool while in the lathe. Finish the sphere before cutting into halves, using filler, or filler and stain, and wax. Sand a flat on each and if necessary weight with lead. As a finishing touch, glue soft leather, flannel or felt to the bottom of the bases of candleholders, lamp bases, book ends, ash trays, etc. Line jewel boxes with velvet or other suitable fabric carefully glued in place so that it is free of wrinkles.

Linoleum Is Fitted Accurately By Measuring Depth of Corner

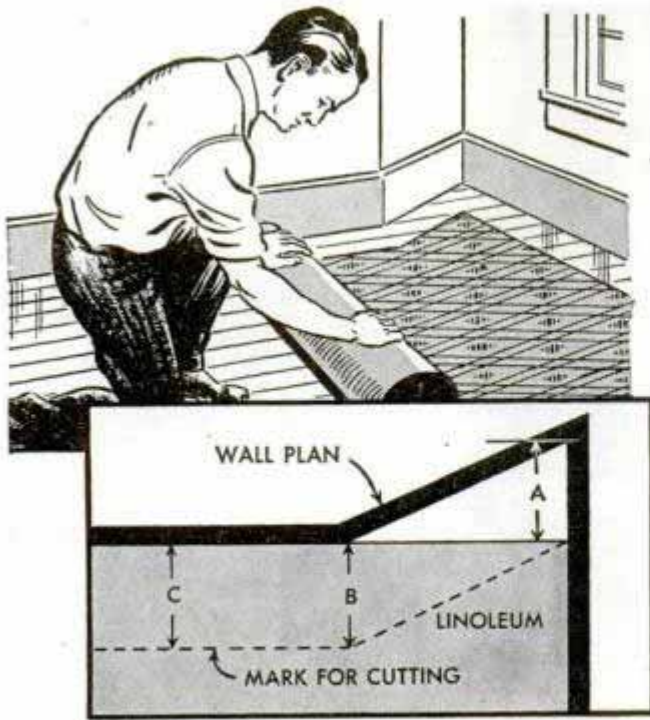

To lay linoleum on an irregularly shaped floor, fit it exactly into all corners by using the method illustrated. The linoleum is aligned against the wall and distance A in the diagram is marked off at points B and C. A line is drawn through these points to the corner of the linoleum, which then is cut as marked.

Jack Bronte, Grass Valley, Cal.

Concealed Opening in House Wall For Storing Wet Rubbers

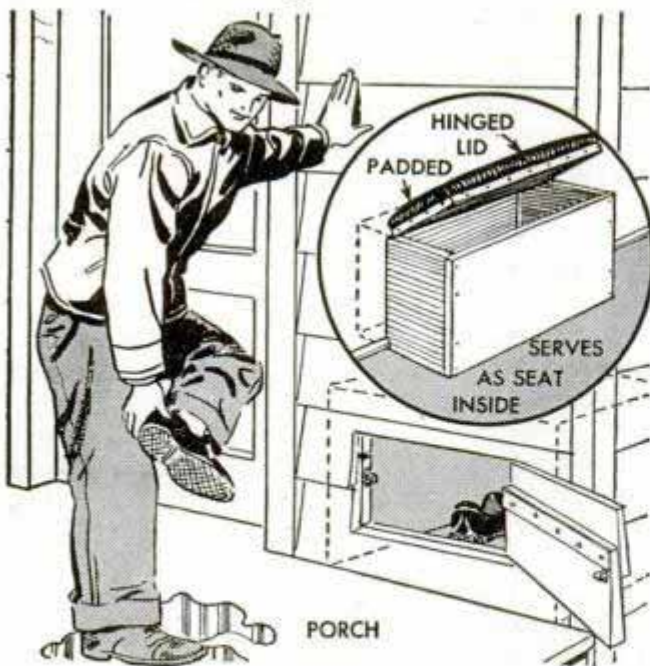

By cutting an opening in a house wall adjoining the back porch and building a cabinet around it on the inside of the house, you can provide a handy compartment in which to store wet or muddy rubbers and over-

shoes. The cutaway siding swings on concealed hinges so that the opening is not easily detected, and is held shut by a friction catch. A padded lid is hinged on the cabinet to serve as a seat when you put on the rubbers, and the compartment is lined with linoleum, the outside being painted or varnished to match the trim.

B. A. Rhoades, Omaha, Neb.

Wax Paper Wrapped on Dry Cells Protects Flashlight Case

To prevent dry cells from corroding the case of a flashlight when they wear out and begin leaking, they can be wrapped in wax paper before inserting in the case. The strip should be long enough to fold over the ends of each cell, leaving just the contacts exposed. A wrapping of this kind also will help in removing cells that have swollen within the case.

Ben L. Ashley, Santa Monica, Calif.

Shoe-Polishing Kit in a Brush

Those who like to travel light will find that this shoe-polishing kit takes up very little space. It consists of a brush, a piece of wood of the same size and shape as the brush handle and a $\frac{1}{4}$ -in. lid hinged at one end and provided with an eye for a hook as illustrated. The brush handle is planed down flat, then the piece of wood is recessed to take a can of polish and a strip of cloth, after which the piece is glued to the brush handle. Two coats of varnish will add to the appearance of the kit as well as protect it against hard usage.—D. E. Horn, River Forest, Ill.



Proper Way to Slide Down a Rope

The correct way to slide down a rope is to stand upright, extend your right leg, and by swinging it in a circular motion, wrap the rope around it one complete turn. Then grip the rope in the crook of your right elbow to steady your descent. In this way, your clothes will prevent the rope from being in contact with the skin and burning it if you descend rapidly. By straightening your leg you will release tension on the rope so that you can slide down rapidly, and by bending your hip you increase the grip to slow your speed.

Mrs. Louise G. Royston, Los Angeles, Cal.

look for...

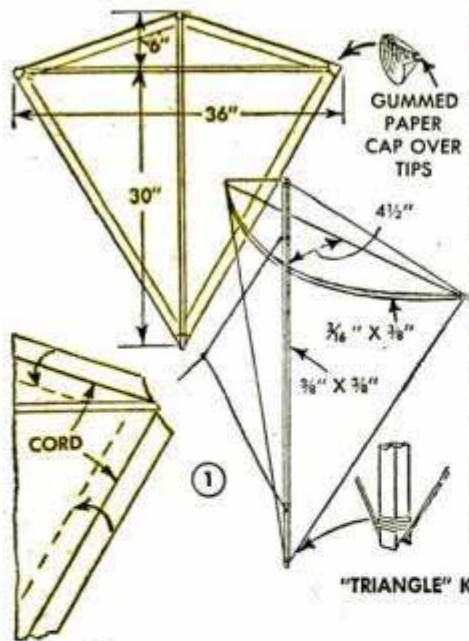

"TRIANGLE" KITE

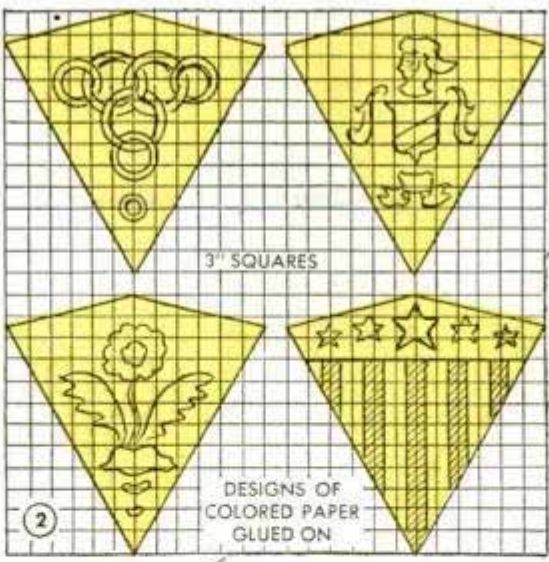

DESIGNS OF COLORED PAPER GLUED ON

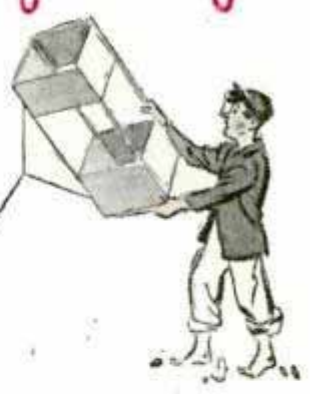

SIX GOOD KITES

By Hi Sibley

UNLESS you prefer the more complicated designs, kites are simple to build. You need only a few sticks, string, paper and a tube of glue to build a flying kite. A few details are important. Where there are curved surfaces it's necessary that the curves be regular, and most kites do not fly well unless you have the bridle properly attached. Some need a tail to hold them steady in the air.

Figs. 1 and 2 detail the reliable tail-less kite which has always been a favorite. The dimensions given are for a convenient size, but the same proportions should be maintained for larger or smaller ones. This kite consists essentially of two sticks tied together at right angles, the shorter one bowed as indicated. A string drawn taut over the ends of the sticks holds the parts in position under tension. Fig. 2 suggests four designs that may be used to decorate the kite. Note that the cross stick is six inches from the top. The sticks are joined at the center with glue and a brad and then tied with heavy thread. The cross stick is bowed after the paper is glued on.

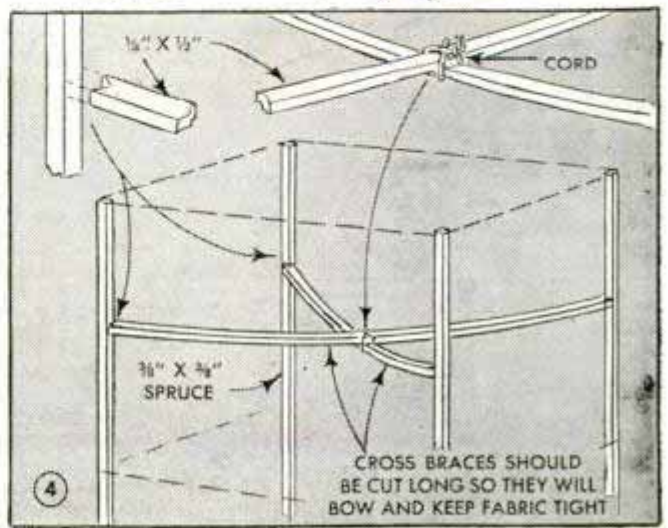
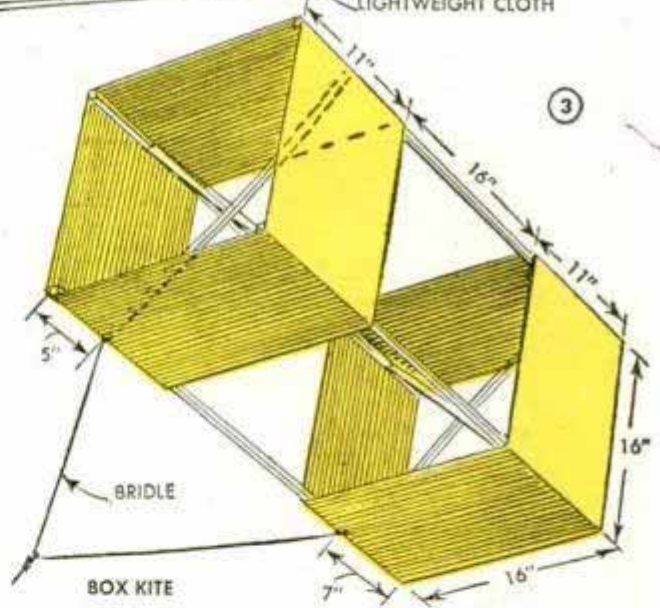

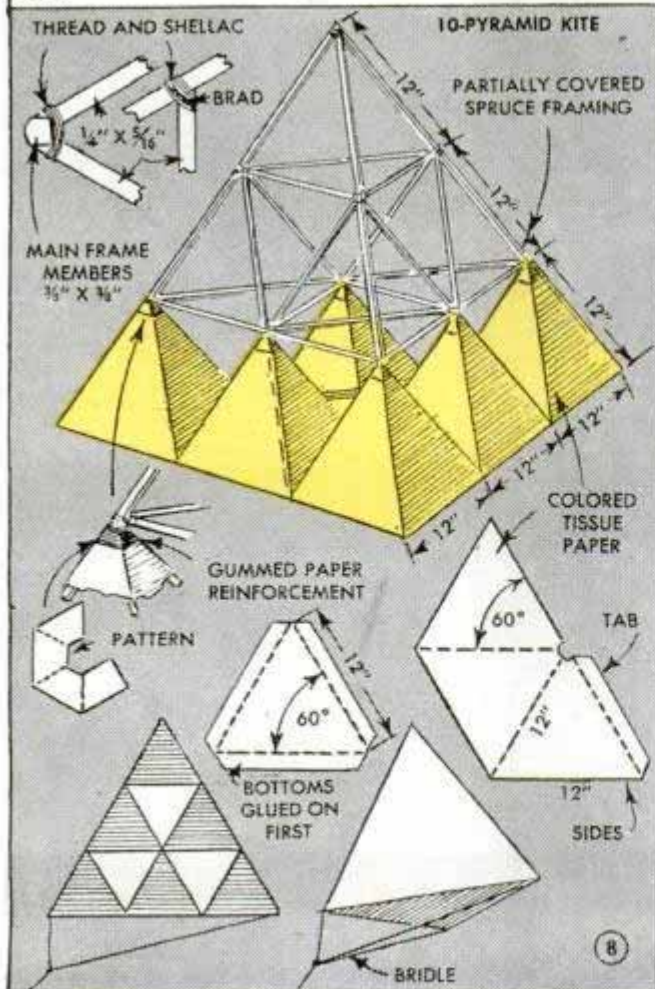
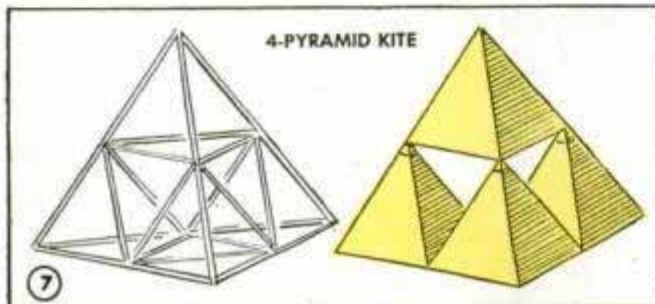
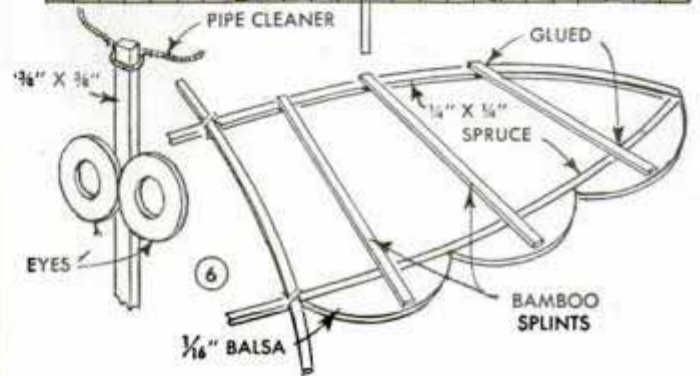
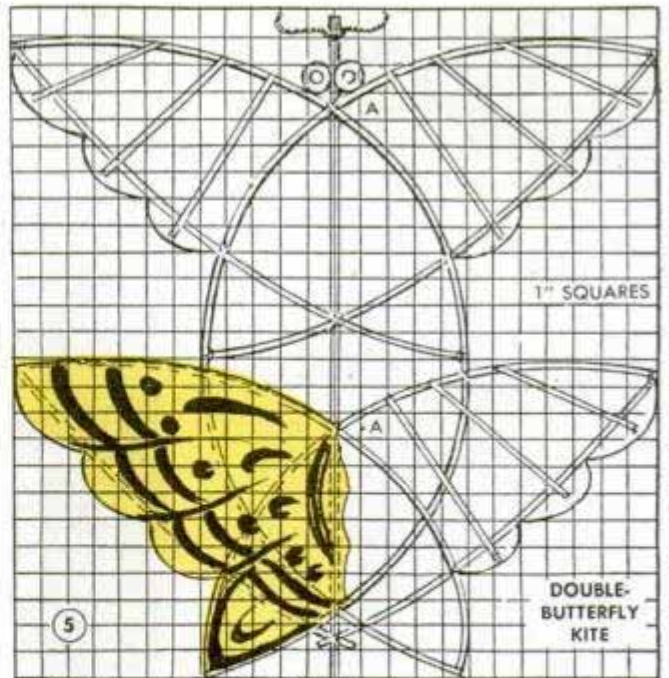
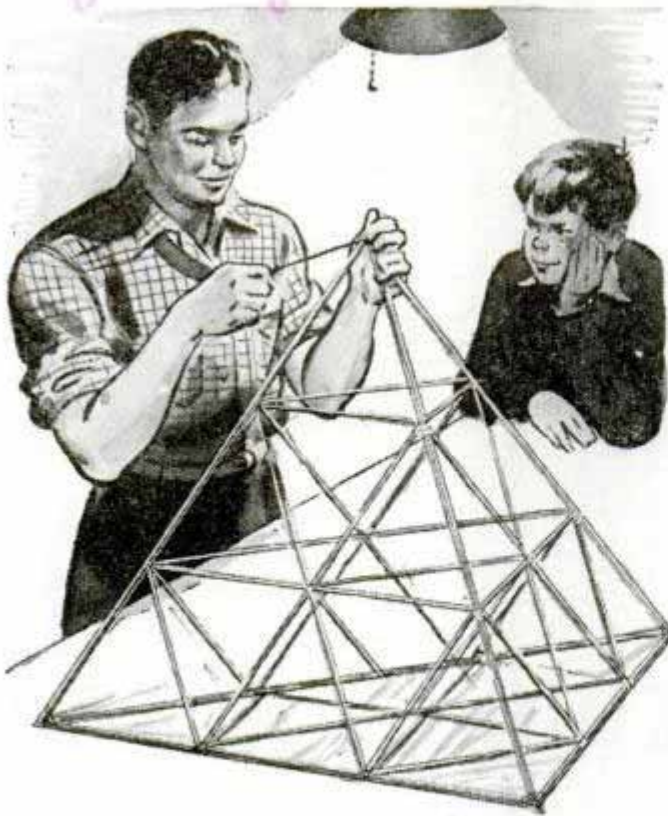

The details in Fig. 3 show how to make a high-flying box kite. Be sure the corner sticks are an equal distance apart and mark the cloth covering accordingly. Note that the diagonal braces are cut slightly longer than the actual measurement so that when installed they will keep the covering under tension, Fig. 4. Fabric is glued or stitched to the corner sticks and the diagonal braces are installed last.

The tetrahedral kite, Figs. 7 and 8, can be built in any size. The smallest one, Fig. 7, has four units. Each side of the individual unit is an equilateral triangle. The main pyramid is made first, and then the horizontal members are installed, followed by the separate units. The main frame members are rounded at the outer corners with joints glued and tied. The tissue covering is glued to the individual units bottom first, lapping the edges over the framework. Unusual effects can be achieved by using paper of contrasting colors on adjacent units. The bridle is attached to the three bottom corners.

It takes a little more time and care to make the butterfly kite, shown in Figs. 5 and 6, because of the several curved parts, but properly made it's a vigorous flyer and novel in design. The curved framework is made from spruce or rattan strips braced with balsa and bamboo splints. Wings are

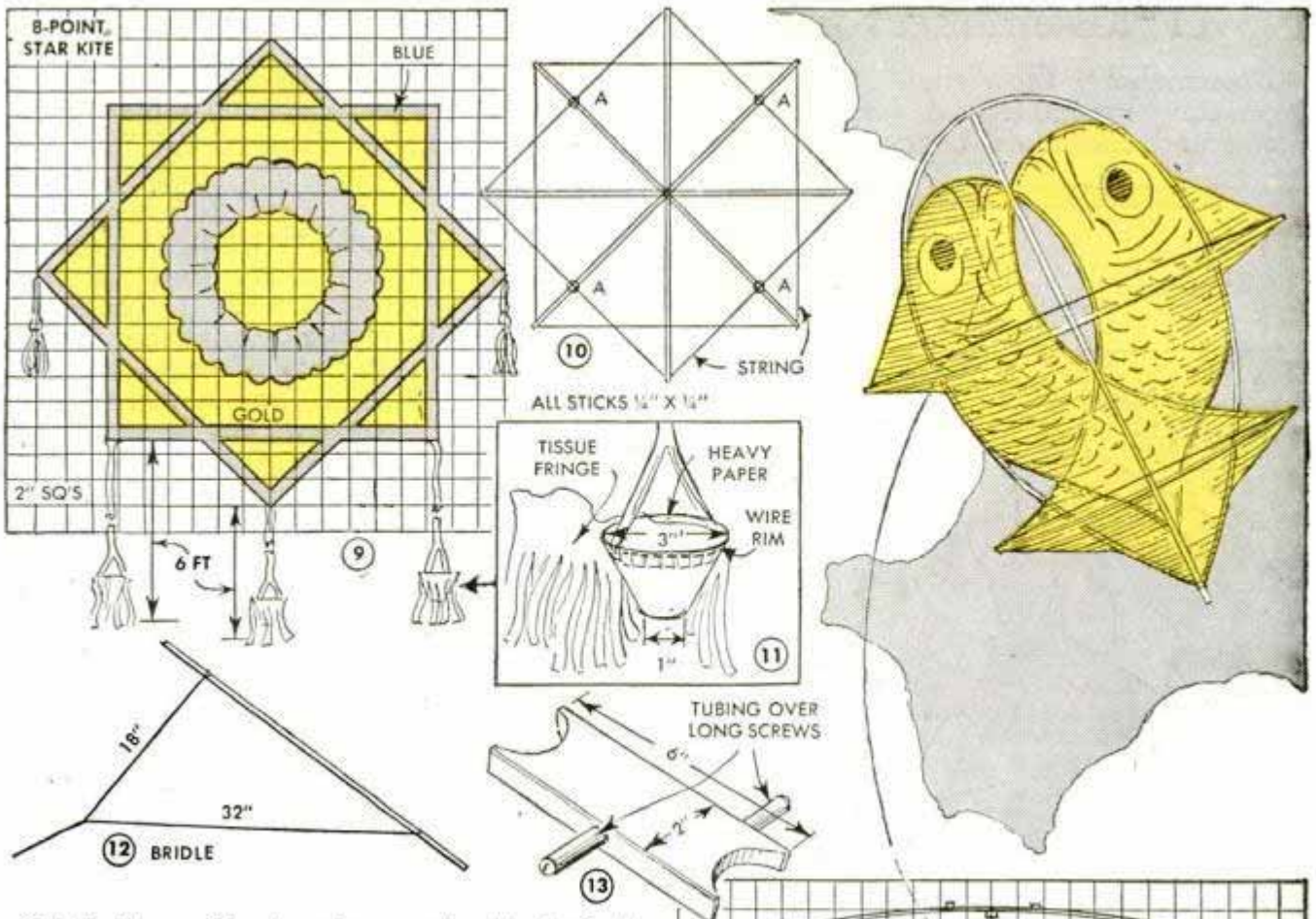

slightly bowed by tension cords attached at the tips and are covered with tissue paper in the pattern shown. The left-hand detail of Fig. 6 shows how the eyes and antennae are made. The bridle is attached at points A-A. A conventional tail is required for this kite. In bending spruce wood for this type of frame the strips should be soaked in water overnight.

The twin-fish kite, Fig. 14, is similar to the butterfly kite in construction, consisting of a curved spruce frame with back fins and part of the tail covering fastened to string, which shapes the fish. Paper coverings may be hand painted or separate scales of blended blues glued to a light-tinted ground, with red eyes and gills. The kite is bowed with a cord tied to tips of the horizontal member. It requires a tail made in the conventional manner. The star kite, Figs. 9, 10, 11 and 12, depends upon its decoration and balancing cups for novelty. The bridle is attached at four points, A-A-A-A, using two 18-in. strings at the top and two 32-in. strings at the bottom as indicated in Fig. 12. Balancing cups, Fig. 11, are open at the bottom to permit air to pass through and furnish a light drag.

Two easily made reels are shown in Figs. 13 and 15. One consists of a flanged wood disk mounted on a handle, Fig. 15. A hook bent from heavy wire locks the disk. The other reel, Fig. 13, is simply a piece of 1-in. pine shaped as shown and provided with handles for turning. A reel is a necessity in handling the larger kites.

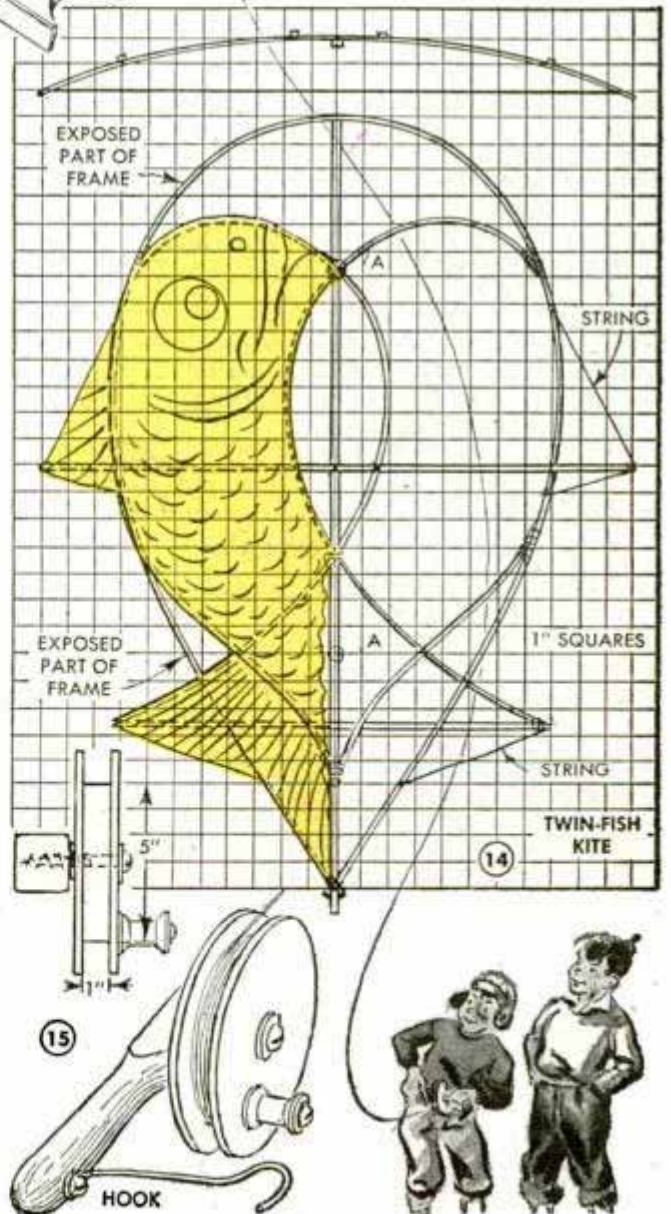

Novel Noisemaker for Children Made From Sheet of Paper

Noisemakers, the delight of all small boys, can be made from paper, and, unlike metal and cardboard horns, are safe for

young children as there are no detachable mouthpieces or sharp edges to cause injury. Begin by rolling a sheet of thin but stiff paper on a pencil, dowel or round stick to form a tube, starting at one corner of the sheet as indicated in Fig. 1. The rolled paper then is secured with a strip of cellulose tape, Fig. 2, and the pencil is removed. One projecting end of the tube is sliced with a razor blade, Fig. 3, to form a tab, Fig. 4. This is bent upward against the tube as shown in Fig. 5. When the tube is placed in the mouth, breathing in and out will make the tab vibrate against the end of the tube and produce a whirring or rasping sound.—Paul Le Bel, Pembroke, Ont., Can.

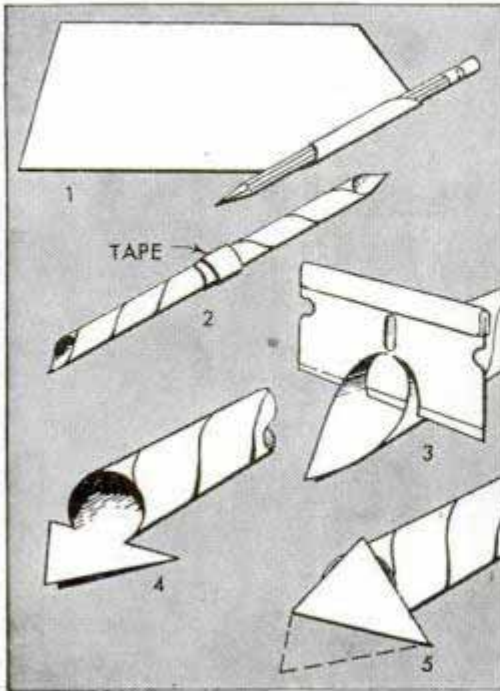

Dog's Own Private Entrance Installed in Large Gate

Every dog has his day, but not every dog has his own gate. You can, however, cut a square opening in a large gate, nail a cleat at top and bottom to hold the pieces together, and pivot the cutout on a rod as illustrated. Then the dog can leave the back yard without your help, and he'll let himself in again just as independently.

Donald Schlichting, Brownsdale, Minn.

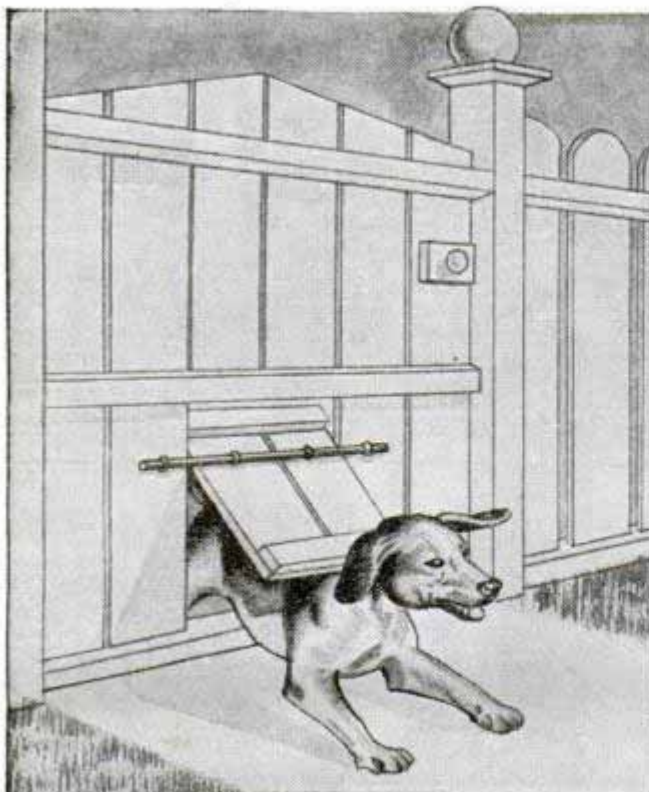

Canvas Covers for Animal Traps

To prevent stones, dirt and other objects from becoming wedged under the pans of animal traps and clogging the spring release, lightweight brown canvas covers can be slipped over the pans. A paper pattern should be made first to fit the traps exactly, after which the outline is traced on the canvas and then cut out.

R. Jenkins, Los Angeles, Calif.

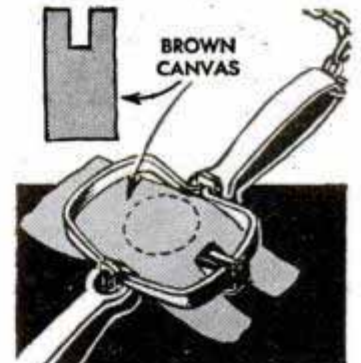

Ring on Fishhook Grips Line

Formed into an eye and twisted around the shank of a fishhook, a short length of light wire will grip the line so that it cannot loosen and become untied. This method is especially suitable for lines made of plastics and similar material, which may become slippery when wet. When the line is tied, the ring clamps against it to prevent loosening.—L. Meehan, Toronto, Ont., Can.

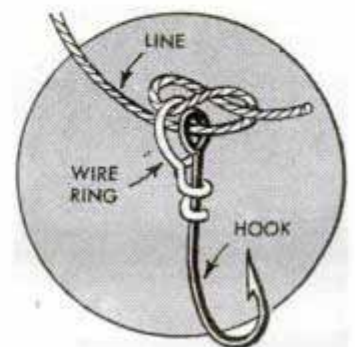

"KILTIE" A Model Racing Yacht

By John Black

Ex-President International Model Yacht Racing Union
(Continued from last month)

AFTER completing the hull of Kiltie described last month, you are ready to rig her for the "maiden voyage." The stock for the mast, boom and jib pole should be clear, straight-grained spruce or white pine tapered to the dimensions given in Fig. 12. This is best done by first planing the stock to 4-square, tapering the ends 4-square and trimming the corners for the full length to produce eight-sided pieces. You now can round the work with a block plane as in Fig. 14 and finish with sandpaper. Give all spars one coat of white shellac at this time.

Next to the shape of the hull the most important parts of a yacht are the sails. Every skipper is desirous of getting the best-cut sails and is very careful how he uses them. Do not use new sails in a strong breeze until they have been stretched thoroughly. If new sails are to be used in wet weather, stretch them loosely on the spars.

Material for the sails should be a strong, closely woven fabric, preferably long-staple sea-island cotton. Number 4 sailcloth is a very good material for sails and can be purchased in white or bright colors. When laying out the sails dimensioned in Fig. 13, place the cloth on a table or the building board used in making the hull and tack or weight down the corners. Be careful not to stretch the material as this may alter the cut of the sails. From one corner of the selvage edge measure $3\frac{1}{2}$ in. in from each edge and make a pencil mark. Label this point No. 1. From this position measure 68 in. along the selvage edge and make a second mark $3\frac{1}{2}$ in. in from the edge, and mark this No. 2. From this position measure $\frac{3}{4}$ in. at right angles from a light line drawn between Nos. 1 and 2, and mark this No. 3. Now measure 66 in. from No. 3 and 24 in. from No. 1; the point where

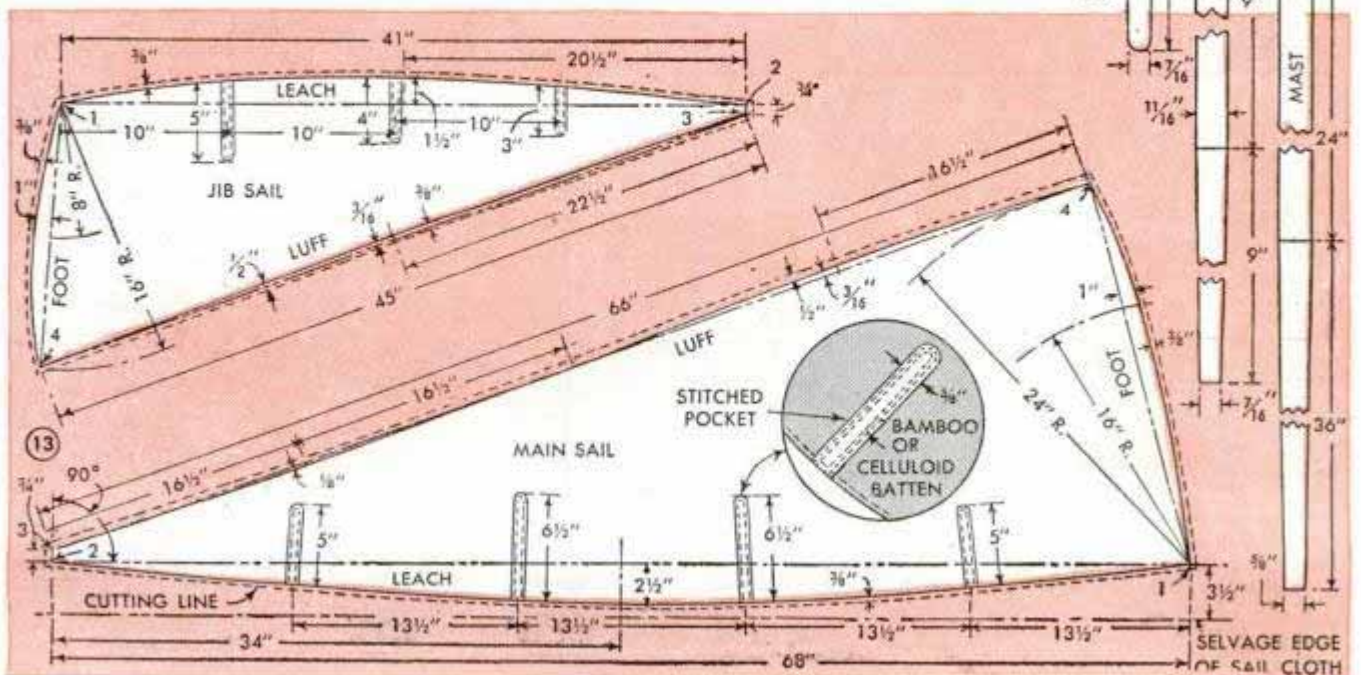
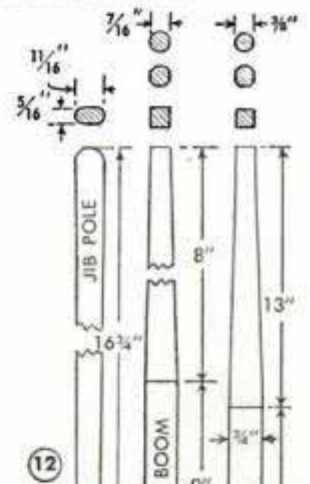



dimensions shown in Fig. 13, which allow $\frac{3}{8}$ in. for hemming the foot and $\frac{1}{2}$ in. for the luff. Make the same allowances on the jib sail. Before cutting the sails, $\frac{1}{4}$ -in. or $\frac{3}{8}$ -in. linen tape should be sewed on both sails inside the solid curved line between corners 3 and 4, and sewed straight between 4 and 1. The tape will keep the cloth from stretching while the edges are being cut. Corners of the sails should be reinforced by sewing a triangular piece of cloth across each one before hemming. The batten pockets are made from linen tape $\frac{3}{8}$ in. wide with the outer end left open to allow the battens to be inserted. When the sails have been completed, press them with a hot iron and put an eyelet in each corner. Dress hooks spaced as shown in Fig. 18 are sewed to the luff of the main sail to attach it to the mast by means of the wire jack line.

Although model-yacht fittings can be purchased at a reasonable cost many builders like to make them because of the desire to have every part of the model hand made. For those who wish to make their own, complete detailed drawings showing materials to be used are given in Figs. 15 to 18 inclusive and 20 and 21. Note that there are two travelers required. The forward one should be $\frac{1}{2}$ in. high and the after one $\frac{3}{4}$ in. high. Be sure to assemble the trolleys in position on the travelers before soldering the traveler hold-down flanges in place. The following sizes of bowsers will be needed:

these two lines intersect will be the tack of the main sail, or No. 4. From the center of the light line measure $2\frac{1}{2}$ in. towards the selvage edge, and with a strip of wood or batten, Fig. 19, draw a curve between Nos. 1 and 2, passing through the $2\frac{1}{2}$ -in. mark. Then measure $\frac{3}{8}$ in. outside of this line and draw a second line; this is indicated by the dotted line in Fig. 13 and is the cutting line which allows $\frac{3}{8}$ in. for the hem. Repeat this procedure on the other sides using the

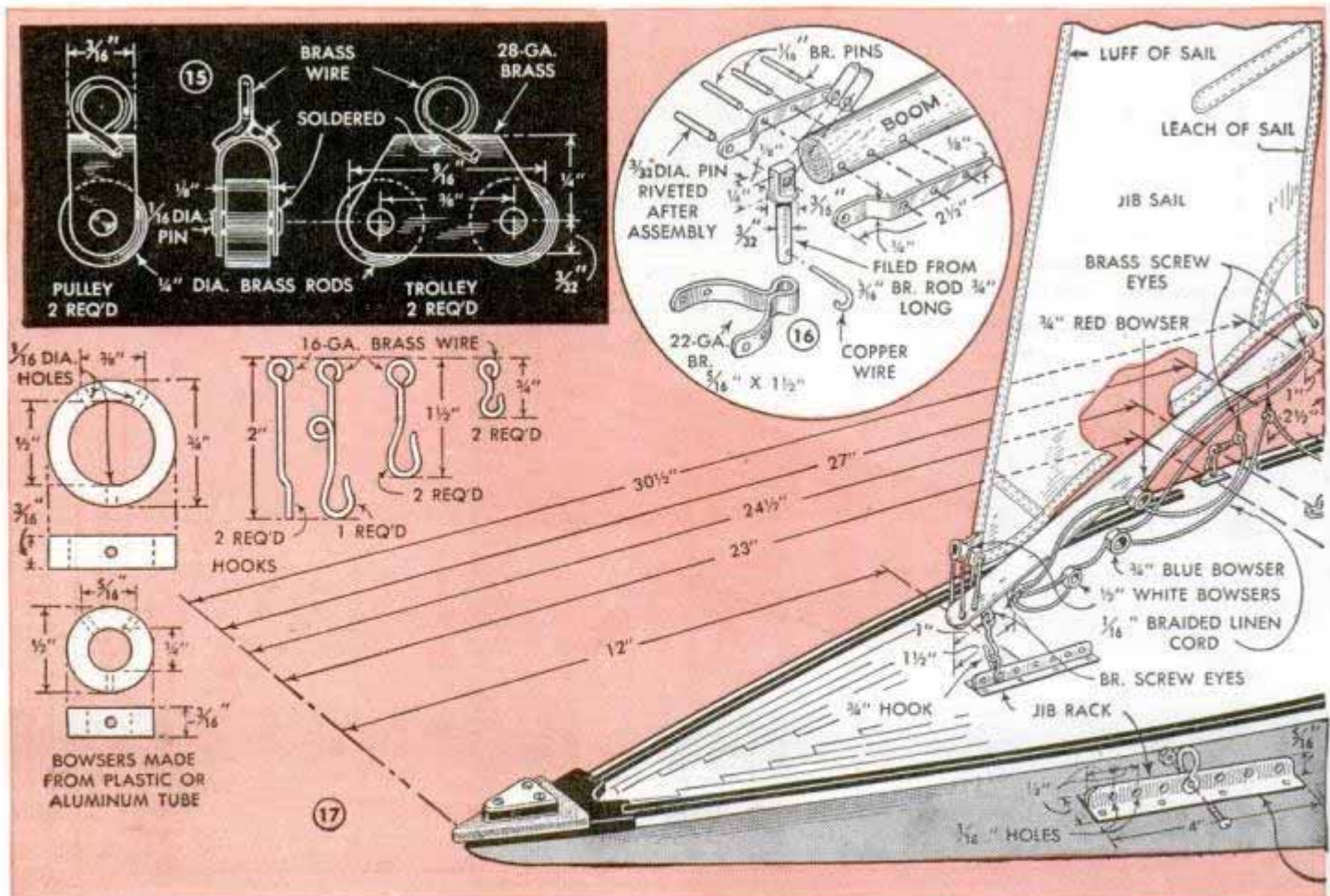

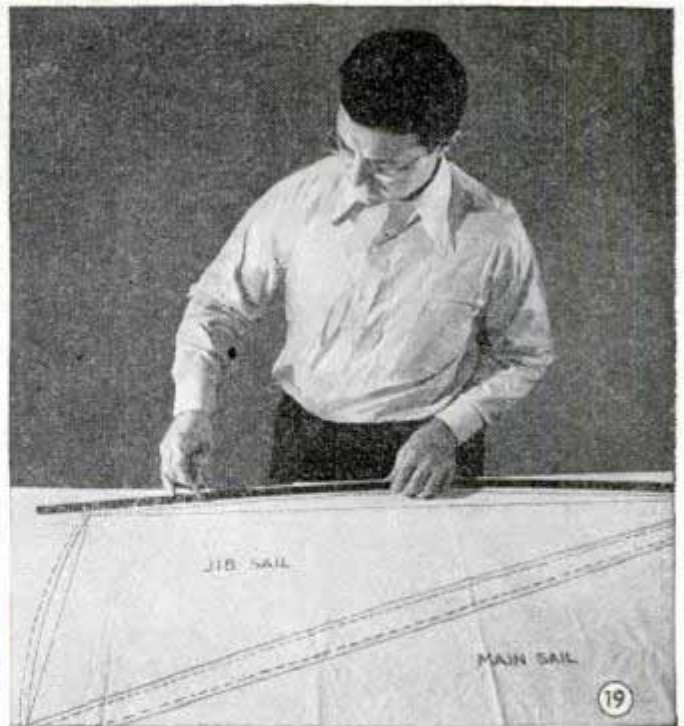
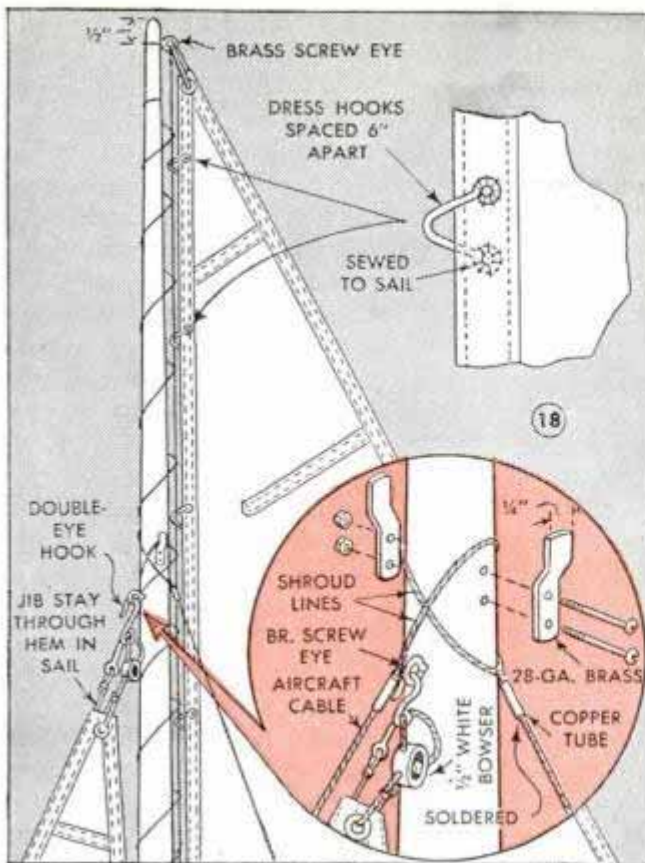

two $\frac{3}{4}$ -in. red, two $\frac{3}{4}$ -in. blue and six $\frac{1}{2}$ -in. white. These may be made from colored plastic tubing or from aluminum tubing and painted. The track detailed in the upper right-hand corner of Fig. 17 is formed over a strip of metal $\frac{1}{16}$ by $\frac{1}{4}$ by 6 in. which has the long edges rounded. When finished the

track should have a slot $\frac{1}{8}$ in. wide. The slide shown just to the right of the track should move easily in it. In making the quadrant it is suggested that the layout be transferred to the stock from a scaled enlargement of Fig. 21. The center lines of the various arcs are on the line that passes through the center of the $\frac{1}{4}$ -in. tube. The latter can be cut from the same tubing as used in making the rudder tube. When the fittings have been made file all the edges

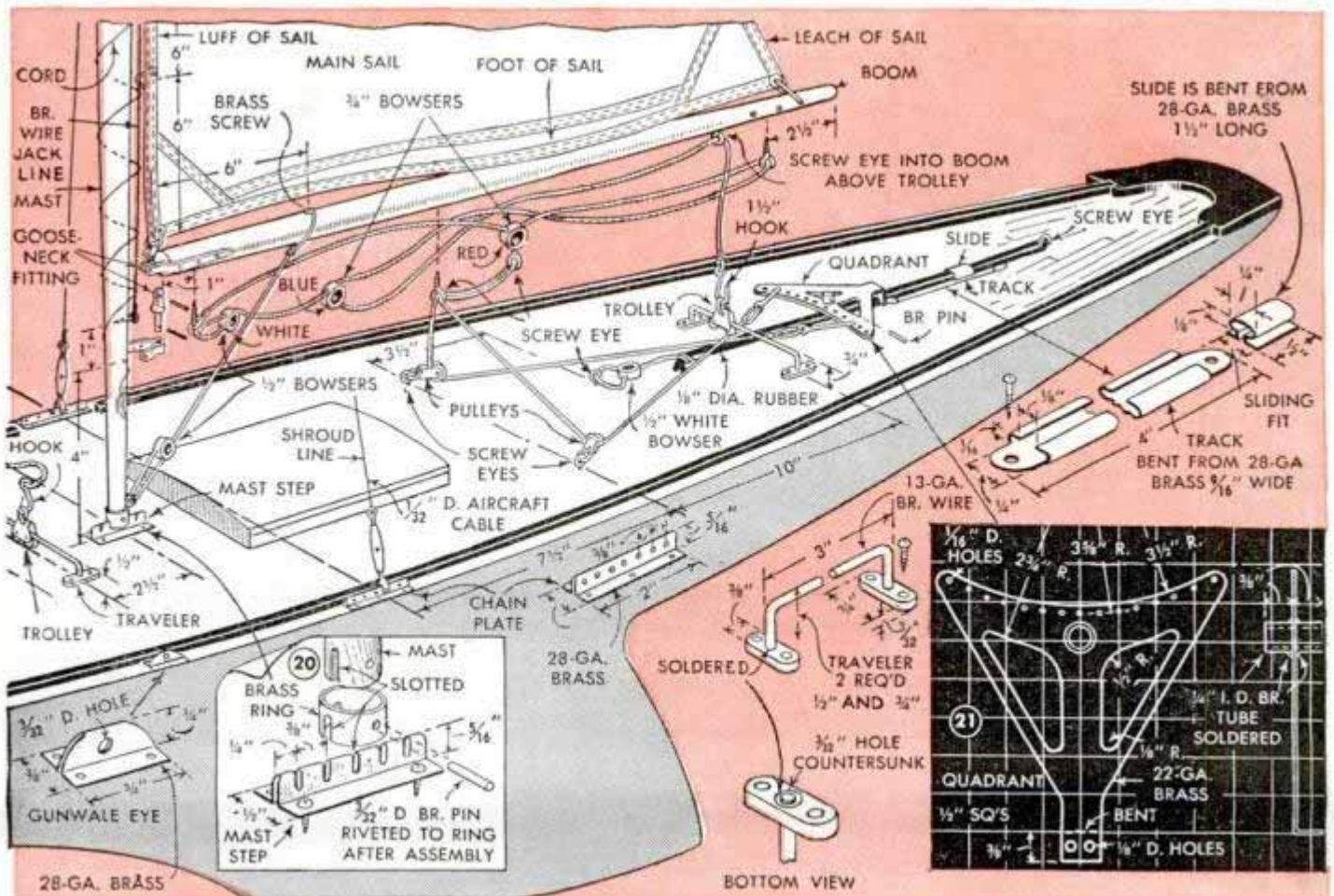

round and smooth with fine emery cloth.

You now are ready to assemble the spars, fittings and sails. It is best to start from the bow and secure each fitting in its order according to the dimensions given in Fig. 17. Note that the dimensions are shown to the center of the fittings. When assembling the quadrant to the rudder post be sure the rudder is centered exactly and is free enough to move at the slightest touch. The track and slide are placed directly astern of the tail of the quadrant. A screw eye $\frac{1}{2}$ in. aft of the end of the track holds the $\frac{1}{8}$ -in. round rubber, which should be about 18 in. long. The ends of the rubber are inserted through the slide, the two holes in the tail of the quadrant and then forward on each side of the rudder tube, Fig. 17. A $\frac{1}{2}$ -in. bowser and piece of braided cord about 50 in. long is passed through the pulleys on the deck and fastened to the quadrant by means of long hooks as shown in Fig. 22. With all the fittings in place the deck should appear as in the photo Fig. 23. The bottom of the mast is fitted with a $\frac{5}{8}$ -in. brass ring or ferrule $\frac{3}{8}$ in. long, which is slotted $\frac{1}{4}$ in. deep through the center to fit over the mast step. The $\frac{3}{32}$ -in.-dia. pin placed $\frac{3}{16}$ in. from the bottom will engage the notches cut in the mast step. Place a $\frac{1}{4}$ -in. screw eye 51 in. from the bottom on the forward side of the mast. This is to anchor the linen-cord jib stay, which passes through the hem of the luff on the jib sail. The other end of the

jib stay is fastened to a hole in the jib pole as are the two lower corners of the jib sail. A hook on the lower edge of the pole is fastened to the jib rack to brace the mast against the two shroud lines that are held on the mast by the brass fittings shown in the circular detail of Fig. 18. Adjust the jib stay line and the shroud-line turnbuckles to give the mast a rake aft of about 2 in. The jib sheets then can be rigged as shown in Fig. 17. The rigging of the main boom is slightly different from the jib pole. First fasten the boom to the mast with the gooseneck fitting. Then a piece of $\frac{1}{16}$ -in. cord about 58 in. long is threaded carefully through the various screw eyes and bowser as in the illustration. The line from the trolley to the bottom hole in the blue bowser passes through a screw eye placed in the mast directly above the traveler and should be about 16 in. long. The running sheet passes through a screw eye placed in the mast directly above the pulleys and is fastened to an open screw eye in the bottom hole in the red bowser. The main sail then is lashed to the boom and mast at the three corners and a fine brass jack line is threaded through the dress hooks on the luff of the sail. A cord around the mast and jack line will hold it securely in place.

The kicking strap is a short length of cord which has one end fastened to a screw eye at the bottom-afterside of the mast. The other end is held in place around the boom with a small round-head screw placed in the top of the boom. The bowser can be adjusted to suit the tension desired on the boom. The mainsail now is rigged with the exception of placing the battens in the pockets and sewing the ends to prevent them from working loose in a strong breeze.

Kiltie now is ready to sail. There is one thing a beginner should remember when sailing a model and that is to have the jib set a trifle flatter than the mainsail. This is to keep the jib full at all times and to prevent the boat from coming up into the wind and shaking. When reaching across the wind, hook up the running sheet and allow for a slight helm or rudder. Every fitting on Kiltie is simple and effective and a few trials will teach a skipper the use of each.

(Conclusion)

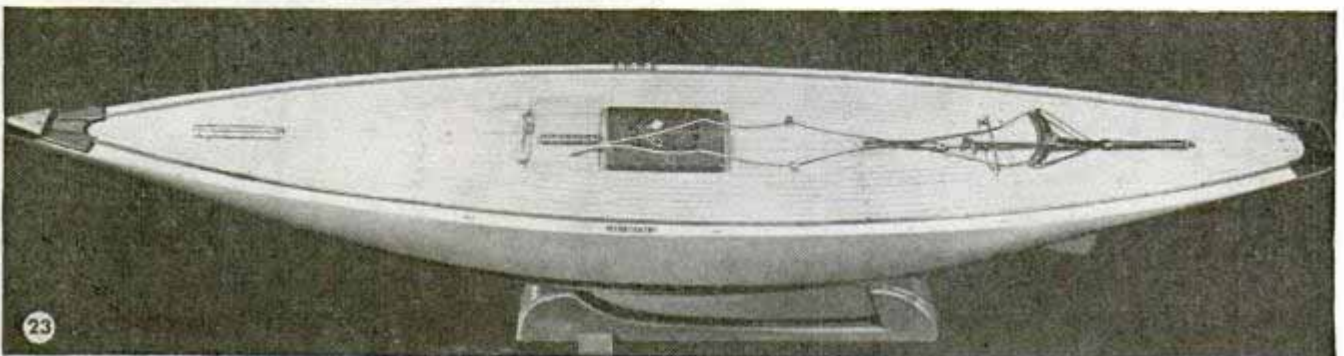
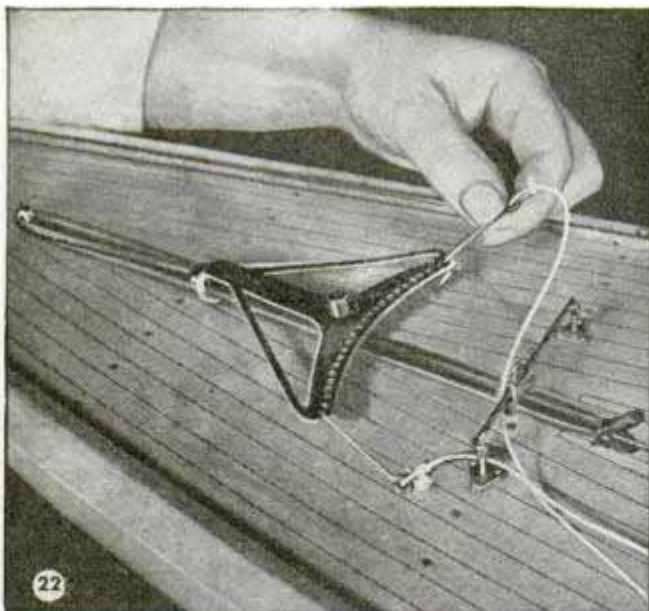

Plastic Cigarette Box Has Novel Tilting Cover

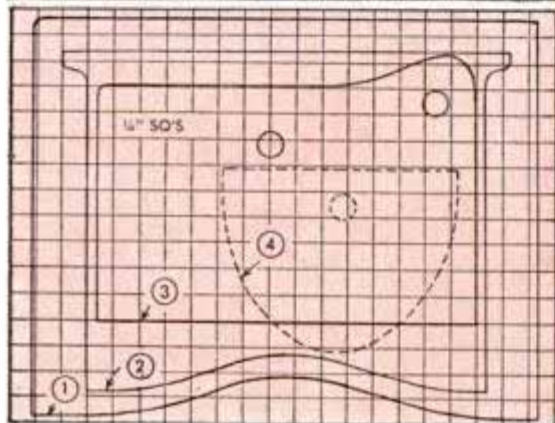
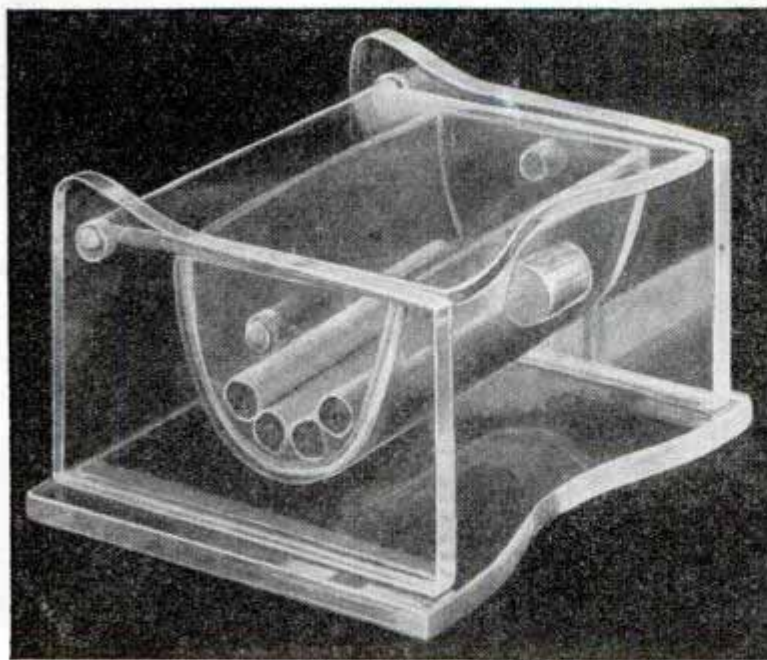

Made from transparent plastic, this cigarette box consists of a tilting compartment or tray pivoted in a frame formed by two ends and a base as shown. The tray is of sufficient size to hold twenty or more cigarettes, either regular or "king" size. The cover also is pivoted between the ends. Pressing the knob tilts the tray and lifts the cover simultaneously. When the tray is released it swings back to the horizontal position and the cover automatically closes. All parts are shown in the cross-hatched diagram above, the two end pieces of the frame, part No. 3, and those of the tray, part No. 4, being duplicates. Parts Nos. 1 and 2 are the bottom and top. Pivot pins for the tray are cut from $\frac{3}{16}$ -in. plastic rod and the lifting knob is cut from the same material, $\frac{1}{2}$ in. in diameter and $\frac{3}{4}$ in. long. A flat is filed on one side of the knob as shown so that it can be cemented to the tray easily. All other parts are cut from $\frac{3}{16}$ -in. sheet plastic to the sizes indicated in the cross-hatched details, except the curved portion of the tray, which is $\frac{1}{8}$ in. thick. Material can be cut with a bandsaw or jigsaw if slow-speed attachments and metal-cutting blades are available, otherwise by hand with a hacksaw or

coping saw. Finish the edges of the plastic with fine wet-or-dry sandpaper and be sure the joining edges of bottom and ends are square. The entire assembly is joined with plastic cement.—E. N. Moore, Chicago.

Easy Way to Cut Square Opening

Cutting a square or rectangular opening with round corners in a piece of wood is easily done if you drill holes of the proper radius for the corners. Then all you have to do is saw straight down from one hole to the next, and the opening will be of the right dimensions with corners of the correct radius.

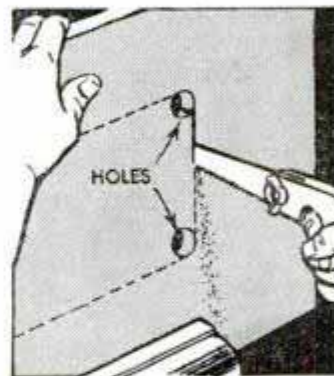

Charles W. Eckenlaub, Altoona, Pa.

☐ Hanging shelves can be supported by old skid chains hung from the ceiling with the shelf board resting on the cross chains.

Running-Water Supply and Sink Provided for Home Laboratory

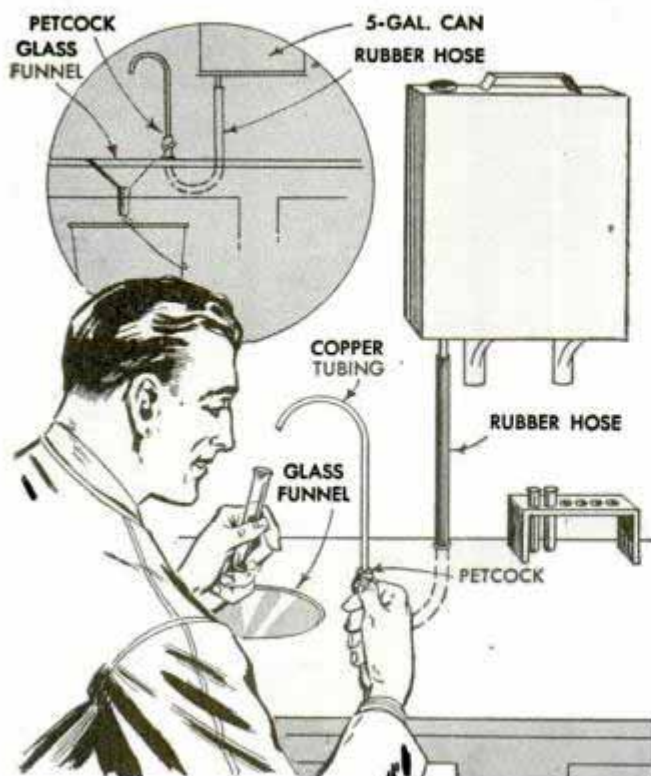

Suitable for the home laboratory located where running water is not available, this improvised water system will provide a ready supply. The reservoir and sink consist of a 5-gal. can mounted on shelf brackets above the workbench, some rubber hose and copper tubing, a radiator petcock and a glass funnel. A hole is punched in the bottom of the can and a short length of copper tubing is soldered to it so that rubber hose can be connected. This is run through two holes that have been drilled in the bench, as illustrated, then joined to the petcock which controls the flow of water. A length of copper tubing bent to form a spout is soldered to the petcock to direct water into the funnel which is set in a hole in the workbench with a pail beneath it to catch the water.

John F. Stewack, Downers Grove, Ill.

Narrow Hacksaw Frame Allows Working in Close Quarters

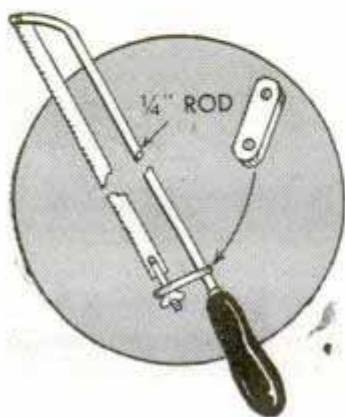

For working in restricted places where a regular hacksaw will not enter, this improvised saw frame will solve the problem. It consists of a length of rod and a piece of flat iron in which two holes are drilled, one to permit it to slide

snugly over the rod and the other to take a slotted bolt. The rod is bent at one end and is slotted to take a saw blade, which is held by a retaining screw. The other end of the blade is held by the bolt, which in turn is held in the piece of flat iron by a wing nut. When the nut is tightened, this piece is pulled at an angle and prevented from sliding on the rod, allowing the blade to be tightened.

Robert A. Horacek, Burbank, Calif.

Machine Bolt Helps Drive Nails In Hard-to-Reach Places

When you have to drive a nail that cannot be reached with a hammer, use a long bolt as a nail set in the manner shown. To prevent the bolt from slipping off the nail, screw a nut only part way on the bolt so that the end is recessed slightly within the nut, leaving a pocket in which the nailhead will be held.

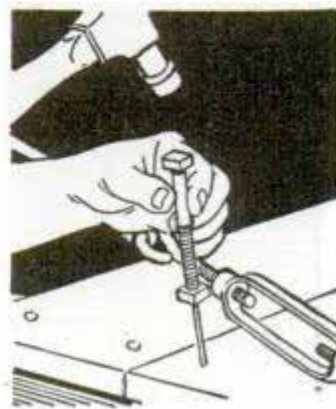

Bert L. Force, Washington, D. C.

Renovating Your Briar Pipes

After briar pipes have been used for some time they develop a soiled, dark appearance so that the grain cannot be seen. To bring back the original luster, remove the stem and plug the shank and bowl. Rub soapsuds over the outside, then rinse and dry thoroughly. The briar now will have a dull finish, but the application of a very small quantity of olive oil will restore the luster.—Donald Munson, Boston, Mass.

Repair for Broken Coal-Stove Lid

If the projections for a lifter have been broken away from the slot in a coal-stove lid, a nail will serve the purpose. Blind holes are drilled at an angle in the sides of the slot near the inner end, and a headless nail is inserted in the holes to form a strap under which the lifter will fit. After being bent up to fit into the holes, the nail will not come out if it is tapped lightly with a hammer to force in the ends. —P. Criton, Jr., Kayville, Sask., Can.

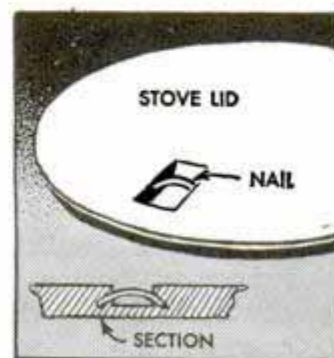

How to Make Your Own MOVIE TITLER

by
WALTER E. BURTON



PICTURES tell the story, but it's the words with the story that give it continuity. Movie titles identify and date each reel. Subtitles explain the scenes and tie them in with the action.

The titler illustrated has several features not commonly found in title-making outfits, such as the turret mount for auxiliary lenses, Fig. 4, title-card board for producing novel effects, Figs. 10 to 14 inclusive, and lamps mounted horizontally instead of vertically for greater freedom in making adjustments and manipulating camera and title-card controls.

First make a base for the titler of seasoned hardwood as shown in Fig. 6 and fit one leg with leveling screws, Fig. 9. The camera block, base of the lamp support, and other parts are provided with $\frac{1}{4}$ -in.-wide strips that slide in the opening between the horizontal members of the base. The sliding parts clamp to the base members, or "ways," with small bolts fitted with wing nuts and washers.

Because of the lighting arrangement it is necessary to support the camera on a sliding auxiliary base so the lens is 8 in. or

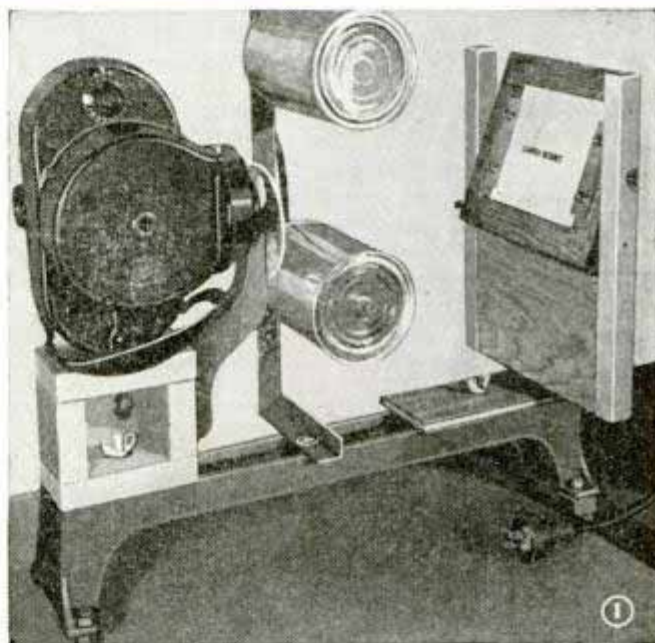

so above the top of the titler base. Drill the sliding base for a clamping bolt and also for a $\frac{1}{4}$ -No. 20 thumbscrew made from a bolt and washer as in Fig. 9. This latter bolt is used to attach the camera rigidly to the base. Dimensions given will vary with different makes of cameras.

In making titles, an auxiliary lens, which is a positive supplementary lens, is placed directly in front of the camera lens. With the latter set at infinity, the title card is placed so the distance from it to the auxiliary lens is the same as the focal length of that lens. Thus for a 10-in. auxiliary lens the title card is placed 10 in. away. Auxiliary lenses of different focal

Focal length	Diameter	Lens-to-card distance*	Approximate field covered**
186 mm. 7.33"	31 mm.	7.33"	2 $\frac{1}{8}$ " X 2 $\frac{1}{4}$ "
254 mm. 10"	28 mm.	10"	2 $\frac{7}{8}$ " X 3 $\frac{1}{2}$ "
393 mm. 15.5"	28 mm.	15.5"	4 $\frac{1}{2}$ " X 6 $\frac{3}{8}$ "

*With camera lens set at "infinity" or in fixed-focus position.
**By 1" lens on 16-mm. camera or $\frac{1}{2}$ " lens on 8-mm. camera. ③

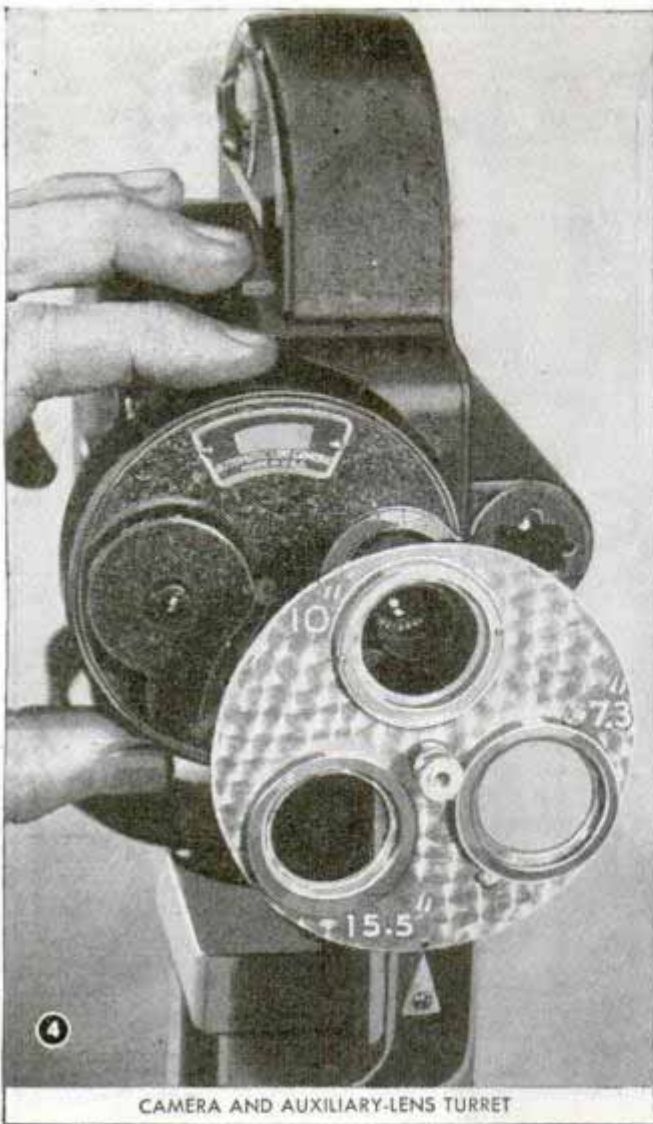

CAMERA AND AUXILIARY-LENS TURRET

lengths permit use of different-sized title cards. Also, the titler may be used for shooting close-ups of flowers, insects, etc.

It is convenient to have a selection of ranges and areas in focus, so, to avoid handling several auxiliary lenses individually, a three-lens turret arrangement was constructed as in Figs. 2, 4 and 9. This consists of a $3\frac{1}{4}$ -in. disk of sheet metal pivoted on a curved hardwood turret arm screwed to the camera support as in Fig. 9. Select auxiliary lenses that range in diameter from about 25 mm., 1 in., to 35 mm., 1.37 in. The turret illustrated is fitted with three lenses whose characteristics are listed in the table, Fig. 3.

Scribe a 2-in. circle on the turret disk and at equidistant points mark centers for three holes about $\frac{7}{8}$ in. in diameter, Fig. 9. For each lens, machine a brass ring as in Fig. 2. The turret disk is locked on the No. 6-32 screw with a knurled binding-post nut to which a short length of tubing has been soldered as in Fig. 9. Just below the disk screw a small metal pointer to the arm, Fig. 4, and opposite it make marks on the disk to indicate when each auxiliary lens is centered over the camera lens. Mark the focal length of each lens beside its ring.

The title-card support is assembled as in Fig. 6. Before gluing the $\frac{1}{8}$ -in. panels together, flutes are cut and filed in each panel as in Fig. 5, the flutes being equally spaced on both panels so that when the latter are placed together three longitudinal round holes are formed as in Fig. 6. A long stud, threaded at both ends, passes through the center hole. A nut is soldered to the threads at one end of the stud. A wing nut and washer on the other end provide a quick means of tightening the title board between the uprights. For novel effects in which the title swings into or out of focus from

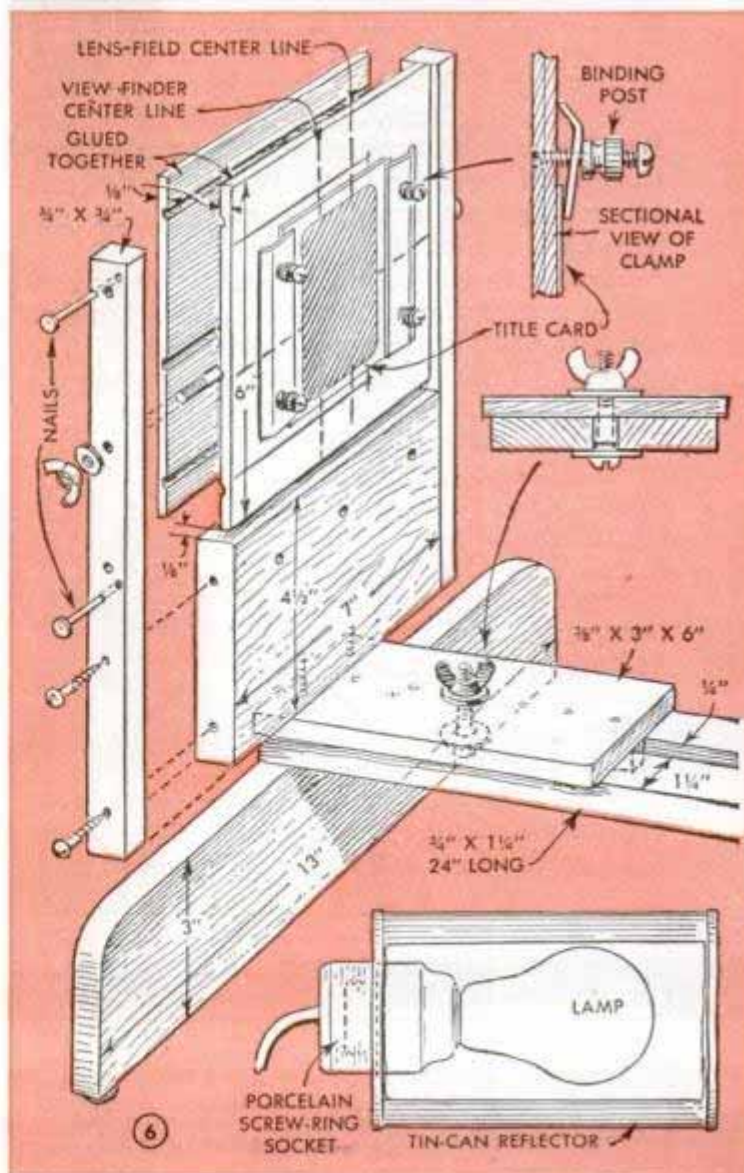
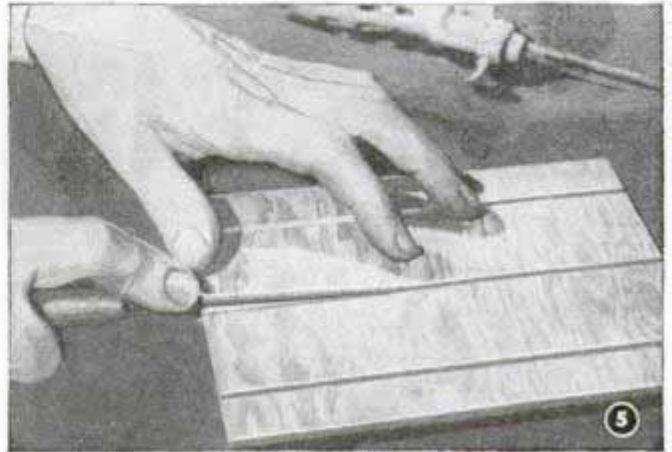

above or below, pass the stud through the top or bottom hole, and do not tighten the nut. To hold the title in focus, drill two holes in one of the uprights as shown in Fig. 6 and insert nails.

Camera and title card are aligned with the aid of the camera view finder as in Fig. 7. Clamp the blank title board securely in position. Fasten the camera so its lens is directly above the center of the titler base and the lens axis is at right angles to the title board. Be sure the distance from the board to the auxiliary lens is equal to the focal length of that lens. Look through the camera finder and, with a pencil, mark on the board the boundaries of the finder field. Then correct for parallax. If the finder is notched or ruled to indicate the center lines of the field, mark these also. Now remove the title board from its mount and continue.

Measure carefully the distance from the center of the camera lens to the center of the finder lens. If the finder is not directly



ADJUSTING CAMERA BY SIGHTING THROUGH VIEWFINDER

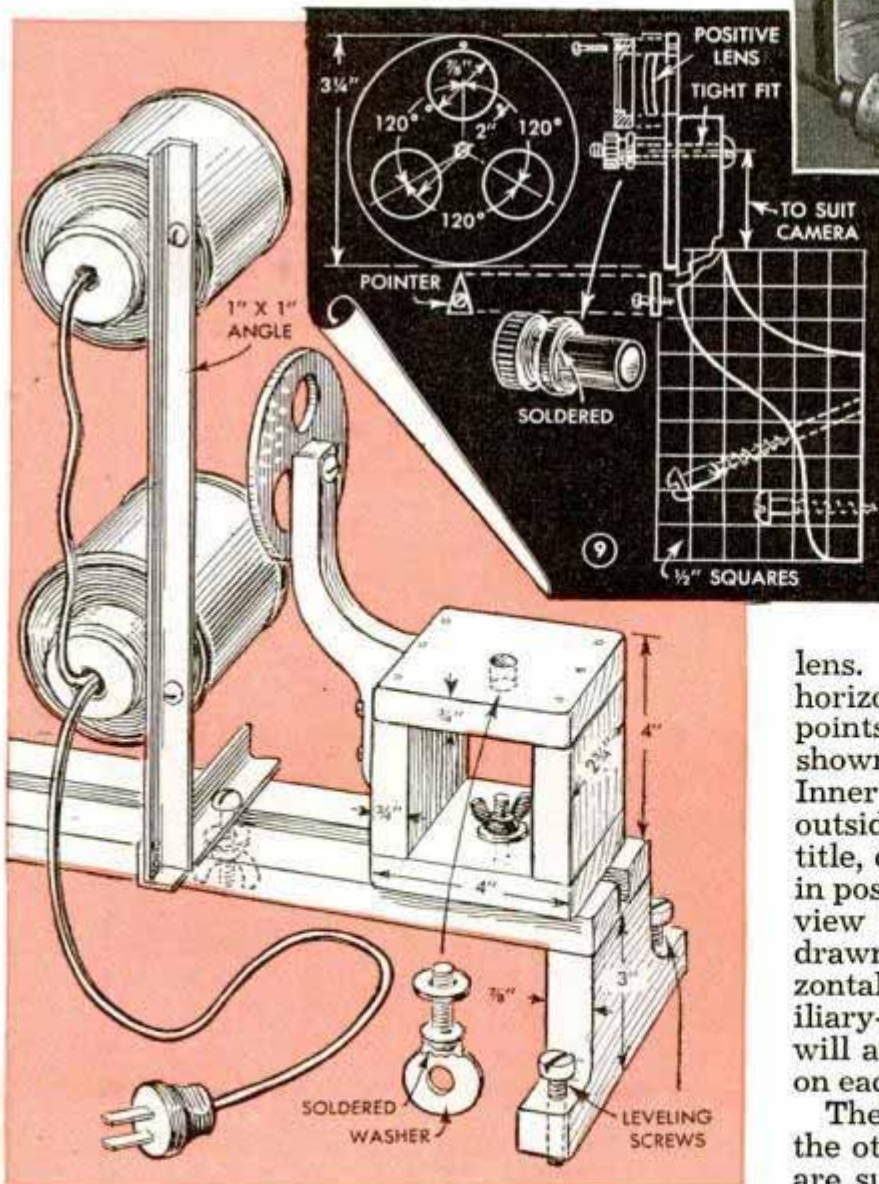
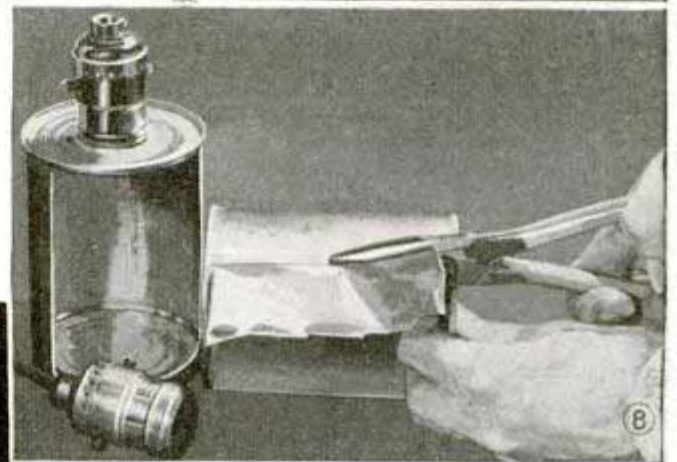

above or directly at one side of the camera lens, measure both the vertical and horizontal displacements. Lay off the same distances on the title board, using the center of the finder-field area as a starting point. This gives you the center of the field covered by the camera lens. Draw a vertical and a horizontal line through this center point. When you make a title card, draw a line around it indicating the precise size of the field covered by the

lens. Outside the frame draw vertical and horizontal center lines, indicating mid-points of the frame sides. Clamps made as shown in Fig. 6 hold the cards as in Fig. 11. Inner edges of the clamps should be just outside the camera field. When shooting a title, center the card, clamp the title board in position, and adjust the camera until the view finder field matches the finder area drawn on the board. Alignment in the horizontal plane is automatic. Mark the auxiliary-lens focus on each panel. One board will accommodate two title-card sizes, one on each surface.

The lamp units are located one above the other as in Figs. 1, 7 and 9. The lamps are supported on a lightweight angle-iron

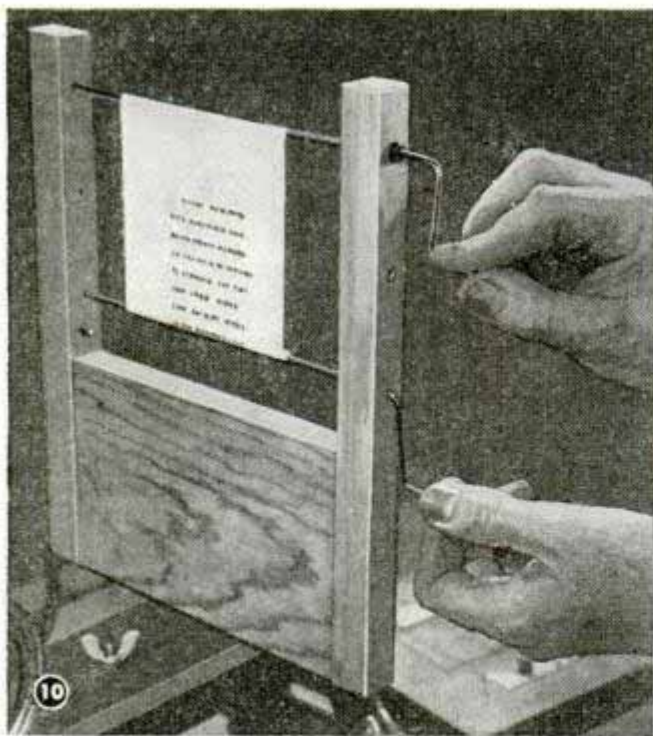

USE A STRIP TITLE FOR LONG DESCRIPTION

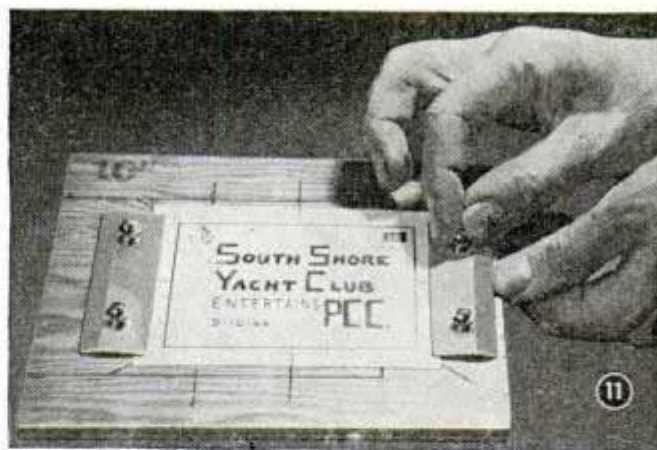

When fast film is used, 40 to 60-watt lamps usually are adequate. Strip titles are printed on paper wound around two cranks bent from stiff wire and inserted into upper and lower holes in the title-board uprights as in Fig. 10. Wind the strip slowly from the lower crank to the upper one.

"Wipe-on" and "wipe-off" effects are produced by a simple arrangement consisting of a bent-wire crank extending through holes below the title board and supporting a piece of black or white cardboard or metal, Figs. 12, 13 and 14. The wiper "fan" is shaped so it completely covers the title card in one position, Fig. 13, and uncovers it in another, Fig. 14. When using positive film that is to be developed as a negative the fan is white. For reversible film it is black. Likewise, use black letters on white for positive film, white on black for reversible. For close-up shooting of flowers and small objects you can use a board having the camera-field opening cut out so the board serves as a mask, finder and range finder.

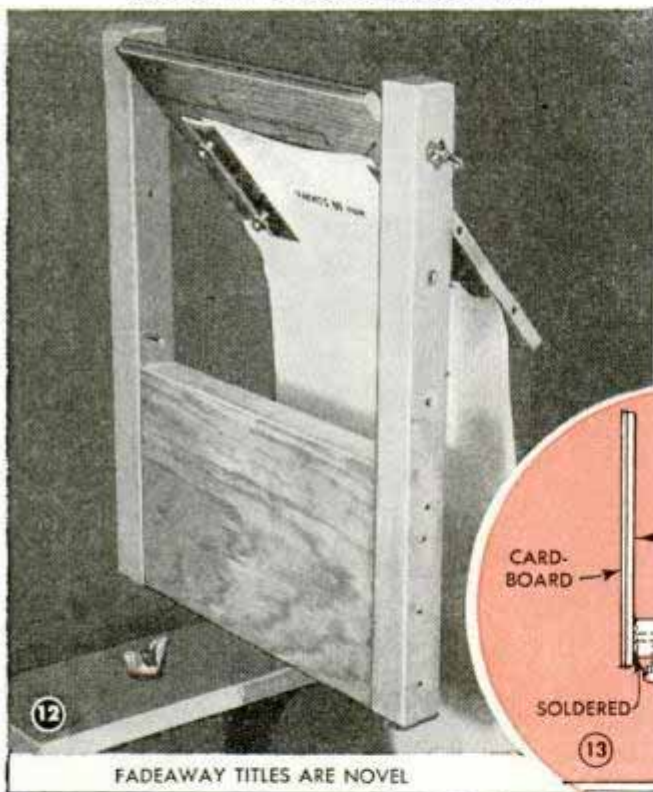

FADEAWAY TITLES ARE NOVEL

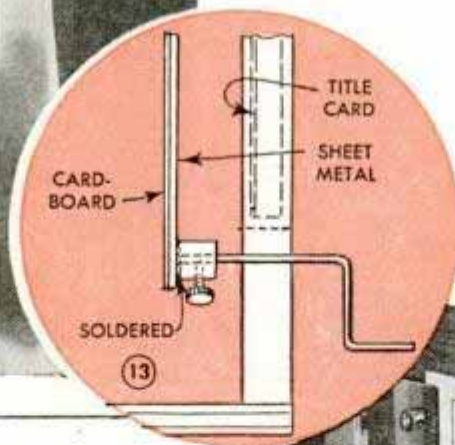

TITLES WITH WIPE-ON AND WIPE-OFF EFFECT

frame, 13½ in. high and 5 in. across the leg, which is held in place with a ¼-in. bolt. The lamp reflectors can be made from No. 2 tin cans which are large enough to house No. 1 photoflood lamps. Porcelain screwing sockets are soldered to the ends if they and the lamp will fit in the reflector, otherwise use metal sockets. Insides of the reflectors are coated with white casein paint. Use small bolts or metal screws to fasten reflectors to the upright. The reflectors are located about 7 in. apart, center-to-center distance. Aim the openings, Fig. 8, at the title card. For making titles directly on positive film, use No. 1 photoflood lamps.

Adapting Your Camera for Color Transparencies

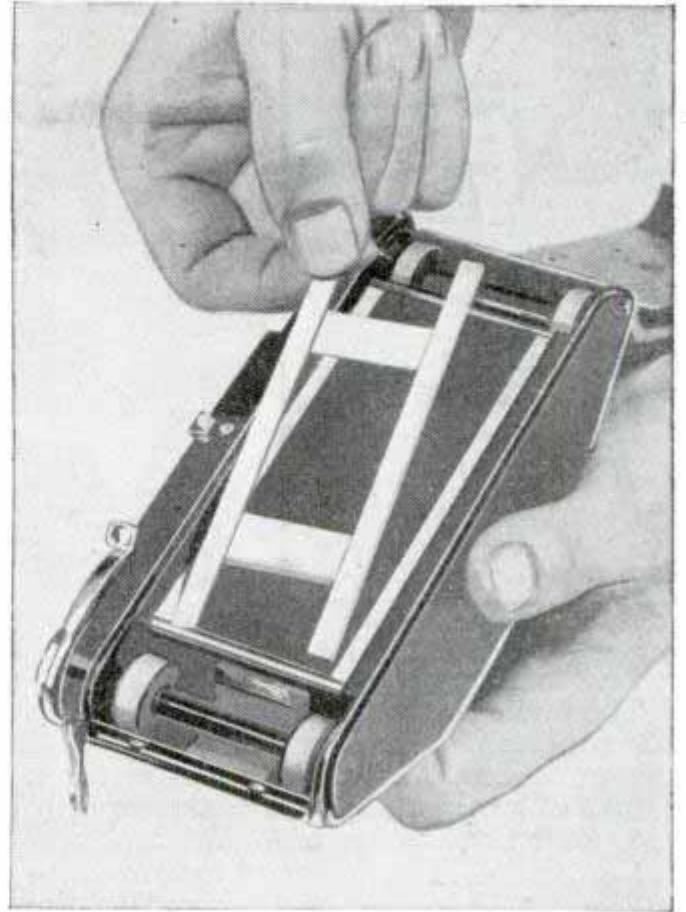
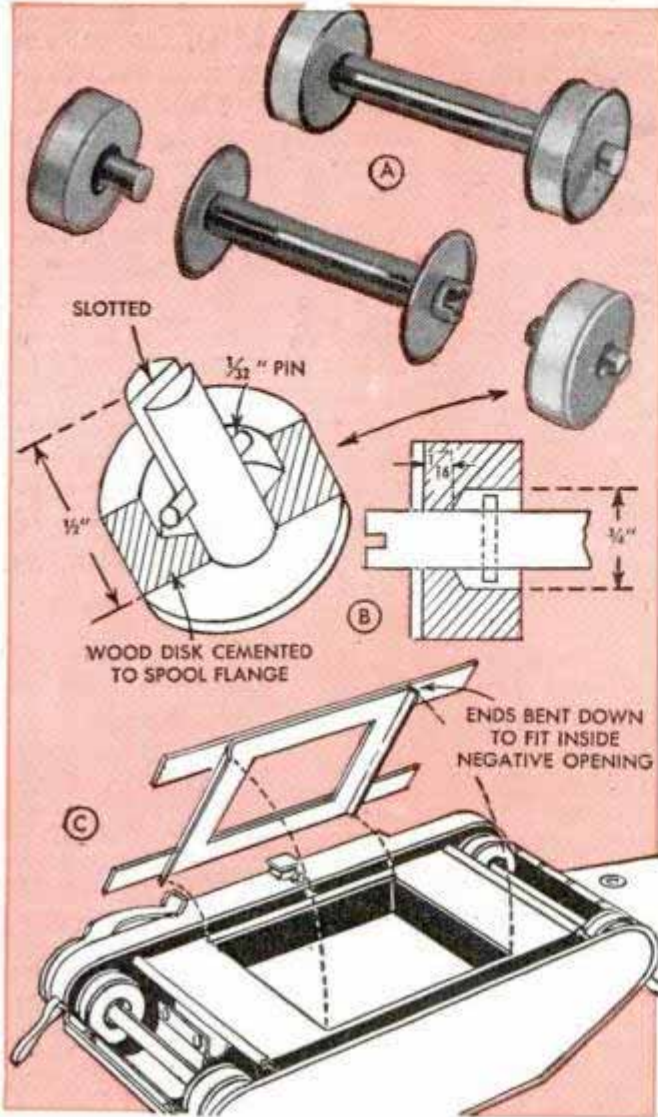

If you want to take 35-mm. transparencies for projection but do not have a 35-mm. camera, you can adapt your camera for this film by making a mask and spools of the proper size. Although the one shown takes No. 127 film, many roll film cameras can be converted by making a mask and spools to fit the model in question. Small spools, approximately 35 mm. between flanges, are used and their width is increased by adding wooden disks and the flanges from spools that fit your camera, as indicated in details A and B. The pin which is shown in detail B need be on one side only so the spool will turn with the winding key.

The mask which fits over the aperture plate is made of two pieces of fiber cardboard or light metal, with the ends of the lower piece bent to fit inside the negative opening, detail C. The opening which frames the film should be a little under 1 in. by 1 1/2 in. After the mask has been cut and fitted, it should be finished with a lusterless black paint. Then paste a piece of opaque paper over the indicating window in the back and the job is complete.

The camera can be loaded with either bulk film or film taken from a regular car-

tridge. This operation must be performed in the dark, of course, and you can save film by pasting a leader strip on to start the roll over the empty spool. To indicate how many turns are necessary to expose a new frame, place marks on the side of the camera near the key. These marks can be located by experimenting with exposed film. Since the negative area is reduced, allowance must be made for this reduction in the view finder.

How to Test an Exposure Meter

Check your exposure meter while it is in good condition so that if it is dropped, or you have reason later to question its accuracy, you can compare readings. To check it, remove the lens board of your enlarger and place the meter over the opening with the "eye" or cell turned toward the lamp. Then, with the light turned on, note the meter reading and the position of the enlarger bellows. By comparing later readings with this data, you can tell quickly whether or not the meter is accurate.



Pistol Grip Aids in Taking Fast-Action "Shots"

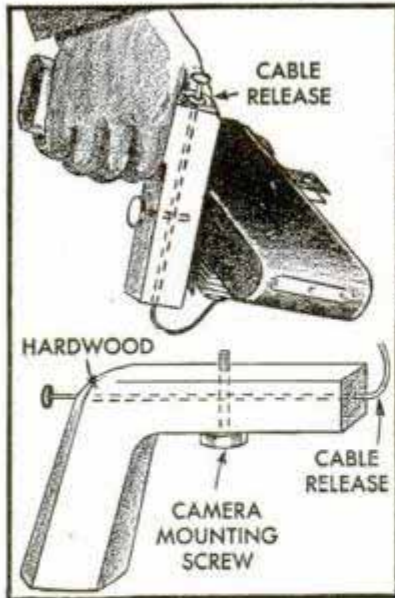

For taking fast-action pictures, where split-second viewing and focusing are necessary, a pistol grip like the one shown allows you to hold the camera with both hands for greater steadiness while pressing the cable release with the thumb. The grip is made of hardwood and is drilled for the camera mounting screw and release, the dimensions being made to suit your particular make or type of camera.—Ken Murray, Baltimore, Md.

Noise of Water in Tray Reduced

The photographer who washes prints in a tray placed in a sink or bathtub may find the noise made by the flow of water a source of annoyance. An effective remedy is to fasten one corner of a large handkerchief around the faucet and let the remaining ends trail in the tray.

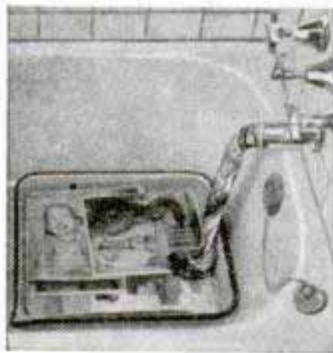

A smooth and quiet flow of water, which gently agitates the prints, results.—H. Schlossberg, Washington, D. C.

Prints Will Not Crumple on Tin

In ferrotyping small prints, the operation may be difficult because the pictures slide and crumple on the tin. To avoid this and do the job faster, place a few sheets of newspaper over the prints to serve as a combination blotter and backing sheet.

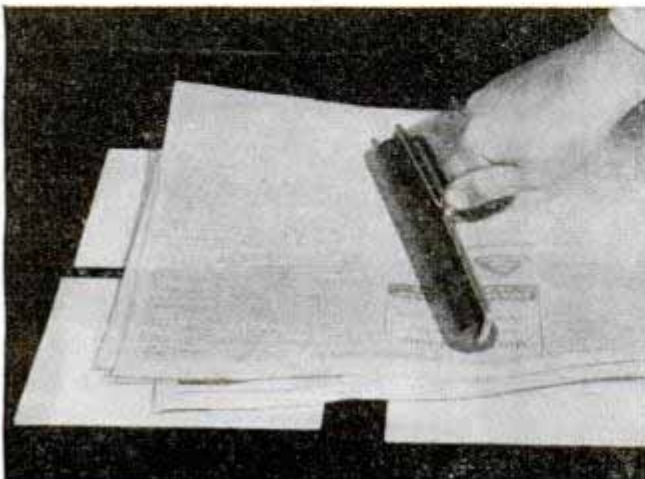

Rounded Corners Protect Films

When several negatives are handled at one time, the corners of one negative may scratch the emulsion on another. One



photographer avoids this by trimming the corners with a nail clipper. Any other rough edges can be smoothed with a fingernail file or nail board.

William Swallow, Brooklyn, N. Y.

Wiper Blade Used to Spread Paste

A windshield wiper blade provides a handy applicator for spreading paste on the backs of photoprints that are to be mounted. The prints can be laid face down on newspapers so that any paste wiped over the edges will not damage the table on which the work is being done.



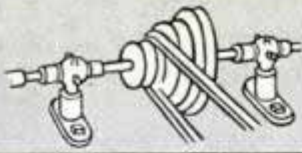

Care and Use of THE MICROMETER

By Arthur Youngquist

ALTHOUGH micrometers are made in many shapes, types and sizes, the principles of operation are very much the same and should be understood thoroughly by anyone attempting to clean or adjust these delicate measuring instruments. If you're not familiar with the operation of a micrometer think of a C-clamp, Fig. 2, as a comparison. Most micrometers have 40 threads to the inch, therefore you can assume that the C-clamp has 40 threads to the inch. Now, if you can imagine the threaded spindle on the clamp as being a coil spring and assuming that you

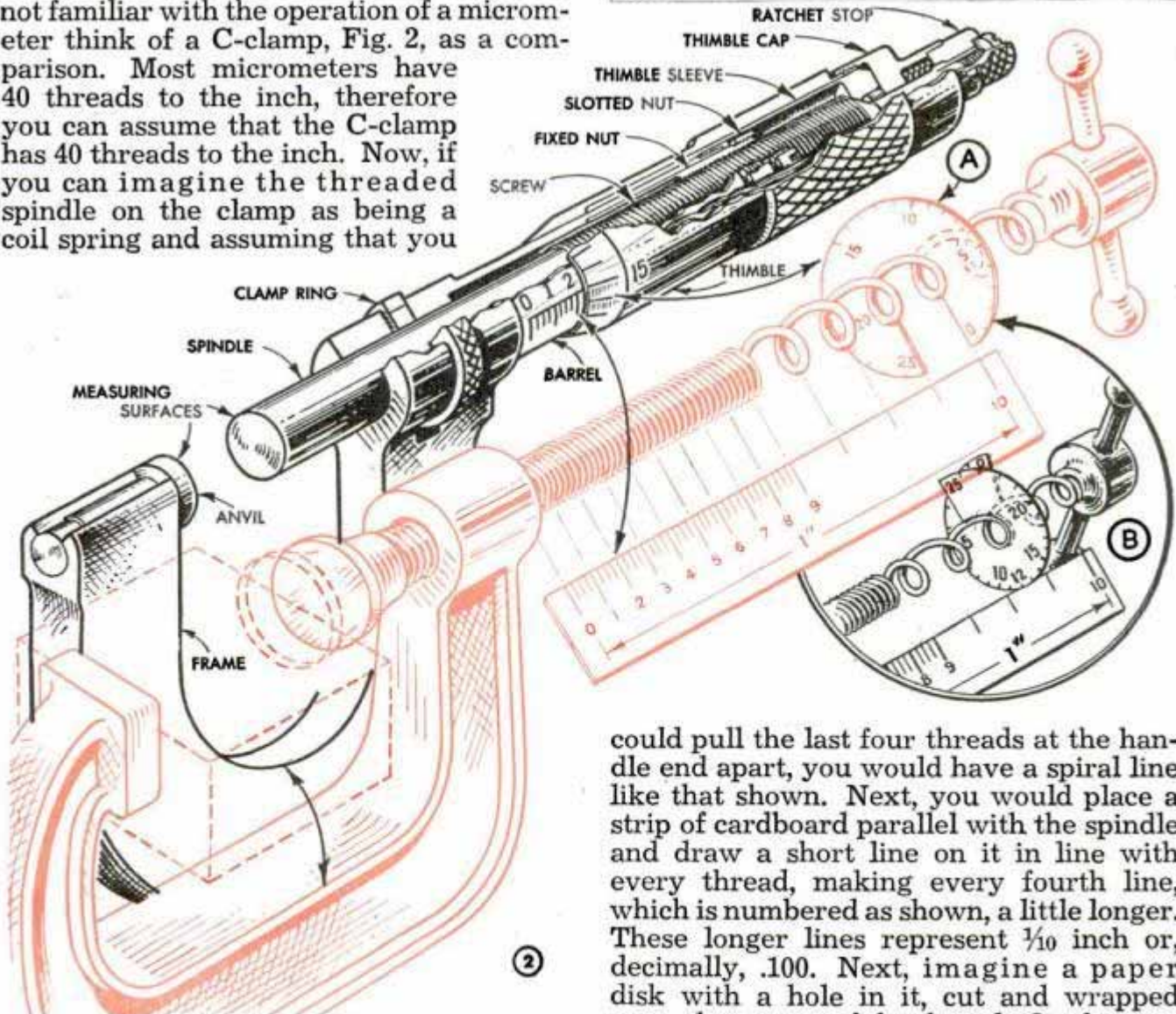

could pull the last four threads at the handle end apart, you would have a spiral line like that shown. Next, you would place a strip of cardboard parallel with the spindle and draw a short line on it in line with every thread, making every fourth line, which is numbered as shown, a little longer. These longer lines represent $\frac{1}{10}$ inch or, decimally, .100. Next, imagine a paper disk with a hole in it, cut and wrapped around one turn of the thread. On this you

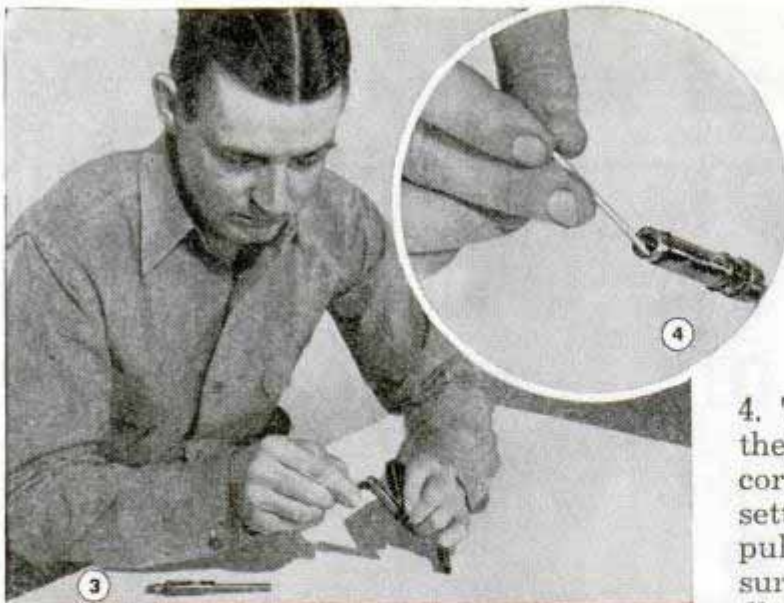

C-clamp, but by studying the comparisons you will have a better understanding of the micrometer mechanism.

If the micrometer does not give a correct reading due to play in the threads, adjust it with the slotted nut, Fig. 2. Remove the screw spindle from the barrel and clean with pure naphtha, Fig. 1. Then place a few drops of light oil on the threads with a toothpick as in Fig.

4. Tighten the slotted nut on the end of the barrel, Fig. 3, by stages to secure the correct adjustment. To adjust for zero setting clean the anvil and spindle by pulling a piece of soft paper between the surfaces, Fig. 5. With the anvil and spindle apart, unlock the thimble cap with a spanner wrench, Fig. 6, then tighten the cap lightly. Bring the anvil and spindle together and set the zero line on the thimble to coincide with the line on the barrel, Fig. 7. Hold the micrometer by the frame and move the spindle away from the anvil by turning the spindle only. Then, grasping the thimble, tighten

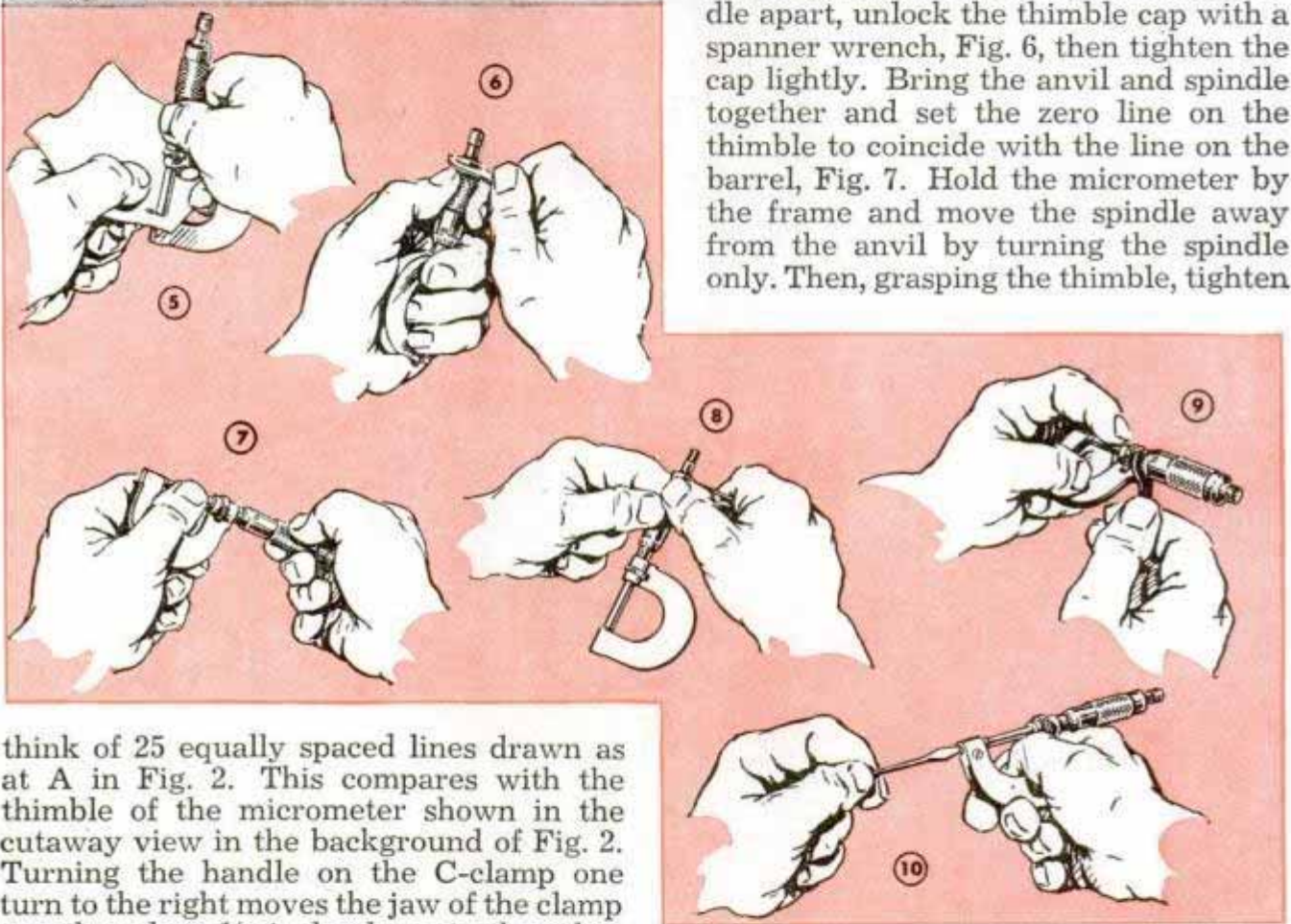

think of 25 equally spaced lines drawn as at A in Fig. 2. This compares with the thimble of the micrometer shown in the cutaway view in the background of Fig. 2. Turning the handle on the C-clamp one turn to the right moves the jaw of the clamp one thread, or $\frac{1}{40}$ inch, closer to the other jaw. Decimally this would be .025. By turning the handle one mark on the paper disk A the jaw would move $\frac{1}{25}$ of $\frac{1}{40}$ inch, or .001.

Now, if you turn the handle until the C-clamp jaws lightly touch the "block" indicated by the broken lines, the paper disk will advance to the position shown in detail B, Fig. 2. To read this imaginary "mike," you first count the number of lines representing $\frac{1}{40}$ inch and write it decimally .900; then the $\frac{1}{40}$ -inch lines, which is $\frac{2}{40}$ or .050, and finally the paper-disk lines $1\frac{1}{25}$ of $\frac{1}{40}$ inch, or .012. The sum of these values is .962 of an inch, which is the thickness of the block. Of course, it would be impossible to measure within .001 inch with an ordinary

the cap with the wrench as shown in Fig. 8.

On some types of micrometers the zero setting is made by first cleaning and then bringing the spindle and anvil together, then turning a friction sleeve on the barrel until a line on the sleeve coincides with the zero line on the thimble, Fig. 9. If the micrometer is the adjustable-anvil type the zero setting can be made by loosening the binding screw in the frame next to the anvil and adjusting the anvil screw as in Fig. 10. Micrometer readings should be taken occasionally with a precision gauge block of known dimensions to determine the accuracy of the instrument.

Inside-Outside Turning Done Without Template

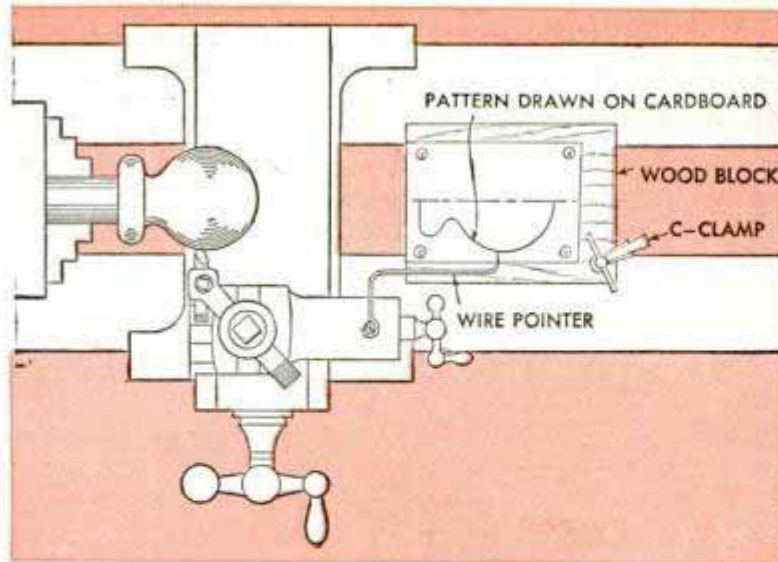

By Axel E. Jensen

When turning a sphere, a sphere-and-bead form or other similar shapes, you must have some means of accurately truing the profile after roughing the work to approximate shape. The method shown makes a separate template unnecessary and is much faster and more accurate because both hands are always free to handle the lathe carriage. The setup is simple, consisting merely of a rigid pointer attached to the tool-post saddle in the position indicated, and a wood block which is clamped to the lathe bed. The block can be of any convenient size that will provide space for tacking the full-size pattern on the top surface. In most cases a length of heavy wire will do for a pointer. One end

is ground to a sharp point and a round eye is bent in the opposite end so that the pointer can be fastened securely with a machine screw. Just how the pointer is bent or shaped will depend on the nature and length of the pattern and also on the type of lathe. In use the work is mounted in a chuck and turned down to the rough shape. Then the wood block, with the pattern outline attached as shown, is clamped to the lathe bed. The tool is located at the start of the cut. Then either the pointer or pattern, or both, is moved so the starting point on the pattern corresponds to the position of the tool on the work. The same setup can be used when boring a blind hole to a given depth.

Auto Transmission Is Removed by One Man With Hoist

This hoist has been designed to enable one man to remove and install the transmission in a car. Of a size to fit into the front compartment, the hoist is placed on the floorboards and the chain is fastened around the transmission which then is lowered after being disconnected from the clutch and drive shaft. The framework is of welded-steel construction and the crank is made of iron pipe. All other parts, such as the casters and ratchet wheel, are standard hardware items which are easily obtained.—Jerome J. Ford, Lancaster, Ohio.

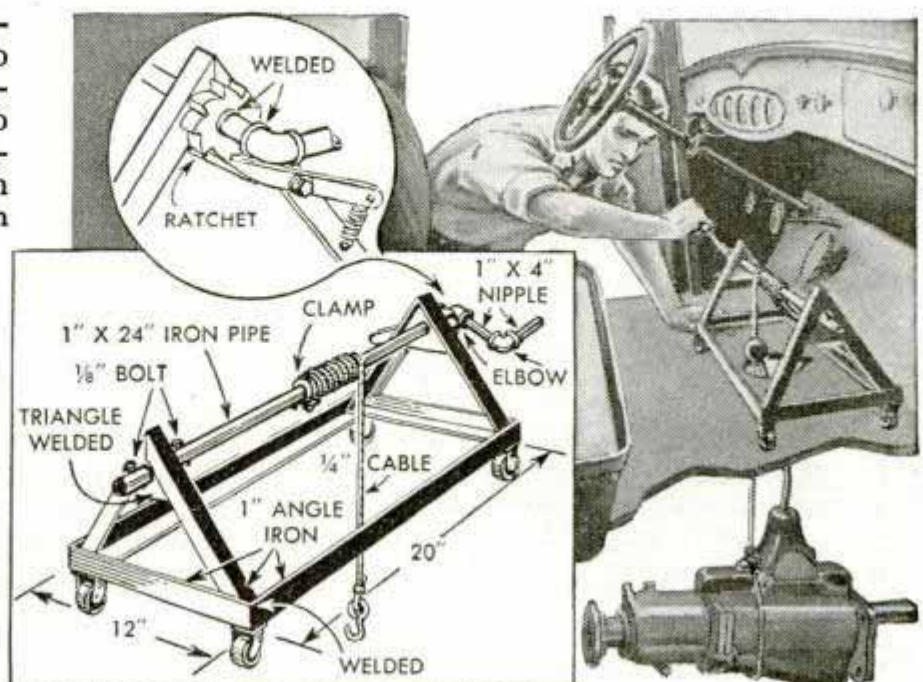

Holes Drilled From Opposite Sides Simplify Slotting Flat Iron



Here's a good way of drilling a length of heavy flat iron preparatory to slotting it. Ordinarily, if the holes are spaced far apart, much stock is left to be filed or chiseled out, and if the holes are closely spaced, the drill has a tendency to lead back into the hole previously made. But by drilling half-way through from either side, as shown in the upper detail, this trouble is avoided. Or you can stagger the holes from opposite sides, as indicated in the lower diagram. By the latter means, the holes will overlap, yet the drill will not be drawn to either side.

Leigh B. Freed, North Manchester, Ind.

Filled Screw Slots Protect Box

When shipping wooden boxes that have lids held on with screws, you can discourage tampering by filling the slots in the screw heads with solder and wiping off the excess metal with a cloth. A hot soldering iron applied to the heads will melt the solder when the box is to be opened again.

S/Sgt. Chas. L. Ganong, Alexandria, La.

Multiple Outlets for Power Tools From One Connection

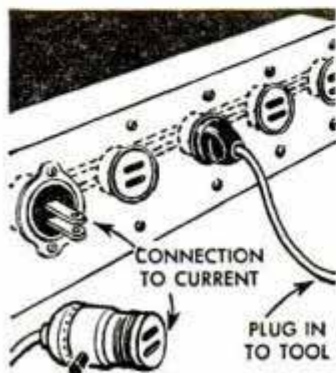

If you do not have enough electrical outlets for your light power tools, you can make this multiple box with as many connections as are required. In no case, however, should the total

load taken from the box exceed the wattage or amperage for which it and the other fixtures on the circuit have been rated. The box is made of sheet metal with base plug outlets which are well insulated to prevent metal-to-metal contact between the fixtures and the sheet metal. One male outlet to connect to the current source, and as many female outlets as are needed for the tools, are mounted in the box. All of the fixtures are wired in parallel, as is indicated by the illustration.

Rolled Metal Strip Forms Spacers

For sheet-metal work where spacers of exact length are required to hold pieces of steel the same distance apart, they can be cut from a strip of sheet metal and rolled to fit around the fastening bolt. The metal used should be a light gauge so it can be bent easily. Insert the bolt through the two pieces and run the nut on the threads to hold the bolt in place. Then cut a short length of steel from the strip and wind a number of turns around the bolt to form the spacer. Tightening the nut will hold the parts firmly in place.

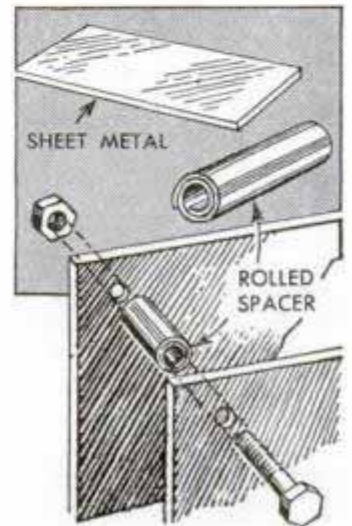

Fine Jewelry Chain Is Soldered On Needle Fixture

A needle stuck vertically into a wooden block will provide a fixture for holding fine jewelry chains to solder a broken link. Slip the two links adjoining the broken one over the needle as indicated. This will hold the broken link in position for soldering with a small soldering iron. In some cases, it may be better to support the needle at an angle or in a horizontal position. You can do this by gripping the fixture in a small vise. Size of the needle to use will depend on the size of the chain links. These should not slide more than halfway down the length of the needle.—Ed Pelczar, Wilkes Barre, Pa.

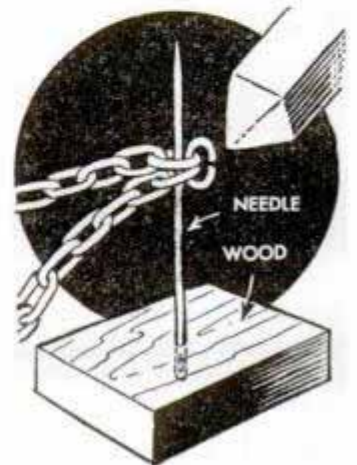

Attachment on Compass to Cut Paper Patterns

When scribing or cutting circles to make patterns for sheet-metal work, gaskets, etc., the compass shown here is handy. Since the knife is the narrow section of a razor blade, it is renewed easily when worn. The blade is held between the split halves of a pencil and clamped to one arm of the compass. Note that only a short length of blade extends beyond the end of the holder. So that both arms of the compass will be of equal length, it may be necessary to shorten the point. A knife for straight cutting can be made by splitting a pencil, removing the lead and inserting a strip of razor blade. If the pencil were cut only far enough to hold the blade and the lead left in the remaining section, the pencil end could be used for marking.

R. Boettinger, Englewood, N. J.

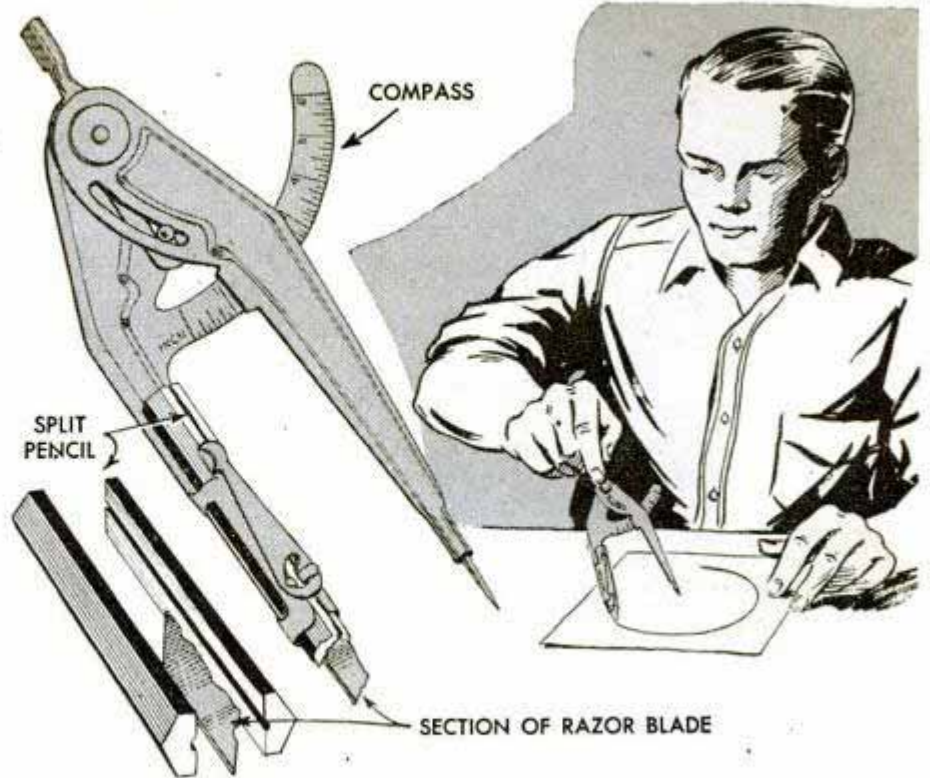

to fit the table, and provided with a set-screw to fasten it at any point along the edge, which is graduated to form a measuring rule.

Guide Used to Measure and Cut Drafting Paper

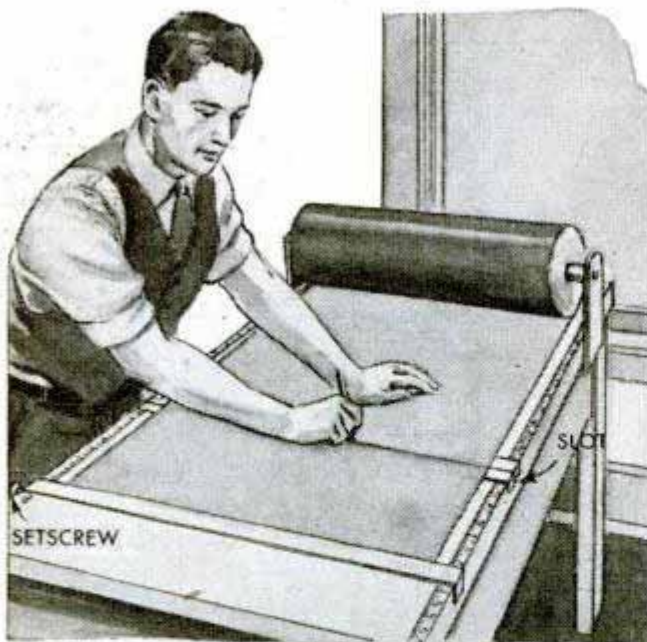

If two metal strips are recessed in a table, as shown, they will serve as a knife guide for cutting drafting paper squarely and quickly. Countersunk holes are drilled through the strips and flathead wood screws are used to hold them in place. To measure off required lengths of paper, use is made of a flat metal stop, bent over at both ends

Mercury Makes Solder Brittle

Ordinary wire solder, which is very pliable, will be almost as brittle as glass when coated with mercury. Pass the solder through a small pool of mercury and then rub it until it shines. After this treatment, the wire will snap like glass.

Rotation of Crossed-Belt Drives Arranged to Lessen Wear

To prevent scarfed joints on crossed-belt drives from tending to pull apart due to the rubbing action where the belts cross, have the belt rotate in such a direction that the rubbing will press the edge of the joint down. If rotated in the opposite direction, the edges may catch and the lap will be opened. Another cause of breakdown of this type of belt occurs when the belt is run over pulleys of too small diameter. In such a case use of a lighter belt is indicated.

W. F. Schaphorst, Newark, N. J.

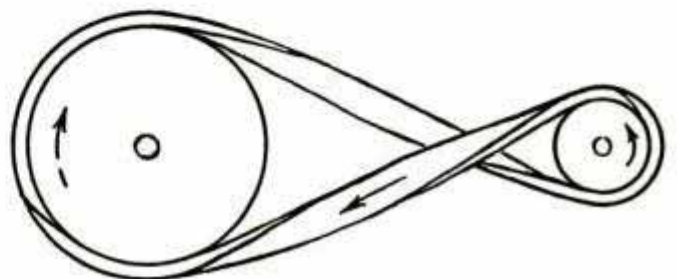

Build Your

PART 1-D.C. RELAYS

By C. A. Crowley

A RELAY is a simple device for controlling one electrical circuit by means of another. A low-voltage current flowing through the coil of a relay energizes it and causes movement of the relay armature, which, in turn, opens or closes one or more circuits to be controlled. Relays are important in places where a controlling device such as a home or office thermostat, a photoelectric cell, a burglar alarm, a fire alarm or other equipment is used, that can stand only a small current, but which must control a heavy current such as that required by a heater or motor. Relays also can be used to control shop motors remotely at a number of locations with ordinary push buttons.

It will be seen from Fig. 4 that the relay consists of a core, a coil wound on the core, a frame or "heel" piece, an armature and an arm on the armature which moves the contact springs. In some designs there are additional springs as in Fig. 6, A, where the moving contact is placed directly on the armature, while in Fig. 6, B, as well as in other designs shown, the fixed and moving contacts are insulated from the frame, and the moving contact is operated by a fiber "button" mounted on the armature. This form of construction generally is preferable to grounding the moving contact to the frame and armature. In any case, the contact springs must be insulated

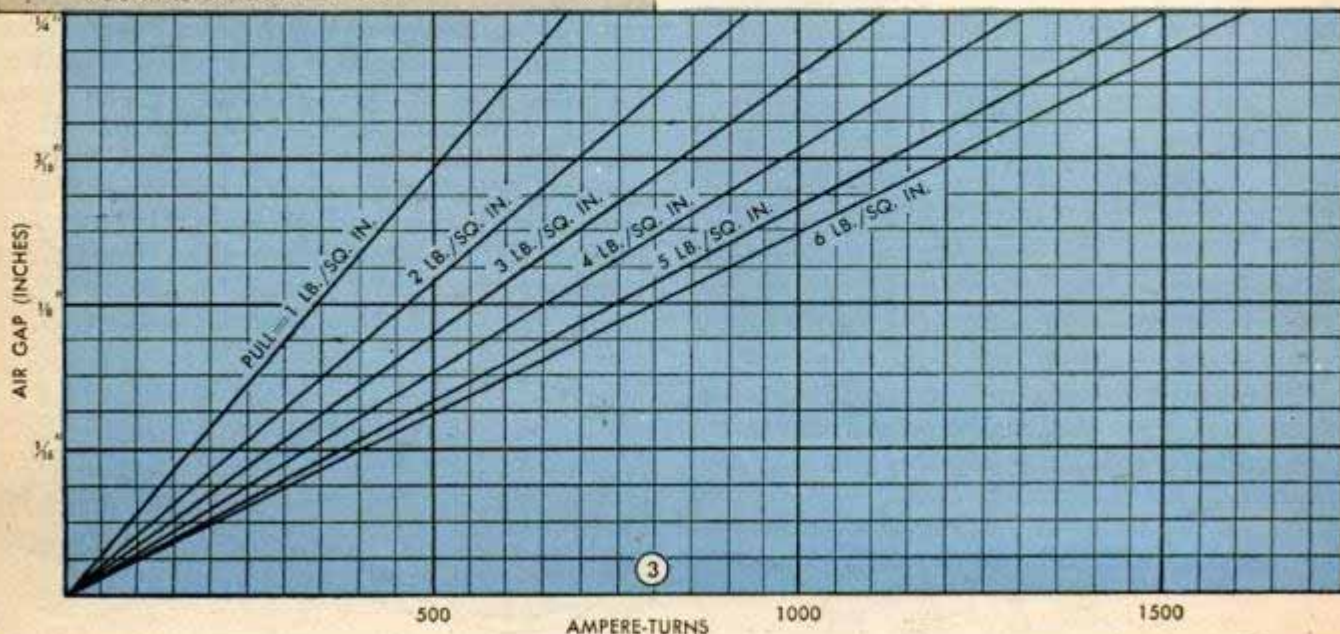
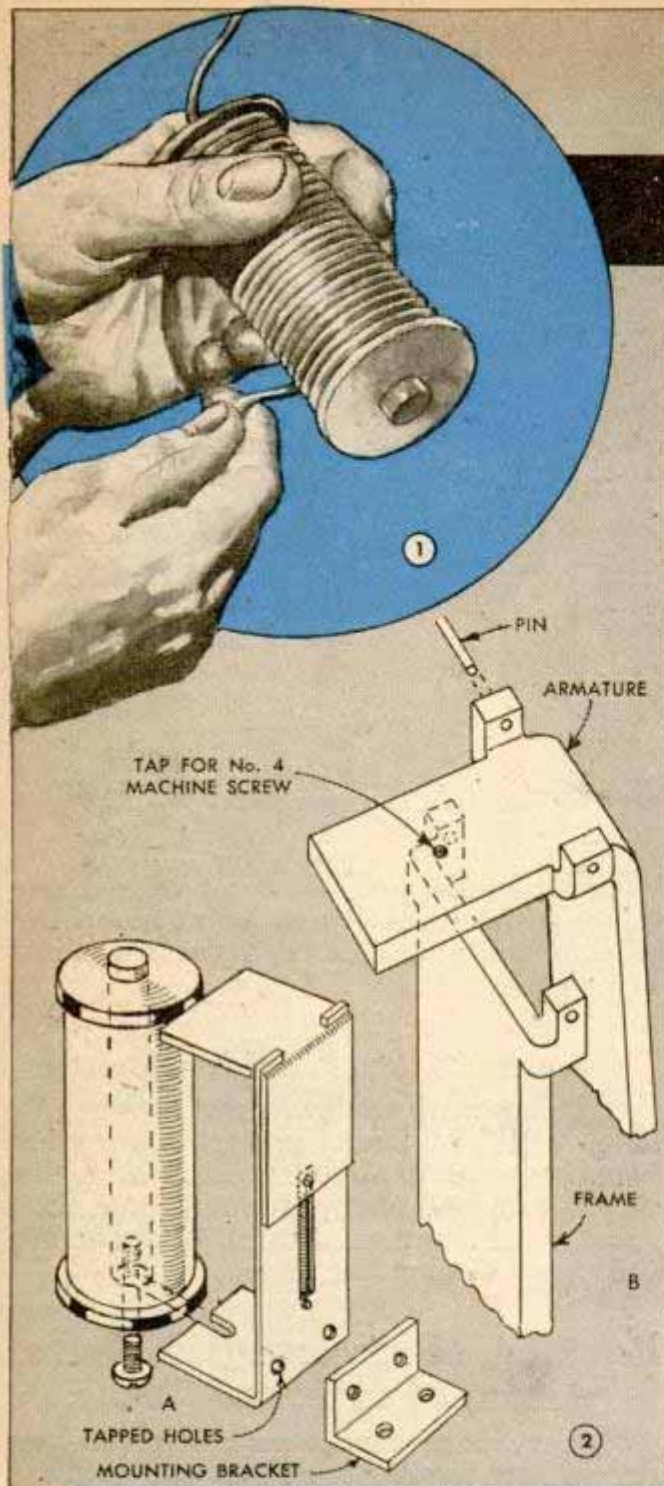

Own RELAYS

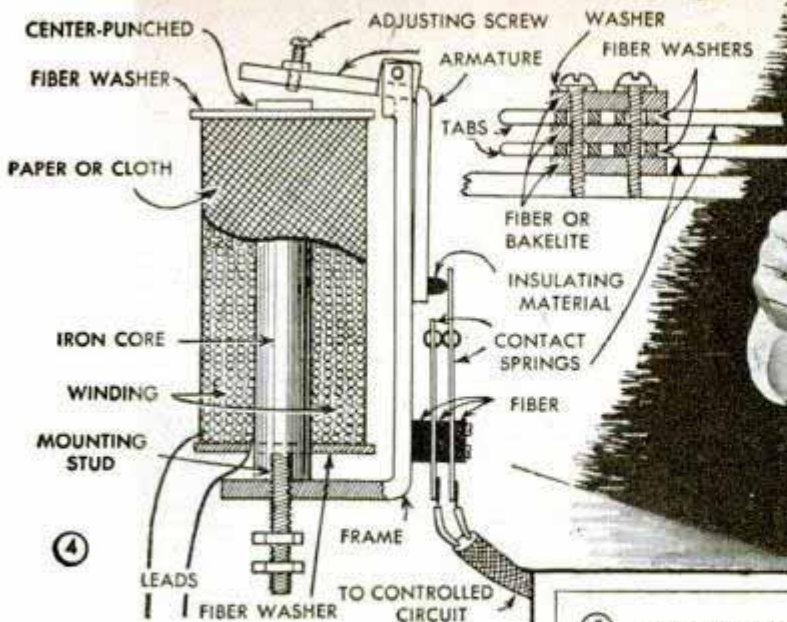

carefully and completely from each other as shown in the detail Fig. 4.

When deciding upon the type to use for a given purpose the following generalizations will be helpful: Heavy contact springs to handle large currents—use designs shown in Fig. 2, B, and Fig. 4; light contact springs to handle medium or small currents—use design shown in Fig. 6, B; simple two-contact relays for low voltages—use design shown in Fig. 6, A, and for sensitive relays to operate on very small currents such as those available from photoelectric cells, radio tubes, etc., use design shown in Fig. 2, A.

The frame and armature should be formed from 1/8-in. soft flat iron, which should be about the same width as the diameter of the coil to be wound. Contact springs are made from nickel silver or spring brass, and contact units may be assembled as in Fig. 7, details B, C and D. Two or more spring units also can be operated by one armature, either "piled up" as shown in Fig. 7, A, or side by side as in Fig. 9. Contact points for light and medium currents can be made from silver wire, forced into a hole drilled in the spring and then riveted down as in Fig. 8. For heavier currents, silver rivets or tungsten contacts of the type shown in Fig. 8 should be used. The arm which opens and closes the contact springs must be an integral part of the armature or must be rigidly attached to it. It also should be insulated from the contact springs as in Fig. 11.

Having determined the general design characteristics the next step is to calculate the coil size and winding data. The gov-

5 TOTAL PULL FOR VARIOUS SIZES OF MAGNET CORES

Diameter of Core	Lb. Pull Per Sq. In. of Core Area					
	1	2	3	4	5	6
1/4"	.05	.10	.15	.20	.25	.30
3/8"	.11	.22	.33	.44	.55	.66
1/2"	.20	.39	.59	.78	.98	1.17
3/4"	.31	.61	.92	1.22	1.53	1.84

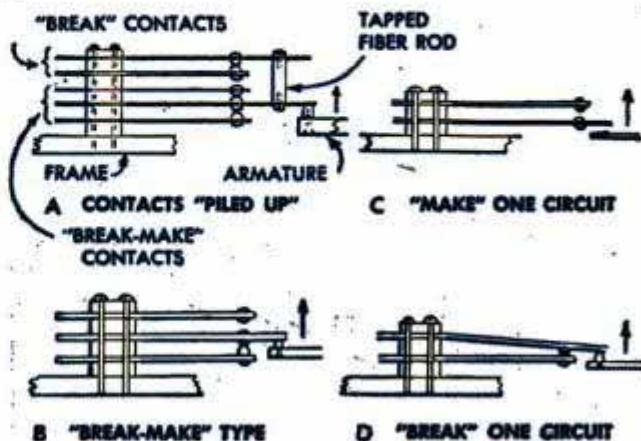
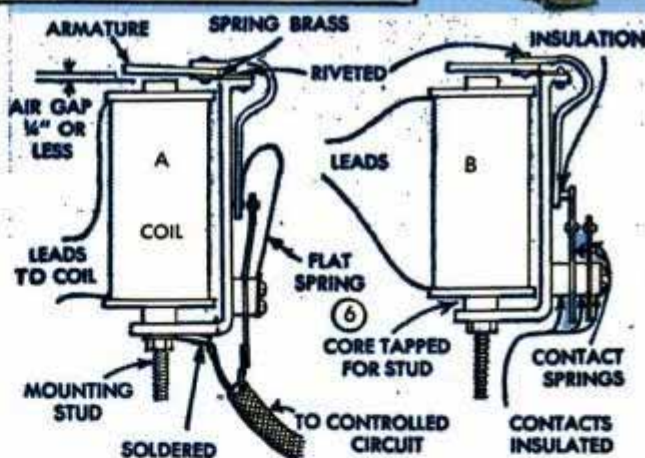

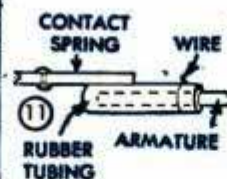
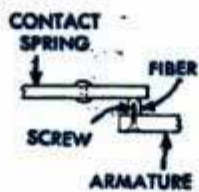
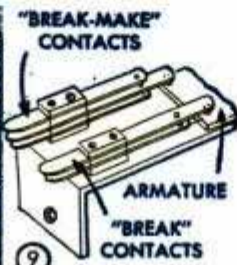
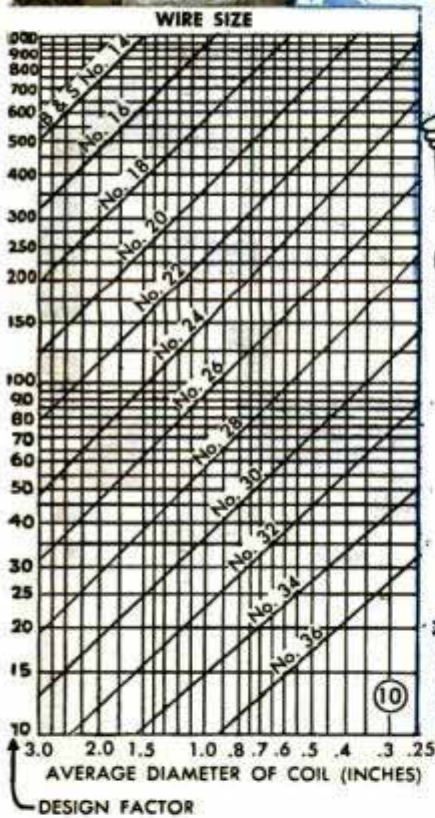
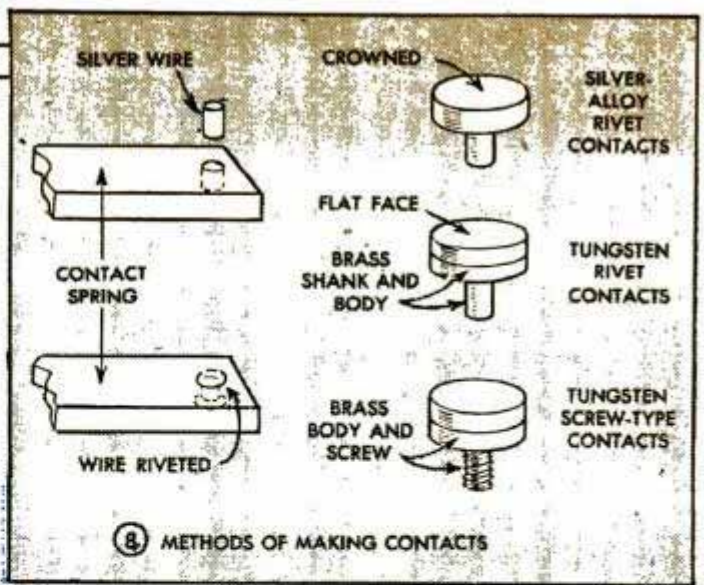

poses a $\frac{1}{4}$ -in. diameter core will be ample. However, for larger or heavy-duty relays, a heavier core may be more desirable. Refer to Fig. 5, from which it will be easy to calculate the pull required per sq. in. of core area, that is, the cross-sectional area of the core. As an example, suppose it is desired to construct a relay to operate three light springs. The pull required would be .0625 by 3 or .1875 lb. Now, referring to the table it will be seen that a $\frac{1}{4}$ -in.-diameter core wound to give a pull of 4 lbs. per sq. in. of magnet surface will pull .2 lb., or a little more than the requirement. However, as indicated in Fig. 5, a $\frac{3}{8}$ -in. core wound for a pull of 2 lbs. per sq. in. or a $\frac{1}{2}$ -in. core wound for a pull of 1 lb. per sq. in. would also meet the need. Since it is desirable to use the smallest practical core diameter, the $\frac{1}{4}$ -in. core is selected. However, for low-voltage relays it is sometimes desirable to use a larger core to reduce the current required.

Next step is to determine the number of ampere-turns required to give the desired pull. This depends on the air gap, or space between the end of the core and the armature when the relay is in the open position. See Fig. 6, A. This gap should be not more than $\frac{1}{4}$ in. and preferably should be less. In highly sensitive relays the allowable gap usually is between $\frac{1}{32}$ and $\frac{1}{16}$ in. For purposes of illustration use an air gap of $\frac{1}{8}$ in. Referring to Fig. 3, find the air gap, $\frac{1}{8}$ in., along the left-hand edge of the chart, then read straight across to the line marked with the required pull per sq. in. Then read down to the bottom where the number of ampere-turns required will be found, in this example approximately 660. Thickness of the coil should roughly equal the diameter of the magnet core, in this case approximately $\frac{1}{4}$ in., making the overall diameter of the coil $\frac{3}{4}$ in. Length of the coil proper should be about $1\frac{1}{2}$ in., which is the length of the winding space. The core

erning characteristic is the pull required of the magnet which will operate the relay. This, in turn, depends on the tension of the springs which hold the armature and contacts in their normal positions. Tension on an average contact spring should not exceed 1 oz., or .0625 lb., and may be less with very light springs. For a greater number of contact springs operated by one armature, or if an auxiliary spring is used, the pull required will be correspondingly greater. After estimating the pull required, the next step is to determine the core size. The core required will range from $\frac{1}{4}$ to $\frac{1}{2}$ in. in diameter for most relays. For ordinary pur-

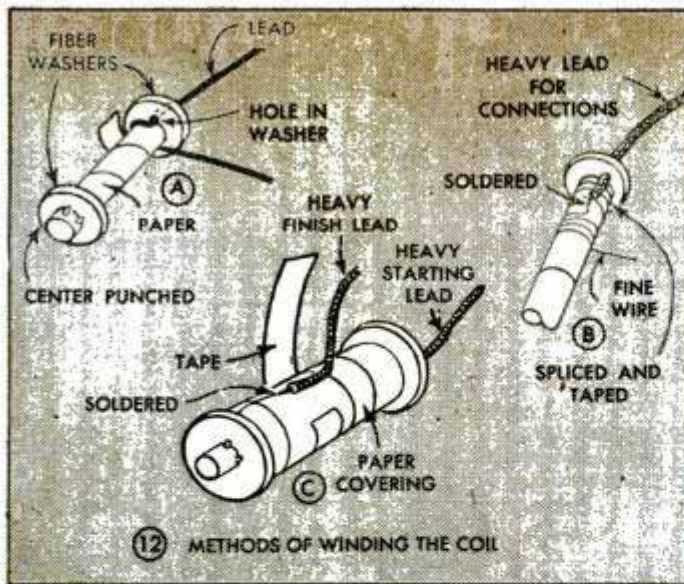

12 METHODS OF WINDING THE COIL

must be somewhat longer to allow for thickness of the insulating washers. However, these dimensions are not critical. The coil can be made longer or thicker.

The wire size for the coil is determined by the operating voltage. As an example assume that the relay is for an alarm system which will be operated on four No. 6 dry cells in series, giving a total of 6 volts. The "design factor" for a d.c. relay is found by dividing the ampere-turns by the voltage, that is, 660 ampere-turns divided by 6, or 110. Next determine the average diameter of the coil by adding the diameter of the core to the outside diameter of the coil and dividing by 2. From this it will be found that the average diameter of a coil $\frac{3}{4}$ in. outside diameter, wound on a $\frac{1}{4}$ -in. core, is 0.5 in. Now, with the aid of the chart, Fig. 10, find the design factor, 110, along the left-hand margin. Next, find the average diameter of the coil, 0.5 in., along the bottom. Finally, read straight across from the left and straight up to the intersection of the two lines. This intersection is nearest the line marked "No. 28 B & S," which is the size of wire required.

With these calculations completed you're ready to wind the coil after the manner shown in Fig. 1. First, cut the core $1\frac{3}{4}$ in. long and fit a fiber insulating washer at each end with a space of $1\frac{1}{2}$ in. between. Washers should be a tight fit and slightly larger than the outside diameter of the finished coil. Wrap the core with several turns of brown paper and coat with shellac. Start the winding as in Fig. 12, A and B, which suggest two methods of anchoring the starting end of the wire. Each two or three layers of winding should be wrapped with thin paper and coated with shellac. In winding d.c. relays it is not necessary to count the turns of wire but care should be taken to wind evenly so that the space will be filled uniformly. When the coil is finished it should be wrapped with paper or

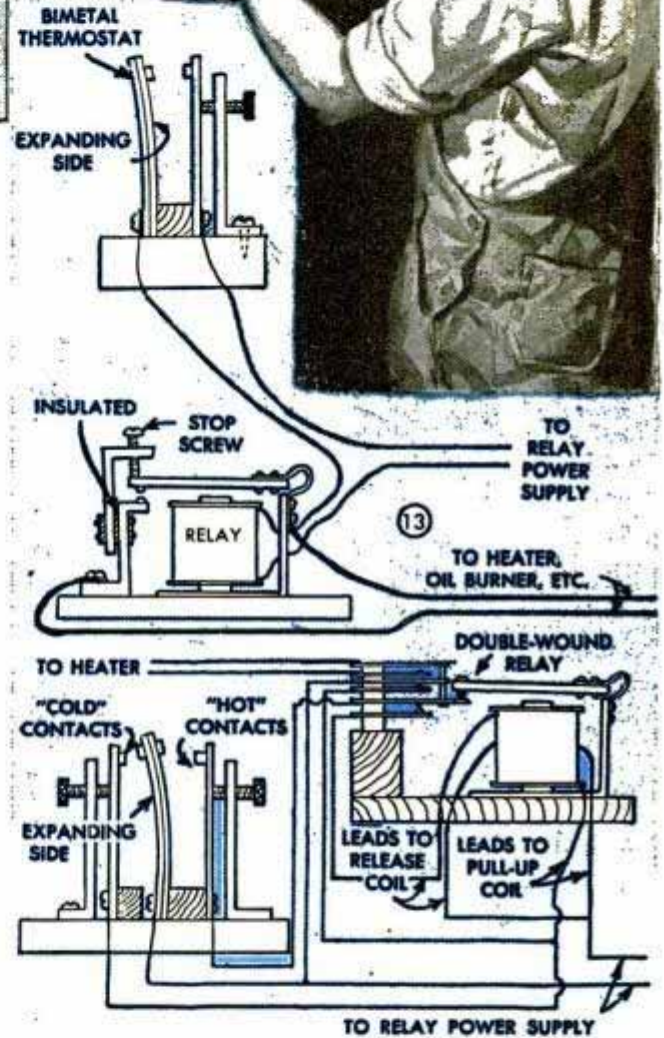
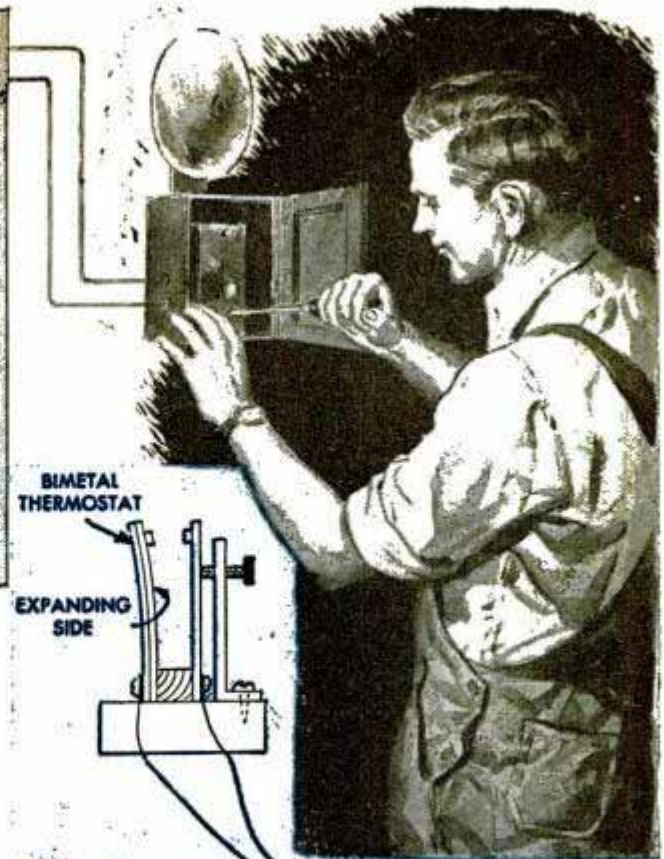

varnished cloth. If wound with fine wire, heavier leads should be soldered on and taped securely as in Fig. 12, B and C. The coil then can be mounted in the frame in the manner indicated in Fig. 4.

Contact springs should be fastened rigidly to the frame and fully insulated from it with fiber, bakelite or a similar insulating material, as in Fig. 4. Usually it will be found that the greatest sensitivity is secured when this adjusting screw just barely extends below the lower face of the armature. Provide a lock nut so that the screw can be held in the proper position. Fig. 13 details the connections for two practical applications of relay-controlled circuits.

(Continued next month)

Canvas Cover Protects Lathe Bed From Metal Filings

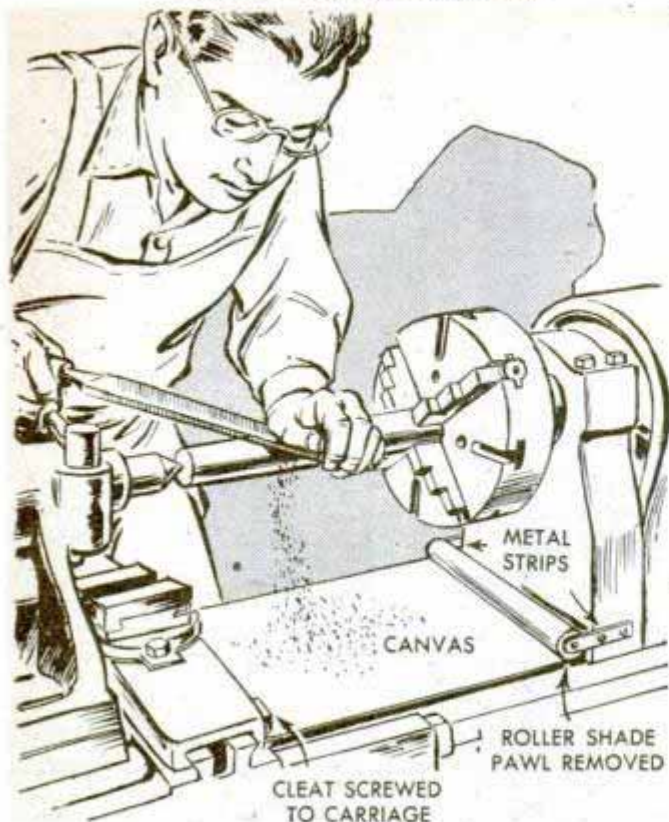

Instead of putting a cover over your lathe bed when filing a piece of work, you can use a roller shade and some canvas to make the one shown here. If desired, the cover can be detachable so that it is easily removed for cleaning. The catch on the shade should be removed so that it will roll in either direction.

Axel E. Jensen, New York

Arrow Points to Latest Notice On Bulletin Board

An arrow which is made of sheet metal and lettered to read "Latest Notice" or "Special Notice" can be tacked on a bulletin board to attract attention to the last item posted. The background of the arrow is



painted white and two thumbtacks are soldered on the back to hold it and to permit changing its position easily. The utility of this arrow lies in the fact that where a number of notices are posted, a new one frequently is overlooked.

Disks Prevent Triangle Smudge

If round pieces of plastic or celluloid are glued near the angles on one side of a triangle, the entire surface will not rub on the paper and smudge the pencil lines on the drawing, as will occur when the triangle rests flat on the paper. Doing this also makes it easier to pick up the instrument. The disks must be cut fairly thin since drawing a straight line is difficult if the guide is not close to the paper. Similar disks could be glued to French curves, celluloid scales and other ruling instruments.



Sante Vananzini, Astoria, N. Y.

Pencil Pointer From Match Book

A good substitute for a pencil sanding block that can be carried with you is made by removing the matches from a paper-match book and inserting several sheets of fine sandpaper cut to fit the book. The sheets are fastened with a staple. When the top sheet has been covered with pencil lead and no longer is usable, it is torn out to expose the one below it.



Orville Buser, Kankakee, Ill.

Ink for Writing on Glass

Ink that will adhere to glass can be made by mixing, drop by drop, a 13-percent alcoholic solution of shellac, 3 parts by volume, to a 13-percent solution of borax in water, 5 parts by volume. If a precipitate forms the solution will clear on being heated. As the amounts used are not critical, approximate volumes will do, as, for instance, 2 oz. of borax to a half pint of water. To obtain different and contrasting colors methylene blue, gentian violet or any other similar dye can be dissolved in the solution.

Arthur Beiser, New York

Resistance Unit for Welding Light Sheet Metal

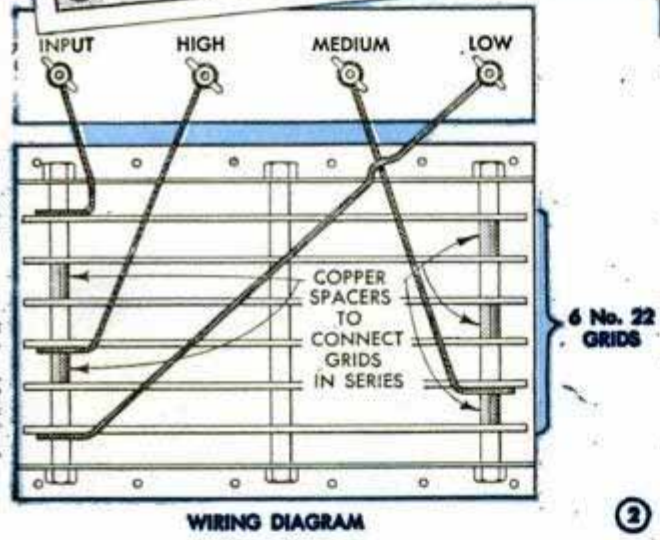
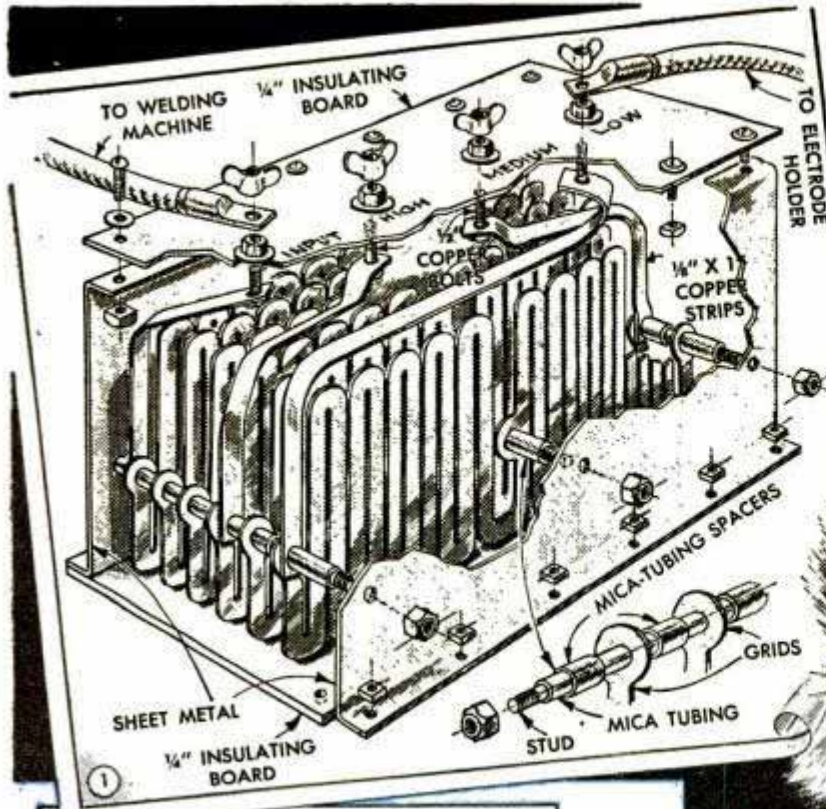

This resistance unit permits welding light-gauge sheet metal as thin as No. 26 gauge, using a regular 300 or 400-ampere welding machine on which you ordinarily would be unable to limit heat sufficiently to prevent "blowing" holes in the metal, even at the lowest setting. Using this device, the heat may be cut down sufficiently to permit a smooth, uninterrupted weld. The unit consists of six No. 22 cast-iron resistance grids mounted in series, with taps to the output terminals at the end of the fourth, fifth and sixth grids. Since each of the grids is of approximately $\frac{1}{4}$ -ohm resistance, taps are therefore at 1, $1\frac{1}{4}$ and $1\frac{1}{2}$ ohms respectively. Input terminal connects, of course, with the outside end of the first grid. No. 22 grids are of sufficient size to prevent undue heating. Details above show the layout and connections. The taps, which provide

various heats for metals of different thicknesses, are ordinary $\frac{1}{2}$ -in. bolts with wing nuts and are connected to grids at the points indicated with $\frac{1}{8}$ by 1-in. copper strips. The three studs shown in the side of the box run through the grids and hold the unit together, being insulated from the grids by mica tubing and washers. Both baseboard and top panel on which terminal bolts are mounted are of $\frac{1}{4}$ -in. asbestos-type insulating board. Sides are of sheet metal. Use copper tubing instead of mica tubing, Fig. 2, where grids are connected in series. The unit is connected in series with either the electrode or ground lead when working alone, but in cases where a number of welding machines are working off a common ground it is essential that the unit be placed in the ground lead—especially if some of the machines are using straight polarity and the others reversed polarity.

William R. Lewis, San Francisco, Calif.

'Gummed' Manifold Sandblasted To Improve Motor Operation

Sometimes deposits are built up on the inside of the intake manifold of a car which affect the efficient vaporization of the fuel. If this occurs, you can sandblast the inside to remove the deposit. At the same time it would be well to clean the exhaust manifold and install new gaskets.

Charles P. Fitz Patrick, Philadelphia, Pa.

Oil Drum Converted to Container For Greasy Mops

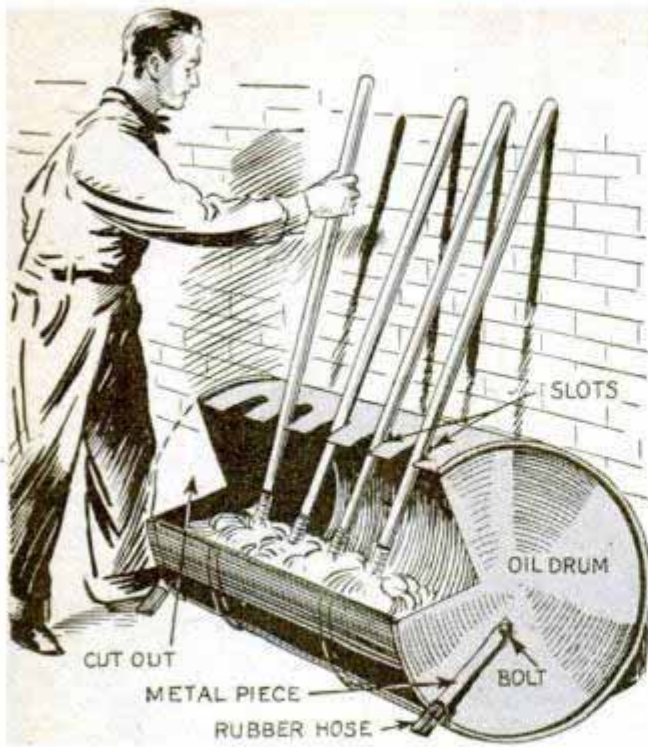

Handy for holding greasy mops, this rack is used in a garage where, since the container prevents oil and grease from spreading over the floor, it serves to reduce fire hazard. It is made by cutting a V-shaped section from an oil drum and notching it to hold the mops upright. To complete the rack, legs with rubber-hose tips are bolted to the drum to prevent it from rolling.

Keep Star-Drilled Holes Clean

When vertical holes are driven in concrete or brick with a star drill, the removal of dust presents a problem since this accumulation creates a pad that slows the action of the drill. To overcome this, one mason bushed a piece of rubber tubing to fit the auxiliary connection on a vacuum cleaner and then removed the dust by inserting the other end of the tubing in the partially drilled hole.

A. K. Brumbaugh, Jr., Inglewood, Calif.

Tongs to Grip Tapered Work

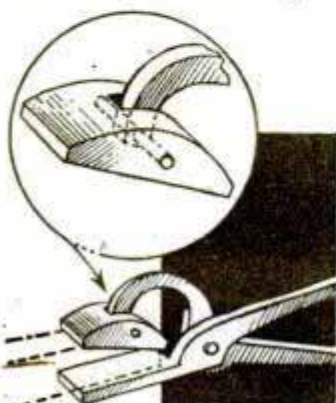

For handling tapered work, a pair of tongs having a small piece of metal shaped as indicated and pivoted to one jaw will be found useful, especially in a blacksmith shop or where hot forgings are handled. The

jaw is forged to the shape shown to fit into a recess in the pivoted member, and then a hole is drilled through this piece and the jaw for a pin to hold the jaw. The pivoted member will adjust to the surface of the work and afford a firm grip to hold the material securely.

Caliper Efficiency Is Increased By Painting Ends White

Where illumination is insufficient when using either inside or outside calipers, you can avoid eyestrain, as well as possible error in taking the caliper reading from a scale, by painting the ends of the calipers

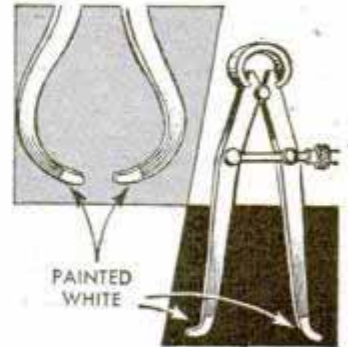

white. This will enable you to see the ends more clearly. If accuracy is critical, remove the paint from the surfaces of the calipers that contact the work. It is best to use a flat white paint as glossy paint might cause light reflections that would result in an inaccurate reading.

Thomas Trail, Baltimore, Md.

Castings Supported on Steel Wool While Welding Them

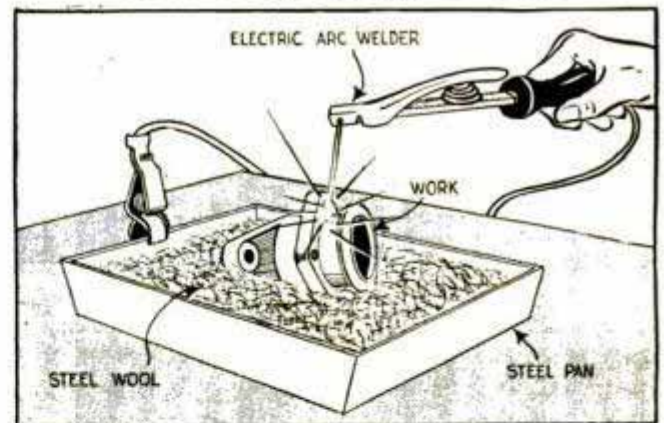

Sometimes when using an electric welding outfit on work that is irregular in shape it is difficult to attach the ground clamp to it. Try making a nest of steel wool in an iron or steel pan to hold the work and fasten the ground clamp to one edge of the pan. The steel wool assures a good electrical contact with the work and assists in holding the parts together in the desired position for welding.

☛ If the front of a fabric typewriter cover is identified with a bright spot of nail polish, replacement will be easier because the mark will show how the cover fits.

POST-HOLE AUGER Driven By Tractor

*Farm Manual
(47 + 55
eds.)*

Assembled from junk parts, this post-hole auger makes easy work of a tiresome job

DRIVEN from the tractor power takeoff through a V-belt, this post-hole auger has the advantage of an easily controlled hand feed which makes it possible to dig holes in fence rows where roots, stones and other obstructions sometimes cause delay and breakage. The necessary angle drive is made by adapting an old Dodge differential, but any of the older automobile differentials having square holes for the axles can be used. Of course, complete dimensions cannot be given in the detail drawing, nor can the arrangement be followed closely when mounting the auger on the various makes of tractors. Hence the details shown at the right are only suggestions on how to make the assembly of the various parts.

In this case the square drive shaft was taken from a rod weeder, but any square steel shaft of good quality material can be used. The top end of the shaft is carried in a single ball bearing and fitting this properly likely will require some alteration, such as turning down the end of the shaft to fit the inner ball race. On a tractor of a different make than that shown it will be necessary to alter the horizontal drive-shaft support so that it will fit the tractor transmission housing. It also will be necessary to change the braces to the tractor drawbar. The details show one way of making these adjustable for length. Other methods of accomplishing this can be used when necessary. The combine header lift makes a handy arrangement for lowering and raising the auger and controlling the rate of feed. Although one man can operate the auger there is less danger of breakage where there are two operators, one to drive the tractor, the other to handle the digger.

Photo and certain constructional details courtesy of State College of Washington

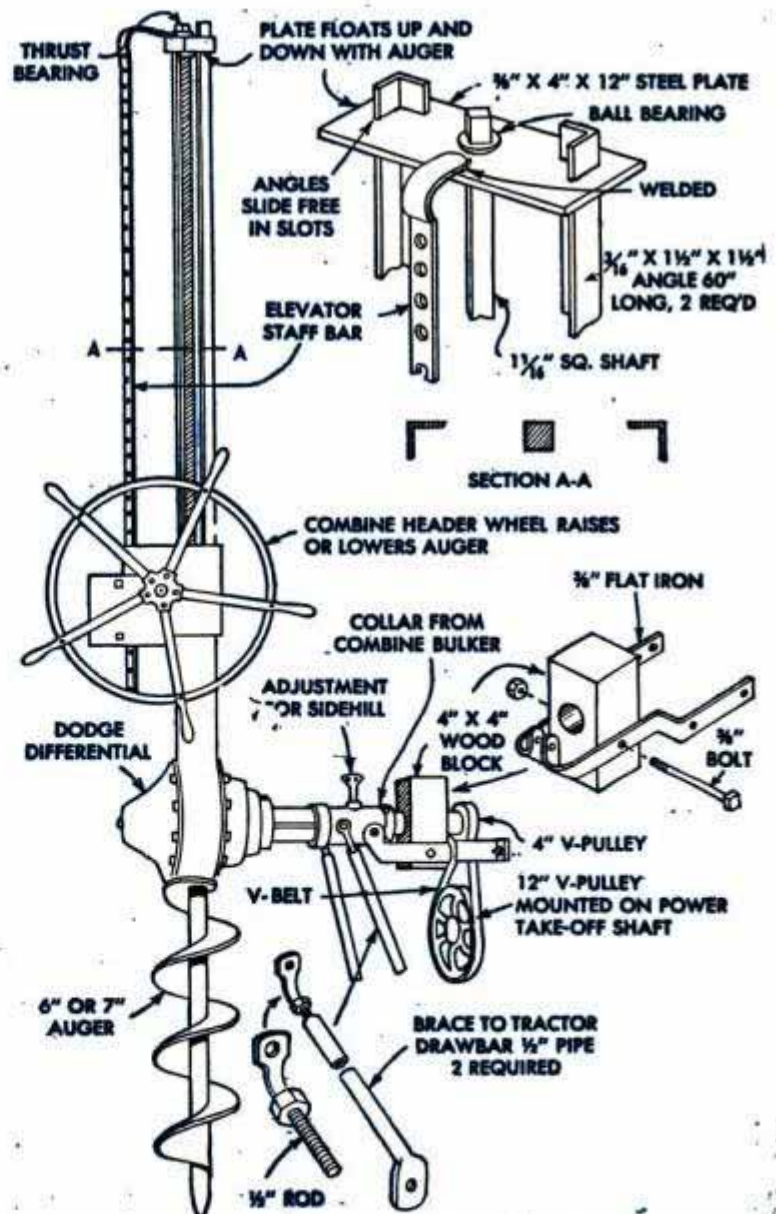
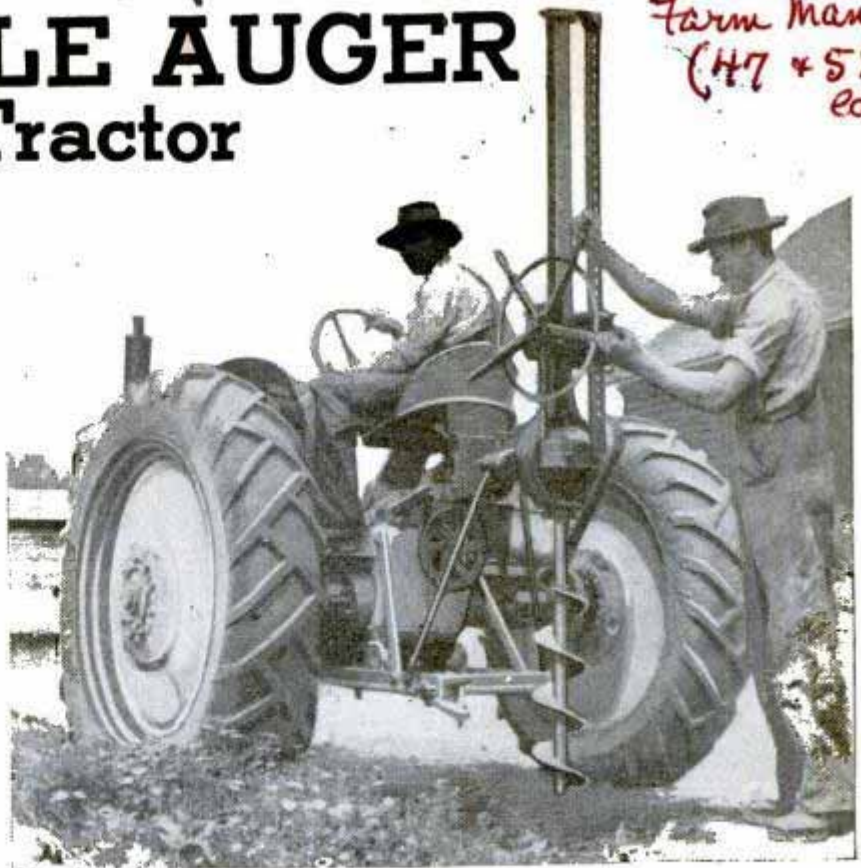

Slit Cut in Mitten Helps Surveyor Take Transit Readings



Surveyors and others whose work keeps them in the open during cold weather will find that a mitten with a slit in the palm is handy. Instead of withdrawing the hand from the mitten to make adjustments on the transit, the fingers are extended through the slit and the rest of the hand is protected.

G. E. Hendrickson, San Diego, Calif.

Extension Anvil on Office Stapler For Tacking Large Work

Large cutouts, notices and pictures can be posted on an office bulletin board or announcement poster without a special stapler for this purpose by adding an extension to an ordinary stapler. The extension,

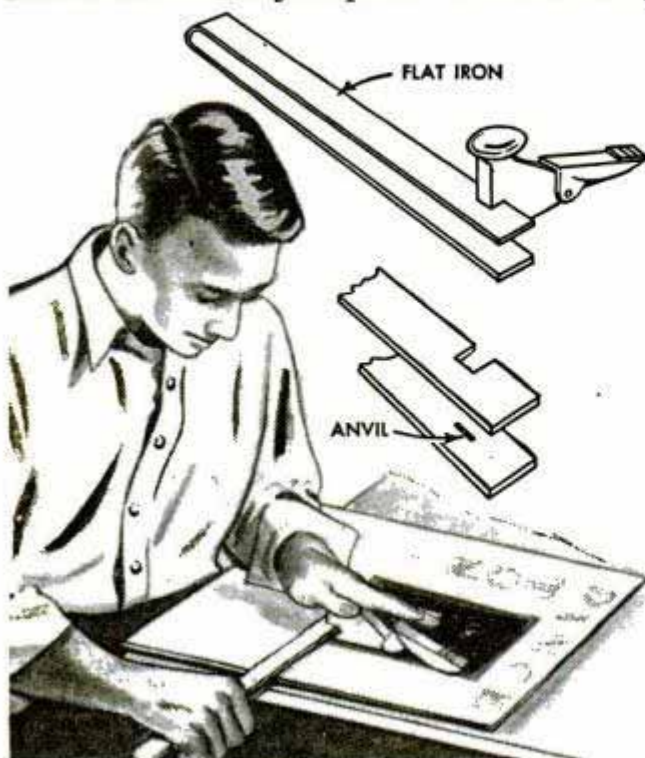

which is a 4-ft. 4-in. length of $\frac{1}{8}$ by 1-in. flat iron, is bent to a U shape, the two ends being about $1\frac{1}{2}$ in. apart. These are prepared as shown in the detail, one being notched to fit snugly over the sides of the stapler and the other grooved to form an anvil to clinch the staple. In use the extension is slipped over the edges of the poster board, the notice is positioned and the staple is driven in.

Pencil Is Marker for Dressmaking

A white manicure pencil is a good marker when a dressmaker is working on dark materials. The pencil should be moistened. After the work is completed the marks can be brushed off.

—M. T. Fox, Wellesley Hills, Mass.

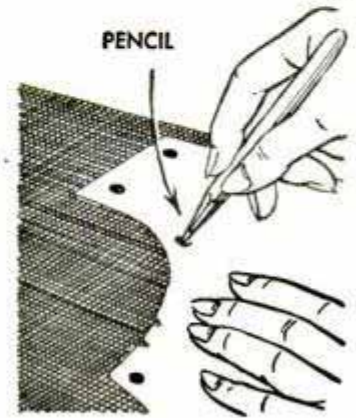

Heating Will Clean Brake Lining

Brake linings that are saturated with grease not only are unreliable but may be the cause of a serious accident. Greasy brake linings may hold for a second or two, but as soon as heat caused by friction softens the grease they are almost as bad as no brakes. It is best to replace greasy linings, but they can be made partially effective by removing the grease with heat. This is applied directly to the band to drive out the grease which is wiped off with a cloth, repeating the operation until most of the grease has been removed.

Robert R. Kottmeier, Hamilton, Ont., Can.

Water-Level Float in Gauge Tube Made From Cork and Wire

When the water level on a boiler gauge glass cannot be seen easily, a colored float can be placed in the tubing to show the height of the column. The float is made from a piece of cork that fits loosely inside the tubing, and a short length of wire is driven into the cork to weight it so that it will not adhere to the sides of the glass. Because the cork is colored, it will be noticed readily even in a boiler room where it is semidark.

—F. T. Brown, Chicago.

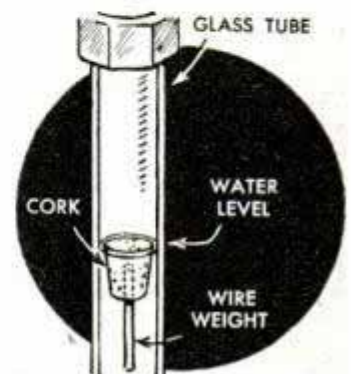

Handy Level Sights Made From Small C-Clamps

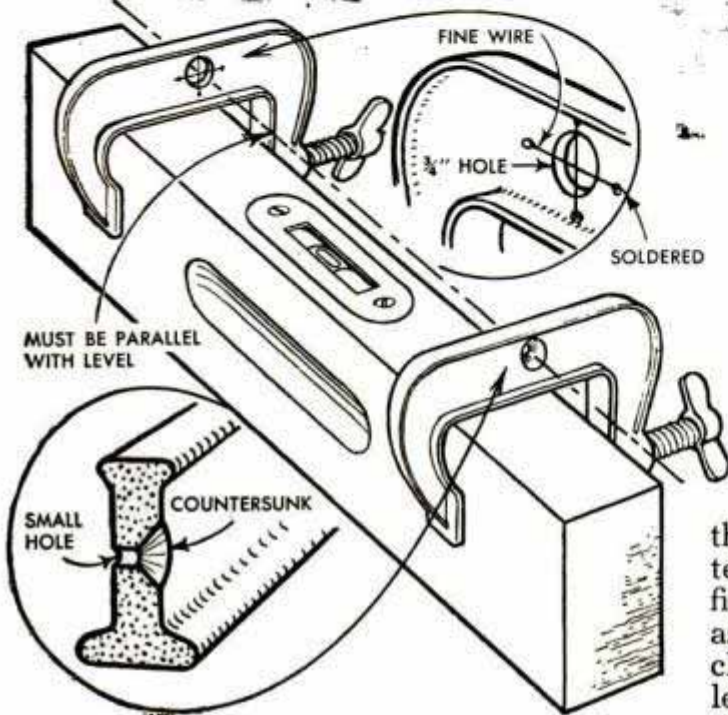
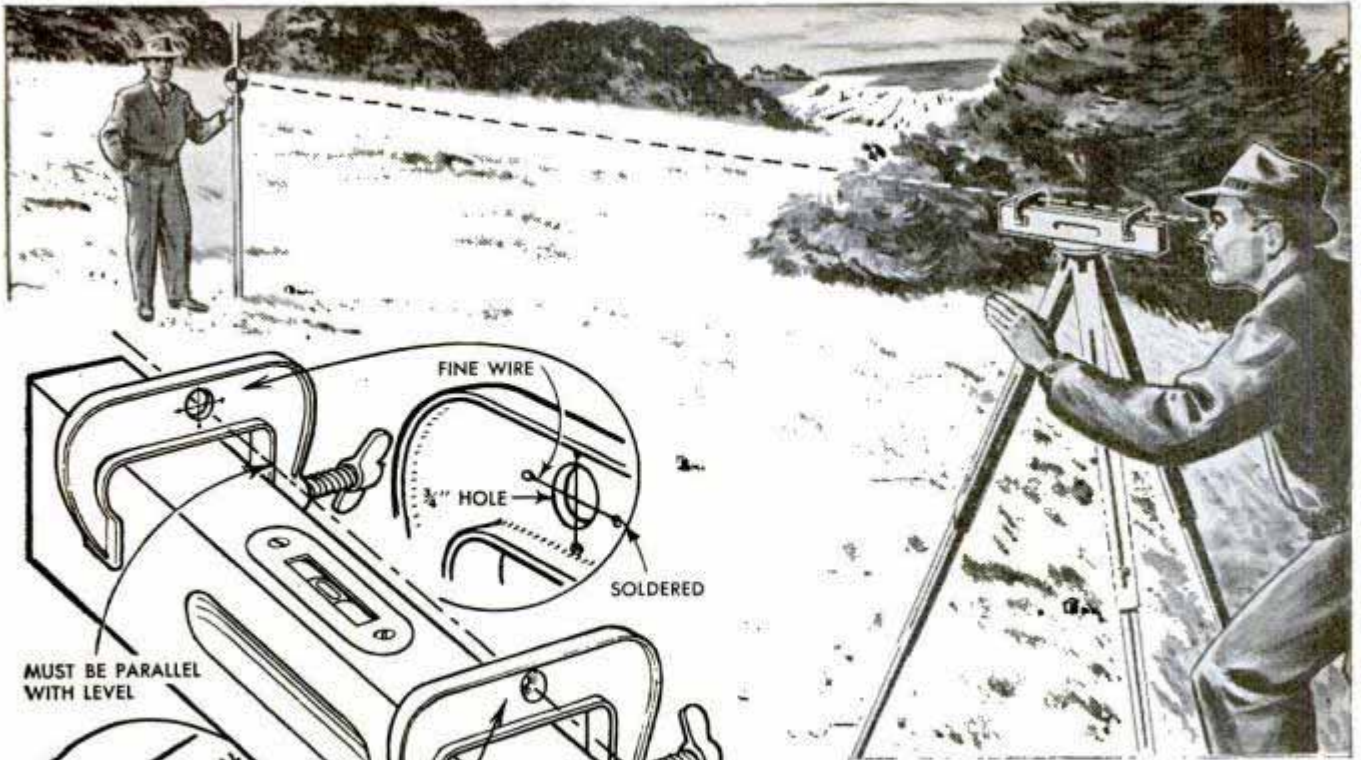

same distance from the inside face of the frame on both clamps. Then countersink the smaller hole with a "rose"-type countersink as shown. "Cross hairs" made from fine wire are soldered over the larger hole as indicated in the detail. Then the two clamps are tightened on the frame of the level. With this assembly mounted on a tripod you can do quite accurate work in determining grades for ditches, field terraces and the settings for walls and foundations, using the conventional surveyor's rod and target. For rough work you can easily improvise a target from a 1 by 2-in. wood strip and a colored disk cut from heavy paper.—Charles F. Murray, Omaha, Neb.

An ordinary wood-frame carpenter's level and a pair of small C-clamps can be made a satisfactory substitute for more expensive leveling instruments. Center a $\frac{3}{4}$ -in. hole through the frame of one clamp and a $\frac{1}{8}$ -in. hole through the other. Be sure that the holes are centered exactly the

Movable T-Square Blade Pivots on Protractor Set in Head

A T-square can be made adjustable so that lines can be drawn at predetermined angles if the blade is removed and pivoted over a small protractor, which is attached to the head of the T-square in the position indicated. The blade is rounded at the pivoted end to correspond with the inner arc of the protractor and is attached to the head with a carriage bolt held by a wing nut over a washer. A witness mark then is cut in the curved end of the blade to coincide with the 90-deg. mark on the protractor when the blade is set at a right angle to the head.—S. S. Palestrant and E. I. Russ, Bronx, N. Y.



☛ To make a temporary repair in a leaky iron pipe, fill the hole with iron cement and hold it with a band around the pipe.

Rubber Grip Allows Better Hold On Large Oil Cans



Because the handles on five and ten-gallon oil cans are small, one filling-station operator made a rubber grip which affords a better handhold. A piece of $\frac{1}{2}$ -in. rubber hose is cut $1\frac{1}{2}$ to 2 in. longer than the handle and slit lengthwise. It then is notched as shown in the center detail. To use the grip, slip it on the handle and turn it around so the notches catch on the wire, as illustrated in the lower detail.

Ground Edge Improves Mattock

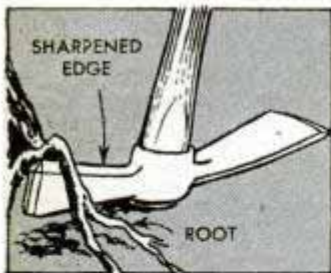

By grinding the inner edge of the chopping blade to a sharp cutting edge all along its length, the usefulness and efficiency of a mattock is greatly increased.

When the blade becomes wedged under a root, a quick upward pull will sever a small root and free the blade.

Robert Hewitt, West Hartford, Conn.

Method of Varnishing Armatures

When rewinding the armatures of electric motors, it is necessary to have the windings thoroughly impregnated with insulating varnish. One way to do this is to soak the finished winding in the varnish. The armature is placed on end by resting the shaft in a hole drilled in a block of wood with the commutator end up. A rubber sleeve, cut from an inner tube, is pulled down over the armature and fastened

around the shaft at the lower end with two or three twists of wire. Varnish then is poured into the sleeve up to the commutator level. After soaking several hours, excess varnish is drained off, the sleeve is removed and the armature set aside to dry. Sidney Wooler, Fort Erie North, Ont., Can.

Cigarette Box Is Ideal Container For Taps and Dies

Flat cigarette boxes of the type illustrated are ideal as a storage place in which to keep small taps and dies. A block of wood which has been sawed to hold the pieces, as shown in the photograph, is fitted in the box. When kept in this manner, threads on taps and dies will not become dulled by contact with other tools. Taps, dies and any other tools kept in small boxes over a period of time always should be coated with light oil to prevent rusting.

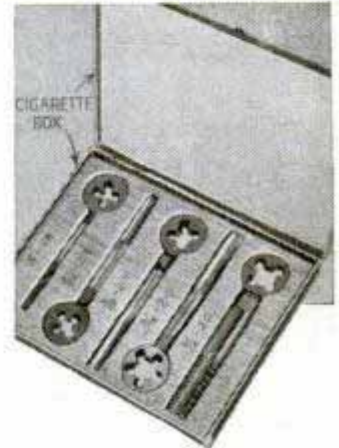

Grease Holds Chips in Tap Flutes

Chips from a cut may drop into oil sumps, bearings or elsewhere and damage machinery when tapping holes. To prevent this, one machinist fills the flutes of the tap with heavy grease to hold the chips while the hole is being threaded. It may be necessary to add grease during the operation. If you can't run the tap clear through to free it of chips, be especially careful when backing the tap out that the chips do not "ball" and cause breakage. Also, when tapping deep holes it's a good idea to back the tap out occasionally and clean it in gasoline. Regrease the flutes each time after this has been done. — H. Funkey, San Francisco, Calif.

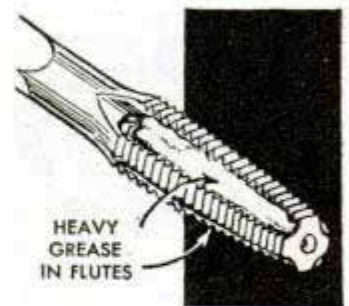

ⓁAgricultural gypsum, available at poultry and feed stores, is useful around chicken coops and rabbit hutches not only as a deodorant but as an absorbent that retains the ammonia and so preserves the nitrogen content of droppings which are used as a fertilizer. A handful sprinkled over the dropping boards occasionally is all that is needed.



Postwar Sets of Advanced Design

SOME manufacturers are claiming up to 60 percent greater sensitivity and selectivity for their postwar models, also better reception unmarred by interference from extraneous sources.

RCA Victor's new "personal" radio illustrated in photo 1 is small enough to fit into a topcoat pocket. It weighs only 3½ pounds complete with batteries but has sufficient volume for room-level performance. Compactly housed in a wear-resistant plastic case, it turns on automatically as the lid swings open. Photos 2 and 3 show Stewart-Warner's 6-tube a.c. table-type combination radio and phonograph, the phono section of which has an automatic record changer. Single control changer operation eliminates switches, levers and knobs. From one to twelve 10-in. records or up to ten 12-inch records are handled by the automatic changer. Other features include a sensitive floating-point needle claimed to be good for five thousand or more playings. Record surface sounds and motor noises are eliminated. The receiver employs a built-in loop antenna and the audio output is four watts.

Period dignity and elegance in some of the new console receivers will be a selling factor. This is clearly indicated in the "concert grand" which appears in photo 4. Fashioned of seasoned hardwood and rich mahogany veneers, this Westinghouse phono-radio 7-tube combination console is claimed to be of true 18th century design in its distinctive bow-front.

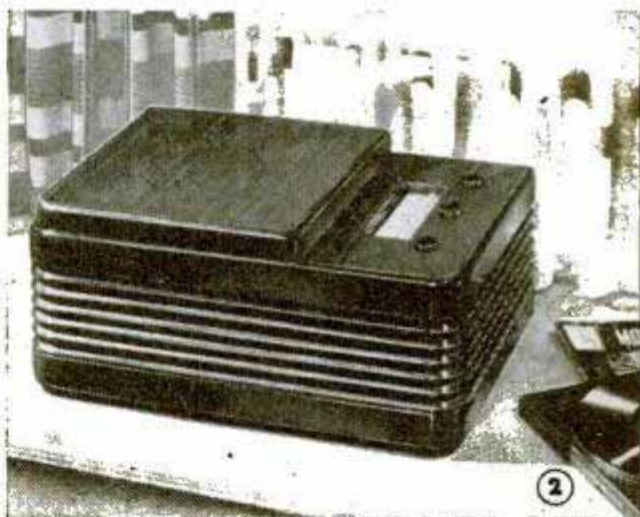

1946 "LITTLE GIANT" A.C.-D.C. SUPER

By S. A. Johnson

NOW that radio parts are gradually becoming available this postwar model of the popular Little Giant student set employs standard coils.

Although the receiver uses but four tubes it is a full-fledged superheterodyne. As three of the tubes are of the dual-purpose type it has 7-tube efficiency and excellent tone. The cabinet is a blank stock model which includes the speaker grille; it is 13½ in. long, 6½ in. deep and 8 in. high.

Owing to the fact that tubes are still scarce, the 6 series may be substituted for the 12's, if desired. For example, a 6SA7 for the 12SA7 mixer tube, a 6K7 for the 12K7 I.F. amplifier and a 6SQ7 for the 12SQ7 2nd detector-1st audio tube. If these substitutions are made, use a type 32L7 instead of the 70L7, change value of resistor R11 to 220 ohms and omit pilot lights.

Chassis base details appear in Fig. 1 and various views of the set are shown in the photos. A schematic circuit diagram is given in Fig. 2 and a pictorial wiring diagram in Fig. 3.

The variable ganged condenser used in

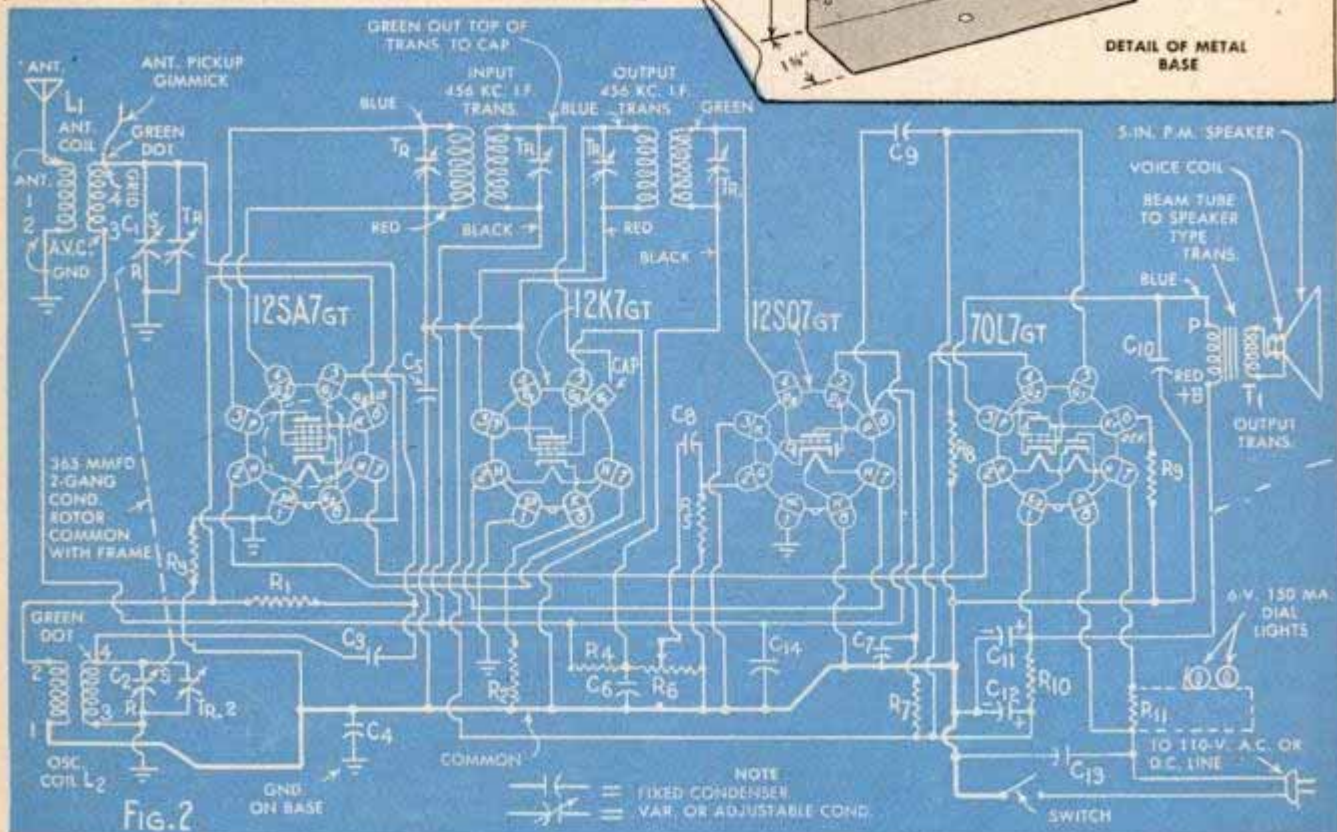
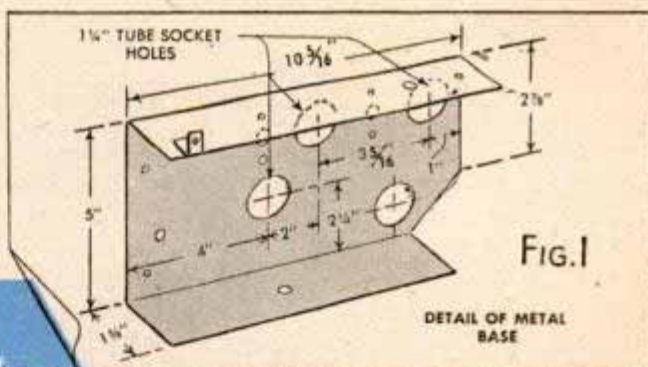
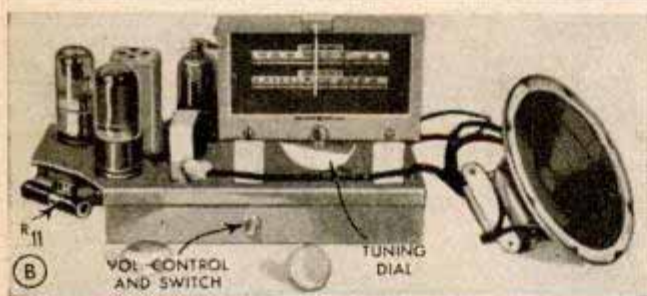
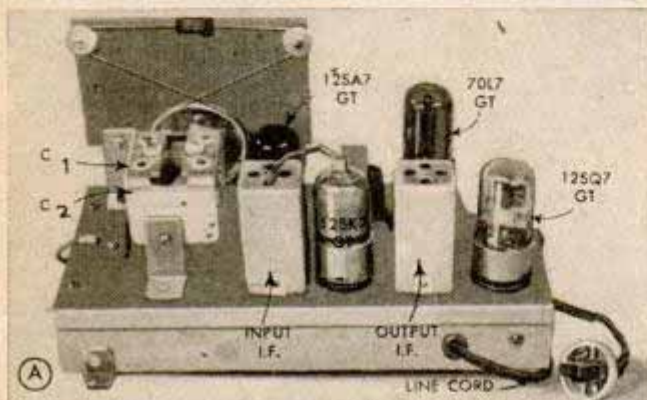

USES DUAL-PURPOSE TUBES

the final model has a cut plate oscillator section in C2 which does away with the need for a padder condenser. If your condenser does not have a cut plate section, insert a 350-mmfd. padder condenser in series with the green dot (S) lead from the oscillator coil. The antenna and oscillator coils are unshielded adjustable "universal" Meissner types and the I.F. coils are 456 kc. shielded Meissner standard transformers.

To line up the set use a 50-ft. antenna and tune in a weak station; adjust trimmers on I.F. transformers with an insulated screwdriver for maximum signal. Set the dial to some known station near 550 kc. and adjust the iron core in the base of the oscillator coil until the station is at the proper dial setting; then adjust the iron core in the antenna coil for loudest signal. Detailed student material list R-342 is available upon receipt of ordinary letter postage.

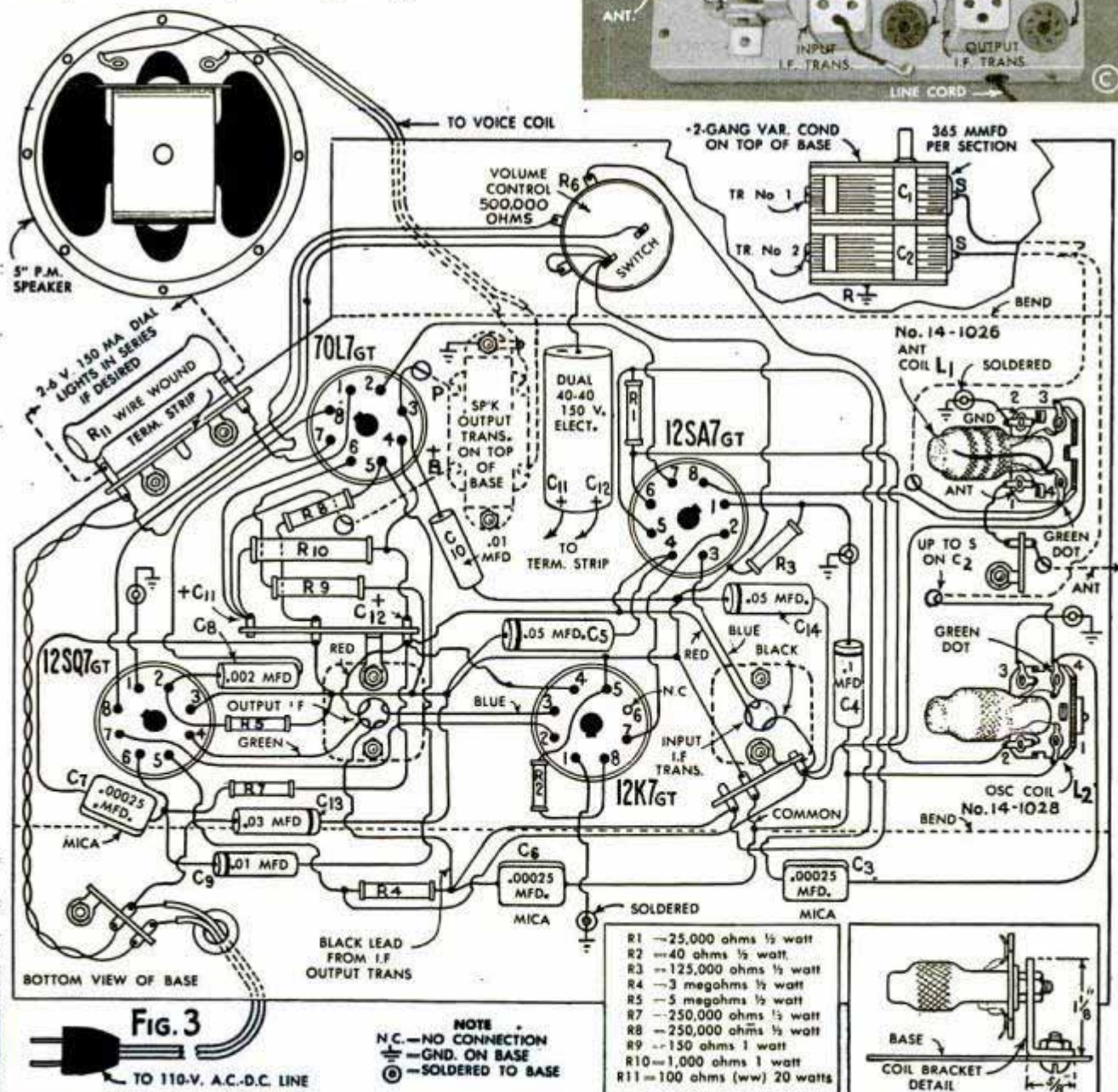
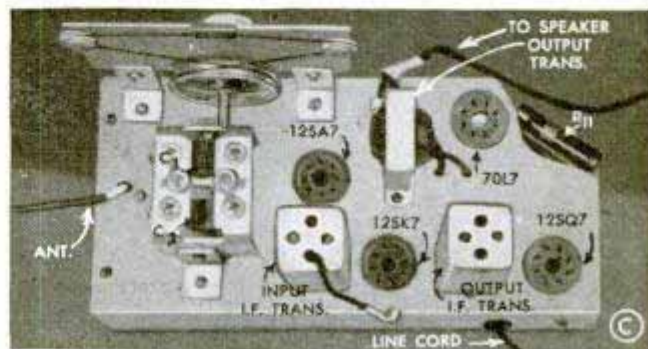

Helpful RADIO SUGGESTIONS



(A) Fragile cones often are damaged when the speaker is removed from the cabinet unless it is handled correctly. Grasp the speaker by the metal enclosure and place it cone down on a flat surface as illustrated



(B) Do not hold the speaker near the outer rim as shown in the photo as this forces the fingers through the cone. Always remove wrist watch before handling a speaker to avoid troublesome magnetizing



(C) Voice coil centering is checked easily by pressing on the cone rim as illustrated and listening for rubbing sounds; often scraping on the pole pieces is felt through the fingers. This is a common cause of distortion and indicates a recentering operation

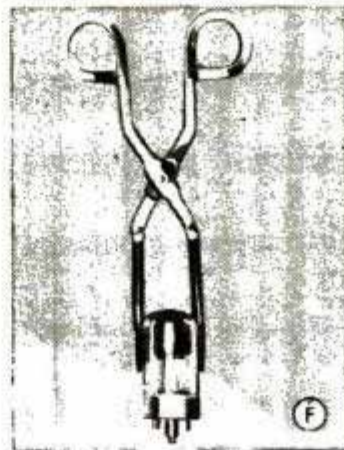

(D) To center the speaker voice coil loosen the "spider" supporting screws behind the cone and insert thin celluloid or cardboard shims between the center pole piece and the voice coil at equal distances apart. The screws holding the "spider" then are tightened, after which the shims are removed and speaker is rechecked



(G) Adjustable unit in new speaker permits recentering cone without removing speaker from the chassis



(E) Split friction tape and use half width for taping small wire connections

(F) "Scissorslike" tube extractor has rubber-covered gripping prongs for extracting delicate miniature and straight-side glass tubes in radio receivers and electronic equipment. These tube pullers are available in four standard bulb sizes for production, inspection and service uses

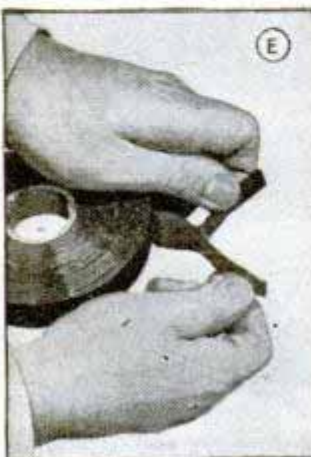

(H) Shorting plates in variable ganged condensers may be detected easily if you have a low reading ohmmeter. As rotor plates often become bent they touch the stator plates at certain settings. To check, connect one test probe to the rotor, or frame, and touch the other probe to the stator while rotating the condenser. If plates touch at any point, the meter will read zero ohms

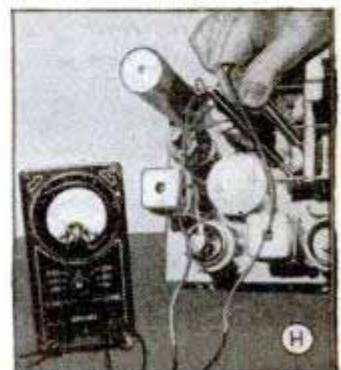

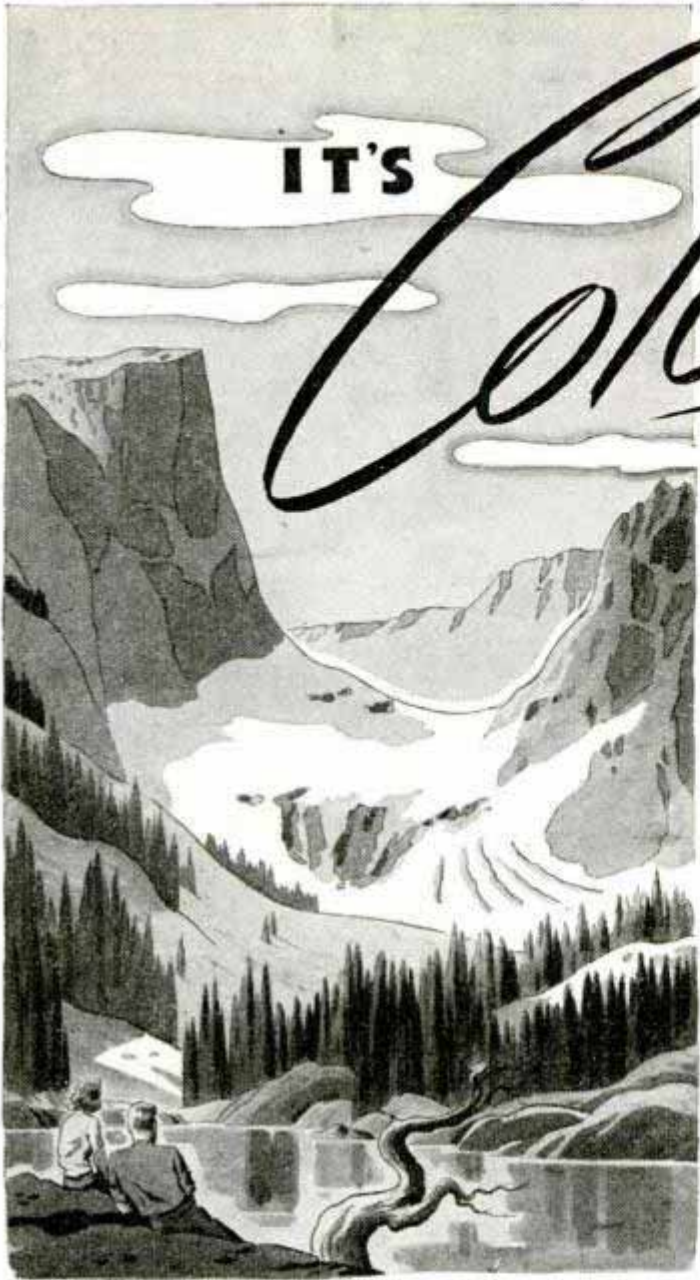

IT'S

Colorado

CALLING

"As soon as summer arrives—and with rail travel conditions greatly improved—we'll be looking for you."

Yes, it's Colorado calling . . . the Colorado of mighty mountains and singing streams . . . invigorating sun-warmed days and restful blanket nights.

When you go, there's the swift Union Pacific Streamliner "City of Denver"—overnight, everynight, between Chicago and Denver; also fine train service from other points east and west of Denver. Your journey by rail will be the high spot of your vacation or business trip.

Remember that Union Pacific also serves California, the Pacific Northwest, and a number of famous National Parks such as Yellowstone; more western scenic regions, in fact, than any other railroad. It's the world's greatest vacation travel bargain.

For unexcelled rail service, to or from the West, go Union Pacific.

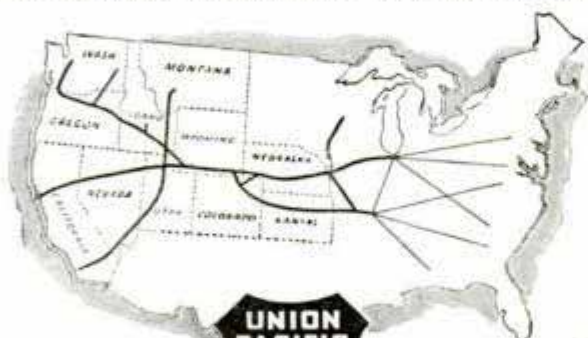

*be Specific—
say "Union Pacific"*



The Progressive

UNION PACIFIC RAILROAD

ROAD OF THE Streamliners AND THE Challengers

HAWAIIAN WIGGLERS Get Bass!



(Left to right) Wayne Ballard, M. L. Knight, Homer Patton and Buster Patton.

Texas Anglers Say "There's Nothing To It!"

Ed Cromer, member of the Fort Worth Anglers Club and editor of the *Fisherman*, sends us this photo of four of their members with catfish and bass. In his story he reports:

"These boys say there's nothing to it. All you have to do is to go to Lake Texoma, fish in the Cedar Bayou and haul them in. The bass were caught on Hawaiian Wigglers."



No. 2 Shallow Running
Hawaiian Wiggler \$1.10

Send For Free Catalog

How would you like to see the photographs of catches of bass and read letters from anglers all over the country telling where and how they made record catches

with Hawaiian Wigglers? Catalog also beautifully illustrates and describes Jitterbug, my famous surface bait that runs fish crazy day or night. A copy is yours for the asking.

FRED ARBOGAST & CO., 1603 North St., Akron 3, Ohio

LIGHTER MOMENTS

with **fresh** ^

Dated

"Eveready"

Batteries

FOR A LONG TIME, you had to take whatever flashlight batteries you could get!

But that time has passed. "Eveready" Flashlight Batteries are back. You can buy them. Ask for them at your dealer's.

And that's good news indeed. For, although flashlight batteries may look alike on the outside, that similarity is only skin-deep. There are important differences inside every "Eveready" Battery — differences that mean a longer life of stronger light. Differences that have made the "Eveready" flashlight battery the largest seller in the world!



"I'm afraid he isn't quite reconverted yet!"

Fresh
DATED BATTERIES
Last Longer
Look for the date line



EVEREADY

TRADE-MARK

The word "Eveready" is a registered trade-mark of National Carbon Company, Inc.

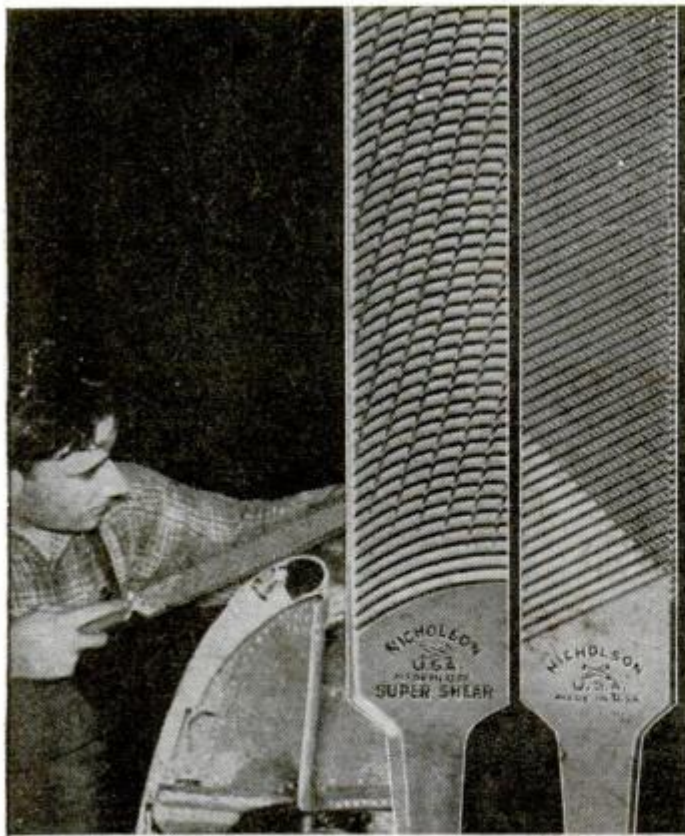

Files for aluminum

MANY of today's tools for working aluminum far outmode those of pre-war days. In files Nicholson has perfected these two distinctive types (illustrated above):

NICHOLSON SUPER-SHEAR FILE (left)—This is a recently developed curved-tooth file that "smooths as it roughs." Its milled "razor-sharp" edges can whittle down a piece of aluminum in amazingly fast time, with the final stroke leaving the surface scratchlessly smooth. Excellent also for plastics, bronze, brass, babbitt, cast iron and annealed tool steel.

NICHOLSON ALUMINUM "TYPE A" FILE—a special-cut file combining moderate cutting speed with good finishing qualities. Deep, "open-throat" upcut and fine overcut break up the soft aluminum filings, permit file to clear itself, overcome chatter, and prevent taking too large a bite.

FREE BOOK, "FILE FILOSOPHY"—48 illustrated pages on kinds, use and care of files.

NICHOLSON FILE CO., 22 Acorn St., Providence 1, R. I.
(In Canada, Port Hope, Ont.)

NICHOLSON
FILES FOR EVERY
PURPOSE

NICHOLSON
U.S.A.
MADE IN U.S.A.

Raising the Dead Ships

(Continued from page 173)

made and she was pumped dry and refloated, eventually coming to America for overhauling and refitting.

Battleships of even greater weight were salvaged after more serious damage in the great cleanup of Pearl Harbor under Rear Admiral William R. Furlong. How the battleships California, Nevada, West Virginia and Oklahoma were patched, refloated and sent to sea again is a familiar story of American war enterprise.

Salvage teams from Pearl Harbor, San Diego, Pier 88 in New York and from a later established diving school on New Caledonia had vital roles in all of the campaigns of the war. Wreckage of 26 vessels, for example, clogged a 300-foot channel near Bizerte, Tunisia. Seven had been sunk purposely by the fleeing Germans to shut off the harbor. Within a week, Commodore Sullivan's crews blasted out the obstructions, and within three weeks 800 Allied vessels assembled there for the invasion of Sicily.

Air and sea bombardment ruined all docks at Casablanca but salvage provided berths for all ships requiring them six weeks after the Allied landing. The story was the same at Palermo, Naples and Cherbourg. A month after the Germans fled Naples, 18 Liberty ships were unloading there at the same time, and piers for 28 vessels were provided within two months. A total of 170 ships were cleared from the Bay of Naples and 90 vessels were removed at Cherbourg.

While divers are the mainstays of salvage work, it is a team operation that requires usually 20 men on the surface for every one below even when operating in less than 50 feet of water, the depth in which most economical salvage takes place. Tenders, winchmen, wreckers, engineers, carpenters

(Continued to page 238)

Model Builders
Attention!



	V	V-2	V-3
Hex	1/2"	3/8"	5/16"
Thread	3/8"-24	1/4"-32	1/4"-32
Thread Length	7/32	7/32	5/32
Weight, Grams	8	3 1/2	2 1/2

Actual Size V-Plug

Champion spark plugs for model gas engines give the same dependable performance as regular Champions. Silliment sealed. Sillimanite insulator. Alloy needlepoint electrodes for easy starting. One piece construction.

CHAMPION

SPARK PLUG COMPANY • TOLEDO 1, OHIO

Here's why most Truck Fleets specify Champion Spark Plugs



THEY'RE DEPENDABLE!

When most of the country's leading truck fleets—to whom spark plugs are a cold matter of cost per ton mile—specify dependable Champions, you have substantial proof that Champions will insure maximum economy and peak performance in your engine. Champion Spark Plug Company, Toledo 1, Ohio.



FOLLOW THE EXPERTS . . . DEMAND DEPENDABLE CHAMPIONS FOR YOUR CAR

NEXT TIME SAY BRIGHT STAR

and you will get a
FLASHLIGHT & BATTERIES
famous since 1909
for QUALITY,
STYLE and
SERVICE



BRIGHT STAR BATTERY CO. CLIFTON N. J.

and welders are needed to help the divers.

Where practicable, the hull of a ship is used as an air compartment to aid in salvaging. Openings are sealed and the water is pumped or blown out. Sometimes engineers build a cofferdam on deck, seal it tightly and then pump out the water. Pontoons occasionally are used. Compartmented floating dry docks are considered by Navy men the easiest to salvage, with tankers next. Cargo ships are considered the most difficult. Stranded vessels that can be pulled off with tugs or anchors are the most profitable operation. Capsized and sunken ships, especially in deep water and badly damaged, present the hardest salvage problem.

Not all salvageable wrecks are being salvaged by the Navy, but only those where it appears that the chances are good of recovering a value greater than the expenditure. For salvage work the Navy now has about 50 ships and special equipment costing more than \$12,000,000.

Cuppa Coffee, Chum?

(Continued from page 151)

Soldiers who operated the Marseilles factory were trained in Oran by an international coffee team of Arabs, Spaniards and Frenchmen. Moving with the invasion forces into southern France, the soldiers set up shop in an old factory, assisted by a platoon of Italian soldiers. Improvisation was a necessity. One of the GIs summed up his first coffee roasting experience this way: "If it weren't for good old American ingenuity, we'd never have turned out a finished bean."

A network of bins and pipes carried the green coffee through a half-dozen technical processes, up and down three floors. The bins were made of large French oil refinery tanks purchased on reverse lend-lease. The pipe line system was made of sheet metal, five-gallon cans, powdered-milk cans and unused petroleum pipe line.

Oil-burning and coke-burning ovens roasted the coffee, turning out fresh batches every 20 minutes. From the ovens coffee was poured into cooling bins where rotary blades shuffled the beans automatically until they were cool.

The roasted coffee next was ground into a fine powder. Pneumatic tubes blew it to the third floor, where it was left to accumulate in 500-pound bins. Air jets were controlled so that just enough pressure was used to blow the coffee grounds upstairs. Foreign particles that may have mixed with the coffee stayed out of the top bins. Ground coffee from the bins was fed into

(Continued to page 240)



**"WE'RE GOING TO SEE OUR COUNTRY
from the saddle of a HARLEY-DAVIDSON"**

"We want to tour all sections of the good old U. S. A. on new Harley-Davidsons!" That's what thousands of Harley-Davidson fans told us during the war, in letters which poured in from all over the country and the world. Now, the new Harley-Davidsons are

rolling off the production line in ever-increasing numbers — the beauty and fun spots of America are waiting for your coming! See your Harley-Davidson Motorcycle dealer EARLY — and get set to make the most of the glorious touring months that are ahead!

HARLEY-DAVIDSON

Motorcycles

HARLEY-DAVIDSON MOTOR CO., Dept. P, Milwaukee 1, Wisconsin

Please send at once free copy of 24-page "ENTHUSIAST" Magazine, filled with motorcycle action pictures and touring stories.

Name.....

Address.....

City..... State.....



ANCO RAIN-MASTER

"Dead-Locker"

WINDSHIELD WIPER
ARMS and BLADES

BLADE SNAPS ON...
STAYS PUT

FINGER-
TIP
RELEASE

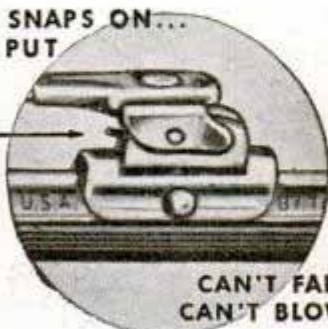

CAN'T FALL OFF
CAN'T BLOW OFF

(A war-born invention—by ANCO—first)
for military aircraft—now for your car.)

DON'T SHOOT YOUR GAS-PUMP MAN!

He's doing the best he can. Sure, he knows how dangerous it is for you to drive your car... in stormy weather... with your dull old windshield wipers that smear and smear. He'd gladly put on for you quickly a pair of keen new ANCO RAIN-MASTER Wiper Blades and Arms. He has them—Newest Models! But he forgets to remind you? Too busy? You can't shoot him for that!



After all, it's *your* car to protect. So *you* remind *him*. Get RAIN-MASTERS...patented features...original equipment on many makes of high grade cars and trucks... used in war—on our fighting tanks and trucks and ships and bombers too...because ANCO RAIN-MASTERS clean quicker, clean cleaner... last longer. May save you a costly smashup.

Ask for RAIN-MASTER Windshield Wiper Arms and Blades next time you buy gas.

THE ANDERSON COMPANY
Established 1918
GARY, INDIANA

four gravity-flow spouts to the second floor where soldiers held bags on scales under the spouts.

Since ground coffee loses body and flavor after 10 days, the object was to get the coffee to Army kitchens as quickly as possible. Weighed and packaged coffee was loaded on trucks and sent out immediately.

Grand touch to the whole job, definitely beyond the line of duty, was a mimeographed recipe for making good coffee which the men slipped into every bag. It was addressed to mess sergeants and cooks, and started: "Listen, fellow, we have done a lot of work to put good coffee in this sack—how about you following through...?"

Radar Cues the Navy Fighters

(Continued from page 125)

We mentioned the fact that fighter direction was inherently a simple proposition, but take the land-based fighter director on the island of Apamama who was faced with this situation: a night raid, with Japanese planes orbiting a few miles north, south, east and west of the air strip; returning planes from a strike mission suddenly appearing on the radar screen, with all of these friendly planes low on gas and anxious to land on a well-lighted field; two Army planes in the air as night fighters, neither equipped with airborne radar gear; thousands of impatient Seabees waiting in foxholes, fretting and stewing because they don't know—as the fighter director knows—if there actually are enemy planes in the area or if it would be like last night, a false alarm due to the fact that returning strike planes failed to show the IFF (Identification—Friend or Foe) signals.

Would you turn on the field lights for the returning strike? Then you would be a perfect target for the enemy orbiting all around you, waiting for that stray bit of light. Will you keep a complete black-out? How about the returning pilots who have finished a bombing mission and deserve a break? Send your Army planes to intercept the Japanese? Without airborne radar, it is an impossible task to direct your friendly planes close enough to enemy planes to see them on a completely dark night—or a moonlight night, for that matter. Maybe the returning strike does have enough fuel to stay up another hour. Still, you have the Seabees anxious to finish that extra fighter strip in record time—have you ever spent an extra hour in a foxhole?

Of course, you might be fortunate enough to be dealing with the red-helmeted bombers of the Japanese air force who—you

(Continued to page 242)



*"Switch to
Auto-Lite Spark Plugs"*

DICK HAYMES

*"They make sweet
music in any engine"*

HELEN FORREST



*"Ignition Engineering
helps give economy, too"*

GORDON JENKINS



Tune in the Dick Haymes Show with Helen
Forrest • Gordon Jenkins' Orchestra and
Chorus • Saturdays, 8:00 P.M.—E.S.T. on CBS



*Money
cannot buy
a better
Spark Plug*

AUTO-LITE spark plugs are designed by the same engineers who design complete electrical systems for leading cars and trucks. This specialized engineering experience is one reason why money cannot buy a better spark plug. A complete set of ignition engineered Auto-Lite spark plugs in your car, helps give you quick starts and full mileage from every gallon of gas. So switch to Auto-Lite when faulty spark plugs need replacing. See your friendly Auto-Lite Spark Plug Dealer today.

THE ELECTRIC AUTO-LITE COMPANY
Toronto 1, Ontario Toledo 1, Ohio

AUTO-LITE SPARK PLUGS
"Ignition Engineered"



*So inconspicuous

CAN'T YOU SEE—I'm wearing a new Zenith Hearing Aid and I can hear again! You don't have to shout any more.

Sure... I admit I used to think it was *my* business if I didn't choose to wear an aid. But when folks stopped *trying* to make me hear because they had to shout... I realized my defective hearing involved more than just *myself*.

So I got smart and tried a Zenith. Wear it as casually as eyeglasses now because its Neutral-Color Earphone and Cord are so inconspicuous. (Even *you* didn't notice it, remember?) And I'm getting out among people more... getting on better with my work, too.

Smartest thing I ever did for myself *and* my friends was putting on a Zenith. No one will ever have to raise his voice to *me* again.

* * *

If you are hard of hearing—do yourself *and* your friends a favor. Visit your local Zenith dispenser for a *free* demonstration of the New Zenith Radionic Hearing Aid.

No one will press you to buy. You adjust the Zenith yourself to your own hearing needs with the flick of a finger. It's easy as focusing binoculars! See your dispenser soon... and drop a note to Zenith Radio Corporation, Dept. PM-3B, Chicago 39, Illinois, for *free* descriptive literature.

Choice of Amplifier Colors at no Extra Cost.

- Super-powered Model A-3-A \$50
- Model B-3-A (Bone Conduction) \$50
- Standard Model A-2-A \$40



THE NEW
ZENITH
 RADIONIC
 HEARING AID
 BY THE MAKERS OF ZENITH RADIOS

found out through intelligence—are proud of their teamwork and ability to stay alive, a distinct contrast to the later Kamikaze tactics. You know of their fear of the American fighter pilot and it may have been an accident that you suddenly revealed to those red-helmeted bombers of the Mikado that you have night fighter planes up by quickly spotting a friendly plane with a searchlight, then quickly extinguishing the light. It worked! The raid soon left the area and finally, 100 miles north, disappeared from your radar screen.

This, of course, was at a time when few, if any, planes in the forward areas were equipped with radar. The story of the Navy's use of night fighters already has been told. Wartime restrictions, however, prevented telling the tale behind the tale—the use of fighter direction in the control of night-flying aircraft. The other half of the story recording the triumphs of Air Group 41 night fighter pilots is the effort and skill displayed by night fighter controllers operating in the CICs of the Enterprise and Essex on which the air group embarked.

Night fighting, certainly, is almost solely an enterprise of radar. From the moment the bogey is first picked up it is the magic, electronic eye of radar, both ship and airborne, which guides pilot and guns to the kill. Essentially a specialized development of the daytime interception, night fighting is done entirely by instrument up to seconds before the shooting begins.

The drama of a night shutdown begins in CIC. It is, let us say, 0300 (3 a.m.). The task force is steaming toward its objective—a strike against one of the innumerable airfields of the Philippines. The night fighter director, who has come on at midnight, has been manning his PPI scope or disk, watching his two airborne “chickens”—night fighter planes—orbiting slowly to the west and north of the force, checking occasionally to see that communications are okay and to coach the planes back when they drift off station.

“Hello, One. This is Silver. You are drifting off station. Vector three-four-zero for five miles, over.”

“Wilco, vector three-four-zero for five miles, out.”

Communications five by five, which means perfect! In two minutes, Silver One will be back at his assigned station of 270, 15 miles west of the force. To the north, at 300, 15 miles, Silver Two is a tiny white dot moving slowly in a wide orbit.

Suddenly, at the far edge of the screen, another white dot or blob of light appears, drifting down toward the task group. Plotters mark an X on the board. The familiar

(Continued to page 244)

Know your
Hardware Dealer
better!



To your hardware dealer you are a preferred customer—because you read this magazine.

You like *Popular Mechanics* because you have the kind of mind that insists on knowing all there is to know about new inventions, new ideas, better ways of doing things. It's the "P. M. Mind"—active, alert, inquisitive—and it sets you apart from ordinary customers.

That is why your hardware dealer likes to serve *you*. He talks your language, you talk his—and both of you know that *quality* tools and hardware always do a better job.

With his huge stock of thousands of *quality* items . . . his wide experience in solving problems for men who like to do things and do them *right* . . . your hardware dealer is ready to help you any time you say.

Your HARDWARE DEALER sells QUALITY Tools and Hardware
...BUY FROM HIM

**POPULAR
MECHANICS**

SWIVEL-HEAD

FLASHLIGHT

nothing else like it!

HEAD TURNS LIGHT AT ANY ANGLE



Greatest advance in flashlight design in a generation. Turn powerful pre-focused beam where you want it . . . stand it up . . . clip it on . . . both hands are free. A handsome, durable, all-purpose flashlight for everyone. Ask your dealer.

No. SW-22
Patented

No. 75 Heavy-Duty Dated Cell. Fresh Lasts longer. 10¢



\$2 LESS
BATTERIES



Flashlights & Batteries

If dealer cannot supply, send \$2.00 to Dept. P
UNITED STATES ELECTRIC MFG. CORP., New York 11, N. Y.

*USAILITE Red-Head Safety Flashlight -
a "MUST" for the motorist.

Thompson
BEATS
the World
on BOATS



**Better Built
Lower Prices**



Canoes

Rowboats

Outboards

Light Boat for Auto

Safe Boats With Full Length Spray Rails
Keep passengers perfectly dry—even at high speeds. Catalog also shows two new models of "Take-Along" Boats. Two big factories—save you freight.

CATALOG FREE
Write for your copy. State kind of boat in which you are interested.

THOMPSON BROS. BOAT MFG. CO. (151)
213 Ann St. PESHIGO, Wis. (Write to either place)

113 Elm St. CORTLAND, N. Y.

checkback through the other ships begins: "Bogey at two-five-zero . . . 60 miles . . . closing . . . altitude 3000 . . . a snooper, Air Intelligence says . . ." A snooper because it does not show IFF and none of our own search planes is expected in this area!

The night fighter director adjusts the gain on his set to the greatest brilliance and waits for the signal from the flagship. He does not have long to wait.

"Hello, Silver. This is Tar-Baby. Intercept bogey at two-four-zero with Silver Two."

The night FDO picks up his microphone. This is a job for a man who can make quick decisions and give orders in a voice that inspires confidence, for he is talking to a pilot who is sitting up there in the darkness with only the faint glow of an instrument panel and the far glow of the stars, the only lights in the world. The pilot must put complete trust in the night fighter director officer down there in CIC thousands of feet below.

"Hello, Two. This is Silver," says the FDO. "I have a customer for you. Vector port two-four-zero, buster, angels two point five—"

"This is Two. Wilco, vector two-four-zero, buster, angels two point five—"

Armed with computers which will figure out mechanically the air speed of the bogey, plotters begin tracking on a horizontal board at the night FDO's elbow. Since night fighter direction involves bringing the friendly plane into very close proximity to the bogey—into visual range, as a matter of fact, for firing purposes—the bogey's exact speed is important. The plot too is necessary in case the tiny blobs of light which represent the enemy and the friendly begin to fade as a result of atmospheric disturbances as they sometimes do. Now the steady flow of information to the pilot begins to go out:

"Hello, Two. This is Silver. Your customer looks like a single."

A few moments later:

"Hello, Two. This is Silver. Bogey's course zero-four-zero indicating 260 (speed)."

Still later: "Hello, Two. This is Silver. Bogey at 3000. Your angels okay."

The pilot, flying through the dark, begins to see the picture in his mind's eye. His enemy is a single aircraft, flying at 3000 feet. At 500 feet beneath that altitude he is in the best position to spot and attack when the planes draw close together. So far all of this information has come from the ship's CIC and all of it has been provided by radar in the ship.

The night fighter director, noting that the planes are drawing close now, begins to position his fighter for the final approach—the crucial moment when the plane's short-

(Continued to page 246)

VanRoy *Ajustomatic*

with the NEW STEM



The one and only Pipe of its Kind

There is nothing in screw-stem pipes like the VanRoy Ajustomatic! With this new kind of pipe the stem can't lock at an off-angle—can't freeze out of line . . . That's because the patented stem is "float-mounted". It can be turned repeatedly yet stem and bowl hold their precision alignment for the life of the pipe . . . Take a turn for the better in a screw-stem—get the VanRoy Ajustomatic pipe for permanent smoking contentment. . . .

VANROY CO. INC., EMPIRE STATE BLDG., N. Y. 1, N. Y.



VanRoy Ajustomatic Bard \$5



SIGNET OF QUALITY IN PIPES

MAKE MORE MONEY

APPLYING OR SELLING

CORKSTONE PLASTIC FLOORING

EASY TO APPLY

Here's your opportunity to get into business for

yourself applying or selling Corkstone, the economical, top-grade plastic flooring. Plenty of profit. Act without delay!



Dealers & Agents Wanted

WRITE FOR DETAILS OF OUR PROPOSITION

We believe in teamwork and cooperation. We'll help you get started. No cost; no obligation. Act today!

LASTING PRODUCTS COMPANY

MANUFACTURERS OF PAINTS, PUTTIES, PLASTICS, FRANKLINTOWN ROAD PLANT, BALTIMORE 23, MARYLAND

Say you saw it in Popular Mechanics

\$1 RIDES YOUR LAWN OF UGLY WEEDS!



WEED-NO-MORE

Magic Weed Killer

Destroys Ugly Weeds but Won't Harm Common Lawn Grasses!

NO MORE back-breaking digging! Destroy ugly leafy weeds with WEED-NO-MORE!

The 8-ounce lawn-size package treats 1600 square feet! Now you can enjoy a beautiful weed-free lawn for only \$1!

WEED-NO-MORE kills dandelion, plantain and other ugly weeds—yet won't injure soil.

Get it today! Rid your lawn of ugly weeds for only \$1. Just spray on . . . WEED-NO-MORE!

On Sale at Paint, Hardware, Garden Supply, Department and Drug Stores

WEED-NO-MORE

THE AMAZING NEW WEED KILLER

Made by THE SHERWIN-WILLIAMS Co. Cleveland, Ohio

NO MORE SWEEPING COMPOUND



Sweeping the modern "Dustless" way forever eliminates sweeping compound.

Here's why: As you sweep with a Dustless brush, Arbitrary sweeping fluid, fed from a reservoir in the back of the brush, moistens the dust. Instead of rising into the air, the dust itself is converted into a sweeping compound that sweeps many times cleaner and safer than any commercially prepared sweeping compound at any price. Thousands of factories, shops, offices, and schools have adopted this "Dustless" method of sweeping. You ought to know more about it. Write for complete facts today.

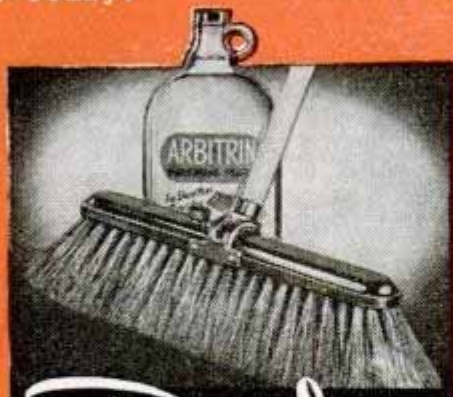

Dustless
DOES MORE FOR LESS

- Dustless
- Speed Sweep
- Speed Wash brushes

MILWAUKEE DUSTLESS BRUSH COMPANY

528 N. 22nd Street • Milwaukee 3, Wisconsin

er range airborne radar will be switched on to pick up the unsuspecting bogey.

"Hello, Two. This is Silver, Bogey 12 o'clock, 20." To the pilot in the air, that means the bogey is dead ahead of him, 20 miles away.

"Hello, Two. Bogey one o'clock 10. Vector starboard 30."

Now the pilot realizes he is to one side of the bogey. He glances at his compass, swings his plane slowly to the right to the new course which should bring him behind and below the bogey.

"Hello, Two. Throttle back 30."

Down in CIC the night fighter director officer has noted that the planes are approaching each other at too rapid a rate.

A series of orders . . . changes in vectors . . . speed . . . and then the night FDO gives the order:

"Punch!"

"Wilco, punch," replies the pilot and switches on his own airborne gear. He turns a handle and the antenna begins a slow scan of the area in front of him.

"Hello, Two. Bogey 12 o'clock, two."

The pilot centers his antenna dead ahead. Suddenly, on his own scope, a little dancing blob leaps up from the screen.

"Contact!"

The night fighter director officer's work is done for the present—the pilot is ready for the kill.

(Continued next month)

Twice as Natural

(Continued from page 157)

the fresh fish and take careful color and pattern notes. After this was done, the fins and eyes of the fish were removed, care being taken to preserve the fins in one piece. The fish then was placed in a lifelike position on a bed of damp sand. Since most fish specimens are displayed against a panel or screen with only one side showing, such mounts naturally require only that a one-piece mold be made. After the fish is removed, the inside of the plaster mold is coated with a plaster separator, composed of wax, vaseline and kerosene. Another batch of plaster is poured and patted into the mold. The thickness of the cast varies according to the size of the fish. Usually a 1/2-inch-thick shell is ample for a fish the size of a five-pound bass.

Next the original fins are laid on a sheet of celluloid of the desired thickness and a tracing made of each. The celluloid fins then are cut out with tinner's shears or a coping saw and carved and scraped to the correct thickness, with attention to natural details. Fish eyes also are made from celluloid. They are filed to convexity, sanded

(Continued to page 248)

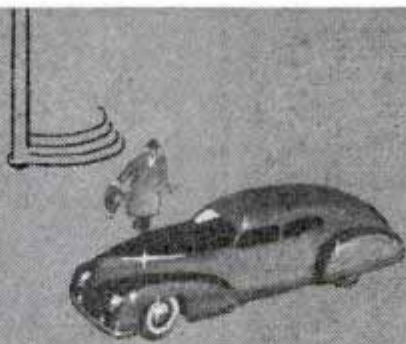

WHEN IT'S AN EXIDE... *you start*



Discriminating buyers rely on brand names not only to help them select good merchandise, but also to identify dealers from whom dependable service may be expected.

THE ELECTRIC STORAGE BATTERY COMPANY, Philadelphia 32

Exide Batteries of Canada, Limited, Toronto

BUY TO LAST

Depend on the Exide dealer for good products, good service.

with the **MASTER**

Streamline

you get the
right
MEASUREMENT



without
**MENTAL
ARITHMETIC**

The ingenious design of the MASTER Streamline Rule permits the positive, accurate, inside measurement to be read direct from where the tape enters the case . . . no mental arithmetic . . . No adding or subtracting . . . or making allowances for thickness of case . . . And the Streamline can also be used as a caliper, scribe or height gauge.

Your hardware dealer carries the Streamline, with spare blades. Or you may use the coupon to order direct from MASTER.



MASTER

WOOD AND TAPE RULES

TRADE MARK

MASTER RULE MFG. CO., INC.

815 E. 136th St., New York 54, N. Y., Dept. F-3

Branch: P.O. Box 1587, Oakland, Cal.

Enclosed find \$2.00 for the new 6 ft. "Streamline"
(Spare blade 65¢ extra.)

NAME _____
ADDRESS _____
CITY _____ STATE _____

smooth and lacquered on the front surface. Fins and eyes are anchored in grooves and sockets with papier-mache.

The case then is ready for painting. A great majority of fishes have a silver or bronze sheen, which is lost in the dried specimen. This can be reproduced by using silver or bronze powder mixed in translucent oil colors. Extra-brilliant aluminum and bright gold and copper powders are most durable.

When fresh specimens are unavailable, Mr. Pray uses a model-making process with preserved specimens and photographs as guides. He begins his model with a wooden framework. When the fish is exceptionally large the wooden armature has to be made from many pieces of wood screwed and nailed together to make the outline of the fish. For easier handling Mr. Pray attaches his wooden outline to a simple core board silhouette and mounts this on a pivot. This process was used recently to make the rare oceanic fishes, the mola and the opah, more commonly known as the ocean sunfish and moonfish.

Celluloid fins, which are made to represent the natural details of the fresh fins, are attached to the wooden frame. To build up the width of the model, Mr. Pray saws wood ribbing to the required outlines and nails these pieces lattice-fashion to the sides of the fish. The form then is covered with a wire mesh. The next step is to spread a composition of casein paint and chopped tow over the wire mesh. Casein paint makes a hard and durable surface to receive the oil colors that produce the lifelike finish.

One of these days the Walters and Pray specimens may add a new expression to the English language: "As lifelike as a stuffed animal in a museum!"

Vegetables Given "Acid" Test As Aid in Preserving

In canning experiments at Ohio State University garden vegetables were kept from spoiling by adding enough dilute hydrochloric acid to make them very sour. Hydrochloric acid was selected as the bacteria killer because, although this acid is poisonous in concentrated form, it is harmless in a dilute condition and is a normal part of gastric juice. In the first experiments it was found that the acid made the vegetables too sour to eat. This was overcome by stirring in a little baking soda before preparing the vegetables for use. An added benefit of acid canning, the university chemists reported, was the retention of most vitamins in the vegetables.

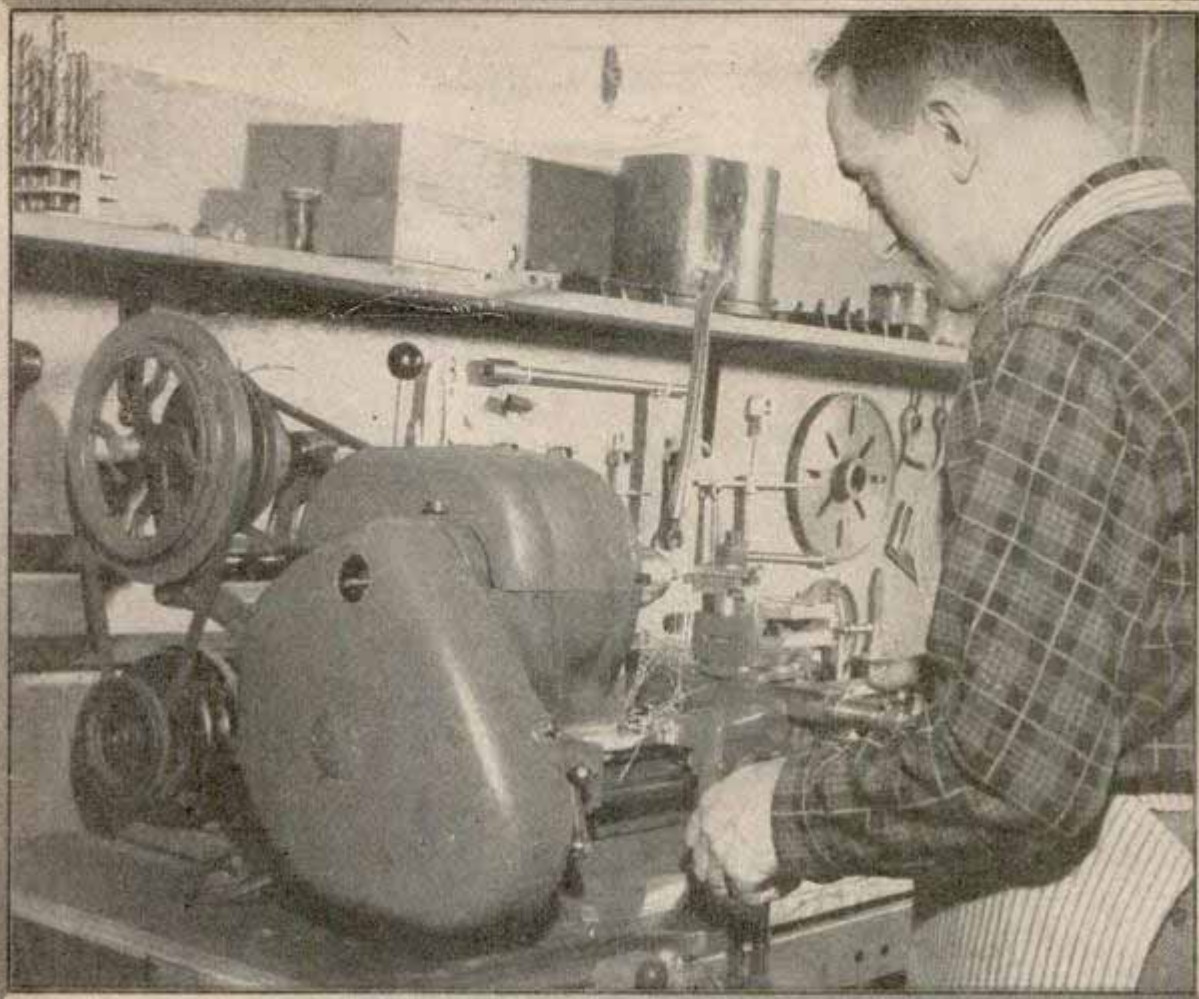

Portrait of a **HAPPY MAN!**

Relaxation and recreation to the hum of busy tools . . . making useful things for home or business . . . making quick repairs to home equipment — you're lucky if you have such a practical hobby!

Atlas tools will be available soon to help you equip your shop — at exceptionally low cost — for every project you want to undertake. They will give you the precision you need for close tolerance work — the strength required for heavy cuts. They are tools designed in every way to help you make the

most of your mechanical skill and ability on useful home projects.

Ask your distributor to let you know when you can see and operate Atlas tools in his showroom.



SEND FOR FREE CATALOG

You can get a preview of what to expect by sending for this new 64-page Atlas catalog. Hundreds of illustrations of special tools and operating views. Write for your copy today. Atlas Press Company, 343 N. Pitcher St., Kalamazoo 13D, Michigan.

Atlas 4 TOOL TEAM

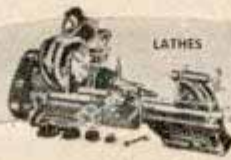

for that Professional
FINISH...

Use **PLASTIC WOOD**



in your **HOME WORKSHOP!**

- **PLASTIC WOOD** is the most versatile material for the wood working hobbyist... Not only can you do many things with **PLASTIC WOOD**, such as special moldings, decorative effects in relief, and strengthened joints, but you can cover any mistakes or fill in knot holes for a perfect surface.
- **PLASTIC WOOD** can be carved, sanded, planed, sawed, drilled, or nailed . . . and it won't split, crack or chip.

PLASTIC WOOD is an all purpose material for any wood working shop. Sold in cans or tubes in all hardware, paint, and 10¢ stores.

Did you ever use **PLASTIC WOOD** for dowel pins?

PLASTIC WOOD

A CELLULOSE FIBRE FILLER



Bantamweight Challengers

(Continued from page 135)

of 10,000 to 20,000-ton capacity. It meant that the Germans were using magnesium alloys to build fast, lightweight bombers that could outfly anything the United States or England then had in production.

The Allied aircraft industry sat up with a start. Congress appropriated the money necessary for the United States to build a magnesium industry that would top Germany's. Uncle Sam became superior in the light metals field.

During the war about half the United States' production of magnesium alloy went into airplane wheels, wings, fuselages, motor parts, rocket launching tubes, gun carriages and other mechanical equipment. The rest was used in pure form as incendiary bullets, tracer ammunition, signal flares and fire bombs.

Shortly before the war, Pan American Airways replaced its aluminum seats with seats made of magnesium alloy. Such weight saving enabled each plane to carry one additional passenger. With an average passenger fare of \$100 and a total of 20,000 trips a year, Pan American stood to boost its gross revenue \$2,000,000.

Wartime experience indicates that "Maggie" is extremely suitable for aircraft wheels and landing gear because of its shock resistant properties. It also may find widespread use in the manufacture of train, bus and automobile wheels.

Because of its extremely light weight, magnesium may replace steel or even aluminum in production of objects that must be moved by hand. Magnesium alloy can be machined more easily than any other commercial metal. Thus it offers economies in power, machinery deterioration, tool costs, handling and transportation expense.

The surface has just been scratched in the use of light metals. Large stockpiles of both lightweight miracle twins now are available in the United States, with war-born facilities for making more.

"Maggie" and "Al" are at your service whenever you, the customers, say the word.

All the Answers at Your Fingertips

(Continued from page 167)

to single out for special attention any material remaining in port unattended for only five days. Punched cards enable the Transportation Corps to know at all times the volume and direction of traffic and to provide for the proper coordination of loading and unloading operations.

(Continued to page 252)

*Young looking...
with lots of "hustle"*

Any way you look at it—this new 1916 Ford has what it takes! New comfort. New economy. New beauty. And under the hood, new stepped-up power to match its eager, youthful look... Inside, you'll find colorful fabrics and trim in smart two-tone combinations. Seats that are wide and deep... For a smooth and level ride, this car has new multi-leaf springs—long and slow-acting. While extra-large hydraulic brakes of a new design assure you quick, soft stops... Two great engines to choose from: the V-8, now increased from 90 to 100 horsepower—the 90 horsepower Six... See this smartest Ford car ever built—at your Ford dealer's today.

FORD MOTOR COMPANY

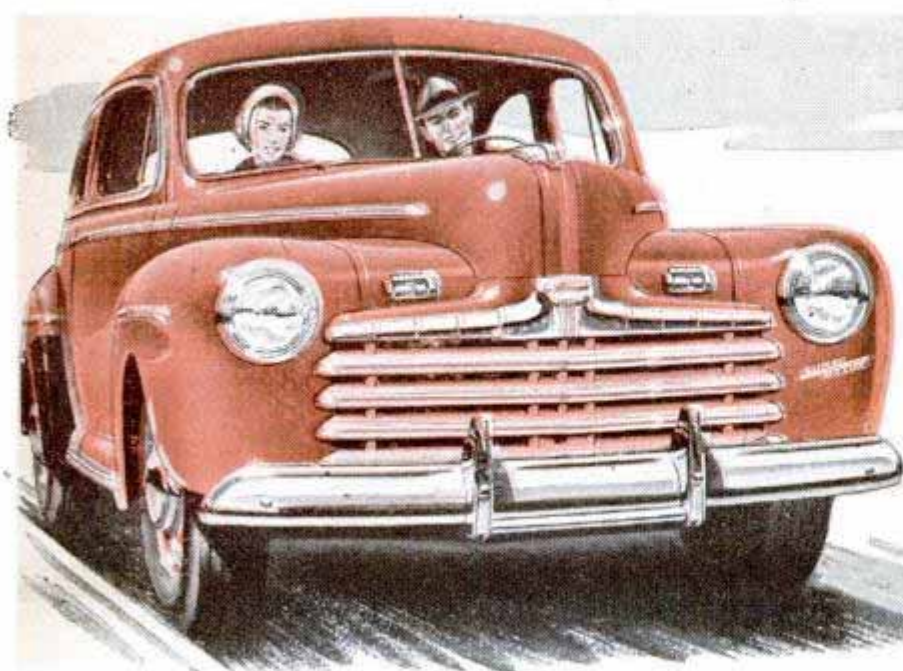

THERE'S A
Ford
IN YOUR FUTURE



TUNE IN... THE FORD SHOW... CBS, Tuesdays. 10-10:30 P.M., E.S.T. THE FORD SUNDAY EVENING HOUR... ABC, Sundays. 8-9 P.M., E.S.T.

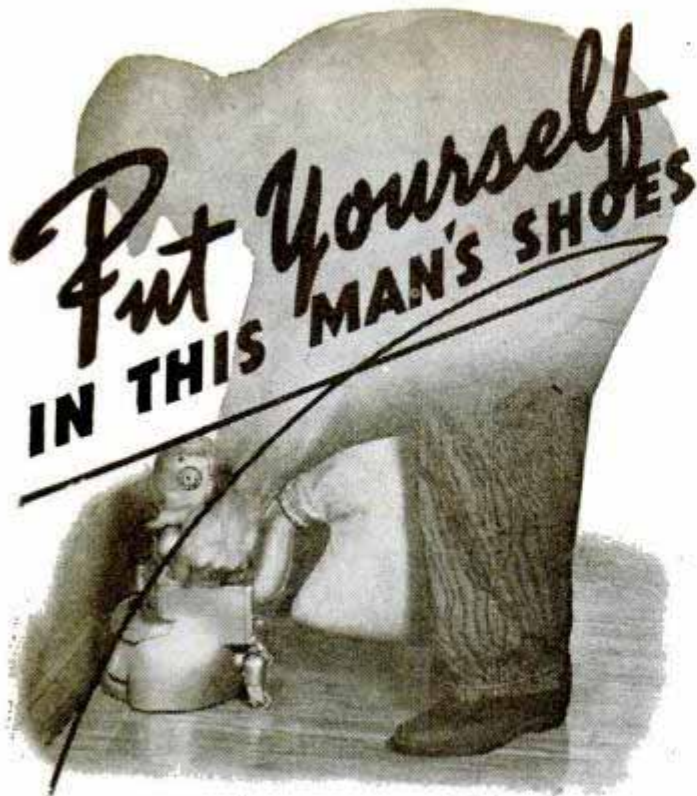

**Put Yourself
IN THIS MAN'S SHOES**

You, too, can follow the path to success in floor surfacing. American floor sanders have made hundreds of men like yourself, independent with a good income.

The investment is very small compared with most enterprises... work is pleasant, indoors... all the profits go into your own pocket... and your success is only limited by your ambition to get ahead.



Now available—
"tell-all" booklet on the
How—Why—What—
Who of going into some-
thing for yourself. Send
in coupon today for your
copy of "Opportunities in
Floor Surfacing," enclos-
ing 25c in coin or stamps
to cover handling.



**AMERICAN
FLOOR SURFACING MACHINE CO.**

535 So. St. Clair St. • Toledo 3, Ohio
Gentlemen:
Enclosed find 25c in stamps or coin for book-
let "Opportunities in Floor Surfacing," telling
me how I can start my own floor sanding business.

Name _____
Street _____
City _____ State _____

Complicated calculations necessary in machinery design problems have been made practically effortless by General Electric engineers who have learned that these standard accounting machines can do the "mental work" automatically in less than one quarter of the time previously required manually.

Calculations required for designing large turbine generators involve a tremendous amount of numerical work, and punched card machines have been found to do the work automatically in a much shorter time and completely eliminate mental fatigue.

While the calculations of the critical speeds of turbine generators are not too difficult in a theoretical sense, the most tiring part of the previous manual calculations was encountered in writing down the extremely large number of calculated quantities and then reading them to set up on hand comptometers.

Alongside the growing use of more complicated tabulating machines, inventors kept steadily at the task of making a simple calculating machine for everyday business use. Today several manufacturers make an easily operated calculator light enough to be carried about the shop or office.

Adaptations of mechanical calculators to various specific purposes were made, chiefly to bookkeeping. These bookkeeping machines are combined typewriters and calculators, ranging from simple billing machines, which automatically total the amounts on each bill, to complicated posting machines. Ordinarily, the handling of customers' accounts requires several separate operations—posting, making ledger entries, preparing the journal and writing customers' statements. A fast and simple method has been provided by one bookkeeping machine which posts the customer's account, writes the statement, proves the figures on both and provides a journal—all in one speedy operation. Each day's work is a completed job. The statements are ready for mailing immediately upon completion of the last posting. The machine takes care of everything except one minor detail, which is left for the recipient of the statement—it doesn't pay the bill.

Unlocking the Universe

(Continued from page 93)

in the intensity of the penetrating radiations at higher altitudes. In fact, there is a truly significant increase. Since, at great heights, any contribution of rays from the earth should have decreased, I have concluded that these radiations almost cer-

(Continued to page 254)

Tough..

BUT OH SO GENTLE

When you install new piston rings, it will pay you to get Hastings rings. They *stop* oil-pumping, *check* cylinder wear and *restore* engine performance . . . Ask your motor specialist.

HASTINGS MANUFACTURING COMPANY
HASTINGS, MICHIGAN
Hastings Ltd., Toronto

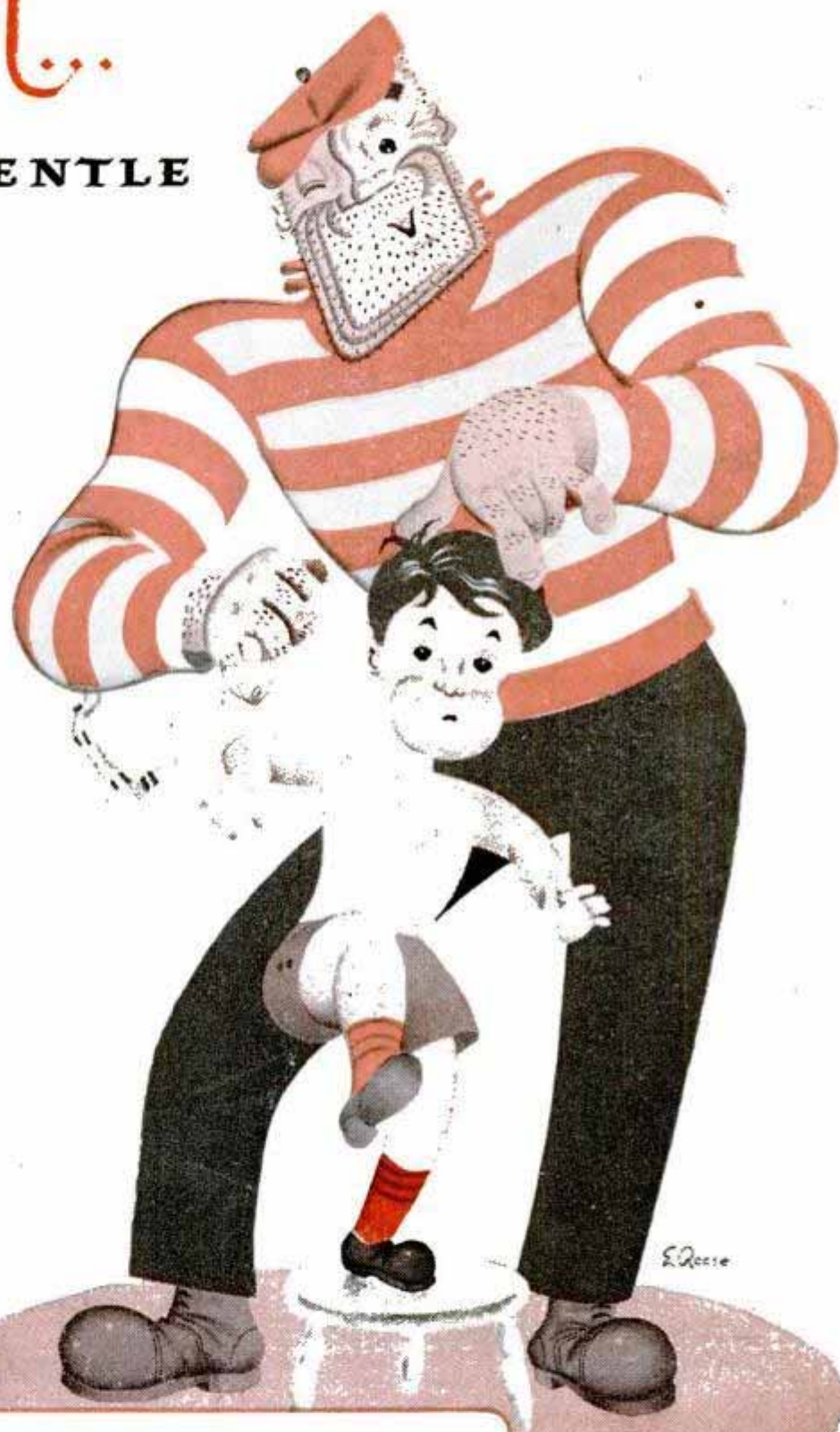

HASTINGS STEEL-VENT PISTON RINGS

U. S. PAT. 2,148,997



TOUGH ON OIL-PUMPING GENTLE ON CYLINDER WALLS

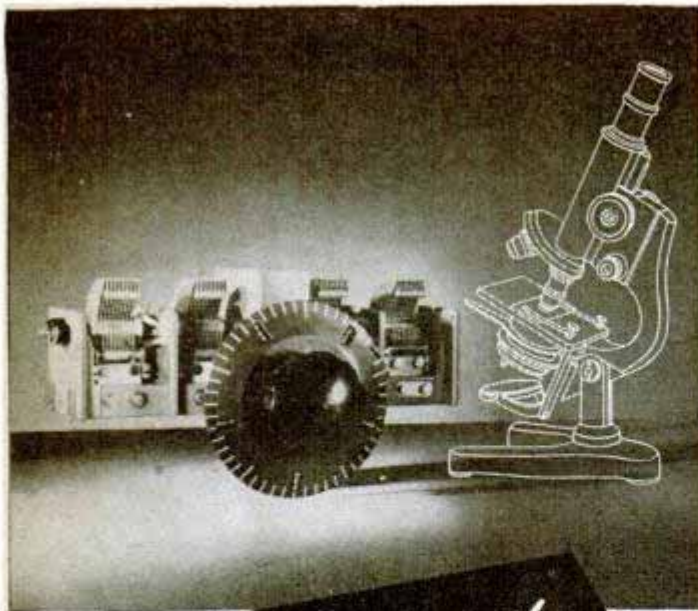

Marconi and the Microscope

When Marconi developed the wireless and for many years thereafter, there was no such thing as "microscopic tuning" of a receiving set. Signal fading and overlapping of signals plagued all radio listeners, whether they were "hams" or householders, shipboard operators or commercial store stations.

For a number of years, National Company has been building increased sensitivity and selectivity into its radio receivers and during the war developed them to a new high stage of perfection. In the NC-2-40C you will find a radio that will bring in a

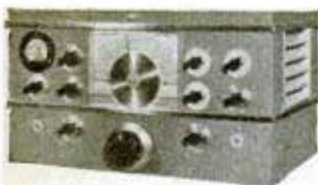

NC-2-40C

station if only one-millionth of a volt of signal strength is present.

Such precision can be found only in a few high-quality receivers and National is one of them.



NATIONAL COMPANY

EST.  1914

MALDEN, MASS.

THE MOST DISTINCTIVE NAME IN RADIO COMMUNICATIONS

tainly come from beyond the atmosphere itself."

The cosmic ray hunt was interrupted for virtually a decade by World War I, but the delay seemed to have added impetus once the search was renewed. Scientists the world over, fascinated and challenged by this Mystery Visitor No. 1 to our universe, got on the trail with the vim of crusaders.

As early as 1922 Dr. Millikan made cosmic ray measurements 50,000 feet high in the stratosphere by suspending instruments from a 15-foot cord strung between two balloons. The instruments included electroscope, barometer and thermometer. The experiment was repeated and material results were attained in determining the energy of the cosmic rays falling upon the earth. Dr. Millikan also took soundings deep in a lake, where the resistance to the rays was the equivalent of 25 feet of lead.

Within a decade, research was going on in various parts of the earth, but the most intense center of all was the University of Chicago, where Dr. Compton directed a "world survey of cosmic rays." Preparation of this stupendous project was as orderly as the preparation of a nation for war. Large expeditions were outfitted, the best available scientific minds were enlisted and strategy was developed on a global scale. The climax of action was reached between 1931 and 1934 when 12 expeditions from the great Chicago institution scattered to their observation points. In their travels, the crews covered 250,000 miles.

One went to South Africa, another to Peru, a third to Alaska, a fourth to Australia, and so on. They visited the tropic and arctic regions alike. The earth was used as a gigantic magnet and the mountain peaks as laboratories. Cosmic radiations were measured at high altitudes and compared with those on the surface of the earth and deep in mines.

Compton's experiments were conducted on the principle that lines of magnetic force are passing constantly around the earth between the north and south magnetic poles. These lines of force deflect the needle of a compass and all substances electrically charged, but they do not affect substances that are electrically neutral. Compton's expeditions found that cosmic rays were much denser in the Arctic Circle than near the equator. At the time this seemed to indicate that cosmic rays are deflected toward the magnetic poles of the earth and are therefore electrically charged.

Cosmic ray research reached a high spot in spectacularity during the Century of Progress Exposition in Chicago in 1933-34.

(Continued to page 256)

**"IT'S A SNAP-ON
... THAT'S ALL YOU
NEED TO KNOW"**

"... take a look, Mac — it's funny how you never lose the kick a good tool gives. When I was still a cub I got smart to what every old-timer knows . . . the heap of difference that fine tools make. You know — the fun of working with them, and the extra dollars they put in the old pay envelope. Snap-ons taught me that, and Snap-ons keep right on proving it, year after year. And I've saved a lot of time and trouble buying tools the Snap-on way. That's why the Snap-on man is welcome in every shop . . . he saves our time, keeps our kits in shape . . . and gives us a chance 'to see and try before we buy.'"

The complete catalog of more than 3,000 Snap-on tools is yours for the asking—write for it today!

SNAP-ON TOOLS CORPORATION
8062-C 28TH AVE., KENOSHA, WIS.



Snap-on Tools

THE CHOICE OF BETTER MECHANICS

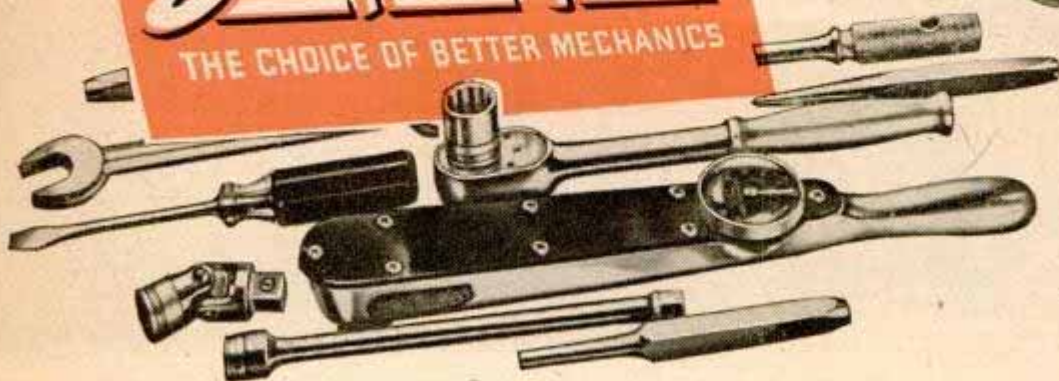

Knock-Out DRILL CHUCKS

SLIP-PROOF

SELF-ENERGIZING

KEYLESS

ACCURATE

FIVE SIZES

RANGE 0 TO $\frac{1}{8}$ "



Write for bulletin DC. 42-TD



K. O. LEE CO.
ABERDEEN, S. DAK.

Airplane and balloon flights were sponsored by the Chicago Daily News, the National Broadcasting Company and the Exposition. One of them was made by Professor Auguste Piccard, the famous French pioneer of the stratosphere, who attained a height of 15½ miles.

In 1934 a mammoth instrument, called "a new sentinel for cosmic rays," was designed by Dr. Compton, and seven of them, labeled "scientific outposts," were set up at far corners of the earth. One, operated by the Massachusetts Institute of Technology, was carted to the top of Mt. Evans, more than 14,000 feet high. The instrument weighed a ton and a half, and the idea was to conduct cosmic ray tests not only at high altitudes but also under violent weather changes. Studies were made where the temperature often dropped from a balmy 60 above zero to below freezing in five minutes, and where also, with equal brevity, summer sunshine would shift to a blinding blizzard. The meters were designed to operate for a long period, under the most severe conditions, each having an automatic photographic recording device and equipment to compensate for temperature and atmospheric pressure changes. As we said of them at the time:

"They will record the tides in the ceaseless rain of invisible rays which penetrate their thick lead shields and produce a flash of light in the argon-filled chamber. They will show the direction of the rays over a long period of time and any rise or fall in their numbers. They will record changes, if any, of the rays with the time movements of the stars, with fluctuations of the earth's magnetic field and the frequency of sunspots."

Other ray meters were distributed from Peru to Greenland.

Thus the hunters followed the trail with relentless zeal. Danger meant nothing to them. An entire Russian group of scientists and helpers plunged to their death in a balloon crash, while a similar American outfit had to take to their parachutes. A noted scientist, Dr. Allen Carpe, and his assistant, who scaled Mt. McKinley and made observations, were killed while making explorations of a huge Alaskan glacier. Cosmic ray observations were made in airplanes soaring 30,000 feet over huge volcanoes in the southern Andes. A specially built electromagnet weighing more than eight tons was brought into use to observe the deflection of rays passing through a magnetic field. Observations were taken regularly at 40 widely separated stations—one of them a copper mine near Mohawk,

(Continued to page 258)

Lubricated-for-life Ball Bearings...

—double-sealed against
harmful shop dust...

—an advanced
engineering feature that
assures greater operating
satisfaction from your

Delta
MILWAUKEE
REG. U.S.
PAT. OFF.
Power Tools



Other Delta features include:

- ✓ **Pre-loaded Bearings.** This is the result of an extra manufacturing operation that reduces the "play" in the bearings, to help you enjoy long-time operating efficiency and accuracy.
- ✓ **Precision-bored Bearing Seats.** These bearing seats help keep all parts lined up properly, so that you have greater assurance of producing finished pieces exactly according to dimensions.
- ✓ **Precision-ground Shafts.** These are shafts built to run without any "wobbling" which might throw off your measurements.
- ✓ **Dynamically-balanced Pulleys.** The pulleys which transmit the power from your motor to your power tool are balanced to help eliminate annoying, damaging vibration.

IN YOUR favorite store, Delta-Milwaukee Power Tools don't look much different from most other makes of power tools. But — see Delta tools in action. Actually use them. Then you can tell there is a difference.

Delta's advanced engineering features make this difference. You can't always see them with your eyes. For they are "hidden values" in construction. But the trouble-free performance and safety of Delta-Milwaukee Power Tools tell you that *they're there*.

The accuracy and precision built into Delta tools largely replace the manual skill of the old-time hand craftsman. Once you set a tool for the job, it takes care of keeping the work true and straight... helps you know the thrill of producing attractive, professional-looking work.

It's because *quality* is so important to satisfactory results that Delta-Milwaukee Power Tools are used by happy woodworking hobbyists everywhere.

There's a store near you — perhaps right in your own neighborhood — that carries Delta tools. The people there are looking forward to giving you the complete Delta story. Drop in to see them soon.

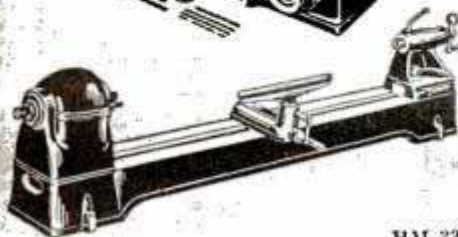
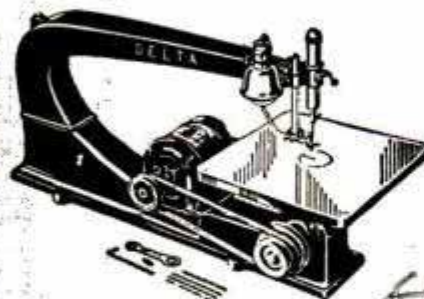
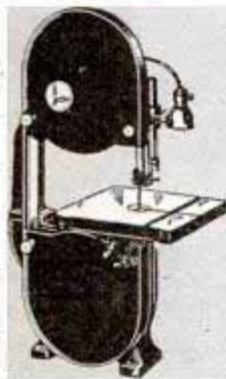

HMI-33

HAPPINESS HERALD

Educator Urges Hobby for Health



FREE!

"Happiness Herald"

—an illustrated tabloid newspaper that gives interesting facts about woodworking, a fascinating hobby. Tells about woodworking as an aid to mental health and happiness. Pictures typical shops and projects. Shows how the hobby can pay its way. Enjoy its inspiration and ideas. Send coupon for your free copy now.

Tear out coupon and mail today!

THE DELTA MANUFACTURING CO.
681C E. Vienna Ave., Milwaukee 1, Wis.

Please send me my free copy
of the "Happiness Herald."

Name.....

Address.....

City.....

(---) State.....

Cracked Engine?

TAKE IT EASY:
That's nothing to
worry about
these days!

Right! When your service man speaks lightly of cracked engine heads and blocks—relax! It's a sure sign he stands ready to serve you quickly and economically with

K & W METALLIC SEAL MECHANICAL METHOD

—two war-proved methods that restore cracked engines to unimpaired service. Imagine—heads and blocks once consigned to the junk heap are easily repaired at an amazing low cost! 85% of all repairs are made in only 30 minutes with one can of K & W Metallic Seal—the other 15%, of unusually serious nature, are repaired in a matter of hours the Mechanical Method way.

For years, K & W Metallic Seal and Mechanical Method repairs have been standard practice among leading engine rebuilders, fleet operators, railroads and military repair centers. Today, these amazing time and money saving services are available to car owners at better service shops everywhere. Remember—all K & W repairs are guaranteed for the life of the engine!

**INVESTIGATE K & W
GUARANTEED PRODUCTS
FOR BETTER CAR SERVICE**

Want finer car performance, appearance? Ask for these K & W products: Knock 'Er Loose (fast-acting penetrating compound), Radiator and Block Cleaner, Chrome Cleaner, Rust Inhibitor and Radiator Seal.



If you cannot locate a K & W Mechanical Method Shop, wire or write Kerkling & Company, Bloomington, Indiana, for names of those nearest you.

Michigan, where rays were found to have penetrated 1600 feet of rock.

One of the most ambitious experiments in cosmic ray research was staged shortly before World War II, when a 21-passenger air liner was used in Chicago to take soundings. The plane reached a height of 26,000 feet, flying 450 miles in three hours with the temperature below zero. At that height, Dr. Marcel Schein and Dr. Volney C. Wilson, of the University of Chicago, kept constant watch over the ray meter, which was composed of copper tubes and excluded all but cosmic rays. They observed that the more penetrating cosmic rays beat down 10 times faster at that elevation than at the earth's surface. It also was found that a recently discovered particle—the mesotron—was created by the action of neutral rays in the lead filter placed above the counters.

For three years before the war, cosmic ray observations were conducted on a ship running regularly between Vancouver, B. C., and New Zealand. The effort was to discover whether the rays originate in our universe or outside. A year later another cosmic ray research plane reached an elevation of 29,000 feet with photographic equipment that effectively used the "cloud chamber," an apparatus which includes a glass-walled chamber in which is produced an artificial cloud. As the cosmic ray shoots through the air, it breaks the molecules into ions. In the artificial cloud, the ions form drops of moisture and these mark the track of the rays. The track is photographed by the aid of bright lights.

Cosmic rays from the direction of a "star cloud," estimated to be 5000 light-years away, were employed to turn on a cluster of fluorescent lights at the Hayden Planetarium, New York, on June 17, 1941, which in turn, illuminated a "letter to the future" to be opened 5000 years hence.

Much research has been done through the years by means of "free" balloons which are sent aloft with delicate registering apparatus in cosmic ray research. Many of the balloon experiments were conducted by Dr. Compton and Dr. W. P. Jesse of the University of Chicago. Two years ago cosmic ray equipment supported by 29 balloons was sent up from Chicago and came down 40 miles from Columbus, Ohio. The device consisted of a 30-foot pole with two sets of three cosmic ray counters and batteries designed to register cosmic ray showers. Dr. Schein reported that cosmic ray showers were discovered at heights of more than 50,000 feet.

Six months later, another "free" balloon ascension was made, the equipment coming

(Continued to page 260)

CRESCENT

...The Wrench known the World over

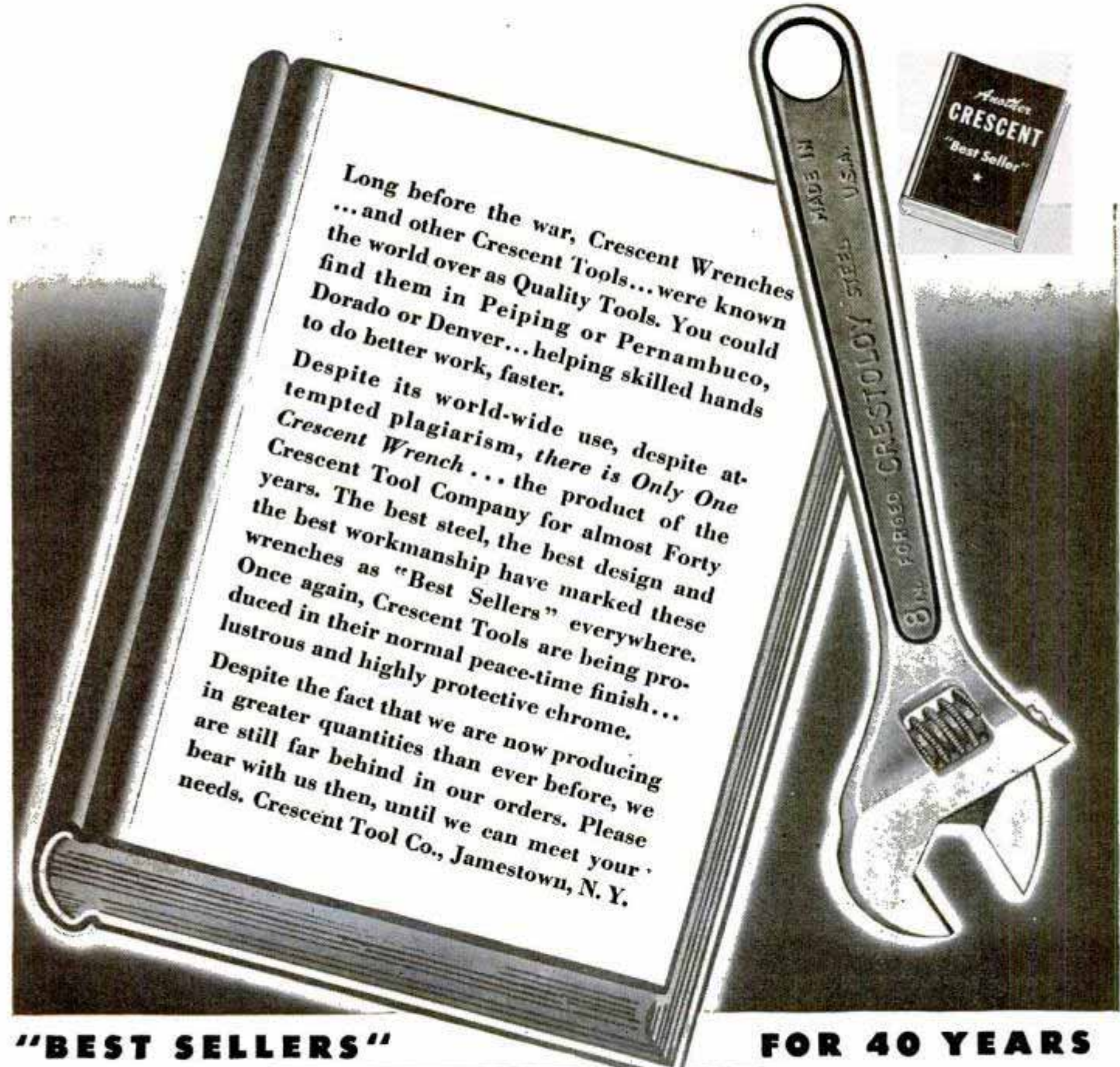

Long before the war, Crescent Wrenches ... and other Crescent Tools... were known the world over as Quality Tools. You could find them in Peiping or Pernambuco, Dorado or Denver... helping skilled hands to do better work, faster.

Despite its world-wide use, despite attempted plagiarism, there is *Only One Crescent Wrench*... the product of the Crescent Tool Company for almost Forty years. The best steel, the best design and the best workmanship have marked these wrenches as "Best Sellers" everywhere. Once again, Crescent Tools are being produced in their normal peace-time finish... lustrous and highly protective chrome. Despite the fact that we are now producing in greater quantities than ever before, we are still far behind in our orders. Please bear with us then, until we can meet your needs. Crescent Tool Co., Jamestown, N. Y.

"BEST SELLERS"

FOR 40 YEARS

CRESCENT TOOLS

Give Wings to Work

POWER KING TOOLS ARE BACK!

TO SPEED YOUR WORKSHOP "PRODUCTION"

TABLE SAWS, JIG SAWS, WOOD LATHES, DRILL PRESSES, BAND SAWS, BELT AND DISC SANDERS, JOINTER PLANERS, SHAPERS — all the great Power King Tools are in production again with scores of new improvements to save time on your workshop projects.

You'll be surprised at the sensational values, the rugged construction of the machines, and their smooth performance. Every modern, easy-operating feature is included — and prices are so reasonable you can equip your shop completely at an amazingly low cost.

FREE CATALOG SHEETS

Write today for descriptive literature to help you make your new power tool shop plans. Keep in touch with your Power King dealer to see the new tools when they arrive.

POWER KING TOOL Corp.
320 Cleveland St., Warsaw, Indiana

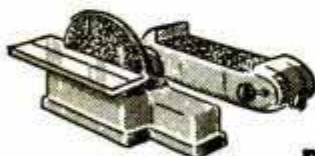
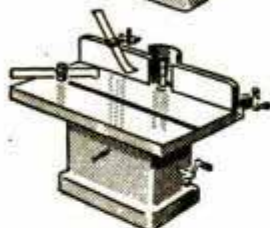
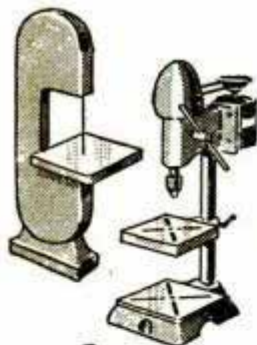
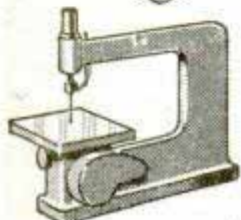

down in Virginia after a 500-mile record-breaking flight. A little more than a year ago University of Chicago physicists launched 36 balloons bearing a 60-pound cosmic ray photographic apparatus. The "free" balloons have carried automatic cosmic ray apparatus more than 17 miles in the air on different occasions, or upwards of 90,000 feet! The balloons, inflated with hydrogen, are made of extraordinarily elastic material, so that while they measure only five feet in diameter at the start of the ascent, they inflate to 20 feet in diameter when 16 miles or more in the air. Sometimes when a cluster of the balloons descends people take them for paratroopers. A note offering a reward for return of the equipment to the sender is attached to each unit, and nine times out of 10 the records and material are returned. Free balloon flights have registered up to 100 miles an hour in cross-country flight. They ascend at the rate of 700 to 1000 feet a minute. One of the strangest happenings was when a cluster was sent up from the University of Chicago, traveled several hundred recorded miles, and returned like a boomerang to a point within five miles of the campus!

Another device is a short-wave radio system that sends the impulses to scientists on the ground, dispensing with the need for a film record. Still another unique experiment was conducted late last fall when 49 balloons were released from Stag Field at the University of Chicago. This experiment was in charge of Dr. Schein of the university. Along with 70 pounds of cosmic ray apparatus were sent 200 flour beetles to determine the effect of cosmic rays on insect life. This experiment was thwarted by the accidental death of the beetles through escaping gases, but the effort will be repeated as the objective is considered of paramount importance.

Other studies show that gamma rays found in cosmic radiation are the shortest known. X-rays are too short to be visible, and gamma rays in radioactive materials are from 10 to 100 times as short as X-rays. However, the shortest known gamma rays of cosmic radiation are 100 million times shorter than the gamma rays of radioactive bodies. Research shows there are various kinds of cosmic rays, particularly the "soft" (electrons and gamma rays) and the "hard" (mesotrons). The former are easy to absorb, but the hard rays of high energy are the ones that penetrate anything. They are millions of times stronger than any other known radiation and shoot like irresistible bullets through every known thing.

Another dramatic discovery is the fact

(Continued to page 262)



CHECK truth-of-taper
or any angle, to
.000010" ± easily!

With a set of Ford Jo-Blocks and Sine Bar, you can quickly establish or verify angularity. Hundreds of other daily shop uses, from checking mikes to precision set-up of machine tool jobs, verifying marks, locating, laying-out, scribing, etc.



Made to warranted accuracy standards of two, four or eight millionths of an inch, plus or minus. Sold in sets or singly. Pioneer measurement standards of world-wide acceptance. Made in America only by Ford Motor Co., Johansson Division, Dearborn, Mich. Write to Dept. 411 for new catalog.

PREVENT WASHDAY MISHAPS with TITE-LINE Clothes Line Holders



String your clothes line on TITE LINE clothes line holders. It's quick. It's easy. It's the surest way to prevent that exasperating washday disaster—broken clothes lines. Each section is securely gripped—a line break affects only one section.

EASILY INSTALLED ON FLAT OR ROUND SURFACES

TITE-LINE clothes line holders are used in attics, basements, outdoors—wherever clothes line is used. Saves line, saves time, prevents knots and kinks, holds line tight, no tying. Get TITE-LINE at your favorite hardware or variety store. If not in stock, send us your dealer's name.



THE MIDLAND COMPANY
SOUTH MILWAUKEE, WISCONSIN

SAFE HANDS



WORK FASTER

with Steel-Grip Gloves

The best opportunity for lower costs lies in speeding production. Keep materials moving with Steel-Grip Reinforced Gloves. They handle rough, heavy, jagged materials at breathless pace. Chrome tanned cowhide. Steel ribbon reinforced palm and fingers. Steel thread sewed. Protect against cuts, bruises. Or what's your need? Over 4300 proved Steel-Grip Safeguards may give immediate answer. Used by big industrials since 1910. Write for catalog or state your need today.

INDUSTRIAL GLOVES CO.
647 Garfield Blvd., Danville, Ill.
Canada: Safety Supply Co., Toronto

pipe-smoking in
king frederick's day...



King Frederick's club
— only pipe-smokers
were admitted.
From an old print.

... but then not even a king
could have an



No, not even a king in those days could enjoy the sweet smoke of an LHS, made of rare imported briar.

A good pipe is an investment in daily pleasure.



Other LHS Pipes

- LHS Sterncrest Ultra-fine . . \$10.00
- LHS Sterncrest 14K . . . 7.50
- LHS Certified Purex . . . 3.50
- LHS Purex Superfine (Domestic Briar) 1.50

at good dealers everywhere.



FREE. Write for "Pipes—
for a World of Pleasure"

L & H STERN, INC., Stern Bldg., 56 Pearl St., Bklyn 1, N.Y.

\$5

Model No. 14.
Others—plain or
antique finish.

**IMPORTED
BRIAR**

STERLING SILVER BAND

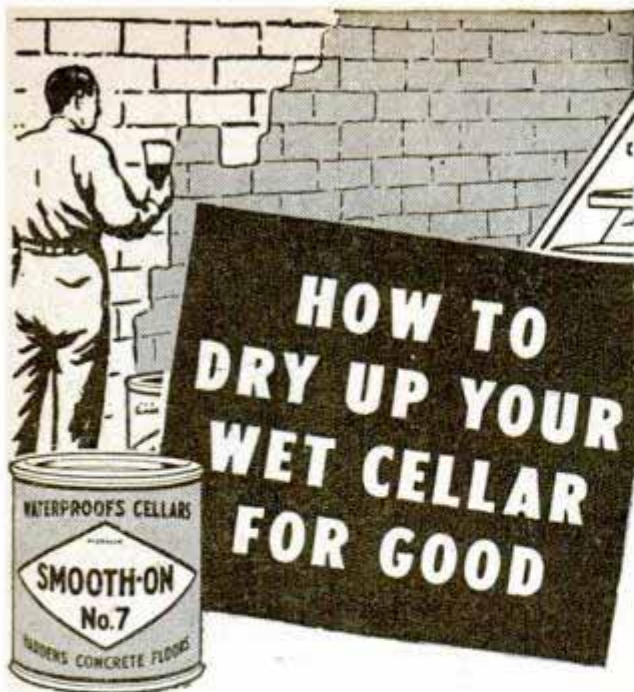

YOU can do it *yourself*—get rid of leaks, dripping, dampness, mustiness—by applying Smooth-On No. 7 Iron Cement to **INSIDE** cellar wall and floor surfaces. You brush it on like paint. Fills in cracks, crevices, pores in concrete, brick, stone. Hardens in 24 hours, expanding slightly, sealing tightly. Inexpensive, for you don't need professional help—and you get a lasting result.

Use it, too, to waterproof troughs, cisterns, tanks, fountains, swimming pool, garage, outbuildings.

Ask for Smooth-On No. 7 at your nearest hardware store—or write us direct if store hasn't it. Comes in 1-, 5-, 25- and 100-lb. sizes. 25 lbs. cover 100 sq. ft.

REPAIR HANDBOOK **FREE**

Full directions for waterproofing cellars, with instructions for repairing leaky heating and plumbing systems, household equipment, auto parts, etc. 40 pages. 170 diagrams. Pocket size. Just send coupon.



— Sign and Mail NOW —

Smooth-On Mfg. Co., Dept. 37
570 Communipaw Ave., Jersey City 4, N. J.

Please send me Smooth-On Handbook

Name.....

Address.....

3-46.....

Do it with SMOOTH-ON

that there are frequent cosmic ray "showers," the particles falling like heavy rain over an area equal to two or three acres. As many as a million rays are contained in a single shower and 50 or 60 showers fall in a single hour. They are called "Auger showers" in honor of the famous French scientist, Pierre Auger, whose research in the Alps mountains brought the new discovery to light. You can listen in, through an ingenious loudspeaker device, on a cosmic ray shower, and it sounds something like a summer storm. It is a roaring sound, like rain driven by wind, then sudden quiet for a moment, followed by another squall.

While we are struck constantly by both the continuous downpour of cosmic rays and the occasional heavy blast of a shower, they do not register any known effects on us. People living at high altitudes get a double dose, while men working deep in mines receive only a fraction of the rays, but neither seem in the least affected.

The latest scientific effort is mostly in the field of relating the cosmic rays to atomic radiations. Nearly 15 years ago one scientist predicted that cosmic ray study would throw light on the problem of how the core of the atom is built, and thus open the way for the release of atomic energy for human uses. As far as it can be gathered from guarded statements by scientists, it is likely that the cosmic ray is the key to the release of atomic energy and to the analysis of the atomic ray. In fact, it is reported that the cosmic ray is held to be the means of unlocking the secret of X-ray and radium as well. Further than that, a professor, John Archibald Wheeler of Princeton University, holds that by studying cosmic rays man eventually may discover means of transforming any kind of matter, not uranium alone, into atomic energy.

A new giant, called the betatron, invented by 34-year-old Donald W. Kerst, a University of Illinois professor, is soon to come into the field of cosmic ray research. The instrument uses electric magnetic energy to speed the flight of electrons up to 185,000 miles a second, virtually the same as that of light. It is expected to reproduce cosmic rays for close study, possibly eliminating the need for scientists to fly into the stratosphere or burrow into mines.

How long must the relentless search move on before the cosmic ray finally is brought into captivity and tamed? No one knows. Most scientists say that, if human cussedness in the form of war will lie dormant long enough to let science carry on its hunt uninterrupted, 10 to 20 years ought to be enough to make us master of the supreme source of unlimited power.

The "BIG THREE" of Outboard Motoring



It is *Johnson* that offers you this great combination of features: 1. Perfected Alternate Firing for silken smoothness; 2. 360° Steering and Reverse for complete maneuverability; 3. Dual Carburetion for full range, quality performance, at both high and low speeds.

In addition to the "big three" Johnson offers you 27 other quality features for performance, long life, convenience and **DEPENDability**. All yours in the most beautiful motor we have ever built—with a sparkling Sea-Green finish.

And for extra measure, the Johnson dealer organization offers you expert, nation-wide service. That's important!

Johnson makes Sea-Horse motors only!

FREE! NEW SEA-HORSE HANDY CHART. A full-color presentation of the 5 great Sea-Horses for 1946. Complete specifications and details on all features. Write for copy, or see your Johnson dealer. Look for his name under "Outboard Motors" in your phone book. JOHNSON MOTORS, 400 Pershing Rd., Waukegan, Ill.



JOHNSON SEA-HORSES for **DEPENDability**

T H E R E I S N O S U B S T I T U T E F O R E X P E R I E N C E



When you want to fix things fast . . . remember Weldwood Glue. It's quick to mix . . . easy to use . . . tremendously strong . . . stain-free . . . rot-proof . . . and permanent. At hardware stores, lumber yards, chain stores.



WELDWOOD
PLASTIC RESIN
WATERPROOF GLUE

UNITED STATES PLYWOOD CORPORATION, New York 18, N. Y.

We take pride
in making it
You'll take pride
in owning it

**Sterling
Hall**
by Briarcraft



\$3.50

The pride that comes of making so fine a pipe is *ours*. The pride of ownership will be *yours*. . . We say this, because a Sterling Hall pipe reflects superiority in every feature. Any connoisseur of pipes will instantly appreciate the beauty of its selected grain . . . its perfect proportions . . . the rich, lustrous finish . . . and its neatly inlaid sterling silver band, which strengthens the shank and maintains a perfect fit for the stem.

All this reflects the expert craftsmanship that makes a Sterling Hall so sweet smoking and satisfying. At leading dealers, in many handsome models, individually boxed, \$3.50.

Briarcraft, Inc., 347 Fifth Avenue, New York 16, N. Y.



Do a Better Job

WITH ONE OF THESE
EMPIRE LEVELS

Smallest, most handy and accurate Level made. "Cigar-shaped"—no sharp corners to tear pocket. Aluminum stock. Only 3 oz. wgt. 9" long. Has Level, Plumb, 45° Vials.
No. 26.....\$1.75



ALUMINUM LEVEL — No. 151

Cast and Machined, a Beautiful Tool, with Patented, Removable Level and Vial.
With 2 Plumb, 2 Levels, 2 — 45° Vials. 18".....\$5.00
24".....\$5.50 28".....\$6.25

Order EMPIRE LEVELS from your local dealer.
Write direct for literature.

EMPIRE LEVEL MFG. CO.
717 S. 6th St. Dept. P-239 Milwaukee 4, Wis.

A TOOL—
NOT A
BRUSH

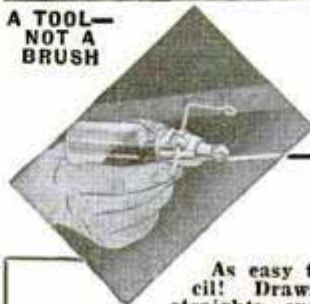

**PAINTERS'
STRIPING**

TOOL

ONLY
\$1.00
POST
PAID

As easy to use as a pencil! Draws parallel lines, straights, curves, circles with paint, enamel, lacquer. Use to stripe autos, furniture, toys, bikes, model planes, signs, bulletin boards, linoleum. (Makes wall board look like tile.) Every painter and craftsman should own one! Type "8" MASTER Painters' Striping Tool with instructions, adj. guide, 1/16" tip, complete only \$1.00. C. O. D. 25c extra. Order Today! PAINT DEALERS! WRITE FOR LITERATURE, ETC.

WENDELL MFG. CO., 4234-B, Lincoln Ave., Chicago 18, Ill.

WRITE
For
FREE
Literature

**BUILD YOUR OWN
POWER LAWN MOWER**

**WHY BREAK YOUR BACK
MOWING FIELD OR LAWN?**

Now anyone can save time and effort mowing field or lawn, by building their own whirl type power mower.

We furnish complete information, and whirl type blade attachment. Write today.



THE RITE-WAY
MOWER ATTACHMENT

T & H Mfg. Co.

811 E. 31, Dept. B-1, Kans. City 3, Mo.

The
Chief

WORK BENCH

Built to Last a Lifetime!

With Bottom Shelf and 18" Sq. Drawer. 2"x6", Solid Plank, Grooved and Dovetailed Top and 1"x8" Back Rail, Shellacked to a Smooth, Satiny Finish.

MOHAWK LUMBER CO. Dept. 32
14525 W. Chicago Blvd. Detroit 27, Mich.
Enclosed Check Money Order for \$.....
Ship..... CHIEF WORK BENCHES at
Quantity.....
\$16.95 each, F.O.B. Detroit, Mich.
 Send C.O.D., \$5 Deposit Enclosed.
NAME.....
ADDRESS.....
CITY..... STATE.....
No Priority Necessary!

• 6 Ft. Long • 34" High • 26" Deep. Shipped Knock-down, with Bolts, Nuts and Screws and ABC Chart for Quick, Simple Assembly.

Prompt Delivery
MOHAWK LUMBER CO.
14525 W. Chicago Boulevard
DETROIT 27, MICHIGAN



\$16.95
F.O.B. DETROIT

Send Check or Money Order, or Will Ship C. O. D. (\$5 Deposit)

It all adds up to one word . . .

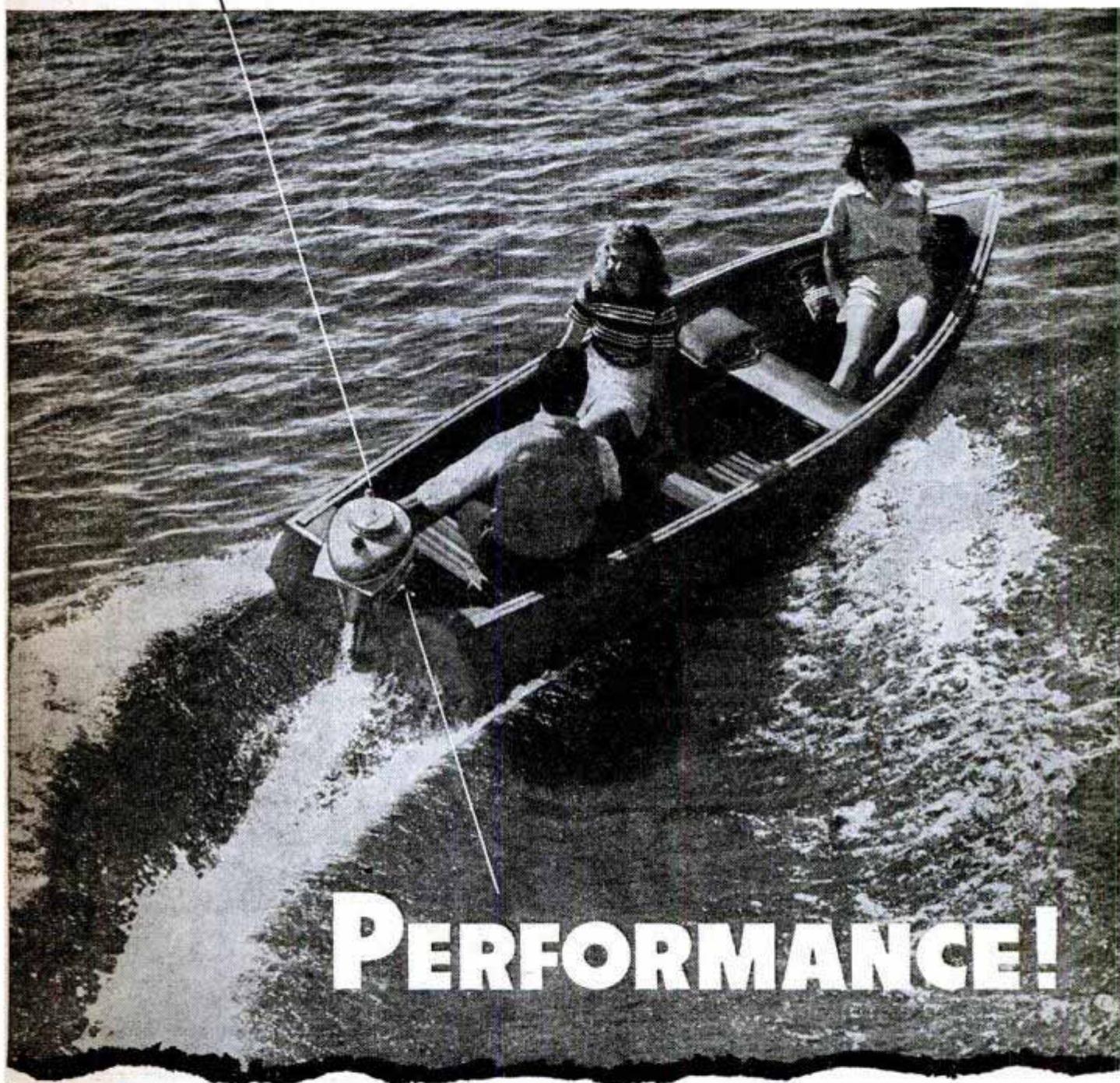

● Eager power that flows smoothly, quietly at every speed . . . finger-touch handling ease, and starting sureness built right in . . . these, and every other quality you'd like in a motor, come right down to one word . . . *performance.*

And *performance* is what's waiting for you in every model of Evinrude's complete 1946 line. *Performance* that has been perfected step

by step during 36 years of building fine outboard motors. *Performance you can bank on!*

See your Evinrude dealer soon — and send for free catalog of the complete Evinrude line.

Write for it today! Address, EVINRUDE MOTORS, 5187 N. 27th St., Milwaukee 9, Wis.

EVINRUDE

OUTBOARD MOTORS



BOY CARVES BUTCHER...WITH X-ACTO!

Patriotic Puppet Fights Black Market

Hobby Expert says X-acto Knives "Marvelous" for Model Building, too

Sanford Solarz of Brooklyn is a versatile young hobby crafter. And he finds X-acto Knives the most versatile of tools.

At Midwood High he made wooden puppets for the school play against black markets. X-acto Knives, he says, were "perfect for getting just the right expression on the puppets' faces".

And for his model planes (which have won him prizes, and an exhibit at Brooklyn Museum) X-acto's variety of blades and handles produced "results which would be impossible with ordinary tools".

For ship models (yes, he makes those, too) he has "yet to find a better set of tools". He uses the heavy and medium-weight X-acto for hull and

deck parts, and the light No. 1 Knife for shaping mast and yard arms.

You'll do a slicker job at your hobby, too, with X-acto. It's sharp as a surgeon's scalpel, easy to use as a pencil, gives you that confident feeling. You'll have a lot more fun with X-acto every time.

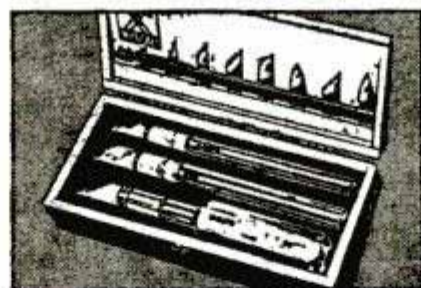

Singly or in sets!

Here's the X-acto De Luxe All-Metal Knife Set—3 firm-grip X-acto Knives, with 20 assorted, interchangeable blades, in a handy wooden chest. Complete, for \$5. Other X-acto Knives and Knife Chests, from 50c to \$3.50.

NEW FEATURE MAKES X-ACTO BETTER THAN EVER!

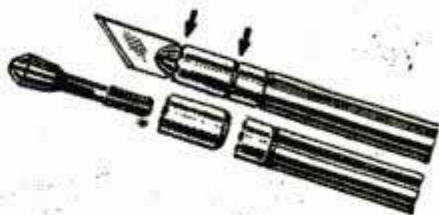

X-ACTO'S CHUCK COLLET device has always been one of its biggest advantages over ordinary knives. Now it's been made even better. The new collet grips blade more firmly. The blade tightens with less pressure, and extends further, allowing knife to get into deeper crevices. It's terrific!



HELPFUL "HOW-TO" BOOKLETS to help you have fun with X-acto. 10c each.

- (1) How To Build Scale Model Planes
- (2) Whittling Is Easy With X-acto
- (3) Commercial Artists' Handbook
- (4) Twelve Technics—The Knife As A Drawing Instrument



THEY ALL USE X-ACTO: Artists, photographers, leathercrafters, furriers, bookkeepers, lithographers, taxidermists, tree nurseries, printers. You'll find it useful in your work, too.

X-ACTO TOOLS, TOO!



Sander; Plane; Balsa Stripper; Hobby Crafter's Saw; Drill Holder and Pin Vise



X-acto

KNIVES & TOOLS

X-acto Knives & Knife Chests From 50c to \$5.00

* Buy where you see this sign. At better hardware, hobby and gift shops — or if not available write direct to X-acto Crescent Products Co., Inc., 440 Fourth Avenue, New York 16, N. Y.

*Reg. U. S. Pat. Off.



STOP LEAKS!

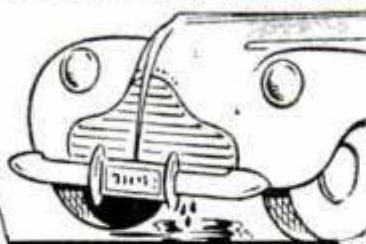

**Cooling Systems
Made Leak-Proof QUICKLY**

WARNER LIQUID SOLDER—Non-Metallic—
Deposits Tiny Fibers to Repair Leaks Any-
where in Cooling Systems. Simply pour in!
Finds and REPAIRS every crack or hole. Do
it yourself—or see your service man.

Warner-Patterson Co., 920 S. Michigan Ave., Chicago 5

TURNER VT-73 DESK MICROPHONE



Here's the mike you want for your rig. It's got looks, it's tough, and man, oh man how it performs. It's a TURNER! Ask your dealer or write for Free Literature on other low cost Turner Microphones.

THE TURNER COMPANY
921 17th St., N.E., Cedar Rapids, Iowa

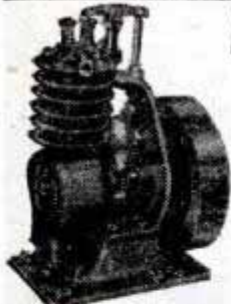

MODEL: Gasoline Engine Ready to Run

A precision built and engineered single cylinder FOUR-CYCLE model gasoline engine. Bench tested and ready to run. Available with stationary or marine engine base. Full instructions. Lots of fun. Engine \$27.50. Coil and condenser \$2.75. Immediate delivery.

The THOMPSON ENGINEERING CO.
206 Winchester Place, Grand Rapids, Mich.

7 3/4" high—3" wide

HOLD-E-ZEE AUTOMATIC GRIP SCREWDRIVERS

Hold-E-Zees do the job better, faster. They excel wherever screwdrivers are used. Gripper instantly released by spring action, sliding up out of way when not in use. Highest quality materials throughout. Sold at leading dealers everywhere.

PATENTED

UPSON BROS., INC.
86 Exchange St., Rochester 4, N. Y.

\$32,750 in AWARDS

4 UNIVERSITY SCHOLARSHIPS

PLUS

294 CASH AWARDS

FOR
BOY
CAR

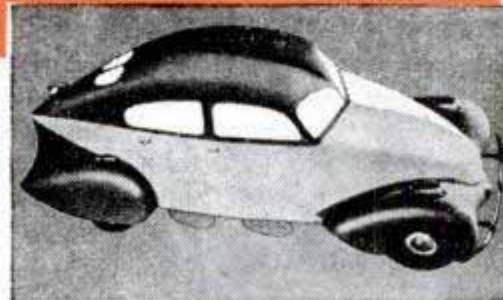

MODEL BUILDERS

If you are a boy 12-19, inclusive, and live in the United States, you are eligible for free membership in the Fisher Body Craftsman's Guild and to compete in its car model builders' competition. Here's your chance to win one of four university scholarships, worth \$2,000 to \$4,000 each; or one of 294 cash awards of from \$25 to \$100 each. In addition, 18 other winners will be given free trips to the annual Guild convention in Detroit. Half of all awards go to Juniors (12 years old and under 16); half to Seniors (16-19 years old, inclusive). Cash awards divided equally among all states and the District of Columbia. Free plans and instructions. 1946 competition closes July 15.

MAIL COUPON—TODAY!

FISHER BODY CRAFTSMAN'S GUILD

An educational foundation sponsored by

Fisher Body Division of General Motors
General Motors Bldg., Detroit 2, Michigan

Gentlemen: Please enroll me in the Fisher Body Craftsman's Guild for 1946, in the Model Car Design Competition.

Send me full instructions without charge.

Name _____

Address _____

City _____ Zone _____ State _____

I was born on the _____ day of _____ 19 _____

Name of parent or guardian _____

Dept. 55



Companion for your leisure hours

Make the most of those precious moments of relaxation. Enjoy them with the honest fragrance, the just-right mildness of Christian Peper Pouch Mixture.

There's down-to-earth satisfaction in "Peper's Pouch," masterfully blended from fine imported and domestic tobaccos in the Christian Peper manner.

POCKET-SIZE PACKAGE
AT TOBACCO COUNTERS **25c**

Christian Peper SAINT LOUIS

FINE TOBACCOS SINCE 1852

SAY YOU SAW IT IN POPULAR MECHANICS

Now! A Better Soldering Tool...

THE
VANAITA

KWIKHEAT

THERMOSTATIC SOLDERING IRON

Has Built-in
Thermostat
Control!



6 TIP STYLES

- #0—\$1.25
- #1—\$1.25
- #2—\$1.25
- #3—\$1.25
- #4—\$1.75

#5—Melting Pot
for Tinning—\$1.25

HOT, READY FOR USE ONLY 90 SECONDS after plugging in! Kwikheat is the only soldering iron with a thermostat built into the tool itself*—maintaining the proper level of heat for most efficient, economical operation. **SAFE!** ... Cannot overheat—**ECONOMICAL!** ... Lasts longer—saves tips and requires less retinning. **POWERFUL!**—225 watts—yet exceptionally light weight (14 oz.). Well-balanced with cool protecting plastic handle. Modern streamlined design. Six interchangeable tip styles adapt one Kwikheat Iron to all your soldering jobs. You will be proud to own America's finest and most versatile soldering tool... from tip to plug Kwikheat is in a class by itself. Ask your dealer to demonstrate the quick-heating feature now!

*patented
Kwikheat Iron with choice of #0, 1, 2, 3, or 5 tips. \$11.00
Set of 5 Tips, consisting of #0, 2, 3, 4, and 5... \$4.00

6 TIP STYLES—QUICK-HEATING ELEMENT—BUILT-IN THERMOSTAT—WELL-BALANCED—COOL, PROTECTING HANDLE—LIGHT WEIGHT

Dept. PM-3, Kwikheat Division of

SOUND EQUIPMENT CORP., 3903 San Fernando Rd., Glendale, 4 Calif.

POWERlite

6-VOLT 2-LITE
ELECTRIC LANTERN

Millions now in use. 2-Lites: spotlight *plus* floodlight. Runs 80 to 100 hours on one battery. Rugged. Lenses don't break. At Hdwe., sport, electric dealers.

\$3³⁵
LESS
BATTERY

Delta

DELTA ELECTRIC CO.
MARION, INDIANA



Mortite

PLASTIC TAPE PLUGGER-UPPER

Plugs holes in and around screens, casements, roofs, sinks, tubs, baseboards. Stops rattles. Keeps out dust, dirt, insects. For all calking. **Easy to Apply** — Just press into place with fingers.

A roll covers about 80 ft. At hardware, paint, dept. stores and lumberyards.

Ask for **FREE J. W. MORTELL CO.**
Mortite Circular 522 Burch St., Kankakee, Ill.



\$1²⁵

Higher west of
Rockies & Canada



SIMPLIFY HOME WOODWORKING!

LOCATE DOWEL HOLES EASILY...



KENKRAFT Metal Dowel Centers leave clear, accurate impressions on mating piece. Mating holes easily drilled to accurate fit. Made for 1/4", 3/8" and 1/2" dowels. Two of each size prepaid \$1.00

KENKRAFT

EXPERIMENT WITH BLACK LIGHT!

FUN! THRILLS! PROFITS! See seven page article on this fascinating science in June 1945 issue of Popular Mechanics. We furnish all supplies. Trial Kit of 8 lacquers only \$6.25. Black bulb for testing, \$2.00. Lamps, lacquers, crayons, fabrics, etc. Write for descriptive list and full details today!

BLACK LIGHT PRODUCTS, 450 East Ohio Street Chicago 11, Illinois



G E A R S

In Stock - Immediate Delivery

Gears, speed reducers, sprockets, thrust bearings, flexible couplings, pulleys, etc. A complete line is carried in our Chicago stock. Can also quote on special gears of any kind. Send us your blueprints and inquiries.

Send for Complete Catalog No. 10

CHICAGO GEAR WORKS
440-50 N. Oakley Blvd., CHICAGO 12, ILL.

POPULAR MECHANICS



MOTO-TOOL ★ THE "POCKET-SIZE" MACHINE SHOP

PUT THIS "WAR VETERAN" TO WORK *Approximately 27,000 R.P.M.*

READ MOTO-TOOL'S RECORD

Long before Pearl Harbor Dremel Moto-Tools had won their spurs in tool rooms, machine shops, home workshops. Now they have the respect of every branch of the armed forces. And thousands of them helped establish production records at General Electric, Westinghouse, Remington Arms, Ford, Nash-Kelvinator, Consolidated Aircraft, Douglas and others.



MOTO-TOOL KIT

Kit No. 2 with 23 high grade accessories and Model 2 Moto-Tool, in hardwood case. \$23.50
Model 2 Moto-Tool, with 1 accessory... \$16.50

Now that priorities have been lifted, Moto-Tool can work for you. Moto-Tool owners daily discover new jobs that can be done more expertly in less time. In fact, new purchasers find dozens of uses in addition to those they had in mind. So great is the saving of time and labor with Moto-Tools, thousands of mechanics and craftsmen would find it difficult to get along without their "mighty little midgets."

ONLY MOTO-TOOLS HAVE ALL THESE FEATURES

A Model 2 Moto-Tool develops a speed of approximately 27,000 rpm. Weighs only 13 oz. Shaped to fit the hand. Sturdily built with shock-proof bakelite housing. Balanced for vibrationless operation. Uses 110-120 AC or DC current.

10 DAY TRIAL—MONEY BACK GUARANTEE

Ask your dealer today about Dremel Moto-Tools and Accessories. If he does not handle them, order direct from factory on 10 day trial. We ship post-paid if cash in full accompanies order. If you prefer to send only \$2.00, Moto-Tool will be shipped C.O.D. for balance plus postage. Catalog sent FREE.



Model 2 Illustrated

A FEW OF THE JOBS THAT MOTO-TOOL CAN DO FOR YOU

- Sharpening
- Finishing
- Touching Up
- Sanding
- Drilling
- Mortising
- Engraving
- Burring
- Grinding
- Polishing
- Burnishing
- Inlaying
- Sawing
- Scoring
- Cleaning
- Routing
- Cutting
- Rasping
- Carving
- Brushing
- Dressing

WATCH FOR THE RETURN OF MOTO-SAW

Dremel Moto-Saw... the sensational electric scroll saw... will be back as soon as materials are available.

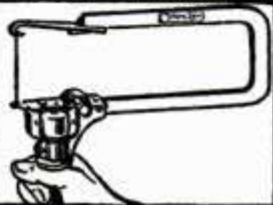

DREMEL MFG. CO. 116-G RACINE, WIS. U.S.A.

QUICK WARMTH FOR ROOMS WITH THE CHILLS



Equipped with safety automatic shut-off, Thermo Electric Control and other advantages.



Now you can bring *real steam heat* into any room! WITTIE Electric Steam Heater is a new revolutionary heater that provides quick, uniform warmth wherever and whenever you need it. Luggage-light, good-looking as a piece of furniture, and so economical to operate! Safer, too, because WITTIE is steam heat—no glowing coils. You'll want to see the WITTIE Portable Heater, so send coupon right away!

Weights only 37 lbs.; baked Hammerloid mahogany color; 110 volts AC

WITTIE MFG. & SALES COMPANY

1414 S. Wabash Ave., Dept. 17, Chicago 5, Ill.

Please tell me where and when I can see the new Wittie Portable Electric Steam Heater.

Name

Address

City State

OVER **75** MILES PER GAL!

Cushman
MOTOR SCOOTER



For getting there Quick—Comfortably—and at Lowest Possible Cost, you can't beat the Cushman—and the new 1946 model is 'way ahead of anything you have ever seen!

POWER TO BURN! Rugged 4 H. P. engine with 2-speed transmission speeds you up steepest hills!

COSTS LITTLE! \$1 worth of gas takes you 400 miles! Any speed up to 35 miles an hour!

TRULY COMFORTABLE! Long wheel base, improved spring action, big balloon tires, insure smooth riding!

Many 2-wheel or 3-wheel models—with or without side or front package-box for carrying big loads.

WRITE See your dealer or send for Free Folders, Prices.

CUSHMAN MOTOR WORKS
Dept. P-73, Lincoln, Nebr.

OTHER MODELS



SIDE-KAR—3 wheels. Package-box carries 200-lbs.



PACKAGE-KAR—3 wheels. Front package-box carries 250-lbs.

PRECISION DRIVES for your POWER EQUIPMENT

CONGRESS

PULLEYS & COUPLINGS

Available in a large range of sizes, **CONGRESS DRIVES** increase the performance of your workshop. They are the same precision drives that are being used as standard equipment by many of the worlds largest manufacturers of high priced precision machinery.

Better hardware, hobby shop and farm equipment dealers are selling **CONGRESS DRIVES**. They are available in all popular sizes with diameters ranging from 1½" to 14". You pay no more for **CONGRESS** than for ordinary drives.

CONGRESS DIE CASTING DIVISION
Detroit 12, Michigan



LOOK FOR THIS DISPLAY

It identifies the dealer selling superior **CONGRESS** pulleys and couplings.



SAY YOU SAW IT IN POPULAR MECHANICS

ELECTRICITY FOR ANY JOB ANYWHERE



Reliable, economical electric service anywhere, anytime, with an Onan Electric Generating Plant. Driven by Onan built, 4-cycle, gasoline engines, these power plants are of single-unit, compact design and sturdy construction. Suitable for all types of service.

Models range from 350 to 35,000 watts. A.C. types from 115 to 660 volts; 50, 60, 180 cycles, single or three-phase; 400, 500 and 800 cycle, single phase; also special frequencies. D.C. types range from 6 to 4000 volts. Dual voltage types available. Write for engineering assistance or detailed literature.

ONAN

D.W. ONAN & SONS, 2515 Royalston Ave., Minneapolis 5, Minn.

FISHERMEN

MAKE OR REPAIR YOUR OWN STEEL LEADERS... QUICKLY... EASILY

Any fisherman now can make tightly wrapped, factory-perfect steel leader connections with "HOOK-ON." This new winding tool takes all the "chore" out of attaching hooks and swivels to steel wire leaders. Also simplifies repairing broken leaders. Stainless steel, precision made, lifelong construction.

"HOOK-ON" Only \$1.50

If your dealer does not yet have "HOOK-ON," order direct. Mailed postpaid upon receipt of cash or money order.

HOOK-ON



PARAMOUNT MACHINE PRODUCTS
1361 Newton Street, Los Angeles 21, California, Dept. PM-3



LOCATES TROUBLE INSTANTLY IN ALL ELECTRICAL DEVICES

HANLAN APPLIANCE TESTER

In this single unit are combined all the necessary tests for examining every appliance. Checks thermostats under actual working conditions. Tells instant it opens or closes. Controls the heat on soldering irons. Prevents over-heating. Tests continuity, open circuits, etc. Checks automatic irons, vacuum cleaners, motors, shavers, bulbs, appliances with 3-way switches, etc. Great time, effort and money saver! ONLY \$9.50 COMPLETE.

Pat. Pend.

FREE with each Tester. New, Complete Practical Course in electrical appliance repairing. **WRITE FOR CIRCULAR.**
HANLAN CO., 1419-A, West Jefferson, Los Angeles 7, Calif.

THERE'S NO OIL... just like 3-IN-ONE!

INSIST ON 3-IN-ONE

For over 50 years the accepted household oil in America... Sold everywhere.



Light or Heavy Body

One or Three Oz. cans



3-IN-ONE Oil

SpeedWay

No. 6 1/4" drill \$9.95

No. 8 1/4" drill \$32.50

SpeedWay announces that an even better and more complete line of SpeedWay Electric Tools will soon be available to you at the same attractive pre-war SpeedWay prices. Already coming off the line, these are tools worth waiting for. Ask your dealer about them NOW!

SPEEDWAY MFG. CO.
1863 S. 52nd Ave.
Cicero 50, Ill.

VICE-GRIP WRENCH

Mightiest OF ALL HAND TOOLS

GIVES I HAND A TON GRIP!

See the DOUBLE LEVER!

Vise-Grip does more things, easier, than any other tool! Remains locked to the work with hands removed. Holds anything, any shape, with a grip that never slips. Built with strength to back up its tremendous power. Is actually Hand-Vise, Clamp, Super-Plier, Adjustable End-Wrench, Pipe-Wrench, Locking Wrench and Toggle-Press—ALL IN ONE! Light, trim, handsome. Made of fine alloy steel. Electro plated. 7" and 10" sizes.

Sold by Tool Jobbers and Dealers.
PETERSEN MFG. CO., Dept. P-36, DeWitt, Nebr.

HULL Gets You There

Know directions in rain, snow, fog or night driving. **HULL AUTO-MOBILE COMPASS** is accurate, dependable. Easily installed. Circular free. At your dealer's. Price \$3.50.

HULL MFG. CO.
P. O. BOX 246-D3 WARREN, OHIO

IT'S EASY! IT'S FUN!

Build Your Own

• Transmitter Kits • Phono Amplifier Kits • Antenna Kits • Crystal Sets and many others.

FREE NEW 52 PAGE PARTS CATALOG SEND FOR YOUR COPY TODAY!

Write for these exclusive items:
 Tube and Circuit Book 10c
 Giant Radio Reference Map 15c
 Handy Tube-Base Calculator 25c

Address PM-3, Council Bluffs, Iowa

Wholesale RADIO LABORATORIES



GET NEW-CAR PEP AND ECONOMY WITH BURD "GRAF-FLOX" PISTON RINGS

● If you're not one of the fortunate few who have a new 1946 Model car, give your engine a brand new lease on life by installing Burd "Graf-Flox" Piston Rings. You'll be surprised at the new-car pep it gives and be pleased when you add up your fuel and oil savings. The secret of Burd's superior performance lies in (1) the use of electric furnace iron—scientifically controlled, producing piston ring castings having uniform tension; (2) precision grinding and finishing operations, which include the removal of all harmful metal surface particles; (3) the exclusive Burd process of applying deeply penetrating colloidal graphite, preventing the finished rings from scuffing, scoring, seizing, or sticking in grooves. Mail the coupon today for two FREE booklets described below.

BURD PISTON RING CO. DEPT. PM ROCKFORD, ILL.



THIS COUPON BRINGS FREE BOOKS

BURD PISTON RING CO., DEPT. PM
Rockford, Illinois
Gentlemen:

I'd like a FREE copy of your "Handy Handbook" which tells how to keep my car in good working order. Also send a "Car Economy Record Book."

Name.....
 Address.....
 City..... State.....

Handy Handbook
 Victory

ANTON PARALLELS

AVAILABLE NOW — IMMEDIATE SHIPMENT

**INCREASE PRODUCTION
IMPROVE QUALITY OF WORK**

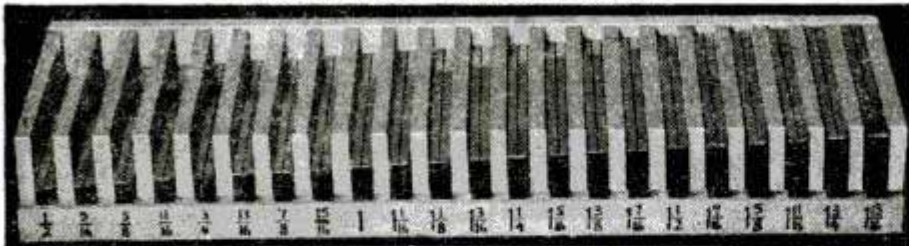

ANTON PARALLELS COME IN THREE STANDARD SIZES—

3/4" Thick x 6" Long—1/2" to 1-13/16" High in Steps of 1/16" \$85.00 per set—22 pairs

1/2" Thick x 6" Long—1-3/16" to 1-13/16" High in Steps of 1/16" \$71.00 per set—11 pairs

3/4" Thick x 6" Long—1-3/16" to 1-13/16" High in Steps of 1/16" \$106.00 per set of 11—3 each size

Price per set includes a large Wooden Container — Large Stock of Single Pairs also Available — All Prices are F.O.B. New York

ROCKWELL "C" HARDNESS 65 UP.

MAXIMUM SIZE TOLERANCE .001 INCH ON GROUND SIDES—Maximum Variation in Parallelism and Straightness within Length, .0001.

ALL PARALLELS FULLY GUARANTEED—To be within the Limits Specified.

ANTON PARALLELS FILL A LONG-FELT NEED—permanently straight and accurate, yet priced for everyday general machine shop use.

ANTON PARALLELS COME IN THREE STANDARD SIZES—

ANTON MACHINE WORKS

52 SANDS STREET
BROOKLYN 1, N. Y.

AMMCO 7" SHAPER

"A Precision Machine of a Thousand Uses"

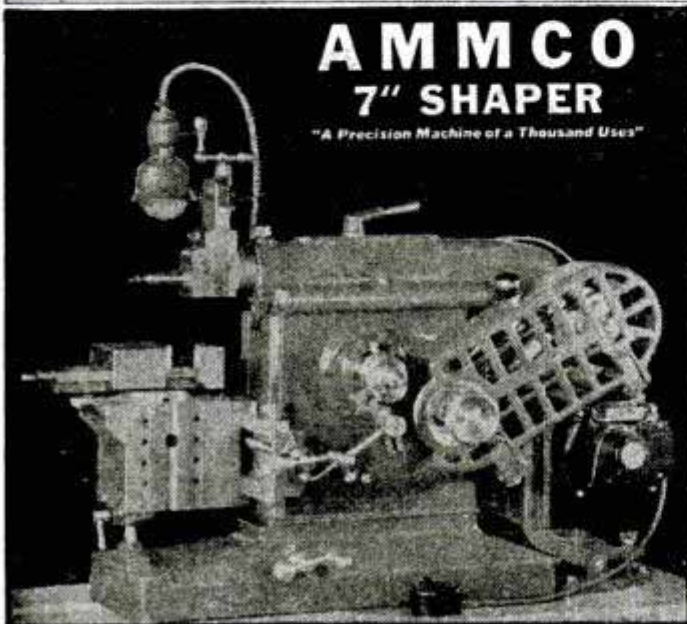

A wide variety of jobs can be done accurately, quickly, easily, and economically on the AMMCO Shaper (7" stroke).

Construction incorporates many features you would expect to find only in larger, more expensive machines. For example: WAYS of ram, tool head, and front face of the main frame are of the "VEE" type, hand scraped to insure accuracy and long life. Available for stationary installation or as portable unit.

Write today for specifications and prices

AMMCO

2140 Commonwealth Ave. North Chicago, Ill.

DON'T USE CHISEL

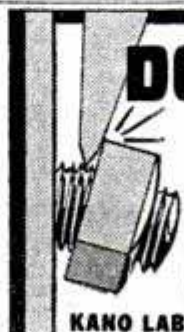

Use KROIL, the new chemical lubricant that creeps into millionth inch spaces, dissolves rust and dried grease.

KROIL LOOSENS FROZEN PARTS

The fastest penetrating oil known, 5000 industrial plants used Kroil to keep war production going. Try it on money back basis. AT YOUR DEALER or send \$1 for two 8 oz. spout cans, postpaid, send dealers name.

KANO LABS., 3023 LINCOLN TOWER, CHICAGO 1, ILL.



DRILL-INDEX A compact container for indexing and filing twist drills. Eliminates search. Made entirely of steel in nine sizes. See your dealer or write to

HUOT MFG. CO. St. Paul 1, Minn.

KEEP YOURSELF UP-TO-DATE ON WOOD LUMBER & SUPPLIES

with CONSTANTINE'S MASTER MANUAL

Published by the leading suppliers to woodworkers, the most complete book ever offered. More than a catalog, contains valuable information on lumber inlays, veneers, wood finishing, etc. 88 inlay border designs in full color, 6 pages of full color inlays plus a wood identification chart showing over 60 rare woods in natural color. Send only 25c today and we will include FREE a year's subscription to our publication, Chips & Chats.

ALBERT CONSTANTINE & SON, INC.
791 G E. 135th Street, New York 54, N. Y.



BLACK on WHITE for BETTER SIGHT

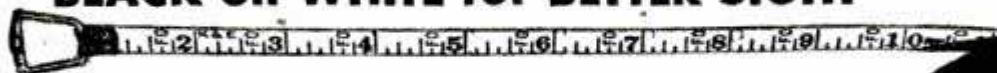

WYTEFACE Steel Tapes have black graduations on a crack-proof white surface. Easy to read in any light, from any angle. Faster measurements with fewer errors. Designed for hard service. Resists abrasion from rails, pipe, rocks, concrete. Protected against rust.

WYTEFACE
STEEL MEASURING TAPES

KEUFFEL & ESSER CO.
EST. 1867

NEW YORK • HOBOKEN, N. J.
CHICAGO • DETROIT • ST. LOUIS
SAN FRANCISCO • LOS ANGELES
MONTREAL



Drafting
Reproduction
Surveying Equipment
and Materials
Slide Rules
Measuring Tapes

Mows and Trims Lawns

In One Simple
Easy Operation

8¼ Lbs.

Save Time
and Labor with a
MONTAMOWER

New model. New type metal handle has special device to adjust cutting height. Drive shaft now mounted on free rolling, factory lubricated, and sealed ball bearings. No tired backs or aching arms. 8¼ lbs. of live precision made mechanism that first gathers, then cuts smoothly a clean 16" swath through grass, dandelions, spike grass and weeds. No noise or clatter. As modern and efficient as your electric razor. Cuts right up to walls, fences, trees or posts; leaves no fringes to be trimmed by hand. Cutters are self-sharpening. Built to last many years. Many thousands in use. Sold direct from factory. Costs little. Write at once for guarantee information and literature.

MONTAMOWER DISTRIBUTING CO.
821 Keeler Bldg. GRAND RAPIDS 2, MICHIGAN

ONE TOOL . . .
THE **SEAMAN TILLER**
DOES COMBINED WORK OF

PLOW DISC HARROW

Saves time and labor. Tears up and pulverizes soil in one trip over field under favorable conditions. Increases yields. Mixes nutrient elements into seedbed, assuring better availability of plant food; aids production of nitrogen by aerating soil; takes up and holds more moisture . . . protects against drought. Kills weeds. The most efficient tool ever developed for eradicating quack grass and other crop-choking weeds.

Write for Seaman Tiller Circular

SEAMAN MOTORS 327 No. 25th St., MILWAUKEE 3, WIS.

FACTORY TO YOU!
KITSELMAN FENCE
Buy Farm, Poultry, Hog Fence, Steel Posts, Barbed Wire at **FACTORY PRICES!** Save too on quality Paints, Roofing, Hay Tools, Hog Feeders, Fountains, Poultry Supplies and other farm needs! **WE PAY FREIGHT.** Write today for **FREE Catalog!**
KITSELMAN BROTHERS
Dept. 94 Muncie, Indiana.

If They'll Bite You Can **CATCH 'EM** With The **FISHIN' GADGET** Sets Hook Automatically

The greatest fishing invention since the fishhook! Automatically sets the hook on fish that bite. First day's results insure lifetime use. Will last for years. Made of non-corrosive metal. Use on any line . . . for any kind of fishing. See your dealer or send coupon and \$1 bill for your Fishin' Gadget . . . now!

Send Coupon and \$1 Bill
Sent Postpaid
Get Yours Now!

Graham - Campbell Co.
1405-7 Walnut St.
Kansas City 6, Mo.
Here is a \$1 Bill. Send me a FISHIN' GADGET quick!

Money Back Guarantee

TRIGGER GUIDE "E"
TRIGGER "H"
SLIDE "C"
MOORING "D"
LINE GUIDE "F"

NAME.....
TOWN.....
STREET..... STATE.....

the making of *Marlin* GUNS

Marlin brings to sportsmen, through this series of advertisements, interesting facts on gun-making—to enhance appreciation of fine sporting firearms and to encourage their thoughtful handling and care.

BARREL-MAKING... A FINE ART • The barrel gives rifle and shotgun their accuracy. The steel used, the science and skill with which the barrel is made vitally affect the life and safety of the firearm as well. Barrel-making is a fine art of manufacture.

STEEL • Special-analysis steel, developed by metallurgical engineers to withstand proof loads 150% of normal pressure is the "raw material" of a Marlin barrel.

BORING • The solid steel bar is bored with special cutting tools.

TURNING • Cut to length, the special steel bar is turned on a lathe to proper diameter. A continuous "taper" is turned on rifle barrels to make for scientific strength distribution and "balance." The barrel is then highly polished and blued.

ALIGNMENT • The alignment of Marlin barrels touches a peak in the art of gun-making. Only one in hundreds of craftsmen has the "eye" for this delicate job. Marlin barrels are aligned at three distinct and separate times in the process of manufacture. Final alignment is the most exacting and gives the barrel its high potential of accuracy.

RIFLING • The Ballard rifling—which has long been a prime factor in the accuracy of Marlin Rifles—is done with specially-designed cutting tools. This operation is in charge of highly-skilled, experienced craftsmen.



Rifling a Marlin Barrel

(The next advertisement in this Marlin series will reveal more interesting facts on fine gun-making.)

THE *Marlin*
FIREARMS CO.
New Haven, Conn.

**SEE MARLIN 1946 MODELS ON
DISPLAY AT YOUR DEALER'S**

Say you saw it in Popular Mechanics

WELD IT YOURSELF!
SAVE TIME—SAVE MONEY
 with the Portable
Magic Wand
WELDER



DO your own welding and brazing! Any metal—iron, steel, bronze, brass, aluminum, etc. Just plug the Magic Wand Welder in on any 100-V, 60-cycle AC line and make all kinds of metal repairs that now cause you inconvenience, delay, expense. Do electric flame torch and metallic arc welding, brazing, light and heavy soldering, all with this one handy outfit. Six ranges of welding heat. A complete professional welder, consisting of heavy-duty transformer built into a sturdy, shock-proof carrying case, 15-amp. polarized outlet plug, electrode holders and a supply of brazing rods, fluxes, extra carbon electrodes, welding helmet, instruction manual, etc. Weighs less than 30 lbs. packed. Quickly pays for itself in savings. If your hardware dealer or automotive jobber hasn't the Magic Wand Welder, write us.

COMPLETE
\$34.50
 F. O. B. FACTORY

For Descriptive Folder, address:
JOHN H. GRAHAM & CO., Inc.
 General Sales Agent
 Dept. P, 105 Duane St., New York 8, N.Y.

MADE BY PATENT SPECIALTIES, INC., NEW YORK, N. Y.

Say you saw it in Popular Mechanics



Have
YOUR OWN
 Business

SAW FILING

You can have a good, steady, cash business of your own reconditioning saws with the Foley Automatic Saw Filer, which makes old saws cut like new again. The Foley is the **ONLY** machine that files all hand saws, also band and circular saws. Easy to operate—no eyestrain.



SEND FOR FREE PLAN—shows how to start in spare time—no canvassing. Send coupon today—no salesman will call.



FOLEY Automatic SAW FILER

FOLEY MANUFACTURING CO.
 316-6 Foley Bldg., Minneapolis 13, Minnesota
 Send Free Plan on Saw Filing business, no obligation

Name _____

Address _____

Fuse Puller—Circuit Tester

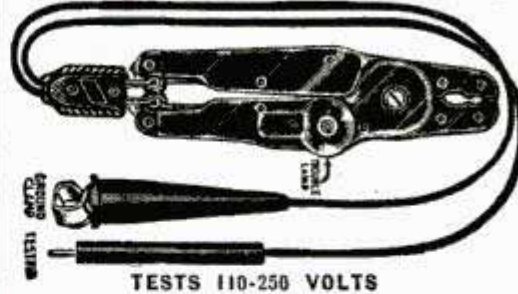

For
 Home
 or
 Factory

TESTS 110-250 VOLTS

When motors stop and lights go out, this tool quickly **LOCATES DEAD CIRCUITS** and safely removes blown Fuse. The Star Test Pocket Plier is made of a Transparent Plastic having in one of the legs a small lamp in series with a resistance and can be used to test 110 to 250 volts circuit. The Plier will pull fuses from 19 to 100 Amperes. Thousands of Electricians find this tool handier than Test Lamps. Price \$2.75 each without Leads, \$1.50 additional for Leads. Can be obtained from General Electric or Westinghouse Stores or from your local dealer or jobber. Order NOW. **STAR FUSE CO., 235 Canal St., New York 13, N. Y.**

FIND UNDERGROUND MINERALS and METALS with M-SCOPE

Employs same principle as Army Mine Detector. Unsurpassed in Efficiency. Write for Free 16 page booklet.



FISHER RESEARCH LABORATORY
 PALO ALTO CALIFORNIA

Sand Casting—Forging—Heat Treating—Case Hardening
BRONZE FOUNDRY



is again available in limited quantity without priority. Orders filled in sequence as received. **INVENTORS—SCHOOLS—CRAFTSMEN** use **FOUNDRYETTE** for making castings quickly for new inventions, for instruction, and general purpose. Order now for early delivery. Three sizes are available capable of making bronze castings of 1½, 3, and 6 pounds weight, aluminum, copper, brass, etc., \$17.50, \$24.00, \$34.50, f.o.b. Kansas City. Domestic gas supply and 110 volt AC or DC energy required for operation. Write for circular.

KANSAS CITY SPECIALTIES CO.

Box 6022, Dept. P-64

Kansas City, Mo.

HAUCK FLAME GUN KILLS WEEDS ★



2000° F controlled heat quickly, easily destroys seeds, roots, brush, poison ivy, wild morning glory, Canada thistle, other unwanted growths. Many uses: splitting rocks, burning stumps, sterilizing poultry houses. Burns kerosene. Does the work of 4 men. Safe, easy to use. 10 day trial. Satisfaction guaranteed. Free catalog.

HAUCK MFG. CO.

122 Tenth St.

Brooklyn 15, N. Y.

New - Improved OIL FOR ALL ---
HOUSEHOLD-SPORTSMAN-MECHANIC
 Lubricates - Prevents Rust - Cleans Metal

3 oz. 40c

FIENDOIL

STOKER EMPTIES OWN ASH!

A remarkable stoker already used by thousands of home owners—fits into any furnace or boiler. Manufactured since 1934. So automatic it takes the coal from your present coal bin through a pipe to the furnace, going around corners if necessary. Keeps house at even temperature, empties its own ash in sealed containers, no coal to shovel, no clinkers to dig, only bituminous stoker of its kind on the market. Send for full information NOW!

POCAHONTAS FUEL COMPANY INCORPORATED
344 EAST 131st STREET • CLEVELAND 8, OHIO

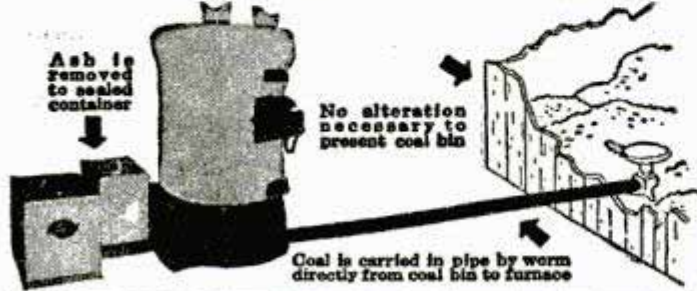

Army-Navy Type HEADPHONES

TYPE HS-23

Save up to 70% on genuine U.S. Signal Corps headphones. These are the better \$10.00 headphones for only \$2.95. Leather-covered headband, detachable rubber cushions, lightweight construction, impedance 8000 ohms. Ea. **\$2.95**

Signal Corps TELEGRAPH KEY

Genuine U.S. Signal Corps key with switch to close contacts, polished durable enameled metal base mounting on a bakelite base, key lever is nickel-plated brass, silver contacts; **95c** packed in new original boxes. Shipping wt., 1 lb. Ea.

Write for our illustrated literature featuring all types of radio parts.

Plus shipping charges.

Arrow Radio Co., Dept. G, 2205 W. Division St., Chicago 22, Ill.

SANDING "HANDEE RUBLOK" POLISHING

USED BY BIG MANUFACTURERS . . . NOW AVAILABLE FOR WORKSHOP, HOME AND SHOP USE

Rub wood, metal surfaces to a smooth factory finish . . . quickly, easily. Fine for paint work, waxing, polishing . . . gives even pressure over entire surface . . . gets into corners, irregular shapes. Special rubber cushion relieves hand fatigue. 6" x 2" rubbing surface. Complete with 6 durable, quick change covers only \$1.00 C.O.D.; postpaid if cash with order. Established dealers and agents invited.

FELD ENGINEERING CORP., DEPT. HB132, 12264 WASHBURN, DETROIT 4, MICH.

REPAIR YOUR OWN ELECTRIC APPLIANCES WITH NEW AMAZING NICHROCITE

Simply overlap ends, apply Nichrocite paste and turn on the current—a perfect weld results. Used by big utility companies and repair shops. Just the thing for that broken or burned out heating element in your electric iron, stove, toaster or heater. Does the job in a jiffy. Trial order, \$1; 4 ozs., \$2.50; 1 lb., \$8.00.

Handy for Home or Industrial Use

ARMSTRONG ELECTRIC CO., Box 861-MP, Minneapolis, Minn.

A TOOLSHOP IN YOUR HAND!

- GRIND • DRILL • ROUT
- POLISH • ENGRAVE
- CUT • SAND • SAW, etc.

Make Things From Wood—Plastics—Metals—Glass—Linoleum—Leather—Alloys—Horn—Stone—Bone, etc.

HANDEE TOOL OF 1001 USES

Smooth, steady power at your fingertips! You can turn out professional looking projects for pleasure or profit—ship, plane or train models, costume jewelry, wood carvings, puppets, initialed tumblers, etc. Handee, first small portable tool and today's finest, uses 300 different accessories. AC or DC. 25,000 r.p.m. Weight, 12 oz. With 7 accessories, postpaid..... **\$18.50**

GET A GOOD START

Get the **HANDEE KIT**

HANDEE Too and 45 of the most popular accessories, all packed in handsome, compact steel carrying case. You'll be amazed at what you'll accomplish!

Complete, postpaid, **\$25.00**

FOR YOURSELF OR A FRIEND... THE GIFT OF A LIFETIME!

HANDEE PRECISION ATTACHMENTS

Magically, easily, your offhand carving, routing, shaping, etc. will be perfect as to depth of cut, accuracy of line. These remarkable new tools for novice or experienced craftsman fit Handee only. Set of 6 attachments, with full instructions, complete, postpaid..... **\$7.95**



ORDER NOW—USE COUPON

FREE 64-PAGE Catalog

CHICAGO WHEEL & MFG. CO.
1101 W. Monroe St., Dept. PM
Chicago 7, Ill.

Send me HANDEE TOOL HANDEE KIT PRECISION ATTACHMENTS

Remittance enclosed. Send C.O.D.

Send 64-page Catalog.

Name.....

Address.....

POST-WAR Special



6 TUBE "SUPER HET" RADIO KIT

Complete, including Attractive Walnut Cabinet. Diagram Furnished. Uses One 25L6—One 25Z6—Two 6SJ7—One 6SQ7—One 6SK7—or—One 50L6—One 35Z5—Two 12SJ7—One 12SQ7—One 12SK7

ALL PARTS MOUNTED

To assemble, all one needs is a soldering iron and 30 minutes of your time.

\$16⁹⁵ LESS TUBES

Limited Quantity on Hand

TERMS: 10% DEPOSIT WITH ORDER—BALANCE C. O. D.

LIBERTY SALES CO., INC.

115 WEST BROADWAY · NEW YORK 13, N. Y.

TELESCOPING MEASURING TOOLS

Measure All Holes, Slots, Etc.—5/16 Inch to 6 inches . . . Gives You Outside Micrometer Accuracy on Inside Measurements
FINISH YOUR OWN SET OF FOUR TOOLS



Only **\$2⁹⁵** C.O.D.

Plus Usual Small Postal Charge
PART OF THE MACHINE WORK ALREADY DONE—ONLY SIMPLE LATHE WORK NECESSARY TO COMPLETE. No special tools required—Threading, Knurling, etc., already done. Kit includes all material (part machined); simple drawings, and detailed instructions. Send \$2.95 cash with order and we pay postage.
ALCO SHOP, Dept. 6, 1459 Sunset Blvd., Los Angeles 26, Calif.



WRITE FOR YOUR FREE COPY OF THE NEW KRW HYDRAULIC PRESS BOOK

Describes all manner of Production and Shop Work on KRW Hydraulic and Bench Type Arbor Presses. 32 pages illustrating the new KRW Hand-operated, Electric-operated and Air-operated Hydraulic Presses.
Write for your copy today.



K. R. WILSON, DEPT. 17, 215 MAIN ST., BUFFALO 3, N. Y.

Builders of Shop Equipment for Ford Dealers Since 1916

READY CUT HOMES

Order Now

Homes \$1182 and up, freight paid. Orders filled in order received. Post war delivery. Save at least \$500 on modern production method homes. Much more compared with builders' prices. Anyone can assemble with simple plans furnished. Complete, including paint, hardware, roofing, glass, nails, etc. Send 25c in coin for full color catalog showing 56 modern low-priced homes and floor plans. Complete building plans ready for filing at low cost.



NEW COLOR CATALOG FOR ONLY **25¢**

Dept. P.M.36
INTERNATIONAL MILL & TIMBER CO.
Bay City, Mich.

THE GEM MAKER

Amateurs or professionals . . . hobbyists or jewelers . . . Polish your own gems with a B&I Gem Maker. You will find this a profitable adventure. All necessary lapidary equipment is furnished, including a super-charged diamond blade for sawing, and all wheels for grinding, shaping and polishing, also complete instructions. The complete equipment as shown, less motor and belt, for only \$29.50, f.o.b. Burlington, Wis. Write today for information and literature on the Gem Maker and accessories.
B&I MFG. CO., Dept. S, Burlington, Wis.

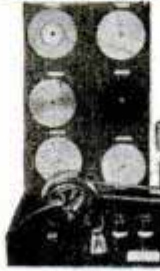

ONLY \$9.95 — ENGINES IN STOCK



The G. H. Q. miniature gasoline engine that really operates is available. Over 100,000 sold to date. 1/5 H. P. Complete with coil and condenser and full illustrated instructions for only \$9.95. Fully bench tested and ready to run. Power for all models. Send only \$1.00—Shipped Collect C.O.D. same day. Send for free illustrated Catalog of hundreds of hobby items.

GHQ MOTORS, Dept. BX36, Box 193, Sta. O, N. Y. 11, N. Y.

METALLIZE BABY SHOES

Learn this easy, money making business from nationally recognized consultant. Small investment; perpetual market. For free details write Joseph B. Kushner, B.S. Ch.E., Metal Finishing Consultant, Stroudsburg, Pennsylvania, R.D. 3A.

New OTTAWA WOOD SAW

For Tractors



Makes wood sawing fast and easy. Can cut enough wood to pay for itself quickly. Easily moved while attached. Big heavy blade. FREE details.

LOW PRICE

OTTAWA MFG. CO.
W327 Oak Ave., Ottawa, Kans.

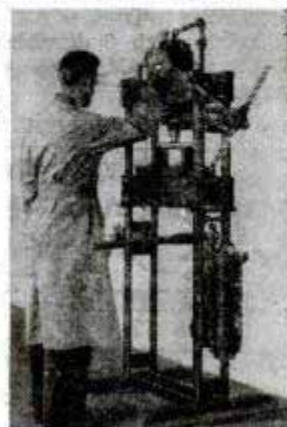

For Men who Really Know Pipes



\$1.50

Selected Briar

Royalton
CROWN

EVEN THE BEST TOBACCO CAN BE A WET BLANKET in a pipe that permits the entry of harsh juices and slugs into the mouthpiece. These smoking pests are so effectively blocked by Royalton Crown's unique condensing chamber and patented features that you find new relish in your favorite blend . . . The smoke always tastes sweeter in a Royalton Crown because it's the one pipe that stays constantly cool and everlastingly dry.

HENRY LEONARD & THOMAS, INC. • OZONE PARK 17, N. Y.

Marvelous New 3 WHEEL ROLLER SKATE

• Faster, Smoother, Easier Skating •



\$4.25 pair

Plus 35c for Postage & Handling. Give Size. Higher in Canada.

SALES . . . SALES . . . EVERYWHERE . . . No matter where these outstanding 3 Wheel Roller Skates are shown they win instant approval . . . Lighter in weight makes for Easier Skating . . . The Streamlined principle gives more SPEED and Smoother Skating . . . For Rink, Figure and Sidewalk Skating . . . Fully Chrome Plated. EXCLUSIVE FEATURE: Has a Brake for quick stopping.

Sales Are Tremendous!

This is an unusual opportunity for QUICK, BIG VOLUME SALES and we want wide-a-wake Distributors and Local Agents to take care of this business in their territory . . . The interesting part of this BEB Skate is . . . it is interchangeable to Ice Skating in a few minutes . . . Ice Skate Attachment \$1.90 extra.

DISTRIBUTORS . . . AGENTS WANTED EVERYWHERE

We want every territory covered . . . Dealers are enthusiastic and order in large quantities . . . We want Go-Getters to supply this demand and offer a BIG MONEY-MAKING Proposition.

BEB SKATE CO., Dept. P3, 4529 Ravenswood Ave., CHICAGO 40, ILLINOIS



THREE BALL BEARING WHEELS in line gives MORE SPEED with LESS EFFORT . . . Simply raise the toe to STOP QUICK.

CHANGEABLE FROM ROLLER TO ICE SKATES

YOU NEED THESE CRAFTSMAN'S TOOLS

SUPER DRILL GRINDER

SUPER ARBOR

SUPER HACKSAW

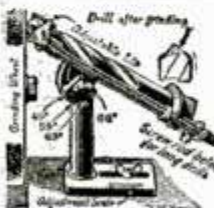

Sharpens round shank drills from 3/32" to 1 1/16" diameter. Grinds Old Drills like new in 4 different drill point angles. Grinds Short, Medium and Long Twist Drills from 1 1/4" up to 11" long, for hand or power grinding wheels.

70,000 NOW IN USE!

Grinds your drills like factory in 25 seconds. Gives perfect center and clearance. Saves drills, time and money. No shop should be without the Super Drill Grinder. Guaranteed to do the work or money back. The Grinder that gives a round point!

Only \$2.95

(PATENT PENDING)

A combination drilling or grinding wheel attachment. For 1/2" motor shafts. Will take grinding wheel with 1" hole on shaft and 3/8" hole on small end. Extension can be used for rag or wire wheel, or 3/4", 24-thread drill chuck which holds drills from No. 60 to 3/8" in diameter. Right hand thread only.

Price Only \$1.50

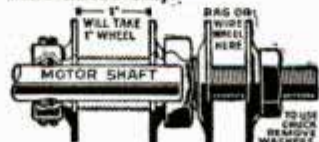

AND FLAT DIE FILE HOLDER



The tool with 100 uses! Holds broken hacksaw blades—used by mechanics, electricians, plumbers, auto mechanics, hobbyists and repairmen. Perfect for all-round household needs; ideal for difficult close-quarter work. Nothing like it for tool and die men. Price, without saw blade, 95c

At Your Dealer's or Postpaid
CRANDALL MFG. CO.
1512 West Slauson, Dept. FA-3
Los Angeles 44, Calif.

Authenticast Exclusive!



FAMED USS MISSOURI
Full-hull official scale model
with replica of surrender plaque



Kit plaque is size
of a quarter ready
for mounting.

A DREAM OF A MODEL . . . you'll have hours of fun building it! And you'll enjoy owning this fine model for years to come.

Authenticast assembly kit includes easy directions, diagram, tools, over 100 cast-metal precision-perfect parts. Scale: 1 inch to 500 inches, finished model is 21 inches long. Priced \$12.95 complete at hobby shops.



Send 35c in coin for colorful 32-page *Authenticast* catalog.



132-01 91st Avenue, Richmond Hill 18, L. I., N. Y.



★ **SHOT GUN SIGHT**

Yes, the Nydar gunsight offers much more than just a mere sighting device. A distinct ring and dot are projected into the sky, greatly aiding in lead shooting and in the correct judging of range. People of every age, both men and women, say Nydar provides a new thrill, new sport, and new satisfaction for hunters.

Go to your dealer's; see for yourself that Nydar is the greatest advance in shotgun sighting yet made. Nydar is priced at \$27.45 plus installation. Interesting circular on request.

SWAIN NELSON CO.

2390 GLENVIEW ROAD
GLENVIEW, ILLINOIS

Attention! HAMS

... FINISH YOUR OWN CRYSTALS

**NEW... Complete
Crystal Finishing Set**



only \$4.95 postpaid

Meet F. C. C. regulations for frequency control with Quartz Crystals. Finish your own crystals to meet your individual requirements. It's fun—it's easy—it's economical. Kit contains 4 AT or BT low drift Quartz Crystals cut to U.S. Signal Corps war-time specification. Complete accessories including a holder with stainless steel hand lapped electrodes and special device for making limited frequency adjustments—flat glass grinding plates—coarse and fine special grinding abrasives—cleaning brush and syntex beads and complete instructions. Be sure to specify frequency desired so we can send blanks within easy grinding range. **All at amazing low cost.** Send money order, check or cash for your kit today.

COMMERCIAL EQUIPMENT CO.

Dept. D

1416 McGee St., Kansas City 6, Mo.

**FREE
INSTRUCTION**

Larson **HANDI-CRAFTS**
HEADQUARTERS!

Make Belts, Moccasins, Purses,
Gloves and other useful things
for profit

We have a fairly well balanced stock
of leather, tools and accessories.

Send 10c for catalog

J. C. LARSON & CO.

180 No. Wacker Drive, Dept. D
Chicago 6, Ill.



**U-MAK-IT New
AQUAMOBILE V-18**

FOR HOME ASSEMBLY

Cut-to-Fit Parts & Assembled
Frames, Ready for Installation. Designed for Automobile Engines,
open or with cab. Fast V-bottom marine plywood hulls. Ready for
delivery. Send for free detailed illustrated information.
KAYAK BOAT CO., BOX 397 B—ROSLYN, L.I., NEW YORK



No
experience
necessary.

NOW AVAILABLE

Red Latex Molding Compound

Make your own molds for plaster objects
Write for information and prices

COLUMBUS GLOVE MFG. CO.

474 Lilley Avenue

Columbus 5, Ohio



Your Lighter Will WORK
... better—with

RUMIN

Gold Coated **FLINTS**
and **LIGHTER FLUID**

**ROCK FLINT CO., 123 Doughty
Boulevard, Far Rockaway, N. Y.**

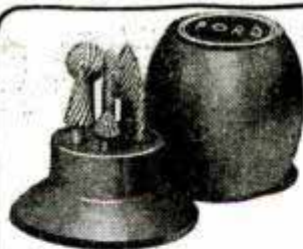

Superior Quality
**ROTARY
FILES**

FOR HOME CRAFTSMEN

The nationally famous Ford Rotary Files, used for the past 25 years by leading precision manufacturers, are now available for the home craftsman in a handy dust proof case which contains six popular shaped tools.

The tools are made of the finest quality high-speed steel, hardened and tempered for maximum life. These ground cutters are efficient on steel, aluminum, brass, plastic or wood. The shapes will meet most home craftsman applications. These tools are made with standard 1/8-inch shank. Additional shapes and sizes are available.

Money with order prepaid
C.O.D. — postage extra

SIX TOOLS in
Dust Proof Case \$6.25

M. A. FORD MFG. CO. 800 WEST FIRST STREET
DAVENPORT, IOWA

PLASTICS

There's fun and profit in making plastic jewelry, novelties, and furnishings, in your home workshop! We have every material you need — Plexiglas, Lucite, Bakelite, Lignolite, Tenite II, Lumarith, in a large variety of sheets, rods, tubes, and special shapes. Also dyes, cements and other plastic supplies and accessories. Send 10 cents today for complete catalog.

CARMEN-BRONSON CO.

165 East 3rd St., Dept. 3-B Mt. Vernon, N. Y.

ARMSTRONG TOOL HOLDERS

enabled American industry to change to war production "over night." For they are the permanent, multi-purpose tools used by 96 per cent of the machine shops and tool rooms, on lathes, planers and shapers—the tools used to make dies and jigs; to build production machines. They are the tools you will want for your own shop—ARMSTRONG TOOL HOLDERS for industry, ACE Tool Holders for home work shops.



ARMSTRONG BROS. TOOL CO.

"The Tool Holder People"

368 N. Francisco Ave., Chicago 12, U.S.A.



MAKE MONEY BY MAIL!

Start your own business at home, spare time. I get CASH in every mail . . . YOU can too! I'll tell you HOW! Send for FREE folder, "Your Own Mail Order Business."
B. W. COATES, 46-P King Street, Dorchester, Mass.

MACHINE SHOP EQUIPMENT

Every man who owns a workshop should have a copy of this new, authentic catalog of Machine Shop Equipment . . . the latest tools made by the biggest manufacturers in the United States. Replete with illustrations, descriptions, prices. Prompt delivery on most tools listed in this catalog. Available at the cost of printing—50¢ a copy—Get yours today! Price of Catalog Refunded on First Order over \$5.00. Send check or Money Order to

CENTER TOOL CO.

154 Centre St., New York 13, N. Y.

SAY YOU SAW IT IN POPULAR MECHANICS



YESTERDAY A DUB...



...TODAY AN EXPERT!

Anybody can be a candid camera expert almost overnight with the new

MERCURY II (It's a UNIVERSAL)

**ESPECIALLY
DESIGNED
FOR COLOR!**

Mercury II's sensational simplicity, foolproof built-in features and almost unbelievable accuracy make it everybody's camera, as



well as the choice of initiates—for everything from portraits to split-second action shots. Check Mercury II carefully before deciding on your new camera. You owe it to your photo future.

**UNIVERSAL CAMERA
CORPORATION**

NEW YORK • CHICAGO • HOLLYWOOD

Manufacturers of Mercury, Cinémaster, Corsair Cameras and Photographic Equipment

3 OUTSTANDING, TIME-TESTED DRILL PRESS ACCESSORIES

THE BARRON ROTARY SURFACE SANDER

\$5.95
COMPLETE



Note these Special

Features—Made of Alcoa aluminum. Machined and balanced for smooth operation in drill press chuck. For surface sanding woods, plastics or polishing metal surfaces. Complete with 20 instantly removable sanding cup discs. No messy glueing needed. Leaves an agate smooth, absolutely true surface finish. Does not leave waves, ripples, steps or striations in work piece. The only tool of its kind. Shipped prepaid on 10 DAY MONEY BACK GUARANTEE for \$5.95.



The IMPROVED Barron Multi-Purpose Drill Press Planer.. \$7.50

Not only surface planes toughest woods and plastics to precision limits—but rabbets, routs, tenons, panels, grooves, beads. Will cut rabbets, tenons, panels, etc. to a depth of 1" with special Barron extra long hi-speed cutter blades. Thousands now in use. Made of Alcoa aluminum, machine finished thru-out. Vibrationless. Fits any drill press. Shipped prepaid on 10 DAY MONEY BACK GUARANTEE on receipt of cash, money order or C.O.D. for \$7.50.

Baron ALL-METAL Auxiliary DRILL PRESS Table.. \$8.85



Hard Alcoa aluminum die casting heavily ribbed—machined both sides. Has 234 sq. inch extra large working surface. Equipped with Barron Steel Planer Fence. Can also be used for shaper operations, innumerable other drill press uses. A real buy at \$8.85, express collect.

See Your DEALER . . . Or Write For CATALOG

BARRON TOOL CO., INCORPORATED
369 Architects Bldg. Detroit 1, Mich.

BARRON PRECISION WORK SHOP TOOLS

V-8 DUALS AND SINGLES

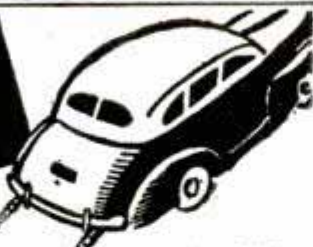

A genuine steel pack muffler WITH A BEAUTIFUL MOTORBOAT TONE. Sandee Mufflers feature improvements far in the lead, years ahead of competition. Increases mileage and power, reduces back pressure and gives better performance. Savings in gasoline will pay for a Sandee Muffler.

V-8 FORD AND
MERCURY DUALS \$17.50

SINGLES—FIT IN PLACE OF REGULAR MUFFLER

Chev., V-8 Ford, Plym., \$5.00 Chrys., Olds., Buick, etc., \$7.00
These mufflers will outlast two regular stock replacements.

Dealers Wanted

SANDEE MUFFLER CO.
7523 S. WESTERN AVE., LOS ANGELES 44, CALIF.

SAY YOU SAW IT IN POPULAR MECHANICS

Keep your Plane Irons and Chisels SHARP as NEW!

Unique grinding attachment insures a perfectly straight hollow grind on plane irons and chisels. Results in a sharp, keen, even-cutting edge. Adds life to tool—permits better and faster work. Enables you to do an expert grinding job. Easy to install and use. Endorsed by home craftsmen and carpenters. Satisfaction guaranteed—write for folder.

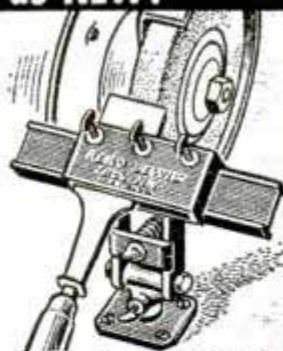

READ-LEWIS MACHINE CO.
387 Third Ave., Troy, N. Y.

At dealers or sent direct on receipt of \$6.95.



METAL Watch Band

New! Stainless steel! Ideal for men. Overcomes leather's faults. Handsome, comfortable, rust and stain-proof. Always looks new. Fits any wrist. SEND NO MONEY. Pay on arrival plus fees. Or send \$1.98 for prepaid shipment. 7-day money-back guarantee.

PROGRESSIVE PRODUCTS, Box PM-302, Madeira, O.

MARCOT KEY MACHINE

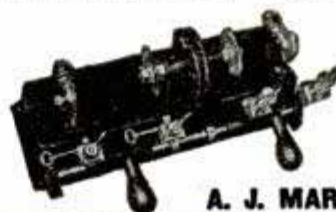

Marcot No. 8 Key Machine
Mounted on Cabinet. . . . \$ 75.00
Book on Modern Locksmithing 3.95
Auto Code Book and Depth Keys 12.50
2592 Assorted Key Blanks. 77.76
Set Key Files, Tools, Pins, Springs, Thimble 10.50

\$179.71

A. J. MARCOTTE CO., 1200 N. Kedzie Ave., CHICAGO 51, ILL.

KEEL-GUIDED BOAT ROLLER



FOR BOATS and CANOES. Easily mounted to dock, pier, trailer. Boat rolls on even keel, simplifies handling. Cuts damage and repair cost. Rollers of hard durable rubber. Assembled ready to use, \$7.95, F.O.B. FREE FOLDER. See your dealer or order from BERG'S, Madison 4, Wis.

NOW AVAILABLE!

Crosman Silent Rifles—America's favorite compressed air rifles for indoor and outdoor shooting are back again! Available in 22 cal. single shot and Magazine Loading Types. At your dealer—or order direct. Ask for Crosman SUPER-PELLS too—the better ammunition for all compressed air rifles. .177 Cal.—\$1.80 per M. .22 Cal.—\$2.00 per M.

CROSMAN ARMS CO., INC. • Rochester 7, N. Y.

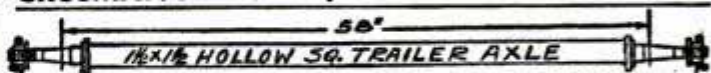

CAP.—2000 LBS.—\$6.75 EACH F.O.B. DETROIT

STRONG MACHINE & AXLE COMPANY
9710 Lumpkin Hamtramck 12, Michigan

WOOD WORKERS

LUMBER—PLYWOOD AVAILABLE
Harold Hunt wants to send new No. 15 catalog. Over 124 pages of woodworking ideas. UNEQUALLED BARGAINS in imported and American woods, supplies, hard-to-find hardware. Send only 10c to cover postage and handling.

CRAFTSMAN WOOD SERVICE CO.
2729 S. Mary St., Dept. A-67, Chicago 8, Ill.

only
10¢



EVERY SHIP MODEL ENTHUSIAST SHOULD OWN THIS BOOK!

"SHIP MODELS ILLUSTRATED"

\$2
POSTPAID

The ace of all ship model books. Pictures all types from Clippers to Corvettes. A guide to modeling. Close-up photos and detailed drawings. Actual plans—and a glossary of nautical terms. Catalogue of kits and supplies included. Catalogue only—10c.

Address Dept. 11

MARINE MODEL CO., INC., Halesite, Huntington, N. Y.

SILVER SOLDER KITS! For Silver Soldering ALL METALS



All welding, brazing and general repair shops, garages, toolmakers, machine and engineering establishments, etc., need this convenient silver solder kit. **\$1.00 POST-PAID**

KIT INCLUDES

One 3 oz. Tube XCEL-FLUX "SS" Silver Solder Paste. Nine 5 inch lengths (total 45 inches) of SIL-FOS and EASY-FLO Silver Brazing Alloy— $\frac{1}{16}$ " and $\frac{3}{32}$ " wires, and one EASY-FLO .005" x 1" strip.
Economy size with 100 in. Silver Solder wire \$2. American Products Corp., 422 S. Dearborn St., Chicago 5, Ill.

FREE

— ENGRAVING —
NAME or INITIALS on

NEW
1946

14k Gold Finish

FRIENDSHIP PIN

SEND **50c** TAX INCLUDED
We Pay Postage

Write for Free Catalog



TASH NOVELTY ENGRAVING CO.

1301 SURF AVENUE, DEPT 92-P BROOKLYN (24), N. Y.

DEXTER UNIVERSAL LATHE CHUCK

well-made, accurate, strong, serviceable



2"—\$12; 3"—\$14; 4"—\$17; 5"—\$21;
6"—\$27; complete with two sets of jaws, no adapter required

Includes inside and outside jaws
State spindle size and threads per inch
Distributors Wanted

THE LEAVITT MACHINE COMPANY
ORANGE • MASSACHUSETTS

BURN YOUR NAME ON TOOLS

WITH THE ARKOGRAF

PROTECT YOUR TOOLS FROM THEFT
Write with electricity any name or design on the hardest and finest tools and instruments or any metal. Like writing on paper with pen or pencil. Thousands used by mechanics, garages, machine shops. Complete Outfit \$3.50—Prepaid Anywhere. Interesting illustrated circular free. Write today. ARKOGRAF PEN CO., 3927 S.E. Stark, Portland 15, Ore.



Plexiglas Lucite PLASTICS Catalin Bakelite

Sheets 12" x 12" $\frac{1}{16}$ " \$1.60, $\frac{1}{8}$ " \$2.00, $\frac{3}{16}$ " \$2.25, $\frac{1}{4}$ " \$2.75, $\frac{1}{2}$ " \$4.75. Round, Square and Novelty shaped rods. Jewelry Findings, Dyes, Cements, Compounds, Kits etc. FREE Project suggestions, Illustrations and instructions with our price list ONLY 10c. Send for your copy now.
DOUGLAS HOME CRAFTSMAN, BOX 34A, STAMFORD, CONN.

DECORATIVE DECALCOMANIA



TRANSFERS Imported Designs of all Sizes & Types—Flowers, Fruits, Figures, Silhouettes, Birds, Dogs, Horse Heads, Ships, Juvenile, Tropical, Chinese, Peasant, Colonial, Patriotic, Inlay, Borders, Initials, etc., for Furniture, Doors, Walls, Trays and what not. Catalog with 800 illustrations in Color sent for 25c. Deductible on first order of \$1.00 up. L. C. WELLS, Dept. PM-63, 25 E. 26th St., New York 10.

Large Profits in Arc Welding



HOBART Simplified ARC WELDING'S Remote Control and Multi-Range are exclusive features

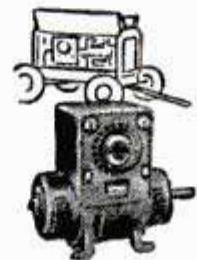

It's easy to make big money in arc welding when you have such operation and convenience features as offered by Hobart Arc Welders! With the Multi-Range Control you are able to select the exact welding heat from a choice of 1000 combinations—that means better welds. With the Remote Control Dial you can change welding heat at the work—that means less time per job.

A WELDER FOR EVERY PURPOSE. Whether you want a welder for light repair work, or one for heavy construction work—there's a Hobart for you. An electric drive for permanent shop installation, or a gasoline drive welder that goes out in the field after the profitable jobs—Hobart has them all.

BUILD YOUR OWN WELDER. With a Hobart generator, used auto motor and other easy-to-get automotive parts, you can build your own gasoline driven arc welder that will go any place for the big money emergency repair and construction jobs. And you save money, too! Write for free booklet, and ask about terms.

HOBART ELECTRODES ARE BETTER. You can get all the newest coated and bare electrodes for every type of metal.

Hobart Bros. Co., Box M-36, Troy, O. "One of the World's Largest Builders of Arc Welders"



Hobart School of Arc Welding

trains you in a few weeks



Individual instruction by veteran operators. Intensive course on all type welders. Economical. Enroll under G. I. Bill.

Reach for Your Scissors
Hobart Bros. Co., Box M-36, Troy, O.

I'm interested in Hobart Welders—send me free books I've checked:

Hobart Catalog Vest Pocket Guide
 "How to Build-Your-Own"

NAME _____

ADDRESS _____



Free!
Valuable
"Vest Pocket
Guide for
Arc Welders"

SAY YOU SAW IT IN POPULAR MECHANICS

At Last
**LABORATORY
PRECISION**
for your work shop
heat treating



Never before has this ultimate precision of large production capacity furnaces been made available in laboratory and small unit production furnaces as is featured by this Huppert Model 2 De Luxe Unit. Now you can attain the ultimate in precision in your shop thru the automatic, hair-line temperature control of this sturdy, all-steel, multi-insulated furnace. You set the temperature and it is automatically maintained "on-the-line." It is ideal for heat processing in laboratory, work shop or home. It operates on 110 V. AC with a current consumption of only 800 watts. Heat range from 325° to 1800° F. The Model 2 De Luxe is fully equal to the demands of continuous operation and long hard usage. It is equipped with 2 indicator lights (one for indicating that furnace is turned "ON" and the other to verify the continuous throttling action of the automatic control feature); a removable porcelain tray; a quality Fahrenheit pyrometer; special alloy elements and counterweighted door. I.D. measurement 4 1/4" x 3 3/4" x 4 1/2" — O.D. 12" x 13" x 12".

Price (complete—ready to operate)— **\$75.00**
F.O.B. Chicago

K. H. HUPPERT CO., 6872 Cottage Grove Ave., Chicago, Ill.

Gentlemen:

- I am enclosing my Money Order for (\$.....) for..... Huppert Model 2 De Luxe Heat Treating Furnace.
 Please send me illustrated, descriptive literature on your Model 2 De Luxe Furnace at once.

NAME.....

ADDRESS.....

CITY..... STATE.....

Quick, Easy, Lasting REPAIRS!

Cracks, holes, dents in wood, plaster, concrete, metal, etc. — loose handles, rungs, knobs, screws — mistakes in carpentry, etc. — fix them all with Savogran Crack Filler (hard as stone) or Savogran Wood Putty (easily tooled). Just mix with water, press into place. Stays put, hardens quickly, will not shrink! Can be painted, pre-colored. Ideal for models, inlays, etc. Patented! Big 1-lb. can only 30c at hardware and paint stores.

FREE CIRCULAR

Describes these and other Savogran Products: Heavy Duty Cleaner, Remover & Bleacher (renews floors), Paint Brush Cleaner, Strypeeze (removes all finishes), Coldfoam Soapless Soap Powder.

THE SAVOGRAN CO.
Dept. 28, Boston 10, Mass.



SAVOGRAN
CRACK FILLER • WOOD PUTTY
IN EVERY WELL-EQUIPPED HOME WORKSHOP

Your Rust Troubles are Over
CORODEX Rust Remover

is the war-time miracle liquid which cleaned millions of parts during war effort. CORODEX positively removes RUST and CORROSION regardless of depth, from iron, steel, brass, bronze, copper, chromium and nickel. Cleans tools, hardware, sports equipment, household utensils, etc., for a few cents a piece. No RUBBING or hard work.

CORODEX IS UNCONDITIONALLY GUARANTEED TO REMOVE RUST WHEN DIRECTIONS ARE FOLLOWED. Valuable Manual of Rust Control free with order.

At Sears Chicago, Suburban and Gary stores, 50c and \$1.00. Mail orders **QUART SIZE ONLY \$1.00** Money Order or Check F.O.B. Chicago Express to:

SEARS, ROEBUCK AND CO.
403 SO. STATE STREET, DEPT. 8500-9, CHICAGO 5, ILLINOIS
(CorOdex is made by Allied Products Co., 1133 Newport Ave., Chicago)

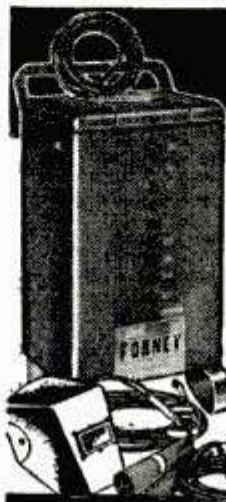

WELD ANYTHING
ANYWHERE
ANYTIME



ALL PURPOSE ARC WELDER

9 Models . . . 32 Volt D.C., 110 to 440 A.C.
A complete workshop in itself! Weld, cut, braze or solder any type metal; iron, castings, aluminum, steel, bronze . . . in any gauge or weight, with equal ease. Compact, complete, as sturdy as the Rockies. Formed steel and cast aluminum case, welded steel base, 4" cast wheels. Built with voltage control. Better on R.E.A. lines. Completely equipped. No instructions needed. Sold throughout the world. Several dealer territories open. Write;

FORNEY MFG. CO.
FORT COLLINS 2, COLORADO

BUILD MARTIN HOUSES FROM "CRAFTSMAN" PLANS

- Easy to Follow, Completely Dimensioned
M20 Mt. Vernon Style, 31 Family House, Plans **\$1.00**
M15 Tower Style, 12 Family (Illustrated Plans) **.75**
M10 Castle Style, 8 Family Martin House, Plans **.50**
BHS Group of 4 Houses, 2 Wren, Woodpecker, Bluebird. All 4 on 1 Plan. **.50**

SPECIAL OFFER: All 4 Plans Listed—\$2.75 Value
SEND 10c for New Catalog of **Only \$2.00** over 100 Projects. if ordered from this ad

CRAFTSMAN'S MODEL CO. 2030 N. 41st St. Dept. P89, Milwaukee 8, Wis.



VETERANS! DISPLAY YOUR DISCHARGE EMBLEM ON YOUR AUTO

Made of heavy metal, chrome finish, brilliantly enameled in gold, blue, red and white. **\$1**
Quantity discount to veteran's organizations.
F. ROESCH, 502 1st St., Hoboken, N. J.

CUT Any SIZE HOLE TO Any DEPTH IN WOOD

Something new in wood-boring tools! Bruno Expansive Bit works like a lathe . . . requires less pressure . . . actually pulls itself through. Positive lock with patented triangle blade. Diamond grind on lead screw prevents splitting. Wide throat for chip clearance. Easy-to-read scale. All cutting surfaces of high grade tool steel. Replaceable blades.

***Wide Cutting Range!**

No. 200-B cuts 3/4" to 1 1/4" Diameter.
No. 201-B cuts 1 1/2", to 3 1/2" Diameter.
Each comes with 1 long, 1 short cutter.

Money Back Guarantee
At All Hardware Stores or Write Dept. PM3

NO. 200-B
\$2.95
COMPLETE



BRUNO TOOLS

Beverly Hills
California

SAY YOU SAW IT IN POPULAR MECHANICS



HUNTER'S COMPASS

Hunting Case, Watch Type, All Metal, Jeweled **\$3.50**

Engineers All Metal Army Type Hand-Sighting

LEVELS

\$1.50



PUBLIC SPORT SHOPS

13 S. 16th St., Phila. 2, Pa.

No COD's



IDENTIFICATION BRACELET only \$1.95. Heavy silver plated, name engraved without extra charge. Orders shipped same day. We also make these with a STERLING SILVER tag, heavy weight, with nickel silver chain, each boxed, \$2.95. We pay tax and postage.

MONT PETIT MFG. CO.
15 E. Pearson St., Dept. T Chicago, Ill.

TUK AWAY BUTCHER BLOCKS



Pat. Pend.
Reg. U. S. Pat. Off.

The ideal gift—A chopping block for the Fisherman, Hunter, Barbecueer, Housewife, Rancher, Farmer and Camper. 3 1/2 inches thick, 10 1/2 to 12 1/2 inches wide, 6 inches overall height.

No. 1 size \$4.14

Five other popular sizes 4 1/4 to 18 1/2 inches wide. If unable to obtain from your local dealer, write

TEXAS MANUFACTURING CO., Brenham, Texas

COMPLETE YOUR HOME WORKSHOP!

Fast cutting grinding wheels will do the job in less time than it takes to "set up" a machine.

COMPLETE SET OF 3 ONLY \$139
FINE — MEDIUM — COARSE. 4 inch wheels, 3/4 inch thick — or send 50c for any one type you want.
FREE with each order of three 2x3/8x3/8 pocket hone.

D & W SPECIALTY CO., 410 N. ASHLAND AVE., CHICAGO 22, ILL.

BUSINESS MEN STATIONERY Special 100 white Bond Letterheads 10x6 3/4. Envelopes 6 1/4 x 3 3/4. Business Cards all three \$1.65. Special low price large quantities.

Also white bond personal stationery—envelopes to match. 100 sheets and envelopes, printed 60c, both \$2.10.
BRUNO, 27 SPENCER ST. BROOKLYN 5, N. Y.

SHAW and "Peppy-Pol" GARDEN TRACTORS

1 to 9 H.P. Circulars on request. Building more now. We supply repairs for all SHAW Tractors sold in our 42 years in business.

BUILD YOUR OWN RIDING TRACTOR—"WAR HORSE"

using old auto parts, powered by 2 H.P. or larger air-cooled engine; or walking type Garden Tractor 1/2 to 3 H.P. or convert truck or auto into Farm Tractor. Each with steel or rubber tires; will plow, cultivate. Plans for building, in few hours, any one of above, postpaid for \$1.00 (state which wanted) or all 3 for \$2.00. Money Back Guaranteed!

SHAW MFG. CO., 4503 Front St.

Galesburg, Kansas

6688 North 4th St., Columbus, Ohio

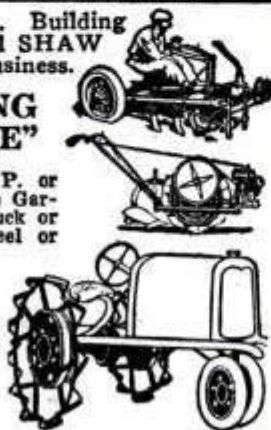

RA-TOX

ROLL-UP • WOOD SPLINT

SHADES

FOR INDUSTRIAL WINDOWS

ELIMINATE GLARE

Stop DRAFTS and SunHEAT

INCREASE EFFICIENCY

SPEED-UP PRODUCTION

REDUCE WORK SPOILAGE

AVOID ACCIDENTS

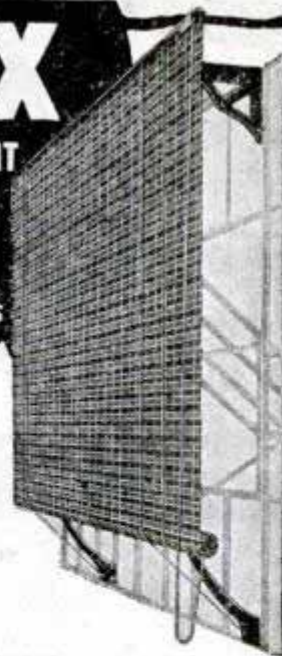

GLARE is one of the common causes of "EYE FATIGUE". Momentary Blindness may result in a severe accident or it may ruin days of painstaking work.

For STEEL or WOOD SASH

RA-TOX SHADES roll up or down to offset changing daylight conditions. They will improve the appearance of your plant and add to the comfort and safety of your employees.

There is a type to fit every industrial window.

LIGHT without GLARE

AIR without DRAFT



A nation-wide shading service. Representatives in all principal cities...

Write for Latest Bulletin

HOUGH SHADE CORPORATION

INDUSTRIAL DIVISION

1107 JACKSON ST., JANESVILLE, WISCONSIN

SAY YOU SAW IT IN POPULAR MECHANICS

TWO Water Systems in ONE!

Convertible at low cost for either shallow or deep wells



Patented convertible feature makes this new Myers "H" Series Ejecto either a shallow or deep well system. Permits use of the same pump, tank and motor. New, improved pump construction provides increased capacity — more water with a smaller motor. Pump handles gas or air in water without repriming. Complete Myers line includes Ejecto and plunger type models in sizes for every need. Mail coupon for free book.

The F. E. Myers & Bro. Co.
Dept. D-82, Ashland, Ohio

Send your new water system book

Name _____

Address _____



NEW Sheppard 2 K.W. Generating Set IS POWERED BY AN AIR-COOLED DIESEL

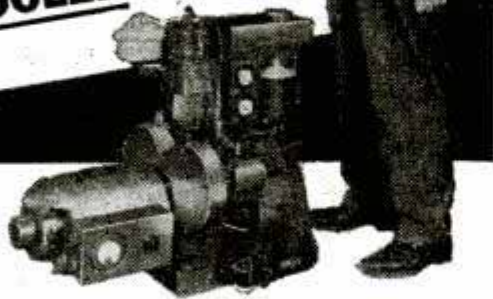

New aircooled 3 3/4 H.P. Sheppard Diesel . . . direct-connected to a 2 K.W. generator . . . will generate your electricity with a minimum of attention . . . in little space . . . with a maximum of economy.

Aircooling eliminates servicing a liquid cooling system. Costs about 1c per K.W. hour to operate. Write for full specifications.

Power Units, 3/4 to 56 H.P. • Generating Sets, 2 to 36 K.W.
R. H. SHEPPARD CO., INC., 48 Middle St., Hanover, Pa.

DIESEL'S THE POWER -

Sheppard's
THE DIESEL!

Say you saw it in Popular Mechanics

Build These Cleveland Model Super-Values

★ ★ ★ ★ Famous U. S. BLACK WIDOW
Big 36" model of the super night fighter that has all the world's popular Industrial Training Models. Build them all. C-D Kit T-155 \$150

Biggest \$1.00 Model in U.S. 34" Super Condor Soarer, Soars for hours. Kit E-5019. \$100

SEE YOUR DEALER FIRST. In ordering direct, add 20c extra for packing-postage.

CATALOG 5c (Circular free)

36" PIPER CUB

The civilian plane that went to war, and did a darn good job. Rubber or gas, tether or free flight. C-D Kit T-94 \$150

CLEVELAND MODEL & SUPPLY CO.
4508F25 Lorain Ave. ★ ★ ★ Cleveland 2, Ohio, U. S. A.

WREN HOUSE and 5 COLORFUL GARDEN BIRDS
Assemble House Yourself

Birds, true types. Weatherproof colors. No assembly. Flexible legs, just twist on bush or shrub. A fine improvement for any garden. Authentic model house. Complete instructions for assembly. All material, hooks, hardware included. Nothing to cut, saw, or paint. **PREPAID** Attaches to wall, post, tree. Will attract wrens. Immediate shipment.

FIVE SPECIES BIRDS TRUE COLORS

STAR MFG. CO.
LINCOLN, NEBRASKA

\$1.00



\$1.98
Send No Money

DIRECT SALES, 154 Nassau St., Dept. P. M. 1, N. Y. 7

The New Improved RADIO MICROPHONE

Sing-Talk through your own radio. Broadcast your voice through your radio from any part of the house. Cut into programs, make announcements, sing. Good Practice. Easily attached to any radio with no extra wire. Shipped Postage Paid if you send \$1.98. If ordered C. O. D. you pay postage and fees.

L*V*M CARBIDE SCRIBER NON-MAGNETIC
FOR HARDEST STEEL, GLASS, ETC.

Tungsten Carbide — the hardest metal made by man — carefully ground on diamond laps, brazed into stainless steel 6" handle for marking steel and other metals — for etching, marking, cutting glass. Cuts all directions. Easy to follow any contour. In plastic case with pocket clip.

LUCAS-MILHAUPT ENGINEERING COMPANY 5049 S. LAKE DRIVE CUDAHY, WISCONSIN

\$2.00
PRICE POST PAID

ACTUAL SIZE ↓ PERSONALIZE YOUR POSSESSIONS ACTUAL SIZE ↓

H.A. JAMIESON
553 MAIN ST. N.Y.C.

Your Name belongs on everything you own!

PERMARK DECALS SHOULD BE ON YOUR

Tools	Books	Toys
Scale Models	Musical Instruments	School Supplies
Auto Accessories	Sporting Equipment	Cigarette Case
Photo Equipment	Electrical Appliances	Lighter

H.A.J.

100 PERMARK Decals \$1.98

HANCOCK DECAL CO. 22 W. 22 St., New York 10, N.Y. Use Margin For Order

AGENTS WANTED

KEN pipes

Six features which make Ken tops in pipe smoking enjoyment.
ONLY KEN GIVES YOU ALL THESE FEATURES!
Sold on money-back guarantee if you are not entirely satisfied.

Prim Associates of America Chicago, 10 Ill.

SEE THE WIDE VARIETY OF KEN PIPES
At Your Dealer's
\$3.50

▲ Interchangeable Genuine Lucite Stem	▲ Bit Tube Eliminates Burnt Tongue	▲ Condensation Chamber, No Slug - No Tar - No Moisture	▲ Reverse Baffle Removes All Impurities	▲ Bowl Tube No Wet Heel	▲ No Break in Bowl Pre-treated - Ready to Smoke
---------------------------------------	------------------------------------	--	---	-------------------------	---

Pat. 2242805
A Prim Product

Fix Scratches, Dents, Nicks the Professional Way!



Get This Handy Kit!

Repair damaged furniture surfaces with new practical kit. Enables anyone to do fast, easy touch-up jobs like a professional cabinet finisher. Makes furniture and cabinets look new. Every home and shop needs this remarkable kit. Pays for itself over and over!

Amazing Results—Easy to Use

Kit includes 23 different items—scratch removers for slight scratches, assorted shades of shellac sticks for deep nicks, bottles of light and dark stains, shading lacquer, alcohol lamp with fuel, stainless steel spatula, touch-up brushes, scratch sticks, steel wool, sandpaper, rubbing liquid. Packed in handy leatherette finish case. Send for it today. Best investment of lifetime. Fully guaranteed. Detailed instructions supplied.

\$3.95

Postpaid

AMERICAN HOUSEHOLD BUREAU
Dept. F, 520 N. Michigan Ave., Chicago, Ill.



CLEAN HANDS

Quickly remove grime and grease from hands, and almost anything, with SKAT, original and best Paste Soap.

AT ALL GROCERS

Skat Co., Dept. P, Hartford 6, Conn.

OTTAWA TRACTOR SAW



FREE BOOK
and
Price List

350 CUTS PER MINUTE

Make money sawing wood. Use Ottawa—fastest cutting. Cuts large, small logs easiest way. Fells trees. One man operates. Thousands in use. Built to last with heavy, stiff saw blade. Positive safety clutch control: uses power take-off any tractor.

OTTAWA MFG. CO., D-327 Forest Ave., Ottawa, Kan.

STANLEY NEW PLAN SET (of Five Plans) 10c



FIVE New Plans for Small Colonial Furniture, including: Book Stand, Magazine Case, Magazine Stand, Bench. Postpaid for 10c. Stanley Tools, 136 Elm St., New Britain, Connecticut.

HOME INDUSTRY OPPORTUNITIES



Make Good Door Mats from Old Tires with simple homemade cutting and hole punching equipment, powered with a 1/4 HP motor. Illustrated instructions, 50c.
Profitable Toy Making. From scrap wood, paper, metal, rubber, linoleum, cloth, plaster, etc., 25c.
Liquid Rubber from Old Tires. Make molds, door mats and rubber articles. Ten formulas and processes, 50c.
How to Make 30 Useful Articles of Wire and Sheet Metal with homemade jigs. Illustrated, 50c.
Rubber Mold Making. Marbleizing, glazing, etc., 25c.
Security in a Small Farm. Twenty ways describes, 25c.
10 Local Business Plans net up to \$200 a month, 25c.
Collection of 100 Selected Formulas, 25c.

All 8 of the Above List of Booklets and Formulas, \$2.00. No C.O.D.

NEW WAYS CUT BUILDING



cost of houses, garages, poultry and farm buildings, cabins and stores. Make wall-high, insulated blocks with inside and outside finish with simple, homemade equipment. Composition roofs and floors. Ten formulas. Cement panels, blocks and tiles in color. Stream-lined roof, walls and gutters. Several ways to use cheap wood with cement makes strong buildings. Wallboard of sawdust. Save hundreds of dollars. 100 money and labor saving ideas. Mixer and buzz saw easily made from an old auto. 40 proved ways to earn \$10 to \$15 a day. Guaranteed illustrated booklets, \$1.00.

MAKE FURNITURE OF COMPOSITION cement, sawdust, asbestos, paper. Some part scrap wood and metal. Illustrated instructions to make tables, cabinets, chests, racks, shelves, inclosed sinks, lawn novelties and toys, 500 per cent profit. 50c.

HOW TO MAKE ACCURATE SHOP MACHINES: Band, jig, and circular saws, electric drills, sanding wheels, forge, tools, electric weed cutters and many other things from old auto parts and washing machine motors. Illustrated, 50c.

HOME MFG. ENTERPRISES, 50 selected home shop projects, illus., 50c. Special: All five booklets described above, \$2.00 postpaid. No C.O.D.

HOME INDUSTRIES, 1318 So. 30th Ave., Dept. PM, Omaha 5, Nebr.

FREE
Send for it
NOW



New 1946 Radio Parts
and Equipment

CATALOG

SERVICEMEN! Dealers! Soundmen! Amateurs! Builders! Here's your handiest, most complete 1946 Buying Guide for Everything in Radio! Features latest sets, parts, equipment of nationally known quality at lowest prices. Assures fastest service from world's largest and most complete stocks under one roof. Expert staff ready to help you.



NEW RADIO SETS
COMPLETE SOUND SYSTEMS
LATEST HAM GEAR
ALL SERVICE EQUIPMENT
BUILDER'S SUPPLIES
RADIO BOOKS



OVER 10,000 ITEMS

Everything for every radio use. New model radio sets, phonoradios, recorders, communication receivers, Ham kits, code apparatus, parts, tubes, tools, test instruments, public address equipment and accessories, low-cost easy-to-build kits, diagrams, matched parts lists, leading technical and non-technical books—at lowest prices.



ALLIED RADIO

ALLIED RADIO CORP.
833 W. Jackson Blvd., Dept 5-C-6
Chicago 7, Illinois

Date.....

Rush new FREE 1946 CATALOG

Name.....

Address.....

City.....Zone.....State.....

YOU CAN'T BEAT this to relieve itching of SKIN and SCALP IRRITATIONS

So
Many
Druggists
Say!



Here's a Doctor's formula — Zemo — a stainless liquid which appears invisible on the skin — yet so highly medicated and soothing that the first applications promptly relieve itching, burning of Eczema, Psoriasis and similar skin and scalp irritations — due to external cause. Zemo ALSO aids healing.

Apply clean, stainless, invisible Zemo any time. It won't show on skin. Buy Extra Strength Zemo for mean cases.

ZEMO



GERSTNER Tool Chests
Toolmakers and Machinists have depended upon GERSTNER Chests for 40 years. Free Catalog.
GERSTNER TOOL CHESTS
446 Columbia St., Dayton 7, Ohio



THE LUCIFER HEAT TREATING FURNACE

for 110-volt operation

\$102.50

F.O.B. PHILA.

Do your own heat treating — make your own tools and parts. Muffle size 5 1/2 x 5 1/2 x 6" deep. Temperature range from 0° to 2000° F. Equipped with pyrometer, pilot light and control switches and AUTOMATIC HEAT CONTROL. Select the heat you desire for hardening, tempering or drawing. Complete — all ready to plug into 110-volt AC-DC outlet. Costs approximately 3¢ an hour to operate.

(Without Automatic Control — \$75.00)

WITH AUTOMATIC HEAT CONTROL

for 220-volt operation

\$222.50

F.O.B. PHILA.

This is the big job for larger work. Muffle size 12 x 12 x 10" deep. Equipped with pyrometer, pilot light and control switches. Range 0° to 2000° F. AUTOMATIC HEAT CONTROL. Ideal for larger pieces or volume hardening of small parts.

(Without Automatic Control — \$180.00)

Sole Selling Agent

GILBERT S. SIMONSKI

401 N. BROAD STREET
PHILA. 8, PENNA.

Distributors Wanted



Adjustable Work Stop

NEW!

simplifies chucking of small parts... machining to accurate lengths

\$3.75

POSTPAID
anywhere
U. S. A.

Handy, useful — for repeat operations on small parts where chucking is involved. No. 2 Morse taper. Positive-locking telescopic rod. Rust-proof finish. Dimension without pin, 4" x 1". Allen wrench included. Order now. Immediate delivery. Send coin or money order to Trebor Machinery Co., 759 N. Milwaukee St., Milwaukee 2, Wisconsin.

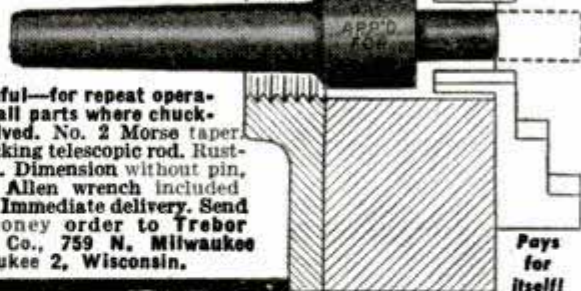

SWISS MADE WATCHES

WEAR AT OUR RISK



Swiss made watches are renowned for accurate time-keeping. The men's watch has a sturdy, finely constructed chrome case and an open figure dial, genuine leather strap. The ladies' watch is sure to evoke enthusiasm because of its exquisite daintiness. **SEND NO MONEY.** Just pay postman for men's wrist watch \$8.50 and for ladies' wrist watch \$15.00 plus few cents postage and 10% Federal excise tax. Wear for 10 days on our money back if not satisfied guarantee.

UNITED PRODUCTS CO.

7759 S. Halsted St., Dept. MMLR-180, Chicago 20, Ill.

King of ELECTRIC SWITCHES



Versatile Switch of a Thousand Uses
Millions in Post War Applications

Floodlights your porch when the door is opened — sounds alarm when window is opened — signals arrival of mail — controls heating of furnace — filling of water tank, these and many other services are performed by this versatile switch. Shipped with instruction sheet showing numerous illustrated uses for this device at the low price of \$1.00 postpaid.

KING PRODUCTS COMPANY

BATAVIA 2, ILLINOIS

TRIG SLIDE RULE

Patent Pending

● Fits the pocket. Quickly solves trigonometry, radio, and electricity problems. Simply set the slides and read the answers for all three sides and angles of a triangle. Gives degrees, sines, cosines, and tangents of angles. Entirely automatic. Easy instructions included. Price only \$1.00 or we will mail C.O.D. plus postage. Resale and wholesale orders taken.

REED MFG. CO., 124 W. 4th St., Los Angeles 13, Calif.

COLOR CONCRETE WITH CHEMICALS

A business of your own. Big money making Hollywood style pottery and birdbaths without moulds. Washing-wells, stucco-rock, benches. Marbling and cement water-paints. 10c brings sample, literature, pictures. Hollywood Cement-Craft, 8529 Wonderland Ave., Hollywood 46, California

LEPAGE'S GLUE

LEPAGE'S
GRIPSPREADER
MUCILAGE

LEPAGE'S
WHITE
PASTE

SAY YOU SAW IT IN POPULAR MECHANICS

POPULAR MECHANICS

Sensational New Invention

Pure Kold



Absorbs Food Odors. Keeps food fresh longer in refrigerators. We furnish scientific proof. Tests made by leading colleges, hospitals. Sold under money-back guarantee. Endorsed by doctors, leading business firms.

EVERY HOUSEWIFE NEEDS PURE KOLD

Sensational plans close 7 in 10. Sells \$3.95. Big profit to you. \$15 day comm. easy. Mail \$3.00 today for sample and complete selling kit. We will refund money if not satisfied.

WEBER & PILE, 542 S. Broadway, Los Angeles, Calif.

Why be an ABECEDARIAN*

25c

*Webster says it's a tyro, a beginner, a novice, i.e., one who hasn't read Hodgman's 1946 Handy Book of Sportsmen's Secrets—the latest, biggest issue, sparkling with 168 pages of authentic, little known outdoor tricks—bulging with facts, crowded with dope on how to cram your creel and garnish your game bag. Order your copy now—it will be off the press soon. Only 25c—or a special DeLuxe edition for \$1.00.



HODGMAN RUBBER CO.
Paul St. Framingham, Mass.



AMAZING MYSTERY BUTTON



Startles Everybody. With this Electronic Button you can make your own Telephone-Amplifier—Detectophone. Attach this button to piece of cardboard—transmit conversation to another room. Music also transmitted to distant places. Most interesting, electrical apparatus ever discovered. Enables you to perform hundreds of experiments. So tiny it can be concealed in dozens of places. A Pre-War Product. Electronic Button including 5000 word instruction booklet with 50 illustrated experiments postpaid only \$1.00.

Electronic Products Company, Saint Charles, Ill.

UNITED WHEELS

Wheel Barrow Wheel Kit. One 7 x 3/4 rubber tired steel disc wheel, axle and fittings complete \$1.98 plus postage. Wheel kit, two 7 x 3/4 wheels, axle and fittings complete \$3.75 plus postage. Also available, 9-8-7-6-5 steel disc, rubber tired wheels. Order today. Cash, Money Order or C.O.D.

UNITED WHEELS MFG. CO., 11727 La Fayette Ave., Chicago 28, Ill.

NEW BIG MONEY FIELD

Make Any Article

GLOW IN THE DARK

with

Magic New Discovery!



Make BIG money in your own business! Tremendous profits being made now by making articles GLOW IN THE DARK! With our complete outfit and confidential instructions—all for only \$1.00—it's easy! A stroke of the brush—any article glows in the dark like magic! Absolutely harmless. Hundreds of uses. Use on statues, jewelry, house numbers, flowers, toys, etc. Order NOW! Supply Limited. Money-back guarantee.

\$1.00
Send
No Money

Complete Lite-Glo Kit, \$1.00. Send name, address, pay postman \$1.00 plus postal charges. Send cash, we pay postage.

LITE-GLO, Dept. 123-LC, Topeka, Kans.

Now... A HANDIER WRENCH for All-Around Use

Fits
as it
Grips

and
it
HOLDS

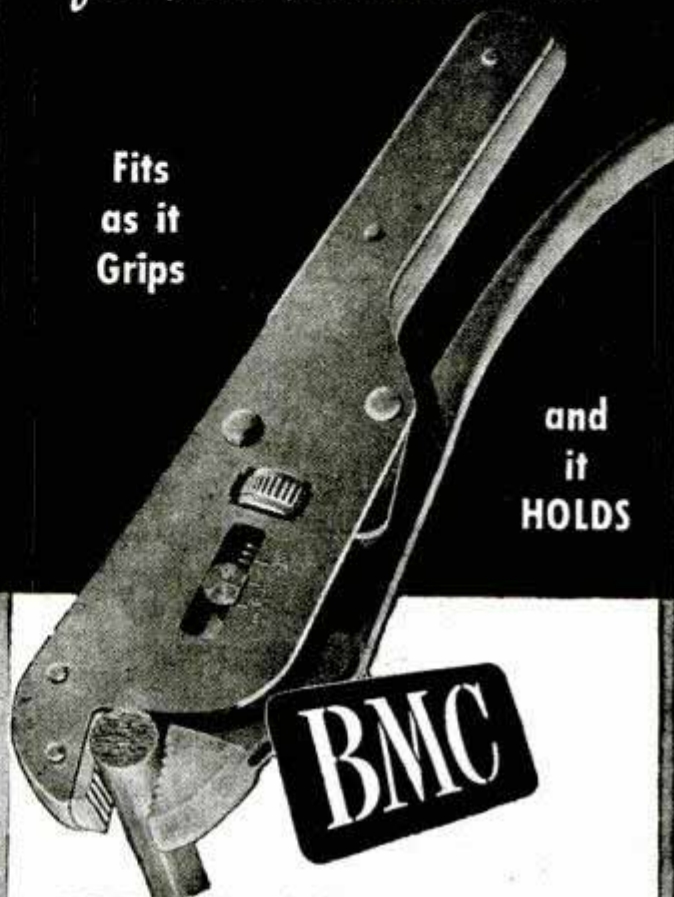

BMC

PRESSURE LOCK WRENCH

thousands of uses on nuts, studs, pipe, short, broken or irregular pieces.

● At last, a wrench that gives a tight, slip-free grip—without fussy adjustment—on any shape piece that you can get hold of. More than a ton gripping power... applied with one hand, and released with the flick of a finger. Use it as a clamp or a vise in any position to hold pieces for soldering, bolting, positioning, assembling. Or use it as a pliers, taking successive grips for tightening or loosening bolts, studs, pipes, without removing the tool from the part being worked.

Jaws Always Parallel

BMC Pressure Lock Wrench will take a locking grip on any size piece, up to 1"—with the jaws always parallel. That exclusive, patented feature prevents rounding of nuts and deforming of thin-walled pieces. It means even pressure and a solid grip when used as a vise or clamp. You'll find hundreds of uses for this triple-purpose tool in the shop, home, garage, or in the tool-kit of your car.

On sale at leading hardware, auto equipment and mill supply stores. Two sizes:
7 1/4" long at \$2.75;
8 1/2" long at \$3.50.

BMC MANUFACTURING CORPORATION
Binghamton, N. Y., U. S. A.

BUILD the COMET INTERCEPTOR!

DE-THERMALIZER
DEVICE

AUTOMATIC RETRACTABLE
LANDING GEAR

\$2⁹⁵

Kit No. T-14

The GAS MODEL with the SENSATIONAL POST-WAR FEATURES!

Sensational GAS MODEL designed by CARL GOLDBERG! Offers amazing De-Thermalizer—which brings your model down out of rising air currents—prevents flying away! Foolproof automatic retractable landing gear; steep climb—graceful glide! Kit contains plans and materials to complete either Class "A" or "B" model.

Many other Comet Kits at your dealer

**COMET MODEL AIRPLANE
& SUPPLY CO. INC.**

128 W. 39th STREET, CHICAGO 16, ILL.

1170 BROADWAY, NEW YORK 1, NEW YORK

RAINBOW MIXTURE GLADIOLUS 60 Bulbs \$1.89



**FREE
200
Bulblets**

Money Back Guarantee
Flower first year. Satisfaction guaranteed. Michigan's finest. All State inspected. First quality — Picardy, Minuet, Maid of Orleans and other radiant colors create a "Blaze of Glory". Same varieties in older bulbs worth up to 20c each. Planting guide included free.

Early Order Bonus
Same varieties 200 bulblets. 1st year growth provides your bulb supply for years. Limited supply. **SEND NO MONEY**

ACT NOW — WRITE TODAY
Pay later, plus C.O.D. and postage, or send \$1.89 and we ship prepaid. Ref. any bank in U.S.A.

336 SMITH BLDG., GRAND RAPIDS 2, MICH.

SMITH BULB CO.

UTICA TOOLS

ALL TYPES
FOR MORE
TOOL MILEAGE

Ask Your Dealer



**UTICA DROP FORGE
AND TOOL CORPORATION**
UTICA 4, NEW YORK

LENSES 500,000 OF THEM

Buy them for a fraction of their original cost. U.S. ARMY & NAVY surplus lenses and prisms. HOBBYIST LENS SET—Magnifiers, reducing lenses, positives, negatives, etc. 10 lens set.....ea. \$ 1.00
5 LBS. OPTICAL GLASS (Lens Blanks), index plainly marked on each piece..... 4.75
ACHRO. OBJ., 32 m/m Dia., 130 m/m F.L. cemented...ea. 1.50
RIGHT ANGLE PRISM, 1" sq. face.....ea. 1.25
5X TANK TELESCOPE (M71), brand new, complete.....ea. 22.50

Send Money Order or Check—3 cent stamp for list

A. JAEGER, 120-14P 115th AVE. SO. OZONE PARK 20, N. Y.



The Modern PLASTIC
for lasting Home Repairs

PERMANENTLY mends cracks or holes in wood, tile, stone or plaster. Sticks and stays put—Does not chip, shrink or fall out. Easy to use. Economical. Mold it, chisel it, polish or paint it. If unobtainable from your lumber, paint or hardware dealer, the big 4-lb. can will be sent you post-paid (in U.S.) for only \$1. Full money-back guarantee, order now.

DONALD DURHAM CO.
Box 804-F, Des Moines, Iowa

New Designs in FRANZITE GRIPS



Modernize Your Gun! Improve Your Score!

Most durable grips made. Positively unbreakable! For Colt, Smith & Wesson, Hi-Standard, Ortgies, Luger & Mausers in a wide choice of beautiful designs in ivory, pearl, walnut, onyx, etc. Low prices. FREE CATALOG. Dealers Wanted.

SPORTS, INC., (Mrs.) 5501 Broadway, Dept. P-3, Chicago 40, Ill.

PLASTIC HOMES



New Building Material! Resurface old homes; build new ones. Colorful, Beautiful! LIQUID MARBLE—Color-gleazed! Molded, brushed, sprayed. SANITARY COMPOSITION FLOORING—Dustless, noiseless; put on like plaster; resilient—yielding as cork; lasts like stone; plain or marked in tile design. RUBBERLASTIC Mold Compound—Mold novelties, statuary, toys, gifts, plaques, plaster animals. COLORED POTTERY—Birdbaths, garden furniture, vases. TILEX colored roofing. Illustrated literature FREE. RAPID MARBLEIZING SERVICE, Dept. 10-B, Edwardsville, Illinois

ONE-MAN SAWMILL LESS THAN Easy To Turn Trees Into Money \$110⁰⁰

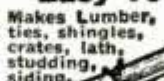

Makes Lumber, ties, shingles, crates, lath, studding, siding. BELSAW MODELS in to 24 feet sawing lengths. Patented Mechanical Feed, accurate set works and positive dogs. Use tractor or old auto engine for low cost power. Thousands used for commercial sawing. Pays for itself quickly. Send postcard today for FREE booklet, "How To Make Lumber" & Catalog of Woodworking Equipment.

BELSAW MACHINERY COMPANY
Dept. 1811-X 3542 Main Street, Kansas City 2, Mo.

SAY YOU SAW IT IN POPULAR MECHANICS

VICTORY DELUXE
Plan NOW to Own a MOTO-SCOOT
for PLEASURE or PROFIT



We are now making deliveries on MOTO-SCOOTS. Amazing new improved MOTO-SCOOT world's most economical form of motorized travel—up to 80 miles per gallon! Completely enclosed package compartment. Both "Solo" and "Delivery" Models ideal for utility and sport. To assure prompt delivery place your order at once. Write for colorful illustrating full details.

DEALERSHIPS OPEN NOW!
 Enter this profitable selling field. Some franchised territory open to responsible parties. Inquire today!

trated booklet
AMERICAN MOTO-SCOOT CO., Dept. 3PM
 1305-23 W. Carroll Ave., Chicago 7, Ill.

FIRST + AID CABINET

Every employer should protect himself against accidents. Keep a well stocked First Aid Kit available for instant need. Columbia All Metal Cabinet for wall or portable use completely stocked in accordance with requirements outlined by foremost authorities for shops, plants, factories, stores and offices. Send cash for prepaid shipment or 25% deposit, balance C.O.D. Money back guarantee. Agents—Write for our liberal offer.

\$10⁰⁰

COLUMBIA FIRST AIDERS, 330 S. Wells St., Chicago 6, Illinois

SWISS MUSICAL UNITS

Ready to install in your own box. Choice of waltz, operatic or classical.

\$4.50 each. Postpaid if cash with order. Literature on request.

Assembly & Repair Co.
 Dept. 103, 582 Third Ave., N. Y. C. 16

SMOKE IN BED?

DON'T—unless you use the sensationally new **6 IN 1 CIG-SMOKER**. Designed scientifically for safe-clean-filtered cigarette smoking. See the Cig burn inside this miracle, durable silverglass creation. It combines a holder, filter, fire shield, ash guard, smoke cooler and automatic snuffer. **PREVENTS** fires, burns, ash mess, accidents, and irritating smoking. It's weather and windproof. New thrills in smoking... nothing else like it.

Sample Cig-Smoker \$ **1.00** post-paid. A Guaranteed 100 Cig-Filters Product

Agents, Dealers, Exporters, Write **Pat. & Mfr., SAFE-GARD MFG. CO.**
 21 Perry-Payne Bldg. Cleveland 13, Ohio

RADIO PARTS KITS

For Immediate Delivery! —

NOW YOU CAN get what you want, and get it quickly! **CONCORD** has complete stocks of all standard radio parts required for **POPULAR MECHANICS KITS** in addition to the well known line of Concord Kits! Also every kind of radio part and electronic equipment... standard lines, dependable quality, exceptional values. Order from former Catalogs No. 94 and No. 345. And write for Special Catalog Supplement, offering thousands of items at money-saving prices. Mail coupon for **FREE COPY**.

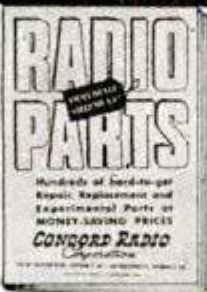

CONCORD RADIO CORP.
 LAFAYETTE RADIO CORPORATION
 CHICAGO 7, ILL. 901 W. Jackson Blvd. • 265 Peachtree St. ATLANTA 3, GA.

CONCORD RADIO CORPORATION, Dept. P-36
 901 W. Jackson Blvd., Chicago 7, Ill.
 Please RUSH FREE New Concord Catalog Supplement.

Name.....
 Address.....
 City..... State.....

"1001" Re-Blade Knife*
 with interchangeable surgical steel blades!



**KEEN!
 EVER SHARP!
 EVER READY!**



"1001" Knife as above, \$1.29
 Knife with 3 extra, different blades and honing stone, \$1.59

The first really "balanced" craft knife

Whether you're an expert craftsman or just a passably fair workman or hobbyist, you'll do better work faster and easier with "1001"—the re-blade knife of 1001 uses! For "1001", thanks to its light, perfectly balanced, colorful plastic handle, is second to none for easy and exact whittling, chiseling, modeling and cutting of all sorts. Its patented, scientifically designed chromium finish blade holder simplifies the insertion and removal of "1001's" all-purpose blades, and keeps them firmly locked in place. Yourself—get a "1001"—feel the difference, see the difference in your work. It's as easy to handle as a pen or pencil.

• Buy "1001" wherever hobbycraft tools are sold. If your dealer cannot supply you, send check or money order for \$1.29 (or \$1.59) direct to

SOMAR SPECIALTY CORP.
 Dept. M12—630 Fifth Ave., New York 20, N. Y.

Say you saw it in Popular Mechanics

Milwaukee, Wis.

You Can't Name Another SCREW-HOLDING SCREWDRIVER



With these Practical XCELITE Advantages

Attaches instantly and rigidly holds any screw—even those without a head. (Fig. 4.) Three point suspension does the trick. Removes screws in hard to get at places, as the runner is not controlled by a coil spring but will remain in position below the screwdriver tip (Fig. 1) without having to be held there. These runners also act as a guard preventing torn pockets. The device stays put. Slide it up the shaft and use as an ordinary screwdriver. (Fig. 2.) For complete details, ask your regular dealer or write Dept. J.

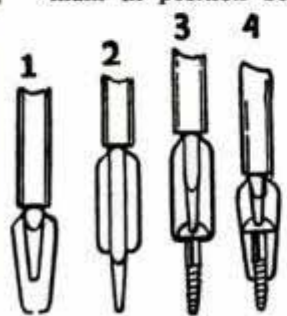

PARK METALWARE COMPANY, Inc.
Orchard Park, N. Y.



Say you saw it in Popular Mechanics



PORTABLE LIGHTING PLANT, packed ready for use and transport on a hand truck that will pass through a 32-inch opening, provides illumination in dark areas beyond reach of electrical plug-in systems. Consisting of a one-horsepower gasoline engine, a 600-watt generator, two large adjustable flood lamps and a 150-watt spotlight, the unit is used to light maintenance and repair jobs in the field and for unloading or loading trucks. The outfit also will power portable tools such as drills or saws. It weighs only 190 pounds

MILL IT ON YOUR LATHE



WITH A PALMGREN MILLING ATTACHMENT



Now — you can do milling, slotting, grinding, grooving, squaring shafts, sawing at angles, and many other important operations on your lathe. PALMGREN MILLING ATTACHMENT is a necessary fixture for small shops, schools and emergency work in large plants. Fits South Bend, Atlas, Craftsman, Logan, Sheldon and all other makes. It has 360° graduation for rotary angle adjustments, also graduated feed and adjustment screw. Easily mounted by straddling lathe's regular tool post. Try one—it will quickly pay for itself.

No. 250

IMMEDIATE DELIVERY

No.	Width Jaws	Depth Jaws	Jaws Open	Weight Pounds	Base Opening	Price F. O. B. Factory
150	1 1/2"	1"	1 1/2"	6 1/2	1"	\$18.75
250	2 1/2"	1 1/8"	2 1/2"	11	1 1/4"	24.75
400	4"	1 1/2"	4"	25	2"	39.75

Order from your dealer or jobber. Write for circular No. 349

CHICAGO TOOL AND ENGINEERING CO.
Mfrs. of PALMGREN PRODUCTS for Over 25 Years
8365 South Chicago Avenue • Chicago 17, Illinois

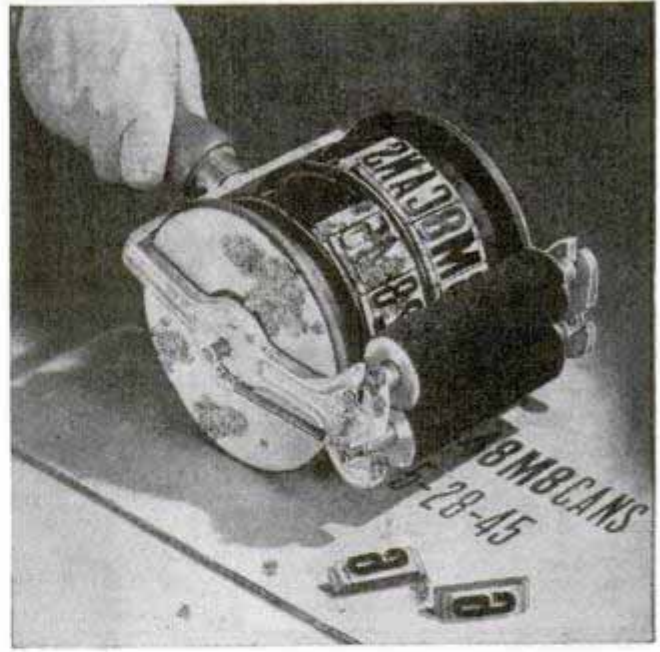

ROLL-ALONG SELF-INKING STAMPER that has interchangeable types or dies is reported to be eight times faster than stenciling. Made of rubber mounted on a sponge rubber base, the type is in special channels and is removed or inserted easily. When lifted from the surface being printed, the stamp automatically returns to starting position. Other stamps that make continuous or repeated imprints also are available

Adolph Hotchkiss, Inc.
190 E. Duane St.



It's this **STEEL** spacer that makes the difference

Simplex Matched-Set Piston Rings give you more power—and less oil burning. These steel rings put new life in worn, tired engines—yet they cost no more than ordinary brands.

They're easy to install, too. Get them wherever *quality* replacement parts are sold. Look for the ✓ on the box. That means *Simplex*—your best bet for piston ring performance.

Here's Why

- ✓ Larger Slots Provide Greater Oil Draining Capacity. Generous Straight Line Flow of Oil through Spacer and Expander Reduces Clogging—*You stop oil pumping—get better combustion.*
- ✓ Four-piece Steel Construction with Spring Action; Ring Breathes as a Unit to Give a Better Fit, Even in Cylinders Worn Out-of-Round—*You cut down "Blow-By" power losses—and restore PEP—with greater economy.*



PISTON RINGS

KROME CHEK

OIL CHEK



FREE!! 40 PAGE HOBBY CATALOG

Over 1000 Items — Over 300 Photos

Our new 40 page catalog is the "bible" of wide-awake modelers. Hundreds of models to choose from! Planes, engines, boats, jeeps, tanks, gliders, supplies, etc. Send for yours today!

AMERICA'S HOBBY CENTER, Dept. 836, 156 W. 22 St. N. Y. 11, N. Y.

WORLD'S LOWEST PRICED ADDING MACHINE

VEST POCKET SIZE

IDEAL FOR BUSINESS OR PERSONAL USE

FREE TRIAL
ONLY \$2.50
TOTAL COST
SEND NO MONEY

FREE!!

Each Baby Calculator in Beautiful, rich-looking Leatherette case—at no extra cost.



Fits vest pocket or purse. Guaranteed accurate. Operated as easily, and as reliable, as machines costing many times as much. Not a toy. Substantially made of 28-gauge steel—guaranteed for life against defects in construction. You positively can't buy a calculator of equal quality for as little money. **ACCEPTED AS THE FINEST LOW PRICED CALCULATOR FOR OVER 30 YEARS!** Operates with a flick of your finger. Adds, subtracts, multiplies, divides—counts up to ten million. Pays for itself over and over in mistakes avoided, and time saved. **MAKES IDEAL GIFT.**

Sold on a positive money back guarantee. Send only name and address, pay postman \$2.50 plus postage (send full cash if outside U. S.). Money back within 10 days if not delighted. **AGENTS WANTED!**

CALCULATOR MACHINE CO. (Mfrs.)
Dept. 176, P. O. Box 248, Glenview, Illinois

BELL
GUARANTEED
WATCHES



**WATERPROOF
SHOCKPROOF**

NOW AVAILABLE! Sturdy, handsome, reliable, a watch for every occasion—backed by the famous BELL guarantee.

Anti-magnetic, radium dial and hands, unbreakable crystal, stainless steel back, precision tested.

- No. GX 195
15 jewels, small second hand..... \$25.95
- No. GX 197
17 jewels, sweep second hand..... \$29.75
- No. GX 189 SELF-WINDING
17 jewels, sweep second hand..... \$49.50

ORDER BY MAIL: Send check, money order, or pay postman C.O.D. Prices Incl. Fed. Tax & Postage. Gift Box. Wide choice of fine watches for men and women.

Write for FREE Illustrated Booklet "GX"

BELL WATCH COMPANY

Time and Life Bldg., Rockefeller Center, New York 20, N. Y.

Quick Change Gear Box for Atlas, Logan, Craftsman and Power-Kraft Lathes

Cut threads from
4 to 224 per inch

Approximately .003 feed
for fine turning

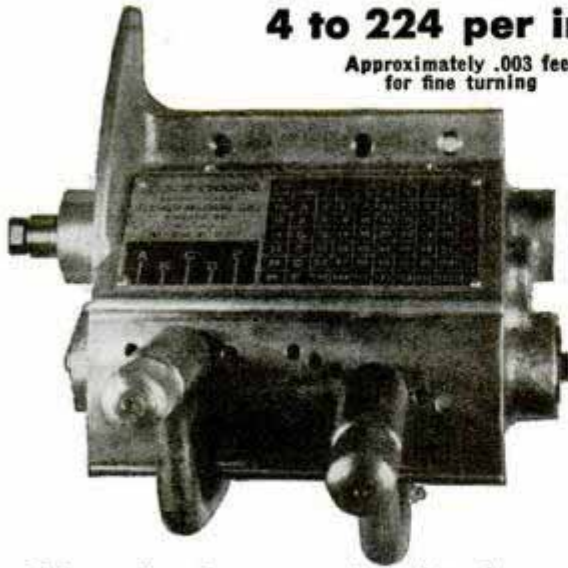

Only
\$75⁰⁰

F.O.B.
Chicago

Sold on
money-back
guarantee
if not
satisfied.

This gear box is constructed of all-steel gears in aluminum casting with bronze bearings throughout. Easy to install. Full instructions with shipment. Speedy production; maintained accuracy. Easy to set. Prompt delivery. Write Today!

THE O'BRIEN MACHINE CO.
Dept. PM-3 1620 Highland Ave. Chicago 26, Ill.

ASSEMBLE YOUR OWN FLUORESCENT FIXTURES

SAVE UP TO 60%

One again—the workers at National Fluorescent are reconverting to the manufacture of Fluorescent fixtures and parts—materials are becoming available, and we can offer the fine fluorescent fixtures that made this organization famous before the war. Once again—our before-the-war agents in the Philippines, Hong Kong, Calcutta, India and Greece are mailing orders to us. All of this in addition to our resumed domestic business.

OPPORTUNITIES GREATER THAN

EVER New, exciting technical developments have been made during the war and new designing techniques developed at the National plants. Be the first in your town to get the facts, write today for our new, free, catalogue and learn how you may become, absolutely free of charge, a trained Fluorescent lighting expert. How we can help you start that business of your own. Learn how you can get your full share of the millions of dollars to be made in Fluorescent lighting the next few years.

ELECTRICIANS, APPLIANCE SHOPS,

RADIO MEN: Write for special discount sheet for fluorescent fixtures and parts. Here is an added profit opportunity for you—without investment in new tools or machinery.

National Fluorescent Sales and Service Co.

325 North 4th St.

Libertyville, Ill.

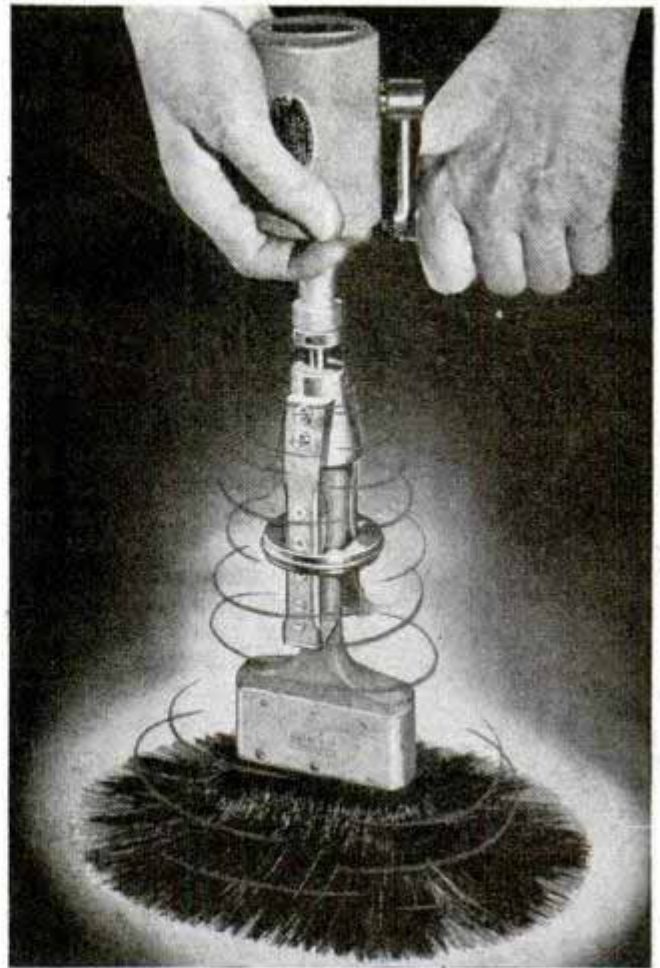

Spinning Paint-Brush Cleaner makes possible painting in several successive colors with only one brush. Requiring only 90 seconds to clean a brush thoroughly, the unit operates easily, is geared 8 to 1, has oil-less bearings and weighs only three pounds.

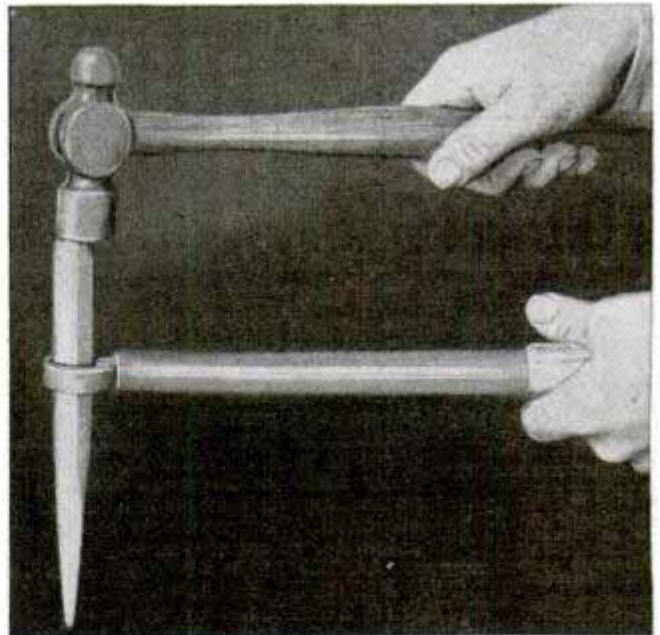

Tool Holder Grips Chisels and does away with the possibility of banging your hand with a hammer. The device has a metal loop on the end that is tightened over chisels, punches and star drills up to 1 1/16 inches in diameter simply by turning the handle.

*Machine Products Co.
2009 West Ave. South
Chicago, Ill.*

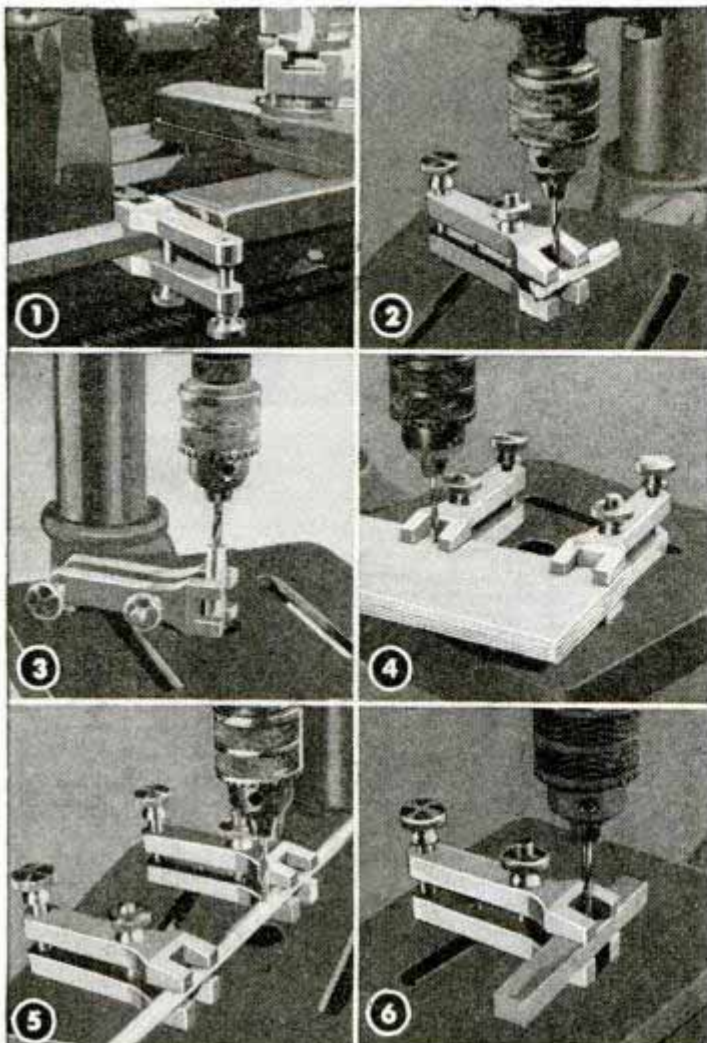

PARALLEL CLAMP VISE AND "V" BLOCK

OVER 100 USES

Something
New!

4 5/8 x 1 3/8
OPENS ONE INCH

Patent Pending

Sets flat on drill press or fastens to lathe. Forked jaws and "V" block for drilling and holding round work. Sets flat on drill-press bed or any working surface. No projecting screws through base. Illustrations show (1) Attached to lathe. (2) On drill press. (3) Drilling end of rod stock. (4) Drilling metal sheets in multiple. (5) Drilling round stock. (6) Drilling square stock. Stud and wing nut furnished to fasten vise to table or DRILL PRESS (not illustrated).

Made of high grade steel throughout. No castings. Perfectly machined. A real addition to your workshop.

Sent postpaid anywhere in United States. Foreign orders:— Send extra postage. Shipping weight 2 lbs. Sent Customs Collect.

\$3²⁵

POSTPAID

WRIGHT MFG. COMPANY, Dept. P.M. 3
21 N. Commonwealth Ave., Elgin, Illinois

Send me parallel bar clamps. I enclose \$

NAME

ADDRESS

CITY ZONE STATE

NEW DESIGN

BAIT CASTING ROD

Immediate Delivery

You can lock both rod and reel in the handle—IN ONE OPERATION. Universal, Offset Handle of bright, solid aluminum, highly polished; cork grip shaped to fit your hand. OFFSET HANDLE \$4.80; STEEL ROD \$7.50; ROD AND HANDLE COMPLETE \$12.30. Cash or pay post-man few cents extra if ordered C.O.D. Dealer inquiries invited.

BISHOFF MFG. CO., 3517 Gratiot, Detroit 7, Mich.



Wonder-Shave BRUSHLESS SHAVING AT IT'S BEST

All over the country, men are hailing this new, different shave cream. Contains ALL FIVE essentials for clean, comfortable shaving. You too, can enjoy cool, zippy shaves. Send 15c for trial size—you'll like it. ROYAL-JAY PRODUCTS CO. Box 337-A Mamaroneck, N. Y.

RADIO PARTS GRAB BAG!!

\$25 original value assortment of Coils, Condensers, Transformers, Resistors, Controls, etc. An experimenter's dream. While they last, only

\$3⁹⁸

MARKO SUPPLY, Dept. P.M. 3
2924 Logan Blvd. Chicago 47, Ill.

60 Assorted CIRCULAR SAW BLADES \$4⁸⁵

and TWO MANDRELS all for **NO PRIORITIES NEEDED!**

For an additional assortment of 6 grinding stones with your order add only **\$1**

This sensational value is limited to supply on hand. Act fast if you want to get in on this bargain. Blades are of laboratory tested fine tool steel (total carbon, 1.19; Manganese, .53; Nickel, Nil; Chromium, .03; Vanadium, .005; Molybdenum, .04). Sixty assorted blades, sizes

from .43 x .005 to 1.20 x .020. Blades to cut all types of materials, steel, wood, fibre, plastics, etc. The mandrels are 3/32".

Use them on Electric Hand Tools, Small Lathes and Millers. Send \$1.00 with order, balance on Delivery plus the usual Parcel Post collection charges.

SURPLUS TRADING CO.

6 MURRAY ST. DEPT. E
NEW YORK 7, N. Y.

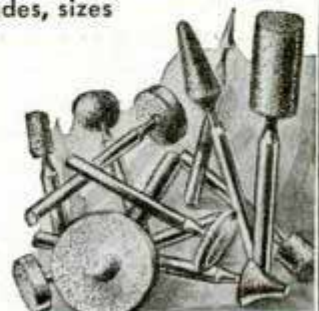
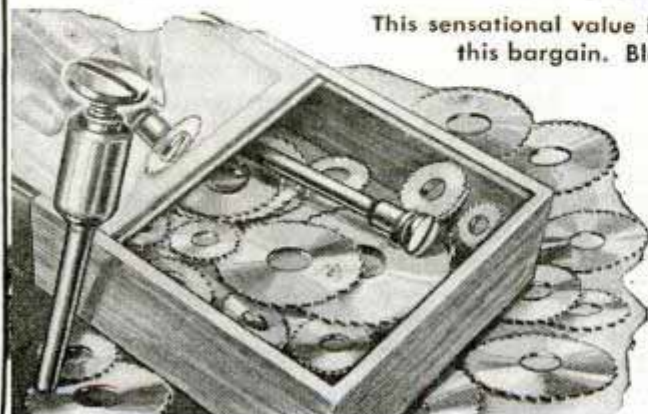

5401 Hamilton

**MORE VERSATILE
THAN EVER**



**BURGESS
vibro-tool**
Trade Mark Reg. U. S. Pat. Off.

Gives power to your craft skill in embossing, tooling, carving, slicing, engraving, and a host of other craft and shop jobs where "hand work" quality is desirable.

Operates by vibration. 120 strokes per sec.; 110 V AC, 60 cycles.

The Vibro-Tool, complete with engraving needle \$7.50; with set of attachments \$16.15.

SEE YOUR DEALER TODAY
Or Order Direct
HANDICRAFT DIVISION
BURGESS BATTERY COMPANY
166 N. Wabash Ave. • Chicago 1, Ill.

**No Need to Wait
for a
HOME
QUICK
FREEZER**

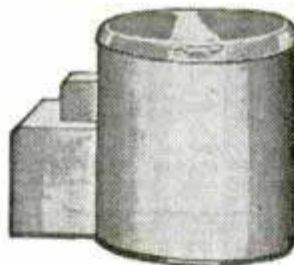

Build Your Own NOW... Save up to 75%

Materials now available . . . anyone with hand tools and these specific plans can build this freezer.

- Complete Easy-To-Follow Plans — First Time Offered. No inventing to do, no catalogues . . . plans come as large dimensioned drawings; pages of explanation; list of materials; recommended sources of supply.
- Designed By Experienced Engineer, exclusive design. Tested, proved practical for average family.
- Ample Capacity — Portable, approximately 4 cu. ft. — holds 150 pounds meat. Not built-in, passes through average door.
- Economical, runs on 1/6 H.P. unit, new or used. Well insulated, runs as little as 25% of time.
- Money-Back Guarantee, if not completely satisfied, return plans within 5 days for complete refund.
- Mail Check or Money Order for \$5, No Cash.

DAVIS ENGINEERING COMPANY
911 E. Elmwood Burbank, California

Power Brushes Clean Out Holes

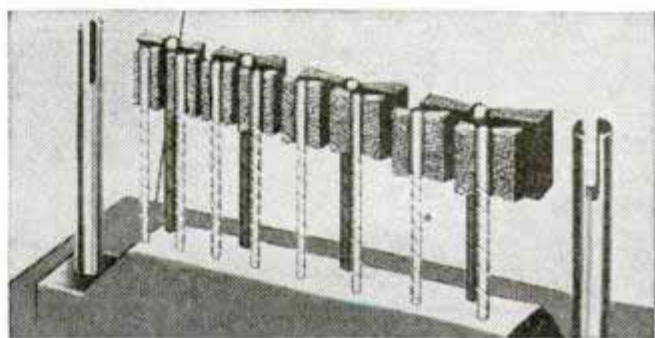
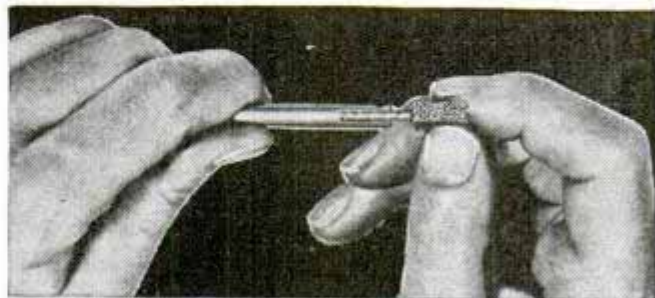
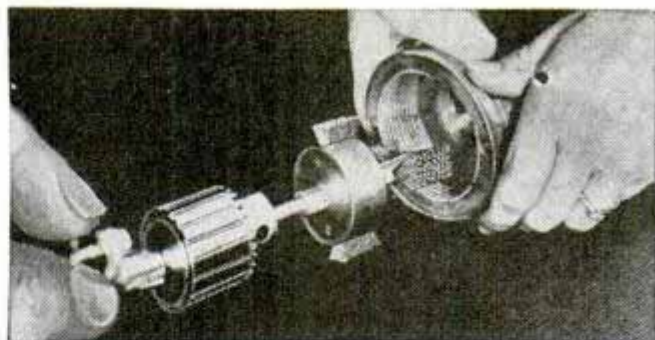

Brushes ranging in size from 1/4 to 1 1/4 inches in diameter are helping eliminate production bottlenecks. The power brushes, made of high grade crimped wire, are designed for use in drill presses, bench grinders and other production and deburring tools. They finish or clean hard-to-get-at parts, removing insulation, rust and mold marks, and are especially useful in smoothing and cleaning drilled holes. The brushes are available in kits containing 12 different sizes. Special holders are furnished in two sizes, one of which fits into the standard 1/4-inch air chuck of portable tools.

Plastic Made of Gas and Wood

Natural gas and wood supply the basic ingredients for a new plastic called Forticel which is tough and has a natural gloss. It is faster to mold than cellulose acetate and in some cases has increased production 25 percent. Odorless and light, Forticel is made from cellulose and propionic acid, the latter produced from natural gas. The plastic has the same electrical properties as cellulose acetate and is little affected by atmospheric changes. Easily colored and mottled, Forticel can be molded into radio housings, steering wheels, telephones, tool handles and many other products.

MAKE MORE MONEY REPAIRING MOTORS!

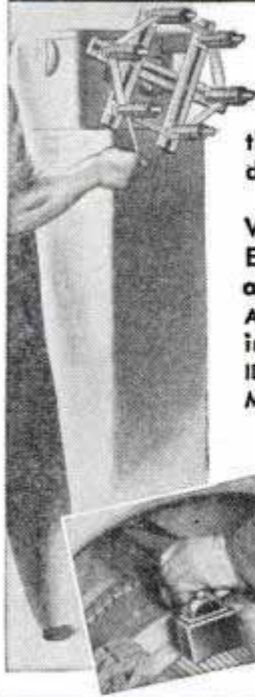

with Modern IDEAL Motor Repair and Maintenance Equipment

Get ready for repair and servicing work on the millions of motors that have been working overtime during the war.

Install the latest type IDEAL Coil Winding and Motor Maintenance Equipment. For winding coils and armatures:—IDEAL COIL WINDER DRIVE AND COIL WINDER HEADS. For servicing Commutators and Slip Rings:—IDEAL RESURFACERS, PRECISION GRINDERS, MICA UNDERCUTTERS.

This work is easy if you have the proper equipment—and profitable!

Write for FREE Motor Maintenance Handbook.

IDEAL Sycamore

IDEAL INDUSTRIES, Inc.

Formerly
Ideal Commutator Dresser Co.
5136 Park Ave. Sycamore, Ill.

It's Back Again! WOOD BURNING PEN

Complete ELECTRIC Wood Burning Outfit—Burn Beautiful Designs in Wood—Comes Complete!

Safe, Constructive, Educational Wood Burning Pen is equipped with the Sta-Kool Handle. Burn and etch deeply on wood in rich shades of brown. It's real fun. Comes complete with 10 different plywood plaques, design imprinted, and 1 plain plaque. All for only..... **\$2.50**

Send check or money order to
UTILITY STORES, Dept. CC4
117 S. Wabash, Chicago 3, Ill.



BRASS RODS For Home Work Shops

For use on model boats, airplanes, etc., keep a supply of these free-turning brass rods on hand. Each kit contains a complete assortment of sizes.

KIT 1 . . . \$1.00 plus postage. 7 pcs. 12" long. 1/8" to 1/2" diameter by 1/16ths.
KIT 2 . . . \$4.00 plus postage. 5 pcs. 12" long. 1/2" to 1" diameter by 1/8ths.

MEIER BRASS & COPPER CO. 1320 E. Larned, Detroit 7, Mich.



RADIO TRAINER

Learn the theory and practical side of radio by building this simplified battery tube set. Experimental model teaches you to design larger radios, not just assemble them. Efficient, sensitive circuit brings in local as well as distant stations. Compact and portable. Can be used on camping trips and on farms without electricity. All parts furnished including tube, batteries, double earphones, aerial and ground wire and easy-to-follow illustrated instructions. Soldered or solderless connections. Complete, postpaid, only \$9.95. Or send \$1.00—shipped C.O.D. for balance plus postage. Money-back guarantee. Order today!
B. G. FLEMING MFG. CO.
Dept. 3-A, 906 Main St., Cincinnati 2, Ohio

Money Making Pay Raising BOOKS Catalog FREE

SEND NAME AND ADDRESS TODAY—Selected books covering all trades, office helps, home workshop, spare time work, hobbies, etc. Learn how to earn more. 1946 edition. Popular Mechanics Press
200 E. Ontario St., Chicago 11

BEFORE RUST RUINS YOUR RADIATOR



CLEAN OUT RUST

with DU PONT

Cooling System CLEANSER

Drain out your anti-freeze, and clean out winter's accumulation of scum, scale and rust. Neglect now may mean trouble and costly repairs later. Just pour a can of DU PONT COOLING SYSTEM CLEANSER into your radiator, run the engine 30 minutes or more, and drain.



Then KEEP OUT RUST

with DU PONT

Acid and Rust INHIBITOR

After cleaning out the radiator, you can keep it free from rust all season by pouring in a can of DU PONT ACID and RUST INHIBITOR. It prevents rust forming, and keeps out acid, too.



AVOID RADIATOR LEAKS

with DU PONT

Cooling System SEALER

You can stop leaks quickly and securely—and make the cooling system LEAK-PROOF—by pouring in DU PONT COOLING SYSTEM SEALER. It will not clog the radiator.



BETTER THINGS FOR BETTER LIVING
... THROUGH CHEMISTRY

San Diego 2 Calif.



YOU CAN NOW BUY

a real
JET ENGINE!

\$35⁰⁰
PLUS TAX
IF YOUR DEALER
CANNOT SUPPLY
SEND CHECK OR
MONEY ORDER
MINIJET MOTORS
3913 Wilshire Boulevard
Beverly Hills, Calif.

THIS is the real thing—a miniature of the famous V-1 buzz bomb engine. The MINIJET is 27" long, 2" in diam., weighs 16 oz. Build it right into your model plane, burns gasoline—2 oz. per minute. Develops in excess of 2 lb. thrust. Get into the new class of model plane builders—Build a Jet Job!

GET REAL SPEED!

The MINIJET is a highly engineered, precision-built engine. It is the lightest engine in existence for the power it develops. It can be used as the fuselage of a Model plane with surfaces attached directly to the engine body.

Ask your dealer for a —

minijet MINIATURE JET ENGINE

(REG. U. S. PAT. OFFICES)

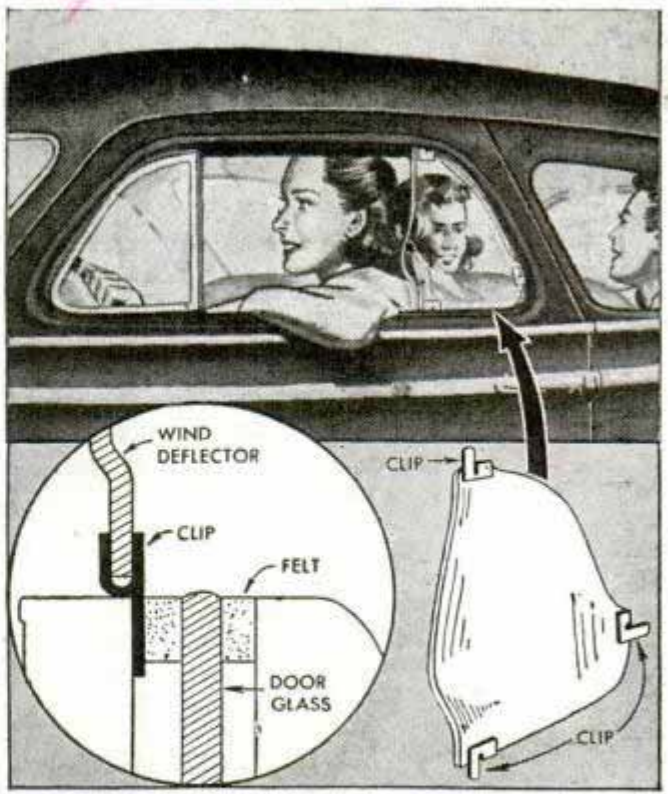

Wind Deflector for Automobiles, made of transparent plastic, is easily installed inside front window frames of closed cars to prevent air from blasting rear seat occupants. When installed, the wind wing (as illustrated in the sketch above) does not interfere with the driver who likes to rest his arm on the door frame while driving.

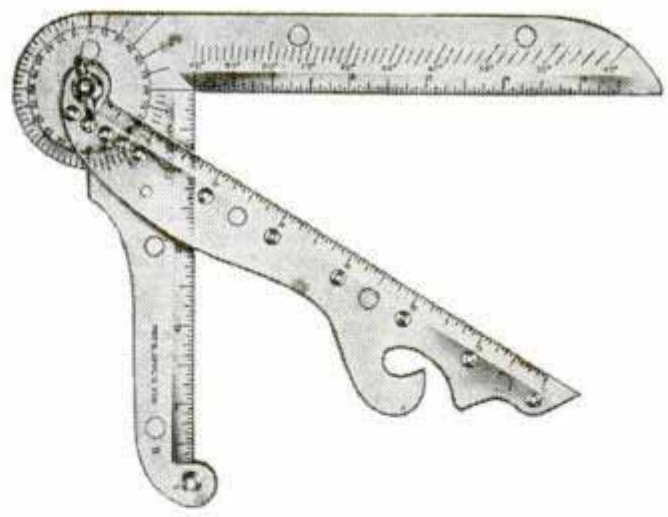

Eight-in-One Drawing Instrument serves as a square, dividers, protractor, triangle, ruler, compass, French curve and mitre. It consists of a combination square and a removable mitre arm which can be locked by a wing nut at any desired position. By varying the position of the mitre arm, angles of any degree can be formed and right angle triangles can be made with acute angles of any degree desired. By removing the mitre arm and using it as a radius, circles can be scribed from 1/2 to 14 inches in diameter. The instrument is made of tough, transparent plastic.

AUTO ENGINE SPEED CONTROL GOVERNORS

(REGULADORES)

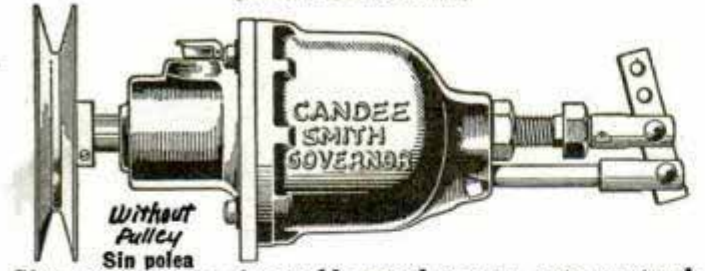

Give constant or changeable speed to any auto or truck engine, when used for power. Guaranteed. Instructions. Oil ring bearing, \$12.50. Full ball bearing, \$19.00. Postage west of Miss., 50c; east of Miss., 85c. Sent COD or—Postage to any country in the world \$1.00 each. Pulleys to 3", \$1.00, wt. 1 lb.; to 6", \$1.50, wt. 1 1/2 lb. Governor speed 1400 to 2400 rpm. Figure your pulley size.

Agents Wanted: Parts and Implement Dealers, Garages, Welders, Wreckers, Catalog and Mailing List Houses, etc.



These valves used where carburetors have outside attachments. State size of opening and distance between bolt holes. 1", \$3.75; 1 1/4", \$5.25; 1 1/2", \$6.50; 1 3/4", \$7.50; V8, \$7.00. Mailing weight, 3 lbs. If remitting, enclose for postage. You may order from this ad, or we will send circulars. Stocks carried: In Montreal 15, Canada: 7546 Wiseman St. In Auburn, N. Y.: 3 Seminary Ave., Auburn Welding Supply.

CANDEE, Dept. 1, 2641 S. Hill, Los Angeles 7, Calif.

GET **BIG PROFITS** from
SMALL INVESTMENT

OTTAWA

6 H-P LOG SAW



**Log Saw of the
Future TODAY!**

**FELLS TREES...
SAWS LOGS Fast, Easy**

**Buzzes
Up
Small
Limbs**

Demand for wood increases! Prices are higher than ever before. You can make real money sawing wood, if you have an Ottawa. Equipped with an easy to start, air-cooled 6 H-P engine. Designed for easy handling. Complete one-man machine with safety Saw Guide and other exclusive Ottawa features for fast sawing.

USE FOR OTHER JOBS—when not sawing wood, use engine for any belt job. Thousands in use. **FREE BOOK** and price list. Write today.

OTTAWA MFG. CO., 327 Pine Street, Ottawa, Kans.



FREE RADIO CATALOG

Latest radio and electronic parts and devices, newest ham gear, gadgets, war surplus items. All in this new **FREE** catalog. Don't delay,

BURSTEIN-APPLEBEE CO.
1012M McGee, Kansas City 6, Mo.

TRAILER AXLES, HITCHES, AND PARTS

● If you are interested in purchasing trailer axles, hitches, and other trailer parts, contact us promptly. Complete house trailer blue prints. \$1.00. Write for free literature. **HAMMER BLOW TOOL COMPANY, Dept. 103, WAUSAU, WIS.**



My Copyrighted Treatise

"KEEPING RABBITS FOR PROFIT"

Postpaid \$1.00

28th Year

KIT C. VICKREY

JOPLIN 1, MISSOURI

CAVALCADE OF MODELS 50c

Contains 6 Kits in one box, plans, all printed Balsa parts for making B-29, King-Cobra, Warhawk, Helldiver, Wildcat and Mustang. 6 inch wings. Complete 50c. Ask Dealer or send direct.

RANDELS MFG. CO.

Hutchinson, Kansas

LAW

STUDY AT HOME for PERSONAL SUCCESS and LARGER EARNINGS. 35 years expert instruction—over 108,000 students enrolled. L.L.B. Degree awarded. All texts furnished. Easy payments. Send for **FREE BOOK**—"Law and Executive Guidance."

AMERICAN EXTENSION SCHOOL OF LAW
Dept. 63-M, 646 N. Michigan Ave., Chicago 11, Ill.

LAWN ORNAMENT-NOVELTY PATTERNS

28 Lawn Ornament Patterns, 25c. Other patterns; 15-20" high; Dutch Girl, Dutch Boy, Pirate, Bull Terrier, Mexican Girl, Mexican Boy, Dwarf, Penguin, Flower Girl. 10c each. 25 Novelty Patterns, 30c. All 62 Full Size Patterns, \$1.00 Postpaid. Strother Pattern Service, Dept. D-8, Box 383, Belington, W. Va.

LEJAY MANUAL

For **FUN & PROFIT**
Get this **LEJAY MANUAL**

ONLY **\$1.50**
WORTH \$12.35

OVER 100
BUILD-YOUR-OWN ITEMS

**SHOWS
YOU HOW TO
BUILD:**

**INCORPORATED IN 50
BASIC EASY-TO-MAKE
PROJECTS**



Thousands of amateurs are having fun or making profits with the many things these plans helped them to build. The illustrations shown are only a few of the many things you can make. These practical things that work and save money are always enjoyable for spare time work, especially when you may have spare material around your own garage or work shop which can be used for the job.

**NO SPECIAL TOOLS
OR EQUIPMENT
NECESSARY**

These plans are made for YOU and others like you, who are not in any sense electrical experts or mechanics. They are simple, yet efficient, and do not require a lot of expensive equipment to carry them out. If you need a welder, the plans show you how to make one, also how to make electric drills, bench grinders and other handy tools.

THE NEW MODERN LEJAY FAST-FREEZER

FROZEN STORAGE

For Fish, Meat, Fruit, etc.
From 5° above to 10°
below zero.

5 SIZES—8 to 40
Cubic Feet Capacity

NO KNOWLEDGE OF REFRIGERATION REQUIRED—Plans are easy to follow and you may have much of the material at hand. **FAST FREEZERS** made from these plans have been in use since 1938.

PLANS ONLY

\$1.00



MILK COOLER PLANS, too, are included at no extra cost. Send only \$1.00 for the **FAST FREEZER** plans

—or save 25c and send \$2.25 for both these plans and the LeJay Manual.

LEJAY MFG. CO

747 LEJAY BUILDING

MINNEAPOLIS - 8 - MINN.

**MAIL YOUR
ORDER NOW**

MAKE EXTRA PROFITS

by Multiplying

YOUR LATHE CAPACITY

**CONVERT YOUR BENCH LATHE
FOR TURRET OPERATIONS WITH**

Enco

**MULTIPLE
TOOLHOLDERS**

and Turn Your Hobby Into PROFITS!

For all bench lathes. Equip your shop for fast precision production. Do a greater variety of jobs in your work shop. These sturdy, versatile turrets mount on compound and tailstock. Together, they hold ten tools instead of two. Save 50% on tool changing time. Install quickly without machining.

ENCO Toolpost Turret

Model 2 $\frac{1}{4}$ -S. Clamps rigidly in compound T-slot. 12-station, 30° indexing. Holds four tools. One tool performs three operations. Provides speedy set-up for threading. Made from solid hardened steel. Price (without tools)

\$23⁰⁰



ENCO Tailstock Turret

Model A mounts six tools. Eliminates single chucking. For drilling, counter-boring, tapping, reaming, etc. Finger tip control. Price (without tools)

\$18⁹⁵

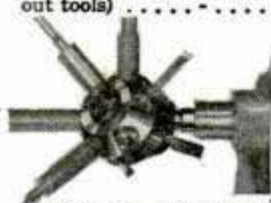

**SPECIAL COMBINATION PRICE
FOR SET OF TWO TURRETS** **\$39⁵⁰**

ORDER TODAY . . . PAY THE POSTMAN

ENCO MANUFACTURING COMPANY
4522-24 Fullerton Avenue
Chicago 39, Illinois

LATHE
 SWING

Please send me a PT set C. O. D.—plus postage—for the lathe indicated above. (Parcel Post prepaid if remittance accompanies order).

Name _____

Address _____

Town _____ State _____

Zone _____

Dealer _____

60 PIECE UNIVERSAL ARBOR TOOL SET (3/32" shaft) **\$1⁹⁵**



Includes assortment of engraving and carving burrs, grind stones, cutoff wheels, polishing buffs, bristle polishing brush, 2 mandrel arbors, garnet and emery sanding discs. If items bought singly value is over \$4.00.

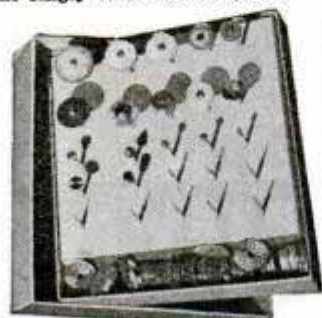

DE LUXE SET \$3⁹⁵
140 Pieces

All the above in larger quantities plus many other hard to get items, many with demountable shafts—Boxed to keep neat and easy to use. Really a \$7.95 value. Will ship to any part of the world prepaid. Send Check, Money Order or Cash.

GENERAL AIRE CO. Dept. PM-3
447 W. Norris Street
Philadelphia 22, Pa.

Tester for Synchronizer Flash



Made until recently for the armed services, a tester for synchronizer flashers provides both visual and photographic tests. This gravity type instrument is designed to test solenoid or other magnetic synchronizers. The unit consists of a carrying case, a sensitized paper holder and a military type flashlight. To test a synchronizer, the lens board with the shutter from the camera is mounted on the paper holder. The shutter is tripped in the regular way and the sensitized paper records the results of the test. The tester is for use with 4x5 cameras of the Speed Graphic type.

Waterproof Pocket Compass

Waterproof and shockproof, a new pocket compass has a watertight compartment which will hold 12 full-size or 24 half-size matches. The compass is a liquid type, similar to navigation compasses used on Army aircraft. Attached to its side is a metal flint for starting camp fires. Immersion in salt water for 12 hours or a fall up to six feet will not affect the instrument.



BERG
the KING of
JEEPS

AMERICA'S
FIRST
JEEP
DISTRIBUTOR



WRITE
TODAY!

RECONDITIONED ARMY JEEPS—ALSO PARTS

Be first to own a rugged Army Jeep. Tough! Speedy! Powerful! 600x16 tires; hydrau. brakes; for farming, hauling, towing. Send NOW for complete infor., prices, terms.

FULL LINE JEEPS; ARMY TRUCKS; TRUCK PARTS

Write today for truck or jeep parts—axles, motors, wheels, etc.

BERG TRUCK & PARTS COMPANY

"America's First Jeep Distributor"

1608 So. Wabash Ave. Chicago 16, Ill.

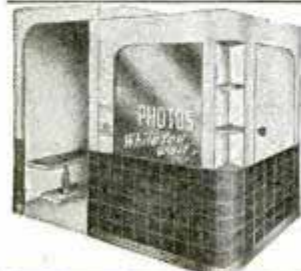

Up to \$600 WEEKLY

with new 5 min. photo equipment. No experience necessary. Write:

FEDERAL IDENTIFICATION CO.
Dept. HA 1012 N.W. 17
Oklahoma City, Okla.



VETERANS-SERVICEMEN! Wear a "SHOULDER PATCH" PIN

Show your pride in your old outfit by wearing a full color enamel lapel pin. Available for all Army divisions and Air Forces. Finely made with safety catches for lifetime wear. Just send name of your outfit and \$1.00. We deliver at once, postpaid. (No C.O.D. or stamps, please). COLLECTORS: Send 10c for illustrated catalogue and special quantity prices.

ZEV SALES CO.

153 Hart St., (Dept. PM 2) B'klyn 6, N.Y.



BALL BEARING CENTERS
WITH NO. 2 MORSE TAPER
ONLY \$2.75 at your Dealers or Post Paid
ME-RE-LAB., 57 Bergen Turnpike, Little Ferry, N. J.

MANY USE Electric VOLT-TESTER
Indicates whether 110, 220, or 440 volts, like thermometer. CHECKS if AC or DC, if 25 or 60 cycles, if broken circuit. LOCATES TROUBLE—from 60 to 550 volts in all appliances, fuses radios, motors, spark-plugs. \$1.50 complete. With 110-220 v. reading \$1.25. Dealer rates. American Standard Labs., 1924 E. Hartlane, Philadelphia, Pa.

GIS WANTING A GOOD BUSINESS PROPOSITION — WRITE
E-Z-ON-PRODUCTS, Box 1061, CHICAGO, ILL.

ANYONE CAN FIX ZIPPERS
In 10 minutes. No special tools required. Big 30 page book of step-by-step instructions, 39 sketches, shows you how. Mail \$1.00 now. MOREHELP, A36, Box 140, Lakewood, N. J.

HELPFUL BOOKS
Send post card asking for FREE catalog
Popular Mechanics Press, 200 E. Ontario, Dept. 601, Chicago 11

Big Money for Workers In Home or Shop

Licensed Concrete Specialists wanted. No experience needed. Make Colorglazed concrete pottery without molds. New, low cost, patented method. Cemetery products, novelties, tiles, etc. Basement leaksealing. Other big pay projects. Booklet, details free. Men only.
NATIONAL POTTERIES COMPANY
542 Lincoln Avenue Fergus Falls, Minnesota

2-Way Talkie!

Hold conversation without the use of tele- phone . . . household electric current . . . Ideal for Home . . . Farm . . . Office . . . etc.



JUST FLIP THE SWITCH AND TALK!

It's lightweight and can easily be moved anywhere.

Talkie comes complete with both units, long life batteries and wire. There's nothing else to buy.

Operates on ordinary flashlight batteries.

Complete for Only
\$1750
Prepaid

Will operate at its Best Efficiency at 100 feet. Here are a few of the many uses for the 2-way talkie

- FROM ROOM-TO-ROOM IN THE HOUSE
- FROM OFFICE TO STOCKROOM
- FROM KITCHEN TO FRONT DOOR
- FROM EXECUTIVE TO SECRETARY
- FROM SICK ROOM TO KITCHEN
- FROM YOUR HOUSE TO A NEIGHBOR
- FROM DOCTOR TO NURSE
- FROM FARM TO BARN OR DAIRY
- FROM LAWYER TO SECRETARY
- FROM MAIN HOUSE TO GUEST HOUSE
- FROM HOUSE TO GARAGE

MAIL COUPON NOW!

UTILITY STORES, (Est. 1906), Dept. CC-5
117 S. Wabash Ave., Chicago 3, Ill.

Please rush complete 2-WAY TALKIE. If I am not more than satisfied with my 2-WAY TALKIE after 5 days' trial I will return it to you and you will promptly refund my money in full.

Name.....
PLEASE PRINT

St. or R.F.D.....

City..... Zone.... State.....

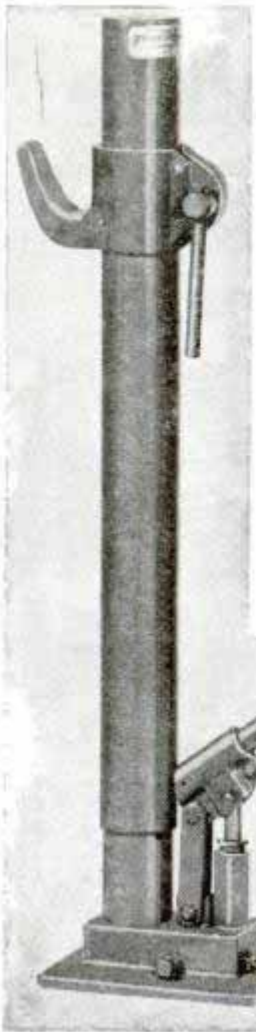

The O'BRIEN ALL-STEEL HYDRAULIC BUMPER-JACK

Newest, finest engineered, most ruggedly constructed jack on the market. Built to lift 2 tons with finger-tip pressure. A life-time accessory.

\$12⁵⁰
F.O.B.
Chicago

- 1—All steel construction.
 - 2—Solid steel piston
 - 3—telescoping steel tubes quadruples its strength.
 - 3—Adjustable hook—over 16½ inch range.
 - 4—Finger pressure hydraulic stroke.
 - 5—No screw parts to rust.
 - 6—17½ inch hydraulic hoist.
- Lifetime guarantee against defects. Perfect workmanship.

If your dealer can't supply you, remit \$12.50 and we will ship immediately. Money cheerfully refunded if not satisfied.

DEALERS:—Write for Information.

Mfd. by O'Brien Machine Co.

AUTO PRODUCTS CO.

Sole Distributor

6349 N. Clark St., Chicago 26, Ill.

Light Bulb Shows Proper Timing

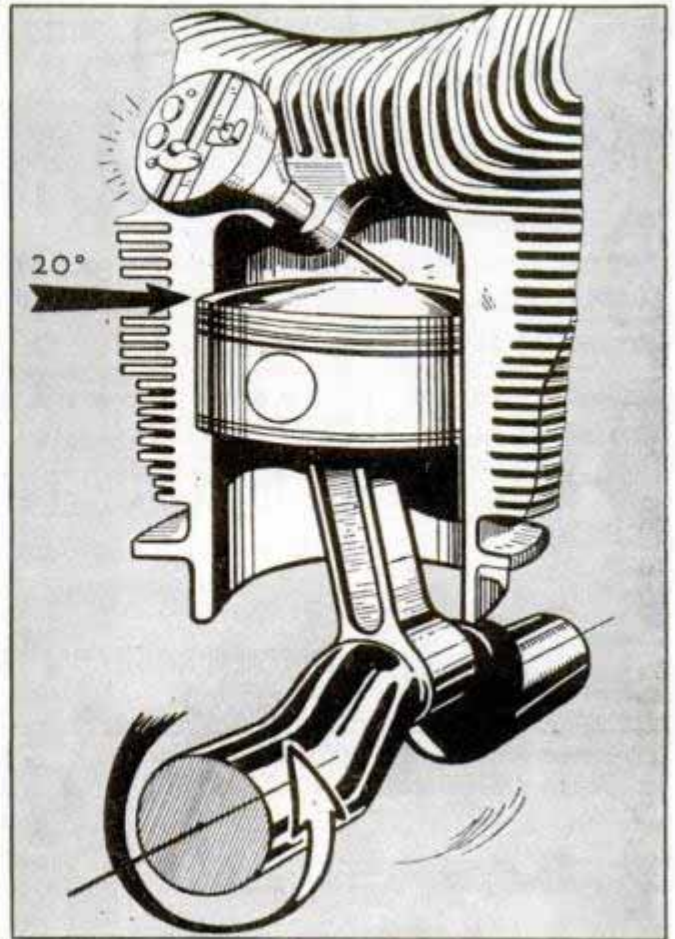

Accurate to plus or minus ¼ degree, a new piston position indicator has been developed for timing aircraft engines. The instrument is inserted in the front spark plug hole of the No. 1 cylinder. A slot in the face is lined up approximately parallel with the vertical axis of the cylinder. As the engine is turned and the piston goes through the top center position, a slide pointer on the instrument is pushed upward. By other similar tests the instrument reveals the necessary adjustments. When correct adjustments have been made a small bulb lights up. The device also may be used to check magneto adjustments.



TENNIS SAVE ON OUR LOW PRICES

• Gut Tennis and Badminton
Strings direct from factory to you.

• Vises & Frames • Tennis Equipment

H. E. WILLS CO. Catalog FREE

1047 W. 47 St.

Dept. PM-36
Chicago



6 Tools in One



MITER- MASTER

- Mitering Guide
- Diameter Gauge
- Accurate Square
- Marking Gauge
- Center Finder
- Handy Ruler

Miter-Master takes the place of an expensive miter box accurately set to any angle. Sturdy steel construction. Set it at any point from 45-90°. Scale is marked for mitering 5, 6, 8 sided frames. Satisfaction guaranteed or your money back. Ask your dealer or order direct.

FOR MITERING: Set at desired angle. Place material against bench stop. Hold saw firmly against Miter-Master guide board. It's that simple!

**\$1.50
POSTPAID**

MASTER SPECIALTY CO.
3018 E. Lake St., Minneapolis 6, Minn.

Enclosed is \$1.50 for Miter-Master, postpaid in U.S.A. (Foreign \$1.75)

NAME

(Print address in margin)

Foods Freeze-Dried Like Plasma

Used successfully to preserve blood plasma and penicillin, freeze-drying is being tried out to preserve fruits and vegetables. Dr. Elmer H. Stotz, chemistry head at Cornell University's agricultural experimental station, explains that food is frozen, placed in a container, then the air is pumped out. The vacuum changes ice surrounding the food to water vapor which is collected in a special apparatus. Food being dried maintains a temperature of 20 or 30 degrees below zero. Another new method is electronic blanching which permits vegetables to retain more vitamin C than when blanched in steam or hot water.



U.S. Govt. BOLO KNIFE

Extra heavy. For farm, home or jungle use. Blade of Gov't formula cutlery steel. Walnut riveted handle, 3 1/2 inch hilt. 10 1/2 inch blade. You'll find hundreds of uses for a Bolo knife. Blade will take and hold a keen cutting edge. Wt., 2 lbs.

- A112—with Army Sheath..... **\$4.95**
- A212—Leather Sheath, extra..... **\$1.50**



PUP TENTS

Regulation Army Pup Tents of durable, brown canvas. Used, but in good condition. Fine for campers, outdoorsmen, boy scouts, etc. Grand Xmas gift for children.

- A1—Tent Only... **\$3.95**
- A110—Tent, new... **\$7.95**
- A101—Ropes, wooden poles and stakes for above. Per set..... **\$1.00**



BIG SHIP'S BELLS

Purchased from U. S. Maritime Comm. Measures 10 inches high, 9 3/4 inch bore. Big 6 inch clapper. Weight 15 lbs. Fine for farms, clubs, estates, etc. All new. Ship. wt. 10 lbs. AS41— ONLY..... **\$9.85**

PROF. TELEGRAPH KEY

Purchased from the gov't. Finest design and construction. Base measures 3x4 3/4 inches. Original value \$2.50. All parts of instrument brass. Adjustable. A147— Each..... **98c**



MEDICAL STERILIZER



Consists of alcohol burner and sterilizing tray in hinged metal case 1 7/8 x 1 1/4 x 2 3/8 inches. Burner may be used separately. Bright nickel finish. All brand new. A125—Each..... **98c**

MESS KITS



Regulation Army Mess Kits. Ideal for campers, boy scouts, etc. Slightly used but guaranteed perfect. Two pieces. Folding handle.

- A-116— Each..... **69c**



Regular U. S. Gov't issue canteens. Plastic screw top cap chained to body. Slightly used.

- A117—METAL BODY. Each... **69c**
- A118—PLASTIC BODY. Each..... **69c**
- A109—Canteen Covers. New. Each..... **69c**
- A119—Canteen Covers. Used. Each..... **39c**
- A120—Canteen Cups. Used. Each..... **25c**

WAR SURPLUS AND HUNDREDS OF OTHER BARGAINS

McCLELLAN SADDLE



Fenders shown are not included

Brand new! McClellan model saddles. Top grade cowhide with hair girth, fenders and 12 inch seat. Has straps for blanket roll and knapsack. Buckles, girth and saddle loops. A splendid value. A-145— Each..... **\$13.95**

27 LENSES, ALL NEW, PERFECT

For experimental work in optics. Consists of 27 precision ground and polished prisms and lens elements in assorted diameters and focal lengths. Big variety, positives, negatives, etc. Actual value over \$100.00.

- A519—27 PIECES..... **\$7.95**

50 LENSES, SEMI-FINISHED

Lenses similar to above but not polished. All are blanked and formed ready for polishing. Negatives, positives, and prisms in Crown and Flint glass. Worth many times this low price.

- A520—50 LENSES, ONLY..... **\$1.95**



GI POCKET BELTS

Of heavy canvas. Adjustable waist size. Each with 5 pockets and metal recoil fitting. Brand new. Fine for hunters, boy scouts, etc. A107..... **98c**

- A107..... **98c**



MICROPHONE BUTTON

Brand new! For experiments in radio, electronics and other electrical apparatus. Used in telephone, amplifier and detector work. Diameter 2 1/2 inches. New.

- A512—EACH..... **98c**

AMMUNITION BOX

Fine for storing valuables, carrying lunches, etc. Of heavy gauge 7 1/2 x 11 x 4 inches. Fireproof. Hinged lid with folding handle. Olive drab finish. Used, but perfect. Shipping wt. 4 lbs.



- A525—EACH..... **25c**



RADIO HEADPHONES

Extremely sensitive with 4000 ohms resistance. Brand new and fully guaranteed. With moisture-proof cord and phone plug. A splendid value for the radio serviceman and experimenter.

- A106—PAIR..... **\$2.95**
- New supersensitive phones. A108—Pair..... **\$5.95**



SADDLE BAGS

Made of finest top grain leather. Rivet reinforced seams. Bottom and side gussets. Each canvas lined bag measures 12 x 13 inches. Fine for motorcyclists. May be separated to make two duffel bags. Used, but perfect.

- A151— Each..... **\$7.95**

MARINE KNIFE

Fine for boy scouts. Blades include knife, bottle opener, screw driver and reamer. All metal handle 3 3/4 in. long. Weight 1 lb.

- Stock No. 217—Each..... **\$1.95**

WATCH COMPASS

Officer's type. Brand new gov't surplus. Army-Navy model. Single jewel mounted needle. Silver colored dial. A splendid value. Weight 1 1/2 lb.



- Stock No. A-174— Each..... **\$3.35**

7-LB. EXPERIMENTERS PARTS ASSORT.

A "gold mine" for the radio serviceman. Hundreds of valuable radio parts, new radar and electronic parts and sub-assemblies, coils, resistors, screw machine parts, etc.—worth many times this low price.

- A130R—7 LBS. **\$1.79**



PLASTICS—LUCITE AND PLEXIGLAS

In sheet form. Good workable sizes. Transparent. For costume jewelry, etc. Easy to work and polish.

- A280—5 LB. ASST..... **\$4.75**

CATALAN—ASST. COLORS

Extruded shapes, rounds, half rounds, etc. Easy to machine. Furnished in assorted colors, shapes and lengths.

- A281—5 LB. ASST..... **\$4.75**

LIFE PRESERVER BELTS



Right from the invasion beaches. Consists of two air chambers. May be inflated automatically with 'sparklet' cartridges or manually by attached hose. Adjustable in waist size. One air chamber guaranteed air tight—other may need a tire patch. All belts are used and slightly soiled but a bargain at this low price.

- No. 1261 Each..... **\$1.00**



ARMY BANDOLEERS

Of fine heavy khaki. Big roomy pockets with snap button fasteners. Fine for hunters, campers, boy scouts, etc., also for shop work in carrying small parts, etc. Material alone is worth this price.

- 11 Pocket Type No. 129 Each.... **49c**
- 5 Pocket Type No. 110 Each.... **29c**

ORDER DIRECT FROM THIS AD

Values galore! Hundreds of hard-to-find items for home, shop and outdoors. Make remittances by money-order, bank draft or personal check. Send 25% deposit on C.O.D. orders. No C.O.D.'s on orders for less than \$5.00. Include sufficient postage on parcel-post orders—any overage will be promptly refunded. All quotations F.O.B. Chicago. Used items and materials are guaranteed serviceable and as described. Your money back if not more than satisfied.

BIG ILLUSTRATED CATALOG FREE

STARK'S

Dept. PM346
509 So. State St.
CHICAGO 5, ILL.



STILLS

Distill your own water with one of these fine portable stills. Purchased from the Gov't. Completely self contained. Has 1 gallon capacity; output 1 1/2 gal. per hour. Fitted with genuine Coleman double burner stove. Operates 5 to 7 hrs. on one filling. Heat output 20,000 BTU's. Stove alone is worth this price. All new and guaranteed. Instr. included. Weight 109 lbs. No. 206\$ **59.50**

IF FALSE TEETH SLIP OR DROP



USE REFIT MAGIC PLASTI-LINER

MAKES ALL PLATES FIT PERFECTLY OR MONEY BACK PERMANENTLY

ONE APPLICATION LASTS FOR LIFE OF PLATE

PLASTI-LINER is a professionally developed re-liner for home use that ends forever the mess and bother of temporary applications that last for only a few hours or a few months. It is NOT a paste, nor a powder; but a strip of genuine dental plastic!

SAFE AND EASY TO USE

PLASTI-LINER is non-toxic, pure, non-irritating, harmless, odorless, tasteless, smooth, molds to mouth. No heat necessary. Just 3 easy steps.

"Excellent Results" say users

"I bought your product over a year ago. Have had no trouble with my plates since. I have told my friends and now all of us with false teeth use PLASTI-LINER. It really works." Mrs. E. S., Brooklyn, N. Y.

FREE! Our competent staff dentist will answer all your plate problems.

SEND NO MONEY — ORDER TODAY

PLASTI-LINER CO. Dept. 52
617-619 Main St., Buffalo 3, N. Y.

Rush PLASTI-LINER with complete directions. I will pay Postman \$..... plus postage charges. I may return package for refund if I am not satisfied.

\$1 for UPPER or LOWER \$2 for Both

Name.....

Address.....

City..... Zone..... State.....

You Save Postage by Enclosing Money

SAY YOU SAW IT IN POPULAR MECHANICS

BUILD THIS FREEZER

AND STORAGE UNIT

for less than \$50!

Easy to make. Holds thirty gallons. Zero temperature keeps meats, fruits, vegetables, etc., in fresh condition for indefinite period of time. Complete instructions, material list, and fourteen view composite photograph of construction details sent for **\$1.00**



MASON FREEZERS, GENEVA, N. Y.

Chimney "Umbrella" Sheds Rain

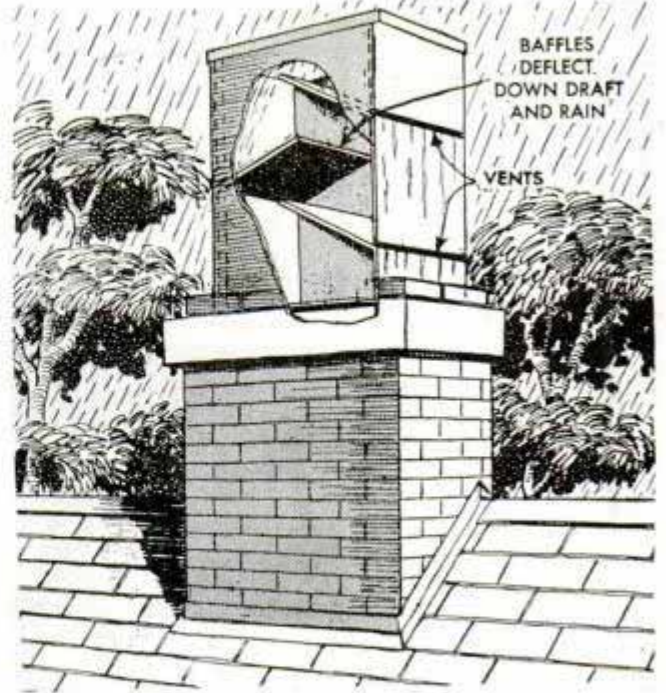

Adaptable to either an ordinary chimney or a ventilator pipe, an umbrella-like protector catches the rain and stops downdrafts. Baffle plates inside the "umbrella" are slanted upward to deflect downward gusts of wind and to catch the rain and conduct it through vents to the outside. The baffles permit the updraft to move in an S curve. This protection keeps chimneys dry, adding to the life of the masonry, keeps out soot and smudge or unwanted fumes and eliminates the musty smell around open fireplaces. The "umbrella" is made of rust-proof materials.

Bottle-Fed Typewriter Cleaner



Bottle-fed brushes now speed and improve the job of cleaning the type on typewriters. With a bottle of cleaning fluid attached, the brush becomes saturated with the liquid when a button is pressed.

*Planet-O-Mfg Co.
Orange,*

IDEAL FOR Auto-Home Appliance and Farm REPAIRS

Now A DYNAMIC HEAVY DUTY INDUSTRIAL WELDER

Available Now Without Priorities!

Designed to Do High-Grade Welding *Inexpensively*

Maintenance men, farmers, mechanics, machine shops, foundries, auto, general repair and job welding shops using the DYNAMIC WELDER find it so indispensable and useful that they cannot afford to be without it. If inexperienced you can easily learn to do a variety of high-grade welding jobs by following the practical, simplified operating and welding instructions furnished.

WORKS ON IRON, STEEL, BRASS, BRONZE and OTHER METALS

Has eight metallic and carbon arc welding heat stages. Does work you would think only possible with a larger, more expensive machine.

READ WHAT USERS SAY . . .

Repair Shop Owner says, "It will do more than you say"

"I want to say I operate a repair garage and am more than satisfied with the welder. It will do more than you say." C. P., Butler, Ohio

It's the Greatest Portable Outfit

"Now I am equipped for all kinds of welding and I must say it's the greatest portable outfit for welding any man could ever wish to own. I wouldn't sell mine for the cost of plenty welders I have seen which were very high in cost but not in convenience. You may put me on file as a booster of your wonderful welding product." W. J. B., St. John, N. B., Canada

Better Than I Expected

"I have done quite a little welding with my welder and will say it is better than I expected. The price, convenience, and variety of work that can be done with the Dynamic are the attractive points." W. R. P., Portland, Ore.

EASY TO OPERATE!

DYNAMIC SUPERCHARGED WELDER

GET DETAILS ON OUR 10-DAY TRIAL OFFER!

Once you see a DYNAMIC in operation you won't want to be without it. Its simplicity will amaze you. In a year the DYNAMIC only costs you about 6c a day. Comes complete, ready to operate, with helmet, rods, cables, electrode holder and operating instructions, etc. Nothing else to buy. Write today for Free particulars. Act now and get details on our amazingly low priced Dynamic Welder and 10 day trial offer.

DYNAMIC WELDER CO.

13 East 23rd Street—FC

CHICAGO 16, ILLINOIS

FOR ONLY
\$23⁵⁰
COMPLETE

AMAZINGLY SIMPLE TO OPERATE!

This portable Dynamic Welder, easily carried right to the job, can be operated from any convenient, properly wired 110 Volt 60 cycle line. Can also be supplied for 220 Volt 60 cycle operation and for other voltages and cycles at slight additional cost.



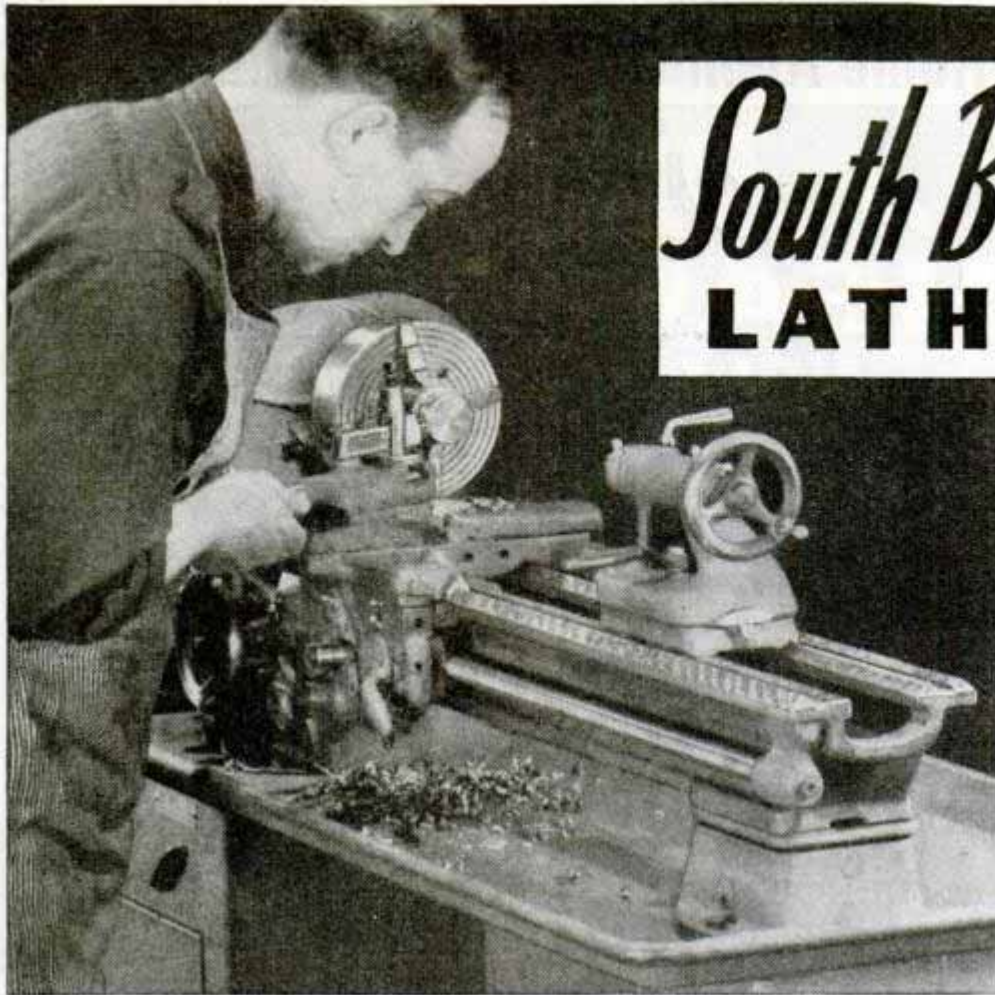

South Bend LATHES

SOUTH BEND LATHES
ARE MADE WITH
9", 10", 13", 14-1/2",
AND 16" SWINGS,
COLLET CAPACITIES TO 1",
BED LENGTHS TO 12'.

•
PRICES
RANGE FROM
\$110.50
TO
\$1673.00
F. O. B. FACTORY

ACCURATE - VERSATILE - DEPENDABLE

9-INCH LATHE FEATURES

Fine workmanship by highly experienced machine tool craftsmen
Superfinished spindle with large bearings
Belt drive for smooth, quiet operation at high speeds
Back-gear drive for power and low speeds
6, 8, 12 or 16 spindle speeds
Thread cutting range (Model A)—4 to 224 per inch, 48 pitches
Precision lead screw for thread cutting
Worm drive and friction clutch for power longitudinal and cross feeds (Models A and B)
Three hand-scraped V-ways and a flat way on bed insure perfect alignment of headstock, saddle and tailstock

South Bend Lathes are the favorites of experienced shopmen everywhere because they are accurate, versatile, fast, easy to operate, and dependable. These lathe qualities are all-important in shops where work requiring a wide variety of exacting machine operations must be done efficiently, quickly, economically, and sometimes with limited equipment. For this reason, more and more owners of job, service, repair, maintenance, laboratory, and model shops are installing South Bend Lathes. A South Bend Lathe will increase the capacity and efficiency of your shop, too. Write today for free catalog and the name of your nearest South Bend Lathe distributor.

Write For FREE Catalog!

Write for free catalog which illustrates South Bend Engine Lathes, Toolroom Lathes and Turret Lathes, gives detailed specifications, shows attachments and accessories. No obligation. State size lathe in which interested—9", 10", 13", 14½", or 16".



SOUTH BEND LATHE WORKS
LATHE BUILDERS SINCE 1906
455 EAST MADISON STREET • • SOUTH BEND 22, INDIANA



Printed by Popular Mechanics Company, Chicago, Ill., U. S. A.

look



feel

SHARP



be

SHARP

SHARP



use

Gillette Blue Blades

with the **SHARPEST** edges ever honed!

You look **SHARP** because you get the best-looking shaves any man ever had!



You feel **SHARP** because Gillette Blue Blades give you the quickest, most refreshing shaves of your life!



You are **SHARP** when you buy Gillette Blue Blades with the **SHARPEST** edges ever honed, because you get more shaves per blade and save money!



**5 for
25¢**

Copyright 1916 Gillette Safety Razor Co.

GILLETTE'S CAVALCADE OF SPORTS presents the major boxing event of the week every Friday night over American Broadcasting Company stations at 10 o'clock E.S.T.

Gillette Safety Razor Company, Boston 6, Mass.

113,597 DOCTORS FROM COAST TO COAST WERE ASKED!

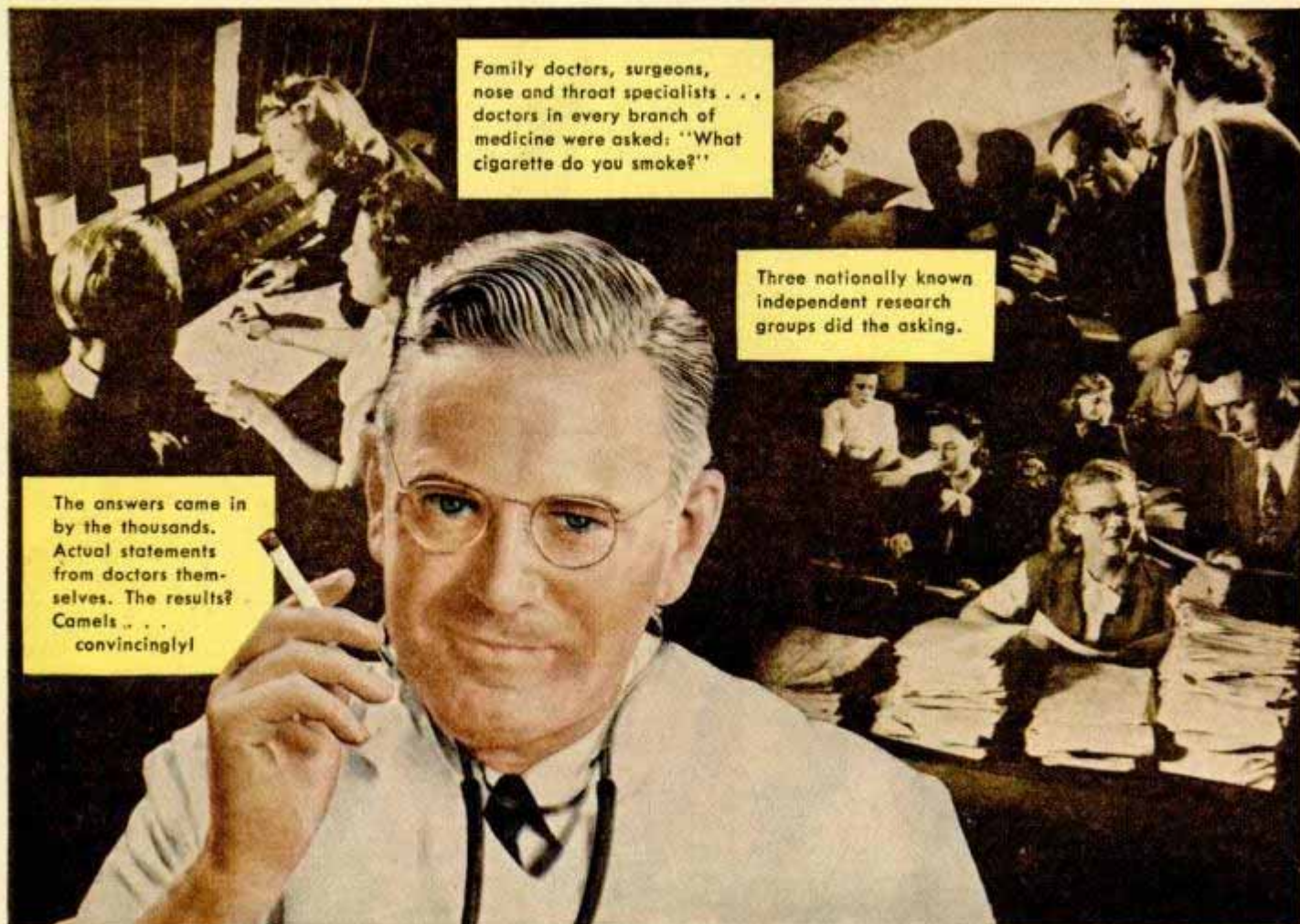

Family doctors, surgeons, nose and throat specialists . . . doctors in every branch of medicine were asked: "What cigarette do you smoke?"

Three nationally known independent research groups did the asking.

The answers came in by the thousands. Actual statements from doctors themselves. The results? Camels . . . convincingly!

According to this recent Nationwide survey:

R. J. Reynolds Tobacco Co., Winston-Salem, N. C.

MORE DOCTORS SMOKE CAMELS THAN ANY OTHER CIGARETTE!

This is no casual claim. It's an actual fact. Based on the statements of doctors themselves to three nationally known independent research organizations.

THE QUESTION was very simple. One that you . . . any smoker . . . might ask a doctor: "What cigarette do you smoke, Doctor?"

After all, doctors are human too. Like you, they smoke for pleasure. Their taste, like yours, enjoys the pleasing flavor of costlier tobaccos. Their throats too appreciate a cool mildness.

And more doctors named Camels than any other cigarette!

If you are a Camel smoker, this preference for Camels among physicians and surgeons will not surprise you. But

CAMEL - COSTLIER TOBACCOS

if you are not now smoking Camels, try them. Compare them in your "T-Zone."

THE "T-ZONE" TEST WILL TELL YOU

The "T-Zone"—T for taste and T for throat—is your own laboratory, your proving ground, for any cigarette. For only your taste and your throat can decide which cigarette tastes best to you . . . and how it affects your throat.

